

AJUNTAMENT DE BARCELONA

TREBALLS
DEL MUSEU DE
ZOOLOGIA

Illustrated keys for the classification of
Mediterranean Bryozoa

M. Zabala & P. Maluquer



BARCELONA 1988 NÚMERO 4

Drawing of the cover: *Scrupocellaria reptans* (Linnaeus), part of a branch with branched scutum, ovicells, frontal avicularia and lateral vibracula.

Treb. Mus. Zool. Barcelona. 4. 1988

Illustrated keys for the classification of Mediterranean Bryozoa

Consell de Redacció: O. Escolà, R. Nos, A. Omedes, C. Prats i F. Uribe.
Assessor científic: P. Hayward

M. ZABALA, Dept. de Ecologia, Fac. de Biologia,
Universitat de Barcelona, Diagonal, 645
08028 Barcelona.

P. MAIUQUER, Dept. de Biologia Animal, Fac. de Biologia,
Universitat de Barcelona, Diagonal, 645
08028 Barcelona.

Edita: Museu de Zoologia, Ajuntament de Barcelona
Parc de la Ciutadella, Ap. de Correus 593, 08003 - Barcelona.

© 1987, Museu de Zoologia, Ajuntament de Barcelona

ISBN: 84-7609-240-7

Depósito legal: B. 28.708-1988

Exp. P0058-88 - Impremta Municipal

Composició i fotolitos: Romargraf, S.A.

FOREWORD

Bryozoans are predominantly marine, invertebrate animals whose curious and often attractive forms have long excited the interest of naturalists. In past times they were regarded as plants, and the plant-like appearance of some species was later formalized in the term “zoophyte”, which also embraced the hydroids and a few other enigmatic animal groups. As “corallines” they were considered to be close to the Cnidaria, while “moss animals” neatly described the appearance of a feeding colony. Establishing their animal nature did not resolve the question of systematic affinity. It is only comparatively recently that Bryozoa have been accepted as a phylum in their own right, although an early view of them as forming a single phylogenetic unit, the Lophophorata, with the sessile, filter-feeding brachiopods and phoronids, still persists. The colonial, or modular, nature of bryozoans, and their tendency to often extreme polymorphic expression at the autozooid, or module, level imparts a complexity which in recent years has attracted the attention of population biologists and geneticists.

Bryozoan systematics has proceeded irregularly over the past 150 years as specialists have endeavoured first to describe, and then to monograph the diversity of living species. No complete catalogue has ever been achieved, most certainly because taxonomists have always underestimated the total number of species and genera, even in well studied areas of the marine realm. Systematic research reached its first pinnacle towards the end of the last century, with the publication of Thomas Hincks' *British Marine Polyzoa* (1880), the first monographic regional fauna, and of important reports such as those of the *Challenger* deep sea expedition (Busk 1884), and the cruise of the *Hirondelle* (Jullien & Calvet 1903). Morphology, ecology and reproductive biology were the subjects of the most significant authors of following years, including Prouho (1892) and Calvet (1902), but another peak in systematic research occurred in the 1920s and 1930s, when specialists such as R. S. Bassler, F. Canu, S. F. Harmer and E. Marcus began to describe the bryozoan faunas of more distant seas. Following a period of decline, bryozoan systematic studies are now expanding again, and each new monograph of fauna stimulates new research as ecologists and taxonomists are provided with improved practical guides. The Mediterranean Sea was an early focus of bryozoan studies. Ferrante Imperato's *Natural History* (1599) introduced several bryozoan taxa, including the now familiar *Retepora* and *Fron dipora*, and described the ‘adorce’ of ancient authors, ‘Lapis spongiae’ of medieval writers, which had been used as an abrasive dentifrice. Imperato's work was republished in 1672, and was almost certainly a source of reference for later writers, such as Donati (1750), who also described a number of bryozoans. During the middle and later nineteenth century, almost all European specialists worked at some time with the rich bryozoan faunas of the Mediterranean. This tradition continued into the present century, and was later maintained by the Spanish bryozoologist M. G. Barroso, who published extensively on the faunas of both the Mediterranean and Atlantic coasts of Spain.

Despite more than a century of active interest, there has never been a comprehensive account of the Mediterranean bryozoan fauna. The two volumes of the *Faune de France* (Prenant & Bobin 1956, 1966) incorporate descriptions of west Mediterranean species, and Y. V. Gautier (1962) produced a detailed

survey of northwest Mediterranean species. Following a series of smaller publications, Gautier conducted a major ecological and biological study, based on a wealth of newly collected field data, which still forms the basis of most modern investigations into ecological distribution patterns and reproductive cycles. Unfortunately, Gautier's systematic accounts are largely unillustrated and lack identification keys; these are severe deficiencies, as non-specialists require such aids if they are to be encouraged to study groups as complex, and unfamiliar, as the Bryozoa. In these respects, M. Zabala's (1986) monograph on the Catalan coast Bryozoa established a new benchmark for Mediterranean bryozoan research. With concise accounts of morphology, biology and ecology, together with systematic descriptions of the Catalan fauna, it provided an invaluable handbook to the northwest Mediterranean fauna. Most importantly, its clear keys and illustrations, including 32 plates of excellent quality SEM micrographs, made it the most practical guide yet produced to the fauna of this region.

Every new field guide, fauna or monograph on the Bryozoa promotes renewed interest, and increased field and laboratory research, and without doubt Dr. Zabala's 1986 monograph will have already stimulated the efforts of many students and specialists. Now, in collaboration with P. Maluquer, Dr. Zabala has extended his research to provide a practical guide to all presently known Mediterranean species. It is a remarkable achievement, and this excellent work will play a significant role in promoting a further flowering of bryozoan studies in the Mediterranean region. Its carefully structured keys, enhanced by marginal illustrations depicting confirmatory characters, will be of immense value. Each keyed species is illustrated by line drawing and micrographs, and reference is made to the most recent or most useful published account. This book is no simply an exercise in scholarship, but incorporates a great deal of original research by the authors, and is completed by an updated glossary and exhaustive bibliography, making it the essential starting point for any work on Mediterranean Bryozoa. It will be indispensable to anyone who wishes to identify Mediterranean bryozoans, to study Mediterranean faunas in depth, to begin systematic revision or phylogenetic study of Mediterranean species, genera or families, or simply to track the bibliographic history of familiar species. Each piece of biological literature has a limited lifespan, beyond which its value becomes largely historical. This new work will stimulate inquiry into understudied areas of the Mediterranean, or into poorly known taxa; it will be of great practical assistance to the marine biologist concerned with the ecology of sessile animal communities. The fruits it will yield will be newly described species, new understandings of systematic relationships, and new studies of ecological and geographical distributions. Yet, its scope, and its significance as a primary source of information, are such that it will remain the most important handbook to the Mediterranean Bryozoa for many years to come.

P. Hayward
Marine Biology, University College
of Swansea, United Kingdom
5 April 1988

CONTENTS

1. INTRODUCTION	9
2. METHODOLOGY	11
3. GLOSSARY OF SPECIAL TERMS	13
4. SYSTEMATIC LIST	21
5. KEY TO ORDERS AND SUBORDERS	31
6. KEY TO GENERA	33
KEY 1: ORDER CTENOSTOMATA	33
KEY 2: ORDER CHEILOSTOMATA	36
2a: Erect Cheilostomata	36
2b: Encrusting and creeping non-stoloniform Cheilostomata	43
2c: Stoloniform Cheilostomata	54
KEY 3: ORDER CYCLOSTOMATA	55
7. KEY TO SPECIES	61
Class GYMNOAEMATA	61
Order CTENOSTOMATA	61
Suborder CARNOSA	61
Suborder STOLONIFERA	67
Order CHEILOSTOMATA	75
Suborder ANASCA	75
Suborder CRIBROMORPHA	105
Suborder ASCOPHORA	111
Class STENOAEMATA	163
Order CYCLOSTOMATA	163
Suborder ARTICULOIDEA	163
Suborder TUBULIPORIDEA	166
Suborder RECTANGULOIDEA	178
Suborder CANCELLOIDEA	181
8. PLATES	183
9. ACKNOWLEDGEMENTS	257
10. ABSTRACT	257
11. CATALAN SUMMARY	257
12. SPANISH SUMMARY	258
13. REFERENCES	261
14. INDEX OF GENERA, SPECIES AND SYNONYMIES	267

1. INTRODUCTION

One of the main difficulties in the benthic study of the Mediterranean fauna is the scarcity or lack of identification keys for a large part of the invertebrate animals. When they exist, keys are often too local and/or they lack the necessary comprehensiveness. In some cases the absence of keys is explained by the numerous difficulties inherent to their construction, but in others an obvious explanation simply does not exist. Most of the problems arise from difficulties of access to taxonomic information, which even though it may exist, is excessively fragmented, scattered, or has a too local character. We are short of syntheses which group, contrast, and update this information.

Bryozoans are a typical case. This group, unknown at a popular level, is considered a difficult one among zoologists. Nevertheless, bryozoans occur in almost all marine habitats, mainly coastal, wherever hard, or more rarely soft, substrata exist as supports or bases. Moreover, it is an extremely diversified group, which in the Mediterranean alone has more than 300 species. Perhaps this high number of species is the reason for its reputation as a taxonomically difficult group; yet, nothing is farther from reality.

The calcareous exoskeleton of most bryozoan species provides many architectural structures, usually so constant and specific that they enable a quick and reliable diagnosis. Furthermore, their colonial nature allows examination on only one specimen of numerous replicates of the same pattern of individual organization, observation in some zooids of traits absent or eroded in others, and, finally, evaluation of the degree of intraspecific variability (i.e., biometry). Thus, diagnosis is much more reliable than in other groups, which also have exoskeletons, but of non-colonial organization (i.e., molluscs, crustaceans, echinoderms, and so on).

On the other hand, the Mediterranean Bryozoa can be considered relatively well known. The works of PRENANT & BOBIN (1956, 1966), GAUTIER (1962), HARMELIN (1968, 1970), GERACI (1973), D'HONDT (1979, 1983), OCCHIPINTI (1980, 1981), HAYWARD (1975, 1976), and ZABALA (1986), among others, have contributed to the updating of descriptions of many early naturalists who studied the Mediterranean species (such as Ferranto, Imperato, Barroso, Waters, Calvet, Canu & Bassler, etc.). The check-list of Mediterranean bryozoans may be considered very comprehensive. For instance, the list of Cheilostomata has not increased by more than 15 species since the excellent monograph by GAUTIER (1962).

All these reasons, and the acquired experience of more than 15 years of study of the Bryozoa of the Catalanian coasts, have decided the authors to produce these keys, accepting that they will have to be periodically modified although they are comprehensive in a general way.

The main objective was the construction of clear, easy to use keys. For that purpose the keys should be well illustrated, and the criteria of classification in each case would be the clearest necessary for a determination, even if they did not coincide with the most orthodox from the taxonomic point of view. Due to the large number of existing species, the keys could only be concise if they were limited to generic levels. But, a key to genera only, with which it is impossible to classify the species, loses a lot of its

value. On the other hand, there is the problem that the diagnosis of a species simply from a key can never be definitive, or is at least open to doubt. In order to avoid this obstacle it was decided that a concise, schematic illustration may help to compensate for the impossibility of describing more exhaustively all of the species which constitute the Mediterranean fauna, within the criteria of brevity of this work.

Illustrated dichotomous keys for the classification of the Mediterranean marine Bryozoa are thus presented in this monograph. After a first part dealing with keys to higher taxa and genera, a second more substantial part deals with keys to species.

2. METHODOLOGY

These keys are a corrected translation of those published in the "Fauna de Briozous dels Països Catalans" by ZABALA (1986). In spite of the publication date of 1986, the original work was finished in 1981, with only minor additions made in between. In that work the methodology employed for their preparation is described, as well as the reference sources which helped make possible a Fauna of Western Mediterranean Bryozoa.

In the arrangement of species the taxonomic criteria followed are to those of PRENANT & BOBIN (1956), D'HONDT (1983), and HAYWARD (1985) for the Ctenostomata; those of COOK (1965a, 1968a), PRENANT & BOBIN (1966), RYLAND & HAYWARD (1977) for the Anasca; those of HARMER (1957), GAUTIER (1962), and HAYWARD & RYLAND (1979) for the Ascophora; and finally those of HARMELIN (1968, 1976) and HAYWARD & RYLAND (1985) for the Cyclostomata.

These keys include all the Mediterranean species of which there is knowledge, but the precise revision of some genera (e.g., *Cribrilaria*) may result in the recognition of new species in a not very distant future.

Some species are not known from Catalan (western Mediterranean) shores and others that had been reported from these shores by early authors have not been found again. For both categories, only bibliographical references or other collections have been consulted.

The occurrence in the Mediterranean Sea of species whose names are preceded by a question mark is very improbable. They have been included here either because they were cited for this sea by early authors, presumably by mistake, or because they are Atlantic species that have been recently distinguished taxonomically from species of broad Atlanto-Mediterranean distribution, and their occurrence in the Mediterranean cannot be entirely ruled out.

Illustrations are diagrammatic, simplified to the essential features; distinctive features have been emphasized, and in many cases are arrowed. The illustrations in the keys to genera come from ZABALA (1986), whereas those in the keys to species have been drawn specially for this work. To facilitate their comparison, all the drawings of the species of the same genus are presented on a single sheet and, given the systematic value of biometry in the classification of bryozoans, at a similar scale. This graphic information is supplemented with a catalogue of SEM micrographs which includes some of the most frequent species on the Catalan shores.

In the key to species the following information is presented next to each species name:

The species not known from Catalan shores are indicated with an asterisk (*) and those whose occurrence in the Mediterranean Sea is very improbable with a question mark (?). The drawing corresponding to the species is indicated by a number and the photograph (whenever present) by a number and a letter in brackets. The work that fully describes and/or illustrates the species is identified by a bibliographical reference.

The classification of bryozoans presents another apparently inescapable difficulty: the terminology necessary to describe their morphology. Even after the removal of a great deal of archaic and other re-

dundant terms, it remains indispensable. Consequently, the work includes a glossary where all the terms used in this monograph are defined. Finally, an index of obsolete synonymies and updated specific and generic names is included at the end of the work.

3. GLOSSARY OF SPECIAL TERMS

- ABORTIVE ZOOID:** Zooid in which the polypide has degenerated and the distal parts of the zooid have been absorbed.
- ACLEITHRAL OOECIUM:** One not closed by the parental operculum.
- ADEONIFORM:** Colony erect, rigid, arborescent, bilaminar, of flattened branches, firmly attached to the hard substratum by means of a calcareous base (e.g. *Adeonella calveti*).
- ADNATE:** Zoarium that grows with one face adherent to the substratum.
- ADVENTITIOUS AVICULARIUM:** One occupying some position on the external wall of an autozooid (cf. vicarious).
- ALVEOLES:** In Rectanguloidea, small cavities where the extrazoidal or colonial coelom remains partly divided by a network of vertical septa extending frontally, on the autozooidal peristomes and concealing partially the distribution of these laterals (syn. = Cancelli).
- ANCESTRULA:** First-formed zooid of a colony, derived by metamorphosis of a free-swimming larva.
- ANTER:** Part of the orifice distal to the condyles in ascophoran Cheilostomata.
- APERTURAL BAR:** Fused pair of costae immediately proximal to the orifice in cribrimorph Cheilostomata.
- APERTURE:** In ascophorans, an opening in the frontal wall not necessarily coextensive with the orifice.
- AREA:** Space occupied in life by the frontal membrane in anascan Cheilostomata.
- AREOLA:** Space, between two buttresses formed by secondary thickening, above an areolar pore in some Cheilostomata.
- AREOLAR PORE:** Marginal pore in the frontal wall of some Cheilostomata.
- ASCOPEORE:** Median frontal pore which serves as inlet of the ascus in some ascophoran Cheilostomata.
- ASCUS:** Sac-like hydrostatic organ in ascophoran Cheilostomata (syn. Compensation Sac, Compensatrix).
- ASTOGENETIC CHANGE:** The progressive elaboration of zooidal morphology from the ancestrula through the first few generations of autozooids budded from it.
- ASTOGENY:** Development of a colony by budding.
- ATRIUM:** Space just below the aperture, between this latter and the tentacle sheath when the lophophore is withdrawn. The walls of the atrium are formed by muscular fibres which participate both in the protrusion and the retraction (atrial muscles).
- AUTOZOOID:** Feeding zooid in Bryozoa.
- AVICELLARIUM:** Small chamber that forms the fixed part, calcified, of the avicularium and contains the mandibular muscles.
- AVICULARIUM** (pl. AVICULARIA): Specialized zooid in Cheilostomata with reduced polypide but strong muscles which operate a mandible-like operculum (see ADVENTITIOUS, INTERZOOIDAL, VICARIOUS).
- BASAL:** Under of reverse side of an encrusting or

- freely-growing colony (cf. PROXIMAL).
- BILAMINAR:** Consisting of two layers of zooids growing back to back.
- BISERIAL:** With zooids arranged in two series.
- BROWN BODY:** Coloured spheroid in bryozoan zooid resulting from aggregation of non-histo-lyzable residue of a degenerated polypide.
- CANCELLI:** Synonym of alveole, used by Smitt and other early authors (see ALVEOLES).
- CARDELLA:** See CONDYLE.
- CATENICELLIFORM:** Colony type with erect jointed branches.
- CAUDA:** Thread-like proximal portion of club-shaped autozooid.
- CELLEPORIFORM:** Colony type characterized by the heaping of multilaminar masses of zooids, forming nodular colonies generally of small size. Species of *Cellepora*, *Celleporina*, *Rhynchozoon*, and *Turbicellepora* show this colony type.
- CILIATED GROOVE:** The groove on the lower surface of a larva which enables it to grip the substratum when settling.
- CLEITHRAL OOECIUM:** One closed by the operculum of the parent zooid.
- CLEITHRIDIAE:** Key-hole shaped orifice. Operculum closes simultaneously the autozooid and ovicell orifice. Term also used for the ovicells (synonymous with lepralioid).
- COELOCYST:** Kind of wall present in three groups of Cyclostomata (Canelloidea, Cerioporoida and Rectanguloidea), in which living tissues surrounding the zooidal wall continue on the outer side giving rise to extrazooidal (or colonial) tissues. The result is a double epithelium separated by an extension of the exosacal coelom. The epithelium inner to the calcareous layer is zooidal, in contradistinction to the remaining layers of the coelocyst, which are colonial. Of these, the innermost epithelium is called hypostegal, while the outermost, the one in contact with the cuticle, is the eutegal, (= double wall).
- COELOMOPORE:** A pore in the body wall connecting the coelom with the exterior. Applied specifically to the pore at the base of the tentacles through which ova are extruded (syn. Supraneural pore).
- COLONY:** Supra-individual group in which the members or individuals are connected physically, intercommunicating together, and developing from a common ancestor by asexual reproduction. In Bryozoans the colony or zoarium is made up of individuals or zooids, physiologically autonomous; or autozooids and/or of specialized and dependent individuals or heterozooids.
- COLUMELLA:** In avicularia of some Ascophora, a small column formed on the mid-point of the pivotal bar (bar of articulation), on which the avicularian mandible articulates.
- COMMUNICATION PORE:** Opening in interzooidal wall (syn. Mural Pore Chamber; cf. DIETELLA, SEPTULUM).
- COMPENSATION SAC:** See ASCUS.
- COMPENSATRIX:** See ASCUS.
- CONDYLE:** One of a pair of oppositely placed protuberances, on which the operculum pivots in the orifice of ascophoran Cheilostomata (syn. Cardella).
- COSTA (pl. COSTAE):** One of the modified spines overarching the frontal membrane in cribrimorph Cheilostomata; usually united with neighbouring costae to form a frontal shield (syn. Costula).
- COSTATE SHIELD:** The frontal wall of cribrimorph ascophorans formed from series of fused spines, or costae.
- COSTULA:** See COSTA.
- CRIBRIMORPH:** Zooid characterized by the presence of radial costae on the central wall, separated by Lacunae. All the species having these traits form the suborder Cribrimorpha.
- CRYPTOCYST:** More or less horizontal calcareous lamina on the basal side of the frontal membrane but separated from it by a coelomic space, in some anascan Cheilostomata. Developed from the vertical walls of the zooid but not completely dividing its body cavity.
- CRYPTOCYSTIDEAN:** Ascophorans in which the frontal wall forms an interior partition below an overlying hypostegal coelom.
- CYPHONAUTES:** Pelagic bivalved larva of some Bryozoans.
- CYSTID:** Cellular plus skeletal layers of the zooid wall (cf. POLYPIDE, ZOOECIUM).

- DEPENDENT OOECIUM:** One which develops resting on the distal zooid.
- DIAPHRAGM:** In Cyclostomata, transverse calcareous sheet placed at an indeterminate level of the peristomial tubes, obstructing them totally.
- DIETELLA** (pl. **DIETELLAE**): Small enclosed space near the base of vertical walls in the distal part of a zooid; separated from that zooid by a porous septum and communicating through a pore with an adjacent zooid (syn. Pore-chamber).
- DISTAL:** Pertaining to the side away from the ancestrula or origin of growth.
- DIVARICATOR MUSCLES:** Muscles employed in opening the operculum.
- DORSAL:** Face of the zoarium opposed to the orifice-bearing side.
- ECTO CYST:** Cuticle of the cystid produced by the epidermis more or less thickened and calcified.
- ECTO OECIUM:** Outer, generally calcified, layer of ooeccial wall.
- ENDO CYST:** Obsolete term that designates the epidermis of the cystid which originates the ectocyst.
- ENDO OECIUM:** Inner, generally membranous, layer of ooeccial wall.
- ENDOTOICHAL OOECIUM:** An ooeccium which appears immersed in the distal zooids, while opening independently to the exterior.
- ENDOZOOIDAL OOECIUM:** An ooeccium which appears immersed in the distal zooid, while opening below the operculum of the parent zooid.
- EPISTEGAL SPACE:** see **EPISTEGE**
- EPISTEGE:** In Cribrilinidae, the space between the frontal membrane and the overlying frontal shield (syn. Epistegal Space).
- EXTRAZOOIDAL:** Structures arising from, or shared by, more than a single zooid.
- FENESTRA:** Uncalcified area in the ectooecium through which the endooecium is displayed.
- FENESTRULA:** Open space in reticulate colony, (e.g. *Sertella*).
- FLAGELLUM:** See **SETA**.
- FRONTAL:** Pertaining to the exposed or orifice-bearing side of zooid or colony.
- FRONTAL AREA:** Space occupied in life by the frontal membrane in anascan Cheilostomata.
- FRONTAL MEMBRANE:** Uncalcified part of frontal body wall in Cheilostomata; may be exposed or covered by modified spines, or by a frontal shield.
- FRONTAL SHIELD:** The calcified frontal surface of ascophoran zooids, not necessarily homologous in all groups; coextensive with the outer body wall, formed as a partition below it, from the fusion of overarched spines or by the calcification of a proximally derived fold.
- FRONTAL WALL:** A calcareous frontal body wall (covering the ascus in ascophoran Cheilostomata).
- FUNICULUS:** Mesenchymatous strands connecting the polypide with the zooidal wall (actually with the communication pores in Cheilostomata and Ctenostomata).
- GONOOZOID:** Zooid modified as a brood chamber.
- GYMNO CYST:** Part of the calcified (in Anascans) frontal wall which lies between the frontal membrane and the free edges of the vertical walls, usually most developed on the proximal side.
- GYMNO CYSTIDEAN:** Ascophorans in which the frontal wall is formed by the calcification of the outer body wall.
- HEMIPHHRAGMS:** Sheets or thin walls obstructing partly the peristomial tubes of the Cyclostomata and the extinct orders Trepostomata and Cystoporata. They differ from hemisepta in that they are numerous and do not occupy a fixed position.
- HEMISEPTA:** One or two opposed calcified sheets, situated in a fixed position at a certain distance from the aperture, within the peristomial tube in the extinct order Cryptostomata and some Cyclostomata (*Annectocyma indistincta*). These sheets partially separate the distal part of the tube or vestibule from the proximal part where the polypide is lodged.
- HETEROZOOID:** Specialized zooid; one not an autozooid.
- HYPERSTOMIAL OOECIUM:** One which rests on or is partly embedded in the distal zooid, and

- opens above the operculum of the parent zooid.
- HYPOSTEGE:** Cavity situated between the ectocyst and the cryptocyst, acting as an hydrostatic organ in some *Anasca*.
- HYPOSTEGAL COELOM:** An extension of the main coelom overlying the frontal calcification in umbonuloid and cryptocystidean species.
- IDMIDRONEIFORM:** See **IDMONEIFORM**.
- IDMONEIFORM:** Colony type of creeping or semi-erect, arborescent colonies with numerous and regular dichotomies. Relatively narrow branches with the autozooids opening on one face only and arranged in bundles that, issuing from the mid-line, are directed alternately from right to left of the branch. Present in genera *Idmidronea*, *Tervia* and *Platonea*.
- INDEPENDENT OOECIUM:** One which develops independently of the distal zooid.
- INNER VESICLE:** See **OEICIAL VESICLE**.
- INTERNODE:** Segment of jointed colony between surfaces of articulation (Syn. Segment).
- INTERTENTACULAR ORGAN:** Tubular extension of the coelomopore (used for the extrusion of ova) between the dorso-medial tentacles.
- INTERZOOID:** Heterozooid specialized as an interzooidal communication organ. With this term are included the septula (or multiporous walls) and the Dietellae (or basal pore-chambers).
- INTERZOOIDAL AVICULARIUM:** One which extends to the basal surface of the colony, but is wedged in between zooids rather than replacing one of them in a series.
- INTROVERT:** See **TENTACLE SHEATH**.
- JOINTS:** Segments of union between two internodes; narrower than these, uncalcified and horny, acting as points of articulation.
- KENOOID:** Heterozooid without a polypide, and usually without either orifice or muscles.
- LABELLUM:** See **LIP**.
- LACUNA (pl. LACUNAE):** Perforation (true pore) between costae making up the frontal shield in cribrimorph Cheilostomata.
- LEPRALOID:** See **Cleithriate**
- LIP:** Calcified languet of the ovicell whose free inner edge ends in the peristome.
- LOPHOPHORE:** The ring of hollow, ciliated tentacles surrounding the mouth of the zooid.
- LUCIDA:** A transparent spot on the surface of a chitinous operculum
- LUMEN:** Row of small pores situated on the mid-point of a costa in Cribrimorph zooids.
- LUNULITIFORM:** Discoidal or conical-shaped colony, normally not anchored to the substratum, which is usually sandy or muddy. Autozooids restricted to the convex face. Vibracula with long setae carry out co-ordinated movements which stabilize the colony. Locomotion proven only in *Selenaria*. Present in genera *Cupuladria* and *Discoporella*.
- LYRULA:** Median tooth, often anvil-shaped, on the proximal side of the orifice in some Cheilostomata.
- MANDIBLE:** Articulated part of an avicularium, moved by muscles, and homologous with the operculum of an autozooid.
- MARGINAL SPINE:** Spine, often jointed at the base, in a series surrounding the frontal area in Cheilostomata (Syn. Mural Spine).
- MATERNAL ZOOID:** The proximal reproductive zooid from which ova pass to an ooecium.
- MEMBRANIPORIFORM:** Encrusting colony type, usually unilaminar, with basal side partly or totally calcified, in such a way that it may cover flexible and rigid substrata.
- MUCRO (pl. MUCRONES):** A blunt or spinous elevation of the (usually proximal) lip of the orifice in some Cheilostomata.
- MULTIPOROUS SEPTULUM:** See **SEPTULUM**.
- MULTIZOOIDAL:** See **EXTRAZOOIDAL**.
- MURAL PORE-CHAMBER:** Cavity enclosed by the rosette plate, in the vertical zooid walls of some species.
- MURAL RIM:** Raised edge of the gymnocyst, where it meets the frontal area, in many anascan Cheilostomata; often bearing marginal spines
- MURAL SPINE:** See **MARGINAL SPINE**.
- NANOOID:** Dwarf zooid containing reduced polypide in some Cyclostomata.
- NODE:** Place of articulation in jointed colony.

- OCCLUSOR MUSCLES:** Muscles closing the operculum.
- ONYCHOCELLARIUM:** Avicularium with a mandible bearing a lateral membranous expansion. Characteristic of the genera *Onychocella* and *Rectonyhocella*.
- ONTOGENETIC CHANGE:** The development of zooidal morphology from undifferentiated buds at the growing edge of a colony, through the series of zooids preceding them.
- OEOECIAL VESICLE:** The inner membrane and means of closure of an ooeecium (Syn. Inner vesicle).
- OEOECIUM** (pl. OEOECIA): Ovicell or brood-chamber in Cheilostomata, excluding the inner vesicle.
- OEOECIOPORE:** Orifice of the gonozooid through which the larva goes out.
- OEOECIOSTOME:** Peristome formed on the gonozooid of some Cyclostomata surrounding the ooeeciopore. May be tubular, funnel-like, fan-shaped, etc.
- OPERCULUM** (pl. OPERCULA): A generally uncalcified lamina, hinged or pivoting on condyles, which closes the zooidal orifice in Cheilostomata.
- OPESIA** (pl. OPESIAE): In zooids of anascan Cheilostomata, the opening below the frontal membrane which remains after development of a cryptocyst.
- OPESIULE:** One of the small notches or pores in a cryptocyst through which the depressor muscles pass to the frontal membrane.
- ORAL:** Pertaining to the orifice of a bryozoan zooid (not to the mouth).
- ORIFICE:** Opening in the zooid wall through which the lophophore and tentacles are exerted.
- OVICELL:** The globular brood-chamber in Cheilostomata.
- PALATE:** See **ROSTRUM** (2).
- PARENTAL ZOOID:** With respect to the ovicell, the reproductive zooid immediately proximal to it which supplies the egg that the former will brood.
- PEDUNCULATE:** Stalked.
- PERICYST:** Calcified frontal wall not covered by the ectocyst, generally made up of marginal spines, fused, exclusive of some *Anasca*.
- PERISTOME:** A rim, which may become elevated, surrounding the primary orifice.
- PETRALIIFORM:** Colony unilaminar, attached to the substratum by chitinous rhizoids only, issuing from isolated pores of the dorsal face of the colony (e.g. *Beania*).
- PIVOTAL BAR:** Calcareous bar passing over both sides of the heel of the avicularia of some *Ascophora*, where the opercular mandible is articulated.
- PLUME CILIA:** Long sensory cilia present in most bryozoan larvae.
- PLURILAMINAR:** Type of growth in which the successive layers of zooids are formed by frontal budding, superposing each other.
- POLYPIDE:** Those organs and tissues in a bryozoan autozooid which undergo periodic replacement; namely, tentacles, tentacle sheath, alimentary canal, associated musculature and nerve ganglion.
- PORE-CHAMBER:** See **DIETELLA**.
- PORTA:** Anterior part of the orifice.
- POSTER:** Part of the orifice in ascophoran Cheilostomata proximal to the condyles and leading to the ascus.
- PRIMARY ORIFICE:** The opening in the outer body wall through which the polypide is extruded, in cheilostomes coextensive with the operculum.
- PROANCESTRULA:** In Cyclostomata, first rounded cellular mass, formed after larval metamorphosis, that gives place both to the first zooid tube (or ancestrula) and to the basal sheet in which the growing margin is located.
- PROXIMAL:** Pertaining to the side toward the ancestrula or origin of growth.
- PSEUDOPORE:** Tissue filled lacuna in the calcification of the outer zooid wall in many Bryozoa.
- PSEUDOSINUS:** A notch or hole in the peristome of some ascophorans.
- PSEUDOSPIRAMEN:** Asymmetrical sinus, unilateral, in the proximal part of the peristome of some *Celleporidae*.
- PUSTULIPORIFORM:** Colony type made up of erect

- cylindrical branches, formed by autozooids distributed radially and equally in all directions (zooids, all around the main axis). This term is a synonymy of entalophoriform and is named by reference to the fossil genus *Pustulopora*. Present in genera *Entalophoroecia*, *Annectocyma*, *Mecynoecia* and "*Cardioecia*".
- QUINCUNCIAL:** Arrangement of five objects such that four are placed at the corners of a rectangle with the other in the centre (Syn. Reticulate).
- RETEPORIFORM:** Having net-shaped (*Retepora*-like) colonies as in the Sertellidae (Cheilostomata).
- RETICULATE:** See QUINCUNCIAL.
- RETRACTOR MUSCLES:** Muscles arising from the proximal end of the zooid inserted on the pharynx and the base of the lophophore, serving to withdraw the polypide.
- RHIZOID:** Rootlike structure composed of one or more kenozooids.
- RIMULA:** Posterior languet of some ascophoran opercula, and by extension corresponding notch of the aperture.
- ROSETTE-PLATE:** Multiporous subcircular area in the vertical walls of Cheilostomata for the passage of mesenchymatous fibres between zooids.
- ROSTRUM:** (1) Spike-like prolongation of an avicularium; (2) distal part of avicularium occupied by the mandible (syn. palate).
- SCHIZOPORELLID:** Characterized by a median sinus at proximal margin of the orifice, as in Schizoporellidae (Cheilostomata).
- SCLERITE:** Thickened line in operculum, mandible or frontal membrane.
- SCUTUM (pl. SCUTA):** A lateral marginal spine, generally broad and flat, overhanging the frontal area in some anascan Cheilostomata.
- SECONDARY ORIFICE:** In those species with an immersed primary orifice the outer opening of the peristome.
- SEGMENT:** See INTERNODE.
- SEPTULUM (pl. SEPTULA):** Single (uniporous) or grouped (multiporous) perforations in the wall of Cheilostomata for the passage of mesenchymatous fibres between zooids (Syn. Multiporous Septulum).
- SEPTUM (pl. SEPTA):** An interior wall or partition, not associated with cuticle, for example, transverse vertical walls of most species.
- SETA (pl. SETAE):** Bristle-like component of vibraculum, homologous with the operculum of an autozooid. Syn. FLAGELLUM.
- SETOSELLINIFORM:** Discoidal colony, encrusting hard substrata, of spiraled growth, with autozooids and vibracula distributed in a definite way throughout the colony. Present in genera *Setosellina* and *Setosella*.
- SINUS:** Slit at proximal edge of orifice in some ascophoran Cheilostomata.
- SPINE:** Small hollow projection, more or less long, and opened or closed at the end, marginal or oral. In some cases they are heterozooids with a high degree of regression and specialization.
- SPINULA (pl. SPINULAE):** False spine; simple projections, lacking inner canal and more or less calcified; it appears in the margin of the cryptocyst.
- SPIRAMEN (pl. SPIRAMINA):** Median pore in the proximal wall of the peristome, into the cavity of which it leads.
- STERNUM:** In some Cribrimorpha, central separation between the costulae that converge from each side.
- STICTOCYST:** Kind of wall present in two groups which include most of the species of living Cyclostomata (Articuloidea and Tubuliporoidea) and characterized by the occurrence of the same layers existing in other groups of calcareous bryozoans (from inside to outside): peritoneum, epidermis, calcareous layer and cuticle; the latter pierced by numerous pseudopores, which gave it its name (by opposition to coelocyst).
- STOLON:** A slender tube of kenozooids bearing autozooids along its length.
- STOMATOPORIFORM:** In Cyclostomata, linear colony type, uniserial or pluriserial; runner, creeping and dichotomous ramifications; the clearest example is the genus *Stomatopora*.
- SULCUS (pl. SULCI):** A groove delineating the

- boundary between adjacent zooids.
- SUPRANEURAL PORE:** See COELOMOPORE.
- TATIFORM:** An ancestrula with a membranous frontal wall, often surrounded by spines.
- TENTACLE:** Long ciliate projections surrounding the mouth which serve for catching and guiding the food.
- TENTACLE SHEATH:** Thin part of body wall introverted in retraction of tentacles and then enclosing them.
- TERMEN:** Calcareous edge that surrounds the frontal area of some Anasca. Often bearing marginal spines; its structure is different to that of the gymnocyst to which it is continuous with.
- TRABECULA:** Branch separating the fenestrulae in reticulate Cheilostomata (e.g. *Sertella*).
- TRANSVERSE PARIETAL MUSCLES:** Short muscles inserted on the frontal membrane of anascans, or the ascus of ascophorans, which contract to depress the membrane (or ascus floor), thus raising coelomic pressure.
- TUBULIPORIFORM:** Colony type consisting of flattened branches, more or less broad, little ramified, with all the autozooids opening on one face only. Thus named after the genus *Tubulipora*, in which this colony type is frequent. Also present in the Mediterranean species of *Annectocyma*.
- UNILAMINAR:** Consisting of one layer of zooids.
- UMBO (pl. UMBONES):** A blunt prominence on the frontal wall or ovicell in some Cheilostomata.
- UMBONULOID:** Ascophorans in which the frontal shield forms through the calcification of the lower side of a fold of body wall, derived from the proximal end of the zooid.
- VACUOLES:** Pores situated in the colony walls of the Cyclostomata Cancellioidea (*Hornera*).
- VANNA:** Posterior part of the aperture where the compensation sac opens.
- VIBRACULUM (pl. VIBRACULA):** Heterozooid in Cheilostomata with operculum in the form of a long seta slung between condyles.
- VICARIOUS AVICULARIUM:** One that replaces an autozooid in a series.
- VINCULARIIFORM:** Erect colony type; rigid, arborescent, made up of subcylindrical branches divided dichotomously, and firmly attached to the substratum by means of a calcareous basis (e.g. *Myriapora truncata* or *Diporula verrucosa*).
- ZOARIUM (pl. ZOARIA):** See COLONY.
- ZOOECIUM (pl. ZOOECIA):** Skeleton of a bryozoan zooid.
- ZOOID:** Single bryozoan individual. Various types are distinguished by prefixes (see COLONY).

4. SYSTEMATIC LIST

CLASS GYMNOLEAMATA

ORDER CTENOSTOMATA

SUBORDER CARNOSA

Family Flustrellidae

Pherusella tubulosa (Ellis & Solander)

Family Alcyonidiidae

Alcyonidium albidum (Alder)

Alcyonidium cellarioides (Calvet)

Alcyonidium diaphanum (Hudson)

Alcyonidium duplex Prouho

Alcyonidium gelatinosum (Linnaeus)

Alcyonidium variegatum (Prouho)

Clavopora hystericis (Busk)

Family Arachnidiidae

Arachnidium hipbothoides (Hincks)

Arachnoidea annosciae D'Hondt & Geraci

Nolella dilatata (Hincks)

Nolella stipata (Gosse)

Victorella pavidata Saville Kent

Tanganella muelleri Kraepelin

Family Lobiancoporidae

Lobiancopora hyalina Pergens

Family Benedeniporidae

Benedenipora catenata Pergens

Benedenipora delicatula D'Hondt & Geraci

Family Paludicellidae

(?) *Paludicella articulata* (Ehrenberg)

SUBORDER STOLONIFERA

Family Hypophorellidae

Hypophorella expansa Ehlers

Family Penetrantiidae

Penetrantia brevis Silen

Family Terebriporidae

Immergentia orbignyana Fischer

Spathipora comma (Soule)

- Spathipora sertum* Fischer
 Family Walkeriidae
Farrella repens (Farre)
Walkeria tuberosa Heller
Walkeria uva (Linnaeus)
 Family Mimosellidae
Mimosella gracilis Hincks
Mimosella verticillata (Heller)
 Family Buskiidae
Buskia nitens Alder
Buskia socialis Hincks
 Family Triticellidae
Triticella pedicellata (Alder)
Triticella flava Dalyell
Triticellopsis tissieri Gautier
 Family Vesiculariidae
Vesicularia spinosa (Linnaeus)
Amathia lendigera (Linnaeus)
Amathia pruvoti (Calvet)
Amathia semiconvoluta (Lamouroux)
Amathia vidovici (Heller)
Zoobothryon verticillatum (Delle Chiaje)
Bowerbankia gracilis Leidy
Bowerbankia imbricata (Adans)
Bowerbankia pustulosa (Ellis & Solander)

ORDER CHEILOSTOMATA

SUBORDER ANASCA

- Family Aeteidae
Aetea anguina (Linnaeus)
Aetea longicollis (Jullien)
Aetea sica (Couch)
Aetea truncata (Landsborough)
 Family Scrupariidae
Scruparia ambigua (D'Orbigny)
Scruparia chelata (Linnaeus)
 Family Membraniporidae
Conopeum reticulum (Linnaeus)
Conopeum seuratii (Canu)
Membranipora membranacea (Linnaeus)
Membranipora tenuis Desor
 Family Electridae
Electra monostachys (Busk)
Electra pilosa (Linnaeus)
Electra posidoniae Gautier
Electra verticillata (Ellis & Solander)
Pyripora catenularia (Fleming)
 Family Flustridae
 (?)*Carbacea carbacea* Ellis & Solander
Chartella papyrea (Pallas)
Chartella tenella (Hincks)

Hincksinoflustra octodon (Busk)
Securiflustra securifrons (Pallas)
Hincksina flustroides f. crassispinata Calvet
Hincksina flustroides (Hincks)
Spiralaria gregaria (Heller)
Ellisina cf. antarctica (Hastings)

Family Calloporidae

Alderina imbellis (Hincks)
(?) *Amphiblestrum flemingii* (Busk)
Amphiblestrum minax (Busk)
Aplousina capriensis (Waters)
Aplousina filum (Jullien)
Callopora dumerilii (Audouin)
Callopora dumerilii f. pouilleti (Alder)
Callopora lineata (Linnaeus)
Callopora minuta Harmelin
Copidozoum exiguum (Barroso)
Copidozoum planum (Hincks)
Copidozoum tenuirostre (Hincks)
Crassimarginatella crassimarginata (Hincks)
Crassimarginatella maderensis (Waters)
Crassimarginatella solidula (Hincks)
Parellisina curvirostris (Hincks)

Family Chaperiidae

Chaperia annulus (Manzoni)

Family Onychozellidae

Onychozella marioni (Jullien)
Onychozella vibraculifera Neviani
Rectonychozella disjuncta Canu & Bassler

Family Lunulariidae

Setosellina capriensis (Waters)
Cupuladria biporosa (Canu & Bassler)
Cupuladria canariensis (Busk)
Cupuladria doma (D'Orbigny)
Cupuladria multispinata (Canu & Bassler)

Family Microporidae

Micropora coriacea (Johnston)
(?) *Micropora normani* Levinsen
Calpensia nobilis (Esper)
Coronellina fagei (Gautier)
Rosseliana rosselii (Audouin)
Mollia patellaria (Moll)
Mollia circumcincta (Heller)
Monoporella nodulifera (Hincks)

Family Setosellidae

Setosella cavernicola Harmelin
Setosella folini (Jullien)
Setosella vulnerata (Busk)

Family Chlidoniidae

Chlidonia pyriformis (Bertoloni)

Family Cellariidae

- Cellaria fistulosa* auctt. (non Linnaeus)
Cellaria salicornioides Audouin
Cellaria sinuosa (Hassall)
- Family Scrupocellariidae
- Caberea boryi* (Audouin)
Scrupocellaria aegeensis Harmelin
Scrupocellaria bertholleti (Audouin)
Scrupocellaria delilii (Audouin)
Scrupocellaria incurvata Waters
 (?) *Scrupocellaria macrorhyncha* Gautier
Scrupocellaria maderensis Busk
Scrupocellaria reptans (Linnaeus)
Scrupocellaria scrupea Busk
Scrupocellaria scruposa (Linnaeus)
- Family Epistomiidae
- Epistomia bursaria* (Linnaeus)
Synnotum aegyptiacum (Audouin)
- Family Bicellariidae
- Bicelliarella ciliata* (Linnaeus)
- Family Beaniidae
- Beania hirtissima* (Heller)
Beania hirtissima f. *cylindrica* (Hincks)
Beania magellanica (Busk)
Beania mirabilis (Johnston)
Beania robusta (Hincks)
- Family Bugulidae
- (?) *Bugula aperta* (Hincks)
Bugula avicularia (Linnaeus)
Bugula calathus ssp. *calathus* Ryland
Bugula calathus ssp. *minor* Ryland
Bugula flabellata (Thompson & Gray)
Bugula fulva Ryland
Bugula gautieri Ryland
Bugula germanae Calvet
Bugula gracilis (Busk)
Bugula neritina (Linnaeus)
Bugula plumosa (Pallas)
Bugula simplex (Hincks)
Bugula spicata (Hincks)
Bugula stolonifera Ryland
Bugula turbinata Alder

SUBORDER CRIBRIMORPHIA

Family Cribrilinidae

- Collarina balzaci* (Audouin)
Puellina (Puellina) gattyae (Landsborough)
Puellina (Puellina) setosa (Waters)
Puellina (Cribrilaria) arrecta Bishop & Househam
Puellina (Cribrilaria) cassidainsis (Harmelin)
Puellina (Cribrilaria) hincksi (Friedl)
Puellina (Cribrilaria) innominata (Couch)

Puellina (Cribrilaria) minima (Harmelin)
Puellina (Cribrilaria) picardi Harmelin
Puellina (Cribrilaria) pseudoradiata ssp. *pseudoradiata* Harmelin & Aristegui
Puellina (Cribrilaria) radiata (Moll)
(?) *Puellina (Cribrilaria) scripta* (Reuss)
Puellina (Cribrilaria) setiformis Harmelin & Aristegui
Puellina (Cribrilaria) venusta (Canu & Bassler)
Puellina (Cribrilaria) n. sp. (aff. *arrecta*)
Puellina (Glabrilaria) corbula Bishop & Househam
Puellina (Glabrilaria) orientalis s. sp. *orientalis* Harmelin & Aristegui
Puellina (Glabrilaria) pedunculata Gautier
(?) *Cribrilina punctata* (Hassall)
Figularia figularis (Johnston)
Membraniporella nitida (Johnston)

SUBORDER ASCOPHORA

Family Umbonulidae

Umbonula ovicellata Hastings
Hippopleurifera pulchra (Manzoni)

Family Exochellidae

Escharoides coccinea (Abildgaard)
Escharoides mamillata (Wood)
Escharoides megarostris (Canu & Bassler)

Family Adeonidae

Adeonellopsis distoma (Busk)
Reptadeonella violacea (Johnston)

Family Exechonellidae

Anarthropora monodon (Busk)
Exechonella antillea (Osburn)

Family Watersiporidae

Watersipora complanata (Norman)
Watersipora subovoidea (D'Orbigny)

Family Cryptosulidae

Cryptosula pallasiana (Moll)

Family Hippoporinidae

Hippoporina pertusa (Esper)
Pentapora fascialis (Pallas)
Pentapora ottomulleriana (Moll)

Family Hippopodinidae

Cheiloporina circumcincta (Neviani)
Cosciniopsis ambita Hayward
Hippaliosina depressa (Busk)
Hippomenella mucronelliformis (Waters)
Hippopodina feegensis (Busk)

Family Smittinidae

Palmicellaria elegans Alder
Palmicellaria cf. *aviculifera* (Canu & Bassler)
Palmicellaria skenei (Ellis & Solander)
Parasmittina raigii (Audouin) (?)
Parasmittina tropica (Waters)
Parasmittina tropica f. *rouvillei* (Calvet)

- Parasmittina tropica* f. *trispinosa* (sensu Calvet, not *P. trispinosa* Johnston)
Porella concinna (Busk)
Porella concinna f. *tubulata* Calvet
Porella minuta (Norman)
Porella tubulata (Busk)
Smittina cervicornis (Pallas)
Smittina colleti (Jullien)
Smittina crystallina (Norman)
Smittina landsborovii (Johnston)
Smittina remotorostrata (Canu & Bassler)
Smittina tubulifera (Heller)
Porelloides laevis (Fleming)
Prenantia cheilostoma (Manzoni)
Prenantia inerma (Calvet)
Smittoidea marmorea (Hincks)
Smittoidea ophidiana (Waters)
Smittoidea reticulata (Mac Gillivray)
- Family Rhamphostomellidae
- Rhamphostomella argentea* (Hincks)
Rhamphostomellina posidoniae Hayward
- Family Escharellidae
- Escharella hexaspinosa* Aristegui
Escharella octodentata (Hincks)
Escharella rylandi Geraci
Escharella variolosa (Johnston)
Escharella ventricosa (Hassall)
Escharella n. sp.
Hemicyclopora multispinata (Busk)
- Family Phylactellidae
- Phylactellipora eximia* (Hincks)
- Family Schizoporellidae
- Arthropoma cecilia* (Audouin)
Buffonellaria divergens (Smitt)
Calyptotheca rugosa Hayward
Calyptotheca n. sp.
Calyptotheca triarmata Hayward
Cribellopora trichotoma (Waters)
 (?) *Escharina dutertrei* (Audouin)
Escharina n. sp. (aff. *dutertrei*)
Escharina hyndmanni (Johnston)
Escharina porosa (Smitt)
Escharina vulgaris (Moll)
Metropieriella lepralioides (Calvet)
Schizobrachiella sanguinea (Norman)
Schizomavella auriculata (Hassall)
Schizomavella auriculata f. *asymetrica* Calvet
Schizomavella auriculata f. *cuspidata* Hinks
Schizomavella auriculata f. *hirsuta* Calvet
Schizomavella auriculata f. *inordinata* (Canu & Bassler)
Schizomavella auriculata f. *leontiniensis* (Waters)
Schizomavella arrogata (Waters)

- Schizomavella discoidea* (Busk)
Schizomavella hastata (Hincks)
Schizomavella linearis (Hassall)
Schizomavella mamillata (Hincks)
Schizomavella marsupifera (Busk)
Schizomavella monoecensis (Calvet)
Schizomavella rudis (Manzoni)
Schizoporella dunkeri (Reuss)
(?) *Schizoporella elliptica* (= *tetragona* ?) (Canu & Bassler)
Schizoporella errata (Waters)
Schizoporella longirostris Hincks
Schizoporella magnifica Hincks
Schizoporella mutabilis Calvet
Schizoporella neptuni (Jullien)
Schizoporella tetragona Reuss
Schizoporella unicornis (Johnston)
- Family Cleidochasmatidae
- Characodoma bifurcatum* (Waters)
Cleidochasma oranense (Waters)
Cleidochasma porcellanum (Busk)
Hippopodinella kirchenpaueri (Heller)
Hippopodinella lata (Busk)
Hippoporidra picardi Gautier
- Family Microporellidae
- Calloporina decorata* (Reuss)
Diporula verrucosa (Peach)
Fenestrulina joannae (Calvet)
Fenestrulina malusii (Audouin)
Haplopoma bimucronatum (Moll)
Haplopoma bimucronatum f. *occiduum* (Waters)
Haplopoma graniferum (Johnston)
Haplopoma graniferum f. *carinatum* (Calvet)
Haplopoma impressum (Audouin)
Haplopoma sciaphilum (Silen & Harmelin)
Microporella ciliata (Pallas)
Microporella umbracula (Audouin)
(?) *Microporella marsupiata* (Busk)
Microporella orientalis Harmer
Microporella pseudomarsupiata Aristegui
- Family Chorizoporidae
- Chorizopora brongniartii* (Audouin)
- Family Tessaradomidae
- Tessaradoma boreale* (Busk)
Cylindroporella tubulosa (Norman)
- Family Hippothoidae
- Hippothoa divaricata* Lamouroux
Hippothoa flagellum Manzoni
Celleporella hyalina (Linnaeus)
Trypostega claviculata (Hincks)
Trypostega venusta (Norman)

Family Adeonellidae

Adeonella calveti (Canu & Bassler)

Adeonella polystomella (Reuss)

Family Savignyellidae

Savignyella lafontii (Audouin)

Family Reteporidae

Reteporellina delicatula Hayward

Reteporella elegans Harmelin

Rhynchozoon bispinosum (Johnston)

Rhynchozoon neapolitanum Gautier

Rhynchozoon pseudodigitatum nom. nov.

Rhynchozoon quadrispinatum n. sp.

Rhynchozoon sp. I Hayward

Rhynchozoon sp. II Hayward

Brodieella armata (Hincks)

Schizotheca fissa (Busk)

Schizotheca serratimargo (Hincks)

Schizoretepora imperati (Busk)

Schizoretepora longisetae (Canu & Bassler)

Schizoretepora solanderia (Risso)

Hipellozoon mediterraneum (Waters)

Sertella aporosa (Waters)

Sertella complanata (Waters)

Sertella couchii (Hincks)

Sertella harmeri Hass

Sertella feuerbornii Hass

Sertella mediterranea Hass

Sertella septentrionalis Harmer

Sertella sudbourniensis Gautier

Family Jaculinidae

Jaculina blanchardi Julien

Jaculina paralellata (Waters)

Family Margarettidae

Margaretta cereoides (Ellis & Solander)

Family Phoceaniidae

Phoceana columnaris Jullien & Calvet

Family Celleporidae

Buchneria fayalensis (Waters)

Buskea dichotoma (Hincks)

Buskea nitida (Heller)

Cellepora pumicosa (auctt. no Linneaus)

Cellepora "pumicosa" Waters (no auctt.)

Celleporina caminata (Waters)

Celleporina decipiens Hayward

Celleporina hassallii (Johnston)

Celleporina hassallii f. *tubulosa* (Hincks)

Celleporina lucida (Hincks)

Celleporina canariensis Aristegui

Cigclisula turrita (Smitt)

"*Dentiporella*" *sardonica* (Waters)

Lagenipora lepralioides (Norman)

Lagenipora n. sp.
Omalosecosa ramulosa (Linnaeus)
Turbicellepora avicularis (Hincks)
Turbicellepora camera Hayward
(?) *Turbicellepora cantabra* (Barroso)
Turbicellepora coronopus (Wood)
Turbicellepora coronopusoida Calvet
Turbicellepora crenulata Hayward
Turbicellepora magnicostata (Barroso)
Turbicellepora torquata Hayward
Turbicellepora tubigera (Busk)

Family Myriaporidae

Myriapora truncata (Pallas)

CLASS STENOLAEMATA

ORDER CYCLOSTOMATA

SUBORDER ARTICULOIDEA

Family Crisidae

Crisia cuneata Maplestone
Crisia denticulata (Lamarck)
Crisia fistulosa Heller
Crisia cf. *kerguelensis* Busk
Crisia cf. *occidentalis* (Trask)
Crisia oranensis Waters
Crisia ramosa Harmer
Crisia sigmoidea Waters
Crisia sp. II Harmelin
Filicrisia geniculata (Milne Edwards)

SUBORDER TUBULIPORIDEA

Family Oncousocciidae

Stomatopora gingrina Jullien

Family Annectocymidae

Annectocyma arcuata (Harmelin)
Annectocyma indistincta Canu & Bassler
Annectocyma major (Johnston)
Annectocyma tubulosa (Busk)
Enthalophoroecia deflexa (Couch)
Enthalophoroecia gracilis Harmelin
Enthalophoroecia robusta Harmelin

Family Diastoporidae

Cardioecia watersi (O'Donogue & De Wateville)
Liripora amphorae (Harmelin)
Liripora violacea (Harmelin)
Diplosolen obelia (Johnston)
Eurystrotos occulta (Harmelin)
Eurystrotos compacta (Norman)
Plagioecia dorsalis (Waters)
Plagioecia inoedificata (Jullien)
Plagioecia patina (Lamarck)
Plagioecia platydiscus Harmelin

Plagioecia sarniensis (Norman)

Diplosolen obelia Canu

Family Mecynoeciidae

Mecynoecia delicatula (Busk)

Family Frondiporidae

Frondipora verrucosa (Lamouroux)

Family Terviidae

Tervia irregularis (Meneghini)

Family Tubuliporidae

Idmidronea atlantica (Forbes in Johnston)

Idmidronea coerulea Harmelin

Platonea stoechas Harmelin

Tubulipora aperta Harmer

Tubulipora hemiphragmata Harmelin

Tubulipora liliacea (Pallas)

Tubulipora notomale (Busk)

(?) *Tubulipora phalangea* Couch

Tubulipora plumosa Thompson in Harmer

Tubulipora ziczac Harmelin

SUBORDER RECTANGULOIDEA

Family Lichenoporidae

Disporella hispida (Fleming)

Lichenopora radiata (Audouin)

Lichenopora n. sp.

(?) *Lichenopora verrucaria* (Fabricius)

SUBORDER CANCELLOIDEA

Family Horneridae

Hornera frondiculata Lamouroux

Hornera lichenoides (Linnaeus)

5. KEY TO ORDERS AND SUBORDERS

1. Non-calcified bryozoans; the colonies forming fleshy or gelatinous incrustations, stoloniferous networks, or dense, erect tufts. Zooids frequently semi-transparent; orifice terminal, or frontal in encrusting species, without an opercular flap. Chitinous spines may be present, other heterozooids represented only by stolons (1, 2) CTENOSTOMATA: Key 1 (p. 33)
 - Calcified bryozoans. Colony erect, creeping or encrusting. At least the vertical walls calcified; the colony often constituting a rigid calcareous formation in which the position of each zooid is indicated only by the orifice 2
2. Zooids tubular, perfectly cylindrical, long and narrow, completely calcified. Orifice of the zooid terminal and circular. Colonies erect or forming lobed, discoid or hemispherical incrustations. Gonozooids, appearing as conspicuous, stippled, swollen regions, often present. No avicularia, vibracula or ovicells (3) CYCLOSTOMATA: Key 3 (p. 55)
 - Zooids frontally flattened, with the orifice sub-terminal or frontal, not circular, almost invariably closed by a hinged operculum. Colony erect, encrusting or creeping. Spines often present around the zooid or its orifice. Various specialized heterozooids may be present (avicularia, vibracula, ovicells, etc.) CHEILOSTOMATA: Key 2 (p. 36)
3. Zooids with at least part of the frontal surface membranous, so that (generally) internal structures are visible. The membrane in which the operculum is set, may comprise a greater or lesser part of the frontal surface; it may be underlain by a concave calcareous shield or be overarched by ribs, but it is always present. Erect colonies frequently jointed (4) CHEILOSTOMATA ANASCA: Key 2 (p. 36)
 - Zooids with the frontal surface apart from the orifice completely calcified. The wall so formed smooth and entire and entire, rugose, or punctured by numerous pores or only by marginal pores. Colonies encrusting or erect; when erect usually rigid and unjointed, with zooid boundaries sometimes becoming obscured as calcification proceeds (5) CHEILOSTOMATA ASCOPHORA: Key 2 (p. 36)

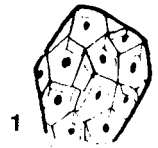

1



2

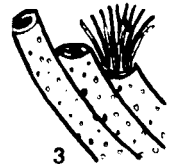

3



4



5

6. KEYS TO GENERA

KEY 1: ORDER CTENOSTOMATA

1. Zooids in close contact, at least at the bases, forming massive colonies, frequently fleshy or gelatinous; encrusting, or rarely erect (superfamily Alcyonelloidea) (1) 2
 - Zooids in more or less branching, linear series; or in isolated groups linked together by filiform, tube-like, stoloniform kenozooids; colonies running, creeping or more rarely erect (2) 4
2. Rim of orifice thickened with a chitinized, quadrangular, clearly shaped, peristomial edge. Colony coriaceous, made up of a single layer of large zooids ($Lz > 1mm$), encrusting, or erect and branching (3) *Pherusella* (p. 61)
 - Rim of orifice not thickened, without definite shape 3
3. Claviform (nail-shaped) colony. Deep-water, rare, species. Peduncle lacking autozooids, all of them lodged in the head (tip) (4) *Clavopora* (p. 62)
 - Encrusting colony, or, when erect, not nail-shaped. Autozooids distributed all over the colony *Alcyonidium* (p. 61)
4. Colony with autozooids only; each rising directly from the others without anastomoses or stolonial kenozooids (5) 10
 - Colony with tube-like zooidal elongations or true stolonial kenozooids joining the autozooids (6) 5
5. Colony forming a network of slender, anastomosed zooidal elongations. Each autozooid situated at a node (7) 6
 - Colony formed by a stolon composed of tubular kenozooids or stoloniform zooidal elongations; branching but not forming a network. The autozooids arise directly from the stolon or are linked to it by short lateral branches. Autozooids grouped or isolated, with or without peduncles (8) 12

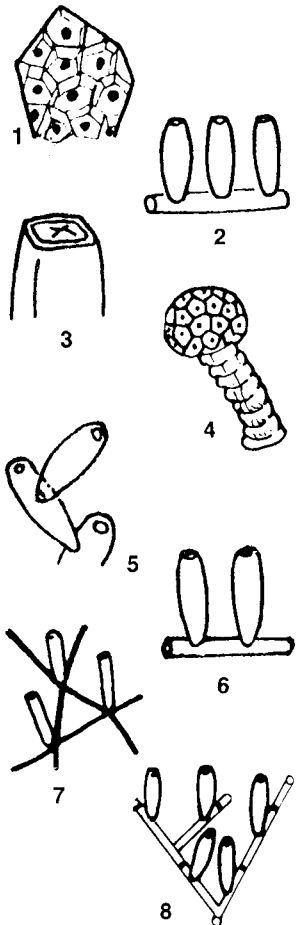

6. Zooid orifice opening on top of a short rounded prominence, rising from a well-developed encrusting base (1) *Arachnidium* (p. 64)
 – Zooid orifice opening on top of a long peristomial tube, which rises from a more or less developed base (2) 7
7. Encrusting base well-developed, as long as or longer than the peristomial tube; with lateral granules, but spines absent *Arachnoidea* (p. 64)
 – Encrusting base absent or reduced, shorter than the peristomial tube; without granulations though spines or lateral expansions may be present 8
8. Peristomial tube able to bud at any level. Brackish water species (3) 9
 – Peristomial tube unable to bud. Marine species. Deep brown coloured (4) *Nolella* (p. 64)
9. Cardial muscle situated halfway along length of cardia; tubular peristome containing the whole of the polypide; narrow encrusting portion like a stolon *Victorella* (p. 64)
 – Cardial muscle at the end of the cardia, just before the entrance of the stomacal caecum *Tanganella* (1) (p. 65)
10. Branches of colony with zooids arranged in biserial rows (5) *Lobiancopora* (p. 66)
 – Branches of colony with zooids arranged in uniserial rows (6) 11
11. Single funicular strand. Marine species *Benedenipora* (p. 66)
 – Double funicular strand. Freshwater species *Paludicella* (p. 67)
12. Bryozoans boring in shells and tubes 13
 – Non-boring bryozoans 16
13. Borers of membranous tubes of marine worms *Hypophorella* (p. 67)
 – Borers of calcareous tubes and shells 14
14. Orifice closed by an operculum. Gonozooid conspicuous, with a laterally developed brooding sac (7) *Penetrantia* (p. 68)
 – No operculum or conspicuous gonozooids (8) 15
15. Colony without true stolons; secondary autozooid elongations anastomosing with primary stoloniform elongations, forming a lax network. Autozooids closely attached to the stolon at their distal ends, not divergent or only slightly (9) *Immergentia* (p. 68)

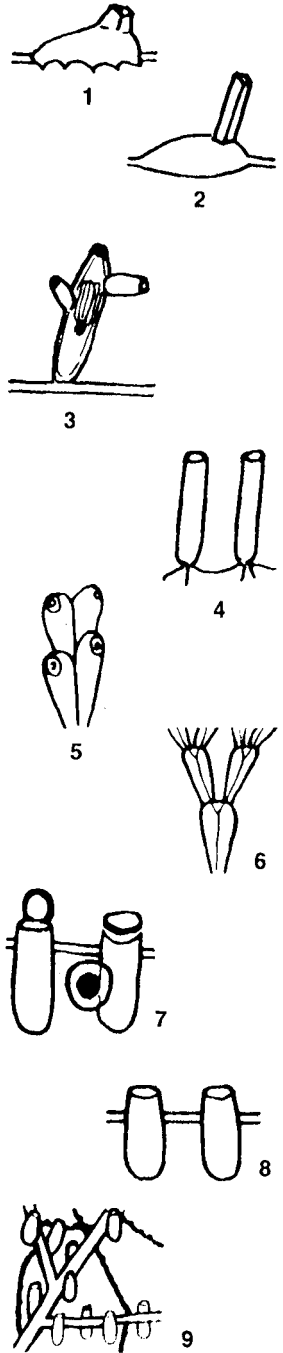

(1) D'HONDT (1983) and JEBRAM defend the maintenance of this genus but not everybody agrees with them (SOULE, 1957). Nevertheless, D'HONDT recognizes that the position of the cardial muscle is the only god feature distinguishing *Tanganella* from *Victorella*

- Colony with true stolons (kenozooids); branching but never forming a network, so autozooid-bearing stolons are not joined by secondary stoloniform elongations. Autozooids arranged on both sides of the stolon, attached at their proximal ends, very divergent to it (1) *Spathipora* (p. 69)
- 16. Stolonal kenozooids of two kinds (broad and slender), or only slender. Autozooids arise only from the slender kenozooids (2) 17
 - Stolonal kenozooids always broad, of constant width. Autozooids arising directly from the broad stolon (3) 19
- 17. Autozooids not articulated, unable to move; closely packed in dense groups isolated on the stolons; no bilateral symmetry (4) *Walkeria* (p. 70)
 - Autozooids articulated and able to move; not with the above arrangement; bilateral symmetry 18
- 18. Autozooids without integral pedicle but placed on top of a long, stalked stolonal elongation, several times longer than the autozooid (5) 23
 - Autozooids with a narrow acute base forming an integral pedicle, which gives them a relative mobility (6) *Farrella* (p. 69)
 - Autozooids lacking pedicle and basal narrowing, articulated by short, polygonal stolons which are formed at their bases. Colonies with very conspicuous symmetry (7, 8) *Mimosella* (p.70)
- 19. Autozooids bearing a membranous area on the anterior side. Not narrowing at the base (9) *Buskia* (p. 71)
 - Autozooids lacking membranous area, narrowing at the base 20
- 20. Autozooids arranged singly, spaced apart along the stolon, with no more than 2-3 zooids per kenozooid. Stolon with spinous tips *Vesicularia* (p. 72)
 - Autozooids arranged in dense groups; the groups spaced apart, or almost continuous along the colony stolon 21
- 21. Tubular autozooids closely packed, contiguous along their entire length; arranged in two close parallel series; continuous or divided in groups; straight or helicoidal (10, 11) *Amathia* (p. 73)
 - Ovoid autozooids, not contiguous along their entire length; arranged in more or less irregular groups (12) 22
- 22. Big colony (about 1 meter long and 2 mm. branch diameter); erect or creeping, branching, vitreous, translucent. Autozooids arising from the distal stems of the branches; arranged in longitudinal series or in dense groups, but never covering the whole width of subjacent stolon *Zoobotryon* (p. 74)
 - Colony smaller; frequently creeping but also erect and free; opaque Autozooids variously arranged, depending on the species; but if seried, not so coalescent, regular or helicoidal as in *Amathia* and

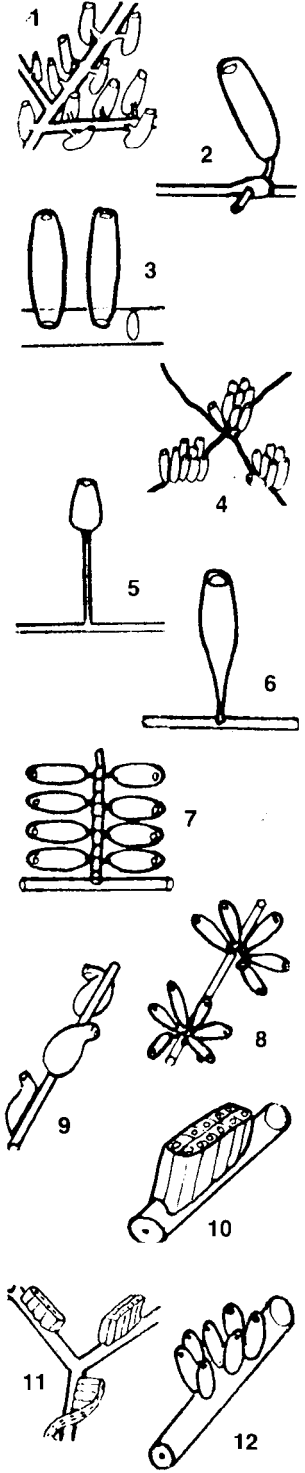

if grouped, so compact as to hide the whole subjacent stolon
 *Bowerbankia* (p. 74)

23. Creeping kenozooids, which give rise only to primary pedicles.
 Autozooids arising from the tip of these primary pedicles
 *Triticella* (p. 72)
- Erect kenozooids, branching, bearing two kinds of pedicles.
 Autozooid arises only from the most slender secondary pedicles
 and from the axils of the branches *Triticellopsis* (p. 72)

KEY 2: ORDER CHEILOSTOMATA

1. Colony erect. Most autozooids not directly in contact with the substratum, but linked to it by means of a reduced number of autozooids which form the colony basis. With rigid calcified skeletons, or flexible. Articulated or not. With or without anchoring rhizoids (rootlets) (1) Key 2a (p. 36)
- Colony encrusting, flattened, composed of zooids densely packed in one plane; if there are free spaces among them, they always make up a continuous network (each zooid is in contact with three or more others) (2) Key 2b (p. 43)
- Colony encrusting, stoloniform, creeping; formed by uniserial rows of zooids, which occasionally ramify to make a lax discontinuous network (each zooid is in contact with two others, rarely three). No avicularia or vibracula, and often no ovicells (3) Key 2c (p. 54)

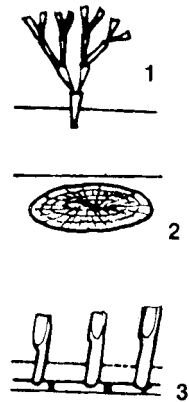

KEY 2a: ERECT CHEILOSTOMATA

1. Colonies erect, less than 3 cm in height and 0.3 cm in branch breadth 2
- Colonies erect, more than 3 cm in height and 0.3 cm in branch breadth 15
2. Colonies jointed or flexible, attached to the substratum by rhizoids (4) 3
- Colonies rigid, well-calcified and unjointed. Attached to the substratum by a solid calcareous base, without rhizoids (5) 11
3. Internodes (colony branches) flattened, with two asymmetrical faces: 1/ frontal, zooids all facing in the same direction and 2/basal (the opposite), smooth and without autozooids, but sometimes with vibracula, avicularia or rhizoids (6) 4
- Internodes cylindrical or with a nearly radial symmetry; autozooids facing in all directions, or at least not facing in only one (7) 8
4. Zooids tubular, cylindrical, speckled with pseudopores. No avicularia, vibracula or ovicells. Gonozooids swollen (*Crisia* and

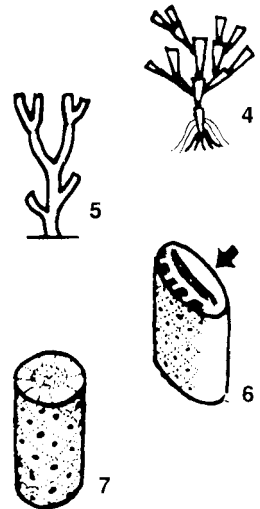

- Filicrisia* (1) CYCLOSTOMATA: Key 3 (p. 55)
 – Zooids flattened, polygonal, with a large membranous area frontally. Calcified parts with pseudopores. Avicularia, vibracula and ovicells present in various combinations (2) 5
5. Branches with chitinized joints between the internodes. Avicularia sessile (rarely pedunculate). Vibracula present on basal or lateral surface of the zooids. A frontal scutum, formed from a modified lateral spine, may partly conceal the frontal membrane (3) 6
 – Branches unjointed. Avicularia pedunculate. Vibracula absent. Spines present, but no scutum (4) 7
6. Basal surface completely obscured by elongated vibracular chambers, closely packed, alternating and obliquely disposed; with very long and rectilinear setae; spike-like. Inconspicuous joints. Rhizoids abundant, forming bundles of anchoring rootlets (5) *Caberea* (p. 96)
 – Vibracula smaller, orientated parallel with, or oblique to, the long axis of the zooid, but occupying only a small lateral portion of the basal surface, so that they remain individually isolated. Articulation joints conspicuous. Rhizoids fewer, descending to the substratum individually (3) *Scrupocellaria* (p. 96)
7. Colony biserial, zooids in strictly alternating series. Zooids very slender proximally, widening distally. Opesia oval, small, confined to the distal edge of the zooid and always less than half zooidal length. Numerous spines (4-9 per zooid), constant in number, long (more than twice zooidal length), flexible (6) *Bicelliariella* (p. 100)
 – Colony biserial or multiserial, zooids in partly alternating series. Zooids parallel-sided from their bases (along their length). A large opesia occupying most of the frontal surface of the zooid. Spines fewer (usually no more than four; maximum six), short and rigid (4) *Bugula* (p. 102)
8. A radial section of the branch cuts at least 3 autozooids and almost always 5 or more. Internodes cylindrical, joints conspicuous. Autozooids strongly calcified, flattened, polygonal and symmetrical; rhomboidal or hexagonal (7) *Cellaria* (p. 94)
 – A radial section of the branch cuts only 1 or 2 autozooids. Autozooids poorly calcified, prominent, globular and symmetrical, with rounded margins 9
9. Each internode formed by a single, calcified, stalked autozooid; each zooid generates two others, distally, both articulated with the former through stalked bases (8) *Savigniella* (p. 145)
 – Internodes (branches) formed by several zooids, arranged in uniserial rows: each branch is formed by a chain of individual zooids (9) *Chlidonia* (p. 93)
 – Internodes (branches) formed by several zooids arranged back to back in biserial rows, hydrozoan-like 10

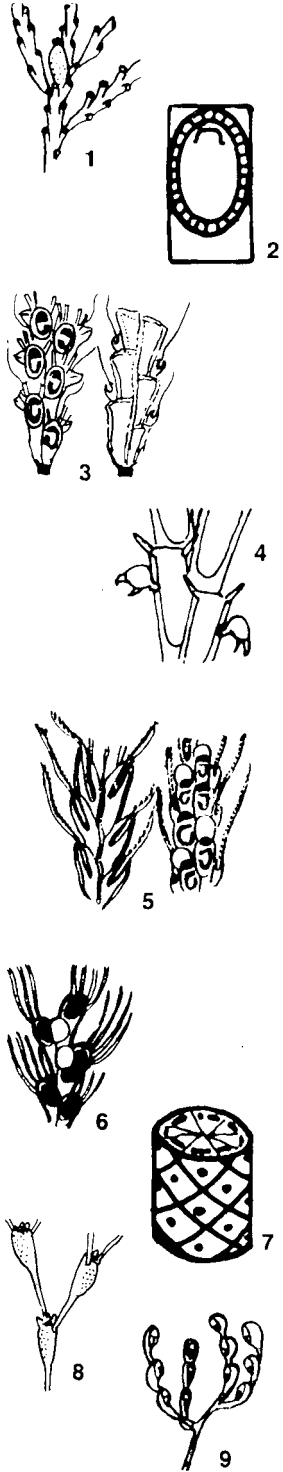

10. Avicularia always pedunculate. Joints inconspicuous. Zooids with rounded borders, less symmetrically arranged along the branches (1) *Synnotum* (p. 100)
 – Avicularia sessile, rarely pedunculate. Joints inconspicuous. Zooids more angular, arranged more symmetrically along the branches (2) *Epistomia* (p. 99)
11. Avicularia and ovicells absent. With a tubular peristome broadening at top to form a fluted, funnel-shaped tip (3) *Phoceana* (p. 155)
 – Avicularia and ovicells present 12
12. Frontal wall with pores and tubercles scattered over the entire surface. Primary orifice visible, keyhole-shaped (4) *Characodoma* (p. 135)
 – Frontal wall smooth, with marginal pores (areolae) only. Primary orifice hidden by a peristome (5) 13
13. Spiramen frontal, suboral, very conspicuous. No oral avicularia; only frontal and paired avicularia (6) *Tessaradoma* (p. 142)
 – Without spiramen. Oral avicularia placed on the peristomial rim. Frontal avicularia, when present, never paired 14
14. Primary orifice with a proximal sinus. Secondary orifice with a pseudosinus (7) *Buskea* (p. 156)
 – Primary orifice without sinus, D-shaped. Secondary orifice without pseudo-sinus (8) *Buchneria* (p. 155)
15. In detail, branches are formed by series of tubular, cylindrical zooids with many pseudopores. No avicularia, vibracula or ovicells. Gonozooids appearing as conspicuous stippled, swollen regions *CYCLOSTOMATA: Key 3* (p. 55)
 – In detail, branches are formed by series of flattened, polygonal or elliptical zooids; if tubular, never perfectly cylindrical. No pseudopores. With avicularia and ovicells 16
16. Colony flexible, 10-15 cm height, tufted; formed by filiform non-branching stems, grouped in regular zooidal verticills. Autozooids characteristic of *Electra*; without avicularia or ovicells, but with spines (9) *Electra* (p. 77)
 – Colony flexible (unjointed), with flattened branches, lamellate. Though the colony is arborescent, branches are clearly orientated in only one plane (10) 17
 – Colony rigid (jointed or not) well-calcified, with branches usually cylindrical, or if flattened, very narrow (11) 22
17. Colony branches with a nearly constant width; lateral margins more or less convoluted, approaching a cylinder. Often bearing abundant long spines and stalked avicularia (12) 18
 – Colony branches fan-shaped, broadening distally, totally flattened. When present, no more than 2 spines per zooid; avicularia never stalked (10) 19

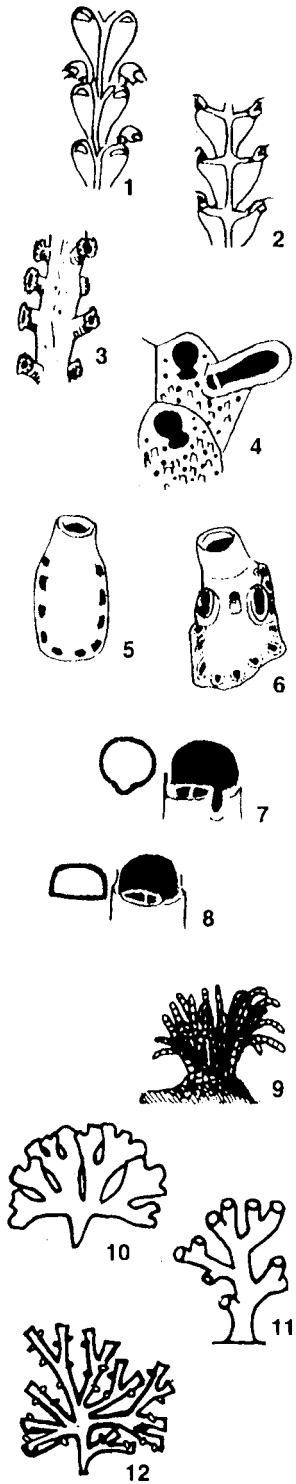

18. Colony consisting of convoluted sheets, which become open cylinders. Discontinuous zooids, linked by connecting tubes, with a hispid appearance due to the large number of spines (11-17 pairs per zooid) surrounding the whole zooid. Basal face also with spines. No avicularia (1) *Beania* (p. 101)
- Colony consisting of closely joined zooids, contiguous along their entire edge, parallel-sided. If spines occur, they are confined to the two distal angles of the zooid. No spines on the basal face. Often with stalked avicularia (2) *Bugula* (p. 102)
19. Colony unilaminar. No avicularia or spines (3) *Carbasea* (p. 79)
- Colony usually bilaminar. Avicularia more or less numerous, but never completely absent from a colony 20
20. Colony surrounded laterally by one or several series of tubular kenozooids, leading to a fixed colonial structure; autozooidal vertical rows bifurcate only at very definite intervals throughout the colony (4) 21
- Colony lacking marginal series of tubular kenozooids. Vertical rows bifurcate throughout the colony, in such a way that the colony structure is variable (not fixed). Spines absent, or reduced to a simple and inconspicuous rounded prominence, placed at each distal corner of the zooid. Avicularia, when present, situated at the bifurcation of zooid rows (5) *Chartella* (p. 79)
21. Avicularia situated mainly at the bifurcations of vertical rows of autozooids (though some may be scattered among the series). Autozooids with spines (6) *Hincksinoflustra* (p. 79)
- Avicularia within the autozooidal rows, never at the bifurcations. Without spines (7) *Securiflustra* (p. 79)
22. Colony jointed, made up of cylindrical calcified internodes, separated by conspicuous non-calcified joints. Anchoring rhizoids present (8) 23
- Colony unjointed, wholly rigid. Rhizoids absent (9) 24
23. Zooids bottle-shaped, with a tubular, fluted peristome. No avicularia. Colony thick (diameter of branches 1 to 1.8 mm), pink or orange-coloured (10) *Margaretta* (p. 155)
- Zooids hexagonal or lozenge-shaped, without peristome. With avicularia. Colony more slender (diameter of branches less than 1 mm), white or light brown in colour (11) *Cellaria* (p. 94)
24. Colony reteporiform: anastomosing branches making a calcareous network which becomes convoluted and reminiscent of a reticulate cup. Zooids opening on one face of the colony only (12, 13) 25
- Colony massive, without open spaces between the zooidal series 28
25. Colony flattened, delicate, made up of uniserial or biserial branches joined by tubular kenozooidal trabeculae. Aperture with a

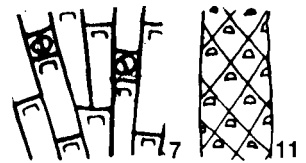
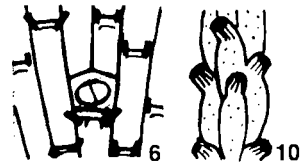
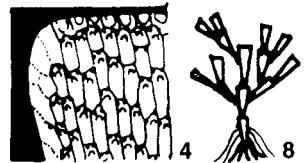
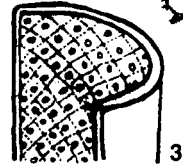
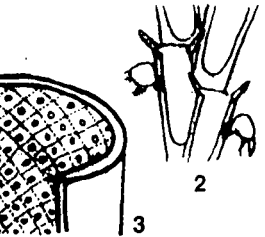

- proximal sinus. Colony attached to the substratum by rhizoids only (1) *Jaculina* (p. 154)
- Colony convoluted, stronger, made up of multiserial branches joined together (without connecting tubes); attached to the substratum by a calcareous base, without rhizoids (2) 26
26. Primary orifice bearing a proximal sinus. Labial avicularia absent. Ovicell with a broad frontal fissure, lacking labellum (3) *Schizoretepora* (p. 150)
- Primary orifice with proximal margin straight (4) 27
27. Lacking spiramen (pseudosinus or labial pore) and strictly labial avicularia. Primary orifice visible, bearing two cardellae. Operculum with a distal peripheral sclerite *Hippellozoon* (p. 151)
- Spiramen well developed. Labial avicularia usually present. Frontal and dorsal avicularia variously placed and shaped. Primary orifice immersed, partly hidden by peristomial lips; no cardellae (5) *Sertella* (p. 151)
28. Colony foliaceous (eschariform), bilaminar, rigid and large (about 20 cm high) made up of anastomosed flattened sheets (6) *Pentapora* (p. 115)
- Colony arborescent, made up of cylindrical branches; or, if flattened, very narrow 29
29. In detail, colony branches are celleporiform: zooids are disorientated, loosely jumbled and closely arranged, due to frontal budding. Branches are coarsely conical, digitate, with the base thicker than the apex (7) 30
- Colony branches, whether cylindrical or flattened, are formed by series of linearly ordered zooids, which are generated by lateral budding (forming regular rows or reticles). The colonial growth follows a regular architectural pattern, so branches have a constant thickness (8) 31
30. Colony well branched, with finely saw-toothed outline, delicate, (branch-diameter less than 3 mm.). The young portions of the colony (distal tips of branches) show an ordered zooidal arrangement (8 to 10 rows at each diameter). Aperture semicircular. Peristome with a long pointed rostrum. Only two types of avicularia: suboral, rostrate and vicarious, spatulate (9) *Omalosecosa* (p. 160)
- Colony digitiform, little branched, rugose and thick (diameter of branches 5 mm). Even the young portions of the colony are disordered. Aperture orbicular, with a proximal sinus. Peristome lacking pointed rostrum. Four types of avicularia: suboral, rostrate, spatulate vicarious, triangular vicarious, and parallel-sided vicarious (7) *Turbicellepora* (p. 161)

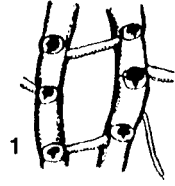

31. Colony vinculariiform: branches more or less cylindrical (1) 32
 – Colony adeoniform: branches clearly flattened (2) 37
32. Zooids lacking peristome and wholly enclosed in the colony surface, in such a way that they give perfectly cylindrical branches; smooth to the touch (3) 33
 – Zooids with peristomes projecting over the general surface of the colony, so that branches are irregularly cylindrical, granular and rugose to touch (4) 34
33. Zooids without avicularia and lacking any other feature excepting the aperture. Ovicell immersed, only visible because of a thickening of the branches. Colony stout *Myriapora* (p. 163)
 – Zooid with fronto-lateral and setiform avicularium. Ascopore suboral, crescentic. Hyperstomial ovicell. Colony more slender, brown or light-brown (5) *Diporula* (p. 137)
34. Asymmetrical branches, with two well-differentiated faces. The frontal side bears all the autozooids, while the basal shows only obliterated zooids and kenozooids (6) 35
 – Branches not with the above features. Orifices facing in all directions. Zooids with a peristome bearing one or more pointed mucrones. No marginal denticles, pores or pseudosinus. Ovicell lacking frontal fissure and labellum. Adventitious avicularia labial or frontal, usually placed on the rostrum *Palmicellaria* (p. 117)
35. Zooids with a tubular peristome, bearing marginal denticles and a labial pore (pseudosinus closed). Ovicell with a frontal fissure; with or without labellum (family Sertellidae) (7) 36
 – Zooids with a proximally notched peristome, lacking denticles, spines and labial pore (or pseudosinus). Ovicell without frontal fissure and labellum. Suboral, elliptical avicularium situated in the peristomial notch. Primary orifice, hidden by the peristome, with lyrula but no condyles *Porelloides* (p. 122)
36. Peristome with distal, cylindrical or antenna-shaped spines. Ovicell lacking small lateral wings or, if present, hardly distinguishable (8) *Reteporella* (p. 146)
 – Peristome without spines. Ovicell bearing well developed small, lateral wings, surmounting proximally the level of the labellum (7) *Reteporellina* (p. 145)
37. Peristome concealing the aperture, always or temporarily (always observable in some phase of development in some part of the colony. Sometimes the peristome is developed accordingly as calcification proceeds: lacking in young zooids; in others precociously grown; eroded with age and disappearing). Species without oral spines (*Palmicellaria skenei* is the only exception) 38
 – Without peristome. Primary orifice and its operculum are always visible. Species in general provided with oral spines, though deciduous (*Pentapora fascialis* is the only exception) 41

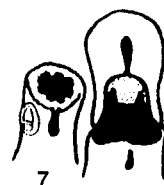
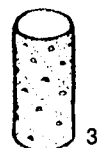

38. Secondary orifice sub-semicircular with a straight proximal border. Suboral spiramen and ascopore present. No ovicells. Embryos brooded in special gonozooids. Avicularia clearly frontal with elongated and triangular mandible, oblique to the main zooidal axis 39
- Secondary orifice rounded. Without visible spiramen or ascopore. Ovicells present (though more or less prominent and conspicuous). A single suboral avicularium situated in the peristomial notch, or on one of the mucrones of the peristome; placed at the zooidal centre and parallel to its principal axis 40
39. A single avicularium, directed distally. Depressed suboral area with a sieve-like ascopore, with 1 to 10 perforations *Adeonellopsis* (p. 113)
- Two or more avicularia directed proximally. Suboral, single spiramen, sometimes occluded *Adeonella* (p. 144)
40. Peristome proximally immersed, enclosing an elliptical avicularium within the notch. Primary orifice suborbicular, with a short lyrula and deep condyles. No oral spines. Ovicells immersed or little prominent; smooth or regularly punctured 42
- Peristome with one or more proximal mucrones, supporting a triangular avicularium. Primary orifice longer than broad, margin rounded distally and straight proximally. No lyrula, but fragile condyles. Two oral spines in young zooids. Prominent ovicells punctured by irregular pores *Palmicellaria* (p. 117)
41. Zooidal aperture cleithridiate (keyhole-shaped). With a median constriction marked by two strong condyles. Avicularium vicarious only, mandible long, triangular with a curving apex. Four oral spines. Ovicell smooth, frontal area lightly calcified (1) *Cleidochasma* (p. 135)
- Zooidal aperture rounded, with a proximal sinus and denticulate distal rim. Adventitious avicularia triangular, frontal and directed towards the aperture; vicarious avicularia triangular, elongated and large, situated on the lateral margins of the branches. 2-4 oral and deciduous spines. Ovicell smooth with a broad triangular frontal fissure (2) *Schizotheca* (p. 149)
 - Zooidal aperture with a rounded distal rim and straight proximal rim. Single suboral avicularium, elliptical and not constant. No spines. Hyperstomial ovicell perforated by large pores (3) *Pentapora* (p. 115)
42. Pores scattered over the entire frontal wall *Smittina* (p. 120)
- Marginal pores only *Porella* (p. 119)

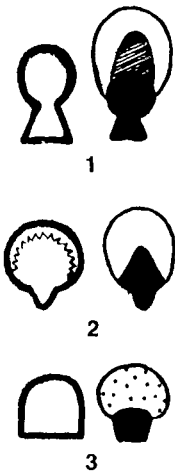

KEY 2b: ENCRUSTING AND CREEPING NON-STOLONIFORM CHEILOSTOMATA

1. Colony discoidal, domed or cone-shaped. At first encrusting and attached to substratum, later free. Zooids spirally arranged, opening on the convex frontal face (the upper). One vibraculum per autozooid directed to the outer part of the colony. The concave basal face (the lower) formed by one calcified sheet garnished with trabeculae and pores. Species of soft, sandy or muddy bottoms (1) *Cupuladria* (p. 88)
 - Without the above features. Colony attached to the substratum 2

2. Colony unilaminar, composed of zooids with non-contiguous margins leaving between them free spaces, and linked by several connecting tubes (2) 3
 - Colony formed by closely joined zooids, without intervening spaces (3) 5

3. Colony forming a slender network creeping over the substratum and attached to it by a single series of connecting tubes issuing from the basal face of the zooids (petraliiform); lightly calcified and flexible. Zooids boat-shaped with the whole frontal surface occupied by a broad opesia, usually surrounded by spines. Stalked avicularia. In the species of this fauna there are no ovicells (4) *Beania* (p. 101)
 - Basal surface of colony firmly attached to substratum. Well-calcified and rigid. No avicularia or spines. Ovicells small, immersed and crescentic 4

4. Cryptocyst extensive, occupying approximately half the frontal wall defining an oval, trifoliate or triangular area with rounded edges. Opesiules absent (5) *Mollia* (p. 91)
 - Cryptocyst much more extensive, leaving free only the distal aperture area. Two frontal opesiules, rounded, very reduced and not very conspicuous (6) *Coronellina* (p. 91)

5. Zooids shoe-shaped; that is, like a box with all the walls calcified, except for a small aperture, more or less rounded, placed at one end of the upper face: S.O. Anasca, S. Fam. Coelostegoidea; S.O. Cribrimorpha and encrusting Ascophora (7) 23
 - Zooids like an open tin of pilchards: upper face wholly decalcified, forming an oval opesia (membranous zone) occupying almost its entire extent: S.O. Anasca, S. Fam. Malacostegoidea I (8) 6
 - Zooids like membranous, forming an oval, triangular or trifoliate opesia; the remaining half is finely calcified: S.O. Anasca, S. Fam. Malacostegoidea II (9) 19

6. Without avicularia; dietellae and ovicells usually absent (*Alderina* is an exception), or with ovicell reduced to a small distal hood

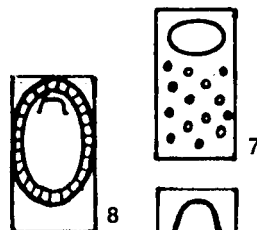
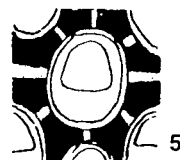
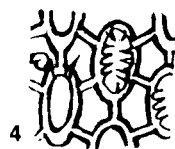

- (*Aplousina*) 7
- With avicularia (sometimes rare) and ovicells (although endozooidal), well developed and conspicuous 12
7. Zooids rectangular, regular with the entire frontal surface membranous; one short, rounded spine placed at each distal corner. Colonies ribbon-shaped; exclusive epibiont of algae (1) *Membranipora* (p. 77)
- Zooids otherwise shaped. Always with a small calcified gymnocyst, at least visible proximally (2) 8
8. Opesia surrounded by a fine edge (cryptocyst), not granular. Gymnocyst proximally developed comprising 1/4 to 1/2 of the frontal area, thin and translucent, generally perforated. Spines surrounding the aperture: the longest and stoutest (sometimes the only) placed on the proximal margin; usually bearing on each side several shorter, paired spines. No ovicells. Running species, forming ribbon-shaped colonies of directed growth, usually on algal substrata. Brackish waters, or in *Posidonia* fields (3) *Electra* (p. 77)
- Opesia surrounded by a granular and thickened edge. Gymnocyst proximally little developed, lacking pores. Spines absent, or when present distributed along the opesial margin, all of the same size (4) 9
9. Without ovicell. Spines short and thin (not covering the whole opesial area), deciduous, or absent. Operculum with a folded membranous edge, crescentic and without sclerites. Kenozooids (constant or not) triangular and much smaller than an autozooid. Running species of directed growth. Estuarine or marine (5) *Conopeum* (p. 76)
- With ovicell. Operculum otherwise shaped. Typically marine species 10
10. Kenozooid similar to autozooid, but slightly smaller in size. Large hyperstomial ovicell, with a central area lacking ectoocium. No spines. Dietellae present: 1 pair in the distal wall of the zooid and 2 pairs in the lateral (6) *Alderina* (p. 82)
- No kenozooids. Ovicell endozooidal, or very small and restricted to the distal top of the zooid. Septula present 11
11. Ovicell small, restricted to a narrow hood on the distal margin of the zooid. Usually without spines, but sometimes two, deciduous, on the distal corners of the zooid (7) *Aplousina* (p. 83)
- Ovicell endozooidal, ridged, or with two decalcified areas. Many spines (12-14), stout and erect, covering the whole opesial area, or absent. (These species have vicarious avicularia, but among Mediterranean specimens colonies without them predominate) *Crassimarginatella* (p. 85)
12. Avicularium vicarious or adventitious, always pointed; mandible triangular often setiform (8) 14

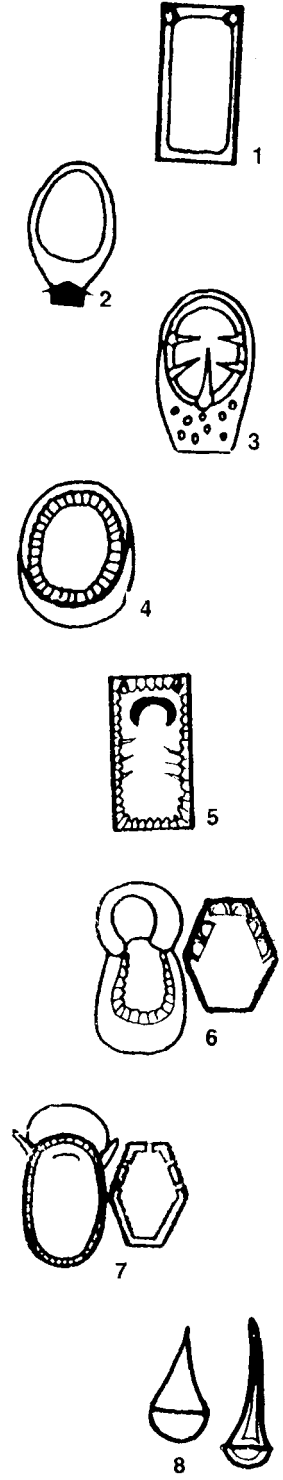

- Avicularium always vicarious, elliptical, with rounded mandible (though it can finish in a narrow tooth) (1) 13
- 13. Many spines (9-14), all of them –except the distal ones– curved over the opesia. Opesial border slightly granular. Abundant avicularia, inserted between the autozooidal series, with flat edges and a complete pivot articulation. Ovicell endozooidal, smooth, with the frontal wall entirely calcified (2) *Hincksina* (p. 80)
- Spines absent or scarce (1-3). Or, if as numerous as in the above case (12-14) six are distal, perioral, divergent and upwardly directed; opesial border granular, avicularium (very rare) with granular rims and only two short, articulation condyles. Endozooidal ovicell, more prominent, ridged transversely or having decalcified lacunae (3) *Crassimarginatella* (p. 85)
- 14. Avicularia adventitious; or if vicarious very much smaller than a zooid, not setiform; situated on the gymnocyst and sometimes also accompanying the ovicell 15
- Avicularia vicarious, almost as large as an autozooid, mandible setiform or curved; situated between the autozooidal series, never accompanying the ovicell 17
- 15. Avicularium vicarious (though very small) directed obliquely. Its cystid always associated with the ovicell, which is endozooidal and ridged. No spines (4) *Ellisina* (p. 81)
- Avicularia always adventitious. Hyperstomial, smooth, ovicell. Spines usually present (though often deciduous) 16
- 16. Two lateral calcareous apophyses placed on the distal portion of the zooid. Avicularium stalked, situated on the proximal gymnocyst of some zooids (rare); distal, triangular avicularium placed between the distal pair of spines, constant. Cryptocyst smooth (5) *Chaperia* (p. 86)
- Without apophyses and pedunculate avicularia. Sessile avicularia: proximal, lateral or accompanying the ovicell, but never situated between distal spines. Cryptocyst finely granular *Callopora* (p. 83)
- 17. Avicularium large, curved, with a small, rounded or triangular, kenozooid immediately distal to it. No spines. Ovicell hyperstomial (6) *Parellisina* (p. 86)
- Avicularium with straight edges without associated kenozooid. Spines usually present, but may be deciduous 18
- 18. Avicularium orientated parallel to the long axis of zooids, setiform, situated latero-distally to autozooids. Ovicell hyperstomial (7) *Copidozoum* (p. 84)
- Avicularium obliquely orientated to the long axis of zooids; pointed but not setiform. Situated distal to zooids intervening in zooidal columns. Endozooidal ovicell lodged in the avicularial cystid (8) *Spiralaria* (p. 81)

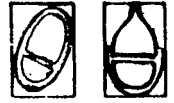

1

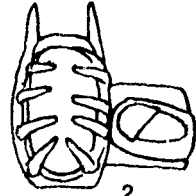

2

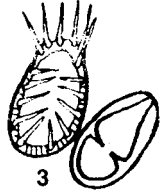

3



4

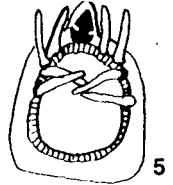

5



6

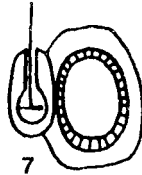

7

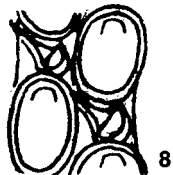

8

19. Avicularia absent 20
 - Avicularia present 21
20. Zooids with interzooidal separation spaces, linked by connecting tubes (1) *Mollia* (p. 91)
 - Zooids closely joined (without visible connecting tubes)
 *Rosseliana* (p. 91)
21. Avicularia adventitious, triangular, small; situated on the autozooidal gymnocyst. Spines present. Ovicell swollen, globular, with a frontal area of reduced calcification (2)
 *Amphiblestrum* (p. 82)
 - Avicularia vicarious, large, setiform; with a membranous margin to the mandible (onychocellaria). No spines. Ovicell small, immersed, limited to the distal part of the zooid and crescentic (3) 22
22. Mandible of the avicularium with straight edges, with membranous expansions at both sides (4) *Rectonychocella* (p. 87)
 - Mandible of the avicularium curved, with the membranous expansion on one side only (5) *Onychocella* (p. 87)
23. Frontal shield formed by series of flattened spines (or costulae), overarching the central part, fused and leaving median lineal series of pores (lacunae): S.O. *Cribrimorpha* (6) 24
 - Frontal wall made up of a fine and perforated cryptocyst, externally overlain by a compensating membrane which occupies the whole frontal surface. In addition to the opesia of the aperture, the cryptocyst has a series of non-calcified, paired and symmetrical orifices (opesiules), through which the depressor muscles pass to the frontal membrane. Without frontal spines and avicularia (but may have vibracula): S.O. *Anasca*, S. Fam. *Coelostegoidea* (7, 8) 29
 - Frontal wall extremely flat and not punctured, except for a row of marginal pores; or, if regularly punctured by many frontal pores, without costulae and opesiules. Generally with avicularia: S.O. *Ascophora* (9) 33
24. Costulae independent, or slightly fused on the central axis, but each separated laterally by continuous and broad slits (no lacunae) (10) *Membraniporella* (p. 110)
 - Costulae fused on the central axis, but also laterally, leaving between them no more than a row of small pores (lacunae) (11) 25
25. Orifice of zooid semicircular, with straight proximal margin (well defined) (12) 26
 - Orifice of zooid quadrangular, elliptical or semicircular, but without a straight proximal margin 28
26. Costate shield occupying the entire frontal wall. Vicarious avicularia

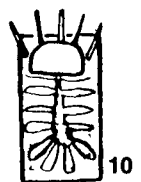
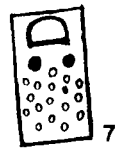
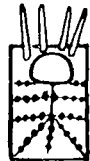
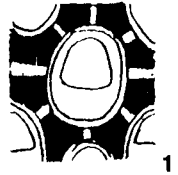

- ria mostly triangular, elongated, placed between interzoooid grooves. Ovicell dependent (1) *Puellina* (S.G. *Cribrilaria*) (p. 105)
- Costate shield occupying approximately half of the frontal wall (or more). Peripheral edges occupied by a flat gymnocyst. Costulae narrower. Adventitious avicularia small and suboral, or absent (2) 27
27. One pair of setiform or vibraculoid papillae, small, placed at the base of the first pair of costulae. No avicularia. Ancestrula of tata type (large oval opesia, with 10-11 straight, cylindrical spines) (3) *Puellina* (S.G. *Puellina*) (p. 105)
- Typical avicularia: triangular, symmetrical, suboral and directed laterally. Zooid margin surrounded by a collar of dietellae resembling pores (4) *Collarina* (p. 105)
28. Costate shield restricted to the central area of the frontal wall enclosed by a large, smooth gymnocyst. Prominent and large ovicell bearing two lateral and symmetrical uncalcified areas. Orifice quadrangular. Vicarious avicularia with spatulate mandible. Zooids very large; without dietellae (5) *Figularia* (p. 110)
- Costate shield occupying most of the frontal wall. Ovicell small, imperforate or with small pores. Avicularia, when present, adventitious and small, placed on the margins of zooid orifice. Zooids unarmed. With dietellae (6) *Cribrilina* (p. 110)
29. Two lateral ridges and one central, parallel to long axis of the zooid. 6-7 dark spines. Operculum dark or black. Two opesiules, somewhat larger than pores, lateral to central ridge. Ovicell broad, smooth, with 5-6 distal notches (7) *Monoporella* (p. 92)
- Without spines or central ridges 30
30. Zooids rectangular, regular. Large opesiules, conspicuous, at the base of tubular indentations of the cryptocyst. No ovicells (8) *Calpensia* (p. 90)
- Zooids oval. Small opesiules. With ovicells 31
31. Each zooid alternating with a vicarious vibraculum bearing a long whip-like seta (9) *Setosella* (p. 92)
- Colony irregular, without vibracula 32
32. Zooids separated by interzoooidal spaces and joined by connecting tubes. Cryptocyst granular but not punctured. Lacking lateral calcareous borders and umbones. Opsiules scarcely conspicuous, placed towards the midpoint of the frontal wall and close to each other. Ovicell small, granular, with a central pore (10) *Coronellina* (p. 91)
- Zooids closely joined, without connecting tubes. Cryptocyst finely punctured; with two lateral ridges, thickening distally and swelling to form a pair of suboral umbones. Opsiules small but conspi-

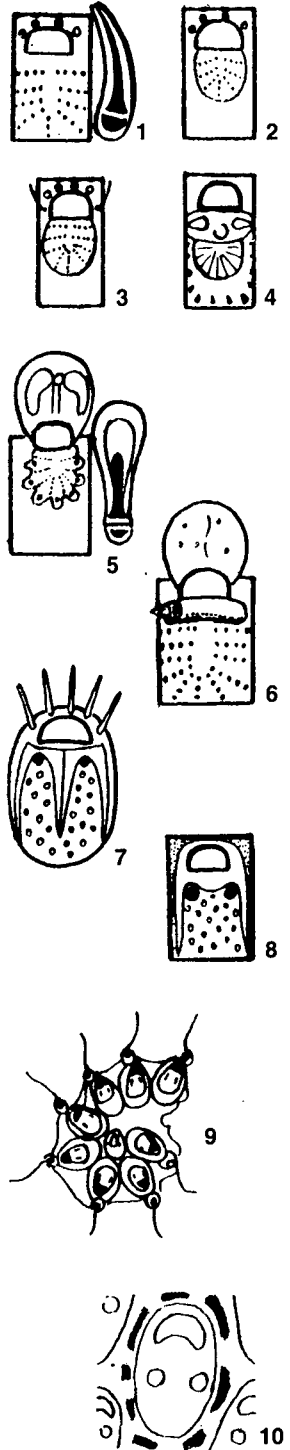

cuous, situated distally beneath the umbones. Ovicell large, submersed. Zooidal lateral ridges continuing over the ovicell, fusing and often forming an umbo on the centre of the frontal surface (1) *Micropora* (p. 90)

- 33. Zooids frontally flattened. (Zooid length much greater than breadth or height). Even with a convex frontal wall, or a more or less swollen and tubular peristome, the flattened zooid margins define a frontal surface much larger than any other face of the zooid. Zooids generally in ordered series, with well-defined boundaries. Frontal wall evenly porous, or with marginal pores only (2) 34
 - Zooids not flattened, spherical or tubular, usually not regularly orientated, edges ill-defined (at first sight, under the stereomicroscope, it is difficult to understand the zooidal structure and the disposition of the zooids). Frontal wall always flat, with marginal pores only (3) 75
- 34. Even though flattened, zooids have a tubular or sharp peristome concealing totally the primary orifice (4) 73
 - Primary orifice partly or totally visible 35
- 35. Primary orifice sub-circular, with proximal border straight and flat (D-shaped), perfectly visible (5) 36
 - Primary orifice otherwise shaped 40
- 36. With ascopore (6) 37
 - With spiramen. Avicularia triangular, large, situated on the median frontal wall directed distally (7) *Reptadeonella* (p. 113)
 - Lacking ascopore and spiramen *Chorizopora* (p. 141)
- 37. Avicularia absent. Frontal wall smooth, glassy or translucent 38
 - Avicularia present. Frontal wall rugose and evenly punctured 39
- 38. Zooids with small marginal pores, and a series of pores concentrated between the aperture and the ascopore. Oral spines present. Ovicell with distinct pores, restricted to disto-basal border (8) *Fenestulina* (p. 138)
 - Zooids with marginal pores, or, if scattered over the frontal wall, never concentrated between ascopore and orifice. Ovicell with pores over the entire surface (9) *Haplopoma* (p. 138)
- 39. Avicularium setiform, directed laterally. Ovicell slightly flattened or with umbones, but lacking perforation and notches (10) *Microporella* (p. 140)
 - Avicularium triangular, not setiform, directed distally and parallel to lateral border of zooid. Ovicell with a crescentic slit (11) *Calloporina* (p. 137)

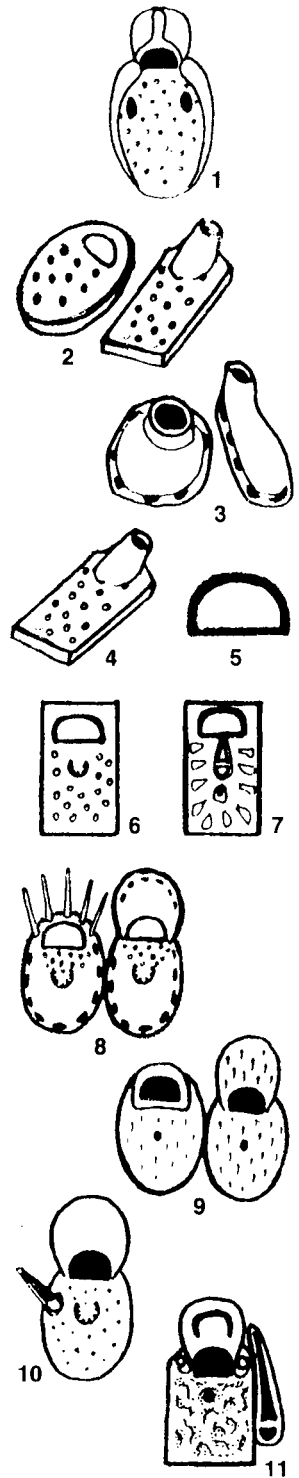

40. Aperture with a more or less rounded or acute sinus in the proximal border (1) 41
 - Aperture without sinus. (If there is a proximal constriction of the aperture, it is not formed in the proximal border but is due to the development of lateral condyles) (2) 49
41. Proximal edge straight, with a narrow and sharp sinus, parallel-sided (3) 42
 - Proximal edge not perfectly straight. Sinus rounded (1) 43
42. Without avicularia *Arthropoma* (p. 126)
 - With avicularia *Escharina* (p. 128)
43. Without avicularia 44
 - With avicularia 45
44. Frontal wall imperforate. Three different types of zooids: 1/ feeding autozooids, 2/ Female autozooids, 3/ dwarf kenozooids (4, 5) *Hippothoa* (p. 143)
 - Frontal wall perforated by special stellate pores. Only one type of zooid: autozooids. Ovicell hyperstomial, globular, with a frontal protuberance (6) *Cribellopora* (p. 128)
45. Colony petraliiform, with tubercles on basal surface and separation spaces between zooids (7) *Ramphostomella* (p. 123)
 - Colony firmly attached to the substratum along the whole basal face, without basal tubercles. No gaps between zooids 46
46. Sinus shallow, broad and rounded, hardly visible. Ovicell enveloping with its edges the whole aperture, globular and evenly punctured (8) *Metroperiella* (p. 129)
 - Sinus narrower. Lateral edges of the ovicell never enveloping more than distal half of the aperture. Ovicell frontal rugose and often bearing umbones, ridges or spiniform columns 47
47. Primary orifice with a pointed sinus, V-shaped, and two prominent lateral condyles, giving a tridentate appearance to the proximal border. Avicularium absent or so minute that it is easily missed, being confused with a pore disto-lateral to the orifice (9) *Schizobrachiella* (p. 130)
 - Primary orifice regularly sinuate, not tridentate. Avicularia, when present, distinct and/or large 48
48. Avicularia (single or paired) laterally adjacent or distal to the aperture, directed distally or disto-laterally. Ovicell with scattered pores, often with channeled margins (10)
 *Schizoporella* (p. 132)
 - Avicularium single, suboral, median, directed proximally. If there are two, situated symmetrically on the centre of the frontal wall (proximal to aperture). Ovicell with frontal pores only, smooth margins, not channeled (11) *Schizomavella* (p. 130)

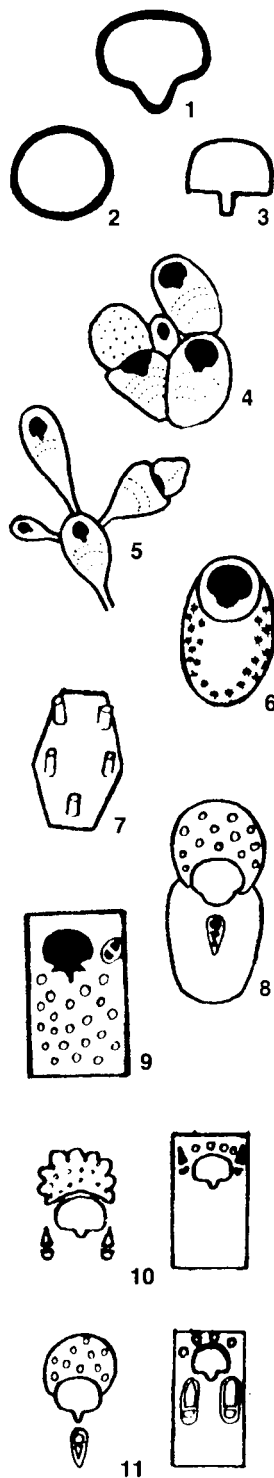

49. Aperture with two distinct lateral cardellae (condyles), which divide it into two well-differentiated parts (1) 50
 – Cardellae lacking or so smooth that they become indistinct and do not divide the aperture into two well-defined parts (2) 66
50. Aperture without lyrula 51
 – Aperture with lyrula (3) 59
51. Two types of avicularia: 1/ adventitious, frontal, elliptical and small, variously placed; 2/ vicarious, large, triangular or crescentic. Ovicell imperforate (4) *Hippoporidra* (p. 136)
 – No avicularia; or avicularia of only one type, adventitious and small. Ovicells perforated 52
52. Avicularia absent; or inconstant, frontal (distant from the aperture), or suboral, elliptical or oval (5) 53
 – Avicularia very constant, lateral or distal to the aperture, triangular or setiform (6) 55
53. Avicularia frequent (but inconstant), suboral, median, directed proximally, and to the long axis of the zoid, elliptical and sometimes spatulate. Frontal wall tuberculate or spiny. Orifice surrounded by 6-8 oral spines (7) *Pentapora* (p. 115)
 – Without the above association of characters 54
54. The condyles, placed at mid-aperture, separate a porta from an almost identical vanna in such a way that the aperture is 8-shaped. Avicularium fronto-lateral, oval, sporadic. Frontal wall umbonuloid, with many perforations bearing the pores at their furthest ends. Peristome distal to aperture, formed by a horseshoe-shaped thickening (8) *Exechonella* (p. 114)
 – The condyles, placed in the proximal third of the aperture, separate a long and narrow porta from a short and broad vanna. Frontal wall with 2-3 large umbones, bearing sporadically a rounded avicularium on their apices. Epibiont on shells of living gastropods (9) *Hippopodinella* (p. 136)
 – The condyles, placed in the proximal third of the aperture, separate a large rounded porta from a rounded or triangular, but much smaller, vanna, in such a way that the aperture is keyhole-shaped. Each autozoid bears distally a small associated kenozooid. Never with avicularia (10) *Trypostega* (p. 143)
55. Marginal pores only. The remaining frontal wall smooth and imperforate (11) 56
 – Pores scattered over the whole frontal wall (12) 57
56. Stout cardellae situated in the proximal third, leaving a typical keyhole-shaped aperture; with spines. Avicularium triangular, large, not setiform, variously placed over the whole frontal wall but never distal to the aperture; less frequently, two symmetrical avicularia. Ovicell hyperstomial (13)
 *Cleidochasma* (p. 135)

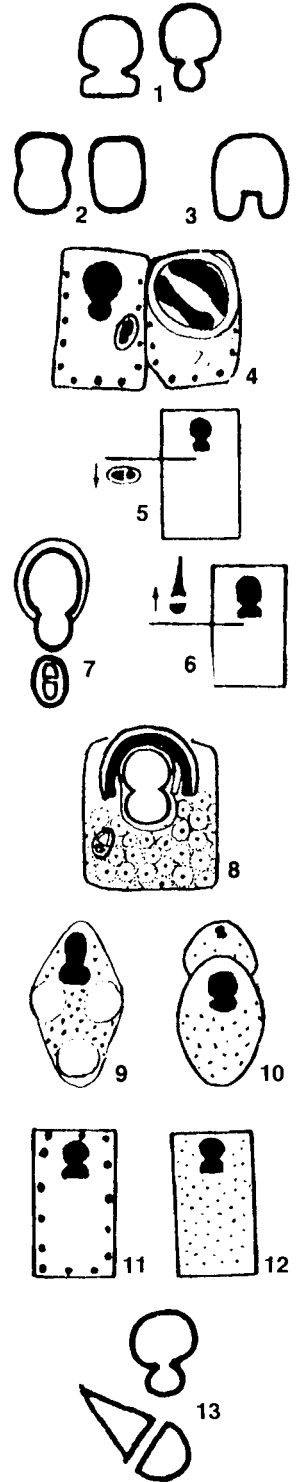

- Smooth cardellae, situated at mid-perture, delimiting a porta and a vanna approximately equal in size. No spines. Avicularium setiform, latero-distal to the aperture, directed to the midpoint of the distal rim of the zooid; typically two, symmetrical, convergent. Gonozooids heteromorphic, with a broad and short aperture (1) *Hippaliosina* (p. 116)
- 57. Orifice enclosed by a peristome which supports and avicularium, situated laterally and strongly curved (2) *Cosciniopsis*
 - Without peristome. Avicularium straight or, if curved, occupying other positions on the frontal wall; often two avicularia, sometimes symmetrical 58
- 58. Ovicell hyperstomial, perforated by many pores. Avicularia triangular with very long, sometimes curved, mandible; usually in distal position and convergent (directed medially), but may be scattered over the frontal wall (3) *Hippopodina* (p. 117)
 - Without ovicell. Gonozooid heteromorphic, with a much broader aperture than that of the autozooids; frontal wall strongly granular. Avicularia triangular, mandible short, situated at the level of the zooid proximal margin and divergent (typically directed proximally or laterally). Endemic to the African shores (4) *Cheiloporina* (p. 116)
- 59. Avicularia absent 60
 - Avicularia present 61
- 60. Frontal wall with pores scattered over the entire surface (5) *Prenantia* (p. 122)
 - Frontal wall with marginal pores only (6) 61
- 61. Lyrula quadrate. Ovicell imperforate (7) *Escharella* (p. 124)
 - Lyrula with a distal tooth. Ovicell porous (8) *Phylactellipora* (p. 126)
- 62. Avicularia setiform. Frontal wall with ordered series of tubercles and pores, forming more or less concentric series. Aperture longer than broad, horseshoe-shaped (9) *Hippomenella* (p. 117)
 - Avicularium and frontal wall without the above features..... 63
- 63. Avicularia (generally more than one) oblique to the zooidal long axis (10) *Parasmittina* (p. 118)
 - Avicularia (generally one) suboral, parallel to the zooidal long axis (11) 64
- 64. Frontal wall with pores scattered over the entire frontal surface (5) *Smittina* (p. 120)
 - Frontal wall with marginal pores only (6) 65
- 65. Avicularium frontal, proximal to the orifice but not enclosed by the peristome; triangular and in the same plane as the frontal wall.

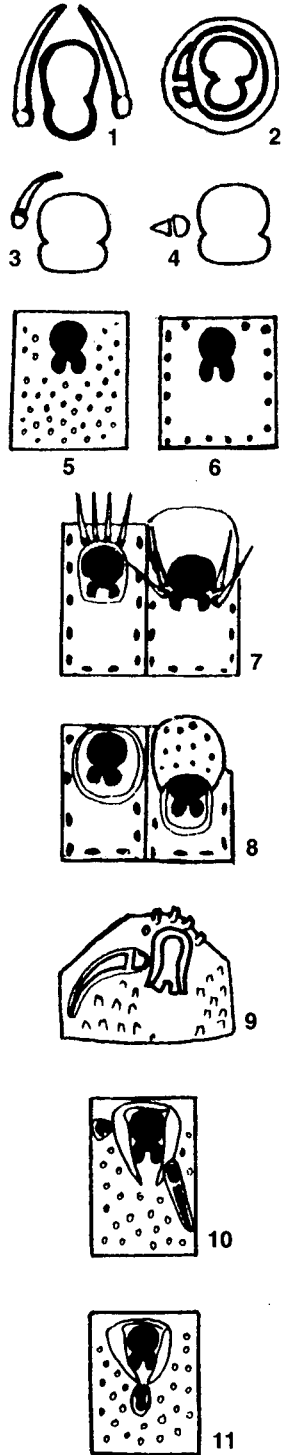

- Ovicell perforated by numerous small pores (1) *Smittoidea* (p. 123)
- Avicularium suboral, enclosed within the peristome, elliptical and typically perpendicular to the lyrula. Ovicell imperforate or with single pore, central and inconspicuous (2) *Porella* (p. 119)
66. Lyrula present (3) *Escharella* (p. 124)
- Lyrula absent 67
67. With two symmetrical avicularia (not constant), situated at each side of the aperture, orientated distally and more or less spatulate (4) *Hippopleurifera* (p. 112)
- Without avicularia, or rare and otherwise placed 68
68. Frontal wall strongly convex, formed by a series of ridges converging to a suboral umbo, rarely bearing an elliptical avicularium; 8-12 large areolae delimited by the ridges (5) *Umbonula* (p. 111)
- Frontal wall without above features 69
69. Frontal wall with very fine pores and ridges (suboral and lateral) giving an *Anasca Coelostegoidea* appearance, but lacking opesiules. No avicularia or ovicells (6) *Watersipora* (p. 114)
- Frontal wall with large pores over its entire surface 70
70. Frontal wall rugose. Aperture longer than wide. Condyles absent, or placed at mid level of aperture. Avicularia suboral, sporadic 71
- Frontal wall porous, but not rugose. Aperture more rounded; condyles smooth, placed at the base of the orifice. No avicularia 72
71. Primary orifice longer than wide. Ovicells present (7) *Pentapora* (p. 115)
- Primary orifice as wide as long. Ovicells absent (8) *Cryptosula* (p. 114)
72. Primary orifice wider than long. Operculum very dark or black, with a central dark ribbon, two lateral clearer "ocelli" and two proximal refringent points. Colony of very large zooids (Lz = 1000 μ), deep purple pigmented. No ovicells (9) *Watersipora* (p. 114)
- Primary orifice longer than wide. Operculum without the above features. Zooids smaller and not so pigmented. Ovicells hyperstomial. *Hippoporina* (p. 114)
73. Peristome more or less tubular, supporting one or more acute avicularia on top. Frontal wall smooth; pores marginal, or if frontal, very rare and of special type. No spines 74
- Frontal wall wholly porous and granular. Aperture enclosed by a

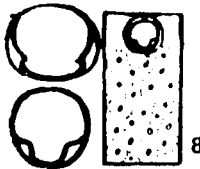
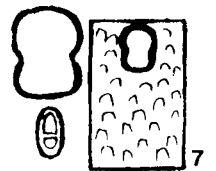
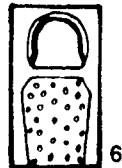
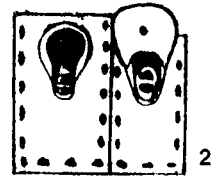
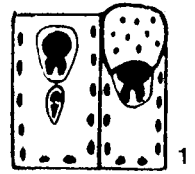

non-tubular peristome, with a proximal denticle hidden by a large frontal mucro, which also conceals the aperture. This latter surrounded by spines. Avicularia lateral to aperture, often paired, divergent (1) *Escharoides* (p. 112)

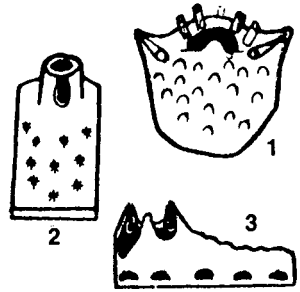

74. Peristome perfectly tubular, cylindrical. Pores scattered over the frontal wall, stellate (2) *Anarthropora* (p. 113)
 – Peristome not perfectly tubular, not distally raised, with from 3 to 5 umbones proximally, each supporting an avicularium. Only normal, marginal pores present (3) *Palmicellaria* (p. 117)

75. Peristome long, tubular, cylindrical and erect, concealing the whole primary orifice (4) 76
 – No peristome; or peristome variously shaped but not cylindrical, if so, without concealing entirely the primary orifice (5) 80

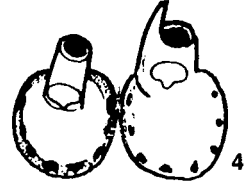

76. Distal rim of the aperture denticulate (difficult to observe without breaking the peristomes, except in peripheral zooids). Aperture with a straight proximal border; a strongly acuminate peristomial rostrum. Vicarious avicularia triangular (6) "*Dentiporella*" (p. 157)
 – Distal rim of primary orifice not denticulate, proximal border concave or even sinuous (7) 77

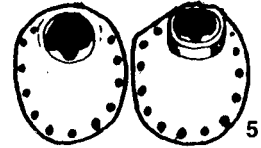

77. Peristome with a pointed rostrum supporting an acute adventitious avicularium, distally orientated (vertical). Ovicell distal to peristome, spherical; scarcely punctured, with pores irregularly disposed (8) 78
 – Peristome lacking columnar processes; or with 2 or 3, not pointed, often lodging a small oval avicularium (not acute) orientated in the same plane as the colony (horizontal). Ovicell lateral to peristome, spherical; with a flattened frontal area, crescentic, ornamented with a series of peripheral pores, orientated in a convergent radial, manner, symmetrical (9) 79



78. Primary orifice orbicular, without a visible sinus. No vicarious spatulate avicularia (10) *Cellepora* (p. 157)
 – Primary orifice with an acute sinus. Vicarious spatulate avicularia present (11) *Turbicellepora* (p. 161)

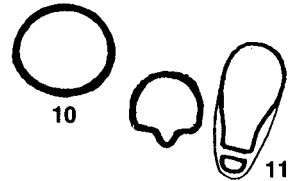

79. Spatulate vicarious avicularia present. Two or more columnar processes. Aperture with a rounded sinus (12) *Celleporina* (p. 158)
 – Spatulate vicarious avicularia absent. Aperture without rounded sinus (13) *Lagenipora* (p. 159)

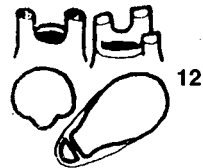

80. No peristome. Primary orifice completely visible 81
 – A variously shaped peristome wholly or partially concealing the primary orifice 84

81. Aperture cleithridiate (keyhole-shaped). Pores (although not very abundant) scattered over the whole frontal surface. Species



- living on pagurised gastropods (1) *Hippoporidra* (p. 136)
- Aperture otherwise shaped. Marginal pores only. On fixed substratum 82
82. Aperture with a proximal sinus. No condyles. Avicularia bulky, arising from marginal pores, generally lateral to aperture; triangular or spatulate, large. Ovicell imperforate (2) 83
- Aperture without sinus, but with lateral condyles; surrounded distally by 3-5 umbones lacking avicularia. Avicularium adventitious (rare), ogival and small, variously placed on the frontal wall. Ovicell with a longitudinal central fissure (3) *Cigclisula* (p. 159)
83. With oral spines and denticles in the distal border of the orifice (4) *Brodiella* (p. 146)
- Lacking spines and denticles (5) *Buffonellaria* (p. 127)
84. Distal rim of the aperture denticulate (difficult to observe without breaking the peristome, except in young peripheral zooids) (6) 85
- Distal rim smooth (7) 86
85. Vicarious avicularia inserted between the zooidal series. Peristome regular. Many spines (but deciduous). Ovicell with a frontal triangular notch (8) *Schizotheca* (p. 149)
- Adventitious avicularia only. Peristome irregular. No spines, or with only two oral spines in young zooids (marginal). Ovicell globular without notch (9) *Rynchozoon* (p. 147)
86. Avicularia absent. 6-8 oral spines (10) *Hemicyclopora* (p. 126)
- Avicularia present. No spines 87
87. Peristome regular, tubular (but not hiding the whole aperture); without pseudo-sinus, supporting an oval avicularium with short, rounded mandible. Primary orifice sinuate. Vicarious avicularium, triangular or spatulate (11) *Turbicellepora* (p. 161)
- Peristome irregular, with pseudo-sinus on one side and avicularium on the other. Labial avicularium more elongated, parallel-sided. Primary orifice orbicular, lacking sinus. No vicarious avicularia (12) *Ramphostomellina* (p. 124)

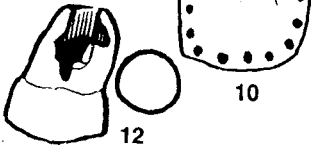
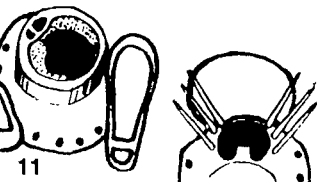
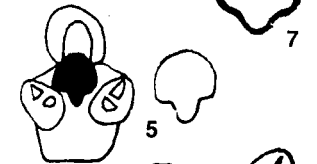
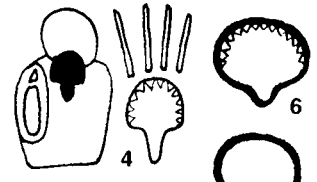
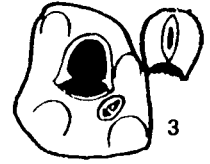
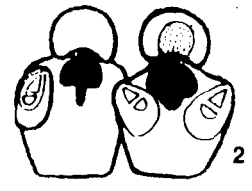

KEY 2c: STOLONIFORM CHEILOSTOMATA

1. Colony consisting of an encrusting part (more or less stoloniform, more or less thickened, forming a sac) and an erect part (more or less tubular or conical) Species little calcified, semihorny and

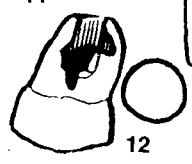

flexible (1, 2) 2
 - Colony consisting of wholly encrusting zooids. Species well calcified, rigid. Zooids with a long and narrow proximal part (stoloniform), and a thickened distal part pyriform, which lodges the aperture (3) 3



2. Colony formed only by autozooids; these consist of an encrusting basal part, stoloniform, which supports an erect, tubular, flexible part bearing the membranous area at its upper end, like a spatula. The tubular portion ornamented with refringent rings, or finely punctured. These ornaments may be repeated on the basal part (4) *Aetea* (p. 75)



- The stoloniform part may be formed by kenozooids or by autozooids, but these are not divided into creeping and erect part; Autozooids horn-shaped or inverted cone-like, with distal oval membranous area. Ovisacs external, conspicuous and ridged (2) *Scruparia* (p. 76)

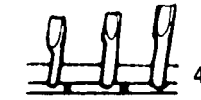
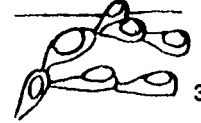

3. Frontal surface with a broad oval opesia occupying most (more than half length) of the distal zooidal thickening (*Anasca*). Only one type of zooid (autozooids), or two types (autozooids and kenozooids), but never more than two 4

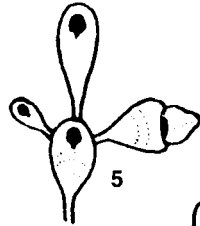

- Frontal surface almost wholly calcified, with only a small distal aperture provided with sinus and weak condyles (*Ascophora*). Zooids of three different types: autozooids of trophic function, female zooids forming the gonozooids, and dwarf zoeciules of unknown function (5) *Hippothoa* (p. 143)

4. Cryptocyst granular, bearing spines (11-12). Ovicells globular or very conspicuous. Autozooids only occur (6) *Callopora*

- Cryptocyst reduced to a narrow, smooth rim. No spines or ovicells. Among the zooid networks are spread connecting kenozooids (7) *Pyripora* (p. 78)

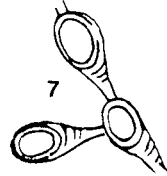
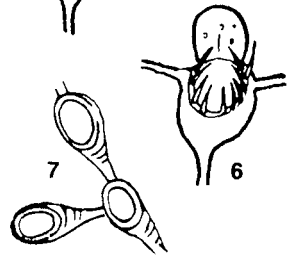

KEY 3: CYCLOSTOMATA

1. Colony pie-shaped, discoidal, completely encrusting and surrounded by a peripheral laminar ring (basal sheet) (8) 2



- Colony erect, jointed and with anchoring rhizoids. Internodes with two well-differentiated faces. All the autozooids opening on the frontal face. Peristomes, biserial, directed alternatively to both sides of the branch (*Crisiidae*) (9) 5

- Colony encrusting or erect but without the above characters.. 6



2. Peristomial tubes arranged in coalescent, radial series, or irregularly disposed forming a reticle, but always separated by a series of irregular compartments (alveoles or cancelli) obscuring their distribution. Brooding chambers with inconspicuous boundaries, hidden by the alveolar growth. Peristomes not deciduous, ge-

- nerally pointed (bi- or tricuspidate), rarely with smooth circular margin, lacking internal diaphragms: Fam. Lichenoporidae (1) *Lichenopora* and *Disporella* (p. 178)
- Peristomial tubes forming an irregular reticle, or if serial, never coalescent. Zooids occupying entirely the colonial frontal surface. No alveoles or extrazoooidal structures. Peristomes often broken at the base of their free portion (at level of colonial surface), leaving visible a rounded or oval aperture, which may be occluded by a calcareous diaphragm perforated or not. Gonozooids with ovate outlines or crescentic, margins conspicuous (2) 3
3. With dwarf heterozooids (nanozooids) inserted among the autozooids (3) *Diplosolen* (p. 169)
- Without heterozooids 4
4. Colony well-calcified (with calcification rings). Zooids arranged in uniserial radii; though not coalescent, they are closely chained. Gonozooid scalloped, but not pierced, by zooidal peristomes (4) *Liripora* (p. 169)
- Colony less calcified. Zooids in reticle, or if serial, clearly distant. Gonozooid pierced by several peristomial tubes. Diaphragms often bearing a small central tube (5) *Plagioecia* (p. 171)
5. Sterile internodes with 1 to 3 zooids (3 to 5 when fertile). Gonozooid long and little swollen, adnate to internode for its whole length; oeciostome terminal, orientated towards the basal face (6) *Filicrisia* (p. 165)
- Always more than 3 zooids per internode. Gonozooid swollen, disengaged from the internode for its distal portion; oeciostome sub-terminal, usually opening to the frontal face (7) *Crisia* (p. 163)
6. Colony repent, stoloniform; formed by uni- or biserial axes, of creeping and ramifying zooids, which may anastomose to form a more or less lax network (8) 7
- Colony encrusting or erect, formed by broad and compact series of zooids (9) 8
7. Colony always uniserial, ramifying through uneven budding to give a dendritiform colony, but without anastomosis. Gonozooid forming a minute sac, linked to the distal extremity of a peristome (10) *Stomatopora* (p. 166)
- Colony sometimes uniserial, but in many points bi- or triserial. Branches, when meeting, may anastomose, forming a network. Often at the point where several branches join, a multiserial base is formed, and a pustuliporiform column (typical form of *E. deflexa*) arises. If the creeping part is fertile, the gonozooid is placed among several peristomial tubes and produces an independent tubular oeciostome of slightly inferior length and diameter to these of the peristomes (11, next page) *Entalophoroecia* (Stomatoporiform) (p. 167)

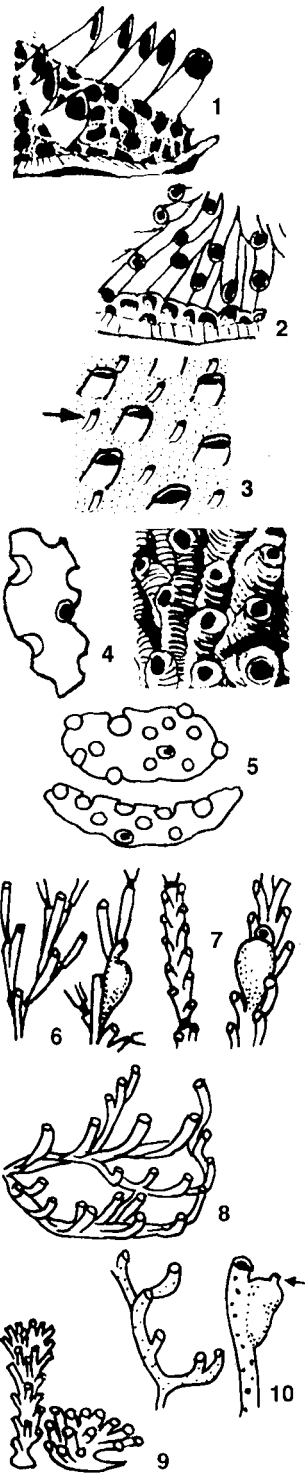

8. Colonies large from 2 to 10 cm height (a developed colony always at least 2 cm in its greater length), erect and well branching. Externally, the zooid apertures are separated by lamellate calcareous spaces 9
- Colonies small (generally less than 1 cm maximum length), erect or creeping. No laminar layer conceals the arrangement of the peristomial tubes, which are closely contiguous and occupy the whole frontal surface 10

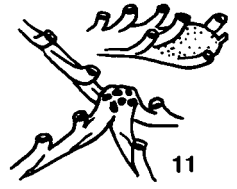

9. Colony branching in one plane. Flattened branches (elliptical in section), of progressively decreasing width and never anastomosed. Zooids forming a reticle; all opening to the frontal face through short, immersed, but perceptible peristomes. External calcareous surface grooved and ridged. Brooding chamber dorsally positioned, bulky (1) *Hornera* (p.181)

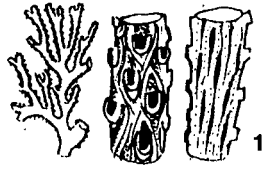

- Colony arborescent with branches orientated in all directions, or if in only one plane, reteporiform. Branches anastomosing to give massive and complex colonies. Zooids, grouped in compact bundles, do not show peristomial lengthening. Smooth external calcareous surface. Gonozooid scarcely conspicuous, extends between the zooidal bundles, sometimes only distinguished by the presence of the semi-circular or crescentic oeciostome, often associated with one zooid or with one bundle of zooids (2) *Fron dipora* (p. 173)

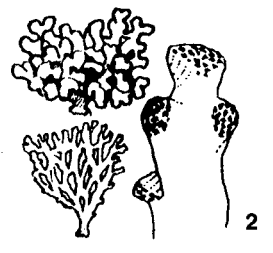

10. Zooid peristomes independent, irregular or arranged in reticle or perceptible series, but never coalescent (3) 11
- Zooid peristomes joined, forming well-arranged series, coalescent for half or more of their length, making up compact bundles (4) 21



11. Colonies erect 12
- Colonies encrusting 16

12. Colonies roughly cylindrical. Peristomes opening all around the axis of the branch and orientated in all directions (5) 13
- Colonies flattened. Peristomes opening only on the frontal face (6) *Annectocyma* (p. 166)

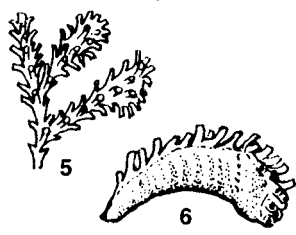
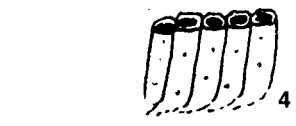

13. Distal tip of the branches showing a basal sheet that divides the branch sagittally into two symmetrical halves. Gonozooid sac-like and heart-shaped, not pierced by peristomes. Oeciostome like a short tube, isolated in the centre of the gonozooid. Pigmentation granules green-bluish (7, 8) "*Cardioecia*" (p. 168)
- Without a distal sagittal sheet. Gonozooid without these characteristics. No green-bluish pigmentation granules 14

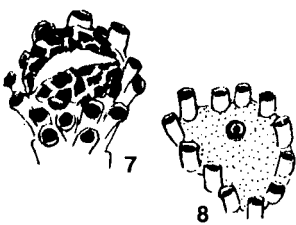

14. Peristomial tubes very slender and long ($\varnothing = 110 \mu$). Gonozooid like a simple sac, elongated and not pierced by peristomes. Oeciostome distal: a short tube, compressed proximo-distally, joined to the basis of a peristome. Spinulae large, formed by a peduncle

- and a spiny head (1) *Mecynoecia* (p. 173)
- Peristomial tubes stout ($\text{\O} = 140 \mu$). Gonozooid situated on the distal tip of the branches; sac-like, pierced or not by the peristomial tubes. Oeciostome distal: funnel-shaped or long and cylindrical (just shorter and more slender than the peristomes); independent, or weakly attached to a peristome. Spinulae absent, or as granules, or small and stick-like, never pedunculate 15
15. Gonozooid central, with oeciostome funnel-shaped, broad and more or less flattened. On the repent bases of the colony there are usually adventitious branches, near to the ancestrula and very divergent from the main branch (2, 3) *Annectocyma* (p. 166)
- Gonozooid distal, with tubular oeciostome consisting of a long, narrow cylinder. Creeping bases never forming adventitious branches (4) *Entalophoroecia* (p. 167)
16. Peristomes very stout, diameter large ($\text{\O} > 140 \mu$). Gonozooid very large, elongated between the peristomes and pierced by several of these 15
- Peristomes slender, smaller in diameter ($\text{\O} < 130 \mu$). Gonozooid small, sac-like, scalloped but never pierced by peristomes .. 17
17. Colony strongly calcified (often with calcification striae). Diaphragm punctured by pseudopores occluding the non-functional zooids. Gonozooid sac-like, where it is possible to distinguish its tubular origin (5) 18
- Calcification very thin, peristomes often translucent. No occluding diaphragms. Gonozooids simple, sac-like, pear-shaped, showing clearly its tubular origin (6) 19
18. A basal sheet, narrow but readily distinguishable, surrounding the growth margin. Gonozooid short and broad (oval or crescentic), with a tubular oeciostome, distal and more slender in diameter than the peristomes (7) *Liripora* (p. 169)
- No basal sheet. Gonozooid longer than broad; oeciostome central, with a very short tube (just projecting above the gonozooidal surface), diameter similar to that of the peristomes. Pigmentation granules blue-greenish (8) "*Cardioecia*" (p. 168)
19. Creeping part of the autozooidal peristomes describing a distinct zigzag, which internally is exaggerated by hemiphragms disposed alternately at each angle. Oeciostome forming a long cylindrical tube, but distinctly smaller than peristomes (9) *Tubulipora* (p. 176)
- Without those features. Oeciostome tube short 20
20. Peristomes very slender ($\text{\O} = 90 \mu$). Gonozooid pear-shaped, broader than long; oeciostome a short distal tube, neither compressed, nor associated with any peristome. No inner spinulae 21

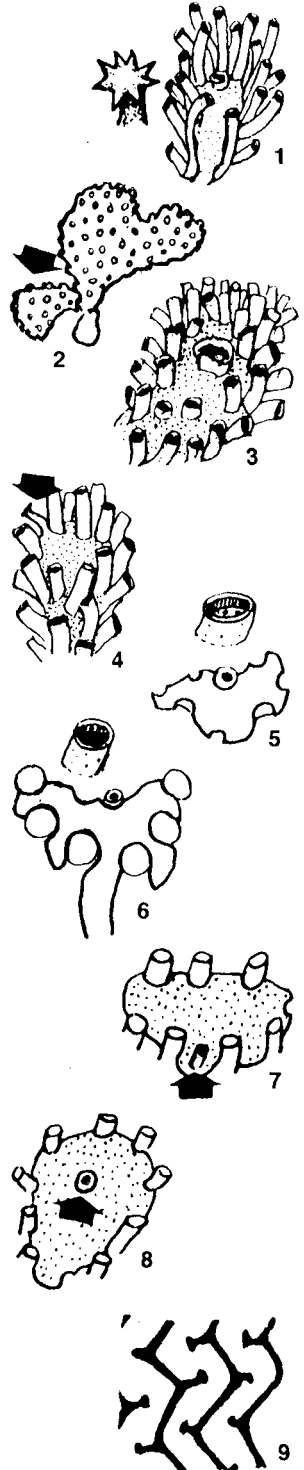

- Peristomes, even the most slender, thicker ($\text{\O} > 100 \mu$). Gonozooid forming an elongated sac, with short, tubular oeciostome, compressed dorso-ventrally and joined to the basis of a peristome. Inner spinulae, large, stalked, with denticulate head (1, previous page) *Mecynoecia* (p. 173)
- 21. Colony encrusting, lobate or discoidal, with a narrow basal sheet. Gonozooid in the form of a broad, short sac. Oeciostome tubular *Lyripora* (p. 169)
 - Colony erect; no basal sheet. Gonozooid more complex 22
- 22. Colony completely erect. Gonozooid placed on dorsal face, resembling an elongated sac, covered by a hooded distal oeciostome (2) *Tervia* (p. 174)
 - Colony idmoneiform or tubuliporiform (when erect, not vertically so). Gonozooid placed on frontal face among the autozooidal peristomes (3) 23
- 23. Colony idmoneiform, well branched. Branches narrow, of a constant width and oval or circular section. Peristomial series alternating regularly on both sides of the branch; always uniserial (4) 24
 - Colony tubuliporiform, forming a scarcely ramified fan. Flattened branches progressively widening. Peristomial series uni- or pluri-serial (5) 26
- 24. Peristomes stout, quadrangular in section ($\text{\O} = 235 \mu$). No basal kenozooids. Oeciostome lateral, funnel-shaped, compressed and distally directed (6) *Tubulipora* (p. 176)
 - Peristomes slender ($\text{\O} = 100\text{-}130 \mu$), circular in section (7) 25
- 25. Basal face bearing kenozooids. Oeciostome lateral, situated between the peristomial series, forming a curving tube, with or without hood (8) *Idmidronea* (p. 174)
 - Basal face lacking kenozooids. Colonies rosy-salmon coloured. Oeciostome central, forming a wide funnel (9) *Platonea* (p. 174)
- 26. Colonies rosy-salmon. Gonozooid situated at the bifurcations or on the centre of the branch; oeciostome funnel-shaped and placed in central position, near the inner margin of a peristomial bundle (10) *Platonea* (p. 174)
 - Colonies translucent, white, purple, or of another colour but never rosy. Gonozooid asymmetrically lobate between peristomial bundles. Oeciostome: 1/ tubular, long and narrow; or 2/ forming a compressed funnel; isolated in terminal position, or placed between the peristomial bundles, but never near their inner margin (11, 12) *Tubulipora* (p. 176)

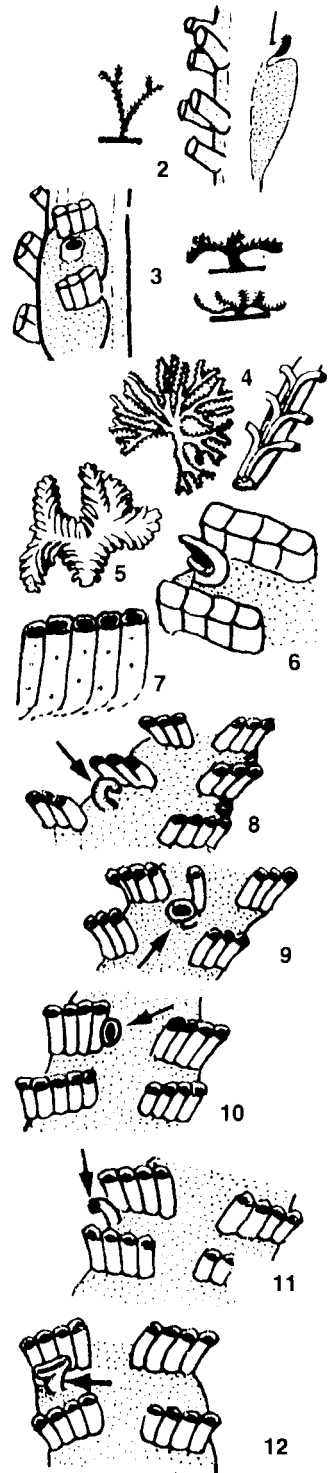

7. KEYS TO SPECIES

CLASS GYMNOLAEMATA
ORDER CTENOSTOMATA
SUBORDER CARNOSA

PHERUSELLA Soule, 1951

Colony coriaceous, encrusting (when young) or erect and branching (when adult). Zooids close together, fused by their lower half, tubular, distally projecting; finishing in a clearly quadrangular orifice which is closed by means of four symmetrical, marginal folds.

Type species: *Flustra tubulosa* Ellis & Solander

Only one species *P. tubulosa*; 1 (PRENANT & BOBIN, 1956: 189)

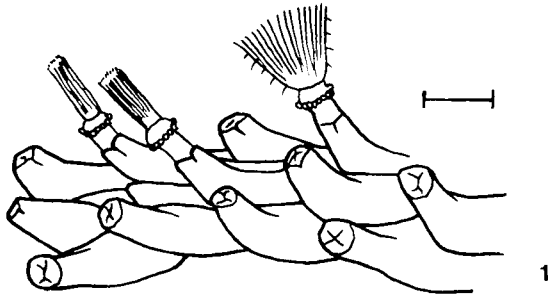

ALCYONIDIUM Lamouroux, 1813

Colony membranous or fleshy, encrusting or forming an erect lobe, simple or lightly ramified, but never with a distinct muscular peduncle. Autozooid orifice usually circular, without cuticular thickenings and closed by invagination of the tentacular cover.

Type species: *Alcyonidium diaphanum* (Hudson, 1778).

Almost all species of *Alcyonidium* show severe taxonomic problems. It is difficult to distinguish one species from another, as it has been proved by enzyme electrophoresis in genetic population studies, which clearly show that, even the most compact species enclose two or three genetically different species (THORPE et al., 1978 a, b). THORPE & WINSTON (1985) demonstrated conclusively that all of Medi-

terranean citations of *A. gelatinosum* belong to *A. diaphanum* Hudson, and the widely used *A. polyoum* (Hassall) must be regarded as a junior synonym of the real *A. gelatinosum* (Linnaeus, 1761, non 1767). This species is an epiphyte of *Fucus serratus*, on northwest European shores, and Hayward (pers. com.) thinks doubtful that it reaches the Mediterranean coast.

1. Orifice on top of a long peristomial tube 2
 - Orifice on the frontal plane or on small prominences 3

2. Colony forming irregular, lobed patches, or open meshworks; often with single linear series of autozooids budded from the periphery. Autozooids appearing randomly orientated; spaces within colony often filled by irregularly shaped kenozooids; on hard substrata, on small red algae, or epizootic, particularly on ascidians *A. albidum* (Alder, 1857); 2,3 (HAYWARD, 1985: 48)
 - Colony continuous, not developing the above mentioned kenozooids. Colony encrusting hydroids or erect bryozoans; gelatinous. Zooids hexagonal, frontal wall traversed by smooth ribs, but translucent, showing the polypide. Orifice subterminal, papillate but squat *A. cellarioides* (Calvet, 1956); 4,5 (HAYWARD, 1985: 50)

3. Colony erect, cylindrical, lobed or digitate; attached by a slender basal “stalk” to hard substrata. Rarely in shallow waters, abundant offshore *A. diaphanum* (Hudson, 1778); 6, 7, 7 bis (HAYWARD, 1985: 44)
 - Colony always encrusting, or with fleshy irregular lobes but not erect 4

4. Pigmentation in irregular network, brown in colour, with whitish or pinkish spots. Colony forming thick sheets, even in the margins *A. variegatum* (Prouho, 1892); 8 (PRENANT & BOBIN, 1956:211)
 - Colony otherwise coloured, forming thin, smooth, sheets except in the margins 5

5. Oviparous species, larger in size (Lz \geq 880 μ m). Zooids often with two polypides *A. duplex* (Prouho, 1892); 9, 9 bis (PRENANT & BOBIN, 1956:219)
 - Viviparous species, smaller, (Lz \geq 350-750 μ m). Zooids always with only one polypide *A. gelatinosum* (Linnaeus, 1761); 10 (HAYWARD, 1985:52)

CLAVOPORA Busk, 1874

Colony small, erect, coriaceous, claviform (nail-shaped), with two well differentiated parts: 1/ a peduncle formed by special kenozooids (called myozooids), without polypide but strengthened with muscle fibres; 2/ a distal swelling or capitulum where all the autozooids are concentrated; these are typically alcyoniform. The peduncular tube is filled with a fluid that contains nourishing elements, and acts as a communication organ between the filtering autozooids of the capitulum and the muscular peduncle kenozooids. The contraction of the muscle fibres of one side and the relaxation of those of the opposite side, allow the movement of the colony in any direction, as well as twisting.

Type species: *Clavopora hystricis* Busk, 1874.

Following other authors, this genus may or may not include *Ascorhiza* Fewkes, characterized by a greater differentiation of the peduncle or stem, which is also more slender, ringed, and has a discoidal base and a differentiated budding zone. In its more strict sense, *Clavopora* is a monospecific genus and exclusively Mediterranean *C. hystricis* Busk, 1874; (*) 11 (PRENANT & BOBIN, 1956:221)

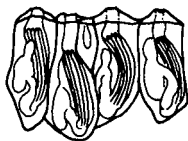
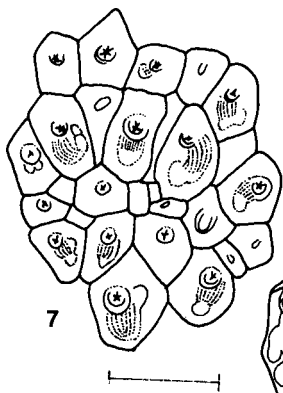
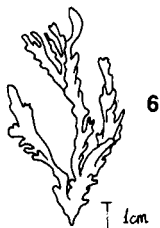
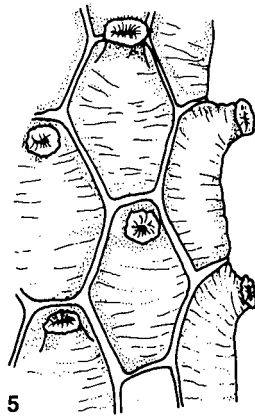
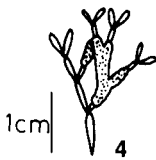
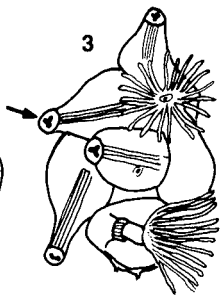
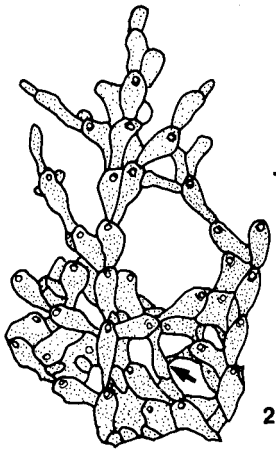

7 bis

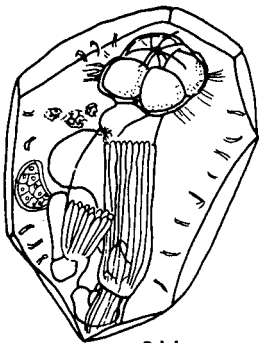
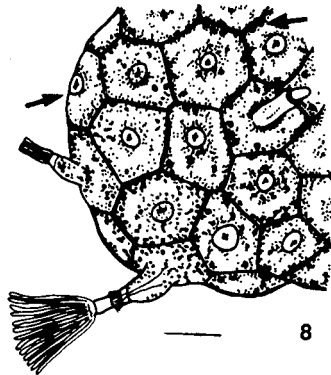

9 bis

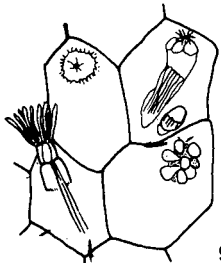

9

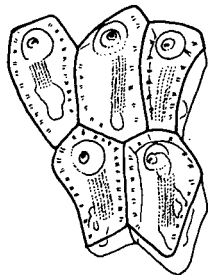

10

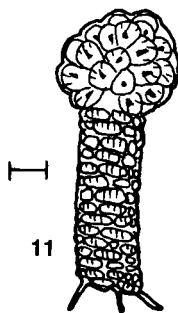

11

ARACHNIDIUM Hincks, 1859

Colony adherent to the substratum, very disjunct, forming a network, in the nodes of which are placed the autozooids (one on each node), and in which the linkages are made by means of slender, anastomosed zooidal elongations. Without filiform processes at the base, or in the peristomial region. Zooids with a clearly distinct proximal part, tubular or mamillated.

Type species: *Arachnidia hippothooides* Hincks, 1859

The type species seems to be the only Mediterranean representative of this genus
..... *A. hippothooides* Hincks, 1859; (*) 12 (PRENANT & BOBIN, 1956:224)

ARACHNOIDEA Moore, 1903

Colony encrusting, ramified but not forming networks. Encrusting basis, as long as or longer than the peristome, formed by a tubular proximal portion and a very widened distal portion, ornamented with lateral granules or expansions but never with spines.

Type species: *Arachnoidea raylankesteri* Moore, 1903

Recently D'HONDT & GERACI (1976) have described the only species of this genus known in the Mediterranean. It is a small species, scarcely conspicuous, deep-water and probably rare
..... *A. annosciae* D'Hondt & Geraci (1976); (*) 13 (D'HONDT & GERACI, 1976: 139)

NOLELLA Gosse, 1855

Colony adherent to the substratum, formed by a network of nodes linked through stolons, from which arise long, thick and opaque peristomial tubes. Nodular thickenings stellate, giving rise, at first, to the polypide and later to the entire peristomial tube. Larvae are brooded within an invagination of the tentacle sheath and set free through the tubular wall.

Type species: *Nolella stipata* Gosse, 1855

- 1. Peristomial tube very long (1500 to 2000 μ), not widened at the base
..... *N. stipata* Gosse, 1855; 15 (PRENANT & BOBIN, 1956:235, as *N. gigantea*)
- Peristomial tube smaller (up to 1400 μ), widened at the base
..... *N. dilatata* Hincks, 1860; 14 (PRENANT & BOBIN, 1956:232)

VICTORELLA Saville Kent, 1870

Colony creeping or slightly erect; zooids formed by a basal widening and a more or less long, cylindrical, transparent peristomial tube; formation of new autozooids by budding which may be on the peristomial tubes (characteristic) or from the basal thickenings (there are wintering buds). Eight tentacles. Without true gizzard. The adults brood their larvae. Cardial muscle on halfway along length of the cardia.

Type species: *Victorella pavida* Saville Kent, 1870

Only one species *V. pavida* (Saville Kent, 1870); 16, 17 (PRENANT & BOBIN, 1956:240)

TANGANELLA Braem, 1951

Cystid appendages, on the encrusting zooids, at the sides from which the lateral daughter zooids originate from the basal part of the cystid: 1/ None or 2 latero-distally and 3 distally (*T. muelleri*); 2/ None or 2 distally, 1 or 2 latero-proximally (*T. appendiculata*). The only good discriminative characteristic of *Tanganella* is the position of the cardinal muscle; SOULE (1957) considers this character to be insufficient to define this genus, or even to justify a specific distinction. We maintain the genus according to D'HONDT (1983).

Only one species in the Mediterranean *T. muelleri* Kraepelin, 1887; (*) 18 (D'HONDT, 1983: 51)

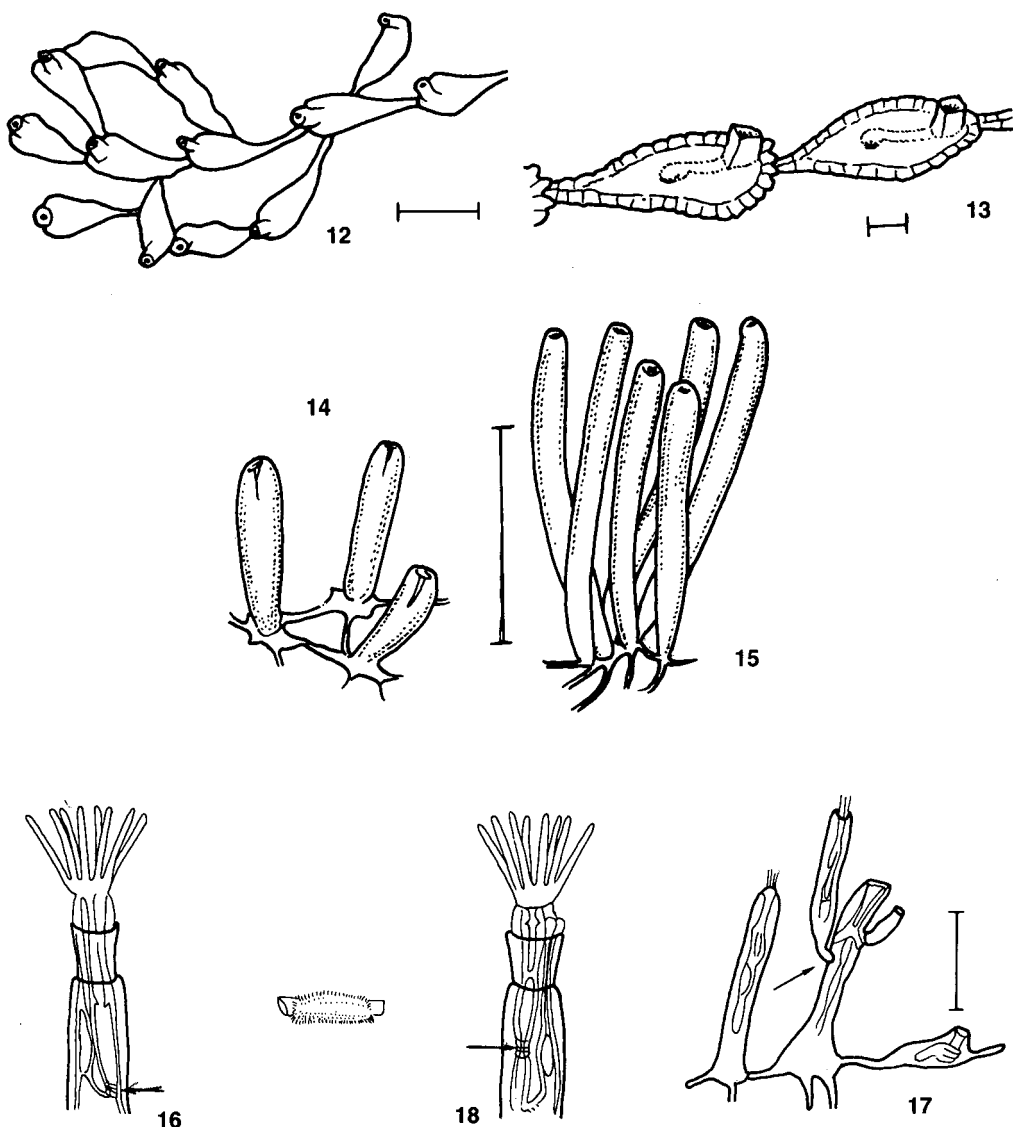

LOBIANCOPORA Pergens, 1889

Colony erect and ramified, formed by biserial zooids or ordered in an irregular helix and orientated in all directions. Funicular strand abundantly ramified within the autozooids, of which it occupies a substantial part.

Type species: *Lobiancopora hyalina* Pergens, 1889

Monospecific genus. *L. hyalina* is a sufficiently distinctive species to warrant its own genus and family. Very rare; deepwater species; dredged from Naples at 250 m depth
 *L. hyalina* (Pergens, 1889); (*) 19 (PRENANT & BOBIN, 1956: 251)

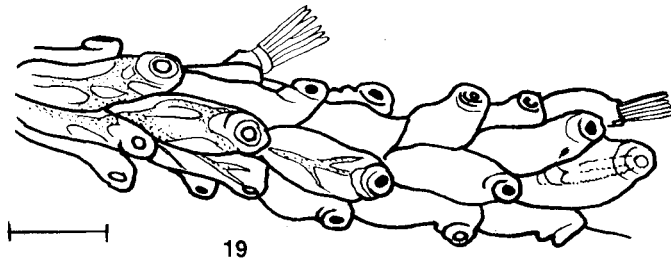

BENEDENIPORA Pergens, 1889

Colony erect, slender and dichotomously ramified; composed of uniserial, conical and elongated zooids. Each zooid appears by budding from the distal end of the preceding zooid. A single funicular strand crosses the zooids without touching the digestive tube.

Type species: *Benedenipora catenata* Pergens, 1889

The type species was formerly the only one known in the Mediterranean, but recently D'HONDT & GERACI (1975) have described a second species: *B. delicatula*.

- 1. Zooidal length more than 1 mm, with conspicuous peduncle
 *B. delicatula* D'Hondt & Geraci, 1975; (*) 20 (D'HONDT, 1983: 19)
- Zooidal length less than 1 mm, without basal peduncle
 *B. catenata* (Pergens, 1889); (*) 21 (D'HONDT, 1983: 19)

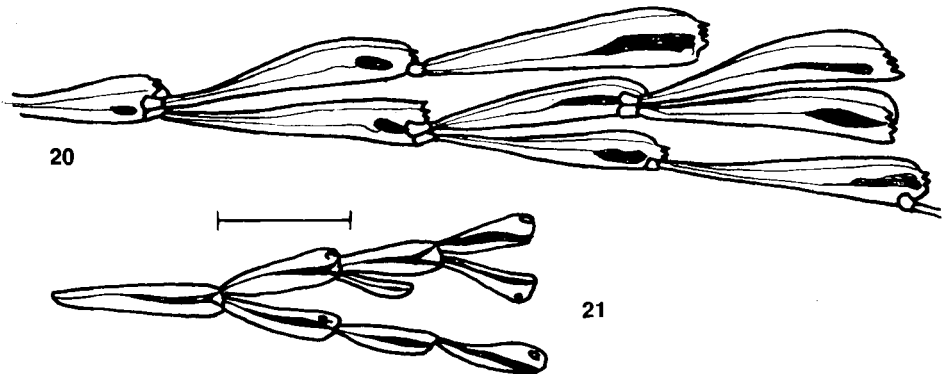

PALUDICELLA Gervais, 1836

Colony stoloniform, delicate; branching, with erect branches arising from a creeping portion. Uniserial autozooids, like inverted cones, with distinct peristomial tubes arising from preceding zooids by distal budding. Each zooid gives place to two buds opposed in a cross. Two funicular strands per zooid: one bearing the testis, the other the ovary. One type of cystidial diverticulum becomes in the autumn, wintering heterozoids that germinate in spring, regenerating the colonies degenerated during the winter. Freshwater species.

Type species: *Alcyonella articulata* Ehrenberg, 1831

The type species is widespread in all brackish and fresh waters of the boreal hemisphere
 *P. articulata* (Ehrenberg, 1831); (*) 22, 23 (PRENANT & BOBIN, 1956: 244)

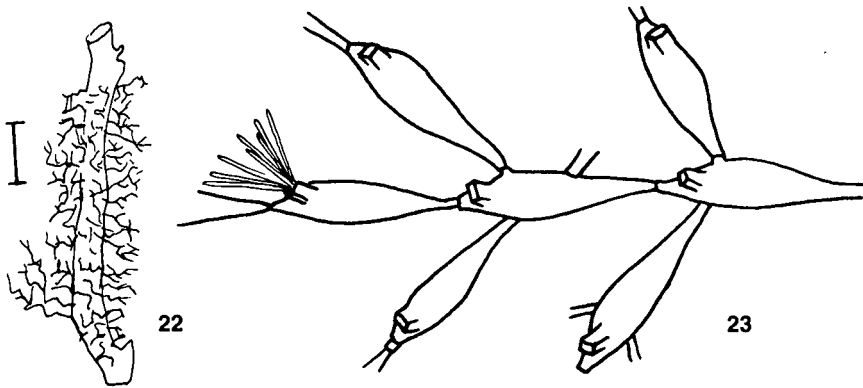

SUBORDER STOLONIFERA

HYPOPHORELLA Ehlers, 1876

Colony boring in membranous tubes of marine worms; stoloniform, creeping and ramified. Autozooids scattered, fixed laterally to the stolon, lying on the substratum; urn-shaped, ornamented with a layer composed of sheets; one spherule situated at each side of the orifice, representing simply two abortive zooids lacking polypides.

Type species: *Hypophorella expansa* Ehlers, 1876

Monospecific genus, known in the Mediterranean
 *H. expansa* Ehlers, 1876; 24 (PRENANT & BOBIN, 1956: 272)

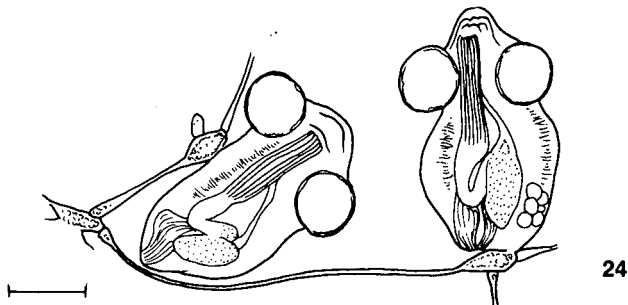

PENETRANTIA Silen, 1946

Colony boring in mollusc shells, and the plates of living or dead cirripedes; formed by a slender, septate primary stolon, from which arise secondary stolons linking the autozooids, isolated and scattered. Zooids sac-shaped, enveloped by a double cuticle and bearing an operculum (not homologous to that of Cheilostomata); connected to the stolon laterally, close to the distal end. Gonozooids very differentiated, with a rudimentary polypide and a wide, ovoid, embryo chamber; externally distinct from the autozooids. Zooids with gizzard.

Type species: *Penetrantia densa* Silen, 1946

Only one Mediterranean species; cited from the island of Majorca
 *P. brevis* Silen, 1946; 25 (PRENANT & BOBIN, 1956: 330)

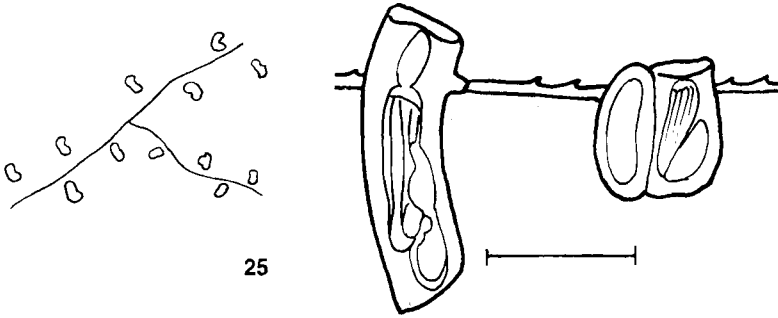

IMMERGENTIA Silen, 1946

Genus boring in shell, imperfectly known. Number of autozooidal tentacles between 8 and 10. Morphology of the proximal part of the autozooids very variable (round, with a digitiform process, etc.). With or without interzooidal anastomoses. Autozooids straight or curved at the distal end below the aperture. Variable number of stolonal tubules. For further details see D'HONDT (1983: 41).

There seems to be only one Mediterranean species
 *I. orbignyana* (Fischer, 1866); (*) 26 (D'HONDT, 1983: 42)

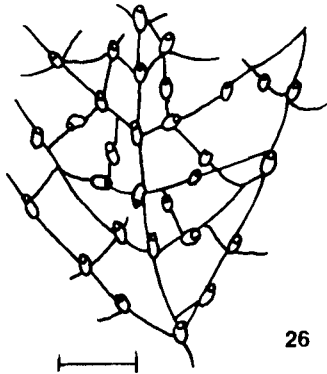

SPATHIPORA Fischer, 1866

Colony boring very superficially in gastropod shells (living or dead); ramified but never forming anastomosed networks (stolons do not anastomose even when they meet). Autozooids vesiculiform, attached to the primary stolon by means of a short secondary stolon, alternating on both sides of the stolon and orientated in a divergent way.

1. Autozooidal apertural scars distinctly in shape of comma. Polypide length: 200-360 μ . Peduncular insertion of zooid near the mid point of the zooid *S. comma* Soule, 1950; (*) 27 (D'HONDT 1983:84)
- Shape of the autozooidal apertural scars oval, with a narrow sinus (2-3 times longer than broad), resulting from the very frequent secondary confluence of preapertural pores; polypide length: 450-550 μ , polypide width: 120-170 μ . Peduncular insertion of zooid at the proximal end *S. sertum* Fischer, 1860; (*) 28 (D'HONDT 1983:84)

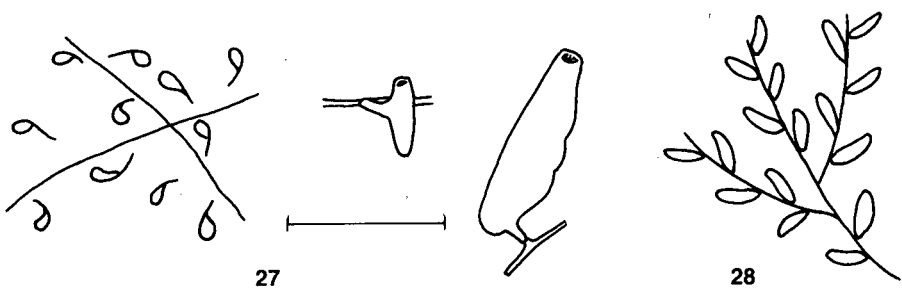

FARRELLA Ehrenberg, 1838

Colony stoloniform, creeping. Vesicular autozooids with a basal constriction and a short jointed peduncle, on a salient of the primary stolon, which allows them to move. Autozooids spread along the stolons without forming compact groups. Aperture bilabiate.

Type species: *Lagenella repens* Farre, 1837

Only one Mediterranean species *F. repens* (Farre, 1837); (*) 29 (PRENANT & BOBIN, 1956:258)

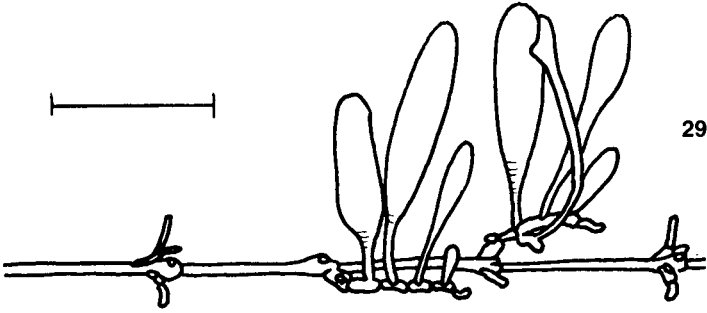

WALKERIA Fleming, 1823

Colony stoloniform, creeping, formed by a slender stolon, from which arise, diversely spaced, dense groups of ovoid or tubular autozooids, somewhat narrowed at the base, without peduncle, fixed. Orifice nearly quadrangular. Eight tentacles.

Type species: *Sertularia uva* Linnaeus, 1758

- 1. Zooids large (700-850 μ length), arranged in numerous and very dense groups *W. tuberosa* (Heller, 1867); 30, 31 (PRENANT & BOBIN, 1956:255)
- Zooids smaller (400-500 μ), arranged in more lax groups *W. uva* (Linnaeus, 1758); 32, 33 (PRENANT & BOBIN, 1956:253)

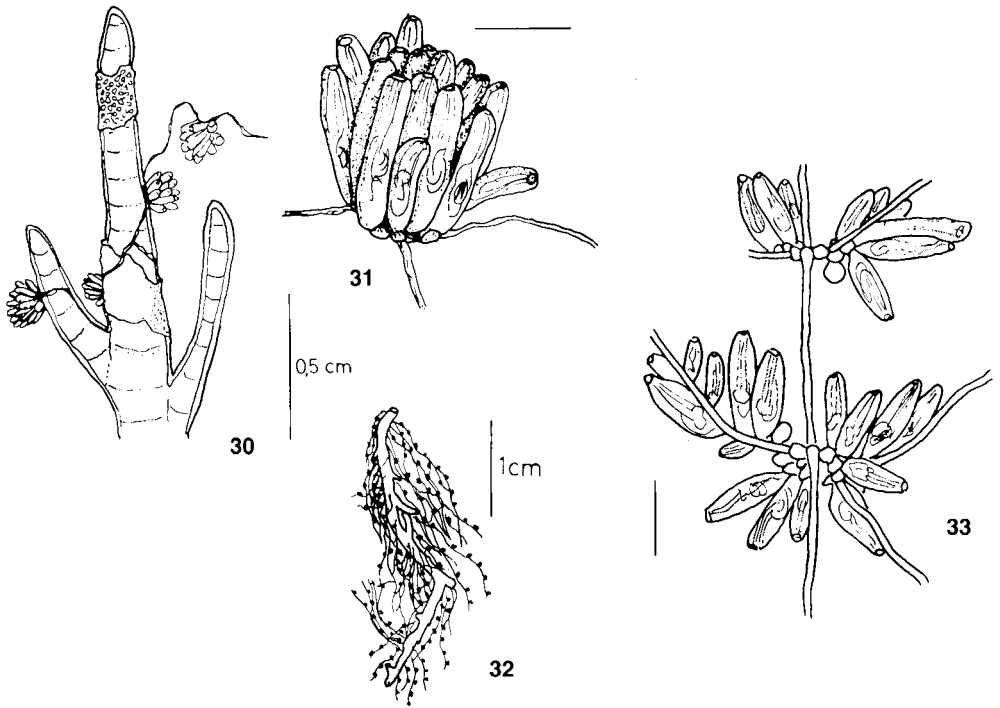

MIMOSELLA Hincks, 1851

Autozooids narrowed at the base, lacking own pedicle, or with a very short one; deciduous, very mobile in all directions around its insertion (owing to the action of a pair of muscles). Autozooid terminating in a quadrangular orifice. With 8 tentacles (2 tentacles project from the crown when it is expanded). Bilateral symmetry: with a poorly differentiated frontal membranous area. The appearance and movement of colonies of *M. gracilis* recalls the branches of the plant Mimosa.

- 1. Colony creeping; stolons long and very slender. Autozooids arranged in verticle groups, at more or less constant distances along the bare stolons *M. verticillata* (Heller, 1867); 34, 35 (PRENANT & BOBIN, 1956: 264)
- Colony erect and stout, branching; branch stolons short and thick. Autozooids along the branches like Mimosa-leaves *M. gracilis* (Hincks, 1851); 36, 37 (PRENANT & BOBIN, 1956: 262)

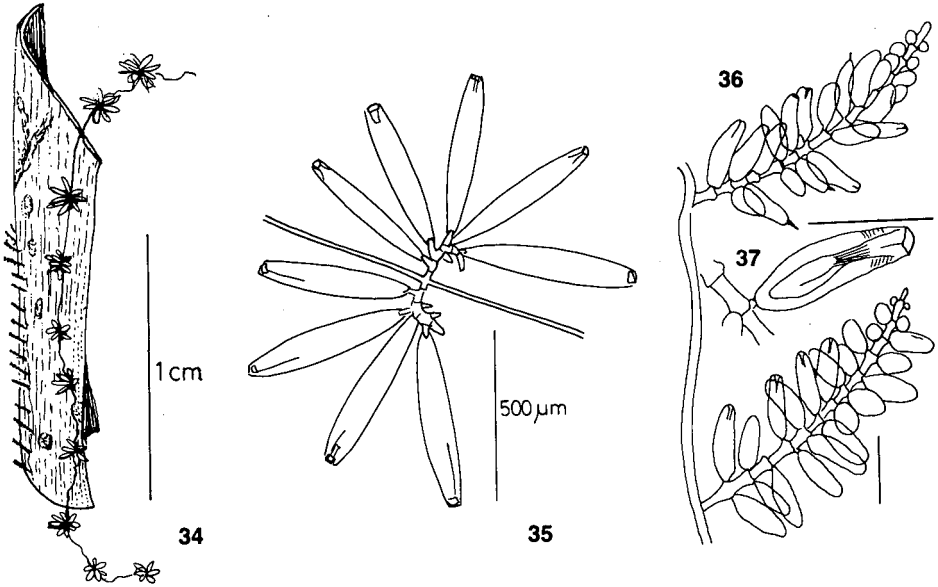

BUSKIA Alder, 1856

Colony stoloniform, creeping or erect. Autozooids arising directly from the stolon (without secondary kenozooids), irregularly scattered and recumbent on it; showing a very marked bilateral symmetry; with dentiform or spinose processes at the base.

Type species: *Buskia nitens* Alder, 1856

1. Stolon thin (50 μ diameter) and creeping, much narrower than the autozooids, which are scattered and lying on it and show a swollen basal portion *B. nitens* Alder, 1857; (*) 38 (PRENANT & BOBIN, 1956:310)
- Stolon thick and stout, with almost the same width as the autozooids (150 μ diameter). Colony erect, ramified. Autozooids along the stolon or grouped, but more dense; larger but relatively less swollen at the base *B. socialis* Hincks, 1887; 39 (1 B) (PRENANT & BOBIN, 1956:310)

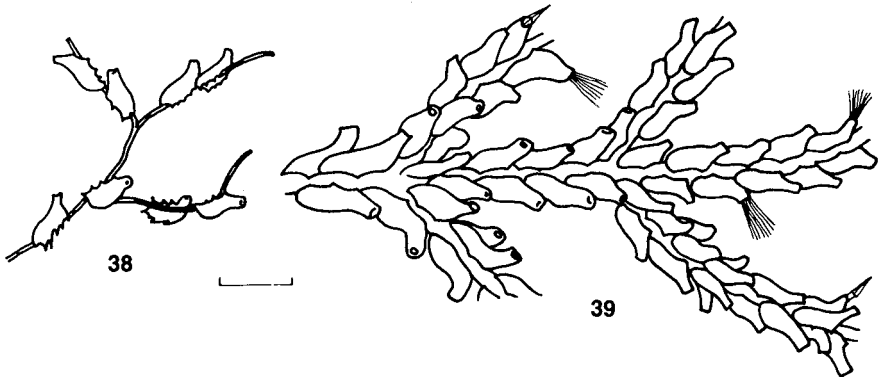

TRITICELLA Dalyell, 1848

Colony stoloniform, creeping, without free branches. Erect zooids attached to the stolon by means of a rigid pedicle which bears an articulation joint. The articulation is on the distal end of the pedicle, which is not a lengthening of the autozooid but a stolon. Zooids deciduous, elongated, ovoid, with bilateral symmetry and a flat, membranous, frontal area, or depressed in its ventral face. No gizzard. Epizootic on the limbs of Decapod crustaceans.

Type species: *Triticella flava* Dalyell, 1848

1. A semicircular, thick, and cuticular band (frenaculum), more or less distinguishable, crosses the dorsal face and goes up towards the orifice; pedicle shorter than in the following species. About 20 tentacles, on average (18-21) *T. flava* (Dalyell, 1848); 40 (HAYWARD, 1985:117)
- Without a cuticular band (no frenaculum). Pedicle generally two or three times longer than the autozooid, but sometimes shorter than it. 12 tentacles on average *T. pedicellata* (Alder, 1857); (*) 41 (PRENANT & BOBIN, 1956:268)

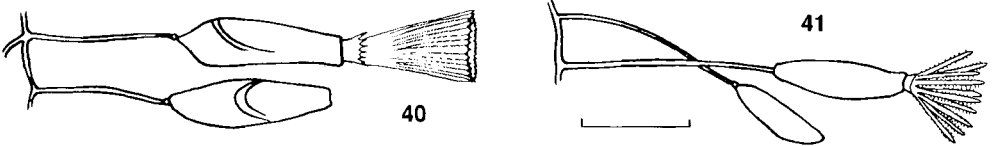

TRITICELLOPSIS Gautier, 1961

Colony stoloniform. Stolonal zooids bearing autozooids at their extremities; the ramification of the colony stolon is lateral and axillary with respect to the autozooids. Lacking intermediate kenozooids. With or without spines at the level of each secondary ramification.

- Only one species reported from the Mediterranean
 *T. tissieri* Gautier, 1962; (*) 42 (D'HONDT 1983:72)

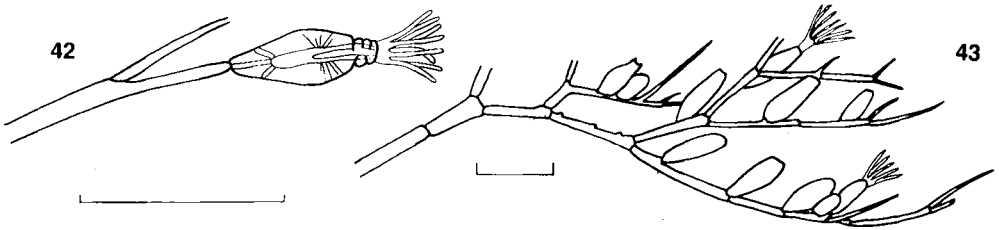

VESICULARIA Thompson, 1830

Colony stoloniform, erect and branching. Attached to the substratum by rhizoids. Zooids ovoid, with a basal constriction, deciduous, inserted directly on the stolonal axis, isolated and separated from each other by regular distances; tentacles little numerous, without membranous frontal area but with a clear gizzard.

Type species: *Sertularia spinosa* Linnaeus, 1767

- The type species is the only species known in the Mediterranean, from where it was cited by PRENANT & BOBIN (1956) without further details
 *V. spinosa* (Linnaeus, 1767); (*) 43 (PRENANT & BOBIN, 1956:277)

AMATHIA Lamouroux, 1812

Colony formed by a creeping, tubular stolon and erect, filiform buds, generally dichotomously ramified, on which are disposed the autozooids, more or less tubular, forming two parallel series. This double series may be continuous or divided in differentiated groups, which may occupy one side of the branch, both sides or wind, in spiral, around it. Embryos develop in the tentacle sheath.

Type species: *Sertularia lendigera* Linnaeus, 1761

1. Autozooids placed along the branches between two bifurcations. From 2 to 6 groups per branch, each with many autozooids (18-25)
 *A. semiconvoluta* (Lamouroux, 1824); 44, 45, 46 (1 A) (PRENANT & BOBIN, 1956:282)
 - Autozooids placed at the bifurcations, sometimes a second group on the internode. Groups with few autozooids, helicoidal, encompassing the branch
 *A. vidovici* (Heller, 1867); (*) 47, 48, 49 (PRENANT & BOBIN, 1956:283)
 - Autozooids just preceding the bifurcation. Groups of moderate size. If they wind, never forming a complete whorl 2

2. From 8 to 13 pairs of autozooids per group. Winding in spiral without completing a whorl
 *A. pruvoti* (Calvet, 1911); 50, 53, 54 (PRENANT & BOBIN, 1956:287)
 - From 4 to 8 pairs of autozooids per group. Never winding in spiral
 *A. lendigera* (Linnaeus, 1761); 50, 51, 52 (PRENANT & BOBIN, 1956:280)

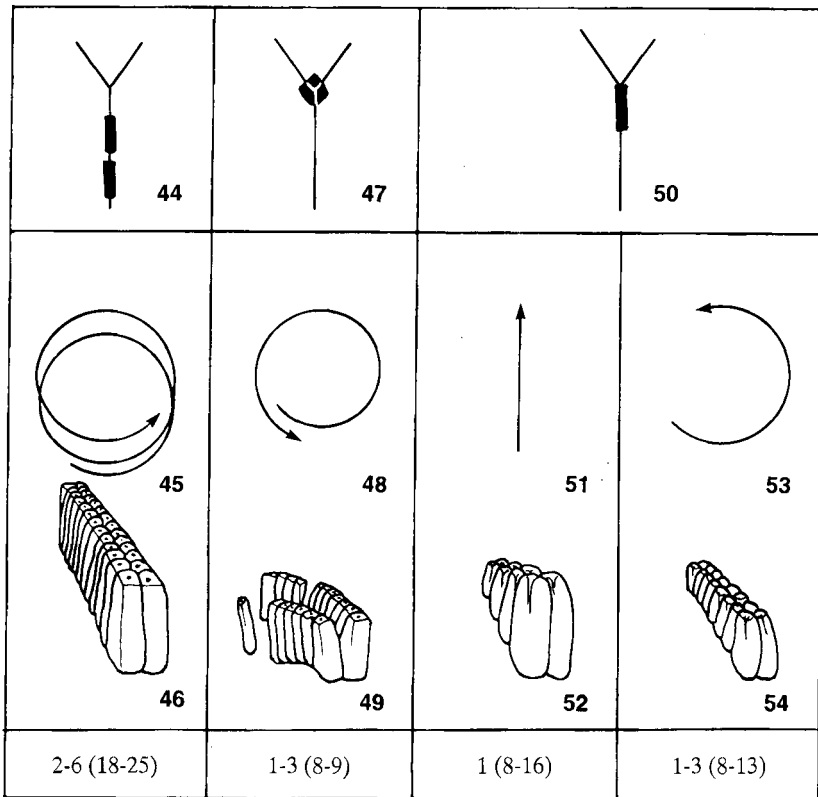

ZOOBOTHRYON Ehrenberg, 1829

Colony erect, dichotomously or trichotomously ramified or rarely whorled (in verticils of 4 or even 5 branches). Stems and branches divided into long, thick segments which grow for a long time by means of distal elongation of the main axis. Autozooids arranged in the same way on all the segments: several helicoidal series, more or less regular, each comprising two parallel rows, with additional series budding later; this arrangement loses its regularity owing to the later loss of some of the autozooids. Polypides with 8 tentacles.

Type species: *Hydra verticillata* Delle Chiaje, 1822

Only one species *Z. verticillatum* (Delle Chiaje, 1822); 55 (PRENANT & BOBIN, 1956:288)

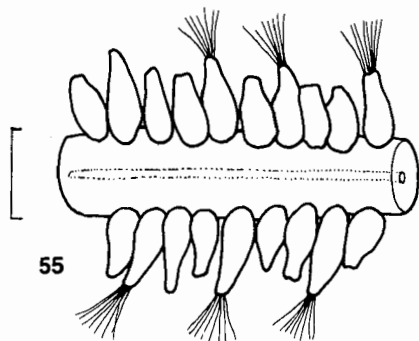

BOWERBANKIA Farre, 1837

Colony creeping or erect, with more or less elongated autozooids, ovoid or cylindrical, isolated, grouped or arranged in spiral on the stolon, but never closely contiguous. Polypide with gizzard and a small number of tentacles (8-10).

Type species: *Sertularia imbricata* Adams, 1798

1. Autozooids forming helicoidal groups similar to those of *Amathia*, but zooids are more separated and never fused. Eight tentacles
 *B. pustulosa* (Ellis & Solander, 1786); (*) 56 (PRENANT & BOBIN, 1956:297)
- Autozooids isolated or forming very loose groups; creeping and slender stolon. Eight tentacles ...
 *B. gracilis* (Leidy, 1855); (*) 57 (PRENANT & BOBIN, 1956:303)
- Autozooids joined in dense groups, not helicoidal (some may be isolated on the stolon). Colony erect or, sometimes, creeping; 10 tentacles
 *B. imbricata* (Adams, 1798); (*) 58 (PRENANT & BOBIN, 1956:293)

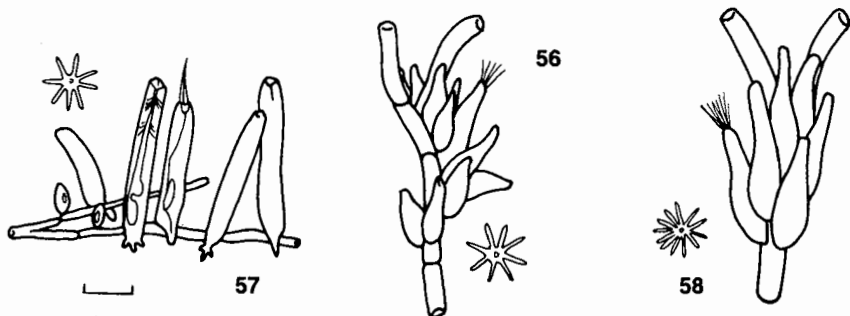

ORDER CHEILOSTOMATA
SUBORDER ANASCA

AETEA Lamouroux, 1812

Colony composed of tubular zooids, each with a decumbent proximal portion and a free, erect distal portion. The adherent parts contribute to stolon formations, which may be filiform throughout or moniliform, i.e. with slender sections separating dilatations. The "stolon" consists of uniserially arranged zooids, and represents the sum of the proximal ends of the autozooids; what appear to be kenozooids may sometimes be intercalated between the autozooids. The stolon ramifies, with branches arising from the dilatations; it is mainly adherent, but may in places become entirely free from the substratum.

The autozooid comprises basal dilatation, middle cylindrical stem, and a distal region with basal and frontal surfaces.

The frontal membrane bears terminally a typical anascan operculum. There are no avicularia or vibracula. Embryos are brooded in delicate, evanescent ovisacs, not in ovicells, which may be proximal to the operculum and frontal, or distal to the operculum, basal and subterminal. The ancestrula resembles an ordinary zooid, but has fewer tentacles (normal zooids bear about 12).

Type species: *Sertularia anguina* Linnaeus, 1758

- 1. Zooid wall (basal widening and peristome), smooth, without rings or punctures. Zooids large (L peristome > 200 μ) *A. longicollis* (Jullien, 1903); 59 (PRENANT & BOBIN, 1966:89)
 - Zooid wall (at least the peristome) punctured, ringed or striated. Zooids smaller (L perist. < 200 μ) 2
- 2. Stem region of zooid closely punctured, not appearing ringed. Peristome straight or slightly curved. Membranous area scarcely widened, clearly truncate *A. truncata* (Landsborough, 1852); 60 (1 D) (PRENANT & BOBIN, 1966:86)
 - Stem region of zooid clearly marked with successive close annulations 3
- 3. Distal membranous area spatulate, wider than the tubular portion and typically facing downwards, punctate. Basal portion ringed. Small species (L perist. < 80 μ) *A. anguina* (Linnaeus, 1758); 61 (PRENANT & BOBIN, 1966:80)
 - Distal membranous area narrow, no wider than the tubular portion, neither spatulate nor facing downwards, punctate. Basal portion punctate. Larger species (L perist. > 80 μ) *A. sica* (Couch, 1844); 62 (1 C) (PRENANT & BOBIN, 1966:83)

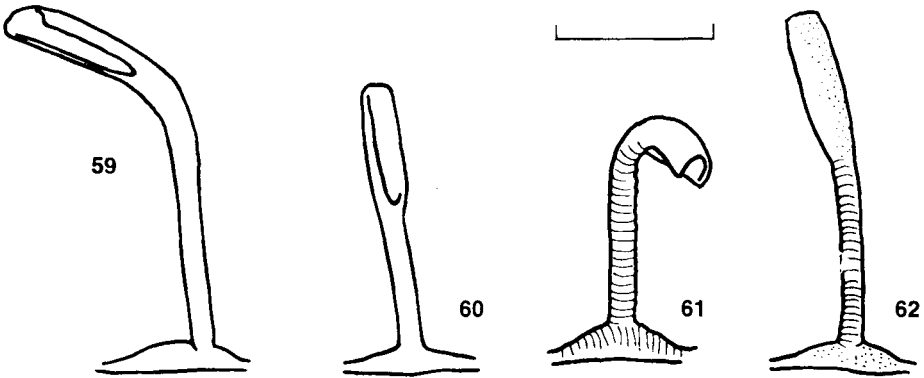

SCRUPARIA Oken, 1815

Colony stoloniform, giving rise to erect, tubular portions. Zooids uniseriably arranged in chains. Budding takes place from the frontal surface of zooids as well as distally and laterally. Autozooids nearly tubular, with a subterminal frontal membrane, oval or rounded; no marginal spines. Without ovicells. Embryos are brooded (several at a time) in special reproductive zooids: globular, shorter and more squat than normal autozooids, finishing in a bivalved hood (brood chamber) with the two halves contributing to a median calcareous keel along the line of fusion. The walls are double, consisting of an outer membranous and an inner calcified wall. The fertile zooids are budded frontally, not as part of a chain. Type species: *Sertularia chelata* Linnaeus, 1758

1. Creeping part of colony a line of autozooids. No kenozooids. Zooids slender, with the frontal membrane almost parallel to the zooidal axis *S. ambigua* (D'Orbigny, 1841); 63 (RYLAND & HAYWARD, 1977:50)
- Creeping part of colony a stolon (composed of kenozooids). Zooids more swollen. Frontal membrane at a marked angle to the zooidal axis *S. chelata* (Linnaeus, 1758); 64 (RYLAND & HAYWARD, 1977:52)

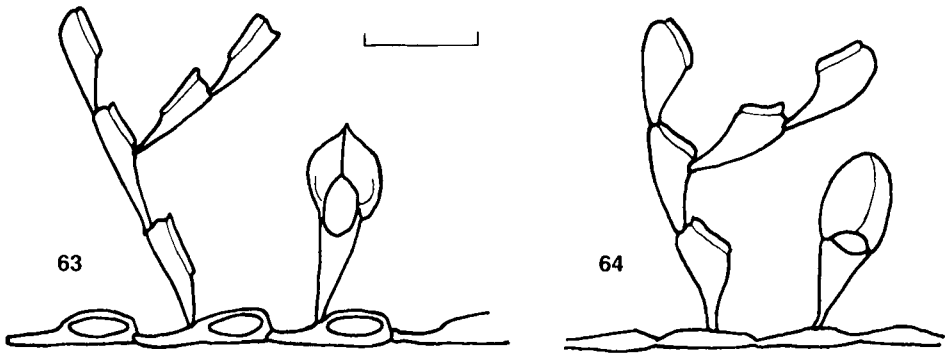

CONOPEUM Gray, 1848

Colony encrusting. Zooids irregularly oval, without tubercles but generally with thin marginal spines. Wall calcification somewhat thicker than in *Membranipora*. The orifice of the zooid closed by a characteristic operculum with a folded, membranous edge; when closed, it appears as a thick, crescentic structure, lightly chitinized and without the thin marginal sclerite typical of *Membranipora*. Larva a cyphonautes, metamorphosing to a single ancestrula; subsequent budding from the primary zooid predominantly distal and proximal in direction. No avicularia, vibracula or ovicells.

Type species: *Millepora reticulum* Linnaeus, 1767

Only one species, *C. seurati*, is well known on Mediterranean coasts. The type species, *C. reticulum* has been very infrequently reported (Corsica Island, CALVET, 1902) but there are recent records on commercial mussels from Minorca island. The introduction on shells of young commercial mussels, imported from Atlantic coasts and grown up in Mediterranean factories, may be the cause of this occurrence.

1. Gymnocyst and cryptocyst present, though reduced. Paired triangular kenozooids situated at distal end of each zooid. Spines, if present, placed all around frontal area. On marine or estuarine hard substrata *C. reticulum* (Linnaeus, 1767); 65 (1 E) (RYLAND & HAYWARD, 1977:60)
- Gymnocyst and cryptocyst practically absent. Kenozooids not paired, rare and irregular in shape. Spines, if present, confined to a single small pair at the distal end of the zooid. Only on estuarine plants of brackish water *C. seurati* (Canu, 1928); 66 (RYLAND & HAYWARD, 1977:62)

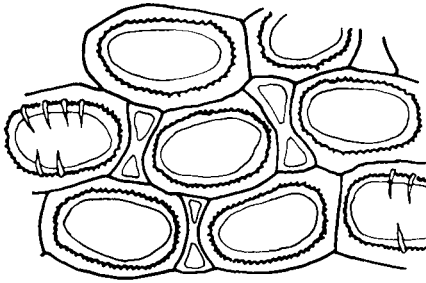

65

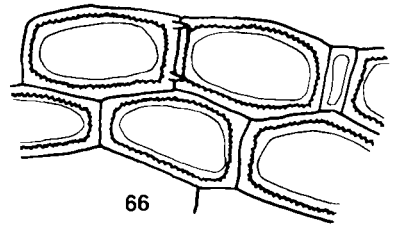

66

MEMBRANIPORA Blainville, 1830

Colony encrusting, typically on marine algae. Zooids rectangular, simple, lightly calcified; the corners provided with tubercles; operculum bounded by a simple sclerite. Ancestrula double. Avicularia and ovicells absent.

Type species: *Flustra membranacea* Linnaeus, 1767

Early authors included in this genus a great number of species which gradually have been removed to new genera. Finally, only two mediterranean species remain: *M. membranacea* and *M. tenuis*. The first has a wide distribution around the Mediterranean shores. *M. tenuis* is a circumtropical species, recorded as *Hemiseptella africana* by CANU & BASSLER (1930) from Tunisian shores.

- 1. Cryptocyst practically absent. Opesia fully developed occupying the whole frontal surface. With distal tubercles, but no true spines. Very lightly calcified colonies *M. membranacea* (Linnaeus, 1767); 67 (RYLAND & HAYWARD, 1977:56)
- Cryptocyst well developed. Opesia occupying only the distal half of the zooid. With distal tubercles, and five spines around the opesia. Well calcified colonies *M. tenuis* Desor, 1848; (*) 68 (CANU & BASSLER, 1930:29)

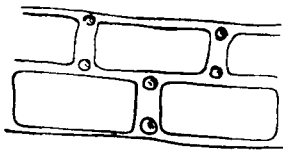

67

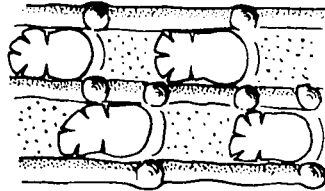

68

ELECTRA Lamouroux, 1816

Colony creeping or erect, uni- or plurilaminar, with determinate growth forming elongated colonies, often ribbon-like, adapted to the shape of the algal substrata. Zooids oval or rounded triangular; opesia more or less large, surrounded by spines. Median proximal spine constant in all species; the others are very variable, in number as well as in development, often reduced to simple tubercles. Gymnocyst more or less developed, perforated by a variable number of pores. No avicularia, vibracula or ovicells. Ancestrula resembling a normal autozooid. Two or three pairs of lateral multiporous septula; a transverse row of distal uniporous septula; dietellae sometimes present.

Type species: *Flustra verticillata* Ellis & Solander, 1786

1. Colony erect, forming dense tufts in which zooids seem arranged in verticils (other characters identical to those of *E. pilosa*)
..... *E. verticillata* (Ellis & Solander, 1786); 69, 69 bis (PRENANT & BOBIN, 1966:138)
– Colony encrusting 2

2. Gymnocyst imperforate or with few pores; median proximal spine constant; other spines may be absent, or very delicate. Estuarine and coastal
..... *E. monostachys* (Busk, 1854); 73, 74 (RYLAND & HAYWARD, 1977:70)
– Gymnocyst perforated proximally by numerous pores. A variable number of spines surrounding the opesia, the proximal spine most prominent, often very well developed 3

3. Colony lightly calcified. Gymnocyst with few pores (20 at most). Spines short, not numerous (2-4). Ancestrula imperforate (1-2 pores), with two distal spines and a single asymmetrical dietella (latero-distal). Strictly epiphytic on *Posidonia*
..... *E. posidoniae* Gautier, 1957; 71, 72 (PRENANT & BOBIN, 1966:147)
– Colony well calcified. Numerous pores (more than 20). 4-12 spines (mean 5) long, proximal, usually conspicuous. Ancestrula with 25 to 40 pores, 5 spines and 2 symmetrical lateral dietellae
..... *E. pilosa* (Linnaeus, 1766); 70, 70 bis (PRENANT & BOBIN, 1966:140)

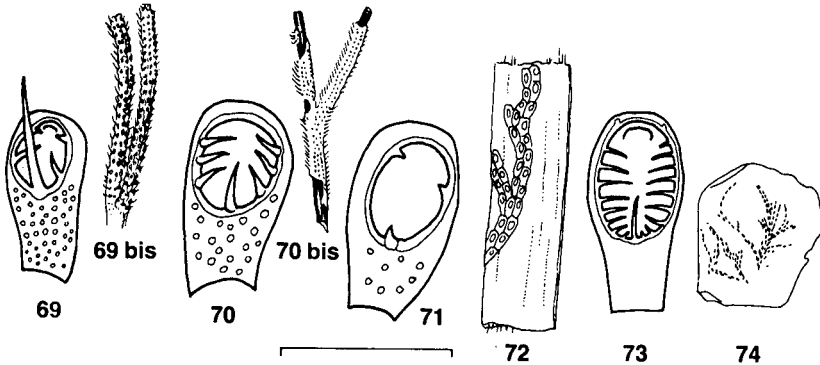

PYRIPORA D'Orbigny, 1852

Colony encrusting, typically occurring in branching, uniserial chains, anastomosing to form meshes, sometimes forming dense patches. Zooids pyriform; gymnocyst well developed, narrowing proximally, often striated, without pores. Opesia rather large. No differentiated cryptocyst; without spines, avicularia or ovicells.

Type species: *Hippothoa catenularia* Fleming, 1828

The type species is the only representative of the genus in the Mediterranean.
..... *P. catenularia* Fleming, 1828; (*) 75 (RYLAND & HAYWARD, 1977:72)

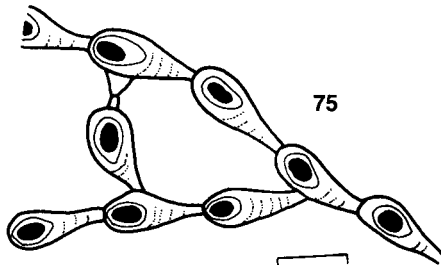

CARBASEA Gray, 1848

Colony erect, fronds broadening distally, but not usually producing the palmate frond form of *Flustra* (a related Atlantic genus); unilaminar. Zooids simple, rectangular, very lightly calcified. No avicularia; spines reduced or absent. Embryos brooded in internal ovisacs or in endozooidal ovicells closed by the zooidal operculum.

Type species: *Carbasea carbasea* Ellis & Solander, 1786

C. carbasea has been cited wrongly by several authors from Mediterranean localities, including Catalonia (Majorca: CALVET, 1927; Maó: BARROSO, 1921-22). Nevertheless, *C. carbasea* is a boreal/arctic species, rare even off Northern Britain, and the most recent opinion (GAUTIER, 1962; PRENANT & BOBIN, 1966; RYLAND & HAYWARD, 1977), is that this species is not Mediterranean. These records may be attributed to systematic confusion, probably with *Charrella papyrea* (even though Calvet was familiar with this species, and its differences from the former), a Mediterranean endemic species "sensu lato" and possibly vicarious of *C. carbasea*

..... *C. carbasea* Ellis & Solander, 1786; (*) 76, 77 (RYLAND & HAYWARD, 1977:79)

CHARTELLA Gray, 1848

Colony erect, fronds bilaminar, unilaminar in some species. Avicularia situated at the bifurcation of zooid rows, disto-terminal to the zooid from which they bud, or absent. Ovicells endozooidal, opening distally to the operculum of the maternal zooids. Spines reduced: generally a single, short pair at the distal end of each zooid; may be absent.

Type species: *Flustra papyracea* Ellis & Solander, 1786.

- 1. Avicularia and spines (1 pair) present
- *Ch. tenella* (Hincks, 1887); 80, 81 (GAUTIER, 1962:48)
- Avicularia and spines absent
- *Ch. papyrea* (Pallas, 1766); 78, 79 (PRENANT & BOBIN, 1966:179, as *Carbasea papyrea*)

HINCKSINOFLUSTRA Prenant & Bobin, 1966

Colony erect, bilaminar, flustriform. Frond edges bounded by a series of elongated and narrow kenozooids. Zooids with 4-6 pairs of spines around the opesia. Avicularia small, quadrangular, with straight proximal wall and situated usually at the bifurcations of zooid rows; distal and terminal to the maternal zooid. Ovicell immersed in the distal contiguous zooid.

Type species: *Flustra octodon* BUSK, 1852

Deepwater species, from muddy bottoms; known on the Spanish coasts (BUSK, 1852), Oran Sea and Algerian coasts

..... *H. octodon* (Busk, 1852); (*) 82, 83 (PRENANT & BOBIN, 1966:196)

SECURIFLUSTRA Silen, 1941

Colony erect, bilaminar, flustriform. Zooids very elongated, simple, without spines. Avicularia small, quadrate, interposed into linear series of zooids, not at bifurcations. Ovicell almost completely immersed, only the distal arch of the orifice projecting above the surface of the colony; closed by a special membrane. Fronds with one or two series of very long, narrow kenozooids which bifurcate frequently, giving rise to new rows of autozooids. The autozooid rows by contrast, rarely bifurcate.

Type species: *Eschara securifrons* Pallas, 1766

Monospecific genus. Although essentially a cold temperate and boreal species, GAUTIER (1962) reported it from Banyuls de la Marenda (Northern Catalonia)

..... *S. securifrons* (Pallas, 1766); 84, 85 (RYLAND & HAYWARD 1977:84)

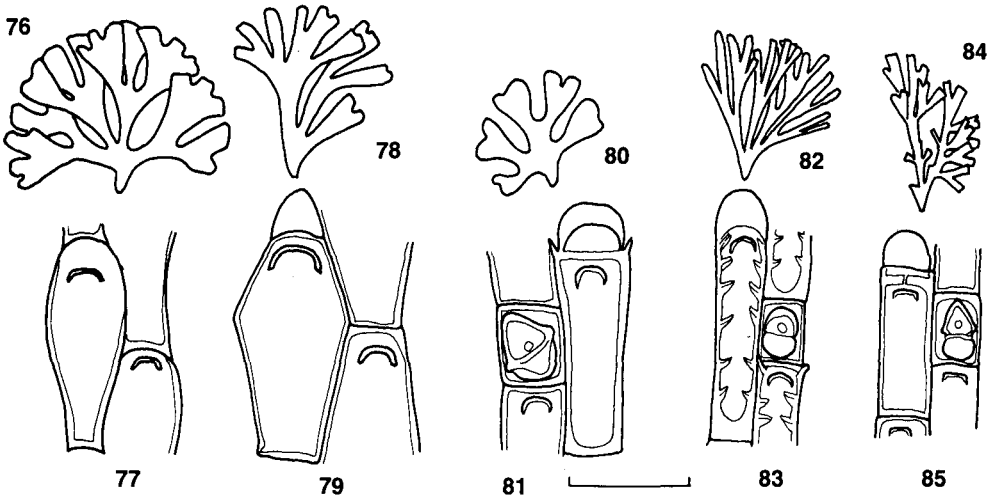

HINCKSINA Norman, 1903

Colony encrusting or flustriform. Zooids more thickly calcified than in erect flustrines. Gymnocyist and cryptocyst very reduced, leaving a well developed area and opesia. Walls (gymnocyist) finely denticulate, bearing numerous short and thick spines around the opesia. Avicularia vicarious, small, with a rounded or elliptical mandible. Ovicell endozooidal, immersed in either the avicularian cystid or the distal autozooid.

Type species: *Membranipora flustroides* Hincks, 1877

The type species is the only representative of the genus found in the Mediterranean. Two forms have been described. The typical form has flattened spines, but in the Mediterranean another form is more frequent, called *crassispinata* (GAUTIER, 1962) (fig. 86) which bears numerous cylindrical spines. *H. flustroides* (Hincks, 1877); 86, 87 (3 A) (PRENANT & BOBIN, 1966:200)

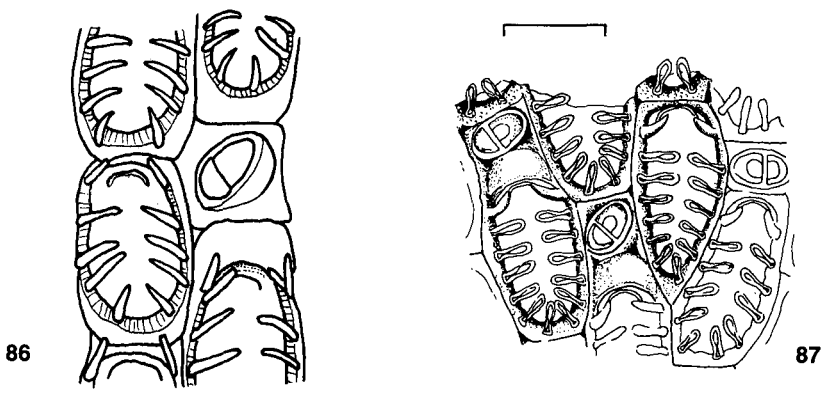

SPIRALARIA Busk, 1861

Colony, in general, erect and flexible –flustriform–, but sometimes encrusting –membraniporiform–, calcified. Zooids with a scarcely developed gymnocyst and an almost non-existent cryptocyst, delimiting a very large, oval, opesia, surrounded by a row of spines or denticles. Often there are, furthermore, oral spines. Vicarious avicularia situated distal to the maternal zooid, hiding the ovicell, very pointed. Lateral walls have numerous uniporous septula. Ovicell endozooidal, concealed under the avicularian zooid (or exceptionally, depending on the species, of an autozooid or a kenozooid).

Type species: *Spiralaria florea* Busk, 1861

The only species shows a membraniporiform colony, and the ovicells are lodged in the avicularian zooid
 *S. gregaria* (Heller, 1847); 88 (1F) (PRENANT & BOBIN, 1966:203)

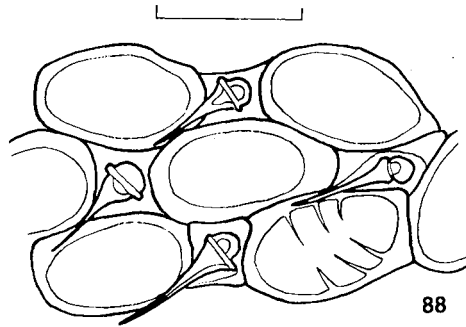

88

ELLISINA Norman, 1903

Colony membraniporiform. Zooids oval with a narrow, granular, cryptocyst delimiting a large opesia that occupies the whole frontal surface. Vicarious avicularia with dietellae. Ovicells endozooidal, closed by the operculum and hidden beneath another zooid, (kenozooid, autozooid or avicularium).

Type species: *Membranipora levata* Hincks, 1882

This genus is represented in the Mediterranean by one species reported by GAUTIER (1962) and later by HARMELIN (1969), which seems confined to dark caves and to the most sciaphilic bottoms. It resembles *E. antarctica* (Hastings), from which it differs in measurements and in the appearance of the frontal surface of the ovicell. Recently we recorded it from the caves of the Medes Islands and from Minorca Isle (though this latter comes from a shallow and photophilic sample).

Respecting HARMELIN's (1969) and PRENANT & BOBIN's (1966) opinion, we will denominate it as
 *E. cf. antarctica* (Hastings, 1945); 89, 90 (HARMELIN, 1969:799)

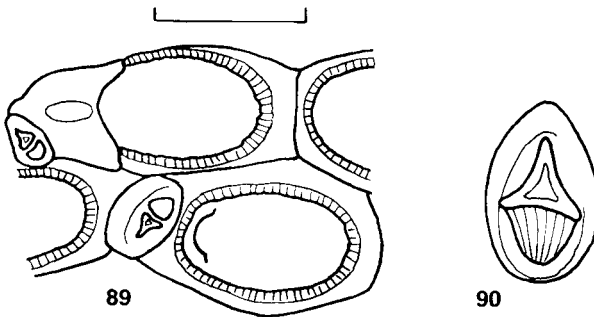

89

90

ALDERINA Norman, 1903

Colony encrusting. Zooids oval with a large opesia occupying the greater part of the frontal surface. Cryptocyst reduced, such that the opesia occupies almost the entire frontal surface. Gymnocyst present but very reduced. Lateral walls thickened and often crenellate. Lateral spines and avicularia absent. Umbones may be present on the gymnocyst (proximally in general). Ovicell prominent, with a pronounced ridge or a depressed frontal area. Numerous small dietellae occur around the periphery of the autozoid.

Type species: *Membranipora imbellis* Hincks, 1860

This genus has only one species in the Mediterranean, the type species, which, moreover, is extremely rare. The only records are from Tunis (CANU & BASSLER, 1930) and the Aegean Sea (HAYWARD, 1974)

A. imbellis (Hincks, 1860); (*) 91 (PRENANT & BOBIN, 1966:212) (RYLAND & HAYWARD 1977:96)

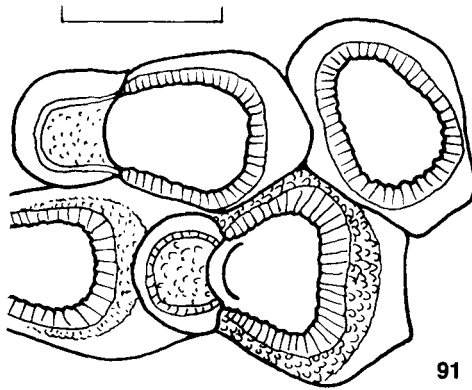

AMPHIBLESTRUM Gray, 1848

Colony encrusting. Extensive cryptocyst occupying about one-third of the frontal area of the zooid and delimiting a trifoliate opesia. Avicularia present, situated most commonly on the gymnocyst. Ovicell prominent, globular, with a frontal region of reduced calcification. Spines few, restricted to distal part of the zooid. Dietellae present, generally one distal and two pairs disto-lateral.

Type species: *Membranipora flemingii* Busk, 1854

Despite Gautier's opinion, *A. flemingii* is likely to be present in the Western Mediterranean, as is confirmed by its occurrence on sub-recent or recent calcareous concretions (REGUANT et al., 1986).

- 1. Up to six spines present; ovicell with a thinner area of calcification frontally *A. flemingii* (Busk, 1854); (*) 92 (RYLAND & HAYWARD, 1977:104)
- Three or fewer distal spines present; ovicell with a uniformly granular face *A. minax* (Busk, 1860); 93 (3 B) (RYLAND & HAYWARD, 1977:106)

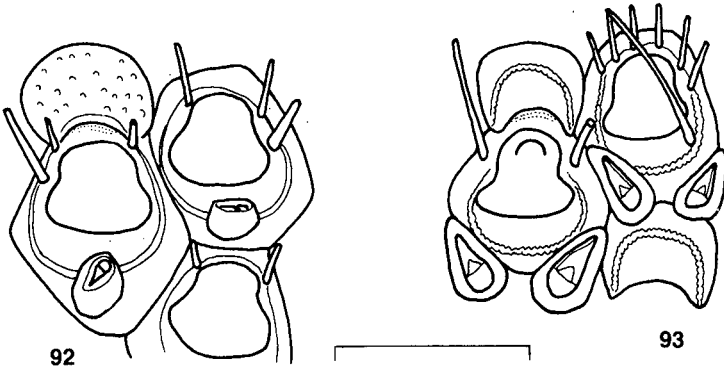

APLOUSINA Canu & Bassler, 1927

Colony encrusting. Zooids with a large opesia occupying the greater part of the frontal surface, wholly occupied by the opesia. Cryptocyst granular, very narrow; reduced proximally, more developed laterally. Gymnocyst very reduced. Lateral walls narrow, vertical, granular. Without spines (or rarely paired) or avicularia. Ovicells generally little developed, with 3 kinds of gradation between endozooidal and vestigial, reduced to a distal crescentic thickening and forming a small proximal roof on the aperture, leaving a broad orifice.

Type species: *Aplousina gigantea* Cany & Bassler, 1927

- 1. Cryptocyst wider (60 μ). Zooids larger *A. filum* (Jullien, 1903); (*) 94 (GAUTIER, 1962:38)
- Cryptocyst narrower (10 μ). Zooids smaller
 *A. capriensis* (Waters, 1898); (*) 95 (GAUTIER; 1962:38) (PRENANT & BOBIN, 1966:216)

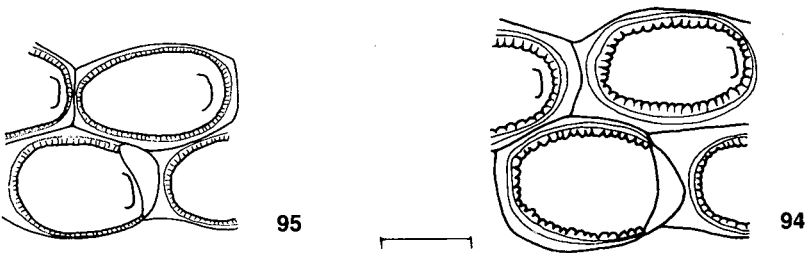

CALLOPORA Gray, 1848

Colony encrusting. Zooids rectangular or oval. Gymnocyst present, often well developed, frequently bearing one or more avicularia. Cryptocyst generally reduced. Spines few or many. Ovicell hyperstomial, often with ridges or umbones and a thinly calcified frontal area; normally prominent, closed by zooidal operculum. Basal pore chambers present.

Type species: *Flustra lineata* Linnaeus, 1767

1. Colony composed of isolates zooids, linked by pseudostolons. Without avicularia
 *C. minuta* (Harmelin, 1973); (*) 96 (HARMELIN, 1973:1)
 – Colony membraniporiform; zooids in close contact with each other. Avicularia more or less rare but
 always present 2

2. Four spines at the distal end of young zooids, of which only one or two remain as the zooid ages. Ovi-
 cell with surface uniformly granular 3
 – From 8 to 11 spines disposed around the opesia. Ovicell with an area of thinner calcification
 frontally, but not limited by a marked ridge
 *C. lineata* (Linnaeus, 1767); 97 (RYLAND & HAYWARD, 1977:88)

3. Avicularia scarce; 4-5 spines
 *C. dumerilii typica* (Audouin, 1826); 98 (3 C) (PRENANT & BOBIN, 1966:234)
 – Avicularia abundant, constant on the gymnocyst of each zooid; two typically situated on the ovicells.
 Always 4 spines *C. dumerilii f. pouillei* (Alder, 1857); 99 (GAUTIER, 1962:36)

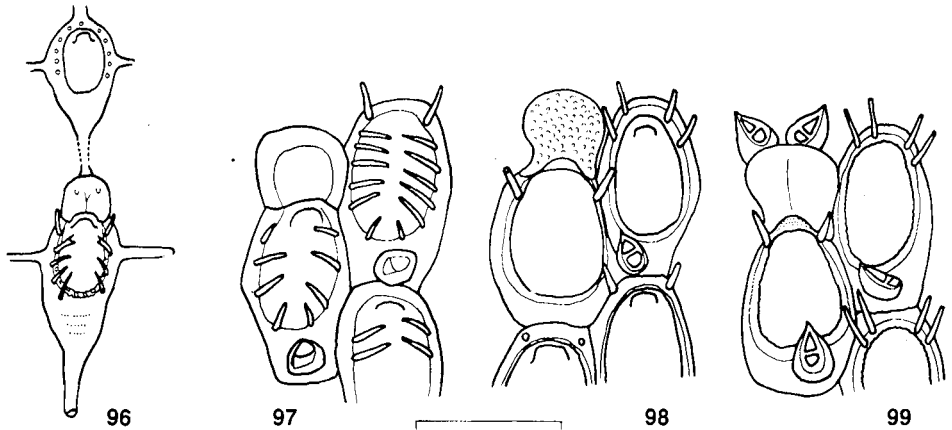

COPIDOZOOM Harmer, 1926

Colony membraniporiform, encrusting. Zooids with gymnocyst so reduced that the opesia occupies most of the frontal surface. Cryptocyst more or less wide, particularly developed proximally. Numerous vicarious avicularia alternating with the autozooids; rostrum typically narrowing in a sharp ribbon-shape, with a setiform mandible. Ovicell hyperstomial, projecting and globular, not closed by the operculum but by a special membrane.

Type species: *Membranipora plana* Hincks, 1880

1. With 8-10 spines, not deciduous. Large avicularium with a rounded mandible and hooked rostrum. Ovicell smooth. Very rare and deep species
 *C. exiguum* (Barroso, 1920); 102 (2 F) (BARROSO, 1920:354)
 – Without spines, or 3-4 deciduous. Avicularium smaller. Ovicell garnished 2

2. Termen regularly ornamented in a slightly different way to that of the cryptocyst, which is quite wide, and has a channeled opesia margin. Usually with stout spines. Ovicell with frontal surface garnished with tubercles, tubules and granules. Zooids of variable length but always small (Lz < 500 μ) *C. tenuirostre* (Hincks, 1880); 100 (PRENANT & BOBIN, 1966:257)
- Termen ornamented with irregular crystals, very different to the small ones separated by transverse striae that ornament the cryptocyst, which is narrow and has a smooth opesia margin. Spines generally absent. Ovicell with frontal surface garnished with irregular crystals. Zooids longer (Lz = 700 μ) *C. planum* (Hincks, 1880); 101 (PRENANT & BOBIN, 1966:254)

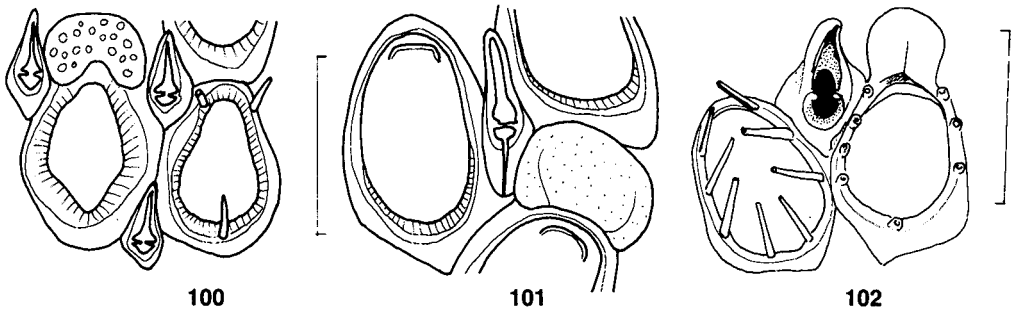

CRASSIMARGINATELLA Canu, 1900

Colony encrusting, membranoporiform. Usually composed of a single layer of zooids. Zooids oval or polygonal, with cryptocyst and gymnocyst little developed (but strongly calcified), delimiting a large oval opesia that occupies most of the frontal surface. Spines present, vestigial or absent depending on the species. Vicarious avicularia large, rounded (sometimes absent or rare). Adventitious avicularia absent. Ovicells endozooidal, prominent (after HARMELIN, 1973), surrounded by a cryptocystian expansion of the next, distal, zooid, closed by the operculum. Uniporous septula or dietellae more or less evolved according to species.

Type species: *Membranipora crassimarginata* Hincks, 1880

1. Spines absent, or only present on young zooids and then scarce (less than 5) 2
- Spines present and numerous (more than 10). Avicularia rare, with short hooked condyles and 4 small and curving spines on the proximal border
 *C. maderensis* (Waters, 1898); 103 (1 G) (HARMELIN, 1973; 481)
2. Avicularia abundant, each with a stout pivotal bar; mandible terminating in a distal tooth which fits into the margin of the rostrum and overlaps it. Cryptocyst well calcified. Gymnocyst without tubercles. Ovicell completely covered by distal zooid, without lateral fenestrae
 *C. crassimarginata* (Hincks, 1880); 104 (HARMELIN, 1973:483)
- Avicularia rare; each with 2 distinct condyles, not joined to form a pivotal bar; mandible rounded. Cryptocyst thinly calcified. Gymnocyst proximally developed as a triangular or trapezoidal area, with one or two low rounded knobs. Ovicell incompletely covered, leaving two fenestrae
 *C. solidula* (Hincks, 1880); 105 (1 H) (HARMELIN, 1973:487)

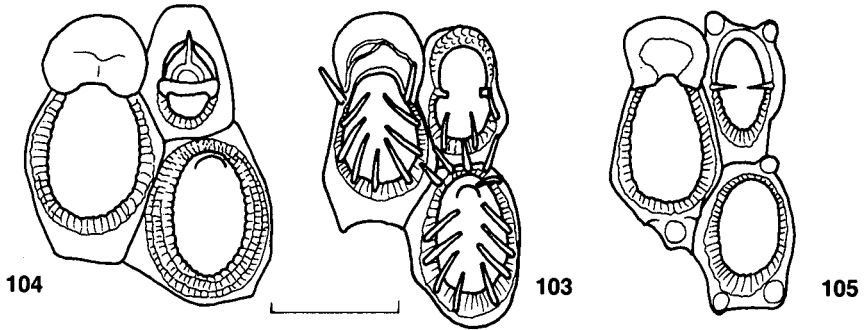

PARELLISINA Osburn, 1940

Colony encrusting. Zooids with a small gymnocyst; cryptocyst reduced to a narrow rim. Spines reduced or absent. Ovicell hyperstomial, prominent. Vicarious avicularia characteristic, asymmetrical, always associated with a kenozooid with a small, membranous frontal area.

Type species: *Membranipora curvirostris* Hincks, 1862

The type species is the only representative of this genus in the Mediterranean. Reported from northern Catalonia by MEDIONI (1970) *P. curvirostris* (Hincks, 1862); 106 (GAUTIER, 1962:44)

CHAPERIA Willey, 1900

Colony encrusting. Distal part of zooid with two lateral spaces open towards the frontal surface (sometimes coalescent in a single horseshoe shape), formed by two sheets, each projecting from the side and both converging to the distal wall. Aperture with an opercular membranous valve or with a chitinous operculum surrounded by spines. Avicularium trumpet-like, not always present. Ovicell hyperstomial, projecting, not closed by the zooidal operculum, with frontal surface depressed in the anterior area. Multiporous septula: two at the distal wall, and one at each distal half of both lateral walls.

Type species: *Flustra acanthina* Quoy & Gaimard, 1825

Only one species occurs in the Mediterranean. We have recorded a small fragment of this species from deep sediments (80-120 m) off the Cabo de Gata (southern Spain)
 *Ch. annulus* (Manzoni, 1870); 107 (GAUTIER, 1962:39)

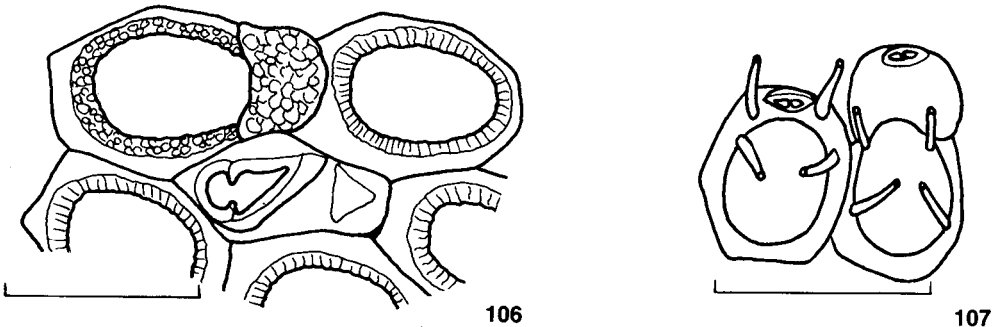

ONYCHOCELLA Jullien, 1881

Colony encrusting. Zooids with depressed, well developed cryptocyst, delimiting a small opesia, more or less trifoliate or oval. Gymnocyst almost inexistent. Vicarious avicularia modified as onychocellaria, of characteristic shape, asymmetrical, falciform; rostrum well developed, and mandible membranous, articulated on two condyles which do not divide the avicularian opesia. Ovicells endozooidal, small, hidden beneath the distal zooid and only visible as a slight thickening.

Type species: *Onychocella marioni* Jullien, 1881

O. marioni and *O. angulosa* probably represent only one species in view of the little consistence in their differential characteristics. However, since *O. marioni* was the type species selected by Jullien to define the genus *Onychocella*, and is the name usually employed by the Mediterranean specialists, we prefer to maintain *O. marioni*.

1. Cryptocyst deeply depressed towards the centre. Opesia oval (never trifoliate), with concave proximal border. Without tuberosities at the zooid junctions *O. marioni* Jullien, 1881; 108 (2 A) (PRENANT & BOBIN, 1966:288)
- Cryptocyst flattened or slightly convex towards the centre, shallow. Opesia trifoliate with concave proximal border. Tuberosities frequent at the zooid junctions *O. vibraculifera* (Neviani, 1895); (*) 109 (HAYWARD, 1974: 373) (PRENANT & BOBIN, 1966:293)

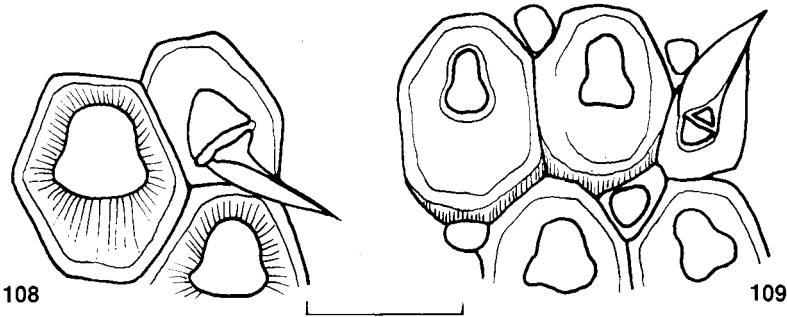

RECTONYCHOCELLA Canu & Bassler, 1917

Colony encrusting. Autozooids with cryptocyst, opesia and ovicell identical to *Onychocella*, though the opesial indentations are symmetrical and the retractor muscles of the polypide are inserted in the central zooidal area. Onychocellaria vicarious, symmetrical, straight (characteristic), without a distinct rostrum; with entire opesia and a narrow denticulated proximal part. Their mandibles are symmetrical and bear a large membranous expansion at each side of the rachis.

Type species: *Onychocella solida* Nordgaard, 1907

Rectonyhocella Canu & Bassler and *Smittipora* Jullien are synonymous. HARMER (1957), HARMELIN (1969b) and other authors prefer *Smittipora*. BOBIN & PRENANT (1966) and HAYWARD (1974) prefer *Rectonyhocella*. HARMELIN (1969b:1191) states that the Mediterranean species *S. disjuncta* Canu & Bassler has a hyperstomial oecium and, consequently, should not be included in either *Rectonyhocella*, or *Smittipora*, or even among the family Onychocellidae. This species, described from the Tunisian

shores (CANU & BASSLER, 1930), had not been found again until quite recently, when HAYWARD (1974) recorded it from the Aegean Sea
R. disjuncta (Canu & Bassler, 1930) (*) 110 (PRENANT & BOBIN, 1966:296) (HAYWARD, 1974:374)

SETOSELLINA Calvet, 1906

Colony free, lunulariform, discoidal, of spiraled growth. Zooids with a large opesia occupying almost the whole frontal surface; gymnocyst very reduced or absent. Cryptocyst narrow, little developed proximally and disappearing distally; ornamented with tubercles and delimiting a large opesia, oval or widened proximally. Vicarious vibracula, situated within the longitudinal zooid series, one per zooid, symmetrical to the long axis of the zooid, more or less transverse (characteristic). Ovicells wider than long, with a small, oval, median fenestra. With or without dictellae.

Type species: *Setosellina roulei* Calvet, 1906

Only *S. capriensis* (WATERS, 1926) occurs in the Mediterranean. Deepwater species
 *S. capriensis* (Waters, 1926); (*) 111 (PRENANT & BOBIN, 1966:301)

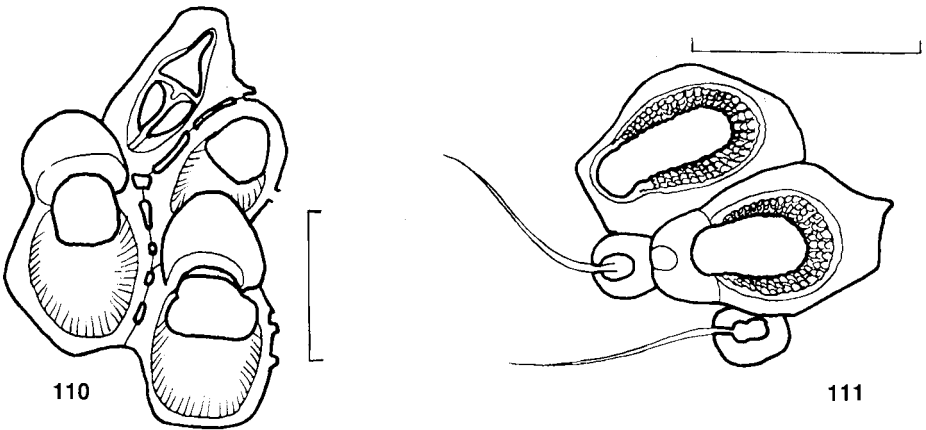

CUPULADRIA Canu & Bassler, 1919

Colony lunulitiform, dome or cone-shaped, at first attached to a minimum support, later free. Colony growth spiral, with zooid apertures opening only on the frontal face, which is the convex face (superior). Autozooids rhomboidal, forming radial series, with a vibracula of asymmetrical structure, distal to each autozooid. The opesia occupies the whole central area, gymnocyst very narrow or absent. Membraniporiform structure, not microporoid: cryptocyst not extensive; when it bears spines on the opesial margin, these, only rarely, form an opesial shield which never isolates the vestibular arch from the proximal part of the opesia (non cf. *Discoporella* D'Orbigny, 1852). Ovicells unknown, but embryos and eggs have been observed in peripheral zooids. Basal side of the colony (inferior face), concave, formed by a calcified sheet ornamented with tubercles and pores. This sheet is secreted by the basal face of zooids and is crossed, perpendicularly, by series of slender canals or of chambers that divide it in small prisms, not

corresponding, as previously thought, to the zooidal limits. Genus of soft, sandy or muddy, bottoms. Type species: *Cupuladria canariensis* Busk, 1859

1. Basal surface covered by a thick sheet forming rectangular, unequal meshes. Large pores, circular, unequal. Autozooidal cryptocyst unarmed, or with insignificant denticles 2
 - Basal surface without thick calcareous sheet. Tubercles more or less large. Slender pores. Lateral edges of the cryptocyst with denticles or very marked spinulae which are sometimes fused above the opesia 3

2. Rectangular meshes, unequal; the longest with 6-20 pores. Vicarious vibracula (apart from the advertitious) rare, concentrated in the periancestrular region. Operculum wider than long. Cryptocyst narrow, lightly immersed *C. canariensis* (Busk, 1859); (*) 112, 113, 114 (PRENANT & BOBIN, 1966:307) (COOK, 1965a: 167)
 - Rectangular meshes short, subequal; with 1-6 pores. Vicarious vibracula common in the periancestrular region. Operculum longer than wide. Cryptocyst broader, immersed *C. biporosa* (Canu & Bassler, 1923); (*) 115, 116, 117 (PRENANT & BOBIN, 1966:312) (COOK, 1965b:203)

3. Colony very convex and high; abrupt edges. Base flat, or if concave with spiny tubercles. Zooids small (400 μ). Cryptocyst with no more than 3 spinulae at each side *C. doma* (D'Orbigny, 1851); (*) 118, 119, 120 (PRENANT & BOBIN, 1966:314)
 - Colony flattened, low. Base concave with non-spiniform tubercles. Zooids large (550-760 μ). Cryptocyst with up to six spines at each side *C. multispinata* (Canu & Bassler, 1923); (*) 121, 122, 123 (PRENANT & BOBIN, 1966:319) (COOK, 1965b:210)

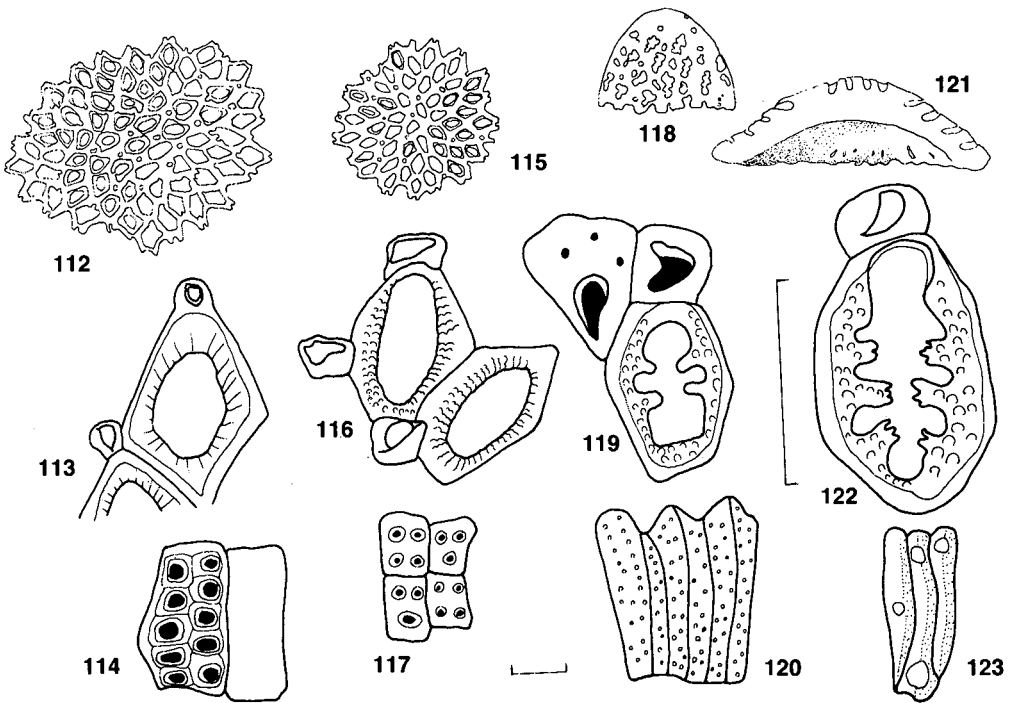

MICROPORA Grau, 1848

Colony encrusting. Zooids with lateral walls raised as a rim terminating in a pair of calcareous bosses adjacent to orifice. Cryptocyst flat or slightly concave, pierced distally by a pair of small opesiules. Ovicells present, usually partly immersed, sometimes ornamented with ridges or umbones. Spines generally absent. Avicularia vicarious or absent. Multiporous septula present.

Type species: *Flustra coriacea* Johnston, 1847

The difference between *M. coriacea* and *M. normani* has only recently been recognized, the latter previously being included in the former (PRENANT & BOBIN, 1966). The most distinct trait is the presence or absence of avicularia. GAUTIER (1962) had already observed that the Mediterranean specimens of *M. coriacea* had no avicularium. *M. normani*-bearing avicularia-is a typically Atlantic species but we cannot categorically assert that it does not occur in the Mediterranean.

- 1. Avicularia present. Cryptocyst smooth, fine grained, with a few, widely spaced pores *M. normani* Levisen, 1909; (*) 124 (RYLAND & HAYWARD, 1977:114)
- Avicularia absent. Cryptocyst coarse grained, rugose, closely and regularly punctured by numerous pores *M. coriacea* Johnston, 1847; 125 (RYLAND & HAYWARD, 1977:113)

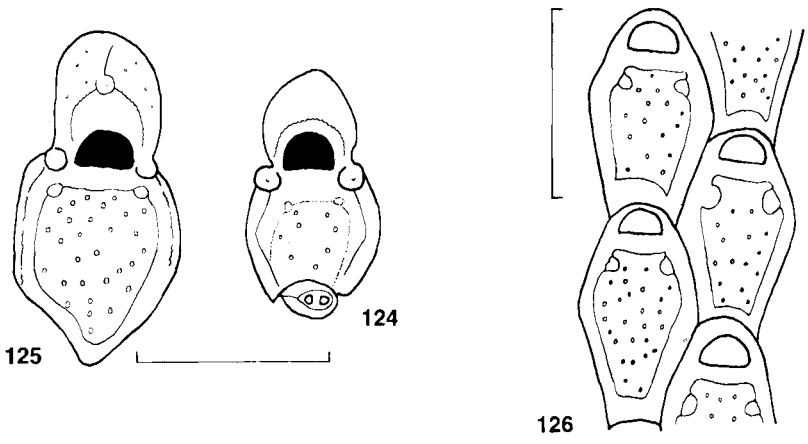

CALPENSIA Jullien, 1888

Colony encrusting. Cryptocyst greatly developed, covering the entire frontal surface; opesia coextensive with the operculum. Opsiules large, tubular, descending deeply into the zooid. Spines absent, although lateral walls may bear tubercles. Ovicells absent, avicularia rarely present. Multiporous septula present.

Type species: *Membranipora calpensis* Busk, 1854

- Only one species present in the Mediterranean *C. nobilis* Esper, 1796; 126 (2 B) (PRENANT & BOBIN, 1966:337)

CORONELLINA Prenant & Bobin, 1966

Colony disjunct, resembling that of *Mollia*. Zooids with very extensive cryptocyst, delimiting a small, distal, semicircular opesia which has proximally two lateral indentations marking a projecting lip. Beneath the opesia are two symmetrical opesiules, small and closed, indicating opesiular tubes (as in *Micropora*). No avicularia. Ovicell hyperstomial, broad and flat, obliquely recumbent on the contiguous distal zooid, ornamented with a crown of peripheral tubercles, with a frontal pore.

Type species: *Mollia fagei* Gautier, 1962

Only the type species *C. fagei* (Gautier, 1962); 127 (PRENANT & BOBIN, 1966:343)

ROSSELIANA Jullien, 1888

Colony encrusting. Zooids closely joined; frontal surface occupied for approximately half its length by a well developed, little immersed cryptocyst, leaving free a semicircular or ogival opesia, with straight or slightly convex proximal edge; opesiular incisions small, or absent.

Without spines or avicularia. Ovicell small, immersed, crescentic. Two pairs, rarely three, of lateral dietellae, and another large and distal dietella (sometimes divided in two or three).

No *Rosseliana* Canu, 1900

Type species: *Flustra rosselii* Audouin, 1826

RYLAND & HAYWARD, (1977) considered *Rosseliana* Jullien to be a junior subjective synonym of *Mollia* Lamouroux. In our thinking, whether the zooids are disjunct and only connected by cylindrical tubes, or wholly continuous is as good a character as any others selected for distinguishing between genera.

Only one species *R. rosselii* Audouin, 1826; 128 (GAUTIER, 1962:63)

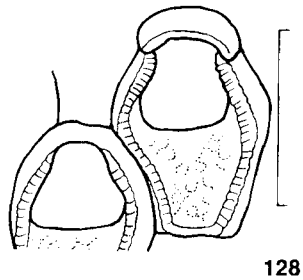
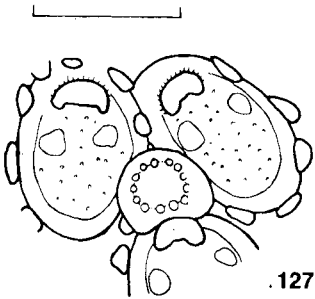

MOLLIA Lamouroux, 1821

Zoarium encrusting, disjunct, with zooids only linked by connecting tubes. Gymnocyst absent, cryptocyst occupying half the frontal area and delimiting a more or less triangular opesia with rounded angles. Spines and avicularia absent. Ovicells closed by zooidal operculum. Distellae present.

Type species: *Eschara patellaria* Moll, 1816

There are two contrasting forms of the type species *M. patellaria*. The form *multijuncta* Waters (1879), which has 8-12 connecting tubes, has been attributed by different authors to *M. patellaria* (PRENANT &

BOBIN, 1966) or to *Mollia* (= *Rosselliana*) *rosselii* (RYLAND & HAYWARD, 1974). *Membranipora circumcincta* Heller (1867), which was confused with *M. patellaria* (PRENANT & BOBIN, 1966), has features that may justify its separation as a species (GAUTIER, 1962), namely, the zooid form and size, the number of connecting tubes (8-12 like *multijuncta* form), and the shape and size of the ovicell.

- 1. From 6 to 8 connecting tubes *M. patellaria* (Moll, 1816); 129 (GAUTIER 1962:60)
- From 8 to 12 connecting tubes 2
- 2. Zooids oval and relatively small (Lz: 0,20 - 0,60 mm). Ovicells large, rounded
 *M. patellaria* f. *multijuncta* (Waters, 1879); (PRENANT & BOBIN, 1966:281)
- Zooids elongated, larger (Lz: 0,60 - 0,80 mm). Ovicells narrower, triangular, with a little calcified area enclosed by granular edges
 *M. circumcincta* (Heller, 1867); 130 (2 C-D) (GAUTIER, 1962:61)

MONOPORELLA Hincks, 1881

Colony encrusting; ovicell hyperstomial, closed by zooidal operculum, lodged and immersed in the distal zooid, surrounded by costulae or with a fringe. Aperture with two very small teeth situated laterally to the proximal border. Peristomial spines present. Two small opesiules perforate the porous cryptocyst (after CANU & BASSLER 1929).

Type species: *Monoporella nodulifera* Hincks, 1881

Only *M. nodulifera* occurs in the Mediterranean, seemingly restricted to the eastern Mediterranean and cited by O'DONOGHUE & DE WATEVILLE (1939) and HARMELIN 1968 (1969) (as *M. fimbriata carinifera*), and by HAYWARD (1974) *M. nodulifera* Hincks, 1881; (*) 131 (HAYWARD, 1974: 374)

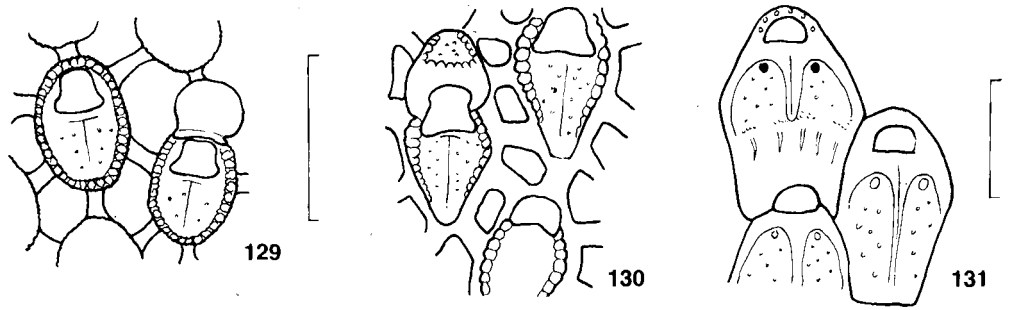

SETOSELLA Hincks, 1877

Colony encrusting, free or semierect. Frontal surface almost entirely covered by an extended cryptocyst. Opesia reduced to a semicircular or subtriangular area coextensive with the operculum, which is simple, lightly chitinized with a distinct marginal sclerite. Depressor muscles of the frontal membrane emerging through a pair of slit-like lateral opesiules situated a little below the opesia in the distal half of the zooid. Vicarious vibracula occur at the distal end of the zooids (one per zooid). Avicularia and spines absent. Ovicell hyperstomial, subimmersed, small and closed by zooidal operculum. Lateral walls provided with large membranous pore plates; no dietellae.

Type species: *Membranipora vulnerata* Busk, 1860

1. Colony free, scorpioid spiral; formed by uniserial spires of autozooids, each bearing a strong vibro-
cularium. Bathyal species (555-3700 m) *S. folini* Jullien, 1882; (*) 132 (PRENANT & BOBIN 1966:359)
- Colony encrusting, membraniporiform 2
2. Zooids large (Lz: 0.30-0.38). A pair or narrow slit-like opesiules, placed distally. Offshore species
occurring on deep sedimentary bottoms *S. vulnerata* Busk, 1860; (*) 133 (2 E) (PRENANT & BOBIN 1966:358) (HAYWARD & RYLAND 1977:118)
- Two pairs of rounded opesiules. Inhabiting dark caves *S. cavernicola* Harmelin, 1977; 134 (HARMELIN, 1977:1064)

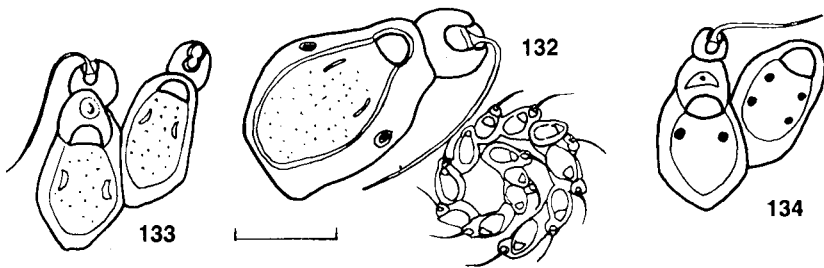

CHLIDONIA Lamouroux, 1824

Colony consisting of a creeping stolon system from which arise erect buds. These are formed by a stem divided at the end in two main branches, then divided again into secondary branches lodging the autozooids. The stolon is formed by kenozooids separated by a uniporous septula. Autozooid pyriform, with a ridge on the basal face. Frontal surfaces flat, all facing towards the same side, lacking pores and spines. The opesia occupies practically the entire frontal surface. Orifice and operculum have a semicircular or semielliptical shape, covering approximately the distal third of the opesia; cryptocyst reaching the level of the opercular hinge. Slightly convex proximally, the cryptocyst is deeply depressed in the median region, which is separated from the proximal opesial edge by a bar (distinct but narrow) of projecting cryptocyst. Proximal to this thickening and in about the middle of the zooid, there is a small oval fossa in the cryptocyst, perforated by a transverse opesiular fissure, or by two pores. Avicularia and ovicells absent.

Type species: *Cellaria pyriformis* Bertoloni, 1810

- Only the type species *Ch. pyriformis* (Bertoloni, 1810); 135, 136 (2 G) (PRENANT & BOBIN 1966:363)

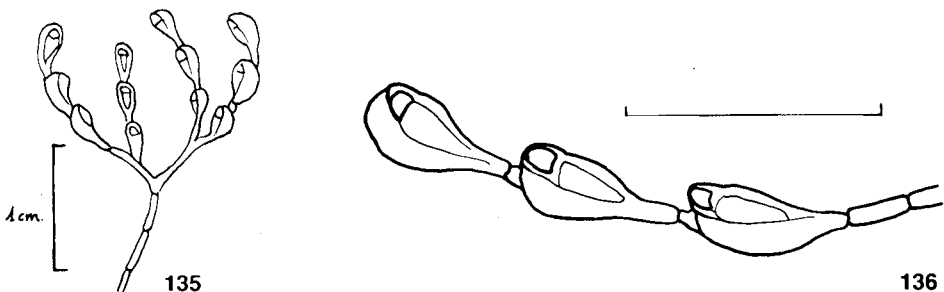

CELLARIA Ellis & Solander, 1786

Colony erect, tufted, branching dichotomously; typically with conspicuous chitinous joints linking rigid cylindrical internodes. The joints (nodes) comprise a number of tubular, chitinous processes enclosed at each end by tubular prolongations of the internodes.

Occasionally a branch may bifurcate without producing joints, although a discontinuity is apparent in the zooid series. Zooids lozenge-shaped or hexagonal, disposed in alternating series around the whole branch. Opesia barely larger than the operculum, semicircular, with a raised border proximally and two condyles laterally, sometimes opposed by a second pair present on the distal border. Avicularia vicarious; either small, rounded or rectangular, interposed in the longitudinal series of zooids, or large, replacing a zooid. Ovicells immersed, with a rounded or irregular opening close to distal border of the opesia. The colony is anchored by a bundle of chitinous tubular rootlets, each of which originates from a small rounded heterozooid budded from the proximal cryptocyst of an autozooid set low in its internode.

Type species: *Farcimia sinuosa* Hassall, 1840

1. Areolation thombic or pseudo-hexagonal, with rhombs or pseudo-hexagons in direct contact in each longitudinal series, except when there are avicularia intercalated between two zooids of the same series (avicularia much smaller than zooids) (1) (2) 2
- Areolation hexagonal, with hexagons distant in the same series but being contiguous to each other in alternating transverse rows. Avicularia replacing and as large as an autozooid (3) *C. salicornioides* Audouin, 1826; 137, 138, 139, 140 (2 H) (PRENANT & BOBIN, 1966:382)

2. Colony stout, internodes thick (about 1000 μ diameter), and long (7-30 mm). Zooids commonly hexagonal, with broad ends. Avicularia half the size of autozooids, quadrate, with a semicircular or roughly triangular mandible mounted obliquely to the internode axis *C. sinuosa* (Hassall, 1840); 141, 142, 143, 144, 145 (HAYWARD & RYLAND, 1977:121)
- Colony often larger and more diffuse than the preceding, internodes more slender (to about 500 μ diameter) and shorter (5-8 mm). Zooids commonly rhombic or hexagonal with pointed ends. Avicularia about one-third the size of the autozooids, quadrate, with a narrow crescentic mandible mounted transversely *C. fistulosa* auctt. (no Linnaeus); 146, 147, 148, 149, 150 (PRENANT & BOBIN, 1966:378)

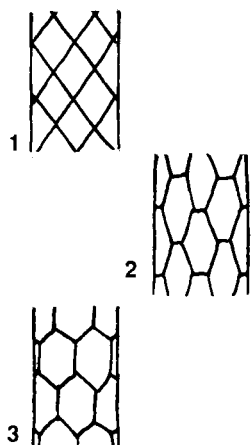

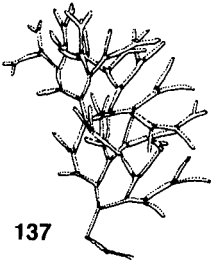

137

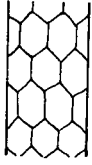

138

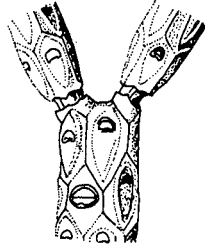

139

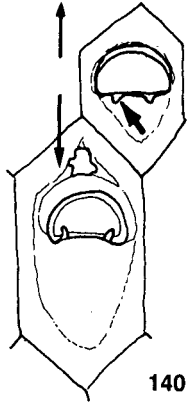

140

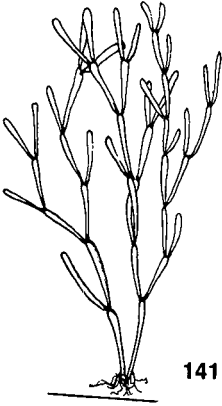

141

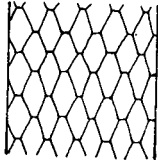

142

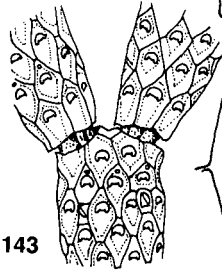

143

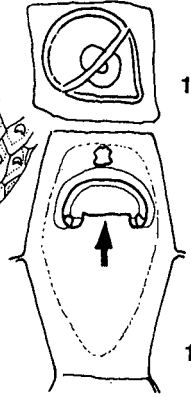

144

145

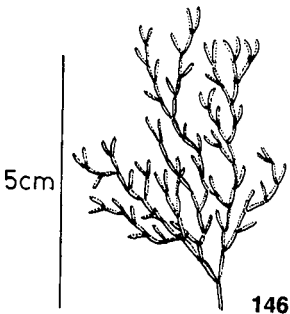

5cm

146



147



148

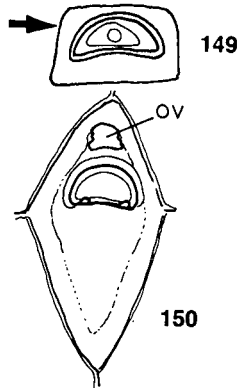

149

150

CABEREA Lamouroux, 1816

Colony erect, free and branched, stiff and fan-shaped, anchored by clustered rhizoids. Branches with zooids in two or more series, alternating; with relatively few bifurcations. Apparently unjointed, the chitinous tubules actually present but covered by calcification. Zooids rhomboid; the oval membranous area occupying most of the frontal surface. Distal spines present but often inconspicuous, and a specially modified lateral spine—the scutum—frequently present overarching the frontal membrane. Small, unstalked avicularia may occur laterally and proximally; the former constituting triangular prominences on the side of the zooid with the mandible distal-facing. Basal vibracula well developed, their chambers covering the basal surface of the branch and forming a median keel; with a long, obliquely orientated, setal groove extending to the proximal extremity of the chamber; seta long and barbed. Rhizoids originating from the vibracula and passing down the basal surface of the branch on the crest of the vibracula keel. Ovicell hyperstomial, subglobular. An ancestrula of elongate flask shape, bearing about eight long spines, has been described.

Type species: *Caberea dichotoma* Lamouroux, 1816

Only one Mediterranean species
..... *C. boryi* (Audouin, 1826); 151, 152 (3 D-E) (PRENANT & BOBIN 1966:449)

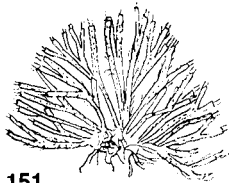

151

0,5 cm



152

SCRUPOCELLARIA Van Beneden, 1845

Colony free and branched, but often creeping rather than bushy, with the branches anchored at intervals to the substratum by rhizoids. Branches consisting of alternating zooids in two series; dividing regularly at intervals, each ramus jointed at its inception. Zooids rhombic, with an oval frontal membrane. Spines usually present on the distal margin of the zooid, and a specially modified lateral spine—the scutum—frequently overarches the frontal membrane. The shape of the scutum varies considerably from species to species. Small, unstalked avicularia present laterally and often frontally. Lateral avicularia constituting triangular prominences, arising distally from the side of the zooid; with a distal-facing mandible. Frontal avicularia located just proximal to the membranous area in many species, though sometimes only in association with ovicells. Vibracula present in almost all species, baso-laterally situated;

additionally there may be one or two in the axil of bifucations. The vibracularian chamber transversely partitioned: the upper chamber containing the muscles which move the seta; the smaller, lower chamber sometimes gives issue to a rhizoid, particularly in the lower part of the colony. Ooecia subglobular, hyperstomial. Ancestrula vase-shaped, attached to the substratum by a pair of rhizoids.

Type species: *Sertularia scruposa* Linnaeus, 1758

The number and identity of the different species of *Scrupocellaria* in the Mediterranean seem well established. Nevertheless two problems remain. *S. macrorhyncha* Gautier (1962) is an enigmatic species. Undoubtedly, the *S. macrorhynchus* described and illustrated by PRENANT & BOBIN (1966, p. 416) belongs to *S. reptans* (see HAYWARD & RYLAND, 1977, p. 135-fig. 64 for comparison). On the other hand, the *S. reptans* described and illustrated by PRENANT & BOBIN (1966, p. 413 fig. 134 V-VII-VIII) is, due to its pedunculate *Bugula*-like avicularia, an unknown species never described by other authors. However, it is possible that Gautier's species exists, but has never been reported by recent Mediterranean authors (the specimens reported by ZABALA (1979) from the Catalonian coasts should be ascribed to *S. reptans*). *S. maderensis* form *aegeensis* was described from the Aegean Sea by HARMELIN (1969), who considered that in all traits, except for the original shape of the scutum, it coincided with *S. maderensis*. Recently, however, we have seen ovicellate specimens from the Balearic Islands which convince us that it is a new species, for which we propose the name *Scrupocellaria aegeensis* (Zabala & Maluquer, in prep.). *S. aegeensis* differs from *S. maderensis* in the crescentic scutum, size of the zooids (larger than *maderensis*), ovicells with rare frontal avicularia (very constant in *S. maderensis*), form and size of vibracula, and in spine number: 3-4 outer/2 inner in *S. maderensis*, always 3 outer/1 inner in *S. aegeensis*.

- 1. Zooids without scutum (1) *S. scruposa*
Linnaeus, 1758; 153, 154 (4 F) (PRENANT & BOBIN, 1966:359)
– Zooids with scutum (2) 2
- 2. One axillary vibraculum present; scutum generally branched, forming a hart's horn (one only exception: *S. incurvata*) (3) (4) 3
– Two axillary vibracula; scutum never branched (5) (6) 5
- 3. Scutum entire, covering the whole membranous area. Vibracula with very long and curved groove. Spine formula 1:1. Deepwater species.
..... *S. incurvata*
Waters, 1896; 155, 156 (4 A-B) (PRENANT & BOBIN, 1966:326)
– Scutum branched, forming a hart's horn; sometimes absent from many zooids. Always more than 2 outer spines. Coastal species... 3
- 4. Lateral avicularia constant (but small). Scutum hart's horn shaped, never overlapping the margins of the membranous area, sometimes absent or reduced, in the form of small cane or fork
..... *S. bertholleti* Audouin, 1826; 157, 158 (GAUTIER, 1962: 85)
– Lateral avicularia absent or very inconstant. Scutum hart's horn shaped, often overlapping the margins of the area.
..... *S. reptans* Linnaeus, 1758; 159, 160 (5 A-B)
(HAYWARD & RYLAND, 1977:138) (not PRENANT & BOBIN, 1966:413)

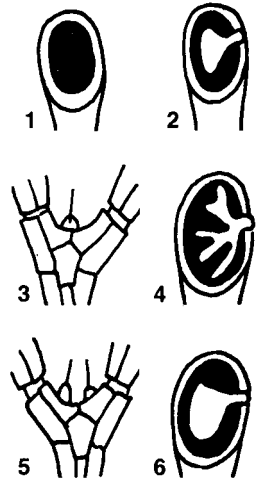

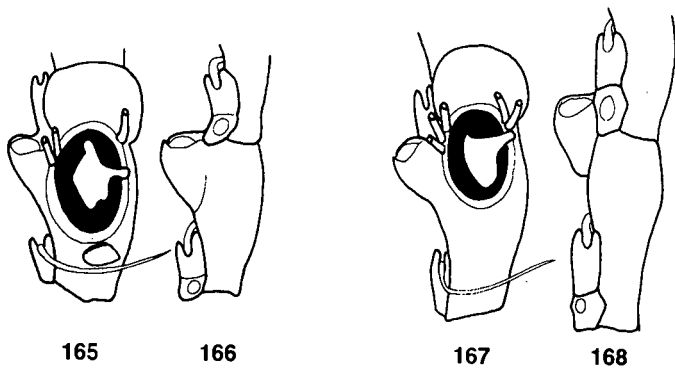
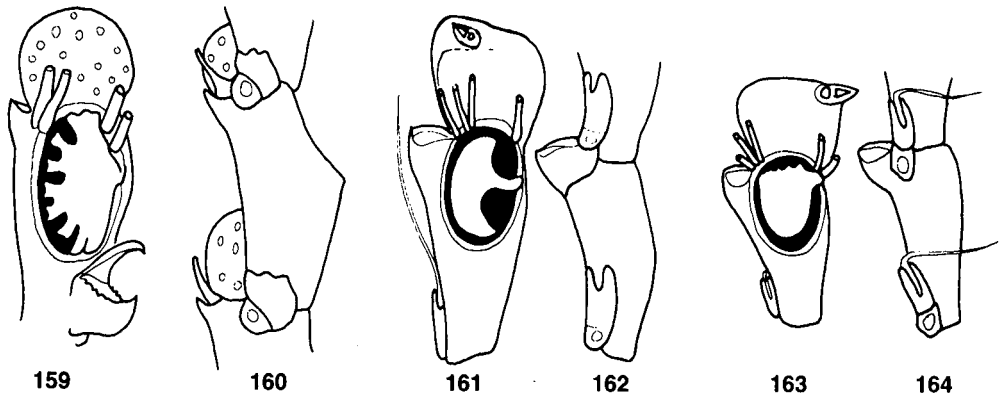
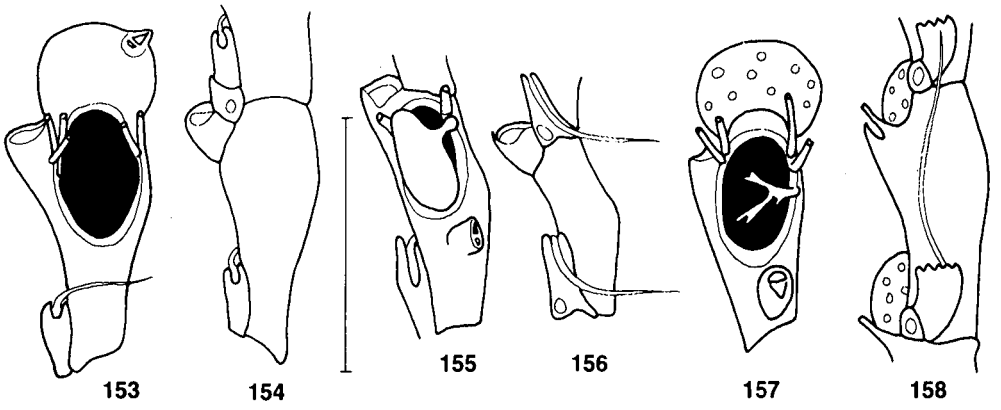

5. Scutum crescentic, with the distal and proximal halves almost equal in size (symmetrical). Spine formula 3:1 *S. aegeensis* Harmelin, 1969; 161, 162 (4 C-D) (HARMELIN, 1969:1195)
 – Scutum not crescentic, with the distal half always smaller than proximal. Spine formula different 6
6. Scutum very large, covering the entire membranous area; distal edge straight, sometimes lightly denticulated. 3(4):2 convergent spines *S. maderensis* Busk, 1860; 163, 164 (4 E) (PRENANT & BOBIN, 1966:428)
 – Scutum smaller, not covering the entire membranous area 7
7. Spine formula 2:1, convergent. Scutum inserted at a certain distance from the inner spine; reniform limb with a point (more or less sharp) on its distal lobe. Zooidal length less than twice the opesia length. *S. delilii* Audouin, 1826; 165, 166 (3 F) (PRENANT & BOBIN, 1966:435)
 – Spine formula 2(3):1(2). Scutum inserted close to the first inner spine; reniform limb without any kind of distal salient. Zooidal length more than twice the opesia length. Frontal avicularia never present *S. scrupea* Busk, 1851; 167, 168 (PRENANT & BOBIN, 1966:432)

EPISTOMIA Fleming, 1828

Colony erect, branching. Zooids in non-alternating pairs, in contact laterally; each comprises a slender proximal portion, which arises from the distal end of its parent zooid, traverses the basal side of the succeeding zooid as a slender tube, and expands to form the distal, operculate portion. Frontal surface largely membranous. Avicularia squat, swollen, with a small hooked mandible. Spines and ovicells absent. Embryos brooded in gonozooids, equal to an autozooid, but larger.

Type species: *Sertularia bursaria* Linnaeus, 1758

This genus includes only the type species
 *E. bursaria* (Linnaeus, 1758); 169, 170 (PRENANT & BOBIN, 1966:458)

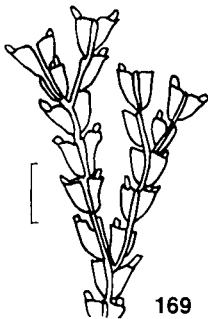

169

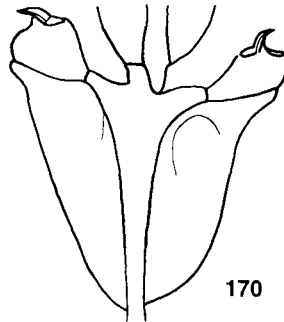

170

SYNNOTUM Pieper, 1881

Colony erect, jointed and attached to the substratum by rhizoids. Internodes separated by joints composed of four chitinous tubes, sometimes indistinct. Zooids arranged in non-alternating pairs, with a slender and very long proximal portion extended along two internodes (not conspicuous) and a globular distal portion (distinct), situated in a third internode. Zooids symmetrical (more than in *Epistomia*), lacking spines. One avicularium on the frontal face of each internode and two on the basal face; most of them sessile but sometimes stalked. No ovicells. Embryos brooded in gonozooids, which are hypertrophiate autozooids of an ordinary internode, or the most proximal zooids of a double internode.

Type species: *Gemellaria avicularia* Pieper, 1881
(= *Loricaria aegyptiaca* Audouin, 1826)

Monospecific genus. Widely distributed throughout the Mediterranean
..... *S. aegyptiacum* Audouin, 1826; 171 (PRENANT & BOBIN, 1966:461)

BICELLARIELLA Levinsen, 1909

Colony erect, arborescent, growing from an upright ancestrula; attached by rhizoids which issue distally from the basal face of the zooids. Zooids arranged in two series, alternating; horn-shaped with a short, wide, forked base separated by a constriction from a slender, cylindrical middle portion (actually constituting most of the proximal half of the zooid), in turn separated from a flaring distal portion by a second constriction. Frontal membrane oval, incorporating an operculum; several long marginal spines present. Avicularia pedunculate, shaped like birds' heads, attached proximal to the frontal membrane. Ooecia helmet-shaped, attached by a peduncle to the inner margin of the membranous area; at right angles to the branch axis; ectooecium membranous.

Type species: *Sertularia ciliata* Linnaeus, 1758

Monospecific genus
..... *B. ciliata* (Linnaeus, 1758); 172, 173 (5 C-D) (PRENANT & BOBIN, 1966:466)

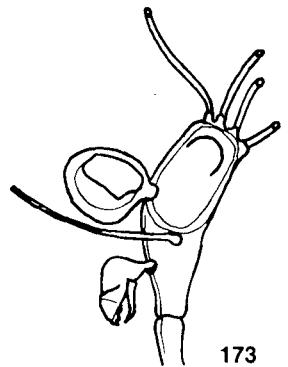
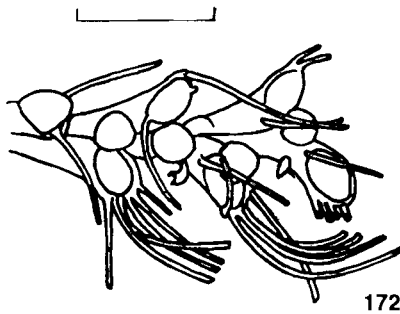
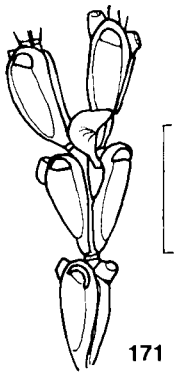

BEANIA Johnston, 1840

Colony unilamellar, loosely adherent, ramifying or reticulate; the zooids quincuncially or irregularly spaced, approximated or distant, joined by tubular extensions of the proximal part; a multiporous septulum present at the proximal end of each tube. Zooids attached to the substratum by rhizoids issuing from the basal surface. Frontal membrane occupying all the distal part of the zooid, incorporating an operculum; usually surrounded by spines. Pedunculate avicularia often present. Ovicells only present in some foreign species; in the remainder, embryos brooded in fertile autozooids, the polypide of which is often very reduced.

Type species: *Beania mirabilis* Johnston, 1840

1. Colony erect, composed of sheets, often digitate and convoluted, forming narrow cones
 *B. hirtissima* f. *cylindrica* (Hincks, 1886); 174, 177 (GAUTIER, 1962:96)
 – Colony always creeping, adherent to substratum 2
2. Colony ramifying, not reticulate (each zooid bearing only one zooid distally and another proximally), lax; with short and curved spines. No avicularia
 *B. mirabilis* (Johnston, 1839); 175 (PRENANT & BOBIN, 1966:552)
 – Colony reticulate (each zooid is surrounded by four other zooids), dense 3
3. Zooids smooth, spines absent (or at most vestigial). Avicularia very large, pedunculate
 *B. magellanica* (Busk, 1852); 176 (PRENANT & BOBIN, 1966:555)
 – Zooids bordered by numerous spines surrounding the opesia, or only at the oral region, long and strong 4
4. Opesia bordered by numerous spines overarching its frontal membrane (11-17 pairs of spines): from 3 to 5 oral pairs and from 8 to 12 lateral pairs; numerous basal spines (5). No avicularia. Zoarium delicate and with a hirsute appearance
 *B. hirtissima* (Heller, 1867); 177 (PRENANT & BOBIN, 1966:557)
 – Opesia bordered by a limited number of thick spines (about 7-9 pairs: one distal spine, 2 oral pairs and 3-5 lateral pairs), more than 3-5 pairs directed outwards. Without basal spines, or with just a few. Avicularia rare, pedunculate. Colony stout, not so hirsute.
 *B. robusta* (Hincks, 1881); 178 (PRENANT & BOBIN, 1966:560)

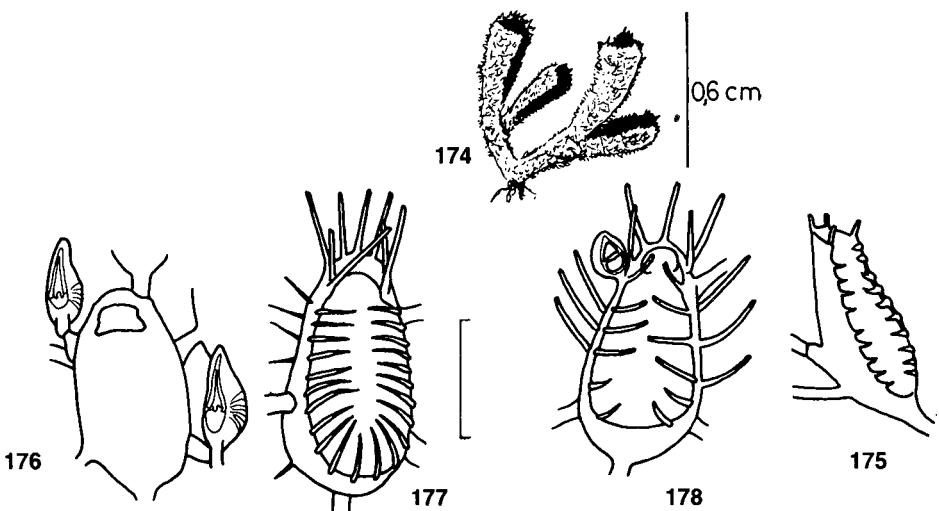

BUGULA Oken, 1815

Colony erect, growing from an upright ancestrula, branching; attached by rhizoids which issue from frontal, lateral and basal surfaces of the autozooids. The latter arranged in two or more series, alternating; boat-shaped, with the proximal end forked and the distal end of the next lowest zooid wedged into the fork, extending beyond it on the frontal side; with a row of uniporous, or one to two multiporous, septula. Seen from the front the zooids are usually truncate distally and slightly attenuate proximally. The basal and lateral walls are lightly calcified, but the membrane occupies most of the front; the orifice is closed by a sphincter and no operculum can be distinguished. One or more spines may be present, usually confined to the distal angles of the zooid. A pedunculate avicularium shaped like a bird's head is present on the side of all or many zooids. Ooecia hyperstomial, with calcified endooecium and membranous ectooecium; typically globular, but sometimes reduced to a hemisphere or less, closed by the inner vesicle which sometimes forms the major part of the ovicell.

Type species: *Sertularia neritina* Linnaeus, 1758

1. Avicularia absent. Colonies purplish-brown when living, translucent brown when dead; zooids large; ovicells attached to the inner distal angle of the zooids, obliquely orientated (1)
 ... *B. neritina* (Linnaeus, 1758); 179 (RENANT & BOBIN, 1966:492)
 - Avicularia present (2) 2
2. Colony slender with biserial branches narrowing basally to form a horny joint; no more than 4 zooids between two successive constrictions. Ooecia occupying scarcely half the zooid length (3)
 ... *B. germanae* (Calvet, 1902); 180 (5 E) (HARMELIN, 1968:1192)
 - Colony neither constricted nor jointed. Ooecia occupying more than half the zooid length (4) 3
3. Zooidal inner distal angle unarmed, round or acute; outer angle acute or pointing outwards as a digitate process, but lacking true spines (5) 4
 - Each distal angle bearing true spines 6
4. Ovicells well developed; outer distal angle pointing outwards as a digitate process; avicularia small (100 μ length) situated 1/4 to 1/2 zooidal length down the outer zooid margin 5
 - Ovicells vestigial; the embryos develop within zooids; outer distal angle acute, not digitate; avicularia larger (length about 250 μ) situated 2/3 to 3/4 zooidal length down the outer zooid margin
 *B. gautieri* Ryland, 1961; 181 (PRENANT & BOBIN, 1966:497)
5. Ovicell globular; zooids three times as long as wide; beak of avicularium slightly downcurved *B. plumosa* (Pallas, 1766); 188, 189 (*) (RYLAND & HAYWARD, 1966:164)
 - Ovicell very shallow; zooids about five times as long as wide; the beak conspicuously downcurved *B. aperta* (Hincks, 1886); (*) 190, 191 (PRENANT & BOBIN, 1966:527)
6. Both distal angles bearing at least 2 spines (6) 7
 - One or both distal angles bearing one spine (7) 10

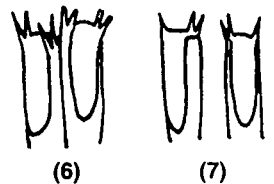
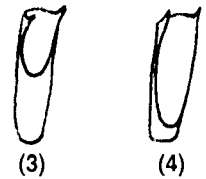
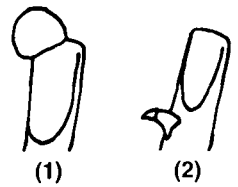

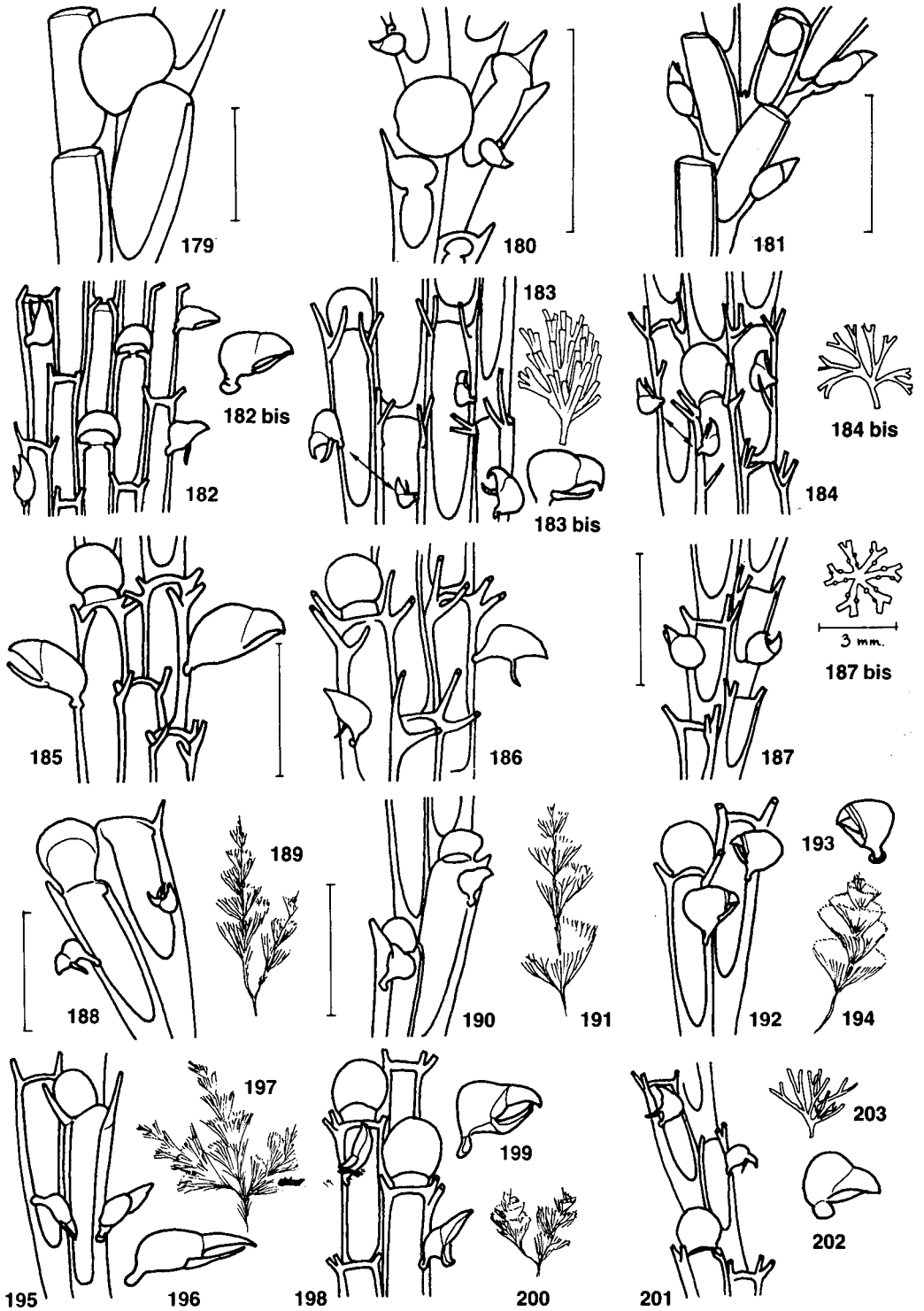

7. Beak of avicularium rectangularly hooked (1) *B. flabellata* (Thompson, 1848); 182, 182 bis (5 F) (PRENANT & BOBIN, 1966:527)
 - Beak downcurved (2) 8
8. Multiserial branches; non-ovicellate zooids never show more than five distal spines (3) (6) *B. calathus* (Norman, 1868) 9
 - Generally biserial branches (sometimes quadriserial before the final bifurcations of the colony); non-ovicellate zooids bearing normally six spines, more or less developed (4) (5) *B. fulva* Ryland, 1960; 183, 183 bis (PRENANT & BOBIN, 1966:510)
9. Avicularia on the marginal zooids very large (400-500 μ length) their length equalling or exceeding the width of two zooids
 *B. calathus* ssp. *calathus* Ryland, 1962; 185 (PRENANT & BOBIN, 1966:501)
 - Marginal avicularia smaller (300 μ or less), scarcely exceeding the width of one zooid *B. calathus* ssp. *minor* Ryland, 1962; 186 (PRENANT & BOBIN, 1966:501)
10. Branches biserial (sometimes quadriserial before the final bifurcations of the colony) (5) 11
 - Branches multiserial (6) 15
11. Inner distal angle with two spines; outer angle with one spine (1:2) (7) *B. spicata* Hincks, 1880; 187, 187 bis (PRENANT & BOBIN, 1966:514)
 - Inner distal angle with one spine; outer angle with one or two spines (1:1 or 2:1) (8) 12
12. Outer distal angle bearing one spine (1:1) (9) 13
 - Outer distal angle bearing two spines (2:1) (8) 14
13. Avicularium very distal; rounded head; beak short, rectangularly hooked *B. turbinata* (Alder, 1857); 192, 193, 194 (PRENANT & BOBIN, 1966: 516)
 - Avicularium situated at the level of the proximal half or third of the opesia; long and narrow; beak long and downcurved (not hooked) *B. gracilis* (Busk, 1852); 195, 196, 197 (PRENANT & BOBIN, 1966:529)
14. Colony in a short compact tuft with the branches not spirally disposed; zooids long and narrow; frontal membrane occupying 2/3 to 3/4 or the length of the zooid; avicularia small (175 μ length), their length not exceeding the width of a zooid (10) *B. stoloni-fera* Ryland, 1960; (*) 201, 202, 203 (PRENANT & BOBIN, 1966:541)
 - Branches of the colony spirally disposed; frontal membrane occupying almost the whole length of the zooid; avicularia large (300 μ length), their length exceeding the width of a zooid (11) *B. avicularia* (Linnaeus, 1758); 198, 199, 200 (PRENANT & BOBIN, 1966:537)

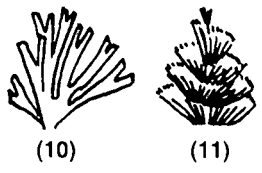
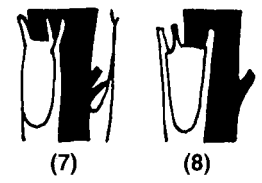
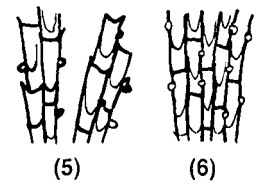
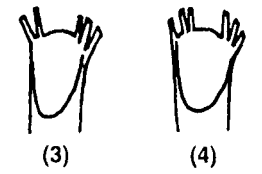

15. Ovicell hemispherical; avicularia restricted to the marginal zooids, the beak downcurved (not hooked) (1) *B. simplex* (HINCKS, 1886); 184, 184 bis (PRENANT & BOBIN, 1966:505)
 - Ovicell globular. Avicularia not restricted to the marginal zooids; the beaks rectangularly hooked (2) *B. turbinata* Alder, 1857; 192, 193, 194 (PRENANT & BOBIN, 1966:516)

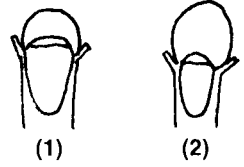

SUBORDER CRIBRIMORPHA

COLLARINA Jullien, 1886

Colony encrusting, cribrimorph. Zooids, seen from the front, are surrounded, except for their proximal portion, by a collar of broad pores which are really dietellae. Base of the costula may be ornamented with a large pore (pelma). Costal area always surrounded by a smooth gymnocyst, more or less extensive, so that the pericyst does not occupy more than a relatively small part of the frontal surface. Orifice semicircular. Without vibracula or vicarious avicularia. Adventitious avicularia usually symmetrical and marginal; sometimes one avicularium situated on the ovicell.

Type species: *Lepralia cribosa* Waters, 1879

- Only one Mediterranean species
 *C. balzaci* (Audouin, 1826); 204 (6 A) (PRENANT & BOBIN, 1966:602)

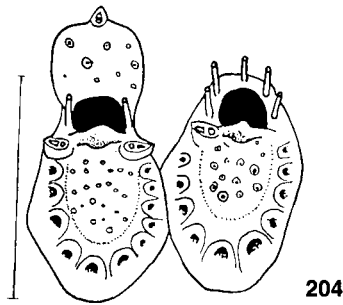

PUELLINA Jullien, 1886

Colony encrusting. Gymnocyst of zooids extensive, continuous with the lateral walls, forming a smooth border around the frontal shield; the latter comprising half, or less, of the total zooid length. Orifice with calcified rim, fused proximally to the apertural bar. Paired setiform papillae lateral to the orifice, long and slender. Oral spines and pore-chambers present; avicularia absent. Ovicell hyperstomial, prominent, with scattered pores, closed by zooidal operculum.

Type species: *Puellina gattyae* (Landsborough, 1812)

Recently, GORDON (1984) and BISHOP & HOUSEHAM (1987) have regressed the genus *Cribrilaria* Canu & Bassler, 1928, to a subgeneric division of *Puellina* Jullien, 1886, so that this latter genus comprises three subgeneric groups: *Cribrilaria*, *Puellina* and *Glabrilaria*.

At specific level, ancient citations are often based on superficial identifications leading to recognize a small number of species suspectedly cosmopolites in distribution. Scanning Electron Microscopy used in recent taxonomic works on Cribrimorphs (BISHOP & HOUSEHAM, 1987; HARMELIN, 1970; 1978, 1984 and HARMELIN & ARISTEGUI, 1987) have shown more precise morphological features which increase exponentially the number of known species; i.e. the five species recorded in the Mediterranean by GAUTIER (1962) contrast with the 17 species (at least) recorded recently by Harmelin (HARMELIN & ARISTEGUI, 1987). Most of these species are so recent that it is not possible to assess their validity or their distribution along Mediterranean coasts. Then, the definitive number of Mediterranean species cannot be well established at present and the value of the following key is doubtful.

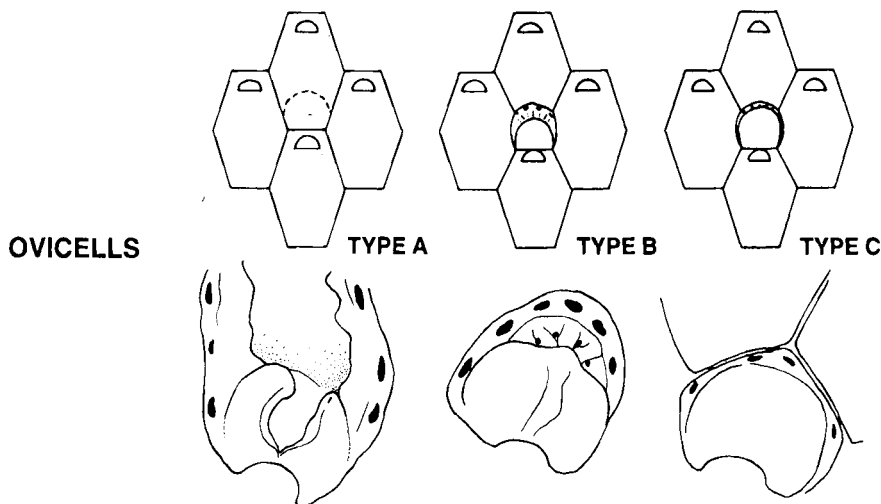

1. Without avicularia. Ovicells of C type (BISHOP & HOUSEHAM, 1987)(1), perforated *P. S.G. Puellina* 3
 - Generally with avicularia (1). Ovicells of another type (A or B) or if C type, imperforated 2
2. Avicularia adventitious, formed from porous chambers, erect or semierect, latero-proximal to maternal zooid. Ovicells of B type or if C type, imperforated *P. S.G. Glabrilaria* 4
 - Avicularia interzooidal, usually situated in the grooves between autozooids (1), not erect. Ovicells of A type (2) *P. S.G. Cribrilaria* 6
3. Pericyst occupying no more than half of the frontal surface; spines short and thick. Intercostal grooves with only one lacuna. Zooids very small (Lz: 0.22 - 0.36 mm.) *P. (Puellina) gattyae* (Landsborough, 1852); 206 (6 B) (HAYWARD & RYLAND, 1979:66)
 - Pericyst occupying most of the frontal surface; spines long and slender. intercostal grooves with 3-4 lacuna. Zooids larger (Lz > 0.4 mm) *P. (Puellina) setosa* (Waters, 1899); (HARMELIN, 1984:81)

(1) Two exceptions, *C. minima* and *C. pseudoradiata* have no avicularia, but have ovicells of A type.

(2) In exceptional cases, due to malformations by lack of space, ovicells of B type have been observed in species that usually have A type (Aristegui, pers. com.).

4. Ovicell of C type not perforated. Seven oral spines. Avicularia semi-erect on broad peduncles with basal pore chambers.
P. (Glabrilaria) corbula Bishop & Househam, 1987; (*) 207 (HARMELIN & ARISTEGUI, in press)
 – Ovicell of B type perforated. Six oral spines. Avicularia erect on a narrow peduncle without basal pore chambers 5
5. Two avicularia laterally united to each ovicell. Scutum flat (with 9-11 costae). Eastern Mediterranean. *P. (Glabrilaria) orientalis* ssp. *orientalis* Harmelin & Aristegui, 1987; (*) 208 (HARMELIN & ARISTEGUI, in press)
 – Without avicularia united to the ovicells. Scutum very concave (with 13 costae)
 *P. (Glabrilaria) pedunculata* Gautier, 1962; 209 (7 E) (HARMELIN, 1970:93)
6. Without avicularia 7
 – With avicularia 8
7. Four oral spines. Zooids large *P. (Cribrilaria) pseudoradiata* ssp. *pseudoradiata* Harmelin & Aristegui, 1987; (*) 210 (HARMELIN & ARISTEGUI, in press)
 – Five oral spines. Zooids smaller. Costae with strong denticulated tubercles. Two small umbones between the proximal border of the orifice and the suboral lacuna
 *P. (Cribrilaria) minima* Harmelin, 1984; (*) 211 (HARMELIN, 1984:87)
8. Mandible of avicularia palmate 9
 – Mandible of avicularia triangular, acute 10
9. Six spines
 *P. (Cribrilaria) arrecta* Bishop & Househam, 1987; (*) 212 (BISHOP & HOUSEHAM, 1987: 43)
 – Five spines
 *P. (Cribrilaria)* n. sp. (aff. *arrecta*); 213 (7 F-G) (ZABALA, 1986 as *Cribrilaria flabellifera*)
10. Four oral spines *P. (Cribrilaria) radiata* (Moll, 1803); 214 (7 A-B) (HARMELIN, 1970:80)
 – Five oral spines 11
11. Zooids very large, flat, with numerous costae. Proximal border of the orifice denticulated
 *P. (Cribrilaria) venusta* (Canu & Bassler, 1928); 215 (7 C-D) (HARMELIN, 1978:180) (ARISTEGUI, 1984:227)
 – Zooids smaller, with reduced number of costae. Proximal border of the orifice smooth 12
12. Avicularium very long, narrow, recumbent on the frontal wall of an autozoid *P. (Cribrilaria) hincksi* (Friedl, 1917); 216 (6 C-D) (HARMELIN, 1970:82 as *Cribrilaria innominata* f. A)
 – Avicularium wider, more triangular, between the autozooids 13
13. Without umbo or only one. Rostrum of avicularium very large 14
 – Two suboral umbones 15
14. Rostrum of avicularium widened at the base
P. (Cribrilaria) cassidainsis Harmelin, 1984; (*) 217 (HARMELIN, 1984:86) (ARISTEGUI, 1984:220)
 – Rostrum of avicularium very long. Gymnocyst well developed
P. (Cribrilaria) setiformis Bishop & Househam, 1987; (*) 218 (HARMELIN & ARISTEGUI, in press)

15. Two umbones lateral to suboral plate, like small wings
 *P. (Cribrilaria) picardi* Harmelin, 1987; (*) 219 (HARMELIN, 1987, in press)
 – Umbones proximal to suboral plate, pointed, divergent but not like small wings 16
16. Suboral lacuna very large, never hidden by the umbo. Foramen of intercostal spaces not denticulated. Common and shallow waters
 *P. (Cribrilaria) innominata* (Couch, 1844); 220 (6 E-F) (HARMELIN, 1970:82, as *C. innominata* f. B)
 – Suboral lacuna small, proximal to umbo and partly hidden by it. Foramen of intercostal spaces with denticles. Bathyal; only known from Gibraltar strait, but not cited in the Mediterranean, rare.
 *P. (Cribrilaria) scripta* (Reuss, 1848); (*) 221 (HARMELIN & ARISTEGUI, in press)

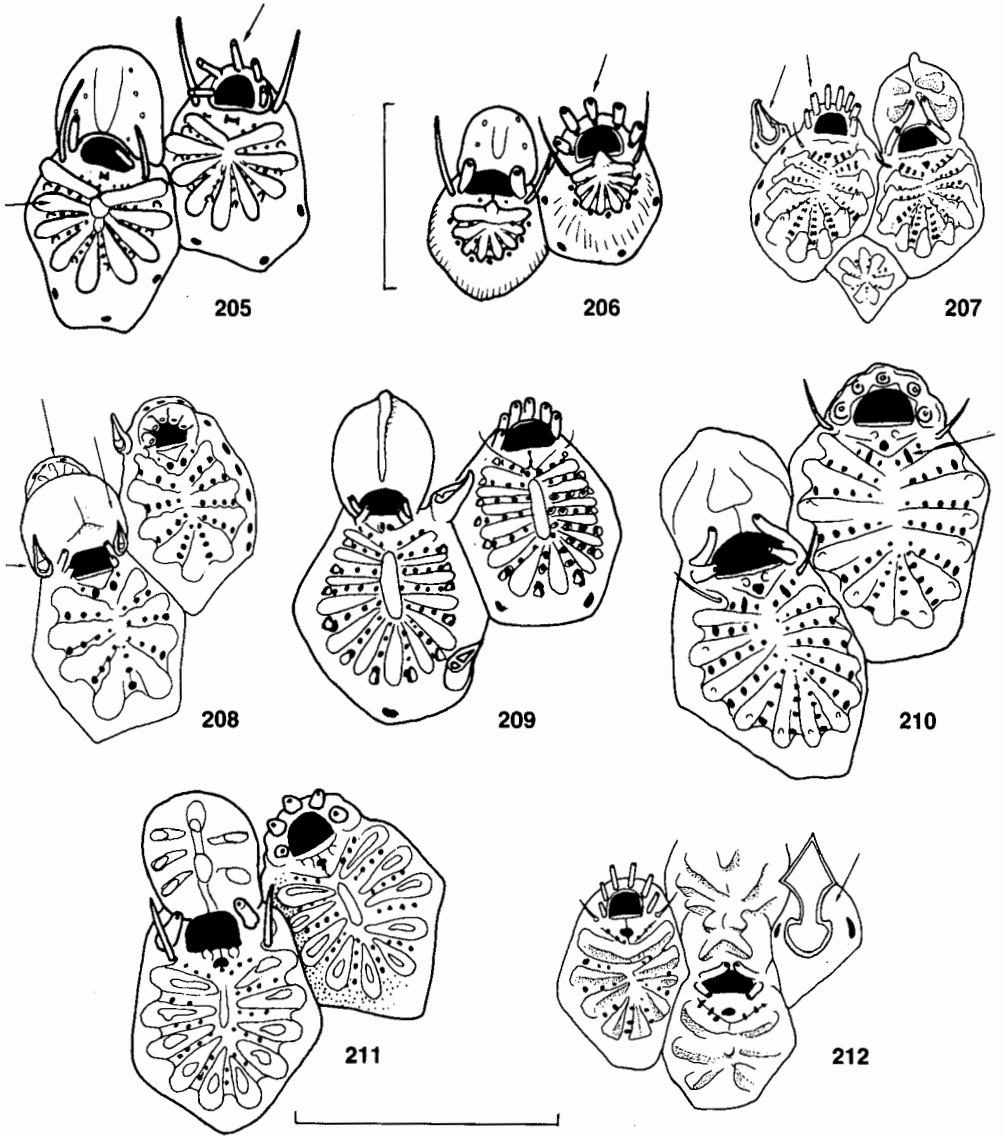

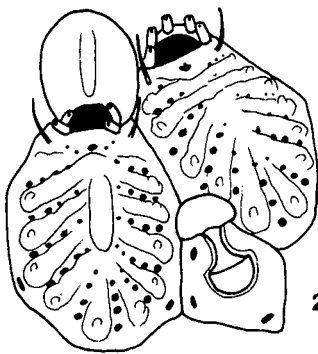

213

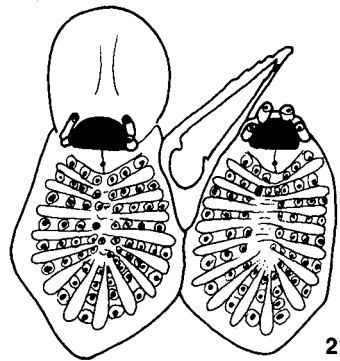

214

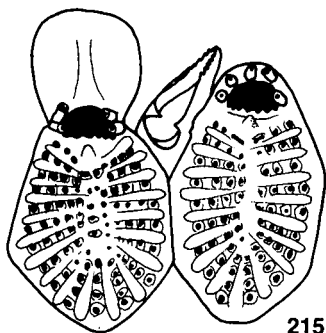

215

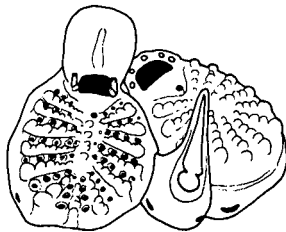

216

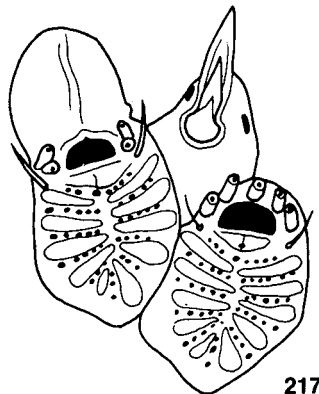

217

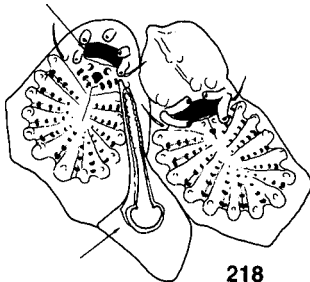

218

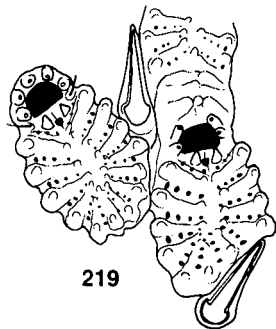

219

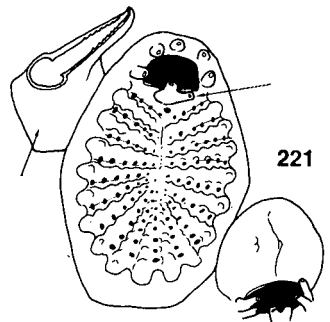

221

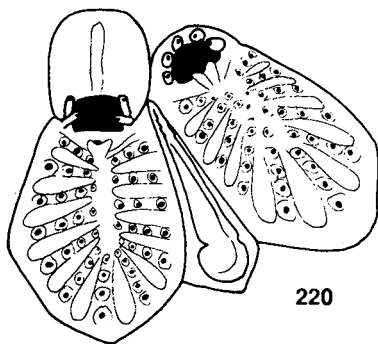

220

CRIBRILINA Gray, 1848

Colony encrusting. Zooids cribrimorph, with frontal shield of broad, flattened costulae, overarching the frontal membrane and fusing along the midline of the zooid. Costulae (modified spines) are also fused (in a variable degree) laterally, leaving between them small rounded lacunae. Orifice subsemicircular, with distal border armed with 2-4 deciduous spines; proximal lip of secondary orifice bearing a more or less developed mucro. Ovicell hyperstomial, globular, proximo-laterally on one or both sides of the orifice. Dietellae or septula present, depending on the species.

Type species: *Lepralia punctata* Hassall, 1841

The only species of this boreo-arctic genus reputed to occur in the Mediterranean is *C. punctata* (Hassall). Many authors (Hincks and Marcus i.e.) have considered that *C. punctata* and *Collarina balzaci* are varieties of the same species. On the contrary, GAUTIER (1962) who states that both species occur in the Mediterranean, separates them by the dimensions and structure of the frontal pericyst, the shape of the secondary orifice and the position of the avicularia (more proximal in *C. balzaci*). However, the description and illustration of *C. punctata* from the British coasts by HAYWARD & RYLAND (1979, p. 57) corresponds to the species described in the Mediterranean as *C. balzaci* (see for example HARMELIN 1978, p. 181 pl. 1 fig. 7). It is possible that Hayward & Ryland's, *C. punctata* was not the same *C. punctata* of GAUTIER (1962), or that of PRENANT & BOBIN (1966). This latter, has a wide pericyst covering the whole frontal surface, in such a way that the gymnocyst is hardly visible. Marginal pores are no larger than the rest of the frontal pores and the avicularia are placed at the level of the orifice, never proximally to this (see PRENANT & BOBIN, 1966, p. 582 fig. 202). The possible occurrence of this species in the Mediterranean leads us to maintain *C. "punctata"* as a doubtful member of this fauna.

Only one species reported *C. "punctata"* (Hassall, 1841); 221 bis (PRENANT & BOBIN, 1966: 581, fig. 202) (not *Cribrilina punctata* HAYWARD & RYLAND, 1979)

FIGULARIA Jullien, 1886

Colony encrusting. Zooids cribrimorph. Gymnocyst extensive; frontal shield of closely fused costae restricted to central area of zooid. Pseudopores present in the costae. Orifice quadrate, subrectangular, with an arched proximal border between lateral condyles. Vicarious avicularia present. Ovicell hyperstomial, prominent, with pores or larger fenestrae in the ectoocium; closed by zooidal operculum. Without spines or dietellae; uni- or multiporous septula present.

Type species: *Lepralia figularis* Johnston, 1847

The type species is the only Mediterranean representative of the genus
..... *F. figularis* (Johnston, 1847); 222 (7 H) (HAYWARD & RYLAND, 1979:70)

MEMBRANIPORELLA Smitt, 1873

Colony encrusting. Frontal membrane occupying most of the frontal surface, but covered by a shield formed by a series of broad spines (between spines and costulae), closely juxtaposed and partly fused. Ovicell hyperstomial, closed by zooidal operculum. Dietellae present. Adventitious avicularia present in some species. Ancestrula membraniporiform.

Type species: *Lepralia nitida* Johnston, 1838

The affinities of this genus are open to question. It is generally placed among or close to the cribrimor-

pha and yet is patently different from most cribrimorph genera. After several authors, the structure of the ovicell proves that this genus is closely related to *Callopora* and consequently must be placed at the end of the Calloporidae.

Only the type species represents the genus in the Mediterranean
 *M. nitida* (Johnston, 1838); 223 (8 A) (PRENANT & BOBIN, 1966:567)

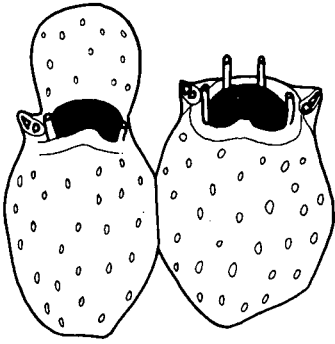

221 bis

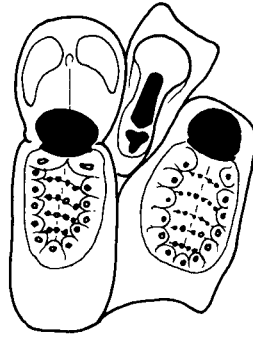

222

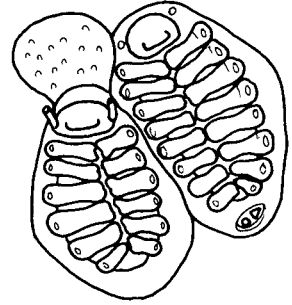

223

SUBORDER ASCOPHORA

UMBONULA Hincks, 1880

Colony encrusting or foliaceous. Frontal wall with large marginal areolae. Avicularia present, median suboral or lateral. Embryos brooded in internal ovisacs or in perforated hyperstomial ovicells. Vertical lateral walls with dietellae (multiporous septula).

Type species: *Umbonula ovicellata* Hastings, 1944

The type species is the only species in the Mediterranean
 *U. ovicellata* Hastings, 1944; 224 (9 A-B) (GAUTIER, 1962: 188)

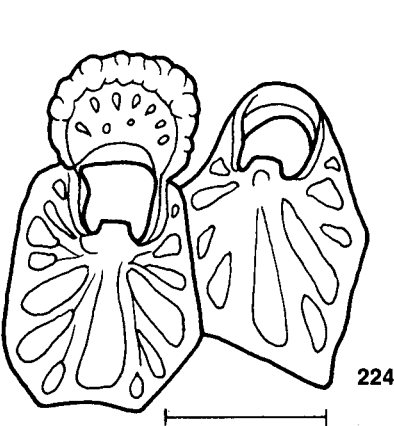

224

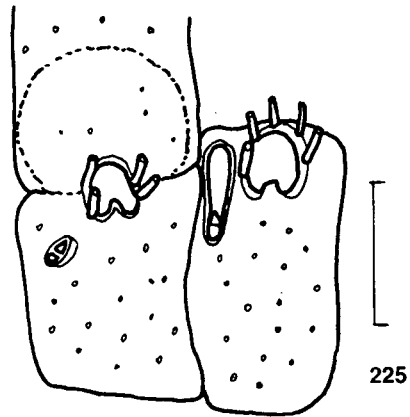

225

HIPPOPLEURIFERA Canu & Bassler, 1925

Colony encrusting. Frontal wall with a double row, at least, of marginal areolae separated by radial costulae. Small cardellae (condyles). With peristomial spines and an adventitious avicularium, the mandible of which is always orientated towards the distal end of the zooid.

Type species: *Eschara biauriculata* Reuss, 1848

Only one Mediterranean species, *H. pulchra*, very near to the type species, which is fossil
 *H. pulchra* Manzoni, 1870; 225 (GAUTIER, 1962:189)

ESCHAROIDES Milne-Edwards, 1836

Colony encrusting. Frontal wall with large marginal areolae. Proximal border of aperture with denticles; oral spines present on distal border. Avicularia well developed, paired, lateral to orifice symmetrically placed. Ovicell prominent, hyperstomial.

Type species: *Cellepora coccinea* Abildgaard, 1806

The distinction between *E. megarostris* and *E. coccinea* based on avicularia sizes is not a convincing character. In our opinion *E. megarostris* could just be an ectype of *E. coccinea*. In the same sense, the features to distinguish *E. coccinea* from *E. mamillata*—orientation of avicularia and arrangement of nodular calcification—are often mixed; for example, it is possible to find specimens with parallel avicularia and calcification irregularly nodular, as well as the contrary, calcification regularly nodular and oblique avicularia.

1. With giant vicarious avicularia (besides the pairs of adventitious avicularia). Zooids large
 *E. megarostris* (Canu & Bassler, 1928); 228 (GAUTIER, 1962:187)
 – Without vicarious avicularia. Zooids smaller 2
2. Frontal calcification irregularly nodular. Avicularia large, with swollen cystid, directed disto-laterally (oblique). *E. coccinea* (Abildgaard, 1806); 226 (9 C) (GAUTIER, 1962:184)
 – Frontal calcification nodular, in regular radiating series converging on the suboral mucro. Avicularia small, cystid often inconspicuous, directed distally (parallel)
 *E. mamillata* (Wood, 1884); (GAUTIER, 1962:186)

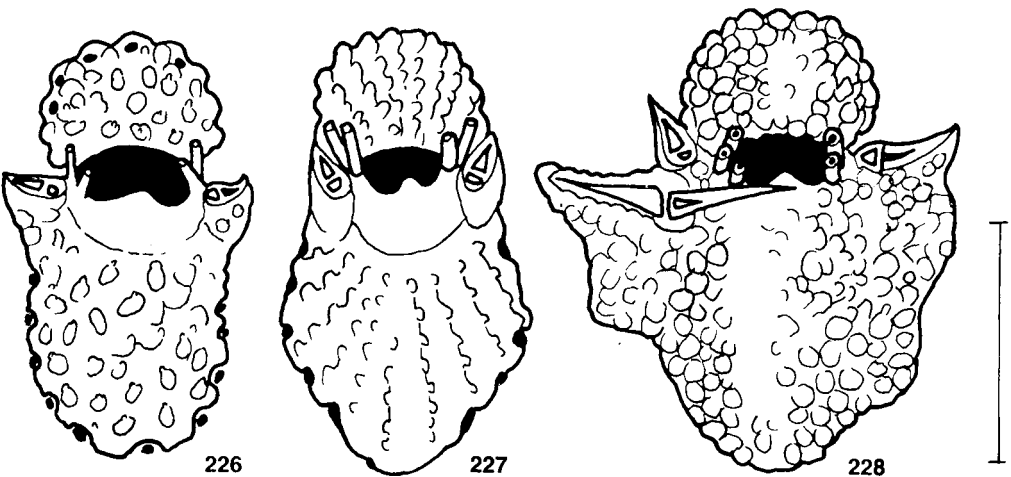

ADEONELLOPSIS Mac Gillivray, 1886

Colony erect, aedeoniform (branches flattened, bilaminar) or encrusting. Ascopore simple, circular or multiporous. Large vicarious avicularia sometimes present. Operculum without sinus, sub-circular. Gonozooid not restricted to the edges of the colony (after HARMER, 1957).

Type species: *Adeonellopsis foliacea* Mac Gillivray, 1886

Only one species represents this genus in the Mediterranean: *A. distoma* (Busk, 1858); deepwater species *A. distoma* (Busk, 1858); 229 (8 B) (GAUTIER, 1962:221)

REPTADEONELLA Busk, 1884

Colony encrusting. Primary orifice and operculum semicircular. Frontal wall with marginal pores and a single, or twinned, central spiramen. Avicularia adventitious, situated on the frontal wall proximal to the orifice. Embryos brooded in enlarged gonozooids (not in ovicells). Dietellae present.

Type species: *Reptadeonella violacea* Johnston, 1847

Only the type species represents the genus in the Mediterranean
 *R. violacea* Johnston, 1847; 230 (GAUTIER, 1962:218)

ANARTHROPORA Smitt, 1868

Colony encrusting. Frontal wall perforated by numerous, scattered, stellate pores. Avicularia oral, associated with the peristome and semicircular secondary orifice.

Type species: *Lepralia monodon* Busk 1860

The type species is the only species occurring in the Mediterranean, where it seems to be rare. Only cited in the Aegean Sea *A. monodon* (Busk, 1860); (*) 231 (HARMELIN, 1969:295)

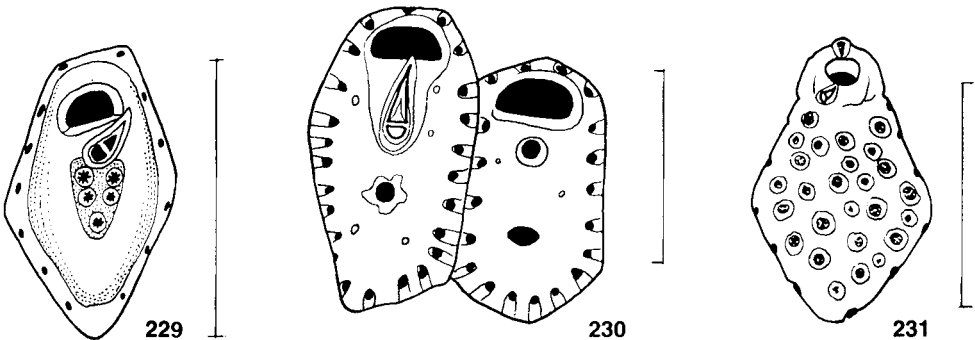

EXECHONELLA Canu & Bassler, 1927

Colony encrusting. Frontal wall of umbonuloid growth, made up by the partial fusion of irregular processes derived from the lateral and proximal zooid walls. Foramina open in the frontal wall allow communication between the epistegal space and the exterior. Peristome more or less tubular, often long and cylindrical. Adventitious avicularium sometimes present. Ovicell small, situated on distal margin of the peristome.

Type species: *Hiantopora magna* Macgillivray, 1895 (?)

This genus was unknown in the Mediterranean until 1974, when HAYWARD (1974) reported an ancient species of circumtropical affinities, *E. antillea* Osburn (1927), from the Aegean Sea
..... *E. antillea* (Osburn, 1927); (*) 232 (HAYWARD, 1974:377)

WATERSIPORA Neviani, 1895

Colony encrusting. Frontal wall cryptocystidean; uniformly porous, with frontal septula linking the main and hypostegal coeloms. Vertical walls with large, multiporous septula. Aperture prominent, paired condyles present; with or without sinus. Spines and avicularia absent. Ovicells absent, embryos brooded internally.

Type species: *Lepralia subovoidea* D'Orbigny, 1852

- 1. Aperture oval, with proximal border forming a shallow, broad, rounded sinus. Operculum pigmented, with a dark central ribbon and two clearer lateral areas, very distinct. Zooids dark purple to black pigmented. Zooids very large
..... *W. subovoidea* (D'Orbigny, 1852); 234 (9 D) (GAUTIER, 1962:183)
- Aperture D-shaped, straight proximal border. Neither the operculum nor the frontal wall are pigmented. Rim of orifice thickened by secondary calcification. Zooid sizes small
..... *W. complanata* (Norman, 1864); 233 (HAYWARD & RYLAND, 1979:88)

CRYPTOSULA Canu & Bassler, 1925

Colony encrusting. Frontal wall cryptocystidean, uniformly porous. Vertical walls with multiporous septula. Aperture rectangular or bells-haped, often with a broad, raised peristome. Suboral avicularia small, rounded, inconstant. No spines or ovicells. Embryos brooded internally.

Type species: *Eschara pallasiana* Moll, 1803

The type species is the only representative of the genus in the Mediterranean. Littoral species
..... *C. pallasiana* (Moll, 1803); 235 (GAUTIER, 1962:169)

HIPPOPORINA Neviani, 1895

Colony encrusting. Frontal wall cryptocystidean, closely and regularly perforated. Aperture with prominent lateral condyles. Ovicell hyperstomial, prominent, perforated; closed by zooidal operculum. Multiporous septula in the vertical lateral walls. Adventitious avicularia may be present. Spines present in the ancestrula.

Type species: *Cellepora pertusa* Esper, 1796

Type species is the only representative of the genus in the Mediterranean
..... *H. pertusa* (Esper, 1769); 236 (8 C-D) (GAUTIER, 1962:168)

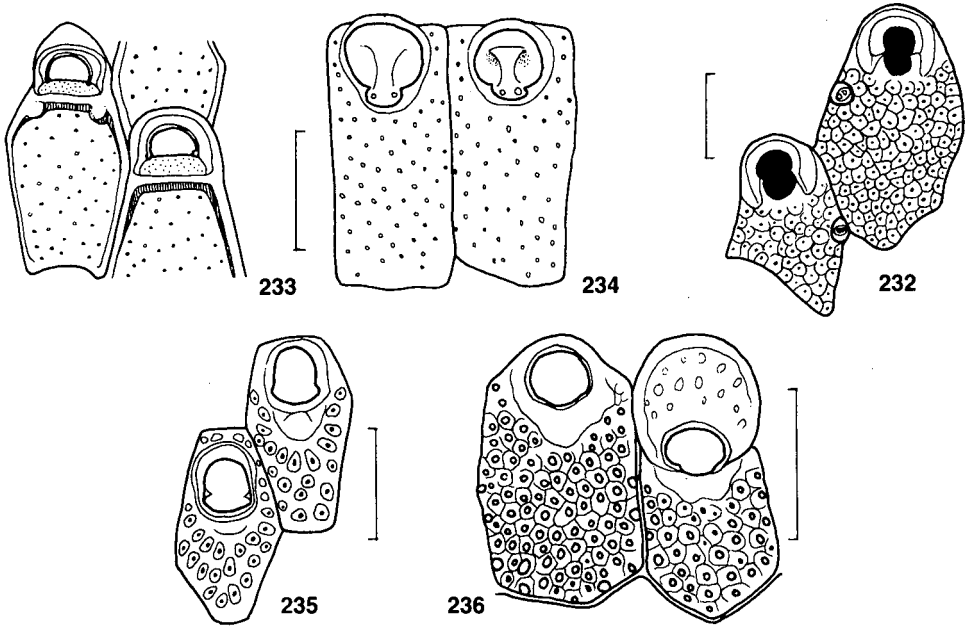

PENTAPORA Fischer, 1807

Colony encrusting or erect, rigid or foliaceous (eschariform). Frontal wall uniformly porous tending to be very rugose and calcified. Aperture subquadrate, with conspicuous lateral condyles which separate a narrow vana from a wider porta. Vertical walls with broad multiporous septula. Ovicell hyperstomial, closed by zooidal operculum. Avicularia present, adventitious, suboral.

Type species: *Eschara fascialis* Pallas, 1766

1. Colony always encrusting. Zooids rugose and with spines *P. ottomulleriana* (Moll, 1803); 237 (8 F-G) (GAUTIER, 1962:168 as "*Hippodiplosia*" *ottomulleriana*)
 – Colony erect, arborescent or foliaceous; zooids without spines
P. fascialis (Pallas, 1766); 238 (8 E) (GAUTIER, 1962:165 as "*Hippodiplosia*" *fascialis*) 2
2. Colony erect but made up of narrow branches, arborescent *P. fascialis* f. *fascialis*; 239
 – Colony eschariform, foliaceous. Branches forming broad sheets, anastomosing when they meet
P. fascialis f. *foliacea*; 240

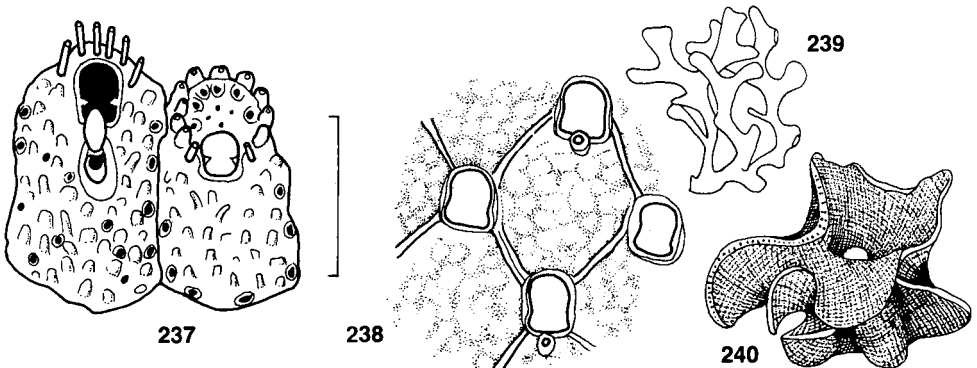

CHEILOPORINA Canu & Bassler, 1927

Colony eschariform. Zooids with frontal wall perforated by many pores. Apertures dimorphous: in fertile zooids much broader than long; in sterile longer than broad. With a large distal sclerite and two small condyles. Avicularia lateral, oral (some species without). Ovicell small, immersed, traversing the surface as a narrow ribbon that surrounds the distal border of the aperture.

Type species: *Hippoporina circumcincta* Neviani, 1896

Type species is the only representative of this genus in the Mediterranean
Ch. circumcincta (Neviani, 1896); (*) 241 (GAUTIER, 1962:183) (CANU & BASSLER, 1928:52, pl. 7-1)

COSCINIOPSIS Canu & Bassler, 1927

Colony encrusting. Aperture with condyles; visible frontally but surrounded by a short peristome. Operculum large, with a broad proximal sinus surrounded by strong basal and lateral sclerites; with occlusor muscles inserted in paired points (?), distant from the marginal sclerite. Avicularia oral, lateral, sharp, sometimes absent. Ovicells generally large, hyperstomial, closed by zooidal operculum, with small pores resembling those of the zooid frontal.

Type species: *Cosciniopsis coelatus* Canu & Bassler, 1927

This genus was not known in the Mediterranean until a few years ago, when HARMELIN (1968) found one species which could be referred to it. Recently, HAYWARD (1974) described it as *C. ambita* sp. nov. Only known in the eastern Mediterranean

..... *C. ambita* Hayward, 1974; (*) 242 (HARMELIN, 1969:1206), (HAYWARD, 1974:389)

HIPPALIOSINA Canu, 1919

Colony encrusting. Frontal wall with a series of marginal pores, which continue distally around the orifice. Orifice and operculum typically elongated, with a wide poster delimited by minute, sharp condyles at each side; other apertures (presumably the fertile) are larger and otherwise shaped. Avicularium oral, lateral; often paired (one at each side); rostrum lacking calcareous pivotal bar; mandibles often setiform or vibraculoid (HARMER, 1957).

Type species: *Escharella rostrigera* Smitt, 1873

Only one Mediterranean species (Eastern Mediterranean)
..... *H. depressa* (Busk, 1854); (*) 243 (HARMELIN, 1969:1206)

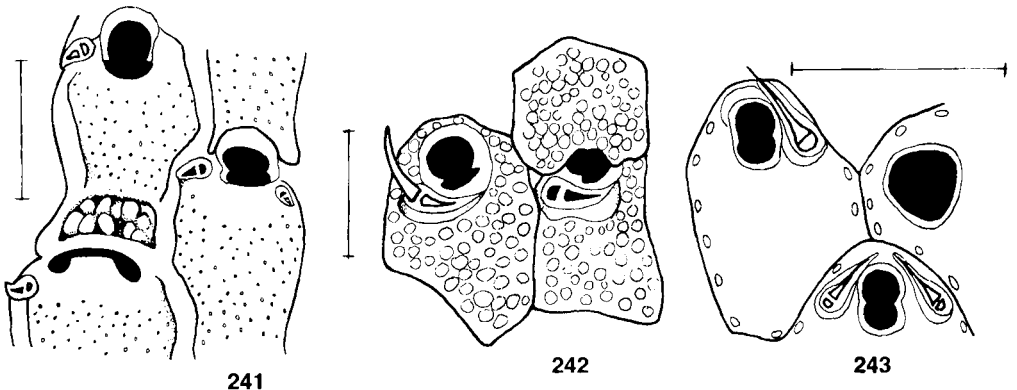

HIPPOMENELLA Canu & Bassler, 1917

Colony encrusting. Frontal wall imperforate centrally, with a porous marginal fringe. Orifice approximately circular or elongated, bearing condyles situated very close to the proximal border. Short peristome, generally with 6 spines. Avicularia erect, subtriangular, pointing laterally and proximally, placed near the orifice, or distant from it. Operculum with a strong central sclerite. Ovicells usually with a crescentic orifice placed on each side, or punctured by numerous pores that sometimes become reduced to a pair (HARMER, 1957).

Type species: *Lepralia mucronelliformis* Waters, 1899

The type species is the only representative in the Mediterranean. This species, even though known from shallow waters in the Atlantic (Madeira and Morocco) and in the Aegean Sea, is rare in the Mediterranean. We have found it in caves in Majorca

..... *H. mucronelliformis* (Waters, 1899); 244 (8 H) (HARMELIN, 1969:1208)

HIPPOPODINA Levinsen, 1909

Colony encrusting. Frontal wall perforated by numerous small pores. Orifice cleithridial, with condyles and straight borders. Orifice of fertile zooids broader than long. Absence of spines. Adventitious avicularia close to the orifice, directed generally to the distal region of the orifice; rostrum sharp, triangular. Large hyperstomial ovicells, perforated by many pores.

Type species: *Hippopodina feegensis* (Busk, 1884)

The only Mediterranean species, the type species, has a circumtropical distribution, and has only been cited in the Eastern Mediterranean *H. feegensis* (Busk, 1884); 245 (ARISTEGUI, 1984:314)

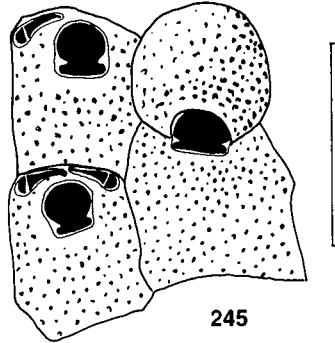
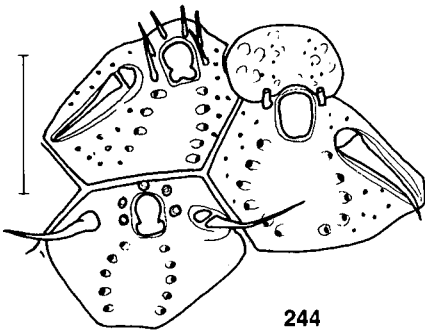

PALMICELLARIA Alder, 1864

Colony erect, viculariform. Frontal wall smooth, with marginal areolae only. Orifice with or without a sinus, encircled by a peristome bearing one or two prominent mucrones. Avicularia adventitious, oral (generally peristomial) or frontal in position. Ovicell prominent, not closed by zooidal operculum. Small dietellae present.

Type species: *Palmicellaria elegans* Alder, 1864

1. Colony slender, composed of alternating pairs of back-to-back zooids. Only one peristomial mucro and one avicularium *P. elegans* Alder, 1864; 246, 247 (HAYWARD & RYLAND, 1979:130)
 - Colony stouter, composed of several zooid series per branch
2. Colony erect, of flattened branches. Aperture without sinus; peristome with 1 to 3 mucrones, but always with the central one much more developed. Ovicell large, long *P. skenei* (Ellis & Solander, 1786); 248, 249 (9 F) (HAYWARD & RYLAND, 1979:134)
 - Colony usually found in pre-vasculariform state, of cylindrical branches. Aperture with sinus, surrounded by a peristome with 2 or 3 mucrones, each bearing an avicularium *P. aff. aviculifera* (Canu & Bassler, 1928); 250, 251 (9 E) (HARME LIN, 1969:297)

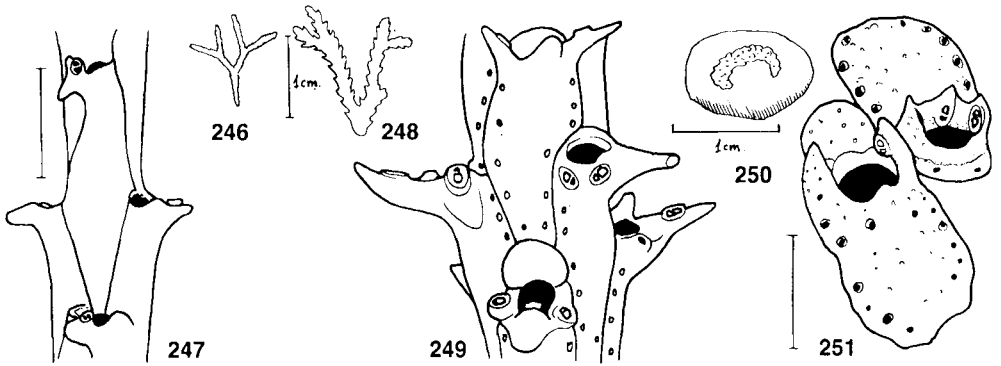

PARASMITTINA Osburn, 1952

Colony encrusting. Frontal wall with marginal areolae. Primary orifice with lyrula and a pair of condyles. Peristome well developed, with a proximal notch. Oral spines present. Different types of avicularia, but those which characterize the genus are typically asymmetrical, lateral to aperture and directed distally or proximally. Additional avicularia are situated preferably around the orifice. Small dietellae present.

Type species: *Smittina jeffreysi* Norman, 1909

Parasmittina, so characteristic and homogeneous at generic level, is a very difficult group at specific level, since it includes many forms in the *Smittina trispinosa* Johnston (1838) group, from which has been differentiated about 15 varieties. In our opinion only a few of those are, perhaps, distinct species. BROWN (1952:332) has selected a type specimen for *P. trispinosa* (see the description in HAYWARD & RYLAND, 1979) which has, at present, an Atlantic-restricted distribution (the occurrence of this species in the Mediterranean during the latest Pleistocene has been proved by REGUANT et al., 1987).

Four species have been reported by GAUTIER (1962) from the Western Mediterranean: *P. baccata* (Canu & Bassler), *P. parsevalii* (Audouin), *P. raigii* (Audouin) and *P. rouvillei* (Calvet). Taxonomical characters largely used have been: shape, position, number and size of frontal avicularia. The only well stated (see below) species, *P. tropica* (Waters) shows a wide inter- and intracolony-variability in avicularial arrangement. The basis of this variability seems to be caused by the capability of frontal budding in *Parasmittina*. Zooids and avicularia are budded from the areolar pores and this process leads to a very chaotic distribution in both, zooids, and avicularia. Obviously, characters such as number, position, shape and orientation of the avicularia have not the same value than in unilaminar, strictly lateral-budding species.

The size and shape of the condyles-lyrula complex and the ovicellar architecture seem to be better characters for discrimination.

With regard to these characters the validity of *P. baccata* (Canu & Bassler), *P. parsevalii* sensu GAUTIER (1962) (which is probably different from the species described by HARMER in 1957), *P. porosa* (Canu & Bassler) and *P. rouvillei* (Calvet) would have to be checked. Provisionally, they are here regarded as local forms of a very plastic single species, *P. tropica* (Waters). *P. rouvillei* (Calvet, 1902) would have priority but it was described in a very restricted sense, whilst *P. tropica* (Waters) as redescribed by HARMER (1957) has a wider acception, which could include all the forms hitherto described.

Finally, only two different species seem to be present in Western Mediterranean, *P. raigii* (Audouin) sensu GAUTIER (1962) and *P. tropica* (Waters) sensu HARMER (1957).

1. Lyrula broad, wider than long. Ovicell regularly perforate by rounded pores, without associate avicularia. Great frontal triangular avicularia, variously placed and distally directed, characteristic but not exclusive *P. raigii* (Audouin, 1826); 252 (GAUTIER, 1962:198)
- Lyrula smaller, longer or equal than width. Ovicell with irregular pores only in the distal part, with an imperforate area, coarse calcificated, bearing (commonly) small triangular avicularia. Frontal triangular avicularia smaller if present *P. tropica* (Waters, 1909); 253, 254, 255, 256 (10 A-F) (GAUTIER, 1962: 199 as *P. rouvillei*).

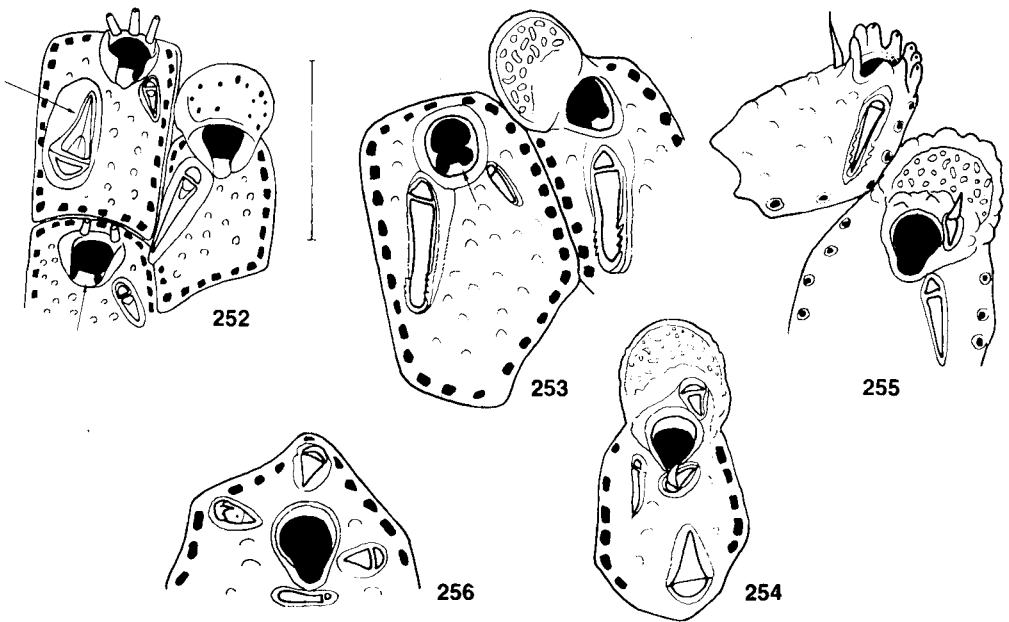

PORELLA Gray, 1848

Colony encrusting or erect. Frontal wall smooth with marginal pores only. Primary orifice with lyrula and condyles variously developed, occasionally absent. Oral spines absent. Avicularium suboral, usually within a well developed peristome. Vicarious avicularia absent. Ovicell prominent, spherical, becoming immersed; imperforate or with a single central pore, not closed by zooidal operculum. Dietsellae present.

Type species: *Millepora compressa* Sowerby, 1805

Following OSBURN'S (1952) division and COOK'S (1969) criteria, the group of Mediterranean species

with uniformly porous frontal wall, though classically included in the genus *Porella*, must be moved to the genus *Smittina*. This includes *Millepora cervicornis* Pallas, *Porella remotorostrata* (Canu & Bassler), *P. tubulifera* (Heller) and *P. colleti* (Jullien & Calvet).

1. Colony encrusting 2
 - Colony erect 3

2. Zooids small (Lz < 0.40 mm). Ovicell distinct, always imperforate. Calcification thickening to produce conspicuous interareolar struts between adjacent zooids. Avicularium situated perpendicularly to the zooid plane, oval. With a peristomial umbo
 - *P. minuta* (Norman, 1868); 257, 258 (11 A-B) (GAUTIER, 1962:210)
 - Zooids large (Lz < 0.40 mm). Ovicell semi-immersed, with a central pore. Avicularium suboral, often immersed and obscured by the calcification
 - *P. concinna* (Busk, 1854); 259 (GAUTIER, 1962:207)

3. Colony made up of small horns anastomosing in a characteristic way. Zooidal characters of *P. concinna* *P. concinna* form *tubulata* (Calvet, 1927); (GAUTIER, 1962:208)
 - Colony vinculariform or adeonelliform, orifice without lyrula nor cardellae. Avicularium not obscured, prominent, ogival and sharp pointed, directed proximally
 - *P. tubulata* (Busk, 1861); 260 (12 A) (JULLIEN & CALVET 1903:77) (COOK 1968:212)

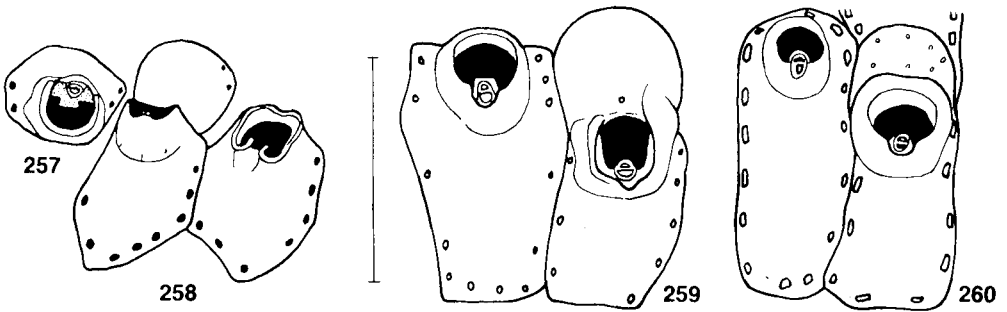

SMITTINA Norman, 1903

Colony encrusting. Frontal wall cryptocystidean, uniformly porous. Orifice with lyrula and condyles; peristome well developed, with a proximal fissure. Oral spines present in some species. Avicularium generally median, suboral, close to proximal border of the orifice and directed proximally or transversely (occasionally absent). Ovicell punctured by numerous small pores. Uniporous or multiporous septula present.

Type species: *Lepralia landsborovii* Johnston, 1847

Following the transfer of the two species without avicularia (*S. cheilostoma* and *S. inerma*) to the genus *Prenantia* (GAUTIER, 1962), it seems that only two encrusting species of proven (1) mediterranean distribution remain into the genus *Smittina*: the type species *S. landsborovii*. and *S. crystallina*. Six species occur in the Mediterranean; five have been found in Catalan shores.

(1) Justified because there are indications of the existence of a third smaller species (Harmelin, pers. comm.), whose identity will need a more accurate study.

1. Colony encrusting 2
 - Colony erect, adeoniform or viculariform 3

2. Three distal spines in marginal zooids. Lyrula broad. Avicularia only peristomial, ogival, sharp pointed directed proximally
 - *S. crystallina* (Hincks, 1880); 261 (12 B) (HAYWARD & RYLAND, 1979:100)
 - Spines absent. Lyrula narrower. Two types of avicularia: 1/peristomial (constant); 2/ spatulate, orientated transversely, sporadic but characteristic
 - *S. landsborovii* (Johnston, 1847); 262 (11 F) (GAUTIER, 1962:190)

3. Avicularia absent. Peristome with a sharp and projecting crest in proximal position
 - *S. tubulifera* (Heller, 1867); (*) 263 (HARMELIN, 1968-69: 299)
 - Avicularia present 4

4. Avicularium separated from the peristomial aperture, that is, more frontal and less oral than in the other species, ogival, sharp pointed directed proximally *S. remotorostrata* (Canu & Bassler, 1928); 264, (COOK, 1968:211, pl. 8b, 11) (HAYWARD, 1974: 382, fig. 6c)
 - Avicularium within the peristomial notch, on the lyrula; semielliptical, with rounded end 5
 - Colony white. Zooids smaller, avicularium oval, relatively large. Deep water species (100 m) *S. colleti* Jullien & Calvet, 1905; 265 (HARMELIN, 1969:297)
 - Colony orange coloured. Zooids larger. Avicularium always small. Shallow species (15-60 m) *S. cervicornis* (Pallas; 1766); 266 (12 C) (GAUTIER, 1962:204)

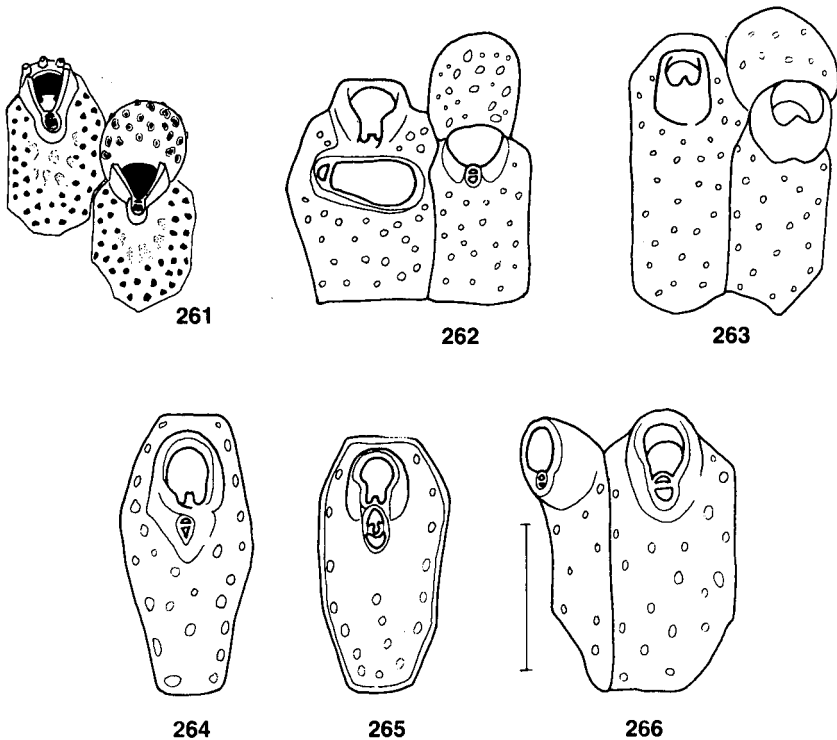

PORELLOIDES Hayward, 1979

Colony erect, vinculariform or encrusting. Erect colonies with a frontal side bearing the apertures and a basal side formed by autozooids with obliterated orifices or kenozooids. Frontal wall smooth, with marginal pores only. Primary orifice with lyrula; no condyles. Peristome well developed, incorporating a suboral avicularium (cf. *Porella*). Vertical walls deep, with large multiporous septula (non cf. *Porella*). Ovicell prominent, imperforate, not closed by zooidal operculum.

Type species: *Cellepora laevis* Fleming, 1828

The type species, as it seems, is the only mediterranean representative of this new genus
 *P. laevis* (Fleming, 1828); (*) 267, 268, 269 (HAYWARD & RYLAND, 1979:126)

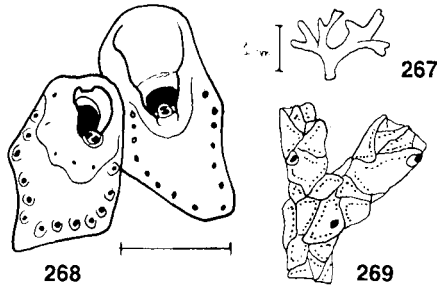

PRENANTIA Gautier, 1962

Colony encrusting. Frontal wall wide, regularly and evenly punctured. Primary orifice with lyrula and condyles. Peristome well developed; notched proximally. The absence of spines and avicularia is characteristic. Ovicell hyperstomial, partially immersed, punctured or imperforate, closed by zooidal operculum. Small dietellae (basal pore-chambers) present (cf. *Smittina*).

Type species: *Lepralia cheilostoma* Manzoni, 1869

1. Condyles (cardellae) long and slender, readily distinguishable at the level of the lyrula. This latter is narrow in the centre widening at the end. Peristome more raised and stout; at the base of the notch and just at the level of the lyrula there is a small, clear, fusiform spot. Zooids large
 *P. inerma* (Calvet, 1906); 271 (11 D-E) (GAUTIER, 1962:193)
- Condyles smaller, blunt, deep (not at the level of the lyrula), scarcely distinguishable. Lyrula broad. Peristome less developed, not so tall; without spots in the notch. Zooids smaller. Ovicell surrounded by a calcareous fringe, crown-shaped, immersed in the succeeding zooid
 *P. cheilostoma* (Manzoni, 1869); 270 (11 C) (GAUTIER, 1962:192)

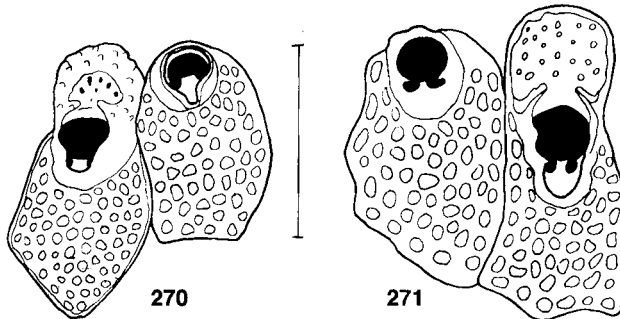

SMITTOIDEA Osburn, 1952

Colony encrusting. Zooid frontal wall imperforate centrally, with large areolae peripherally. Primary orifice with lyrula and paired lateral condyles. Avicularium adventitious, situated medially on the frontal wall, proximal to the orifice. Multiporous or uniporous septula present in vertical walls. Dietellae absent. Ovicell hyperstomial, prominent, evenly perforated by numerous small round pores; not closed by zooidal operculum.

Type species: *Smittoidea prolifica* Osburn, 1952

- 1. Avicularium large, often spatulate, with the end resting on the peristomial border of the inferior zooid. Peristome well developed, high, with a deep and narrow proximal fissure. Two suboral, symmetrical pores (which may be missing)
 *S. ophidiuna* (Waters, 1879); 274 (GAUTIER, 1962:196)
- Avicularium not so large, triangular, frontal in position and in the plane of the frontal wall, never resting on the inferior zooid. No suboral pores 2

- 2. Oral spines present. Orifice obscured by peristome but not becoming deeply immersed. interareolar ridges distinct. Lyrula proportionately narrower
 *S. reticulata* (Mac Gillivray, 1842); 272 (12 D) (GAUTIER, 1962:194)
- Oral spines absent. Orifice (and sometimes the avicularium) becoming deeply immersed by calcification. Areolae often indistinct. Lyrula proportionately broader
 *S. marmorea* (Hincks, 1877) 273; (12 E) (GAUTIER, 1962:195)

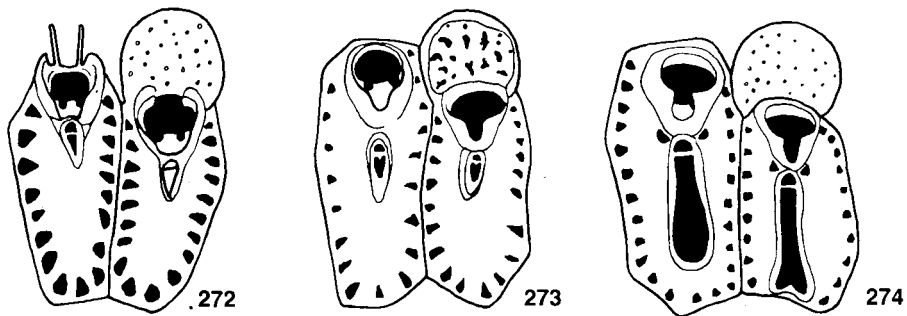

RAMPHOSTOMELLA Lorenz, 1886

Colony erect, attached by slender, cylindrical, basal calcareous processes. Zooids convex, tubercular, often leaving open foramina where three zooids converge. Marginal pores often separated by projecting fringes converging distally towards a suboral umbo, incorporating an avicularium. Aperture with condyles delimiting a sinus, of variable breadth, operculum delicate. Ovicells large, tubercular, hyperstomial (Harmer, 1957).

Type species: *Ramphostomella costata* Lorenz, 1886

Only one species, *R. argentea* (Hincks, 1881), occurs in the Mediterranean. It is a deepwater species *R. argentea* (Hincks, 1881); (*) 275 (GAUTIER, 1962:160)

RAMPHOSTOMELLINA Hayward, 1975

Colony encrusting. Primary frontal wall smooth and imperforate, apart from a pair of pores, one at each side of the orifice. Primary orifice orbicular, without lyrula or condyles; hidden by peristomial calcification. Ovicell hyperstomial, perforated by several large frontal lacunae; not closed by zooidal operculum (HAYWARD, 1975).

Type species: *Ramphostomellina posidoniae* Hayward, 1975

This genus has been introduced only recently, exclusively for the type species, *R. posidoniae*, discovered in the Aegean Sea *R. posidoniae* Hayward, 1975; (*) 276 (HAYWARD, 1975:208)

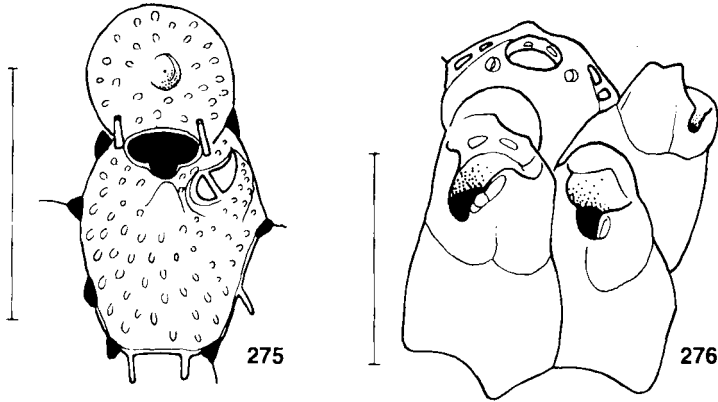

ESCHARELLA Gray, 1848

Frontal wall imperforate, with marginal areolae only. Orifice typically with a large characteristic lyrula; condyles, when present, very small, inconspicuous. Oral spines present. No avicularia. Ovicell imperforate, prominent, not closed by zooidal operculum. Numerous small dietellae present. Ancestrula produces one distal followed by two distolateral buds.

Type species: *Lepralia immersa* Fleming, 1828

Four species are well known on the Mediterranean shores. Recently, ARISTEGUI (1986) described a new species, *E. hexaspinosa*, from the Canary Islands which has been found by LOPEZ DE LA CUADRA (in press) in the vicinity of the Gibraltar Strait. This species is close to *E. octodentata* and to *Hemicyclopora multispirata*. *E. hexaspinosa* has larger zooids (0.60 - 0.90 mm) and always six spines in both ovicellate and non-ovicellate zooids. Moreover, it has a lyrula (*Hemicyclopora* never) but no condyles (*E. octodentata* has both lyrula and conspicuous condyles). A new species has recently been found in deep Mediterranean waters in the *Madrepora oculata* community (Zabala & Maluquer, in prep.). By the spiny number (six in non-ovicellate zooids) this species is close to *E. hexaspinosa*, but only four spines remains in ovicellated zooids (two more are still visible but totally embeded in the ovicell). By the frontal appearance of both autozooids and ovicells, rugose and flattened, is very similar to *E. ventricosa* which has only four spines in non-ovicellate zooids.

- 1. Spines only in the ancestrula. A peristome with lobed margins surrounds the aperture *E. rylandi* Geraci, 1974; 282 (13 A-B) (GERACI, 1974:1-4)
- Spines always visible 2
- 2. Four oral spines or less in non-ovicellate zooids 2
- Six oral spines or more in non-ovicellate zooids 4

3. Four oral spines. Small areolae, inconspicuous. Lyrula quadrate, with upturned, cuspidate corners. Peristome incomplete centrally, often forming proximally an abrupt, quadrate mucro, as if it was a second lyrula *E. ventricosa* (Hassall, 1842); 279 (GAUTIER, 1962: 215)
 - Two oral spines. Marginal areolae large and conspicuous; lyrula slender, anvil-shaped; mucro often bifid. *E. variolosa* (Johnston, 1838); 282 (13 C) (GAUTIER, 1962:213)
4. Eight oral spines in non-ovicellate zooids. Lyrula broad and stout; with condyles *E. octodentata* (Hincks, 1880); 278 (14 A-B) (HAYWARD & RYLAND, 1979:142)
 - Six oral spines in non-ovicellate zooids 5
5. Six oral spines remaining in ovicellate zooids, condyles absent. Acute lyrula. Zooids swollen, raised; ovicell sphaerical, small, recumbent in the distal side of the parental zooid *E. hexaspinosa* (Aristegui, 1986); 277 (ARISTEGUI 1986:184) (LOPEZ, 1987: in press)
 - Ovicellate zooids with only four spines, condyles present. Lyrula broad and stout. Zooids and ovicells flattened, greater, occupying a space between the autozooids n. sp.; 280 (13 E-F) (Zabala & Maluquer, in prep.)

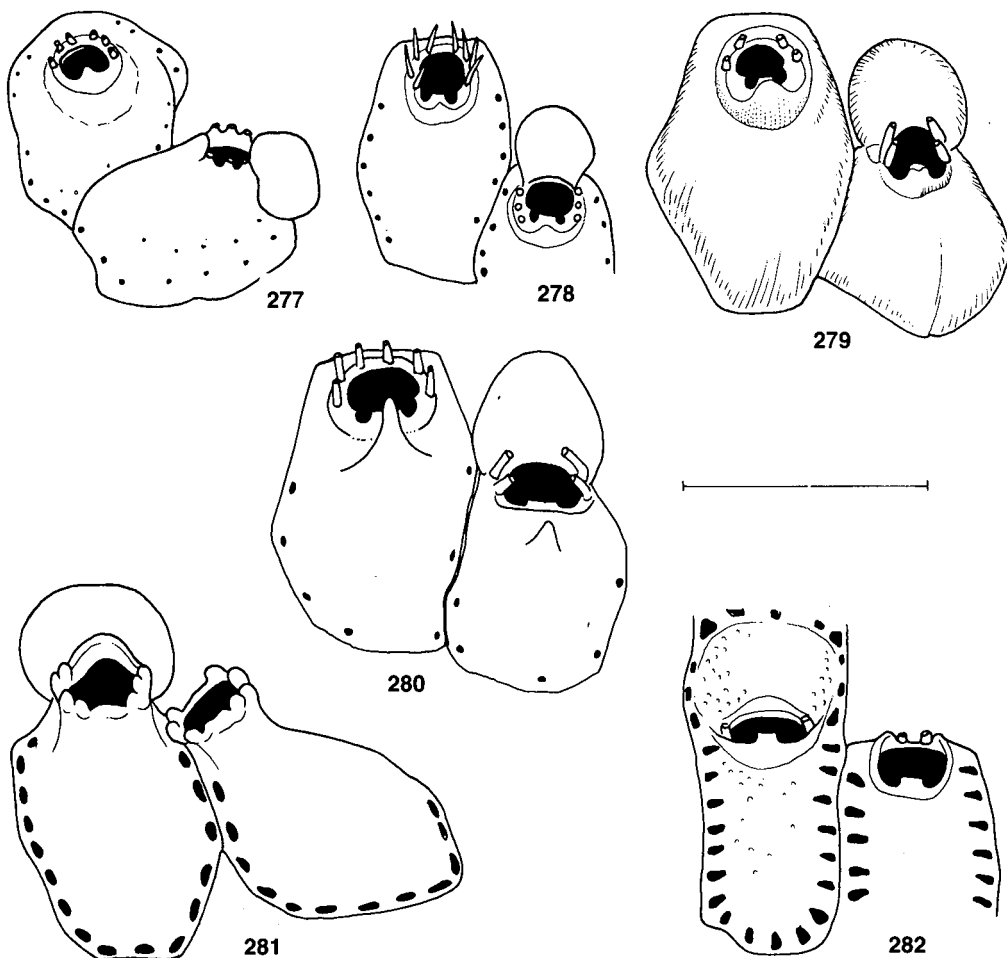

HEMICYCLOPORA Norman, 1894

Colony encrusting. Frontal wall with minute marginal pores. Lateral walls practically absent, numerous very small dietellae present. Orifice simple, without sinus or lyrula. Peristome present or absent. Ovicell hyperstomial, prominent, closed by zooidal operculum, imperforate. No avicularia.

Type species: *Hemicyclopora polita* Norman, 1864

One species of this genus has been described from northern African shores. Deepwater species: found in Cassidaigne (110-130 m) by Harmelin (pers. com.)
..... *H. multispinata* (Norman, 1909); 283 (COOK, 1968:216)

In the Mediterranean exists another species typical of caves, that has recently been described from Gibraltar with the name *H. dentata* (LOPEZ DE LA CUADRA et al., in press).

PHYLACTELLIPORA Bassler, 1953

Colony encrusting. Frontal wall with marginal pores only. Primary orifice with prominent lateral condyles, lyrula present or absent. Ovicell hyperstomial, prominent, perforate. No avicularia. Basal pore-chambers (dietellae) present.

Type species: *Lepralia collaris* Norman, 1867

The species of this typically atlantic genus are small, rarely cited in the literature, and were unknown on Mediterranean shores until a few years ago. Recently, HARMELIN (1967) recorded *P. eximia* (Hincks, 1860) from deep detritic bottoms (100-200 m) of the Marseillaise region. This rare species had not been found since its description, even on the British coasts where it was first discovered (see HAYWARD & RYLAND, 1979: 164), We found it on Catalonian coast, very abundant on the *Lophelia pertusa* community. This finding enabled us to observe the presence of two oral spines which had not been described in the bibliography (Zabala & Maluquer, in prep.)

..... *P. eximia* (Hincks, 1860); 284 (12 F) (HAYWARD & RYLAND, 1979:164)

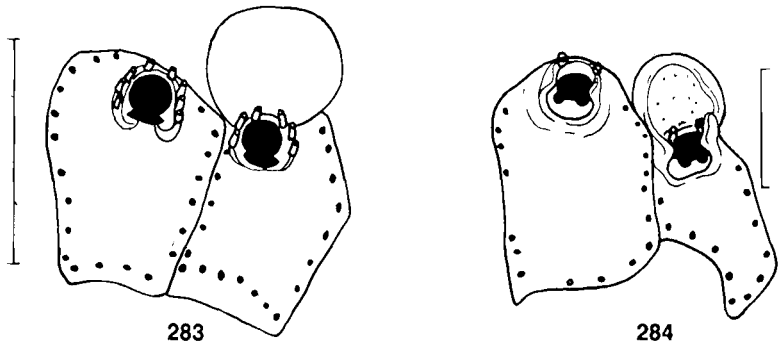

ARTHROPOMA Levinsen, 1909

Colony encrusting. Zooids lacking covering membrane and ornamented with scattered pores. Aperture with a distinct low vestibular arch, with straight proximal border indented by a narrow, deep, U-shaped sinus; operculum well chitinized, formed by two parts joined by an articulation (that is, a connecting part feebly calcified): a main broad part (which closes the almost entire aperture) with two muscular insertion points, and an accessory part (small) occupying the sinus. Avicularia may be present. Ovicell consisting of a calcified entoocium without pores, and a membranous ectoocium. Three dietellae or three septula placed in the distal half of the zooid.

Type species: *Arthropoma cecilia* Audouin, 1826

This genus, curious by its jointed operculum, is represented by only one mediterranean species, the type species *A. cecilia* (Audouin, 1826); 285 (13 D) (GAUTIER, 1962:127)

BUFFONELLARIA Canu & Bassler, 1917

Colony encrusting. Frontal wall with marginal pores only. Primary orifice with a sinus. Oral spines present or absent. Avicularia adventitious, lateral to orifice, frequently enlarged, with acute or spatulate mandible. Ovicell prominent, imperforate, not closed by zooidal operculum. Diatellae present (after HAYWARD & RYLAND, 1979).

Type species: "*Hippothoa*" *divergens* Smitt, 1873

Only one species *B. divergens* (Smitt, 1873); 286 (HAYWARD & RYLAND, 1979:204)

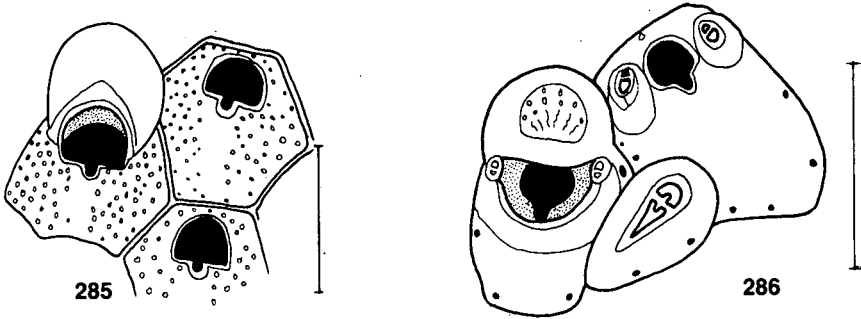

CALYPTOTHECA Harmer, 1957

Colony encrusting. Surface of zooids and ovicells with evenly distributed pores, rarely smooth. Orifice and operculum with a broad sinus and small condyles; dimorphic: fertile broader than long. An umbo of moderate size, sometimes present. Avicularium vicarious and large in some species, but generally adventitious and small; one usually present on each side of the orifice; one additional avicularium, sutural (in the peristomial suture), in some species. Ovicell immersed, formed by an isolated fertile zooid or by two or three components, separated by suture lines (after HARMER, 1957).

Type species: *Schizoporella nivea* var. *wasinensis* Waters, 1913

The presence of *Calyptotheca* in the Mediterranean was unknown until 1974, when Hayward describe two new species referable to the genus: *C. rugosa* and *C. triarmata*. The first one seems to be very close to *C. wasinensis*, which Harmer chose as a genotype. Systematic position as well as geographic distribution of both species need to be verified. As it seems, they do not pass beyond the bounds of the eastern Mediterranean.

- 1. Three suboral avicularia, constant ... *C. triarmata* Hayward, 1974; (*) 288 (HAYWARD, 1974:381)
- One suboral avicularium, rare *C. rugosa* Hayward, 1974; (*) 287 (HAYWARD, 1974:379)

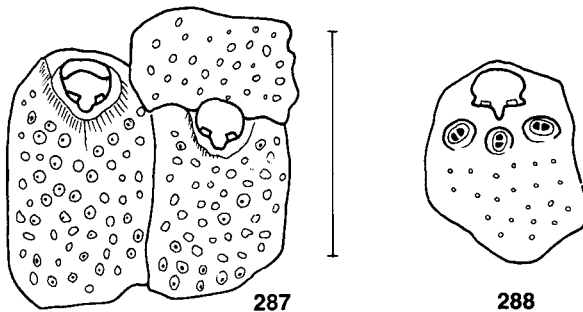

CRIBELLOPORA Gautier, 1957

Colony encrusting. Zooids rhomboidal with a flat frontal wall perforated by a series of pores, sieve-like, each compose of 3 or 4 simple pores very close together. Aperture and operculum with a rounded sinus (cf. *Schizoporella*). Calcareous periapertural fringe not forming a peristome. Neither spines nor avicularia. Ovicell hyperstomial, closed by zooidal operculum and perforated by the same sieve-like pores, apart from the central region where there is a calcareous tuberosity. With dietellae (after GAUTIER, 1957).

Type species: *Schizoporella trichotoma* Waters, 1918

Gautier erected this genus for *S. trichotoma* Waters, which shows a peculiar system of pores, grouped in a stellate manner. This species, well known in other warm seas, is on the contrary very rare in the Mediterranean, where it does not seem to have been found off Balearic Islands. Nevertheless, GAUTIER's description (1957) is based on material from Majorca
 *C. trichotoma* (Waters, 1918); 289 (14 G-H) (GAUTIER, 1962:154)

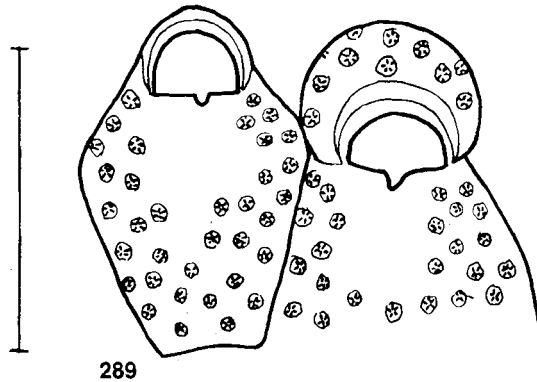

ESCHARINA Milne-Edwards, 1836

Colony encrusting. Frontal wall with marginal areolae. Orifice with oval, distal border; proximal border with a short, narrow and quadrate sinus (U-shaped). Avicularia vicarious or adventitious, developed from pore-chambers; mandible acute or setiform (sometimes very long). Ovicell hyperstomial, closed by zooidal operculum; prominent or immersed; imperforate, with or without frontal umbones. Basal pore-chambers (dietellae) numerous, small (after HAYWARD & RYLAND, 1979).

Type species: *Eschara vulgaris* Moll, 1803

- 1. Avicularia typically paired, rostrum acute, mandible rarely larger than an autozooid. Ovicell prominent, longer than broad (*Escharina* s. stricto) 2
 - Avicularia typically single, rostrum oval, mandible often exceeding length of autozooid. Ovicell immersed, broader than long (sensu *Herentia*) 3
- 2. Paired avicularia lateral to orifice; cystid small, mandible whip like
 - *E. aff. duterrei* (Audouin, 1826); 293, 293 bis (15 A-C) (GAUTIER, 1962:157)
 - Paired avicularia distant and proximal to orifice; mandible setiform, rostrum acute
 - *E. vulgaris* (Moll, 1803); 290, 290 bis (GAUTIER, 1962:158)

3. Frontal wall evenly perforated by small pores, granular. Ovicell reduced to a calcareous ridge distal to aperture *E. porosa* (Smitt, 1873); 291 (15 F) (HAYWARD, 1974:377)
- Frontal wall smooth and flat with a series of distinct marginal areolae. Ovicell immersed but more developed, with a prominent, transverse ridge
 *E. hyndmanni* (Johnston, 1847); 292, 292 bis (15 D-E) (HAYWARD & RYLAND, 1979:196)

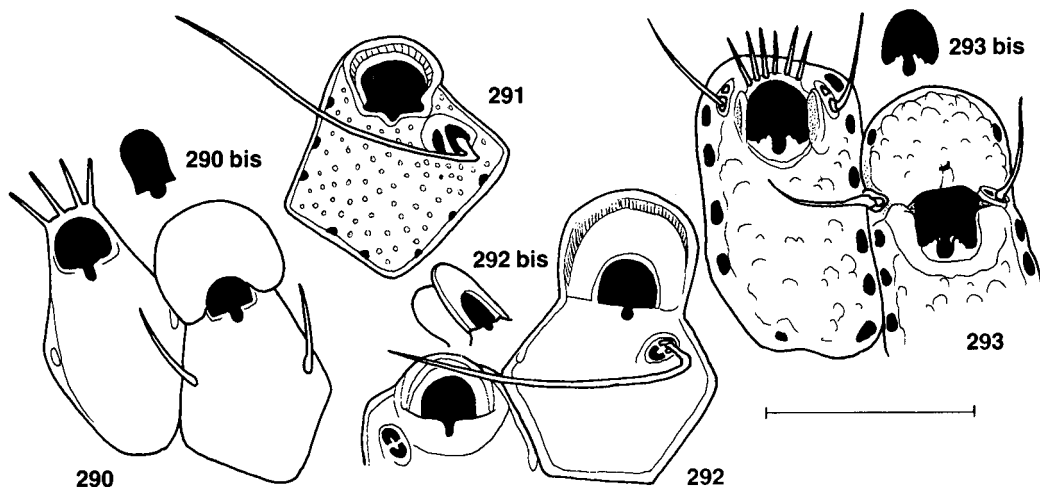

METROPERIELLA Canu & Bassler, 1917

Colony encrusting. Zooids with frontal wall perforated by numerous pores, and with median suboral avicularium. Orifice with a broad, rounded sinus, larger than in *Schizomavella*. Ovicell hyperstomial, large, globular and porous.

Type species: *Schizoporella lepralioides* Calvet, 1903

Only one species; common *M. lepralioides* (Calvet, 1903); 294 (16 A) (GAUTIER, 1962:130)

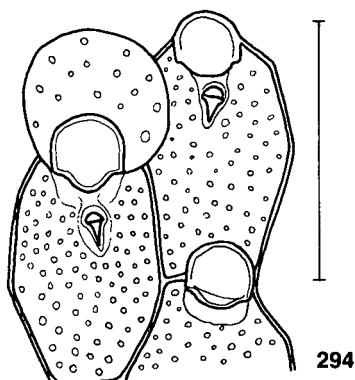

SCHIZOBRACHIELLA Canu & Bassler, 1920

Colony encrusting. Frontal wall regularly and evenly perforated. Primary orifice with sinus and prominent lateral condyles. Oral spines absent. Avicularium adventitious, minute, rare, adjacent to orifice. Vicarious avicularia absent. Ovicell hyperstomial, prominent, perforated, closed by zooidal operculum. Uniporous septula present in vertical walls.

Type species: *Hemeschara sanguinea* Norman, 1868

This genus was erected exclusively for the type species, a common species, readily distinguishable and widespread in the Mediterranean *S. sanguinea* (Norman, 1868); 295 (16 E) (GAUTIER, 1962:128)

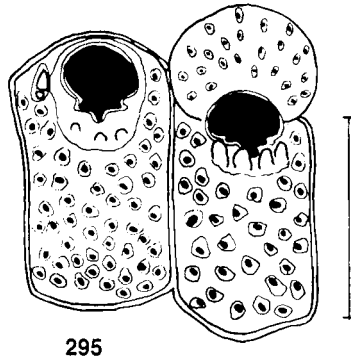

SCHIZOMAVELLA Canu & Bassler, 1917

Colony encrusting. Primary orifice with a sinus. Oral spines present. Frontal wall with evenly distributed perforations over the whole surface. Avicularia typically single, suboral, proximal to the sinus, often on a stout umbo. Enlarged adventitious avicularia often present. Ovicell prominent, globular with irregular perforations, closed by zooidal operculum. Multiporous or uniporous septula present.

Type species: *Lepralia auriculata* Hassall, 1842

1. Primary orifice of ovicellate zooids surrounded by a deep peristome. Six (5-7) oral spines. Two types of avicularia: 1/ small and elliptical, asymmetrical and sometimes paired; or 2/ large and spatulate, covering the frontal wall, sporadic but characteristic. Zooids small (Lz < 0.500 mm) *S. discoidea* (Busk, 1859); 296 (16 F) (GAUTIER, 1962:158)
 - Never with a peristome. Two to 4 oral spines, or absent. Zooids larger (Lz > 0.500 mm) 2
2. Oral spines always absent. No suboral umbo, or if present without avicularium 3
 - Two to four oral spines in young zooids. An umbonate suboral avicularium more or less constant (in the largest part of the species) 5
3. Avicularium triangular, narrow and very large (Lav > 0.15 mm), directed proximally and often somewhat oblique. Ovicell immersed, flat, surrounded by a crown of tubercles. Deepwater species (more than 100 m) *S. arrogata* (Waters, 1879); 297 (GAUTIER, 1962:131)
 - Avicularium elliptical, large or small, but always smaller than in the preceding species (Lav < 0.15 mm); always median. Ovicell without any crown of peripheral tubercles. Littoral species 4

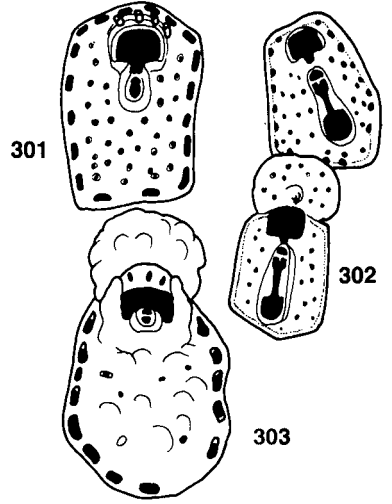
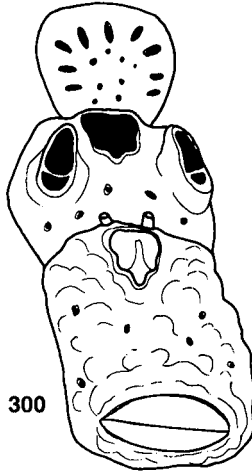
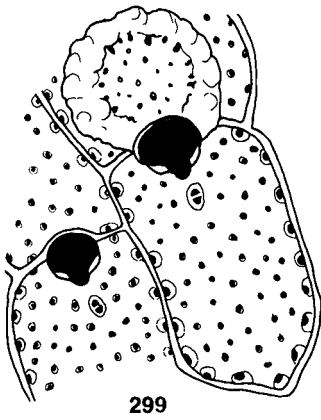
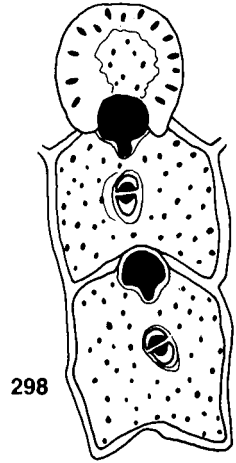
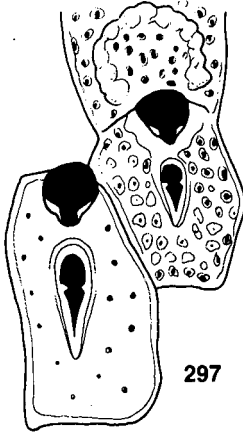
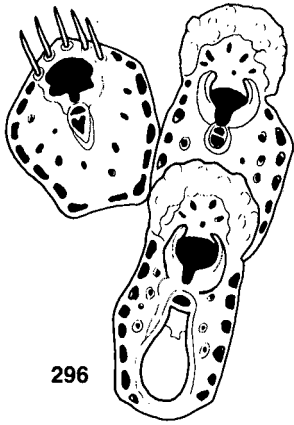

302

303

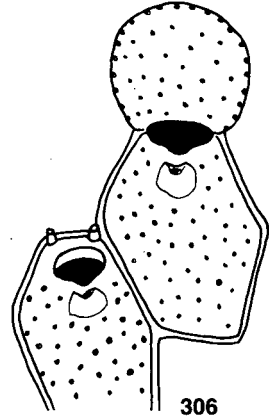
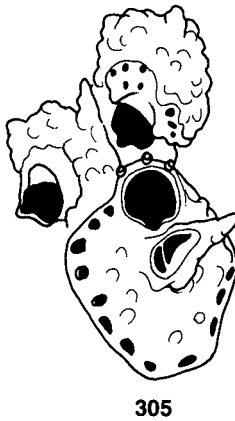
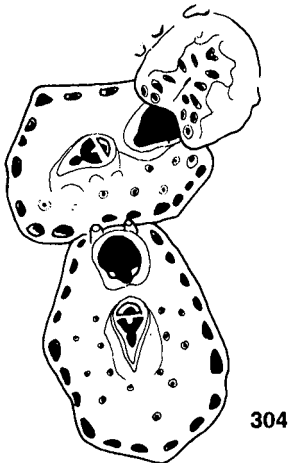

4. Avicularium large (Lav > 0.100 mm), situated on the mid-point of the frontal wall (separated from the aperture), ogival *S. monoecensis* (Calvet, 1927); 298 (GAUTIER, 1962:145)
 - Avicularium small (Lav = 0.06 - 0.07 mm), close to the sinus, elliptical
..... *S. rudis* (Manzoni, 1869); 299 (17 D) (GAUTIER, 1962:146)
5. Generally two avicularia per zooid, small, triangular or subogival, symmetrical and proximal to the aperture; directed obliquely distally. Sporadically substituted by a large avicularium with crescentic mandible *S. linearis* (Hassall, 1841); 300 (18 A) (GAUTIER, 1962:140)
 - Never more than one avicularium per zooid 6
6. Avicularium elliptical, suboral, small, often placed on a small umbo. In some zooids these avicularia are replaced by an enlarged type with elongate, spatulate mandible, following the long zooidal axis *S. auriculata* (Hassall, 1842); 301 (forma *typica*), 302 (forma *leontiniensis*), 303 (forma *cuspidata*) (16 B, 17A) (GAUTIER, 1962:145)
 - Avicularium always triangular 8
7. Avicularium always associated with a more or less developed umbo 8
 - Without suboral umbo. Avicularium supported by a bulky avicellarium, triangular, broad and large (Lav > 0.100 mm), situated on the centre of the frontal wall in flat position
..... *S. mamillata* Gautier, 1958; 304 (17 B-C) (GAUTIER, 1962:143)
8. Avicularium triangular, elongated; situated on the lateral edge of a prominent spiked umbo which arises perpendicularly from the frontal wall, in vertical position and directed towards the apex of the umbo. Orofice with a broad, shallow sinus and opercular sclerites. Ovicell with tubercles and processes *S. hastata* (Hincks, 1862); 305 (17 E-F) (GAUTIER, 1962:149)
 - Avicularium triangular, small (Lav < 0.05 mm), situated on a small suboral umbo. Zooids separated by a smooth, conspicuous and projecting calcareous fringe. Frontal wall with stellate pores. Ovicell with a peripheral fringe. Rare species
..... *S. marsupifera* (Busk, 1884); (*) 306 (GAUTIER, 1962:144)(BUSK, 1884:165 pl. 12)

SCHIZOPORELLA Hincks, 1877

Colony encrusting. Frontal wall evenly perforated. Primary orifice with a sinus on the proximal border and inconspicuous condyles. Avicularia adventitious, paired or single, situated lateral to the orifice; occasionally developed elsewhere on the frontal wall (may be three or none). Spines absent or present only in peripheral zooids. Ovicell typically globular, prominent; recumbent on the succeeding zooid, not closed by zooidal operculum, with scattered pores, ridges or umbones.

Type species: *Lepralia unicornis* Johnston in Wood, 1844

Schizoporella tetragona (Reuss) was described as a fossil species from the Tertiary; subsequently it was wrongly used by several authors (i.e. MANZONI, 1879; or CIPOLLA, 1921 as *S. unicornis* var. *longirostris* to denominate specimens of *S. longirostris*); more recently RYLAND (1968) recognized it as present in the Mediterranean, taking for this as a synonym the recent species *Schizopodrella elliptica*. This species, unfortunately incompletely described from dead specimens by CANU & BASSLER (1930), has been rediscovered by GAUTIER (1962) and presents differences from the Ryland's *S. tetragona*; the number of spines and, particularly, the proportions of the orifice (ratio L/w) are not coincident.

The early authors described other mediterranean species, the identity of which has still to be proven.

After GAUTIER's opinion (1962), *S. latreillei* (Waters, 1925) is a distinct species, and *S. mutabilis* (Calvet, 1927) seems equally well defined. *S. neptuni* Jullien (1882) is a deep atlantic species that has recently been re-found in deep samples from the Mediterranean (siculo-tunisian line, 320-600 m, Harmelin, pers. com.).

It is not unlikely that other valid species exist among those cited by early authors but which we have overlooked.

Therefore, we could provisionally accept as present in the Mediterranean the following species: *Schizoporella dunkeri* (Reuss), *S. errata* (Waters), *S. longirostris* (Hincks), *S. magnifica* (Hincks), *S. mutabilis* (Calvet), *S. neptuni* (Jullien), *S. unicornis* (Johnston), and *S. tetragona* (Reuss).

Of these eight species, five occur (provisionally) on our shores: *S. dunkeri*, *S. errata*, *S. longirostris*, *S. magnifica* and *S. unicornis*, although many of the citations of the latter are doubtful.

1. Sinus broad, low, U-shaped, wider than deep 2
 - Sinus narrow, U or V-shaped, as deep as or deeper than wide 4
2. Orifice wider than long, appearing semicircular; sinus occupying half the proximal border. Suboral umbo. Avicularia typically paired.
 - *S. unicornis* (Johnston in Wood, 1844); 309 (HAYWARD & RYLAND, 1979:168)
 - Orifice as wide as long, appearing circular; sinus occupying more than half the proximal border. Avicularium single 3
3. Frontal wall rugose, with numerous deep perforations. Without umbo or spines. Avicularium lateral to the sinus, directed parallel, transverse or oblique to zooidal axis; elongated, triangular in shape. Zooids large (Lap > 140 μ), rectangular, aligned
 - *S. errata* (Waters, 1848); 308 (GAUTIER, 1962:149)
 - Frontal wall more or less smooth. With a well developed suboral umbo (sometimes spiked) and 2-5 spines (on marginal zooids). Avicularium distal to the sinus, directed distally or distolaterally; short triangular in shape. Zooids small (Lap < 130 μ), oval or hexagonal, forming a reticle
 - *S. tetragona* (Reuss, 1848); (*) 310 (RYLAND, 1968:537)
4. Sinus V-shaped, narrow and deep. Maximum width of sinus 1/4 width of proximal border of orifice 5
 - Sinus U or V-shaped, but wider. Maximum width of sinus 1/3 width of proximal border of orifice 7
5. Avicularia generally paired, triangular, short; lateral and level with the orifice
 - *S. mutabilis*. Calvet, 1927; 311 (GAUTIER, 1962:152)
 - Avicularium generally single, triangular, elongated and narrow; proximal to the orifice, or lateral and situated towards the zooid margins 6
6. Avicularia setiform, always proximal to the orifice. Six or more oral spines. Always deep species .
 - *S. neptuni* (Jullien, 1882); (*) 314 (18 F)
 - Avicularium long but never setiform; when paired, level with the orifice. Without spines
 - *S. longirostris* (Hincks, 1886); 312 (18 C-D) (HAYWARD & RYLAND, 1979:173)
7. Orifice wider than long; sinus V-shaped, as deep as its maximum width. Avicularia situated level with the sinus and typically directed distally or disto-laterally
 - *S. dunkeri* (Reuss, 1848); 307 (18 B) (HAYWARD & RYLAND, 1979:172)
 - Orifice longer than wide (or sometimes as wide as long); sinus U-shaped, deeper than wide. Avicularia situated distal to the sinus, directed distally
 - *S. magnifica* (Hincks, 1886); 313 (18 E) (HAYWARD & RYLAND, 1979:174)

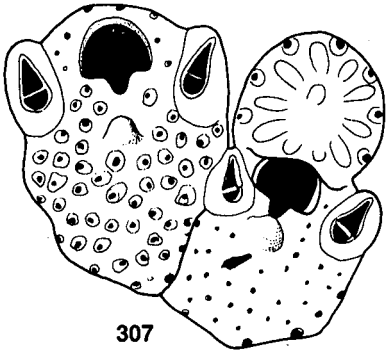

307

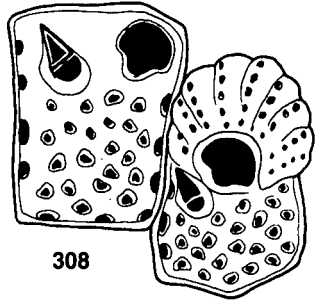

308

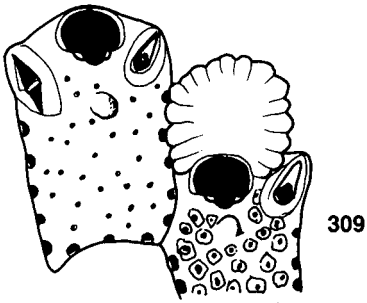

309

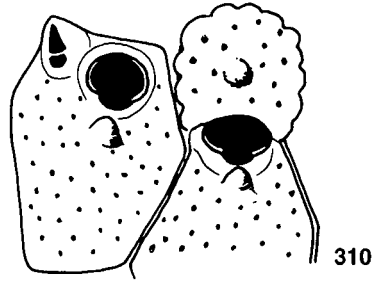

310

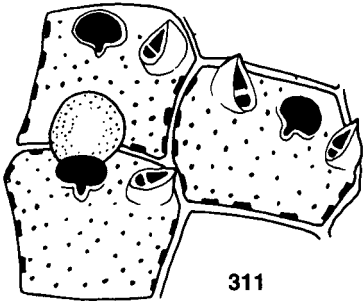

311

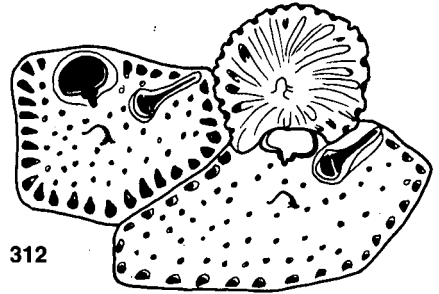

312

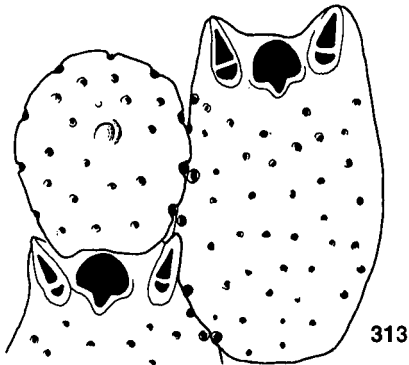

313

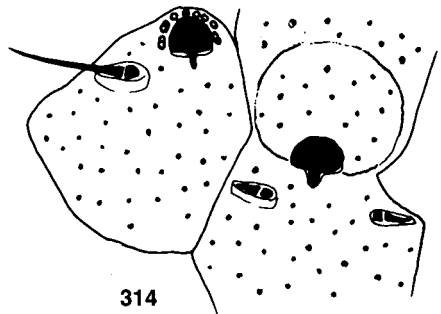

314

CHARACODOMA Maplestone, 1900 (in HARMER, 1957)

Colony erect, slender, little ramified. Zooids small, convex, tubular. Orifice keyhole-shaped or with a broad sinus. Ovicell globular, not closed by zooidal operculum (1). Frontal wall ornamented with numerous cylindrical or pointed processes. Vicarious avicularium large and spatulate.

Type species: *Characodoma halli* Maplestone, 1900

After HARMER (1957), this genus comprises two species besides the type species: *Characodoma bifurcatum* and *Ch. latisinuatum*. Only the first seems to be Mediterranean, although the only citation refers to Capri, from where WATERS (1918) described *Lepralia bifurcata*. The species has never been found again; it is an extremely rare species

..... *Ch. bifurcatum* (Waters, 1918); (*) 315 (WATERS, 1918; (9)II: 96) (HARMER, 1957:1006)

(1) Up to this point, Maplestone's original diagnosis, without further correction, would refer also to *Cleidochasma* Harmer (1957), which seems to be very close to *Characodoma*. Harmer defines the two genera a little more clearly but it remains to decide whether the presence of cylindrical processes over the frontal wall justifies the separation of them.

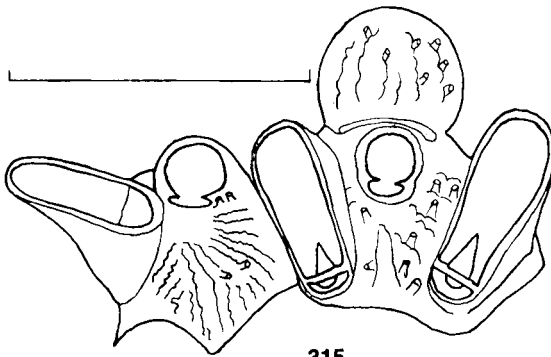

CLEIDOCHASMA Harmer, 1957

Colony plurilaminar, encrusting or erect. Orifice clethridiate (keyhole-shaped), with well developed paired condyles. Oral spines often present. Frontal wall with marginal pores and additional scattered frontal pores. Avicularia adventitious and vicarious. Ovicell hyperstomial with a frontal area; not closed by zooidal operculum. Uniporous or multiporous septula, or dietellae, present.

Type species: *Gemellipora protusa* Thornley, 1905

Two species occur in the Mediterranean, though they seem confined to the westernmost north African shores.

1. Colony erect, adeoniform. Orifice with four spines, proximal border or the poster straight or slightly convex. Avicularium with long, triangular, curved mandible
 *C. oranense* (Waters, 1918); (*) 316 (COOK, 1964:17)
- Colony encrusting. Orifice with three spines, proximal border of the poster concave. Avicularia with triangular mandible but more rounded, always symmetrical, straight
 *C. porcellanum* (Busk, 1860); (*) 317 (COOK, 1964:11)

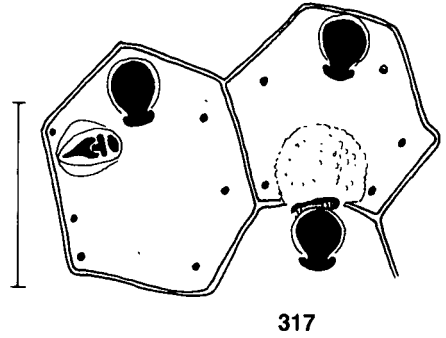
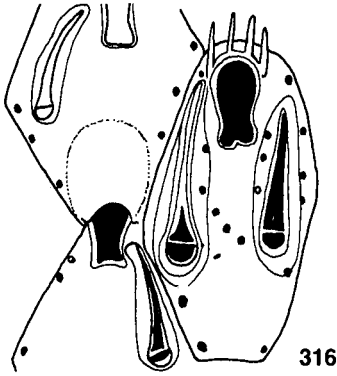

HIPPOPODINELLA Barroso, 1924

Colony encrusting. Frontal wall with numerous, evenly spaced pores, or with marginal pores only. Orifice lepralioid (horseshoe – shaped) with strong lateral condyles. Oral spines absent. Nodular umbones developed lateral to orifice, occasionally supporting small, elliptical avicularia. Other avicularia absent. Ovicell partially immersed, sparsely perforated, closed by zooidal operculum. Numerous dietellae present.

Type species: *Lepralia adpressa* Busk, 1856

1. Aperture very distal. Peripheral opercular sclerites disappearing towards the distal border. Umbones two to three, always well developed, sometimes with avicularia 2
- Aperture not very distal. Opercular sclerites not peripheral. Umbones less developed, always without avicularia *H. lata* (Busk, 1856); 318 (GAUTIER, 1962:181)
2. Zooids small; lateral umbones always lodging avicularia. Colony deeply pigmented
..... *H. kirchenpaueri* v. *tregoubovii* Gautier, 1962; (*) 320 (GAUTIER, 1962:180)
- Zooids much larger. umbones without avicularia, or very inconstant. Colony paler in colour
..... *H. kirchenpaueri* (Heller, 1867); 319 (19 A) (GAUTIER, 1962:179)

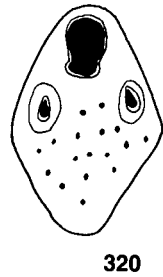
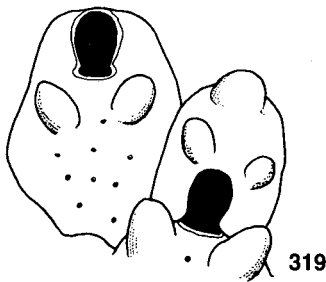
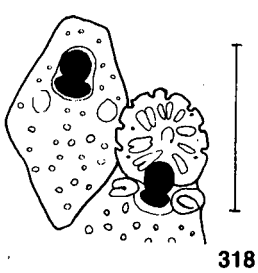

HIPPOPORIDRA Canu & Bassler, 1927

Colony encrusting, typically on gastropod shells inhabited by hermit crabs; nodular, massive, plurilaminar. Frontal wall with marginal pores and some scarce frontal; with dietellae. Orifice cleithridiate, condyles variable. No oral spines. Peripheral zooids (cortical), heteromorphic with 3 to 4 rows of marginal

pores and reduced apertures. Frontal avicularia small, and vicarious, variously sized and triangular or spatulate in shape. Ovicell hyperstomial, not closed by zooidal operculum and with a lightly calcified frontal area.

Type species: *Cellepora edax* Busk, 1859

One species represents the genus *Hippoporidra* in the Mediterranean: *H. picardi*, a rare species, described by GAUTIER (1962) from the Aegean Sea

..... *H. picardi* Gautier, 1962; (*) 321 (GAUTIER,1962:254, fig. 22) (COOK; 1964:31)

CALLOPORINA Neviani, 1895

Colony encrusting. Zooids with the frontal wall thick, rugose and with suboral ascopore. Orifice with curving distal border, and straight proximal border, surrounded by stout oral spines (cf. *Microporella*). Avicularium adventitious, lateral to orifice, long and acute. Ovicell characteristic: with a crescentic scar separating an imperforate proximo-frontal area from the distal lateral area, ornamented with radiating series of pores.

Type species: *Cellepora decorata* Reuss, 1848

Only one Mediterranean species, the type species, which is rare and has been only infrequently cited

..... *C. decorata* (Reuss, 1848); (*) 322 (HARMER, 1957:970)

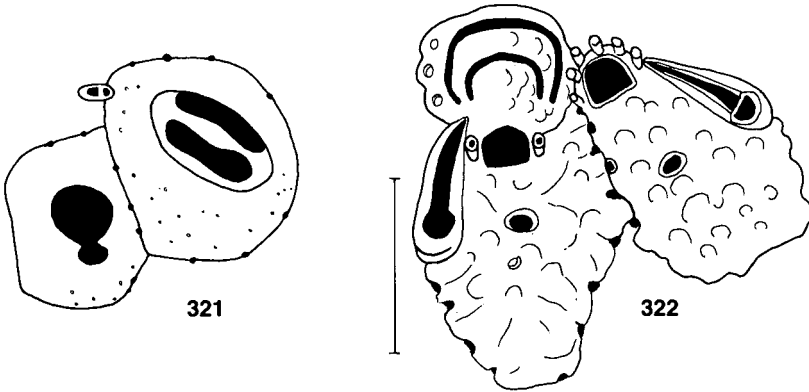

DIPORULA Hincks, 1879

Colony erect, vinculariiform. Primary orifice semicircular, ascopore proximal to lower rim. Frontal wall with scattered pores and very large marginal areolae. Avicularium adventitious, proximo-lateral to the orifice, developing from a marginal pore. Ovicell globular, perforated. Small multiporous septula present (after HAYWARD & RYLAND, 1979).

Type species: *Eschara verrucosa* Peach, 1868

Only one Mediterranean species, the type species

..... *D. verrucosa* (Peach, 1868); 323 (19 B) (GAUTIER1962:176)

FENESTRULINA Jullien, 1888

Colony encrusting. Primary orifice semicircular; ascopore distinct and denticulate. Frontal wall with scattered pores. No avicularia. Ovicell hyperstomial, prominent, closed by zooidal operculum; entoecium calcified, ectoecium membranous, with conspicuous lateral pores. Dietellae large and distinct.

Type species: *Cellepora malusii* Audouin, 1826

1. From 6 to 8 oral spines; zooids small (Lz < 0.40 mm); prominent suboral umbo. Non-stellate pores. Almost exclusively epiphytic on *Posidonia* leaves *F. joannae* (Calvet, 1902); 324 (GAUTIER, 1962:171)
- From 2 to 4 oral spines; zooids larger (Lz > 0.40 mm); suboral umbo absent. Stellate pores. In other habitats *F. malusii* (Audouin, 1826); 325 (GAUTIER, 1962:170)

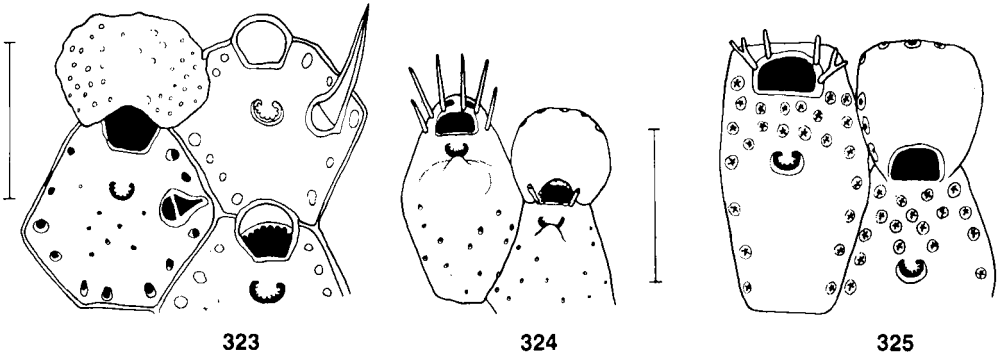

HAPLOPOMA Levinsen, 1909

Colony encrusting. Zooids very convex, with translucent frontal wall, calcification often transversely striated. Pores few or numerous, but always present, evenly scattered or grouped along zooid margins; often extended distally by a thin suture; simple or stellate. Neither avicularia nor spines. Ovicellate zooids indistinguishable from other zooids, separable only by orifice size; or conspicuously shorter. Ovicell subglobular, porous, surrounded by a ring of pore-chambers, recumbent on the distal zooid, with orifice closed by zooidal operculum (after HAYWARD & RYLAND, 1979).

Type species: *Flustra impressa* Audouin, 1826

1. Frontal pores scattered in a single marginal series. Orifice as long as broad; ovicellate zooids much shorter than non-ovicellate zooids. In caves (1) *H. sciaphilum* Silen & Harmelin, 1976; (*) 326 (HAYWARD & RYLAND, 1979:232)
- Frontal pores scattered all over the frontal surface; orifice broader than long. All zooids about the same size (2) 2
2. Frontal pores simple. Dietellae clearly visible (in frontal view) as a series of internal blisters. Orifice of ovicellate zooids about 1/3 wider than non-ovicellate zooids. The deepest occurring species (10-100 m) (3) *H. impressum* (Audouin, 1829); 329, 330 (GAUTIER, 1962:125)

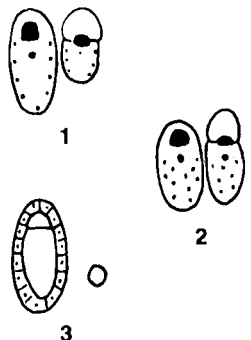

- Frontal pores stellate, evenly scattered. Dietellae scarcely visible from the front, tubular in basal view. Orifice of ovicellate zooids not much wider than in other zooids (4) 3

3. Zooids with two lateral ridges. Basal surface with a central uncalcified window (5) 4

- Zooids without lateral ridges. Basal surface completely calcified, without uncalcified window (6) 5

4. Zooids very large (Lz > 0.50 mm), without suboral umbo; ascopore always visible. On *Posidonia* and *Vidalia* *H. bimucronatum* (Moll, 1803); 327 (GAUTIER, 1962:121)

- Zooids small (Lz < 0.50 mm). A large suboral umbo usually concealing the ascopore. From 0 to 2 m depth (on the "trottoir" of *Pseudolithophyllum tortuosum*, especially on *Mytilus*) *H. bimucronatum* f. *occiduum* (Waters, 1879); 328 (GAUTIER, 1962:122)

5. Zooids with median longitudinal ridge and well developed umbo (suboral). Always on gastropod shells. The only species with dense calcification *H. graniferum* f. *carinatum* (Calvet, 1902); (*) 333 (GAUTIER, 1962:124)

- Zooids without ridge and with poorly developed umbo. On gastropod shells, stones and calcareous algae *H. graniferum* (Johnston, 1847); (*) 331, 332 (GAUTIER, 1962:123)

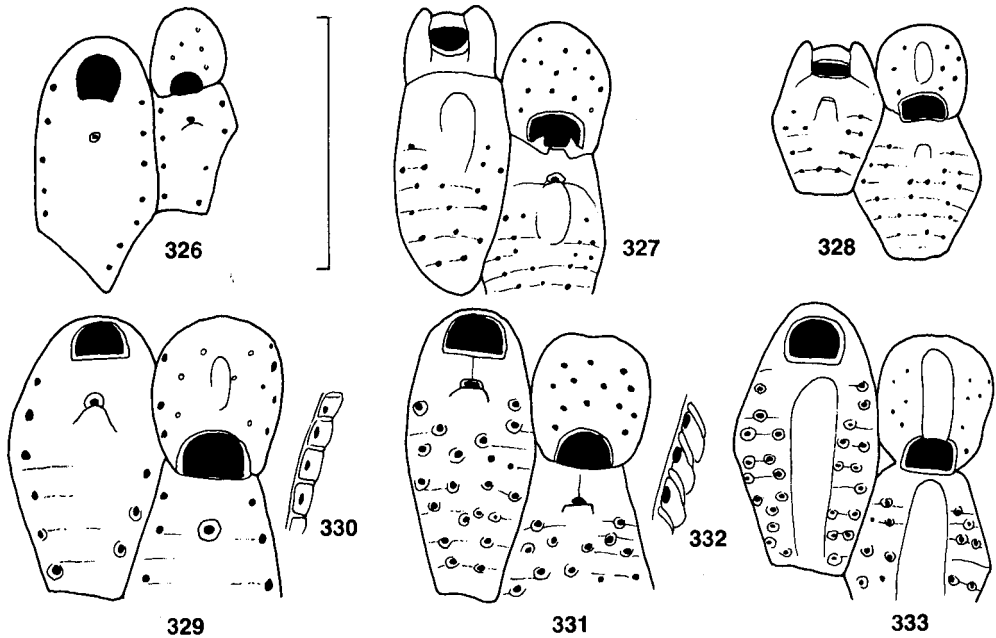
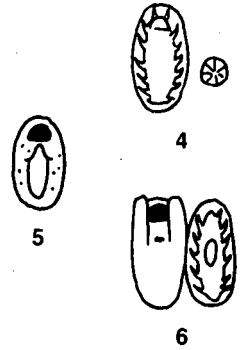

MICROPORELLA Hincks, 1877

Colony encrusting. Frontal wall with scattered, isolated pores. Primary orifice semicircular, without sinus. Ascopore distinct, denticulate, proximal to orifice on a raised base. Oral spines present. Avicularia adventitious, generally paired, with acute or setiform mandibles. Ovicell hyperstomial, prominent, imperforate, closed by zooidal operculum. Dietellae large and distinct (after HAYWARD & RYLAND, 1979).

Type species: *Eschara ciliata* Pallas, 1766

ARISTEGUI (1984) pointed out the differences between *Lepralia marsupiata* Busk and the *Microporella marsupiata* of recent European authors (i.e. HAYWARD & RYLAND 1979, p. 220). In his opinion they are two different species and he suggests for the second species the name *Microporella pseudomarsupiata* Aristegui. Thus, the distribution of *Microporella marsupiata* Busk would remain restricted to Madeira and the Canary islands, while *Microporella pseudomarsupiata* would be distributed from Cabo Verde to English Channel and throughout the Mediterranean.

1. Avicularia generally paired. Five to eight oral spines, thick and coloured 2
 – Avicularium single (one per zooid). Four to six oral spines slender and translucent 3

2. Colony brown or yellow. Six to eight spines, the proximal pair forked. Base of the avicularium situated distal to the ascopore. Ovicell with a calcareous transverse rib 4
 – Colony glossy white. Five to six spines, none of them forked. Avicularium proximal to the ascopore. Ovicell smooth, without rib. *M. umbracula* (Audouin, 1826); 336 (ARISTEGUI, 1984:331)

3. Mandible setiform, with a pair of hook-shaped processes, situated halfway along its length. Expansions of the ovicell surrounding the aperture, often forming a tube rising above the orifice or curving towards the ascopore. Very rare *M. orientalis* Harmer, 1957; (*) 338 (HAYWARD, 1974:381)

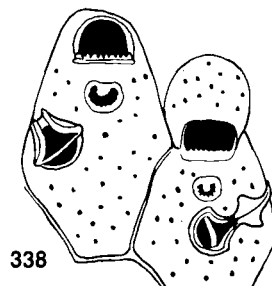
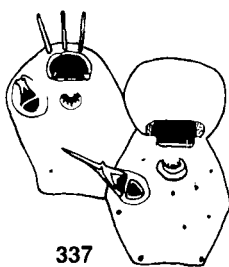
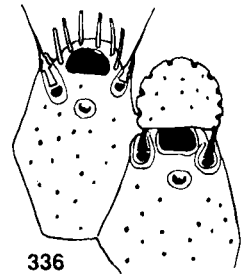
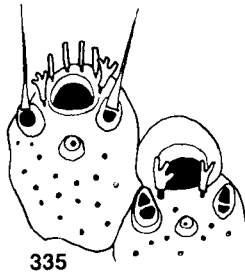
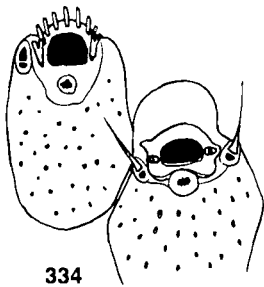

- Mandible setiform, but without lateral processes. Ovicell uniformly granulate, without expansions surrounding the aperture. Very common
 *M. ciliata* (Pallas, 1766); 337 (HAYWARD & RYLAND, 1979:222)

- 4. Zooids large (Lz > 0.90 mm) and convex. Frontal pores small and numerous. Six to eight oral spines. Avicularium generally single, situated between the ascopore and the orifice, with a small rostrum. Colony yellow *M. marsupiata* (Busk, 1860); 334 (ARISTEGUI, 1984:323)
- Zooids shorter (Lz < 0.80 mm) flat or little convex. Frontal pores few and larger. Five to seven oral spines. Avicularia typically paired, situated laterally to the orifice, with a large rostrum. Colony brown *M. pseudomarsupiata* (Aristegui, 1984); 335 (19 C) (ARISTEGUI, 1984:325)

CHORIZOPORA Hincks, 1879

Colony encrusting. Primary orifice semicircular. Frontal wall thinly calcified, translucent, imperforate. Avicularia vicarious, small, elliptical. Ovicell hyperstomial, prominent, imperforate, closed by zooidal operculum. Zooids often separated by broad spaces in such a way that interzooidal connexions are made by tubular extensions of the pore-chambers (diatellae). Small kenozooids present in the interzooidal spaces.

Type species: *Flustra brongniartii* Audouin, 1826

The type species is the only representative of the genus in the Mediterranean. Very abundant.....
 *Ch. brongniartii* (Audouin, 1826); 339, 340, 341, 342 (19 D) (GAUTIER, 1962:126)

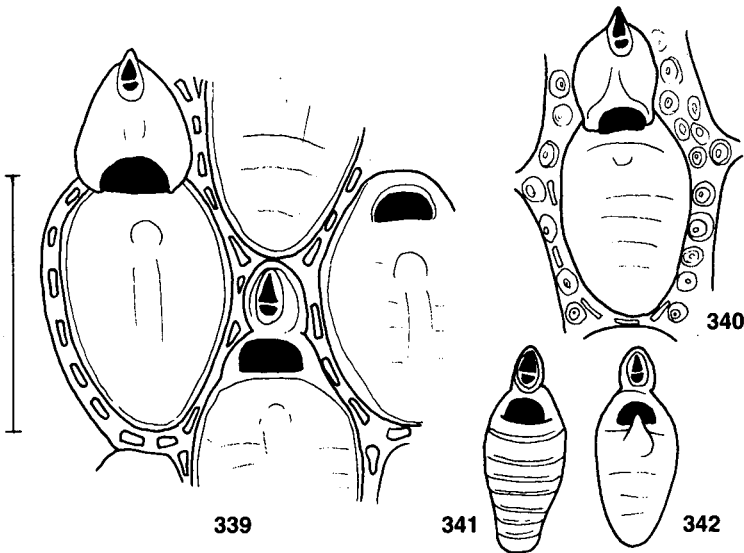

TESSARADOMA Norman, 1869

Colony erect, vinculariform, unjointed; attached by an encrusting base. Frontal wall with distinct marginal pores. Peristome projecting, smooth, tubular. Spiramen prominent, not becoming immersed by calcification. Ovicell visible only on youngest zooids, elsewhere obscured by continued calcification. Adventitious avicularia present.

Type species: *Onchopora borealis* Busk, 1860

Monospecific genus characteristic of cold waters. In the Mediterranean it is a deepwater, rare species. We have found it as a component of superficial sediments of the Cabo de Gata continental shelf (southern Spain) *T. boreale* (Busk, 1860); 343 (HAYWARD & RYLAND, 1979:242)

CYLINDROPORELLA Hincks, 1877

Colony encrusting. Primary orifice orbicular, enclosed by an erect, cylindrical peristome. Spiramen at the base of the peristome, opening immediately above the operculum. Frontal wall evenly perforated. Ovicell prominent, imperforate, opening into peristome, not closed by zooidal operculum. Avicularia and spines absent. Dietellae present.

Type species: *Lepralia tubulosa* Norman, 1868

The type species is the only Recent representative of this genus, at least on European shores. After HAYWARD & RYLAND (1979), *C. tubulosa* is an arctic-boreal species, circumpolar in distribution, and probable not ranging further south than Scotland. Therefore, LAUBIER'S (1966) record of this species (not otherwise cited in the Mediterranean) from the coralligenous of Les Alberes (northern Catalonia), must be regarded with extreme doubt (especially as this author is not a bryozoologist)
..... *C. tubulosa* (Norman, 1868); 344 (HAYWARD & RYLAND, 1970:244)

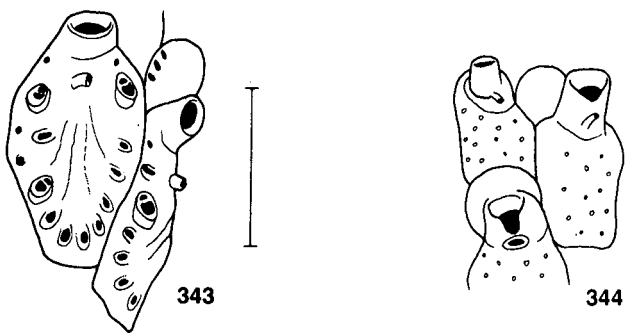

CELLEPORELLA Gray, 1848

Colony crustose, zooids coherent. Polymorphs include feeding autozooids, female ovicellate zooids, and smaller zooids which have been described as males. Frontal wall smooth, non-porous. Autozooids sausage shaped, lacking a cauda, frontally convex, separated by sulci; orifice sinusoid. Female orifice usually wide and without condyles. Pore-chambers tubular. Polypides without gizzard.

Type species: *Celleporella hyalina* (Linnaeus, 1767)

Only one species
C. hyalina (Linnaeus 1767); (*) 345, 346, 347, 348 (MORRIS, 1980:13) (HAYWARD & RYLAND, 1979:252)

HIPPOTHOA Lamouroux, 1821

Colony encrusting, sometimes multiserial but typically formed by branching, uniserial chains of zooids. Several types of polymorphs, which include: feeding autozooids, female zooids bearing ovicells and minute zoeciules of unknown function. Autozooids club-shaped comprising a distal dilatation and a thread-like proximal portion. Frontal wall gymnocystidean, smooth, fine, non-porous. Orifice schzoporelloid, with a sinus and paired condyles; that of female zooids not greatly different from that of autozooids. Neither spines nor avicularia. Ovicells of female zooids prominent and bulky, with the orifice combined with that of the zooid, closed by zooidal operculum.

Type species: *Hippothoa divaricata* Lamouroux, 1821

1. Zooids branching in the form of an X (up to two buds each side, spreading diagonally). Female zooids caudate, the dilated portion as long as in an autozooid. Sinus of orifice small, V-shaped. *H. divaricata* (Lamouroux, 1828); (*) 349, 350, 351, 352 (HAYWARD & RYLAND, 1979: 246)
- Zooids branching in the form of a + (no more than one bud each side). Female zooids almost ecaudate, the entire zooid short and inversely triangular. Sinus wide, almost semicircular *H. flagellum* (Manzoni, 1870); 353, 354, 355, 356 (HAYWARD & RYLAND, 1979:248)

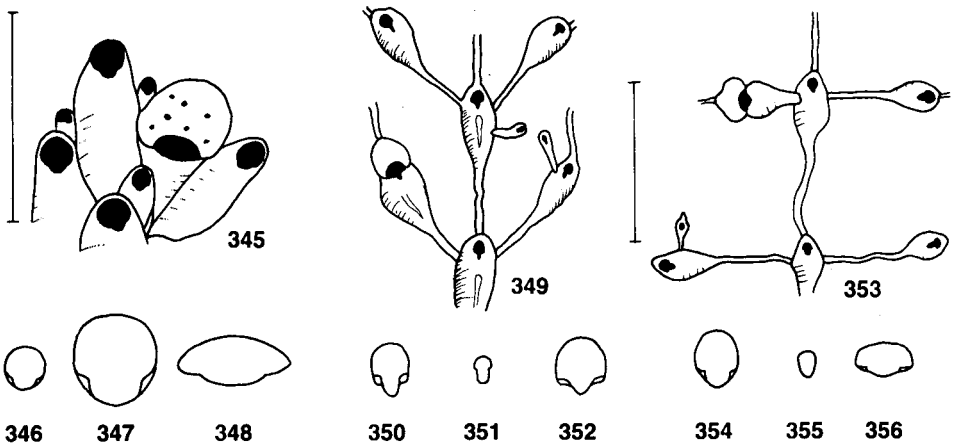

TRYPOSTEGA Levinsen, 1909

Colony encrusting. Primary orifice cleithridiate, with prominent condyles. Frontal wall evenly porous. Heterozooids ("zoeciules") regularly interspersed with autozooids, each with and orifice and operculum. Ovicell hyperstomial, prominent, perforated; closed by zooidal operculum. Dietellae present.

Type species: *Lepralia venusta* Norman, 1864

T. claviculata (Hincks, 1884) is an indo-pacific species rare in Mediterranean waters. GAUTIER (1962) found four dead colonies off the Tunisian coast at great depth (140-200 m), and HARMELIN (1978) reported very few colonies on detritic bottoms. A second species, *T. venusta* (Norman) is a warm temperate species with a circumtropical distribution, frequent in the Eastern Atlantic but not recorded from the Mediterranean sea. Recently, it has been found in a cave at Cala Ratjada, Majorca (Zabala & Maluquer, in prep.).

1. Orifice as long as broad, with broad, shallow sinus. Heterozoids inconstant, larger, lateral to the autozooids and with pyriform aperture. Zooid size larger (lz: 0.4 - 0.65 mm; lov: 0.35 mm). Ovicell trilobate, carinate *T. claviculata* (Hincks, 1884); 358 (ARISTEGUI, 1984:344)
- Orifice longer than broad, with a deep, narrow, triangular sinus. Heterozoids constant and smaller, distal to the autozooids, with rounded aperture. Zooid size smaller (lz: 0.42 - 0.55 mm; lov: 0.35 mm). Ovicell with or without an umbo but not carinate
 *T. venusta* (Norman, 1864); 357 (19 E) (HAYWARD & RYLAND, 1979: 258)

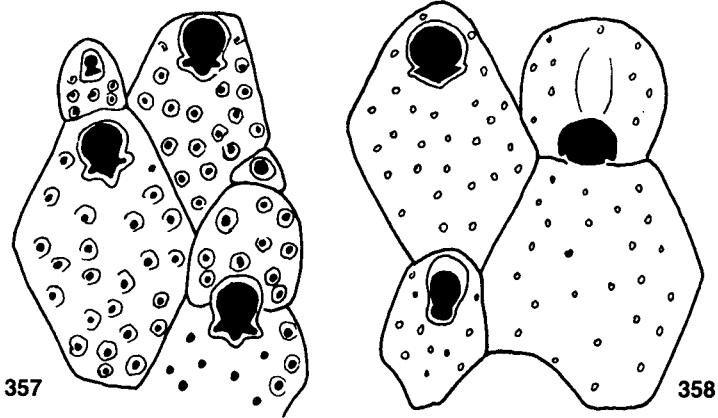

ADEONELLA Busk, 1884

Colony erect, adeoniform (branches flattened, bilaminar). Peristome at first regularly erect, sometimes even tubular; secondary orifice semicircular or circular. Spiramen made up by the union of two lateral peristomial lobes. Primary orifice and operculum with a very large, rounded sinus. Avicularia small, situated in latero-oral and frontal position; often numerous. Vicarious avicularia in various positions: 1/ frontal, large, long, rounded or sharp (sometimes absent); or 2/ marginal, short and generally sharp. Gonozooid marginal, dimorphic: the female with a transversely elongated spiramen, usually subdivided by a proximally directed languet; the male with a circular, undivided spiramen (after HARMER, 1957). Type species: *Adeonella polymorpha* Busk, 1884

1. Avicularia paired, large, triangular, narrow, in latero-frontal position, proximally directed somewhat convergent *A. calveti* (Canu & Bassler, 1930); 359 (GAUTIER, 1962:220)
- Avicularia paired, smaller, elliptical, in sub-peristomial position, transversely orientated
 *A. polystomella* (Reuss, 1847); (*) 360 (COOK, 1968:180) (HAYWARD, 1983: 588)

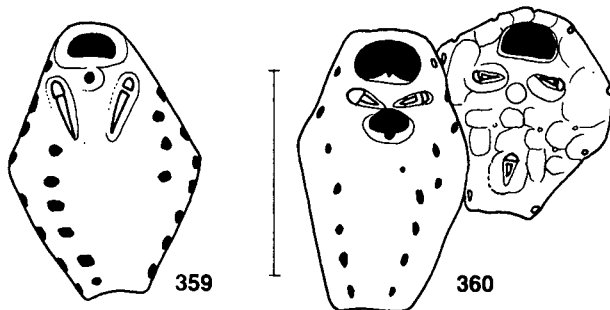

SAVYGNIELLA Levinsen, 1909

Colony erect, delicate, well ramified. Uniserial branches, each internode formed by a single zooid. Zooids composed of a tubular proximal part, and a swollen distal part; both lightly calcified; frontal wall with scattered pores, separated from basal side by a more or less marked delimitation line. Orifice surrounded by spines, with concave poster (proximal border), lacking sinus. One avicularium situated proximal to orifice, projecting. Ovicells present. Distal wall with uniporous septula.

Type species: *Eucratea lafontii* Audouin, 1826

This genus is constituted by only one species, the types species; which is present in the Mediterranean *S. lafontii* (Audouin, 1826); 361 (19 F) (GAUTIER, 1962:102)

RETEPORELLINA Harmer, 1933

Colony erect, branching, not reteporiform (that is, not fenestrate), or if anastomosed, leaving very long fenestrulae. Frontal wall smooth rarely with more than a pair of pores, often inconspicuous or absent. Peristome cylindrical or tubular, with marginal denticles and a sinus or a closed labial pore. Oral spines absent (non cf. *Reteporella*). Avicularia frontal, variously shaped, characteristic, although not always present; one avicularium clearly bicuspidate. Ovicell typically elongated and pear-shaped, widening distally, often with central fissure narrow and persistent; labellum distinct but not ridged; small lateral wings well developed, proximally extending beyond the level of the labellum (non cf. *Reteporella*).

Type species: *Retepora denticulata* Busk, 1884

The occurrence of representatives of this genus in the Mediterranean was unknown until HAYWARD (1974) reported from the eastern Mediterranean one species that with no doubt belonged to the genus: *R. delicatula* Hayward (1974). *R. delicatula* (Hayward, 1974); (*) 362 (HAYWARD, 1974:385)

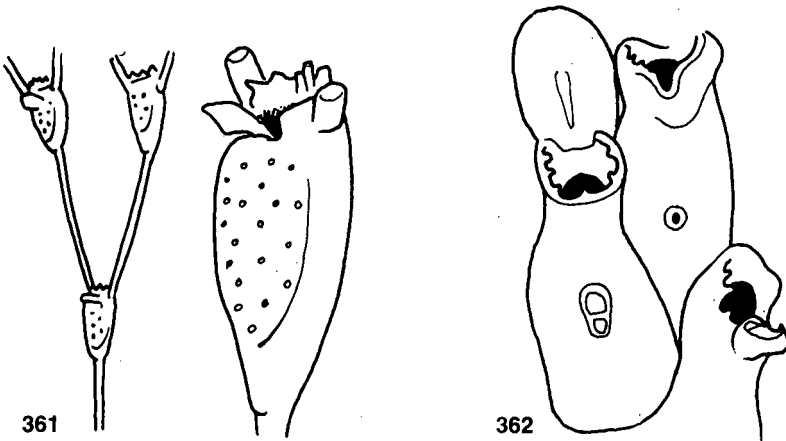

RETEPORELLA Busk, 1884

Colony erect, not reteporiform but vinculariiform, branching. Frontal wall smooth, rarely with more than a pair of pores, often indistinct or absent. Primary orifice partly visible only on young zooids; hidden in old zooids by a peristome, distally armed by a series of marginal denticles; cylindrical or antenniform spines, and proximally a closed labial pore, and one lateral avicularium on the pore. Ovicells immersed, pyriform, with narrow labial fissure (may be closed by calcification); without conspicuous labellum (lip) but with a descending sheet of straight or convex edge; small lateral wings absent or difficult to distinguish. Basal face with or without sutures; with or without avicularia.

Type species: *Reteporella flabellata* Busk, 1884

The distribution of the only Mediterranean species is very enigmatic. Even though a large species (colonies, up to 5 cm, are readily seen with the naked eye), and shallow (20-40 m), its occurrence in our sea was unknown till 1976, when, unexpectedly a diver collected it from the Hyères islands. Unknown on the Catalanian coasts. *R. elegans* Harmelin, 1976; (*) 363, 364, 365 (HARMELIN, 1976:99)

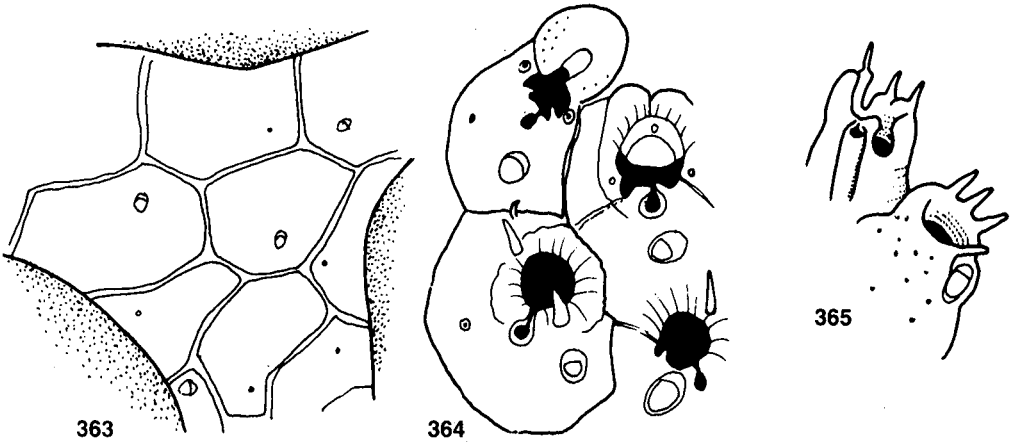

BRODIELLA Utley & Bullivant, 1972

Schizoporellid aperture with a cleithridiate sinus and beaded vestibular arch. Frontal an olocyst; ovicell imperforate, with a trapeziform process hanging down over the cooeciopore. Large vicarious avicularia and small avicularia on either side of the orifice. Zoarial growth encrusting or cumulus.

Type species: *Brodrella longispinata* (Busk, 1884)

Only one species in the Mediterranean *B. armata* (Hincks, 1861); 366 (24 E-F) (HAYWARD & RYLAND, 1979: 206 as *Buffonellaria armata*); GAUTIER, 1962:238 as *Rhynchozoon armatum*)

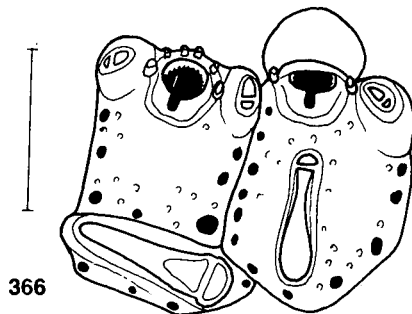

RHYNCHOZOON Hincks, 1895

Colony encrusting. Frontal wall with marginal pores. Orifice with denticulate distal margin and proximal sinus. Small condyles present. Peristome well developed, with an asymmetrical pseudosinus and typically bearing a columnar mucro, a suboral avicularium or both. Additional adventitious avicularia present. No vicarious avicularia. Ovicell prominent, imperforate, flattened frontally with an uncovered area of endooecium. Small dietellae present.

Type species: *Rhynchopora bispinosa* Hincks, 1880

As remarked by HAYWARD (1974), the systematic status of the Mediterranean species of *Rhynchozoon* requires a deeper investigation than is possible here. Five species have been described (but not figured) by GAUTIER (1962): *R. armatum*, *R. bispinosum*, *R. digitatum*, *R. lobulatum* and *R. neapolitanum*. Later, HAYWARD (1974) described two other species from Chios which in his opinion are different from the formers: *R. sp. I* and *R. sp. II*. *R. armatum* is here referred to *Brodiella*, following HAYWARD & COOK (1983). *R. neapolitanum* is the only well-defined and easily recognizable species. *R. digitatum* and *R. lobulatum* were inadequately described by WATERS (1879:197-198). The characters used in the description, such as the number and appearance of the tubercles which ornament the secondary orifice, are very variable and age dependent.

After its description by Waters, *R. lobulatum* has only been cited by GAUTIER (1962) who found only one specimen (Marseille). In Hayward's opinion (see HAYWARD, 1974: 387 for discussion) *R. lobulatum* differs little from *R. digitatum* and perhaps belongs to an aged form of the latter. On the other hand, *R. digitatum* is an inadequate name because the original description was based on specimens from Australia, which were considered to be the same as those from Naples. Nevertheless, in our material one species can be recognized as the *R. digitatum* redescribed by GAUTIER (1962); the discriminative characters are: large areolae, frontal wall very smooth, and a high number of frontal avicularia (often 2-3) with narrow, triangular mandible. This species will have to be renamed and is here cited as *R. pseudodigitatum* (figures 371 to 375).

In disagreement with HAYWARD (1974), we think that *R. bispinosum* and *R. sp. I* from Chios are very close species. They are very similar in: 1) the frontal wall shape, granular and coarsely granulate with conspicuous areolae, 2) the orifice with a shallow, concave sinus with lateral cardellae and a broad proximal edge, 3) the two oral spines present in peripheral zooids, 4) the large lateral, suboral avicularia and 5) one small, raised, frontal avicularia with narrow mandible.

Comparing HAYWARD & RYLAND'S (1979) description for *R. bispinosum* to HAYWARD (1974) description for *R. sp. I*, and taking into account the great intraspecific variability, we are unable to find any definitive discriminating character. Perhaps within the two-spine group of *Rhynchozoon*, two different species exist: the well-known (?) Atlantic species *R. bispinosum*, Johnston (1847) and Hincks (1880), and other meridional species that would be the *R. sp. I* of Hayward. If, as this author states, both species are present in the Mediterranean area, a mistake between *R. bispinosum* and *R. sp. I* is possible among the Mediterranean authors.

R. sp. II of HAYWARD (1974), seems a well-defined species. By its frontal appearance and very small areolae, it would be close to our *R. pseudodigitatum*.

They differ in the number and appearance of the frontal avicularia and in the ovicell shape.

Finally, among our material another new species, readily distinguishable from the formers, appeared. This species has the following differential traits: zooids hexagonal or quadrangular, strongly convex, separated by deep grooves. Frontal wall thick, always smooth and vitreous with few, small, little conspicuous areolae. Primary orifice orbicular, clearly wider than long, smaller than in the remaining species (Lap < 100 μ); distal rim denticulate. Proximal border with a shallow concave sinus, bordered by a pair of blunt condyles; three to four stout oral spines present only in peripheral zooids. Peristome well developed enclosing the primary orifice, thickened with a tall mucro. Frontal avicularium, often more than three, small (< 100 μ length), oval in shape (characteristic) with triangular mandible. Ovicell and ancestrula not observed (Plate 22 B-C). We propose the name *R. quadrispinatum* making reference to the oral spine number present in peripheral zooids.

The only specimen found, comes from a *Vidalia volubilis* bottom (42 m depth) in Pollensa bay (Majorca).

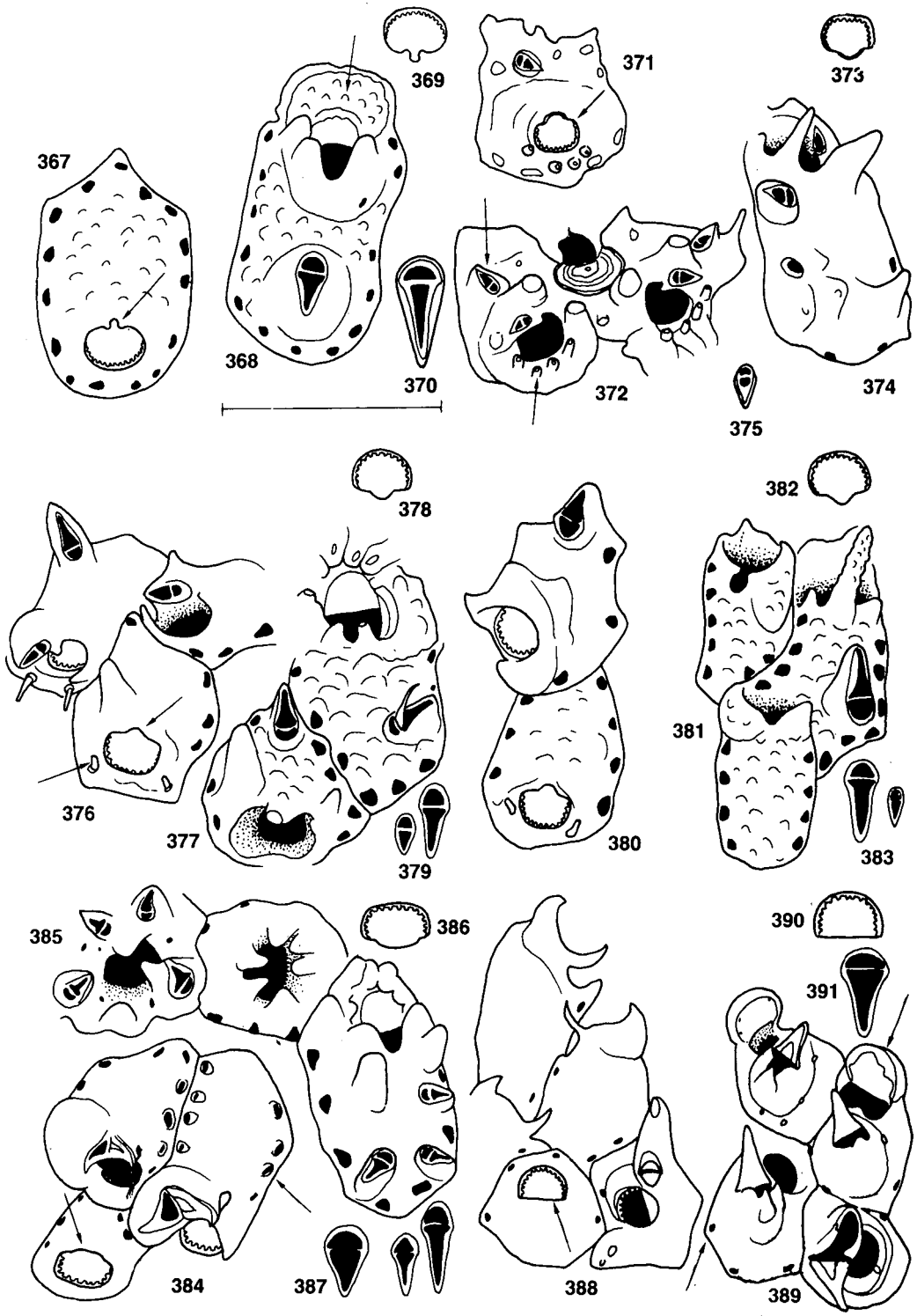

1. Oral spines present on young zooids (peripheral). Proximal border of the orifice with a shallow concave sinus 2
 - Oral spines always absent. Proximal border of the orifice straight or deeply sinuate 4
2. Up to four spines on young zooids. Frontal wall smooth. Orifice and frontal avicularia length small (less than 100 μ) *R. quadrispinatum* n. sp.; 371, 372, 373, 374, 375 (22 B-C)
 - Only one pair of spines on young zooids. Frontal wall granular. Orifice and avicularia greater in size 3
3. Frontal avicularia rare. Ovicell hemispherical, often mucronate
 - *R. bispinosum* (Johnston, 1847); 376, 377, 378, 379 (20 A-D) (GAUTIER, 1962: 240)
 - Frontal avicularia common on old zooids. Ovicell not mucronate
 - sp. I Hayward, 1974; 380, 381, 382, 383, (21 B-D) (HAYWARD, 1974:387)
4. Orifice with a narrow and shallow sinus. Peristome little developed (not hiding the orifice), sinuate. Frontal wall granular. Frontal avicularium triangular, wide, directed downwards; situated on a large avicellarium
 - R. neapolitanum* (Gautier, 1962) 367, 368, 369, 370 (21 F, 22 A) (GAUTIER, 1962: 243)
 - Orifice with proximal border somewhat concave, but without distinct sinus. Peristome developed, hiding the orifice. Frontal wall smooth. Frontal avicularium directed distally, rounded or triangular, narrow 5
5. One frontal avicularium, rare. Marginal areolae small and inconspicuous. Mucrones and uncinat process little developed. Ovicell projecting, erect
 - *R. sp. II* Hayward, 1974; (*) 388, 389, 390, 391 (21 E) (HAYWARD, 1974:389)
 - Frontal avicularia abundant (1 to 3), triangular, narrow. Areolae broad and conspicuous. From three to five digitate peristomial mucrones. Ovicell immersed inclined towards the aperture. *R. pseudo-digitatum* n. sp.; 384, 385, 386, 387 (20 E-F, 21 A) (GAUTIER, 1962:241 as *R. digitatum* ?)

SCHIZOTHECA Hincks, 1877

Colony encrusting or erect. Frontal wall of zooids with few marginal pores. Primary orifice subcircular; border distal to blunt lateral condyles with fine denticulations. Oral spines present. Vicarious avicularia always present. Adventitious avicularia sometimes present. Ovicell with frontal fissure, imperforate, not closed by zooidal operculum. Large septula present in distal and lateral walls.

Type species: *Lepralia fissa* Busk, 1856

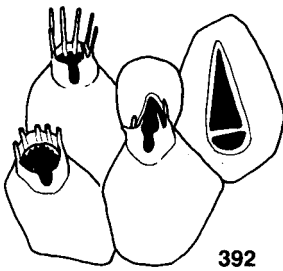

392

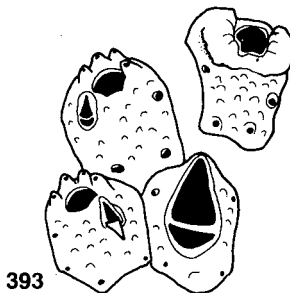

393

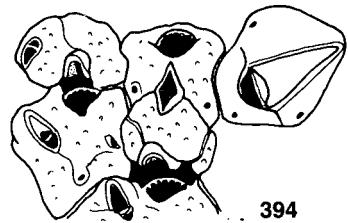

394

- 1. An adventitious avicularium oblique on the zooid frontal wall. Colony erect, adconiform
 *S. serratimargo* (Hincks, 1886); 393, 394 (22 E-F) (GAUTIER, 1962:224)
- Without adventitious avicularium (only vicarious). Colony encrusting
 *S. fissa* (Busk, 1856); 392 (23 A) (GAUTIER, 1962:223)

SCHIZORETEPORA Gregory, 1893

Colony erect, reteporiform or vinculariiform. Zooids with sinuate primary orifice. Oral proximal avicularium absent. Ovicell with a broad frontal fissure; without labellum.

Type species: *Retepora imperati* Busk, 1884

- 1. Colony vinculariiform, not reteporiform. Primary orifice obscured by a peristome with spiramen; 4 short spines and 1 large frontal avicularium
 *S. solandera* (Risso, 1826); 395, 396 (22 D) (CALVET, 1902:35) (GAUTIER, 1962:237)
- Colony reteporiform 2
- 2. Primary orifice obscured by a peristome with spiramen. 4 to 6 oral spines. Frontal avicularia not very prominent
 .. *S. longisetae* (Canu & Bassler, 1928); (*) 397, 398 (CANU & BASSLER, 1928) (GAUTIER, 1962:236)
- Without peristome concealing the primary orifice. 2 oral spines. Frontal avicularia very prominent
 *S. imperati* (Busk, 1884); 399, 400 (BARROSO, 1935)

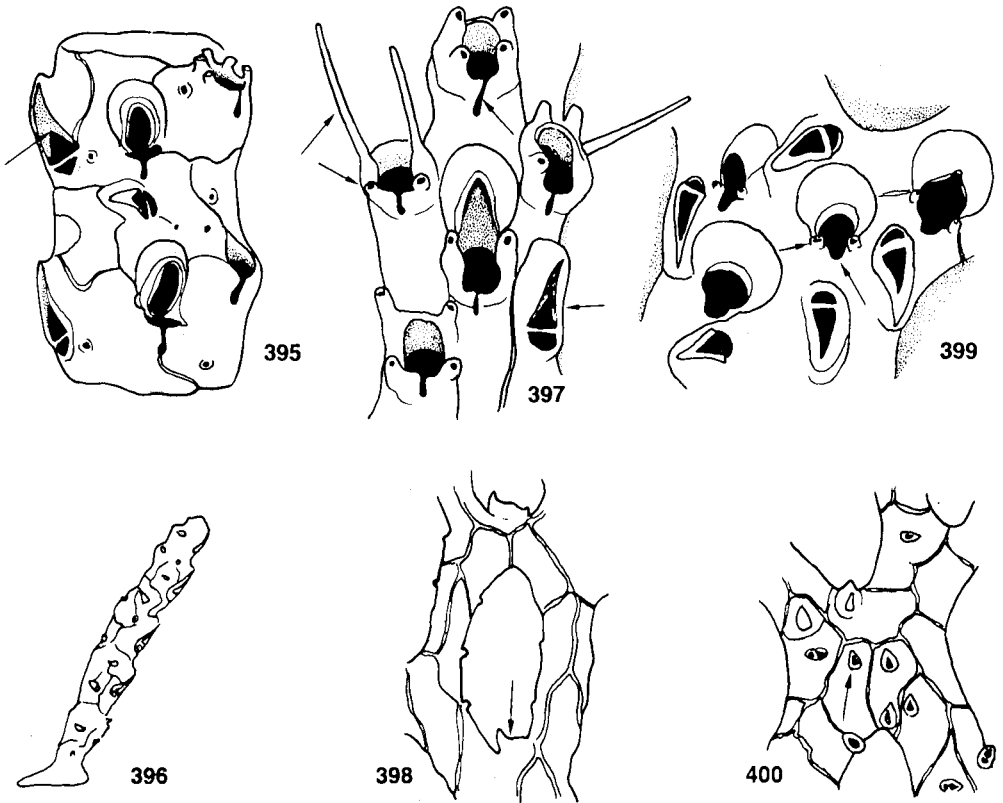

HIPPELLOZOON Canu & Bassler, 1917

Colony reteporiform. Zooidal orifice without labial pore (reteporidian pore) or labial avicularium; strong lateral condyles and straight proximal border (no sinus). Operculum with lateral constrictions and with stout lateral sclerites.

Type species: *Retepora novaezelandiae* Waters, 1895

Retepora mediterranea Waters could be included with more propriety in this genus, and would resolve the problem of two different species with the same name: "*Sertella*" *mediterranea* Waters and *Sertella mediterranea* Hass (this latter is in fact a true *Sertella*)

..... *H. mediterraneum* (Waters, 1894); 401 (GAUTIER, 1962:231)

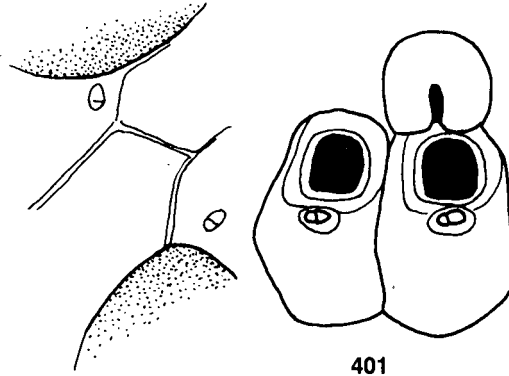

SERTELLA Jullien, 1903

Colony erect, reteporiform; branches (trabeculae) slender, anastomosing, leaving a series of open spaces (fenestrulae) between them. Zooids opening on one face of the colony only, the basal surface crossed by thickened sutures. Frontal wall with a few marginal pores. Primary orifice without a marked sinus, semicircular or transversely elliptical. Peristome with a notch, fissure or pore (pseudosinus). Avicularia variously shaped and placed, distributed on both sides of the colony. Oral spines present or absent. Ovicell prominent, with a median frontal fissure and a lip on the free edge (labellum), not closed by zooidal operculum. Small multiporous septula present.

Type species: *Retepora beaniana* King, 1846

1. Frontal notch (spiramen) absent 2
 - Frontal notch or spiramen present 3
2. Flattened zooids. Without rostrum or peristome, or spines ... (see *Hippellozoon mediterraneum*)
 - Cylindrical zooids. Peristome well developed. Orifice immersed, with two spines (rare)
 *S. aporosa* (Waters, 1894); (*) 406, 407 (GAUTIER, 1962: 225)
3. Labial avicularium present (although it may be very rare) 4
 - Labial avicularium always absent. Frontal avicularium triangular only
 *S. complanata* (Waters, 1894); 404, 405 (GAUTIER, 1962:226)
4. Labial avicularium on an erect process, more or less perpendicular to the frontal plane, generally triangular 5
 - Labial avicularium directly on the peristomial lip, beside the frontal notch, always elliptical .. 8

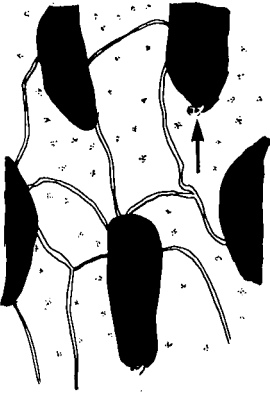

403

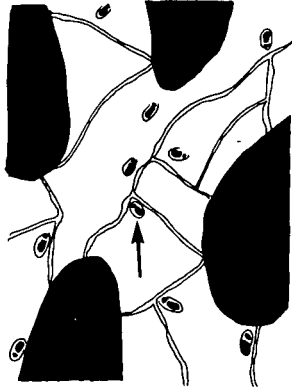

407

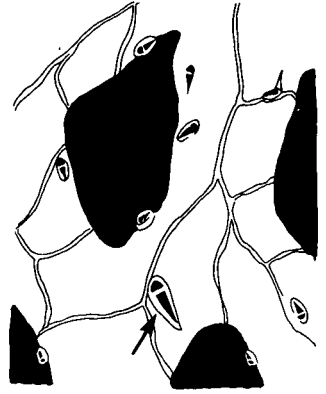

413



408

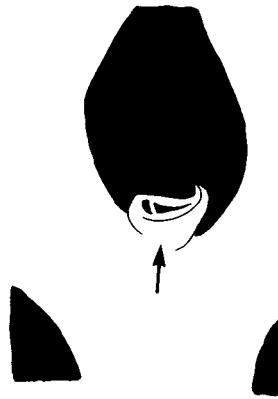

411

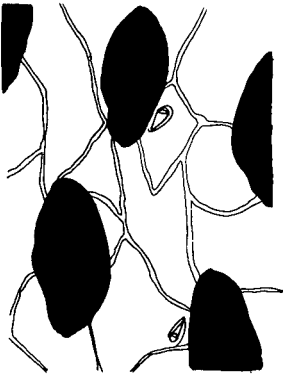

415 bis

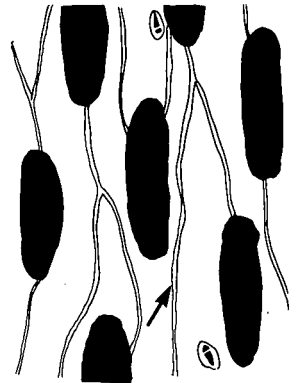

405



402

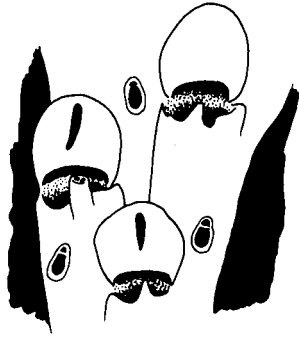

406

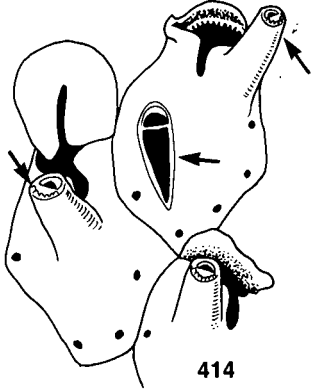

414

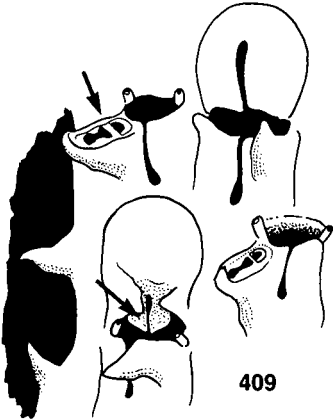

409

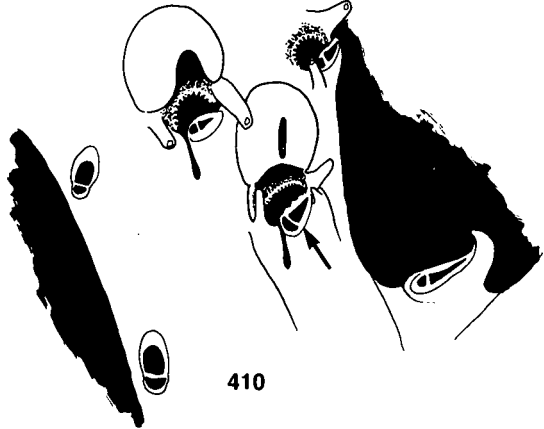

410



415

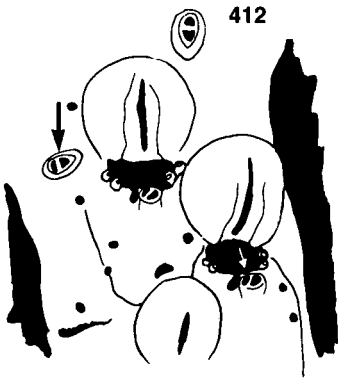

412

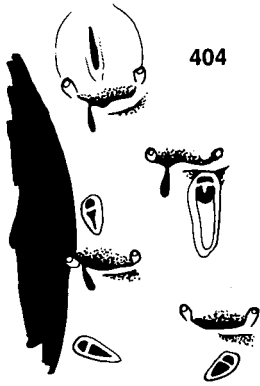

404

5. Labial avicularium elliptical on top of a cylindrical, tubular process; edges of these avicularia finely denticulate (visible with S.E.M.) *S. couchii* (Hincks, 1878); 414, 415 (23 E, 23 G) (GAUTIER, 1962: 227)
 – Labial avicularium acute, placed along the upper side of a massive triangular umbo 6
6. Labial avicularium very constant, assymmetrically directed to right and left 7
 – Labial avicularium rare, on a large process pointing perpendicularly to the frontal plane
 *S. septentrionalis* (Harmer, 1933); 402, 403 (23 F, 23 H) (GAUTIER, 1962: 233)
7. Frontal avicularia only elliptical. Labellum and frontal notch large. Labial avicularium on a prominent process giving a “spiny” appearance to the frontal face; Palate with parallel borders narrowing towards the centre. Frontal and dorsal walls regularly rugose (as hammered)
 *S. harmeri* Hass, 1948; (*) 408, 409 (GAUTIER, 1962:230)
 – Frontal avicularia of different types: elliptical and triangular. Labellum and frontal notch smaller. Large triangular avicularium at the base of fenestrae (similar to but larger than *septentrionalis*)
 *S. sudbournensis* (Gautier, 1962); (*) 410, 411 (GAUTIER, 1962:234)
8. Labial avicularium placed on a tab, delimited by the frontal notch and a pseudosinus, which has a denticulate border. Palate of triangular frontal avicularium trifoliate
 *S. feuerbornii* (Hass, 1948); 412 (23, C-D) (HASS, 1948)
 – Peristomial edge where labial avicularium is placed, straight; without differentiated tab and denticulate border. Palate of frontal avicularium clearly triangular
 *S. mediterranea* (Hass, 1948); 413 (GAUTIER, 1962:234)

JACULINA Jullien & Calvet, 1903

Colony erect, reteporiform, made up of uniserial or biserial branches, linked together by connecting trabeculae composed of kenozooids. All the apertures opening towards the same side. Primary orifice orbicular, with sinus. Peristome collar-shaped, surrounding the orifice and lodging a small avicularium. Ovicell large, closed (?) by zooidal operculum. Basal attachment kenozooids (rootlets) present.

Type species: *Jaculina blanchardi* Jullien, 1903

1. Colony of biserial branches. Proximal peristomial umbo well developed
 *J. parallellata* (Waters, 1895); 416, 416 bis (CANU & BASSIER, 1925: 43)
 – Colony of uniserial branches. Peristome little developed, without umbo
 *J. blanchardi* (Jullien, 1903); (*) 417 (JULLIEN & CALVET, 1903: 65) (GAUTIER, 1962:204)

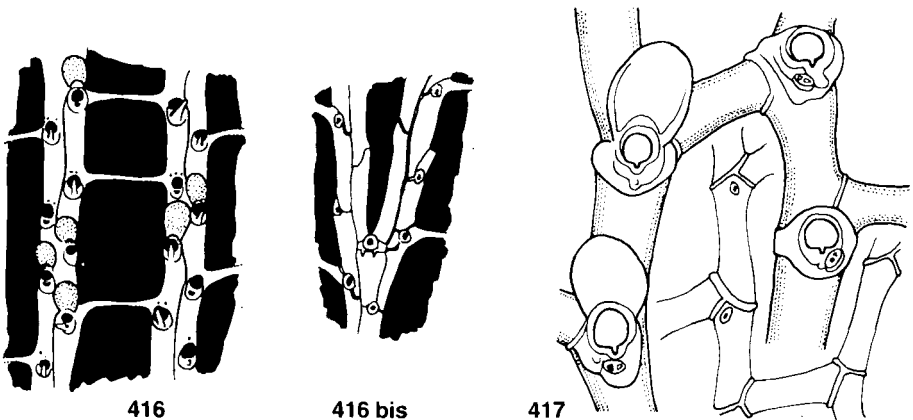

MARGARETTA Gray, 1848

Colony erect, branching, jointed, consisting of a series of cylindrical internodes separated by chitinous joints. Zooids porous, whorled, regularly alternate, from 2 to 6 individuals. Peristomes tubular, straight or curved, striated, with a circular orifice. No avicularia. A pore (ascopore ?) situated proximally to orifice, at the base of the peristome. Ovicell peristomial, fertile zooids swelling proximally, but remaining cylindrical (after HARMER, 1957).

Type species: *Cellaria hirsuta* Lamouroux, 1816

Only one recent species present in the Mediterranean
..... *M. cereoides* (Ellis & Solander, 1786); 418, 419 (GAUTIER, 1962:216)

PHOCEANA Jullien, 1903 (in Jullien & Calvet, 1903)

Colony erect. Aperture without condyles; with a lyrula extending along almost the entire length of the peristomial tube: this lyrula, well developed, bears a small semicircular tooth which grows together with the peristome forming an elongated prominence, semicylindrical, fixed by its flat face and attenuated at the distal end.

Type species: *Phoceana columnaris* Jullien, 1903

Monospecific genus, the type species of which has been cited in the Mediterranean, but always in deep bottoms, below 80 m depth
..... *P. columnaris* (Jullien 1903); (*) 420 (JULLIEN & CALVET, 1903:107) (GAUTIER, 1962:212)

BUCHNERIA Harmer, 1957

Colony erect, more or less calcified. Unjointed. Frontal wall smooth or with scarce pores. Peristome low; primary orifice and operculum nearly straight proximally, with a very shallow sinus. Ovicell hyperstomial partly covered by the calcareous thickening of the lateral edges, showing an imperforate central area or with few marginal pores. A small acute avicularium situated on the rim of the peristome (secondary orifice), suboral or lateral in position. Avicularium (vicarious ?) large and spatulate, on the frontal surface.

Type species: *Palmicellaria dofleini* Buchner

Only one species, *B. fayalensis* Waters (1888), has been found in the Mediterranean (GAUTIER, 1962), but always deep and very rare *B. fayalensis* (Waters, 1888); (*) 421 (GAUTIER, 1962:217)

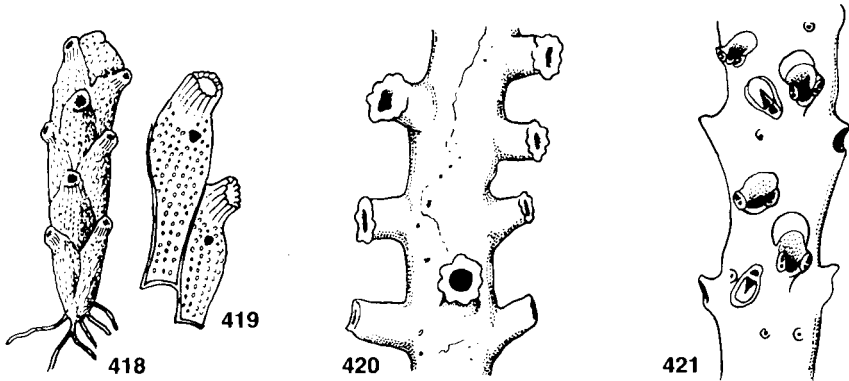

BUSKEA Heller, 1867

Colony erect, viculariiform. Frontal wall with small marginal pores. Primary orifice with a sinus; encircled by a peristome which encloses a suboral avicularium, with a median notch (pseudosinus). Additional adventitious avicularia and vicarious avicularia present. Ovicell globular, little prominent, perforated by small frontal pores, not closed by zooidal operculum. Small dietellae present.

Type species: *Buskea nitida* Heller, 1867

In the same year of 1867, Norman described his *Eschara quincuncialis* and Heller his *Buskea nitida*, two taxa that in our opinion constitute only one species. The choice of the specific name is problematic because of the date of both descriptions.

Norman described *E. quincuncialis* from a cylindrical, single fragment "not more than a quarter inch long", collected from the Minch (West Scotland).

Later the species was collected from the same area by RYLAND (1963c) and two small colonies have recently been recovered from off Lundy. These new specimens of *B. quincuncialis* were compared with Norman's type, and the species redescribed by HAYWARD (1979a).

Buskea nitida was well described (but badly figured) by Heller from material from the Adriatic. There are several reports of this species from the western Mediterranean and it is the type species chosen by Heller for the genus *Buskea*.

Despite the discussion on the features distinguishing *B. nitida* and *B. quincuncialis* by HAYWARD (1979a), we still suspect that both species could be synonymous (ZABALA, 1986). All the mediterranean specimens attributed in the past to *B. quincuncialis* have been ascribed to *B. nitida*.

1. Zooids large (Lz > 0.5 mm), colonies stout. Spatulate vicarious avicularia present. Ovicell distinct, with irregular frontal pores
 *B. dichotoma* (Hincks, 1862); 425, 426, 427 (24 A-B) (HAYWARD & RYLAND, 1979:294)
- Zooids small (Lz < 0.5 mm), colonies delicate. Vicarious avicularia absent. Ovicell usually completely immersed, only the frontal surface showing, with numerous small pores
 *B. nitida* (Heller, 1867); 422, 423, 424 (24 C-D) (ZABALA, 1986:553)

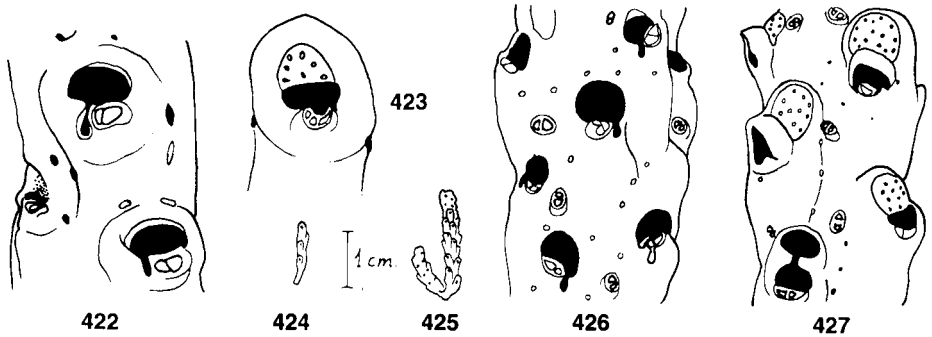

CELLEPORA Linnaeus, 1767

Colony encrusting, often massive (celleporiform); frontally budded zooids obscuring early orientation. Primary orifice orbicular. Frontal wall with scattered marginal pores. Avicularia adventitious, suboral, columnar; vicarious avicularia absent. Ovicell hyperstomial, with a few pores, not closed by zooidal operculum. Small dietellae present (after HAYWARD & RYLAND, 1979).

Type species: *Millepora pumicosa* Pallas, 1766

Two species have been cited under the name *C. pumicosa* in the Mediterranean: *C. pumicosa* sensu Pallas and *C. pumicosa* sensu Waters. Following GAUTIER's opinion (1962), these are two different species, and since Waters's diagnosis was wrong, it will be necessary to find a new specific denomination for it (we cite it with the original name enclosed between quotation marks).

Both species, as it seems, occur on our shores. Nevertheless, it is desirable to resolve this problem through the comparison of specimens.

- 1. Aperture orbicular, vanna and porta indistinguishable. Zooid sizes large (Lap > 0.15 mm) *C. pumicosa* (Pallas, 1766); 430, 431 (GAUTIER, 1962:265)
- Aperture orbicular, but with a broad vanna. Zooid sizes smaller (Lap < 0.13 mm) *C. "pumicosa"* (Waters, 1879); 428, 429 (25 A) (GAUTIER, 1962:266)

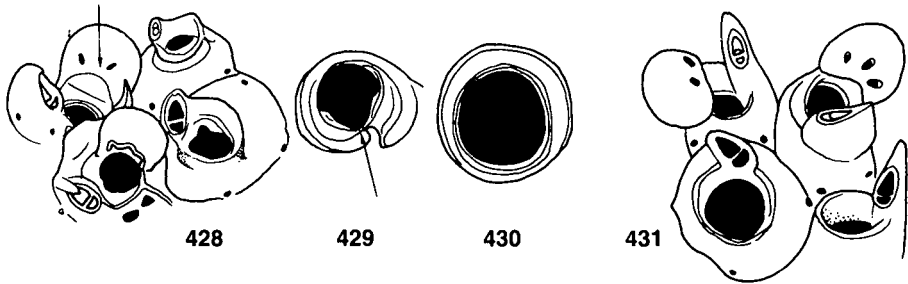

"DENTIPORELLA" Barroso, 1927

Colony encrusting, nodular, celleporiform. Zooids erect, disorientated, heaped. Frontal wall swollen, perforated by small areolar pores (marginal) only. Orifice semicircular, composed of an anter with numerous small teeth (20-22), and an almost straight and smooth poster. Two small condyles corresponding with the small opercular lateral depressions. Operculum with strong marginal sclerites and two small punctuations for muscle insertion. No oral spines. Peristome stout, not hiding the orifice. Oral adventitious avicularia, small, subogival, constant. Triangular vicarious avicularia. Ovicell imperforate, immersed, inclined and opening into the peristome.

Type species: *Cellepora sardonica* Waters, 1879

- Only one species in the Mediterranean *"D". sardonica* (Waters, 1879); 432 (27 A-B) (GAUTIER, 1962:250 as *Celleporaria sardonica*)

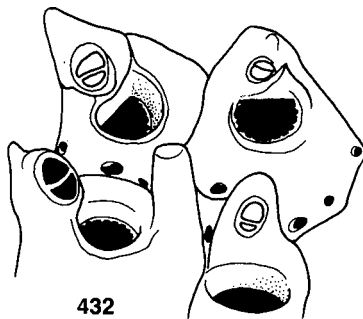

CELLEPORINA Gray, 1848

Colony encrusting, celleporiform or lenticular, multilaminar. Orifice with a sinus. Peristome stout, encompassing the whole aperture and also a series of columnar processes supporting, on their apices, small, elliptical or rounded avicularia. Vicarious avicularia spatulate. Ovicell prominent, spherical, lateral to orifice, with a perforated area of entoecium frontally: not closed by zooidal operculum. Small dietellae present.

Type species: *Lepralia hassallii* Johnston, 1847

1. Peristome with three cylindrical umbones bearing avicularia, erect, tubular. Zooids globular, swollen, large (Lz > 0.60 mm)
 *C. caminata* (Waters, 1879); 433, 434 (25 B-C) (GAUTIER, 1962:244)
 - Peristome with only two avicularian umbones, not always prominent. Zooids less swollen, smaller 2
 - Peristome very tubular, only one umbo with channelled rims; with a small avicularium on top of a tubular avicellarium, slightly in spiral
 *C. lucida* (Hincks, 1880); 435, 436 (26 D) (COOK, 1968:220)
2. Ovicell with a conspicuous mucro on mid-proximal border. Avicularian umbones not prominent, with avicularia distally directed (parallel), pointed. Proximally, the peristome is slightly excavated. Only found in caves *C. canariensis* Aristegui, in press (not *C. costazii* Audouin, 1826); 442 (25 D-E) (ARISTEGUI, 1984:364)

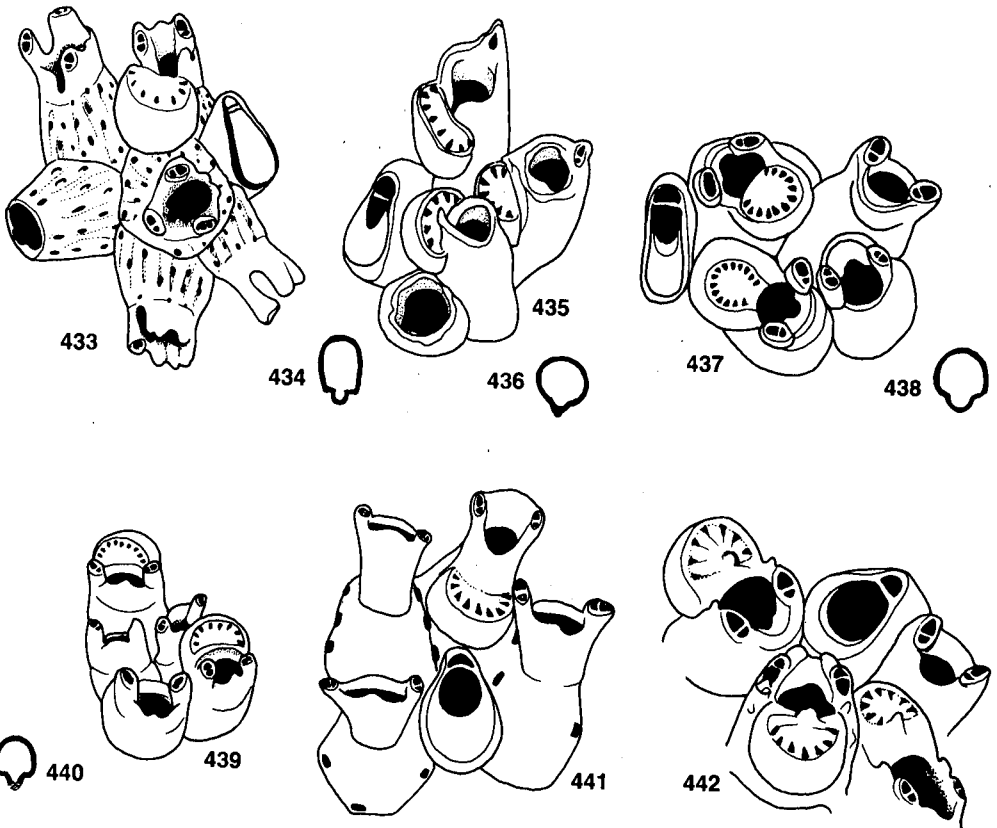

- Ovicell without mucro. Avicularian umbones more or less prominent, avicularia with rounded edges directed disto-laterally (divergent). Proximally the peristome is straight or somewhat raised. Open habitats, though also in caves 3
- 3. Between both umbones the peristome shows a small proximal mucro which causes that lip to be somewhat curved. Sinus triangular, deep. Zooid and colony sizes very small (Lap < 0.100 mm).
..... *C. decipiens* Hayward, 1976; 439, 440 (26 A-B?) (HAYWARD & RYLAND, 1979:278)
- Peristomial lip between both umbones straight. Mucro absent. Rounded sinus, shallow. Zooid and colony sizes larger (Lap > 0.100 mm) 4
- 4. Umbones very prominent, forming a tubular peristome (resembling *C. caminata* but with two umbones) *C. hassallii* var. *tubulosa* (Hincks, 1880 ?); 441 (26 C) (GAUTIER, 1962:247?)
- Umbones little prominent; peristome joining both umbones forming an erect, not tubular, thin wall *C. hassallii* (Johnston, 1847); 437, 438 (25 F) (GAUTIER, 1962:245)

CIGCLISULA Canu & Bassler, 1927

Colony celleporiform. Ovicell hyperstomial, opening in the peristome, never closed by zooidal operculum; frontal surface perforated by large pores. Zooid frontal wall with tubular pores. Aperture oval, encircled by a peristome with a broad pseudo-rimula bordered by a peristomial avicularium. Operculum bearing two large lateral sclerites ending in two strong muscular attachments. Large vicarious avicularia sporadic. From 17 to 19 tentacles. With special oral glands.

Type species: *Escharoides oclusa* Busk, 1884

Only one species has been cited in the Mediterranean: *C. turrita* Smitt, 1873, known on the southern (African) coasts only. Recently, HONDT (1980) reported it from Portitxol Isle, below Cape Nao, which could be its northernmost limit *C. turrita* Smitt, 1873; (*) 443 (HARMER, 1957:1059) (BANTA & CARSON, 1977, *Pacific Science* 41 (4): 381-424)

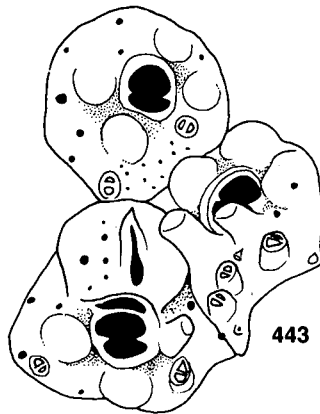

LAGENIPORA Hincks, 1877

Colony encrusting, unilaminar. Primary orifice orbicular, with or without an ill-defined sinus. Frontal wall perforated by small marginal pores, often distinct. Peristome well developed, tubular, with spinous projections often bearing a minute avicularium. No vicarious avicularia. With or without kenozooids. Large dietellae present.

Type species: *Celleporella lepralioides* Norman, 1868

At present, it is impossible to determine the number of species of *Lagenipora* in the Mediterranean. The only species whose occurrence is well documented is the type species, but there is evidence of the presence of other species, still not well described.

1. Avicularium absent. Frontal area of the ovicell in a narrow, crescentic tabula bearing fine radiating ridges but not well marked pores *L. lepralioides* (Norman, 1868); (*) 444 (HAYWARD & RYLAND, 1979:280)
- Minute avicularium present on the apex of columnar peristomial processes. Frontal area of the ovicell broader, flat, with 2 pores placed near the corners *L. n. sp.*; 445, 446 (26 E, F)

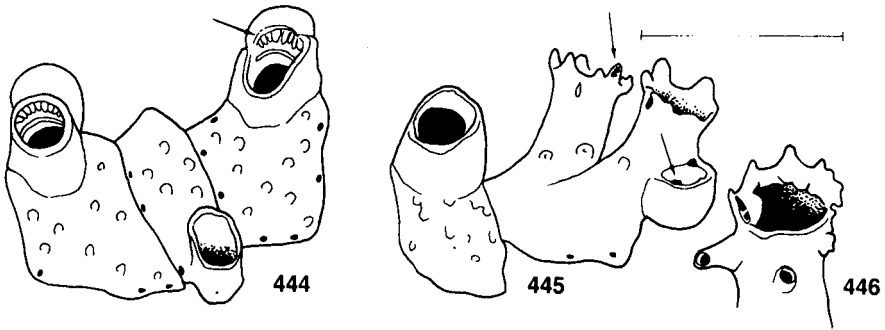

OMALOSECOSA Canu & Bassler, 1925

Colony erect, vinculariiform. Primary orifice semicircular, not sinuate. Frontal wall with small marginal pores. No spines. Adventitious avicularium suboral, on a stout column or chamber; enclosed within a flaring peristome, which is characteristically notched on one side (pseudosinus). No vicarious avicularia. Ovicell hyperstomial, prominent, imperforate, not closed by zooidal operculum. Small dietellae present.

Type species: *Cellepora ramulosa* Linnaeus, 1767

- Only one Mediterranean species *O. ramulosa* (Linnaeus, 1767); 447, 448 (27 C-D) (GAUTIER, 1962:255)

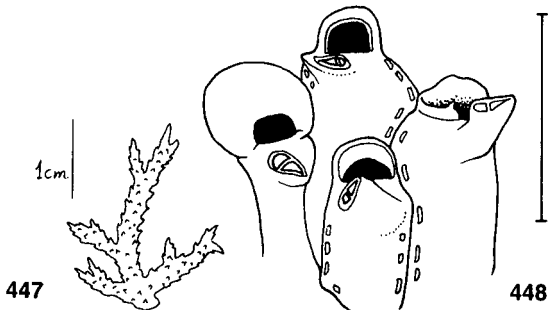

TURBICELLEPORA Ryland, 1963

Colony celleporiform, encrusting and nodular, or erect and branching, often massive. Orientation of zooids irregular, usually disordered. Frontal wall with marginal pores. Primary orifice with a proximal sinus, sometimes hidden by the peristome. Lateral oral avicularia present; additional adventitious or vicarious avicularia often abundant, typically with enlarged spatulate mandibles. Ovicell hyperstomial with scattered frontal pores, not closed by zooidal operculum. Dietellae present.

Type species: *Cellepora coronopus* Wood, 1884

1. Orifice with broad, shallow sinus. Large frontal areolae
 *T. magnicostata* (Barroso, 1919); 463, 464 (28 A-B) (HAYWARD & RYLAND, 1979:286)
 – Orifice with narrow U- or V-shaped sinus. Normal areolae 2

2. Vicarious avicularia light-bulb shaped (broadly spatulate) 3
 – Vicarious avicularia spatulate but without the above shape 4

3. Short sinus, U-shaped. Slender pivotal bar, without columella
 *T. crenulata* (Hayward, 1978); (*) 465, 466 (HAYWARD, 1978: 573)
 – Deep sinus, V-shaped. Stout pivotal bar and columella. Ovicell with a projecting mucro medio-frontally *T. cantabra* (Barroso, 1919); (*) (HAYWARD, 1978:573)

4. More than one oral avicularium 5
 – Only one oral avicularium 6

5. Only one type of vicarious avicularium (spatulate); pivotal bar and columella slender; palate almost absent *T. camera* (Hayward, 1978); (*) 461, 462 (HAYWARD, 1978:570)
 – Three possible types of vicarious avicularia (spatulate, parallel-sided or triangular): stout columella and pivotal bar, and large palate
 *T. coronopusoida* (Calvet, 1931); 457, 458 (HAYWARD, 1978:577)

6. Columella and pivotal bar slender. Only one type of vicarious avicularium (spatulate). More than 12 pores on the ovicell 7
 – Columella and pivotal bar thick. More than one type of vicarious avicularia (triangular and parallel-sided at least). Less than 12 pores on the ovicell 8

7. Oral avicularium columnar, on a pointed rostrum. Peristome well developed
 *T. torquata* (Hayward, 1978); (*) 455, 456 (HAYWARD, 1978:585)
 – Oral avicularium not columnar, without rostrum. Peristome little developed
 *T. coronopus* (Wood, 1884); 452, 453, 454 (HAYWARD, 1978:575)

8. Spatulate (or scarcely) vicarious avicularia absent. Poster orifice well rounded. Ovicell with irregular pores *I. tubigera* (Busk, 1859); 459, 460 (HAYWARD, 1978:586)
 – Vicarious avicularia clearly spatulate. Poster more open. Ovicell with regular, round pores
 *T. avicularis* (Hincks, 1867); 449, 450, 451 (27 E-F) (HAYWARD, 1978:566)

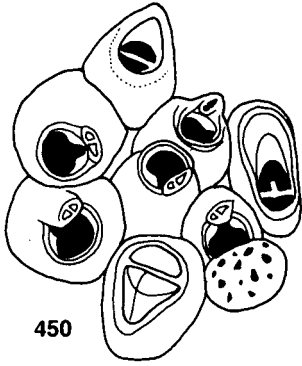

450



451



449

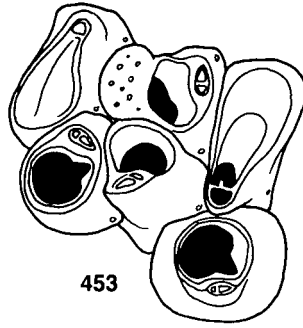

453



454



452

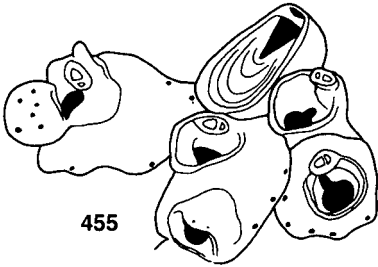

455



456

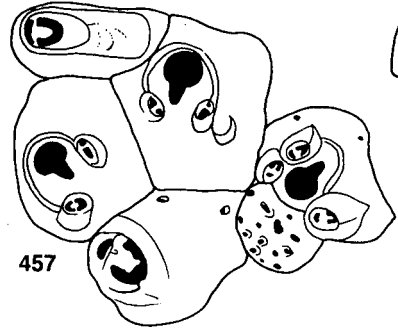

457



458

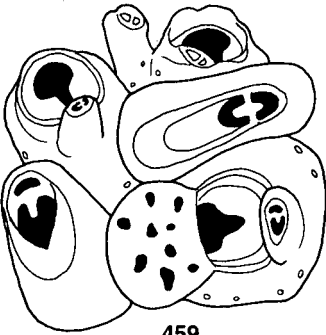

459



460

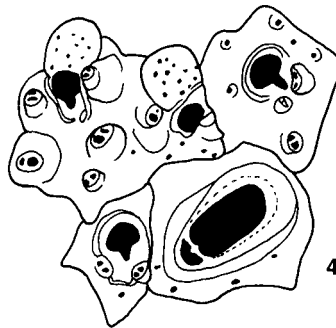

461



462

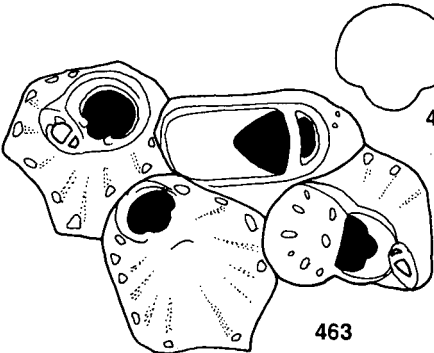

463



464

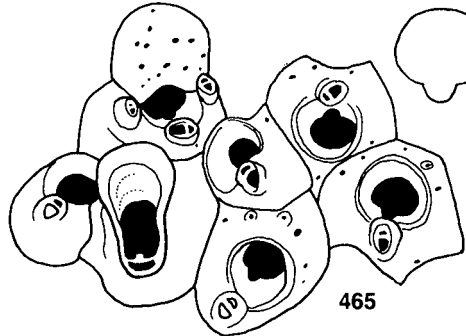

465



466

MYRIAPORA Donati, 1750

Colony erect, cylindrical, vinculariiform (with a small encrusting base, irregularly branching and unjointed). Frontal wall stout, with tubular pores. Adventitious avicularium with a pivotal bar, sometimes absent. Ovicell indistinct, immersed in a depression in distal zooid (excepted young zooids).

Type species: *Millepora truncata* Pallas, 1766

Due to its size and beauty, *M. truncata* (the named "false coral") is, doubtless, the most popularly well-known bryozoan in the Mediterranean

..... *M. truncata* (Pallas, 1766); 467, 468, 469 (GAUTIER, 1962: 268)

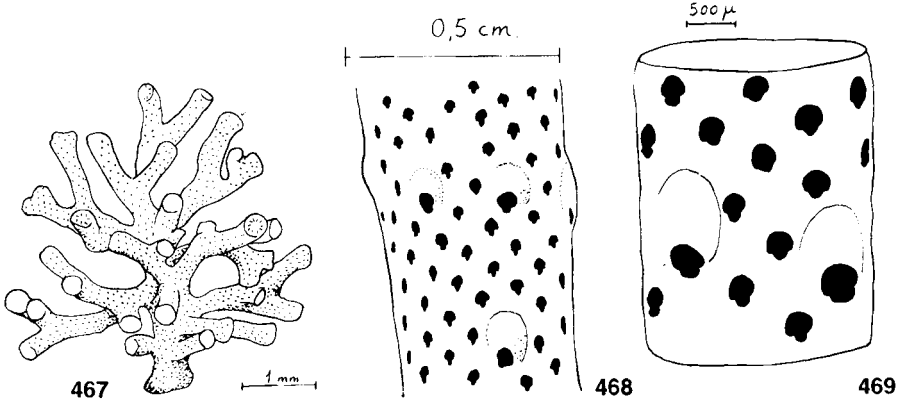

CLASS STENOLAEMATA
ORDER CYCLOSTOMATA
SUBORDER ARTICULOIDEA

CRISIA Lamouroux, 1813

Colony erect, arborescent, small size (mean height 1 cm.), made up of jointed internodes. Zooids tubular, arranged in two alternating, symmetrical series in the internodes. Short, free parts of the zooid peristomes, which project from the branch, give to the internode a saw-toothed appearance. Gonozooids globular and projecting, situated in frontal position towards the centre between both zooidal series.

Type species: *Sertularia eburnea* Linnaeus, 1758

- 1. Always less than 20 zooids on each sterile internode 2
 - Sterile internodes up to 20 zooids (though may be some less) 7
- 2. Length of the second zooid of each internode always greater than 1000 μ. Always less than 10 zooids on fertile internodes. Zooids large and long
 - *C. fistulosa* (Heller, 1867); 474, 475 (HARMELIN, 1968b:427)
 - Length of the second zooid always smaller than 1000 μ 3
- 3. Species with very slender and delicate branches. Maximum width of internodes, at the level of the second zooid, less than 150 μ. Zooids overlapping dorsally
 - *C. cuneata* Maplestone, 1905; 478, 479 (29 A) (HARMELIN, 1968:429)
 - Species with broader internodes. Width up to 150 μ at the level of the second zooid. Not overlapping dorsally 4

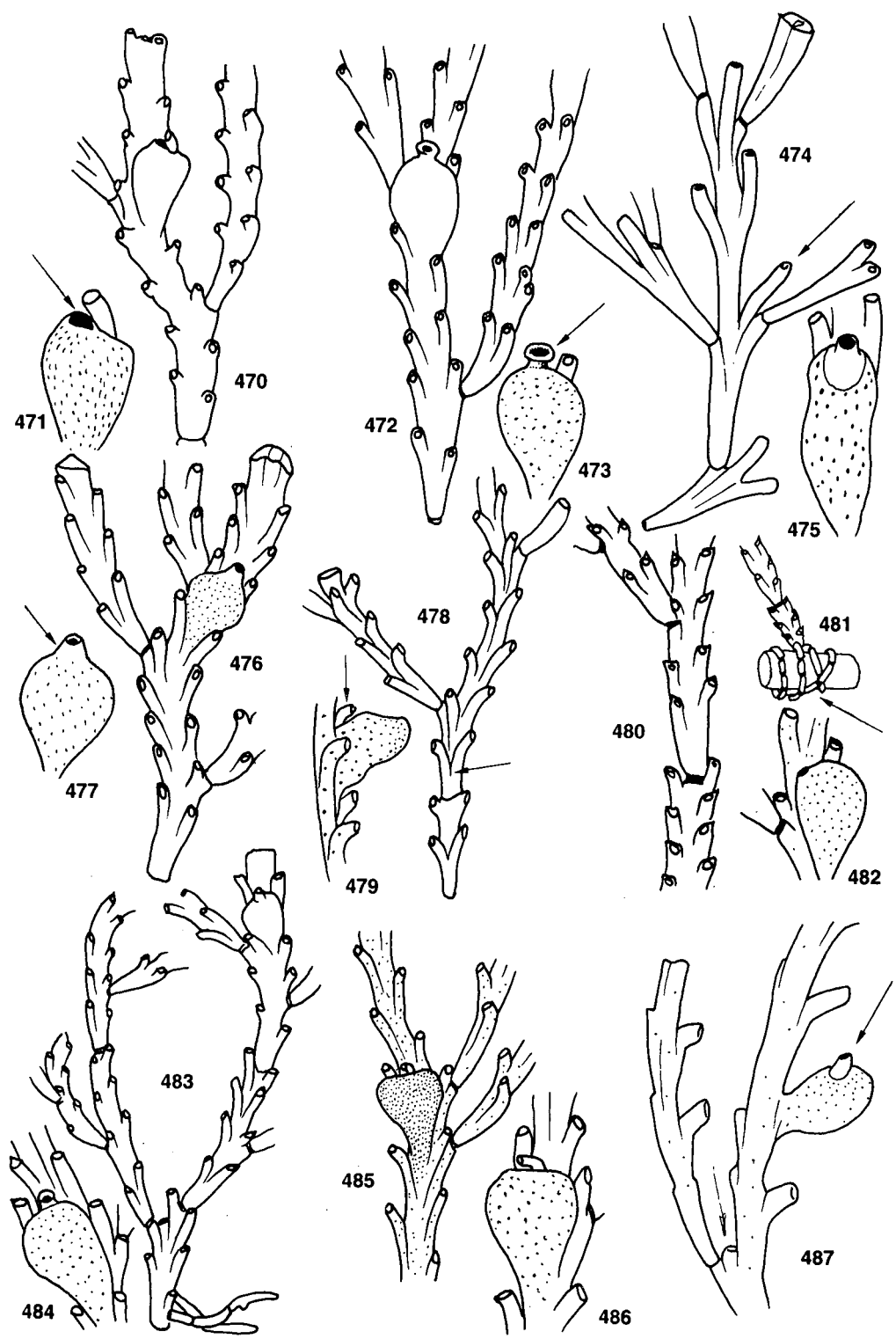

- 4. Gonozooid distally separate from the branch, only coalescent by the basis. Always less than 10 zooids on fertile internodes *C. kerguelensis* Harmelin, 1976; 487 (Harmelin, 1976)
 - Gonozooid totally coalescent with the branch. Always more than ten zooids on fertile internodes 5

- 5. Many sterile internodes with less than 9 zooids (though may be between 6 and 14). Colony typically with branches curving towards the centre *C. cf. occidentalis* (Trask, 1857); 483, 484 (29 C) (HARMELIN, 1968b:423)
 - Internodes never with less than 9 zooids 6

- 6. Peristomes stout, diameter greater than 75 μ (65-100 μ), at least in some cases, and with long free portion. Gonozooid pear-shaped, with the oeciostome forming a tube widened at the base and not punctured *C. oranensis* (Waters, 1916); 476, 477 (HARMELIN, 1968, 426)
 - Peristome diameter always smaller than 75 μ . Rounded gonozooid. Oeciostome without tube, opening directly in to an oval orifice. Rhizoids long and numerous, formed by short segments separated by black joints *C. denticulata* (Lamarck, 1816); 480, 481, 482 (29 B) (HAYWARD & RYLAND, 1985a:54)

- 7. Internodes very narrow (minimum width, towards the mid-point of the internode, always less than 200 μ). R d/w = 2 *C. sp. II* Harmelin, 1968; (*) 485, 486 (HARMELIN, 1968b:431)
 - Internodes broader (int. w 200 μ). R d/w = 1.9 8

- 8. Internodes with characteristic sigmoid shape, with a central, broad, calcified space. Gonozooid distally angular; oeciostome without tube. R d/w between 0.86 and 1.6 *C. sigmoidea* (Waters, 1916); 470, 471 (29 E) (HARMELIN, 1968b:417)
 - Internodes rectilinear, without central calcified space. Zooids larger. R d/w greater (1.5 to 1.8). Gonozooid rounded. Oeciostome funnel-shaped *C. ramosa* (Harmer, 1891); 472, 473 (29 D) (HARMELIN, 1968b:419)

FILICRISIA D'Orbigny, 1853

Colony erect, made up of internodes with 1 to 3 zooids (3 to 5 in fertile internodes) separated by chitinous articulation joints, black coloured. Gonozooid thin, adnate to the internode along its whole length, bearing a terminal oeciostome. No filiform spines.

Type species: *Crisia geniculata* Milne-Edwards, 1838

Only one species in the Mediterranean *F. geniculata* (Milne-Edwards, 1838); 488, 489 (HAYWARD & RYLAND, 1985a:40)

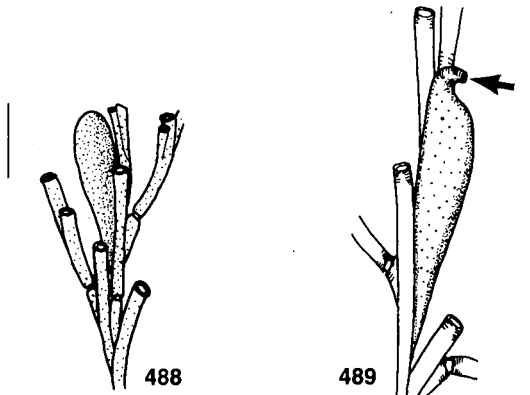

SUBORDER TUBULIPORIDEA

STOMATOPORA Brown, 1825

Colony uniserial, apart from the fragment that immediately surrounds the brood chamber which is a simple, swollen and weakly lobate sac, with a terminal oeciostome (after OSBURN, 1953:619).

Type species: *Alecto dichotoma* Lamouroux, 1821

Only one species described from the Mediterranean
 *S. gingrina* (Jullien, 1882); 490, 491 (HARMEN, 1976:73) (HAYWARD & RYLAND, 1985a:62)

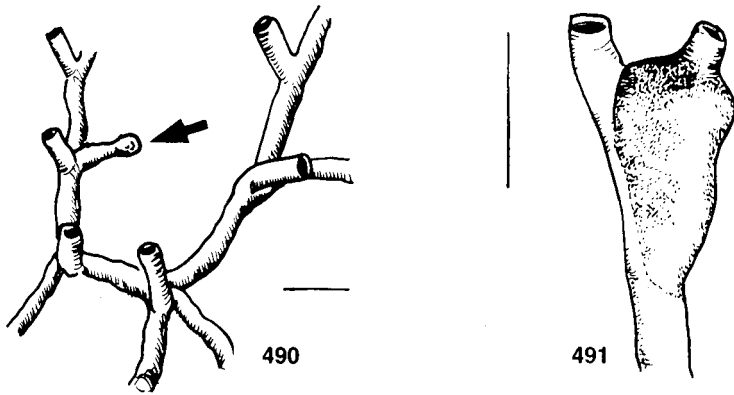

ANNECTOCYMA Hayward & Ryland, 1985

Colony encrusting, frequently developing erect, cylindrical portions; expanding by dichotomous branching, and by production of adventitious branches. Calcification thick, rugose, with coarse punctuation. Autozooids in alternating quincuncial series, the peristomes frequently fused basally in transverse rows of two to four. Gonozooid typically pyriform or elongate oval, the oeciostome a short, reflected cylinder with a flared, hood-like apertural rim.

Type species: *Alecto major* Johnston, 1847

Annectocyma was introduced by HAYWARD & RYLAND (1985a) for the European species formerly assigned to *Diaperoecia* Canu, which is restricted to its Australian type species *D. intricaria* (Busk). All four mediterranean species described and figured by HARMELIN (1976) as *Diaperoecia* should be removed to *Annectocyma*.

1. Colony always creeping, ribbon-shaped (breadth very constant). Zooids in only one layer, overlapping very little; creeping portion short and broad, peristomial portion forming a strong angle with, and separated from, the former by two hemi-septa. Without inner spinulae. Oeciostome with three partial, echeloned divisions. Mean peristomial diameter small ($\varnothing t = 0.15$ mm)
 *A. indistincta* (Canu & Bassler, 1929); 499, 500, 501 (29 F-G) (HARMELIN, 1976:90 as *Diaperoecia indistincta*)
- Colony creeping or erect, when erect opening in fan. Zooids in more than one layer, very much overlapping. With inner spinulae. Without remaining features above. Mean peristomial diameter greater 2

2. Colony only erect tubuliporiform, very arched, never ramified; mace-shaped. Zooids only on the convex face. Mean peristomial diameter = 0.175 mm.
 *A. arcuata* (Harmelin, 1976); 497, 498 (HARMELIN, 1976 as *Diaperoecia arcuata*)
 – Without the above colony shape. Colony branching; when erect, cylindrical, with peristomes on all faces. Mean peristomial diameter greater ($\varnothing t > 0.175$ mm) 3
3. Colony tubuliporiform, purple. Zooids in reticle, very much overlapping; peristomes very long. Pseudopores clearly oblique. Mean peristomial diameter relatively small ($\varnothing t = 0.177$ mm)
 *A. tubulosa* (Busk, 1875); 495, 496 (29 H) (HARMELIN, 1976: 85 as *Diaperoecia tubulosa*)
 – Colony creeping or erect pustuliporiform, white or brown coloured but never purple. Zooids tending to align in series, although series difficult to distinguish. Pseudopores distinct, clearly round, perpendicular. Mean peristomial diameter large ($\varnothing t = 0.18 - 0.20$ mm)
 ... *A. major* (Johnston, 1847); 492, 493, 494 (30 A-B) (HARMELIN, 1976:79 as *Diaperoecia major*)

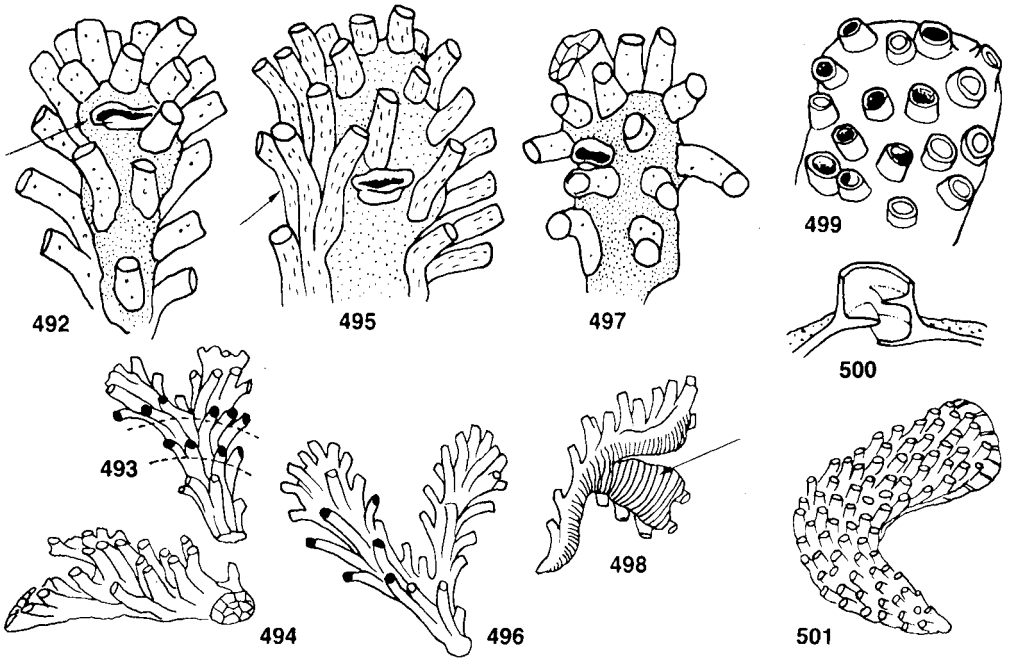

ENTALOPHOROECIA Harmelin, 1976

Colony creeping stomatoporiform or erect pustuliporiform. Peristomes in reticle. Growth of the ancestral zone similar to *Stomatopora* type. Tendency to erect growth (pustuliporiform type) and to formation of gonozooids similar to *Annectocyma* type. Colonies in creeping stomatoporiform, uni- or pluriserial stage, may become well developed and be fertile. Gonozooid generally perforated by several peristomes, with tubular oeciostome of slightly inferior diameter to that of the peristomes, usually attached to the proximal face of one of them, situated on the distal third of the gonozooid.

Type species: *Tubulipora deflexa* Couch, 1844

1. Diameter of the oeciostome no larger than $110\ \mu$ ($\emptyset = 95\ \mu$), associated with a peristome. Ratio h/\emptyset of the oeciostome = 3.5-8. Without inner spinulae. Fine and delicate species; peristomes diameter small, though variable ($115-185\ \mu$; $\emptyset = 145\ \mu$)
 *E. gracilis* (Harmelin, 1976); 502, 503 (30 E) (HARMELIN, 1976:100)
 - Diameter of the oeciostome (almost) always greater than $110\ \mu$; only sometimes associated with a peristome. With inner spinulae. Autozooid peristomes in general larger 2
2. Oeciostome a short and very wide ($\emptyset > 135\ \mu$) tube. Ratio $h/\emptyset < 3$ (always). Stout and well-calcified species; peristome with a considerable diameter ($\emptyset = 135-210\ \mu$; $\emptyset = 190\ \mu$)
 *E. robusta* (Harmelin, 1976); 506, 507 (30 F) (HARMELIN, 1976:116)
 - Oeciostome a long and not so wide tube ($\emptyset < 135\ \mu$). Ratio $h/\emptyset > 3$ (always). Less stout species. Peristomes smaller ($\emptyset = 135-200\ \mu$; $\emptyset = 165\ \mu$)
 *E. deflexa* (Couch, 1844); 504, 505 (30 C-D) (HARMELIN, 1976:108)

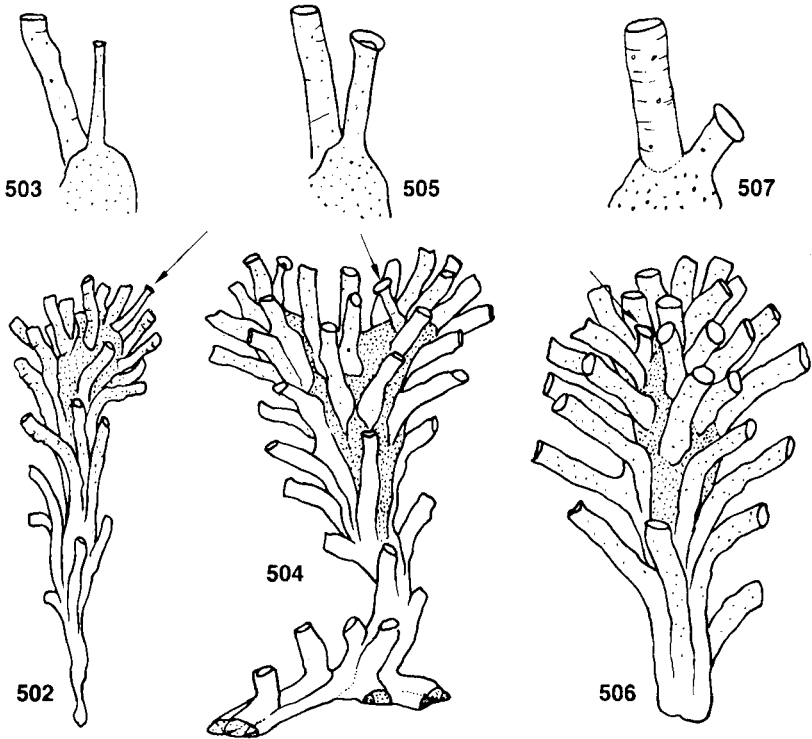

CARDIOECIA Canu & Bassler, 1922

Colony erect, bifurcated, cylindrical or elliptical in section, with bilaminar structure. Gonozooid triangular or heart-shaped, with a terminal oeciostome smaller in diameter than the autozooidal tubes.

Type species: *Bidiastopora neocomiensis* D'Orbigny, 1853

Only one species occurs in the Mediterranean
 *C. watersi* (O'Donoghue & De Wateville, 1939); 508, 509, 510, 511 (31 A-B)(Harmelin, 1976: 155)

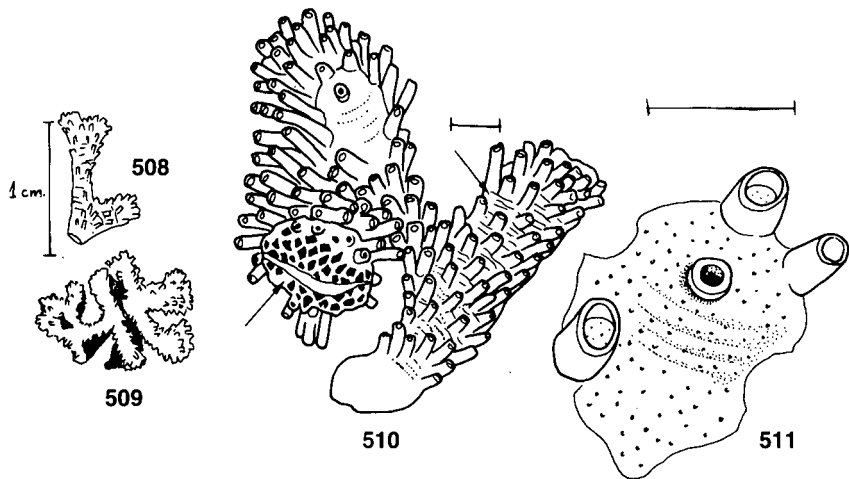

LIRIPORA Macgillivray, 1887

Colony encrusting, lobate. Autozooids in radiating multiserial or fasciculate rows, peristomes partly connate. Gonozooid small, transversely elongate extending between autozooids but not enveloping any; oeciostome a short, simple tube.

Type species: *Liripora lineata* (Macgillivray, 1887)

HARMELIN (1976) described two species, *Desmeplagioecia amphorae* and *Desmeplagioecia violacea* from the western Mediterranean. HAYWARD & COOK (1983) considered *Desmeplagioecia* (Canu & Bassler) to be a junior objective synonym of *Liripora* (Macgillivray).

1. Colour deep violet, due to spherular pigmented leucocytes. Peristomes of small diameter (94 μ) almost always isolated, rarely forming bundles. Numerous inner and large spinulae. Primary ancestrular disk of small diameter. Colony discoidal or fan-shaped. *L. violacea* Harmelin, 1976; (*) 516, 517, 518, 519, 520 (HARMELIN, 1976: 157 as *Desmeplagioecia violacea*)
- Colour beige or pale yellow. Peristomes of larger diameter (130 μ), grouped forming irregular rows, very calcified. No inner spinulae. Primary ancestrular disk large (\varnothing anc. = 265 μ). Colony always with fanned lobes *L. amphorae* Harmelin, 1976; (*) 512, 513, 514, 515 (HARMELIN, 1976:160 as *Desmeplagioecia amphorae*)

DIPLOSOLEN Canu, 1918

Colony encrusting, discoid or forming bilaminar sheets, thin. Nanozooids present in almost equal number to that of autozooids. Autozooidal peristomes distributed in reticle, functional in the peripheral margin only, later closed by calcareous diaphragms, flattened and bearing pseudopores. Gonozooid large, often rounded or quadrangular, pierced by many peristomes. Oeciostome a short tube, of small diameter, medio-distal to sub-central.

Only one mediterranean species, the type species
 *D. obelia* (Johnston, 1838); 521, 522, 523, 524 (32 F) (HARMELIN, 1976:145 as *D. obelium*)

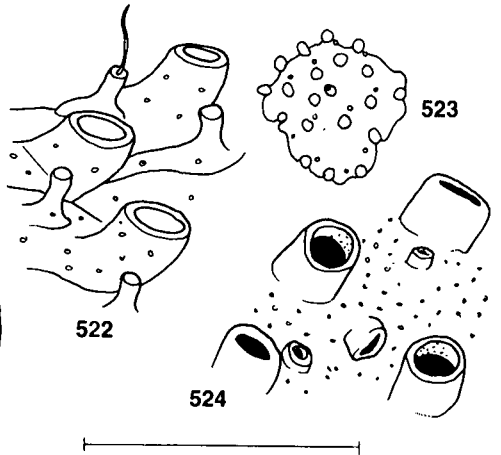
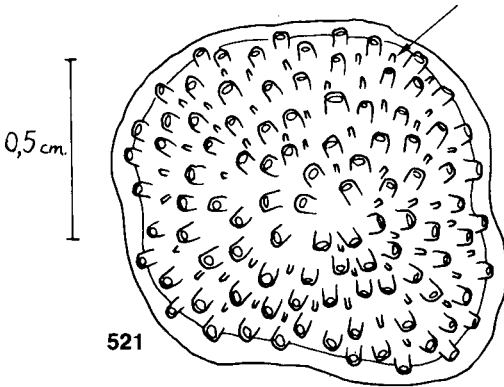
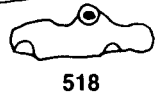
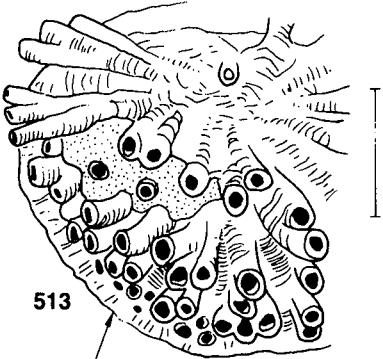
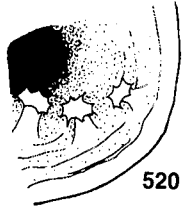
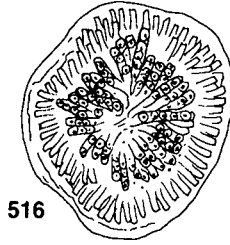
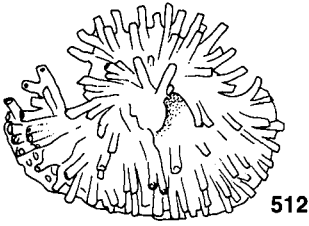

EURYSTROTOS Hayward & Ryland, 1985

Colony entirely adnate, thin and flat, without a broad growing margin. Autozooids quincuncially arranged, without terminal diaphragms. Gonozooid small, oval or slightly lobed but not enveloping adjacent peristomes, constituted by the distal swelling of a peristome, the proximal part of which remains visible. Ooeciostome distal, short, cylindrical, diameter less than that of the peristomes.

Type species: *Alecto compacta* Norman, 1866

Eurystrotos compacta replaces the widely but incorrectly used *Microecia suborbicularis* (Hincks). *Microecia occulta* Harmelin may also be referred to *Eurystrotos*.

1. Colony well-calcified, forming lobes, seldom fan-shaped. The surface of the zooidal proximal parts gives to the colony a thick appearance. Sides of branches surrounded by blind zooids. Primary ancestrular disk oval. Mean peristomial diameter somewhat larger (80 μ) *E. occulta* Harmelin, 1976; 527, 528 (Harmelin, 1976:126 as *Microecia occulta*)
- Colony thinly calcified; glassy, forming fan-shaped lobes, or closed disks. Only one layer of scarcely overlapping zooids. Primary ancestrular disk circular. Mean peristomial diameter smaller (74-77 μ) *E. compacta* (Norman, 1866); 525, 526 (31 C) (HARMELIN, 1976:122 as *Microecia suborbicularis*) (HAYWARD RYLAND, 1985:94)

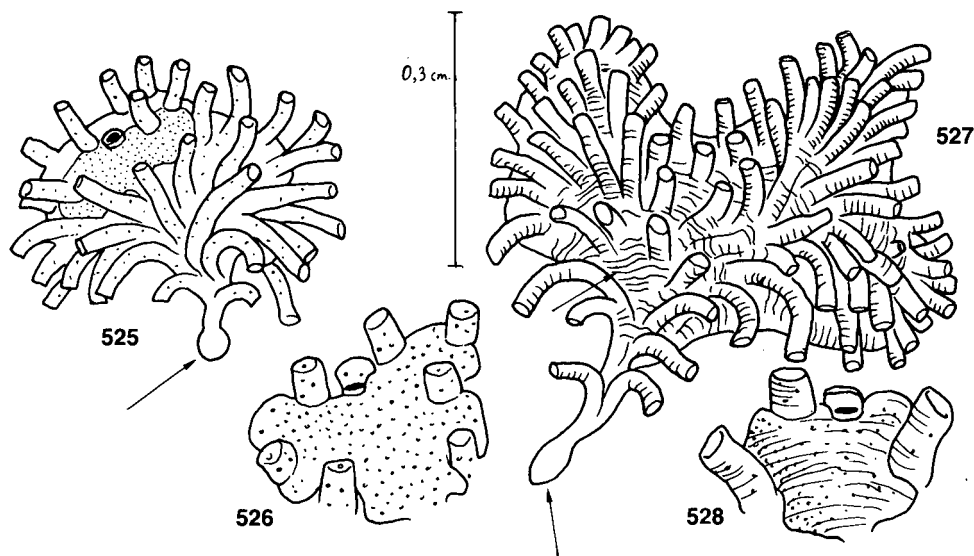

PLAGIOECIA Canu, 1918

Colony generally discoidal (even though it may be lobate), encrusting, adnate (at least in the median region), sometimes with narrow bilaminar expansions, or producing secondary colonies superposed by budding in the centre, or at the periphery, of the mother colony. Basal sheet may be very developed distally. Growing end composed of four delicate layers of zooids in formation. Peristomes distributed in reticle or in radial rows. Degenerate zooids occluded by calcareous, flat, alternating diaphragms, subterminal or terminal, perforated, with or without central tube. Gonozooid very widened transversely; usually very short, pierced, or at least with edges scalloped, by peristomes. Ooeciostome a short tube opening upwards or in proximal direction, placed in terminal or subterminal position.

Type species: *Tubulipora patina* Lamarck, 1816

1. Peristomial diaphragms pierced by a central tubule 3
 - Peristomial diaphragms flattened, punctured by several pseudopores but without central tubule 2

2. Inner spinulae like small granules. Gonozooid pierced by several peristomes. Diaphragms with 10-20 pseudopores *P. patina* (Lamarck, 1816); 529, 530, 531, 532, 533 (HARMELIN, 1976:129)
 - Inner spinulae stalked and with a spiny head. Gonozooid scalloped at the periphery, but not pierced by peristomes. Diaphragms with no more than 10 pseudopores
 *P. inoedificata* (Jullien); 534, 535, 536, 537, 538 (HARMELIN, 1976:133)

3. Colony made up of a basal disk from which erect falciform expansions arise, sometimes anastomosing to form a reticulate colony
 *P. dorsalis* (Waters, 1879); 545, 546, 547, 548, 549 (31 D-E) (HARMELIN, 1976:140)
 - Colony made up of a single layer of delicate, overlapping zooids forming a vertical pile. Peristomes deciduous. Creeping part of the peristomes sinuate. Inner spinulae absent or hardly distinguishable
 *P. platydiscus* (Jullien); 550, 551, 552, 553, 554, 555 (31 F, 32 A) (HARMELIN, 1976:143)
 - Colony thicker, irregular and almost never superposed. Peristomes not deciduous, with rectilinear creeping part. Inner spinulae present along the entire tubule
 *P. sarniensis* (Norman, 1864); 539, 540, 541, 542, 543, 544 (32 B-D) (HARMELIN, 1976:136)

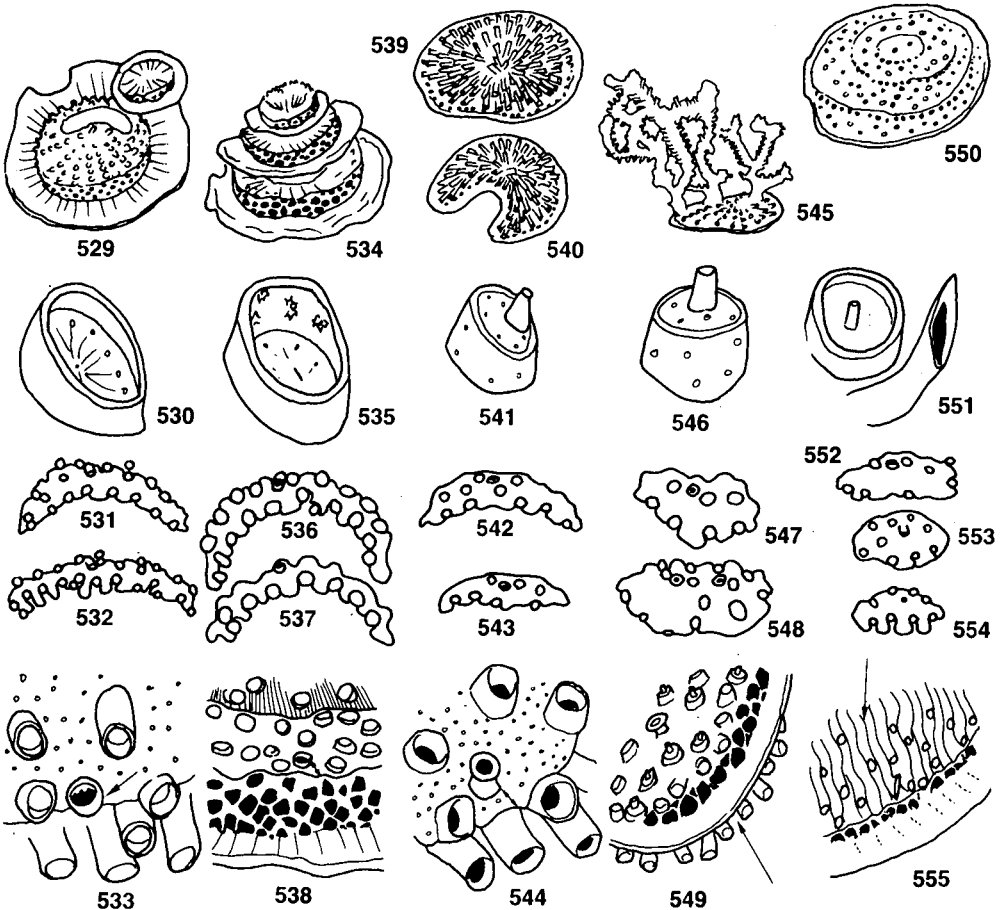

MECYNOCIA Canu, 1918

Colony encrusting, tubuliporiform, tending develop pustuliporiform branches. Gonozooid a simple sac, bearing a terminal central oeciostome, formed by a proximo-distally compressed tube.

Type species: *Pustulopora delicatula* Busk, 1875

Only one species in the Mediterranean
 *M. delicatula* (Busk, 1875); 556, 557, 558 (32 E) (HARMELIN, 1976:160)

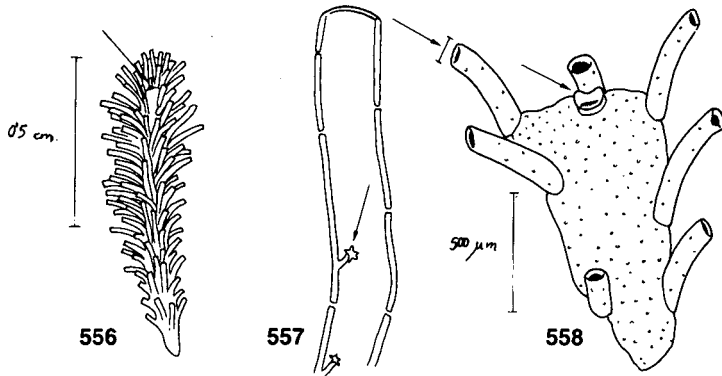

FRONDIPORA Link, 1807

Colony erect, stalked, well-ramified, arborescent. In some cases may be detached from the substratum and become free. Zooids opening on only one side of the branch, grouped in bundles which open at the same level forming individual plaques of a more or less large extent. As growth proceeds, a process of closing of the orifices of peripheral zooids begins, by means of the outer wall leading to a reduction of the surface or the terminal plaques. Gonozooid developed in height, lobate among the bundles, pierced by some zooids. Oeciostome basal, subcentral, attached to one zooid, provided with a large orifice.

Type species: *Millepora reticulata* Linnaeus, 1758

Only one species in the Mediterranean fauna
 *F. verrucosa* (Lamouroux, 1821); 559, 560, 561, 562 (34 A-B) (HARMELIN, 1976:192)

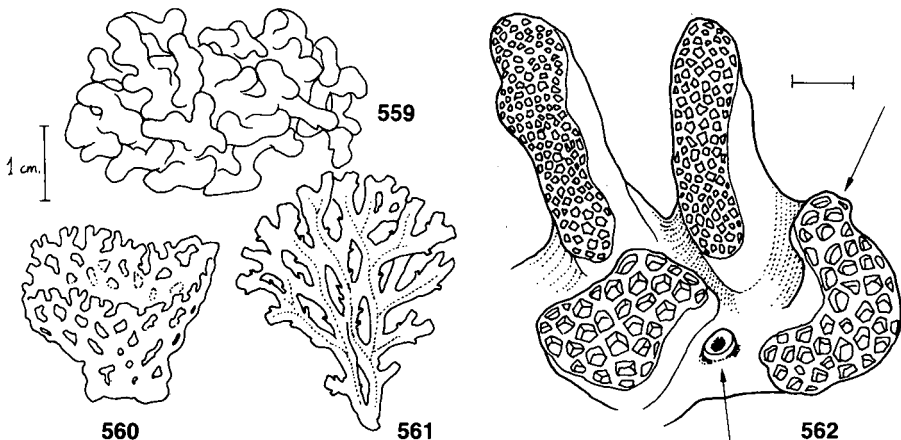

TERVIA Jullien, 1882

Colony erect. Zooids arising from the median branch axis and opening on the frontal face, on which they are arranged in alternating series. Gonozooid dorsal (characteristic), made up of a simple thickening provided with a terminal oeciostome.

Type species: *Idmonea irregularis* Meneghini, 1844

Only one Mediterranean species
 *T. irregularis* (Meneghini, 1844); 563, 564, 565, 566, 567, 568 (HARMELIN, 1976:163)

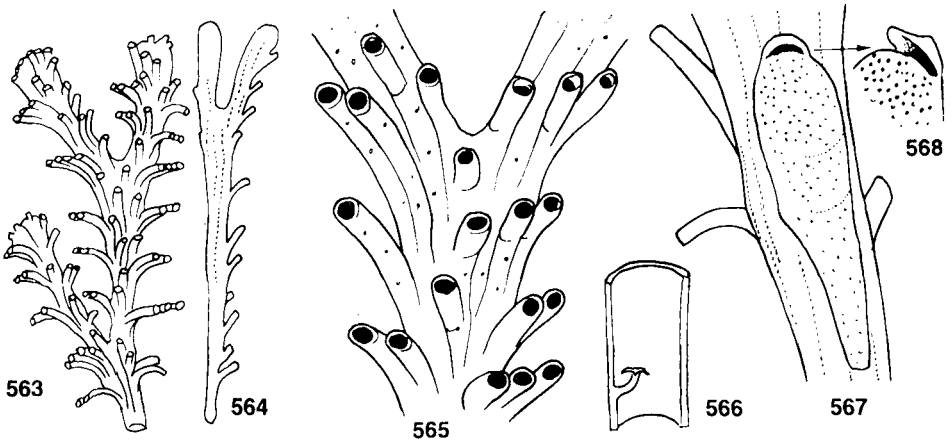

IDMIDRONEA Canu & Bassler, 1920

Most of colony erect. Branches regularly dichotomous with a constant breadth. Zooids long, originating on the basal side, and opening only on the frontal side in uniserial bundles, alternating to each side along the longitudinal axis. Peristomes long, coalescent along almost their entire length. Basal face (dorsal) totally or partly occupied by supporting kenozooids, well-developed at the base of the colony. Gonozooid elongated, spreading over the frontal face and lobed on both sides between the series of zooids. Oeciostome a more or less short tube (characteristic), situated at halfway along gonozooid against the distal side of a peristomial series.

Type species: *Idmonea coronopus* De France, 1822

1. From two to five peristomes per series. Oeciostome a cylindrical tube, long, narrow and curved. Peristomes small ($\varnothing = 102 \mu$); interserial separation small ($\bar{S} = 285 \mu$). Gonozooid uncoloured. Inner spinulae absent
 *Latlantica* (Forbes in Johnston, 1847); 569, 570, 571, 572 (33 A) (HARMELIN, 1976:182)
- From five to eight peristomes per series. Oeciostome a short tube, not curved, ending in a dorsoventrally flattened funnel. Peristomes larger ($\varnothing = 130 \mu$); interserial separation broader ($\bar{S} = 362 \mu$). Gonozooid blue-greenish. Inner spinulae present (hardly visible)
 *I. coerulea* (Harmelin, 1976); 573, 574, 575, 576 (HARMELIN, 1976:185)

PLATONEA Canu & Bassler, 1920

Colony tubuliporiform, creeping or erect, made up of groups of peristomes in alternating series, coalescent for almost their entire length, and opening on dorsal face only. Basal face not strengthened with kenozooids. Gonozooid spreading symmetrically on each side to the lateral edge of the colony, between

several series of zooids. Oeciostome a short tube attached to one of the nearest peristomes of the central line.

Type species: *Reptotubigera philippisae* Harmer, 1915

Only one species in the Mediterranean
 *P. stoechas* (Harmelin, 1976); 577, 578, 579, 580, 581 (33 B-C)(HARMELIN, 1976)

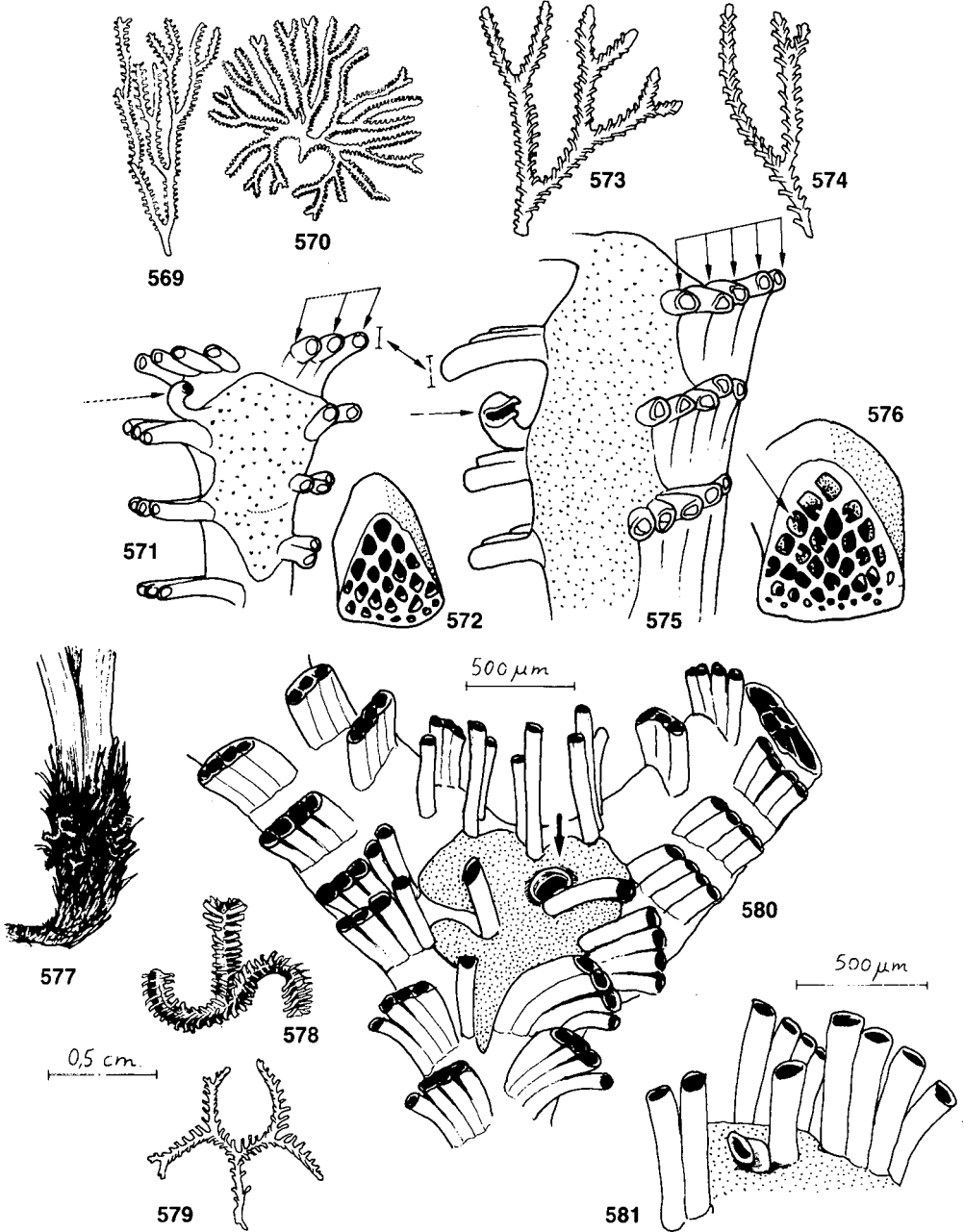

TUBULIPORA Lamarck, 1816

Colony creeping, semi-erect or erect, forming lobes normally broadening in a fan (seldom may be elongated without broadening). Zooids with very marked tendency to group in uni- or pluriserial, alternating rows (although some may project in isolation), with peristomes coalescent along their whole length, or part of it (length is often considerable). Gonozooid well developed, lobate between the peristomial series. Oeciostome: 1) tubular, long and narrow; or 2) broad and funnel-shaped; or 3) tubular and hood-like; placed in position 1/ terminal and isolated, 2/ lateral and attached to a series of tubes.

Type species: *Tubulipora transversa* Lamarck, 1816 (*Millepora liliacea* Pallas, 1766)

1. Colony always adnate; peristomes generally isolated, or if serial, little coalescent; circular in section 2
– Colony semi-erect or erect; peristomes arranged in series and coalescent for almost their entire length; quadrangular section 4
2. Gonozooid a simple sac, with a terminal oeciostome forming a straight, slender and simple tube. Hemiphragms present 3
– Gonozooid lobate among the zooid series, with a short, broad oeciostome ending in funnel
..... *T. aperta* (Harmer, 1898); (*) 598, 599, 600 (HARMELIN, 1976:179)
3. Peristomes isolated, in reticle. Creeping part of peristomes in zigzag
..... *T. ziczac* Harmelin, 1976; (*) 582, 583, 584 (HARMELIN, 1976)
– Peristomes tending to group in rows. Creeping part of peristomes rectilinear
..... *T. hemiphragmata* Harmelin, 1976; 585, 586, 587 (HARMELIN, 1976:169)
4. Peristomes large ($\varnothing > 200 \mu$), coalescent up to their tips and always uniserial. Colonies ribbon-shaped, little, or non-, ramified
..... *T. notomale* (Busk, 1875); 594, 595, 596, 597 (HARMELIN, 1976:175)
– Peristomes smaller (\varnothing almost always less than 200μ), not coalescent at their tips (or not always), sometimes multiserial. Colonies in broad fan with frequent ramifications 5
5. Autozooids in multiserial connate rows. Oeciostome at the end of a gonozooidal lobe; very large funnel (wide oec. 0,35 mm) opening upwards the lip variously folded but without a distal hood
..... *T. plumosa* (Harmer, 1898); 592, 593 (33 E-F) (HARMELIN, 1976: 177)
– Autozooids usually in uniserial connate rows. Oeciostome lateral; a short tube closely opposed to an autozooid tube, with a downwards or laterally directed distal hood 6
6. Oeciostome of similar width to a zooid tube, usually situated on the distal face of an autozooid with a broad (0.18-0,30 mm) distal hood, or a small funnel, dorso-ventrally compressed, basally or laterally directed *T. liliacea* (Pallas, 1766); 588, 589, 590 (33 D) (HAYWARD & RYLAND, 1985a:74)
– Oeciostome half or less than the width of a zooid tube, rather inconspicuous, with a small distal hood (about 0,10 mm wide)
..... *T. phalangea* (Couch, 1844); 591 (HAYWARD & RYLAND; 1985a:78)

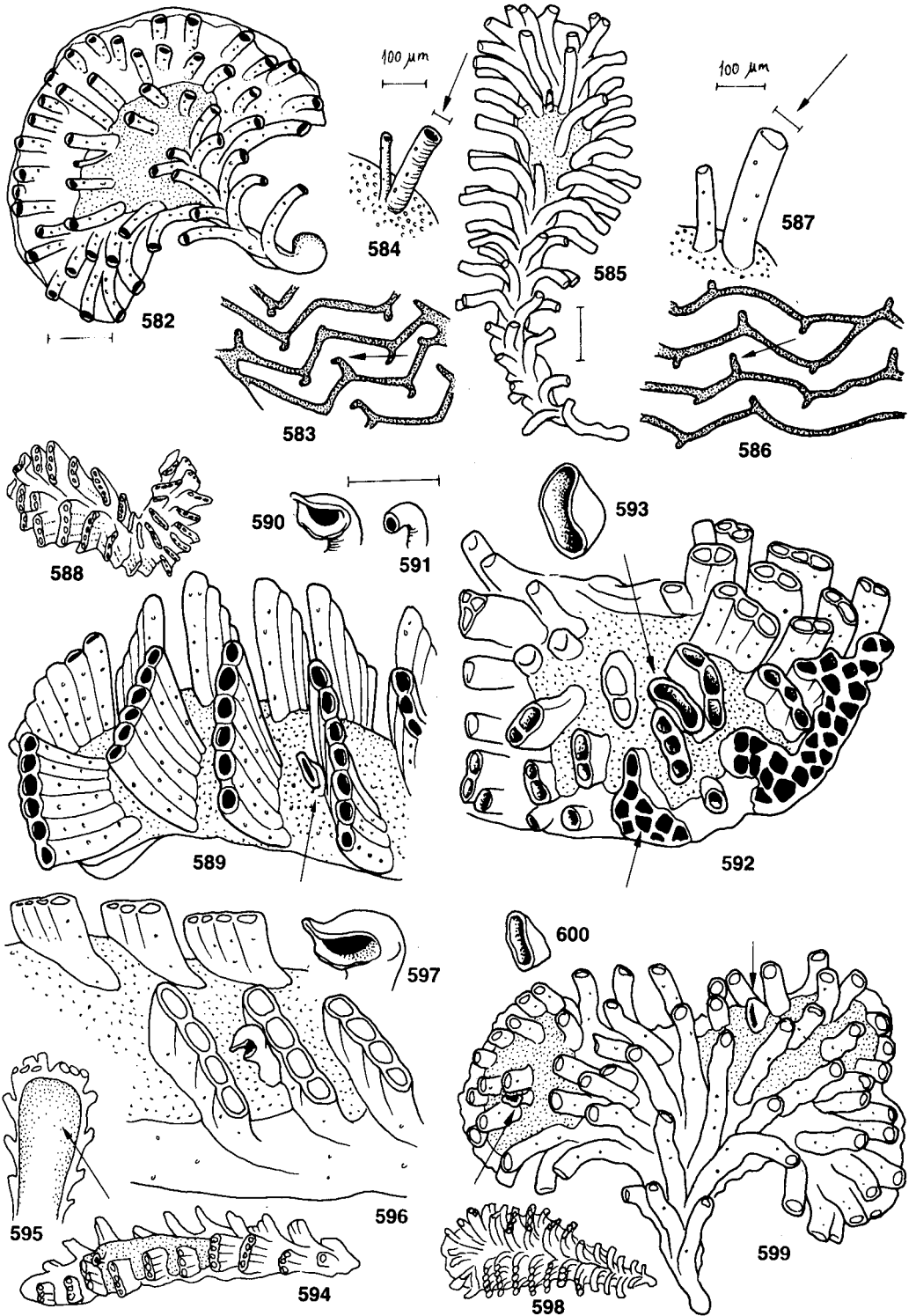

SUBORDER RECTANGULOIDEA

Colony adnate; ancestrula developing initially a fan-shaped primary colony which then recurves, overgrows ancestrular portion and forms a more or less circular colony. In later astogeny the colony may be regularly circular or oval, or may form cylinders around erect substrata; it is frequently concave, but may be domed, nodular or mamillate, and often forms extensive multicentred sheets. New colonies may be produced by peripheral budding from established colonies. Basal wall gymnocystal, usually extending beyond growing edge as a conspicuous peripheral lamina; all other walls, and extrazoidal structures, cryptocystal. Autozooids radiating from the centre of the colony, which is typically devoid of autozooids, in connate uniserial or multiserial rows, or in regular quincuncial arrangements, or without regular order. Extrazoidal pseudocoelomic spaces between autozoid rows, referred to as alveoli, divided by extrazoidal calcified struts. Brood chambers occur in the middle of the colony, single or multiple, often extending as lobes between the autozoid rows, roofed with texturally distinctive extrazoidal calcification; oeciostomes single or multiple, typically situated at the edges of the brood chambers. Polymorphism does not occur. Pseudopores absent.

The family Lichenporidae comprises two genera: *Disporella* Gray and *Lichenopora* DeFrance, the differences between which are not always readily distinguishable. To avoid these difficulties a common key to both genera is preferable.

LICHENOPORA DeFrance, 1823

Autozooids arranged in radiating series, or in quincunx, or irregularly. Alveoli delimited by calcified struts, open at the top or sealed later in ontogeny by porous plates; successive division of extrazoidal pseudocoelomic spaces may occur when new struts develop along different directions to those preceding them, giving rise to "secondary" and "tertiary" alveoli. Brood chamber a single confluent cavity occupying the greater part of the central region of the colony and extending to a varying degree between the autozoid rows; oeciostome single or multiple, situated at periphery of brood chamber, typically with a broadly flared orifice.

Type species: *Lichenopora turbinata* DeFrance, 1823

On the Mediterranean coasts, a large number of different species have been cited, such as *Lichenopora radiata*, *L. verrucaria*, *L. novazelandiae*, *L. nevirianii*, and *L. mediterranea*. Most of these citations seem to be erroneous. Only the occurrence of *L. radiata* has been verified, and in theory that of *L. verrucaria*. A third species recently found is probably a new species. It is necessary to clarify the status of this genus in the Mediterranean, taking into account details revealed by Scanning Electron Microscopy of the external morphology (shape of the alveoli, brooding chambers, shape of inner spines, etc.)

DISPORELLA Gray, 1848

Autozooids in radial or quincuncial series. Alveoli progressively reduced by centripetal calcification around edges of struts, but not closed completely, retaining a central foramen; all calcification imperforate. Embryos brooded in small, independent brood chambers occupying parts of the central area of the colony, or situated entirely between zooid rows. Oeciostome short, tubular, opening directly upwards, without a flared aperture.

Type species: *Disporella hispida* (Fleming, 1828)

The type species is the only species occurring in the Mediterranean. This is a very plastic species, showing a very variable appearance, especially if individual and compound colonies are compared. For this reason early authors described it under different names. The compound form has been named *Discopora meandrina* Peach, 1877; *Lichenopora hispida* var. *meandrina* Hincks, 1880; *Radiopora pustulosa* D'Orbigny, 1851-54 in Waters, 1879 and *Lichenopora mamillata* Lagaaij, 1952. The *fimbriata* form is probably the same *Discoporella fimbriata* and *Discoporella ciliata* by Busk and was recorded by Waters, at Naples, as *Radiopora pustulosa* form *fimbriata*.

1. Colony large (up to 6 cm²), irregular, composed of several disks originated by lateral budding from an original disk, and afterwards becoming fused. The disks remain visible, like crowns overlapping the general surface; these are formed by radiating or convergent bundles of peristomes. Brood chambers present as distinct, independent lobes occupying parts of central region of colony, or spaces between autozooid rows; star-shaped, smooth surface (finely punctured), often furrowed by converging, radiating crests. Oeciostome interradiial (or always peripheral), very short; diameter twice that of peristomes. Peristomes uni- or biacuminate. With a crown of inner denticles. Alveoli rounded or irregular (not polygonal), almost closed leaving a central pore
- *Disporella hispida* form *meandrina*
 (Hincks, 1880); 610, 612, 613, 614, 615, 616, (34 C-D) (ZABALA, 1986:678 as *Lichenopora* sp. 1)
 - Colony discoidal, of limited size (max. Ø = 0.5 – 1 cm) 2

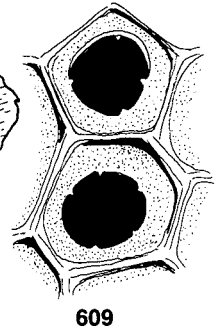
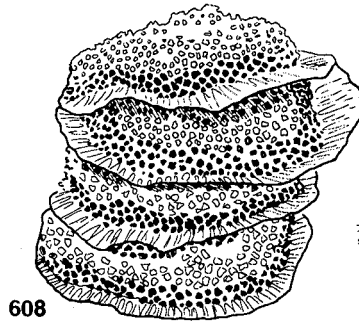
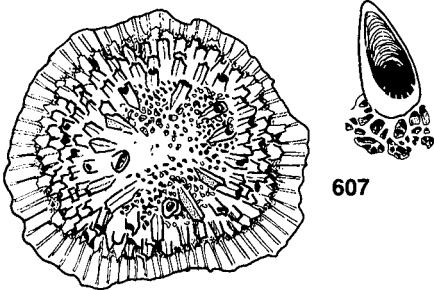
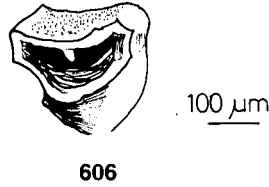
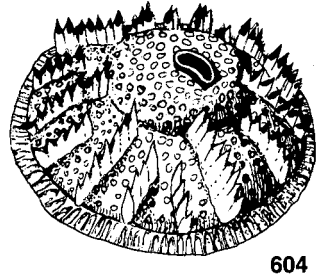
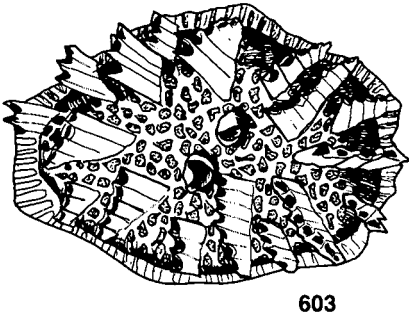
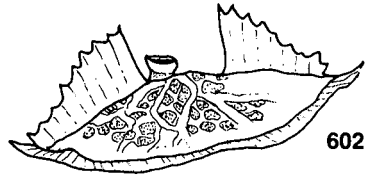
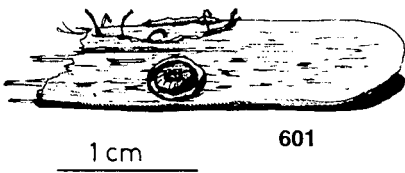

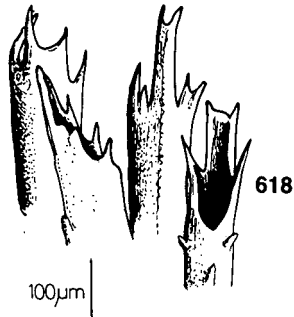
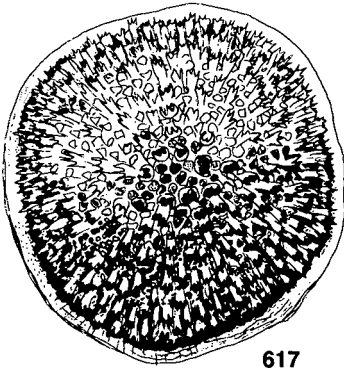
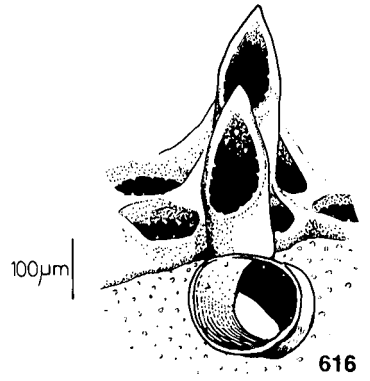
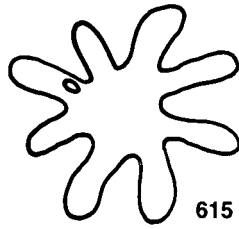
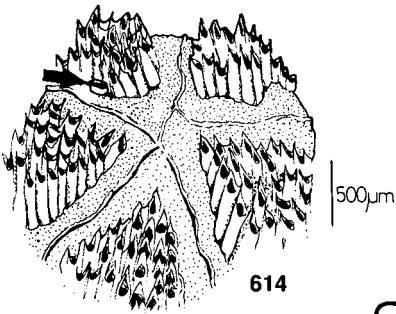
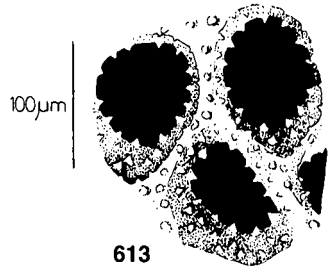
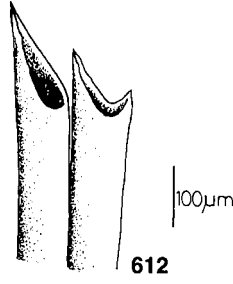
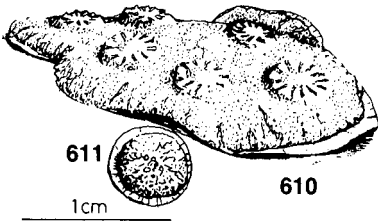

2. Colony growth by vertical regeneration. Disks heaped in cylindrical turrets. Alveoli hexagonal, of constant proportions, more or less closed by a circular diaphragm; with denticles. Peristomes radiating, little prominent, uniserial, of constant height from the centre to the periphery. Brood chamber with smooth surface limited by a flaring calcareous edge. Oeciostome peripheral, interradial, as a short tube, somewhat quadrangular, diameter slightly smaller than that of the peristomes
..... *Lichenopora* sp. n.; 608, 609 (34 F, 35 A-B) (ZABALA, 1986:671 as *Lichenopora* sp. 2)
- Colony a single disk, without known vertical heaping of disks. Alveoli irregular or, if polygonal, always quadrangular, of variable proportions. Peristomes in reticle or in radiating “organ-pipes”, of decreasing length from the centre to the periphery 3
3. Surface or brood chambers smooth or finely punctured. Oeciostome interradial or always peripheral (at the margin of the chamber), a short tube, cylindrical without distal enlargement (or very small), diameter twice that of the peristomes. Alveoli irregular or rounded. Peristomes radiating or in irregular reticle 4
- Surface or brood chamber covered by large, regular or irregular, alveoli. Oeciostome (sometimes several) central (although often associated with the first peristome –the innermost– of a radial series of zooids), projecting, widened distally, forming a large laterally compressed funnel much larger (at least the axis is longer) than the peristomes: 5
4. Colony of hirsute appearance due to the fimbriated character of the peristomes. Peristomes in disordered reticle or in non-coalescent series form *Disporella hispida fimbriata* (Waters, 1879); 617, 618, 619 (34 E) (ZABALA, 1986:678 as *Lichenopora* sp. 1)
- Colony otherwise shaped. Peristomes acuminate or biacuminate but not fimbriate. Generally ordered in radiating series, coalescent, at least at the bases (even though sometimes separated and reticulate) simple form of *Disporella hispida* (Fleming, 1828); 611, 612, 613, 614, 615, 616 (34 C-D) (ZABALA, 1986:678 as *Lichenopora* sp. 1)
5. Autozooids in strictly connate series, in “organ-pipes”, with only the distal projections of the peristome free *Lichenopora radiata* (Audouin, 1826); 601, 602, 603, 604, 605, 606 (35 C-F) (ZABALA, 1986:672 as *Lichenopora* sp. 3)
- Autozooids quincuncially arranged, the peristomes free for the whole of their length
..... *Lichenopora verrucaria* (Fabricius); (*) 607 (HAYWARD & RYLAND, 1985a:126)

SUBORDER CANCELLOIDEA

HORNERA Lamouroux, 1821

Colony erect, branching or reticulate, with a base formed by supporting kenozooids. Zooid apertures confined to the frontal face of the colony. With foramina at either frontal and basal faces (at the base of the sulci). Gonozooid with the most visible part (distal swelling) situated on the dorsal face, large, elongated, with terminal or lateral oeciostome, usually placed at the beginning of a bifurcation and distinguishable even in frontal view.

Type species: *Hornera frondiculata* Lamouroux, 1821

1. Colony small (1-5 cm in height). Zooids arranged in reticle (not in rows). Peristomes with entire, circular edge (section in O). Basal surface smooth, feebly fronto-reticulate, with narrow longitudinal grooves (sulci). Gonozooid with the oeciostome usually lateral
H. lichenoides (Linnaeus, 1758); 620, 621, 622, 623, 624 (36 C) (HAYWARD & RYLAND, 1985a:116)
- Colony larger (5-10 cm in height). Zooids in rather conspicuous rows. Frontal surface strongly reticulate in rhomboidal meshes, enclosing the peristomes, which are surrounded by numerous pores. Peristomes with circular edge, but notched above (section in U). Basal surface strongly reticulate, with deep, broad grooves. Gonozooid with oeciostome always in upper position
H. frondiculata (Lamouroux, 1821); 625, 626, 627, 628, 629 (36 A-B) (ZABALA, 1986:686)

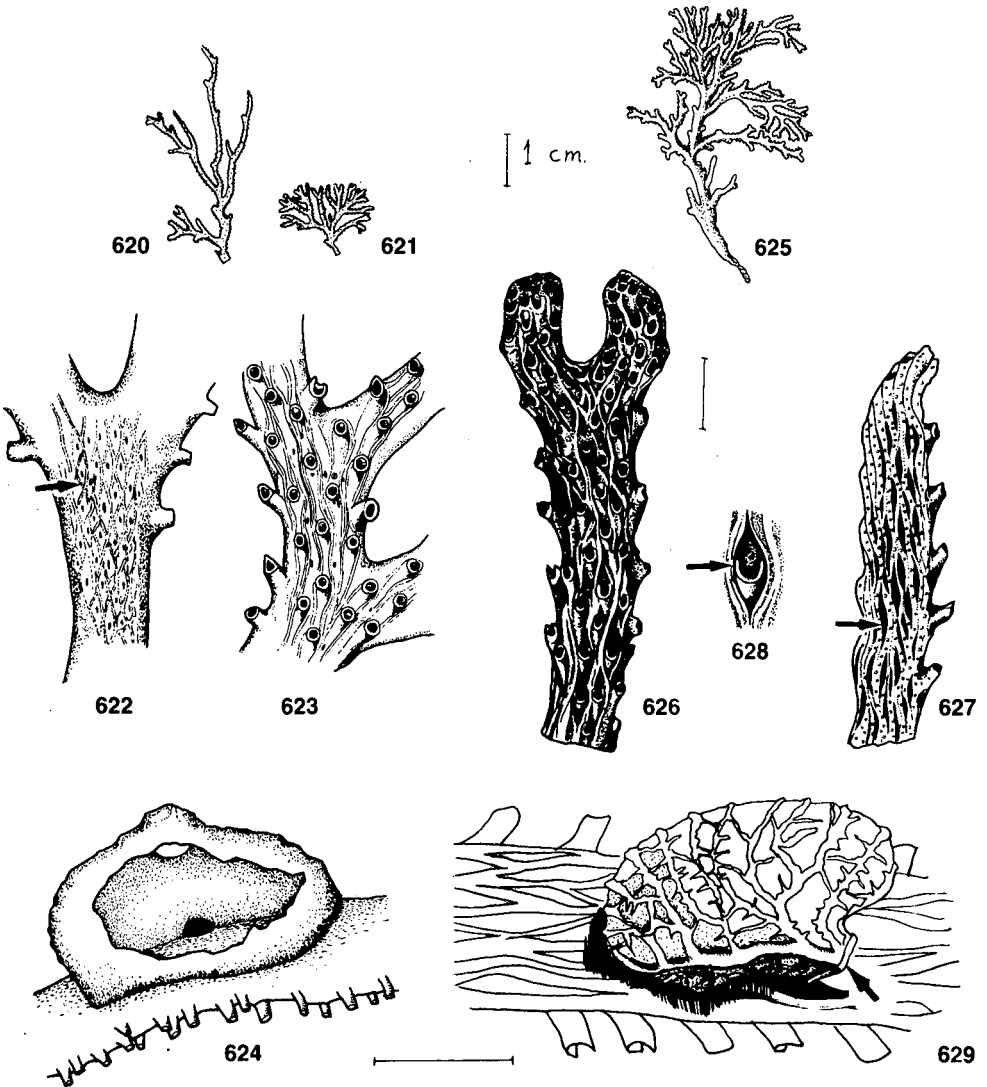

8. PLATES

Plate 1.

- A. *Amathia semiconvoluta*. Group of zooids.
- B. *Buskia socialis*. Group of zooids showing the typical basal shape (arrowed).
- C. *Aetea sica*. A peristome with the typically ringed base (arrowed).
- D. *Aetea truncata*. Group of zooids.
- E. *Conopeum reticulum*. Autozooids and kenozooids typically paired. On a *Mytilus edulis* bought in Maó (Minorca), probably imported from the Atlantic, Galicia.
- F. *Spiralaria gregaria*. Zooids, avicularia and one ovicell (centre).
- G. *Crassimarginatella maderensis*. Group of zooids.
- H. *Crassimarginatella solidula*. Zooids, ovicells and one avicularium (arrowed).

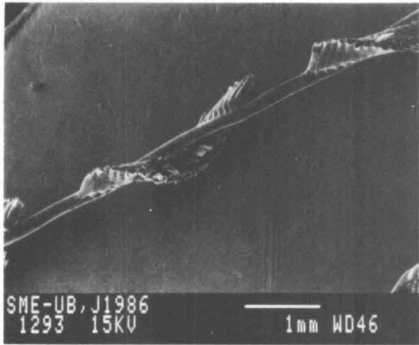

A

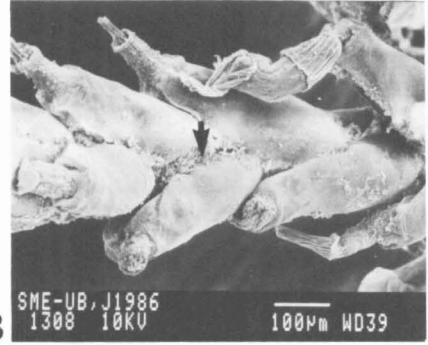

B

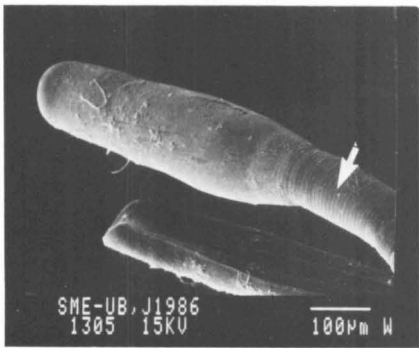

C

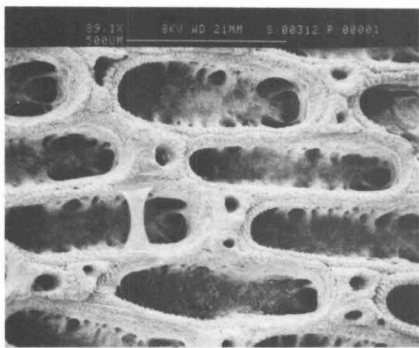
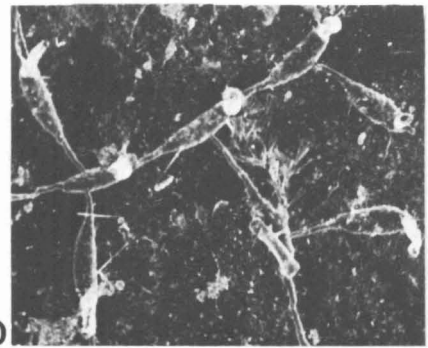

E



F

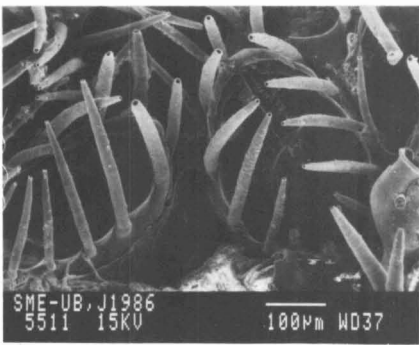

G

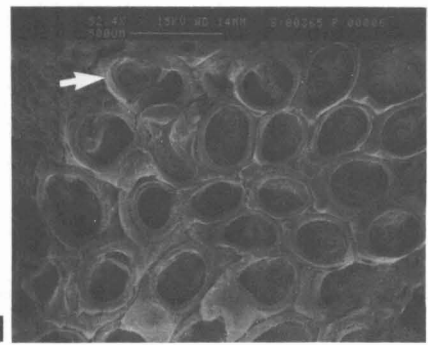

H

Plate 2

- A. *Onychocella marioni*. Zooids and onychocellaria.
- B. *Calpensia nobilis*. Group of zooids.
- C. *Mollia circumcincta*. Group of zooids.
- D. *Mollia circumcincta*. Ovicellate zooid.
- E. *Setosella vulnerata*. Colony.
- F. *Copidozoum exiguum*. Ovicellate zooids and avicularia (characteristic).
- G. *Chlidonia pyriformis*. Group of zooids seen by their basal (foreground) and frontal face (background).
- H. *Cellaria salicornioides*. Ovicellate zooids and avicularia (arrowed).

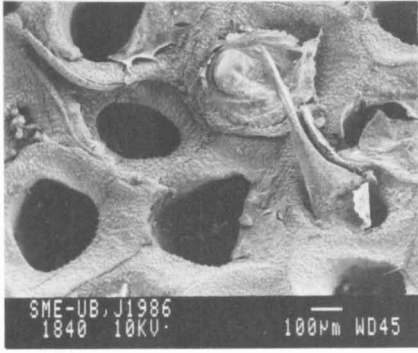

A

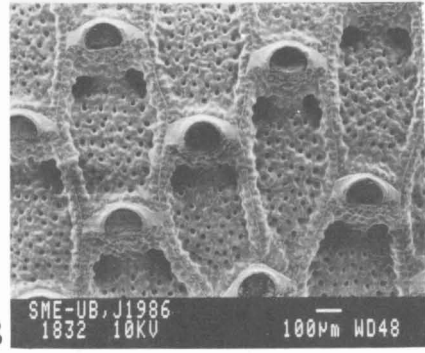

B

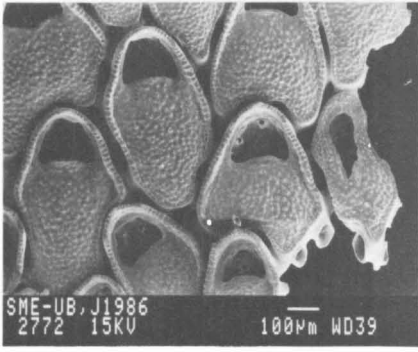

C

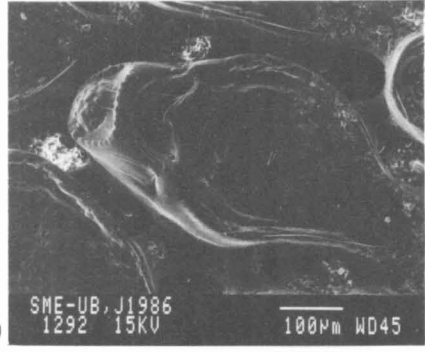

D

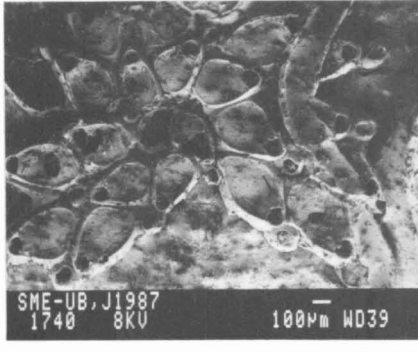

E

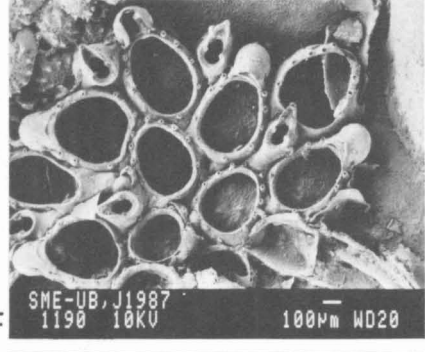

F

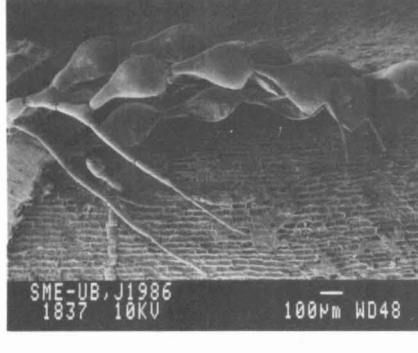

G

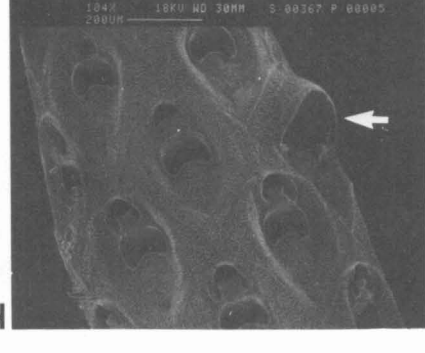
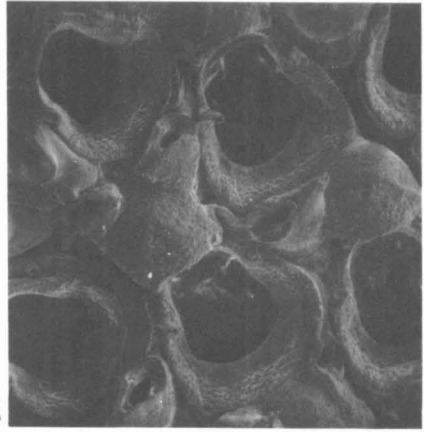

Plate 3

- A. *Hincksina flustroides crassispinata*. Group of zooids and one avicularium.
- B. *Amphiblestrum minax*. Zooids with avicularia and one ovicell.
- C. *Callopora dumerilii*. Growing margin of the colony.
- D. *Caberea boryi*. Frontal face.
- E. *Caberea boryi*. Basal face.
- F. *Scrupocellaria delilii*. Frontal face. Distal apophysis of the operculum and characteristic frontal avicularium are arrowed.



A



B



C

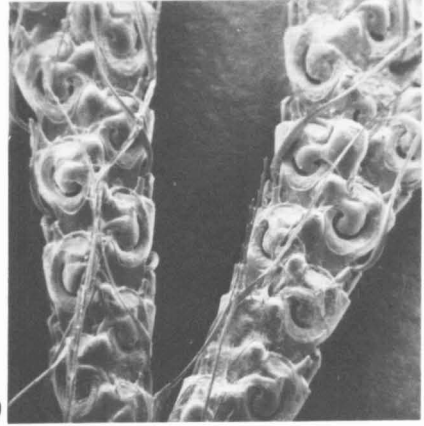

D



E

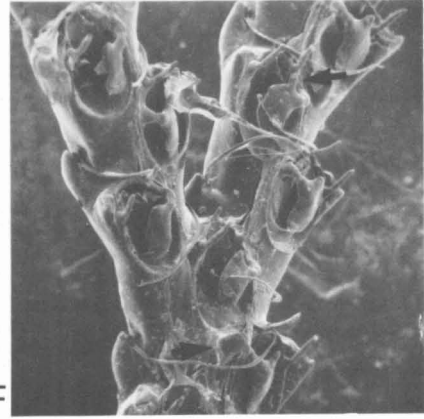

F

Plate 4

- A. *Scrupocellaria incurvata*. Frontal face.
- B. *Scrupocellaria incurvata*. Basal face. Notice the bended shape of vibracular groove.
- C. *Scrupocellaria aegeensis*. Zooids with one ovicell.
- D. *Scrupocellaria aegeensis*. Ovicellate zooid.
- E. *Scrupocellaria maderensis*. Ovicellate zooids.
- F. *Scrupocellaria scruposa*. Ovicellate zooids.

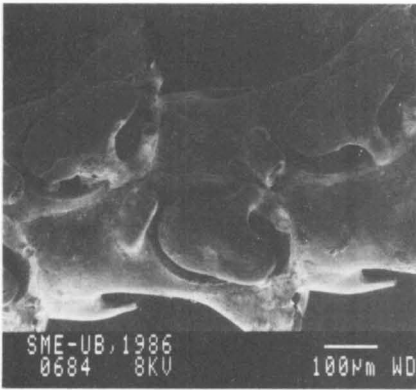

A

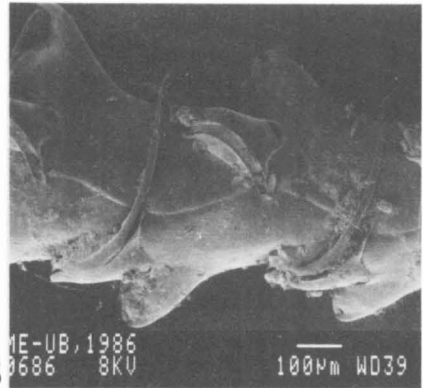

B



C

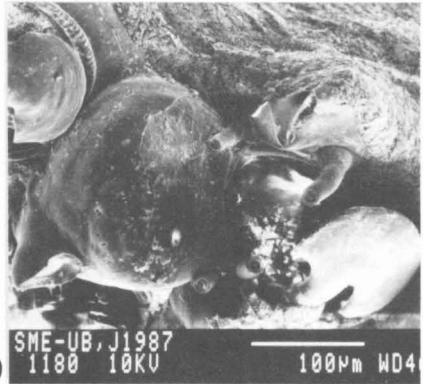

D

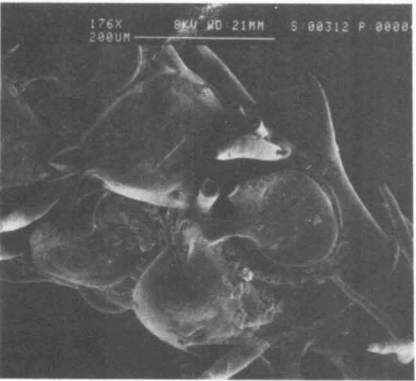

E

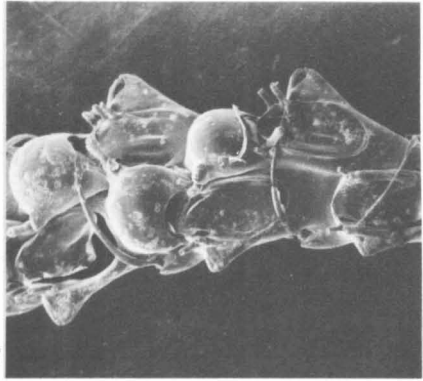

F

Plate 5

- A. *Scrupocellaria reptans*. Ovicellate zooids and a typical frontal avicularium.
- B. *Scrupocellaria reptans*. Basal face.
- C. *Bicellariella ciliata*. Ovicellate zooids. General aspect of the colony.
- D. *Bicellariella ciliata*. Ovicellate zooids. Tip of a branch showing the frontal membrane and one avicularium (arrowed)
- E. *Bugula germanae*. Ovicellate zooids.
- F. *Bugula flabellata*. Group of ovicellate zooids. Observe the difference in size between marginal and central avicularia.

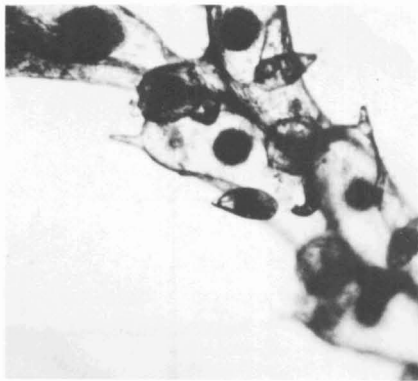
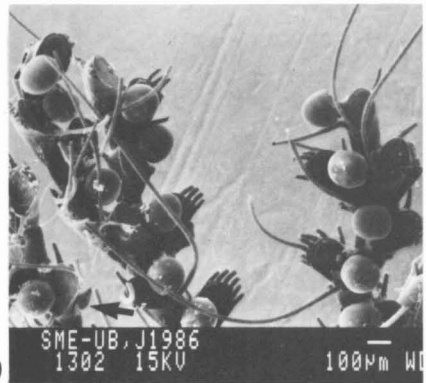
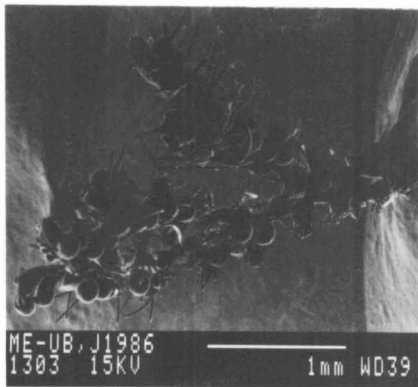
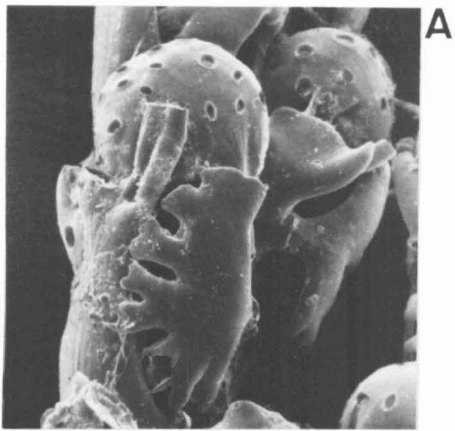
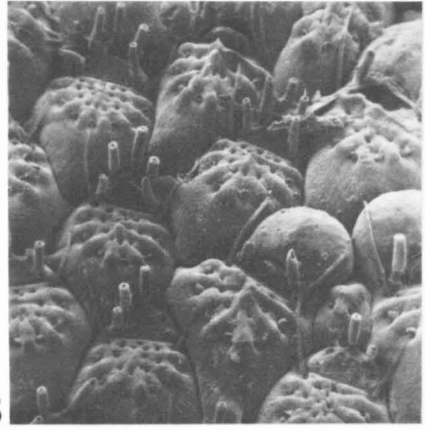

Plate 6

- A. *Collarina balzaci*. Zooids with and without ovicell.
- B. *Puellina (Puellina) gattyae*. Zooids with ovicells.
- C. *Puellina (Cribrilaria) hincksi*. Detail of suboral plate.
- D. *Puellina (Cribrilaria) hincksi*. Ovicellate zooids.
- E. *Puellina (Cribrilaria) innominata*. Zooids with ovicells type A and large suboral umbones.
- F. *Puellina (Cribrilaria) innominata*. Zooids with one ovicell type B.



A



B

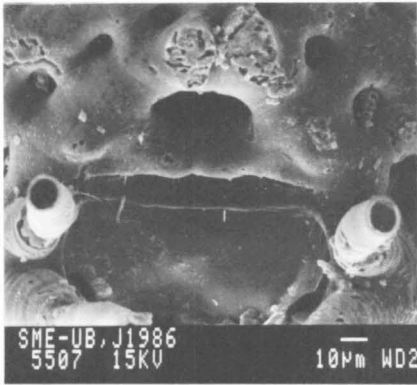

C

SME-UB, J1986
5507 15KV
10µm WD2

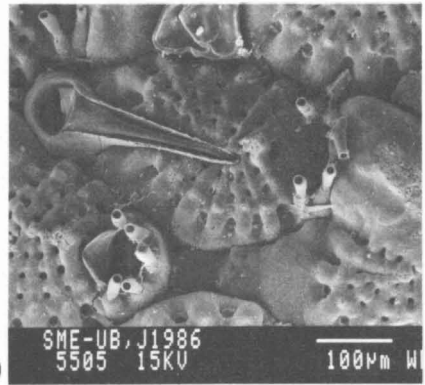

D

SME-UB, J1986
5505 15KV
100µm W

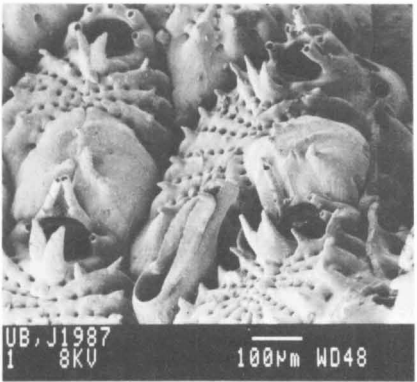

E

UB, J1987
1 8KV
100µm WD48

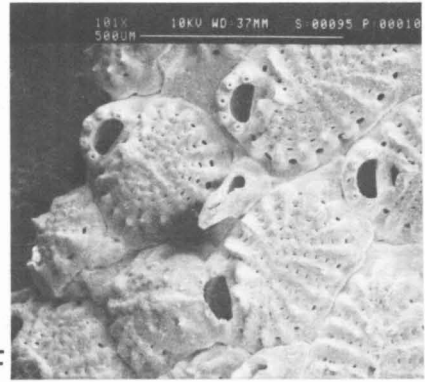

F

10KV 10KV WD 37MM S: 00095 P: 00010
500µm

Plate 7

- A. *Puellina (Cribrilaria) radiata*. Ovicellate zooids.
- B. *Puellina (Cribrilaria) radiata*. Detail of one autozooid and avicularium
- C. *Puellina (Cribrilaria) venusta*. Zooids with one ovicell.
- D. *Puellina (Cribrilaria) venusta*. One autozooid and one kenozooid (arrowed).
- E. *Puellina (Glabrilaria) pedunculata*. Non-ovicellate zooid. Notice the spine number (6) and the characteristic shape of pedunculate avicularium.
- F. *Puellina (Glabrilaria) pedunculata*. Ovicell.
- G. *Puellina (Glabrilaria) n. sp. (aff. arrecta)*. Autozooids with one ovicell. Only five spines can be observed. Notice the characteristic shape of the avicularian gymnocyst and mandible (arrowed).
- H. *Figularia figularis*. Ovicellate zooids and two avicularia.



A

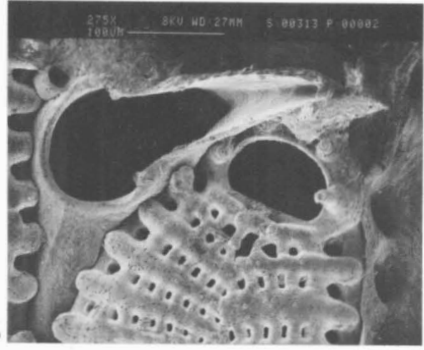

B

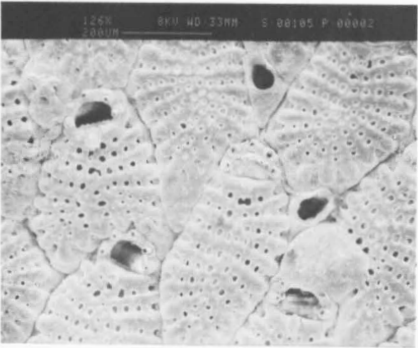

C

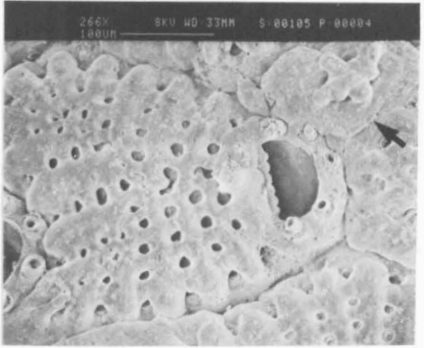

D



E

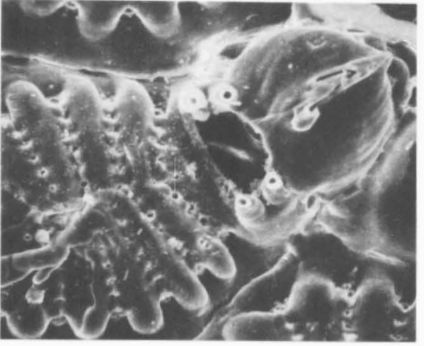

F

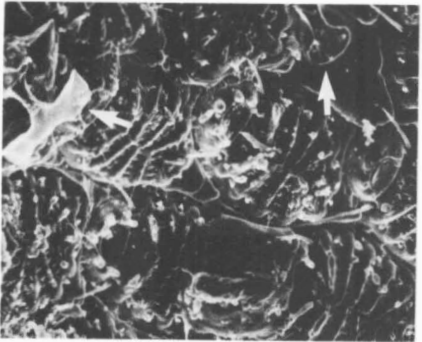

G

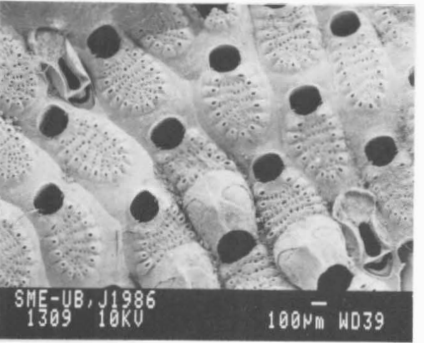

H

Plate 8.

- A. *Membraniporella nitida*. Autozooids with avicularia.
- B. *Adeonellopsis distoma*. Group of zooids.
- C. *Hippoporina pertusa*. Autozooid.
- D. *Hippoporina pertusa*. One ovicell.
- E. *Pentapora fascialis*. Group of zooids.
- F. *Pentapora ottomulleriana*. Autozooids.
- G. *Pentapora ottomulleriana*. Ovicellate zooids.
- H. *Hippomenella mucronelliformis*. Zooids with one ovicell.

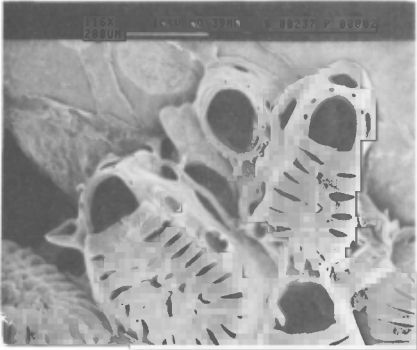

A

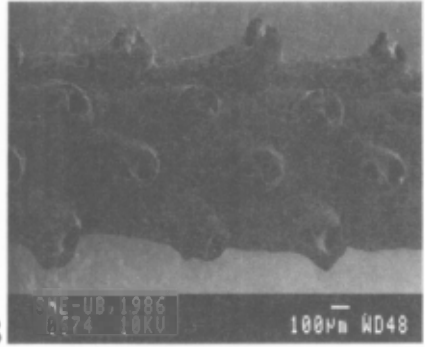

B

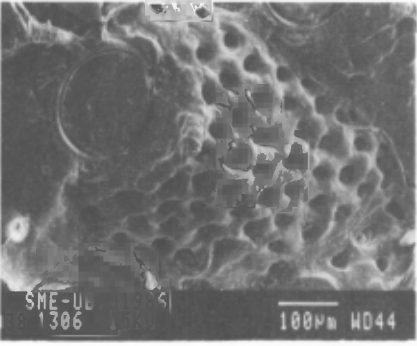

C

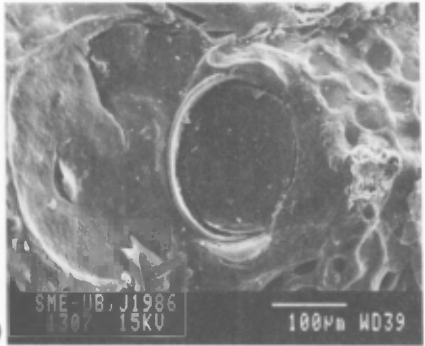

D

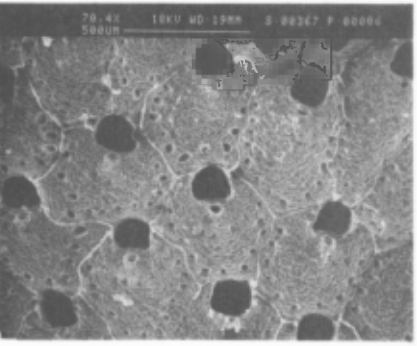

E

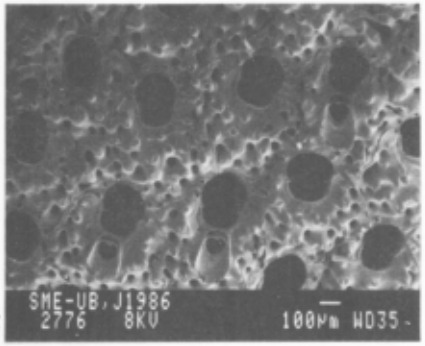

F

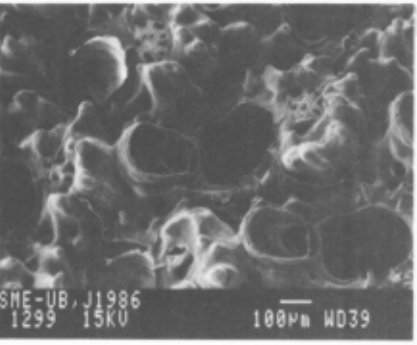

G

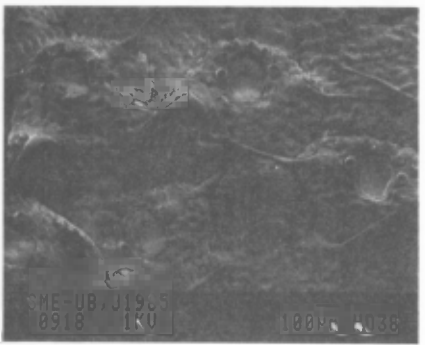

H

Plate 9

- A. *Umbonula oviceolata*. Group of zooids.
- B. *Umbonula oviceolata*. Ovicell.
- C. *Escharoides coccinea*. Ovicellate zooids.
- D. *Watersipora subovoidea*. Aperture with typical operculum.
- E. *Palmicellaria* aff. *aviculifera*. The arrow shows the position of the avicularium.
- F. *Palmicellaria skenei*. Group of zooids and one ovicell (arrowed).

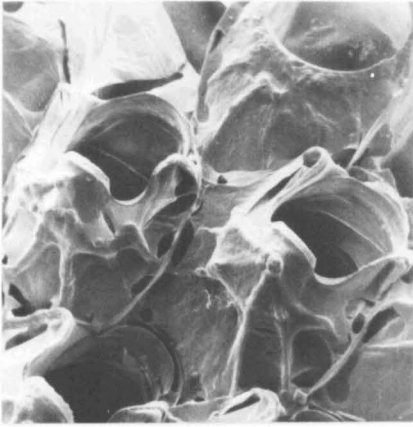

A

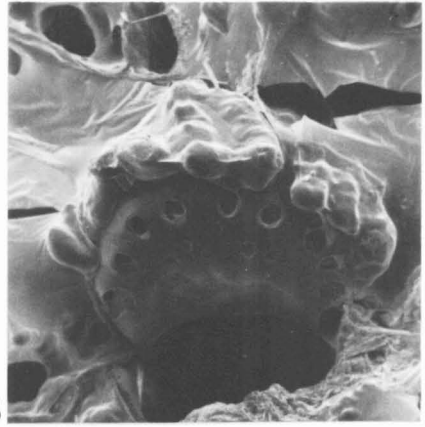

B

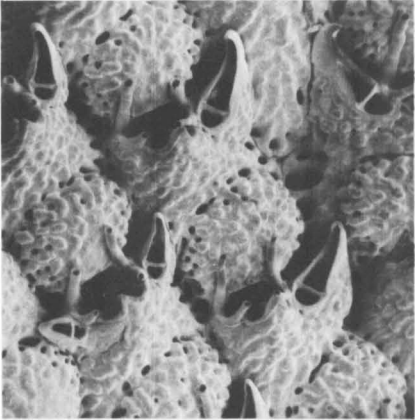

C

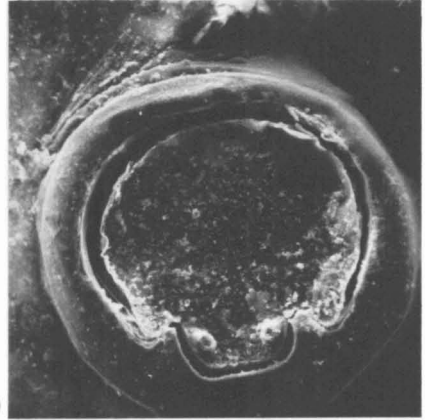

D

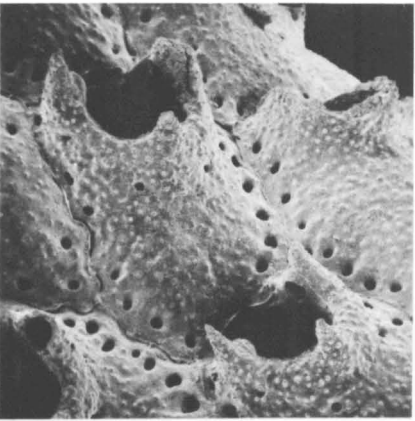

E

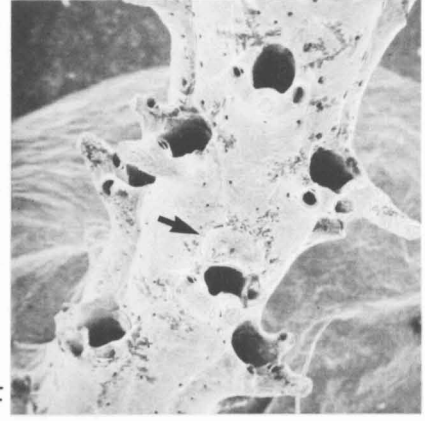

F

Plate 10

- A. *Parasmittina tropica*. Young zooids with peristome and spines.
- B. *Parasmittina tropica*. Young zooids with peristome and spines.
- C. *Parasmittina tropica* f. *rouvillei* (Calvet). Old zooids with calcified peristome
- D. *Parasmittina tropica* f. *rouvillei* (Calvet). Zooids with avicularia pointing to the aperture.
- E. *Parasmittina tropica*. Ovicellate zooids.
- F. *Parasmittina tropica* f. *porosa* (Canu & Bassler). One zooid very calcified.

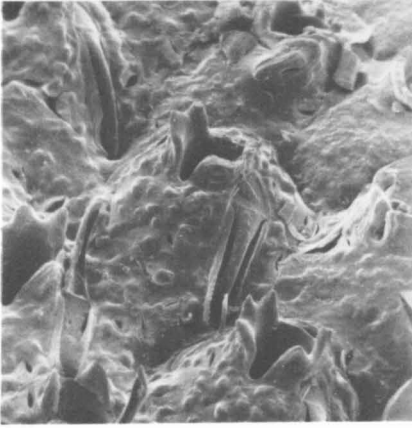

A

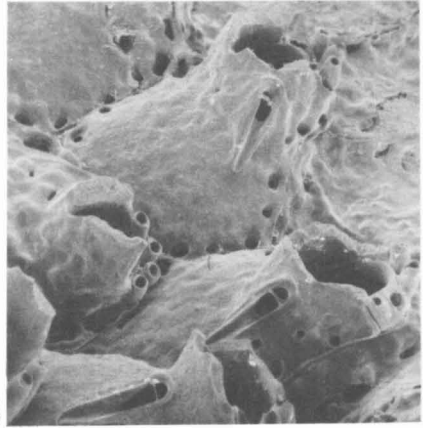

B

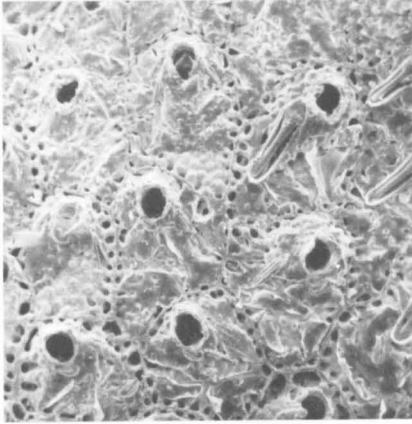

C

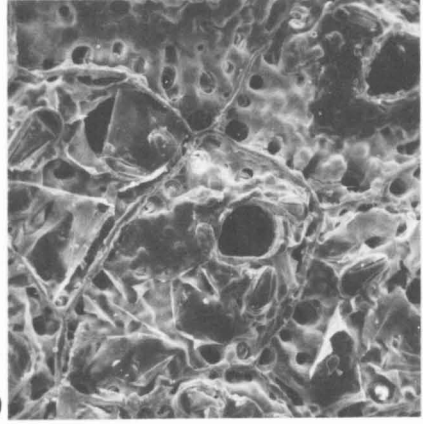

D



E

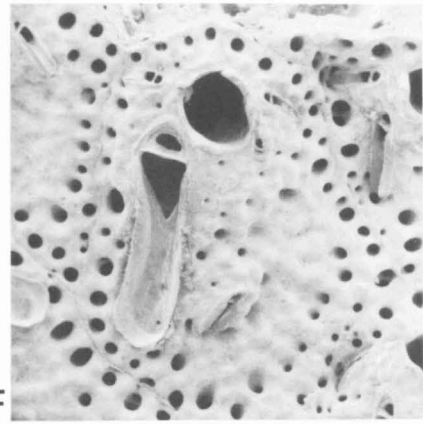

F

Plate 11

- A. *Porella minuta*. Only from a distal perspective the avicularium can be seen (arrowed).
- B. *Smitina landsborovii*. Ovicellate zooids with one spatulate avicularium in a typically transverse position.
- C. *Prenantia cheilostoma*. Ovicellate zooids.
- D. *Porella minuta*. Ovicellate zooids.
- E. *Prenantia inerma*. Detail of primary orifice.
- F. *Prenantia inerma*. Ovicellate zooids.

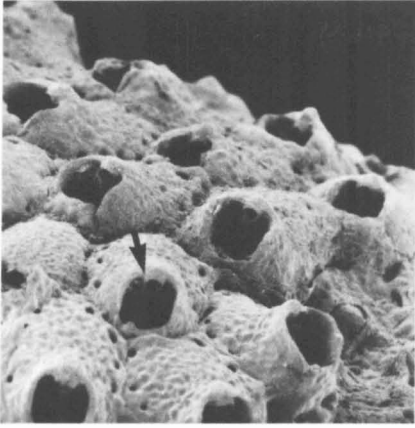

A

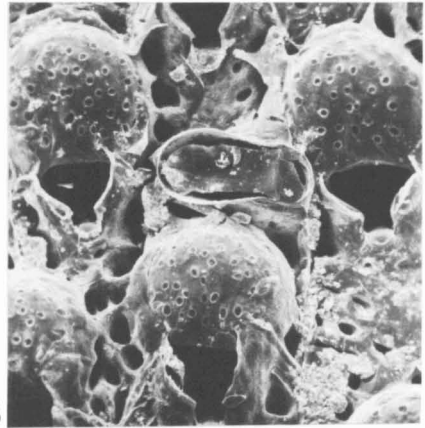

B

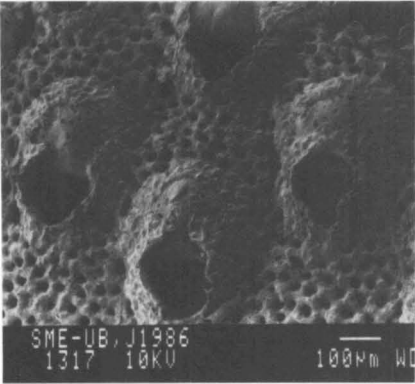

C

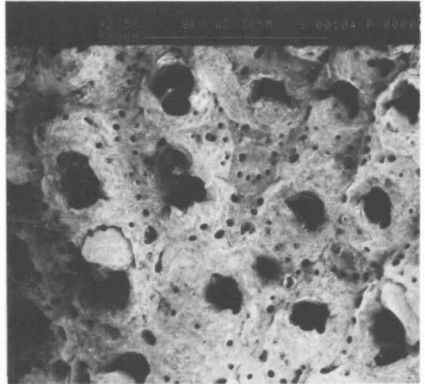

D

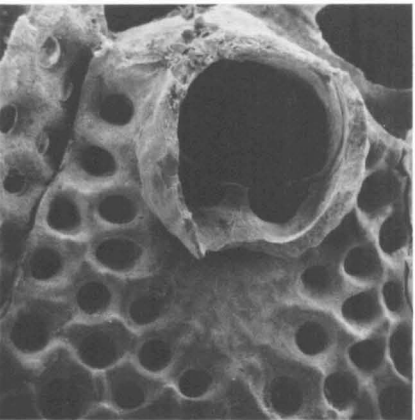

E



F

Plate 12

- A. *Porella tubulata*. Fragment of a branch.
- B. *Smittina crystallina*. Ovicellate zooids. See the shape of the lyrula and condyles and the presence of spines on marginal zooids.
- C. *Smittina cervicornis*. Fragment of a branch.
- D. *Smittoidea reticulata*
- E. *Smittoidea marmorea*. Marginal zooids.
- F. *Phylactellipora eximia*. Zooids and one ovicell. Observe the presence of two spines on distal part of primary orifices (arrowed).

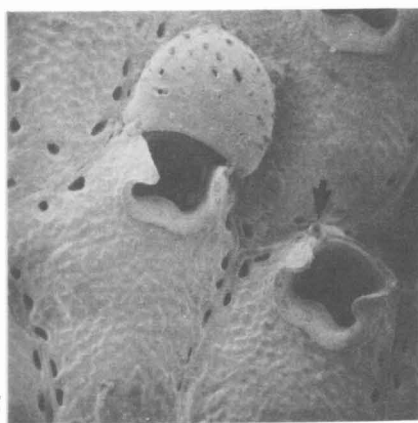
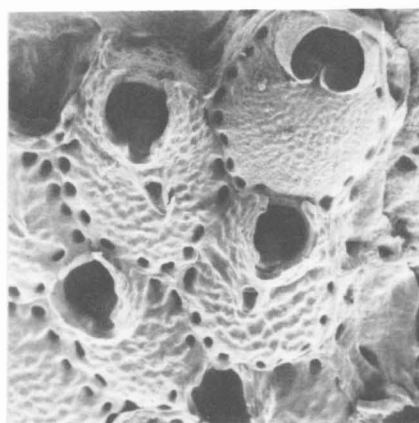
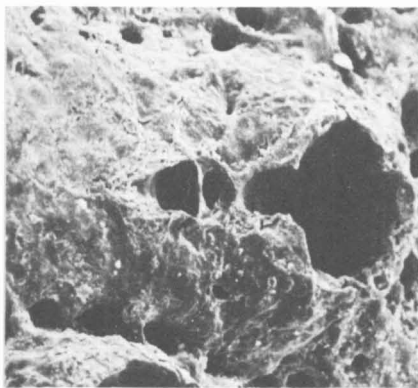
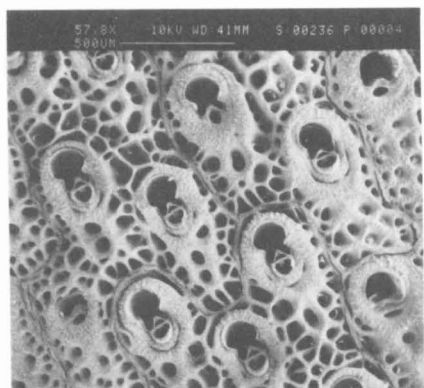
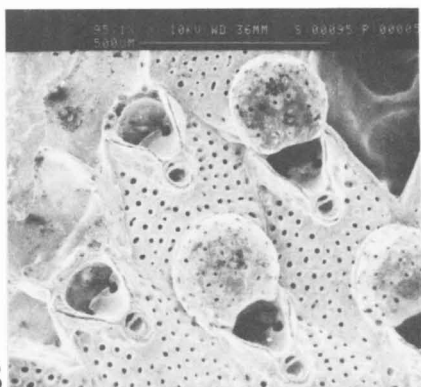
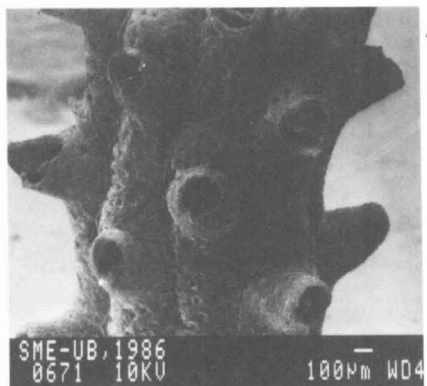
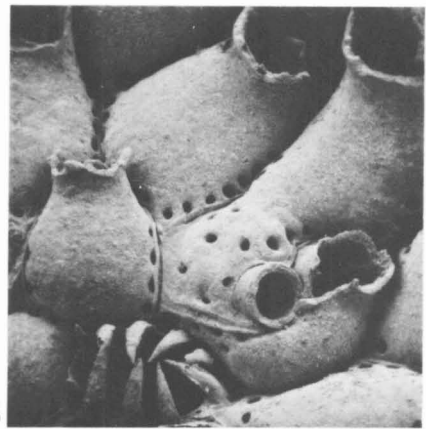

Plate 13

- A. *Escharella rylandi*. Ovicellate zooids.
- B. *Escharella rylandi*. Ancestrula and periancestrular zooids.
- C. *Escharella variolosa*. Ovicellate zooids.
- D. *Arthropoma cecilii*. Ovicellate zooids.
- E. *Escharella* n. sp. Ovicellate zooids. Observe the six oral spines (arrowed).
- F. *Escharella* n. sp. Non-ovicellate zooids. Observe the shape of the lyrula (arrowed).



A



B

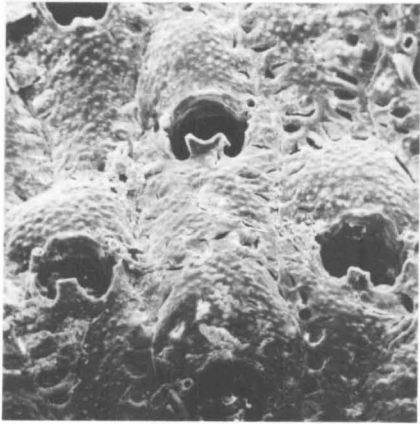

C

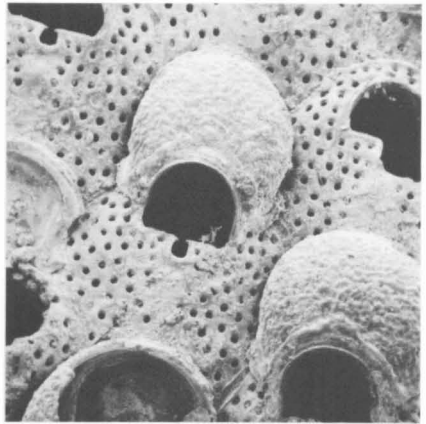

D

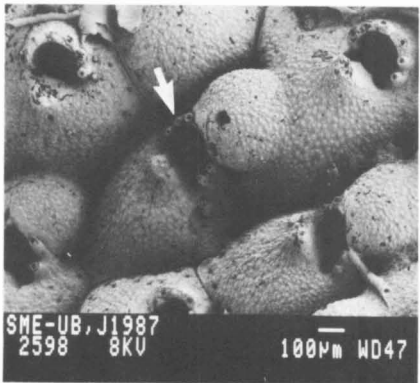

E

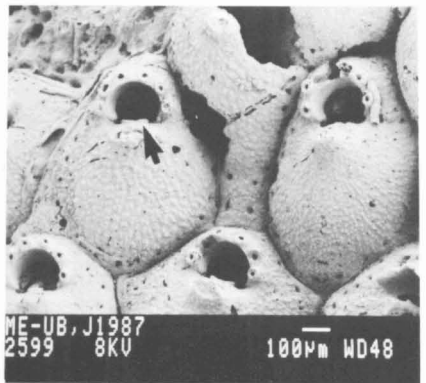

F

Plate 14

- A. *Escharella octodentata*. Ovicellate zooids.
- B. *Escharella octodentata*. Detail.
- C. *Calyptotheca* n. sp. Non-ovicellate zooids with primary orifices closed by the operculum.
- D. *Calyptotheca* n. sp. Ovicellate zooids (arrowed).
- E. *Calyptotheca* n. sp. Non-ovicellate zooids without operculum showing the sinus well defined by strong lateral condyles.
- F. *Calyptotheca* n. sp. The rest of the ovicells subimmersed in the frontal wall of distal zooid can be seen.
- G. *Cribellopora trichotoma*. Group of zooids with two ovicells.
- H. *Cribellopora trichotoma*. Detail of one autozooid.

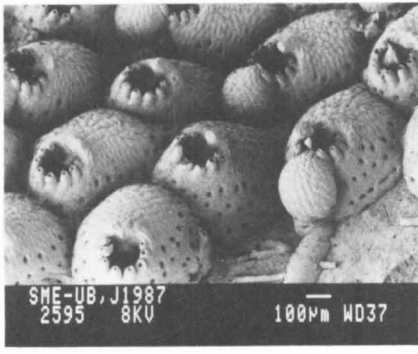

A

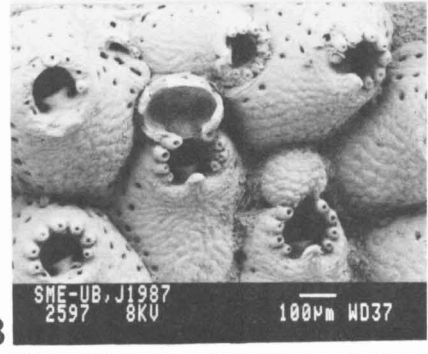

B

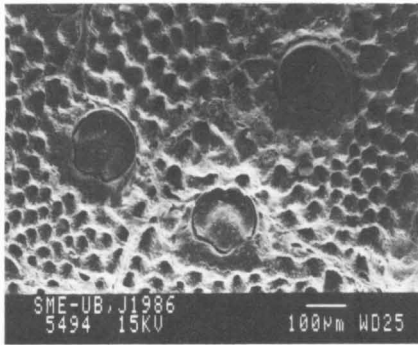

C

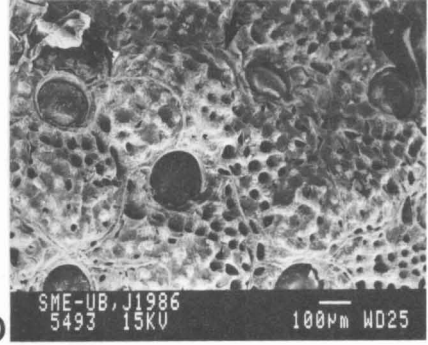

D

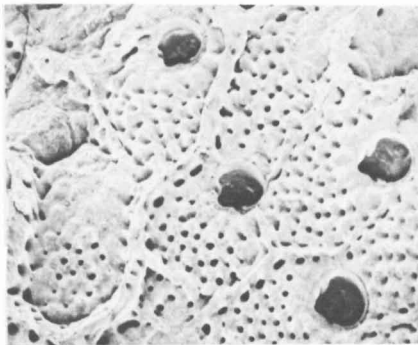

E

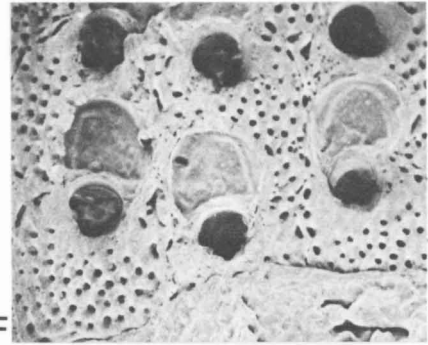

F

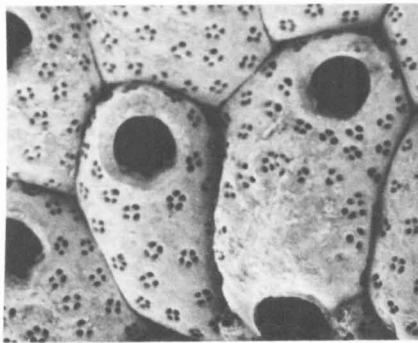

G

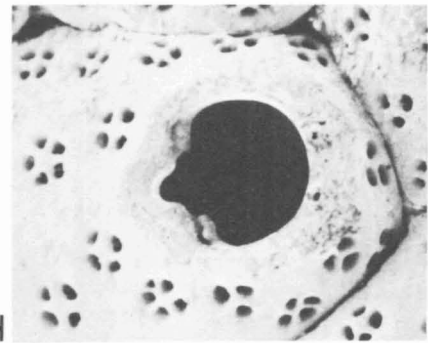

H

Plate 15

- A. *Escharina* aff. *dutertrei*. Non-ovicellate zooids.
- B. *Escharina* aff. *dutertrei*. Ovicellate zooids.
- C. *Escharina* aff. *dutertrei*. Detail of the primary orifice showing the denticulate anter (arrowed).
- D. *Escharina* aff. *dutertrei*. Ovicellate and non-ovicellate zooids. Notice the shape of the peristomial avicularium (arrowed).
- E. *Escharina* *hyndmanni*. Ovicellate zooids.
- F. *Escharina* *porosa*. Zooids with an ovicell in development (bottom).

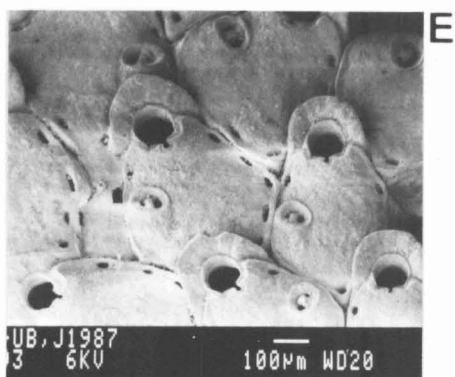
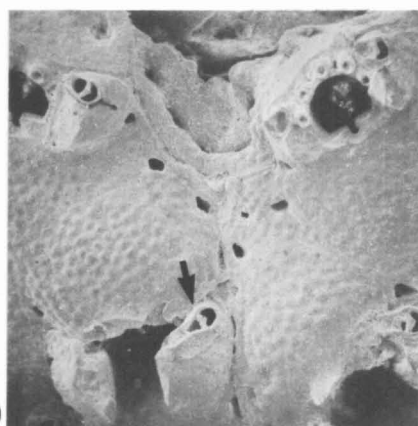
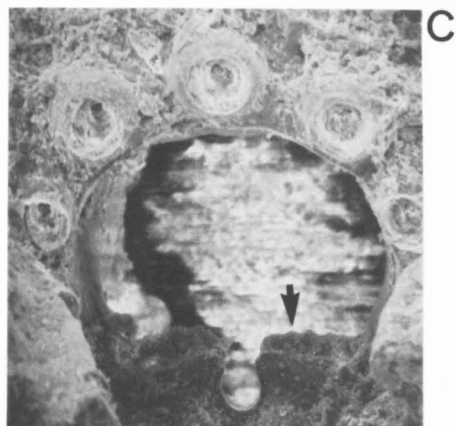
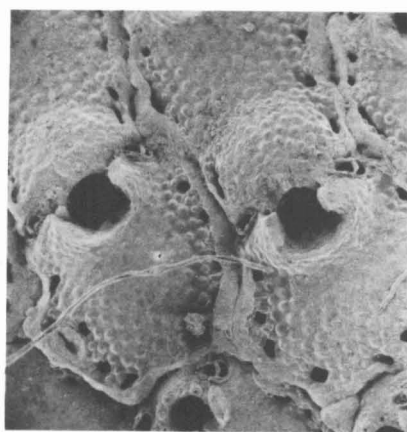
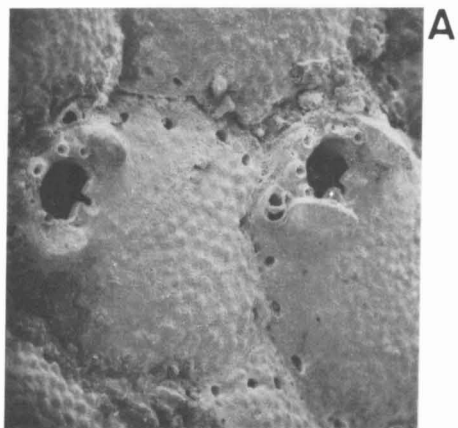
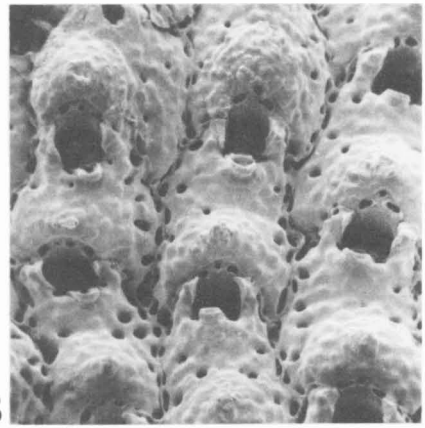

Plate 16.

- A. *Metroperiella lepralioides*. Ovicellate zooids.
- B. *Schizomavella auriculata* var. *cuspidata*. Ovicellate zooids.
- C. *Schizomavella discoidea*. Ovicellate zooids. Notice the development of the peristome and the typical spatulate avicularium.
- D. *Schizomavella linearis*. One marginal zooid.
- E. *Schizobrachiella sanguinea*. Non-ovicellate zooid and avicularium (arrowed).
- F. *Schizomavella discoidea*. Marginal zooids with spines and showing the shape of primary orifice.



A



B

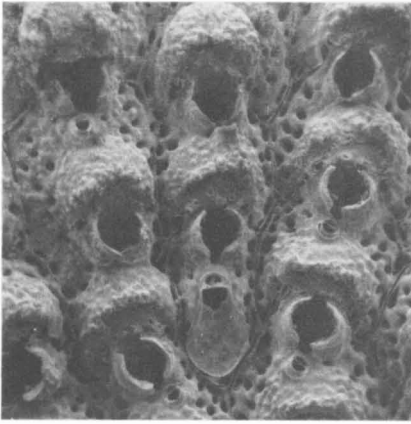

C

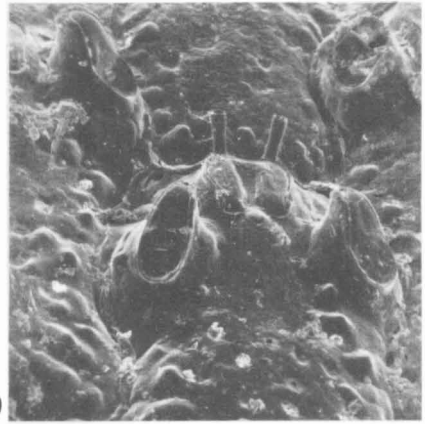

D

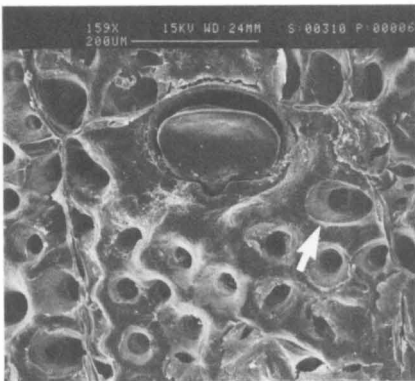

E

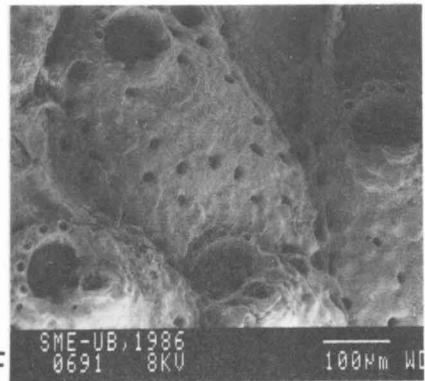

F

Plate 17

- A. *Schizomavella auriculata*. Non-ovicellate zooids.
- B. *Schizomavella mamillata*. Marginal zooids with rests of spines.
- C. *Schizomavella mamillata*. One ovicellate zooid.
- D. *Schizomavella rudis*. One autozooid.
- E. *Schizomavella hastata*. Marginal autozooids.
- F. *Schizomavella hastata*. Ovicellate zooids.

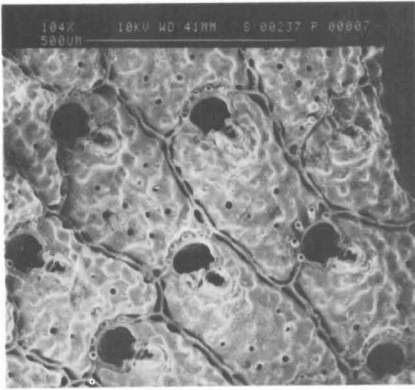

A

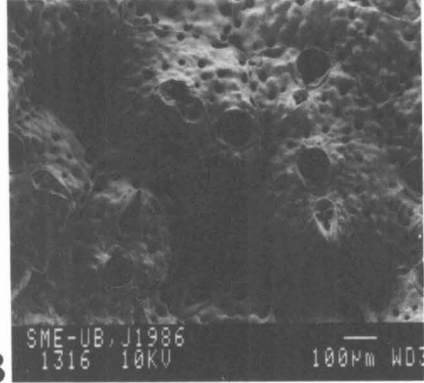

B

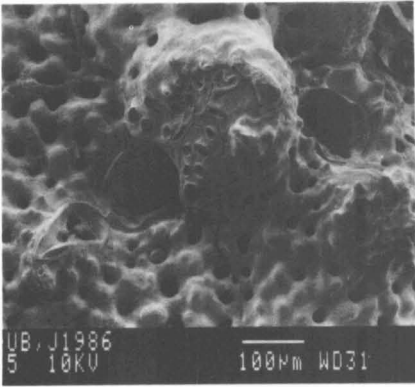

C

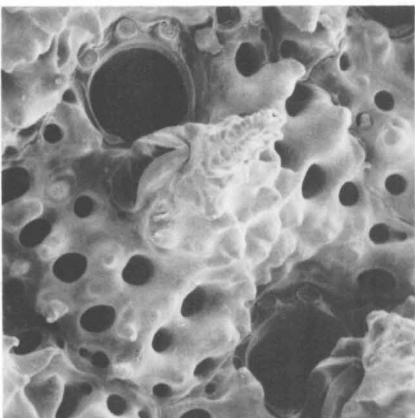
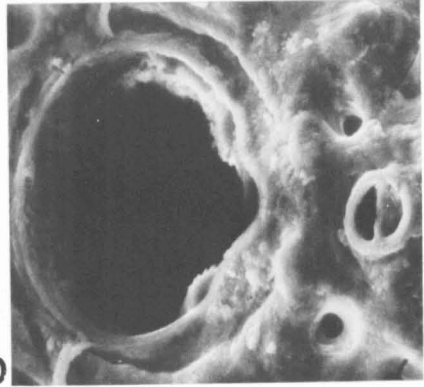

E

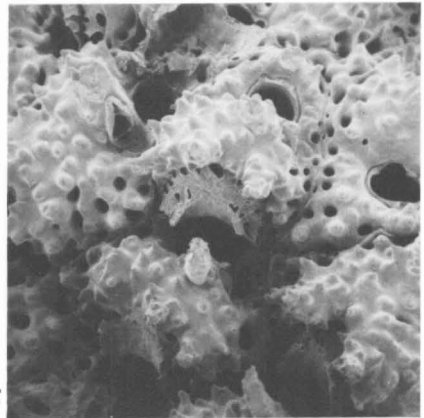

F

Plate 18

- A. *Schizomavella linearis*. Zooids with typical crescentic avicularia.
- B. *Schizoporella dunkeri*. Zooids and one ovicell.
- C. *Schizoporella longirostris*. Non-ovicellate zooids. The elongated shape of the avicularia is readily distinguishable.
- D. *Schizoporella longirostris*. Ovicellate zooids. Observe the calcification of the ovicells.
- E. *Schizoporella magnifica*. Non-ovicellate marginal zooids. Notice the position of the avicularia: lateral or distal to the orifice (arrowed).
- F. *Schizoporella neptuni*. Zooids. Notice the high number of spines.

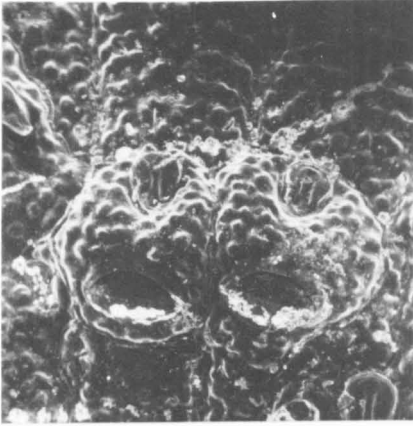

A

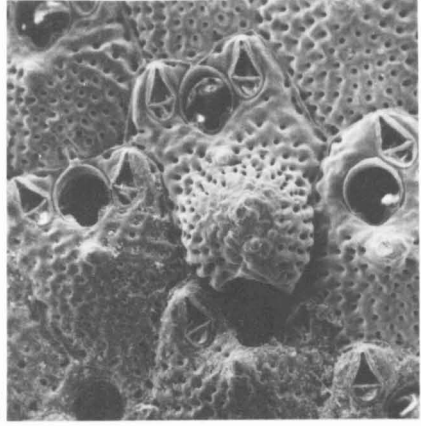

B

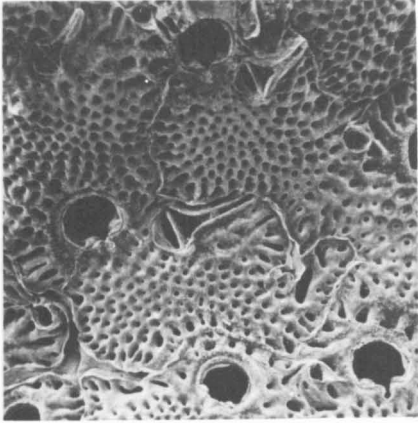

C

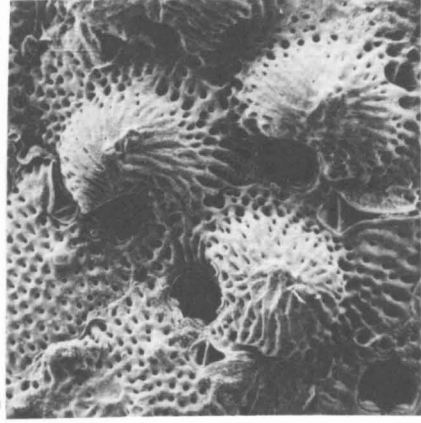

D

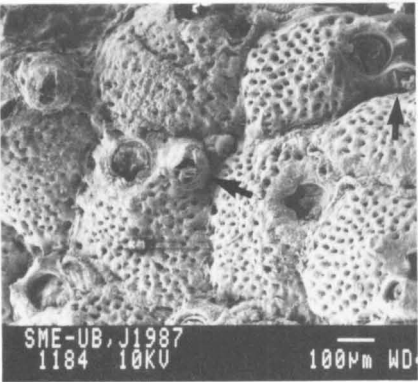

E

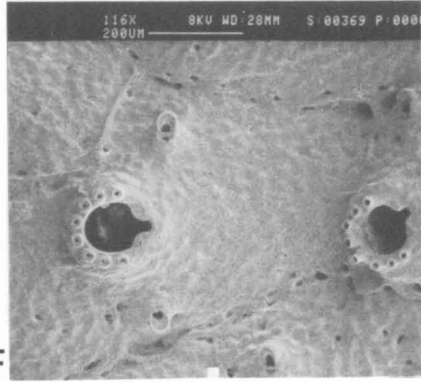

F

Plate 19

- A. *Hippopodinella kirchenpaueri*. Zooids and one ovicell, (arrowed).
- B. *Diporula verrucosa*. Ovicellate zooids.
- C. *Microporella pseudomarsupiata*. The characteristic spines have disappeared due to hypochlorite cleaning.
- D. *Chorizopora brogniartii*. Autozooids, avicularia and dwarf zooids typically placed in the grooves.
- E. *Trypostega venusta*. Autozooids and dwarf zooids.
- F. *Savignyella lafontii*. One autozooid.

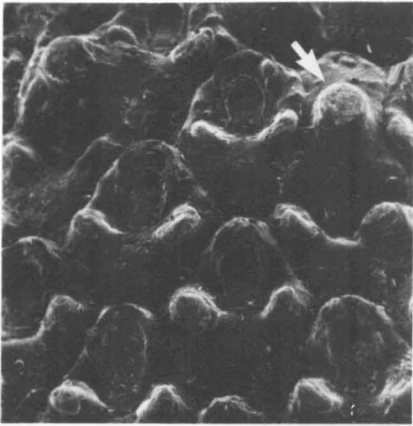

A

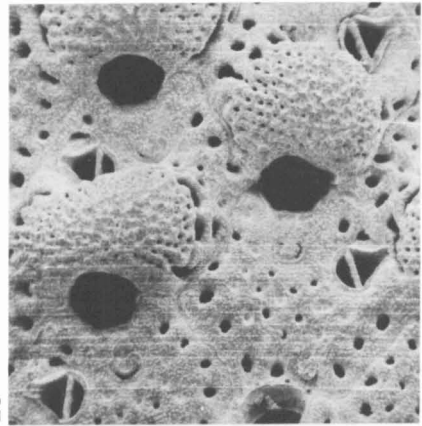

B

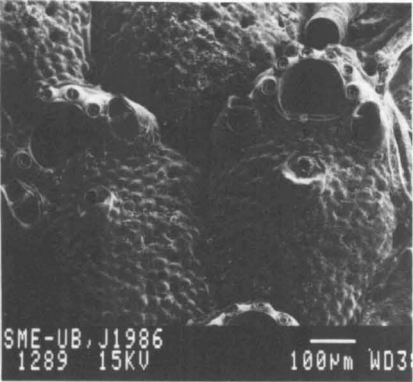

C

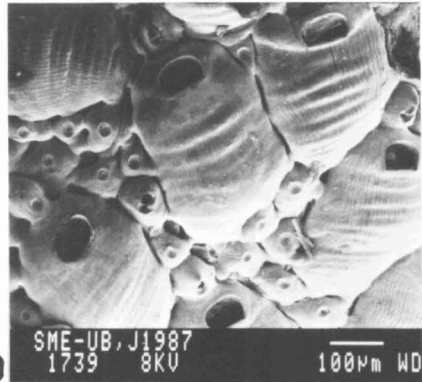

D

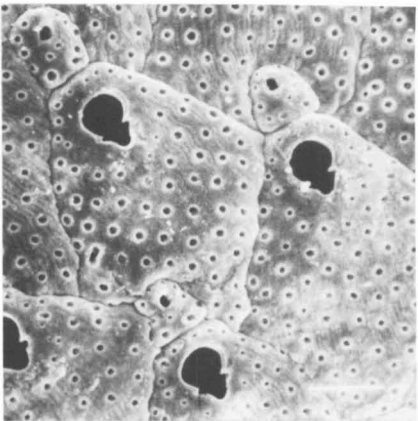

E

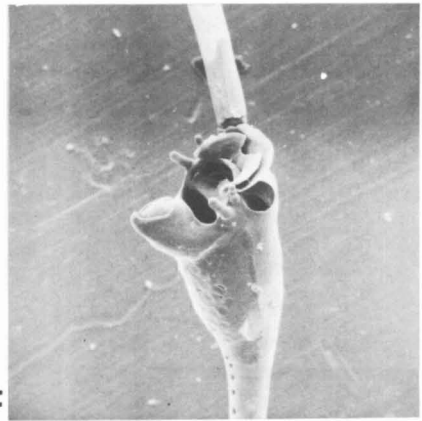

F

Plate 20

- A. *Rhynchozoon bispinosum*. Marginal zooids showing the spines (arrowed).
- B. *Rhynchozoon bispinosum*. Marginal zooids showing partly a primary orifice (arrowed).
- C. *Rhynchozoon bispinosum*. Old zooids with ovicells (arrowed).
- D. *Rhynchozoon bispinosum*. Old zooids with developed digitations and frontal avicularia. The frontal wall is clearly rugose.
- E. *Rhynchozoon pseudodigitatum*. Old zooids. Observe the high number of frontal avicularia and the flat aspect of the frontal wall.
- F. *Rhynchozoon pseudodigitatum*. Marginal zooids with one primary orifice visible.

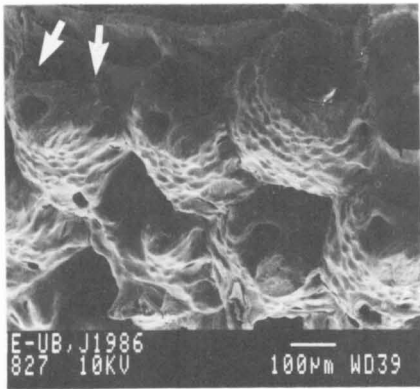

A

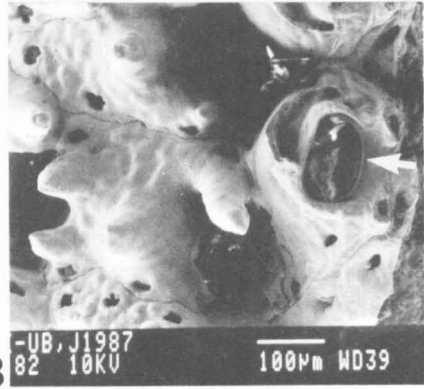

B

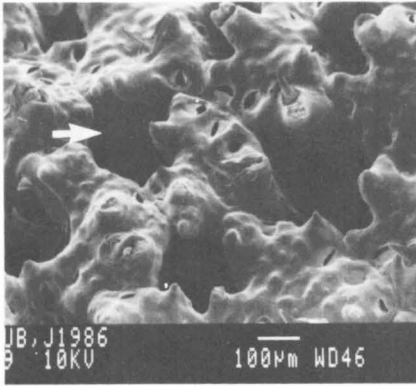

C

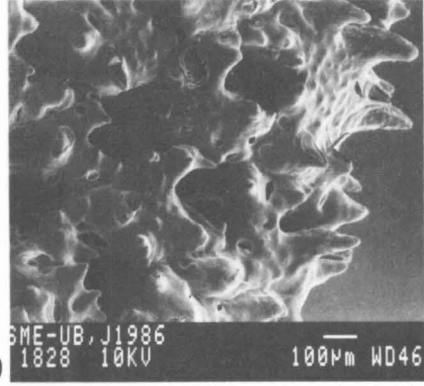

D

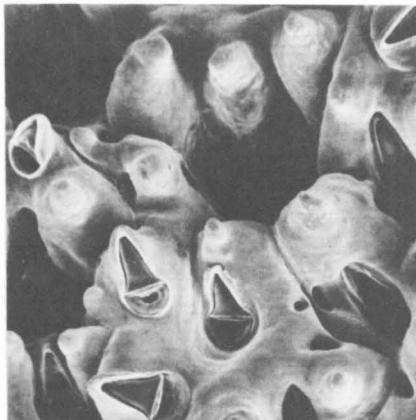

E

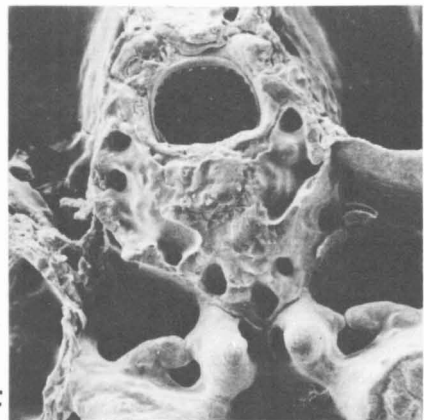

F

Plate 21

- A. *Rhynchozoon pseudodigitatum*. Ovicellate zooid (arrowed).
- B. *Rhynchozoon neapolitanum*. Non-ovicellate zooids. A new budded zooid shows the primary orifice with a deep sinus (arrowed).
- C. *Rhynchozoon* sp. I Hayward (Hayward's collection). Detail of frontal avicularia. They resemble the avicularia of *R. bispinosum*.
- D. *Rhynchozoon* sp. I Hayward (Hayward's collection). Old zooids with large digitations.
- E. *Rhynchozoon* sp. I Hayward (Hayward's collection). Group of zooids with a young zooid formed by frontal budding where the sinuate shape of primary orifice can be seen (arrowed).
- F. *Rhynchozoon* sp. II Hayward (Hayward's collection). Ovicellate zooids and one orifice showing the rec-tilinear anter.



A

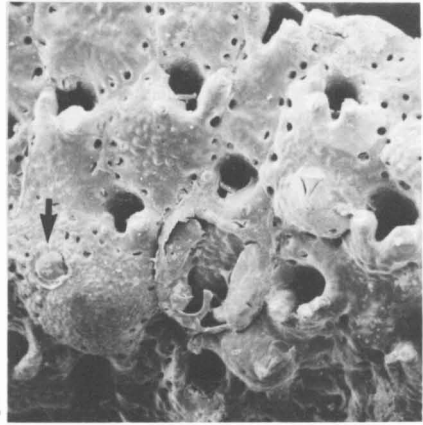

B

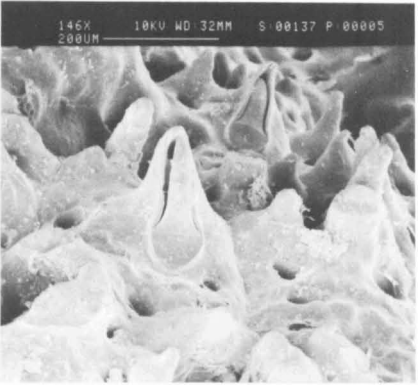

C

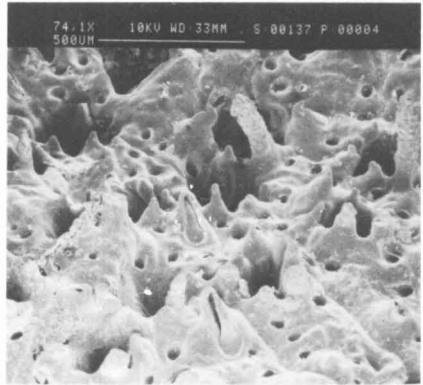

D

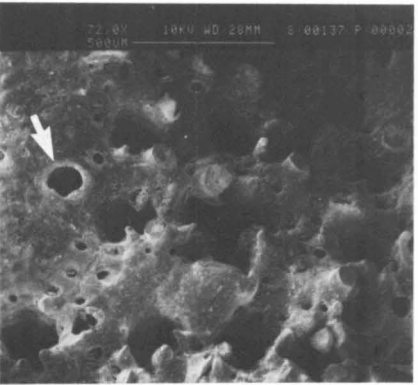

E



F

Plate 22

- A. *Rhynchozoon neapolitanum*. Marginal zooids showing the primary orifice with a deep sinus (arrowed).
- B. *Rhynchozoon quadrispinatum* n. sp. Zooids and one ovicell in development.
- C. *Rhynchozoon quadrispinatum* n. sp. Marginal zooids showing the primary orifice. Observe the shape, size and number of frontal avicularia.
- D. *Schizoretepora solanderia*. Fragment of a branch with typical vicarious avicularia (bottom).
- E. *Schizotheca serratimargo*. Ovicellate zooids.
- F. *Schizotheca serratimargo*. Marginal zooids with spines, adventitious avicularia and one vicarious avicularium.

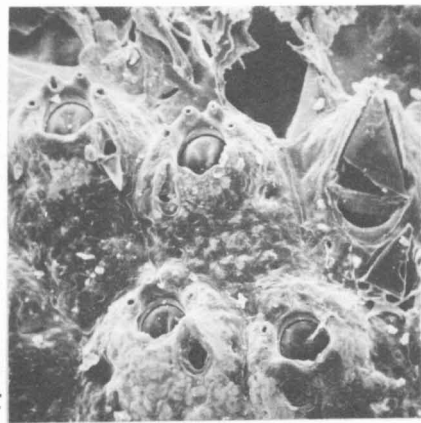
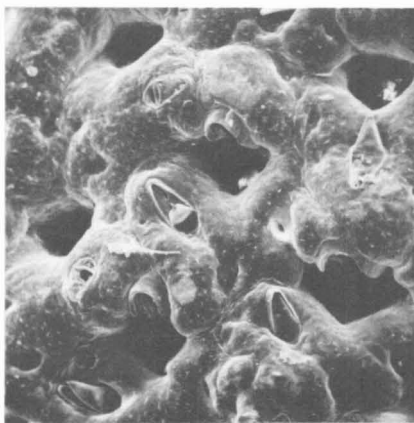
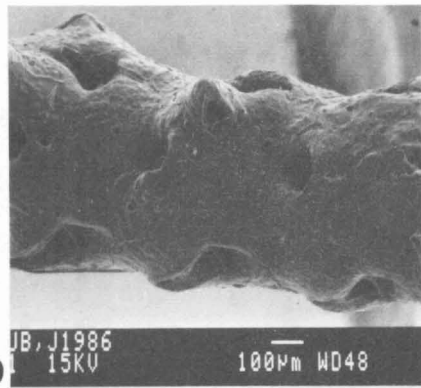
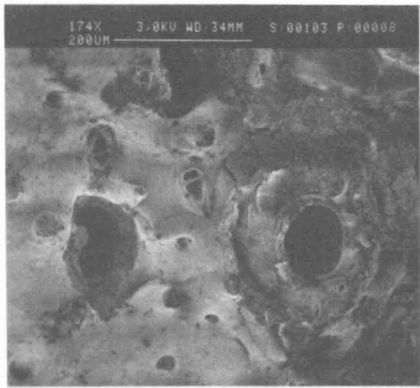
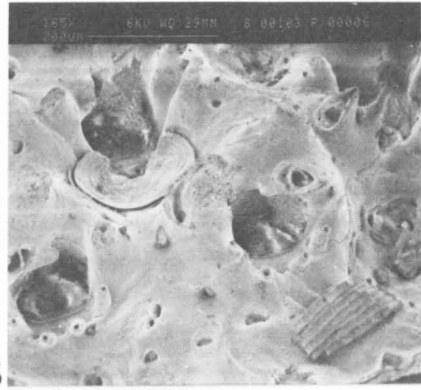
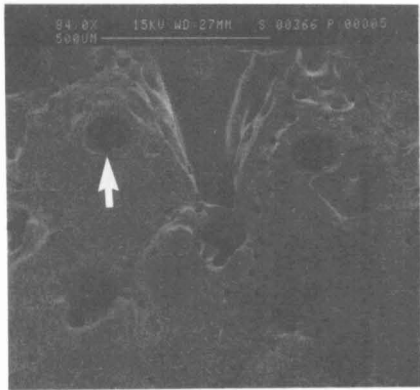
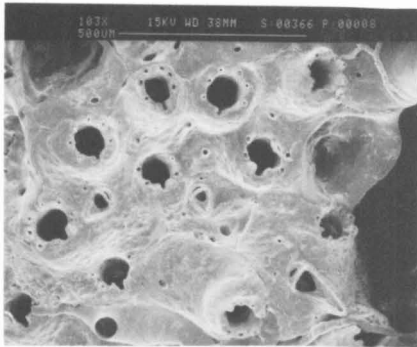
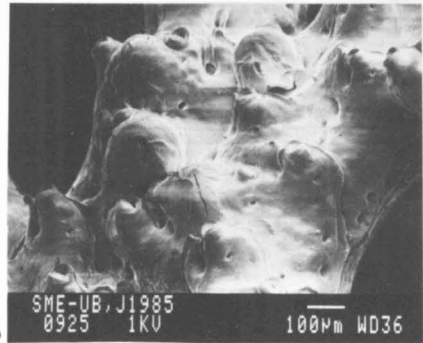

Plate 23.

- A. *Schizotheca fissa*. Non-ovicellate zooids with avicularia. The long spines have disappeared due to hypochlorite cleaning.
- B. *Sertella couchii*. Ovicellate zooids.
- C. *Sertella feuerbornii*. Ovicellate zooids.
- D. *Sertella feuerbornii*. Frontal triangular avicularium.
- E. *Sertella couchii*. Detail of elliptical avicularium on top of the process.
- F. *Sertella couchii*. One autozooid showing the triangular, frontal avicularium (characteristic).
- G. *Sertella septentrionalis*. Zooids, ovicells in development and giant triangular avicularia.
- H. *Sertella septentrionalis*. Non-ovicellate zooids. The small, elliptical, frontal avicularia are very numerous.



A



B

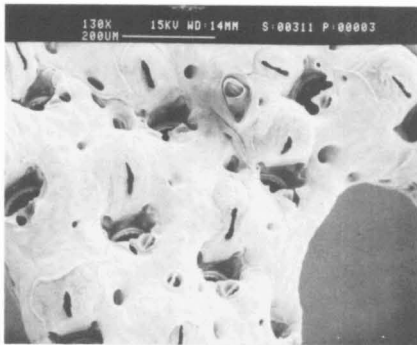

C

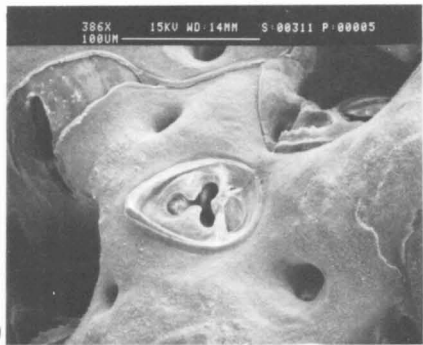

D

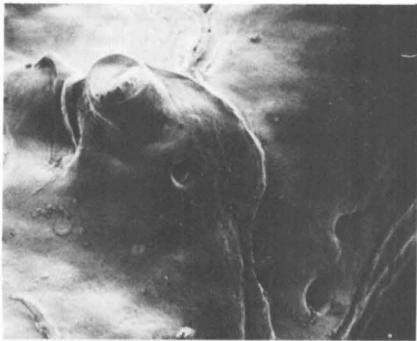

E

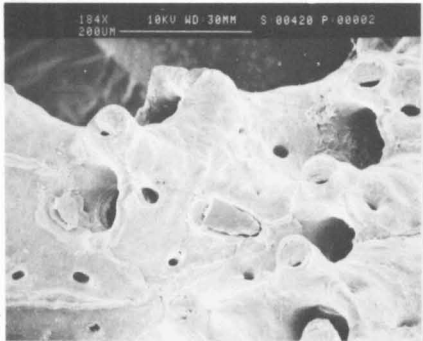

F

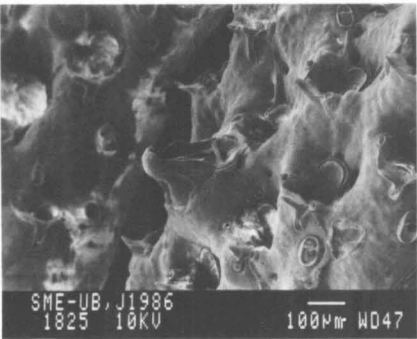

G

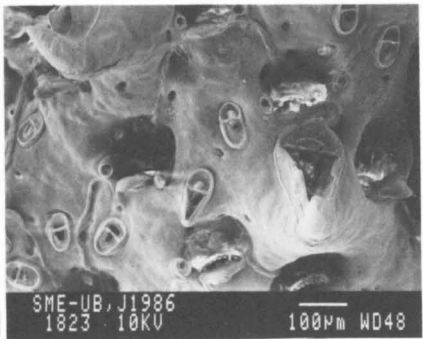

H

Plate 24

- A. *Buskea dichotoma*. Fragment of a branch. Frontal avicularia are arrowed.
- B. *Buskea dichotoma*. Ovicellate and non-ovicellate zooids. The ovicell forms a small roof on the aperture (arrowed).
- C. *Buskea nitida*. Non-ovicellate zooid.
- D. *Buskea nitida*. Ovicellate zooid.
- E. *Brodiella armata*. Non-ovicellate zooids.
- F. *Brodiella armata*. Zooids and ovicells.

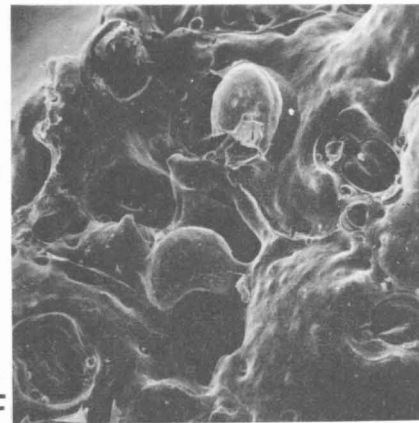
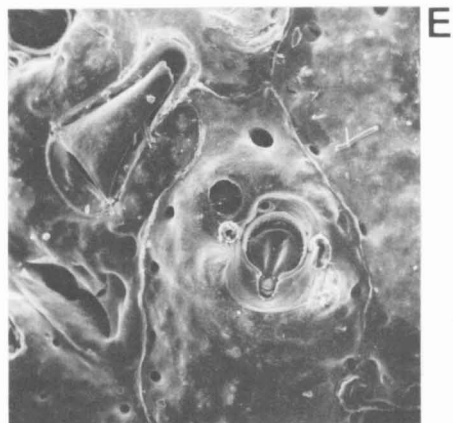
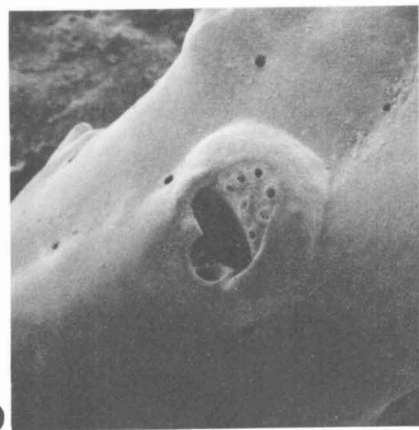
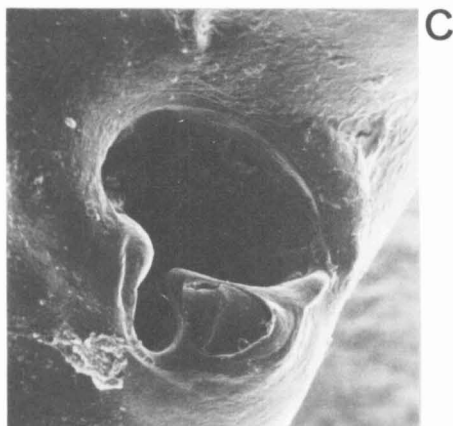
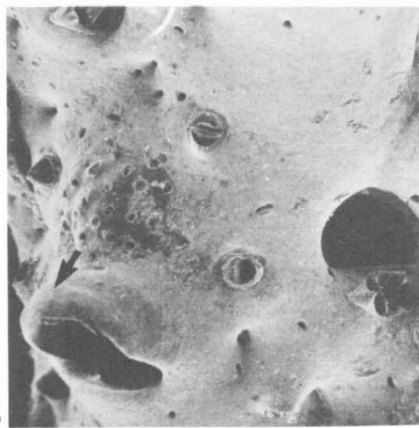
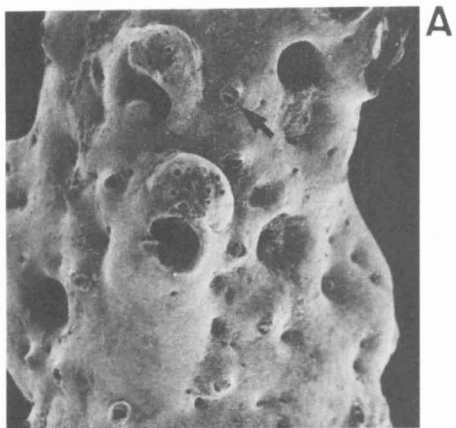
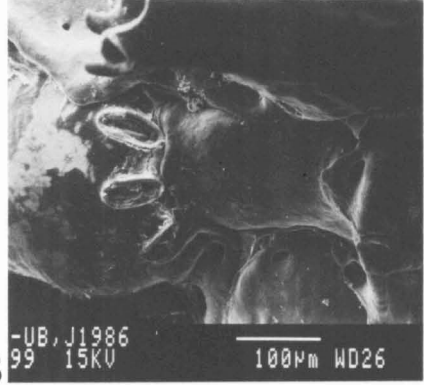

Plate 25

- A. *Cellepora* "*pumicosa*" Waters sensu Gautier (?). Ovicellate zooids.
- B. *Celleporina caminata*. Ancestrula.
- C. *Celleporina caminata*. Group of zooids with ovicells (arrowed). Observe the characteristic shape of the aperture and the frontal pores.
- D. *Celleporina canariensis*. Ovicellate zooid and spatulate avicularium.
- E. *Celleporina canariensis*. Ovicellate zooid. The ovicell is umbonate and the avicularia are almost parallel.
- F. *Celleporina hassallii*. Ovicellate zooids and one vicarious avicularium with parallel edges (characteristic).



A



B

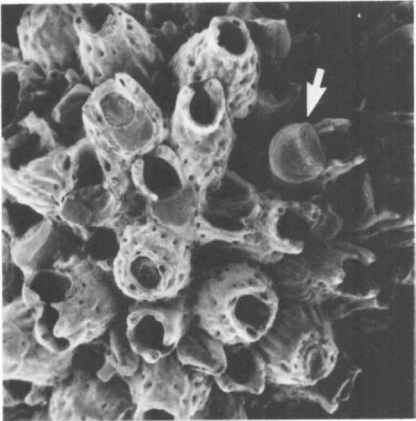

C



D

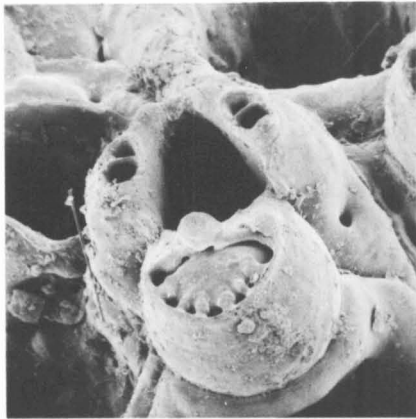

E

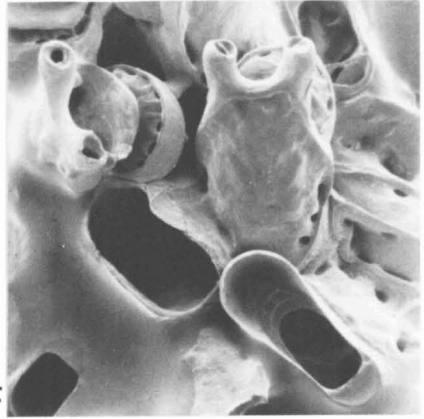

F

Plate 26

- A. *Celleporina decipiens* (?). Ovicellate zooids and one rounded vicarious avicularium (arrowed).
- B. *Celleporina decipiens* (?). Ovicellate zooids showing the well developed peristome between the avicularian processes (arrowed).
- C. *Celleporina hassalli* f. *tubulosa* Hincks. Group of zooids and spatulate vicarious avicularia.
- D. *Celleporina lucida*. Ovicellate zooids with broken peristome.
- E. *Lagenipora* n. sp. Zooids and one ovicell. The ovicellar tabula shows only two pores (arrowed).
- F. *Lagenipora* n. sp. Ancestrula.

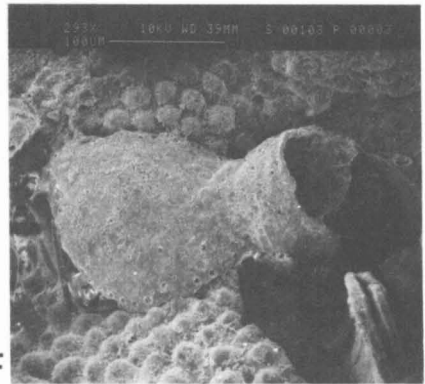
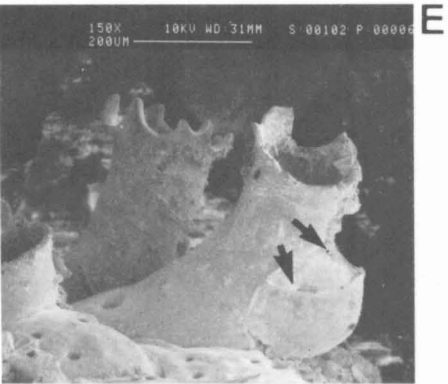
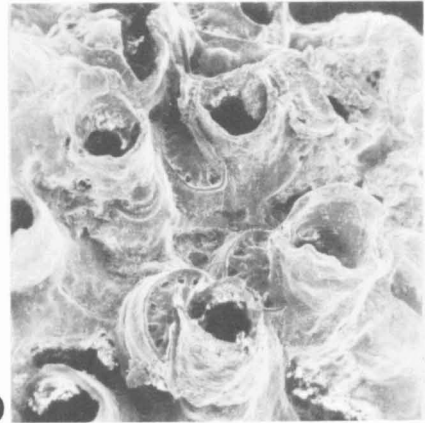
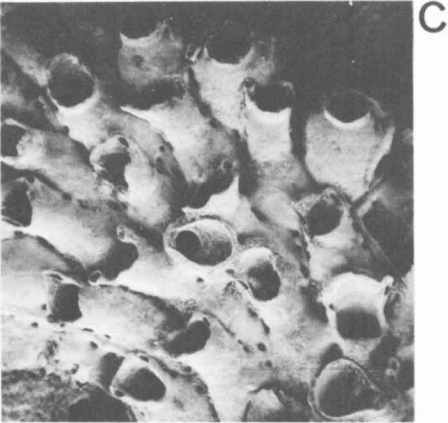
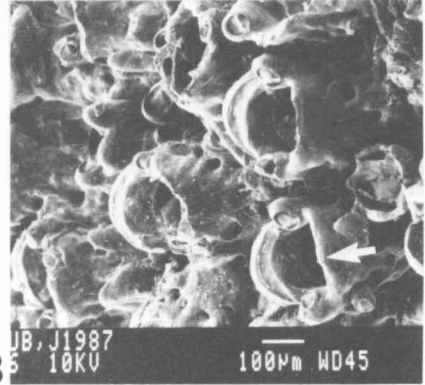
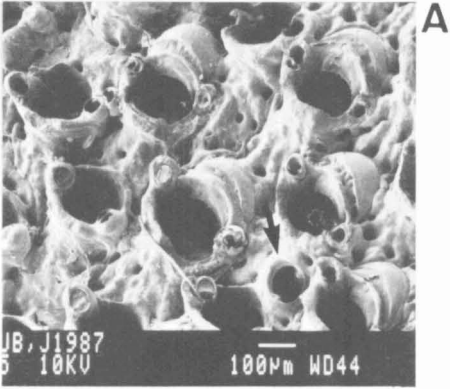
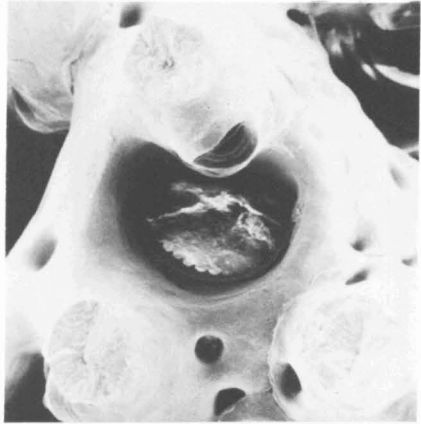

Plate 27

- A. "*Dentiporella*" *sardonica*. Zooid with typical avicularium on the columnar cystid.
- B. "*Dentiporella*" *sardonica*. Detail of denticulate primary orifice.
- C. *Omalosecosa ramulosa*. Non-ovicellate zooids.
- D. *Omalosecosa ramulosa*. Superior view of one end of a branch.
- E. *Turbicellepora avicularis*. Group of ovicellate zooids with triangular and spatulate vicarious avicularia (arrowed).
- F. *Turbicellepora avicularis*. Detail of spatulate avicularium showing the strong pivotal bar and columella.



A



B

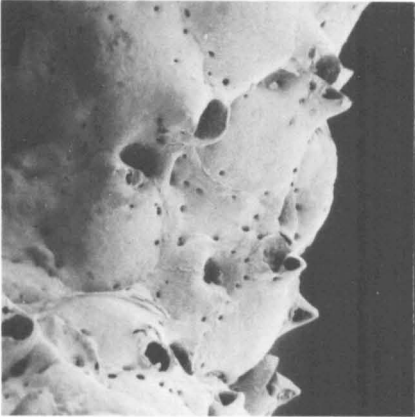

C

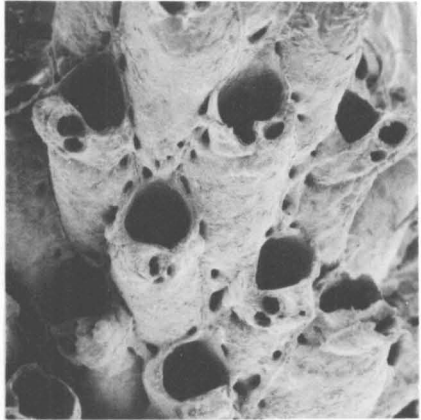

D

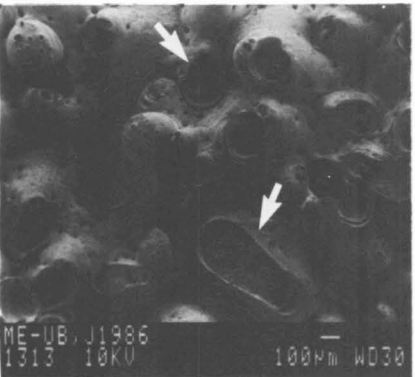

E

ME-UB, J1986
1313 10KV 100µm WD30

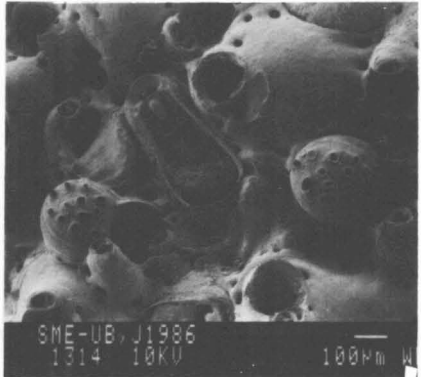

F

SME-UB, J1986
1314 10KV 100µm W

Plate 28

- A. *Turbicellepora magnicostata*. Group of zooids and two ovicells.
- B. *Turbicellepora magnicostata*. Typical vicarious avicularium of parallel margins.
- C. *Turbicellepora camera*. Group of zooids with numerous small vicarious avicularia (arrowed).
- D. *Turbicellepora camera*. Zooids with one ovicell. Notice the orifice shape (arrowed).
- E. *Turbicellepora* sp. Zooids with very large, rounded, orifice and little developed peristome. Notice the shape of peristomial avicularia and spatulate vicarious avicularium (arrowed).
- F. *Turbicellepora* sp. Spatulate avicularium.

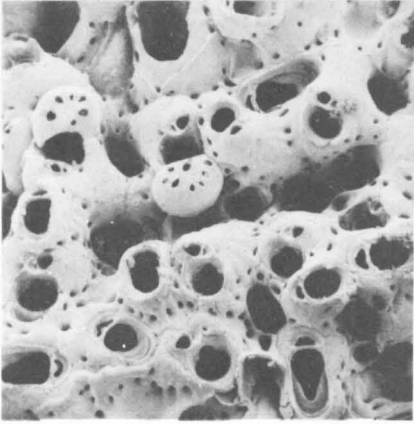

A

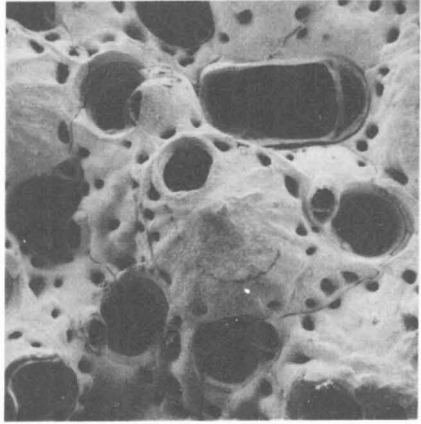

B

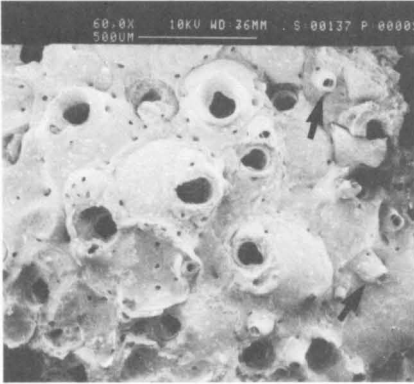

C

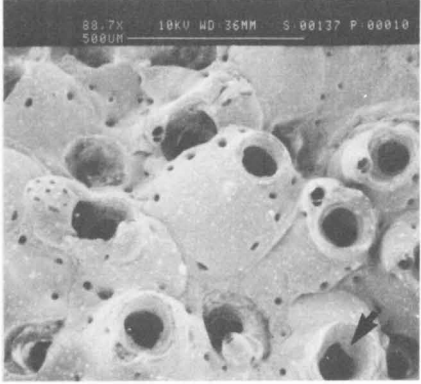

D

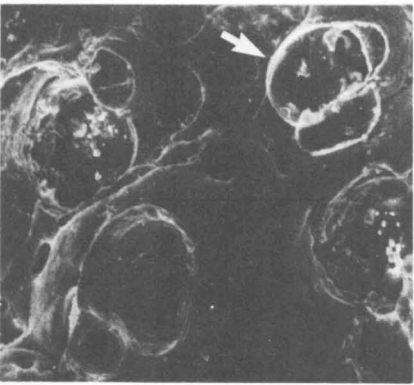

E

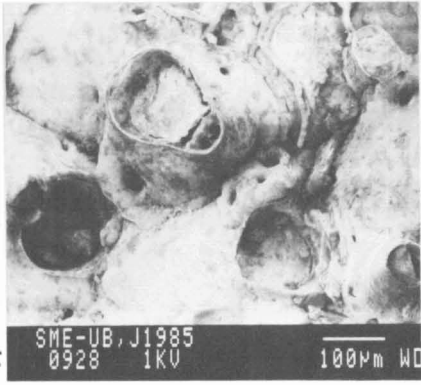

F

Plate 29

- A. *Crisia cuneata*. Gonozooid.
- B. *Crisia denticulata*. Gonozooid.
- C. *Crisia occidentalis*. Gonozooid.
- D. *Crisia ramosa*. Gonozooid.
- E. *Crisia sigmoidea*. Gonozooid.
- F. *Annectocyma indistincta*. Fragment of fertile colony. The arrow shows the oocystome.
- G. *Annectocyma indistincta*. Detail of peristomes showing the inner hemisepta (arrowed).
- H. *Annectocyma tubulosa*. Oocystome.

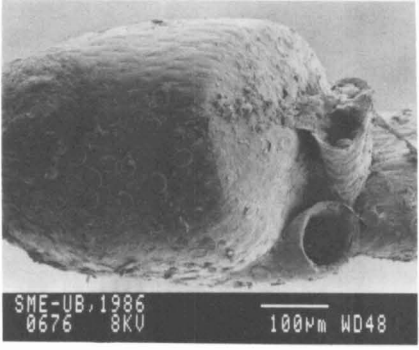

A

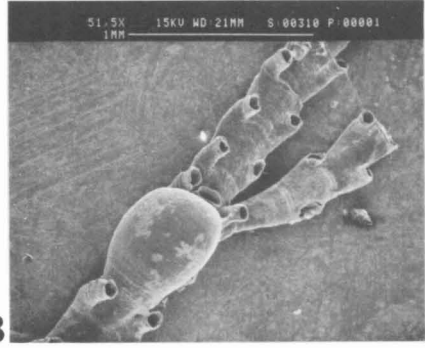

B

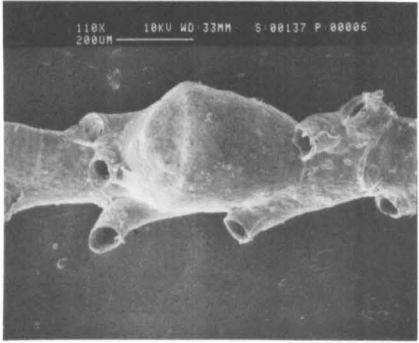

C

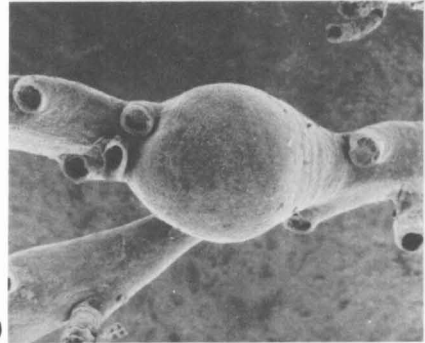

D

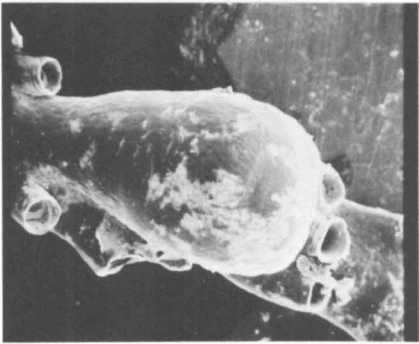

E

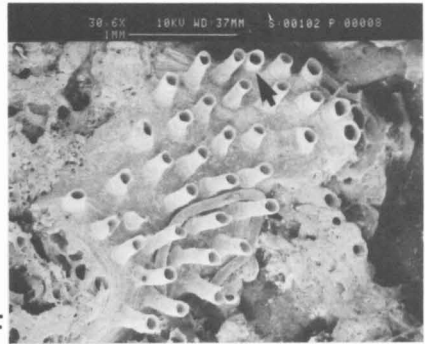

F

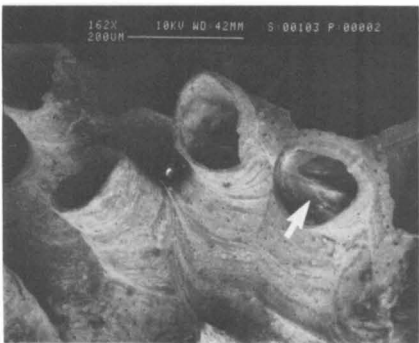

G

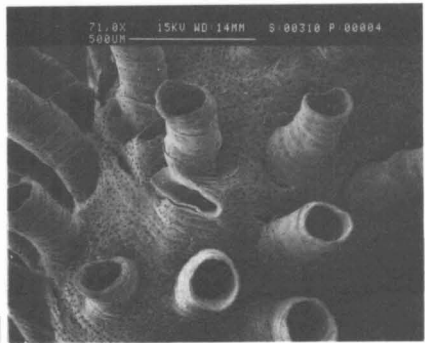

H

Plate 30.

- A. *Annectocyma major*. Fragment of fertile colony.
- B. *Annectocyma major*. Detail of one gonozooid and oeciostome (arrowed).
- C. *Enthalophoroecia deflexa*. Fragment of colony. the arrow shows one oeciostome.
- D. *Enthalophoroecia deflexa*. Detail of one gonozooid and oeciostome (arrowed).
- E. *Enthalophoroecia gracilis*. Fertile branch with oeciostome (arrowed).
- F. *Enthalophoroecia robusta*. Gonozooid and oeciostome (arrowed).

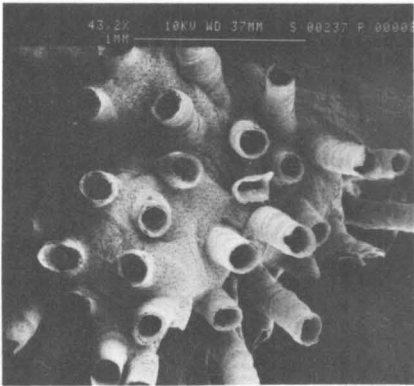

A

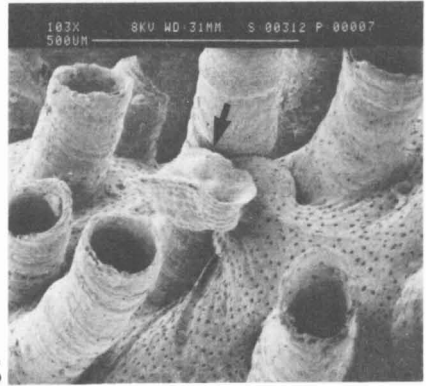

B

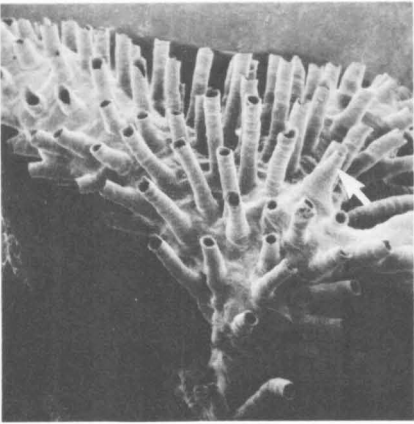

C

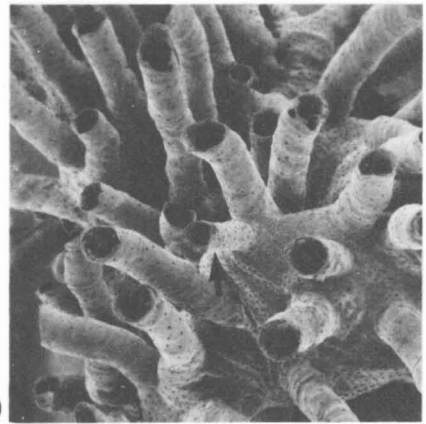

D

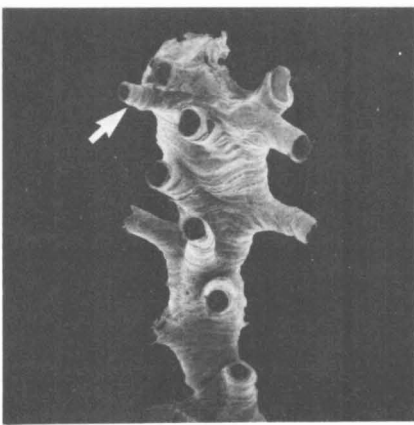

E

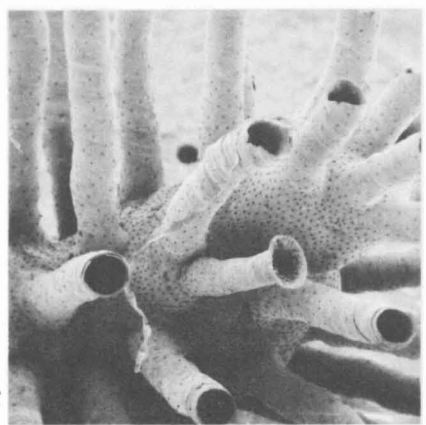

F

Plate 31

- A. *Cardioecia watersi*. Piece of colony showing the basal sheet of growth that divides each branch into two symmetrical parts (arrowed).
- B. *Cardioecia watersi*. Gonozooid and oocciostome.
- C. *Eurystrotes compacta*. Fertile colony with three oocciostomes (arrowed).
- D. *Plagioecia dorsalis*. Basal sheet of an erect branch.
- E. *Plagioecia dorsalis*. Peristomes with an imperforate diaphragm pierced by a tubule.
- F. *Plagioecia platydiscus*. Detail of the growing margin showing the inner granules of zooids in formation (arrowed).

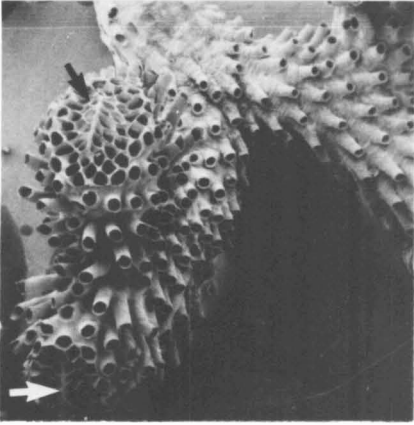

A

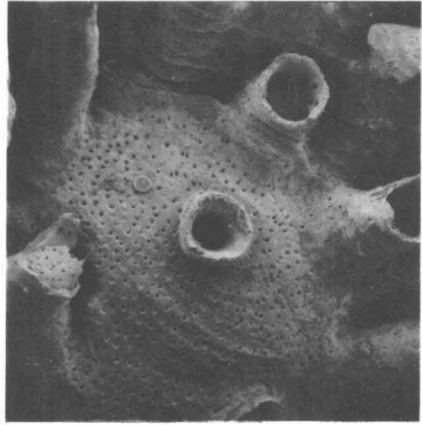

B



C

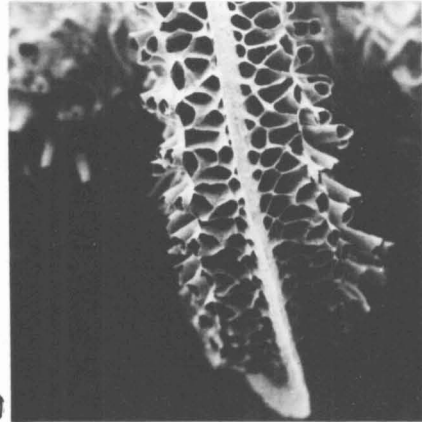

D

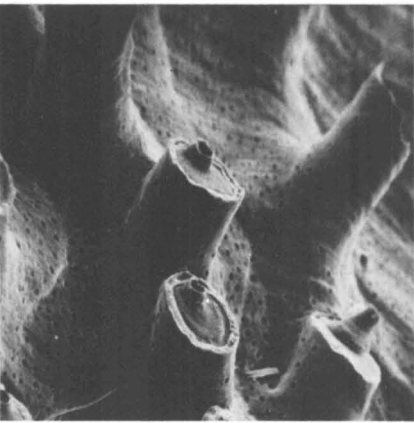

E

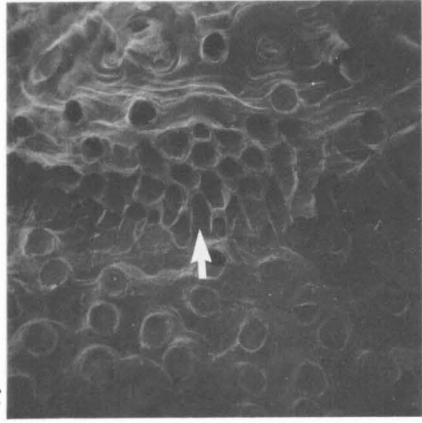

F

Plate 32

- A. *Plagioecia platydiscus*. Several layers of zooids.
- B. *Diplosolen obelia*. Fragment of fertile colony with one gonozooid (arrowed). Observe the nanozooids characteristic of this species.
- C. *Plagioecia sarniensis*. Fertile colony with two gonozooids.
- D. *Plagioecia sarniensis*. Detail of gonozooid with ooeciostome (arrowed).
- E. *Plagioecia sarniensis*. Detail of one peristome with central tubule.
- F. *Mecynoecia delicatula*. Fertile colony with two ooeciostomes (arrowed).

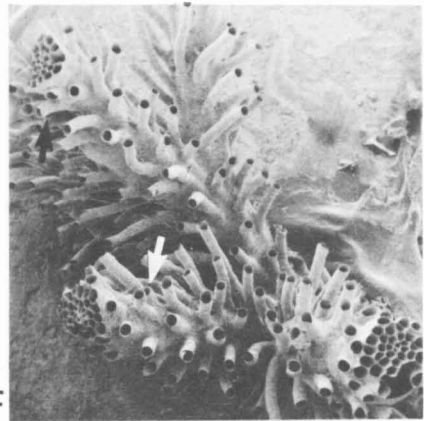
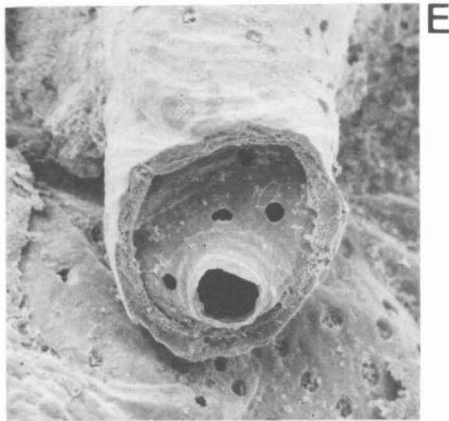
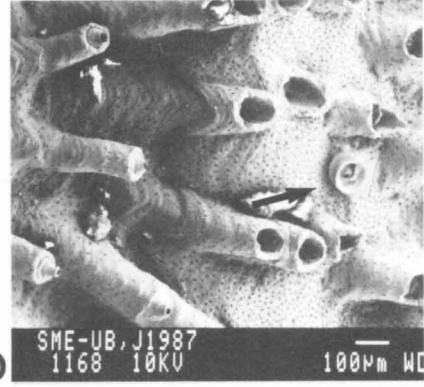
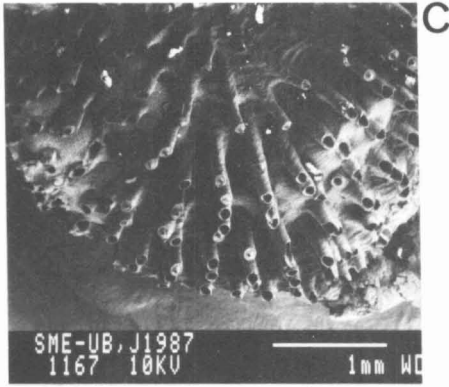
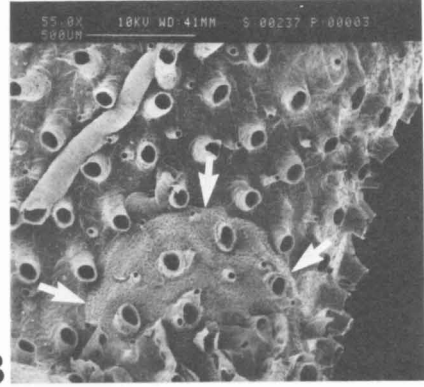
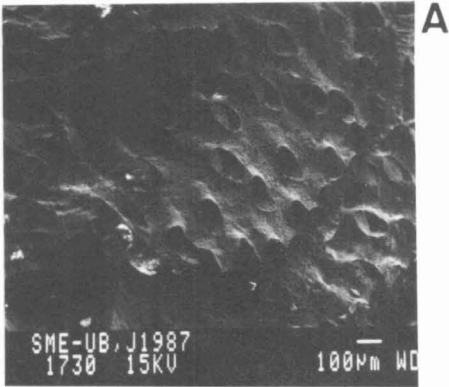

Plate 33

- A. *Idmidronea atlantica*. Fragment of fertile colony. The arrow shows the oocciostome.
- B. *Platonea stoechas*. Fertile branch. The arrow shows the oocciostome.
- C. *Platonea stoechas*. Detail of gonozoid and oocciostome (centre).
- D. *Tubulipora liliacea*. Fertile colony.
- E. *Tubulipora plumosa*. Fertile colony with the typical oocciostomes (arrowed) in a compressed funnel shape.
- F. *Tubulipora plumosa*. Detail of the oocciostome.

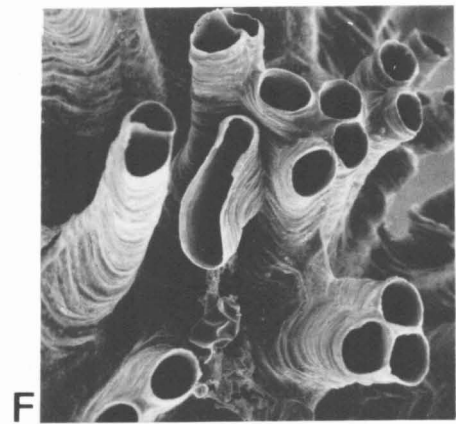
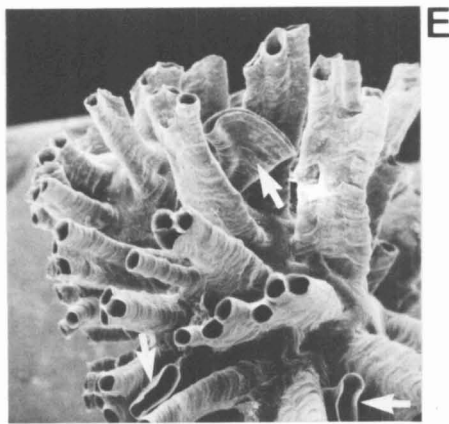
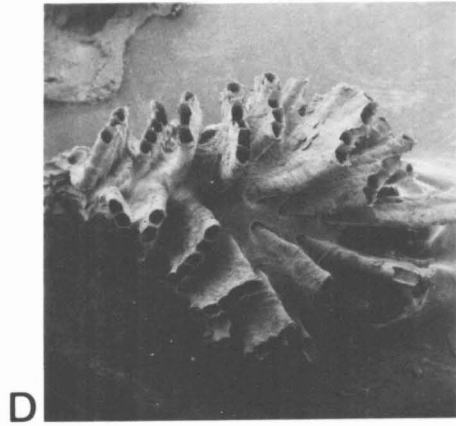
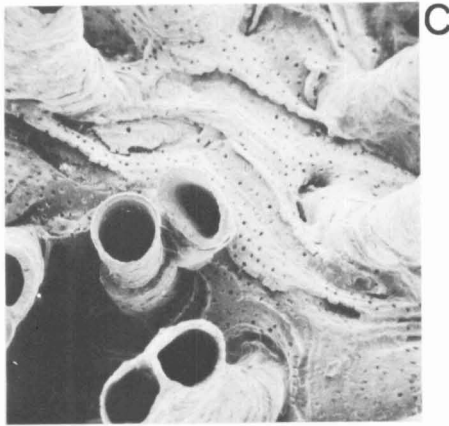
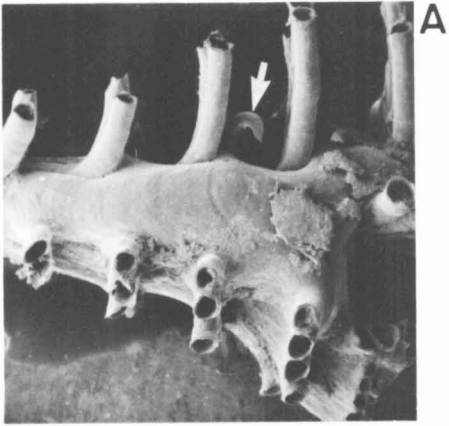
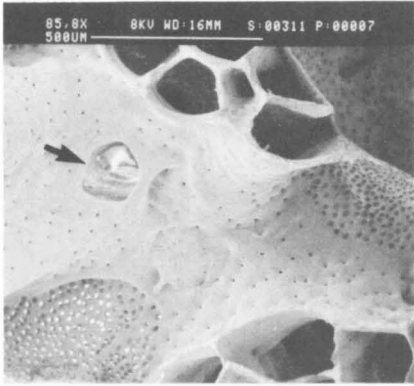
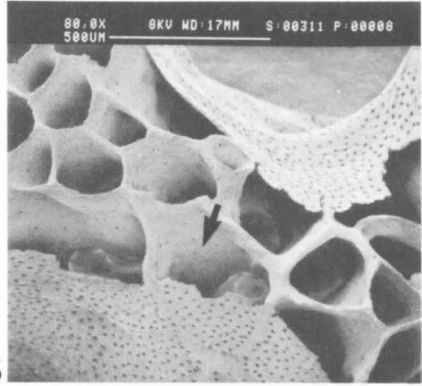

Plate 34

- A. *Fron dipora verrucosa*. Fragment of a branch and ooeciostome (arrowed).
- B. *Fron dipora verrucosa*. Detail of the inner walls of the zooids showing the communication pores between zooids (arrowed).
- C. *Disporella hispida*. Fragment of composed fertile colony.
- D. *Disporella hispida*. Detail of the alveolar structure showing the acuminate spinulae.
- E. *Disporella hispida* f. *fimbriata*. Acuminate peristomes.
- F. *Lichenopora* n. sp. Heaping of colonies.



A



B

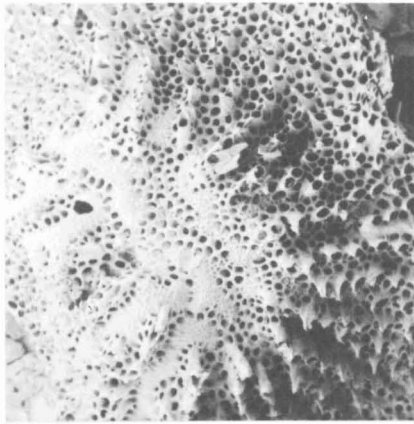

C

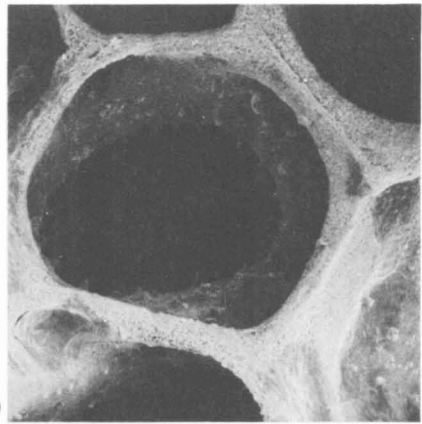

D

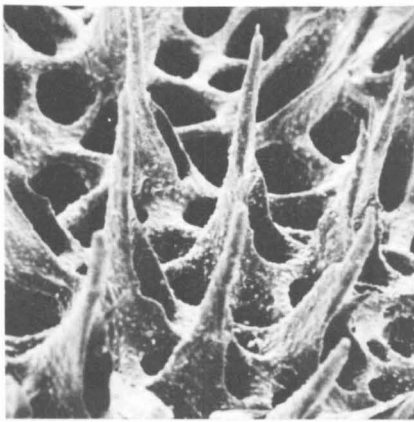

E

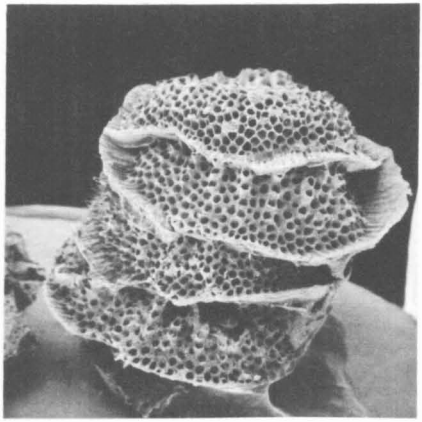

F

Plate 35

- A. *Lichenopora* n. sp. Hexagonal alveoli with few inner denticles.
- B. *Lichenopora* n. sp. Detail of an inner denticle.
- C. *Lichenopora radiata*. Sterile colony with polygonal alveoli.
- D. *Lichenopora radiata*. Fertile colony with irregular alveoli and oocciostomial funnel.
- E. *Lichenopora radiata*. An inner spinula.
- F. *Lichenopora radiata*. Detail of the oocciostome.

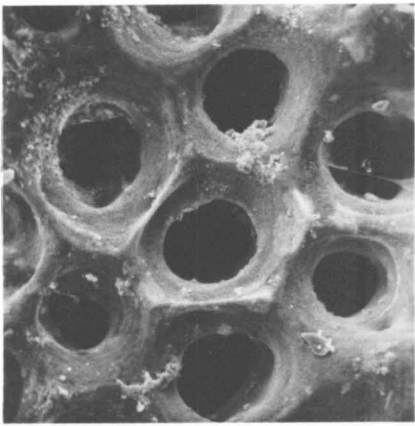

A

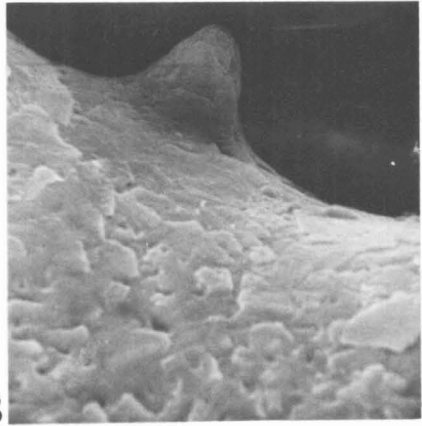

B

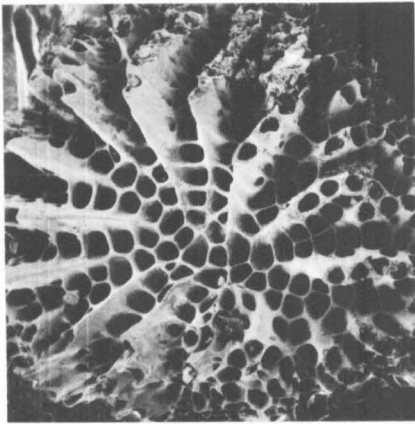

C

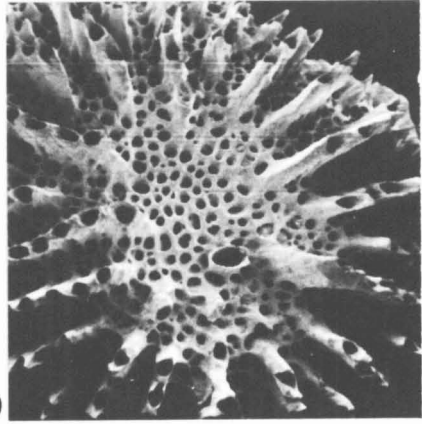

D

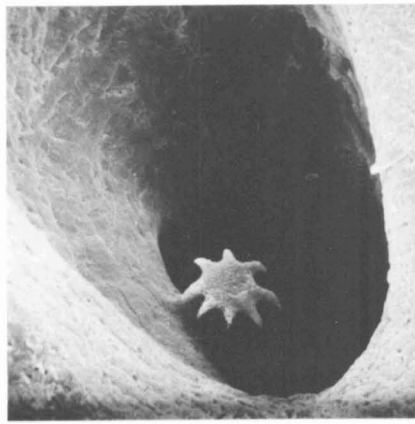

E

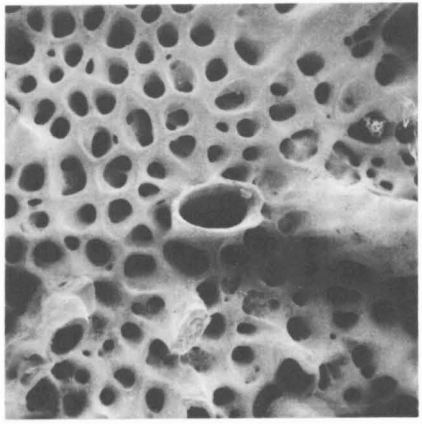

F

Plate 36

- A. *Hornera frondiculata*. Gonozooid situated on the basal face.
- B. *Hornera frondiculata*. Frontal face with peristomes typically U-shaped.
- C. *Hornera lichenoides*. Fragment of a branch.
- D. *Hornera lichenoides*. Frontal face with peristomes O-shaped.

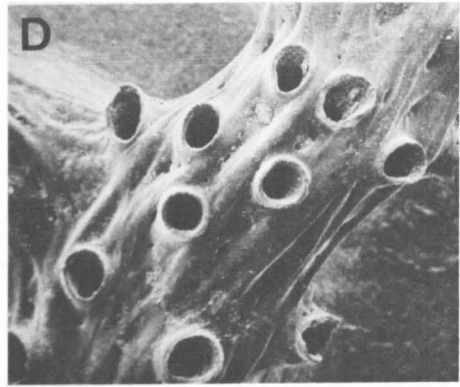
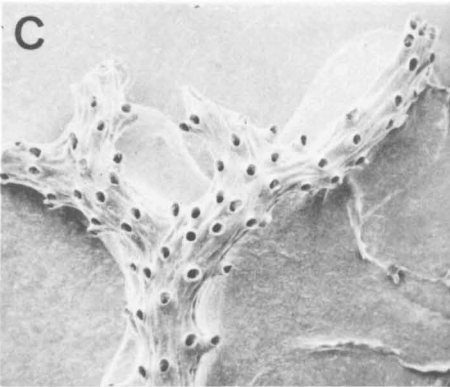
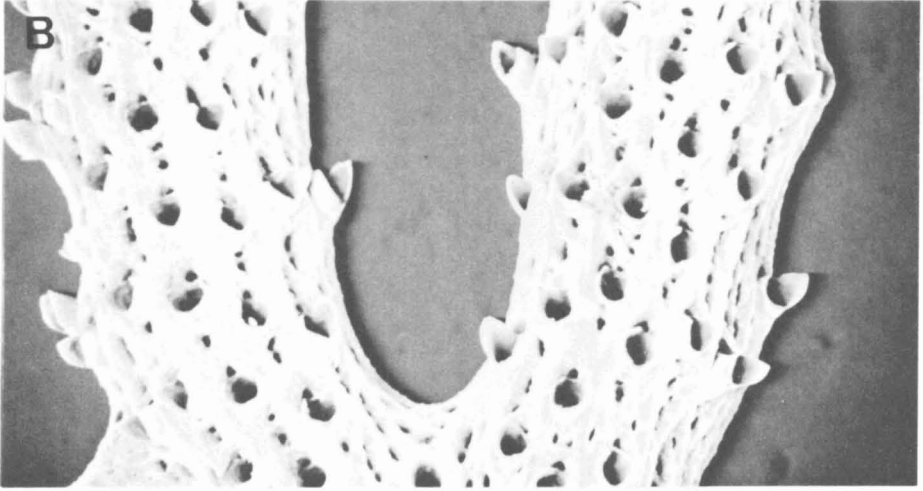
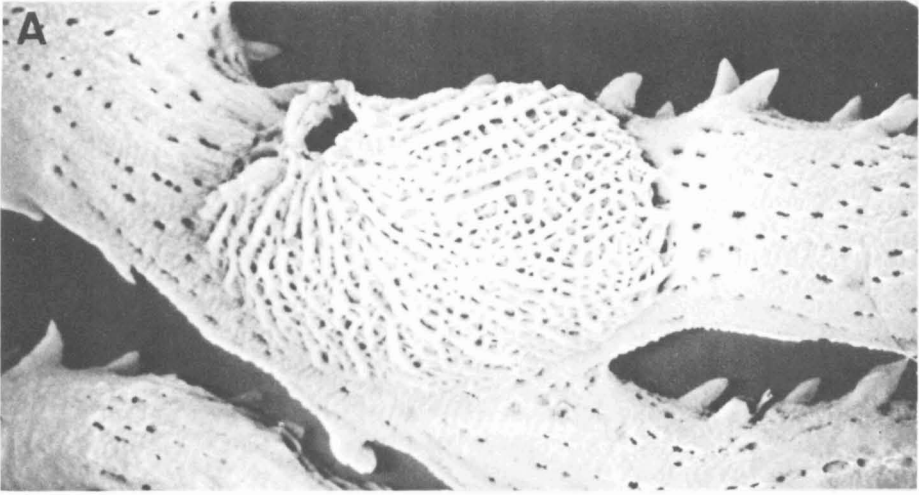

9. ACKNOWLEDGEMENTS

We are grateful to Dr. J.G. Harmelin of the Station Marine d'Endoume (Marseille) for making accesible to us his collections and library. We should also like to thank Dr. R. Fontarnau for his guidance and patience through long hours at the Scanning Electron Microscope; and to Mr. Corbera for his drawing assistance. Finally we acknowledge Dr. P.J. Hayward for carefully reviewing and criticizing the manuscript.

10. ABSTRACT

Illustrated keys for the classification of Mediterranean Bryozoa.— Illustrated dichotomous keys for the classification of the Western Mediterranean marine Bryozoans are presented. Separate keys are given for genera and species. All the Mediterranean species of which there is knowledge (379 species and forms: 42 Ctenostomata, 287 Cheilostomata and 50 Cyclostomata) are included. Some of the species were not directly familiar, and specimens from other collections had to be consulted; these, and the species for which there was only bibliographical references, are indicated in the text. To remedy the lack of description, a bibliographical reference directs the reader to a work where each species has been fully described and/or illustrated. Illustrations are diagrammatic, simplified to the essential features, and the differential traits have been emphasized (arrowed in many cases). This graphic information is complemented with a catalogue of SEM micrographs of some of the most frequent species of the Catalan (Western Mediterranean) coast. There is a glossary of special terms used in this monograph. An index of obsolete synonymies and updated specific and generic names is also included.

11. CATALAN SUMMARY

Claus dicotòmiques il·lustrades per a la classificació dels Briozous marins del Mediterrani.

Una de les principals dificultats en l'estudi de la fauna mediterrània bentònica és l'escassetat o manca de claus d'identificació per a una gran part de grups d'animals invertebrats. Sovint, quan existeixen, les claus són excessivament locals i/o manquen de la necessària exhaustivitat. En alguns casos l'absència de claus està justificada per les nombroses dificultats inherents a llur elaboració, però en d'altres no existeix una explicació evident. La major part dels problemes sorgeixen de la dificultat d'accés a una informació taxonòmica, la qual malgrat poder existir està excessivament fraccionada, dispersa o té un caràcter massa local. Falten obres de síntesi que agrupin, contrastin i actualitzin aquesta informació.

El dels Briozous és un cas típic. Aquest grup, desconegut a nivell popular, té fama de difícil entre els

zoòlegs. Tanmateix els Briozous estan presents en quasi tots els fons marins, majoritàriament costaners, sempre i quan existeixin superfícies dures de qualsevol naturalesa que els hi puguin servir de suport, encara que també es pot trobar algun representant de fons tous. Es tracta a més d'un grup summament diversificat que només al Mediterrani compta amb més de 300 espècies.

Totes aquestes raons i l'experiència adquirida durant més de 15 anys d'estudi dels Briozous de les costes catalanes, decidiren els autors a elaborar unes claus dicotòmiques il·lustrades per a la classificació dels Briozous marins del Mediterrani, essent conscients de que puntualment hauràn de ser modificades, malgrat ser en conjunt unes claus exhaustives.

El propòsit original va ser la confecció d'unes claus concises i de fàcil utilització. Per això les claus havien de ser il·lustrades i els criteris de classificació serien en cada cas els més clars per a un profà, encara que no coincidissin amb els més ortodoxos des del punt de vista de la taxonomia. Donat l'elevat nombre d'espècies existent, les claus només podien ser concises si es situaven a un nivell genèric. Però una clau de gèneres en la que resulta impossible arribar a la identificació de les espècies perd molt del seu valor. Per aquesta raó, a una primera part dedicada a les claus de gèneres, segueix una segona més voluminosa dedicada a les claus d'espècies. Per altra banda aquí es planteja el problema de que el diagnòstic d'una espècie a partir simplement d'una clau resulta insegur, o és si mes no un resultat obert al dubte. Així, hem pensat que una il·lustració concisa pot ajudar a compensar la impossibilitat de descriure més exhaustivament totes les espècies que componen la fauna mediterrània, dins els criteris de brevetat d'aquest treball.

Aquestes claus són una traducció corregida i actualitzada de les publicades a la "Fauna de Briozous dels Països Catalans" de ZABALA (1987). En aquest treball es descriu la metodologia emprada per a la seva elaboració, així com les fonts de documentació que ajudaren i feren possible la confecció de la Fauna de Briozous del Mediterrani.

Les claus inclouen totes les espècies mediterrànies de les que tenim coneixement (366 espècies), però la precisa revisió d'alguns gèneres (p.e. *Cribrilaria*) pot proporcionar l'aparició de noves espècies en un futur no molt llunyà.

Les il·lustracions són esquemàtiques, simplifiades a les característiques principals i s'han ressaltat els trets diferencials (que en molts casos s'indiquen amb fletxes). Els dibuixos pertanyents a les claus de gèneres provenen de ZABALA (1987), mentre que els pertanyents a les claus d'espècies s'han dibuixat per a aquest treball. Aquesta informació gràfica es completa amb un catàleg de fotografies al Microscopi Electrònic d'Escombrada, que reuneix algunes de les espècies més freqüents a les nostres costes. Un número a continuació del nom específic serveix per a identificar el dibuix i una referència entre parèntesis per a la identificació de la fotografia en cas d'existir.

Les espècies desconegudes de les nostres costes que s'hagueren de consultar d'altres col·leccions o aquelles de les que tan sols es tenien referències bibliogràfiques, s'assenyalen en el text amb un asterisc. A fi de suplir la manca de descripció, a cada clau i junt a cada espècie, una referència bibliogràfica enviarà al lector a un treball on aquella espècie és tractada amb detall.

L'última part del treball inclou un glossari en el que es descriuen tots els termes específics emprats en la monografia, així com un índex de sinònims obsolets i noms genèrics i específics actualitzats.

12. SPANISH SUMMARY

Claves dicotómicas ilustradas para la clasificación de los Briozoos marinos del Mediterráneo.

Una de las principales dificultades en el estudio de la fauna mediterránea bentónica es la escasez o falta de claves de identificación para una gran parte de grupos de animales invertebrados. A menudo, cuando existen, las claves son excesivamente locales y/o carecen de la necesaria exhaustividad. En algunos casos la ausencia de claves está justificada por las numerosas dificultades inherentes a su elaboración, pero en otros no existe una explicación evidente. La mayor parte de los problemas surgen de la dificultad de acceso a una información taxonómica, la cual aunque pueda existir está excesivamente

fraccionada, dispersa o tiene un carácter demasiado local. Faltan obras de síntesis que agrupen, contrasten y actualicen esta información.

El de los Briozoos es un caso típico. Este grupo, desconocido a nivel popular, tiene fama de difícil entre los zoólogos. Sin embargo, los Briozoos están presentes en casi todos los fondos marinos, mayoritariamente costeros, siempre y cuando existan superficies duras de cualquier naturaleza que les puedan servir de soporte, aunque también se puede encontrar algún representante de fondos blandos. Se trata además de un grupo sumamente diversificado que sólo en el Mediterráneo cuenta con más de 300 especies.

Todas estas razones y la experiencia adquirida durante más de 15 años de estudio de los Briozoos de las costas catalanas, decidieron a los autores a elaborar unas claves dicotómicas para la clasificación de los Briozoos marinos del Mediterráneo, conscientes de que puntualmente deberán ser modificadas aunque globalmente sean unas claves exhaustivas.

El propósito original fue la confección de unas claves concisas y de fácil utilización. Para ello las claves debían ser ilustradas y los criterios de clasificación serían en cada caso los más claros para un profano, aún cuando no coincidieran con los más ortodoxos desde el punto de vista de la taxonomía. Dado el elevado número de especies existente, las claves sólo podían ser concisas si se situaban a un nivel genérico. Pero una clave de géneros en la que resulta imposible llegar a la identificación de las especies pierde mucho de su valor. Por esta razón, a una primera parte dedicada a las claves de géneros, sigue una segunda más voluminosa dedicada a las claves de especies. Por otra parte aquí se plantea el problema de que el diagnóstico de una especie a partir simplemente de una clave resulta inseguro, o es por lo menos, un resultado abierto a la duda. Por este motivo se ha pensado que una ilustración puede ayudar a compensar la imposibilidad de describir más exhaustivamente todas las especies que componen la fauna mediterránea, dentro de los criterios de brevedad de este trabajo.

Estas claves son una traducción corregida y actualizada de las publicadas en la "Fauna de Briozoos dels Països Catalans" de ZABALA (1987). En dicho trabajo se describe la metodología empleada para su elaboración, así como las fuentes de documentación que ayudaron e hicieron posible la confección de la Fauna de Briozoos del Mediterráneo.

Las claves incluyen todas las especies mediterráneas de las cuales se tiene conocimiento (366 especies), pero la precisa revisión de algunos géneros (p.e. *Cribrilaria*) puede deparar la aparición de nuevas especies en un futuro no muy lejano.

Las ilustraciones son esquemáticas, simplificadas a las características principales y se han remarcado los rasgos diferenciales (que en muchos casos se indican con flechas). Los dibujos pertenecientes a las claves de géneros provienen de ZABALA (1987), mientras que los pertenecientes a las claves de especies se han dibujado para esta obra. Esta información gráfica se completa con un catálogo de fotografías al Microscopio Electrónico de Barrido, que reúne algunas de las especies más frecuentes en nuestras costas. Un número a continuación del nombre específico sirve para identificar el dibujo y una referencia entre paréntesis para la identificación de la fotografía en caso de existir.

Las especies desconocidas de nuestras costas que se tuvieron que consultar de otras colecciones o aquellas de las que sólo se tenían referencias bibliográficas, se señalan en el texto con un asterisco. A fin de suplir la falta de descripción, en cada clave y junto a cada especie, una referencia bibliográfica enviará al lector a un trabajo donde esa especie es tratada con detalle.

La última parte del trabajo incluye un glosario en el que se describen todos los términos específicos usados en la monografía, así como un índice de sinónimos obsoletos y nombres genéricos y específicos actualizados.

13. REFERENCES

- ALDER, J., 1857, A catalogue of the Zoophytes of Northumberland and Durham. *Trans. Tyneside Natur. Field Club*, 3 (2): 93-162.
- 1864. Description of new British Polyzoa with remarks on some imperfectly known species. *Quart Jour. Micr. Sci.*, 4: 95-109.
- ARISTEGUI, J., 1984. Briozoos Quilostomados de Canarias (Ectoprocta, Cheilostomata): Estudio sistemático, faunístico y biogeográfico. Tesis Doctoral, Universidad de La Laguna.
- ARISTEGUI, J. & CRUZ, T., 1986. Consideraciones biogeográficas sobre el orden Cheilostomata (Ectoprocta) en Canarias. *Vieraea*, 16: 161-171.
- AUDOUIN, 1826. Explication sommaire des planches des polypes de l’Egypte et de la Syrie, publiées par Jules-César Savigny. *Desc. de l’Egypte, Hist. Nat.*, 1 (4): 225-244.
- BARROSO, M.G., 1921. Notas sobre algunas especies de Briozoos de España (especies del golfo de Valencia). *Bol. R. Soc. Esp. Hist. Nat.*, 50 aniv.: 68-78.
- 1922. Notas sobre Briozoos marinos españoles. *Bol. R. Soc. Esp. Hist. Nat.*, 22(1-2): 88-101.
- 1924. Notas sobre Briozoos de Tánger. *Bol. R. Soc. Esp. Hist. Nat.*, 24(6): 291-298.
- 1927. Notas sobre Briozoos españoles. *Bol. R. Soc. Esp. Hist. Nat.*, 27(6): 284.
- 1935. Notas sobre Briozoos españoles. *Bol. R. Soc. Esp. Hist. Nat.*, 35(7): 373-380.
- BASSLER, R.S., 1953. Bryozoa. In: *Treatise on Invertebrate Paleontology. Part G* (R.C. Moore Ed.). Geol. Soc. Am. New York and Univ. of Kansas Press. New York.
- BISHOP, J.D. & HOUSEHAM, B.C., 1987. *Puellina* (Bryozoa; Cheilostomata; Cribriliniidae) from British and adjacent waters. *Bull. Br. Mus. Nat. Hist. (zool.)*, 53(1): 1-63.
- BOBIN, G. & PRENANT, M., 1961. Remarques sur certaines *Hincksinidae*, *Alderinidae* et *Flustriidae* (Bryozoaires Chilostomes). *Cah. Biol. Mar.*, 2:161-175.
- BORG, F., 1926. Studies on recent cyclostomatous Bryozoa. *Zool. Bidrag. Fran Upsala*, 10: 181-507.
- 1944. The Stenolematous Bryozoa. *Further zool. results of the Swedish Antarctic Expedition, 1901-1903*, 3(5): 1-276.
- BROWN, D.A., 1952. The Tertiary Cheilostomatous Polyzoa of New Zealand. *Cat. Brit. Mus. (Nat. Hist.)*: 1-405.
- BUSK, G., 1851. Notices on three undescribed species of Polyzoa. *Ann. Mag. Nat. Hist. ser 2*, 7:81-86.
- 1852. *Catalogue of Marine Polyzoa in the collection of the British Museum. Cheilostomata*. London.
- 1854. *Catalogue of Marine Polyzoa in the collection of the British Museum. Part 2. Cheilostomata (part.)*. London.
- 1856. Zoophytology. *Quart. Journ. Micr. Sci.*, 4: 93-96. London.
- 1858. On some madeiran Polyzoa. *Quart. Journ. Micr. Sci.*, 6: 124-130.
- 1859. On some madeiran Polyzoa. *Quart. Journ. Micr. Sci.*, 7: 65-67.
- 1860. Zoophytology: catalogue of the polyzoa collected by J.Y. Johnson Esq. at Madeira in the year 1859-60 with descriptions of new species. *Quart. Journ. Micr. Sci.*, 8: 280-285.
- 1861. Description of new Polyzoa collected at Madeira in 1859-60 by J.Y. Johnson Esq.

- Quart. Journ. Micr. Sci.*, 1: 77-80.
- 1875. *Catalogue of Marine Polyzoa in the collection of the British Museum. Part 3*: London.
 - 1884. Report on the Polyzoa collected by H.M.S. "Challenger" during the years 1873-76. Part I. Cheilostomata. *Rep. Sci. Res. Voy. Chall. Zool.*, 10 (30): 1-216.
 - CALVET, L., 1900. Contribution à l'histoire naturelle des Bryozoaires Ectoproctes marins. *Trav. Inst. Zool. Univ. Montpellier*, 8(1-9): 1-488.
 - 1902a. Bryozoaires marins de la région de Cette. *Trav. Inst. Zool. Univ. Montpellier et Stat. Zool. Cette* 11: 1-103.
 - 1902b. Bryozoaires marins des côtes de Corse. *Trav. Inst. Zool. Univ. Montpellier et Stat. Zool. Cette*, 12: 1-52.
 - 1906a. Bryozoaires. *Exp. Sci. du "Travailleur" et du "Talisman" pendant les années 1880-81-82-83*, 8: 355-495.
 - 1906b. Deuxième note préliminaire sur les Bryozoaires récoltés par les expéditions du "Travailleur" (1881-82) et du "Talisman" (1883). *Exp. Sci. du "Travailleur" et du "Talisman" pendant les années 1880-81-82-83*, 12(4): 215-223.
 - 1927. Bryozoaires de Monaco et environs. *Bull. Inst. Océan. Monaco*, 503: 1-46.
 - 1931. Bryozoaires provenant des campagnes scientifiques du Prince Albert 1er. de Monaco. *Res. Camp. Scient. Albert 1er.*, 83: 1-152.
 - CANU, F., 1900. Révision des Bryozoaires du Crétacé figurés par D'Orbigny. Part 2. Cheilostomata. *Bull. Soc. Géol. France*, 3 (28): 88-94.
 - 1918. *Hippaliosina*, un nouveau genre de Bryozoaire. *Bull. Soc. Géol. France*, 4, (18): 88-94.
 - 1919. 6ème Contribution à l'étude des Bryozoaires fossiles: XVII: Pleistocène de Palerme. *Bull. Soc. Géol. France*, 4 (19): 214-215.
 - 1928. Trois nouveaux Bryozoaires d'eau douce. *Bull. Soc. Hist. Nat. Afr. du nord*, XIX: 262-264.
 - CANU, F. & BASSLER, R.S., 1917. Synopsis of American Early Tertiary Cheilostome Bryozoa. *Bull. U.S. Nat. Mus.*, 96: 1-87.
 - 1920a. North American Early Tertiary Bryozoa. *Smiths. Inst. U.S. Nat. Mus. Bull.*, 106(1):279.
 - 1920b. North American Early Tertiary Bryozoa. *Smiths. Inst. U.S. Nat. Mus. Bull.*, 106(2):162.
 - 1923. North American Later Tertiary and Quaternary Bryozoa, *Smiths. Inst. U.S. Nat. Mus. Bull.*, 125: 1-302.
 - 1925. Les Bryozoaires du Maroc et du Mauritanie. *Mém. Soc. Sci. Nat. Maroc*, X(1): 1-79.
 - 1927. Classification of the Cheilostomatous Bryozoa. *Proc. U.S. Nat. Mus.*, 69 (14), n° 2640: 1-42.
 - 1928a. Les Bryozoaires du Maroc et Mauritanie (2ème mémoire). *Mém. Soc. Sci. Nat. Maroc*, 18: 1-85.
 - 1928b. Fossil and recent Bryozoa of the Gulf of Mexico region. *Proc. U.S. Nat. Mus.*, 72(14): 1-199.
 - 1929. Bryozoa of the Philippine Region. *Smith. Inst. U.S. Nat. Mus. Bull.*, 109(9): 1-685.
 - 1930. Bryozoaires marins de Tunisie. *Ann. St. Océan. Salambo*, 5: 1-91.
 - CIPOLLA, F., 1921. I Briozoi pliocenici di Altavilla presso Palermo. *Giorn. Soc. Sci. Natur. Econ. Palermo*, 32: 163-337.
 - COOK, P.L., 1964. Polyzoa from West Africa: notes on the genera *Hippoporina* Neviani, *Hippoporella* Canu, *Cleidochasma* Harmer and *Hippoporidra* Canu & Bassler (Cheilostomata Ascophora). *Bull. Br. Mus. Nat. Hist. (Zool.)*, 12(1): 1-35.
 - 1965a. Polyzoa from West Africa: the *Cupuladriidae* (Cheilostomata Anasca). *Bull. Br. Mus. Nat. Hist. (Zool.)*, 13 (6): 191-227.
 - 1965b. Notes on the *Cupuladriidae* (Polyzoa Anasca). *Bull. Br. Mus. Nat. Hist. (Zool.)*, 13: 151-187.
 - 1968a. Polyzoa from West Africa. The Malacostega, part I. *Bull. Br. Mus. Nat. Hist. (Zool.)*, 16 (3): 113-160.
 - 1968b. Bryozoa (Polyzoa) from the coast of tropical West Africa. *Atlantide Report*, 10: 115-262.
 - COUCH, R.Q., 1844. *A cornish fauna. Part III. The zoophytes and calcareous Corallines*. Truro.
 - DALYELL, J.G., 1848. Rare and remarkable animals of Scotland, represented from living subjects, with practical observations on their nature. Part II, London.
 - EHLERS, E., 1876. *Hypophorella expansa*. Ein Beitrag zur Kenntnis der minierenden Bryozoen. *Abh. Königl. Ges. Wiss. Göttingen*, 21: 1-126.

- FARRE, A., 1837. Observations on the minute structure of some of the higher forms of Polypi. *Phil. Trans. Roy. Soc. London.*: 387-426.
- FISCHER, P., 1866. Etudes sur les Bryozoaires perforants de la famille des Térébriporides. *Nouv. Arch. Mus. Hist. Nat.*, 2: 293-313.
- FRIEDL, P.H., 1917a. Bryozoen der Adria. *Zool. Anz.*, I. 49 (9): 225-240.
- 1917b. Bryozoen der Adria. *Zool. Anz.*, 49(10):268-280.
- GAUTIER, Y.V., 1953. Contribution à l'étude des Bryozoaires de Corse. *Rec. Trav. Sta. Mar. Endoume*, 9:39-66.
- 1954. Sur l'*Electra pilosa* des feuilles de Posidonies. *Vie et Milieu*, 5(1): 67-70.
- 1957. Bryozoaires des îles Baléares. Résult. Camp. "Prof. Lacaze-Duthiers". *Vie et Milieu*, 2 (6): 205-222.
- 1958a. Bryozoaires marins actuels de Sicilie. *Atti. Soc. Pelor. Sc. Fis. Nat.*, 4(2): 45-68.
- 1958b. Bryozoaires de la côte ligure. *Ann. Mus. Civ. Stor. Nat. Genova*, 70 (104): 193-206.
- 1958c. Sur quelques Bryozoaires de la "zone à coraux profonds" du golfe de Gênes. *Bull. Ins. Océan. Monaco*, 1123: 1-11.
- 1962. Recherches écologiques sur les Bryozoaires Chilostomes en Méditerranée occidentale. *Rec. Trav. Stat. Mar. Endoume*, 38(24): 1-434.
- GERACI, S., 1973. Popolamenti di substrati artificiali posti in fondo a "coralligeno" e in una prateria di Posidonia, II: I Briozoi. *Publ. Staz. Zool. Napoli*, 40 suppl.: 53-68.
- 1974. On a new species of Bryozoa from the Ligurian Sea: *Escharella rylandi* nov. sp. *Ann. Mus. Civ. Stor. Nat. G. Doria*, 5: 1-3.
- GORDON, D.P., 1984. The marine fauna of New Zealand: Bryozoa: Gymnolaemata, from the Kermadec Ridge. *New Zeal. Ocean. Ins. Mem.*, 91: 1-198.
- GOSSE, P.H., 1855. Notes on some new or little known marine animals. *Ann. Mag. Nat. Hist.*, (2)16: 27-36.
- HARME LIN, J.G., 1968a (1969). Bryozoaires récoltés au cours de la campagne du Jean Charcot en Méditerranée orientale (août-septembre 1967). Dragages. *Bull. Mus. Nat. Hist. Nat.*, 2ème sér. 40(6): 1179-1208.
- 1968b. Contribution à l'étude des Bryozoaires cyclostomes de Méditerranée: les *Crisia* des côtes de Provence. *Bull. Mus. Nat. Hist. Nat.*, 2ème sér, 40(2): 413-437.
- 1969a. Bryozoaires des grottes sous-marines obscures de la région marseillaise. Faunistique et écologie. *Téthys*, 1(3): 793-806.
- 1969b. Bryozoaires récoltés au cours de la campagne du Jean Charcot en Méditerranée Orientale (août-septembre 1967). Dragages. *Bull. Mus. Nat. Hist. Nat.*, 41(1): 295-311.
- 1970. Les *Cribrilaria* (Bryozoaires Chilostomes) de Méditerranée; systématique et écologie. *Cah. Biol. Mar.*, 11(1): 77-98.
- 1973. Les Bryozoaires des peuplements sciaphiles de Méditerranée: le genre *Crassimarginatella* Canu (Chilostome Anasca). *Cah. Biol. Mar.*, 14: 471-492.
- 1976. The suborder *Tubuliporina* (Bryozoa Cyclostomata) in Mediterranean. Ecology and systematics. *Mém. Inst. Océan. Monaco.*, 10: 1-326.
- 1977a. Bryozoaires du banc de la Conception (nord des Canaries). Campagne Cineca I du "Jean Charcot". *Bull. Mus. Nat. Hist. Nat.*, 492(341): 1057-1076.
- 1977b. Présence de *Chaperia annulus* (Manzoni, 1870) (Bryzoaire Chilostome) dans l'herbier de posidonies de Port-Cros. *Trav. Sci. Parc Nat. Port-Cros*, 3: 207-209.
- 1978. Sur quelques Cribrimorphes (Bryozoa Cheilostomata) de l'Atlantique oriental. *Téthys*, 8(2): 173-192.
- 1984. Bryozoaires des peuplements sciaphiles de Méditerranée: Révision de *Cribrilina setosa* Waters et description de deux nouvelles espèces de *Cribrilaria* (Bryozoa Cheilostomata). *Zoologica Scripta*, 13(2): 81-88.
- HARME LIN, J.G. & ARISTEGUI, J., (in press). New Cribrilineidae (Bryozoa Cheilostomata) from the upper-bathyal of the Atlanto-Mediterranean region. *J. Nat. Hist.*
- HARMER, S.F., 1923. On Cellularine and other Polyzoa. *J. Lin. Soc. Zool.*, 35: 293-361.
- 1926. The Polyzoa of the Siboga expedition, part 2. Cheilostomata Anasca. *Rep. Siboga Exp.*, 28B: 181-501.
- 1957. The Polyzoa of the Siboga expedition, part 4. Ascophora. *Rep. Siboga Exp.*, 28D: 641-1147.
- HASS, H., 1948. Beitrag zur Kenntnis der Reteporiden zweiter Hauptteil. *Zoologia*, 37(101): 125-135.

- HASSALL, A.H., 1842. Remarks on the genus *Lepralia*. *Ann. Mag. Nat. Hist.*, 9(1): 407-413.
- HASTINGS, A.B., 1966. Observations on the type material of some genera and species of Polyzoa. *Bull. Br. Mus. Nat. Hist. (Zool.)*, 14: 57-78.
- HAYWARD, P.J., 1974. Studies on the Cheilostome bryozoan fauna of the Aegean island of Chios. *J. Nat. Hist.*, 8: 369-402.
- 1975a. A new species of epiphytic Bryozoan from the Aegean Sea. *Cah. Biol. Mar.*, 16: 207-212.
- 1975b. Observations on the Bryozoa epiphytes of *Posidonia oceanica* from the island of Chios, (Aegean Sea). “Bryozoa 1974”. *Doc. Lab. Geol. Fac. Sci. Lyon*, 3(2): 347-356.
- 1976. The marine fauna and flora of the Isles of Scilly. Bryozoa II. *J. Nat. Hist.*, 10: 319-330.
- 1978a. Bryozoa from the west European continental slope. *J. Zool. London*, 184: 207-224.
- 1978b. Systematic and morphological studies on some European species of *Turbicellepora* (Bryozoa Cheilostomata). *J. Nat. Hist.*, 12: 551-590.
- 1979a. Systematic notes on some British Ascophora (Bryozoa Cheilostomata). *Zool. J. Lin. Soc.*, 66: 73-90.
- 1979b. Deep water Bryozoa from the coasts of Spain and Portugal. *Cah. Biol. Mar.*, 20: 59-75.
- 1983. Biogeography of *Adeonella* (Bryozoa, Cheilostomata): a preliminary account. *Bull. Mar. Sci.*, 33(3): 582-596.
- 1985. *Ctenostome Bryozoans. Synopses of the British Fauna*. Ac. Press. London.
- HAYWARD, P.J. & COOK, P.L., 1983. The South African Museum’s *Meiring Naude* Cruises. Part 13. Bryozoa 2. *Ann. South Afr. Mus.*, 91: 1-161.
- HAYWARD, P.J. & RYLAND, J.S., 1979. *British Ascophoran Bryozoans. Synopses of the British Fauna*. Ac. Press. London.
- 1985a. *Cyclostome Bryozoans. Synopses of the British fauna*. Ac. Press. London.
- 1985b. Systematic notes on some british cyclostomata (Bryozoa). *J. Nat. Hist.*, 19: 1073-1078.
- HELLER, C., 1867. Die Bryozoen des Adriatischen Meeres. *Verhandl. Zool. Bot. Ges.*, 17: 77-136.
- HINCKS, T.A., 1878. Notes on the genus *Retepora* with description of new species. *Ann. Mag. Nat. Hist.*, 5(1): 353-365.
- 1880. *A History of the British Marine Polyzoa*. John van Voorst Ed. London.
- 1886. The polyzoa of the Adriatic: a supplement to Prof. Heller’s, “die Bryozoen des Adriatischen Meeres” (1967). *Ann. Mag. Nat. Hist.*, 17: 254-271.
- 1887. The polyzoa of the Adriatic: a supplement to Prof. Heller’s, “die Bryozoen des Adriatischen Meeres” (1967). *Ann. Mag. Nat. Hist.*, 19: 302-316.
- HONDT, J.L., 1979. Briozoos del levante español. *Bol. R. Soc. Esp. Hist. Nat.*, 77 (3-4): 457-472.
- 1983. Tabular keys for identification of Recent Ctenostomatous Bryozoa. *Mem. Inst. Océan. Monaco*, 14: 1-134.
- HONDT, J.L. & GERACI, S., 1975. *Benedenipora delicatula* n. sp., nouveau Bryozoaire Ctenostome de Méditerranée occidentale. *Ann. Mus. Civ. St. Nat. Genova*, 80: 294-303.
- 1976. *Arachnoidea annosciae* n. sp., nouveau Bryozoaire Ctenostome Arachnidiidae du golfe de Gênes. *Ann. Mus. Civ. St. Nat. Genova*, 81: 139-152.
- JOHNSTON, G., 1838. *A History of British Zoophytes*. 1st. Edition. W.H. Lizars Ed. Edinburgh.
- 1847. *A History of British Zoophytes*. 2nd. Edition. John van Voorst Ed. London.
- JULLIEN, J., 1882. Bryozoaires dragués dans l’Atlantique en 1881 (Dragages du “Travailleur”). *Bull. Soc. Zool. Fr.*, 6: 271-285.
- JULLIEN, J. & CALVET, L., 1903. Bryozoaires provenant des campagnes de l’“Hirondelle” (1886-1888) (Golfe de Gascogne, Açores, Terre Neuve). *Résult. Camp. Sci. Albert 1er. Prince de Monaco*, 23: 1-188.
- LAGAAN, R., 1952. The pliocene Bryozoa of the Low Countries and their bearing on the stratigraphy of the North Sea région. *Mededelingen van de Geologische Stichting*, (c), 5(5): 1-223.
- LAUBIER, L., 1966. Le coralligène des Albères, monographie biocénotique. *Ann. Inst. Océan. Paris*, 43 (2): 137-31.
- LEVINSEN, G.M.R., 1909. *Morphological and systematic studies on the cheilostomatous Bryozoa*. Nationale forfatterers Forlag. København.
- LÓPEZ DE LA CUADRA, C.M. & GARCÍA-GÓMEZ, J.C. (in press). Briozoos Quilostomados del Estrecho de Gibraltar y áreas próximas. *Cah.*

- MANZONI, A., 1878. I Briozoi fossili del Miocene d'Austria ed Ungheria. *Akad. Wiss. Math. Natur.*, 38:1-24.
- MARCUS, E., 1920. Mittelmeer Bryozoen aus der Sammlung des zoologischen Museums zu Berlin. *Sitzungb. Ges. Naturforsch. Freude zu Berlin*, 2-3: 65-108.
- MILNE-EDWARDS, H., 1836. Recherches anatomiques, physiologiques et zoologiques sur les Eschares. *Ann. Sci. Nat. Zool.*, 2(6): 1-53.
- MORRIS, P.A., 1980. The Bryozoa family Hippothoidae (Cheilostomata, Ascophora), with emphasis on the genus *Hippothoa*. *Allan Hancock Found.*, 10: 1-115.
- NORMAN, A.M., 1909. The Polyzoa of Madeira and neighbouring islands. *J. Lin. Soc. Zool.*, 30: 257-314.
- OCCHIPINTI, A., 1980a. Osservazioni sui Briozoi di ambienti lagunari Nord-Adriatici, *Atti V Conv. Gr. Gadio (Varese)*: 169-181.
- 1980b. Contributo alla conoscenza dei Briozoi nella Laguna Veneta Settentrionale. *Boll. Mus. Civ. Venezia*, 31: 95-109.
- 1981. Briozoi lagunari. *Cons. Naz. delle Ricerche*, 7:1-145.
- O'DONOGHÚE, H.C. & DE WATEVILLE, D., 1939. Bryozoa. Rep. n° 20. The fishery grounds near Alexandria. *Found. Inst. Hydrob. and Fisheries*, 34: 1-58.
- OSBURN, R.C., 1950. Bryozoa of the Pacific Coast of America. Part 1: Cheilostomata Anasca. *Allan Hancock Pacific Exp.*, 14 (1): 1-269.
- 1952. Bryozoa of the Pacific Coast of America. Part 2: Cheilostomata Ascophora. *Allan Hancock Pacific Exp.*, 14(2): 270-611.
- 1953. Bryozoa of the Pacific Coast of America. Part. 3: Cyclostomata, Ctenostomata, Entoprocta and Addenda. *Allan Hancock Pacific Exp.*, 14(3): 613-841.
- PRENANT, M. & BOBIN, G., 1956. Bryozoaires, 1ère partie. Entoproctes, Phylactolèmes, Ctenostomes. *Faune Fr.*, 60: 1-398.
- 1966. Bryozoaires, 2ème partie. Chilostomes Anasca. *Faune Fr.*, 68: 1-647.
- PROUHO, H., 1892. Contribution à l'histoire des Bryozoaires. *Arch. Zool. Exper. Gen.*, 2. (10): 557-656.
- REGUANT, S., VÁZQUEZ, A., ZAMARREÑO, I. & MALUQUER, P., 1985. Significación de los briozos en los sedimentos superficiales de la plataforma continental del Cabo de Gata (Almería-España). *Acta Geol. Hisp.*, 20(1): 69-80.
- RYLAND, J.S., 1960. The British species of *Bugula*. (Polyzoa). *Proc. Zool. Soc. London*, 134: 65-105.
- 1962. The association between Polyzoa and algal substrata. *J. An. Ecol.*, 31(2): 331-338.
- 1963. Systematic and biological studies on Polyzoa (Bryozoa) from western Norway. *Sarsia*, 14: 1-59.
- 1965. *Catalogue of main marine fouling organisms. 2, Polyzoa*. OCDE, Paris.
- 1968. Terminological problems in Bryozoa. *Atti della Soc. Ital. Sci. Nat.*, 108: 225-236.
- 1969. Nomenclatural index to "A history of the british Marine Polyzoa" by T. Hincks (1880). *Bull. Br. Mus. Nat. Hist. (Zool.)*, 17: 207-260.
- 1970. *Bryozoans*. Hutchinson University Library. London.
- RYLAND, J.S. & HAYWARD, P.J., 1977. *British Anascan Bryozoans. Synopses of the British Fauna*. Ac. Press. London.
- SILEN, L., 1946. On two new groups of Bryozoa living in the shells of Molluscs. *Arkiv. f. Zool.*, 38(1):1-17.
- SOULE, J.D., 1957. Two species of Bryozoa Ctenostomata from the Salton sea. *Bull. Soc. Calif. Acad. Sci.*, 56(1): 21-30.
- THORPE, J.P., BEARDMORE, J.A. & RYLAND, J.S., 1978a. Genetic evidence for cryptic speciation in the marine bryozoan *Alcyonidium gelatinosum*. *Mar. Biol.*, 49: 27-32.
- 1978b. Genetic variation and biochemical systematics in the marine bryozoan *Alcyonidium mytili*. *Mar. Biol.*: 343-350.
- THORPE, J.P. & WINSTON, J.E., (in press). On the identity of *Alcyonidium diaphanum* (Lamouroux, 1813) (Bryozoa, Ctenostomata). *J. Nat. Hist.*
- (in press). On the identity of *Alcyonidium gelatinosum* (Linnaeus, 1761) (Bryozoa, Ctenostomata). *J. Nat. Hist.*
- UTTLEY, G.H. & BULLIVANT, J.F., 1972. Biological results of the Chatham islands 1954 Expedition. *Bull. N. Z. Dep. Sci. Ind. Res.*, 139(7): 1-59.
- WATERS, A.W., 1879. On The Bryozoa of the Bay of Naples. *Ann. Mag. Nat. Hist.*, 5 (3): 28-43, 114-126, 192-202, 267-280.
- 1916. Some species of *Crisia*. *Ann. Mag. Nat.*

- Hist.*, 18:469-477.
- 1918. Some Mediterranean Bryozoa. *Ann. Mag. Nat. Hist.*, 9(2): 96-102.
 - 1925. Some Cheilostomatous Bryozoa from Oran (Alger) *Ann. Mag. Nat. Hist.*, 9 (15): 651-661.
- WOOD, S.V., 1844. Descriptive Catalogue of the zoophytes from the Crag. *Ann. Mag. Nat. Hist.*, 13: 10-21.
- ZABALA, M., 1986. *Fauna dels Briozous dels Països Catalans*. Inst. Est. Cat. Ed. Barcelona.

14. INDEX OF SPECIES, GENERA AND SYNONYMIES

This index includes both current and out of date names of species and genera.

Archaic names are followed by a = sign and the name which is their updated correspondent. Generic and specific names on their own are all in use.

Species which have been denominated the same name by different authors have a complex synonymy. In these cases the author's name in whose sense the synonymy is valid, is given in brackets.

Acamarchis bertholetti (Savigny) = Scrupocellaria bertholetti	97
Acamarchis geoffroyi (Audouin) = Scrupocellaria reptans	97
Adeona heckeli (Canu & Bassler) = Reptadeonella violacea	113
Adeona violacea = Reptadeonella violacea	113
Adeonella	144
Adeonella calveti	144
Adeonella palasii = Adeonella polystomella (?)	144
Adeonella polystomella	144
Adeonellopsis	113
Adeonellopsis distoma	113
aegeensis, Scrupocellaria	99
aegyptiacum, Synnotum	100
Aetea	75
Aetea anguina	75
Aetea longicollis	75
Aetea recta (Hincks) = Aetea sica	75
Aetea sica	75
Aetea truncata	75
albidum, Alcyonidium	62
Alcyonidium	61
Alcyonidium albidum	62
Alcyonidium cellarioides	62
Alcyonidium diaphanum	62
Alcyonidium duplex	62
Alcyonidium gelatinosum	62
Alcyonidium polyoum = Alcyonidium gelatinosum	62
Alcyonidium variegatum	62
Alderina	82

Alderina imbellis	82
Alderina solidula = Crassimarginatella solidula	85
Alecto compacta = Eurystrotos compacta	171
Alecto major (Johnston) = Annectocyma major	167
Alecto repens (Wood) = Annectocyma major	167
Alysidium lafontii (Busk) = Savignyella lafontii	145
Amathia	73
Amathia lendigera	73
Amathia pruvoti	73
Amathia semiconvoluta	73
Amathia vidovici	73
ambigua, Scruparia	76
ambita, Cosciniopsis	116
Amphiblestrum	82
Amphiblestrum flemingii	82
Amphiblestrum minax	82
amphorae, Liripora	169
amphorae, Desmeplagioecia = Liripora amphorae	169
Anarthropora	113
Anarthropora monodon	113
anguina, Aetea	75
Anguinaria truncata (Landsborough) = Aetea truncata	75
Annectocyma	166
Annectocyma arcuata	167
Annectocyma indistincta	166
Annectocyma major	167
Annectocyma tubulosa	167
annosciae, Arachnoidea	64
annulus, Chaperia	86
antarctica (cf.), Ellisina	81
antillea, Exechonella	114
aperta, Bugula	102
aperta cf., Tubulipora	176
Aplousina	83
Aplousina capriensis	83
Aplousina filum	83
aporosa, Sertella	151
Arachnidium	64
Arachnidium hipbothoides	64
Arachnoidea	64
Arachnoidea annosciae	64
arcuata, Annectocyma	167
arcuata, Diaperocia = Annectocyma arcuata	167
argentea, Ramphostomella	123
armata, Brodiella	146
armata, Buffonellaria = Brodiella armata	146
arrecta, Puellina (Cribrilaria)	107
arrogata, Schizomavella	130
Arthropoma	126
Arthropoma ceciliai	126
articulata, Paludicella	67

atlantica, Idmidronea	174
auriculata, Schizomavella	132
auriculata f. cuspidata, Schizomavella	132
auriculata f. leontiniensis, Schizomavella	132
auriculata f. typica, Schizomavella	132
avicularia, Bugula	104
Avicularia flabellata (Thompson) = Bugula flabellata	104
avicularis, Turbicellepora	161
aviculifera (cf.), Palmicellaria	118
baccata, Parasmittina = Parasmittina tropica f. baccata?	119
balzaci, Collarina	105
Beania	101
Beania hirtissima	101
Beania hirtissima f. cylindrica	101
Beania magellanica	101
Beania mirabilis	101
Beania robusta	101
Benedenipora	66
Benedenipora catenata	66
Benedenipora delicatula	66
Berenicea patina (Borg) = Plagioecia patina	172
Berenicea sarniensis (Harmer) = Plagioecia sarniensis	172
bertholetti, Scrupocellaria	97
Bicellariella	100
Bicellariella ciliata	100
bifurcatum, Characodoma	135
bimucronatum, Haplopoma	139
bimucronatum f. occidum, Haplopoma	139
biporosa, Cupuladria	89
bispinosum, Rhynchozoon	149
blanchardi, Jaculina	154
boreale, Tessaradoma	142
boryi, Caberea	96
Bowerbankia	74
Bowerbankia gracilis	74
Bowerbankia imbricata	74
Bowerbankia pustulosa	74
brevis, Penetrantia	68
Brodiella	146
Brodiella armata	146
brongiartii, Chorizopora	141
Buchneria	155
Buchneria fayalensis	155
Buffonellaria	127
Buffonellaria armata = Brodiella armata	146
Buffonellaria divergens	127
Bugula	102
Bugula aperta	102
Bugula aquilirostris (Ryland) = Bugula fulva	104
Bugula avicularia	104
Bugula avicularia f. flabellata (Waters) = Bugula calathus	104

Bugula calathus	104
Bugula flabellata	104
Bugula fulva	104
Bugula gautieri	102
Bugula germanae	102
Bugula gracilis	104
Bugula neritina	102
Bugula plumosa	102
Bugula sabatieri (Calvet) = Bugula simplex	105
Bugula simplex	105
Bugula spicata	104
Bugula stolonifera	104
Bugula turbinata	104, 105
Bugula turrita = Bugula gracilis	104
bursaria, Epistomia	99
Buskea	156
Buskea dichotoma	156
Buskea nitida	156
Buskea quincuncialis (Hayward) = Buskea nitida	156
Buskia	71
Buskia nitens	71
Buskia socialis	71
Caberea	96
Caberea boryi	96
calathus, Bugula	104
calathus, Bugula (Calathus)	104
Caleschara patellaria (Friedl) = Mollia patellaria	92
Callopora	83
Callopora curvirostris (Canu & Bassler) = Parellisina curvirostris	86
Callopora dumerilii typica	84
Callopora dumerilii f. pouilleti	84
Callopora guernei (Canu & Bassler) = Parellisina curvirostris	86
Callopora lineata	84
Callopora minuta	84
Callopora pouilletii (Gautier) = Callopora dumerilii f. pouilleti	84
Calloporina	137
Calloporina decorata	137
Calpensia	90
Calpensia calpensis = Calpensia nobilis (?)	90
Calpensia impressa (Moll) = Calpensia nobilis	90
Calpensia nobilis	90
calveti, Adeonella	144
Calyptotheca	127
Calyptotheca rugosa	127
Calyptotheca triarmata	127
camera, Turbicellepora	161
caminata, Celleporina	158
canariensis, Celleporina	158
canariensis, Cupuladria	89
Canda reptans (Busk) = Scrupocellaria reptans	97
cantabra, Turbicellepora	161

capriensis, Aplousina	83
capriensis, Setosellina	88
Carbasea	79
Carbasea carbasea	79
Cardioecia	168
“Cardioecia” watersi	168
cassidainsis, Puellina (Cribrilaria)	107
Catenaria lafontii (Canu & Bassler) = Savygniella lafontii	145
catenata, Benedenipora	66
catenularia, Pyripora	78
cavernicola, Setosella	93
cecili, Arthropoma	126
Cellaria	94
Cellaria cereoides (Ellis & solander) = Margaretta cereoides	155
Cellaria farciminioides (Ellis & Solander) = Cellaria fistulosa	94
Cellaria fistulosa	94
Cellaria johnstoni (Hincks) = Cellaria salicornioides	94
Cellaria normani = Cellaria salicornioides	94
Cellaria plumosa (Pallas) = Bugula plumosa	94
Cellaria pyriformis (Bertoloni) = Chlidonia pyriformis	93
Cellaria salicornia (Marcus) = Cellaria fistulosa	94
Cellaria salicornioides	94
Cellaria sinuosa	94
cellarioides, Alcyonidium	62
Cellepora	157
Cellepora angulosa (Reuss) = Onychocella marioni (?)	87
Cellepora armata (Hincks) = Turbicellepora avicularis	161
Cellepora avicularis (Hincks) = Turbicellepora avicularis	161
Cellepora coccinea (Abildgaard) = Escharoides coccinea	112
Cellepora costazii (Hincks) = Celleporina hassalii	159
Cellepora decorata (Reuss) = Calloporina decorata	137
Cellepora dichotoma (Hincks) = Buskea dichotoma	156
Cellepora dunkeri (Reuss) = Schizoporella dunkeri	133
Cellepora heckeli (Reuss) = Reptadeonella violacea	113
Cellepora laevis (Fleming) = Porelloides laevis	122
Cellepora malusii (Audouin) = Fenestulina malusii	138
Cellepora nitida = Buskea nitida	156
Cellepora nobilis (Esper) = Calpensia nobilis	90
Cellepora ovoidea (Audouin) = Watersipora subovoidea	114
Cellepora pertursa (Esper) = Hippoporina pertusa	114
Cellepora pulchra (Manzoni) = Hippopleurifera pulchra	112
Cellepora pumicosa (auctt.)	157
Cellepora “pumicosa” Waters	157
Cellepora ramulosa (Hincks) = Omalosecosa ramulosa	160
Cellepora retusa (Waters) = Celleporina caminata	158
Cellepora sardonica = “Dentiporella” sardonica	157
Cellepora subovoidea (D’Orbigny) = Watersipora subovoidea	114
Cellepora tubigera (Busk) = Turbicellepora tubigera	161
Cellepora verruculata (Waters) = Rhynchozoon neapolitanum	149
Cellepora lepralioides (Norman) = Lagenipora lepralioides	160
Celleporella	142

Celleporella hyalina	142
Celleporina	158
Celleporina caminata	158
Celleporina canariensis	158
Celleporina decipiens	159
Celleporina hassallii	159
Celleporina hassallii var. tubulosa	159
Celleporina ignota = Celleporina lucida	158
Celleporina lucida	158
Cellularia plumosa (Pallas) = Bugula plumosa	102
Cellularia reptans (Johnston) = Scrupocellaria reptans	98
Cellularia salicornia (Pallas) = Cellaria fistulosa	94
cereooides, Margaretta	155
cervicornis, "Porella" = Smittina cervicornis	121
cervicornis, Smittina	121
Chaperia	86
Chaperia annulus	86
Characodoma	135
Characodoma bifurcatum	135
Chartella	79
Chartella papyrea	79
Chartella tenella	79
Cheiloporina	116
Cheiloporina circumcincta	116
cheilostoma, Prenantia	122
chelata, Scruparia	76
Chlidonia	93
Chlidonia cordieri (Calvet) = Chlidonia pyriformis	93
Chlidonia pyriformis	93
Chorizopora	141
Chorizopora brongiartii	141
Cigclisula	159
Cigclisula turrita	159
ciliata, Bicellariella	100
ciliata, Microporella	141
circumcincta, Cheiloporina	116
circumcincta, Mollia	92
claviculata, Trypostega	144
Clavopora	62
Clavopora hystricis	62
Cleidochasma	135
Cleidochasma oranense	135
Cleidochasma porcellanum	135
coccinea, Escharoides	112
Codonellina montferrandii = Metroperiella lepralioides (?)	129
coerulea, Idmidronea	174
Collarina	105
Collarina balzaci	105
colleti, "Porella" = Smittina colleti	121
colleti, Smittina	121
Colletosia innominata (Harmelin) = Cribrilaria innominata	121

Colletosia radiata (Prenant & Bobin) = Puellina (Cribrilaria) radiata	107
columnaris, Phoceana	155
comma, Spathipora	69
comma, Terebripora = Spathipora comma	69
compacta, Eurystrotos	171
complanata, Sertella	151
complanata, Watersipora	114
concinna, Porella	120
concinna f. tubulata, Porella	120
Conopeum	76
Conopeum reticulum	76
Conopeum seurati	76
Copidozoum	84
Copidozoum curvirostre (Gautier) = Parellisina curvirostris	86
Copidozoum exiguum	84
Copidozoum planum	85
Copidozoum tenuirostre	85
Copidozoum vibraculoides (Okada) = Copidozoum planum	85
corbula, Puellina (Glabrilaria)	107
coriacea, Micropora	90
coronata, Microporella = Microporella umbracula	140
Coronellina	91
Coronellina fagei	91
coronopus, Turbicellepora	161
coronopusoida, Turbicellepora	161
Cosciniopsis	116
Cosciniopsis ambita	116
Cothurnicella daedala (Thompson) = Chlidonia pyriformis	93
Cothurnicella pyriformis (Bassler) = Chlidonia pyriformis	93
couchii, Sertella	154
crassimarginata, Crassimarginatella	85
Crassimarginatella	85
Crassimarginatella crassimarginata	85
Crassimarginatella maderensis	85
Crassimarginatella solidula	85
crenulata, Turbicellepora	161
Cribellopora	128
Cribellopora trichotoma	128
Cribrilaria = Puellina (Cribrilaria)	107, 108
Cribrilina	110
Cribrilina balzaci (Waters) = Collarina balzaci	105
Cribrilina figularis (Hincks) = Figularia figularis	110
Cribrilina gattyaе (Hincks) = Puellina (Puellina) gattyaе	106
Cribrilina "punctata"	110
Cribrilina radiata (Hincks) = Puellina (Cribrilaria) radiata	107
Crisia	163
Crisia boryi (Audouin) = Caberea boryi	96
Crisia cuneata	163
Crisia delilii (Audouin) = Scrupocellaria delilii	99
Crisia denticulata	165
Crisia fistulosa	163

<i>Crisia geniculata</i> (Milne-Edwards) = <i>Filicrisia geniculata</i>	165
<i>Crisia kerguelensis</i>	165
<i>Crisia</i> cf. <i>occidentalis</i>	165
<i>Crisia oranensis</i>	165
<i>Crisia ramosa</i>	165
<i>Crisia sigmoidea</i>	165
<i>Crisia</i> sp. II	165
<i>Crisidia cornuta</i> var. <i>geniculata</i> (Busk, 1875) = <i>Filicrisia geniculata</i>	165
<i>Cryptosula</i>	114
<i>Cryptosula pallasiana</i>	114
<i>crystallina</i> , <i>Smittina</i>	121
<i>cuneata</i> , <i>Crisia</i>	163
<i>Cupuladria</i>	88
<i>Cupuladria biporosa</i>	88
<i>Cupuladria canariensis</i>	88
<i>Cupuladria doma</i>	88
<i>Cupuladria multispina</i>	88
<i>Cupularia canariensis</i> (Canu & Bassler) = <i>Cupuladria canariensis</i>	88
<i>Cupularia johnsoni</i> (Busk) = <i>Cupuladria doma</i>	88
<i>Cupularia reussiana</i> (Manzoni) = <i>Cupuladria doma</i>	88
<i>curvirostris</i> , <i>Parellisina</i>	86
<i>Cylindroporella</i>	142
<i>Cylindroporella tubulosa</i>	142
<i>Dakaria subovoidea</i> (Harmer) = <i>Watersipora subovoidea</i>	114
<i>decipiens</i> , <i>Celleporina</i>	159
<i>decorata</i> , <i>Calloporina</i>	137
<i>deflexa</i> , <i>Enthalophoroecia</i>	168
<i>delicatula</i> , <i>Benedenipora</i>	66
<i>delicatula</i> , <i>Mecynoecia</i>	173
<i>delicatula</i> , <i>Reteporellina</i>	145
<i>delilii</i> , <i>Scrupocellaria</i>	99
<i>denticulata</i> , <i>Crisia</i>	165
" <i>Dentiporella</i> "	157
" <i>Dentiporella</i> " <i>sardonica</i>	157
<i>depressa</i> , <i>Hippaliosina</i>	116
<i>Desmoplagioecia amphorae</i> = <i>Liripora amphorae</i>	169
<i>Desmoplagioecia violacea</i> = <i>Liripora violacea</i>	169
<i>Diachoris buskea</i> (Heller) = <i>Beania magellanica</i>	101
<i>Diachoris hirtissima</i> (Heller) = <i>Beania hirtissima</i>	101
<i>Diachoris hirtissima</i> for. <i>robusta</i> (Hincks) = <i>Beania robusta</i>	101
<i>Diachoris magellanica</i> (Busk) = <i>Beania magellanica</i>	101
<i>Diachoris patellaria</i> (Waters) = <i>Mollia patellaria</i>	92
<i>Diachoris patellaria</i> v. <i>multijuncta</i> = <i>Mollia patellaria</i> f. <i>multijuncta</i>	92
<i>Diachoris simplex</i> (Heller) = <i>Mollia patellaria</i>	92
<i>Diaperoecia arcuata</i> = <i>Annectocyma arcuata</i>	167
<i>Diaperoecia dorsalis</i> (Canu & Bassler) = <i>Plagioecia dorsalis</i>	172
<i>Diaperoecia indistincta</i> = <i>Annectocyma indistincta</i>	166
<i>Diaperoecia major</i> = <i>Annectocyma major</i>	167
<i>Diaperoecia tubulosa</i> = <i>Annectocyma tubulosa</i>	167
<i>diaphanum</i> , <i>Alcyonidium</i>	62
<i>Diastopora congesta</i> (D'Orbigny) = <i>Plagioecia inoedificata</i>	172

Diastopora flabellum (Reuss) = Eurystrotos compacta	171
Diastopora hyalina f. latomarginata (Smitt) = Plagioecia patina	172
Diastopora inoedificata (Jullien) = Plagioecia inoedificata	172
Diastopora latomarginata (Waters) = Plagioecia patina	172
Diastopora obelia (Heller) = Diplosolen obelia	169
Diastopora patina (Calvet) = Plagioecia patina	172
Diastopora sarniensis (Norman) = Plagioecia sarniensis	172
Diastopora simplex (Busk) = Plagioecia patina	172
Diastopora suborbicularis (Hincks) = Eurystrotos compacta	171
dichotoma, Buskea	156
dilatata, Nolella	64
Diplopora obelia (Jullien & Calvet) = Diplosolen obelia	169
Diplosolen	169
Diplosolen obelia	169
Diplosolen obelium = Diplosolen obelia	169
Diporula	137
Diporula verrucosa	137
Discoflustrellaria doma (D'Orbigny) = Cupuladria doma	88
discoidea, Schizomavella	130
Discoparsa annularis (Heller) = Plagioecia patina	172
Discoparsa marginata (D'Orbigny) = Plagioecia patina	172
Discopora meandrina = Disporella hispida	180, 181
disjuncta, Rectonychoecella	88
Disporella	178
Disporella hispida f. fimbriata	181
Disporella hispida f. meandrina	179
distoma, Adeonellopsis	113
divaricata, Hippothoa	143
divergens, Buffonellaria	127
doma, Cupuladria	89
dorsalis, Plagioecia	172
dumerilii, Callopora	84
dumerilii f. pouilleti, Callopora	84
dunkeri, Schizoporella	133
duplex, Alcyonidium	62
dutertrei, Escharina	128
Electra	77
Electra hastingsae (Prenant & Bobin) = Electra monostachys	78
Electra monostachys	78
Electra pilosa	78
Electra pilosa f. verticillata = Electra verticillata	78
Electra posidoniae	78
Electra verticillata	78
elegans, Palmicellaria	118
elegans, Reteporella	146
Ellisina	81
Ellisina cf. antarctica	81
Ellisina curvirostris (Harmer) = Parellisina curvirostris	86
Entalophora clavata (Hincks) = Entalophoroecia deflexa	168
Entalophora deflexa = Entalophoroecia deflexa + Mecynoecia delicatula	168, 173
Entalophora gallica (D'Orbigny) = Entalophoroecia deflexa	168

Entalophora proboscidea (Calvet) = Annectocyma major	167
Entalophora proboscideoides (Smitt) = Entalophoroecia deflexa	168
Entalophora rugosa (D'Orbigny) = "Cardioecia" watersi	168
Entalophora translucida (Calvet) = Mecynoecia delicatula	173
Entalophora wasiniensis (Waters) = Mecynoecia delicatula	173
Enthalophoroecia	167
Enthalophoroecia deflexa	168
Enthalophoroecia gracilis	168
Enthalophoroecia robusta	168
Epistomia	99
Epistomia bursaria	99
errata, Schizoporella	133
Eschara bimucronata (Moll) = Haplopoma bimucronatum	139
Eschara cervicornis (Milne Edwards) = Smittina cervicornis	121
Eschara ciliata (Pallas) = Microporella ciliata	141
Eschara fascialis = Pentapora fascialis	115
Eschara fistulosa (Linnaeus) = Cellaria fistulosa	94
Eschara impressa (Moll) = Calpensia nobilis	90
Eschara patellaria (Moll) = Molliia patellaria	92
Eschara polystomella = Adeonella polystomella	144
Eschara quincuncialis (Norman) = Buskea nitida	156
Eschara radiata (Moll) = Puellina (Cribrilaria) radiata	107
Eschara securifrons (Pallas) = Securiflustra securifrons	79
Eschara tubulifera (Heller) = Smittina tubulifera	121
Eschara verrucosa (Peach) = Diporula verrucosa	137
Eschara vulgaris (Moll) = Escharina vulgaris	128
Escharella	124
Escharella hexaspinosa	125
Escharella octodentata	125
Escharella rylandi	124
Escharella variolosa	125
Escharella ventricosa	125
Escharella n. sp.	125
Escharina	128
Escharina aff. dutertrei	128
Escharina hyndmanni	129
Escharina porosa	129
Escharina vulgaris	128
Escharoides	112
Escharoides coccinea	112
Escharoides quincuncialis (Hincks) = Buskea nitida	156
Escharoides mamillata	112
Escharoides megarostris	112
Eucratea ambigua (D'Orbigny) = Scruparia ambigua	76
Eucratea cordieri (Audouin) = Chlidonia pyriformis	93
Eucratea chelata (Hincks) = Scruparia chelata	76
Eucratea lafontii (Audouin) = Saygniella lafontii	145
Eurystrotos	171
Eurystrotos compacta	171
Eurystrotos occulta	171
Exechonella	114

Exechonella antillea	114
exiguum, Copidozoum	84
eximia, Phylactellipora	126
expansa, Hyppoporella	67
fagei, Coronellina	91
Farcimia salicornia (Johnston) = Cellaria fistulosa	94
Farcimia sinuosa (Hassall) = Cellaria sinuosa	94
Farella dilatata (Hincks) = Nolella dilatata	94
Farrella	69
Farrella repens	69
fascialis, Pentapora	115
fayalensis, Buchneria	155
feegensis, Hippopodina	117
Fenestrulina	138
Fenestrulina joannae	138
Fenestrulina malusii	138
feuerbornii, Sertella	154
Figularia	110
Figularia figularis	110
figularis, Figularia	110
Filicrisia	165
Filicrisia geniculata	165
Filisparsa tubulosa (Calvet) = Annectocyma tubulosa	167
filum, Aplousina	83
fissa, Schizotheca	150
fistulosa, Cellaria	94
fistulosa, Crisia	163
flabellata, Bugula	104
flagellum, Hippothoa	143
flava, Triticella	72
flemingii, Amphiblestrum	82
Flustra barrosoi (Calvet) = Chartella tenella	79
Flustra brongniarti (Audouin) = Chorizopora brongniarti	141
Flustra carbacea (Ellis & Solander) = Carbacea carbacea	79
Flustra cecillii (Audouin) = Arthropoma cecillii	126
Flustra coriacea (Johnston) = Micropora coriacea	90
Flustra dumerilii (Audouin) = Callopora dumerilii	84
Flustra dutertrei (Audouin) = Escharina dutertrei	128
Flustra impressa (Audouin) = Haplopoma impresum	139
Flustra laciniosa (Barroso) = Chartella tenella	79
Flustra lineata (Linnaeus) = Callopora lineata	84
Flustra membranacea (Linnaeus) = Membranipora membranacea	77
Flustra montferrandii (Audouin) = Metroperiella lepralioides (?)	129
Flustra octodon = Hincksinoflustra octodon	79
Flustra papyracea (Calvet) = Chartella tenella	79
Flustra pilosa (Linnaeus) = Electra pilosa	78
Flustra rosselii (Canu & Bassler) = Rosseliana rosselii	91
Flustra securifrons (Hincks) = Securiflustra securifrons	79
Flustra tenella (Hincks) = Chartella tenella	79
Flustra truncata (Busk) = Securiflustra securifrons	79
flustroides, Hincksina	80

flustroides f. crassispinata, Hincksina	80
folini, Setosella	93
frondiculata, Hornera	182
Fron dipora	173
Fron dipora gracilis (Canu & Bassler) = Fron dipora verrucosa	173
Fron dipora maderensis (Johnston) = Fron dipora verrucosa	173
Fron dipora verrucosa	173
fulva, Bugula	104
gattyae, Puellina	106
gautieri, Bugula	102
gelatinosum, Alcyonidium	62
Gemellaria avicularis = Synnotum aegyptiacum	100
geniculata, Filicrisia	165
germanae, Bugula	102
gigantea, Nolella = Nolella stipata	64
gingrina, Stomatopora	166
gracilis, Bowerbankia	74
gracilis, Bugula	104
gracilis, Enthallophoroecia	168
gracilis, Mimosella	70
Grammella crassimarginata (Canu & Bassler) = Crasimarginatella crassimarginata	85
graniferum, Haplopoma	139
graniferum f. carinatum, Haplopoma	139
gregaria, Spiralaria	81
Haplopoma	138
Haplopoma bimucronatum	139
Haplopoma bimucronatum f. occiduum	139
Haplopoma carinatum = Haplopoma graniferum f. carinatum	139
Haplopoma graniferum	139
Haplopoma graniferum f. carinatum	139
Haplopoma impressum	139
Haplopoma sciaphilum	138
Haploporella nodulifera (Hincks) = Monoporella nodulifera	92
Harmerella dichotoma (Gautier) = Buskea dichotoma	156
harmeri, Sertella	154
hassallii, Celleporina	159
hassallii f. tubulosa, Celleporina	159
hastata, Schizomavella	132
Hemeschara sanguinea (Norman) = Schizobrachiella sanguinea	130
Hemicyclopora	126
Hemicyclopora multispinata	126
hemiphragmata, Tubulipora	176
Hemiseptella africana (Canu & Bassler) = Membranipora tenuis	77
Herentia = Escharina	128
Herentia hyndmanni (Gautier) = Escharina hyndmanni	129
Herentia porosa = Escharina porosa	129
hexaspinosa, Escharella	125
hincksi, Puellina (Cribrilaria)	107
Hincksina	80
Hincksina flustroides	80
Hincksina flustroides f. crassispinata	80

Hincksinoflustra	79
Hincksinoflustra octodon	79
Hippaliosina	116
Hippaliosina depressa	116
Hippellozoon	151
Hippellozoon mediterraneum	151
Hippodiplosia ottomulleriana = Pentapora ottomulleriana	115
Hippomenella	117
Hippomenella mucronelliformis	117
Hippopleurifera	112
Hippopleurifera pulchra	112
Hippopodina	117
Hippopodina feegensis	117
Hippopodinella	136
Hippopodinella kirchenpaueri	136
Hippopodinella kirchenpaueri v. tregoubovii	136
Hippopodinella lata	136
Hippoporidra	136
Hippoporidra picardi	136
Hippoporina	114
Hippoporina circumcincta = Cheiloporina circumcincta	116
Hippoporina pertusa	114
Hippoporina porcellana (Busk) = Cleidochasma porcellanum	135
Hippoporina simplex (Canu & Bassler) = Cleidochasma porcellanum	135
Hippothoa	143
Hippothoa catenularia (Feming) = Pyripora catenularia	78
Hippothoa divaricata	143
Hippothoa divergens (Smitt) = Buffonellaria divergens	127
Hippothoa flagellum	143
Hippothoa hyalina = Celleporella hyalina	142
Hippothoa porosa (Smitt) = Escharina porosa	129
Hippothoa sica (Couch) = Aetea sica	75
hippoothoides, Arachnidium	64
hirtissima, Beania	101
hirtissima f. cylindrica, Beania	101
hispida f. fimbriata, Disporella	181
hispida f. meandrina, Disporella	179
Holoporella turrata (Osburn) = Cigclisula turrata	159
Hornera	181
Hornera frondiculata	182
Hornera lichenoides	182
Hornera violacea v. tubulosa (Busk) = Annectocyma tubulosa	167
hyalina, Celleporella	142
hyalina, Lobiancopora	66
hyndmanni, Escharina	129
Hypophorella	67
Hypophorella expansa	67
hystricis, Clavopora	62
Idmidronea	174
Idmidronea atlantica	174
Idmidronea coerulea	174

<i>Idmonea atlantica</i> (Johnston) = <i>Idmidronea atlantica</i>	174
<i>Idmonea concava</i> (Reuss) = <i>Idmidronea atlantica</i>	174
<i>Idmonea dilatata</i> (D'Orbigny) = <i>Tubulipora liliacea</i>	176
<i>Idmonea irregularis</i> (Meneghini) = <i>Tervia irregularis</i>	174
<i>Idmonea marionensis</i> (Busk) = <i>Idmidronea atlantica</i>	174
<i>Idmonea meneghini</i> (Heller) = <i>Platonea stoechas</i>	174
<i>Idmonea milneana</i> (D'Orbigny) = <i>Tubulipora notomale</i>	176
<i>Idmonea notomala</i> (Busk) = <i>Tubulipora notomale</i>	176
<i>Idmonea philippisae</i> (Waters) = <i>Platonea stoechas</i>	174
<i>Idmonea radians</i> = <i>Idmidronea atlantica</i>	174
<i>Idmonea serpens</i> (Neviani) = <i>Idmidronea atlantica</i>	174
<i>imbellis</i> , <i>Alderina</i>	82
<i>imbricata</i> , <i>Bowerbankia</i>	74
<i>Immergentia</i>	68
<i>Immergentia orbignyana</i>	68
<i>imperati</i> , <i>Schizoretopena</i>	150
<i>impressum</i> , <i>Haplopoma</i>	138
<i>incurvata</i> , <i>Scrupocellaria</i>	97
<i>indistincta</i> , <i>Annectocyma</i>	166
<i>indistincta</i> , <i>Diaperoecia</i> = <i>Annectocyma indistincta</i>	166
<i>inerma</i> , <i>Prenantia</i>	122
<i>innominata</i> , <i>Cribrilaria</i> = <i>Puellina (Cribrilaria) innominata</i>	108
<i>innominata</i> , <i>Puellina (Cribrilaria)</i>	108
<i>innominata f. hincksi</i> , <i>Cribrilaria</i> = <i>Puellina (Cribrilaria) hincksi</i>	107
<i>inoedificata</i> , <i>Plagioecia</i>	172
<i>irregularis</i> , <i>Tervia</i>	174
<i>Jaculina</i>	154
<i>Jaculina blanchardi</i>	154
<i>Jaculina dichotoma</i> = <i>Buskea dichotoma</i>	156
<i>Jaculina paralellata</i>	154
<i>joannae</i> , <i>Fenestrulina</i>	138
<i>kerquelensis</i> , <i>Crisia</i>	165
<i>kirchenpaueri</i> , <i>Hippopodinella</i>	136
<i>koreni</i> , <i>Triticella</i> = <i>Triticella flava</i>	72
<i>Krusensterna verrucosa</i> (Lamoroux) = <i>Fron dipora verrucosa</i>	173
<i>laevis</i> , <i>Porelloides</i>	122
<i>lafontii</i> , <i>Savignyella</i>	145
<i>Lagenipora</i>	159
<i>Lagenipora lepralioides</i>	160
<i>Lagenipora socialis</i> (Hincks) = <i>Lagenipora lepralioides</i>	160
<i>Lagenipora n. sp.</i>	160
<i>landsborovii</i> , <i>Parasmittina</i> = <i>Smittina landsborovii</i>	121
<i>landsborovii</i> , <i>Smittina</i>	121
<i>lata</i> , <i>Hippopodinella</i>	136
<i>Leiosella quincuncialis</i> (Gautier) = <i>Buskea nitida</i>	156
<i>lendigera</i> , <i>Amathia</i>	73
<i>Lepralia adpressa</i> (Hincks) = <i>Hippopodinella lata</i> (?)	136
<i>Lepralia antillea</i> (Osburn) = <i>Exechonella antillea</i>	114
<i>Lepralia armata</i> (Hincks) = <i>Brodiella armata</i>	146
<i>Lepralia auriculata</i> (Hassall) = <i>Schizomavella auriculata</i>	132
<i>Lepralia bifurcata</i> = <i>Characodoma bifurcatum</i>	135

Lepralia bisinuosa (Johnston) = Rhynchozoon bispinosum	147
Lepralia cheilostoma (Manzoni) = Prenantia cheilostoma	122
Lepralia clavula (Manzoni) = Hippaliosina depressa	116
Lepralia complanata (Norman) = Watersipora complanata	114
Lepralia concinna (Busk) = Porella concinna	120
Lepralia cucullata (Busk) = Watersipora subovoidea	114
Lepralia depressa (Busk) = Hippaliosina depressa	116
Lepralia discoidea (Busk) = Schizomavella discoidea	130
Lepralia errata (Waters) = Schizoporella errata	133
Lepralia eximia (Hincks) = Phylactellipora eximia	126
Lepralia figularis (Johnston) = Figularia figularis	110
Lepralia fissa (Busk) = Schizotheca fissa	150
Lepralia gattyaе (Landsborough) = Puellina (Puellina) gattyaе	106
Lepralia granifera (Johnston) = Haplopoma graniferum	139
Lepralia hassallii (Johnston) = Celleporina hassallii	159
Lepralia hyndmanni (Johnston) = Escharina hyndmanni	129
Lepralia innominata (Couch) = Puellina (Cribrilaria) innominata	108
Lepralia kirchenpaueri = Hippopodinella kirchenpaueri	136
Lepralia landsborovii (Johnston) = Smittina landsborovii	121
Lepralia lata (Busk) = Hippopodinella lata	136
Lepralia linearis (Busk) = Schizomavella discoidea	130
Lepralia mamillata (Wood) = Escharoides mamillata	112
Lepralia marmorea (Hincks) = Smittoidea marmorea	123
Lepralia marsupiata (Busk) = Microporella marsupiata	141
Lepralia minuta (Normal) = Porella minuta	120
Lepralia monodon (Busk) = Anarthropora monodon	113
Lepralia mucronelliformis (Waters) = Hippomenella mucronelliformis	117
Lepralia nitida = Buskea nitida	156
Lepralia oraniensis = Cleidochasma oranense	135
Lepralia ottomulleriana = Pentapora ottomulleriana	115
Lepralia pertusa (Hincks) = Hippoporina pertusa	114
Lepralia porcellana (Busk) = Cleidochasma porcellanum	135
Lepralia punctata (Hassall) = "Cribrilaria" punctata	110
Lepralia reticulata (MacGillivray) = Smittoidea reticulata	123
Lepralia rudis (Manzoni) = Schizomavella rudis	132
Lepralia turrita (Smitt) = Cigclisula turrita	159
Lepralia unicornis (Johnston) = Schizoporella unicornis	133
Lepralia variolosa (Johnston) = Escharella variolosa	125
Lepralia ventricosa (Hassall) = Escharella ventricosa	125
Lepralia venusta = Puellina (Cribrilaria) venusta	107
Lepralia violacea (Johnston) = Reptadeonella violacea	113
lepralioides, Lagenipora	160
lepralioides, Metroperiella	129
lichenoides, Hornera	182
Lichenopora	178
Lichenopora hispida var. meandrina = Disporella hispida	179, 181
Lichenopora radiata	181
Lichenopora sp. n.	181
Lichenopora verrucaria	181
liliacea, Tubulipora	176
linearis, Schizomavella	132

lineata, Callopora	84
Liripora	169
Liripora amphorae	169
Liripora violacea	169
Lobiancopora	66
Lobiancopora hyalina	66
longicollis, Aetea	75
longirostris, Schizoporella	133
longisetae, Schizoretepora	150
Loricaria aegyptiaca = Synnotum aegyptiacum	100
lucida, Celleporina	158
macrohyncha, Scrupocellaria (Zabala) = Scrupocellaria reptans	97
maderensis f. aegeensis, Scrupocellaria = Scrupocellaria aegeensis	99
maderensis, Crassimarginatella	85
maderensis, Scrupocellaria	99
magellanica, Beania	101
magnicostata, Turbicellepora	161
magnifica, Schizoporella	133
major, Annectocyma	167
major, Diaperocia = Annectocyma major	167
malusii, Fenestrulina	138
mamillata, Escharoides	112
mamillata, Schizomavella	132
Margaretta	155
Margaretta cereoides	155
marioni, Onychocella	87
marmorea, Smittoidea	123
marsupiata, Microporella	141
marsupifera, Schizomavella	132
Mastigophora dutertrei (Hicks) = Escharina aff. dutertrei	128
Mastigophora hyndmanni (Hincks) = Escharina hyndmanni	129
Mecynoecia	173
Mecynoecia deflexa (Smitt) = Mecynoecia delicatula	173
Mecynoecia delicatula	173
Mecynoecia proboscidea (Canu & Bassler) = Entalophoroecia deflexa	168
mediterranea, Sertella	154
mediterraneum, Hippellozoon	151
megarostis, Escharoides	112
Melicerita fistulosa (Jullien & Calvet) = Cellaria fistulosa	94
Melicerita sinuosa (Jullien & Calvet) = Cellaria sinuosa	94
membranacea, Membranipora	77
Membranipora	77
Membranipora annulus (Manzoni) = Chaperia annulus	86
Membranipora aperta (Manzoni) = Spiralaria gregaria	81
Membranipora calpensis = Calpensia nobilis (?)	90
Membranipora capriensis (Waters) = Aplousina capriensis	83
Membranipora catenularia (Hincks) = Pyripora catenularia	78
Membranipora circumcincta (Heller) = Mollia circumcincta	92
Membranipora crassimarginata (Hincks) = Crassimarginatella crassimarginata	85
Membranipora curvirostris (Hincks) = Parelisina curvirostris	86
Membranipora dumerilii (Ryland) = Callopora dumerilii	84

<i>Membranipora flemingii</i> (Busk) = <i>Amphiblestrum flemingii</i>	82
<i>Membranipora flustroides</i> = <i>Hincksina flustroides</i>	80
<i>Membranipora gregaria</i> (Heller) = <i>Spiralaria gregaria</i>	81
<i>Membranipora imbellis</i> (Hincks) = <i>Alderina imbellis</i>	82
<i>Membranipora lineata</i> (Ryland) = <i>Callopora lineata</i>	84
<i>Membranipora membranacea</i>	77
<i>Membranipora minax</i> (Busk) = <i>Amphiblestrum minax</i>	82
<i>Membranipora monostachys</i> (Busk) = <i>Electra monostachys</i>	78
<i>Membranipora patellaria</i> (Calvet) = <i>Mollia patellaria</i>	92
<i>Membranipora pilosa</i> (Hincks) = <i>Electra pilosa</i>	78
<i>Membranipora plana</i> (Hincks) = <i>Copidozoum planum</i>	85
<i>Membranipora pouilletii</i> (Alder) = <i>Callopora dumerilii</i> f. <i>pouilletii</i>	84
<i>Membranipora solidula</i> (Hincks) = <i>Crassimarginatella solidula</i>	85
<i>Membranipora tenuis</i>	77
<i>Membranipora vulnerata</i> (Busk) = <i>Setosella vulnerata</i>	92
<i>Membraniporella</i>	110
<i>Membraniporella nitida</i>	111
<i>Metroperiella</i>	129
<i>Metroperiella lepralioides</i>	129
<i>Metroperiella montferrandii</i> = <i>Metroperiella lepralioides</i> (?)	129
<i>Microecia occulta</i> = <i>Euristrotos occulta</i>	171
<i>Microecia sarniensis</i> (Canu) = <i>Plagioecia sarniensis</i>	172
<i>Microecia suborbicularis</i> = <i>Eurystrotos compacta</i>	171
<i>Micropora</i>	90
<i>Micropora complanata</i> (Hincks) = <i>Watersipora complanata</i>	114
<i>Micropora coriacea</i>	90
<i>Micropora normani</i>	90
<i>Microporella</i>	140
<i>Microporella ciliata</i>	141
<i>Microporella coronata</i> = <i>Microporella umbracula</i>	140
<i>Microporella decorata</i> (Hincks) = <i>Calloporina decorata</i>	137
<i>Microporella impresa</i> (Hincks) = <i>Haplopoma bimucronatum</i>	139
<i>Microporella malusii</i> (Hinks) = <i>Fenestrulina malusii</i>	138
<i>Microporella marsupiata</i>	141
<i>Microporella orientalis</i>	140
<i>Microporella pseudomarsupiata</i>	141
<i>Microporella umbracula</i>	140
<i>Microporella violacea</i> (Hincks) = <i>Reptadeonella violacea</i>	113
<i>Millepora liliacea</i> (Pallas) = <i>Tubulipora liliacea</i>	176
<i>Millepora pumicosa</i> (Pallas) = <i>Cellepora pumicosa</i>	157
<i>Millepora reticulum</i> = <i>Conopeum reticulum</i>	76
<i>Millepora skenei</i> (Hincks) = <i>Palmicellaria skenei</i>	118
<i>Millepora truncata</i> (Pallas) = <i>Myriapora truncata</i>	163
<i>Mimosella</i>	70
<i>Mimosella gracilis</i>	70
<i>Mimosella verticillata</i>	70
<i>minax</i> , <i>Amphiblestrum</i>	82
<i>minima</i> , <i>Cribrilaria</i> = <i>Puellina</i> (<i>Cribrilaria</i>) <i>minima</i>	107
<i>minima</i> , <i>Puellina</i> (<i>Cribrilaria</i>)	107
<i>minor</i> , <i>Bugula</i> (<i>Calathus</i>)	104
<i>minuta</i> , <i>Callopora</i>	84

minuta, Porella	120
mirabilis, Beania	101
Mollia	91
Mollia circumcincta	92
Mollia fagei (Gautier) = Coronellina fagei	91
Mollia patellaria	92
Mollia patellaria f. circumcincta = Mollia circumcincta	92
Mollia patellaria f. multijuncta	92
monodon, Anarthropora	113
monoecensis, Schizomavella	132
Monoporella	92
Monoporella fimbriata carinifera (Canu & Bassler) = Monoporella nodulifera	92
Monoporella nodulifera	92
monostachys, Electra	78
Mucronella coccinea (Hincks) = Escharoides coccinea	112
Mucronella peachii (Hincks) = Escharella octodentata	125
Mucronella variolosa (Hincks) = Escharella variolosa	125
Mucronella ventricosa (Marcus) = Escharella ventricosa	125
mucronelliformis, Hippomenella	117
muelleri, Tanganella	65
multispinata, Cupuladria	89
multispinata, Hemicyclopora	126
mutabilis, Schizoporella	133
Myriapora	163
Myriapora truncata	163
Myriozoum truncatum (Jelly) = Myriapora truncata	163
neapolitanum, Rhynchozoon	149
neptuni, Schizoporella	133
neritina, Bugula	102
nitens, Buskia	71
nitida, Buskea	156
nitida, Membraniporella	111
Nitscheina pulchella (Canu & Bassler) = Conopeum seurati	76
Nitscheina seurati (Canu) = Conopeum seurati	76
nobilis, Calpensia	90
nodulifera, Monoporella	92
Nolella	64
Nolella dilatata	64
Nolella gigantea = Nolella stipata	64
Nolella stipata	64
normani, Cellaria = Cellaria salicornioides	94
normani, Micropora	90
Notamia bursaria (Hincks) = Epistomia bursaria	99
notomale, Tubulipora	176
obelis, Diplosolen	169
occidentalis cf., Crisia	165
occulta, Eurystrotos	171
occulta, Microecia = Eurystrotos occulta	171
octodentata, Escharella	125
octodon, Hincksinoflustra	79
Omalosecosa	160

Omalosecosa ramulosa	160
Onchopora borealis (Busk) = Tessaradoma boreale	142
Oncousoecia major (Canu & Bassler) = Annectocyma major	167
Onychoecia	87
Onychoecia angulosa = Onychoecia marioni (?)	87
Onychoecia marioni	87
Onychoecia vibraculifera	87
ophidiana, Smittoidea	123
oranense, Cleidochasma	135
oranensis cf., Crisia	165
orbignyana, Immergentia	68
orbignyana, Terebripora = Immergentia orbignyana	68
orientalis, Microporella	140
orientalis, Puellina (Glabilaria)	107
Osthimosia armata (Barroso) = Turbicellepora magnicostata (?)	161
Osthimosia cantabra (Barroso) = Turbicellepora cantabra	161
Osthimosia coronopus (Lagaaij) = Turbicellepora coronopus	161
Osthimosia tubigera (Cipolla) = Turbicellepora tubigera	161
Osthimosia verruculata (Canu & Bassler) = Rhynchozoon neapolitanum	149
ottomulleriana, Pentapora	115
ovicellata, Umbonula	111
pallasiana, Cryptosula	114
Palmicellaria	117
Palmicellaria cf. aviculifera	118
Palmicellaria elegans	118
Palmicellaria skenei	118
Paludicella	67
Paludicella articulata	67
papyrea, Chartella	79
paralellata, Jaculina	154
Parasmittina	118
Parasmittina baccata = Parasmittina tropica (?)	119
Parasmittina raigii	119
Parasmittina rouvillei = Parasmittina tropica f. rouvillei	119
Parasmittina tropica	119
Parellisina	86
Parellisina curvirostris	86
patellaria, Mollia	92
patellaria f. circumcincta, Mollia = Mollia circumcincta	91
patellaria f. multijuncta	92
patina, Plagioecia	172
pavida, Victorella	64
pedicellata, Triticella	72
pedunculata, Cribilaria = Puellina (Glabilaria) pedunculata	107
pedunculata, Puellina (Glabilaria)	107
Penetrantia	68
Penetrantia brevis	68
Pentapora	115
Pentapora fascialis	115
Pentapora ottomulleriana	115
Peristomella coccinea (Marcus) = Escharoides coccinea	112

pertusa, Hippoporina	114
phalangea, Tubulipora	176
Pherusella	61
Pherusella tubulosa	61
Phoceana	155
Phoceana columnaris	155
Phylactellipora	126
Phylactellipora eximia	126
picardi, Hippoporidra	137
picardi, Puellina (Cribrilaria)	108
pilosa, Electra	78
Plagioecia	171
Plagioecia congesta (Harmelin) = Plagioecia inoedificata	172
Plagioecia dorsalis	172
Plagioecia inoedificata	172
Plagioecia patina	172
Plagioecia platydiscus	172
Plagioecia sarniensis	172
planum, Copidozoum	85
Platonea	174
Platonea stoechas	174
platydiscus, Plagioecia	172
plumosa, Bugula	102
plumosa, Tubulipora	176
polyoum, Alcyonidium = Alcyonidium gelatinosum	62
polystomella, Adeonella	144
porcellanum, Cleidochasma	135
Porella	119
Porella cervicornis = Smittina cervicornis	121
Porella colleti = Smittina colleti	121
Porella concinna	120
Porella concinna f. tubulata	120
Porella laevis (Hincks) = Porelloides laevis	122
Porella minuta	120
Porella remotorostrata (Canu & Bassler) = Smittina remotorostrata	121
Porella tubulata	120
Porella tubulifera = Smittina tubulifera	121
Porelloides	122
Porelloides laevis	122
Porina borealis (Hincks) = Tessaradoma boreale	142
porosa, Escharina	129
posidoniae, Electra	78
posidoniae, Ramphostomellina	124
Prenantia	122
Prenantia cheilostoma	122
Prenantia inerma	122
pruvoti, Amathia	73
pseudodigitatum, Rhynchozoon	149
pseudomarsupiata, Microporella	141
pseudoradiata, Puellina (Cribrilaria)	107
Puellina	105

Puellina gattyae = Puellina (Puellina) gattyae	106
Puellina setosa = Puellina (Puellina) setosa	106
Puellina (Cribrilaria) arrecta	107
Puellina (Cribrilaria) cassidainis	107
Puellina (Cribrilaria) hincksi	107
Puellina (Cribrilaria) innominata	108
Puellina (Cribrilaria) minima	107
Puellina (Cribrilaria) n. sp. (aff. arrecta)	107
Puellina (Cribrilaria) picardi	108
Puellina (Cribrilaria) pseudoradiata ssp. pseudoradiata	107
Puellina (Cribrilaria) radiata	107
Puellina (Cribrilaria) scripta	108
Puellina (Cribrilaria) setiformis	107
Puellina (Cribrilaria) venusta	107
Puellina (Glabrilaria) corbula	107
Puellina (Glabrilaria) orientalis ssp. orientalis	107
Puellina (Glabrilaria) pedunculata	107
Puellina (Puellina) gattyae	106
Puellina (Puellina) setosa	106
pulchra, Hipopleurifera	112
pumicosa, Cellepora (auctt.)	157
“pumicosa”, Cellepora (Waters)	157
punctata, Cribrilina	110
Pustulopora deflexa (Johnston) = Entalophoroecia deflexa	168
Pustulopora clavata (Busk) = Entalophoroecia deflexa	168
Pustulopora deflexa (Heller) = Entalophoroecia deflexa	168
Pustulopora delicatula (Busk) = Mecynoecia delicatula	173
pustulosa, Bowerbankia	74
pyriformis, Chlidonia	93
Pyripora	78
Pyripora catenularia	78
quadriscopatum n. sp., Rhynhozoon	149
radiata, Cribrilaria = Puellina (Cribrilaria) radiata	107
radiata, Puellina (Cribrilaria)	107
radiata, Lichenopora	181
Radiopora pustulosa = Disporella hispida	179, 181
raigii, Parasmittina	119
ramosa, Crisia	165
Ramphonotus minax (Prenant & Bobin) = Amphiblestrum minax	82
Ramphostomella	123
Ramphostomella argentea	123
Ramphostomellina	124
Ramphostomellina posidoniae	124
ramulosa, Omalosecosa	160
Rectonychocella	87
Rectonychocella disjuncta	88
Rectonychocella vibraculifera = Onychocella vibraculifera	87
remotorostrata, Porella = Smittina remotorostrata	121
remorostrata, Smittina	121
repens, Farrella	69
Reptadeonella	113

Reptadeonella violacea	113
reptans, Scrupocellaria	97
Retepora complanata (Waters) = Sertella complanata	151
Retepora couchii (Hincks) = Sertella couchii	154
Retepora imperati = Schizoretepora imperati	150
Retepora mediterranea (Waters) = Sertella mediterranea	154
Retepora solanderia (Risso) = Schizoretepora solanderia	150
Reteporella	146
Reteporella elegans	146
reticulata, Smittoidea	123
Reteporellina	145
Reteporellina delicatula	145
Reticulipora dorsalis (Waters) = Plagioecia dorsalis	172
reticulum, Conopeun	76
Rhynchopora bispinosa (Hincks) = Rhynchozoon bispinosum	149
Rhynchozoon	147
Rhynchozoon sp I	149
Rhynchozoon sp II	149
Rhynchozoon armatum (Gautier) = Brodiella armata	146
Rhynchozoon bispinosum	149
Rhynchozoon digitatum = Rhynchozoon pseudodigitatum (?)	149
Rhynchozoon neapolitanum	149
Rhynchozoon pseudodigitatum	149
Rhynchozoon quadrispinatum n. sp.	149
Rhynchozoon verruculatum = Rhynchozoon neapolitanum	149
robusta, Beania	101
robusta, Enthalophoreocia	168
Rosseliana	91
Rosseliana patellaria (Waters) = Mollia patellaria	92
Rosseliana rosselii	91
rosselii, Rosseliana	91
rouvillei, Parasmittina = Parasmittina tropica f. rouvillei	119
rudis, Schizomavella	132
rugosa, Calyptotheca	127
rylandi, Escharella	124
Salicornaria gracilis (heller) = Cellaria salicornioides	94
Salicornaria sinuosa (Busk) = Cellaria sinuosa	94
salicornioides, Cellaria	94
sanguinea, Schizobrachiella	130
sardonica, "Dentiporella"	157
sarniensis, Plagioecia	172
Savygniella	145
Savygniella lafontii	145
Schismopora areolata (Canuy & Bassler) = Turbicellepora magnicostata	161
Schismopora armata (Pars) = Turbicellepora magnicostata	161
Schismopora cantabra (Canu & Bassler) = Turbicellepora cantabra	161
Schismopora coronopus = Turbicellepora coronopus	161
Schismopora coronopusoida (Calvet) = Turbicellepora coronopusoida	161
Schismopora liouvillei (Canu & Bassler) = Turbicellepora magnicostata	161
Schismopora magnicostata (Barroso) = Turbicellepora magnicostata	161
Schizellozoon (Canu & Bassler) = Schizoretepora	150

Schizellozoon aviculiferum (Canu & Bassler) = Schizoretepora imperati	150
Schizellozoon pungens (Canu & Bassler) = Schizoretepora imperati	150
Schizobrachiella	130
Schizobrachiella sanguinea	130
Schizolavella vulgaris (Moll) = Escharina vulgaris	128
Schizomavella	130
Schizomavella arrogata	130
Schizomavella auriculata	132
Schizomavella auriculata f. cuspidata	132
Schizomavella auriculata f. leontiniensis	132
Schizomavella auriculata f. ornata = Schizomavella auriculata f. leontiniensis	132
Schizomavella auriculata f. typica	132
Schizomavella discoidea	130
Schizomavella hastata	132
Schizomavella linearis	132
Schizomavella linearis f. mamillata (Gautier) = Schizomavella mamillata	132
Schizomavella magnifica = Schizoporella magnifica	133
Schizomavella mamillata	132
Schizomavella marsupifera	132
Schizomavella monoecensis	132
Schizomavella rudis	132
Schizopodrella ansata (Canu & Bassler) = Schizoporella magnifica	133
Schizopodrella elliptica = Schizoporella tetragona (?)	132
Schizopodrella erectorostirs = Schizoporella magnifica	133
Schizopodrella errata (Canu & Bassler) = Schizoporella errata	133
Schizopodrella grandicella (?) = Schizoporella longirostris	133
Schizopodrella longirostris = Schizoporella longirostris	133
Schizopodrella violacea (Canu & Bassler) = Schizoporella errata	133
Schizoporella	132
Schizoporella ansata (Gautier) = Schizoporella magnifica	133
Schizoporella armata (Hincks) = Brodiella armata	132
Schizoporella auriculata = Schizomavella auriculata	132
Schizoporella auriculata v. cuspidata (Hincks) = Schizomavella auriculata v. cuspidata	132
Schizoporella biapertura (Hincks) = Buffonellaria divergens	127
Schizoporella cecilii (Hincks) = Arthropoma cecilii	126
Schizoporella discoidea = Schizomavella discoidea	130
Schizoporella dunkeri	133
Schizoporella elliptica = Schizoporella tetragona (?)	132
Schizoporella errata	133
Schizoporella lepralioides (Calvet) = Metroperiella lepralioides	129
Schizoporella linearis v. mamillata (Hincks) = Schizomavella mamillata	132
Schizoporella longirostris	133
Schizoporella magnifica	133
Schizoporella mutabilis	133
Schizoporella neptuni	133
Schizoporella sanguinea (Hincks) = Schizobrachiella sanguinea	130
Schizoporella serratimargo (Hincks) = Schizotheca serratimargo	150
Schizoporella tetragona	133
Schizoporella trichotoma = Cribellopora trichotoma	128
Schizoporella unicornis	133
Schizoporella unicornis f. ansata (Hincks) = Schizoporella dunkeri	133

Schizoporella unicornis var. longirostris = Schizoporella longirostris	133
Schizoporella violacea (Canu & Bassler) = Schizoporella errata	133
Schizoporella vulgaris (Hincks) = Escharina vulgaris	128
Schizoretepora	150
Schizoretepora imperati	150
Schizoretepora longisetae	150
Schizoretepora solanderia	150
Schizotheca	149
Schizotheca fissa	150
Schizotheca serratimargo	150
sciaphilum, Haplopoma	138
scripta, Puellina (Cribrilaria)	108
Scruparia	76
Scruparia ambigua	76
Scruparia chelata	76
scrupea, Scrupocellaria	99
Scrupocellaria	96
Scrupocellaria aegeensis	99
Scrupocellaria aquitanica (Jullien & Calvet) = Scrupocellaria incurvata	97
Scrupocellaria bertholleti	97
Scrupocellaria capreolus (Heller) = Scrupocellaria bertholleti	97
Scrupocellaria delilii	99
Scrupocellaria elliptica (Pars) = Scrupocellaria inermis + incurvata	97
Scrupocellaria incurvata	97
Scrupocellaria macandrei = Scrupocellaria maderensis + delilii	99
Scrupocellaria macrorhyncha Gautier = (?) Scrupocellaria reptans	97
Scrupocellaria macrorhynchus (Prenant & Bobin) = Scrupocellaria n. sp. (?)	97
Scrupocellaria maderensis	99
Scrupocellaria maderensis f. aegeensis = Scrupocellaria aegeensis	99
Scrupocellaria reptans	97
Scrupocellaria scrupea	99
Scrupocellaria scruposa	97
scruposa, Scrupocellaria	97
Securiflustra	79
Securiflustra securifrons	79
securifrons, Securiflustra	79
semiconvoluta, Amathia	73
septentrionalis, Sertella	154
serratimargo, Schizoporella = Schizotheca serratimargo	150
serratimargo, Schizotheca	150
Sertella	151
Sertella aporosa	151
Sertella cellulosa (auctt.) (Pars) = Sertella septentrionalis	154
Sertella complanata	151
Sertella couchii	154
Sertella feuerbornii	154
Sertella harmeri	154
Sertella mediterranea	154
Sertella septentrionalis	154
Sertella sudbournensis	154
Sertularia anguina (Linnaeus) = Aetea anguina	75

Sertularia avicularia (Linnaeus) = Bugula avicularia	104
Sertularia bursaria (Linnaeus) = Epistomia bursaria	99
Sertularia chelata (Linnaeus) = Scruparia chelata	76
Sertularia ciliata (Linnaeus) = Bicellariella ciliata	100
Sertularia neritina (Linnaeus) = Bugula neritina	102
Sertularia reptans (Linnaeus) = Scrupocellaria reptans	97
Sertularia scruposa (Linnaeus) = Scrupocellaria scruposa	97
sertum, Spathipora	69
setiformis, Puellina (Cribrilaria)	107
setosa, Cribrilaria (sensu Harmelin) = Puellina (Puellina) setosa	106
setosa, Puellina (Puellina)	106
Setosella	92
Setosella cavernicola	93
Setosella folini	93
Setosella vulnerata	93
Setosellina	88
Setosellina capriensis	88
seurati, Conopeum	76
sica, Aetea	75
sigmoidea, Crisia	165
simplex, Bugula	105
sinuosa, Cellaria	94
skenei, Palmicellaria	118
Smittia cervicornis (Calvet) = Smittina cervicornis	121
Smittia cheilostoma (Hincks) = Prenantia cheilostoma	122
Smittia colleti (Jullien) = Smittina colleti	121
Smittia landsborovii (Hincks) = Smittina landsborovii	121
Smittia marmorea (Hincks) = Smittoidea marmorea	123
Smittia reticulata (Hincks) = Smittoidea reticulata	123
Smittia rouvillei (Calvet) = Parasmittina tropica f. rouvillei	119
Smittia tropica (Waters) = Parasmittina tropica	119
Smittina	120
Smittina cervicornis	121
Smittina cheilostoma = Prenantia cheilostoma	122
Smittina colleti	121
Smittina concinna (Kluge) = Porella concinna	120
Smittina crystallina	121
Smittina inerma = Prenantia inerma	122
Smittina landsborovii	121
Smittina remotorostrata	121
Smittina rouvillei = Parastimittina tropica f. rouvillei	119
Smittina tropica (Waters) = Parasmittina tropica	119
Smittina tubulifera	121
Smittipora disjuncta (Canu & Bassler) = Rectonychocella disjuncta	88
Smittoidea	123
Smittoidea ophidiana	123
Smittoidea marmorea	123
Smittoidea reticulata	123
socialis, Buskia	71
solanderia, Schizoretepora	150
solidula, Crassimarginatella	85

Spathipora	69
Spathipora comma	69
Spathipora sertum	69
spicata, Bugula	104
spinosa, Vesicularia	72
Spiralaria	81
Spiralaria gregaria	81
Stephanosella biaperta (Ryland) = Buffonellaria divergens	127
stipata, Nolella	64
stoechas, Platonea	175
stolonifera, Bugula	104
Stomatopora	166
Stomatopora compacta (Hincks) = Eurystrotos compacta	171
Stomatopora deflexa (Hincks) = Enthalophoroecia deflexa	168
Stomatopora gingrina	166
Stomatopora major (Hincks) = Annectocyma major	167
Stomatopora incrassa (Smitt) = Enthalophoroecia deflexa	168
Stomatopora reticulata (Calvet) = Enthalophoroecia deflexa	168
suborbicularis, Microecia = Eurystrotos compacta	171
subovoidea, Watersipora	114
sudbourniensis, Sertella	154
Synnotum	100
Synnotum aegyptiacum	100
Synnotum aviculare (Hincks) = Synnotum aegyptiacum	100
Tanganella	65
Tanganella muelleri	65
tenella, Chartella	79
tenuirostre, Copidozoum	85
tenuis, Membranipora	77
Terebripora coma = Spathipora comma	69
Terebripora orbignyana = Inmergentia orbignyana	68
Tervia	174
Tervia discreta (Jullien) = Tervia irregularis	174
Tervia irregularis	174
Tervia solida = Tervia irregularis	174
Tessaradoma	142
Tessaradoma boreale	142
Tessaradoma gracile (Norman) = Tessaradoma boreale	142
tetragona, Schizoporella	133
tissieri, Triticellopsis	72
torquata, Turbicellepora	161
triarmata, Calypotheca	127
trichotoma, Cribellopora	128
trichotoma, Schizoporella = Cribellopora trichotoma	128
Triticella	72
Triticella flava	72
Triticella koreni = Triticella flava	72
Triticella pedicellata	72
Triticellopsis	72
Triticellopsis tissieri	72
tropica, Parasmittina	119

truncata, Aetea	75
truncata, Myriapora	163
Trypostega	143
Trypostega claviculata	143
Trypostega venusta	143
tuberosa, Walkeria	70
tubigera, Turbicellepora	161
Tubucellaria cereoides = Margareta cereoides	155
Tubucellaria mediterranea = Margareta cereoides	155
tubulata, Briocryptella = Porella tubulata	120
tubulata, Porella	120
tubulifera, Porella = Smittina tubulifera	121
tubulifera, Smittina	121
Tubulipora	176
Tubulipora aperta	176
Tubulipora atlantica (Harmer) = Idmidronea atlantica	174
Tubulipora concinna (Harmer) = Tubulipora ziczac	176
Tubulipora deflexa (Couch) = Enthallophoroecia deflexa	168
Tubulipora fimbria (Hincks) = Tubulipora plumosa	176
Tubulipora flabellaris (Johnston) = Tubulipora plumosa	176
Tubulipora hemiphragmata	176
Tubulipora liliacea	176
Tubulipora notomale	176
Tubulipora obelia (Johnston) = Diplosolen obelia	169
Tubulipora parvus-serpens (Canu & Bassler) = Tubulipora liliacea	176
Tubulipora patina (Lamarck) = Plagioecia patina	172
Tubulipora phalangea	176
Tubulipora plumosa	176
Tubulipora serpens (Smitt) = Tubulipora liliacea	176
Tubulipora transversa (Lamarck) = Tubulipora liliacea	176
Tubulipora tubulifera (Canu & Bassler) = Platonea stoechas	174
Tubulipora ziczac	176
tubulosa, Annectocyma	167
tubulosa, Cyliindroporella	142
tubulosa, Diaperoecia = Annectocyma tubulosa	167
tubulosa, Pherusella	61
Turbicellepora	161
Turbicellepora avicularis	161
Turbicellepora camera	161
Turbicellepora cantabra	161
Turbicellepora coronopus	161
Turbicellepora coronopusoida	161
Turbicellepora crenulata	161
Turbicellepora magnicostata	161
Turbicellepora torquata	161
Turbicellepora tubigera	161
turbinata, Bugula	104, 105
turrita, Cigclisula	159
Umbonula	111
Umbonula ovicellata	111
Umbonula verrucosa (Hincks) = Umbonula ovicellata	111

umbracula, Microporella	140
unicornis, Schizoporella	133
unicornis f. ansata, Schizoporella = Schizoporella dunkeri	133
unicornis v. longirostris, Schizoporella = Schizoporella longirostris	133
uva, Walkeria	70
Valkeria = Walkeria	70
Valkeria tuberosa = Walkeria tuberosa	70
Valkeria uva = Walkeria uva	70
variegatum, Alcyonidium	62
variolosa, Escharella	125
ventricosa, Escharella	125
venusta, Puellina (Cribrilaria)	107
venusta, Trypostega	144
verrucaria, Lichenpora	181
verrucosa, Diporula	137
verrucosa, Frondipora	173
verruculata, Cellepora = Rhynchozoon neapolitanum	149
verticillata, Electra	78
verticillata, Mimosella	70
verticillatum, Zoobotrhyon	74
Vesicularia	72
Vesicularia spinosa	72
vibraculifera, Onychocella	87
Victorella	64
Victorella pavida	64
vidovici, Amathia	73
violacea, Desmeplagioecia = Liripora violacea	169
violacea, Liripora	169
violacea, Reptadeonella	113
violacea, Schizoporella (Canu & Bassler) = Schizoporella errata	133
vulgaris, Escharina	128
vulnerata, Setosella	93
Walkeria	70
Walkeria tuberosa	70
Walkeria uva	70
watersi, "Cardioecia"	168
Watersipora	114
Watersipora complanata	114
Watersipora cucullata (Pars) = Watersipora subovoidea	114
Watersipora subovoidea	114
ziczac, Tubulipora	176
Zoobotrhyon	74
Zoobotrhyon pellucidum = Zoobotrhyon verticillatum	74
Zoobotrhyon verticillatum	74