

**NASA
Technical
Paper
2681**

May 1987

Experimental Evaluation of Turning
Vane Designs for High-Speed and
Coupled Fan-Drive Corners of
0.1-Scale Model of NASA Lewis
Research Center's Proposed
Altitude Wind Tunnel

Thomas F. Gelder,
Royce D. Moore,
Rickey J. Shyne,
and Donald R. Boldman

**NASA
Technical
Paper
2681**

1987

Experimental Evaluation of Turning
Vane Designs for High-Speed and
Coupled Fan-Drive Corners of
0.1-Scale Model of NASA Lewis
Research Center's Proposed
Altitude Wind Tunnel

Thomas F. Gelder,
Royce D. Moore,
Rickey J. Shyne,
and Donald R. Boldman

*Lewis Research Center
Cleveland, Ohio*

NASA

National Aeronautics
and Space Administration

Scientific and Technical
Information Branch

Summary

Two turning vane designs were experimentally evaluated for the fan-drive corner (corner 2) coupled to an upstream diffuser and the high-speed corner (corner 1) of the 0.1-scale model of NASA Lewis's proposed Altitude Wind Tunnel. For corner 2 both a controlled-diffusion vane design (vane A4) and a circular-arc vane design (vane B) were studied. Corner 2 also contained a simulated shaft fairing for the fan-drive system. The corner 1 configuration was the best of several tested earlier as an isolated element. It consisted of a controlled-diffusion turning vane (vane A10) and a simulated scoop to remove exhaust from the tunnel test section. Both uniform and screen-induced distorted inflow to corner 1 were studied at inlet Mach numbers from about 0.18 to 0.46. Detailed static pressure patterns on the corner walls and on the turning vane surfaces are reported along with detailed total pressure profiles at the corner inlets and outlets.

Near design inlet conditions the corner 1 total pressure loss coefficient was about 0.16, the same value as when tested as an isolated element, as expected. The corner 2 loss coefficient was about 0.12 with either the controlled-diffusion or the circular-arc vane design. This loss was about 25 percent less than when corner 2 was tested alone instead of coupled to corner 1. The controlled-diffusion vane design (A4) has the advantage of 20 percent fewer vanes than the circular-arc vane design (B). Only 22 A4 vanes are required in contrast to 28 B vanes; however, the A4 vane shape is more complex. The effects of simulated inlet flow distortion on the overall losses for corner 1 or 2 were small with little difference due to vane design.

Introduction

It has been proposed that the inactive Altitude Wind Tunnel (AWT) at the NASA Lewis Research Center be rehabilitated to meet the aeropropulsion needs of the future. The proposed program would extend the capabilities of the tunnel to permit testing at Mach numbers up to 0.92. The tunnel would accommodate tests involving fuel-burning engines, adverse weather conditions, and acoustic evaluations. The tunnel internal components were removed when it was converted to altitude test chambers for space research in the late 1950's and early 1960's. Therefore the proposed AWT (fig. 1) would require all new internal components but retain the original

tunnel shell. In addition to a new test section and heat exchanger, four new sets of turning vanes and a new two-stage fan-drive system would be required. The high-speed corner (corner 1, downstream of the test section) would have an engine exhaust removal scoop extending through the center of the turning vanes. The fan-drive corner (corner 2) would have a drive-shaft fairing extending through the center of its turning vanes. Corners 3 and 4 turning vanes would be clean (i.e., no other parts would pass through these corners). The tunnel components are described in detail in references 1 to 3.

Because of the magnitude of the proposed AWT rehabilitation, including the much higher than usual inlet Mach numbers required for corners 1 and 2, a modeling effort was undertaken to ensure the technical soundness of the new component designs. A 0.1 scale was chosen as the common size for the various components partly because it represented the upper limit of the NASA Lewis exhauster flow capabilities. After the individual components have been tested, various subassemblies could also be tested to evaluate the interactions of the various tunnel loop components.

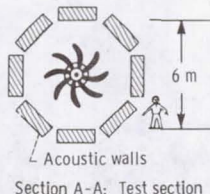
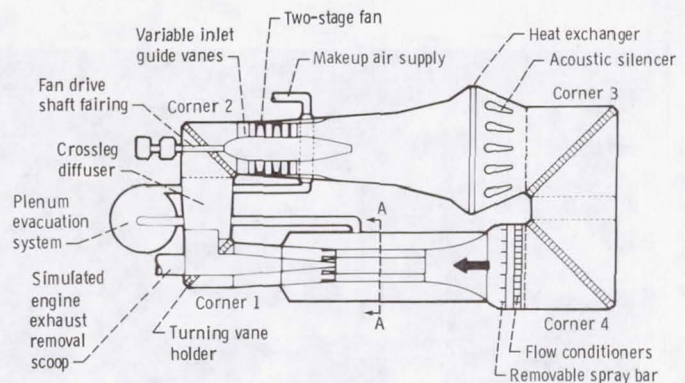

Mach number	0 to 0.9+
Altitude, m	0 to 17 000+
Total temperature, °C	-40 to 15
Test-section acoustic level, dB (OASPL)	120

Figure 1.—Capabilities of modified and rehabilitated AWT.

The results from the corner 1 turning vane studies are presented in references 4 and 5 and include configurations with and without the simulated exhaust removal scoop in place. Results from the corner 2 studies are given in reference 6. This configuration consisted of a crossleg diffuser, the corner turning vanes, the simulated fan drive-shaft fairing, and the fan variable inlet guide vanes (VIGV's). Except for corner 1 with the scoop, all the configurations were tested with two turning vane designs. The A vanes were controlled-diffusion-shaped airfoils; the B vanes were circular-arc-shaped airfoils. The B vane shapes and spacings were identical for both corners 1 and 2. The A vane shapes and spacings, although not identical for both corners because of different design inlet Mach numbers, were essentially the same (i.e., within typical machining tolerances).

To determine the interaction effects, if any, corner 1 with its simulated scoop was connected to the crossleg diffuser and the corner 2 configuration. This report presents and discusses the results obtained with this combination of corners. The discussion includes comparisons with the isolated-corner results previously published (refs. 4 to 6). Also, both uniform inlet flow and distorted inlet flow (generated by screens) were considered.

Because the results from the corner 1 studies (ref. 4) indicated that vanes A10 (controlled-diffusion airfoils reset -5° from design) gave the lowest loss, that vane set was the only one used for corner 1 in the present investigation. Both a controlled-diffusion airfoil (vane A4) and the circular-arc airfoil (vane B) were used for corner 2 because corner 2 studies (ref. 6) did not favor a particular vane design.

Data were obtained at corner 1 inlet Mach numbers from about 0.18 to 0.46, which corresponded (approximately) to tunnel test-section Mach numbers from about 0.3 to 0.92. Total pressure distributions at the corner 1 inlet, the diffuser exit, downstream of the corner 2 vanes (VIGV inlet), and downstream of the VIGV's were obtained from rakes. Axial wall static pressure and vane surface pressure measurements were also obtained. All the pressure data are presented in tabular form for all configurations tested. Only the tables for overall performance are shown full size in this report; all others are available in microfiche supplement at the end of the report.

Apparatus and Procedure

Test Apparatus

In the combined corner 1–corner 2 test rig (figs. 2 and 3) room air entered a bellmouth and passed through a honeycomb flow straightener and two 1-diameter-long ($D = 82.296$ cm) spool pieces before reaching corner 1 with the simulated scoop. The air was then turned by the vanes and flowed through the crossleg diffuser to corner 2. After the corner 2 turn the air flowed through the inlet guide vanes and three spool pieces before exhausting through a choke-plate assembly to the central altitude exhauster system. The individual components were the same as those described in references 4 and 6, but they were combined in the manner shown in figure 3.

The choke-plate assembly was used for flow control. It consisted of a series of six removable plates plus one fixed plate arranged in the form of a converging nozzle. This

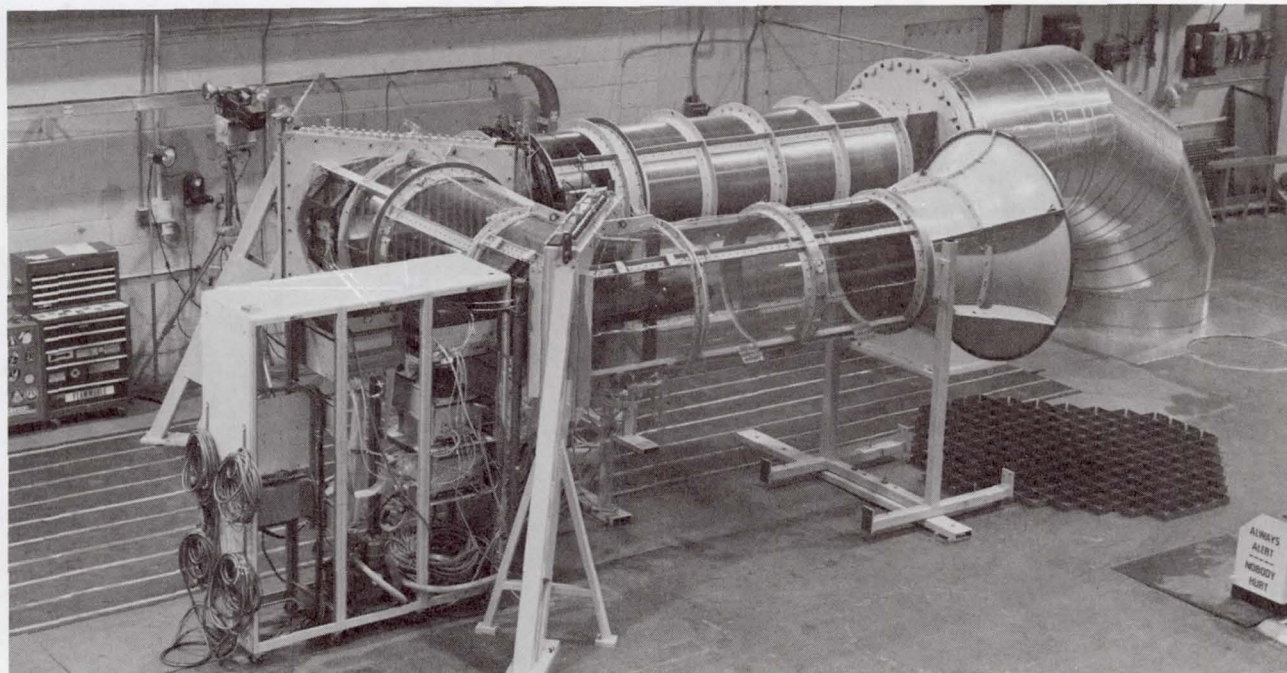

Figure 2.—Overall view of 0.1-scale corner 1–corner 2 test configuration.

Axial station	X/82.296	Axial station	Y/82.296	Axial station	Z/82.296
1	-2.04	34	0.075	54	-1.21
2	-1.84	35	.10	55	-1.10
3	-1.64	36	.14	56	-.98
4	-1.44	37	.18	57	-.86
5	-1.24	38	.22	58	-.75
6	-.95	39	.265	59	-.63
7	-.75	40	.31	60	-.52
8	-.55	41	.43	61	-.40
9	-.35	42	.55	62	-.29
10	-.15	43	.65	63	-.26
12	0	44	.80	64	-.23
13	.05	45	.92	65	-.20
14	.15	46	1.05	66	-.17
15	.25	47	1.10	67	-.14
16	.35	48	1.33	68	-.10
17	.45	49	1.45	69	-.07
18	.55	50	1.56	70	-.04
19	.65	51	1.68	71	-.01
20	.75	52	1.79	72	.02
		53	2.37	73	.05
				74	.08
				75	.11
				76	.14
				77	.17
				78	.20
				79	.24

See table 6(a) for circumferential locations.

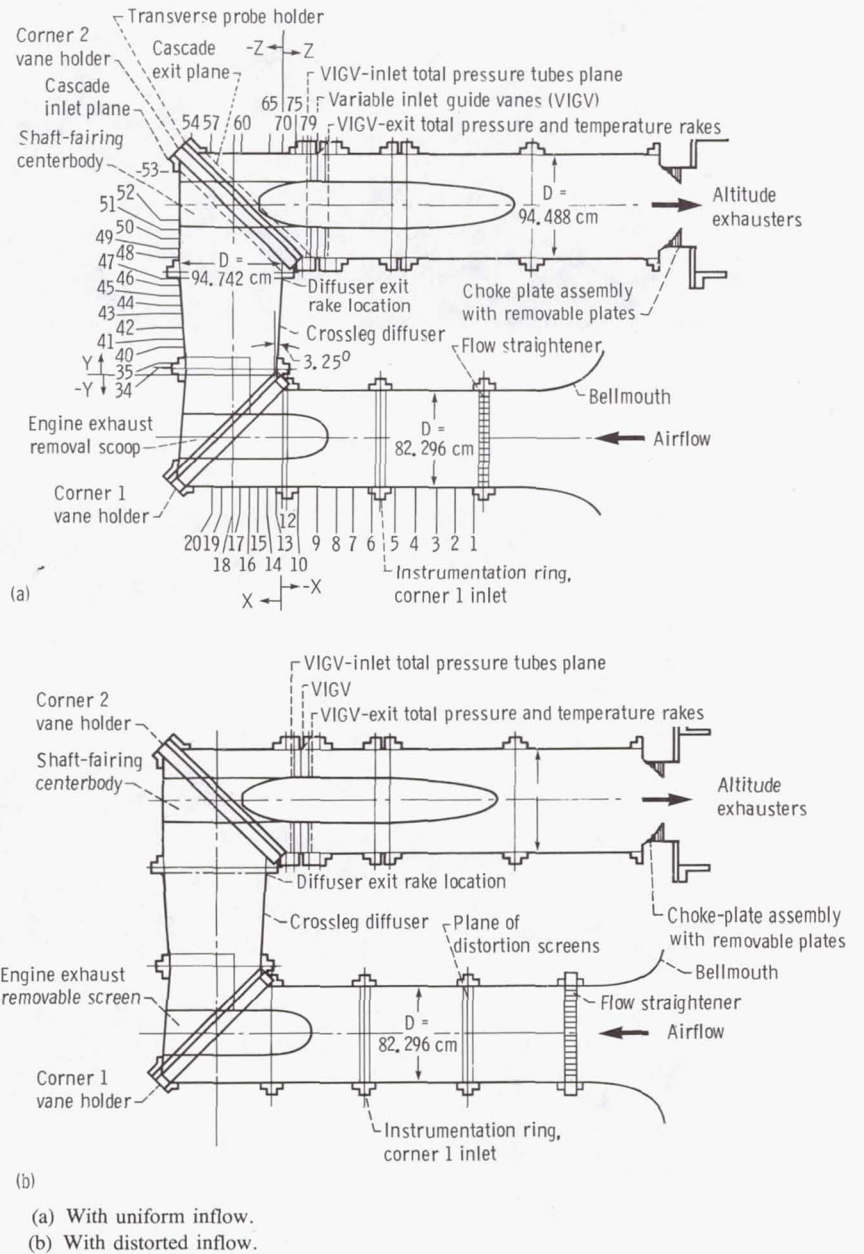

Figure 3.—Schematic of corner 1-corner 2 test apparatus.

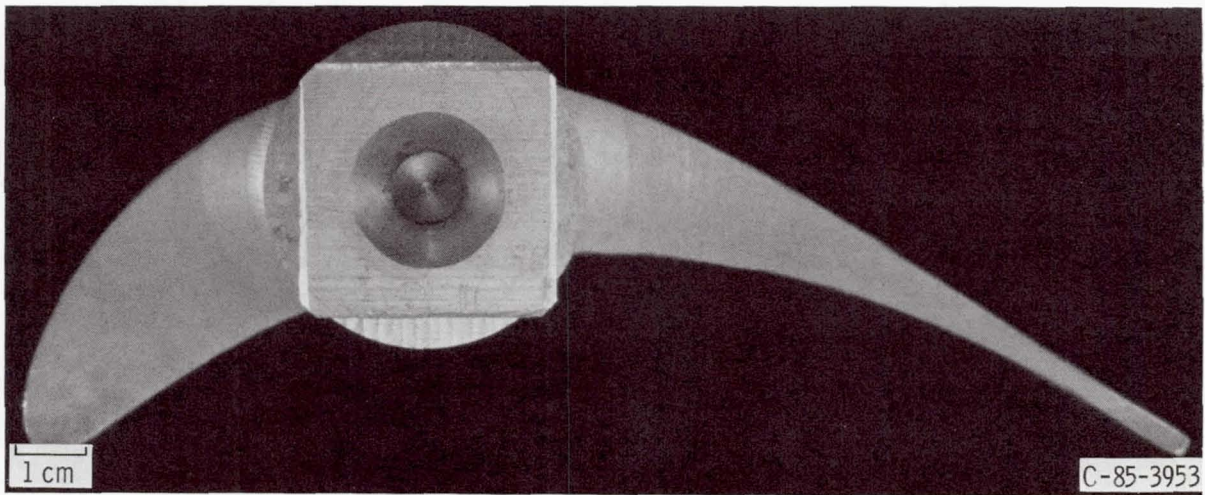
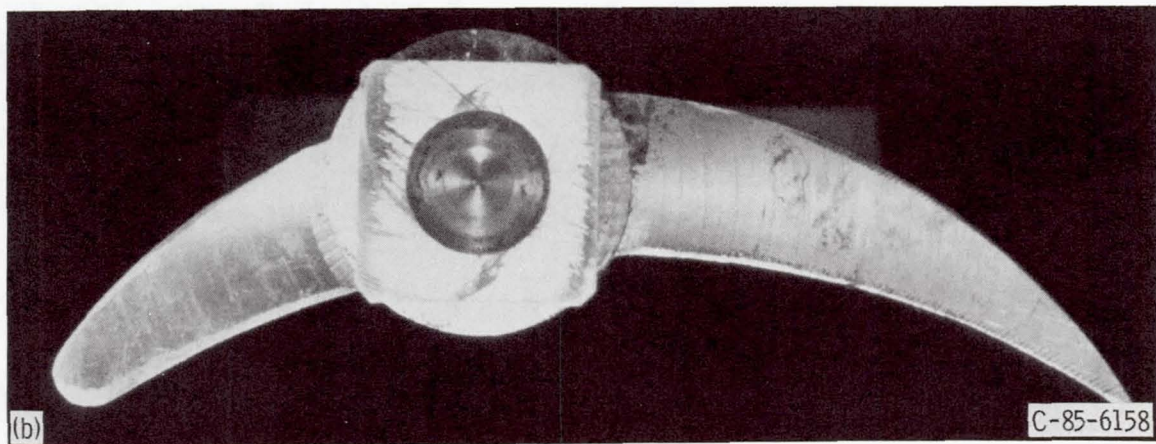
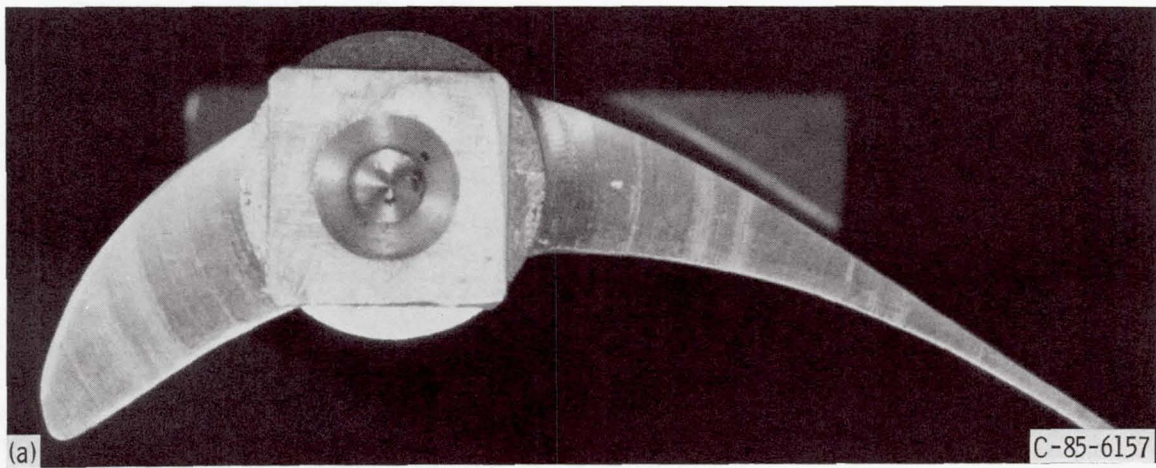
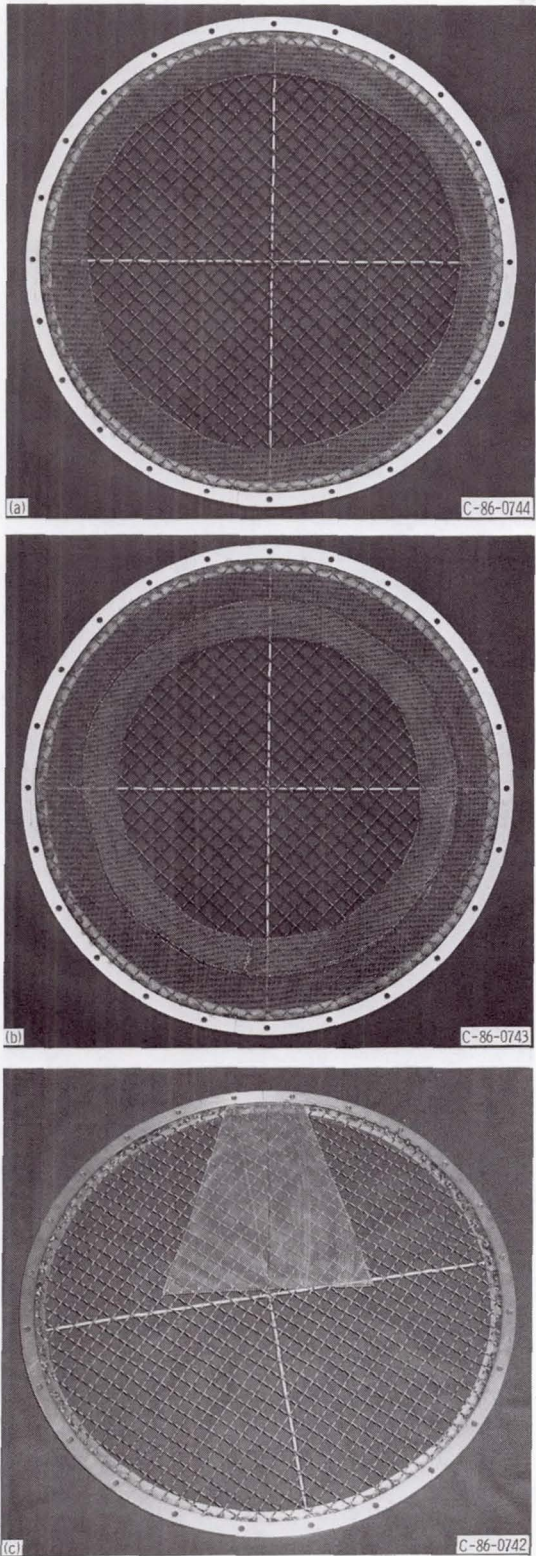

Figure 4.—End view of corner 1 vane A10.



(a) Vane A4. (b) Vane B.

Figure 5.—End views of corner 2 vanes.



(a) 6.35-cm (~15-percent radius) tip radial distortion screen.
 (b) 12.70-cm (~30-percent radius) tip radial distortion screen.
 (c) Approximately 50° sector circumferential distortion screen.

Figure 6.—Inlet distortion screens mounted on backup screen and rods.

assembly of plates provided seven specific flow rates between about 35 and 82 kg/sec. The inlet flow straightener was an aluminum honeycomb with a hexagonal cell pattern (0.95 cm across flats by 7.08 cm long).

The turning vane designs are described in detail (including vane coordinates) in references 4 and 6. For the present study vane A10 (controlled-diffusion airfoil reset -5° from design) of figure 4 was used exclusively for corner 1. Two vane shapes (fig. 5) were used for corner 2: vane A4 (controlled-diffusion airfoil reset -5° from design with outside vane of cascade removed), and vane B (circular-arc airfoil).

To simulate distorted inflow patterns, screens were installed 2 diameters ahead of corner 1 (fig. 3(b)). Two tip radial profiles were tested. As illustrated in figures 6(a) and (b), one had a fine screen (12 mesh; 0.07-cm-diam wire) that extended 6.35 cm from the outer wall; the other had a fine screen that extended 12.70 cm. These fine screens were mounted on a coarse backup screen (1 mesh; 0.32-cm-diam wire). The circumferential distortion was generated from a fine-screen sector of about 50° (fig. 6(c)). This pattern was chosen to simulate the effect of the exhaust removal scoop pivoted to its highest expected angle of attack. The radial screen patterns were to simulate the effect of wall boundary layers from the high-speed diffuser between the test section and corner 1 (fig. 1).

Instrumentation

The airflow was determined from measurements on the choke-plate nozzle previously described. To determine the overall performance of corner 1 including the diffuser, diametrical rakes (fig. 7) were used upstream of corner 1 and at the diffuser exit (corner 2 inlet) as indicated in figure 3(a). These rakes could be moved to four positions around the circumference (45° spacing). The rakes contained 16 elements for total pressure measurement and 6 elements for total temperature measurement. Boundary layer rakes (fig. 8) were also installed at the same stations as the diametrical rakes. Outer wall static pressure taps were located at approximately the same axial planes as the rakes.

The overall performance of corner 2 was determined from the diffuser exit diametrical rakes and the total pressure probes mounted on the VIGV leading edge (fig. 9). Each of the 12 VIGV's had five total pressure probes. Downstream of the VIGV's in the flow region outside the guide vane wakes, four radial rakes were mounted (see one in fig. 9). These rakes could be moved to three other circumferential locations, which provided data every 30° of circumference. These VIGV exit rakes furnished additional detail on the total pressure patterns downstream of corner 2. For example (as indicated in table 3(a)), the exit rakes surveyed 12 more circumferential locations and 3 more spanwise locations than the inlet rakes.

Other wall static pressure taps were installed in the spool pieces, the diffuser, the shaft fairing, and the corner. The axial locations of these wall taps are given in figure 3 and their circumferential locations in table 6(a).

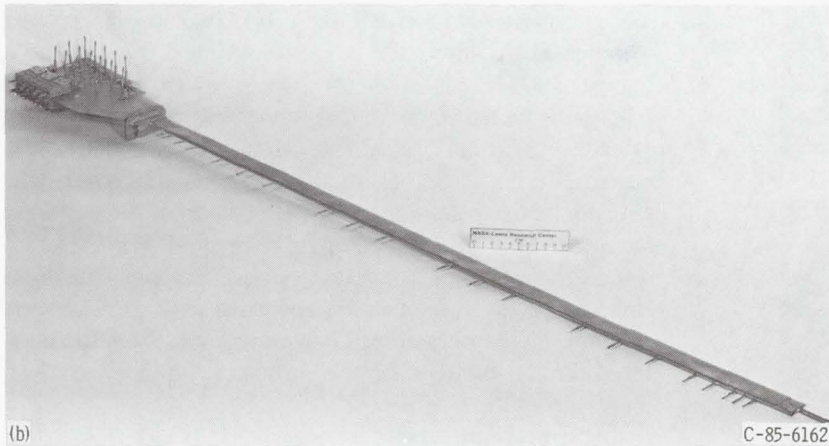
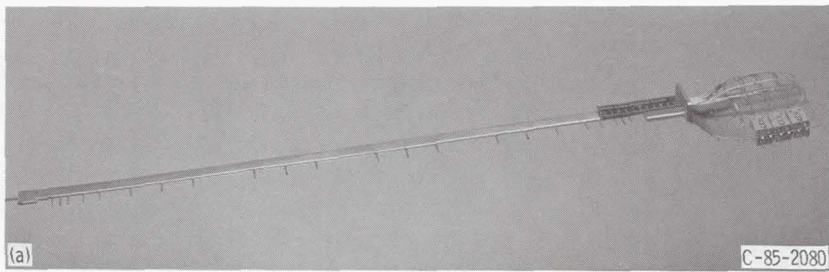

(a) Corner 1 inlet. (b) Diffuser exit.

Figure 7.—Diametrical rakes for measuring total pressure and temperature.

Element	Type (a)	Distance from outer wall to centerline, percent of span	Distance from outer wall, cm	
			Inlet	Exit
1	P	5.0	2.057	2.314
2	T	7.5	3.086	3.470
3	P	10.0	4.115	4.028
4		15.0	6.172	6.139
5		20.0	8.230	9.253
6	↓	30.0	12.344	13.881
7	T	40.0	16.459	18.506
8	P	50.0	20.574	23.134
9	P	70.0	28.804	32.388
10	T	80.0	32.918	37.013
11	P	90.0	37.033	41.641
12	P	90.0	45.263	50.891
13	T	80.0	49.378	55.519
14	P	70.0	53.492	60.144
15	P	50.0	61.722	69.395
16	T	40.0	65.837	74.026
17	P	30.0	69.952	78.651
18		20.0	74.066	83.273
19	↓	15.0	76.124	85.593
20	↓	10.0	78.181	87.904
21	T	7.5	79.210	89.065
22	P	5.0	80.239	90.216

^aP denotes pressure; T denotes temperature.

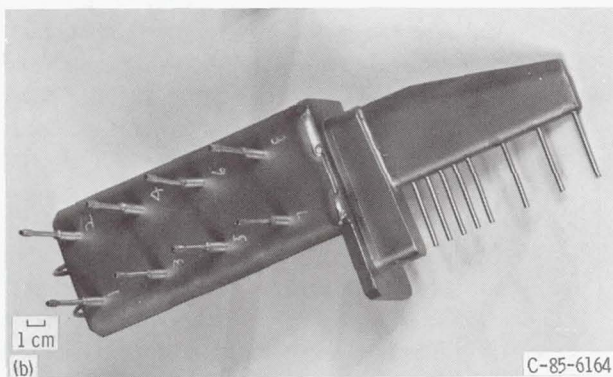
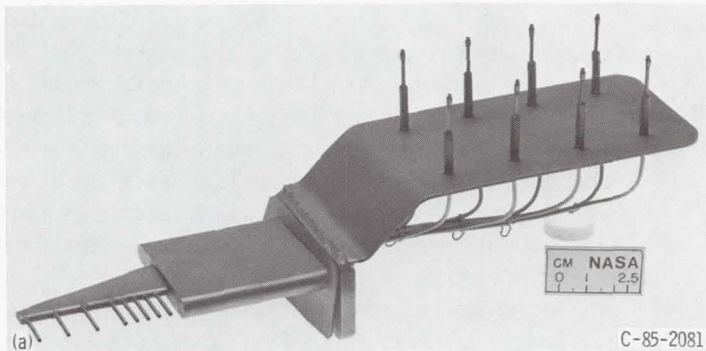

(a) Corner 1 inlet. (b) Diffuser exit.

Figure 8.—Boundary layer rakes for measuring total pressure.

Element	Distance from outer wall to centerline, percent of span	Distance from outer wall, cm	
		Inlet	Exit
1	1.0	0.411	0.462
2	2.0	.823	.925
3	3.0	1.234	1.387
4	4.0	1.646	1.852
5	5.0	2.057	2.314
6	7.5	3.086	3.470
7	10.0	4.115	4.628
8	12.5	5.144	5.784

Element	Distance from outer wall to inner wall, percent of span	Distance from outer wall, cm
1	10.0	3.785
2	30.0	8.966
3	50.0	14.148
4	70.0	19.329
5	90.0	24.511

(a)

Element	Type (a)	Distance from outer wall to inner wall, percent of span	Distance from outer wall, cm
1	P	5.0	1.295
2	T	7.5	1.943
3	P	10.0	2.591
4	↓	15.0	3.886
5	↓	20.0	5.207
6	▼	30.0	7.772
7	T	40.0	10.363
8	P	50.0	12.954
9	P	70.0	18.136
10	T	80.0	20.726
11	P	90.0	23.317

^aP denotes pressure and T denotes temperature.
(b)

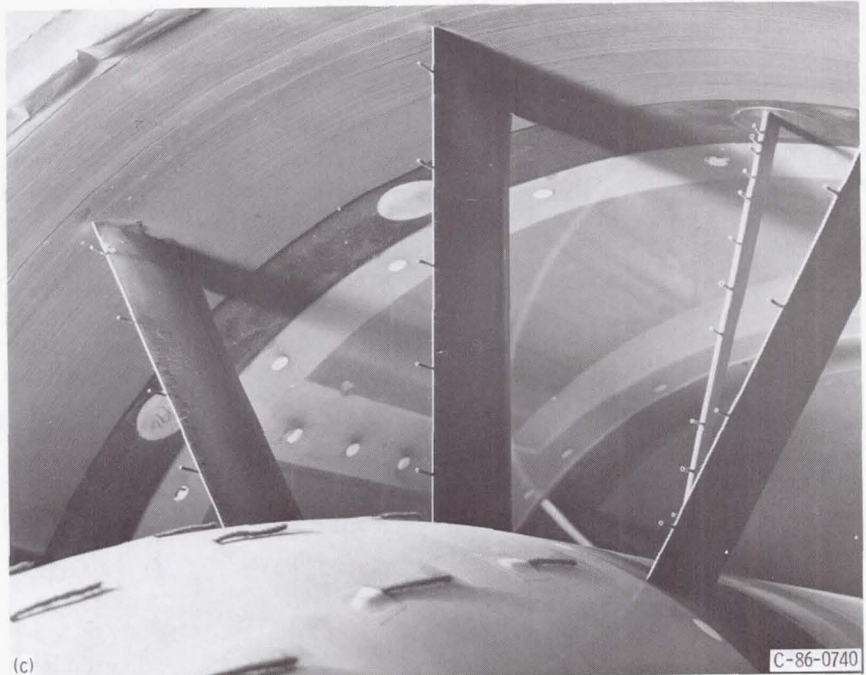

(c)

- (a) VIGV inlet locations.
- (b) VIGV exit locations.
- (c) VIGV instrumentation.

Figure 9.—Instrumentation at inlet and exit of variable inlet guide vanes (VIGV's).

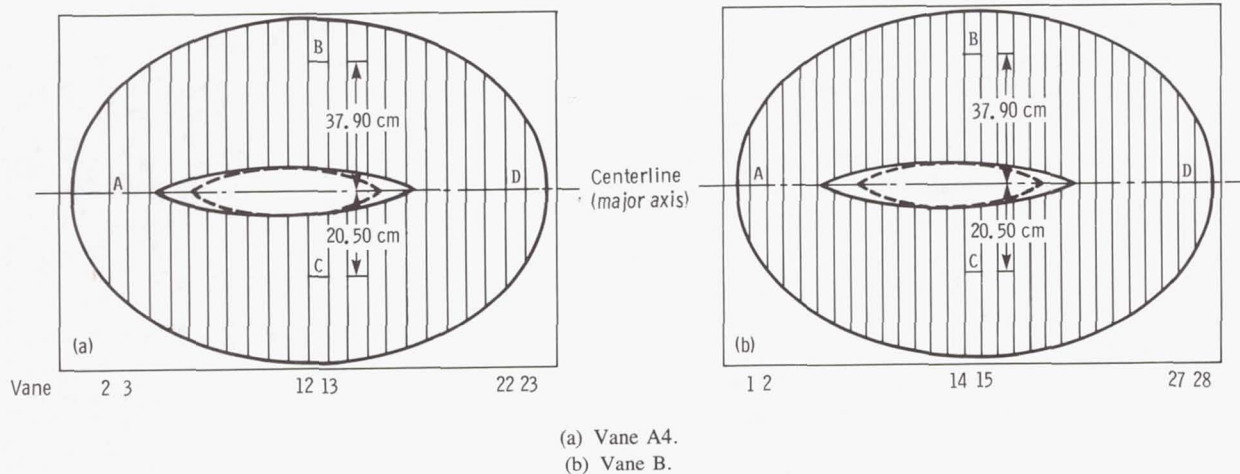

- (a) Vane A4.
- (b) Vane B.

Figure 10.—Location of vane surface static pressure taps (looking downstream).

Corner 2 vane performance was evaluated in part from surface static pressures obtained from taps on adjacent vanes in four passages (fig. 10). Two of the passages were along the major axis near the outside and inside corners (labeled locations A and D in fig. 10). The other two locations were in the central passage (B above the centerbody and C below).

To visually illustrate the flow conditions, tufts were taped to the walls and centerbodies.

All the rake total pressure and static pressure measurements were recorded on individual transducers that were calibrated just before each reading. The temperatures were determined from Chromel-constantan thermocouples by using a floating-point temperature reference.

Test Procedure

For a given vane configuration a particular choke-plate assembly was installed to set the desired airflow. The corner 1 inlet diametrical rake was positioned in the instrumentation ring (fig. 3) at either 0° or 225° (clockwise looking downstream). The inlet boundary layer rakes were positioned 90° from the large inlet rake. The diffuser exit (corner 2 inlet) diametrical rake was positioned at either 225° or 0° (opposite the upstream rake position). The outlet boundary layer rakes were also positioned 90° from the large diffuser exit rake. The four VIGV exit rakes were positioned 90° apart. Data were recorded with this particular rake arrangement. The facility was then shut down and all rakes except those at the VIGV exit were manually indexed 45°. The VIGV exit rakes were manually indexed 30°. The flow point was reestablished and data were then recorded at the next position. This procedure was repeated until data were recorded at the four diametrical and boundary layer rake positions and the three VIGV exit rake positions. The upstream and downstream rakes were rotated in opposite directions to minimize the effect of the upstream rake wake on the downstream pressure measurement. All the static pressures as well as the VIGV leading-edge total pressures were recorded at each rake position.

Calculation Procedure

The VIGV leading-edge total pressures and all static pressures recorded at the four rake positions were arithmetically averaged and corrected to standard-day conditions at the VIGV inlet plane to obtain the tabulated data presented in this report.

The total pressure measurements from the rakes were arranged for a given flow point to form the tabulated arrays of total pressure at a given circumferential location θ (in degrees from top dead center, clockwise looking downstream) and given percent of span (from the outer wall). Table 2(a) shows the typical array. The total pressures from the diametrical rakes were area averaged at each station to obtain the overall performance values presented in tables 1, 8, 15, and 22.

The airflow was calculated from Fliegner's formula (ref. 9) for a choked flow by using measured values of nozzle

total pressure and total temperature. This calculated airflow agreed within 2 percent with the mass-averaged airflow calculated from several cases in which very detailed flow surveys were made. The velocity head (dynamic pressure) and the average corner inlet and exit Mach numbers were based on the calculated airflow. Total pressure, static pressure (including room pressure), total temperature, velocity head, and airflow were all corrected to standard-day conditions based on the VIGV inlet condition.

The symbols and equations used in the calculations are presented in appendixes A and B, respectively.

Results and Discussion

The effects of inlet Mach number (flow rate), vane design, inlet distortion, coupling of corners 1 and 2, and circumferential location on corner performance are evaluated in this section. Corner 1 used vane A10 and included the simulated exhaust scoop throughout this study unless otherwise noted. Corner 2 used either vane A4 (controlled-diffusion type) or vane B (circular-arc type) and included a simulated drive-shaft fairing. Most of this section concerns overall corner performance in terms of total pressure at various stations. Then the static pressure distributions on the ducting walls and fairings are examined. Finally vane surface pressure profiles are considered.

Presentation of Results

Tables. — All of the data from the corner 1–corner 2 studies are presented in tables. Absolute pressures are in newtons per square centimeter (corrected to standard-day conditions at the VIGV inlet) unless otherwise noted. The total array of data tables is as follows:

Content of table	Inflow			
	Uniform		Distorted	
	Vane configuration in corner 2			
	B	A4	B	A4
	Table numbers			
Overall performance for each flow rate	1	8	15	22
Distributions for each flow rate: ^a				
P_t across corner	2	9	16	23
P_t across VIGV	3	10	17	24
P_s at VIGV exit	4	11	18	25
P_s at vane inlet and exit	5	12	19	26
P_s throughout corner	6	13	20	27
P_s on vane surfaces	7	14	21	28

^aThese tables are presented as microfiche.

Plots.—To illustrate and thus clarify the effects of the many different variables involved in these studies, selected data from the tables were plotted. When total or static pressure was the dependent variable, it was made dimensionless for all plots by dividing by the pressure in the room (corrected to standard-day conditions at the VIGV inlet) from which the air was drawn into the bellmouth (fig. 2). These room, or reservoir, pressures are listed for all conditions in tables 1, 8, 15, and 22. Dimensionless ratios were used to avoid the possible unfamiliarity with the pressure units of newtons per square centimeter used in the tables. Pressures ratioed to room values also provide a numerical value the reader can relate to.

In the tables total pressures are listed as a function of percent of span from the tip (outer wall). In the plots, however, a uniform scale of percent of total flow area was selected as the independent variable (abscissa). This was done to reveal the effect of area weighting or area averaging on the pressures, which was to give more weight to regions near the outer wall than did radius or span averaging. It is area-averaged pressures that are required for determining the corner loss coefficient (defined in appendix B). For convenient reference, however, percent-of-span scales (nonuniformly spaced of course) are also indicated along the abscissa for the total pressure plots.

Corner Losses with Uniform Inflow

As expected the corner 2 vane design had no effect on the corner 1 losses (fig. 11). With the tunnel test-section Mach number at its design value of 0.8 the inlet Mach numbers to corners 1 and 2 were estimated to be nominally 0.4 and 0.26, respectively. Thus at design the corner 1 loss coefficient was

about 0.16. Corner 1 loss coefficients increased from about 0.14 to 0.17 as the inlet Mach number increased from about 0.2 to 0.45.

At its design inlet Mach number corner 2, when operating downstream of corner 1 and the crossleg diffuser, had a loss coefficient with either vanes A4 or vanes B of about 0.12. Also, there was essentially no change in loss coefficient as the inlet Mach number was varied from about 0.1 to 0.3. When corner 2 was operating with a bellmouth instead of corner 1 upstream (results from ref. 6), the loss coefficient was about 0.165 irrespective of vane design or inlet Mach number. The reasons for lower corner 2 losses when operating downstream of corner 1 than when operating alone are explained immediately after the discussion of inlet distortion effects.

Inlet Distortion Effects

Two radial patterns and one circumferential pattern of inlet flow distortion were imposed on the corner 1–corner 2 configurations. These distortions were generated by screens as previously discussed (fig. 6). The resulting levels and patterns of inlet distortion for the design flow rate are shown by the total pressure contours in figure 12. The radial distortions (figs. 12(a) and (b)) were intended to cover the range of those expected from the boundary layer growth on the walls of the high-speed diffuser upstream of corner 1 (fig. 1). The local to room total pressure ratios ranged from about 0.90 to 0.96 near the outer wall for these radial inflow distortions. (The backing screen across the entire duct (fig. 6) limited the maximum pressure recovery to about 0.96.) The total pressure disturbances caused by the radial screens extended nearly twice

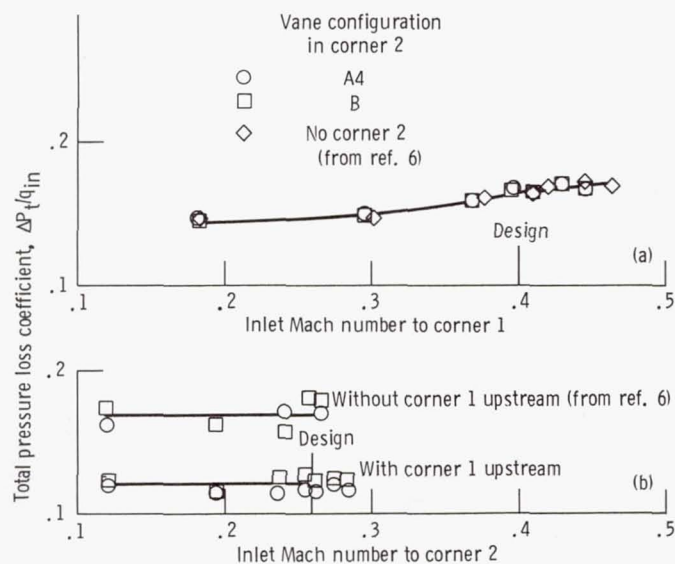

(a) Corner 1 with vanes A10, scoop, and diffuser.
(b) Corner 2.

Figure 11.—Comparison of corner loss coefficients.

Contour	Local to room total pressure ratio, $P_t/P_{t, \text{room}}$
F	0.961
G	.955
H	.948
I	.942
J	.936
K	.930
L	.923
M	.917
N	.911
C	.904

Contour	Local to room total pressure ratio, $P_t/P_{t, \text{room}}$
B	0.961
C	.955
D	.948
E	.942
F	.936
G	.930
H	.924
I	.918
J	.912
K	.906
L	.900
M	.894

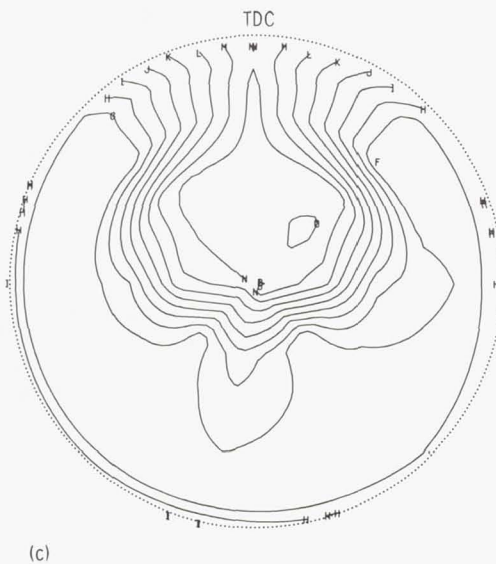
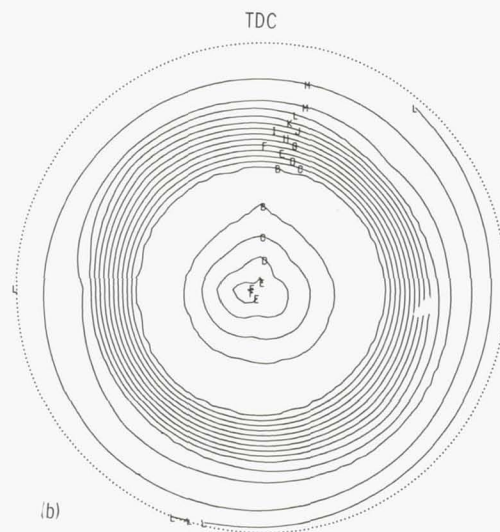
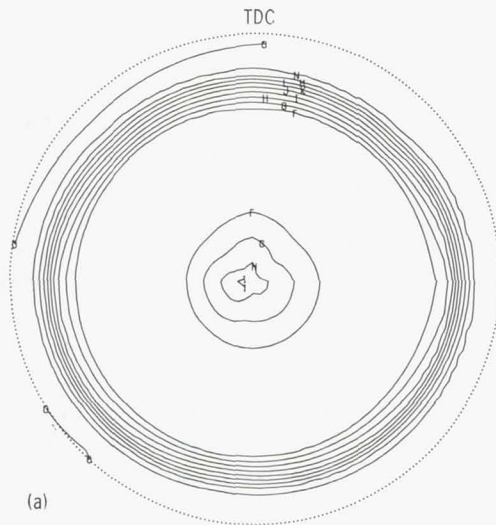

Contour	Local to room total pressure ratio, $P_t/P_{t, \text{room}}$
G	0.961
H	.955
I	.949
J	.942
K	.936
L	.930
M	.923
N	.917
O	.911

- (a) With 6.35-cm (~15-percent radius) tip radial distortion screen. Readings 1241 to 1244.
 (b) With 12.70-cm (~30-percent radius) tip radial distortion screen. Readings 1224 to 1227.
 (c) With ~50° sector circumferential distortion screen. Readings 1258 to 1261.

Figure 12.—Contour plots of corner 1 inlet local to room total pressure ratios for imposed inlet distortions. Looking downstream; nominal airflow, 72.8 kg/sec; nominal corner 1 inlet Mach number, 0.395.

as far from the wall as the radial extent of the screen. For example, in figure 12(a) the total pressure falloff extended to about 30 percent of radius from a screen that extended about 15 percent (6.35 cm from wall). In figure 12(b) the pressure falloff extended to about 50 percent of radius from a screen that extended about 30 percent (12.70 cm from wall).

The circumferential distortion in figure 12(c) was intended to simulate the exhaust removal scoop (fig. 1) at its maximum expected angle of attack. The local to room total pressure ratios ranged from about 0.91 to 0.96 in an 80° (approximately) sector centered along a line from the top dead center of the duct (TDC, $\theta = 0^\circ$) to its centerline. This circumferential distortion resulted from a screen sector of about 50° (fig. 6(c)).

The various screen-induced distortions of the inlet flow had little effect on the total pressure loss coefficients (fig. 13). Although some scatter appears in the corner 2 results with distorted inflow, vane design had no consistent effect on corner loss. Some of the reasons behind these responses to inlet distortion are discussed in the next section.

Total Pressure Profiles for Corner 2 with Vane B

Circumferentially averaged pressures.—With corner 2 alone (fig. 14(a)) the loss coefficient $\Delta P_t/q_{in}$ was 0.18. The corner inlet (diffuser exit) total pressure profile was essentially flat except near the wall, where the boundary layer extended to about 25 percent of the flow area (about 13 percent of radius). The ratios of diffuser exit local to room total pressure were about 0.987 in the core flow region and 0.955 near the wall. At the VIGV inlet downstream of vanes B in corner 2 the entire pressure profile shifted to a lower level as expected. Also an additional falloff occurred near the central shaft fairing (figs. 3 and 10), which is the inner flow boundary at this measuring station. The boundary layer extended to about 30 percent of span from the inner wall.

With corner 2 operating downstream of corner 1 (fig. 14(b)) the loss coefficient was 0.127 (table 1), in contrast to 0.18 when corner 2 was operated alone. The loss near the outer and inner (shaft fairing) walls across corner 2 was less when it was downstream of corner 1 as indicated by the reduced difference in total pressure between the diffuser exit (corner 2 inlet) and the VIGV inlet at 10 and 90 percent of span. Losses in the near-wall regions of corner 1 were relatively high, as indicated by the difference in diffuser exit total pressure between figures 14(a) and (b). However, the additional loss experienced in the near-wall regions of corner 2 was reduced because of the relatively lower momentum inflow to these regions.

A similar effect is demonstrated by the radially distorted inflow data of figure 14(c). The difference in diffuser exit pressures between figures 14(a) and (b) indicate relatively large losses in total pressure across the distortion screens. These losses further reduced the momentum of the inflow to corner 2 especially over the outer 60 percent of the flow area. The loss across this region was essentially zero for corner 2 with the tip radial distortions studied. Because of this the overall loss coefficients were reduced to 0.122 with the 6.35-cm distortion screen and to 0.101 with the 12.70-cm distortion screen.

With circumferentially distorted inflow (fig. 14(d)) the overall loss coefficient was 0.139. Here, all the loss across corner 2 appeared to occur over the outer 70 percent of the flow area. However, these total pressures were the result of a circumferential average at each radius. This hid the true circumferential dependence of these corner 2 inlet and exit pressures, as discussed in the following section.

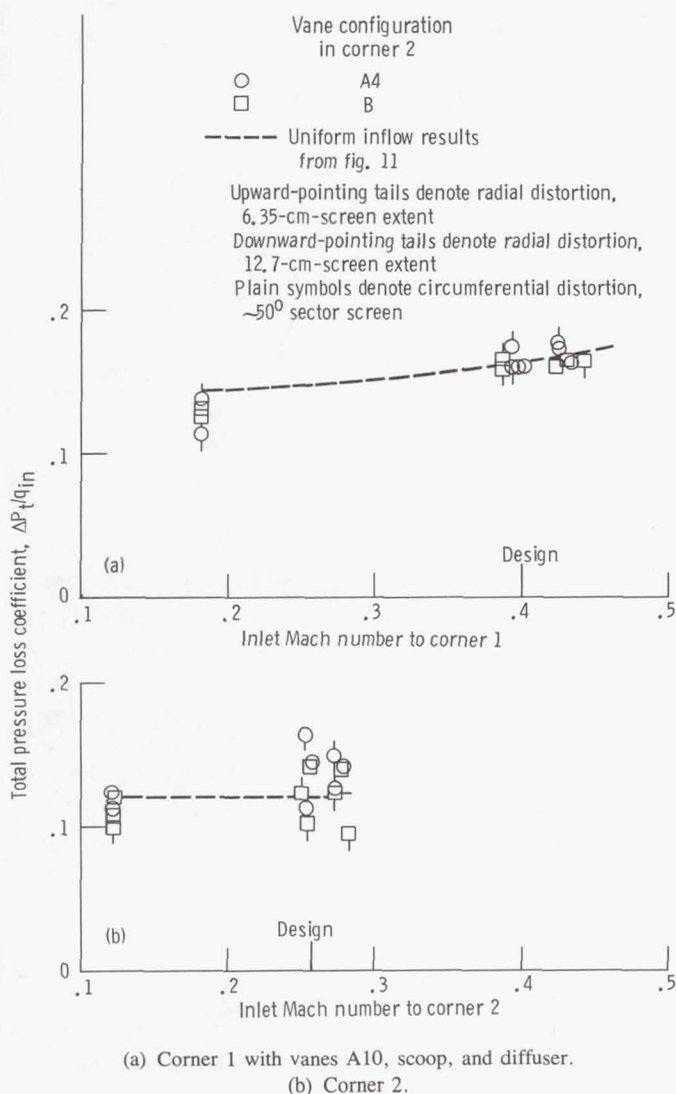
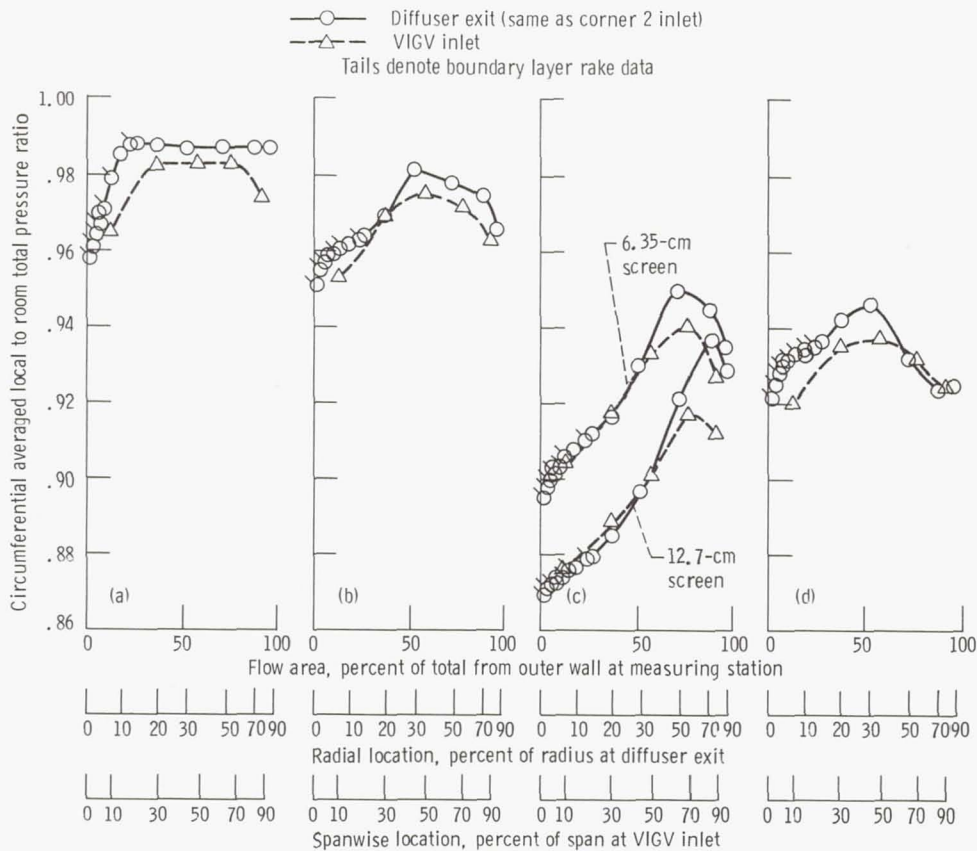

Figure 13.—Effects of inlet distortion on corner loss coefficients.



(a) Corner 2 alone. Readings 36 to 40 (of ref. 6); loss coefficient, $\Delta P_t/q_{in}$, 0.180.

(b) Corner 2 with corner 1. Readings 293 to 296; loss coefficient, $\Delta P_t/q_{in}$, 0.127.

(c) Corner 2 with corner 1 and tip radial distortion. Readings 527 to 530 for 6.35-cm screen (loss coefficient, $\Delta P_t/q_{in}$, 0.122) and readings 515 to 518 for 12.70-cm screen (loss coefficient, $\Delta P_t/q_{in}$, 0.101).

(d) Corner 2 with corner 1 and circumferential distortion. Readings 541 to 544; loss coefficient, $\Delta P_t/q_{in}$, 0.139.

Figure 14.—Spanwise variation of circumferentially averaged diffuser exit and VIGV inlet total pressures ratioed to room pressure for corner 2 with vanes B. Nominal airflow, 72.8 kg/sec; nominal corner 2 inlet Mach number, 0.255.

Pressures at particular circumferential locations.—The spanwise variations of total pressure across corner 2 with vanes B at eight circumferential locations for four configurations are shown as parts (a) of figures 15 to 18. Parts (b) of these figures show contour plots of constant pressure drawn from these data. Each figure provides details for one of the four configurations in figure 14. There circumferentially averaged data are presented for design inflow conditions.

For corner 2 alone (fig. 15(a)) the total pressure profiles differed little at the various circumferential locations (identified by θ in degrees) except in the horizontal plane, where θ is either 90° or 270° . The sharp decrease in total pressure measured by the VIGV inlet probe nearest the wall (at 13 percent of flow area or 10 percent of span) at $\theta = 90^\circ$ suggests an upstream flow separation in this region. Visual observation of wool tufts mounted along the inner wall at $\theta = 90^\circ$ indicated a pocket of flow separation from the wall. This pocket was confined in axial extent from about midchord to the trailing edge of vane B. Also, evidence of the corner 2 shaft fairing (with its major axis in the horizontal plane) appears as a relatively

greater loss in total pressure over the innermost flow region at θ of 90° and 270° . The contour plot (fig. 15(b)) also shows flow symmetry about a horizontal reference plane.

For corner 2 operating downstream of corner 1 (fig. 16(a)) the losses (proportional to differences in total pressure across the corner) were lower than those for corner 2 alone (fig. 15(a)) at nearly every θ location over the outer 40 percent of the flow area. Comparing these two configurations at $\theta = 90^\circ$ shows several differences. Diffuser exit total pressure dropped sharply near the wall when corner 1 with vanes A10 was upstream of corner 2 (fig. 16(a)). This drop was indicative of an upstream separation from the wall in this region of corner 1. Also, at $\theta = 90^\circ$ the dip in diffuser exit pressure at about 73 percent of the flow area may be the center of a vortex believed to be shed off the inner edge of the corner 1 scoop afterbody (fig. 3). These features are also evident in the contour plots (fig. 16(b)).

On occasion an increase in pressure was indicated at the VIGV inlet over that at the diffuser exit (e.g., see θ of 225° or 315° at 37 percent of flow area from wall, fig. 16(a)). This

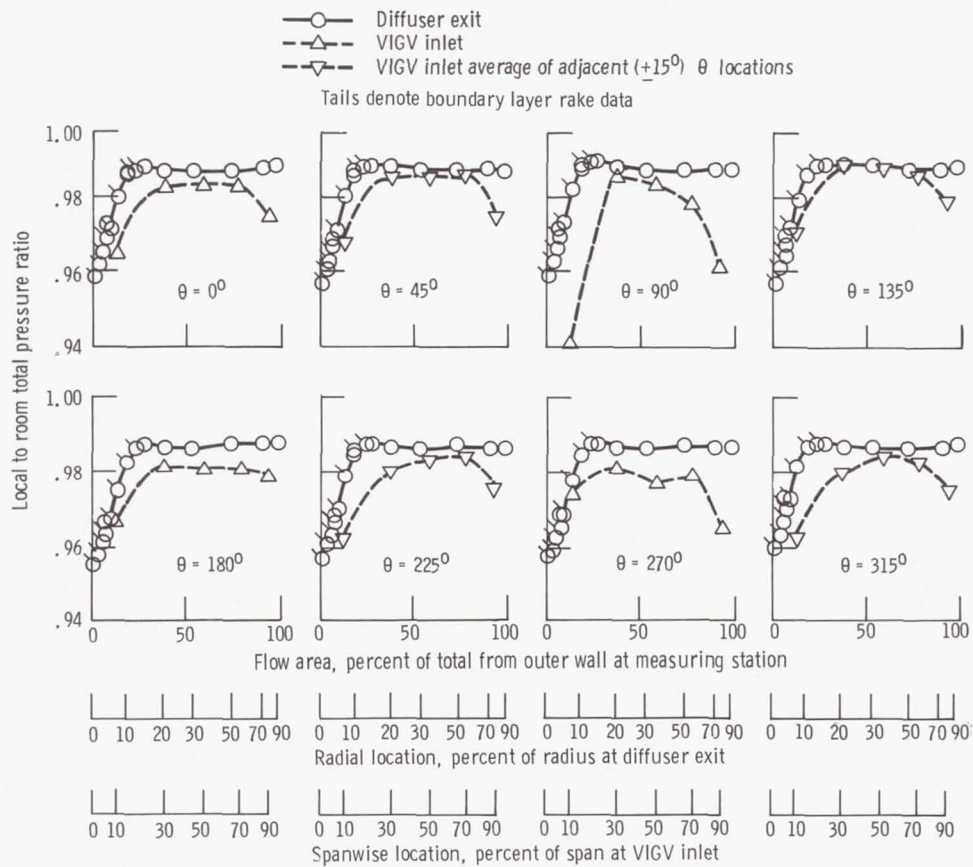

(a)

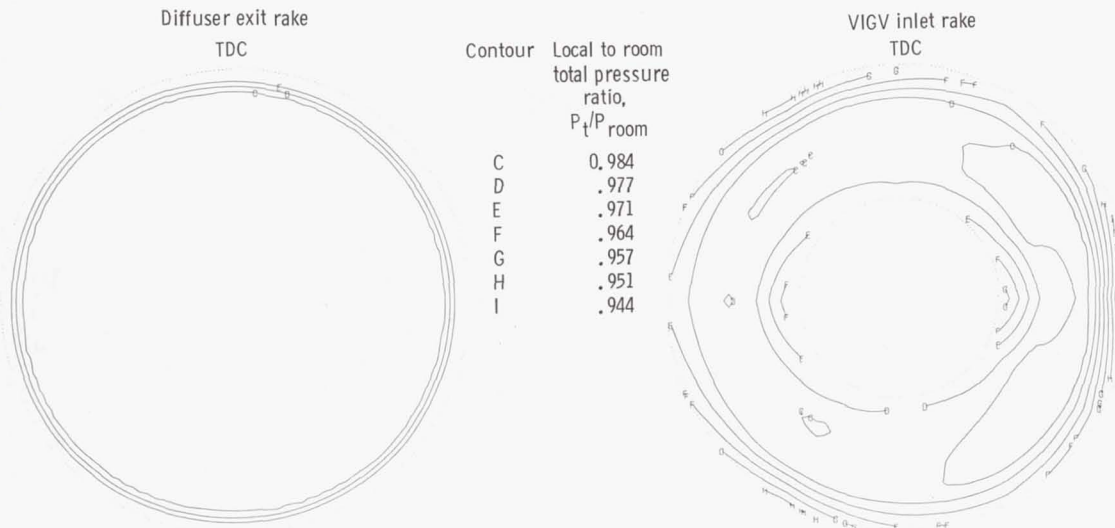

(b)

(a) Spanwise variation at discrete circumferential locations.
 (b) Contour plots of constant pressure (looking downstream).

Figure 15.—Local total pressures ratioed to room pressure across corner 2 with vanes B without corner 1 upstream. Airflow, 74.1 kg/sec; corner 2 inlet Mach number, 0.259; readings 36 to 40 (of ref. 6); loss coefficient, $\Delta P_t/q_{in}$, 0.180.

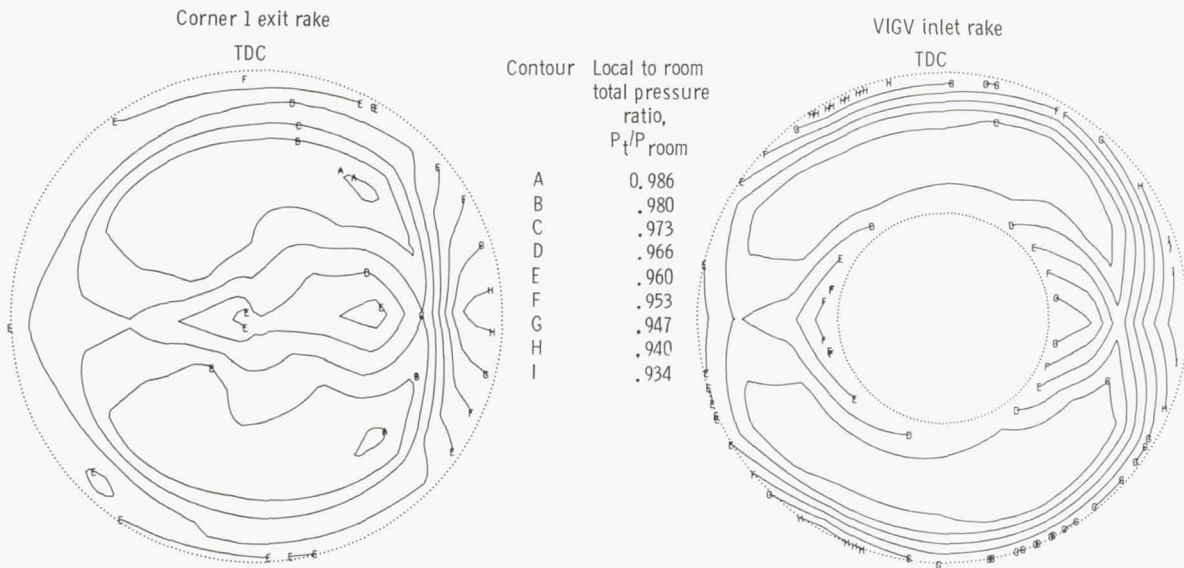
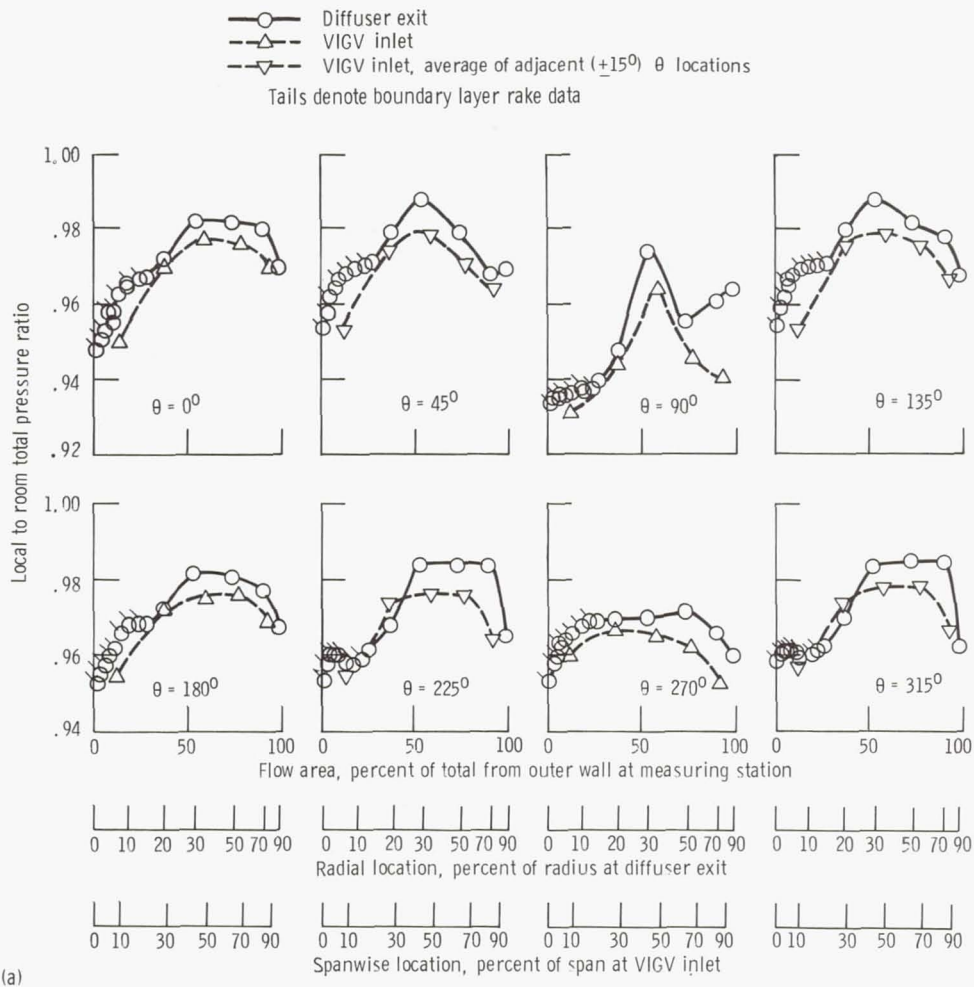

(a) Spanwise variation at discrete circumferential locations.
 (b) Contour plots of constant pressure (looking downstream).

Figure 16.—Local total pressures ratioed to room pressure across corner 2 with vanes B downstream of corner 1 with vanes A10 and scoop. Airflow, 73.1 kg/sec; corner 2 inlet Mach number, 0.255; readings 293 to 296; loss coefficient, $\Delta P_t/q_{in}$, 0.127.

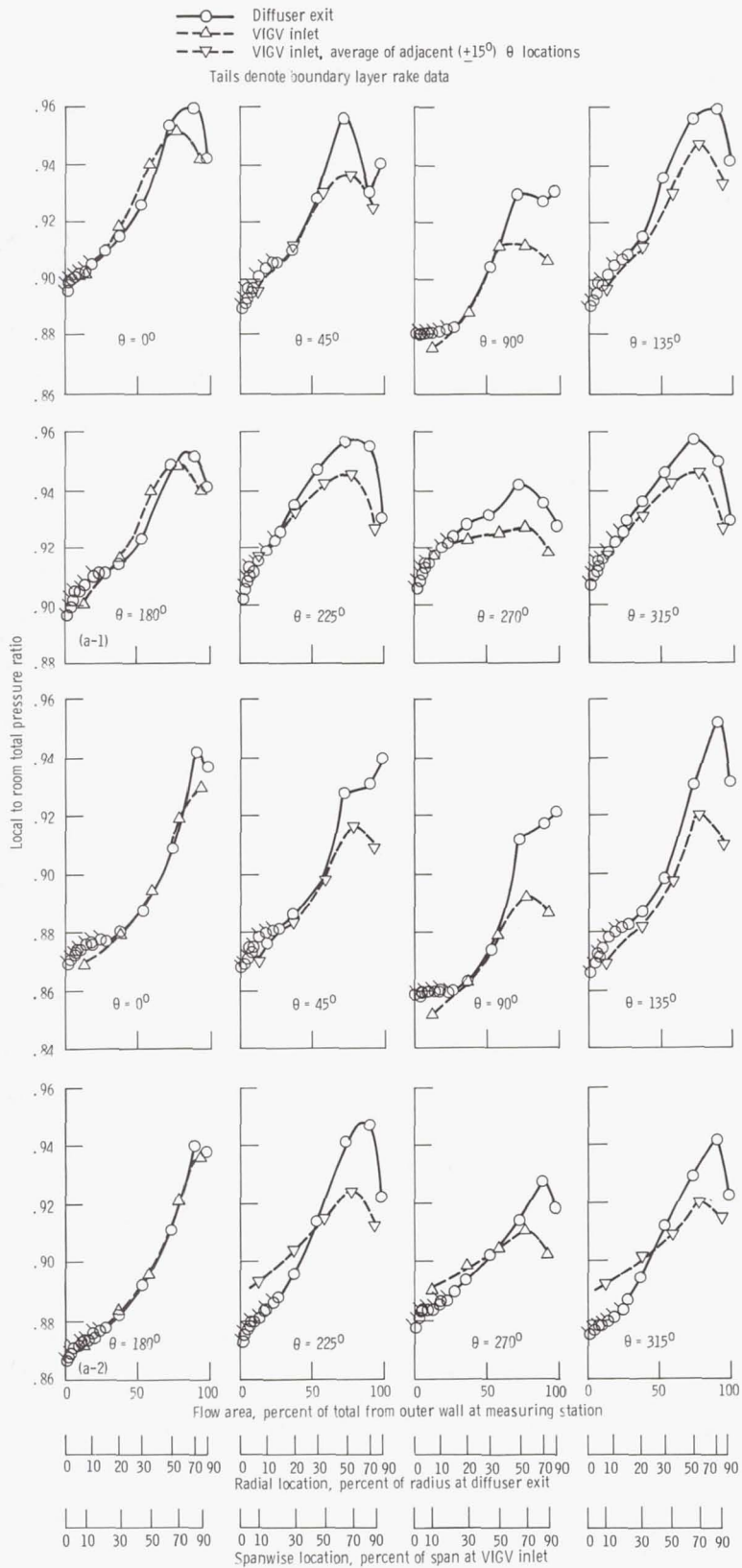

(a-1) Spanwise variation at discrete circumferential locations with 6.35-cm distortion screen. Readings 527 to 530; loss coefficient, $\Delta P_t/q_{in}$, 0.122.
 (a-2) Spanwise variation at discrete circumferential locations with 12.70-cm distortion screen. Readings 515 to 518; loss coefficient, $\Delta P_t/q_{in}$, 0.101.

Figure 17.—Local total pressures ratioed to room pressure across corner 2 with vanes B downstream of corner 1 with vanes A10 and scoop. Nominal airflow, 71.8 kg/sec; nominal corner 2 inlet Mach number, 0.252; tip radially distorted inflow.

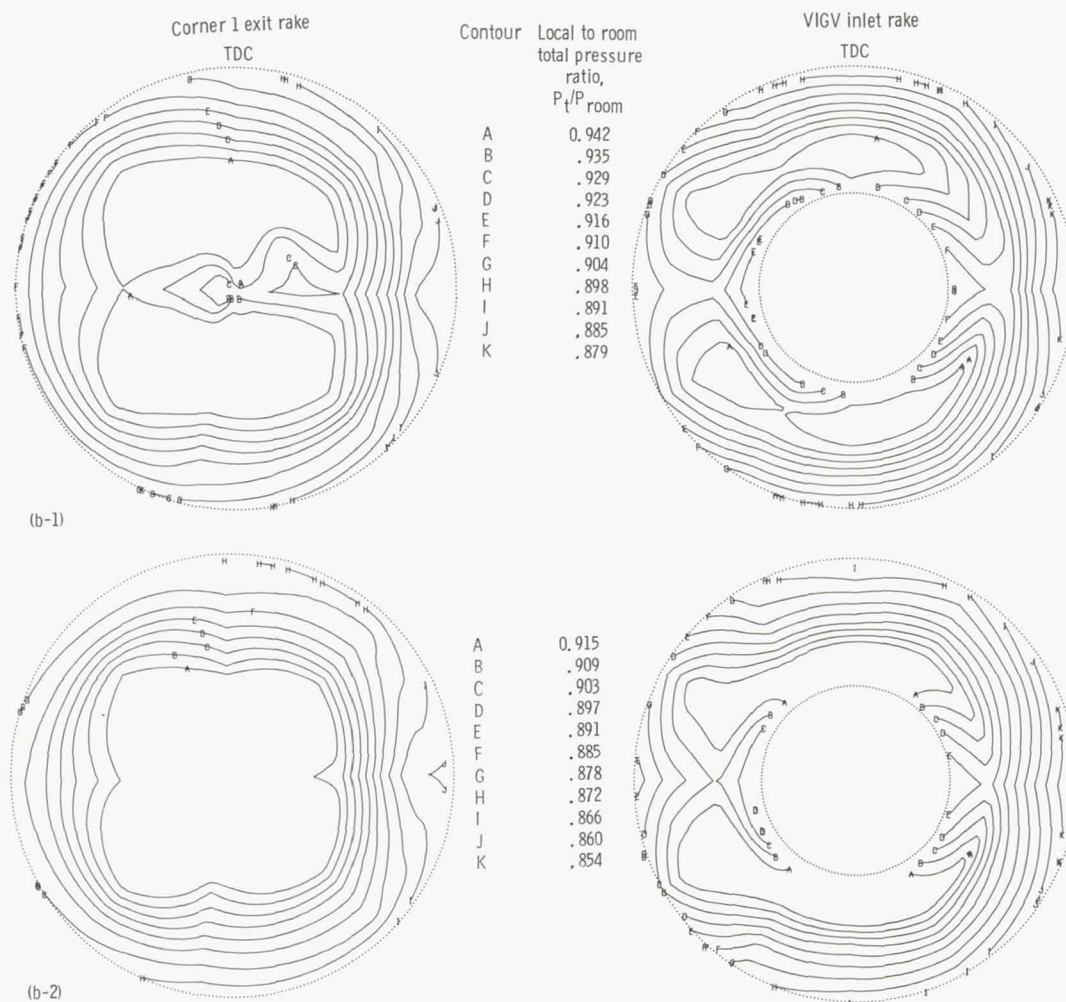

(b-1) Contour plots of constant pressure with 6.35-cm distortion screen. Looking downstream; readings 527 to 530; loss coefficient, $\Delta P_t/q_{in}$, 0.122.
 (b-2) Contour plots of constant pressure with 12.70-cm distortion screen. Looking downstream; readings 515 to 518; loss coefficient, $\Delta P_t/q_{in}$, 0.101.

Figure 17.—Concluded.

was attributed to a mismatch in θ or flow area (or both) between these two measuring stations. In other words the stream tube at a particular θ and flow area at the diffuser exit ended up at a different θ or flow area at the VIGV inlet because of flow skewing. Such a skewing was not surprising with the asymmetric scoop fairing in corner 1. More evidence of these apparent pressure increases across corner 2 occurred in the distorted inflow studies of figures 17(a) and 18(a).

With two extents of tip radial distortion imposed upstream of corner 1 (fig. 17(a)) the losses in pressure were near zero at nearly every θ location over the outer half of the flow area. Thus the circumferentially averaged pressures (fig. 14(c)) were similar to those at the eight θ locations with the symmetrically imposed tip radial distortions. Flow symmetry with respect to a horizontal plane is also evident in figure 17(b). Such was

not the case with circumferentially imposed distortion, as indicated by the θ -dependent pressure patterns in figure 18.

The screen sector for circumferential distortion was centered at $\theta = 0^\circ$ (fig. 12(c)). The pressure patterns in figure 18(a) were relatively flat there, with nearly zero loss across the corner. Some flow symmetry about $\theta = 0^\circ$ (TDC) is evident at the exit of corner 1 (fig. 18(b)) for about $\pm 45^\circ$. Because the flow was skewed by the circumferentially imposed distortion screen, losses were negative at 45° , 90° , and 315° over the inner 30 percent of the flow area (fig. 18(a)). These results make a significant contribution to the near-zero losses indicated by the circumferentially averaged data of figure 14(d). Away from the distortion screen the pressure data of figure 18 resemble the undistorted inflow data of figure 16, as might be expected.

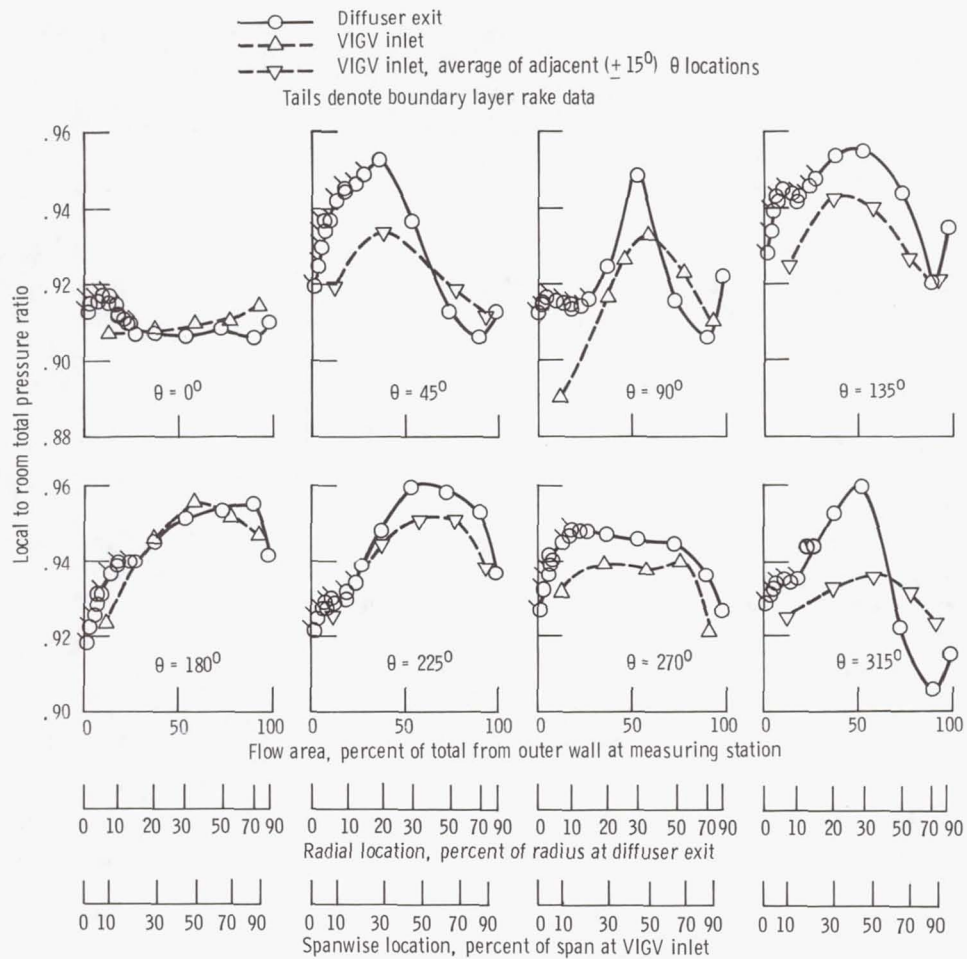

(a)

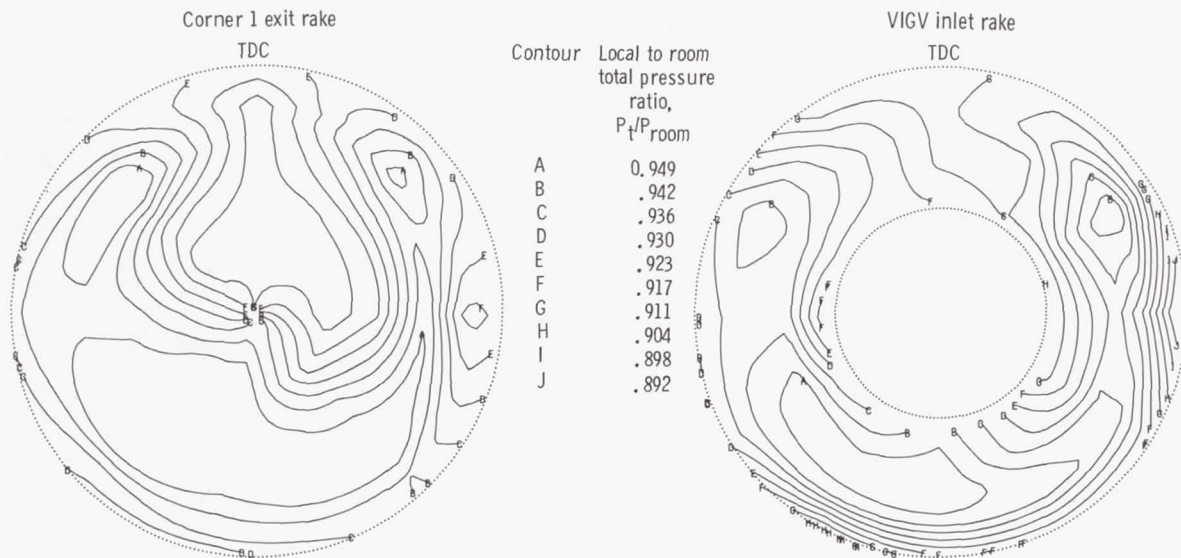

(b)

(a) Spanwise variation at discrete circumferential locations.
 (b) Contour plots of constant pressure (looking downstream).

Figure 18.—Local total pressures ratioed to room pressure across corner 2 with vanes B downstream of corner 1 with vanes A10 and scoop. Airflow, 73.3 kg/sec; corner 2 inlet Mach number, 0.256; circumferentially distorted inflow, $\sim 50^\circ$ sector screen; readings 541 to 544; loss coefficient, $\Delta P_t/q_{in}$, 0.139.

Total Pressure Profiles for Corner 2 with Vane A4

From the study of corner 2 operating alone (ref. 6) the combination of resetting vanes A to -5° and removing the outermost vane (configuration called vane A4) produced the lowest corner loss coefficient. Therefore vane A4 was the only vane A configuration studied in corner 2 operating downstream of corner 1. The presentation and discussion of these data parallel that just completed for vanes B in corner 2.

Circumferentially averaged pressures.—The spanwise variations of circumferentially averaged total pressures across corner 2 with vanes A4 (fig. 19) were nearly the same as those for corner 2 with vanes B (fig. 14). The overall corner loss coefficients for comparable configurations were also nearly the same. From the data for corner 2 alone the minimum difference in local to room total pressure ratio in the core flow region was about 25 percent less across vanes A4 (fig. 19(a)) than across vanes B (fig. 14(a)). This somewhat reflects the relative profile loss coefficients for the two vane designs. More

detailed vane wake measurements taken about one-half chord from the vane trailing edge would provide for a more reliable determination of absolute profile loss coefficients. Such data and determinations are reported in reference 11.

The circumferential dependence of inlet and exit pressures across corner 2 with vanes A4 is discussed in the following section.

Pressures at particular circumferential locations.—The spanwise variations of total pressure across corner 2 with vanes A4 at eight circumferential locations for four configurations are shown in figures 20 to 23. Each figure provides details of one of the four configurations in figure 19. There circumferentially averaged data are presented for design inflow conditions. After a brief discussion of the pressure profile difference due to circumferential location, comparisons are made with vanes B.

For corner 2 alone (fig. 20) the total pressure profiles differed little at the various circumferential locations except in the horizontal plane (θ of 90° and 270°) and in the outer

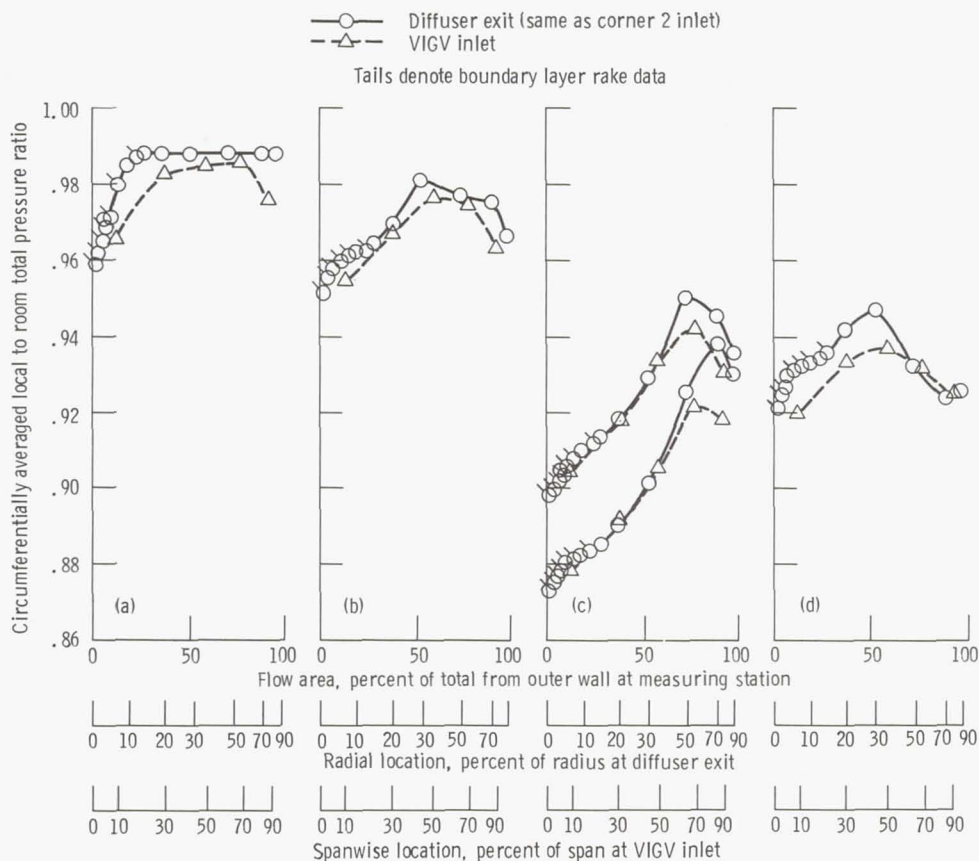

(a) Corner 2 alone. Readings 331 to 338 (of ref. 6) interpolated to 72.9 kg/sec; loss coefficient, $\Delta P_t/q_{in}$, 0.169.

(b) Corner 2 with corner 1. Readings 4 to 16; loss coefficient, $\Delta P_t/q_{in}$, 0.116.

(c) Corner 2 with corner 1 and tip radial distortion. Readings 1241 to 1244 for 6.35-cm screen (loss coefficient, $\Delta P_t/q_{in}$, 0.112) and readings 1224 to 1227 for 12.70-cm screen (loss coefficient, $\Delta P_t/q_{in}$, 0.125); at 5 percent of span data are from boundary layer rakes.

(d) Corner 2 with corner 1 and circumferential distortion. Readings 1258 to 1261; loss coefficient, $\Delta P_t/q_{in}$, 0.142.

Figure 19.—Spanwise variation of circumferentially averaged diffuser exit and vlgv inlet total pressures ratioed to room pressure for corner 2 with vanes A4. Nominal airflow, 72.9 kg/sec; nominal corner 2 inlet Mach number, 0.256.

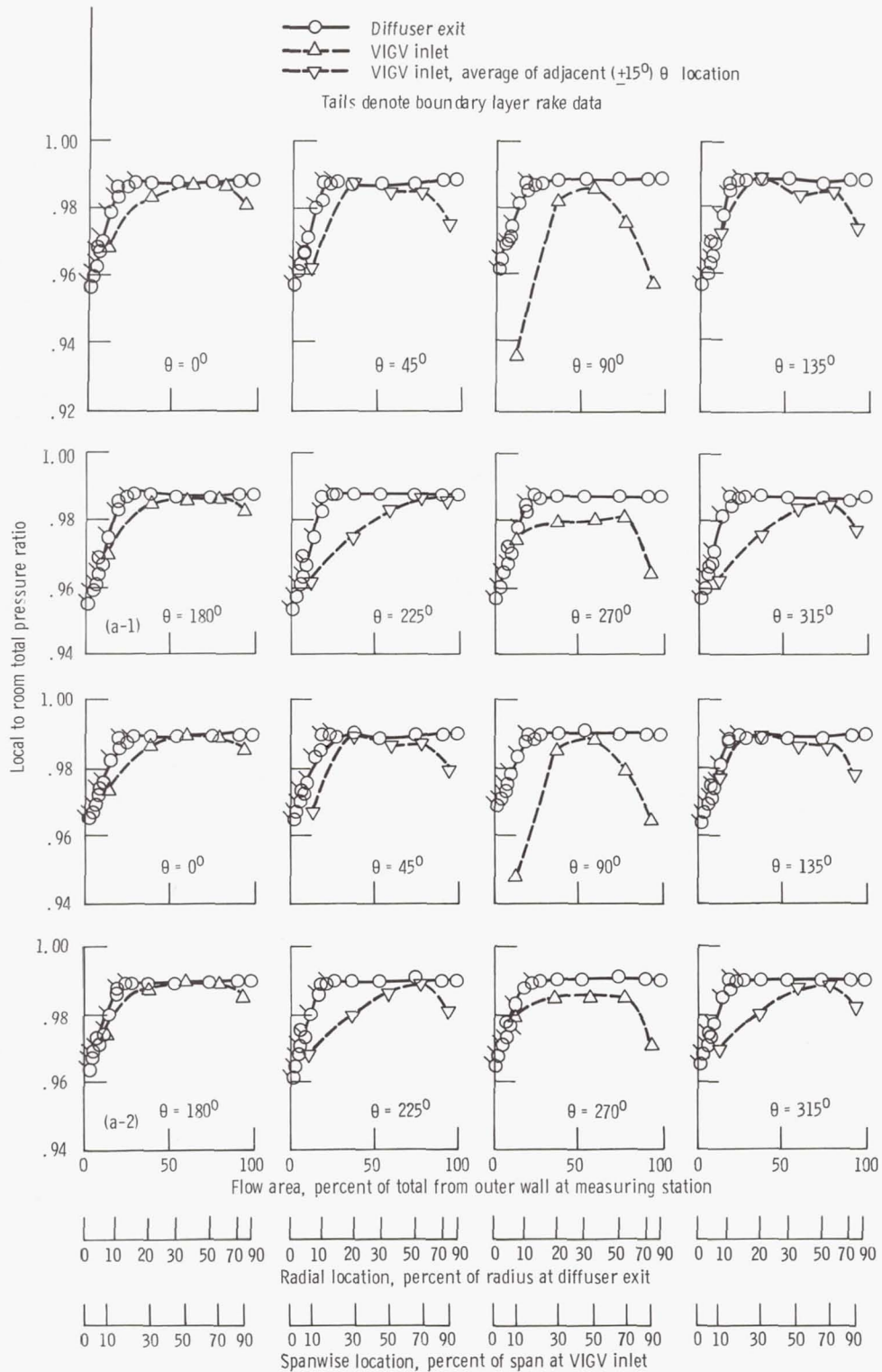

(a-1) Spanwise variations at discrete circumferential locations for airflow of 76.3 kg/sec and corner 2 inlet Mach number of 0.266. Readings 331 to 334 (of ref. 6); loss coefficient, $\Delta P_t/q_{in}$, 0.169.

(a-2) Spanwise variations at discrete circumferential locations for airflow of 69.3 kg/sec and corner 2 inlet Mach number of 0.241. Readings 335 to 338 (of ref. 6); loss coefficient, $\Delta P_t/q_{in}$, 0.170.

Figure 20.—Local total pressures ratioed to room pressure across corner 2 with vanes A4 without corner 1 upstream.

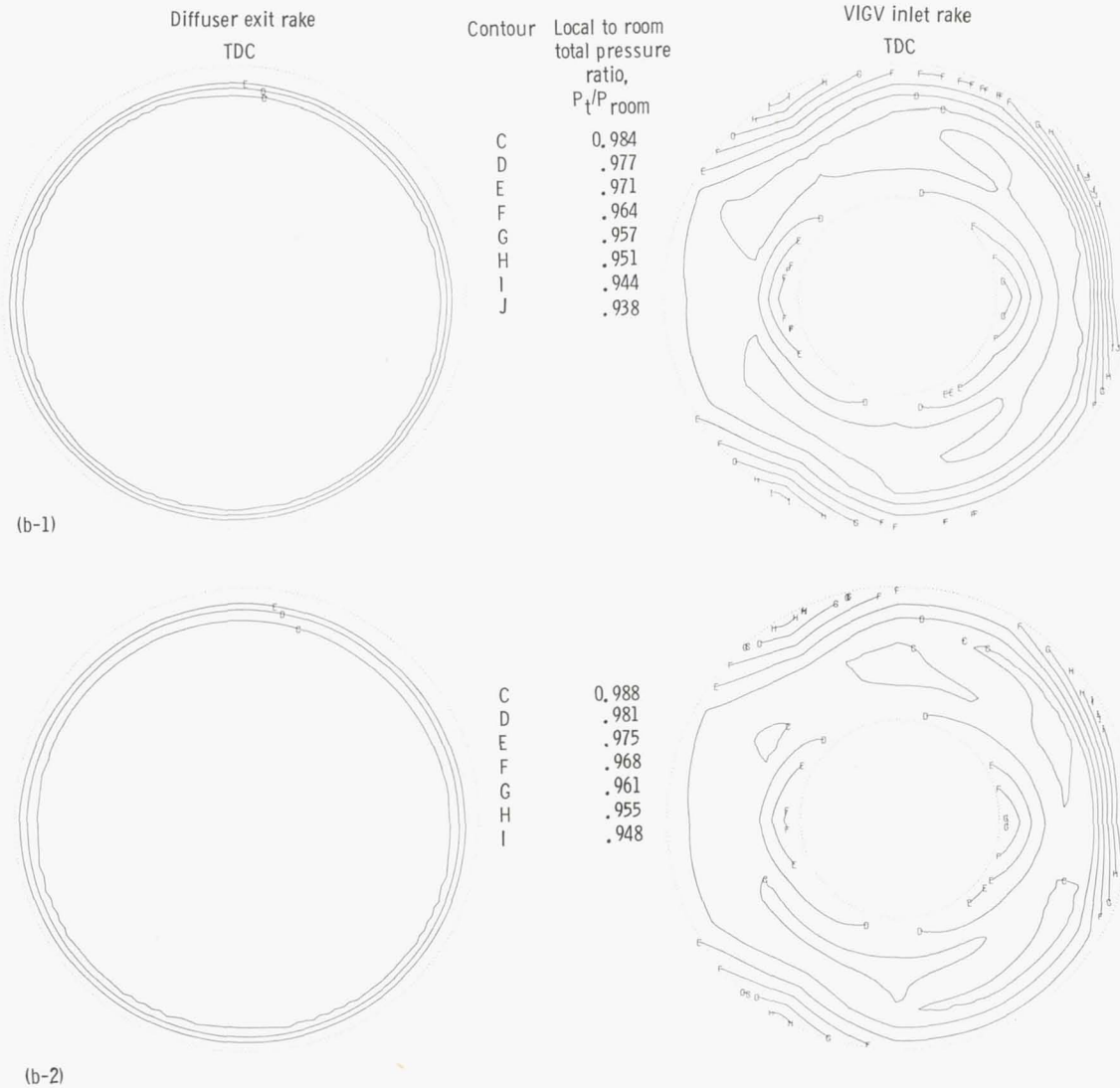

(b-1) Contour plots of constant pressure for airflow of 76.3 kg/sec and corner 2 inlet Mach number of 0.266. Looking downstream; readings 331 to 334 (of ref. 6); loss coefficient, $\Delta P_t/q_{in}$, 0.169.
 (b-2) Contour plots of constant pressure for airflow of 69.3 kg/sec and corner 2 inlet Mach number of 0.241. Looking downstream; readings 335 to 338 (of ref. 6); loss coefficient, $\Delta P_t/q_{in}$, 0.170.

Figure 20.—Concluded.

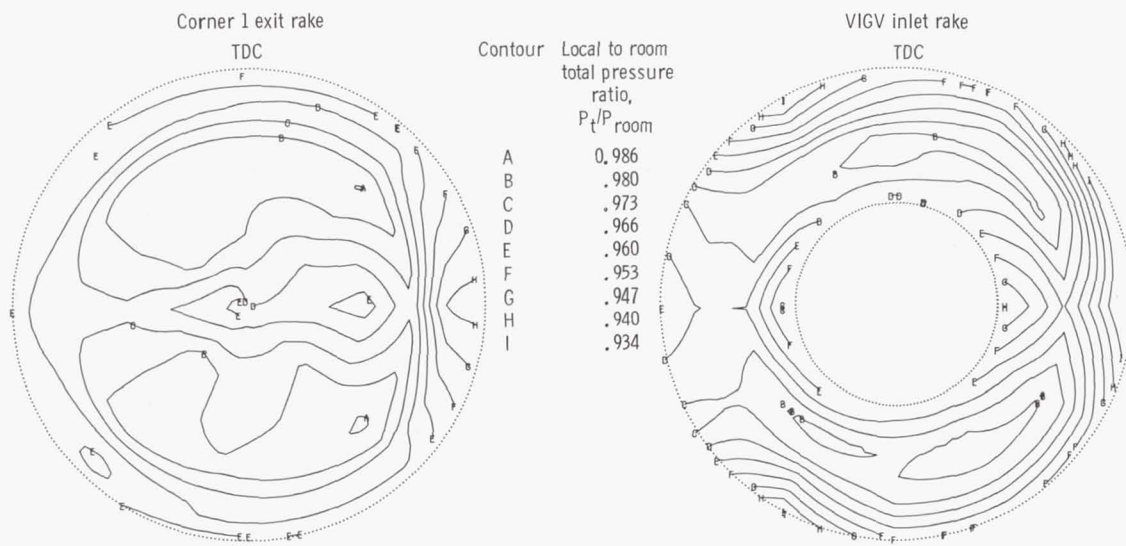
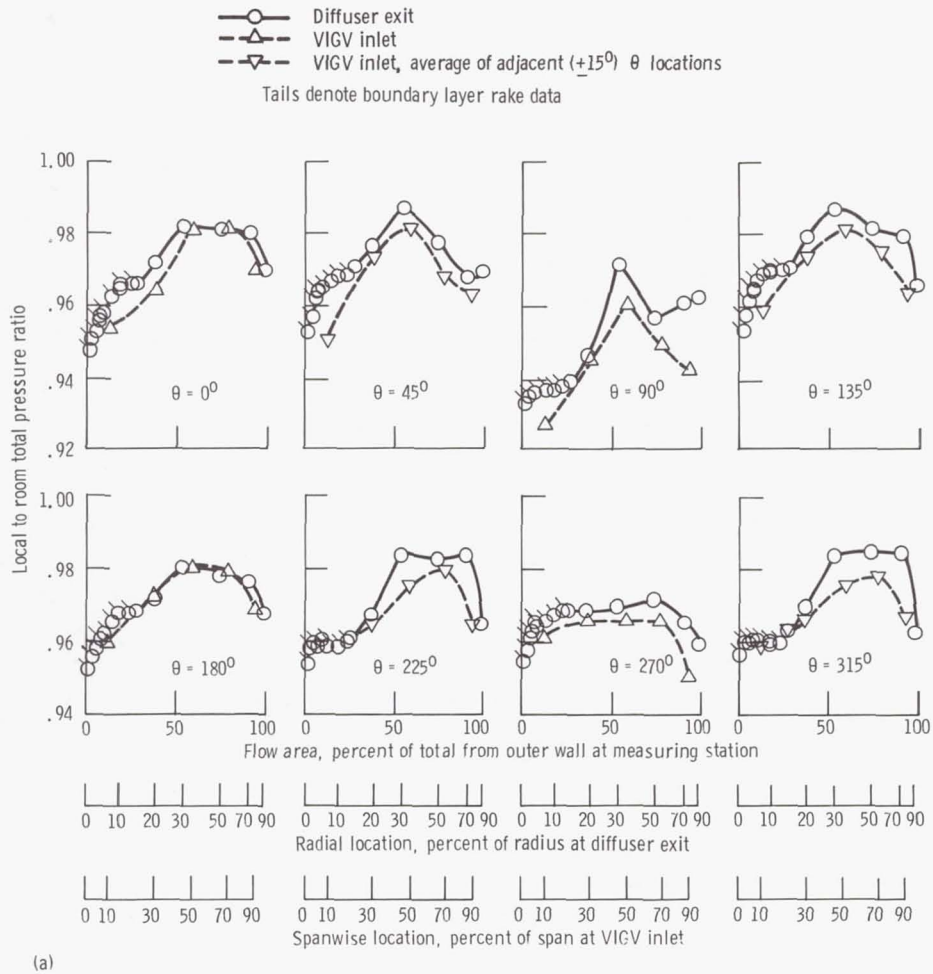

(a) Spanwise variation at discrete circumferential locations.
 (b) Contour plots of constant pressure (looking downstream).

Figure 21.—Local total pressures ratioed to room pressure across corner 2 with vanes A4 downstream of corner 1 with vanes A10 and scoop. Airflow, 73.1 kg/sec; corner 2 inlet Mach number, 0.256; readings 4 to 16; loss coefficient, $\Delta P_t/q_{in}$, 0.116.

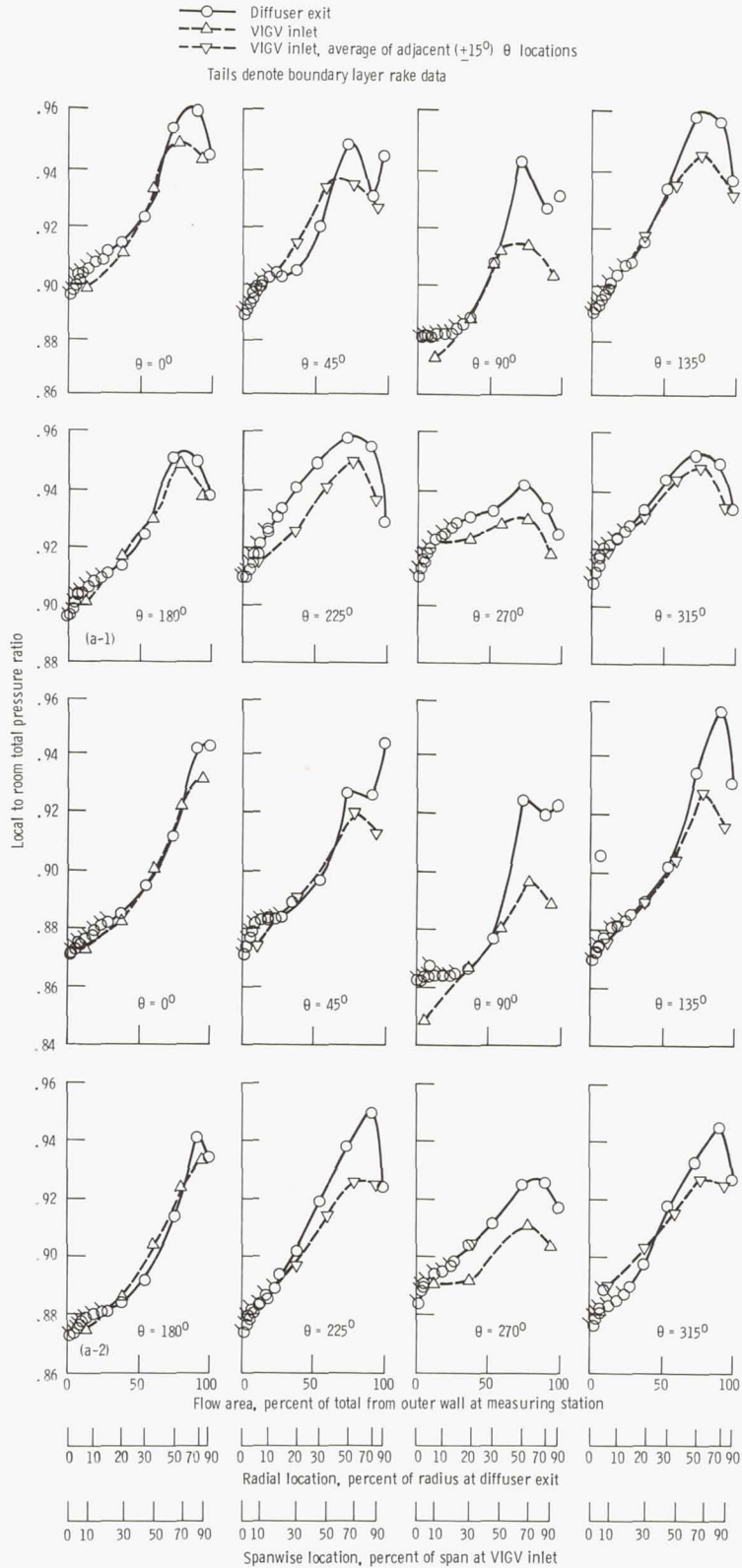

(a-1) Spanwise variations at discrete circumferential locations with 6.35-cm distortion screen. Readings 1241 to 1244; loss coefficient, $\Delta P_t/q_{in}$, 0.112.
 (a-2) Spanwise variations at discrete circumferential locations with 12.70-cm distortion screen. Readings 1224 to 1227; loss coefficient, $\Delta P_t/q_{in}$, 0.125.

Figure 22.—Local total pressures ratioed to room pressure across corner 2 with vanes A4 downstream of corner 1 with vanes A10 and scoop. Nominal airflow, 72.3 kg/sec; nominal corner 2 inlet Mach number, 0.254; tip radially distorted inflow.

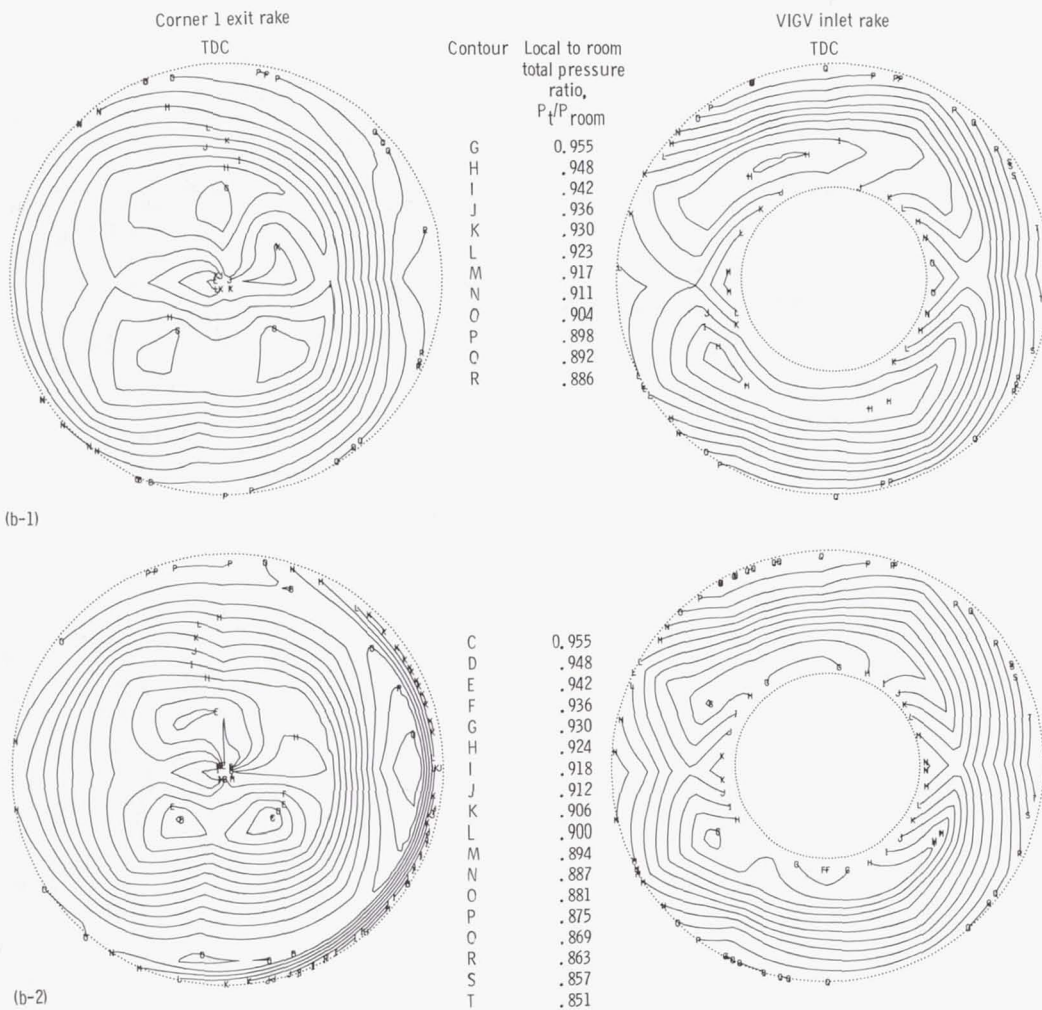

(b-1) Contour plots of constant pressure with 6.35-cm distortion screen. Looking downstream; readings 1241 to 1244; loss coefficient, $\Delta P_t/q_{in}$, 0.112.
 (b-2) Contour plots of constant pressure with 12.7-cm distortion screen. Looking downstream; readings 1224 to 1227; loss coefficient, $\Delta P_t/q_{in}$, 0.125.

Figure 22.—Concluded.

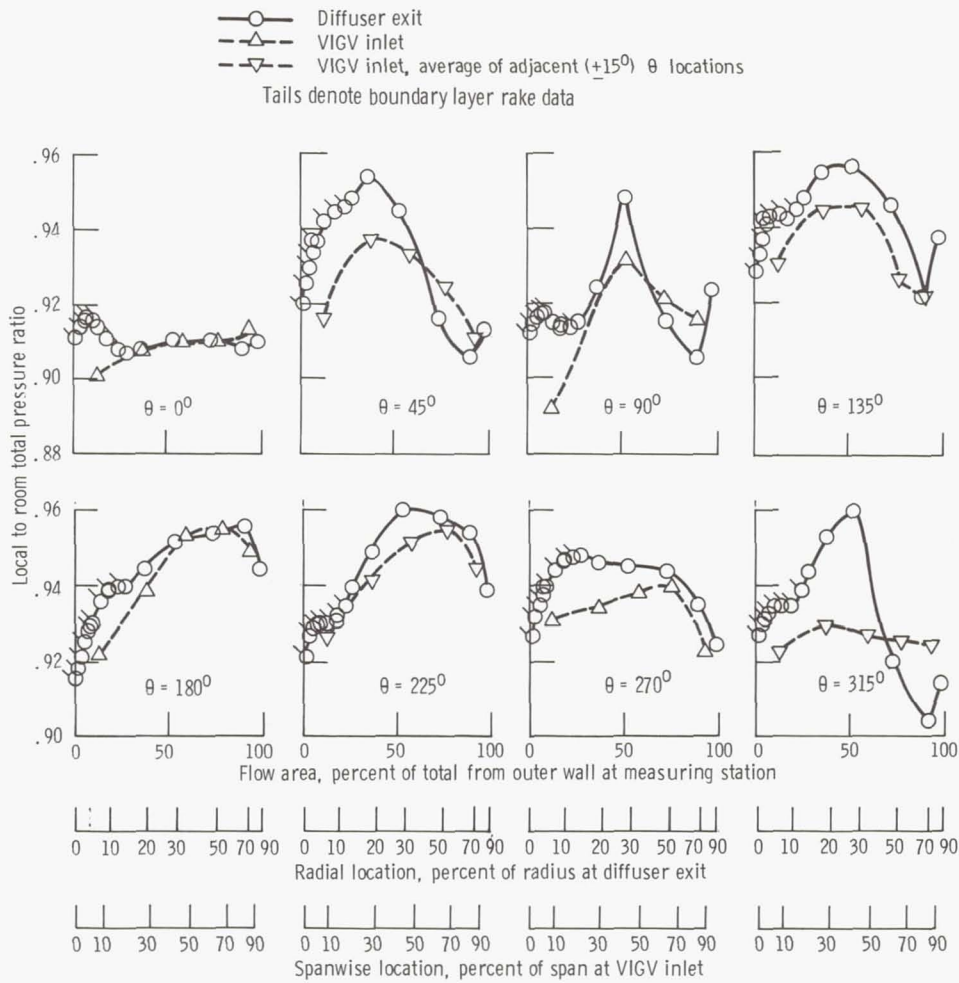

(a)

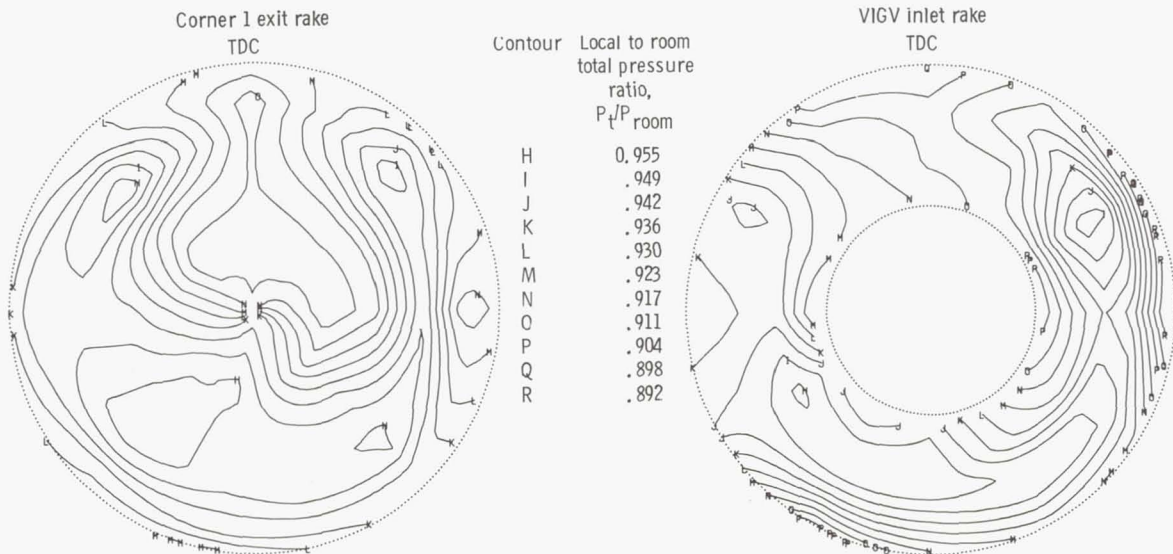

(b)

(a) Spanwise variation at discrete circumferential locations.

(b) Contour plots of constant pressure (looking downstream).

Figure 23.—Local total pressures ratioed to room pressure across corner 2 with vanes A4 downstream of corner 1 with vanes A10 and scoop. Airflow, 73.7 kg/sec; corner 2 inlet Mach number, 0.258; circumferentially distorted inflow ($\sim 50^\circ$ sector screen); readings 1258 to 1261; loss coefficient, $\Delta P_t/q_{in}$, 0.142.

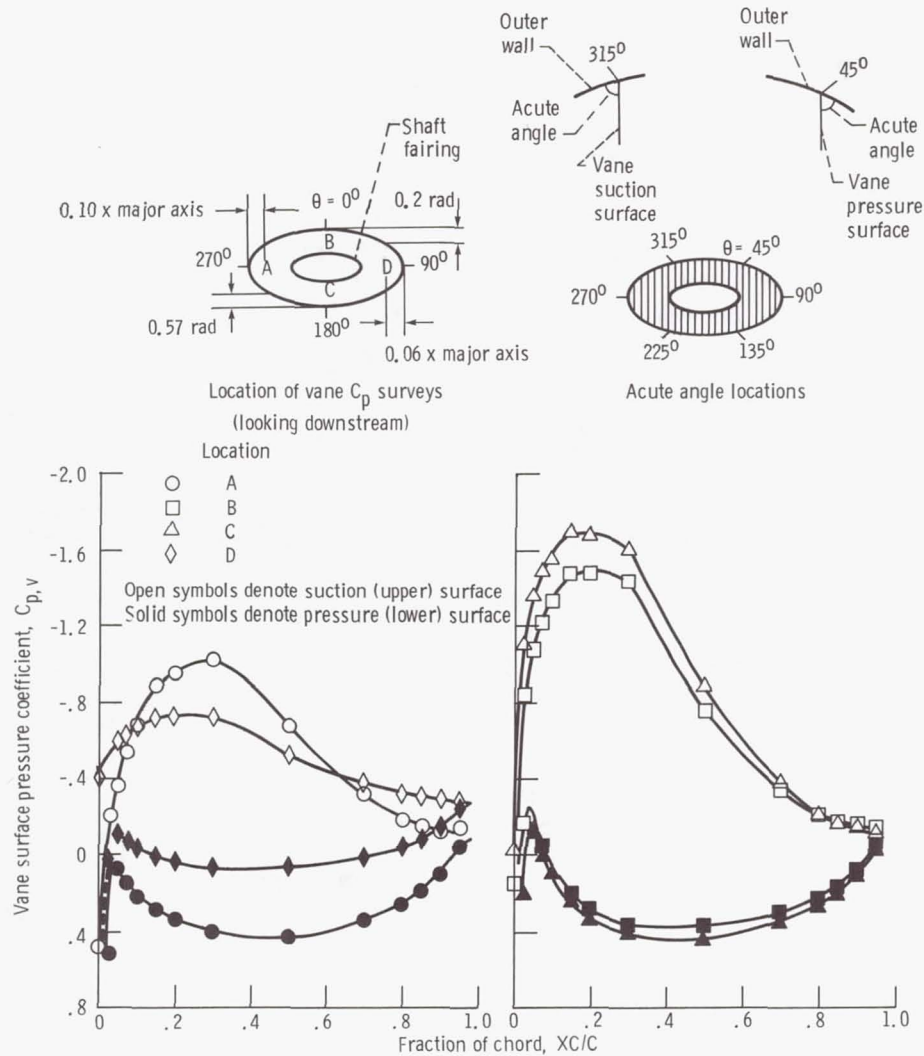

Figure 24.—Vane surface pressure distributions on vanes A4 at four locations in corner 2. Uniform inflow with airflow of 73.1 kg/sec; corner 2 inlet Mach number, 0.256; readings 4 to 16.

θ locations of 225° and 315° . The relatively large reduction in total pressure approaching the outer wall for the VIGV inlet at $\theta = 90^\circ$ indicated flow separation from the wall. At θ of 90° and 270° near the inner wall the horizontal bias of the shaft-fairing centerbody was shown by the relatively greater loss in VIGV inlet total pressure there. At θ of 225° and 315° the boundary layer associated with the outer wall appeared thicker than that at the other locations. At and near these values of θ an acute angle was formed by the intersection of the vane suction (upper) surface and the outer wall, as depicted by the sketches in figure 24. This geometry concentrated the boundary layer flows on the wall and on the vane suction surface. Now the boundary layer growth on the vane suction surface was more rapid than on the pressure surface because of its more adverse chordwise pressure gradient. This is illustrated by the vane surface pressure distributions shown in figure 24 (table 14(d)) at all four instrumented locations. Thus the acute corners formed by the wall and the vane suction surfaces are believed to be more critical flow regions than those

formed with the vane pressure (lower) surfaces (sketches in fig. 24). Vane surface pressure distributions are further discussed in a later section so entitled.

For corner 2 operating with corner 1 (fig. 21) the main differences in total pressure profiles at the various circumferential locations occurred at θ of 90° and 270° . The upstream presence of the corner 1 scoop and its afterbody is evident in the reduced total pressures across the corner 2 inlet (diffuser exit) at $\theta = 270^\circ$. The corner 1 scoop also caused a unique corner 2 inlet pressure profile at $\theta = 90^\circ$. The total pressure dip near 50-percent radius at the diffuser exit could reflect a vortex shed off the inner edge of the scoop afterbody, as previously discussed with figure 16. The large dropoff in total pressure at the corner 2 inlet from midradius to the outer wall at $\theta = 90^\circ$ suggests some upstream flow separation from the wall, as previously discussed for this region.

With tip radial distortion imposed upstream of corner 1 the total pressure profiles across corner 2 with vanes A4 (fig. 22) are similar at the various circumferential locations shown. As

expected, the total pressure levels were lower at all θ locations with the 12.70-cm distortion screen (fig. 22(a-2)) than with the 6.35-cm distortion screen (fig. 22(a-1)).

With circumferentially distorted inflow the pressure profiles across corner 2 (fig. 23) were dependent on their θ location as expected. The profiles at θ of 45° and 315° are similar. These locations were symmetrical about the center of the screen sector at $\theta = 0^\circ$. The pressure patterns were relatively flat behind the screen with little additional loss across corner 2 at $\theta = 0^\circ$.

Comparisons of Total Pressure Profiles for Corner 2 with Vanes B and A4

With uniform inflow (fig. 25) vanes A4 had a slight advantage over vanes B in the core region of corner 2 at nearly every θ location. This suggests lower profile losses as previously discussed. Conversely vanes B had a slight advantage over vanes A4 over the outer half span for θ of 225° and 315° . The loading was less with the 28 vanes B than with the 22 vanes A4. Thus the flow in the acute corners formed by vane B suction surfaces and the wall was better able to finish the turn, which resulted in less loss. There appeared to be no significant difference between vanes B and A4 at $\theta = 90^\circ$; upstream outer wall separation was indicated for both cases.

The overall loss coefficients for corner 2 operating downstream of corner 1 were 0.116 for vanes A4 and 0.127 for vanes B. The lower core flow losses with vanes A4 at nearly every θ location slightly outweighed the near-wall loss advantage with vanes B at θ of 225° and 315° when the overall corner loss was evaluated.

With tip radially distorted inflow (figs. 26 and 27) the pressure profiles had similar shapes at each θ location with either vanes A4 or B, but the A4 levels were slightly higher at most locations. The overall corner loss coefficients were mixed. With the 6.35-cm distortion screen the coefficients were 0.112 with vanes A4 and 0.122 with vanes B. With the 12.70-cm distortion screen the coefficients were 0.125 with vanes A4 and 0.101 with vanes B.

With circumferentially distorted inflow the pressure profiles for vanes A4 and B differed little at the various θ locations (fig. 28). This was confirmed by nearly equal values of corner 2 loss coefficients, 0.142 with vanes A4 and 0.139 with vanes B.

In summary, for corner 1 with the scoop installed upstream, corner 2 losses may be lower with the controlled-diffusion vanes (A4) than with the circular-arc vanes (B). Also, only 22 of the A4 vanes are required in contrast to 28 of the B vanes. However, these advantages need to be weighed against the more complex vane A4 cross section in selecting a design for application.

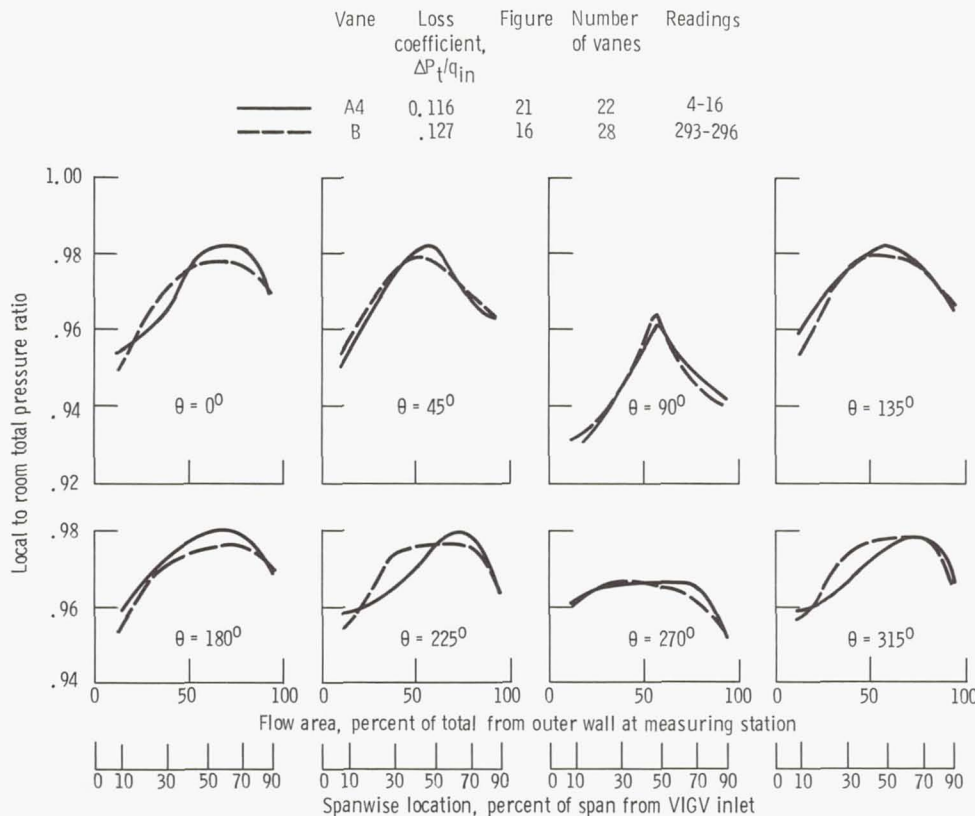

Figure 25.—Comparison of effects of vanes A4 and B in corner 2 with corner 1 upstream on the spanwise variation of vlgv inlet total pressure ratioed to room pressure at eight circumferential locations—uniform inflow. Nominal airflow, 73.1 kg/sec; nominal inlet Mach number, 0.255. (Faired curves from data in figures cited in key.)

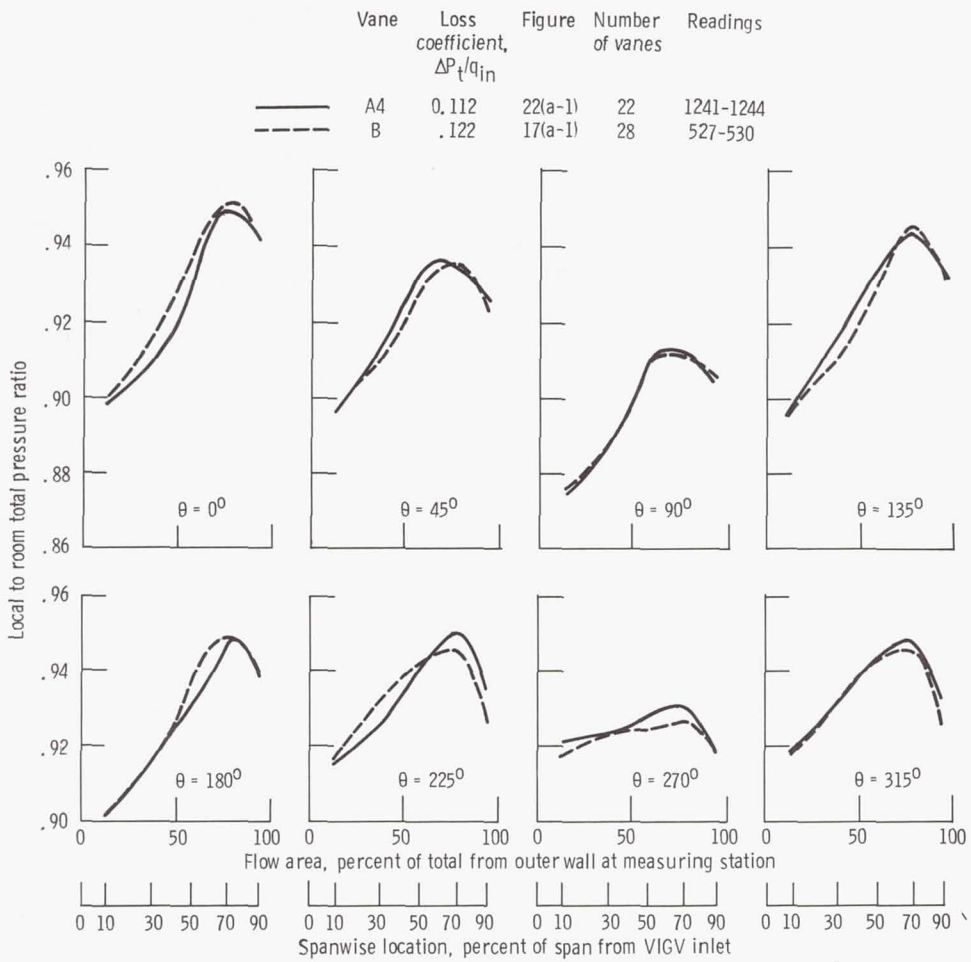

Figure 26.—Comparison of effects of vanes A4 and B in corner 2 with corner 1 upstream on the spanwise variation of vlgv inlet total pressure ratioed to room pressure at eight circumferential locations—tip inflow radially distorted with 6.35-cm screen. Nominal airflow, 72.0 kg/sec; nominal inlet Mach number, 0.253. (Faired curves from data in figures cited in key.)

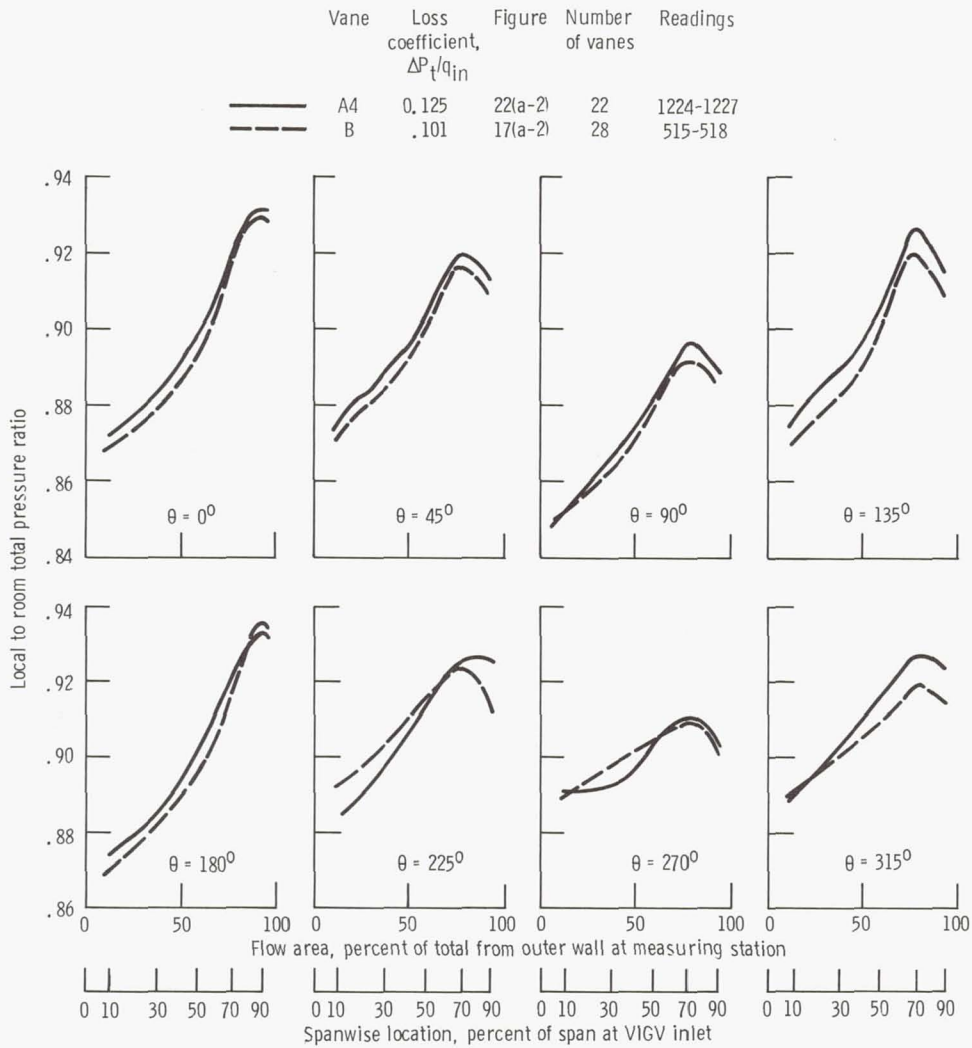

Figure 27.—Comparison of effects of vanes A4 and B in corner 2 with corner 1 upstream on the spanwise variation of vlgv inlet total pressure ratioed to room pressure at eight circumferential locations—tip inflow radially distorted with 12.70-cm screen. Nominal airflow, 72.0 kg/sec; nominal inlet Mach number, 0.253. (Faired curves from data in figures cited in key.)

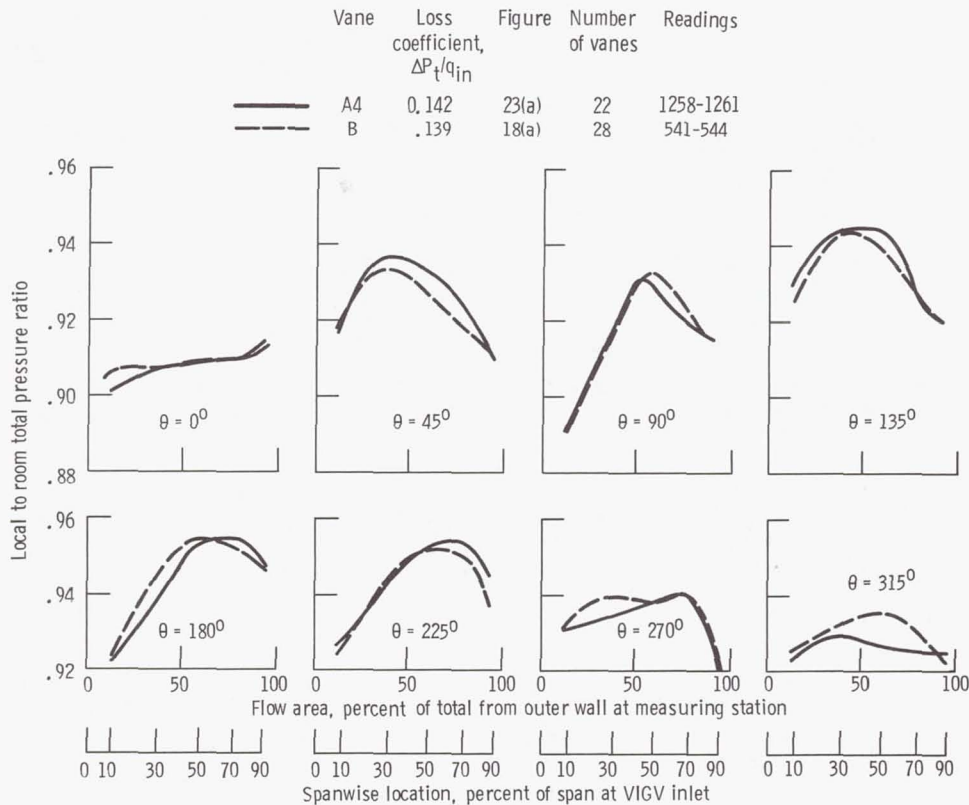

Figure 28.—Comparison of effects of vanes A4 and B in corner 2 with corner 1 upstream on the spanwise variation of VIGV inlet total pressure ratioed to room pressure at eight circumferential locations—inflow circumferentially distorted with $\sim 50^\circ$ sector screen. Nominal airflow, 73.5 kg/sec; nominal inlet Mach number, 0.257. (Faired curves from data in figures cited in key.)

Circumferential Variation of Pressures Near VIGV's

In this and the following section the character of the flow near the VIGV's is illustrated with typical pressure and Mach number distributions for various configurations of corner 2 operating downstream of corner 1. Such information may be useful in evaluating the design and performance of the tunnel drive fan since it is the next component in the circuit (fig. 1).

With the uniform inflow (fig. 29(a)) the circumferential variation of inlet and exit total pressures ratioed to room pressure across the VIGV's differed little between vanes A4 and B. Also, as expected, the VIGV exit total pressures followed the same pattern and level as the inlet values. The reason is that the VIGV exit probes were located midway between the vanes, not in their wake. The dips in total pressure at 90° and 270° at 50 percent of span reflected the presence of the horizontally biased centerbodies upstream. This was also evident near the walls (at 10 and 90 percent of span) except near the tip, where the 270° dip was replaced by ones about 70° to either side.

With tip radial distortion (fig. 29(b)) the total pressure patterns were generally similar to those for the uniform inflow,

but the levels were lower because of the drop across the distortion screen. There was some difference at midspan, where an additional pressure dip occurred at about 200° with the radially distorted inflow. No significant differences were due to vane design.

With circumferentially distorted inflow from an approximately 50° sector screen (fig. 29(c)) the total pressure dip behind the upstream screen sector centered at $\theta = 0^\circ$ was evident at 50 and 90 percent of span. However, at 10 percent of span the pressure pattern was more like those at the same span for either uniform or radially distorted inflow. As before, vane design did not significantly affect the total pressure results.

The VIGV exit static pressure distributions around the circumference (fig. 30) were interpolated from the inner and outer wall taps. Generally static pressure differed little across the span at any θ location. The circumferential variation was also small, and the difference due to vane design was negligible. Only the pressure levels differed as a direct result of the different inflow conditions. From the total and static pressure distributions at the VIGV exit (figs. 29 and 30) local Mach numbers were determined.

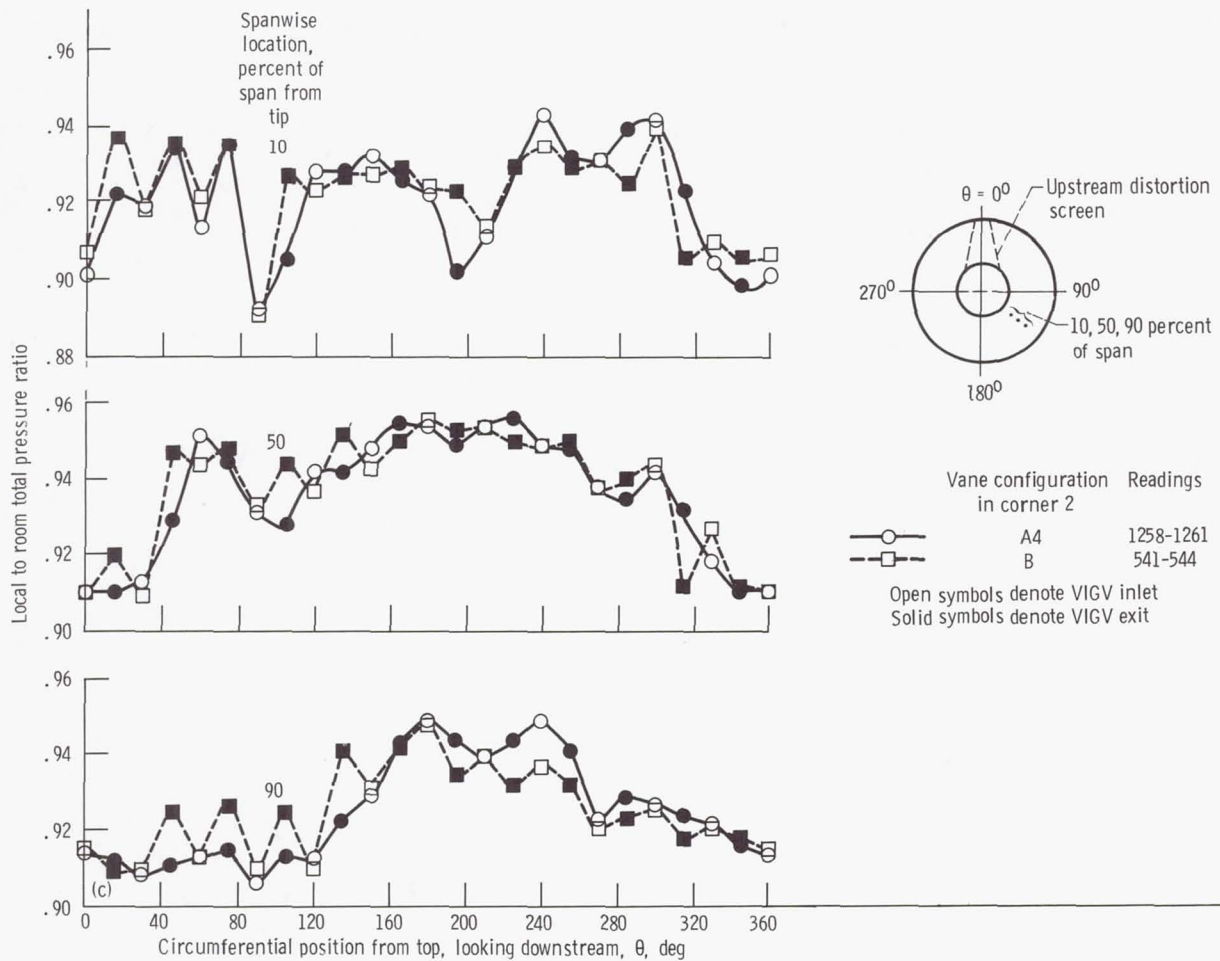

(c) Inflow circumferentially distorted with $\sim 50^\circ$ sector screen.

Figure 29.—Concluded.

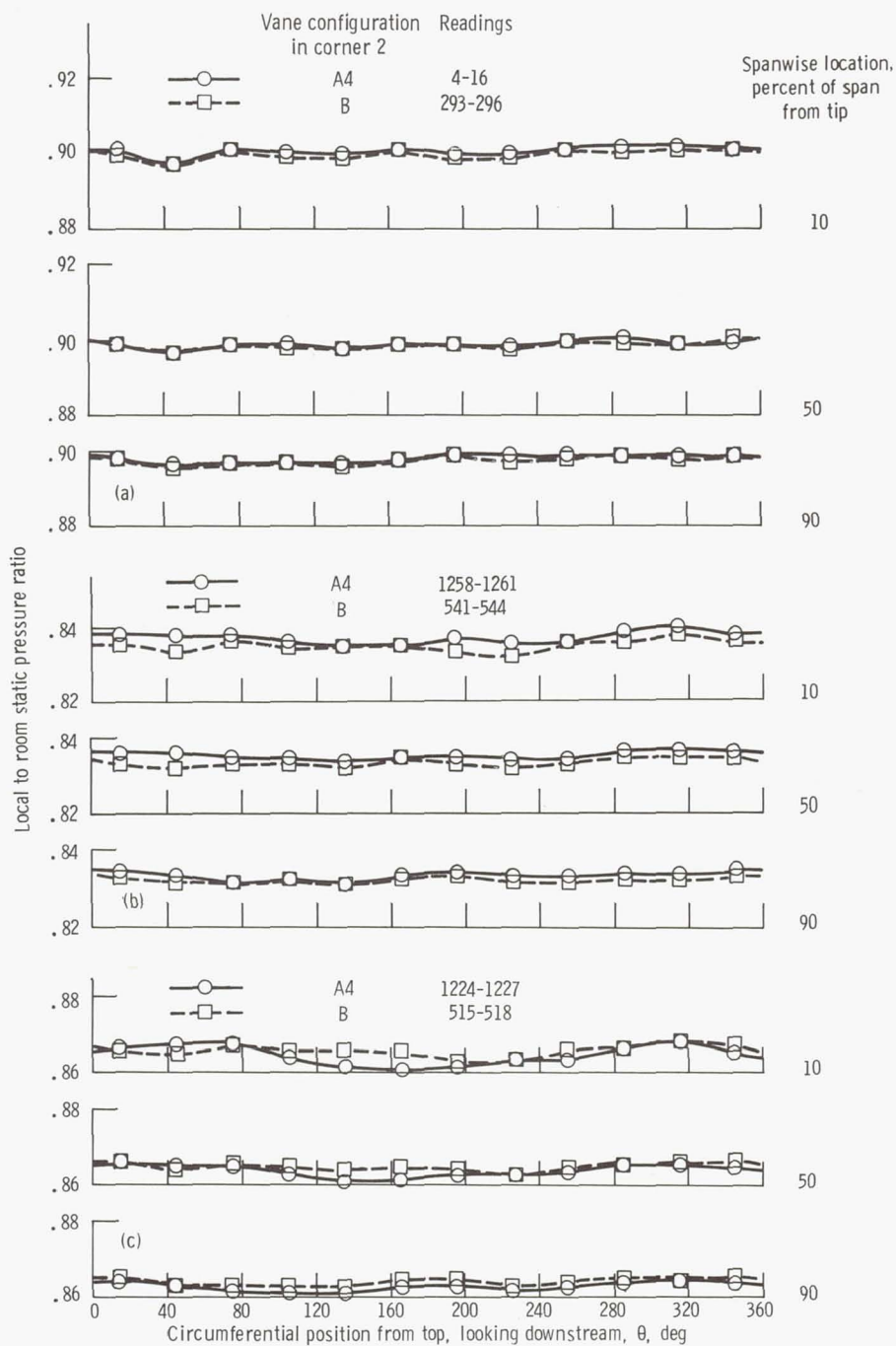
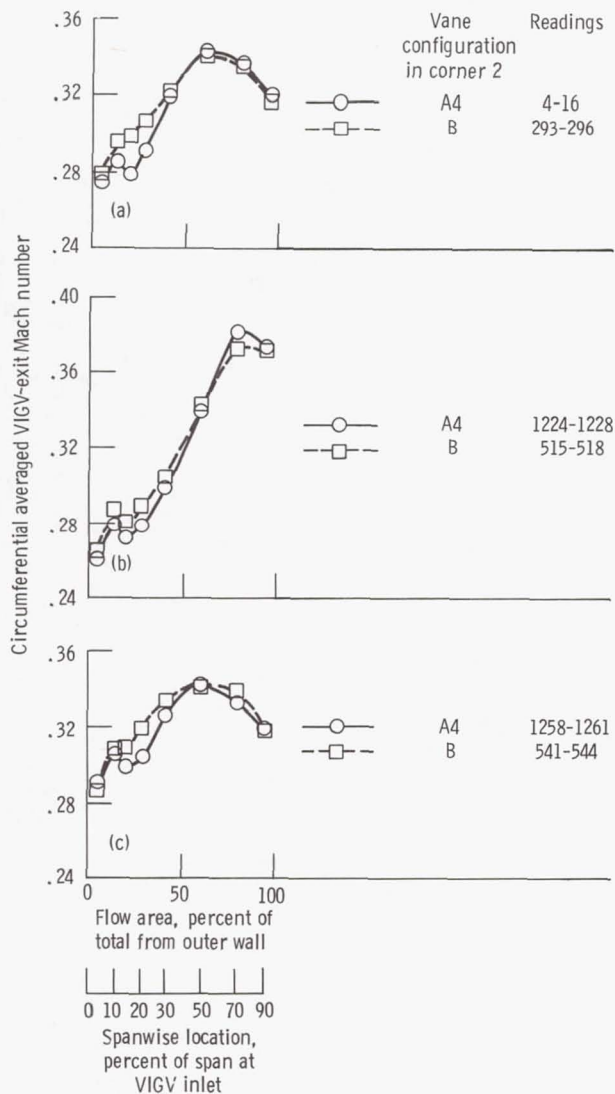

Figure 30.—Circumferential variation of vlgv exit static pressure ratioed to room pressure for three inflow conditions to corner 1 with effects of corner 2 vane design indicated. Nominal airflow, 73.0 kg/sec; nominal corner 1 inlet Mach number, 0.395.



(a) Uniform inflow.

(b) Tip inflow radially distorted with 12.70-cm screen.

(c) Inflow circumferentially distorted with ~50° sector screen.

Figure 31.—Spanwise variation of circumferentially averaged VIGV exit Mach number for three inflow conditions to corner 1 with vanes A10 plus corner 2 with either vanes A4 or B. Nominal airflow, 73.0 kg/sec; nominal corner 1 inlet Mach number, 0.395.

VIGV Exit Mach Number Profiles

The circumferentially averaged Mach number profiles were nearly the same with either vanes A4 or B in corner 2 irrespective of the inflow condition (fig. 31). Also, there was little difference between the uniform inflow and the small-sector circumferentially distorted inflow. The maximum spanwise difference in Mach number in either figure 31(a) or (c) was from about 0.28 near the tip (outer wall) to about 0.34 near midspan. For the proposed tunnel drive fan with a design tip speed of 221 m/sec (724 ft/sec) this maximum difference in fan inlet Mach number resulted in a maximum change in

inlet air angle of about 4°. With the 12.70-cm tip radial distortion screen (fig. 31(b)) the maximum difference in inlet air angle at design fan speed was about 7° from the outer to the inner wall.

Although the circumferentially averaged Mach number profiles were nearly the same with uniform inflow or with small-sector circumferentially distorted inflow with either vane design, both θ location and vane design differences are evident in figures 32(a) and (c). With uniform inflow (fig. 32(a)) the spanwise extremes varied less with θ location for vanes B than for vanes A4. With circumferentially distorted inflow (fig. 32(c)) the regions nearest the screen wake (θ of 15° and 315°) had less spanwise Mach number variation with vanes A4 than with vanes B. However, at $\theta = 195^\circ$ vanes B had less of a Mach number gradient than vanes A4. We believe the effects of such differences on tunnel drive fan performance to be small.

The largest differences in VIGV exit Mach number profiles due to θ location or vane design occurred for tip radial distortion with the 12.70-cm screen (fig. 32(b)). Near the outer wall at $\theta = 195^\circ$ the Mach number was about 0.23 with vanes A4 but 0.33 with vanes B. An opposite trend with about half the magnitude change occurred at $\theta = 315^\circ$. Again we believe these local differences due to θ location and vane design to be insignificant in terms of expected fan performance.

To conclude this section on VIGV exit Mach number profiles, let us consider the effects of resetting the aft part of the VIGV $\pm 10^\circ$ for uniform inflow with vanes A4 in corner 2 (fig. 33). The faired data for the 0° reset of the VIGV's are also indicated. In general the VIGV reset had little effect on the Mach number profiles. The maximum change in Mach number from a reset of $\pm 10^\circ$ was about 0.04 near the outer wall at $\theta = 195^\circ$. At some θ locations reset had little effect on Mach number. The effect on inlet air angle was much greater, of course. Assuming no separation of flow from the surfaces of the VIGV's with reset, the change in inlet air angle would directly follow the amount of reset in degrees. Such changes in inlet air angle to the fan will affect its useful range of operation between wide-open-throttle and fan-stall flow rates. This is why, of course, such VIGV reset capability is provided.

Static Pressure Distributions on Walls and Fairings

The axial distributions of wall static pressure around the configuration of corner 1 (with vanes A10) coupled to corner 2 (with either vanes A4 or B) at design inflow conditions are described here for the different parts of the assembly. This section indicates the general behavior of the flow along the walls and illustrates the detail contained in the tables.

Upstream of corner 1.—Generally the local static to room pressure patterns were the same for all inflow conditions with either vanes A4 or vanes B in corner 2 (fig. 34). However, the overall levels were lower with inlet distortion. Because the loss in total pressure from stations 1 to 20 was minimal, these static pressure patterns indicated flow acceleration along

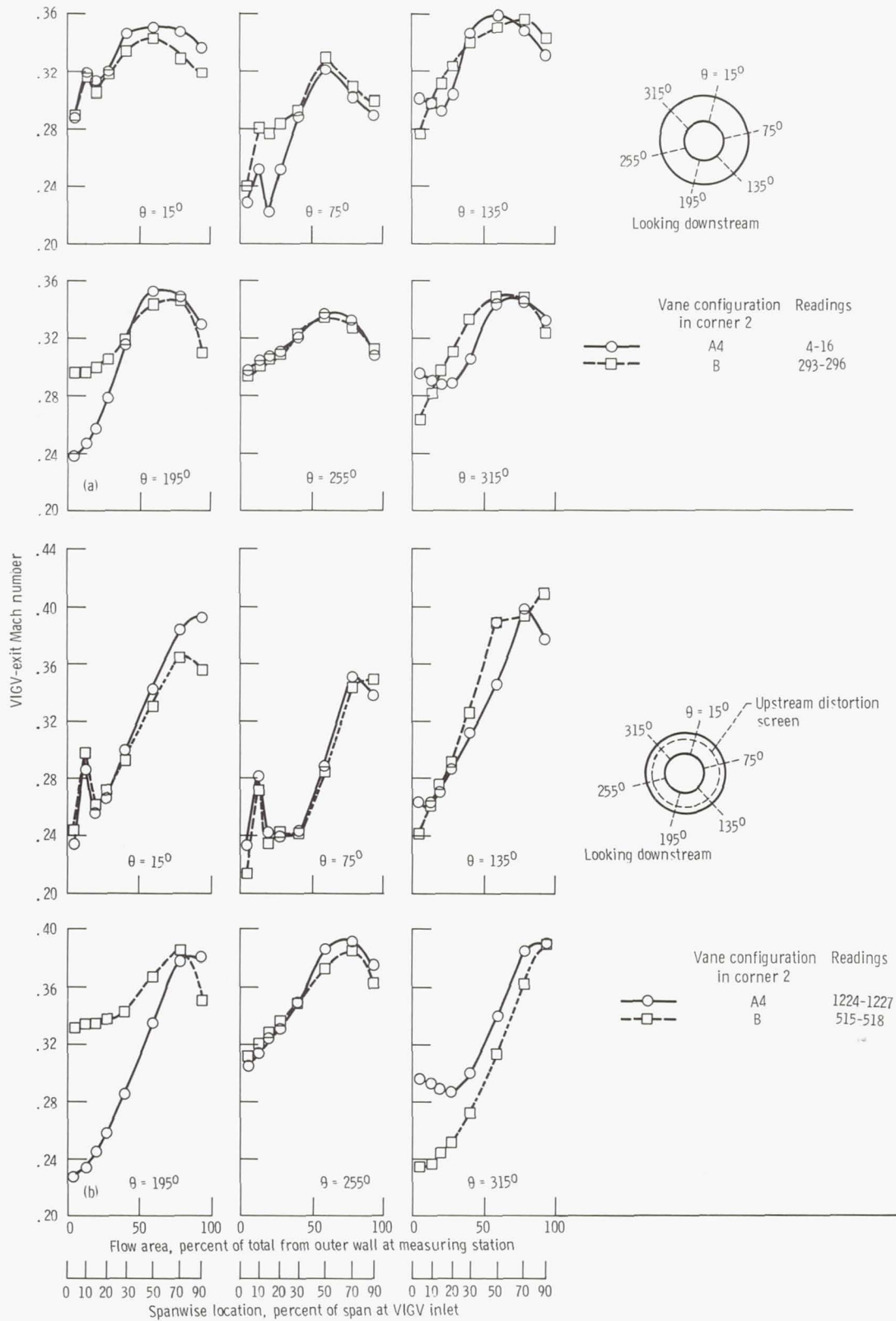
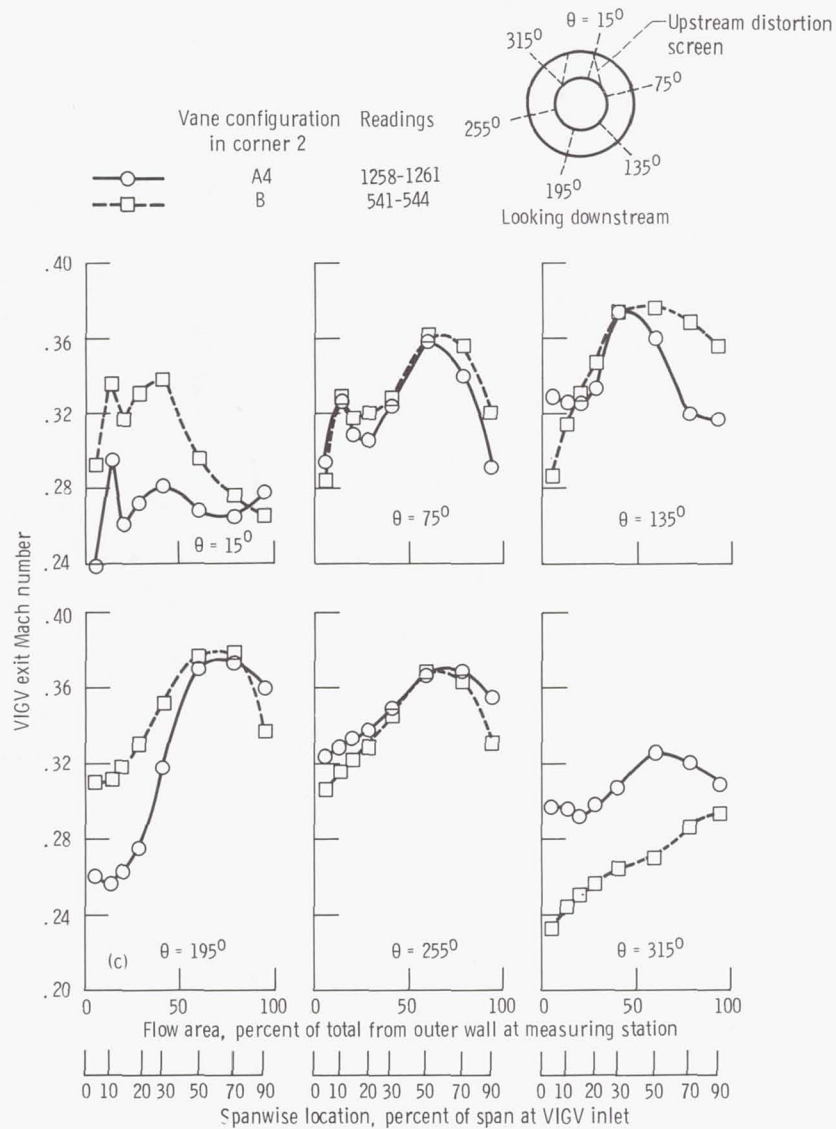

Figure 32.—Spanwise variation of v1GV exit Mach number at six circumferential locations. Corner 1 with vanes A10 plus corner 2 with either vanes A4 or B. Nominal airflow, 73.0 kg/sec; nominal corner 1 inlet Mach number, 0.395.



(c) Inflow circumferentially distorted with $\sim 50^\circ$ sector screen.

Figure 32.—Concluded.

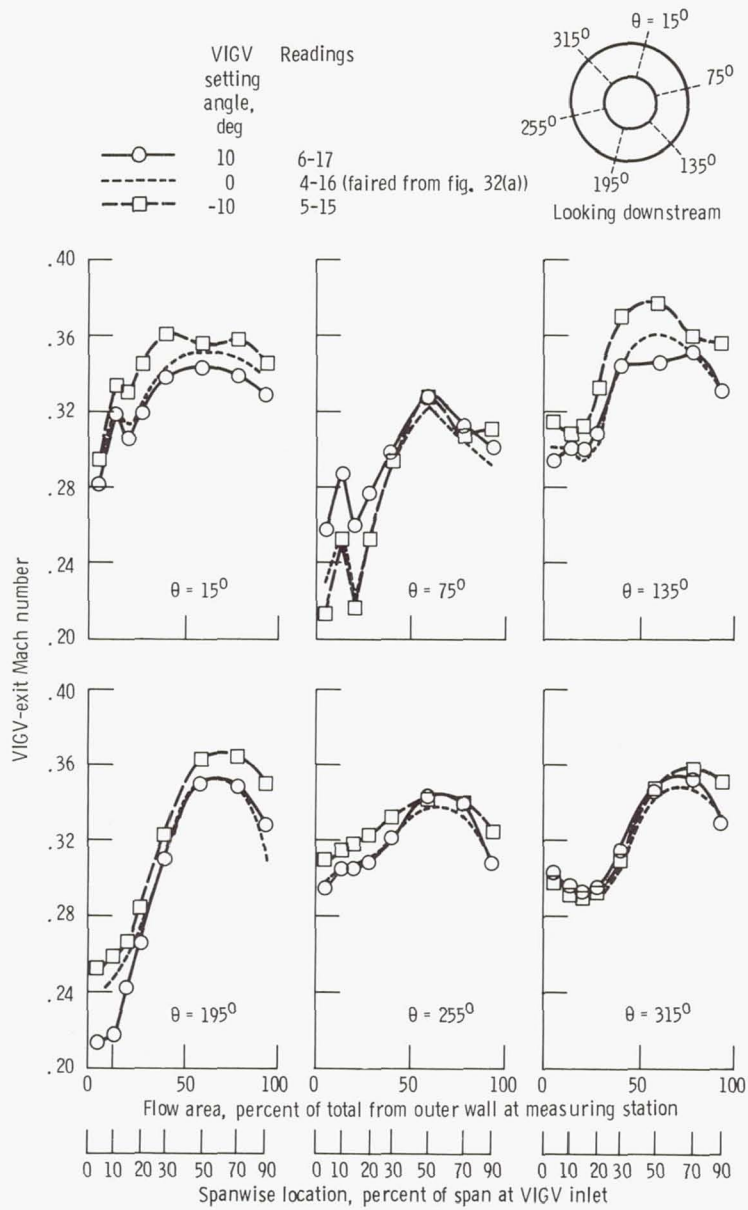
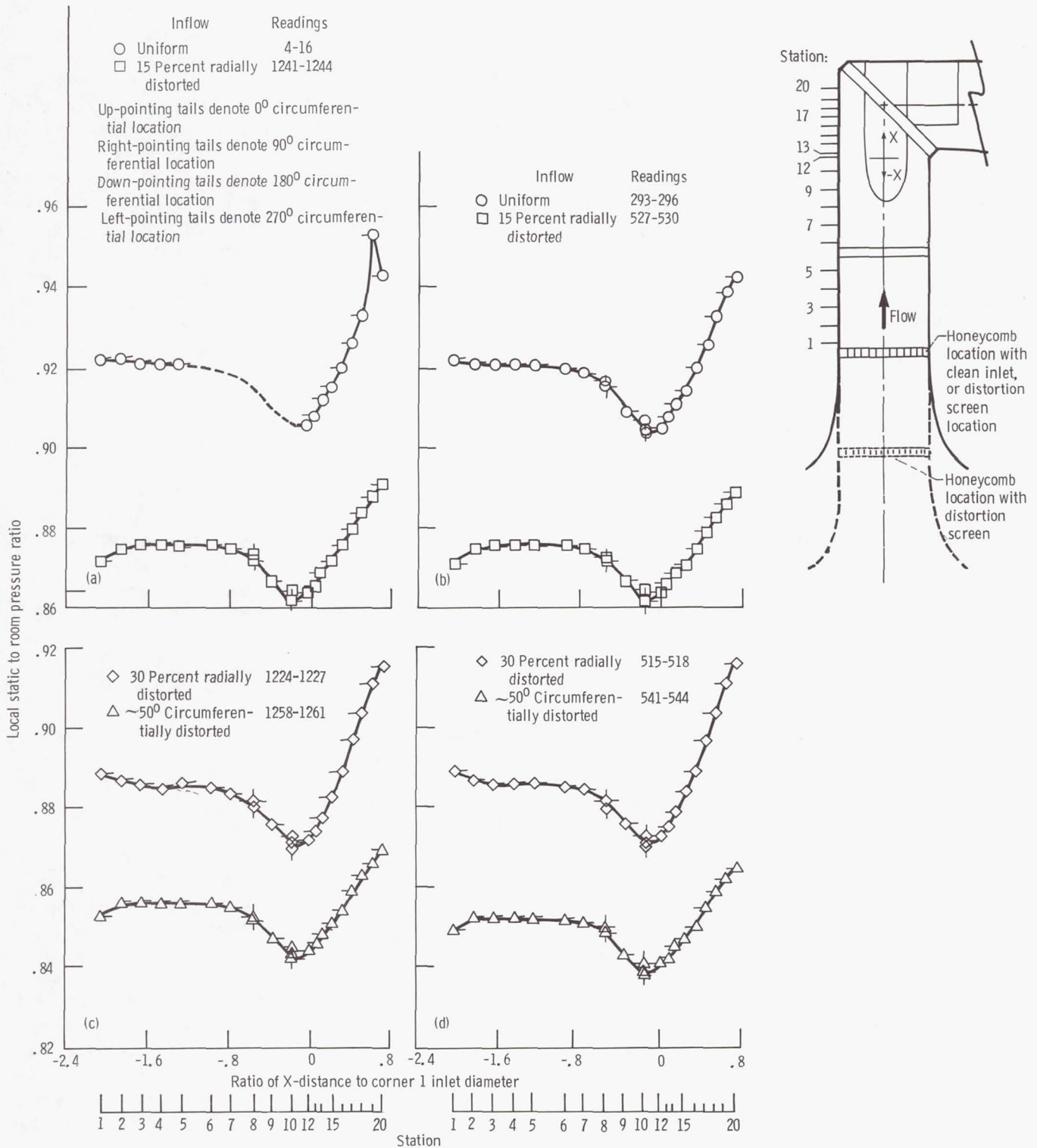

Figure 33.—Effects of VIGV setting angle on the spanwise variation of VIGV exit Mach number at six circumferential locations. Corner 1 with vanes A10 plus corner 2 with vanes A4. Nominal airflow, 72.9 kg/sec; nominal corner 1 inlet Mach number, 0.395; uniform inflow.



(a) Vanes A4 in corner 2, comparing uniform and 15-percent radially distorted inflow.

(b) Vanes B in corner 2, comparing uniform and 15-percent radially distorted inflow.

(c) Vanes A4 in corner 2, comparing 30-percent radially distorted and ~50° circumferentially distorted inflow.

(d) Vanes B in corner 2, comparing 30-percent radially distorted and ~50° circumferentially distorted inflow.

Figure 34.—Axial wall static pressure distribution upstream of corner 1 (with vanes A10) with and without inlet distortion. Nominal airflow, 72.7 kg/sec; nominal corner 1 inlet Mach number, 0.395 (station 12).

the tunnel walls starting at about one-half centerbody diameter upstream of the centerbody. This continued and was the same for all θ 's until the maximum centerbody thickness was reached at about station 10. From there the measurements along the outer wall ($\theta = 270^\circ$) indicated a flow deceleration to velocity levels at station 20 that were lower than those at station 1. As discussed in reference 4 the simulated scoop and its afterbody fairing in corner 1 blocks and thus slows some of the flow near the outer wall. Since the total oncoming flow rate does not change, some of this outer flow must be diverted inward. For undistorted, or uniform, inlet flow approximate flow Mach numbers along the outer wall ($\theta = 270^\circ$) calculated from the local static to room pressure ratios shown were 0.35, 0.38, and 0.29 at stations 1, 10, and 20, respectively.

Crossleg diffuser and inlet to corner 2.—In the diffuser section (fig. 35), stations 34 to 47, the wall static pressure patterns with uniform inlet flow were similar irrespective of the vane design in corner 2 as expected. The circumferential variation in the diffuser flow was slight but consistent, with higher static pressures along $\theta = 270^\circ$ than along $\theta = 90^\circ$. This trend was also apparent with distorted inflow.

Except for $\theta = 270^\circ$ pressures in the inlet section to corner 2 (fig. 35), stations 48 to 53, were relatively constant because of the constant duct diameter. At $\theta = 270^\circ$ the wall pressures continued to increase throughout the corner inlet. This was caused by the blockage effects of the centerbody, which had its major axis along $\theta = 270^\circ$ (fig. 10). Aft of this centerbody at station 53 the pressure at $\theta = 270^\circ$ returned approximately to its preblockage level at station 48.

The corner 2 inlet pressure patterns changed little with various types of inlet distortion. However, an overall level shift occurred in the ratios because of a reduction in wall pressures that was comparable to the total pressure reduction across the distortion screens (figs. 14 and 19).

Downstream of corner 2.—Along the outer wall, at $\theta = 270^\circ$ and for stations 57 to 60 just downstream of the corner vanes, the wall pressures were a little higher with vanes B in the corner than with vanes A4, for both uniform and distorted inflow conditions (fig. 36). With uniform inflow total pressures along the outer wall at $\theta = 270^\circ$ were essentially the same with either vanes B or A4 (figs. 16(a) and 21(a)). Thus the higher wall pressures downstream of vanes B indicated a slightly slower flow in this region with vanes B. Since the physical flow areas were the same, apparently the vane and wall boundary layers caused slightly less blockage in the stream with vanes B. Similar trends were noted with distorted inflow. However, from stations 61 to 75 the difference due to vane design was negligible with or without distorted inflow. At station 79, near the VIGV's, the wall pressures at θ of 0° and 90° were nearly equal to but consistently lower than those at θ of 180° and 270° , which were also nearly equal. This slight flow skewness appeared irrespective of inflow conditions, but its cause was not readily apparent.

Corner 2 shaft fairing.—The static pressures for the corner 2 shaft fairing centerbody at $\theta = 270^\circ$ matched those along the outer wall at the same θ (fig. 37), as expected. At $\theta = 90^\circ$ and for stations 54 to 60 the centerbody pressures were close to the total pressure values for comparable inflow conditions (figs. 16 to 18 and 21 to 23). This suggested a stagnation of the oncoming flow. Just ahead of the vanes (stations 54 to 57) and along the top and bottom of the fairing (θ of 0° and 180°) static pressures were relatively low for all cases. This reflected the accelerating flow caused by blockage at the maximum fairing thickness (see end view in fig. 37 sketch). The top and bottom pressures on the fairing showed a sharp decline from stations 63 to 78. Again this reflected accelerating flow caused by the increasing blockage as the drive fan centerbody was encountered. Its maximum diameter occurred near station 78. The fairing pressures from stations 54 to 78 were nearly equal at θ of 0° and 180° , indicative of flow symmetry about the horizontal plane.

Cascade inlet plane to corner 2.—The local static to room pressure ratio distribution around the cascade inlet plane as a function of circumferential location is shown in figure 38. The horizontal scale is double valued to illustrate the data symmetry about the horizontal plane. Uniform inflow data for corner 2 alone (from ref. 6) are presented (figs. 38(a) and (b)) for a convenient reference to the other parts of the figure. The total pressures in the cascade inlet plane of corner 2 without corner 1 upstream were essentially constant around the circumference (see diffuser exit values in figs. 15(a) and 20(a)). Thus the static pressure patterns in figures 38(a) and (b) can be used to infer velocity and flow patterns. The cascade inlet flow was more uniform around the duct with vanes A4 in corner 2 than with vanes B (fig. 38(b)). With vanes B the flow has been skewed so that less is in the outer half ($180^\circ < \theta < 360^\circ$) and more is in the inner half ($0^\circ < \theta < 180^\circ$). However, the skewing was not large since the maximum variation in inlet Mach number was from about 0.263 at $\theta = 270^\circ$ to about 0.293 at $\theta = 90^\circ$. The maximum static pressure occurred at $\theta = 270^\circ$ for either vane design. As indicated in reference 6, this may be attributed to being in the wake of the downstream edge of the shaft fairing (see sketch in fig. 37). The pressure patterns where corner 2 is preceded by corner 1 (fig. 38(c)) were similar to those for corner 2 alone.

With distorted inflow imposed ahead of corner 1 (figs. 38(d) to (f)) the flow shifted slightly more from the outer to the inner half. But as with uniform inflow this shift was somewhat less with vanes A4 than with vanes B, except for the 12.70-cm radial distortion, where the reverse occurred. Circumferential distortion (fig. 38(f)) resulted in less horizontal symmetry than for the other inflow conditions. Lower pressures or more flow appeared over the central part of the lower elliptical cross section than over the upper part. This seemed a reasonable shift when the location of the circumferential distortion screen was considered (see fig. 12(c)).

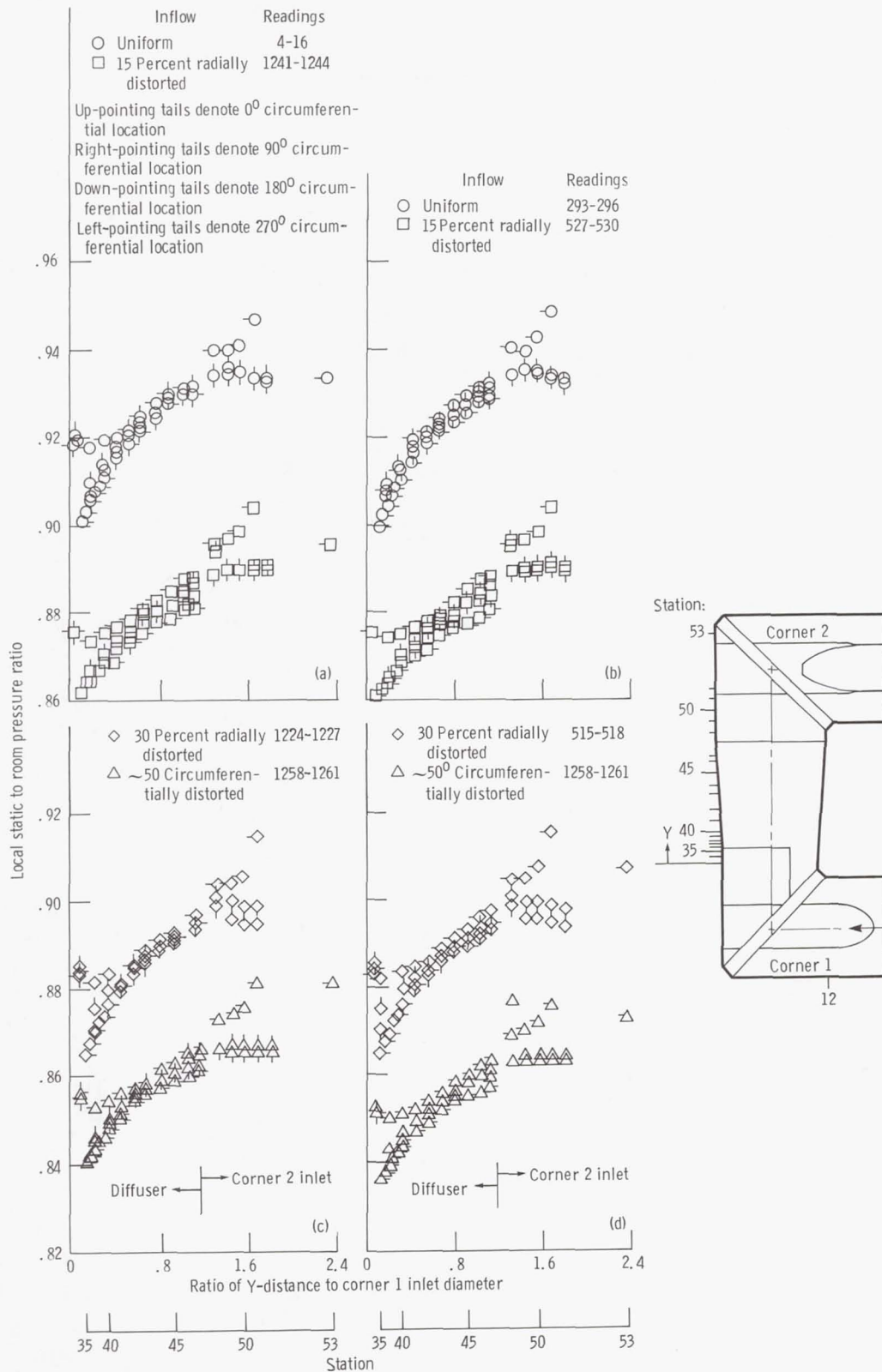

(a) Vanes A4 in corner 2, comparing uniform and 15-percent radially distorted inflow.
 (b) Vanes B in corner 2, comparing uniform and 15-percent radially distorted inflow.
 (c) Vanes A4 in corner 2, comparing 30-percent radially distorted and $\sim 50^\circ$ circumferentially distorted inflow.
 (d) Vanes B in corner 2, comparing 30-percent radially distorted and $\sim 50^\circ$ circumferentially distorted inflow.

Figure 35.—Axial wall static pressure distribution on crossleg diffuser and corner 2 inlet with and without inlet distortion. Nominal airflow, 72.8 kg/sec; nominal corner 1 inlet Mach number, 0.395 (station 12).

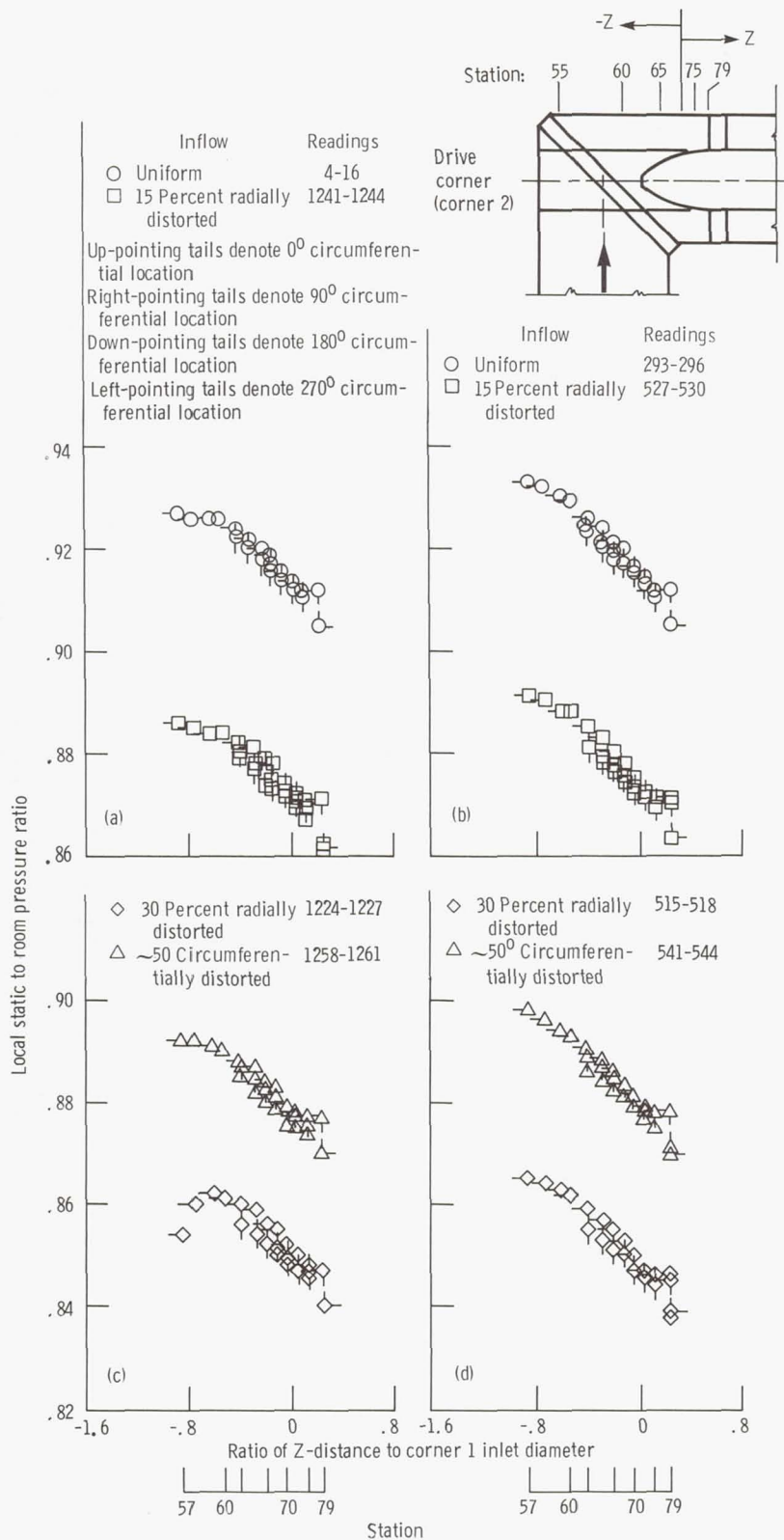

(a) Vanes A4 in corner 2, comparing uniform and 15-percent radially distorted inflow.
 (b) Vanes B in corner 2, comparing uniform and 15-percent radially distorted inflow.
 (c) Vanes A4 in corner 2, comparing 30-percent radially distorted and ~50° circumferentially distorted inflow.
 (d) Vanes B in corner 2, comparing 30-percent radially distorted and ~50° circumferentially distorted inflow.

Figure 36.—Axial wall static pressure distribution on corner 2 outlet with and without inlet distortion. Nominal airflow, 72.8 kg/sec; nominal corner 1 inlet Mach number, 0.395 (station 12).

Circumferential locations looking downstream, θ , deg

○ 0
 ○ 90
 ○ 180
 ○ 270

Solid symbols denote wall values

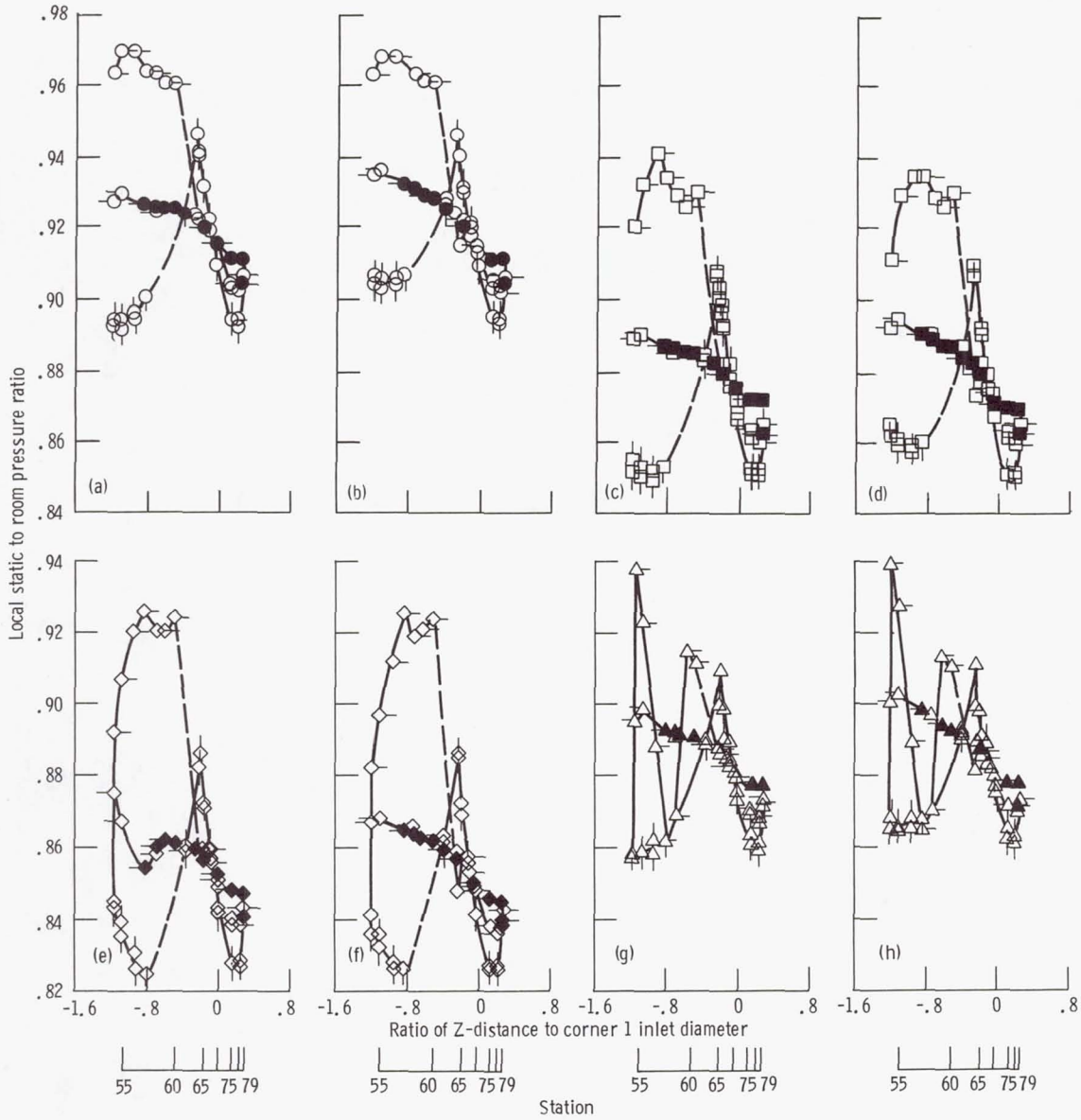
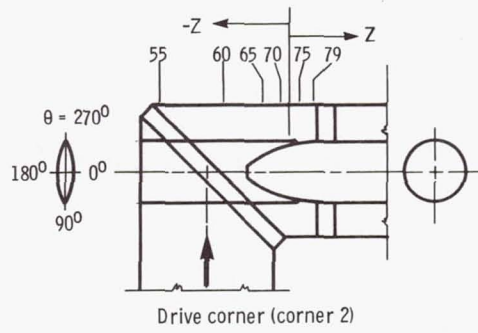

- (a) Vanes A4 in corner 2, uniform inflow (readings 4 to 16).
 (b) Vanes B in corner 2, uniform inflow (readings 293 to 296).
 (c) Vanes A4 in corner 2, 15-percent radial distortion (readings 1241 to 1244).
 (d) Vanes B in corner 2, 15-percent radial distortion (readings 527 to 530).
 (e) Vanes A4 in corner 2, 30-percent radial distortion (readings 1224 to 1227).
 (f) Vanes B in corner 2, 30-percent radial distortion (readings 575 to 578).
 (g) Vanes A4 in corner 2, $\sim 50^\circ$ circumferential distortion (readings 1258 to 1261).
 (h) Vanes B in corner 2, $\sim 50^\circ$ circumferential distortion (readings 541 to 544).

Figure 37.—Axial static pressure distribution on corner 2 shaft fairing and adjacent walls with and without inlet distortion. Nominal airflow, 72.8 kg/sec; nominal corner 1 inlet Mach number, 0.395 (station 12).

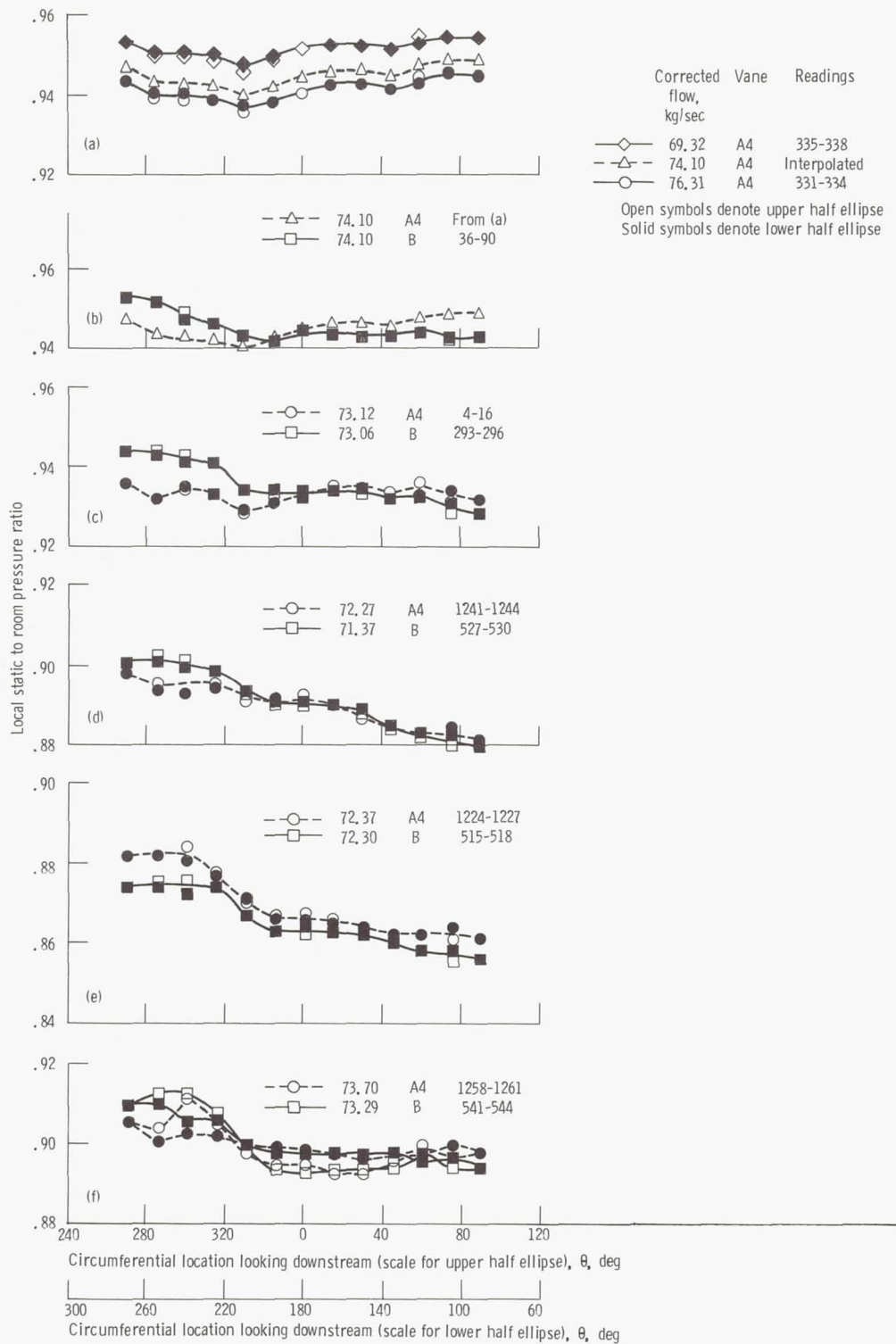

Figure 38.—Effects of various upstream conditions and vane design in corner 2 on static pressure distribution around cascade inlet plane to corner 2. Nominal inlet Mach number to corner 2, 0.255.

Vane Surface Pressure Distributions

Some of the surface pressure data for vanes B and A4 operating in corner 2 with corner 1 upstream are shown in figures 39 to 42. Only data behind the central pair of vanes are shown, but all the data are contained in tables 7 and 21 for vanes B and tables 14 and 28 for vanes A4. Comparisons are made with similar data from an isolated corner 2 (ref. 6). The effects of imposed flow distortion upstream of corner 1 are also shown.

Vanes B.—With uniform inflow neither corner 1 nor the radius from the wall locations above or below the shaft fairing had a significant effect on the pressure distributions (figs. 39(a) and 40(a)). The strong adverse pressure gradient on the upper (suction) surface near the trailing edge actually started near 80 percent of chord, although nearly 90 percent of chord had been predicted. The boundary layer on this surface was likely to separate before the trailing edge, resulting in somewhat higher two-dimensional or profile losses than with a non-separated layer. Other than the premature separation on the suction surface the remaining pressure distribution patterns agreed reasonably well with predictions, especially for the measurement location above the shaft fairing (fig. 39(a)).

With distorted inflow sizable differences occurred in pressure distribution between the above-shaft location at 0.2 radius from the wall (fig. 39(b)) and the below-shaft location

at 0.57 radius (fig. 40(b)). The 0.2-radius-from-the-wall location was well within the low total pressure region behind the various distortion screens as shown in figures 17 and 18 for $\theta = 0^\circ$. In this region the inlet Mach numbers were only about 0.15 based on the static pressures from figure 37 and the total pressures from figures 17 and 18. The resulting pressure distributions show less-negative pressures on the upper surface and more-positive pressures on the lower surface than with uniform inflow. Below the shaft fairing at 0.57 radius from the wall the total pressures ahead of the vanes were relatively high (figs. 17 and 18 for $\theta = 180^\circ$) with resulting inlet Mach numbers of about 0.30 in contrast to a design value of about 0.26. This resulted in lower than design surface pressures on the upper surface of the vanes (fig. 40(b)).

Vanes A4.—With uniform inflow again neither corner 1 nor the radius from the wall locations above or below the shaft fairing had a significant effect on the pressure distributions (figs. 41(a) and 42(a)). These pressures agreed well with those predicted by the analysis code of reference 8 for the vane A design (ref. 4) operating at a setting angle 5° less than design. On the upper surface near the trailing edge the pressure data show no signs of significant boundary layer separation. The two-dimensional or profile losses are thus likely to be less for vanes A4 than for vanes B. Such is shown to be true in references 5 and 11.

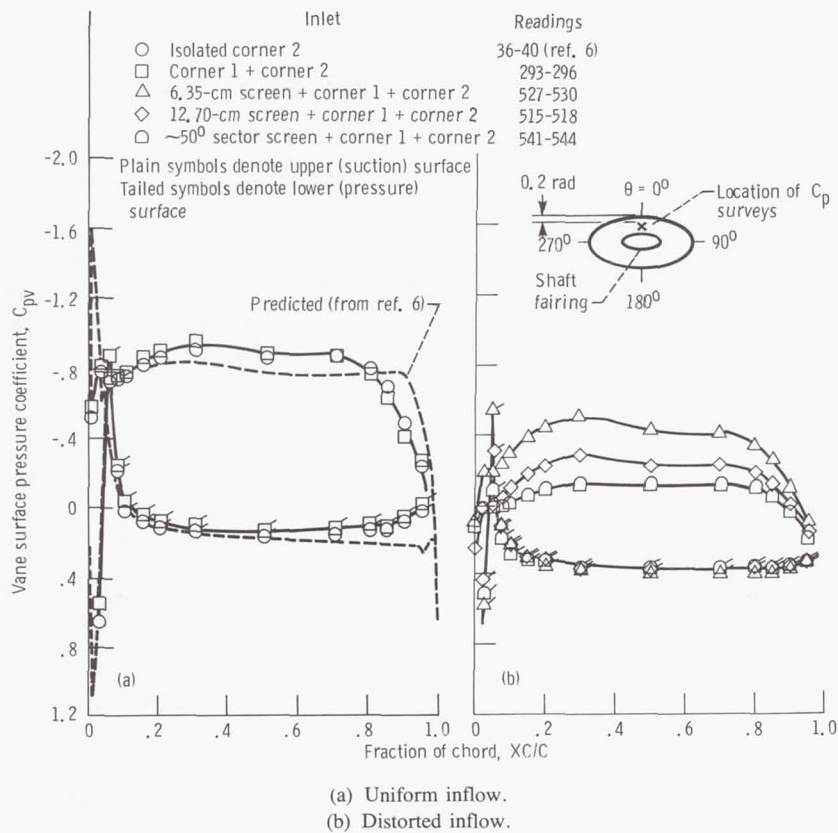

Figure 39.—Vane surface pressure distributions on vanes B in corner 2, near-wall region of central vanes at 0.2 radius from wall above shaft fairing, with and without inlet distortion. Nominal airflow, 72.8 kg/sec; nominal corner 2 inlet Mach number, 0.26.

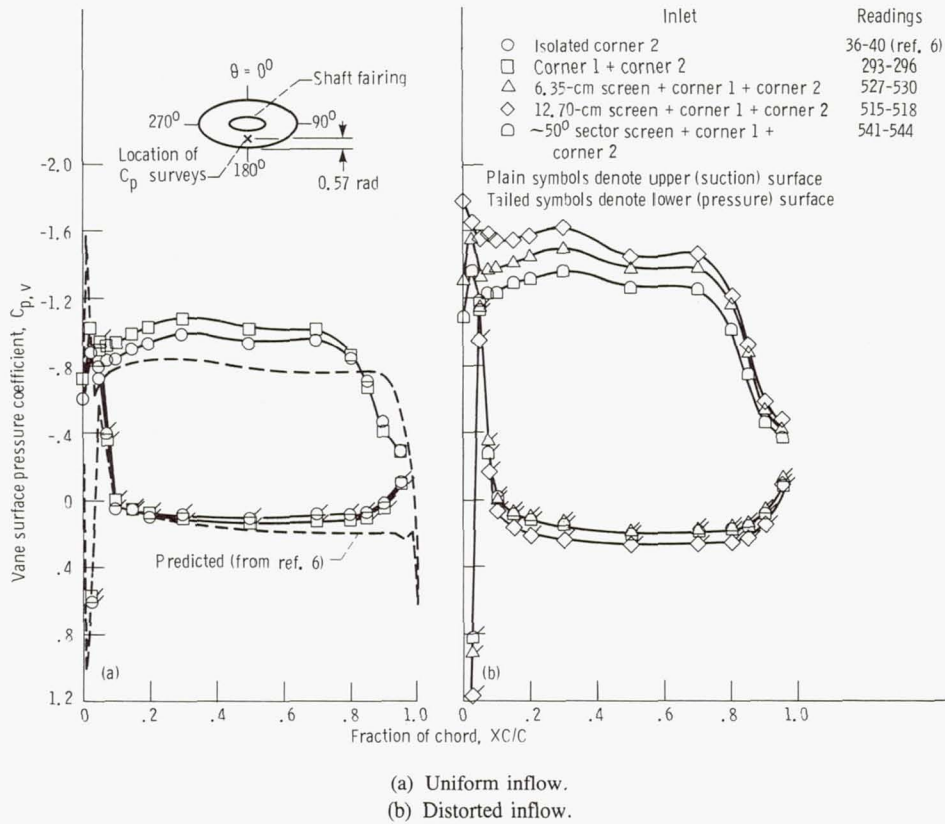

Figure 40.—Vane surface pressure distributions on vanes B in corner 2, midspan region of central vanes at 0.57 radius from wall below shaft fairing, with and without inlet distortion. Nominal airflow, 72.8 kg/sec; nominal corner 2 inlet Mach number, 0.26.

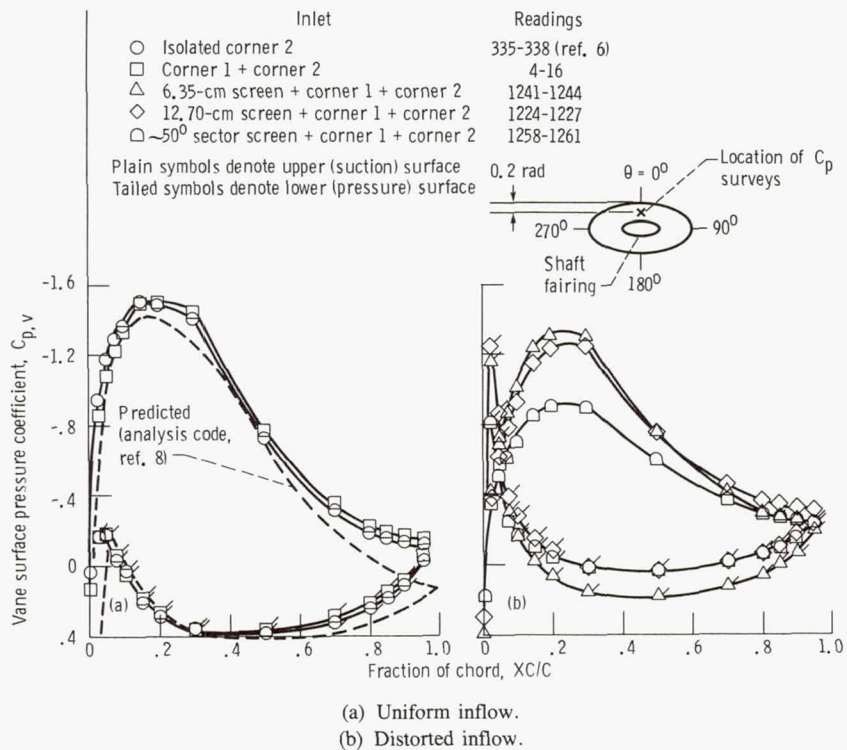

Figure 41.—Vane surface pressure distributions on vanes A4 in corner 2, near-wall region of central vanes at 0.2 radius from wall above shaft fairing, with and without inlet distortion. Nominal airflow, 72.2 kg/sec; nominal corner 2 inlet Mach number, 0.25.

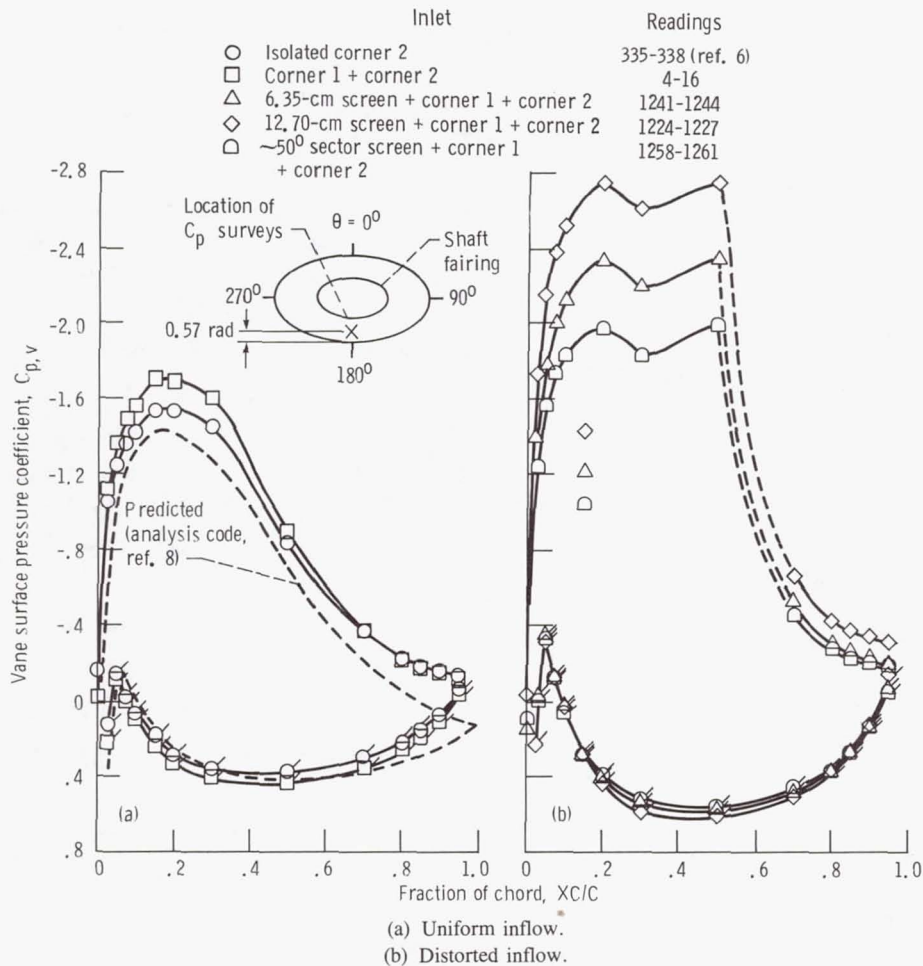

Figure 42.—Vane surface pressure distributions on A4 vanes in corner 2, midspan region of central vanes at 0.57 radius from wall below shaft fairing, with and without inlet distortion. Nominal airflow, 72.2 kg/sec; nominal corner 2 inlet Mach number, 0.25.

With distorted inflow the surface pressure trends for vanes A4 were very similar to those previously discussed for vanes B. This is reasonable since their inlet conditions were about the same, as seen by comparing figures 22 and 23 with 17 and 18.

Summary of Results

For the high-speed corner 1 with exhaust scoop coupled to a diffuser and then to the fan-drive corner 2 with drive-shaft fairing, operating at near-design corner inlet Mach numbers of about 0.4 (to corner 1) and 0.26 (to corner 2), the following principal results were obtained:

1. The total pressure loss coefficient was about 0.16 for corner 1 with a controlled-diffusion vane design (vanes A10) and about 0.12 for corner 2 with either a controlled-diffusion vane design (vanes A4) or a circular-arc vane design (vanes B).

2. The corner 2 loss coefficient depended on whether

corner 2 was preceded by corner 1 or not. At the same corner inlet Mach number the loss coefficient was about 25 percent lower with corner 1 upstream. This was due to lower losses near the outer wall of corner 2, which in turn resulted from the lower momentum inflow to this region caused by the near-wall losses of corner 1.

3. Fewer controlled-diffusion vanes (A4) than circular-arc vanes (B) are needed in corner 2—only 22 of vanes A4 in contrast to 28 of vanes B. However, the A4 vane shape is more complex.

4. Expected inlet flow distortions to corner 1 were simulated with radial and circumferential screen sections upstream of that corner. Their effects on the loss coefficients for either corner 1 or 2 were small and differed little with vane design.

National Aeronautics and Space Administration
Lewis Research Center
Cleveland, Ohio 44135, November 24, 1986

Appendix A

Symbols

A	area, cm ²	P_t	standard-day-corrected total pressure, N/cm ²
A_{ex}	area at corner 1 exit, cm ²	$P_{t,\text{ex}}$	area-averaged, standard-day-corrected exit total pressure, N/cm ²
ΔA_{ex}	incremental area for rake element at exit, cm ²	$P_{t,i}$	individual rake element standard-day-corrected total pressure, N/cm ²
A_{in}	area at corner 1 inlet, cm ²	$P_{t,\text{in}}$	area-averaged standard-day-corrected inlet total pressure, N/cm ²
ΔA_{in}	incremental area for rake elements at inlet, cm ²	$\Delta P_t/q_{\text{in}}$	loss coefficient for corner 2
A_s	cross-sectional area of scoop at corner 1 inlet, cm ²	q_{in}	standard-day-corrected velocity head, N/cm ²
C	vane chord, cm	R	gas constant
$C_{p,v}$	vane surface static pressure coefficient	T_n	standard-day-corrected nozzle total temperature, K
$C_{p,w}$	wall static pressure coefficient	T_t	standard-day-corrected total temperature, K
D	diameter, cm	V	distance from corner 1, cm
d_n	nozzle plate diameter, cm	W	airflow, kg/sec
M	Mach number	X	axial distance from corner 1 inlet, cm
M_{in}	Mach number at corner inlet	XC/C	fraction of vane chord in chordwise direction
N	station	Y	axial distance from corner 1 exit, cm
P_n	standard-day-corrected nozzle total pressure, N/cm ²	Z	axial distance from corner 2 exit, cm
P_{room}	room pressure, N/cm ²	γ	ratio of specific heats, 1.40
P_s	standard-day-corrected static pressure, N/cm ²	θ	circumferential location from top dead center (clockwise looking downstream), deg
$P_{s,\text{in}}$	standard-day-corrected static pressure at corner 1 inlet, N/cm ²		
$P_{s,v}$	standard-day-corrected vane surface static pressure, N/cm ²		
$P_{s,X}$	standard-day-corrected wall static pressure at X location, N/cm ²		

Appendix B

Equations

Airflow

$$W = 0.04044 \frac{P_n \pi}{T_n} d_n^2 \quad (\text{B1})$$

Overall Inlet Total Pressure

$$P_{t,\text{in}} = \frac{\sum_{i=1}^{64} \Delta A_{\text{in}} P_{t,i}}{A_{\text{in}}} \quad (\text{B2})$$

Overall Exit Total Pressure

$$P_{t,\text{ex}} = \frac{\sum_{i=1}^{64} \Delta A_{\text{ex}} P_{t,i}}{A_{\text{ex}}} \quad (\text{B3})$$

Loss Coefficient

$$\frac{P_{t,\text{in}} - P_{t,\text{ex}}}{q_{\text{in}}} = \frac{\Delta P_t}{q_{\text{in}}} \quad (\text{B4})$$

Wall Static Pressure Coefficient

$$\frac{P_{t,in} - P_{s,X}}{q_{in}} = C_{p,w} \quad (B5)$$

Vane Surface Static Pressure Coefficient

$$\frac{P_{s,v} - P_{s,in}}{q_{in}} = C_{p,v} \quad (B6)$$

Mach Number

$$\frac{M}{(1 + 0.2M^2)^{0.5}} = \frac{W}{(A - A_s)P_t} \sqrt{\frac{RT_t}{\gamma}} \quad (B7)$$

Velocity Head

$$q_{in} = 0.7P_{s,in}M_{in}^2 \quad (B8)$$

Average Inlet Static Pressure

$$P_{s,in} = P_{t,in} \left(1 + \frac{M_{in}^2}{5}\right)^{-3.5} \quad (B9)$$

References

1. Chamberlin, R.: The Altitude Wind Tunnel (AWT)—A Unique Facility for Propulsion System and Adverse Weather Testing. AIAA Paper 85-0314, Jan. 1985.
2. Blaha, B.; and Shaw, R.J.: The NASA Altitude Wind Tunnel: Its Role in Advanced Icing Research and Development. AIAA Paper 85-0090, Jan. 1985.
3. Abbott, J.M., et al.: Analytical and Physical Modeling Program for the NASA Lewis Research Center's Altitude Wind Tunnel (AWT). AIAA Paper 85-0379, Jan. 1985.
4. Moore, R.D.; Boldman, D.R.; and Shyne, R.J.: Experimental Evaluation of Two Turning Vane Designs for High-Speed Corner of 0.1-Scale Model of NASA Lewis Research Center's Proposed Altitude Wind Tunnel. NASA TP-2570, 1986.
5. Gelder, T.F., et al.: Wind Tunnel Turning Vanes of Modern Design. AIAA Paper 86-0044, Jan. 1986.
6. Boldman, D.R.; Moore, R.D.; and Shyne, R.J.: Experimental Evaluation of Two Turning Vane Designs for Fan Drive Corner of 0.1-Scale Model of NASA Lewis Research Center's Proposed Altitude Wind Tunnel. NASA TP-2646, 1987.
7. Sanz, J. M.: Improved Design of Subcritical and Supercritical Cascades Using Complex Characteristics and Boundary Layer Correction. NASA CR-168166, 1983.
8. McFarland, E.R.: A Rapid Blade-to-Blade Solution for Use in Turbomachinery Design. J. Eng. Gas Turbines Power, vol. 106, no. 2, Apr. 1984, pp. 376-382.
9. Shapiro, A. H.: The Dynamics and Thermodynamics of Compressible Fluid Flow. Vol. 1, Ronald Press Co., 1953, p. 85.
10. Ciepluch, C.C., et al.: Progress in the Lewis Research Center Altitude Wind Tunnel (AWT) Modeling Program. AIAA Paper 86-0757, Mar. 1986.
11. Moore, R.D., et al.: Detailed Flow Surveys of Turning Vanes Designed for a 0.1-Scale Model of NASA Lewis Research Center's Proposed Altitude Wind Tunnel. NASA TP-2680, 1987.

TABLE 1.—OVERALL PERFORMANCE BASED ON RAKE MEASUREMENTS IN CORNERS 1 AND 2 WITH VANES B IN CORNER 2—UNIFORM INFLOW

Parameter	Reading						
	313-316	301-304	297-300	293-296	317-320	309-312	305-308
Airflow, kg/sec	81.19	78.49	75.31	73.04	68.45	56.21	35.38
Mach number:							
Corner 1 inlet	0.447	0.430	0.410	0.396	0.368	0.296	0.182
Diffuser exit	0.285	0.275	0.263	0.255	0.238	0.194	0.121
VIGV:							
Inlet	0.331	0.323	0.307	0.300	0.275	0.218	0.133
Exit	0.355	0.347	0.329	0.322	0.294	0.233	0.142
Total pressure, N/cm ² :							
Corner 1 inlet	10.411	10.398	10.369	10.357	10.322	10.250	10.178
Diffuser exit	10.199	10.195	10.189	10.188	10.180	10.161	10.144
VIGV:							
Inlet	10.131	10.131	10.131	10.131	10.131	10.131	10.131
Exit	10.131	10.128	10.130	10.127	10.131	10.129	10.131
Total pressure loss, N/cm ² :							
Corner 1 with diffuser	0.212	0.203	0.180	0.169	0.142	0.088	0.033
Corner 2	0.067	0.064	0.058	0.056	0.048	0.030	0.013
VIGV	0.001	0.003	0.002	0.004	0.001	0.002	0
Total pressure loss coefficient:							
Corner 1 with diffuser	0.167	0.171	0.165	0.166	0.159	0.149	0.145
Corner 2	0.123	0.124	0.123	0.127	0.125	0.115	0.122
VIGV	0.001	0.004	0.002	0.006	0.001	0.005	0.002
Room pressure, N/cm ²	10.566	10.545	10.503	10.490	10.421	10.317	10.207

TABLE 8.—OVERALL PERFORMANCE BASED ON RAKE MEASUREMENTS IN CORNERS 1 AND 2 WITH VANES A4 IN CORNER 2—UNIFORM INFLOW

Parameter	Reading								
	38-41	22-25	18-21	4-16	5-15	6-17	34-37	30-33	26-29
Airflow, kg/sec	81.16	78.37	75.21	73.10	73.03	72.77	68.61	56.23	35.35
Mach number:									
Corner 1 inlet	0.447	0.430	0.410	0.397	0.396	0.395	0.369	0.296	0.182
Diffuser exit	0.285	0.275	0.263	0.256	0.255	0.254	0.239	0.194	0.121
vigv:									
Inlet	0.331	0.324	0.306	0.300	0.299	0.300	0.276	0.219	0.133
Exit	0.354	0.346	0.326	0.320	0.333	0.320	0.293	0.233	0.142
Total pressure, N/cm ² :									
Corner 1 inlet	10.406	10.394	10.364	10.355	10.352	10.354	10.319	10.250	10.178
Diffuser exit	10.195	10.193	10.186	10.183	10.183	10.183	10.176	10.161	10.144
vigv:									
Inlet	10.131	10.131	10.131	10.131	10.131	10.131	10.131	10.131	10.131
Exit	10.127	10.125	10.124	10.127	10.135	10.120	10.129	10.130	10.130
Total pressure loss, N/cm ² :									
Corner 1 with diffuser	0.210	0.201	0.179	0.172	0.168	0.170	0.143	0.089	0.034
Corner 2	0.064	0.061	0.054	0.052	0.052	0.052	0.045	0.029	0.012
vigv	0.005	0.007	0.008	0.004	-0.004	0.011	0.003	0.002	0.002
Total pressure loss coefficient:									
Corner 1 with diffuser	0.166	0.170	0.165	0.168	0.165	0.168	0.160	0.150	0.147
Corner 2	0.116	0.120	0.115	0.116	0.117	0.118	0.115	0.112	0.117
vigv	0.006	0.009	0.011	0.007	-0.005	0.017	0.005	0.004	0.012
Room pressure, N/cm ²	10.559	10.545	10.503	10.490	10.483	10.490	10.428	10.317	10.200

TABLE 15.—OVERALL PERFORMANCE BASED ON RAKE MEASUREMENTS IN CORNERS 1 AND 2 WITH VANES B IN CORNER 2—DISTORTED INFLOW

Parameter	12.70-cm tip radial distortion			6.35-cm tip radial distortion			~ 50° Sector circumferential distortion		
	Reading								
	519-522	515-518	511-514	523-526	527-530	532-536	545-548	541-544	537-540
Airflow, kg/sec	80.11	72.28	35.30	77.07	71.36	35.26	78.72	73.27	35.41
Mach number:									
Corner 1 inlet	0.441	0.388	0.182	0.423	0.387	0.182	0.431	0.397	0.183
Diffuser exit	0.283	0.254	0.121	0.272	0.250	0.121	0.276	0.256	0.121
vIGV:									
Inlet	0.331	0.300	0.132	0.324	0.301	0.132	0.321	0.298	0.130
Exit	0.363	0.330	0.143	0.353	0.326	0.142	0.346	0.328	0.140
Total pressure, N/cm ² :									
Corner 1 inlet	10.386	10.339	10.171	10.376	10.337	10.170	10.397	10.358	10.174
Diffuser exit	10.182	10.176	10.143	10.193	10.184	10.142	10.203	10.194	10.144
vIGV:									
Inlet	10.131	10.131	10.131	10.131	10.131	10.131	10.131	10.131	10.131
Exit	10.163	10.158	10.136	10.150	10.146	10.133	10.131	10.161	10.132
Total pressure loss, N/cm ² :									
Corner 1 with diffuser	0.203	0.163	0.029	0.182	0.153	0.029	0.194	0.164	0.030
Corner 2	0.051	0.044	0.011	0.062	0.052	0.010	0.072	0.062	0.012
vIGV	-0.031	-0.027	-0.004	-0.018	-0.015	-0.001	0.001	-0.030	0
Total pressure loss coefficient:									
Corner 1 with diffuser	0.164	0.166	0.125	0.159	0.157	0.126	0.163	0.160	0.131
Corner 2	0.094	0.101	0.108	0.124	0.122	0.098	0.139	0.139	0.120
vIGV	-0.039	-0.041	-0.027	-0.025	-0.023	-0.009	0.001	-0.044	-0.002
Room pressure, N/cm ²	11.566	11.303	10.345	11.145	10.986	10.276	11.028	10.903	10.269

TABLE 22.—OVERALL PERFORMANCE BASED ON RAKE MEASUREMENTS IN CORNERS 1 AND 2 WITH VANES A4 IN CORNER 2—DISTORTED INFLOW

Parameter	12.70-cm tip radial distortion			6.35-cm tip radial distortion			~50° Sector circumferential distortion		
	Reading								
	1232-1235	1224-1227	1228-1231	1236-1239	1241-1244	1246-1249	1254-1257	1258-1261	1250-1253
Airflow, kg/sec	77.64	72.35	33.34	77.56	72.25	35.26	79.22	73.68	35.41
Mach number:									
Corner 1 inlet	0.425	0.393	0.182	0.425	0.393	0.182	0.434	0.400	0.183
Diffuser exit	0.273	0.254	0.121	0.273	0.254	0.121	0.278	0.258	0.121
VIGV:									
Inlet	0.326	0.303	0.132	0.326	0.304	0.133	0.324	0.301	0.132
Exit	0.353	0.329	0.143	0.352	0.328	0.142	0.353	0.322	0.140
Total pressure, N/cm ² :									
Corner 1 inlet	10.401	10.363	10.177	10.407	10.356	10.175	10.402	10.362	10.176
Diffuser exit	10.195	10.203	10.151	10.206	10.180	10.143	10.205	10.196	10.144
VIGV:									
Inlet	10.131	10.131	10.131	10.131	10.131	10.131	10.131	10.131	10.131
Exit	10.149	10.149	10.137	10.151	10.139	10.134	10.149	10.122	10.129
Total pressure loss, N/cm ² :									
Corner 1 with diffuser	0.206	0.160	0.026	0.201	0.175	0.032	0.197	0.166	0.032
Corner 2	0.064	0.072	0.020	0.075	0.049	0.011	0.073	0.064	0.013
vlgv	-0.018	-0.017	-0.005	-0.020	-0.007	-0.002	-0.017	0.010	0.002
Total pressure loss coefficient:									
Corner 1 with diffuser	0.177	0.159	0.113	0.173	0.174	0.138	0.163	0.160	0.137
Corner 2	0.126	0.163	0.192	0.148	0.112	0.111	0.140	0.142	0.124
vlgv	-0.024	-0.026	-0.032	-0.026	-0.011	-0.013	-0.022	0.014	0.012
Room pressure, N/cm ²	11.455	11.269	10.338	11.131	10.979	10.276	11.028	10.903	10.269

1. Report No. NASA TP-2681	2. Government Accession No.	3. Recipient's Catalog No.	
4. Title and Subtitle Experimental Evaluation of Turning Vane Designs for High-Speed and Coupled Fan-Drive Corners of 0.1-Scale Model of NASA Lewis Research Center's Proposed Altitude Wind Tunnel		5. Report Date May 1987	6. Performing Organization Code 505-62-3A
		8. Performing Organization Report No. E-3218	10. Work Unit No.
7. Author(s) Thomas F. Gelder, Royce D. Moore, Rickey J. Shyne, and Donald R. Boldman		11. Contract or Grant No.	
9. Performing Organization Name and Address National Aeronautics and Space Administration Lewis Research Center Cleveland, Ohio 44135		13. Type of Report and Period Covered Technical Paper	
		14. Sponsoring Agency Code	
12. Sponsoring Agency Name and Address National Aeronautics and Space Administration Washington, D.C. 20546		15. Supplementary Notes Data tables are included as a microfiche supplement.	
16. Abstract <p>Two turning vane designs were experimentally evaluated for the fan-drive corner (corner 2) coupled to an upstream diffuser and the high-speed corner (corner 1) of the 0.1-scale model of NASA Lewis Research Center's proposed Altitude Wind Tunnel. For corner 2 both a controlled-diffusion vane design (vane A4) and a circular-arc vane design (vane B) were studied. The corner 2 total pressure loss coefficient was about 0.12 with either vane design. This was about 25 percent less loss than when corner 2 was tested alone. Although the vane A4 design has the advantage of 20 percent fewer vanes than the vane B design, its vane shape is more complex. The effects of simulated inlet flow distortion on the overall losses for corner 1 or 2 were small.</p>			
17. Key Words (Suggested by Author(s)) Wind tunnel turning vanes Cascades Guide vanes Corner flows		18. Distribution Statement Unclassified—unlimited STAR Category 09	
19. Security Classif. (of this report) Unclassified	20. Security Classif. (of this page) Unclassified	21. No of pages 53	22. Price* A04

*For sale by the National Technical Information Service, Springfield, Virginia 22161

NASA-Langley, 1987

TABLE 2 —TOTAL PRESSURE DISTRIBUTION FOR CORNER 1 WITH VANES A10
IN CORNER 1 AND VANES B IN CORNER 2—UNIFORM INFLOW

(a) Airflow, 81.19 kg/sec; readings 313 to 316

Span- wise location, percent of span	Circumferential location, θ , deg								Average
	0	45	90	135	180	225	270	315	
Corner 1 inlet rake									
5.0	10.345	10.389	10.399	10.414	10.405	10.380	10.406	10.370	10.389
10.0	10.413	10.420	10.419	10.423	10.416	10.419	10.425	10.415	10.419
15.0	10.414	10.419	10.415	10.421	10.416	10.418	10.423	10.415	10.418
20.0	10.412	10.415	10.415	10.415	10.399	10.416	10.417	10.415	10.413
30.0	10.409	10.421	10.415	10.412	10.410	10.414	10.414	10.412	10.413
50.0	10.413	10.422	10.424	10.422	10.398	10.415	10.416	10.412	10.415
70.0	10.413	10.415	10.414	10.410	10.403	10.419	10.418	10.412	10.413
90.0	10.407	10.413	10.416	10.417	10.411	10.416	10.415	10.417	10.414
Corner 1 inlet boundary layer rake									
1.0	10.072	10.094	10.070	10.117	10.125	10.078	10.131	10.099	10.098
2.0	10.165	10.193	10.185	10.250	10.245	10.191	10.239	10.196	10.209
3.0	10.229	10.270	10.276	10.349	10.329	10.278	10.305	10.262	10.287
4.0	10.306	10.344	10.356	10.407	10.389	10.349	10.376	10.337	10.358
5.0	10.361	10.389	10.397	10.423	10.412	10.388	10.407	10.385	10.395
7.5	10.416	10.418	10.412	10.425	10.417	10.412	10.416	10.422	10.417
10.0	10.417	10.421	10.416	10.426	10.417	10.418	10.424	10.416	10.419
12.5	10.417	10.419	10.414	10.423	10.407	10.418	10.424	10.419	10.418
Diffuser exit rake									
5.0	10.035	10.134	9.767	10.146	10.080	10.049	10.095	10.068	10.047
10.0	10.125	10.170	9.772	10.181	10.156	10.029	10.152	10.052	10.080
15.0	10.148	10.208	9.794	10.202	10.162	10.073	10.178	10.101	10.108
20.0	10.219	10.288	9.883	10.314	10.218	10.157	10.188	10.182	10.182
30.0	10.328	10.409	10.223	10.411	10.312	10.358	10.216	10.356	10.327
50.0	10.324	10.270	9.998	10.326	10.306	10.348	10.230	10.377	10.272
70.0	10.292	10.128	10.061	10.275	10.286	10.357	10.137	10.366	10.238
90.0	10.179	10.163	10.092	10.160	10.175	10.113	10.059	10.102	10.130
Diffuser exit boundary layer rake									
1.0	9.911	9.986	9.732	9.992	9.962	9.981	9.985	10.024	9.947
2.0	9.948	10.040	9.745	10.045	10.007	10.039	10.027	10.061	9.989
3.0	9.980	10.086	9.754	10.092	10.038	10.057	10.056	10.075	10.017
4.0	10.013	10.122	9.762	10.125	10.063	10.062	10.076	10.078	10.038
5.0	10.035	10.139	9.767	10.149	10.083	10.060	10.095	10.075	10.050
7.5	10.093	10.157	9.771	10.172	10.126	10.041	10.126	10.057	10.068
10.0	10.126	10.173	9.770	10.179	10.153	10.038	10.149	10.052	10.080
12.5	10.139	10.191	9.779	10.182	10.158	10.051	10.164	10.070	10.092

TABLE 2.—Continued.

(b) Airflow, 78.49 kg/sec; readings 301 to 304

Span-wise location, percent of span	Circumferential location, θ , deg								Average
	0	45	90	135	180	225	270	315	
Corner 1 inlet rake									
5.0	10.351	10.381	10.379	10.405	10.403	10.364	10.391	10.359	10.379
10.0	10.405	10.405	10.404	10.408	10.410	10.404	10.412	10.402	10.406
15.0	10.407	10.405	10.402	10.403	10.413	10.404	10.412	10.403	10.406
20.0	10.404	10.400	10.402	10.399	10.398	10.400	10.404	10.401	10.401
30.0	10.400	10.405	10.399	10.397	10.405	10.398	10.399	10.398	10.400
50.0	10.405	10.402	10.400	10.398	10.401	10.398	10.402	10.397	10.400
70.0	10.402	10.401	10.398	10.393	10.396	10.401	10.401	10.398	10.399
90.0	10.399	10.397	10.402	10.396	10.399	10.400	10.402	10.400	10.399
Corner 1 inlet boundary layer rake									
1.0	10.045	10.091	10.072	10.111	10.126	10.081	10.119	10.096	10.093
2.0	10.134	10.192	10.184	10.236	10.236	10.190	10.225	10.191	10.199
3.0	10.200	10.262	10.273	10.323	10.318	10.275	10.294	10.258	10.275
4.0	10.281	10.337	10.351	10.378	10.379	10.345	10.368	10.331	10.346
5.0	10.338	10.377	10.390	10.396	10.401	10.380	10.401	10.378	10.382
7.5	10.400	10.402	10.403	10.404	10.403	10.398	10.409	10.410	10.404
10.0	10.402	10.405	10.406	10.409	10.402	10.400	10.416	10.401	10.405
12.5	10.402	10.402	10.405	10.406	10.394	10.399	10.415	10.405	10.404
Diffuser exit rake									
5.0	10.035	10.134	9.778	10.144	10.083	10.050	10.090	10.069	10.048
10.0	10.121	10.172	9.783	10.174	10.152	10.031	10.144	10.052	10.079
15.0	10.145	10.212	9.813	10.195	10.157	10.070	10.169	10.098	10.107
20.0	10.212	10.289	9.908	10.301	10.211	10.149	10.179	10.176	10.178
30.0	10.319	10.401	10.227	10.397	10.298	10.347	10.205	10.343	10.317
50.0	10.308	10.276	10.003	10.314	10.305	10.342	10.221	10.367	10.267
70.0	10.288	10.141	10.069	10.266	10.271	10.356	10.135	10.359	10.236
90.0	10.173	10.173	10.097	10.150	10.166	10.115	10.060	10.100	10.129
Diffuser exit boundary layer rake									
1.0	9.918	9.992	9.748	9.995	9.964	9.989	9.986	10.029	9.953
2.0	9.952	10.043	9.761	10.035	10.005	10.042	10.027	10.064	9.991
3.0	9.980	10.026	9.769	10.090	10.036	10.061	10.052	10.077	10.019
4.0	10.011	10.123	9.778	10.125	10.060	10.065	10.072	10.071	10.038
5.0	10.031	10.137	9.779	10.150	10.081	10.062	10.089	10.078	10.051
7.5	10.090	10.156	9.784	10.174	10.125	10.047	10.119	10.063	10.070
10.0	10.122	10.171	9.782	10.180	10.155	10.045	10.141	10.061	10.082
12.5	10.134	10.187	9.791	10.181	10.159	10.058	10.156	10.077	10.093

TABLE 2.—Continued.

(c) Airflow, 75.31 kg/sec; readings 297 to 300

Span-wise location, percent of span	Circumferential location, θ , deg								Average
	0	45	90	135	180	225	270	315	
Corner 1 inlet rake									
5.0	10.335	10.355	10.358	10.373	10.369	10.342	10.364	10.339	10.354
10.0	10.375	10.376	10.374	10.378	10.379	10.374	10.381	10.375	10.376
15.0	10.375	10.377	10.372	10.377	10.381	10.375	10.380	10.376	10.376
20.0	10.373	10.370	10.373	10.372	10.369	10.372	10.374	10.374	10.372
30.0	10.370	10.377	10.370	10.370	10.371	10.371	10.370	10.371	10.371
50.0	10.374	10.376	10.359	10.373	10.352	10.370	10.374	10.371	10.369
70.0	10.373	10.373	10.370	10.367	10.359	10.372	10.372	10.372	10.370
90.0	10.368	10.369	10.372	10.371	10.370	10.372	10.371	10.375	10.371
Corner 1 inlet boundary layer rake									
1.0	10.054	10.090	10.093	10.121	10.118	10.077	10.110	10.087	10.094
2.0	10.133	10.179	10.185	10.236	10.221	10.175	10.206	10.179	10.189
3.0	10.192	10.240	10.257	10.316	10.297	10.252	10.270	10.240	10.258
4.0	10.265	10.309	10.319	10.365	10.354	10.313	10.340	10.307	10.322
5.0	10.317	10.347	10.355	10.368	10.375	10.348	10.371	10.351	10.354
7.5	10.373	10.375	10.371	10.381	10.377	10.371	10.380	10.382	10.376
10.0	10.373	10.377	10.376	10.382	10.377	10.374	10.386	10.374	10.377
12.5	10.374	10.376	10.375	10.380	10.373	10.375	10.384	10.377	10.377
Diffuser exit rake									
5.0	10.048	10.129	9.818	10.142	10.082	10.063	10.096	10.076	10.057
10.0	10.127	10.166	9.819	10.168	10.153	10.046	10.145	10.059	10.085
15.0	10.146	10.191	9.846	10.184	10.157	10.081	10.163	10.096	10.108
20.0	10.205	10.267	9.935	10.283	10.205	10.153	10.169	10.169	10.173
30.0	10.305	10.371	10.222	10.368	10.284	10.326	10.190	10.307	10.297
50.0	10.294	10.268	10.018	10.305	10.294	10.327	10.204	10.343	10.257
70.0	10.277	10.145	10.081	10.256	10.262	10.329	10.131	10.336	10.227
90.0	10.173	10.163	10.105	10.145	10.163	10.119	10.070	10.106	10.130
Diffuser exit boundary layer rake									
1.0	9.939	9.999	9.784	10.005	9.979	9.996	9.998	10.039	9.967
2.0	9.972	10.048	9.795	10.054	10.015	10.046	10.034	10.069	10.004
3.0	9.998	10.084	9.803	10.095	10.045	10.061	10.058	10.083	10.028
4.0	10.026	10.118	9.810	10.126	10.067	10.066	10.078	10.085	10.047
5.0	10.044	10.131	9.813	10.148	10.089	10.063	10.094	10.081	10.058
7.5	10.097	10.150	9.818	10.168	10.128	10.049	10.125	10.067	10.075
10.0	10.126	10.163	9.818	10.171	10.154	10.046	10.144	10.064	10.086
12.5	10.137	10.179	9.825	10.174	10.159	10.056	10.157	10.080	10.096

TABLE 2.—Continued.

(d) Airflow, 73.04 kg/sec; readings 293 to 296

Span- wise location percent of span	Circumferential location, θ , deg								Average
	0	45	90	135	180	225	270	315	
Corner 1 inlet rake									
5.0	10.322	10.350	10.344	10.359	10.354	10.333	10.352	10.318	10.341
10.0	10.366	10.364	10.364	10.363	10.369	10.361	10.370	10.358	10.364
15.0	10.367	10.364	10.361	10.363	10.368	10.361	10.371	10.359	10.364
20.0	10.365	10.359	10.362	10.357	10.353	10.359	10.364	10.359	10.360
30.0	10.360	10.365	10.359	10.357	10.356	10.359	10.360	10.355	10.359
50.0	10.351	10.364	10.359	10.360	10.349	10.360	10.363	10.355	10.358
70.0	10.363	10.359	10.359	10.352	10.349	10.361	10.361	10.359	10.358
90.0	10.359	10.357	10.361	10.358	10.359	10.360	10.364	10.360	10.360
Corner 1 inlet boundary layer rake									
1.0	10.066	10.084	10.083	10.121	10.117	10.085	10.117	10.091	10.095
2.0	10.144	10.170	10.177	10.232	10.211	10.176	10.209	10.174	10.187
3.0	10.199	10.229	10.251	10.310	10.284	10.248	10.267	10.232	10.253
4.0	10.268	10.294	10.317	10.356	10.338	10.306	10.330	10.296	10.313
5.0	10.316	10.334	10.351	10.367	10.361	10.336	10.359	10.336	10.345
7.5	10.363	10.360	10.364	10.368	10.367	10.352	10.369	10.366	10.363
10.0	10.364	10.361	10.367	10.369	10.364	10.358	10.376	10.360	10.365
12.5	10.362	10.360	10.366	10.366	10.359	10.357	10.375	10.364	10.364
Diffuser exit rake									
5.0	10.043	10.131	9.828	10.142	10.077	10.068	10.103	10.082	10.059
10.0	10.122	10.164	9.831	10.169	10.150	10.053	10.149	10.065	10.088
15.0	10.142	10.187	9.857	10.185	10.153	10.084	10.165	10.101	10.109
20.0	10.192	10.264	9.942	10.275	10.199	10.153	10.167	10.174	10.171
30.0	10.304	10.362	10.214	10.358	10.292	10.320	10.175	10.312	10.292
50.0	10.292	10.266	10.025	10.304	10.286	10.321	10.199	10.331	10.253
70.0	10.273	10.146	10.081	10.254	10.248	10.318	10.135	10.330	10.223
90.0	10.169	10.164	10.107	10.148	10.156	10.121	10.072	10.103	10.130
Diffuser exit boundary layer rake									
1.0	9.942	10.004	9.797	10.011	9.983	10.002	10.007	10.044	9.974
2.0	9.975	10.049	9.808	10.058	10.018	10.049	10.044	10.074	10.009
3.0	10.000	10.085	9.815	10.095	10.044	10.065	10.069	10.086	10.032
4.0	10.029	10.118	9.822	10.123	10.066	10.068	10.088	10.090	10.050
5.0	10.049	10.131	9.825	10.146	10.086	10.066	10.106	10.085	10.062
7.5	10.101	10.150	9.827	10.168	10.127	10.052	10.133	10.072	10.079
10.0	10.127	10.163	9.828	10.172	10.152	10.050	10.152	10.069	10.089
12.5	10.137	10.175	9.835	10.174	10.157	10.060	10.160	10.085	10.098

TABLE 2.—Continued.

(e) Airflow, 68.45 kg/sec; readings 317 to 320

Span-wise location, percent of span	Circumferential location, θ , deg								Average
	0	45	90	135	180	225	270	315	
Corner 1 inlet rake									
5.0	10.286	10.304	10.312	10.329	10.319	10.298	10.316	10.298	10.308
10.0	10.322	10.327	10.326	10.333	10.325	10.315	10.332	10.329	10.326
15.0	10.323	10.326	10.324	10.331	10.323	10.317	10.330	10.330	10.326
20.0	10.321	10.323	10.323	10.328	10.316	10.322	10.325	10.329	10.323
30.0	10.318	10.326	10.322	10.325	10.323	10.324	10.320	10.326	10.323
50.0	10.321	10.325	10.327	10.332	10.322	10.326	10.323	10.326	10.325
70.0	10.319	10.322	10.322	10.324	10.322	10.326	10.323	10.325	10.323
90.0	10.319	10.321	10.324	10.331	10.314	10.323	10.323	10.329	10.323
Corner 1 inlet boundary layer rake									
1.0	10.066	10.096	10.093	10.105	10.129	10.095	10.106	10.103	10.099
2.0	10.133	10.170	10.165	10.197	10.212	10.174	10.183	10.168	10.175
3.0	10.180	10.223	10.222	10.263	10.274	10.234	10.236	10.214	10.231
4.0	10.238	10.278	10.275	10.304	10.315	10.284	10.293	10.267	10.282
5.0	10.279	10.309	10.305	10.317	10.328	10.308	10.319	10.301	10.308
7.5	10.324	10.328	10.321	10.324	10.330	10.324	10.326	10.327	10.326
10.0	10.324	10.332	10.324	10.328	10.330	10.324	10.331	10.322	10.327
12.5	10.324	10.332	10.324	10.327	10.323	10.329	10.330	10.326	10.327
Diffuser exit rake									
5.0	10.065	10.124	9.872	10.138	10.098	10.076	10.113	10.088	10.072
10.0	10.132	10.153	9.874	10.162	10.154	10.062	10.151	10.077	10.096
15.0	10.146	10.179	9.898	10.175	10.156	10.093	10.160	10.109	10.115
20.0	10.195	10.231	9.969	10.255	10.190	10.149	10.160	10.166	10.164
30.0	10.274	10.320	10.200	10.322	10.261	10.281	10.166	10.279	10.263
50.0	10.272	10.249	10.052	10.292	10.264	10.285	10.178	10.302	10.237
70.0	10.258	10.155	10.092	10.253	10.248	10.293	10.155	10.296	10.216
90.0	10.170	10.158	10.113	10.146	10.151	10.124	10.085	10.111	10.132
Diffuser exit boundary layer rake									
1.0	9.971	10.019	9.853	10.026	10.008	10.026	10.028	10.050	9.997
2.0	9.997	10.058	9.862	10.065	10.041	10.068	10.058	10.076	10.028
3.0	10.019	10.090	9.868	10.098	10.063	10.081	10.079	10.087	10.048
4.0	10.044	10.118	9.875	10.124	10.081	10.083	10.097	10.090	10.064
5.0	10.060	10.129	9.876	10.141	10.096	10.079	10.111	10.088	10.072
7.5	10.106	10.145	9.878	10.160	10.128	10.065	10.137	10.076	10.087
10.0	10.129	10.156	9.879	10.160	10.151	10.062	10.152	10.061	10.094
12.5	10.137	10.165	9.883	10.160	10.155	10.071	10.161	10.083	10.102

TABLE 2.—Continued.

(f) Airflow, 56.21 kg/sec; readings 309 to 312

Span-wise location, percent of span	Circumferential location, θ , deg								Average
	0	45	90	135	180	225	270	315	
Corner 1 inlet rake									
5.0	10.229	10.240	10.245	10.254	10.243	10.230	10.246	10.232	10.240
10.0	10.254	10.253	10.257	10.256	10.248	10.250	10.259	10.254	10.254
15.0	10.254	10.254	10.256	10.256	10.248	10.251	10.259	10.254	10.254
20.0	10.251	10.252	10.243	10.252	10.242	10.251	10.256	10.253	10.250
30.0	10.251	10.253	10.254	10.252	10.245	10.252	10.252	10.250	10.251
50.0	10.252	10.252	10.255	10.252	10.242	10.250	10.255	10.249	10.251
70.0	10.251	10.252	10.253	10.249	10.250	10.252	10.255	10.253	10.252
90.0	10.248	10.250	10.254	10.252	10.249	10.250	10.254	10.253	10.251
Corner 1 inlet boundary layer rake									
1.0	10.085	10.102	10.106	10.109	10.122	10.097	10.119	10.096	10.104
2.0	10.127	10.151	10.152	10.169	10.176	10.148	10.167	10.143	10.154
3.0	10.158	10.184	10.187	10.217	10.215	10.187	10.198	10.176	10.190
4.0	10.196	10.219	10.218	10.246	10.242	10.219	10.232	10.212	10.223
5.0	10.224	10.239	10.238	10.255	10.252	10.237	10.249	10.236	10.241
7.5	10.254	10.252	10.250	10.256	10.255	10.249	10.258	10.256	10.254
10.0	10.255	10.255	10.256	10.256	10.255	10.252	10.259	10.252	10.255
12.5	10.257	10.254	10.254	10.255	10.251	10.253	10.258	10.253	10.254
Diffuser exit rake									
5.0	10.085	10.121	9.965	10.137	10.105	10.096	10.115	10.107	10.091
10.0	10.129	10.143	9.967	10.155	10.143	10.087	10.140	10.099	10.108
15.0	10.138	10.150	9.981	10.166	10.146	10.105	10.146	10.120	10.119
20.0	10.166	10.193	10.030	10.215	10.164	10.143	10.146	10.155	10.151
30.0	10.221	10.253	10.178	10.252	10.207	10.226	10.149	10.226	10.214
50.0	10.221	10.210	10.081	10.242	10.207	10.231	10.150	10.242	10.198
70.0	10.213	10.155	10.111	10.210	10.202	10.221	10.132	10.239	10.185
90.0	10.151	10.153	10.125	10.145	10.144	10.130	10.104	10.123	10.135
Diffuser exit boundary layer rake									
1.0	10.026	10.054	9.951	10.063	10.046	10.063	10.063	10.080	10.043
2.0	10.043	10.078	9.957	10.086	10.067	10.090	10.083	10.098	10.063
3.0	10.056	10.097	9.962	10.108	10.084	10.099	10.096	10.104	10.076
4.0	10.072	10.116	9.965	10.125	10.097	10.101	10.108	10.106	10.086
5.0	10.080	10.125	9.966	10.138	10.108	10.100	10.117	10.105	10.092
7.5	10.110	10.142	9.967	10.152	10.130	10.093	10.132	10.097	10.103
10.0	10.127	10.147	9.969	10.153	10.145	10.092	10.141	10.096	10.109
12.5	10.135	10.155	9.974	10.153	10.147	10.098	10.146	10.104	10.114

TABLE 2.—Concluded.

(g) Airflow, 35.38 kg/sec; readings 305 to 308

Span-wise location, percent of span	Circumferential location, θ , deg								Average
	0	45	90	135	180	225	270	315	
Corner 1 inlet rake									
5.0	10.172	10.173	10.173	10.180	10.174	10.168	10.174	10.173	10.173
10.0	10.179	10.178	10.179	10.181	10.177	10.177	10.182	10.181	10.179
15.0	10.178	10.179	10.179	10.180	10.176	10.179	10.182	10.180	10.179
20.0	10.177	10.179	10.179	10.179	10.172	10.178	10.180	10.179	10.178
30.0	10.178	10.179	10.179	10.178	10.174	10.178	10.179	10.178	10.178
50.0	10.178	10.177	10.178	10.180	10.175	10.175	10.180	10.179	10.178
70.0	10.177	10.177	10.179	10.178	10.177	10.179	10.179	10.179	10.178
90.0	10.176	10.177	10.180	10.180	10.177	10.177	10.180	10.179	10.178
Corner 1 inlet boundary layer rake									
1.0	10.117	10.121	10.108	10.123	10.123	10.119	10.122	10.119	10.119
2.0	10.134	10.140	10.138	10.146	10.144	10.138	10.140	10.137	10.140
3.0	10.146	10.152	10.152	10.163	10.160	10.153	10.153	10.148	10.153
4.0	10.162	10.166	10.164	10.174	10.173	10.165	10.168	10.164	10.167
5.0	10.171	10.174	10.172	10.177	10.178	10.174	10.176	10.173	10.174
7.5	10.180	10.179	10.179	10.179	10.180	10.178	10.180	10.179	10.179
10.0	10.183	10.182	10.180	10.180	10.179	10.180	10.180	10.178	10.180
12.5	10.181	10.179	10.180	10.179	10.178	10.179	10.181	10.179	10.179
Diffuser exit rake									
5.0	10.117	10.124	10.069	10.133	10.122	10.117	10.123	10.122	10.116
10.0	10.133	10.135	10.071	10.141	10.140	10.115	10.131	10.120	10.123
15.0	10.137	10.142	10.079	10.146	10.139	10.123	10.136	10.128	10.129
20.0	10.147	10.156	10.098	10.164	10.145	10.137	10.136	10.142	10.141
30.0	10.169	10.177	10.153	10.179	10.165	10.165	10.139	10.166	10.164
50.0	10.168	10.164	10.113	10.175	10.163	10.170	10.134	10.173	10.158
70.0	10.166	10.145	10.126	10.163	10.164	10.170	10.131	10.173	10.155
90.0	10.141	10.140	10.131	10.138	10.138	10.131	10.122	10.130	10.134
Diffuser exit boundary layer rake									
1.0	10.092	10.098	10.064	10.103	10.098	10.104	10.103	10.109	10.096
2.0	10.099	10.108	10.068	10.111	10.106	10.115	10.111	10.116	10.104
3.0	10.104	10.115	10.069	10.120	10.112	10.119	10.117	10.120	10.109
4.0	10.110	10.123	10.070	10.127	10.117	10.120	10.120	10.119	10.113
5.0	10.102	10.127	10.072	10.133	10.122	10.121	10.125	10.120	10.115
7.5	10.124	10.134	10.072	10.138	10.129	10.117	10.131	10.117	10.120
10.0	10.130	10.136	10.073	10.139	10.137	10.116	10.134	10.117	10.123
12.5	10.134	10.139	10.076	10.140	10.138	10.119	10.136	10.121	10.125

TABLE 3.—TOTAL PRESSURE DISTRIBUTION FOR VARIABLE INLET GUIDE VANES WITH VANES A10
IN CORNER 1 AND VANES B IN CORNER 2—UNIFORM INFLOW

(a) Airflow, 81.19 kg/sec; readings 313 to 316

Circum-ferential location, θ , deg	Spanwise location, percent of span from tip							
	5	10	15	20	30	50	70	90
VIGV inlet rake								
0		9.935			10.196	10.276	10.262	10.184
30		10.057			10.287	10.240	10.235	10.164
60		9.886			10.176	10.301	10.114	9.980
90		9.697			9.854	10.107	9.895	9.819
120		9.972			10.216	10.289	10.182	10.010
150		10.000			10.277	10.272	10.294	10.227
180		9.987			10.200	10.213	10.266	10.181
210		9.873			10.182	10.258	10.259	10.142
240		10.127			10.278	10.262	10.247	10.091
270		10.049			10.145	10.126	10.091	9.972
300		10.153			10.271	10.277	10.265	10.092
330		9.904			10.187	10.278	10.303	10.195
AVG		9.970			10.189	10.247	10.201	10.088
VIGV exit rake								
15	9.998	10.139	10.143	10.234	10.316	10.271	10.252	10.177
45	9.975	10.100	10.059	10.128	10.208	10.256	10.146	10.072
75	9.824	9.961	9.934	9.969	10.004	10.154	10.016	9.973
105	9.836	9.880	9.917	9.953	9.988	10.159	10.055	9.973
135	9.968	9.968	10.008	10.080	10.193	10.336	10.228	10.205
165	9.923	10.009	10.083	10.145	10.240	10.268	10.306	10.182
195	9.873	9.945	10.025	10.102	10.214	10.257	10.251	10.132
225	10.005	10.012	10.028	10.063	10.146	10.258	10.275	10.075
255	10.036	10.064	10.088	10.116	10.185	10.225	10.178	10.073
285	10.060	10.072	10.069	10.069	10.098	10.192	10.230	10.073
315	9.990	10.000	10.020	10.060	10.138	10.253	10.282	10.135
345	9.879	9.957	10.034	10.098	10.218	10.289	10.277	10.139
AVG	9.947	10.009	10.034	10.085	10.162	10.243	10.208	10.101

TABLE 3.—Continued.

(b) Airflow, 78.49 kg/sec; readings 301 to 304

Circumferential location, θ , deg	Spanwise location, percent of span from tip							
	5	10	15	20	30	50	70	90
VIGV inlet rake								
0		9.943			10.191	10.268	10.254	10.184
30		10.059			10.282	10.239	10.232	10.165
60		9.895			10.176	10.292	10.113	10.006
90		9.714			9.866	10.109	9.899	9.831
120		9.976			10.211	10.283	10.181	10.037
150		10.003			10.270	10.268	10.286	10.218
180		9.992			10.202	10.265	10.260	10.196
210		9.885			10.181	10.251	10.253	10.139
240		10.123			10.271	10.255	10.241	10.094
270		10.051			10.143	10.123	10.092	9.978
300		10.150			10.262	10.270	10.259	10.094
330		9.914			10.183	10.272	10.297	10.195
AVG		9.975			10.186	10.241	10.197	10.095
VIGV exit rake								
15	9.976	10.104	10.059	10.127	10.199	10.245	10.146	10.078
45	9.835	9.964	9.940	9.973	10.005	10.151	10.026	9.977
75	9.837	9.967	9.945	9.977	10.005	10.172	10.040	9.976
105	9.939	10.021	10.088	10.148	10.242	10.273	10.298	10.165
135	9.928	10.012	10.081	10.143	10.229	10.263	10.302	10.186
165	9.969	9.971	10.013	10.085	10.190	10.326	10.222	10.202
195	10.008	10.016	10.027	10.058	10.136	10.248	10.264	10.074
225	10.034	10.062	10.086	10.112	10.177	10.216	10.171	10.075
255	10.042	10.071	10.091	10.112	10.169	10.212	10.174	10.073
285	9.994	10.002	10.024	10.060	10.133	10.242	10.273	10.134
315	9.887	9.963	10.038	10.097	10.211	10.284	10.271	10.137
345	9.878	9.948	10.022	10.081	10.197	10.282	10.266	10.121
AVG	9.944	10.009	10.034	10.081	10.158	10.243	10.204	10.100

TABLE 3.—Continued.

(c) Airflow, 75.31 kg/sec; readings 297 to 300

Circumferential location, θ , deg	Spanwise location, percent of span from tip							
	5	10	15	20	30	50	70	90
VIGV inlet rake								
0		9.958			10.181	10.249	10.239	10.178
30		10.065			10.268	10.231	10.231	10.170
60		9.921			10.157	10.273	10.120	10.038
90		9.752			9.891	10.113	9.915	9.865
120		9.991			10.205	10.271	10.190	10.075
150		10.015			10.257	10.260	10.274	10.212
180		10.006			10.197	10.244	10.244	10.181
210		9.905			10.175	10.240	10.239	10.135
240		10.123			10.257	10.239	10.233	10.090
270		10.061			10.140	10.121	10.095	9.993
300		10.145			10.249	10.257	10.246	10.098
330		9.932			10.174	10.259	10.281	10.188
AVG		9.990			10.179	10.230	10.192	10.102
VIGV exit rake								
15	10.013	10.161	10.138	10.216	10.286	10.257	10.244	10.183
45	9.988	10.096	10.032	10.090	10.213	10.237	10.148	10.106
75	9.861	9.981	9.956	9.989	10.020	10.148	10.032	9.991
105	9.879	9.921	9.956	9.986	10.015	10.163	10.082	10.005
135	9.982	9.985	10.024	10.087	10.184	10.316	10.220	10.198
165	9.947	10.020	10.083	10.138	10.215	10.251	10.286	10.188
195	9.918	9.977	10.046	10.112	10.208	10.244	10.236	10.120
225	10.019	10.022	10.032	10.059	10.127	10.233	10.252	10.072
255	10.043	10.071	10.091	10.116	10.174	10.205	10.163	10.075
285	10.054	10.068	10.067	10.071	10.102	10.183	10.215	10.082
315	9.995	10.010	10.028	10.065	10.132	10.228	10.262	10.134
345	9.915	9.982	10.047	10.100	10.201	10.269	10.256	10.127
AVG	9.968	10.025	10.042	10.086	10.156	10.228	10.200	10.107

TABLE 3.—Continued.

(d) Airflow, 73.04 kg/sec; readings 293 to 296

Circumferential location, θ , deg	Spanwise location, percent of span from tip							
	5	10	15	20	30	50	70	90
VIGV inlet rake								
0		9.966			10.169	10.243	10.234	10.179
30		10.067			10.261	10.230	10.229	10.172
60		9.926			10.169	10.274	10.121	10.047
90		9.772			9.900	10.112	9.925	9.876
120		9.998			10.206	10.270	10.198	10.082
150		10.021			10.254	10.260	10.267	10.207
180		10.008			10.188	10.226	10.238	10.178
210		9.914			10.172	10.236	10.234	10.133
240		10.124			10.252	10.237	10.231	10.091
270		10.065			10.141	10.120	10.095	9.998
300		10.145			10.245	10.251	10.241	10.099
330		9.938			10.171	10.252	10.273	10.182
AVG		9.995			10.177	10.226	10.190	10.103
VIGV exit rake								
15	9.993	10.109	10.062	10.121	10.186	10.225	10.150	10.107
45	9.869	9.981	9.959	9.992	10.021	10.150	10.044	10.000
75	9.876	9.986	9.965	9.989	10.017	10.164	10.057	10.002
105	9.991	9.991	10.024	10.090	10.182	10.310	10.219	10.199
135	9.958	10.030	10.089	10.143	10.212	10.247	10.272	10.198
165	9.958	10.031	10.092	10.141	10.208	10.251	10.274	10.204
195	10.025	10.027	10.036	10.060	10.125	10.226	10.248	10.071
225	10.042	10.068	10.088	10.112	10.169	10.207	10.162	10.078
255	10.045	10.068	10.084	10.093	10.158	10.200	10.166	10.079
285	10.007	10.018	10.038	10.069	10.130	10.223	10.254	10.134
315	9.922	9.984	10.047	10.098	10.196	10.262	10.249	10.125
345	9.911	9.975	10.037	10.087	10.187	10.261	10.245	10.106
AVG	9.967	10.022	10.044	10.083	10.169	10.227	10.195	10.109

TABLE 3.—Continued.

(e) Airflow, 68.45 kg/sec: readings 317 to 320

Circumferential location, θ , deg	Spanwise location, percent of span from tip							
	5	10	15	20	30	50	70	90
VIGV inlet rake								
0		9.997			10.167	10.220	10.220	10.171
30		10.076			10.244	10.228	10.217	10.164
60		9.959			10.168	10.257	10.128	10.031
90		9.798			9.934	10.121	9.966	9.918
120		10.026			10.196	10.247	10.201	10.073
150		10.035			10.234	10.244	10.251	10.205
180		10.031			10.175	10.219	10.225	10.160
210		9.946			10.159	10.215	10.219	10.139
240		10.121			10.235	10.221	10.220	10.098
270		10.079			10.140	10.114	10.100	10.017
300		10.141			10.225	10.233	10.224	10.103
330		9.966			10.161	10.236	10.252	10.176
AVG		10.015			10.170	10.213	10.185	10.104
VIGV exit rake								
15	10.018	10.113	10.073	10.124	10.185	10.214	10.154	10.102
45	9.918	10.016	9.993	10.014	10.041	10.150	10.058	10.027
75	9.929	10.026	10.001	10.019	10.040	10.169	10.071	10.029
105	10.012	10.012	10.045	10.096	10.176	10.275	10.214	10.199
135	9.984	10.042	10.091	10.135	10.186	10.232	10.254	10.184
165	9.992	10.052	10.099	10.143	10.198	10.237	10.257	10.180
195	10.043	10.047	10.058	10.081	10.136	10.215	10.234	10.082
225	10.056	10.079	10.096	10.115	10.164	10.190	10.152	10.084
255	10.062	10.084	10.100	10.117	10.163	10.193	10.162	10.093
285	10.032	10.043	10.059	10.085	10.135	10.206	10.240	10.138
315	9.959	10.011	10.061	10.102	10.177	10.238	10.233	10.127
345	9.959	10.009	10.060	10.104	10.182	10.245	10.235	10.123
AVG	9.997	10.044	10.061	10.095	10.149	10.214	10.189	10.114

TABLE 3.—Continued.

(f) Airflow, 56.21 kg/sec; readings 309 to 312

Circum-ferential location, θ , deg	Spanwise location, percent of span from tip							
	5	10	15	20	30	50	70	90
VIGV inlet rake								
0		10.046			10.148	10.182	10.184	10.154
30		10.094			10.204	10.208	10.191	10.154
60		10.021			10.163	10.210	10.134	10.078
90		9.939			10.007	10.124	10.025	9.996
120		10.069			10.178	10.204	10.179	10.110
150		10.071			10.198	10.215	10.203	10.178
180		10.066			10.156	10.182	10.182	10.150
210		10.008			10.142	10.187	10.190	10.132
240		10.116			10.193	10.190	10.193	10.108
270		10.096			10.134	10.117	10.110	10.056
300		10.130			10.189	10.198	10.191	10.110
330		10.022			10.142	10.201	10.207	10.155
AVG		10.057			10.155	10.185	10.166	10.115
VIGV exit rake								
15	10.058	10.107	10.089	10.124	10.170	10.183	10.150	10.116
45	9.995	10.055	10.042	10.060	10.077	10.144	10.088	10.065
75	9.996	10.047	10.043	10.058	10.074	10.133	10.092	10.065
105	10.053	10.056	10.075	10.109	10.164	10.205	10.183	10.176
135	10.042	10.078	10.108	10.136	10.166	10.195	10.207	10.171
165	10.043	10.079	10.107	10.133	10.166	10.194	10.207	10.156
195	10.066	10.071	10.076	10.089	10.125	10.178	10.194	10.095
225	10.083	10.085	10.107	10.123	10.155	10.169	10.144	10.102
255	10.078	10.094	10.105	10.117	10.149	10.171	10.146	10.102
285	10.059	10.068	10.080	10.098	10.131	10.173	10.203	10.137
315	10.034	10.066	10.094	10.117	10.163	10.200	10.199	10.128
345	10.023	10.056	10.086	10.112	10.157	10.201	10.194	10.122
AVG	10.044	10.072	10.084	10.106	10.141	10.180	10.167	10.120

TABLE 3.—Concluded

(g) Airflow, 35.38 kg/sec; readings 305 to 308

Circumferential location, θ , deg	Spanwise location, percent of span from tip							
	5	10	15	20	30	50	70	90
VIGV inlet rake								
0		10.102			10.139	10.155	10.153	10.142
30		10.119			10.157	10.161	10.153	10.136
60		10.092			10.150	10.158	10.135	10.119
90		10.062			10.080	10.131	10.093	10.080
120		10.111			10.171	10.159	10.148	10.129
150		10.109			10.158	10.164	10.159	10.148
180		10.109			10.140	10.152	10.152	10.138
210		10.083			10.134	10.159	10.157	10.130
240		10.120			10.151	10.157	10.157	10.122
270		10.119			10.132	10.124	10.124	10.103
300		10.125			10.150	10.158	10.155	10.123
330		10.085			10.123	10.151	10.159	10.141
AVG		10.103			10.139	10.152	10.145	10.126
VIGV exit rake								
15	10.106	10.136	10.123	10.136	10.152	10.160	10.154	10.146
45	10.098	10.130	10.116	10.128	10.147	10.154	10.140	10.128
75	10.082	10.112	10.099	10.107	10.113	10.137	10.116	10.106
105	10.085	10.096	10.101	10.106	10.112	10.142	10.129	10.114
135	10.101	10.103	10.112	10.125	10.145	10.156	10.153	10.145
165	10.102	10.113	10.123	10.132	10.148	10.156	10.158	10.145
195	10.090	10.102	10.111	10.121	10.140	10.156	10.150	10.126
225	10.102	10.106	10.108	10.112	10.125	10.148	10.155	10.116
255	10.115	10.120	10.124	10.118	10.143	10.146	10.136	10.120
285	10.104	10.109	10.112	10.115	10.125	10.140	10.145	10.120
315	10.099	10.103	10.110	10.117	10.131	10.149	10.157	10.137
345	10.101	10.112	10.119	10.126	10.143	10.159	10.162	10.135
AVG	10.099	10.112	10.113	10.120	10.135	10.150	10.146	10.128

TABLE 4.—STATIC PRESSURE DISTRIBUTION AT VIGV EXIT WITH VANES A10 IN CORNER 1 AND VANES B IN CORNER 2—UNIFORM INFLOW

(a) Airflow, 81.19 kg/sec;
readings 313 to 316

Circumferential location, θ deg	Outer wall	Center-body
15	9.300	9.269
45	9.278	9.258
75	9.306	9.251
105	9.304	9.246
135	9.299	9.242
165	9.306	9.272
195	9.297	9.274
225	9.295	9.268
255	9.307	9.273
285	9.317	9.279
315	9.319	9.278
345	9.304	9.279
AVG	9.303	9.266

(c) Airflow, 75.31 kg/sec;
readings 297 to 300

Circumferential location, θ deg	Outer wall	Center-body
15	9.410	9.382
45	9.382	9.372
75	9.415	9.368
105	9.412	9.366
135	9.416	9.358
165	9.415	9.387
195	9.410	9.388
225	9.406	9.383
255	9.415	9.387
285	9.425	9.396
315	9.426	9.390
345	9.415	9.392
AVG	9.412	9.381

(e) Airflow, 68.45 kg/sec;
readings 317 to 320

Circumferential location, θ deg	Outer wall	Center-body
15	9.542	9.530
45	9.533	9.517
75	9.565	9.516
105	9.539	9.515
135	9.552	9.508
165	9.564	9.530
195	9.544	9.535
225	9.547	9.527
255	9.565	9.532
285	9.552	9.538
315	9.562	9.532
345	9.565	9.536
AVG	9.552	9.526

(g) Airflow, 35.38 kg/sec;
readings 305 to 308

Circumferential location, θ deg	Outer wall	Center-body
15	9.992	9.987
45	9.988	9.984
75	9.993	9.983
105	9.993	9.984
135	9.993	9.983
165	9.994	9.987
195	9.993	9.988
225	9.993	9.987
255	9.994	9.988
285	9.994	9.989
315	9.994	9.988
345	9.993	9.988
AVG	9.993	9.986

(b) Airflow, 78.49 kg/sec;
readings 301 to 304

15	9.320	9.305
45	9.299	9.287
75	9.351	9.288
105	9.324	9.288
135	9.331	9.273
165	9.349	9.305
195	9.320	9.312
225	9.326	9.301
255	9.350	9.309
285	9.334	9.322
315	9.348	9.308
345	9.351	9.314
AVG	9.334	9.301

(d) Airflow, 73.04 kg/sec;
readings 293 to 296

15	9.431	9.416
45	9.412	9.401
75	9.456	9.401
105	9.433	9.402
135	9.441	9.388
165	9.455	9.416
195	9.432	9.422
225	9.434	9.413
255	9.458	9.420
285	9.441	9.427
315	9.454	9.419
345	9.456	9.423
AVG	9.442	9.412

(f) Airflow, 56.21 kg/sec;
readings 309 to 312

15	9.755	9.748
45	9.750	9.738
57	9.769	9.738
105	9.757	9.739
135	9.760	9.732
165	9.769	9.747
195	9.757	9.751
225	9.759	9.746
255	9.770	9.748
285	9.761	9.753
315	9.767	9.748
345	9.770	9.749
AVG	9.762	9.745

TABLE 5 —STATIC PRESSURE DISTRIBUTION AT CORNER 2 VANE INLET AND EXIT WITH VANES A10
IN CORNER 1 AND VANES B IN CORNER 2—UNIFORM INFLOW

(a) Airflow, 81.19 kg/sec; readings 313 to 316

Circumferential location, θ , deg	Inlet		Exit	
	Pressure, N/cm ²	Coefficient	Pressure, N/cm ²	Coefficient
0	9.711	0.890	9.585	1.119
15	9.726	0.863	9.520	1.238
30	9.716	0.881	9.487	1.297
45	9.704	0.902	9.411	1.437
60	9.703	0.903	9.382	1.489
75	9.658	0.987	*****	*****
90	9.658	0.986	*****	*****
105	9.694	0.921	*****	*****
120	9.708	0.895	9.422	1.417
135	9.710	0.891	9.418	1.423
150	9.723	0.868	9.466	1.337
165	9.728	0.859	9.521	1.235
180	9.735	0.845	9.604	1.084
195	9.724	0.866	9.611	1.072
210	9.735	0.846	9.634	1.031
225	9.824	0.683	9.627	1.043
240	9.822	0.687	9.665	0.974
255	9.852	0.633	9.744	0.829
270	9.853	0.630	9.737	0.842
285	9.859	0.619	9.739	0.838
300	9.851	0.634	9.650	1.001
315	9.828	0.677	9.635	1.028
330	9.737	0.841	9.620	1.055
345	9.715	0.882	9.612	1.070

(c) Airflow, 75.31 kg/sec; readings 297 to 300

Circumferential location, θ , deg	Inlet		Exit	
	Pressure, N/cm ²	Coefficient	Pressure, N/cm ²	Coefficient
0	9.763	0.904	9.654	1.135
15	9.776	0.877	9.598	1.253
30	9.767	0.895	9.569	1.314
45	9.754	0.922	9.505	1.451
60	9.757	0.917	9.479	1.505
75	9.717	1.000	*****	*****
90	9.718	0.998	*****	*****
105	9.749	0.934	*****	*****
120	9.761	0.908	9.514	1.432
135	9.765	0.899	9.512	1.436
150	9.774	0.880	9.552	1.352
165	9.778	0.872	9.600	1.249
180	9.785	0.856	9.670	1.101
195	9.776	0.876	9.677	1.087
210	9.785	0.857	9.697	1.044
225	9.861	0.695	9.691	1.056
240	9.861	0.697	9.723	0.989
255	9.886	0.643	9.791	0.845
270	9.889	0.636	9.786	0.854
285	9.892	0.631	9.787	0.853
300	9.883	0.650	9.712	1.012
315	9.862	0.694	9.698	1.041
330	9.786	0.855	9.685	1.068
345	9.767	0.896	9.679	1.081

(b) Airflow, 78.49 kg/sec; readings 301 to 304

0	9.727	0.913	9.605	1.149
15	9.741	0.885	9.544	1.269
30	9.731	0.904	9.512	1.331
45	9.720	0.925	9.440	1.472
60	9.720	0.926	9.408	1.533
75	9.676	1.011	*****	*****
90	9.676	1.011	*****	*****
105	9.710	0.945	*****	*****
120	9.724	0.918	9.450	1.451
135	9.728	0.910	9.448	1.455
150	9.739	0.889	9.492	1.370
165	9.742	0.882	9.546	1.265
180	9.751	0.865	9.624	1.113
195	9.740	0.886	9.631	1.100
210	9.751	0.866	9.652	1.059
225	9.835	0.702	9.647	1.069
240	9.833	0.705	9.683	0.998
255	9.861	0.651	9.758	0.852
270	9.865	0.643	9.751	0.865
285	9.868	0.637	9.750	0.868
300	9.861	0.651	9.668	1.027
315	9.838	0.696	9.654	1.054
330	9.752	0.864	9.639	1.083
345	9.731	0.905	9.633	1.096

(d) Airflow, 73.04 kg/sec; readings 293 to 296

0	9.777	0.924	9.674	1.158
15	9.789	0.897	9.621	1.276
30	9.781	0.915	9.593	1.338
45	9.769	0.944	9.532	1.476
60	9.772	0.937	9.508	1.530
75	9.735	1.020	*****	*****
90	9.735	1.019	*****	*****
105	9.761	0.960	*****	*****
120	9.775	0.928	9.540	1.459
135	9.779	0.920	9.538	1.462
150	9.788	0.900	9.576	1.378
165	9.792	0.890	9.622	1.273
180	9.800	0.872	9.689	1.122
195	9.792	0.892	9.696	1.108
210	9.800	0.873	9.714	1.066
225	9.873	0.709	9.709	1.078
240	9.871	0.713	9.742	1.004
255	9.897	0.654	9.804	0.863
270	9.900	0.647	9.801	0.871
285	9.902	0.644	9.802	0.869
300	9.893	0.664	9.728	1.035
315	9.873	0.708	9.716	1.062
330	9.799	0.874	9.704	1.090
345	9.721	0.915	9.698	1.103

TABLE 5.—Continued.

(e) Airflow, 68.45 kg/sec; readings 317 to 320

Circumferential location, θ , deg	Inlet		Exit	
	Pressure, N/cm ²	Coefficient	Pressure, N/cm ²	Coefficient
0	9.830	0.899	9.746	1.118
15	9.841	0.872	9.700	1.234
30	9.834	0.890	9.676	1.295
45	9.826	0.911	9.626	1.425
60	9.826	0.911	9.611	1.463
75	9.795	0.991	*****	*****
90	9.795	0.771	*****	*****
105	9.820	0.926	*****	*****
120	9.828	0.905	9.633	1.408
135	9.832	0.894	9.631	1.413
150	9.839	0.876	9.662	1.331
165	9.842	0.869	9.701	1.233
180	9.849	0.850	9.758	1.087
195	9.841	0.872	9.763	1.073
210	9.833	0.892	9.778	1.034
225	9.910	0.694	9.774	1.044
240	9.908	0.701	9.301	0.975
255	9.928	0.647	9.852	0.845
270	9.933	0.635	9.849	0.851
285	9.935	0.631	9.850	0.848
300	9.925	0.655	9.792	0.998
315	9.911	0.692	9.778	1.035
330	9.849	0.851	9.769	1.057
345	9.833	0.893	9.765	1.068

(g) Airflow, 35.38 kg/sec; readings 305 to 308

Circumferential location, θ , deg	Inlet		Exit	
	Pressure, N/cm ²	Coefficient	Pressure, N/cm ²	Coefficient
0	10.058	0.838	10.037	1.044
15	10.060	0.812	10.028	1.130
30	10.059	0.824	10.020	1.204
45	10.058	0.840	10.012	1.279
60	10.058	0.838	10.007	1.333
75	10.051	0.906	*****	*****
90	10.051	0.906	*****	*****
105	10.057	0.844	*****	*****
120	10.059	0.827	10.012	1.286
135	10.060	0.820	10.013	1.274
150	10.060	0.812	10.019	1.213
165	10.055	0.864	10.028	1.126
180	10.060	0.818	10.039	1.021
195	10.059	0.830	10.040	1.006
210	10.059	0.822	10.044	0.975
225	10.074	0.683	10.040	1.011
240	10.071	0.706	10.047	0.947
255	10.079	0.629	10.056	0.854
270	10.079	0.636	10.056	0.837
285	10.081	0.615	10.057	0.849
300	10.077	0.649	10.044	0.971
315	10.074	0.684	10.043	0.986
330	10.061	0.811	10.041	1.000
345	10.057	0.845	10.041	0.997

(f) Airflow, 56.21 kg/sec; readings 309 to 312

0	9.937	0.860	9.881	1.073
15	9.943	0.837	9.854	1.176
30	9.939	0.853	9.838	1.238
45	9.931	0.882	9.809	1.350
60	9.935	0.867	9.796	1.401
75	9.914	0.947	*****	*****
90	9.916	0.943	*****	*****
105	9.931	0.883	*****	*****
120	9.937	0.861	9.811	1.341
135	9.938	0.856	9.812	1.337
150	9.939	0.852	9.831	1.267
165	9.941	0.845	9.855	1.174
180	9.947	0.821	9.888	1.048
195	9.943	0.836	9.893	1.028
210	9.947	0.820	9.903	0.991
225	9.986	0.672	9.899	1.005
240	9.984	0.682	9.916	0.939
255	9.928	0.627	9.948	0.819
270	10.000	0.619	9.947	0.824
285	10.002	0.613	9.946	0.827
300	9.995	0.639	9.909	0.969
315	9.985	0.675	9.903	0.990
330	9.947	0.820	9.897	1.013
345	9.938	0.856	9.895	1.022

TABLE 6.—AXIAL STATIC PRESSURE DISTRIBUTION WITH VANES A10 IN CORNER 1 AND VANES B IN CORNER 2—UNIFORM INFLOW

(a) Airflow, 81.19 kg/sec; readings 313 to 316

Axial station	Outer wall				Centerbody			
	Circumferential location, θ , deg							
	0	90	180	270	0	90	180	270
1		9.578						
2		9.577						
3		9.574						
4		9.572						
5		9.573						
6		9.564						
7		9.554						
8	9.512	9.510	9.509	9.528				
9		9.423						
10	9.357	9.353	9.363	9.382				
12				9.370				
13				9.393				
14				9.443				
15				9.486				
16				9.548				
17				9.633				
18				9.718				
19				9.791				
20				9.851				
35		9.304						
36		9.336						
37	9.422	9.365	9.392	9.528				
38		9.393						
39		9.413						
40	9.481	9.441	9.464	9.546				
41	9.526	9.492	9.514	9.560				
42	9.563	9.538	9.554	9.587				
43	9.604	9.576	9.591	9.618				
44	9.627	9.608	9.627	9.650				
45	9.650	9.632	9.660	9.679				
46	9.691	9.649	9.683	9.713				
47	9.712	9.667	9.686	9.722				
48	10.550		9.742	9.813				
49	9.753		9.754	9.816				
50	9.744		9.751	9.839				
51	9.735		9.746	9.914				
52	9.716		9.746					
53				9.832				
54				0.000	9.410	10.101	9.366	9.750
55				0.000	9.394	10.187	9.353	9.770
56				*****	9.388	10.174	9.361	
57				9.719	*****	10.096	9.401	
58				9.699		10.115		9.699
59				9.676		10.068		*****
60				9.664	*****	10.085	*****	*****
61	9.589		9.598	9.641	9.653		9.666	
62	9.564		9.566	9.895	9.897		9.620	
63	9.556		9.562	9.590	9.824	9.504	9.825	9.614
64	9.547		9.552	9.574	9.753	9.548	9.759	9.605
65	9.534		9.542	9.569	9.697	9.552	9.700	9.595
66	9.526		9.532	9.558	9.627	9.547	9.641	9.580
67	9.513		9.518	9.546	9.582	9.539	9.584	9.565
68	9.507		9.508	9.532	9.529	9.524	9.529	9.548
69	9.493		9.497	9.522	9.475	9.495	9.478	9.529
70	9.479		9.483	9.503	9.432	9.481	9.429	9.504
71	9.465		9.468	9.492	9.386	9.453	9.381	9.474
72	9.457	*****	9.456	9.476	9.337	9.423	9.336	9.447
73	9.448	*****	9.444	9.464	9.302	9.392	9.304	9.417
74	9.446	*****	9.439	9.445	9.271	9.367	9.275	9.392
75	9.431	*****	9.442	9.457	9.250	9.350	9.251	9.371
76	9.366	*****	9.611	9.368	9.233	9.340	9.236	9.362
77	*****	*****	*****	*****	9.223	9.332	9.227	9.344
78	*****	*****	*****	*****	9.223	9.331	9.234	9.344
79	9.358	9.357	9.445	9.446	9.380	9.379	9.386	9.391

TABLE 6.—Continued.

(b) Airflow, 78.49 kg/sec; readings 301 to 304

Axial station	Outer wall				Centerbody			
	Circumferential location, θ , deg							
	0	90	180	270	0	90	180	270
1		9.597						
2		9.596						
3		9.593						
4		9.596						
5		9.593						
6		9.581						
7		9.575						
8	9.534	9.533	9.532	9.550				
9		9.450						
10	9.387	9.382	9.392	9.417				
12				9.401				
13				9.422				
14				9.470				
15				9.512				
16				9.571				
17				9.651				
18				9.732				
19				9.802				
20				9.860				
35		9.337						
36		9.369						
37	9.449	9.397	9.422	9.551				
38		9.423						
39		9.441						
40	9.507	9.464	9.491	9.570				
41	9.549	9.518	9.538	9.583				
42	9.586	9.562	9.577	9.610				
43	9.624	9.598	9.612	9.638				
44	9.647	9.628	9.647	9.669				
45	9.669	9.651	9.678	9.695				
46	9.708	9.663	9.701	9.728				
47	9.725	9.684	9.703	9.736				
48	10.532		9.757	9.825				
49	9.768		9.765	9.827				
50	9.758		9.765	9.850				
51	9.750		9.759	9.922				
52	9.730							
53				9.844				
54				0.000	9.438	10.102	9.397	9.765
55				0.000	9.422	10.181	9.385	9.784
56				*****	9.418	10.171	9.391	
57				9.736	*****	10.098	9.429	
58				9.715		10.111		9.715
59				9.694		10.070		*****
60				9.682	*****	10.087	*****	*****
61	9.611		9.619	9.658	9.671		9.685	
62	9.587		9.589	9.902	9.904		9.640	
63	9.580		9.584	9.612	9.835	9.528	9.835	9.634
64	9.569		9.575	9.596	9.766	9.570	9.773	9.624
65	9.558		9.567	9.591	9.710	9.575	9.716	9.616
66	9.549		9.555	9.579	9.656	9.570	9.662	9.601
67	9.537		9.544	9.571	9.603	9.560	9.607	9.587
68	9.532		9.534	9.558	9.553	9.548	9.554	9.571
69	9.520		9.523	9.546	9.501	9.526	9.504	9.553
70	9.505		9.509	9.530	9.459	9.507	9.454	9.529
71	9.488		9.496	9.518	9.414	9.479	9.410	9.500
72	9.485	*****	9.483	9.502	9.368	9.450	9.374	9.474
73	9.473	*****	9.473	9.491	9.335	9.421	9.337	9.445
74	9.472	*****	9.466	9.472	9.305	9.398	9.308	9.420
75	9.458	*****	9.470	9.484	9.285	9.381	9.285	9.402
76	9.396	*****	9.617	9.400	9.268	9.372	9.270	9.392
77	*****	*****	*****	*****	9.259	9.365	9.262	9.375
78	*****	*****	*****	*****	9.255	9.364	9.270	9.376
79	9.390	9.389	9.472	9.473	9.411	9.411	9.422	9.421

TABLE 6.—Continued.

(c) Airflow, 75.31 kg/sec; readings 297 to 300

Axial station	Outer wall				Centerbody			
	Circumferential location, θ , deg							
	0	90	180	270	0	90	180	270
1		9.643						
2		9.642						
3		9.641						
4		9.642						
5		9.640						
6		9.631						
7		9.623						
8	9.587	9.586	9.584	9.601				
9		9.511						
10	9.456	9.451	9.461	9.483				
12				9.470				
13				9.489				
14				9.532				
15				9.570				
16				9.623				
17				9.695				
18				9.769				
19				9.832				
20				9.884				
35		9.412						
36		9.440						
37	9.514	9.466	9.489	9.606				
38		9.490						
39		9.507						
40	9.566	9.530	9.551	9.623				
41	9.604	9.575	9.594	9.632				
42	9.636	9.616	9.629	9.657				
43	9.671	9.648	9.660	9.685				
44	9.691	9.674	9.692	9.712				
45	9.711	9.693	9.720	9.737				
46	9.746	9.710	9.740	9.765				
47	9.761	9.724	9.742	9.772				
48	10.491		9.788	9.853				
49	9.800		9.801	9.854				
50	9.791		9.798	9.875				
51	9.783		9.793	9.940				
52	9.767		9.793					
53				9.867				
54				0.000	9.498	10.106	9.467	9.796
55				0.000	9.486	10.170	9.456	9.813
56				*****	9.483	10.164	9.462	
57				9.772	*****	10.102	9.496	
58				9.752		10.114		9.753
59				9.734		10.082		*****
60				9.723	*****	10.091	*****	*****
61	9.658		9.665	9.701	9.714		9.726	
62	9.637		9.639	9.920	9.923		9.685	
63	9.631		9.635	9.660	9.856	9.583	9.863	9.679
64	9.621		9.627	9.646	9.798	9.620	9.804	9.671
65	9.612		9.618	9.642	9.749	9.625	9.753	9.663
66	9.604		9.610	9.632	9.699	9.621	9.703	9.650
67	9.592		9.599	9.622	9.652	9.615	9.654	9.637
68	9.588		9.589	9.611	9.606	9.602	9.606	9.624
69	9.577		9.580	9.601	9.559	9.583	9.561	9.606
70	9.564		9.568	9.585	9.520	9.565	9.519	9.585
71	9.552		9.553	9.576	9.481	9.540	9.478	9.559
72	9.546	*****	9.544	9.561	9.440	9.514	9.445	9.535
73	9.537	*****	9.535	9.551	9.410	9.488	9.412	9.510
74	9.534	*****	9.529	9.535	9.382	9.468	9.386	9.488
75	9.522	*****	9.533	9.545	9.365	9.452	9.366	9.470
76	9.465	*****	9.632	9.469	9.349	9.445	9.353	9.462
77	*****	*****	*****	*****	9.342	9.438	9.345	9.447
78	*****	*****	*****	*****	9.341	9.438	9.351	9.448
79	9.460	9.460	9.535	9.536	9.481	9.479	9.488	9.488

TABLE 6.—Continued.

(d) Airflow, 73.04 kg/sec; readings 293 to 296

Axial station	Outer wall				Centerbody			
	Circumferential location, θ , deg							
	0	90	180	270	0	90	180	270
1		9.663						
2		9.660						
3		9.659						
4		9.661						
5		9.659						
6		9.650						
7		9.642						
8	9.607	9.606	9.606	9.621				
9		9.535						
10	9.482	9.478	9.487	9.510				
12				9.497				
13				9.517				
14				9.557				
15				9.593				
16				9.644				
17				9.713				
18				9.783				
19				9.844				
20				9.893				
35		9.441						
36		9.468						
37	9.540	9.493	9.515	9.627				
38		9.515						
39		9.533						
40	9.590	9.554	9.576	9.643				
41	9.625	9.599	9.615	9.655				
42	9.653	9.636	9.649	9.676				
43	9.690	9.668	9.680	9.703				
44	9.709	9.692	9.709	9.728				
45	9.728	9.708	9.737	9.753				
46	9.762	9.727	9.756	9.780				
47	9.777	9.740	9.757	9.786				
48	10.474		9.805	9.864				
49	9.812		9.815	9.862				
50	9.804		9.812	9.885				
51	9.797		9.807	9.949				
52	9.782		9.807					
53				9.881				
54				0.000	9.524	10.113	9.494	9.811
55				0.000	9.513	10.165	9.483	9.827
56				*****	9.510	10.162	9.489	
57				9.786	*****	10.106	9.521	
58				9.769		10.113		9.770
59				9.750		10.087		*****
60				9.741	*****	10.092	*****	*****
61	9.678		9.685	9.719	9.732		9.743	
62	9.654		9.659	9.926	9.932		9.704	
63	9.651		9.652	9.680	9.869	9.606	9.874	9.698
64	9.642		9.648	9.666	9.808	9.642	9.819	9.691
65	9.633		9.640	9.661	9.765	9.646	9.769	9.682
66	9.625		9.631	9.652	9.717	9.642	9.721	9.670
67	9.614		9.620	9.644	9.671	9.637	9.672	9.658
68	9.611		9.612	9.632	9.628	9.625	9.627	9.645
69	9.599		9.603	9.623	9.583	9.606	9.585	9.629
70	9.587		9.591	9.609	9.547	9.589	9.545	9.609
71	9.576		9.577	9.599	9.510	9.565	9.504	9.583
72	9.570	*****	9.569	9.585	9.469	9.540	9.473	9.560
73	9.562	*****	9.560	9.575	9.441	9.516	9.441	9.536
74	9.559	*****	9.554	9.560	9.414	9.496	9.418	9.515
75	9.548	*****	9.558	9.571	9.397	9.481	9.398	9.498
76	9.494	*****	9.650	9.497	9.382	9.474	9.386	9.490
77	*****	*****	*****	*****	9.375	9.468	9.378	9.476
78	*****	*****	*****	*****	9.374	9.467	9.384	9.477
79	9.490	9.489	9.561	9.560	9.508	9.507	9.516	9.516

TABLE 6.—Continued.

(e) Airflow, 68.45 kg/sec; readings 317 to 320

Axial station	Outer wall				Centerbody			
	Circumferential location, θ , deg							
	0	90	180	270	0	90	180	270
1		9.731						
2		9.729						
3		9.728						
4		9.730						
5		9.727						
6		9.720						
7		9.713						
8	9.685	9.683	9.683	9.697				
9		9.623						
10	9.580	9.576	9.585	9.605				
12				9.595				
13				9.611				
14				9.646				
15				9.676				
16				9.719				
17				9.777				
18				9.836				
19				9.886				
20				9.928				
35		9.548						
36		9.570						
37	9.631	9.591	9.610	9.705				
38		9.609						
39		9.624						
40	9.671	9.641	9.657	9.719				
41	9.703	9.678	9.695	9.728				
42	9.728	9.712	9.723	9.747				
43	9.757	9.738	9.748	9.767				
44	9.773	9.759	9.774	9.789				
45	9.789	9.777	9.796	9.811				
46	9.817	9.789	9.809	9.832				
47	9.831	9.801	9.814	9.838				
48	9.899		9.853	9.904				
49	9.861		9.861	9.905				
50	9.853		9.859	9.922				
51	9.848		9.854	9.976				
52	9.833		9.854					
53				9.918				
54				0.000	9.614	10.108	9.588	9.860
55				0.000	9.605	10.161	9.580	9.872
56				*****	9.604	10.155	9.585	
57				9.838	*****	10.112	9.607	
58				9.823		10.118		9.824
59				9.808		10.101		*****
60				9.799	*****	10.108	*****	*****
61	9.749		9.754	9.782	9.791		9.802	
62	9.731		9.732	9.955	9.963		9.768	
63	9.726		9.727	9.748	9.907	9.685	9.914	9.765
64	9.717		9.722	9.738	9.861	9.715	9.866	9.758
65	9.710		9.715	9.731	9.822	9.721	9.824	9.751
66	9.704		9.707	9.726	9.781	9.718	9.784	9.741
67	9.694		9.699	9.718	9.743	9.713	9.744	9.730
68	9.689		9.692	9.710	9.706	9.703	9.705	9.719
69	9.682		9.685	9.701	9.666	9.687	9.668	9.705
70	9.672		9.674	9.689	9.637	9.673	9.634	9.690
71	9.662		9.665	9.681	9.606	9.653	9.601	9.667
72	9.657	*****	9.656	9.670	9.572	9.633	9.574	9.649
73	9.651	*****	9.649	9.661	9.548	9.612	9.548	9.628
74	9.650	*****	9.644	9.650	9.526	9.594	9.528	9.610
75	9.639	*****	9.647	9.657	9.512	9.579	9.512	9.596
76	9.590	*****	9.713	9.597	9.500	9.575	9.502	9.590
77	*****	*****	*****	*****	9.494	9.570	9.495	9.578
78	*****	*****	*****	*****	9.493	9.569	9.502	9.579
79	9.586	9.586	9.650	9.651	9.603	9.604	9.612	9.611

TABLE 6.—Continued.

(f) Airflow, 56.21 kg/sec; readings 309 to 312

Axial station	Outer wall				Centerbody			
	Circumferential location, θ , deg							
	0	90	180	270	0	90	180	270
1		9.871						
2		9.871						
3		9.870						
4		9.871						
5		9.869						
6		9.865						
7		9.859						
8	9.842	9.840	9.841	9.850				
9		9.803						
10	9.779	9.775	9.782	9.795				
12				9.790				
13				9.800				
14				9.822				
15				9.841				
16				9.867				
17				9.903				
18				9.940				
19				9.972				
20				9.998				
35		9.757						
36		9.772						
37	9.810	9.785	9.797	9.859				
38		9.797						
39		9.806						
40	9.836	9.817	9.830	9.867				
41	9.856	9.841	9.851	9.873				
42	9.872	9.862	9.869	9.884				
43	9.890	9.878	9.885	9.898				
44	9.900	9.891	9.900	9.911				
45	9.911	9.903	9.915	9.924				
46	9.929	9.910	9.925	9.938				
47	9.936	9.917	9.926	9.941				
48	10.314		9.952	9.983				
49	9.956		9.956	9.984				
50	9.952		9.954	9.994				
51	9.947		9.951	10.028				
52	9.938		9.951					
53				9.990				
54				0.000	9.796	10.117	9.783	9.952
55				0.000	9.790	10.147	9.776	9.961
56				*****	9.790	10.144	9.779	
57				9.940	*****	10.122	9.794	
58				9.930		10.117		9.933
59				9.921		10.116		*****
60				9.916	*****	10.121	*****	*****
61	9.883		9.888	9.905	9.911		9.918	
62	9.873		9.874	10.012	10.020		9.897	
63	9.870		9.871	9.884	9.987	9.839	9.990	9.894
64	9.865		9.867	9.878	9.957	9.861	9.959	9.890
65	9.860		9.863	9.875	9.932	9.865	9.932	9.886
66	9.856		9.859	9.870	9.906	9.864	9.907	9.880
67	9.851		9.853	9.865	9.881	9.862	9.880	9.873
68	9.849		9.849	9.860	9.858	9.857	9.857	9.866
69	9.843		9.844	9.855	9.834	9.846	9.834	9.860
70	9.837		9.839	9.848	9.814	9.837	9.812	9.847
71	9.831		9.832	9.843	9.794	9.824	9.790	9.833
72	9.828	*****	9.827	9.836	9.773	9.812	9.775	9.821
73	9.824	*****	9.822	9.830	9.758	9.798	9.758	9.808
74	9.822	*****	9.819	9.822	9.744	9.788	9.746	9.797
75	9.817	*****	9.821	9.827	9.735	9.779	9.736	9.788
76	9.784	*****	9.842	9.790	9.727	9.776	9.729	9.784
77	*****	*****	*****	*****	9.723	9.772	9.725	9.776
78	*****	*****	*****	*****	9.723	9.772	9.728	9.777
79	9.786	9.786	9.824	9.824	9.794	9.794	9.797	9.797

TABLE 6.—Concluded.

(g) Airflow, 35.38 kg/sec; readings 305 to 308

Axial station	Outer wall				Centerbody			
	Circumferential location, θ , deg							
	0	90	180	270	0	90	180	270
1		10.034						
2		10.034						
3		10.033						
4		10.034						
5		10.034						
6		10.031						
7		10.030						
8	10.022	10.022	10.022	10.027				
9		10.008						
10	10.000	9.998	10.001	10.007				
12				10.005				
13				10.008				
14				10.017				
15				10.024				
16				10.034				
17				10.044				
18				10.061				
19				10.069				
20				10.082				
35		9.991						
36		9.997						
37	10.011	10.002	10.006	10.030				
38		10.006						
39		10.010						
40	10.015	10.014	10.018	10.032				
41	10.028	10.023	10.026	10.035				
42	10.034	10.031	10.033	10.039				
43	10.041	10.037	10.039	10.044				
44	10.045	10.042	10.045	10.049				
45	10.050	10.046	10.050	10.054				
46	10.055	10.049	10.054	10.059				
47	10.058	10.051	10.054	10.059				
48	10.201		10.064	10.075				
49	10.065		10.065	10.075				
50	10.064		10.064	10.080				
51	10.061		10.060	10.091				
52	10.058		10.060					
53				10.075				
54				0.000	10.004	10.123	9.996	10.061
55				0.000	10.002	10.139	9.992	10.066
56				*****	10.001	10.132	9.994	
57				10.056	*****	10.129	10.001	
58				10.053		10.125		10.055
59				10.050		10.126		*****
60				10.048	*****	10.130	*****	*****
61	10.038		10.039	10.045	10.047		10.049	
62	10.033		10.034	10.085	10.088		10.043	
63	10.032		10.033	10.037	10.077	10.017	10.077	10.041
64	10.030		10.031	10.036	10.067	10.029	10.067	10.040
65	10.029		10.029	10.034	10.058	10.031	10.057	10.038
66	10.027		10.029	10.033	10.048	10.031	10.047	10.036
67	10.026		10.027	10.030	10.038	10.030	10.035	10.033
68	10.024		10.025	10.029	10.029	10.028	10.028	10.030
69	10.023		10.023	10.027	10.020	10.024	10.020	10.027
70	10.021		10.021	10.025	10.013	10.021	10.012	10.024
71	10.019		10.019	10.023	10.005	10.017	10.004	10.018
72	10.017	*****	10.017	10.019	9.997	10.012	9.998	10.014
73	10.016	*****	10.016	10.019	9.991	10.007	9.991	10.009
74	10.015	*****	10.014	10.016	9.986	10.003	9.984	10.006
75	10.013	*****	10.014	10.017	9.983	9.998	9.982	10.001
76	10.001	*****	10.017	10.004	9.979	9.998	9.981	10.000
77	*****	*****	*****	*****	9.978	9.996	9.979	9.997
78	*****	*****	*****	*****	9.978	9.997	9.981	9.998
79	10.003	10.003	10.017	10.016	10.005	10.004	10.005	10.005

TABLE 7.—CORNER 2 VANE SURFACE STATIC PRESSURE DISTRIBUTION WITH VANES A10 IN CORNER 1 AND VANES B IN CORNER 2—UNIFORM INFLOW

(a) Airflow, 81.19 kg/sec; readings 313 to 316

Fraction of chord, XC/C	Pressure, N/cm ²		Mach number		Coefficient	
	(a)	(b)	(a)	(b)	(a)	(b)
Section A						
0.000	9.752	9.752	0.254	0.254	0.205	0.206
0.025	9.684	9.812	0.273	0.236	0.082	0.315
0.050	9.687	9.609	0.272	0.293	0.086	-0.055
0.075	9.673	9.719	0.276	0.263	0.062	0.145
0.100	9.657	9.756	0.280	0.253	0.032	0.212
0.150	9.617	9.771	0.291	0.248	-0.040	0.240
0.200	9.581	9.775	0.300	0.247	-0.105	0.248
0.300	9.527	9.776	0.314	0.247	-0.204	0.249
0.500	9.466	9.780	0.328	0.246	-0.316	0.256
0.700	9.443	9.766	0.333	0.250	-0.357	0.231
0.800	9.458	9.759	0.330	0.252	-0.331	0.218
0.850	9.484	9.754	0.324	0.253	-0.282	0.209
0.900	9.537	9.740	0.311	0.257	-0.187	0.184
0.950	9.627	9.742	0.288	0.257	-0.022	0.188
Section B						
0.000	9.338	9.337	0.357	0.357	-0.550	-0.551
0.025	9.225	9.957	0.381	0.185	-0.755	0.580
0.050	9.265	9.177	0.373	0.391	-0.682	-0.843
0.075	9.253	9.577	0.376	0.301	-0.705	-0.113
0.100	9.235	9.631	0.379	0.287	-0.738	-0.016
0.150	9.190	9.677	0.389	0.275	-0.818	0.069
0.200	9.166	9.698	0.394	0.269	-0.863	0.108
0.300	9.139	9.709	0.399	0.266	-0.913	0.127
0.500	9.179	9.724	0.391	0.262	-0.839	0.155
0.700	9.179	9.722	0.391	0.263	-0.838	0.150
0.800	9.244	9.710	0.377	0.266	-0.720	0.130
0.850	9.320	9.711	0.361	0.266	-0.583	0.131
0.900	9.441	9.680	0.334	0.274	-0.362	0.074
0.950	9.506	9.640	0.319	0.285	-0.244	0.002
Section C						
0.000	9.257	9.257	0.375	0.375	-0.698	-0.697
0.025	9.101	9.984	0.407	0.175	-0.982	0.620
0.050	9.179	9.147	0.391	0.397	-0.839	-0.897
0.075	9.161	9.496	0.395	0.321	-0.872	-0.262
0.100	9.154	9.654	0.396	0.281	-0.885	0.028
0.150	9.123	9.688	0.402	0.272	-0.940	0.089
0.200	9.104	9.705	0.406	0.267	-0.977	0.120
0.300	9.072	9.717	0.412	0.264	-1.034	0.143
0.500	9.109	9.733	0.405	0.259	-0.966	0.171
0.700	9.105	9.730	0.406	0.260	-0.973	0.165
0.800	9.189	9.722	0.389	0.263	-0.820	0.151
0.850	9.297	9.713	0.366	0.265	-0.623	0.134
0.900	9.438	9.683	0.335	0.273	-0.367	0.079
0.950	9.494	9.601	0.321	0.295	-0.264	-0.070
Section D						
0.000	9.446	9.447	0.333	0.333	-0.352	-0.351
0.025	10.000	9.692	0.168	0.271	0.658	0.097
0.050	9.422	9.417	0.338	0.340	-0.395	-0.406
0.075	9.413	9.499	0.340	0.320	-0.412	-0.256
0.100	9.400	9.565	0.343	0.304	-0.435	-0.135
0.150	9.374	9.580	0.349	0.300	-0.483	-0.109
0.200	9.350	9.586	0.355	0.299	-0.528	-0.097
0.300	9.318	9.581	0.361	0.300	-0.585	-0.106
0.500	9.299	9.583	0.366	0.300	-0.620	-0.102
0.700	9.261	9.578	0.374	0.301	-0.689	-0.112
0.800	9.271	9.557	0.372	0.306	-0.671	-0.149
0.850	9.310	9.550	0.363	0.308	-0.600	-0.163
0.900	9.380	9.536	0.348	0.311	-0.473	-0.189
0.950	9.450	9.503	0.332	0.319	-0.345	-0.248

^aSuction surface

^bPressure surface.

TABLE 7.—Continued.

(b) Airflow, 78.49 kg/sec; readings 301 to 304

Fraction of chord, XC/C	Pressure, N/cm ²		Mach number		Coefficient	
	(a)	(b)	(a)	(b)	(a)	(b)
Section A						
0.000	9.764	9.765	0.249	0.249	0.179	0.180
0.025	9.700	9.821	0.268	0.232	0.055	0.290
0.050	9.702	9.628	0.267	0.287	0.059	-0.085
0.075	9.689	9.734	0.271	0.258	0.034	0.120
0.100	9.673	9.768	0.275	0.248	0.002	0.187
0.150	9.635	9.783	0.285	0.244	-0.072	0.216
0.200	9.601	9.787	0.294	0.242	-0.138	0.224
0.300	9.550	9.787	0.307	0.242	-0.239	0.224
0.500	9.494	9.792	0.321	0.241	-0.348	0.234
0.700	9.470	9.778	0.326	0.245	-0.393	0.207
0.800	9.482	9.772	0.323	0.247	-0.369	0.195
0.850	9.509	9.767	0.317	0.248	-0.318	0.184
0.900	9.555	9.754	0.306	0.252	-0.227	0.160
0.950	9.646	9.756	0.282	0.252	-0.051	0.163
Section B						
0.000	9.370	9.369	0.349	0.349	-0.589	-0.590
0.025	9.263	9.962	0.373	0.182	-0.798	0.564
0.050	9.300	9.219	0.365	0.382	-0.726	-0.883
0.075	9.288	9.599	0.367	0.295	-0.748	-0.142
0.100	9.270	9.648	0.371	0.282	-0.783	-0.047
0.150	9.225	9.696	0.381	0.269	-0.871	0.046
0.200	9.205	9.715	0.385	0.263	-0.911	0.084
0.300	9.175	9.726	0.390	0.260	-0.960	0.105
0.500	9.216	9.741	0.382	0.256	-0.888	0.134
0.700	9.223	9.738	0.381	0.257	-0.874	0.129
0.800	9.279	9.726	0.369	0.260	-0.765	0.105
0.850	9.351	9.727	0.354	0.260	-0.625	0.108
0.900	9.467	9.698	0.327	0.268	-0.400	0.050
0.950	9.530	9.658	0.312	0.270	-0.276	-0.027
Section C						
0.000	9.295	9.294	0.366	0.366	-0.735	-0.736
0.025	9.142	9.995	0.398	0.169	-1.032	0.629
0.050	9.215	9.184	0.383	0.389	-0.890	-0.951
0.075	9.198	9.513	0.386	0.316	-0.923	-0.311
0.100	9.191	9.676	0.388	0.274	-0.936	0.008
0.150	9.163	9.707	0.394	0.266	-0.993	0.068
0.200	9.143	9.723	0.398	0.261	-1.030	0.099
0.300	9.113	9.735	0.404	0.258	-1.089	0.122
0.500	9.148	9.750	0.397	0.253	-1.022	0.152
0.700	9.143	9.745	0.397	0.255	-1.030	0.142
0.800	9.220	9.739	0.382	0.257	-0.880	0.130
0.850	9.327	9.730	0.359	0.259	-0.672	0.112
0.900	9.464	9.700	0.328	0.268	-0.405	0.055
0.950	9.519	9.621	0.315	0.289	-0.299	-0.099
Section D						
0.000	9.472	9.472	0.326	0.326	-0.390	-0.390
0.025	10.012	9.711	0.161	0.265	0.662	0.076
0.050	9.449	9.446	0.331	0.332	-0.435	-0.441
0.075	9.441	9.524	0.333	0.313	-0.450	-0.288
0.100	9.428	9.588	0.336	0.297	-0.475	-0.164
0.150	9.402	9.603	0.342	0.294	-0.525	-0.134
0.200	9.381	9.608	0.347	0.292	-0.567	-0.126
0.300	9.350	9.603	0.354	0.294	-0.627	-0.134
0.500	9.333	9.606	0.358	0.293	-0.661	-0.129
0.700	9.296	9.599	0.366	0.295	-0.733	-0.142
0.800	9.305	9.580	0.364	0.299	-0.715	-0.179
0.850	9.341	9.575	0.356	0.301	-0.644	-0.139
0.900	9.406	9.558	0.341	0.305	-0.518	-0.222
0.950	9.478	9.528	0.325	0.312	-0.379	-0.280

^aSuction surface.
^bPressure surface.

TABLE 7.—Continued.

(c) Airflow, 75.31 kg/sec; readings 297 to 300

Fraction of chord, XC/C	Pressure, N/cm ²		Mach number		Coefficient	
	(a)	(b)	(a)	(b)	(a)	(b)
Section A						
0.000	9.798	9.797	0.237	0.237	0.187	0.187
0.025	9.741	9.844	0.254	0.222	0.067	0.286
0.050	9.742	9.671	0.254	0.274	0.069	-0.081
0.075	9.730	9.768	0.258	0.246	0.043	0.125
0.100	9.714	9.801	0.262	0.236	0.010	0.195
0.150	9.679	9.815	0.272	0.232	-0.065	0.223
0.200	9.649	9.819	0.280	0.231	-0.128	0.232
0.300	9.601	9.817	0.293	0.231	-0.230	0.232
0.500	9.551	9.823	0.305	0.229	-0.336	0.240
0.700	9.529	9.811	0.311	0.233	-0.382	0.215
0.800	9.541	9.805	0.308	0.235	-0.357	0.203
0.850	9.565	9.800	0.302	0.236	-0.305	0.193
0.900	9.611	9.789	0.290	0.240	-0.209	0.168
0.950	9.687	9.790	0.270	0.240	-0.047	0.172
Section B						
0.000	9.437	9.437	0.333	0.333	-0.578	-0.578
0.025	9.338	9.978	0.355	0.173	-0.787	0.570
0.050	9.375	9.309	0.347	0.362	-0.709	-0.849
0.075	9.365	9.646	0.349	0.281	-0.731	-0.135
0.100	9.349	9.698	0.353	0.267	-0.763	-0.025
0.150	9.312	9.737	0.361	0.256	-0.843	0.058
0.200	9.292	9.755	0.365	0.250	-0.885	0.097
0.300	9.269	9.764	0.370	0.247	-0.934	0.117
0.500	9.302	9.778	0.363	0.243	-0.864	0.145
0.700	9.308	9.775	0.362	0.244	-0.851	0.139
0.800	9.358	9.762	0.351	0.248	-0.744	0.111
0.850	9.423	9.762	0.336	0.248	-0.608	0.112
0.900	9.527	9.739	0.311	0.255	-0.387	0.063
0.950	9.589	9.705	0.296	0.265	-0.256	-0.010
Section C						
0.000	9.378	9.377	0.346	0.346	-0.703	-0.703
0.025	9.239	10.005	0.377	0.162	-0.996	0.626
0.050	9.302	9.277	0.363	0.369	-0.864	-0.917
0.075	9.288	9.562	0.366	0.303	-0.893	-0.312
0.100	9.282	9.721	0.367	0.260	-0.905	0.024
0.150	9.257	9.747	0.373	0.253	-0.959	0.080
0.200	9.239	9.761	0.377	0.248	-0.996	0.109
0.300	9.212	9.772	0.382	0.245	-1.053	0.133
0.500	9.242	9.785	0.376	0.241	-0.990	0.160
0.700	9.240	9.781	0.376	0.242	-0.995	0.153
0.800	9.311	9.775	0.361	0.244	-0.844	0.139
0.850	9.403	9.767	0.341	0.247	-0.648	0.122
0.900	9.526	9.741	0.312	0.254	-0.388	0.068
0.950	9.578	9.671	0.299	0.274	-0.278	-0.080
Section D						
0.000	9.531	9.531	0.310	0.310	-0.377	-0.377
0.025	10.028	9.752	0.151	0.251	0.674	0.090
0.050	9.512	9.512	0.315	0.315	-0.419	-0.419
0.075	9.504	9.581	0.317	0.298	-0.435	-0.271
0.100	9.490	9.639	0.320	0.283	-0.466	-0.149
0.150	9.470	9.652	0.325	0.279	-0.506	-0.121
0.200	9.451	9.657	0.330	0.278	-0.548	-0.111
0.300	9.423	9.654	0.336	0.279	-0.606	-0.118
0.500	9.407	9.656	0.340	0.278	-0.641	-0.114
0.700	9.372	9.649	0.348	0.280	-0.716	-0.127
0.800	9.384	9.632	0.345	0.285	-0.689	-0.163
0.850	9.416	9.627	0.338	0.286	-0.622	-0.175
0.900	9.476	9.614	0.324	0.289	-0.494	-0.202
0.950	9.539	9.585	0.308	0.297	-0.361	-0.262

^aSuction surface.^bPressure surface.

TABLE 7.—Continued.

(d) Airflow, 73.04 kg/sec; readings 293 to 296

Fraction of chord, XC/C	Pressure, N/cm ²		Mach number		Coefficient	
	(a)	(b)	(a)	(b)	(a)	(b)
Section A						
0.000	9.813	9.812	0.232	0.232	0.172	0.172
0.025	9.757	9.858	0.249	0.217	0.047	0.274
0.050	9.758	9.691	0.249	0.268	0.050	-0.101
0.075	9.747	9.784	0.252	0.241	0.025	0.106
0.100	9.732	9.815	0.257	0.231	-0.010	0.177
0.150	9.698	9.828	0.266	0.227	-0.087	0.207
0.200	9.668	9.832	0.274	0.226	-0.153	0.215
0.300	9.621	9.852	0.287	0.226	-0.259	0.216
0.500	9.574	9.836	0.299	0.224	-0.366	0.226
0.700	9.554	9.825	0.304	0.228	-0.412	0.199
0.800	9.564	9.819	0.302	0.230	-0.388	0.187
0.850	9.588	9.815	0.296	0.231	-0.334	0.177
0.900	9.630	9.804	0.285	0.235	-0.238	0.153
0.950	9.708	9.806	0.263	0.234	-0.064	0.157
Section B						
0.000	9.472	9.472	0.324	0.324	-0.595	-0.596
0.025	9.377	9.980	0.345	0.172	-0.808	0.549
0.050	9.408	9.343	0.339	0.354	-0.739	-0.885
0.075	9.398	9.662	0.342	0.276	-0.762	-0.167
0.100	9.383	9.716	0.345	0.261	-0.796	-0.045
0.150	9.347	9.753	0.353	0.250	-0.876	0.037
0.200	9.328	9.770	0.357	0.245	-0.919	0.076
0.300	9.306	9.779	0.362	0.243	-0.969	0.096
0.500	9.338	9.792	0.355	0.239	-0.897	0.125
0.700	9.340	9.789	0.354	0.239	-0.891	0.119
0.800	9.390	9.780	0.343	0.242	-0.779	0.097
0.850	9.451	9.780	0.329	0.242	-0.642	0.099
0.900	9.551	9.756	0.305	0.249	-0.417	0.044
0.950	9.613	9.724	0.289	0.259	-0.279	-0.029
Section C						
0.000	9.414	9.414	0.338	0.338	-0.725	-0.726
0.025	9.280	10.011	0.368	0.158	-1.028	0.620
0.050	9.338	9.316	0.355	0.360	-0.897	-0.946
0.075	9.305	9.582	0.358	0.297	-0.926	-0.348
0.100	9.320	9.740	0.359	0.254	-0.938	0.008
0.150	9.295	9.764	0.364	0.247	-0.994	0.063
0.200	9.276	9.771	0.369	0.243	-1.037	0.092
0.300	9.253	9.787	0.373	0.240	-1.088	0.114
0.500	9.281	9.802	0.367	0.236	-1.025	0.147
0.700	9.279	9.797	0.368	0.237	-1.030	0.136
0.800	9.347	9.790	0.353	0.239	-0.875	0.122
0.850	9.436	9.782	0.333	0.242	-0.677	0.103
0.900	9.552	9.758	0.305	0.249	-0.414	0.048
0.950	9.603	9.691	0.292	0.268	-0.300	-0.103
Section D						
0.000	9.551	9.552	0.305	0.305	-0.416	-0.415
0.025	10.066	9.771	0.131	0.245	0.742	0.078
0.050	9.537	9.541	0.308	0.307	-0.448	-0.439
0.075	9.529	9.606	0.311	0.291	-0.467	-0.294
0.100	9.520	9.660	0.313	0.277	-0.488	-0.171
0.150	9.499	9.672	0.318	0.273	-0.535	-0.145
0.200	9.480	9.677	0.322	0.272	-0.577	-0.134
0.300	9.454	9.674	0.329	0.273	-0.636	-0.140
0.500	9.437	9.675	0.332	0.273	-0.673	-0.139
0.700	9.407	9.669	0.339	0.274	-0.741	-0.151
0.800	9.414	9.654	0.338	0.278	-0.725	-0.186
0.850	9.445	9.648	0.331	0.280	-0.656	-0.199
0.900	9.503	9.635	0.317	0.283	-0.525	-0.228
0.950	9.563	9.609	0.302	0.290	-0.389	-0.287

^aSuction surface^bPressure surface

TABLE 7.—Continued.

(e) Airflow, 68.45 kg/sec; readings 317 to 320

Fraction of chord, XC/C	Pressure, N/cm ²		Mach number		Coefficient	
	(a)	(b)	(a)	(b)	(a)	(b)
Section A						
0.000	9.859	9.859	0.214	0.214	0.188	0.189
0.025	9.808	9.898	0.231	0.201	0.057	0.289
0.050	9.810	9.751	0.231	0.249	0.062	-0.090
0.075	9.799	9.832	0.234	0.224	0.034	0.118
0.100	9.786	9.860	0.238	0.214	0.001	0.192
0.150	9.757	9.872	0.247	0.210	-0.074	0.222
0.200	9.731	9.875	0.255	0.209	-0.142	0.230
0.300	9.692	9.875	0.266	0.209	-0.241	0.230
0.500	9.651	9.879	0.277	0.208	-0.345	0.240
0.700	9.634	9.869	0.282	0.211	-0.389	0.215
0.800	9.645	9.865	0.279	0.212	-0.362	0.204
0.850	9.664	9.860	0.273	0.214	-0.312	0.192
0.900	9.703	9.852	0.263	0.217	-0.213	0.169
0.950	9.769	9.853	0.243	0.217	-0.043	0.173
Section B						
0.000	9.566	9.565	0.299	0.300	-0.565	-0.569
0.025	9.488	10.006	0.319	0.157	-0.767	0.566
0.050	9.515	9.470	0.312	0.323	-0.698	-0.813
0.075	9.506	9.725	0.314	0.256	-0.720	-0.157
0.100	9.494	9.781	0.317	0.240	-0.751	-0.012
0.150	9.465	9.811	0.324	0.230	-0.826	0.065
0.200	9.448	9.826	0.328	0.226	-0.869	0.102
0.300	9.430	9.833	0.333	0.223	-0.916	0.122
0.500	9.456	9.845	0.326	0.219	-0.848	0.152
0.700	9.464	9.843	0.325	0.220	-0.829	0.147
0.800	9.503	9.835	0.315	0.222	-0.728	0.127
0.850	9.554	9.835	0.302	0.222	-0.595	0.127
0.900	9.639	9.815	0.280	0.229	-0.378	0.075
0.950	9.693	9.788	0.266	0.238	-0.239	0.006
Section C						
0.000	9.497	9.498	0.316	0.316	-0.742	-0.740
0.025	9.394	10.034	0.341	0.144	-1.008	0.640
0.050	9.447	9.444	0.329	0.329	-0.872	-0.878
0.075	9.436	9.652	0.331	0.277	-0.899	-0.343
0.100	9.432	9.802	0.332	0.233	-0.911	0.042
0.150	9.412	9.821	0.337	0.227	-0.961	0.091
0.200	9.398	9.832	0.340	0.223	-0.997	0.119
0.300	9.377	9.841	0.345	0.221	-1.051	0.142
0.500	9.403	9.852	0.339	0.217	-0.983	0.170
0.700	9.400	9.850	0.339	0.218	-0.992	0.164
0.800	9.463	9.845	0.325	0.219	-0.831	0.152
0.850	9.539	9.838	0.306	0.221	-0.635	0.134
0.900	9.639	9.817	0.280	0.228	-0.377	0.080
0.950	9.682	9.759	0.269	0.246	-0.266	-0.068
Section D						
0.000	9.641	9.641	0.280	0.280	-0.372	-0.373
0.025	10.073	9.826	0.123	0.226	0.738	0.102
0.050	9.629	9.632	0.283	0.282	-0.403	-0.396
0.075	9.623	9.686	0.285	0.267	-0.418	-0.256
0.100	9.614	9.734	0.287	0.254	-0.441	-0.134
0.150	9.596	9.744	0.292	0.251	-0.487	-0.108
0.200	9.582	9.747	0.295	0.250	-0.524	-0.100
0.300	9.560	9.744	0.301	0.251	-0.581	-0.106
0.500	9.548	9.747	0.304	0.250	-0.613	-0.101
0.700	9.521	9.741	0.311	0.252	-0.681	-0.114
0.800	9.528	9.727	0.309	0.256	-0.663	-0.150
0.850	9.554	9.725	0.303	0.256	-0.597	-0.156
0.900	9.602	9.712	0.290	0.260	-0.473	-0.190
0.950	9.653	9.692	0.277	0.266	-0.340	-0.241

^aSuction surface.^bPressure surface.

TABLE 7.—Continued.

(f) Airflow, 56.21 kg/sec; readings 309 to 312

Fraction of chord, XC/C	Pressure, N/cm ²		Mach number		Coefficient	
	(a)	(b)	(a)	(b)	(a)	(b)
Section A						
0.000	9.950	9.950	0.174	0.174	0.199	0.198
0.025	9.917	9.978	0.187	0.162	0.073	0.305
0.050	9.919	9.885	0.186	0.199	0.082	-0.050
0.075	9.912	9.935	0.189	0.180	0.055	0.140
0.100	9.905	9.953	0.192	0.172	0.025	0.212
0.150	9.885	9.960	0.199	0.169	-0.049	0.238
0.200	9.866	9.963	0.206	0.168	-0.123	0.248
0.300	9.843	9.963	0.214	0.168	-0.209	0.250
0.500	9.818	9.965	0.222	0.167	-0.306	0.256
0.700	9.807	9.966	0.226	0.171	-0.347	0.222
0.800	9.814	9.957	0.224	0.171	-0.323	0.226
0.850	9.827	9.954	0.219	0.172	-0.271	0.213
0.900	9.852	9.948	0.211	0.174	-0.175	0.192
0.950	9.895	9.949	0.195	0.174	-0.011	0.197
Section B						
0.000	9.765	9.765	0.239	0.239	-0.511	-0.510
0.025	9.716	10.052	0.254	0.124	-0.698	0.591
0.050	9.732	9.725	0.249	0.251	-0.635	-0.663
0.075	9.727	9.847	0.251	0.213	-0.656	-0.197
0.100	9.720	9.911	0.253	0.189	-0.683	0.050
0.150	9.702	9.927	0.258	0.183	-0.750	0.111
0.200	9.693	9.936	0.261	0.179	-0.785	0.145
0.300	9.682	9.941	0.264	0.177	-0.829	0.166
0.500	9.699	9.948	0.259	0.175	-0.762	0.191
0.700	9.701	9.947	0.258	0.175	-0.757	0.187
0.800	9.727	9.943	0.251	0.177	-0.657	0.172
0.850	9.757	9.943	0.242	0.176	-0.542	0.173
0.900	9.809	9.931	0.225	0.181	-0.339	0.128
0.950	9.854	9.916	0.210	0.187	-0.170	0.067
Section C						
0.000	9.725	9.725	0.251	0.251	-0.664	-0.665
0.025	9.664	10.066	0.269	0.116	-0.898	0.643
0.050	9.691	9.698	0.261	0.259	-0.792	-0.768
0.075	9.685	9.803	0.263	0.227	-0.815	-0.365
0.100	9.680	9.925	0.264	0.184	-0.856	0.103
0.150	9.671	9.932	0.267	0.181	-0.871	0.131
0.200	9.663	9.939	0.269	0.178	-0.902	0.158
0.300	9.650	9.945	0.273	0.176	-0.951	0.178
0.500	9.667	9.951	0.268	0.173	-0.886	0.204
0.700	9.666	9.950	0.268	0.173	-0.891	0.200
0.800	9.701	9.947	0.258	0.175	-0.755	0.186
0.850	9.745	9.943	0.245	0.176	-0.585	0.173
0.900	9.809	9.930	0.225	0.182	-0.340	0.124
0.950	9.847	9.896	0.212	0.195	-0.196	-0.008
Section D						
0.000	9.812	9.812	0.224	0.224	-0.331	-0.330
0.025	10.118	9.941	0.078	0.177	0.844	0.163
0.050	9.808	9.819	0.225	0.222	-0.345	-0.303
0.075	9.805	9.849	0.227	0.212	-0.358	-0.188
0.100	9.801	9.878	0.228	0.201	-0.373	-0.075
0.150	9.789	9.885	0.231	0.199	-0.416	-0.050
0.200	9.780	9.887	0.234	0.198	-0.450	-0.041
0.300	9.767	9.885	0.239	0.199	-0.503	-0.049
0.500	9.759	9.886	0.241	0.198	-0.534	-0.045
0.700	9.742	9.883	0.246	0.200	-0.597	-0.058
0.800	9.746	9.874	0.245	0.203	-0.581	-0.090
0.850	9.760	9.869	0.241	0.205	-0.527	-0.110
0.900	9.790	9.865	0.231	0.206	-0.414	-0.125
0.950	9.826	9.853	0.220	0.210	-0.278	-0.174

^aSuction surface^bPressure surface

TABLE 9.—TOTAL PRESSURE DISTRIBUTION FOR CORNER 1 WITH VANES A10
IN CORNER 1 AND VANES A4 IN CORNER 2—UNIFORM INFLOW

(a) Airflow, 81.16 kg/sec; readings 38 to 41

Span-wise location, percent of span	Circumferential location, θ , deg								Average
	0	45	90	135	180	225	270	315	
Corner 1 inlet rake									
5.0	10.359	10.381	10.382	10.414	10.403	10.385	10.405	10.371	10.387
10.0	10.412	10.410	10.411	10.418	10.406	10.408	10.420	10.408	10.412
15.0	10.415	10.413	10.409	10.414	10.403	10.407	10.421	10.410	10.412
20.0	10.412	10.405	10.409	10.410	10.393	10.407	10.412	10.411	10.407
30.0	10.411	10.412	10.407	10.411	10.393	10.410	10.409	10.412	10.408
50.0	10.413	10.413	10.407	10.410	10.388	10.414	10.408	10.406	10.407
70.0	10.412	10.410	10.411	10.400	10.407	10.412	10.409	10.408	10.409
90.0	10.409	10.409	10.410	10.407	10.412	10.410	10.409	10.412	10.410
Corner 1 inlet boundary layer rake									
1.0	10.054	10.079	10.127	10.103	10.116	10.073	10.099	10.105	10.095
2.0	10.145	10.182	10.213	10.250	10.228	10.183	10.212	10.196	10.201
3.0	10.212	10.253	10.275	10.345	10.312	10.270	10.289	10.259	10.277
4.0	10.294	10.331	10.338	10.401	10.377	10.341	10.373	10.335	10.349
5.0	10.352	10.373	10.381	10.416	10.404	10.381	10.408	10.381	10.387
7.5	10.409	10.405	10.412	10.419	10.412	10.404	10.418	10.416	10.412
10.0	10.409	10.410	10.418	10.419	10.412	10.410	10.425	10.409	10.414
12.5	10.410	10.410	10.415	10.417	10.401	10.408	10.424	10.411	10.412
Diffuser exit rake									
5.0	10.044	10.134	9.767	10.144	10.073	10.049	10.092	10.070	10.047
10.0	10.124	10.165	9.772	10.183	10.149	10.033	10.149	10.055	10.079
15.0	10.142	10.198	9.796	10.203	10.156	10.078	10.172	10.101	10.106
20.0	10.207	10.273	9.891	10.308	10.211	10.163	10.182	10.185	10.177
30.0	10.336	10.405	10.206	10.404	10.284	10.358	10.209	10.352	10.319
50.0	10.316	10.275	9.998	10.315	10.284	10.341	10.218	10.371	10.265
70.0	10.304	10.129	10.357	10.285	10.272	10.363	10.130	10.365	10.238
90.0	10.178	10.181	10.088	10.145	10.167	10.112	10.056	10.102	10.129
Diffuser exit boundary layer rake									
1.0	9.908	9.981	9.736	9.989	9.960	9.989	9.981	10.027	9.946
2.0	9.945	10.036	9.747	10.042	10.005	10.042	10.023	10.063	9.988
3.0	9.977	10.079	9.756	10.087	10.037	10.059	10.052	10.076	10.015
4.0	10.012	10.114	9.763	10.123	10.061	10.061	10.075	10.077	10.036
5.0	10.036	10.130	9.767	10.151	10.092	10.057	10.097	10.072	10.050
7.5	10.098	10.150	9.770	10.180	10.125	10.037	10.128	10.054	10.068
10.0	10.134	10.173	9.771	10.187	10.152	10.033	10.149	10.066	10.083
12.5	10.127	10.162	9.769	10.187	10.159	10.046	10.164	10.050	10.083

TABLE 9.—Continued.

(b) Airflow, 78.37 kg/sec; readings 22 to 25

Span-wise location, percent of span	Circumferential location, θ , deg								Average
	0	45	90	135	180	225	270	315	
Corner 1 inlet rake									
5.0	10.354	10.374	10.371	10.400	10.392	10.368	10.391	10.365	10.377
10.0	10.396	10.400	10.400	10.404	10.405	10.399	10.410	10.394	10.401
15.0	10.399	10.400	10.397	10.402	10.404	10.400	10.408	10.398	10.401
20.0	10.398	10.392	10.396	10.396	10.393	10.396	10.399	10.398	10.396
30.0	10.395	10.398	10.395	10.396	10.389	10.397	10.397	10.398	10.396
50.0	10.399	10.399	10.398	10.398	10.372	10.401	10.398	10.395	10.395
70.0	10.398	10.398	10.398	10.388	10.382	10.399	10.398	10.395	10.394
90.0	10.397	10.396	10.396	10.397	10.392	10.398	10.399	10.399	10.397
Corner 1 inlet boundary layer rake									
1.0	10.052	10.091	10.103	10.115	10.114	10.083	10.084	10.097	10.092
2.0	10.140	10.194	10.192	10.244	10.223	10.189	10.195	10.192	10.196
3.0	10.206	10.263	10.260	10.335	10.305	10.270	10.273	10.255	10.271
4.0	10.283	10.336	10.328	10.388	10.370	10.338	10.357	10.327	10.341
5.0	10.340	10.371	10.371	10.402	10.395	10.373	10.394	10.372	10.377
7.5	10.397	10.394	10.396	10.405	10.400	10.395	10.402	10.404	10.399
10.0	10.397	10.398	10.402	10.406	10.400	10.399	10.411	10.396	10.401
12.5	10.397	10.397	10.400	10.403	10.391	10.398	10.410	10.387	10.398
Diffuser exit rake									
5.0	10.043	10.126	9.782	10.143	10.075	10.054	10.097	10.075	10.049
10.0	10.124	10.158	9.787	10.179	10.148	10.040	10.147	10.056	10.080
15.0	10.141	10.189	9.808	10.201	10.153	10.087	10.169	10.099	10.106
20.0	10.203	10.266	9.895	10.303	10.203	10.170	10.176	10.181	10.175
30.0	10.326	10.392	10.198	10.394	10.303	10.347	10.204	10.346	10.314
50.0	10.311	10.268	10.008	10.313	10.274	10.330	10.211	10.362	10.260
70.0	10.299	10.129	10.065	10.283	10.273	10.346	10.129	10.356	10.235
90.0	10.178	10.184	10.092	10.132	10.161	10.114	10.063	10.107	10.129
Diffuser exit boundary layer rake									
1.0	9.917	9.986	9.752	9.991	9.967	9.988	9.982	10.023	9.951
2.0	9.952	10.037	9.763	10.045	10.009	10.039	10.024	10.059	9.991
3.0	9.981	10.077	9.771	10.089	10.038	10.056	10.051	10.072	10.017
4.0	10.015	10.113	9.776	10.123	10.061	10.060	10.073	10.073	10.037
5.0	10.038	10.130	9.780	10.151	10.082	10.056	10.097	10.068	10.050
7.5	10.097	10.150	9.784	10.177	10.125	10.039	10.122	10.050	10.068
10.0	10.133	10.171	9.789	10.184	10.154	10.039	10.145	10.064	10.085
12.5	10.125	10.161	9.785	10.182	10.160	10.055	10.160	10.049	10.085

TABLE 9.—Continued.

(c) Airflow, 75.21 kg/sec; readings 18 to 21

Span-wise location, percent of span	Circumferential location, θ , deg								Average
	0	45	90	135	180	225	270	315	
Corner 1 inlet rake									
5.0	10.325	10.351	10.350	10.376	10.366	10.345	10.361	10.335	10.351
10.0	10.367	10.368	10.369	10.377	10.375	10.369	10.378	10.365	10.371
15.0	10.369	10.369	10.368	10.372	10.376	10.367	10.377	10.367	10.371
20.0	10.368	10.362	10.367	10.365	10.366	10.365	10.369	10.369	10.366
30.0	10.365	10.369	10.365	10.367	10.364	10.367	10.368	10.369	10.367
50.0	10.369	10.370	10.367	10.367	10.346	10.370	10.367	10.366	10.365
70.0	10.367	10.366	10.368	10.350	10.358	10.367	10.367	10.368	10.364
90.0	10.366	10.366	10.368	10.364	10.366	10.355	10.369	10.369	10.365
Corner 1 inlet boundary layer rake									
1.0	10.061	10.097	10.100	10.120	10.113	10.084	10.090	10.086	10.094
2.0	10.141	10.189	10.179	10.239	10.215	10.181	10.190	10.173	10.188
3.0	10.198	10.252	10.242	10.318	10.289	10.254	10.260	10.234	10.256
4.0	10.269	10.319	10.303	10.365	10.344	10.316	10.334	10.301	10.319
5.0	10.318	10.350	10.341	10.376	10.367	10.347	10.365	10.343	10.351
7.5	10.367	10.367	10.364	10.377	10.373	10.364	10.373	10.374	10.370
10.0	10.367	10.369	10.370	10.378	10.373	10.370	10.380	10.365	10.372
12.5	10.368	10.367	10.369	10.374	10.366	10.371	10.378	10.369	10.370
Diffuser exit rake									
5.0	10.050	10.124	9.817	10.137	10.081	10.059	10.108	10.079	10.057
10.0	10.126	10.154	9.820	10.174	10.152	10.046	10.152	10.066	10.086
15.0	10.141	10.183	9.841	10.187	10.156	10.086	10.165	10.107	10.108
20.0	10.195	10.248	9.916	10.282	10.200	10.160	10.166	10.180	10.168
30.0	10.304	10.361	10.190	10.365	10.296	10.322	10.178	10.320	10.292
50.0	10.290	10.260	10.022	10.305	10.261	10.311	10.196	10.333	10.247
70.0	10.277	10.137	10.073	10.271	10.249	10.326	10.129	10.335	10.224
90.0	10.176	10.181	10.099	10.135	10.139	10.120	10.073	10.112	10.129
Diffuser exit boundary layer rake									
1.0	9.936	9.995	9.789	10.004	10.007	10.002	10.003	10.032	9.971
2.0	9.969	10.041	9.801	10.050	10.054	10.049	10.042	10.063	10.009
3.0	9.996	10.076	9.807	10.090	10.092	10.066	10.067	10.075	10.034
4.0	10.025	10.110	9.813	10.122	10.123	10.070	10.416	10.077	10.094
5.0	10.045	10.125	9.815	10.146	10.145	10.067	10.113	10.073	10.066
7.5	10.086	10.145	9.818	10.171	10.166	10.049	10.136	10.059	10.079
10.0	10.135	10.164	9.823	10.175	10.171	10.045	10.154	10.075	10.093
12.5	10.128	10.154	9.817	10.175	10.174	10.055	10.164	10.060	10.091

TABLE 9.—Continued.

(d) Airflow, 73.10 kg/sec; readings 4 to 16

Span-wise location, percent of span	Circumferential location, θ , deg								Average
	0	45	90	135	180	225	270	315	
Corner 1 inlet rake									
5.0	10.309	10.340	10.331	10.362	10.352	10.334	10.354	10.315	10.337
10.0	10.356	10.358	10.360	10.364	10.362	10.359	10.367	10.354	10.360
15.0	10.360	10.358	10.358	10.362	10.362	10.359	10.366	10.359	10.360
20.0	10.358	10.353	10.356	10.357	10.353	10.356	10.359	10.357	10.356
30.0	10.355	10.359	10.355	10.356	10.348	10.356	10.356	10.357	10.355
50.0	10.398	10.361	10.359	10.354	10.345	10.360	10.358	10.356	10.361
70.0	10.358	10.359	10.358	10.347	10.345	10.358	10.345	10.356	10.353
90.0	10.356	10.356	10.357	10.357	10.354	10.355	10.358	10.360	10.357
Corner 1 inlet boundary layer rake									
1.0	10.068	10.081	10.098	10.118	10.103	10.088	10.087	10.091	10.092
2.0	10.146	10.168	10.180	10.229	10.198	10.180	10.184	10.173	10.182
3.0	10.201	10.228	10.245	10.308	10.268	10.249	10.249	10.229	10.247
4.0	10.270	10.293	10.303	10.353	10.323	10.308	10.320	10.292	10.308
5.0	10.318	10.329	10.339	10.365	10.348	10.337	10.352	10.332	10.340
7.5	10.357	10.353	10.356	10.366	10.358	10.349	10.362	10.362	10.358
10.0	10.357	10.357	10.361	10.367	10.356	10.355	10.367	10.355	10.360
12.5	10.357	10.357	10.359	10.365	10.350	10.358	10.368	10.357	10.359
Diffuser exit rake									
5.0	10.045	10.112	9.827	10.139	10.082	10.069	10.103	10.075	10.056
10.0	10.123	10.155	9.831	10.172	10.147	10.049	10.153	10.063	10.086
15.0	10.138	10.182	9.851	10.186	10.152	10.083	10.165	10.100	10.107
20.0	10.193	10.245	9.931	10.275	10.190	10.150	10.166	10.175	10.166
30.0	10.296	10.352	10.192	10.354	10.285	10.315	10.174	10.312	10.285
50.0	10.288	10.259	10.029	10.300	10.250	10.310	10.189	10.325	10.244
70.0	10.273	10.146	10.079	10.270	10.248	10.317	10.131	10.326	10.224
90.0	10.174	10.176	10.103	10.134	10.149	10.121	10.072	10.104	10.129
Diffuser exit boundary layer rake									
1.0	9.942	9.998	9.800	10.006	9.986	10.006	10.010	10.037	9.973
2.0	9.973	10.042	9.811	10.051	10.022	10.052	10.047	10.068	10.008
3.0	9.999	10.075	9.818	10.089	10.047	10.066	10.072	10.080	10.031
4.0	10.027	10.109	9.825	10.121	10.068	10.056	10.134	10.083	10.053
5.0	10.045	10.123	9.828	10.149	10.088	10.073	10.117	10.079	10.063
7.5	10.098	10.143	9.831	10.170	10.124	10.049	10.139	10.065	10.078
10.0	10.135	10.159	9.834	10.173	10.151	10.048	10.155	10.074	10.091
12.5	10.126	10.151	9.831	10.170	10.157	10.058	10.161	10.061	10.089

TABLE 9.—Continued.

(e) Airflow, 73.03 kg/sec; readings 5 to 15

Span-wise location, percent of span	Circumferential location, θ , deg								Average
	0	45	90	135	180	225	270	315	
Corner 1 inlet rake									
5.0	10.314	10.332	10.324	10.345	10.351	10.336	10.349	10.323	10.334
10.0	10.356	10.354	10.356	10.361	10.361	10.362	10.366	10.354	10.359
15.0	10.359	10.357	10.355	10.360	10.360	10.358	10.363	10.356	10.358
20.0	10.356	10.351	10.354	10.357	10.349	10.354	10.356	10.357	10.354
30.0	10.354	10.356	10.353	10.354	10.345	10.355	10.355	10.357	10.354
50.0	10.359	10.359	10.355	10.355	10.328	10.358	10.355	10.353	10.353
70.0	10.357	10.357	10.355	10.347	10.342	10.358	10.354	10.354	10.353
90.0	10.356	10.354	10.356	10.353	10.351	10.353	10.356	10.357	10.355
Corner 1 inlet boundary layer rake									
1.0	10.056	10.081	10.098	10.119	10.097	10.081	10.099	10.090	10.090
2.0	10.133	10.166	10.175	10.230	10.187	10.171	10.193	10.167	10.178
3.0	10.188	10.225	10.237	10.307	10.255	10.240	10.256	10.220	10.241
4.0	10.255	10.288	10.296	10.351	10.309	10.298	10.323	10.282	10.300
5.0	10.304	10.325	10.333	10.363	10.334	10.330	10.353	10.322	10.333
7.5	10.354	10.352	10.356	10.364	10.343	10.348	10.361	10.356	10.354
10.0	10.354	10.355	10.359	10.366	10.343	10.352	10.367	10.352	10.356
12.5	10.355	10.356	10.358	10.362	10.327	10.355	10.366	10.355	10.354
Diffuser exit rake									
5.0	10.050	10.115	9.829	10.137	10.083	10.066	10.106	10.075	10.058
10.0	10.125	10.154	9.834	10.172	10.147	10.048	10.152	10.066	10.087
15.0	10.139	10.183	9.858	10.188	10.151	10.080	10.165	10.106	10.109
20.0	10.193	10.242	9.937	10.274	10.189	10.146	10.164	10.175	10.165
30.0	10.294	10.352	10.191	10.352	10.278	10.315	10.173	10.309	10.283
50.0	10.289	10.259	10.031	10.300	10.255	10.310	10.188	10.323	10.244
70.0	10.273	10.145	10.081	10.270	10.250	10.320	10.132	10.323	10.224
90.0	10.174	10.176	10.104	10.139	10.147	10.122	10.074	10.117	10.132
Diffuser exit boundary layer rake									
1.0	9.944	9.998	9.806	10.010	9.988	10.006	10.011	10.039	9.975
2.0	9.976	10.043	9.816	10.056	10.025	10.052	10.046	10.068	10.010
3.0	10.000	10.078	9.824	10.092	10.051	10.066	10.035	10.080	10.028
4.0	10.029	10.109	9.830	10.123	10.073	10.069	10.096	10.084	10.052
5.0	10.049	10.123	9.833	10.148	10.093	10.072	10.113	10.080	10.064
7.5	10.099	10.143	9.835	10.170	10.128	10.051	10.136	10.065	10.078
10.0	10.134	10.163	9.839	10.173	10.154	10.046	10.150	10.076	10.092
12.5	10.126	10.154	9.834	10.173	10.160	10.056	10.158	10.064	10.091

TABLE 9.—Continued.

(f) Airflow, 72.77 kg/sec; readings 6 to 17

Span-wise location, percent of span	Circumferential location, θ , deg								Average
	0	45	90	135	180	225	270	315	
Corner 1 inlet rake									
5.0	10.321	10.336	10.333	10.360	10.356	10.332	10.353	10.323	10.339
10.0	10.358	10.357	10.362	10.361	10.366	10.359	10.368	10.354	10.361
15.0	10.360	10.358	10.358	10.360	10.362	10.360	10.367	10.355	10.360
20.0	10.358	10.352	10.358	10.355	10.352	10.355	10.361	10.355	10.355
30.0	10.357	10.357	10.356	10.355	10.345	10.356	10.359	10.357	10.355
50.0	10.360	10.360	10.359	10.354	10.342	10.360	10.358	10.353	10.356
70.0	10.358	10.358	10.359	10.345	10.351	10.361	10.346	10.352	10.354
90.0	10.357	10.357	10.357	10.353	10.356	10.357	10.359	10.357	10.357
Corner 1 inlet boundary layer rake									
1.0	10.067	10.082	10.104	10.101	10.112	10.073	10.092	10.097	10.091
2.0	10.144	10.167	10.182	10.214	10.206	10.165	10.184	10.177	10.180
3.0	10.198	10.226	10.243	10.297	10.276	10.238	10.250	10.230	10.245
4.0	10.266	10.292	10.300	10.349	10.327	10.299	10.320	10.295	10.306
5.0	10.314	10.328	10.337	10.362	10.348	10.333	10.351	10.335	10.339
7.5	10.356	10.352	10.358	10.364	10.357	10.351	10.363	10.363	10.358
10.0	10.358	10.355	10.361	10.367	10.355	10.357	10.370	10.355	10.360
12.5	10.358	10.355	10.360	10.364	10.347	10.357	10.370	10.359	10.359
Diffuser exit rake									
5.0	10.047	10.117	9.825	10.140	10.081	10.073	10.105	10.075	10.058
10.0	10.122	10.155	9.831	10.172	10.146	10.056	10.152	10.065	10.087
15.0	10.136	10.186	9.852	10.189	10.152	10.092	10.167	10.105	10.110
20.0	10.191	10.245	9.930	10.276	10.192	10.158	10.166	10.177	10.167
30.0	10.290	10.354	10.192	10.354	10.270	10.317	10.173	10.313	10.283
50.0	10.287	10.262	10.031	10.302	10.243	10.312	10.192	10.325	10.244
70.0	10.272	10.150	10.080	10.270	10.238	10.327	10.129	10.325	10.224
90.0	10.172	10.179	10.104	10.133	10.147	10.124	10.074	10.105	10.130
Diffuser exit boundary layer rake									
1.0	9.945	9.997	9.798	10.017	9.981	10.005	10.008	10.043	9.974
2.0	9.978	10.041	9.809	10.061	10.016	10.051	10.045	10.073	10.009
3.0	10.004	10.074	9.815	10.098	10.041	10.067	10.069	10.084	10.031
4.0	10.034	10.109	9.822	10.127	10.062	10.057	10.107	10.087	10.051
5.0	10.054	10.123	9.824	10.152	10.085	10.073	10.112	10.084	10.063
7.5	10.104	10.142	9.829	10.174	10.124	10.051	10.133	10.071	10.078
10.0	10.135	10.159	9.831	10.177	10.149	10.050	10.148	10.083	10.092
12.5	10.129	10.151	9.829	10.176	10.155	10.061	10.157	10.069	10.091

TABLE 9.—Continued.

(g) Airflow, 68.61 kg/sec; readings 34 to 37

Span-wise location, percent of span	Circumferential location, θ , deg								Average
	0	45	90	135	180	225	270	315	
Corner 1 inlet rake									
5.0	10.287	10.301	10.299	10.327	10.316	10.298	10.314	10.294	10.305
10.0	10.320	10.321	10.325	10.327	10.326	10.320	10.331	10.322	10.324
15.0	10.322	10.323	10.324	10.324	10.324	10.322	10.331	10.323	10.324
20.0	10.321	10.317	10.321	10.322	10.315	10.320	10.324	10.322	10.320
30.0	10.320	10.322	10.320	10.320	10.315	10.321	10.321	10.323	10.320
50.0	10.323	10.324	10.324	10.321	10.314	10.324	10.322	10.320	10.322
70.0	10.320	10.324	10.322	10.316	10.317	10.323	10.321	10.320	10.320
90.0	10.320	10.320	10.322	10.321	10.322	10.322	10.322	10.325	10.322
Corner 1 inlet boundary layer rake									
1.0	10.070	10.091	10.112	10.106	10.110	10.082	10.110	10.101	10.098
2.0	10.135	10.166	10.173	10.198	10.192	10.161	10.184	10.165	10.172
3.0	10.182	10.217	10.218	10.266	10.254	10.222	10.237	10.210	10.226
4.0	10.239	10.272	10.262	10.313	10.302	10.275	10.292	10.263	10.277
5.0	10.281	10.299	10.292	10.326	10.321	10.302	10.319	10.296	10.304
7.5	10.321	10.315	10.316	10.328	10.325	10.320	10.326	10.324	10.322
10.0	10.321	10.319	10.325	10.329	10.324	10.322	10.331	10.320	10.324
12.5	10.322	10.321	10.323	10.327	10.318	10.322	10.330	10.322	10.323
Diffuser exit rake									
5.0	10.058	10.121	9.875	10.140	10.092	10.070	10.116	10.089	10.070
10.0	10.124	10.147	9.878	10.166	10.147	10.061	10.151	10.079	10.094
15.0	10.127	10.170	9.894	10.180	10.151	10.090	10.161	10.114	10.111
20.0	10.182	10.220	9.955	10.255	10.185	10.151	10.161	10.172	10.160
30.0	10.269	10.315	10.175	10.320	10.248	10.284	10.166	10.284	10.258
50.0	10.266	10.244	10.053	10.288	10.241	10.279	10.175	10.297	10.231
70.0	10.258	10.149	10.092	10.254	10.234	10.288	10.134	10.299	10.213
90.0	10.169	10.170	10.116	10.140	10.146	10.127	10.099	10.116	10.135
Diffuser exit boundary layer rake									
1.0	9.972	10.018	9.851	10.018	10.007	10.027	10.025	10.049	9.996
2.0	9.998	10.055	9.860	10.055	10.037	10.066	10.057	10.075	10.025
3.0	10.018	10.084	9.865	10.089	10.061	10.080	10.078	10.086	10.045
4.0	10.042	10.111	9.872	10.116	10.079	10.082	10.094	10.088	10.061
5.0	10.057	10.123	9.874	10.138	10.085	10.084	10.111	10.085	10.070
7.5	10.102	10.139	9.876	10.163	10.127	10.066	10.132	10.076	10.085
10.0	10.135	10.155	9.878	10.167	10.149	10.064	10.146	10.087	10.098
12.5	10.126	10.147	9.876	10.167	10.153	10.074	10.155	10.076	10.097

TABLE 9.--Continued.

(h) Airflow, 56.23 kg/sec; readings 30 to 33

Span-wise location, percent of span	Circumferential location, θ , deg								Average
	0	45	90	135	180	225	270	315	
Corner 1 inlet rake									
5.0	10.223	10.240	10.237	10.256	10.249	10.236	10.248	10.232	10.240
10.0	10.249	10.253	10.254	10.256	10.254	10.252	10.256	10.252	10.253
15.0	10.251	10.253	10.253	10.256	10.253	10.250	10.257	10.253	10.253
20.0	10.250	10.250	10.250	10.251	10.247	10.251	10.252	10.253	10.251
30.0	10.248	10.252	10.250	10.251	10.248	10.253	10.251	10.253	10.251
50.0	10.251	10.254	10.251	10.253	10.245	10.254	10.252	10.250	10.251
70.0	10.252	10.253	10.252	10.248	10.249	10.253	10.251	10.252	10.251
90.0	10.250	10.251	10.252	10.251	10.250	10.253	10.253	10.253	10.252
Corner 1 inlet boundary layer rake									
1.0	10.090	10.099	10.105	10.110	10.104	10.102	10.107	10.108	10.103
2.0	10.134	10.145	10.150	10.171	10.157	10.153	10.155	10.150	10.152
3.0	10.164	10.180	10.183	10.217	10.196	10.192	10.189	10.181	10.188
4.0	10.202	10.216	10.216	10.247	10.228	10.225	10.226	10.216	10.222
5.0	10.227	10.237	10.237	10.255	10.244	10.243	10.247	10.238	10.241
7.5	10.251	10.253	10.250	10.257	10.248	10.251	10.255	10.256	10.253
10.0	10.251	10.253	10.253	10.257	10.249	10.254	10.256	10.253	10.253
12.5	10.252	10.253	10.251	10.256	10.246	10.254	10.257	10.254	10.253
Diffuser exit rake									
5.0	10.086	10.120	9.968	10.134	10.103	10.097	10.120	10.107	10.092
10.0	10.128	10.139	9.969	10.152	10.140	10.089	10.143	10.102	10.108
15.0	10.138	10.157	9.982	10.163	10.141	10.108	10.150	10.123	10.120
20.0	10.164	10.187	10.026	10.210	10.157	10.147	10.151	10.161	10.150
30.0	10.220	10.248	10.168	10.250	10.205	10.227	10.151	10.227	10.212
50.0	10.221	10.209	10.084	10.237	10.194	10.228	10.149	10.236	10.195
70.0	10.217	10.152	10.112	10.210	10.200	10.232	10.133	10.238	10.187
90.0	10.155	10.160	10.125	10.141	10.144	10.130	10.116	10.125	10.137
Diffuser exit boundary layer rake									
1.0	10.029	10.051	9.952	10.055	10.052	10.064	10.063	10.075	10.043
2.0	10.046	10.075	9.958	10.080	10.072	10.091	10.083	10.092	10.062
3.0	10.058	10.093	9.962	10.102	10.086	10.100	10.096	10.099	10.074
4.0	10.073	10.111	9.965	10.120	10.098	10.102	10.108	10.102	10.085
5.0	10.084	10.120	9.966	10.139	10.113	10.100	10.118	10.100	10.093
7.5	10.111	10.136	9.969	10.151	10.129	10.091	10.131	10.096	10.102
10.0	10.135	10.147	9.974	10.151	10.144	10.089	10.141	10.102	10.110
12.5	10.128	10.141	9.971	10.153	10.147	10.095	10.145	10.095	10.109

TABLE 9.—Concluded.

(i) Airflow, 35.35 kg/sec; readings 26 to 29

Span-wise location, percent of span	Circumferential location, θ , deg								Average
	0	45	90	135	180	225	270	315	
Corner 1 inlet rake									
5.0	10.172	10.172	10.170	10.179	10.179	10.173	10.175	10.173	10.174
10.0	10.181	10.179	10.176	10.178	10.182	10.180	10.179	10.178	10.179
15.0	10.180	10.179	10.176	10.179	10.181	10.181	10.180	10.178	10.179
20.0	10.180	10.178	10.176	10.177	10.180	10.178	10.178	10.178	10.178
30.0	10.178	10.179	10.174	10.175	10.180	10.179	10.176	10.178	10.177
50.0	10.180	10.179	10.176	10.177	10.180	10.179	10.179	10.178	10.178
70.0	10.180	10.179	10.177	10.176	10.178	10.179	10.175	10.176	10.177
90.0	10.179	10.178	10.177	10.177	10.181	10.179	10.178	10.178	10.178
Corner 1 inlet boundary layer rake									
1.0	10.092	10.095	10.063	10.102	10.100	10.101	10.103	10.112	10.096
2.0	10.100	10.103	10.064	10.111	10.108	10.111	10.110	10.119	10.103
3.0	10.103	10.110	10.066	10.119	10.114	10.115	10.116	10.121	10.108
4.0	10.109	10.112	10.069	10.127	10.119	10.116	10.120	10.122	10.113
5.0	10.111	10.121	10.068	10.135	10.125	10.116	10.125	10.120	10.115
7.5	10.123	10.130	10.071	10.141	10.133	10.114	10.129	10.118	10.120
10.0	10.134	10.133	10.072	10.141	10.138	10.113	10.133	10.121	10.123
12.5	10.130	10.131	10.072	10.141	10.139	10.115	10.133	10.118	10.122
Diffuser exit rake									
1.0	10.114	10.116	10.124	10.123	10.120	10.117	10.116	10.119	10.119
2.0	10.131	10.134	10.137	10.145	10.141	10.137	10.135	10.136	10.137
3.0	10.143	10.147	10.150	10.162	10.158	10.152	10.149	10.148	10.151
4.0	10.159	10.161	10.162	10.174	10.172	10.167	10.165	10.161	10.165
5.0	10.169	10.169	10.170	10.179	10.175	10.173	10.174	10.170	10.172
7.5	10.177	10.174	10.177	10.180	10.178	10.178	10.180	10.180	10.178
10.0	10.178	10.177	10.179	10.180	10.176	10.178	10.180	10.179	10.178
12.5	10.179	10.177	10.180	10.180	10.175	10.177	10.182	10.179	10.178
Diffuser exit boundary layer rake									
5.0	10.114	10.127	10.071	10.131	10.122	10.119	10.124	10.119	10.116
10.0	10.131	10.134	10.072	10.138	10.135	10.117	10.133	10.117	10.122
15.0	10.133	10.142	10.080	10.145	10.136	10.124	10.137	10.124	10.128
20.0	10.144	10.155	10.100	10.162	10.141	10.138	10.137	10.140	10.140
30.0	10.168	10.179	10.152	10.177	10.161	10.169	10.141	10.165	10.164
50.0	10.166	10.164	10.115	10.173	10.163	10.173	10.134	10.171	10.158
70.0	10.166	10.140	10.126	10.159	10.160	10.175	10.131	10.174	10.154
90.0	10.138	10.144	10.131	10.135	10.136	10.134	10.128	10.128	10.134

TABLE 10.—TOTAL PRESSURE DISTRIBUTION FOR VARIABLE INLET GUIDE VANES WITH VANES A10
IN CORNER 1 AND VANES A4 IN CORNER 2—UNIFORM INFLOW

(a) Airflow, 81.16 kg/sec; readings 38 to 41

Circum-ferential location, θ , deg	Spanwise location, percent of span from tip							
	5	10	15	20	30	50	70	90
VIGV inlet rake								
0		9.962			10.076	10.327	10.330	10.190
30		10.053			10.252	10.329	10.214	10.163
60		9.832			10.195	10.316	10.109	10.014
90		9.674			9.870	10.070	9.930	9.835
120		10.001			10.218	10.303	10.171	10.048
150		10.068			10.249	10.347	10.292	10.178
180		10.037			10.219	10.305	10.289	10.188
210		9.784			10.005	10.250	10.337	10.129
240		10.252			10.227	10.230	10.284	10.089
270		10.076			10.142	10.143	10.138	9.950
300		10.247			10.266	10.255	10.275	10.080
330		9.800			10.017	10.265	10.304	10.218
AVG		9.982			10.145	10.262	10.223	10.090
VIGV exit rake								
15	9.740	9.801	9.719	9.828	9.974	10.153	10.062	9.957
45	10.003	10.112	10.039	10.091	10.226	10.255	10.149	10.091
75	9.936	10.118	10.086	10.145	10.274	10.301	10.261	10.216
105	10.046	10.119	10.131	10.127	10.342	10.281	10.297	10.209
135	10.039	10.024	10.017	10.037	10.239	10.308	10.246	10.146
165	9.895	9.939	9.904	9.917	10.039	10.119	10.067	10.007
195	10.088	10.098	10.089	10.090	10.135	10.238	10.234	10.076
225	10.041	10.012	10.000	10.015	10.088	10.285	10.307	10.125
255	9.752	9.782	9.800	9.907	10.092	10.306	10.284	10.176
285	9.770	9.804	9.855	9.947	10.149	10.288	10.293	10.213
315	10.048	10.015	9.999	10.023	10.112	10.304	10.279	10.180
345	10.100	10.106	10.096	10.096	10.134	10.200	10.214	10.073
AVG	9.955	9.994	9.980	10.018	10.150	10.253	10.224	10.122

TABLE 10.—Continued.

(b) Airflow, 78.37 kg/sec; readings 22 to 25

Circumferential location, θ , deg	Spanwise location, percent of span from tip							
	5	10	15	20	30	50	70	90
VIGV inlet rake								
0		9.976			10.073	10.316	10.324	10.187
30		10.057			10.244	10.321	10.209	10.166
60		9.842			10.198	10.308	10.110	10.022
90		9.684			9.880	10.073	9.936	9.847
120		10.014			10.214	10.298	10.170	10.051
150		10.070			10.245	10.337	10.289	10.172
180		10.043			10.216	10.293	10.287	10.180
210		9.801			10.009	10.245	10.329	10.136
240		10.248			10.225	10.226	10.280	10.089
270		10.077			10.142	10.147	10.139	9.955
300		10.244			10.260	10.244	10.270	10.083
330		9.814			10.016	10.261	10.295	10.209
AVG		9.989			10.143	10.256	10.220	10.091
VIGV exit rake								
15	9.926	10.111	10.076	10.133	10.267	10.295	10.259	10.184
45	10.008	10.127	10.042	10.088	10.222	10.247	10.149	10.095
75	9.744	9.813	9.725	9.832	9.977	10.125	10.016	9.970
105	9.924	9.954	9.927	9.933	10.057	10.140	10.074	10.003
135	10.046	10.028	10.022	10.039	10.239	10.305	10.245	10.148
165	10.056	10.125	10.134	10.138	10.339	10.263	10.269	10.179
195	9.774	9.803	9.848	9.927	10.103	10.300	10.279	10.169
225	10.044	10.018	10.006	10.021	10.091	10.281	10.297	10.116
255	10.041	10.067	10.081	10.096	10.145	10.238	10.206	10.060
285	10.088	10.094	10.082	10.078	10.107	10.203	10.219	10.077
315	10.054	10.020	10.007	10.028	10.117	10.294	10.272	10.177
345	9.781	9.822	9.879	9.972	10.170	10.270	10.296	10.220
AVG	9.957	9.998	9.986	10.024	10.153	10.247	10.215	10.117

TABLE 10.—Continued.

(c) Airflow, 75.21 kg/sec; readings 18 to 21

Circumferential location, θ , deg	Spanwise location, percent of span from tip							
	5	10	15	20	30	50	70	90
VIGV inlet rake								
0		9.994			10.082	10.294	10.305	10.176
30		10.064			10.231	10.303	10.207	10.167
60		9.868			10.192	10.294	10.114	10.035
90		9.722			9.907	10.079	9.952	9.876
120		10.032			10.204	10.281	10.178	10.066
150		10.074			10.233	10.314	10.284	10.164
180		10.056			10.214	10.277	10.275	10.160
210		9.834			10.023	10.233	10.307	10.131
240		10.233			10.214	10.214	10.267	10.094
270		10.082			10.133	10.139	10.135	9.973
300		10.233			10.248	10.233	10.256	10.089
330		9.845			10.028	10.248	10.277	10.202
AVG		10.003			10.143	10.242	10.213	10.094
VIGV exit rake								
15	10.022	10.109	10.052	10.095	10.213	10.233	10.152	10.103
45	9.787	9.831	9.768	9.864	9.992	10.133	10.026	9.986
75	9.788	9.828	9.765	9.864	9.989	10.144	10.063	9.991
105	10.048	10.030	10.024	10.046	10.250	10.299	10.235	10.151
135	10.062	10.126	10.133	10.132	10.321	10.252	10.260	10.164
165	10.063	10.124	10.127	10.128	10.334	10.261	10.271	10.136
195	10.054	10.029	10.018	10.035	10.096	10.263	10.279	10.115
225	10.050	10.076	10.085	10.093	10.141	10.222	10.197	10.068
255	10.057	10.079	10.082	10.089	10.130	10.218	10.208	10.081
285	10.061	10.030	10.015	10.033	10.111	10.273	10.254	10.177
315	9.817	9.852	9.905	9.992	10.173	10.255	10.279	10.206
345	9.819	9.852	9.900	9.981	10.156	10.254	10.281	10.205
AVG	9.969	9.997	9.990	10.030	10.157	10.234	10.209	10.115

TABLE 10.—Continued.

(d) Airflow, 73.10 kg/sec; readings 4 to 16

Circum-ferential location, θ , deg	Spanwise location, percent of span from tip							
	5	10	15	20	30	50	70	90
VIGV inlet rake								
0		10.001			10.112	10.288	10.298	10.175
30		10.072			10.224	10.293	10.206	10.167
60		9.878			10.190	10.287	10.115	10.038
90		9.730			9.911	10.080	9.961	9.885
120		10.033			10.204	10.279	10.184	10.070
150		10.077			10.232	10.310	10.279	10.158
180		10.054			10.207	10.272	10.267	10.162
210		9.846			10.025	10.229	10.301	10.136
240		10.229			10.209	10.210	10.261	10.097
270		10.083			10.136	10.137	10.133	9.978
300		10.227			10.245	10.228	10.256	10.092
330		9.851			10.024	10.239	10.269	10.200
AVG		10.007			10.143	10.237	10.211	10.096
VIGV exit rake								
15	10.006	10.142	10.101	10.135	10.256	10.273	10.244	10.185
45	10.029	10.104	10.054	10.095	10.212	10.231	10.148	10.102
75	9.801	9.866	9.770	9.864	9.992	10.125	10.031	9.993
105	9.952	9.979	9.961	9.965	10.112	10.143	10.095	10.037
135	10.057	10.041	10.020	10.052	10.252	10.249	10.231	10.149
165	10.048	10.123	10.135	10.134	10.322	10.246	10.248	10.183
195	9.870	9.849	9.890	9.955	10.105	10.278	10.257	10.163
225	10.056	10.034	10.027	10.038	10.100	10.258	10.272	10.117
255	10.051	10.074	10.084	10.099	10.142	10.214	10.188	10.066
285	10.085	10.097	10.089	10.086	10.112	10.194	10.214	10.089
315	10.060	10.032	10.015	10.026	10.088	10.249	10.251	10.175
345	9.827	9.865	9.917	9.999	10.173	10.248	10.275	10.196
AVG	9.983	10.017	10.005	10.037	10.155	10.230	10.204	10.121

TABLE 10.—Continued.

(e) Airflow, 73.03 kg/sec; readings 5 to 15

Circumferential location, θ , deg	Spanwise location, percent of span from tip							
	5	10	15	20	30	50	70	90
VIGV inlet rake								
0		10.004			10.106	10.287	10.296	10.175
30		10.072			10.225	10.291	10.208	10.167
60		9.874			10.188	10.287	10.117	10.043
90		9.722			9.914	10.084	9.963	9.886
120		10.039			10.203	10.277	10.182	10.073
150		10.077			10.231	10.307	10.279	10.160
180		10.056			10.201	10.271	10.265	10.160
210		9.851			10.032	10.227	10.299	10.134
240		10.226			10.210	10.209	10.259	10.098
270		10.084			10.135	10.137	10.134	9.980
300		10.227			10.245	10.228	10.254	10.094
330		9.850			10.050	10.241	10.268	10.198
AVG		10.007			10.143	10.237	10.210	10.097
VIGV exit rake								
15	10.014	10.179	10.152	10.218	10.296	10.252	10.249	10.168
45	10.037	10.119	10.076	10.129	10.212	10.257	10.145	10.086
75	9.733	9.843	9.732	9.841	9.984	10.106	10.004	9.999
105	9.938	9.992	10.002	10.005	10.141	10.170	10.107	10.056
135	10.074	10.047	10.052	10.133	10.317	10.327	10.221	10.175
165	10.042	10.108	10.155	10.205	10.311	10.279	10.281	10.205
195	9.832	9.844	9.871	9.933	10.100	10.274	10.256	10.182
225	10.075	10.052	10.045	10.063	10.130	10.246	10.271	10.124
255	10.067	10.084	10.095	10.112	10.150	10.183	10.158	10.073
285	10.115	10.123	10.112	10.104	10.129	10.217	10.221	10.089
315	10.050	10.020	10.001	10.011	10.071	10.226	10.255	10.199
345	9.851	9.897	9.963	10.042	10.162	10.253	10.279	10.193
AVG	9.986	10.026	10.021	10.066	10.167	10.233	10.204	10.129

TABLE 10.—Continued.

(f) Airflow, 72.77 kg/sec; readings 6 to 17

Circum-ferential location, θ , deg	Spanwise location, percent of span from tip							
	5	10	15	20	30	50	70	90
VIGV inlet rake								
0		10.003			10.117	10.287	10.296	10.175
30		10.072			10.225	10.292	10.207	10.167
60		9.878			10.190	10.287	10.114	10.040
90		9.733			9.912	10.081	9.963	9.888
120		10.031			10.204	10.279	10.185	10.071
150		10.076			10.235	10.305	10.278	10.161
180		10.054			10.208	10.267	10.260	10.164
210		9.847			10.025	10.227	10.299	10.135
240		10.227			10.211	10.209	10.260	10.098
270		10.084			10.133	10.138	10.134	9.979
300		10.227			10.243	10.228	10.256	10.092
330		9.854			10.021	10.239	10.268	10.201
AVG		10.007			10.144	10.237	10.210	10.098
VIGV exit rake								
15	10.001	10.144	10.089	10.147	10.227	10.232	10.205	10.147
45	10.037	10.090	10.032	10.076	10.216	10.205	10.157	10.120
75	9.881	9.989	9.886	9.946	10.017	10.147	10.051	9.999
105	9.851	9.954	9.967	9.980	10.119	10.151	10.090	10.020
135	10.035	10.050	10.047	10.086	10.241	10.225	10.235	10.127
165	10.045	10.095	10.094	10.091	10.300	10.278	10.250	10.150
195	9.754	9.762	9.841	9.923	10.091	10.266	10.252	10.144
225	10.037	10.011	9.998	10.004	10.060	10.216	10.251	10.113
255	10.047	10.072	10.082	10.096	10.142	10.234	10.209	10.060
285	10.063	10.081	10.083	10.084	10.107	10.188	10.194	10.058
315	10.080	10.049	10.029	10.043	10.121	10.275	10.280	10.154
345	9.830	9.849	9.881	9.949	10.151	10.272	10.251	10.170
AVG	9.972	10.012	10.003	10.035	10.149	10.224	10.202	10.105

TABLE 10.—Continued.

(g) Airflow, 68.61 kg/sec; readings 34 to 37

Circumferential location, θ , deg	Spanwise location, percent of span from tip							
	5	10	15	20	30	50	70	90
VIGV inlet rake								
0		10.019			10.087	10.262	10.269	10.171
30		10.076			10.214	10.268	10.199	10.167
60		9.912			10.181	10.266	10.125	10.058
90		9.803			9.943	10.088	9.988	9.926
120		10.039			10.193	10.255	10.186	10.088
150		10.083			10.216	10.279	10.264	10.156
180		10.066			10.193	10.249	10.241	10.164
210		9.888			10.040	10.211	10.277	10.142
240		10.214			10.202	10.200	10.244	10.103
270		10.091			10.133	10.134	10.132	10.002
300		10.209			10.226	10.216	10.237	10.100
330		9.897			10.044	10.223	10.251	10.181
AVG		10.025			10.139	10.221	10.201	10.105
VIGV exit rake								
15	10.047	10.139	10.034	10.075	10.189	10.205	10.160	10.118
45	9.990	10.129	10.092	10.131	10.220	10.252	10.228	10.194
75	10.003	10.144	10.103	10.138	10.223	10.252	10.228	10.184
105	10.067	10.056	10.040	10.065	10.205	10.269	10.224	10.151
135	9.971	9.998	9.976	9.985	10.064	10.127	10.106	10.069
165	9.973	10.006	9.983	9.990	10.077	10.141	10.107	10.053
195	10.071	10.051	10.042	10.054	10.104	10.237	10.251	10.111
225	9.867	9.891	9.924	9.979	10.107	10.256	10.244	10.159
255	9.868	9.888	9.917	9.968	10.098	10.244	10.234	10.175
285	10.071	10.046	10.033	10.044	10.101	10.235	10.228	10.173
315	10.085	10.097	10.098	10.102	10.135	10.177	10.193	10.092
345	10.086	10.095	10.093	10.094	10.123	10.179	10.188	10.087
AVG	10.008	10.045	10.029	10.052	10.137	10.214	10.199	10.131

TABLE 10.—Continued.

(h) Airflow, 56.23 kg/sec; readings 30 to 33

Circum-ferential location, θ , deg	Spanwise location, percent of span from tip							
	5	10	15	20	30	50	70	90
VIGV inlet rake								
0		10.059			10.096	10.214	10.218	10.155
30		10.092			10.181	10.219	10.178	10.159
60		9.987			10.167	10.219	10.131	10.088
90		9.923			10.012	10.108	10.042	10.002
120		10.079			10.173	10.213	10.171	10.108
150		10.100			10.187	10.223	10.215	10.147
180		10.089			10.167	10.202	10.200	10.150
210		9.977			10.071	10.179	10.223	10.143
240		10.181			10.177	10.175	10.206	10.113
270		10.106			10.130	10.131	10.129	10.047
300		10.179			10.194	10.188	10.202	10.113
330		9.982			10.077	10.190	10.206	10.161
AVG		10.063			10.136	10.188	10.177	10.115
VIGV exit rake								
15	10.046	10.149	10.104	10.124	10.181	10.207	10.193	10.168
45	10.076	10.151	10.088	10.109	10.169	10.181	10.152	10.123
75	10.046	10.143	10.108	10.129	10.172	10.209	10.193	10.172
105	10.029	10.046	10.029	10.036	10.100	10.138	10.119	10.088
135	10.084	10.080	10.076	10.088	10.179	10.224	10.188	10.148
165	10.026	10.045	10.027	10.035	10.100	10.131	10.120	10.096
195	9.964	9.980	10.002	10.036	10.120	10.209	10.201	10.139
225	10.092	10.080	10.074	10.080	10.113	10.197	10.206	10.114
255	9.962	9.978	9.998	10.032	10.118	10.211	10.203	10.149
285	10.078	10.100	10.102	10.105	10.122	10.162	10.172	10.107
315	10.096	10.079	10.071	10.078	10.120	10.199	10.192	10.158
345	10.093	10.103	10.104	10.113	10.136	10.160	10.171	10.107
AVG	10.049	10.088	10.066	10.081	10.136	10.186	10.176	10.131

TABLE 10.—Concluded.

(i) Airflow, 35.35 kg/sec; readings 26 to 29

Circum-ferential location, θ , deg	Spanwise location, percent of span from tip							
	5	10	15	20	30	50	70	90
VIGV inlet rake								
0		10.102			10.114	10.161	10.163	10.141
30		10.118			10.151	10.163	10.149	10.143
60		10.075			10.148	10.166	10.139	10.117
90		10.051			10.087	10.125	10.098	10.084
120		10.112			10.148	10.161	10.143	10.124
150		10.118			10.150	10.166	10.165	10.138
180		10.116			10.147	10.161	10.161	10.139
210		10.074			10.107	10.149	10.166	10.138
240		10.146			10.147	10.146	10.159	10.125
270		10.122			10.129	10.131	10.131	10.099
300		10.147			10.154	10.152	10.160	10.126
330		10.078			10.113	10.154	10.161	10.142
AVG		10.105			10.133	10.153	10.149	10.126
VIGV exit rake								
15	10.110	10.142	10.114	10.122	10.143	10.151	10.144	10.128
45	10.062	10.087	10.054	10.072	10.101	10.128	10.106	10.103
75	10.062	10.087	10.054	10.073	10.100	10.133	10.120	10.104
105	10.113	10.111	10.111	10.116	10.148	10.164	10.154	10.139
135	10.114	10.126	10.129	10.132	10.164	10.154	10.159	10.140
165	10.116	10.127	10.129	10.131	10.165	10.155	10.162	10.132
195	10.115	10.112	10.108	10.113	10.125	10.157	10.159	10.127
225	10.116	10.121	10.124	10.128	10.138	10.146	10.136	10.118
255	10.117	10.122	10.125	10.130	10.140	10.149	10.140	10.122
285	10.119	10.112	10.110	10.113	10.127	10.159	10.154	10.142
315	10.070	10.076	10.087	10.103	10.141	10.156	10.159	10.143
345	10.069	10.075	10.086	10.102	10.140	10.156	10.159	10.146
AVG	10.099	10.108	10.103	10.111	10.136	10.151	10.146	10.129

TABLE 11.—STATIC PRESSURE DISTRIBUTION AT VIGV EXIT WITH VANES A10 IN CORNER 1 AND VANES A4 IN CORNER 2—UNIFORM INFLOW

(a) Airflow, 81.16 kg/sec;
readings 38 to 41

Circumferential location, θ deg	Outer wall	Center-body
15	9.299	9.275
45	9.264	9.263
75	9.303	9.254
105	9.305	9.255
135	9.308	9.244
165	9.313	9.276
195	9.289	9.281
225	9.300	9.276
255	9.308	9.279
285	9.319	9.283
315	9.328	9.280
345	9.301	9.284
AVG	9.303	9.271

(c) Airflow, 75.21 kg/sec;
readings 18 to 21

Circumferential location, θ deg	Outer wall	Center-body
15	9.404	9.395
45	9.382	9.376
75	9.429	9.375
105	9.399	9.381
135	9.419	9.366
165	9.437	9.393
195	9.403	9.401
225	9.413	9.394
255	9.435	9.399
285	9.417	9.403
315	9.436	9.395
345	9.425	9.402
AVG	9.417	9.390

(e) Airflow, 73.03 kg/sec;
readings 5 to 15

Circumferential location, θ deg	Outer wall	Center-body
15	9.426	9.356
45	9.399	9.346
57	9.429	9.342
105	9.411	9.339
135	9.411	9.317
165	9.426	9.347
195	9.407	9.352
225	9.408	9.352
255	9.424	9.358
285	9.434	9.363
315	9.452	9.356
345	9.429	9.364
AVG	9.421	9.349

(b) Airflow, 78.37 kg/sec;
readings 22 to 25

Circumferential location, θ deg	Outer wall	Center-body
15	9.332	9.309
45	9.300	9.298
75	9.336	9.289
105	9.342	9.292
135	9.342	9.281
165	9.346	9.310
195	9.329	9.314
225	9.332	9.310
255	9.340	9.314
285	9.352	9.318
315	9.360	9.315
345	9.337	9.318
AVG	9.337	9.306

(d) Airflow, 73.10 kg/sec;
readings 4 to 16

Circumferential location, θ deg	Outer wall	Center-body
15	9.444	9.421
45	9.414	9.412
75	9.448	9.404
105	9.448	9.406
135	9.447	9.396
165	9.451	9.421
195	9.441	9.425
225	9.441	9.423
255	9.451	9.426
285	9.458	9.430
315	9.465	9.428
345	9.446	9.430
AVG	9.446	9.419

(f) Airflow, 72.77 kg/sec;
readings 6 to 17

Circumferential location, θ deg	Outer wall	Center-body
15	9.457	9.408
45	9.408	9.399
74	9.439	9.387
105	9.463	9.391
135	9.454	9.385
165	9.459	9.408
195	9.454	9.413
225	9.446	9.411
255	9.451	9.414
285	9.479	9.419
315	9.462	9.417
345	9.441	9.421
AVG	9.451	9.406

TABLE 11.—Concluded.

(g) Airflow, 68.61 kg/sec:
readings 34 to 37

Circumferential location, θ deg	Outer wall	Center-body
15	9.636	9.531
45	9.527	9.526
75	9.535	9.513
105	9.566	9.513
135	9.554	9.510
165	9.543	9.530
195	9.552	9.530
225	9.547	9.531
255	9.539	9.531
285	9.570	9.533
315	9.568	9.535
345	9.537	9.537
AVG	9.556	9.527

(i) Airflow, 35.35 kg/sec:
readings 26 to 29

Circumferential location, θ deg	Outer wall	Center-body
15	9.988	9.979
45	9.985	9.976
75	9.993	9.983
105	9.988	9.985
135	9.993	9.982
165	9.995	9.987
195	9.990	9.989
225	9.992	9.987
255	9.994	9.988
285	9.993	9.991
315	9.996	9.988
345	9.994	9.988
AVG	9.992	9.985

(h) Airflow, 56.23 kg/sec:
readings 30 to 33

15	9.764	9.744
45	9.744	9.742
75	9.753	9.737
105	9.772	9.737
135	9.766	9.735
165	9.758	9.748
195	9.763	9.748
225	9.760	9.748
255	9.754	9.749
285	9.775	9.753
315	9.773	9.751
345	9.756	9.751
AVG	9.761	9.745

TABLE 12.—CORNER 2 STATIC PRESSURE DISTRIBUTION AT VANE INLET AND EXIT WITH VANES A10
IN CORNER 1 AND VANES A4 IN CORNER 2—UNIFORM INFLOW

(a) Airflow, 81.16 kg/sec; readings 38 to 41

(c) Airflow, 75.21 kg/sec; readings 18 to 21

Circum-ferential location, θ , deg	Inlet		Exit	
	Pressure, N/cm ²	Coefficient	Pressure, N/cm ²	Coefficient
0	9.729	0.851	9.583	1.117
15	9.734	0.833	9.525	1.224
30	9.724	0.859	9.478	1.309
45	9.734	0.841	9.399	1.453
60	9.753	0.806	9.415	1.424
75	9.706	0.893	*****	*****
90	9.696	0.910	*****	*****
105	9.723	0.862	*****	*****
120	9.716	0.874	9.423	1.410
135	9.713	0.879	9.411	1.430
150	9.723	0.861	9.473	1.319
165	9.736	0.837	9.523	1.226
180	9.711	0.883	9.598	1.090
195	9.691	0.919	9.581	1.120
210	9.670	0.958	9.548	1.181
225	9.717	0.872	9.494	1.280
240	9.754	0.806	9.431	1.394
255	9.715	0.876	9.618	1.053
270	9.759	0.797	9.660	0.977
285	9.705	0.894	9.599	1.088
300	9.738	0.834	9.458	1.346
315	9.724	0.861	9.496	1.276
330	9.755	0.985	9.547	1.183
345	9.689	0.924	9.581	1.121

Circum-ferential location, θ , deg	Inlet		Exit	
	Pressure, N/cm ²	Coefficient	Pressure, N/cm ²	Coefficient
0	9.782	0.858	9.658	1.123
15	9.790	0.841	9.607	1.230
30	9.777	0.868	9.567	1.316
45	9.784	0.854	9.499	1.460
60	9.800	0.820	9.512	1.433
75	9.761	0.902	*****	*****
90	9.753	0.919	*****	*****
105	9.776	0.872	*****	*****
120	9.768	0.888	9.516	1.424
135	9.765	0.895	9.510	1.437
150	9.777	0.869	9.563	1.324
165	9.788	0.847	9.606	1.233
180	9.768	0.888	9.670	1.096
195	9.749	0.929	9.657	1.124
210	9.730	0.968	9.628	1.185
225	9.769	0.886	9.582	1.284
240	9.794	0.833	9.535	1.384
255	9.765	0.895	9.689	1.056
270	9.808	0.802	9.728	0.972
285	9.762	0.900	9.674	1.088
300	9.778	0.866	9.560	1.330
315	9.772	0.880	9.587	1.273
330	9.714	1.002	9.629	1.184
345	9.744	0.939	9.657	1.125

(b) Airflow, 78.37 kg/sec; readings 22 to 25

(d) Airflow, 73.10 kg/sec; readings 4 to 16

0	9.744	0.876	9.605	1.149
15	9.754	0.858	9.549	1.258
30	9.740	0.884	9.505	1.344
45	9.748	0.868	9.428	1.494
60	9.766	0.834	9.444	1.463
75	9.722	0.920	*****	*****
90	9.713	0.937	*****	*****
105	9.738	0.889	*****	*****
120	9.731	0.901	9.450	1.451
135	9.728	0.908	9.441	1.469
150	9.739	0.886	9.499	1.355
165	9.751	0.862	9.548	1.260
180	9.727	0.910	9.619	1.120
195	9.708	0.947	9.605	1.149
210	9.688	0.987	9.572	1.213
225	9.731	0.902	9.521	1.312
240	9.762	0.841	9.465	1.423
255	9.728	0.909	9.639	1.081
270	9.773	0.820	9.681	1.000
285	9.722	0.919	9.622	1.116
300	9.746	0.873	9.492	1.370
315	9.736	0.893	9.523	1.308
330	9.672	1.018	9.571	1.214
345	9.704	0.955	9.603	1.151

0	9.789	0.887	9.674	1.144
15	9.801	0.858	9.626	1.252
30	9.789	0.886	9.585	1.345
45	9.795	0.873	9.524	1.483
60	9.810	0.838	9.538	1.451
75	9.774	0.920	*****	*****
90	9.767	0.935	*****	*****
105	9.789	0.887	*****	*****
120	9.782	0.902	9.539	1.449
135	9.778	0.910	9.534	1.460
150	9.790	0.883	9.585	1.346
165	9.801	0.860	9.626	1.253
180	9.779	0.908	9.686	1.117
195	9.764	0.942	9.675	1.141
210	9.746	0.984	9.648	1.203
225	9.782	0.902	9.603	1.305
240	9.805	0.850	9.559	1.402
255	9.778	0.910	9.706	1.073
270	9.821	0.815	9.743	0.989
285	9.776	0.916	9.693	1.103
300	9.792	0.880	9.584	1.347
315	9.786	0.892	9.609	1.291
330	9.731	1.017	9.651	1.197
345	9.760	0.952	9.678	1.137

TABLE 12.—Continued.

(e) Airflow, 73.03 kg/sec; readings 5 to 15

Circumferential location, θ , deg	Inlet		Exit	
	Pressure, N/cm ²	Coefficient	Pressure, N/cm ²	Coefficient
0	9.795	0.875	9.679	1.136
15	9.805	0.852	9.632	1.243
30	9.793	0.879	9.594	1.328
45	9.799	0.866	9.530	1.471
60	9.814	0.833	9.543	1.442
75	9.777	0.916	*****	*****
90	9.771	0.930	*****	*****
105	9.792	0.882	*****	*****
120	9.785	0.898	9.542	1.446
135	9.782	0.905	9.539	1.452
150	9.794	0.878	9.590	1.338
165	9.804	0.855	9.631	1.246
180	9.785	0.898	9.691	1.110
195	9.768	0.936	9.681	1.133
210	9.750	0.977	9.654	1.193
225	9.786	0.896	9.609	1.294
240	9.808	0.845	9.565	1.394
255	9.782	0.904	9.710	1.066
270	9.824	0.811	9.748	0.981
285	9.779	0.912	9.698	1.095
300	9.795	0.876	9.590	1.338
315	9.789	0.888	9.614	1.283
330	9.735	1.011	9.655	1.190
345	9.763	0.947	9.681	1.131

(g) Airflow, 68.61 kg/sec; readings 34 to 37

Circumferential location, θ , deg	Inlet		Exit	
	Pressure, N/cm ²	Coefficient	Pressure, N/cm ²	Coefficient
0	9.845	0.848	9.742	1.111
15	9.851	0.833	9.703	1.211
30	9.840	0.862	9.671	1.295
45	9.846	0.846	9.617	1.432
60	9.858	0.814	9.625	1.412
75	9.824	0.903	*****	*****
90	9.821	0.909	*****	*****
105	9.839	0.864	*****	*****
120	9.833	0.879	9.627	1.407
135	9.830	0.888	9.622	1.419
150	9.840	0.862	9.665	1.309
165	9.849	0.839	9.700	1.219
180	9.829	0.888	9.752	1.086
195	9.818	0.918	9.743	1.110
210	9.803	0.955	9.720	1.169
225	9.835	0.874	9.679	1.274
240	9.856	0.820	9.643	1.367
255	9.833	0.878	9.770	1.041
270	9.866	0.793	9.802	0.958
285	9.826	0.897	9.757	1.073
300	9.843	0.854	9.662	1.317
315	9.837	0.868	9.685	1.258
330	9.791	0.988	9.720	1.169
345	9.813	0.930	9.742	1.111

(f) Airflow, 72.77 kg/sec; readings 6 to 17

0	9.790	0.893	9.676	1.152
15	9.802	0.864	9.628	1.259
30	9.790	0.892	9.587	1.354
45	9.795	0.880	9.524	1.495
60	9.811	0.845	9.537	1.466
75	9.774	0.929	*****	*****
90	9.768	0.942	*****	*****
105	9.790	0.893	*****	*****
120	9.783	0.908	9.539	1.462
135	9.779	0.917	9.534	1.472
150	9.791	0.890	9.585	1.356
165	9.801	0.866	9.627	1.262
180	9.782	0.911	9.688	1.124
195	9.766	0.947	9.677	1.148
210	9.747	0.989	9.650	1.209
225	9.783	0.908	9.605	1.311
240	9.807	0.855	9.561	1.411
255	9.780	0.914	9.707	1.080
270	9.822	0.820	9.745	0.994
285	9.776	0.924	9.694	1.110
300	9.792	0.887	9.586	1.356
315	9.788	0.897	9.610	1.301
330	9.733	1.022	9.652	1.205
345	9.761	0.957	9.680	1.143

(h) Airflow, 56.23 kg/sec; readings 30 to 33

0	9.948	0.814	9.880	1.073
15	9.950	0.807	9.856	1.168
30	9.943	0.832	9.834	1.252
45	9.947	0.820	9.802	1.375
60	9.954	0.790	9.806	1.357
75	9.937	0.858	*****	*****
90	9.932	0.877	*****	*****
105	9.944	0.831	*****	*****
120	9.939	0.848	9.810	1.343
135	9.937	0.856	9.808	1.352
150	9.943	0.834	9.834	1.253
165	9.950	0.809	9.856	1.167
180	9.940	0.845	9.889	1.042
195	9.930	0.884	9.883	1.063
210	9.921	0.920	9.869	1.118
225	9.941	0.843	9.843	1.215
240	9.952	0.799	9.822	1.299
255	9.939	0.850	9.899	1.002
270	9.961	0.763	9.922	0.914
285	9.935	0.863	9.893	1.026
300	9.945	0.827	9.833	1.256
315	9.942	0.838	9.847	1.203
330	9.913	0.950	9.869	1.119
345	9.926	0.900	9.883	1.065

TABLE 12.—Concluded.

(i) Airflow, 35.35 kg/sec; readings 26 to 29

Circumferential location, θ , deg	Inlet		Exit	
	Pressure, N/cm ²	Coefficient	Pressure, N/cm ²	Coefficient
0	10.063	0.779	10.037	1.034
15	10.063	0.778	10.028	1.128
30	10.060	0.808	10.018	1.222
45	10.061	0.807	10.008	1.323
60	10.064	0.769	10.009	1.305
75	10.058	0.834	*****	*****
90	10.056	0.854	*****	*****
105	10.062	0.796	*****	*****
120	10.059	0.825	10.011	1.293
135	10.058	0.834	10.010	1.300
150	10.061	0.805	10.019	1.207
165	10.063	0.787	10.028	1.128
180	10.058	0.835	10.039	1.012
195	10.055	0.860	10.038	1.024
210	10.051	0.898	10.033	1.077
225	10.058	0.831	10.022	1.186
240	10.062	0.792	10.015	1.246
255	10.057	0.838	10.042	0.983
270	10.066	0.750	10.053	0.879
285	10.058	0.831	10.042	0.987
300	10.061	0.799	10.020	1.199
315	10.060	0.815	10.025	1.155
330	10.050	0.913	10.032	1.082
345	10.054	0.874	10.037	1.034

TABLE 13.—AXIAL STATIC PRESSURE DISTRIBUTION WITH VANES A10 IN CORNER 1
AND VANES A4 IN CORNER 2—UNIFORM INFLOW

(a) Airflow, 81.16 kg/sec; readings 38 to 41

Axial station	Outer wall				Centerbody			
	Circumferential location, θ , deg							
	0	90	180	270	0	90	180	270
1		9.580						
2		9.578						
3		9.574						
4		9.578						
5		9.575						
6		9.565						
7		9.555						
8	9.512	9.512	9.511	9.530				
9		9.426						
10	9.360	9.357	9.366	9.390				
12				9.375				
13				9.397				
14				9.449				
15				9.490				
16				9.551				
17				9.635				
18				9.719				
19				9.792				
20				9.852				
35		9.311						
36		9.343						
37	9.427	9.372	9.394	9.525				
38		9.399						
39		9.418						
40	9.485	9.445	9.466	9.545				
41	9.528	9.497	9.515	9.559				
42	9.564	9.547	9.555	9.585				
43	9.604	9.582	9.591	9.615				
44	9.627	9.615	9.627	9.646				
45	9.649	9.643	9.659	9.675				
46	9.689	9.663	9.681	9.706				
47	9.705	9.678	9.685	9.711				
48	9.827		9.735	9.803				
49	9.750		9.746	9.801				
50	9.742		9.740	9.821				
51	9.736		9.729	9.898				
52	9.729		9.729					
53				9.735				
54				0.000	9.237	10.110	9.205	9.652
55				0.000	9.239	10.192	9.204	9.687
56				*****	9.259	10.184	9.233	
57				9.634	*****	10.107	9.307	
58				9.630		10.104		9.614
59				9.623		10.069		*****
60				9.628	*****	10.067	*****	*****
61	9.588		9.593	9.612	9.614		9.611	
62	9.559		9.559	9.912	9.893		9.602	
63	9.551		9.553	9.572	9.838	9.591	9.822	9.599
64	9.540		9.547	9.556	9.769	9.587	9.758	9.591
65	9.527		9.536	9.555	9.713	9.577	9.700	9.583
66	9.516		9.527	9.546	9.651	9.563	9.648	9.569
67	9.505		9.515	9.535	9.591	9.548	9.588	9.555
68	9.503		9.504	9.523	9.529	9.528	9.533	9.539
69	9.489		9.495	9.511	9.476	9.505	9.478	9.520
70	9.475		9.480	9.496	9.428	9.483	9.427	9.496
71	9.459		9.464	9.485	9.380	9.452	9.377	9.463
72	9.455	*****	9.455	9.469	9.329	9.422	9.338	9.440
73	9.445	*****	9.443	9.456	9.292	9.390	9.298	9.410
74	9.440	*****	9.437	9.436	9.260	9.366	9.267	9.386
75	9.426	*****	9.442	9.448	9.239	9.344	9.243	9.364
76	9.340	*****	9.559	9.355	9.222	9.337	9.228	9.356
77	*****	*****	*****	*****	9.213	9.327	9.219	9.339
78	*****	*****	*****	*****	9.213	9.325	9.227	9.341
79	9.357	9.356	9.448	9.448	9.378	9.377	9.388	9.388

TABLE 13.—Continued.

(b) Airflow, 78.37 kg/sec; readings 22 to 25

Axial station	Outer wall				Centerbody			
	Circumferential location, θ , deg							
	0	90	180	270	0	90	180	270
1		9.600						
2		9.597						
3		9.595						
4		9.598						
5		9.595						
6		9.585						
7		9.576						
8	9.535	9.535	9.533	9.518				
9		9.452						
10	9.390	9.387	9.395	9.452				
12				9.404				
13				9.425				
14				9.477				
15				9.515				
16				9.573				
17				9.654				
18				9.735				
19				9.804				
20				9.863				
35		9.343						
36		9.374						
37	9.456	9.402	9.423	9.548				
38		9.428						
39		9.446						
40	9.511	9.471	9.493	9.568				
41	9.552	9.522	9.539	9.582				
42	9.586	9.566	9.577	9.607				
43	9.625	9.603	9.612	9.636				
44	9.647	9.634	9.646	9.665				
45	9.668	9.661	9.678	9.692				
46	9.706	9.681	9.698	9.721				
47	9.721	9.696	9.703	9.727				
48	9.847		9.749	9.815				
49	9.765		9.760	9.813				
50	9.757		9.755	9.832				
51	9.752		9.746	9.906				
52	9.744		9.746					
53				9.750				
54				0.000	9.270	10.110	9.241	9.670
55				0.000	9.272	10.186	9.241	9.703
56				*****	9.293	10.181	9.268	
57				9.655	*****	10.109	9.339	
58				9.650		10.106		9.636
59				9.643		10.071		*****
60				9.649	*****	10.067	*****	*****
61	9.606		9.615	9.634	9.635		9.632	
62	9.581		9.582	9.919	9.909		9.624	
63	9.574		9.576	9.595	9.849	9.613	9.836	9.620
64	9.563		9.571	9.579	9.783	9.610	9.773	9.614
65	9.551		9.560	9.574	9.728	9.600	9.720	9.604
66	9.545		9.551	9.570	9.669	9.585	9.668	9.591
67	9.531		9.539	9.559	9.612	9.572	9.610	9.578
68	9.529		9.530	9.547	9.555	9.553	9.557	9.564
69	9.516		9.520	9.538	9.502	9.530	9.505	9.546
70	9.502		9.507	9.521	9.454	9.509	9.456	9.523
71	9.489		9.491	9.511	9.409	9.480	9.407	9.492
72	9.483	*****	9.482	9.496	9.361	9.450	9.369	9.468
73	9.473	*****	9.471	9.484	9.326	9.420	9.331	9.439
74	9.469	*****	9.467	9.465	9.296	9.396	9.302	9.416
75	9.455	*****	9.470	9.476	9.275	9.377	9.280	9.394
76	9.372	*****	9.599	9.387	9.241	9.368	9.265	9.388
77	*****	*****	*****	*****	9.251	9.360	9.257	9.371
78	*****	*****	*****	*****	9.248	9.359	9.265	9.374
79	9.388	9.388	9.475	9.476	9.410	9.409	9.418	9.419

TABLE 13.—Continued.

(c) Airflow, 75.21 kg/sec; readings 18 to 21

Axial station	Outer wall				Centerbody			
	Circumferential location, θ , deg							
	0	90	180	270	0	90	180	270
1		9.647						
2		9.647						
3		9.643						
4		9.645						
5		9.643						
6		*****						
7		*****						
8	*****	*****	*****	*****				
9		*****						
10	*****	*****	*****	*****				
12				9.476				
13				9.496				
14				9.541				
15				9.575				
16				9.628				
17				9.700				
18				9.772				
19				9.834				
20				9.886				
35		9.421						
36		9.448						
37	9.523	9.474	9.494	9.604				
38		9.498						
39		9.514						
40	9.571	9.536	9.556	9.624				
41	9.608	9.582	9.597	9.636				
42	9.640	9.622	9.631	9.658				
43	9.674	9.652	9.662	9.684				
44	9.691	9.683	9.693	9.711				
45	9.713	9.706	9.720	9.735				
46	9.747	9.747	9.740	9.760				
47	9.760	9.738	9.744	9.766				
48	9.784		9.784	9.845				
49	9.794		9.796	9.843				
50	9.791		9.786	9.860				
51	9.787		9.782	9.928				
52	9.781		9.782					
53				9.787				
54				0.000	9.354	10.118	9.328	9.714
55				0.000	9.356	10.175	9.329	9.744
56				*****	9.374	10.175	9.354	
57				9.703	*****	10.112	9.417	
58				9.698		10.104		9.685
59				9.692		10.081		*****
60				9.697	*****	10.077	*****	*****
61	9.657		9.666	9.682	9.685		9.682	
62	9.636		9.637	9.935	9.925		9.671	
63	9.629		9.633	9.648	9.874	9.665	9.862	9.671
64	9.620		9.626	9.634	9.816	9.662	9.806	9.664
65	9.609		9.618	9.632	9.767	9.652	9.758	9.656
66	9.602		9.609	9.625	9.714	9.639	9.711	9.646
67	9.590		9.599	9.616	9.664	9.628	9.660	9.633
68	9.589		9.590	9.605	9.613	9.611	9.613	9.620
69	9.577		9.581	9.596	9.564	9.591	9.567	9.604
70	9.565		9.569	9.582	9.523	9.572	9.520	9.583
71	9.553		9.555	9.573	9.482	9.545	9.479	9.556
72	9.548	*****	9.547	9.559	9.439	9.519	9.446	9.534
73	9.539	*****	9.538	9.549	9.408	9.492	9.412	9.508
74	9.532	*****	9.533	9.532	9.379	9.471	9.386	9.488
75	9.524	*****	9.537	9.542	9.362	9.454	9.366	9.468
76	9.447	*****	9.628	9.463	9.347	9.446	9.353	9.463
77	*****	*****	*****	*****	9.340	9.438	9.346	9.448
78	*****	*****	*****	*****	9.340	9.437	9.353	9.450
79	9.464	9.463	9.542	9.542	9.483	9.482	9.490	9.490

TABLE 13.—Continued.

(d) Airflow, 73.10 kg/sec; readings 4 to 16

Axial station	Outer wall				Centerbody			
	Circumferential location, θ , deg							
	0	90	180	270	0	90	180	270
1		9.665						
2		9.663						
3		9.660						
4		9.663						
5		9.661						
6		*****						
7		*****						
8	*****	*****	*****	*****				
9		*****						
10	*****	*****	*****	*****				
12				9.501				
13				9.520				
14				9.564				
15				9.596				
16				9.647				
17				9.715				
18				9.784				
19				10.000				
20				9.894				
35		9.447						
36		9.473						
37	9.545	9.498	9.518	9.626				
38		9.521						
39		9.537						
40	9.592	9.559	9.577	9.643				
41	9.627	9.602	9.517	9.654				
42	9.657	9.640	9.647	9.675				
43	9.691	9.672	9.679	9.700				
44	9.709	9.698	9.708	9.725				
45	9.727	9.721	9.735	9.748				
46	9.760	9.760	9.754	9.774				
47	9.772	9.748	9.756	9.778				
48	9.798		9.798	9.855				
49	9.810		9.808	9.853				
50	9.803		9.804	9.870				
51	9.796		9.795	9.935				
52	9.789		9.795					
53				9.800				
54				0.000	9.384	10.117	9.360	9.729
55				0.000	9.387	10.169	9.360	9.758
56				*****	9.404	10.171	9.383	
57				9.719	*****	10.113	9.443	
58				9.715		10.104		9.703
59				9.707		10.082		*****
60				9.713	*****	10.077	*****	*****
61	9.675		9.684	9.699	9.702		9.700	
62	9.655		9.656	9.939	9.935		9.691	
63	9.649		9.651	9.656	9.882	9.683	9.873	9.688
64	9.640		9.645	9.653	9.826	9.680	9.819	9.681
65	9.630		9.637	9.650	9.779	9.670	9.773	9.674
66	9.623		9.629	9.644	9.729	9.658	9.727	9.664
67	9.612		9.618	9.636	9.680	9.647	9.677	9.652
68	9.609		9.610	9.625	9.634	9.631	9.633	9.640
69	9.598		9.603	9.617	9.586	9.612	9.588	9.624
70	9.587		9.590	9.603	9.546	9.592	9.545	9.604
71	9.576		9.573	9.595	9.506	9.567	9.504	9.578
72	9.571	*****	9.570	9.581	9.462	9.542	9.472	9.557
73	9.562	*****	9.560	9.572	9.436	9.516	9.438	9.532
74	9.557	*****	9.554	9.554	9.408	9.496	9.413	9.513
75	9.544	*****	9.558	9.564	9.391	9.479	9.394	9.495
76	9.469	*****	9.641	9.488	9.377	9.471	9.382	9.488
77	*****	*****	*****	*****	9.371	9.464	9.375	9.474
78	*****	*****	*****	*****	9.371	9.463	9.381	9.476
79	9.488	9.488	9.564	9.564	9.506	9.507	9.514	9.515

TABLE 13.—Continued.

(e) Airflow, 73.03 kg/sec; readings 5 to 15

Axial station	Outer wall				Centerbody			
	Circumferential location, θ , deg							
	0	90	180	270	0	90	180	270
1		9.670						
2		9.667						
3		9.665						
4		9.667						
5		9.665						
6		*****						
7		*****						
8	*****	*****	*****	*****				
9		*****						
10	*****	*****	*****	*****				
12				9.508				
13				9.526				
14				9.571				
15				9.602				
16				9.652				
17				9.720				
18				9.787				
19				10.001				
20				9.897				
35		9.455						
36		9.480						
37	9.551	9.505	9.525	9.631				
38		9.528						
39		9.544						
40	9.598	9.565	9.583	9.649				
41	9.632	9.607	9.622	9.660				
42	9.662	9.646	9.655	9.682				
43	9.695	9.677	9.685	9.705				
44	9.714	9.703	9.713	9.730				
45	9.732	9.725	9.740	9.753				
46	9.765	9.765	9.758	9.778				
47	9.775	9.754	9.760	9.782				
48	9.803		9.803	9.858				
49	9.814		9.811	9.856				
50	9.807		9.808	9.873				
51	9.801		9.798	9.937				
52	9.794		9.798					
53				9.804				
54				0.000	9.391	10.116	9.369	9.731
55				0.000	9.395	10.170	9.369	9.763
56				*****	9.411	10.172	9.392	
57				9.724	*****	10.113	9.451	
58				9.720		10.104		9.708
59				9.713		10.081		*****
60				9.718	*****	10.079	*****	*****
61	9.681		9.689	9.704	9.706		9.704	
62	9.661		9.661	9.942	9.935		9.696	
63	9.654		9.656	9.672	9.886	9.688	9.875	9.693
64	9.645		9.650	9.659	9.830	9.683	9.821	9.686
65	9.635		9.639	9.657	9.784	9.674	9.776	9.679
66	9.630		9.634	9.651	9.734	9.662	9.731	9.670
67	9.618		9.624	9.642	9.686	9.651	9.681	9.658
68	9.616		9.617	9.631	9.639	9.635	9.638	9.646
69	9.605		9.605	9.623	9.593	9.616	9.593	9.630
70	9.593		9.596	9.609	9.554	9.596	9.551	9.610
71	9.583		9.583	9.602	9.514	9.571	9.511	9.585
72	9.577	*****	9.576	9.588	9.471	9.546	9.478	9.564
73	9.569	*****	9.566	9.578	9.444	9.520	9.446	9.540
74	9.564	*****	9.561	9.562	9.418	9.500	9.422	9.521
75	9.553	*****	9.565	9.571	9.402	9.482	9.403	9.503
76	9.478	*****	9.644	9.497	9.388	9.475	9.392	9.497
77	*****	*****	*****	*****	9.382	9.468	9.385	9.482
78	*****	*****	*****	*****	9.382	9.466	9.393	9.484
79	9.487	9.487	9.573	9.572	9.508	9.508	9.521	9.521

TABLE 13.—Continued.

(f) Airflow, 72.77 kg/sec; readings 6 to 17

Axial station	Outer wall				Centerbody			
	Circumferential location, θ , deg							
	0	90	180	270	0	90	180	270
1		9.667						
2		9.665						
3		9.662						
4		9.664						
5		9.662						
6		*****						
7		*****						
8	*****	*****	*****	*****				
9		*****						
10	*****	*****	*****	*****				
12				9.503				
13				9.521				
14				9.566				
15				9.597				
16				9.648				
17				9.716				
18				9.785				
19				9.844				
20				9.894				
35		9.449						
36		9.175						
37	9.546	9.500	9.520	9.628				
38		9.523						
39		9.538						
40	9.593	9.560	9.579	9.645				
41	9.629	9.604	9.618	9.656				
42	9.659	9.641	9.648	9.676				
43	9.692	9.674	9.681	9.702				
44	9.710	9.699	9.710	9.726				
45	9.729	9.723	9.737	9.750				
46	9.761	9.761	9.756	9.776				
47	9.773	9.748	9.757	9.779				
48	9.800		9.800	9.856				
49	9.811		9.809	9.854				
50	9.804		9.805	9.871				
51	9.797		9.796	9.935				
52	9.789		9.796					
53				9.801				
54				0.000	9.386	10.116	9.361	9.732
55				0.000	9.389	10.169	9.364	9.760
56				*****	9.406	10.171	9.386	
57				9.721	*****	10.113	9.446	
58				9.718		10.104		9.704
59				9.710		10.083		*****
60				9.715	*****	10.080	*****	*****
61	9.677		9.686	9.701	9.703		9.701	
62	9.657		9.658	9.940	9.937		9.693	
63	9.651		9.653	9.669	9.883	9.684	9.875	9.690
64	9.642		9.647	9.656	9.827	9.680	9.820	9.684
65	9.632		9.639	9.653	9.781	9.671	9.775	9.676
66	9.622		9.631	9.646	9.731	9.658	9.728	9.666
67	9.614		9.619	9.638	9.682	9.647	9.678	9.654
68	9.613		9.612	9.628	9.635	9.631	9.635	9.642
69	9.601		9.604	9.619	9.589	9.611	9.590	9.625
70	9.589		9.592	9.605	9.549	9.592	9.547	9.606
71	9.578		9.579	9.598	9.509	9.568	9.503	9.581
72	9.573	*****	9.571	9.584	9.468	9.542	9.473	9.560
73	9.565	*****	9.561	9.574	9.439	9.515	9.441	9.535
74	9.560	*****	9.556	9.557	9.411	9.495	9.415	9.516
75	9.549	*****	9.560	9.567	9.395	9.478	9.397	9.498
76	9.472	*****	9.641	9.492	9.381	9.471	9.384	9.491
77	*****	*****	*****	*****	9.375	9.462	9.377	9.477
78	*****	*****	*****	*****	9.376	9.462	9.384	9.480
79	9.486	9.486	9.568	9.567	9.504	9.504	9.518	9.518

TABLE 13.—Continued.

(g) Airflow, 68.61 kg/sec; readings 34 to 37

Axial station	Outer wall				Centerbody			
	Circumferential location, θ , deg							
	0	90	180	270	0	90	180	270
1		9.732						
2		9.731						
3		9.729						
4		9.731						
5		9.728						
6		9.722						
7		9.714						
8	9.685	9.685	9.683	9.698				
9		9.625						
10	9.583	9.579	9.588	9.607				
12				9.597				
13				9.613				
14				9.650				
15				9.675				
16				9.720				
17				9.778				
18				9.835				
19				9.886				
20				9.928				
35		9.552						
36		9.573						
37	9.634	9.595	9.611	9.703				
38		9.613						
39		9.627						
40	9.674	9.645	9.661	9.718				
41	9.703	9.682	9.695	9.727				
42	9.729	9.714	9.722	9.745				
43	9.757	9.742	9.747	9.765				
44	9.773	9.764	9.772	9.786				
45	9.789	9.783	9.794	9.807				
46	9.815	9.797	9.807	9.827				
47	9.826	9.808	9.812	9.831				
48	9.904		9.847	9.896				
49	9.859		9.855	9.894				
50	9.853		9.852	9.909				
51	9.849		9.843	9.964				
52	9.844		9.843					
53				9.849				
54				0.000	9.494	10.118	9.474	9.789
55				0.000	9.497	10.166	9.478	9.811
56				*****	9.512	10.165	9.496	
57				9.781	*****	10.120	9.547	
58				9.777		10.103		9.766
59				9.771		10.101		*****
60				9.775	*****	10.099	*****	*****
61	9.744		9.749	9.763	9.765		9.764	
62	9.725		9.727	9.962	9.960		9.756	
63	9.721		9.720	9.735	9.918	9.750	9.909	9.754
64	9.713		9.718	9.724	9.871	9.748	9.866	9.749
65	9.704		9.710	9.722	9.832	9.740	9.827	9.742
66	9.699		9.703	9.716	9.789	9.729	9.788	9.733
67	9.689		9.694	9.708	9.748	9.719	9.744	9.723
68	9.688		9.688	9.700	9.707	9.706	9.706	9.712
69	9.679		9.681	9.693	9.665	9.689	9.668	9.698
70	9.670		9.671	9.681	9.631	9.660	9.632	9.682
71	9.661		9.660	9.675	9.601	9.652	9.597	9.660
72	9.656	*****	9.654	9.663	9.567	9.630	9.569	9.643
73	9.650	*****	9.646	9.655	9.542	9.608	9.541	9.622
74	9.646	*****	9.641	9.641	9.520	9.591	9.520	9.605
75	9.638	*****	9.644	9.648	9.506	9.576	9.504	9.589
76	9.574	*****	9.688	9.585	9.494	9.571	9.493	9.584
77	*****	*****	*****	*****	9.488	9.564	9.488	9.572
78	*****	*****	*****	*****	9.489	9.563	9.493	9.574
79	9.585	9.585	9.648	9.648	9.599	9.599	9.606	9.606

TABLE 13.—Continued.

(h) Airflow, 56.23 kg/sec; readings 30 to 33

Axial station	Outer wall				Centerbody			
	Circumferential location, θ , deg							
	0	90	180	270	0	90	180	270
1		9.872						
2		9.871						
3		9.871						
4		9.872						
5		9.870						
6		9.866						
7		9.861						
8	9.840	9.842	9.842	9.851				
9		9.805						
10	9.780	9.777	9.783	9.796				
12				9.791				
13				9.801				
14				9.825				
15				9.843				
16				9.869				
17				9.905				
18				9.941				
19				9.973				
20				9.999				
35		9.761						
36		9.774						
37	9.812	9.788	9.799	9.858				
38		9.799						
39		9.808						
40	9.838	9.819	9.831	9.867				
41	9.857	9.843	9.852	9.873				
42	9.873	9.864	9.869	9.884				
43	9.891	9.881	9.884	9.897				
44	9.901	9.895	9.901	9.910				
45	9.912	9.907	9.915	9.923				
46	9.928	9.916	9.925	9.936				
47	9.934	9.923	9.926	9.937				
48	9.976		9.946	9.979				
49	9.956		9.954	9.978				
50	9.951		9.951	9.987				
51	9.949		9.946	10.022				
52	9.947		9.946					
53				9.950				
54				0.000	9.725	10.121	9.713	9.911
55				0.000	9.726	10.153	9.712	9.928
56				*****	9.735	10.148	9.725	
57				9.909	*****	10.126	9.755	
58				9.905		10.110		9.898
59				9.901		10.116		*****
60				9.903	*****	10.114	*****	*****
61	9.883		9.887	9.895	9.896		9.896	
62	9.871		9.873	10.019	10.022		9.891	
63	9.868		9.870	9.877	9.993	9.888	9.992	9.889
64	9.862		9.867	9.872	9.964	9.886	9.962	9.886
65	9.857		9.863	9.870	9.939	9.881	9.937	9.883
66	9.853		9.858	9.866	9.912	9.874	9.912	9.877
67	9.848		9.853	9.861	9.886	9.867	9.883	9.870
68	9.843		9.849	9.856	9.858	9.859	9.859	9.863
69	9.841		9.845	9.848	9.834	9.848	9.835	9.855
70	9.835		9.835	9.844	9.812	9.838	9.813	9.844
71	9.829		9.831	9.841	9.791	9.825	9.790	9.831
72	9.825	*****	9.827	9.833	9.769	9.811	9.772	9.819
73	9.821	*****	9.823	9.828	9.753	9.797	9.755	9.806
74	9.818	*****	9.818	9.819	9.738	9.786	9.742	9.795
75	9.813	*****	9.821	9.823	9.730	9.776	9.732	9.785
76	9.773	*****	9.834	9.785	9.722	9.774	9.722	9.783
77	*****	*****	*****	*****	9.719	9.769	9.722	9.774
78	*****	*****	*****	*****	9.719	9.769	9.725	9.776
79	9.783	9.783	9.823	9.823	9.793	9.792	9.796	9.796

TABLE 13.—Concluded.

(i) Airflow, 35.35 kg/sec; readings 26 to 29

Axial station	Outer wall				Centerbody			
	Circumferential location, θ , deg							
	0	90	180	270	0	90	180	270
1		10.035						
2		10.034						
3		10.034						
4		10.034						
5		10.034						
6		10.032						
7		10.030						
8	10.023	10.024	10.023	10.027				
9		10.009						
10	10.001	9.999	10.002	10.007				
12				10.005				
13				10.009				
14				10.019				
15				10.024				
16				10.034				
17				10.047				
18				10.060				
19				10.072				
20				10.082				
35		9.993						
36		9.998						
37	10.012	10.004	10.008	10.029				
38		10.007						
39		10.010						
40	10.021	10.014	10.019	10.034				
41	10.029	10.023	10.027	10.035				
42	10.035	10.031	10.033	10.039				
43	10.040	10.038	10.038	10.043				
44	10.046	10.043	10.045	10.051				
45	10.050	10.047	10.050	10.054				
46	10.056	10.050	10.054	10.057				
47	10.056	10.053	10.053	10.059				
48	10.070		10.062	10.074				
49	10.066		10.065	10.073				
50	10.064		10.064	10.078				
51	10.064		10.060	10.090				
52	10.062		10.060					
53				10.057				
54				0.000	9.981	10.125	9.973	10.047
55				0.000	9.980	10.141	9.974	10.056
56				*****	9.984	10.133	9.977	
57				10.049	*****	10.122	9.989	
58				10.046		10.123		10.043
59				10.045		10.126		*****
60				10.045	*****	10.126	*****	*****
61	10.039		10.039	10.042	10.042		10.042	
62	10.035		10.031	10.088	10.089		10.040	
63	10.032		10.032	10.036	10.079	10.040	10.080	10.039
64	10.030		10.031	10.034	10.069	10.039	10.068	10.039
65	10.026		10.031	10.034	10.060	10.037	10.058	10.038
66	10.026		10.029	10.032	10.049	10.034	10.049	10.035
67	10.025		10.027	10.030	10.039	10.032	10.036	10.033
68	10.024		10.026	10.028	10.029	10.029	10.029	10.030
69	10.023		10.024	10.026	10.020	10.025	10.020	10.028
70	10.019		10.021	10.023	10.011	10.021	10.012	10.024
71	10.017		10.018	10.020	10.004	10.016	10.003	10.018
72	10.016	*****	10.017	10.020	9.995	10.011	9.996	10.014
73	10.015	*****	10.016	10.017	9.989	10.005	9.986	10.009
74	10.013	*****	10.014	10.015	9.983	10.001	9.985	10.005
75	10.011	*****	10.015	10.016	9.980	9.997	9.981	10.001
76	9.993	*****	10.017	10.003	9.977	9.997	9.979	10.001
77	*****	*****	*****	*****	9.976	9.995	9.977	9.997
78	*****	*****	*****	*****	9.976	9.995	9.979	9.998
79	10.001	10.000	10.017	10.017	10.004	10.003	10.005	10.005

TABLE 14.—CORNER 2 VANE SURFACE STATIC PRESSURE DISTRIBUTION WITH VANES A10
IN CORNER 1 AND VANES A4 IN CORNER 2—UNIFORM INFLOW

(a) Airflow, 81.16 kg/sec; readings 38 to 41

Fraction of chord, XC/C	Pressure, N/cm ²		Mach number		Coefficient	
	(a)	(b)	(a)	(b)	(a)	(b)
Section A						
0.000	9.912	9.913	0.201	0.201	0.504	0.505
0.025	9.546	9.926	0.308	0.196	-0.164	0.529
0.050	9.454	9.686	0.330	0.271	-0.332	0.092
0.075	9.353	9.722	0.353	0.264	-0.517	0.157
0.100	9.280	9.765	0.369	0.249	-0.649	0.235
0.150	9.161	9.798	0.394	0.239	-0.867	0.295
0.200	9.126	9.827	0.401	0.230	-0.931	0.349
0.250	9.087	9.862	0.409	0.218	-1.001	0.412
0.300	9.276	9.878	0.370	0.213	-0.656	0.441
0.350	9.470	9.826	0.326	0.230	-0.303	0.347
0.400	9.541	9.778	0.309	0.245	-0.172	0.260
0.450	9.562	9.743	0.304	0.255	-0.135	0.195
0.500	9.571	9.696	0.302	0.269	-0.118	0.110
0.550	9.561	9.623	0.304	0.288	-0.136	-0.023
Section B						
0.000	9.751	9.751	0.253	0.253	0.210	0.210
0.025	9.212	9.485	0.383	0.323	-0.774	-0.275
0.050	9.079	9.514	0.410	0.316	-1.017	-0.223
0.075	8.999	9.601	0.426	0.294	-1.161	-0.063
0.100	8.938	9.670	0.438	0.276	-1.273	0.061
0.150	8.840	9.745	0.456	0.255	-1.453	0.198
0.200	8.831	9.783	0.458	0.243	-1.469	0.269
0.300	8.857	9.838	0.453	0.226	-1.422	0.368
0.500	9.225	9.839	0.381	0.226	-0.749	0.370
0.700	9.453	9.801	0.330	0.238	-0.335	0.302
0.800	9.527	9.760	0.313	0.250	-0.200	0.227
0.850	9.544	9.727	0.308	0.260	-0.167	0.165
0.900	9.553	9.683	0.306	0.272	-0.151	0.086
0.950	9.566	9.610	0.303	0.292	-0.127	-0.047
Section C						
0.000	9.645	9.646	0.283	0.282	0.017	0.018
0.025	9.061	9.738	0.414	0.257	-1.049	0.186
0.050	8.927	9.573	0.440	0.301	-1.294	-0.115
0.075	8.852	9.645	0.454	0.283	-1.430	0.017
0.100	8.816	9.694	0.460	0.269	-1.495	0.106
0.150	8.740	9.777	0.474	0.245	-1.635	0.258
0.200	8.744	9.825	0.473	0.230	-1.627	0.345
0.300	8.792	9.872	0.465	0.215	-1.540	0.430
0.500	9.163	9.882	0.393	0.211	-0.863	0.450
0.700	9.444	9.838	0.332	0.226	-0.350	0.369
0.800	9.533	9.793	0.311	0.240	-0.188	0.286
0.850	9.557	9.755	0.305	0.252	-0.144	0.217
0.900	9.569	9.709	0.302	0.265	-0.122	0.133
0.950	9.584	9.630	0.298	0.287	-0.095	-0.010
Section D						
0.000	9.443	9.446	0.333	0.332	-0.352	-0.347
0.025	10.062	9.655	0.137	0.280	0.778	0.034
0.050	9.342	9.588	0.356	0.298	-0.536	-0.088
0.075	9.319	9.613	0.361	0.291	-0.579	-0.042
0.100	9.304	9.632	0.364	0.286	-0.606	-0.006
0.150	9.275	9.653	0.370	0.281	-0.658	0.030
0.200	9.267	9.669	0.372	0.276	-0.673	0.060
0.300	9.266	9.685	0.372	0.272	-0.675	0.090
0.500	9.365	9.682	0.350	0.273	-0.494	0.085
0.700	9.445	9.655	0.332	0.280	-0.347	0.035
0.800	9.475	9.624	0.325	0.288	-0.294	-0.022
0.850	9.483	9.602	0.323	0.294	-0.278	-0.063
0.900	9.488	9.572	0.322	0.302	-0.270	-0.117
0.950	9.493	9.516	0.321	0.315	-0.260	-0.219

^aSuction surface.

^bPressure surface.

TABLE 14.—Continued.

(b) Airflow, 78.37 kg/sec; readings 22 to 25

Fraction of chord, <i>XC/C</i>	Pressure, N/cm ²		Mach number		Coefficient	
	(a)	(b)	(a)	(b)	(a)	(b)
Section A						
0.000	9.917	9.918	0.198	0.198	0.480	0.482
0.025	9.567	9.939	0.302	0.190	-0.203	0.522
0.050	9.480	9.706	0.324	0.265	-0.374	0.068
0.075	9.383	9.741	0.346	0.255	-0.564	0.137
0.100	9.315	9.780	0.361	0.244	-0.695	0.213
0.150	9.201	9.812	0.385	0.234	-0.921	0.275
0.200	9.168	9.840	0.392	0.225	-0.983	0.330
0.300	9.132	9.873	0.399	0.214	-1.053	0.395
0.500	9.310	9.889	0.362	0.208	-0.705	0.426
0.700	9.498	9.840	0.319	0.225	-0.338	0.331
0.800	9.567	9.794	0.302	0.239	-0.203	0.240
0.850	9.587	9.760	0.297	0.250	-0.165	0.173
0.900	9.593	9.716	0.296	0.263	-0.154	0.087
0.950	9.582	9.645	0.298	0.282	-0.173	-0.051
Section B						
0.000	9.761	9.761	0.249	0.249	0.176	0.176
0.025	9.249	9.524	0.375	0.313	-0.826	-0.288
0.050	9.122	9.547	0.401	0.307	-1.072	-0.243
0.075	9.047	9.627	0.416	0.287	-1.218	-0.086
0.100	8.990	9.691	0.427	0.270	-1.331	0.039
0.150	8.898	9.762	0.445	0.249	-1.511	0.178
0.200	8.890	9.803	0.446	0.237	-1.526	0.257
0.300	8.914	9.850	0.442	0.221	-1.480	0.350
0.500	9.267	9.851	0.371	0.221	-0.790	0.351
0.700	9.484	9.816	0.323	0.233	-0.367	0.283
0.800	9.554	9.776	0.305	0.245	-0.228	0.206
0.850	9.571	9.744	0.301	0.254	-0.196	0.143
0.900	9.580	9.703	0.299	0.266	-0.178	0.062
0.950	9.591	9.632	0.296	0.285	-0.156	-0.076
Section C						
0.000	9.662	9.662	0.278	0.277	-0.018	-0.018
0.025	9.101	9.762	0.406	0.249	-1.115	0.178
0.050	8.971	9.601	0.431	0.294	-1.367	-0.137
0.075	8.901	9.668	0.444	0.276	-1.505	-0.006
0.100	8.866	9.715	0.451	0.263	-1.572	0.085
0.150	8.795	9.793	0.464	0.240	-1.712	0.237
0.200	8.799	9.879	0.463	0.225	-1.703	0.327
0.300	8.846	9.883	0.454	0.210	-1.611	0.414
0.500	9.203	9.893	0.385	0.207	-0.915	0.433
0.700	9.471	9.851	0.326	0.221	-0.391	0.351
0.800	9.557	9.807	0.305	0.235	-0.224	0.266
0.850	9.578	9.771	0.299	0.247	-0.181	0.195
0.900	9.592	9.726	0.296	0.260	-0.155	0.107
0.950	9.606	9.650	0.292	0.281	-0.127	-0.041
Section D						
0.000	9.470	9.470	0.326	0.326	-0.393	-0.394
0.025	10.062	9.672	0.136	0.275	0.763	0.001
0.050	9.369	9.608	0.349	0.292	-0.589	-0.123
0.075	9.348	9.633	0.354	0.285	-0.631	-0.075
0.100	9.334	9.652	0.357	0.280	-0.659	-0.038
0.150	9.305	9.670	0.363	0.275	-0.715	-0.002
0.200	9.299	9.687	0.364	0.271	-0.726	0.031
0.300	9.297	9.702	0.365	0.266	-0.730	0.061
0.500	9.394	9.701	0.343	0.267	-0.541	0.059
0.700	9.469	9.674	0.326	0.274	-0.396	0.005
0.800	9.501	9.643	0.319	0.283	-0.333	-0.055
0.850	9.509	9.623	0.316	0.288	-0.316	-0.094
0.900	9.514	9.595	0.315	0.295	-0.308	-0.149
0.950	9.519	9.540	0.314	0.309	-0.298	-0.256

^aSuction surface.^bPressure surface.

TABLE 14.—Continued.

(c) Airflow, 75.21 kg/sec; readings 18 to 21

Fraction of chord, XC/C	Pressure, N/cm ²		Mach number		Coefficient	
	(a)	(b)	(a)	(b)	(a)	(b)
Section A						
0.000	9.935	9.933	0.189	0.190	0.485	0.479
0.025	9.621	9.956	0.287	0.181	-0.184	0.528
0.050	9.543	9.746	0.306	0.252	-0.348	0.083
0.075	9.458	9.780	0.327	0.242	-0.530	0.156
0.100	9.398	9.815	0.341	0.231	-0.657	0.230
0.150	9.296	9.844	0.364	0.221	-0.875	0.291
0.200	9.268	9.869	0.370	0.213	-0.935	0.345
0.300	9.235	9.899	0.377	0.202	-1.004	0.408
0.500	9.397	9.914	0.341	0.197	-0.659	0.440
0.700	9.563	9.870	0.302	0.213	-0.307	0.346
0.800	9.625	9.828	0.286	0.226	-0.174	0.257
0.850	9.643	9.798	0.281	0.236	-0.136	0.194
0.900	9.652	9.758	0.278	0.248	-0.118	0.108
0.950	9.642	9.695	0.281	0.267	-0.138	-0.026
Section B						
0.000	9.794	9.794	0.237	0.237	0.185	0.185
0.025	9.335	9.586	0.355	0.296	-0.791	-0.258
0.050	9.223	9.605	0.379	0.291	-1.030	-0.218
0.075	9.156	9.678	0.393	0.271	-1.173	-0.062
0.100	9.104	9.735	0.404	0.255	-1.283	0.059
0.150	9.022	9.800	0.420	0.235	-1.456	0.198
0.200	9.014	9.836	0.422	0.224	-1.475	0.273
0.300	9.037	9.875	0.417	0.211	-1.426	0.358
0.500	9.352	9.879	0.351	0.209	-0.755	0.365
0.700	9.547	9.847	0.306	0.220	-0.340	0.297
0.800	9.611	9.811	0.289	0.232	-0.205	0.222
0.850	9.626	9.782	0.285	0.241	-0.172	0.160
0.900	9.634	9.745	0.283	0.252	-0.155	0.080
0.950	9.644	9.682	0.280	0.270	-0.134	-0.055
Section C						
0.000	9.699	9.702	0.265	0.265	-0.017	-0.011
0.025	9.199	9.813	0.384	0.232	-1.081	0.224
0.050	9.081	9.661	0.408	0.276	-1.332	-0.097
0.075	9.021	9.719	0.420	0.260	-1.458	0.025
0.100	8.991	9.761	0.426	0.247	-1.523	0.114
0.150	8.928	9.828	0.438	0.227	-1.657	0.257
0.200	8.933	9.870	0.437	0.213	-1.645	0.346
0.300	8.976	9.909	0.429	0.199	-1.555	0.429
0.500	9.300	9.919	0.363	0.195	-0.867	0.451
0.700	9.538	9.880	0.308	0.209	-0.360	0.368
0.800	9.614	9.840	0.288	0.223	-0.198	0.283
0.850	9.635	9.808	0.283	0.233	-0.154	0.213
0.900	9.646	9.768	0.280	0.245	-0.130	0.128
0.950	9.658	9.697	0.277	0.265	-0.104	-0.018
Section D						
0.000	9.529	9.530	0.310	0.310	-0.379	-0.378
0.025	10.067	9.719	0.130	0.260	0.764	0.026
0.050	9.441	9.662	0.331	0.276	-0.567	-0.096
0.075	9.423	9.683	0.335	0.270	-0.605	-0.052
0.100	9.410	9.699	0.338	0.265	-0.633	-0.017
0.150	9.385	9.716	0.344	0.261	-0.686	0.018
0.200	9.379	9.730	0.345	0.256	-0.698	0.049
0.300	9.379	9.745	0.345	0.252	-0.699	0.080
0.500	9.468	9.743	0.325	0.253	-0.510	0.076
0.700	9.537	9.719	0.308	0.260	-0.362	0.024
0.800	9.563	9.692	0.302	0.267	-0.306	-0.033
0.850	9.571	9.673	0.300	0.273	-0.290	-0.073
0.900	9.575	9.648	0.299	0.279	-0.282	-0.125
0.950	9.579	9.599	0.297	0.292	-0.272	-0.230

^aSuction surface.^bPressure surface.

TABLE 14.—Continued.

(d) Airflow, 73.10 kg/sec; readings 4 to 16

Fraction of chord, XC/C	Pressure, N/cm^2		Mach number		Coefficient	
	(a)	(b)	(a)	(b)	(a)	(b)
Section A						
0.000	9.943	9.942	0.185	0.185	0.476	0.475
0.025	9.638	9.961	0.282	0.178	-0.210	0.517
0.050	9.565	9.763	0.300	0.246	-0.374	0.073
0.075	9.485	9.794	0.320	0.236	-0.554	0.142
0.100	9.427	9.828	0.334	0.226	-0.683	0.218
0.150	9.331	9.851	0.356	0.217	-0.900	0.281
0.200	9.204	9.881	0.361	0.208	-0.960	0.337
0.300	9.273	9.909	0.368	0.198	-1.031	0.400
0.500	9.426	9.923	0.334	0.193	-0.686	0.431
0.700	9.585	9.881	0.295	0.208	-0.328	0.336
0.800	9.645	9.840	0.280	0.222	-0.193	0.246
0.850	9.662	9.811	0.275	0.231	-0.155	0.181
0.900	9.670	9.773	0.273	0.243	-0.137	0.095
0.950	9.662	9.713	0.275	0.261	-0.156	-0.041
Section B						
0.000	9.793	9.794	0.237	0.237	0.139	0.141
0.025	9.353	9.653	0.351	0.277	-0.850	-0.175
0.050	9.249	9.650	0.373	0.278	-1.083	-0.183
0.075	9.187	9.707	0.386	0.262	-1.223	-0.053
0.100	9.141	9.756	0.396	0.248	-1.328	0.055
0.150	9.067	9.818	0.411	0.229	-1.493	0.196
0.200	9.065	9.851	0.411	0.218	-1.498	0.270
0.300	9.087	9.892	0.407	0.204	-1.448	0.362
0.500	9.390	9.892	0.342	0.204	-0.766	0.362
0.700	9.575	9.862	0.298	0.214	-0.350	0.294
0.800	9.635	9.829	0.282	0.225	-0.216	0.220
0.850	9.649	9.802	0.279	0.234	-0.185	0.159
0.900	9.656	9.766	0.277	0.245	-0.169	0.080
0.950	9.666	9.708	0.274	0.262	-0.146	-0.052
Section C						
0.000	9.716	9.713	0.260	0.261	-0.034	-0.040
0.025	9.235	9.821	0.376	0.228	-1.116	0.203
0.050	9.124	9.678	0.399	0.271	-1.364	-0.120
0.075	9.064	9.734	0.411	0.255	-1.499	0.007
0.100	9.035	9.774	0.417	0.243	-1.566	0.097
0.150	8.974	9.839	0.429	0.222	-1.703	0.242
0.200	8.979	9.880	0.428	0.208	-1.692	0.335
0.300	9.018	9.914	0.420	0.196	-1.602	0.411
0.500	9.333	9.927	0.355	0.191	-0.896	0.440
0.700	9.561	9.889	0.301	0.205	-0.382	0.355
0.800	9.634	9.851	0.282	0.218	-0.218	0.269
0.850	9.654	9.820	0.277	0.228	-0.174	0.199
0.900	9.665	9.781	0.274	0.240	-0.150	0.113
0.950	9.677	9.716	0.271	0.260	-0.122	-0.034
Section D						
0.000	9.546	9.546	0.305	0.305	-0.417	-0.416
0.025	10.060	9.740	0.132	0.253	0.739	0.020
0.050	9.465	9.683	0.325	0.269	-0.599	-0.109
0.075	9.447	9.701	0.329	0.264	-0.638	-0.068
0.100	9.436	9.716	0.332	0.260	-0.663	-0.034
0.150	9.411	9.731	0.338	0.256	-0.720	-0.001
0.200	9.404	9.744	0.339	0.252	-0.735	0.030
0.300	9.408	9.758	0.338	0.247	-0.727	0.061
0.500	9.492	9.777	0.318	0.248	-0.537	0.057
0.700	9.559	9.734	0.302	0.255	-0.386	0.006
0.800	9.585	9.708	0.295	0.262	-0.329	-0.052
0.850	9.592	9.690	0.294	0.267	-0.314	-0.092
0.900	9.595	9.666	0.293	0.274	-0.305	-0.147
0.950	9.600	9.619	0.291	0.287	-0.294	-0.253

^aSuction surface.^bPressure surface.

TABLE 14.—Continued.

(e) Airflow, 73.03 kg/sec; readings 5 to 15

Fraction of chord, XC/C	Pressure, N/cm ²		Mach number		Coefficient	
	(a)	(b)	(a)	(b)	(a)	(b)
Section A						
0.000	9.945	9.945	0.184	0.184	0.479	0.479
0.025	9.643	9.962	0.280	0.177	-0.252	0.517
0.050	9.568	9.767	0.300	0.245	-0.370	0.078
0.075	9.491	9.798	0.319	0.235	-0.543	0.148
0.100	9.435	9.831	0.332	0.225	-0.671	0.223
0.150	9.339	9.859	0.354	0.216	-0.886	0.285
0.200	9.315	9.883	0.359	0.207	-0.941	0.340
0.300	9.282	9.908	0.366	0.198	-1.014	0.396
0.500	9.433	9.922	0.333	0.193	-0.676	0.427
0.700	9.591	9.883	0.294	0.207	-0.318	0.340
0.800	9.650	9.844	0.278	0.221	-0.185	0.251
0.850	9.667	9.815	0.274	0.230	-0.147	0.186
0.900	9.675	9.776	0.271	0.242	-0.129	0.099
0.950	9.667	9.717	0.274	0.260	-0.147	-0.035
Section B						
0.000	9.803	9.803	0.234	0.234	0.159	0.158
0.025	9.367	9.636	0.348	0.282	-0.823	-0.218
0.050	9.262	9.644	0.371	0.280	-1.060	-0.198
0.075	9.200	9.707	0.384	0.263	-1.200	-0.058
0.100	9.153	9.757	0.393	0.248	-1.307	0.056
0.150	9.077	9.819	0.409	0.229	-1.478	0.196
0.200	9.073	9.853	0.409	0.218	-1.486	0.271
0.300	9.093	9.893	0.405	0.204	-1.440	0.361
0.500	9.395	9.893	0.341	0.204	-0.762	0.362
0.700	9.579	9.863	0.297	0.214	-0.345	0.295
0.800	9.639	9.830	0.281	0.225	-0.211	0.220
0.850	9.653	9.802	0.278	0.234	-0.180	0.156
0.900	9.660	9.767	0.276	0.245	-0.163	0.077
0.950	9.669	9.708	0.273	0.262	-0.143	-0.056
Section C						
0.000	9.721	9.718	0.258	0.259	-0.026	-0.031
0.025	9.247	9.823	0.374	0.228	-1.094	0.203
0.050	9.138	9.681	0.397	0.270	-1.341	-0.115
0.075	9.078	9.738	0.408	0.254	-1.475	0.012
0.100	9.049	9.777	0.414	0.242	-1.539	0.101
0.150	8.989	9.841	0.426	0.222	-1.674	0.245
0.200	8.993	9.882	0.425	0.208	-1.666	0.337
0.300	9.033	9.918	0.417	0.194	-1.577	0.419
0.500	9.341	9.926	0.353	0.191	-0.882	0.437
0.700	9.567	9.891	0.300	0.205	-0.373	0.357
0.800	9.639	9.853	0.281	0.218	-0.211	0.272
0.850	9.658	9.822	0.276	0.228	-0.167	0.202
0.900	9.669	9.784	0.273	0.240	-0.143	0.117
0.950	9.681	9.720	0.270	0.259	-0.115	-0.028
Section D						
0.000	9.553	9.552	0.303	0.304	-0.404	-0.405
0.025	10.054	9.737	0.135	0.254	0.726	0.010
0.050	9.471	9.681	0.324	0.270	-0.590	-0.116
0.075	9.453	9.702	0.328	0.264	-0.629	-0.070
0.100	9.442	9.717	0.330	0.260	-0.655	-0.034
0.150	9.419	9.734	0.336	0.255	-0.707	0.004
0.200	9.413	9.747	0.337	0.251	-0.720	0.032
0.300	9.413	9.761	0.337	0.247	-0.720	0.064
0.500	9.497	9.760	0.317	0.247	-0.531	0.061
0.700	9.564	9.736	0.301	0.254	-0.380	0.008
0.800	9.589	9.710	0.294	0.262	-0.324	-0.049
0.850	9.596	9.693	0.293	0.266	-0.308	-0.088
0.900	9.600	9.668	0.292	0.273	-0.298	-0.145
0.950	9.604	9.623	0.290	0.286	-0.288	-0.248

^aSuction surface.^bPressure surface.

TABLE 14.—Continued.

(f) Airflow, 72.77 kg/sec; readings 6 to 17

Fraction of chord, <i>XC/C</i>	Pressure, N/cm ²		Mach number		Coefficient	
	(a)	(b)	(a)	(b)	(a)	(b)
Section A						
0.000	9.944	9.944	0.185	0.185	0.473	0.472
0.025	9.639	9.961	0.281	0.178	-0.218	0.511
0.050	9.564	9.764	0.301	0.246	-0.388	0.066
0.075	9.487	9.796	0.320	0.236	-0.564	0.138
0.100	9.428	9.830	0.334	0.225	-0.698	0.214
0.150	9.334	9.858	0.355	0.216	-0.911	0.277
0.200	9.307	9.882	0.361	0.208	-0.972	0.333
0.300	9.277	9.911	0.367	0.197	-1.040	0.398
0.500	9.426	9.924	0.334	0.192	-0.702	0.428
0.700	9.588	9.882	0.295	0.208	-0.334	0.332
0.800	9.647	9.842	0.279	0.221	-0.200	0.242
0.850	9.664	9.813	0.274	0.231	-0.162	0.176
0.900	9.672	9.775	0.272	0.243	-0.144	0.089
0.950	9.664	9.715	0.274	0.260	-0.161	-0.047
Section B						
0.000	9.795	9.794	0.236	0.237	0.134	0.134
0.025	9.355	9.655	0.350	0.277	-0.863	-0.182
0.050	9.251	9.651	0.373	0.278	-1.098	-0.190
0.075	9.189	9.710	0.386	0.262	-1.240	-0.058
0.100	9.144	9.757	0.395	0.248	-1.342	0.050
0.150	9.070	9.821	0.410	0.228	-1.509	0.193
0.200	9.066	9.853	0.411	0.218	-1.517	0.267
0.300	9.091	9.894	0.406	0.203	-1.462	0.359
0.500	9.393	9.894	0.342	0.203	-0.776	0.360
0.700	9.578	9.864	0.297	0.214	-0.357	0.292
0.800	9.637	9.831	0.282	0.225	-0.222	0.217
0.850	9.651	9.804	0.278	0.234	-0.191	0.155
0.900	9.658	9.769	0.276	0.244	-0.175	0.077
0.950	9.668	9.710	0.273	0.262	-0.153	-0.057
Section C						
0.000	9.717	9.714	0.260	0.260	-0.041	-0.047
0.025	9.242	9.816	0.375	0.230	-1.118	0.184
0.050	9.133	9.677	0.397	0.271	-1.366	-0.133
0.075	9.073	9.734	0.409	0.255	-1.502	-0.004
0.100	9.044	9.733	0.415	0.243	-1.569	0.086
0.150	8.983	9.838	0.427	0.223	-1.707	0.233
0.200	8.987	9.879	0.426	0.209	-1.697	0.325
0.300	9.026	9.916	0.419	0.196	-1.608	0.409
0.500	9.337	9.922	0.354	0.193	-0.904	0.422
0.700	9.563	9.888	0.301	0.206	-0.391	0.345
0.800	9.636	9.850	0.282	0.219	-0.226	0.260
0.850	9.655	9.819	0.277	0.229	-0.182	0.190
0.900	9.666	9.781	0.274	0.241	-0.158	0.104
0.950	9.678	9.716	0.271	0.260	-0.130	-0.043
Section D						
0.000	9.546	9.547	0.305	0.305	-0.429	-0.428
0.025	10.050	9.739	0.138	0.253	0.713	0.008
0.050	9.465	9.682	0.325	0.270	-0.613	-0.122
0.075	9.448	9.700	0.329	0.265	-0.652	-0.080
0.100	9.435	9.717	0.332	0.260	-0.680	-0.042
0.150	9.410	9.731	0.338	0.256	-0.739	-0.009
0.200	9.406	9.746	0.339	0.251	-0.746	0.023
0.300	9.408	9.759	0.338	0.247	-0.743	0.053
0.500	9.439	9.758	0.319	0.248	-0.558	0.050
0.700	9.560	9.734	0.302	0.255	-0.398	-0.004
0.800	9.585	9.708	0.295	0.262	-0.341	-0.062
0.850	9.591	9.670	0.294	0.267	-0.327	-0.103
0.900	9.595	9.660	0.293	0.274	-0.317	-0.157
0.950	9.600	9.619	0.292	0.287	-0.307	-0.264

^aSuction surface.^bPressure surface.

TABLE 14.—Continued.

(g) Airflow, 68.61 kg/sec; readings 34 to 37

Fraction of chord, XC/C	Pressure, N/cm ²		Mach number		Coefficient	
	(a)	(b)	(a)	(b)	(a)	(b)
Section A						
0.000	9.970	9.970	0.171	0.171	0.485	0.485
0.025	9.914	9.982	0.259	0.166	-0.171	0.517
0.050	9.652	9.817	0.276	0.227	-0.328	0.094
0.075	9.584	9.846	0.294	0.218	-0.503	0.169
0.100	9.535	9.873	0.306	0.208	-0.629	0.238
0.150	9.453	9.898	0.326	0.199	-0.837	0.302
0.200	9.430	9.918	0.332	0.192	-0.898	0.354
0.300	9.403	9.943	0.338	0.182	-0.967	0.418
0.500	9.531	9.955	0.307	0.177	-0.638	0.448
0.700	9.666	9.918	0.272	0.192	-0.292	0.353
0.800	9.718	9.884	0.258	0.204	-0.160	0.266
0.850	9.732	9.859	0.253	0.213	-0.123	0.202
0.900	9.738	9.827	0.251	0.224	-0.107	0.119
0.950	9.732	9.775	0.253	0.240	-0.124	-0.013
Section B						
0.000	9.854	9.853	0.215	0.215	-0.189	0.187
0.025	9.481	9.684	0.320	0.267	-0.766	-0.247
0.050	9.390	9.701	0.341	0.262	-0.999	-0.202
0.075	9.335	9.761	0.353	0.245	-1.140	-0.050
0.100	9.293	9.807	0.363	0.230	-1.249	0.068
0.150	9.226	9.861	0.377	0.212	-1.420	0.208
0.200	9.220	9.889	0.378	0.203	-1.436	0.279
0.300	9.237	9.924	0.374	0.190	-1.390	0.368
0.500	9.495	9.924	0.316	0.190	-0.730	0.367
0.700	9.653	9.897	0.276	0.200	-0.325	0.300
0.800	9.705	9.869	0.261	0.210	-0.193	0.226
0.850	9.717	9.844	0.258	0.218	-0.161	0.164
0.900	9.724	9.814	0.256	0.228	-0.144	0.086
0.950	9.732	9.762	0.253	0.244	-0.122	-0.046
Section C						
0.000	9.773	9.773	0.241	0.241	-0.013	-0.018
0.025	9.368	9.860	0.346	0.213	-1.055	0.204
0.050	9.272	9.742	0.367	0.250	-1.300	-0.098
0.075	9.224	9.792	0.377	0.235	-1.425	0.030
0.100	9.196	9.827	0.383	0.224	-1.495	0.119
0.150	9.144	9.881	0.394	0.205	-1.630	0.258
0.200	9.146	9.918	0.394	0.192	-1.678	0.352
0.300	9.178	9.950	0.387	0.180	-1.542	0.435
0.500	9.450	9.956	0.327	0.177	-0.346	0.449
0.700	9.644	9.924	0.278	0.190	-0.349	0.368
0.800	9.707	9.892	0.260	0.202	-0.186	0.287
0.850	9.724	9.866	0.256	0.211	-0.145	0.219
0.900	9.733	9.833	0.253	0.222	-0.120	0.135
0.950	9.744	9.777	0.250	0.240	-0.093	-0.008
Section D						
0.000	9.621	9.621	0.284	0.284	-0.408	-0.408
0.025	10.110	9.812	0.097	0.229	0.845	0.081
0.050	9.560	9.759	0.300	0.245	-0.563	-0.054
0.075	9.548	9.771	0.303	0.242	-0.595	-0.024
0.100	9.539	9.781	0.305	0.239	-0.617	0.002
0.150	9.521	9.793	0.310	0.235	-0.665	0.033
0.200	9.517	9.803	0.311	0.232	-0.674	0.053
0.300	9.516	9.815	0.311	0.228	-0.676	0.089
0.500	9.588	9.813	0.293	0.228	-0.492	0.085
0.700	9.645	9.792	0.278	0.235	-0.347	0.031
0.800	9.666	9.771	0.272	0.242	-0.292	-0.024
0.850	9.671	9.756	0.271	0.246	-0.279	-0.062
0.900	9.675	9.735	0.269	0.252	-0.269	-0.116
0.950	9.679	9.696	0.268	0.264	-0.259	-0.216

^aSuction surface^bPressure surface.

TABLE 14.—Continued.

(h) Airflow, 56.23 kg/sec; readings 30 to 33

Fraction of chord, XC/C	Pressure, N/cm ²		Mach number		Coefficient	
	(a)	(b)	(a)	(b)	(a)	(b)
	Section A					
0.000	10.023	10.022	0.140	0.140	0.481	0.480
0.025	9.861	10.036	0.207	0.133	-0.137	0.533
0.050	9.824	9.931	0.220	0.181	-0.281	0.129
0.075	9.781	9.950	0.234	0.173	-0.443	0.203
0.100	9.753	9.967	0.243	0.166	-0.554	0.268
0.150	9.702	9.983	0.258	0.159	-0.749	0.330
0.200	9.626	9.996	0.262	0.153	-0.809	0.578
0.300	9.669	10.012	0.267	0.145	-0.873	0.440
0.500	9.748	10.019	0.244	0.142	-0.569	0.467
0.700	9.835	9.996	0.216	0.153	-0.239	0.378
0.800	9.867	9.974	0.205	0.163	-0.115	0.295
0.850	9.877	9.958	0.202	0.170	-0.078	0.232
0.900	9.881	9.938	0.200	0.178	-0.063	0.155
0.950	9.877	9.975	0.202	0.191	-0.078	0.029
Section B						
0.000	9.953	9.952	0.172	0.172	0.214	0.210
0.025	9.717	9.845	0.253	0.213	-0.691	-0.201
0.050	9.659	9.860	0.270	0.208	-0.913	-0.143
0.075	9.623	9.895	0.280	0.195	-1.049	-0.009
0.100	9.597	9.923	0.287	0.184	-1.149	0.097
0.150	9.554	9.956	0.298	0.171	-1.313	0.227
0.200	9.549	9.977	0.299	0.162	-1.334	0.306
0.300	9.560	9.999	0.296	0.152	-1.290	0.388
0.500	9.726	9.998	0.251	0.152	-0.657	0.387
0.700	9.824	9.981	0.220	0.160	-0.279	0.320
0.800	9.858	9.962	0.208	0.168	-0.152	0.247
0.850	9.866	9.946	0.206	0.175	-0.120	0.187
0.900	9.870	9.925	0.204	0.183	-0.105	0.108
0.950	9.875	9.891	0.202	0.196	-0.086	-0.023
Section C						
0.000	9.877	9.897	0.194	0.194	-0.002	-0.000
0.025	9.642	9.961	0.275	0.169	-0.977	0.243
0.050	9.583	9.885	0.290	0.199	-1.202	-0.047
0.075	9.551	9.916	0.299	0.187	-1.327	0.073
0.100	9.534	9.938	0.303	0.178	-1.390	0.156
0.150	9.501	9.970	0.311	0.165	-1.518	0.278
0.200	9.502	9.995	0.311	0.153	-1.514	0.375
0.300	9.523	10.015	0.306	0.144	-1.434	0.452
0.500	9.697	10.018	0.259	0.142	-0.769	0.463
0.700	9.818	9.998	0.222	0.152	-0.301	0.388
0.800	9.859	9.978	0.208	0.161	-0.146	0.309
0.850	9.870	9.961	0.204	0.169	-0.105	0.244
0.900	9.876	9.943	0.202	0.178	-0.081	0.162
0.950	9.883	9.904	0.199	0.192	-0.054	0.026
Section D						
0.000	9.809	9.809	0.225	0.225	-0.337	-0.337
0.025	10.146	9.920	0.046	0.185	0.952	0.088
0.050	9.764	9.886	0.239	0.198	-0.510	-0.042
0.075	9.755	9.896	0.242	0.195	-0.545	-0.004
0.100	9.749	9.905	0.244	0.191	-0.569	0.029
0.150	9.736	9.914	0.248	0.188	-0.616	0.065
0.200	9.734	9.921	0.248	0.185	-0.623	0.091
0.300	9.734	9.928	0.248	0.182	-0.625	0.119
0.500	9.781	9.927	0.234	0.182	-0.444	0.116
0.700	9.819	9.914	0.222	0.188	-0.300	0.065
0.800	9.833	9.900	0.217	0.193	-0.247	0.010
0.850	9.836	9.891	0.216	0.196	-0.234	-0.023
0.900	9.839	9.876	0.215	0.202	-0.222	-0.081
0.950	9.841	9.853	0.214	0.210	-0.214	-0.171

^aSuction surface.^bPressure surface.

TABLE 14.—Concluded.

(i) Airflow, 35.35 kg/sec; readings 26 to 29

Fraction of chord, XC/C	Pressure, N/cm ²		Mach number		Coefficient	
	(a)	(b)	(a)	(b)	(a)	(b)
Section A						
0.000	10.086	10.086	0.090	0.091	0.443	0.440
0.025	10.027	10.101	0.129	0.078	-0.128	0.585
0.050	10.014	10.058	0.135	0.110	-0.253	0.170
0.075	9.999	10.064	0.144	0.106	-0.407	0.232
0.100	9.989	10.070	0.148	0.102	-0.497	0.289
0.150	9.970	10.076	0.157	0.098	-0.684	0.348
0.200	9.965	10.080	0.160	0.095	-0.735	0.387
0.300	9.960	10.087	0.162	0.090	-0.786	0.451
0.500	9.982	10.087	0.152	0.089	-0.566	0.455
0.700	10.020	10.080	0.132	0.094	-0.197	0.390
0.800	10.032	10.074	0.126	0.099	-0.085	0.325
0.850	10.035	10.066	0.124	0.104	-0.050	0.254
0.900	10.037	10.059	0.123	0.110	-0.033	0.177
0.950	10.030	10.046	0.127	0.118	-0.100	0.054
Section B						
0.000	10.067	10.065	0.104	0.105	0.255	0.240
0.025	9.979	10.024	0.153	0.130	-0.596	-0.155
0.050	9.957	10.031	0.163	0.126	-0.812	-0.089
0.075	9.943	10.045	0.169	0.118	-0.942	0.043
0.100	9.933	10.053	0.173	0.113	-1.040	0.126
0.150	9.917	10.069	0.180	0.103	-1.196	0.277
0.200	9.915	10.075	0.181	0.098	-1.219	0.338
0.300	9.919	10.077	0.179	0.097	-1.178	0.356
0.500	9.980	10.083	0.153	0.093	-0.586	0.410
0.700	10.019	10.076	0.133	0.098	-0.210	0.348
0.800	10.030	10.068	0.127	0.103	-0.101	0.273
0.850	10.033	10.061	0.125	0.108	-0.074	0.205
0.900	10.034	10.053	0.125	0.113	-0.063	0.125
0.950	10.035	10.037	0.124	0.123	-0.049	-0.036
Section C						
0.000	10.039	10.039	0.122	0.122	-0.015	-0.015
0.025	9.942	10.070	0.170	0.102	-0.957	0.290
0.050	9.920	10.040	0.179	0.121	-1.174	-0.003
0.075	9.908	10.052	0.184	0.114	-1.289	0.110
0.100	9.901	10.060	0.186	0.109	-1.356	0.188
0.150	9.890	10.070	0.191	0.102	-1.462	0.288
0.200	9.889	10.079	0.191	0.096	-1.470	0.373
0.300	9.897	10.088	0.188	0.089	-1.392	0.461
0.500	9.967	10.087	0.159	0.089	-0.718	0.457
0.700	10.011	10.081	0.137	0.094	-0.284	0.396
0.800	10.026	10.073	0.129	0.100	-0.136	0.319
0.850	10.031	10.067	0.126	0.104	-0.092	0.259
0.900	10.034	10.058	0.125	0.110	-0.064	0.176
0.950	10.037	10.045	0.123	0.118	-0.036	0.040
Section D						
0.000	10.007	10.007	0.139	0.139	-0.320	-0.320
0.025	10.153	10.053	0.000	0.115	1.091	0.120
0.050	9.991	10.038	0.147	0.122	-0.477	-0.022
0.075	9.988	10.042	0.149	0.120	-0.511	0.018
0.100	9.986	10.045	0.150	0.118	-0.531	0.048
0.150	9.980	10.050	0.152	0.115	-0.584	0.099
0.200	9.982	10.052	0.152	0.114	-0.572	0.118
0.300	9.980	10.055	0.152	0.112	-0.583	0.142
0.500	9.999	10.055	0.144	0.112	-0.405	0.140
0.700	10.012	10.050	0.136	0.115	-0.271	0.091
0.800	10.018	10.043	0.134	0.119	-0.217	0.025
0.850	10.019	10.041	0.133	0.120	-0.205	0.009
0.900	10.021	10.035	0.132	0.124	-0.186	-0.055
0.950	10.022	10.026	0.131	0.129	-0.181	-0.135

^aSuction surface^bPressure surface

TABLE 16.—TOTAL PRESSURE DISTRIBUTION FOR DIFFUSER WITH VANES A10
IN CORNER 1 AND VANES B IN CORNER 2—DISTORTED INFLOW

(a) 12.70-cm tip radial distortion; airflow, 80.11 kg/sec; readings 519 to 522

Span- wise location, percent of span	Circumferential location, θ , deg								Average
	0	45	90	135	180	225	270	315	
Corner 1 inlet rake									
5.0	10.067	10.136	10.089	10.114	10.097	10.050	10.063	10.118	10.092
10.0	10.039	10.113	10.084	10.129	10.065	10.071	10.063	10.081	10.081
15.0	9.933	10.041	10.047	10.066	10.073	10.013	10.034	9.985	10.024
20.0	9.914	9.992	10.019	10.035	10.059	9.985	10.003	9.931	9.992
30.0	10.145	10.157	10.140	10.207	10.253	10.071	10.053	10.112	10.142
50.0	10.864	11.017	10.854	11.039	10.912	11.008	10.909	11.024	10.954
70.0	10.801	11.023	10.841	11.035	10.839	11.026	10.877	11.039	10.935
90.0	10.761	10.892	10.769	10.856	10.753	10.856	10.722	10.851	10.807
Corner 1 inlet boundary layer rake									
1.0	9.955	9.932	9.966	10.025	9.938	9.903	9.884	9.937	9.942
2.0	10.017	10.007	10.039	10.109	10.005	9.962	9.953	10.017	10.013
3.0	10.042	10.052	10.068	10.122	10.053	9.996	10.001	10.069	10.050
4.0	10.061	10.098	10.079	10.121	10.087	10.025	10.047	10.114	10.079
5.0	10.068	10.121	10.086	10.124	10.098	10.044	10.069	10.128	10.092
7.5	10.074	10.131	10.099	10.136	10.082	10.059	10.072	10.121	10.097
10.0	10.038	10.103	10.082	10.140	10.065	10.058	10.054	10.081	10.078
12.5	9.975	10.056	10.059	10.112	10.068	10.024	10.041	10.032	10.046
Diffuser exit rake									
5.0	9.836	9.837	9.648	9.807	9.789	9.892	9.960	9.853	9.828
10.0	9.858	9.904	9.653	9.891	9.833	9.940	9.990	9.892	9.870
15.0	9.872	9.911	9.660	9.930	9.892	10.012	10.032	9.966	9.909
20.0	9.909	9.984	9.689	9.996	9.936	10.133	10.088	10.085	9.978
30.0	10.017	10.125	9.848	10.143	10.069	10.376	10.213	10.344	10.142
50.0	10.308	10.565	10.313	10.619	10.341	10.738	10.371	10.569	10.478
70.0	10.762	10.562	10.417	10.907	10.763	10.825	10.555	10.742	10.692
90.0	10.652	10.675	10.445	10.608	10.668	10.448	10.437	10.454	10.548
Diffuser exit boundary layer rake									
1.0	9.772	9.729	9.620	9.711	9.753	9.813	9.878	9.802	9.760
2.0	9.798	9.758	9.625	9.737	9.756	9.849	9.913	9.823	9.782
3.0	9.820	9.786	9.628	9.763	9.783	9.865	9.932	9.834	9.801
4.0	9.835	9.815	9.629	9.789	9.791	9.878	9.942	9.844	9.815
5.0	9.847	9.834	9.632	9.819	9.808	9.891	9.953	9.852	9.830
7.5	9.862	9.885	9.635	9.865	9.819	9.909	9.966	9.872	9.852
10.0	9.870	9.905	9.638	9.896	9.847	9.932	9.981	9.889	9.870
12.5	9.877	9.909	9.641	9.915	9.877	9.965	9.999	9.923	9.888

TABLE 16.—Continued.

(b) 12.70-cm tip radial distortion; airflow, 72.28 kg/sec; readings 515 to 518

Span-wise location, percent of span	Circumferential location, θ , deg								Average
	0	45	90	135	180	225	270	315	
Corner 1 inlet rake									
5.0	10.082	10.116	10.097	10.108	10.110	10.052	10.073	10.108	10.093
10.0	10.048	10.106	10.099	10.119	10.086	10.078	10.070	10.083	10.086
15.0	9.969	10.050	10.065	10.077	10.089	10.025	10.054	10.008	10.042
20.0	9.964	10.009	10.043	10.049	10.082	10.002	10.028	9.959	10.017
30.0	10.154	10.149	10.145	10.185	10.249	10.077	10.066	10.100	10.141
50.0	10.737	10.260	10.728	10.870	10.774	10.849	10.778	10.859	10.807
70.0	10.686	10.859	10.718	10.867	10.714	10.880	10.748	10.870	10.793
90.0	10.651	10.749	10.660	10.717	10.647	10.709	10.607	10.708	10.681
Corner 1 inlet boundary layer rake									
1.0	9.994	9.954	9.992	10.032	9.976	9.931	9.906	9.961	9.968
2.0	10.047	10.017	10.055	10.103	10.034	9.979	9.969	10.032	10.029
3.0	10.065	10.055	10.079	10.113	10.072	10.008	10.010	10.071	10.059
4.0	10.077	10.093	10.091	10.109	10.097	10.035	10.052	10.106	10.082
5.0	10.080	10.110	10.099	10.113	10.107	10.050	10.077	10.118	10.094
7.5	10.077	10.122	10.113	10.123	10.094	10.067	10.087	10.111	10.099
10.0	10.041	10.100	10.103	10.129	10.081	10.069	10.074	10.081	10.085
12.5	9.991	10.065	10.083	10.104	10.082	10.045	10.065	10.044	10.060
Diffuser exit rake									
5.0	9.876	9.892	9.714	9.867	9.844	9.940	9.984	9.912	9.879
10.0	9.900	9.948	9.722	9.943	9.880	9.983	10.011	9.950	9.917
15.0	9.914	9.963	9.724	9.973	9.930	10.040	10.047	10.012	9.950
20.0	9.944	10.013	9.756	10.031	9.971	10.134	10.092	10.107	10.006
30.0	10.040	10.128	9.884	10.146	10.087	10.332	10.200	10.311	10.141
50.0	10.280	10.493	10.304	10.524	10.293	10.640	10.337	10.502	10.422
70.0	10.651	10.528	10.369	10.774	10.622	10.705	10.475	10.640	10.596
90.0	10.594	10.620	10.406	10.538	10.601	10.428	10.380	10.425	10.499
Diffuser exit boundary layer rake									
1.0	9.820	9.805	9.699	9.793	9.812	9.869	9.912	9.873	9.823
2.0	9.840	9.826	9.702	9.814	9.826	9.898	9.941	9.887	9.842
3.0	9.859	9.848	9.706	9.837	9.837	9.912	9.956	9.900	9.857
4.0	9.870	9.863	9.708	9.858	9.845	9.923	9.966	9.907	9.868
5.0	9.882	9.885	9.709	9.883	9.857	9.938	9.976	9.912	9.880
7.5	9.899	9.927	9.711	9.921	9.866	9.953	9.985	9.928	9.899
10.0	9.908	9.947	9.711	9.946	9.894	9.976	10.002	9.947	9.916
12.5	9.919	9.956	9.715	9.962	9.917	10.001	10.017	9.972	9.932

TABLE 16.—Continued.

(c) 12.70-cm tip radial distortion; airflow, 35.30 kg/sec; readings 511 to 514

Span-wise location, percent of span	Circumferential location, θ , deg								Average
	0	45	90	135	180	225	270	315	
Corner 1 inlet rake									
5.0	10.123	10.123	10.119	10.127	10.129	10.112	10.113	10.124	10.121
10.0	10.122	10.127	10.123	10.130	10.127	10.120	10.119	10.124	10.124
15.0	10.104	10.112	10.119	10.123	10.127	10.111	10.116	10.113	10.116
20.0	10.105	10.104	10.115	10.121	10.125	10.108	10.115	10.101	10.112
30.0	10.143	10.142	10.130	10.149	10.153	10.124	10.120	10.133	10.137
50.0	10.251	10.268	10.244	10.270	10.250	10.267	10.255	10.271	10.260
70.0	10.241	10.268	10.242	10.270	10.245	10.270	10.246	10.271	10.257
90.0	10.232	10.242	10.227	10.237	10.228	10.244	10.223	10.243	10.234
Corner 1 inlet boundary layer rake									
1.0	10.098	10.093	10.102	10.104	10.096	10.091	10.086	10.092	10.095
2.0	10.107	10.104	10.113	10.119	10.109	10.101	10.098	10.106	10.107
3.0	10.112	10.112	10.119	10.122	10.117	10.108	10.106	10.113	10.114
4.0	10.116	10.120	10.123	10.123	10.122	10.112	10.114	10.120	10.119
5.0	10.119	10.124	10.125	10.123	10.124	10.116	10.120	10.124	10.122
7.5	10.121	10.131	10.129	10.127	10.122	10.121	10.126	10.127	10.125
10.0	10.117	10.128	10.128	10.128	10.121	10.122	10.123	10.122	10.124
12.5	10.107	10.121	10.126	10.125	10.122	10.117	10.122	10.117	10.120
Diffuser exit rake									
5.0	10.081	10.081	10.047	10.074	10.078	10.101	10.100	10.092	10.082
10.0	10.087	10.095	10.047	10.092	10.088	10.113	10.111	10.099	10.092
15.0	10.090	10.103	10.050	10.101	10.094	10.125	10.123	10.111	10.100
20.0	10.095	10.111	10.057	10.112	10.102	10.146	10.138	10.130	10.111
30.0	10.114	10.135	10.085	10.136	10.126	10.179	10.162	10.165	10.138
50.0	10.162	10.204	10.170	10.207	10.163	10.235	10.179	10.201	10.190
70.0	10.233	10.225	10.183	10.253	10.228	10.242	10.194	10.227	10.223
90.0	10.228	10.231	10.189	10.204	10.219	10.205	10.176	10.193	10.206
Diffuser exit boundary layer rake									
1.0	10.064	10.060	10.047	10.064	10.065	10.077	10.085	10.088	10.069
2.0	10.067	10.064	10.048	10.068	10.070	10.086	10.092	10.091	10.073
3.0	10.071	10.067	10.048	10.073	10.072	10.089	10.097	10.094	10.076
4.0	10.075	10.072	10.049	10.077	10.075	10.092	10.100	10.097	10.080
5.0	10.078	10.075	10.049	10.082	10.079	10.097	10.103	10.098	10.083
7.5	10.083	10.085	10.049	10.091	10.083	10.101	10.109	10.104	10.088
10.0	10.086	10.090	10.049	10.098	10.087	10.107	10.114	10.106	10.092
12.5	10.087	10.094	10.050	10.102	10.091	10.113	10.121	10.111	10.096

TABLE 16.—Continued.

(d) 6.35-cm tip radial distortion; airflow, 77.07 kg/sec; readings 523 to 526

Span-wise location, percent of span	Circumferential location, θ , deg								Average
	0	45	90	135	180	225	270	315	
Corner 1 inlet rake									
5.0	9.899	9.922	9.897	9.920	9.924	9.882	9.876	9.913	9.904
10.0	9.933	9.947	9.935	9.977	9.942	9.917	9.900	9.925	9.934
15.0	10.058	10.096	10.066	10.192	10.140	10.083	9.945	10.035	10.077
20.0	10.320	10.381	10.339	10.515	10.464	10.379	10.135	10.339	10.359
30.0	10.627	10.675	10.595	10.666	10.631	10.686	10.594	10.690	10.645
50.0	10.589	10.674	10.530	10.672	10.609	10.663	10.577	10.663	10.622
70.0	10.497	10.676	10.525	10.672	10.518	10.681	10.540	10.675	10.578
90.0	10.463	10.556	10.467	10.536	10.452	10.533	10.414	10.497	10.490
Corner 1 inlet boundary layer rake									
1.0	9.790	9.793	9.789	9.861	9.805	9.793	9.766	9.809	9.801
2.0	9.830	9.839	9.831	9.912	9.848	9.833	9.810	9.853	9.845
3.0	9.856	9.870	9.860	9.923	9.877	9.853	9.836	9.881	9.869
4.0	9.880	9.903	9.888	9.925	9.903	9.864	9.869	9.913	9.893
5.0	9.889	9.922	9.906	9.932	9.916	9.874	9.889	9.929	9.907
7.5	9.908	9.937	9.934	9.950	9.915	9.884	9.915	9.937	9.923
10.0	9.924	9.934	9.942	9.987	9.940	9.917	9.909	9.938	9.936
12.5	9.966	9.980	9.986	10.080	10.031	9.989	9.921	9.981	9.992
Diffuser exit rake									
5.0	9.869	9.813	9.603	9.813	9.903	10.015	10.036	10.042	9.887
10.0	9.903	9.911	9.618	9.903	9.962	10.101	10.108	10.118	9.953
15.0	9.963	9.930	9.638	9.940	9.989	10.194	10.160	10.214	10.003
20.0	10.030	9.980	9.691	10.022	10.015	10.300	10.201	10.304	10.068
30.0	10.173	10.214	9.901	10.281	10.146	10.460	10.246	10.419	10.230
50.0	10.532	10.579	10.219	10.550	10.467	10.584	10.375	10.568	10.484
70.0	10.606	10.210	10.187	10.548	10.513	10.568	10.289	10.471	10.424
90.0	10.345	10.364	10.220	10.348	10.369	10.227	10.196	10.203	10.284
Diffuser exit boundary layer rake									
1.0	9.808	9.709	9.588	9.734	9.810	9.885	9.910	9.951	9.800
2.0	9.834	9.734	9.591	9.755	9.840	9.934	9.948	9.973	9.826
3.0	9.852	9.756	9.590	9.779	9.870	9.959	9.975	10.010	9.849
4.0	9.866	9.783	9.589	9.803	9.892	9.981	9.996	10.035	9.868
5.0	9.874	9.789	9.591	9.827	9.915	10.005	10.018	10.050	9.884
7.5	9.892	9.862	9.595	9.878	9.950	10.044	10.056	10.094	9.921
10.0	9.912	9.903	9.603	9.915	9.976	10.088	10.091	10.136	9.953
12.5	9.937	9.923	9.615	9.935	9.989	10.133	10.119	10.175	9.978

TABLE 16.—Continued.

(e) 6.35-cm tip radial distortion; airflow, 71.36 kg/sec; readings 527 to 530

Span-wise location, percent of span	Circumferential location, θ , deg								Average
	0	45	90	135	180	225	270	315	
Corner 1 inlet rake									
5.0	9.917	9.953	9.929	9.954	9.942	9.912	9.905	9.945	9.932
10.0	9.947	9.969	9.963	10.004	9.955	9.943	9.933	9.958	9.959
15.0	10.056	10.100	10.076	10.193	10.127	10.088	9.968	10.052	10.083
20.0	10.282	10.336	10.308	10.470	10.402	10.342	10.114	10.302	10.320
30.0	10.541	10.595	10.527	10.594	10.542	10.605	10.525	10.617	10.568
50.0	10.514	10.593	10.476	10.602	10.522	10.588	10.515	10.591	10.550
70.0	10.431	10.598	10.468	10.602	10.453	10.600	10.476	10.599	10.528
90.0	10.404	10.499	10.421	10.477	10.392	10.470	10.364	10.442	10.434
Corner 1 inlet boundary layer rake									
1.0	9.833	9.834	9.825	9.890	9.849	9.845	9.799	9.840	9.839
2.0	9.869	9.875	9.860	9.936	9.889	9.873	9.835	9.879	9.877
3.0	9.890	9.902	9.886	9.945	9.918	9.894	9.859	9.906	9.900
4.0	9.912	9.931	9.907	9.951	9.941	9.906	9.886	9.935	9.921
5.0	9.922	9.950	9.923	9.954	9.948	9.913	9.905	9.950	9.933
7.5	9.937	9.966	9.949	9.972	9.945	9.925	9.931	9.962	9.948
10.0	9.952	9.968	9.958	10.004	9.967	9.948	9.927	9.962	9.961
12.5	9.992	10.009	9.995	10.085	10.052	10.016	9.937	10.001	10.011
Diffuser exit rake									
5.0	9.911	9.844	9.670	9.860	9.942	10.024	10.038	10.054	9.918
10.0	9.937	9.927	9.681	9.936	9.993	10.097	10.104	10.125	9.975
15.0	9.989	9.950	9.700	9.969	10.017	10.179	10.150	10.203	10.020
20.0	10.049	9.995	9.745	10.040	10.039	10.270	10.190	10.281	10.076
30.0	10.172	10.198	9.927	10.260	10.146	10.403	10.226	10.391	10.216
50.0	10.483	10.502	10.206	10.486	10.427	10.510	10.340	10.506	10.432
70.0	10.547	10.209	10.185	10.507	10.460	10.495	10.267	10.423	10.386
90.0	10.340	10.328	10.213	10.323	10.350	10.214	10.184	10.204	10.269
Diffuser exit boundary layer rake									
1.0	9.848	9.769	9.663	9.777	9.855	9.917	9.944	9.960	9.842
2.0	9.871	9.790	9.663	9.796	9.880	9.957	9.975	9.990	9.865
3.0	9.887	9.809	9.664	9.817	9.905	9.981	10.000	10.012	9.884
4.0	9.901	9.835	9.665	9.836	9.926	9.998	10.019	10.032	9.901
5.0	9.908	9.849	9.665	9.856	9.945	10.017	10.040	10.047	9.916
7.5	9.925	9.898	9.671	9.901	9.962	10.056	10.075	10.089	9.947
10.0	9.939	9.932	9.674	9.934	9.997	10.095	10.105	10.124	9.975
12.5	9.962	9.948	9.685	9.951	10.011	10.135	10.132	10.160	9.998

TABLE 16.—Continued.

(f) 6.35-cm tip radial distortion; airflow, 35.26 kg/sec; readings 532 to 536

Span-wise location, percent of span	Circumferential location, θ , deg								Average
	0	45	90	135	180	225	270	315	
Corner 1 inlet rake									
5.0	10.088	10.091	10.089	10.096	10.093	10.086	10.083	10.092	10.090
10.0	10.098	10.100	10.097	10.106	10.100	10.093	10.093	10.098	10.098
15.0	10.122	10.122	10.118	10.141	10.134	10.119	10.100	10.119	10.122
20.0	10.170	10.169	10.163	10.192	10.186	10.170	10.134	10.173	10.170
30.0	10.210	10.219	10.208	10.220	10.214	10.222	10.209	10.224	10.216
50.0	10.208	10.219	10.196	10.220	10.207	10.219	10.206	10.218	10.212
70.0	10.191	10.218	10.193	10.220	10.195	10.223	10.195	10.220	10.207
90.0	10.182	10.195	10.184	10.193	10.180	10.197	10.180	10.192	10.188
Corner 1 inlet boundary layer rake									
1.0	10.067	10.069	10.070	10.075	10.070	10.070	10.062	10.069	10.069
2.0	10.074	10.076	10.075	10.085	10.080	10.077	10.069	10.077	10.077
3.0	10.079	10.082	10.081	10.090	10.085	10.081	10.073	10.083	10.082
4.0	10.083	10.088	10.086	10.092	10.090	10.085	10.079	10.088	10.086
5.0	10.087	10.091	10.089	10.094	10.093	10.087	10.084	10.093	10.090
7.5	10.093	10.099	10.093	10.099	10.095	10.091	10.093	10.097	10.095
10.0	10.098	10.100	10.096	10.105	10.101	10.094	10.093	10.098	10.098
12.5	10.107	10.106	10.106	10.121	10.118	10.106	10.095	10.106	10.108
Diffuser exit rake									
5.0	10.089	10.074	10.039	10.076	10.091	10.107	10.116	10.117	10.089
10.0	10.096	10.089	10.042	10.091	10.101	10.124	10.131	10.134	10.101
15.0	10.102	10.095	10.046	10.098	10.108	10.141	10.143	10.148	10.110
20.0	10.116	10.108	10.054	10.112	10.113	10.158	10.150	10.162	10.122
30.0	10.140	10.151	10.091	10.153	10.133	10.183	10.151	10.183	10.148
50.0	10.199	10.202	10.146	10.198	10.184	10.205	10.168	10.203	10.188
70.0	10.210	10.158	10.146	10.207	10.189	10.202	10.157	10.186	10.182
90.0	10.170	10.172	10.151	10.167	10.174	10.159	10.140	10.149	10.160
Diffuser exit boundary layer rake									
1.0	10.073	10.059	10.039	10.060	10.071	10.085	10.095	10.095	10.072
2.0	10.079	10.063	10.039	10.065	10.077	10.093	10.103	10.103	10.078
3.0	10.083	10.065	10.039	10.069	10.081	10.098	10.107	10.106	10.081
4.0	10.086	10.070	10.040	10.073	10.086	10.102	10.112	10.112	10.085
5.0	10.089	10.073	10.039	10.078	10.090	10.107	10.116	10.115	10.088
7.5	10.092	10.082	10.041	10.085	10.098	10.114	10.124	10.124	10.095
10.0	10.094	10.088	10.043	10.092	10.102	10.123	10.131	10.131	10.100
12.5	10.098	10.093	10.045	10.095	10.106	10.131	10.137	10.140	10.106

TABLE 16.—Continued.

(g) Circumferential distortion; airflow, 78.72 kg/sec; readings 545 to 548

Span-wise location, percent of span	Circumferential location, θ , deg								Average
	0	45	90	135	180	225	270	315	
Corner 1 inlet rake									
5.0	9.943	10.519	10.501	10.575	10.486	10.517	10.518	10.558	10.452
10.0	9.977	10.600	10.565	10.605	10.580	10.597	10.618	10.620	10.520
15.0	9.963	10.609	10.542	10.602	10.595	10.580	10.612	10.599	10.512
20.0	9.955	10.619	10.526	10.614	10.575	10.587	10.614	10.604	10.512
30.0	9.924	10.606	10.492	10.600	10.534	10.598	10.599	10.603	10.494
50.0	9.924	9.905	10.425	10.585	10.488	10.592	10.453	9.988	10.295
70.0	9.925	9.825	10.028	10.610	10.393	10.581	10.080	9.969	10.176
90.0	9.929	9.904	9.921	10.023	10.133	10.164	10.052	9.961	10.011
Corner 1 inlet boundary layer rake									
1.0	9.799	10.247	10.210	10.320	10.240	10.309	10.298	10.288	10.214
2.0	9.858	10.345	10.311	10.454	10.341	10.402	10.391	10.419	10.315
3.0	9.886	10.401	10.389	10.517	10.410	10.455	10.440	10.487	10.372
4.0	9.922	10.466	10.444	10.552	10.468	10.497	10.489	10.537	10.422
5.0	9.944	10.509	10.492	10.571	10.506	10.529	10.523	10.562	10.455
7.5	9.982	10.577	10.563	10.601	10.566	10.585	10.595	10.602	10.511
10.0	9.982	10.602	10.562	10.603	10.589	10.603	10.615	10.617	10.521
12.5	9.978	10.619	10.548	10.593	10.597	10.594	10.611	10.603	10.518
Diffuser exit rake									
5.0	9.977	10.231	9.966	10.314	10.150	10.132	10.276	10.173	10.152
10.0	9.917	10.320	9.938	10.299	10.258	10.158	10.350	10.209	10.181
15.0	9.854	10.370	9.960	10.362	10.273	10.256	10.361	10.318	10.219
20.0	9.858	10.414	10.082	10.452	10.332	10.370	10.349	10.441	10.287
30.0	9.867	10.235	10.375	10.472	10.417	10.520	10.333	10.518	10.342
50.0	9.886	9.913	9.939	10.358	10.450	10.494	10.320	10.027	10.171
70.0	9.854	9.835	9.827	9.999	10.453	10.430	10.199	9.836	10.054
90.0	9.877	9.890	9.993	10.185	10.289	10.224	10.073	9.948	10.060
Diffuser exit boundary layer rake									
1.0	9.912	10.028	9.929	10.107	9.995	10.039	10.111	10.099	10.028
2.0	9.947	10.086	9.956	10.179	10.046	10.098	10.174	10.145	10.079
3.0	9.964	10.140	9.969	10.240	10.085	10.127	10.216	10.165	10.113
4.0	9.969	10.197	9.975	10.286	10.120	10.139	10.250	10.175	10.139
5.0	9.970	10.234	9.975	10.320	10.155	10.143	10.281	10.174	10.157
7.5	9.948	10.305	9.961	10.312	10.217	10.140	10.331	10.181	10.174
10.0	9.908	10.322	9.943	10.298	10.254	10.159	10.361	10.210	10.182
12.5	9.873	10.344	9.946	10.327	10.264	10.200	10.373	10.255	10.198

TABLE 16.—Continued.

(h) Circumferential distortion: airflow, 73.27 kg/sec; readings 541 to 544

Span-wise location, percent of span	Circumferential location, θ , deg								Average
	0	45	90	135	180	225	270	315	
Corner 1 inlet rake									
5.0	9.969	10.467	10.415	10.510	10.434	10.465	10.453	10.491	10.401
10.0	10.003	10.537	10.496	10.532	10.521	10.531	10.542	10.548	10.464
15.0	9.991	10.546	10.502	10.536	10.532	10.519	10.538	10.531	10.462
20.0	9.980	10.555	10.464	10.546	10.514	10.525	10.540	10.536	10.458
30.0	9.956	10.543	10.432	10.534	10.478	10.537	10.530	10.536	10.443
50.0	9.954	9.942	10.377	10.520	10.436	10.532	10.398	10.006	10.271
70.0	9.958	9.869	10.031	10.545	10.357	10.523	10.074	9.977	10.167
90.0	9.960	9.944	9.938	10.030	10.135	10.170	10.052	9.974	10.025
Corner 1 inlet boundary layer rake									
1.0	9.835	10.236	10.195	10.237	10.202	10.287	10.276	10.257	10.197
2.0	9.876	10.308	10.284	10.405	10.287	10.366	10.356	10.371	10.282
3.0	9.901	10.358	10.347	10.462	10.348	10.409	10.395	10.434	10.332
4.0	9.931	10.414	10.399	10.493	10.398	10.444	10.438	10.481	10.375
5.0	9.955	10.454	10.442	10.511	10.436	10.474	10.468	10.502	10.405
7.5	9.991	10.514	10.504	10.537	10.494	10.520	10.532	10.537	10.454
10.0	9.991	10.534	10.507	10.538	10.516	10.534	10.547	10.552	10.465
12.5	9.989	10.549	10.494	10.533	10.523	10.529	10.543	10.542	10.463
Diffuser exit rake									
5.0	9.991	10.220	9.996	10.278	10.147	10.137	10.269	10.161	10.150
10.0	9.939	10.299	9.971	10.271	10.239	10.157	10.327	10.192	10.174
15.0	9.884	10.341	9.985	10.329	10.250	10.242	10.334	10.288	10.207
20.0	9.884	10.383	10.087	10.407	10.299	10.340	10.323	10.392	10.264
30.0	9.883	10.221	10.346	10.416	10.376	10.469	10.314	10.458	10.310
50.0	9.898	9.947	9.985	10.294	10.405	10.449	10.301	10.043	10.165
70.0	9.879	9.880	9.877	10.027	10.417	10.394	10.206	9.870	10.069
90.0	9.913	9.948	10.048	10.188	10.276	10.221	10.099	9.968	10.082
Diffuser exit boundary layer rake									
1.0	9.948	10.030	9.958	10.115	10.018	10.037	10.109	10.113	10.041
2.0	9.976	10.085	9.981	10.182	10.062	10.088	10.163	10.153	10.086
3.0	9.990	10.134	9.993	10.234	10.095	10.115	10.201	10.168	10.116
4.0	9.998	10.184	9.999	10.270	10.122	10.124	10.230	10.174	10.138
5.0	9.996	10.216	9.994	10.298	10.152	10.130	10.255	10.174	10.152
7.5	9.980	10.274	9.977	10.289	10.212	10.128	10.298	10.177	10.167
10.0	9.946	10.291	9.959	10.282	10.245	10.145	10.321	10.200	10.174
12.5	9.915	10.310	9.959	10.310	10.255	10.181	10.332	10.240	10.188

TABLE 16.—Concluded.

(i) Circumferential distortion; airflow, 35.41 kg/sec; readings 537 to 540

Span-wise location, percent of span	Circumferential location, θ , deg								Average
	0	45	90	135	180	225	270	315	
Corner 1 inlet rake									
5.0	10.091	10.189	10.183	10.199	10.180	10.194	10.186	10.197	10.177
10.0	10.105	10.209	10.200	10.208	10.204	10.212	10.209	10.209	10.194
15.0	10.101	10.211	10.195	10.210	10.207	10.210	10.207	10.210	10.194
20.0	10.099	10.215	10.196	10.210	10.204	10.208	10.208	10.209	10.194
30.0	10.092	10.213	10.193	10.209	10.198	10.212	10.206	10.210	10.192
50.0	10.093	10.098	10.181	10.207	10.190	10.211	10.183	10.111	10.159
70.0	10.091	10.087	10.113	10.212	10.176	10.211	10.122	10.106	10.140
90.0	10.093	10.098	10.096	10.116	10.125	10.141	10.115	10.103	10.111
Corner 1 inlet boundary layer rake									
1.0	10.095	10.110	10.089	10.124	10.106	10.109	10.120	10.122	10.110
2.0	10.102	10.121	10.095	10.138	10.116	10.121	10.132	10.130	10.119
3.0	10.104	10.129	10.098	10.148	10.122	10.126	10.138	10.133	10.125
4.0	10.106	10.138	10.099	10.154	10.128	10.129	10.143	10.135	10.129
5.0	10.106	10.145	10.099	10.158	10.135	10.131	10.149	10.135	10.132
7.5	10.103	10.155	10.099	10.157	10.146	10.130	10.158	10.136	10.135
10.0	10.097	10.157	10.097	10.164	10.152	10.133	10.165	10.140	10.138
12.5	10.091	10.162	10.099	10.173	10.143	10.140	10.168	10.147	10.140
Diffuser exit rake									
1.0	10.070	10.142	10.135	10.153	10.134	10.155	10.147	10.148	10.136
2.0	10.077	10.155	10.153	10.178	10.150	10.170	10.163	10.171	10.152
3.0	10.070	10.165	10.165	10.190	10.163	10.180	10.170	10.184	10.161
4.0	10.087	10.177	10.176	10.198	10.174	10.186	10.180	10.195	10.172
5.0	10.091	10.187	10.185	10.203	10.184	10.194	10.188	10.199	10.179
7.5	10.102	10.202	10.199	10.208	10.200	10.206	10.204	10.208	10.191
10.0	10.105	10.208	10.201	10.210	10.205	10.209	10.210	10.212	10.195
12.5	10.103	10.210	10.199	10.212	10.205	10.209	10.209	10.213	10.195
Diffuser exit boundary layer rake									
5.0	10.104	10.147	10.101	10.156	10.134	10.130	10.141	10.135	10.131
10.0	10.095	10.158	10.099	10.161	10.155	10.134	10.167	10.139	10.139
15.0	10.083	10.169	10.106	10.179	10.156	10.151	10.171	10.157	10.147
20.0	10.084	10.182	10.131	10.186	10.163	10.171	10.172	10.178	10.158
30.0	10.084	10.153	10.178	10.185	10.180	10.195	10.170	10.194	10.167
50.0	10.084	10.091	10.106	10.162	10.184	10.193	10.163	10.122	10.138
70.0	10.085	10.079	10.085	10.123	10.190	10.184	10.152	10.083	10.122
90.0	10.086	10.102	10.127	10.160	10.170	10.149	10.131	10.104	10.129

TABLE 17.—TOTAL PRESSURE DISTRIBUTION FOR VARIABLE INLET GUIDE VANES WITH VANES A10
IN CORNER 1 AND VANES B IN CORNER 2—DISTORTED INFLOW

(a) 12.70-cm tip radial distortion; ai.flow, 80.11 kg/sec; readings 519 to 522

Circum-ferential location, θ , deg	Spanwise location, percent of span from tip							
	5	10	15	20	30	50	70	90
VIGV inlet rake								
0		9.758			9.908	10.115	10.455	10.576
30		9.876			10.007	10.255	10.467	10.411
60		9.686			9.909	10.083	10.325	10.174
90		9.523			9.694	9.922	10.065	9.996
120		9.712			9.914	10.082	10.427	10.200
150		9.813			9.989	10.251	10.523	10.417
180		9.791			9.949	10.130	10.468	10.635
210		9.872			9.969	10.193	10.432	10.430
240		10.300			10.491	10.577	10.580	10.265
270		10.040			10.153	10.229	10.308	10.196
300		10.257			10.445	10.466	10.506	10.288
330		9.872			9.926	10.119	10.373	10.464
AVG		9.875			10.030	10.202	10.411	10.338
VIGV exit rake								
15	9.783	9.994	9.874	9.930	10.053	10.275	10.499	10.426
45	9.780	10.003	9.849	9.898	9.982	10.181	10.363	10.289
75	9.683	9.899	9.762	9.778	9.774	9.970	10.223	10.225
105	9.699	9.736	9.778	9.784	9.791	9.961	10.244	10.217
135	9.778	9.813	9.873	9.935	10.036	10.242	10.444	10.391
165	9.766	9.846	9.922	10.007	10.229	10.527	10.530	10.610
195	9.794	9.792	9.789	9.822	9.912	10.151	10.451	10.548
225	10.167	10.186	10.194	10.205	10.244	10.377	10.511	10.301
255	10.108	10.154	10.193	10.233	10.303	10.415	10.472	10.330
285	10.082	10.124	10.153	10.189	10.282	10.514	10.514	10.300
315	10.162	10.170	10.168	10.171	10.174	10.189	10.453	10.391
345	9.773	9.775	9.791	9.827	9.915	10.094	10.366	10.498
AVG	9.881	9.958	9.946	9.981	10.058	10.241	10.423	10.377

TABLE 17.—Continued.

(b) 12.70-cm tip radial distortion; airflow, 72.28 kg/sec; readings 515 to 518

Circumferential location, θ , deg	Spanwise location, percent of span from tip							
	5	10	15	20	30	50	70	90
VIGV inlet rake								
0		9.822			9.953	10.114	10.391	10.516
30		9.919			10.029	10.230	10.420	10.380
60		9.759			9.944	10.084	10.302	10.176
90		9.626			9.767	9.937	10.087	10.027
120		9.773			9.927	10.068	10.355	10.191
150		9.867			10.017	10.231	10.445	10.378
180		9.850			9.987	10.128	10.407	10.578
210		9.916			9.998	10.188	10.385	10.385
240		10.270			10.429	10.497	10.495	10.237
270		10.062			10.155	10.220	10.281	10.196
300		10.237			10.395	10.411	10.443	10.256
330		9.907			9.964	10.126	10.345	10.406
AVG		9.917			10.047	10.186	10.363	10.310
VIGV exit rake								
15	9.833	10.034	9.889	9.924	10.004	10.163	10.324	10.267
45	9.767	9.951	9.830	9.839	9.836	9.982	10.223	10.230
75	9.759	9.942	9.819	9.830	9.823	9.966	10.214	10.219
105	9.830	9.860	9.911	9.960	10.037	10.192	10.384	10.348
135	9.824	9.877	9.933	9.989	10.132	10.433	10.459	10.543
165	9.816	9.867	9.926	9.995	10.163	10.464	10.480	10.543
195	10.153	10.168	10.172	10.185	10.220	10.338	10.438	10.257
225	10.126	10.165	10.196	10.232	10.280	10.389	10.436	10.306
255	10.104	10.140	10.171	10.203	10.261	10.380	10.433	10.298
285	10.148	10.163	10.157	10.159	10.164	10.187	10.412	10.327
315	9.840	9.846	9.857	9.887	9.960	10.111	10.322	10.451
345	9.836	9.837	9.846	9.872	9.937	10.080	10.303	10.431
AVG	9.920	9.988	9.976	10.006	10.068	10.224	10.369	10.352

TABLE 17.—Continued.

(c) 12.70-cm tip radial distortion; airflow, 35.30 kg/sec; readings 511 to 514

Circumferential location, θ , deg	Spanwise location, percent of span from tip							
	5	10	15	20	30	50	70	90
VIGV inlet rake								
0		10.069			10.095	10.125	10.179	10.208
30		10.086			10.108	10.147	10.185	10.187
60		10.060			10.095	10.125	10.167	10.144
90		10.036			10.058	10.087	10.127	10.112
120		10.060			10.091	10.122	10.173	10.161
150		10.076			10.108	10.144	10.182	10.199
180		10.076			10.103	10.133	10.177	10.217
210		10.090			10.110	10.145	10.180	10.186
240		10.147			10.184	10.203	10.198	10.149
270		10.126			10.149	10.160	10.163	10.145
300		10.145			10.176	10.187	10.194	10.152
330		10.088			10.100	10.131	10.176	10.193
AVG		10.088			10.115	10.142	10.175	10.171
VIGV exit rake								
15	10.076	10.145	10.089	10.097	10.114	10.155	10.190	10.188
45	10.067	10.125	10.079	10.088	10.102	10.133	10.169	10.159
75	10.055	10.117	10.056	10.070	10.069	10.100	10.155	10.148
105	10.065	10.071	10.075	10.078	10.078	10.101	10.156	10.160
135	10.054	10.071	10.082	10.094	10.109	10.138	10.185	10.182
165	10.068	10.075	10.083	10.093	10.112	10.155	10.187	10.206
195	10.077	10.078	10.079	10.082	10.096	10.138	10.188	10.205
225	10.124	10.130	10.133	10.137	10.152	10.176	10.188	10.157
255	10.127	10.136	10.145	10.152	10.166	10.190	10.193	10.163
285	10.136	10.145	10.153	10.161	10.181	10.211	10.195	10.158
315	10.122	10.125	10.127	10.130	10.139	10.148	10.185	10.171
345	10.069	10.071	10.074	10.080	10.094	10.126	10.166	10.198
AVG	10.087	10.107	10.098	10.105	10.118	10.148	10.180	10.174

TABLE 17.—Continued.

(d) 6.35-cm tip radial distortion; airflow, 77.07 kg/sec; readings 523 to 526

Circumferential location, θ , deg	Spanwise location, percent of span from tip							
	5	10	15	20	30	50	70	90
VIGV inlet rake								
0		9.857			10.085	10.362	10.502	10.362
30		9.911			10.091	10.348	10.380	10.250
60		9.681			9.884	10.119	10.212	10.043
90		9.534			9.691	9.994	9.981	9.903
120		9.731			9.909	10.124	10.371	10.098
150		9.855			10.071	10.324	10.485	10.335
180		9.867			10.063	10.352	10.482	10.323
210		9.918			10.122	10.326	10.376	10.195
240		10.201			10.375	10.436	10.456	10.200
270		10.069			10.144	10.171	10.189	10.071
300		10.232			10.401	10.464	10.461	10.169
330		9.900			10.066	10.303	10.398	10.197
AVG		9.896			10.076	10.277	10.358	10.179
VIGV exit rake								
15	9.797	9.966	9.852	9.901	9.993	10.233	10.242	10.134
45	9.643	9.834	9.717	9.741	9.765	10.020	10.094	10.058
75	9.643	9.831	9.717	9.738	9.759	10.008	10.110	10.057
105	9.792	9.827	9.890	9.960	10.075	10.322	10.403	10.274
135	9.839	9.910	9.991	10.095	10.305	10.539	10.511	10.398
165	9.848	9.930	10.019	10.123	10.315	10.523	10.509	10.398
195	10.101	10.124	10.148	10.186	10.293	10.442	10.494	10.226
225	10.103	10.141	10.167	10.183	10.227	10.223	10.278	10.206
255	10.093	10.126	10.150	10.175	10.212	10.216	10.286	10.204
285	10.082	10.094	10.112	10.150	10.234	10.309	10.379	10.178
315	9.818	9.845	9.893	9.955	10.081	10.301	10.448	10.312
345	9.817	9.842	9.870	9.938	10.059	10.266	10.427	10.256
AVG	9.881	9.956	9.961	10.013	10.110	10.284	10.348	10.225

TABLE 17.—Continued.

(e) 6.35-cm tip radial distortion; airflow, 71.36 kg/sec; readings 527 to 530

Circumferential location, θ , deg	Spanwise location, percent of span from tip							
	5	10	15	20	30	50	70	90
VIGV inlet rake								
0		9.894			10.083	10.318	10.450	10.345
30		9.936			10.091	10.311	10.357	10.245
60		9.740			9.915	10.120	10.203	10.063
90		9.613			9.748	10.005	10.004	9.946
120		9.784			9.939	10.124	10.349	10.149
150		9.888			10.076	10.296	10.429	10.323
180		9.899			10.070	10.320	10.425	10.330
210		9.948			10.128	10.306	10.345	10.172
240		10.189			10.342	10.393	10.413	10.197
270		10.076			10.141	10.164	10.181	10.077
300		10.216			10.367	10.417	10.415	10.160
330		9.932			10.072	10.278	10.359	10.185
AVG		9.926			10.081	10.254	10.328	10.183
VIGV exit rake								
15	9.920	10.103	10.032	10.100	10.194	10.384	10.384	10.269
45	9.835	9.975	9.886	9.930	9.809	10.219	10.234	10.139
75	9.711	9.958	9.775	9.795	9.814	10.038	10.114	10.071
105	9.742	9.768	9.796	9.814	9.839	10.034	10.182	10.091
135	9.832	9.863	9.914	9.979	9.979	10.291	10.388	10.270
165	9.875	9.918	9.975	10.045	10.170	10.398	10.466	10.370
195	9.872	9.887	9.914	9.956	10.062	10.275	10.338	10.193
225	10.101	10.120	10.139	10.171	10.269	10.401	10.444	10.201
255	10.101	10.130	10.149	10.172	10.208	10.214	10.272	10.195
285	10.128	10.159	10.179	10.198	10.231	10.335	10.394	10.187
315	10.081	10.093	10.109	10.141	10.216	10.281	10.342	10.160
345	9.864	9.886	9.924	9.981	10.091	10.280	10.406	10.295
AVG	9.922	9.988	9.983	10.024	10.098	10.263	10.330	10.203

TABLE 17.—Continued.

(f) 6.35 cm tip radial distortion; airflow, 35.26 kg/sec; readings 532 to 536

Circumferential location, θ , deg	Spanwise location, percent of span from tip							
	5	10	15	20	30	50	70	90
VIGV inlet rake								
0		10.084			10.120	10.162	10.191	10.176
30		10.090			10.123	10.169	10.180	10.158
60		10.054			10.090	10.134	10.147	10.118
90		10.031			10.054	10.103	10.113	10.096
120		10.062			10.095	10.135	10.181	10.150
150		10.082			10.122	10.170	10.200	10.172
180		10.084			10.115	10.160	10.185	10.172
210		10.094			10.133	10.167	10.176	10.138
240		10.136			10.172	10.186	10.187	10.142
270		10.128			10.137	10.139	10.144	10.121
300		10.140			10.172	10.188	10.189	10.133
330		10.089			10.119	10.158	10.175	10.139
AVG		10.089			10.121	10.156	10.172	10.143
VIGV exit rake								
15	10.068	10.125	10.083	10.092	10.107	10.151	10.154	10.137
45	10.047	10.120	10.058	10.063	10.067	10.115	10.129	10.121
75	10.047	10.119	10.059	10.063	10.066	10.113	10.131	10.120
105	10.067	10.074	10.086	10.099	10.120	10.163	10.194	10.175
135	10.077	10.086	10.095	10.110	10.133	10.178	10.197	10.180
165	10.078	10.089	10.100	10.115	10.139	10.183	10.196	10.176
195	10.121	10.128	10.131	10.138	10.155	10.182	10.191	10.136
225	10.115	10.123	10.128	10.132	10.143	10.149	10.161	10.141
255	10.117	10.122	10.126	10.131	10.141	10.150	10.164	10.141
285	10.114	10.118	10.124	10.131	10.149	10.163	10.173	10.133
315	10.075	10.083	10.092	10.103	10.124	10.162	10.184	10.166
345	10.076	10.081	10.090	10.100	10.121	10.159	10.180	10.157
AVG	10.083	10.106	10.098	10.106	10.122	10.156	10.171	10.149

TABLE 17.—Continued.

(g) Circumferential distortion; airflow, 78.72 kg/sec; readings 545 to 548

Circumferential location, θ , deg	Spanwise location, percent of span from tip							
	5	10	15	20	30	50	70	90
VIGV inlet rake								
0		9.854			9.872	9.883	9.886	9.947
30		9.982			10.026	9.881	9.841	9.881
60		10.023			10.374	10.325	10.185	9.954
90		9.636			9.976	10.175	10.026	9.878
120		10.063			10.252	10.229	10.020	9.873
150		10.102			10.341	10.299	10.178	10.150
180		10.063			10.351	10.458	10.411	10.349
210		9.937			10.319	10.428	10.362	10.265
240		10.197			10.313	10.388	10.434	10.232
270		10.156			10.251	10.22	10.263	10.018
300		10.266			10.351	10.314	10.231	10.087
330		9.899			10.033	10.102	10.098	10.027
AVG		10.015			10.205	10.227	10.161	10.055
VIGV exit rake								
15	9.877	10.053	9.915	9.924	9.897	9.848	9.846	9.920
45	9.991	10.191	10.120	10.189	10.220	10.009	9.940	9.868
75	10.006	10.208	10.151	10.163	10.195	10.349	10.262	10.061
105	9.827	9.833	9.883	9.964	10.042	10.122	9.970	9.895
135	10.073	10.092	10.124	10.201	10.346	10.298	10.048	10.044
165	9.991	10.104	10.192	10.280	10.429	10.422	10.358	10.272
195	9.899	9.988	10.065	10.136	10.255	10.341	10.357	10.291
225	10.038	10.054	10.083	10.147	10.275	10.425	10.428	10.204
255	10.105	10.141	10.166	10.200	10.287	10.396	10.350	10.164
285	10.187	10.207	10.202	10.190	10.196	10.221	10.149	10.103
315	10.066	10.075	10.056	10.138	10.229	10.254	10.180	10.049
345	9.812	9.843	9.866	9.884	9.913	9.912	9.971	9.996
AVG	9.989	10.066	10.072	10.118	10.190	10.216	10.155	10.072

TABLE 17.—Continued.

(h) Circumferential distortion; airflow, 73.27 kg/sec; readings 541 to 544

Circumferential location, θ , deg	Spanwise location, percent of span from tip							
	5	10	15	20	30	50	70	90
VIGV inlet rake								
0		9.890			9.904	9.913	9.922	9.976
30		10.001			10.031	9.908	9.881	9.922
60		10.037			10.343	10.290	10.161	9.957
90		9.704			9.997	10.170	10.059	9.923
120		10.069			10.235	10.212	10.028	9.917
150		10.108			10.313	10.282	10.176	10.165
180		10.071			10.318	10.415	10.383	10.329
210		9.964			10.300	10.390	10.334	10.245
240		10.192			10.289	10.352	10.395	10.219
270		10.152			10.235	10.226	10.247	10.036
300		10.246			10.321	10.290	10.215	10.093
330		9.922			10.046	10.110	10.097	10.042
AVG		10.030			10.194	10.213	10.158	10.069
VIGV exit rake								
15	10.027	10.213	10.129	10.188	10.219	10.033	9.955	9.908
45	10.016	10.201	10.138	10.149	10.184	10.318	10.265	10.082
75	10.018	10.207	10.141	10.154	10.186	10.325	10.285	10.103
105	10.088	10.108	10.137	10.204	10.322	10.286	10.074	10.087
135	10.006	10.104	10.177	10.254	10.380	10.379	10.336	10.263
165	10.022	10.126	10.199	10.285	10.393	10.357	10.325	10.272
195	10.056	10.069	10.099	10.147	10.258	10.392	10.395	10.198
225	10.095	10.126	10.148	10.176	10.253	10.355	10.319	10.154
255	10.096	10.129	10.155	10.185	10.259	10.359	10.321	10.159
285	10.082	10.090	10.107	10.146	10.227	10.245	10.181	10.067
315	9.841	9.870	9.891	9.905	9.930	9.934	9.992	10.007
345	9.848	9.872	9.895	9.911	9.935	9.935	9.991	10.010
AVG	10.016	10.093	10.101	10.142	10.212	10.243	10.203	10.109

TABLE 17.—Concluded.

(i) Circumferential distortion; airflow, 35.41 kg/sec; readings 537 to 540

Circumferential location, θ , deg	Spanwise location, percent of span from tip							
	5	10	15	20	30	50	70	90
VIGV inlet rake								
0		10.083			10.084	10.086	10.091	10.102
30		10.106			10.118	10.098	10.084	10.096
60		10.108			10.173	10.156	10.127	10.097
90		10.054			10.103	10.142	10.118	10.093
120		10.120			10.154	10.146	10.108	10.100
150		10.123			10.165	10.168	10.145	10.153
180		10.118			10.169	10.182	10.180	10.175
210		10.097			10.165	10.180	10.177	10.151
240		10.137			10.170	10.174	10.185	10.145
270		10.136			10.151	10.150	10.154	10.109
300		10.146			10.164	10.165	10.149	10.120
330		10.087			10.110	10.134	10.125	10.114
AVG		10.109			10.144	10.148	10.137	10.121
VIGV exit rake								
15	10.086	10.137	10.093	10.094	10.090	10.082	10.082	10.102
45	10.111	10.161	10.127	10.141	10.152	10.113	10.091	10.087
75	10.104	10.156	10.127	10.134	10.142	10.171	10.157	10.124
105	10.079	10.083	10.090	10.104	10.116	10.130	10.103	10.095
135	10.122	10.131	10.140	10.154	10.174	10.165	10.126	10.137
165	10.111	10.128	10.139	10.154	10.176	10.182	10.179	10.172
195	10.103	10.114	10.123	10.135	10.155	10.168	10.165	10.161
225	10.112	10.115	10.118	10.126	10.149	10.183	10.186	10.143
255	10.118	10.123	10.127	10.132	10.148	10.173	10.165	10.136
285	10.125	10.129	10.130	10.130	10.139	10.145	10.132	10.123
315	10.117	10.120	10.125	10.135	10.152	10.164	10.142	10.119
345	10.074	10.081	10.083	10.087	10.093	10.095	10.104	10.107
AVG	10.105	10.123	10.119	10.127	10.141	10.148	10.136	10.125

TABLE 18.—CORNER 2 STATIC PRESSURE DISTRIBUTION AT VIGV EXIT WITH VANES A10 IN CORNER 1 AND VANES B IN CORNER 2—DISTORTED INFLOW

(a) 12.70-cm tip radial distortion; airflow, 80.11 kg/sec; readings 519 to 522

Circumferential location, θ , deg	Outer wall	Center-body
15	9.296	9.268
45	9.275	9.254
75	9.301	9.245
105	9.299	9.239
135	9.294	9.232
165	9.298	9.270
195	9.283	9.278
225	9.263	9.256
255	9.292	9.250
285	9.325	9.258
315	9.340	9.263
345	9.315	9.277
AVG	9.298	9.257

(c) 12.70-cm tip radial distortion; airflow, 35.30 kg/sec; readings 511 to 514

Circumferential location, θ , deg	Outer wall	Center-body
15	9.995	9.989
45	9.993	9.987
75	9.996	9.986
105	9.996	9.987
135	9.996	9.984
165	9.995	9.991
195	9.993	9.992
225	9.990	9.988
255	9.994	9.986
285	10.000	9.988
315	10.002	9.988
345	9.998	9.991
AVG	9.996	9.988

(e) 6.35-cm tip radial distortion; airflow, 71.36 kg/sec; readings 527 to 530

Circumferential location, θ , deg	Outer wall	Center-body
15	9.441	9.409
45	9.422	9.402
57	9.440	9.398
105	9.440	9.395
135	9.439	9.388
165	9.443	9.414
195	9.422	9.415
225	9.414	9.404
255	9.437	9.410
285	9.470	9.416
315	9.478	9.413
345	9.456	9.417
AVG	9.442	9.407

(b) 12.70-cm tip radial distortion; airflow, 72.28 kg/sec; readings 515 to 518

15	9.434	9.414
45	9.418	9.397
75	9.450	9.394
105	9.435	9.397
135	9.431	9.381
165	9.445	9.411
195	9.414	9.423
225	9.408	9.398
255	9.452	9.395
285	9.448	9.409
315	9.472	9.406
345	9.461	9.419
AVG	9.439	9.404

(d) 6.35-cm tip radial distortion; airflow, 77.07 kg/sec; readings 523 to 526

15	9.323	9.296
45	9.302	9.281
57	9.334	9.281
105	9.323	9.280
135	9.328	9.262
165	9.350	9.298
195	9.303	9.308
225	9.298	9.289
255	9.346	9.293
285	9.340	9.305
315	9.369	9.295
345	9.359	9.303
AVG	9.331	9.291

(f) 6.35-cm tip radial distortion; airflow, 35.26 kg/sec; readings 532 to 536

15	9.994	9.989
45	9.994	9.986
75	9.997	9.987
105	9.994	9.987
135	9.995	9.985
165	9.997	9.990
195	9.991	9.991
225	9.990	9.987
255	9.997	9.989
285	9.999	9.990
315	10.002	9.989
345	10.001	9.990
AVG	9.996	9.988

TABLE 18.—Concluded.

(g) Circumferential distortion;
airflow, 78.72 kg/sec;
readings 545 to 548

Circumferential location, θ , deg	Outer wall	Center-body
15	9.346	9.321
45	9.322	9.304
75	9.353	9.294
105	9.347	9.294
135	9.350	9.287
165	9.336	9.308
195	9.333	9.315
225	9.309	9.305
255	9.338	9.302
285	9.371	9.315
315	9.386	9.321
345	9.361	9.326
AVG	9.346	9.308

(i) Circumferential distortion;
airflow, 35.41 kg/sec;
readings 537 to 540

Circumferential location, θ , deg	Outer wall	Center-body
15	9.998	9.994
45	9.994	9.990
75	9.999	9.988
105	9.999	9.990
135	9.998	9.988
165	9.996	9.991
195	9.993	9.993
225	9.992	9.991
255	9.997	9.991
285	10.001	9.992
315	10.004	9.993
345	10.001	9.995
AVG	9.998	9.991

(h) Circumferential distortion;
airflow, 73.27 kg/sec;
readings 541 to 544

15	9.443	9.434
45	9.429	9.412
75	9.471	9.405
105	9.441	9.410
135	9.446	9.398
165	9.455	9.419
195	9.414	9.426
225	9.416	9.413
255	9.459	9.415
285	9.455	9.427
315	9.481	9.418
345	9.472	9.433
AVG	9.448	9.418

TABLE 19.—CORNER 2 STATIC PRESSURE DISTRIBUTION AT VANE INLET AND EXIT WITH VANES A10
IN CORNER 1 AND VANES B IN CORNER 2—DISTORTED INFLOW

(a) 12.70-cm tip radial distortion; airflow, 80.11 kg/sec; readings 519 to 522

Circumferential location, θ , deg	Inlet		Exit	
	Pressure, N/cm ²	Coefficient	Pressure, N/cm ²	Coefficient
0	9.665	0.960	9.545	1.181
15	9.674	0.943	9.499	1.266
30	9.659	0.969	9.460	1.338
45	9.630	1.025	9.397	1.456
60	9.611	1.059	9.380	1.488
75	9.586	1.106	*****	*****
90	9.583	1.111	*****	*****
105	9.623	1.037	*****	*****
120	9.612	1.058	9.385	1.477
135	9.640	1.006	9.394	1.461
150	9.675	0.940	9.449	1.360
165	9.684	0.924	9.501	1.263
180	9.687	0.917	9.573	1.129
195	9.680	0.931	9.579	1.119
210	9.727	0.844	9.595	1.089
225	9.830	0.652	9.609	1.063
240	9.804	0.701	9.647	0.992
255	9.831	0.651	9.728	0.842
270	9.827	0.659	9.721	0.855
285	9.846	0.623	9.729	0.841
300	9.848	0.619	9.655	0.978
315	9.831	0.651	9.619	1.044
330	9.726	0.847	9.589	1.099
345	9.670	0.951	9.578	1.119

(c) 12.70-cm tip radial distortion; airflow, 35.30 kg/sec; readings 511 to 514

Circumferential location, θ , deg	Inlet		Exit	
	Pressure, N/cm ²	Coefficient	Pressure, N/cm ²	Coefficient
0	10.052	0.883	10.053	1.063
15	10.053	0.872	10.026	1.139
30	10.052	0.885	10.020	1.198
45	10.047	0.927	10.011	1.278
60	10.045	0.955	10.008	1.307
75	10.040	0.996	*****	*****
90	10.040	0.997	*****	*****
105	10.048	0.921	*****	*****
120	10.045	0.954	10.009	1.304
135	10.049	0.911	10.011	1.280
150	10.054	0.866	10.018	1.212
165	10.056	0.847	10.026	1.135
180	10.057	0.835	10.036	1.037
195	10.055	0.852	10.038	1.017
210	10.060	0.800	10.042	0.983
225	10.075	0.660	10.043	0.972
240	10.074	0.669	10.049	0.908
255	10.082	0.592	10.063	0.780
270	10.083	0.579	10.062	0.785
285	10.085	0.565	10.063	0.777
300	10.081	0.604	10.049	0.913
315	10.074	0.665	10.044	0.959
330	10.062	0.781	10.040	0.998
345	10.053	0.877	10.038	1.021

(b) 12.70-cm tip radial distortion; airflow, 72.28 kg/sec; readings 515 to 518

0	9.743	0.986	9.641	1.220
15	9.749	0.974	9.605	1.302
30	9.737	1.001	9.573	1.375
45	9.712	1.059	9.520	1.496
60	9.696	1.094	9.510	1.520
75	9.674	1.144	*****	*****
90	9.673	1.148	*****	*****
105	9.704	1.077	*****	*****
120	9.696	1.094	9.513	1.513
135	9.719	1.041	9.519	1.498
150	9.747	0.978	9.563	1.399
165	9.756	0.957	9.605	1.301
180	9.760	0.948	9.665	1.164
195	9.754	0.961	9.672	1.150
210	9.795	0.868	9.686	1.118
225	9.879	0.677	9.696	1.094
240	9.860	0.721	9.730	1.018
255	9.882	0.670	9.799	0.861
270	9.879	0.678	9.791	0.877
285	9.896	0.639	9.799	0.859
300	9.897	0.635	9.737	1.002
315	9.882	0.670	9.706	1.071
330	9.795	0.869	9.682	1.127
345	9.747	0.978	9.671	1.152

(d) 6.35-cm tip radial distortion; airflow, 77.07 kg/sec; readings 523 to 526

0	9.721	0.945	9.592	1.202
15	9.717	0.952	9.529	1.329
30	9.693	0.999	9.488	1.409
45	9.650	1.087	9.422	1.543
60	9.619	1.148	9.406	1.575
75	9.594	1.198	*****	*****
90	9.590	1.206	*****	*****
105	9.627	1.131	*****	*****
120	9.627	1.132	9.412	1.563
135	9.665	1.057	9.418	1.551
150	9.708	0.969	9.474	1.437
165	9.727	0.933	9.529	1.328
180	9.744	0.898	9.613	1.159
195	9.738	0.911	9.620	1.147
210	9.775	0.836	9.643	1.100
225	9.839	0.709	9.654	1.078
240	9.835	0.717	9.686	1.015
255	9.870	0.646	9.760	0.866
270	9.869	0.649	9.754	0.879
285	9.888	0.610	9.761	0.864
300	9.863	0.660	9.676	1.034
315	9.835	0.717	9.646	1.094
330	9.767	0.853	9.629	1.128
345	9.720	0.946	9.619	1.148

TABLE 19.—Continued.

(e) 6.35-cm tip radial distortion; airflow, 71.36 kg/sec; readings 527 to 530

Circumferential location, θ , deg	Inlet		Exit	
	Pressure, N/cm ²	Coefficient	Pressure, N/cm ²	Coefficient
0	9.773	0.960	9.663	1.217
15	9.772	0.963	9.607	1.347
30	9.750	1.015	9.572	1.430
45	9.708	1.111	9.518	1.557
60	9.686	1.163	9.504	1.589
75	9.664	1.215	*****	*****
90	9.657	1.231	*****	*****
105	9.694	1.145	*****	*****
120	9.692	1.149	9.508	1.578
135	9.725	1.073	9.517	1.559
150	9.762	0.985	9.562	1.453
165	9.780	0.944	9.608	1.345
180	9.794	0.912	9.682	1.173
195	9.790	0.921	9.688	1.159
210	9.822	0.845	9.708	1.111
225	9.873	0.720	9.719	1.086
240	9.874	0.723	9.746	1.023
255	9.902	0.659	9.810	0.874
270	9.901	0.661	9.804	0.888
285	9.916	0.626	9.810	0.874
300	9.897	0.671	9.736	1.048
315	9.871	0.731	9.711	1.104
330	9.812	0.868	9.696	1.140
345	9.772	0.961	9.686	1.163

(g) Circumferential distortion; airflow, 78.72 kg/sec; readings 545 to 548

Circumferential location, θ , deg	Inlet		Exit	
	Pressure, N/cm ²	Coefficient	Pressure, N/cm ²	Coefficient
0	9.682	1.007	9.584	1.197
15	9.690	0.991	9.533	1.296
30	9.690	0.993	9.504	1.352
45	9.696	0.980	9.436	1.483
60	9.736	0.904	9.427	1.500
75	9.687	0.998	*****	*****
90	9.692	0.993	*****	*****
105	9.724	0.926	*****	*****
120	9.718	0.938	9.471	1.416
135	9.736	0.904	9.451	1.454
150	9.736	0.903	9.502	1.355
165	9.739	0.898	9.557	1.249
180	9.742	0.892	9.642	1.084
195	9.739	0.897	9.628	1.112
210	9.763	0.850	9.647	1.075
225	9.840	0.701	9.634	1.101
240	9.848	0.686	9.673	1.025
255	9.886	0.613	9.756	0.864
270	9.896	0.594	9.765	0.847
285	9.928	0.532	9.786	0.807
300	9.927	0.534	9.676	1.020
315	9.872	0.640	9.636	1.097
330	9.759	0.859	9.617	1.134
345	9.697	0.979	9.607	1.152

(f) 6.35-cm tip radial distortion; airflow, 35.26 kg/sec; readings 532 to 536

0	10.058	0.819	10.037	1.024
15	10.057	0.825	10.027	1.122
30	10.054	0.855	10.019	1.196
45	10.048	0.917	10.011	1.276
60	10.043	0.965	10.008	1.304
75	10.038	1.011	*****	*****
90	10.037	1.021	*****	*****
105	10.045	0.938	*****	*****
120	10.044	0.954	10.008	1.300
135	10.050	0.897	10.011	1.275
150	10.056	0.833	10.018	1.202
165	10.060	0.799	10.027	1.121
180	10.063	0.769	10.039	0.998
195	10.061	0.782	10.041	0.978
210	10.067	0.723	10.046	0.933
225	10.078	0.620	10.044	0.952
240	10.078	0.622	10.053	0.868
255	10.082	0.580	10.064	0.760
270	10.083	0.571	10.063	0.769
285	10.086	0.544	10.063	0.768
300	10.080	0.604	10.049	0.903
315	10.074	0.657	10.045	0.947
330	10.064	0.753	10.043	0.963
345	10.057	0.828	10.041	0.979

(h) Circumferential distortion; airflow, 77.07 kg/sec; readings 523 to 526

0	9.741	1.011	9.656	1.201
15	9.748	0.996	9.613	1.297
30	9.747	0.999	9.588	1.354
45	9.753	0.985	9.529	1.485
60	9.787	0.909	9.521	1.503
75	9.744	1.004	*****	*****
90	9.748	0.995	*****	*****
105	9.777	0.932	*****	*****
120	9.773	0.940	9.559	1.419
135	9.788	0.907	9.542	1.456
150	9.788	0.906	9.586	1.359
165	9.789	0.904	9.634	1.250
180	9.792	0.897	9.706	1.690
195	9.792	0.898	9.695	1.114
210	9.813	0.851	9.712	1.077
225	9.879	0.703	9.701	1.101
240	9.884	0.691	9.734	1.027
255	9.918	0.615	9.805	0.869
270	9.926	0.598	9.812	0.853
285	9.953	0.538	9.829	0.815
300	9.950	0.545	9.735	1.025
315	9.903	0.649	9.701	1.101
330	9.808	0.862	9.684	1.138
345	9.752	0.986	9.676	1.156

TABLE 19.—Concluded.

(i) Circumferential distortion; airflow, 35.41 kg/sec; readings 537 to 540

Circum- ferential location, θ , deg	Inlet		Exit	
	Pres- sure, N/cm ²	Coeffi- cient	Pres- sure, N/cm ²	Coeffi- cient
0	10.053	0.881	10.036	1.049
15	10.054	0.868	10.028	1.120
30	10.054	0.870	10.022	1.183
45	10.055	0.860	10.013	1.267
60	10.061	0.805	10.011	1.287
75	10.053	0.881	*****	*****
90	10.051	0.897	*****	*****
105	10.061	0.807	*****	*****
120	10.059	0.820	10.016	1.236
135	10.062	0.789	10.015	1.248
150	10.061	0.808	10.023	1.171
165	10.062	0.798	10.032	1.082
180	10.062	0.793	10.044	0.966
195	10.061	0.801	10.043	0.973
210	10.064	0.771	10.047	0.943
225	10.078	0.641	10.044	0.967
240	10.077	0.645	10.050	0.914
255	10.085	0.573	10.061	0.807
270	10.085	0.571	10.062	0.794
285	10.089	0.530	10.064	0.769
300	10.089	0.530	10.047	0.934
315	10.081	0.613	10.043	0.977
330	10.063	0.783	10.041	1.000
345	10.053	0.877	10.040	1.010

TABLE 20.—AXIAL STATIC PRESSURE DISTRIBUTION WITH VANES A10 IN CORNER 1
AND VANES B IN CORNER 2—DISTORTED INFLOW

(a) 12.70-cm tip radial distortion; airflow, 80.11 kg/sec; readings 519 to 522

Axial station	Outer wall				Centerbody			
	Circumferer aa. location, θ , deg							
	0	90	180	270	0	90	180	270
1		9.485						
2		9.529						
3		9.535						
4		9.540						
5		9.539						
6		9.533						
7		9.526						
8	9.492	9.451	9.486	9.505				
9		9.415						
10	9.350	9.347	9.354	9.385				
12				9.374				
13				9.390				
14				9.429				
15				9.460				
16				9.510				
17				9.570				
18				9.623				
19				9.664				
20				9.703				
35		9.317						
36		9.341						
37	9.404	9.364	9.377	9.496				
38		9.386						
39		9.401						
40	9.458	9.420	9.439	9.514				
41	9.498	9.458	9.482	9.531				
42	9.528	9.497	9.518	9.552				
43	9.562	9.526	9.551	9.580				
44	9.585	9.552	9.582	9.607				
45	9.609	9.571	9.610	9.634				
46	9.638	9.584	9.631	9.666				
47	9.653	9.600	9.625	9.672				
48	9.871		9.681	9.759				
49	9.686		9.691	9.772				
50	9.685		9.695	9.775				
51	9.682		9.696	9.849				
52	9.670		9.696					
53				9.814				
54				0.000	9.376	9.922	9.323	9.730
55				0.000	9.302	10.126	9.259	9.748
56				*****	9.203	10.320	9.183	
57				9.708	*****	10.536	9.179	
58				9.691		10.443		9.716
59				9.670		10.433		*****
60				9.662	*****	10.490	*****	*****
61	9.565		9.565	9.640	9.655		9.672	
62	9.538		9.542	10.064	10.098		9.626	
63	9.533		9.536	9.585	9.968	9.482	9.987	9.620
64	9.523		9.529	9.569	9.851	9.559	9.887	9.609
65	9.514		9.518	9.564	9.756	9.565	9.800	9.599
66	9.506		9.511	9.554	9.666	9.554	9.710	9.583
67	9.494		9.499	9.541	9.532	9.544	9.620	9.563
68	9.487		9.489	9.526	9.507	9.522	9.535	9.547
69	9.474		9.480	9.515	9.437	9.495	9.460	9.521
70	9.460		9.466	9.495	9.383	9.474	9.391	9.492
71	9.449		9.452	9.485	9.325	9.435	9.327	9.453
72	9.440	*****	9.441	9.467	9.268	9.403	9.280	9.422
73	9.432	*****	9.431	9.458	9.230	9.368	9.233	9.383
74	9.427	*****	9.426	9.442	9.199	9.344	9.200	9.355
75	9.410	*****	9.423	9.451	9.181	9.325	9.178	9.334
76	9.448	*****	10.266	9.361	9.166	9.318	9.165	9.328
77	*****	*****	*****	*****	9.163	9.313	9.162	9.309
78	*****	*****	*****	*****	9.172	9.317	9.182	9.318
79	9.340	9.339	9.435	9.435	9.397	9.396	9.390	9.391

TABLE 20.—Continued.

(b) 12.70-cm tip radial distortion; airflow, 72.28 kg/sec; readings 515 to 518

Axial station	Outer wall				Centerbody			
	Circumferential location, θ , deg							
	0	90	180	270	0	90	180	270
1		9.588						
2		9.625						
3		9.629						
4		9.633						
5		9.633						
6		9.628						
7		9.621						
8	9.593	9.591	9.591	9.607				
9		9.531						
10	9.479	9.477	9.471	9.507				
12				9.501				
13				9.515				
14				9.547				
15				9.574				
16				9.613				
17				9.663				
18				9.708				
19				9.741				
20				9.774				
35		9.452						
36		9.471						
37	9.528	9.490	9.503	9.605				
38		9.510						
39		9.524						
40	9.570	9.541	9.555	9.618				
41	9.601	9.577	9.588	9.630				
42	9.627	9.601	9.619	9.648				
43	9.656	9.625	9.646	9.672				
44	9.669	9.647	9.671	9.693				
45	9.694	9.664	9.695	9.715				
46	9.720	9.672	9.713	9.743				
47	9.731	9.686	9.708	9.746				
48	9.905		9.755	9.819				
49	9.758		9.761	9.832				
50	9.757		9.765	9.853				
51	9.758		9.768	9.895				
52	9.750		9.768					
53				9.868				
54				0.000	9.505	9.960	9.455	9.797
55				0.000	9.443	10.135	9.401	9.511
56				*****	9.356	10.301	9.338	
57				9.779	*****	10.468	9.335	
58				9.766		10.392		9.789
59				9.747		10.412		*****
60				9.744	*****	10.446	*****	*****
61	9.662		9.661	9.723	9.735		9.751	
62	9.637		9.640	10.089	10.114		9.710	
63	9.631		9.636	9.678	11.005	9.585	10.019	9.705
64	9.625		9.628	9.666	9.905	9.654	9.932	9.696
65	9.616		9.619	9.657	9.824	9.658	9.856	9.687
66	9.614		9.613	9.650	9.746	9.649	9.779	9.673
67	9.603		9.603	9.641	9.674	9.641	9.704	9.659
68	9.598		9.596	9.627	9.611	9.626	9.632	9.642
69	9.582		9.586	9.618	9.550	9.603	9.568	9.621
70	9.575		9.578	9.602	9.506	9.585	9.510	9.597
71	9.563		9.565	9.592	9.461	9.558	9.456	9.567
72	9.556	*****	9.555	9.579	9.410	9.528	9.421	9.540
73	9.549	*****	9.549	9.571	9.381	9.501	9.383	9.511
74	9.545	*****	9.545	9.557	9.353	9.479	9.357	9.486
75	9.534	*****	9.541	9.566	9.341	9.466	9.337	9.470
76	9.543	*****	10.114	9.492	9.328	9.457	9.325	9.463
77	*****	*****	*****	*****	9.325	9.454	9.323	9.447
78	*****	*****	*****	*****	9.332	9.459	9.340	9.456
79	9.473	9.478	9.554	9.551	9.524	9.524	9.516	9.516

TABLE 20.—Continued.

(c) 12.70-cm tip radial distortion; airflow, 35.30 kg/sec; readings 511 to 514

Axial station	Outer wall				Centerbody			
	Circumferential location, θ , deg							
	0	90	180	270	0	90	180	270
1		10.018						
2		10.028						
3		10.029						
4		10.030						
5		10.030						
6		10.028						
7		10.027						
8	10.022	10.021	10.022	10.025				
9		10.009						
10	10.001	9.999	10.002	10.008				
12				10.007				
13				10.010				
14				10.017				
15				10.022				
16				10.029				
17				10.038				
18				10.046				
19				10.053				
20				10.060				
35		9.997						
36		10.000						
37	10.011	10.005	10.007	10.027				
38		10.007						
39		10.010						
40	10.019	10.014	10.017	10.029				
41	10.026	10.021	10.023	10.032				
42	10.031	10.027	10.029	10.036				
43	10.036	10.031	10.034	10.040				
44	10.040	10.035	10.039	10.044				
45	10.044	10.038	10.044	10.048				
46	10.042	10.040	10.047	10.053				
47	10.050	10.042	10.046	10.054				
48	10.059		10.056	10.068				
49	10.056		10.057	10.070				
50	10.056		10.057	10.076				
51	10.055		10.057	10.086				
52	10.053		10.057					
53				10.082				
54				0.000	9.995	10.105	9.994	10.066
55				0.000	9.982	10.155	9.978	10.068
56				*****	9.967	10.179	9.968	
57				10.060	*****	10.193	9.970	
58				10.054		10.177		10.061
59				10.053		10.191		*****
60				10.052	*****	10.197	*****	*****
61	10.035		10.035	10.048	10.050		10.053	
62	10.032		10.032	10.126	10.127		10.045	
63	10.030		10.031	10.039	10.107	10.012	10.110	10.044
64	10.029		10.029	10.037	10.086	10.028	10.091	10.043
65	10.028		10.028	10.037	10.069	10.032	10.075	10.041
66	10.026		10.027	10.034	10.053	10.032	10.060	10.038
67	10.024		10.025	10.033	10.039	10.031	10.044	10.035
68	10.023		10.024	10.031	10.028	10.029	10.030	10.032
69	10.021		10.022	10.029	10.015	10.025	10.018	10.029
70	10.020		10.018	10.027	10.006	10.021	10.007	10.024
71	10.018		10.019	10.025	9.997	10.016	9.996	10.017
72	10.017	*****	10.017	10.022	9.988	10.011	9.989	10.013
73	10.015	*****	10.016	10.020	9.981	10.006	9.982	10.004
74	10.011	*****	10.014	10.018	9.976	10.002	9.977	10.002
75	10.012	*****	10.014	10.019	9.974	9.999	9.973	9.999
76	10.006	*****	10.039	10.006	9.971	9.999	9.972	9.998
77	*****	*****	*****	*****	9.971	9.997	9.971	9.994
78	*****	*****	*****	*****	9.972	9.998	9.974	9.996
79	10.003	10.003	10.018	10.018	10.010	10.010	10.007	10.007

TABLE 20.—Continued.

(d) 6.35-cm tip radial distortion; airflow, 77.07 kg/sec; readings 523 to 526

Axial station	Outer wall				Centerbody			
	Circumferential location, θ , deg							
	0	90	180	270	0	90	180	270
1		9.489						
2		9.537						
3		9.545						
4		9.549						
5		9.550						
6		9.544						
7		9.536						
8	9.503	9.502	9.499	9.516				
9		9.434						
10	9.374	9.377	9.376	9.476				
12				9.398				
13				9.414				
14				9.455				
15				9.488				
16				9.537				
17				9.591				
18				9.640				
19				9.675				
20				9.708				
35		9.364						
36		9.385						
37	9.421	9.402	9.399	9.533				
38		9.418						
39		9.430						
40	9.473	9.441	9.458	9.545				
41	9.511	9.469	9.498	9.557				
42	9.544	9.499	9.535	9.579				
43	9.578	9.527	9.566	9.606				
44	9.602	9.551	9.597	9.636				
45	9.625	9.573	9.626	9.666				
46	9.662	9.585	9.651	9.699				
47	9.687	9.608	9.644	9.705				
48	9.801		9.716	9.801				
49	9.727		9.730	9.813				
50	9.731		9.742	9.839				
51	9.736		9.748	9.899				
52	9.724		9.748					
53				9.856				
54				0.000	9.382	9.999	9.405	9.768
55				0.000	9.345	10.221	9.367	9.787
56				*****	9.311	10.296	9.343	
57					*****	10.293	9.352	
58				9.718		10.210		9.729
59				9.698		10.176		*****
60				9.688	*****	10.224	*****	*****
61	9.603		9.608	9.665	9.679		9.695	
62	9.574		9.578	9.939	9.979		9.650	
63	9.566		9.569	9.614	9.875	9.520	9.894	9.646
64	9.557		9.564	9.599	9.802	9.572	9.827	9.634
65	9.547		9.553	9.593	9.741	9.574	9.763	9.625
66	9.539		9.544	9.583	9.674	9.564	9.696	9.610
67	9.527		9.532	9.573	9.609	9.554	9.629	9.595
68	9.522		9.523	9.557	9.550	9.535	9.563	9.578
69	9.508		9.512	9.542	9.490	9.512	9.501	9.557
70	9.494		9.502	9.527	9.441	9.492	9.443	9.532
71	9.482		9.486	9.517	9.390	9.462	9.388	9.498
72	9.475	*****	9.476	9.501	9.337	9.431	9.346	9.470
73	9.467	*****	9.467	9.490	9.300	9.401	9.304	9.439
74	9.466	*****	9.460	9.475	9.268	9.379	9.273	9.412
75	9.449	*****	9.462	9.484	9.248	9.363	9.249	9.390
76	9.439	*****	10.041	9.394	9.232	9.355	9.236	9.381
77	*****	*****	*****	*****	9.226	9.350	9.231	9.363
78	*****	*****	*****	*****	9.229	9.351	9.242	9.366
79	9.374	9.373	9.472	9.471	9.411	9.409	9.422	9.422

0-2

TABLE 20.—Continued.

(e) 6.35-cm tip radial distortion; airflow, 71.36 kg/sec; readings 527 to 530

Axial station	Outer wall				Centerbody			
	Circumferential location, θ , deg							
	0	90	180	270	0	90	180	270
1		9.570						
2		9.610						
3		9.617						
4		9.621						
5		9.622						
6		9.617						
7		9.609						
8	9.580	9.591	9.580	9.593				
9		9.522						
10	9.471	9.472	9.473	9.500				
12				9.493				
13				9.507				
14				9.540				
15				9.572				
16				9.613				
17				9.661				
18				9.702				
19				9.732				
20				9.760				
35		9.465						
36		9.483						
37	9.515	9.498	9.498	9.611				
38		9.511						
39		9.521						
40	9.560	9.531	9.547	9.622				
41	9.594	9.557	9.583	9.633				
42	9.622	9.583	9.613	9.653				
43	9.651	9.608	9.639	9.669				
44	9.670	9.631	9.667	9.702				
45	9.692	9.644	9.692	9.728				
46	9.722	9.656	9.713	9.754				
47	9.741	9.677	9.707	9.762				
48	9.851		9.772	9.843				
49	9.779		9.785	9.853				
50	9.780		9.792	9.873				
51	9.786		9.796	9.928				
52	9.775		9.796					
53				9.890				
54				0.000	9.478	10.015	9.506	9.812
55				0.000	9.447	10.209	9.473	9.831
56				*****	9.418	10.271	9.449	
57				9.790	*****	10.267	9.455	
58				9.774		10.204		9.782
59				9.757		10.186		*****
60				9.746	*****	10.222	*****	*****
61	9.671		9.676	9.726	9.738		9.753	
62	9.649		9.651	9.963	9.995		9.712	
63	9.642		9.644	9.683	9.912	9.598	9.928	9.708
64	9.633		9.637	9.669	9.847	9.643	9.865	9.699
65	9.625		9.631	9.665	9.793	9.649	9.806	9.692
66	9.616		9.622	9.657	9.736	9.640	9.748	9.679
67	9.608		9.613	9.645	9.680	9.628	9.688	9.666
68	9.602		9.603	9.635	9.626	9.616	9.630	9.650
69	9.592		9.595	9.625	9.575	9.596	9.577	9.633
70	9.578		9.583	9.609	9.533	9.579	9.528	9.612
71	9.568		9.571	9.599	9.488	9.551	9.481	9.582
72	9.563	*****	9.562	9.585	9.443	9.525	9.446	9.556
73	9.555	*****	9.554	9.575	9.411	9.499	9.409	9.530
74	9.555	*****	9.551	9.563	9.382	9.479	9.383	9.507
75	9.540	*****	9.551	9.570	9.365	9.466	9.363	9.488
76	9.519	*****	9.994	9.496	9.351	9.461	9.352	9.482
77	*****	*****	*****	*****	9.346	9.455	9.347	9.466
78	*****	*****	*****	*****	9.350	9.457	9.359	9.469
79	9.476	9.475	9.559	9.560	9.510	9.510	9.517	9.518

TABLE 20.—Continued.

(f) 6.35-cm tip radial distortion; airflow, 35.26 kg/sec; readings 532 to 536

Axial station	Outer wall				Centerbody			
	Circumferential location, θ , deg							
	0	90	180	270	0	90	180	270
1		10.017						
2		10.025						
3		10.026						
4		10.027						
5		10.028						
6		10.026						
7		10.024						
8	10.019	10.019	10.019	10.022				
9		10.007						
10	9.999	9.999	10.000	10.006				
12				10.005				
13				10.008				
14				10.015				
15				10.021				
16				10.028				
17				10.037				
18				10.044				
19				10.051				
20				10.057				
35		9.998						
36		10.002						
37	10.009	10.005	10.007	10.029				
38		10.007						
39		10.009						
40	10.017	10.011	10.015	10.030				
41	10.024	10.014	10.022	10.033				
42	10.030	10.023	10.028	10.036				
43	10.035	10.028	10.033	10.038				
44	10.040	10.032	10.038	10.045				
45	10.044	10.035	10.043	10.050				
46	10.049	10.037	10.047	10.055				
47	10.052	10.041	10.046	10.057				
48	10.061		10.059	10.073				
49	10.059		10.061	10.074				
50	10.060		10.062	10.079				
51	10.060		10.062	10.091				
52	10.058		10.062					
53				10.081				
54				0.000	9.992	10.111	10.005	10.065
55				0.000	9.987	10.154	9.998	10.071
56				*****	9.983	10.158	9.992	
57				10.062	*****	10.155	9.994	
58				10.058		10.143		10.060
59				10.055		10.151		*****
60				10.052	*****	10.154	*****	*****
61	10.038		10.038	10.049	10.051		10.054	
62	10.034		10.034	10.095	10.102		10.046	
63	10.033		10.033	10.040	10.087	10.017	10.093	10.045
64	10.031		10.029	10.038	10.075	10.028	10.078	10.041
65	10.030		10.031	10.038	10.064	10.032	10.065	10.039
66	10.028		10.029	10.036	10.052	10.031	10.052	10.040
67	10.026		10.028	10.033	10.042	10.027	10.040	10.037
68	10.025		10.026	10.032	10.031	10.028	10.029	10.031
69	10.024		10.025	10.030	10.021	10.021	10.019	10.030
70	10.021		10.021	10.027	10.012	10.021	10.009	10.027
71	10.019		10.020	10.026	10.003	10.016	10.000	10.020
72	10.018	*****	10.018	10.023	9.994	10.011	9.994	10.016
73	10.017	*****	10.017	10.021	9.988	10.006	9.986	10.011
74	10.016	*****	10.015	10.019	9.982	10.002	9.982	10.007
75	10.014	*****	10.015	10.020	9.979	10.003	9.978	10.002
76	10.005	*****	10.062	10.006	9.976	9.998	9.977	10.001
77	*****	*****	*****	*****	9.975	9.997	9.975	9.998
78	*****	*****	*****	*****	9.975	9.998	9.979	9.999
79	10.003	10.003	10.019	10.019	10.008	10.008	10.008	10.008

TABLE 20.—Continued.

(g) Circumferential distortion; airflow, 78.72 kg/sec; readings 545 to 548

Axial station	Outer wall				Centerbody			
	Circumferential location, θ , deg							
	0	90	180	270	0	90	180	270
1		9.636						
2		9.605						
3		9.588						
4		9.587						
5		9.583						
6		9.576						
7		9.57 ^a						
8	9.526	9.553	9.535	9.545				
9		9.464						
10	9.395	9.412	9.404	9.427				
12				9.418				
13				9.445				
14				9.499				
15				9.556				
16				9.631				
17				9.728				
18				9.824				
19				9.902				
20				9.964				
35		9.327						
36		9.360						
37	9.462	9.388	9.398	9.545				
38		9.417						
39		9.435						
40	9.511	9.464	9.476	9.557				
41	9.547	9.515	9.527	9.568				
42	9.576	9.562	9.567	9.591				
43	9.611	9.595	9.603	9.620				
44	9.625	9.623	9.638	9.649				
45	9.637	9.645	9.671	9.677				
46	9.673	9.661	9.692	9.708				
47	9.694	9.682	9.703	9.729				
48	9.805		9.753	9.827				
49	9.716		9.765	9.826				
50	9.705		9.760	9.857				
51	9.703		9.759	9.966				
52	9.685		9.759					
53				9.860				
54				0.000	9.365	10.243	9.316	9.763
55				0.000	9.349	10.088	9.313	9.790
56				*****	9.369	9.630	9.318	
57				9.742	*****	9.311	9.355	
58				9.718		9.370		9.723
59				9.694		9.908		*****
60				9.678	*****	9.873	*****	*****
61	9.590		9.631	9.641	9.657		9.677	
62	9.566		9.595	9.864	9.993		9.627	
63	9.558		9.589	9.607	9.751	9.530	9.893	9.624
64	9.549		9.580	9.591	9.684	9.565	9.805	9.614
65	9.539		9.572	9.587	9.632	9.569	9.740	9.609
66	9.530		9.561	9.578	9.587	9.565	9.680	9.598
67	9.519		9.549	9.568	9.546	9.559	9.624	9.584
68	9.515		9.537	9.554	9.510	9.547	9.569	9.571
69	9.503		9.528	9.545	9.475	9.528	9.518	9.555
70	9.490		9.513	9.526	9.446	9.512	9.469	9.531
71	9.478		9.499	9.516	9.418	9.487	9.420	9.500
72	9.473	*****	9.483	9.501	9.386	9.463	9.381	9.475
73	9.466	*****	9.479	9.493	9.362	9.436	9.340	9.444
74	9.468	*****	9.480	9.479	9.340	9.415	9.309	9.419
75	9.451	*****	9.482	9.491	9.325	9.397	9.284	9.399
76	9.422	*****	10.006	9.394	9.311	9.388	9.269	9.393
77	*****	*****	*****	*****	9.302	9.381	9.261	9.373
78	*****	*****	*****	*****	9.296	9.377	9.270	9.380
79	9.391	9.392	9.488	9.489	9.424	9.422	9.431	9.430

TABLE 20.—Continued.

(h) Circumferential distortion; airflow, 73.27 kg/sec; readings 541 to 544

Axial station	Outer wall				Centerbody			
	Circumferential location, θ , deg							
	0	90	180	270	0	90	180	270
1		9.695						
2		9.670						
3		9.654						
4		9.653						
5		9.650						
6		9.644						
7		9.631						
8	9.601	9.607	9.608	9.618				
9		9.546						
10	9.490	9.504	9.498	9.518				
12				9.513				
13				9.535				
14				9.582				
15				9.631				
16				9.694				
17				9.779				
18				9.860				
19				9.928				
20				9.982				
35		9.432						
36		9.461						
37	9.552	9.485	9.495	9.625				
38		9.512						
39		9.526						
40	9.593	9.525	9.563	9.632				
41	9.625	9.597	9.606	9.644				
42	9.649	9.637	9.640	9.661				
43	9.680	9.666	9.673	9.688				
44	9.691	9.688	9.703	9.712				
45	9.702	9.707	9.730	9.736				
46	9.732	9.722	9.748	9.764				
47	9.752	9.740	9.758	9.780				
48	9.828		9.804	9.867				
49	9.770		9.813	9.864				
50	9.760		9.809	9.891				
51	9.759		9.807	9.986				
52	9.743		9.807					
53				9.895				
54				0.000	9.461	10.233	9.429	9.811
55				0.000	9.449	10.098	9.424	9.835
56				*****	9.467	9.604	9.427	
57				9.792	*****	9.415	9.457	
58				9.772		9.478		9.778
59				9.749		9.948		*****
60				9.739	*****	9.922	*****	*****
61	9.661		9.696	9.699	9.719		9.738	
62	9.640		9.667	9.901	10.014		9.693	
63	9.633		9.662	9.676	9.804	9.607	9.927	9.690
64	9.625		9.648	9.662	9.743	9.641	9.852	9.682
65	9.617		9.644	9.659	9.699	9.644	9.794	9.677
66	9.610		9.636	9.651	9.658	9.640	9.743	9.668
67	9.601		9.626	9.642	9.622	9.635	9.693	9.652
68	9.597		9.616	9.631	9.591	9.625	9.644	9.644
69	9.586		9.607	9.622	9.561	9.609	9.599	9.630
70	9.575		9.596	9.607	9.537	9.594	9.557	9.611
71	9.566		9.583	9.598	9.510	9.572	9.514	9.584
72	9.562	*****	9.574	9.585	9.484	9.552	9.479	9.562
73	9.555	*****	9.566	9.578	9.464	9.528	9.445	9.535
74	9.555	*****	9.566	9.558	9.445	9.511	9.418	9.515
75	9.545	*****	9.567	9.570	9.432	9.496	9.396	9.497
76	9.506	*****	9.950	9.494	9.419	9.488	9.382	9.491
77	*****	*****	*****	*****	9.412	9.481	9.375	9.474
78	*****	*****	*****	*****	9.409	9.480	9.384	9.480
79	9.491	9.491	9.575	9.574	9.519	9.519	9.524	9.524

TABLE 20.—Concluded.

(i) Circumferential distortion; airflow, 35.41 kg/sec; readings 537 to 540

Axial station	Outer wall				Centerbody			
	Circumferential location, θ , deg							
	0	90	180	270	0	90	180	270
1		10.042						
2		10.037						
3		10.035						
4		10.032						
5		10.034						
6		10.032						
7		10.030						
8	10.024	10.025	10.025	10.027				
9		10.013						
10	10.004	10.005	10.006	10.010				
12				10.011				
13				10.015				
14				10.024				
15				10.033				
16				10.044				
17				10.060				
18				10.075				
19				10.087				
20				10.097				
35		9.993						
36		9.999						
37	10.013	10.003	10.005	10.031				
38		10.008						
39		10.011						
40	10.024	10.016	10.018	10.033				
41	10.030	10.024	10.026	10.035				
42	10.035	10.032	10.030	10.039				
43	10.041	10.038	10.039	10.043				
44	10.044	10.042	10.045	10.048				
45	10.046	10.047	10.051	10.052				
46	10.052	10.049	10.054	10.058				
47	10.054	10.049	10.055	10.060				
48	10.062		10.066	10.077				
49	10.059		10.067	10.076				
50	10.057		10.065	10.082				
51	10.056		10.064	10.099				
52	10.053		10.064					
53				10.080				
54				0.000	9.995	10.147	9.990	10.064
55				0.000	9.992	10.136	9.988	10.071
56				*****	9.996	10.048	9.987	
57				10.060	*****	10.003	9.993	
58				10.056		10.009		10.058
59				10.052		10.107		*****
60				10.051	*****	10.097	*****	*****
61	10.037		10.044	10.046	10.048		10.050	
62	10.033		10.039	10.082	10.106		10.043	
63	10.032		10.037	10.039	10.067	10.022	10.092	10.043
64	10.027		10.036	10.037	10.055	10.032	10.078	10.039
65	10.029		10.034	10.037	10.046	10.033	10.067	10.040
66	10.028		10.033	10.035	10.038	10.030	10.056	10.039
67	10.026		10.030	10.033	10.030	10.032	10.045	10.036
68	10.025		10.029	10.032	10.024	10.030	10.035	10.033
69	10.023		10.027	10.030	10.018	10.027	10.027	10.030
70	10.022		10.025	10.027	10.013	10.024	10.018	10.027
71	10.019		10.023	10.026	10.007	10.020	10.008	10.021
72	10.019	*****	10.021	10.023	10.003	10.016	10.002	10.017
73	10.017	*****	10.020	10.022	9.999	10.012	9.995	10.012
74	10.017	*****	10.019	10.019	9.995	10.009	9.990	10.008
75	10.015	*****	10.020	10.021	9.993	10.005	9.985	10.004
76	10.005	*****	10.056	10.007	9.990	10.004	9.983	10.003
77	*****	*****	*****	*****	9.989	10.002	9.981	10.000
78	*****	*****	*****	*****	9.988	10.002	9.984	10.001
79	10.007	10.007	10.022	10.021	10.011	10.011	10.010	10.010

TABLE 21.—CORNER 2 VANE SURFACE STATIC PRESSURE DISTRIBUTION WITH VANES A10
IN CORNER 1 AND VANES B IN CORNER 2—DISTORTED INFLOW

(a) 12.70-cm tip radial distortion; airflow, 80.11 kg/sec; readings 519 to 522

Fraction of chord, XC/C	Pressure, N/cm ²		Mach number		Coefficient	
	(a)	(b)	(a)	(b)	(a)	(b)
Section A						
0.000	9.776	9.777	0.242	0.242	0.267	0.268
0.025	9.681	9.776	0.269	0.242	0.091	0.266
0.050	9.676	9.564	0.271	0.301	0.082	-0.127
0.075	9.660	9.685	0.275	0.268	0.053	0.099
0.100	9.644	9.728	0.280	0.256	0.022	0.177
0.150	9.603	9.744	0.291	0.252	-0.054	0.207
0.200	9.568	9.750	0.299	0.250	-0.118	0.219
0.300	9.515	9.750	0.313	0.250	-0.217	0.219
0.500	9.457	9.753	0.327	0.249	-0.324	0.225
0.700	9.436	9.743	0.332	0.252	-0.363	0.206
0.800	9.450	9.734	0.328	0.255	-0.338	0.188
0.850	9.478	9.731	0.322	0.255	-0.286	0.184
0.900	9.539	9.717	0.309	0.259	-0.189	0.157
0.950	9.612	9.719	0.288	0.259	-0.036	0.161
Section B						
0.000	9.567	9.568	0.300	0.299	-0.120	-0.118
0.025	9.450	9.667	0.328	0.273	-0.337	0.065
0.050	9.441	9.273	0.330	0.367	-0.355	-0.655
0.075	9.418	9.508	0.336	0.314	-0.397	-0.229
0.100	9.395	9.563	0.341	0.301	-0.439	-0.129
0.150	9.352	9.594	0.351	0.293	-0.519	-0.070
0.200	9.326	9.609	0.357	0.289	-0.568	-0.043
0.300	9.298	9.618	0.363	0.287	-0.619	-0.026
0.500	9.325	9.629	0.357	0.284	-0.569	-0.005
0.700	9.329	9.630	0.356	0.283	-0.561	-0.004
0.800	9.353	9.627	0.351	0.234	-0.517	-0.009
0.850	9.383	9.629	0.344	0.284	-0.461	-0.006
0.900	9.444	9.615	0.330	0.287	-0.348	-0.032
0.950	9.524	9.601	0.310	0.291	-0.200	-0.057
Section C						
0.000	8.685	8.686	0.482	0.482	-1.755	-1.754
0.025	8.763	10.275	0.468	0.000	-1.611	1.192
0.050	8.804	9.116	0.461	0.401	-1.534	-0.956
0.075	8.797	9.567	0.462	0.300	-1.549	-0.121
0.100	8.814	9.684	0.459	0.269	-1.516	0.096
0.150	8.813	9.735	0.459	0.254	-1.518	0.190
0.200	8.801	9.759	0.461	0.247	-1.541	0.235
0.300	8.776	9.775	0.466	0.242	-1.586	0.265
0.500	8.875	9.790	0.447	0.238	-1.403	0.292
0.700	8.862	9.791	0.450	0.237	-1.427	0.294
0.800	8.994	9.785	0.425	0.239	-1.183	0.284
0.850	9.159	9.771	0.392	0.243	-0.877	0.258
0.900	9.331	9.725	0.355	0.257	-0.558	0.173
0.950	9.379	9.591	0.345	0.294	-0.469	-0.075
Section D						
0.000	9.472	9.469	0.323	0.324	-0.297	-0.302
0.025	10.241	9.584	0.000	0.295	1.129	-0.088
0.050	9.437	9.410	0.331	0.338	-0.361	-0.412
0.075	9.429	9.465	0.333	0.325	-0.376	-0.310
0.100	9.420	9.511	0.335	0.314	-0.393	-0.224
0.150	9.398	9.520	0.340	0.311	-0.433	-0.207
0.200	9.380	9.525	0.344	0.310	-0.467	-0.198
0.300	9.355	9.521	0.350	0.311	-0.513	-0.205
0.500	9.335	9.523	0.355	0.311	-0.551	-0.202
0.700	9.308	9.517	0.360	0.312	-0.601	-0.212
0.800	9.312	9.504	0.360	0.315	-0.594	-0.237
0.850	9.335	9.500	0.354	0.316	-0.550	-0.244
0.900	9.378	9.491	0.345	0.319	-0.471	-0.262
0.950	9.432	9.472	0.332	0.323	-0.376	-0.297

^aSuction surface.

^bPressure surface.

TABLE 21.—Continued.

(b) 12.70-cm tip radial distortion; airflow, 72.28 kg/sec; readings 515 to 518

Fraction of chord, XC/C	Pressure, N/cm ²		Mach number		Coefficient	
	(a)	(b)	(a)	(b)	(a)	(b)
Section A						
0.000	9.837	9.836	0.221	0.221	0.243	0.240
0.025	9.757	9.836	0.246	0.221	0.060	0.241
0.050	9.752	9.660	0.247	0.274	0.050	-0.160
0.075	9.741	9.761	0.250	0.245	0.025	0.069
0.100	9.724	9.794	0.256	0.234	-0.014	0.146
0.150	9.691	9.811	0.265	0.229	-0.089	0.184
0.200	9.663	9.816	0.273	0.227	-0.153	0.195
0.300	9.615	9.816	0.286	0.227	-0.262	0.195
0.500	9.568	9.819	0.298	0.226	-0.371	0.203
0.700	9.554	9.810	0.302	0.229	-0.403	0.181
0.800	9.566	9.799	0.299	0.233	-0.376	0.156
0.850	9.588	9.799	0.293	0.233	-0.325	0.157
0.900	9.630	9.789	0.282	0.236	-0.229	0.133
0.950	9.700	9.790	0.262	0.236	-0.069	0.135
Section B						
0.000	9.660	9.663	0.274	0.273	-0.160	-0.154
0.025	9.559	9.745	0.300	0.249	-0.391	0.034
0.050	9.550	9.414	0.303	0.335	-0.412	-0.722
0.075	9.530	9.606	0.308	0.288	-0.458	-0.283
0.100	9.511	9.658	0.312	0.274	-0.501	-0.166
0.150	9.473	9.682	0.321	0.267	-0.587	-0.110
0.200	9.454	9.694	0.326	0.264	-0.630	-0.082
0.300	9.429	9.704	0.332	0.261	-0.688	-0.060
0.500	9.453	9.714	0.326	0.258	-0.634	-0.037
0.700	9.454	9.714	0.326	0.259	-0.631	-0.038
0.800	9.474	9.711	0.321	0.259	-0.585	-0.044
0.850	9.500	9.714	0.315	0.258	-0.524	-0.038
0.900	9.554	9.702	0.302	0.262	-0.403	-0.064
0.950	9.623	9.691	0.284	0.265	-0.244	-0.089
Section C						
0.000	8.947	8.946	0.433	0.433	-1.788	-1.789
0.025	9.003	10.239	0.422	0.000	-1.658	1.161
0.050	9.048	9.306	0.413	0.360	-1.557	-0.969
0.075	9.038	9.657	0.415	0.274	-1.579	-0.167
0.100	9.051	9.762	0.413	0.244	-1.550	0.072
0.150	9.049	9.802	0.413	0.232	-1.553	0.165
0.200	9.040	9.822	0.415	0.226	-1.575	0.208
0.300	9.019	9.835	0.419	0.221	-1.623	0.239
0.500	9.097	9.845	0.403	0.218	-1.445	0.261
0.700	9.086	9.845	0.406	0.218	-1.470	0.262
0.800	9.189	9.839	0.384	0.220	-1.234	0.249
0.850	9.322	9.829	0.356	0.223	-0.932	0.224
0.900	9.469	9.793	0.322	0.235	-0.596	0.144
0.950	9.514	9.607	0.312	0.266	-0.494	-0.100
Section D						
0.000	9.578	9.574	0.295	0.297	-0.348	-0.358
0.025	10.280	9.671	0.000	0.271	1.253	-0.135
0.050	9.556	9.533	0.301	0.307	-0.397	-0.451
0.075	9.542	9.574	0.304	0.296	-0.429	-0.356
0.100	9.536	9.614	0.306	0.286	-0.443	-0.266
0.150	9.516	9.619	0.311	0.285	-0.489	-0.253
0.200	9.502	9.625	0.314	0.283	-0.521	-0.240
0.300	9.484	9.622	0.319	0.284	-0.561	-0.247
0.500	9.466	9.623	0.323	0.284	-0.602	-0.245
0.700	9.448	9.620	0.327	0.285	-0.645	-0.253
0.800	9.449	9.610	0.327	0.287	-0.642	-0.275
0.850	9.471	9.603	0.322	0.289	-0.592	-0.291
0.900	9.503	9.599	0.314	0.290	-0.519	-0.301
0.950	9.548	9.584	0.303	0.294	-0.417	-0.334

^aSuction surface
^bPressure surface.

TABLE 21.—Continued.

(c) 12.70-cm tip radial distortion; airflow, 35.30 kg/sec; readings 511 to 514

Fraction of chord. XC/C	Pressure, N/cm ²		Mach number		Coefficient	
	(a)	(b)	(a)	(b)	(a)	(b)
Section A						
0.000	10.070	10.070	0.101	0.101	0.294	0.297
0.025	10.051	10.068	0.114	0.103	0.111	0.279
0.050	10.051	10.029	0.114	0.127	0.109	-0.100
0.075	10.047	10.050	0.116	0.114	0.072	0.105
0.100	10.043	10.061	0.119	0.107	0.030	0.211
0.150	10.035	10.065	0.123	0.105	-0.043	0.246
0.200	10.028	10.067	0.128	0.103	-0.117	0.266
0.300	10.017	10.067	0.133	0.104	-0.218	0.265
0.500	10.009	10.067	0.138	0.103	-0.299	0.272
0.700	10.006	10.066	0.140	0.104	-0.331	0.256
0.800	10.009	10.062	0.138	0.107	-0.302	0.218
0.850	10.014	10.064	0.135	0.105	-0.246	0.238
0.900	10.022	10.062	0.131	0.107	-0.175	0.217
0.950	10.041	10.062	0.120	0.107	0.016	0.222
Section B						
0.000	10.033	10.033	0.125	0.124	-0.061	-0.060
0.025	10.013	10.016	0.136	0.111	-0.258	0.158
0.050	10.011	9.997	0.137	0.144	-0.278	-0.412
0.075	10.007	10.008	0.139	0.138	-0.315	-0.308
0.100	10.003	10.039	0.141	0.121	-0.351	-0.003
0.150	9.997	10.042	0.144	0.119	-0.418	0.024
0.200	9.992	10.041	0.146	0.120	-0.460	0.017
0.300	9.988	10.046	0.148	0.117	-0.504	0.060
0.500	9.992	10.048	0.146	0.116	-0.462	0.079
0.700	9.993	10.048	0.146	0.116	-0.449	0.078
0.800	9.997	10.048	0.144	0.116	-0.414	0.080
0.850	10.002	10.048	0.141	0.116	-0.365	0.086
0.900	10.009	10.046	0.138	0.117	-0.297	0.067
0.950	10.026	10.043	0.129	0.119	-0.137	0.037
Section C						
0.000	9.897	9.897	0.188	0.187	-1.393	-1.389
0.025	9.887	10.147	0.191	0.000	-1.483	1.042
0.050	9.920	9.979	0.178	0.153	-1.162	-0.593
0.075	9.919	10.018	0.179	0.133	-1.177	-0.212
0.100	9.920	10.061	0.178	0.107	-1.168	0.209
0.150	9.918	10.066	0.179	0.104	-1.181	0.258
0.200	9.917	10.069	0.180	0.102	-1.196	0.283
0.300	9.913	10.071	0.181	0.101	-1.238	0.306
0.500	9.927	10.072	0.175	0.100	-1.097	0.316
0.700	9.926	10.072	0.176	0.100	-1.111	0.313
0.800	9.943	10.071	0.169	0.101	-0.943	0.304
0.850	9.966	10.069	0.159	0.102	-0.719	0.286
0.900	9.997	10.062	0.144	0.107	-0.415	0.222
0.950	10.014	10.045	0.135	0.118	-0.248	0.051
Section D						
0.000	10.020	10.020	0.132	0.132	-0.193	-0.190
0.025	10.218	10.043	0.000	0.119	1.741	0.029
0.050	10.017	10.017	0.134	0.134	-0.225	-0.223
0.075	10.015	10.023	0.135	0.131	-0.238	-0.166
0.100	10.014	10.029	0.135	0.127	-0.248	-0.100
0.150	10.011	10.032	0.137	0.125	-0.277	-0.078
0.200	10.009	10.032	0.138	0.125	-0.300	-0.073
0.300	10.005	10.031	0.140	0.126	-0.334	-0.083
0.500	10.002	10.031	0.141	0.126	-0.367	-0.079
0.700	9.997	10.030	0.144	0.126	-0.412	-0.091
0.800	9.998	10.028	0.143	0.127	-0.405	-0.108
0.850	10.001	10.028	0.142	0.127	-0.377	-0.111
0.900	10.007	10.027	0.139	0.128	-0.319	-0.122
0.950	10.015	10.025	0.134	0.129	-0.237	-0.147

^aSection surface.
^bPressure surface.

TABLE 21.—Continued.

(d) 6.35-cm tip radial distortion; airflow, 77.07 kg/sec; readings 523 to 526

Fraction of chord, XC/C	Pressure, N/cm^2		Mach number		Coefficient	
	(a)	(b)	(a)	(b)	(a)	(b)
Section A						
0.000	9.823	9.822	0.231	0.231	0.278	0.177
0.025	9.733	9.797	0.258	0.239	0.099	0.225
0.050	9.722	9.602	0.261	0.293	0.076	-0.164
0.075	9.702	9.723	0.267	0.261	0.036	0.078
0.100	9.680	9.702	0.273	0.249	-0.007	0.157
0.150	9.633	9.779	0.285	0.244	-0.102	0.139
0.200	9.596	9.786	0.295	0.242	-0.176	0.204
0.300	9.538	9.787	0.310	0.242	-0.292	0.205
0.500	9.492	9.786	0.321	0.242	-0.384	0.204
0.700	9.466	9.775	0.327	0.246	-0.435	0.181
0.800	9.479	9.767	0.324	0.248	-0.410	0.166
0.850	9.502	9.764	0.318	0.249	-0.364	0.161
0.900	9.556	9.751	0.305	0.252	-0.255	0.135
0.950	9.645	9.754	0.282	0.252	-0.077	0.141
Section B						
0.000	9.538	9.539	0.310	0.309	-0.292	-0.290
0.025	9.402	9.778	0.342	0.245	-0.563	0.187
0.050	9.399	9.216	0.342	0.382	-0.570	-0.935
0.075	9.373	9.552	0.348	0.306	-0.621	-0.264
0.100	9.350	9.602	0.354	0.293	-0.668	-0.163
0.150	9.300	9.644	0.364	0.282	-0.767	-0.079
0.200	9.274	9.665	0.370	0.277	-0.820	-0.038
0.300	9.245	9.676	0.376	0.274	-0.878	-0.016
0.500	9.279	9.650	0.369	0.270	-0.809	0.012
0.700	9.284	9.690	0.368	0.270	-0.799	0.012
0.800	9.318	9.684	0.360	0.272	-0.731	-0.000
0.850	9.359	9.686	0.351	0.271	-0.649	0.005
0.900	9.447	9.666	0.331	0.276	-0.473	-0.035
0.950	9.538	9.645	0.309	0.282	-0.291	-0.079
Section C						
0.000	9.017	9.021	0.422	0.422	-1.334	-1.326
0.025	8.929	10.136	0.439	0.090	-1.510	0.904
0.050	9.020	9.099	0.422	0.406	-1.327	-1.169
0.075	8.998	9.521	0.426	0.312	-1.372	-0.310
0.100	9.000	9.678	0.425	0.273	-1.367	-0.012
0.150	8.981	9.721	0.429	0.261	-1.405	0.074
0.200	8.965	9.740	0.432	0.256	-1.438	0.113
0.300	8.936	9.755	0.438	0.251	-1.495	0.142
0.500	8.996	9.779	0.426	0.244	-1.375	0.190
0.700	8.990	9.775	0.428	0.246	-1.388	0.181
0.800	9.101	9.766	0.406	0.248	-1.166	0.164
0.850	9.244	9.752	0.376	0.252	-0.879	0.135
0.900	9.417	9.715	0.338	0.263	-0.534	0.062
0.950	9.469	9.614	0.326	0.290	-0.429	-0.139
Section D						
0.000	9.558	9.558	0.305	0.305	-0.252	-0.252
0.025	10.172	9.484	0.055	0.323	0.975	-0.400
0.050	9.503	9.363	0.317	0.351	-0.356	-0.642
0.075	9.491	9.457	0.321	0.329	-0.385	-0.453
0.100	9.478	9.504	0.324	0.318	-0.412	-0.360
0.150	9.452	9.520	0.330	0.314	-0.464	-0.328
0.200	9.430	9.526	0.335	0.313	-0.507	-0.316
0.300	9.404	9.525	0.341	0.313	-0.560	-0.318
0.500	9.379	9.525	0.347	0.313	-0.609	-0.317
0.700	9.361	9.523	0.351	0.313	-0.646	-0.322
0.800	9.364	9.512	0.350	0.316	-0.640	-0.344
0.850	9.381	9.509	0.347	0.317	-0.606	-0.349
0.900	9.412	9.502	0.339	0.318	-0.543	-0.364
0.950	9.458	9.488	0.329	0.322	-0.452	-0.391

^aSuction surface.^bPressure surface.

TABLE 21.—Continued.

(e) 6.35-cm tip radial distortion; airflow, 71.36 kg/sec; readings 527 to 530

Fraction of chord, <i>XC/C</i>	Pressure, N/cm ²		Mach number		Coefficient	
	(a)	(b)	(a)	(b)	(a)	(b)
Section A						
0.000	9.858	9.857	0.216	0.216	0.254	0.253
0.025	9.784	9.836	0.240	0.223	0.080	0.202
0.050	9.774	9.673	0.243	0.272	0.059	-0.178
0.075	9.757	9.775	0.248	0.243	0.018	0.061
0.100	9.738	9.811	0.254	0.232	-0.027	0.144
0.150	9.697	9.826	0.265	0.227	-0.121	0.178
0.200	9.664	9.829	0.275	0.226	-0.198	0.186
0.300	9.616	9.830	0.287	0.225	-0.311	0.189
0.500	9.579	9.831	0.297	0.225	-0.398	0.190
0.700	9.558	9.821	0.302	0.228	-0.448	0.167
0.800	9.568	9.817	0.300	0.230	-0.424	0.158
0.850	9.590	9.811	0.294	0.231	-0.371	0.146
0.900	9.634	9.802	0.283	0.234	-0.269	0.123
0.950	9.709	9.803	0.262	0.234	-0.094	0.126
Section B						
0.000	9.619	9.618	0.287	0.287	-0.303	-0.308
0.025	9.500	9.823	0.317	0.228	-0.582	0.172
0.050	9.497	9.344	0.317	0.353	-0.589	-0.947
0.075	9.475	9.625	0.323	0.285	-0.640	-0.291
0.100	9.453	9.617	0.328	0.273	-0.692	-0.182
0.150	9.413	9.709	0.337	0.262	-0.785	-0.094
0.200	9.387	9.720	0.343	0.257	-0.845	-0.054
0.300	9.363	9.737	0.349	0.254	-0.903	-0.029
0.500	9.392	9.748	0.342	0.251	-0.834	-0.002
0.700	9.399	9.749	0.341	0.250	-0.819	0.000
0.800	9.426	9.744	0.334	0.252	-0.755	-0.013
0.850	9.464	9.746	0.325	0.251	-0.668	-0.007
0.900	9.535	9.729	0.308	0.256	-0.501	-0.046
0.950	9.616	9.709	0.287	0.262	-0.311	-0.094
Section C						
0.000	9.191	9.192	0.386	0.385	-1.305	-1.303
0.025	9.083	10.135	0.408	0.083	-1.557	0.901
0.050	9.181	9.254	0.388	0.372	-1.328	-1.156
0.075	9.161	9.597	0.392	0.292	-1.374	-0.355
0.100	9.160	9.745	0.392	0.252	-1.378	-0.009
0.150	9.145	9.780	0.395	0.241	-1.412	0.071
0.200	9.131	9.795	0.398	0.236	-1.444	0.108
0.300	9.107	9.808	0.403	0.232	-1.500	0.137
0.500	9.158	9.828	0.393	0.226	-1.383	0.185
0.700	9.153	9.824	0.393	0.227	-1.392	0.175
0.800	9.247	9.817	0.374	0.230	-1.174	0.158
0.850	9.368	9.804	0.347	0.234	-0.891	0.129
0.900	9.515	9.772	0.313	0.243	-0.547	0.054
0.950	9.566	9.688	0.300	0.268	-0.428	-0.142
Section D						
0.000	9.633	9.633	0.283	0.283	-0.273	-0.271
0.025	10.192	9.573	0.000	0.299	1.036	-0.412
0.050	9.589	9.469	0.294	0.324	-0.374	-0.656
0.075	9.577	9.547	0.298	0.305	-0.403	-0.472
0.100	9.566	9.588	0.300	0.295	-0.428	-0.377
0.150	9.543	9.602	0.306	0.291	-0.482	-0.343
0.200	9.526	9.606	0.310	0.290	-0.522	-0.334
0.300	9.502	9.606	0.316	0.290	-0.578	-0.334
0.500	9.484	9.609	0.321	0.289	-0.620	-0.327
0.700	9.465	9.603	0.325	0.291	-0.665	-0.341
0.800	9.468	9.593	0.324	0.293	-0.657	-0.364
0.850	9.481	9.591	0.321	0.294	-0.627	-0.369
0.900	9.509	9.581	0.314	0.297	-0.561	-0.393
0.950	9.547	9.576	0.305	0.298	-0.472	-0.405

^aSuction surface.^bPressure surface.

TABLE 21 —Continued.

(f) 6.35-cm tip radial distortion; airflow, 35.26 kg/sec; readings 532 to 536

Fraction of chord, XC/C	Pressure, N/cm ²		Mach number		Coefficient	
	(a)	(b)	(a)	(b)	(a)	(b)
Section A						
0.000	10.067	10.067	0.103	0.103	0.273	0.275
0.025	10.053	10.072	0.112	0.099	0.134	0.324
0.050	10.052	10.036	0.113	0.122	0.127	-0.024
0.075	10.048	10.054	0.115	0.111	0.088	0.148
0.100	10.043	10.064	0.118	0.105	0.045	0.248
0.150	10.035	10.068	0.123	0.102	-0.038	0.282
0.200	10.027	10.068	0.127	0.102	-0.112	0.285
0.300	10.017	10.068	0.133	0.102	-0.208	0.290
0.500	10.012	10.069	0.136	0.101	-0.266	0.297
0.700	10.007	10.066	0.138	0.103	-0.311	0.271
0.800	10.010	10.066	0.137	0.103	-0.284	0.270
0.850	10.015	10.064	0.134	0.105	-0.234	0.250
0.900	10.025	10.063	0.128	0.105	-0.130	0.236
0.950	10.042	10.063	0.119	0.105	0.027	0.240
Section B						
0.000	10.022	10.021	0.130	0.131	-0.159	-0.172
0.025	10.000	10.072	0.142	0.099	-0.380	0.327
0.050	10.000	9.986	0.142	0.149	-0.381	-0.512
0.075	9.996	10.009	0.144	0.137	-0.422	-0.294
0.100	9.992	10.042	0.146	0.118	-0.460	0.036
0.150	9.981	10.048	0.151	0.115	-0.562	0.086
0.200	9.980	10.051	0.152	0.113	-0.578	0.117
0.300	9.975	10.053	0.154	0.112	-0.625	0.136
0.500	9.984	10.055	0.151	0.111	-0.569	0.158
0.700	9.982	10.055	0.150	0.110	-0.551	0.163
0.800	9.987	10.055	0.148	0.111	-0.501	0.157
0.850	9.994	10.055	0.145	0.111	-0.433	0.157
0.900	10.006	10.053	0.139	0.112	-0.323	0.137
0.950	10.025	10.048	0.129	0.115	-0.136	0.090
Section C						
0.000	9.938	9.938	0.170	0.170	-0.984	-0.980
0.025	9.918	10.130	0.179	0.040	-1.179	0.895
0.050	9.939	9.971	0.170	0.156	-0.978	-0.664
0.075	9.938	10.008	0.171	0.138	-0.988	-0.305
0.100	9.938	10.063	0.171	0.105	-0.986	0.236
0.150	9.935	10.063	0.172	0.105	-1.016	0.239
0.200	9.932	10.062	0.173	0.106	-1.039	0.229
0.300	9.928	10.067	0.175	0.102	-1.082	0.278
0.500	9.938	10.071	0.171	0.100	-0.988	0.312
0.700	9.938	10.070	0.171	0.101	-0.988	0.305
0.800	9.953	10.069	0.164	0.101	-0.841	0.295
0.850	9.972	10.064	0.155	0.105	-0.651	0.248
0.900	10.002	10.062	0.141	0.106	-0.363	0.223
0.950	10.023	10.047	0.129	0.116	-0.150	0.083
Section D						
0.000	10.032	10.022	0.124	0.125	-0.063	-0.068
0.025	10.184	10.024	0.000	0.129	1.417	-0.146
0.050	10.023	10.004	0.130	0.140	-0.151	-0.338
0.075	10.021	10.014	0.131	0.135	-0.172	-0.241
0.100	10.019	10.024	0.132	0.129	-0.194	-0.142
0.150	10.014	10.024	0.134	0.129	-0.237	-0.139
0.200	10.013	10.028	0.135	0.127	-0.256	-0.109
0.300	10.007	10.027	0.138	0.127	-0.306	-0.111
0.500	10.004	10.027	0.140	0.127	-0.340	-0.112
0.700	10.000	10.026	0.142	0.128	-0.376	-0.125
0.800	10.001	10.024	0.141	0.129	-0.370	-0.140
0.850	10.003	10.025	0.140	0.128	-0.351	-0.130
0.900	10.007	10.023	0.138	0.130	-0.306	-0.155
0.950	10.015	10.022	0.134	0.130	-0.235	-0.163

^aSuction surface.^bPressure surface.

TABLE 21.—Continued.

(g) Circumferential distortion; airflow, 78.72 kg/sec; readings 545 to 548

Fraction of chord, XC/C	Pressure, N/cm ²		Mach number		Coefficient	
	(a)	(b)	(a)	(b)	(a)	(b)
Section A						
0.000	9.744	9.744	0.257	0.257	0.131	0.131
0.025	9.635	9.916	0.287	0.202	-0.079	0.463
0.050	9.653	9.595	0.282	0.298	-0.044	-0.156
0.075	9.648	9.763	0.284	0.258	-0.053	0.130
0.100	9.637	9.797	0.287	0.241	-0.075	0.235
0.150	9.601	9.814	0.296	0.236	-0.145	0.267
0.200	9.570	9.818	0.304	0.235	-0.205	0.275
0.300	9.514	9.816	0.318	0.236	-0.313	0.271
0.500	9.435	9.828	0.336	0.232	-0.466	0.295
0.700	9.413	9.809	0.341	0.238	-0.508	0.256
0.800	9.436	9.787	0.336	0.242	-0.463	0.234
0.850	9.475	9.787	0.327	0.244	-0.388	0.219
0.900	9.541	9.771	0.311	0.249	-0.262	0.184
0.950	9.632	9.771	0.288	0.249	-0.085	0.184
Section B						
0.000	9.543	9.542	0.311	0.311	-0.257	-0.259
0.025	9.480	9.732	0.326	0.261	-0.379	0.109
0.050	9.485	9.415	0.324	0.341	-0.368	-0.505
0.075	9.475	9.575	0.327	0.303	-0.388	-0.195
0.100	9.465	9.617	0.329	0.292	-0.409	-0.114
0.150	9.439	9.637	0.335	0.287	-0.458	-0.076
0.200	9.424	9.646	0.339	0.284	-0.486	-0.058
0.300	9.406	9.651	0.343	0.283	-0.521	-0.048
0.500	9.408	9.659	0.342	0.281	-0.517	-0.033
0.700	9.405	9.657	0.343	0.281	-0.524	-0.036
0.800	9.418	9.646	0.340	0.284	-0.498	-0.058
0.850	9.441	9.652	0.335	0.283	-0.455	-0.046
0.900	9.486	9.642	0.324	0.285	-0.367	-0.066
0.950	9.558	9.631	0.307	0.288	-0.228	-0.087
Section C						
0.000	9.110	9.110	0.406	0.406	-1.094	-1.094
0.025	8.988	10.097	0.430	0.123	-1.330	0.813
0.050	9.067	9.071	0.414	0.413	-1.177	-1.170
0.075	9.043	9.547	0.418	0.310	-1.215	-0.250
0.100	9.049	9.668	0.418	0.279	-1.213	-0.016
0.150	9.025	9.718	0.422	0.265	-1.258	0.081
0.200	9.008	9.738	0.426	0.259	-1.291	0.121
0.300	8.981	9.754	0.431	0.254	-1.343	0.151
0.500	9.027	9.779	0.422	0.247	-1.254	0.199
0.700	9.038	9.776	0.420	0.248	-1.233	0.194
0.800	9.155	9.770	0.397	0.250	-1.008	0.182
0.850	9.289	9.756	0.369	0.254	-0.748	0.155
0.900	9.434	9.721	0.337	0.264	-0.469	0.087
0.950	9.477	9.525	0.326	0.290	-0.385	-0.099
Section D						
0.000	9.340	9.340	0.358	0.358	-0.650	-0.649
0.025	9.988	9.838	0.175	0.229	0.602	0.314
0.050	9.340	9.431	0.358	0.337	-0.649	-0.474
0.075	9.338	9.527	0.358	0.315	-0.653	-0.289
0.100	9.328	9.618	0.360	0.292	-0.673	-0.113
0.150	9.306	9.639	0.365	0.286	-0.715	-0.071
0.200	9.284	9.648	0.370	0.284	-0.758	-0.053
0.300	9.256	9.645	0.376	0.285	-0.812	-0.059
0.500	9.263	9.651	0.374	0.283	-0.799	-0.049
0.700	9.229	9.650	0.381	0.283	-0.865	-0.051
0.800	9.259	9.624	0.375	0.290	-0.806	-0.101
0.850	9.320	9.616	0.362	0.292	-0.689	-0.115
0.900	9.416	9.597	0.341	0.297	-0.502	-0.153
0.950	9.472	9.554	0.328	0.308	-0.394	-0.237

^aSuction surface.^bPressure surface.

TABLE 21.—Continued.

(h) Circumferential distortion; airflow, 73.27 kg/sec; readings 541 to 544

Fraction of chord, XC/C	Pressure, N/cm ²		Mach number		Coefficient	
	(a)	(b)	(a)	(b)	(a)	(b)
Section A						
0.000	9.792	9.792	0.240	0.240	0.119	0.119
0.025	9.704	9.938	0.266	0.191	-0.077	0.445
0.050	9.718	9.670	0.262	0.275	-0.047	0.153
0.075	9.713	9.792	0.264	0.240	-0.057	0.119
0.100	9.703	9.838	0.266	0.226	-0.080	0.223
0.150	9.671	9.853	0.275	0.221	-0.151	0.256
0.200	9.643	9.858	0.283	0.219	-0.213	0.267
0.300	9.593	9.855	0.296	0.220	-0.325	0.260
0.500	9.526	9.866	0.313	0.217	-0.476	0.283
0.700	9.504	9.848	0.317	0.222	-0.514	0.245
0.800	9.530	9.837	0.312	0.226	-0.467	0.220
0.850	9.561	9.833	0.304	0.227	-0.397	0.212
0.900	9.618	9.817	0.289	0.232	-0.271	0.175
0.950	9.698	9.818	0.268	0.232	-0.091	0.177
Section B						
0.000	9.614	9.615	0.290	0.290	-0.278	-0.276
0.025	9.562	9.785	0.304	0.242	-0.396	0.104
0.050	9.568	9.515	0.302	0.315	-0.381	-0.499
0.075	9.561	9.642	0.304	0.283	-0.398	-0.217
0.100	9.552	9.687	0.306	0.271	-0.418	-0.115
0.150	9.530	9.702	0.311	0.267	-0.466	-0.082
0.200	9.517	9.709	0.315	0.265	-0.495	-0.066
0.300	9.504	9.713	0.318	0.263	-0.526	-0.057
0.500	9.505	9.720	0.318	0.261	-0.522	-0.041
0.700	9.500	9.718	0.319	0.262	-0.532	-0.046
0.800	9.512	9.714	0.316	0.263	-0.507	-0.055
0.850	9.531	9.714	0.311	0.263	-0.464	-0.054
0.900	9.571	9.700	0.302	0.266	-0.376	-0.073
0.950	9.633	9.697	0.285	0.268	-0.237	-0.092
Section C						
0.000	9.250	9.250	0.375	0.375	-1.092	-1.093
0.025	9.125	10.101	0.401	0.114	-1.372	0.811
0.050	9.202	9.224	0.385	0.381	-1.199	-1.150
0.075	9.185	9.611	0.389	0.291	-1.237	-0.285
0.100	9.186	9.729	0.389	0.259	-1.236	-0.021
0.150	9.157	9.775	0.394	0.245	-1.299	0.082
0.200	9.149	9.794	0.396	0.240	-1.318	0.123
0.300	9.125	9.807	0.401	0.256	-1.371	0.154
0.500	9.166	9.828	0.393	0.229	-1.279	0.200
0.700	9.174	9.826	0.391	0.230	-1.262	0.194
0.800	9.277	9.820	0.369	0.232	-1.033	0.181
0.850	9.396	9.808	0.343	0.235	-0.767	0.156
0.900	9.527	9.779	0.312	0.244	-0.473	0.090
0.950	9.568	9.697	0.302	0.268	-0.381	-0.094
Section D						
0.000	9.440	9.438	0.333	0.334	-0.667	-0.672
0.025	10.036	9.879	0.149	0.212	0.664	0.313
0.050	9.442	9.525	0.333	0.313	-0.663	-0.477
0.075	9.438	9.605	0.334	0.293	-0.672	-0.298
0.100	9.431	9.686	0.335	0.271	-0.688	-0.118
0.150	9.413	9.703	0.339	0.266	-0.729	-0.080
0.200	9.391	9.712	0.344	0.264	-0.777	-0.060
0.300	9.370	9.709	0.349	0.265	-0.823	-0.066
0.500	9.376	9.716	0.348	0.263	-0.810	-0.050
0.700	9.348	9.713	0.354	0.264	-0.874	-0.057
0.800	9.374	9.692	0.348	0.269	-0.815	-0.104
0.850	9.428	9.684	0.333	0.272	-0.695	-0.123
0.900	9.510	9.669	0.317	0.276	-0.512	-0.157
0.950	9.559	9.629	0.304	0.286	-0.401	-0.245

^aSuction surface.^bPressure surface.

TABLE 21.—Concluded.

(i) Circumferential distortion; airflow, 35.41 kg/sec; readings 537 to 540

Fraction of chord, XC/C	Pressure, N/cm ²		Mach number		Coefficient	
	(a)	(b)	(a)	(b)	(a)	(b)
Section A						
0.000	10.053	10.054	0.113	0.113	0.127	0.130
0.025	10.032	10.084	0.126	0.092	-0.081	0.428
0.050	10.040	10.035	0.121	0.124	-0.003	-0.047
0.075	10.039	10.055	0.122	0.112	-0.013	0.142
0.100	10.036	10.066	0.123	0.105	-0.038	0.251
0.150	10.030	10.070	0.127	0.102	-0.101	0.286
0.200	10.024	10.070	0.131	0.102	-0.162	0.287
0.300	10.013	10.069	0.136	0.103	-0.261	0.280
0.500	10.000	10.071	0.143	0.101	-0.387	0.300
0.700	9.998	10.069	0.144	0.103	-0.413	0.276
0.800	10.001	10.067	0.142	0.104	-0.376	0.256
0.850	10.009	10.066	0.138	0.105	-0.299	0.246
0.900	10.021	10.063	0.132	0.107	-0.190	0.219
0.950	10.039	10.063	0.122	0.107	-0.015	0.219
Section B						
0.000	10.025	10.025	0.130	0.130	-0.151	-0.149
0.025	10.016	10.064	0.135	0.106	-0.239	0.232
0.050	10.018	10.017	0.134	0.134	-0.221	-0.228
0.075	10.016	10.026	0.135	0.129	-0.235	-0.139
0.100	10.015	10.044	0.135	0.119	-0.244	0.037
0.150	10.011	10.042	0.137	0.117	-0.283	0.059
0.200	10.009	10.047	0.138	0.117	-0.302	0.066
0.300	10.007	10.048	0.139	0.117	-0.322	0.073
0.500	10.007	10.049	0.140	0.116	-0.326	0.089
0.700	10.006	10.049	0.140	0.116	-0.331	0.086
0.800	10.008	10.049	0.139	0.116	-0.311	0.081
0.850	10.012	10.049	0.137	0.116	-0.273	0.082
0.900	10.016	10.048	0.135	0.117	-0.235	0.071
0.950	10.027	10.045	0.129	0.118	-0.126	0.047
Section C						
0.000	9.947	9.947	0.168	0.168	-0.908	-0.905
0.025	9.923	10.124	0.178	0.053	-1.139	0.807
0.050	9.941	9.969	0.170	0.158	-0.965	-0.689
0.075	9.940	10.002	0.171	0.142	-0.974	-0.371
0.100	9.939	10.061	0.171	0.108	-0.979	0.202
0.150	9.935	10.062	0.173	0.108	-1.018	0.208
0.200	9.933	10.065	0.174	0.106	-1.041	0.235
0.300	9.928	10.067	0.175	0.104	-1.084	0.258
0.500	9.938	10.070	0.171	0.102	-0.988	0.293
0.700	9.939	10.070	0.171	0.102	-0.982	0.287
0.800	9.953	10.070	0.165	0.103	-0.843	0.283
0.850	9.972	10.068	0.156	0.104	-0.661	0.265
0.900	10.001	10.063	0.143	0.107	-0.384	0.224
0.950	10.025	10.051	0.130	0.115	-0.145	0.104
Section D						
0.000	9.993	9.993	0.146	0.147	-0.457	-0.461
0.025	10.156	10.077	0.000	0.097	1.121	0.356
0.050	9.997	10.016	0.145	0.135	-0.421	-0.235
0.075	9.996	10.028	0.145	0.128	-0.432	-0.116
0.100	9.994	10.042	0.146	0.120	-0.445	0.019
0.150	9.991	10.047	0.147	0.117	-0.478	0.064
0.200	9.988	10.048	0.149	0.117	-0.508	0.073
0.300	9.983	10.048	0.151	0.117	-0.552	0.072
0.500	9.985	10.048	0.151	0.116	-0.540	0.079
0.700	9.980	10.048	0.153	0.117	-0.585	0.071
0.800	9.984	10.044	0.151	0.119	-0.550	0.033
0.850	9.992	10.044	0.147	0.119	-0.469	0.032
0.900	10.006	10.040	0.140	0.121	-0.331	0.001
0.950	10.019	10.034	0.133	0.125	-0.208	-0.057

^aSuction surface^bPressure surface

TABLE 23.—TOTAL PRESSURE DISTRIBUTION FOR CORNER 1 WITH VANES A10
IN CORNER 1 AND VANES A4 IN CORNER 2—DISTORTED INFLOW

(a) 12.70-cm tip radial distortion; airflow, 77.64 kg/sec; readings 1232 to 1235

Span- wise location, percent of span	Circumferential location, θ , deg								Average
	0	45	90	135	180	225	270	315	
Corner 1 inlet rake									
5.0	10.118	10.132	10.142	10.143	10.120	10.084	10.110	10.095	10.118
10.0	10.122	10.096	10.095	10.075	10.065	10.060	10.089	10.110	10.089
15.0	10.025	10.049	10.035	10.036	10.012	10.030	10.038	10.048	10.034
20.0	10.001	10.013	10.032	10.047	10.023	10.042	9.990	9.997	10.018
30.0	10.235	10.086	10.179	10.308	10.152	10.100	10.071	10.309	10.180
50.0	10.952	10.956	10.978	10.954	10.962	10.971	10.945	10.955	10.959
70.0	10.929	10.954	10.938	10.928	10.941	10.938	10.940	10.952	10.940
90.0	10.744	10.798	10.770	10.752	10.785	10.727	10.691	10.772	10.755
Corner 1 inlet boundary layer rake									
1.0	9.987	10.054	10.006	9.926	9.956	9.960	9.995	9.932	9.977
2.0	10.044	10.127	10.082	10.004	10.023	10.024	10.067	9.999	10.046
3.0	10.072	10.138	10.127	10.065	10.071	10.059	10.094	10.037	10.083
4.0	10.101	10.136	10.146	10.114	10.106	10.080	10.107	10.076	10.108
5.0	10.117	10.130	10.142	10.139	10.123	10.087	10.109	10.092	10.118
7.5	10.132	10.115	10.117	10.115	10.106	10.034	10.106	10.110	10.111
10.0	10.124	10.097	10.100	10.075	10.056	10.055	10.080	10.106	10.087
12.5	10.079	10.075	10.067	10.050	10.019	10.037	10.053	10.075	10.057
Diffuser exit rake									
5.0	9.817	10.062	9.680	9.844	9.854	9.901	10.032	9.897	9.886
10.0	9.875	9.923	9.681	9.912	9.882	9.959	10.072	9.938	9.905
15.0	9.913	9.935	9.682	9.954	9.898	10.044	10.121	10.008	9.944
20.0	9.947	9.979	9.710	10.019	9.933	10.164	10.181	10.116	10.006
30.0	10.071	10.098	9.845	10.168	10.034	10.387	10.293	10.370	10.158
50.0	10.303	10.493	10.445	10.594	10.319	10.624	10.449	10.569	10.475
70.0	10.698	10.459	10.386	10.871	10.674	10.796	10.474	10.727	10.636
90.0	10.692	10.696	10.428	10.537	10.578	10.422	10.369	10.485	10.526
Diffuser exit boundary layer rake									
1.0	9.765	9.777	9.661	9.759	9.786	9.826	9.945	9.841	9.795
2.0	9.783	9.813	9.668	9.784	9.809	9.854	9.983	9.864	9.820
3.0	9.792	9.841	9.674	9.805	9.828	9.870	10.005	9.876	9.836
4.0	9.801	9.871	9.678	9.833	9.846	9.884	10.021	9.886	9.853
5.0	9.813	9.920	9.739	9.851	9.857	9.894	10.031	9.956	9.882
7.5	9.837	9.925	9.669	9.893	9.873	9.925	10.057	9.916	9.887
10.0	9.871	9.922	9.683	9.916	9.881	9.960	10.074	9.940	9.906
12.5	9.897	9.925	9.684	9.933	9.888	9.999	10.098	9.972	9.924

TABLE 23.—Continued.

(b) 12.70-cm tip radial distortion; airflow, 72.35 kg/sec; readings 1224 to 1227

Span-wise location, percent of span	Circumferential location, θ , deg								Average
	0	45	90	135	180	225	270	315	
Corner 1 inlet rake									
5.0	10.109	10.123	10.137	10.136	10.118	10.085	10.110	10.092	10.114
10.0	10.121	10.096	10.098	10.077	10.069	10.068	10.080	10.095	10.088
15.0	10.041	10.060	10.045	10.049	10.021	10.043	10.050	10.056	10.046
20.0	10.017	10.027	10.042	10.058	10.038	10.054	10.006	10.011	10.032
30.0	10.228	10.088	10.178	10.272	10.162	10.107	10.080	10.285	10.175
50.0	10.840	10.843	10.865	10.844	10.852	10.854	10.834	10.843	10.847
70.0	10.819	10.842	10.828	10.823	10.834	10.825	10.828	10.840	10.830
90.0	10.656	10.703	10.679	10.665	10.690	10.643	10.604	10.675	10.664
Corner 1 inlet boundary layer rake									
1.0	10.005	10.049	10.014	9.944	9.979	9.970	10.009	9.946	9.990
2.0	10.052	10.115	10.081	10.010	10.038	10.025	10.071	10.006	10.050
3.0	10.077	10.127	10.119	10.063	10.077	10.057	10.096	10.042	10.082
4.0	10.101	10.129	10.136	10.108	10.106	10.075	10.107	10.079	10.105
5.0	10.112	10.124	10.135	10.132	10.118	10.086	10.111	10.096	10.114
7.5	10.127	10.110	10.116	10.117	10.105	10.086	10.105	10.107	10.109
10.0	10.123	10.099	10.097	10.079	10.059	10.064	10.082	10.106	10.089
12.5	10.086	10.080	10.073	10.061	10.028	10.045	10.061	10.081	10.064
Diffuser exit rake									
5.0	9.861	10.100	10.020	10.213	10.068	9.934	10.046	9.933	10.022
10.0	9.904	9.949	9.737	9.939	9.913	9.979	10.085	9.970	9.935
15.0	9.940	9.957	9.742	9.977	9.926	10.064	10.129	10.029	9.971
20.0	9.972	9.998	9.765	10.033	9.954	10.161	10.187	10.122	10.024
30.0	10.080	10.103	9.879	10.164	10.050	10.346	10.282	10.339	10.155
50.0	10.281	10.437	10.419	10.534	10.293	10.560	10.420	10.505	10.431
70.0	10.616	10.433	10.362	10.773	10.598	10.706	10.435	10.643	10.571
90.0	10.624	10.628	10.399	10.488	10.529	10.401	10.339	10.447	10.482
Diffuser exit boundary layer rake									
1.0	9.814	9.820	9.720	9.804	9.830	9.865	9.965	9.882	9.837
2.0	9.827	9.851	9.724	9.826	9.852	9.892	10.000	9.903	9.859
3.0	9.837	9.879	9.730	9.846	9.869	9.907	10.019	9.914	9.875
4.0	9.847	9.903	9.733	9.867	9.883	9.918	10.032	9.925	9.838
5.0	9.850	9.941	9.787	9.885	9.892	9.929	10.041	10.009	9.917
7.5	9.871	9.949	9.734	9.923	9.907	9.959	10.063	9.949	9.919
10.0	9.897	9.951	9.738	9.942	9.912	9.987	10.082	9.969	9.935
12.5	9.922	9.951	9.736	9.960	9.919	10.020	10.102	9.997	9.951

TABLE 23.—Continued.

(c) 12.70-cm tip radial distortion; airflow, 35.34 kg/sec; readings 1228 to 1231

Span-wise location, percent of span	Circumferential location, θ , deg								Average
	0	45	90	135	180	225	270	315	
Corner 1 inlet rake									
5.0	10.124	10.131	10.133	10.129	10.124	10.116	10.124	10.118	10.125
10.0	10.132	10.130	10.130	10.124	10.123	10.121	10.129	10.129	10.127
15.0	10.118	10.121	10.116	10.119	10.113	10.121	10.121	10.121	10.119
20.0	10.112	10.115	10.119	10.121	10.117	10.122	10.120	10.111	10.117
30.0	10.158	10.128	10.146	10.164	10.143	10.126	10.126	10.161	10.144
50.0	10.268	10.267	10.273	10.267	10.269	10.269	10.265	10.269	10.268
70.0	10.263	10.266	10.265	10.264	10.267	10.265	10.265	10.264	10.265
90.0	10.230	10.238	10.235	10.231	10.235	10.236	10.225	10.235	10.237
Corner 1 inlet boundary layer rake									
1.0	10.094	10.107	10.099	10.095	10.101	10.086	10.097	10.089	10.096
2.0	10.105	10.119	10.113	10.107	10.113	10.098	10.107	10.100	10.108
3.0	10.112	10.124	10.124	10.117	10.119	10.105	10.113	10.107	10.115
4.0	10.120	10.129	10.130	10.124	10.122	10.112	10.120	10.115	10.121
5.0	10.124	10.129	10.133	10.130	10.126	10.116	10.126	10.120	10.126
7.5	10.131	10.129	10.134	10.129	10.126	10.121	10.131	10.128	10.129
10.0	10.131	10.128	10.131	10.124	10.120	10.119	10.128	10.130	10.127
12.5	10.125	10.126	10.124	10.121	10.115	10.119	10.123	10.128	10.123
Diffuser exit rake									
5.0	10.079	10.197	10.151	10.130	10.134	10.102	10.122	10.099	10.127
10.0	10.086	10.098	10.055	10.094	10.088	10.115	10.136	10.108	10.097
15.0	10.094	10.102	10.058	10.103	10.093	10.127	10.148	10.120	10.106
20.0	10.103	10.111	10.062	10.114	10.086	10.145	10.159	10.138	10.115
30.0	10.125	10.126	10.091	10.140	10.120	10.175	10.177	10.178	10.142
50.0	10.165	10.185	10.195	10.211	10.165	10.218	10.200	10.199	10.192
70.0	10.229	10.201	10.187	10.253	10.221	10.243	10.192	10.231	10.220
90.0	10.231	10.224	10.190	10.204	10.214	10.198	10.179	10.202	10.205
Diffuser exit boundary layer rake									
1.0	10.070	10.068	10.051	10.068	10.072	10.063	10.101	10.085	10.075
2.0	10.074	10.074	10.052	10.072	10.077	10.090	10.109	10.092	10.080
3.0	10.076	10.078	10.053	10.076	10.081	10.093	10.113	10.095	10.083
4.0	10.078	10.082	10.054	10.080	10.084	10.097	10.119	10.097	10.086
5.0	10.081	10.109	10.077	10.083	10.086	10.100	10.121	10.133	10.099
7.5	10.083	10.095	10.055	10.091	10.090	10.107	10.129	10.104	10.094
10.0	10.088	10.098	10.055	10.095	10.090	10.113	10.135	10.110	10.098
12.5	10.091	10.099	10.056	10.100	10.091	10.119	10.141	10.115	10.101

TABLE 23.—Continued.

(d) 6.35-cm tip radial distortion; airflow, 77.56 kg/sec; readings 1236 to 1239

Span-wise location, percent of span	Circumferential location, θ , deg								Average
	0	45	90	135	180	225	270	315	
Corner 1 inlet rake									
5.0	9.928	9.959	9.970	9.960	9.943	9.932	9.945	9.904	9.943
10.0	9.955	9.942	9.999	9.958	9.924	9.932	9.960	9.942	9.952
15.0	10.010	10.013	10.255	10.108	10.021	10.100	10.148	10.009	10.083
20.0	10.290	10.250	10.574	10.401	10.249	10.409	10.468	10.220	10.358
30.0	10.657	10.683	10.680	10.663	10.682	10.681	10.677	10.691	10.677
50.0	10.665	10.679	10.691	10.672	10.672	10.687	10.660	10.682	10.676
70.0	10.642	10.668	10.651	10.650	10.647	10.663	10.664	10.661	10.656
90.0	10.482	10.537	10.501	10.501	10.504	10.461	10.434	10.503	10.490
Corner 1 inlet boundary layer rake									
1.0	9.817	9.876	9.865	9.808	9.844	9.831	9.862	9.815	9.840
2.0	9.858	9.924	9.918	9.857	9.888	9.874	9.909	9.851	9.885
3.0	9.884	9.943	9.950	9.897	9.917	9.902	9.926	9.871	9.911
4.0	9.910	9.953	9.965	9.932	9.938	9.920	9.937	9.895	9.931
5.0	9.930	9.958	9.967	9.958	9.949	9.928	9.943	9.914	9.943
7.5	9.951	9.948	9.955	9.973	9.942	9.928	9.941	9.939	9.947
10.0	9.956	9.939	9.995	9.961	9.927	9.936	9.969	9.947	9.954
12.5	9.961	9.951	10.109	10.010	9.966	10.010	10.055	9.970	10.004
Diffuser exit rake									
5.0	9.898	9.816	9.647	9.799	9.904	10.087	10.115	10.087	9.918
10.0	9.943	9.889	9.652	9.899	9.953	10.194	10.184	10.159	9.984
15.0	9.990	9.889	9.668	9.956	9.995	10.299	10.228	10.218	10.030
20.0	10.033	9.919	9.719	10.048	10.044	10.384	10.256	10.284	10.086
30.0	10.154	10.110	9.947	10.292	10.170	10.473	10.275	10.414	10.229
50.0	10.533	10.462	10.339	10.594	10.505	10.591	10.391	10.517	10.492
70.0	10.616	10.221	10.187	10.543	10.496	10.550	10.280	10.477	10.421
90.0	10.414	10.404	10.221	10.306	10.327	10.214	10.172	10.263	10.290
Diffuser exit boundary layer rake									
1.0	9.814	9.727	9.632	9.729	9.836	9.939	9.997	9.959	9.829
2.0	9.846	9.755	9.633	9.747	9.864	9.989	10.037	10.002	9.859
3.0	9.863	9.775	9.633	9.765	9.886	10.023	10.064	10.028	9.880
4.0	9.881	9.798	9.637	9.786	9.906	10.056	10.092	10.052	9.901
5.0	9.895	9.851	9.698	9.803	9.918	10.076	10.105	10.108	9.932
7.5	9.921	9.865	9.642	9.855	9.939	10.134	10.146	10.116	9.952
10.0	9.943	9.892	9.647	9.902	9.948	10.187	10.177	10.148	9.981
12.5	9.968	9.898	9.655	9.930	9.956	10.239	10.199	10.177	10.003

TABLE 23.—Continued.

(e) 6.35-cm tip radial distortion; airflow, 72.25 kg/sec; readings 1241 to 1244

Span-wise location, percent of span	Circumferential location, θ , deg								Average
	0	45	90	135	180	225	270	315	
Corner 1 inlet rake									
5.0	9.937	9.958	9.971	9.959	9.954	9.931	9.950	9.910	9.946
10.0	9.965	9.948	9.996	9.962	9.935	9.939	9.966	9.950	9.958
15.0	10.012	10.010	10.220	10.084	10.018	10.082	10.131	10.009	10.071
20.0	10.261	10.222	10.503	10.349	10.221	10.352	10.411	10.193	10.314
30.0	10.577	10.599	10.593	10.578	10.603	10.593	10.590	10.604	10.592
50.0	10.587	10.594	10.601	10.588	10.594	10.599	10.576	10.595	10.592
70.0	10.562	10.585	10.566	10.569	10.566	10.579	10.577	10.581	10.573
90.0	10.426	10.470	10.435	10.433	10.443	10.399	10.379	10.442	10.428
Corner 1 inlet boundary layer rake									
1.0	9.837	9.885	9.878	9.826	9.865	9.845	9.865	9.824	9.853
2.0	9.873	9.928	9.924	9.869	9.903	9.884	9.918	9.857	9.894
3.0	9.896	9.944	9.954	9.903	9.928	9.909	9.935	9.878	9.918
4.0	9.920	9.958	9.971	9.934	9.945	9.924	9.947	9.901	9.937
5.0	9.934	9.960	9.972	9.958	9.955	9.932	9.952	9.917	9.948
7.5	9.957	9.956	9.962	9.973	9.947	9.934	9.954	9.943	9.953
10.0	9.962	9.947	10.001	9.964	9.934	9.945	9.978	9.952	9.960
12.5	9.965	9.958	10.101	10.006	9.967	10.006	10.055	9.971	10.004
Diffuser exit rake									
5.0	9.909	9.842	9.681	9.825	9.919	10.070	10.090	10.067	9.925
10.0	9.953	9.902	9.689	9.910	9.962	10.165	10.154	10.132	9.983
15.0	9.995	9.902	9.707	9.957	9.997	10.254	10.195	10.184	10.024
20.0	10.032	9.929	9.747	10.034	10.041	10.331	10.221	10.247	10.073
30.0	10.135	10.096	9.941	10.248	10.146	10.415	10.238	10.361	10.198
50.0	10.467	10.410	10.334	10.522	10.438	10.512	10.335	10.449	10.434
70.0	10.542	10.205	10.172	10.493	10.428	10.486	10.254	10.418	10.375
90.0	10.374	10.365	10.203	10.264	10.291	10.201	10.149	10.237	10.260
Diffuser exit boundary layer rake									
1.0	9.835	9.758	9.673	9.767	9.845	9.943	9.991	9.972	9.848
2.0	9.862	9.784	9.676	9.783	9.870	9.989	10.026	10.011	9.875
3.0	9.880	9.801	9.676	9.799	9.892	10.020	10.053	10.036	9.895
4.0	9.896	9.820	9.676	9.816	9.912	10.049	10.074	10.057	9.913
5.0	9.918	9.851	9.708	9.832	9.926	10.070	10.091	10.094	9.936
7.5	9.933	9.882	9.684	9.879	9.951	10.123	10.126	10.110	9.961
10.0	9.955	9.902	9.689	9.917	9.969	10.173	10.156	10.137	9.987
12.5	9.973	9.905	9.697	9.941	9.985	10.217	10.177	10.162	10.007

TABLE 23.—Continued.

(f) 6.35-cm tip radial distortion; airflow, 35.26 kg/sec; readings 1246 to 1249

Span-wise location, percent of span	Circumferential location, θ , deg								Average
	0	45	90	135	180	225	270	315	
Corner 1 inlet rake									
5.0	10.088	10.096	10.103	10.098	10.078	10.086	10.098	10.089	10.092
10.0	10.098	10.097	10.108	10.104	10.093	10.093	10.103	10.101	10.100
15.0	10.107	10.111	10.146	10.128	10.113	10.127	10.133	10.111	10.122
20.0	10.154	10.152	10.200	10.179	10.156	10.179	10.191	10.147	10.170
30.0	10.215	10.219	10.222	10.220	10.220	10.217	10.222	10.226	10.220
50.0	10.217	10.218	10.224	10.220	10.215	10.213	10.221	10.223	10.220
70.0	10.214	10.214	10.217	10.219	10.216	10.215	10.219	10.220	10.217
90.0	10.186	10.193	10.191	10.189	10.186	10.186	10.186	10.194	10.189
Corner 1 inlet boundary layer rake									
1.0	10.070	10.081	10.075	10.066	10.074	10.067	10.072	10.061	10.071
2.0	10.076	10.088	10.085	10.075	10.083	10.076	10.080	10.069	10.079
3.0	10.081	10.094	10.091	10.081	10.087	10.080	10.086	10.074	10.084
4.0	10.087	10.098	10.097	10.087	10.093	10.087	10.091	10.080	10.090
5.0	10.091	10.099	10.099	10.092	10.096	10.090	10.095	10.084	10.093
7.5	10.099	10.102	10.101	10.099	10.100	10.094	10.098	10.094	10.098
10.0	10.104	10.103	10.104	10.099	10.097	10.098	10.101	10.097	10.100
12.5	10.104	10.107	10.120	10.108	10.107	10.116	10.114	10.102	10.110
Diffuser exit rake									
5.0	10.090	10.073	10.043	10.077	10.093	10.116	10.123	10.124	10.093
10.0	10.100	10.083	10.043	10.091	10.101	10.136	10.136	10.139	10.104
15.0	10.107	10.087	10.049	10.103	10.109	10.155	10.144	10.147	10.113
20.0	10.116	10.097	10.058	10.119	10.116	10.171	10.151	10.158	10.123
30.0	10.137	10.133	10.099	10.161	10.138	10.183	10.151	10.177	10.147
50.0	10.201	10.184	10.168	10.204	10.196	10.204	10.164	10.194	10.189
70.0	10.211	10.155	10.144	10.211	10.189	10.200	10.156	10.191	10.182
90.0	10.181	10.176	10.150	10.163	10.173	10.153	10.139	10.160	10.162
Diffuser exit boundary layer rake									
1.0	10.069	10.063	10.044	10.061	10.072	10.094	10.106	10.099	10.076
2.0	10.075	10.067	10.043	10.064	10.077	10.103	10.113	10.107	10.081
3.0	10.079	10.070	10.044	10.066	10.080	10.108	10.118	10.112	10.085
4.0	10.081	10.074	10.045	10.070	10.085	10.114	10.123	10.117	10.089
5.0	10.086	10.082	10.057	10.073	10.087	10.117	10.125	10.131	10.095
7.5	10.090	10.083	10.046	10.082	10.095	10.129	10.133	10.130	10.098
10.0	10.095	10.087	10.047	10.089	10.098	10.138	10.139	10.136	10.104
12.5	10.099	10.088	10.049	10.094	10.102	10.147	10.143	10.142	10.108

TABLE 23.—Continued.

(g) Circumferential distortion; airflow, 79.22 kg/sec; readings 1254 to 1257

Span-wise location, percent of span	Circumferential location, θ , deg								Average
	0	45	90	135	180	225	270	315	
Corner 1 inlet rake									
5.0	9.982	10.534	10.503	10.560	10.473	10.509	10.506	10.562	10.454
10.0	9.988	10.607	10.568	10.601	10.566	10.599	10.615	10.619	10.520
15.0	9.971	10.616	10.552	10.601	10.600	10.588	10.610	10.593	10.516
20.0	9.953	10.618	10.534	10.610	10.582	10.590	10.607	10.601	10.512
30.0	9.940	10.623	10.506	10.593	10.543	10.604	10.597	10.597	10.500
50.0	9.940	9.937	10.437	10.582	10.498	10.599	10.453	9.977	10.303
70.0	9.946	9.876	10.044	10.607	10.404	10.591	10.083	9.954	10.188
90.0	9.932	9.918	9.926	10.054	10.141	10.171	10.039	9.954	10.017
Corner 1 inlet boundary layer rake									
1.0	9.856	10.267	10.225	10.291	10.221	10.317	10.306	10.272	10.219
2.0	9.913	10.360	10.327	10.430	10.322	10.402	10.391	10.413	10.320
3.0	9.944	10.420	10.394	10.501	10.387	10.446	10.433	10.492	10.377
4.0	9.968	10.483	10.455	10.537	10.443	10.484	10.478	10.551	10.425
5.0	9.980	10.525	10.502	10.562	10.485	10.516	10.516	10.580	10.458
7.5	9.989	10.583	10.570	10.598	10.553	10.574	10.596	10.614	10.510
10.0	9.986	10.604	10.572	10.609	10.587	10.596	10.616	10.624	10.524
12.5	9.976	10.621	10.560	10.600	10.595	10.592	10.611	10.604	10.520
Diffuser exit rake									
5.0	9.961	10.222	9.973	10.295	10.136	10.135	10.276	10.167	10.146
10.0	9.895	10.312	9.946	10.290	10.246	10.161	10.358	10.200	10.176
15.0	9.841	10.363	9.961	10.358	10.264	10.263	10.373	10.314	10.217
20.0	9.856	10.437	10.080	10.454	10.321	10.383	10.343	10.434	10.288
30.0	9.874	10.312	10.382	10.471	10.413	10.520	10.324	10.522	10.352
50.0	9.879	9.973	9.941	10.324	10.442	10.498	10.320	10.016	10.174
70.0	9.847	9.848	9.832	10.001	10.455	10.433	10.189	9.819	10.053
90.0	9.871	9.904	10.034	10.210	10.301	10.236	10.079	9.931	10.071
Diffuser exit boundary layer rake									
1.0	9.912	10.013	9.915	10.106	10.006	10.038	10.106	10.101	10.025
2.0	9.947	10.077	9.946	10.172	10.051	10.093	10.166	10.153	10.076
3.0	9.964	10.132	9.962	10.231	10.089	10.122	10.207	10.172	10.110
4.0	9.969	10.183	9.970	10.282	10.121	10.130	10.245	10.178	10.135
5.0	9.970	10.230	10.022	10.306	10.149	10.135	10.269	10.203	10.161
7.5	9.944	10.295	9.958	10.304	10.215	10.137	10.326	10.182	10.170
10.0	9.907	10.314	9.939	10.292	10.256	10.158	10.359	10.207	10.179
12.5	9.871	10.332	9.936	10.323	10.269	10.198	10.373	10.251	10.194

TABLE 23.—Continued.

(h) Circumferential distortion; airflow, 73.68 kg/sec; readings 1258 to 1261

Span-wise location, percent of span	Circumferential location, θ , deg								Average
	0	45	90	135	180	225	270	315	
Corner 1 inlet rake									
5.0	9.997	10.475	10.451	10.496	10.419	10.446	10.441	10.500	10.403
10.0	10.005	10.537	10.507	10.535	10.514	10.525	10.545	10.550	10.465
15.0	9.991	10.543	10.491	10.535	10.530	10.522	10.541	10.529	10.460
20.0	9.975	10.547	10.476	10.542	10.515	10.525	10.539	10.532	10.456
30.0	9.967	10.550	10.453	10.533	10.482	10.535	10.531	10.531	10.447
50.0	9.963	9.960	10.392	10.521	10.438	10.531	10.412	10.005	10.278
70.0	9.967	9.908	10.055	10.544	10.362	10.519	10.090	9.985	10.179
90.0	9.956	9.949	9.955	10.084	10.132	10.170	10.052	9.981	10.035
Corner 1 inlet boundary layer rake									
1.0	9.889	10.240	10.211	10.260	10.196	10.287	10.276	10.239	10.200
2.0	9.936	10.323	10.298	10.378	10.286	10.365	10.348	10.360	10.287
3.0	9.963	10.373	10.355	10.439	10.345	10.402	10.384	10.430	10.336
4.0	9.985	10.425	10.408	10.474	10.393	10.428	10.423	10.484	10.377
5.0	9.997	10.463	10.448	10.496	10.432	10.459	10.455	10.508	10.407
7.5	10.006	10.515	10.504	10.529	10.490	10.510	10.527	10.539	10.453
10.0	10.003	10.533	10.506	10.536	10.520	10.534	10.546	10.551	10.466
12.5	9.997	10.547	10.496	10.531	10.529	10.527	10.542	10.536	10.463
Diffuser exit rake									
5.0	9.987	10.210	9.987	10.272	10.128	10.130	10.248	10.172	10.142
10.0	9.933	10.287	9.959	10.270	10.236	10.152	10.321	10.195	10.169
15.0	9.887	10.334	9.972	10.334	10.248	10.243	10.328	10.286	10.204
20.0	9.894	10.402	10.074	10.413	10.301	10.344	10.309	10.391	10.266
30.0	9.915	10.298	10.338	10.421	10.377	10.466	10.298	10.467	10.323
50.0	9.922	9.992	9.969	10.304	10.396	10.445	10.293	10.035	10.170
70.0	9.894	9.883	9.867	10.039	10.424	10.395	10.190	9.868	10.070
90.0	9.925	9.951	10.063	10.220	10.299	10.230	10.089	9.969	10.093
Diffuser exit boundary layer rake									
1.0	9.933	10.033	9.944	10.110	10.014	10.055	10.107	10.102	10.037
2.0	9.964	10.094	9.972	10.170	10.053	10.102	10.157	10.149	10.083
3.0	9.977	10.135	9.983	10.219	10.084	10.128	10.195	10.166	10.111
4.0	9.984	10.178	9.990	10.263	10.116	10.134	10.225	10.172	10.133
5.0	9.986	10.220	9.999	10.282	10.139	10.138	10.248	10.193	10.150
7.5	9.964	10.276	9.980	10.278	10.202	10.136	10.294	10.174	10.163
10.0	9.926	10.288	9.965	10.272	10.237	10.153	10.322	10.193	10.169
12.5	9.897	10.305	9.963	10.301	10.249	10.192	10.337	10.231	10.184

TABLE 23.—Concluded.

(i) Circumferential distortion; airflow, 35.41 kg/sec; readings 1250 to 1253

Span-wise location, percent of span	Circumferential location, θ , deg								Average
	0	45	90	135	180	225	270	315	
Corner 1 inlet rake									
5.0	10.109	10.189	10.192	10.198	10.181	10.188	10.185	10.197	10.180
10.0	10.110	10.207	10.205	10.209	10.205	10.207	10.212	10.210	10.196
15.0	10.106	10.208	10.202	10.211	10.209	10.205	10.210	10.209	10.195
20.0	10.104	10.211	10.198	10.209	10.206	10.206	10.210	10.208	10.194
30.0	10.099	10.210	10.200	10.212	10.200	10.208	10.209	10.209	10.194
50.0	10.100	10.100	10.184	10.208	10.193	10.207	10.186	10.111	10.161
70.0	10.098	10.086	10.120	10.211	10.180	10.207	10.127	10.105	10.142
90.0	10.096	10.096	10.101	10.121	10.130	10.137	10.116	10.101	10.112
Corner 1 inlet boundary layer rake									
1.0	10.083	10.146	10.146	10.147	10.134	10.154	10.151	10.145	10.138
2.0	10.091	10.160	10.163	10.170	10.151	10.169	10.166	10.169	10.155
3.0	10.097	10.170	10.174	10.185	10.163	10.178	10.173	10.183	10.165
4.0	10.104	10.181	10.184	10.193	10.175	10.183	10.181	10.194	10.174
5.0	10.107	10.190	10.192	10.198	10.185	10.191	10.190	10.198	10.181
7.5	10.110	10.205	10.206	10.206	10.201	10.205	10.207	10.204	10.193
10.0	10.109	10.208	10.206	10.208	10.206	10.209	10.214	10.208	10.196
12.5	10.108	10.210	10.204	10.210	10.209	10.207	10.212	10.210	10.196
Diffuser exit rake									
5.0	10.103	10.146	10.097	10.157	10.129	10.133	10.146	10.137	10.131
10.0	10.092	10.159	10.092	10.166	10.153	10.136	10.161	10.141	10.137
15.0	10.083	10.171	10.100	10.182	10.153	10.154	10.165	10.159	10.146
20.0	10.084	10.190	10.111	10.189	10.159	10.174	10.166	10.180	10.157
30.0	10.088	10.173	10.174	10.187	10.176	10.197	10.165	10.197	10.170
50.0	10.088	10.109	10.101	10.167	10.178	10.194	10.160	10.120	10.140
70.0	10.085	10.083	10.076	10.126	10.187	10.185	10.146	10.083	10.122
90.0	10.099	10.104	10.124	10.162	10.171	10.155	10.127	10.106	10.131
Diffuser exit boundary layer rake									
1.0	10.088	10.113	10.087	10.126	10.104	10.113	10.120	10.124	10.109
2.0	10.095	10.125	10.093	10.139	10.112	10.124	10.131	10.133	10.119
3.0	10.097	10.133	10.095	10.148	10.118	10.129	10.137	10.136	10.124
4.0	10.098	10.141	10.097	10.156	10.125	10.132	10.143	10.139	10.129
5.0	10.100	10.149	10.128	10.159	10.130	10.132	10.147	10.145	10.136
7.5	10.096	10.157	10.097	10.161	10.143	10.134	10.157	10.139	10.135
10.0	10.090	10.158	10.094	10.167	10.150	10.135	10.163	10.143	10.137
12.5	10.085	10.163	10.098	10.176	10.152	10.143	10.167	10.150	10.142

TABLE 24.—TOTAL PRESSURE DISTRIBUTION FOR VARIABLE INLET GUIDE VANES WITH VANES A10 IN CORNER 1 AND VANES A4 IN CORNER 2—DISTORTED INFLOW

(a) 12.70-cm tip radial distortion; airflow, 77.64 kg/sec; readings 1232 to 1235

Circumferential location, θ , deg	Spanwise location, percent of span from tip							
	5	10	15	20	30	50	70	90
VIGV inlet rake								
0		9.785			9.908	10.166	10.429	10.542
30		9.947			10.133	10.280	10.442	10.426
60		9.698			9.922	10.132	10.338	10.188
90		9.493			9.747	9.905	10.094	9.990
120		9.770			9.937	10.143	10.458	10.249
150		9.857			10.106	10.260	10.521	10.433
180		9.801			9.979	10.194	10.454	10.556
210		9.776			9.900	10.192	10.397	10.451
240		10.107			10.295	10.435	10.570	10.503
270		9.959			10.029	10.194	10.275	10.196
300		10.216			10.390	10.449	10.554	10.387
330		9.802			9.956	10.206	10.434	10.526
AVG		9.851			10.025	10.213	10.414	10.370
VIGV exit rake								
15	9.780	9.998	9.865	9.906	10.039	10.248	10.473	10.508
45	9.864	9.994	9.835	9.889	10.039	10.172	10.376	10.298
75	9.762	9.922	9.774	9.773	9.772	9.952	10.232	10.156
105	9.737	9.781	9.770	9.766	9.815	9.979	10.302	10.232
135	9.821	9.829	9.862	9.926	10.050	10.210	10.508	10.349
165	9.829	9.890	9.934	9.988	10.118	10.356	10.578	10.462
195	9.703	9.727	9.761	9.814	9.936	10.157	10.428	10.452
225	9.972	9.974	9.973	9.981	10.041	10.244	10.452	10.506
255	10.036	10.076	10.119	10.160	10.243	10.479	10.499	10.382
285	10.100	10.136	10.162	10.189	10.246	10.464	10.512	10.336
315	10.044	10.036	10.014	10.010	10.047	10.230	10.475	10.494
345	9.732	9.767	9.822	9.887	10.002	10.207	10.460	10.495
AVG	9.865	9.928	9.908	9.941	10.029	10.225	10.441	10.387

TABLE 24.—Continued.

(b) 12.70-cm tip radial distortion; airflow, 72.35 kg/sec; readings 1224 to 1227

Circumferential location, θ , deg	Spanwise location, percent of span from tip							
	5	10	15	20	30	50	70	90
VIGV inlet rake								
0		9.830			9.934	10.157	10.390	10.490
30		9.972			10.127	10.251	10.405	10.394
60		9.746			9.948	10.126	10.320	10.184
90		9.569			9.786	9.925	10.104	10.014
120		9.822			9.963	10.137	10.420	10.242
150		9.900			10.109	10.239	10.471	10.390
180		9.849			9.997	10.180	10.404	10.517
210		9.821			9.927	10.184	10.368	10.401
240		10.130			10.279	10.397	10.515	10.446
270		9.974			10.045	10.189	10.266	10.187
300		10.210			10.353	10.404	10.495	10.354
330		9.844			9.974	10.196	10.395	10.476
AVG		9.889			10.037	10.157	10.379	10.342
VIGV exit rake								
15	9.822	9.997	9.890	9.922	10.047	10.228	10.424	10.466
45	9.892	10.041	9.869	9.919	10.043	10.161	10.344	10.277
75	9.806	9.969	9.825	9.819	9.817	9.962	10.225	10.141
105	9.790	9.828	9.824	9.820	9.865	10.002	10.287	10.233
135	9.864	9.868	9.894	9.955	10.054	10.199	10.463	10.326
165	9.859	9.921	9.970	10.018	10.127	10.324	10.516	10.430
195	9.760	9.779	9.811	9.861	9.966	10.160	10.377	10.400
225	10.000	10.003	9.998	10.004	10.058	10.235	10.414	10.448
255	10.058	10.097	10.133	10.171	10.244	10.430	10.454	10.347
285	10.119	10.153	10.174	10.197	10.249	10.443	10.461	10.311
315	10.060	10.044	10.022	10.019	10.057	10.218	10.428	10.447
345	9.784	9.813	9.860	9.912	10.017	10.195	10.417	10.442
AVG	9.901	9.959	9.939	9.968	10.045	10.213	10.401	10.356

TABLE 24.—Continued.

(c) 12.70-cm tip radial distortion; airflow, 35.34 kg/sec; readings 1228 to 1231

Circumferential location, θ , deg	Spanwise location, percent of span from tip							
	5	10	15	20	30	50	70	90
VIGV inlet rake								
0		10.072			10.089	10.127	10.180	10.204
30		10.099			10.128	10.147	10.185	10.187
60		10.055			10.096	10.128	10.169	10.145
90		10.023			10.064	10.088	10.132	10.111
120		10.072			10.100	10.132	10.186	10.163
150		10.086			10.123	10.154	10.197	10.193
180		10.078			10.106	10.138	10.184	10.204
210		10.073			10.094	10.142	10.177	10.185
240		10.111			10.151	10.183	10.211	10.186
270		10.111			10.134	10.159	10.167	10.143
300		10.134			10.162	10.182	10.204	10.172
330		10.075			10.103	10.146	10.184	10.200
AVG		10.083			10.113	10.144	10.181	10.175
VIGV exit rake								
15	10.083	10.141	10.078	10.086	10.111	10.135	10.172	10.163
45	10.061	10.122	10.067	10.067	10.068	10.097	10.152	10.135
75	10.060	10.119	10.066	10.066	10.067	10.093	10.153	10.135
105	10.077	10.078	10.082	10.095	10.115	10.144	10.197	10.180
135	10.073	10.087	10.097	10.108	10.128	10.160	10.201	10.194
165	10.074	10.089	10.099	10.110	10.130	10.168	10.211	10.197
195	10.105	10.107	10.108	10.109	10.123	10.159	10.193	10.183
225	10.123	10.132	10.142	10.153	10.171	10.199	10.199	10.173
255	10.124	10.132	10.140	10.149	10.166	10.196	10.198	10.175
285	10.110	10.109	10.108	10.110	10.121	10.153	10.191	10.195
315	10.064	10.070	10.078	10.089	10.109	10.144	10.185	10.196
345	10.065	10.067	10.075	10.086	10.106	10.138	10.177	10.192
AVG	10.085	10.105	10.095	10.102	10.118	10.149	10.186	10.176

TABLE 24.—Continued.

(d) 6.35-cm tip radial distortion; airflow, 77.56 kg/sec; readings 1236 to 1239

Circumferential location, θ , deg	Spanwise location, percent of span from tip							
	5	10	15	20	30	50	70	90
VIGV inlet rake								
0		9.864			10.029	10.301	10.490	10.400
30		9.959			10.188	10.369	10.322	10.290
60		9.672			9.909	10.197	10.248	10.073
90		9.524			9.709	10.020	10.012	9.881
120		9.741			9.941	10.211	10.361	10.133
150		9.893			10.207	10.410	10.461	10.324
180		9.886			10.166	10.262	10.472	10.321
210		9.815			10.031	10.315	10.437	10.336
240		10.030			10.241	10.425	10.498	10.340
270		9.980			9.999	10.153	10.159	10.079
300		10.193			10.357	10.435	10.448	10.226
330		9.818			10.069	10.378	10.501	10.357
AVG		9.865			10.066	10.285	10.367	10.230
VIGV exit rake								
15	9.859	9.950	9.844	9.910	10.078	10.262	10.281	10.174
45	9.729	9.847	9.700	9.715	9.758	10.043	10.137	10.031
75	9.728	9.850	9.697	9.717	9.753	10.034	10.150	10.035
105	9.649	9.874	9.905	9.970	10.105	10.310	10.429	10.243
135	9.900	9.977	10.020	10.071	10.211	10.472	10.496	10.290
165	9.916	9.990	10.024	10.069	10.221	10.496	10.511	10.259
195	9.965	9.992	10.019	10.054	10.168	10.405	10.497	10.355
225	10.020	10.053	10.085	10.122	10.193	10.310	10.325	10.211
255	10.000	10.038	10.074	10.110	10.181	10.315	10.332	10.214
285	10.025	10.032	10.033	10.053	10.132	10.309	10.462	10.306
315	9.780	9.834	9.905	9.992	10.128	10.353	10.458	10.414
345	9.784	9.833	9.897	9.979	10.107	10.336	10.425	10.404
AVG	9.880	9.939	9.934	9.980	10.086	10.304	10.375	10.245

TABLE 24.—Continued.

(e) 6.35-cm tip radial distortion; airflow, 72.25 kg/sec; readings 1241 to 1244

Circumferential location, θ , deg	Spanwise location, percent of span from tip							
	5	10	15	20	30	50	70	90
VIGV inlet rake								
0		9.852			9.994	10.240	10.421	10.347
30		9.977			10.163	10.316	10.283	10.257
60		9.718			9.914	10.160	10.228	10.076
90		9.586			9.740	10.000	10.028	9.916
120		9.773			9.938	10.171	10.324	10.130
150		9.938			10.188	10.344	10.412	10.285
180		9.886			10.078	10.212	10.419	10.291
210		9.898			10.051	10.260	10.397	10.260
240		10.180			10.290	10.388	10.457	10.301
270		10.115			10.138	10.181	10.206	10.081
300		10.265			10.334	10.333	10.379	10.195
330		9.882			10.070	10.338	10.430	10.301
AVG		9.922			10.075	10.249	10.332	10.203
VIGV exit rake								
15	9.862	10.088	9.970	10.009	10.098	10.334	10.386	10.331
45	9.874	10.030	9.869	9.922	10.055	10.220	10.253	10.159
75	9.750	9.875	9.738	9.749	9.779	10.022	10.127	10.043
105	9.729	9.754	9.767	9.779	9.831	10.037	10.205	10.093
135	9.878	9.885	9.911	9.959	10.050	10.261	10.369	10.218
165	9.906	9.969	10.020	10.065	10.184	10.370	10.426	10.270
195	9.833	9.821	9.835	9.875	10.004	10.290	10.388	10.237
225	10.109	10.108	10.104	10.119	10.178	10.322	10.432	10.333
255	10.171	10.191	10.205	10.223	10.252	10.314	10.292	10.205
285	10.174	10.194	10.200	10.208	10.226	10.294	10.371	10.206
315	10.117	10.084	10.043	10.066	10.128	10.285	10.410	10.248
345	9.841	9.824	9.829	9.870	9.996	10.273	10.361	10.365
AVG	9.937	9.985	9.958	9.987	10.065	10.252	10.335	10.226

TABLE 24.—Continued.

(f) 6.35-cm tip radial distortion; airflow, 35.26 kg/sec; readings 1246 to 1249

Circumferential location, θ , deg	Spanwise location, percent of span from tip							
	5	10	15	20	30	50	70	90
VIGV inlet rake								
0		10.079			10.099	10.139	10.187	10.178
30		10.100			10.135	10.167	10.166	10.162
60		10.050			10.091	10.138	10.153	10.124
90		10.023			10.055	10.104	10.114	10.093
120		10.063			10.097	10.140	10.173	10.140
150		10.093			10.137	10.170	10.199	10.164
180		10.085			10.123	10.146	10.182	10.164
210		10.088			10.115	10.158	10.183	10.148
240		10.137			10.159	10.177	10.191	10.163
270		10.130			10.134	10.143	10.150	10.122
300		10.151			10.168	10.180	10.179	10.145
330		10.086			10.120	10.172	10.190	10.161
AVG		10.091			10.119	10.153	10.172	10.147
VIGV exit rake								
15	10.078	10.128	10.077	10.087	10.115	10.149	10.157	10.137
45	10.053	10.103	10.056	10.060	10.064	10.111	10.133	10.116
75	10.052	10.102	10.056	10.060	10.064	10.110	10.133	10.117
105	10.072	10.081	10.084	10.096	10.115	10.158	10.181	10.155
135	10.084	10.097	10.108	10.119	10.129	10.178	10.187	10.166
165	10.086	10.102	10.112	10.124	10.136	10.182	10.191	10.163
195	10.123	10.122	10.122	10.125	10.137	10.164	10.186	10.159
225	10.144	10.149	10.151	10.154	10.160	10.170	10.164	10.150
255	10.143	10.148	10.150	10.154	10.161	10.172	10.164	10.152
285	10.127	10.121	10.116	10.118	10.130	10.157	10.181	10.153
315	10.079	10.075	10.066	10.087	10.113	10.164	10.177	10.172
345	10.081	10.075	10.066	10.086	10.111	10.162	10.172	10.166
AVG	10.094	10.109	10.097	10.106	10.120	10.156	10.169	10.150

TABLE 24.—Continued.

(g) Circumferential distortion; airflow, 79.22 kg/sec; readings 1254 to 1257

Circumferential location, θ , deg	Spanwise location, percent of span from tip							
	5	10	15	20	30	50	70	90
VIGV inlet rake								
0		9.769			9.847	9.879	9.885	9.936
30		10.000			10.063	9.906	9.855	9.858
60		9.929			10.383	10.419	10.271	9.937
90		9.660			10.046	10.144	10.030	9.837
120		10.109			10.285	10.290	10.032	9.917
150		10.170			10.347	10.355	10.153	10.116
180		10.024			10.256	10.441	10.436	10.361
210		9.902			10.242	10.448	10.403	10.280
240		10.320			10.337	10.387	10.486	10.370
270		10.165			10.185	10.242	10.260	10.058
300		10.305			10.321	10.290	10.194	10.097
330		9.826			9.943	9.979	10.019	10.034
AVG		10.015			10.188	10.232	10.169	10.067
VIGV exit rake								
15	10.058	10.216	10.083	10.124	10.266	10.114	10.041	9.916
45	10.009	10.245	10.119	10.083	10.158	10.324	10.202	9.949
75	10.056	10.297	10.133	10.089	10.157	10.334	10.220	9.961
105	10.133	10.116	10.117	10.152	10.382	10.300	10.063	10.045
135	10.027	10.090	10.118	10.144	10.294	10.443	10.318	10.283
165	10.020	10.083	10.115	10.154	10.314	10.408	10.299	10.288
195	10.140	10.130	10.137	10.178	10.297	10.479	10.453	10.321
225	10.147	10.167	10.181	10.207	10.279	10.371	10.368	10.272
255	10.143	10.166	10.181	10.205	10.278	10.371	10.374	10.272
285	10.080	10.064	10.053	10.064	10.105	10.161	10.144	10.066
315	9.775	9.746	9.732	9.755	9.823	9.878	9.895	9.964
345	9.785	9.757	9.745	9.766	9.834	9.881	9.891	9.962
AVG	10.031	10.090	10.060	10.077	10.182	10.255	10.189	10.108

TABLE 24.—Continued.

(h) Circumferential distortion; airflow, 73.68 kg/sec; readings 1258 to 1261

Circumferential location, θ , deg	Spanwise location, percent of span from tip							
	5	10	15	20	30	50	70	90
VIGV inlet rake								
0		9.822			9.885	9.914	9.919	9.963
30		10.018			10.078	9.950	9.893	9.901
60		9.956			10.352	10.382	10.242	9.953
90		9.725			10.039	10.148	10.038	9.877
120		10.111			10.267	10.266	10.038	9.953
150		10.165			10.319	10.330	10.157	10.130
180		10.046			10.235	10.397	10.409	10.341
210		9.935			10.225	10.407	10.370	10.256
240		10.292			10.309	10.347	10.436	10.344
270		10.152			10.178	10.227	10.246	10.067
300		10.272			10.293	10.268	10.185	10.101
330		9.863			9.966	10.002	10.033	10.045
AVG		10.030			10.179	10.220	10.164	10.078
VIGV exit rake								
15	9.844	10.043	9.913	9.955	9.976	9.924	9.906	9.945
45	10.062	10.184	10.084	10.122	10.243	10.127	10.040	9.931
75	10.043	10.190	10.098	10.087	10.154	10.304	10.199	9.967
105	9.943	9.866	9.833	9.871	10.009	10.119	10.028	9.955
135	10.127	10.114	10.113	10.145	10.343	10.273	10.074	10.062
165	10.032	10.092	10.122	10.146	10.273	10.410	10.307	10.280
195	9.849	9.836	9.860	9.909	10.085	10.344	10.354	10.292
225	10.139	10.129	10.138	10.168	10.266	10.425	10.406	10.296
255	10.145	10.162	10.176	10.197	10.256	10.336	10.342	10.258
285	10.234	10.251	10.245	10.240	10.236	10.193	10.145	10.126
315	10.083	10.068	10.056	10.066	10.103	10.154	10.137	10.071
345	9.816	9.795	9.788	9.805	9.860	9.913	9.932	9.986
AVG	10.027	10.061	10.035	10.059	10.150	10.210	10.156	10.097

TABLE 24.—Concluded.

(i) Circumferential distortion; airflow, 35.41 kg/sec; readings 1250 to 1253

Circumferential location, θ , deg	Spanwise location, percent of span from tip							
	5	10	15	20	30	50	70	90
VIGV inlet rake								
0		10.073			10.078	10.086	10.089	10.098
30		10.109			10.123	10.104	10.085	10.089
60		10.079			10.175	10.178	10.148	10.094
90		10.047			10.109	10.137	10.116	10.081
120		10.129			10.159	10.156	10.109	10.101
150		10.135			10.165	10.171	10.141	10.140
180		10.119			10.146	10.179	10.189	10.176
210		10.092			10.147	10.185	10.178	10.154
240		10.159			10.162	10.171	10.188	10.171
270		10.135			10.144	10.151	10.155	10.117
300		10.167			10.166	10.161	10.143	10.124
330		10.084			10.160	10.110	10.112	10.113
AVG		10.112			10.139	10.149	10.138	10.121
VIGV exit rake								
15	10.077	10.141	10.092	10.097	10.101	10.094	10.090	10.098
45	10.111	10.176	10.116	10.124	10.152	10.132	10.112	10.090
75	10.101	10.165	10.121	10.119	10.133	10.165	10.148	10.099
105	10.094	10.082	10.076	10.086	10.113	10.132	10.111	10.100
135	10.125	10.126	10.128	10.134	10.173	10.159	10.121	10.121
165	10.105	10.121	10.132	10.138	10.156	10.186	10.172	10.170
195	10.077	10.076	10.078	10.088	10.121	10.167	10.169	10.161
225	10.128	10.126	10.126	10.132	10.150	10.182	10.180	10.160
255	10.131	10.135	10.137	10.141	10.153	10.172	10.175	10.157
285	10.145	10.147	10.147	10.144	10.146	10.146	10.136	10.130
315	10.129	10.122	10.119	10.121	10.129	10.136	10.131	10.116
345	10.074	10.069	10.068	10.072	10.082	10.086	10.093	10.103
AVG	10.108	10.124	10.112	10.117	10.134	10.146	10.137	10.125

TABLE 25.—CORNER 2 STATIC PRESSURE DISTRIBUTION AT VIGV EXIT WITH VANES A10 IN CORNER 1 AND VANES A4 IN CORNER 2—DISTORTED INFLOW

(a) 12.70-cm tip radial
distortion: airflow,
77.64 kg/sec; readings
1232 to 1235

Circumferential location, θ , deg	Outer wall	Center-body
15	9.353	9.299
45	9.343	9.277
75	9.342	9.263
105	9.317	9.268
135	9.303	9.258
165	9.304	9.293
195	9.303	9.303
225	9.325	9.297
255	9.328	9.288
285	9.359	9.297
315	9.370	9.293
345	9.356	9.305
AVG	9.334	9.287

(c) 12.70-cm tip radial
distortion: airflow,
35.34 kg/sec; readings
1228 to 1231

Circumferential location, θ , deg	Outer wall	Center-body
15	9.999	9.991
45	9.997	9.985
75	9.998	9.983
105	9.990	9.986
135	9.991	9.982
165	9.994	9.989
195	9.989	9.991
225	10.002	9.998
255	9.997	9.988
285	9.999	9.991
315	10.003	9.989
345	10.002	9.991
AVG	9.997	9.988

(e) 6.35-cm tip radial
distortion: airflow,
72.25 kg/sec; readings
1241 to 1244

Circumferential location, θ , deg	Outer wall	Center-body
15	9.455	9.397
45	9.443	9.384
57	9.436	9.374
105	9.416	9.379
135	9.405	9.372
165	9.400	9.394
195	9.400	9.400
225	9.423	9.394
255	9.429	9.397
285	9.453	9.403
315	9.477	9.399
345	9.449	9.399
AVG	9.432	9.391

(b) 12.70-cm tip radial
distortion: airflow,
72.35 kg/sec; readings
1224 to 1227

15	9.456	9.403
45	9.446	9.384
75	9.444	9.373
105	9.422	9.378
135	9.409	9.366
165	9.409	9.397
195	9.409	9.403
225	9.427	9.398
255	9.432	9.391
285	9.459	9.404
315	9.470	9.400
345	9.456	9.408
AVG	9.437	9.392

(d) 6.35-cm tip radial
distortion: airflow,
72.25 kg/sec; readings
1241 to 1244

15	9.360	9.303
45	9.349	9.281
75	9.355	9.272
105	9.303	9.279
135	9.303	9.265
165	9.323	9.294
195	9.297	9.308
225	9.328	9.300
255	9.353	9.305
285	9.351	9.310
315	9.375	9.297
345	9.373	9.307
AVG	9.339	9.293

(f) 6.35-cm tip radial
distortion: airflow,
35.26 kg/sec; readings
1246 to 1249

15	9.999	9.988
45	9.997	9.984
75	9.997	9.983
105	9.990	9.985
135	9.990	9.983
165	9.992	9.987
195	9.985	9.989
225	10.000	9.987
255	9.996	9.989
285	9.998	9.991
315	10.005	9.988
345	9.994	9.988
AVG	9.995	9.987

TABLE 25.—Concluded.

(g) Circumferential distortion;
airflow, 79.22 kg/sec;
readings 1254 to 1257

Circumferential location, θ , deg	Outer wall	Center-body
15	9.348	9.305
45	9.364	9.284
75	9.387	9.278
105	9.290	9.277
135	9.287	9.263
165	9.303	9.291
195	9.255	9.301
225	9.312	9.281
255	9.348	9.292
285	9.337	9.305
315	9.379	9.300
345	9.365	9.309
AVG	9.331	9.290

(i) Circumferential distortion;
airflow, 35.41 kg/sec;
readings 1250 to 1253

Circumferential location, θ , deg	Outer wall	Center-body
15	10.000	9.991
45	10.001	9.987
75	9.998	9.985
105	9.994	9.985
135	9.988	9.984
165	9.987	9.989
195	9.987	9.989
225	9.999	9.987
255	9.994	9.988
285	9.999	9.991
315	10.004	9.990
345	9.999	9.991
AVG	9.996	9.988

(h) Circumferential distortion;
airflow, 73.68 kg/sec;
readings 1258 to 1261

15	9.463	9.415
45	9.468	9.400
75	9.464	9.391
105	9.426	9.387
135	9.397	9.383
165	9.394	9.405
195	9.395	9.409
225	9.424	9.397
255	9.433	9.404
285	9.460	9.415
315	9.482	9.415
345	9.453	9.419
AVG	9.438	9.403

TABLE 26.—CORNER 2 STATIC PRESSURE DISTRIBUTION AT VANE INLET AND EXIT WITH VANES A10
IN CORNER 1 AND VANES A4 IN CORNER 2—DISTORTED INFLOW

(a) 12.70-cm tip radial distortion; airflow, 77.64 kg/sec; readings 1232 to 1235

Circum-ferential location, θ , deg	Inlet		Exit	
	Pressure, N/cm ²	Coefficient	Pressure, N/cm ²	Coefficient
0	9.724	1.930	9.556	1.262
15	9.699	0.980	9.510	1.353
30	9.679	1.020	9.465	1.442
45	9.666	1.045	9.414	1.542
60	9.663	1.050	9.396	1.579
75	9.648	1.080	*****	*****
90	9.644	1.088	*****	*****
105	9.673	1.030	*****	*****
120	9.657	1.063	9.433	1.504
135	9.664	1.049	9.420	1.530
150	9.681	1.016	9.467	1.437
165	9.698	0.982	9.504	1.365
180	9.713	0.953	9.567	1.240
195	9.715	0.947	9.552	1.269
210	9.770	0.840	9.515	1.343
225	9.850	0.681	9.471	1.429
240	9.893	0.596	9.392	1.587
255	9.908	0.567	9.350	1.668
270	9.913	0.557	9.305	1.758
285	9.914	0.555	9.329	1.710
300	9.924	0.536	9.386	1.598
315	9.860	0.641	9.499	1.375
330	9.745	0.889	9.536	1.302
345	9.712	0.954	9.557	1.260

(c) 12.70-cm tip radial distortion; airflow, 35.34 kg/sec; readings 1228 to 1231

Circum-ferential location, θ , deg	Inlet		Exit	
	Pressure, N/cm ²	Coefficient	Pressure, N/cm ²	Coefficient
0	10.062	0.870	10.032	1.154
15	10.056	0.928	10.024	1.236
30	10.053	0.954	10.017	1.310
45	10.051	0.975	10.010	1.377
60	10.050	0.984	10.004	1.429
75	10.047	1.012	*****	*****
90	10.044	1.040	*****	*****
105	10.054	0.945	*****	*****
120	10.049	0.994	10.011	1.363
135	10.050	0.989	10.010	1.375
150	10.053	0.954	10.018	1.294
165	10.056	0.929	10.024	1.236
180	10.057	0.916	10.034	1.138
195	10.060	0.891	10.034	1.142
210	10.070	0.792	10.029	1.187
225	10.080	0.695	10.021	1.271
240	10.091	0.586	10.010	1.363
255	10.100	0.494	9.994	1.527
270	10.103	0.467	9.998	1.491
285	10.091	0.583	9.998	1.486
300	10.096	0.541	10.006	1.408
315	10.082	0.672	10.023	1.247
330	10.067	0.818	10.030	1.178
345	10.059	0.896	10.032	1.155

(b) 12.70-cm tip radial distortion; airflow, 72.35 kg/sec; readings 1224 to 1227

0	9.778	0.967	9.629	1.307
15	9.754	1.023	9.588	1.400
30	9.735	1.065	9.553	1.430
45	9.724	1.090	9.507	1.584
60	9.720	1.098	9.488	1.628
75	9.700	1.146	*****	*****
90	9.703	1.138	*****	*****
105	9.729	1.079	*****	*****
120	9.714	1.112	9.520	1.555
135	9.717	1.106	9.511	1.575
150	9.736	1.063	9.554	1.477
165	9.751	1.029	9.585	1.406
180	9.761	1.007	9.641	1.279
195	9.763	1.001	9.630	1.304
210	9.813	0.888	9.599	1.374
225	9.881	0.734	9.560	1.464
240	9.922	0.639	9.499	1.603
255	9.942	0.594	9.455	1.702
270	9.936	0.607	9.427	1.766
285	9.943	0.592	9.431	1.758
300	9.953	0.570	9.490	1.622
315	9.890	0.713	9.580	1.418
330	9.795	0.929	9.612	1.346
345	9.765	0.996	9.632	1.299

(d) 6.35-cm tip radial distortion; airflow, 77.56 kg/sec; readings 1236 to 1239

0	9.764	0.876	9.573	1.253
15	9.727	0.949	9.515	1.369
30	9.697	1.009	9.475	1.448
45	9.670	1.062	9.420	1.557
60	9.650	1.101	9.401	1.595
75	9.635	1.131	*****	*****
90	9.630	1.141	*****	*****
105	9.659	1.083	*****	*****
120	9.651	1.099	9.433	1.531
135	9.674	1.055	9.425	1.547
150	9.708	0.987	9.474	1.449
165	9.734	0.934	9.509	1.380
180	9.761	0.881	9.589	1.223
195	9.771	0.863	9.567	1.265
210	9.822	0.761	9.522	1.356
225	9.874	0.658	9.470	1.457
240	9.925	0.557	9.405	1.587
255	9.943	0.521	9.365	1.665
270	9.914	0.579	9.333	1.730
285	9.932	0.543	9.347	1.701
300	9.957	0.494	9.392	1.613
315	9.868	0.670	9.505	1.329
330	9.782	0.841	9.546	1.303
345	9.749	0.905	9.572	1.255

TABLE 26.—Continued.

(e) 6.35-cm tip radial distortion; airflow, 72.25 kg/sec; readings 1241 to 1244

Circumferential location, θ , deg	Inlet		Exit	
	Pressure, N/cm ²	Coefficient	Pressure, N/cm ²	Coefficient
0	9.792	0.886	9.647	1.216
15	9.761	0.957	9.592	1.343
30	9.735	1.016	9.554	1.427
45	9.710	1.073	9.505	1.540
60	9.694	1.110	9.486	1.583
75	9.676	1.150	*****	*****
90	9.674	1.156	*****	*****
105	9.699	1.098	*****	*****
120	9.691	1.117	9.512	1.524
135	9.715	1.062	9.510	1.529
150	9.746	0.992	9.555	1.425
165	9.770	0.937	9.591	1.345
180	9.786	0.899	9.662	1.182
195	9.789	0.893	9.658	1.191
210	9.814	0.836	9.626	1.264
225	9.810	0.844	9.587	1.353
240	9.803	0.860	9.571	1.389
255	9.808	0.849	9.708	1.077
270	9.857	0.737	9.751	0.980
285	9.830	0.799	9.702	1.091
300	9.868	0.713	9.536	1.471
315	9.834	0.790	9.609	1.304
330	9.786	0.899	9.633	1.247
345	9.773	0.930	9.653	1.202

(g) Circumferential distortion; airflow, 79.22 kg/sec; readings 1254 to 1257

Circumferential location, θ , deg	Inlet		Exit	
	Pressure, N/cm ²	Coefficient	Pressure, N/cm ²	Coefficient
0	9.706	0.953	9.568	1.216
15	9.681	1.000	9.508	1.330
30	9.676	1.010	9.476	1.391
45	9.714	0.938	9.424	1.491
60	9.778	0.814	9.416	1.506
75	9.729	0.908	*****	*****
90	9.744	0.879	*****	*****
105	9.765	0.840	*****	*****
120	9.741	0.885	9.492	1.362
135	9.743	0.882	9.442	1.457
150	9.733	0.902	9.489	1.367
165	9.747	0.874	9.535	1.280
180	9.758	0.853	9.616	1.124
195	9.760	0.848	9.594	1.166
210	9.769	0.831	9.540	1.269
225	9.794	0.785	9.493	1.359
240	9.805	0.762	9.428	1.484
255	9.782	0.808	9.630	1.098
270	9.841	0.695	9.696	0.971
285	9.825	0.726	9.661	1.038
300	9.921	0.543	9.405	1.528
315	9.843	0.690	9.510	1.328
330	9.739	0.889	9.543	1.264
345	9.707	0.951	9.574	1.204

(f) 6.35-cm tip radial distortion; airflow, 35.26 kg/sec; readings 1246 to 1249

0	10.064	0.772	10.036	1.045
15	10.057	0.839	10.024	1.157
30	10.052	0.883	10.016	1.236
45	10.049	0.921	10.008	1.314
60	10.045	0.957	10.004	1.358
75	10.041	0.990	*****	*****
90	10.041	0.992	*****	*****
105	10.049	0.920	*****	*****
120	10.044	0.961	10.009	1.306
135	10.049	0.919	10.010	1.298
150	10.055	0.860	10.018	1.222
165	10.059	0.819	10.025	1.152
180	10.063	0.778	10.038	1.027
195	10.063	0.780	10.039	1.011
210	10.068	0.730	10.034	1.065
225	10.067	0.743	10.025	1.148
240	10.066	0.749	10.025	1.153
255	10.068	0.726	10.050	0.905
270	10.079	0.628	10.059	0.818
285	10.072	0.694	10.048	0.923
300	10.077	0.638	10.018	1.215
315	10.073	0.685	10.028	1.118
330	10.064	0.772	10.033	1.069
345	10.059	0.817	10.037	1.033

(h) Circumferential distortion; airflow, 73.68 kg/sec; readings 1258 to 1261

0	9.761	0.961	9.643	1.223
15	9.740	1.006	9.592	1.335
30	9.735	1.019	9.563	1.399
45	9.768	0.945	9.519	1.496
60	9.819	0.832	9.509	1.518
75	9.779	0.921	*****	*****
90	9.792	0.892	*****	*****
105	9.810	0.852	*****	*****
120	9.792	0.892	9.575	1.371
135	9.793	0.890	9.533	1.464
150	9.783	0.913	9.573	1.376
165	9.796	0.884	9.612	1.291
180	9.803	0.868	9.679	1.141
195	9.810	0.853	9.665	1.173
210	9.819	0.833	9.620	1.273
225	9.841	0.784	9.578	1.365
240	9.849	0.766	9.529	1.473
255	9.829	0.812	9.697	1.103
270	9.879	0.701	9.754	0.977
285	9.859	0.745	9.723	1.044
300	9.949	0.546	9.496	1.548
315	9.882	0.694	9.580	1.361
330	9.790	0.897	9.620	1.273
345	9.761	0.960	9.648	1.211

TABLE 28.—CORNER 2 VANE SURFACE STATIC PRESSURE DISTRIBUTION WITH VANES A10 IN CORNER 1 AND VANES A4 IN CORNER 2—DISTORTED INFLOW

(a) 12.70-cm tip radial distortion; airflow, 77.64 kg/sec; readings 1232 to 1235

Fraction of chord, XC/C	Pressure, N/cm ²		Mach number		Coefficient	
	(a)	(b)	(a)	(b)	(a)	(b)
Section A						
0.000	9.994	9.995	0.169	0.169	0.621	0.623
0.025	9.820	8.573	0.232	0.504	0.279	-2.185
0.050	9.683	8.904	0.272	0.444	0.008	-1.531
0.075	9.511	9.301	0.317	0.364	-0.333	-0.746
0.100	9.356	9.276	0.352	0.370	-0.638	-0.796
0.150	9.045	9.419	0.417	0.338	-1.251	-0.514
0.200	8.869	9.505	0.451	0.318	-1.600	-0.343
0.300	8.716	9.595	0.479	0.296	-1.902	-0.166
0.500	8.971	9.646	0.431	0.282	-1.397	-0.066
0.700	9.218	9.609	0.382	0.292	-0.910	-0.138
0.800	9.305	9.566	0.364	0.303	-0.739	-0.223
0.850	9.327	9.528	0.359	0.312	-0.696	-0.298
0.900	9.340	9.473	0.356	0.326	-0.670	-0.407
0.950	9.332	9.382	0.358	0.347	-0.686	-0.586
Section B						
0.000	9.850	9.850	0.222	0.222	0.337	0.337
0.025	9.517	9.079	0.315	0.410	-0.320	-1.185
0.050	9.396	9.273	0.343	0.371	-0.559	-0.803
0.075	9.310	9.509	0.363	0.317	-0.729	-0.335
0.100	9.241	9.564	0.377	0.304	-0.866	-0.227
0.150	9.122	9.627	0.402	0.287	-1.100	-0.102
0.200	9.083	9.665	0.410	0.277	-1.178	-0.028
0.300	9.077	9.708	0.411	0.265	-1.189	0.058
0.500	9.323	9.718	0.360	0.263	-0.704	0.077
0.700	9.472	9.692	0.326	0.270	-0.408	0.024
0.800	9.520	9.671	0.314	0.276	-0.313	-0.015
0.850	9.532	9.647	0.312	0.282	-0.291	-0.063
0.900	9.557	9.617	0.310	0.290	-0.280	-0.124
0.950	9.544	9.563	0.308	0.304	-0.266	-0.229
Section C						
0.000	9.705	9.706	0.266	0.266	0.052	0.053
0.025	8.822	9.808	0.459	0.236	-1.692	0.255
0.050	8.604	9.525	0.498	0.313	-2.123	-0.304
0.075	8.483	9.631	0.519	0.286	-2.363	-0.095
0.100	8.418	9.715	0.530	0.263	-2.490	0.072
0.150	8.971	9.843	0.431	0.225	-1.398	0.322
0.200	8.298	9.921	0.550	0.198	-2.726	0.478
0.300	8.375	10.005	0.538	0.164	-2.575	0.644
0.500	8.297	10.015	0.551	0.160	-2.730	0.664
0.700	9.364	9.961	0.351	0.182	-0.622	0.557
0.800	9.482	9.894	0.324	0.207	-0.390	0.425
0.850	9.511	9.838	0.317	0.226	-0.332	0.313
0.900	9.525	9.763	0.313	0.250	-0.305	0.165
0.950	9.542	9.626	0.309	0.288	-0.271	-0.106
Section D						
0.000	9.526	9.529	0.313	0.312	-0.302	-0.297
0.025	9.864	9.694	0.218	0.269	0.365	0.029
0.050	9.469	9.647	0.327	0.282	-0.415	-0.063
0.075	9.461	9.641	0.329	0.284	-0.431	-0.076
0.100	9.456	9.642	0.330	0.283	-0.441	-0.073
0.150	9.447	9.644	0.332	0.283	-0.459	-0.069
0.200	9.443	9.648	0.333	0.282	-0.466	-0.062
0.300	9.432	9.653	0.335	0.281	-0.487	-0.052
0.500	9.460	9.648	0.329	0.282	-0.432	-0.062
0.700	9.487	9.623	0.322	0.288	-0.380	-0.111
0.800	9.499	9.599	0.320	0.295	-0.356	-0.158
0.850	9.499	9.585	0.320	0.298	-0.357	-0.186
0.900	9.502	9.564	0.319	0.304	-0.350	-0.228
0.950	9.502	9.523	0.319	0.314	-0.350	-0.309

^aSuction surface.
^bPressure surface.

TABLE 28.—Continued.

(b) 12.70-cm tip radial distortion; airflow, 72.35 kg/sec; readings 1224 to 1227

Fraction of chord, XC/C	Pressure, N/cm ²		Mach number		Coefficient	
	(a)	(b)	(a)	(b)	(a)	(b)
Section A						
0.000	10.004	10.003	0.168	0.168	0.564	0.562
0.025	9.861	8.754	0.221	0.473	0.238	-2.281
0.050	9.740	9.062	0.258	0.415	-0.037	-1.580
0.075	9.590	9.445	0.299	0.334	-0.380	-0.708
0.100	9.453	9.412	0.332	0.342	-0.690	-0.784
0.150	9.124	9.535	0.391	0.312	-1.302	-0.503
0.200	9.028	9.608	0.422	0.294	-1.657	-0.337
0.300	8.890	9.682	0.448	0.275	-1.971	-0.170
0.500	9.108	9.723	0.406	0.263	-1.475	-0.076
0.700	9.329	9.690	0.360	0.273	-0.972	-0.152
0.800	9.409	9.645	0.342	0.285	-0.791	-0.254
0.850	9.431	9.609	0.337	0.294	-0.741	-0.335
0.900	9.443	9.561	0.334	0.306	-0.712	-0.444
0.950	9.440	9.479	0.335	0.326	-0.720	-0.631
Section B						
0.000	9.886	9.887	0.213	0.213	0.294	0.296
0.025	9.593	9.208	0.298	0.386	-0.371	-1.248
0.050	9.488	9.377	0.324	0.349	-0.611	-0.864
0.075	9.412	9.588	0.342	0.299	-0.785	-0.383
0.100	9.350	9.636	0.355	0.287	-0.926	-0.275
0.150	9.247	9.692	0.378	0.272	-1.159	-0.146
0.200	9.213	9.725	0.385	0.263	-1.237	-0.072
0.300	9.217	9.763	0.386	0.252	-1.251	0.016
0.500	9.425	9.772	0.339	0.249	-0.754	0.035
0.700	9.557	9.754	0.307	0.254	-0.454	-0.006
0.800	9.598	9.730	0.297	0.261	-0.361	-0.060
0.850	9.604	9.700	0.295	0.267	-0.346	-0.108
0.900	9.615	9.681	0.293	0.275	-0.323	-0.171
0.950	9.620	9.634	0.291	0.288	-0.311	-0.279
Section C						
0.000	9.744	9.744	0.257	0.257	-0.029	-0.029
0.025	8.994	9.858	0.428	0.222	-1.735	0.231
0.050	8.811	9.620	0.463	0.291	-2.152	-0.311
0.075	8.708	9.703	0.481	0.269	-2.387	-0.121
0.100	8.651	9.772	0.491	0.249	-2.515	0.036
0.150	9.127	9.880	0.402	0.215	-1.432	0.280
0.200	8.551	9.947	0.509	0.191	-2.743	0.434
0.300	8.612	10.019	0.498	0.162	-2.604	0.597
0.500	8.550	10.026	0.509	0.158	-2.745	0.614
0.700	9.465	9.978	0.329	0.179	-0.663	0.505
0.800	9.569	9.921	0.304	0.200	-0.427	0.375
0.850	9.593	9.873	0.298	0.217	-0.373	0.265
0.900	9.604	9.809	0.295	0.238	-0.346	0.120
0.950	9.620	9.692	0.291	0.272	-0.311	-0.146
Section D						
0.000	9.600	9.601	0.296	0.296	-0.357	-0.355
0.025	9.877	9.748	0.216	0.256	0.274	-0.019
0.050	9.552	9.709	0.308	0.267	-0.465	-0.109
0.075	9.543	9.702	0.311	0.269	-0.486	-0.124
0.100	9.539	9.713	0.312	0.269	-0.495	-0.121
0.150	9.529	9.705	0.314	0.268	-0.517	-0.117
0.200	9.526	9.707	0.315	0.268	-0.525	-0.112
0.300	9.519	9.710	0.316	0.267	-0.540	-0.105
0.500	9.543	9.705	0.310	0.268	-0.485	-0.116
0.700	9.568	9.686	0.304	0.274	-0.428	-0.161
0.800	9.577	9.666	0.302	0.279	-0.409	-0.207
0.850	9.581	9.652	0.301	0.283	-0.400	-0.238
0.900	9.581	9.632	0.301	0.288	-0.399	-0.283
0.950	9.583	9.599	0.301	0.297	-0.394	-0.359

^aSuction surface.^bPressure surface.

TABLE 28.—Continued.

(c) 12.70-cm tip radial distortion; airflow, 35.34 kg/sec; readings 1228 to 1231

Fraction of chord, XC/C	Pressure, N/cm ²		Mach number		Coefficient	
	(a)	(b)	(a)	(b)	(a)	(b)
Section A						
0.000	10.112	10.111	0.075	0.075	0.620	0.611
0.025	10.089	9.845	0.094	0.210	0.400	-1.975
0.050	10.060	9.915	0.114	0.184	0.112	-1.295
0.075	10.024	10.042	0.134	0.125	-0.233	-0.061
0.100	9.992	9.997	0.151	0.148	-0.548	-0.495
0.150	9.933	10.022	0.177	0.136	-1.120	-0.257
0.200	9.898	10.035	0.190	0.128	-1.458	-0.121
0.300	9.868	10.050	0.201	0.119	-1.747	0.024
0.500	9.918	10.060	0.183	0.114	-1.266	0.116
0.700	9.969	10.052	0.161	0.119	-0.764	0.036
0.800	9.987	10.042	0.153	0.124	-0.590	-0.059
0.850	9.992	10.034	0.150	0.129	-0.540	-0.135
0.900	9.996	10.023	0.149	0.135	-0.505	-0.243
0.950	9.995	10.006	0.149	0.143	-0.515	-0.404
Section B						
0.000	10.086	10.086	0.096	0.096	0.369	0.366
0.025	10.025	9.959	0.134	0.165	-0.226	-0.863
0.050	10.003	9.984	0.145	0.154	-0.438	-0.618
0.075	9.987	10.019	0.153	0.137	-0.593	-0.283
0.100	9.975	10.035	0.158	0.128	-0.711	-0.123
0.150	9.954	10.047	0.167	0.122	-0.909	-0.014
0.200	9.947	10.052	0.171	0.118	-0.985	0.043
0.300	9.946	10.060	0.171	0.114	-0.990	0.114
0.500	9.989	10.062	0.152	0.113	-0.575	0.134
0.700	10.019	10.058	0.137	0.115	-0.285	0.101
0.800	10.027	10.053	0.133	0.118	-0.206	0.053
0.850	10.029	10.048	0.132	0.121	-0.187	0.003
0.900	10.030	10.043	0.131	0.124	-0.178	-0.047
0.950	10.031	10.031	0.130	0.131	-0.162	-0.166
Section C						
0.000	10.046	10.046	0.122	0.122	-0.016	-0.017
0.025	9.915	10.079	0.184	0.101	-1.294	0.303
0.050	9.882	10.037	0.197	0.127	-1.618	-0.108
0.075	9.862	10.052	0.204	0.118	-1.808	0.040
0.100	9.851	10.063	0.207	0.112	-1.913	0.146
0.150	9.939	10.079	0.174	0.101	-1.057	0.306
0.200	9.830	10.093	0.215	0.091	-2.116	0.436
0.300	9.838	10.106	0.212	0.080	-2.039	0.564
0.500	9.832	10.105	0.214	0.080	-2.100	0.558
0.700	10.000	10.096	0.146	0.088	-0.462	0.469
0.800	10.020	10.086	0.137	0.096	-0.276	0.370
0.850	10.025	10.077	0.134	0.102	-0.226	0.285
0.900	10.027	10.066	0.133	0.110	-0.203	0.170
0.950	10.031	10.044	0.131	0.123	-0.167	-0.039
Section D						
0.000	10.027	10.026	0.133	0.133	-0.209	-0.211
0.025	10.143	10.057	0.035	0.116	0.921	0.084
0.050	10.016	10.047	0.139	0.121	-0.315	-0.007
0.075	10.013	10.047	0.140	0.122	-0.338	-0.012
0.100	10.012	10.047	0.141	0.122	-0.349	-0.014
0.150	10.010	10.048	0.141	0.121	-0.366	-0.001
0.200	10.010	10.047	0.141	0.121	-0.365	-0.008
0.300	10.008	10.049	0.143	0.120	-0.387	0.009
0.500	10.014	10.047	0.140	0.121	-0.332	-0.009
0.700	10.019	10.043	0.137	0.124	-0.280	-0.049
0.800	10.022	10.038	0.135	0.127	-0.254	-0.095
0.850	10.022	10.037	0.135	0.127	-0.253	-0.104
0.900	10.023	10.033	0.135	0.130	-0.241	-0.150
0.950	10.024	10.026	0.134	0.133	-0.235	-0.212

^aSuction surface.^bPressure surface.

TABLE 28.—Continued.

(d) 6.35-cm tip radial distortion; airflow, 77.56 kg/sec; readings 1236 to 1239

Fraction of chord, <i>XC/C</i>	Pressure, N/cm ²		Mach number		Coefficient	
	(a)	(b)	(a)	(b)	(a)	(b)
Section A						
0.000	10.102	10.101	0.121	0.122	0.812	0.809
0.025	9.821	8.659	0.235	0.490	0.255	-2.044
0.050	9.664	8.909	0.280	0.445	-0.056	-1.549
0.075	9.479	9.263	0.327	0.375	-0.422	-0.849
0.100	9.314	9.233	0.363	0.381	-0.744	-0.907
0.150	9.003	9.373	0.427	0.351	-1.364	-0.630
0.200	8.835	9.470	0.459	0.329	-1.695	-0.440
0.300	8.704	9.569	0.482	0.305	-1.955	-0.243
0.500	9.000	9.610	0.428	0.295	-1.370	-0.162
0.700	9.240	9.591	0.380	0.299	-0.894	-0.199
0.800	9.322	9.553	0.362	0.309	-0.733	-0.276
0.850	9.342	9.522	0.358	0.316	-0.692	-0.335
0.900	9.353	9.475	0.355	0.328	-0.670	-0.429
0.950	9.347	9.590	0.357	0.347	-0.683	-0.597
Section B						
0.000	9.910	9.910	0.206	0.205	0.432	0.433
0.025	9.491	8.980	0.324	0.432	-0.398	-1.408
0.050	9.345	9.246	0.357	0.378	-0.686	-0.882
0.075	9.241	9.508	0.379	0.320	-0.892	-0.363
0.100	9.159	9.578	0.396	0.303	-1.054	-0.225
0.150	9.022	9.660	0.423	0.282	-1.325	-0.063
0.200	8.983	9.707	0.431	0.269	-1.404	0.031
0.300	8.986	9.760	0.430	0.254	-1.397	0.135
0.500	9.282	9.771	0.371	0.250	-0.812	0.150
0.700	9.465	9.746	0.330	0.258	-0.448	0.107
0.800	9.523	9.712	0.316	0.267	-0.335	0.039
0.850	9.536	9.682	0.313	0.275	-0.309	-0.019
0.900	9.541	9.647	0.312	0.285	-0.298	-0.089
0.950	9.551	9.582	0.309	0.302	-0.279	-0.217
Section C						
0.000	9.819	9.819	0.236	0.236	0.252	0.252
0.025	9.010	9.588	0.426	0.300	-1.349	-0.205
0.050	8.798	9.439	0.465	0.336	-1.769	-0.501
0.075	8.677	9.573	0.487	0.304	-2.009	-0.235
0.100	8.602	9.669	0.500	0.279	-2.157	-0.044
0.150	9.042	9.798	0.420	0.242	-1.286	0.210
0.200	8.467	9.808	0.524	0.220	-2.425	0.348
0.300	8.535	9.941	0.512	0.195	-2.291	0.492
0.500	8.475	9.966	0.522	0.185	-2.409	0.543
0.700	9.401	9.914	0.345	0.204	-0.575	0.440
0.800	9.515	9.856	0.318	0.224	-0.349	0.326
0.850	9.541	9.806	0.312	0.240	-0.299	0.226
0.900	9.552	9.743	0.309	0.259	-0.277	0.101
0.950	9.569	9.635	0.305	0.288	-0.243	-0.113
Section D						
0.000	9.582	9.580	0.302	0.302	-0.217	-0.222
0.025	9.854	9.591	0.225	0.299	0.322	-0.199
0.050	9.510	9.577	0.319	0.303	-0.359	-0.227
0.075	9.495	9.592	0.323	0.299	-0.390	-0.197
0.100	9.484	9.602	0.326	0.297	-0.411	-0.178
0.150	9.466	9.611	0.330	0.294	-0.447	-0.161
0.200	9.455	9.617	0.332	0.293	-0.469	-0.148
0.300	9.443	9.623	0.335	0.291	-0.493	-0.136
0.500	9.459	9.617	0.331	0.293	-0.461	-0.148
0.700	9.482	9.599	0.326	0.297	-0.414	-0.183
0.800	9.493	9.581	0.323	0.302	-0.393	-0.220
0.850	9.494	9.565	0.323	0.306	-0.391	-0.251
0.900	9.495	9.548	0.323	0.310	-0.390	-0.285
0.950	9.497	9.512	0.323	0.319	-0.386	-0.355

^aSuction surface.^bPressure surface.

TABLE 28.—Continued.

(e) 6.35-cm tip radial distortion; airflow, 72.25 kg/sec; readings 1241 to 1244

Fraction of chord, XC/C	Pressure, N/cm^2		Mach number		Coefficient	
	(a)	(b)	(a)	(b)	(a)	(b)
Section A						
0.000	9.991	9.991	0.164	0.164	0.584	0.585
0.025	9.741	9.874	0.252	0.209	0.013	0.318
0.050	9.648	9.717	0.278	0.259	-0.197	-0.040
0.075	9.551	9.818	0.303	0.228	-0.418	0.191
0.100	9.477	9.813	0.321	0.230	-0.588	0.179
0.150	9.356	9.848	0.350	0.218	-0.865	0.258
0.200	9.311	9.877	0.359	0.208	-0.967	0.324
0.300	9.269	9.911	0.369	0.196	-1.063	0.402
0.500	9.430	9.928	0.332	0.190	-0.694	0.441
0.700	9.586	9.888	0.294	0.205	-0.339	0.348
0.800	9.644	9.846	0.279	0.219	-0.207	0.254
0.850	9.661	9.818	0.274	0.228	-0.168	0.189
0.900	9.667	9.777	0.273	0.241	-0.154	0.096
0.950	9.661	9.712	0.275	0.260	-0.169	-0.052
Section B						
0.000	9.906	9.908	0.198	0.197	0.391	0.395
0.025	9.552	9.224	0.303	0.378	-0.418	-1.164
0.050	9.435	9.414	0.331	0.336	-0.683	-0.732
0.075	9.355	9.607	0.350	0.289	-0.867	-0.292
0.100	9.290	9.663	0.364	0.274	-1.014	-0.163
0.150	9.188	9.726	0.386	0.256	-1.247	-0.021
0.200	9.159	9.763	0.392	0.245	-1.312	0.065
0.300	9.164	9.805	0.391	0.232	-1.302	0.159
0.500	9.409	9.814	0.337	0.230	-0.743	0.179
0.700	9.559	9.791	0.301	0.237	-0.401	0.128
0.800	9.607	9.763	0.289	0.245	-0.292	0.063
0.850	9.618	9.738	0.286	0.253	-0.267	0.007
0.900	9.623	9.706	0.285	0.262	-0.256	-0.065
0.950	9.630	9.650	0.283	0.277	-0.238	-0.193
Section C						
0.000	9.804	9.803	0.233	0.233	0.158	0.156
0.025	9.120	9.744	0.399	0.251	-1.401	0.021
0.050	8.951	9.579	0.433	0.296	-1.788	-0.355
0.075	8.856	9.679	0.451	0.270	-2.003	-0.127
0.100	8.803	9.745	0.461	0.251	-2.125	0.023
0.150	9.200	9.855	0.383	0.216	-1.221	0.273
0.200	8.709	9.912	0.478	0.196	-2.340	0.403
0.300	8.771	9.971	0.466	0.173	-2.198	0.538
0.500	8.708	9.991	0.478	0.164	-2.341	0.583
0.700	9.506	9.946	0.314	0.183	-0.521	0.481
0.800	9.602	9.894	0.290	0.202	-0.303	0.363
0.850	9.624	9.851	0.285	0.217	-0.254	0.266
0.900	9.633	9.799	0.282	0.234	-0.232	0.146
0.950	9.643	9.706	0.278	0.262	-0.198	-0.065
Section D						
0.000	9.636	9.637	0.281	0.281	-0.226	-0.224
0.025	10.114	9.644	0.097	0.279	0.865	-0.207
0.050	9.582	9.633	0.296	0.282	-0.349	-0.233
0.075	9.567	9.645	0.299	0.279	-0.383	-0.205
0.100	9.559	9.654	0.301	0.276	-0.401	-0.184
0.150	9.546	9.660	0.305	0.275	-0.432	-0.170
0.200	9.536	9.666	0.307	0.273	-0.454	-0.158
0.300	9.525	9.671	0.310	0.272	-0.477	-0.147
0.500	9.540	9.667	0.306	0.273	-0.445	-0.155
0.700	9.555	9.651	0.302	0.277	-0.410	-0.192
0.800	9.563	9.635	0.300	0.281	-0.391	-0.227
0.850	9.566	9.623	0.299	0.285	-0.385	-0.255
0.900	9.564	9.604	0.300	0.290	-0.389	-0.298
0.950	10.981	9.579	0.000	0.296	2.841	-0.356

^aSuction surface.^bPressure surface.

TABLE 28.—Continued.

(f) 6.35-cm tip radial distortion; airflow, 35.26 kg/sec; readings 1246 to 1249

Fraction of chord, <i>XC/C</i>	Pressure, N/cm ²		Mach number		Coefficient	
	(a)	(b)	(a)	(b)	(a)	(b)
Section A						
0.000	10.099	10.102	0.079	0.076	0.574	0.606
0.025	10.052	10.089	0.114	0.087	0.115	0.478
0.050	10.035	10.055	0.124	0.111	-0.047	0.147
0.075	10.017	10.086	0.134	0.090	-0.229	0.443
0.100	10.002	10.072	0.141	0.100	-0.367	0.310
0.150	9.980	10.080	0.152	0.094	-0.590	0.387
0.200	9.970	10.083	0.157	0.092	-0.681	0.422
0.300	9.963	10.090	0.160	0.087	-0.751	0.485
0.500	9.994	10.095	0.145	0.082	-0.447	0.535
0.700	10.026	10.086	0.129	0.089	-0.141	0.452
0.800	10.037	10.080	0.123	0.094	-0.034	0.388
0.850	10.041	10.072	0.120	0.100	0.006	0.311
0.900	10.042	10.064	0.120	0.105	0.019	0.236
0.950	10.041	10.052	0.120	0.114	0.009	0.113
Section B						
0.000	10.090	10.088	0.087	0.088	0.486	0.466
0.025	10.019	9.953	0.133	0.165	-0.208	-0.851
0.050	9.995	9.980	0.145	0.152	-0.438	-0.583
0.075	9.979	10.029	0.153	0.127	-0.598	-0.107
0.100	9.966	10.040	0.159	0.121	-0.719	-0.003
0.150	9.947	10.052	0.167	0.113	-0.913	0.121
0.200	9.940	10.060	0.170	0.108	-0.981	0.192
0.300	9.941	10.068	0.170	0.103	-0.968	0.275
0.500	9.988	10.069	0.148	0.102	-0.507	0.287
0.700	10.020	10.065	0.132	0.105	-0.196	0.247
0.800	10.029	10.059	0.127	0.109	-0.112	0.188
0.850	10.030	10.054	0.126	0.112	-0.094	0.136
0.900	10.032	10.047	0.125	0.117	-0.080	0.064
0.950	10.032	10.033	0.125	0.125	-0.077	-0.073
Section C						
0.000	10.058	10.058	0.109	0.109	0.177	0.178
0.025	9.933	10.056	0.173	0.111	-1.043	0.159
0.050	9.901	10.026	0.186	0.129	-1.355	-0.137
0.075	9.883	10.045	0.193	0.118	-1.533	0.045
0.100	9.872	10.057	0.197	0.110	-1.636	0.162
0.150	9.953	10.074	0.165	0.099	-0.853	0.332
0.200	9.854	10.086	0.203	0.089	-1.814	0.452
0.300	9.866	10.097	0.199	0.080	-1.703	0.557
0.500	9.855	10.100	0.203	0.078	-1.807	0.582
0.700	10.006	10.091	0.139	0.085	-0.330	0.499
0.800	10.023	10.081	0.130	0.093	-0.162	0.404
0.850	10.029	10.074	0.127	0.099	-0.110	0.327
0.900	10.031	10.063	0.126	0.106	-0.086	0.224
0.950	10.034	10.045	0.124	0.117	-0.054	0.053
Section D						
0.000	10.033	10.033	0.125	0.125	-0.065	-0.065
0.025	10.172	10.038	0.000	0.122	1.287	-0.024
0.050	10.021	10.032	0.131	0.125	-0.182	-0.081
0.075	10.019	10.036	0.133	0.123	-0.205	-0.043
0.100	10.017	10.037	0.134	0.122	-0.229	-0.027
0.150	10.013	10.040	0.136	0.121	-0.265	0.001
0.200	10.013	10.040	0.136	0.121	-0.266	0.000
0.300	10.010	10.041	0.138	0.120	-0.298	0.009
0.500	10.014	10.041	0.135	0.120	-0.257	0.005
0.700	10.017	10.036	0.134	0.123	-0.223	-0.035
0.800	10.019	10.033	0.132	0.125	-0.201	-0.073
0.850	10.019	10.032	0.133	0.125	-0.206	-0.077
0.900	10.020	10.028	0.132	0.127	-0.194	-0.114
0.950	10.293	10.023	0.000	0.131	2.470	-0.171

^aSuction surface.^bPressure surface.

TABLE 28.—Continued.

(g) Circumferential distortion; airflow, 79.22 kg/sec; readings 1254 to 1257

Fraction of chord, XC/C	Pressure, N/cm ²		Mach number		Coefficient	
	(a)	(b)	(a)	(b)	(a)	(b)
Section A						
0.000	10.015	10.014	0.164	0.164	0.656	0.656
0.025	9.655	9.979	0.282	0.179	-0.031	0.589
0.050	9.552	9.735	0.314	0.260	-0.264	0.123
0.075	9.405	9.811	0.343	0.238	-0.507	0.268
0.100	9.311	9.807	0.364	0.239	-0.688	0.260
0.150	9.159	9.847	0.396	0.228	-0.977	0.327
0.200	9.111	9.874	0.406	0.218	-1.070	0.387
0.300	9.054	9.911	0.417	0.205	-1.179	0.459
0.500	9.285	9.931	0.370	0.198	-0.737	0.496
0.700	9.490	9.877	0.324	0.216	-0.345	0.394
0.800	9.565	9.821	0.306	0.235	-0.202	0.287
0.850	9.586	9.786	0.300	0.245	-0.162	0.220
0.900	9.596	9.732	0.298	0.261	-0.144	0.117
0.950	9.579	9.650	0.302	0.284	-0.176	-0.039
Section B						
0.000	9.770	9.774	0.250	0.249	0.189	0.197
0.025	9.495	9.252	0.323	0.377	-0.336	-0.799
0.050	9.411	9.385	0.342	0.348	-0.497	-0.546
0.075	9.355	9.550	0.355	0.309	-0.604	-0.230
0.100	9.308	9.584	0.365	0.301	-0.692	-0.165
0.150	9.231	9.628	0.381	0.290	-0.839	-0.082
0.200	9.211	9.653	0.385	0.283	-0.877	-0.033
0.300	9.205	9.683	0.387	0.275	-0.889	0.022
0.500	9.366	9.692	0.352	0.272	-0.582	0.041
0.700	9.485	9.671	0.325	0.278	-0.355	0.000
0.800	9.526	9.648	0.315	0.284	-0.277	-0.044
0.850	9.536	9.628	0.313	0.290	-0.257	-0.083
0.900	9.542	9.604	0.311	0.296	-0.246	-0.127
0.950	9.553	9.565	0.309	0.305	-0.226	-0.201
Section C						
0.000	9.722	9.722	0.264	0.264	0.097	0.097
0.025	9.046	9.681	0.419	0.275	-1.194	0.019
0.050	8.885	9.503	0.449	0.321	-1.500	-0.320
0.075	8.800	9.619	0.465	0.292	-1.662	-0.098
0.100	8.759	9.708	0.472	0.268	-1.741	0.070
0.150	9.150	9.809	0.398	0.238	-0.995	0.264
0.200	8.688	9.874	0.485	0.217	-1.877	0.388
0.300	8.767	9.938	0.471	0.195	-1.726	0.509
0.500	8.674	9.966	0.487	0.184	-1.903	0.563
0.700	9.445	9.914	0.334	0.204	-0.431	0.464
0.800	9.532	9.856	0.314	0.224	-0.265	0.353
0.850	9.553	9.807	0.308	0.239	-0.224	0.259
0.900	9.562	9.747	0.306	0.257	-0.208	0.145
0.950	9.574	9.644	0.303	0.285	-0.185	-0.051
Section D						
0.000	9.438	9.435	0.336	0.337	-0.445	-0.451
0.025	9.911	9.927	0.205	0.199	0.459	0.488
0.050	9.307	9.819	0.365	0.235	-0.696	0.283
0.075	9.300	9.799	0.367	0.241	-0.708	0.244
0.100	9.304	9.803	0.366	0.240	-0.702	0.252
0.150	9.299	9.807	0.367	0.239	-0.710	0.259
0.200	9.305	9.821	0.365	0.234	-0.698	0.288
0.300	9.320	9.835	0.362	0.230	-0.669	0.313
0.500	9.442	9.840	0.335	0.235	-0.438	0.285
0.700	9.518	9.781	0.317	0.247	-0.292	0.211
0.800	9.542	9.742	0.311	0.258	-0.246	0.137
0.850	9.556	9.710	0.308	0.268	-0.219	0.074
0.900	9.555	9.674	0.308	0.277	-0.222	0.006
0.950	11.031	9.590	0.000	0.299	2.596	-0.154

^aSuction surface.^bPressure surface.

121

TABLE 28.—Continued.

(h) Circumferential distortion; airflow, 73.68 kg/sec; readings 1258 to 1261

Fraction of chord, XC/C	Pressure, N/cm ²		Mach number		Coefficient	
	(a)	(b)	(a)	(b)	(a)	(b)
Section A						
0.000	10.037	10.037	0.150	0.150	0.666	0.666
0.025	9.724	9.996	0.261	0.168	-0.025	0.576
0.050	9.613	9.793	0.291	0.241	-0.271	0.127
0.075	9.501	9.863	0.319	0.218	-0.520	0.281
0.100	9.417	9.854	0.339	0.221	-0.704	0.260
0.150	9.285	9.884	0.368	0.211	-0.996	0.327
0.200	9.235	9.912	0.379	0.201	-1.107	0.390
0.300	9.189	9.945	0.388	0.189	-1.209	0.463
0.500	9.397	9.958	0.343	0.184	-0.748	0.491
0.700	9.575	9.912	0.301	0.201	-0.356	0.390
0.800	9.640	9.863	0.284	0.218	-0.211	0.280
0.850	9.657	9.823	0.279	0.231	-0.173	0.194
0.900	9.664	9.787	0.278	0.243	-0.158	0.113
0.950	9.651	9.716	0.281	0.263	-0.187	-0.043
Section B						
0.000	9.816	9.821	0.233	0.232	0.178	0.187
0.025	9.579	9.363	0.300	0.351	-0.346	-0.824
0.050	9.506	9.477	0.318	0.325	-0.508	-0.573
0.075	9.456	9.627	0.330	0.288	-0.618	-0.241
0.100	9.416	9.656	0.339	0.280	-0.706	-0.176
0.150	9.348	9.693	0.354	0.270	-0.858	-0.094
0.200	9.328	9.716	0.359	0.263	-0.901	-0.044
0.300	9.324	9.741	0.360	0.256	-0.909	0.010
0.500	9.465	9.749	0.328	0.254	-0.599	0.030
0.700	9.568	9.731	0.303	0.259	-0.370	-0.011
0.800	9.605	9.711	0.293	0.265	-0.290	-0.056
0.850	9.615	9.693	0.291	0.270	-0.267	-0.094
0.900	9.619	9.672	0.290	0.276	-0.258	-0.141
0.950	9.628	9.639	0.287	0.284	-0.238	-0.215
Section C						
0.000	9.780	9.779	0.245	0.245	0.097	0.095
0.025	9.173	9.732	0.392	0.259	-1.244	-0.007
0.050	9.026	9.583	0.421	0.299	-1.569	-0.339
0.075	8.948	9.686	0.436	0.272	-1.740	-0.110
0.100	8.909	9.763	0.443	0.250	-1.828	0.060
0.150	9.262	9.857	0.373	0.220	-1.046	0.269
0.200	8.840	9.914	0.456	0.201	-1.979	0.393
0.300	8.908	9.971	0.443	0.179	-1.829	0.519
0.500	8.833	9.994	0.457	0.169	-1.995	0.571
0.700	9.531	9.949	0.312	0.188	-0.452	0.470
0.800	9.611	9.897	0.292	0.206	-0.276	0.357
0.850	9.630	9.854	0.287	0.221	-0.234	0.261
0.900	9.638	9.802	0.285	0.238	-0.217	0.146
0.950	9.649	9.712	0.282	0.264	-0.191	-0.052
Section D						
0.000	9.521	9.519	0.314	0.315	-0.475	-0.479
0.025	9.959	9.945	0.183	0.189	0.494	0.462
0.050	9.408	9.848	0.341	0.223	-0.724	0.247
0.075	9.401	9.832	0.343	0.228	-0.741	0.213
0.100	9.403	9.835	0.342	0.227	-0.735	0.220
0.150	9.396	9.841	0.344	0.226	-0.751	0.231
0.200	9.406	9.854	0.341	0.221	-0.729	0.260
0.300	9.415	9.866	0.339	0.217	-0.709	0.288
0.500	9.524	9.852	0.314	0.222	-0.468	0.258
0.700	9.593	9.819	0.296	0.233	-0.315	0.184
0.800	9.619	9.785	0.290	0.243	-0.259	0.109
0.850	9.627	9.758	0.288	0.251	-0.242	0.049
0.900	9.628	9.726	0.287	0.260	-0.239	-0.022
0.950	10.902	9.657	0.000	0.279	2.578	-0.173

^aSuction surface^bPressure surface

TABLE 28.—Concluded.

(i) Circumferential distortion; airflow, 35.41 kg/sec; readings 1250 to 1253

Fraction of chord, XC/C	Pressure, N/cm ²		Mach number		Coefficient	
	(a)	(b)	(a)	(b)	(a)	(b)
Section A						
0.000	10.100	10.101	0.079	0.079	0.578	0.580
0.025	10.039	10.112	0.122	0.067	-0.020	0.695
0.050	10.021	10.069	0.133	0.104	-0.195	0.269
0.075	10.003	10.091	0.142	0.086	-0.369	0.492
0.100	9.987	10.078	0.150	0.097	-0.520	0.357
0.150	9.965	10.084	0.160	0.093	-0.735	0.416
0.200	9.956	10.088	0.164	0.089	-0.817	0.463
0.300	9.947	10.095	0.168	0.084	-0.906	0.524
0.500	9.986	10.099	0.150	0.080	-0.526	0.561
0.700	10.023	10.089	0.131	0.088	-0.171	0.467
0.800	10.036	10.080	0.124	0.095	-0.050	0.383
0.850	10.040	10.074	0.122	0.100	-0.010	0.320
0.900	10.041	10.065	0.121	0.106	0.002	0.232
0.950	10.039	10.051	0.122	0.115	-0.016	0.102
Section B						
0.000	10.068	10.069	0.104	0.103	0.269	0.277
0.025	10.022	9.990	0.132	0.148	-0.184	-0.494
0.050	10.008	10.007	0.139	0.139	-0.321	-0.323
0.075	9.998	10.028	0.144	0.129	-0.415	-0.125
0.100	9.990	10.039	0.148	0.122	-0.488	-0.015
0.150	9.977	10.046	0.154	0.118	-0.614	0.049
0.200	9.973	10.049	0.156	0.116	-0.657	0.084
0.300	9.973	10.054	0.156	0.113	-0.657	0.130
0.500	9.994	10.056	0.146	0.112	-0.457	0.149
0.700	10.021	10.052	0.132	0.114	-0.192	0.108
0.800	10.028	10.048	0.129	0.117	-0.128	0.072
0.850	10.030	10.045	0.128	0.118	-0.109	0.044
0.900	10.030	10.045	0.127	0.122	-0.099	-0.008
0.950	10.033	10.032	0.126	0.126	-0.079	-0.084
Section C						
0.000	10.059	10.059	0.110	0.110	0.177	0.178
0.025	9.931	10.053	0.174	0.114	-1.059	0.119
0.050	9.899	10.025	0.187	0.130	-1.374	-0.152
0.075	9.881	10.045	0.194	0.119	-1.544	0.037
0.100	9.872	10.057	0.198	0.111	-1.638	0.154
0.150	9.951	10.077	0.166	0.098	-0.871	0.348
0.200	9.854	10.089	0.204	0.089	-1.807	0.465
0.300	9.862	10.100	0.201	0.079	-1.734	0.571
0.500	9.854	10.103	0.204	0.076	-1.806	0.606
0.700	10.007	10.094	0.140	0.084	-0.324	0.517
0.800	10.026	10.084	0.130	0.092	-0.145	0.423
0.850	10.030	10.076	0.127	0.098	-0.102	0.341
0.900	10.032	10.065	0.126	0.106	-0.085	0.239
0.950	10.035	10.047	0.125	0.117	-0.060	0.063
Section D						
0.000	10.011	10.011	0.138	0.138	-0.287	-0.292
0.025	10.149	10.091	0.000	0.087	1.053	0.488
0.050	9.990	10.072	0.148	0.101	-0.493	0.304
0.075	9.987	10.069	0.150	0.103	-0.521	0.277
0.100	9.987	10.070	0.150	0.103	-0.522	0.281
0.150	9.986	10.071	0.150	0.102	-0.531	0.297
0.200	9.987	10.073	0.150	0.100	-0.523	0.315
0.300	9.989	10.075	0.149	0.099	-0.503	0.336
0.500	10.009	10.073	0.138	0.101	-0.304	0.308
0.700	10.023	10.066	0.131	0.105	-0.171	0.245
0.800	10.027	10.059	0.129	0.110	-0.132	0.179
0.850	10.029	10.055	0.128	0.112	-0.118	0.140
0.900	10.029	10.048	0.128	0.117	-0.111	0.070
0.950	10.280	10.035	0.000	0.124	2.315	-0.051

^aSuction surface.^bPressure surface.

TABLE 26.—Concluded.

(i) Circumferential distortion: airflow, 35.41 kg/sec; readings 1250 to 1253

Circum-ferential location, θ , deg	Inlet		Exit	
	Pres- sure, N/cm ²	Coeffi- cient	Pres- sure, N/cm ²	Coeffi- cient
0	10.055	0.870	10.036	1.051
15	10.053	0.885	10.024	1.165
30	10.051	0.901	10.017	1.233
45	10.057	0.848	10.011	1.291
60	10.067	0.745	10.007	1.326
75	10.060	0.815	*****	*****
90	10.062	0.802	*****	*****
105	10.067	0.750	*****	*****
120	10.062	0.796	10.019	1.214
135	10.062	0.795	10.012	1.281
150	10.060	0.821	10.021	1.198
165	10.062	0.797	10.028	1.127
180	10.062	0.801	10.039	1.017
195	10.066	0.762	10.039	1.025
210	10.067	0.753	10.031	1.096
225	10.070	0.715	10.021	1.197
240	10.069	0.730	10.018	1.225
255	10.069	0.732	10.046	0.954
270	10.078	0.641	10.057	0.847
285	10.074	0.677	10.051	0.903
300	10.084	0.580	10.014	1.265
315	10.074	0.678	10.025	1.160
330	10.060	0.812	10.031	1.100
345	10.055	0.862	10.035	1.063

TABLE 27.—AXIAL STATIC PRESSURE DISTRIBUTION WITH VANES A10 IN CORNER 1
AND VANES A4 IN CORNER 2—DISTORTED INFLOW

(a) 12.70-cm tip radial distortion; airflow, 77.64 kg/sec; readings 1232 to 1235

Axial station	Outer wall				Centerbody			
	Circumferential location, θ , deg							
	0	90	180	270	0	90	180	270
1		9.540						
2		9.571						
3		9.576						
4		9.581						
5		9.577						
6		9.572						
7		9.563						
8	9.533	9.533	9.531	9.545				
9		9.462						
10	9.394	9.395	9.404	9.436				
12				9.425				
13				9.442				
14				9.472				
15				9.510				
16				9.556				
17				9.612				
18				9.663				
19				9.704				
20				9.738				
35		9.366						
36		9.393						
37	9.451	9.414	9.435	9.538				
38		9.435						
39		9.450						
40	9.499	9.470	9.489	9.556				
41	9.537	9.506	9.528	9.570				
42	9.568	9.563	9.561	9.590				
43	9.600	9.573	9.590	11.458				
44	9.619	9.596	9.617	9.644				
45	9.642	9.616	9.641	9.665				
46	9.670	9.628	9.658	9.693				
47	9.686	9.639	9.657	9.701				
48	9.797		9.702	9.793				
49	9.717		9.712	9.804				
50	9.717		9.712	9.834				
51	9.717		9.714	9.901				
52	9.719		9.714					
53				9.901				
54				0.000	9.445	10.026	9.412	9.811
55				0.000	9.362	10.209	9.319	9.706
56				*****	9.244	10.390	9.199	
57				9.513	*****	10.472	9.169	
58				9.618		10.403		9.586
59				9.638		10.374		*****
60				9.639	*****	10.445	*****	*****
61	9.567		9.564	9.623	9.617		9.599	
62	9.539		9.542	10.049	9.994		9.623	
63	9.532		9.537	9.595	9.958	9.606	9.906	9.617
64	9.526		9.531	9.584	9.862	9.610	9.831	9.615
65	9.518		9.523	9.578	9.783	9.598	9.763	9.608
66	9.509		9.519	9.568	9.696	9.582	9.690	9.594
67	9.499		9.506	9.560	9.614	9.566	9.611	9.578
68	9.494		9.501	9.547	9.537	9.541	9.534	9.562
69	9.482		9.492	9.534	9.462	9.512	9.461	9.540
70	9.473		9.481	9.520	9.406	9.489	9.396	9.511
71	9.459		9.468	9.509	9.348	9.452	9.337	9.472
72	9.453	*****	9.457	9.493	9.289	9.418	9.290	9.442
73	9.444	*****	9.449	9.485	9.253	9.382	9.247	9.405
74	9.441	*****	9.447	9.467	9.222	9.357	9.219	9.377
75	9.429	*****	9.444	9.475	9.205	9.338	9.200	9.359
76	9.415	*****	10.236	9.390	9.192	9.333	9.191	9.352
77	*****	*****	*****	*****	9.189	9.327	9.187	9.333
78	*****	*****	*****	*****	9.199	9.331	9.209	9.345
79	9.366	9.364	9.458	9.455	9.407	9.409	9.416	9.416

TABLE 27.—Continued.

(b) 12.70-cm tip radial distortion; airflow, 72.35 kg/sec; readings 1224 to 1227

Axial station	Outer wall				Centerbody			
	Circumferential location, θ , deg							
	0	90	180	270		90	180	270
1		9.608						
2		9.637						
3		9.642						
4		9.645						
5		9.642						
6		9.636						
7		9.630						
8	9.602	9.602	9.601	9.614				
9		9.540						
10	9.486	9.486	9.492	9.521				
12				9.513				
13				9.527				
14				9.555				
15				9.587				
16				9.626				
17				9.675				
18				9.720				
19				9.756				
20				9.786				
35		9.461						
36		9.485						
37	9.535	9.503	9.523	9.614				
38		9.522						
39		9.535						
40	9.578	9.552	9.569	9.625				
41	9.612	9.586	9.603	9.640				
42	9.637	9.615	9.630	9.658				
43	9.664	9.641	9.656	11.297				
44	9.683	9.662	9.679	9.708				
45	9.702	9.677	9.700	9.723				
46	9.727	9.688	9.717	9.747				
47	9.741	9.699	9.715	9.753				
48	9.829		9.755	9.833				
49	9.767		9.761	9.843				
50	9.767		9.763	9.870				
51	9.771		9.764	9.928				
52	9.772		9.764					
53				9.931				
54				0.000	7.521	10.043	9.492	9.860
55				0.000	9.453	10.219	9.412	9.765
56				*****	9.351	10.371	9.308	
57				9.620	*****	10.429	9.287	
58				9.694		10.363		9.665
59				9.706		10.360		*****
60				9.703	*****	10.411	*****	*****
61	9.639		9.637	9.690	9.685		9.674	
62	9.616		9.616	10.057	10.018		9.688	
63	9.610		9.613	9.663	9.981	9.674	9.940	9.688
64	9.607		9.608	9.653	9.898	9.677	9.875	9.680
65	9.570		9.501	9.648	9.828	9.666	9.816	9.673
66	9.588		9.594	9.640	9.751	9.652	9.750	9.662
67	9.580		9.586	9.630	9.679	9.637	9.681	9.647
68	9.577		9.579	9.620	9.611	9.617	9.614	9.633
69	9.565		9.572	9.613	9.547	9.592	9.550	9.614
70	9.556		9.562	9.600	9.497	9.571	9.489	9.590
71	9.546		9.555	9.589	9.445	9.540	9.440	9.559
72	9.542	*****	9.545	9.576	9.400	9.510	9.401	9.533
73	9.532	*****	9.537	9.560	9.369	9.481	9.364	9.502
74	9.530	*****	9.533	9.554	9.341	9.458	9.338	9.477
75	9.519	*****	9.532	9.558	9.325	9.443	9.321	9.462
76	9.497	*****	10.133	9.491	9.315	9.438	9.312	9.455
77	*****	*****	*****	*****	9.313	9.434	9.311	9.440
78	*****	*****	*****	*****	9.322	9.437	9.329	9.449
79	9.466	9.466	9.544	9.543	9.504	9.503	9.511	9.509

TABLE 27.—Continued.

(c) 12.70-cm tip radial distortion; airflow, 35.34 kg/sec; readings 1228 to 1231

Axial station	Outer wall				Centerbody			
	Circumferential location, θ , deg							
	0	90	180	270	0	90	180	270
1		10.027						
2		10.032						
3		10.033						
4		10.034						
5		10.034						
6		10.032						
7		10.030						
8	10.025	10.025	10.025	10.028				
9		10.013						
10	10.005	10.003	10.005	10.009				
12				10.011				
13				10.013				
14				10.019				
15				10.026				
16				10.033				
17				10.042				
18				10.051				
19				10.055				
20				10.064				
35		10.000						
36		10.005						
37	10.013	10.008	10.012	10.030				
38		10.011						
39		10.015						
40	10.022	10.017	10.021	10.033				
41	10.029	10.024	10.028	10.035				
42	10.035	10.030	10.033	10.039				
43	10.039	10.035	10.038	10.378				
44	10.043	10.039	10.042	10.047				
45	10.048	10.042	10.047	10.052				
46	10.052	10.044	10.050	10.055				
47	10.053	10.046	10.049	10.057				
48	10.062		10.057	10.074				
49	10.059		10.058	10.075				
50	10.060		10.059	10.082				
51	10.060		10.058	10.096				
52	10.060		10.058					
53				10.100				
54				0.000	10.009	10.128	9.999	10.088
55				0.000	9.994	10.172	9.984	10.064
56				*****	9.971	10.191	9.965	
57				10.031	*****	10.190	9.964	
58				10.049		10.178		10.040
59				10.051		10.186		*****
60				10.049	*****	10.194	*****	*****
61	10.035		10.034	10.044	10.044		10.041	
62	10.030		10.030	10.120	10.116		10.044	
63	10.029		10.029	10.041	10.106	10.041	10.099	10.043
64	10.028		10.028	10.036	10.088	10.042	10.086	10.043
65	10.027		10.027	10.038	10.074	10.040	10.073	10.041
66	10.025		10.026	10.036	10.058	10.037	10.059	10.039
67	10.023		10.024	10.031	10.043	10.034	10.044	10.035
68	10.022		10.024	10.032	10.029	10.030	10.030	10.033
69	10.021		10.022	10.030	10.016	10.026	10.017	10.030
70	10.018		10.020	10.028	10.006	10.022	10.006	10.025
71	10.017		10.018	10.026	9.997	10.016	9.995	10.018
72	10.015	*****	10.017	10.023	9.987	10.010	9.988	10.013
73	10.014	*****	10.016	10.021	9.981	10.004	9.981	10.007
74	10.013	*****	10.013	10.019	9.975	9.999	9.975	10.003
75	10.011	*****	10.014	10.020	9.973	9.995	9.972	10.000
76	10.004	*****	10.070	10.005	9.971	9.996	9.971	9.999
77	*****	*****	*****	*****	9.971	9.994	9.970	9.995
78	*****	*****	*****	*****	9.972	9.995	9.974	9.997
79	10.002	10.001	10.019	10.019	10.008	10.008	10.009	10.009

TABLE 27.—Continued.

(d) 6.35-cm tip radial distortion; airflow, 77.56 kg/sec; readings 1236 to 1239

Axial station	Outer wall				Centerbody			
	Circumferential location, θ , deg							
	0	90	180	270	0	90	180	270
1		9.523						
2		9.561						
3		9.566						
4		9.572						
5		9.572						
6		9.567						
7		9.555						
8	9.525	9.525	9.522	9.539				
9		9.458						
10	9.398	9.401	9.403	9.432				
12				9.423				
13				9.439				
14				9.471				
15				9.516				
16				9.561				
17				9.619				
18				9.671				
19				9.711				
20				9.748				
35		9.385						
36		9.409						
37	9.448	9.426	9.426	9.537				
38		9.442						
39		9.455						
40	9.498	9.470	9.485	9.565				
41	9.534	9.497	9.522	9.577				
42	9.568	9.530	9.556	9.597				
43	9.601	9.559	9.586	11.113				
44	9.622	9.585	9.615	9.669				
45	9.648	9.606	9.642	9.685				
46	9.681	9.620	9.665	9.716				
47	9.702	9.632	9.658	9.726				
48	9.795		9.729	9.827				
49	9.741		9.742	9.836				
50	9.743		9.750	9.865				
51	9.752		9.754	9.935				
52	9.757		9.754					
53				9.901				
54				0.000	9.450	10.091	9.455	9.774
55				0.000	9.395	10.219	9.399	9.739
56				*****	9.334	10.338	9.325	
57				9.532	*****	10.250	9.320	
58				9.630		10.215		9.590
59				9.645		10.168		*****
60				9.646	*****	10.219	*****	*****
61	9.575		9.582	9.628	9.620		9.603	
62	9.549		9.555	9.931	9.924		9.626	
63	9.546		9.552	9.604	9.876	9.592	9.845	9.622
64	9.538		9.544	9.589	9.810	9.599	9.786	9.616
65	9.528		9.536	9.584	9.751	9.588	9.733	9.609
66	9.521		9.528	9.577	9.687	9.575	9.673	9.598
67	9.510		9.518	9.566	9.619	9.558	9.608	9.581
68	9.505		9.511	9.555	9.552	9.538	9.542	9.564
69	9.494		9.508	9.544	9.487	9.510	9.479	9.543
70	9.481		9.490	9.527	9.483	9.488	9.424	9.519
71	9.472		9.479	9.518	9.377	9.453	9.367	9.485
72	9.467	*****	9.467	9.501	9.320	9.422	9.324	9.457
73	9.456	*****	9.460	9.493	9.282	9.391	9.283	9.425
74	9.455	*****	9.454	9.472	9.250	9.365	9.252	9.398
75	9.439	*****	9.457	9.482	9.229	9.351	9.232	9.381
76	9.400	*****	10.050	9.400	9.214	9.344	9.220	9.370
77	*****	*****	*****	*****	9.210	9.335	9.215	9.353
78	*****	*****	*****	*****	9.217	9.337	9.231	9.360
79	9.366	9.368	9.470	9.468	9.399	9.401	9.418	9.420

TABLE 27.—Continued.

(e) 6.35-cm tip radial distortion; airflow, 72.25 kg/sec; readings 1241 to 1244

Axial station	Outer wall				Centerbody			
	Circumferential location, θ , deg							
	0	90	180	270	0	90	180	270
1		9.576						
2		9.607						
3		9.614						
4		9.617						
5		9.617						
6		9.612						
7		9.603						
8	9.577	9.577	9.575	9.589				
9		9.518						
10	9.464	9.468	9.469	9.497				
12				9.490				
13				9.504				
14				9.533				
15				9.570				
16				9.612				
17				9.662				
18				9.707				
19				9.744				
20				9.775				
35		9.458						
36		9.478						
37	9.512	9.493	9.490	9.599				
38		9.507						
39		9.517						
40	9.557	9.530	9.540	9.615				
41	9.590	9.557	9.575	9.626				
42	9.616	9.585	9.605	9.642				
43	9.646	9.611	9.632	9.673				
44	9.664	9.633	9.653	9.696				
45	9.686	9.651	9.683	9.717				
46	9.714	9.671	9.699	9.745				
47	9.733	9.676	9.698	9.750				
48	9.821		9.760	9.839				
49	9.769		9.769	9.845				
50	9.773		9.776	9.867				
51	9.780		9.780	9.931				
52	9.786		9.780					
53				9.834				
54				0.000	9.374	10.084	9.338	9.745
55				0.000	9.357	10.216	9.324	9.761
56				*****	9.341	10.311	9.311	
57				9.720	*****	10.236	9.352	
58				9.718		10.188		9.709
59				9.708		10.158		*****
60				9.702	*****	10.201	*****	*****
61	9.651		9.658	9.696	9.699		9.700	
62	9.622		9.631	9.953	9.940		9.690	
63	9.617		9.626	9.661	9.904	9.657	9.876	9.687
64	9.609		9.619	9.648	9.844	9.661	9.824	9.681
65	9.600		9.611	9.645	9.792	9.652	9.778	9.674
66	9.593		9.603	9.638	9.733	9.639	9.726	9.662
67	9.582		9.595	9.629	9.675	9.625	9.671	9.649
68	9.579		9.586	9.617	9.617	9.605	9.614	9.634
69	9.569		9.578	9.608	9.559	9.584	9.560	9.617
70	9.560		9.567	9.592	9.514	9.562	9.503	9.595
71	9.548		9.557	9.583	9.465	9.534	9.461	9.565
72	9.542	*****	9.548	9.569	9.418	9.507	9.424	9.539
73	9.534	*****	9.540	9.562	9.384	9.479	9.388	9.512
74	9.530	*****	9.537	9.546	9.356	9.458	9.362	9.488
75	9.519	*****	9.534	9.559	9.339	9.443	9.342	9.471
76	9.485	*****	10.021	9.472	9.326	9.437	9.332	9.464
77	*****	*****	*****	*****	9.322	9.432	9.328	9.448
78	*****	*****	*****	*****	9.328	9.433	9.340	9.454
79	9.453	9.459	9.554	9.553	9.487	9.486	9.507	9.506

TABLE 27.—Continued.

(f) 6.35-cm tip radial distortion; airflow, 35.26 kg/sec; readings 1246 to 1249

Axial station	Outer wall				Centerbody			
	Circumferential location, θ , deg							
	0	90	180	270	0	90	180	270
1		10.021						
2		10.026						
3		10.026						
4		10.028						
5		10.028						
6		10.026						
7		10.024						
8	10.019	10.020	10.019	10.022				
9		10.008						
10	10.000	9.999	10.001	10.007				
12				10.006				
13				10.009				
14				10.015				
15				10.021				
16				10.029				
17				10.038				
18				10.047				
19				10.054				
20				10.061				
35		9.998						
36		10.002						
37	10.009	10.006	10.007	10.028				
38		10.008						
39		10.011						
40	10.018	10.012	10.015	10.031				
41	10.025	10.019	10.023	10.033				
42	10.031	10.025	10.029	10.037				
43	10.035	10.030	10.033	10.041				
44	10.041	10.034	10.039	10.046				
45	10.045	10.038	10.044	10.051				
46	10.050	10.038	10.048	10.055				
47	10.051	10.042	10.046	10.057				
48	10.063		10.057	10.074				
49	10.060		10.060	10.069				
50	10.060		10.061	10.081				
51	10.062		10.059	10.093				
52	10.062		10.059					
53				10.072				
54				0.000	9.983	10.124	9.974	10.049
55				0.000	9.977	10.155	9.971	10.059
56				*****	9.974	10.166	9.968	
57				10.053	*****	10.155	9.977	
58				10.051		10.141		10.047
59				10.049		10.148		*****
60				10.046	*****	10.152	*****	*****
61	10.037		10.037	10.044	10.046		10.046	
62	10.032		10.032	10.095	10.093		10.043	
63	10.031		10.031	10.038	10.087	10.038	10.084	10.043
64	10.029		10.030	10.036	10.076	10.039	10.075	10.042
65	10.028		10.029	10.036	10.066	10.037	10.065	10.041
66	10.025		10.028	10.028	10.053	10.035	10.054	10.039
67	10.018		10.026	10.032	10.042	10.032	10.042	10.036
68	10.023		10.025	10.031	10.031	10.028	10.030	10.033
69	10.021		10.023	10.028	10.019	10.024	10.019	10.030
70	10.019		10.021	10.026	10.010	10.020	10.009	10.026
71	10.017		10.018	10.024	10.001	10.015	10.000	10.020
72	10.016	*****	10.018	10.022	9.991	10.010	9.993	10.016
73	10.014	*****	10.016	10.020	9.985	10.003	9.986	10.009
74	10.013	*****	10.014	10.018	9.979	9.999	9.981	10.006
75	10.011	*****	10.014	10.019	9.970	9.997	9.977	10.001
76	10.003	*****	10.061	10.004	9.973	9.996	9.975	10.001
77	*****	*****	*****	*****	9.972	9.994	9.974	9.998
78	*****	*****	*****	*****	9.973	9.994	9.977	9.999
79	9.999	10.000	10.019	10.013	10.006	10.005	10.008	10.008

TABLE 27.—Continued.

(g) Circumferential distortion; airflow, 79.22 kg/sec; readings 1254 to 1257

Axial station	Outer wall				Centerbody			
	Circumferential location, θ , deg							
	0	90	180	270	0	90	180	270
1		9.638						
2		9.606						
3		9.590						
4		9.588						
5		9.582						
6		9.577						
7		9.566						
8	9.526	9.534	9.535	9.543				
9		9.465						
10	9.391	9.409	9.405	9.428				
12				9.419				
13				9.443				
14				9.490				
15				9.555				
16				9.629				
17				9.728				
18				9.822				
19				9.901				
20				9.962				
35		9.325						
36		9.359						
37	9.461	9.386	9.395	9.541				
38		9.417						
39		9.435						
40	9.510	9.468	9.476	9.553				
41	9.546	9.518	9.525	9.567				
42	9.573	9.563	9.566	9.587				
43	9.611	9.597	9.604	9.625				
44	9.623	9.626	9.638	9.648				
45	9.635	9.651	9.672	9.671				
46	9.669	9.805	9.691	9.707				
47	9.691	9.689	9.704	9.722				
48	9.793		9.752	9.819				
49	9.710		9.761	9.816				
50	9.698		9.755	9.844				
51	9.696		9.759	9.952				
52	9.699		9.759					
53				9.802				
54				0.000	9.217	10.225	9.219	9.691
55				0.000	9.225	10.026	9.220	9.739
56				*****	9.275	9.594	9.221	
57				9.666	*****	9.274	9.268	
58				9.660		9.361		9.646
59				9.646		9.923		*****
60				9.635	*****	9.892	*****	*****
61	9.571		9.604	9.610	9.616		9.622	
62	9.534		9.567	9.842	9.980		9.601	
63	9.528		9.563	9.587	9.745	9.578	9.873	9.597
64	9.521		9.555	9.571	9.679	9.583	9.805	9.588
65	9.507		9.545	9.567	9.625	9.573	9.746	9.583
66	9.503		9.536	9.560	9.574	9.561	9.685	9.571
67	9.491		9.525	9.550	9.530	9.552	9.623	9.559
68	9.486		9.514	9.537	9.492	9.535	9.563	9.546
69	9.474		9.506	9.528	9.454	9.514	9.503	9.529
70	9.465		9.492	9.509	9.424	9.497	9.449	9.509
71	9.456		9.480	9.499	9.392	9.471	9.394	9.476
72	9.449	*****	9.469	9.484	9.361	9.445	9.352	9.452
73	9.440	*****	9.460	9.477	9.336	9.418	9.309	9.422
74	9.437	*****	9.458	9.461	9.317	9.394	9.277	9.398
75	9.424	*****	9.459	9.478	9.300	9.381	9.254	9.378
76	9.387	*****	10.028	9.371	9.287	9.366	9.238	9.373
77	*****	*****	*****	*****	9.277	9.356	9.228	9.353
78	*****	*****	*****	*****	9.276	9.352	9.241	9.363
79	9.387	9.389	9.479	9.475	9.399	9.400	9.419	9.420

TABLE 27.—Continued.

(h) Circumferential distortion; airflow, 73.68 kg/sec; readings 1258 to 1261

Axial station	Outer wall				Centerbody			
	Circumferential location, θ , deg							
	0	90	180	270	0	90	180	270
1		9.696						
2		9.671						
3		9.656						
4		9.645						
5		9.649						
6		9.644						
7		9.634						
8	9.602	9.607	9.607	9.616				
9		9.547						
10	9.485	9.500	9.498	9.519				
12				9.511				
13				9.532				
14				9.575				
15				9.628				
16				9.691				
17				9.777				
18				9.857				
19				9.926				
20				9.978				
35		9.434						
36		9.457						
37	9.549	9.485	9.493	9.619				
38		9.512						
39		9.527						
40	9.592	9.553	9.561	9.630				
41	9.621	9.598	9.604	9.641				
42	9.646	9.636	9.640	9.659				
43	9.679	9.667	9.671	9.691				
44	9.689	9.692	9.702	9.720				
45	9.701	9.714	9.730	9.732				
46	9.731	10.865	9.748	9.761				
47	9.747	9.744	9.758	9.775				
48	9.824		9.803	9.859				
49	9.764		9.809	9.856				
50	9.755		9.804	9.880				
51	9.754		9.805	9.973				
52	9.755		9.805					
53				9.846				
54				0.000	9.338	10.218	9.349	9.750
55				0.000	9.347	10.050	9.346	9.790
56				*****	9.388	9.665	9.346	
57				9.727	*****	9.389	9.384	
58				9.721		9.468		9.710
59				9.710		9.963		*****
60				9.701	*****	9.937	*****	*****
61	9.644		9.673	9.677	9.684		9.690	
62	9.613		9.640	9.881	9.998		9.670	
63	9.607		9.638	9.658	9.798	9.651	9.909	9.666
64	9.600		9.630	9.644	9.739	9.654	9.850	9.658
65	9.590		9.622	9.641	9.695	9.647	9.799	9.653
66	9.587		9.614	9.635	9.648	9.636	9.745	9.644
67	9.576		9.603	9.628	9.609	9.629	9.692	9.632
68	9.573		9.596	9.614	9.575	9.613	9.638	9.621
69	9.563		9.588	9.608	9.542	9.597	9.586	9.609
70	9.544		9.577	9.592	9.517	9.581	9.538	9.590
71	9.544		9.567	9.584	9.491	9.557	9.492	9.563
72	9.539	*****	9.557	9.570	9.463	9.536	9.455	9.541
73	9.531	*****	9.548	9.563	9.442	9.512	9.418	9.516
74	9.528	*****	9.547	9.549	9.424	9.493	9.391	9.495
75	9.518	*****	9.548	9.563	9.411	9.477	9.369	9.478
76	9.480	*****	9.977	9.475	9.398	9.468	9.355	9.472
77	*****	*****	*****	*****	9.391	9.458	9.347	9.456
78	*****	*****	*****	*****	9.384	9.456	9.355	9.466
79	9.490	9.490	9.563	9.562	9.497	9.496	9.514	9.514

TABLE 27.—Concluded.

(i) Circumferential distortion; airflow, 35.41 kg/sec; readings 1250 to 1253

Axial station	Outer wall				Centerbody			
	Circumferential location, θ , deg							
	0	90	180	270	0	90	180	270
1		10.041						
2		10.037						
3		10.034						
4		10.034						
5		10.033						
6		10.031						
7		10.030						
8	10.024	10.024	10.024	10.027				
9		10.012						
10	10.002	10.004	10.002	10.010				
12				10.010				
13				10.013				
14				10.021				
15				10.032				
16				10.043				
17				10.059				
18				10.071				
19				10.087				
20				10.097				
35		9.993						
36		9.998						
37	10.015	10.003	10.001	10.029				
38		10.008						
39		10.011						
40	10.023	10.015	10.017	10.032				
41	10.029	10.024	10.025	10.034				
42	10.035	10.032	10.033	10.037				
43	10.040	10.038	10.039	10.043				
44	10.043	10.043	10.045	10.047				
45	10.047	10.047	10.050	10.051				
46	10.051	10.050	10.054	10.057				
47	10.053	10.052	10.055	10.058				
48	10.062		10.064	10.075				
49	10.058		10.065	10.074				
50	10.056		10.063	10.079				
51	10.055		10.063	10.097				
52	10.056		10.063					
53				10.070				
54				0.000	9.975	10.145	9.973	10.052
55				0.000	9.976	10.134	9.972	10.063
56				*****	9.983	10.043	9.970	
57				10.046	*****	10.000	9.979	
58				10.050		10.007		10.048
59				10.047		10.109		*****
60				10.045	*****	10.099	*****	*****
61	10.036		10.039	10.041	10.042		10.043	
62	10.029		10.033	10.082	10.102		10.030	
63	10.029		10.032	10.036	10.066	10.035	10.088	10.039
64	10.026		10.031	10.034	10.055	10.036	10.077	10.038
65	10.025		10.030	10.034	10.045	10.034	10.067	10.036
66	10.023		10.029	10.032	10.035	10.032	10.055	10.034
67	10.022		10.026	10.030	10.028	10.030	10.044	10.032
68	10.021		10.026	10.023	10.021	10.028	10.035	10.030
69	10.019		10.024	10.027	10.015	10.025	10.024	10.028
70	10.017		10.022	10.024	10.004	10.022	10.014	10.024
71	10.016		10.019	10.023	10.005	10.018	10.004	10.018
72	10.015	*****	10.018	10.020	9.998	10.012	9.997	10.013
73	10.013	*****	10.016	10.019	9.994	10.007	9.989	10.008
74	10.012	*****	10.015	10.016	9.991	10.004	9.984	10.006
75	10.010	*****	10.016	10.018	9.989	10.002	9.980	10.002
76	10.001	*****	10.060	10.003	9.987	10.000	9.979	10.001
77	*****	*****	*****	*****	9.986	9.998	9.976	9.997
78	*****	*****	*****	*****	9.984	9.997	9.978	9.999
79	10.004	10.005	10.020	10.019	10.005	10.005	10.008	10.007