

1988

Adaptability of Scanning Electron Microscopy to Studies of Pollen Morphology

John J. Skvarla
University of Oklahoma

John R. Rowley
University of Stockholm

William F. Chissoe
University of Oklahoma

Follow this and additional works at: <http://scholarship.claremont.edu/aliso>



Part of the [Botany Commons](#)

Recommended Citation

Skvarla, John J.; Rowley, John R.; and Chissoe, William F. (1988) "Adaptability of Scanning Electron Microscopy to Studies of Pollen Morphology," *Aliso: A Journal of Systematic and Evolutionary Botany*: Vol. 12: Iss. 1, Article 13.
Available at: <http://scholarship.claremont.edu/aliso/vol12/iss1/13>

ADAPTABILITY OF SCANNING ELECTRON MICROSCOPY
TO STUDIES OF POLLEN MORPHOLOGY¹

JOHN J. SKVARLA

*Oklahoma Biological Survey
and Department of Botany-Microbiology
University of Oklahoma
Norman, Oklahoma 73019*

JOHN R. ROWLEY

*Department of Botany
University of Stockholm
S-106 91 Stockholm, Sweden*

AND

WILLIAM F. CHISSOE

*Department of Botany-Microbiology
University of Oklahoma
Norman, Oklahoma 73019*

ABSTRACT

We have explored methods to achieve excellent results in study of the pollen grain wall by using only one electron microscope, the scanning electron microscope (SEM). While the secondary electron imaging mode, the most common in use, has great value in characterizing the exine surface it is possible to obtain a more comprehensive representation of pollen grain walls by expanding the capability of the secondary mode and making use of backscatter and transmission imaging detectors. In this way information is obtained about internal exine features that are likely to be more stable phylogenetically than the generally late-to-form surface structure. We illustrate the usefulness of natural and induced fractures, cryomicrotomy, thin-section examination, section deplasticization, localized acetolysis and pollen erosion by ionic bombardment in imaging exine structure. Techniques for expanding the use of SEM in taxonomic studies of mature pollen grain walls are outlined in flow chart sketches and illustrated with numerous examples from angiosperm pollen.

Key words: backscatter imaging, coverslip acetolysis, cryomicrotomy, etched pollen, fractured pollen, frozen sections, ion and fast-atom etching, LM, microtechnique, pollen, polyethylene glycol, SEM, TEM, TSEM.

INTRODUCTION

The theme of this report is an investigation of ways to achieve uncompromised results in the study of pollen grain walls by using only one electron microscope, the scanning electron microscope (SEM). The adaptability of SEM has been underutilized in taxonomic studies of mature pollen grain walls due to an almost exclusive dependence upon a single operating mode. By expanding application of

¹ Based on a lecture presented by John J. Skvarla at the Rancho Santa Ana Botanic Garden symposium, *Trends in Systematic and Evolutionary Botany*, 25-26 May 1985.

SEM and incorporating a number of procedures, some that are well known and others more innovative, it is possible to comprehensively model pollen grain walls. Electron microscope observations on pollen grain walls have depended largely on the transmission electron microscope (TEM) to obtain structural and stratigraphic information by analysis of the internal morphology and the scanning electron microscope (SEM) to obtain information about sculpturing and surface morphology. There was about a 14-year hiatus between the application of these two instruments to studies of pollen with the TEM work by Fernandez-Moran and Dahl (1952) and the SEM work of Thornhill, Matta, and Wood (1965). It is interesting for the record that Gunnar Erdtman and K. G. Thorsson took TEM micrographs of isolated spines of pollen of Malvaceae as well as fragments of the reticulum of *Lycopodium* spores as early as 1949, although these were not published until 1969 (Erdtman 1969).

During that hiatus metal-coated carbon replicas were used to describe pollen surfaces using TEM (Mühlethaler 1955; Yamazaki and Takeota 1959; Bradley 1958, 1960; Rowley 1959, 1960; Rowley, Mühlethaler, and Frey-Wyssling 1959; Tsukada and Rowley 1964), but the technique met with limited popularity because of the arduous nature of the replication procedure. Furthermore, interpretation of replicas was difficult as they were usually restricted to very small areas of the pollen surface. In effect, information about the pollen surface at the ultrastructural level lagged considerably, although remarkable characterizations were made with the light microscope (LM) (e.g., Brorson-Christensen 1949; Carlquist 1960, 1961). Needless to say light microscopy remains a fundamental and substantial tool in palynology (*viz.*, see historical reviews of Wodehouse 1935; Manten 1969a, b, 1970; and Erdtman texts of 1943, 1952, 1969). Replicas as means of obtaining basic morphologic/taxonomic data virtually disappeared from the palynologists' repertoire when the SEM impacted in the mid 1960s. The SEM technology deserves direct credit for the sharp increase in pollen research activities which have continued to the present time (Fig. 1). SEM now embraces a broad spectrum from descriptive to experimental research as is evident in the most recent pollen literature (see *Pollen and Spores. Form and Function*. Linnean Society of London. Academic Press. 1986. S. Blackmore and I. K. Ferguson, editors).

While logic would suggest that the two electron microscope approaches, coupled with basic light microscopy, should work in concert for precise characterization of the pollen grain wall, the literature indicates a remarkable polarization. Approximately 1627 genera of 267 dicotyledon families and 298 genera of 37 monocotyledon families have been scanned according to the comprehensive reference tabulation of Thanikaimoni (1981). This record stands in contrast to 708 genera of 191 dicot families and 121 genera of 38 monocot families studied using TEM (Thanikaimoni 1980). Figure 1 summarizes the relative activity of SEM, TEM, and LM with respect to studies of pollen grain walls of extant plants.

Perusal of the general botanical literature of the past 20 or so years shows a widespread acceptance of SEM although the actual proportion of SEM to TEM is unknown to us. The survey of EM instruments in the United Kingdom presented by Robards (1984) showed that 480 laboratories were using the TEM in biology while 209 used SEM. These figures, however, indicate instruments available rather than published work. In any case, according to a recent estimate, Robards (1984) notes that SEMs and TEMs are selling in the ratio of 3:1.

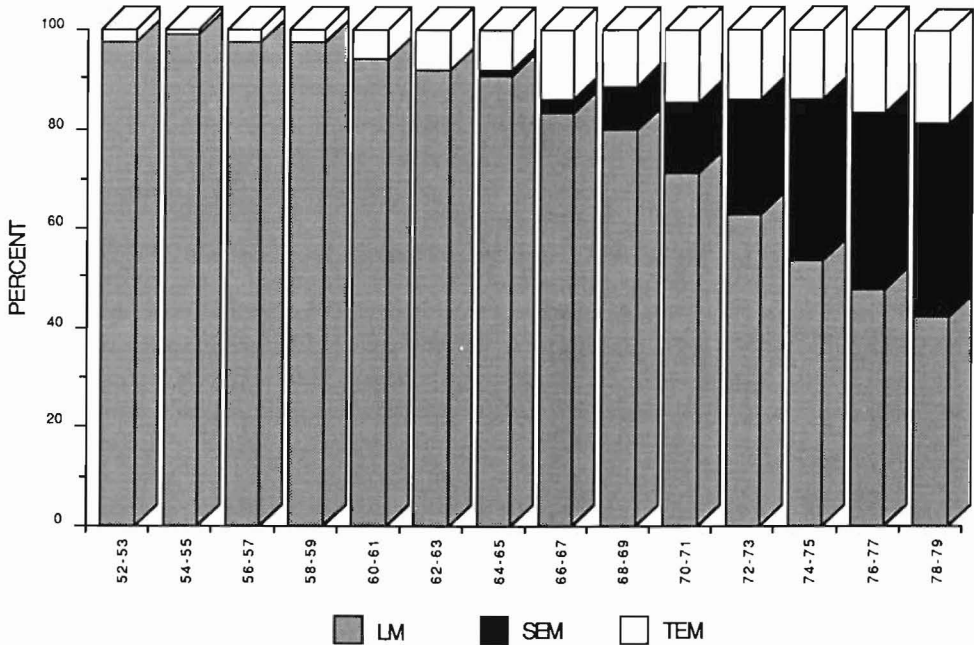

Fig. 1. Stacked column graph reflecting the percentage of utilization of LM, TEM, and SEM in research on extant angiosperm pollen as catalogued in the bibliographic indices of Thanikaimoni (1972, 1973, 1976, 1980). TEM references start with the publication of Fernandez-Moran and Dahl (1952); SEM references start with the publication of Thornhill, Matta, and Wood (1965). Although LM references have their origins in the eighteenth century (see review by Wodehouse 1935) our data for LM begins in 1952. The vertical dimension indicates the relative percentage of the two reference categories (TEM, SEM) that include micrographs of pollen. Additionally, those references that incorporate both TEM and SEM are represented in both TEM and SEM portions of the column. The LM references take into account all pollen work (LM, abstracts, reviews, etc.) exclusive of electron microscopy. The horizontal scale is based upon two-year intervals beginning with 1952–1953, and the relative decrease in references for 1978–1979 can be attributed to incomplete literature surveys (recommendations and comments from Professor Thanikaimoni, personal communication, March 1985).

The following points may explain this polarization:

1. Dramatic and spectacular results on a wide variety of biological materials that are relatively simple to comprehend are very quickly acquired with SEM. This is in contrast to results from TEM which require specialized skills for interpretation. It is in the realm of sample preparation that SEM is considerably easier and faster than TEM. Procedures like fixing, bulk staining, sequential dehydration, and section staining are not obligatory as they are for TEM. Furthermore, the mastery of thin sectioning (“ultramicrotomy”) to acquire less than approximately 800 Å-thick sections, while useful, is not necessary.

2. Total operational expenditures for SEM are far less than for TEM. For example, costly fixatives such as OsO_4 , embedding resins, and electron stains are not needed. Furthermore, the most singular expense of sample preparation, diamond knives, is eliminated. Currently the yearly cost of electron microscope maintenance contracts is in the neighborhood of \$7500 to \$8500, irrespective of

microscope type. In many academic institutions the \$15,000 to \$17,000 required to maintain both a TEM and SEM is prohibitive.

3. Perhaps the most compelling reason favoring usage of the SEM is that the instrument has considerably greater flexibility than the TEM. Since many academic electron microscope laboratories are multidisciplinary, the adaptability of the SEM has considerable appeal, particularly in nonbiological areas such as the physical sciences which require sophisticated analytical accessories. The relative flexibility of operational modes of the two electron microscopes is compared in the following list.

	SEM	TEM
1. Surface morphology	+	+
2. Subsurface morphology (by backscatter imaging)	+	-
3. Transmission imaging	+	+
4. X-ray microanalysis	+	+
5. Surface X-ray microanalysis (Auger)	+	-
6. Cathodoluminescence	+	-
7. Specimen/current interactions	+	-
8. Examination of living materials	+	-
9. Microprobe capabilities	+	-

In view of the above considerations the popularity of the SEM is quite understandable. Certainly, in laboratories emphasizing taxonomic characters at the low to medium levels of magnification the SEM is the instrument of choice. However, we should not ignore data available from TEM. A satisfactory solution would be to maintain one instrument and modify it and preparational methods in order to get information corresponding to results from both TEM and SEM. Procedures, which provide SEM alternatives to TEM, are summarized as follows:

1. Fractured pollen
 - A. Natural and "fortuitous" breaks
 - B. Induced breaks
 - (1) Low temperature breaks (liquid nitrogen, ice cubes)
 - (2) Mechanical breaks (sonication, "apothecary")
 - C. Cryomicrotomy (freezing microtome)
 - (1) Cryoprotectants, etc.
 - (2) Water-drop method
2. Backscatter electron imaging
3. TSEM (=transmission microscopy in a scanning electron microscope) and "Pseudo-TSEM"
4. Thick-section deplasticization (etching)
5. Polyethylene glycols (PEG)
6. Coverslip acetolysis
7. Ion-beam erosion (etching) of exines

Each of the above alternatives is discussed in terms of how it can contribute toward modeling the pollen grain wall. This will be done as follows: (1) reference to relevant previous work, (2) introducing new innovations, (3) diagrammatic representation of methods, and (4) electron micrographs illustrating results having general as well as taxonomic implications.

FRACTURED POLLEN

This SEM alternative pertains to pollen that in some manner, either intentionally or fortuitously, has been broken, fractured, or cracked, so that surfaces of the exine interior are exposed. The information from such grains presents a characterization of basic pollen wall structural patterns that can be of great value in describing different taxonomic hierarchies (e.g., Echlin 1967; Chanda and Rowley 1967; Cerceau-Larrival 1971; Cerceau-Larrival and Roland-Heydacker 1976; Le Thomas and Lugardon 1976; Kalis 1979; Lobreau-Callen 1980, 1983; Guyot, Cerceau-Larrival, Carbonnier-Jarreau, Derouet, and Relot 1980; Poole 1981; Argue 1983; Tormo, Ubera, Dominguez, and Guerrero 1984; Sengin 1986; Nilsson 1986; see other citations below). Figures 2–9 illustrate this with an unsystematic selection of angiosperm genera while in Figures 10–16 the selection is familial. The fracture planes found in these grains are, for purposes of this report, considered to be “uncontrolled” or perhaps even “random” in contrast to “controlled” breaks acquired by cryomicrotomy to be discussed later. Surfaces suitable for study on broken grains are rarely found in sufficient quantity to insure information adequate for interpretation. Consequently one must usually induce fractures. Such fracturing is not easily accomplished because physical properties of pollen make breakage highly unpredictable, sometimes unattainable. A wide spectrum of techniques to cause fracturing is in use and a sampling of such techniques is listed here:

1. Sonication (Marceau 1969; Cerceau, Hideux, Marceau, and Roland 1970; Cerceau-Larrival 1971; Hideux 1972; Hideux and Marceau 1972).
2. Dissection fracturing (Van Campo and Sivak 1972; Van Campo 1978; Donoghue 1985; Robinson and Marticorena 1986).
3. Grinding of aqueous pollen suspension under liquid nitrogen (Robbins, Dickinson, and Rhodes 1979).
4. Laser fracturing (Olsson 1975).
5. Quick freezing in liquid nitrogen followed by smashing (Blackmore and Barnes, 1986; numerous authors).
6. Freezing in ice followed by smashing (numerous authors).
7. Freezing microtomy
 - A. Freezing after concentration in gum arabic, gelatin, etc. and commercial freezing compounds (viz., Hideux and Marceau 1972; Blackmore and Dickinson 1981).
 - B. Water embedding/freezing (Muller 1973).

Results of freezing microtomy are treated as controlled breaks but all others as uncontrolled or random breaks. These techniques, regardless of type, are aimed at increasing the population of broken grains in SEM preparations along with the production of a great variety of fracture planes. The multiplicity of these techniques is due to their adaptation for diverse taxonomic studies; the fracturing of pollen is a “customized” methodology. Although pollen grains present different structural and morphological features, a standard method that reliably produces freshly broken pollen grain internal surfaces is sought here.

The method outlined in Figure 17 has provided reasonably high percentages of freshly broken internal pollen surfaces. Basically, it is a variation of the dis-

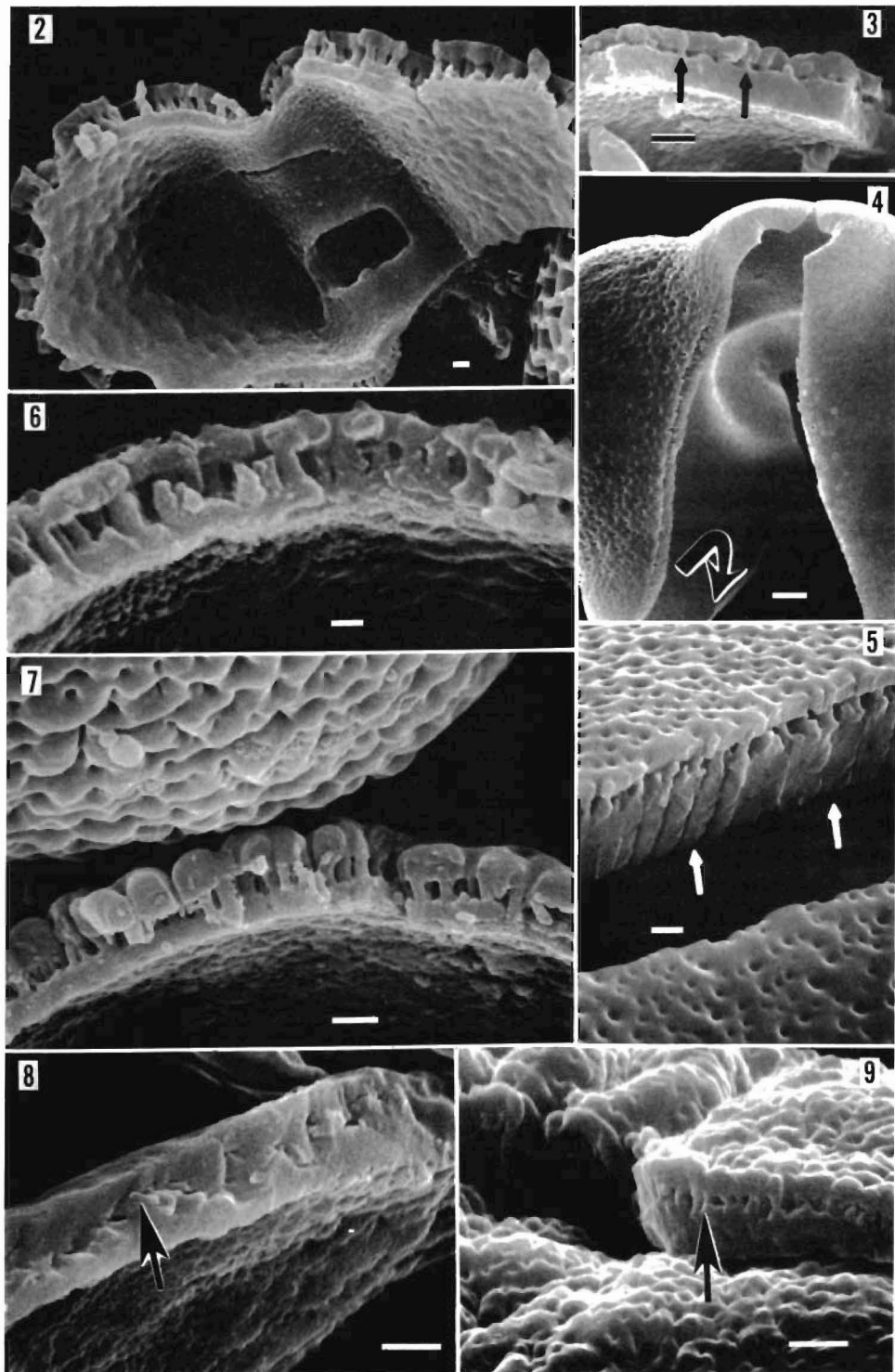

Fig. 2-9. Fractured pollen resulting from natural or fortuitous breaks.—2. *Montinia caryophyllacea* Thunb. (Montiniaceae). The great value of fractured pollen is exemplified by this micrograph. In addition to acquiring basic information on exine structure there are considerable data on aperture

section-fracturing (No. 2) and grinding-under-liquid-nitrogen (No. 3) techniques and because of the grinding analogy of a pharmacist's mortar and pestle we call it the "apothecary" method. Its effectiveness can be judged from Figures 18–32.

The second type, the controlled break, is produced by freezing microtomy. Fractures occur in greater number and planes than uncontrolled breaks, primarily because only points of exine weakness are exploited by the uncontrolled methods. Frozen sections can be obtained in a variety of ways. Excellent sections of pollen walls were obtained after initial concentration in gum arabic (Hideux and Marceau 1972) or gelatin (Blackmore and Dickinson 1981) prior to freezing and microtomy. The epitome of this technique is evident in the work of Feuer, Niezgoda, and Nevling (1985) and Feuer (1987) whereby osmicated pollen of legume tetrads and polyads was incorporated in agar, coated in a water soluble freezing medium, Tissue-Tek®, and frozen in liquid nitrogen subsequent to cryomicrotomy. Sections, after further preparation, were correlated with TEM sections to explain mechanisms of pollen grain cohesion in the Fabaceae. We have also obtained satisfactory results through use of this compound (Fig. 33–37 show the taxonomic utility in the three sections of *Scabiosa* of the Dipsacaceae). The only drawback with commercial freezing compounds is a lack of consistency between various brands and grades.

The simplest and most reliable cryomicrotomy method likely to produce controlled breaks is that described by the late professor Jan Muller (1973) for *Barringtonia* pollen (Lecythidaceae) in which a pollen/water suspension is rapidly frozen onto a mound of ice on a chilled pedestal and then sectioned with a steel knife. The vast number of different sectional views available at low magnification on the SEM cathode ray tube is very impressive and this advantage is exemplified in pollen studies in the Araliaceae (Shoup and Tseng 1977; Tseng and Shoup 1978), Valerianaceae (Clarke and Jones 1977), Dipsacaceae (Clarke and Jones 1981), Convolvulaceae (Cronk and Clarke 1981), Arecaceae (Frederiksen, Wiggins, Ferguson, Dransfield, and Ager 1985), and Asteraceae (Siljak-Yakovlev 1986). This method is depicted in Figure 38 and results are illustrated in Figures 39–44.

BACKSCATTER ELECTRON IMAGING

The use of backscatter imaging for morphological analysis in the biological sciences has been neglected. In this laboratory backscatter imaging most recently has been utilized to describe silica bodies in the grasses (Brandenburg, Russell,

←

configuration and on the internal sculpturing of the exine, including the different inner exine surface textures in the colpal and mesocolpal areas. The outer surface is seen in the fragment at the lower right-hand corner of this electron micrograph.—3. *Brabejum stellatifolium* L. The fragment is small but, like Figure 2, it gives considerable information. Arrows indicate the extremely short columellae.—4–5. *Conospermum caeruleum* R. Br. The exine has been fractured through an aperture region. The curved arrow is to indicate an area along the wall enlarged in Figure 5 in which long columellae (arrows) are arranged in massive files. The taxonomic value of fractured pollen fragments is evident when comparing the columellar patterns represented in *Brabejum* (Fig. 3) and *Conospermum* (Fig. 5), both members of the Proteaceae.—6. *Rhabdodendron microphyllum* Huber. (Rhabdodendraceae). See discussion of Figure 2.—7. *Asteranthos brasiliensis* Desf. (Asteranthaceae). See discussion of Figure 2.—8. *Coupeia edulis* (Prance) Prance. Note the highly irregular separation (arrow) throughout exine and absence of columellae.—9. *Hirtella racemosa* Lam. The short columellae (arrow) contrast with columellae absence in Figure 8 as both taxa belong to the Chrysobalanaceae. (The scales equal 1 μ m.)

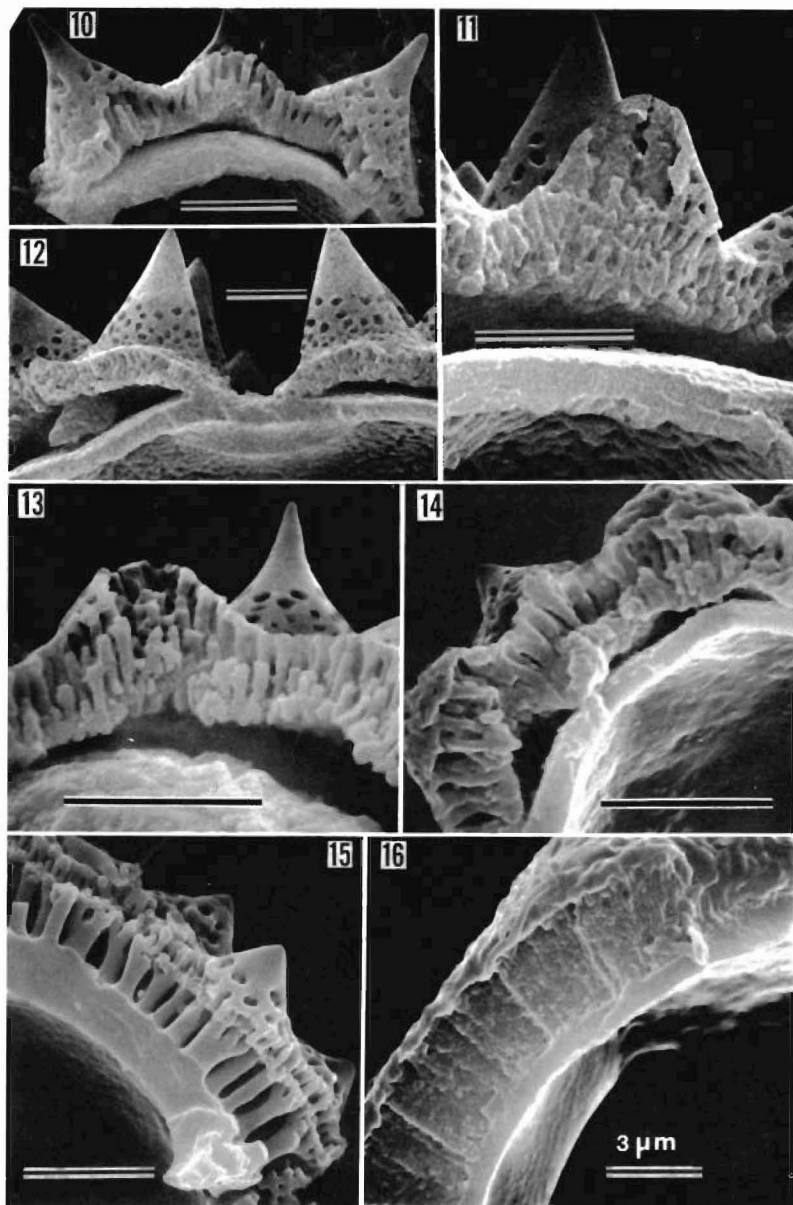
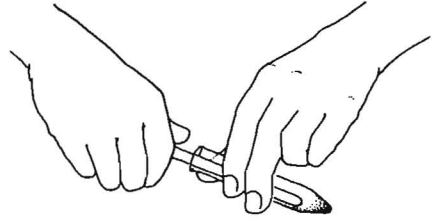

Fig. 10–16. Fractured pollen resulting from fortuitous breaks; taxonomic applications. The electron microscope images of fractured grains represent six tribes of the Asteraceae and graphically demonstrate the great value of making use of broken pollen grains on SEM stubs. Through application of fortuitous breaks with no special preparation it is possible to obtain a fundamental understanding of morphological exine patterns in this large family.—10. *Flaveria robusta* Rose (tribe Heliantheae).—11–12. *Lepidospartum latisquamum* S. Wats. (tribe Senecioneae).—13. *Dimorphotheca pluvialis* (L.) Moench. (tribe Calenduleae).—14. *Arctotis acaulis* L. (tribe Arctotideae).—15. *Onopordum billitanum* (tribe Cynareae).—16. *Chuquiraga straminea* Sand. (Mutisieae). (The scales equal 3 μm .)

APOTHECARY METHOD

Crush dried or acetolyzed pollen in bottom of tube.



A



Add 95% EtOH.

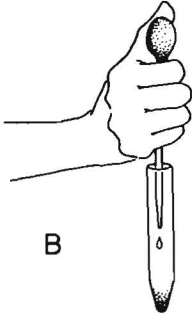

B



Pipette pollen + EtOH onto stub.



C



Sputter coat.

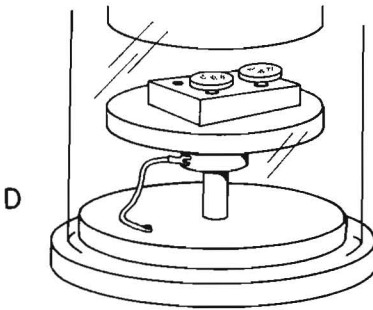

D



SEM

Fig. 17. Illustration of apothecary method.—A. Dried pollen from any source (freshly collected, herbarium sheets, or from acetolysis) is placed in a test tube and *gently* ground with a blunt glass or plexiglass rod. Care should be taken with the grinding action as too vigorous grinding can contribute shavings from the tube interior as well as the grinding rod.—B. Pollen is bathed in 97% ethanol.—C. Pollen/ethanol mixture is pipetted onto SEM specimen stub.—D. After allowing a few minutes for ethanol to evaporate the dried pollen is sputter-coated with gold and then placed in SEM for examination and photography.

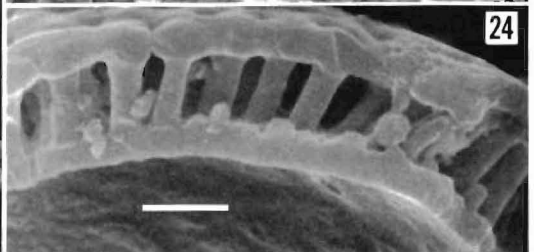
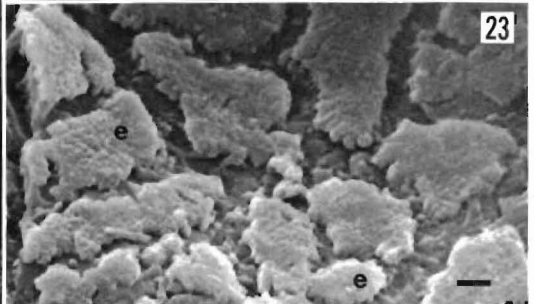
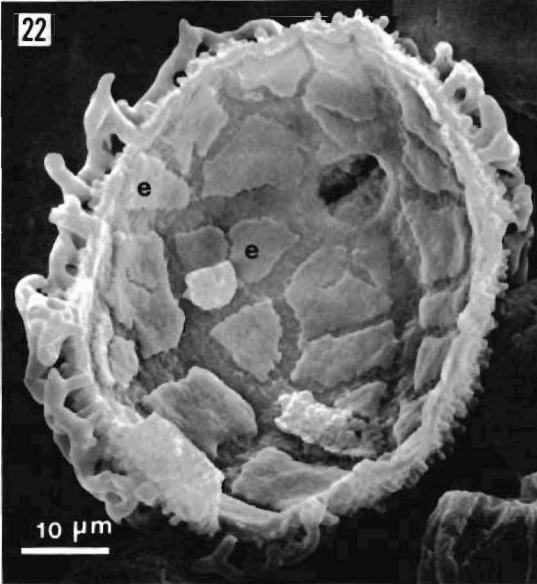
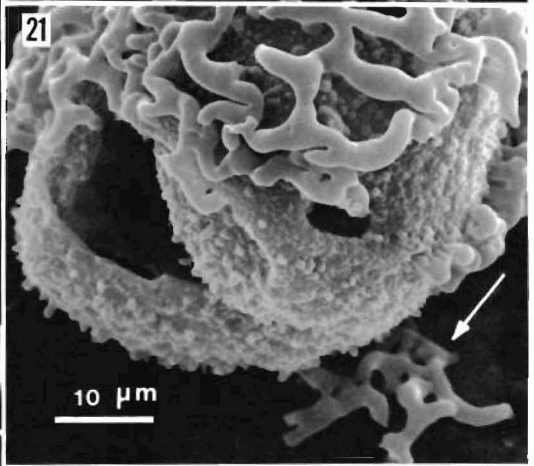
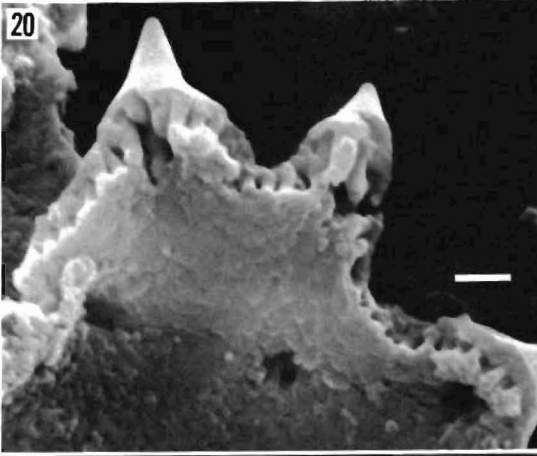
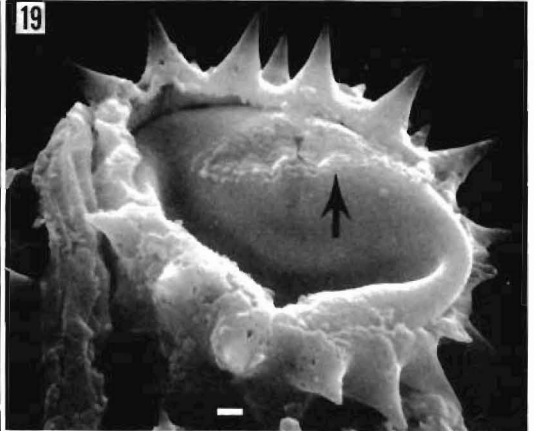
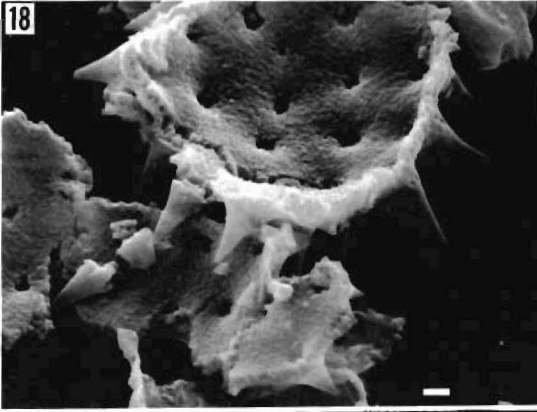

Estes, and Chissoe 1985). Backscatter electron imaging has unrealized potential in palynology. We have found that SEM viewing of frozen sections by use of the backscatter electron detector can greatly enhance structural data by "seeing through" to the opposite side of the exine. Figures 45–46 of *Espeletia schultzei* Wedd. (Asteraceae) present images for comparison of backscatter and secondary detector systems. Further discussion and additional examples of exine viewing with the backscatter detector are shown in other parts of this report (see THICK-SECTION DEPLASTICIZATION).

TRANSMISSION MICROSCOPY IN THE SCANNING ELECTRON MICROSCOPE (TSEM) AND "PSEUDO-TSEM"

Examination of ultrathin sections by TEM is widely accepted as the definitive way to study the structure and stratification of the exine. Considerable technical skill as well as time are required, however, for the detailed and meticulous procedures necessary. These considerations may help to explain why TEM observations have commonly been minimal or excluded from pollen studies since SEM has become generally available (see Fig. 1). SEM has until recently lacked both resolution and a capacity to differentiate layers in exines although fractured pollen grains have provided a 3-dimensional matrix of exine structure and expanded the 2-dimensional observations of TEM.

For some time thin sections have been examined in the transmission mode, TSEM, of the SEM. Thin sections of a variety of animal tissues were successfully examined by TSEM (Swift and Brown 1970) as the direct result of the development of a detector and specimen grid module for adaptation in a conventional SEM (Swift, Brown, and Saxton 1969). We do not attempt here to trace the history of transmitted systems in SEM, but rather we are concerned with their application in palynology. An impressive technical literature is available (Crawford and Liley 1970; Woolf, Joy, and Tansley 1972; Nemanic and Everhart 1973; Lyman 1978). Although resolution and magnification are more restrictive with TSEM than with TEM, the easy attainment of low-magnification overviews, high electron contrast, and ostensibly less rigid requirements for section thicknesses are distinct advantages. Surprisingly, TSEM has been essentially ignored in pollen research despite its potential value as a tool for pollen morphology. In a review paper of SEM in palynology, Muir (1970) broached the possibility of using the SEM for TEM

←

Fig. 18–24. Fractured pollen resulting from the apothecary method. — 18–20. *Agiabampoa congesta* Rose (Asteraceae). — 18. Fragments of exine show sculpturing of internal surfaces and relationship of spines to ectexine. — 19. Separation and withdrawal of the surrounding exine exposes sculpturing of endoaperture (arrow). — 20. See description for Figure 18. — 21–23. *Jacqueshuberia amplifoliola* Cowan (Fabaceae). — 21. The fracture in this case sheared off a portion of the reticulate ectexine (arrow) exposing columellae and foot layer. — 22–23. The "patchy" nature of the internal exine surface of the endexine (e) is well shown. These views of inner surface morphology complement previous work with TEM (Patel, Skvarla, Ferguson, Graham, and Raven 1985). — 24. *Poinciana gilliesii* Hook. (Fabaceae). The fractured grain shows exine structure as well as external and internal surface sculpturing patterns. Compare internal sculpturing with Figure 23, *Jacqueshuberia*. (The scales equal 1 μm .)

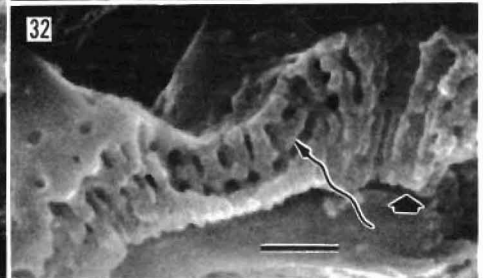
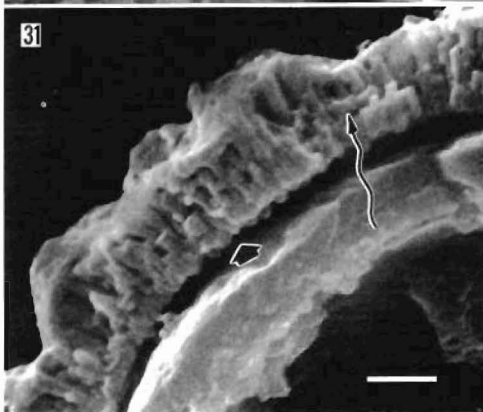
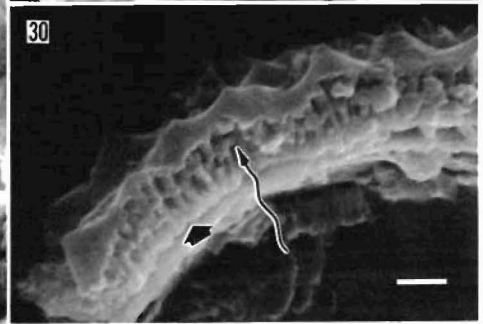
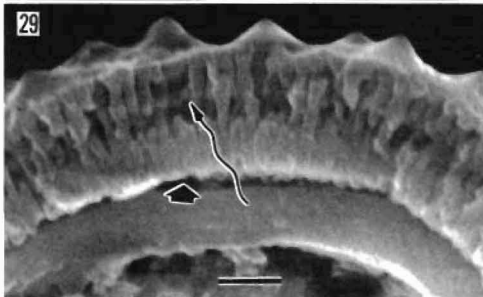
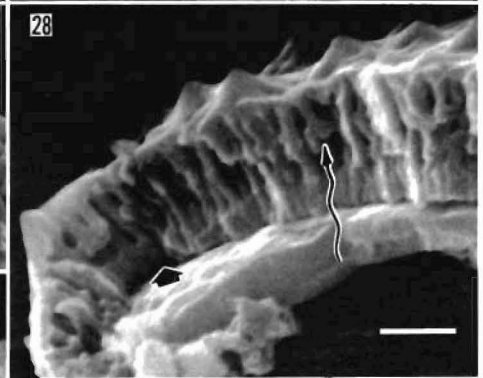
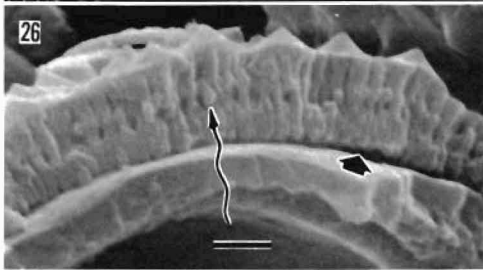
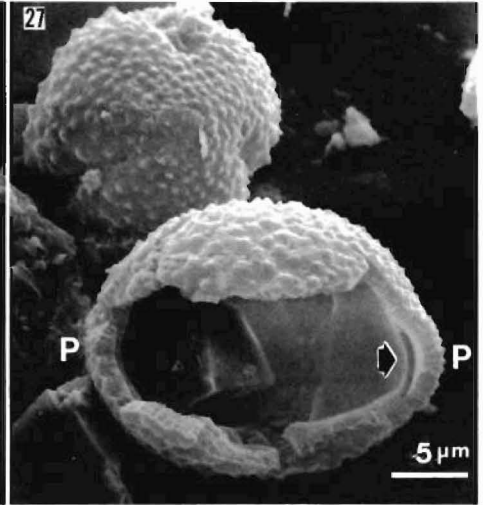

analyses and cited the specially constructed specimen holder of Sandberg (1968) which accepted TEM grids in the SEM. The method failed to win immediate acceptance, possibly, because Sandberg's interest had been directed to carbon replicas and actual specimens of calcareous and siliceous microfossils rather than sectioned material. To our knowledge palynological application of TSEM is confined to a single report by Taylor, Maihle, and Hills (1980) concerning a Devonian megaspore, *Nikitinsporites canadensis* Chaloner, in which electron micrographs were shown of the entire spore and the spore trilete suture. Their clear demonstration of the lamellate and spongy components of the wall is of particular significance with respect to the capability of the TSEM mode (see Plate II, Fig. 6, of Taylor et al. 1980).

There are two technically well understood but apparently little-used procedures for examining biological thin sections with SEM. In the first, transmitted electrons passing through sections are collected on a specially designed detector and imaged on recording and cathode ray tubes (TSEM). The detector system used for this TSEM mode is a scintillator detector designated as a "STEM" detector, which is actually a misnomer since STEM refers to scanning electron microscopy in a TEM (Lyman 1978). In the second, less well-known but older procedure, the standard SEM stage is replaced by a relatively inexpensive specimen grid stage and transmitted electrons, after striking an underlying metal foil, are collected on the secondary detector and imaged as described above. For purposes of comparison this type of transmission imaging is herein termed "pseudo-TSEM." In order to test the potential for examining thin sections of pollen walls in the SEM both of these microscope procedures, TSEM and pseudo-TSEM, are evaluated below.

Preparation

Pollen was either collected fresh and then preserved in a solution of 2.5% glutaraldehyde with 0.25 M cacodylate buffer or acetolyzed (Erdtman 1960). Subsequently, pollen was either stained in ca. 0.5% OsO₄/cacodylate buffer at room

←

Fig. 25–32. Fractured pollen resulting from apothecary method: taxonomic applications illustrated by *Centaurea* of the Asteraceae tribe Cynareae. The species illustrated below represent some of the eight major pollen types recognized for this large genus (>620 species) through LM (Wagenitz 1955) and partially substantiated by TEM (Nordenstam and El-Ghazaly 1978).—25–27. *C. diluta* Ait. ssp. *diluta* (pollen type "s").—25. The fractured grain shows a double layer of columellae along the mesocolpus.—26. Enlargement of portion of Figure 25 to emphasize weak development of the internal tectum (wavy arrow). The solid arrow indicates cavus.—27. In contrast to the fractured equatorial region in Figure 25 this fracture exposes internal exine at the poles (P). The arrow indicates a cavus area.—28. *C. napifolia* L. (pollen type "s"). Note similarities (including arrow designations) to *C. diluta* sp. *diluta* (Fig. 26).—29. *C. sinaica* DC. (pollen type "s"). Similar to preceding two figures.—30. *C. dracunculifolia* Duf. (pollen type "m"). Arrow designations similar to above.—31. *C. jacea* L. ssp. *angustifolia* Gugl. var. *approximata* Gren (pollen type "m"). A double columellae layer (wavy arrow) is most pronounced as a result of fracture-removal of portions of the columellae. Arrow designations similar to above.—32. *C. pulchella* Led. (pollen type "e"). The fractured exine is less massive than the above examples and columellae seem unequally divided by internal tectum. Arrow designations similar to above. (Unless indicated the scales equal 1 μ m.)

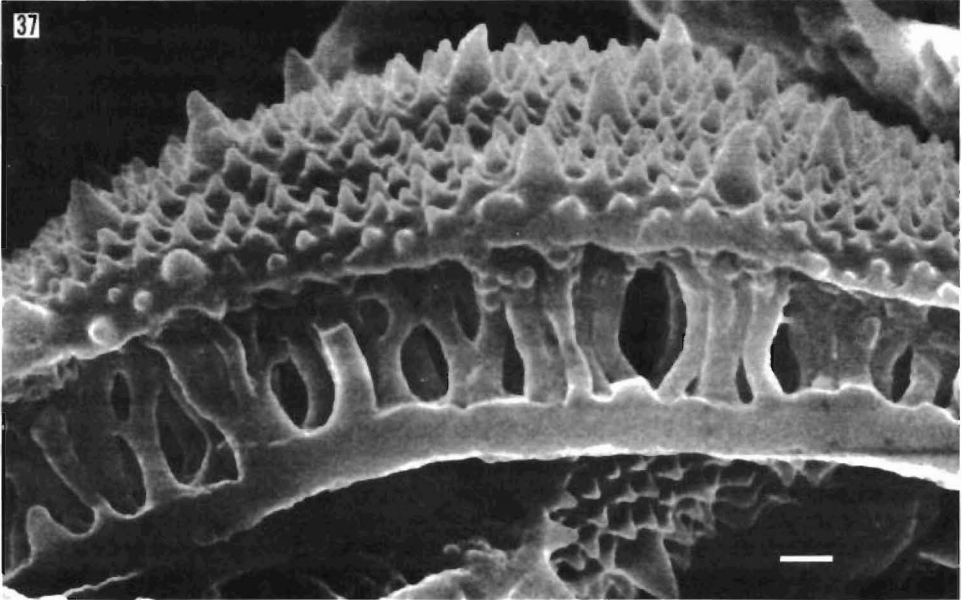
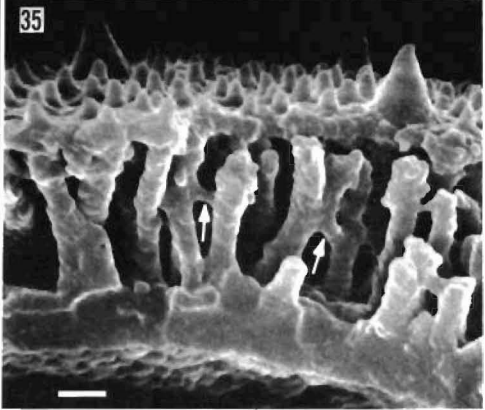
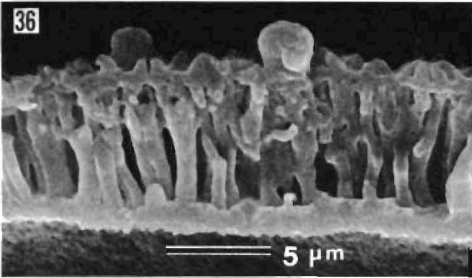
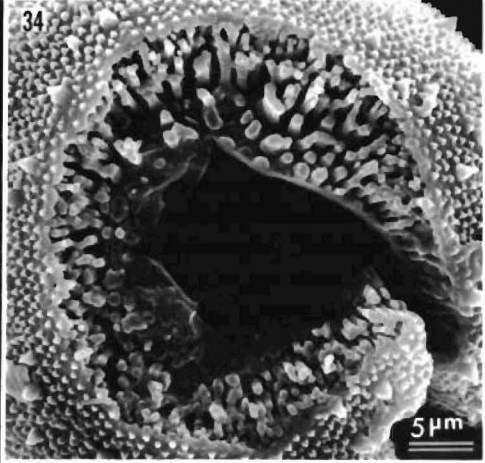
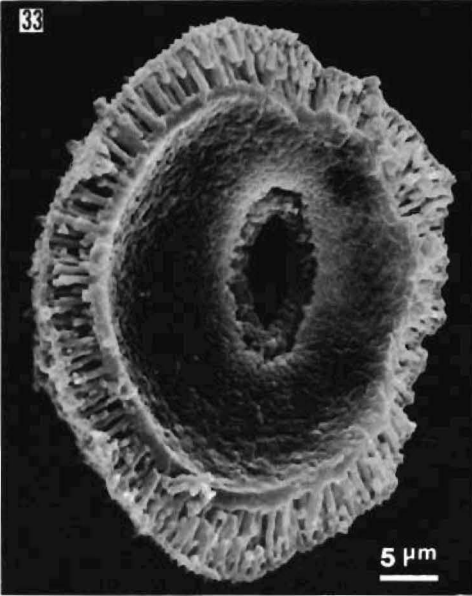

temperature for 2 h or left unstained. Specimens prepared by both methods were embedded in routine fashion (Skvarla 1974).

Microtomy

Pollen was sectioned with a Sorvall MT 2-B Ultra Microtome using a diamond knife. Thickness of the sections ranged from those normally required for TEM to sections about half a micrometer thick. Sections were retrieved on standard copper-mesh grids and secondary staining, unless omitted, was by the standard procedure of uranyl acetate and lead citrate.

Instrumentation

The SEM employed to image and record transmitted electrons on a transmitted electron detector was the ETEC model Autoscan SEM. It was equipped with a transmitted detector brand model listed as Transmitted Electron Imaging Systems P/N 521-0000-11. The instrument used to image and record transmitted electrons on a secondary electron detector (i.e., pseudo-TSEM) was an International Scientific Instruments ISI model Super II SEM. In the latter, the stage in the specimen chamber was replaced with a TEM grid specimen holder having a platinum-coated reflector foil which directed transmitted electrons passing through the thin sections onto the secondary electron detector with subsequent signal processing done in the usual SEM manner.

Photography

All electron micrographs were obtained from Polaroid Type 665 Positive/Negative Land film.

Results of TSEM Imaging

In the directly comparative TSEM/TEM sets of electron micrographs of *Licania michauxii* Prance (Chrysobalanaceae), *Myriophyllum pinnatum* (Walt.) BSP. (Haloragaceae) and *Fuchsia verrucosa* Hartweg (Onagraceae) one can easily see which ones are illustrative of TEM (Fig. 47, 50, 56, 58) and which were obtained by TSEM (Fig. 48, 49, 55, 57). Equally notable is that in the absence of the companion TEM micrographs, the TSEM micrographs satisfactorily depict the fine structure of the pollen walls in these families. In fact, the differences in the two electron

←

Fig. 33–37. Cryomicrotomy: taxonomic application. Exines from the three generally recognized sections of the Dipsacaceae genus *Scabiosa* (>100 species) were sectioned after initial freezing with commercial freezing agent O.C.T. (Miles Laboratories).—33–35. *Scabiosa atropurpurea* L. (section *Cyrtostemma*). These three views clearly underscore the nearly complete model of pollen morphology obtainable by cryomicrotomy. In Figure 35 both sectioned and sculptural views are evident. Note irregular lateral connections to columellae (arrows); these would be difficult to obtain solely with TEM.—36. *S. sphaciotica* Roemer & Schultes (section *Trophocephalus*).—37. *S. triniifolia* Friv. (section *Scabiosa*). See Diez and Devesa (1981) and Verlaque (1981) for comparative electron microscopy of Dipsacaceae pollen. (Unless indicated the scales equal 1 μm .)

CRYOMICROTOMY

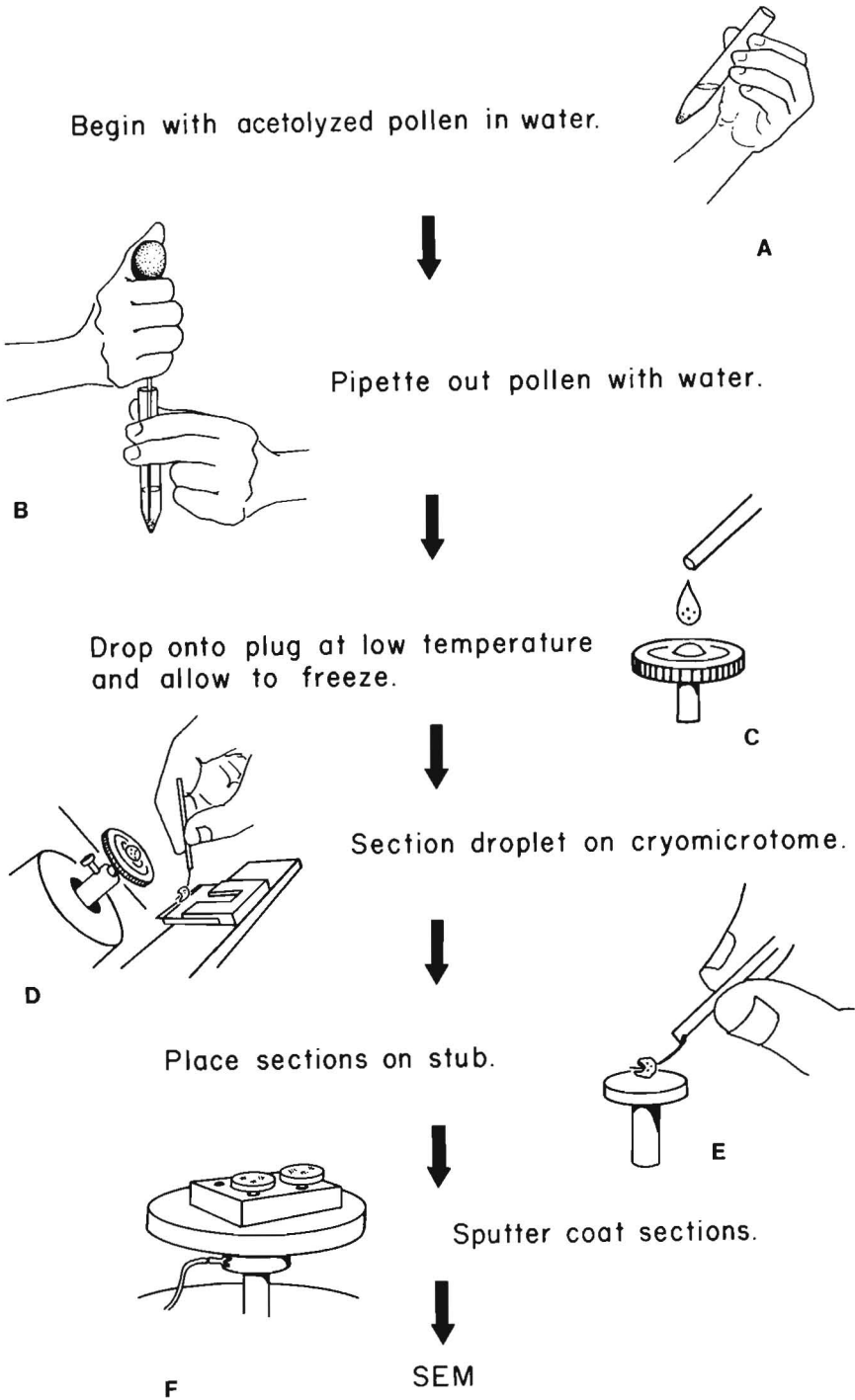

Fig. 38. Cryomicrotomy method of Muller (1973).—A. Pollen in test tube with distilled water.—B–C. Pollen/water mixture pipetted from test tube (B) and onto a mound of ice (C) on a prechilled

microscope systems are evident *only* when *directly* compared. The conclusion from these examples is that the pollen data are not compromised by TSEM.

A major advantage of TSEM is the ease of obtaining low-magnification overviews. The numerous pollen grains occurring in a variety of sectional views such as illustrated by *Petalodactylus obovata* J. Ar. (Rhizophoraceae), Figure 51, and *F. verrucosa* (Fig. 59, 60) are relatively simple to photograph with TSEM. The ideal aspect of this is that a wide choice of section orientations is *immediately* available for subsequent examination at more critical magnifications (Fig. 52–54). Low-magnification overviews are also extremely useful in examining large pollen grains like *Oenothera macrosceles* A. Gray of the Onagraceae (Fig. 61). If one assumes that there is no grid-bar interference in Figure 61, then the very low magnification needed to photograph this grain in entirety, approximately $\times 600$, is both simple and routine with TSEM but would present difficulty with conventional TEM. Grid-bar obstructions can be corrected by better placement of sections on grids or by using larger-mesh grids. Neither of these alternatives is desirable as the former requires inordinate tedium and the latter requires the added procedure of grid membrane-coating and carbon stabilization. With TSEM, however, grid coating would be unnecessary because the lower beam currents used with TSEM essentially eliminate section “drift,” a universal consideration during examination of pollen and other objects using TEM. Sublimation of sections under the electron beam, another thermal instability obstacle inherent to TEM, appears minimal with TSEM. These two heat-related factors, section drift and sublimation, are particularly important with relation to pollen because the dense and heat-sensitive sporopollenin of the exine tends to be incompletely impregnated by embedding resins, so that one must usually delay photography with TEM until the desired viewing area has stabilized.

Disadvantages to low-magnification TSEM are that imperfections such as knife tracks, excess stains, dirt, etc. (Fig. 51) are emphasized. We consider these disadvantages to be trivial.

At higher magnifications stratification patterns as well as structural components of the exine are readily distinguished by TSEM (Fig. 52–54). Delicate structural components such as endexine channels in *Camissonia cardiophylla* (Torr.) Raven ssp. *robusta* (Raven) Raven (Fig. 68) and finely granular exine elements and lamellae in the latter (Fig. 64, 66, 67) as well as in *F. verrucosa* (Fig. 55) and *Petalodactylus obovata* (Fig. 53, 54) are well within the limits of useful resolution.

A very attractive aspect of TSEM as expounded in the early technical literature of commercial microscope manufacturers was that section thickness could be on the order of 2 μm instead of the less than 0.2 μm -thick sections required for conventional TEM. Contemporary reports, however, indicate this claim to be somewhat exaggerated (Russ and McNatt 1969; Ogilvie and Sutfin 1970; Swift and Brown 1970; Thurston and Russ 1971). These studies report resolving powers between 10 and 30 nm for sections up to 500 nm thick for a variety of biological

←

freezing microtome pedestal.—D. Sections (“shavings”) are made in the range of 5–8 μm and transferred from edge of a razor or steel knife with an eyebrow hair onto an SEM specimen stub.—E. Within a few minutes the ice sublimates and sections dry.—F. Sections are placed on specimen stub, sputter-coated, and examined with SEM.

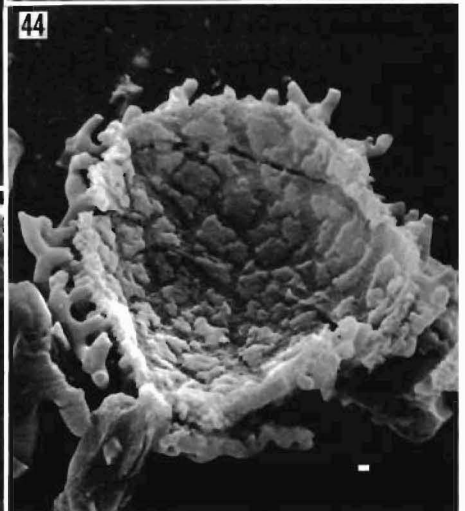
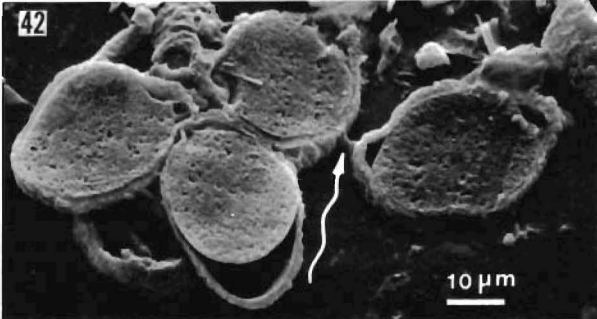
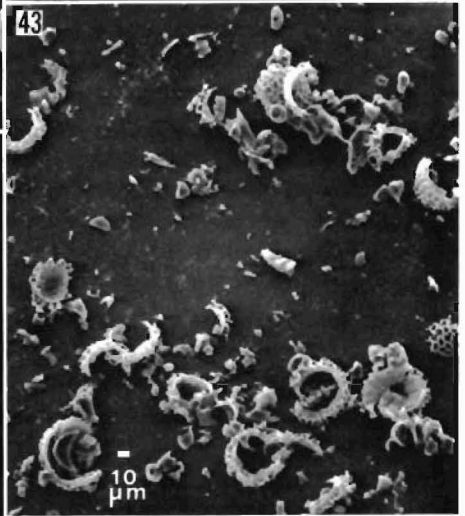
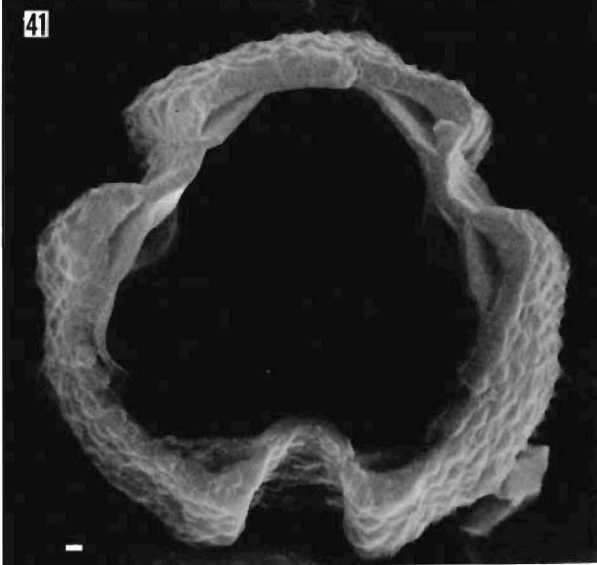
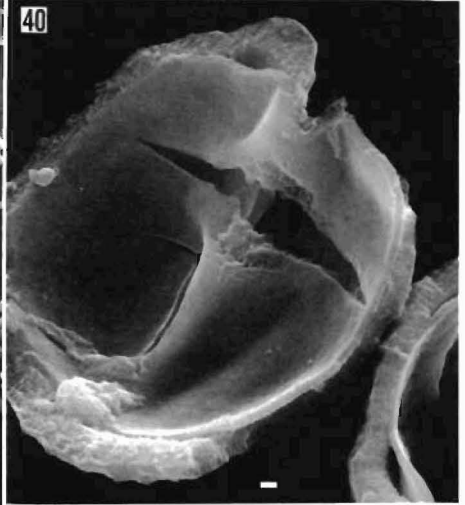
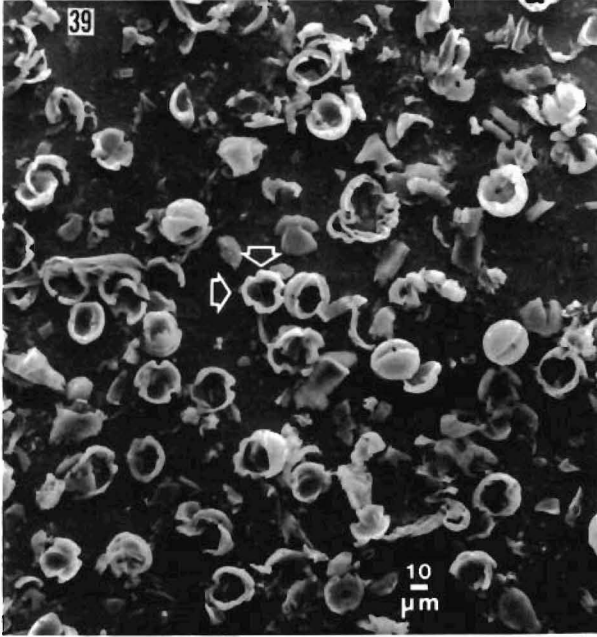

materials but a reduction to 50 nm when the sections were 1000 nm thick. The notable lack of interest in TSEM for biological studies at the subcellular level appears to be influenced by decreased resolution caused by microscope "noise."

The potentially diminished need for precision ultrathin sections that TSEM might bring to palynology was tested with tetrad pollen of *C. cardiophylla* ssp. *robusta*. Sections made at a TEM thickness grade of 80–90 nm (Fig. 67, 68) were clearly superior to considerably thicker sections in the range of one-quarter to one-half micrometer (Fig. 62–66). With these thick sections the images were not always reproducible.

Microscope accelerating voltage is also a factor needing consideration in order to achieve quality results with pollen using TSEM. In standard SEM there is a relationship between accelerating voltage, specimen resolution, and specimen contrast, with the lower accelerating voltages producing the greatest contrast at the sacrifice of resolution. With TSEM there is the further complication that resolution is already suboptimal. The ETEC SEM that we used has accelerating voltages of 10, 20, 30, and 40 KV. In general, the most reliable voltage for TSEM was 30 KV; when raised the pollen wall image had poor contrast and when lowered it was difficult to visualize.

The influence of staining on the quality of TSEM imaging contrast was explored to see if it was useful for TSEM. A number of pollen grains were examined and it was found that favorable contrast was obtained with exines: (1) stained with osmium tetroxide, uranyl acetate and lead citrate; (2) stained only with osmium; and (3) stained only with uranyl acetate and lead citrate. Without any stain results were also satisfactory.

Pseudo-TSEM Imaging

Results from this system, although less satisfactory than TSEM, nevertheless adequately fulfill the three critical palynological requirements for examining sections by conventional TEM: (1) low-magnification overviews of entire pollen grains shown for *Mentzelia ravenii* Thompson & Roberts (Fig. 69), *Angelica venenosa* (Greenway) Fern (Fig. 77), *Vernonia amygdalina* Del. (Fig. 78), and

←

Fig. 39–44. Exines from cryomicrotomy method of Muller (1973).—39–41. *Dasyphyllum reticulatum* (DC.) Cabr. (Asteraceae).—39. Low-magnification overview. This method provides numerous and different sectional and internal surface views as well as information on endoaperture patterns. The exine circumscribed by arrows (see Fig. 41) illustrates the ease of selecting favorably cut grains for further study.—40. The endoaperture configuration and sculpturing of the internal exine are clearly exposed; the cryomicrotomy method provides such information more consistently than other methods described in this manuscript.—41. Pollen grain marked by arrows in Figure 39 taken at higher magnification.—42. *Ludwigia peruviana* (L.) Hara (Onagraceae). These grains show the applicability of the cryomicrotomy technique for analysis of unacetolyzed pollen. The polyad nature is indicated by an external bridge connection (wavy arrow).—43–44. *Jacqueshubergia amplifoliola* (Fabaceae).—43. Low-magnification overview showing variety of sectioning planes.—44. Internal sculptured exine; note direct correlation with Figure 22, 23 above. (Unless indicated the scales equal 1 μ m.)

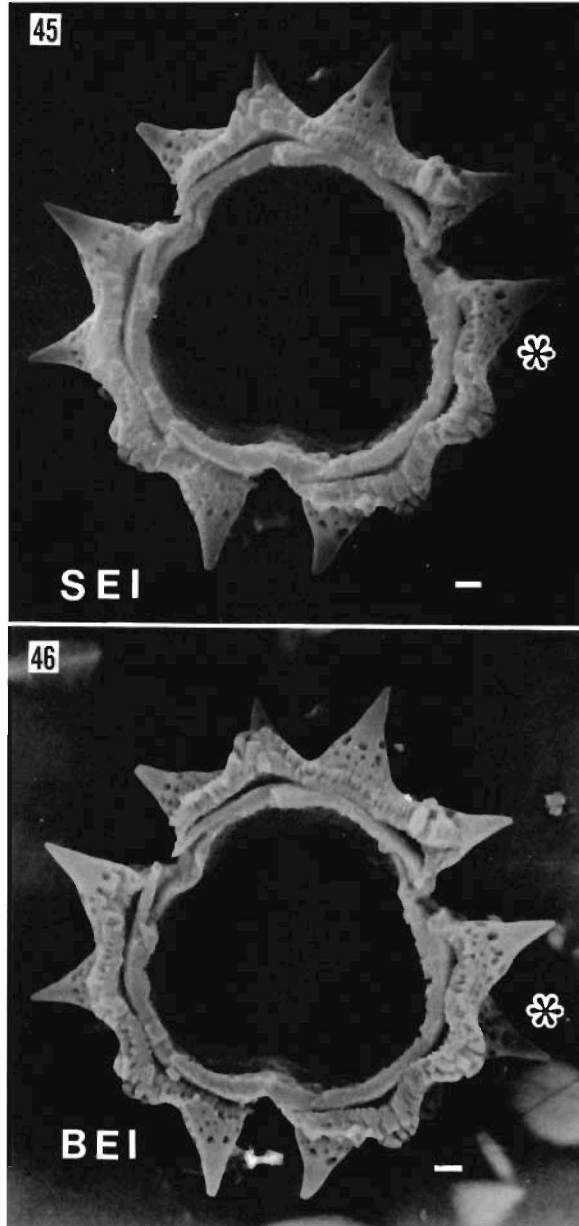
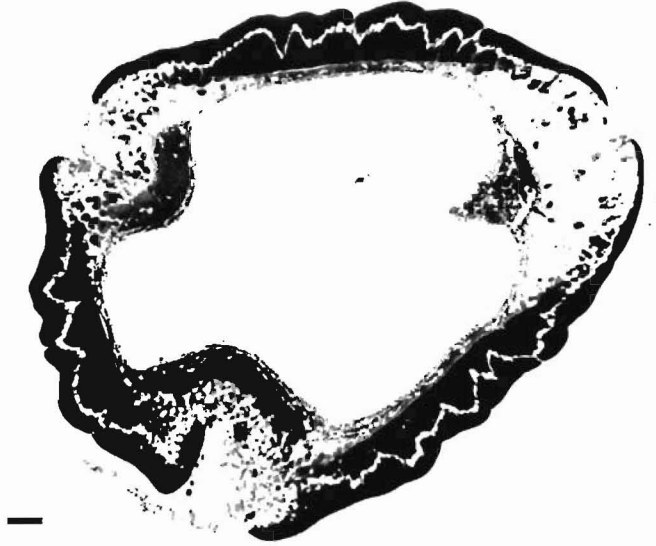

Fig. 45–46. Cryomicrotomy and electron imaging of *Espelitia schultzii* (Asteraceae). The frozen and sectioned exine was imaged with secondary (SEI) (Fig. 45) and backscatter (BEI) (Fig. 46) detector systems. These comparative micrographs demonstrate the much greater depth of focus obtained with BEI. Note that spine features (opposite asterisks) are nearly unresolved with secondary imaging. General exine details are also considerably enhanced with BEI. (The scales equal 1 μm .)

47



48



Fig. 47–48. Comparison of TEM and TSEM imaging systems. Both electron micrographs are of the same pollen grain section of *Licania michauxii* (Chrysobalanaceae). Figure 47 was obtained with conventional TEM while Fig. 48 was with TSEM imaging. Although there is no doubt that clarity is better with TEM, the TSEM image, at least at this magnification is impressive. The endexine is easily distinguished from the ectexine in the TSEM image. (Section thickness: TEM grade. Staining: OsO₄; section staining with uranyl acetate and lead citrate. The scales equal 1 μm .)

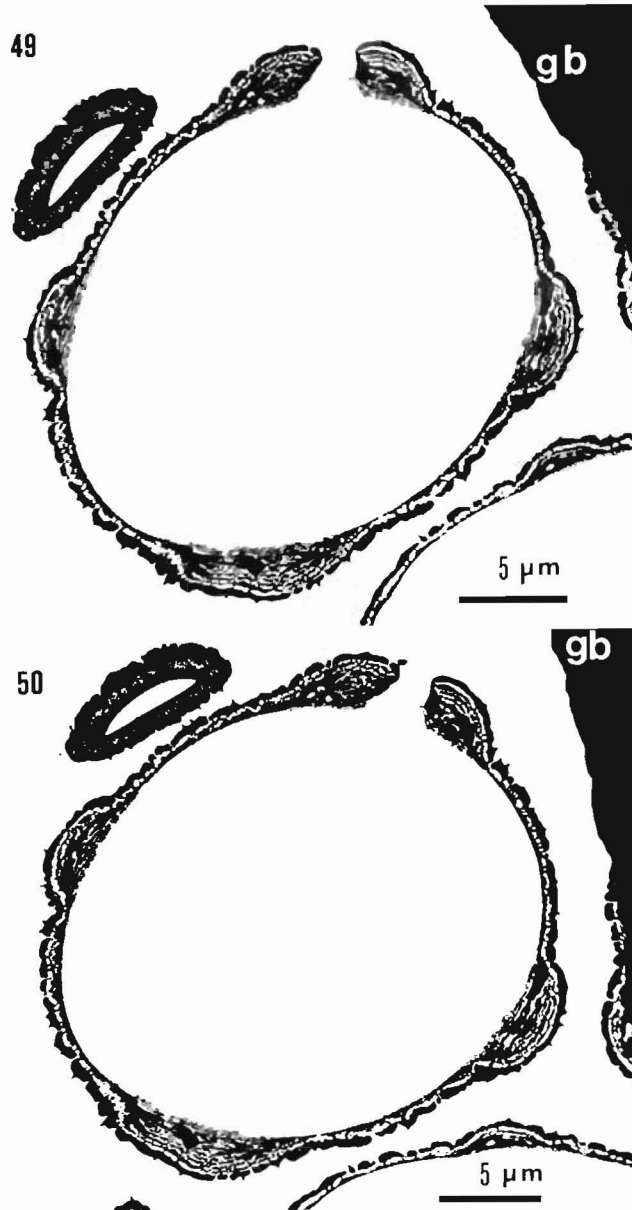

Fig. 49–50. Comparison of TEM and TSEM imaging systems. Both electron micrographs of the same pollen grain section of *Myriophyllum pinnatum* (Haloragaceae).—49. TSEM.—50. TEM. See Pragłowski (1970) and Engel (1978) for comparable TEM sections. (Section thickness: TEM grade. Staining: OsO₄; section staining with uranyl acetate and lead citrate. Grid bar = (gb). The scales equal 5 μm.)

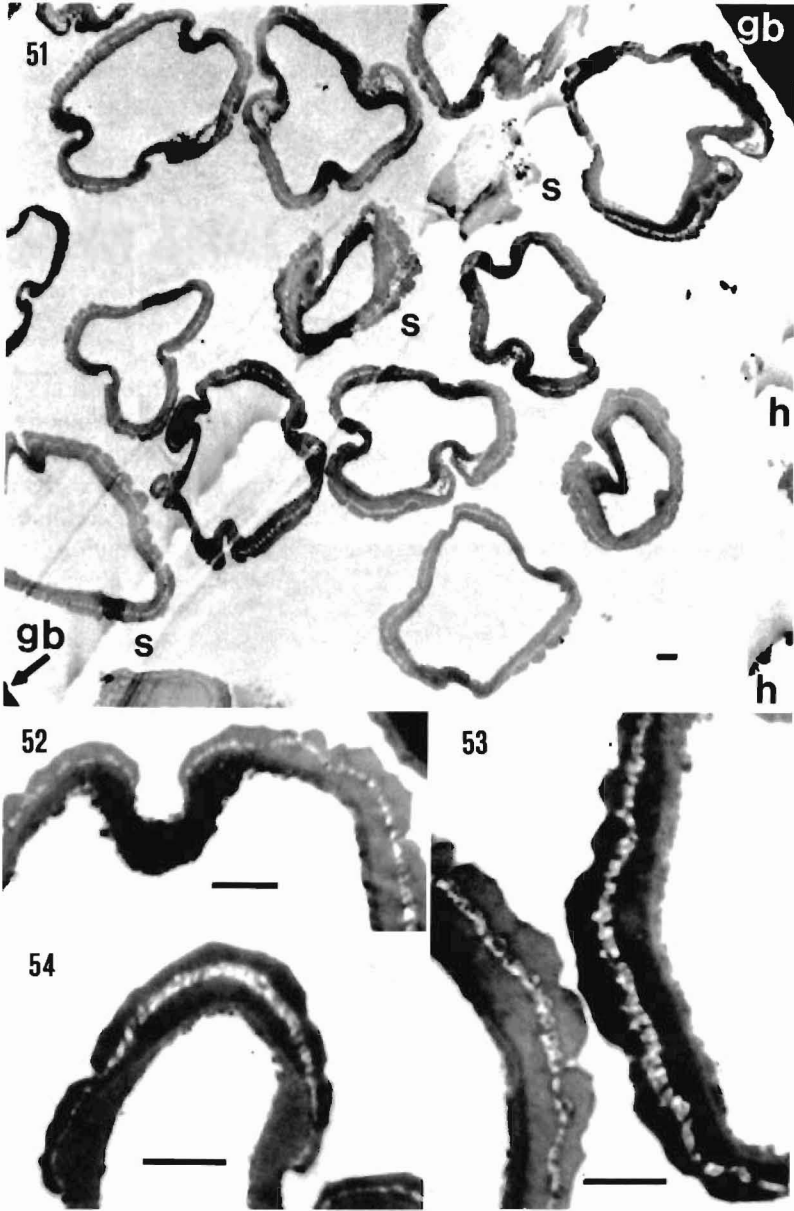
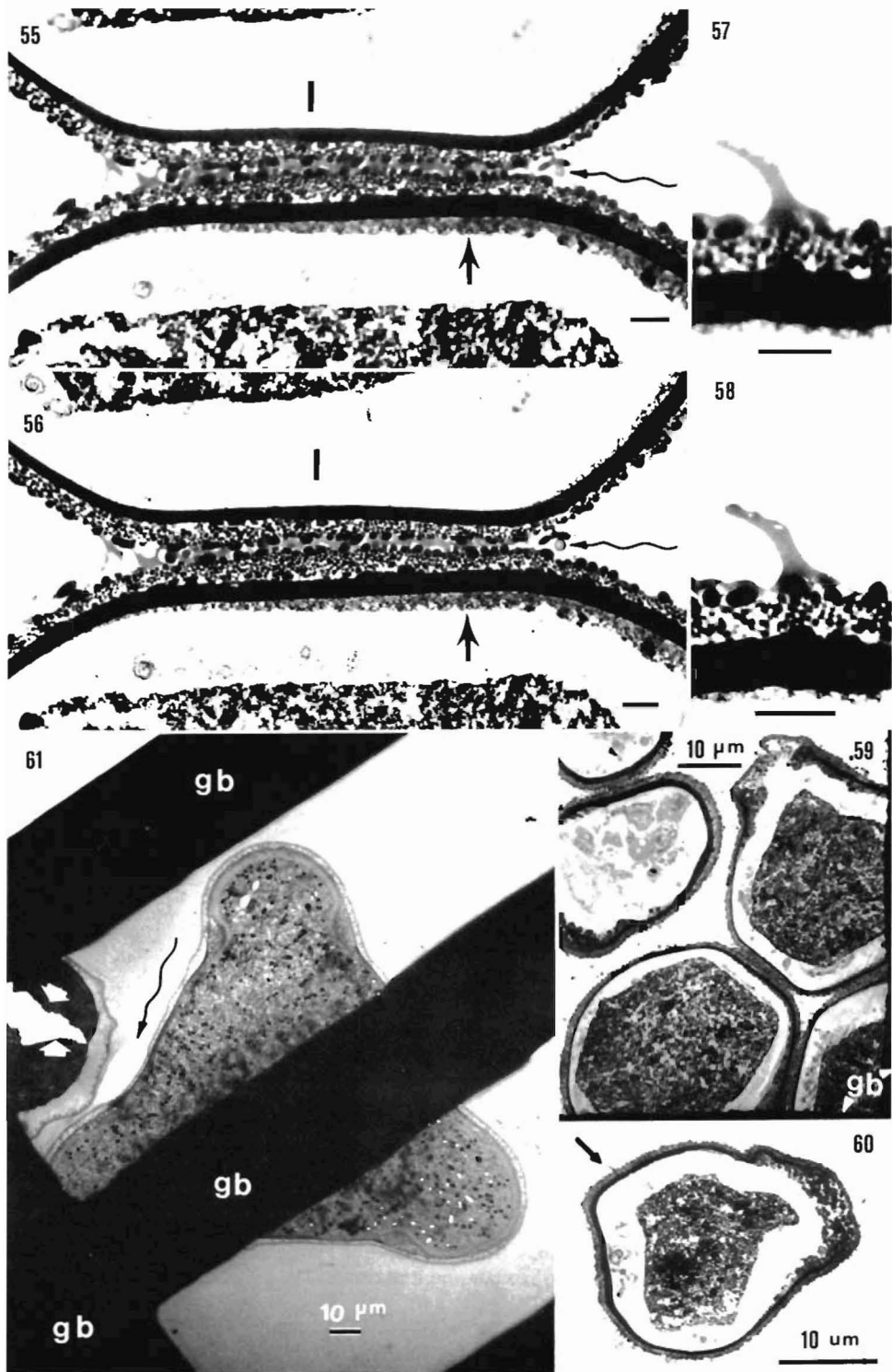

Fig. 51–54. TSEM of *Petalodactylus obovata* (Rhizophoraceae).—51. Low-magnification overview. With TSEM mechanical/procedural flaws are readily evident, for example, scratches (S) in the plastic result from dull knives and holes (h) result from lack of embedding resin infiltration; gb = grid bar.—52–54. These micrographs illustrate the satisfactory resolution of exine stratification in aperture (Fig. 52) and nonapertural (Fig. 53, 54) regions. (All sections are of TEM grade thicknesses; pollen stained with OsO₄; sections stained with uranyl acetate and lead citrate. The scales equal 1 μm.)



Pelucha trifida Wats. (Fig. 81); (2) density differences in exine strata as seen in the numerous appropriate micrographs (Fig. 69 inset, 78–81, 83); and (3) elucidation of the structural organization of the exine, particularly exemplified by *Pelucha trifida* (Fig. 82), *Canna generalis* L. (Fig. 70, 71), *Hauya elegans* DC. ssp. *elegans* (Fig. 72), *Circaea erubescens* Frnch. & Sav. (Fig. 74), and *Epilobium canum* (Greene) Raven ssp. *garrettii* (A. Nels.) Raven (Fig. 73, 75, 76). *Pelucha trifida* (Fig. 82) is of prime interest because one can see the numerous holes in the ectexine. These holes, long identified by the term internal foramina (Skvarla and Larson 1965), are generally observed by TEM. Their importance to pollen morphology and taxonomy of Asteraceae is well known. The pollen of Onagraceae represented by *Circaea erubescens* (Fig. 74) and *Epilobium canum* ssp. *garretti* (Fig. 73, 75, 76) was not acetolyzed and shows three important morphological features: (1) uniform exine density; (2) a lamellate basal ectexine layer; and (3) beaded appearing “columellae.” These “columellae” are also depicted in acetolyzed preparations of *Hauya elegans* ssp. *elegans* (Fig. 72).

The fragile channeled intinelike pollen wall of *Canna generalis* surmounted by sporopollenin containing spinules is portrayed in two developmental stages (Fig. 70, 71) by pseudo-TSEM. Differentiation of the ectexine from the endexine by density differences also is an important benefit of this SEM mode as can be seen for micrographs in *Mentzelia ravenii* (Fig. 69), *Angelica venenosa* (Fig. 77), *Vernonia amygdalina* (Fig. 78) and *Pelucha trifida* (Fig. 81). Although comparative electron micrographs from TEM are not included here, they are available in the literature (Skvarla and Turner 1966; Skvarla, Raven, and Praglowski 1976; Skvarla, Turner, Patel, and Tomb 1978).

Pseudo-TSEM, under the operating conditions utilized for this study, was regarded to be less satisfactory than TSEM. Each specimen was experimental with

←

Fig. 55–61. TSEM method.—55–60. *Fuchsia verrucosa* (Onagraceae) is used to compare conventional TEM and TSEM imaging.—55–56. Identical section of adjacent pollen grains photographed with TSEM (Fig. 55) and TEM (Fig. 56). Note the overall clarity with TEM. However, TSEM provides a morphologically equivalent image: tryphine is seen between the juxtaposed pollen walls, viscin threads are indicated in cross section (wavy arrow), the intine (I) has membranous inclusions and a granular exine component (arrow) is evident in the peripheral intine.—57–58. Directly comparable electron micrographs of identical section of an exine and a tryphine projection examined with TSEM (Fig. 57) and TEM (Fig. 58). With increased magnification the deterioration of TSEM resolution becomes evident.—59. Low-magnification overview exposing several pollen grains. With conventional TEM a similar area would be difficult to photograph; gb = grid bar.—60. Arrow indicates tryphine shown in Figure 57–58 and illustrates the accuracy of TSEM: at this magnification the structure appears to be a viscin thread. The interpretation is clarified in Figures 57–58 which clearly show its nonexinous nature.—61. *Oenothera macroseles*. Low-magnification overview of a pollen grain crossed by grid bars (gb). This electron micrograph is an example of the potential usefulness of TSEM in palynology. Under normal TEM operating conditions several limitations would restrict or impede examination and photography of the whole grain: (1) the large size of the grain would require extremely low magnification and (2) a large grid mesh opening would be required, necessitating a coating with a thin membrane, usually of formvar, butvar, or collodion. With TEM this procedure is made more difficult because the membrane frequently cracks or partially sublimates. On the other hand, with TSEM the beam is less harsh on the sections and a supporting membrane is unnecessary. Wavy arrow indicates absence of embedding media. Arrowheads = crack in pollen cytoplasm. (Unless indicated the scales equal 1 μm . Sections are of TEM grade thicknesses; pollen stained with OsO_4 ; sections stained with uranyl acetate and lead citrate.)

respect to section thickness and accelerating voltage; this procedure is reassessed below (see CONCLUSIONS).

Summary of TSEM and Pseudo-TSEM

It should be made clear that the technology utilized to obtain the transmitted images of the sectioned pollen grains in Figures 47–83 is not new or actually innovative on our part. The two systems tested gave accurate information on pollen wall structure and stratification. The pseudo-TSEM system, using the specimen grid stage, is considerably less expensive than the TSEM system that requires a transmitted electron detector. The pseudo-TSEM method can be adapted for scanning microscopes, primarily older models, in which a transmitted electron detector cannot be fitted. The required specimen grid stage can easily be constructed in most laboratories without the need to purchase commercial models.

→

Fig. 62–68. Section thickness evaluation with TSEM using tetrad pollen of *Camissonia cardiophylla* ssp. *robusta*.—62. Section through aperture approximately $\frac{1}{2}$ μm (5000 Å) thick does not provide a clear image of the exine.—63. Enlargement of a part of previous figure.—64. Section slightly greater than $\frac{1}{4}$ μm (2880 Å) thick “suggests” the spongy nature of the exine. Note good definition of viscin thread cross section.—65–66. Sections at $\frac{1}{4}$ μm (2500 Å) are slightly thinner than preceding. Note in Figure 65 that channels are distinguishable in the apertural exine.—67–68. Sections are TEM grade (850 Å) and exhibit the morphology characterized by conventional TEM. (Pollen stained with OsO_4 ; not section stained.)

Fig. 69–77. Pseudo-TSEM.—69. *Mentzelia ravenii* (Onagraceae). Section includes three aperture regions. The center of one mesocolpus (arrow) is enlarged in the inset to show that endexine (en) and foot layer (fl) are distinguishable.—70–71. *Canna generalis* (Cannaceae). The sensitivity of pseudo-TSEM is clearly demonstrated in these two developmental stages.—72. *Hauya elegans* ssp. *elegans* (Onagraceae). The spongy organization of the exine is well depicted, as are the short “columellae” protrusions (arrowheads).—73. *Epilobium canum* ssp. *garrettii* (Onagraceae). Fusion of adjacent apertural exines in tetrad.—74. *Circaea erubescens* (Onagraceae). Unacetolyzed pollen.—75. *Epilobium canum* ssp. *garrettii*. Proximal wall of tetrad member of unacetolyzed, starch-filled, grain.—76. Enlarged portion of above figure clearly showing that pseudo-TSEM resolution is sufficient to elucidate the character of the ectexine.—77. *Angelica venenosa* (Apiaceae). Differentiation in zones of the exine (arrows) is clear in this view; gb = grid bar. (Unless indicated the scales equal 1 μm .)

Fig. 78–83. Pseudo-TSEM: systematic applications at tribal level for some Asteraceae.—78–80. *Vernonia amygdalina* (Vernoniaeae).—78–79. Different sectional planes illustrating low-magnification overviews easily obtained with this SEM mode. Arrows indicate grid bars.—80. Exine structure and stratification layers are shown in this micrograph at intermediate magnification. Endexine (en), foot layer (fl).—81–82. *Pelucha trifida* (Inuleae).—81. Low-magnification view. Arrow indicates thick fragmented endexine overlain by a narrow foot layer.—82. Intermediate magnification of a portion of Fig. 81. In this electron micrograph holes, termed internal foramina (Skvarla and Larson 1965), are evident in the ectexine. These holes have long been recognized as having taxonomic value in certain Asteraceae groups but, usually, have only been identified with conventional TEM.—83. *Ursinia abrotanifolia* (Spreng.) Prassler (either Anthemideae or Arctotideae). The prominently thickened and very uniform foot layer (arrows) is notable, as is the delicately constructed ectexine. (The scales equal 1 μm .)

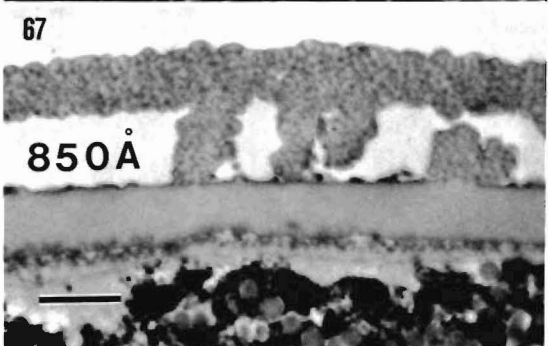
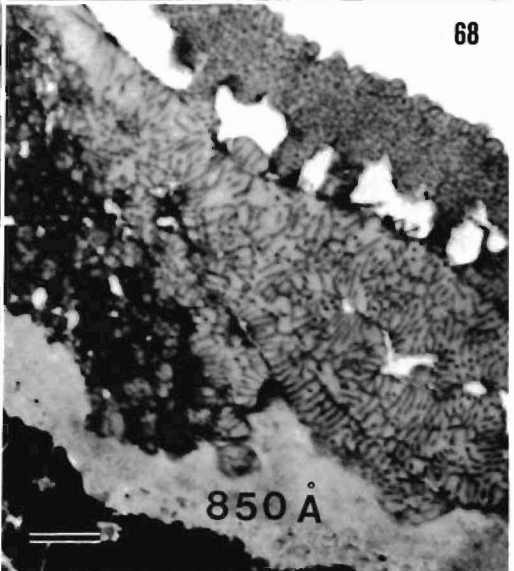
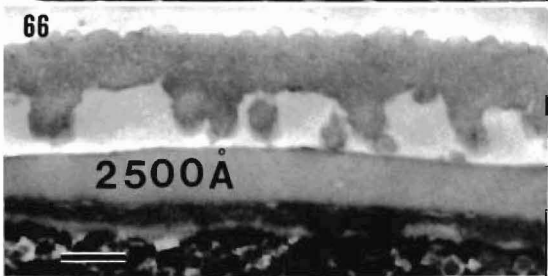
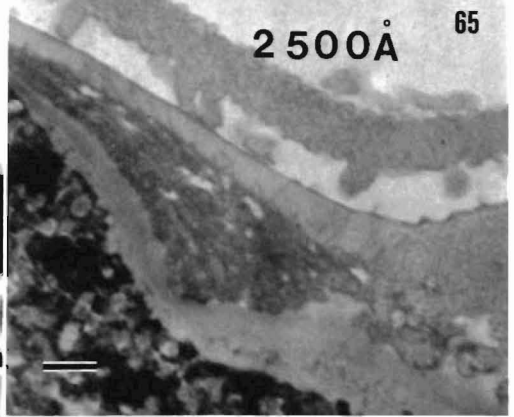
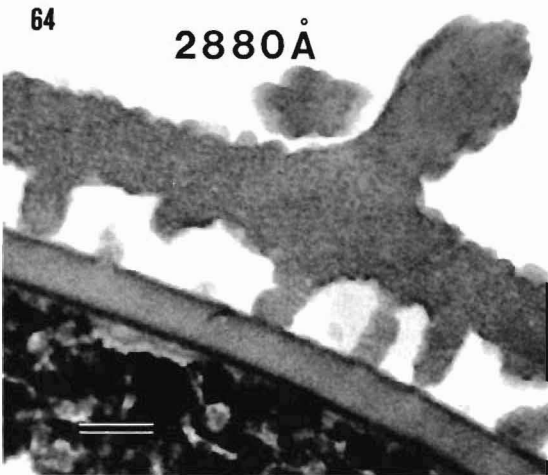
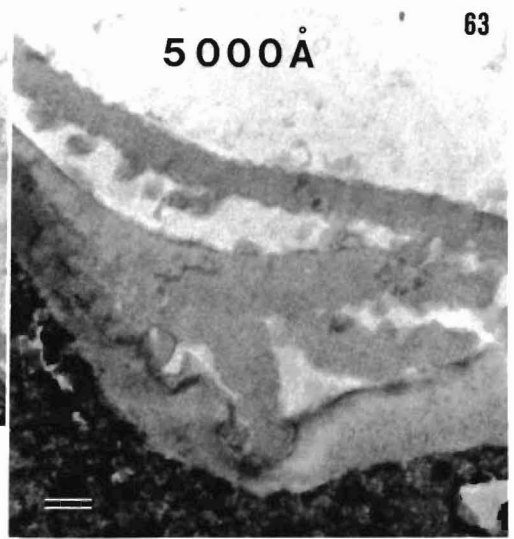
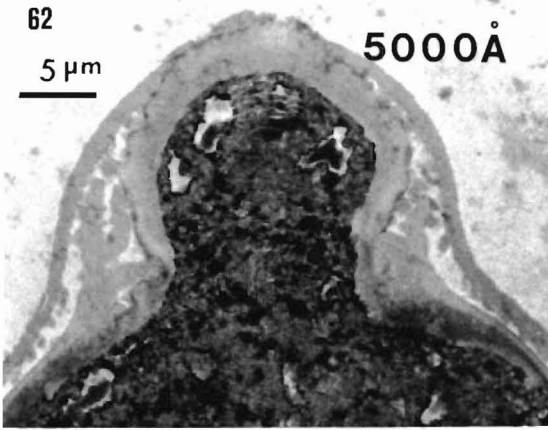

69

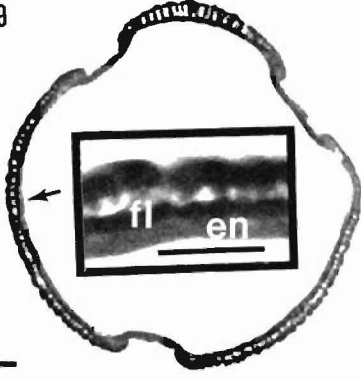

70

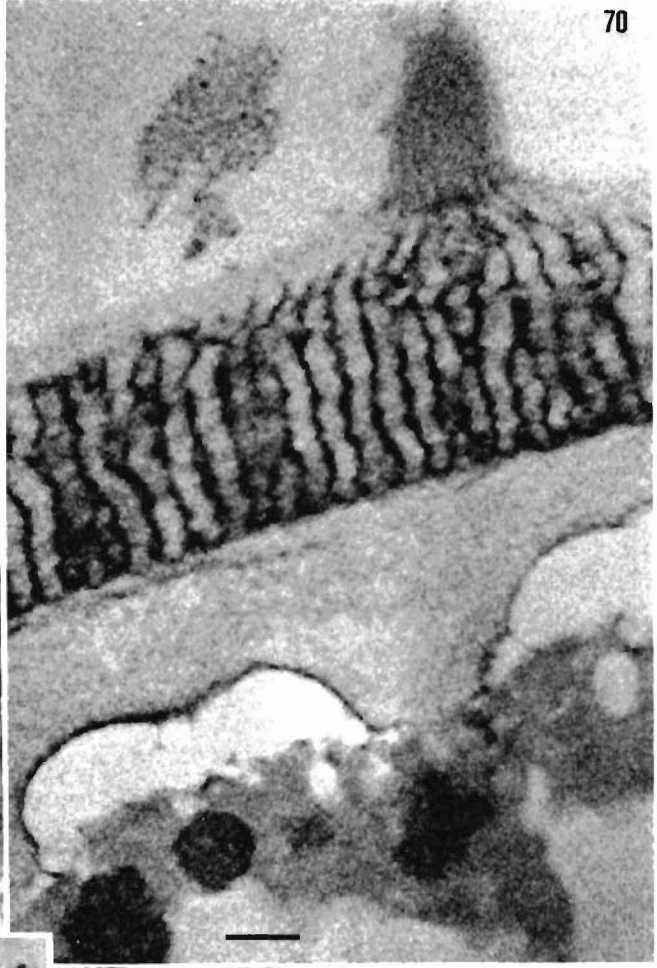

71

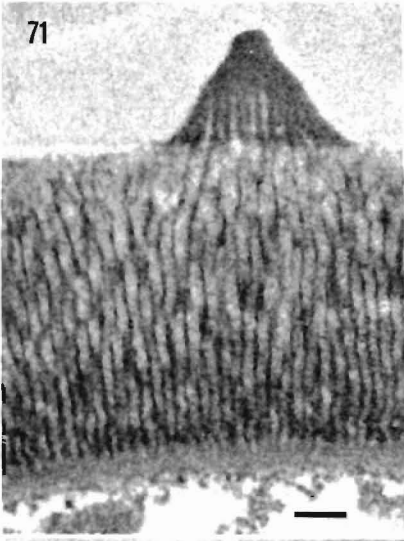

72

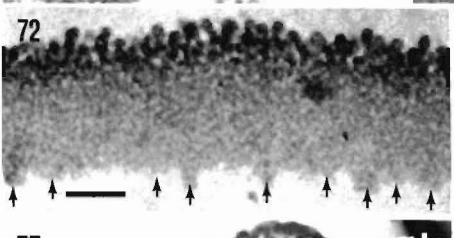

73

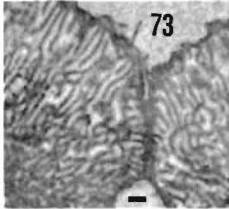

74

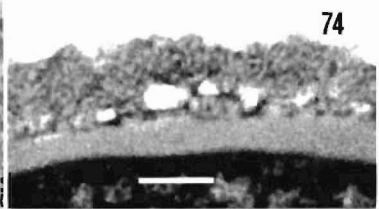

77

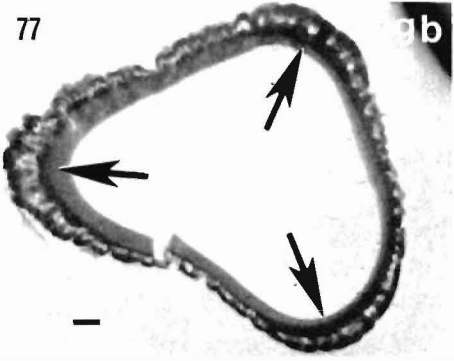

7b

75

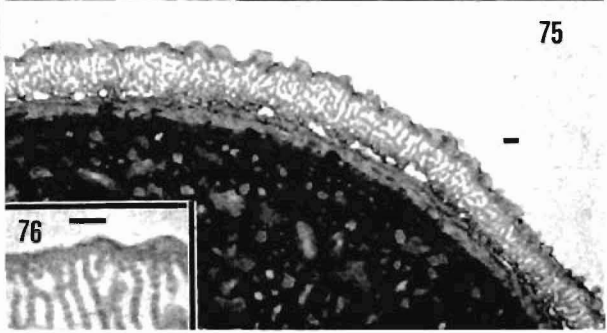

76

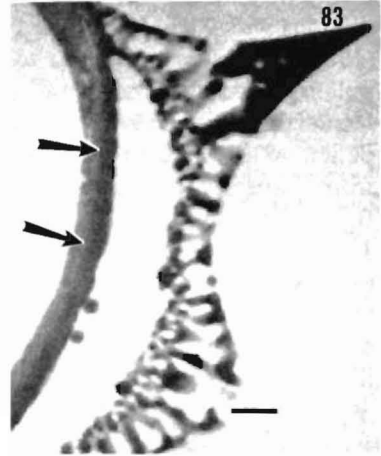
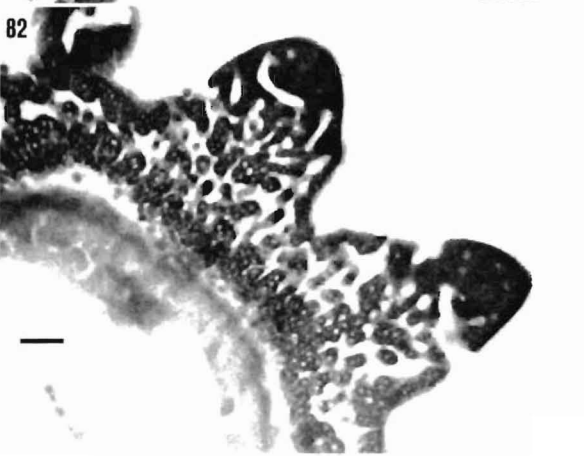
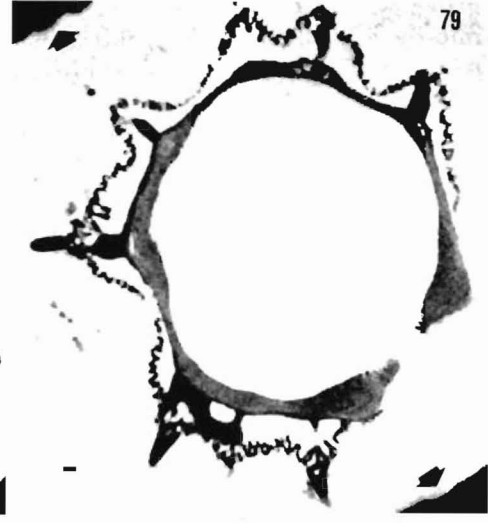

Provided that one can obtain a transmitted electron detector and it can be fitted into the SEM then TSEM is surely the system of choice offering superior results with less effort, although see CONCLUSIONS.

Utilization of TSEM in palynology will help to provide information on internal structure of the exine. The very wide field at low magnification and good resolution bridges the gap between light microscope oil immersion work and high-magnification/resolution studies with conventional TEM. The quality of results will be directly influenced by the quality of SEM-TEM instrumentation available and with the rapid advances occurring in this technology there is little doubt the overall quality of the exines represented in our figures would be appreciably improved by use of the most advanced of contemporary microscopes. Now the potential of TSEM should be applied to studies of fossil pollen.

THICK-SECTION DEPLASTICIZATION (ETCHING)

There are at least two alternatives to viewing pollen sections in SEM without resorting to TSEM or pseudo-TSEM imaging modes. One of these employs sections with a minimum thickness of $0.25\ \mu\text{m}$, therefore, substantially above the thickness level needed for standard TEM or TSEM, and consequently having considerable technical appeal. This method is herein termed THICK-SECTION DEPLASTICIZATION (ETCHING). The second alternative, designed with the purpose of diagnosing pollen wall components before and after acetolysis, is termed COVERSLIP ACETOLYSIS and will be discussed later.

Viewing of sections by TEM after removal of surrounding embedding media has proven to be most useful in interpreting pollen wall and anther tissue associations throughout pollen ontogeny (Rowley 1959, 1960, 1962, 1964; Rowley, et al. 1959; Dahl and Rowley 1965). More recently, such preparations have been utilized to characterize the substructure of modern and fossil pollen grains (Rowley and Dahl 1982; Rowley and Srivastava 1986). The embedding resins used in these investigations, either methacrylate or epoxy, were removed by treatment with amyl acetate or sodium methoxide. Subsequently, platinum or palladium shadowing was usually applied. To our knowledge, examination of deplasticized thick sections with SEM is confined to the study of Rowley, Dahl, Wallis, and Huynh (1983), whereby viscin threads of *Epilobium* were described as extending from pollen grains to the tapetum.

Success of the above prompted application of these SEM methods with mature pollen. While a number of methods are available for removing embedding resins from tissue sections (see Mayor, Hampton, and Rosario 1961; Snodgrass, Dorsey, Bailey, and Dickson 1972; and reviews of Lane and Europa 1965, and Jarvis 1975) the procedure used in this study is essentially a hybrid of the key elements of these previous techniques, and follows the suggestions of Hogan and Smith (1982) for immunocytochemical analysis of epoxy-embedded tissues by means of either light or electron microscopy. The pollen deplasticization method is illustrated in Figure 84 and outlined as follows:

1. Fresh or acetolyzed pollen is sectioned at a thickness on the order of $\frac{1}{4}$ – $\frac{1}{2}\ \mu\text{m}$.
2. Sections are collected with a wire loop (see Fig. 9A of Skvarla and Pyle

DEPLASTICIZED SECTIONS

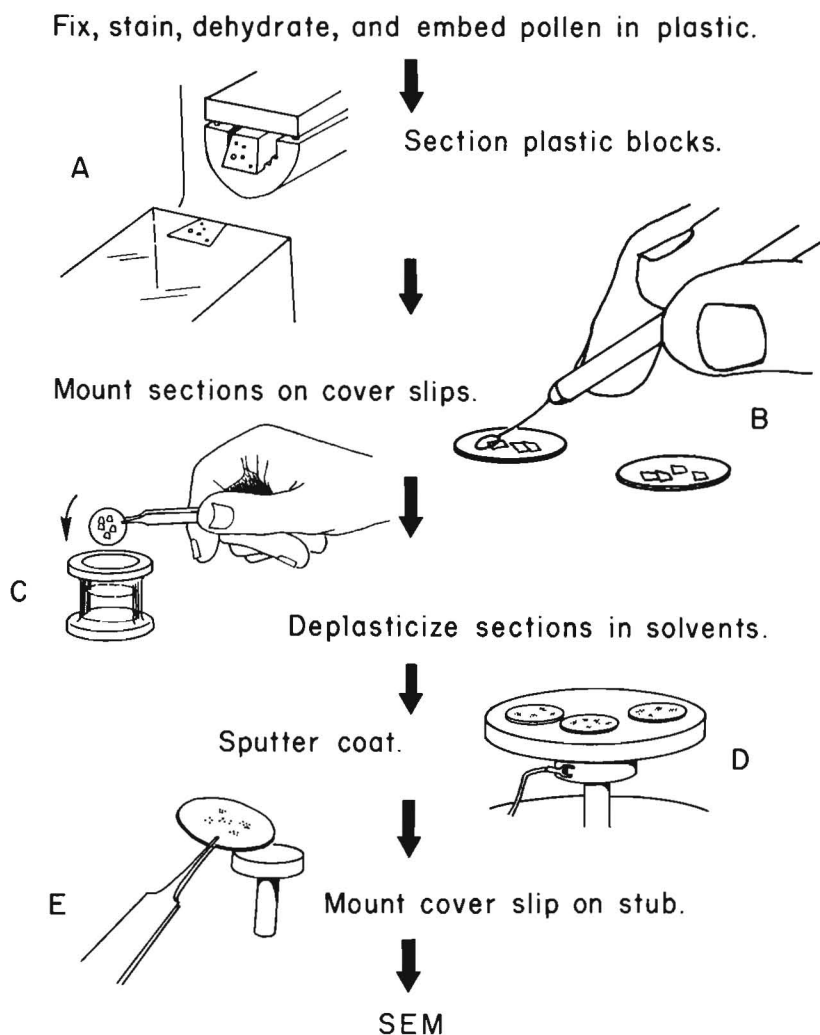
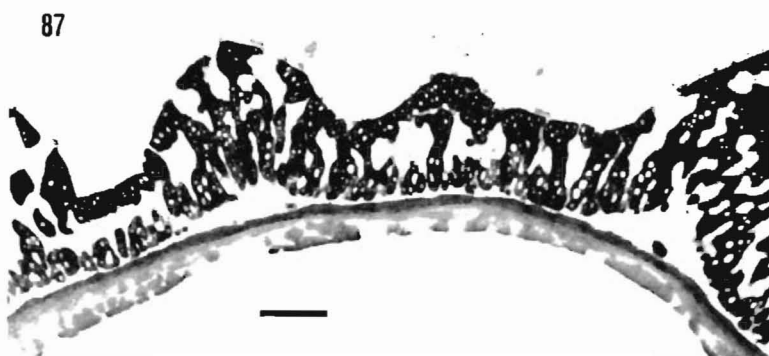
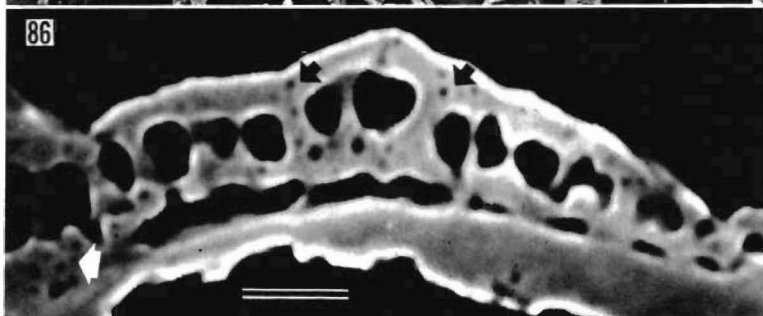
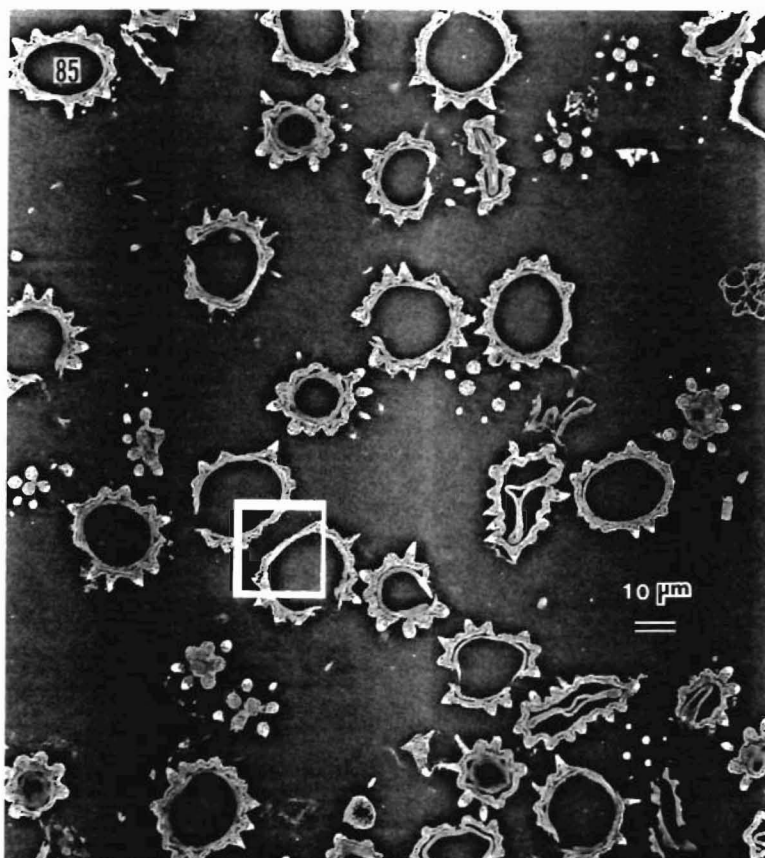

Fig. 84. Thick-section deplastification method.—A. Sections may be cut in the range of 0.25-0.5 μm .—B. Sections are collected on a wire loop and transferred to standard glass coverslips and allowed to dry, then heat sealed to the glass.—C. Coverslips are placed in coplin jar containing epoxy solvent of 15 ml of freshly prepared 0.5% KOH in methanol in 30 ml of a 1:1 stock solution of acetone and benzene for 30 min. This is followed by neutralization for one min with 1% acetic acid in methanol in a coplin jar. Subsequently, the material is rinsed in absolute methanol for one min. Uranyl acetate-lead citrate staining is optional at this stage.—D. Sections are sputter-coated. Coverslips are mounted on specimen stubs and subsequently examined with SEM.

1968), transferred to standard glass coverslips (circular or rectangular) and heat sealed on a hot plate.

3. Sections are etched by soaking in solvent (15 ml of freshly prepared 0.5% KOH in methanol in 30 ml of a 1:1 stock solution of acetone and benzene) for 30 min.



4. Material is neutralized for 1 min in a solution of 1% acetic acid in methanol.
5. Sections are rinsed in 100% methanol for 1 min (if desired, sections can be stained with uranyl acetate and lead citrate).
6. The coverslip is attached to the SEM stub by means of rubber cement.
7. The coverslip is sputter coated.
8. Material on the coated coverslip is examined with SEM by means of either secondary or backscatter electron detectors.

Deplasticized sections of *Pelucha trifida* (Fig. 85–87) and *Flaveria trinervia* Mohr. (Asteraceae) (Fig. 88–93), *Camissonia cardiophylla* ssp. *robusta* (Onagraceae) (Fig. 94, 95), and *Zingiber spectabile* Grif. of the Zingiberaceae (Fig. 96, 97) are illustrations of this method. Remarkably improved quality of the final image is obtained by use of the backscatter electron detector (see earlier discussion). Visualization of structural exine characters like ectexine internal foramina, endexine lamellae (Fig. 86, 90, 92, 93) and the “spongy” or paracrystalline exine (Fig. 95) is clearly improved with the backscatter mode. Because the semithin sections show a certain amount of “depth” the image differs from the two-dimensionality of standard TEM and such sections are thus ideally suitable for backscatter imaging, which is specifically geared to penetrate slightly beneath the specimen surface for sequestering of an electron signal. In a sense, results of backscatter imaging can be equated with Erdtman’s (1952) ideas on “thru-focusing” because they enable us to “see” the other side of the section. Another advantage in using the backscattered mode is that there is no “raster” effect from high-magnification focusing and micrographs are free from this electrical artifact.

However, pollen grains imaged with this method have a highlighted outline (Fig. 86, 90, 92, 93). One could misinterpret the highlighted edge effect as, for example, exine stratification. A second, although minor disadvantage is that background may be prominent and distracting compared to the background obtained in secondary imaging. This disadvantage is inconsequential, however, when compared to the information available from backscattering. The quality of the backscattered exine image may be improved by following the suggestions of de Harven (1983) for biological structures.

Other positive aspects of deplasticization are the great variety of section planes that are readily available (Fig. 85) and the suitability of “thick” sections for SEM. As pointed out earlier in the TSEM discussion, lowering of the requirements for making ultrathin sections would stimulate interest in the use of sections in palynology.

As with previously described SEM methods the procedures outlined above and in the diagram for section deplasticization (Fig. 84) are not considered as definitive;

←

Fig. 85–87. Thick-section deplasticization method using *Pelucha trifida* (Asteraceae).—85. Low-magnification overview illustrating a wide selection of exine views. Imaging with backscatter detector.—86. Intermediate magnification of portion of an exine framed in Figure 85. The arrows indicate internal foramina. The halo at surfaces is an edge effect produced by imaging with a backscatter detector.—87. TEM control showing that except for delineation of the foot layer, all of the basic morphological information is represented in deplasticized sections examined by SEM. (Unless otherwise indicated the scales equal 1 μm .)

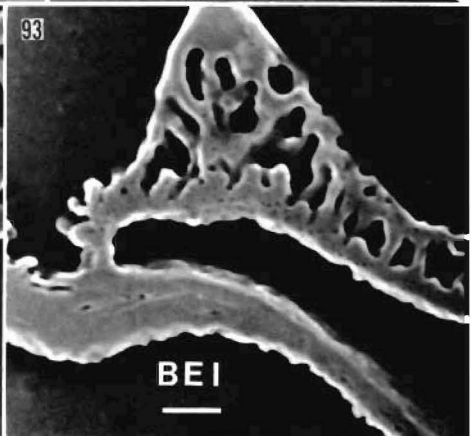
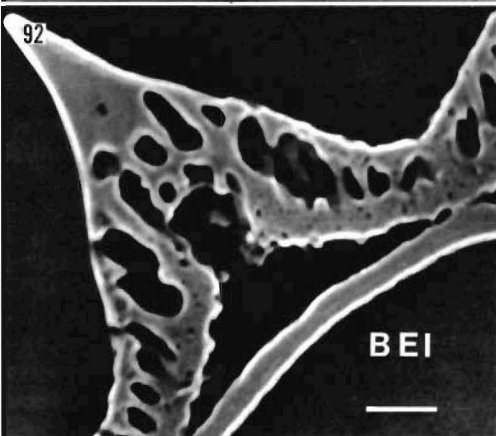
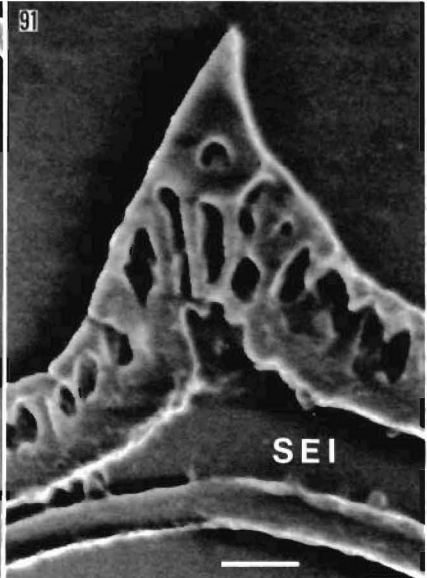
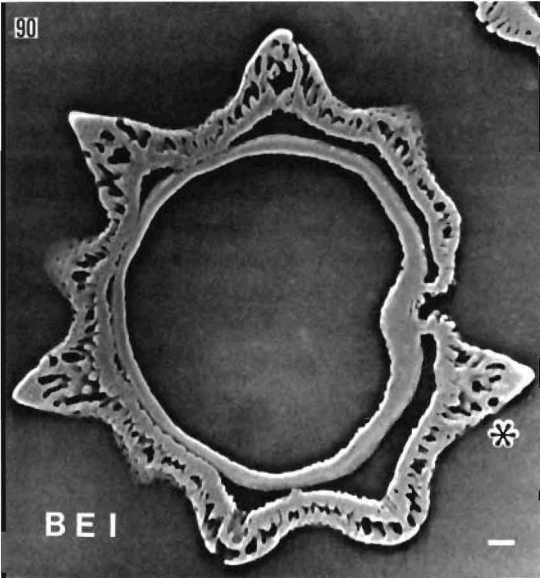
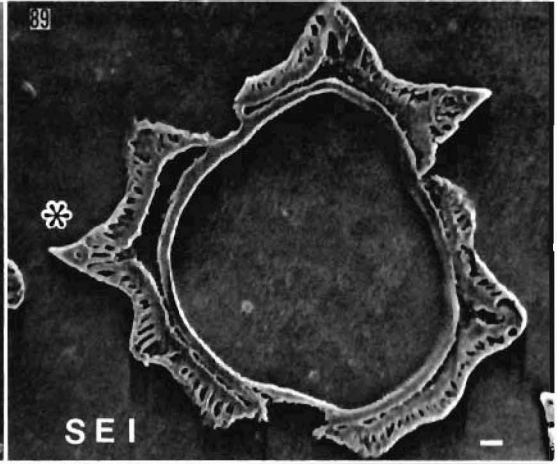
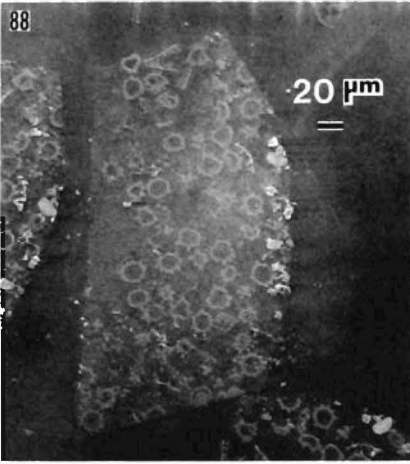

refinement in all operational and instrument levels should improve upon this initial effort. Table 1 is intended to assist in pilot studies.

POLYETHYLENE GLYCOLS (PEG)

The recent introduction by Wolosewick (1980) of the highly water/alcohol soluble wax, polyethylene glycol (PEG), as a temporary embedding medium has enabled TEM observation of cell microtrabeculae, organelles, and cytoskeletal elements in sections free from embedding resins. Furthermore, retention of antigenicity and the ease of introduction of macromolecular antibodies into cells has made it most useful for immunohistochemical applications (Bosman and Go 1981; Wolosewick and De Mey 1982). We were encouraged to consider possibilities of PEG sectioning in palynology because of those successful applications and work of Kondo and Ushiki (1985) linking LM, SEM and TEM data.

Anthers of *Plumbago zeylanica* L. were processed according to the following schedule, partially adapted from Kondo (1984).

1. Initial glutaraldehyde fixation and osmium staining. These are optional procedures.
2. Dehydration in ethyl alcohol (ETOH). The temperature of the final immersion in absolute ETOH must be 60 C or slightly above (exercise caution in heating the alcohol).
3. First infiltration: PEG 4000 (Polysciences, Inc.) in absolute ETOH in a ratio of 1:2; 2 h above 60 C (embedding oven).
4. Second infiltration: PEG /ETOH mixture in a ratio of 2:1; 2 h above 60 C.
5. Third infiltration: 100% PEG in gelatin capsules that have been heated and dried. Anthers should be arranged at top of capsule before solidification of PEG since the opaque nature of solidified PEG causes difficulty in locating anthers.
6. Solidify PEG by immersing capsules in liquid nitrogen for a few sec.
7. Prior to sectioning it is important to trim off *all excess* PEG with a razor.
8. Section with a knife, preferably a diamond no longer suitable for TEM quality sections, at thicknesses in the range of $\frac{1}{4}$ to 1 μm . Make sure the knife edge and trough are totally dry.
9. Collect dry sections from knife edge on to the fluid surface of a film of 2.5% sucrose in a wire loop.
10. Transfer to a drop of water on a glass microscope coverslip.

←

Fig. 88–93. Thick-section deplasticization method comparing secondary and backscatter detector systems using pollen of *Flaveria trinervia* (Asteraceae).—88. Low-magnification overview of a microtome section. Subsequent figures on the plate are related to this slice. Secondary imaging; section thickness $\frac{1}{4}$ – $\frac{1}{2}$ μm .—89–90. General comparison of single exines using secondary (SEI, Fig. 89) and backscatter (BEI, Fig. 90) electron imaging.—91. High magnification of spine area opposite the asterisk in Figure 89. Secondary electron imaging (SEI).—92. Another spine area photographed with backscatter detector (BEI). The images obtained with the backscatter detector system in Figure 90, 92–93, clearly show the characteristic and important internal foramina which are obscured in comparable secondary detector analyses (Fig. 89, 91).—93. High magnification of spine area near the asterisk in Figure 90. Backscatter imaging (BEI). (Unless indicated the scales equal 1 μm .)

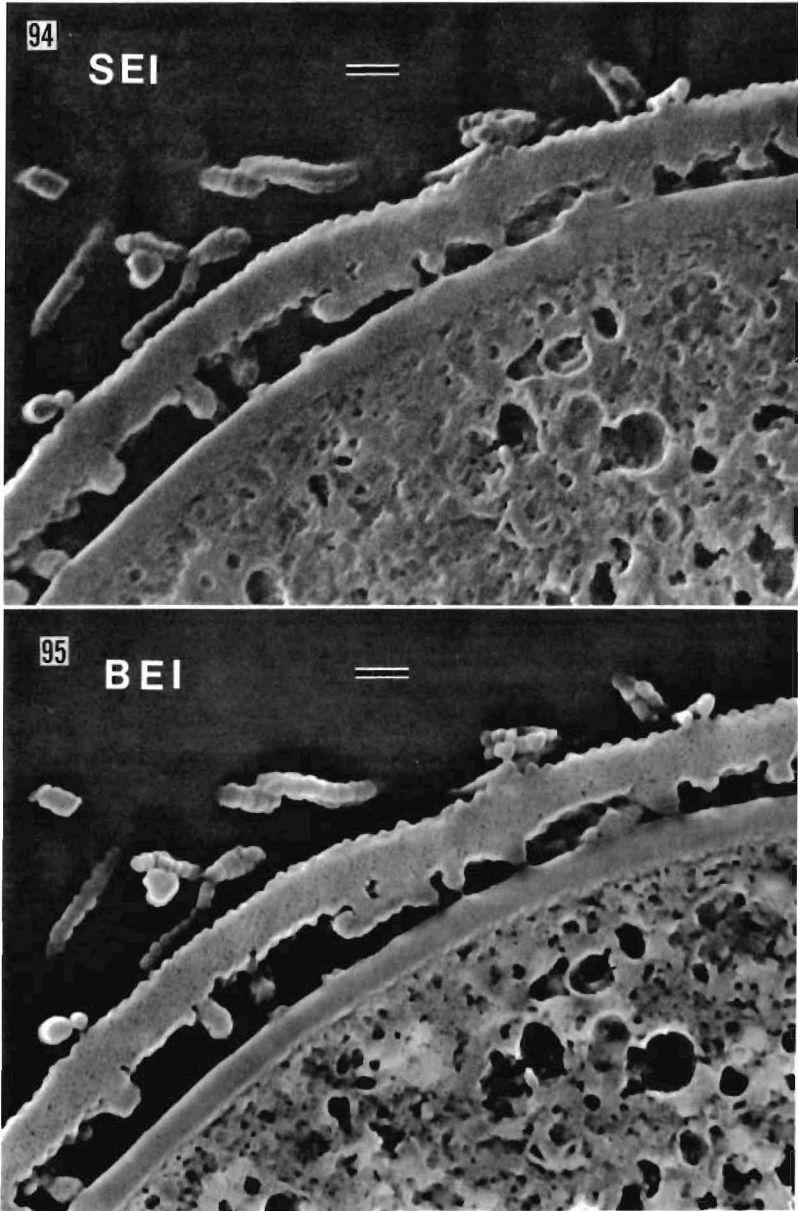

Fig. 94–95. Thick-section deplastization method using *Camissonia cardiophylla* ssp. *robusta* (Onagraceae) pollen and illustrated with secondary and backscatter detector systems.—94. Section ($\frac{1}{4}$ – $\frac{1}{2}$ μm thick) deplastitized and examined with secondary electron detector system (SEI).—95. Identical section examined with backscatter electron detector system (BEI). Comparison of all exine components (viscin threads, exine, cytoplasm) by both detectors dramatically indicates the superior detail obtained with backscatter electron imaging. (The scales equal 1 μm .)

Table 1. Evaluation of some variations in techniques used in examination of etched (deplasticized) pollen.

	+ = Satisfactory; - = Unsatisfactory; ++ = Optimal	
1. SECTION THICKNESS		
> 1/4 μm	+	++
1/4 μm	+	++
< 1/4 μm		-
2. ETCHING TIME		
No etch		-
15-30 min	+	++
30 min-2 h	+	
3. STAINING		
Osmium staining	+	
No osmium staining	+	
4. POST STAINING		
Uranyl acetate & lead citrate	+	
No staining	+	++ (?)
5. ELECTRON DETECTOR SYSTEM		
Secondary	+	
Backscatter	+	++

11. Flood with water to remove PEG and dry.

12. Sputter coat in standard manner and examine with SEM.

Sections (Fig. 98, 99) compare favorably with those acquired by the deplasticization technique. The range of acceptable section thicknesses seems to be 1/4 to 1 μm . Sections at the thicker end of this range provide extensive views of sectioned and unsectioned portions of exines reminiscent of freeze fracturing. Exine sculpturing is exceptionally well imaged in the secondary electron beam after these steps.

Another benefit of PEG embedding is that after desired sectioning is completed the PEG can be removed from the tissue block itself and the entire exposed section face can be easily examined. Removal of PEG embedment from incorporated anthers is an SEM modification of a procedure used by Ferguson (1978) to study exines remaining in epoxy-embedded blocks after thin-section acquisition. Ferguson exposed exines by dissolving the surrounding embedding medium from the block-face with sodium methoxide.

The application of PEG in palynology appears well suited for studies of progressive wall degradation, enzyme digestion, particularly as related to the intine, and overviews of relationships of pollen within entire anthers.

COVERSLIP ACETOLYSIS

Deplasticized Epoxy Resin

The "individualized" application of acetolysis instead of the common "bulk" test tube processing was initiated by Avetisian (1950). The method consisted of

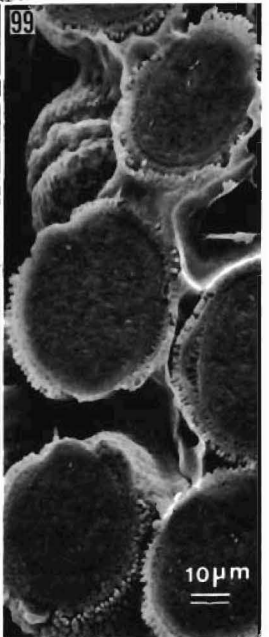
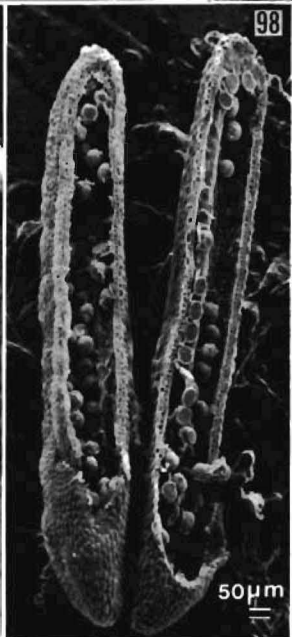
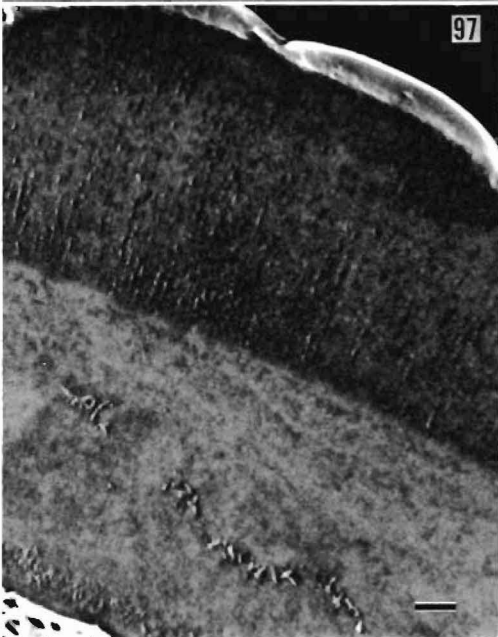
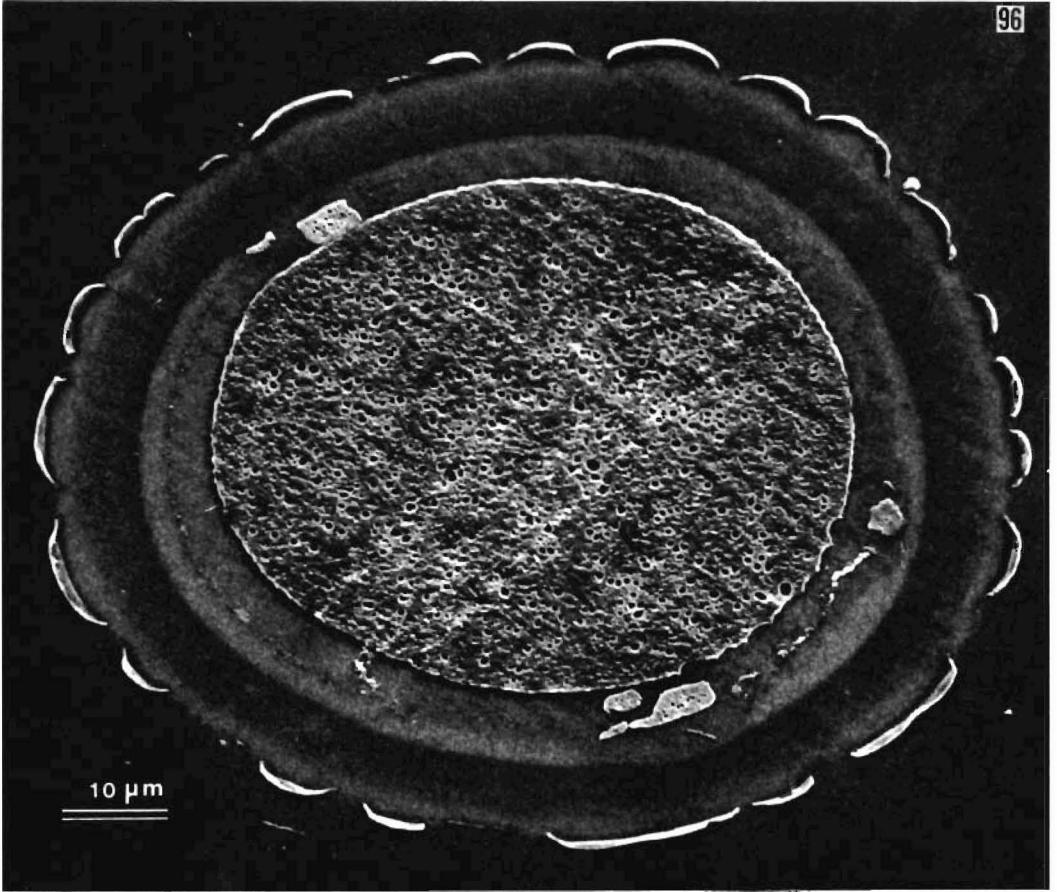

dropping an acetolysis solution onto whole pollen grains dissected out of anthers on microscope slides and then heating them over an alcohol lamp. The process was monitored with the light microscope. There are examples of localized acetolysis involving thin sections for TEM in the work of Rowley and Dunbar (1967), and Rowley, Dahl, and Rowley (1981). Rowley and Dunbar exposed thin sections of the aperture areas of *Anthurium* pollen to sodium methoxide in order to partially dissolve the surrounding Epon embedding resin, then acetolyzed them for 10 min, and finally shadowed them with gold. Their subsequent TEM examination showed that white-line-centered lamellations had resisted acetolysis and were likely to consist of sporopollenin. Dickinson and Bell (1973) also adapted Avetisian's acetolysis of whole grains to sectioned material. Accordingly, 2–4 μm epoxy-embedded sections were mounted upon gelatin-coated slides, flooded with acetolysis mixture, covered with a coverslip, flame-boiled for 5 min, and, after cooling, viewed with phase-contrast microscopy. They successfully utilized this method for identification of sporopollenin in peritapetal membranes and Ubisch bodies in the microsporangium of *Pinus*. They termed the technique "section or controlled acetolysis."

The method proposed in this report (Fig. 100) follows the deplasticization (section etching) method discussed previously. The newly etched sections are treated with a 5-min acetolysis in a coplin jar at about 98 C. Results as illustrated for *Zingiber spectabile* (Fig. 101–105), *Fuchsia verrucosa* (Fig. 106, 107), *Canna generalis* (Fig. 108–114), and *Camissonia cardiophylla* ssp. *robusta* (Fig. 115–118) are very consistently obtained and yield extremely interesting and exciting information; for example, in *Canna* the channeled zone under spinules has a radially oriented component containing sporopollenin and the exine between spinules is netlike (see illustration descriptions for Fig. 109, 113–114).

"Deplasticized" Polyethylene Glycol (PEG)

The acetolysis procedure is used as described above for epoxy sections. After step 10 in the outline for preparing PEG sections as discussed previously, the sections were heat-sealed to the coverslips in order to prevent their loss during acetolysis. Results are illustrated with *Plumbago zeylanica* (Fig. 119, 120).

←

Fig. 96–99. Thick-section deplasticization method using *Zingiber spectabile* (Zingiberaceae) (Fig. 96–97) and polyethylene glycol (PEG) removal using *Plumbago zeylanica* (Plumbaginaceae) (Fig. 98–99).—96. Low-magnification view of entire, deplasticized and unacetolyzed (control) pollen grain. Three distinctive parts of the wall are evident: the outer, discontinuous layer of sporopollenin, an underlying opaque layer (see Fig. 97), and an inner layer of low contrast which in this specimen contains large inclusions apparently continuous with a thin band at the surface of the cytoplasm. *Zingiber* has a wall which is largely not resistant to acetolysis and provides an example of the potential usefulness of this method.—97. Higher magnification of portion of wall in Figure 96 showing the channeled nature of the opaque part of the wall and the immediately underlying less opaque layer with band of inclusions. The outer sporopollenin "cap" is the upward termination of the underlying channels from the opaque layer. Sections in both figures are approximately $\frac{1}{2}$ μm thick.—98. The two anthers in this figure represent the *unsectioned* "residue" after sections have been acquired. They were obtained by removing the PEG by the addition of water drops.—99. Close-up of pollen grains within anther (not the same anther as shown in Fig. 98). The sectioned counterparts to Figures 98–99 are shown later (see Fig. 119–120 in section on coverslip acetolysis). (The scale bar in Fig. 97 equals 1 μm .)

COVERSLIP ACETOLYSIS

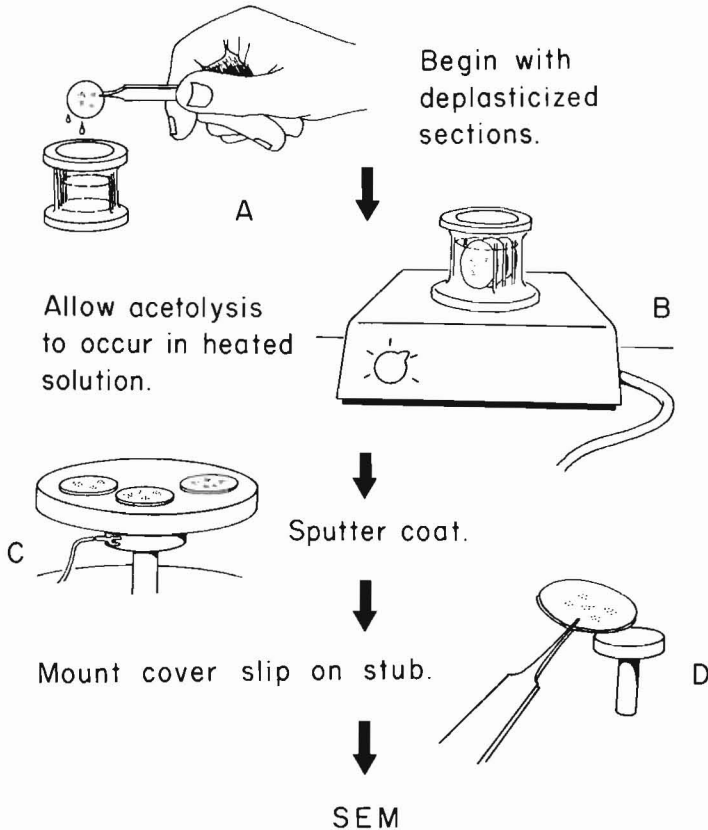
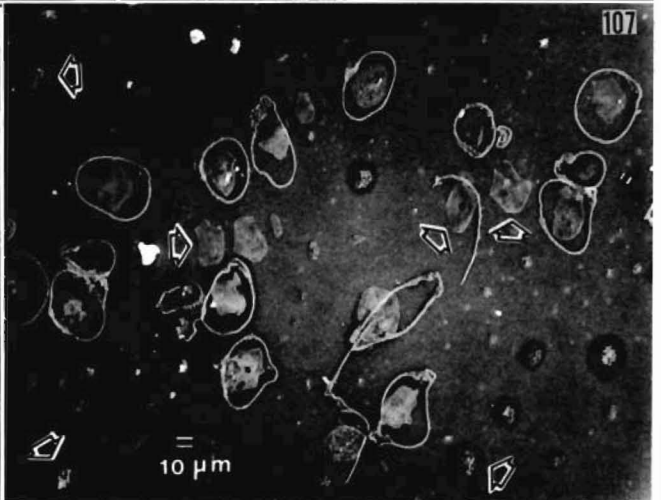
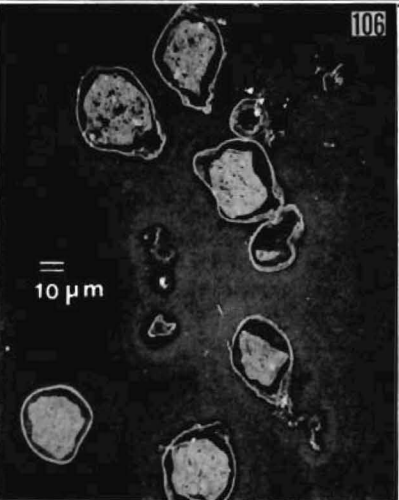
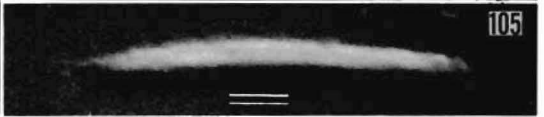
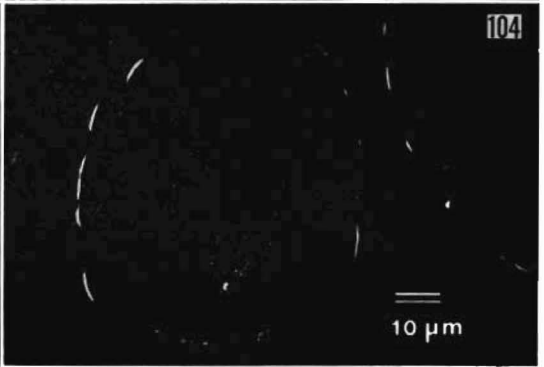
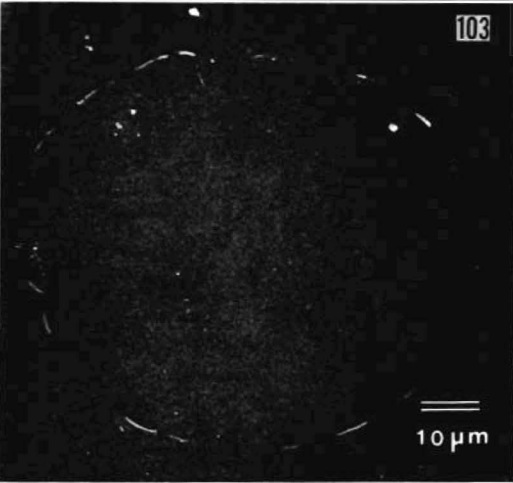
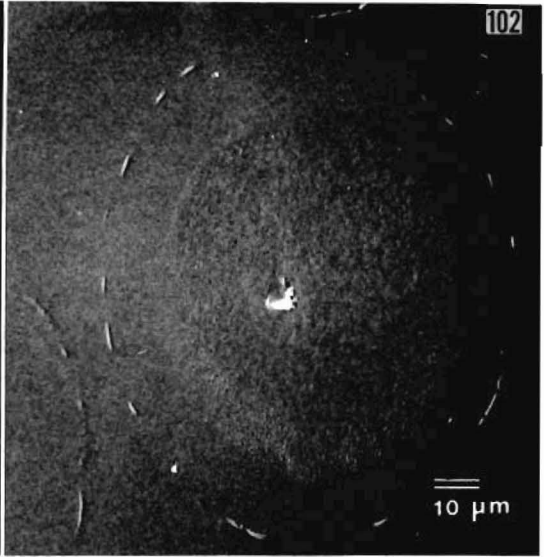
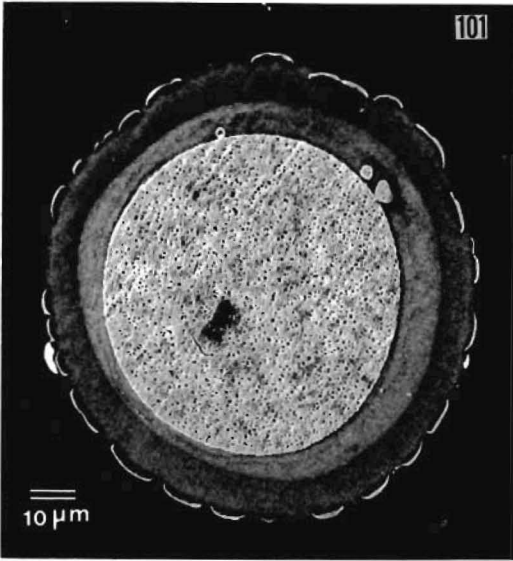
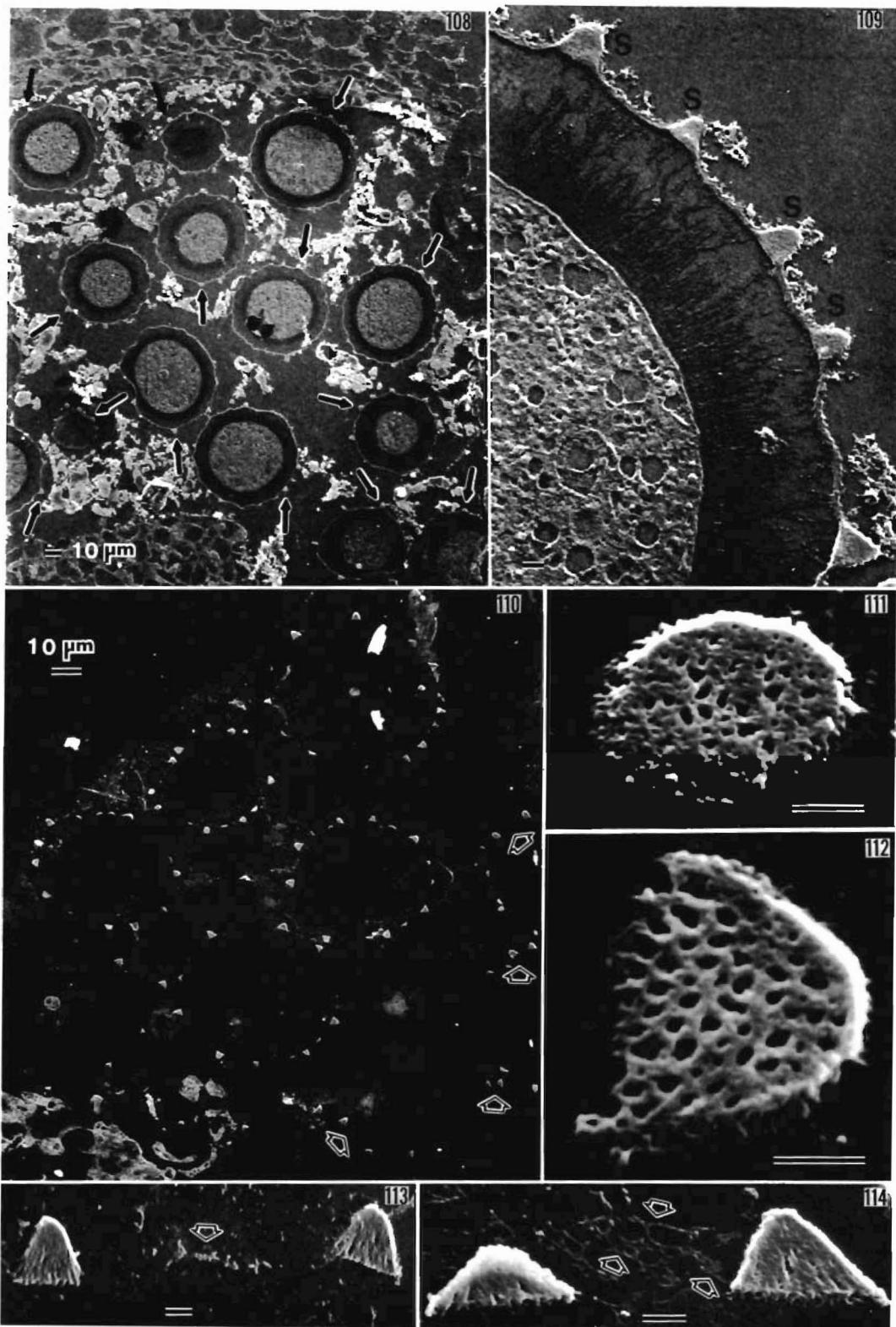

Fig. 100. Coverslip acetolysis method.—A. Start with sections of unacetolyzed pollen with epoxy embedding media removed by deplastitization method.—B. Coverslips with attached pollen sections are placed in a Pyrex coplin jar containing acetolysis solution and carefully heated on a hot plate for 5 min.—C. After removal from acetolysis solution, rinsing and drying, the coverslips are sputter coated.—D. Coverslips are sealed to specimen stub and placed in SEM for examination and photography.

Fig. 101–107. Coverslip acetolysis method illustrated with *Zingiber spectabile* (Zingiberaceae) (Fig. 101–105) and *Fuchsia verrucosa* (Onagraceae) (Fig. 106–107).—101. Deplastitized $\frac{1}{2}$ - μm control section through whole pollen grain. The wall is composed of several layers as discussed in Figure 96.—102. This 5-min acetolysis treatment, in contrast to Figure 103 and 104, was for some reason insufficient to entirely remove pollen cytoplasm.—103–104. Five-min acetolysis exposure shows wheellike outline of sporopollenin component of exine.—105. Intermediate magnification of portion of outer layer of sporopollenin.—106. Low-magnification overview of control section. Section $\frac{1}{2}$ μm thick.—107. Acetolysis is incomplete and the cytoplasm of the pollen grains is either still in place or separated from the pollen wall (arrowheads). The scale for Figure 105 equals 1 μm .





"Deplasticized" Paraffin-Embedded Anthers/Pollen

Paraffin-embedded pollen/anther tissue sectioned at thicknesses of 5–10 μm under routine conditions for light microscopy can also be examined with SEM. Heslop-Harrison (1969) successfully characterized *Cosmos bipinnatus* Cav. (Asteraceae) pollen wall morphology, particularly internal surfaces, by examination of 6- μm anther sections after deparaffinization and acetolysis while Chaturvedi and Datta (1984), using similar methods, followed wall development in *Hibiscus*. In Figures 121–126 *Plumbago zeylanica* pollen sections approximately 10 μm thick obtained from paraffin embedding were first deparaffinized using standard methods and then subjected to coverslip acetolysis as described earlier.

ION-BEAM EROSION (ETCHING) OF EXINES

The final SEM application to be considered is one that erodes the exine surface allowing internal structure within the exine to be visualized. Erosion is due to a directional or nondirectional ion beam which can be originated by a variety of sources. There is a recent and highly informative review of the use of ion-beam etching with biological materials by Claugher (1986). Although etching with ion beams has been an integral part of the physical or materials sciences for many years and actually antedated SEM, application in the biological sciences has been limited and more or less exclusively associated with SEM (Claugher 1986).

Pollen has had very limited study with this technique. According to Claugher (1986), first mention of pollen ion etching has to be credited to Cambridge Instrument Company (brochure no. 17819). Subsequently, scanning electron micrographs depicting ion-etched pollen were published by Echlin (1971), Barthlott, Ehler, and Schill (1976), Claugher (1984, 1986), and Blackmore and Claugher (1984). Results are somewhat variable as might be expected during a period of rapid technological advance when methods and instruments are frequently modified. Echlin (1971) used an ion source within the SEM column, Barthlott et al. (1976) relied on oxidation by high-frequency gas discharge, while Blackmore and Claugher (1984) utilized a saddle field source for ion-beam etching. The saddle field source can produce a highly directional beam that can be generally charge-free. Thus, while not explicitly stated the exine erosion illustrated by Blackmore and Claugher (1984) apparently was produced by a beam that included neutrally charged "fast atom" bombardment of specimens. Some of their illustrations show

←

Fig. 108–114. Coverslip acetolysis method illustrated with *Canna generalis*. The nonacetolysis-resistant channeled zone of *Canna* is a good example of the utility of this method.—108. Deplasticized $\frac{1}{2}$ - μm section of a mature anther. Arrows indicate the spines which adorn the thin exine surface layer.—109. The thick region of the wall without sporopollenin is filled with channels. Section deplasticized.—110. Section similar to Figure 108 but after treatment with acetolysis. The "pinwheel" effect is the result of sporopollenin (arrows) in the channeled zone of the *Canna* wall, as was indicated by TEM studies (Skvarla and Rowley 1970).—111–112. Various sectional views of acetolysis-resistant spinules.—113–114. Views showing the fragile nature and netlike configuration of the sporopollenin-containing exine (arrows) connecting spinules. (Unless indicated the scales equal 1 μm .)

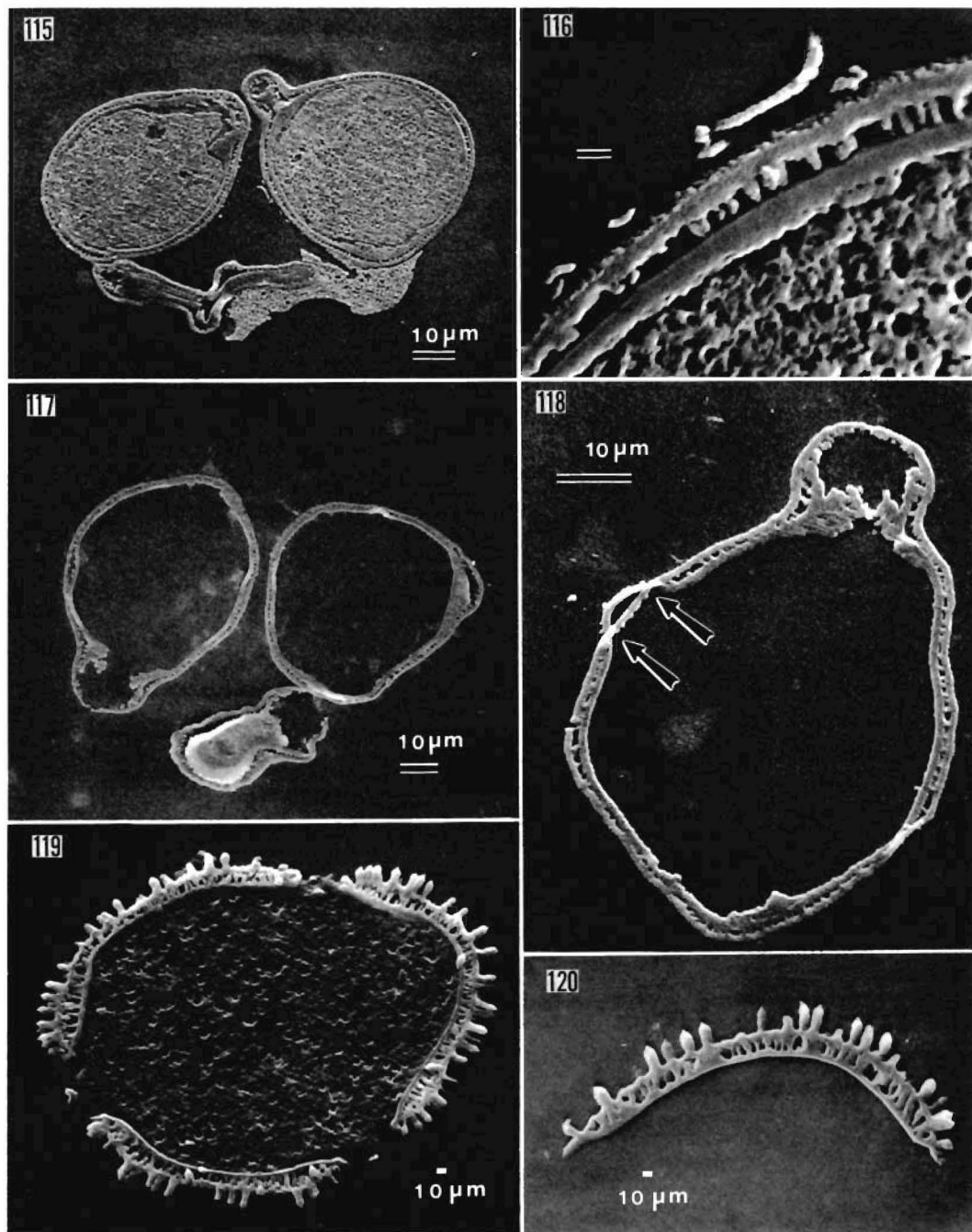

Fig. 115–120. Coverslip acetolysis method illustrated with Araldite-Epon embedded *Camissonia cardiophylla* ssp. *robusta* (Onagraceae) (Fig. 115–118) and polyethylene glycol (PEG) embedded *Plumbago zeylanica* (Plumbaginaceae) (Fig. 119–120).—115. Tetrad section deplasticized but not subjected to acetolysis (control). One pollen grain member is highly distorted, probably an aborted grain.—116. Intermediate magnification of part of above including viscin threads.—117. Acetolyzed counterpart

exposed processes 70 to 100 nm in diameter having a central (core) discontinuity about 40 nm. Freedom from charging with a fast-atom source was deemed crucial in elimination of artifacts at the pollen surface which commonly accompanied standard ion-beam sources (Claugher 1984, 1986). Nevertheless, Blackmore and Claugher (1984) and Claugher (1986) point out that the use of "fast atoms" also has numerous limitations and may be best in palynological applications when applied to thick, microperforate exines without high relief features.

The revelation of substructure within the exine can be realized through erosion with a fast atom source in favorable material and careful timing of exine erosion. In work with pollen of *Betula verrucosa* L. Claugher and Rowley (1987) report that these exines consist of tubular structures about 100 nm in diameter having a central core ca. 40 nm in diameter. Spinules arranged on ridges and their underlying supporting tubules were more resistant to fast-atom bombardment than exine components in the "valley" between the ridges. There is circumstantial evidence that the exine of ridges is formed early in development; valley components added later accommodate expansion of the exine (Dunbar and Rowley 1984). Examples of etched exine of *Betula* are shown in three figures and a sketch (Fig. 127–130) reprinted from Claugher and Rowley (1987).

There is a taxonomic application for plasma ashing which is like ion-beam etching in that it can erode the exine (Nowicke, Bittner, and Skvarla 1986). Plasma ashed exines of *Paeonia* showed reduced exine sculpturing components which were more similar to ashed exines of Dilleniaceae than to those of Ranunculaceae. Plasma ashing may have special utility in studies of exine substructure. The technique brings about nondirectional etching and there are numerous examples in the pilot study of Nowicke et al. (1986) of rod-shaped structures exposed as a result of plasma ashing. Rods measuring between 100 and 120 nm in diameter were eroded from exines which had shown little or no indication of such substructure. The method was used to analyze the substructure of tectal types in members of the families Campanulaceae, Cistaceae, Berberidaceae, Thymelaeaceae, Geraniaceae, Euphorbiaceae, Sapindaceae, Dilleniaceae, and Ranunculaceae (Nowicke et al. 1986).

CONCLUSIONS

We give attention to many methods whereby the palynologist may achieve results through scanning electron microscopy adequate for complete descriptions of pollen walls up to an intermediate or even a fine-structural standard. The most significant advantages of SEM usage instead of TEM have to do with time and cost. Where actual money-cost is of primary concern as distinct from "costs" such as time, energy, image quality, personal experience, then our message is that an

←

to Figure 115.—118. In this isolated exine arrows indicate a breaking and twisting of exine components, a frequent effect of coverslip acetolysis, resulting from inadequate bonding of sections to coverslips. The columellae are well differentiated.—119 (control) and 120 (acetolyzed). These $\frac{1}{2}$ –1 μm PEG sections were obtained from the "residue" anthers (taken after section acquisition) shown in Figure 98. (The scale for Fig. 116 equals 1 μm .)

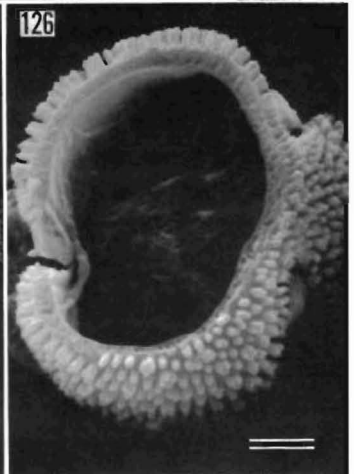
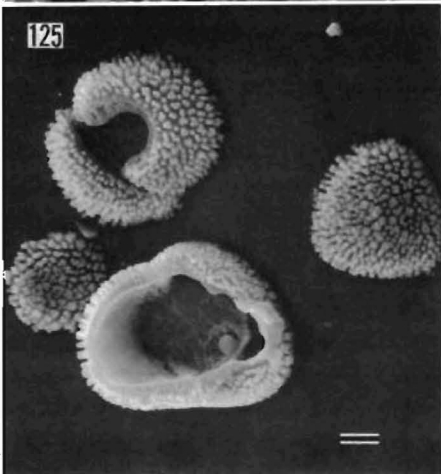
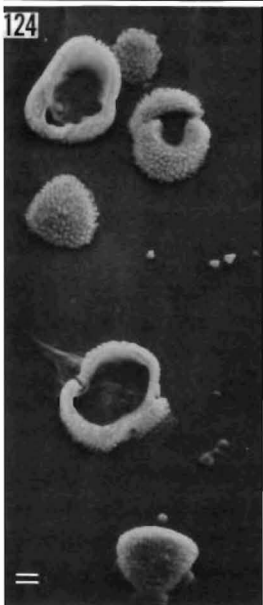
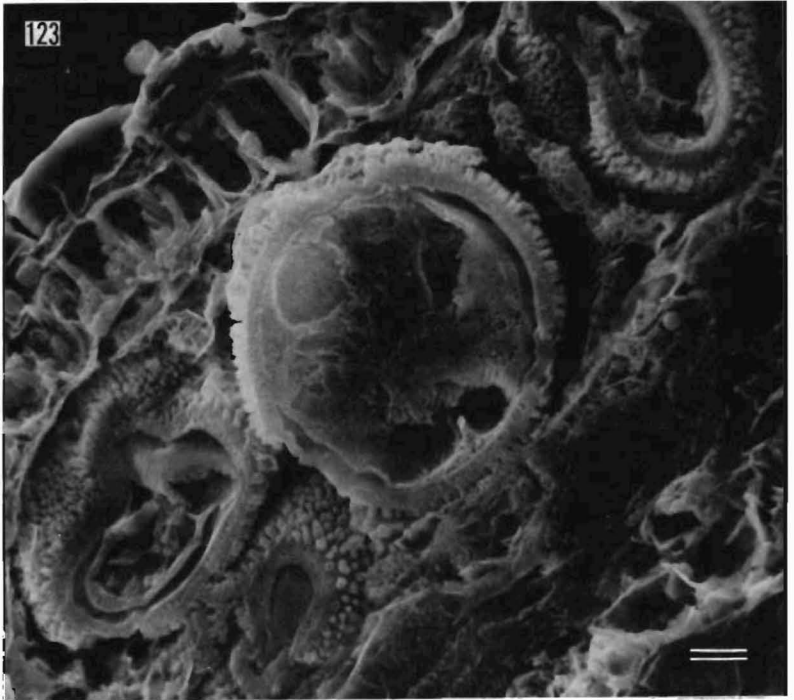
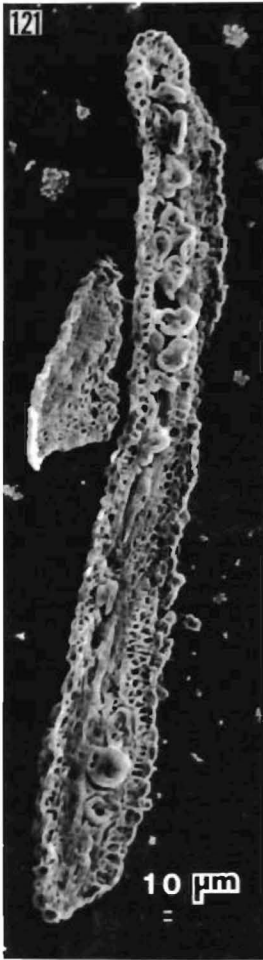

investigator or research group can engage in almost any kind of pollen morphological study through inventive adaptation of scanning electron microscopy.

The ultimate economy in microscopic image-forming systems is, of course, realized with the light microscope. While not specifically discussed above, the survey presented in our Figure 1 shows that a very substantial proportion of pollen studies involves the use of light microscopy. Senior investigators will appreciate the grand potential of the well-equipped LM. Nomarski differential interference contrast in combination with other LM optical systems can match information obtained from low-magnification survey-level SEM, at much less cost. The excitement for students of operating an electron microscope would not likely hinder awareness of the current renaissance in light microscopy in both design and application. If it has, then any adequate demonstration of pollen material correctly mounted for differential interference contrast is likely to make a lifelong convert.

We have made use of micrographs taken with what might be termed second generation SEMs. Our readers will know that the currently available high-resolution ("third generation") instruments have the capacity to equal or exceed the useful resolution of TEM with respect to biological sections. The high-resolution SEM has a capacity of ca. 1.5 nm and while most TEMs give resolutions much better than 1 nm it has long been appreciated that the resolution that can be realized for biological sections is around 2.5 to 3.5 nm. The images we show came from instruments like those that will remain most commonly available throughout the world for years into the future.

By means of selected micrographs, although without making specific recommendations, we have shown beneficial aspects and some of the problems of different methods of specimen preparation and SEM modes of observation. For work restricted to micrographs at low magnifications the advantages in the cryomicrotomy method of Muller (1973) include freedom from organic solvents. Thin to semithin sections are recommended for best resolution and information on exine fine structure. Thin sections can be cut, of course, with low-temperature cryomicrotomes and these instruments may provide prime specimen conditions. The most favorable specimens in our SEM tests have, however, been prepared using methods developed from TEM. Reasons for the superior images from these TEM sections used for SEM apparently involve generally careful preparation including excellent cutting conditions. Superior preservation and stabilization can be expected from rapid freezing and sectioning at low temperature provided the sections are freeze substituted, etc., before examination or transferred cold to an SEM equipped with a cold stage. Without equipment for these low-temperature methods it is rational we feel, to use the preparational methods for TEM to aid in solving fine-structural problems using SEM.

←
 Fig. 121–126. The adaptability of the coverslip acetolysis method is illustrated with sectioned paraffin-embedded anthers of *Plumbago zeylanica*. After standard deparaffinization the anthers were subjected to acetolysis as described in Figure 100B.—121. Longitudinal section through anther.—122–123. Enlarged views of portions of Figure 121. Note retention of cytoplasm in pollen grains.—124. Portion of anther in Figure 121 after acetolysis.—125–126. Enlarged views of acetolyzed pollen from Figure 124. (Unless indicated the scales equal 1 μm .)

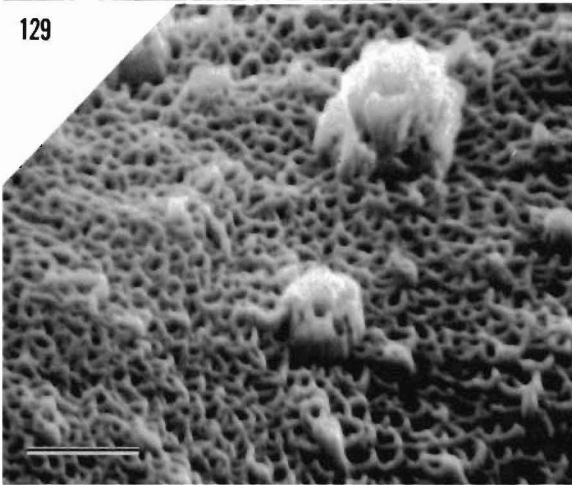
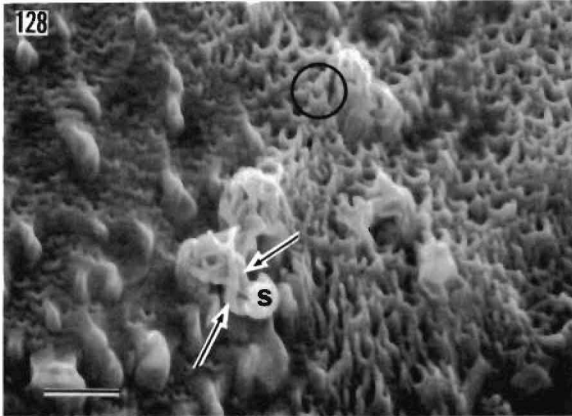
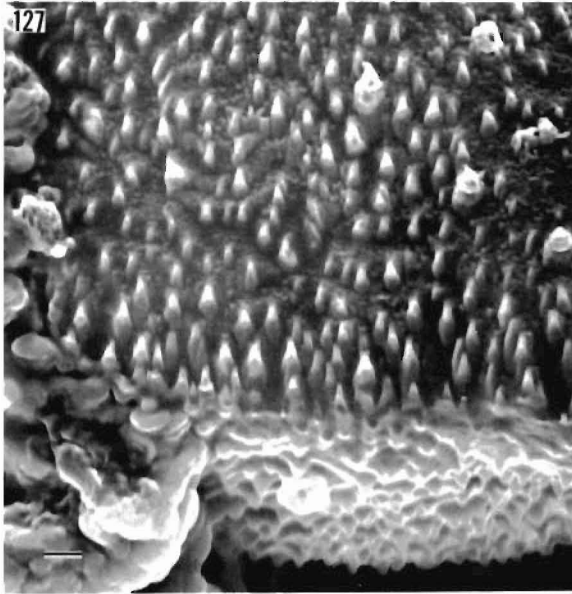

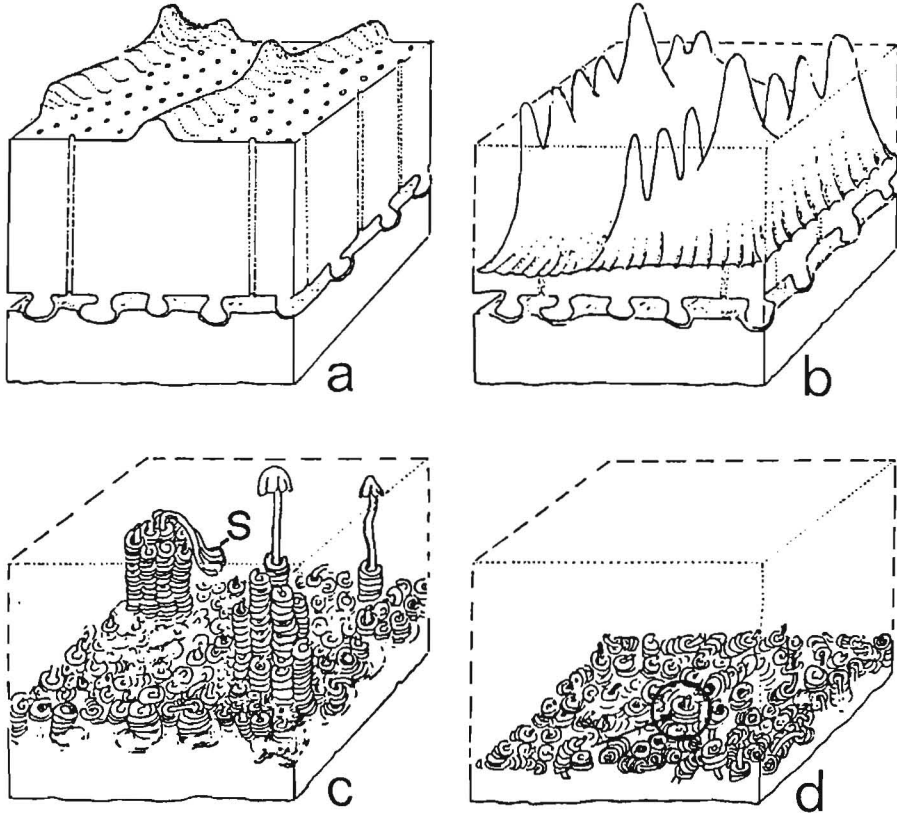

Fig. 130. Four sketches reprinted from Claugher and Rowley (1987).—(a). The untreated exine of *Betula*.—(b). Interpretation of the exine etched as in Figure 127.—(c). The cairnlike bases (Fig. 129) of spinules with a bent-down spinule head (S) as in Figure 128.—(d). A representation of the circular exine units in the base of the tectum or in the foot layer. An upright process with a protruding central core (arrow and circle) is modeled after circled site in Figure 128.

Provided that thin to semithin sections prove to be of continuing importance in pollen morphological studies using SEM, then one must seek an easily removed embedding material like polyethylene glycol. In our hands, however, polyethylene glycol, glycol methacrylate, and some other readily solubilized embedding mixtures have given a variety of severe problems, e.g., our materials in polyethylene glycol were difficult to section.

There are actually several points of considerable advantage in the use of epoxy

Fig. 127–129. Results of fast atom etching of *Betula verrucosa* (all figures reprinted from Claugher and Rowley 1987).—127. The region of the exine at the bottom of the figure was protected from fast-atom bombardment and the spinules on the tectal surface are more or less unetched. Elsewhere the upper portion of the tectum is eroded leaving spinules free-standing.—128. Etching is deepest on the right side of the micrograph and deeper throughout than in Figure 127. The bases of spinules are relatively large and they come from a background of loops. A bent-down spinule (s) is subtended by rod-shaped core subunits (arrows). Circled site is favorable for a core extending out from an exine-process.—129. The micrograph emphasizes the cairnlike base of a spinule on a deeply eroded portion of the tectum. Subunits of the spinule base are circular with a central core zone. (Scales equal $0.5 \mu\text{m}$.)

resin for SEM. These resins are reliable, easily available, and have excellent sectioning qualities but the most tangible benefits with respect to our SEM methods come from the many studies concerned with removal of polymerized epoxy embedding materials from blocks and sections. These studies are cited and commented upon in the applications in pollen morphology by Rowley and Jarai-Komlodi (1976), Ferguson (1978), Pacini, Ciampolini, and Cresti (1980), and Rowley and Srivastava (1986). The methods are reviewed by Maxwell (1978). The two very significant points for our methods here are that the epoxy resins can be completely removed by many of the solvent systems described and that for several (including the one we have used) resin removal causes no detected distortion of the specimen (Horobin and Proctor 1982).

Backscattered electron imaging can be expected to gain acceptance for the detection of the ektexine-endexine boundary. A backscattered electron detector generates compositionally dependent images because the system uses reflected high-energy electrons, the number of which is proportional to the mean atomic number of the material under the incident electron beam. Where there are differences in composition between endexine and ektexine the backscatter method ought to have greater reliability than section staining for TEM, since staining is dependent upon pH, shelf life of the stain, and procedures which are generally difficult to control. A problem with backscatter is that the technique requires a flat surface for brightness distinction based upon differences in elemental composition.

The least expensive system for obtaining TEM-like images with almost any SEM, the mode we have called pseudo-TSEM, has been reassessed recently by Oho, Sasaki, Adachi, Muranaka, and Kanaya (1987). These investigators made an inexpensive and highly efficient device for observing a transmitted electron image in SEM. The efficiency of their device was found to be comparable in resolution with a relatively expensive standard detector system (scintillator detector). They illustrated, for example, cristae and the double limiting membrane of mitochondria in unstained sections as well as the approximately 6 nm iron cores of ferritin particles.

Heywood (1971) considered the easy comprehensibility of SEM images to be their most valuable characteristic. These three-dimensional images lead to a better understanding of the spatial relations of features and reveal unsuspected detail (Heywood 1971). The impact of SEM in the study of surface features was immediate as Heywood (1971, 1984) had foreseen, especially in systematics and evolution. SEM is much used in studies of pollen although palynologists seemingly use few of its many imaging modes. Marjorie Muir is an outstanding exception and users of SEM can find helpful suggestions and explanations in her 1970 paper. She gave attention, for example, to the great enhancement of the three-dimensional effect of the normal image by photographing stereo-pairs, to information on the use of cathodoluminescence (electron-stimulated fluorescence) which can be applied in the same way as ultraviolet fluorescence, and to the potential of TEM detectors, as we note above.

We have given considerable attention to methods for "seeing" the structure within exines and wish to discuss reasons why this is important. In consideration of the importance of ultrastructural data for the plant systematist Stuessy (1979) concluded that in general there is a trend of more rapid response to environmental selection pressures in surface structures than more internal features. Thus, Stuessy

contends, features within plant organs usually studied with TEM are more evolutionarily conservative and useful systematically at the higher levels in the taxonomic hierarchy than are surface features that are usually seen with SEM. Pollen grains are unusual since both surface sculpture and internal structure of the wall are useful in angiosperm systematics from specific through ordinal and class hierarchies (Stuessy 1979).

The explanation for this unusual nature of pollen grains resides, we consider, both in the origin of the pollen grain exine as part of the plasma membrane and in the sequence of its ontogeny. The importance of an ontogenetic sequence is presented in the principle formulated by Tucker (1983, 1984) whereby the earliest systems formed during development are generally the most stable phylogenetically. In an applied example we have found that the inner surface of the tectum forms very early in the preexine of the legume genus *Poinciana* while the outer surface was completed only during late free microspore time (Skvarla and Rowley 1987; Rowley and Skvarla 1987). The inner surface retains the initial irregular form while the form of the outer surface is modified later in development. In *Poinciana gilliesii* the foot layer forms early in development and is not modified structurally throughout growth. This foot layer consists of individual tubules arranged in a single layer joining columellae in a characteristic way a little above their bases and also a little above the later-formed endexine.

Internal features such as these are quickly recorded along with surface features by means of the various modes of SEM and one or a few methods of preparation. As a result of our TEM study of preexine initiation and later development in *P. gilliesii* we consider that both the sequence of preexine initiation and the extent of later modification will be touchstones for studies pertaining to systematics and interpretation of phylogeny.

These recommendations call for ontogenetic studies starting with the microspore tetrad period combined with observations of exine surface and internal structure at maturity. After the vigorous beginning in the work of Larson and Lewis (1962), Heslop-Harrison (1963) and others, there has been a marked curtailment of studies of microspore ontogeny. Apparently there was a belief that data from microspore ontogeny were not promising as an aid to phylogeny because of similarity among taxa studied. Now several to many distinct developmental sequences are apparent (see reviews by Hideux 1981; Skvarla and Rowley 1987; Blackmore and Barnes 1987).

Morphogenetic studies may have been hindered also by the tedious aspects of the work using methods for TEM. Results of the simple fracturing method used by Barnes and Blackmore (1986) and Blackmore and Barnes (1987) show how effective SEM can be for study of morphogenesis beginning with the preexine during the microspore tetrad period. As shown and discussed above we can expect to make studies of pollen grains at all developmental stages relatively quick and easy by giving greater emphasis to use of SEM and its several modes.

ACKNOWLEDGMENTS

The technical assistance of Dr. Varsha Patel, Pam Hudson, Susan Russell and E. L. Vezey is greatly appreciated. Thanks to Tim Mislin and Dr. S. R. Russell for micrographs of PEG embedded material. We are grateful to Susan Gray of

Animax for technical drawings. We warmly thank Dr. R. K. Benjamin and an anonymous reviewer for many suggestions with respect to the manuscript. Supported in part by National Science Foundation grant BSR-8315186.

LITERATURE CITED

- Argue, C. L. 1983. Pollen morphology in *Dodaria*, *Lancea*, *Leucocarpus*, and *Mazus* and an analysis of pollen morphotypes in the Mimuleae (Scrophulariaceae). *Canad. J. Bot.* 62:1287-1297.
- Avetisyan, N. M. 1950. Methode simplifié d'acétolyse dans la préparation de pollens. *Bot. Žurn.* (Moscow & Leningrad) 35:385-386.
- Barnes, S. H., and S. Blackmore. 1986. Some functional features in pollen development, pp. 71-80. *In* S. Blackmore and I. K. Ferguson [eds.], *Pollen and spores. Form and function.* Linn. Soc. Symp. Ser. 12. Academic Press, London.
- Barthlott, W., N. Ehler, and R. Schill. 1976. Abtragung biologischer Oberflächen durch hochfrequenzaktivierten Sauerstoff für die Raster-Elektronmikroskopie. *Mikroskopie* 32:35-44.
- Blackmore, S., and S. Barnes. 1986. Freeze fracture and cytoplasmic maceration of pollen grains. *Grana* 25:41-45.
- , and ———. 1987. Pollen wall morphogenesis in *Tragopogon porrifolius* L. (Compositae: Lactuceae) and its taxonomic significance. *Rev. Paleobot. Palynol.* 52:233-246.
- , and D. Claugher. 1984. Ion beam etching in palynology. *Grana* 23:85-89.
- , and H. G. Dickinson. 1981. A simple technique for sectioning pollen grains. *Pollen & Spores* 23:281-286.
- Bosman, F. T., and P. M. Go. 1981. Polyethylene glycol embedded tissue sections for immunoelectron microscopy. *Histochemistry* 73:195-199.
- Bradley, D. E. 1958. The study of pollen grain surface in the electron microscope. *New Phytol.* 57:226-229.
- . 1960. The electron microscopy of pollen and spore surfaces. *Grana Palynol.* 2:3-8.
- Brandenburg, D. M., S. D. Russell, J. R. Estes, and W. F. Chissoe. 1985. Backscattered electron imaging as a technique for visualizing silica bodies in grasses. *Scanning Electron Microscopy* 1985; IV:1909-1917.
- Brorson-Christensen, B. 1949. Om mikrotomsnit af pollenexiner. *Meddel. Dansk. Geol. Foren.* 11:441-444.
- Carlquist, S. 1960. Anatomy of Guyana Xyridaceae: *Abolboda*, *Orectanthe*, and *Achlyphila*. *Mem. N.Y. Bot. Gard.* 10:65-117.
- . 1961. Pollen morphology of Rapateaceae. *Aliso* 5:39-66.
- Cerceau-Larrival, M.-Th. 1971. Morphologie pollinique et corrélations phylogénétiques chez les ombellifères, pp. 109-156. *In* V. H. Heywood [ed.], *The biology and chemistry of the Umbelliferae.* Suppl. 1 (Vol. 64). Academic Press, London.
- , M. Hideux, L. Marceau, and F. Roland. 1970. Cassure du pollen par les ultrasons pour l'étude structurale de l'exine au microscope électronique à balayage. *Compt. Rend. Hebd. Séances Acad. Sci., Sér. D* 270:66-69.
- , and F. Roland-Heydacker. 1976. The evolutionary significance of the ultrastructure of the exine in umbelliferous pollen grains, pp. 481-498. *In* I. K. Ferguson and J. Muller [eds.], *The evolutionary significance of the exine.* Linn. Soc. Symp. Ser. 1. Academic Press, London.
- Chanda, C., and J. R. Rowley. 1967. Apertural types in pollen of Restionaceae and Flagellariaceae. *Grana Palynol.* 7:16-36.
- Chaturvedi, M., and K. Datta. 1984. On the development of pollen surface pattern in *Hibiscus rosasinensis* L. *J. Palynol.* 20:1-11.
- Clarke, G. C. S., and M. R. Jones. 1977. The Northwest European pollen flora (NEPF), 16. Valerianaceae. *Rev. Paleobot. Palynol.* 24:155-179.
- , and ———. 1981. The Northwest European pollen flora (NEPF), 21. Dipsacaceae. *Rev. Paleobot. Palynol.* 33:1-25.
- Claugher, D. 1984. Ion and fast atom beam etching of biological materials for scanning electron microscope studies. *Proc. Roy. Microscop. Soc.* 19:146-148.
- . 1986. A summary of ion beam etching of biological material with special reference to the saddle field source. *Scanning Electron Microscopy* 1986; I:139-149.

- , and J. R. Rowley. 1987. *Betula* pollen grain substructure revealed by fast atom etching. *Pollen & Spores* 29:5–20.
- Crawford, B. J., and C. R. W. Liley. 1970. A simple transmission stage using the standard collection system in the scanning electron microscope. *J. Phys. E: Sci. Instrum.* 3:461–462.
- Cronk, Q. C. B., and G. C. S. Clarke. 1981. The Northwest European pollen flora (NEPF), 28. *Convolvulaceae*. *Rev. Paleobot. Palynol.* 33:117–135.
- Dahl, A. O., and J. R. Rowley. 1965. Pollen of *Degeneria vitiensis*. *J. Arnold Arbor.* 46:308–323.
- Dickinson, H. G., and P. R. Bell. 1973. The identification of sporopollenin in sections of resin-embedded tissues by controlled acetolysis. *Stain Technol.* 48:17–22.
- Diez, M. J., and J. A. Devesa. 1981. Contribucion al estudio palinologico del genero *Scabiosa* L. (*Dipsacaceae*) en la peninsula Iberica y Baleares. *Bot. Macaronesica* 8–9:129–146.
- Donoghue, M. J. 1985. Pollen diversity and exine evolution in *Viburnum* and the *Caprifoliaceae* sensu lato. *J. Arnold Arbor.* 66:421–469.
- Dunbar, A., and J. R. Rowley. 1984. *Betula* pollen development before and after dormancy: exine and intine. *Pollen & Spores* 26:299–338.
- Echlin, P. 1967. The use of the scanning reflection electron microscope in the study of plant and microbial material. *J. Roy. Microscop. Soc.* 88:407–418.
- . 1971. The application of scanning electron microscopy to biological research. *Philos. Trans., Ser. B* 261:51–59.
- Engel, M. S. 1978. The Northwest European pollen flora (NEPF), 19. *Haloragaceae*. *Rev. Paleobot. Palynol.* 26:199–207.
- Erdtman, G. 1943. An introduction to pollen analysis. The Ronald Press Company, New York. 239 p.
- . 1952. Pollen morphology and plant taxonomy. *Angiosperms*. Almquist & Wiksell, Stockholm. 539 p.
- . 1960. The acetolysis method. A revised description. *Svensk Bot. Tidskr.* 39:561–564.
- . 1969. Handbook of palynology. Morphology-taxonomy-ecology. An introduction to the study of pollen grains and spores. Munksgaard, Copenhagen. 486 p.
- Ferguson, I. K. 1978. Technique utilisant le méthylate de sodium comme solvant de la résine époxy des blocs d'inclusion "type MET" pour les observations de l'exine des grains de pollen. *Ann. Mines Belgique* 2:153–157.
- Fernández-Morán, H., and A. O. Dahl. 1952. Electron microscopy of ultra-thin frozen sections of pollen grains. *Science* 116:465–567.
- Feuer, S. 1987. Combined cryo- and thin sectioning (TEM) in the elucidation of mimosoid tetrad/polyad ultrastructure. *Rev. Paleobot. Palynol.* 52:367–374.
- , Niezgodna, C. J., and L. I. Nevling. 1985. Ultrastructure of *Parkia* polyads (Mimosoideae: Leguminosae). *Amer. J. Bot.* 72:1871–1890.
- Frederiksen, N. O., V. D. Wiggins, I. K. Ferguson, J. Dransfield, and C. M. Ager. 1985. Distribution, paleoecology, paleoclimatology, and botanical affinity of the Eocene pollen genus *Diporoconia* n. gen. *Palynology* 9:37–60.
- Guyot, M., M.-T. Cerceau-Larival, M.-C. Carbonnier-Jarreau, L. Derouet, and J. Relot. 1980. Correlations entre types stomatiques et types polliniques dans la tribu des Caucaledées (*Ombellifères*). *Bull. Mus. Nat. Paris* 2:341–385.
- Harven, E., de 1983. Remarks on the application of backscattered electron imaging (BEI) to the scanning electron microscopy (SEM) of biological structures, pp. 484–487. *In* 41st Ann. Proc. Electron Microscope Society of America. Claitor's Publishing Division, Baton Rouge.
- Heslop-Harrison, J. 1963. An ultrastructural study of pollen wall ontogeny in *Silene pendula*. *Grana Palynol.* 4:7–24.
- . 1969. Scanning electron microscopic observations on the wall of the pollen grain of *Cosmos bipinnatus* (*Compositae*). *Proc. Engis Stereoscan Colloquium*. Engis Equip. Co., pp. 89–96.
- Heywood, V. H. 1971. The characteristics of the SEM and their importance in biological studies, pp. 1–16. *In* V. H. Heywood [ed.], *Scanning electron microscopy*. Academic Press, London, New York.
- . 1984. The current scene in plant taxonomy, pp. 3–21. *In* V. H. Heywood and D. M. Moore [eds.], *Current concepts in plant taxonomy*. Academic Press, London.
- Hideux, M. 1972. Techniques d'étude du pollen au MEB: effets comparés des différents traitements physicochimiques. *Micron* 3:1–31.

- . 1981. Le pollen. Données nouvelles de la microscopie électronique de l'informatique. Structure du sporoderme des Rosidae-Saxifragales: étude comparative et dynamique. Agence de Coopération Culturelle et Technique, Paris 2 edit. revue et augmentée d'un index taxonomique, 341 p., 41 plates, 27 tables.
- , and L. Marceau. 1972. Techniques d'étude du pollen au MEB: méthode simple de coupes. *Adansonia* 12:609–618.
- Hogan, D. L., and G. H. Smith. 1982. Unconventional application of standard light and electron immunocytochemical analysis to aldehyde-fixed, araldite-embedded tissues. *J. Histochem. Cytochem.* 30:1301–1306.
- Horobin, R. W., and J. Proctor. 1982. Estimating the effect of etching agents on plastic sections. *J. Microscop.* 126:169–172.
- Jarvis, L. R. 1975. A simple method for exposing plastic embedded structures for scanning electron microscopy. *J. Microscop.* 105:115–117.
- Kalis, A. J. 1979. The Northwest European pollen flora (NEPF), 20. Papaveraceae. *Rev. Paleobot. Palynol.* 28:209–260.
- Kondo, H. 1984. Polyethylene glycol (PEG) embedding and subsequent de-embedding as a method for the structural and immunocytochemical examination of biological specimens by electron microscopy. *J. Electron Microsc. Tech.* 1:227–241.
- , and T. Ushiki. 1985. Polyethylene glycol (PEG) embedding and subsequent de-embedding as a method for the correlation of light microscopy, scanning electron microscopy, and transmission electron microscopy. *J. Electron Microsc. Tech.* 2:457–462.
- Lane, B. P., and D. L. Europa. 1965. Differential staining of ultrathin sections of Epon-embedded tissues for light microscopy. *J. Histochem. Cytochem.* 13:579–582.
- Larson, D. A., and W. C. Lewis. 1962. Pollen wall development in *Parkinsonia aculeata*. *Grana Palynol.* 3:21–27.
- Le Thomas, A., and B. Lugardon. 1976. De la structure grenue à la structure columellaire dans le pollen des Annonacées. *Adansonia* 15:543–572.
- Lobreau-Callen, D. 1980. Caractères comparés du pollen des Icacinaceae et des Olacaceae. *Adansonia* 20:28–29.
- . 1983. Analyse de la répartition géographique des Malphigiaceae d'après les caractères du pollen et de la pollinisation. *Bothalia* 14:871–881.
- Lyman, C. E. 1978. Comparison of SEM, TEM, STEM, scanning work on a TEM and transmission work on a SEM. *Scanning Electron Microscopy 1978*; I:529–536.
- Marceau, L. 1969. Effets, sur le pollen, des ultra-sons de basse fréquence. *Pollen & Spores* 11: 147–164.
- Manten, A. A. 1969a. On the earliest microscopical observations of pollen grains. *Rev. Paleobot. Palynol.* 9:5–16.
- . 1969b. The history of the microscope and its impact on the development of palynology. *Rev. Paleobot. Palynol.* 9:137–148.
- . 1970. Ultra-violet and electron microscopy and their application in palynology. *Rev. Paleobot. Palynol.* 10:5–37.
- Mayor, H. D., J. C. Hampton, and B. Rosario. 1961. A simple method for removing the resin from epoxy-embedded tissue. *J. Cell Biol.* 9:909–910.
- Maxwell, M. H. 1978. Two rapid and simple methods used for the removal of resins from 1.0 μm thick epoxy sections. *J. Microscop.* 112:253–255.
- Mühlethaler, K. 1955. Die Struktur einiger Pollenmembranen. *Planta* 46:1–13.
- Muir, M. 1970. Guest editorial: scanning electron microscopy in palynology. *Rev. Paleobot. Palynol.* 10:85–97.
- Muller, J. 1973. Pollen morphology of *Barringtonia calyptrocalyx* K. Sch. (Lecythidaceae). *Grana* 13:29–44.
- Nemanic, M. K., and T. E. Everhart. 1973. The SEM to STEM conversion stub. *Scanning Electron Microscopy 1973*; I:25–32.
- Nilsson, S. 1986. The significance of pollen morphology in the Apocynaceae, pp. 359–374. *In* S. Blackmore and I. K. Ferguson [eds.], *Pollen and spores. Form and function*. Linnean Soc. Symp. Ser. 12. Academic Press, London.
- Nordenstam, B., and G. El-Ghazaly. 1978. Floral micromorphology and pollen ultrastructure in some Centaureinae (Compositae) mainly from Egypt. *Cairo Univ. Herbarium* 7&8:143–155.

- Nowicke, J. W., J. L. Bittner, and J. J. Skvarla. 1986. *Paeonia*, exine substructure and plasma etching, pp. 81–95. In S. Blackmore and I. K. Ferguson [eds.], Pollen and spores. Form and function. Linnean Soc. Symp. Ser. 12. Academic Press, London.
- Ogilvie, R. E., and L. V. Sutfin. 1970. New techniques in scanning electron microscopy, pp. 348–349. In C. J. Arceneaux [ed.], 28th Ann. Proc. Electron Microscope Society of America. Claitor's Publishing Division, Baton Rouge.
- Oho, E., T. Sasaki, K. Adachi, Y. Muranaka, and K. Kanaya. 1987. An inexpensive and highly efficient device for observing a transmitted electron image in SEM. *J. Electron Microscopy* Tech. 5:51–58.
- Olsson, U. 1975. On the use of laser for fracturing pollen grain of *Quercus robur* L. (Fagaceae). *Grana* 14:10–102.
- Pacini, E., F. Ciampolini, and M. Cresti. 1980. A technique for observing the same anther or pollen grain both by TEM and SEM. *Grana* 19:193–195.
- Patel, V. C., J. J. Skvarla, I. K. Ferguson, A. Graham, and P. H. Raven. 1985. The nature of threadlike structures and other morphological characters in *Jacqueshuberia* pollen (Leguminosae:Caesalpinioideae). *Amer. J. Bot.* 72:407–413.
- Poole, M. M. 1981. Pollen diversity in *Zimmermannia* (Euphorbiaceae). *Kew Bull.* 36:129–138.
- Pragowski, J. 1970. The pollen morphology of the Haloragaceae with reference to taxonomy. *Grana* 10:159–239.
- Robards, A. W. 1984. Fact or artifact—a cool look at biological electron microscopy. *Roy. Microscop. Soc.* 19:195–208.
- Robbins, R. R., D. B. Dickinson, and A. M. Rhodes. 1979. Morphometric analysis of pollen from four species of *Ambrosia* (Compositae). *Amer. J. Bot.* 66:538–545.
- Robinson, H., and C. Marticorena. 1986. A palynological study of the Liabeae (Asteraceae). *Smithsonian Contrib. Bot.* 64:1–50.
- Rowley, J. R. 1959. The fine structure of the pollen wall in the Commelinaceae. *Grana Palynol.* 2:3–31.
- . 1960. The exine structure of “cereal” and “wild” type grass pollen. *Grana Palynol.* 2:9–15.
- . 1962. Nonhomogeneous sporopollenin in microspores of *Poa annua* L. *Grana Palynol.* 3:3–19.
- . 1964. Formation of the pore in pollen of *Poa annua*, pp. 59–73. In H. F. Linskens [ed.], Pollen physiology and fertilization. North-Holland Publishing Co., Amsterdam.
- , and A. O. Dahl. 1982. A similar substructure for tapetal surface and exine “tuft” units. *Pollen & Spores* 24:5–8.
- , ———, and J. S. Rowley. 1981. Substructure in exines of *Artemisia vulgaris* (Asteraceae). *Rev. Paleobot. Palynol.* 35:1–38.
- , ———, B. Walles, and K.-L. Huynh. 1983. Viscin threads considered as connective structures between pollen grains and tapetal cells, pp. 89–91. In *Fertilization in ovulated plants*. Veda, Bratislava, Czechoslovakia.
- , and A. Dunbar. 1967. Sources of membranes for exine formation. *Svensk Bot. Tidskr.* 61:49–71.
- , and M. Jarai-Komlodi. 1976. Observation of one pollen grain by SEM, TEM, and light microscopy. *Acta Bot. Acad. Sci. Hung.* 22:449–461.
- , K. Mühlethaler, and A. Frey-Wyssling. 1959. A route for the transfer of materials through the pollen grain wall. *J. Biophys. Biochem. Res.* 6:537–539.
- , and J. J. Skvarla. 1987. Ontogeny of pollen in *Poinciana* (Leguminosae). II. Microspore and pollen grain periods. *Rev. Paleobot. Palynol.* 50:313–331.
- , and S. K. Srivastava. 1986. Fine structure of *Classopollis* exines. *Canad. J. Bot.* 64:3059–3074.
- Russ, J. C., and E. McNatt. 1969. Copper localization in cirrhotic rat liver by scanning electron microscopy, pp. 38–39. In C. J. Arceneaux [ed.], 27th Ann. Proc. Electron Microscope Society of America. Claitor's Publishing Division, Baton Rouge.
- Sandberg, P. A. 1968. A new specimen stub for stereophotography with the scanning electron microscope. *Micropaleontology* 14:489–498.
- Sengin, L. 1986. Observations on the submicroscopic structures of plant pollen grains with the scanning electron microscope by the separating technique, pp. 3263–3264. In T. Imura, S. Maruse, and T. Suzuki [eds.], Proc. XI Int. Congress Electron Microscopy. Kyoto. Vol 4.

- Shoup, J. R., and C. C. Tseng. 1977. A palynological study of *Schefflera paraensis* Huber ex Duke (Araliaceae). *Grana* 16:81–84.
- Siljak-Yakovlev, S. 1986. Functional dynamics of the pollen exine and apertures in Compositae of the Dinaric Alps, pp. 413–415. In S. Blackmore and I. K. Ferguson [eds.], *Pollen and spores. Form and function*. Linnean Soc. Symp. Ser. 12. Academic Press, London.
- Skvarla, J. J. 1974. Pollen, pp. 456–459. In P. Gray [ed.], *Encyclopedia of microscopy and micro-technique*. Van Nostrand-Reinhold, New York.
- , and D. A. Larson. 1965. An electron microscope study of pollen morphology in the Compositae with special reference to the Ambrosiinae. *Grana Palynol.* 6:210–269.
- , and C. C. Pyle. 1968. Techniques of pollen and spore electron microscopy. Part II. Ultramicrotomy and associated techniques. *Grana Palynol.* 8:255–270.
- , P. R. Raven, and J. R. Pragowski. 1976. Evolutionary significance of Onagraceae pollen. *Bot. J. Linn. Soc.*:447–479.
- , and J. R. Rowley. 1970. The pollen wall of *Canna* and its similarity to the germinal apertures of other pollen. *Amer. J. Bot.* 57:519–529.
- , and ———. 1987. Ontogeny of pollen in *Poinciana* (Leguminosae). I. Development of exine template. *Rev. Paleobot. Palynol.* 50:293–311.
- , and B. L. Turner. 1966. Systematic implications from electron microscopic studies of Compositae pollen. A review. *Ann. Missouri Bot. Gard.* 53:220–256.
- , ———, V. Patel, and A. S. Tomb. 1978. Pollen morphology in the Compositae and in morphologically related families, pp. 141–248. In V. H. Heywood, J. B. Harborne, and B. L. Turner [eds.], *The biology and chemistry of the Compositae*. Academic Press, London.
- Snodgrass, A. B., C. H. Dorsey, G. W. H. Bailey, and L. G. Dickson. 1972. Conventional histopathologic staining methods compatible with Epon-embedded, osmicated tissue. *Lab. Invest.* 26:329–337.
- Stuessy, T. F. 1979. Ultrastructural data for the practicing plant systematist. *Amer. Zool.* 19:621–635.
- Swift, J. A., and A. C. Brown. 1970. Transmission scanning electron microscopy of sectioned biological materials. *Scanning Electron Microscopy* 1970:113–120.
- , ———, and C. A. Saxton. 1969. Scanning transmission electron microscopy with a Cambridge Stereoscan Mk II. *J. Phys. E: Sci. Instrum.* 2(Ser. 2):744–746.
- Taylor, T. N., N. J. Maihle, and L. V. Hills. 1980. Morphological and ultrastructural features of *Nikitinsporites canadensis* Chaloner, a Devonian megaspore from the Frasnian of Canada. *Rev. Paleobot. Palynol.* 30:89–99.
- Thanikaimoni, G. 1972. Index bibliographique sur la morphologie des pollens d'angiospermes. Institut Francais de Pondichéry. All India Press, Pondichery. 337 p.
- . 1973. Index bibliographique sur la morphologie des pollens d'angiospermes. Supplement I. Institut Francais de Pondichéry. All India Press, Pondichery. 162 p.
- . 1976. Index bibliographique sur la morphologie des pollens d'angiospermes. Supplement II. Institut Francais de Pondichéry. All India Press, Pondichery. 386 p.
- . 1980. Quatrième index bibliographique sur la morphologie des pollens d'angiospermes. Institut Francais de Pondichéry. All India Press, Pondichery. 336 p.
- . 1981. Index palynologus. Proc. IV Int. Palynol. Conf., Lucknow (1976–77)3:344–348.
- Thornhill, J. W., R. K. Matta, and W. H. Wood. 1965. Examining three dimensional microstructures with the scanning electron microscope. *Grana Palynol.* 6:3–6.
- Thurston, E. L., and J. C. Russ. 1971. Scanning electron microscopy and thin section microanalysis of plant cells, pp. 58–59. In C. J. Arceneaux [ed.], 29th Ann. Proc. Electron Microscope Society of America. Claitor's Publishing Division, Baton Rouge.
- Tormo, R., J. L. Ubera, E. Dominguez, and F. H. Guerrero. 1984. Estudio palinológico de *Carlina* L. y *Atractylis* L. (Compositae L.) en Andalucía Occidental. *Anales de la Asociacion de palinólogos de lengua Espanola (A.P.L.E.)* 1:31–38.
- Tseng, C. C., and J. R. Shoup. 1978. Pollen morphology of *Schefflera* (Araliaceae). *Amer. J. Bot.* 65:384–394.
- Tsukada, M., and J. R. Rowley. 1964. Identification of modern and fossil maize pollen. *Grana Palynol.* 5:406–412.
- Tucker, S. C. 1983. Character weighting in Leguminosae based on time of initiation. *Amer. J. Bot.* 70:33.
- . 1984. Origin of symmetry in flowers, pp. 351–394. In R. A. White and W. C. Dickison [eds.], *Contemporary problems in plant anatomy*. Academic Press, Orlando.

- Van Campo, M. 1978. La face interne de l'exine. *Rev. Paleobot. Palynol.* 26:301-311.
- , and J. Sivak. 1972. Structure alvéolaire des pollens a ballonets des Abietacées. *Pollen & Spores* 14:115-141.
- Verlaque, R. 1981. Utilisation des caractères du pollen pour la réorganisation taxinomique de la famille des Dipsacaceae. *Compt. Rend. Hebd. Séances Acad. Sci., Sér. III* 293:351-354.
- Wagenitz, G. 1955. Pollenmorphologie und Systematik in der Gattung *Centaurea* L.s.l. *Flora*:15-279.
- Wodehouse, R. P. 1935. *Pollen grains*. McGraw-Hill Book Co., New York. 574 p.
- Wolosewick, J. J. 1980. The application of polyethylene glycol (PEG) to electron microscopy. *J. Cell Biol.* 86:675-681.
- , and J. De Mey. 1982. Localization of tubulin and actin in polyethylene glycol embedded rat seminiferous epithelium. *Biol. Cell* 44:85-88.
- Woolf, R. J., D. C. Joy, and D. W. Tansley. 1972. A transmission stage for the scanning electron microscope. *J. Phys. E: Sci. Instrum.* 5:230-233.
- Yamazaki, T., and M. Takeoka. 1959. Electron microscope investigations on the surface structure of the pollen membrane, based on the replica method. Especially, on the pollen of the genus *Quercus*. *J. Jap. Forest. Soc.* 41:125-129.