



Table of Contents

Core Publishing Solutions	1-1
Overview.....	1-1
Manufacturing Client Services	2-1
Roles and Responsibilities.....	2-2
Team.....	2-3
Job Planning.....	2-4
Paper.....	2-6
Raw Materials Warehousing.....	2-7
Engineering and Safety	3-1
Engineering.....	3-2
Safety.....	3-5
Recycling.....	3-6
Prepress	4-1
Electronic File Delivery.....	4-2
Fonts.....	4-3
PDF Files.....	4-5
Preparing your Textbook.....	4-7
Covers.....	4-8
Proofs.....	4-10
Digital Print	5-1
Digital Cut Sheet.....	5-2
Digital Web Printers.....	5-4
Cover Cell Area.....	5-6
Press	6-1
Offset.....	6-2
Web Press.....	6-2
Sheet-Fed Press.....	6-6
Color.....	6-8
Considerations: Sheet-Fed vs. Web.....	6-9
Web Press Specifications.....	6-10
Bindery	7-1
Softbound.....	7-1
Hardbound.....	7-6
Stitching.....	7-9
Other Operations.....	7-10
Product Finishing.....	7-11
Folding.....	7-12
Process Flow.....	7-14
Subscription Services	8-1
Mailing Areas.....	8-2
Sorting/Packing.....	8-3
Packing Bench - Special Handling.....	8-5
Subscription Fulfillment.....	8-6
Distribution	9-1
Picking Areas.....	9-2
Order Processing.....	9-3
Shipping - Outbound Fulfillment.....	9-4
History	10-1
Glossary	11-1





Manufacturing Facility:
1.3 M sq. feet.



Employees:
400+ full-time, **3** shifts,
5-7 days/week



Products:
54 M produced annually



Single, 2-color and 4-color books from 4" x 6" to 8" x 11"
Offset web and digital print
Full-service Bindery

Overview

Thomson Reuters Core Publishing Solutions

Thomson Reuters Core Publishing Solutions is part of the Thomson Reuters Legal organization.

West

West is the foremost provider of integrated information solutions to the U.S. legal market. Since the company's founding in 1872, West has been a trusted partner in the practice and business of law, providing comprehensive, authoritative information resources, research tools, and business and practice management applications and services.

Basic Workflow

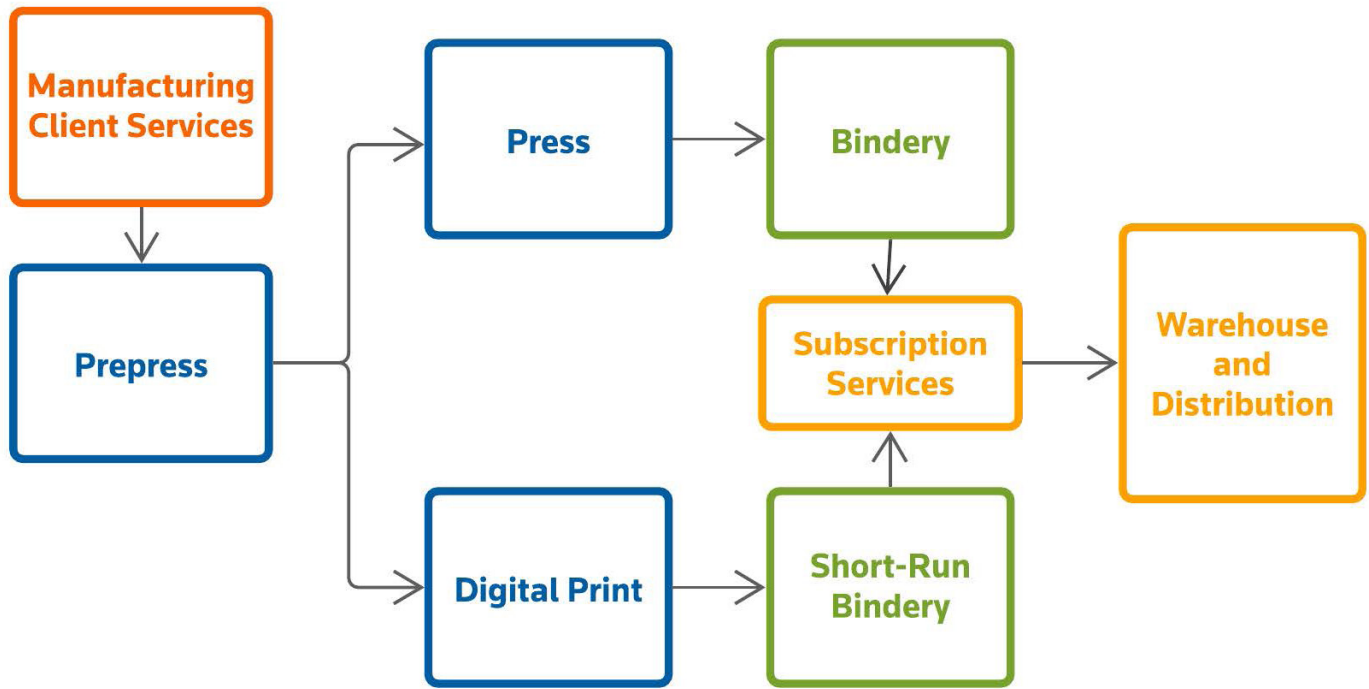

Department Overviews

Manufacturing Client Services

Manufacturing Client Services (MCS) coordinates work for all Thomson Reuters, Thomson Reuters affiliate customers, and other publishers serving as the liaison between the customer and manufacturing. MCS production planners create production and material specifications for all manufacturing jobs, and capacity planners schedule, prioritize and organize daily workloads for the manufacturing operating departments.

MCS account managers work with their customers throughout the manufacturing process to ensure their expectations are met with quality products.

Prepress

The Prepress department's main function is to transform a book's content, provided by customers as digital files, to electronic data for digital presses or to aluminum plates for offset presses. It is the first stage of book manufacturing, followed by the actual printing by the Press department.

Department Overviews

Press

The Press department is made up of web and sheet-fed presses. Their main function is to transform images from aluminum plates that are made in Prepress onto stock paper.

Digital Print

Digital Print or Print-on-Demand operation provides its customers with the opportunity to produce short-run, high-quality print products more cost-effectively than our competitors. Print-on-Demand uses state-of-the-art digital printing equipment and imaging software to transform a product from file to print in less than 24 hours. Print-on-Demand prints bound volume products, loose-leaf binder subscription products, newsletters, circuit court slip opinions, advertisements for shipment inserts and other miscellaneous products.

Bindery

The Bindery department's main function is to take printed signatures and glued book blocks from Press and bind them into a finished product. The binding methods include the following: loose-leaf; saddle-stitch; side-stitch; soft-bound; and hard-bound binding. More than 100 different processes or machines are used daily, including folding, perforating, stitching, sewing, cutting, binding, case-making and drilling.

Subscription Services

Subscription Services packs and ships product to subscription customers as well as bulk product orders for other Thomson Reuters businesses. Shipments include hardbound and softbound books, pamphlets, loose-leaf materials, newsletters, CDs, advance sheets, legislative service pamphlets and pocket parts. Products are shipped in cartons, polybags, envelopes, shrink-wrap, kraft paper and self-mailers. This area is also responsible for the mailing of all customer invoices and all Thomson Reuters first-class mail.

Distribution

The Distribution department picks, packs and ships single orders to our customers. It makes up half of the 1.3 million square feet of the manufacturing facility in Eagan, Minn. 1.46 million units are shipped annually, averaging about 4,000 units per day.

Inventory Control

Inventory Control uses ABC analysis for materials management, an industry best practice, to strive for carrying the optimal level of inventory at any given time. Finished goods inventory is maintained via a cycle count program, whereby materials are counted on a cyclical schedule throughout the entire year.

Department Overviews

Engineering & Manufacturing Technology

The Engineering & Manufacturing Technology department serves manufacturing and distribution operations by performing preventative maintenance, equipment repairs, recycling and engineering modifications.

Safety

Thomson Reuters is committed to achieving the highest performance in occupational health and safety with the aim of creating and maintaining a safe and healthy work environment enterprise wide.

Manufacturing Operations Support

This team supports the business systems used throughout Core Publishing Solutions. Some of the key systems include the shop floor data collection system called MII, the company-wide ERP of SAP, and the warehouse Order Fulfillment system. There are over 40+ unique systems in use in CPS that this team supports for stability and enhancements. The team also manages the data within those systems and leverages it for operational reporting so the business can identify where it can make improvements operationally. The team works closely with the vendor supported hardware and network teams for operational stability as well.

Supporting Departments

Human Resources

Human Resources aims to align employees with business priorities and responsibilities supporting the framework for optimal individual contribution and driving business success. At Thomson Reuters, high-performing talent functions in an environment that:

- Is customer-focused
- Has employees personally aligned with business objectives
- Is marked by accountability/ownership and employee engagement





Manufacturing Client Services

MCS includes professionals, who are responsible for selling, scheduling, prioritizing and organizing production along with managing inventory of raw materials for manufacturing. MCS releases and tracks approximately 50,000 projects annually. Each team works hard to ensure on-time, high-quality production of each of its projects. The department also provides the short-term and long-term capacity forecasts to ensure that customers' needs are met.

The various roles in the department include:

- Business Development Managers
- Account managers
- Production planners
- Estimators
- Buyers
- Schedulers

Roles and Responsibilities

Account Manager

The account manager is the liaison between customers and production. Detailed communication and organizational skills support account managers in overseeing each project – from when it first arrives to Core Publishing Solutions until customers receive the finished product. Account managers are responsible for obtaining information needed to forecast and schedule each project, and they also answer questions from customers, production planners, schedulers and from the production floor.

Production Planner

The production planner translates the specifics of a project by creating a production order (job spec), which describes the process, materials and information needed to get the project completed. To do this, the planner needs to assign the correct equipment and materials for the specific trim and run quantity of each project.

Business Development Manager

Core Publishing Solutions has multiple individuals whose responsibility it is to introduce and educate new prospective publishers to all our service offerings. When projects are a good fit and initial projects are awarded, they will hand-off to the Client Services Team to manage all the on-going production processes.

Buyer

The buyers review the demands placed on raw materials by the production orders and determine which materials need to be ordered. Buyers identify sources of supply, negotiate pricing, coordinate, and track shipments of raw materials and outsourced services to ensure everything arrives on-time. They also closely follow industry news to ensure they are up to date on pricing trends, lead times and new raw material offerings.

Scheduler

Schedulers organize and schedule production orders, according to materials and equipment that are available to meet customers' needs.

Estimators

The estimators work with the Account Management team and perform the quoting tasks necessary to accurately cost all production processes, services and raw materials to ensure they are accurate prior to presenting a quote to the customers.

Teamwork is the Key to Success

Each department in Thomson Reuters Core Publishing Solutions is committed to producing high-quality products for all customers.

MCS has helped contribute to this success by working with our customers to make sure that we are responsive to their needs. We have a “must ship” system to help ensure that projects ship on time. MCS works with Forecasting and the Content Centers to establish a consistent tracking system for these projects.

MCS Account Managers utilize a **File Evaluation Tool** prior to sending customer delivered files to our Prepress department. This gives them alerts to file makeup that may result in less than optimal quality and communicates this upfront before we get deep into the production process.

The MCS leadership team continually evaluates its team to make sure employees’ talents are fully optimized. Team members are trained to back each other up as needed. The fluidity of these skills is important so resources can be focused on areas that need extra help. The account manager takes time to become familiar with the requirements and expectations of each customer.

MCS creates value in the organization by linking our customers’ needs to our manufacturing core competencies. The result of our effort improves the performance of others and anticipates our customers’ current and future needs, while fostering new business opportunities.

Job-Planning Process

How does a project get through manufacturing?

Assignment of Title to Core Publishing Solutions

The projects come to MCS in two ways. A Thomson Reuters legal product is often forecasted from our own list of titles that we publish, or other publishers product is bid on and awarded. This work includes products such as college textbooks and reference publications, University Press and Association books, Faith-based publications, Trade novels as well as the right to publish and/or print state government products.

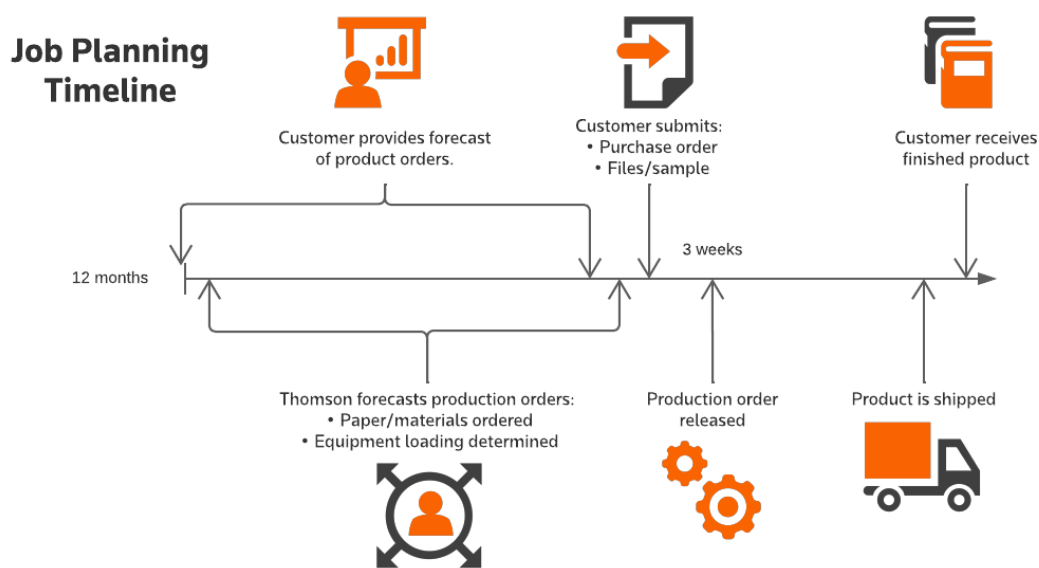

Jobs are Forecast and Released in SAP

The titles are entered into SAP, our ERP system to reserve a spot in the schedule and assign raw materials to produce each title. The production orders (job specs) document the equipment and materials necessary to produce each project. The information needed to forecast each project includes the following:

- Title
- Run quantity
- Desired schedule
- Trim size
- Estimated page count
- Type of binding
- Desired text and cover papers
- Ink colors for text and cover
- Any necessary miscellaneous information

Job-Planning Process

The account managers gather this information so the production planner can forecast each project into SAP. The majority of Thomson Reuters work is forecast into SAP by in-house forecasters and is then reviewed by MCS's production planners. Thomson Reuters Content and Editorial teams provide the specific information to the forecasters. Much of the legal work is forecast two to three years in advance.

A portion of the legal work is government contracts, and all of this is forecast by MCS. The Account Manager team forecasts all projects for non-Thomson Reuters titles.

Correct customer information is essential. This helps to ensure that each product is forecast correctly so it will effectively progress through the plant. The importance of forecasting cannot be overemphasized, to ensure that the appropriate materials and equipment are available to produce each publication. Clear and concise requests or instructions help produce production orders (job specs) that are easy to read and clearly understood by manufacturing personnel.

Account managers and production planners work with Scheduling and Procurement to help ensure that the desired ship date is met and to arrange for any special-order materials needed. Scheduling and Procurement run SAP reports to find areas of concern, such as overbooking of equipment or shortages of raw materials, such as paper. Production account coordinators track the projects through the plant to ensure that each project stays on schedule.

The role of the schedulers is to prioritize, schedule and organize workloads for the manufacturing facility. The schedulers provide direction to ensure timely and efficient processing of projects that meet ship dates, revenue goals and contract requirements. Capacity forecasts are created for each manufacturing department to determine both short- and long-term staffing and equipment requirements. The schedulers work with various departments throughout the organization; troubleshooting problems experienced in the editorial, manufacturing and distribution processes.

Paper Making Process

A paper-making machine measures the length of two football fields and consists of two primary sections, the wet end and the dry end. Prior to arriving here, a group of processes take place to extract wood fibers for the paper. This includes separating the lignin from the wood fibers to get a more pure pulp. The pulp is then bleached to the desired shade and made suitable for publications designed to last for hundreds of years without yellowing/reverting. The resulting mixture is commonly known as furnish.

The furnish, which is 99 percent water and 1 percent pulp, is moved to a head box, where the diluted pulp is sprayed on a moving mesh wire. About 20 percent of the water drops through the screen, leaving the pulp mat behind. This mat is then pressed between water-removing fabric rollers at a speed of more than 3,000 feet per minute, or about 60 miles an hour, and reduces the water content to about 65 percent. It is then moved to the drying section where more water is removed, down to about 5 percent. After the paper is at its desired consistency, it has additional coatings or fillers applied and is calendared before being rolled for storage. The paper rolls can weigh as much as 8 tons, and the workers can start a new roll without stopping the machine.

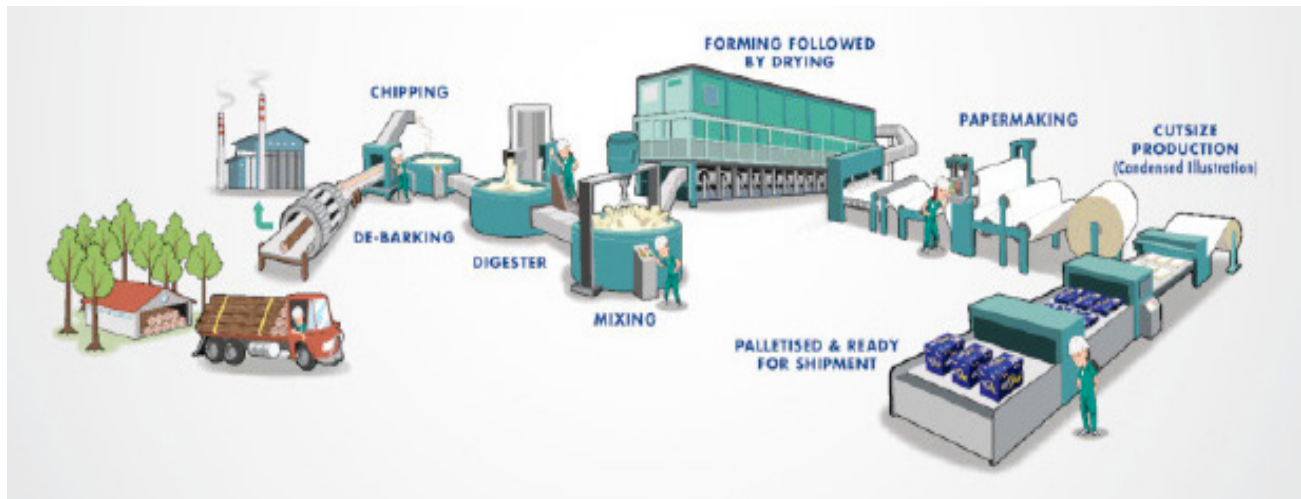

Manufacturing Operations Support

The Manufacturing Operations Support group ensures that the business systems used by Manufacturing are stable for uninterrupted production. The group also prioritizes and implements key system enhancements which drive data accuracy, transaction consolidation, and improved functionality. The main business system is SAP, but there are over 70 additional systems used throughout Manufacturing.

As a service group, the team also supports operational reporting, giving manufacturing the information they need to make timely decisions. Support for quality and process improvements is another key contribution. The group partners with the business for continuous improvements and efficiencies.

Types of Paper Available

At Thomson Reuters Manufacturing, we use both roll stock and sheet stock paper. Following are the types of paper we keep in stock:

Roll Stock (for web presses)

- Offset
- Coated/uncoated Groundwood
- Lightweight hybrid opaque
- Directory/Catalog papers

Sheet Stock (for sheet-fed presses)

- white offset 50-80 lb.
- index 90-lb.
- white cover stock, coated one side (C1S) and coated two sides (C2S) 10 & 12 pt
- matte 65-lb.

Our papers are 20.9-lb. to 80-lb. basis weights and have a 10,000-lb. minimum order quantity. Standard roll stocks require an average lead time of six to eight weeks. Custom orders may carry up to a 60 ton minimum.

Standard Sizes:

- 22 by 25 inches
- 23 by 29 inches
- 11 by 17 inches
- 12 by 18 inches
- 20 by 12 1/2 inches
- 8 1/2 by 11 inches

Our common grades of paper require an average lead time of two weeks.

What We Buy

- Paper (\$18M spend)
- Printing plates, ink glue, cover material, cover boards, shipping materials, binding materials
- Company forms and stationery
- Service outside of our manufacturing capability

Raw Materials Warehousing

This team ensures that departments across manufacturing receive raw materials quickly to meet customers' needs, 24 hours a day. The team's main function is to receive all incoming products, maintain a raw material inventory equivalent of 5 million dollars and deliver these materials to the production floor as accurately and efficiently as possible.

Approximately 140,000 square feet are used to store raw materials. Receiving uses SAP to manage the inventory in the warehouse.

Raw materials are brought in every day by truck and rail car, rail car being utilized primarily for paper. Receiving can process up to 600,000 pounds of paper per day.





Empowering Behaviors

Every individual is involved in creating a safe work place

Leadership Commitment

Management champions a safe work place

Celebrating Success

Safe behaviors are recognized

Engineering & Safety

The Engineering Department provides 24-hour, weekday support of Manufacturing operations and weekend overtime production as needed. Safety is of primary importance in all department activities and service delivery. Engineering supports the company's safety goal of a 100% safe work environment through engaging and empowering all employees to initiate or take immediate corrective action on safety-related people, processes, or equipment issues. By performing safety systems audits of existing and new equipment, we can proactively ensure all necessary and required protective devices are present and working correctly. Production maintenance staff provide planned, preventative maintenance, as well as service response for equipment repair events on over 480 equipment assets organized as both individual work cells and as components of a production line. Engineering and maintenance staff collaborate with manufacturing operations staff on continuous improvement projects and provide development, design, fabrication, installation, and support of equipment and process enhancements and additions. Recycling operations support our goal of creating and sustaining safe, environmentally, and fiscally responsible processes and practices that comply with all regulations. To keep as many production by-products and waste materials as possible out of landfills and, instead, capture them for recycling, resale, and repurpose.

Engineering

Engineering team members possess diverse, complementary skill sets. Most roles are technical in nature and require at least a general knowledge of maintenance operations and of electrical and mechanical systems present in industrial operations. Further, service staff members have advanced, specific equipment knowledge, training and experience on conventional and digital print equipment and processes, as well as with bindery and finishing equipment and operations. A collaborative team environment and a combination of in-house and OEM/Vendor training opportunities support employee skill development and knowledge sharing, which also helps us keep pace with necessary technology advancements in our operations and industry.

Safety

All employees of Thomson Reuters Core Publishing Solutions are dedicated to the goal of achieving a 100% Safe work environment through regulatory and workplace safety education, engagement in the form of training, safety teams, safety observations and safety audits, as well as incident cause investigations and subsequent continuous improvement actions. All employees are empowered to immediately report and take other proactive steps, actions and communication in response to an observed safety risk. In addition to participating in safety-related continuous improvement actions, Engineering and Production Maintenance teams give top priority to proactive and corrective safety-related work orders.

Maintenance Management

Production Maintenance uses a custom-developed SAP module as our computerized maintenance management system (CMMS). This CMMS is the primary resource used to manage all aspects of equipment service plans and histories, work orders, MRO purchasing and supply management and metrics.

Work Orders

Equipment maintenance and service is documented and tracked using a work order system created within our CMMS and are classified as emergency/unplanned, planned or preventative. Among key service goals of maintenance and engineering staff is to reduce equipment downtime, extend equipment life and maximize equipment efficiency. In addition to operator input and SAP data analysis of unplanned events contributing to driving continuous improvement ideas and actions, preventative planned maintenance schedules are a critical part of supporting those complementary objectives. Approximately 1,200 hours of all forms of production service, maintenance and support are performed each week across all shifts.

Engineering

Part Fabrication

A wide variety of parts can be fabricated by Engineering. The first step of any proposed fabrication is to determine economic feasibility. If a part can be purchased at a lower price and delivered when needed, there would be no advantage to making the part. In situations where equipment downtime is involved and a needed part cannot be obtained within an acceptable time, the ability to fabricate parts is invaluable.



Nipping machine for sewn book blocks

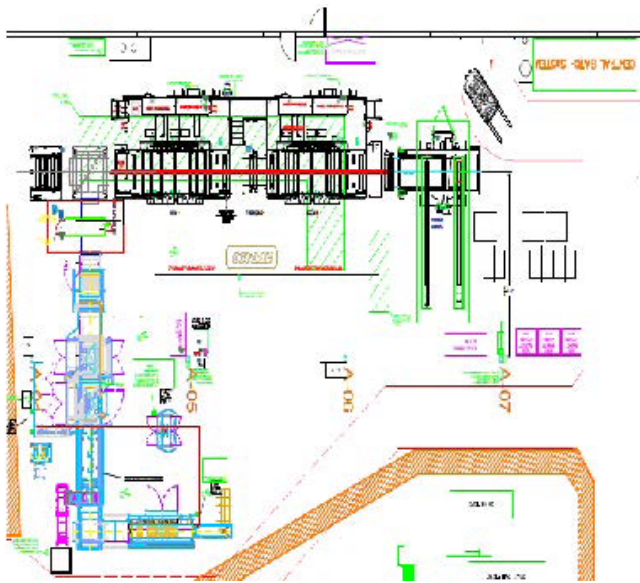

Layout design for HP T490 web press with Muller Martini Sigma folder

Equipment Layout Designs

Every equipment installation is unique and the first step is to prepare a layout drawing developed with participation of all stakeholders. The layout defines equipment placement, locations of all necessary utilities (electricity, compressed air, water, vacuum, cooling, etc.) and people and material movement routes, evaluating not just for efficient material flow, but also to maximize staff safety as well as minimize ergonomic risks.

Mechanical Design

Engineering utilizes both 2D and 3D CAD for mechanical design. When designing parts and assemblies, it is not unusual to go through several iterations of design. This can be a costly and time-consuming process, especially if done by an outside supplier. Engineering has many advantages when designing in-house: immediate access to equipment and operators, a well-equipped machine shop and knowledge of printing and bindery operations.

Engineering

Supply Services

Engineering also operates Supply Services, a 3,000-square-foot storeroom within the Engineering and Maintenance Shop that contains parts and supplies for both manufacturing and facilities, with an average combined value of approximately \$2MM. Supply Services is staffed with a Maintenance Stores Attendant on each shift. Among key tasks attendants perform are receiving and issuing stock, receiving and routing to appropriate staff, the daily manufacturing requests for equipment service to solve an issue causing downtime and executing recurring inventory cycle counts and audits to ensure accurate materials counts and values. They also support the process of receiving parts for internal or external rebuilding and entry and location assignment of new, inventoried parts.

Engineering

There are three Engineer roles dedicated to design, fabrication and implementation and Production Maintenance employees as well as vendor contractors who also participate as needed to support and collaborate on project development and execution.

Projects are funded by either capital or expense budgets. Capitalized projects are typically larger than expensed projects and also require participation of staff from multiple Operations areas. Expensed projects normally affect a single department and are beyond the scope of routine maintenance. Both capitalized and expensed projects are implemented using the same project management principles and processes, with work scope, project milestones and completion date established at project outset, then managed and updated throughout the project duration.

Equipment Installs

Once site layout is established, Engineering and Production Maintenance staff collaborate to execute the install plan. Installations of major, new production equipment and lines are also typically supported by manufacturer technicians, including commissioning, training and both onsite and remote support during the ramp-up to full production.

Equipment Specification Preparation

Engineering works with manufacturing technical supervisors, operators and purchasing to prepare equipment specifications and develop acceptance tests. Equipment specifications may be written to include a design approval process for custom equipment.

Engineering

Electrical Engineering

Engineering Production Maintenance Electricians, project managers and our electrical contractor and inspector partners all collaborate to ensure that all work in power distribution, equipment controls design and all electrical wiring complies with the National Electric Code (NEC) and local building codes, that new equipment meets current UL/NRTL listing standards and that electrical work is performed in accordance with State of Minnesota statutes governing work scope per electrical license and supervision requirements. In addition to organized storage and indexing of OEM electrical schematics, wiring diagrams and PLC programs, CAD software is used to create electrical change documentation of any equipment power and controls modifications. PLC program backup and revision histories are maintained on network drives with consistent backup schedules.

Safety

Thomson Reuters is a company dedicated to retaining, attracting, and developing exemplary talent. We believe that we must operate our business operation in a manner that maintains and improves the health and safety of its' people. This is achieved by conducting all operations safely, to protect employees and the public from injury or illness resulting from our operations, and to prevent damage to property and equipment. As part of this commitment, we strive to comply with all federal standards and laws, state codes and statutes, and local ordinances. Thomson Reuters Core Publishing Solutions maintains robust programs to train employees in safety and health practices. We depend on managers, supervisors, and team leaders to be proactive in carrying these programs out. However, every employee has an obligation to be a leader when it comes to safety. Every employee must be dedicated to recognizing that safety is not just for the other person, it is for everyone.

Overall, our goal is to achieve a 100% Safe work environment through: empowering behaviors, leadership commitment, continuous improvement and celebrating success. This goal contributes to our competitive strength and benefits our customers, shareholders, and employees by improving the overall well-being of our employees, the community, and the financial health of the company.

Recycling

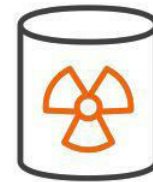
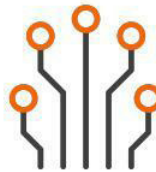

Average resources used to manufacture 1 ton of paper

3,500 gallons of
water

9-15 trees

2,000 KWh of
electricity

30 lbs. of air
pollutants

Core Publishing Solutions manufacturing annual recycling saves:

21,626,500 gallons

92,685 trees

12,358,000 KWh

185,370 lbs.

Thomson Reuters Core Publishing Solutions recognizes conservation of natural resources and protection of the environment as among the most important issues facing businesses and all of us. We're committed to reducing energy consumption and promoting recycling throughout our business. Centralized building automation controls and occupancy sensors maximize HVAC and lighting energy use efficiency throughout the campus and in the 2 million square feet of manufacturing and warehouse space. Press inks are environmentally friendly soy, water and UV-based and all shop rags contents from press and other cleaning functions are spun in a centrifuge and extracted contents are recycled for fuels blending. Paper waste of all types is of course our largest recycling opportunity in both print and binding operations and the collection and recycling of it is managed by Engineering. Printing paper can be separated into two major groups, ledger and groundwood, and each has a corresponding paper recycling and reuse market. Our collected paper and trim waste is resold to major recycling partners who, in turn, sell it to their customers for a variety of reuse purposes, including office paper, corrugated products, magazines and newspapers, insulation, sheetrock production, etc.

- **LEDGER** – paper made from a “kraft,” or a chemical process, that breaks down the wood fibers by removing lignin through the application of sulphates. Lignin is a bio-chemical in wood that binds the fibers together at the cellular level. Lignin gives wood its strength and is the primary source of heat during combustion.
- **GROUNDWOOD** – paper made from a mechanical process, where grinding separates the wood fibers. The lignin is left, more or less, in the pulp. Due to the presence of lignin, which is sensitive to pH, achieving brightness in the paper requires the pulp to be acidic.

Recycling

Ledger commands a higher price on the market than groundwood for two reasons: First, the grinding process used to make groundwood can damage some of the wood fibers, making them unrecoverable during repulping; Second, the presence of lignin in groundwood causes the paper to age (or darken) over time, makes the repulping process more pH-sensitive and prevents itself from being recycled into ledger (ledger, however, can be recycled into groundwood).

Annual average revenue to Thomson Reuters from all material captured for recycling at our Eagan campus currently ranges from \$1 to \$1.5 million, depending on production type volume variances and market price fluctuations.

Annual Summary of recycled materials

Paper from Manufacturing Process – (combined total of the 14 different grades that we collect, identify and/ or process separately) – **10,648,440 lbs.** (5324 tons)

Book Destroy (destruction and recycling of finished products, either obsolete finished product from warehouse or customer returns that are not re-inventoried) – **2,609,120 lbs.** (1305 tons)

Cardboard (OCC) – **372,560 lbs.** (186 tons)

Plastic – includes pallet wrap, shrinkwrap and HDPE containers. **22,080 lbs.** (11 tons)

Aluminum – printing plates **281,538 lbs.** (140.8 tons)

Steel (scrapped equipment, steel scrap from machine shop, scrapped other misc. steel) – **196,700 lbs.** (98 tons)

Wood (bad or unusable pallets) **20 semi trailer loads.** (170 tons)

Baler Room – 11,550 total bales of paper created. 6,731 from the shredder/ baler system. 796 from vertical balers and loose shipments. 4,023 from inline balers connected to bindery equipment.

Recycling Equipment - 4 inline balers, 1 shredder/ baler combination, 3 vertical/ down stroke balers and 2 cardboard compactors.

We also have corporate-wide collection and recycling of:

- Aluminum cans
- Cardboard
- Toner Cartridges
- Batteries
- Computers/Electronic equipment
- Cell phones
- Carpet
- Recyclable plastics
- Waste office paper (collected to join the manufacturing waste paper collection stream)



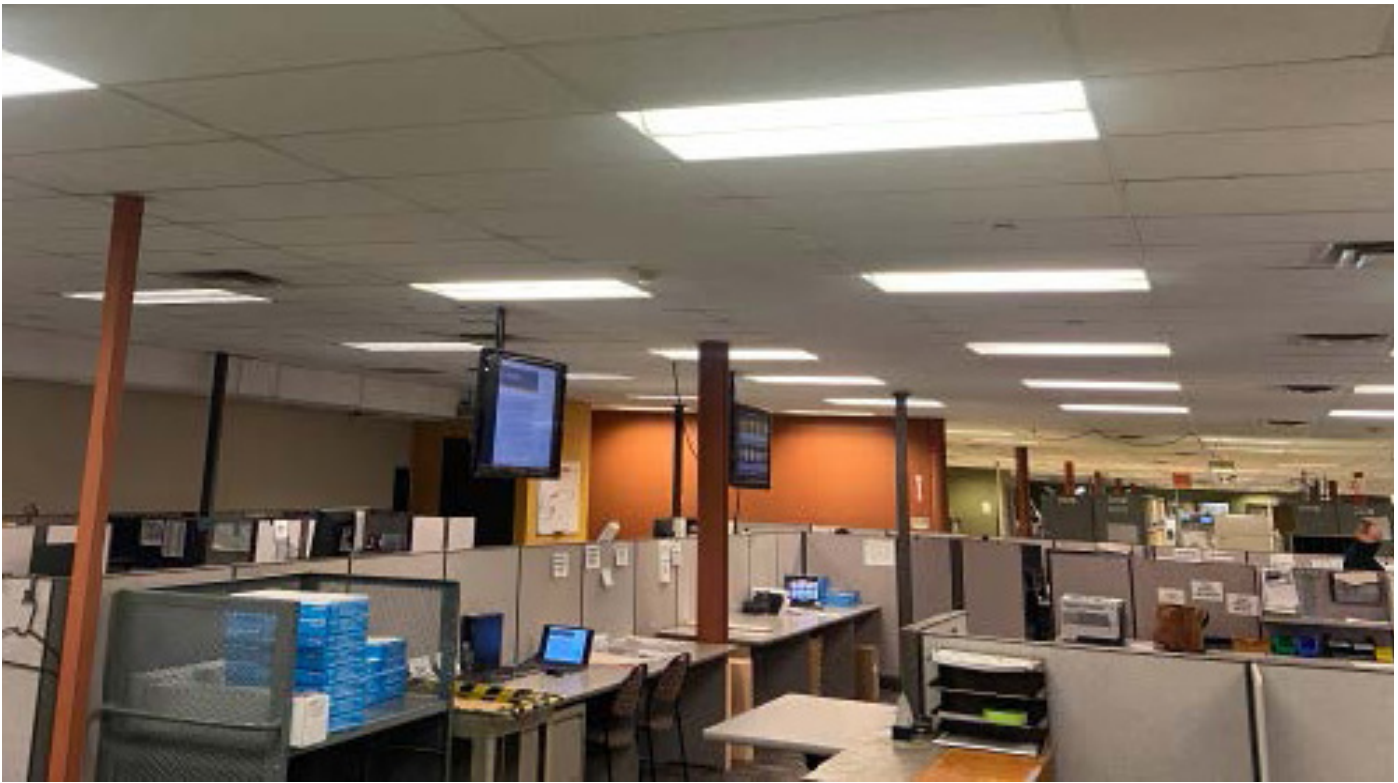

Prepress

Prepress is the first step in the print production process. Customers provide Prepress with their product files, which are eventually turned into a book. The individual pages are set up for the appropriate offset or digital press. As simple as this sounds, many tasks and processes need to occur. The files are checked by our Prepress Preflight area to make sure they are accurate and compatible with our various workflow systems. During this stage, the following issues are discovered and fixed before the production order continues:

- Images and fonts are not embedded.
- Fonts are not supplied.
- The type is not set to black.
- High-resolution images are not provided.
- Pages are not designed using cyan, magenta, yellow, black or Pantone.
- The overprints, trims, spines and bleeds are incorrect.

If an issue is found, the Manufacturing Client Services Account Manager is contacted to make sure that the customers' needs are met.

Once the issues have been resolved, the following steps occur:

- Electronic files are imposed, and proofs are sent out for approval.
- Imposed jobs are sent to the plating systems or to the digital print division.

Prepress Central

Core Publishing Solutions Prepress uses Kodak Prinergy systems to process incoming customer electronic files. Our team is centrally located to foster constant communication between our various setup areas.

Prepress, Preflight and Imposition Workstations

Core Publishing Solutions uses both Adobe Acrobat Professional enhanced with PitStop Professional. High-end Macintosh production computers are used to perform all preflighting and imposing work for clients.

This combination of software and server expertise feeds our CTP platesetters. We currently have five Prinergy Connect servers, which process thousands of final output images per day. Our imposition and graphic specialists are seasoned Kodak Prinergy Connect and InSite operators.

The Xerox Versant 280 with the latest Adobe Print Engine produces our textbook hardcopy proofs. Once proofs are printed, we offer softcover binding prior to delivery for client approval.

Our two Epson large-format printers provide contract proofing for all of our client covers and four-color work. They use the ORIS color calibration system to produce optimum results.

Electronic File Delivery

Kodak's InSite File Delivery System

Any file, big or small can be uploaded to our InSite Prepress Portal. It can also be used for online proof approvals of your products. Contact your Account Manager to set up a demonstration and/or user account to access system.

E-mail: Small files, such as logos and single pages, can be sent through e-mail to the Account Manager.

Electronic File Delivery

File Naming Conventions

Clear file names are a quick and easy way to communicate key information for each project. A consistent file naming convention can help avoid any confusion about the files received.

Identify files with a unique name that differentiates each file. For example, when sending multiple files for each chapter of a book, clearly identify the chapters in numerical order. This will facilitate accurate positioning. See the sample convention listed below.

Author's name, title, volume and chapter number (text, cover, tabs)

File names should not exceed 23 characters, including any application extension. The file names include one period before the file extension and need to have the correct file extension name such as .doc, .jpg or .tif for a specific file type or application.

Fonts 101

Reduce common mistakes at the beginning of a new project by supplying the correct fonts. Below are steps to help customers *when application files are supplied*.

- Provide the name of the font manufacturer and the original version created.
- Include a copy of all the used fonts, including standard fonts like Times and Helvetica.
- Supply the bitmap screen and printer fonts for PostScript fonts that have both. OpenType, TrueType and Composite fonts are also acceptable.
- Each font should have its own suitcase, rather than collecting all of them in one.
- Supply fonts that are used in files that have been placed into documents, such as .eps files.
- Provide fonts, even if they have been previously submitted for other jobs.

General Font Handling Suggestions

As a rule of thumb, use the actual stylized typeface needed and avoid “menu-styled” attributes, such as bold, italic, outline and shadow effects.

The ideal scenario is when the customer supplies a Print-Ready PDF file with all needed fonts embedded in the PDF. This minimizes document handling by CPS and any associated potential errors.

Font Management

Core Publishing Solutions uses Suitcase Fusion from Extensis to centrally manage our font libraries. The entire Adobe Font Folio as well as the majority of the Bitstream family fonts is included in our Prepress library.

Suitcase Fusion assists us in creating a conflict-free environment with a single font data source. Font auto-activation with Adobe® and Quark® applications assists in loading only the fonts needed for each job.

Fonts that are supplied by the customer that are not part of our standard library are loaded only temporarily on the Macintosh workstation. We do this by putting them into the Macintosh User Library Font folder. They are deleted after the job is processed. This prevents unlicensed or rogue fonts from entering our permanent type library.

Electronic Merge Area

**we recommend our customer
to scan their text at**



The Electronic Merge area uses the functionality of Adobe Acrobat to update loose-leaf files submitted through a proprietary data repository called POWER, among other Base files held for our customers. Most files updated by Electronic Merge are sent to be imposed for both our digital and offset production areas. After files are imposed, they are electronically submitted into a queue for production on a continuous feed or cut-sheet press.

Some of the daily functions of the operators in our Electronic Merge area include:

- Performing electronic interfiling of updated content with the electronic base content to maintain uninterrupted production of loose-leaf print operations.
- Ensuring that they have completed updates, base and filing instructions according to customer production orders and filing instructions.
- Ensuring that the filing instructions and electronic updates/bases are complete and available to meet production requirements.
- Maintaining the master library to accurately reflect updated electronic files instructions.

How to create PDF files for TR

Contact your account manager to acquire a copy of the Thomson Prinerger.joboptions file. Import this file into the Distiller application, and then you will have the option to select Thomson Prinerger in the Adobe PDF Settings. After installation, the settings will help you create PDF files with any Adobe application installed on your computer.

You also have the option to follow the steps included in the screens below, which are equivalent to the Prinerger Thomson job options file settings. After selecting the options listed below, save the work to a file, creating compliant PDF files with Thomson Reuters' systems.

Image Options

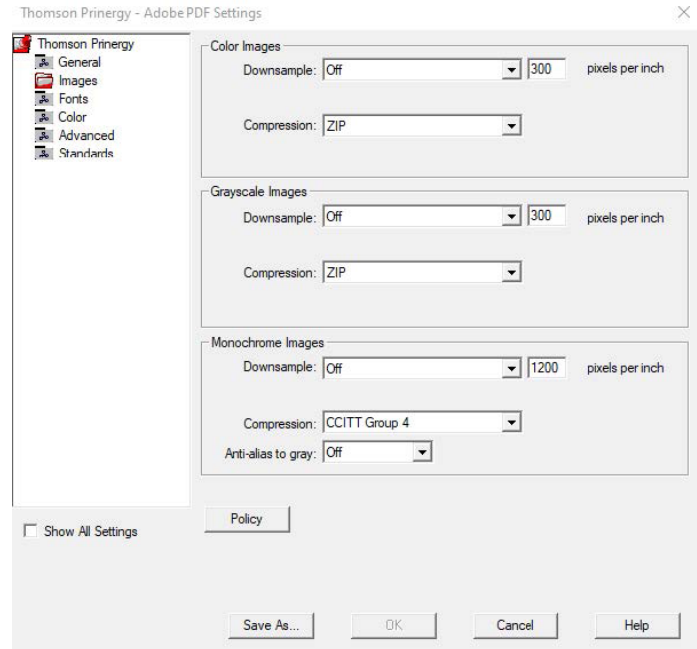

General Options

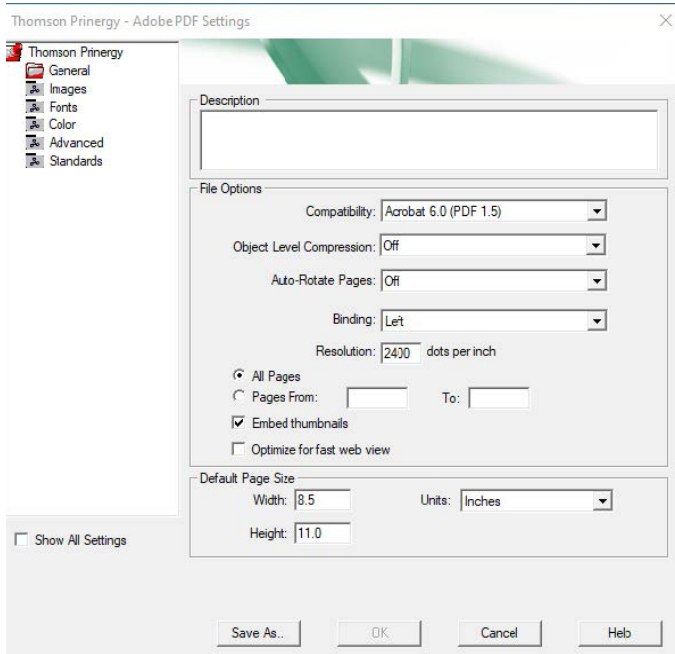

Font Options

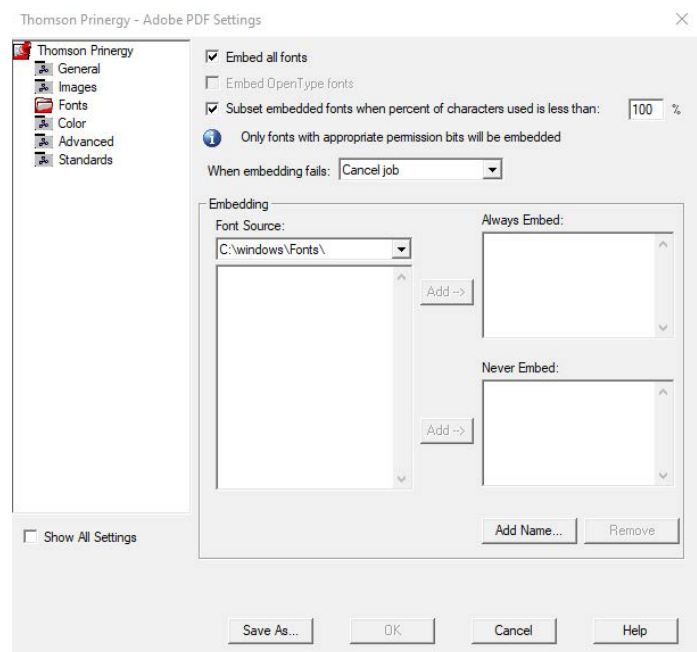

How to create PDF files for TR

Color Options

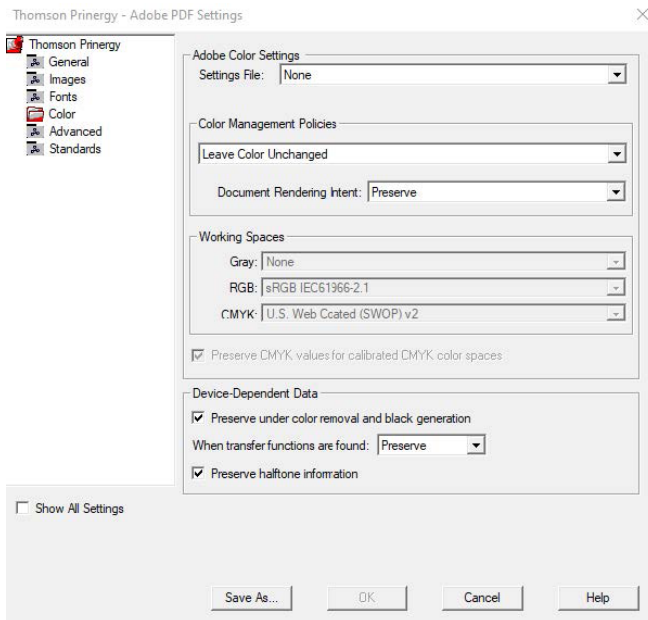

Standard Options

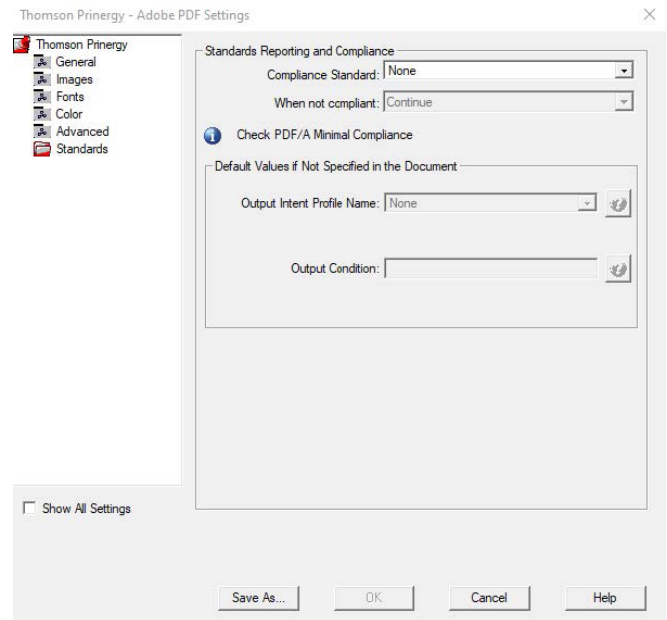

Advanced Options

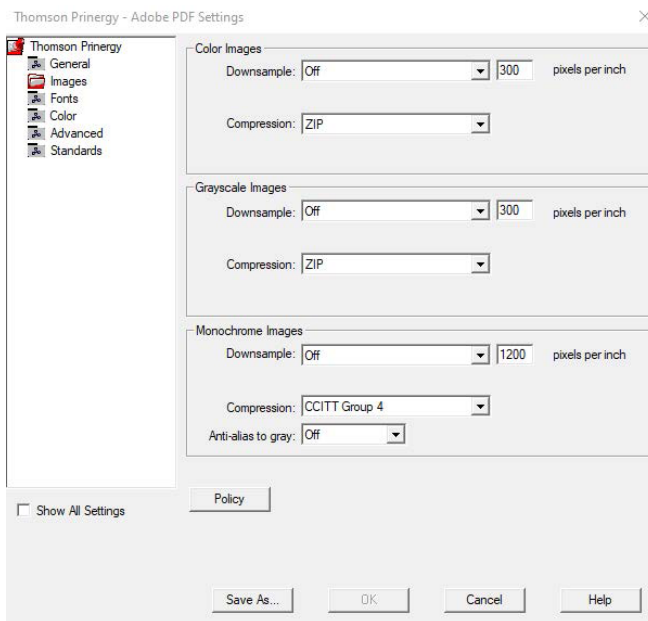

Supported Mac Applications
QuarkXPress 2020 & lower
Illustrator CC current version & lower
Photoshop CC current version & lower
InDesign CC current version & lower

We encourage all customers to send test files in advance of a new job. This allows us to troubleshoot any problems before they might affect the project's schedule. There is no cost for this service. Contact your account representative with any questions.

Thomson Reuters supports from PDF v1.2 going forward

1.2: Acrobat 3.0 (1996)
1.4: Acrobat 5.0 (2001)
1.6: Acrobat 7.0 (2005)
Acrobat 9.0 (2008)
Acrobat XI (2013)

1.3: Acrobat 4.0 (1999)
1.5: Acrobat 6.0 (2003)
1.7: Acrobat 8.0 (2006)
Acrobat X (2010)
Acrobat DC

How to send PDF files

The best way to send PDF files to Thomson Reuters is by using the Thomson Prinergy Setup files to create them with **Adobe Acrobat Distiller** and **Adobe Acrobat Professional**. Using these setups, a client will create a PDF that will work smoothly through our workflow processes. This setup file can also be used for any version of **Adobe InDesign** or **Adobe Illustrator**.

The Thomson Reuters preferred method of file delivery is via PDF. Text files created in supported Macintosh-based programs can be supplied as application files, if necessary. Supply PC, proprietary-based or jobs in unsupported applications as properly created PDF or PostScript files.

Prinergy is a Kodak product that we use to create a PDF work environment. If you work with multiple Prinergy facilities, you will see that every vendor's settings may differ slightly. By using the Thomson Prinergy.joboptions file, you can be confident that files will flow through our systems seamlessly.

Preparing your Textbook

Create the textbook to the exact trim size of the final product. Make sure all margins are correct so the book can be accurately positioned when printed.

The final PDF can be created either as a single PDF or separated as chapters. There is no need for physical trim/crop or bleed marks. The electronic trim/media and bleed boxes are all that are needed to position the file for the press.

If you are sending multiple files, make sure that all the files are setup to the same trim size and positioned identically in the application you are using to create them.

Bleeds

Please provide an adequate amount for your bleed margins, approximately 3/16" inch. This will allow us to adjust the heads and backs without the potential of losing any bleed. These are the specs for a NON-Power project.

Tabs

When creating a book with tabs, please call your account manager for specifications.

Preparing your Textbook

Images

Provide continuous tone images that are at a resolution to provide a good print quality, typically 300 dpi. When printing your book, Thomson Reuters uses a 133-line screen on offset Text, and 175-line screen for offset Covers. We realize that any screen captures that are done in a book will be of lower quality and will reproduce accordingly.

Thomson Reuters Quality

In efforts to produce a quality product for our textbook clients, we use various techniques to compensate for the folding and binding production processes. These techniques are called shingling and bottling. For further details on these processes, please see the Glossary.

Sending Textbook Page Revisions

Thomson Reuters realizes that many clients work with multiple sources to produce their books. Because of this and other factors, such as complexity and number of pages in a book, we may receive either a single PDF file for the entire book, or individual PDF files for each of the front matter and chapter pages in a book.

All textbook work including corrections or last-minute changes go through our Preflight department. This allows us to make sure we have all the revisions in place for current production and future archival.

How should revisions be sent? If the book has 10 single-page corrections or fewer, send us single-page PDF files. They will be merged into the book properly. If it has more than 10 single-page corrections, it is more efficient to send an entire new PDF file.

Softbound Cover Specifications



The length of the tick marks should be 1/8 inch

A lot of production time is saved when cover files include the correct bleed. The standard bleed for a soft-printed cover is 3/16 inch. If there's too much bleed, it will run into or cover up the color bars on the templates. At the same time, the trimming process becomes more challenging if there's not enough bleed. It is better to have more bleed than too little.

Hardbound Cover Specifications

The standard bleed for a hardbound printed cover is 3/4 inch. Too much bleed will run into or cover up the color bars on the templates, but too little bleed will not wrap properly. Similar to soft covers, it is better to have a little too much bleed than too little bleed.



Hinges for hardbound covers should be 3/8 inch

Contact your account rep for any special binding requests, such as spiral-bound books.

Cover Tips

Color Trapping: Because of Thomson Reuters' Prinergy workflow and in-house trapping solutions, make sure the cover files have no color trapping when they are sent for production. If a special trapping situation is required, contact your account manager. For example, if you sent a two-color job in light blue and dark blue and want the dark blue to overprint the light blue, this needs to be discussed with your account manager.

Support Files: Below are tips for support files. Supply all application files, fonts and other support files (.eps, .tif, .ps, etc.) in Macintosh-compatible format.

Make sure that all files are in the appropriate color space. An example of an incorrect color space includes using RGB or LAB instead of CMYK, or RGB, instead of grayscale.

Provide a PDF or printed sample of what the finished product should look like along with any other special directions or requests.

ISBN and bar codes are printed in one color to eliminate potential registration problems. Double-check that the tick and trim marks are colored registration and not black. Make sure that type going down the spine of saddle-stitch covers is 3/16 inch away from that fold.

Supported Cover Applications:

QuarkXPress, Adobe Illustrator, Photoshop, and InDesign.

InDesign for Softbound Covers

Step 1:

- Create new document
- Set page size to Front cover final trim
- Use value of 0" for Margins and Slug
- Use value of .188" for bleeds

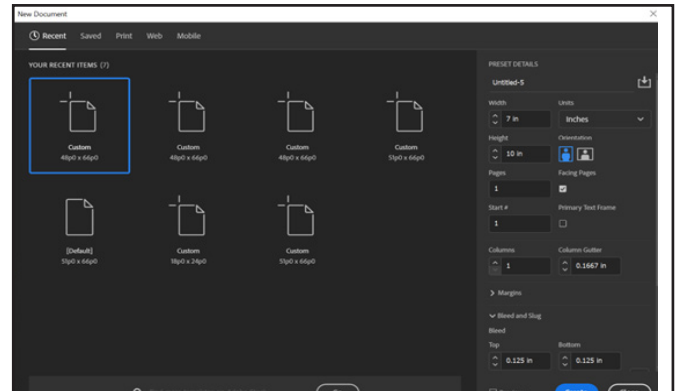

Step 2:

- Select Pages palette options
- Deselect "Allow document pages to shuffle".
- From the same menu choose "Insert pages"
- Add 2 pages

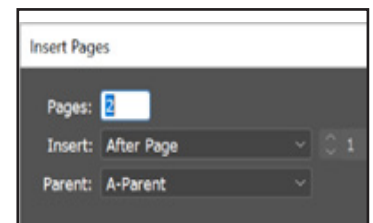
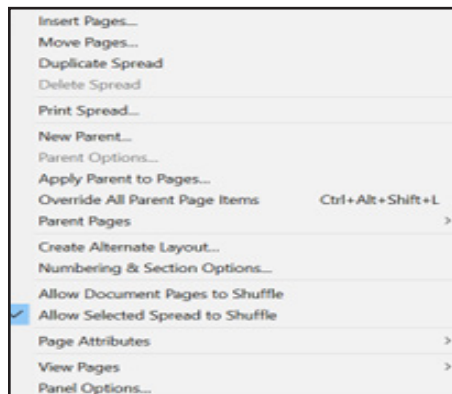

Step 3:

- Select center page
- Select "Page Tool" from tool palette
- Navigate to measurements tool box
- Insert width measurement for the spine size in "W" box

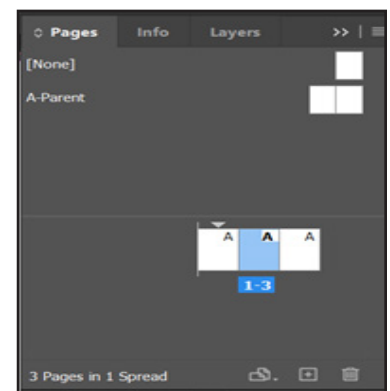
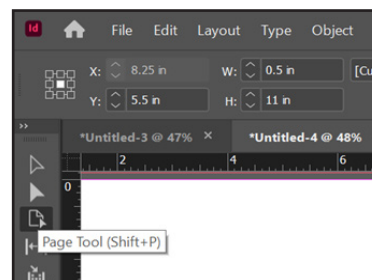

Step 4:

- Place art within page boxes
- Extend bleeds on all four sides (if applicable)
- Remove all unused items from art board
- Resolve missing art and font issues

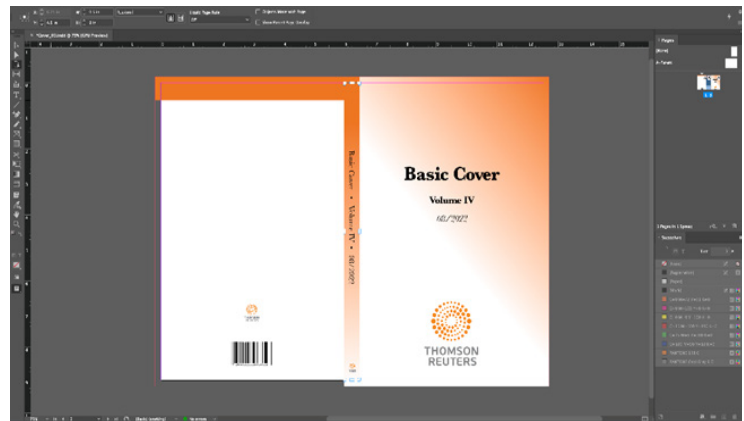

Step 5:

- Export PDF
- Choose TR export preset
- DO NOT CHANGE EXPORT SETTINGS

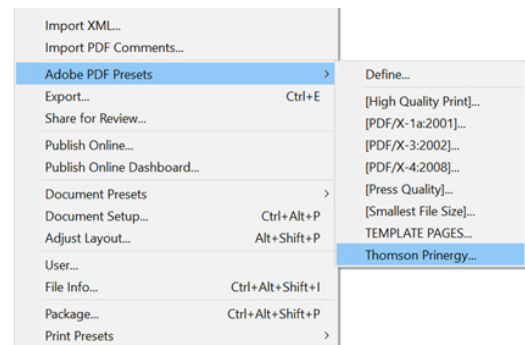
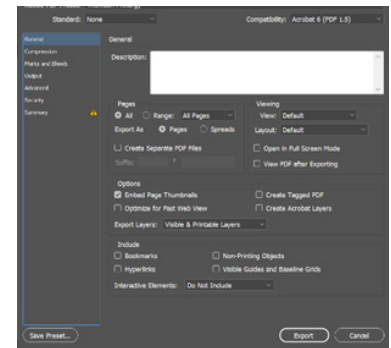

Proofs

Content vs. Contract

Contract Proof

- A proof that is color-certified and can be used for color matching at the press. These proofs are to be used for color accuracy, image quality and content.
- This proof is approved by the customer and is used for matching color and content at the press.
- Only certified proofs printed from Thomson Reuters' Epson/Oris proofing systems are considered contract proofs.
- A Contract Proof will not be an exact match if the customer requires a Spot PMS color. It will be a close assimilation, but a Pantone book will be used at press time.

Content Proof

- Simple layout proof that provides an idea of what the final product will look like.
- Proofs are used only to verify content, the position of elements on the page and the page order. Content proofs are not used for image quality or color.

Proof Storage System

The Proof Storage Area was designed as an easy-to-use organized method for storing both proofs and printed samples. Each time a job is produced whether in our Sheetfed Press or Digital Print /iGen area, the operators save a printed sample along with the original proof. Both are used for any subsequent printings to ensure consistent color between printings and even between digital and conventional print.

Every file is stored using a color-coded "Terminal Digit" filing system, using the last 3 digits as the primary sort. This evenly divides the over 5,000 folders and makes it very easy to find the correct folder. We are using a software called OpusLite to keep the files organized.



Proofs

Proof Methods

PDF (Soft) Proof

- Used typically as a content proof.
- This is a proof that is sent electronically to the customer after the file has been through the Prepress workflow system and is ready to be sent through the printing process. The electronic file is distilled into a PDF file, which can be viewed by anyone with the free Acrobat Reader.
- The quality of your monitor will influence the quality of your soft proof, with high-resolution monitors better suited for soft proofing. You will be able to preview soft proofs on any type of monitor.

Bound Text Proof

- Used typically as a content proof.
- A proof produced on the Xerox Versant 80 that shows imposed pages and indicates the final product trim marks, per a dotted line, around each page. The pages are then bound with a false cover, trimmed and then sent out to be approved.

Epson Four-Color Proof

- Used as a contract proof for fourcolor products. Our proofs are certified using the Oris Certified Proof process to meet or exceed GRACoL Production Proof Tolerances.
- The proof process can be certified to match a four-color print product. However, it is an Inkjet process, not a screened process like the sheetfed presses, so it will not indicate dot patterns.
- Matching PMS colors using cyan, magenta, yellow and black inks are not exact and often not possible. Therefore, proofs that contain PMS colors are to be used for content only. The PMS formula guide swatch book will be used by the press operator for the final color match.





Digital Print

Core Publishing Solutions Print-on-Demand operation allows its customers to produce short-run, high-quality print products in a cost-effective manner. We manage several areas with equipment that operates at different speeds and can support similar stocks to our offset operations. Using continuous feed (web-fed) equipment, one-color cut-sheet and four and five-color cut-sheet printers, state-of-the-art imaging software and printing equipment, we can quickly transform a product from file to print.

The term on-demand printing evolved from high-speed digital printing technology, allowing customers to print a quantity of one to several copies of a product, as they demanded, in a short turnaround time compared to the amount of time required to produce the same product via traditional offset printing.

Our digital print areas produce bound-volume products, looseleaf binder products, saddle-stitch products, covers, newsletters, circuit court slip opinions, shipment inserts and other miscellaneous products.

Digital Cut Sheet

The digital cut sheet printing areas at Core Publishing Solutions contain four VarioPrint machines, two black and white toner machines and two inkjet color machines. This group produces loose-leaf, inserts, tabs, newsletters, and more at blazing fast speeds. The VarioPrint machines are centrally fed from a Prisma Workflow server.

SPEED

320 A4 (Letter) pgs/min.

PAPER SIZES

Minimum 8"x10"

Maximum 11"x17"

INK COLORS

Black

PAPER TRAYS

4 Paper Trays

HIGH-CAPACITY

STACKER

Can hold 2 Stacks of 3,000 sheets (20 lb. Bond)

WORKFLOW

Prisma Sync Workflow

Custom XM

2 B & W VarioPrint 6320



Binding Options:

- Stitches: Dual, Signature and Portrait (200 pages max. depending on paper weight – consult your account manager for more information)
- Loose-leaf

Folding Options:

- up to 11 x 17
- 9 x 11 or 9 x 12 1/2
- 8 1/2 x 11

Digital Cut Sheet

2 Canon i300 X-Series

SPEED

312 A4 (Letter) pgs/ min.

PAPER SIZES

Minimum 8" x 8"

Maximum 13.78" x 20"

INK COLORS

CMYK Standard

PAPER TRAYS

8 Paper Trays, that can run any qualified stock sizes

HIGH-CAPACITY STACKER

2 Stacks of 3,000 sheets (20 lb. Bond)

WORKFLOW

Prisma Sync Workflow

Custom XM



How Inkjet is Different than Toner

If you are currently designing for color toner devices, you already have access to personalization and a wide color gamut but not to the speed or capacity that inkjet printing can offer. Inkjet presses turn jobs around in a fraction of the time that toner machines do. Also, if you've ever had challenges with color drifting from one run to another in a toner environment, that problem will be virtually eliminated with inkjet. The inkjet process allows consistent run to run color because, unlike toner devices, there are no moving parts used to transfer an image onto paper and fewer parts that degrade print quality as they age.

Digital Web Printers

HP T360 Mono 2015



HP T390 2020



SPEED

Up to 800 FPM

WEB WIDTH

T360: Standardized at 28"

T390: 762 mm (30")

INK COLORS

Black

TRIM WIDTHS

Up to and including 6.625" wide will be run as 8-page forms
Greater than 6.625" will be run as 6-page forms

BOOK SIZES

4" x 6" to 8 1/2" x 11"

WORKFLOW

HP Production / Ultimate Impostrip

BINDING METHODS

- Hardbound
- Softbound
- Loose-leaf

T360 Goal: 1 Billion pages annually

T390 Goal: 1.6 Billion pages annually

Digital Web Printers

HP T490 HD 2021

SPEED

1000 FPM

PAPER SIZES

Minimum 8" x 8"

Maximum 12.6" x 19.2"

INK COLORS

CMYK Standard

Length

WORKFLOW

HP Production / Connex

BINDING METHODS

- Hardbound
- Softbound
- Loose-leaf



Goal: 1.6 Billion pages annually

Cover Cell Area



In 2020, we added a spot UV coater and two new laminators to expand our reach in digital print cover making for our sheet fed machines.

MGI JetVarnish 3D One

This machine uses MGI's exclusive Inkjet technology: Drop-on Demand to create 3D raised effects and tactile finish. The JetVarnish 3D can print up to 2,007 A3 sheets per hour in 2D/flat mode and up to 1,260 A3 sheets per hour in 3D/raised mode.

Ecosystem Best 76 Thermal Film Laminator

This thermal laminator has the ability to print at a maximum sheet size 760 x 1060 mm | 30" x 41" and a minimum sheet size 200 x 200 mm | 7.87" x 7.87". Its maximum mechanical speed 50 m/min | 164 feet/minute and can run a variety of paper weights ranging from 115-600 gsm.

The two laminators in our Digital Cover Cell feature hot knife separation technology. The hot knife contacts the laminate where the sheets overlap, effectively melting the film to separate the sheets. The use of the hot knife results in flat sheets that feed well on the Spot UV coater, or for processing in the bindery.

Cover Cell Area

Kodak Nexpress 2700SX

The NexPress SX platform is a fully modular design, which allows us to easily expand as our business needs change. This 5-color digital press includes a long-sheet pile feeder for additional paper feeds and expands our sheet size capabilities to a maximum of 14 x 36 inches.

The system also includes the NexPress fifth imaging unit, which will allow us to print gold, dimensional raised print, more accurate spot colors, and high impact spot gloss. RGB Color Stations for additional Pantone Matching.

Kodak NexPress Specifications

Smallest sheet size: 7.9 x 11 inches (smallest we run: 8.5 x 11)

Largest sheet size: 14 x 36 inches (Standard sheet size 14 x 20)

Speeds: 91 impressions per minute (8.5 x 11 inches)

FRONT-END TECHNOLOGY

All of the equipment that is upgraded has the latest Adobe Print Engine, to allow us to tackle even the most complex files with layers. We have also added other software tools to allow us to automate front-end impositions and file routing more seamlessly.

Digital Paper List

Uncoated Text Stock	PPI	Opacity	Brightness
23.4# Directory (UPM)	892	83	60
50# Husky Offset (Domtar)	512	91	94
60# Husky Offset (Domtar)	434	93	94
70# Husky Offset (Domtar)	378	95	94
80# Husky Offset (Domtar)	338	96	94
22# Law Book (Twin Rivers)	1400	78	85
25# Law Book (Twin Rivers)	1180	81	85
27# Frabite (Twin Rivers)	904	82	76
33# Frabite (Twin Rivers)	758	84.5	76
30# Borderbrite (Twin Rivers)	900	82.5	85
35# Borderbrite (Twin Rivers)	750	84	85
30# Stabilite Smooth (Pixelle)	900	81	90
35# Norbrite Insert (Norpac)	606	92	70
35# Norbrite Book (Norpac)	500	93	70
40# Norbrite Plus (Norpac)	556	95	80
40# Norbrite Book Cream (Norpac)	400	93	73
35# Book White (Resolute)	444	90	70
45# Alternative Book White (Resolute)	400	92	79
45# Alternative Book Crème (Resolute)	400	92	74
40# Offset: Smooth eggshell (Pixelle)	692	88	92
45# Offset: Smooth eggshell (Pixelle)	590	89	92
50# Offset: Smooth eggshell (Pixelle)	540	91	92
60# Offset: Smooth eggshell (Pixelle)	440	92	92
70# Offset: Smooth eggshell (Pixelle)	380	94	92
45# Tradebook Machine Fin. (Pixelle)	640	91	74
50# Tradebook Antique (Pixelle)	400	92	74
50# Omnilux Opaque (Pixelle)	500	96	92
60# Omnilux Opaque (Pixelle)	420	96	94

Coated Text Stock			
40# New Era Matte (Verso)	870	91	83
45# New Era Matte (Verso)	800	92	83
60# Sterling Ultra Matte (Verso)	606	93	90
80# Sterling Ultra Matte (Verso)	434	95	90
100# Sterling Ultra Matte (Verso)	344	96	90

Cover Stocks			
Opus Dull 120# (SAPPI)	Caliper-12pt	99	94
Opus Dull 100# (SAPPI)	Caliper-10pt	99	94
65# Opus Matte (SAPPI)	Caliper -7pt	100	92
10pt Tango C15 (West Rock)	10pt	100	92
12pt Tango C15 (West Rock)	12pt	100	92

Dust Jacket Stock			
95# Sterling Ultra C15 Litho Label (Verso)	Caliper -5pt	94	89

Insert Stock			
80# Opus Gloss Text (SAPPI)	556	93.5	94

This is not an all-inclusive list. If you don't see the desired stock, please reach out to your Account Manager.







Press

Traditionally, offset lithography was the most common form of printing. This is when images get transferred from an inked plate to a rubber blanket, which meets the paper and transfers the image. This has developed with advancements of presses with multiple units (each containing one printing plate) that can print multi-color images in one pass on both sides of the sheet and presses that accommodate continuous rolls (webs) of paper, known as web presses. Another innovation was the continuous dampening system which increased control over the water flow to the plate and allowed for better ink and water balance.

Modern high-volume lithography produces posters, maps, books, newspapers, and packaging – just about any smooth, mass-produced item with print on it. In this form of lithography, flexible aluminum or plastic printing plates are in place of stone tablets.

Offset Presses

The offset press is responsible for four important advantages of lithography:

- The rubber blanket surface conforms to irregular printing surfaces, resulting in the need for less pressure and make-ready, and improved print quality of text and half-tones on rough-surface papers.
- Paper does not contact the printing plate, increasing plate life and reducing abrasive wear.
- The plate image is right-reading rather than reverse-reading.
- Less ink is required for equal coverage, drying is speeded up, and smudging and offset is reduced.

Presses are either sheet-fed or web-fed (roll). Presses can be single-color or multi-color. Each color on a multi-color press requires a complete printing unit of cylinders, rollers, and ink. A two-color press has two printing units; a four-color press has four units, etc. Perfecting presses print both sides of the paper in one pass through the press.

Single-Color Web Press

Core Publishing Solutions has 6 offset web presses and 3 digital web presses in its manufacturing facility. Most of the web presses are configured as single-color, high-speed perfecting units. They print black ink on both sides of the paper in one pass through the press. These presses use very large rolls of paper, which continuously feed the press. They can run as many as 31 million pages per day. As the paper unrolls on the roll stand, it passes through a series of rollers that assist in smoothing out the paper and also acts as a storage of paper for roll splices (one roll of paper being spliced to another roll with two-way tape) during a press run. The web then passes through the infeed, to control web tension, and then on to the printing unit/units, where both sides of the paper are printed at once. The final step includes folding and cutting to produce signatures. The signatures are then bundled together and sent to the Bindery, where they are gathered into either a soft- or hardbound book

Heat-Set Web Press

With a heat-set press, the printed web proceeds through a natural-gas-supplied hot-air dryer (to evaporate the chemicals in the ink) and then go over a set of chilled rollers that cool and set the ink on the web. The web then travels into the folder, where it is cut and folded into a signature (8-, 16-, 24-, 32-, 48- or 64-page book section). Heat-set presses are used to produce high-quality print on coated paper.

Cold-Set Web Press

The printed web travels directly to the folder, where it is cut and folded into a signature. Producing signatures on a cold-set press is more cost-efficient than printing on a heat-set press because of the higher cost of heat-set ink and the cost of operating the hot-air dryer and the chill rollers. Cold-set presses are more economical but do not perform as well on jobs containing half-tones, solids, or heavy coverage.

Web Press Components



1. Roll stand (splicer):

Holds the rolls of paper and allows the press to maintain running speed while changing from one roll to another.



2. In-feed/web guide:

Used to control web tension and steer the web through the printing unit.



3. Printing unit, consists of:

Plate cylinder: A cylinder that carries the printing plate.

Blanket cylinder: A cylinder that carries the offset blanket, a fabric-coated rubber blanket that transfers the image from the printing plate to the substrate or printed material.

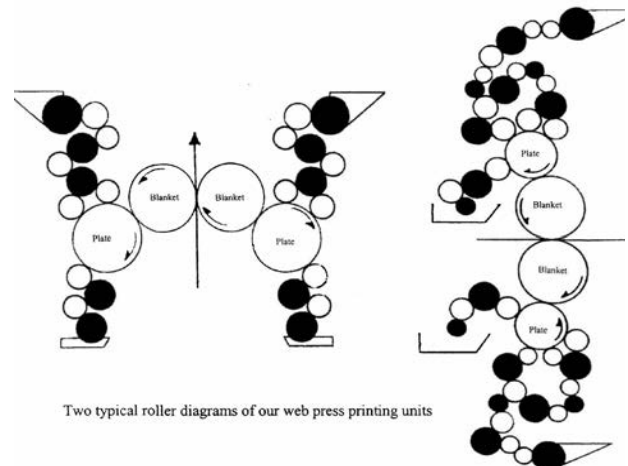

Two typical roller diagrams of our web press printing units

Dampening system: A series of rollers that dampen the printing plate with a water-based dampening solution that contains additives, such as acid, gum arabic, and other wetting agents.

Inking system: A series of rollers that apply a metered film of ink to a printing plate.

Web Press Components



4. Dryer (if heat-set):

A natural-gas hot-air dryer (to evaporate the chemicals from the ink) as the web passes through.



5. Chill stand (if heat-set):

Sets the ink to the paper.



6. Slitter/Former:

Cuts or folds the web before folding.

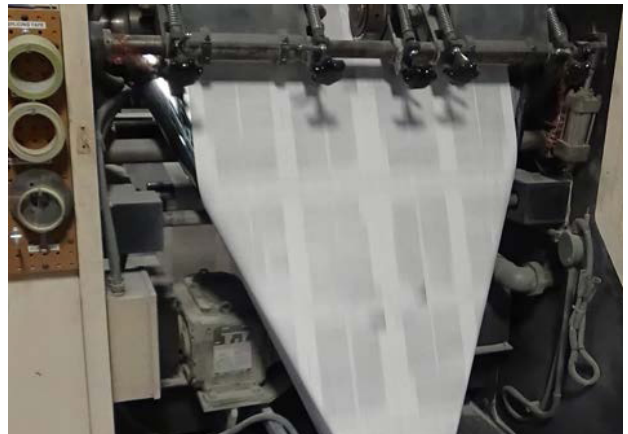

7. Folder:

Folds the cut or folded web into a signature format.



8. Delivery

Delivers the folded signatures to the stacker.

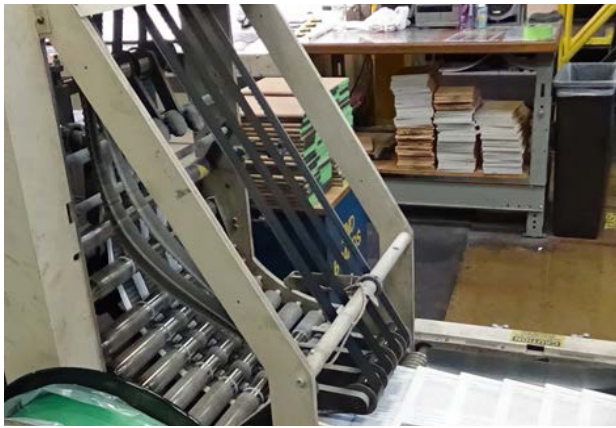

9. Stacker:

Bundles the signatures to be transported to the Bindery.

Mitsubishi Press

Capable of printing 8 to 64 page single-color jobs at speeds of up to 1,400 feet of paper per minute.



Timsons T48 ZMR

Capable of switching from one signature to the next signature without stopping and speeds up to 1,500 feet per minute.

Multi-Color Sheet-Fed Presses

Multi-color sheet-fed presses print more than one color on one side of a sheet during a single pass through the press because there is more than one printing unit. This press is used to print book covers as well as color book inserts, newsletters, and marketing materials.

On Core Publishing Solutions' sheet-fed press, the multiple printing units are identical and arranged in tandem. These can print a different color on each unit. A transfer cylinder is placed between units to transport the sheet from one printing unit to the next. A multi-color press is capable of wet trapping, which is the ability of a wet, printed ink film to accept another wet ink film printed over it. Core Publishing Solutions' Komori 6-color press is capable of printing one color in each printing unit.

The printing unit of a sheet-fed offset lithographic press consists of three primary cylinders and a system for dampening and inking the printing plate:



Delivery and Stacker



Feeder

A sheet-fed press includes the following:

Feeder: Lifts and forwards each sheet of paper from a pile to the first printing unit.

Transfer devices: Often auxiliary cylinders with sheet grippers that facilitate sheet transport through the press.

Coater: Applies an aqueous coating to the sheet.

Delivery: The area of the press that receives and stacks the printed sheets.

Sheet-Fed Press Components

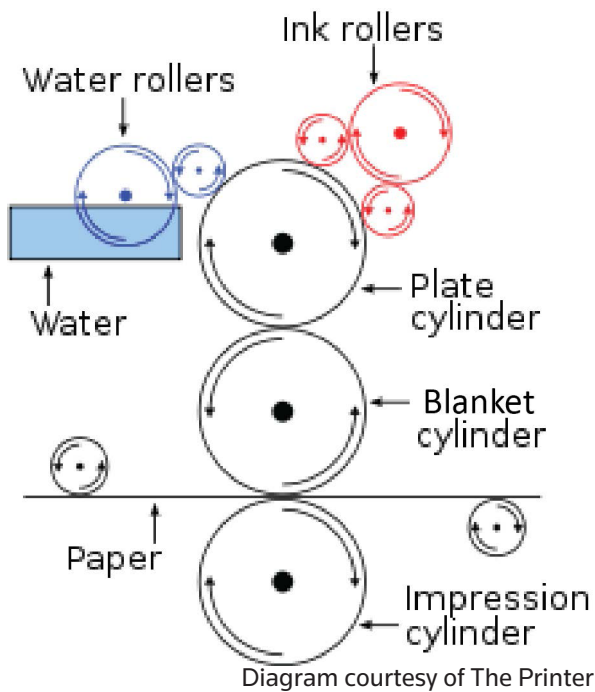

The printing unit of a sheet-fed offset lithographic press consists of three primary cylinders and a system for dampening and inking the printing plate:

Plate cylinder: A cylinder that carries the printing plate.

Blanket cylinder: A cylinder that carries the offset blanket, a rubber-coated fabric that transfers the image from the printing plate to the paper.

Impression Cylinder: A cylinder running in contact with the blanket cylinder that transports the paper or other substrate.

Dampening system: A series of rollers that dampen the printing plate with a water-based dampening solution that contains additives, such as acid, gum Arabic, and other wetting agents.

Inking system: A series of rollers that apply a metered film of ink to a printing plate.

Quality Printing

Quality checks are continuous and built into our printing processes. We use state-of-the-art technology and highly skilled employees to prevent the following list of printing problems from showing up in your products:

Density issues:

The degree of color or darkness of an image or photograph.

Gussets:

Sharp creases usually on the head or face of some pages due to the inability to release all air during the folding process.

Hickeys:

Recurring unplanned spots that appear in the printed image from dust, lint, or dried ink.

Registration:

Pages not in register.

Perforation issues:

Pages falling out of books due to poor perforation.

Rolled spines:

This occurs during the bundling of the signatures and prevents glue penetration on the spines.

Scumming:

Most often caused by a balance issue with water and ink; can also be a water form issue.

Scratches:

Unwanted lines on the printed material.

Turned corners:

Usually caused by web position in folder or improper folder adjustments.

Unwanted image:

Any unwanted printing appearing on the printed product. Ex. pepper spots, fingerprints, scratches, erase marks showing up, process marks, etc.

Color Printing

Thomson Reuters uses the GATF (Graphic Arts Technical Foundation) color control bar. This color bar lets press operators monitor ink densities, print contrast, ink trapping, slur, and doubling. Here is a sample of this color bar.



Color bars are rows of different-colored patches printed in the trim area of the press sheet. They are used by proofers and press operators to control the trapping, ink density, dot gain, and print contrast of the proof or the printed sheet. They usually consist of solid and tint blocks of cyan, magenta, yellow and black; two- and three-color solids and tints; and additional elements and patterns such as resolution targets and dot gain scales.

There are several different types of color bars and determining which one to use involves identifying the type of printing being used. Prepress and print suppliers purchase original film or the rights to digital files of color bars and other test images. The film and files can then serve as constant reference points throughout the proofing, plate making, and print processes. They are available from GATF, DuPont, RIT (Rochester Institute of Technology), and others.

Color bars are an essential troubleshooting tool. They are easy to analyze, both visually and with a densitometer, an instrument used for measuring the relative density of any part of an image.

Colored Ink

In four-color work, printers use the primary colors: yellow, cyan (blue), magenta (red), and black. The sequence that these four colors are printed in may vary depending on the job. The most common four-color sequence is black, cyan (blue), magenta (red), and yellow. Colored inks are based on the Pantone Matching System or PMS. For the best color match, we request that customers provide the specific PMS color from the most current PMS swatch book, along with a printed sample.

Metallic inks use metallic powders, such as aluminum and bronze, mixed with the proper varnish base. The powders are flakes that deposit in reflective layers to produce a pleasing metallic luster. The varnish dries rapidly and has sufficient binding qualities to hold the powder to the paper surface. Metallic inks should not be used on uncoated paper stock unless a base ink is printed first and allowed to dry. It is better to reverse out type rather than trying to overprint.

Considerations: Sheet-Fed vs. Web

Many factors influence the type of technology a printer might purchase, including the following:

Run speed: A sheet-fed press will usually run consistently at 5,500 to 10,500 impressions per hour. A web press can run at 10,000 to 60,000 impressions per hour.



Komori 6-Color Press

Run length: Web presses are designed to run jobs from 1,500 impressions and up. A sheet-fed press is much more economical on the shorter-run length.

Thomson Reuters has become very efficient at running web presses with run lengths in the 300 to the 2,000 run-length range.

Make-ready: New-job make-ready time on a web press can be from 10 minutes to two hours in length (depending on the type of job being printed). The Thomson ZMR press has a stacked printing unit that allows plates to be changed while the previous form is running, which greatly reduces downtime and make-ready times.

Paper waste: As a result of high run speed on a web, paper waste could be very high on a short run-length job. The initial makeready might waste 1,000 to 2,000 signatures or more. The signature to-signature plate change can waste from 50 to 300 signatures. By contrast, a sheet-fed press can be set up using wastepaper. Anywhere from 20 to 50 sheets can be lost on an initial make-ready, and 15 to 25 sheets can be lost on plate change or press stops. Obviously, on short-run-length jobs, the amount of paper wasted would have an impact on the cost of a job. Waste per form in the web operation is averaging 270 signatures.

Quality: The quality of both types of presses is very good. Top-quality-type half-tones should run on a heat-set web press or a sheet-fed press. The impression cylinder on a sheet-fed press is made of metal, allowing the printer to print a very precise half-tone dot. The impression cylinder is the blanket cylinder (rubber) used to print the backup side of the sheet.

Flexibility: A few issues that should be considered:

A web press can go from a roll of paper to a printed, folded signature in a matter of seconds. A sheet-fed press must have paper piled, printed, and then sent to the Bindery and folded.

Sheet-fed presses can run many different trim sizes by printing on different-sized sheets of paper. A web press can change the roll width of a roll between its minimum and maximum widths, but the "cutoff" (length of product) is a fixed measurement.

Considerations: Sheet-Fed vs. Web

A sheet-fed press can run the paper grain either “long grain” or “short grain,” whereas a web press can only run the paper grain parallel to the web.

On a sheet-fed press, the paper must be piled at the feeder end before it goes to press. We do not have the capability of running roll stock on our sheet-fed presses. These sheets are then fed individually into and through the press by a series of grippers. Some sheet-fed presses print only one side of the sheet in one pass; others can print both sides at once. We print one side only. Folding is not done on the press but folding equipment in the Bindery.

Web Press Specifications

Press	Cutoff	Width	Untrimmed Sig Length (inches)	Product	Top Speed (fpm)	# pages	Heatset	Color
20-18 Timsons 148 ZMR	41 1/4"	54" (ribbons)	11 1/2	9 13/16	1200	24,32,48,64	Yes	2 (two units ZMR)
20-07 Timsons 148 ZMR	41 1/4"	54" (ribbons)	10 5/16	9 13/16	1500	24,32,48,64	No	1 (two units ZMR)
20-13 Timsons 148 ZMR	41 1/4"	54" (ribbons)	10 5/6	9 13/16	1500	24,32,48,64	No	1 (two units ZMR)
20-3, Mitsubishi	22 3/4"	36" (former)	11 1/2	8 1/2 x 11	600	8,16,32	Yes	2
25-5,95-6 Mitsubishi (BT1)	21 1/2"	55" (ribbons)	10 13/16	8 1/2 x 10	1500	32, 48, 64	Yes	1 (four units)

Impressions per Hour converted to Feet per Minute

IPH speed x cutoff = inches / 12 to get feet / 60 to get FPM (feet per minute)

Feet per Minute converted to Impressions per Hour

FPM x 12 = inches / cutoff = IPM x 60 = IPH

Offset Paper List

Uncoated Text Stock	PPI	Opacity	Brightness
23.4# Directory (UPM)	892	83	60
20.9# Directory (Catalyst)	880	89	57
22# Law Book (Twin Rivers)	1400	78	85
25# Law Book (Twin Rivers)	1180	81	85
30# Stabilite Smooth (Pixelle)	900	81	90
35# Stabilite Smooth (Pixelle)	750	83	90
30# Borderbrite (Twin Rivers)	900	82.5	85
35# Borderbrite (Twin Rivers)	750	84	85
27# Frabite (Twin Rivers)	904	82	76
33# Frabite (Twin Rivers)	758	84.5	76
35# Norbrite Insert (Norpac)	606	92	70
35# Norbrite Book (Norpac)	500	93	70
40# Norbrite Plus (Norpac)	556	95	80
40# Norbrite Book Cream (Norpac)	400	93	73
35# Book White (Resolute)	444	90	70
45# Alternative Book White (Resolute)	400	92	79
45# Alternative Book Crème (Resolute)	400	92	74
40# Offset: Smooth eggshell (Pixelle)	692	88	92
45# Offset: Smooth eggshell (Pixelle)	590	89	92
50# Offset: Smooth eggshell (Pixelle)	540	91	92
60# Offset: Smooth eggshell (Pixelle)	440	92	92
70# Offset: Smooth eggshell (Pixelle)	380	94	92
70# Husky Offset (Domtar)	378	95	94
80# Husky Offset (Domatar)	338	96	94
50# Omnilux Opaque (Pixe)	500	96	92
60# Omnilux Opaque (Pixe)	420	96	94
45# Tradebook Machine Fin. (Pixelle)	640	91	74
50# Tradebook Antique (Pixelle)	400	92	74
Coated Text Stock			
40# New Era Matte (Verso)	870	91	83
45# New Era Matte (Verso)	800	92	83
50# New Era Matte (Verso)	714	93	83
24# Thincoat Plus (Tervakoski)	1340	85	89
Cover Stocks			
10pt Tango C15 / C25 (West Rock)	10pt	100	92
12pt Tango C15 / C25 (West Rock)	12pt	100	92
80# Opus Gloss (SAPPI)	6.9	80	94
100# Opus Gloss (SAPPI)	9.1	100	94
65# Opus Matte (SAPPI)	7	100	94
Dust Jacket Stock			
95# Sterling Ultra C15 Litho Label (Verso)	Caliper -5pt	94	89
Insert Stock			
80# Opus Gloss Text (SAPPI)	556	93.5	94
70# Opus Matte Text (SAPPI)	512	9.5	94
80# Opus Matte Text (SAPPI)	454	94.5	94
100# Opus Dull Text (SAPPI)	408	96	94
Boards for Hardcover Books			
Eska Low Density Graphic Board (Sage Graphic)		3.28 Dens.	0.88
WestRock High Density NASTA Spec Board (Sage Binder)		4.2 Dens.	0.98

This is not an all-inclusive list. If you don't see the desired stock, please reach out to your Account Manager.





Softbound Bindery

The Bindery department is responsible for creating a finished print product. To create this look, the Bindery uses more than 100 processes each day to fold, perforate, stitch, cut, drill, case-in and bind the pages. Throughout the plant, our run lengths vary from more than 100,000 books to a couple dozen. The Bindery works to make sure customers' needs are met in a timely fashion.

Softbound

Softbound books are books or pamphlets with soft covers, typically paper (plain, varnished, UV Coated or laminated), or cover stock that is hot foil stamped or screen printed. Some books are bound without a cover. Common examples include paperback novels, technical manuals, pocket parts, telephone books and brochures.

Burst Pamphlet

Burst-binding a softbound pamphlet is similar to the perfect-binding process, except the Bindery saws only enough paper from the spine fold to remove the bumps created by the burst perforation on the fold. No spine trim is allotted in Prepress for a burst pamphlet. Burst pamphlets should be produced only when the roll stock used on press allows the minimum 1/8-inch face trim. This bind style is also used when product is overrun with adhesive case bound books. Burst-binding is only used on Thomson Reuters products.

Softbound Bindery

Perfect Binding

Perfect binding is an economical and functional binding style. To perfect bind a book, the printed and folded signatures are first gathered (stacked on top of each other). The cover is scored to the thickness of the spine, creating a channel or groove for the gathered signatures. Often, an additional score is placed on the front or back cover, or both, to act as a hinge to help prevent stress at the binding when the cover is opened. The gathered signatures are clamped together, and the spine is sawed to expose the paper's fibers. Hot glue is applied to the roughened edge, and then the covers are applied to the text. The bound books are then trimmed on three sides in a three-knife trimmer. A perfect-bound book has a clean, finished and professional look. This process can also be achieved using digitally printed text. In this case, the text is delivered as a pre-collated unit, also known as a book block. This eliminates the need to gather the signatures. All other steps are the same.

Burst Loose

Burst-binding a loose-leaf product is similar to the burst pamphlet process, where only the perforations are smoothed out on the spine before applying a false cover to the signatures. The signatures are collated and bound together using hot melt only to allow for consistent drilling and trimming. After the bound signatures are drilled, 3/16 inch is trimmed from the spine to create a loose-leaf product.

Binders

Muller Martini Alegro Hybrid Binder

The Muller Martini Hybrid Binder can bind both hardbound and softbound web and digital signatures. The machine produces hardbound and softbound products up to 2.5" in thickness.

The gather section has 27 pockets with bundle loaders, and signature recognition on each feeder. It also has three book block feeders that can be utilized in combination with the feeders to combine book blocks and signatures together in a single run.



Binders

The Alegro binder applies hot melt to the spine and side joints prior to cover application. For softbound products, a three-knife trimmer finishes the product and the books are stacked, boxed and palletized through automation on the back end. For hardbound book blocks, cold glue is applied and dried prior to application of hot melt. “Crash” is applied instead of a cover to the hardbound book block to prepare it for the hardbound in process. Crash is crepe paper that helps create a beautiful well-rounded back, reduces splitting, and reinforces the spine from head to tail. Hardbound book blocks are then delivered to the casing in line for completion.



Muller Martini Alegro Digital Binder

Installed in 2020, the Muller Martini Digital Binder includes the same process and specifications as the Muller Martini Hybrid binder. This binder supports the increasing demand for digitally printed softbound or hardbound work. Once fed, a book block goes through an all-in-one binding process. The book is first clamped in place before the spine is sawed. The book is then glued for application of the cover or crash, depending on the job description. Once applied, the finished book is sent through a three knife trimmer and is palletized for shipping.

New in 2022 is the addition of Polyurethane Reactive (PUR) binding option on our Alegro Digital binder. PUR adhesive is used on heavy weight matte and gloss coated papers to provide a robust binding solution. These types of paper stocks tend to have very little paper fiber exposed for binding with traditional EVA hot melt adhesives. The PUR alternative creates a strong bond with the coated stocks through a chemical reaction with moisture in the air. This bond can take up to 24-36 hours to achieve full strength. Once the PUR is fully cured, it cannot be manipulated. Because of this, it is not ideal for thicker hard cover books since the spine cannot be rounded.

Binders

Muller Martini Norm Binder

The Muller Martini binder does softbound and hardbound binding. The machine produces books using high-quality text and cover stock. The gatherer has 40 pockets with bundle loaders, and collates up to 40 signatures, endsheets or inserts. The binder has 67 clamps and a two-shot gluing system. For perfect bound, hot melt is applied to the spine and side joints prior to cover application. The three-knife trimmer finishes the product. The product is then palletized. For hardbound book blocks, cold glue is applied and dried prior to application of the hot melt. This feature helps create a beautiful well-rounded back, helps eliminate splitting and reinforces the spine from head to tail. It creates a strong bond to the book block with cold glue or hot-melt adhesive.



Horizon BQ470 Perfect Binder

The Horizon BQ470 is a 4-clamp perfect binder designed for use with digitally printed text. The binder operator hand feeds gathered text into the clamp infeed. As with all other perfect binders, the BwQ470 has a saw to prepare the spine for optimal glue application using a combination of milling and notching. Both spine and side-joint hot melt glues are applied, and the cover is affixed to the book. After nipping the cover to the signatures, the book is carried to the binder delivery belt where it can be delivered into a three-knife trimmer and stacker.

Binders

Kolbus Binder

The Kolbus binder produces books with extreme thickness requirements from 1/8 to 2-5/8 inches. The gatherer has 40 pockets with signature recognition and 35 hopper loaders.

For books containing more than 40 signatures, the Kolbus will perform a double gather. A double gather consists of collating some of the signatures and creating a book block without a cover. This book block is then dropped on at the start of the gatherer and all remaining signatures are gathered on top to make the complete book.

The binder has 25 clamps and a one-shot hot melt and side joint glue application. The finishing trim is done on the high-quality three-knife trimmer. The product is then palletized for shipment or boxing.



Muller Martini Corona Binder

Similar to the Kolbus binder, the Corona binder also only processes perfect bound books. The Corona binder has a higher speed capacity and is targeted for low signature count production, but can bind books up to 2 3/8" thick. The bound books are three-knife trimmed, stacked, and directed to either a palletizer or an in-line boxing cell.



Hardbound Bindery

All hardbound books need a protective cover for the book block. Covers for hardbound books can be stamped with a decorative design. Covers that are a part of a series have specific guidelines that are followed so a book that may have been produced 80 years ago has the same unified look today. Covers can also be produced using printed sheets.

Stamping

The decoration of a cover starts with a metal die and hot-stamping foil. The stamping machine uses heat, pressure and time to transfer an image to a hard cover. The metal die may be used alone for embossing or blank stamping.



Deflores Automatic Stamping Machines

Our three Deflores stamping machines apply four to six impressions (hits) per cover. Heated dies on each head apply embossing patterns, foil panels or foil lettering to cover materials. Foil may be a solid pigmented color or may be a reflective metallic color.

Kluge Stampers

Two Kluge presses are used to process sheet stock and soft or flexible covers.

Both presses are capable of:

- Foil stamping
- Embossing
- Die cutting
- Kiss cutting

Pocket Application

Many legal hard cover books must contain a pocket envelope inside the back cover to hold the Pocket Part. This is achieved in-line on the Case In-Line. After casing in, the back cover is opened, glue is applied, and an open side envelope is affixed.

Hardbound Bindery

Kolbus Case Maker

Case makers adhere binder boards and lining to cover materials. The cover materials can consist of cloth, paper, leather or printed laminate sheets. Installed in 2008, the Kolbus case maker can produce about 60 hard cover cases per minute.



Sewing

Another way of binding is using sewing machines and sewing through the spine of individual signatures, which have been gathered with endsheets on the binder. This process is referred to as Smyth sewing. Two Aster Pro sewing machines deliver completed books.

After sewing, the completed book blocks are sent to a binder for nipping. During the nipping process, endsheets are glued to the first and last page of the book. The book passes by a glue nozzle approximately 1/8" up from the spine of the book and sprays a narrow bead of hot melt adhesive. The endsheets are fed into channels which are parallel to the book and are pressed onto the glue to attach the endsheets.

After the endsheets are attached, the combined book block passes over a set of hot glue rollers and a stretchable crash or mull backing material is added to the spine. This nipping process provides a tight spine and adds strength to the overall book block with the addition of the flexible hot melt and crash. The use of a rubber based hot melt with the crash allows for rounding of the spine when casing in.

Hardbound Bindery

Casing-In Process

The casing-in process combines the burst or sewn book blocks with the hard cover. This process can also be used to produce flexible cover books. This is a hybrid with a thick soft cover used to case-in the book instead of a hard cover. Bibles are a common example.

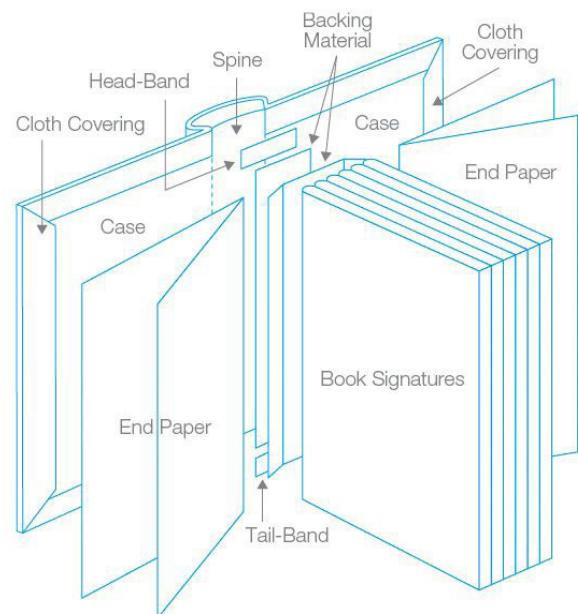

Courtesy of ibookbinding

Muller Martini Diamant

The Diamant line was installed in 2008 and cases-in up to 60 books per minute. The Diamant line can run pocketed work, as it has a "pocket applicator" to automatically finish the product in-line. Multiple-copy packing can be done on the tech boxer. The Diamant is only used on Thomson Reuters products.



Hardbound Bindery

Head Bands

Head and tail bands are available in a variety of color combinations and provide a nice finishing touch.



Courtesy of 4bind

Stitching

Saddle Stitching

Saddle stitching is a method that gets its name from the “saddle” that the folded booklet is placed on during the stitching process. The booklet is produced by opening the signature at the middle fold and placing it over the spine fold of the next signature. After all signatures are collated, a stitching head containing wire stitches (or staples) the booklet directly in the crease of the fold, tightly binding the signatures together. The stitched booklet is then trimmed on three sides: top, outside and bottom. In saddle-stitched work, the printed sections are inserted one inside the other. This method is used for softbound books only and is limited to 1/4-inch or less.

Side Stitching

Side stitching is done by gathering and securing signatures with stitches through the top side of the first to the last. On pocket parts, the signature has a piece of manila at the end, used to secure the pocket part in the back cover of a hardbound book. Side stitching is only used on Thomson Reuters products.

Muller Martini Side Stitcher

Gathers up to 13 signatures (usually 4) on top of one another and a manila card on the back. Two-wire staples are placed through the book approximately 3/16-inch from the spine. Pocket parts are trimmed one at a time on the in-line three-knife trimmer.

XG-3 (Harris) Side Stitcher

Gathers up to 10 signatures (usually four) on top of one another, and a manila card on the back. Pocket parts are trimmed one at a time on the in-line three-knife trimmer. Drilled Binder pamphlets are also produced here. These will look similar to a Pocket Part; except they do not have the manila card and are drilled in-line.

Other Supporting Operations

Longford (Gathering Machine)

The Longford has 30 feeder boxes and gathers pocket parts into complete sets and odd titles. It can bundle up to a maximum 7 ¼ -inch height (usually run at a 5 ½ inch height). At the Longford, bundles are strapped or shrink wrapped and sent to the next operation for shipping. The Longford is only used on Thomson Reuters products.

Laminators

Laminators apply lay-flat poly or nylon film to printed sheets, which are used as the cover for softbound or hardbound books. Film is available in satin, matte and gloss finishes. Gloss lamination greatly increases luster and shine; matte and satin finishes are softer and less obvious to the eye, as well as less reflective. Laminating creates a very durable book cover.



UV Coating

UV coating is an alternative process to lamination with similar visual properties. UV coating uses an ultra-violet light to cross link the photo-reactive polymers of a liquid material into a thin plastic layer. UV coating is available in gloss, satin and matte finishes and is suitable for softcover or marketing materials.

Endsheet Area

The Endsheet Area is used to create four- or six-page reinforced endsheets (four pages is standard). For hardbound books, endsheets are attached to the front and back of the book block during the binding process. Endsheets are critical to the strength, durability and overall longevity of a hardcover casebound book.

Brackett Stripper

Custom printed endsheets can be printed in the pressroom to be added to the inside cover of a hardbound book.

Tipping

Tipping is used to combine two signatures or a signature and an endsheet. A 1/8-inch bead of glue is applied to secure two forms together. Tipping is used for jobs consisting of more signatures than the binders have feeders, therefore requiring that two signatures be tipped together and doubling capacity.

Product Finishing

The Product Finishing area performs all the custom finishing work to products before they are shipped or sent to storage. Processes include the following:

Binder Assembly

In the loose-leaf area, employees assemble binders and content. Responsibilities include:

- Customer orders for shipment of loose-leaf products
- Updating inventory

Hand Assembly

The hand assembly area includes processes done by hand, including the following:

- Binder assembling
- Applying stickers
- Tip-ins
- Ribboning

Drilling

- Drilling is a process where holes are drilled using a hollow point drill according to a pattern or template to fit into binders.
- Saddle-stitched pamphlets and loose pages are done on five manually operated Lawson machines.
- Perfect bound pamphlets and burst loose are drilled on an automatic Dexter Lawson drill.
- After drilling, loose-leaf products are final trimmed (at spine).

Shrink Wrapper

The shrink wrapper is used to collate and wrap products with poly film. The minimum size is 5" x 5" and the maximum size is 9" x 12", with a maximum thickness of 4.5". The following products are shrink-wrapped:

- Loose-leaf updates or binder supplement sets for subscription mailing and for stock
- Book sets for customers
- Kits for customers

Flatbed (Polar) Cutters

The flatbed cutters are used to trim covers for case making or perfect binding. They are also used to cut materials for endsheets, tip-ins, or reference materials.

Tabbing

Tabbing is a process that converts sheet stock by cutting away extra material, leaving a protruded tab that is used to identify a section in a binder or in documents.

Three-Knife Trimmers

Three-knife trimmers, which are incorporated into the softbound binding and casing-in lines, trim the head, tail and face of products.

Folding

Folders bend and crease a sheet of stock to form a printed product. A sheet is carried through conveyor belts from the feeder. The sheet enters the folding plate, which adjusts the length of the fold. The sheet hits a stop, buckles and is carried between two rollers to fold the sheet. There can be up to 64 pages to a folded signature.

Buckle

The buckle fold uses two rollers pushing the sheet between two metal plates, stopping it and causing it to buckle at the entrance to the folder. A third roller working with one of the original rollers uses the buckle to fold the paper.

Gate

The gate fold creates a flap from the front edge, with a fold running parallel to the spine of the book. The finished page is marginally smaller than the normal trimmed page. A card or heavy board is double folded from the two outside edges of a folder. The two folded pages meet in the center of the page, edge to edge, like a double gate.

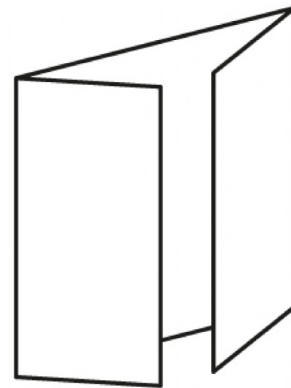

Accordion

The accordion fold is commonly used for brochures. One advantage to this type of folder is that every panel is the same size, simplifying mechanical production by eliminating allowances for “creep” from panel to panel. In addition, all folds are in the same direction (parallel), avoiding folding specific panels against the “grain” – often troubling when printing on coated papers because of the potential for cracking of surface coatings.

Perforation

Perforations are used to allow glue to penetrate to the center of the form when binding. Different perforations are needed depending on binding styles. Perfect-bound books have a small perforation on the spine, whereas burst-bound books have an open perforation on the spine. For sewn, cover or saddle-stitched products, there is no perforation on the spine.

Folding

Basic Four-Page Fold



Basic Six-Page Fold

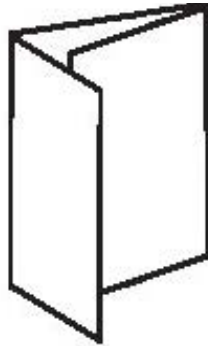

Basic Accordion Fold

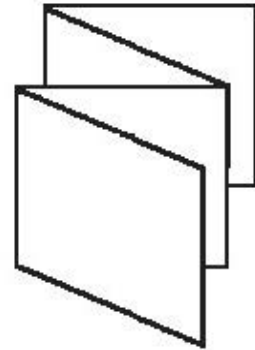

Eight-Page Right-Angle Fold

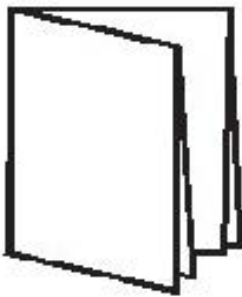

Variation to Eight-Page Fold

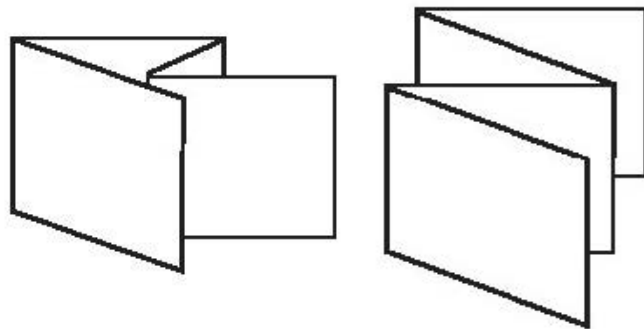

Variation Six-Page Accordion Fold

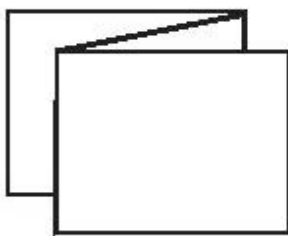

12-Page Fold

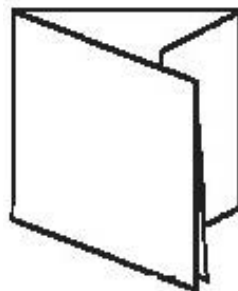

16-Page Fold

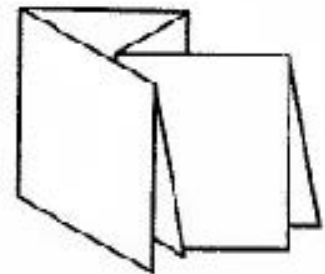

Process Flow

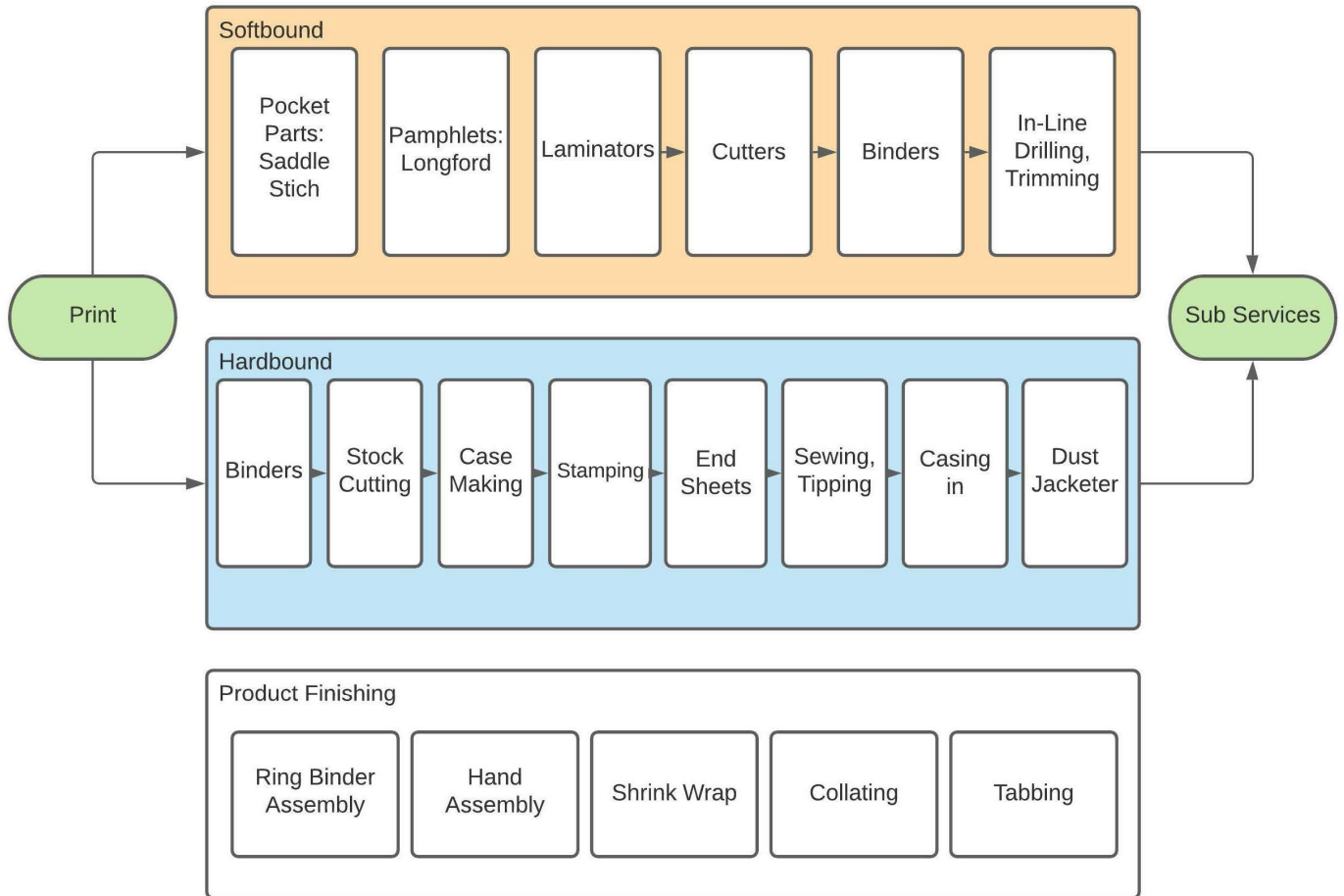







Subscription Services

Subscription Services consists of mailing, packaging lines, and packing benches with special handling areas.

Products ship in the following types of packages:

- Cartons
- Shrink wrap
- Poly bags
- Jiffy bags

Subscription Services packs and ships products to subscription customers, as well as bulk product orders for other customers. We utilize flex packaging, which ensures customers requesting multiple copies receive the fewest number of packages possible. By analyzing each subscription list, we determine how to package the multiple shipments using our automated equipment most efficiently. We strive to minimize postage and freight costs for our customers, always putting you first.

Mailing Areas

The Mailing Area folds and inserts documents into envelopes that have printed postal rates on them. These items are then placed in a tray or sack and loaded onto a USPS trailer.

The Computer Operations Print Center prints SAP generated company bills, accounting documents, and other items. These items prepare for mailing in Subscription Services.

The Facilities department delivers mail from the campus center mail room to Subscription Services for mailing.

Inserting Lines

Inserting lines are used primarily for first-class and standard mail (¼-inch thick maximum), which includes:

- Billing documents
- CDs
- Newsletters
- Marketing materials

The inserting line contains two Pitney Bowes postage meters.

The three inserters are:

- Bell & Howell (BH) BH2000: Inserts invoices into envelopes before going to packing line
- BH400: Invoices customers directly
- Flowmaster: Subscription newsletters and CDs inserted into mailing envelop

Flowmaster

The Flowmaster inserts products into 6 x 9 and 9 x 12 envelopes for mailing to customers or storage in the warehouse. This six-station inserting machine creates marketing mailings, newsletters, and CD-ROM/DVD discs. The inkjet-printer places an address directly on each envelope.

Inkjet

The Inkjet machine prints customer's information on envelopes, which is then used on other machines.

Hand Mail

The Hand Mail area is responsible for anything not being mailed from an automatic line.

Meters

Meters process pieces that weigh over 2 oz. These pieces get diverted from the automatic lines to be metered manually.

Sorting/Packing

Packaging Lines

The packaging lines automatically place products in cartons or wrap and affix subscription notices, with addresses, to the packages.



Levomatic: 1- or 2- book carton machine

The Levomatic machine inserts up to two books in a carton automatically. Once auto-fed into the machine, a die-cut box forms around the material and is glued. Capable of 11 different package sizes, the Levomatic glues subscription notices to the outside of the box for the final step.

Red/Blue Line: Multiple-book carton packing line

The red/blue line packs multiple sets of books in cartons. The books are fed by hand into preformed boxes. These lines process 38 different package sizes and have a maximum of 12 feeding stations. Subscription notices are glued to the outside of the box and carton labels automatically apply as needed. Most pocket part sets and ship groups ship from these lines.

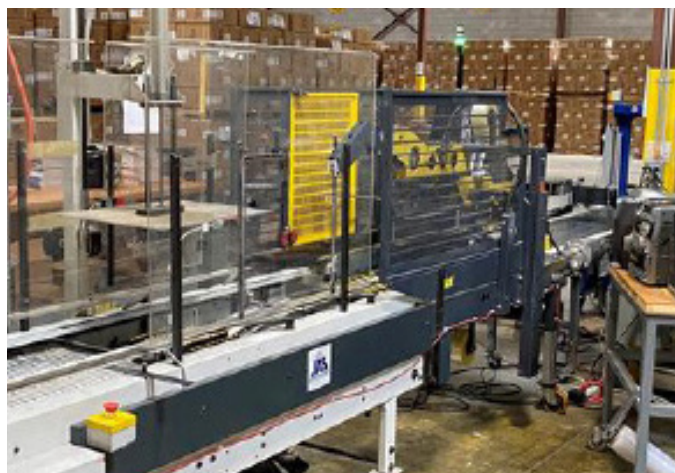

Tech Boxer: Multiple book carton packing line

- Books stage on an air table
- A carton is manually opened and placed on top of books
- Provides flexibility by assisting with Red/Blue Line workload
- Has added ability to auto-strap and auto-label cartons if needed

Sorting/Packing

Sitma: Individual product poly-wrap machine

The Sitma uses poly wrap on individual pamphlets after it inkjets customer addresses on the front cover of the publication.

- Primarily periodicals, single packages
- Individual poly bag for shipping protection
- Sorted, bundled, strapped, and sacked for routing efficiency and lower transportation rates
- Applies Post-Net bar code to obtain postal automation discounts

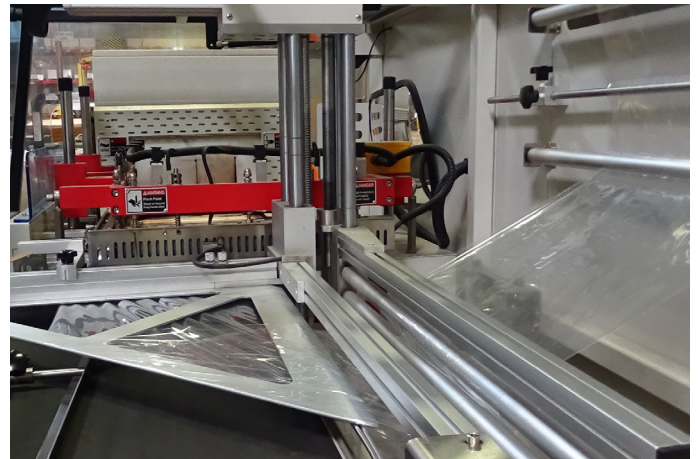

Polybagger: Single or multiple product poly-wrap machine

Similar to the shrink wrapper, the Polybagger also wraps products in poly film for shipment.

- Individual or multiple piece pamphlets or loose-leaf products
- Manual feed process
- Individual poly bag for shipping protection
- Primarily international shipments
- Subscription notices
- Applies Post-Net bar code to obtain postal automation discounts

Shrink Wrapper: Multiple product poly-wrap machine

The shrink wrapper uses poly film to prep products for shipment.

- Loose-leaf is the common product
- Manual feed process
- USPS sorts, and discounts apply to these packages
- Gathers materials for publication updates that send directly to customer
- Subscription notices



Packing Bench - Special Handling

All products are packed into cartons or envelopes.

The types of products processed at the packing bench include:

- Primarily parcels, small carriers and less-than-truckload
- Multiple copies of books to a single address

Special handling:

- International
- Priority shipments
- Packages going through Online Shipping Invoices (OSIs)
- Machine parts
- Product samples for machine testing by various machine vendors
- Marketing materials and trade show supplies
- Expedited shipments
- Special orders

The packing bench utilizes “range process” to generate labels. These labels have a bar code which specifies the quantity of books requested.

Once the order is packed, the operator utilizes SendSuite to “rate shop” for the highest quality, lowest price shipping method.

Why Do We Rate Shop?

- Pick the least expensive carrier that will deliver in the requested timeline.
 - Select Ground Services that can deliver in 1 or 2 days instead of Air Services.
 - Look at all possible carriers instead of using predetermined rules.
- Use actual weight from the scale to select the carrier instead of an estimated weight.
- Allow a shipping operator to ship small parcel, less-than-truckload, truckload, international and multi-pack shipments all from one, easy to understand, intuitive interface.
- Print appropriate shipping labels and necessary documents from WMS, ERP and IM systems, simplifying and automating the process, resulting in increased productivity.
- Customer service improves by the ability to respond quickly to delivery status questions.
- Automatically generate the Bill of Lading, Air Bills, COD Tags and Return Labels.

Subscription Fulfillment

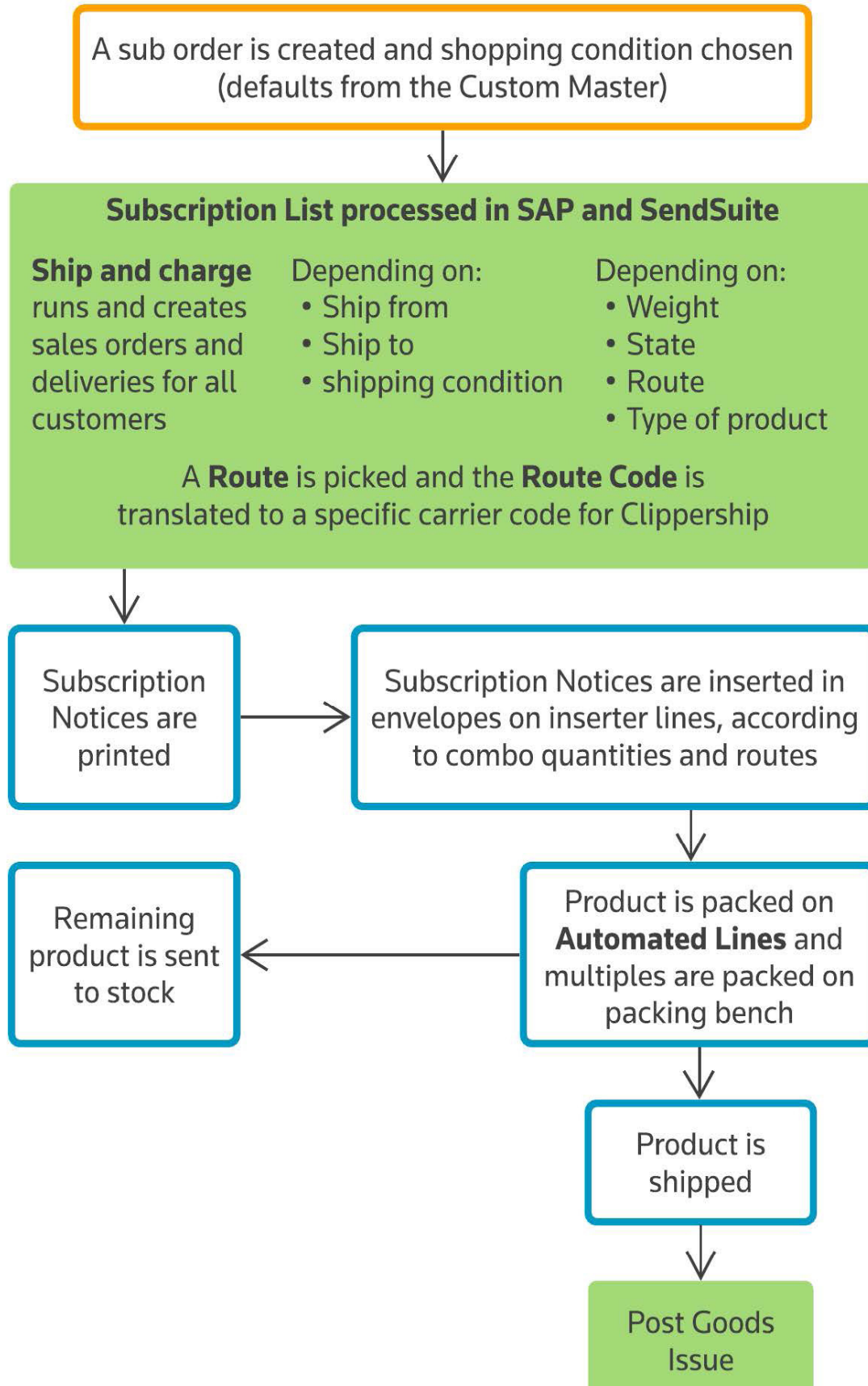







Distribution

Distribution Center

Core Publishing Solutions' Distribution Center picks, packs, and ships orders to thousands of customers worldwide. On average, we distribute 4,000 units a day.

We turn priority orders around the same day and strive to turnaround all other orders in 24 hours. At Core Publishing Solutions, we also pride ourselves in processing customer returns within five business days.

What sets us apart:

We meticulously "cycle count" all products and utilize a Sarbanes-Oxley-compliant inventory program. This allows us to have a 99.94 percent inventory accuracy rating.

Storage Area

The storage area contains full-pallet, half-pallet, tray, and tote boxes to accommodate all types of inventory. We can process and store any type of media.

Picking Areas

Wide Aisle

The Wide Aisle boasts the largest fixed-bin picking area in distribution. We assign like brand products in close proximity locations in order to optimize efficient picking. The Wide Aisle holds both customer and contract products.



Very Narrow Aisle

The Very Narrow Aisle accommodates bound volume product sets. Wiring in the aisle's floor enables the order pickers to self-guide. The operator only controls the truck's speed and elevation as they pick both sides of the aisle.



Flow Rack

Flow rack picking contains high order, high volume products. Picked materials flow to the packing stations via an overhead conveyor system.

Bulk Picking Locations

The Bulk Picking locations primarily house large, single product quantities of educational titles. A small number of customers typically employ this area.

Order Processing

Picking

All areas have unique location assignments for specific product placement. Using the SAP business system, Distribution knows where every product resides, allowing for quick and immediate retrieval. Utilizing computers on order pickers and handheld RFs, guarantees accurate picking.

Packing

The Packing area consists of 10 packing benches. A PLC-controlled conveyor feed transfers material from the flow rack to this packing area.

Main Packing Benches

The main packing benches process most of the orders. The specific variety of boxes and envelopes allows “perfect-fit packing.” This makes certain that the material is undisturbed during transit.

Large-Order Packing Bench

The large-order bench processes multiple packages at once. Multiple packages transpire from customers ordering the same product or set of products. In these cases, identical packaging requirements repeat from order to order.



Long-Term Storage

Products prepare for long-term storage by being stretch wrapped. This eliminates the fear of blemishes or damages during longer periods of storing.

Shipping - Outbound Fulfillment

Distribution's Shipping - Outbound Fulfillment group is responsible for:

- Package quality, package quantity verification, and proper packaging.
- Generating customer address labels.
- Assigning a carrier, creating shipping documents and loading carrier vehicles.
- Posting shipment system tracking updates.

The most recurrent types of shipments are:

- Parcel shipment
- Less-than-truckload (LTL) freight orders
- Truckload (TL) freight orders
- International (including ocean freight)



After the shipment has passed through SendSuite (the traffic management system), an e-mail providing shipping details and tracking data is automatically sent to customers.

Third-Party Logistics

Distribution offers unique third-party logistics (3PL) services to our customers. Since the order entry using Web Services is not SAP-specific, it allows communication with most other business systems. We can accommodate nearly any business with only minor modifications.

SendSuite allows us to easily support shipping requirements and gives customers the ability to track all shipments. This information flows through the Web Services and all standard tracking records. Additionally, inventory interfaces provide live visibility of current inventory levels. Customers can easily access this information.

To support our customers, we have an account manager who acts as a personal liaison between 3PL customers and the Distribution Center.

Also, reverse logistics activity is processed through SAP and can be transmitted to our contract customers via this same Web Service.

Our team of talented business analysts provide process and business analytics, as well as routine performance and status reports. We provide the support customers deserve.

Shipping - Outbound Fulfillment

Returns

Distribution's returns, also known as reverse logistics, is responsible for:

- Receiving customer returns.
- Applying credit to automated returns in SAP.
- Restocking or recycling product as appropriate.
- Collaborating with Accounts Receivable to ensure correct processing of complex returns.

Inventory Control

To ensure the accuracy of inventory and to support efficiency of the overall manufacturing operation, Distribution also has a separate inventory control function.

This group's responsibilities include:

- Assignment of picking locations to support efficient picking and cost-effective storage.
- Execution of the Cycle Counting program to validate and correct inventory accuracy.
- Control of product reorder points to minimize potential stockouts.
- Ensuring overall inventory integrity.

Order Fulfillment

Core Publishing Solutions uses a variety of different methods for customers to submit orders to us to fulfill. Our standard uses an API customers can call, but we also can use EDI through EDI providers, as well as pick up FTP files. We can accommodate multiple methods based on the customer's ability to submit orders electronically. The API has the most options for submitting and receiving data about the orders, tracking numbers, advance shipment notifications and inventory. We can work with customers to accommodate their needs, from basic manual Excel file submissions to fully automated API calls.

Typical Order Fulfillment Flow

Even with 94,000 titles in a warehouse as big as 10 football fields, our automated system helps forklift drivers find products efficiently. We proudly distribute millions of items annually!



History



Core Publishing Solutions has a global reputation for developing innovative solutions that fulfill our clients' needs for high-quality products at a competitive price point.

This dedication began nearly 150 years ago, when two brothers opened John B. West, a storefront book publisher and bookstore that was one of the precursors to what eventually became Thomson Reuters. The business owners soon realized that their customers did not have an effective way to get current opinions from Minnesota courts. West responded in 1876 by publishing *The Syllabi*, a weekly publication that provided attorneys with court opinions at an unprecedented rate.

From that point in time, West focused on providing high-quality printing and trusted legal information to clients throughout the United States. West eventually merged with Thomson in 1996 to form Thomson West.

With an eye focused on its customers, Thomson West developed print-on-demand publishing to quickly provide customers with short-run, high-quality print products. In 2006, Thomson West introduced the first-ever short-run binding machine. Custom-made in Germany, the machine binds hard and softbound books simultaneously and turns products around in record time.

Thomson West subsequently acquired Reuters in 2008 and formed the Thomson Reuters that we know today.

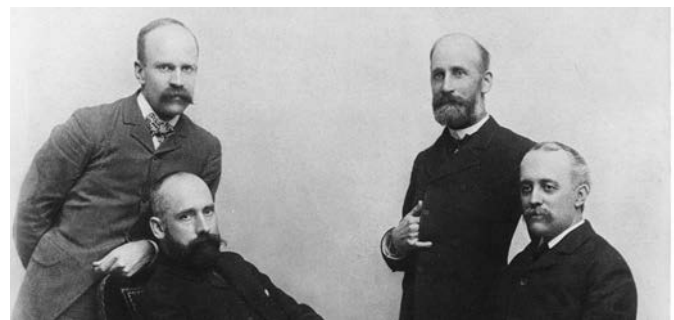

Core Publishing Solutions

In 2013, the Core Publishing Solutions brand was created to market print and warehousing services to publishers.

In 2015, we switched from toner-based digital printing to Ink Jet digital printing with the purchase of an HP Inkjet web roll printer.

In 2016 we produced our first Bible, marking our entry into the Bible production and spiritual printing market.

In 2020, we installed an HP T490 4-color inkjet press, expanding our capabilities and allowing us to offer even more solutions to our clients.

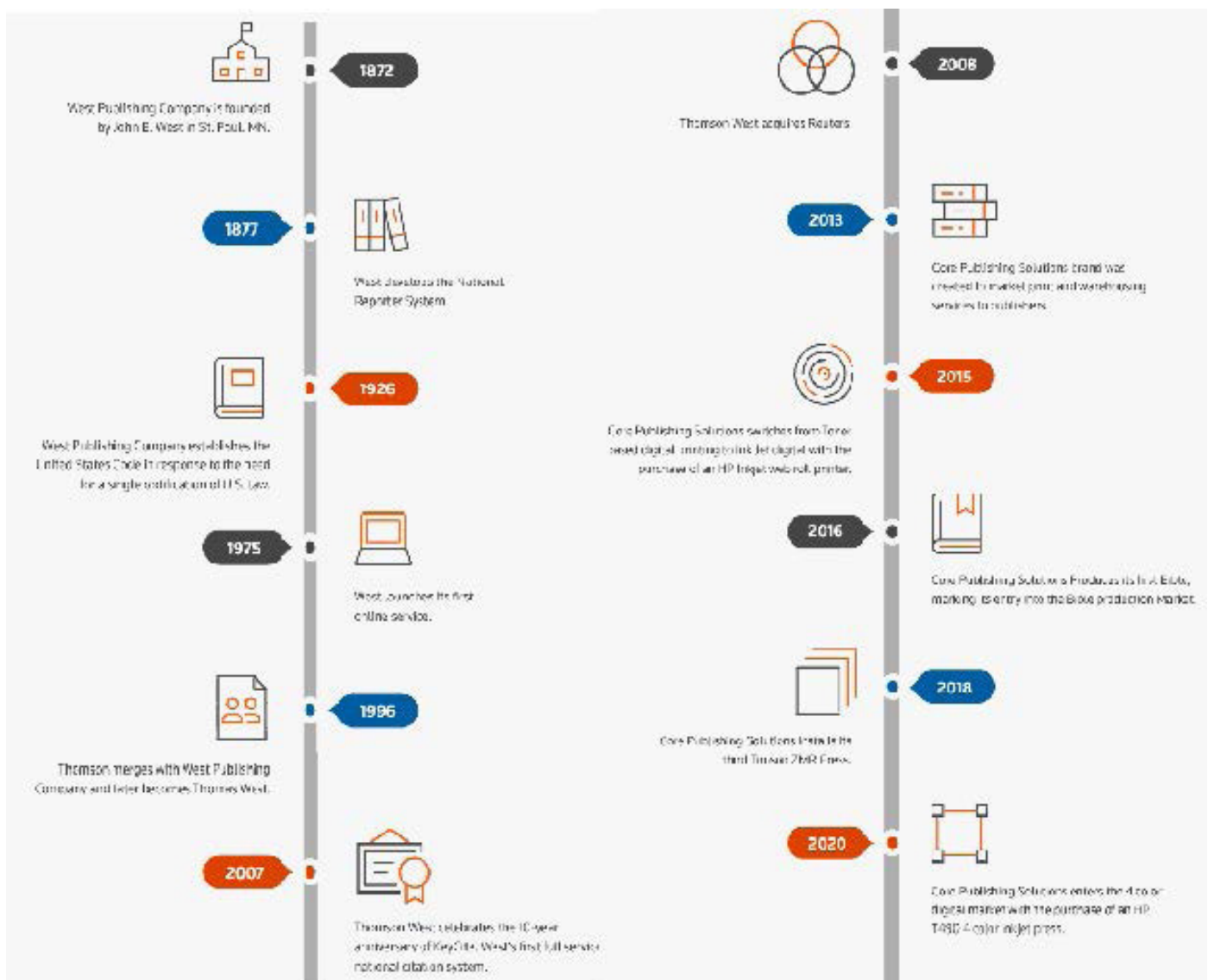



Thomson Reuters

Core Publishing Solutions

Book Manufacturing Terminology

A

Adhesive. A hot-melt or cold-set glue used in book binding.

Adhesive Binding. Generic term for book binding, which uses adhesives along the backbone edges of assembled printed sheets. The book or magazine cover is applied directly on top of the tacky adhesive. Examples are perfect-bound and burst-bound.

Adobe Acrobat. A program or suite of programs from Adobe Systems, Inc. which creates, edits, and manipulates PDF files that can be viewed on any computer system that has PDF-reading software (such as the Adobe Acrobat Reader). PDF documents are often referred to as Adobe Acrobat files, even if a different program was used to generate the file.

Against the Grain. Folding or feeding paper at right angles to the grain of the paper; also called cross grain.

Anti-Aliasing. Smoothing or blending the transition of pixels in an image. Anti-aliasing the edges on a graphic image makes the edges appear smooth, not “jagged” or bit-mapped.

Anti-offset Powder. Finely powdered starch sprayed on the printed surface of coated paper as sheets exit the sheet-fed press. This prevents wet ink transfer from the top of one sheet to the bottom of the next sheet.

API (Application Programming Interface). A means for computer applications to communicate with one another. It is an access point to an app that can access a database.

Aqueous Coating. Water-based coating applied like ink by a printing press to protect and enhance the printed surface.

Archive. A place or collection containing records, documents or other materials of historical interest.

Artwork Mock-up. A comprehensive design produced primarily to give the client an approximate idea of what the printed piece will look like.

Attribute (Font). A font characteristic (such as bold or italic,) created by highlighting a font and clicking on a button. Font characteristics created in this way may not print properly (e.g., a bold version of the font might not exist, but it will look bold on your computer screen). Instead, you choose the bold version of the font from the Font menu in the application you are working in.

Automatic Picture Replacement (APR). Scheme where low resolution images are swapped with their high-resolution counterparts.

Automatic Plate Changing. Capability of a press to automatically change plates.

B

Back. The inner margin of page.

Backbone. The back of a bound book connecting the two covers; also called a spine.

Backing. Shaping the spine of a book block to form a shoulder on its front and back; one of the case binding operations, (see *also* rounding).

Back Lining. Reinforcing material, paper or fabric, that is glued to the book block backbone or spine in a case-bound book after rounding and backing.

Back Up. In printing: to print the second side of a sheet already printed on one side. In computers: to make a copy of your work on a separate disk in case something happens to the original.

Banding. In digital printing, this term refers to patterns on a print caused by insufficient color or gray-scale ranges within the output device's image processor, or insufficient information contained within the original scan. Banding is most noticeable in printed areas that fade from light to dark.

Bar Code. A binary coding system using a numerical series and bars of varying thicknesses or positions that can be read by optical character recognition (OCR) equipment. Bar codes are used in printing as tracking devices for jobs and sections of jobs in production.

Basis Weight. Weight in pounds of a ream (500 sheets) of paper cut to a given standard size for that grade; example: 500 sheets of 17-by-22-inch 20 lb. bond paper weighs 20 pounds. In countries using ISO paper sizes the weight, in grams, of one square meter of paper.

Bearers. The flat surfaces or rings at the ends of press cylinders that come in contact with each other during printing and serve as a basis for determining packing thickness.

Bill of Material (BOM). A list of parts or components by Original Equipment Manufacturer (OEM) part number, or by other description.

Binders Board. Paper board used in making the front and back covers of a case-bound book.

Binding. Joining the assembled (collated) pages of a printed piece together. Binding takes many forms, including saddle-stitching, adhesive binding, mechanical binding and loose-leaf binding. Binding is also used as a general term to describe all finishing operations.

Bitmap Font. A font used to display text on a computer screen. The letters in a bitmap font are broken up into pixels. When the font is sent to a printer, or enlarged to large point sizes on the screen, the letters will look "jagged" or bitmapped.

Blanket. In offset printing, a rubber-surfaced fabric that is clamped around a cylinder. The image is transferred from the plate to the blanket, and from which it is transferred to the paper.

Blanket Cylinder. The cylinder that carries the offset rubber blanket.

Bleed. When any image or element on a page touches the edge of the page, extending beyond the trim edge, leaving no margin, it is said to bleed. It may bleed or extend off one or more sides.

Bleed Tab. A bleeding ink square at the edge of a page that functions as a guide for locating specific material.

Blind Stamp or Emboss. A design, that is stamped or embossed without metallic ink or foil. Giving a bas-relief effect.

Blueline. Prepress photographic proof made from stripped negatives where all colors show as shades of a single color on white paper. Also called brownline, silverprint, Dylux®.

Body. The printed text of a book not including end papers or covers.

Bond Paper. A grade of writing or printing paper where strength, durability and performance are essential requirements; used for letterheads, business forms, etc.

Book Block. The gathered signatures of a publication before the cover is added.

Book Paper. General term used to define a class or group of papers having common physical characteristics that, in general, are most suitable for book production.

Bottling. If a page skews because of the number of pages, the thickness of the paper or the folding equipment, bottling is a method to adjust/compensate for the page skewing in folded signatures.

Brightness. In paper, the reflectance or brilliance of the paper.

Buckle Folder. A bindery machine in which two rollers push the sheet between two metal plates, stopping it and causing it to buckle at the entrance to the folder. A third roller working with one of the original rollers uses the buckle to fold the paper.

Building-In. A forming and pressing machine that holds cased-in books tightly under heat and pressure while the adhesive is drying.

Burnish. A similar process to stamping, but is done without a clear Mylar or foil and results in a color change of the material when debossed. This technique only works on certain types of materials and should always be tested to determine results. Depending on the material used, the burnished area could appear lighter or darker than the original material.

Burst Binding. A form of binding similar to, but more durable than, perfect binding, where the spine of each section is slotted or perforated during the folding operation. Glue is pushed up between the perforations during binding and the cover is then drawn on. Its advantages are that it allows the text pages to remain held together as a folded sheet and the adhesive has a larger area to grip by penetrating the slots and the backs of the signatures.

Burst Bound. The book block created for final processing with a hard cover using cold glue and hot-melt glue to hold the pages/signatures together. The signatures are collated, along with the needed end sheets to bind to the cover, and cold glue is applied to the spine folds. The cold glue is forced into the burst perforation, binding the pages to each other as well as binding the signatures. After the cold glue is dried, hot-melt adhesive is applied to the spine with a paper cap or "crash" in place of a cover. Layout Standard Trim: Spine – 0"; Head – 3/16"; Face – 1/8" Min.; Tail – 1/8" Min.

Burst Loose. Similar to burst pamphlet process where only the perforations are smoothed out on the spine before applying a false cover to the signatures. The signatures are collated and bound together using hot melt only to allow for consistent drilling and trimming. After the bound signatures are drilled, 3/16" is trimmed from the spine to create a loose-leaf product. Layout Standard Trim: Spine – 3/16"; Head – 3/16"; Face – 1/8" Min.; Tail – 1/8" Min.

Burst Pamphlet. Similar to perfect bound process, except that the bindery trims only enough paper from the spine fold to remove the bumps created by the burst perforation on the fold. No spine trim is allotted in Prepress for a burst pamphlet. Burst pamphlets should only be produced when the roll stock used on press only provides enough trim to take the minimum 1/8" face trim. Layout Standard Trim: Spine – 0"; Head – 3/16"; Face – 1/8" Min.; Tail – 1/8" Min.

C **Calender.** To make the surface of paper smooth by pressing it between rollers during manufacturing.

Calibrate. To adjust the scale on a measurement instrument, such as a densitometer, to a standard for specific conditions.

Calibration. A process by which a scanner, monitor or output device is adjusted to provide a more accurate display and reproduction of images.

Caliper. The thickness of paper, usually expressed in thousandths of an inch (mils). In board, however, it is expressed as "points". Also a device on a sheetfed press that detects double sheets or on a binding machine that detects missing signatures or inserts.

Carrier. The base solution of an ink used to distribute dye or pigment color. Water is the carrier for aqueous inkjet ink.

Cartons. Corrugated boxes used to pack a finished product.

Case. The covers of a Hardback (case bound) book; made with cloth or similar material and boards.

Case-Bound. A book bound with a stiff, hard cover which is covered by fabric or other material.

Case Maker. A machine that produces hard covers for case-bound books.

Casing-In. Insertion of text contents of a book block into the case when binding.

Cast-Coated Paper. Paper dried under pressure against a heated, polished cylinder to produce a high-gloss enamel finish.

Chalking. Refers to improper drying of ink. Pigments dust off because ink has been absorbed too rapidly into the paper.

Chill Rollers. On a web offset press, the section located after the drying oven where heat-set inks are cooled below their setting temperature.

Choke. To slightly overlap touching colors in order to compensate for minor misalignments on the printing press. Choke is one process where a lighter color surrounds and overlaps a darker color.

Chopper Fold. Conveying a signature from the first parallel fold in a horizontal plane, spine forward, until it passes under a reciprocating blade that forces it down between folding rollers to complete the fold.

CIE LAB. The CIE Lab color space was defined by the Commission Internationale de l'Eclairage (CIE) in 1976 and represents a three-dimensional, rectangular coordinate system. The vertical coordinate, L, specifies the lightness of a color; the 2 horizontal coordinates a and b represent the hue and the saturation on red/green and blue/yellow axes respectively. The CIE Lab color space is also ideal for representing color differences, since geometric distances in the color space more or less approximate the intuitive color differences.

CIP3. International Cooperation for Integration in Prepress, Press and Postpress is a Manufacturers' Association established in 1995 to promote the non-proprietary digital integration of the printing process, from Prepress to Post-press. Its most important achievement has been the definition of the Print Production Format, a data format for recording all information relevant for the print process. In 1999, CIP3 was incorporated into CIP4, which deals with a broader range of subjects.

CIP4. Created in 2000 from the Manufacturers' Association CIP3 (see above), seeks to provide the basis for the computer-based integration of the entire process involved in the production of print products, from preliminary costing and quotations to delivery and billing. One of the first results has been the establishment of the Job Definition Format (JDF) as a common standard.

Coated Paper. Paper with a coating of clay or other substances that improves reflectivity and ink holdout.

Collate. A finishing term for gathering paper in a precise order.

Colophon. Publisher's imprint or trademark. Generally used on the title page, jacket and binding.

Color Balance. Maintaining the ratio of cyan, magenta and yellow ink to produce a picture with the desired color and without an unwanted color cast or color bias.

Color Bar. A series of colored shapes printed outside of the finished area. These bars are used to verify the accuracy of the printing job and allows the press operator to calibrate the print job and adjust the press if necessary.

Color Electronic Prepress System (CEPS). A computer-based system for the Graphics Art Industry that electronically simulates the traditionally labor intensive or cumbersome tasks associated with page makeup and color image manipulation.

Color Model. Also referred to as color space. A color model is a geometric or mathematical representation of visible colors. Well-known color models include, CMYK, RGB and HLS (hue, lightness, saturation).

Color Separation. The process whereby the four process printing colors (CMYK) are separated into their primary colors to allow for professional printing.

Colorant. Colored particles or dyes added to inks giving them vibrancy and hue value.

Comb, Plastic Binding. A curved or rake-shaped plastic strip inserted through slots punched along the binding edge of the sheet. It is used to hold the product together mechanically.

Compact Disc, Read Only Memory (CD-ROM). An adaptation of the CD that is designed to store computer data in the form of text and graphics, as well as hi-fi stereo sound.

Compensator. A device used on the web press to assist with keeping registration by means of electronic eyes and a compensator bar on a plate.

Composite. Color separation file which contains all color information in one file which can be printed as a composite or separated into the individual color plates for printing.

Computer Aided Design (CAD). The use of computer programs to design detailed two- or three-dimensional models of physical objects, such as mechanical parts.

Computer Aided Manufacturing (CAM). The process of using computers to control tools and machinery in Manufacturing.

Computer to Plate (CTP). The production of printing plates directly from the computer without requiring film as an intermediate step. Also called "direct-to-plate." The plates are typically made of aluminum, but polyester, polymer and silicon plates are also used.

Continuous Tone. Also known as Contone; an image which contains gradient tones from black to white.

Contrast. The tonal change in color from light to dark.

Copy. Original job material (paste-ups, film, photos, and other graphics) furnished for the print job.

Coverage. The amount of ink on a page or sheet, usually given in percentages.

Cover Paper. Papers used for the outside covers of catalogues, brochures and booklets.

CPS. Core Publishing Solutions. The division of Thomson Reuters that manufactures Books for Publishers.

Crash. A flexible paper material used to cover hot-melt adhesive on the spine of a book block.

Creep. Sometimes called "push out," it is the distance margins shift when paper is folded and/or inserted during finishing. The amount of creep will vary depending on both the number and thickness of the sheets and must be compensated for during layout and imposition.

CREO. A company purchased by Kodak that was one of the original creators of direct-to-plate devices that Thomson Reuters utilizes.

Crop Marks. Crossed lines placed at the corners of an image or a page to indicate where to trim printed material. Crop marks may be drawn on manually or automatically applied with some desktop publishing software programs.

Cross Direction. In paper, the direction across the grain. Paper is weaker and more sensitive to humidity in its cross direction.

Crossover. Sometimes called "hook-up". Printing across the gutter or from one page to the facing page of a publication.

Curl. In paper, distortion of the unrestrained sheet due to differences in structure or coatings from one side to the other or to absorption of moisture on an offset press. The curl side is the concave side of the sheet.

Cutoff. Circumference of the impression cylinder of a web press, therefore the length of the printed sheet on roll to sheet presses or the length of the repeat pattern on roll to roll presses.

Cyan. One of the three subtractive primary colors used in process printing; commonly known as "process blue."

Cyan, Magenta, Yellow, Black (CMYK). A color model based on four process colors. The colors are mixed to create a full-color image on a printer or press.

Cylinder. Part of a system of large rollers on an offset lithography press. The plate cylinder transfers an image onto the blanket cylinder, which is then offset onto a press sheet passing between the blanket and impression cylinders.

D

Deboss. A plate-sunk image. To press an image into paper so it lies below the surface.

Densitometer. An instrument that measures transmitted or reflected light by indicating the percentage of a given area that is covered by halftone dots. This instrument is used to ensure consistency between films, proofs and printed pieces.

Density. The degree of color or darkness of an image or photograph.

Desktop Color Separation (DCS). An enhanced EPS file format. Not used as much as it was in the past, the DCS format is still necessary for some types of graphics work. DCS separates a CMYK graphic into five files: one gray scale image for each of the four CMYK process colors and an FPO file with preview which goes into the page layout document.

Device Driver. A program that controls a particular type of device which is attached to a computer. There are device drivers for printers, displays, CD-ROM readers, diskette drives to name a few.

Die. Device for cutting, scoring, stamping, embossing or debossing.

Die Cutting. Using sharp steel rules to cut special shapes from printed sheets. Die cutting can be done on either flatbed or rotary presses.

Die Stamping. Printing from lettering or other designs engraved into copper, brass, or magnesium.

Digital Press. A printing device that produces high-quality output directly from digital files without the creation of printing plates.

Digital Video Disc (DVD). A type of optical disk similar to the CD-ROM but with much greater storage capacity. A DVD holds a minimum of 4.7GB of data, enough for a full-length movie. DVD drives are backward-compatible with CD-ROMs, thus enabling them to play old CD-ROMs, CD-I disks, and video CDs.

Dot. An individual element in a halftone reproduction. Using a loupe you will see that printed pictures are made of many dots.

Dot (Gain). An increase in size of each dot of ink when printed due to temperature, ink and paper type. A press operator tries to minimize dot gain, which can muddy the printed image.

DTP. An acronym for either "Desktop Publishing System" or "Direct-to-Plate."

Dummy. A sample of the proposed work made to establish the exact dimensions of the bound book, e.g., size, shape, form and general appearance.

Duotone. A term for a two-color halftone reproduction from a one-color photograph.

Dust Jacket. Printed wrapper around a case-bound book to protect the binding.

E **EDI.** Electronic Data Interchange. EDI allows companies to exchange transactional data electronically.

Electronic Layout Sheet (ELS). Used for checking signature page order.

Embossing. Relief image to achieve a raised printed surface (blind embossing gives an unlinked impression on blank paper). To press an image into paper so it lies above the surface.

Encapsulated PostScript (EPS). A file format used to transfer PostScript image information from one program to another. The preferred file format for saving images, as it is resolution independent, as opposed to TIFF.

End Matter. Printed matter (usually explanatory) following the text of a book, e.g. appendices, bibliography, index etc.

End Papers/Sheets. Also called End Sheets; Folded pair of papers attached to the first and last signatures of a book and pasted to the inside covers. Sheet that attaches the inside pages of a case bound book to its cover. End Papers add to binding strength. Self-end Papers are a type of end paper which uses the text pages.

Errata Slips. Correction slips. Tipped in or inserted as separate sheets, after printing.

Ethernet. A very common method of networking computers in a Local Area Network (LAN). There is more than one type of Ethernet.

Even Pages. Left-hand pages bearing even numbers.

F **Fabric.** Cloth-like cover material used to make cases.

Face. Edge of signature that is handled when turning pages.

Filler Pads. Corrugated cardboard squares to fill space in cartons.

Filter. Also called a Plug-In for various programs, e.g., Adobe Photoshop or Illustrator, allowing the program to produce different effects. E.g., sharpening, blurring, and a multitude of special effects.

Final Size. The size of the printed piece after folding and any finished work.

Finished Goods. A complete and billable product.

Finishing. All post press operations, including folding, trimming, assembling sections and specialized tasks such as die cutting and foil stamping.

Flat. Another name for an imposition, ready for plating.

Flush Cover. Cover trimmed to the same size as the text pages, e.g., paperback books.

Fly Leaf. Blank leaf at the beginning or end of a book.

Foil. Metallic material used for printing (blocking) the wording on the binding case.

Foil Stamp. To press a heated die onto a sheet of foil, release the foil from its backing and adhere it to a substrate.

Fold. Bending and creasing a sheet of paper as required forming a printed product.

Folding. There are two kinds of folds: parallel and right angle. In parallel folding, each fold is parallel to the other. An example is a letter that requires a two parallel fold for mailing. Right angle folds are folds that are made at right angles to each other.

Fold Marks. Guides on the original copy and printed sheet that indicate where a printed piece will be creased.

Folio. The page number.

Font (Font Family). A font is a complete set of characters in a particular size and style of type. This includes the letter set, the number set, and all of the special character and diacritical marks you get by pressing the shift, option, or command/control keys.

Foot. Bottom or tail edge of the signature or page in a book.

Fore Edge. The outer margin of a page opposite side to spine.

Foreword. Prelude to the true text, usually written by someone other than the author.

French Fold. Two folds at right angles to each other.

Frontispiece. Left hand page illustration facing the title page.

FTP. "File Transfer Protocol." A method of file transfer through the internet. CPS preferred method of file delivery is Kodak's InSite (also listed in dictionary).

G

Gang. Print two or more finished products on the same sheet during one press run.

Gatefold. Flap from the fore edge, with a fold running parallel to the spine of the Book. The finished page is marginally smaller than the normal trimmed page. The two folded pages meet in the centre of the page, edge to edge, rather like a double gate.

Gathering. Lacing the sections of a book in correct order before binding.

Gradient. The blending from one color to another color.

Grain Direction. In paper making, the direction in which most fibers lie depending on the direction that the paper travels during the paper making process.

Graphics Interchange Format (GIF). One of the two most common image file formats on the Internet today, especially for animated banners. A GIF image can consist of a maximum of 256 colors.

Gripper Edge. The leading edge of paper as it passes through a printing press.

Gripper Margin. Unprinted blank edge of paper on which printing press grippers bear, usually half an inch or less.

Grippers. The metal fingers on a printing press which holds the paper as it passes through the press.

Gussets. Sharp creases usually on the head or face of some pages due to the inability to release all air during the folding process.

Gutter. The inside margin between facing pages, or the margin at the binding edge.

H **Halftone.** A process in which a black-and-white photograph is re-photographed through a screen so that the gradations of light and dark in the original photograph are reproduced as a series of tiny dots that print as a continuous tone. The fineness of the screen is measured in lines per inch, as in a "150-line screen," and is a factor in determining the quality of a printed photo.

Hardcover. A book with a separate case bound cover.

Head. The top of the page of a book or the top of a signature.

Head (Margin). Margin from the of the type area to the top of the page.

Headbands. Strips of material (often decorative) placed at the head and sometimes also at the foot of the spine of a case bound book block.

Head-to-Head. Arranging pages on a form during planning so that the top of one page imposition butts up against the top of the opposite page.

Heat-to-Tail Imposition. Arranging pages on a form during planning so that the top of one page butts against the bottom of the opposite page.

Hickey. Reoccurring, unplanned spots that appear in the printed image from dust, lint, or dried ink.

Hot Melt. Type of adhesive used on unsewn binding.

Image. A digitized representation of a photograph with the ability to be displayed on a computer monitor and output to paper or plate.

Image Area. Portion of paper on which ink can appear.

Imposition. Print operators will print books using large sheets of paper which will be folded later. This allows for faster printing, simplified binding and lower production costs. Imposition is the process of arranging pages correctly prior to printing so that they fold in the correct order.

Impression. Putting an image on paper.

InDesign. The latest, state-of-the-art software from Adobe for publication design and layout.

Index. Alphabetical listing of topics or subjects in a book showing the page numbers on which they appear.

Indicia. Postal information place on a printed product.

Ink Fountain. The reservoir on a printing press that holds the ink.

Inkjet Printer. A type of printing that recreates a digital image by propelling droplets of ink onto paper, plastic, or other substrates.

Insert. Specially printed piece for insertion in a publication.

InSite. Kodak's internet / intranet File Delivery and proof approval system.

Interleaf. Leaves inserted between the pages of a book.

ISBN. International Standard Book Numbering System

ISO. International Standards Organization

J

Job Definition Format File (JDF). A non-proprietary information carrier that can link and refer to multiple production devices; based on XML. This allows creators and print service providers to describe the intent of a printed piece, as well as each of the process steps that are required to achieve the intent. Also considered an electronic job ticket.

Joint. Groove going along the spine on case binding.

Joint Photographic Experts Group (JPEG). An image compression format used to transfer color photographs and images over computer networks. Along with GIF, it is the most common way photos are moved over the Web.

K

Kerning. In typesetting, the process of subtracting space between specific pairs of characters so that the overall letter spacing appears to be even.

Kiss Die Cut. Cutting the top layer of a pressure-sensitive sheet and not the backing.

Knock Out. To clear an area of absolutely every printing dot, or to outline an image and drop out all dots surrounding it. e.g., when white type appears on a color field (hence "knocking out" of the color).

L

LAB (Color Model). A color model that describes color in terms of its luminosity or brightness (L). It then describes color on an axis from green to magenta (A) and then from blue to yellow (B). LAB contains every color in both the RGB and CMYK gamut.

Laminate. Bonding clear plastic film by heat and pressure to a sheet of paper to protect the print and improve its appearance.

Landscape. Page or illustration wider than it is deep.

Layflat binding. A binding method where the cover is glued only to the sides of the spine so that a perfect bound book can lay flat when open. A strip of gauze is glued to the spine edge of the book block to hold the signatures or pages together. This allows the book block to "float" over the spine and lay flat when opened. In traditional perfect binding, the cover is actually glued to the spine of the book which means the book will not open as far as a lay flat book.

Layout 1/8-inch. Used for the perfect bound binding method. Layout Standard Trim: Spine Trim – 1/8"; Head – 3/16"; Face – 1/8" Min.; Tail – 1/8" Min.

Layout 3/16-inch. Used for the Burst Loose binding method. Layout Standard Trim: Spine Trim 3/16"; Head – 3/16"; Face – 1/8" Min.; Tail – 1/8" Min.

Layout No Spine Trim. Used for the following binding methods: Burst Pamphlet, Saddle Stitched, Side Stitched, Burst Bound, Side Sewn, and Smythe Sewn. Layout Standard Trim: Spine – 0"; Head – 3/16"; Face – 1/8" Min.; Tail – 1/8" Min.

Leading. The space between lines of type, often measured from the baseline of one line to the baseline of the next.

Leaf. Two pages of a book. The front and back of a single piece of paper.

Line Gauge. A printer's ruler, usually marked off in points, picas, agates, and inches, and sometimes also in centimeters. A 12"-inch, two-sided gauge has inches in 16ths and agate lines on the front. The back has 6 and 12 point (Picas) and point scales.

Line Screen. Refers to the organization of elements of a printing screen; used to define the density of the screen, e.g., a 133-line screen refers to a pattern with halftone dots per inch. The higher the number, the higher the quality of detail reproduction.

Lining Material. Stock used in the center between boards when making cases. Also used at the case in line to attach headbands.

Lip. The extended edge of one side of a signature that is gripped to open the signature to the centre spread to facilitate the opening of the section. Also known as lap or pick-up.

Loose-leaf. Finished product that is provided as loose sheets, often drilled for insertion into binders.

Loose-Leaf Binding. A process in which individual sheets can be inserted and removed at will from a section of a larger document often held in a three-ring binder.

LZW Compression. A type of compression that can be used automatically when saving TIFF files. Using LZW compression will not result in a loss in quality, but the compression rate decreases as the amount of information (number of bits) increases.

M

Magnus. A high-speed plating device used by Thomson Reuters and developed by Kodak.

Make-Ready. Machine preparation for each operation in the production process. A significant percentage of the cost of production, particularly for short runs.

Margins. Space surrounding printed area of a page.

Mark. A set of horizontal and vertical lines which indicate where a page should be positioned or trimmed. It could also be a mark on a plate that specifies a fold, a bleed, etc.

Match print. Trade name for 3M integral color proof.

Mechanical Binding. A generic term to describe book binding by mechanical means, such as ring, post, comb, spiral, wire and wiro, and by holding pages and cover together by staples such as saddle-wired (stitched) and side-wired (stitched).

Micrometer. Instrument used to measure the thickness of different papers.

Midtone. The middle range of tones in an image.

Moiré. The noticeable, unwanted pattern generated by scanning or rescreening a piece of art that already contains a dot pattern. This effect can also be caused by the misalignment of screen angles in color work.

O

OEM. Original Equipment Manufacturer

Offset Printing. Offset printing is a technique where the inked image is transferred (or "offset") from a plate to a rubber blanket, then to the printing surface.

OK Book. A set of signatures gathered from the Press to use as a sample in the Bindery.

Opacity. Property which minimizes "show through" of printing from the reverse side of a sheet of paper. The more opacity or the thicker the paper, the less show-through.

Open Prepress Interface (OPI). Also known as image-swapping technology, this is the process that allows low-resolution images inserted into a page layout program to be swapped with the high-resolution version for plate setting.

OS. A commonly used acronym referring to an operating system.

Outline Font. This is the correct name for what many people call a printer font. An outline font is the part of a PostScript Type 1 font that is installed on the computer hard disk and that gets downloaded to the output device when printing. It contains the PostScript instructions necessary to correctly describe the font shape.

Overhang Cover. Cover larger in size than the pages it encloses.

Overprint. To print one ink directly on top of another ink.

Overs. Copies produced in excess of the quantity ordered.

O-Wrap. A custom book sleeve, or vertical book wrap open on the spine and face of the book. Usually made with cover stock and a coating; UV or Laminate.

P

Page Count. Total number of pages in a book, including blanks.

Pallet. A portable platform used to enable drivers to move finished goods from one area to another. Also used to store product in the warehouse.

Pantone Matching System (PMS). An ink color system containing over 500 color swatches, each of which is identified by a color number and a formula for the ink.

Perfect Binding. An adhesive-binding method. Signatures are collated on top of each other, the spine of the book block is sawed off to create loose-leaf pages and roughened before adhesive is applied and the cover is drawn on. Note that 3mm of the back of the book is trimmed off during binding.

Perfecting. Printing both sides of the paper (or other material) on the same pass through the printing press.

Perfecting Press. A sheet-fed printing press that prints both sides of a sheet in one pass.

Pica. A typographic measurement. There are 12 points to a pica and approximately 6 picas to an inch.

Pico liter. The unit of measure for the volume of ink contained in a drop of ink. A pico liter = one trillionth of a liter.

Pigment. Water-based ink which contains solid, opaque pigment particles suspended in ink to provide color. Both the HP360 and Canon i300 ink uses pigment.

Pinholes. Tiny areas that are not covered by foil in stamping.

Pixel. Pixel is an abbreviation for picture element. It is the smallest individual dot that can be displayed on a computer screen.

Plate. Short for printing plate, this is generally a thin sheet of metal that carries the printing image. The plate surface is treated or configured so that only the printing image is ink-receptive.

Plug-In. A self-contained software component that adds or changes functions in a particular software system. When a user adds a plug-in to a software system, the foundation of the original software system remains intact.

Pocket. Slit in the cover board in the back of a hard bound book to store pocket part.

Pocket Part. A side-stitched supplement for a legal bound volume. This is usually published yearly.

Point. A printer's measure for type specifications. There are 12 points in a pica and 72 points in an inch.

Portable Document Format (PDF). A file format developed Adobe Systems. PDF captures formatting information from a variety of desktop publishing applications, making it possible to send formatted documents and have them appear on the recipient's monitor or printer as they were intended. To view a file in PDF format, you need Adobe Acrobat Reader, a free application distributed by Adobe Systems.

Portrait. A type of page orientation or illustration deeper than it is wide.

Postscript (PS). A page description language developed by Adobe Systems, Inc. to describe an image for printing. It handles both text and graphics. A PostScript file is a purely text-based description of a page. The computer language most recognized by printing devices.

PostScript Printer Description (PPD). A file that contains information on screen angle, resolution, page size and device-specific information for a file to be printed on a PostScript device.

Preflight. The test used to evaluate or analyze every component needed to produce a printing job. Preflight confirms the color gamut, color breaks, any art required (illustrations, transparencies, reflective photos, etc.), layout files, screen fonts, printer fonts, EPS or TIFF files, laser proofs, page sizes, print driver, crop marks, etc.

Preps. An imposition software that electronically places all of the client pages properly for plating. They are then sent to Prinergy (see below) for refining and trapping prior to plating.

Prinergy. A software/hardware system used by Thomson Reuters developed by Kodak. The system processes client electronic files by "refining" and trapping the electronic information prior to plating for the printing press.

Printer Driver. A program that controls printing and sets options such as print quality and paper size for a particular printer.

Printers Spreads. Pages of a document that are arranged in the order that they will be printed on a press. Thomson Reuters preference: Readers Spreads (see below).

Process Color. Also called full color. Refers to the four-color process reproduction of the full range of colors by the use of four separate printing plates, one for each of the primary colors - magenta (process red), yellow, cyan (process blue), and black.

Production Order. A precise description of a print order which contains all specifications and comments required for a job.

Profile. A file which describes how colors look on a specific output device. These profiles are used by Color Management Systems to automatically adjust colors as it passes from one device to another, making sure that the image looks the same on all devices.

Proof. The first copy of the actual book, used to find errors and make necessary corrections.

Quadtone. A gray scale image reproduced using four spot or process colors to add depth and color.

QuarkXpress. A desktop publishing (page layout) application for Mac OS and Windows, produced by Quark, Inc.



R

Raster Graphics. A type of graphics file which stores the images as a collection of pixels. They are also called bit-mapped images.

Raster Image Processor (RIP). A component used in a printing system which produces a bit map. The bit map is then sent to a printing device for output. The input may be a page description in a high-level page-description language such as PostScript, Portable Document Format or another bit map of higher or lower resolution than the output device.

Readers Spreads. Pages in a document arranged in the same order that they would be if a reader were reading the finished product. Publications are not printed this way on the press. Software rearranges or imposes the pages on a layout for plating that allows for folding and cutting into the final product.

Ream. Five hundred sheet of paper.

Reece Case. A flexible round corner case that utilizes a variety of materials available, i.e., genuine leather, bonded leather or PU materials. Reece is the name of the machine that makes the case, also known as a flexible case. Freeman is another machine that is used to make them.

Recto. The right-hand page of a book.

Red, Green Blue (RGB). The color space commonly used for computer monitors that divides color into the three primary colors of light: red, green and blue. They are not used in the printing process.

Register. To position print in the proper position in relation to the edge of the sheet and to other printing on the same sheet.

Register Marks. Cross-hair lines or some other marks on film, plates, and paper that guide production personnel in processing a print order from start to finish.

Resolution. Generally used as an expression of image output quality; usually expressed as either dots per inch (DPI), which refers to the number of pixels per inch, or lines per inch (LPI), which is the number of rows of dots per inch in a printed halftone image. The number of pixels in an image. The more pixels, the higher the resolution. The higher the resolution, the better the picture.

Rich Black. A black color that is made by printing with cyan and black ink units. This produces a much darker, deeper black on press than can be achieved by using the black ink unit alone.

Right-Angle Fold. A term used for two or more folds that are 90-degree angles to each other.

Rolled Spines. This occurs during the bundling of the signatures and prevents glue penetration on the spines.

Rounding. Creating a round spine of a book block during the hardcover binding process.

Run. Number of copies to be produced. This is also called print run.

Running Head. Title repeated at the top of each page of a book.

S

Saddle Collation. Pages are ordered consecutively for the first half of the signature; the second half of the signature contains the last pages of the job in consecutive order. The next signature in the layout will contain the pages that follow the first half of the previous signature and which precede the second half of the previous signature. (E.g., In two 32-page signatures, signature 1 would contain pages 1-16 and 49-64. Signature 2 would contain pages 17-48).

Saddle Glued. A binding method where a line of glue is applied along the spine folds to hold leaves and the cover together.

Saddle Stitched. Pamphlet produced by opening the signature at the middle fold and Pamphlet placing it over the spine fold of the next signature. After all signatures are collated in this fashion, wire is “stitched” or stapled through the spine fold to hold the product together (usually two stitch positions). The product may be produced with a cover or may be a self-cover pamphlet. Layout Standard Trim: Spine – 0”; Head – 3/16”; Face – 1/8” Min.; Tail – 1/8” Min.

Scanner. A digitizing device used to translate a picture or typed text into a pattern of dots which can be understood and stored by a computer.

Scoring. A crease put on paper to help it fold better, particularly helpful with heavier paper stocks, so that it will fold without cracking.

Screen Ruling. The number of lines or dots per inch used in both directions on a contact screen to make halftones or separations. Screen rulings are available from 65 lines per inch to 200 lines per inch. For color separations, however, it is better to use 150 line screens for best press control and visual resolution.

Scumming. Most often caused by a balance issue with water and ink; can also be a water form issue.

Self Cover. Cover printed on the same stock as a book.

Self-Ends. A type of end paper. If the extent of the book is such that blanks are left at front and back, the blanks can be used as end papers and are known as self-ends.

Server. A host computer that holds and delivers information and software to other computers linked by a network.

Sewn Binding. A book binding method using threads to hold signatures together, e.g thread-sewn, section-sewn with either cover drawn on or case bound.

Sheet-Fed Press. Press that uses pre-cut sheets of paper, rather than rolls.

Sheets. Plain or printed paper in the large flat form before folding.

Sheetwise. To print one side of the paper, then turn the sheet over to print the other side of the paper, using the same gripper and opposite side guide.

Shingling. A technique used to compensate for creep. The gutter margin on a page is gradually narrowed from the outside pages to the middle pages of the signature.

Short-Grain Paper. Direction of paper in which the machine is parallel to its shortest dimension.

Side Guide. The mechanical register unit on a printing press that positions a sheet from the side.

Side-Sewn. After initial burst binding, the book block has heavy-gauge thread “sewn” through the side of the entire book block near the spine. This method is used only for Elementary/High School textbooks and is similar to burst bound except no hot melt or crash is used. Layout Standard Trim: Spine – 0”; Head – 3/16”; Face – 1/8” Min.; Tail – 1/8” Min.

Side-Stitched. Type of stitching produced by collating the signatures and “stitching” or stapling wire through the side of the collated signatures in 2 stitch positions. This is also known as a Pocket Part. Layout Standard Trim: Spine – 0”; Head – 3/16”; Face – 1/8” Min.; Tail – 1/8” Min.

Signature. A printed flat sheet that is to be later folded into a multi-page document.

Signature Mark. Used in book work as a guide to gathering. The signature mark is usually a small capital letter but may also be a figure or bar printed at the bottom of the first page of each section (signature) of the book. The sequence of signatures is progressive throughout the book.

Slip Case. Protective custom made case that holds an individual book, or set of books. Usually open on the spine of the book.

Slitting. Cutting printed sheets into two or more sections by means of cutting wheels on the folding machine.

Smythe Sewn. Signatures are collated in order with end sheets. After collating, the signatures are fed into a sewing machine that sews thread through the spine fold of one signature at a time in consecutive order. After sewing, the book block must be “nipped” to tighten the spine by squeezing the book together and applying a thin layer of cold glue to the spine to keep the spine tight. Layout Standard Trim: Spine – 0”; Head – 3/16”; Face – 1/8” Min.; Tail – 1/8” Min.

Specifications for Web Offset Publications (SWOP). A standard set of specifications for color separations, proofs, and printing Web Offset to encourage uniform standards in the industry.

Spine. Part of a book's cover or jacket, visible when the book is on a shelf, or the binding edge of a book or publication.

Spine Perforation. Cuts on the spine of a signature. Styles vary depending on binding requirements. Examples are Burst, Mini Burst, Saddle, and Sewn.

Spiral Binding. Binding with wires in spiral form inserted through holes punched along the binding side.

Spoilage. Planned paper waste for all printing operations.

Spot Color. A specific color in a design, usually designated to be printed with a specific matching ink, rather than through process CMYK printing.

Spot UV or Varnish. UV or Varnish used to highlight a specific part of the printed sheet.

Spread. When a publication is printed with several interacting spot colors, gaps or color shifts may appear between objects. A spread closes the gap by overlapping a light foreground object to a dark background.

Square Back Binding. This is similar to perfect binding, but the cover contains no type on the spine. This style of binding can be used to replace products that have traditionally been bound as saddle stitched from 1/16” – 1/4” in thickness.

Squares. Projection of the boards beyond the head, fore edge, and tail of a book

Stamping. Using a die and often colored foil or gold leaf to press a design into a book cover, a sheet of paper or other substrate. The die may be used alone (in blank stamping) if no color or other ornamentation is necessary. Special presses fitted with heating devices can stamp designs into book covers.

Standard Collation. Pages run in consecutive order within the signature for collating one Format signature on top of the next. (If 2 32-page signatures, Signature 1 would contain pages 1-32, Signature 2 would contain pages 33-64.)

Stay Drill. Cloth reinforcement used when making six-page or pocket end sheets.

Step and Repeat. Prepress technique of exposing an image in a precise, multiple pattern to create a flat or plate. Images are said to be stepped across the film or plate.

Stock. Paper or other material to be printed and bound.

Substrate. Any surface on which printing or stamping is done.

Super. A gauze-like material added to the book block when casing in the add strength to the hard bound book.

T **Table of Contents.** A list of chapter titles, main headings or other divisions of a book inserted in the preliminary pages before the main text.

Tagged Image File Format (TIFF). An industry-standard file format developed for the purpose of storing high-resolution, bit-mapped, gray-scale, and color images.

Tail. Foot or bottom of a signature.

Tail Margin. Margin from the bottom of the type area to the bottom of the page.

Tear-Out Perf. A perforation made in the folder of a web press to allow the end user to easily tear out a page of the book.

Text. Body matter of a page or book, as distinguished from headings.

Thermoplastic Binding. A form of binding in which the pages are attached to a cover by means of a heat set plastic adhesive.

Throw-Out. Folded map or plan printed and bound in a book to fold out to a size larger than the page size.

Thumb Index. Alphabetical or subject index cut into the fore-edge of a book (Thumb Cut) to facilitate quick reference. Dictionaries are sometimes thumb cut.

Tipped-In. An illustration or printed matter separate from the main work and pasted in correct position at its inner edge to the page following/preceding it.

Title Page. The right-hand page at the front of a book following the half-title page. The title page shows the title of the book, the author's name, the publisher's name and the year of publication.

Tracking. The process of uniformly increasing or decreasing the space between all glyphs (letters) in a block of text. Tracking is sometimes called character spacing or letter spacing.

Transparency. A selected color or area on an element in a page design that allows another page element behind it to become visible.

Trapping. A technique in which abutting colors are slightly overlapped to minimize the effects of misregistration of the printing plates.

Trim. The cutting of the finished product to the correct size. Marks are incorporated on the printed sheet to show where the trimming is to be made.

Trim Marks. Crop marks placed on copy to indicate the edge of the page for trimming.

Trim Size. The final size of one printed image after the last trim is made.

TrueType. An outline font standard originally developed by Apple Computer in the late 1980s as a competitor to Adobe's Type 1 Font used in PostScript.

Typeface. The design name of the characters within a type family or font, for example, Times New Roman.

U **Unders.** Numbers of copies short of the quantity ordered.

Up. In printing, two-up, three-up, etc. This refers to the impositions of material to be printed on a larger size sheet, to take advantage of full press and binder capacity.

UV. UV printing is a form of digital printing that uses ultra-violet lights to dry or cure ink as it is printed. As the printer distributes ink on the surface of a material (called a "substrate"), specially designed UV lights follow close behind, curing - or drying - the ink instantly.

V

Varnish. A clear liquid applied to printed surfaces for looks and protection.

Vector Graphic. A graphics format that uses shapes and lines, called paths. Vector graphics are resolution-independent graphics that appear smooth and crisp regardless of how magnified the image is on screen. They also can be enlarged as big as you want them without having jagged edges. This format is best for line art and logos that don't require complicated coloring or textures.

Veranda. Projection of the boards beyond the head, fore edge and tail of a book, known as squares.

Verso. The left-hand page of a book.

Vignette. A photo or illustration, etc., in which the tones fade gradually away until they blend with the surface they are printed on or into another color.

Vignette Halftone. A halftone whose background gradually fades to white.

Virtual Proof. Looking at a visual representation of a project on a computer screen versus looking at a physical hard-copy proof. Typically delivered to a client as a PDF file.

W

Wash-up. Removing printing ink from a press and washing the rollers and blanket. Certain ink colors require multiple wash-ups to avoid ink and chemical contamination.

Waste. A term for planned spoilage.

Web. Roll of paper used in a web press and most often folded, pasted and converted in one continuous form. Also a ribbon of paper as it unwinds from a roll and threads through the press.

Web Guide. A device on a web press that by use of electronic eyes, keeps the paper web straight as it runs through the different sections of the press.

Web Press. A high-run, fast-speed printing press that uses rolls of paper rather than individual sheets.

Wire-O Binding. Continuous double series of wire loops run through punched slots along the binding side of a booklet.

With the Grain. Folding paper parallel to the grain of the paper.

Work and Tumble. To print one side of a sheet of paper, then turn the sheet over from gripper to back using the same side guide and plate to print the second side.

Work and Turn. To print one side of a sheet of paper, then turn the sheet over from left to right and print the second side. The same gripper and plate are used for printing both sides.

Workflow Automation. Using software technology to manage and optimize production processes.

X

Xtension. A plug-in for the page layout program QuarkXPress.

Z

ZIP. The filename extension used by files compressed into the ZIP format common on PCs.

