

Supplement to

CRST EUROPE

Cataract & Refractive Surgery Today

January 2015

Sponsored by Oculentis

The Oculentis Toolbox for Lens Surgery

LENTIS Comfort for cataract surgery, LENTIS Mplus Family for refractive cataract surgery, FEMTIS for laser-assisted cataract surgery.



The Oculentis Toolbox for Lens Surgery

LENTIS Comfort for cataract surgery, LENTIS Mplus Family for refractive cataract surgery, FEMTIS for laser-assisted cataract surgery.

CONTENTS

LENTIS® **Comfort**: A Modern Monofocal IOL..... 3
BY OLIVER FINDL, MD, MBA, FEBO

LENTIS® Blended Vision 4
BY DETLEV R.H. BREYER, MD

Photic Phenomena of Different Multifocal IOL Designs 6
BY PATRICK VERSACE, MD

The LENTIS® **Mplusfamily** 7
BY JOSEPH REITER, MD; JAN A. VENTER, MD; JORGE L. ALIÓ, MD, PhD;
AND CHRISTOPH BINDER, MD

First Experiences With the FEMTIS® Laser Lens..... 11
BY DETLEF HOLLAND, MD

Postoperative Stability and Lens Position of the FEMTIS® Laser Lens ... 13
BY FLORIAN T.A. KRETZ, MD, FEBO; AND GERD U. AUFFARTH, MD, PhD

LENTIS[®] Comfort:

A Modern Monofocal IOL

With good visual results, this lens can be implanted in even the most demanding cataract surgery patients.

BY OLIVER FINDL, MD, MBA, FEBO

So often today, patients expect not only functional results after cataract surgery but excellent UCVA and, more specifically, excellent intermediate UCVA. Although many monofocal IOLs can provide patients with good distance vision, spectacle correction is typically required for near and intermediate vision tasks. Likewise, many multifocal IOLs can provide patients with excellent near and distance vision but lack in the intermediate range. One trend that is surfacing today is the use of low-add multifocal IOLs to boost intermediate vision and leave patients with good contrast sensitivity.

One such IOL, the LENTIS Comfort MF15 (Oculentis; Figure 1), includes an addition of 1.50 D. This IOL is based on the company's Mplus IOL technology. Its single, blended transition zone works to deliver patients the same kind of distance vision as a monofocal IOL with the addition of excellent intermediate vision. In particular, this design provides enhanced vision at a distance of 60 cm and more. Additional key features of the Comfort IOL include excellent contrast sensitivity for improved twilight vision, optimized depth of focus, and natural imaging quality and color sensitivity. The lens is aberration neutral and rotationally stable, with an aspheric optic design. The optic size is 6 mm, and the overall length is 11 mm. It is available in -10.00 to 36.00 D, in 0.50 D increments above 0.00 D.

The Comfort lens design is somewhere between a standard monofocal lens and a premium IOL. Its biggest benefit compared with a monofocal IOL is that it provides the spectacle independence in the intermediate range that patients are looking for. Patients should be made aware that they may need reading glasses postoperatively and that some rare optical phenomena including glare and halos are possible and comparable with monofocal IOL designs.

STUDY

We recently conducted a monocentric, randomized trial to compare moderate monovision (1.25 D difference between eyes) with a monofocal IOL to micro-monovision (0.50 D difference between eyes) with low-add multifocality



Figure 1. The LENTIS Comfort is designed to provide enhanced vision at a distance of 60 cm and more.

with the LENTIS Comfort. We included 72 patients with age-related cataract and corneal astigmatism of less than 1.50 D who were motivated to decrease spectacle dependence.

A total of 35 patients were allocated to each group. Postoperative measurements included visual acuities at different distances, defocus curves, reading speed using the Salzburg reading test, stereo vision, contrast sensitivity, and spectacle dependence using a patient questionnaire. Most of these tests showed similar outcomes for both groups. Preliminary results at 3 months showed that results in two of the stereo vision tests were significantly better with the LENTIS Comfort, probably due to the lower anisometropia in this group. Additionally, the proportion of patients never needing glasses for near work was higher for the LENTIS Comfort group. There were no reports of dysphotopsia, and visual acuity results were similar in both groups.

CONCLUSION

Implanting a monofocal IOL remains the most appropriate choice for cataract patients who are com-

portable wearing glasses for near and intermediate vision tasks postoperatively; however, for those patients who ask for excellent intermediate and distance vision after cataract surgery, a low-add multifocal IOL like the LENTIS Comfort is a better option. This IOL is slightly more affordable than a true multifocal IOL and can provide the cataract patient with far more than functional results—enhanced vision at 60 cm and above and a wide range of spectacle independence for most daily tasks.

Oliver Findl, MD, MBA, FEBO, is Director and Professor of Ophthalmology at the Hanusch Hospital, Vienna, Austria, and a Consultant Ophthalmic Surgeon at Moorfields Eye Hospital, London. He is the Founder and Head of the Vienna Institute for Research in Ocular Surgery (VIROS), Hanusch Hospital, Department of Ophthalmology, Vienna, Austria. Dr. Findl states that he has no financial interest in the products or companies mentioned. He may be reached at oliver@findl.at.



LENTIS[®] Blended Vision

A new approach to fulfill patients' individual visual needs and reduce side effects with multifocal IOLs.

BY DETLEV R.H. BREYER, MD

Rotationally symmetric multifocal lenses typically provide patients with excellent far vision and good near vision; however, as we all know, intermediate vision, contrast sensitivity, halos, and glare remain problematic. Because today's world requires an increasing number of intermediate vision tasks, including computer work, nighttime driving, and mobile telephone use, the baby boomer generation is, generally speaking, not happy with the typical compromises in vision associated with multifocal IOLs.

A rotationally asymmetric IOL like the LENTIS Comfort IOL (Oculentis) increases patients' capacity for unaided intermediate visual acuity, but near vision, including reading small print in dim light conditions, may continue to require spectacle correction. One solution for this disparity in visual acuity is to create a blended vision system, in which the intended target refraction in each eye is different or the segmental Oculentis multifocal IOL is implanted bilaterally, with different additions of 1.50, 2.00, or 3.00 D. Furthermore, better contrast vision and less halos and glare are true clinical advantages of this blended vision strategy.

We first introduced this LENTIS Blended Vision optical model at the 2014 ISOP and ESCRS meetings, both in London. We have found success in targeting emmetropia in the dominant eye and -1.50 D in the nondominant. This strategy can ensure that patients achieve excellent distance UCVA, very good intermediate UCVA, and adequate near UCVA. Herein I share several pearls that can help other surgeons also achieve excellent UCVA at all distances and, in turn, enhance patient satisfaction.

THREE PEARLS

No 1. Understand your defocus curve and defocus capacity. We all know and understand the term *defocus curve*. In an attempt to compare defocus curves of different multifocal IOLs, we defined the area under the defocus curve of our young nonpresbyopic patients as 100% and put all others in correlation to that. We refer to this as *defocus capacity*. Although a juvenile phakic eye has a maximum defocus capacity of 100% (Figure 1A), a pseudophakic eye with a monofocal IOL has a defocus capacity of approximately 46% (Figure 1B). When we implant the LENTIS Comfort IOL with a different refractive target of 1.50 D, we can achieve a defocus capacity of 76%, and when we create blended vision with the Mplus X and Comfort IOLs, we can achieve a defocus capacity of 84% (Figure 2). This result is extremely close to the defocus capacity of trifocal IOLs.

Understanding one's own defocus curve and defocus capacity is essential to meet the visual needs of patients. Additionally, it can be used as a tool for patient education. Showing patients the defocus curves and supplementing that data with simulations of halos and glare, as suggested by Patrick Versace, MD (see *Photoc Phenomena of Different Multifocal IOL Designs*, pg 6, for more information), is empowering for patients; they know what to expect and what kind of results are possible, thereby minimizing the risk for unsatisfied patients postoperatively.

No 2. Get to know your patients. A strategy that works for one patient may not necessarily work for the next. In addition to understanding defocus curves, it is crucial for surgeons to understand exactly what kind of vision a patient expects postoperatively.

Patients who enjoy golfing, driving a motorbike, sail-

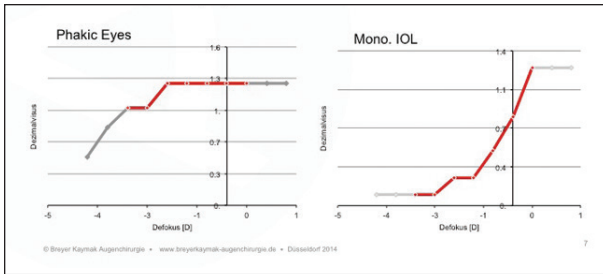

Figure 1. Defocus curves in phakic eyes (left) and pseudo-phakic eyes implanted with a monofocal IOL (right).

ing, playing tennis, and skiing, for instance, are distance-dominant. I have found that implanting the LENTIS Comfort in both eyes and targeting emmetropia works well in this group. At Breyer & Kaymak & Klabe Augenchirurgie, we call this strategy *Comfort Sports Vision*. This will ensure that patients achieve perfect far and intermediate vision and that newspaper reading is possible in good lighting conditions.

A second patient type is near-dominant. These are patients who enjoy reading e-books and playing with and working on a tablet or personal computer and spend most of their time in the office or at home. If they do not have a problem wearing glasses outdoors but want spectacle independence for indoor activities, like reading and computer work, we implant the LENTIS Comfort bilaterally and target a refraction of -1.50 D in both eyes. We call this strategy *Comfort Office Vision*. This will ensure that patients achieve easy reading and computer use without progressive glasses.

The last optical strategy happens to be my favorite, and there is a story behind the origination of the concept. A hunter wanted to see near and far perfectly in dusk and dawn and did not want to wear glasses in bad weather conditions. In this case, I targeted emmetropia in the dominant eye and -1.50 D in the nondominant so that the hunter could achieve a broad range of very good vision. An added bonus with this strategy, which we call *Comfort Overall Blended Vision*, is that the majority of patients do not experience any halos and glare and have outstanding contrast vision. Other patients who do well with Comfort Overall Blended Vision enjoy activities that involve far and near vision and desire spectacle independence for both.

No 3. Take advantage of advanced IOL technologies. Although the three strategies described above have given me the tools I need to increase patient satisfaction in the majority of patients, another group of patients—the *I-want-it-all patients*—expect excellent vision at all distances, regardless of lighting conditions. In these cases, it is beneficial to use other advanced IOL technologies, like the LENTIS Mplus X, provided they are generally positive people with realistic expectations.

I always start by showing the I-want-it-all patients the same defocus curves I show other patients, and I simulate postoperative halos and glare, in order for them to get a feel for what they can expect after surgery. However, my favorite

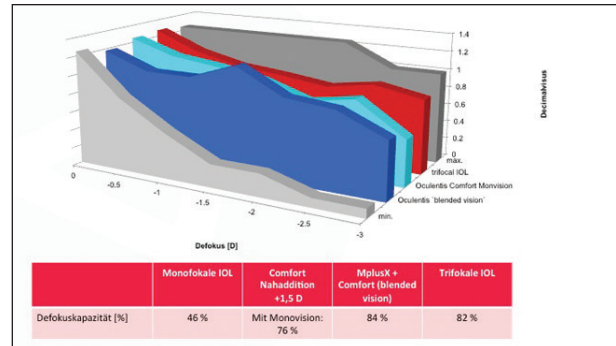

Figure 2. Defocus capacity of different multifocal IOLs.

option in these patients is a strategy I call *Mplus X Comfort Vision*: a target of emmetropia with the Comfort IOL in the dominant eye and the Mplus X in the nondominant. This will ensure that patients achieve a broad range of very good vision. The trade off of slight halos and glare in the nondominant eye should not affect patients too strongly.

The other group of patients in whom I prefer to implant the Mplus X is those who stay at home most of the time, do not do a lot of night driving, and are not bothered by halos and glare. I implant the Mplus X bilaterally in these patients and target emmetropia in both eyes, and we refer to this strategy as *MplusXL Vision*. This ensures that patients will achieve perfect far and intermediate vision and near vision in nearly all lighting conditions. The downside, however, is angle-wing glare.

OTHER CONSIDERATIONS

A few other things to keep in mind prior to implementing this (or a similar) strategy in your own clinic:

- Always perform a contact lens trial so that patients know exactly what their vision will be like after surgery.
- If a secondary enhancement is needed after surgery (which is rare with the Oculentis line of IOLs in my clinic), consider implanting a supplementary IOL in the sulcus rather than performing LASIK, as it will avoid induced spherical aberrations.

Surgeons have many IOLs to choose from. The best strategy one can employ is to study the defocus curves and pair them with patients’ demands. When one does so successfully, the result is happy patients. This may require one to implant the same IOL in both eyes with different refractive targets or to implant different IOLs in each eye, like the Comfort and Mplus X, with different refractive targets.

Detlev R.H. Breyer, MD, is Head of Breyer.Kaymak.Klabe Eye Surgery, a private practice and day clinic and Premium Eyes Refractive Surgery in Düsseldorf, Germany. Dr. Breyer states that he is a consultant to Oculentis. He may be reached at d.breyer@breyerkaymak-augenchirurgie.de.



The LENTIS[®] Mplus Family

These IOLs can help surgeons to provide a customized approach to vision for their patients.

BY JOSEPH REITER, MD; JAN A. VENTER, MD; JORGE L. ALIÓ, MD, PhD;
AND CHRISTOPH BINDER, MD

Mplus MF20: The Secret Formula for Near Additions



By Josef Reiter, MD

My experience with the LENTIS Mplus MF20 IOL (Oculentis; Figure 1) has been extremely positive. It represents an improvement in multifocal IOL designs and a new option,

allowing me to provide patients with excellent vision in the distance and intermediate ranges and good vision in the near range (up to 45 cm). I find that targeting slight myopia in the first eye is beneficial, as it is better for patients to be slightly myopic than hyperopic, especially with this lens.

PROSPECTIVE STUDY

In a prospective study of 20 patients (40 eyes) in whom the Mplus MF20 IOL was implanted during routine cataract surgery, we noticed an increase in distance UCVA (5 m) from 0.25 preoperatively to 0.8 at 3 months postoperatively, and in distance BCVA from 0.5 preoperatively to almost 1.0 at 3 months postoperatively. We also showed that the Mplus MF20 provided patients with very good intermediate acuity, both uncorrected and distance corrected, and surprisingly good reading

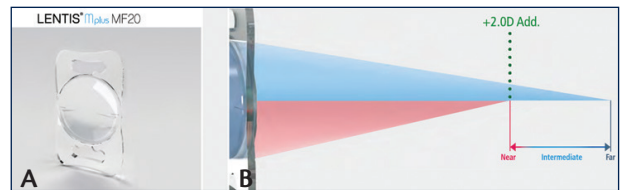

Figure 1. The LENTIS Mplus MF20 IOL (A) and a schematic diagram of the range of vision (B).

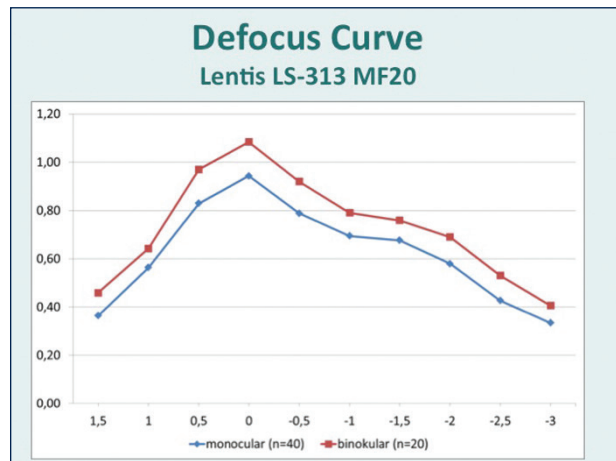

Figure 2. Binocular and monocular defocus curves of the Mplus MF20.

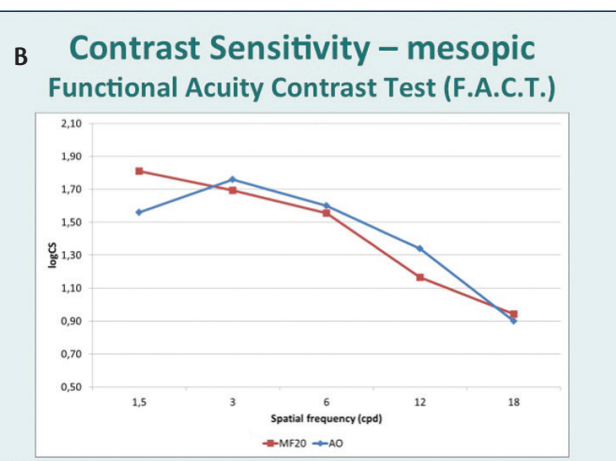
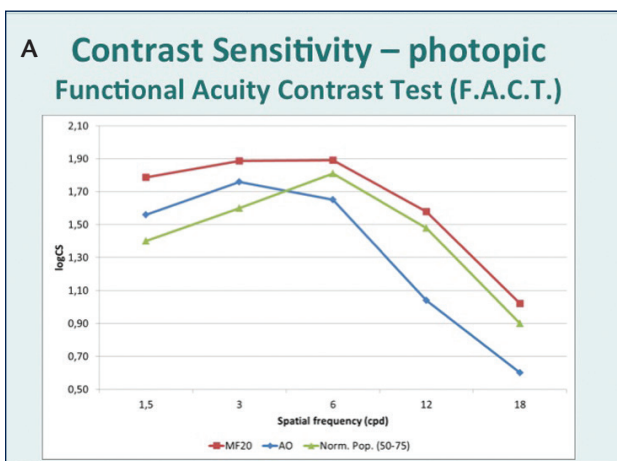

Figure 3. Contrast sensitivity in photic (A) and mesopic (B) conditions with the Mplus MF20.

acuity that is almost comparable with our results with the LENTIS Mplus MF30 IOL.

The binocular and monocular defocus curves (Figure 2) of the MF20 confirm that the lens provides good near vision and very good intermediate vision. These defocus curves fit well with patients' everyday experiences. Under photic conditions at 40 cm, most had a distance-corrected near reading acuity of 0.21 logRAD (Radner chart) and were able to read a critical print size of 0.4 (newspaper size). About 50% of patients required spectacle correction for print smaller than newspaper size. Similar to the Mplus MF30, contrast sensitivity in photic and mesopic conditions are quite good with the Mplus MF20 IOL (Figure 3).

We also were impressed with the results of our patient questionnaire. Only one patient reported moderate glare during the day, and no patient reported little or medium glare. Also, at night, eight and three patients experienced little or medium glare, respectively. These subjective results correspond well with our halo and glare simulation tests. Additionally, all patients had good intermediate visual acuity, which is important in everyday life, and 50% did not use reading glasses. In conclusion, the worst that can happen, in my experience, is that half of patients will temporarily need reading glasses for small print. In many cataract surgery patients, this is an acceptable result.

Josef Reiter, MD, is an ophthalmic surgeon at the Eye Clinic Landshut, Germany, and at LASIK Landshut Refractive Center, Bavaria. Dr. Reiter states that he has no financial interest in the products or companies mentioned. He may be reached at info@augenreiter.de.

The Mplus X IOL Versus The Mplus

By Jan A. Venter, MD

The LENTIS Mplus, introduced about 6 years ago, was the first available rotationally asymmetric IOL. Its design provided patients with better contrast sensitivity and balanced vision, which was a direct result of the IOL's two refractive segments—a large aspheric, asymmetric distance-dominant zone and a sector-shaped near vision zone with an addition of 3.00 D to direct light to a near focal point. Early results with the Mplus were promising; however, as with any premium IOL, there were some compromises, namely near (reading) vision, pupil independency, and depth of focus.

Last year, the LENTIS Mplus X (Figure 4) was released; improvements to the lens' design have enhanced and extended the entire depth of focus rather than improving any one focal point. This was achieved by introducing two modifications in the central part of the lens, Additive Paraxial Asphericity (APA) and Surface Design Optimization (SDO; Figure 5). The benefits of APA and SDO and the overall advantages of the Mplus X technology

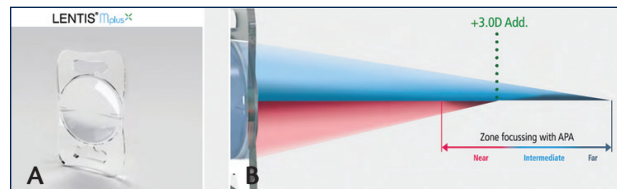

Figure 4. The LENTIS Mplus X IOL (A) and a schematic diagram of the range of vision (B).

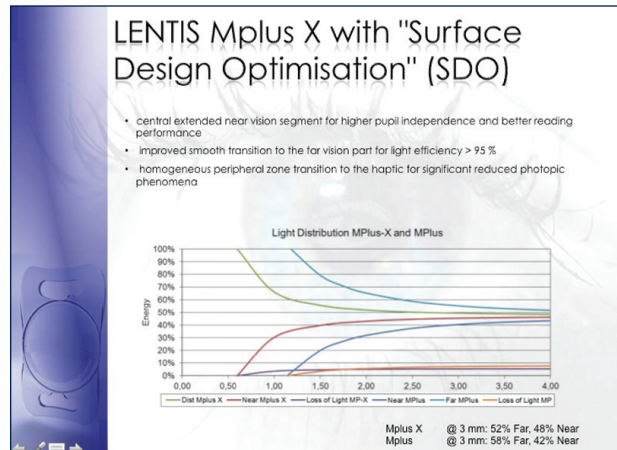

Figure 5. Light distribution of the LENTIS Mplus and LENTIS Mplus X IOLs.

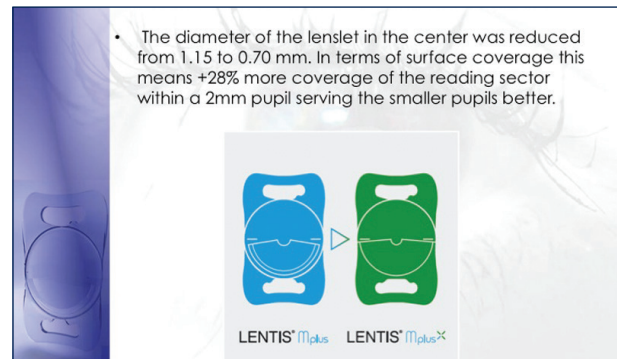

Figure 6. Central design of the LENTIS Mplus X IOL (green), in comparison to the LENTIS Mplus (blue).

are outlined in *Mplus X: An IOL With an Enhanced Design*.

Other changes to the Mplus X include a smaller lenslet (0.7 mm vs 1.15 mm with the Mplus), which translates into 28% more coverage of the reading sector within a 2-mm pupil, and elimination of the ridge in the near vision zone, resulting in fewer photic phenomena that are otherwise common in patients with large pupils (Figure 6). There is also a change in power along the axis of the near vision zone segment, now varying from 3.00 to 3.50 D at a diameter of 1.5 mm. The adjacent distance vision zone remains aspherical, so that the functional ± 0.50 D remains in the center and ensures that the lens is more near-dominant. With the Mplus X, a 3-mm pupil size can provide good functional image quality from 2.75 to 3.50 D.

STUDY AND RESULTS

We conducted a 3-month comparative study of the Mplus versus the Mplus X. A total of 2,010 eyes were enrolled, 1,035 in the Mplus group and 975 in the Mplus X group. There were no statistically significant differences between the two groups preoperatively in age (57 ± 7 years vs 58 ± 7 years, respectively), mean BCVA (-0.04 ± 0.09 vs -0.05 ± 0.08 , respectively), sphere (1.4 ± 2.77 D vs 1.37 ± 2.24 D, respectively), mean spherical equivalent (1.11 ± 2.78 D vs 1.07 ± 2.28 D, respectively), and cylinder (-0.60 ± 0.43 D vs -0.61 ± 0.52 D, respectively).

Mean spherical equivalent. At 3 months postoperatively, the mean spherical equivalent was the same in both groups (-0.03 D), and 80.7% and 80% of patients in the Mplus X and Mplus groups, respectively, achieved a standard deviation of ≤ 0.50 D; 95.7% in both groups achieved a standard deviation of ≤ 1.00 D.

Distance UCVA. Monocular distance UCVA was similar between groups, with 35.5% and 35.8% achieving 20/16 at 3 months postoperative in the Mplus X and Mplus groups, respectively. Additionally, 64.7% and 67.1%, achieved 20/20, respectively; 85.2% and 86.4%

achieved 20/25, respectively; and 97.9% and 97.4% achieved 20/40, respectively. Regarding binocular distance UCVA, 57.1% and 60.1% achieved 20/16, respectively; 83.7% and 86.5% achieved 20/20, respectively; 94.9% and 96.8% achieved 20/25, respectively; and 100% and 99.1% achieved 20/40, respectively.

Near UCVA. Although monocular near UCVA was similar at 20/20 (Mplus X, 8.8% and Mplus, 11.1%) and 20/25 (Mplus X, 28.3% and Mplus, 28.2%), more patients implanted with the Mplus X achieved 20/32 (73% vs 59.2%) and 20/40 (87.4% vs 80.1%). Regarding binocular near UCVA, more patients in the Mplus X group (20.9%) than in the Mplus group (14.5%) achieved 20/20. The same trend occurred with 20/25 (43.9% vs 37.7%), 20/32 (86.7% vs 77%), and 20/40 (97% vs 93.6%) binocular near UCVA.

Change in BCVA. The majority of patients in both groups had no change in BCVA from pre- to postoperatively.

Visual disturbances and patient satisfaction. The incidence of starbursts, glare, and halos was fewer in the Mplus X compared with the Mplus group. When asked, "How satisfied are you with your vision?" 51.2% of patients in the Mplus X group said very satisfied, 36.8% said satisfied, and only 1.3% said very dissatisfied. In the Mplus group, 43.4% said very satisfied, 41.7% said satisfied, and only 1.6% said very dissatisfied.

MPLUS X: AN IOL WITH AN ENHANCED DESIGN

APA:

- Enhances far and near focus zones for better depth of focus and balanced vision at all viewing distances
- Adapted zone focusing provides outstanding visual performance in the entire intermediate vision field
- Intelligent focal modulation for all light conditions simplifies neuronal image interpretation

SDO:

- New surface design of the near vision segment achieves higher pupil independence and better reading vision
- Improved SML production technology increases light efficiency to more than 95%
- Homogenous peripheral transition zone design significantly reduces photic phenomena

Advantages of the Mplus X Technology:

- Excellent visual acuity results for the complete near vision range
- Very good visual acuity results for the complete intermediate vision range due to the extended depth of focus
- Maximized light efficiency of more than 95%
- Natural contrast and color perception
- True 360° sharp optic edge
- Proven HydroSmart Acrylate material

CONCLUSION

Our study showed a decrease in visual disturbances and better reading vision with the Mplus X. Furthermore, there was no statistical difference between the two IOLs with regard to distance UCVA, and more patients were satisfied with the outcomes of the Mplus X.

Jan A. Venter, MD, is the Medical Director for Optical Express. Dr. Venter states that he has no financial interest in the products or companies mentioned. He may be reached at drjanventer@googlemail.com.

The LENTIS Mplus X IOL: A Varifocal Lens

By Jorge L. Alió, MD, PhD

With so many multifocal lenses to choose from, it can take any surgeon a long time to decide exactly what lenses to fit into his or her armamentarium. For me, I like the LENTIS Mplus family of IOLs; herein I share why I prefer the LENTIS Mplus X.

The redesigned LENTIS Mplus, the Mplus X, provides a continuous range of vision from near to far. The addition of two new features (APA and SDO; described above by Dr. Venter) have enhanced and extended the

level of depth of focus that can be achieved with this IOL. In my experience, patients achieve J1 near vision and comment that their intermediate vision in the office setting is just as good. Because the Mplus X is independent of pupil size, the lens can be implanted in a wide range of eyes.

I always try to under-promise and over-deliver in my postoperative promises, and this is exactly why I select the Mplus X for about 60% of my patients. Simply put, the refractive outcomes are excellent, patients do not experience a loss in contrast sensitivity, and visual quality is more than acceptable. Another advantage is that the IOL is tolerant of minimal to moderate decentration.

My optical bench tests on the LENTIS Mplus X have shown that depth of focus is better than the average of many other diffractive multifocal lenses, and there is little loss of light. Additionally, similar results to other diffractive models were detected in optical quality in distance- and near-simulated foci. In contrast, better optical quality was observed with the LENTIS Mplus X in the intermediate focus.

CONCLUSION

A varifocal IOL design is a sophisticated concept, but one that I think is fully accomplished by the Mplus X. With its unique surface design, this IOL provides a continuous change in power across all distances. As a result, patients have excellent near vision, acceptable immediate vision, and excellent distance vision. Although there is no intermediate focus with the Mplus X design, there is a focal area that extends depth of focus. This is really is what our patients are demanding today.

Jorge L. Alió, MD, PhD, is a Professor and the Chairman of Ophthalmology at the Miguel Hernandez University, Alicante, Spain, and the Medical Director of VissumCorporación in Spain. Dr. Alió states that he has no financial interest in the products or companies mentioned. He may be reached at jlalio@vissum.com.



Easy Handling of the LENTIS Mplus Toric MF20T

By Christoph Binder, MD

The LENTIS Mplus Toric MF20T IOL offers a personalized vision correction solution for patients with regular corneal astigmatism in combination with presbyopia. Due to its customizable optics, this IOL corrects nearly the complete range of all possible refractions, thus providing sharp and clear vision. With increasing demands for near-complete spectacle independence, the toric Mplus family of IOLs is my first choice for lens-based corrections. I offer them to patients with different near

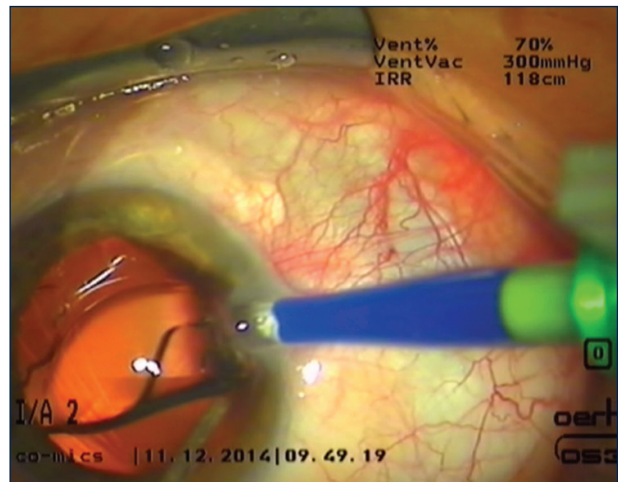

Figure 7. The LENTIS Mplus Toric MF20T IOL can be implanted through an incision size as small as 2 mm.

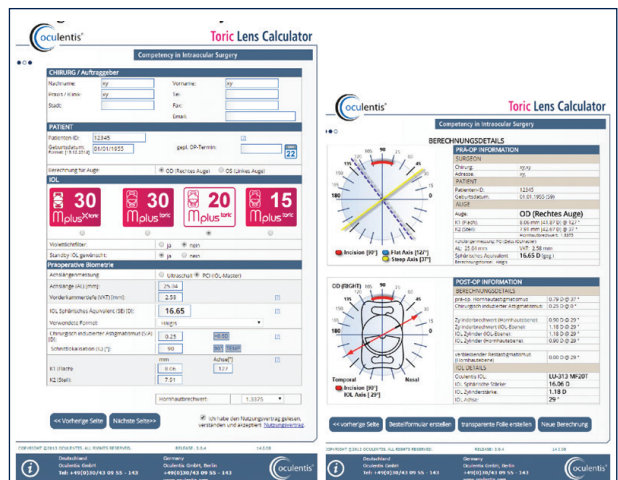

Figure 8. The Oculentis Online Calculator makes IOL power calculation and online ordering of the correct IOL easy.

additions and, when indicated, an optional violet light filter, so that each patient receives the best solution to his or her visual needs.

Additionally, the preset inferior placement of the multifocal near segment and the accordingly adjusted torus of the LENTIS Mplus Toric IOL facilitate easy orientation and, thus, easy implantation. The proven plate-haptic design of this IOL guarantees optimal rotational stability.

NO ASSOCIATED DRAWBACKS

With the introduction of the Mplus Toric IOL with a lower near addition (2.00 D), finally an all-in-one lens solution with no associated drawbacks of multifocal lenses is available. A softer transition between the two optical zones results in maximum light usage for daily intermediate tasks, thereby leading to brilliant vision.

In my perspective, the entire Mplus family of IOLs (Table 1) and the possibility to mix-and-match differ-

TABLE 1. LENTIS MPLUS FAMILY OF IOLs

Description	LENTIS® Mplus ^{XX}	LENTIS® Mplus MF30	LENTIS® Mplus MF20
Patient type	■ NDL "near-dominated lifestyle"	■ DDL "distance-dominated lifestyle"	■ IDL "intermediate-dominated lifestyle"
IOL performance	<ul style="list-style-type: none"> ■ Very good distance vision ■ Very good intermediate vision ■ Excellent near vision up to 30 cm 	<ul style="list-style-type: none"> ■ Excellent distance vision ■ Good intermediate vision ■ Very good near vision up to 35 cm 	<ul style="list-style-type: none"> ■ Excellent distance vision ■ Very good intermediate vision ■ Good near vision up to 45 cm
D (distance vision)	★★★★	★★★★	★★★★
I (intermediate vision)	★★★★	★★	★★★★
N (near vision)	★★★★	★★	★★
Features	<ul style="list-style-type: none"> ■ Addition of 3 diopters and additional depth of field APA ■ For mix-and-match strategy with LENTIS® Mplus MF20 ■ Minimal halos and glare phenomena 	<ul style="list-style-type: none"> ■ Addition of 3 diopters ■ Fast neuro-adaption ■ Minimal halos and glare phenomena 	<ul style="list-style-type: none"> ■ Addition of 2 diopters ■ Very good low-light vision ■ Patients with zero tolerance for halos and glare phenomena

Rating: good (★★), very good (★★★★) and excellent (★★★★★)

ent add powers give great opportunities for surgeons to treat patients as individuals, addressing one’s specific visual needs and wants.

In a small-scale clinical trial, I was able to tailor lens selection with an accuracy of 0.01 D with the toric versions and achieve excellent refractive results. Additionally, the precise correction of astigmatism and presbyopia led to above-average patient satisfaction.

Other advantages of the LENTIS Mplus Toric MF20T are that it can be implanted through an inci-

sion as small as 2 mm (Figure 7), it is easy to position due to the near segment, and it is easy to calculate IOL power and order the correct lens with the Oculentis Online Calculator (www.lentistoric.com; Figure 8).

Christoph Binder, MD, practices at Schwarzwald Augenlinik. Dr. Binder did not provide financial disclosure information. He may be reached at www.schwarzwaldaugenlinik.de.

First Experiences With the FEMTIS® Laser Lens

At 10-month follow-up, this IOL remains perfectly centered and stable in the capsular bag.

BY DETLEF HOLLAND, MD

With all of the excitement surrounding laser-assisted cataract surgery (LACS), it was only a matter of time before IOL technologies that take advantage of the laser’s perfect capsulotomy came to market. I am lucky enough to be one of the first surgeons using the FEMTIS laser lens (Oculentis), an IOL with a special haptic system that allows the lens to clamp into the capsulorrhexis.

I have been performing LACS for 2 years, and it currently takes me about 2 minutes to complete an entire procedure, including capsulorrhexis and lens fragmentation. While the procedure has already been enhanced by the laser’s precision, now incorporating the FEMTIS Laser Lens further improves the results, as there is no longer a risk for the lens to dislocate postoperatively.

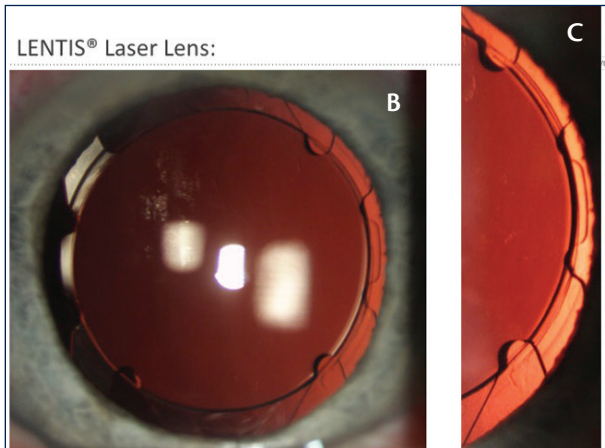
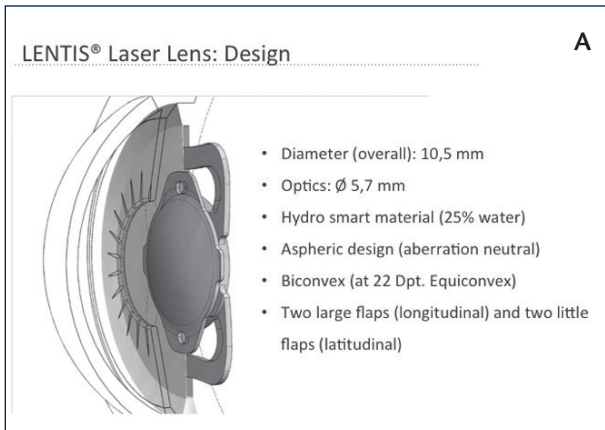

Figure 1. The LENTIS IOL design (A). Notice the perfect centration and overlapping of the rhexis (B,C).

The FEMTIS IOL is made of the HydroSmart material (hydrophilic acrylic with hydrophobic surface; 25% water); it has an aspheric, aberration-neutral design, with an overall diameter of 10.5 mm and an optic size of 5.7 mm. The IOL has two large longitudinal haptics and two little latitudinal haptics (Figure 1), all of which are enclaved in the capsulorrhexis and positioned in front of the anterior capsule.

IOL IMPLANTATION

A capsulorrhexis size of 4.8 mm is recommended for the FEMTIS IOL. Although there is almost no learning curve, as it is implanted like a standard plate-haptic IOL, one must be careful to remove the ophthalmic viscosurgical device (OVD) from behind the FEMTIS IOL prior to clamping the additional haptics inside the capsulorrhexis. Also, positioning the four haptics can require slightly more time than an IOL with standard haptics. After the larger haptics are in place, the two smaller ones are easily brought forward and guided into position in the capsulorrhexis.

At the end of the procedure, the FEMTIS is nicely centered, with perfect overlap of the rhexis and the IOL optic. This is especially important in younger patients and in those with wide pupils. In my experience, at



Figure 2. The FEMTIS Comfort IOL will have a 1.50 D addition.

10 months postoperatively, the four haptics are still well positioned within the capsulorrhexis, there is perfect overlap of the rhexis and the optic, and the IOL is stable in the capsular bag (Figure 1B and 1C).

PERSONAL EXPERIENCE

Thus far, we have implanted the FEMTIS IOL in 30 eyes with no intraoperative complications, capsulorrhexis tears, or postoperative complications. We have also had no problems with iris pigmentation and posterior capsular opacification, no signs of elevated intraocular pressure, and no cases of iris capture. Lastly, the lens has been centered and the haptics in position in all 30 cases. In my experience (with up to 10 months of follow-up), perfect centration has been independent of the influences of the capsular bag.

Because there has been no postoperative rotation, we can conclude that the FEMTIS IOL is safe; it is also easy to implant, with promising short-term follow-up. I think this IOL will be the femto lens of the future; however, long-term observations are still required.

THE NEXT STEPS FORWARD

One of the next steps forward is the FEMTIS Comfort IOL with a 1.50 D addition to provide patients with more spectacle independence for their daily life (Figure 2). The combination of perfect positioning and additional optical use can raise the Comfort concept to a new level of patient satisfaction.

Another future advantage of all FEMTIS lens types, which are positioned as base lenses fixated at the capsulorrhexis, is the possibility to use it with an add-on or supplementary IOL.

Detlef Holland, MD, is a cataract and refractive surgeon at the Augenklinik Bellevue in Kiel, Germany. Dr. Holland states that he has no financial interest in the products or companies mentioned. He may be reached at d.holland@augenlinik-bellevue.de.

Postoperative Stability and Lens Position of the FEMTIS[®] Laser Lens

An international multicenter study aims to show that, in conjunction with laser-assisted cataract surgery, this IOL has excellent centration.

BY FLORIAN T.A. KRETZ, MD, FEBO; AND GERD U. AUFFARTH, MD, PhD

The significance of refractive outcomes after cataract surgery is increasing, with patients expecting not only good visual quality but spectacle independence for most daily tasks. Over the past several years, a plethora of premium IOLs have been introduced into the marketplace, some successfully and others only arguably so. Many of these IOLs are considered premium technologies because of their advanced optic designs, improved haptic materials and designs, or combinations of both. The FEMTIS laser lens (Oculentis; Figure 1), however, is a new kind of premium lens—one that is designed to lock into place in the opening of a laser-created capsulotomy.

ADVANTAGES OF LACS AND THE LASER LENS

One of the most important advances in cataract surgery in the past decade is laser-assisted cataract surgery (LACS). Rather than performing the entire procedure manually with the help of ultrasound devices, the surgeon can now rely on a femtosecond laser to complete various steps of the procedure, including highly precise incisions, the capsulorhexis, and lens fragmentation.

LACS introduces several new advantages to cataract surgery, such as the improved ability to plan and control incision and capsulotomy shape, size, and placement and a reduction in the amount of ultrasound energy induced in the eye. But, if IOL placement is not precise or if it shifts too much postoperatively—especially in the presence of a premium IOL—these advantages may be lost.

This is where the FEMTIS laser lens come into play: The IOL locks in place inside the capsulotomy rather than being held in position in the capsular bag by the back-pressure of the capsule against the haptics, as with traditional IOL implantation. Whereas traditional IOLs can be affected by decentration, tilt, and rotation that can possibly lead to induced higher-order aberrations

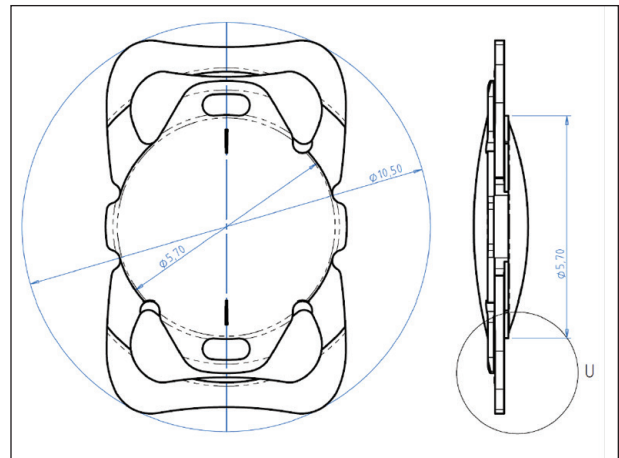

Figure 1. The haptic design of the FEMTIS IOL is a rhexis clip with a 360° barrier edge.

and reduced optical quality of the visual system, the combination of LACS and the FEMTIS IOL results in a highly precise capsulotomy (with a predictable size and position) and a minimal risk of poor lens position, even years after surgery. This should, in effect, result in higher predictability and precision of refractive outcomes.

STUDY DESIGN

We are currently conducting an open-label, prospective, international, multicenter study to investigate the stability of lens position and the visual outcomes after implantation of the FEMTIS IOL after LACS. Ten participating centers are involved in the study; in total, 180 patients (360 eyes) will be enrolled. All clinical investigators are asked to include consecutive patients electing to have the FEMTIS IOL implanted in both eyes. Patients with strabismus; previous refractive or glaucoma surgery or keratoplasty,

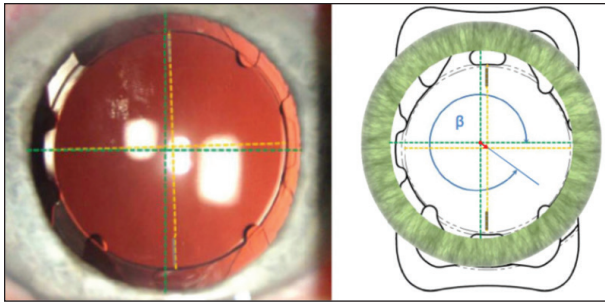

Figure 2. Measurement of decentration of the FEMTIS IOL.

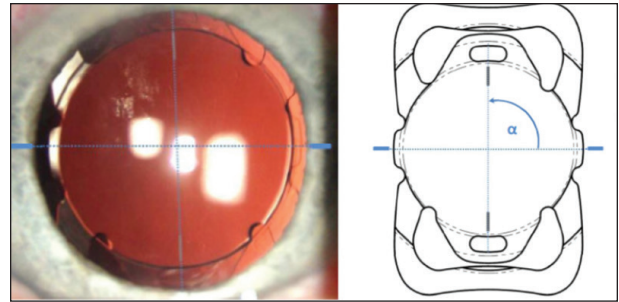

Figure 3. Measurement of IOL rotation of the FEMTIS IOL.

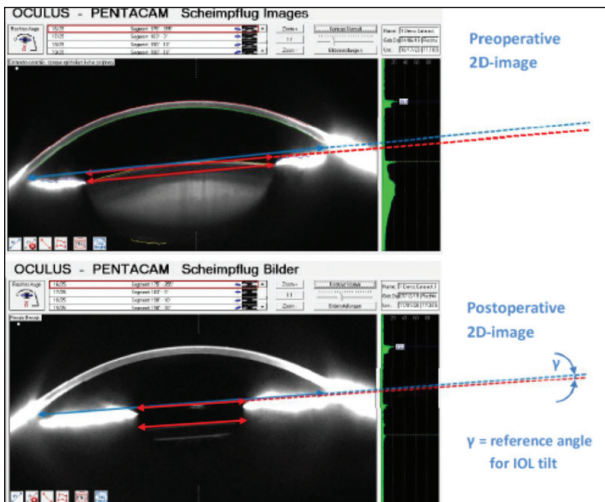

Figure 4. Measurement of IOL tilt of the FEMTIS IOL.

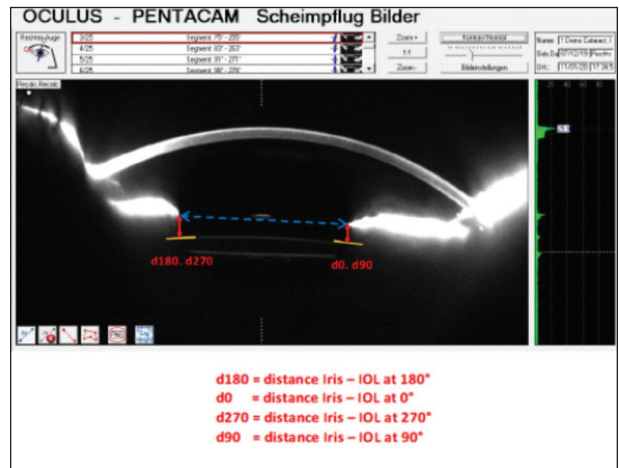

Figure 5. Measurement of the distance between the iris and the FEMTIS IOL.

corneal scars, ocular disorders other than cataract; and relevant concomitant ophthalmic diseases (eg, pseudoexfoliation, glaucoma, traumatic cataract, and any comorbidity that could affect capsular bag stability) will be excluded from the study.

Patients will be followed for 12 months in order to assess postoperative refractive outcomes, which we assume will be better than outcomes with IOL implantation of a traditional posterior chamber lens after phacoemulsification surgery. Follow-up visits are scheduled for 1 to 7 days postoperatively, 6 to 8 weeks postoperatively, and 6 and 12 months postoperatively. The primary endpoint of our study is IOL decentration (Figure 2), and key secondary endpoints include IOL rotation (Figure 3) and tilt (Figure 4), the distance between the iris and IOL (Figure 5), subjective refraction, and distance BCVA. All postoperative imaging will be sent to the University of Heidelberg reading center for evaluation.

PROCEDURE AND FOLLOW-UP

All patients underwent LACS, with the femtosecond laser used for incision creation and the capsulorhexis. When feasible, it was also used for lens fragmentation; otherwise, a standard irrigation and aspiration tech-

nique was used. The FEMTIS IOL was inserted with the Viscoject Bio 2.2 injector (Medcel) or a comparable injector of the same size. The schedule for follow-up examinations is listed in Table 1.

To date, the first patients have been enrolled in the study, with implantations scheduled to begin in early 2015. Detlef Holland, MD, from the Augenklinik Bellevue in Kiel, Germany, has preliminary 10-month follow-up from 30 patients in whom the FEMTIS IOL was implanted. These results, described in detail on page 11, make us believe that this technology is the right approach following the introduction of LACS.

CONCLUSION

We all know that LACS is here to stay. Combining this procedure with implantation of a laser lens can provide surgeons with an even more predictable and safe surgical method and patients with even better refractive outcomes after surgery.

What we have concluded from the overall preliminary results with the FEMTIS laser lens is that there is a short learning curve (mainly associated with fixation of the additional haptics), but there have been no intra- and postoperative complications, including iris capture, and perfect centration on the capsulorhexis. Therefore, this IOL is a

TABLE 1. FOLLOW-UP EXAMINATIONS

Examination	Preop	OP	Postop			
			1–7 days	6–8 weeks	6 month (22–30 weeks)	12 month (48–56 weeks)
(1) Inclusion and exclusion criteria	x					
(2) Demography and anamnesis	x					
(3) Written consent of the patient	x					
(4) Condition of the eye*	x		x	x	x	x
(5) Fundus examination only if clinically evident*	(x)		(x)	(x)	(x)	(x)
(6) Subjective refraction (sphere, cylinder, degree)	x			x	x	x
(7) VA: UDVA, CDVA (monocular, photopic)	x		x (UDVA)	x	x	x
(8) Biometry and keratometry	x					x
(9) White-to-White	x					x
(10) Lens thickness	x					x
(11) Topography: K1, K2, A	x					x
(12) IOP**	x		x	x	x	x
(13) IOL rotation*		x(m)	x(s)	x(s)	x(s)	x(s)
(14) IOL decentration*		x(m)	x(s)	x(s)	x(s)	x(s)
(15) IOL tilt*	x			x	x	x
(16) Pupil size*				x	x	x
(17) Pupil decentration	x					x
(18) Rhexis size*		x				
(19) Distance Iris - IOL *				x	x	x
(20) PCO rate *					x	x
(21) Investigator questionnaire		x				

* = at mydriasis / ** = measure the IOP before pupil dilatation

promising technology for increasing refractive outcomes postoperatively, especially in conjunction with centration-dependent premium IOLs. ■

Gerd U. Auffarth, MD, PhD, is Chairman of the Department of Ophthalmology at the University of Heidelberg and Director of the International Vision Correction Research Center & David J. Apple Laboratory for Ocular Pathology in Heidelberg, Germany. Professor Auffarth states that he has received research grants, travel



expenses, and lecture honorarium from Oculentis. He may be reached at auffarthg@aol.com.

Florian T.A. Kretz, MD, FEBO, is a Senior Research Specialist at the International Vision Correction Research Center & David J. Apple Laboratory for Ocular Pathology at the Department of Ophthalmology, University of Heidelberg, Germany. Dr. Kretz states that he has received research grants, travel expenses, and lecture honorarium from Oculentis. He may be reached at mail@florian-kretz.de.



Oculentis GmbH

Am Borsigturm 58

13507 Berlin, Germany

Tel: +49 (0) 30 430 955 - 0

Fax: +49 (0) 30 430 955 - 11

E-mail: info@Oculentis.com

Web: www.Oculentis.com

CRST EUROPE

Cataract & Refractive Surgery Today