

AWS
re:Invent



ARC304

400 years of serverless land deeds

Keith Robertson
Lead Architect
Registers of Scotland

Charlie Batchelor
Senior Consultant
AWS





**Registers
of Scotland**
ros.gov.uk

Session agenda

Registers of Scotland story and serverless archive architecture

Meeting strong public sector governance requirements

Encouraging adoption and unforeseen benefits

General Register of Sasines (1617)

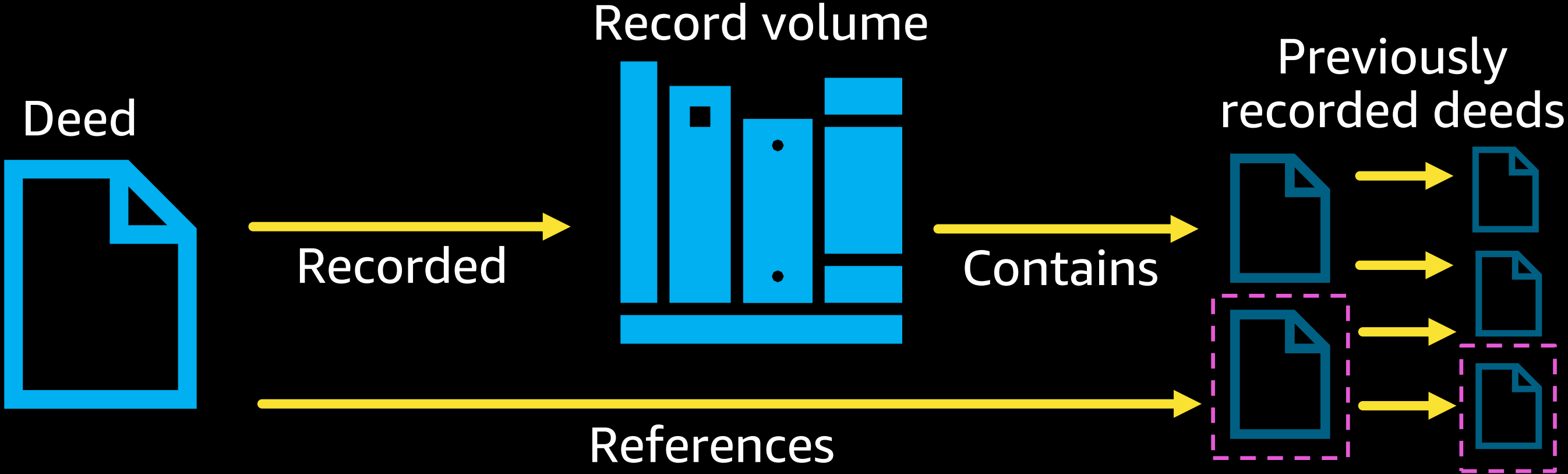

Land Register (1981) – First registration

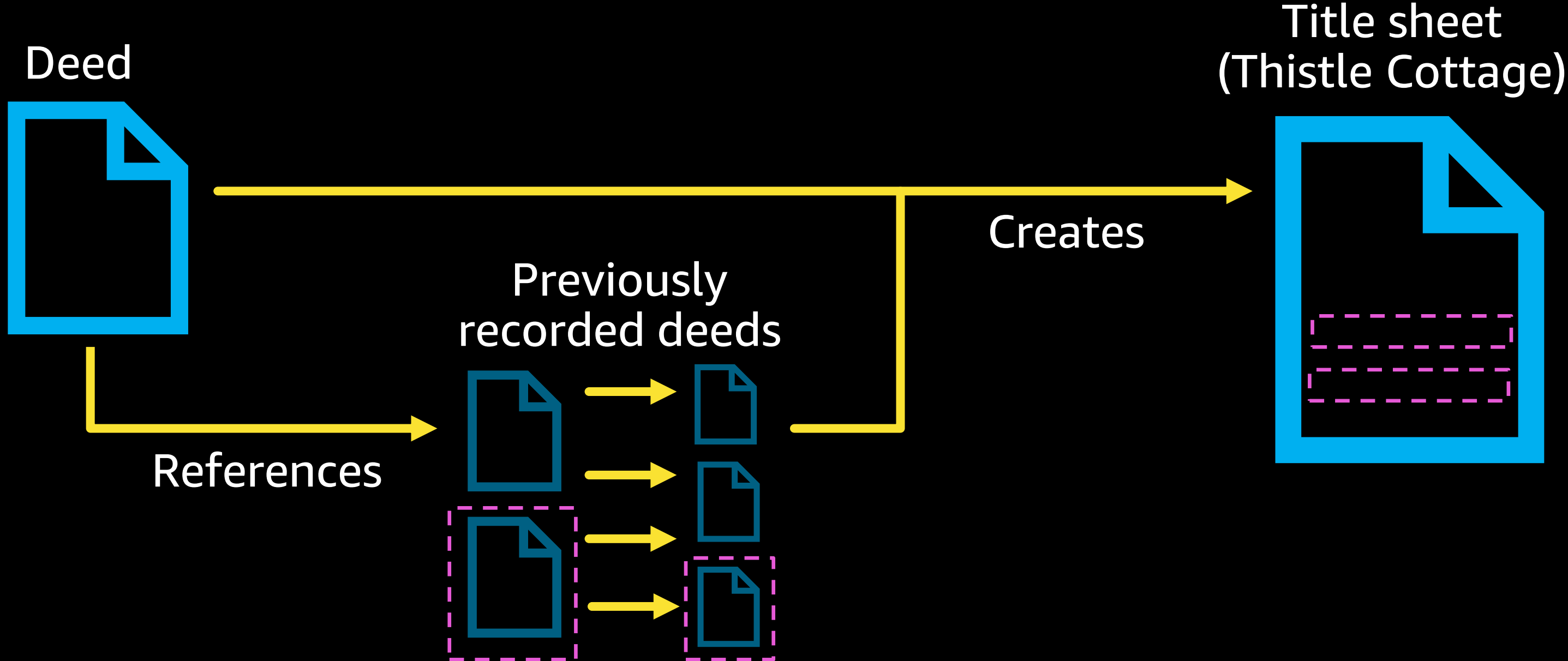

Indexing Sasines

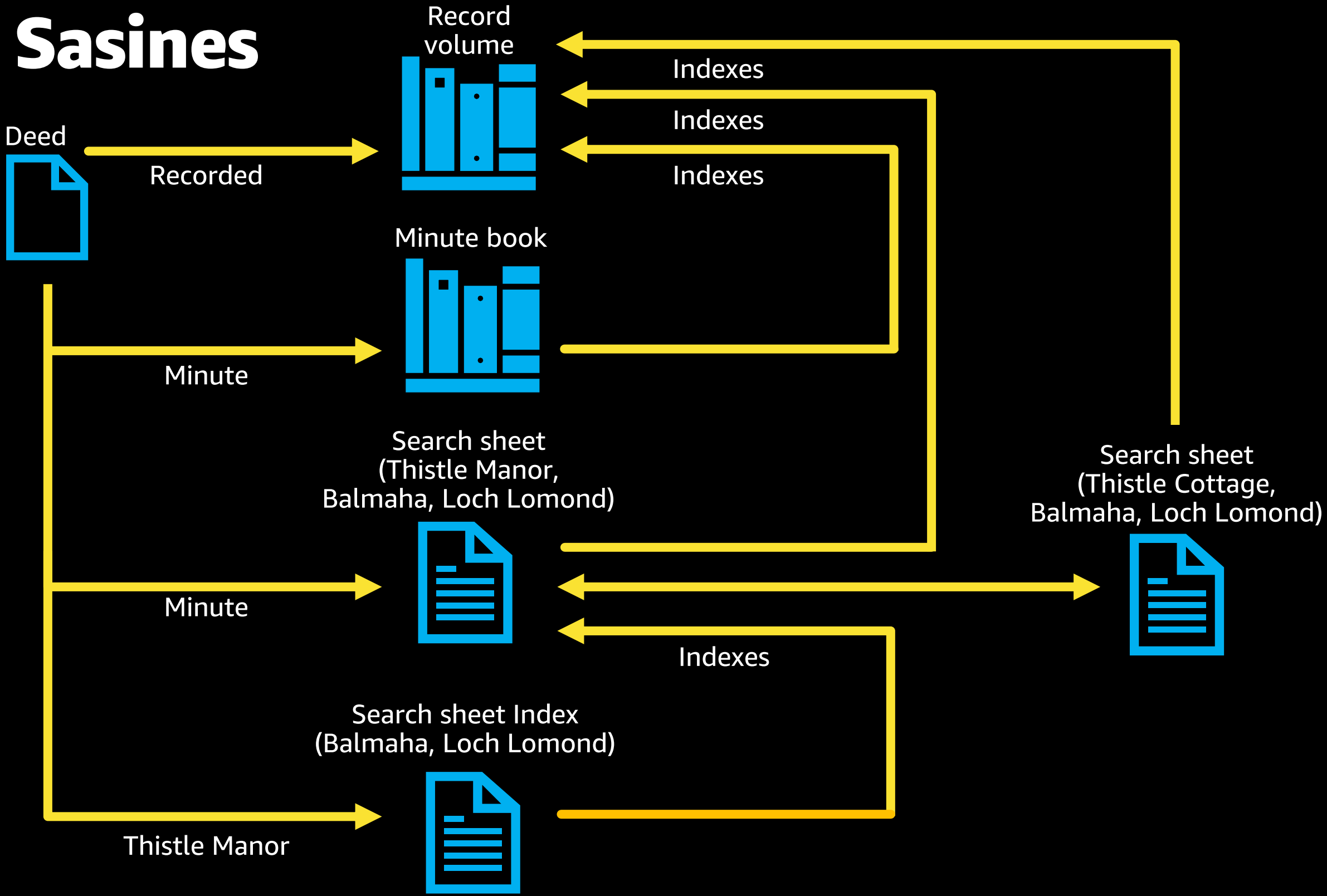

Archive architecture – Overview

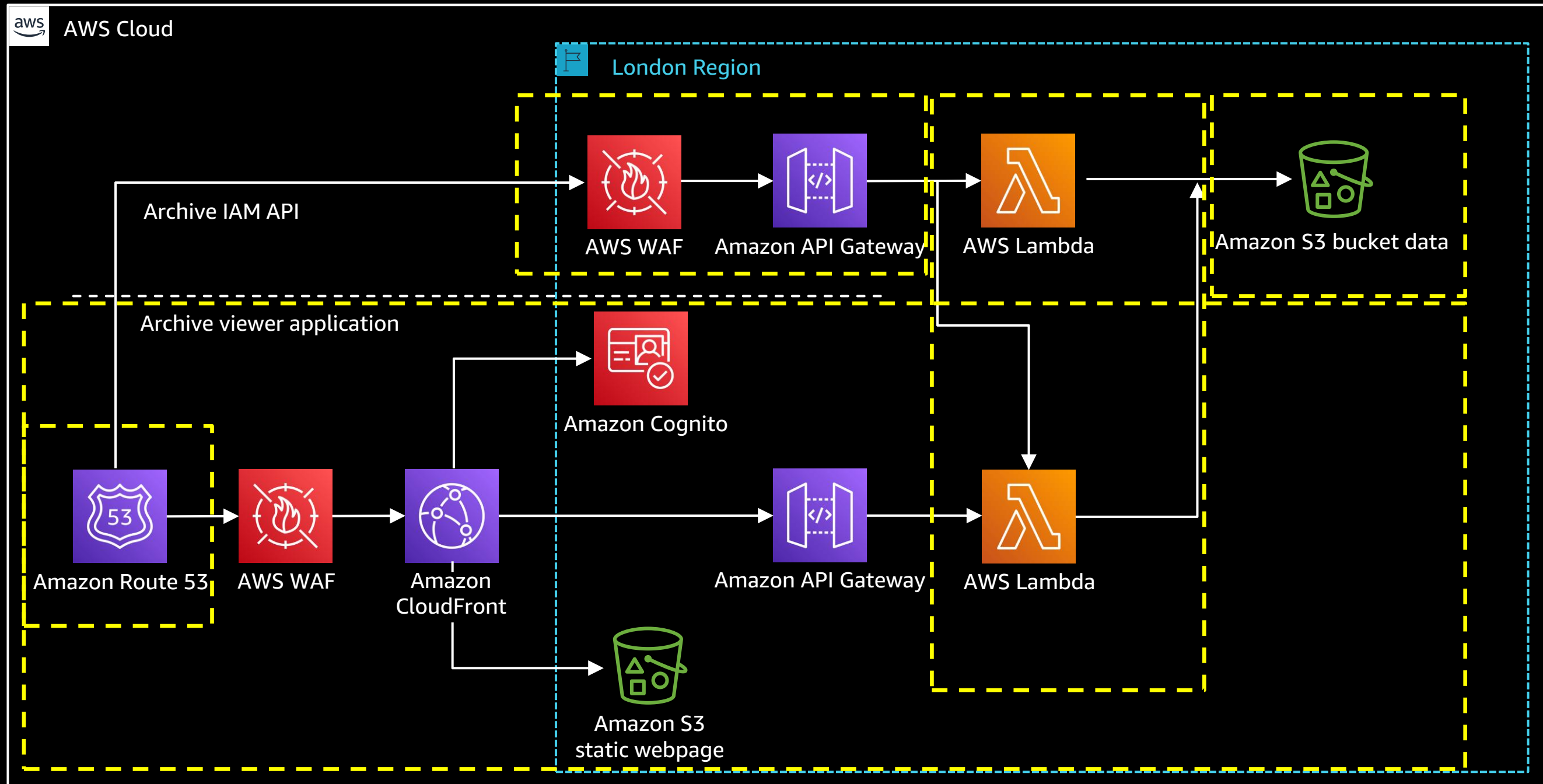

Archive architecture – Components

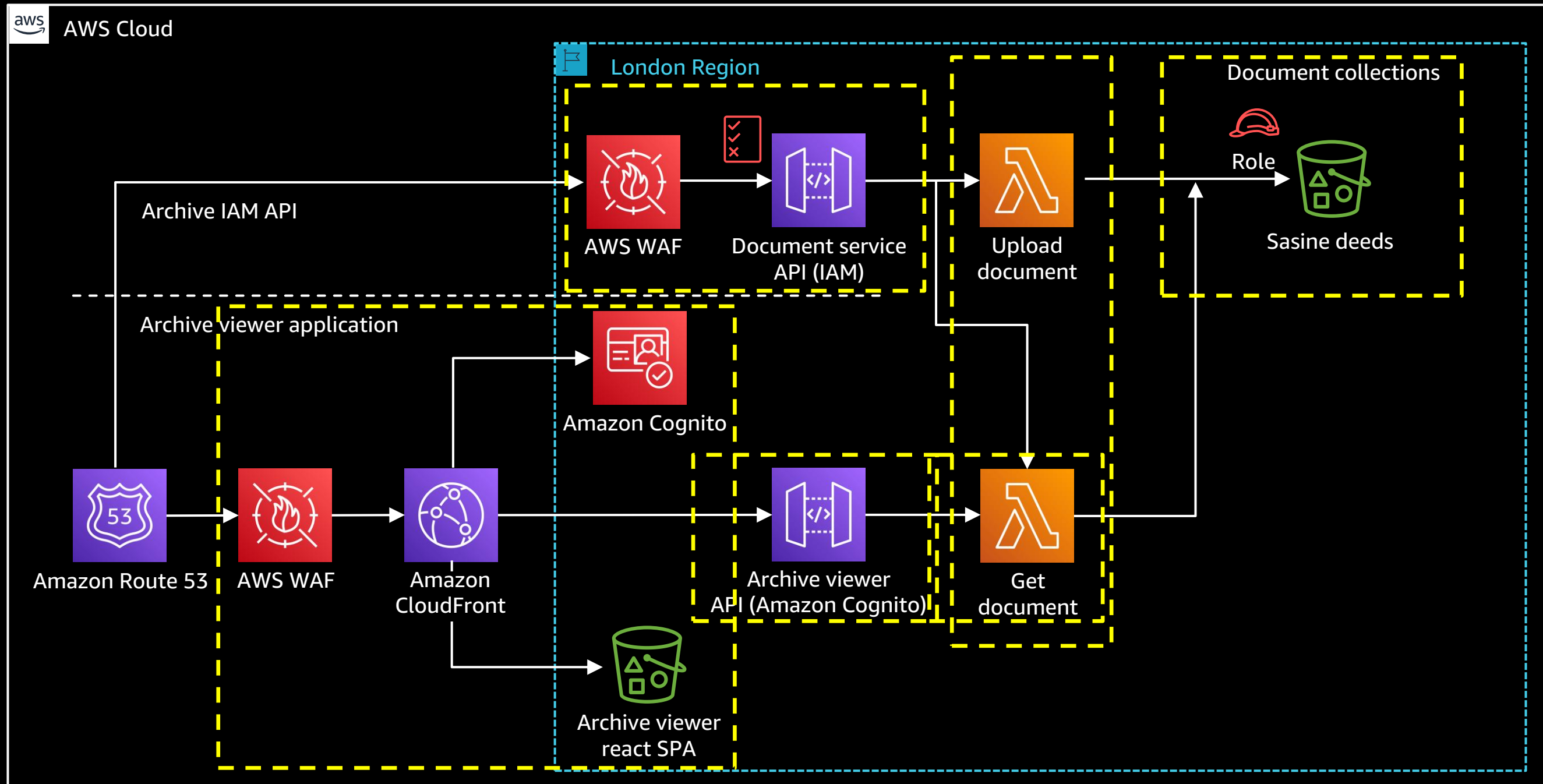

Team roles

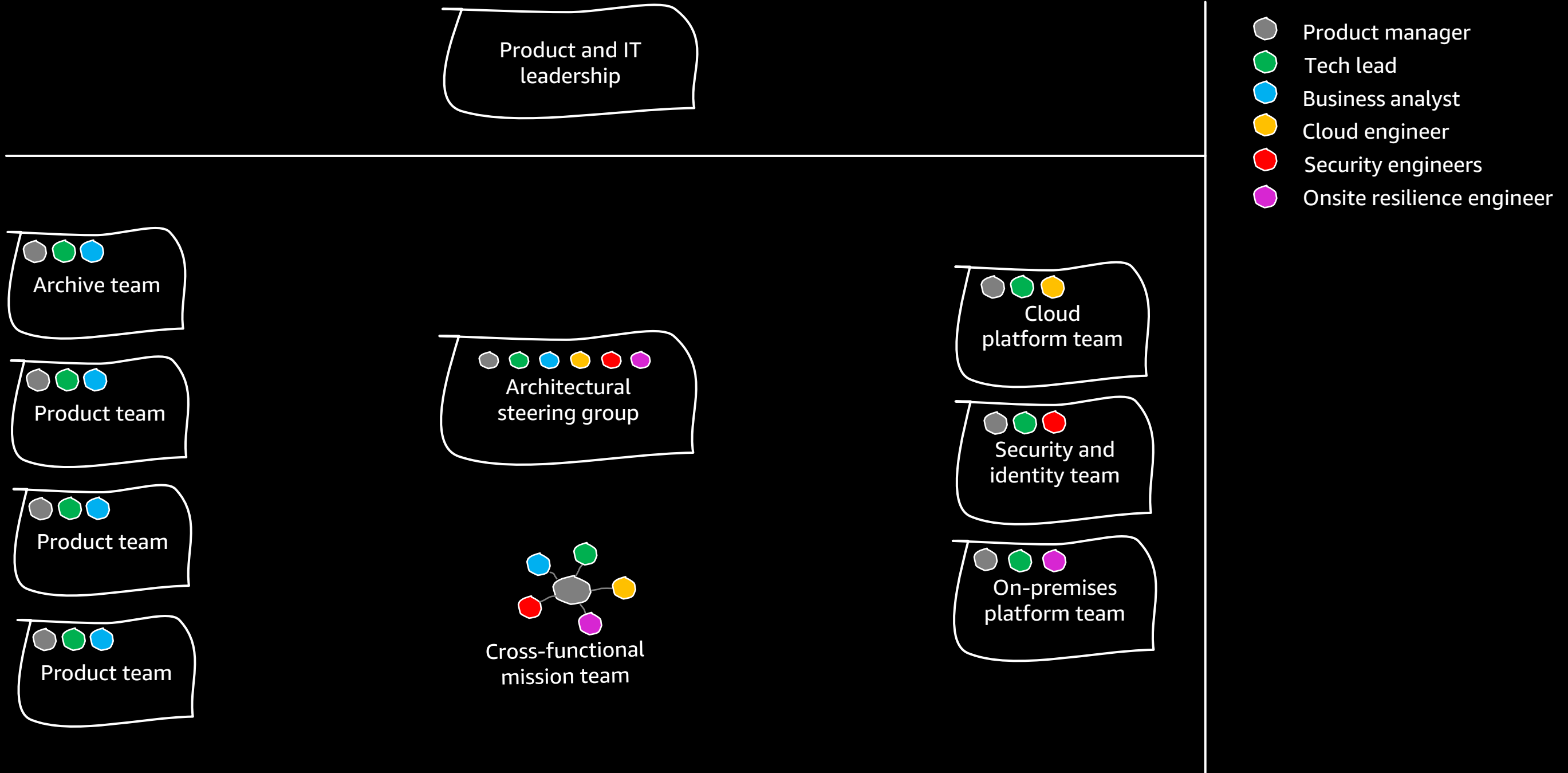

Application deployment pipeline

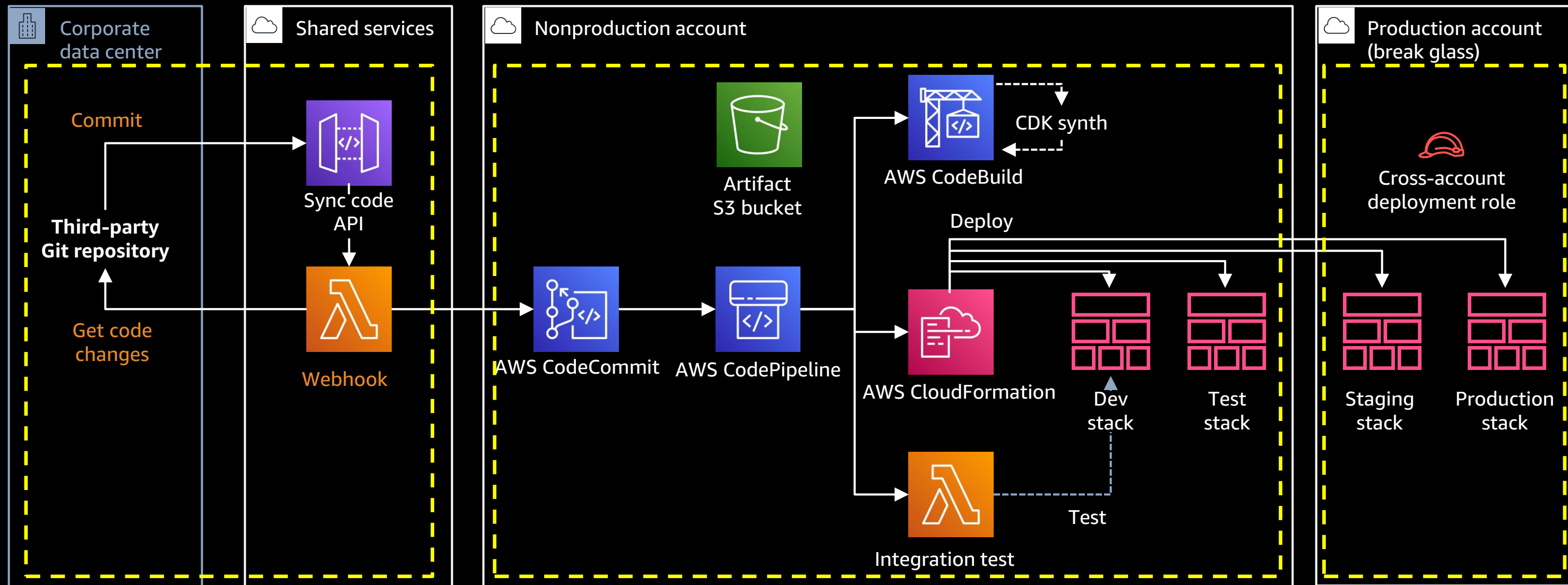

Application deployment grouping



Document service

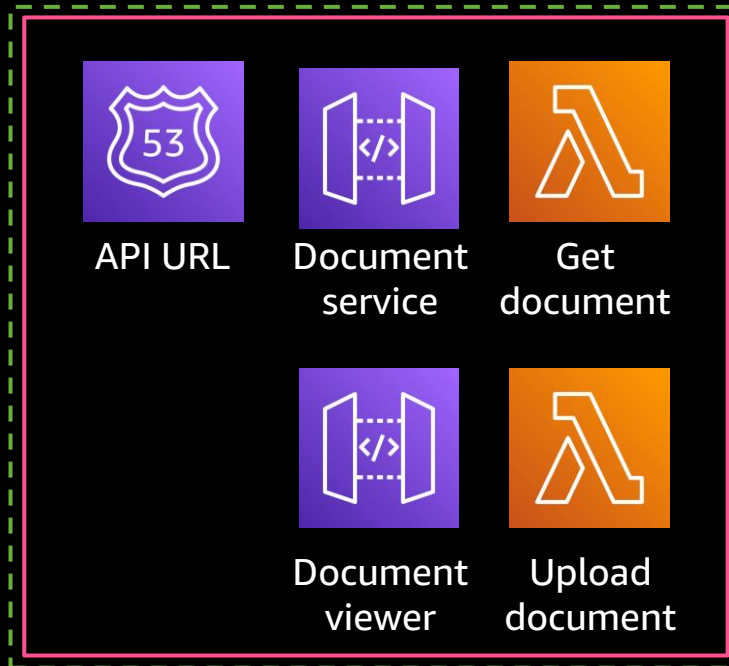

Pipeline

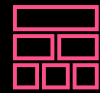

CDK stack



Document collections



Infrastructure



Web application

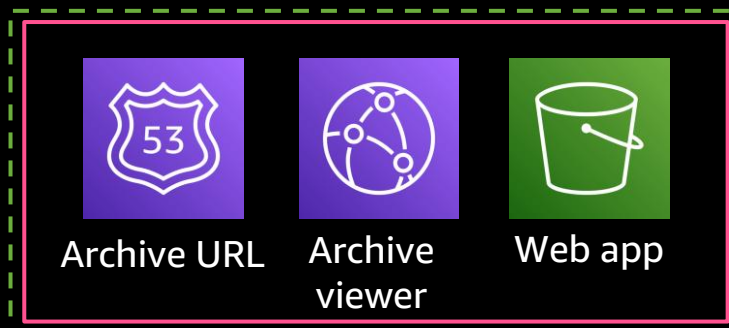

Monitoring

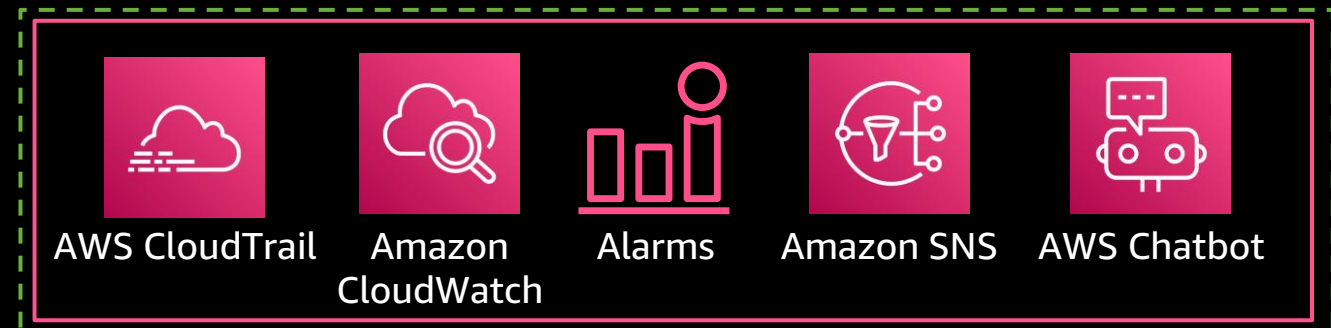

Monitoring

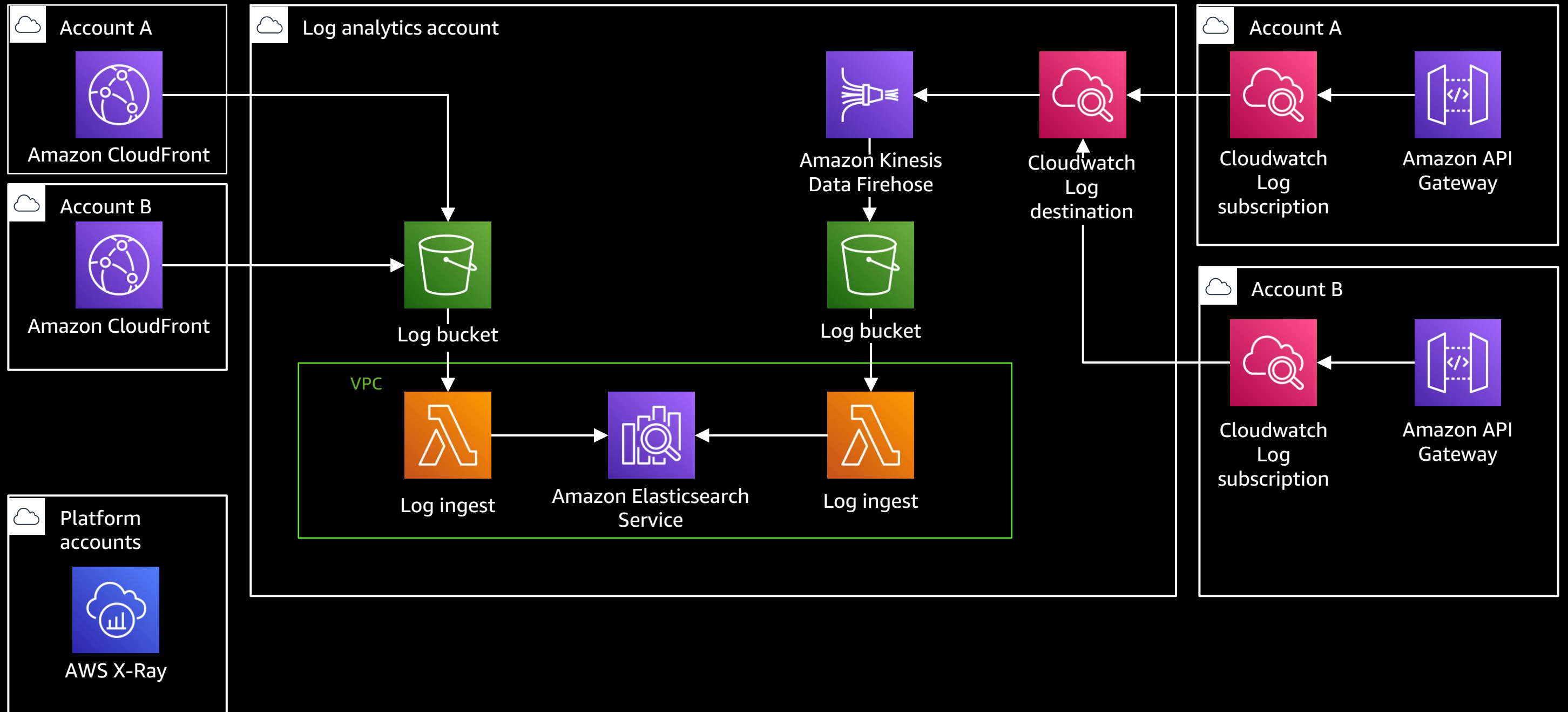

Resilience

The ability to provide an agreed level of service in the face of anticipated threats and faults

Backup

Additional copies of information assets
that allow recovery when resilience has failed

Archive replication

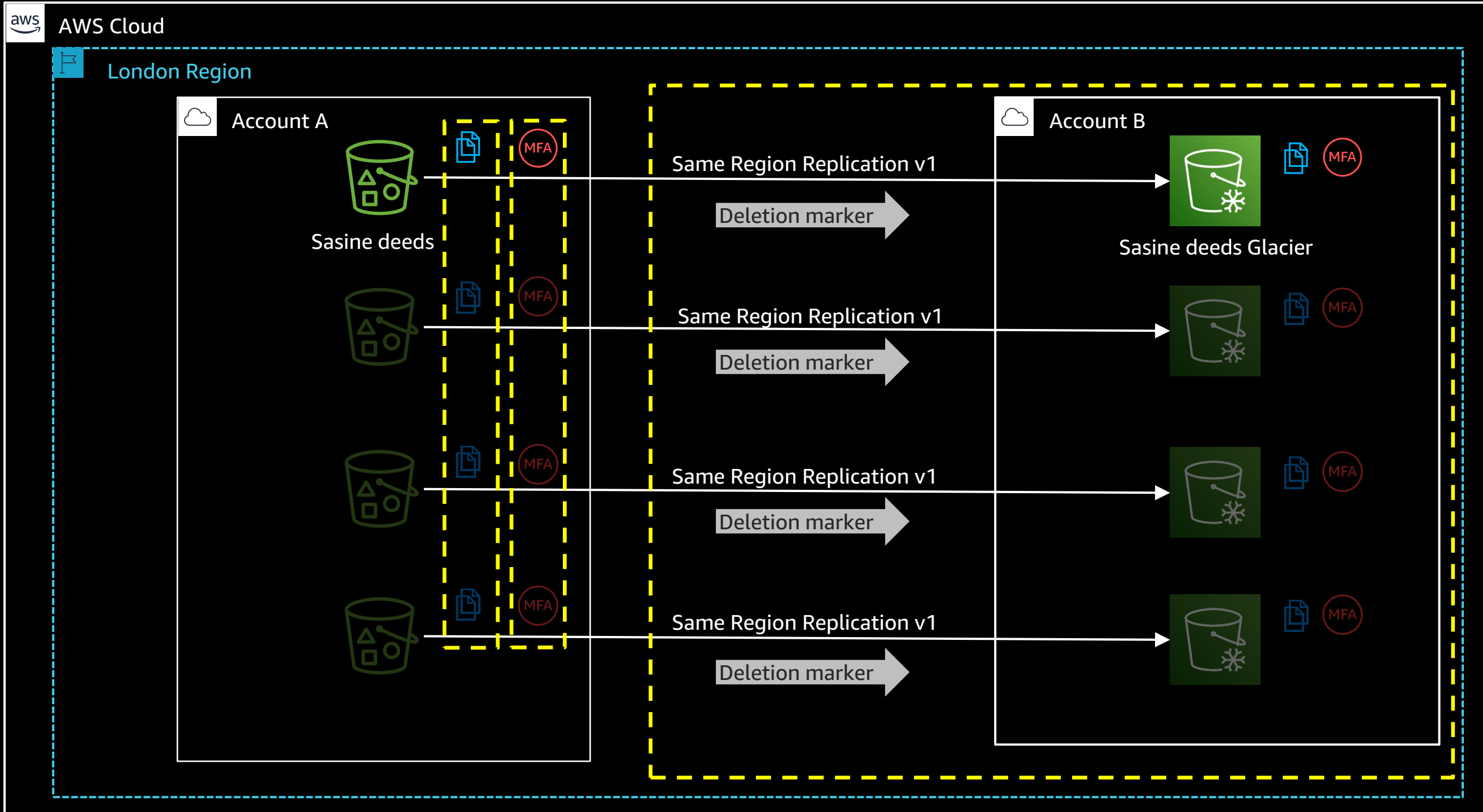

Encouraging adoption

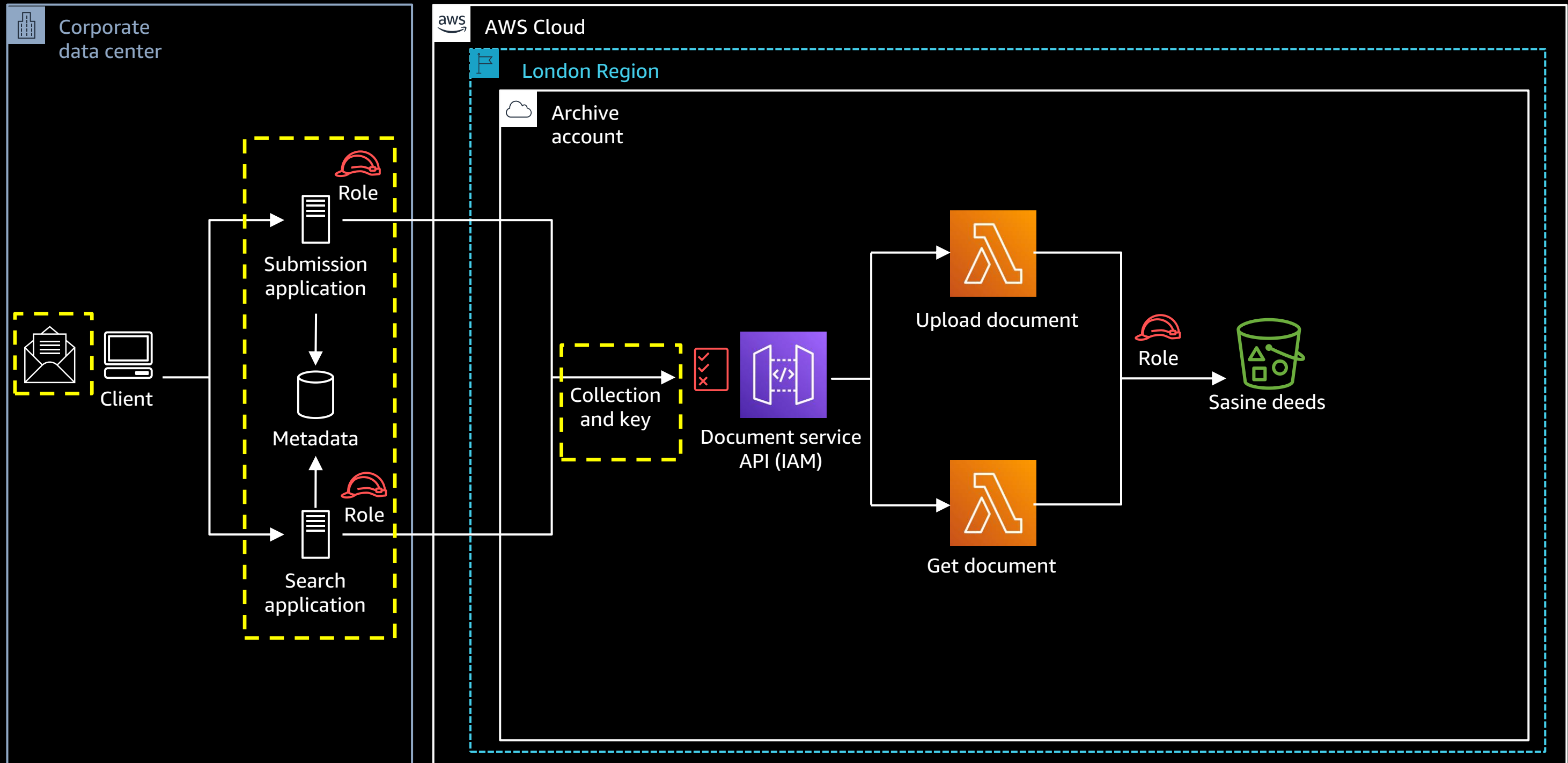

Archiving digital submissions

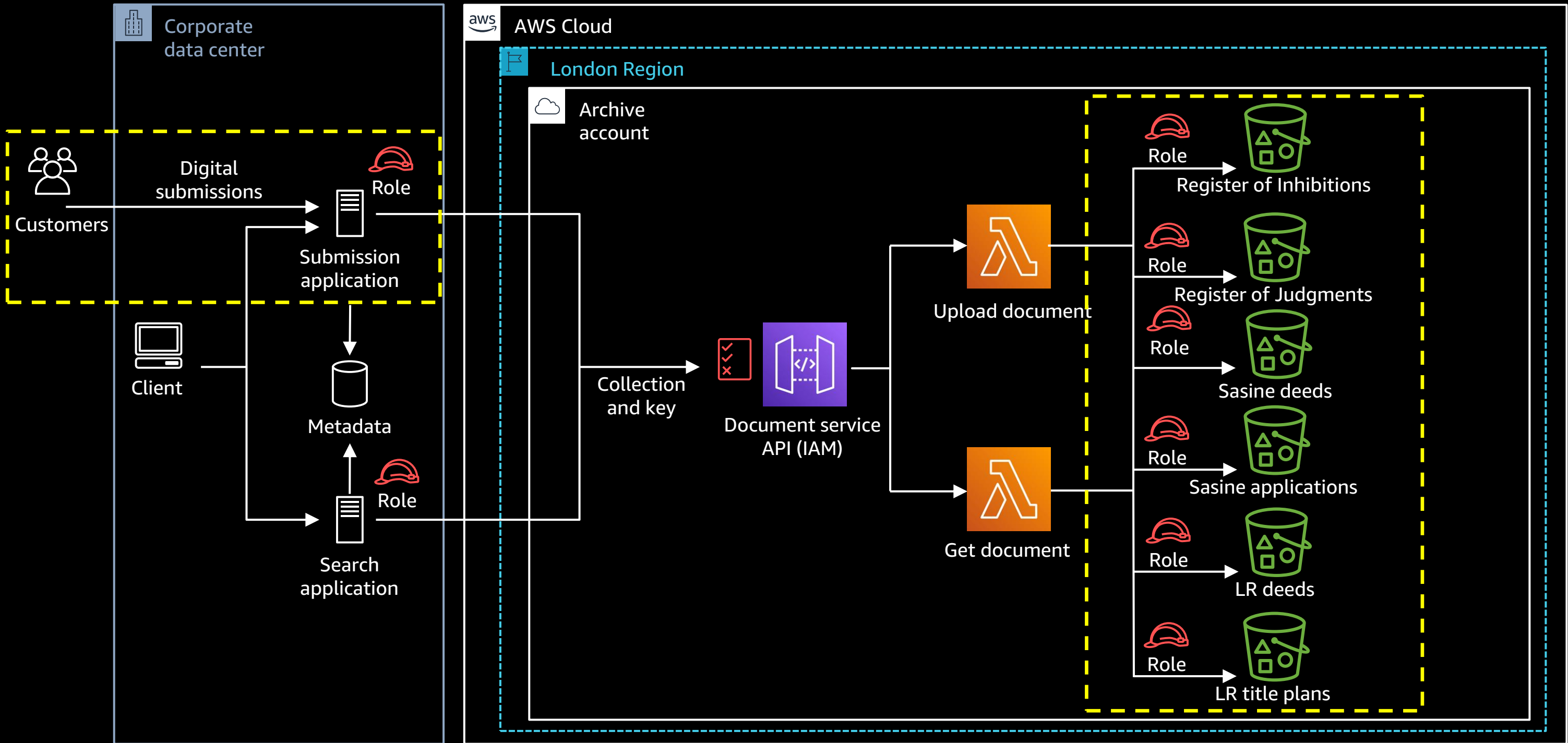

Unforeseen benefits – First registration

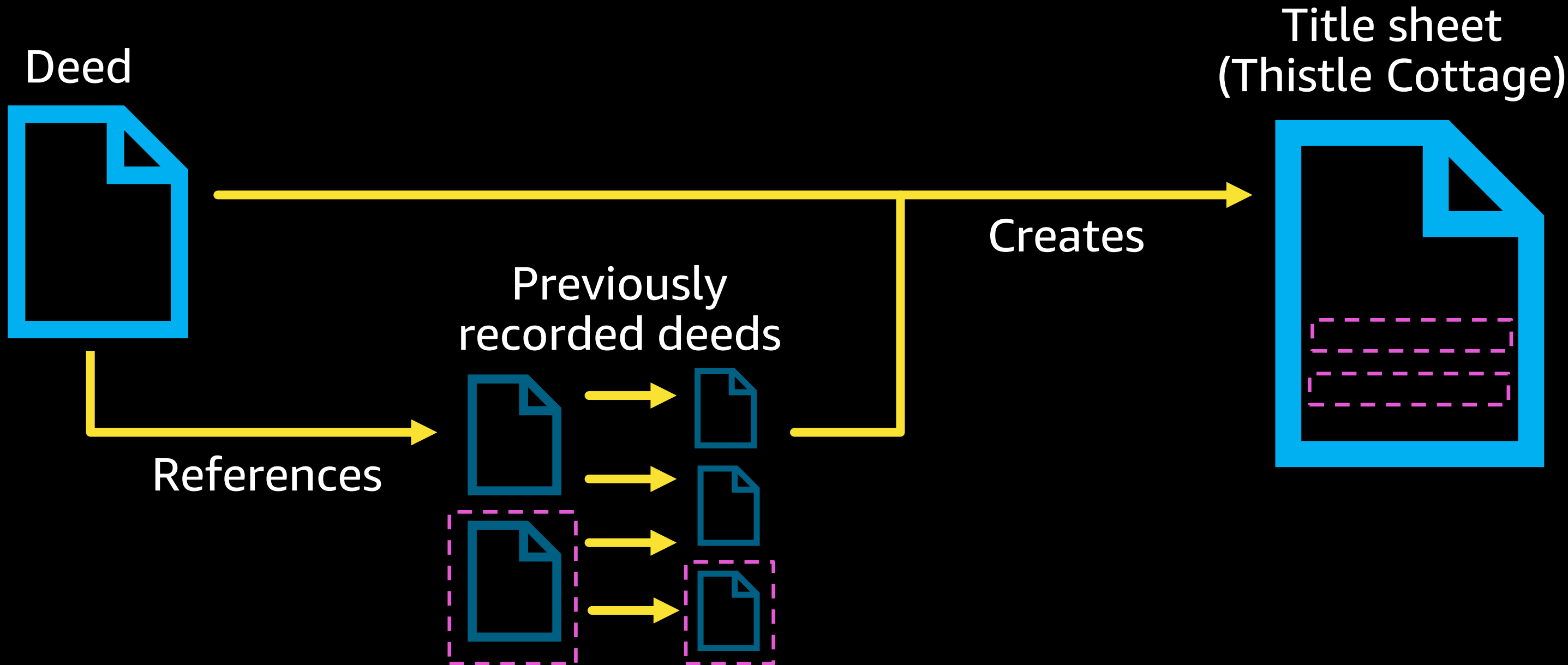

Unforeseen benefits – Amazon Textract

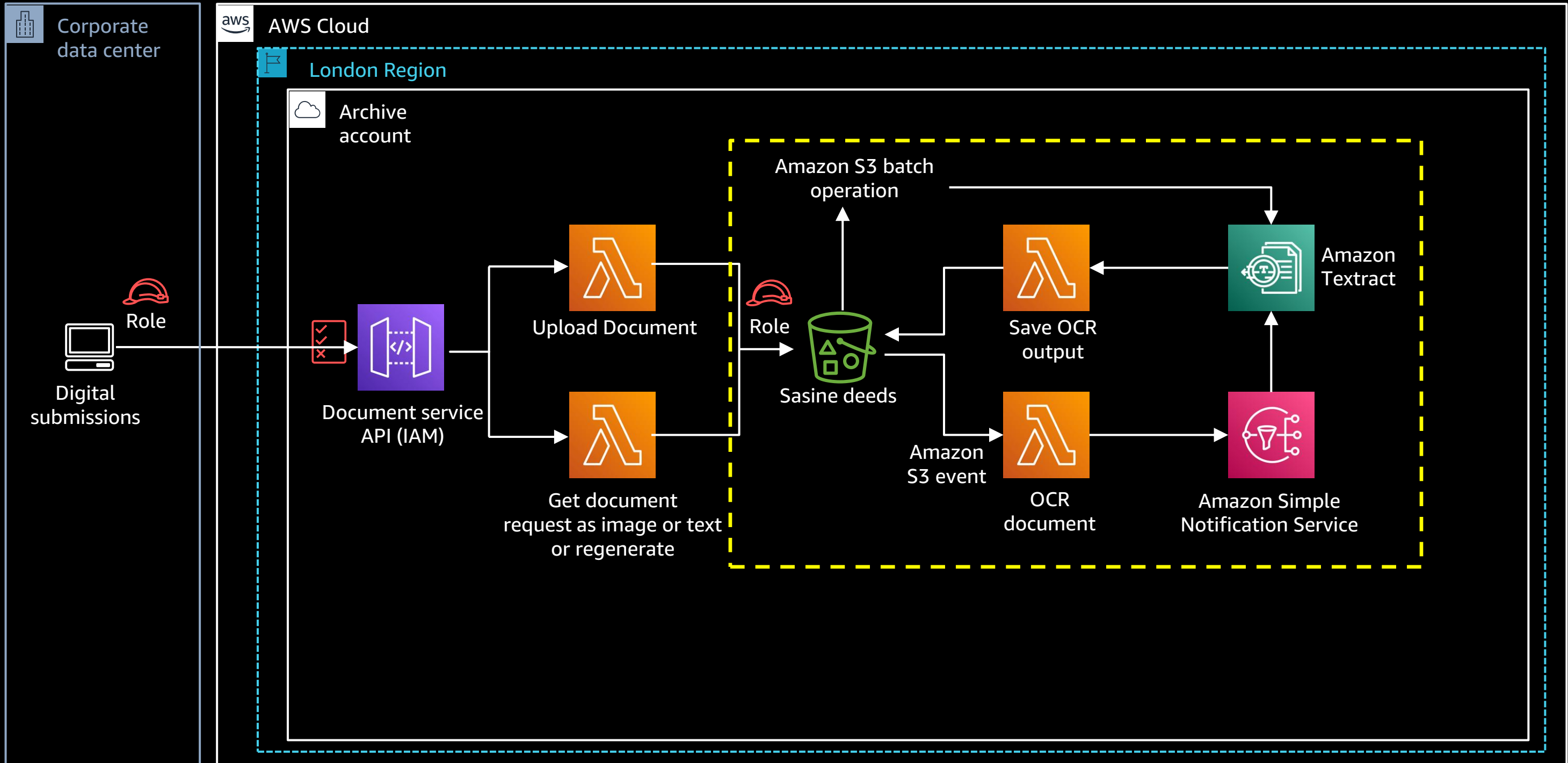

Summary

Registers of Scotland story and serverless archive architecture

Meeting strong public sector governance requirements

Encouraging adoption and unforeseen benefits

Wrap-up and takeaways

1. Use the best tools – CDK with CDK pipelines is a game changer
2. Adoption – share a service, not a stack
3. Executive sponsorship – drive a serverless first strategy
4. Architect for the unforeseen – enable business process simplification
5. AWS Well-Architected – apply best practices and stay up to date

Architecture resources

AWS Well-Architected Framework

The official best practices for Architecting in the AWS Cloud

aws.amazon.com/architecture/well-architected

AWS Well-Architected Labs

Hands-on labs to help you learn, measure, and build using architectural best practices

wellarchitectedlabs.com

AWS Architecture Center

Official AWS repository for all Architecture resources

aws.amazon.com/architecture

AWS Solutions Library

Vetted reference implementations and well-architected patterns

aws.amazon.com/solutions

Thank you!





Please complete
the session survey