

textiles

program guide

01.22.2024



teknion

update summary

Please be advised that information has been updated within the Textiles Program Guide. To highlight these updates, a summary has been created for your reference.

new

Kiosk has been added to Panel Fabrics.

Quilted Screens have been added to the Panel Fabrics and Upholstery Fabrics

New textiles have been added:

- Soft Static (Upholstery Gr. 6)
- Super Shearling (Upholstery Gr. 9)
- High Frequency (Panel Gr. 5, Architectural Gr. 4, Upholstery Gr. 4)
- Textured Map (Panel Gr. 4, Architectural Gr. 3, Upholstery Gr. 3)

delisted

The following Chairs have been removed from Upholstery Fabrics

- Taiga
- Synaspe
- Zone
- Variable HybrED
- Amicus
- Marini
- T-3
- Metric

Please note, first orders for new products will be accepted on January 22, 2024. All software will also be updated by January 22, 2024. If you have any questions regarding the information enclosed, please contact your Teknion Customer Service Representative.





PANEL FABRICS 7

UPHOLSTERY FABRICS 29

GENERAL INFORMATION 87

ZONES TEXTILES 97

panel fabrics

panel fabrics

APPLICATION MATRICES

PANEL FABRICS	8
ARCHITECTURAL FABRICS	12
VARIABLE PRIVACY SCREEN	14

LISTINGS MATRICES

PANEL FABRICS

GRADE A	
BEELINE	16
BITSTREAM	16
EGYPT	16
NITTY GRITTY	16
TANGLE	16
WALES	16
WIRED UP	16

GRADE 1	
BANDEAU	16
BRAZIL	16
EMIT	16
ESSENTIALS	16
FLICKER	16
HEATHER TECH	16
INDIA	16
LINEN WEAVE	16
LUSTRADO	17
MAKAH	17
PERU	17
PRESSE	17
RATIONALE	17
TOPOLOGY	17
WARP SPEED	17

GRADE 2	
ACTUATE	17
BOUCLE GRID	17
COMPECT	17
COMPLEMENT	17
CROSSGRAIN	17
DIGI TWEED	17
GRAVITON	18
MEGACHECK	18
PERCEPT	18
STRATIFORM	18
TWINING	18

GRADE 3	
ARTOPIA	18
CROSS DYE	18

GRADE 4	
INTONE	18
INTRAWEB	18
MILIEU	18
 TEXTURED MAP	19
TWISTED TWEED	18

GRADE 5	
ECOTONE	19
 HIGH FREQUENCY	19
MARL CLOTH	18

ARCHITECTURAL FABRICS

GRADE 1	
RATIONALE	20

GRADE 2	
ACTUATE	20
ARTOPIA	20
BANDEAU	20
BITSTREAM	20
BOUCLE GRID	20
COMPECT	20
COMPLEMENT	20
CROSSGRAIN	20
DIGI TWEED	20
EMIT	20
GRAVITON	20
HEATHER TECH	21
INTONE	21
LUSTRADO	21
MEGACHECK	21
PERCEPT	21
PRESSE	21
STRATIFORM	21
STRIO	21
TWINING	21

GRADE 3	
ECOTONE	21
GRID STATE	22
INTRAWEB	22
MILIEU	22
 TEXTURED MAP	22
TWISTED TWEED	22

GRADE 4	
 HIGH FREQUENCY	22
JUSTAPOSE	22

ENVIRONMENTAL DATA

STANDARD PANEL FABRICS	24
ARCHITECTURAL FABRICS	26

application matrices

PANEL FABRICS

	PANEL SYSTEMS				FREESTANDING SYSTEMS				DESKING SYSTEMS				CASEGOODS			ARCHITECTURAL PRODUCTS						
	LEVERAGE®	T/O/s®	LYFT®	DISTRICT®	ABILITY®	KIOSK	ROUTES	UPSTAGE	EXPANSION® DESKING	EXPANSION® CITYLINE	INTERPRET™	HEIGHT-ADJUSTABLE BENCH	DOSSIER®	JOURNAL	EXPANSION® CASEGOODS	ALTOS®	OPTOS®	FOCUS WALL	POD	TEK VUE	ARCHITECTURAL COMPLEMENTS	WITHIN
Grade A																						
Beeline																					**	
Bitstream																					**	
Egypt																					**	
Nitty Gritty																					**	
Tangle																					**	
Wales																					**	
Wired Up																					**	
Grade 1																						
Bandeau																						
Brazil																						
Emit																						
Essentials																						
Flicker																						
Heather Tech																						
India					*	•	•															
Linen Weave																						
Lustrado																					**	
Makah																					**	
Peru																					**	
Presse																					**	
Rationale																					**	
Topology																					**	
Warp Speed																					**	
Grade 2																						
Actuate																						
Boucle Grid																						
Complect																						
Complement																						
Crossgrain																						
Digi Tweed																						
Graviton																						
Megacheck																						
Percept																						
Stratiform																					**	
Twining																					**	
Grade 3																						
Artopia																					**	
Cross Dye																					***	

Panel Fabrics on Altos are only available with portrait working wall elevations and landscape fascias.

- * India is not available on the ACTS Screen
- ** Not available Articulate
- *** Not available Clarify
- Available for Add-On Board

application matrices

PANEL FABRICS (Continued)

	FILING & STORAGE				TABLES, LEARNING & COLLABORATIVE								MISC.						
	LEDGER®	MOUNTED STORAGE	CUSTOM STORAGE	UNIVERSAL OVERHEAD	COMPLEMENTS	WORK TABLES	MEETING TABLES	AUDIENCE™ BOARDROOM TABLES	AUDIENCE™ BOARDROOM STORAGE	EXPANSION® LEARNING	CASUAL TABLES	CLUBTALK	STORAGE	WORK TOOLS	INFINITY SCREEN	FRAMED SCREEN	QUILTED SCREEN	KIOSK FRAMED FABRIC ADD-ON	ROUTES ADD-ON BOARD
Grade A																			
Beeline																			
Bitstream																			
Egypt																			
Nitty Gritty																			
Tangle																			
Wales																			
Wired Up																			
Grade 1																			
Bandeau																			
Brazil																			
Emit																			
Essentials																			
Flicker																			
Heather Tech																			
India																		•	•
Linen Weave																			
Lustrado																			
Makah																			
Peru																			
Presse																			
Rationale																			
Topology																			
Warp Speed																			
Grade 2																			
Actuate																			
Boucle Grid																			
Complect																			
Complement																			
Crossgrain																			
Digi Tweed																			
Graviton																			
Megacheck																			
Percept																			
Stratiform																			
Twining																			
Grade 3																			
Artopia																			
Cross Dye																			

Panel Fabrics on Altos are only available with working wall elevations.

- Available for Add-On Board

application matrices

PANEL FABRICS



<div style="display: flex; align-items: center;"> <div style="width: 15px; height: 15px; background-color: #0070C0; margin-right: 5px;"></div> Available </div> <div style="display: flex; align-items: center;"> <div style="width: 15px; height: 15px; border: 1px solid black; margin-right: 5px;"></div> Not Available </div>	PANEL SYSTEMS				FREESTANDING SYSTEMS				DESKING SYSTEMS				CASEGOODS			ARCHITECTURAL PRODUCTS						
	LEVERAGE®	T/O/S®	LYFT®	DISTRICT®	ABILITY®	KIOSK	ROUTES	UPSTAGE	EXPANSION® DESKING	EXPANSION® CITYLINE	INTERPRET™	HEIGHT-ADJUSTABLE BENCH	DOSSIER®	JOURNAL	EXPANSION® CASEGOODS	ALTOS®	OPTOS®	FOCUS WALL	POD	TEK VUE	ARCHITECTURAL COMPLEMENTS	WITHIN
Grade 4																						
Intone																						
Intraweb																						
Milieu																						
Textured Map																						
Twisted Tweed																						
Grade 5																						
Ecotone																						
High Frequency																						
Marl Cloth																						

Panel Fabrics on Altos are only available with portrait working wall elevations and landscape fascias.

- * India is not available on the ACTS Screen
- ** Not available Articulate
- *** Not available Clarify
- N** Not available for Variable Privacy Screen

application matrices



PANEL FABRICS (Continued)

	FILING & STORAGE				TABLES, LEARNING & COLLABORATIVE									MISC.					
	LEDGER®	MOUNTED STORAGE	CUSTOM STORAGE	UNIVERSAL OVERHEAD	COMPLEMENTS	WORK TABLES	MEETING TABLES	AUDIENCE™ BOARDROOM TABLES	AUDIENCE™ BOARDROOM STORAGE	EXPANSION® LEARNING	CASUAL TABLES	CLUBTALK	STORAGE	WORK TOOLS	INFINITY SCREEN	FRAMED SCREEN	QUILTED SCREEN	KIOSK FRAMED FABRIC ADD-ON	ROUTES ADD-ON BOARD
Grade 4																			
Intone																			
Intraweb																			
Milieu																			
Textured Map 																			
Twisted Tweed																			
Grade 5																			
Ecotone																			
High Frequency 																			
Marl Cloth																			

Panel Fabrics on Altos are only available with working wall elevations.

application matrices

ARCHITECTURAL FABRICS

	PANEL SYSTEMS			FREESTANDING SYSTEMS			DESKING SYSTEMS				CASEGOODS			ARCHITECTURAL PRODUCTS									
	LEVERAGE®	T/O/S®	LYFT®	DISTRICT®	ABILITY®	KIOSK	ROUTES	UPSTAGE	EXPANSION® DESKING	EXPANSION® CITYLINE	INTERPRET™	HEIGHT-ADJUSTABLE BENCH	DOSSIER®	JOURNAL	EXPANSION® CASEGOODS	ALTOS®	OPTOS®	FOCUS WALL	POD	TEK VUE	ARCHITECTURAL COMPLEMENTS	WITHIN	AI HEALTHCARE
Grade 1																							
Rationale															*								
Grade 2																							
Actuate															*								
Artopia															*								
Bandeau															*								
Bitstream															*								
Boucle Grid															*								
Complect															*								
Complement															*								
Crossgrain															*								
Digi Tweed															*								
Emit															*								
Graviton															*								
Heather Tech															*								
Intone															*								
Lustrado															*								
Megacheck															*								
Percept															*								
Presse															*								
Stratiform															*								
Strio															*								
Twining															*								
Grade 3																							
Ecotone															*								
Grid State															*								
Intraweb															*								
Milieu															*								
Textured Map 															*								
Twisted Tweed															*								
Grade 4																							
High Frequency 																							
Juxtapose															*								

Panel Fabrics on Altos are only available with portrait working wall elevations and landscape fascias.

* Applicable on Altos landscape seat cushion

application matrices

ARCHITECTURAL FABRICS (Continued)

<div style="display: flex; align-items: center;"> <div style="width: 15px; height: 15px; background-color: #007bff; margin-right: 5px;"></div> Available </div> <div style="display: flex; align-items: center;"> <div style="width: 15px; height: 15px; border: 1px solid black; margin-right: 5px;"></div> Not Available </div>	FILING & STORAGE				TABLES, LEARNING & COLLABORATIVE										MISC.				
	LEDGER®	MOUNTED STORAGE	CUSTOM STORAGE	UNIVERSAL OVERHEAD	COMPLEMENTS	WORK TABLES	MEETING TABLES	AUDIENCE™ BOARDROOM TABLES	AUDIENCE™ BOARDROOM STORAGE	EXPANSION® LEARNING	CASUAL TABLES	CLUBTALK	STORAGE	WORK TOOLS	INFINITY SCREEN	FRAMED SCREEN	QUILTED SCREEN	KIOSK FRAMED FABRIC ADD-ON	ROUTES ADD-ON BOARD
Grade 1																			
Rationale																			
Grade 2																			
Actuate																			
Artopia																			
Bandeau																			
Bitstream																			
Boucle Grid																			
Complect																			
Complement																			
Crossgrain																			
Digi Tweed																			
Emit																			
Graviton																			
Heather Tech																			
Intone																			
Lustrado																			
Megacheck																			
Percept																			
Presse																			
Stratiform																			
Strio																			
Twining																			
Grade 3																			
Ecotone																			
Grid State																			
Intraweb																			
Milieu																			
Textured Map																			
Twisted Tweed																			
Grade 4																			
High Frequency																			
Juxtapose																			

application matrices

VARIABLE PRIVACY SCREEN

	PANEL SYSTEMS				FREESTANDING SYSTEMS				DESKING SYSTEMS				CASEGOODS			ARCHITECTURAL PRODUCTS								
	LEVERAGE®	T/O/S®	LYFT®	DISTRICT®	ABILITY®	KIOSK	ROUTES	UPSTAGE	EXPANSION® DESKING	EXPANSION® CITYLINE	INTERPRET™	HEIGHT- ADJUSTABLE BENCH	DOSSIER®	JOURNAL	EXPANSION® CASEGOODS	ALTOS®	OPTOS®	FOCUS WALL	POD	TEK VUE	ARCHITECTURAL COMPLEMENTS	WITHIN	AI HEALTHCARE	
Heather Felt																								
Noil	H510																							
Bone Ash	H512																							
Indian Ocean	H516																							
Mustard Seed	H517																							

Panel Fabrics on Altos are only available with working wall elevations.

application matrices

VARIABLE PRIVACY SCREEN (Continued)

<input checked="" type="checkbox"/> Available <input type="checkbox"/> Not Available	FILING & STORAGE				TABLES, LEARNING & COLLABORATIVE										MISC.				
	LEDGER [®]	MOUNTED STORAGE	CUSTOM STORAGE	UNIVERSAL OVERHEAD	COMPLEMENTS	WORK TABLES	MEETING TABLES	AUDIENCE™ BOARDROOM TABLES	AUDIENCE™ BOARDROOM STORAGE	EXPANSION [®] LEARNING	CASUAL TABLES	CLUBTALK	STORAGE	WORK TOOLS	INFINITY SCREEN	FRAMED SCREEN	QUILTED SCREEN	KIOSK FRAMED FABRIC ADD-ON	ROUTES ADD-ON BOARD
Heather Felt																			
Noil	H510																		
Bone Ash	H512																		
Indian Ocean	H516																		
Mustard Seed	H517																		

Panel Fabrics on Altos are only available with working wall elevations.

listings matrices

PANEL FABRICS

GRADE A

Beeline

Plumb	B631
String	B632
Strand	B633
Thread	B634

Bitstream

Tablet	R582
Hardware	R583
Trackback	R584
Lithium	R585
Grey Code	R586
Silicone	R587
White Noise	R588
Xenon	R589
Wavelet	R590
Blue Team	R591
Firewire	R592
Flash Drive	R593

Egypt

Cairo	E301
Giza	E302
Port Said	E304
Suez	E305
Mallawi	E352
Jirja	E354
Idku	E355
Edfu	E356

Nitty Gritty

Block	N122
Detail	N123
Think	N130
Gist	N133
Factor	N134
Specific	N135

Tangle

Snarl	T531
Knot	T532
Interweave	T533
Ravel	T534
Kinks	T535
Spangle	T536
Tousle	T537
Crook	T538
Muddle	T539
Entwine	T540

Wales

Swansea	W402
Teifi	W403
Newport	W404
Wrexham	W414
Corwen	W416
Bangor	W417
Newbridge	W418
Pembroke	W419
Kidwelly	W420
Goodwick	W421

GRADE A (Continued)

Wired Up

Caged	W731
Intermingle	W739
Mesh	W740
Linkage	W741
Drawplate	W742
Nichrome	W743
Circuit	W744

GRADE 1

Bandeau

Washi	B124
Grosgrain	B126
Palla	B127
Farran	B128

Brazil

Betim	B220
Canela	B204
Olinda	B231
Timbo	B208
Manaus	B203
Jacarei	B217
Laguna	B233
Campo Grande	B260
Serra	B261

Emit

Watt	T727
Hertz	T728
Joule	T729
Dazzle	T730
Surge	T731
Particle	T732

Essentials

Gris	E380
Dove	E382
Brier	E383
Light Grey	E384
Slate	E385
Banner	E391
Snowdrift	E409
Mist	E410
Basil	E412
Atlantic	E413
Pebble	E415
Tropic	E416

Flicker

Glitter	F531
Beam	F532
Sparkle	F533
Flash	F534
Glint	F535
Sheen	F536
Gleam	F537
Glow	F538
Luster	F539
Twinkle	F540

GRADE 1 (Continued)

Heather Tech

Dust Tech	R240
Topaz Tech	R241
Oat Tech	R242
Flax Tech	R243
Silt Tech	R244
Loam Tech	R245
Crag Tech	R246
Basalt Tech	R247
Loden Tech	R248
Sagebrush Tech	R249
Meadow Tech	R250
Sundew Tech	R251
Rose Tech	R252
Raspite Tech	R253
Madder Tech	R254
Beetroot Tech	R255
Thistle Tech	R256
Lav Tech	R257
Clear Tech	R258
Loch Tech	R259
Ocean Tech	R260
North Sea Tech	R261
Onyx Tech	R262
Obsidian Tech	R263

India

Bombay	D402
Agra	D404
Gwalior	D405
Varanasi	D407
Haora	D408
Surat	D409
Manali	D425
Kashmir	D417
Pushkar	D418
Kerala	D419
Chennai	D422
Mumbai	D424
Pune	D423
Munnar	D420
Nanital	D421

Linen Weave

Gate	L308
Sesame	L309
Coir	L327
Bast	L328
Dusty Grey	L329
Mineral	L330
Linseed	L331

listings matrices

PANEL FABRICS (Continued)

GRADE 1 (Continued)

Lustrado

Glassine	L363
Acetate	L364
Brilliance	L365
Alloy	L366
Gallium	L367
Incandescent	L368
Resin	L369
Sterling	L370
Varnish	L372
Vitreous	L373

Makah

Shaker	M415
Luminous	M416
Arundo	M417
Solano	M418
Flitch	M419
Splint	M420

Peru

Tacna	P401
Nazca	P402
Lima	P403
Casma	P404
Puno	P405
Cuzco	P406
Tingo Maria	P407
Callao	P409
Tumbes	P411
Puerto	P412

Presse

Halo Effect	P100
Overlay	P101
Masked	P102
Relief	P103
Plaited	P104
Gravure	P105

Rationale

Classical	R380
Drift	R381
Firma	R382
Lucid	R383
Abstract	R384
Mind's Eye	R385
Infinite	R386
Transcend	R387

Topology

Ceramic	T100
Open Space	T101
Natural	T102
Cooling	T103
Shadow	T104

GRADE 1 (Continued)

Warp Speed

Headwind	W110
White Space	W111
Strobe	W112
Reed Arrow	W113
Jet	W114
Steel Racer	W115
Earth Orbit	W116

GRADE 2

Actuate

Aqueous	T740
Spectral	T741
Aether	T742
Facet	T743
Syntax	T744
Vanish	T745
Suffuse	T746
Mordant	T747
Lambent	T748
Conscious	T749
Fortify	T750
Favrite	T751
Prelude	T752
Meridian	T753
Thermal	T754
Induction	T755

Boucle Grid

Craie	B119
Bis	B120
Ardoise	B121
Fauve	B122
Nuage	B123

Complect

Melanite	P800
Quarry	P801
Silverleaf	P802
Jute	P803
Cumulus	P804
Yolk	P805
Apricot	P806
Highlighter Pink	P807
Deep Crimson	P808
Autumn	P809
Opaline	P810
Reservoir	P811
Gentian	P812
Blue Ice	P813
Winter	P814
Boreal	P815
Turquoise	P816
Okra	P817
Agave	P818

GRADE 2 (Continued)

Complement

Nightfall	C279
Dusk	C280
Grey Wolf	C281
Sea Salt	C282
Roan	C283
Amarillo	C284
Arancia	C285
Carnelian	C286
Garnet	C287
Fresh Air	C289
Peacock	C290

Crossgrain

Underbrush	G157
Dado	G158
Blackwood	G159
Cove	G160
Xylem	G161
Tenon	G162
Amaranth	G163
Red Oak	G164
Tuliptree	G165
Iroko	G166
Ginkgo	G167
Burl	G168
Cypress	G169
Springwood	G170
Driftwood	G171

Digi Tweed

Dust Tweed	B130
Topaz Tweed	B131
Oat Tweed	B132
Flax Tweed	B133
Silt Tweed	B134
Loam Tweed	B135
Crag Tweed	B136
Basalt Tweed	B137
Loden Tweed	B138
Sagebrush Tweed	B139
Meadow Tweed	B140
Sundew Tweed	B141
Rose Tweed	B142
Raspite Tweed	B143
Madder Tweed	B144
Beetroot Tweed	B145
Thistle Tweed	B146
Lav Tweed	B147
Clear Tweed	B148
Loch Tweed	B149
Ocean Tweed	B150
North Sea Tweed	B151
Onyx Tweed	B152
Obsidian Tweed	B153

Panel Fabrics on Altos are only available with working wall elevations.

listings matrices

PANEL FABRICS (Continued)

GRADE 2 (Continued)

Graviton

Dark Matter	R351
Chain Reaction	R352
Echo	R353
Cloud Chamber	R354
Albedo	R355
Half Life	R356
Luminous Flux	R357
Fission	R358
Kelvin	R359
Boiling Point	R360
Quantum	R361
Condensation	R362
Centigrade	R363
Ampere	R364
Cold Fusion	R365
Hydrostatic	R366

Megacheck

Liminal	R654
Convex	R655
Concave	R656
Drop Shadow	R657
Litmus	R658
Gradient	R659
Distort	R660
Resolution	R661
Glitch	R662
Flashbulb	R663
Visage	R664
Magnitude	R665

Percept

Schema	C813
Pristine	C814
Intrinsic	C815
Sublime	C817
Context	C818
Essence	C819
Tenet	C820
Epiphany	C821
Verve	C822
Amplitude	C823
Reason	C824
Cardinality	C825
Nebula	C826
Jubilant	C827
Ignite	C828
Harmonic	C829
Peak	C830
Devotion	C831
Transmit	C832
Render	C833
Pulse	C834
Constant	C835

GRADE 2 (Continued)

Percept (Continued)

Radiant	C836
Propagate	C837
Placid	C838
Singular	C839
Fringe	C840

Stratiform

Calcify	R600
Limestone	R601
Sandhill	R602
Moraine	R603
Glacial	R604
Bedrock	R605
Flint	R606

Twining

Ivory Vine	W117
Pale Straw	W118
Abaca	W119
Sisal	W120
Quill	W121
Silvery Strand	W122
Bulrush	W123

GRADE 3

Artopia

Primer	R176
Kinetic	R177
Stencil	R178
Magenta	R179
Amerlith	R180
Cadmium	R181
Aquatint	R182
Vivid Blue	R183

Cross Dye

Earl Grey	R150
Linen	R151
Light Birch	R152
Almond	R153
Soft Shadow	R154
Ace Grey	R155
Cool Ash	R156
Carotene	R157
Crimson	R158
Carmine	R159
Tea Tree	R160
Artichoke	R161
Plum	R162
Watercolor	R163
Azure	R164
Logwood	R165

GRADE 4

Intone

Ash	LP11
Creme	LP12
Harbor	LP13
Quicksilver	LP14
Caraway	LP15
Oxide	LP16
Cinder	LP17
Lute	LP18
Pome	LP19
Eclipse	LP20

Intraweb

Raster	W235
Dual Trace	W236
Polytope	W237
Superposition	W238
Coaxial	W239
Origin	W240
Slope	W241
Polarity	W242
Isosurface	W243

Milieu

Kettle	L165
Thunder	L166
Memory	L167
Steam	L168
Wing	L169
Nest	L170
Leap	L171
Troupe	L172
Peregrine	L173
Hedge	L174
Prickle	L175
Spring	L176
Muster	L177
Herd	L178
Parcel	L179
Bloom	L180
Fling	L181
Flamboyance	L182
Bazaar	L183
Rabble	L184
Zeal	L185
Bevy	L186
Loft	L187
Float	L188
Paddling	L189
Shoal	L190
Fleet	L191

listings matrices

PANEL FABRICS (Continued)

GRADE 4 (Continued)

Textured Map

Mineralize	R523
Henge	R524
Rockfall	R525
Trace Fossil	R526
Windblown Silt	R527
Holocene	R528
Coralline	R529
Latent Heat	R530
Water Table	R531
Elm Pollen	R532
Miocene	R533
Linden	R534
Green Algae	R535
Thaw	R536
Continental Drift	R537
Ocean Basin	R538

Twisted Tweed

Wrought Iron	R325
Rock Garden	R326
Shady Patch	R327
Moongate	R328
Plaster	R329
Stucco	R330
Thatch	R331
Arbor	R332
Daylight	R333
Sundial	R334
Koi Pond	R335
Brickwork	R336
Annual	R337
Perennial	R338
Rain Chain	R339
Open Air	R340
Water Feature	R341
Terrace	R342
Veranda	R343

GRADE 5

Ecotone

Abyss	R285
Ravine	R286
Rocky Shore	R287
Permafrost	R288
Tundra	R289
Arid	R290
Savanna	R291
Desert Bloom	R292
Badlands	R293
Caldera	R294
Freshwater	R295
Intertidal	R296
Rain Shadow	R297
Lichen	R298
Mangrove	R299
Treeline	R300

High Frequency

Eclipse Shadow	R264
Flash Lag	R265
Motion Blur	R266
Moon Illusion	R267
Solar Halo	R268
Laser Speckle	R269
Photon Shot	R270
Sea Fret	R271
Fata Morgana	R272
Hyperbolic Green	R273
Iceblink	R274
Plane Wave	R275
Liquid Crystal	R276
Aftereffect	R277
Gaussian	R278
Occlusion	R279

Marl Cloth

Yurt	R166
Guy Rope	R167
Camp Fire	R169
Dry Stone	R170
Berry	R172
Blacksmith	R173
Sea Nomad	R174
Wild Fruit	R175
Dreamscape	R195
Landmark	R196
Tree Bark	R197

Panel Fabrics on Altos are only available with working wall elevations.

listings matrices

ARCHITECTURAL FABRICS

GRADE 1

Rationale

Classical.....	B380
Drift.....	B381
Firma.....	B382
Lucid.....	B383
Abstract.....	B384
Mind's Eye.....	B385
Infinite.....	B386
Transcend.....	B387

GRADE 2

Actuate

Aqueous.....	A209
Spectral.....	A210
Aether.....	A211
Facet.....	A212
Syntax.....	A213
Vanish.....	A214
Suffuse.....	A215
Mordant.....	A216
Lambent.....	A217
Conscious.....	A218
Fortify.....	A219
Favrile.....	A220
Prelude.....	A221
Meridian.....	A222
Thermal.....	A223
Induction.....	A224

Artopia

Primer.....	R230
Kinetic.....	R231
Stencil.....	R232
Magenta.....	R233
Amerlith.....	R234
Cadmium.....	R235
Aquatint.....	R236
Vivid Blue.....	R237

Bandeau

Washi.....	D111
Grograin.....	D113
Palla.....	D114
Farran.....	D115

Bitstream

Tablet.....	B582
Hardware.....	B583
Trackback.....	B584
Lithium.....	B585
Grey Code.....	B586
Silicone.....	B587
White Noise.....	B588
Xenon.....	B589
Wavelet.....	B590
Blue Team.....	B591
Firewire.....	B592
Flash Drive.....	B593

GRADE 2 (Continued)

Boucle Grid

Craie.....	C111
Bis.....	C112
Ardoise.....	C113
Fauve.....	C114
Nuage.....	C115

Complect

Melanite.....	C293
Quarry.....	C294
Silverleaf.....	C295
Jute.....	C296
Cumulus.....	C297
Yolk.....	C298
Apricot.....	C299
Highlighter Pink.....	C300
Deep Crimson.....	C301
Autumn.....	C302
Opaline.....	C303
Reservoir.....	C304
Gentian.....	C305
Blue Ice.....	C306
Winter.....	C307
Boreal.....	C308
Turquoise.....	C309
Okra.....	C310
Agave.....	C311

Complement

Nightfall.....	T148
Dusk.....	T149
Grey Wolf.....	T150
Sea Salt.....	T151
Roan.....	T152
Amarillo.....	T153
Arancia.....	T154
Carnelian.....	T155
Garnet.....	T156
Fresh Air.....	T158
Peacock.....	T159

Crossgrain

Underbrush.....	C157
Dado.....	C158
Blackwood.....	C159
Cove.....	C160
Xylem.....	C161
Tenon.....	C162
Amaranth.....	C163
Red Oak.....	C164
Tuliptree.....	C165
Iroko.....	C166
Ginkgo.....	C167
Burl.....	C168
Cypress.....	C169
Springwood.....	C170
Driftwood.....	C171

GRADE 2 (Continued)

Digi Tweed

Dust Tweed.....	D310
Topaz Tweed.....	D311
Oat Tweed.....	D312
Flax Tweed.....	D313
Silt Tweed.....	D314
Loam Tweed.....	D315
Crag Tweed.....	D316
Basalt Tweed.....	D317
Loden Tweed.....	D318
Sagebrush Tweed.....	D319
Meadow Tweed.....	D320
Sundew Tweed.....	D321
Rose Tweed.....	D322
Raspite Tweed.....	D323
Madder Tweed.....	D324
Beetroot Tweed.....	D325
Thistle Tweed.....	D326
Lav Tweed.....	D327
Clear Tweed.....	D328
Loch Tweed.....	D329
Ocean Tweed.....	D330
North Sea Tweed.....	D331
Onyx Tweed.....	D332
Obsidian Tweed.....	D333

Emit

Watt.....	E314
Hertz.....	E315
Joule.....	E316
Dazzle.....	E317
Surge.....	E318
Particle.....	E319

Graviton

Dark Matter.....	G222
Chain Reaction.....	G223
Echo.....	G224
Cloud Chamber.....	G225
Albedo.....	G226
Half Life.....	G227
Luminous Flux.....	G228
Fission.....	G229
Kelvin.....	G230
Boiling Point.....	G231
Quantum.....	G232
Condensation.....	G233
Centigrade.....	G234
Ampere.....	G235
Cold Fusion.....	G236
Hydrostatic.....	G237

Panel Fabrics on Altos are only available with working wall elevations.

listings matrices

ARCHITECTURAL FABRICS (Continued)

GRADE 2 (Continued)

Heather Tech

Dust Tech	T162
Topaz Tech	T163
Oat Tech	T164
Flax Tech	T165
Silt Tech	T166
Loam Tech	T167
Crag Tech	T168
Basalt Tech	T169
Loden Tech	T170
Sagebrush Tech	T171
Meadow Tech	T172
Sundew Tech	T173
Rose Tech	T174
Raspite Tech	T175
Madder Tech	T176
Beetroot Tech	T177
Thisle Tech	T178
Lav Tech	T179
Clear Tech	T180
Loch Tech	T181
Ocean Tech	T182
North Sea Tech	T183
Onyx Tech	T184
Obsidian Tech	T185

Intone

Ash	LM12
Creme	LM13
Harbor	LM14
Quicksilver	LM15
Caraway	LM16
Oxide	LM17
Cinder	LM18
Lute	LM19
Pome	LM20
Eclipse	LM21

Lustrado

Glassine	D100
Acetate	D101
Brilliance	D102
Alloy	D103
Gallium	D104
Incandescent	D105
Resin	D106
Sterling	D107
Varnish	D109
Vitreous	D110

GRADE 2 (Continued)

Megacheck

Liminal	M328
Convex	M329
Concave	M330
Drop Shadow	M331
Litmus	M332
Gradient	M333
Distort	M334
Resolution	M335
Glitch	M336
Flashbulb	M337
Visage	M338
Magnitude	M339

Percept

Schema	P106
Pristine	P107
Intrinsic	P108
Sublime	P110
Context	P111
Essence	P112
Tenet	P113
Epiphany	P114
Verve	P115
Amplitude	P116
Reason	P117
Cardinality	P118
Nebula	P119
Jubilant	P120
Ignite	P121
Harmonic	P122
Peak	P123
Devotion	P124
Transmit	P125
Render	P126
Pulse	P127
Constant	P128
Radiant	P129
Propagate	P130
Placid	P131
Singular	P132
Fringe	P133

Presse

Halo Effect	R186
Overlay	R187
Masked	R188
Relief	R189
Plaited	R190
Gravure	R191

GRADE 2 (Continued)

Stratiform

Calcify	B590
Limestone	B591
Sandhill	B592
Moraine	B593
Glacial	B594
Bedrock	B595
Flint	B596

Strio

Mineral	S236
Dolomite	S237
Lithic	S238
Calcite	S239
Silica	S240
Feldspar	S242
Sandstone	S243
Tor	S244

Twining

Ivory Vine	T141
Pale Straw	T142
Abaca	T143
Sisal	T144
Quill	T145
Silvery Strand	T146
Bulrush	T147

GRADE 3

Ecotone

Abyss	E136
Ravine	E137
Rocky Shore	E138
Permafrost	E139
Tundra	E140
Arid	E141
Savanna	E142
Desert Bloom	E143
Badlands	E144
Caldera	E145
Freshwater	E146
Intertidal	E147
Rain Shadow	E148
Lichen	E149
Mangrove	E150
Treeline	E151

Panel Fabrics on Altos are only available with working wall elevations.

listings matrices

ARCHITECTURAL FABRICS (Continued)

GRADE 3 (Continued)

Grid State

Arc Flash	.G132
Open Circuit	.G133
Volt Switch	.G134
Hydropower	.G135
Switchboard	.G136
Megawatt	.G137
Circuit Break	.G138
Electrode	.G139
Live Wire	.G140
Turbine	.G141
Neon Bulb	.G142
Wolfram	.G143

Intraweb

Raster	.T397
Dual Trace	.T398
Polytope	.T397
Superposition	.T400
Coaxial	.T401
Origin	.T402
Slope	.T403
Polarity	.T404
Isosurface	.T405

Milieu

Kettle	M570
Thunder	M571
Memory	M572
Steam	M573
Wing	M574
Nest	M575
Leap	M576
Troupe	M577
Peregrine	M578
Hedge	M579
Prickle	M580
Spring	M581
Muster	M582
Herd	M583
Parcel	M584
Bloom	M585
Fling	M586
Flamboyance	M587
Bazaar	M588
Rabble	M589
Zeal	M590
Bevy	M591
Loft	M592
Float	M593
Paddling	M594
Shoal	M595
Fleet	M596

GRADE 3 (Continued)

Textured Map

Mineralize	.T541
Henge	.T542
Rockfall	.T543
Trace Fossil	.T544
Windblown Silt	.T545
Holocene	.T546
Coralline	.T547
Latent Heat	.T548
Water Table	.T549
Elm Pollen	.T550
Miocene	.T551
Linden	.T552
Green Algae	.T553
Thaw	.T554
Continental Drift	.T555
Ocean Basin	.T556

Twisted Tweed

Wrought Iron	.T278
Rock Garden	.T279
Shady Patch	.T280
Moongate	.T281
Plaster	.T282
Stucco	.T283
Thatch	.T284
Arbor	.T285
Daylight	.T286
Sundial	.T287
Koi Pond	.T288
Brickwork	.T289
Annual	.T290
Perennial	.T291
Rain Chain	.T292
Open Air	.T293
Water Feature	.T294
Terrace	.T295
Veranda	.T296

GRADE 4

High Frequency

Eclipse Shadow	H713
Flash Lag	H714
Motion Blur	H715
Moon Illusion	H716
Solar Halo	H717
Laser Speckle	H718
Photon Shot	H719
Sea Fret	H720
Fata Morgana	H721
Hyperbolic Green	H722
Iceblink	H723
Plane Wave	H724
Liquid Crystal	H725
Aftereffect	H726
Gaussian	H727
Occlusion	H728

Juxtapose

Greenheart	J207
Yakisugi	J208
Lacquer	J209
Timber	J210
Lumber	J211
Rosewood	J212



environmental data

STANDARD PANEL FABRICS

Pattern	Composition	Recycled Polyester	
		Post Consumer	Pre Consumer
Grade A			
Beeline	100% Recycled Polyester	39%	61%
Bitstream	100% Recycled Polyester	58%	42%
Egypt	100% Recycled Polyester		100%
Nitty Gritty	100% Recycled Polyester		100%
Tangle	80% Recycled Polyester 20% Polyester		80%
Wales	93% Recycled Polyester 7% Polyester		93%
Wired Up	100% Recycled Polyester	45%	55%
Grade 1			
Bandeau	100% Recycled Polyester		100%
Brazil	50% Recycled Polyester 50% Polyester		50%
Emit	44% Recycled Polyester 56% Polyester	29%	15%
Essentials	100% Recycled Polyester	35%	65%
Flicker	100% Recycled Polyester	46%	54%
Heather Tech	67% Recycled Polyester 33% Polyester	100%	
India	78% Recycled Polyester 22% Polyester	78%	
Linen Weave	100% Recycled Polyester		100%
Lustrado	75% Recycled Polyester 25% Polypropylene		75%
Makah	100% Recycled Polyester	54%	46%
Peru	100% Recycled Polyester	34%	66%
Presse	100% Recycled Polyester		100%
Rationale	80% Recycled Polyester 20% Polyester	80%	
Topology	53% Recycled Polyester 47% Polyester		53%
Warp Speed	67% Recycled Polyester 33% Polyester		67%

environmental data

STANDARD PANEL FABRICS (Continued)

Pattern	Composition	Recycled Polyester	
		Post Consumer	Pre Consumer
Grade 2			
Actuate	40% Recycled Polyester 60% Polyester	40%	
Boucle Grid	100% Recycled Polyester		100%
Complect	100% Recycled Polyester	100%	
Complement	100% Polyester		
Crossgrain	100% Polyester		
Digi Tweed	55% Recycled Polyester 45% Polyester	100%	
Graviton	100% Recycled Polyester	100%	
Megacheck	100% Recycled Polyester		
Percept	81% Recycled Polyester 19% Polyester	81%	
Stratiform	52% Recycled Polyester 48% Polypropylene	43%	9%
Twining	100% Recycled Polyester		100%
Grade 3			
Artopia	100% Polyester		
Cross Dye	66% Recycled Polyester 34% Polyester	61%	5%
Grade 4			
Intone	53% Recycled Polyester 47% Polyester	34.4%	18.6%
Intraweb	100% Recycled Biodegradable** Polyester (Postconsumer)		
Milieu	90% Recycled Polyester, 10% Polyester	90%	
Textured Map 	100% Recycled Biodegradable** Polyester		
Twisted Tweed	100% Recycled Polyester	100%	
Grade 5			
Ecotone	100% Recycled Biodegradable** Polyester		
High Frequency 	87% Recycled Polyester (Postconsumer), 12% Polyester, 1% Nylon		
Marl Cloth	57% Recycled Polyester 42% Polyester, 1% Nylon	30%	27%

** Rate and extent of biodegradation into elements found in nature is 91% after 1,278 days under ASTM D5511 (Anaerobic Biodegradation of Plastic Materials Under High Solids Anaerobic Digestion Conditions.) The test was done with the same component (PET) polyester and biocatalyst additive. No evidence of further degradation.

environmental data



ARCHITECTURAL FABRICS

Pattern	Composition	Recycled Polyester	
		Post Consumer	Pre Consumer
Grade 1			
Rationale	80% Recycled Polyester 20% Polyester	80%	
Grade 2			
Actuate	40% Recycled Polyester 60% Polyester	40%	
Artopia	100% Polyester		
Bandeau	100% Recycled Polyester		100%
Bitstream	100% Recycled Polyester	58%	42%
Boucle Grid	100% Recycled Polyester		100%
Complect	100% Recycled Polyester	100%	
Complement	100% Polyester		
Crossgrain	100% Polyester		
Digi Tweed	55% Recycled Polyester 45% Polyester	55%	
Emit	44% Recycled Polyester 56% Polyester	29%	15%
Graviton	100% Recycled Polyester	100%	
Heather Tech	67% Recycled Polyester 33% Polyester	67%	
Intone	53% Recycled Polyester 47% Polyester	34.4%	18.6%
Lustrado	75% Recycled Polyester 25% Polypropylene		75%
Megacheck	100% Recycled Polyester		
Percept	81% Recycled Polyester 19% Polyester	81%	
Presse	100% Recycled Polyester		100%
Stratiform	52% Recycled Polyester 48% Polypropylene	43%	9%
Strio	100% Polyester		
Twining	100% Recycled Polyester		100%

** Rate and extent of biodegradation into elements found in nature is 91% after 1,278 days under ASTM D5511 (Anaerobic Biodegradation of Plastic Materials Under High Solids Anaerobic Digestion Conditions.) The test was done with the same component (PET) polyester and biocatalyst additive. No evidence of further degradation.

environmental data

ARCHITECTURAL FABRICS

Pattern	Composition	Recycled Polyester	
		Post Consumer	Pre Consumer
Grade 3			
Ecotone	100% Recycled Biodegradable** Polyester		
Grid State	BIODEGRADABLE CLEAN IMPACT TEXTILES™ - 100% Post-Consumer Recycled Biodegradable Polyester**	100%	
Intraweb	100% Recycled Biodegradable* Polyester	100%	
Milieu	90% Recycled Polyester, 10% Polyester	90%	
Textured Map 	100% Recycled Biodegradable** Polyester		
Twisted Tweed	100% Recycled Polyester	100%	
Grade 4			
High Frequency 	87% Recycled Polyester (Postconsumer), 12% Polyester, 1% Nylon		
Jaxtapse	70% Recycled Polyester, 30% Polyester	70%	

** Rate and extent of biodegradation into elements found in nature is 91% after 1,278 days under ASTM D5511 (Anaerobic Biodegradation of Plastic Materials Under High Solids Anaerobic Digestion Conditions.) The test was done with the same component (PET) polyester and biocatalyst additive. No evidence of further degradation.

upholstery fabrics

upholstery fabrics

APPLICATION MATRICES

UPHOLSTERY FABRICS	32
LEATHER	38
MESH	40

LISTING MATRICES

UPHOLSTERY

GRADE 1

BITSTREAM	44
FUNDAMENTALS	44
HEATHER TECH.	44
MAGNIFY	44
STIMULI	44

GRADE 2

ACTUATE	44
COMPECT	44
COMPLEMENT	44
CROSS DYE	44
CROSSGRAIN	45
DECOY	45
DIGI TWEED	45
GRAVITON	45
INTONE	45
MEGACHECK	45
PERCEPT	46
ULTRA DURABLE	46

GRADE 3

AMPLE	46
DOYENNE	46
ECOTONE	46
FINE GRAIN	46
INTRAWEB	46
MARL CLOTH	46
MILIEU	46
SITU	46
SUPERSPUN	46
TEXTURED MAP	46
TWISTED TWEED	47

GRADE 4

ELASTIC WOOL	47
FORMWORK.	47
GRID STATE	47
HIGH FREQUENCY	47
INTERSTICE	47
META TEXTURE.	47
MODULUS.	47
VELVET UNDERGROUND	47

GRADE 5

ADAGE	47
CULT CLASSIC.	48
MONOTEX	48
PARTICULATE	48
SYNAPTIC	48

GRADE 6

AMALGAM	48
DUO CHROME.	48
HAPTIC.	48
OUTPRESS	48
PERILUNE	48
PHOTOGRAM.	48
SOFT STATIC.	48
VECTOR	48

GRADE 7

CONTRAST SLUB	48
EPHEMERA	48
EVERYDAY BOUCLE	49
FLEX WOOL.	49
OEUVRE	49
PEBBLE MELANGE	49
STRUCTURED STRIPE.	49
TILTED SHIFT REDUX	49
WOOL FLECK.	49

GRADE 8

BARBERPOLE BASKET.	49
CONSTRUCT	49
FULL WOOL	49
GEOGLYPH	49
HOMAGE	50
WAVEFIELD	50
WELDED	50

GRADE 9

EQUILUX.	50
GRAPH SPECK	50
HEATHER FELT	50
MELANGE CHECK	50
SUPER SHEARLING	50
TOP COAT.	50

GRADE 10

COLOR FUSE	50
FLEECE	50

GRADE 11

RUBRIC.	50
-----------------	----

GRADE 13

EMERGENT	51
--------------------	----

GRADE 14

ARC ANGLE.	51
SCALE FACTOR	51

GRADE 16

MITERED.	51
NAVIGATE.	51
SECOND NATURE	51

LEATHER

LEATHER - LA	51
LEATHER - LB	51
LEATHER - LC	51
LEATHER - LD	51

ENVIRONMENTAL DATA

STANDARD UPHOLSTERY FABRICS	52
MESH	57

TEXTILE LISTINGS BY PATTERN NUMBER	58
--	----

upholstery fabrics

TEKNION STANDARD UPHOLSTERY FABRIC PROGRAM

All fabrics are developed to enhance Teknion systems products incorporating technology in fiber development. They are designed to coordinate with the other finishes in Teknion system and seating programs. The fabrics are offered in a range of low intensity colors with some stronger hues and a variety of solids, patterns and textures. All Teknion fabrics are developed to exceed technical standards.

Teknion has a full program of standard fabrics, vinyl and leather appropriate for most seating lines. All fabrics are covered by Teknion standard warranty and meet all standards for CAL 116 and 117 and exceed industry durability requirements. All upholstery coverings may not be approved for use on all chair families. Please refer to the **Listing & Application Matrices** within this section for fabric applications.

Fabrics meet or exceed performance standards by ACT (Association for Contract Textiles).

Please note, leathers and faux-leathers may show natural blemishes, scars and wrinkles which are inherent material characteristics and as such deemed acceptable by Teknion. Variation of color, grain and texture found in wood and leather are also natural. Teknion is not responsible for reverse crocking of dyes from clothing onto our seating upholstery and finishes.

FABRIC PATTERN DIRECTIONAL GUIDELINES

Directional specifications are not required for any of Teknion Standard Upholstery to Teknion products. All Standard Upholstery Fabrics will be run off-the-bolt, as shown on the sample card. See the **Fabric Pattern Directional Guidelines** in the General Information section at the back of the book for more details.

upholstery fabrics

application matrices

UPHOLSTERY FABRICS

	MISC.										WORK CHAIRS										STACKING CHAIRS				
	ALL PEDESTALS W/ SEAT	TEKNON BENE BOX SEATING PAD	DISTRICT™ CUSHION	EXPANSION CUSHION	INFINITY SCREEN	FRAMED SCREEN	QUILTED SCREEN	KIOSK FRAMED FABRIC ADD-ON	ROUTES MOBILE SOFT SCREEN	AROUND	ESSA	NUOVA CONTESSA	PROJEK™	SABRINA	SAVERA®	SAVERA XL	SAVERA STOOL	STONE	VARIABLE	VISIO	NAMI®	NAMI® 3D	VARIABLE	VOLUME™	
<div style="display: flex; align-items: center;"> <div style="width: 20px; height: 20px; background-color: #0070C0; margin-right: 5px;"></div> Available <div style="width: 20px; height: 20px; border: 1px solid black; margin-left: 20px; margin-right: 5px;"></div> Not Available </div> <p>See notes at the beginning of the section for more information.</p>																									
Grade 1																									
Bitstream									*			*						*X							
Fundamentals									*		*	*	*					*X							
Heather Tech							•	•	*			*	*					*							
Magnify									*		*	*	*					*							
Stimuli									*			*	*					*							
Grade 2																									
Actuate							•	•	*			*						*							
Complect									*			*						*							
Complement									*		*	*	*					*						*	
Cross Dye									*		*	*	*					*						*	
Crossgrain									*			*						*						*	
Decoy									*			*						*							
Digi Tweed							•	•	*			*						*							
Graviton									*			*						*							
Intone							•	•	*			*						*							
Megacheck												*													
Percept												*						*							
Ultra Durable									*		*	*	*					*							
Grade 3																									
Ample									*			*						*							
Doyenne									*			*													
Ecotone							•	•	*			*						*							
Fine Grain									*			*													
Intraweb									*			*													
Marl Cloth							•	•	*		*	*	*				*							*	
Milieu									*			*						*							
Situ									*		*	*	*					*							
Superspun							•	•	*			*						*							
Textured Map							•	•	*																
Twisted Tweed							•	•	*			*						*							
Grade 4																									
Elastic Wool									*			*						*X							
Formwork									*			*						*							
Grid State																									
High Frequency							•	•	*																
Interstice									*			*						*							
Meta Texture																									
Modulus									*		*	*	*				*								
Velvet Underground									*		*	*	*				*							*	

Only select colors of Percept available on the Visio Chair.

- * Applicable for seat only.
- X Fabric available as a sleeve.
- Available for Add-On Board

application matrices



UPHOLSTERY FABRICS (Continued)

	MULTI-USE CHAIRS														SOFT SEATING													
	ABILITY SPINNER STOOL	AMICUS (GUEST)	ARNE (NORTH 56)	AROUND (GUEST)	CHEZ (NORTH 56)	JUST-US	KUPP	LARU (NORTH 56)	OCCO	ROUTES	SCHALE (NORTH 56)	SICLA (NORTH 56)	SITARA™ (GUEST)	SPROUT STOOL	VARIABLE	AEGIS™	BANQ	BELIZE™	BONDS	COLLABORATIVE OTTOMAN	ROUTES (ARC/LOUNGE)	ROUTES (MEET N GREET/ROCKING CHAIR)	ROUTES (SOFA)	TEKNION DNA™	FERRARRA®	TUX	VASARI®	VIGNETTE™
<div style="display: flex; align-items: center;"> <div style="margin-right: 10px;"> Available Not Available </div> <p>See notes at the beginning of the section for more information.</p> </div>																												
Grade 1																												
Bitstream			*				*																C					
Fundamentals							*																C					
Heather Tech							*																C					
Magnify							*																C					
Stimuli			*				*																C					
Grade 2																												
Actuate							*																C					
Complect							*																C					
Complement			*				*																C					
Cross Dye			*				*																C					
Crossgrain			*				*																C					
Decoy			*				*																C					
Digi Tweed							*																C					
Graviton							*																C					
Intone			*				*																C					
Megacheck							*																C					
Percept							*																C					
Ultra Durable			*				*																C					
Grade 3																												
Ample			*				*																C					
Doyenne			*				*																C					
Ecotone							*																C					
Fine Grain							*																C					
Intraweb							*																C					
Marl Cloth			*				*																C					
Milieu							*																C					
Situ			*				*																C					
Superspun			*				*																C					
Textured Map 🗺️																							C					
Twisted Tweed							*																C					
Grade 4																												
Elastic Wool							*																C					
Formwork							*																C					
Grid State			*				*																C					
High Frequency 📡																							C					
Interstice			*				*																C					
Meta Texture							*																C					
Modulus			*																				C					
Velvet Underground			*				*																C					

* Applicable for seat only.
 C Available on Cushion

application matrices

UPHOLSTERY FABRICS (Continued)

	MISC.											WORK CHAIRS											STACKING CHAIRS		
	ALL PEDESTALS W/ SEAT	TEKNON BENE BOX SEATING PAD	DISTRICT™ CUSHION	EXPANSION CUSHION	INFINITY SCREEN	FRAMED SCREEN	QUILTED SCREEN	KIOSK FRAMED FABRIC ADD-ON	ROUTES MOBILE SOFT SCREEN	AROUND	ESSA	NUOVA CONTESSA	PROJEK™	SABRINA	SAVERA®	SAVERA XL	SAVERA STOOL	STONE	VARIABLE	VISIO	NAMI®	NAMI® 3D	VARIABLE	VOLUME™	
Grade 5																									
Adage							•	•	*			*						*							
Cult Classic									*			*						*							
Monotex												*													
Particulate									*			*						*							
Synaptic									*			*						*							
Grade 6																									
Amalgam							•	•	*			*						*							
Duo Chrome									*			*						*							
Haptic												*						*							
Outpress									*			*						*							
Perilune												*						*							
Photogram												*						*							
Soft Static 																									
Vector																									
Grade 7																									
Contrast Slub									*			*													
Ephemera									*			*						*							
Everyday Boucle									*			*						*							
Flex Wool									*			*						*X							
Oeuvre									*			*						*							
Pebble Melange									*			*													
Structured Stripe									*			*													
Tilt Shift Redux									*			*						*							
Wool Fleck									*			*						*							
Grade 8																									
Barberpole Basket									*			*						*							
Construct									*			*						*X							
Geoglyph									*			*						*							
Full Wool									*		*	*						*X							*
Homage									*			*						*							
Wavefield									*			*						*							
Welded									*			*						*							
Grade 9																									
Equilux									*									*X							
Graph Speck									*			*						*							
Heather Felt									*			*						*X							
Melange Check									*			*						*							
Super Shearling 									*			*						*							
Top Coat									*			*						*							

- * Applicable for seat only.
- X Fabric available as a sleeve.
- Available for Add-On Board.

application matrices

UPHOLSTERY FABRICS (Continued)

<div style="display: flex; align-items: center;"> <div style="width: 15px; height: 15px; background-color: #0070C0; margin-right: 5px;"></div> Available <div style="width: 15px; height: 15px; border: 1px solid black; margin-left: 10px; margin-right: 5px;"></div> Not Available </div>	MISC.										WORK CHAIRS										STACKING CHAIRS				
	ALL PEDESTALS W/ SEAT	TEKNION BENE BOX SEATING PAD	DISTRICT™ CUSHION	EXPANSION CUSHION	INFINITY SCREEN	FRAMED SCREEN	QUILTED SCREEN	KIOSK FRAMED FABRIC ADD-ON	ROUTES MOBILE SOFT SCREEN	AROUND	ESSA	NUOVA CONTESSA	PROJEK™	SABRINA	SAVERA®	SAVERA XL	SAVERA STOOL	STONE	VARIABLE	VISIO	NAMI®	NAMI® 3D	VARIABLE	VOLUME™	
Grade 10																									
Color Fuse												*					*								
Fleece												*					*X								
Grade 11																									
Rubric																									
Grade 13																									
Emergent																									
Grade 14																									
Arc Angle																									
Scale Factor																									
Grade 16																									
Mitered																									
Navigate																	*X								
Second Nature																	*X								

* Applicable for seat only.
 X Fabric available as a sleeve.

application matrices

UPHOLSTERY FABRICS (Continued)

See notes at the beginning of the section for more information.	MULTI-USE CHAIRS										SOFT SEATING																											
	ABILITY SPINNER STOOL	AMICUS (GUEST)	ARNE (NORTH 56)	AROUND (GUEST)	CHEZ (NORTH 56)	JUST-US	KUPP	LARU (NORTH 56)	OCCO	ROUTES	SCHALE (NORTH 56)	SICLA (NORTH 56)	SITARA™ (GUEST)	SPROUT STOOL	VARIABLE	AEGIS™	BANQS	BELIZE™	BONDS	COLLABORATIVE	OTTOMAN	ROUTES (ARC/LOUNGE)	ROUTES (MEET N GREET/ROCKING CHAIR)	ROUTES (SOFA)	TEKNION DNA™	FERRARRA®	TUX	VASARI®	VIGNETTE™									
Grade 10																																						
Color Fuse			*				*																															
Fleece			*				*																															
Grade 11																																						
Rubric																																						
Grade 13																																						
Emergent																																						
Grade 14																																						
Arc Angle																																						
Scale Factor																																						
Grade 16																																						
Mitered																																						
Navigate																																						
Second Nature																																						

- * Applicable for seat only.
- X Fabric available as a sleeve.
- C Available on Cushion

application matrices

LEATHER

<div style="display: flex; align-items: center;"> <div style="width: 15px; height: 15px; background-color: #0070C0; margin-right: 5px;"></div> Available <div style="width: 15px; height: 15px; border: 1px solid black; margin-left: 10px; margin-right: 5px;"></div> Not Available </div>	MISC.										WORK CHAIRS										STACKING CHAIRS				
	ALL PEDESTALS W/ SEAT	TEKNION BENE BOX SEATING PAD	DISTRICT™ CUSHION	EXPANSION CUSHION	INFINITY SCREEN	FRAMED SCREEN	QUILTED SCREEN	KIOSK FRAMED FABRIC.ADD-ON	ROUTES MOBILE SOFT SCREEN	AROUND	ESSA	NUOVA CONTESSA	PROJEK™	SABRINA	SAVERA®	SAVERA XL	SAVERA STOOL	STONE	VARIABLE	VISIO	NAMI®	NAMI® 3D	VARIABLE	VOLUME™	
Leather - LA																									
Base Grade Leather	Available	Available	Not Available ▲	Available	Not Available	Not Available	Not Available	Not Available	Available	Available	Available *	Available *	Available *	Available	Available	Available	Available	Available	Available	Available	Available	Available	Available	Available	Available
Leather - LB																									
Merus	Available	Available	Available ▲	Available	Not Available	Not Available	Not Available	Not Available	Available *	Available	Available	Available	Available	Available	Available	Available	Available	Available	Available	Available	Available	Available	Available	Available	Available
Leather - LC																									
Pela	Available	Available	Available ▲	Available	Not Available	Not Available	Not Available	Not Available	Available *	Available *	Available *	Available *	Available	Available	Available	Available	Available	Available	Available	Available	Available	Available	Available	Available	Available
Leather - LD																									
Fortis	Available	Available	Available ▲	Available	Not Available	Not Available	Not Available	Not Available	Available *	Available	Available	Available	Available	Available	Available	Available	Available	Available	Available	Available	Available	Available	Available	Available	Available

* Applicable for seat only.

▲ Does **not** apply to fitted seat cushion.

application matrices

LEATHER (Continued)

<div style="display: flex; align-items: center;"> <div style="width: 15px; height: 15px; background-color: #0070C0; margin-right: 5px;"></div> Available <div style="width: 15px; height: 15px; border: 1px solid black; margin-left: 10px; margin-right: 5px;"></div> Not Available </div>	MULTI-USE CHAIRS														SOFT SEATING																						
	ABILITY SPINNER STOOL	AMICUS (GUEST)	ARNE (NORTH 56)	AROUND (GUEST)	CHEZ (NORTH 56)	JUST-US	KUPP	LARU (NORTH 56)	OCCO	ROUTES	SCHALE (NORTH 56)	SICLA (NORTH 56)	SITARA™ (GUEST)	SPROUT STOOL	VARIABLE	AEGIS™	BANQ	BELIZE™	BONDS	COLLABORATIVE	OTTOMAN	ROUTES (ARC/LOUNGE)	ROUTES (MEET N GREET/ROCKING CHAIR)	ROUTES (SOFA)	TEKNION DNA™	FERRARRA®	TUX	VASARI®	VIGNETTE™								
Leather - LA																																					
Base Grade Leather	Available	Available	Available*	Available	Available	Available	Available	Available	Available	Available	Available	Available	Available	Available	Available	Available	Available	Available	Available	Available	Available	Available	Available	Available	Available	Available	Available	Available	Available	Available	Available	Available	Available	Available	Available		
Leather - LB																																					
Merus	Available	Available	Available*	Available	Available	Available	Available	Available	Available	Available	Available	Available	Available	Available	Available	Available	Available	Available	Available	Available	Available	Available	Available	Available	Available	Available	Available	Available	Available	Available	Available	Available	Available	Available	Available	Available	
Leather - LC																																					
Pela	Available	Available	Available*	Available	Available	Available	Available	Available	Available	Available	Available	Available	Available	Available	Available	Available	Available	Available	Available	Available	Available	Available	Available	Available	Available	Available	Available	Available	Available	Available	Available	Available	Available	Available	Available	Available	Available
Leather - LD																																					
Fortis	Available	Available	Available*	Available	Available	Available	Available	Available	Available	Available	Available	Available	Available	Available	Available	Available	Available	Available	Available	Available	Available	Available	Available	Available	Available	Available	Available	Available	Available	Available	Available	Available	Available	Available	Available	Available	Available

* Applicable for seat only.

application matrices

MESH

		MISC.													WORK CHAIRS										STACKING CHAIRS		
		ALL PEDESTALS W/ SEAT	TEKNON BENE BOX SEATING PAD	DISTRICT™ CUSHION	EXPANSION CUSHION	INFINITY SCREEN	FRAMED SCREEN	QUILTED SCREEN	KIOSK FRAMED FABRIC ADD-ON	ROUTES MOBILE SOFT SCREEN	AROUND	ESSA	NUOVA CONTESSA	PROJEK™	SABRINA	SAVERA®	SAVERA XL	SAVERA STOOL	STONE	VARIABLE	VISIO	NAMI®	NAMI® 3D	VARIABLE	VOLUME™		
See notes at the beginning of the section for more information.																											
Nu-Tess Mesh																											
Iron	SB15											*															
Basalt	SB16											*															
Brier	SB19											*															
Banner	SB20											*															
Lapis	SB21											*															
Shrinx Fleck Mesh																											
Charcoal	F1												B														
Smoke	F2												B														
Dune	F3												B														
Peat	F4												B														
Shrinx Original Mesh																											
Ebony	S2												B														
Shrinx Veil Mesh																											
Veil Noir	S4												B														
Veil Blanc	S5												B														
Veil Grau	S6												B														
Sabrina Mesh																											
Iron	SB15													B													
Basalt	SB16													B													
Chainlink	SB17													B													
Brier	SB19													B													
Banner	SB20													B													
Lapis	SB21													B													
Around Mesh																											
Banner	A123																										
Lapis	A124																										
Brier	A125																										
Dove	A126																										
Black	A127																										
Just-Us Mesh																											
Black	J100																										
Charcoal	J101																										
Smoke	J102																										
Fleece	J103																										
Khaki	J104																										
Spice	J105																										
Surf	J106																										

* Applicable for seat only.

B Applicable to back only.

application matrices

MESH (Continued)

<div style="display: flex; align-items: center;"> <div style="width: 15px; height: 15px; background-color: #007bff; margin-right: 5px;"></div> Available <div style="width: 15px; height: 15px; border: 1px solid black; margin-left: 10px; margin-right: 5px;"></div> Not Available </div>		MULTI-USE CHAIRS											SOFT SEATING															
		ABILITY SPINNER STOOL	AMICUS (GUEST)	ARNE (NORTH 56)	AROUND (GUEST)	CHEZ (NORTH 56)	JUST-US	KUPP	LARU (NORTH 56)	OCCO	ROUTES	SCHALE (NORTH 56)	SICLA (NORTH 56)	SITARA™ (GUEST)	SPROUT STOOL	VARIABLE	AEGIS™	BANQ	BELIZE™	BONDS	COLLABORATIVE	OTTOMAN	ROUTES (ARC/LOUNGE)	ROUTES (MEET N GREET/ROCKING CHAIR)	ROUTES (SOFA)	TEKNION DNA™	FERRARRA®	TUX
Nu-Tess Mesh																												
Iron	SB15																											
Basalt	SB16																											
Brier	SB19																											
Banner	SB20																											
Lapis	SB21																											
Shrinx Fleck Mesh																												
Charcoal	F1																											
Smoke	F2																											
Dune	F3																											
Peat	F4																											
Shrinx Original Mesh																												
Ebony	S2																											
Shrinx Veil Mesh																												
Veil Noir	S4																											
Veil Blanc	S5																											
Veil Grau	S6																											
Sabrina Mesh																												
Iron	SB15																											
Basalt	SB16																											
Chainlink	SB17																											
Brier	SB19																											
Banner	SB20																											
Lapis	SB21																											
Around Mesh																												
Banner	A123																											
Lapis	A124																											
Brier	A125																											
Dove	A126																											
Black	A127																											
Just-Us Mesh																												
Black	J100																											
Charcoal	J101																											
Smoke	J102																											
Fleece	J103																											
Khaki	J104																											
Spice	J105																											
Surf	J106																											

application matrices

MESH (Continued)

<div style="display: flex; align-items: center;"> <div style="width: 15px; height: 15px; background-color: #007bff; margin-right: 5px;"></div> Available <div style="width: 15px; height: 15px; border: 1px solid black; margin-left: 10px; margin-right: 5px;"></div> Not Available </div>		MISC.										WORK CHAIRS										STACKING CHAIRS				
		ALL PEDESTALS W/ SEAT	TEKNON BENE BOX SEATING PAD	DISTRICT™ CUSHION	EXPANSION CUSHION	INFINITY SCREEN	FRAMED SCREEN	QUILTED SCREEN	KIOSK FRAMED FABRIC ADD-ON	ROUTES MOBILE SOFT SCREEN	AROUND	ESSA	NUOVA CONTESSA	PROJEK™	SABRINA	SAVERA®	SAVERA XL	SAVERA STOOL	STONE	VARIABLE	VISIO	NAMI®	NAMI® 3D	VARIABLE	VOLUME™	
Visio Mesh																										
Black	VM01																									
Grey	VM02																									
Arc Mesh																										
Midnight	AR01																									
Peppercorn	AR02																									
Tone Performance Mesh																										
Pebble	KK02																									
Pebble	KK02																									
Charcoal	KK03																									
Onyx	KK04																									
Ochre	KK05																									
Rooibos	KK06																									
Umber	KK07																									
Coral	KK08																									
Eucalyptus	KK09																									
Indigo	KK10																									
Seaweed	KK11																									
Minuit	KK12																									
Tone Lifestyle Mesh																										
Pearl	WW01																									
Pebble	WW02																									
Charcoal	WW03																									
Onyx	WW04																									
Ochre	WW05																									
Rooibos	WW06																									
Umber	WW07																									
Coral	WW08																									
Eucalyptus	WW09																									
Indigo	WW10																									
Seaweed	WW11																									
Minuit	WW12																									
Tone Knit Sleeve																										
Pearl	KN22																									
Pebble	KN23																									
Charcoal	KN24																									
Onyx	KN25																									
Ochre	KN26																									
Dark Eucalyptus	KN27																									
Dark Corel	KN28																									
Dark Indigo	KN29																									

application matrices

MESH (Continued)

<div style="display: flex; align-items: center;"> <div style="width: 20px; height: 10px; background-color: #0070C0; margin-right: 5px;"></div> Available <div style="width: 20px; height: 10px; border: 1px solid black; margin-left: 10px; margin-right: 5px;"></div> Not Available </div>		MULTI-USE CHAIRS														SOFT SEATING													
		ABILITY SPINNER STOOL	AMICUS (GUEST)	ARNE (NORTH 56)	AROUND (GUEST)	CHEZ (NORTH 56)	JUST-US	KUPP	LARU (NORTH 56)	OCCO	ROUTES	SCHALE (NORTH 56)	SICLA (NORTH 56)	SITARA™ (GUEST)	SPROUT STOOL	VARIABLE	AEGIS™	BANQS	BELIZE™	BONDS	COLLABORATIVE	OTTOMAN	ROUTES (ARC/LOUNGE)	ROUTES (MEET N GREET/ROCKING CHAIR)	ROUTES (SOFA)	TEKNION DNA™	FERRARRA®	TUX	VASARI®
Visio Mesh																													
Black	VM01																												
Grey	VM02																												
Arc Mesh																													
Midnight	AR01																												
Peppercorn	AR02																												
Tone Performance Mesh																													
Pebble	KK02																												
Pebble	KK02																												
Charcoal	KK03																												
Onyx	KK04																												
Ochre	KK05																												
Rooibos	KK06																												
Umber	KK07																												
Coral	KK08																												
Eucalyptus	KK09																												
Indigo	KK10																												
Seaweed	KK11																												
Minuit	KK12																												
Tone Lifestyle Mesh																													
Pearl	WW01																												
Pebble	WW02																												
Charcoal	WW03																												
Onyx	WW04																												
Ochre	WW05																												
Rooibos	WW06																												
Umber	WW07																												
Coral	WW08																												
Eucalyptus	WW09																												
Indigo	WW10																												
Seaweed	WW11																												
Minuit	WW12																												
Tone Knit Sleeve																													
Pearl	KN22																												
Pebble	KN23																												
Charcoal	KN24																												
Onyx	KN25																												
Ochre	KN26																												
Dark Eucalyptus	KN27																												
Dark Corel	KN28																												
Dark Indigo	KN29																												

listings matrices

UPHOLSTERY FABRICS

GRADE 1

Bitstream

Tablet	B160
Hardware	B161
Trackback	B162
Lithium	B163
Grey code	B164
Silicone	B165
White Noise	B166
Xenon	B167
Wavelet	B168
Blue Team	B169
Firewire	B170
Flash Drive	B171

Fundamentals

Salsa	E504
Banner	E505
Parakeet	E516
Brier	E518
Sudan	E519
Wendigo	E520
Armory	E521
Light Grey	E522
Black	E523
Tangelo	E526
Verde	E528
Aqua	E529
Azure	E530
Dove	E532
Nickel	E533
Slate	E534
Latte	E535
Marble	E536
Moonstone	E537
Lapris	E538
Malachite	E539

Heather Tech

Dust Tech	T162
Topaz Tech	T163
Oat Tech	T164
Flax Tech	T165
Silt Tech	T166
Loam Tech	T167
Crag Tech	T168
Basalt Tech	T169
Loden Tech	T170
Sagebrush Tech	T171
Meadow Tech	T172
Sundew Tech	T173
Rose Tech	T174
Raspite Tech	T175
Madder Tech	T176
Beetroot Tech	T177
Thistle Tech	T178
Lav Tech	T179
Clear Tech	T180

GRADE 1 (Continued)

Heather Tech (Continued)

Loch Tech	T181
Ocean Tech	T182
North Sea Tech	T183
Onyx Tech	T184
Obsidian Tech	T185

Magnify

Telescope	M140
Polished Mirror	M141
Reflection	M142
Zoom Lens	M143
Force Field	M144
Long Wave	M145
Deep Water	M146
Light Beam	M147
Flare Up	M148
Viewfinder	M149
Infrared	M151

Stimuli

Sensitive	S145
Turbinado	S146
Rush	S147
Zest	S148
Tactile	S149
Daredevil	S150
Euphoria	S151
Vigor	S152
Thrill	S153
Catalyst	S154
Black Tea	S155

GRADE 2

Actuate

Aqueous	A209
Spectral	A210
Aether	A211
Facet	A212
Syntax	A213
Vanish	A214
Suffuse	A215
Mordant	A216
Lambent	A217
Conscious	A218
Fortify	A219
Favrile	A220
Prelude	A221
Meridian	A222
Thermal	A223
Induction	A224

GRADE 2 (Continued)

Complex

Melanite	C293
Quarry	C294
Silverleaf	C295
Jute	C296
Cumulus	C297
Yolk	C298
Apricot	C299
Highlighter Pink	C300
Deep Crimson	C301
Autumn	C302
Opaline	C303
Reservoir	C304
Gentian	C305
Blue Ice	C306
Winter	C307
Boreal	C308
Turquoise	C309
Okra	C310
Agave	C311

Complement

Nightfall	T148
Dusk	T149
Grey Wolf	T150
Sea Salt	T151
Roan	T152
Amarillo	T153
Arancia	T154
Carnelian	T155
Garnet	T156
Fresh Air	T158
Peacock	T159

Cross Dye

Earl Grey	C120
Linen	C121
Light Birch	C122
Almond	C123
Soft Shadow	C124
Ace Grey	C125
Cool Ash	C126
Carotene	C127
Crimson	C128
Carmine	C129
Tea Tree	C130
Artichoke	C131
Plum	C132
Watercolor	C133
Azure	C134
Logwood	C135

listings matrices

UPHOLSTERY FABRICS (Continued)

GRADE 2 (Continued)

Crossgrain

Underbrush	C163
Dado	C164
Blackwood	C165
Cove	C166
Xylem	C167
Tenon	C168
Amaranth	C169
Red Oak	C170
Tuliptree	C171
Iroko	C172
Ginkgo	C173
Burl	C174
Cypress	C175
Springwood	C176
Driftwood	C177

Decoy

Double Bluff	D150
Sheep's Clothing	D151
Trick Mirror	D152
Ditto	D153
Proxy	D154
Çaçade	D155
Rook	D156
Copycat	D157
Incognito	D158
Pipe Dream	D159
Trip Wire	D160
Feign	D161
Atlantis	D162
Mirage	D163
Reverie	D164
Lure	D165
Cloak	D166
Mystify	D167
Figment	D168
Ruse	D169
Red Handed	D170
Clandestine	D171
Cahoots	D172
Synonym	D173
Mimic	D174
Retort	D175
Masquerade	D176
Lookalike	D177
Eavesdrop	D178
Lark	D179
Stand In	D180
Encore	D181
Sweet Talk	D182
Pretense	D183
Fool's Gold	D184

GRADE 2 (Continued)

Decoy (Continued)

Monkey Business	D185
Alias	D186
Crocodile Tears	D187
Parrot	D188
Face Value	D189
Garden Path	D190
Espionage	D191
Emulate	D192
Replay	D193
Parallel	D194
Mare's Nest	D195

Digi Tweed

Dust Tweed	D310
Topaz Tweed	D311
Oat Tweed	D312
Flax Tweed	D313
Silt Tweed	D314
Loam Tweed	D315
Crag Tweed	D316
Basalt Tweed	D317
Loden Tweed	D318
Sagebrush Tweed	D319
Meadow Tweed	D320
Sundew Tweed	D321
Rose Tweed	D322
Raspite Tweed	D323
Madder Tweed	D324
Beetroot Tweed	D325
Thistle Tweed	D326
Lav Tweed	D327
Clear Tweed	D328
Loch Tweed	D329
Ocean Tweed	D330
North Sea Tweed	D331
Onyx Tweed	D332
Obsidian Tweed	D333

Graviton

Dark Matter	G222
Chain Reaction	G223
Echo	G224
Cloud Chamber	G225
Albedo	G226
Half Life	G227
Luminous Flux	G228
Fission	G229
Kelvin	G230
Boiling Point	G231
Quantum	G232
Condensation	G233
Centigrade	G234
Ampere	G235
Cold Fusion	G236
Hydrostatic	G237

GRADE 2 (Continued)

Intone

Ash	LM12
Creme	LM13
Harbor	LM14
Quicksilver	LM15
Caraway	LM16
Oxide	LM17
Cinder	LM18
Lute	LM19
Pome	LM20
Eclipse	LM21

Megacheck

Liminal	M328
Convex	M329
Concave	M330
Drop Shadow	M331
Litmus	M332
Gradient	M333
Distort	M334
Resolution	M335
Glitch	M336
Flashbulb	M337
Visage	M338
Magnitude	M339

Percept

Schema	P106
Pristine	P107
Intrinsic	P108
Sublime	P110
Context	P111
Essence	P112
Tenet	P113
Epiphany	P114
Verve	P115
Amplitude	P116
Reason	P117
Cardinality	P118
Nebula	P119
Jubilant	P120
Ignite	P121
Harmonic	P122
Peak	P123
Devotion	P124
Transmit	P125
Render	P126
Pulse	P127
Constant	P128
Radiant	P129
Propagate	P130
Placid	P131
Singular	P132
Fringe	P133

listings matrices

UPHOLSTERY FABRICS (Continued)

GRADE 2 (Continued)

Ultra Durable

Mohair	V180
Iced Coffee	V182
Tungsten	V184
Black Velvet	V187
Wet Clay	V490
Silver Age	V493
Morning Glory	V497
Neptune	V500
Fig	V503

GRADE 3

Ample

Quark	T220
Voltage	T221
Sunburst	T222
Radioactive	T224
Reaction	T227
Cosmic	T229
Blue Comet	T239
Vortex	T241
Neutron	T242
Tempered	T243
Charge	T270
Equilibrium	T271
Magnetic Field	T272
Convection	T273
Radar	T274
Conductor	T275
Evaporate	T276
Halide	T277

Doyenne

Woodblock	Y100
Sepia Tone	Y101
Intaglio	Y102
Grisailles	Y103
Aquamedia	Y104
Watermark	Y105
Verdigris	Y106
Phthalo	Y107
Terre Verte	Y108
Copperplate	Y109
Sienna	Y110
Alizarin	Y111

Ecotone

Abyss	E136
Ravine	E137
Rocky Shore	E138
Permafrost	E139
Tundra	E140
Arid	E141
Savanna	E142
Desert Bloom	E143
Badlands	E144
Caldera	E145
Freshwater	E146
Intertidal	E147
Rain Shadow	E148
Lichen	E149
Mangrove	E150
Treeline	E151

GRADE 3 (Continued)

Fine Grain

Warm Earth	F401
River One	F402
Saw Dust	F403
Putty Paste	F404
White Out	F405
Lunar Regolith	F406
Metallic Swarf	F407
Volcanic Ash	F408
Carbon Neutral	F409
Frosted Zephyr	F410
Deep Indigo	F411
Fathom Blue	F412
Sea Weed	F413
Matcha Leaves	F414
French Beige	F415
Ginger Snap	F416
Martian Soil	F417
Madder Root	F418
Garnet Sand	F419
Iron Oxide	F420
Peat Moss	F421

Intraweb

Raster	T397
Dual Trace	T398
Polytope	T397
Superposition	T400
Coaxial	T401
Origin	T402
Slope	T403
Polarity	T404
Isosurface	T405

Marl Cloth

Yurt	F314
Guy Rope	F315
Camp Fire	F317
Dry Stone	F318
Berry	F320
Blacksmith	F321
Sea Nomad	F322
Wild Fruit	F323
Dreamscape	F324
Landmark	F325
Tree Bark	F326

Milieu

Kettle	M570
Thunder	M571
Memory	M572
Steam	M573
Wing	M574
Nest	M575
Leap	M576
Troupe	M577
Peregrine	M578
Hedge	M579
Prickle	M580
Spring	M581
Mustard	M582
Herd	M583
Parcel	M584
Bloom	M585
Fling	M586

GRADE 3 (Continued)

Milieu (Continued)

Flamboyance	M587
Bazaar	M588
Rabble	M589
Zeal	M590
Bevy	M591
Loft	M592
Float	M593
Paddling	M594
Shoal	M595
Fleet	M596

Situ

Archeology	F115
Pozzolana	F116
Amphora	F117
Statue	F118
Wind Tower	F119
Tunnel	F120
Phosphor	F121
Flamante	F122
Hydro	F123
Terrena	F125
Mar	F126

Superspun

Drawdown	S442
Denier	S443
Tensile	S444
Roving	S445
Staple	S446
Spindle	S447
Harness	S448
Tenter	S449
Red Cast	S450
Selvedge	S451
Skein	S452
Bluing	S453
Treadle	S454
Sett	S455
Pirn	S456
Creel	S457

Textured Map 

Mineralize	T541
Henge	T542
Rockfall	T543
Trace Fossil	T544
Windblown Silt	T545
Holocene	T546
Coralline	T547
Latent Heat	T548
Water Table	T549
Elm Pollen	T550
Miocene	T551
Linden	T552
Green Algae	T553
Thaw	T554
Continental Drift	T555
Ocean Basin	T556

listings matrices

UPHOLSTERY FABRICS (Continued)

GRADE 3 (Continued)

Twisted Tweed

Wrought Iron	T278
Rock Garden	T279
Shady Patch	T280
Moongate	T281
Plaster	T282
Stucco	T283
Thatch	T284
Arbor	T285
Daylight	T286
Sundial	T287
Koi Pond	T288
Brickwork	T289
Annual	T290
Perennial	T291
Rain Chain	T292
Open Air	T293
Water Feature	T294
Terrace	T295
Veranda	T296

GRADE 4

Elastic Wool

Fortress	E120
Fantom	E121
Mercury	E122
Clean	E123
Seed	E124
Tea	E125
Rust	E126
Ruby	E127
Ceylon	E128
Lovelace	E129
Jovial	E130
Elm	E131
Python	E132
Aegean	E133
Delphi	E134
Dart	E135

Formwork

Metallurgy	F136
Lead	F137
Selenite	F138
Opal	F139
Pearl Ash	F140
Candela	F141
Kiln	F142
Distill	F143
Azurite	F144
Verditer	F145
Elixir	F146
Precipitant	F147

GRADE 4 (Continued)

Grid State

Arc Flash	G132
Open Circuit	G133
Volt Switch	G134
Hydropower	G135
Switchboard	G136
Megawatt	G137
Circuit Break	G138
Electrode	G139
Live Wire	G140
Trubine	G141
Neon Bulb	G142
Wolfram	G143

High Frequency

Eclipse Shadow	H713
Flash Lag	H714
Motion Blur	H715
Moon Illusion	H716
Solar Halo	H717
Laser Speckle	H718
Photon Shot	H719
Sea Fret	H720
Fata Morgana	H721
Hyperbolic Green	H722
Iceblink	H723
Plane Wave	H724
Liquid Crystal	H725
Aftereffect	H726
Gaussian	H727
Occlusion	H728

Interstice

Inkling	R307
Lacuna	R309
Whit	R310
Scintilla	R311
Fragment	R312
Atom	R313
Trace	R314
Respite	R315
Vestige	R316
Interval	R317
Caesura	R318

Meta Texture

Deep Space	M224
Grey Matter	M225
Pale Shadow	M226
Silver Lining	M227
Hive Mind	M228
Neutral Ground	M229
Grassroots	M230
Jaded	M231
Deep Dive	M232
Blue Skies	M233
Rosy Outlook	M234
Heat Wave	M235
Punchline	M236

GRADE 4 (Continued)

Modulus

Plinth	M172
Landscape	M173
Masonry	M174
Superstructure	M175
Skylight	M176
Site	M177
Form	M178
Shadow Play	M179
Rebar	M180
Spatial	M181
Threshold	M182
Monument	M183

Velvet Underground

Metal Machine	V310
Flame Desire	V313
Blue Denim	V315
Dark Moon	V317
Blacktop	V318
Brass Section	V319
Shock Wave	V320
Full Phase	V321
Dark Current	V322
Smoke Screen	V323
Wallflower	V324
Ultraviolet	V325
Purple Rain	V326
Green Room	V327
Garden Level	V328
New Wave	V329

GRADE 5

Adage

Script	A166
Anthracite	A146
Carbon Fiber	A147
Splice	A148
Chromite	A149
Singularity	A150
Valence	A151
Halite	A152
Quartzite	A153
Rubelite	A154
Thremite	A155
Orchil	A156
Holograph	A157
Photon	A158
Halogen	A159
Canopy	A160
Raw Jade	A161
Petrol	A162
Diffraction	A163
Amythyst	A164
Pascal	A165

listings matrices

UPHOLSTERY FABRICS (Continued)

GRADE 5 (Continued)

Cult Classic

Blue Velvet	C246
Black Lagoon	C247
Metropolis	C248
Grey Gardens	C249
White Heat	C250
Ziggy Stardust	C251
Pink Flamingos	C252
Purple Noon	C253
Blue Sunshine	C254
Xanadu	C255
Emerald City	C256
Forrest Gump	C257

Monotex

Silver Lane	G106
Sharkskin	G107
Grey Flannel	G108
Grey Marl	G109
Tarpaper	G110
Ferrous	G111
Bark Cloth	G112
Burlap	G113
Sumac	G114
Redroot	G115
Tyrian	G116
Annatto	G117
Jean	G118
Kingfisher	G119
Oxalis	G120
Sulfur	G121

Particulate

Molecule	P212
Light Speed	P213
Granule	P214
Allotrope	P215
Current	P216
Corrosion	P217
Inertia	P218
Swell	P219
Oxidation	P220
Proton	P221
Irrigation	P222
Isotope	P223
Electrostatic	P224
Quasar	P225
Smolder	P226

Synaptic

Contact	S135
Phase	S136
Conduit	S138
Sensory	S139
Receptor	S140
Traverse	S141
Transmission	S142
Axon	S144

GRADE 6

Amalgam

Aura	K106
Pyrite	K107
Medallion	K108
Fluid	K109
Ultraviolet	K110
Jolt	K111
Nitro	K112
Magma	K113
Fuse	K114

Haptic

Cliffline	H616
Gravel	H617
Alluvium	H618
Sediment	H619
Pink Salt	H620
Montane	H621
Butte	H622
Arroyo	H623
Superbloom	H624
Mantle	H625
Geode	H626
Flood Plain	H627
Isthmus	H628
Aquifer	H629
Delta	H630
Fjord	H631

Outpress

Ashen	C237
Sand	C238
Stone	C239
Soot	C240
Raven	C241
Pepper	C242
Monarch	C243
Caribbean	C244
Denim	C245

Perilune

Terrene	M160
Asteroid	M161
Stellar	M162
Satellite	M163
Gravity	M164
Red Shift	M165
Blue Moon	M166
Space Age	M167
Verdant	M168
Pulsar	M169
Solar	M170
Hot Crater	M171

Photogram

Mitere	P160
Toner	P161
Silver Salts	P162
Light Meter	P163
Sunprint	P164
Heliograph	P165
Safelight	P166
Cyanotype	P167
Mezzotint	P168
Darkroom	P169

GRADE 6 (Continued)

Soft Static

Semitone	S432
Desert Wind	S433
Whirr	S434
Carillon	S435
Heartbeats	S436
Timbre	S437
Arpeggio	S438
Waterfall	S439
Ambient Nature	S440

Vector

Dovetail	V221
Horizon Line	V222
Tessera	V223
Latitude	V224
Vertex	V225
Radial	V226
Hypercube	V227
Scalar	V228
Parallax	V229

GRADE 7

Contrast Slub

Charred Seed	F428
Silver Thyme	F429
Cotton Blossom	F430
Tumbleweed	F431
Bramble	F432
Manzanita	F433
Cactus Flower	F434
Scarlet Sage	F435
Anemone	F436
Crepe Myrtle	F437
Wild Indigo	F438
Jacaranda	F439
Cenote	F440
Oleander	F441
Eucalyptus	F442
Lemongrass	F443

Ephemera

Lucent	E108
Afterglow	E109
Ice Cloud	E110
Halcyon	E111
Phosphene	E112
Solar Flare	E113
Gamma Burst	E114
Green Flash	E115
Blue Shift	E116
Ashfall	E117
Nightglow	E118
Penumbra	E119

listings matrices

UPHOLSTERY FABRICS (Continued)

GRADE 7 (Continued)

Everyday Boucle

Black Lily	E216
Stonecrop	E217
Smokebush	E218
Silver Aster	E219
Artemisia	E220
Lamb's Ear	E221
Cassava	E222
Tussock	E223
Thicket	E224
Moss	E225
Wintergreen	E226
Bay Laurel	E227
Delphinium	E228
Night Bloom	E229
Blue Phlox	E230
Larkspur	E231
Yarrow	E232
Honeysuckle	E233
Spicebush	E234
Rockrose	E235
Firethorn	E236
Purple Basil	E237

Flex Wool

Rebound	F480
Tempo	F481
Dynamo	F482
Vim	F483
Spark	F484
Thrive	F485
Arena	F486
Agile	F487
Buoyant	F488
Torque	F489
Raceway	F490
Blur	F491

Oeuvre

Blithe	V520
Salient	V521
Austere	V522
Earnest	V523
Ardent	V524
Fervor	V525
Finesse	V526
Mettle	V527
Flourish	V528
Charm	V529
Deft	V530
Crest	V531

Pebble Melange

Esker	P186
Earthen	P187
Pewter	P188
Tectonic	P189
Geyser	P190
Palustrine	P191
Forest Marble	P192
Everglade	P193
Estuary	P194
Meteor	P195
Barkhan	P196
Lava	P197

GRADE 7 (Continued)

Structured Stripe

Shadow Weave	S335
Silver Lap	S336
Countermarche	S337
Double Beam	S338
Block Draw	S339
Box Motion	S340
Overshot	S341
Punch Card	S342

Tilt Shift Redux

Elevation	T440
Plexus	T441
Baseline	T442
Beta	T443
Fluctuate	T444
Alpha	T445
Amplifier	T446
Sensor	T447
Bandwidth	T448
Synapse	T449
Sonar	T450
Modulate	T451

Wool Fleck

Boulder	W128
Packstone	W129
Zinc	W130
Micrite	W131
Coquina	W132
Beachrock	W133
Tawny	W134
Corten	W135
Pink Nacre	W136
Birchbark	W137
Firesand	W138
Chamotte	W139
Blackberry	W140
Mussel Dust	W141
Gitti	W142
Iolite	W143
Storm Petrel	W144
Bittercress	W145
Oat Grass	W146
Aloe	W147
Wild Mustard	W148

GRADE 8

Barberpole Basket

Licorice Root	B388
Maelstrom	B389
Double Helix	B390
Wisp	B391
Mycelium	B392
Braided Rope	B393
Uzumaki	B394
Copper Coil	B395
Cherry Twist	B396
Tendrils	B397
Meander	B398
Tempest	B399

GRADE 8 (Continued)

Construct

Fawn	C511
Clay	C512
Brandy	C513
Vermilion	C514
Cadmium Orange	C515
Zinnia	C516
Auburn	C517
Wisteria	C518
Ultramarine	C519
Cornflower	C520
Pacific	C521
Celadon	C522
Canary	C523
Turmeric	C524
Ochre	C525
Beryl	C526
Viridian	C527
Fir	C528
Midnight	C529
Argent	C530
Gunmetal	C531
Noir	C532

Full Wool

Blanc	F207
Hot Stone	F209
Éclair	F210
Macchiato	F211
Ink	F212
Tigerlily	F214
Fresh Water	F215
Serpent	F216
Neptune	F218
Safari	F219
Vintage Red	F220
Lagoon	F221
Oak Room	F222
Deep Orchid	F223
Aries	F224
Seashell	F225
Star Fruit	F226
Clover	F227
Ocean Shadow	F228
Deep Sea	F229
Sea Holly	F230
London Fog	F231

Geoglyph

Drifting Sediment	G270
Polar Lights	G271
Moonlit Mountain	G272
Organic Compound	G273
Dappled Sunlight	G274
Painted Desert	G275

listings matrices

UPHOLSTERY FABRICS (Continued)

GRADE 8 (Continued)

Homage

Respect	H100
Winsome	H101
Esteem	H102
Dashing	H103
Authority	H104
Soigné	H106
Valor	H107
Sanguine	H108
Vivant	H109
Guild	H110
Pinnacle	H111
Noble	H112

Wavefield

Tideline	W480
Groundwater	W481
Red Tide	W482
Aspen Reflection	W483
Rivulet	W484
Cascade	W485
Sea Level	W486
Brackish	W487
Wake Zone	W488

Welded

Alliance	W209
Charcoal Flux	W210
Bond	W211
Soda Ash	W212
Palladium	W213
Brass Alloy	W214
Rose Torch	W215
Copper Foil	W216
Mingle	W217
Synergy	W218
Synthesis	W219

GRADE 9

Equilux

Eventide	E100
Diamond Dust	E101
Solstice	E102
Moonbow	E103
Corona	E104
Blue Hour	E105
Kindle	E106
Sunspot	E107

GRADE 9 (Continued)

Graph Speck

Cavern	G250
Steel Frame	G251
Stonework	G252
Gypsum	G253
Earthworks	G254
Cob	G255
Breccia	G256
Hearth	G257
Fired Clay	G258
Ionic Order	G259
Waterwheel	G260
Trellis	G261
Limecrete	G262
Plate Glass	G263
Riverfront	G264
Structure	G265

Heather Felt

Noil	H510
Alumina	H511
Bone Ash	H512
Pinon Tree	H513
Indian Ocean	H516
Mustard Seed	H517
Saffron	H518
Acai	H519
Armor	H520
Marina	H522
Grove	H523
Scarlet	H525

Melange Check

Cobblestone	M534
Bisque	M535
Soda Fired	M536
Goldspeck	M537
Pink Kaolin	M538
Brick Dust	M539
Alkaline	M540
Vapor Glaze	M541
Faience Blue	M542
Greenware	M543

Super Shearling

Neroli	S181
Ambergris	S182
Aromatic Water	S183
Musk	S184
Earth Tincture	S185
Petitgrain	S186
Carrissa	S187
Enfleurage	S188
Cedar	S189
Heart Note	S190
Incense	S191
Ginger	S192
Green Sap	S193
Oakmoss	S194
Conifer	S195
Blue Cypress	S196
Seawater	S197
Lupine	S198
Attar	S199
Blackcurrant	S200

GRADE 9 (Continued)

Top Coat

Shell	T418
Glaze	T419
Chromate	T420
Stoneware	T421
Aniline	T422
Braze	T423
Conduct	T424
Heat Set	T425
Claycast	T426
Toast	T427
Polish	T428
Frit	T429
Shellac	T430
Dip	T431
Indigo Ink	T432
Seal	T433
Weld	T434
Black Oxide	T435

GRADE 10

Color Fuse

Wax	C154
Emulsion	C155
Jell	C156
Enamel	C157
Liquefy	C158
Freeze	C159
Molten	C160
Solvent	C161
Plasma	C162

Fleece

Alum	M191
Aer	M192
Linseed	M193
Rubedo	M194
Ignis	M195
Cypher	M196
Balsam	M197
Glyph	M198
Nero	M199

GRADE 11

Rubric

Straw Clay	R388
Pink Laterite	R389
Rammed Earth	R390
Submerged Stone	R391
Glass Block	R392
Stacked Slate	R393

listings matrices

UPHOLSTERY FABRICS (Continued)

GRADE 13

Emergent

Galaxy	E417
Lunar Eclipse	E418
Backscatter	E419
Pegasus	E420
Earthshine	E421
Stardust	E422
Andromeda	E423
Astra	E424
Celestial	E425
Nova	E426
Meteor Shower	E427

GRADE 14

Arc Angle

Selene	A135
Erebus	A136
Theia	A137
Proteus	A138
Hestia	A139

Scale Factor

Basis	S257
Compound	S258
Tangent	S259
Tensor	S260
Matrix	S261

GRADE 16

Mitered

Black Walnut	F422
White Birch	F423
Golden Oak	F424
Redwood	F425
Blue Spruce	F426
Sapling	F427

Navigate

Florescent	N300
Pumice	N301
Interlace Camel	N302
Reticulated Stone	N303
Network Orange	N304

Second Nature

Moonflower	S426
Muscadine	S427
Chaparral	S428
Bougainvillea	S429
Nightshade	S430
Peppervine	S431

Leather - LA

Base Grade Leather

White	L215
Shale	L101
Chocolate	L204
Chime	L205
Fossil	L206
Buttercup	L214
Poppy	L210
Parlor	L211
Marine	L212
Black	L104
Sand	L200

Leather - LB

Merus

Teak	L110
White Birch	L111
Beechwood	L112
Almond Shell	L114
Smoke	L117
Hopi	L118
Crushed Bark	L119
Black Truffle	L123

Leather - LC

Pela

Clove	L216
White Clay	L217
Chamois	L218
Buckwheat	L220
Hemlock	L221
Fern	L222
Cerulean	L226
Marigold	L227
Pomegranate	L228
Cordon	L229
Black Cherry	L230
Nightshade	L232
Morel	L233
Russet	L234
Carbon	L235
Pitch	L236

Leather - LD

Fortis

Canyon	L310
Bone	L311
Terra	L313
Nugget	L314
Black Rock	L316

environmental data

STANDARD UPHOLSTERY FABRICS

Pattern	Composition	Recycled Polyester	
		Post Consumer	Pre Consumer
Grade 1			
Bitstream	100% Recycled Polyester	58%	42%
Fundamentals	100% Recycled Polyester	80%	20%
Heather Tech	67% Recycled Polyester 33% Polyester	67%	
Magnify	54% Recycled Polyester 46% Polyester	54%	
Stimuli	100% Recycled Polyester	75%	25%
Grade 2			
Actuate	40% Recycled Polyester 60% Polyester	40%	
Complect	100% Recycled Polyester	100%	
Complement	100% Polyester		
Cross Dye	66% Recycled Polyester 34% Polyester	61%	5%
Crossgrain	39% Recycled Polyester 61% Polyester	39%	
Decoy	Face: 100% PVC Back: 100% Polyester Knit		
Digi Tweed	55% Recycled Polyester 45% Polyester	55%	
Graviton	100% Recycled Polyester	100%	
Intone	53% Recycled Polyester 47% Polyester	18.6%	34.4%
Megacheck	100% Recycled Polyester		
Percept	81% Recycled Polyester 19% Polyester	81%	
Ultra Durable	Anti-Bacterial, Anti-Microbial Treated Vinyl		
Grade 3			
Ample	77% Polyester, 17% Cotton 6% Acrylic		
Doyenne	38.5% Recycled Polyester 61.5% Polyester	38.5%	
Ecotone	100% Recycled Biodegradable** Polyester		
Fine Grain	100% Polyurethane Face 100% Polyester Backing		

environmental data

STANDARD UPHOLSTERY FABRICS (Continued)

Pattern	Composition	Recycled Polyester	
		Post Consumer	Pre Consumer
Grade 3			
Intraweb	100% Recycled Biodegradable* Polyester (Postconsumer)		
Marl Cloth	57% Recycled Polyester 42% Polyester, 1% Nylon	30%	27%
Milieu	90% Recycled Polyester, 10% Polyester	90%	
Situ	55% Recycled Polyester 45% Polyester		55%
Superspun	55% Recycled Polyester 45% Polyester	55%	
Textured Map 	100% Recycled Biodegradable** Polyester		
Twisted Tweed	100% Recycled Polyester	100%	
Grade 4			
Elastic Wool	50% Wool, 27% Polyester 21% Nylon, 2% Elastane		
Formwork	51% Recycled Polyester 49% Polyester	51%	
Grid State	BIODEGRADABLE CLEAN IMPACT TEXTILES™ - 100% Post-Consumer Recycled Biodegradable Polyester**		
High Frequency 	87% Recycled Polyester (Postconsumer), 12% Polyester, 1% Nylon		
Interstice	85% Polyester 12% Cotton, 3% Acrylic		
Meta Texture	95% Polycarbonate Polyurethane 5% Silicon Back: Polyester Knit		
Modulus	75% Recycled Polyester 25% Polyester	52%	23%
Velvet Underground	100% Recycled Polyester		
Grade 5			
Adage	82% Polyester 14% Cotton, 4% Acrylic		
Cult Classic	100% Polyester		
Monotex	100% Polyurethane Face 100% Polyester Knit Backing		
Particulate	65% Recycled Polyester 35% Polyester	65%	
Synaptic	100% Polyurethane Face 100% Polyester Knit Backing		

** Rate and extent of biodegradation into elements found in nature is 91% after 1,278 days under ASTM D5511 (Anaerobic Biodegradation of Plastic Materials Under High Solids Anaerobic Digestion Conditions.) The test was done with the same component (PET) polyester and biocatalyst additive. No evidence of further degradation.

environmental data

STANDARD UPHOLSTERY FABRICS (Continued)

Pattern	Composition	Recycled Polyester	
		Post Consumer	Pre Consumer
Grade 6			
Amalgam	100% Recycled Polyester		
Duo Chrome	100% Polyester		
Haptic	68% Acrylic 32% Polyester		
Outpress	82.7% Polyester 17.33% Nylon		
Perilune	Face: 100% Polyurethane Back: 100% Polyester Knit		
Photogram	55% Polyester 45% Recycled Polyester		45%
Soft Static 	77% Recycled Polyester (Postconsumer), 22% Polyester, 1% Nylon		
Vector	78% Recycled Polyester 22% Nylon	78%	
Grade 7			
Contrast Slub	62% Cotton, 17% Polyester, 14% Viscose, 7% Linen		
Ephemera	57% Polyester 43% Acrylic		
Everyday Boucle	35% Recycled Wool, 27% Recycled Acrylic, 17% Acrylic, 8% Wool, 7% Recycled Polyester, 6% Polyester	3.5%	3.5%
Flex Wool	41% Wool, 41% Polyester 17% Nylon, 1% Elastane		
Oeuvre	30% Wool, 22% Polyester 18% Nylon, 18% Cotton, 12% Silk		
Pebble Melange	98% Polypropylene, 2% Polyester		
Structured Stripe	100% Polyester		
Tilted Shift Redux	82% Recycled Polyester 18% Nylon	82%	
Wool Fleck	51% Recycled Wool, 39% Recycled Acrylic, 10% Recycled Polyester		

environmental data

STANDARD UPHOLSTERY FABRICS (Continued)

Pattern	Composition	Recycled Polyester	
		Post Consumer	Pre Consumer
Grade 8			
Barberpole Basket	35% Cotton, 28% Wool, 26% Recycled Cotton, 7% Recycled Polyester, 4% Nylon	3.5%	3.5%
Construct	80% Wool, 20% Nylon		
Full Wool	100% Wool		
Geoglyph	98% Polypropylene, 2% Polyester		
Homage	40% Wool, 24% Nylon 20% Polyester, 16% Silk		
Wavefield	68% Polyester 32% Recycled Polyester	32%	
Welded	Coating: 100% Tekloom TPE Base Cloth: 100% Polyester Woven		
Grade 9			
Equilux	54% Rayon 43% Wool, 3% Nylon		
Graph Speck	51% Recycled Wool, 39% Recycled Acrylic, 10% Recycled Polyester		
Heather Felt	100% Wool		
Melange Check	51% Recycled Wool, 39% Recycled Acrylic, 10% Recycled Polyester		
Super Shearling 	60% Wool, 28% Recycled Nylon (Preconsumer), 12% Nylon		
Top Coat	100% Silicone		
Grade 10			
Color Fuse	Coating: 100% Polycarbonate Polyurethane Base Cloth: 100% Cotton Woven		
Fleece	60% Wool, 24% Polyester, 16% Cotton		
Grade 11			
Rubric	55% Wool, 30% Recycled Cotton, 7% Recycled Polyester, 5% Cotton, 3% Nylon		

environmental data

STANDARD UPHOLSTERY FABRICS (Continued)

Pattern	Composition	Recycled Polyester	
		Post Consumer	Pre Consumer
Grade 13			
Emergent	45% Cotton, 40% Recycled Wool, 10% Recycled Polyester, 3% Recycled Acrylic, 2% Recycled Nylon	10%	
Grade 14			
Arc Angle	100% Polyester Face, 50% Nylon, 50% Polyester Stitching, 100% Polyfill Back		
Scale Factor	60% Polyester, 40% Recycled Polyester Face	40%	
Grade 16			
Miltered	49% Wool, 38% Recycled Cotton, 10% Polyester, 3% Nylon		38%
Navigate	92.5% Wool, 5.4% Nylon, 2.1% Polyester		
Second Nature	78% Wool, 21% Nylon, 1% Polyester		
Leather			
Base Grade Leather			
Merus	European Top Grain Semi-Aniline Dyed Cowhide		
Pela	Scandinavian Full Grain Semi- Aniline Dyed Cowhide		
Fortis	European Full Grain Semi-Aniline Dyed Cowhide		

environmental data

MESH

Pattern	Composition	Recycled Polyester	
		Post Consumer	Pre Consumer
Mesh			
Nu-Tess Mesh	100% Polyester		
Shrinx Original Mesh	76% Polyester, 24% Nylon		
Shrinx Veil Mesh	96% Polyester, 2% Nylon, 2% Elastane		
Sabrina Mesh	100% Esters		
Around Mesh	100% Polyester		
Visio Mesh	100% Polyester		
Tone Performance Mesh	Elastoester/Polyester		
Tone Lifestyle Mesh	Elastoester/Polyester		

textile listings by pattern number

FABRIC PATTERN	COLOR CODE	TEKNION COLOR CODE	PATTERN NAME	COLOR NAME	APPLICATION GRADE
1001	02	E354	Egypt	Jirja	Panel - A
1001	03	E355	Egypt	Idku	Panel - A
1001	05	E352	Egypt	Mallawi	Panel - A
1001	06	E301	Egypt	Cairo	Panel - A
1001	07	E302	Egypt	Giza	Panel - A
1001	10	E304	Egypt	Port Said	Panel - A
1001	11	E356	Egypt	Edfu	Panel - A
1001	13	E305	Egypt	Suez	Panel - A
1002	01	W417	Wales	Bangor	Panel - A
1002	02	W403	Wales	Teifi	Panel - A
1002	03	W404	Wales	Newport	Panel - A
1002	04	W402	Wales	Swansea	Panel - A
1002	05	W416	Wales	Corwen	Panel - A
1002	06	W414	Wales	Wrexham	Panel - A
1002	07	W419	Wales	Pembroke	Panel - A
1002	08	W420	Wales	Kidwelly	Panel - A
1002	09	W418	Wales	Newbridge	Panel - A
1002	10	W421	Wales	Goodwick	Panel - A
1003	01	D418	India	Pushkar	Panel - 1
1003	02	D405	India	Gwalior	Panel - 1
1003	03	D404	India	Agra	Panel - 1
1003	04	D419	India	Kerala	Panel - 1
1003	05	D402	India	Bombay	Panel - 1
1003	06	D425	India	Manali	Panel - 1
1003	07	D408	India	Haora	Panel - 1
1003	08	D417	India	Kashmir	Panel - 1
1003	09	D423	India	Pune	Panel - 1
1003	10	D424	India	Mumbai	Panel - 1
1003	11	D407	India	Varanasi	Panel - 1
1003	12	D420	India	Munnar	Panel - 1
1003	13	D422	India	Chennai	Panel - 1
1003	14	D409	India	Surat	Panel - 1
1003	15	D421	India	Nanital	Panel - 1
1004	01	B260	Brazil	Campo Grande	Panel - 1
1004	02	B220	Brazil	Betim	Panel - 1
1004	03	B208	Brazil	Timbo	Panel - 1
1004	04	B204	Brazil	Canela	Panel - 1
1004	05	B203	Brazil	Manaus	Panel - 1
1004	06	B261	Brazil	Serra	Panel - 1
1004	08	B217	Brazil	Jacarei	Panel - 1
1004	09	B231	Brazil	Olinda	Panel - 1
1004	10	B233	Brazil	Laguna	Panel - 1
1006	01	E380	Essentials	Gris	Panel - 1
1006	03	E382	Essentials	Dove	Panel - 1
1006	04	E383	Essentials	Brier	Panel - 1
1006	05	E384	Essentials	Light Grey	Panel - 1
1006	06	E385	Essentials	Slate	Panel - 1
1006	12	E391	Essentials	Banner	Panel - 1
1006	13	E409	Essentials	Snowdrift	Panel - 1
1006	14	E410	Essentials	Mist	Panel - 1
1006	16	E412	Essentials	Basil	Panel - 1
1006	17	E413	Essentials	Atlantic	Panel - 1
1006	19	E415	Essentials	Pebble	Panel - 1
1006	20	E416	Essentials	Tropic	Panel - 1

textile listings by pattern number (continued)

FABRIC PATTERN	COLOR CODE	TEKNION COLOR CODE	PATTERN NAME	COLOR NAME	APPLICATION GRADE
1007	01	W110	Warp Speed	Headwind	Panel - 1
1007	02	W111	Warp Speed	White Space	Panel - 1
1007	03	W112	Warp Speed	Strobe	Panel - 1
1007	04	W113	Warp Speed	Reed Arrow	Panel - 1
1007	05	W114	Warp Speed	Jet	Panel - 1
1007	06	W115	Warp Speed	Steel Racer	Panel - 1
1007	07	W116	Warp Speed	Earth Orbit	Panel - 1
1008	01	F537	Flicker	Gleam	Panel - 1
1008	02	F531	Flicker	Glitter	Panel - 1
1008	03	F532	Flicker	Beam	Panel - 1
1008	04	F535	Flicker	Glint	Panel - 1
1008	05	F533	Flicker	Sparkle	Panel - 1
1008	06	F534	Flicker	Flash	Panel - 1
1008	07	F536	Flicker	Sheen	Panel - 1
1008	08	F539	Flicker	Luster	Panel - 1
1008	09	F538	Flicker	Glow	Panel - 1
1008	10	F540	Flicker	Twinkle	Panel - 1
1009	01	T531	Tangle	Snarl	Panel - A
1009	02	T533	Tangle	Interweave	Panel - A
1009	03	T532	Tangle	Knot	Panel - A
1009	04	T540	Tangle	Entwine	Panel - A
1009	05	T534	Tangle	Ravel	Panel - A
1009	06	T535	Tangle	Kinks	Panel - A
1009	07	T538	Tangle	Crook	Panel - A
1009	08	T536	Tangle	Spangle	Panel - A
1009	09	T537	Tangle	Tousle	Panel - A
1009	10	T539	Tangle	Muddle	Panel - A
1010	01	P401	Peru	Tacna	Panel - 1
1010	02	P402	Peru	Nazca	Panel - 1
1010	03	P407	Peru	Tingo Maria	Panel - 1
1010	04	P404	Peru	Casma	Panel - 1
1010	05	P403	Peru	Lima	Panel - 1
1010	06	P409	Peru	Callao	Panel - 1
1010	07	P406	Peru	Cuzco	Panel - 1
1010	08	P412	Peru	Puerto	Panel - 1
1010	09	P411	Peru	Tumbes	Panel - 1
1010	10	P405	Peru	Puno	Panel - 1
1011	01	T100	Topology	Ceramic	Panel - 1
1011	02	T101	Topology	Open Space	Panel - 1
1011	03	T102	Topology	Natural	Panel - 1
1011	04	T103	Topology	Cooling	Panel - 1
1011	05	T104	Topology	Shadow	Panel - 1
1012	01	M415	Makah	Shaker	Panel - 1
1012	02	M416	Makah	Luminous	Panel - 1
1012	03	M417	Makah	Arundo	Panel - 1
1012	04	M418	Makah	Solano	Panel - 1
1012	05	M419	Makah	Flitch	Panel - 1
1012	06	M420	Makah	Splint	Panel - 1

textile listings by pattern number (continued)

FABRIC PATTERN	COLOR CODE	TEKNION COLOR CODE	PATTERN NAME	COLOR NAME	APPLICATION GRADE
1015	02	B631	Beeline	Plumb	Panel - A
1015	03	B633	Beeline	Strand	Panel - A
1015	04	B634	Beeline	Thread	Panel - A
1015	05	B632	Beeline	String	Panel - A
1016	01	N122	Nitty Gritty	Block	Panel - A
1016	02	N133	Nitty Gritty	Gist	Panel - A
1016	03	N123	Nitty Gritty	Detail	Panel - A
1016	04	N134	Nitty Gritty	Factor	Panel - A
1016	05	N130	Nitty Gritty	Think	Panel - A
1016	06	N135	Nitty Gritty	Specific	Panel - A
1017	01	W741	Wired Up	Linkage	Panel - A
1017	02	W742	Wired Up	Drawplate	Panel - A
1017	03	W743	Wired Up	Nichrome	Panel - A
1017	04	W739	Wired Up	Intermingle	Panel - A
1017	05	W731	Wired Up	Caged	Panel - A
1017	06	W744	Wired Up	Circuit	Panel - A
1017	07	W740	Wired Up	Mesh	Panel - A
1018	01	L327	Linen Weave	Coir	Panel - 1
1018	02	L328	Linen Weave	Bast	Panel - 1
1018	03	L329	Linen Weave	Dusty Grey	Panel - 1
1018	04	L330	Linen Weave	Mineral	Panel - 1
1018	05	L331	Linen Weave	Linseed	Panel - 1
1018	06	L308	Linen Weave	Gate	Panel - 1
1018	07	L309	Linen Weave	Sesame	Panel - 1
1019	01	B119 (P) - C111 (A)	Boucle Grid	Craie	Panel - 2, Architectural - 2
1019	02	B120 (P) - C112 (A)	Boucle Grid	Bis	Panel - 2, Architectural - 2
1019	03	B121 (P) - C113 (A)	Boucle Grid	Ardoise	Panel - 2, Architectural - 2
1019	04	B122 (P) - C114 (A)	Boucle Grid	Fauve	Panel - 2, Architectural - 2
1019	05	B123 (P) - C115 (A)	Boucle Grid	Nuage	Panel - 2, Architectural - 2
1020	01	L363 (P) - D100 (A)	Lustrado	Glassine	Panel - 1, Architectural - 2
1020	02	L364 (P) - D101 (A)	Lustrado	Acetate	Panel - 1, Architectural - 2
1020	03	L365 (P) - D102 (A)	Lustrado	Brilliance	Panel - 1, Architectural - 2
1020	04	L366 (P) - D103 (A)	Lustrado	Alloy	Panel - 1, Architectural - 2
1020	05	L367 (P) - D104 (A)	Lustrado	Gallium	Panel - 1, Architectural - 2
1020	06	L368 (P) - D105 (A)	Lustrado	Incandescent	Panel - 1, Architectural - 2
1020	07	L369 (P) - D106 (A)	Lustrado	Resin	Panel - 1, Architectural - 2
1020	08	L370 (P) - D107 (A)	Lustrado	Sterling	Panel - 1, Architectural - 2
1020	10	L372 (P) - D109 (A)	Lustrado	Varnish	Panel - 1, Architectural - 2
1020	11	L373 (P) - D110 (A)	Lustrado	Vitreous	Panel - 1, Architectural - 2
1021	01	P100 (P) - R186 (A)	Presse	Halo Effect	Panel - 1, Architectural - 2
1021	02	P101 (P) - R187 (A)	Presse	Overlay	Panel - 1, Architectural - 2
1021	03	P102 (P) - R188 (A)	Presse	Masked	Panel - 1, Architectural - 2
1021	04	P103 (P) - R189 (A)	Presse	Relief	Panel - 1, Architectural - 2
1021	05	P104 (P) - R190 (A)	Presse	Plaited	Panel - 1, Architectural - 2
1021	06	P105 (P) - R191 (A)	Presse	Gravure	Panel - 1, Architectural - 2
1022	01	B124 (P) - D111 (A)	Bandeau	Washi	Panel - 1, Architectural - 2
1022	03	B126 (P) - D113 (A)	Bandeau	Grosgrain	Panel - 1, Architectural - 2
1022	04	B127 (P) - D114 (A)	Bandeau	Palla	Panel - 1, Architectural - 2
1022	05	B128 (P) - D115 (A)	Bandeau	Farran	Panel - 1, Architectural - 2

textile listings by pattern number (continued)

FABRIC PATTERN	COLOR CODE	TEKNION COLOR CODE	PATTERN NAME	COLOR NAME	APPLICATION GRADE
1023	01	R176 (P) - R230 (A)	Artopia	Primer	Panel - 3, Architectural - 2
1023	02	R177 (P) - R231 (A)	Artopia	Kinetic	Panel - 3, Architectural - 2
1023	03	R178 (P) - R232 (A)	Artopia	Stencil	Panel - 3, Architectural - 2
1023	04	R179 (P) - R233 (A)	Artopia	Magenta	Panel - 3, Architectural - 2
1023	05	R180 (P) - R234 (A)	Artopia	Amberlith	Panel - 3, Architectural - 2
1023	06	R181 (P) - R235 (A)	Artopia	Cadmium	Panel - 3, Architectural - 2
1023	07	R182 (P) - R236 (A)	Artopia	Aquatint	Panel - 3, Architectural - 2
1023	08	R183 (P) - R237 (A)	Artopia	Vivid Blue	Panel - 3, Architectural - 2
1025	01	T727 (P) - E314 (A)	Emit	Watt	Panel - 1, Architectural 2
1025	02	T728 (P) - E315 (A)	Emit	Hertz	Panel - 1, Architectural 2
1025	03	T729 (P) - E316 (A)	Emit	Joule	Panel - 1, Architectural 2
1025	04	T730 (P) - E317 (A)	Emit	Dazzle	Panel - 1, Architectural 2
1025	05	T731 (P) - E318 (A)	Emit	Surge	Panel - 1, Architectural 2
1025	06	T732 (P) - E319 (A)	Emit	Particle	Panel - 1, Architectural 2
1030	01	R600 (P) - 8590 (A)	Stratiform	Calcify	Panel - 2, Architectural - 2
1030	02	R601 (P) - 8591 (A)	Stratiform	Limestone	Panel - 2, Architectural - 2
1030	03	R602 (P) - 8592 (A)	Stratiform	Sandhill	Panel - 2, Architectural - 2
1030	04	R603 (P) - 8593 (A)	Stratiform	Moraine	Panel - 2, Architectural - 2
1030	05	R604 (P) - 8594 (A)	Stratiform	Glacial	Panel - 2, Architectural - 2
1030	06	R605 (P) - 8595 (A)	Stratiform	Bedrock	Panel - 2, Architectural - 2
1030	07	R606 (P) - 8596 (A)	Stratiform	Flint	Panel - 2, Architectural - 2
1031	01	C246	Cult Classic	Blue Velvet	Upholstery - 5
1031	02	C247	Cult Classic	Black Lagoon	Upholstery - 5
1031	03	C248	Cult Classic	Metropolis	Upholstery - 5
1031	04	C249	Cult Classic	Grey Gardens	Upholstery - 5
1031	05	C250	Cult Classic	White Heat	Upholstery - 5
1031	06	C251	Cult Classic	Ziggy Stardust	Upholstery - 5
1031	07	C252	Cult Classic	Pink Flamingos	Upholstery - 5
1031	08	C253	Cult Classic	Purple Noon	Upholstery - 5
1031	09	C254	Cult Classic	Blue Sunshine	Upholstery - 5
1031	10	C255	Cult Classic	Xanadu	Upholstery - 5
1031	11	C256	Cult Classic	Emerald City	Upholstery - 5
1031	12	C257	Cult Classic	Forrest Gump	Upholstery - 5
1032	01	P800 (P) - C293 (U/A)	Complect	Melanite	Panel - 2, Upholstery - 2, Architectural - 2
1032	02	P801 (P) - C294 (U/A)	Complect	Quarry	Panel - 2, Upholstery - 2, Architectural - 2
1032	03	P802 (P) - C295 (U/A)	Complect	Silverleaf	Panel - 2, Upholstery - 2, Architectural - 2
1032	04	P803 (P) - C296 (U/A)	Complect	Jute	Panel - 2, Upholstery - 2, Architectural - 2
1032	05	P804 (P) - C297 (U/A)	Complect	Cumulus	Panel - 2, Upholstery - 2, Architectural - 2
1032	06	P805 (P) - C298 (U/A)	Complect	Yolk	Panel - 2, Upholstery - 2, Architectural - 2
1032	07	P806 (P) - C299 (U/A)	Complect	Apricot	Panel - 2, Upholstery - 2, Architectural - 2
1032	08	P807 (P) - C300 (U/A)	Complect	Highlighter Pink	Panel - 2, Upholstery - 2, Architectural - 2
1032	09	P808 (P) - C301 (U/A)	Complect	Deep Crimson	Panel - 2, Upholstery - 2, Architectural - 2
1032	10	P809 (P) - C302 (U/A)	Complect	Autumn	Panel - 2, Upholstery - 2, Architectural - 2
1032	11	P810 (P) - C303 (U/A)	Complect	Opaline	Panel - 2, Upholstery - 2, Architectural - 2
1032	12	P811 (P) - C304 (U/A)	Complect	Reservoir	Panel - 2, Upholstery - 2, Architectural - 2
1032	13	P812 (P) - C305 (U/A)	Complect	Gentian	Panel - 2, Upholstery - 2, Architectural - 2
1032	14	P813 (P) - C306 (U/A)	Complect	Blue Ice	Panel - 2, Upholstery - 2, Architectural - 2
1032	15	P814 (P) - C307 (U/A)	Complect	Winter	Panel - 2, Upholstery - 2, Architectural - 2
1032	16	P815 (P) - C308 (U/A)	Complect	Boreal	Panel - 2, Upholstery - 2, Architectural - 2
1032	17	P816 (P) - C309 (U/A)	Complect	Turquoise	Panel - 2, Upholstery - 2, Architectural - 2
1032	18	P817 (P) - C310 (U/A)	Complect	Okra	Panel - 2, Upholstery - 2, Architectural - 2
1032	19	P818 (P) - C311 (U/A)	Complect	Agave	Panel - 2, Upholstery - 2, Architectural - 2

textile listings by pattern number (continued)

FABRIC PATTERN	COLOR CODE	TEKNION COLOR CODE	PATTERN NAME	COLOR NAME	APPLICATION GRADE
1034	01	R351 (P) - G222 (U/A)	Graviton	Dark Matter	Panel - 2, Upholstery - 2, Architectural - 2
1034	02	R352 (P) - G223 (U/A)	Graviton	Chain Reaction	Panel - 2, Upholstery - 2, Architectural - 2
1034	03	R353 (P) - G224 (U/A)	Graviton	Echo	Panel - 2, Upholstery - 2, Architectural - 2
1034	04	R354 (P) - G225 (U/A)	Graviton	Cloud Chamber	Panel - 2, Upholstery - 2, Architectural - 2
1034	05	R355 (P) - G226 (U/A)	Graviton	Albedo	Panel - 2, Upholstery - 2, Architectural - 2
1034	06	R356 (P) - G227 (U/A)	Graviton	Half Life	Panel - 2, Upholstery - 2, Architectural - 2
1034	07	R357 (P) - G228 (U/A)	Graviton	Luminous Flux	Panel - 2, Upholstery - 2, Architectural - 2
1034	08	R358 (P) - G229 (U/A)	Graviton	Fission	Panel - 2, Upholstery - 2, Architectural - 2
1034	09	R359 (P) - G230 (U/A)	Graviton	Kelvin	Panel - 2, Upholstery - 2, Architectural - 2
1034	10	R360 (P) - G231 (U/A)	Graviton	Boiling Point	Panel - 2, Upholstery - 2, Architectural - 2
1034	11	R361 (P) - G232 (U/A)	Graviton	Quantum	Panel - 2, Upholstery - 2, Architectural - 2
1034	12	R362 (P) - G233 (U/A)	Graviton	Condensation	Panel - 2, Upholstery - 2, Architectural - 2
1034	13	R363 (P) - G234 (U/A)	Graviton	Centigrade	Panel - 2, Upholstery - 2, Architectural - 2
1034	14	R364 (P) - G235 (U/A)	Graviton	Ampere	Panel - 2, Upholstery - 2, Architectural - 2
1034	15	R365 (P) - G236 (U/A)	Graviton	Cold Fusion	Panel - 2, Upholstery - 2, Architectural - 2
1034	16	R366 (P) - G237 (U/A)	Graviton	Hydrostatic	Panel - 2, Upholstery - 2, Architectural - 2
2001	01	L165 (P) - M570 (U/A)	Milieu	Kettle	Panel - 4, Upholstery - 3, Architectural - 3
2001	02	L166 (P) - M571 (U/A)	Milieu	Thunder	Panel - 4, Upholstery - 3, Architectural - 3
2001	03	L167 (P) - M572 (U/A)	Milieu	Memory	Panel - 4, Upholstery - 3, Architectural - 3
2001	04	L168 (P) - M573 (U/A)	Milieu	Steam	Panel - 4, Upholstery - 3, Architectural - 3
2001	05	L169 (P) - M574 (U/A)	Milieu	Wing	Panel - 4, Upholstery - 3, Architectural - 3
2001	06	L170 (P) - M575 (U/A)	Milieu	Nest	Panel - 4, Upholstery - 3, Architectural - 3
2001	07	L171 (P) - M576 (U/A)	Milieu	Leap	Panel - 4, Upholstery - 3, Architectural - 3
2001	08	L172 (P) - M577 (U/A)	Milieu	Troupe	Panel - 4, Upholstery - 3, Architectural - 3
2001	09	L173 (P) - M578 (U/A)	Milieu	Peregrine	Panel - 4, Upholstery - 3, Architectural - 3
2001	10	L174 (P) - M579 (U/A)	Milieu	Hedge	Panel - 4, Upholstery - 3, Architectural - 3
2001	11	L175 (P) - M580 (U/A)	Milieu	Prickle	Panel - 4, Upholstery - 3, Architectural - 3
2001	12	L176 (P) - M581 (U/A)	Milieu	Spring	Panel - 4, Upholstery - 3, Architectural - 3
2001	13	L177 (P) - M582 (U/A)	Milieu	Muster	Panel - 4, Upholstery - 3, Architectural - 3
2001	14	L178 (P) - M583 (U/A)	Milieu	Herd	Panel - 4, Upholstery - 3, Architectural - 3
2001	15	L179 (P) - M584 (U/A)	Milieu	Parcel	Panel - 4, Upholstery - 3, Architectural - 3
2001	16	L180 (P) - M585 (U/A)	Milieu	Bloom	Panel - 4, Upholstery - 3, Architectural - 3
2001	17	L181 (P) - M586 (U/A)	Milieu	Fling	Panel - 4, Upholstery - 3, Architectural - 3
2001	18	L182 (P) - M587 (U/A)	Milieu	Flamboyance	Panel - 4, Upholstery - 3, Architectural - 3
2001	19	L183 (P) - M588 (U/A)	Milieu	Bazaar	Panel - 4, Upholstery - 3, Architectural - 3
2001	20	L184 (P) - M589 (U/A)	Milieu	Rabble	Panel - 4, Upholstery - 3, Architectural - 3
2001	21	L185 (P) - M590 (U/A)	Milieu	Zeal	Panel - 4, Upholstery - 3, Architectural - 3
2001	22	L186 (P) - M591 (U/A)	Milieu	Bevy	Panel - 4, Upholstery - 3, Architectural - 3
2001	23	L187 (P) - M592 (U/A)	Milieu	Loft	Panel - 4, Upholstery - 3, Architectural - 3
2001	24	L188 (P) - M593 (U/A)	Milieu	Float	Panel - 4, Upholstery - 3, Architectural - 3
2001	25	L189 (P) - M594 (U/A)	Milieu	Paddling	Panel - 4, Upholstery - 3, Architectural - 3
2001	26	L190 (P) - M595 (U/A)	Milieu	Shoal	Panel - 4, Upholstery - 3, Architectural - 3
2001	27	L191 (P) - M596 (U/A)	Milieu	Fleet	Panel - 4, Upholstery - 3, Architectural - 3
2002	01	W235 (P) - T397 (U/A)	Intraweb	Raster	Panel - 4, Upholstery - 3, Architectural - 3
2002	02	W236 (P) - T398 (U/A)	Intraweb	Dual Trace	Panel - 4, Upholstery - 3, Architectural - 3
2002	03	W237 (P) - T399 (U/A)	Intraweb	Polytope	Panel - 4, Upholstery - 3, Architectural - 3
2002	04	W238 (P) - T400 (U/A)	Intraweb	Superposition	Panel - 4, Upholstery - 3, Architectural - 3
2002	05	W239 (P) - T401 (U/A)	Intraweb	Coaxial	Panel - 4, Upholstery - 3, Architectural - 3
2002	06	W240 (P) - T402 (U/A)	Intraweb	Origin	Panel - 4, Upholstery - 3, Architectural - 3
2002	07	W241 (P) - T403 (U/A)	Intraweb	Slope	Panel - 4, Upholstery - 3, Architectural - 3
2002	08	W242 (P) - T404 (U/A)	Intraweb	Polarity	Panel - 4, Upholstery - 3, Architectural - 3
2002	09	W243 (P) - T405 (U/A)	Intraweb	Isosurface	Panel - 4, Upholstery - 3, Architectural - 3

textile listings by pattern number (continued)

FABRIC PATTERN	COLOR CODE	TEKNION COLOR CODE	PATTERN NAME	COLOR NAME	APPLICATION GRADE
2003	01	R264 (P) - H713 (U/A)	High Frequency	Eclipse Shadow	Panel - 5, Upholstery - 4, Architectural - 4
2003	02	R265 (P) - H714 (U/A)	High Frequency	Flash Lag	Panel - 5, Upholstery - 4, Architectural - 4
2003	03	R266 (P) - H715 (U/A)	High Frequency	Motion Blur	Panel - 5, Upholstery - 4, Architectural - 4
2003	04	R267 (P) - H716 (U/A)	High Frequency	Moon Illusion	Panel - 5, Upholstery - 4, Architectural - 4
2003	05	R268 (P) - H717 (U/A)	High Frequency	Solar Halo	Panel - 5, Upholstery - 4, Architectural - 4
2003	06	R269 (P) - H718 (U/A)	High Frequency	Laser Speckle	Panel - 5, Upholstery - 4, Architectural - 4
2003	07	R270 (P) - H719 (U/A)	High Frequency	Photon Shot	Panel - 5, Upholstery - 4, Architectural - 4
2003	08	R271 (P) - H720 (U/A)	High Frequency	Sea Fret	Panel - 5, Upholstery - 4, Architectural - 4
2003	09	R272 (P) - H721 (U/A)	High Frequency	Fata Morgana	Panel - 5, Upholstery - 4, Architectural - 4
2003	10	R273 (P) - H722 (U/A)	High Frequency	Hyperbolic Green	Panel - 5, Upholstery - 4, Architectural - 4
2003	11	R274 (P) - H723 (U/A)	High Frequency	Iceblink	Panel - 5, Upholstery - 4, Architectural - 4
2003	12	R275 (P) - H724 (U/A)	High Frequency	Plane Wave	Panel - 5, Upholstery - 4, Architectural - 4
2003	13	R276 (P) - H725 (U/A)	High Frequency	Liquid Crystal	Panel - 5, Upholstery - 4, Architectural - 4
2003	14	R277 (P) - H726 (U/A)	High Frequency	Aftereffect	Panel - 5, Upholstery - 4, Architectural - 4
2003	15	R278 (P) - H727 (U/A)	High Frequency	Gaussian	Panel - 5, Upholstery - 4, Architectural - 4
2003	16	R279 (P) - H728 (U/A)	High Frequency	Occlusion	Panel - 5, Upholstery - 4, Architectural - 4
2004	01	R523 (P) - T541 (U/A)	Textured Map	Mineralize	Panel - 4, Upholstery - 3, Architectural - 3
2004	02	R524 (P) - T542 (U/A)	Textured Map	Henge	Panel - 4, Upholstery - 3, Architectural - 3
2004	03	R525 (P) - T543 (U/A)	Textured Map	Rockfall	Panel - 4, Upholstery - 3, Architectural - 3
2004	04	R526 (P) - T544 (U/A)	Textured Map	Trace Fossil	Panel - 4, Upholstery - 3, Architectural - 3
2004	05	R527 (P) - T545 (U/A)	Textured Map	Windblown Silt	Panel - 4, Upholstery - 3, Architectural - 3
2004	06	R528 (P) - T546 (U/A)	Textured Map	Holocene	Panel - 4, Upholstery - 3, Architectural - 3
2004	07	R529 (P) - T547 (U/A)	Textured Map	Coralline	Panel - 4, Upholstery - 3, Architectural - 3
2004	08	R530 (P) - T548 (U/A)	Textured Map	Latent Heat	Panel - 4, Upholstery - 3, Architectural - 3
2004	09	R531 (P) - T549 (U/A)	Textured Map	Water Table	Panel - 4, Upholstery - 3, Architectural - 3
2004	10	R532 (P) - T550 (U/A)	Textured Map	Elm Pollen	Panel - 4, Upholstery - 3, Architectural - 3
2004	11	R533 (P) - T551 (U/A)	Textured Map	Miocene	Panel - 4, Upholstery - 3, Architectural - 3
2004	12	R534 (P) - T552 (U/A)	Textured Map	Linden	Panel - 4, Upholstery - 3, Architectural - 3
2004	13	R535 (P) - T553 (U/A)	Textured Map	Green Algae	Panel - 4, Upholstery - 3, Architectural - 3
2004	14	R536 (P) - T554 (U/A)	Textured Map	Thaw	Panel - 4, Upholstery - 3, Architectural - 3
2004	15	R537 (P) - T555 (U/A)	Textured Map	Continental Drift	Panel - 4, Upholstery - 3, Architectural - 3
2004	16	R538 (P) - T556 (U/A)	Textured Map	Ocean Basin	Panel - 4, Upholstery - 3, Architectural - 3
4001	01	E505	Fundamentals	Banner	Upholstery - 1
4001	03	E535	Fundamentals	Latte	Upholstery - 1
4001	04	E518	Fundamentals	Brier	Upholstery - 1
4001	05	E532	Fundamentals	Dove	Upholstery - 1
4001	06	E522	Fundamentals	Light Grey	Upholstery - 1
4001	07	E519	Fundamentals	Sudan	Upholstery - 1
4001	09	E528	Fundamentals	Verde	Upholstery - 1
4001	10	E533	Fundamentals	Nickel	Upholstery - 1
4001	12	E516	Fundamentals	Parakeet	Upholstery - 1
4001	13	E534	Fundamentals	Slate	Upholstery - 1
4001	14	E526	Fundamentals	Tangelo	Upholstery - 1
4001	15	E529	Fundamentals	Aqua	Upholstery - 1
4001	16	E521	Fundamentals	Armory	Upholstery - 1
4001	17	E504	Fundamentals	Salsa	Upholstery - 1
4001	18	E530	Fundamentals	Azure	Upholstery - 1
4001	19	E523	Fundamentals	Black	Upholstery - 1
4001	21	E520	Fundamentals	Wendigo	Upholstery - 1
4001	22	E536	Fundamentals	Marble	Upholstery - 1
4001	23	E537	Fundamentals	Moonstone	Upholstery - 1
4001	24	E538	Fundamentals	Lapris	Upholstery - 1
4001	25	E539	Fundamentals	Malachite	Upholstery - 1

textile listings by pattern number (continued)

FABRIC PATTERN	COLOR CODE	TEKNION COLOR CODE	PATTERN NAME	COLOR NAME	APPLICATION GRADE
4007	01	H510	Heather Felt	Noil	Upholstery - 9
4007	02	H511	Heather Felt	Alumina	Upholstery - 9
4007	03	H512	Heather Felt	Bone Ash	Upholstery - 9
4007	04	H513	Heather Felt	Pinon Tree	Upholstery - 9
4007	07	H516	Heather Felt	Indian Ocean	Upholstery - 9
4007	08	H517	Heather Felt	Mustard Seed	Upholstery - 9
4007	09	H518	Heather Felt	Saffron	Upholstery - 9
4007	10	H519	Heather Felt	Acai	Upholstery - 9
4007	11	H520	Heather Felt	Armor	Upholstery - 9
4007	13	H522	Heather Felt	Marina	Upholstery - 9
4007	14	H523	Heather Felt	Grove	Upholstery - 9
4007	16	H525	Heather Felt	Scarlet	Upholstery - 9
4008	02	F207	Full Wool	Blanc	Upholstery - 8
4008	04	F209	Full Wool	Hot Stone	Upholstery - 8
4008	05	F210	Full Wool	Éclair	Upholstery - 8
4008	06	F211	Full Wool	Macchiato	Upholstery - 8
4008	07	F212	Full Wool	Ink	Upholstery - 8
4008	09	F214	Full Wool	Tigerlily	Upholstery - 8
4008	10	F215	Full Wool	Fresh Water	Upholstery - 8
4008	11	F216	Full Wool	Serpent	Upholstery - 8
4008	13	F218	Full Wool	Neptune	Upholstery - 8
4008	14	F219	Full Wool	Safari	Upholstery - 8
4008	15	F220	Full Wool	Vintage Red	Upholstery - 8
4008	16	F221	Full Wool	Lagoon	Upholstery - 8
4008	17	F222	Full Wool	Oak Room	Upholstery - 8
4008	18	F223	Full Wool	Deep Orchid	Upholstery - 8
4008	19	F224	Full Wool	Aries	Upholstery - 8
4008	20	F225	Full Wool	Seashell	Upholstery - 8
4008	21	F226	Full Wool	Star Fruit	Upholstery - 8
4008	22	F227	Full Wool	Clover	Upholstery - 8
4008	23	F228	Full Wool	Ocean Shadow	Upholstery - 8
4008	24	F229	Full Wool	Deep Sea	Upholstery - 8
4008	25	F230	Full Wool	Sea Holly	Upholstery - 8
4008	26	F231	Full Wool	London Fog	Upholstery - 8
4009	01	R150 (P) - C120 (U)	Cross Dye	Earl Grey	Panel - 1, Upholstery - 2
4009	02	R151 (P) - C121 (U)	Cross Dye	Linen	Panel - 1, Upholstery - 2
4009	03	R152 (P) - C122 (U)	Cross Dye	Light Birch	Panel - 1, Upholstery - 2
4009	04	R153 (P) - C123 (U)	Cross Dye	Almond	Panel - 1, Upholstery - 2
4009	05	R154 (P) - C124 (U)	Cross Dye	Soft Shadow	Panel - 1, Upholstery - 2
4009	06	R155 (P) - C125 (U)	Cross Dye	Ace Grey	Panel - 1, Upholstery - 2
4009	07	R156 (P) - C126 (U)	Cross Dye	Cool Ash	Panel - 1, Upholstery - 2
4009	08	R157 (P) - C127 (U)	Cross Dye	Carotene	Panel - 1, Upholstery - 2
4009	09	R158 (P) - C128 (U)	Cross Dye	Crimson	Panel - 1, Upholstery - 2
4009	10	R159 (P) - C129 (U)	Cross Dye	Carmine	Panel - 1, Upholstery - 2
4009	11	R160 (P) - C130 (U)	Cross Dye	Tea Tree	Panel - 1, Upholstery - 2
4009	12	R161 (P) - C131 (U)	Cross Dye	Artichoke	Panel - 1, Upholstery - 2
4009	13	R162 (P) - C132 (U)	Cross Dye	Plum	Panel - 1, Upholstery - 2
4009	14	R163 (P) - C133 (U)	Cross Dye	Watercolor	Panel - 1, Upholstery - 2
4009	15	R164 (P) - C134 (U)	Cross Dye	Azure	Panel - 1, Upholstery - 2
4009	16	R165 (P) - C135 (U)	Cross Dye	Logwood	Panel - 1, Upholstery - 2

textile listings by pattern number (continued)

FABRIC PATTERN	COLOR CODE	TEKNION COLOR CODE	PATTERN NAME	COLOR NAME	APPLICATION GRADE
4010	01	R166 (P) - F314 (U)	Marl Cloth	Yurt	Panel - 2, Upholstery - 3
4010	02	R167 (P) - F315 (U)	Marl Cloth	Guy Rope	Panel - 2, Upholstery - 3
4010	04	R169 (P) - F317 (U)	Marl Cloth	Camp Fire	Panel - 2, Upholstery - 3
4010	05	R170 (P) - F318 (U)	Marl Cloth	Dry Stone	Panel - 2, Upholstery - 3
4010	07	R172 (P) - F320 (U)	Marl Cloth	Berry	Panel - 2, Upholstery - 3
4010	08	R173 (P) - F321 (U)	Marl Cloth	Blacksmith	Panel - 2, Upholstery - 3
4010	09	R174 (P) - F322 (U)	Marl Cloth	Sea Nomad	Panel - 2, Upholstery - 3
4010	10	R175 (P) - F323 (U)	Marl Cloth	Wild Fruit	Panel - 2, Upholstery - 3
4010	11	R195 (P) - F324 (U)	Marl Cloth	Dreamscape	Panel - 2, Upholstery - 3
4010	12	R196 (P) - F325 (U)	Marl Cloth	Landmark	Panel - 2, Upholstery - 3
4010	13	R197 (P) - F326 (U)	Marl Cloth	Tree Bark	Panel - 2, Upholstery - 3
4015	01	V310	Velvet Underground	Metal Machine	Upholstery - 4
4015	04	V313	Velvet Underground	Flame Desire	Upholstery - 4
4015	06	V315	Velvet Underground	Blue Denim	Upholstery - 4
4015	08	V317	Velvet Underground	Dark Moon	Upholstery - 4
4015	09	V318	Velvet Underground	Blacktop	Upholstery - 4
4015	11	V319	Velvet Underground	Brass Section	Upholstery - 4
4015	13	V320	Velvet Underground	Shock Wave	Upholstery - 4
4015	19	V321	Velvet Underground	Full Phase	Upholstery - 4
4015	20	V322	Velvet Underground	Dark Current	Upholstery - 4
4015	10	V323	Velvet Underground	Smoke Screen	Upholstery - 4
4015	12	V324	Velvet Underground	Wallflower	Upholstery - 4
4015	14	V325	Velvet Underground	Ultraviolet	Upholstery - 4
4015	15	V326	Velvet Underground	Purple Rain	Upholstery - 4
4015	16	V327	Velvet Underground	Green Room	Upholstery - 4
4015	17	V328	Velvet Underground	Garden Level	Upholstery - 4
4015	18	V329	Velvet Underground	New Wave	Upholstery - 4
4019	01	M140	Magnify	Telescope	Upholstery - 1
4019	02	M141	Magnify	Polished Mirror	Upholstery - 1
4019	03	M142	Magnify	Reflection	Upholstery - 1
4019	04	M143	Magnify	Zoom Lens	Upholstery - 1
4019	05	M144	Magnify	Force Field	Upholstery - 1
4019	06	M145	Magnify	Long Wave	Upholstery - 1
4019	07	M146	Magnify	Deep Water	Upholstery - 1
4019	08	M147	Magnify	Light Beam	Upholstery - 1
4019	09	M148	Magnify	Flare Up	Upholstery - 1
4019	10	M149	Magnify	Viewfinder	Upholstery - 1
4019	11	M150	Magnify	Bright Eyes	Upholstery - 1
4019	12	M151	Magnify	Infrared	Upholstery - 1
4019	13	M152	Magnify	Intensity	Upholstery - 1
4021	01	V490	Ultra Durable	Wet Clay	Upholstery - 2
4021	02	V180	Ultra Durable	Mohair	Upholstery - 2
4021	03	V182	Ultra Durable	Iced Coffee	Upholstery - 2
4021	04	V493	Ultra Durable	Silver Age	Upholstery - 2
4021	08	V497	Ultra Durable	Morning Glory	Upholstery - 2
4021	11	V500	Ultra Durable	Neptune	Upholstery - 2
4021	12	V184	Ultra Durable	Tungsten	Upholstery - 2
4021	14	V503	Ultra Durable	Fig	Upholstery - 2
4021	15	V187	Ultra Durable	Black Velvet	Upholstery - 2

textile listings by pattern number (continued)

FABRIC PATTERN	COLOR CODE	TEKNION COLOR CODE	PATTERN NAME	COLOR NAME	APPLICATION GRADE
4023	01	L110	Merus	Teak	Leather - LB
4023	02	L111	Merus	White Birch	Leather - LB
4023	03	L112	Merus	Beechwood	Leather - LB
4023	05	L114	Merus	Almond Shell	Leather - LB
4023	08	L117	Merus	Smoke	Leather - LB
4023	09	L118	Merus	Hopi	Leather - LB
4023	10	L119	Merus	Crushed Bark	Leather - LB
4023	14	L123	Merus	Black Truffle	Leather - LB
4024	01	L216	Pela	Clove	Leather - LC
4024	02	L217	Pela	White Clay	Leather - LC
4024	03	L218	Pela	Chamois	Leather - LC
4024	05	L220	Pela	Buckwheat	Leather - LC
4024	06	L221	Pela	Hemlock	Leather - LC
4024	07	L222	Pela	Fern	Leather - LC
4024	11	L226	Pela	Cerulean	Leather - LC
4024	12	L227	Pela	Marigold	Leather - LC
4024	13	L228	Pela	Pomegranate	Leather - LC
4024	14	L229	Pela	Cordon	Leather - LC
4024	15	L230	Pela	Black Cherry	Leather - LC
4024	17	L232	Pela	Nightshade	Leather - LC
4024	18	L233	Pela	Morel	Leather - LC
4024	19	L234	Pela	Russet	Leather - LC
4024	20	L235	Pela	Carbon	Leather - LC
4024	21	L236	Pela	Pitch	Leather - LC
4025	01	L310	Fortis	Canyon	Leather - LD
4025	02	L311	Fortis	Bone	Leather - LD
4025	04	L313	Fortis	Terra	Leather - LD
4025	05	L314	Fortis	Nugget	Leather - LD
4025	07	L316	Fortis	Black Rock	Leather - LD
4029	01	F115	Situ	Archeology	Upholstery - 3
4029	02	F116	Situ	Pozzolana	Upholstery - 3
4029	03	F117	Situ	Amphora	Upholstery - 3
4029	04	F118	Situ	Statue	Upholstery - 3
4029	05	F119	Situ	Wind Tower	Upholstery - 3
4029	06	F120	Situ	Tunnel	Upholstery - 3
4029	07	F121	Situ	Phosphor	Upholstery - 3
4029	08	F122	Situ	Flamante	Upholstery - 3
4029	09	F123	Situ	Hydro	Upholstery - 3
4029	11	F125	Situ	Terrena	Upholstery - 3
4029	12	F126	Situ	Mar	Upholstery - 3
4030	01	S135	Synaptic	Contact	Upholstery - 5
4030	02	S136	Synaptic	Phase	Upholstery - 5
4030	04	S138	Synaptic	Conduit	Upholstery - 5
4030	05	S139	Synaptic	Sensory	Upholstery - 5
4030	06	S140	Synaptic	Receptor	Upholstery - 5
4030	07	S141	Synaptic	Traverse	Upholstery - 5
4030	08	S142	Synaptic	Transmission	Upholstery - 5
4030	10	S144	Synaptic	Axon	Upholstery - 5

textile listings by pattern number (continued)

FABRIC PATTERN	COLOR CODE	TEKNION COLOR CODE	PATTERN NAME	COLOR NAME	APPLICATION GRADE
4033	01	S145	Stimuli	Sensitive	Upholstery - 1
4033	02	S146	Stimuli	Turbinado	Upholstery - 1
4033	03	S147	Stimuli	Rush	Upholstery - 1
4033	04	S148	Stimuli	Zest	Upholstery - 1
4033	05	S149	Stimuli	Tactile	Upholstery - 1
4033	06	S150	Stimuli	Daredevil	Upholstery - 1
4033	07	S151	Stimuli	Euphoria	Upholstery - 1
4033	08	S152	Stimuli	Vigor	Upholstery - 1
4033	09	S153	Stimuli	Thrill	Upholstery - 1
4033	10	S154	Stimuli	Catalyst	Upholstery - 1
4033	11	S155	Stimuli	Black Tea	Upholstery - 1
4034	01	T220	Ample	Quark	Upholstery - 3
4034	02	T221	Ample	Voltage	Upholstery - 3
4034	03	T222	Ample	Sunburst	Upholstery - 3
4034	04	T223	Ample	Gamma	Upholstery - 3
4034	05	T224	Ample	Radioactive	Upholstery - 3
4034	06	T225	Ample	Chameleon	Upholstery - 3
4034	07	T226	Ample	Volcanic	Upholstery - 3
4034	08	T227	Ample	Reaction	Upholstery - 3
4034	09	T228	Ample	Zeal	Upholstery - 3
4034	10	T229	Ample	Cosmic	Upholstery - 3
4034	11	T239	Ample	Blue Comet	Upholstery - 3
4034	12	T240	Ample	Cavern	Upholstery - 3
4034	13	T241	Ample	Vortex	Upholstery - 3
4034	14	T242	Ample	Neutron	Upholstery - 3
4034	15	T243	Ample	Tempered	Upholstery - 3
4034	16	T244	Ample	Aurora	Upholstery - 3
4035	01	H100	Homage	Respect	Upholstery - 8
4035	02	H102	Homage	Winsome	Upholstery - 8
4035	03	H105	Homage	Esteem	Upholstery - 8
4035	04	H103	Homage	Dashing	Upholstery - 8
4035	05	H104	Homage	Authority	Upholstery - 8
4035	07	H106	Homage	Soigné	Upholstery - 8
4035	08	H107	Homage	Valor	Upholstery - 8
4035	09	H108	Homage	Sanguine	Upholstery - 8
4035	10	H109	Homage	Vivant	Upholstery - 8
4035	11	H110	Homage	Guild	Upholstery - 8
4035	12	H111	Homage	Pinnacle	Upholstery - 8
4035	13	H112	Homage	Noble	Upholstery - 8

textile listings by pattern number (continued)

FABRIC PATTERN	COLOR CODE	TEKNION COLOR CODE	PATTERN NAME	COLOR NAME	APPLICATION GRADE
4040	01	C814 (P) - P107 (U/A)	Percept	Pristine	Panel - 2, Upholstery - 2, Architectural - 2
4040	02	C817 (P) - P110 (U/A)	Percept	Sublime	Panel - 2, Upholstery - 2, Architectural - 2
4040	03	C818 (P) - P111 (U/A)	Percept	Context	Panel - 2, Upholstery - 2, Architectural - 2
4040	04	C819 (P) - P112 (U/A)	Percept	Essence	Panel - 2, Upholstery - 2, Architectural - 2
4040	06	C815 (P) - P108 (U/A)	Percept	Intrinsic	Panel - 2, Upholstery - 2, Architectural - 2
4040	07	C813 (P) - P106 (U/A)	Percept	Schema	Panel - 2, Upholstery - 2, Architectural - 2
4040	08	C821 (P) - P114 (U/A)	Percept	Epiphany	Panel - 2, Upholstery - 2, Architectural - 2
4040	09	C824 (P) - P117 (U/A)	Percept	Reason	Panel - 2, Upholstery - 2, Architectural - 2
4040	10	C827 (P) - P120 (U/A)	Percept	Jubilant	Panel - 2, Upholstery - 2, Architectural - 2
4040	11	C820 (P) - P113 (U/A)	Percept	Tenet	Panel - 2, Upholstery - 2, Architectural - 2
4040	12	C830 (P) - P123 (U/A)	Percept	Peak	Panel - 2, Upholstery - 2, Architectural - 2
4040	13	C823 (P) - P116 (U/A)	Percept	Amplitude	Panel - 2, Upholstery - 2, Architectural - 2
4040	14	C829 (P) - P122 (U/A)	Percept	Harmonic	Panel - 2, Upholstery - 2, Architectural - 2
4040	15	C826 (P) - P119 (U/A)	Percept	Nebula	Panel - 2, Upholstery - 2, Architectural - 2
4040	16	C831 (P) - P124 (U/A)	Percept	Devotion	Panel - 2, Upholstery - 2, Architectural - 2
4040	17	C825 (P) - P118 (U/A)	Percept	Cardinality	Panel - 2, Upholstery - 2, Architectural - 2
4040	18	C828 (P) - P121 (U/A)	Percept	Ignite	Panel - 2, Upholstery - 2, Architectural - 2
4040	19	C822 (P) - P115 (U/A)	Percept	Verve	Panel - 2, Upholstery - 2, Architectural - 2
4040	20	C832 (P) - P125 (U/A)	Percept	Transmit	Panel - 2, Upholstery - 2, Architectural - 2
4040	21	C833 (P) - P126 (U/A)	Percept	Render	Panel - 2, Upholstery - 2, Architectural - 2
4040	22	C834 (P) - P127 (U/A)	Percept	Pulse	Panel - 2, Upholstery - 2, Architectural - 2
4040	23	C835 (P) - P128 (U/A)	Percept	Constant	Panel - 2, Upholstery - 2, Architectural - 2
4040	24	C836 (P) - P129 (U/A)	Percept	Radiant	Panel - 2, Upholstery - 2, Architectural - 2
4040	25	C837 (P) - P130 (U/A)	Percept	Propagate	Panel - 2, Upholstery - 2, Architectural - 2
4040	26	C838 (P) - P131 (U/A)	Percept	Placid	Panel - 2, Upholstery - 2, Architectural - 2
4040	27	C839 (P) - P132 (U/A)	Percept	Singular	Panel - 2, Upholstery - 2, Architectural - 2
4040	28	C840 (P) - P133 (U/A)	Percept	Fringe	Panel - 2, Upholstery - 2, Architectural - 2
<hr/>					
4041	01	M160	Perilune	Terrene	Upholstery - 6
4041	02	M161	Perilune	Asteroid	Upholstery - 6
4041	03	M162	Perilune	Stellar	Upholstery - 6
4041	04	M163	Perilune	Satellite	Upholstery - 6
4041	05	M164	Perilune	Gravity	Upholstery - 6
4041	06	M165	Perilune	Red Shift	Upholstery - 6
4041	07	M166	Perilune	Blue Moon	Upholstery - 6
4041	08	M167	Perilune	Space Age	Upholstery - 6
4041	09	M168	Perilune	Verdant	Upholstery - 6
4041	10	M169	Perilune	Pulsar	Upholstery - 6
4041	11	M170	Perilune	Solar	Upholstery - 6
4041	12	M171	Perilune	Hot Crater	Upholstery - 6
<hr/>					
4042	01	C279 (P) - T148 (U/A)	Complement	Nightfall	Panel - 2, Upholstery 2, Architectural - 2
4042	02	C280 (P) - T149 (U/A)	Complement	Dusk	Panel - 2, Upholstery 2, Architectural - 2
4042	03	C281 (P) - T150 (U/A)	Complement	Grey Wolf	Panel - 2, Upholstery 2, Architectural - 2
4042	04	C281 (P) - T151 (U/A)	Complement	Sea Salt	Panel - 2, Upholstery 2, Architectural - 2
4042	05	C283 (P) - T152 (U/A)	Complement	Roan	Panel - 2, Upholstery 2, Architectural - 2
4042	06	C284 (P) - T153 (U/A)	Complement	Amarillo	Panel - 2, Upholstery 2, Architectural - 2
4042	07	C285 (P) - T154 (U/A)	Complement	Arancia	Panel - 2, Upholstery 2, Architectural - 2
4042	08	C286 (P) - T155 (U/A)	Complement	Carnelian	Panel - 2, Upholstery 2, Architectural - 2
4042	09	C287 (P) - T156 (U/A)	Complement	Garnet	Panel - 2, Upholstery 2, Architectural - 2
4042	11	C289 (P) - T158 (U/A)	Complement	Fresh Air	Panel - 2, Upholstery 2, Architectural - 2
4042	12	C290 (P) - T159 (U/A)	Complement	Peacock	Panel - 2, Upholstery 2, Architectural - 2

textile listings by pattern number (continued)

FABRIC PATTERN	COLOR CODE	TEKNION COLOR CODE	PATTERN NAME	COLOR NAME	APPLICATION GRADE
4046	01	F401	Fine Grain	Warm Earth	Upholstery - 3
4046	02	F402	Fine Grain	River Ore	Upholstery - 3
4046	03	F403	Fine Grain	Saw Dust	Upholstery - 3
4046	04	F404	Fine Grain	Putty Paste	Upholstery - 3
4046	05	F405	Fine Grain	White Out	Upholstery - 3
4046	06	F406	Fine Grain	Lunar Regolith	Upholstery - 3
4046	07	F407	Fine Grain	Metallic Swarf	Upholstery - 3
4046	08	F408	Fine Grain	Volcanic Ash	Upholstery - 3
4046	09	F409	Fine Grain	Carbon Neutral	Upholstery - 3
4046	10	F410	Fine Grain	Frosted Zephyr	Upholstery - 3
4046	11	F411	Fine Grain	Deep Indigo	Upholstery - 3
4046	12	F412	Fine Grain	Fathom Blue	Upholstery - 3
4046	13	F413	Fine Grain	Sea Weed	Upholstery - 3
4046	14	F414	Fine Grain	Matcha Leaves	Upholstery - 3
4046	15	F415	Fine Grain	French Beige	Upholstery - 3
4046	16	F416	Fine Grain	Ginger Snap	Upholstery - 3
4046	17	F417	Fine Grain	Martian Soil	Upholstery - 3
4046	18	F418	Fine Grain	Madder Root	Upholstery - 3
4046	19	F419	Fine Grain	Garnet Sand	Upholstery - 3
4046	20	F420	Fine Grain	Iron Oxide	Upholstery - 3
4046	21	F421	Fine Grain	Peat Moss	Upholstery - 3
<hr/>					
4048	01	LP11 (P) - LM12 (U/A)	Intone	Ash	Panel - 3, Upholstery 2, Architectural 2
4048	02	LP12 (P) - LM13 (U/A)	Intone	Creme	Panel - 3, Upholstery 2, Architectural 2
4048	03	LP13 (P) - LM14 (U/A)	Intone	Harbor	Panel - 3, Upholstery 2, Architectural 2
4048	04	LP14 (P) - LM15 (U/A)	Intone	Quicksilver	Panel - 3, Upholstery 2, Architectural 2
4048	05	LP15 (P) - LM16 (U/A)	Intone	Caraway	Panel - 3, Upholstery 2, Architectural 2
4048	06	LP16 (P) - LM17 (U/A)	Intone	Oxide	Panel - 3, Upholstery 2, Architectural 2
4048	07	LP17 (P) - LM18 (U/A)	Intone	Cinder	Panel - 3, Upholstery 2, Architectural 2
4048	08	LP18 (P) - LM19 (U/A)	Intone	Lute	Panel - 3, Upholstery 2, Architectural 2
4048	09	LP19 (P) - LM20 (U/A)	Intone	Pome	Panel - 3, Upholstery 2, Architectural 2
4048	10	LP20 (P) - LM21 (U/A)	Intone	Eclipse	Panel - 3, Upholstery 2, Architectural 2
<hr/>					
4049	01	C237	Outpress	Ashen	Upholstery - 6
4049	02	C238	Outpress	Sand	Upholstery - 6
4049	03	C239	Outpress	Stone	Upholstery - 6
4049	04	C240	Outpress	Soot	Upholstery - 6
4049	05	C241	Outpress	Raven	Upholstery - 6
4049	06	C242	Outpress	Pepper	Upholstery - 6
4049	07	C243	Outpress	Monarch	Upholstery - 6
4049	08	C244	Outpress	Caribbean	Upholstery - 6
4049	09	C245	Outpress	Denim	Upholstery - 6
<hr/>					
4051	01	K106	Amalgam	Aura	Upholstery - 6
4051	02	K107	Amalgam	Pyrite	Upholstery - 6
4051	03	K108	Amalgam	Medallion	Upholstery - 6
4051	04	K109	Amalgam	Fluid	Upholstery - 6
4051	05	K110	Amalgam	Ultraviolet	Upholstery - 6
4051	06	K111	Amalgam	Jolt	Upholstery - 6
4051	07	K112	Amalgam	Nitro	Upholstery - 6
4051	08	K113	Amalgam	Magma	Upholstery - 6
4051	09	K114	Amalgam	Fuse	Upholstery - 6

textile listings by pattern number (continued)

FABRIC PATTERN	COLOR CODE	TEKNION COLOR CODE	PATTERN NAME	COLOR NAME	APPLICATION GRADE
4052	01	N300	Navigate	Florescent	Upholstery - 16
4052	02	N301	Navigate	Pumice	Upholstery - 16
4052	03	N302	Navigate	Interlace Camel	Upholstery - 16
4052	04	N303	Navigate	Reticulated Stone	Upholstery - 16
4052	05	N304	Navigate	Network Orange	Upholstery - 16
4053	01	G106	Monotex	Silver Lane	Upholstery - 5
4053	02	G107	Monotex	Sharkskin	Upholstery - 5
4053	03	G108	Monotex	Grey Flannel	Upholstery - 5
4053	04	G109	Monotex	Grey Marl	Upholstery - 5
4053	05	G110	Monotex	Tarpaper	Upholstery - 5
4053	06	G111	Monotex	Ferrous	Upholstery - 5
4053	07	G112	Monotex	Bark Cloth	Upholstery - 5
4053	08	G113	Monotex	Burlap	Upholstery - 5
4053	09	G114	Monotex	Sumac	Upholstery - 5
4053	10	G115	Monotex	Redroot	Upholstery - 5
4053	11	G116	Monotex	Tyrian	Upholstery - 5
4053	12	G117	Monotex	Annatto	Upholstery - 5
4053	13	G118	Monotex	Jean	Upholstery - 5
4053	14	G119	Monotex	Kingfisher	Upholstery - 5
4053	15	G120	Monotex	Oxalis	Upholstery - 5
4053	16	G121	Monotex	Sulfur	Upholstery - 5
4057	01	M172	Modulus	Plinth	Upholstery - 4
4057	02	M173	Modulus	Landscape	Upholstery - 4
4057	03	M174	Modulus	Masonry	Upholstery - 4
4057	04	M175	Modulus	Superstructer	Upholstery - 4
4057	05	M176	Modulus	Skylight	Upholstery - 4
4057	06	M177	Modulus	Site	Upholstery - 4
4057	07	M178	Modulus	Form	Upholstery - 4
4057	08	M179	Modulus	Shadow Play	Upholstery - 4
4057	09	M180	Modulus	Rebar	Upholstery - 4
4057	10	M181	Modulus	Spatial	Upholstery - 4
4057	11	M182	Modulus	Threshold	Upholstery - 4
4057	12	M183	Modulus	Monument	Upholstery - 4
4058	01	B130 (P) - D310 (U/A) -	Digi Tweed	Dust Tweed	Panel - 2, Upholstery - 2, Architectural - 2
4058	02	B131 (P) - D311 (U/A) -	Digi Tweed	Topaz Tweed	Panel - 2, Upholstery - 2, Architectural - 2
4058	03	B132 (P) - D312 (U/A)	Digi Tweed	Oat Tweed	Panel - 2, Upholstery - 2, Architectural - 2
4058	04	B133 (P) - D313 (U/A)	Digi Tweed	Flax Tweed	Panel - 2, Upholstery - 2, Architectural - 2
4058	05	B134 (P) - D314 (U/A)	Digi Tweed	Silt Tweed	Panel - 2, Upholstery - 2, Architectural - 2
4058	06	B135 (P) - D315 (U/A)	Digi Tweed	Loam Tweed	Panel - 2, Upholstery - 2, Architectural - 2
4058	07	B136 (P) - D316 (U/A)	Digi Tweed	Crag Tweed	Panel - 2, Upholstery - 2, Architectural - 2
4058	08	B137 (P) - D317 (U/A)	Digi Tweed	Basalt Tweed	Panel - 2, Upholstery - 2, Architectural - 2
4058	09	B138 (P) - D318 (U/A)	Digi Tweed	Loden Tweed	Panel - 2, Upholstery - 2, Architectural - 2
4058	10	B139 (P) - D319 (U/A)	Digi Tweed	Sagebrush Tweed	Panel - 2, Upholstery - 2, Architectural - 2
4058	11	B140 (P) - D320 (U/A)	Digi Tweed	Meadow Tweed	Panel - 2, Upholstery - 2, Architectural - 2
4058	12	B141 (P) - D321 (U/A)	Digi Tweed	Sundew Tweed	Panel - 2, Upholstery - 2, Architectural - 2
4058	13	B142 (P) - D322 (U/A)	Digi Tweed	Rose Tweed	Panel - 2, Upholstery - 2, Architectural - 2
4058	14	B143 (P) - D323 (U/A)	Digi Tweed	Raspite Tweed	Panel - 2, Upholstery - 2, Architectural - 2
4058	15	B144 (P) - D324 (U/A)	Digi Tweed	Madder Tweed	Panel - 2, Upholstery - 2, Architectural - 2
4058	16	B145 (P) - D325 (U/A)	Digi Tweed	Beetroot Tweed	Panel - 2, Upholstery - 2, Architectural - 2
4058	17	B146 (P) - D326 (U/A)	Digi Tweed	Thistle Tweed	Panel - 2, Upholstery - 2, Architectural - 2
4058	18	B147 (P) - D327 (U/A)	Digi Tweed	Lav Tweed	Panel - 2, Upholstery - 2, Architectural - 2
4058	19	B148 (P) - D328 (U/A)	Digi Tweed	Clear Tweed	Panel - 2, Upholstery - 2, Architectural - 2
4058	20	B149 (P) - D329 (U/A)	Digi Tweed	Loch Tweed	Panel - 2, Upholstery - 2, Architectural - 2
4058	21	B150 (P) - D330 (U/A)	Digi Tweed	Ocean Tweed	Panel - 2, Upholstery - 2, Architectural - 2
4058	22	B151 (P) - D331 (U/A)	Digi Tweed	North Sea Tweed	Panel - 2, Upholstery - 2, Architectural - 2
4058	23	B152 (P) - D332 (U/A)	Digi Tweed	Onyx Tweed	Panel - 2, Upholstery - 2, Architectural - 2
4058	24	B153 (P) - D333 (U/A)	Digi Tweed	Obsidian Tweed	Panel - 2, Upholstery - 2, Architectural - 2

textile listings by pattern number (continued)

FABRIC PATTERN	COLOR CODE	TEKNION COLOR CODE	PATTERN NAME	COLOR NAME	APPLICATION GRADE
4059	01	R240 (P) - T162 (U/A)	Heather Tech	Dust Tech	Panel - 1, Upholstery - 1, Architectural - 2
4059	02	R241 (P) - T163 (U/A)	Heather Tech	Topaz Tech	Panel - 1, Upholstery - 1, Architectural - 2
4059	03	R242 (P) - T164 (U/A)	Heather Tech	Oat Tech	Panel - 1, Upholstery - 1, Architectural - 2
4059	04	R243 (P) - T165 (U/A)	Heather Tech	Flax Tech	Panel - 1, Upholstery - 1, Architectural - 2
4059	05	R244 (P) - T166 (U/A)	Heather Tech	Silt Tweed	Panel - 1, Upholstery - 1, Architectural - 2
4059	06	R245 (P) - T167 (U/A)	Heather Tech	Loam Tweed	Panel - 1, Upholstery - 1, Architectural - 2
4059	07	R246 (P) - T168 (U/A)	Heather Tech	Crag Tech	Panel - 1, Upholstery - 1, Architectural - 2
4059	08	R247 (P) - T169 (U/A)	Heather Tech	Basalt Tech	Panel - 1, Upholstery - 1, Architectural - 2
4059	09	R248 (P) - T170 (U/A)	Heather Tech	Loden Tech	Panel - 1, Upholstery - 1, Architectural - 2
4059	10	R249 (P) - T171 (U/A)	Heather Tech	Sagebrush Tech	Panel - 1, Upholstery - 1, Architectural - 2
4059	11	R250 (P) - T172 (U/A)	Heather Tech	Meadow Tech	Panel - 1, Upholstery - 1, Architectural - 2
4059	12	R251 (P) - T173 (U/A)	Heather Tech	Sundew Tech	Panel - 1, Upholstery - 1, Architectural - 2
4059	13	R252 (P) - T174 (U/A)	Heather Tech	Rose Tech	Panel - 1, Upholstery - 1, Architectural - 2
4059	14	R253 (P) - T175 (U/A)	Heather Tech	Raspite Tech	Panel - 1, Upholstery - 1, Architectural - 2
4059	15	R254 (P) - T176 (U/A)	Heather Tech	Madder Tech	Panel - 1, Upholstery - 1, Architectural - 2
4059	16	R255 (P) - T177 (U/A)	Heather Tech	Beetroot Tech	Panel - 1, Upholstery - 1, Architectural - 2
4059	17	R256 (P) - T178 (U/A)	Heather Tech	Thistle Tech	Panel - 1, Upholstery - 1, Architectural - 2
4059	18	R257 (P) - T179 (U/A)	Heather Tech	Lav Tech	Panel - 1, Upholstery - 1, Architectural - 2
4059	19	R258 (P) - T180 (U/A)	Heather Tech	Clear Tech	Panel - 1, Upholstery - 1, Architectural - 2
4059	20	R259 (P) - T181 (U/A)	Heather Tech	Loch Tech	Panel - 1, Upholstery - 1, Architectural - 2
4059	21	R260 (P) - T182 (U/A)	Heather Tech	Ocean Tech	Panel - 1, Upholstery - 1, Architectural - 2
4059	22	R261 (P) - T183 (U/A)	Heather Tech	North Sea Tech	Panel - 1, Upholstery - 1, Architectural - 2
4059	23	R262 (P) - T184 (U/A)	Heather Tech	Onyx Tech	Panel - 1, Upholstery - 1, Architectural - 2
4059	24	R263 (P) - T185 (U/A)	Heather Tech	Obsidian Tech	Panel - 1, Upholstery - 1, Architectural - 2
4060	01	E100	Equilux	Eventide	Upholstery - 9
4060	02	E101	Equilux	Diamond Dust	Upholstery - 9
4060	03	E102	Equilux	Solstice	Upholstery - 9
4060	04	E103	Equilux	Moonbow	Upholstery - 9
4060	05	E104	Equilux	Corona	Upholstery - 9
4060	06	E105	Equilux	Blue Hour	Upholstery - 9
4060	07	E106	Equilux	Kindle	Upholstery - 9
4060	08	E107	Equilux	Sunspot	Upholstery - 9
4061	01	R307	Interstice	Inkling	Upholstery - 4
4061	03	R309	Interstice	Lacuna	Upholstery - 4
4061	04	R310	Interstice	Whit	Upholstery - 4
4061	05	R311	Interstice	Scintilla	Upholstery - 4
4061	06	R312	Interstice	Fragment	Upholstery - 4
4061	07	R313	Interstice	Atom	Upholstery - 4
4061	08	R314	Interstice	Trace	Upholstery - 4
4061	09	R315	Interstice	Respite	Upholstery - 4
4061	10	R316	Interstice	Vestige	Upholstery - 4
4061	11	R317	Interstice	Interval	Upholstery - 4
4061	12	R318	Interstice	Caesura	Upholstery - 4
4062	01	A135	Arc Angle	Selene	Upholstery - 14
4062	02	A136	Arc Angle	Erebus	Upholstery - 14
4062	03	A137	Arc Angle	Theia	Upholstery - 14
4062	04	A138	Arc Angle	Proteus	Upholstery - 14
4062	05	A139	Arc Angle	Hestia	Upholstery - 14

textile listings by pattern number (continued)

FABRIC PATTERN	COLOR CODE	TEKNION COLOR CODE	PATTERN NAME	COLOR NAME	APPLICATION GRADE
4063	01	M224	Meta Texture	Deep Space	Upholstery - 4
4063	02	M225	Meta Texture	Grey Matter	Upholstery - 4
4063	03	M226	Meta Texture	Pale Shadow	Upholstery - 4
4063	04	M227	Meta Texture	Silver Lining	Upholstery - 4
4063	05	M228	Meta Texture	Hive Mind	Upholstery - 4
4063	06	M229	Meta Texture	Neutral Ground	Upholstery - 4
4063	07	M230	Meta Texture	Grassroots	Upholstery - 4
4063	08	M231	Meta Texture	Jaded	Upholstery - 4
4063	09	M232	Meta Texture	Deep Dive	Upholstery - 4
4063	10	M233	Meta Texture	Blue Skies	Upholstery - 4
4063	11	M234	Meta Texture	Rosy Outlook	Upholstery - 4
4063	12	M235	Meta Texture	Heat Wave	Upholstery - 4
4063	13	M236	Meta Texture	Punchline	Upholstery - 4
<hr/>					
4064	01	S442	Superspun	Drawdown	Upholstery - 3
4064	02	S443	Superspun	Denier	Upholstery - 3
4064	03	S444	Superspun	Tensile	Upholstery - 3
4064	04	S445	Superspun	Roving	Upholstery - 3
4064	05	S446	Superspun	Staple	Upholstery - 3
4064	06	S447	Superspun	Spindle	Upholstery - 3
4064	07	S448	Superspun	Harness	Upholstery - 3
4064	08	S449	Superspun	Tenter	Upholstery - 3
4064	09	S450	Superspun	Red Cast	Upholstery - 3
4064	10	S451	Superspun	Selvedge	Upholstery - 3
4064	11	S452	Superspun	Skein	Upholstery - 3
4064	12	S453	Superspun	Bluing	Upholstery - 3
4064	13	S454	Superspun	Treadle	Upholstery - 3
4064	14	S455	Superspun	Sett	Upholstery - 3
4064	15	S456	Superspun	Pirn	Upholstery - 3
4064	16	S457	Superspun	Creel	Upholstery - 3
<hr/>					
4065	01	E108	Ephemera	Lucent	Upholstery - 7
4065	02	E109	Ephemera	Afterglow	Upholstery - 7
4065	03	E110	Ephemera	Ice Cloud	Upholstery - 7
4065	04	E111	Ephemera	Halcyon	Upholstery - 7
4065	05	E112	Ephemera	Phosphene	Upholstery - 7
4065	06	E113	Ephemera	Solar Flare	Upholstery - 7
4065	07	E114	Ephemera	Gamma Burst	Upholstery - 7
4065	08	E115	Ephemera	Green Flash	Upholstery - 7
4065	09	E116	Ephemera	Blue Shift	Upholstery - 7
4065	10	E117	Ephemera	Ashfall	Upholstery - 7
4065	11	E118	Ephemera	Nightglow	Upholstery - 7
4065	12	E119	Ephemera	Penumbra	Upholstery - 7
<hr/>					
4066	01	R582 (P) - B160 (U)	Bitstream	Tablet	Panel - A, Upholstery - 1
4066	02	R583 (P) - B161 (U)	Bitstream	Hardware	Panel - A, Upholstery - 1
4066	03	R584 (P) - B162 (U)	Bitstream	Trackback	Panel - A, Upholstery - 1
4066	04	R585 (P) - B163 (U)	Bitstream	Lithium	Panel - A, Upholstery - 1
4066	05	R586 (P) - B164 (U)	Bitstream	Grey Code	Panel - A, Upholstery - 1
4066	06	R587 (P) - B165 (U)	Bitstream	Silicone	Panel - A, Upholstery - 1
4066	07	R588 (P) - B166 (U)	Bitstream	White Noise	Panel - A, Upholstery - 1
4066	08	R589 (P) - B167 (U)	Bitstream	Xenon	Panel - A, Upholstery - 1
4066	09	R590 (P) - B168 (U)	Bitstream	Wavelet	Panel - A, Upholstery - 1
4066	10	R591 (P) - B169 (U)	Bitstream	Blue Team	Panel - A, Upholstery - 1
4066	11	R592 (P) - B170 (U)	Bitstream	Firewire	Panel - A, Upholstery - 1
4066	12	R593 (P) - B171 (U)	Bitstream	Flash Drive	Panel - A, Upholstery - 1

textile listings by pattern number (continued)

FABRIC PATTERN	COLOR CODE	TEKNION COLOR CODE	PATTERN NAME	COLOR NAME	APPLICATION GRADE
4067	01	E120	Elastic Wool	Fortress	Upholstery - 4
4067	02	E121	Elastic Wool	Fantom	Upholstery - 4
4067	03	E122	Elastic Wool	Mercury	Upholstery - 4
4067	04	E123	Elastic Wool	Clean	Upholstery - 4
4067	05	E124	Elastic Wool	Seed	Upholstery - 4
4067	06	E125	Elastic Wool	Tea	Upholstery - 4
4067	07	E126	Elastic Wool	Rust	Upholstery - 4
4067	08	E127	Elastic Wool	Ruby	Upholstery - 4
4067	09	E128	Elastic Wool	Ceylon	Upholstery - 4
4067	10	E129	Elastic Wool	Lovelace	Upholstery - 4
4067	11	E130	Elastic Wool	Jovial	Upholstery - 4
4067	12	E131	Elastic Wool	Elm	Upholstery - 4
4067	13	E132	Elastic Wool	Python	Upholstery - 4
4067	14	E133	Elastic Wool	Aegean	Upholstery - 4
4067	15	E134	Elastic Wool	Delphi	Upholstery - 4
4067	16	E135	Elastic Wool	Dart	Upholstery - 4
<hr/>					
4069	01	A166	Adage	Script	Upholstery - 5
4069	02	A146	Adage	Anthracite	Upholstery - 5
4069	03	A147	Adage	Carbon Fiber	Upholstery - 5
4069	04	A148	Adage	Splice	Upholstery - 5
4069	05	A149	Adage	Chromite	Upholstery - 5
4069	06	A150	Adage	Singularity	Upholstery - 5
4069	07	A151	Adage	Valence	Upholstery - 5
4069	08	A152	Adage	Halite	Upholstery - 5
4069	09	A153	Adage	Quartzite	Upholstery - 5
4069	10	A154	Adage	Rubelite	Upholstery - 5
4069	11	A155	Adage	Thremite	Upholstery - 5
4069	12	A156	Adage	Orchil	Upholstery - 5
4069	13	A157	Adage	Holograph	Upholstery - 5
4069	14	A158	Adage	Photon	Upholstery - 5
4069	15	A159	Adage	Halogen	Upholstery - 5
4069	16	A160	Adage	Canopy	Upholstery - 5
4069	17	A161	Adage	Raw Jade	Upholstery - 5
4069	18	A162	Adage	Petrol	Upholstery - 5
4069	19	A163	Adage	Diffraction	Upholstery - 5
4069	20	A164	Adage	Amethyst	Upholstery - 5
4069	21	A165	Adage	Pascal	Upholstery - 5
<hr/>					
4070	01	C154	Color Fuse	Wax	Upholstery - 10
4070	02	C155	Color Fuse	Emulsion	Upholstery - 10
4070	03	C156	Color Fuse	Jell	Upholstery - 10
4070	04	C157	Color Fuse	Enamel	Upholstery - 10
4070	05	C158	Color Fuse	Liquefy	Upholstery - 10
4070	06	C159	Color Fuse	Freeze	Upholstery - 10
4070	07	C160	Color Fuse	Molten	Upholstery - 10
4070	08	C161	Color Fuse	Solvent	Upholstery - 10
4070	09	C162	Color Fuse	Plasma	Upholstery - 10

textile listings by pattern number (continued)

FABRIC PATTERN	COLOR CODE	TEKNION COLOR CODE	PATTERN NAME	COLOR NAME	APPLICATION GRADE
4073	01	T740 (P) - A209 (U/A)	Actuate	Aqueous	Panel - 2, Upholstery - 2, Architectural - 2
4073	02	T741 (P) - A210 (U/A)	Actuate	Spectral	Panel - 2, Upholstery - 2, Architectural - 2
4073	03	T742 (P) - A211 (U/A)	Actuate	Aether	Panel - 2, Upholstery - 2, Architectural - 2
4073	04	T743 (P) - A212 (U/A)	Actuate	Facet	Panel - 2, Upholstery - 2, Architectural - 2
4073	05	T744 (P) - A213 (U/A)	Actuate	Syntax	Panel - 2, Upholstery - 2, Architectural - 2
4073	06	T745 (P) - A214 (U/A)	Actuate	Vanish	Panel - 2, Upholstery - 2, Architectural - 2
4073	07	T746 (P) - A215 (U/A)	Actuate	Suffuse	Panel - 2, Upholstery - 2, Architectural - 2
4073	08	T747 (P) - A216 (U/A)	Actuate	Mordant	Panel - 2, Upholstery - 2, Architectural - 2
4073	09	T748 (P) - A217 (U/A)	Actuate	Lambent	Panel - 2, Upholstery - 2, Architectural - 2
4073	10	T749 (P) - A218 (U/A)	Actuate	Conscious	Panel - 2, Upholstery - 2, Architectural - 2
4073	11	T750 (P) - A219 (U/A)	Actuate	Fortify	Panel - 2, Upholstery - 2, Architectural - 2
4073	12	T751 (P) - A220 (U/A)	Actuate	Favile	Panel - 2, Upholstery - 2, Architectural - 2
4073	13	T752 (P) - A221 (U/A)	Actuate	Prelude	Panel - 2, Upholstery - 2, Architectural - 2
4073	14	T753 (P) - A222 (U/A)	Actuate	Meridian	Panel - 2, Upholstery - 2, Architectural - 2
4073	15	T754 (P) - A223 (U/A)	Actuate	Thermal	Panel - 2, Upholstery - 2, Architectural - 2
4073	16	T755 (P) - A224 (U/A)	Actuate	Induction	Panel - 2, Upholstery - 2, Architectural - 2
<hr/>					
4075	01	S335	Structured Stripe	Shadow Weave	Upholstery - 7
4075	01	S336	Structured Stripe	Silver Lap	Upholstery - 7
4075	01	S337	Structured Stripe	Countermarche	Upholstery - 7
4075	01	S338	Structured Stripe	Double Beam	Upholstery - 7
4075	01	S339	Structured Stripe	Block Draw	Upholstery - 7
4075	01	S340	Structured Stripe	Box Motion	Upholstery - 7
4075	01	S341	Structured Stripe	Overshot	Upholstery - 7
4075	01	S342	Structured Stripe	Punch Card	Upholstery - 7
<hr/>					
4076	01	D130	Duo Chrome	Ebony	Upholstery - 6
4076	02	D131	Duo Chrome	Charcoal	Upholstery - 6
4076	03	D132	Duo Chrome	Black Pepper	Upholstery - 6
4076	04	D133	Duo Chrome	Platinum	Upholstery - 6
4076	05	D134	Duo Chrome	Canvas	Upholstery - 6
4076	06	D135	Duo Chrome	Copper	Upholstery - 6
4076	07	D136	Duo Chrome	Goldenrod	Upholstery - 6
4076	08	D137	Duo Chrome	Citron	Upholstery - 6
4076	09	D138	Duo Chrome	Emerald	Upholstery - 6
4076	10	D139	Duo Chrome	Silver Elm	Upholstery - 6
4076	11	D140	Duo Chrome	Evergreen	Upholstery - 6
4076	12	D141	Duo Chrome	Aquamarine	Upholstery - 6
4076	13	D142	Duo Chrome	Navy	Upholstery - 6
4076	14	D143	Duo Chrome	Iris	Upholstery - 6
4076	15	D144	Duo Chrome	Boysenberry	Upholstery - 6
4076	16	D145	Duo Chrome	Hydrangea	Upholstery - 6
4076	17	D146	Duo Chrome	Dusty Plum	Upholstery - 6
4076	18	D147	Duo Chrome	Oxblood	Upholstery - 6
4076	19	D148	Duo Chrome	Red Oxide	Upholstery - 6
4076	20	D149	Duo Chrome	Persimmon	Upholstery - 6
<hr/>					
4077	01	V520	Oeuvre	Blithe	Upholstery - 7
4077	02	V521	Oeuvre	Salient	Upholstery - 7
4077	03	V522	Oeuvre	Austere	Upholstery - 7
4077	04	V523	Oeuvre	Earnest	Upholstery - 7
4077	05	V524	Oeuvre	Ardent	Upholstery - 7
4077	06	V525	Oeuvre	Fervor	Upholstery - 7
4077	07	V526	Oeuvre	Finesse	Upholstery - 7
4077	08	V527	Oeuvre	Mettle	Upholstery - 7
4077	09	V528	Oeuvre	Flourish	Upholstery - 7
4077	10	V529	Oeuvre	Charm	Upholstery - 7
4077	11	V530	Oeuvre	Deft	Upholstery - 7
4077	12	V531	Oeuvre	Crest	Upholstery - 7

textile listings by pattern number (continued)

FABRIC PATTERN	COLOR CODE	TEKNION COLOR CODE	PATTERN NAME	COLOR NAME	APPLICATION GRADE
4078	01	Y100	Doyenne	Woodbrick	Upholstery - 3
4078	02	Y101	Doyenne	Sepia Tone	Upholstery - 3
4078	03	Y102	Doyenne	Intaglio	Upholstery - 3
4078	04	Y103	Doyenne	Grisailles	Upholstery - 3
4078	05	Y104	Doyenne	Aquamedia	Upholstery - 3
4078	06	Y105	Doyenne	Watermark	Upholstery - 3
4078	07	Y106	Doyenne	Verdigris	Upholstery - 3
4078	08	Y107	Doyenne	Phthalo	Upholstery - 3
4078	09	Y108	Doyenne	Terre Verte	Upholstery - 3
4078	10	Y109	Doyenne	Copperplate	Upholstery - 3
4078	11	Y110	Doyenne	Sienna	Upholstery - 3
4078	12	Y111	Doyenne	Alizarin	Upholstery - 3
4079	01	C511	Construct	Fawn	Upholstery - 8
4079	02	C512	Construct	Clay	Upholstery - 8
4079	03	C513	Construct	Brandy	Upholstery - 8
4079	04	C514	Construct	Vermilion	Upholstery - 8
4079	05	C515	Construct	Cadmium Orange	Upholstery - 8
4079	06	C516	Construct	Zinnia	Upholstery - 8
4079	07	C517	Construct	Auburn	Upholstery - 8
4079	08	C518	Construct	Wisteria	Upholstery - 8
4079	09	C519	Construct	Ultramarine	Upholstery - 8
4079	10	C520	Construct	Cornflower	Upholstery - 8
4079	11	C521	Construct	Pacific	Upholstery - 8
4079	12	C522	Construct	Celadon	Upholstery - 8
4079	13	C523	Construct	Canary	Upholstery - 8
4079	14	C524	Construct	Turmeric	Upholstery - 8
4079	15	C525	Construct	Ochre	Upholstery - 8
4079	16	C526	Construct	Beryl	Upholstery - 8
4079	17	C527	Construct	Viridian	Upholstery - 8
4079	18	C528	Construct	Fir	Upholstery - 8
4079	19	C529	Construct	Midnight	Upholstery - 8
4079	20	C530	Construct	Argent	Upholstery - 8
4079	21	C531	Construct	Gunmetal	Upholstery - 8
4079	22	C532	Construct	Noir	Upholstery - 8
4080	01	S426	Second Nature	Moonflower	Upholstery - 16
4080	02	S427	Second Nature	Muscadine	Upholstery - 16
4080	03	S428	Second Nature	Chaparral	Upholstery - 16
4080	04	S429	Second Nature	Bougainvillea	Upholstery - 16
4080	05	S430	Second Nature	Nightshade	Upholstery - 16
4080	06	S431	Second Nature	Peppervine	Upholstery - 16
4081	01	F480	Flex Wool	Rebound	Upholstery - 7
4081	02	F481	Flex Wool	Tempo	Upholstery - 7
4081	03	F482	Flex Wool	Dynamo	Upholstery - 7
4081	04	F483	Flex Wool	Vim	Upholstery - 7
4081	05	F484	Flex Wool	Spark	Upholstery - 7
4081	06	F485	Flex Wool	Thrive	Upholstery - 7
4081	07	F486	Flex Wool	Arena	Upholstery - 7
4081	08	F487	Flex Wool	Agile	Upholstery - 7
4081	09	F488	Flex Wool	Buoyant	Upholstery - 7
4081	10	F489	Flex Wool	Torque	Upholstery - 7
4081	11	F490	Flex Wool	Raceway	Upholstery - 7
4081	12	F491	Flex Wool	Blur	Upholstery - 7

textile listings by pattern number (continued)

FABRIC PATTERN	COLOR CODE	TEKNION COLOR CODE	PATTERN NAME	COLOR NAME	APPLICATION GRADE
4082	01	V221	Vector	Dovetail	Upholstery - 6
4082	02	V222	Vector	Horizon Line	Upholstery - 6
4082	03	V223	Vector	Tessera	Upholstery - 6
4082	04	V224	Vector	Latitude	Upholstery - 6
4082	05	V225	Vector	Vertex	Upholstery - 6
4082	06	V226	Vector	Radial	Upholstery - 6
4082	07	V227	Vector	Hypercube	Upholstery - 6
4082	08	V228	Vector	Scalar	Upholstery - 6
4082	09	V229	Vector	Parallax	Upholstery - 6
<hr/>					
4083	01	T418	Top Coat	Shell	Upholstery - 9
4083	02	T419	Top Coat	Glaze	Upholstery - 9
4083	03	T420	Top Coat	Chromate	Upholstery - 9
4083	04	T421	Top Coat	Stoneware	Upholstery - 9
4083	05	T422	Top Coat	Aniline	Upholstery - 9
4083	06	T423	Top Coat	Braze	Upholstery - 9
4083	07	T424	Top Coat	Conduct	Upholstery - 9
4083	08	T425	Top Coat	Heat Set	Upholstery - 9
4083	09	T426	Top Coat	Claycast	Upholstery - 9
4083	10	T427	Top Coat	Toast	Upholstery - 9
4083	11	T428	Top Coat	Polish	Upholstery - 9
4083	12	T429	Top Coat	Frit	Upholstery - 9
4083	13	T430	Top Coat	Shellac	Upholstery - 9
4083	14	T431	Top Coat	Dip	Upholstery - 9
4083	15	T432	Top Coat	Indigo Ink	Upholstery - 9
4083	16	T433	Top Coat	Seal	Upholstery - 9
4083	17	T434	Top Coat	Weld	Upholstery - 9
4083	18	T435	Top Coat	Black Oxide	Upholstery - 9
<hr/>					
4084	01	M191	Fleece	Alum	Upholstery - 10
4084	02	M192	Fleece	Aer	Upholstery - 10
4084	03	M193	Fleece	Linseed	Upholstery - 10
4084	04	M194	Fleece	Rubedo	Upholstery - 10
4084	05	M195	Fleece	Ignis	Upholstery - 10
4084	06	M196	Fleece	Cypher	Upholstery - 10
4084	07	M197	Fleece	Balsam	Upholstery - 10
4084	08	M198	Fleece	Glyph	Upholstery - 10
4084	09	M199	Fleece	Nero	Upholstery - 10
<hr/>					
4086	01	F422	Mitered	Black Walnut	Upholstery - 16
4086	02	F423	Mitered	White Birch	Upholstery - 16
4086	03	F424	Mitered	Golden Oak	Upholstery - 16
4086	04	F425	Mitered	Redwood	Upholstery - 16
4086	05	F426	Mitered	Blue Spruce	Upholstery - 16
4086	06	F427	Mitered	Sapling	Upholstery - 16

textile listings by pattern number (continued)

FABRIC PATTERN	COLOR CODE	TEKNION COLOR CODE	PATTERN NAME	COLOR NAME	APPLICATION GRADE
4087	01	D150	Decoy	Double Bluff	Upholstery - 2
4087	02	D151	Decoy	Sheep's Clothing	Upholstery - 2
4087	03	D152	Decoy	Trick Mirror	Upholstery - 2
4087	04	D153	Decoy	Ditto	Upholstery - 2
4087	05	D154	Decoy	Proxy	Upholstery - 2
4087	06	D155	Decoy	Façade	Upholstery - 2
4087	07	D156	Decoy	Rook	Upholstery - 2
4087	08	D157	Decoy	Copycat	Upholstery - 2
4087	09	D158	Decoy	Incognito	Upholstery - 2
4087	10	D159	Decoy	Pipe Dream	Upholstery - 2
4087	11	D160	Decoy	Trip Wire	Upholstery - 2
4087	12	D161	Decoy	Feign	Upholstery - 2
4087	13	D162	Decoy	Atlantis	Upholstery - 2
4087	14	D163	Decoy	Mirage	Upholstery - 2
4087	15	D164	Decoy	Reverie	Upholstery - 2
4087	16	D165	Decoy	Lure	Upholstery - 2
4087	17	D166	Decoy	Cloak	Upholstery - 2
4087	18	D167	Decoy	Mystify	Upholstery - 2
4087	19	D168	Decoy	Figment	Upholstery - 2
4087	20	D169	Decoy	Ruse	Upholstery - 2
4087	21	D170	Decoy	Red Handed	Upholstery - 2
4087	22	D171	Decoy	Clandestine	Upholstery - 2
4087	23	D172	Decoy	Cahoots	Upholstery - 2
4087	24	D173	Decoy	Synonym	Upholstery - 2
4087	25	D174	Decoy	Mimic	Upholstery - 2
4087	26	D175	Decoy	Retort	Upholstery - 2
4087	27	D176	Decoy	Masquerade	Upholstery - 2
4087	28	D177	Decoy	Lookalike	Upholstery - 2
4087	29	D178	Decoy	Eavesdrop	Upholstery - 2
4087	30	D179	Decoy	Lark	Upholstery - 2
4087	31	D180	Decoy	Stand In	Upholstery - 2
4087	32	D181	Decoy	Encore	Upholstery - 2
4087	33	D182	Decoy	Sweet Talk	Upholstery - 2
4087	34	D183	Decoy	Pretense	Upholstery - 2
4087	35	D184	Decoy	Fool's Gold	Upholstery - 2
4087	36	D185	Decoy	Monkey Business	Upholstery - 2
4087	37	D186	Decoy	Alias	Upholstery - 2
4087	38	D187	Decoy	Crocodile Tears	Upholstery - 2
4087	39	D188	Decoy	Parrot	Upholstery - 2
4087	40	D189	Decoy	Face Value	Upholstery - 2
4087	41	D190	Decoy	Garden Path	Upholstery - 2
4087	42	D191	Decoy	Espionage	Upholstery - 2
4087	43	D192	Decoy	Emulate	Upholstery - 2
4087	44	D193	Decoy	Replay	Upholstery - 2
4087	45	D194	Decoy	Parallel	Upholstery - 2
4087	46	D195	Decoy	Mare's Nest	Upholstery - 2
4088	01	S257	Scale Factor	Basis	Upholstery - 14
4088	02	S258	Scale Factor	Compound	Upholstery - 14
4088	03	S259	Scale Factor	Tangent	Upholstery - 14
4088	04	S260	Scale Factor	Tensor	Upholstery - 14
4088	05	S261	Scale Factor	Matrix	Upholstery - 14

textile listings by pattern number (continued)

FABRIC PATTERN	COLOR CODE	TEKNION COLOR CODE	PATTERN NAME	COLOR NAME	APPLICATION GRADE
4089	01	C163	Crossgrain	Underbrush	Panel - 2, Upholstery - 2
4089	02	C164	Crossgrain	Dado	Panel - 2, Upholstery - 2
4089	03	C165	Crossgrain	Blackwood	Panel - 2, Upholstery - 2
4089	04	C166	Crossgrain	Cove	Panel - 2, Upholstery - 2
4089	05	C167	Crossgrain	Xylem	Panel - 2, Upholstery - 2
4089	06	C168	Crossgrain	Tenon	Panel - 2, Upholstery - 2
4089	07	C169	Crossgrain	Amaranth	Panel - 2, Upholstery - 2
4089	08	C170	Crossgrain	Red Oak	Panel - 2, Upholstery - 2
4089	09	C171	Crossgrain	Tuliptree	Panel - 2, Upholstery - 2
4089	10	C172	Crossgrain	Iroko	Panel - 2, Upholstery - 2
4089	11	C173	Crossgrain	Ginkgo	Panel - 2, Upholstery - 2
4089	12	C174	Crossgrain	Burl	Panel - 2, Upholstery - 2
4089	13	C175	Crossgrain	Cypress	Panel - 2, Upholstery - 2
4089	14	C176	Crossgrain	Springwood	Panel - 2, Upholstery - 2
4089	15	C177	Crossgrain	Driftwood	Panel - 2, Upholstery - 2
<hr/>					
4090	01	4090	Grid State	Arc Flash	Upholstery - 4, Architectural - 3
4090	02	4090	Grid State	Open Circuit	Upholstery - 4, Architectural - 3
4090	03	4090	Grid State	Volt Switch	Upholstery - 4, Architectural - 3
4090	04	4090	Grid State	Hydropower	Upholstery - 4, Architectural - 3
4090	05	4090	Grid State	Switchboard	Upholstery - 4, Architectural - 3
4090	06	4090	Grid State	Megawatt	Upholstery - 4, Architectural - 3
4090	07	4090	Grid State	Circuit Break	Upholstery - 4, Architectural - 3
4090	08	4090	Grid State	Electrode	Upholstery - 4, Architectural - 3
4090	09	4090	Grid State	Live Wire	Upholstery - 4, Architectural - 3
4090	10	4090	Grid State	Turbine	Upholstery - 4, Architectural - 3
4090	11	4090	Grid State	Neon Bulb	Upholstery - 4, Architectural - 3
4090	12	4090	Grid State	Wolfram	Upholstery - 4, Architectural - 3
<hr/>					
4092	01	R285 (P) - E136 (U/A)	Ecotone	Abyss	Panel - 5, Upholstery - 3, Architectural - 5
4092	02	R286 (P) - E137 (U/A)	Ecotone	Ravine	Panel - 5, Upholstery - 3, Architectural - 5
4092	03	R287 (P) - E138 (U/A)	Ecotone	Rocky Shore	Panel - 5, Upholstery - 3, Architectural - 5
4092	04	R288 (P) - E139 (U/A)	Ecotone	Permafrost	Panel - 5, Upholstery - 3, Architectural - 5
4092	05	R289 (P) - E140 (U/A)	Ecotone	Tundra	Panel - 5, Upholstery - 3, Architectural - 5
4092	06	R290 (P) - E141 (U/A)	Ecotone	Arid	Panel - 5, Upholstery - 3, Architectural - 5
4092	07	R291 (P) - E142 (U/A)	Ecotone	Savanna	Panel - 5, Upholstery - 3, Architectural - 5
4092	08	R292 (P) - E143 (U/A)	Ecotone	Desert Bloom	Panel - 5, Upholstery - 3, Architectural - 5
4092	09	R293 (P) - E144 (U/A)	Ecotone	Badlands	Panel - 5, Upholstery - 3, Architectural - 5
4092	10	R294 (P) - E145 (U/A)	Ecotone	Caldera	Panel - 5, Upholstery - 3, Architectural - 5
4092	11	R295 (P) - E146 (U/A)	Ecotone	Freshwater	Panel - 5, Upholstery - 3, Architectural - 5
4092	12	R296 (P) - E147 (U/A)	Ecotone	Intertidal	Panel - 5, Upholstery - 3, Architectural - 5
4092	13	R297 (P) - E148 (U/A)	Ecotone	Rain Shadow	Panel - 5, Upholstery - 3, Architectural - 5
4092	14	R298 (P) - E149 (U/A)	Ecotone	Lichen	Panel - 5, Upholstery - 3, Architectural - 5
4092	15	R299 (P) - E150 (U/A)	Ecotone	Mangrove	Panel - 5, Upholstery - 3, Architectural - 5
4092	16	R300 (P) - E151 (U/A)	Ecotone	Treeline	Panel - 5, Upholstery - 3, Architectural - 5
<hr/>					
4093	01	H616	Haptic	Cliffline	Upholstery - 6
4093	02	H617	Haptic	Gravel	Upholstery - 6
4093	03	H618	Haptic	Alluvium	Upholstery - 6
4093	04	H619	Haptic	Sediment	Upholstery - 6
4093	05	H620	Haptic	Pink Salt	Upholstery - 6
4093	06	H621	Haptic	Montane	Upholstery - 6
4093	07	H622	Haptic	Butte	Upholstery - 6
4093	08	H623	Haptic	Arroyo	Upholstery - 6
4093	09	H624	Haptic	Superbloom	Upholstery - 6
4093	10	H625	Haptic	Mantle	Upholstery - 6
4093	11	H626	Haptic	Geode	Upholstery - 6
4093	12	H627	Haptic	Flood Plain	Upholstery - 6
4093	13	H628	Haptic	Isthmus	Upholstery - 6
4093	14	H629	Haptic	Aquifer	Upholstery - 6
4093	15	H630	Haptic	Delta	Upholstery - 6
4093	16	H631	Haptic	Fjord	Upholstery - 6

Teknion Color Code Identifier (P) - Panel (U) - Upholstery (A) - Architectural

textile listings by pattern number (continued)

FABRIC PATTERN	COLOR CODE	TEKNION COLOR CODE	PATTERN NAME	COLOR NAME	APPLICATION GRADE
4094	01	P160	Photogram	Shadowgraph	Upholstery - 6
4094	02	P161	Photogram	Toner	Upholstery - 6
4094	03	P162	Photogram	Silver Salts	Upholstery - 6
4094	04	P163	Photogram	Light Meter	Upholstery - 6
4094	05	P164	Photogram	Sunprint	Upholstery - 6
4094	06	P165	Photogram	Heliograph	Upholstery - 6
4094	07	P166	Photogram	Safelight	Upholstery - 6
4094	08	P167	Photogram	Cyanotype	Upholstery - 6
4094	09	P168	Photogram	Mezzotint	Upholstery - 6
4094	10	P169	Photogram	Darkroom	Upholstery - 6
<hr/>					
4096	01	R325 (P) - T278 (A)	Twisted Tweed	Wrought Iron	Panel - 4, Upholstery - 3, Architectural - 3
4096	02	R326 (P) - T279 (A)	Twisted Tweed	Rock Garden	Panel - 4, Upholstery - 3, Architectural - 3
4096	03	R327 (P) - T280 (A)	Twisted Tweed	Shady Patch	Panel - 4, Upholstery - 3, Architectural - 3
4096	04	R328 (P) - T281 (A)	Twisted Tweed	Moongate	Panel - 4, Upholstery - 3, Architectural - 3
4096	05	R329 (P) - T282 (A)	Twisted Tweed	Plaster	Panel - 4, Upholstery - 3, Architectural - 3
4096	06	R330 (P) - T283 (A)	Twisted Tweed	Stucco	Panel - 4, Upholstery - 3, Architectural - 3
4096	07	R331 (P) - T284 (A)	Twisted Tweed	Thatch	Panel - 4, Upholstery - 3, Architectural - 3
4096	08	R332 (P) - T285 (A)	Twisted Tweed	Arbor	Panel - 4, Upholstery - 3, Architectural - 3
4096	09	R333 (P) - T286 (A)	Twisted Tweed	Daylight	Panel - 4, Upholstery - 3, Architectural - 3
4096	10	R334 (P) - T287 (A)	Twisted Tweed	Sundial	Panel - 4, Upholstery - 3, Architectural - 3
4096	11	R335 (P) - T288 (A)	Twisted Tweed	Koi Pond	Panel - 4, Upholstery - 3, Architectural - 3
4096	12	R336 (P) - T289 (A)	Twisted Tweed	Brickwork	Panel - 4, Upholstery - 3, Architectural - 3
4096	13	R337 (P) - T290 (A)	Twisted Tweed	Annual	Panel - 4, Upholstery - 3, Architectural - 3
4096	14	R338 (P) - T291 (A)	Twisted Tweed	Perennial	Panel - 4, Upholstery - 3, Architectural - 3
4096	15	R339 (P) - T292 (A)	Twisted Tweed	Rain Chain	Panel - 4, Upholstery - 3, Architectural - 3
4096	16	R340 (P) - T293 (A)	Twisted Tweed	Open Air	Panel - 4, Upholstery - 3, Architectural - 3
4096	17	R341 (P) - T294 (A)	Twisted Tweed	Water Feature	Panel - 4, Upholstery - 3, Architectural - 3
4096	18	R342 (P) - T295 (A)	Twisted Tweed	Terrace	Panel - 4, Upholstery - 3, Architectural - 3
4096	19	R343 (P) - T296 (A)	Twisted Tweed	Veranda	Panel - 4, Upholstery - 3, Architectural - 3
<hr/>					
4091	01	W480	Wavefield	Tideline	Upholstery - 8
4091	02	W481	Wavefield	Groundwater	Upholstery - 8
4091	03	W482	Wavefield	Red Tide	Upholstery - 8
4091	04	W483	Wavefield	Aspen Reflection	Upholstery - 8
4091	05	W484	Wavefield	Rivulet	Upholstery - 8
4091	06	W485	Wavefield	Cascade	Upholstery - 8
4091	07	W486	Wavefield	Sea Level	Upholstery - 8
4091	08	W487	Wavefield	Brackish	Upholstery - 8
4091	09	W488	Wavefield	Wake Zone	Upholstery - 8
<hr/>					
4095	01	W209	Welded	Alliance	Upholstery - 8
4095	02	W210	Welded	Charcoal Flux	Upholstery - 8
4095	03	W211	Welded	Bond	Upholstery - 8
4095	04	W212	Welded	Soda Ash	Upholstery - 8
4095	05	W213	Welded	Palladium	Upholstery - 8
4095	06	W214	Welded	Brass Alloy	Upholstery - 8
4095	07	W215	Welded	Rose Torch	Upholstery - 8
4095	08	W216	Welded	Copper Foil	Upholstery - 8
4095	09	W217	Welded	Mingle	Upholstery - 8
4095	10	W218	Welded	Synergy	Upholstery - 8
4095	11	W219	Welded	Synthesis	Upholstery - 8

textile listings by pattern number (continued)

FABRIC PATTERN	COLOR CODE	TEKNION COLOR CODE	PATTERN NAME	COLOR NAME	APPLICATION GRADE
4098	01	T440	Tilt Shift Redux	Elevation	Upholstery - 7
4098	02	T441	Tilt Shift Redux	Plexus	Upholstery - 7
4098	03	T442	Tilt Shift Redux	Baseline	Upholstery - 7
4098	04	T443	Tilt Shift Redux	Beta	Upholstery - 7
4098	05	T444	Tilt Shift Redux	Fluctuate	Upholstery - 7
4098	06	T445	Tilt Shift Redux	Alpha	Upholstery - 7
4098	07	T446	Tilt Shift Redux	Amplifier	Upholstery - 7
4098	08	T447	Tilt Shift Redux	Sensor	Upholstery - 7
4098	09	T448	Tilt Shift Redux	Bandwidth	Upholstery - 7
4098	10	T449	Tilt Shift Redux	Synapse	Upholstery - 7
4098	11	T450	Tilt Shift Redux	Sonar	Upholstery - 7
4098	12	T451	Tilt Shift Redux	Modulate	Upholstery - 7
4099	01	W128	Wool Fleck	Boulder	Upholstery - 7
4099	02	W129	Wool Fleck	Packstone	Upholstery - 7
4099	03	W130	Wool Fleck	Zinc	Upholstery - 7
4099	04	W131	Wool Fleck	Micrite	Upholstery - 7
4099	05	W132	Wool Fleck	Coquina	Upholstery - 7
4099	06	W133	Wool Fleck	Beachrock	Upholstery - 7
4099	07	W134	Wool Fleck	Tawny	Upholstery - 7
4099	08	W135	Wool Fleck	Corten	Upholstery - 7
4099	09	W136	Wool Fleck	Pink Nacre	Upholstery - 7
4099	10	W137	Wool Fleck	Birchbark	Upholstery - 7
4099	11	W138	Wool Fleck	Firesand	Upholstery - 7
4099	12	W139	Wool Fleck	Chamotte	Upholstery - 7
4099	13	W140	Wool Fleck	Blackberry	Upholstery - 7
4099	14	W141	Wool Fleck	Mussel Dust	Upholstery - 7
4099	15	W142	Wool Fleck	Gitti	Upholstery - 7
4099	16	W143	Wool Fleck	Iolite	Upholstery - 7
4099	17	W144	Wool Fleck	Storm Petrel	Upholstery - 7
4099	18	W145	Wool Fleck	Bittercress	Upholstery - 7
4099	19	W146	Wool Fleck	Oat Grass	Upholstery - 7
4099	20	W147	Wool Fleck	Aloe	Upholstery - 7
4099	21	W148	Wool Fleck	Wild Mustard	Upholstery - 7
4100	01	M534	Melange Check	Cobblestone	Upholstery - 9
4100	02	M535	Melange Check	Bisque	Upholstery - 9
4100	03	M536	Melange Check	Soda Fired	Upholstery - 9
4100	04	M537	Melange Check	Goldspeck	Upholstery - 9
4100	05	M538	Melange Check	Pink Kaolin	Upholstery - 9
4100	06	M539	Melange Check	Brick Dust	Upholstery - 9
4100	07	M540	Melange Check	Alkaline	Upholstery - 9
4100	08	M541	Melange Check	Vapor Glaze	Upholstery - 9
4100	09	M542	Melange Check	Faience Blue	Upholstery - 9
4100	10	M543	Melange Check	Greenware	Upholstery - 9
4101	01	E417	Emergent	Galaxy	Upholstery - 13
4101	02	E418	Emergent	Lunar Eclipse	Upholstery - 13
4101	03	E419	Emergent	Backscatter	Upholstery - 13
4101	04	E420	Emergent	Pegasus	Upholstery - 13
4101	05	E421	Emergent	Earthshine	Upholstery - 13
4101	06	E422	Emergent	Stardust	Upholstery - 13
4101	07	E423	Emergent	Andromeda	Upholstery - 13
4101	08	E424	Emergent	Astra	Upholstery - 13
4101	09	E425	Emergent	Celestial	Upholstery - 13
4101	10	E426	Emergent	Nova	Upholstery - 13
4101	11	E427	Emergent	Meteor Shower	Upholstery - 13

textile listings by pattern number (continued)

FABRIC PATTERN	COLOR CODE	TEKNION COLOR CODE	PATTERN NAME	COLOR NAME	APPLICATION GRADE
4102	01	F136	Formwork	Metallurgy	Upholstery - 4
4102	02	F137	Formwork	Lead	Upholstery - 4
4102	03	F138	Formwork	Selenite	Upholstery - 4
4102	04	F139	Formwork	Opal	Upholstery - 4
4102	05	F140	Formwork	Pearl Ash	Upholstery - 4
4102	06	F141	Formwork	Candela	Upholstery - 4
4102	07	F142	Formwork	Kiln	Upholstery - 4
4102	08	F143	Formwork	Distill	Upholstery - 4
4102	09	F144	Formwork	Azurite	Upholstery - 4
4102	10	F145	Formwork	Verditer	Upholstery - 4
4102	11	F146	Formwork	Elixir	Upholstery - 4
4102	12	F147	Formwork	Precipitant	Upholstery - 4
<hr/>					
4106	01	G250	Graphic Speck	Cavern	Upholstery - 9
4106	02	G251	Graphic Speck	Steel Frame	Upholstery - 9
4106	03	G252	Graphic Speck	Stonework	Upholstery - 9
4106	04	G253	Graphic Speck	Gypsum	Upholstery - 9
4106	05	G254	Graphic Speck	Earthworks	Upholstery - 9
4106	06	G255	Graphic Speck	Cob	Upholstery - 9
4106	07	G256	Graphic Speck	Breccia	Upholstery - 9
4106	08	G257	Graphic Speck	Hearth	Upholstery - 9
4106	09	G258	Graphic Speck	Fired Clay	Upholstery - 9
4106	10	G259	Graphic Speck	Ionic Order	Upholstery - 9
4106	11	G260	Graphic Speck	Waterwheel	Upholstery - 9
4106	12	G261	Graphic Speck	Trellis	Upholstery - 9
4106	13	G262	Graphic Speck	Limecrete	Upholstery - 9
4106	14	G263	Graphic Speck	Plate Glass	Upholstery - 9
4106	15	G264	Graphic Speck	Riverfront	Upholstery - 9
4106	16	G265	Graphic Speck	Structure	Upholstery - 9
<hr/>					
4107	01	G270	Geoglyph	Drifting Sediment	Upholstery - 8
4107	02	G271	Geoglyph	Polar Lights	Upholstery - 8
4107	03	G272	Geoglyph	Moonlit Mountain	Upholstery - 8
4107	04	G273	Geoglyph	Organic Compound	Upholstery - 8
4107	05	G274	Geoglyph	Dappled Sunlight	Upholstery - 8
4107	06	G275	Geoglyph	Painted Desert	Upholstery - 8
<hr/>					
4108	01	P186	Pebble Melange	Esker	Upholstery - 7
4108	02	P187	Pebble Melange	Earthen	Upholstery - 7
4108	03	P188	Pebble Melange	Pewter	Upholstery - 7
4108	04	P189	Pebble Melange	Tectonic	Upholstery - 7
4108	05	P190	Pebble Melange	Geyser	Upholstery - 7
4108	06	P191	Pebble Melange	Palustrine	Upholstery - 7
4108	07	P192	Pebble Melange	Forest Marble	Upholstery - 7
4108	08	P193	Pebble Melange	Everglade	Upholstery - 7
4108	09	P194	Pebble Melange	Estuary	Upholstery - 7
4108	10	P195	Pebble Melange	Meteor	Upholstery - 7
4108	11	P196	Pebble Melange	Barkhan	Upholstery - 7
4108	12	P197	Pebble Melange	Lava	Upholstery - 7

textile listings by pattern number (continued)

FABRIC PATTERN	COLOR CODE	TEKNION COLOR CODE	PATTERN NAME	COLOR NAME	APPLICATION GRADE
4109	01	P212	Particulate	Molecule	Upholstery - 5
4109	02	P213	Particulate	Light Speed	Upholstery - 5
4109	03	P214	Particulate	Granule	Upholstery - 5
4109	04	P215	Particulate	Allotrope	Upholstery - 5
4109	05	P216	Particulate	Current	Upholstery - 5
4109	06	P217	Particulate	Corrosion	Upholstery - 5
4109	07	P218	Particulate	Inertia	Upholstery - 5
4109	08	P219	Particulate	Swell	Upholstery - 5
4109	09	P220	Particulate	Oxidation	Upholstery - 5
4109	10	P221	Particulate	Proton	Upholstery - 5
4109	11	P222	Particulate	Irrigation	Upholstery - 5
4109	12	P223	Particulate	Isotope	Upholstery - 5
4109	13	P224	Particulate	Electrostatic	Upholstery - 5
4109	14	P225	Particulate	Quasar	Upholstery - 5
4109	15	P226	Particulate	Smolder	Upholstery - 5
<hr/>					
4110	01	R654 (P) -M328 (U/A)	Megacheck	Liminal	Panel - 2, Upholstery - 2, Architectural - 2
4110	02	R655 (P) -M329 (U/A)	Megacheck	Convex	Panel - 2, Upholstery - 2, Architectural - 2
4110	03	R656 (P) -M330 (U/A)	Megacheck	Concave	Panel - 2, Upholstery - 2, Architectural - 2
4110	04	R657 (P) -M331 (U/A)	Megacheck	Drop Shadow	Panel - 2, Upholstery - 2, Architectural - 2
4110	05	R658 (P) -M332 (U/A)	Megacheck	Litmus	Panel - 2, Upholstery - 2, Architectural - 2
4110	06	R659 (P) -M333 (U/A)	Megacheck	Gradient	Panel - 2, Upholstery - 2, Architectural - 2
4110	07	R660 (P) -M334 (U/A)	Megacheck	Distort	Panel - 2, Upholstery - 2, Architectural - 2
4110	08	R661 (P) -M335 (U/A)	Megacheck	Resolution	Panel - 2, Upholstery - 2, Architectural - 2
4110	09	R662 (P) -M336 (U/A)	Megacheck	Glitch	Panel - 2, Upholstery - 2, Architectural - 2
4110	10	R663 (P) -M337 (U/A)	Megacheck	Flashbulb	Panel - 2, Upholstery - 2, Architectural - 2
4110	11	R664 (P) -M338 (U/A)	Megacheck	Visage	Panel - 2, Upholstery - 2, Architectural - 2
4110	12	R665 (P) -M339 (U/A)	Megacheck	Magnitude	Panel - 2, Upholstery - 2, Architectural - 2
<hr/>					
4111	01	E216	Everyday Boucle	Black Lily	Upholstery - 7
4111	02	E217	Everyday Boucle	Stonecrop	Upholstery - 7
4111	03	E218	Everyday Boucle	Smokebush	Upholstery - 7
4111	04	E219	Everyday Boucle	Silver Aster	Upholstery - 7
4111	05	E220	Everyday Boucle	Artemisia	Upholstery - 7
4111	06	E221	Everyday Boucle	Lamb's Ear	Upholstery - 7
4111	07	E222	Everyday Boucle	Cassava	Upholstery - 7
4111	08	E223	Everyday Boucle	Tussock	Upholstery - 7
4111	09	E224	Everyday Boucle	Thicket	Upholstery - 7
4111	10	E225	Everyday Boucle	Moss	Upholstery - 7
4111	11	E226	Everyday Boucle	Wintergreen	Upholstery - 7
4111	12	E227	Everyday Boucle	Bay Laurel	Upholstery - 7
4111	13	E228	Everyday Boucle	Delphinium	Upholstery - 7
4111	14	E229	Everyday Boucle	Night Bloom	Upholstery - 7
4111	15	E230	Everyday Boucle	Blue Phlox	Upholstery - 7
4111	16	E231	Everyday Boucle	Larkspur	Upholstery - 7
4111	17	E232	Everyday Boucle	Yarrow	Upholstery - 7
4111	18	E233	Everyday Boucle	Honeysuckle	Upholstery - 7
4111	19	E234	Everyday Boucle	Spicebush	Upholstery - 7
4111	20	E235	Everyday Boucle	Rockrose	Upholstery - 7
4111	21	E236	Everyday Boucle	Firethorn	Upholstery - 7
4111	22	E237	Everyday Boucle	Purple Basil	Upholstery - 7
<hr/>					
4112	01	R388	Rubric	Straw Clay	Upholstery - 11
4112	02	R389	Rubric	Pink Laterite	Upholstery - 11
4112	03	R390	Rubric	Rammed Earth	Upholstery - 11
4112	04	R391	Rubric	Submerged Stone	Upholstery - 11
4112	05	R392	Rubric	Glass Block	Upholstery - 11
4112	06	R393	Rubric	Stacked Slate	Upholstery - 11

Teknion Color Code Identifier (P) - Panel (U) - Upholstery (A) - Architectural

textile listings by pattern number (continued)

FABRIC PATTERN	COLOR CODE	TEKNION COLOR CODE	PATTERN NAME	COLOR NAME	APPLICATION GRADE
4114	01	B388	Barberpole Basket	Licorice Root	Upholstery - 8
4114	02	B389	Barberpole Basket	Maelstrom	Upholstery - 8
4114	03	B390	Barberpole Basket	Double Helix	Upholstery - 8
4114	04	B391	Barberpole Basket	Whisp	Upholstery - 8
4114	05	B392	Barberpole Basket	Mycelium	Upholstery - 8
4114	06	B393	Barberpole Basket	Braided Rope	Upholstery - 8
4114	07	B394	Barberpole Basket	Uzumaki	Upholstery - 8
4114	08	B395	Barberpole Basket	Copper Coil	Upholstery - 8
4114	09	B396	Barberpole Basket	Cherry Twist	Upholstery - 8
4114	10	B397	Barberpole Basket	Tendrill	Upholstery - 8
4114	11	B398	Barberpole Basket	Meander	Upholstery - 8
4114	12	B399	Barberpole Basket	Tempest	Upholstery - 8
4115	01	F428	Contrast Slub	Charred Seed	Architectural - 4
4115	02	F429	Contrast Slub	Silver Thyme	Architectural - 4
4115	03	F430	Contrast Slub	Cotton Blossom	Architectural - 4
4115	04	F431	Contrast Slub	Tumbleweed	Architectural - 4
4115	05	F432	Contrast Slub	Bramble	Architectural - 4
4115	06	F433	Contrast Slub	Manzanita	Architectural - 4
4115	07	F434	Contrast Slub	Cactus Flower	Architectural - 4
4115	08	F435	Contrast Slub	Scarlet Sage	Architectural - 4
4115	09	F436	Contrast Slub	Anemone	Architectural - 4
4115	10	F437	Contrast Slub	Crepe Myrtle	Architectural - 4
4115	11	F438	Contrast Slub	Wild Indigo	Architectural - 4
4115	12	F439	Contrast Slub	Jacaranda	Architectural - 4
4115	13	F440	Contrast Slub	Cenote	Architectural - 4
4115	14	F441	Contrast Slub	Oleander	Architectural - 4
4115	15	F442	Contrast Slub	Eucalyptus	Architectural - 4
4115	16	F443	Contrast Slub	Lemongrass	Architectural - 4
4118	01	S432	Soft Static	Semitone	Upholstery - 6
4118	02	S433	Soft Static	Desert Wind	Upholstery - 6
4118	03	S434	Soft Static	Whirr	Upholstery - 6
4118	04	S435	Soft Static	Carillon	Upholstery - 6
4118	05	S436	Soft Static	Heartbeats	Upholstery - 6
4118	06	S437	Soft Static	Timbre	Upholstery - 6
4118	07	S438	Soft Static	Arpeggio	Upholstery - 6
4118	08	S439	Soft Static	Waterfall	Upholstery - 6
4118	09	S440	Soft Static	Ambient Nature	Upholstery - 6
4119	01	S181	Super Shearling	Neroli	Upholstery - 9
4119	02	S182	Super Shearling	Ambergris	Upholstery - 9
4119	03	S183	Super Shearling	Aromatic Water	Upholstery - 9
4119	04	S184	Super Shearling	Musk	Upholstery - 9
4119	05	S185	Super Shearling	Earth Tincture	Upholstery - 9
4119	06	S186	Super Shearling	Petitgrain	Upholstery - 9
4119	07	S187	Super Shearling	Carrissa	Upholstery - 9
4119	08	S188	Super Shearling	Enfleurage	Upholstery - 9
4119	09	S189	Super Shearling	Cedar	Upholstery - 9
4119	10	S190	Super Shearling	Heart Note	Upholstery - 9
4119	11	S191	Super Shearling	Incense	Upholstery - 9
4119	12	S192	Super Shearling	Ginger	Upholstery - 9
4119	13	S193	Super Shearling	Green Sap	Upholstery - 9
4119	14	S194	Super Shearling	Oakmoss	Upholstery - 9
4119	15	S195	Super Shearling	Conifer	Upholstery - 9
4119	16	S196	Super Shearling	Blue Cypress	Upholstery - 9
4119	17	S197	Super Shearling	Seawater	Upholstery - 9
4119	18	S198	Super Shearling	Lupine	Upholstery - 9
4119	19	S199	Super Shearling	Attar	Upholstery - 9
4119	20	S200	Super Shearling	Blackcurrant	Upholstery - 9

Teknion Color Code Identifier (P) - Panel (U) - Upholstery (A) - Architectural

textile listings by pattern number (continued)

FABRIC PATTERN	COLOR CODE	TEKNION COLOR CODE	PATTERN NAME	COLOR NAME	APPLICATION GRADE
7003	01	R380 (P) - B380 (A)	Rationale	Classical	Panel - 1, Architectural - 1
7003	02	R381 (P) - B381 (A)	Rationale	Drift	Panel - 1, Architectural - 1
7003	03	R382 (P) - B382 (A)	Rationale	Firma	Panel - 1, Architectural - 1
7003	04	R383 (P) - B383 (A)	Rationale	Lucid	Panel - 1, Architectural - 1
7003	05	R384 (P) - B384 (A)	Rationale	Abstract	Panel - 1, Architectural - 1
7003	06	R385 (P) - B385 (A)	Rationale	Mind's Eye	Panel - 1, Architectural - 1
7003	07	R386 (P) - B386 (A)	Rationale	Infinite	Panel - 1, Architectural - 1
7003	08	R387 (P) - B387 (A)	Rationale	Transcend	Panel - 1, Architectural - 1
7007	01	S236	Strio	Mineral	Architectural - 2
7007	02	S237	Strio	Dolomite	Architectural - 2
7007	03	S238	Strio	Lithic	Architectural - 2
7007	04	S239	Strio	Calcite	Architectural - 2
7007	05	S240	Strio	Silica	Architectural - 2
7007	07	S242	Strio	Feldspar	Architectural - 2
7007	08	S243	Strio	Sandstone	Architectural - 2
7007	09	S244	Strio	Tor	Architectural - 2
7012	01	W117 (P) - T141 (A)	Twining	Ivory Vine	Panel - 2, Architectural - 2
7012	02	W121 (P) - T145 (A)	Twining	Quill	Panel - 2, Architectural - 2
7012	03	W122 (P) - T146 (A)	Twining	Silvery Strand	Panel - 2, Architectural - 2
7012	04	W123 (P) - T147 (A)	Twining	Bulrush	Panel - 2, Architectural - 2
7012	05	W120 (P) - T144 (A)	Twining	Sisal	Panel - 2, Architectural - 2
7012	06	W119 (P) - T143 (A)	Twining	Abaca	Panel - 2, Architectural - 2
7012	07	W118 (P) - T142 (A)	Twining	Pale Straw	Panel - 2, Architectural - 2
7020	01	J207	Juxtapose	Greenheart	Upholstery - 7
7020	02	J208	Juxtapose	Yakisugi	Upholstery - 7
7020	03	J209	Juxtapose	Lacquer	Upholstery - 7
7020	04	J210	Juxtapose	Timber	Upholstery - 7
7020	05	J211	Juxtapose	Lumber	Upholstery - 7
7020	06	J212	Juxtapose	Rosewood	Upholstery - 7

general information

general information

TEKNIPAINT & TEKNISTAIN89
FABRIC DIRECTIONAL GUIDELINES90
CUSTOMER'S OWN MATERIAL (COM)92
CARE & MAINTENANCE93
TOUCH-UP-KITS94

teknipaint & teknistain

TekniPaint

A TekniPaint form is required if the customer requires a custom paint color.

The color matching procedures will take a minimum of 10 working days.

Standard lead times apply once customer approved sample is received by Teknion Customer Service Representative.

Using the TekniPaint

Prior to placing the order, Dealer submits the color match sample (minimum size 2" x 2") to Teknion Customer Service Representative in conjunction with a completed TekniPaint form.

After the color match process is completed, two (2) samples are returned to the Customer Service Representative who forwards them to the Dealer with a sign-off sticker, attached to the back of the sample, for approval by the customer.

Customer formally signs-off on the color samples by signing the attached sticker.

Dealer returns one (1) of the customer approved samples to a Customer Service Representative or a fax of the signed off sample to Teknion.

Dealer submits the order, quoting the paint name and paint number as indicated on the customer sign-off sticker.

Teknion products included in this program:

- Panels and Supports
- Providers, Overheads & Active Storage Products
- Electrical Products
- Pedestals, Lateral files & Storage Cabinets.

TekniPaint forms and information on how to use these forms can be found at www.teknion.com/products for your printing convenience.

TekniStain

A TekniStain form is required if a Teknion Wood product is needed in colors outside our standard offering.

To order a Custom Wood Stain, follow these instructions:

If specifying a custom color for Seating, please use code NOCWS.

If specifying a custom color for District, Interpret, Leverage, Marketplace, TOS, Transit or Expansion Casegoods, please use code ZOCWS.

If specifying a custom color for Dossier, Cana, Westcoast, Solitär, Grayson, Agenda, Gemini, Table&Conferencing and Executive Casegoods, please use code ZCCWS.

Please forward a TekniStain form to your Customer Service Representative along with two color samples. Allow two (2) weeks for the TekniStain approval process. The Custom Wood Stain sample must be signed off prior to placing product order. The total lead time will begin once final approval samples have been received from customer to Teknion.

Using the TekniStain

Teknion requires dealer or client to supply one (1) TekniStain form for each color being custom matched.

Include three (3) for U.S./two (2) for Canada minimum 3 x 3 color samples for each color being submitted for Custom Wood Stain

Teknion will provide customer with two color samples for each TekniStain submitted. The customer must sign the back of the approved sample. The second sample to be kept for customer reference.

TekniStain forms and information on how to use these forms can be found at www.teknion.com/products for your printing convenience.

fabric directional guidelines

Railroaded and Off-the-Bolt are terms that describe the orientation the fabric is applied to furniture.

Railroaded

All Teknion Standard panel fabrics are applied Railroaded.

Panel fabrics are typically 66" wide and are applied Railroaded regardless of a pattern orientation on the fabric. The fabric width equals the height of the element. For panel elements or screens greater than 60" in height, fabric direction is applied Off-the-Bolt, as the height of the product is greater than the width of the fabric.

The combination of panel heights up to 60" with higher panels will result in opposite pattern directions. Non-directional fabrics are recommended for these installations.

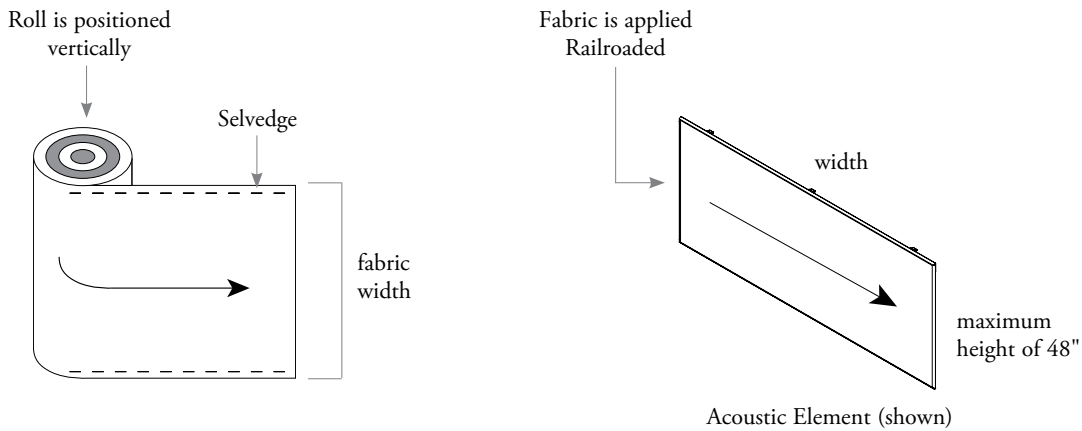

Off-the-Bolt

All Teknion Standard Architectural and Upholstery fabrics are applied Off-the-Bolt. Most upholstery fabrics are 54" wide.

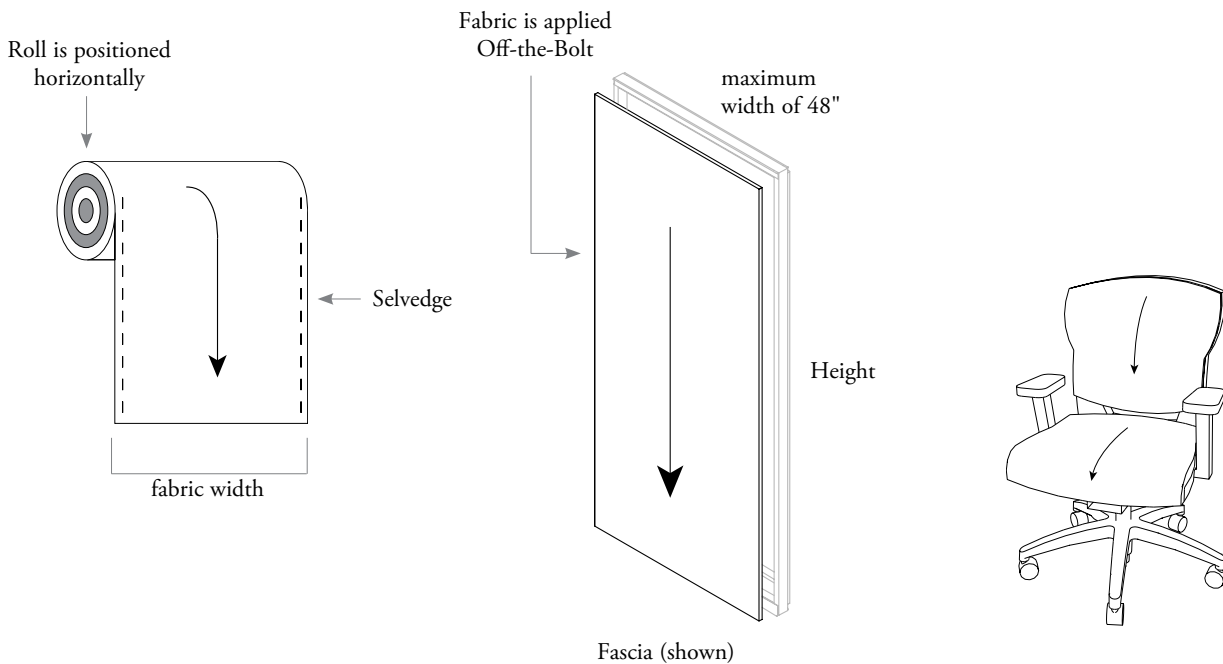

fabric directional guidelines (continued)

Pedestal & Credenza Cushions

Cushions on Teknion Pedestals and Credenzas are also applied Off-the-Bolt as illustrated below. The combination of storage cushions and the orientation of these products within an environment will result in fabric patterns appearing in opposite directions. If there is a need to change the orientation of the pattern on the cushion, a CR/Special is required.

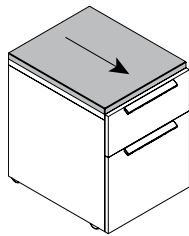

Pedestal

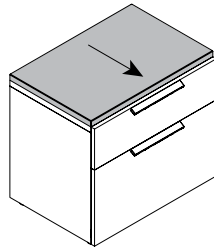

Stretch Pedestal

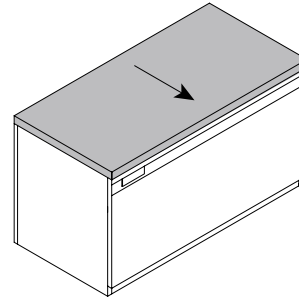

Extra Large Stretch Pedestal

Pattern Directions

The placement of storage within the workstation can result in the fabric pattern running in the opposite direction. Please see example below.

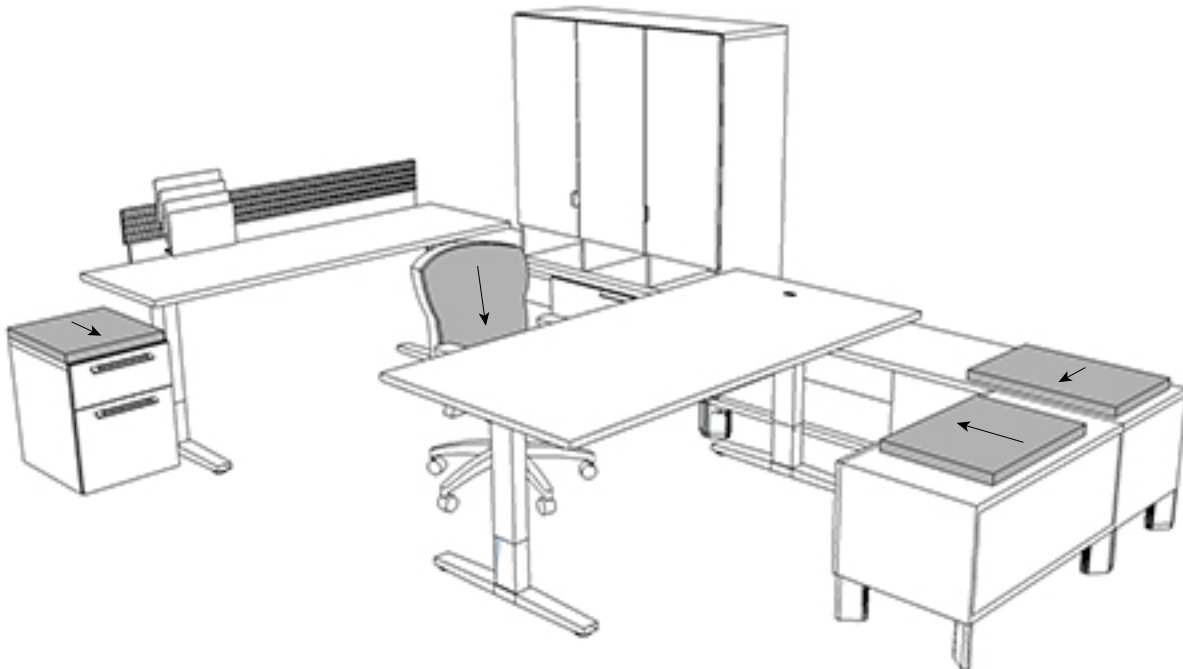

customer's own material (COM)

Customers Own Material or Leather (COM / COL)

A COM form is required if a Teknion product is needed in a textile outside our Standard or Graded-In Programs. For any COM/COL requests, please check with Teknion Customer Service for a record of the test results. If the fabric/leather has been approved, a serial number for the fabric and a cutting direction will be supplied by Teknion. This number must be shown on the order. Please note, for various reasons, certain fabrics/leathers may not be approved for use. The required COM/COL yardages given on the price pages are for orders up to 100 chairs. This number is approximate and can vary depending on the pattern repeat.

The COM process will take a minimum of 5 working days once the test yardage has been received by Teknion.

COM forms and information on how to use these forms can be found at www.teknion.com/products for your printing convenience.

COM Pattern Directional Guidelines for Seating

Usually, seating fabrics are patterned to run Off-the-Bolt. At the request of the customer, upholstery can be applied railroaded but yardage requirements may vary.

To avoid unnecessary confusion, you must always specify Off-the-Bolt or railroaded when using a COM fabric.

Estimated Material Requirement

More yardage may be required depending upon the upholstery pattern, repeat, directionality and pattern matching. Leather yield varies from 60-80% and may be affected by the quality of the COL including location and quantity of blemishes, size and shape of hide. The size of the sewing pattern and the number of units ordered may also impact yield. Always round-up to the next hide.

Teknion dna™

When selecting a COM fabric on Teknion dna, please note fabrics containing the following characteristics may result in poor application and therefore may be rejected :

- Lack of elasticity & recovery from an extension (below 3% threshold)
- Higher percentage of fiber content, (i.e. Cotton, Viscose rayon & polyolefin fibers)
- Very tight fabric construction
- Special finishes (Crypton, GreenShield, stain resistant, etc.)

Fabric Direction

All Standard Panel Fabrics are applied railroaded.

Railroaded application (RR)

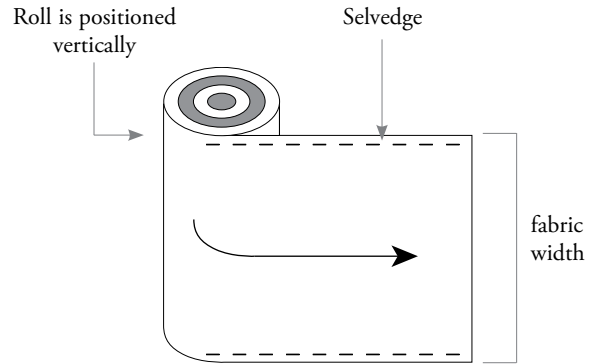

All Standard Seating and Architectural Fabrics are applied Off-the-Bolt.

Off-the-Bolt application (OB)

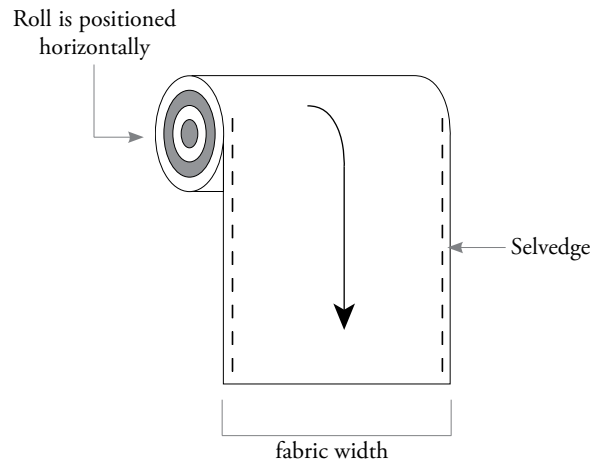

care & maintenance

Regular cleaning of your furniture system will maintain the appearance and optimize the long term return on investment.

Fabric

Panel and Seating fabrics are comprised of a variety of fiber construction. They are colorfast to standard wet and dry cleaning procedures. Avoid excessive brushing or rubbing during cleaning to prevent fuzzing of the fabric surface. Due to the low absorption properties, soiling will tend to remain on the fiber surface. To prevent overall soiling, frequent vacuuming or light brushing to remove dust and grime is recommended.

Oil or grease-type spots will respond to mild solvents or dry cleaning agents. When spot cleaning with a mild solvent or dry cleaning agent, follow instructions carefully and clean only in a well ventilated room. Avoid any product which contains carbon tetrachloride or other toxic materials. The blotting technique, without rubbing, should be sufficient to remove most spots.

To remove general dirt or grime spots, sponge with the foam from a mild detergent or upholstery shampoo. Rinse well with a clean sponge to remove traces of the water-based cleaning agent.

When spot cleaning with either the water-base or solvent-base type cleaning agents, test a small inconspicuous area before proceeding to spot clean the fabric any further. If an overall soiled condition has been reached, contact a professional furniture cleaning service.

Leather

Clean leather with a damp cloth and mild soap using light, circular motions. Repeat the process with a clean moist cloth and allow the leather to dry. A soft, dry cloth can then be used to polish the leather. Do not clean leather with detergents.

Vinyl Durable

Should be periodically cleaned to maintain its appearance and prevent build-up of dirt and contaminants. Any stain, spill or soiling should be cleaned up promptly to prevent the possibility of permanent staining. When cleaning, always rub gently.

Dried on Dirt

Remove with a soft cloth dampened with water. Wipe with soft cloth dampened with water. Allow to air dry.

Liquid Spills

Wipe immediately with a clean absorbent cloth. Rinse with clean water.

Stubborn Dirt

Wash with a soft cloth moistened with a mild soap and water. Rinse with clean water. Stubborn Spots and Stains: Spray with either *Formula 409*®, or *Tannery Car Care Cleaner*® and rub with a soft cloth. Rinse with clean water. Powdered abrasives, abrasive cleaners, and steel wool damage vinyl, as do strong solvents, lacquer solvents and inks. Lotions, waxes and polishes, etc., contain oils and dyes that can cause stiffening and staining of vinyls.

Ultra Durable

Cleaning Ultra Durable vinyl for most stains is achieved by prompt, energetic washing using a sponge and warm, soapy water, clear water rinses or a mild, non-abrasive cleaner. Moderate scrubbing with a medium bristle brush will help to loosen soiling materials from the depressions of embossed surfaces but have not penetrated the vinyl surface.

Advanced Cleaning Methods

Use the following commercially available mild detergents in accordance with the manufacturer's instructions, *Formula 409*®, *Fantastik*®, or *Mr. Clean*®. When opening a new container, please test the cleaner in an inconspicuous area as cleaner manufacturers may change formula without notice.

Full strength rubbing alcohol or mineral spirits may be tried with caution if the commercially available cleaners do not work. Indiscriminate use of strong solvents can severely damage or discolor Ultra Durable vinyl.

Ultra Durable offers enhanced resistance to most of the common chemicals used for sterilization and cleaning in medical environments. Ultra Durable will resist, without serious discoloration, the repeated action of normal dilutions of chlorine bleaches, ammonia based cleaners, excluding Quaternary Ammonium Compounds and Phenolics, as well as many common oxidizing and reducing chemicals.

Bleach can be diluted up to 9:1 ratio (10%). Liberally apply diluted disinfectant using a sponge, rinse with cold water several times, and then wipe dry. Repeat if necessary. Federal regulation requires that guidelines on the bleach label need to be followed for antiseptic or antimicrobial purposes.

touch-up kits

Teknion offers two types of Touch-Up Kits; a bottle with brush (paint) or a crayon, depending on which finish the product is applied.

KT100 – Bottle with brush is available for:

Foundation
Mica
Accent
Filling & Storage Paint Colors
Seamless Color (not available for Group 2 colors)

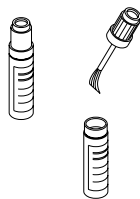

KT401 – Crayon is available for:

Fascia Laminate
Flintwood
Natural Veneer
Seamless Color (available for Group 1 colors)



KT402 – Marker is available for:

Flintwood
Natural Veneer
Seamless Color (available for Group 1 colors)

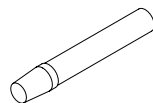

Ordering Touch-Up Kits:

Touch-Up Kits can be ordered through the Leverage product line specification software.

Touch-Up Kit Directions

Before You Begin

Make sure the surface is clean, dry and free of grease and oil. If needed, use a mild solvent and a clean cloth to wipe down surface. NOTE: Touch-Up should be used on small nicks and scratches only. It is not meant for large areas or deep gouges.

How to Use the Small Brush (KT100)

Always shake the bottle for at least one minute after the mixing balls begin to rattle. If the product is not adequately mixed, the color of the paint will not be correct. (Do not try to get all of the residue on the bottom of the bottle; it will never totally blend). Make sure that the product is capped tightly before shaking.

Dip brush into the bottle as far as it will go.

Slowly remove the brush from the bottle. The brush wiper which is mounted in the bottle opening reduces the opening diameter and helps to wipe excess paint from the brush. This eliminates dripping paint from the brush after removing it from the bottle.

Brush paint on with smooth strokes. Use very slight pressure when touching the brush to the substrate. Avoid retouching the wet paint film with the brush after it is applied. Do not try to retouch applied paint after paint has set up for more than 2 minutes.

When finished, recap the bottle.

How to Use the Crayon (KT401)

Apply by simply rubbing the semi-hard compound into the defect or damaged substrate or finish in a variety of directions.

Once applied, and slightly overfilled, the excess filler is removed by carefully leveling off using a semi-flexible plastic leveling card. An old bank card works sufficiently for this step. To finish off the task, use a soft lint free cloth for wiping off any further excess material from the area being worked on. Paper towel can also be substituted for a lint free cloth and this purpose.

How to Use the Marker (KT402)

Shake marker thoroughly to get full color strength. Depress the nib to begin material flow. Do not overload the nib with material. With light strokes, slowly apply color to the damaged area being careful not to “puddle” the material. Gently feather the applied material with a finger to blend the color in with the surrounding area.

zones textiles

zones textiles

ZONES PANEL FABRICS99

ZONES UPHOLSTERY FABRICS107

ZONES GENERAL INFORMATION123

























































































































zones panel fabrics

zones panel fabrics

PANEL FABRICS APPLICATION MATRICES	101
PANEL FABRICS LISTING MATRICES	
GRADE A	
BEELINE	102
BITSTREAM	102
EGYPT	102
NITTY GRITTY	102
TANGLE	102
WALES	102
WIRED UP	102
GRADE 1	
BANDEAU	102
BRAZIL	102
EMIT	102
ESSENTIALS	102
FLICKER	102
INDIA	102
LINEN WEAVE	102
LUSTRADO	102
MAKAH	102
PERU	103
PRESSE	103
RATIONALE	103
TOPOLOGY	103
WARP SPEED	103
GRADE 2	
ACTUATE	103
BOUCLE GRID	103
COMPECT	103
COMPLEMENT	103
MEGACHECK	103
PERCEPT	103
TWINING	103
GRADE 3	
ARTOPIA	104
CROSS DYE	104
GRADE 4	
INTONE	104
INTRAWEB	104
MILIEU	104
TEXTURED MAP	104
TWISTED TWEED	104
GRADE 5	
ECOTONE	104
HIGH FREQUENCY	105
MARL CLOTH	105

panel fabrics application matrices

The following charts outlines panel fabrics that are available for use on Zones Easel and Fabric Buffer.

	EASEL	BUFFERS	
		FLAT	QUILTED
 Available			
 Not Available			
Grade A			
Beeline			
Bitstream			
Egypt			
Nitty Gritty			
Tangle			
Wales			
Wired Up			
Grade 1			
Bandeau			
Brazil			
Emit			
Essentials			
Heather Tech			
Flicker			
India			
Linen Weave			
Lustrado			
Makah			
Peru			
Presse			
Rationale			
Topology			
Warp Speed			
Grade 2			
Actuate			
Boucle Grid			
Complect			
Complement			
Megacheck			
Percept			
Twining			
Grade 3			
Artopia			
Cross Dye			
Grade 4			
Intone			
Intraweb			
Milieu			
Textured Map 			
Twisted Tweed			
Grade 5			
Ecotone			
High Frequency 			
Marl Cloth			

panel fabrics listings matrices

PANEL FABRICS

GRADE A

Beeline

Plumb.....	B631
String.....	B632
Strand.....	B633
Thread.....	B634

Bitstream

Tablet.....	R582
Hardware.....	R583
Trackback.....	R584
Lithium.....	R585
Grey Code.....	R586
Silicone.....	R587
White Noise.....	R588
Xenon.....	R589
Wavelet.....	R590
Blue Team.....	R591
Firewire.....	R592
Flash Drive.....	R593

Egypt

Cairo.....	E301
Giza.....	E302
Port Said.....	E304
Suez.....	E305
Mallawi.....	E352
Jirja.....	E354
Idku.....	E355
Edfu.....	E356

Nitty Gritty

Block.....	N122
Detail.....	N123
Think.....	N130
Gist.....	N133
Factor.....	N134
Specific.....	N135

Tangle

Snarl.....	T531
Knot.....	T532
Interweave.....	T533
Ravel.....	T534
Kinks.....	T535
Spangle.....	T536
Tousle.....	T537
Crook.....	T538
Muddle.....	T539
Entwine.....	T540

Wales

Swansea.....	W402
Teifi.....	W403
Newport.....	W404
Wrexham.....	W414
Corwen.....	W416
Bangor.....	W417
Newbridge.....	W418
Pembroke.....	W419
Kidwelly.....	W420
Goodwick.....	W421

GRADE A (Continued)

Wired Up

Caged.....	W731
Intermingle.....	W739
Mesh.....	W740
Linkage.....	W741
Drawplate.....	W742
Nichrome.....	W743
Circuit.....	W744

GRADE I

Bandeau

Washi.....	B124
Grosgrain.....	B126
Palla.....	B127
Farran.....	B128

Brazil

Betim.....	B220
Canela.....	B204
Olinda.....	B231
Timbo.....	B208
Manaus.....	B203
Jacarei.....	B217
Laguna.....	B233
Campo Grande.....	B260
Serra.....	B261

Emit

Watt.....	T727
Hertz.....	T728
Joule.....	T729
Dazzle.....	T730
Surge.....	T731
Particle.....	T732

Essentials

Gris.....	E380
Dove.....	E382
Brier.....	E383
Light Grey.....	E384
Slate.....	E385
Banner.....	E391
Snowdrift.....	E409
Mist.....	E410
Basil.....	E412
Atlantic.....	E413
Pebble.....	E415
Tropic.....	E416

GRADE I (Continued)

Flicker

Glitter.....	F531
Beam.....	F532
Sparkle.....	F533
Flash.....	F534
Glint.....	F535
Sheen.....	F536
Gleam.....	F537
Glow.....	F538
Luster.....	F539
Twinkle.....	F540

India

Bombay.....	D402
Agra.....	D404
Gwalior.....	D405
Varanasi.....	D407
Haora.....	D408
Surat.....	D409
Manali.....	D425
Kashmir.....	D417
Pushkar.....	D418
Kerala.....	D419
Chennai.....	D422
Mumbai.....	D424
Pune.....	D423
Munnar.....	D420
Nanital.....	D421

Linen Weave

Gate.....	L308
Sesame.....	L309
Coir.....	L327
Bast.....	L328
Dusty Grey.....	L329
Mineral.....	L330
Linseed.....	L331

Lustrado

Glassine.....	L363
Acetate.....	L364
Brilliance.....	L365
Alloy.....	L366
Gallium.....	L367
Incandescent.....	L368
Resin.....	L369
Sterling.....	L370
Varnish.....	L372
Vitreous.....	L373

Makah

Shaker.....	M415
Luminous.....	M416
Arundo.....	M417
Solano.....	M418
Fritch.....	M419
Splint.....	M420

panel fabrics listings matrices

PANEL FABRICS

GRADE 1 (Continued)

Peru

Tacna	P401
Nazca	P402
Lima	P403
Casma	P404
Puno	P405
Cuzco	P406
Tingo Maria	P407
Callao	P409
Tumbes	P411
Puerto	P412

Presse

Halo Effect	P100
Overlay	P101
Masked	P102
Relief	P103
Plaited	P104
Gravure	P105

Rationale

Classical	R380
Drift	R381
Firma	R382
Lucid	R383
Abstract	R384
Mind's Eye	R385
Infinite	R386
Transcend.	R387

Topology

Ceramic	T100
Open Space	T101
Natural	T102
Cooling	T103
Shadow	T104

Warp Speed

Headwind	W110
White Space	W111
Strobe	W112
Reed Arrow	W113
Jet	W114
Steel Racer	W115
Earth Orbit	W116

GRADE 2

Actuate

Aqueous	A209
Spectral	A210
Aether	A211
Facet	A212
Syntax	A213
Vanish	A214
Suffuse	A215
Mordant	A216
Lambent	A217
Conscious	A218
Fortify	A219
Favrite	A220
Prelude	A221
Meridian	A222
Thermal	A223
Induction	A224

Boucle Grid

Craie	B119
Bis	B120
Ardoise	B121
Fauve	B122
Nuage	B123

Complect

Melanite	P800
Quarry	P801
Silverleaf	P802
Jute	P803
Cumulus	P804
Yolk	P805
Apricot	P806
Highlighter Pink	P807
Deep Crimson	P808
Autumn	P809
Opaline	P810
Reservoir	P811
Gentian	P812
Blue Ice	P813
Winter	P814
Boreal	P815
Turquoise	P816
Okra	P817
Agave	P818

GRADE 2 (Continued)

Complement

Nightfall	C279
Dusk	C280
Grey Wolf	C281
Sea Salt	C282
Roan	C283
Amarillo	C284
Arancia	C285
Carnelian	C286
Garnet	C287
Fresh Air	C289
Peacock	C290

Megacheck

Liminal	R654
Convex	R655
Concave	R656
Drop Shadow	R657
Litmus	R658
Gradient	R659
Distort	R660
Resolution	R661
Glitch	R662
Flashbulb	R663
Visage	R664
Magnitude	R665

Percept

Schema	C813
Pristine	C814
Intrinsic	C815
Methodic	C816
Sublime	C817
Context	C818
Essence	C819
Tenet	C820
Epiphany	C821
Verve	C822
Amplitude	C823
Reason	C824
Cardinality	C825
Nebula	C826
Jubilant	C827
Ignite	C828
Harmonic	C829
Peak	C830
Devotion	C831

Twining

Ivory Vine	W117
Pale Straw	W118
Abaca	W119
Sisal	W120
Quill	W121
Silvery Strand	W122
Bulrush	W123

panel fabrics listings matrices

PANEL FABRICS

GRADE 3

Artopia

Primer	R176
Kinetic	R177
Stencil	R178
Magenta	R179
Amerlith	R180
Cadmium	R181
Aquatint	R182
Vivid Blue	R183

Cross Dye

Earl Grey	R150
Linen	R151
Light Birch	R152
Almond	R153
Soft Shadow	R154
Ace Grey	R155
Cool Ash	R156
Carotene	R157
Crimson	R158
Carmine	R159
Tea Tree	R160
Artichoke	R161
Plum	R162
Watercolor	R163
Azure	R164
Logwood	R165

GRADE 4

Intone

Ash	LP11
Creme	LP12
Harbor	LP13
Quicksilver	LP14
Caraway	LP15
Oxide	LP16
Cinder	LP17
Lute	LP18
Pome	LP19
Eclipse	LP20

Intraweb

Raster	W235
Dual Trace	W236
Polytope	W237
Superposition	W238
Coaxial	W239
Origin	W240
Slope	W241
Polarity	W242
Isosurface	W243

GRADE 4 (Continued)

Milieu

Kettle	L165
Thunder	L166
Memory	L167
Steam	L168
Wing	L169
Nest	L170
Leap	L171
Troupe	L172
Peregrine	L173
Hedge	L174
Prickle	L175
Spring	L176
Mustard	L177
Herd	L178
Parcel	L179
Bloom	L180
Fling	L181
Flamboyance	L182
Bazaar	L183
Rabble	L184
Zeal	L185
Bevy	L186
Loft	L187
Float	L188
Paddling	L189
Shoal	L190
Fleet	L191

Textured Map

Mineralize	R523
Henge	R524
Rockfall	R525
Trace Fossil	R526
Windblown Silt	R527
Holocene	R528
Coralline	R529
Latent Heat	R530
Water Table	R531
Elm Pollen	R532
Miocene	R533
Linden	R534
Green Algae	R535
Thaw	R536
Continental Drift	R537
Ocean Basin	R538

GRADE 4 (Continued)

Twisted Tweed

Wrought Iron	R325
Rock Garden	R326
Shady Patch	R327
Moongate	R328
Plaster	R329
Stucco	R330
Thatch	R331
Arbor	R332
Daylight	R333
Sundial	R334
Koi Pond	R335
Brickwork	R336
Annual	R337
Perennial	R338
Rain Chain	R339
Open Air	R340
Water Feature	R341
Terrace	R342
Veranda	R343

GRADE 5

Ecotone

Abyss	E136
Ravine	E137
Rocky Shore	E138
Permafrost	E139
Tundra	E140
Arid	E141
Savanna	E142
Desert Bloom	E143
Badlands	E144
Caldera	E145
Freshwater	E146
Intertidal	E147
Rain Shadow	E148
Lichen	E149
Mangrove	E150
Treeline	E151

panel fabrics listings matrices

PANEL FABRICS

GRADE 5 (Continued)

High Frequency

Eclipse Shadow	R264
Flash Lag	R265
Motion Blur	R266
Moon Illusion	R267
Solar Halo	R268
Laser Speckle	R269
Photon Shot	R270
Sea Fret	R271
Fata Morgana	R272
Hyperbolic Green	R273
Iceblink	R274
Plane Wave	R275
Liquid Crystal	R276
Aftereffect	R277
Gaussian	R278
Occlusion	R279

Marl Cloth

Yurt	R166
Guy Rope	R167
Camp Fire	R169
Dry Stone	R170
Berry	R172
Blacksmith	R173
Sea Nomad	R174
Wild Fruit	R175
Dreamscape	R195
Landmark	R196
Tree Bark	R197

zones upholstery
fabrics

zones upholstery fabrics

UPHOLSTERY FABRICS OVERVIEW 109

UPHOLSTERY FABRICS APPLICATION MATRICES 110

UPHOLSTERY FABRICS APPLICATION LISTINGS

GRADE 1

BITSTREAM 114
 FUNDAMENTALS 114
 HEATHER TECH. 114
 MAGNIFY 114
 STIMULI 114

GRADE 2

ACTUATE 114
 COMPLECT 114
 COMPLEMENT 114
 CROSS DYE 114
 CROSSGRAIN 115
 DECOY 115
 DIGI TWEED 115
 GRAVITON 115
 INTONE 115
 MEGACHECK 115
 PERCEPT 115
 ULTRA DURABLE 116

GRADE 3

AMPLE 116
 DOYENNE 116
 ECOTONE 116
 FINE GRAIN. 116
 INTRAWEB 116
 MARL CLOTH 116
 MILIEU 116
 SITU 116
 SUPERSpun 117
 TEXTURED MAP 117
 TWISTED TWEED 117

GRADE 4

ELASTIC WOOL 117
 FORMWORK. 117
 GRID STATE 117
 INTERSTICE 117
 HIGH FREQUENCY 117
 META TEXTURE 117
 MODULUS. 117
 VELVET UNDERGROUND . . 117

GRADE 5

ADAGE 118
 CULT CLASSIC. 118
 MONOTEX. 118
 PARTICULATE 118
 SYNAPTIC 118

GRADE 6

AMALGAM 118
 DUO CHROME 118
 HAPTIC. 118
 OUTPRESS 118
 PERILUNE 118
 PHOTOGRAM 118
 SOFT STATIC 119
 VECTOR 119

GRADE 7

CONTRAST SLUB 119
 EPHEMERA 119
 EVERYDAY BOUCLE 119
 FLEX WOOL. 119
 OEUVRE 119
 PEBBLE MELANGE 119
 STRUCTURED STRIPE. . . 119
 TILT SHIFT REDUX 119
 WOOL FLECK. 119

GRADE 8

BARBERPOLE BASKET. . . 120
 CONSTRUCT 120
 FULL WOOL 120
 GEOGLYPH 120
 HOMAGE 120
 WAVEFIELD 120
 WELDED 120

GRADE 9

EQUILUX 120
 GRAPH SPECK 120
 HEATHER FELT 120
 MELANGE CHECK 120
 SUPER SHEARLING 120
 TOP COAT. 121

GRADE 10

COLOR FUSE 121
 FLEECE 121

GRADE 11

RUBRIC. 121

GRADE 13

EMERGENT 121

GRADE 14

ARC ANGLE 121
 SCALE FACTOR 121

GRADE 16

MITERED. 121
 NAVIGATE. 121
 SECOND NATURE. 121

LEATHER

LEATHER - LA 121
 LEATHER - LB 121
 LEATHER - LC 121
 LEATHER - LD 121

upholstery fabrics overview

teknion standard upholstery fabric program

All fabrics are developed to enhance Teknion systems products incorporating technology in fiber development. They are designed to coordinate with the other finishes in Teknion system and seating programs. The fabrics are offered in a range of low intensity colors with some stronger hues and a variety of solids, patterns and textures. All Teknion fabrics are developed to exceed technical standards.

Teknion has a full program of standard fabrics, vinyl and leather appropriate for most seating lines. All fabrics are covered by Teknion standard warranty and meet all standards for CAL 116 and 117 and exceed industry durability requirements. All upholstery coverings may not be approved for use on all chair families. Please refer to the **Listing & Application Matrices** within this section for fabric applications.

Fabrics meet or exceed performance standards by ACT (Association for Contract Textiles).



Please note, leathers and faux-leathers may show natural blemishes, scars and wrinkles which are inherent material characteristics and as such deemed acceptable by Teknion. Variation of color, grain and texture found in wood and leather are also natural. Teknion is not responsible for reverse crocking of dyes from clothing onto our seating upholstery and finishes.

fabric pattern directional guidelines

Directional specifications are not required for any of Teknion Standard Upholstery to Teknion products. All Standard Upholstery Fabrics will be run Off-the-Bolt, as shown on the sample card. See the Fabric Pattern Directional Guidelines in the General Information section at the back of the book for more details.

upholstery fabrics application matrices



The following charts outlines upholstery fabrics that are available for use on Zones Seating and Vertical Surfaces.

	VERTICAL SURFACES				SEATING												
	DESK EDGE SCREENS	EASELS	BUFFERS		CLUB		MULTI-USE					SOFA	SOFT				
			FLAT	QUILTED	CLUB CHAIRS	CLUB STOOLS	ARM CHAIRS	SIDE CHAIRS	BENCHES	SIDE STOOLS	BACKLESS STOOLS	SOFAS	SOLO LOUNGE CHAIRS	SLED LOUNGE CHAIRS	CONFERENCE LOUNGE CHAIRS	SLED LOUNGE OTTOMANS	MODULAR SEATING
Grade 1																	
Bitstream	Available	Available	Available	Available	Available	Available	Available	Available	Available	Available	Available	Available	Available	Available	Available	Available	Available
Fundamentals	Available	Available	Available	Not Available *	Available	Available	Available	Available	Available	Available	Available	Available	Available	Available	Available	Available	Available
Heather Tech	Available	Available	Available	Available	Available	Available	Available	Available	Available	Available	Available	Available	Available	Available	Available	Available	Available
Magnify	Available	Available	Available	Available	Available	Available	Available	Available	Available	Available	Available	Available	Available	Available	Available	Available	Available
Stimuli	Available	Available	Available	Available	Available	Available	Available	Available	Available	Available	Available	Available	Available	Available	Available	Available	Available
Grade 2																	
Actuate	Available	Available	Available	Available	Available	Available	Available	Available	Available	Available	Available	Available	Available	Available	Available	Available	Available
Complect	Available	Available	Available	Available	Available	Available	Available	Available	Available	Available	Available	Available	Available	Available	Available	Available	Available
Complement	Available	Available	Available	Available	Available	Available	Available	Available	Available	Available	Available	Available	Available	Available	Available	Available	Available
Cross Dye	Available	Available	Available	Available	Available	Available	Available	Available	Available	Available	Available	Available	Available	Available	Available	Available	Available
Crossgrain	Available	Available	Available	Available	Available	Available	Available	Available	Available	Available	Available	Available	Available	Available	Available	Available	Available
Decoy	Available	Available	Available	Available	Available	Available	Available	Available	Available	Available	Available	Available	Available	Available	Available	Available	Available
Digi Tweed	Available	Available	Available	Available	Available	Available	Available	Available	Available	Available	Available	Available	Available	Available	Available	Available	Available
Graviton	Available	Available	Available	Available	Available	Available	Available	Available	Available	Available	Available	Available	Available	Available	Available	Available	Available
Intone	Available	Available	Available	Available	Available	Available	Available	Available	Available	Available	Available	Available	Available	Available	Available	Available	Available
Megacheck	Available	Available	Available	Available	Available	Available	Available	Available	Available	Available	Available	Available	Available	Available	Available	Available	Available
Percept	Available	Available	Available	Not Available *	Available	Available	Available	Available	Available	Available	Available	Available	Available	Available	Available	Available	Available
Ultra Durable	Available	Available	Available	Available	Available	Available	Available	Available	Available	Available	Available	Available	Available	Available	Available	Available	Available
Grade 3																	
Ample	Available	Available	Available	Not Available *	Available	Available	Available	Available	Available	Available	Available	Available	Available	Available	Available	Available	Available
Doyenne	Available	Available	Available	Available	Available	Available	Available	Available	Available	Available	Available	Available	Available	Available	Available	Available	Available
Ecotone	Available	Available	Available	Available	Available	Available	Available	Available	Available	Available	Available	Available	Available	Available	Available	Available	Available
Fine Grain	Available	Available	Available	Available	Available	Available	Available	Available	Available	Available	Available	Available	Available	Available	Available	Available	Available
Intraweb	Available	Available	Available	Available	Available	Available	Available	Available	Available	Available	Available	Available	Available	Available	Available	Available	Available
Marl Cloth	Available	Available	Available	Available	Available	Available	Available	Available	Available	Available	Available	Available	Available	Available	Available	Available	Available
Milieu	Available	Available	Available	Available	Available	Available	Available	Available	Available	Available	Available	Available	Available	Available	Available	Available	Available
Situ	Available	Available	Available	Available	Available	Available	Available	Available	Available	Available	Available	Available	Available	Available	Available	Available	Available
Superspun	Available	Available	Available	Available	Available	Available	Available	Available	Available	Available	Available	Available	Available	Available	Available	Available	Available
Textured Map 	Available	Available	Available	Available	Available	Available	Available	Available	Available	Available	Available	Available	Available	Available	Available	Available	Available
Twisted Tweed	Available	Available	Available	Available	Available	Available	Available	Available	Available	Available	Available	Available	Available	Available	Available	Available	Available
Grade 4																	
Elastic Wool	Available	Available	Available	Available	Available	Available	Available	Available	Available	Available	Available	Available	Available	Available	Available	Available	Available
Formwork	Available	Available	Available	Available	Available	Available	Available	Available	Available	Available	Available	Available	Available	Available	Available	Available	Available
Grid State	Available	Available	Available	Available	Available	Available	Available	Available	Available	Available	Available	Available	Available	Available	Available	Available	Available
Interstice	Available	Available	Available	Available	Available	Available	Available	Available	Available	Available	Available	Available	Available	Available	Available	Available	Available
High Frequency 	Available	Available	Available	Available	Available	Available	Available	Available	Available	Available	Available	Available	Available	Available	Available	Available	Available
Meta Texture	Available	Available	Available	Available	Available	Available	Available	Available	Available	Available	Available	Available	Available	Available	Available	Available	Available
Modulus	Available	Available	Available	Available	Available	Available	Available	Available	Available	Available	Available	Available	Available	Available	Available	Available	Available
Velvet Underground	Available	Available	Available	Available	Available	Available	Available	Available	Available	Available	Available	Available	Available	Available	Available	Available	Available

* Not all colorways are approved.

upholstery fabrics application matrices

The following charts outlines upholstery fabrics that are available for use on Zones Seating and Vertical Surfaces.

	VERTICAL SURFACES				SEATING												
	DESK EDGE SCREENS	EASELS	BUFFERS		CLUB		MULTI-USE					SOFA	SOFT				
			FLAT	QUILTED	CLUB CHAIRS	CLUB STOOLS	ARM CHAIRS	SIDE CHAIRS	BENCHES	SIDE STOOLS	BACKLESS STOOLS	SOFAS	SOLO LOUNGE CHAIRS	SLED LOUNGE CHAIRS	CONFERENCE LOUNGE CHAIRS	SLED LOUNGE OTTOMANS	MODULAR SEATING
Grade 5																	
Adage																	
Cult Classic																	
Monotex																	
Particulate																	
Synaptic																	
Grade 6																	
Amalgam																	
Duo Chrome																	
Haptic																	
Outpress																	
Perilune																	
Photogram																	
Soft Static 																	
Vector																	
Grade 7																	
Contrast Slub																	
Ephemera																	
Everyday Boucle																	
Flex Wool																	
Oeuvre																	
Pebble Melange																	
Structured Stripe																	
Tilt Shift Redux																	
Wool Fleck																	
Grade 8																	
Barberpole Basket																	
Contruct																	
Full Wool				*													
Homage				*													
Geoglyph																	
Wavefield																	
Welded																	
Grade 9																	
Equilux																	
Graph Speck																	
Heather Felt				*													
Melange Check																	
Super Shearling 																	
Top Coat																	

* Not all colorways are approved.

upholstery fabrics application matrices

The following charts outlines upholstery fabrics that are available for use on Zones Seating and Vertical Surfaces.

	VERTICAL SURFACES				SEATING												
	DESK EDGE SCREENS	EASELS	BUFFERS		CLUB		MULTI-USE				SOFA	SOFT					
			FLAT	QUILTED	CLUB CHAIRS	CLUB STOOLS	ARM CHAIRS	SIDE CHAIRS	BENCHES	SIDE STOOLS	BACKLESS STOOLS	SOFAS	SOLO LOUNGE CHAIRS	SLED LOUNGE CHAIRS	CONFERENCE LOUNGE CHAIRS	SLED LOUNGE OTTOMANS	MODULAR SEATING
Grade 10																	
Color Fuse																	
Fleece																	
Grade 11																	
Rubric																	
Grade 13																	
Emergent																	
Grade 14																	
Arc Angle																	
Scale Factor																	
Grade 16																	
Mitered																	
Navigate																	
Second Nature																	
Leather - LA																	
Base Grade Leather																	
Leather - LB																	
Merus																	
Leather - LC																	
Pela																	
Leather - LD																	
Fortis																	

upholstery fabrics listings matrices

UPHOLSTERY FABRICS

GRADE 1

Bitstream

Tablet	B160
Hardware	B161
Trackback	B162
Lithium	B163
Grey code	B164
Silicone	B165
White Noise	B166
Xenon	B167
Wavelet	B168
Blue Team	B169
Firewire	B170
Flash Drive	B171

Fundamentals

* Salsa	E504
* Banner	E505
* Parakeet	E516
* Brier	E518
* Sudan	E519
* Wendigo	E520
* Armory	E521
* Light Grey	E522
* Black	E523
* Tangelo	E526
* Verde	E528
* Aqua	E529
* Azure	E530
* Dove	E532
* Nickel	E533
* Slate	E534
* Latte	E535
* Marble	E536
* Moonstone	E537
* Lapis	E538
* Malachite	E539

Heather Tech

Dust Tech	T162
Topaz Tech	T163
Oat Tech	T164
Flax Tech	T165
Silt Tech	T166
Loam Tech	T167
Crag Tech	T168
Basalt Tech	T169
Loden Tech	T170
Sagebrush Tech	T171
Meadow Tech	T172
Sundew Tech	T173
Rose Tech	T174
Raspite Tech	T175
Madder Tech	T176
Beetroot Tech	T177

GRADE 1 (Continued)

Heather Tech (Continued)

Thistle Tech	T178
Lav Tech	T179
Clear Tech	T180
Loch Tech	T181
Ocean Tech (suite)	T182
North Sea Tech	T183
Onyx Tech	T184
Obsidian Tech	T185

Magnify

Telescope	M140
Polished Mirror	M141
Reflection	M142
Zoom Lens	M143
Force Field	M144
Long Wave	M145
Deep Water	M146
Light Beam	M147
Flare Up	M148
Viewfinder	M149
Infrared	M151

Stimuli

Sensitive	S145
Turbinado	S146
Rush	S147
Zest	S148
Tactile	S149
Daredevil	S150
Euphoria	S151
Vigor	S152
Thrill	S153
Catalyst	S154
Black Tea	S155

GRADE 2

Actuate

Aqueous	A209
Spectral	A210
Aether	A211
Facet	A212
Syntax	A213
Vanish	A214
Suffuse	A215
Mordant	A216
Lambent	A217
Conscious	A218
Fortify	A219
Favrite	A220
Prelude	A221
Meridian	A222
Thermal	A223
Induction	A224

GRADE 2 (Continued)

Complect

Melanite	C293
Quarry	C294
Silverleaf	C295
Jute	C296
Cumulus	C297
Yolk	C298
Apricot	C299
Highlighter Pink	C300
Deep Crimson	C301
Autumn	C302
Opaline	C303
Reservoir	C304
Gentian	C305
Blue Ice	C306
Winter	C307
Boreal	C308
Turquoise	C309
Okra	C310
Agave	C311

Complement

Nightfall	T148
Dusk	T149
Grey Wolf	T150
Sea Salt	T151
Roan	T152
Amarillo	T153
Arancia	T154
Carnelian	T155
Garnet	T156
Fresh Air	T158
Peacock	T159

Cross Dye

Earl Grey	C120
Linen	C121
Light Birch	C122
Almond	C123
Soft Shadow	C124
Ace Grey	C125
Cool Ash	C126
Carotene	C127
Crimson	C128
Carmine	C129
Tea Tree	C130
Artichoke	C131
Plum	C132
Watercolor	C133
Azure	C134
Logwood	C135

* Colorway approved for Quilted Fabric Buffer.

upholstery fabrics listings matrices

UPHOLSTERY FABRICS

GRADE 2 (Continued)

Crossgrain

Underbrush	C163
Dado	C164
Blackwood	C165
Cove	C166
Xylem	C167
Tenon	C168
Amaranth	C169
Red Oak	C170
Tuliptree	C171
Iroko	C172
Ginkgo	C173
Burl	C174
Cypress	C175
Springwood	C176
Driftwood	C177

Decoy

Double Bluff	D150
Sheep's Clothing	D151
Trick Mirror	D152
Ditto	D153
Proxy	D154
Çaçade	D155
Rook	D156
Copycat	D157
Incognito	D158
Pipe Dream	D159
Trip Wire	D160
Feign	D161
Atlantis	D162
Mirage	D163
Reverie	D164
Lure	D165
Cloak	D166
Mystify	D167
Figment	D168
Ruse	D169
Red Handed	D170
Clandestine	D171
Cahoots	D172
Synonym	D173
Mimic	D174
Retort	D175
Masquerade	D176
Lookalike	D177
Eavesdrop	D178
Lark	D179
Stand In	D180
Encore	D181
Sweet Talk	D182
Pretense	D183
Fool's Gold	D184
Monkey Business	D185

GRADE 2 (Continued)

Alias	D186
Crocodile Tears	D187
Parrot	D188
Face Value	D189
Golden Path	D190
Espionage	D191
Emulate	D192
Replay	D193
Parallel	D194
Mare's Nest	D195

Digi Tweed

* Dust Tweed	D310
* Topaz Tweed	D311
Oat Tweed	D312
* Flax Tweed	D313
* Silt Tweed	D314
* Loam Tweed	D315
* Crag Tweed	D316
Basalt Tweed	D317
Loden Tweed	D318
* Sagebrush Tweed	D319
Meadow Tweed	D320
* Sundew Tweed	D321
Rose Tweed	D322
* Raspite Tweed	D323
Madder Tweed	D324
* Beetroot Tweed	D325
Thistle Tweed	D326
* Lav Tweed	D327
Clear Tweed	D328
Loch Tweed	D329
Ocean Tweed	D330
North Sea Tweed	D331
Onyx Tweed	D332
Obsidian Tweed	D333

Intone

Ash	LM12
Creme	LM13
Harbor	LM14
Quicksilver	LM15
Caraway	LM16
Oxide	LM17
Cinder	LM18
Lute	LM19
Pome	LM20
Eclipse	LM21

GRADE 2 (Continued)

Graviton

Dark Matter	G222
Chain Reaction	G223
Echo	G224
Cloud Chamber	G225
Albedo	G226
Half Life	G227
Luminous Flux	G228
Fission	G229
Kelvin	G230
Boiling Point	G231
Quantum	G232
Condensation	G233
Centigrade	G234
Ampere	G235
Cold Fusion	G236
Hydrostatic	G237

Megacheck

Liminal	M328
Convex	M329
Concave	M330
Drop Shadow	M331
* Litmus	M332
Gradient	M333
* Distort	M334
Resolution	M335
Glitch	M336
Flashbulb	M337
Visage	M338
Magnitude	M339

Percept

* Schema	P106
Pristine	P107
Intrinsic	P108
Methodic	P109
Sublime	P110
* Context	P111
Essence	P112
* Tenet	P113
* Epiphany	P114
* Verve	P115
Amplitude	P116
Reason	P117
Cardinality	P118
Nebula	P119
Jubilant	P120
Ignite	P121
Harmonic	P122
Peak	P123
Devotion	P124

* Colorway approved for Quilted Fabric Buffer.

upholstery fabrics listings matrices

UPHOLSTERY FABRICS

GRADE 2 (Continued)

Ultra Durable

Mohair	V180
Iced Coffee	V182
Bark	V183
Tungsten	V184
Black Velvet	V187
Wet Clay	V490
Silver Age	V493
Cashew	V494
Harvest	V495
Apricot	V496
Morning Glory	V497
Olivine	V498
Sunset	V499
Neptune	V500
Rhubarb	V502
Fig	V503

GRADE 3

Ample

Quark	T220
Voltage	T221
Sunburst	T222
Radioactive	T224
Reaction	T227
Cosmic	T229
Blue Comet	T239
Vortex	T241
Neutron	T242
Tempered	T243
Charge	T270
Equilibrium	T271
Magnetic Field	T272
Convection	T273
Radar	T274
Conductor	T275
Evaporate	T276
Halide	T277

Doyenne

Woodblock	Y100
Sepia Tone	Y101
Intaglio	Y102
Grisailles	Y103
Aquamedia	Y104
Watermark	Y105
Verdigris	Y106
Phthalo	Y107
Terre Verte	Y108
Copperplate	Y109
Sienna	Y110
Alizarin	Y111

GRADE 3 (Continued)

Ecotone

Abyss	E136
Ravine	E137
Rocky Shore	E138
Permafrost	E139
Tundra	E140
Arid	E141
Savanna	E142
Desert Bloom	E143
Badlands	E144
Caldera	E145
Freshwater	E146
Intertidal	E147
Rain Shadow	E148
Lichen	E149
Mangrove	E150
Treeline	E151

Fine Grain

Warm Earth	F401
River Ore	F402
Saw Dust	F403
Putty Paste	F404
White Out	F405
Lunar Regolith	F406
Metallic Swarf	F407
Volcanic Ash	F408
Carbon Neutral	F409
Frosted Zephyr	F410
Deep Indigo	F411
Fathom Blue	F412
Sea Weed	F413
Matcha Leaves	F414
French Beige	F415
Ginger Snap	F416
Martian Soil	F417
Madder Root	F418
Garnet Sand	F419
Iron Oxide	F420
Peat Moss	F421

Intraweb

Raster	T397
Dual Trace	T398
Polytope	T397
Superposition	T400
Coaxial	T401
Origin	T402
Slope	T403
Polarity	T404
Isosurface	T405

GRADE 3 (Continued)

Marl Cloth

Yurt	F314
Guy Rope	F315
Camp Fire	F317
Dry Stone	F318
Berry	F320
Blacksmith	F321
Sea Nomad	F322
Wild Fruit	F323
Dreamscape	F324
Landmark	F325
Tree Bark	F326

Milieu

Kettle	M570
Thunder	M571
Memory	M572
Steam	M573
Wing	M574
Nest	M575
Leap	M576
Troupe	M577
Peregrine	M578
Hedge	M579
Prickle	M580
Spring	M581
Muster	M582
Herd	M583
Parcel	M584
Bloom	M585
Fling	M586
Flamboyance	M587
Bazaar	M588
Rabble	M589
Zeal	M590
Bevy	M591
Loft	M592
Float	M593
Paddling	M594
Shoal	M595
Fleet	M596

Situ

Archeology	F115
Pozzolana	F116
Amphora	F117
Statue	F118
Wind Tower	F119
Tunnel	F120
Phosphor	F121
Flamante	F122
Hydro	F123
Terrena	F125
Mar	F126

upholstery fabrics listings matrices

UPHOLSTERY FABRICS

GRADE 3 (Continued)

Superspun

Drawdown	S442
Denier	S443
Tensile	S444
Roving	S445
Staple	S446
Spindle	S447
Harness	S448
Tenter	S449
Red Cast	S450
Selvedge	S451
Skein	S452
Bluing	S453
Treadle	S454
Sett	S455
Pirn	S456
Creel	S457

Textured Map

Mineralize	T541
Henge	T542
Rockfall	T543
Trace Fossil	T544
Windblown Silt	T545
Holocene	T546
Coralline	T547
Latent Heat	T548
Water Table	T549
Elm Pollen	T550
Miocene	T551
Linden	T552
Green Algae	T553
Thaw	T554
Continental Drift	T555
Ocean Basin	T556

Twisted Tweed

Wrought Iron	T278
Rock Garden	T279
Shady Patch	T280
Moongate	T281
Plaster	T282
Stucco	T283
Thatch	T284
Arbor	T285
Daylight	T286
Sundial	T287
Koi Pond	T288
Brickwork	T289
Annual	T290
Perennial	T291
Rain Chain	T292
Open Air	T293
Water Feature	T294
Terrace	T295
Veranda	T296

GRADE 4

Elastic Wool

Fortress	E120
Fantom	E121
Mercury	E122
Clean	E123
Seed	E124
Tea	E125
Rust	E126
Ruby	E127
Ceylon	E128
Lovelace	E129
Jovial	E130
Elm	E131
Python	E132
Aegean	E133
Delphi	E134
Dart	E135

Formwork

Metallurgy	F136
Lead	F137
Selenite	F138
Opal	F139
Pearl Ash	F140
Candela	F141
Kiln	F142
Distill	F143
Azurite	F144
Verditer	F145
Elixir	F146
Precipitant	F147

Grid State

Arc Flash	G132
Open Circuit	G133
Volt Switch	G134
Hydropower	G135
Switchboard	G136
Megawatt	G137
Circuit Break	G138
Electrode	G139
Live Wire	G140
Trubine	G141
Neon Bulb	G142
Wolfram	G143

High Frequency

Eclipse Shadow	H713
Flash Lag	H714
Motion Blur	H715
Moon Illusion	H716
Solar Halo	H717
Laser Speckle	H718
Photon Shot	H719
Sea Fret	H720
Fata Morgana	H721
Hyperbolic Green	H722
Iceblink	H723
Plane Wave	H724
Liquid Crystal	H725
Aftereffect	H726
Gaussian	H727
Occlusion	H728

GRADE 4 (Continued)

Interstice

Inkling	R307
Pinpoint	R308
Lacuna	R309
Whit	R310
Scintilla	R311
Fragment	R312
Atom	R313
Trace	R314
Respite	R315
Vestige	R316
Interval	R317
Caesura	R318

Meta Texture

Deep Space	M224
Grey Matter	M225
Pale Shadow	M226
Silver Lining	M227
Hive Mind	M228
Neutral Ground	M229
Grassroots	M230
Jaded	M231
Deep Dive	M232
Blue Skies	M233
Rosy Outlook	M234
Heat Wave	M235
Punchline	M236

Modulus

Plinth	M172
Landscape	M173
Masonry	M174
Superstructure	M175
Skylight	M176
Site	M177
Form	M178
Shadow Play	M179
Rebar	M180
Spatial	M181
Threshold	M182
Monument	M183

Velvet Underground

Metal Machine	V310
Flame Desire	V313
Blue Denim	V315
Dark Moon	V317
Blacktop	V318
Brass Section	V319
Shock Wave	V320
Full Phase	V321
Dark Current	V322
Smoke Screen	V323
Wallflower	V324
Ultraviolet	V325
Purple Rain	V326
Green Room	V327
Garden Level	V328
New Wave	V329

upholstery fabrics listings matrices

UPHOLSTERY FABRICS

GRADE 5

Adage

Script	A166
Anthracite	A146
Carbon Fiber	A147
Splice	A148
Chromite	A149
Singularity	A150
Valence	A151
Halite	A152
Quartzite	A153
Rubelite	A154
Thremite	A155
Orchil	A156
Holograph	A157
Photon	A158
Halogen	A159
Canopy	A160
Raw Jade	A161
Petrol	A162
Diffraction	A163
Amythyst	A164
Pascal	A165

Cult Classic

Blue Velvet	C246
Black Lagoon	C247
Metropolis	C248
Grey Gardens	C249
White Heat	C250
Ziggy Stardust	C251
Pink Flamingos	C252
Purple Noon	C253
Blue Sunshine	C254
Xanadu	C255
Emerald City	C256
Forrest Gump	C257

Monotex

Silver Lane	G106
Sharkskin	G107
Grey Flannel	G108
Grey Marl	G109
Tarpaper	G110
Ferrous	G111
Bark Cloth	G112
Burlap	G113
Sumac	G114
Redroot	G115
Tyrian	G116
Annatto	G117
Jean	G118
Kingfisher	G119
Oxalis	G120
Sulfur	G121

GRADE 5 (Continued)

Particulate

Molecule	P212
Light Speed	P213
Granule	P214
Allotrope	P215
Current	P216
Corrosion	P217
Inertia	P218
Swell	P219
Oxidation	P220
Proton	P221
Irrigation	P222
Isotope	P223
Electrostatic	P224
Quasar	P225
Smolder	P226

Synaptic

Contact	S135
Phase	S136
Conduit	S138
Sensory	S139
Receptor	S140
Traverse	S141
Transmission	S142
Axon	S144

GRADE 6

Amalgam

Aura	K106
Pyrite	K107
Medallion	K108
Fluid	K109
Ultraviolet	K110
Joit	K111
Nitro	K112
Magma	K113
Fuse	K114

Duo Chrome

Ebony	D130
Charcoal	D131
Black Pepper	D132
Platinum	D133
Canvas	D134
Copper	D135
Goldenrod	D136
Citron	D137
Emerald	D138
Silver Elm	D139
Evergreen	D140
Aquamarine	D141
Navy	D142
Iris	D143
Boysenberry	D144
Hydrangea	D145
Dusty Plum	D146
Oxblood	D147
Red Oxide	D148
Persimmon	D149

GRADE 6 (Continued)

Haptic

Cliffline	H616
Gravel	H617
Alluvium	H618
Sediment	H619
Pink Salt	H620
Montane	H621
Butte	H622
Arroyo	H623
Superbloom	H624
Mantle	H625
Geode	H626
Flood Plain	H627
Isthmus	H628
Aquifer	H629
Delta	H630
Fjord	H631

Outpress

Ashen	C237
Sand	C238
Stone	C239
Soot	C240
Raven	C241
Pepper	C242
Monarch	C243
Caribbean	C244
Denim	C245

Perilune

Terrene	M160
Asteroid	M161
Stellar	M162
Satellite	M163
Gravity	M164
Red Shift	M165
Blue Moon	M166
Space Age	M167
Verdant	M168
Pulsar	M169
Solar	M170
Hot Crater	M171

Photogram

Mitere	P160
Toner	P161
Silver Salts	P162
Light Meter	P163
Sunprint	P164
Heliograph	P165
Safelight	P166
Cyanotype	P167
Mezzotint	P168
Darkroom	P169

upholstery fabrics listings matrices

UPHOLSTERY FABRICS

GRADE 6 (Continued)

Soft Static

Semitone	S432
Desert Wind	S433
Whirr	S434
Carillon	S435
Heartbeats	S436
Timbre	S437
Arpeggio	S438
Waterfall	S439
Ambient Nature	S440

Vector

Dovetail	V221
Horizon Line	V222
Tessera	V223
Latitude	V224
Vertex	V225
Radial	V226
Hypercube	V227
Scalar	V228
Parallax	V229

GRADE 7

Contrast Slub

Charred Seed	F428
Silver Thyme	F429
Cotton Blossom	F430
Tumbleweed	F431
Bramble	F432
Manzanita	F433
Cactus Flower	F434
Scarlet Sage	F435
Anemone	F436
Crepe Myrtle	F437
Wild Indigo	F438
Jacaranda	F439
Cenote	F440
Oleander	F441
Eucalyptus	F442
Lemongrass	F443

Ephemera

Lucent	E108
Afterglow	E109
Ice Cloud	E110
Halcyon	E111
Phosphene	E112
Solar Flare	E113
Gamma Burst	E114
Green Flash	E115
Blue Shift	E116
Ashfall	E117
Nightglow	E118
Penumbra	E119

GRADE 7 (Continued)

Everyday Boucle

Black Lily	E216
Stonecrop	E217
Smokebush	E218
Silver Aster	E219
Artemisia	E220
Lamb's Ear	E221
Cassava	E222
Tussock	E223
Thicket	E224
Moss	E225
Wintergreen	E226
Bay Laurel	E227
Delphinium	E228
Night Bloom	E229
Blue Phlox	E230
Larkspur	E231
Yarrow	E232
Honeysuckle	E233
Spicebush	E234
Rockrose	E235
Firethorn	E236
Purple Basil	E237

Flex Wool

Rebound	F480
Tempo	F481
Dynamo	F482
Vim	F483
Spark	F484
Thrive	F485
Arena	F486
Agile	F487
Buoyant	F488
Torque	F489
Raceway	F490
Blur	F491

Oeuvre

Blithe	V520
Salient	V521
Austere	V522
Earnest	V523
Ardent	V524
Fervor	V525
Finesse	V526
Mettle	V527
Flourish	V528
Charm	V529
Deft	V530
Crest	V531

GRADE 7 (Continued)

Pebble Melange

Esker	P186
Earthen	P187
Pewter	P188
Tectonic	P189
Geyser	P190
Palustrine	P191
Forest Marble	P192
Everglade	P193
Estuary	P194
Meteor	P195
Barkhan	P196
Lava	P197

Structured Stripe

Shadow Weave	S335
Silver Lap	S336
Counter marche	S337
Double Beam	S338
Block Draw	S339
Box Motion	S340
Overshot	S341
Punch Card	S342

Tilt Shift Redux

Elevation	T440
Plexus	T441
Baseline	T442
Beta	T443
Fluctuate	T444
Alpha	T445
Amplifier	T446
Sensor	T447
Bandwidth	T448
Synapse	T449
Sonar	T450
Modulate	T451

Wool Fleck

Boulder	W128
Packstone	W129
Zinc	W130
Micrite	W131
Coquina	W132
Beachrock	W133
Tawny	W134
Corten	W135
Pink Nacre	W136
Birchbark	W137
Firesand	W138
Chamotte	W139
Blackberry	W140
Mussel Dust	W141
Gitti	W142
Iolite	W143
Storm Petrel	W144
Bittercress	W145
Oat Grass	W146
Aloe	W147
Wild Mustard	W148

upholstery fabrics listings matrices

UPHOLSTERY FABRICS

GRADE 8

Barberpole Basket

Licorice Root	B388
Maelstrom	B389
Double Helix	B390
Wisp	B391
Mycelium	B392
Braided Rope	B393
Uzumaki	B394
Copper Coil	B395
Cherry Twist	B396
Tendrils	B397
Meander	B398
Tempest	B399

Construct

Fawn	C511
Clay	C512
Brandy	C513
Vermilion	C514
Cadmium Orange	C515
Zinnia	C516
Auburn	C517
Wisteria	C518
Ultramarine	C519
Cornflower	C520
Pacific	C521
Celadon	C522
Canary	C523
Turmeric	C524
Ochre	C525
Beryl	C526
Viridian	C527
Fir	C528
Midnight	C529
Argent	C530
Gunmetal	C531
Noir	C532

Full Wool

Blanc	F207
Hot Stone	F209
* Éclair	F210
Macchiato	F211
Ink	F212
* Tigerlily	F214
Fresh Water	F215
* Serpent	F216
Neptune	F218
* Safari	F219
Vintage Red	F220
* Lagoon	F221
* Oak Room	F222
Deep Orchid	F223

GRADE 8 (Continued)

Homage

* Respect	H100
* Winsome	H101
* Esteem	H102
* Dashing	H103
* Authority	H104
Soigné	H106
Valor	H107
Sanguine	H108
Vivant	H109
Guild	H110
Pinnacle	H111
Noble	H112

Geoglyph

Drifting Sediment	G270
Polar Lights	G271
Moonlit Mountain	G272
Organic Compound	G273
Dappled Sunlight	G274
Painted Desert	G275

Wavefield

Tideline	W480
Groundwater	W481
Red Tide	W482
Aspen Reflection	W483
Rivulet	W484
Cascade	W485
Sea Level	W486
Brackish	W487
Wake Zone	W488

Welded

Alliance	W209
Charcoal Flux	W210
Bond	W211
Soda Ash	W212
Palladium	W213
Brass Alloy	W214
Rose Torch	W215
Copper Foil	W216
Mingle	W217
Synergy	W218
Synthesis	W219

GRADE 9

Equilux

Eventide	E100
Diamond Dust	E101
Solstice	E102
Moonbow	E103
Corona	E104
Blue Hour	E105
Kindle	E106
Sunspot	E107

GRADE 9 (Continued)

Graph Speck

Cavern	G250
Steel Frame	G251
Stonework	G252
Gypsum	G253
Earthworks	G254
Cob	G255
Breccia	G256
Hearth	G257
Fired Clay	G258
Ionic Order	G259
Waterwheel	G260
Trellis	G261
Limecrete	G262
Plate Glass	G263
Riverfront	G264
Structure	G265

Heather Felt

* Noil	H510
Alumina	H511
* Bone Ash	H512
* Pinon Tree	H513
* Indian Ocean	H516
* Mustard Seed	H517
* Saffron	H518
* Acai	H519

Melange Check

Cobblestone	M534
Bisque	M535
Soda Fired	M536
Goldspeck	M537
Pink Kaolin	M538
Brick Dust	M539
Alkaline	M540
Vapor Glaze	M541
Faience Blue	M542
Greenware	M543

Super Shearling 

Neroli	S181
Ambergris	S182
Aromatic Water	S183
Musk	S184
Earth Tincture	S185
Petitgrain	S186
Carrissa	S187
Enfleurage	S188
Cedar	S189
Heart Note	S190
Incense	S191
Ginger	S192
Green Sap	S193
Oakmoss	S194
Conifer	S195
Blue Cypress	S196
Seawater	S197
Lupine	S198
Attar	S199
Blackcurrant	S200

* Colorway approved for Quilted Fabric Buffer.

upholstery fabrics listings matrices

UPHOLSTERY FABRICS

GRADE 9 (Continued)

Top Coat

Shell	T418
Glaze	T419
Chromate	T420
Stoneware	T421
Aniline	T422
Braze	T423
Conduct	T424
Heat Set	T425
Claycast	T426
Toast	T427
Polish	T428
Frit	T429
Shellac	T430
Dip	T431
Indigo Ink	T432
Seal	T433
Weld	T434
Black Oxide	T435

GRADE 10

Color Fuse

Wax	C154
Emulsion	C155
Jell	C156
Enamel	C157
Liquefy	C158
Freeze	C159
Molten	C160
Solvent	C161
Plasma	C162

Fleece

Alum	M191
Aer	M192
Linseed	M193
Rubedo	M194
Ignis	M195
Cypher	M196
Balsam	M197
Glyph	M198
Nero	M199

GRADE 11

Rubric

Straw Clay	R388
Pink Laterite	R389
Rammed Earth	R390
Submerged Stone	R391
Glass Block	R392
Stacked Slate	R393

GRADE 13

Emergent

Galaxy	E417
Lunar Eclipse	E418
Backscatter	E419
Pegasus	E420
Earthshine	E421
Stardust	E422
Andromeda	E423
Astra	E424
Celestial	E425
Nova	E426
Meteor Shower	E427

GRADE 14

Arc Angle

Selene	A135
Erebus	A136
Theia	A137
Proteus	A138
Hestia	A139

Scale Factor

Basis	S257
Compound	S258
Tangent	S259
Tensor	S260
Matrix	S261

GRADE 16

Mitered

Black Walnut	F422
White Birch	F423
Golden Oak	F424
Redwood	F425
Blue Spruce	F426
Sapling	F427

Navigate

Florescent	N300
Pumice	N301
Interlace Camel	N302
Reticulated Stone	N303
Network Orange	N304

Second Nature

Moonflower	S426
Muscadine	S427
Chaparral	S428
Bougainvillea	S429
Nightshade	S430
Peppervine	S431

LEATHER - LA

Base Grade Leather

Shale	L101
Black	L104
Sand	L200
Chocolate	L204
Chime	L205
Fossil	L206
Poppy	L210
Parlor	L211
Marine	L212
Buttercup	L214
White	L215

LEATHER - LB

Merus

Teak	L110
White Birch	L111
Beechwood	L112
Almond Shell	L114
Smoke	L117
Hopi	L118
Crushed Bark	L119
Black Truffle	L123

LEATHER - LC

Pela

Clove	L216
White Clay	L217
Chamois	L218
Buckwheat	L220
Hemlock	L221
Fern	L222
Cerulean	L226
Marigold	L227
Pomegranate	L228
Cordon	L229
Black Cherry	L230
Nightshade	L232
Morel	L233
Russet	L234
Carbon	L235
Pitch	L236

LEATHER - LD

Fortis

Canyon	L310
Bone	L311
Terra	L313
Nugget	L314
Black Rock	L316

zones general
information

zones general information

FABRIC CARE & MAINTENANCE	124
TEKNIPAINT & TEKNISTAIN	125
FABRIC PATTERN DIRECTIONAL GUIDELINES	126
FABRIC PATTERN SEAM GUIDELINES	129
CUSTOMER'S OWN MATERIAL (COM)	130

fabric care & maintenance

Regular cleaning of your furniture system will maintain the appearance and optimize the long term return on investment.

Fabric

Panel and Seating fabrics are comprised of a variety of fiber construction. They are colorfast to standard wet and dry cleaning procedures. Avoid excessive brushing or rubbing during cleaning to prevent fuzzing of the fabric surface. Due to the low absorption properties, soiling will tend to remain on the fiber surface. To prevent overall soiling, frequent vacuuming or light brushing to remove dust and grime is recommended.

Oil or grease-type spots will respond to mild solvents or dry cleaning agents. When spot cleaning with a mild solvent or dry cleaning agent, follow instructions carefully and clean only in a well ventilated room. Avoid any product which contains carbon tetrachloride or other toxic materials. The blotting technique, without rubbing, should be sufficient to remove most spots.

To remove general dirt or grime spots, sponge with the foam from a mild detergent or upholstery shampoo. Rinse well with a clean sponge to remove traces of the water-based cleaning agent.

When spot cleaning with either the water-base or solvent-base type cleaning agents, test a small inconspicuous area before proceeding to spot clean the fabric any further. If an overall soiled condition has been reached, contact a professional furniture cleaning service.

Leather

Clean leather with a damp cloth and mild soap using light, circular motions. Repeat the process with a clean moist cloth and allow the leather to dry. A soft, dry cloth can then be used to polish the leather. Do not clean leather with detergents.

Ultra Durable

Cleaning Ultra Durable vinyl for most stains is achieved by prompt, energetic washing using a sponge and warm, soapy water, clear water rinses or a mild, non-abrasive cleaner. Moderate scrubbing with a medium bristle brush will help to loosen soiling materials from the depressions of embossed surfaces but have not penetrated the vinyl surface.

Advanced Cleaning Methods

Use the following commercially available mild detergents in accordance with the manufacturer's instructions, *Formula 409*®, *Fantastik*®, or *Mr. Clean*®. When opening a new container, please test the cleaner in an inconspicuous area as cleaner manufacturers may change formula without notice.

Full strength rubbing alcohol or mineral spirits may be tried with caution if the commercially available cleaners do not work. Indiscriminate use of strong solvents can severely damage or discolor Ultra Durable vinyl.

Ultra Durable offers enhanced resistance to most of the common chemicals used for sterilization and cleaning in medical environments. Ultra Durable will resist, without serious discoloration, the repeated action of normal dilutions of chlorine bleaches, ammonia based cleaners, excluding Quaternary Ammonium Compounds and Phenolics, as well as many common oxidizing and reducing chemicals.

Bleach can be diluted up to 9:1 ratio (10%). Liberally apply diluted disinfectant using a sponge, rinse with cold water several times, and then wipe dry. Repeat if necessary. Federal regulation requires that guidelines on the bleach label need to be followed for antiseptic or antimicrobial purposes.

teknipaint & teknistain

TekniPaint

A TekniPaint form is required if the customer requires a custom paint color. Custom paint is applicable to metal and seamless product.

The color matching procedures will take a minimum of 10 working days.

Standard lead times apply once customer approved sample is received by Teknion Customer Service Representative.

Using the TekniPaint

Prior to placing the order, Dealer submits the color match sample (minimum size 2" x 2") to Teknion Customer Service Representative in conjunction with a completed TekniPaint form.

After the color match process is completed, two (2) samples are returned to the Paint and Stain Coordinator who forwards them to the Dealer with a sign-off sticker, attached to the back of the sample, for approval by the customer.

Customer formally signs-off on the color samples by signing the attached sticker.

Dealer returns one (1) of the customer approved samples to a Customer Service Representative or a fax of the signed off sample to Teknion.

Dealer submits the order, quoting the paint name and paint number as indicated on the customer sign-off sticker.

TekniPaint forms and information on how to use these forms can be found on My Teknion, Order & Specification, Order Services, PreOrder, Order & Specification Prep, Custom Paint, Stain & Laminate for your printing convenience.

TekniStain

A TekniStain form is required if a wood product is needed in colors outside our standard offering.

Teknion requires dealer or client to supply one (1) TekniStain form for each color being custom matched.

Include three (3) for U.S./two (2) for Canada minimum 3 x 3 color samples for each color being submitted for Custom Wood Stain

Teknion will provide customer with two color samples for each TekniStain submitted. The customer must sign the back of the approved sample. The second sample to be kept for customer reference.

To order a Custom Wood Stain, follow these instructions:

If specifying a custom color for Seating, please use code NOCWS.

If specifying a custom color for District, Interpret, Leverage, Marketplace, TOS, Transit or Expansion Casegoods, please use code ZOCWS.

If specifying a custom color for Dossier, Cana, Westcoast, Table&Conferencing and Executive Casegoods, please use code ZCCWS.

Please forward a TekniStain form to your Customer Service Representative along with two color samples. Allow two (2) weeks for the TekniStain approval process. The Custom Wood Stain sample must be signed off prior to placing product order. The total lead time will begin once final approval samples have been received from customer to Teknion.

Using the TekniStain

TekniPaint forms and information on how to use these forms can be found on My Teknion, Order & Specification, Order Services, PreOrder, Order & Specification Prep, Custom Paint, Stain & Laminate for your printing convenience.

fabric pattern directional guidelines

Railroaded and Off-the-Bolt are terms that describe the orientation the fabric is applied to furniture.

Railroaded

- Panel fabrics are typically 66" wide
- Upholstery fabrics are typically 54" wide

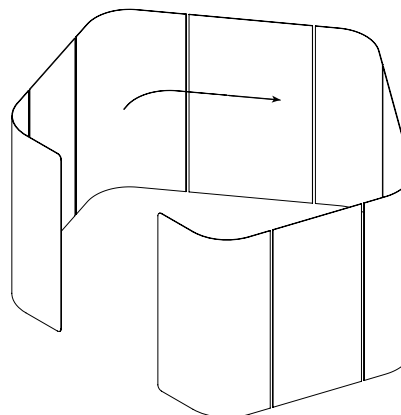
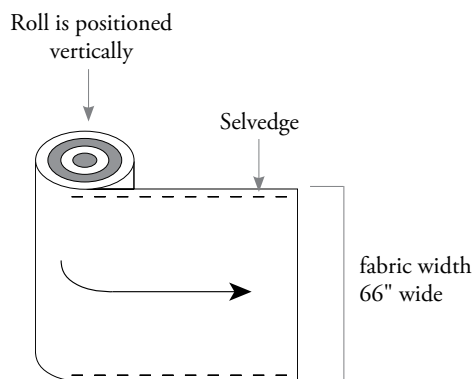

55" high Enclosure (shown)



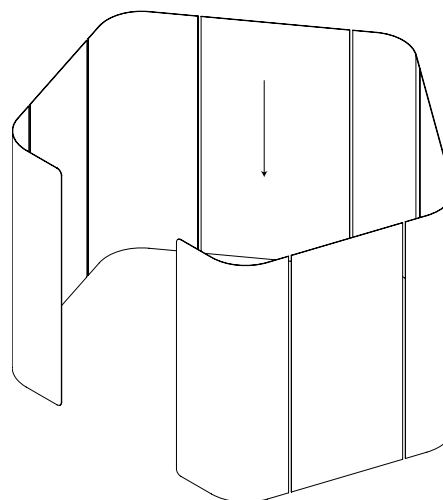
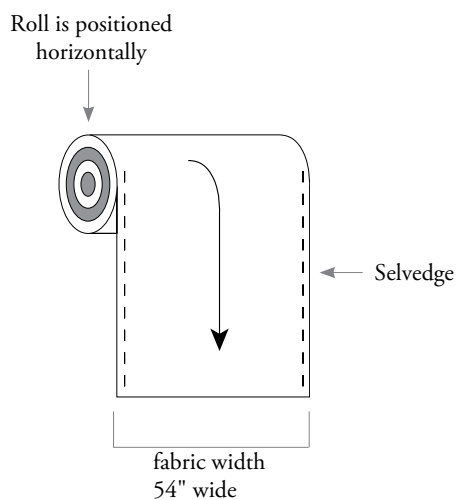



Off-the-Bolt

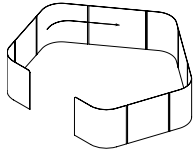
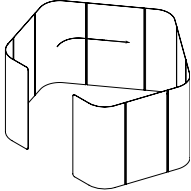
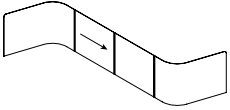
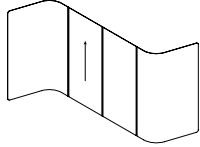
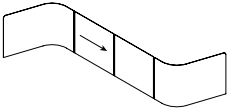
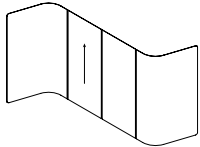

72" high Enclosure (shown)

fabric pattern directional guidelines (continued)

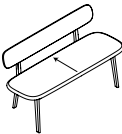
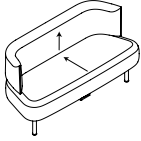
The following should be considered when planning with Enclosures, Screens, Easels and Seating.

	Railroaded	Off-the-Bolt
Zones Enclosures – 55" high (Panel and Upholstery Fabric)	  <p>with partial buffer with full buffer</p>	
Zones Screens – 55" high (Panel and Upholstery Fabric)	 <p>with partial buffer</p>	 <p>with full buffer</p>
Zones Screens – 72" high (Panel and Upholstery Fabric)	 <p>with partial buffer</p>	 <p>with full buffer</p>
Zones Desk Edge Screens (Panel and Upholstery Fabric)	 	
Zones Easels (Panel and Upholstery Fabric)		
Zones Seating (Upholstery Fabric) Note: Panel Fabric not available on Seating		   <p>All Zones Seating</p>

fabric pattern directional guidelines (continued)

Fabric Direction

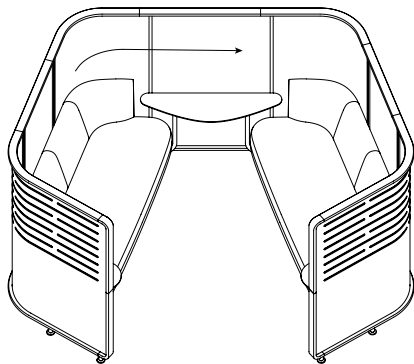

55" High Enclosure

When applying a Panel or Upholstery Fabric to Fabric Buffers, the fabric direction will run Railroaded on the Fabric Buffer.

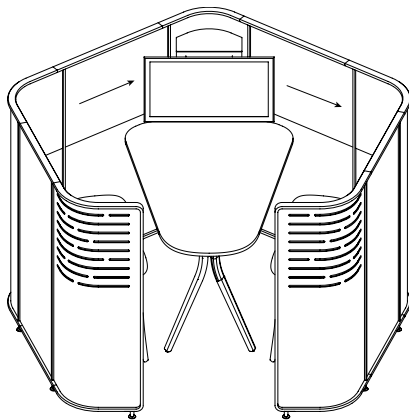

72" High Enclosure, Interior

When applying a Panel or Upholstery Fabric to partial Fabric Buffers, the fabric direction will run Railroaded on the Fabric Buffer.

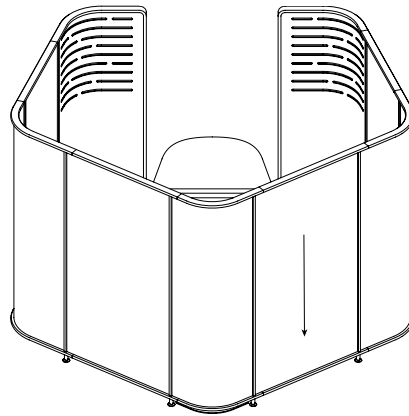

72" High Enclosure, Exterior

When applying a Panel or Upholstery Fabric to full Fabric Buffers, the fabric direction will run Off-the-Bolt on the Fabric Buffer.

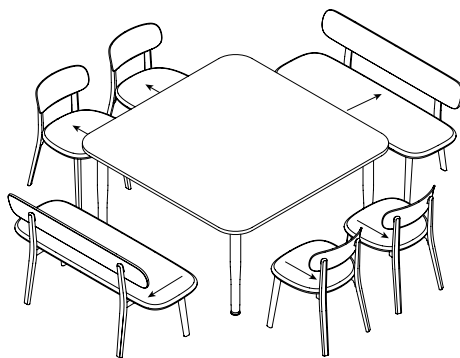

Zones Seating

When applying Upholstery Fabric to all Zones seating, the fabric direction will run Off-the-Bolt.

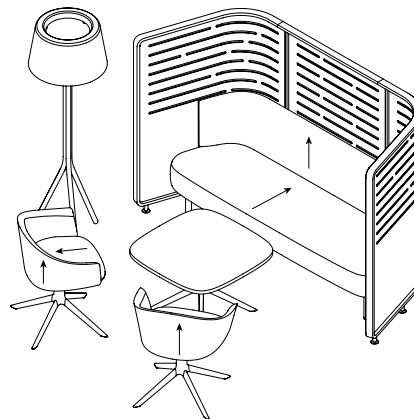

fabric pattern seam guidelines

All fabrics for Zones Modular Seating are applied Off-the-bolt (front to back). Patterned upholstery is not recommended due to the curved form and manner in which the upholstery is applied.

COMs will follow the same fabric orientation and pattern seams.

Seams are required in the center-line of 3-seater straight upholstered benches and curved concave units as indicated below. Seams are applied to the back side and front face of the bench backs.

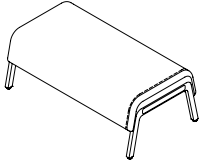
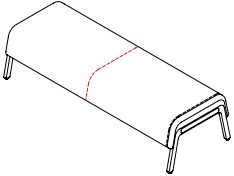
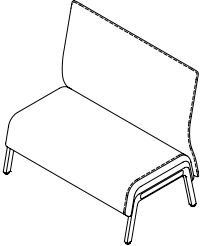
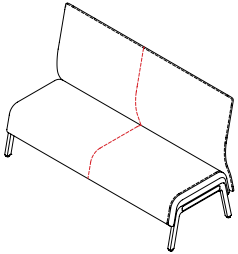
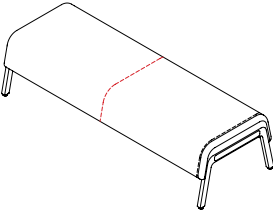
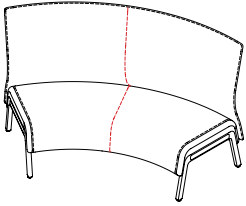
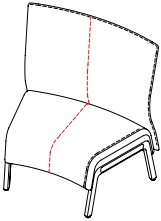
Model	Fabric Pattern Seams	Model	Fabric Pattern Seams
<p>Zones Modular Seating – Straight Upholstered Bench – No Back 2-Seater</p>		<p>Zones Modular Seating – Straight Upholstered Bench – No Back 3-Seater</p>	
<p>Zones Modular Seating Straight Upholstered Bench Low and High Back 2-Seater</p>		<p>Zones Modular Seating Straight Upholstered Bench Low and High Back 3-Seater</p>	
<p>Zones Modular Seating 30° concave Upholstered Bench Low and High Back</p>		<p>Zones Modular Seating 60° concave Upholstered Bench Low and High Back</p>	
<p>Zones Modular Seating 90° concave Upholstered Bench Low and High Back</p>			

customer's own material (COM)

Customers Own Material or Leather (COM / COL)

A COM form is required if a Teknion product is needed in a textile outside our Standard or Graded-In Programs. For any COM/COL requests, please check with Teknion Customer Service for a record of the test results. If the fabric/leather has been approved, a serial number for the fabric and a cutting direction will be supplied by Teknion. This number must be shown on the order. Please note, for various reasons, certain fabrics/leathers may not be approved for use. The required COM/COL yardages given on the price pages are for orders up to 100 chairs. This number is approximate and can vary depending on the pattern repeat.

The COM process will take a minimum of 5 working days once the test yardage has been received by Teknion.

COM forms and information on how to use these forms can be found on My Teknion, Order & Specification, Order Services, PreOrder, Customize, COM, for your printing convenience.

NOTE: Applying the fabric pattern to a rendering may **not** accurately represent the actual product.

COM Pattern Directional Guidelines for Seating

Usually, seating fabrics are patterned to run Off-the-Bolt. At the request of the customer, upholstery can be applied railroaded but yardage requirements may vary.

To avoid unnecessary confusion, you must always specify Off-the-Bolt or railroaded when using a COM fabric.

Due to Zones Modular Seating part geometry and compound surfaces of curved units, fabric patterns with vertical lines will **not** always appear truly vertical and may also show lines converging/diverging on seams at certain points.

It must be noted that the vertical pattern repeat on the fabric may not match exactly from unit to unit, due to the fabric pattern repeat size and also the need for seams on the adjacent units.

See Fabric Pattern Seam Guidelines earlier in this section for more information.

Estimated Material Requirement

COM yardage shown on each products COM/COL Material Requirement Chart is based on unpatterned (plain) fabrics only.

More yardage may be required depending upon the upholstery pattern, repeat, directionality and pattern matching. Leather yield varies from 60-80% and may be affected by the quality of the COL including location and quantity of blemishes, size and shape of hide. The size of the sewing pattern and the number of units ordered may also impact yield. Always round-up to the next yard or hide for each unit that is specified prior to calculating. For larger unit quantities, additional hides may be required.

COL Hide Calculation

When calculating the number of hides required, one must first understand the hide square footage from the chosen COL supplier as the size of leather hides vary by region and by line.

It is not possible to achieve 100% yield optimum due to the nature of hides having various configurations, blemishes and scars, as well as the individual chairs part sizes and part dimensions. Customer order size may also impact yield. Hide calculation requires use of the smallest hide size and applying a yield factor of 70% utilization in order to estimate the usable square footage.

As an example, a supplier of hides from a particular region may advise that their hides vary in size from 55-60 square feet. Hide calculation is required to use the smallest hide size (55 square feet in this case) and apply a yield factor of 70% utilization.

When the square footage required for each chair is **less than the usable square footage of (1X) hide:**

SAMPLE CASE A:

26 chairs are to be ordered and the COL Material Requirement Chart indicates 16.5 square feet COL is required per chair. The smallest hide size identified by the supplier is 55 square feet.

$55 \text{ square feet} \times 70\% \text{ yield} = 38.5 \text{ square feet usable hide size}$

$38.5 \text{ square feet usable hide size} \div 16.5 \text{ square feet required per chair} = 2.33 \text{ chairs per hide}$

Round down the number of chairs produced from a hide = 2 chairs per hide

For 26 units, divide by 2 chairs per hide = 13 hides

A total of 13 hides are estimated to complete the order.

When the square footage required for each chair is **greater than the usable square footage of (1X) hide:**

SAMPLE CASE B:

2 sofas are to be ordered and the COL Material Requirement Chart indicates 88 square feet COL is required per sofa. The smallest hide size identified by the supplier is 55 square feet.

$55 \text{ square feet} \times 70\% = 38.5 \text{ square feet usable hide size}$

$38.5 \text{ square feet usable hide size} \div 88 \text{ square feet required per sofa} = 0.44 \text{ sofas per hide}$

For 1 unit $\div 0.44 \text{ chairs per hide} = 2.27 \text{ hides to create (1x) sofa}$

Round up to 3 hides per sofa

To calculate for (2x) units, multiply by 2

A total of 6 hides are estimated to complete the order.

customer's own material (COM) (continued)

Fabric Direction

All Standard Panel Fabrics are applied railroaded.

Railroaded application (RR)

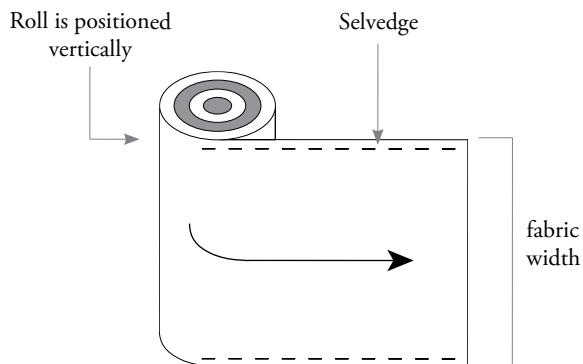

Regular cleaning of your furniture system will maintain the appearance and optimize the long term return on investment.

Zones Seating

Due to the unique shape and size of **Zones Seating** and the inherent properties of some fabrics, mild creasing or puckering may result and is not considered a quality issue by Teknion. In most cases, the fabric can be smoothed-over by hand to improve the appearance.

All Standard Seating and Architectural Fabrics are applied Off-the-Bolt.

Off-the-Bolt application (OB)

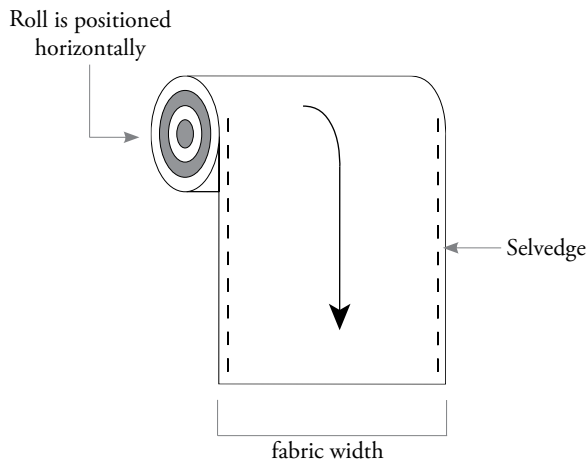

teknion

www.teknion.com

CAN/US/INT 01-22

©Teknion 2024

®, ™ trade marks of Teknion Corporation
and/or its subsidiaries or licensed to it.
Patents may be pending.

Some products may not be available in
all markets. Contact your local Teknion
Representative for availability.

JAN24-TEX