

**OSRAM Customer Service Centre**

OSRAM Ltd.  
Neills Road  
Bold Industrial Park  
St Helens WA9 4XG  
Tel: 01744 812221  
Fax: 01744 831900  
E-mail: [csc@osram.co.uk](mailto:csc@osram.co.uk)

[www.osram.com](http://www.osram.com)



UK edition November 2010 - Subject to modification without notice. Errors and omissions excepted.  Printed on paper treated with chlorine-free bleach.



# Buyers Guide 2010 | 2011

[www.osram.com](http://www.osram.com)

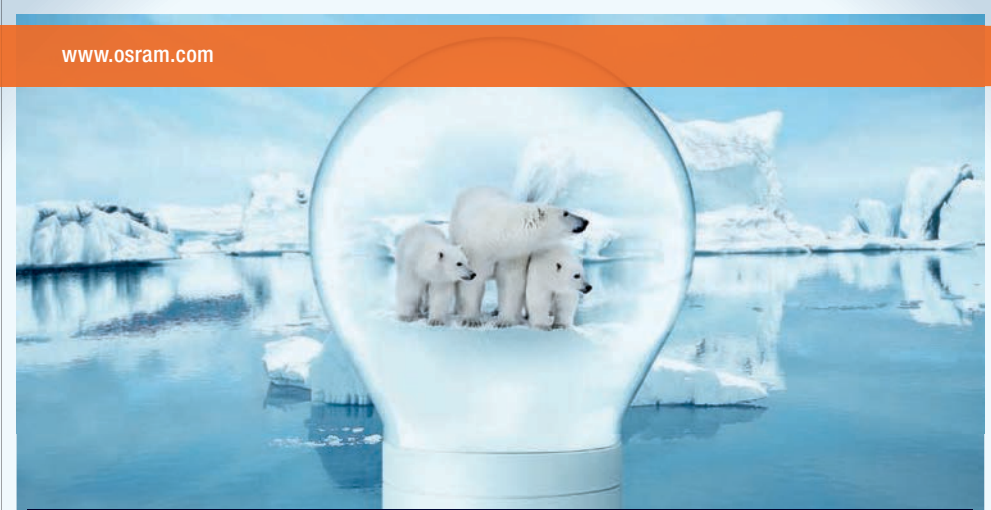

## OSRAM Buyers Guide 2010 | 2011

General Lighting  
LED systems/ LED lamps  
Luminaires  
Electronic Control Gear  
Automotive  
Display Optic

SEE THE WORLD IN A NEW LIGHT



Any manipulation of our products or packaging, including but not limited to modification, reworking or restamping, is prohibited and infringes our registered trademark rights. Such modifications may impair the technical properties of our products, destroy them or cause consequential damage or injury, for which OSRAM cannot under any circumstances be held responsible.

For more information on our products go to:

**[www.osram.com](http://www.osram.com)**



Printed on paper treated with chlorine-free bleach.

Subject to change without notice.

Errors and omission excepted.

<b>General Lighting Service</b>	<b>2</b>
<b>Tungsten Halogen Lamps</b>	<b>12</b>
<b>Compact Fluorescent Lamps</b>	<b>34</b>
<b>LED Lamps</b>	<b>68</b>
<b>Fluorescent Tubes</b>	<b>84</b>
<b>High Pressure Discharge Lamps</b>	<b>120</b>
<b>LED Modules</b>	<b>150</b>
<b>Automotive Lamps</b>	<b>172</b>
<b>Display/Optic Lamps</b>	<b>188</b>
<b>Electronic Control Gear</b>	<b>234</b>
<b>Light Management Systems</b>	<b>266</b>
<b>Luminaires (and NEW Traxon LED luminaire range)</b>	<b>308</b>
<b>Glossary</b>	<b>382</b>



## A world fit to live in – today and tomorrow.

The consequences of global warming are already evident. The polar ice caps and glaciers are melting, sea levels are rising and deserts are expanding. The problem lies with increasing CO<sub>2</sub> emissions throughout the world. As a globally active company we are aware of our enormous responsibility towards people and the environment. This is why sustainability is the basic principle behind all of OSRAM's actions. We are careful with natural resources, avoid waste wherever possible, and help reduce the greenhouse effect by developing energy-saving lamps and systems.



### **Efficient products.**

Our energy-efficient products are helping to restore the balance. By using OSRAM energy-saving lamps for example it is possible to reduce power consumption for lighting by up to 80%. At the same time, because of its long life a single compact fluorescent lamp replaces up to 15 ordinary light bulbs. OSRAM energy-saving lamps therefore not only lead to a considerable reduction in CO<sub>2</sub> emissions they help avoid waste and cut down on purchase costs and electricity costs. Innovative IRC technology is providing impressive savings in halogen lamps. OSRAM HALOGEN ENERGY SAVER CLASSIC is a simple direct replacement for ordinary light bulbs.

### **Economical systems.**

To make lighting even more efficient we are focusing more and more on developing systems comprising of lamps, electronic control gear and lighting management. Electronic operation not only ensures long life but also energy-saving operation and high-quality light. In this way, the enormous potential of our innovative lamps can be fully exploited.

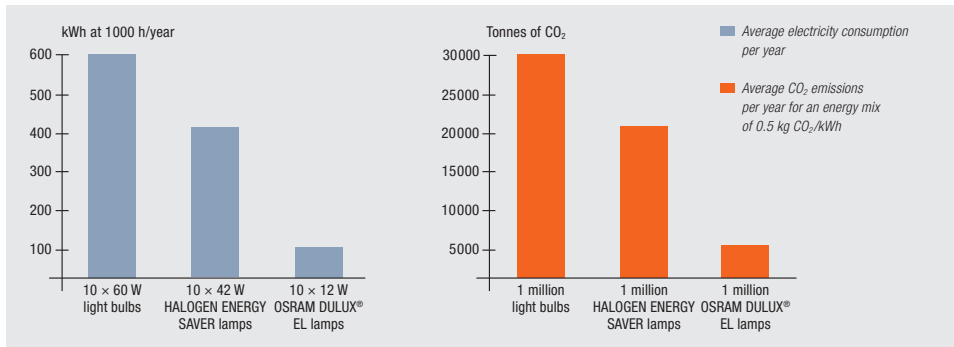

### Extensive recycling, real sustainability.

Even when they come to the end of their lives, OSRAM lamps are almost completely recyclable and provide valuable raw materials. We make use of eco-friendly waste disposal systems and closed material cycles; the recycled materials are then used as far as possible for manufacturing new products. Our packaging is generally made of recycled paper, and in the OEM sector we mainly use multi-use packaging. For OSRAM, sustainability is more than a buzz word.

### Clear labeling, clear statement.

We label products that are particularly energy efficient with the symbol of a green tree. These climate protection products are part of our Global Care Program, to which we have made the following commitment:

**As a globally active company we act responsibly towards society and the environment, meet global challenges with sustainable products and pioneering processes and therefore make a contribution to maintaining the environment for the benefit of future generations.**

With products from the OSRAM Global Care Program you too can make a significant contribution to climate protection and boost your reputation for eco-friendliness.

Each of the 25 million UK households were to replace five 60 W light bulbs with HALOGEN ES 42 W<sup>1,2</sup>.

✂ 1.1 million tonnes of CO<sub>2</sub><sup>3</sup>  
 ✂ 2.25 billion kWh of electricity  
 ✂ £225 million<sup>4</sup>

Six OSRAM DULUX® EL 12 W lamps<sup>2</sup> were to be used in a home<sup>1,2</sup>.

✂ 144 kg CO<sub>2</sub><sup>3</sup>  
 ✂ 288 kWh electricity  
 ✂ £28.80<sup>4</sup>

- 1.1 million tonnes of CO<sub>2</sub> is equivalent to the average emissions of approx. 513,333 cars per year<sup>5</sup>
- One tree absorbs around 20 kg of carbon dioxide per year
- To absorb 1.1 million tonnes of CO<sub>2</sub> you would need 55,000.00 trees.
- 562,500 tonnes of crude oil would be needed to produce 2.25 billion kWh of electricity

<sup>1</sup> Operating for 1000 hours per year

<sup>2</sup> Instead of a 60 W light bulb

<sup>3</sup> Energy mix for the UK

0.5 kg CO<sub>2</sub>/kWh

<sup>4</sup> Electricity price £0.10/kWh

<sup>5</sup> Calculated for CO<sub>2</sub> emissions of 165 g/km, 13,000 km p.a.

# Energy-saving alternatives to standard products

On the basis of the climate protection objectives laid down in Kyoto in 1997 the EU defined a series of measures relating to the economical and sustainable use of natural resources. Following the ban on conventional control gear embodied in directive 2000/55/EC, the reduction of hazardous substances in line with directive 2002/95/EC (RoHS) and the directive for the disposal of waste electrical and electronic equipment 2002/96/EC (WEEE), the EU issued directive 2005/32/EC to define the design requirements (Ecodesign) that energy-using products (EuP) have to meet in terms of their environmental impact. This directive was superseded in November 2009 by the more extensive 2009/125/EC directive relating to the eco-design of energy-relevant products (ErP), but this does not have any additional consequences for the lighting industry.





In March 2009 the EU Commission issued two regulations known as "implementation measures" on the basis of Article 15 of the EuP directive. These regulations impose specific requirements for sections of the electrical lighting market. Regulation EC 244/2009 (amended by regulation EC 859/2009) defines requirements relating to the eco-design of non-directional household lamps. This EC 244/2009 regulation covers the technologies that are generally used in the residential sector, namely incandescent lamps, halogen lamps, compact fluorescent lamps with integrated control gear, and LED retrofits. By contrast, regulation EC 245/2009 defines requirements for the eco-design of products used mainly in street, industry and office lighting, namely fluorescent lamps, compact fluorescent lamps with plug bases, high-intensity discharge lamps with E27, E40 and PGZ12 bases, and control gear and luminaires for fluorescent lamps and high-intensity discharge lamps.

The obvious consequence of the two implementation measures has been the phase-out of various types of lamp, which started on September 1, 2009. Under the provisions of EC 244/2009, incandescent lamps (with the exception of lamps for defined special applications) will be phased out completely by 2012<sup>1)</sup>. Halogen lamps and compact fluorescent lamps with integrated control gear must also meet defined minimum requirements if they are to be marketed in the EU. The criteria used to assess the lamps include efficiency, lamp life and lumen maintenance.

Compliance with the implementation measures of the Ecodesign directive will be indicated by the CE symbol. This means that in future the CE symbol will no longer stand only for compliance with safety regulations but also for compliance with the quality requirements defined in the Ecodesign implementation measures.

Another requirement of EC 245/2009 and EC 244/2009 is the obligation to publish particular product information from April or September 2010. This information must be shown on the packaging and/or published on the internet, depending on which of the two implementation measures applies to the product. This information includes for example the mercury content of the lamp and details of lumen maintenance. The implementation measures already define products that will be phased out by 2016 (EC 244/2009) and 2017 (EC 245/2009). Both EU regulations will be subjected

to a review by 2014 at the latest, which is standard practice for such regulations.

At present the EU Commission is working on a further implementation measure for household lighting which will define the eco-design requirements of household lamps with directional light and all household luminaires. This regulation is expected to be issued at the end of 2010/start of 2011.

The following pages show the impact of the implementation measures on OSRAM's product range. In view of the ongoing change procedure for the products affected by EC 245/2009, there may be further changes.















Irrespective of the statutory requirements, OSRAM is committed to sustainability and therefore already offers energy-saving alternatives to its standard products. The ECO versions of the line-voltage halogen products HALOPIN and HALOLINE already meet the energy efficiency requirements of the regulation, whereas the standard versions will have to be gradually removed from the market. As things stand at present, after 2016 these Energy Class C products may continue to be marketed because of the exemption for G9 and R7s bases.

In addition to direct replacement of high-pressure sodium lamps for which only an adequate ignition voltage needs to be tested OSRAM offers further energy-efficient solutions with the transition to metal halide lamps with ceramic burners. In these cases, it may be necessary to change the control gear. With regard to T12 fluorescent lamps, OSRAM goes beyond the requirements of the regulation and will be removing these products from the market in 2010 – two years before the official deadline. Control gear from OSRAM already meets the efficiency requirements of tomorrow. For example, it already meets the threshold values for standby losses that need to be met by 2012.

For the latest information on the products affected and the energy-efficient alternatives available go to our website at [www.osram.com](http://www.osram.com).

















1) Further information at [www.elcfd.org/documents/Special%20Purpose%20Lamps\\_090515.pdf](http://www.elcfd.org/documents/Special%20Purpose%20Lamps_090515.pdf)

## Implementation measure for non-directional household lighting

	Sep. 2009	Sep. 2010	Sep. 2011	Sep. 2012	Sep. 2013	Sep. 2014	Sep. 2015	Sep. 2016
 Incandescent lamp, clear lamps	15 W 25 W 40 W 60 W 75 W > 100 W	15 W 25 W 40 W 60 W 75 W 100 W	15 W 25 W 40 W 60 W 75 W 100 W	Ban on all clear incandescent lamps				
 Frosted lamps	Incandescent lamps HALOPIN / HALOPIN ECO HALOSTAR STANDARD HALOLUX BT / HALOLUX CERAM HALOGEN ENERGY SAVER CLASSIC A / B / P / BW							
 HALOLUX BT clear								
 HALOGEN ECO Classic clear	18 W 28 W 42 W 52 W 70 W 105 W			18 W 28 W 42 W 52 W 70 W 105 W	Alternatives planned			
 HALOLUX CERAM ECO clear								
 HALOSTAR klar								
 HALOSTAR ECO clear								
 HALOPIN clear	25 W 40 W 60 W 75 W	25 W 40 W 60 W 75 W	25 W 40 W 60 W 75 W	25 W 40 W 60 W 75 W				
 HALOPIN ECO clear								Exception: G9 in Energy Class C
 HALOLINE clear	60 W 100 W 150 W 200 W 300 W 500 W	60 W 100 W 150 W 200 W 300 W 500 W						
 HALOLINE P15 clear	750 W 1000 W 1500 W 2000 W							
 HALOLINE ECO clear								Exception: R7s in Energy Class C
 HALOLUX T clear								
 Special	Further information at <a href="http://www.elcfed.org/documents/Special%20Purpose%20Lamps_090515.pdf">www.elcfed.org/documents/Special%20Purpose%20Lamps_090515.pdf</a>							
 Directional household lamps	The implementation measure for directional light sources will be issued at the end of 2010/start of 2011							



## Implementation measure for tertiary lighting

		Apr. 2010	Apr. 2011	Apr. 2012	Apr. 2013	Apr. 2014	Apr. 2015	Apr. 2016
	NAV-E	NAV-E STANDARD NAV-E/I NAV-E 4Y > 70 W NAV-E 4Y ≤ 70 W NAV-E E/I 4Y ≤ 70 W NAV-E SUPER 4Y		NAV-E STANDARD NAV-E/I NAV-E 4Y > 70 W				
	NAV-E Plug-in	NAV-E Plug-in ≥ 210 W NAV-E Plug-in 110 W NAV-E Plug-in 68 W					NAV-E Plug-in ≥ 210 W	
	NAV-T	NAV-T STANDARD NAV-T 4Y NAV-T SUPER 4Y		NAV-T STANDARD NAV-T 4Y				
	HQL							
	HWL	Exempt from the directive because of the spectrum of the lamp						
	HQI clear							
	HQI non-clear							
	HCI							
	T8	T8 BASIC T8 BASIC U-shape T8 LUMILUX T8 LUMILUX U-shape						
	T12 halophosphate	OSRAM withdrawal		T12				
	Ring lamp	T9 BASIC ring lamp T9 LUMILUX ring lamp						
	DULUX 2pin							
	DULUX 4pin							
	Standby losses FL	$P_{0\%} \leq 1 \text{ W}$		$P_{0\%} \leq 0,5 \text{ W}$				
	Non-DIM QT							
	DIM QT							
	PT							
	Luminaire	Only losses of the integrated control gear		The luminaire must be compatible with at least Class A2 control gear (except IP4X)				

Changes are possible as a result of the change procedure

Review by the EU Commission

# See the world in a new light – www.osram.com

On the OSRAM website you can find more than just the fascinating world of light and lighting, the latest information and interesting links, you can also download various practical tools and services for commercial customers and consumers.

## Focusing on your needs.

To help you find what you're looking for even faster we have reorganised the OSRAM website so it fits better with your requirements. Products for lighting professionals are now all together in the PROFESSIONAL section. You will find advice, costings, business services, downloads and everything to do with training and know-how in the TOOLS & SERVICES section. Consumers can experience the entire OSRAM world of lighting in the CONSUMER section – lamps, luminaires and accessories for the home and automobile, the latest campaigns and competitions.



## OSRAM brochure download centre



The OSRAM download centre enables you to quickly download the information you need to your computer.

## www.voltimum.co.uk

The aim of the portal is to provide information and services to all professionals in the electrical installation market thereby helping to save time and money in the design, specification and estimation of electrical projects. Visit the site to view the most comprehensive OSRAM UK product range catalogue, ask our panel of technical experts for advice and answers to your technical questions or simply to keep abreast of the latest industry news.



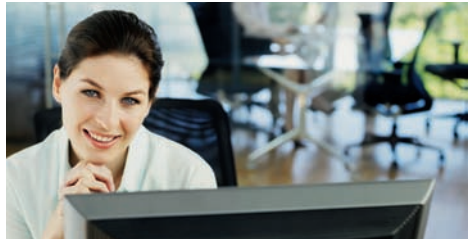

**Web-based training online service.**

Our interactive product training program, comprising eight coordinated and clearly structured modules, is the quick stress-free way of acquiring extensive knowledge relating to light, lamps and lighting. At the end of each module you can monitor your progress by answering twelve questions. When you have successfully completed the training program we will issue you with your own personal certificate.



*More knowledge, more success:  
The online training program gives you a basic understanding on light and lighting.*

**There's no business like E-business**

**www.myOSRAM.com**

– The information and shopping portal 24/7

MyOSRAM.com is the exclusive customer information and shopping portal. Simple to use, fast and convenient providing 24/7 access to ordering online.

If you are already a registered OSRAM customer and you do not have access to the site please contact the OSRAM customer service centre 01744 812221.



**Information on EU directives.**



*At www.osram.com you can read the latest information on the new EU directives and alternative products for the lamps that have to be removed from the market.*

**OSRAM Lighting Consultant.**



*At www.osram.com/light-consultant you can find the right lighting system for optimum illumination of commercial premises and can calculate the savings in energy, costs and CO<sub>2</sub> emissions.*

GENERAL LIGHTING SERVICE LAMPS

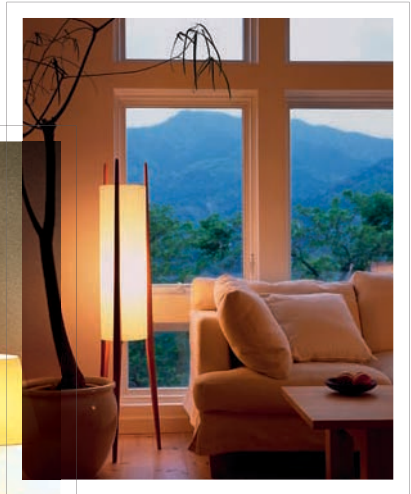

# General Lighting Service Lamps Contents.

GLS clear	4
Candle 35mm clear	5
Globe 45mm clear	6
Reflectors	8
PAR 38	9
Appliance lamps	9
Oven lamps	10
Rough service	10
Striplight	11



## General Lighting Service Lamps

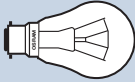

### GLS clear BC

- CLASSIC A
- Classic shape basic incandescent lamps
- Ideal for creating more sparkle in general lighting

Product ID Code	EAN (Single Pack)	Product Description	W	V	lm		FINISH		PPG
24015B22 <sup>2)</sup>	4050300285856	CLASSIC A CL15	15	240	90	BC/B22d	Clear	25	2
24025B22 <sup>2)</sup>	4050300290041	CLASSIC A CL25	25	240	220	BC/B22d	Clear	25	1
24040B22 <sup>2)</sup>	4050300285436	CLASSIC A CL40	40	240	415	BC/B22d	Clear	100	1
24060B22 <sup>1)</sup>	4050300285450	CLASSIC A CL60	60	240	710	BC/B22d	Clear	100	1
<b>Twin pack carton</b>									
24060B22P2 <sup>1)</sup>	4008321083517	CLASSIC A CL60 TC	60	240	710	BC/B22d	Clear	20	6

- 1) Banned from 1.9.2011 as per EU phase-out plan
- 2) Banned from 1.9.2012 as per EU phase-out plan

Alternative: HALOGEN CLASSIC A ECO, PARATHOM® CLASSIC A LED or OSRAM DULUX® retrofit compact fluorescent lamps

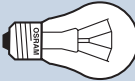

### GLS clear ES

- CLASSIC A
- Classic shape basic GLS lamps
- Ideal for creating more sparkle in general lighting

Product ID Code	EAN (Single Pack)	Product Description	W	V	lm		FINISH		PPG
24040 <sup>2)</sup>	4050300023328	CLASSIC A CL40	40	240	415	ES/E27	Clear	100	1
24060 <sup>1)</sup>	4050300023342	CLASSIC A CL60	60	240	710	ES/E27	Clear	100	1
<b>Twin pack carton</b>									
24060P2 <sup>2)</sup>	4008321081674	CLASSIC A CL60 TC	60	240	710	ES/E27	Clear	20	6

- 1) Banned from 1.9.2011 as per EU phase-out plan
- 2) Banned from 1.9.2012 as per EU phase-out plan

Alternative: HALOGEN CLASSIC A ECO, PARATHOM® CLASSIC A LED or OSRAM DULUX® retrofit compact fluorescent lamps

All orders must be multiples of sales pack

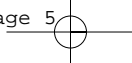

## General Lighting Service Lamps

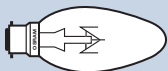
**Candle 35mm clear BC**

- CLASSIC B
- 35mm plain candle lamps
- Ideal for decorative wall, ceiling and table luminaires where more sparkle is required

Product ID Code	EAN (Single Pack)	Product Description	W	V	lm		FINISH		PPG
240B25B22 <sup>2)</sup>	4050300032948	CLASSIC B CL25	25	240	200	BC/B22d	Clear	100	3
240B40B22 <sup>2)</sup>	4050300033143	CLASSIC B CL40	40	240	400	BC/B22d	Clear	100	3
240B60B22 <sup>1)</sup>	4050300033594	CLASSIC B CL60	60	240	660	BC/B22d	Clear	100	3

**Four pack carton**

240B60B22P4 <sup>1)</sup>	4050300797717	CLASSIC B CL60C	60	240	660	BC/B22d	Clear	100	3
---------------------------	---------------	-----------------	----	-----	-----	---------	-------	-----	---

**Twin blister**

240B40B22BLI2 <sup>2)</sup>	4050300149882	CLASSIC B CL40 BL	40	240	400	BC/B22d	Clear	20	6
240B60B22BLI2 <sup>1)</sup>	4050300149899	CLASSIC B CL60 BL	60	240	660	BC/B22d	Clear	20	6

1) Banned from 1.9.2011 as per EU phase-out plan

2) Banned from 1.9.2012 as per EU phase-out plan

Alternative: HALOGEN CLASSIC B ECO, the direct replacement for classic incandescent lamps.

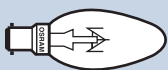
**Candle 35mm clear SBC**

- CLASSIC B ECO
- 35mm plain candle lamps
- Ideal for decorative wall, ceiling and table luminaires where more sparkle is required

Product ID Code	EAN (Single Pack)	Product Description	W	V	lm		FINISH		PPG
240B25B15 <sup>1)</sup>	4050300032900	CLASSIC B CL25	25	240	200	SBC/B15d	Clear	100	3
240B40B15 <sup>1)</sup>	4050300033082	CLASSIC B CL40	40	240	400	SBC/B15d	Clear	100	3
240B60B15 <sup>1)</sup>	4050300033570	CLASSIC B CL60	60	240	660	SBC/B15d	Clear	100	3

**Twin blister**

240B40B15BLI2 <sup>1)</sup>	4050300164229	CLASSIC B CL40 BL	40	240	400	SBC/B15d	Clear	20	6
-----------------------------	---------------	-------------------	----	-----	-----	----------	-------	----	---

1) Banned from 1.9.2012 as per EU phase-out plan

Alternative: HALOGEN CLASSIC B ECO, the direct replacement for classic incandescent lamps.

All orders must be multiples of sales pack

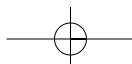



## General Lighting Service Lamps

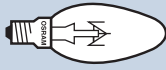

### Candle 35mm clear SES

- CLASSIC B
- 35mm plain candle lamps
- Ideal for decorative wall, ceiling and table luminaires where more sparkle is required

Product ID Code	EAN (Single Pack)	Product Description	W	V	lm		FINISH		PPG
240B25 <sup>2)</sup>	4050300033020	CLASSIC B CL25	25	240	200	SES/E14	Clear	100	3
240B40 <sup>2)</sup>	4050300033471	CLASSIC B CL40	40	240	400	SES/E14	Clear	100	3
240B60 <sup>1)</sup>	4050300328980	CLASSIC B CL60	60	240	660	SES/E14	Clear	100	3
<b>Twin blister</b>									
240B25BLI <sup>2)</sup>	4050300829449	CLASSIC B CL25 BL	25	240	200	SES/E14	Clear	20	6
240B40BLI <sup>2)</sup>	4050300174907	CLASSIC B CL40 BL	40	240	400	SES/E14	Clear	20	6
240B60BLI <sup>2)</sup>	4050300174501	CLASSIC B CL60 BL	60	240	660	SES/E14	Clear	20	6

- 1) Banned from 1.9.2011 as per EU phase-out plan  
2) Banned from 1.9.2012 as per EU phase-out plan

Alternative: HALOGEN CLASSIC B ECO, PARATHOM® CLASSIC B LED, or OSRAM DULUX® retrofit compact fluorescent lamps

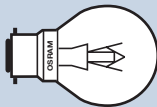

### Globe 45mm clear BC

- CLASSIC P
- 45mm small globe lamps
- Ideal for smaller decorative luminaires where more sparkle is required

Product ID Code	EAN (Single Pack)	Product Description	W	V	lm		FINISH		PPG
240P40B22 <sup>2)</sup>	4050300187846	CLASSIC P CL40	40	240	400	BC/B22d	Clear	50	5
<b>Twin blister</b>									
240P40B22BLI <sup>2)</sup>	4050300164267	CLASSIC P CL40 BL	40	240	400	BC/B22d	Clear	20	6
240P60B22BLI <sup>2)</sup>	4050300164328	CLASSIC P CL60 BL	60	240	660	BC/B22d	Clear	20	6

- 1) Banned from 1.9.2011 as per EU phase-out plan  
2) Banned from 1.9.2012 as per EU phase-out plan

Alternative: HALOGEN CLASSIC P ECO, or OSRAM DULUX® retrofit compact fluorescent lamps

All orders must be multiples of sales pack



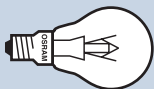

## General Lighting Service Lamps

**Globe 45mm clear SES**

- CLASSIC P
- 45mm small globe lamps
- Ideal for smaller decorative luminaires where more sparkle is required

Product ID Code	EAN (Single Pack)	Product Description	W	V	lm		FINISH		PPG
-----------------	-------------------	---------------------	---	---	----	--	--------	--	-----

**Twin blister**

240P40BLI2 <sup>1)</sup>	4050300134772	CLASSIC P CL40	40	240	400	SES/E14	Clear	20	6
--------------------------	---------------	----------------	----	-----	-----	---------	-------	----	---

1) Banned from 1.9.2012 as per EU phase-out plan

**Alternative: HALOGEN CLASSIC P ECO, or OSRAM DULUX® retrofit compact fluorescent lamps**

All orders must be multiples of sales pack

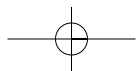



## General Lighting Service Lamps

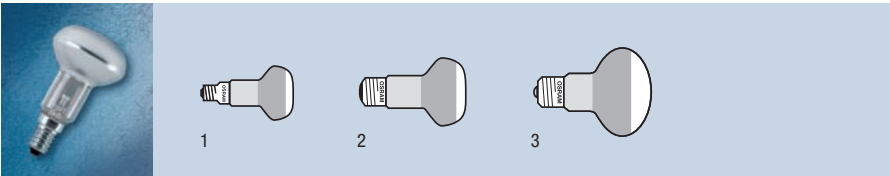

### Reflectors

- CONCENTRA® SPOT
- Blown glass
- Focused shape
- Ideal for commercial and domestic display lighting

Product ID Code	EAN (Single Pack)	Product Description	W	V		No.		PPG
<b>R50</b>								
240R5040	4050300302263	CONCENTRA R50 SP40	40	240	SES/E14	1	25	7
<b>Twin blister</b>								
240R5040BLI2	4050300164427	CONCENTRA R50 SP40 BL	40	240	SES/E14	1	20	6
<b>R63</b>								
240R6340	4050300023397	CONCENTRA R63 SP40	40	240	ES/E27	2	25	7
240R6360	4050300023380	CONCENTRA R63 SP60	60	240	ES/E27	2	25	7
<b>Twin blister</b>								
240R6340BLI2	4050300134826	CONCENTRA R63 SP40BL	40	240	ES/E27	1	20	6
240R6360BLI2	4050300164403	CONCENTRA R63 SP60BL	60	240	ES/E27	1	20	6
<b>R80</b>								
240R8060	4050300066059	CONCENTRA R80 60	60	240	ES/E27	3	100	9
240R8075	4050300066066	CONCENTRA R80 75	75	240	ES/E27	3	100	9
240R80100	4050300066073	CONCENTRA R80 100	100	240	ES/E27	3	100	9
<b>Single blister</b>								
240R8060BLI1	4050300041728	CONCENTRA R80 60 BL	60	240	ES/E27	3	10	6

Alternative: HALOGEN SPOT R50/R63 ECO, PARATHOM® R50/R63 LED or OSRAM DULUX® retrofit compact fluorescent lamps

All orders must be multiples of sales pack

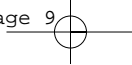

## General Lighting Service Lamps

**PAR 38**

- CONCENTRA® PAR
- Hard glass
- Flood beam angle
- Ideal for display and garden lighting

Product ID Code	EAN (Single Pack)	Product Description	W	V		FINISH		PPG
<b>Coloured</b>								
PAR80RE	4050300007656	CONCENTRA PAR 38 Red	80	240	ES/E27	Red Flood	12	5
PAR80GR	4050300007670	CONCENTRA PAR 38 Green	80	240	ES/E27	Green Flood	12	5
PAR80BL	4050300007687	CONCENTRA PAR 38 Blue	80	240	ES/E27	Blue Flood	12	5
PAR80YE	4050300007663	CONCENTRA PAR 38 Yellow	80	240	ES/E27	Yellow Flood	12	5

**Appliance lamps**

- Small lamps with a clear finish
- Ideal for domestic appliances such as sewing machines and fridges

Product ID Code	EAN (Single Pack)	Product Description	W	V	Im		FINISH		PPG
<b>Single blister</b>									
FRIDGE15BL11	4050300092928	SPC T FRIDGE CL	15	240	110	SES/E14	Clear	10	6
T5715B15BL11	4050300092935	SPC T26/57 CL	15	240	190	SBC/B15d	Clear	10	6

All orders must be multiples of sales pack

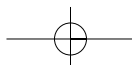



## General Lighting Service Lamps

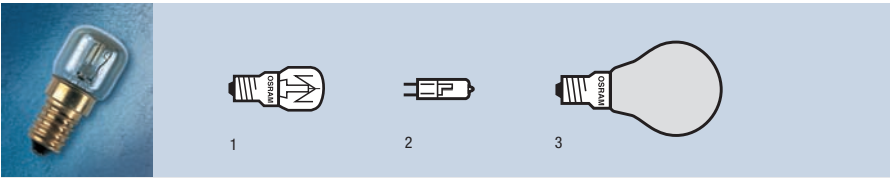

### Oven lamps

- SPC. (pygmy) oven lamp
- 300°C
- Ideal for oven lighting

Product ID Code	EAN (Single Pack)	Product Description	W	V	lm		FINISH			PPG
OVEN15BL1	4050300065052	SPC T OVEN CL 15 OBL	15	240	90	SES/E14	Clear - 22mm	1	10	6
64428	4050300308050	SPC OVEN CL G4	20	12	320	G4	Clear	2	40	38
OVEN40FR	4050300008486	SPC P OVEN FR 40	40	240	-	SES/E14	Clear	3	100	38

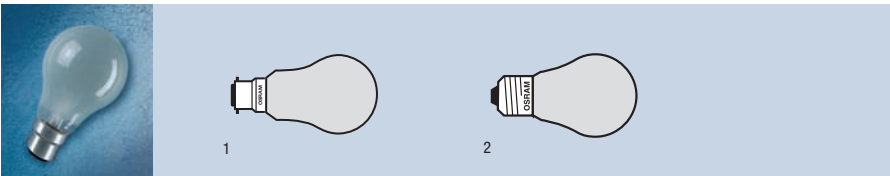

### Rough service

- CENTRA®
- Basic GLS shape
- Extra filament supports
- Ideal for hand inspection lamps

Product ID Code	EAN (Single Pack)	Product Description	W	V	lm		FINISH			PPG
120CTR60FRB22	4050300615073	CENTRA 60/120	60	120	-	BC/B22d	Pearl	1	25	1
240CTR60FRB22	4050300200910	CENTRA 60/240BC	60	240	505	BC/B22d	Pearl	1	25	1
240CTR60FR	4050300200866	CENTRA 60/240	60	240	505	ES/E27	Pearl	2	25	1
240CTR100FRB22	4050300425771	CENTRA 100/240BC	100	240	1000	BC/B22d	Pearl	1	25	1
240CTR100FR	4050300230757	CENTRA 100/240	100	240	1000	ES/E27	Pearl	2	25	1

All orders must be multiples of sales pack

## General Lighting Service Lamps



Product ID Code	EAN (Single Pack)	Product Description	W	V	lm		FINISH		No.		PPG
<b>221mm</b>											
24022130CL <sup>1)</sup>	4050300047768 <sup>8)</sup>	Striplight 221mm	30	240	230	S15	Clear	1	25	11	
<b>221mm (Single blister)</b>											
24022130SILBL1 <sup>1)</sup>	4050300164465	Striplight 221mm Blister	30	240	230	S15	Opal	2	10	6	
<b>284mm</b>											
24028460CL <sup>1)</sup>	4050300292229	Striplight 284mm	60	240	200	S15	Clear	1	25	11	
24028460SIL <sup>1)</sup>	4050300090504	Striplight 284mm	60	240	450	S15	Opal	2	25	11	
<b>284mm (Single blister)</b>											
24028460SILBL1 <sup>1)</sup>	4050300164502	Striplight 284mm Blister	60	240	-	S15	Opal	2	10	6	
1) Banned from 1.9.2012 as per EU phase-out plan											

All orders must be multiples of sales pack

TUNGSTEN HALOGEN LAMPS



# Tungsten Halogen Lamps Contents.

## MAIN VOLTAGE HALOGEN LAMPS

HALOPIN® ECO	14
HALOPIN®	14
DECOPIN®	15
OSRAM HALOPAR® 16 ECO	15
OSRAM HALOPAR® 16	16
OSRAM HALOPAR® 20	16
OSRAM HALOPAR® 30	17
OSRAM HALOPAR® 38	17
HALOGEN CLASSIC ECO	18
HALOGEN SPOT R50/R63 ECO	21
HALOLUX CERAM®	21
HALOLINE® ECO	22
HALOLINE®	22

## LOW VOLTAGE HALOGEN LAMPS

HALOSTAR® ECO	23
HALOSTAR STARLITE®	24
HALOSTAR® STANDARD	24
HALOSPOT® 111 ECO	25
HALOSPOT® 111	26
HALOSPOT® 70, 48	27
DECOSTAR® 51 ECO	28
DECOSTAR® 51 TITAN	29
DECOSTAR® 35 TITAN	30
DECOSTAR® 51 STANDARD	30
DECOSTAR® 51S STANDARD	31
DECOSTAR® 51 ALU	31
DECOSTAR® 51 COOL BLUE®	32
DECOSTAR® 35 STANDARD	32
TRAFFIC SIGNAL LAMPS	33





## HALOGEN LAMPS – MAINS VOLTAGE

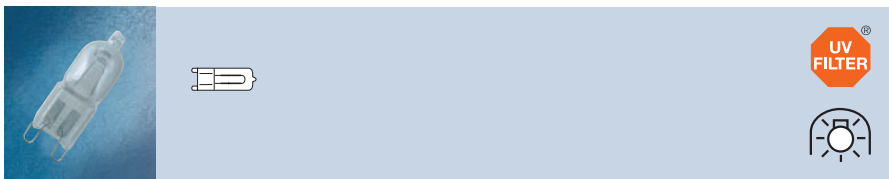

HALOGEN  
ECO



### HALOPIN® ECO

- Mains voltage compact G9 halogen lamps, no transformer required
- 1:1 direct replacement for a standard HALOPIN® lamps
- Approved for use in open luminaires to IEC 60598-1
- Fully dimmable
- Ideal for modern compact luminaires

Product ID Code	EAN (Single Pack)	Product Description	W	V	lm	t [h]		FINISH		PPG
66720	4008321945556	66720 ECO 20W 240V G9	20	240	200	2,000	G9	Clear	20	17
24066733	4008321226341	HEHP33 66733 ECO 33W 240V G9	33	240	460	2,000	G9	Clear	20	17
66748	4008321945617	66748 ECO 48W 240V G9	48	240	740	2,000	G9	Clear	20	17
66760	4008321945655	66760 ECO 60W 240V G9	60	240	980	2,000	G9	Clear	20	17

NEW  
NEW  
NEW

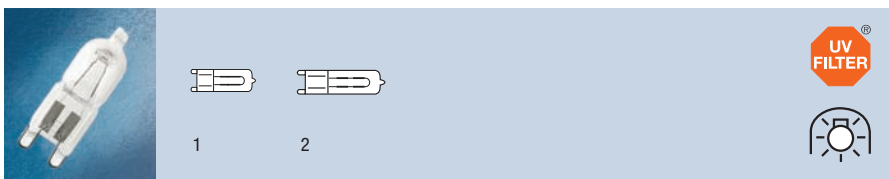

### HALOPIN®

- Mains voltage compact G9 halogen lamp, no transformer required
- Approved for use in open luminaires to IEC 60598-1
- Fully dimmable
- Ideal for modern compact luminaires

Product ID Code	EAN (Single Pack)	Product Description	W	V	lm	t [h]		FINISH		PPG
<b>Clear</b>										
24066725 <sup>1)</sup>	4050300791814	HP25CC 66725 25W 240V G9	25	240	260	2,000	G9	Clear	20	17
24066740 <sup>1)</sup>	4050300791852	HP40CC 66740 40W 240V G9	40	240	490	2,000	G9	Clear	20	17

1) Banned from 1.9.2012 as per EU phase-out plan

All orders must be multiples of sales pack



Halogen Lamps – Mains Voltage



**DECOPIN®**

- World's smallest mains voltage halogen reflector lamp
- 41.5mm diameter
- Polished Alu reflector with matt exterior finish
- Approved for use in open luminaires to IEC 60598-1
- Fully dimmable

Product ID Code	EAN (Single Pack)	Product Description	W	V	lm	t [h]				PPG
24060040 <sup>1)</sup>	4008321122797	DP40 60040 FL 40W 240V G9	40	240	550	2,000	G9	40°	20	17

1) Banned from 1.9.2012 as per EU phase-out plan

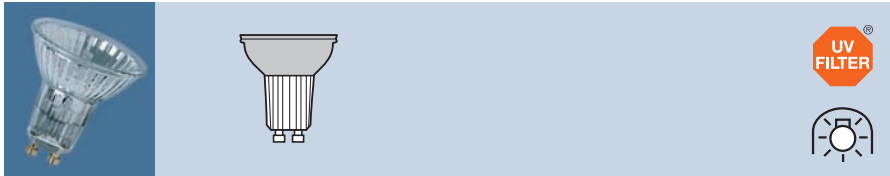
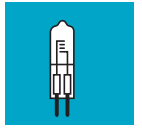

**OSRAM HALOPAR® 16 ECO**

- GU10 mains voltage reflector lamp, no transformer required
- Approved for use in open luminaires to IEC 60432-3
- Fully dimmable
- Ideal for display and down lighting

Product ID Code	EAN (Single Pack)	Product Description	W	V	lm	t [h]		FINISH		PPG
24064819HPES	4008321934369	64819 ECO FL 28W 240V GU10	28	240	570	2,000	GU10	Flood aluminised reflector	20	17
24064823FL	4008321226389	HE1640 64823 ECO FL 40W 240V GU10	40	240	900	2,000	GU10	Flood aluminised reflector	20	17



NEW

All orders must be multiples of sales pack

## Halogen Lamps – Mains Voltage

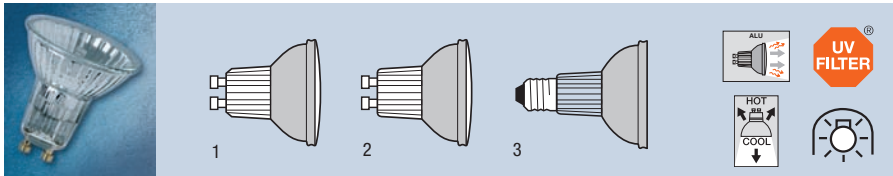
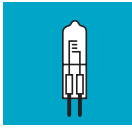

### OSRAM HALOPAR® 16

- Mains voltage reflector lamp, no transformer required
- Aluminium or dichroic reflector
- Approved for use in open luminaires to IEC 60598-1
- Fully dimmable
- 51mm diameter
- Ideal for display and down lighting

Product ID Code	EAN (Single Pack)	Product Description	W	V	t(h)		FINISH			PPG
24064820FL	4050300727226	P163FA 64820 FL 35W 240V GU10	35	240	2,000	GU10	Flood aluminised reflector	1	20	17
24064822FL	4050300772080	P164FA 64822FL 40W 240V E14	40	240	2,000	SES/E14	Flood aluminised reflector	3	20	17
24064824FL	4050300580159	P165FA 64824FL 50W 240V GU10	50	240	2,000	GU10	Flood aluminised reflector	1	20	17
24064826	4050300522708	P165FD 64826 FL 50W 240V GZ10	50	240	2,000	GZ10	Flood dichroic reflector	2	20	17

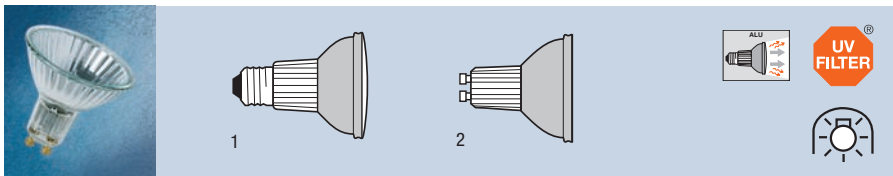

### OSRAM HALOPAR® 20

- Mains voltage, no transformer required
- 64.5mm diameter
- Aluminium or dichroic reflector
- Approved for use in open luminaires to IEC 60598-1
- Fully dimmable
- Ideal for display lighting

Product ID Code	EAN (Single Pack)	Product Description	W	V	t(h)		FINISH			PPG
24064832SP	4050300435268	P205SA 64832 SP 50W 240V E27	50	240	2,000	ES/E27	Spot aluminised reflector	1	15	17
24064832FL	4050300435282	P205FA 64832 FL 50W 240V E27	50	240	2,000	ES/E27	Flood aluminised reflector	1	15	17
24064836SP	4050300435305	P205SD 64836 SP 50W 240V E27	50	240	2,000	ES/E27	Spot dichroic reflector	1	15	17
24064836FL	4050300435329	P205FD 64836 FL 50W 240V E27	50	240	2,000	ES/E27	Flood dichroic reflector	1	15	17
24064830FL	4050300856995	P207FA 64830 FL 75W 240V GU10	75	240	2,000	GU10	Flood aluminised reflector	2	20	17

All orders must be multiples of sales pack

## Halogen Lamps – Mains Voltage

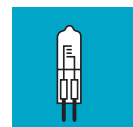
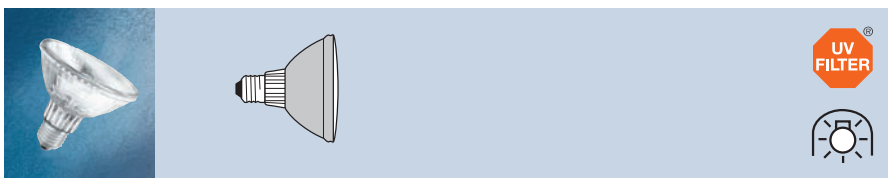
**OSRAM HALOPAR® 30**

- Mains voltage, no transformer required
- 97mm diameter
- Aluminium or dichroic reflector
- Approved for use in open luminaires to IEC 60598-1
- Fully dimmable
- Ideal for display lighting

Product ID Code	EAN (Single Pack)	Product Description	W	V	t[h]		FINISH		PPG
24064841SP	4050300435343	P307SA 64841 SP 75W 240V E27	75	240	2,000	ES/E27	Spot aluminised reflector	15	17
24064841FL	4050300435367	P307FA 64841 FL 75W 240V E27	75	240	2,000	ES/E27	Flood aluminised reflector	15	17
24064845SP	4050300435381	P307SD 64845 SP CB 75W 240V E27	75	240	2,000	ES/E27	Spot dichroic reflector	15	17
24064845FL	4050300435404	P307FD 64845 FL CB 75W 240V E27	75	240	2,000	ES/E27	Flood dichroic reflector	15	17

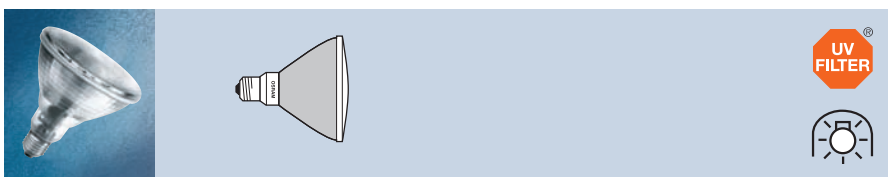
**OSRAM HALOPAR® 38**

- Halogen PAR 38 reflector
- 1:1 replacement to a standard incandescent PAR 38 lamp
- Approved for use in open luminaires to IEC 60598-1
- Fully dimmable
- Ideal for decorative and highlighting effects

Product ID Code	EAN (Single Pack)	Product Description	W	V	t[h]				PPG
64838FL50	4008321380364	64838 FL 50W 240V E27	50	240	2,000	ES/E27	30°	12	17
64838FL75	4008321380340	64838 FL 75W 240V E27	75	240	2,000	ES/E27	30°	12	17
64838SP75	4008321380401	64838 SP 75W 240V E27	75	240	2,000	ES/E27	12°	12	17

All orders must be multiples of sales pack

## Halogen Lamps – Mains Voltage

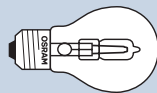
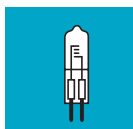

HALOGEN  
ECO

### HALOGEN CLASSIC A ECO

- Mains voltage Classic "A" shape lamps, no transformer required
- Fully dimmable
- Direct eco replacement for classic "A" shape GLS lamps

Product ID Code	EAN (Single Pack)	Product Description	W	V	lm	t <sub>h</sub>		FINISH		PPG
24064541AESB22 <sup>1)</sup>	4008321934239	64541 A ECO 18W 240V B22D	18	240	220	2,000	BC/B22d	Clear	20	17
24064542AB22	4008321918949	HEA2CB 64542 A ECO 28W 240V B22D	28	240	345	2,000	BC/B22d	Clear	20	17
24064543AB22	4008321919083	HEA4CB 64543 A ECO 42W 240V B22D	42	240	630	2,000	BC/B22d	Clear	20	17
64544AESB22	4008321403339	64544 A ECO 53W 240V B22D	52	240	820	2,000	BC/B22d	Clear	20	17
64547AESB22	4008321936073	64547 A ECO 70W 240V B22D	70	240	1200	2,000	BC/B22d	Clear	20	17
64548AESB22	4008321403391	64548 A ECO 105W 240V B22D	105	240	1900	2,000	BC/B22d	Clear	20	17
24064542A	4008321229267	HEA2CE 64542 A ECO 28W 240V E27	28	240	345	2,000	ES/E27	Clear	20	17
24064543A	4008321229281	HEA4CE 64543 A ECO 42W 240V E27	42	240	630	2,000	ES/E27	Clear	20	17
64544AES	4008321403315	64544 A ECO 53W 240V E27	52	240	820	2,000	ES/E27	Clear	20	17
64547AES	4008321936059	64547 A ECO 70W 240V E27	70	240	1200	2,000	ES/E27	Clear	20	17
64548AES	4008321403377	64548 A ECO 105W 240V E27	105	240	1900	2,000	ES/E27	Clear	20	17

1) Banned from 1.9.2012 as per EU phase-out plan



All orders must be multiples of sales pack

## Halogen Lamps – Mains Voltage

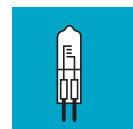
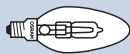
**HALOGEN CLASSIC B ECO**

- Mains voltage candle shape lamps, no transformer required
- Fully dimmable
- Direct eco replacement for basic incandescent candle lamps

Product ID Code	EAN (Single Pack)	Product Description	W	V	lm	t(h)		FINISH		PPG
24064541BESB22 <sup>1)</sup>	4008321934291	64541 B ECO 18W 240V B22D	18	240	220	2,000	BC/B22d	Clear	20	17
24064541BES <sup>1)</sup>	4008321934307	64541 B ECO 18W 240V E14	18	240	220	2,000	SES/E14	Clear	20	17
24064542BB22	4008321919045	HEB2CB 64542 B ECO 28W 240V B22D	28	240	345	2,000	BC/B22d	Clear	20	17
24064542B	4008321229304	HEB2CE 64542 B ECO 28W 240V E14	28	240	345	2,000	SES/E14	Clear	20	17
24064543BESB22	4008321934321	64543 B ECO 42W 240V B22D	42	240	630	2,000	BC/B22d	Clear	20	17
24064543BES	4008321934338	64543 B ECO 42W 240V E14	42	240	630	2,000	SES/E14	Clear	20	17

1) Banned from 1.9.2012 as per EU phase-out plan

All orders must be multiples of sales pack

## Halogen Lamps – Mains Voltage

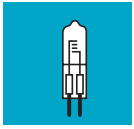

**HALOGEN  
ECO**

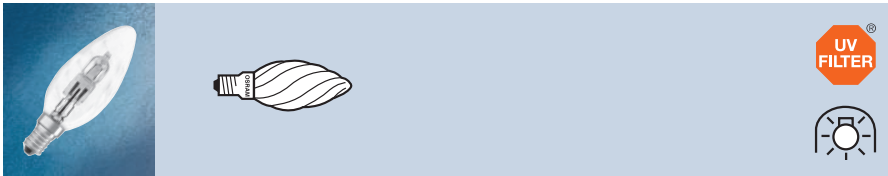

### HALOGEN CLASSIC BW ECO

- Mains voltage twisted candle shape lamps, no transformer required
- Fully dimmable
- Direct eco replacement for basic incandescent candle lamps

Product ID Code	EAN (Single Pack)	Product Description	W	V	lm	t[h]		FINISH		PPG
24064542BWES	4008321934352	64542 BW ECO 28W 240V E14	28	240	345	2,000	SES/E14	Clear	20	17

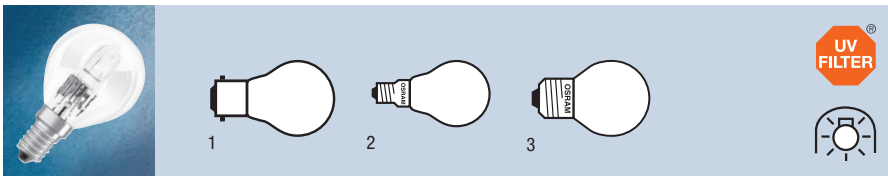

### HALOGEN CLASSIC P ECO

- Mains voltage globe shape lamps, no transformer required
- Fully dimmable
- Direct eco replacement for basic incandescent candle lamps

Product ID Code	EAN (Single Pack)	Product Description	W	V	lm	t[h]		FINISH	No.		PPG
64542PESE14	4008321952851	64542 P ECO 28W 240V E14	28	240	320	2,000	SES/E14	Clear	2	20	17
64543PES	4008321952875	64543 P ECO 42W 240V E14	42	240	580	2,000	SES/E14	Clear	2	20	17
64542PES	4008321952912	64542 P ECO 28W 240V E27	28	240	320	2,000	ES/ E27	Clear	3	20	17
64542PESB22	4008321952950	64542 P ECO 28W 240V B22D	28	240	320	2,000	BC/ B22d	Clear	1	20	17
64543PESB22	4008321952998	64543 P ECO 42W 240V B22D	42	240	580	2,000	BC/ B22d	Clear	1	20	17

NEW  
NEW  
NEW  
NEW

All orders must be multiples of sales pack

Halogen Lamps – Mains Voltage

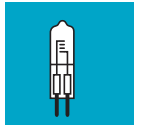
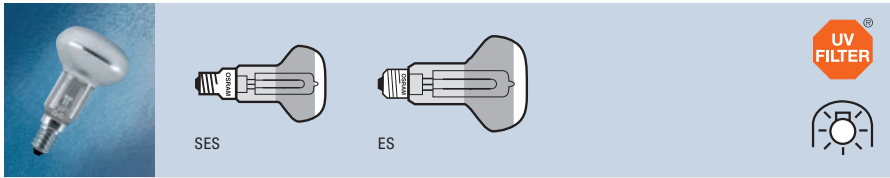

**HALOGEN SPOT R50/R63 ECO**

- Mains voltage reflector shape lamps, no transformer required
- R50 and R63 sizes
- Fully dimmable
- Direct eco replacement for basic incandescent reflector lamps

Product ID Code	EAN (Single Pack)	Product Description	W	V	lm	t [h]			PPG
24064545	4008321229328	HER528 64545 R50ECO 28W 240V E14	28	240	430	2,000	SES/E14 30°	20	17
24064546	4008321229342	HER642 64546 R63ECO 42W 240V E27	42	240	960	2,000	ES/E27 30°	20	17

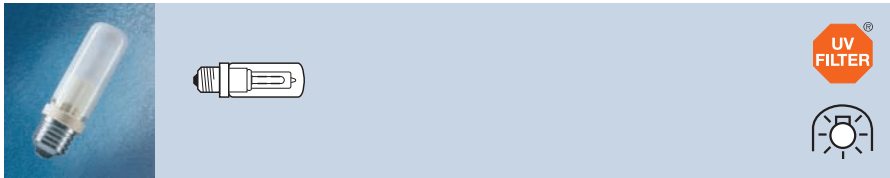

**HALOLUX CERAM® ECO**

- New generation single ended mains voltage lamps
- Up to 20% more lumen per watt
- Lamp life 2,000 hours
- Ideal for uplighting and wall washing

Product ID Code	EAN (Single Pack)	Product Description	W	V	lm	t [h]		FINISH		PPG
64401	4008321393906	64401 ECO 100W 240V E27	100	240	1800	2,000	ES/E27	Clear	12	17
64402	4008321393920	64402 ECO 150W 240V E27	150	240	2870	2,000	ES/E27	Clear	12	17
64404	4008321393944	64404 ECO 205W 240V E27	200	240	4200	2,000	ES/E27	Clear	12	17

NEW  
NEW  
NEW

All orders must be multiples of sales pack

## Halogen Lamps – Mains Voltage

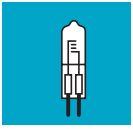

HALOGEN  
ECO

### HALOLINE® ECO

- Mains voltage double ended linear lamps, no transformer required
- Fully dimmable
- Ideal for uplighters, floodlights and security lighting

Product ID Code	EAN (Single Pack)	Product Description	W	V	lm	t [h]		FINISH		PPG
64684ECO	4008321945112	64684 ECO 48W 240V R7S	48	240	800	2,000	R7s	Clear	20	15
24064690ES	4008321325396	64690 ECO 80W 240V R7S	80	240	1500	2,000	R7s	Clear	20	15
24064695ES	4008321325419	64695 ECO 120W 240V R7S	120	240	2300	2,000	R7s	Clear	20	15
64696ECO	4008321952677	64696 ECO 120W 240V R7S	120	240	2300	2,000	R7s	Clear	20	15
64698	4008321955630	64698 ECO 160W 240V R7S	160	240	3300	2,000	R7s	Clear	20	15
24064701ES	4008321275622	HEK230 64701 ECO 230W 240V R7S	230	240	5060	2,000	R7s	Clear	20	15
24064702ES	4008321275646	HEK400 64702 ECO 400W 240V R7S	400	240	9200	2,000	R7s	Clear	20	15

NEW  
NEW  
NEW



### HALOLINE®

- Double ended linear halogen lamps
- Mains voltage
- Fully dimmable
- Ideal for uplighters, floodlights and security lighting

Product ID Code	EAN (Single Pack)	Product Description	W	V	lm	t [h]		FINISH		PPG
12064702	4050300297040	K1LV 64700 500W 115-120V R7S	500	110	-	2,000	R7s	Clear	20	16
24064740	4050300209906	K4 64740 1000W 240V R7S	1000	240	2200	2,000	R7s	Clear	12	16
24064760	4050300209920	K5 64760 1500W 240V R7S	1500	240	3600	2,000	R7s	Clear	12	16

All orders must be multiples of sales pack



Halogen Lamps – Low Voltage

**HALOGEN LAMPS – LOW VOLTAGE**

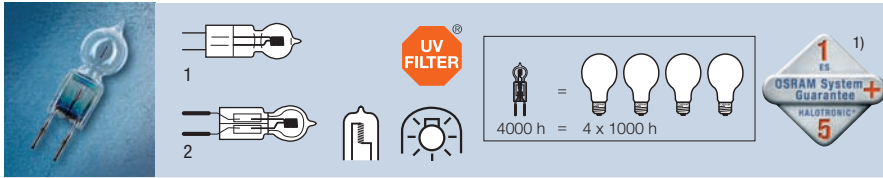

**HALOSTAR® ECO**

- Low voltage capsule lamps
- New G4 base the smallest HALOSTAR® ECO
- Approved for use in open luminaires to IEC 60598-1
- Fully dimmable
- Ideal eco alternative for open luminaires and free-burning applications

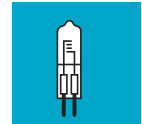

Product ID Code	EAN (Single Pack)	Product Description	W	V	lm	t [h]			PPG
64417	4008321963192	64417 ECO 7W 12V G4	7	12	-	4,000	G4	1	40 13
64423ES	4008321317964	64423 ECO 14W 12V G4	14	12	240	4,000	G4	1	40 13
64429ES	4050300987262	64429IRC 64429 ECO 25W 12V GY6,35	25	12	500	4,000	GY6.35	2	40 13
64432ES	4050300615905	M75IR 64432 ECO 35W 12V GY6,35	35	12	900	4,000	GY6.35	2	40 13
64440ES	4050300615936	M74IR 64440 ECO 50W 12V GY6,35	50	12	1250	4,000	GY6.35	2	40 13
64447ES	4050300785400	M205IR 64447 ECO 60W 12V GY6,35	60	12	1700	4,000	GY6.35	2	40 13

NEW  
NEW

Perfectly matched with HALOTRONIC® electronic control gear  
 1) For more information go to [www.osram.com/system-guarantee](http://www.osram.com/system-guarantee)

All orders must be multiples of sales pack

## Halogen Lamps – Low Voltage

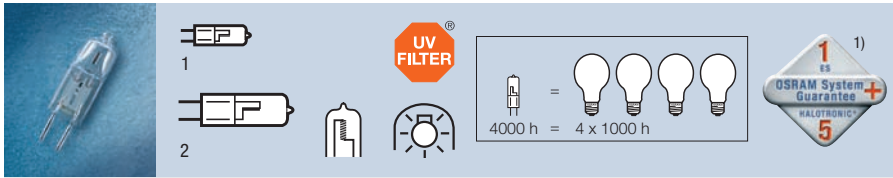
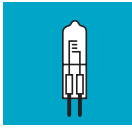

### HALOSTAR STARLITE®

- Low voltage capsule lamps
- Provides decorative and brilliant points of light
- Approved for use in open luminaires to IEC 60598-1
- Fully dimmable
- Ideal for open luminaires and free-burning applications

Product ID Code	EAN (Single Pack)	Product Description	W	V	lm	t[h]			No.	PPG
64405S <sup>2)</sup>	4050300335032	M9 64405 S 5W 12V G4	5	12	60	4,000	G4		1	40 13
64410S <sup>2)</sup>	4050300335131	M42 64410 S 10W 6V G4	10	6	110	4,000	G4		1	40 13
64415S <sup>2)</sup>	4050300335087	M91 64415 S 10W 12V GX4	10	12	130	4,000	G4		1	40 13
64425S <sup>2)</sup>	4050300335162	M47 64425 S 20W 12V G4	20	12	300	4,000	G4		1	40 13
64427S <sup>2)</sup>	4050300328171	M76 64427 S 20W 12V GY6,35	20	12	300	4,000	GY6,35		2	40 13
64432S <sup>2)</sup>	4050300017426	M75 64432 S 35W 12V GY6,35	35	12	600	4,000	GY6,35		2	40 13
64440S <sup>2)</sup>	4050300328201	M74 64440 S 50W 12V GY6,35	50	12	910	4,000	GY6,35		2	40 13
64450S <sup>2)</sup>	4050300490151	M154 64450 S 75W 12V GY6,35	75	12	1450	4,000	GY6,35		2	40 13
64458S <sup>2)</sup>	4050300490182	M180 64458 S 90W 12V GY6,35	90	12	1800	4,000	GY6,35		2	40 13

Perfectly matched with HALOTRONIC® electronic control gear  
 1) For more information go to [www.osram.com/system-guarantee](http://www.osram.com/system-guarantee)  
 2) Banned from 1.9.2016 as per EU phase-out plan

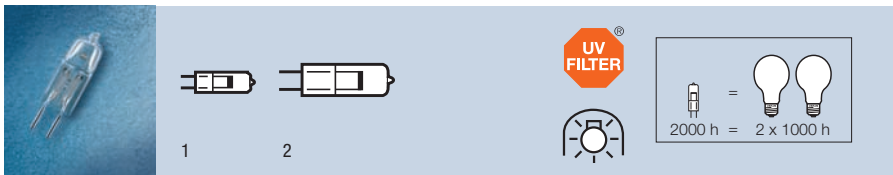

### HALOSTAR® STANDARD

- Low voltage capsule lamps
- Economical choice for general applications
- Approved for use in open luminaires to IEC 60598-1
- Fully dimmable
- Ideal for enclosed luminaires

Product ID Code	EAN (Single Pack)	Product Description	W	V	lm	t[h]			No.	PPG
64435U	4050300335513	M88 64435 U 20W 24V G4	20	24	320	2,000	G4		1	40 13
64440 <sup>1)</sup>	4050300324432	M32 64440 50W 12V GY6,35	50	12	910	2,000	GY6,35		2	40 13
64445U	4050300335544	M89 64445 U AX 50W 24V GY6,35	50	24	900	2,000	GY6,35		2	40 13
64460U	4050300335667	M90 64460 U AX 100W 24V GY6,35	100	24	2200	2,000	GY6,35		2	40 13
64465U	4050300335698	M196 64465 150W 24V GY6,35	150	24	3200	2,000	GY6,35		2	40 13

Perfectly matched with HALOTRONIC® electronic control gear  
 1) Banned from 1.9.2016 as per EU phase-out plan

All orders must be multiples of sales pack

## Halogen Lamps – Low Voltage

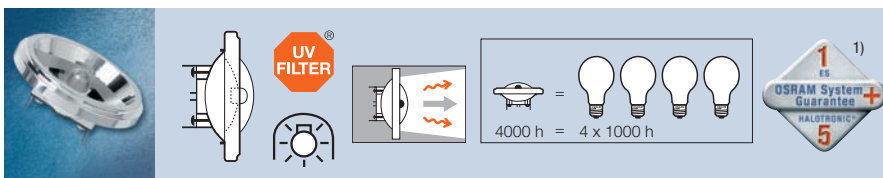

### HALOSPOT® 111 ECO

- Low voltage aluminium reflector lamps
- 111mm diameter
- 48% cost saving due to Infra-red coating (IRC)
- Approved for use in open luminaires to IEC 60598-1
- Fully dimmable
- Ideal for shop lighting restaurants, hotels, art galleries etc

Product ID Code	EAN (Single Pack)	Product Description	W	V	lm	t [h]					PPG
48832ESFL	4008321201201	47832 ECO FL UVS 35W 12V G53	35	12	4200	4,000	G53	Flood 24°	6	17	
48832SPES	4050300656823	M202IR 48832 ECO SP 35W 12V G53	35	12	–	4,000	G53	Spot 8°	6	17	
48832FLES	4050300656847	M353IR 48832 ECO FL 35W 12V G53	35	12	–	4,000	G53	Flood 24°	6	17	
48835SPES	4050300656861	M101IR 48835 ECO SP 50W 12V G53	50	12	–	4,000	G53	Spot 8°	6	17	
48835FLES	4050300656885	M161IR 48835 ECO FL 50W 12V G53	50	12	–	4,000	G53	Flood 24°	6	17	
48835WFLES	4008321909237	48835WFL 48835 ECOWFL 50W 12V G53	50	12	–	4,000	G53	Wide flood 45°	6	17	
48837SPES	4050300786070	M203IR 48837 ECO SP 60W 12V G53	65	12	–	4,000	G53	Spot 8°	6	17	
48837FLES	4050300786094	M204IR 48837 ECO FL 60W 12V G53	65	12	–	4,000	G53	Flood 24°	6	17	
48837WFLES	4008321909251	48837WFL 48837 ECOWFL 60W 12V G53	65	12	–	4,000	G53	Wide flood 45°	6	17	

Perfectly matched with HALOTRONIC® electronic control gear  
 1) For more information go to [www.osram.com/system-guarantee](http://www.osram.com/system-guarantee)

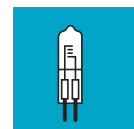

All orders must be multiples of sales pack

## Halogen Lamps – Low Voltage

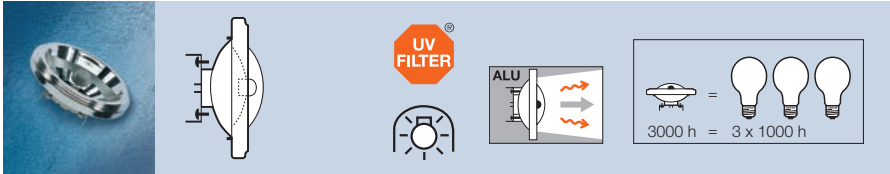
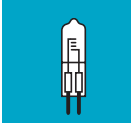
**HALOSPOT® 111**

- Low voltage aluminium reflector lamps
- 111mm diameter
- Approved for use in open luminaires to IEC 60598-1
- Fully dimmable
- Ideal for accent lighting over large distances

Product ID Code	EAN (Single Pack)	Product Description	W	V	t(h)				PPG
41830SSP	4050300011141	M163 41830 SSP 35W 6V G53	35	6	3,000	G53	Super Spot 4°	6	17
41832SSP	4050300335728	M351 41832 SSP 35W 12V G53	35	12	3,000	G53	Super Spot 4°	6	17
41832FL	4050300335766	M353 UVS 35W 12V G53	35	12	3,000	G53	Flood 24°	6	17
41835SSP	4050300011165	M100 41835 SSP 50W 12V G53	50	12	3,000	G53	Super Spot 4°	6	17
41835SP	4050300011752	M101 41835 SP 50W 12V G53	50	12	3,000	G53	Spot 8°	6	17
41835FL	4050300011769	M161 41835 FL 50W 12V G53	50	12	3,000	G53	Flood 24°	6	17
41835WFL	4008321909213	41835 WFL 50W 12V G53	50	12	3,000	G53	Wide flood 45°	6	17
41840SP	4050300011776	M102 41840 SP ND 75W 12V G53	75	12	3,000	G53	Spot 8°	6	17
41840FL	4050300011783	M162 41840 FL ND 75W 12V G53	75	12	3,000	G53	Flood 24°	6	17
41840WFL	4050300011790	M103 41840 WFL ND 75W 12V G53	75	12	3,000	G53	Wide flood 45°	6	17
41850SP	4050300358604	M114 41850 SP ND 100W 12V G53	100	12	3,000	G53	Spot 8°	6	17
41850FL	4050300358628	M152 41850 FL ND 100W 12V G53	100	12	3,000	G53	Flood 24°	6	17
41850WFL	4050300358642	M191 41850 WFL ND 100W 12V G53	100	12	3,000	G53	Wide flood 45°	6	17

Perfectly matched with HALOTRONIC® electronic control gear

All orders must be multiples of sales pack

## Halogen Lamps – Low Voltage

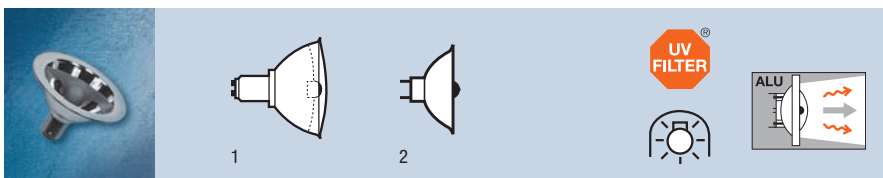

### HALOSPOT® 70, 48

- Low voltage aluminium reflector lamps
- 70mm and 48mm diameter
- Ideal for accent lighting

Product ID Code	EAN (Single Pack)	Product Description	W	V	t(h)					PPG
<b>70mm diameter</b>										
41970SP	4050300010656	M155 41970 SP 20W 12V BA15D	20	12	3,000	B15d	Spot 8°	1	10	17
41970FL	4050300011110	M156 41970 FL 20W 12V BA15D	20	12	3,000	B15d	Flood 24°	1	10	17
41990SP	4050300011158	M157 41990 SP 50W 12V BA15D	50	12	3,000	B15d	Spot 8°	1	10	17
41990FL	4050300004020	M158 41990 FL 50W 12V BA15D	50	12	3,000	B15d	Flood 24°	1	10	17
<b>48mm diameter</b>										
41900SP	4050300003962	M108 41900 SP 20W 12V GY4	20	12	2,000	GY4	Spot 8°	2	10	17
41930SP	4050300003979	M107 41930 SP 20W 24V GY4	20	24	1,000	GY4	Spot 8°	2	10	17

Perfectly matched with HALOTRONIC® electronic control gear

All orders must be multiples of sales pack

## Halogen Lamps – Low Voltage

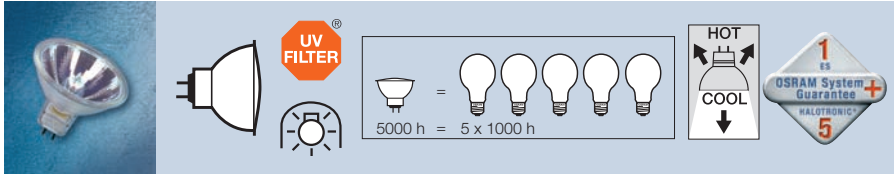
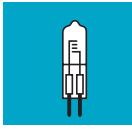

HALOGEN  
ECO

### DECOSTAR® 51 ECO

- Long life low voltage dichroic reflector lamps
- Up to 65% cost saving due to Infra-red coating (IRC)
- 51mm diameter with cover glass
- Fully dimmable
- Approved for use in open luminaires to IEC 60598-1
- Ideal for reduced running costs in display lighting

Product ID Code	EAN (Single Pack)	Product Description	W	V	lm	t(h)		FINISH °		PPG
48855ESSP	4008321945020	48855 ECO SP 14W 12V GU5,3	14	12	2800	5,000	GU5.3	Spot 10°	20	17
48855ESWFL	4008321945044	48855 ECO WFL 14W 12V GU5,3	14	12	480	5,000	GU5.3	Wide flood 36°	20	17
48860SP	4050300620169	M268IR 48860 SP 20W 12V GU5,3	20	12	5500	5,000	GU5.3	Spot 10°	20	17
48860FL	4050300620183	M294IR 48860 FL 20W 12V GU5,3	20	12	2000	5,000	GU5.3	Flood 24°	20	17
48860WFL	4050300620206	M269IR 48860 ECO WFL 20W 12V GU5,3	20	12	1000	5,000	GU5.3	Wide flood 36°	20	17
48860VWFL	4050300620220	M290IR 48860 ECO VWFL 20W 12V GU5,3	20	12	450	5,000	GU5.3	Very wide flood 60°	20	17
48865SP	4050300516592	M271IR 48865 SP 35W 12V GU5,3	35	12	11000	5,000	GU5.3	Spot 10°	20	17
48865FL	4050300516615	M270IR 48865 ECO FL 35W 12V GU5,3	35	12	4100	5,000	GU5.3	Flood 24°	20	17
48865WFL	4050300516639	M281IR 48865 ECO WFL 35W 12V GU5,3	35	12	2200	5,000	GU5.3	Wide flood 36°	20	17
48865VWFL	4050300516653	M224IR 48865 ECO VWFL 35W 12V GU5,3	35	12	1050	5,000	GU5.3	Very wide flood 60°	20	17
48870SP	4050300516677	M249IR 48870 SP 50W 12V GU5,3	50	12	15000	5,000	GU5.3	Spot 10°	20	17
48870FL	4050300516691	M250IR 48870 FL 50W 12V GU5,3	50	12	5300	5,000	GU5.3	Flood 24°	20	17
48870WFL	4050300516714	M258IR 48870 WFL 50W 12V GU5,3	50	12	2850	5,000	GU5.3	Wide flood 36°	20	17
48870VWFL	4050300516738	M280IR 48870 VWFL 50W 12V GU5,3	50	12	1450	5,000	GU5.3	Very wide flood 60°	20	17

NEW  
NEW

Perfectly matched with HALOTRONIC® electronic control gear  
1) For more information go to [www.osram.com/system-guarantee](http://www.osram.com/system-guarantee)

All orders must be multiples of sales pack

Halogen Lamps – Low Voltage

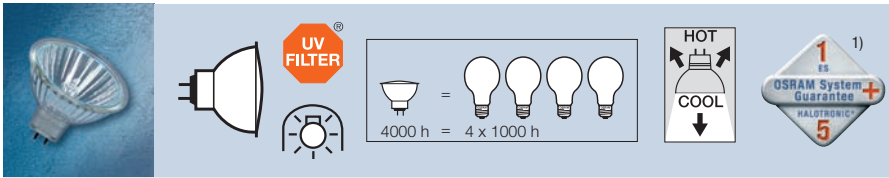

**DECOSTAR® 51 TITAN**

- Long life low voltage dichroic reflector lamps
- 51mm diameter with cover glass
- Dichroic reflector reduces the heat in the light beam up to 66%
- Fully dimmable and approved for use in open luminaires to IEC 60598-1
- Ideal for professional display lighting

Product ID Code	EAN (Single Pack)	Product Description	W	V	t(h)	Finish	Beam	PPG
46860SP	4050300428635	M268T 46860 SP 20W 12V GU5,3	20	12	4,000	GU5,3	Spot 10°	20 13
46860WFL	4050300428659	M269T 46860 WFL 20W 12V GU5,3	20	12	4,000	GU5,3	Wide flood 36°	20 13
46860WVFL	4050300428673	M290T 46860 WVFL 20W 12V GU5,3	20	12	4,000	GU5,3	Very wide flood 60°	20 13
46865SP	4050300428697	M271T 46865 SP 35W 12V GU5,3	35	12	4,000	GU5,3	Spot 10°	20 13
46865FL	4050300476414	M270T 46865 FL 35W 12V GU5,3	35	12	4,000	GU5,3	Flood 24°	20 13
46865WFL	4050300428710	M281T 46865 WFL 35W 12V GU5,3	35	12	4,000	GU5,3	Wide flood 36°	20 13
46865WVFL	4050300428734	M224T 46865 WVFL 35W 12V GU5,3	35	12	4,000	GU5,3	Very wide flood 60°	20 13
46870SP	4050300428758	M249T 46870 SP 50W 12V GU5,3	50	12	4,000	GU5,3	Spot 10°	20 13
46870FL	4050300465708	M250T 46870 FL 50W 12V GU5,3	50	12	4,000	GU5,3	Flood 24°	20 13
46870WFL	4050300428772	M258T 46870 WFL 50W 12V GU5,3	50	12	4,000	GU5,3	Wide flood 36°	20 13
46870WVFL	4050300428796	M280T 46870 WVFL 50W 12V GU5,3	50	12	4,000	GU5,3	Very wide flood 60°	20 13

Perfectly matched with HALOTRONIC® electronic control gear  
 1) For more information go to [www.osram.com/system-guarantee](http://www.osram.com/system-guarantee)



All orders must be multiples of sales pack

## Halogen Lamps – Low Voltage

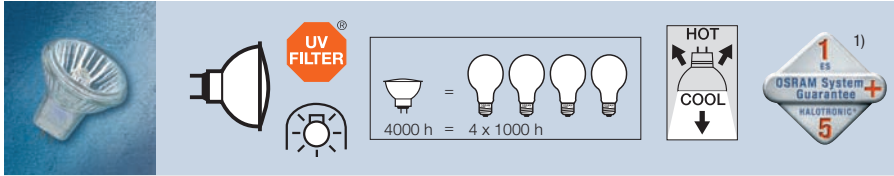
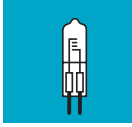

### DECOSTAR® 35 TITAN

- Long life low voltage dichroic reflector lamps
- 35mm diameter
- Dichroic reflector reduces the heat in the light beam up to 66%
- Fully dimmable and approved for use in open luminaires to IEC 60598-1
- Ideal for professional display lighting

Product ID Code	EAN (Single Pack)	Product Description	W	V	t (h)				PPG
46890SP	4050300529301	M252T 46890 SP 20W 12V GU4	20	12	4,000	GU4	Spot 10°	20	13
46890WFL	4050300529325	M221T 46890 WFL 20W 12V GU4	20	12	4,000	GU4	Wide flood 36°	20	13
46892SP	4050300529349	M265T 46892 SP 35W 12V GU4	35	12	4,000	GU4	Spot 10°	20	13
46892WFL	4050300529363	M223T 46892 WFL 35W 12V GU4	35	12	4,000	GU4	Wide flood 36°	20	13

Perfectly matched with HALOTRONIC® electronic control gear  
 1) For more information go to [www.osram.com/system-guarantee](http://www.osram.com/system-guarantee)



### DECOSTAR® 51 STANDARD

- Low voltage dichroic reflector lamps
- 51mm diameter
- Approved for use in open luminaires to IEC 60598-1
- Fully dimmable
- Ideal for economical display lighting

Product ID Code	EAN (Single Pack)	Product Description	W	V	lm	t (h)				PPG
41860SP	4050300012612	M68 41860 SP 20W 12V GU5,3	20	12	3000	2,000	GU5.3	Spot 10°	20	14
41860WFL	4050300012629	M69 41860 WFL 20W 12V GU5,3	20	12	-	2,000	GU5.3	Wide flood 36°	20	14
41865SP	4050300026527	M71 41865 SP 35W 12V GU5,3	35	12	-	2,000	GU5.3	Spot 10°	20	14
41865WFL	4050300026541	M81 41865 WFL AX 35W 12V GU5,3	35	12	-	2,000	GU5.3	Wide flood 36°	20	14
41870SP	4050300012636	M49 41870 SP 50W 12V GU5,3	50	12	-	2,000	GU5.3	Spot 10°	20	14
41870FL	4050300012551	M50 41870 FL 50W 12V GU5,3	50	12	-	2,000	GU5.3	Flood 24°	20	14
41870WFL	4050300012575	M58 41870 WFL 50W 12V GU5,3	50	12	-	2,000	GU5.3	Wide flood 36°	20	14

Perfectly matched with HALOTRONIC® electronic control gear

All orders must be multiples of sales pack



## Halogen Lamps – Low Voltage

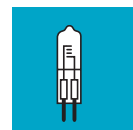
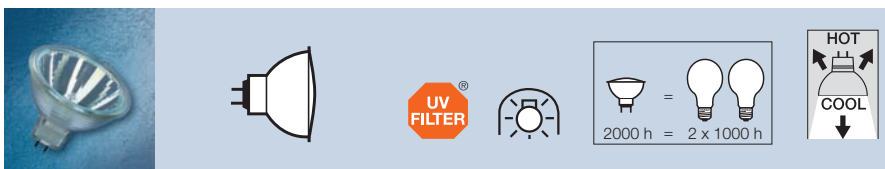

### DECOSTAR® 51S STANDARD

- Low voltage dichroic reflector lamps
- 51 mm diameter
- With cover glass
- Approved for use in open luminaires to IEC 60598-1
- Fully dimmable
- Ideal for economical display lighting

Product ID Code	EAN (Single Pack)	Product Description	W	V	t(h)					PPG
44860SP	4050300272474	M268 44860 SP 20W 12V GU5,3	20	12	2,000	GU5.3	Spot 10°	20	14	
44860WFL	4050300272511	M269 44860 WFL 20W 12V GU5,3	20	12	2,000	GU5.3	Wide flood 36°	20	14	
44865SP	4050300272559	M271 44865 SP 35W 12V GU5,3	35	12	2,000	GU5.3	Spot 10°	20	14	
44865WFL	4050300272634	M281 44865 WFL 35W 12V GU5,3	35	12	2,000	GU5.3	Wide flood 36°	20	14	
44870SP	4050300272672	M249 44870 SP 50W 12V GU5,3	50	12	2,000	GU5.3	Spot 10°	20	14	
44870FL	4050300272719	M250 44870 FL 50W 12V GU5,3	50	12	2,000	GU5.3	Flood 24°	20	14	
44870WFL	4050300272795	M258 44870 WFL 50W 12V GU5,3	50	12	2,000	GU5.3	Wide flood 36°	20	14	

Perfectly matched with HALOTRONIC® electronic control gear



### DECOSTAR® 51 ALU

- Low voltage aluminised reflector lamps
- 51 mm diameter
- Without cover glass
- Fully dimmable
- Approved for use in open luminaires to IEC 60598-1
- Ideal for reducing heat build up in luminaires

Product ID Code	EAN (Single Pack)	Product Description	W	V	t(h)					PPG
41861WFL	4050300428819	M69A 41861 WFL 20W 12V GU5,3	20	12	2,000	GU5.3	Wide flood 36°	20	13	
41866WFL	4050300428833	M81A 41866 WFL 35W 12V GU5,3	35	12	2,000	GU5.3	Wide flood 36°	20	13	
41871WFL	4050300428857	M58A 41871WFL 50W 12V GU5,3	50	12	2,000	GU5.3	Wide flood 36°	20	13	

Perfectly matched with HALOTRONIC® electronic control gear

All orders must be multiples of sales pack

## Halogen Lamps – Low Voltage

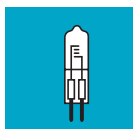

### DECOSTAR® 51 COOL BLUE®

- 4500K cool colour dichroic lamp
- Low voltage
- 51mm diameter
- Dichroic reflector reduces the heat in the light beam up to 66%
- Fully dimmable and approved for use in open luminaires to IEC 60598-1
- Ideal for jewellers, galleries and any other installation where a “cool light” is required

Product ID Code	EAN (Single Pack)	Product Description	W	V	t [h]	FINISH	PPG
46871WFL	4050300816661	M258CB 46871 WFL 50W 12V CB GU5,3	50	12	4,000	GU5.3 Wide flood 36°	20 13

Perfectly matched with HALOTRONIC® electronic control gear

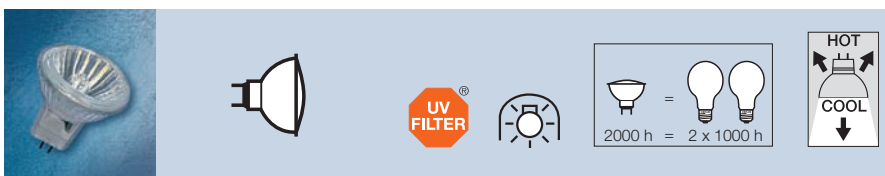

### DECOSTAR® 35 STANDARD

- Low voltage dichroic reflector lamps
- 35mm diameter
- Fully dimmable and approved for use in open luminaires to IEC 60598-1
- Ideal for economical display lighting

Product ID Code	EAN (Single Pack)	Product Description	W	V	t [h]	FINISH	PPG
44888WFL	4050300443935	M200 44888 WFL 10W 12V GU4	10	12	2,000	GU4 Wide flood 36°	10 13
44890SP	4050300346090	M252 44890 SP 20W 12V GU4	20	12	2,000	GU4 Spot 10°	10 13
44890WFL	4050300346168	M221 44890 WFL 20W 12V GU4	20	12	2,000	GU4 Wide flood 36°	10 13
44892SP	4050300346182	M265 44892 SP 35W 12V GU4	35	12	2,000	GU4 Spot 10°	10 13
44892WFL	4050300346229	M223 44892 WFL 35W 12V GU4	35	12	2,000	GU4 Wide flood 36°	10 13

Perfectly matched with HALOTRONIC® electronic control gear

All orders must be multiples of sales pack

## Halogen Lamps – Low Voltage

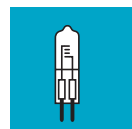
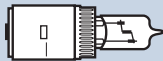
**TRAFFIC SIGNAL LAMPS**

- Low voltage capsule lamps for traffic signalling

Product ID Code	EAN (Single Pack)	Product Description	W	V	t (h)		FINISH		PPG
SIG64015	4050300217543	M133 SIG 64015 50W 10V PKX22S	50	10	750	PKX22s	Clear	100	38
SIG64016	4050300837741	M32TS SIG 64016 50W 12V GY6,35	50	12	900	GY6.35	Clear	100	13
SIG64004	4050300245225	M135 SIG 64004 CL 50W 10V K23D	50	10	350	K23d	Clear	10	38

Perfectly matched with HALOTRONIC® electronic control gear

All orders must be multiples of sales pack

COMPACT FLUORESCENT LAMPS



# Compact Fluorescent Lamps Contents.

## RETROFIT COMPACT FLUORESCENT LAMPS

OSRAM DULUX® INTELLIGENT LONGLIFE	36
OSRAM DULUX® INTELLIGENT VARIO & DIM	37
OSRAM DULUX® INTELLIGENT FACILITY	38
OSRAM DULUX® INTELLIGENT SENSOR	39
OSRAM DULUX® INTELLIGENT SOLAR 12V DC	40
OSRAM DULUX® SUPERSTAR	40
OSRAM DULUX® SUPERSTAR CLASSIC	42
OSRAM DULUX® SUPERSTAR MICRO TWIST	43
OSRAM DULUX SUPERSTAR CIRCOLUX® EL	44
OSRAM DULUXSTAR® STICK	45
OSRAM DULUXSTAR® CLASSIC	46
OSRAM DULUXSTAR® MINI BALL	47
OSRAM DULUXSTAR® MINI BULLET P	47
OSRAM DULUXSTAR® Mini Globe and Globe	49
OSRAM DULUXSTAR® Mini Twist	50
OSRAM DULUXSTAR® Nano Twist	51

## PIN BASED COMPACT FLUORESCENT LAMPS

OSRAM DULUX® T PLUS	52
OSRAM DULUX® T/E PLUS	53
OSRAM DULUX® T/E CONSTANT (IN PLUS)	54
OSRAM DULUX® T/E High Efficiency	55
OSRAM DULUX® T/E XT for ECG	55
OSRAM DULUX® D	56
OSRAM DULUX® D ENERGY SAVER	57
OSRAM DULUX® D /E	58
OSRAM DULUX® D/E XT for ECG	59
OSRAM DULUX® S	60
OSRAM DULUX® S COLOURED	61
OSRAM DULUX® S/E	61
OSRAM DULUX® L LUMILUX®	62
OSRAM DULUX® L CONSTANT	63
OSRAM DULUX® L LUMILUX® DE LUXE	63
OSRAM DULUX® L SP	64
OSRAM DULUX® L HIGH EFFICIENCY	64
OSRAM DULUX® L XT	65
OSRAM DULUX® F	66
OSRAM CFL SQUARE	67
OSRAM ENDURA®	67

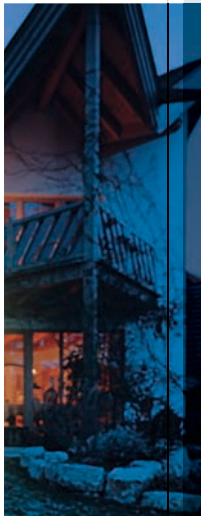



## COMPACT FLUORESCENT LAMPS – RETROFIT

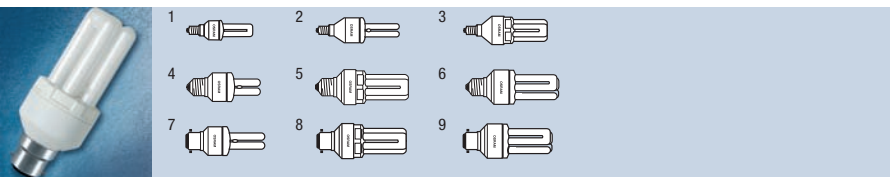

### OSRAM DULUX® INTELLIGENT LONGLIFE

- Retrofit “stick shape” electronic energy saving compact fluorescent lamp
- Up to 80% energy saving
- New QUICKlight technology improves run up time by >50%
- NEW Colour 825 – Warm comfort light the first CFLi light colour with the appearance of GLS
- Ideal for replacing inefficient incandescent lamps



Product ID Code	EAN (Single Pack)	Product Description	t[h]	W	V	lm			No.		PPG
DEL5*	4050300357430	DINT LL 5W/825 E27	20,000	5	220-240	250	ES/E27	825	4	10	27
DEL7*	4050300288819	DINT LL 7W/825 E27	20,000	7	220-240	365	ES/E27	825	4	10	27
DEL11*	4050300811598	DINT LL 11W/825 E27	20,000	11	220-240	620	ES/E27	825	5	10	27
DEL14825*	4008321394965	DINT LL 14W/825 E27	20,000	14	220-240	800	ES/E27	825	5	10	27
DEL18825*	4008321394989	DINT LL 18W/825 E27	20,000	18	220-240	1050	ES/E27	825	5	10	27
DEL22LL	4008321953469	DINT LL 22W/825 E27	20,000	22	220-240	1410	ES/E27	825	5	10	27
DEL30827*	4008321935939	DINT LL 30W/825 E27	20,000	30	220-240	1920	ES/E27	825	6	10	27
DEL7B22	4050300240329	DINT LL 7W/825 B22D	20,000	7	220-240	365	BC/B22d	825	7	10	27
DEL11B22	4050300811611	DINT LL 11W/827 B22D	20,000	11	220-240	620	BC/B22d	825	7	10	27
DEL14B22	4008321440440	DINT LL 14W/825 B22D	20,000	14	220-240	800	BC/B22d	825	8	10	27
DEL18B22	4008321440464	DINT LL 18W/825 B22D	20,000	18	220-240	1050	BC/B22d	825	8	10	27
DEL22B22	4008321440488	DINT LL 22W/825 B22D	20,000	22	220-240	1410	BC/B22d	825	8	10	27
DEL30B22	4050300856889	DINT LL 30W/825 B22D	20,000	30	220-240	1920	BC/B22d	825	9	10	27
DEL5E14*	4050300314747	DINT LL 5W/825 E14	20,000	5	220-240	250	SES/E14	825	1	10	27
DEL7E14*	4050300315157	DINT LL 7W/825 E14	20,000	7	220-240	365	SES/E14	825	2	10	27
DEL11E14*	4050300811451	DINT LL 11W/825 E14	20,000	11	220-240	620	SES/E14	825	3	10	27

\* Also available on request in colour 840 (Cool White) for further information contact OSRAM

All orders must be multiples of sales pack



## Compact Fluorescent Lamps – Retrofit

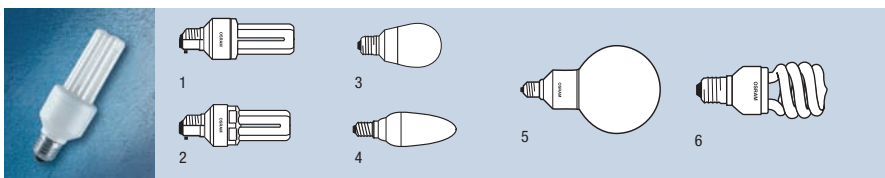

### OSRAM DULUX® INTELLIGENT VARIO & DIM

- VARIO offers two stage dimming 100% and 30% light using a standard on/off light switch
- DIM offers stepless dimming from 7% to 100% light out put using a standard household rotary dimmer switch
- New QUICKlight technology improves run up time by >50%
- NEW Colour 825 – Warm comfort light the first CFLi light colour with the appearance of GLS
- Ideal for providing relaxed lighting in the home

Product ID Code	EAN (Single Pack)	Product Description	t [h]	W	V	lm				No.		PPG
<b>VARIO</b>												
DEL18VAR	4008321953421	DINT VARIO STICK 18W/825 E27	20,000	18	220-240	1200	ES/E27	825	2	10	27	
DEL18VARB22	4008321954503	DINT VARIO STICK 18W/825 B22D	20,000	18	220-240	1200	BC/B22d	825	2	10	27	
<b>DIM</b>												
DEL18DIMB22	4008321954541	DINT DIM STICK 18W/825 B22D	20,000	18	220-240	1050	BC/B22d	825	1	10	27	
DEL18DIM	4008321953445	DINT DIM STICK 18W/825 E27	20,000	18	220-240	1050	ES/E27	825	1	10	27	
DEL15DIMGL	4008321924209	DINT DIM GLOBE 15W/825 E27	20,000	15	220-240	830	ES/E27	825	5	10	27	
-	4008321953520*	DINT DIM MINIBALL 15W/825 E27	20,000	15	220-240	-	ES/E27	825	3	10	27	
-	4008321953568*	DINT DIM MINI CANDLE 11W/825 E27	20,000	11	220-240	-	ES/E27	825	4	10	27	
DEL20DINTW	4008321953605	DINT DIM TWIST 20W/825 E27	20,000	20	220-240	-	ES/E27	825	6	10	27	

\*In preparation at time of print. For further information please contact OSRAM



NEW  
NEW  
NEW

All orders must be multiples of sales pack

Compact Fluorescent Lamps – Retrofit

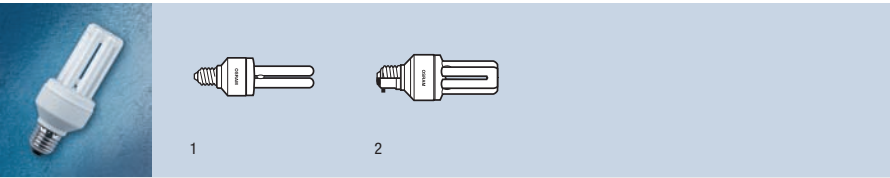

**OSRAM DULUX® INTELLIGENT FACILITY**

- Retrofit electronic energy saving compact fluorescent lamp for unlimited switching
- New QUICKlight technology improves run up time by >50%
- NEW Colour 825 – Warm comfort light the first CFLi light colour with the appearance of GLS
- Ideal where energy saving lamps need to be switched on and off frequently

Product ID Code	EAN (Single Pack)	Product Description	t [h]	W	V	Im		No.		PPG
<b>SES Cap</b>										
DEL10FCYE14	4008321126276	DINT FCY 10W/825 E14	20,000	10	220-240	550	SES/E14	825	1	10 27
<b>ES Cap</b>										
DEL10FCY	4008321126290	DINT FCY 10W/825 E27	20,000	10	220-240	550	ES/E27	825	2	10 27
DEL14FCY	4050300631905	DINT FCY 14W/825 E27	20,000	14	220-240	780	ES/E27	825	2	10 27
DEL18FCY	4008321118356	DINT FCY 18W/825 E27	20,000	18	220-240	1030	ES/E27	825	2	10 27
DEL22FCY	4008321948519	DINT FCY 22W/825 E27	20,000	22	220-240	1360	ES/E27	825	2	10 27
<b>BC Cap</b>										
DEL14FCYB22	4050300633718	DINT FCY 14W/825 B22d	20,000	14	220-240	780	BC/B22d	825	1	10 27

NEW

All orders must be multiples of sales pack





Compact Fluorescent Lamps – Retrofit

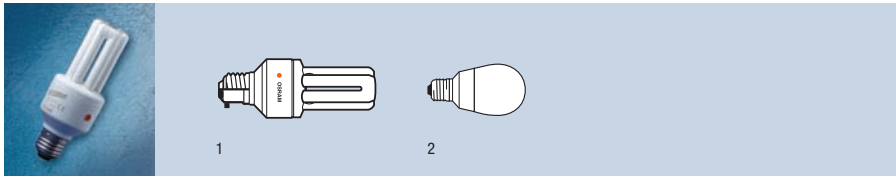

**OSRAM DULUX® INTELLIGENT SENSOR**

- Retrofit electronic energy saving compact fluorescent lamp with light sensor
- Fully automatic operation
- New QUICKlight technology improves run up time by >50%
- NEW Colour 825 – Warm comfort light the first CFLi light colour with the appearance of GLS
- Ideal for automatic dusk till dawn switching in outdoor security lighting

Product ID Code	EAN (Single Pack)	Product Description	t(h)	W	V	lm					PPG
<b>ES Cap</b>											
DEL11SEN	4008321102300	DINT SENSOR 11W/825 E27	20,000	11	220-240	560	ES/E27	825	1	10	27
DEL15SEN	4050300451299	DINT SENSOR 15W/825 E27	20,000	15	220-240	820	ES/E27	825	1	10	27
DSENS11MIBA	4008321377722	DINT SENSMIBA 11W/825 E27	20,000	11	220-240	630	ES/E27	825	2	10	27
<b>BC Cap</b>											
DEL15SEN22	4050300487694	DINT SENSOR 15W/825 B22D	20,000	15	220-240	820	BC/B22d	825	1	10	27



All orders must be multiples of sales pack

## Compact Fluorescent Lamps – Retrofit

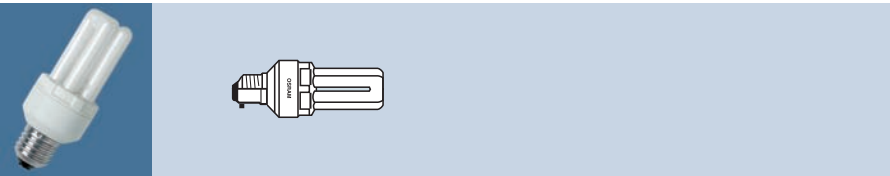

### OSRAM DULUX® INTELLIGENT 12V SOLAR DC

- Retrofit electronic energy saving compact fluorescent lamp
- Can be used with a 12V DC electrical supply
- New QUICKlight technology improves run up time by >50%
- NEW Colour 825 – Warm comfort light the first CFLi light colour with the appearance of GLS
- Ideal for camping and outdoor pursuits where mains electricity is not available

Product ID Code	EAN (Single Pack)	Product Description	t[h]	W	V	lm				PPG
<b>ES cap</b>										
DEL11DC	4008321118370	OSRAM DINT 11W/825 DC	10,000	11	12	540	ES/E27	825	10	27
DEL11840DC	4008321118394	OSRAM DINT 11W/840 DC	10,000	11	12	540	ES/E27	840	10	27
DEL11DCVAR	4008321118417	OSRAM DINT VARIO 11W/825 DC	10,000	11	12	600	ES/E27	825	10	27
DEL11840DCVAR	4008321118936	OSRAM DINT VARIO 11W/840 DC	10,000	11	12	600	ES/E27	840	10	27

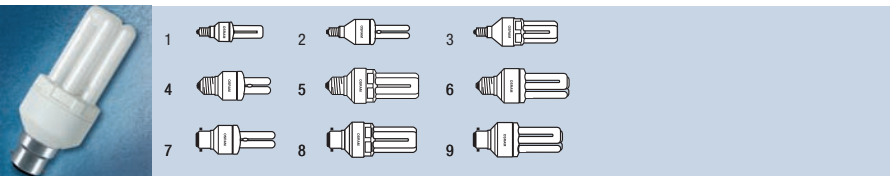

### OSRAM DULUX® SUPERSTAR STICK

- Retrofit “stick shape” electronic energy saving compact fluorescent lamp
- New QUICKlight technology improves run up time by >50%
- NEW Colour 825 – Warm comfort light the first CFLi light colour with the appearance of GLS
- Ideal for replacing inefficient incandescent lamps

Product ID Code	EAN (Single Pack)	Product Description	t[h]	W	V	lm			No.		PPG
DSU5825E14	4008321942845	DSST 5W/825 E14	15,000	5	220-240	250	SES/E14	825	1	10	27
DSU5840E14	4008321948571	DSST 5W/840 E14	15,000	5	220-240	250	SES/E14	840	1	10	27
DSU5865E14*	4008321948588	DSST 5W/865 E14	15,000	5	220-240	-	SES/E14	865	1	10	27
DSU5825	4008321942852	DSST 5W/825 E27	15,000	5	220-240	250	ES/E27	825	4	10	27
DSU5840	4008321948595	DSST 5W/840 E27	15,000	5	220-240	250	ES/E27	840	4	10	27
DSU5865*	4008321948601	DSST 5W/865 E27	15,000	5	220-240	-	ES/E27	865	4	10	27

\*Available on request in colour 865 (Cool Daylight)

Continued



All orders must be multiples of sales pack



Compact Fluorescent Lamps – Retrofit

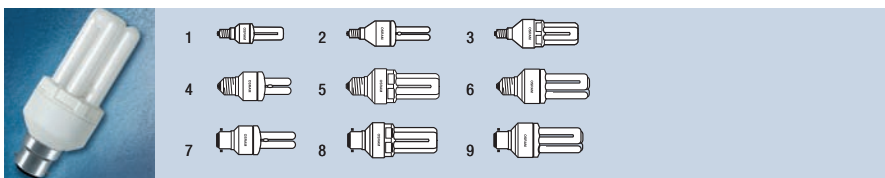

**OSRAM DULUX® SUPERSTAR STICK (continued)**

Product ID Code	EAN (Single Pack)	Product Description	t[h]	W	V	lm					PPG
DSU5825B22	4008321942869	DSST 5W/825 B22d	15,000	5	220-240	250	BC/B22d	825	7	10	27
DSU7825E14	4008321942876	DSST 7W/825 E14	15,000	7	220-240	365	SES/E14	825	2	10	27
DSU7840E14	4008321948618	DSST 7W/840 E14	15,000	7	220-240	365	SES/E14	840	2	10	27
DSU7865E14*	4008321948625	DSST 7W/865 E14	15,000	7	220-240	380	SES/E14	865	2	10	27
DSU7825	4008321942883	DSST 7W/825 E27	15,000	7	220-240	365	ES/E27	825	4	10	27
DSU7840	4008321942890	DSST 7W/840 E27	15,000	7	220-240	365	ES/E27	840	4	10	27
DSU7865*	4008321948632	DSST 7W/865 E27	15,000	7	220-240	380	ES/E27	865	4	10	27
DSU7825B22	4008321942906	DSST 7W/825 B22d	15,000	7	220-240	365	BC/B22d	825	7	10	27
DSU11825E14	4008321942913	DSST 11W/825 E14	15,000	11	220-240	620	SES/E14	825	3	10	27
DSU11840E14	4008321948649	DSST 11W/840 E14	15,000	11	220-240	620	SES/E14	840	3	10	27
DSU11865E14*	4008321948656	DSST 11W/865 E14	15,000	11	220-240	600	SES/E14	865	3	10	27
DSU11825	4008321942920	DSST 11W/825 E27	15,000	11	220-240	620	ES/E27	825	5	10	27
DSU11840	4008321942937	DSST 11W/840 E27	15,000	11	220-240	620	ES/E27	840	5	10	27
DSU11865*	4008321942944	DSST 11W/865 E27	15,000	11	220-240	600	ES/E27	865	5	10	27
DSU11825B22	4008321942951	DSST 11W/825 B22d	15,000	11	220-240	620	BC/B22d	825	7	10	27
DSU14825	4008321942968	DSST 14W/825 E27	15,000	14	220-240	800	ES/E27	825	5	10	27
DSU14840	4008321942975	DSST 14W/840 E27	15,000	14	220-240	800	ES/E27	840	5	10	27
DSU14865*	4008321942982	DSST 14W/865 E27	15,000	14	220-240	855	ES/E27	865	5	10	27
DSU14825B22	4008321942999	DSST 14W/825 B22d	15,000	14	220-240	800	BC/B22d	825	8	10	27
DSU18825	4008321943002	DSST 18W/825 E27	15,000	18	220-240	1050	ES/E27	825	5	10	27
DSU18840	4008321943019	DSST 18W/840 E27	15,000	18	220-240	1050	ES/E27	840	5	10	27
DSU18865*	4008321943026	DSST 18W/865 E27	15,000	18	220-240	1140	ES/E27	865	5	10	27
DSU18825B22	4008321943033	DSST 18W/825 B22d	15,000	18	220-240	1050	BC/B22d	825	8	10	27
DSST22825	4008321953360	DSST 22W/825 E27	15,000	22	220-240	1410	ES/E27	825	5	10	27
DSST22840	4008321953384	DSST 22W/840 E27	15,000	22	220-240	1410	ES/E27	840	5	10	27
DSST22B22	4008321954626	DSST 22W/825 B22d	15,000	22	220-240	1410	BC/B22d	825	8	10	27
DSU30825	4008321942753	DSST 30W/825 E27	15,000	30	220-240	1920	ES/E27	825	6	10	27
DSU30840	4008321942760	DSST 30W/840 E27	15,000	30	220-240	1920	ES/E27	840	6	10	27
DSST30B22	4008321953346	DSST 30W/825 B22d	15,000	30	220-240	1920	BC/B22d	825	9	10	27

\*Available on request in colour 865 (Cool Daylight)



All orders must be multiples of sales pack

Compact Fluorescent Lamps – Retrofit

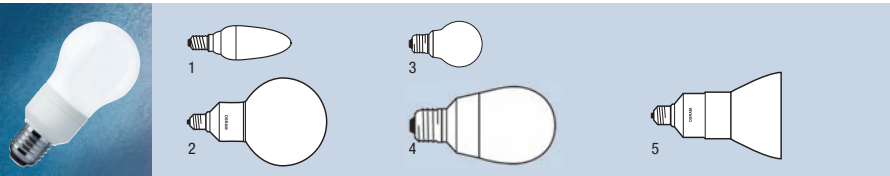

**OSRAM DULUX® SUPERSTAR CLASSIC**

- Retrofit “look-a-like” electronic energy saving compact fluorescent lamp
- New QUICKlight technology improves run up time by >50%
- Up to 80% energy saving
- NEW Colour 825 – Warm comfort light the first CFLi light colour with the appearance of GLS
- NEW compact versions: mini ball/ mini globe/ mini candle/globe/reflector
- Ideal for replacing inefficient incandescent lamps



Product ID Code	EAN (Single Pack)	Product Description	t [h]	W	V	lm			No.		PPG
<b>Mini Candle</b>											
DSST5MICA E14	4008321944535	DSST MICA 5W/825 E14	15,000	5	220-240	240	SES/E14	825	1	10	27
DSST5MICA	4008321944542	DSST MICA 5W/825 E27	15,000	5	220-240	240	ES/E27	825	1	10	27
DSST7MICA E14	4008321944559	DSST MIBA 7W/825 E14	15,000	7	220-240	300	SES/E14	825	1	10	27
DSST7MICA	4008321944566	DSST MIBA 7W/825 E27	15,000	7	220-240	300	ES/E27	825	1	10	27
<b>Globe</b>											
DSU14GL	4008321943873	DSST GL 14W/825 E27	15,000	14	220-240	830	ES/E27	825	2	10	27
DSU18GL	4008321943880	DSST GL 18W/825 E27	15,000	18	220-240	1040	ES/E27	825	2	10	27
<b>Mini Globe</b>											
DSST5MIGL	4008321943637	DSST MIGL 5W/825 E27	15,000	5	220-240	250	ES/E27	825	3	10	27
DSST7MIGL	4008321943675	DSST MIGL 7W/825 E27	15,000	7	220-240	360	ES/E27	825	3	10	27
DSST11MIGL	4008321943712	DSST MIGL 11W/825 E27	15,000	11	220-240	630	ES/E27	825	3	10	27
DSST15MIGL	4008321943736	DSST MIGL 15W/825 E27	15,000	15	220-240	850	ES/E27	825	3	10	27
DSST20MIGL	4008321949363	DSST MIGL 20W/825 E27	15,000	20	220-240	1160	ES/E27	825	3	10	27
DSST20MIGLB22	4008321414984	DSST MIGL 20W/825 B22D	15,000	20	220-240	1160	BC/B22d	825	3	10	27
DSST5MIGLE14	4008321943651	DSST MIGL 5W/825 E14	15,000	5	220-240	250	SES/E14	825	3	10	27
DSST7MIGLE14	4008321943699	DSST MIGL 7W/825 E14	15,000	7	220-240	360	SES/E14	825	3	10	27
<b>Miniball</b>											
DSST5MIBA	4008321943439	DSST MIBA 5W/825 E14	15,000	5	220-240	250	SES/E14	825	4	10	27
DSST7MIBA	4008321943453	DSST MIBA 7W/825 E14	15,000	7	220-240	360	ES/E27	825	4	10	27
DSST11MIBA	4008321943477	DSST MIBA 11W/825 E27	15,000	11	220-240	630	ES/E27	825	4	10	27
DSST11MIBAB22	4008321943491	DSST MIBA 11W/825 E27	15,000	11	220-240	630	BC/B22d	825	4	10	27
DSST15MIBA	4008321943507	DSST MIBA 15W/825 E27	15,000	15	220-240	850	ES/E27	825	4	10	27
DSST15MIBAB22	4008321943521	DSST MIBA 15W/825 B22D	15,000	15	220-240	850	BC/B22d	825	4	10	27
DSST20MIBA	4008321949349	DSST MIBA 20W/825 E27	15,000	20	220-240	1160	ES/E27	825	4	10	27
DSST20MIBAB22	4008321949356	DSST MIBA 20W/825 B22D	15,000	20	220-240	1160	BC/B22d	825	4	10	27
<b>Reflector</b>											
DSST14R825	4008321396440	DSST R 14W/825 E27	15,000	14	220-240		ES/E27	825	5	10	27
DSST14R840	4008321396464	DSST R 14W/840 E27	15,000	14	220-240		ES/E27	840	5	10	27
DSST18R825	4008321396396	DSST R 18W/825 E27	15,000	18	220-240		ES/E27	825	5	10	27
DSST18R840	4008321396419	DSST R 18W/840 E27	15,000	18	220-240		ES/E27	840	5	10	27

NEW  
NEW  
NEW  
NEW

All orders must be multiples of sales pack



## Compact Fluorescent Lamps – Retrofit

**OSRAM DULUX® SUPERSTAR MICRO TWIST**

- New micro twist retrofit energy saving compact fluorescent lamp
- Up to 80% energy saving
- New QUICKlight technology improves run up time by >50%
- NEW Colour 825 – Warm comfort light the first CFLi light colour with the appearance of GLS
- Ideal for replacing inefficient incandescent lamps

Product ID Code	EAN (Single Pack)	Product Description	t (h)	W	V	lm				PPG
NEW MICROTWIST7825E14	4008321948922	MICRO TW 7W/825 E14	12,000	7	220-240	420	SES/E14	825	10	27
NEW MICROTWIST7840E14	4008321948939	MICRO TW 7W/840 E14	12,000	7	220-240	420	SES/E14	840	10	27
NEW MICROTWIST7865E14*	4008321948946	MICRO TW 7W/865 E14	12,000	7	220-240	400	SES/E14	865	10	27
NEW MICROTWIST7825	4008321948953	MICRO TW 7W/825 E27	12,000	7	220-240	420	ES/E27	825	10	27
NEW MICROTWIST7840	4008321948960	MICRO TW 7W/840 E27	12,000	7	220-240	420	ES/E27	840	10	27
NEW MICROTWIST7865*	4008321948977	MICRO TW 7W/865 E27	12,000	7	220-240	400	ES/E27	865	10	27
NEW MICROTWIST7825B22	4008321948984	MICRO TW 7W/825 B22D	12,000	7	220-240	420	BC/B22d	825	10	27
NEW MICROTWIST11825	4008321948991	MICRO TW 11W/825 E27	12,000	11	220-240	650	ES/E27	825	10	27
NEW MICROTWIST11825E14	4008321949004	MICRO TW 11W/825 E14	12,000	11	220-240	650	SES/E14	825	10	27
NEW MICROTWIST11840	4008321949011	MICRO TW 11W/840 E27	12,000	11	220-240	650	ES/E27	840	10	27
NEW MICROTWIST11840E14	4008321949028	MICRO TW 11W/840 E14	12,000	11	220-240	650	SES/E14	840	10	27
NEW MICROTWIST11865*	4008321949035	MICRO TW 11W/865 E27	12,000	11	220-240	620	ES/E27	865	10	27
NEW MICROTWIST11865E14*	4008321949042	MICRO TW 11W/865 E14	12,000	11	220-240	620	SES/E14	865	10	27
NEW MICROTWIST11825B22	4008321949059	MICRO TW 11W/825 B22D	12,000	11	220-240	650	BC/B22d	825	10	27
NEW MICROTWIST14825	4008321949066	MICRO TW 14W/825 E27	12,000	14	220-240	860	ES/E27	825	10	27
NEW MICROTWIST14840	4008321949073	MICRO TW 14W/840 E27	12,000	14	220-240	860	ES/E27	840	10	27
NEW MICROTWIST14865*	4008321949080	MICRO TW 14W/865 E27	12,000	14	220-240	820	ES/E27	865	10	27
NEW MICROTWIST14825B22	4008321949097	MICRO TW 14W/825 B22D	12,000	14	220-240	860	BC/B22d	825	10	27
NEW MICROTWIST18825	4008321949103	MICRO TW 18W/825 E27	12,000	18	220-240	1200	ES/E27	825	10	27
NEW MICROTWIST18840	4008321949110	MICRO TW 18W/840 E27	12,000	18	220-240	1200	ES/E27	840	10	27
NEW MICROTWIST18865*	4008321949127	MICRO TW 18W/865 E27	12,000	18	220-240	1140	ES/E27	865	10	27
NEW MICROTWIST18825B22	4008321949134	MICRO TW 18W/825 B22D	12,000	18	220-240	1200	BC/B22d	825	10	27
NEW MICROTWIST23825	4008321949141	MICRO TW 23W/825 E27	12,000	23	220-240	1600	ES/E27	825	10	27
NEW MICROTWIST23840	4008321949158	MICRO TW 23W/840 E27	12,000	23	220-240	1600	ES/E27	840	10	27
NEW MICROTWIST23865*	4008321949165	MICRO TW 23W/865 E27	12,000	23	220-240	1520	ES/E27	865	10	27
NEW MICROTWIST23825B22	4008321949172	MICRO TW 18W/825 B22D	12,000	23	220-240	1600	BC/B22d	825	10	27

\*Available on request in colour 865 (Cool Daylight)



All orders must be multiples of sales pack

Compact Fluorescent Lamps – Retrofit

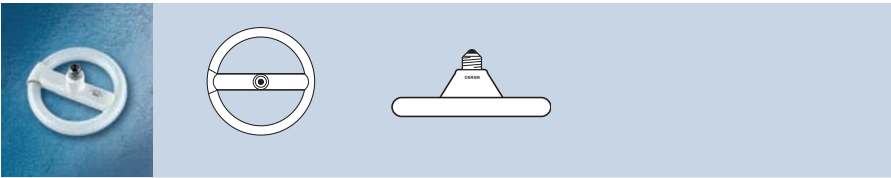

**OSRAM DULUX® SUPERSTAR CIRCOLUX® EL**

- Circular retrofit electronic energy saving compact fluorescent lamp
- Circular low-profile design
- NEW Colour 825 – Warm comfort light the first CFLi light colour with the appearance of GLS
- Ideal for use in shaded pendant luminaires



Product ID Code	EAN (Single Pack)	Product Description	t[h]	W	V	lm				PPG
CEL24825	4050300626628	DSST CIRCOLUX EL 24W/827 E27	15,000	24	220-240	1700	ES/E27	825	10	27
CEL24840	4050300623603	DSST CIRCOLUX 24W/840 E27	15,000	24	220-240	1700	ES/E27	840	10	27

All orders must be multiples of sales pack



## Compact Fluorescent Lamps – Retrofit

**OSRAM DULUXSTAR® STICK**

- Retrofit “stick shape” electronic energy saving compact fluorescent lamp
- NEW Colour 825 – Warm comfort light the first CFLi light colour with the appearance of GLS
- Ideal for replacing inefficient incandescent lamps

Product ID Code	EAN (Single Pack)	Product Description	t (h)	W	V	lm				PPG
DST5E14	4008321063175	DSTAR 5W/825 E14	10,000	5	220-240	250	SES/E14	825	10	27
DST5B22	4008321063328	DSTAR 5W/825 B22D	10,000	5	220-240	250	BC/B22d	825	10	27
DST5	4008321063144	DSTAR 5W/825 E27	10,000	5	220-240	250	ES/E27	825	10	27
DST8E14	4008321063236	DSTAR 8W/825 E14	10,000	8	220-240	400	SES/E14	825	10	27
DST8	4008321063205	DSTAR 8W/825 E27	10,000	8	220-240	400	ES/E27	825	10	27
DST8B22	4008321063359	DSTAR 8W/825 B22D	10,000	8	220-240	400	BC/B22d	825	10	27
DST8840E14	4008321361721	DSTAR 8W/840 E14	10,000	8	220-240	400	SES/E14	840	10	27
DST8840	4008321361752	DSTAR 8W/840 E27	10,000	8	220-240	400	ES/E27	840	10	27
DST8865E14*	4008321361783	DSTAR 8W/865 E14	10,000	8	220-240	380	SES/E14	865	10	27
DST8865*	4008321361813	DSTAR 8W/865 E27	10,000	8	220-240	380	ES/E27	865	10	27
DST11	4008321063267	DSTAR 11W/825 E27	10,000	11	220-240	600	ES/E27	825	10	27
DST11B22	4008321063380	DSTAR 11W/825 B22D	10,000	11	220-240	600	BC/B22d	825	10	27
DST11840	4008321319197	DSTAR 11W/840 E27	10,000	11	220-240	600	ES/E27	840	10	27
DST11860*	4008321246783	DSTAR 11W/865 E27	10,000	11	220-240	570	ES/E27	865	10	27
DST14	4008321063298	DSTAR 14W/825 E27	10,000	14	220-240	750	ES/E27	825	10	27
DST14B22	4008321063410	DSTAR 14W/825 B22D	10,000	14	220-240	750	BC/B22d	825	10	27
DST14840	4008321319159	DSTAR 14W/840 E27	10,000	14	220-240	750	ES/E27	840	10	27
DST14860*	4008321246820	DSTAR 14W/865 E27	10,000	14	220-240	710	ES/E27	865	10	27
DST17	4008321063441	DSTAR 17W/825 E27	10,000	17	220-240	950	ES/E27	825	10	27
DST17B22	4008321063465	DSTAR 17W/825 B22D	10,000	17	220-240	950	BC/B22d	825	10	27
DST17840	4008321945891	DSTAR 17W/840 E27	10,000	17	220-240	950	ES/E27	840	10	27
DST21	4008321063526	DSTAR 21W/825 E27	10,000	21	220-240	1230	ES/E27	825	10	27
DST21B22	4008321131928	DSTAR 21W/825 B22D	10,000	21	220-240	1230	BC/B22d	825	10	27
DST21840	4008321319210	DSTAR 21W/840 E27	10,000	21	220-240	1230	ES/E27	840	10	27
DST24	4008321063502	DSTAR 24W/825 E27	10,000	24	220-240	1500	ES/E27	825	10	27
DST24B22	4008321063540	DSTAR 24W/825 B22	10,000	24	220-240	1500	BC/B22d	825	10	27
DST24840	4008321396518	DSTAR 24W/840 E27	10,000	24	220-240	1500	ES/E27	840	10	27
-	4008321945990**	DSTAR 24W/865 E27	10,000	24	220-240	1400	ES/E27	865	10	27
DST30825	4008321181213	DSTAR 30W/825 E27	10,000	30	220-240	1920	ES/E27	825	10	27
DST30840	4008321181237	DSTAR 30W/840 E27	10,000	30	220-240	1920	ES/E27	840	10	27
DST30865*	4008321181251	DSTAR 30W/865 E27	10,000	30	220-240	1830	ES/E27	865	10	27

\* Also available on request in colour 865 (Cool Daylight)

\*\* In preparation at time of print. For further information please contact OSRAM



NEW

All orders must be multiples of sales pack

## Compact Fluorescent Lamps – Retrofit

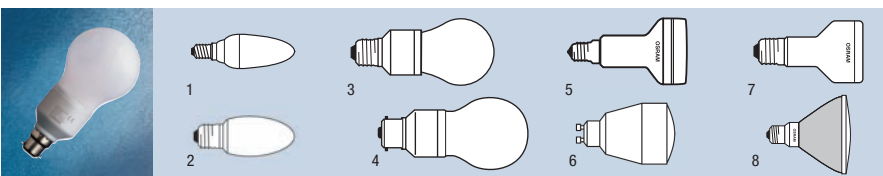

### OSRAM DULUXSTAR® CLASSIC

- Retrofit “look-a-like” electronic energy saving compact fluorescent lamp
- NEW Colour 825 – Warm comfort light the first CFLi light colour with the appearance of GLS
- Up to 80% energy saving
- NEW compact Mini candle version
- Ideal for replacing inefficient incandescent lamps



Product ID Code	EAN (Single Pack)	Product Description	t (h)	W	V	lm	Color	No.	PPG
-----------------	-------------------	---------------------	-------	---	---	----	-------	-----	-----

#### Mini Candle shape

DST5MICAIE14	4008321944450	DSTAR MICA 5W/825 E14	10,000	5	220-240	250	SES/E14	825	1	10	27
DST5MICA	4008321944467	DSTAR MICA 5W/825 E27	10,000	5	220-240	250	ES/E27	825	2	10	27
DST7MICAIE14	4008321944474	DSTAR MICA 7W/825 E14	10,000	7	220-240	340	SES/E14	825	1	10	27
DST7MICA	4008321944481	DSTAR MICA 7W/825 E27	10,000	7	220-240	340	ES/E27	825	2	10	27
DST10MICAIE14	4008321946621	DSTAR MICA 9W/825 E14	10,000	10	220-240	550	SES/E14	825	1	10	27
DST10MICA	4008321946645	DSTAR MICA 9W/825 E27	10,000	10	220-240	550	ES/E27	825	2	10	27

#### GLS shape

DST11CLA	4008321946263	DSTAR CL A 11W/825 E27	10,000	10	220-240	580	ES/E27	825	3	10	27
-	4008321946287*	OSRAM DSTAR CL A 11W/825 B22d	10,000	10	220-240	580	BC/B22d	825	4	10	27
DST20CLA	4008321399878	DSTAR CL A 20W/825 E27	10,000	20	220-240	1160	ES/E27	825	3	10	27
DST20CLAB22	4008321399854	DSTAR CL A 20W/825 B22D	10,000	20	220-240	1160	BC/B22d	825	4	10	27

#### R50

DST7R50	4008321234223	DSTAR R50 7W/825 E14	10,000	7	220-240		SES/E14	825	5	10	27
DST7R50GU10	4008321938572	DSTAR R50 7W/825 GU10	10,000	7	220-240		GU10	825	6	10	27
DST9R50E14	4008321946706	DSTAR R50 9W/825 E14	10,000	9	220-240		SES/E14	825	5	10	27
DST9R50GU10	4008321946720	DSTAR R50 9W/825 GU10	10,000	9	220-240		GU10	825	6	10	27

#### R63

DST11R63	4008321938602	DSTAR R63 11W/825 E27	10,000	11	220-240		ES/E27	825	7	10	27
DST13R63	4008321946744	DSTAR R63 13W/825 E27	10,000	13	220-240		ES/E27	825	7	10	27

#### PAR 38

DSTPAR3820	4008321162878	DSTAR PAR 38 20W/827 E27	10,000	20	220-240		ES/E27	825	8	10	27
------------	---------------	--------------------------	--------	----	---------	--	--------	-----	---	----	----

\* In preparation at time of print. For further information please contact OSRAM

NEW  
NEW  
NEW  
NEW  
NEW  
NEW

All orders must be multiples of sales pack





## Compact Fluorescent Lamps – Retrofit



### OSRAM DULUXSTAR® MINI BALL

- Retrofit mini ball shape energy saving compact fluorescent lamp
- NEW Colour 825 – Warm comfort light the first CFLi light colour with the appearance of GLS
- Ideal for replacing inefficient incandescent lamps

Product ID Code	EAN (Single Pack)	Product Description	t(h)	W	V	lm				PPG
DST5MIBA	4008321946300	DSTAR MIBA 5W/825 E14	10,000	5	220-240	250	SES/E14	825	10	27
DST7MIBA	4008321946324	DSTAR MIBA 7W/825 E14	10,000	7	220-240	360	SES/E14	825	10	27
DST11MIBA	4008321125705	DSTAR MIBA 11W/825 E27	10,000	11	220-240	630	ES/E27	825	10	27
DST11MIBAB22	4008321125668	DSTAR MIBA 11W/825 B22D	10,000	11	220-240	630	BC/B22d	825	10	27
DST15MIBA	4008321125644	DSTAR MIBA 15W/825 E27	10,000	15	220-240	850	ES/E27	825	10	27
DST15MIBAB22	4008321125682	DSTAR MIBA 15W/825 B22D	10,000	15	220-240	850	BC/B22d	825	10	27
DST20MIBA	4008321946409	DSTAR MIBA 20W/825 E27	10,000	20	220-240	1160	ES/E27	825	10	27
DST20MIBAB22	4008321946416	DSTAR MIBA 20W/825 B22D	10,000	20	220-240	1160	BC/B22d	825	10	27

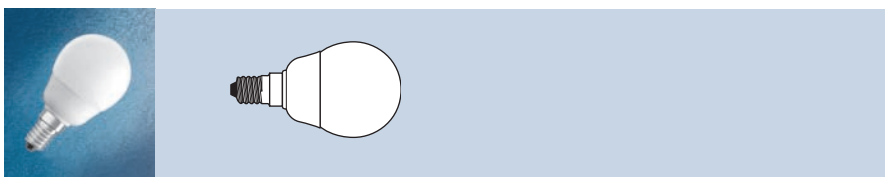

### OSRAM DULUXSTAR® MINI BULLET P

- Retrofit mini globe substitute to a Classic P shape lamp
- Smaller dimensions
- NEW Colour 825 – Warm comfort light the first CFLi light colour with the appearance of GLS
- Ideal for energy saving substitute to a Classic P shape lamp

Product ID Code	EAN (Single Pack)	Product Description	t(h)	W	V	lm				PPG
DSMIBUP5E14	4008321956200	DS MIBU P 5W/825 E14	10,000	5	220-240	210	SES/E14	825	10	27
DSMIBUP7E14	4008321956286	DS MIBU P 7W/825 E14	10,000	7	220-240	320	SES/E14	825	10	27
DSMIBUP5	4008321956187	DS MIBU P 5W/825 E27	10,000	5	220-240	210	ES/E27	825	10	27
DSMIBUP7	4008321956262	DS MIBU P 7W/825 E27	10,000	7	220-240	320	ES/E27	825	10	27



NEW  
NEW  
NEW  
NEW

All orders must be multiples of sales pack

Compact Fluorescent Lamps – Retrofit

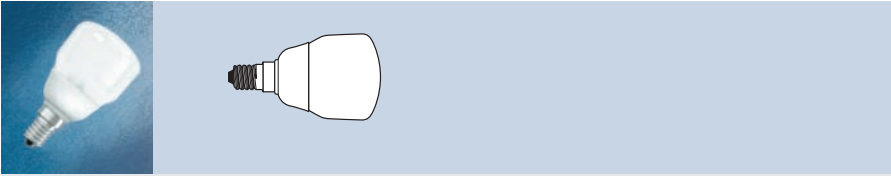

**OSRAM DULUXSTAR® Mini Bullet T**

- Retrofit mini globe substitute to a Classic T shape lamp
- Smaller dimensions
- **NEW Colour 825** – Warm comfort light the first CFLi light colour with the appearance of GLS
- Ideal for energy saving substitute to a Classic T shape lamp

Product ID Code	EAN (Single Pack)	Product Description	t [h]	W	V	lm			PPG
DSMIBUT7	4008321956774	DS MIBU T 5W/825 E14	10,000	5	220-240	210	SES/E14	825	10 27
DSMIBUT7E14	4008321956811	DS MIBU T 7W/825 E14	10,000	7	220-240	320	SES/E14	825	10 27
DSMIBUT5	4008321956750	DS MIBU T 5W/825 E27	10,000	5	220-240	210	ES/E27	825	10 27
DSMIBUT7	4008321956798	DS MIBU T 7W/825 E27	10,000	7	220-240	320	ES/E27	825	10 27

NEW  
NEW  
NEW  
NEW

All orders must be multiples of sales pack



Compact Fluorescent Lamps – Retrofit

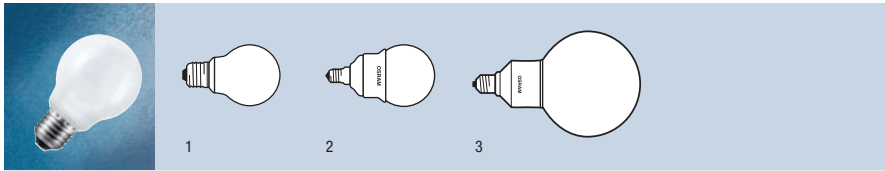

**OSRAM DULUXSTAR® Mini Globe and Globe**

- Retrofit mini globe and globe shape energy saving compact fluorescent lamp
- NEW Colour 825 – Warm comfort light the first CFLi light colour with the appearance of GLS
- Ideal for replacing inefficient incandescent lamps

Product ID Code	EAN (Single Pack)	Product Description	t(h)	W	V	lm					PPG
<b>Mini Globe</b>											
DST5MIGL	4008321205476	DSTAR MIGL 5W/825 E27	10,000	5	220-240	250	ES/E27	825	1	10	27
DST5MIGLE14	4008321205490	DSTAR MIGL 5W/825 E14	10,000	5	220-240	250	SES/E14	825	2	10	27
DST7MIGL	4008321205537	DSTAR MIGL 7W/825 E27	10,000	7	220-240	360	ES/E27	825	1	10	27
DST7MIGLE14	4008321205551	DSTAR MIGL 7W/825 E14	10,000	7	220-240	360	SES/E14	825	2	10	27
DST11MIGL	4008321205575	DSTAR MIGL 11W/825 E27	10,000	11	220-240	630	ES/E27	825	1	10	27
DST15MIGL	4008321205599	DSTAR MIGL 15W/825 E27	10,000	15	220-240	850	ES/E27	825	1	10	27
DST20MIGL	4008321946546	DSTAR MIGL 20W/825 E27	10,000	20	220-240	1160	ES/E27	825	1	10	27
DST20MIGLB22	4008321415127	DSTAR MIGL 20W/825 B22D	10,000	20	220-240	1160	BC/B22d	825	-	10	27
<b>Globe</b>											
DST14GL	4008321946560	DSTAR GL 14W/825 E27	10,000	14	220-240	870	ES/E27	825	3	10	27
DST18GL	4008321946577	DSTAR GL 18W/825 E27	10,000	18	220-240	1100	ES/E27	825	3	10	27



All orders must be multiples of sales pack

## Compact Fluorescent Lamps – Retrofit

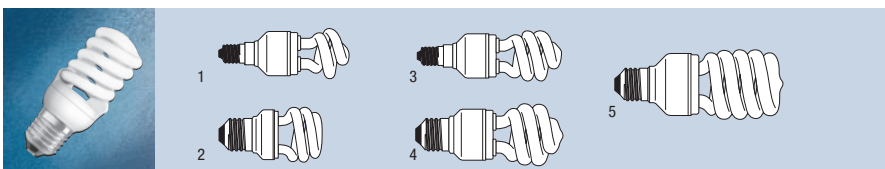

### OSRAM DULUXSTAR® Mini Twist

- Retrofit twist energy saving compact fluorescent lamp
- NEW Colour 825 – Warm comfort light the first CFLi light colour with the appearance of GLS
- NEW compact T3 Mini Twist version 24% shorter than stick version
- Ideal for replacing inefficient incandescent lamps



Product ID Code	EAN (Single Pack)	Product Description	t(h)	W	V	lm			No.		PPG
DMINITWIST5825E14	4008321334633	DSTAR MTW 5W/825 E14	8,000	5	220-240	270	SES/E14	825	1	10	27
DMINITWIST5825	4008321334602	DSTAR MTW 5W/825 E27	8,000	5	220-240	270	ES/E27	825	2	10	27
DMINITWIST5840E14	4008321334695	DSTAR MTW 5W/840 E14	8,000	5	220-240	270	SES/E14	840	1	10	27
DMINITWIST5840	4008321334664	DSTAR MTW 5W/840 E27	8,000	5	220-240	270	ES/E27	840	2	10	27
DMINITWIST5865*	4008321343925	DSTAR MTW 5W/865 E14	8,000	5	220-240	270	SES/E14	865	1	10	27
DMINITWIST5865*	4008321941770	DSTAR MTW 5W/865 E27	8,000	5	220-240	270	ES/E27	865	2	10	27
DMINITWIST8827	4008321334510	DSTAR MTW 8W/825 E14	8,000	8	220-240	470	SES/E14	825	3	10	27
DMINITWIST8825E27	4008321334480	DSTAR MTW 8W/825 E27	8,000	8	220-240	470	ES/E27	825	2	10	27
DMINITWIST8840E14	4008321334572	DSTAR MTW 8W/840 E14	8,000	8	220-240	470	SES/E14	840	3	10	27
DMINITWIST8840	4008321334541	DSTAR MTW 8W/840 E27	8,000	8	220-240	470	ES/E27	840	2	10	27
DMINITWIST8865E14*	4008321343956	DSTAR MTW 8W/865 E14	8,000	8	220-240	470	SES/E14	865	3	10	27
DMINITWIST8865*	4008321343864	DSTAR MTW 8W/865 E27	8,000	8	220-240	470	ES/E27	865	2	10	27
DMINITWIST11825	4008321334398	DSTAR MTW 11W/825 E14	8,000	11	220-240	680	SES/E14	825	3	10	27
DMINITWIST11825E27	4008321334367	DSTAR MTW 11W/825 E27	8,000	11	220-240	680	ES/E27	825	4	10	27
DMINITWIST11840E14	4008321334459	DSTAR MTW 11W/840 E14	8,000	11	220-240	680	SES/E14	840	3	10	27
DMINITWIST11840	4008321334428	DSTAR MTW 11W/840 E27	8,000	11	220-240	680	ES/E27	840	4	10	27
DMINITWIST11865*	4008321343895	DSTAR MTW 11W/865 E27	8,000	11	220-240	640	ES/E27	865	4	10	27
DTWIST13825	4008321293985	DSTAR MTW 13W/825 E27	8,000	13	220-240	850	ES/E27	825	4	10	27
DTWIST13840	4008321294920	DSTAR MTW 13W/840 E27	8,000	13	220-240	850	ES/E27	840	4	10	27
DTWIST13865*	4008321294005	DSTAR MTW 13W/865 E27	8,000	13	220-240	800	ES/E27	865	4	10	27
DTWIST13825B22	4008321299154	DSTAR MTW 13W/825 B22D	8,000	13	220-240	850	BC/B22d	825	4	10	27
DTWIST18	4008321294029	DSTAR MTW 18W/825 E27	8,000	18	220-240	1200	ES/E27	825	5	10	27
DTWIST18865*	4008321294043	DSTAR MTW 18W/865 E27	8,000	18	220-240	1140	ES/E27	865	5	10	27
DTWIST18840	4008321294944	DSTAR MTW 18W/840 E27	8,000	18	220-240	1200	ES/E27	840	5	10	27
DTWIST18827B22	4008321299178	DSTAR MTW 18W/825 B22D	8,000	18	220-240	1200	BC/B22d	825	5	10	27
DTWIST23	4008321294067	DSTAR MTW 23W/825 E27	8,000	23	220-240	1500	ES/E27	825	5	10	27
DTWIST23840	4008321294968	DSTAR MTW 23W/840 E27	8,000	23	220-240	1500	ES/E27	840	5	10	27
DTWIST23865*	4008321294081	DSTAR MTW 23W/865 E27	8,000	23	220-240	1470	ES/E27	865	5	10	27
DTWIST23825	4008321299192	DSTAR MTW 23W/825 B22D	8,000	23	220-240	1500	BC/B22d	825	5	10	27

\* Also available on request in colour 865 (Cool Daylight)

All orders must be multiples of sales pack



## Compact Fluorescent Lamps – Retrofit

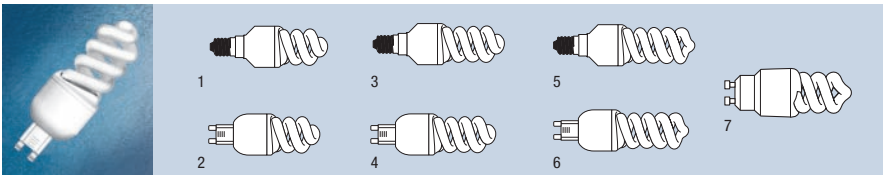

### OSRAM DULUXSTAR® NANO TWIST

- Nano-sized CFLi
- Substitution for standard luminaires
- Ideal for small luminaires

Product ID Code	EAN (Single Pack)	Product Description	t[h]	W	V	lm			No.		PPG
<b>NEW</b> DSTNANOTW5	4008321510730	DST NANO TW 5W/825 G9	8,000	5	220-240	270	G9	825	2	10	27
<b>NEW</b> DSTNANOTW7	4008321510792	DST NANO TW 7W/825 G9	8,000	7	220-240	400	G9	825	3	10	27
<b>NEW</b> DSTNANOTW9	4008321510853	DST NANO TW 9W/825 G9	8,000	9	220-240	480	G9	825	6	10	27
<b>NEW</b> DSTNANOTW5	4008321956149	DST NANO TW 5W/840 G9	8,000	5	220-240	270	G9	840	2	10	27
<b>NEW</b> DSTNANOTW7	4008321956163	DST NANO TW 7W/840 G9	8,000	7	220-240	400	G9	840	3	10	27
<b>NEW</b> DSTNANOTW9	4008321956934	DST NANO TW 9W/840 G9	8,000	9	220-240	480	G9	840	6	10	27
<b>NEW</b> DSTNANOTW5E14	4008321510914	DST NANO TW 5W/825 E14	8,000	5	220-240	270	SES/E14	825	1	10	27
<b>NEW</b> DSTNANOTW7E14	4008321510976	DST NANO TW 7W/825 E14	8,000	7	220-240	400	SES/E14	825	3	10	27
<b>NEW</b> DSTNANOTW9E14	4008321511034	DST NANO TW 9W/825 E14	8,000	9	220-240	480	SES/E14	825	5	10	27
<b>NEW</b> DSTNANOTW5840E14	4008321508898	DST NANO TW 5W/840 E14	8,000	5	220-240	270	SES/E14	840	1	10	27
<b>NEW</b> DSTNANOTW7840E14	4008321509000	DST NANO TW 7W/840 E14	8,000	7	220-240	400	SES/E14	840	3	10	27
<b>NEW</b> DSTNANOTW9840E14	4008321509062	DST NANO TW 9W/840 GU10	8,000	9	220-240	480	SES/E14	840	5	10	27
<b>NEW</b> DSTNANOTW5825GU10	4008321548900	DST NANO TW 5W/825 GU10	8,000	5	220-240	270	GU10	825	7	10	27
<b>NEW</b> DSTNANOTW7825GU10	4008321549082	DST NANO TW 7W/825 GU10	8,000	7	220-240	400	GU10	825	7	10	27
<b>NEW</b> DSTNANOTW9825GU10	4008321549228	DST NANO TW 9W/825 GU10	8,000	9	220-240	480	GU10	825	7	10	27
<b>NEW</b> DSTNANOTW5840GU10	4008321548979	DST NANO TW 5W/840 GU10	8,000	5	220-240	270	GU10	840	7	10	27
<b>NEW</b> DSTNANOTW7840GU10	4008321549167	DST NANO TW 7W/840 GU10	8,000	7	220-240	400	GU10	840	7	10	27
<b>NEW</b> DSTNANOTW9840GU10	4008321549280	DST NANO TW 9W/840 GU10	8,000	9	220-240	480	GU10	840	7	10	27



**NEW**  
**NEW**  
**NEW**  
**NEW**  
**NEW**  
**NEW**  
**NEW**  
**NEW**  
**NEW**  
**NEW**  
**NEW**  
**NEW**  
**NEW**  
**NEW**  
**NEW**  
**NEW**  
**NEW**

All orders must be multiples of sales pack

**COMPACT FLUORESCENT LAMPS – PIN BASED****OSRAM DULUX® T PLUS**

- Triple-turn tube
- 2-pin compact fluorescent lamp
- With integral starter for CCG
- Ideal for downlights with shallow mounting depths

Product ID Code	EAN (Single Pack)	Product Description	t [h]	W	lm				PPG
DT13830	4050300446929	DULUX T 13W/830 PLUS GX24D	10,000	13	900	GX24d-1	830	10	23
DT13840	4050300446905	DULUX T 13W/840 PLUS GX24D	10,000	13	900	GX24d-1	840	10	23
DT18827	4050300333502	DULUX T 18W/827 PLUS GX24D	10,000	18	1200	GX24d-2	827	10	23
DT18830	4050300333489	DULUX T 18W/830 PLUS GX24D	10,000	18	1200	GX24d-2	830	10	23
DT18840	4050300333465	DULUX T 18W/840 PLUS GX24D	10,000	18	1200	GX24d-2	840	10	23
DT26827	4050300342085	DULUX T 26W/827 PLUS GX24D	10,000	26	1800	GX24d-3	827	10	23
DT26830	4050300342061	DULUX T 26W/830 PLUS GX24D	10,000	26	1800	GX24d-3	830	10	23
DT26840	4050300342047	DULUX T 26W/840 PLUS GX24D	10,000	26	1800	GX24d-3	840	10	23

All orders must be multiples of sales pack



## Compact Fluorescent Lamps – Pin Based

**OSRAM DULUX® T/E PLUS**

- Triple-turn tube
- 4-pin compact fluorescent lamp
- 20,000 lifetime with warm start ECG
- For use with ECG and dimming systems
- Ideal for downlights with shallow mounting depths

Product ID Code	EAN (Single Pack)	Product Description	t [h]	W	lm				PPG
DTE13827	4050300447001	DULUX T/E 13W/827 PLUS GX24Q	20,000	13	900	GX24q-1	827	10	23
DTE13830	4050300446981	DULUX T/E 13W/830 PLUS GX24Q	20,000	13	900	GX24q-1	830	10	23
DTE13840	4050300446967	DULUX T/E 13W/840 PLUS GX24Q	20,000	13	900	GX24q-1	840	10	23
DTE18827	4050300342269	DULUX T/E 18W/827 PLUS GX24Q	20,000	18	1200	GX24q-2	827	10	23
DTE18830	4050300342245	DULUX T/E 18W/830 PLUS GX24Q	20,000	18	1200	GX24q-2	830	10	23
DTE18840	4050300342221	DULUX T/E 18W/840 PLUS GX24Q	20,000	18	1200	GX24q-2	840	10	23
DTE26827	4050300342320	DULUX T/E 26W/827 PLUS GX24Q	20,000	26	1800	GX24q-3	827	10	23
DTE26830	4050300342306	DULUX T/E 26W/830 PLUS GX24Q	20,000	26	1800	GX24q-3	830	10	23
DTE26840	4050300342283	DULUX T/E 26W/840 PLUS GX24Q	20,000	26	1800	GX24q-3	840	10	23
DTE32827	4050300348605	DULUX T/E 32W/827 PLUS GX24Q	20,000	32	2400	GX24q-3	827	10	23
DTE32830	4050300348582	DULUX T/E 32W/830 PLUS GX24Q	20,000	32	2400	GX24q-3	830	10	23
DTE32840	4050300348568	DULUX T/E 32W/840 PLUS GX24Q	20,000	32	2400	GX24q-3	840	10	23
DTE42827	4050300425665	DULUX T/E 42W/827 PLUS GX24Q	20,000	42	3200	GX24q-4	827	10	23
DTE42830	4050300425641	DULUX T/E 42W/830 PLUS GX24Q	20,000	42	3200	GX24q-4	830	10	23
DTE42840	4050300425627	DULUX T/E 42W/840 PLUS GX24Q	20,000	42	3200	GX24q-4	840	10	23

Perfectly matched with QUICKTRONIC® electronic control gear



All orders must be multiples of sales pack

## Compact Fluorescent Lamps – Pin Based

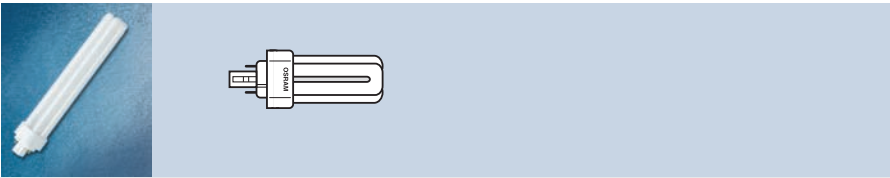
**OSRAM DULUX® T/E CONSTANT (IN PLUS)**

- Triple-turn tube
- 4-pin compact fluorescent lamp
- 20,000 lifetime with warm start ECG
- With amalgam technology
- For use with ECG and dimming systems
- Ideal for operation at low and high ambient temperatures

Product ID Code	EAN (Single Pack)	Product Description	t [h]	W	lm				PPG
DTE26830IN	4050300425467	DULUX T/E 26W/830 CONSTANT GX24Q	20,000	26	1800	GX24q	830	10	23
DTE26840IN	4050300425443	DULUX T/E 26W/840 CONSTANT GX24Q	20,000	26	1800	GX24q	840	10	23
DTE32827IN	4050300425542	DULUX T/E 32W/827 CONSTANT GX24Q	20,000	32	2400	GX24q-3	827	10	23
DTE32830IN	4050300425528	DULUX T/E 32W/830 CONSTANT GX24Q	20,000	32	2400	GX24q-3	830	10	23
DTE32840IN	4050300425504	DULUX T/E 32W/840 CONSTANT GX24Q	20,000	32	2400	GX24q-3	840	10	23
DTE42827IN	4050300425603	DULUX T/E 42W/827 CONSTANT GX24Q	20,000	42	3200	GX24q-4	827	10	23
DTE42830IN	4050300425580	DULUX T/E 42W/830 CONSTANT GX24Q	20,000	42	3200	GX24q-4	830	10	23
DTE42840IN	4050300425566	DULUX T/E 42W/840 CONSTANT GX24Q	20,000	42	3200	GX24q-4	840	10	23

Perfectly matched with QUICKTRONIC® electronic control gear

All orders must be multiples of sales pack





## Compact Fluorescent Lamps – Pin Based



### OSRAM DULUX® T/E High Efficiency

- High efficiency 4 pin triple-turn compact fluorescent
- Long lifetime 20,000 hours (with QUICKTRONIC®)
- 30% more efficacy than conventional DULUX® pin base lamps
- New secure fix twist and lock base (GR14q-1)
- For use with ECG and dimming systems
- Ideal for downlights with shallow mounting depths, office lighting, public buildings



Product ID Code	EAN (Single Pack)	Product Description	t [h]	W	V	lm				PPG
<b>NEW</b> DTE11830	4008321359452	DULUX T/E 11W/830 HE GR14Q-1	20,000	11	80	900	GR14q-1	830	10	23
<b>NEW</b> DTE11840	4008321359476	DULUX T/E 11W/840 HE GR14Q-1	20,000	11	80	900	GR14q-1	840	10	23
<b>NEW</b> DTE14	4008321290496	DULUX T/E 14W/830 HE GR14Q-1	20,000	14	100	1200	GR14q-1	830	10	23
<b>NEW</b> DTE14840	4008321290519	DULUX T/E 14W/840 HE GR14Q-1	20,000	14	100	1200	GR14q-1	840	10	23
<b>NEW</b> DTE17	4008321290533	DULUX T/E 17W/830 HE GR14Q-1	20,000	17	120	1500	GR14q-1	830	10	23
<b>NEW</b> DTE17840	4008321290557	DULUX T/E 17W/840 HE GR14Q-1	20,000	17	120	1500	GR14q-1	840	10	23

Perfectly matched with QUICKTRONIC® electronic control gear



### OSRAM DULUX® T/E XT for ECG

- High efficiency 4 pin triple-turn compact fluorescent
- Extremely long lifetime 36,000 hours (with QUICKTRONIC®)
- Extremely compact for miniature luminaires and shallow mounting depth
- Ideal for luminaires that are difficult to access, or long daily operating times



Product ID Code	EAN (Single Pack)	Product Description	t [h]	W	lm				PPG
<b>NEW</b> DTE32830XT	4008321511911*	DULUX T/E 32W/830 XT GX24Q	36,000	32	2400	GX24q-3	830	10	23
<b>NEW</b> DTE32840XT	4008321511935*	DULUX T/E 32W/840 XT GX24Q	36,000	32	2400	GX24q-3	840	10	23
<b>NEW</b> DTE42830XT	4008321511959*	DULUX T/E 42W/830 XT GX24Q	36,000	42	3200	GX24q-4	830	10	23
<b>NEW</b> DTE42840XT	4008321511973*	DULUX T/E 42W/840 XT GX24Q	36,000	42	3200	GX24q-4	840	10	23

Perfectly matched with QUICKTRONIC® electronic control gear

\*In preparation at time of print. For further information please contact OSRAM

All orders must be multiples of sales pack

## Compact Fluorescent Lamps – Pin Based

**OSRAM DULUX® D**

- Double-turn tube
- 2-pin compact fluorescent lamp
- With integral starter for CCG
- Ideal for miniature luminaires and downlights for shallow recesses

Product ID Code	EAN (Single Pack)	Product Description	t [h]	W	lm				PPG
DD10827	4050300008110	DULUX D 10W/827 G24D-1	10,000	10	600	G24d-1	827	10	24
DD10830	4050300025681	DULUX D 10W/830 G24D-1	10,000	10	600	G24d-1	830	10	24
DD10835	4050300028835	DULUX D 10W/835 G24D-1	10,000	10	600	G24d-1	835	10	24
DD10840	4050300010595	DULUX D 10W/840 G24D-1	10,000	10	600	G24d-1	840	10	24
DD13827	4050300008127	DULUX D 13W/827 G24D-1	10,000	13	900	G24d-1	827	10	24
DD13830	4050300025698	DULUX D 13W/830 G24D-1	10,000	13	900	G24d-1	830	10	24
DD13835	4050300028859	DULUX D 13W/835 G24D-1	10,000	13	900	G24d-1	835	10	24
DD13840	4050300010625	DULUX D 13W/840 G24D-1	10,000	13	900	G24d-1	840	10	24
DD13865	4050300487106	DULUX D 13W/865 G24D-1	10,000	13	855	G24d-1	865	10	24
DD18827	4050300011462	DULUX D 18W/827 G24D-2	10,000	18	1200	G24d-2	827	10	24
DD18830	4050300025704	DULUX D 18W/830 G24D-2	10,000	18	1200	G24d-2	830	10	24
DD18835	4050300028873	DULUX D 18W/835 G24D-2	10,000	18	1200	G24d-2	835	10	24
DD18840	4050300012056	DULUX D 18W/840 G24D-2	10,000	18	1200	G24d-2	840	10	24
DD18865	4050300487120	DULUX D 18W/865 G24D-2	10,000	18	1140	G24d-2	865	10	24
DD26827	4050300011912	DULUX D 26W/827 G24D-3	10,000	26	1800	G24d-3	827	10	24
DD26830	4050300025711	DULUX D 26W/830 G24D-3	10,000	26	1800	G24d-3	830	10	24
DD26835	4050300028897	DULUX D 26W/835 G24D-3	10,000	26	1800	G24d-3	835	10	24
DD26840	4050300012049	DULUX D 26W/840 G24D-3	10,000	26	1800	G24d-3	840	10	24
DD26865	4050300486987	DULUX D 26W/865 G24D-3	10,000	26	1710	G24d-3	865	10	24

NEW

NEW

NEW

NEW

NEW

NEW

NEW

All orders must be multiples of sales pack

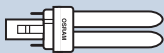

## Compact Fluorescent Lamps – Pin Based

**OSRAM DULUX® D ENERGY SAVER**

- 2 pin double-turn energy saving compact fluorescent
- 10% energy saving (CCG only) compared to DULUX® D
- 1:1 replacement for a standard 18w and 26w DULUX® D
- With integral starter for CCG
- Ideal for miniature luminaires and downlights for shallow recesses



Product ID Code	EAN (Single Pack)	Product Description	t [n]	W	lm				PPG
<b>NEW</b> DD16827ES	4008321940773	DULUX D 16W/827ES G24D-2	10,000	16	1150	G24d-2	827	10	24
<b>NEW</b> DD16830ES	4008321940797	DULUX D 16W/830ES G24D-2	10,000	16	1150	G24d-2	830	10	24
<b>NEW</b> DD16840ES	4008321940810	DULUX D 16W/840ES G24D-2	10,000	16	1150	G24d-2	840	10	24
<b>NEW</b> DD23827ES	4008321940759	DULUX D 23W/827ES G24D-3	10,000	23	1750	G24d-3	827	10	24
<b>NEW</b> DD23830ES	4008321940711	DULUX D 23W/830ES G24D-3	10,000	23	1750	G24d-3	830	10	24
<b>NEW</b> DD23840ES	4008321940735	DULUX D 23W/840ES G24D-3	10,000	23	1750	G24d-3	840	10	24

All orders must be multiples of sales pack

## Compact Fluorescent Lamps – Pin Based

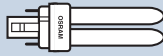
**OSRAM DULUX® D/E**

- Double-turn tube
- 4-pin compact fluorescent lamp
- 20,000 hours lifetime with warm start ECG
- For use with ECG and dimming systems
- Ideal for dimming and battery-powered emergency lighting applications

Product ID Code	EAN (Single Pack)	Product Description	t (h)	W	lm				PPG
DDE10827	4050300012124	DULUX D/E 10W/827 G24Q-1	20,000	10	600	G24q-1	827	10	24
DDE10830	4050300419435	DULUX D/E 10W/830 G24Q-1	20,000	10	600	G24q-1	830	10	24
DDE10835	4050300450933	DULUX D/E 10W/835 G24Q-1	20,000	10	600	G24q-1	835	10	24
DDE10840	4050300017587	DULUX D/E 10W/840 G24Q-1	20,000	10	600	G24q-1	840	10	24
DDE13827	4050300012131	DULUX D/E 13W/827 G24Q-1	20,000	13	900	G24q-1	827	10	24
DDE13830	4050300389059	DULUX D/E 13W/830 G24Q-1	20,000	13	900	G24q-1	830	10	24
DDE13835	4050300450957	DULUX D/E 13W/835 G24Q-1	20,000	13	900	G24q-1	835	10	24
DDE13840	4050300017594	DULUX D/E 13W/840 G24Q-1	20,000	13	900	G24q-1	840	10	24
DDE18827	4050300012148	DULUX D/E 18W/827 G24Q-2	20,000	18	1200	G24q-2	827	10	24
DDE18830	4050300327211	DULUX D/E 18W/830 G24Q-2	20,000	18	1200	G24q-2	830	10	24
DDE18835	4050300450971	DULUX D/E 18W/835 G24Q-2	20,000	18	1200	G24q-2	835	10	24
DDE18840	4050300017617	DULUX D/E 18W/840 G24Q-2	20,000	18	1200	G24q-2	840	10	24
DDE18865	4050300564944	DULUX D/E 18W/865 G24Q-2	20,000	18	1200	G24q-3	865	10	24
DDE26827	4050300012230	DULUX D/E 26W/827 G24Q-3	20,000	26	1800	G24q-3	827	10	24
DDE26830	4050300327235	DULUX D/E 26W/830 G24Q-3	20,000	26	1800	G24q-3	830	10	24
DDE26835	4050300450995	DULUX D/E 26W/835 G24Q-3	20,000	26	1800	G24q-3	835	10	24
DDE26840	4050300020303	DULUX D/E 26W/840 G24Q-3	20,000	26	1800	G24q-3	840	10	24
DDE26865	4008321185877	DULUX D/E 26W/865 G24Q-3	20,000	26	1800	G24q-3	865	10	24

Perfectly matched with QUICKTRONIC® electronic control gear

NEW

NEW

NEW

NEW

NEW

NEW

All orders must be multiples of sales pack

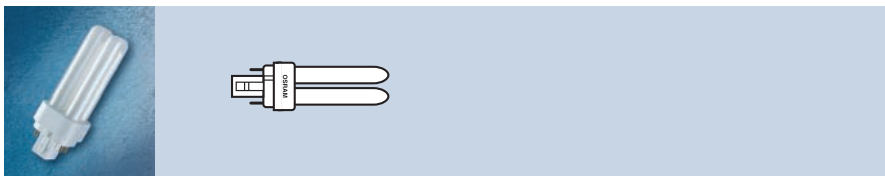

## Compact Fluorescent Lamps – Pin Based

**OSRAM DULUX® D/E XT for ECG**

- Double-turn tube
- 4-pin compact fluorescent lamp
- Extremely long lifetime 36,000 hours (with QUICKTRONIC®)
- Extremely compact for miniature luminaires and shallow mounting depth
- Ideal for shop lighting, hotel & restaurant lighting, office lighting and public buildings



Product ID Code	EAN (Single Pack)	Product Description	t [h]	W				PPG
<b>NEW</b> DDE18830XT	4008321507532*	DULUX D/E 18W/830 XT G24Q-2	36,000	18	G24q-2	830	10	24
<b>NEW</b> DDE18840XT	4008321507556*	DULUX D/E 18W/840 XT G24Q-2	36,000	18	G24q-2	840	10	24
<b>NEW</b> DDE26830XT	4008321508782*	DULUX D/E 26W/830 XT G24Q-3	36,000	26	G24q-3	830	10	24
<b>NEW</b> DDE26840XT	4008321508829*	DULUX D/E 26W/840 XT G24Q-3	36,000	26	G24q-3	840	10	24

Perfectly matched with QUICKTRONIC® electronic control gear

\*In preparation at time of print. For further information please contact OSRAM

All orders must be multiples of sales pack

## Compact Fluorescent Lamps – Pin Based

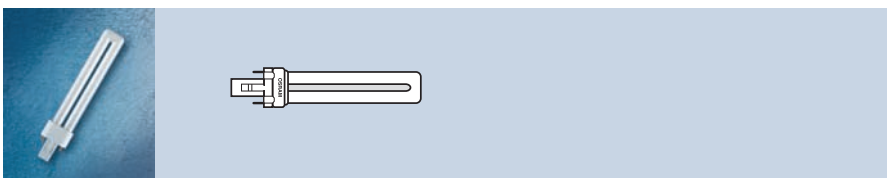
**OSRAM DULUX® S**

- Single-turn tube
- 2-pin compact fluorescent lamp
- With integral starter for CCG
- Extremely compact dimensions
- Ideal for creative luminaire design and modern lighting systems

Product ID Code	EAN (Single Pack)	Product Description	t [h]	W	lm				PPG
DS5827	4050300006130	DULUX S 5W/827 G23	10,000	5	250	G23	827	10	25
DS5840	4050300010564	DULUX S 5W/840 G23	10,000	5	250	G23	840	10	25
DS7827	4050300005997	DULUX S 7W/827 G23	10,000	7	400	G23	827	10	25
DS7830	4050300025735	DULUX S 7W/830 G23	10,000	7	400	G23	830	10	25
DS7835	4050300451039	DULUX S 7W/835 G23	10,000	7	400	G23	835	50	25
DS7840	4050300010571	DULUX S 7W/840 G23	10,000	7	400	G23	840	10	25
DS9827	4050300006000	DULUX S 9W/827 G23	10,000	9	600	G23	827	10	25
DS9830	4050300025742	DULUX S 9W/830 G23	10,000	9	600	G23	830	10	25
DS9835	4050300451053	DULUX S 9W/835 G23	10,000	9	600	G23	835	50	25
DS9840	4050300010588	DULUX S 9W/840 G23	10,000	9	600	G23	840	10	25
DS9860	4050300355320	DULUX S 9W/865 G23	10,000	9	570	G23	865	10	25
DS11827	4050300006017	DULUX S 11W/827 G23	10,000	11	900	G23	827	10	25
DS11830	4050300025759	DULUX S 11W/830 G23	10,000	11	900	G23	830	10	25
DS11835	4050300451077	DULUX S 11W/835 G23	10,000	11	900	G23	835	50	25
DS11840	4050300010618	DULUX S 11W/840 G23	10,000	11	900	G23	840	10	25

NEW

NEW

NEW

All orders must be multiples of sales pack



## Compact Fluorescent Lamps – Pin Based

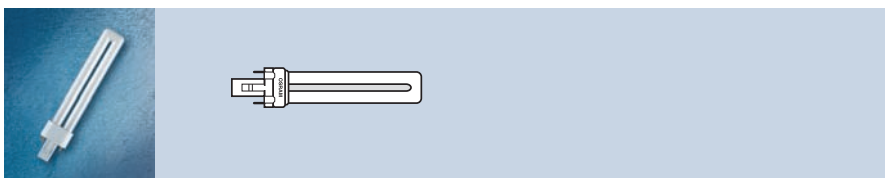

### OSRAM DULUX® S COLOURED

- Single-turn tube
- 2-pin compact fluorescent lamp
- With integral starter for CCG
- Ideal for creative illumination and decoration

Product ID Code	EAN (Single Pack)	Product Description	W	lm				PPG
DS960	4050300015927	DULUX S 9W/60 G23	9	400	G23	Red	10	25
DS966	4050300015934	DULUX S 9W/66 G23	9	800	G23	Green	10	25
DS967	4050300015941	DULUX S 9W/67 G23	9	200	G23	Blue	10	25

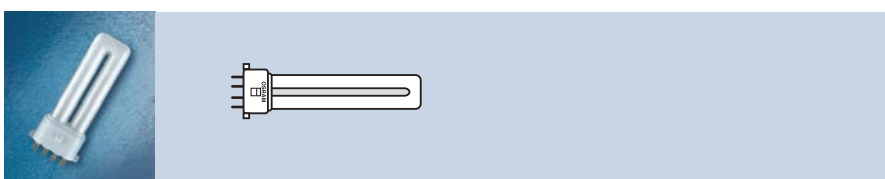

### OSRAM DULUX® S/E

- Single-turn tube
- 4-pin compact fluorescent lamp
- For use with ECG and dimming systems
- Extremely compact dimensions
- Ideal for versatile lighting operation on almost any power supply

Product ID Code	EAN (Single Pack)	Product Description	W	lm				PPG
DSE7827	4050300017648	DULUX S/E 7W/827 2G7	7	400	2G7	827	10	25
DSE7830	4050300591988	DULUX S/E 7W/830 2G7	7	400	2G7	830	10	25
DSE7840	4050300020167	DULUX S/E 7W/840 2G7	7	400	2G7	840	10	25
DSE9827	4050300017655	DULUX S/E 9W/827 2G7	9	600	2G7	827	10	25
DSE9830	4050300589398	DULUX S/E 9W/830 2G7	9	600	2G7	830	10	25
DSE9840	4050300020174	DULUX S/E 9W/840 2G7	9	600	2G7	840	10	25
DSE11827	4050300017662	DULUX S/E 11W/827 2G7	11	900	2G7	827	10	25
DSE11830	4050300589374	DULUX S/E 11W/830 2G7	11	900	2G7	830	10	25
DSE11840	4050300020181	DULUX S/E 11W/840 2G7	11	900	2G7	840	10	25

Perfectly matched with QUICKTRONIC® electronic control gear



All orders must be multiples of sales pack

## Compact Fluorescent Lamps – Pin Based

**OSRAM DULUX® L LUMILUX®**

- Longer single-turn tube
- 4-pin compact fluorescent lamp
- Higher wattage lamp with high luminous flux
- Long lifetime of 20,000 hours with warm start ECG
- For CCG with external starter or ECG and dimming systems
- Ideal for modular luminaires

Product ID Code	EAN (Single Pack)	Product Description	W	lm				PPG
DL18827	4050300010748	DULUX L 18W/827 2G11	18	1200	2G11	827	10	26
DL18830	4050300010731	DULUX L 18W/830 2G11	18	1200	2G11	830	10	26
DL18835	4050300295893	DULUX L 18W/835 2G11	18	1200	2G11	835	10	26
DL18840	4050300010724	DULUX L 18W/840 2G11	18	1200	2G11	840	10	26
DL24827	4050300010779	DULUX L 24W/827 2G11	24	1800	2G11	827	10	26
DL24830	4050300010762	DULUX L 24W/830 2G11	24	1800	2G11	830	10	26
DL24835	4050300295916	DULUX L 24W/835 2G11	24	1800	2G11	835	10	26
DL24840	4050300010755	DULUX L 24W/840 2G11	24	1800	2G11	840	10	26
DL36827	4050300010809	DULUX L 36W/827 2G11	36	2900	2G11	827	10	26
DL36830	4050300010793	DULUX L 36W/830 2G11	36	2900	2G11	830	10	26
DL36835	4050300295930	DULUX L 36W/835 2G11	36	2900	2G11	835	10	26
DL36840	4050300010786	DULUX L 36W/840 2G11	36	2900	2G11	840	10	26
DL36860	4050300328263	DULUX L 36W/8652G11	36	2900	2G11	865	10	26
DL36880	4008321185891	DULUX L 36W/880 SKYWHITE 2G11	36	2600	2G11	880	10	26
DL40827	4050300322285	DULUX L 40W/827 2G11	40	3500	2G11	827	10	26
DL40830	4050300298894	DULUX L 40W/830 2G11	40	3500	2G11	830	10	26
DL40835	4050300295954	DULUX L 40W/835 2G11	40	3500	2G11	835	10	26
DL40840	4050300279909	DULUX L 40W/840 2G11	40	3500	2G11	840	10	26
DL40860	4050300592008	DULUX L 40W/865 2G11	40	3500	2G11	865	10	26
DL40880	4008321185914	DULUX L 40W/880 SKYWHITE 2G11	40	3000	2G11	880	10	26
DL55827	4050300315881	DULUX L 55W/827 2G11	55	4800	2G11	827	10	26
DL55830	4050300298917	DULUX L 55W/830 2G11	55	4800	2G11	830	10	26
DL55835	4050300295978	DULUX L 55W/835 2G11	55	4800	2G11	835	10	26
DL55840	4050300295879	DULUX L 55W/840 2G11	55	4800	2G11	840	10	26
DL55860	4050300553900	DULUX L 55W/865 2G11	55	4800	2G11	865	10	26
DL55880	4008321185938	DULUX L 55W/880 SKYWHITE 2G11	55	4100	2G11	880	10	26
DL80830	4050300665467	DULUX L 80W/830 2G11	80	6000	2G11	830	10	26
DL80840	4050300665481	DULUX L 80W/840 2G11	80	6000	2G11	840	10	26
DL80880	4008321185952	DULUX L 80W/880 SKYWHITE 2G11	80	5600	2G11	880	10	26
<b>Coloured</b>								
DL2467	4050300354033	DULUX L 24W/BLUE 2G11	24	550	2G11	67	10	26

Perfectly matched with QUICKTRONIC® electronic control gear

All orders must be multiples of sales pack





## Compact Fluorescent Lamps – Pin Based

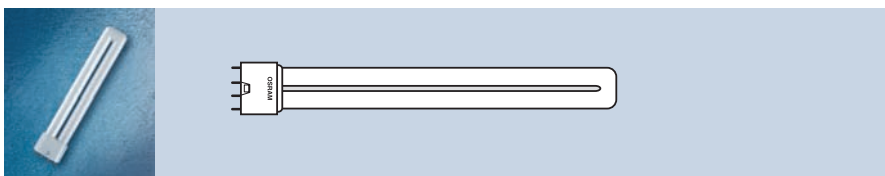

### OSRAM DULUX® L CONSTANT

- Longer single-turn tube
- 4-pin compact fluorescent lamp
- >90% luminous flux between +5°C and +70°C
- Ideal for luminaires with high temperatures

Product ID Code	EAN (Single Pack)	Product Description	W	lm				PPG
DL40840CO	4008321104823	DULUX L 40W/840 CONSTANT 2G11	40	3500	2G11	840	10	26
DL55840CO	4008321104847	DULUX L 55W/840 CONSTANT 2G11	55	4800	2G11	840	10	26
DL80840CO	4008321104861	DULUX L 80W/840 CONSTANT 2G11	80	6000	2G11	840	10	26

Perfectly matched with QUICKTRONIC® electronic control gear

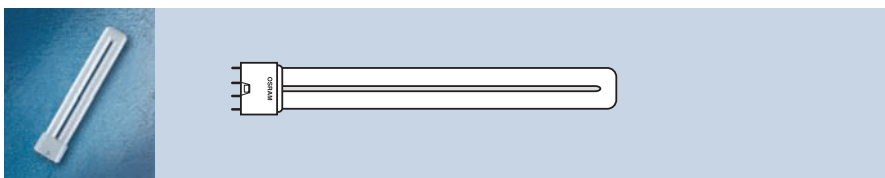

### OSRAM DULUX® L LUMILUX® DE LUXE

- Longer single-turn tube
- 4-pin compact fluorescent lamp
- Long lifetime of 20,000 hours with warm start ECG
- Excellent colour rendering Ra>90
- For CCG with external starter or ECG and dimming systems
- Ideal for modular luminaires

Product ID Code	EAN (Single Pack)	Product Description	W	lm				PPG
DL18930	4050300018324	DULUX L 18W/930 2G11	18	750	2G11	930	10	26
DL18940	4050300018560	DULUX L 18W/940 2G11	18	750	2G11	940	10	26
DL18954	4050300018423	DULUX L 18W/954 2G11	18	750	2G11	954	10	26
DL24930	4050300018386	DULUX L 24W/930 2G11	24	1200	2G11	930	10	26
DL24940	4050300018584	DULUX L 24W/940 2G11	24	1200	2G11	940	10	26
DL24954	4050300018447	DULUX L 24W/954 2G11	24	1200	2G11	954	10	26
DL36930	4050300018393	DULUX L 36W/930 2G11	36	1900	2G11	930	10	26
DL36940	4050300018607	DULUX L 36W/940 2G11	36	1900	2G11	940	10	26
DL36954	4050300018461	DULUX L 36W/954 2G11	36	1900	2G11	954	10	26
DL40954	4050300315799	DULUX L 40W/954 2G11	40	2200	2G11	954	10	26
DL55930	4050300370705	DULUX L 55W/930 2G11	55	3000	2G11	930	10	26
DL55940	4050300197999	DULUX L 55W/940 2G11	55	3000	2G11	940	10	26
DL55954	4050300321400	DULUX L 55W/954 2G11	55	3000	2G11	954	10	26

Perfectly matched with QUICKTRONIC® electronic control gear

All orders must be multiples of sales pack

## Compact Fluorescent Lamps – Pin Based

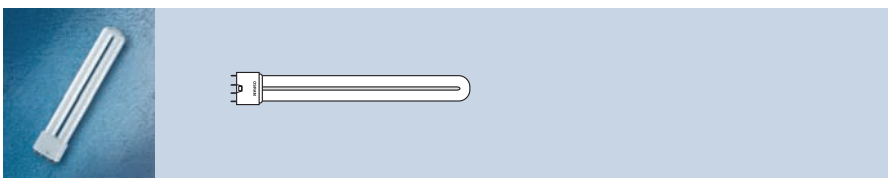

### OSRAM DULUX® L SP

- Longer single-turn tube
- 4-pin compact fluorescent lamp
- Long lifetime of 20,000 hours with warm start ECG
- For operation at low ambient temperatures
- Ideal for low temperature outdoor lighting

Product ID Code	EAN (Single Pack)	Product Description	W	lm				PPG
DL18830SP	4050300300276	DULUX L 18W/830 SP 2G11	18	1200	2G11	830	10	38
DL18840SP	4008321280497	DULUX L 18W/840 SP 2G11	18	1200	2G11	840	10	38
DL24830SP	4050300300238	DULUX L 24W/830 SP 2G11	24	1800	2G11	830	10	38
DL24840SP	4008321280510	DULUX L 24W/840 SP 2G11	24	1800	2G11	840	10	26
DL36830SP	4008321283757	DULUX L 36W/830SP 2G11	36	2900	2G11	830	10	26
DL36840SP	4008321283771	DULUX L 36W/840SP 2G11	36	2900	2G11	840	10	26

Perfectly matched with QUICKTRONIC® electronic control gear

NEW  
NEW  
NEW  
NEW

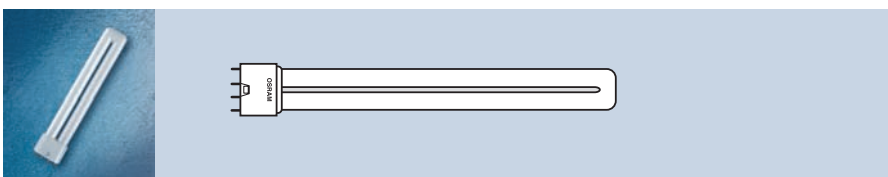

### OSRAM DULUX® L HIGH EFFICIENCY

- High Efficiency 4 pin long single turn compact fluorescent
- Long lifetime of 20,000 hours by 50% mortality
- For CCG with external starter or ECG and dimming systems
- Optimised for light fitting 600 x 600 mm
- Ideal for new short run luminaires

Product ID Code	EAN (Single Pack)	Product Description	W	lm				PPG
DL16830HE	4008321507792	DULUX L 16W/830 HE 2GX11	16	1600	2GX11	830	10	26
DL16840HE	4008321507815	DULUX L 16W/840 HE 2GX11	16	1600	2GX11	840	10	26
DL22830HE	4008321507839	DULUX L 22W/830 HE 2GX11	22	2200	2GX11	830	10	26
DL22840HE	4008321508638	DULUX L 22W/840 HE 2GX11	22	2200	2GX11	840	10	26
DL26830HE	4008321508584	DULUX L 26W/830 HE 2GX11	26	2600	2GX11	830	10	26
DL26840HE	4008321508713	DULUX L 26W/840 HE 2GX11	26	2600	2GX11	840	10	26
DL28830HE	4008321296719	DULUX L 28W/830 HE 2GX11	28	2800	2GX11	830	10	26
DL28840HE	4008321296757	DULUX L 28W/840 HE 2GX11	28	2800	2GX11	840	10	26

Perfectly matched with QUICKTRONIC® electronic control gear

NEW  
NEW  
NEW  
NEW  
NEW  
NEW  
NEW  
NEW

All orders must be multiples of sales pack



## Compact Fluorescent Lamps – Pin Based

**OSRAM DULUX® L XT**

- Longer single-turn tube
- 4-pin compact fluorescent lamp
- Extremely long lifetime 36,000 hours (with QUICKTRONIC®)
- For direct or indirect lighting
- Ideal for industry lighting, trade and commerce, office lighting, public buildings



Product ID Code	EAN (Single Pack)	Product Description	t [h]	W	lm				PPG
<b>NEW</b> DL18830XT	4008321507570*	DULUX L 18W/830 XT 2G11	36,000	18	1200	2G11	830	10	26
<b>NEW</b> DL18840XT	4008321507594*	DULUX L 18W/840 XT 2G11	36,000	18	1200	2G11	840	10	26
<b>NEW</b> DL24830XT	4008321507617*	DULUX L 24W/830 XT 2G11	36,000	24	1800	2G11	830	10	26
<b>NEW</b> DL24840XT	4008321507631*	DULUX L 24W/840 XT 2G11	36,000	24	1800	2G11	840	10	26
<b>NEW</b> DL36830XT	4008321507655*	DULUX L 36W/830 XT 2G11	36,000	36	2900	2G13	830	10	26
<b>NEW</b> DL36840XT	4008321507679*	DULUX L 36W/840 XT 2G11	36,000	36	2900	2G14	840	10	26
<b>NEW</b> DL55830XT	4008321507693*	DULUX L 55W/830 XT 2G11	36,000	55	4800	2G15	830	10	26
<b>NEW</b> DL55840XT	4008321507716*	DULUX L 55W/840 XT 2G11	36,000	55	4800	2G16	840	10	26

Perfectly matched with QUICKTRONIC® electronic control gear

\*In preparation at time of print. For further information please contact OSRAM

All orders must be multiples of sales pack

## Compact Fluorescent Lamps – Pin Based

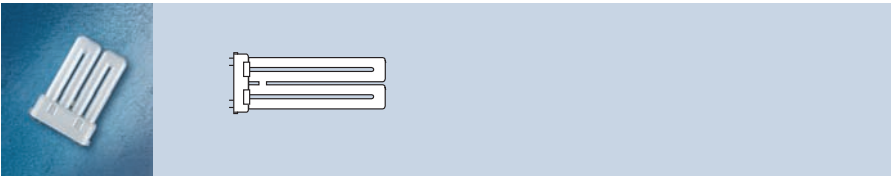
**OSRAM DULUX® F**

- Flat double-turn tube
- 4-pin compact fluorescent lamp
- For CCG with external starter or ECG and dimming systems
- Ideal for area lighting with modular luminaires

Product ID Code	EAN (Single Pack)	Product Description	W		lm		PPG	
			W	lm	W	lm	W	lm
DF18827	4050300333564	DULUX F 18W/827 2G10	18	1100	2G10	827	10	23
DF18830	4050300333540	DULUX F 18W/830 2G10	18	1100	2G10	830	10	23
DF18840	4050300333526	DULUX F 18W/840 2G10	18	1100	2G10	840	10	23
DF24827	4050300333625	DULUX F 24W/827 2G10	24	1700	2G10	827	10	23
DF24830	4050300333601	DULUX F 24W/830 2G10	24	1700	2G10	830	10	23
DF24840	4050300333588	DULUX F 24W/840 2G10	24	1700	2G10	840	10	23
DF36827	4050300312187	DULUX F 36W/827 2G10	36	2800	2G10	827	10	23
DF36830	4050300299051	DULUX F 36W/830 2G10	36	2800	2G10	830	10	23
DF36840	4050300299037	DULUX F 36W/840 2G10	36	2800	2G10	840	10	23

Perfectly matched with QUICKTRONIC® electronic control gear

All orders must be multiples of sales pack

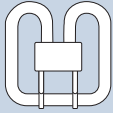

## Compact Fluorescent Lamps – Pin Based

**OSRAM CFL SQUARE**

- Classic square shape
- Uniform distribution of light
- Ideal for bulkhead luminaires

Product ID Code	EAN (Single Pack)	Product Description	W	lm				PPG
<b>2 Pin</b>								
CFL168272P	4050300816852	CFL SQUARE 16W/827 2-PIN GR8	16	1050	GR8	827	20	23
CFL168352P	4050300816838	CFL SQUARE 16W/835 2-PIN GR8	16	1050	GR8	835	20	23
CFL288272P	4050300816913	CFL SQUARE 28W/827 2-PIN GR8	28	2050	GR8	827	20	23
CFL288352P	4050300816937	CFL SQUARE 28W/835 2-PIN GR8	28	2050	GR8	835	20	23
<b>4 Pin</b>								
CFL168274P	4050300816890	CFL SQUARE 16W/827 4-PIN GR10Q	16	1050	GR10q	827	20	23
CFL168354P	4050300816876	CFL SQUARE 16W/835 4-PIN GR10Q	16	1050	GR10q	835	20	23
CFL288274P	4050300816951	CFL SQUARE 28W/827 4-PIN GR10Q	28	2050	GR10q	827	20	23
CFL288354P	4050300816982	CFL SQUARE 28W/835 4-PIN GR10Q	28	2050	GR10q	835	20	23
CFL388274P	4050300817002	CFL SQUARE 38W/827 4-PIN GR10Q	38	2700	GR10q	827	20	23
CFL388354P	4050300817026	CFL SQUARE 38W/835 4-PIN GR10Q	38	2700	GR10q	835	20	23

Perfectly matched with QUICKTRONIC® electronic control gear

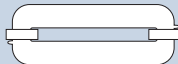
**OSRAM ENDURA®**

- Very long life compact fluorescent lamps
- Ideal for reducing maintenance costs

Product ID Code	EAN (Single Pack)	Product Description	W	lm				PPG
ENDURA70830	4050300817293	ENDURA 70W/830	70	6500	2-pin	830	1	38
ENDURA70840	4050300817286	ENDURA 70W/840	70	6500	2-pin	840	1	38
ENDURA100830	4050300668420	ENDURA 100W/830	100	8000	2-pin	830	1	38
ENDURA100840UK	4050300668437	ENDURA 100W/840	100	8000	2-pin	840	1	38
ENDURA150830UK	4050300668444	ENDURA 150W/830	150	12000	2-pin	830	1	38
ENDURA150840UK	4050300668451	ENDURA 150W/840	150	12000	2-pin	840	1	38

Perfectly matched with QUICKTRONIC® electronic control gear



All orders must be multiples of sales pack

LED LAMPS

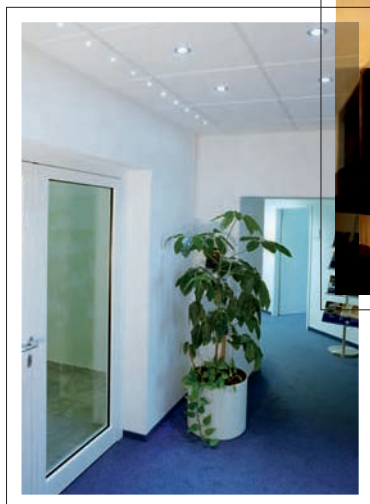
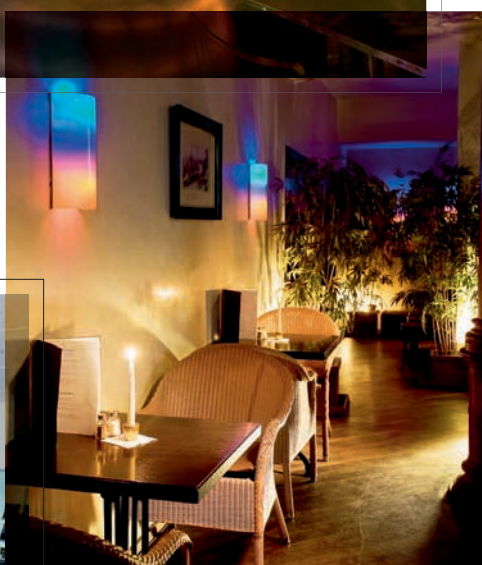

# LED Lamps Contents.

SubstiTUBE® ST8-SD4	70
PARATHOM® PAR 16 20	71
PARATHOM® PAR 16 35	71
PARATHOM® PRO PAR 16 35 ADVANCED	72
PARATHOM® PRO PAR 16 50 ADVANCED	72
PARATHOM® R50	73
PARATHOM® MR16 20	73
PARATHOM® PRO MR16 20 ADVANCED	74
PARATHOM® PRO MR16 35 ADVANCED	74
PARATHOM® CLASSIC A 25	75
PARATHOM® CLASSIC A 40	75
PARATHOM® PRO CLASSIC A	76
PARATHOM® CLASSIC B 25	76
PARATHOM® CLASSIC P 25	77
PARATHOM® DECO CLASSIC A	78
PARATHOM® DECO CLASSIC FROSTED	79
PARATHOM® DECO CLASSIC B	79
PARATHOM® DECO CLASSIC P	80
PARATHOM® G95 40 Warm White	81
PARATHOM® DECO GLOBE	81
DECOSPOT® LED PAR 16	82
PARATHOM® SPECIAL T26	82
DULED®	83



## LED Lamps

**SubstiTUBE® ST8-SD4**

- Replacement for 36W T8 Fluorescent Tube
- Equipped with OSRAM OSOLON LED modules
- Available in 6,500K, 4,000K and 3,000K



Product ID Code	EAN (Single Pack)	Product Description	W	Im	V/mA		PPG
ST8SD4830	4008321966049	SubstiTUBE ST8 SD4 830	23.5	1550	200-240	10	38
ST8SD4840	4008321966056	SubstiTUBE ST8 SD4 840	23.5	1200	200-240	10	38
ST8SD4765	4008321966063	SubstiTUBE ST8 SD4 765	23.5	1200	200-240	10	38

NEW  
NEW  
NEW

All orders must be multiples of sales pack



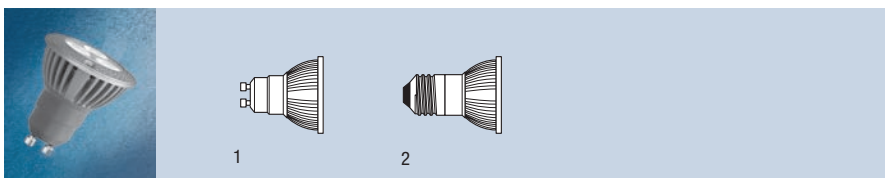

## LED Lamps

**PARATHOM® PAR 16 20**

- Mains voltage LED reflector replacing HALOGEN 20W
- GU10 and ES bases, 35° beam angle

Product ID Code	EAN (Single Pack)	Product Description	W	cd	V/mA	No.	PPG
PARAPAR1620D	4008321965721	PARATHOM PAR16 20 Daylight E27	4.5	600	220-240	2	10 38
PARAPAR1620WW	4008321965769	PARATHOM PAR16 20 Warm White E27	4.5	450	220-240	2	10 38
PARAPAR1620DGU10	4008321965806	PARATHOM PAR16 20 Daylight GU10	4.5	600	220-240	1	10 38
PARAPAR1620WWGU10	4008321965844	PARATHOM PAR16 20 Warm White GU10	4.5	450	220-240	1	10 38

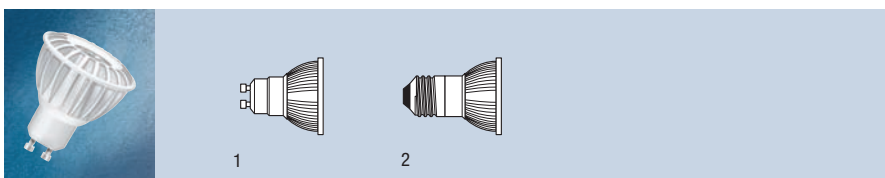
**PARATHOM® PAR 16 35**

- Mains voltage LED reflector replacing HALOGEN 35W
- GU10 bases, 25° and 35° beam angle

Product ID Code	EAN (Single Pack)	Product Description	W	V/mA	No.	PPG
PAR16P4WWBL1	4008321979469	PARATHOM PAR16 35 25° Warm White GU10 blister	4.5	220-240	1	6 38
PAR16P4DGU10	4008321980045	PARATHOM PAR16 35 25° Daylight GU10 blister	4.5	220-240	1	6 38
PAR16P4WW	4008321980069	PARATHOM PAR16 35 25° Warm White E27 blister	4.5	220-240	2	6 38
PAR16P4D	4008321980083	PARATHOM PAR16 35 25° Daylight E27 blister	4.5	220-240	2	6 38
PAR16P5WWGU10	4008321979506	PARATHOM PAR16 35 35° Warm White GU10	6	220-240	1	10 38

All orders must be multiples of sales pack

## LED Lamps

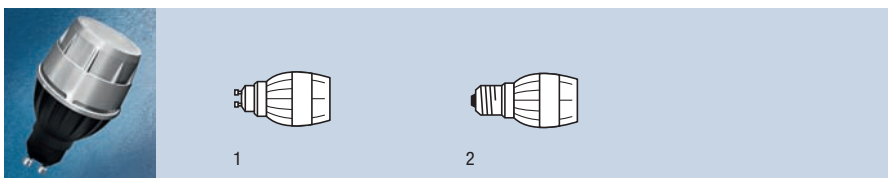
**PARATHOM® PRO PAR 16 35 ADVANCED**

- Dimmable mains voltage LED reflector replacing HALOGEN 35W
- GU10 and ES bases, 35° beam angle

Product ID Code	EAN (Single Pack)	Product Description	W	cd	V/mA	Light No.	PPG
PAR16PRO8WWGU10	4008321963963	PAR16 35 ADVANCED Warm White GU10	8	600	220-240	1	10
PAR16PRO8WW	4008321964007	PAR16 35 ADVANCED Warm White E27	8	600	220-240	2	10
PAR16PRO8DGU10	4008321964045	PAR16 35 ADVANCED Daylight GU10	8	>600	220-240	1	10
PAR16PRO8D	4008321964083	PAR16 35 ADVANCED Daylight E27	8	>600	220-240	2	10
PAR16PRO8830GU10	4008321980144*	PAR 16 35 ADVANCED Warm White D2	8	-	220-240	-	10
PAR16PRO8765GU10	4008321980168*	PAR 16 35 ADVANCED Daylight D2	8	-	220-240	-	10

NEW  
NEW  
NEW  
NEW  
NEW

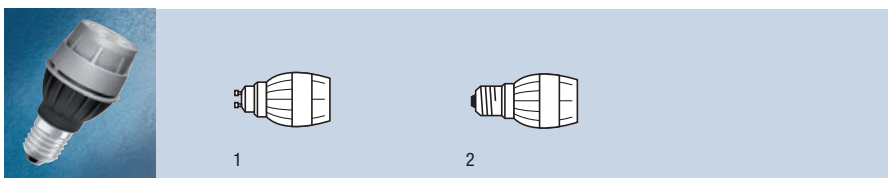
**PARATHOM® PRO PAR 16 50 ADVANCED**

- Dimmable mains voltage LED reflector replacing HALOGEN 50W
- GU10 and ES bases, 35° beam angle

Product ID Code	EAN (Single Pack)	Product Description	W	cd	V/mA	Light No.	PPG
PAR16PRO10WWGU10	4008321964120	PAR16 50 ADVANCED Warm White GU10	10	950	220-240	1	10
PAR16PRO10WW	4008321964168	PAR16 50 ADVANCED Warm White E27	10	950	220-240	2	10
PAR16PRO10DGU10	4008321964205	PAR16 50 ADVANCED Daylight GU10	10	>950	220-240	1	10
PAR16PRO10D	4008321964243	PAR16 50 ADVANCED Daylight E27	10	>950	220-240	2	10
PAR16PRO10830GU10	4008321980182*	PAR16 50 ADVANCED Warm White D2 GU10	10	-	220-240	-	10
PAR16PRO10765GU10	4008321980205*	PAR16 50 ADVANCED Daylight D2 GU10	10	-	220-240	-	10

NEW  
NEW  
NEW  
NEW  
NEW

All orders must be multiples of sales pack

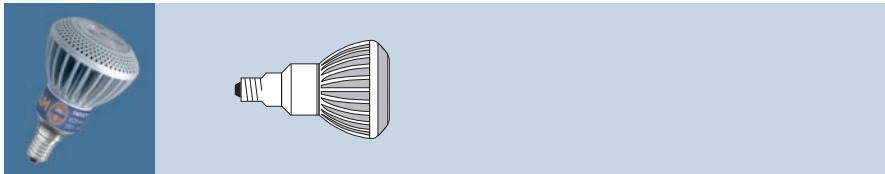

## LED Lamps

**PARATHOM® R50**

- Mains voltage R50 reflector shape LED retrofit lamp
- 3W replaces 25W and 6W replaces 40W incandescent
- Very low energy consumption
- Professional heat management
- 30° beam angle
- Ideal for accent lighting

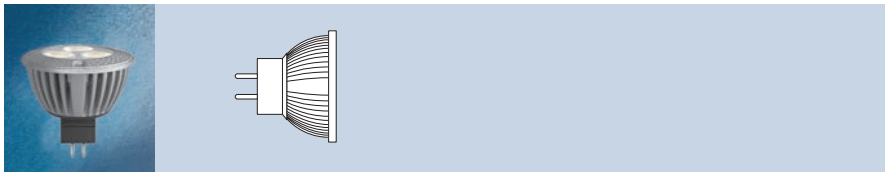

Product ID Code	EAN (Single Pack)	Product Description	W	lm	V/mA		PPG
NEW PAR3R50AE14	4008321965400	R50 25 Daylight E14	3	140	220-240	10	38
NEW PAR3R50AWWE14	4008321965448	R50 25 Warm White E14	3	100	220-240	10	38
NEW PAR3R50AD	4008321965486	R50 25 Daylight E27	3	140	220-240	10	38
NEW PAR3R50AWW	4008321965523	R50 25 Warm White E27	3	100	220-240	10	38
NEW PAR6R50ADE14	4008321965561	R50 40 Daylight E14	6	240	220-240	10	38
NEW PAR6R50AWWE14	4008321965608	R50 40 Warm White E14	6	170	220-240	10	38
NEW PAR6R50AD	4008321965646	R50 40 Daylight E27	6	240	220-240	10	38
NEW PAR6R50AWW	4008321965684	R50 40 Warm White E27	6	170	220-240	10	38

**PARATHOM® MR16 20**

- Low voltage LED replacement to a MR16 HALOGEN 20W
- GU5.3 base with a beam angle of 36°

Product ID Code	EAN (Single Pack)	Product Description	W	lm	V/mA		PPG
NEW PAR4MR16	4008321521927	PARATHOM PRO MR16 20 Warm White	4.5	450	12	6	38

All orders must be multiples of sales pack

## LED Lamps

**PARATHOM® PRO MR16 20 ADVANCED**

- Dimmable LED replacement for a MR16 HALOGEN 20W
- GU5.3 base with a beam angle of 36°
- For use on most ECG

Product ID Code	EAN (Single Pack)	Product Description	W	lm	V/mA		PPG
PAR5MR16	4008321963802	PARATHOM PRO MR16 20 ADVANCED Warm White	5.5	500	12 AC/DC 6	38	
PAR5MR16D	4008321963840	PARATHOM PRO MR16 20 ADVANCED Daylight	5.5	>500	12 AC/DC 6	38	

NEW  
NEW**PARATHOM® PRO MR16 35 ADVANCED**

- Dimmable LED replacement for a MR16 HALOGEN 35W
- GU5.3 base with a beam angle of 36°
- For use on most ECG
- D2 uses a new design with a more efficient heat sink

Product ID Code	EAN (Single Pack)	Product Description	W	lm	V/mA		PPG
PAR10MR16	4008321963888	PARATHOM PRO MR16 35 36° ADVANCED Warm White	10	950	12 AC/DC 10	38	
PAR10MR16D	4008321963925	PARATHOM PRO MR16 35 36° ADVANCED Daylight	10	>950	12 AC/DC 10	38	
PAR10830MR16	4008321980106	PARATHOM PRO MR16 35 36° ADVANCED Warm White D2	10	–	12 AC/DC 10	38	
PAR10765MR16	4008321980120	PARATHOM PRO MR16 35 36° ADVANCED Cool White D2	10	–	12 AC/DC 10	38	

NEW  
NEW  
NEW  
NEW

All orders must be multiples of sales pack

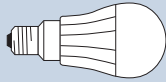

## LED Lamps

**PARATHOM® CLASSIC A 25**

- Mains voltage Classic GLS shape LED retrofit lamp
- Extremely longlife and low energy consumption
- Direct replacement for 25W incandescent lamps

Product ID Code	EAN (Single Pack)	Product Description	W	lm	V/mA	PPG
PAR6ACLA25D	4008321965042	PARATHOM CLASSIC A 25 Daylight 7W E27	7	380	100-240	10 38
PAR6ACLA25WW	4008321965080	PARATHOM CLASSIC A 25 Warm White 7W E27	7	300	100-240	10 38

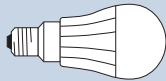
**PARATHOM® CLASSIC A 40**

- Mains voltage Classic GLS shape LED retrofit lamp
- Extremely longlife and low energy consumption
- Direct replacement for 40W incandescent lamps
- High luminous flux > 350 lm (Norm GLS: 345 lm)

Product ID Code	EAN (Single Pack)	Product Description	W	lm	V/mA	PPG
PAR8CLA40	4008321952066	PARATHOM CLASSIC A 40 Warm White 8W E27	8	345	100-240	10 38
PAR8CLA40CW	4008321952141	PARATHOM CLASSIC A 40 Daylight 8W E27	8	450	100-240	10 38

All orders must be multiples of sales pack

## LED Lamps

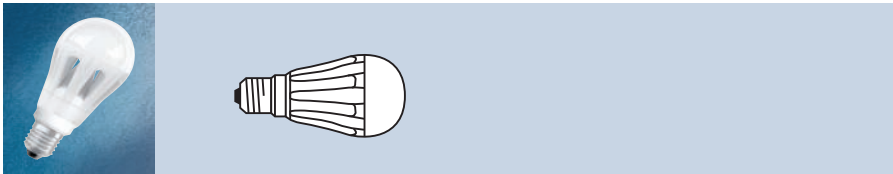
**PARATHOM® PRO CLASSIC A**

- Mains voltage Classic GLS shape LED retrofit lamp
- Dimmable with extremely longlife and low energy consumption
- A80 is 60W replacement according to ErP and A60 is 60W equivalent according to catalogue data

Product ID Code	EAN (Single Pack)	Product Description	W	lm	V/mA		PPG
PAR12CLA60	4008321965165	PARATHOM PRO CLASSIC A 60 Warm White 8W E27	12	640	220-240	10	38
PAR12CLA80	4008321960658	PARATHOM PRO CLASSIC A 80 Warm White 8W E27	12	806	220-240	10	38

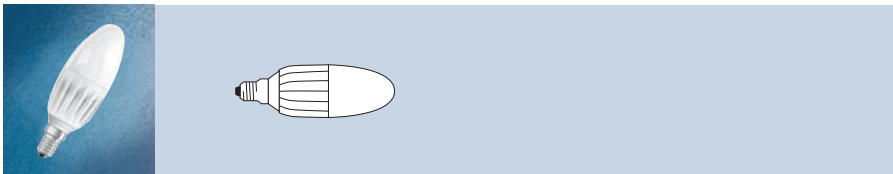
NEW  
NEW**PARATHOM® CLASSIC B 25**

- Mains voltage classic candle shape LED retrofit lamp
- Extremely longlife and low energy consumption
- Direct replacement for 25W incandescent lamps
- Very long lifetime of 25,000 hours

Product ID Code	EAN (Single Pack)	Product Description	W	lm	V/mA		PPG
PAR4CLB25	4008321952202	PARATHOM CLASSIC B 25 Warm White 4W E27	4	170	100-240	10	38

NEW

All orders must be multiples of sales pack



## LED Lamps

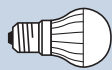

1

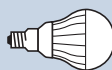

2

**PARATHOM® CLASSIC P 25**

- Mains voltage golf ball shape LED retrofit lamp
- Extremely longlife and low energy consumption
- Direct replacement for 25W incandescent lamps
- Very long lifetime of 25,000 hours

Product ID Code	EAN (Single Pack)	Product Description
-----------------	-------------------	---------------------

W	lm	V/mA	Light No.	PPG
---	----	------	-----------	-----

NEW

PAR4DCLP25	4008321965202	PARATHOM CLASSIC P 25 Daylight E27	~4	230	100-240	1	10	38
------------	---------------	------------------------------------	----	-----	---------	---	----	----

NEW

PAR4CLP25WW	4008321965240	PARATHOM CLASSIC P 25 Warm White E27	~4	200	100-240	1	10	38
-------------	---------------	--------------------------------------	----	-----	---------	---	----	----

NEW

PAR4DCLP25E14	4008321965288	PARATHOM CLASSIC P 25 Daylight E14	~4	230	100-240	2	10	38
---------------	---------------	------------------------------------	----	-----	---------	---	----	----

NEW

PAR4CLP25E14	4008321965325	PARATHOM CLASSIC P 25 Warm White E14	~4	200	100-240	2	10	38
--------------	---------------	--------------------------------------	----	-----	---------	---	----	----



All orders must be multiples of sales pack

## LED Lamps

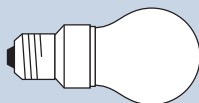
**PARATHOM® DECO CLASSIC A**

- Mains voltage Classic GLS shape LED retrofit lamp
- Colour versions produce same light impression as a coloured 25W incandescent
- White versions produce same light impression as a 15W or 10W incandescent
- Extremely longlife and low energy consumption
- Very long lifetime of 25,000 hours
- Ideal for decorative white or coloured lighting both indoors and outdoors



Product ID Code	EAN (Single Pack)	Product Description	W	V/mA		PPG
<b>ES/E27 base</b>						
80059	4008321929273	80059 PARATHOM CL A Cool White 2.3W E27	2.3	240	10	38
80061	4008321925329	80061 PARATHOM CL A Warm White 2.3W E27	2.3	240	10	38
80060	4008321918253	80060 PARATHOM CL A Colour Change 0.5W E27	0.5	240	10	38
80062	4008321918260	80062 PARATHOM CL A Blue 1.2W E27	1.2	240	10	38
80063	4008321918277	80063 PARATHOM CL A Green 1.2W E27	1.2	240	10	38
80064	4008321918284	80064 PARATHOM CL A Red 1W E27	1	240	10	38
80065	4008321918291	80065 PARATHOM CL A Yellow 1W E27	1	240	10	38
<b>BC/B22d base</b>						
85000	4008321935632	85000 PARATHOM CL A Cool White 2.3W B22d	2.3	240	10	38
85001	4008321935656	85001 PARATHOM CL A Warm White 2.3W B22d	2.3	240	10	38
85002	4008321935496	85002 PARATHOM CL A Colour Change 0.5W B22d	0.5	240	10	38
85003	4008321935526	85003 PARATHOM CL A Blue 1.2W B22d	1.2	240	10	38
85004	4008321935670	85004 PARATHOM CL A Green 1.2W B22d	1.2	240	10	38
85005	4008321935694	85005 PARATHOM CL A Red 1W B22d	1	240	10	38
85006	4008321935717	85006 PARATHOM CL A Yellow 1W B22d	1	240	10	38

NEW

All orders must be multiples of sales pack



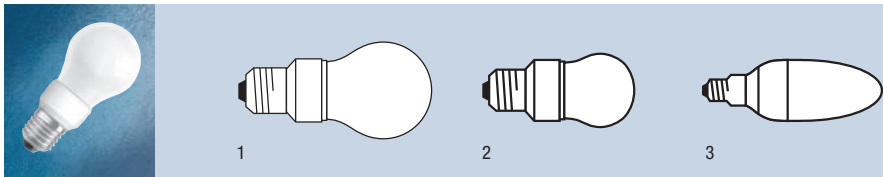

## LED Lamps

**PARATHOM® DECO CLASSIC FROSTED**

- Mains voltage LED retrofit lamp with a frosted bulb for a homogenous light impression
- Available in classic, candle and globe shapes
- Extremely low energy consumption
- Ideal for decorative white lighting both indoors and outdoors

Product ID Code	EAN (Single Pack)	Product Description	W	Im	V/mA	No.	PPG
<b>ES/E27 base</b>							
PAR2CLAFR	4008321951823	PARATHOM DECO CLA A FROSTED Warm White	1	50	240	1	10 38
PAR2DECOCLPFR	4008321951861	PARATHOM DECO CLA P FROSTED Warm White	1	50	240	2	10 38
<b>SES/E14 base</b>							
PAR2DECOCLBFR	4008321951847	PARATHOM DECO CLA B FROSTED Warm White	1	50	240	3	10 38

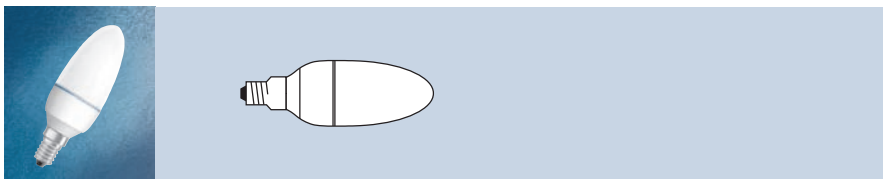
**PARATHOM® DECO CLASSIC B**

- Mains voltage candle shape LED retrofit lamp
- Colour versions produce same light impression as a coloured 25W incandescent
- White versions produce same light impression as a 15W or 10W incandescent
- Extremely longlife and low energy consumption
- Very long lifetime of 25,000 hours
- Ideal for decorative white or coloured lighting both indoors and outdoors

Product ID Code	EAN (Single Pack)	Product Description	W	V/mA	PPG
80094	4008321929310	80094 PARATHOM CL B Cool White 1.6W E14	1.6	240	10 38
80096	4008321925404	80096 PARATHOM CL B Warm White 1.6W E14	1.6	240	10 38
80095	4008321922625	80095 PARATHOM CL B Colour Change 0.5W E14	0.5	240	10 38
80097	4008321922649	80097 PARATHOM CL B Blue 1.2W E14	1.2	240	10 38
80098	4008321922663	80098 PARATHOM CL B Green 1.2W E14	1.2	240	10 38
80099	4008321922687	80099 PARATHOM CL B Red 1W E14	1	240	10 38
80100	4008321922700	80100 PARATHOM CL B Yellow 1W E14	1	240	10 38

All orders must be multiples of sales pack

## LED Lamps

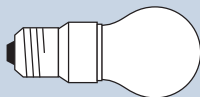
**PARATHOM® DECO CLASSIC P**

- Mains voltage 45mm round shape LED retrofit lamp
- Colour versions produce same light impression as a coloured 25W incandescent
- White versions produce same light impression as a 15W or 10W incandescent
- Extremely longlife and low energy consumption
- Very long lifetime of 25,000 hours
- Ideal for decorative white or coloured lighting both indoors and outdoors



Product ID Code	EAN (Single Pack)	Product Description	W	V/mA		PPG
<b>ES/E27 base</b>						
80087	4008321929297	80087 PARATHOM CL P Cool White 1.6W E27	1.6	240	10	38
80089	4008321925367	80089 PARATHOM CL P Warm White 1.6W E27	1.6	240	10	38
80088	4008321922427	80088 PARATHOM CL P Colour Change 0.5W E27	0.5	240	10	38
80090	4008321922441	80090 PARATHOM CL P Blue 1.2W E27	1.2	240	10	38
80091	4008321922465	80091 PARATHOM CL P Green 1.2W E27	1.2	240	10	38
80092	4008321922489	80092 PARATHOM CL P Red 1W E27	1	240	10	38
80093	4008321922502	80093 PARATHOM CL P Yellow 1W E27	1	240	10	38
<b>SES/E14 base</b>						
PAR1CLP15	4008321962492	PARATHOM CL P Warm White 2W E14	2	240	10	38

NEW

NEW

All orders must be multiples of sales pack

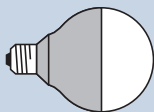

## LED Lamps

**PARATHOM® G95 40 Warm White**

- Mains voltage G95 (95mm globe) shape LED retrofit lamp
- Same light output as a 40W incandescent

Product ID Code	EAN (Single Pack)	Product Description	W	V/mA		PPG
PAR10G9540	4008321965387	PARATHOM G95 40 Warm White	10.5	100-240	10	38

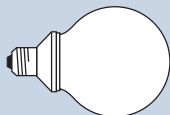
**PARATHOM® DECO GLOBE**

- Mains voltage G95 (95mm globe) shape LED retrofit lamp
- Colour versions produce same light impression as a coloured 25W incandescent
- White versions produce same light impression as a 15W or 10W incandescent
- Extremely longlife and low energy consumption
- Very long lifetime of 25,000 hours
- Ideal for decorative white or coloured lighting both indoors and outdoors

Product ID Code	EAN (Single Pack)	Product Description	W	lm	V/mA		PPG
80845	4008321929334	80845 PARATHOM G95 Cool White 3W E27	3	165	240	10	38
80846	4008321929358	80846 PARATHOM G95 Warm White 3W E27	3	165	240	10	38
80340	4008321925442	80340 PARATHOM G95 Colour Change 1W E27	1	-	240	10	38
80341	4008321925466	80341 PARATHOM G95 Blue 1.8W E27	1.8	4	240	10	38
80342	4008321925480	80342 PARATHOM G95 Green 1.8W E27	1.8	16	240	10	38
80343	4008321925503	80343 PARATHOM G95 Red 1.4W E27	1.4	16	240	10	38
80344	4008321925527	80345 PARATHOM G95 Yellow 1.4W E27	1.4	10	240	10	38

\* B22d/BC versions available on request. For further information contact OSRAM

All orders must be multiples of sales pack

## LED Lamps

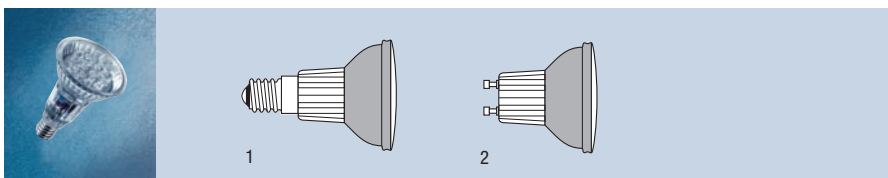
**DECOSPOT® LED PAR 16**

- Economical mains voltage retrofit LED lamp in PAR 16 shape
- Available in 4 single colours and colour changing
- Low energy consumption
- Fits into standard fittings with SES/GU10 base
- Ideal for efficient coloured spot lighting

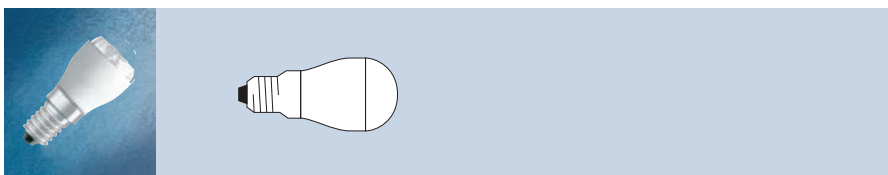

Product ID Code	EAN (Single Pack)	Product Description	W	cd	V/mA	No.	PPG
<b>SES/E14 Base</b>							
80001	4008321905550	DECOSPOT LED PAR 16 Colour Change E14 blister	0.6	8.3-35	240	1	6 38
80002	4008321905635	DECOSPOT LED PAR 16 White E14 blister	0.8	180	240	1	6 38
80003	4008321905529	DECOSPOT LED PAR 16 Red E14 blister	0.7	65	240	1	6 38
80004	4008321905536	DECOSPOT LED PAR 16 Green E14 blister	0.8	325	240	1	6 38
80005	4008321905543	DECOSPOT LED PAR 16 Blue E14 blister	0.8	85	240	1	6 38
<b>GU10 base</b>							
80011	4008321905598	DECOSPOT LED PAR 16 Colour Change GU10 blister	0.6	8.3-35	240	2	6 38
80012	4008321905642	DECOSPOT LED PAR 16 White GU10 blister	0.8	180	240	2	6 38
80013	4008321905567	DECOSPOT LED PAR 16 Red GU10 blister	0.7	65	240	2	6 38
80014	4008321905574	DECOSPOT LED PAR 16 Green GU10 blister	0.8	325	240	2	6 38
80015	4008321905581	DECOSPOT LED PAR 16 Blue GU10 blister	0.8	85	240	2	6 38

**PARATHOM® SPECIAL T26**

- Direct replacement for 15W T26 incandescent lamp
- Extremely low energy consumption (<1W)
- Ideal for fridges/freezers/sewing machines

Product ID Code	EAN (Single Pack)	Product Description	W	lm	V/mA	PPG
<b>SES/E14</b>						
PARAT26	4008321951489	PARATHOM SPECIAL T26 Daylight	1	-	240	10 38
PAR15AT26	4008321965004	PARATHOM SPECIAL CLASSIC T26 15 Daylight	1.5	65	220-240	10 38
PAR10AT26	4008321964960	PARATHOM SPECIAL CLASSIC T26 10 Daylight	-0.7	35	220-240	10 38

NEW  
NEW  
NEW

All orders must be multiples of sales pack

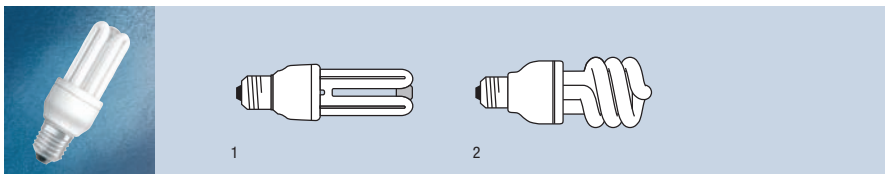

## LED Lamps

**DULED®**

- 2 in 1 energy saving compact fluorescent and LED lamp
- Easy switch between compact fluorescent and LED mode
- Long average life of 6,000 hours
- Available in stick or twist shape
- Ideal for general lighting and as a night light in LED mode

Product ID Code	EAN (Single Pack)	Product Description	W	lm	V/mA	Light No.	PPG
<b>ES/E27 base</b>							
80300	4008321202314	DULED 8W/827 E27 Stick	8	400	240	1	10 38
80302	4008321222350	DULED 12W/827 E27 Stick	12	620	240	1	10 38
80305	4008321929372	DULED 15W/827 E27 Twist	15	830	240	2	10 38
80306	4008321929396	DULED 21W/827 E27 Twist	21	1230	240	2	10 38



All orders must be multiples of sales pack

FLUORESCENT TUBES

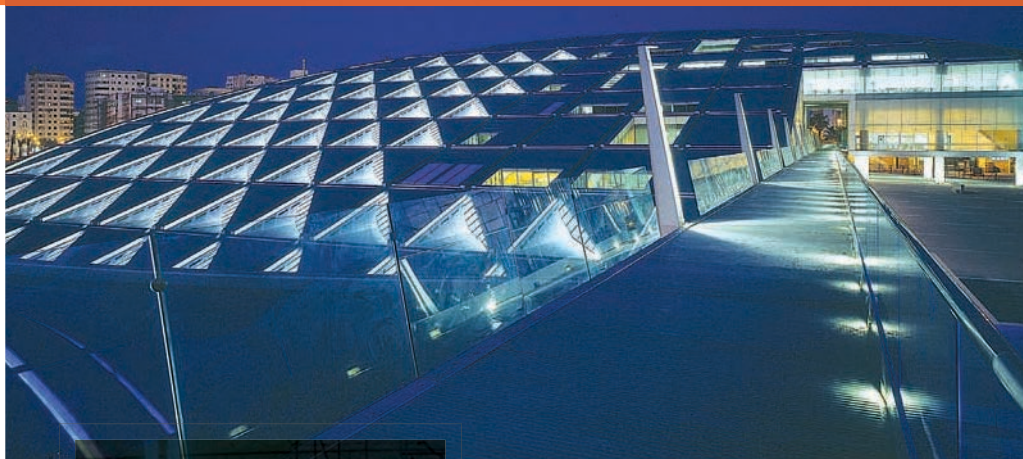

# Fluorescent Tubes Contents.

LUMILUX® T5 HE HIGH EFFICIENCY	86
LUMILUX® T5 HO HIGH OUTPUT	90
LUMILUX® T5 HO ES HIGH OUTPUT ENERGY SAVER	92
LUMILUX® T5 HO XT	94
LUMILUX® T5 HO CONSTANT	95
LUMILUX® DE LUXE T5 HO HIGH OUTPUT	96
LUMILUX® T5 DE LUXE	96
LUMILUX® T5 SEAMLESS	97
LUMILUX® T5 SHORT	98
BASIC T5	98
LUMILUX® T5 OPTIMISED FOR EMERGENCY LIGHTING	99
T5 BASIC OPTIMISED FOR EMERGENCY LIGHTING	99
T5 HE HIGH EFFICIENCY COLOURED	100
T5 HO HIGH OUTPUT COLOURED	101
LUMILUX® SPLIT control T5	102
LUMILUX® CHIP control® T5	102
LUMILUX® T5 FC® FLUORESCENT CIRCLINE	103
T5 NATURA®	103
LUMILUX® T8	104
LUMILUX® T8 ENERGY SAVER	106
LUMILUX® XT T8	107
LUMILUX® XXT T8	108
LUMILUX® DE LUXE T8	109
COLOR proof T8	110
BIOLUX® T8	110
FLUORA® T8	111
Coloured T8	111
NATURA® T8 and NATURA® SPLIT Control T8	112
LUMILUX® SPLIT Control T8	113
LUMILUX® COLOR Control T8	113
LUMILUX® CHIP Control T8	114
U-SHAPED	114
LUMILUX® CIRCULAR	115
T2 FM® FLUORESCENT MINIATURE	116
T12 FOR EXPLOSION PROOF LUMINAIRES SA TYPE	117
T12 FOR EXPLOSION PROOF LUMINAIRES XL TYPE	117
FLUORESCENT STARTERS	118
DEOS® FLUORESCENT STARTERS	118
Starter Application Guide	119

## Fluorescent Tubes

**LUMILUX® T5 HE HIGH EFFICIENCY without cardboard sleeve**

- Triphosphor fluorescent tube only 16mm (<sup>5</sup>/<sub>8</sub> in) diameter
- As much light as a T8 lamp but up to 20% lower wattage
- 20,000 hours lifetime/16,000 hours service life with prestart ECG
- Environmentally friendly fluorescent lamp with a low mercury content
- Ideal for professional office lighting

Product ID Code	EAN (Single Pack)	Product Description	W	COLOR		L [mm]		PPG
FH14827IVP <sup>2)</sup>	4050300645933	LUMILUX T5 HE 14/827	14	827	G5	549mm	40	23
FH14830IVP <sup>2)</sup>	4050300464824	LUMILUX T5 HE 14/830	14	830	G5	549mm	40	23
FH14835IVP <sup>2)</sup>	4050300776514	LUMILUX T5 HE 14/835	14	835	G5	549mm	40	23
FH14840IVP <sup>2)</sup>	4050300464688	LUMILUX T5 HE 14/840	14	840	G5	549mm	40	23
FH14865IVP <sup>2)</sup>	4050300464848	LUMILUX T5 HE 14/865	14	865	G5	549mm	40	23
FH14880 <sup>2)</sup>	4008321225009	LUMILUX T5 HE 14/860	14	880	G5	549mm	40	23
FH21827IVP <sup>2)</sup>	4050300645971	LUMILUX T5 HE 21/827	21	827	G5	849mm	40	23
FH21830IVP <sup>2)</sup>	4050300464800	LUMILUX T5 HE 21/830	21	830	G5	849mm	40	23
FH21835IVP <sup>2)</sup>	4050300776538	LUMILUX T5 HE 21/835	21	835	G5	849mm	40	23
FH21840IVP <sup>2)</sup>	4050300464701	LUMILUX T5 HE 21/840	21	840	G5	849mm	40	23
FH21865IVP <sup>2)</sup>	4050300464626	LUMILUX T5 HE 21/865	21	865	G5	849mm	40	23
FH21880 <sup>2)</sup>	4008321224989	LUMILUX T5 HE 21/880	21	880	G5	849mm	40	23
FH28827IVP <sup>2)</sup>	4050300646015	LUMILUX T5 HE 28/827	28	827	G5	1149mm	40	23
FH28830IVP <sup>2)</sup>	4050300464787	LUMILUX T5 HE 28/830	28	830	G5	1149mm	40	23
FH28835IVP <sup>2)</sup>	4050300776552	LUMILUX T5 HE 28/835	28	835	G5	1149mm	40	23
FH28840IVP <sup>2)</sup>	4050300464725	LUMILUX T5 HE 28/840	28	840	G5	1149mm	40	23
FH28865IVP <sup>2)</sup>	4050300464640	LUMILUX T5 HE 28/865	28	865	G5	1149mm	40	23
FH28880 <sup>2)</sup>	4008321153517	LUMILUX T5 HE 28/880	28	880	G5	1149mm	40	23
FH35827IVP <sup>2)</sup>	4050300646053	LUMILUX T5 HE 35/827	35	827	G5	1449mm	40	23
FH35830IVP <sup>2)</sup>	4050300464763	LUMILUX T5 HE 35/830	35	830	G5	1449mm	40	23
FH35840IVP <sup>2)</sup>	4050300464749	LUMILUX T5 HE 35/840	35	840	G5	1449mm	40	23
FH35865IVP <sup>2)</sup>	4050300464664	LUMILUX T5 HE 35/865	35	865	G5	1449mm	40	23
FH35880 <sup>2)</sup>	4008321153531	LUMILUX T5 HE 38/880	35	880	G5	1449mm	40	23

Perfectly matched with QUICKTRONIC® electronic control gear

1) For more information go to [www.osram.com/system-guarantee](http://www.osram.com/system-guarantee)

2) Suitable for ECG operation only. The lamps are designed for internal luminaire temperatures of 30 to 40°C, the optimum luminaire flux is achieved at 35°C

All orders must be multiples of sales pack



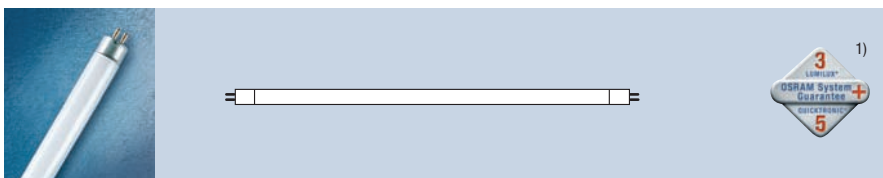

## Fluorescent Tubes

**LUMILUX® T5 HE HIGH EFFICIENCY with cardboard sleeve**

- Triphosphor fluorescent tube only 16mm (<sup>5</sup>/<sub>8</sub> in) diameter
- As much light as a T8 lamp but up to 20% lower wattage
- 20,000 hours life time / 16,000 hours service life with prestart ECG
- Environmentally friendly fluorescent lamp with a low mercury content
- Ideal for professional office lighting

Product ID Code	EAN (Single Pack)	Product Description	W	COLOR		l (mm)		PPG
FH14827 <sup>2)</sup>	4050300645919	LUMILUX T5 HE 14/827 sleeved	14	827	G5	549mm	20	23
FH14830 <sup>2)</sup>	4050300591520	LUMILUX T5 HE 14/830 sleeved	14	830	G5	549mm	20	23
FH14835 <sup>2)</sup>	4050300771991	LUMILUX T5 HE 14/835 sleeved	14	835	G5	549mm	20	23
FH14840 <sup>2)</sup>	4050300591384	LUMILUX T5 HE 14/840 sleeved	14	840	G5	549mm	20	23
FH14865 <sup>2)</sup>	4050300591544	LUMILUX T5 HE 14/865 sleeved	14	865	G5	549mm	20	23
FH21827 <sup>2)</sup>	4050300645957	LUMILUX T5 HE 21/827 sleeved	21	827	G5	849mm	20	23
FH21830 <sup>2)</sup>	4050300591506	LUMILUX T5 HE 21/830 sleeved	21	830	G5	849mm	20	23
FH21835 <sup>2)</sup>	4050300776149	LUMILUX T5 HE 21/835 sleeved	21	835	G5	849mm	20	23
FH21840 <sup>2)</sup>	4050300591407	LUMILUX T5 HE 21/840 sleeved	21	840	G5	849mm	20	23
FH21865 <sup>2)</sup>	4050300591322	LUMILUX T5 HE 21/865 sleeved	21	865	G5	849mm	20	23
FH28827 <sup>2)</sup>	4050300645995	LUMILUX T5 HE 28/827 sleeved	28	827	G5	1149mm	20	23
FH28830 <sup>2)</sup>	4050300591483	LUMILUX T5 HE 28/830 sleeved	28	830	G5	1149mm	20	23
FH28835 <sup>2)</sup>	4050300776392	LUMILUX T5 HE 28/835 sleeved	28	835	G5	1149mm	20	23
FH28840 <sup>2)</sup>	4050300591421	LUMILUX T5 HE 28/840 sleeved	28	840	G5	1149mm	20	23
FH28865 <sup>2)</sup>	4050300591346	LUMILUX T5 HE 28/865 sleeved	28	865	G5	1149mm	20	23
FH35827 <sup>2)</sup>	4050300646039	LUMILUX T5 HE 35/827 sleeved	35	827	G5	1449mm	20	23
FH35830 <sup>2)</sup>	4050300591469	LUMILUX T5 HE 35/830 sleeved	35	830	G5	1449mm	20	23
FH35835 <sup>2)</sup>	4050300776415	LUMILUX T5 HE 35/835 sleeved	35	835	G5	1449mm	20	23
FH35840 <sup>2)</sup>	4050300591445	LUMILUX T5 HE 35/840 sleeved	35	840	G5	1449mm	20	23
FH35865 <sup>2)</sup>	4050300591360	LUMILUX T5 HE 35/865 sleeved	35	865	G5	1449mm	20	23

Perfectly matched with QUICKTRONIC® electronic control gear

1) For more information go to [www.osram.com/system-guarantee](http://www.osram.com/system-guarantee)

2) Suitable for ECG operation only. The lamps are designed for internal luminaire temperatures of 30 to 40°C, the optimum luminaire flux is achieved at 35°C





All orders must be multiples of sales pack

## Fluorescent Tubes

**LUMILUX® T5 HE ES HIGH EFFICIENCY ENERGY SAVER without cardboard sleeve**

- Triphosphor fluorescent tube only 16mm (<sup>5</sup>/<sub>8</sub> in) diameter
- Energy savings of up to 10%
- Up to 20,000 hours average lifetime
- Environmentally friendly fluorescent lamp with a low mercury content
- Ideal for indoor lighting systems e.g. for offices and shopping centres and general illumination

Product ID Code	EAN (Single Pack)	Product Description	W	COLOR		L [mm]		PPG
HE25827 <sup>1)</sup>	4008321516909*	LUMILUX T5 HE ES 25/827	25	827	G5	1149mm	40	23
HE25830 <sup>1)</sup>	4008321516923*	LUMILUX T5 HE ES 25/830	25	830	G5	1149mm	40	23
HE25840 <sup>1)</sup>	4008321516947*	LUMILUX T5 HE ES 25/840	25	840	G5	1149mm	40	23
HE25865 <sup>1)</sup>	4008321516961*	LUMILUX T5 HE ES 25/865	25	865	G5	1149mm	40	23
HE32827 <sup>1)</sup>	4008321517067*	LUMILUX T5 HE ES 32/827	32	827	G5	1449mm	40	23
HE32830 <sup>1)</sup>	4008321517111*	LUMILUX T5 HE ES 32/830	32	830	G5	1449mm	40	23
HE32840 <sup>1)</sup>	4008321517166*	LUMILUX T5 HE ES 32/840	32	840	G5	1449mm	40	23
HE32865 <sup>1)</sup>	4008321517210*	LUMILUX T5 HE ES 32/865	32	865	G5	1449mm	40	23

Perfectly matched with QUICKTRONIC® electronic control gear

1) Suitable for ECG operation only. The lamps are designed for internal luminaire temperatures of 30 to 40°C, the optimum luminaire flux is achieved at 35°C

\* In preparation at time of print. For further information please contact OSRAM

NEW  
NEW  
NEW  
NEW  
NEW  
NEW  
NEW



All orders must be multiples of sales pack



## Fluorescent Tubes

**LUMILUX® T5 HE ES HIGH EFFICIENCY ENERGY SAVER with cardboard sleeve**

- Triphosphor fluorescent tube only 16mm (<sup>5</sup>/<sub>8</sub> in) diameter
- 10% energy saving compared to standard T5 HE fluorescent tubes
- 20,000 hours lifetime / 16,000 hours service life with prestart ECG
- Ideal for energy saving office lighting

Product ID Code	EAN (Single Pack)	Product Description	W	COLOR		l (mm)		PPG
HE25827 <sup>1)</sup>	4008321957887	LUMILUX HE 25W/827 ES sleeved	25	827	G5	1149mm	20	23
HE25830 <sup>1)</sup>	4008321957894	LUMILUX HE 25W/830 ES sleeved	25	830	G5	1149mm	20	23
HE25840 <sup>1)</sup>	4008321957900	LUMILUX HE 25W/840 ES sleeved	25	840	G5	1149mm	20	23
HE25865 <sup>1)</sup>	4008321957917	LUMILUX HE 25W/865 ES sleeved	25	865	G5	1149mm	20	23
HE32827 <sup>1)</sup>	4008321957924	LUMILUX HE 32W/827 ES sleeved	32	827	G5	1449mm	20	23
HE32830 <sup>1)</sup>	4008321957931	LUMILUX HE 32W/830 ES sleeved	32	830	G5	1449mm	20	23
HE32840 <sup>1)</sup>	4008321957948	LUMILUX HE 32W/840 ES sleeved	32	840	G5	1449mm	20	23
HE32865 <sup>1)</sup>	4008321957955	LUMILUX HE 32W/865 ES sleeved	32	865	G5	1449mm	20	23

Perfectly matched with QUICKTRONIC® electronic control gear

1) Suitable for ECG operation only. The lamps are designed for internal luminaire temperatures of 30 to 40°C, the optimum luminaire flux is achieved at 35°C





NEW  
NEW  
NEW  
NEW  
NEW  
NEW  
NEW

All orders must be multiples of sales pack

## Fluorescent Tubes

**LUMILUX® T5 HO HIGH OUTPUT without cardboard sleeve**

- Triphosphor fluorescent tube only 16mm (<sup>5</sup>/<sub>8</sub> in) diameter
- Up to 50% more light than a T8 lamp from the same length
- 24,000 hours lifetime / 18,000 hours service life with prestart ECG
- Environmentally friendly fluorescent lamp with a low mercury content
- Ideal for applications where more light is required

Product ID Code	EAN (Single Pack)	Product Description	W	COLOR		L [mm]		PPG
FQ24830IVP <sup>2)</sup>	4050300453491	LUMILUX T5 HO 24/830	24	830	G5	549mm	40	23
FQ24835IVP <sup>2)</sup>	4050300776590	LUMILUX T5 HO 24/835	24	835	G5	549mm	40	23
FQ24840IVP <sup>2)</sup>	4050300453477	LUMILUX T5 HO 24/840	24	840	G5	549mm	40	23
FQ24865IVP <sup>2)</sup>	4050300453453	LUMILUX T5 HO 24/865	24	865	G5	549mm	40	23
FQ39827IVP <sup>2)</sup>	4050300646138	LUMILUX T5 HO 39/827	39	827	G5	849mm	40	23
FQ39830IVP <sup>2)</sup>	4050300453552	LUMILUX T5 HO 39/830	39	830	G5	849mm	40	23
FQ39840IVP <sup>2)</sup>	4050300453538	LUMILUX T5 HO 39/840	39	840	G5	849mm	40	23
FQ39865IVP <sup>2)</sup>	4050300453514	LUMILUX T5 HO 39/865	39	865	G5	849mm	40	23
FQ49830IVP <sup>2)</sup>	4050300657158	LUMILUX T5 HO 49/830	49	830	G5	1449mm	40	23
FQ49840IVP <sup>2)</sup>	4050300657134	LUMILUX T5 HO 49/840	49	840	G5	1449mm	40	23
FQ49865IVP <sup>2)</sup>	4008321110732	LUMILUX T5 HO 49/865	49	865	G5	1449mm	40	23
FQ49865 <sup>2)</sup>	4050300796628	LUMILUX T5 HO 49/865	49	865	G5	1449mm	40	23
FQ54827IVP <sup>2)</sup>	4050300646176	LUMILUX T5 HO 54/827	54	827	G5	1149mm	40	23
FQ54830IVP <sup>2)</sup>	4050300453415	LUMILUX T5 HO 54/830	54	830	G5	1449mm	40	23
FQ54835IVP <sup>2)</sup>	4050300776637	LUMILUX T5 HO 54/835	54	835	G5	1149mm	40	23
FQ54840IVP <sup>2)</sup>	4050300453392	LUMILUX T5 HO 54/840	54	840	G5	1149mm	40	23
FQ54865IVP <sup>2)</sup>	4050300453378	LUMILUX T5 HO 54/865	54	865	G5	1149mm	40	23
FQ80827IVP <sup>2)</sup>	4050300646213	LUMILUX T5 HO 80/827	80	827	G5	1449mm	40	23
FQ80830IVP <sup>2)</sup>	4050300515137	LUMILUX T5 HO 80/830	80	830	G5	1449mm	40	23
FQ80840IVP <sup>2)</sup>	4050300515151	LUMILUX T5 HO 80/840	80	840	G5	1449mm	40	23
FQ80865IVP <sup>2)</sup>	4050300515113	LUMILUX T5 HO 80/865	80	865	G5	1449mm	40	23

Perfectly matched with QUICKTRONIC® electronic control gear

1) For more information go to [www.osram.com/system-guarantee](http://www.osram.com/system-guarantee)

2) Suitable for ECG operation only. The lamps are designed for internal luminaire temperatures of 30 to 40°C, the optimum luminaire flux is achieved at 35°C

Colour 880 available on request

All orders must be multiples of sales pack



## Fluorescent Tubes

**LUMILUX® T5 HO HIGH OUTPUT with cardboard sleeve**

- Triphosphor fluorescent tube only 16mm (<sup>5</sup>/<sub>8</sub> in) diameter
- Up to 50% more light than a T8 lamp from the same length
- 24,000 hours lifetime / 18,000 hours service life with prestart ECG
- Environmentally friendly fluorescent lamp with a low mercury content
- Ideal for applications where more light is required

Product ID Code	EAN (Single Pack)	Product Description	W	COLOR		l (mm)		PPG
FQ24827 <sup>2)</sup>	4050300646077	LUMILUX T5 HO 24/827 sleeved	24	827	G5	549mm	20	23
FQ24830 <sup>2)</sup>	4050300591667	LUMILUX T5 HO 24/830 sleeved	24	830	G5	549mm	20	23
FQ24835 <sup>2)</sup>	4050300776439	LUMILUX T5 HO 24/835 sleeved	24	835	G5	549mm	20	23
FQ24840 <sup>2)</sup>	4050300591643	LUMILUX T5 HO 24/840 sleeved	24	840	G5	549mm	20	23
FQ24865 <sup>2)</sup>	4050300591629	LUMILUX T5 HO 24/865 sleeved	24	865	G5	549mm	20	23
FQ24880 <sup>2)</sup>	4008321081469	LUMILUX T5 HO 24/880 sleeved	24	880	G5	549mm	20	23
FQ39827 <sup>2)</sup>	4050300646114	LUMILUX T5 HO 39/827 sleeved	39	827	G5	849mm	20	23
FQ39830 <sup>2)</sup>	4050300591728	LUMILUX T5 HO 39/830 sleeved	39	830	G5	849mm	20	23
FQ39840 <sup>2)</sup>	4050300591704	LUMILUX T5 HO 39/840 sleeved	39	840	G5	849mm	20	23
FQ39865 <sup>2)</sup>	4050300591681	LUMILUX T5 HO 39/865 sleeved	39	865	G5	849mm	20	23
FQ39880 <sup>2)</sup>	4008321081445	LUMILUX T5 HO 39/880 sleeved	39	880	G5	849mm	20	23
FQ49827HO <sup>2)</sup>	4008321110664	LUMILUX T5 HO 49/827 sleeved	49	827	G5	1449mm	40	23
FQ49830HO <sup>2)</sup>	4008321110671	LUMILUX T5 HO 49/830 sleeved	49	830	G5	1449mm	40	23
FQ49835HO <sup>2)</sup>	4008321110701	LUMILUX T5 HO 49/835 sleeved	49	835	G5	1449mm	40	23
FQ49840HO <sup>2)</sup>	4008321110688	LUMILUX T5 HO 49/840 sleeved	49	840	G5	1449mm	40	23
FQ49865NP <sup>2)</sup>	4008321110732	LUMILUX T5 HO 49/865 sleeved	49	865	G5	1449mm	40	23
FQ49880HO <sup>2)</sup>	4008321110725	LUMILUX T5 HO 49/880 sleeved	49	880	G5	1449mm	40	23
FQ54827 <sup>2)</sup>	4050300646152	LUMILUX T5 HO 54/827 sleeved	54	827	G5	1149mm	20	23
FQ54830 <sup>2)</sup>	4050300591605	LUMILUX T5 HO 54/830 sleeved	54	830	G5	1149mm	20	23
FQ54835 <sup>2)</sup>	4050300776477	LUMILUX T5 HO 54/835 sleeved	54	835	G5	1149mm	20	23
FQ54840 <sup>2)</sup>	4050300591582	LUMILUX T5 HO 54/840 sleeved	54	840	G5	1149mm	20	23
FQ54865 <sup>2)</sup>	4050300591568	LUMILUX T5 HO 54/865 sleeved	54	865	G5	1149mm	20	23
FQ54880 <sup>2)</sup>	4008321070425	LUMILUX T5 HO 54/880 sleeved	54	880	G5	1149mm	20	23
FQ80827 <sup>2)</sup>	4050300646190	LUMILUX T5 HO 80/827 sleeved	80	827	G5	1449mm	20	23
FQ80830 <sup>2)</sup>	4050300591827	LUMILUX T5 HO 80/830 sleeved	80	830	G5	1449mm	20	23
FQ80835 <sup>2)</sup>	4050300776491	LUMILUX T5 HO 80/835 sleeved	80	835	G5	1449mm	20	23
FQ80840 <sup>2)</sup>	4050300591814	LUMILUX T5 HO 80/840 sleeved	80	840	G5	1449mm	20	23
FQ80865 <sup>2)</sup>	4050300591803	LUMILUX T5 HO 80/865 sleeved	80	865	G5	1449mm	20	23
FQ80880 <sup>2)</sup>	4008321070449	LUMILUX T5 HO 80/880 sleeved	80	880	G5	1449mm	20	23

Perfectly matched with QUICKTRONIC® electronic control gear

1) For more information go to [www.osram.com/system-guarantee](http://www.osram.com/system-guarantee)

2) Suitable for ECG operation only. The lamps are designed for internal luminaire temperatures of 30 to 40°C, the optimum luminaire flux is achieved at 35°C



All orders must be multiples of sales pack

## Fluorescent Tubes

**LUMILUX® T5 HO ES HIGH OUTPUT ENERGY SAVER without cardboard sleeve**

- Triphosphor fluorescent tube only 16mm (<sup>5</sup>/<sub>8</sub> in) diameter
- Energy savings of up to 10%
- Up to 24,000 hours average lifetime
- Environmentally friendly fluorescent lamp with a low mercury content
- Ideal for indoor lighting systems e.g. for factories, warehouses and high ceiling areas and outdoor lighting systems

Product ID Code	EAN (Single Pack)	Product Description	W	COLOR		 [mm]		PPG
H045827 <sup>1)</sup>	4008321958129	LUMILUX T5 HO ES 45/827	45	827	G5	1149mm	40	
H045830 <sup>1)</sup>	4008321958136	LUMILUX T5 HO ES 45/830	45	830	G5	1149mm	40	
H045840 <sup>1)</sup>	4008321958143	LUMILUX T5 HO ES 45/840	45	840	G5	1149mm	40	
H045865 <sup>1)</sup>	4008321958150	LUMILUX T5 HO ES 45/865	45	865	G5	1149mm	40	
H050827 <sup>1)</sup>	4008321958167	LUMILUX T5 HO ES 50/827	50	827	G5	1149mm	40	
H050830 <sup>1)</sup>	4008321958174	LUMILUX T5 HO ES 50/830	50	830	G5	1149mm	40	
H050840 <sup>1)</sup>	4008321958181	LUMILUX T5 HO ES 50/840	50	840	G5	1149mm	40	
H050865 <sup>1)</sup>	4008321958198	LUMILUX T5 HO ES 50/865	50	865	G5	1149mm	40	
H073827 <sup>1)</sup>	4008321958204	LUMILUX T5 HO ES 73/827	73	827	G5	1449mm	40	
H073830 <sup>1)</sup>	4008321958211	LUMILUX T5 HO ES 73/830	73	830	G5	1449mm	40	
H073840 <sup>1)</sup>	4008321958228	LUMILUX T5 HO ES 73/840	73	840	G5	1449mm	40	
H073865 <sup>1)</sup>	4008321958235	LUMILUX T5 HO ES 73/865	73	865	G5	1449mm	40	

Perfectly matched with QUICKTRONIC® electronic control gear

1) Suitable for ECG operation only. The lamps are designed for internal luminaire temperatures of 30 to 40°C, the optimum luminaire flux is achieved at 35°C

NEW  
NEW  
NEW  
NEW  
NEW  
NEW  
NEW  
NEW  
NEW  
NEW  
NEW  
NEW

All orders must be multiples of sales pack



## Fluorescent Tubes

**LUMILUX® T5 HO ES HIGH OUTPUT ENERGY SAVER with cardboard sleeve**

- Triphosphor fluorescent tube only 16mm (<sup>5</sup>/<sub>8</sub> in) diameter
- 10% Energy saving compared to standard T5 HO fluorescent tubes
- 20,000 hours lifetime / 16,000 hours service life with prestart ECG
- Ideal for energy saving office lighting

Product ID Code	EAN (Single Pack)	Product Description	W	COLOR		I (mm)		PPG
NEW H045827 <sup>1)</sup>	4008321515100	LUMILUX HO 45W/827 ES sleeved	45	827	G5	1449mm	20	23
NEW H045830 <sup>1)</sup>	4008321515124	LUMILUX HO 45W/830 ES sleeved	45	830	G5	1449mm	20	23
NEW H045840 <sup>1)</sup>	4008321515148	LUMILUX HO 45W/840 ES sleeved	45	840	G5	1449mm	20	23
NEW H045865 <sup>1)</sup>	4008321515162	LUMILUX HO 45W/865 ES sleeved	45	865	G5	1449mm	20	23
NEW H050827 <sup>1)</sup>	4008321515186	LUMILUX HO 50W/827 ES sleeved	50	827	G5	1149mm	20	23
NEW H050830 <sup>1)</sup>	4008321515209	LUMILUX HO 50W/830 ES sleeved	50	830	G5	1149mm	20	23
NEW H050840 <sup>1)</sup>	4008321515223	LUMILUX HO 50W/840 ES sleeved	50	840	G5	1149mm	20	23
NEW H050865 <sup>1)</sup>	4008321515247	LUMILUX HO 50W/865 ES sleeved	50	865	G5	1149mm	20	23
NEW H073827 <sup>1)</sup>	4008321515261	LUMILUX HO 73W/827 ES sleeved	73	827	G5	1449mm	20	23
NEW H073830 <sup>1)</sup>	4008321515285	LUMILUX HO 73W/830 ES sleeved	73	830	G5	1449mm	20	23
NEW H073840 <sup>1)</sup>	4008321515308	LUMILUX HO 73W/840 ES sleeved	73	840	G5	1449mm	20	23
NEW H073865 <sup>1)</sup>	4008321515322	LUMILUX HO 73W/865 ES sleeved	73	865	G5	1449mm	20	23

Perfectly matched with QUICKTRONIC® electronic control gear

1) Suitable for ECG operation only. The lamps are designed for internal luminaire temperatures of 30 to 40°C, the optimum luminaire flux is achieved at 35°C



All orders must be multiples of sales pack

## Fluorescent Tubes

**LUMILUX® T5 HO XT**

- Triphosphor fluorescent tube only 16mm (<sup>5</sup>/<sub>8</sub> in) diameter
- Extremely long lifetime of up to 45,000 hours
- Longer maintenance intervals
- Industry, tunnels, street lighting, high ceilings and difficult luminaire access

Product ID Code	EAN (Single Pack)	Product Description	W	COLOR				PPG
HO49827XT <sup>1)</sup>	4008321958488*	LUMILUX HO 49W/827 XT	49	827	G5	1449mm	20	23
HO49830XT <sup>1)</sup>	4008321958495*	LUMILUX HO 49W/830 XT	49	830	G5	1449mm	20	23
HO49840XT <sup>1)</sup>	4008321958501*	LUMILUX HO 49W/840 XT	49	840	G5	1449mm	20	23
HO49865XT <sup>1)</sup>	4008321958518*	LUMILUX HO 49W/865 XT	49	865	G5	1449mm	20	23
HO54827XT <sup>1)</sup>	4008321958525*	LUMILUX HO 54W/827 XT	54	827	G5	1149mm	20	23
HO54830XT <sup>1)</sup>	4008321958549*	LUMILUX HO 54W/830 XT	54	830	G5	1149mm	20	23
HO54840XT <sup>1)</sup>	4008321958556*	LUMILUX HO 54W/840 XT	54	840	G5	1149mm	20	23
HO54865XT <sup>1)</sup>	4008321958563*	LUMILUX HO 54W/865 XT	54	865	G5	1149mm	20	23
HO80827XT <sup>1)</sup>	4008321958570*	LUMILUX HO 80W/827 XT	80	827	G5	1449mm	20	23
HO80830XT <sup>1)</sup>	4008321958577*	LUMILUX HO 80W/830 XT	80	830	G5	1449mm	20	23
HO80840XT <sup>1)</sup>	4008321958594*	LUMILUX HO 80W/840 XT	80	840	G5	1449mm	20	23
HO80865XT <sup>1)</sup>	4008321958600*	LUMILUX HO 80W/865 XT	80	865	G5	1449mm	20	23

Perfectly matched with QUICKTRONIC® electronic control gear

1) Suitable for ECG operation only. The lamps are designed for internal luminaire temperatures of 30 to 40°C, the optimum luminaire flux is achieved at 35°C

\* In preparation at time of print. For further information please contact OSRAM

NEW  
NEW  
NEW  
NEW  
NEW  
NEW  
NEW  
NEW  
NEW  
NEW  
NEW

All orders must be multiples of sales pack



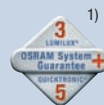

## Fluorescent Tubes

**LUMILUX® T5 HO CONSTANT**

- Triphosphor fluorescent tube only 16mm (<sup>5</sup>/<sub>8</sub> in) diameter
- Perfect solution for very cold and very hot lighting installations
- >90% luminous flux between +5°C and +70°C
- Approved for dimming down to 1% with new OSRAM QT<sub>i</sub> dimming units
- Ideal for outdoor lighting applications and “hot” company luminaries

Product ID Code	EAN (Single Pack)	Product Description	W	COLOR		I (mm)		PPG
FQ24827C0 <sup>2)</sup>	4008321074898	LUMILUX T5 HO CONSTANT 24/827	24	827	G5	549mm	20	23
FQ24830C0 <sup>2)</sup>	4008321074911	LUMILUX T5 HO CONSTANT 24/830	24	830	G5	549mm	20	23
FQ24840C0 <sup>2)</sup>	4008321075451	LUMILUX T5 HO CONSTANT 24/840	24	840	G5	549mm	20	23
FQ24865C0 <sup>2)</sup>	4008321075475	LUMILUX T5 HO CONSTANT 24/865	24	865	G5	549mm	20	23
FQ39830C0 <sup>2)</sup>	4008321075512	LUMILUX T5 HO CONSTANT 39/830	39	830	G5	849mm	20	23
FQ39840C0 <sup>2)</sup>	4008321075550	LUMILUX T5 HO CONSTANT 39/840	39	840	G5	849mm	20	23
FQ39865C0 <sup>2)</sup>	4008321075574	LUMILUX T5 HO CONSTANT 39/865	39	865	G5	849mm	20	23
FQ49830C0 <sup>2)</sup>	4008321958761	LUMILUX T5 HO CONSTANT 49/830	49	830	G7	1449mm	20	23
FQ49840C0 <sup>2)</sup>	4008321958778	LUMILUX T5 HO CONSTANT 49/840	49	840	G8	1449mm	20	23
FQ49865C0 <sup>2)</sup>	4008321958785	LUMILUX T5 HO CONSTANT 49/865	49	865	G9	1449mm	20	23
FQ54830C0 <sup>2)</sup>	4008321075611	LUMILUX T5 HO CONSTANT 54/830	54	830	G5	1149mm	20	23
FQ54840C0 <sup>2)</sup>	4008321075659	LUMILUX T5 HO CONSTANT 54/840	54	840	G5	1149mm	20	23
FQ54865C0 <sup>2)</sup>	4008321075673	LUMILUX T5 HO CONSTANT 54/865	54	865	G5	1149mm	20	23
FQ80830C0 <sup>2)</sup>	4008321075819	LUMILUX T5 HO CONSTANT 80/830	80	830	G5	1449mm	20	23
FQ80840C0 <sup>2)</sup>	4008321080042	LUMILUX T5 HO CONSTANT 80/840	80	840	G5	1449mm	20	23
FQ80865C0 <sup>2)</sup>	4008321080066	LUMILUX T5 HO CONSTANT 80/865	80	865	G5	1449mm	20	23

Perfectly matched with QUICKTRONIC® electronic control gear

1) For more information go to [www.osram.com/system-guarantee](http://www.osram.com/system-guarantee)

2) Suitable for ECG operation only

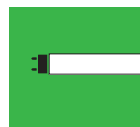

NEW  
NEW  
NEW

All orders must be multiples of sales pack

## Fluorescent Tubes

**LUMILUX® DE LUXE T5 HO HIGH OUTPUT**

- Triphosphor fluorescent tube only 16mm (<sup>5</sup>/<sub>8</sub> in) diameter
- Superior colour rendering
- Ideal where colour rendition is important

Product ID Code	EAN (Single Pack)	Product Description	W	COLOR		L (mm)		PPG
FQ24940 <sup>1)</sup>	4008321233028	LUMILUX DE LUXE T5 HO 24/940	24	940	G5	549mm	10	23
FI24965 <sup>1)</sup>	4008321233042	LUMILUX DE LUXE T5 HO 24/965	24	965	G5	549mm	10	23
FQ49940 <sup>1)</sup>	4008321234025	LUMILUX DE LUXE T5 HO 49/940	49	940	G5	1449mm	10	23
FQ49965 <sup>1)</sup>	4008321233066	LUMILUX DE LUXE T5 HO 49/965	49	965	G5	1449mm	10	23
FQ54940 <sup>1)</sup>	4008321233929	LUMILUX DE LUXE T5 HO 54/940	54	940	G5	1149mm	10	23
FQ54965 <sup>1)</sup>	4008321233943	LUMILUX DE LUXE T5 HO 54/965	54	965	G5	1149mm	10	23

Perfectly matched with QUICKTRONIC® electronic control gear

1) Suitable for ECG operation only

**LUMILUX® T5 DE LUXE**

- Triphosphor fluorescent tube only 16mm (<sup>5</sup>/<sub>8</sub> in) diameter
- Deluxe triphosphor tube
- Superior colour rendering
- Ideal where colour rendition is important

Product ID Code	EAN (Single Pack)	Product Description	W	COLOR		L (mm)		PPG
L6930	4050300015880	LUMILUX T5 DE LUXE 6/930	6	930	G5	212mm	25	23
L8930	4050300015897	LUMILUX T5 DE LUXE 8/930	8	930	G5	288mm	25	23
L8954	4050300018232	LUMILUX T5 DE LUXE 8/954	8	954	G5	288mm	25	23
L13930	4050300015903	LUMILUX T5 DE LUXE 13/930	13	930	G5	517mm	25	23
L13954	4050300327419	LUMILUX T5 DE LUXE 13/954	13	954	G5	517mm	25	23

Perfectly matched with QUICKTRONIC® electronic control gear

All orders must be multiples of sales pack



## Fluorescent Tubes

**LUMILUX® T5 SEAMLESS**

- Triphosphor fluorescent tube only 16mm (<sup>5</sup>/<sub>8</sub> in) diameter
- Innovative base that allows tubes to be side by side
- Provides continuous light for optimal illumination
- Lifetime of up to 12,000 hours
- Ideal for cove lighting without dark spots

Product ID Code	EAN (Single Pack)	Product Description	W	COLOR	l (mm)		PPG
<b>HE Version</b>							
NEW HE14830 <sup>1)</sup>	4008321957719	LUMILUX HE 14W/830 SLS	14	830	481 <sup>2</sup>	25	23
NEW HE14840 <sup>1)</sup>	4008321957733	LUMILUX HE 14W/840 SLS	14	840	481 <sup>2</sup>	25	23
NEW HE14865 <sup>1)</sup>	4008321957757	LUMILUX HE 14W/865 SLS	14	865	481 <sup>2</sup>	25	23
NEW HE21830 <sup>1)</sup>	4008321957771	LUMILUX HE 21W/830 SLS	21	830	781 <sup>2</sup>	25	23
NEW HE21840 <sup>1)</sup>	4008321957795	LUMILUX HE 21W/840 SLS	21	840	781 <sup>2</sup>	25	23
NEW HE21865 <sup>1)</sup>	4008321957818	LUMILUX HE 21W/865 SLS	21	865	781 <sup>2</sup>	25	23
NEW HE28830 <sup>1)</sup>	4008321957832	LUMILUX HE 28W/830 SLS	28	830	1081 <sup>2</sup>	25	23
NEW HE28840 <sup>1)</sup>	4008321957856	LUMILUX HE 28W/840 SLS	28	840	1081 <sup>2</sup>	25	23
NEW HE28865 <sup>1)</sup>	4008321957870	LUMILUX HE 28W/865 SLS	28	865	1081 <sup>2</sup>	25	23
<b>HO Version</b>							
NEW HO24830 <sup>1)</sup>	4008321409959	LUMILUX HO 24W/830 SLS	24	830	582mm	25	23
NEW HO24840 <sup>1)</sup>	4008321357250	LUMILUX HO 24W/840 SLS	24	840	582mm	25	23
NEW HO24865 <sup>1)</sup>	4008321410016	LUMILUX HO 24W/865 SLS	24	865	582mm	25	23
NEW HO39830 <sup>1)</sup>	4008321409973	LUMILUX HO 39W/830 SLS	39	830	882mm	25	23
NEW HO39840 <sup>1)</sup>	4008321357373	LUMILUX HO 39W/840 SLS	39	840	882mm	25	23
NEW HO39865 <sup>1)</sup>	4008321410030	LUMILUX HO 39W/865 SLS	39	865	882mm	25	23
NEW HO54830 <sup>1)</sup>	4008321409997	LUMILUX HO 54W/830 SLS	54	830	1182mm	25	23
NEW HO54840 <sup>1)</sup>	4008321357434	LUMILUX HO 54W/840 SLS	54	840	1182mm	25	23
NEW HO54865 <sup>1)</sup>	4008321410054	LUMILUX HO 54W/865 SLS	54	865	1182mm	25	23

Perfectly matched with QUICKTRONIC® electronic control gear

1) Suitable for ECG operation only

2) Min

All orders must be multiples of sales pack

## Fluorescent Tubes

**LUMILUX® T5 SHORT**

- Triphosphor fluorescent tube only 16mm (<sup>5</sup>/<sub>8</sub> in) diameter
- Long life triphosphor tube
- Environmentally friendly fluorescent lamp with a low mercury content
- Only 8% loss of luminous flux throughout entire life
- Ideal for professional office lighting

Product ID Code	EAN (Single Pack)	Product Description	W	COLOR		L [mm]		PPG
L6830	4008321959874	LUMILUX T5 SHORT 6/830	6	830	G5	212mm	25	20
L8827	4050300008943	LUMILUX T5 SHORT 8/827	8	827	G5	288mm	25	20
L8830	4008321959881	LUMILUX T5 SHORT 8/830	8	830	G5	288mm	25	20
L8840	4050300241623	LUMILUX T5 SHORT 8/840	8	840	G5	288mm	25	20
L13827	4050300008967	LUMILUX T5 SHORT 13/827	13	827	G5	517mm	25	20
L13830	4008321959898	LUMILUX T5 SHORT 13/830	13	830	G5	517mm	25	20
L13840	4050300241647	LUMILUX T5 SHORT 13/840	13	840	G5	517mm	25	20

Perfectly matched with QUICKTRONIC® electronic control gear

**BASIC T5**

- Basic halophosphate tube only 16mm (<sup>5</sup>/<sub>8</sub> in) diameter
- Ideal for small luminaires

Product ID Code	EAN (Single Pack)	Product Description	W	COLOR		L [mm]		PPG
L4640	4050300008875	BASIC T5 4/640	4	20/640	G5	136mm	25	22
L4535	4050300270722	BASIC T5 4/535	4	23/535	G5	136mm	25	22
L6640	4050300008899	BASIC T5 6/640	6	20/640	G5	288mm	25	22
L8640	4050300008912	BASIC T5 8/640	8	20/640	G5	288mm	25	22
L8535	4050300241807	BASIC T5 8/535	8	23/535	G5	288mm	25	22
L8765	4050300035475	BASIC T5 8/765	8	765	G5	288mm	25	22
L13640	4050300008974	BASIC T5 13/640	13	20/640	G5	517mm	25	22

Perfectly matched with QUICKTRONIC® electronic control gear

All orders must be multiples of sales pack



## Fluorescent Tubes

**T5 LUMILUX® OPTIMISED FOR EMERGENCY LIGHTING**

- Triphosphor fluorescent tube only 16mm (<sup>5</sup>/<sub>8</sub> in) diameter
- EL version for emergency lighting
- Ideal for small luminaires

Product ID Code	EAN (Single Pack)	Product Description	W	COLOR		L (mm)	
L6840EL	4008321325662	T5 LUMILUX EMERGENCY 6W	6	840	G5	212mm	25
L8840EL	4008321325846	T5 LUMILUX EMERGENCY 8W	8	840	G5	288mm	25

Perfectly matched with QUICKTRONIC® electronic control gear

**T5 BASIC OPTIMISED FOR EMERGENCY LIGHTING**

- Basic halophosphate tube only 16mm (<sup>5</sup>/<sub>8</sub> in) diameter
- EL version for emergency lighting
- Ideal for small luminaires

Product ID Code	EAN (Single Pack)	Product Description	W	COLOR		L (mm)		PPG
L6640EL	4008321152381	T5 BASIC EMERGENCY 6W	6	20/640	G5	212mm	25	22
L8640EL	4050300606644	T5 BASIC EMERGENCY 8W	8	20/640	G5	288mm	25	22



Perfectly matched with QUICKTRONIC® electronic control gear

All orders must be multiples of sales pack

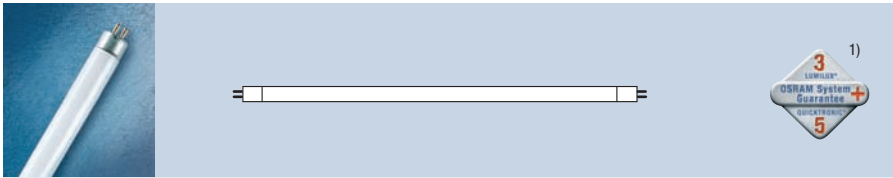
## Fluorescent Tubes

**T5 HE HIGH EFFICIENCY COLOURED**

- Triphosphor fluorescent tube only 16mm (<sup>5</sup>/<sub>8</sub> in) diameter
- Available in red, green and blue colours
- Ideal for special effects

Product ID Code	EAN (Single Pack)	Product Description	W	COLOR		L (mm)		PPG
FH1460 <sup>2)</sup>	4008321170705	Coloured T5 HE 14/R	14	Red 60	G5	549mm	10	23
FH1466 <sup>2)</sup>	4008321170729	Coloured T5 HE 14/G	14	Green 66	G5	549mm	10	23
FH1467 <sup>2)</sup>	4008321170781	Coloured T5 HE 14/BL	14	Blue 67	G5	549mm	10	23
FH2160 <sup>2)</sup>	4008321170682	Coloured T5 HE 21/R	21	Red 60	G5	849mm	10	23
FH2166 <sup>2)</sup>	4008321170743	Coloured T5 HE 21/G	21	Green 66	G5	849mm	10	23
FH2167 <sup>2)</sup>	4008321170804	Coloured T5 HE 21/BL	21	Blue 67	G5	849mm	10	23
FH2860 <sup>2)</sup>	4008321161840	Coloured T5 HE 28/R	28	Red 60	G5	1149mm	10	23
FH2866 <sup>2)</sup>	4008321161864	Coloured T5 HE 28/G	28	Green 66	G5	1149mm	10	23
FH2867 <sup>2)</sup>	4008321161888	Coloured T5 HE 28/BL	28	Blue 67	G5	1149mm	10	23
FH3560 <sup>2)</sup>	4008321133458	Coloured T5 HE 35/R	35	Red 60	G5	1449mm	10	23
FH3566 <sup>2)</sup>	4008321161925	Coloured T5 HE 35/G	35	Green 66	G5	1449mm	10	23
FH3567 <sup>2)</sup>	4008321161949	Coloured T5 HE 35/BL	35	Blue 67	G5	1449mm	10	23

Perfectly matched with QUICKTRONIC® electronic control gear

1) For more information go to [www.osram.com/system-guarantee](http://www.osram.com/system-guarantee)

2) Suitable for ECG operation only. The lamps are designed for internal luminaire temperatures of 30 to 40°C, the optimum luminaire flux is achieved at 35°C

All orders must be multiples of sales pack

100



## Fluorescent Tubes

**T5 HO HIGH OUTPUT COLOURED**

- Triphosphor fluorescent tube only 16mm (<sup>5</sup>/<sub>8</sub> in) diameter
- Available in red, green and blue colours
- Ideal for special effects

Product ID Code	EAN (Single Pack)	Product Description	W	COLOUR		L [mm]		PPG
FQ2460 <sup>2)</sup>	4008321171009	LUMILUX Coloured T5 HO 24/R	24	Red 60	G5	549mm	10	23
FQ2466 <sup>2)</sup>	4008321170941	LUMILUX Coloured T5 HO 24/G	24	Green 66	G5	549mm	10	23
FQ2467 <sup>2)</sup>	4008321170880	LUMILUX Coloured T5 HO 24/BL	24	Blue 67	G5	549mm	10	23
FQ3960 <sup>2)</sup>	4008321170989	LUMILUX Coloured T5 HO 39/R	39	Red 60	G5	849mm	10	23
FQ3966 <sup>2)</sup>	4008321170927	LUMILUX Coloured T5 HO 39/G	39	Green 66	G5	849mm	10	23
FQ3967 <sup>2)</sup>	4008321170866	LUMILUX Coloured T5 HO 39/BL	39	Blue 67	G5	849mm	10	23
FQ5460 <sup>2)</sup>	4008321170965	LUMILUX Coloured T5 HO 54/R	54	Red 60	G5	1149mm	10	23
FQ5466 <sup>2)</sup>	4008321170903	LUMILUX Coloured T5 HO 54/G	54	Green 66	G5	1149mm	10	23
FQ5467 <sup>2)</sup>	4008321170842	LUMILUX Coloured T5 HO 54/BL	54	Blue 67	G5	1149mm	10	23
FQ8060 <sup>2)</sup>	4008321161963	LUMILUX Coloured T5 HO 80/R	80	Red 60	G5	1449mm	10	23
FQ8066 <sup>2)</sup>	4008321161987	LUMILUX Coloured T5 HO 80/G	80	Green 66	G5	1449mm	10	23
FQ8067 <sup>2)</sup>	4008321162007	LUMILUX Coloured T5 HO 80/BL	80	Blue 67	G5	1449mm	10	23

Perfectly matched with QUICKTRONIC® electronic control gear

1) For more information go to [www.osram.com/system-guarantee](http://www.osram.com/system-guarantee)

2) Suitable for ECG operation only. The lamps are designed for internal luminaire temperatures of 30 to 40°C, the optimum luminaire flux is achieved at 35°C



All orders must be multiples of sales pack

## Fluorescent Tubes

**LUMILUX® SPLIT control T5**

- T5 fluorescent tube with a high temperature resistant sleeve
- 16mm (<sup>5</sup>/<sub>8</sub> in) diameter
- Complies with all HACCP directives
- Average life 20,000 hours (with preheat ECG)
- Eco-friendly thanks to recyclable phosphor
- Ideal for use in the food industry and in sensitive food production

Product ID Code	EAN (Single Pack)	Product Description	W	COLOR		L (mm)		PPG
HE28840SPS <sup>2)</sup>	4008321233387	LUMILUX SPLIT Control T5 28/840	28	840	G5	1149mm	10	23
H054840SPS <sup>2)</sup>	4008321233363	LUMILUX SPLIT Control T5 54/840	54	840	G5	1149mm	10	23

Perfectly matched with QUICKTRONIC® electronic control gear

1) For more information go to [www.osram.com/system-guarantee](http://www.osram.com/system-guarantee)

2) Suitable for ECG operation only. The lamps are designed for internal luminaire temperatures of 30 to 40°C, the optimum luminaire flux is achieved at 35°C

**LUMILUX® CHIP control T5**

- T5 fluorescent tube with excellent filter function at 500 nm
- Very good light performance during the life time (90% lumen maintenance throughout life cycle)
- Complies with the requirements of RoHS
- Average life 20,000 hours (with preheat ECG)
- Ideal for semiconductor fabrication plants and areas where UV radiation and light from the blue end of the spectrum must be reduced to the absolute minimum

Product ID Code	EAN (Single Pack)	Product Description	W	COLOR		L (mm)		PPG
HE2862 <sup>2)</sup>	4008321233424	LUMILUX CHIP CONTROL T5 28/Y	28	Yellow	G5	2040mm	10	23
H05462 <sup>2)</sup>	4008321233400	LUMILUX CHIP CONTROL T5 54/Y	54	Yellow	G5	3140mm	10	23

Perfectly matched with QUICKTRONIC® electronic control gear

1) For more information go to [www.osram.com/system-guarantee](http://www.osram.com/system-guarantee)

2) Suitable for ECG operation only. The lamps are designed for internal luminaire temperatures of 30 to 40°C, the optimum luminaire flux is achieved at 35°C

All orders must be multiples of sales pack



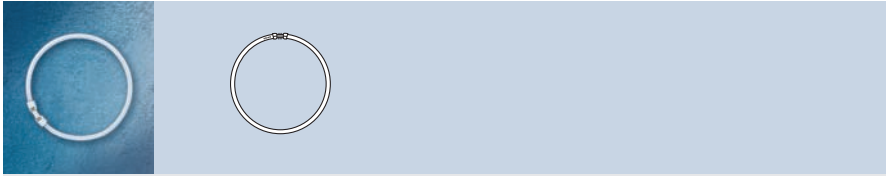

## Fluorescent Tubes

**LUMILUX® T5 FC® FLUORESCENT CIRCLINE**

- Circular triphosphor fluorescent tube only 16mm (5/8 in) diameter
- Very even light distribution
- Ideal for professional office lighting

Product ID Code	EAN (Single Pack)	Product Description	W	COLOR		l (mm)		PPG
FC22827	4050300646237	LUMILUX T5 FC Circular 22/827	22	827	2GX13	225mm	12	23
FC22830	4050300528489	LUMILUX T5 FC Circular 22/830	22	830	2GX13	225mm	12	23
FC22840	4050300528465	LUMILUX T5 FC Circular 22/840	22	840	2GX13	225mm	12	23
FC22865	4050300528441	LUMILUX T5 FC Circular 22/865	22	865	2GX13	225mm	12	23
FC40827	4050300646251	LUMILUX T5 FC Circular 40/827	40	827	2GX13	300mm	12	23
FC40830	4050300528540	LUMILUX T5 FC Circular 40/830	40	830	2GX13	300mm	12	23
FC40840	4050300528526	LUMILUX T5 FC Circular 40/840	40	840	2GX13	300mm	12	23
FC40865	4050300528502	LUMILUX T5 FC Circular 40/865	40	865	2GX13	300mm	12	23
FC55827	4050300646275	LUMILUX T5 FC Circular 55/827	55	827	2GX13	300mm	12	23
FC55830	4050300528601	LUMILUX T5 FC Circular 55/830	55	830	2GX13	300mm	12	23
FC55840	4050300528588	LUMILUX T5 FC Circular 55/840	55	840	2GX13	300mm	12	23
FC55865	4050300528564	LUMILUX T5 FC Circular 55/865	55	865	2GX13	300mm	12	23

Perfectly matched with QUICKTRONIC® electronic control gear

**T5 NATURA®**

- Triphosphor fluorescent tube only 16mm (5/8 in) diameter
- Displays food in an appetizing light
- Excellent colour rendering = 85
- Special colour rendering R9 = 90
- Average lifetime: 28W = 20,000 hours and 54W = 24000 hours

Product ID Code	EAN (Single Pack)	Product Description	W	COLOR		l (mm)		PPG
HE2876	4008321581716	NATURA T5 HE 28/76	28	76	G5	2040mm	25	23
H05476	4008321581693	NATURA T5 HO 54/76	54	76	G5	1149mm	25	23

Perfectly matched with QUICKTRONIC® electronic control gear

1) For more information go to [www.osram.com/system-guarantee](http://www.osram.com/system-guarantee)

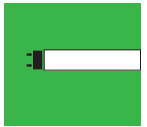

All orders must be multiples of sales pack

## Fluorescent Tubes

**LUMILUX® T8**

- Triphosphor tube 26mm (1in) diameter
- Fewer lamp replacements compared to BASIC tubes due to longer life
- Higher lumen maintenance and colour rendering than BASIC tubes
- Ideal for professional office lighting

Product ID Code	EAN (Single Pack)	Product Description	W	COLOR		l [mm]		PPG
L10827	4050300446165	LUMILUX T8 10/827	10	827	G13	470mm	25	20
L15827	4050300446042	LUMILUX T8 15/827	15	827	G13	438mm	25	20
L15830	4050300446028	LUMILUX T8 15/830	15	830	G13	438mm	25	20
L15840	4050300446004	LUMILUX T8 15/840	15	840	G13	438mm	25	20
L15865	4050300446189	LUMILUX T8 15/865	15	865	G13	438mm	25	20
L16827	4050300446080	LUMILUX T8 16/827	16	827	G13	720mm	25	20
L16830 <sup>2)</sup>	4008321959065	LUMILUX T8 16/830	16	830	G13	720mm	25 <sup>3)</sup>	20
L16840	4050300446066	LUMILUX T8 16/840	16	840	G13	720mm	25	20
L18827	4050300517834	LUMILUX T8 18/827	18	827	G13	590mm	25	20
L18830	4050300517810	LUMILUX T8 18/830	18	830	G13	590mm	25	20
L18835	4050300447964	LUMILUX T8 18/835	18	835	G13	590mm	25	20
L18840	4050300517797	LUMILUX T8 18/840	18	840	G13	590mm	25 <sup>3)</sup>	20
L18865	4050300517773	LUMILUX T8 18/865	18	865	G13	590mm	25	20
L18880	4008321027962	LUMILUX T8 18/880	18	880	G13	590mm	25	20
L23830	4050300446264	LUMILUX T8 23/830	23	830	G13	970mm	25	20
L23840	4050300446240	LUMILUX T8 23/840	23	840	G13	970mm	25	20
L30827	4050300518077	LUMILUX T8 30/827	30	827	G13	895mm	25	20
L30830	4050300518053	LUMILUX T8 30/830	30	830	G13	895mm	25	20
L30840	4050300518039	LUMILUX T8 30/840	30	840	G13	895mm	25	20
L30865	4050300518015	LUMILUX T8 30/865	30	865	G13	895mm	25	20
L30880	4008321027986	LUMILUX T8 30/880	30	880	G13	895mm	25	20
L36827	4050300517919	LUMILUX T8 36/827	36	827	G13	1200mm	25	20
L368271 <sup>2)</sup>	4050300518114	LUMILUX T8 36/8271	36	827	G13	970mm	25	20
L368301 <sup>2)</sup>	4008321959058	LUMILUX T8 36/8301	36	830	G13	970mm	25	20
L36830	4050300517896	LUMILUX T8 36/830	36	830	G13	1200mm	25 <sup>3)</sup>	20
L36835	4050300447988	LUMILUX T8 36/835	36	835	G13	1200mm	25	20
L36840	4050300517872	LUMILUX T8 36/840	36	840	G13	1200mm	25 <sup>3)</sup>	20
L368401 <sup>2)</sup>	4050300518091	LUMILUX T8 36/8401	35	840	G13	970mm	25	20
L36865	4050300517858	LUMILUX T8 36/865	36	865	G13	1200mm	25	20

NEW

NEW

Continued

Perfectly matched with QUICKTRONIC® electronic control gear

1) For more information go to [www.osram.com/system-guarantee](http://www.osram.com/system-guarantee)

2) These lamps are not intended for general illumination. They are suitable for applications such as lighting for means of public transport

3) Also available in industrial packs for bulk packs. Contains 30 lamps

All orders must be multiples of sales pack



## Fluorescent Tubes

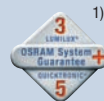

## LUMILUX® T8 (Continued)

Product ID Code	EAN (Single Pack)	Product Description	W		COLOR				PPG
						[mm]			
L36880	4008321002976	LUMILUX T8 36/880	36	880	G13		1200mm	25	20
L38830	4050300518152	LUMILUX T8 38/830	38	830	G13		1047mm	25	20
L38840	4050300518138	LUMILUX T8 38/840	38	840	G13		1047mm	25	20
L38880	4008321072245	LUMILUX T8 38/880	38	880	G13		1047mm	25	20
L58827	4050300603049	LUMILUX T8 58/827	58	827	G13		1500mm	25	20
L58830	4050300517971	LUMILUX T8 58/830	58	830	G13		1500mm	25 <sup>2)</sup>	20
L58835	4050300448008	LUMILUX T8 58/835	58	835	G13		1500mm	25	20
L58840	4050300517957	LUMILUX T8 58/840	58	840	G13		1500mm	25 <sup>2)</sup>	20
L58865	4050300517933	LUMILUX T8 58/865	58	865	G13		1500mm	25	20
L58880	4008321002990	LUMILUX T8 58/880	58	880	G13		1500mm	25	20
L70835	4008321003911	LUMILUX T8 70/835	70	835	G13		1800mm	25	20
L70840	4008321003959	LUMILUX T8 70/840	70	840	G13		1800mm	25	20

Perfectly matched with QUICKTRONIC® electronic control gear

1) For more information go to [www.osram.com/system-guarantee](http://www.osram.com/system-guarantee)

2) Also available in industrial packs for bulk packs. Contains 30 lamps



All orders must be multiples of sales pack

## Fluorescent Tubes

**LUMILUX® T8 ENERGY SAVER**

- Triphosphor tube 26mm (1in) diameter
- To replace BASIC tubes operated only on CCG
- 10% energy saving compared to BASIC tubes
- Ideal for applications using CCG such as warehouses and corridors

Product ID Code	EAN (Single Pack)	Product Description	W	COLOR				PPG
L16830ES	4008321955791	LUMILUX T8 ES 16/830	16	830	G13	590mm	25	20
L16840ES	4008321955777	LUMILUX T8 ES 16/840	16	840	G13	590mm	25	20
L32830ES	4008321339652	LUMILUX T8 ES 32/830	32	830	G13	1200mm	25	20
L32840ES	4008321339676	LUMILUX T8 ES 32/840	32	840	G13	1200mm	25	20
L51830ES	4008321339713	LUMILUX T8 ES 51/830	51	830	G13	1500mm	25	20
L51840ES	4008321339690	LUMILUX T8 ES 51/840	51	840	G13	1500mm	25	20

Perfectly matched with QUICKTRONIC® electronic control gear

NEW  
NEW  
NEW  
NEW  
NEW

All orders must be multiples of sales pack



## Fluorescent Tubes



## LUMILUX® XT T8

- Triphosphor tube 26mm (1in) diameter
- 50,000 hours average life and 42,000 hours extended service life with ECG
- Ideal for applications where relamping is expensive such as factories and warehouses

Product ID Code	EAN (Single Pack)	Product Description	W	COLOR		L (mm)		PPG
XT18830	4008321209085	LUMILUX XT T8 18/830	18	830	G13	590mm	25	20
XT18840	4008321209108	LUMILUX XT T8 18/840	18	840	G13	590mm	25	20
L18865XT	4008321209122	LUMILUX XT T8 18/865	18	865	G13	590mm	25	20
XT36830	4008321209146	LUMILUX XT T8 36/830	36	830	G13	1200mm	25	20
XT36840	4008321209160	LUMILUX XT T8 36/840	36	840	G13	1200mm	25	20
L36865XT	4008321209221	LUMILUX XT T8 36/865	36	865	G13	1200mm	25	20
XT58830	4008321209344	LUMILUX XT T8 58/830	58	830	G13	1500mm	25	20
XT58840	4008321209320	LUMILUX XT T8 58/840	58	840	G13	1500mm	25	20
L58865XT	4008321923622	LUMILUX XT T8 58/865	58	865	G13	1500mm	25	20

Perfectly matched with QUICKTRONIC® electronic control gear

1) For more information go to [www.osram.com/system-guarantee](http://www.osram.com/system-guarantee)

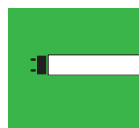

All orders must be multiples of sales pack

## Fluorescent Tubes

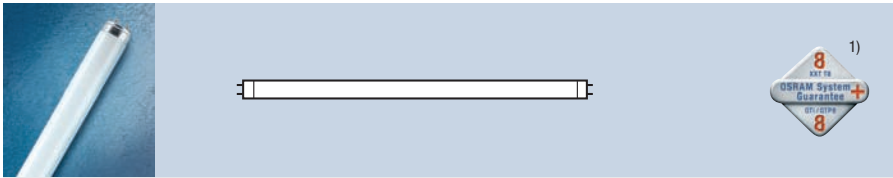
**LUMILUX® XXT T8**

- Triphosphor tube 26mm (1in) diameter
- Extremely reliable and long service life
- 90,000 hours average life (ECG hot restart) and 75,000 hours service life with ECG
- Less maintenance and lower cost of ownership compared to LUMILUX® T8
- Ideal for applications where relamping is expensive such as factories and warehouses



Product ID Code	EAN (Single Pack)	Product Description	W	COLOR		L [mm]		PPG
L18830XXT	4008321923646	LUMILUX XXT T8 18/830	18	830	G13	590mm	25	20
L18840XXT	4008321923660	LUMILUX XXT T8 18/840	18	840	G13	590mm	25	20
L18865XXT*	4008321923684	LUMILUX XXT T8 18/865	18	865	G13	590mm	25	20
L36830XXT	4008321923707	LUMILUX XXT T8 36/830	36	830	G13	1200mm	25	20
L36840XXT	4008321923721	LUMILUX XXT T8 36/840	36	840	G13	1200mm	25	20
L36865XXT*	4008321923745	LUMILUX XXT T8 36/865	36	865	G13	1200mm	25	20
L58830XXT	4008321923769	LUMILUX XXT T8 58/830	58	830	G13	1500mm	25	20
L58840XXT	4008321923783	LUMILUX XXT T8 58/840	58	840	G13	1500mm	25	20
L58865XXT*	4008321923806	LUMILUX XXT T8 58/865	58	865	G13	1500mm	25	20

Perfectly matched with QUICKTRONIC® electronic control gear

1) For more information go to [www.osram.com/system-guarantee](http://www.osram.com/system-guarantee)

\* Available upon request

All orders must be multiples of sales pack



## Fluorescent Tubes

**LUMILUX® DE LUXE T8**

- Triphosphor tube 26mm (1in) diameter
- Deluxe triphosphor tube
- Superior colour rendering
- Ideal where colour rendition is important

Product ID Code	EAN (Single Pack)	Product Description	W	COLOR		I (mm)		PPG
L15930	4050300014395	LUMILUX DE LUXE T8 15/930	15	930	G13	438mm	25	20
L15954	4050300018249	LUMILUX DE LUXE T8 15/954	15	954	G13	438mm	25	20
L16930	4050300242361	LUMILUX DE LUXE T8 16/930	16	930	G13	720mm	25	20
L18930	4050300011264	LUMILUX DE LUXE T8 18/930	18	930	G13	590mm	25	20
L18940	4050300011257	LUMILUX DE LUXE T8 18/940	18	940	G13	590mm	25	20
L18954	4050300018256	LUMILUX DE LUXE T8 18/954	18	954	G13	590mm	25	20
L18965	4008321111371	LUMILUX DE LUXE T8 18/965	18	965	G13	590mm	25	20
L30930	4050300014432	LUMILUX DE LUXE T8 30/930	30	930	G13	895mm	25	20
L36930	4050300011318	LUMILUX DE LUXE T8 36/930	36	930	G13	1200mm	25	20
L36940	4050300011301	LUMILUX DE LUXE T8 36/940	36	940	G13	1200mm	25	20
L36954	4050300018263	LUMILUX DE LUXE T8 36/954	36	954	G13	1200mm	25	20
L369541	4050300024196	LUMILUX DE LUXE T8 36/954-1	36	954-1	G13	970mm	25	20
L36965	4008321111395	LUMILUX DE LUXE T8 36/965	36	965	G13	1200mm	25	20
L58930	4050300011363	LUMILUX DE LUXE T8 58/930	58	930	G13	1500mm	25	20
L58940	4050300011356	LUMILUX DE LUXE T8 58/940	58	940	G13	1500mm	25	20
L58954	4050300018270	LUMILUX DE LUXE T8 58/954	58	954	G13	1500mm	25	20
L58965	4008321090034	LUMILUX DE LUXE T8 58/965	58	965	G13	1500mm	25	20

Perfectly matched with QUICKTRONIC® electronic control gear



All orders must be multiples of sales pack

## Fluorescent Tubes

**COLOR proof T8**

- Triphosphor tube 26mm (1in) diameter
- Deluxe triphosphor tube
- The best colour rendering
- Ideal for colour matching in reprographic workshops, photographic laboratories and dental laboratories

Product ID Code	EAN (Single Pack)	Product Description	W	COLOR		I [mm]		PPG
L18950	4008321423023	COLOR proof T8 18W	18	950	G13	590mm	10	23
L36950	4008321423047	COLOR proof T8 36W	36	950	G13	1200mm	10	23
L58950	4008321423061	COLOR proof T8 58W	58	950	G13	1500mm	10	23

Perfectly matched with QUICKTRONIC® electronic control gear

NEW  
NEW  
NEW

**BIOLUX® T8**

- Triphosphor tube 26mm (1in) diameter
- Full spectrum tube with 6500K colour temperature
- Excellent colour rendering
- Ideal for work areas deficient of natural daylight where colour rendition is important

Product ID Code	EAN (Single Pack)	Product Description	W	COLOR		I [mm]		PPG
L18965BIO	4050300270807	BIOLUX T8 18W	18	965	G13	600mm/2ft	10	23
L30965BIO	4050300302461	BIOLUX T8 30W	30	965	G13	900mm/3ft	10	23
L36965BIO	4050300270821	BIOLUX T8 36W	36	965	G13	1200mm/4ft	10	23
L58965BIO	4050300370613	BIOLUX T8 58W	58	965	G13	1500mm/5ft	10	23

Perfectly matched with QUICKTRONIC® electronic control gear

All orders must be multiples of sales pack





## Fluorescent Tubes

**FLUORA® T8**

- Triphosphor tube 26mm (1in) diameter
- Ideal for stimulating healthy plant growth

Product ID Code	EAN (Single Pack)	Product Description	W	COLOR		L [mm]		PPG
L1577	405030003214	FLUORA T8 15W	15	77	G13	438mm	10	23
L1877	405030004235	FLUORA T8 18W	18	77	G13	600mm/2ft	10	23
L3077	405030003238	FLUORA T8 30W	30	77	G13	895mm	10	23
L3677	405030003184	FLUORA T8 36W	36	77	G13	1200mm/4ft	10	23
L5877	405030004259	FLUORA T8 58W	58	77	G13	1500mm/5ft	10	23

Perfectly matched with QUICKTRONIC® electronic control gear

**Coloured T8**

- Triphosphor tube 26mm (1in) diameter
- Ideal for effect lighting

Product ID Code	EAN (Single Pack)	Product Description	W	COLOR		L [mm]		PPG
L1860	4050300024219	Coloured T8 18/R	18	60 Red	G13	600mm/2ft	10	23
L1862	4008321232700	Coloured T8 18/Y	18	62 Yellow	G13	600mm/2ft	12	23
L1866	4050300024226	Coloured T8 18/G	18	66 Green	G13	600mm/2ft	10	23
L1867	4050300024233	Coloured T8 18/BL	18	67 Blue	G13	600mm/2ft	10	23
L3067	4050300366920	Coloured T8 30/BL	30	67 Blue	G13	900mm/3ft	10	23
L3660	4050300024240	Coloured T8 36/R	36	60 Red	G13	1200mm/4ft	10	23
L3662	4008321232724	Coloured T8 36/Y	36	62 Yellow	G13	1200mm/4ft	12	23
L3666	4050300024257	Coloured T8 66/G	36	66 Green	G13	1200mm/4ft	10	23
L3667	4050300024264	Coloured T8 36/BL	36	67 Blue	G13	1200mm/4ft	10	23
L3862	4008321232984	Coloured T8 38/Y	38	62 Yellow	G13	1047mm	12	23
L5860	4050300024271	Coloured T8 58/R	58	60 Red	G13	1500mm/5ft	10	23
L5862	4008321232748	Coloured T8 62/Y	58	62 Yellow	G13	1500mm/5ft	12	23
L5866	4050300024288	Coloured T8 66/G	58	66 Green	G13	1500mm/5ft	10	23
L5867	4050300024295	Coloured T8 67/BL	58	67 Blue	G13	1500mm/5ft	10	23

Perfectly matched with QUICKTRONIC® electronic control gear

1) For more information go to [www.osram.com/system-guarantee](http://www.osram.com/system-guarantee)

All orders must be multiples of sales pack

## Fluorescent Tubes

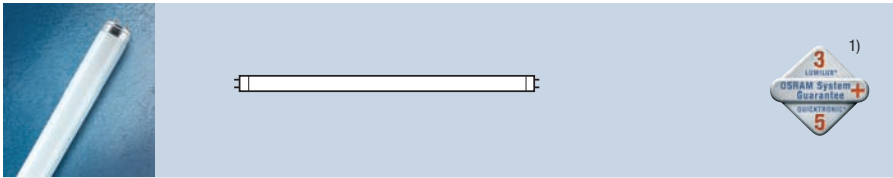
**NATURA® T8**

- Triphosphor tube 26mm (1in) diameter
- Ideal for meat and delicatessen displays

Product ID Code	EAN (Single Pack)	Product Description	W	COLOR		l [mm]		PPG
L1576	4050300018287	NATURA T8 15/76	15	76	G13	438mm	10	23
L1876	4050300010519	NATURA T8 18/76	18	76	G13	600mm/2ft	10	23
L3076	4050300010540	NATURA T8 30/76	30	76	G13	900mm/3ft	10	23
L3676	4050300010526	NATURA T8 36/76	36	76	G13	1200mm/4ft	10	23
L36761	4050300010557	NATURA T8 36/76-1	36	76-1	G13	1600mm	10	23
L5876	4050300010533	NATURA T8 58/76	58	76	G13	1500mm/5ft	10	23

Perfectly matched with QUICKTRONIC® electronic control gear

1) For more information go to [www.osram.com/system-guarantee](http://www.osram.com/system-guarantee)

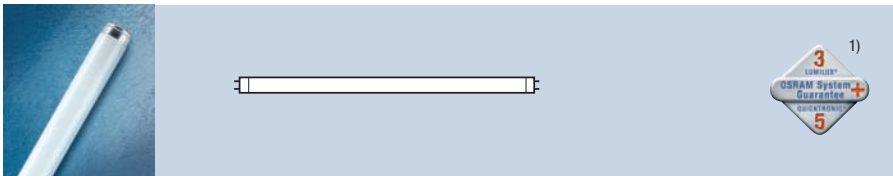
**NATURA® SPLIT Control T8**

- Triphosphor tube 26mm (1in) diameter
- Integral protective sleeve
- Can be used in open luminaires within the food sector
- Ideal for meat and delicatessen displays

Product ID Code	EAN (Single Pack)	Product Description	W	COLOR		l [mm]		PPG
L1876SPS	4008321232762	NATURA SPLIT Control T8 18/76	18	76	G13	590mm	12	23
L3076SPS	4008321232786	NATURA SPLIT Control T8 30/76	30	76	G13	895mm	12	23
L5876SPS	4008321232847	NATURA SPLIT Control T8 58/76	58	76	G13	1500mm	12	23

Perfectly matched with QUICKTRONIC® electronic control gear

1) For more information go to [www.osram.com/system-guarantee](http://www.osram.com/system-guarantee)

All orders must be multiples of sales pack

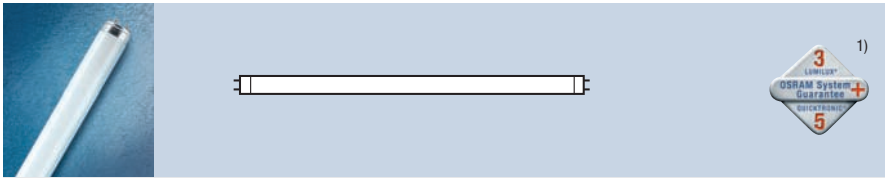

## Fluorescent Tubes

**LUMILUX® SPLIT Control T8**

- Triphosphor tube 26mm (1in) diameter
- With plastic coating that retains splinters if the lamp is broken
- Ideal for food preparation areas and production lines

Product ID Code	EAN (Single Pack)	Product Description	W	COLOR		l [mm]		PPG
L18840SPS	4008321232885	LUMILUX SPLIT Control T8 18/840	18	840	G13	590mm	12	23
L36840SPS	4008321232823	LUMILUX SPLIT Control T8 36/840	36	840	G13	1200mm	12	23
L58840SPS	4008321232922	LUMILUX SPLIT Control T8 58/840	58	840	G13	1500mm	12	23

Perfectly matched with QUICKTRONIC® electronic control gear

1) For more information go to [www.osram.com/system-guarantee](http://www.osram.com/system-guarantee)

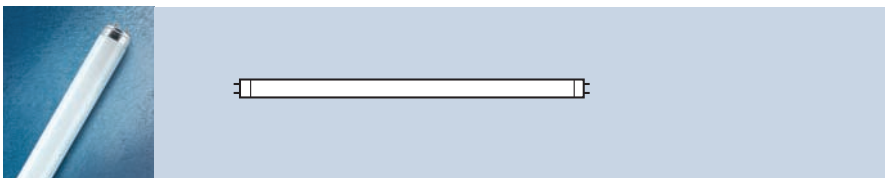
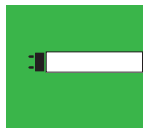
**LUMILUX® COLOR Control T8**

- Triphosphor tube 26mm (1in) diameter
- With neutral density UV filter
- Ideal light source for museums, offices and exhibitions

Product ID Code	EAN (Single Pack)	Product Description	W	COLOR		l [mm]		PPG
L18940UVS	4008321050014	LUMILUX COLOR Control T8 18/940	18	940	G13	590mm	12	23
L18954UVS	4008321120229	LUMILUX COLOR Control T8 18/954	18	954	G13	590mm	12	23
L36940UVS	4008321050038	LUMILUX COLOR Control T8 36/940	36	940	G13	1200mm	12	23
L36954UVS	4008321120243	LUMILUX COLOR Control T8 36/954	36	954	G13	1200mm	12	23
L58940UVS	4008321050090	LUMILUX COLOR Control T8 58/940	58	940	G13	1500mm	12	23
L58954UVS	4008321049957	LUMILUX COLOR Control T8 58/954	58	954	G13	1500mm	12	23

Perfectly matched with QUICKTRONIC® electronic control gear



All orders must be multiples of sales pack

## Fluorescent Tubes

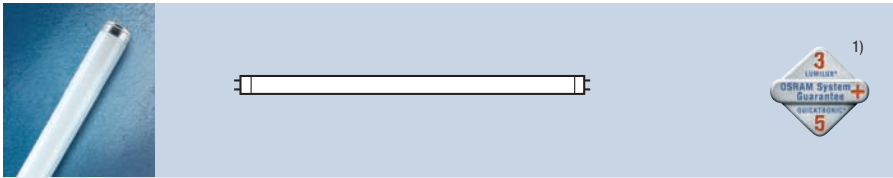
**LUMILUX® CHIP Control T8**

- Triphosphor tube 26mm (1in) diameter
- Yellow tube with neutral density UV and blue light filter
- With neutral density UV and blue light filter
- Ideal light source for microchip production and printing press applications

Product ID Code	EAN (Single Pack)	Product Description	W	COLOR				PPG
L1862	4008321232700	LUMILUX CHIP Control T8 18/Y	18	62 Yellow	G13	590mm	12	23
L3662	4008321232724	LUMILUX CHIP Control T8 36/Y	36	62 Yellow	G13	1200mm	12	23
L3862	4008321232984	LUMILUX CHIP Control T8 38/Y	38	62 Yellow	G13	1047mm	12	23
L5862	4008321232748	LUMILUX CHIP Control T8 58/Y	58	62 Yellow	G13	1500mm	12	23

Perfectly matched with QUICKTRONIC® electronic control gear

1) For more information go to [www.osram.com/system-guarantee](http://www.osram.com/system-guarantee)

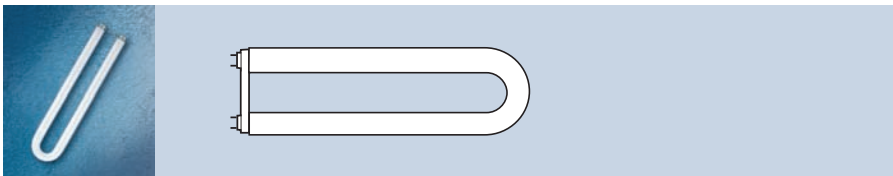
**U-SHAPED**

- U-shaped tubes
- Ideal light source for square luminaires in modular sizes

Product ID Code	EAN (Single Pack)	Product Description	W	COLOR				PPG
L18830U	4008321959904	U-Shaped T8 tube 18/830	18	830	2G13	310mm	24	23
L18840U	4008321469168	U-Shaped T8 tube 18/840	18	840	2G13	310mm	24	23
L36830U	4008321959911	U-Shaped T8 tube 36/830	36	830	2G13	607mm	12	23
L36840U	4008321469182	U-Shaped T8 tube 36/840	36	840	2G13	607mm	12	23
L58830U	4008321959041	U-Shaped T8 tube 58/830	58	830	2G13	765mm	12	23
L58840U	4008321469205	U-Shaped T8 tube 58/840	58	840	2G13	765mm	12	23

Perfectly matched with QUICKTRONIC® electronic control gear

NEW  
NEW  
NEW  
NEW  
NEW

All orders must be multiples of sales pack

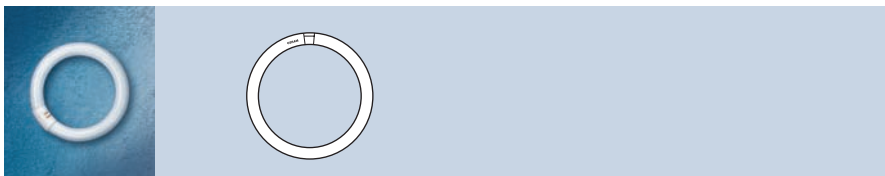

## Fluorescent Tubes

**LUMILUX® CIRCULAR**

- LUMILUX® Circular tubes with G10Q base
- Ideal for office lighting

Product ID Code	EAN (Single Pack)	Product Description	W	COLOR		I (mm)		PPG
L22840C	4008321581082	Circular tube 22/840	22	840	G10Q	216mm dia.	12	21
L22865C	4008321581105	Circular tube 22/865	22	865	G10Q	216mm dia.	12	21
L22827C	4008321581068	Circular tube 22/827	22	827	G10Q	216mm dia.	12	21
L32865C	4008321581167	Circular tube 32/865	32	865	G10Q	305mm dia.	12	21
L32827C	4008321581129	Circular tube 32/827	32	827	G10Q	305mm dia.	12	21
L32840C	4008321581143	Circular tube 32/840	32	840	G10Q	305mm dia.	12	21
L40865C	4008321960139	Circular tube 40/865	40	865	G10Q	406mm dia.	12	21
L40840C	4050300014845	Circular tube 40/840	40	840	G10Q	406mm dia.	12	21

Perfectly matched with QUICKTRONIC® electronic control gear





All orders must be multiples of sales pack

## Fluorescent Tubes

**T2 FM® FLUORESCENT MINIATURE**

- 7mm diameter
- Ideal for slim luminaires for display lighting

Product ID Code	EAN (Single Pack)	Product Description	W	COLOR		L (mm)		PPG
FM6730	4008321157546	T2 FM FLUORESCENT MINIATURE 6/730	6	730	W4.3	218.3mm	20	23
FM6740	4008321157577	T2 FM FLUORESCENT MINIATURE 6/740	6	740	W4.3	218.3mm	20	23
FM6760	4008321157607	T2 FM FLUORESCENT MINIATURE 6/760	6	760	W4.3	218.3mm	20	23
FM8730	4008321157638	T2 FM FLUORESCENT MINIATURE 8/730	8	730	W4.3	319.9mm	20	23
FM8740	4008321157669	T2 FM FLUORESCENT MINIATURE 8/740	8	740	W4.3	319.9mm	20	23
FM8760	4008321157690	T2 FM FLUORESCENT MINIATURE 8/760	8	760	W4.3	319.9mm	20	23
FM11730	4008321157720	T2 FM FLUORESCENT MINIATURE 11/730	11	730	W4.3	421.5mm	20	23
FM11740	4008321157751	T2 FM FLUORESCENT MINIATURE 11/740	11	740	W4.3	421.5mm	20	23
FM11760	4008321157782	T2 FM FLUORESCENT MINIATURE 11/760	11	760	W4.3	421.5mm	20	23
FM13730	4008321157836	T2 FM FLUORESCENT MINIATURE 13/730	13	730	W4.3	523.1mm	20	23
FM13740	4008321157867	T2 FM FLUORESCENT MINIATURE 13/740	13	740	W4.3	523.1mm	20	23
FM13760	4008321157898	T2 FM FLUORESCENT MINIATURE 13/760	13	760	W4.3	523.1mm	20	23

Perfectly matched with QUICKTRONIC® electronic control gear

All orders must be multiples of sales pack



## Fluorescent Tubes

**T12 FOR EXPLOSION PROOF LUMAIRES SA TYPE**

- 38mm (1<sup>1</sup>/<sub>2</sub> in) diameter
- Ideal for normal and low ambient temperatures

Product ID Code	EAN (Single Pack)	Product Description	W	COLOR		L (mm)	
L20640SA	4050300018195	T12 Explosion proof 20/640/SA	20	20/640	G13	590mm	25
L40640SA	4050300018331	T12 Explosion proof 40/640/SA	40	20/640	G13	1200mm	25
L65640SA	4050300018201	T12 Explosion proof 65/640/SA	65	20/640	G13	1500mm	25

**T12 FOR EXPLOSION PROOF LUMAIRES XL TYPE**

- 38mm (1<sup>1</sup>/<sub>2</sub> in) diameter
- Single pin tube
- Ideal for volatile lighting applications especially oil rigs

Product ID Code	EAN (Single Pack)	Product Description	W	COLOR		L (mm)		PPG
L20640X	4050300014630	T12 Explosion proof 20/640/XL	20	20/640	Fa6	574mm	25	38
L40640X	4050300014654	T12 Explosion proof 40/640/XL	40	20/640	Fa6	1184mm	25	38
L65640X	4050300014616	T12 Explosion proof 65/640/XL	65	20/640	Fa6	1484mm	25	38

All orders must be multiples of sales pack

## Fluorescent Tubes

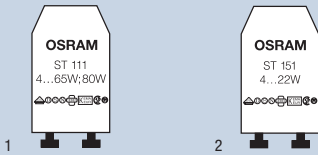

## FLUORESCENT STARTERS

- For the reliable operation of fluorescent tubes

Product ID Code	EAN (Single Pack)	Product Description	No.	PPG
ST111	4050300854045	4W-80W single-tube 240V operation	1	25/400 28
ST111SCH	4050300270166	4W-80W single-tube 240V operation bulk pack	1	1200 28
ST111HT	4050300854021	4W-80W single-tube 240V operation	1	400 28
ST151	4050300854083	4W-22W series pair at 240V or single-tube operation 110V	2	400 28
ST151SCH	4050300012803	4W-22W series pair at 240V or single-tube operation 110V, bulk pack	2	1200 28
<b>Twin blister</b>				
ST111BLI2	4050300064000	4W-80W single-tube 240V operation	-	20 28
ST151BLI2	4050300092638	4W-20W series pair at 240V or single-tube operation 110V	-	20 28

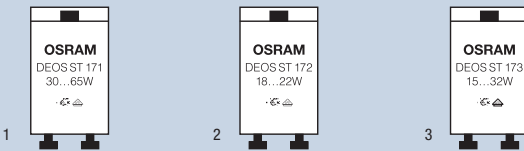

## DEOS® FLUORESCENT STARTERS

- Semi-electronic safety starters
- Superior advantages over conventional starters

Product ID Code	EAN (Single Pack)	Product Description	No.	PPG
ST171	4050300854106	ST171 DEOS 30-65W	1	25/200 28
ST171SCH	4050300422855	ST171SCH 38-80W	1	1200 28
ST173	4050300854120	ST173 DEOS 15-32W	3	25/200 28
ST172	4050300854069	ST172 DEOS 18-22W	2	25/200 28

All orders must be multiples of sales pack





## Fluorescent Tubes

## Starter Application Guide

	Suitable for fluorescent tubes										Suitable for OSRAM DULUX® L&F		
	4W	10W	15W	18W	30W	38W	36W	58W	75W	70W	18W	24W	36W
	6W	13W	16W	20W	32W		40W	65W	85W	100W			
	8W							80W	100W	125W			

For single operation at 240V<sup>1)</sup>

ST 111	X	X	X	X	X	X	X	X			X	X	X
ST 171 <sup>2)</sup>						X	X	X					X
ST173			X	X	X						X	X	

For series pair operation at 240V or single operation at 110V<sup>1)</sup>

ST 151	X		X	X							X	X	
ST 171 <sup>2)</sup>						X	X	X				X	

1) NOT suitable for OSRAM DULUX® S/E, D/E and T/E

2) Except 65W U-tube and 5ft 80W T12

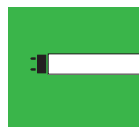

All orders must be multiples of sales pack

HIGH INTENSITY DISCHARGE LAMPS



# High Intensity Discharge Lamps

## Contents.

### CERAMIC METAL HALIDE LAMPS

POWERBALL® HCl® -T for enclosed luminaires	122
POWERBALL® HCl®-TM for enclosed luminaires	123
POWERBALL® HCl®-TC for enclosed luminaires	124
POWERBALL® HCl®-TF for enclosed luminaires	124
POWERBALL® HCl®-T and TC Shoplight for enclosed luminaires	125
POWERBALL® HCl®-TS for enclosed luminaires	126
POWERBALL® HCl®-TX/P for open luminaires	126
POWERBALL® HCl®-T/P for open and enclosed luminaires	127
POWERBALL® HCl®-TT for enclosed luminaires	127
POWERBALL® HCl®-E/P for open and enclosed luminaires	128
POWERBALL® HCl®-E for open and enclosed luminaires	129
POWERBALL® HCl® 70W for enclosed luminaires	129
POWERBALL® HCl®-R111 for open and enclosed luminaires	130
POWERBALL® HCl®-PAR for open and enclosed luminaires	131

### QUARTZ METAL HALIDE LAMPS

POWERSTAR® HQI®-R for enclosed luminaires	132
POWERSTAR® HQI®-T for enclosed luminaires	132
POWERSTAR® HQI®-TS EXCELLENCE for enclosed luminaires	133
POWERSTAR® HQI®-TS for enclosed luminaires	134
POWERSTAR® HQI®-TS High Wattage	134
POWERSTAR® HQI®-TS 2000W/D/S High Flux for enclosed luminaires	135
POWERSTAR® HQI®-TM for enclosed luminaires	135
POWERSTAR® HQI®-T for enclosed luminaires	136
POWERSTAR® HQI®-T NSI and NSI SUPER	136
POWERSTAR® HQI®-E for open and closed luminaires	137
POWERSTAR® HQI®-E/P	138
POWERSTAR® HQI®-E High Wattage	138
POWERSTAR® HQI®-E NSI and NSI SUPER	139

### HIGH PRESSURE SODIUM LAMPS

VIALOX® NAV®-E SUPER 4Y® (SON-E PLUS 4 YEAR)	140
VIALOX® NAV®-E 4Y® (SON-E 4 YEAR)	141
VIALOX® NAV®-E (STANDARD SON-E) without internal igniter	142
VIALOX® NAV®-E 68W Plug-in (SON-E Plug-in)	142
VIALOX® NAV®-E plug-in (SON-E plug-in)	143
VIALOX® NAV®-T SUPER 4Y® (SON-T PLUS 4 YEAR)	143
VIALOX® NAV®-T 4Y® (SON-T 4 YEAR)	144
VIALOX® NAV®-T (STANDARD SON-T)	144
VIALOX® NAV®-TS SUPER 4Y® (SON-TS PLUS) and TS (SON-TS)	145
PLANTASTAR®	146

### LOW PRESSURE SODIUM LAMPS

SOX and SOX PLUS	147
------------------	-----

### MERCURY VAPOUR LAMPS

HQL® SUPER DE LUXE (MBF SUPER DE LUXE)	148
HQL® DE LUXE (MBF DE LUXE)	148
HQL® Standard (MBF)	149
HQL® R DE LUXE	149

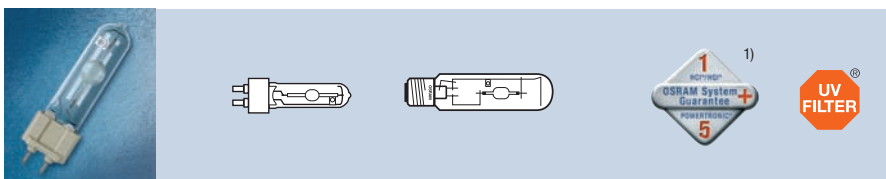

**HIGH INTENSITY DISCHARGE LAMPS – CERAMIC METAL HALIDE****POWERBALL® HCl® -T for enclosed luminaires**

- Compact single ended ceramic metal halide lamp
- Improved performance compared to conventional ceramic lamps
- Outstanding colour rendering and uniform distribution of light
- Ideal for showcasing merchandise and for indirect lighting

Product ID Code	EAN (Single Pack)	Product Description	W	lm	COLOR		t (h)	d (mm)	l (mm)	LCL a (mm)		PPG
HCIT35WDLPB	4008321520258	PB35W HCl-T 830	35	3600	830 - WDL	G12	12,000	19	100	56	1	29
HCIT35NDLPB	4008321521026	PB35N HCl-T 942	35	3500	942 - NDL	G12	12,000	19	100	56	1	29
HCIT70WDLPB	4008321523402	PB70W HCl-T 830	70	7300	830 - WDL	G12	12,000	19	100	56	1	29
HCIT70NDLPB	4008321523488	PB70N HCl-T 942	70	6800	942 - NDL	G12	12,000	19	100	56	1	29
HCIT100830WDL	4008321523563	PB100W HCl-T 830	100	9500	830 - WDL	G12	12,000	19	105	56	1	29
HCIT100942NDL	4008321523587	PB100N HCl-T 942	100	9300	942 - NDL	G12	12,000	19	105	56	1	29
HCIT150WDLPB	4008321523600	PB150W HCl-T 830	150	15000	830 - WDL	G12	12,000	25	105	56	1	29
HCIT150NDLPB	4008321523648	PB150N HCl-T 942	150	14500	942 - NDL	G12	12,000	25	105	56	1	29
HCIT250WDLPB	4008321524225	PB250W HCl-T 830 <sup>2)</sup>	250	26000	830 - WDL	E40	12,000	46	226	150	2	29
HCIT250NDLPB	4008321524249	PB250N HCl-T 942 <sup>2)</sup>	250	25000	942 - NDL	E40	12,000	46	226	150	2	29

Perfectly matched with POWERTRONIC® electronic control gear (PTI and PT FIT)

1) For more information go to [www.osram.com/system-guarantee](http://www.osram.com/system-guarantee)

2) Operate with NAV® control gear

NEW  
NEW

All orders must be multiples of sales pack

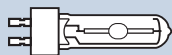

## High Intensity Discharge Lamps – Ceramic Metal Halide

**POWERBALL® HCl®-TM for enclosed luminaires**

- Compact single ended ceramic metal halide lamp
- Very high efficiency and improved performance compared to conventional ceramic lamps
- Outstanding colour rendering and uniform distribution of light
- G22 plug-in base for good positioning
- Hot re-strike available (HR version in GY22 base)
- Ideal for showcasing merchandise and for high power spotlights



Product ID Code	EAN (Single Pack)	Product Description	W	lm	COLOR		t [h]	d [mm]	l [mm]	LCL Å [mm]		PPG
HCITM250WDLPB	4008321524591	PB250TMW HCl-TM 250W/930 <sup>1)</sup>	250	26000	830-WDL	G22	12,000	28	175	90	10	29
HCITM250WDLHR	4008321959423	PBHCl-TM250W/930 HR <sup>2)</sup>	250	26000	830-WDL	GY22	12,000	28	175	90	10	29
HCITM250NDLPB	4008321524638	PB250TMN HCl-TM 250W/942 <sup>1)</sup>	250	25000	942-NDL	G22	12,000	28	175	90	10	29
HCITM250NDLHR	4008321959430	PBHCl-TM250W/942 HR <sup>2)</sup>	250	25000	942-NDL	GY22	12,000	28	175	90	10	29
HCITM400930WDL	4008321524614	PBHCl-TM 400W/930 <sup>1)</sup>	400	41000	930-WDL	G22	12,000	34	175	90	10	29
HCITM400930WDLHR	4008321959447	PBHCl-TM400W/930 HR <sup>2)</sup>	400	41000	930-WDL	GY22	12,000	34	175	90	10	29
HCITM400942NDL	4008321907691	HCITM400942NDL 400W/942 <sup>1)</sup>	400	41000	942-NDL	G22	12,000	34	175	90	10	29
HCITM400942NDL	4008321524577	PB400TMN HCl-TM 400W/942 <sup>1)</sup>	400	41000	942-NDL	G22	12,000	-	-	-	10	29
HCITM400942NDLHR	4008321959454	PBHCl-TM400W/942 HR <sup>2)</sup>	400	41000	942-NDL	GY22	12,000	34	175	90	10	29

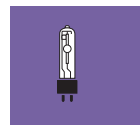

NEW  
NEW  
NEW  
NEW  
NEW

1) Operate with NAV® control gear

2) Operate with NAV® control gear/operate only with a suitable hot restart igniter with an ignition voltage of up to 25kV

All orders must be multiples of sales pack

## High Intensity Discharge Lamps – Ceramic Metal Halide

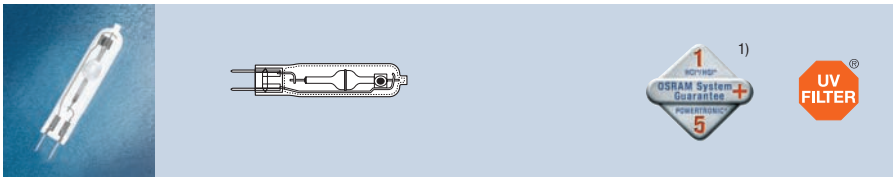
**POWERBALL® HCl®-TC for enclosed luminaires**

- Extremely compact single ended ceramic metal halide lamp
- Excellent focus and directional light source for substituting halogen lighting
- New Secure Fix GU8.5 base ensures stable positioning
- Very high efficiency and improved performance compared to conventional ceramic lamps
- Outstanding colour rendering and uniform distribution of light
- Ideal for very small luminaires used in retail and hospitality lighting

Product ID Code	EAN (Single Pack)	Product Description	W	lm	COLOR		t [h]	d [mm]	l [mm]	LCL [mm]		PPG
HCITC20WDLPB	4008321517647	PB20TCW 830	20	1700	830 - WDL	G8.5	12,000	15	81	52	12	29
HCITC35WDLPB	4008321517739	PB35TCW 830	35	3500	830 - WDL	G8.5	12,000	15	81	52	12	29
HCITC35NDLPB	4008321517784	PB35TCN 942	35	3400	942 - NDL	G8.5	12,000	15	81	52	12	29
HCITC70WDLPB	4008321521040	PB70TCW 830	70	6900	830 - WDL	G8.5	12,000	15	81	52	12	29
HCITC70NDLPB	4008321521866	PB70TCN 942	70	6600	942 - NDL	G8.5	12,000	15	81	52	12	29

Perfectly matched with POWERTRONIC® electronic control gear (PTi and PT FIT)

1) For more information go to [www.osram.com/system-guarantee](http://www.osram.com/system-guarantee)

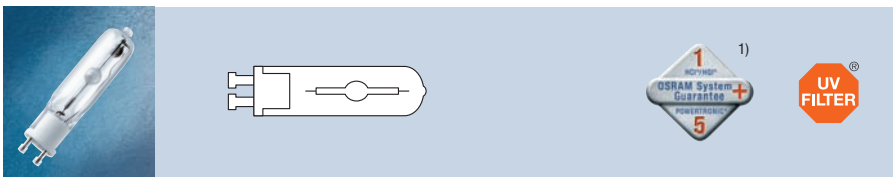
**POWERBALL® HCl®-TF for enclosed luminaires**

- The smallest compact single ended ceramic metal halide lamp from
- New twist and lock GU6.5 base ensures stable positioning
- Very high efficiency and improved performance compared to conventional ceramic lamps
- Outstanding colour rendering and distribution of light
- Operation only with ECG such as POWERTRONIC® PTi
- Ideal for very small luminaires used in shop, hotel, museum and exhibition lighting

Product ID Code	EAN (Single Pack)	Product Description	W	lm	COLOR		t [h]	d [mm]	l [mm]	LCL [mm]		PPG
HCITF20WDLPB	4008321517685	PB20TFW 830	20	1700	830 - WDL	GU6.5	12,000	13	57	30	12	29
HCITF35WDLPB	4008321964427	PB35TFW 930	35	3400	930 - WDL	GU6.5	12,000	13	57	30	12	29

Perfectly matched with POWERTRONIC® electronic control gear (PTi)

1) For more information go to [www.osram.com/system-guarantee](http://www.osram.com/system-guarantee)

NEW

All orders must be multiples of sales pack



## High Intensity Discharge Lamps – Ceramic Metal Halide

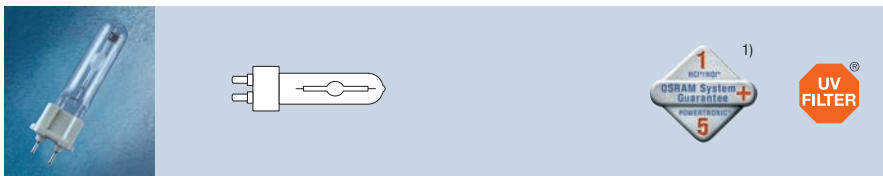

SHOPLIGHT

**POWERBALL® HCI®-T Shoplight for enclosed luminaires**

- Compact single ended ceramic metal halide lamp
- Specifically developed to meet the lighting requirements of shop interiors
- Exceptional natural colour rendering : Ra 95 especially red tones
- Perfect solution where colour rendering and colour matching are an important criteria
- Ideal for the optimum presentation of merchandise



Product ID Code	EAN (Single Pack)	Product Description	W	lm	COLOR		t [h]	d [mm]	l [mm]	LCL & [mm]		PPG
HCIT35930WDLPB	4008321521002	PB35WSL 930 SHOP	35	2800	930 - WDL	G12	12,000	19	100	56	12	29
HCIT70930PB	4008321523440	PB70WSL 930 SHOP	70	6300	930 - WDL	G12	12,000	19	100	56	12	29

Perfectly matched with POWERTRONIC® electronic control gear (PTI)

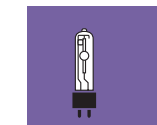
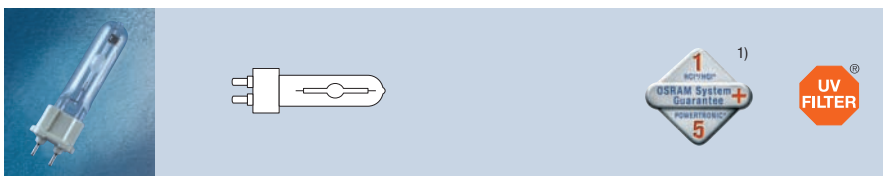
1) For more information go to [www.osram.com/system-guarantee](http://www.osram.com/system-guarantee)

SHOPLIGHT

**POWERBALL® HCI®-TC Shoplight for enclosed luminaires**

- Compact single ended ceramic metal halide lamp
- Specifically developed to meet the lighting requirements of shop interiors
- New Secure Fix GU8.5 base ensures stable positioning
- Exceptional natural colour rendering : Ra 95 especially red tones
- Perfect solution where colour rendering and colour matching are an important criteria
- Ideal for the optimum presentation of merchandise



Product ID Code	EAN (Single Pack)	Product Description	W	lm	COLOR		t [h]	d [mm]	l [mm]	LCL & [mm]		PPG
HCITC35930PB	4008321517760	PB35CWSL TC 35W/930	35	2800	930 - WDL	G8.5	12,000	15	81	52	12	29
HCITC70930PB	4008321520968	PB70CWSL TC 70W/930	70	6300	930 - WDL	G8.5	12,000	15	81	52	12	29

Perfectly matched with POWERTRONIC® electronic control gear (PTI)

1) For more information go to [www.osram.com/system-guarantee](http://www.osram.com/system-guarantee)

All orders must be multiples of sales pack

## High Intensity Discharge Lamps – Ceramic Metal Halide

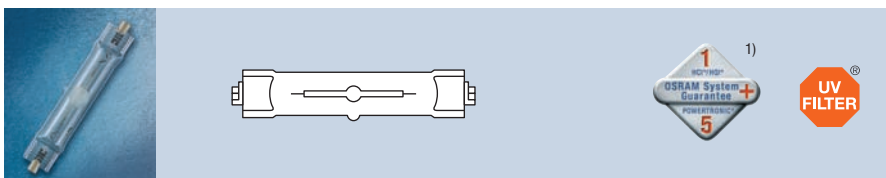
**POWERBALL® HCl®-TS for enclosed luminaires**

- Compact double ended ceramic metal halide lamp
- Suitable for hot restrike (70W, 150W)
- Very high efficiency and improved performance compared to conventional ceramic lamps
- Outstanding colour rendering and distribution of light
- Ideal for lighting shop interiors, reception areas, museums, exhibition halls, buildings and bridges

Product ID Code	EAN (Single Pack)	Product Description	W	lm	COLOR		t [h]	d [mm]	l [mm]	LCL [mm]	No.		PPG
HCITS70WDLPB	4008321523525	PB70SW -TS 70W/830 <sup>1)</sup>	70	6800	830-WDL	RX7s	12,000	20	120	60	2	12	30
HCITS70NDLPB	4008321523549	PB70SN -TS 70W/942 <sup>1)</sup>	70	6500	942-NDL	RX7s	12,000	20	120	60	2	12	30
HCITS150WDLPB	4008321517814	PB15SW -TS 150W/830 <sup>1)</sup>	150	14500	830-WDL	RX7s-24	12,000	23	138	69	2	12	30
HCITS150NDLPB	4008321517838	PB15SN -TS 150W/942 <sup>1)</sup>	150	14400	942-NDL	RX7s-24	12,000	23	138	69	2	12	30
HCITS250WDLPB	4008321519672	PB25SW -TS 250W/830 <sup>2)</sup>	250	25000	830-WDL	Fc2	12,000	25	162	81	3	12	30
HCITS250942NDL	4008321519696	PB25SN -TS 250W/942 <sup>2)</sup>	250	25000	942-NDL	Fc2	12,000	25	162	81	3	12	30

Perfectly matched with POWERTRONIC® electronic control gear (PTI and PTO)

1) For more information go to [www.osram.com/system-guarantee](http://www.osram.com/system-guarantee)

2) Suitable for standard igniters with an ignition voltage of 3.6 to 5 kV

3) Operate on NAV® control gear/Suitable for standard igniters with an ignition voltage of 3.6 to 5 kV

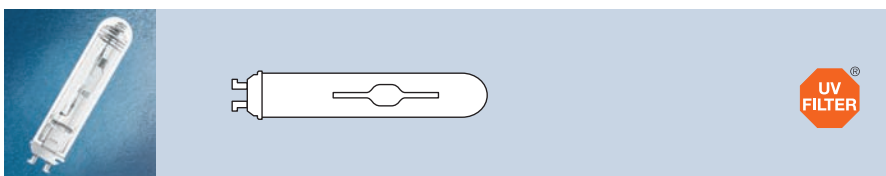
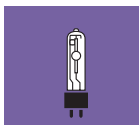
**POWERBALL® HCl®-TX/P for open luminaires**

- New “protected” ceramic metal halide lamp
- Integrated arc tube protection offers maximum protection against shattering
- New GU8.5 “Twist & Lock” base
- Approved for use in open and closed luminaires
- Ideal for shop, office and hospitality lighting

Product ID Code	EAN (Single Pack)	Product Description	W	lm	COLOR		t [h]		PPG
HCITXP35930	4008321539366	PBHCl-TX/P 35W/930	35	3300	930 - WDL	GU8.5	12,000	12	29
HCITXP35942	4008321539380	PBHCl-TX/P 35W/942	35	3300	942 - NDL	GU8.5	12,000	12	29
HCITXP70930	4008321539403	PBHCl-TX/P 70W/930	70	7300	930 - WDL	GU8.5	12,000	12	29
HCITXP70942	4008321539427	PBHCl-TX/P 70W/942	70	7300	942 - NDL	GU8.5	12,000	12	29

NEW  
NEW  
NEW  
NEW

All orders must be multiples of sales pack



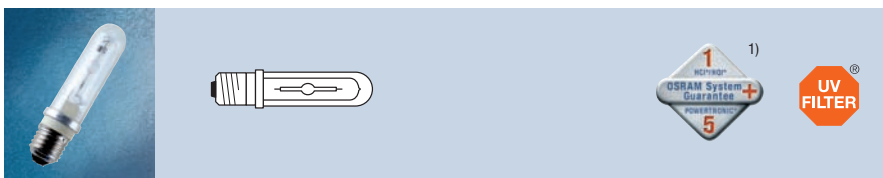

## High Intensity Discharge Lamps – Ceramic Metal Halide

**POWERBALL® HCI®-T/P for open and enclosed luminaires**

- Single ended tubular ceramic metal halide lamp
- Integrated arc tube protection offers maximum protection against shattering
- Outstanding colour rendering and distribution of light
- Very high efficiency and improved performance compared to conventional ceramic lamps
- Ideal for use in open luminaires without cover shields such as exhibitions, sports halls, rail stations and industrial installations

Product ID Code	EAN (Single Pack)	Product Description	W	lm	COLOR		t [h]	d [mm]	l [mm]	LCL [mm]		PPG
<b>Clear</b>												
HCITP70830WDLCL	4008321518828	PB70PWC T/P 70W/830	70	7200	830 - WDL	ES/E27	12,000	34	128	89	12	29
HCITP70942NDLCL	4008321518842	PB70PNC T/P 70W/942	70	6700	942 - NDL	ES/E27	12,000	34	128	89	12	29
HCITP100830WDLCL	4008321518866	PB10PWC T/P 100W/830	100	9000	830 - WDL	ES/E27	12,000	40	133	89	12	29
HCITP100942NDLCL	4008321518880	PB10PNC T/P 100W/942	100	8800	942 - NDL	ES/E27	12,000	40	133	89	12	29
HCITP150830WDLCL	4008321518903	PB15PWC T/P 150W/830	150	14500	830 - WDL	ES/E27	12,000	40	133	89	12	29
HCITP150942NDLCL	4008321518927	PB15PNC T/P 150W/942	150	14500	942 - NDL	ES/E27	12,000	40	133	89	12	29

Perfectly matched with POWERTRONIC® electronic control gear (PTI)

1) For more information go to [www.osram.com/system-guarantee](http://www.osram.com/system-guarantee)

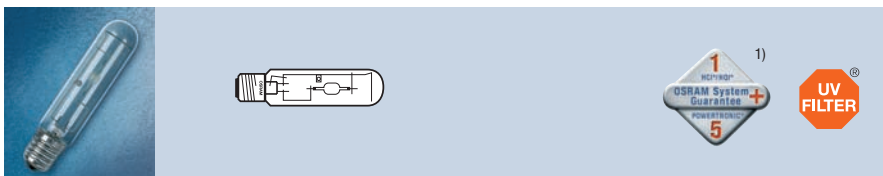
**POWERBALL® HCI®-TT for enclosed luminaires**

- Compact single ended ceramic metal halide lamp
- White light source similar to that of halogen shows surroundings in their natural colour
- Outstanding colour rendering and uniform distribution of light enhances safety
- Specifically developed for outdoor lighting and directly interchangeable with NAV® (SON) lamps
- Ideal for street and outdoor lighting applications

Product ID Code	EAN (Single Pack)	Product Description	W	lm	COLOR		t [h]	d [mm]	l [mm]	LCL [mm]		PPG
HCITT35830WDL	4008321533470	PBHCI-TT 35W/830	35	-	830 - WDL	ES/E27	12,000	-	-	-	12	29
HCITT50830WDL	4008321959416*	PBHCI-TT 50W/830	50	5000	830 - WDL	ES/E27	12,000	32	155	102	12	29
HCITT70WDLPB	4008321524263	PB70-TT 70W/830	70	7000	830 - WDL	ES/E27	12,000	32	155	102	12	29
HCITT100WDLPB	4008321524287	PBHCI-TT 100W/830	100	10000	830 - WDL	GES/E40	12,000	47	210	132	12	29
HCITT150WDLPB	4008321524301	PB150-TT 150W/830	150	14500	830 - WDL	GES/E40	12,000	47	210	132	12	29
HCITT250WDLPB	4008321524324	PBHCI-TT 250W/830	250	26000	830 - WDL	GES/E40	12,000	47	226	158	12	29

Perfectly matched with POWERTRONIC® electronic control gear (PTo)

\*In preparation at time of print. For further information please contact OSRAM

1) For more information go to [www.osram.com/system-guarantee](http://www.osram.com/system-guarantee)

All orders must be multiples of sales pack

## High Intensity Discharge Lamps – Ceramic Metal Halide

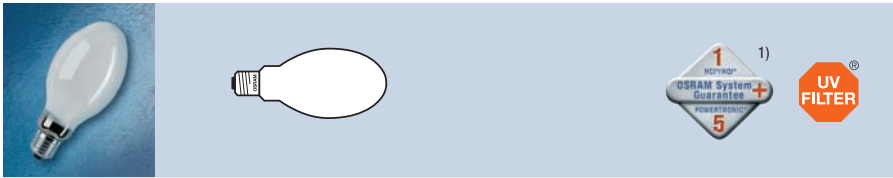
**POWERBALL® HCI®-E/P for open and enclosed luminaires**

- Single ended elliptical ceramic metal halide lamp
- Integrated arc tube protection offers maximum protection against shattering
- New 50W WDL Coated version is an ideal streetlight upgrade for HPS or retrofit for HPM lamps with new ballast and igniter
- Outstanding colour rendering and distribution of light
- Ideal for use in open luminaires without cover shields

Product ID Code	EAN (Single Pack)	Product Description	W	lm	COLOR		t(h)	d (mm)	l (mm)		PPG
<b>Coated</b>											
HCIEP35830WDLCO	4008321518408	PB35EPW HCI-E/P 35W/830	35	3200	830 - WDL	ES/E27	12,000	54	138	12	29
HCIEP35942NDLCO	4008321518446	PB35EPN HCI-E/P 35W/942	35	3100	942 - NDL	ES/E27	12,000	54	138	12	29
HCIEP50830WDL	4008321338488	PB50EPW HCI-E/P 50W/830	50	4000	830 - WDL	ES/E27	12,000	54	138	12	29
HCIEP70WDLPB	4008321518606	PB70EPW HCI-E/P 70W/830	70	6700	830 - WDL	ES/E27	12,000	54	138	12	29
HCIEP70942NDLCO	4008321518675	PB70EPN HCI-E/P 70W/942	70	6300	942 - NDL	ES/E27	12,000	54	138	12	29
HCIEP100WDLPB	4008321518804	PB10EPW HCI-E/P 100W/830	100	8500	830 - WDL	ES/E27	12,000	54	138	12	29
HCIEP100942CO	4008321518781	PB10EPN HCI-E/P 100W/942	100	8300	942 - NDL	ES/E27	12,000	54	138	12	29
HCIEP150830WDLCO	4008321518743	PB15EPW HCI-E/P 150W/830WDL	150	13700	830 - WDL	ES/E27	12,000	54	138	12	29
HCIEP150NDLPB	4008321518767	PB15EPN HCI-E/P 150W/942NDL	150	13700	942 - NDL	ES/E27	12,000	54	138	12	29

Perfectly matched with POWERTRONIC® electronic control gear (PTi and PTø)

1) For more information go to [www.osram.com/system-guarantee](http://www.osram.com/system-guarantee)

NEW

NEW  
NEW

All orders must be multiples of sales pack



High Intensity Discharge Lamps – Ceramic Metal Halide

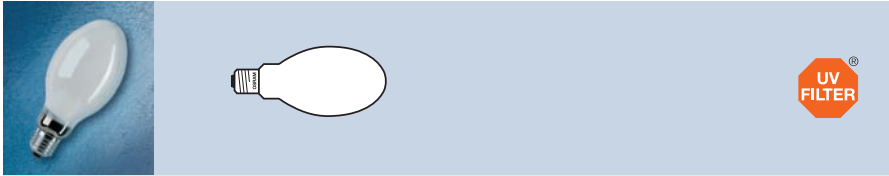

**POWERBALL® HCl®-E for open and enclosed luminaires**

- Single ended elliptical ceramic metal halide lamp
- Outstanding colour rendering and distribution of light
- Ideal for outdoor applications and also in areas with high ceilings such as factories, warehouses, exhibition halls, rail stations and industrial installations

Product ID Code	EAN (Single Pack)	Product Description	W	lm	COLOR		t [h]	d [mm]	l [mm]		PPG
-----------------	-------------------	---------------------	---	----	-------	--	-------	--------	--------	--	-----

**Coated**

HCIE250WDLPB	4008321524188	PB25EW HCl-E 250W/830 <sup>1)</sup>	250	24500	830 - WDL	GES/E40	12,000	91	226	12	29
HCIE250NDLPB	4008321524201	PB25EN HCl-E 250W/942 <sup>1)</sup>	250	22500	942 - NDL	GES/E40	12,000	91	226	12	29

1) Operate with NAV® Control gear



**POWERBALL HCl® 70W for enclosed luminaires**

- Direct replacement to HQL and NAV lamps
- Very good colour rendering
- Can be operated on NAV® control gear by replacing the igniter
- Ideal for white light solution for outdoor application

Product ID Code	EAN (Single Pack)	Product Description	W	lm		t [h]	d [mm]	l [mm]	LCL [mm]		PPG
-----------------	-------------------	---------------------	---	----	--	-------	--------	--------	----------	--	-----

NEW

HCIE70WDLPB	4008321549679	PBHCl-ET 70W/WDL	70	6200	ES/E27	18,000	71	156	71	12	35
-------------	---------------	------------------	----	------	--------	--------	----	-----	----	----	----



All orders must be multiples of sales pack

## High Intensity Discharge Lamps – Ceramic Metal Halide

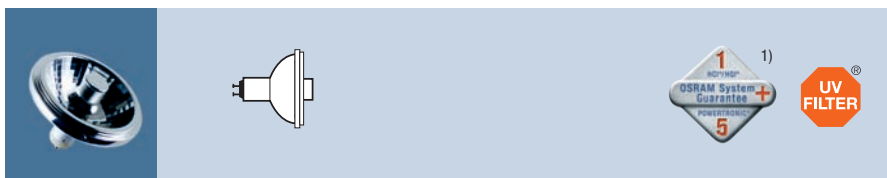
**POWERBALL® HCI®-R111 for open and enclosed luminaires**

- Ceramic metal halide lamp with integrated aluminium R111 metal reflector
- Integrated arc tube protection offering maximum protection against shattering
- A modern alternative to conventional halogen spotlights.
- Spot, flood and wide flood beam angles
- Outstanding colour rendering and uniform distribution of light
- New twist and lock GX8.5 base ensures stable positioning
- Ideal for spotlighting and floodlighting

Product ID Code	EAN (Single Pack)	Product Description	W	COLOR			t [h]	d [mm]	l [mm]		PPG
HCIR1112083010D	4008321519061	PB20RW10 R111 20W/830 10D	20	830 - WDL	10°	GX8.5	12,000	111	95	6	29
HCIR1112083024D	4008321519085	PB20RW24 R111 20W/830 24D	20	830 - WDL	24°	GX8.5	12,000	111	95	6	29
HCIR1112083040D	4008321519108	PB20RW40 R111 20W/830 40D	20	830 - WDL	40°	GX8.5	12,000	111	95	6	29
HCIR1113583010D	4008321519122	PB35RW10 R111 35W/830 10D	35	830 - WDL	10°	GX8.5	12,000	111	95	6	29
HCIR1113583024D	4008321519573	PB35RW24 R111 35W/830 24D	35	830 - WDL	24°	GX8.5	12,000	111	95	6	29
HCIR1113583040D	4008321519597	PB35RW40 R111 35W/830 40D	35	830 - WDL	40°	GX8.5	12,000	111	95	6	29
HCIR1113594210D	4008321519610	PB35RN10 R111 35W/942 10D	35	942 - NDL	10°	GX8.5	12,000	111	95	6	29
HCIR1113594224D	4008321519634	PB35RN24 R111 35W/942 24D	35	942 - NDL	24°	GX8.5	12,000	111	95	6	29
HCIR1113594240D	4008321519658	PB35RN40 R111 35W/942 40D	35	942 - NDL	40°	GX8.5	12,000	111	95	6	29
HCIR1117083010D	4008321518941	PB70RW10 R111 70W/830 10D	70	830 - WDL	10°	GX8.5	12,000	111	95	6	29
HCIR1117083024D	4008321518965	PB70RW24 R111 70W/830 24D	70	830 - WDL	24°	GX8.5	12,000	111	95	6	29
HCIR1117083040D	4008321518989	PB70RW40 R111 70W/830 40D	70	830 - WDL	40°	GX8.5	12,000	111	95	6	29
HCIR111704210D	4008321519009	PB70RN10 R111 70W/942 10D	70	942 - NDL	10°	GX8.5	12,000	111	95	6	29
HCIR1117094224D	4008321519023	PB70RN24 R111 70W/942 24D	70	942 - NDL	24°	GX8.5	12,000	111	95	6	29
HCIR1117094240D	4008321519047	PB70RN40 R111 70W/942 40D	70	942 - NDL	40°	GX8.5	12,000	111	95	6	29

Perfectly matched with POWERTRONIC® electronic control gear (PTi and PT FIT)

1) For more information go to [www.osram.com/system-guarantee](http://www.osram.com/system-guarantee)

NEW  
NEW  
NEW

All orders must be multiples of sales pack

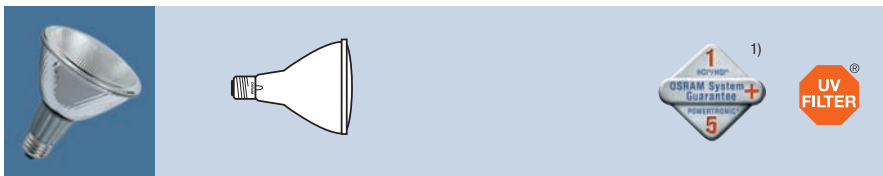

## High Intensity Discharge Lamps – Ceramic Metal Halide

**POWERBALL® HCI®-PAR for open and enclosed luminaires**

- Ceramic metal halide lamp with integrated glass reflector
- In PAR 20 and PAR 30 sizes and spot 10° and flood 30° beam angles
- Outstanding colour rendering and uniform distribution of light
- Ideal for spotlighting and floodlighting



Product ID Code	EAN (Single Pack)	Product Description	W	COLOR			t [h]				PPG
<b>PAR 20</b>											
HCIPAR2035830WDLSP	4008321964502	PB35SP20 PAR20 35W/830	35	830 - WDL	Spot	E27	12,000	65	95	12	29
HCIPAR2035830WDLFL	4008321964519	PB35FL20 PAR20 35W/830	35	830 - WDL	Flood	E27	12,000	65	95	12	29
HCIPAR2035SP	4008321964526	PB35SP20N PAR20 35W/942	35	942 - NDL	Spot	E27	12,000	65	95	12	29
HCIPAR2035FL	4008321964533	PB35FL20N PAR20 35W/942	35	942 - NDL	Flood	E27	12,000	65	95	12	29
<b>PAR 30</b>											
HCIPAR3035WDLPBSP	4008321964540	PB35SP30 PAR30 35W/830	35	830 - WDL	Spot	E27	12,000	97	125	6	29
HCIPAR3035WDLPBFL	4008321964557	PB35FL30 PAR30 35W/830	35	830 - WDL	Flood	E27	12,000	97	125	6	29
HCIPAR3035SP	4008321964564	PB35SP30N PAR30 35W/942	35	942 - NDL	Spot	E27	12,000	97	125	6	29
HCIPAR3035FL	4008321964571	PB35FL30N PAR30 35W/942	35	942 - NDL	Flood	E27	12,000	97	125	6	29
HCIPAR3070WDLPBSPU	4008321964588	PB70SP30 PAR30 70W/830	70	830 - WDL	Spot	E27	12,000	97	125	6	29
HCIPAR3070830WDLFL	4008321964595	PB70FL30 PAR30 70W/830	70	830 - WDL	Flood	E27	12,000	97	125	6	29
HCIPAR3070830WDL40	4008321964601	PB704030 PAR30 70W/830	70	830 - WDL	40°	E27	12,000	97	125	6	29
HCIPAR3070SP	4008321964618	PB70SP30N PAR30 70W/942	70	942 - NDL	Spot	E27	12,000	97	125	6	29
HCIPAR3070FL	4008321964625	PB70FL30N PAR30 70W/942	70	942 - NDL	Flood	E27	12,000	97	125	6	29

Perfectly matched with POWERTRONIC® electronic control gear (PTI)

1) For more information go to [www.osram.com/system-guarantee](http://www.osram.com/system-guarantee)

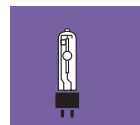

All orders must be multiples of sales pack



## HIGH INTENSITY DISCHARGE LAMPS – QUARTZ METAL HALIDE

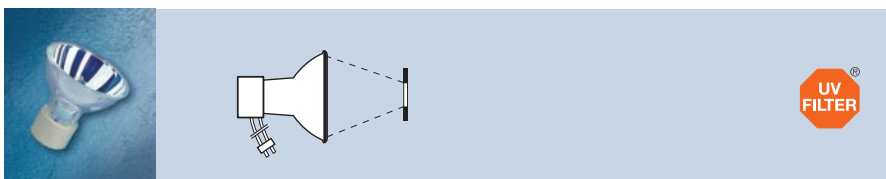

### POWERSTAR® HQI®-R for enclosed luminaires

- Single ended elliptical quartz metal halide lamp
- With integral pre-focused dichroic reflector
- Ideal for light guide systems

Product ID Code	EAN (Single Pack)	Product Description	W	COLOR		t [h]	d [mm]	l [mm]		PPG
HQIR150NDL	4008321528070	H150NR HQI-R	150	NDL/FO	Cable+Plug	9,000	95	93	12	29

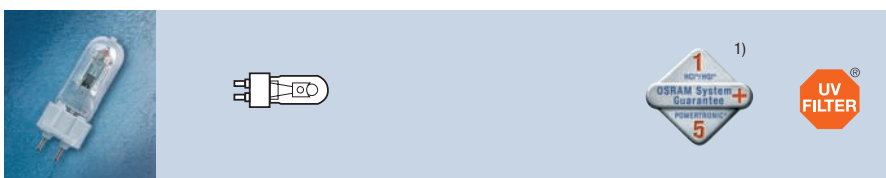
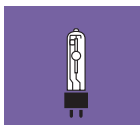

### POWERSTAR® HQI®-T for enclosed luminaires

- Compact single ended quartz metal halide lamp
- Amongst the shortest metal halide lamps in the world for general lighting
- Available in Warm White DE LUXE (WDL) and Neutral White DE LUXE (NDL)
- Ideal for high quality economical lighting

Product ID Code	EAN (Single Pack)	Product Description	W	lm	COLOR		t [h]	d [mm]	l [mm]		PPG
HQIT70NDL	4008321524799	H70N HQI-T	70	5800	NDL	G12	9,000	84	56	12	29
HQIT70WDL	4008321524775	H70W HQI-T	70	5300	WDL	G12	9,000	84	56	12	29
HQIT150NDLPRO	4008321524850	H150N HQI-T	150	13000	NDL	G12	9,000	84	56	12	29
HQIT150WDLPRO	4008321524836	H150W HQI-T	150	13000	WDL	G12	9,000	84	56	12	29

Perfectly matched with POWERTRONIC® electronic control gear (PTI and PTo)

1) For more information go to [www.osram.com/system-guarantee](http://www.osram.com/system-guarantee)

All orders must be multiples of sales pack

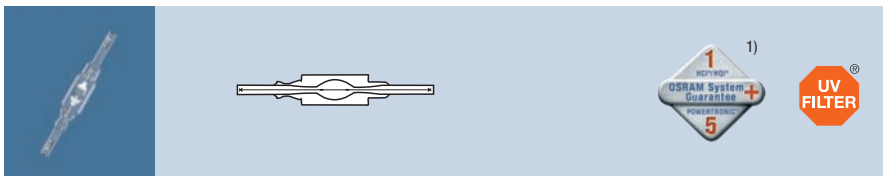

## High Intensity Discharge Lamps – Quartz Metal Halide

**POWERSTAR® HQI®-TS EXCELLENCE for enclosed luminaires**

- Long life double ended quartz metal halide lamps
- Increased efficiency, improved quality of light compared with conventional HQI®-TS lamps .
- High luminous efficacy (Up to 15% more light) and uniform distribution of light
- Up to 15% more light than standard HQI®-TS lamps
- Low thermal output
- Ideal for high quality economical lighting

Product ID Code	EAN (Single Pack)	Product Description	W	lm	COLOR		t [h]	d [mm]	l [mm]		PPG
HQITS70WDLEXC	4008321964281	HQITS70WDLEXC	70	6200	WDL	RX7s	12,000**	19	117	12	30
HQITS70NDLEXC	4008321964304	HQITS70NDLEXC	70	6500	NDL	RX7s	12,000**	19	117	12	30
HQITS70DEXC	4008321964328	HQITS70DEXC	70	6200	D	RX7s	12,000**	19	117	12	30
HQITS150WDLEXC	4008321964342	HQITS150WDLEXC	150	12000	WDL	RX7s-24	12,000**	23	135	12	30
HQITS150NDLEXC	4008321964366	HQITS150NDLEXC	150	12500	NDL	RX7s-24	12,000**	23	135	12	30
HQITS150DEXC	4008321964380	HQITS150DEXC	150	13500	D	RX7s-24	12,000**	23	135	12	30
<b>Colour versions</b>											
HQITS70BLEXC	4008321410115	HQITS70W BL EXC	70	-	Blue	RX7s-24	12000**	19	117	12	30
HQITS150BLEXC	4008321410153	HQITS150W BL EXC	150	-	Blue	RX7s-24	12000**	23	135	12	30
HQITS70GNEXC	4008321410139	HQITS70W GR EXC	70	-	Green	RX7s-24	12000**	19	117	12	31
HQITS150GNEXC	4008321410177	HQITS150W GR EXC	150	-	Green	RX7s-24	12000**	23	135	12	32
-	-	HQITS70W MA EXC*	70	-	Magenta	RX7s-24	12000**	19	117	12	33
-	-	HQITS150W MA EXC*	150	-	Magenta	RX7s-24	12000**	23	135	12	34

Perfectly matched with POWERTRONIC® electronic control gear (PTi and PTo)

1) For more information go to [www.osram.com/system-guarantee](http://www.osram.com/system-guarantee)

\*In preparation at time of print. For further information please contact OSRAM

\*\*with CCG. ECG +30%

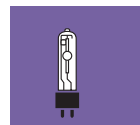

All orders must be multiples of sales pack

## High Intensity Discharge Lamps – Quartz Metal Halide

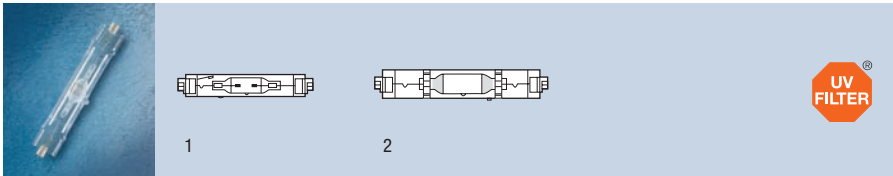

### POWERSTAR® HQI®-TS for enclosed luminaires

- Compact double ended quartz metal halide lamp
- Ideal for high quality economical lighting

Product ID Code	EAN (Single Pack)	Product Description	W	lm	COLOR		t[h]	d [mm]	l [mm]	LCL & [mm]	No.		PPG
HQITS250WDL	4008321525130	H250SW HQI-TS	250	22000	WDL	FC2	12,000	25	162	82	1	12	29
HQITS250NDL	4008321525178	H250SND HQI-TS	250	20000	NDL	FC2	12,000	25	162	82	1	12	29
HQITS250D	4008321525215	H250SD HQI-TS	250	20000	D	FC2	12,000	26	162	82	1	12	29
HQITS400NDL	4008321525758	H400SN HQI-TS <sup>1)</sup>	400	36000	NDL	FC2	12,000	33	206	103	2	12	29
HQITS400D	4008321525734	H400SD PRO HQI-TS <sup>2)</sup>	400	37000	D	FC2	12,000	33	206	103	2	12	29

- 1) Operate only with NAV® control gear  
 2) Operate with NAV® control gear

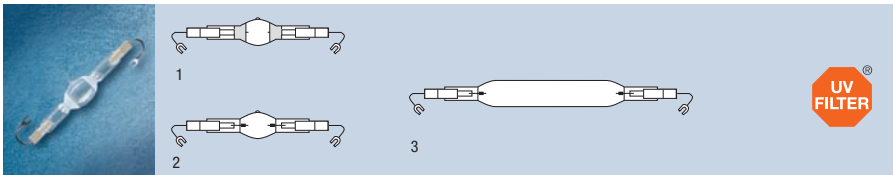
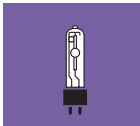

### POWERSTAR® HQI®-TS High Wattage

- Double ended quartz metal halide lamps
- Without outer bulb
- New 1000W PRO version with natural colour appearance and very good colour rendering
- Available with short or long arc
- Ideal for larger floodlighting applications

Product ID Code	EAN (Single Pack)	Product Description	W	lm	COLOR		t[h]	d [mm]	l [mm]	LCL & [mm]	No.		PPG
<b>Short Arc</b>													
HQITS1000DLS	4050300349916	H1KDLS HQI-TS 1000W/D/S	1000	90000	NDL	Cables	6,000	36	187	93	1	10	29
HQITS1000DS	4050300300092	H1KDS HQI-TS 1000W/D/S	1000	90000	D	Cables	6,000	36	187	93	1	10	29
HQITS1000DSPRO	4008321525475	H1KDS PRO HQI-TS 1000W	1000	90000	D	Cables	6,000	36	187	93	1	10	29
HQITS2000DLS	4008321525499	H2KDS LPRO HQI-TS 2000W	2000	215000	NDL	Cables	6,000	36	187	93	1	10	29
HQITS2000DS	4050300271682	H2KDS 2000W/D/S	2000	200000	D	Cables	6,000	36	187	93	2	10	29
<b>Long Arc</b>													
HQITS2000NL	4050300607344	H2KNL HQI-TS2000W/N	2150	230000	N	Cables	6,000	32	274	137	3	10	29
HQITS2000DL400	4008321931825	H2KDL HQI-TS 2000W/D/LK	2150	205000	D	Cables	6,000	32	274	137	3	10	29

NEW

NEW

All orders must be multiples of sales pack

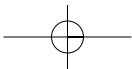





## High Intensity Discharge Lamps – Quartz Metal Halide

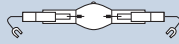

### POWERSTAR® HQI®-TS 2000W/D/S High Flux for enclosed luminaires

- Compact double ended quartz metal halide lamp
- Evolution of the HQI®-TS 2000W/D/S Short arc lamp with 10% more luminous flux
- Less total power consumption
- Suitable for hot restrike
- Ideal for professional sports lighting, TV broadcasting, large area lighting



Product ID Code	EAN (Single Pack)	Product Description	W	lm	COLOR		t [h]	d [mm]	l [mm]	LCL a [mm]		PPG
HQITS2000DSHF	4008321338310	HQI-TS 2000W/D/S HF K12S	2000	220000	WDL	Cable	4,000	36	187	93	12	30

NEW

1) Operate only on a 12.2.A control gear



### POWERSTAR® HQI®-TM for enclosed luminaires

- Robust and very compact single ended quartz metal halide lamp
- Hot re-strike capability (GY22 base HR version only)
- Easy handling and optimum lamp positioning due to plug in bases
- Produce excellent directional light
- Ideal for large area lighting such as factories, airports, stadiums and industrial lighting



Product ID Code	EAN (Single Pack)	Product Description	W	lm	COLOR		t [h]	d [mm]	l [mm]	LCL a [mm]		PPG
HQITM600NDL	4008321959461*	HQI-TM 600W/845 NDL <sup>1)</sup>	600	55000	NDL	G22	10,000	34	188	90	12	29
HQITM600NDLHR	4008321959478*	HQI-TM 600W/845 NDL HR <sup>2)</sup>	600	55000	NDL HR	GY22	10,000	34	188	90	12	29
HQITM600D	4008321959485*	HQI-TM 600W/960 D <sup>1)</sup>	600	58000	D	G22	10,000	34	188	90	12	29
HQITM600DHR	4008321959492*	HQI-TM 600W/960 D HR <sup>2)</sup>	600	58000	D HR	GY22	10,000	34	188	90	12	29
HQITM1000NDL	4008321959508*	HQI-TM 1000W/845 NDL	1000	92000	NDL	G22	10,000	38	188	90	12	29
HQITM1000NDLHR	4008321959515*	HQI-TM 1000W/845 NDL HR <sup>3)</sup>	1000	92000	NDL HR	GY22	10,000	38	188	90	12	29
HQITM1000D	4008321467553	HQI-TM 1000W/960 D	1000	97000	D	G22	10,000	38	188	90	12	29
HQITM1000960DHR	4008321959522	HQI-TM 1000W/960 D HR <sup>3)</sup>	1000	97000	D HR	GY22	10,000	38	188	90	12	29

NEW

NEW

NEW

NEW

NEW

NEW

NEW

\*In preparation at time of print. For further information please contact OSRAM

1) Operate with NAV® control gear

2) Operate only on suitable hot restart igniters with an ignition voltage of up to 25 kV/operate on NAV® control gear

3) Operate only on suitable hot restart igniters with an ignition voltage of up to 25 kV

All orders must be multiples of sales pack

High Intensity Discharge Lamps – Quartz Metal Halide

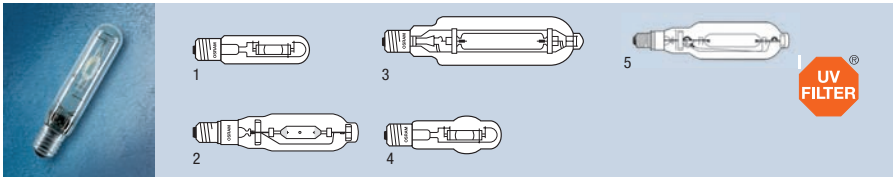

**POWERSTAR® HQI®-T for enclosed luminaires**

- Single ended tubular quartz metal halide lamp
- Ideal for floodlighting buildings and sports facilities

Product ID Code	EAN (Single Pack)	Product Description	W	lm	COLOR		t [h]	d [mm]	l [mm]	LCL a [mm]	No.		PPG
-----------------	-------------------	---------------------	---	----	-------	--	-------	--------	--------	------------	-----	--	-----

**Without igniter for enclosed luminaires**

HQIT250D	4008321525710	H250D T 250W/D PRO <sup>2)</sup>	250	20000 D	GES/E40		12,000	46	226	150	1		29
HQIBT400D	4008321525970	H400D BT 400W/D PRO <sup>2)</sup>	400	35000 D	GES/E40		12,000	62	285	175	4		29
HQIT400N	4008321526786	H400N T 400W/N	400	42000 N	GES/E40		12,000	46	273	175	1		29
HQIT1000N	4008321528285	HQI-T 1000W/N	1000	110000 N	GES/E40		12,000	76	345	220	3		29
HQIT1000D	4008321527035	H1KWD T 1000W/D	1000	85000 D	GES/E40		12,000	76	345	220	3		29
HQIT2000NESUPER	4050300301860	H2KNES T 2000W/N	2000	240000 N	GES/E40		9,000	100	430	265	2		29
HQIT2000D	4008321526809	H2KWD T 2000W/D	2000	180000 D	GES/E40		12,000	100	430	265	2		29

**Coloured**

HQIT400BLUE	4008321526861	H400B HQI-T 400W BL <sup>3)</sup>	400	-	BLUE	GES/E40	-	46	273	175	1		29
HQIT400GREEN	4008321526847	H400G HQI-T 400W GN <sup>3)</sup>	400	-	GREEN	GES/E40	-	46	273	175	1		29
HQIT400REDMAG	4008321526885	H400M HQI-T 400W MA <sup>3)</sup>	400	-	MAGENTA	GES/E40	-	46	273	175	1		29

**With igniter for enclosed luminaires**

HQIT2000N	4050300015347*	83330 T 2000W/N E40 <sup>1)</sup>	2000	205000 N	GES/E40		9,000	100	430	265	2		29
HQIT2000DI	4008321527011*	H2KWDI T 2000W/D/I <sup>1)</sup>	2000	180000 D	GES/E40		100	430	265	2		29	

\*In preparation at time of print. For further information please contact OSRAM

- 1) Operation without an external igniter
- 2) Operate with NAV® control gear
- 3) Operate with HQI® control gear

NEW  
NEW  
NEW  
NEW  
NEW  
NEW  
NEW  
NEW

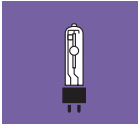

**POWERSTAR® HQI®-T NSI**

- Compact single ended quartz metal halide lamp
- Ideal for floodlighting buildings

Product ID Code	EAN (Single Pack)	Product Description	W	lm	COLOR		t [h]	d [mm]	l [mm]		PPG
-----------------	-------------------	---------------------	---	----	-------	--	-------	--------	--------	--	-----

HQIT250NSI	4050300444604	H25NSI HQI-T 250W/N/SI E40	250	20000 N	GES/E40		12,000	57	248	10	29
HQIT400NSI	4050300376431	H40NSI HQI-T 400W/N/SI E40	400	31000 N	GES/E40		12,000	57	248	10	29

All orders must be multiples of sales pack



## High Intensity Discharge Lamps – Quartz Metal Halide

**POWERSTAR® HQI®-T NSI SUPER**

- Compact tubular single ended quartz metal halide lamp
- High lumen output and extra long life of 20,000 hours
- Ideal for industrial applications, trade shows, exhibition and sports halls and exterior floodlighting systems

Product ID Code	EAN (Single Pack)	Product Description	W	lm	COLOR		t [h]	ø [mm]	l [mm]		PPG
HQIT250NSISUPER	4008321959584*	HQI-T 250W/N/SI SUPER E40 <sup>1)</sup>	250	19500	N	GES/E40	20,000	46	225	10	29
HQIT400NSISUPER	4008321959607*	HQI-T 400W/N/SI SUPER E40 <sup>1)</sup>	400	35000	N	GES/E40	20,000	46	275	10	29

NEW  
NEW

\*In preparation at time of print. For further information please contact OSRAM

1) Operate with HQL® control gear

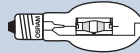
**POWERSTAR® HQI®-E for open and closed luminaires**

- Single ended elliptical quartz metal halide lamp
- Ideal for use in factories, offices, warehouses, rail stations and retail lighting

Product ID Code	EAN (Single Pack)	Product Description	W	lm	COLOR		t [h]	ø [mm]	l [mm]	LCL ā [mm]		No.		PPG
<b>Clear</b>														
HQIE70WDLCLEAR	4050300397788	H70EWC HQI-E 70W/WDL	70	5200	WDL	ES/E27	9,000	55	141	89	1	20	29	
HQIE70NDLCLEAR	4050300397825	H70ENC HQI-E 70W/NDL	70	5500	WDL	ES/E27	6,000	55	141	89	1	141	29	
HQIE100WDLCLEAR	4050300351537	H10EWC HQI-E 100W/WDL	100	8500	WDL	ES/E27	9,000	55	141	89	1	20	29	
HQIE100NDLCLEAR	4050300345871	H10ENC HQI-E 100W/NDL	100	8400	NDL	ES/E27	6,000	55	141	89	1	20	29	
HQIE150WDLCLEAR	4050300433974	H15EWC HQI-E 150W/WDL	150	12900	WDL	ES/E27	9,000	55	141	89	1	20	29	
HQIE150NDLCLEAR	4050300434018	H15ENC HQI-E 150W/NDL	150	12500	NDL	ES/E27	6,000	55	141	89	1	20	29	
<b>Coated</b>														
HQIE70WDL	4050300397801	H70EW HQI-E 70W/WDL	70	4700	WDL	ES/E27	9,000	55	141	-	2	20	29	
HQIE70NDL	4050300397849	H70EN HQI-E 70W/NDL	70	5100	NDL	ES/E27	6,000	55	141	-	2	20	29	
HQIE100WDL	4050300351551	H10EW HQI-E 100W/WDL	100	7900	WDL	ES/E27	9,000	55	141	-	2	20	29	
HQIE100NDL	4050300345833	H10EN HQI-E 100W/NDL	100	7700	NDL	ES/E27	6,000	55	141	-	2	20	29	
HQIE150WDL	4050300433998	H15EW HQI-E 150W/WDL <sup>1)</sup>	150	11600	WDL	ES/E27	9,000	55	141	-	2	20	29	
HQIE150NDL	4050300434032	H15EN HQI-E 150W/NDL <sup>1)</sup>	150	11500	NDL	ES/E27	6,000	55	141	-	2	20	29	

Perfectly matched with POWERTRONIC® electronic control gear (PTI, PTO, PT FIT)

1) Operate with NAV® control gear



All orders must be multiples of sales pack

## High Intensity Discharge Lamps – Quartz Metal Halide

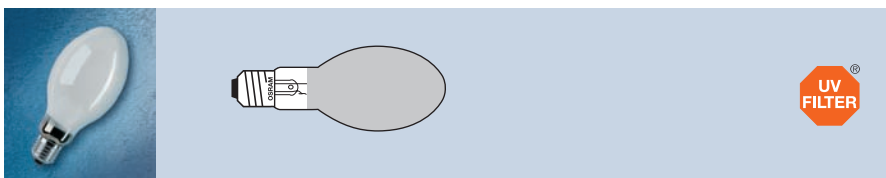

### POWERSTAR® HQI®-E/P

- Protected single ended elliptical quartz metal halide lamp
- Suitable for use in open luminaires without cover shields
- Ideal in factories, offices, warehouses, rail stations and retail lighting

Product ID Code	EAN (Single Pack)	Product Description	W	lm	COLOR		t[h]				PPG
HQIEP250D	4008321525673	H25EDP HQI-E/P 250W/D <sup>1)</sup>	250	17000	D	GES/E40	6,000	90	226	12	29
HQIEP400D	4008321525697	H40EDP HQI-E/P 400W/D <sup>1)</sup>	400	31000	D	GES/E40	12,000	120	290	12	29

1) Operate with NAV® control gear

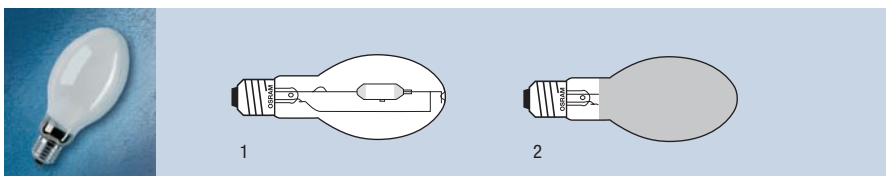
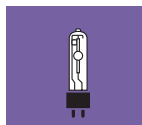

### POWERSTAR® HQI®-E High Wattage

- Single ended elliptical quartz metal halide lamp
- Ideal for enclosed luminaires in factories, offices and warehouses

Product ID Code	EAN (Single Pack)	Product Description	W	lm	COLOR		t[h]						PPG
<b>Clear</b>													
HQIE400NCLEAR	4008321526700	H40ENC HQI-E 400W/N <sup>1)</sup>	400	42000	N	GES/E40	12,000	120	285	198	1	12	29
<b>Coated</b>													
HQIE250D	4008321525659	H250ED HQI-E 250W/D <sup>1)</sup>	250	19000	D	GES/E40	12,000	90	226	-	2	12	29
HQIE400D	4008321525512	H400ED HQI-E 400W/D <sup>1)</sup>	400	34000	D	GES/E40	12,000	120	290	-	2	12	29
HQIE400N	4008321526724	H400EN HQI-E 400W/N <sup>1)</sup>	400	40000	N	GES/E40	12,000	120	285	-	2	12	29
HQIE1000N	4008321528261	H1000EN HQI-E 1000W/N	1000	100000	N	GES/E40	12,000	165	380	-	2	6	29

1) Operate with NAV® control gear

NEW

NEW

NEW

All orders must be multiples of sales pack

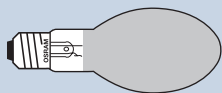

## High Intensity Discharge Lamps – Quartz Metal Halide

**POWERSTAR® HQI®-E NSI**

- Single ended elliptical quartz metal halide lamp
- Ideal for downlights in factories, offices and warehouses

Product ID Code	EAN (Single Pack)	Product Description	W	lm	COLOR		t [h]	d [mm]	l [mm]	LCL & [mm]		PPG
HQIE250NSI	4050300444628	H2ENSI HQI-E 250W/N/SI	250	21500	N	GES/E40	9,000	89	216	-	6	29
HQIE400NSI	4008321302342	H4ENSI HQI-E 400W/N/SI	400	31000	N	GES/E40	9,000	37	297	-	6	29

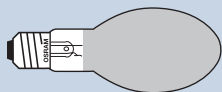
**POWERSTAR® HQI®-E NSI SUPER**

- Compact elliptical single ended quartz metal halide lamp
- High lumen output and extra long life of 20,000 hours
- Ideal for industrial applications, trade shows, exhibition and sports halls and exterior floodlighting systems

Product ID Code	EAN (Single Pack)	Product Description	W	lm	COLOR		t [h]	d [mm]	l [mm]	LCL & [mm]		PPG
HQIE250NSISUPER	4008321959577*	HQI-E 250W/N/SI SUPER <sup>1)</sup>	250	19000	N	GES/E40	20,000	90	225	10	29	
HQIE400NSISUPER	4008321959591*	HQI-E 400W/N/SI SUPER <sup>1)</sup>	400	34000	N	GES/E40	20,000	90	275	10	29	

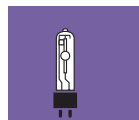

NEW

NEW

\*In preparation at time of print. For further information please contact OSRAM

1) Lamps ignite at an ignition voltage of 0.56 to 1 kvs; lamps must not be operated with an ignition voltage .1.5kVs/Operate on HQL® control gear

All orders must be multiples of sales pack

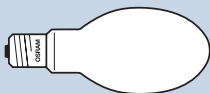
**HIGH INTENSITY DISCHARGE LAMPS – HIGH PRESSURE SODIUM LAMPS****4Y EARS  
LONGLIFE****VIALOX® NAV®-E SUPER 4Y® (SON-E PLUS 4 YEAR)** 

- Elliptical diffuse high pressure sodium lamp
- Brightest and most economical high pressure SON lamps
- 4 year (4Y) relamping cycle
- 20% higher efficiency and direct replacement for NAV®-E Standard and 4Y
- Up to 25% longer life
- Without igniter
- Ideal for street lighting, floodlighting and indoor lighting in heavy industry

Product ID Code	EAN (Single Pack)	Product Description	W	lm	COLOR		t[h]				PPG
NAVE50S4Y	4008321356024	S50P4 NAV-E 50W SUP 4Y E27	50	3800	2000K	ES/E27	28,000	71	156	24	36
NAVE70S4Y	4008321356048	S70P4 NAV-E 70W SUP 4Y E27	70	6300	2000K	ES/E27	28,000	71	156	24	36
NAVE100S4Y	4050300015774	S100P4 NAV-E 100W SUP 4Y E40 <sup>1)</sup>	100	10200	2000K	GES/E40	28,000	76	183	12	36
NAVE150S4Y	4050300024370	S150P4 NAV-E 150W SUP 4Y E40 <sup>1)</sup>	150	17000	2000K	GES/E40	28,000	91	226	12	36
NAVE250S4Y	4050300024387	S250P4 NAV-E 250W SUP 4Y E40 <sup>1)</sup>	250	31100	2000K	GES/E40	28,000	91	226	12	36
NAVE400S4Y	4050300024394	S400P4 NAV-E 400W SUP 4Y E40 <sup>1)</sup>	400	55500	2000K	GES/E40	28,000	122	290	12	36

Perfectly matched with POWERTRONIC® electronic control gear (up to 150W)

1) Important: Before replacing NAV® (SON) Standard lamps in existing installations, check that ignites are suitable

**NEW  
NEW**

All orders must be multiples of sales pack



High Intensity Discharge Lamps – High Pressure Sodium Lamps

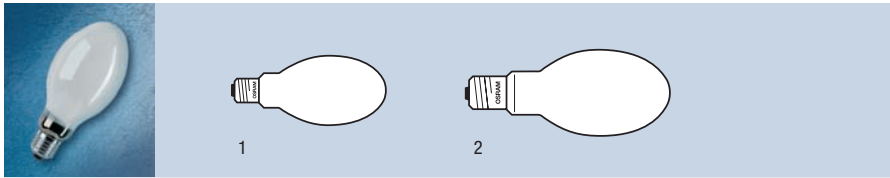

**4Y** YEARS  
LONGLIFE



**VIALOX® NAV®-E 4Y® (SON-E 4 YEAR) △E**

- Elliptical diffuse high pressure sodium lamp
- 4 year (4Y) relamping cycle
- Up to 25% longer life
- Ideal for street lighting, floodlighting and indoor lighting in heavy industry

Product ID Code	EAN (Single Pack)	Product Description	W	lm	COLOR		t [h]	d [mm]	l [mm]	No.		PPG
-----------------	-------------------	---------------------	---	----	-------	--	-------	--------	--------	-----	--	-----

**Without internal igniter**

NAVE50E4Y	4050300577678	S504Y NAV-E 50W/E 4Y	50	3500	2000K	ES/E27	28,000	71	156	1	24	34
NAVE70E4Y	4050300577692	S704Y NAV-E 70W/E 4Y	70	5600	2000K	ES/E27	28,000	71	156	1	24	37
NAVE1504Y <sup>2)</sup>	4050300577555	S1504Y NAV-E 150W 4Y	150	14500	2000K	GES/E40	28,000	91	226	2	12	34
NAVE2504Y <sup>2)</sup>	4050300577579	S2504Y NAV-E 250W 4Y	250	27000	2000K	GES/E40	28,000	91	226	2	12	34
NAVE4004Y <sup>2)</sup>	4050300577593	S4004Y NAV-E 400W 4Y	400	48000	2000K	GES/E40	28,000	122	290	2	12	34

**With internal igniter**

NAVE50I4Y	4050300606033	NAV-E 50W/I 4Y <sup>1)</sup>	50	3500	2000K	ES/E27	28,000	71	156	1	24	34
NAVE70I4Y	4050300606019	NAV-E 70W/I 4Y <sup>1)</sup>	70	5600	2000K	ES/E27	28,000	71	156	1	24	34

Perfectly matched with POWERTRONIC® PTo electronic control gear (up to 150W)

1) Operate only with NAV® control gear/No igniter required

2) Banned from 1.4.2012

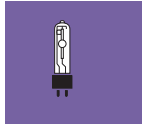

All orders must be multiples of sales pack

High Intensity Discharge Lamps – High Pressure Sodium Lamps

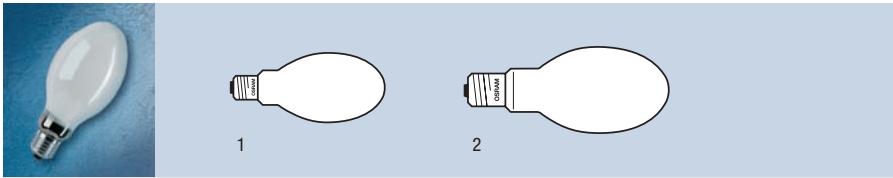

**VIALOX® NAV®-E (STANDARD SON-E) without internal igniter**

- Elliptical diffuse high pressure sodium lamp
- Ideal for economical street lighting and floodlighting

Product ID Code	EAN (Single Pack)	Product Description	W	lm	COLOR		t[h]	d [mm]	l [mm]	No.		PPG
-----------------	-------------------	---------------------	---	----	-------	--	------	--------	--------	-----	--	-----

**Without internal igniter**

NAVE50E <sup>2)</sup>	4050300015750	S50 NAV-E 50W/E	50	3500	2000K ES/E27	18,000	71	156	1	24	34
NAVE70E <sup>2)</sup>	4050300015767	S70 NAV-E 70W/E	70	5600	2000K ES/E27	18,000	71	156	1	24	37
NAVE100 <sup>2)</sup>	4008321087300	S100 NAV-E 100W	100	8500	2000K GES/E40	18,000	76	183	2	12	34
NAVE150 <sup>2)</sup>	4050300015613	S150 NAV-E 150W	150	14500	2000K GES/E40	18,000	91	226	2	12	34
NAVE250 <sup>2)</sup>	4050300015620	S250 NAV-E 250W	250	27000	2000K GES/E40	18,000	91	226	2	12	34
NAVE400 <sup>2)</sup>	4050300015637	S400 NAV-E 400W	400	48000	2000K GES/E40	18,000	122	290	2	12	34
NAVE1000 <sup>2)</sup>	4050300015644	S1000 NAV-E 1000W	1000	128000	2000K GES/E40	18,000	165	370	2	6	34

**With internal igniter**

NAVE50I <sup>2)</sup>	4050300015583	S50I NAV-E 50W/I <sup>1)</sup>	50	3500	2000K ES/E27	16,000	71	156	1	24	35
NAVE70I <sup>2)</sup>	4050300015590	S70I NAV-E 70W/I <sup>1)</sup>	70	5600	2000K ES/E27	16,000	71	156	1	24	35

Perfectly matched with POWERTRONIC® PTo electronic control gear (up to 150W)

1) Operate only with NAV® control gear/No igniter required

2) Banned from 1.4.2012

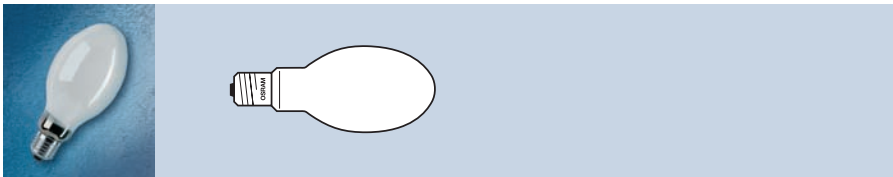
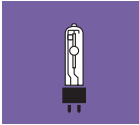

**VIALOX® NAV®-E 68W Plug-in (SON-E plug-in)**

- Direct replacement for HQL® 80W
- Up to 15% energy savings and 42% higher lumen output than HQL® 80W
- Ideal for outdoor and industrial floodlighting applications

Product ID Code	EAN (Single Pack)	Product Description	W	lm	COLOR		t[h]	d [mm]	l [mm]	No.		PPG
-----------------	-------------------	---------------------	---	----	-------	--	------	--------	--------	-----	--	-----

NAVE68	4008321345462	NAV-E 68W PLUGIN	68	5400	2000K ES/E27	14,000	71	152	12	35
--------	---------------	------------------	----	------	--------------	--------	----	-----	----	----

Perfectly matched with POWERTRONIC® electronic control gear (PTo)

NEW

All orders must be multiples of sales pack





## High Intensity Discharge Lamps – High Pressure Sodium Lamps

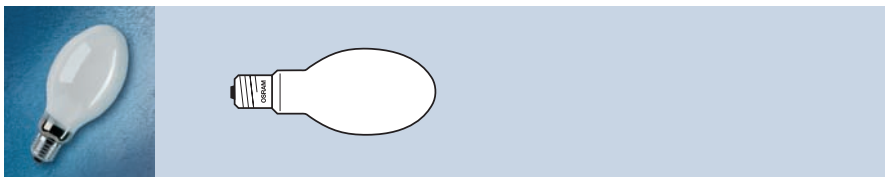

### VIALOX® NAV®-E plug-in (SON-E plug-in) ⚠

- Replacement (retrofit) high pressure sodium lamps for mercury vapour lamp
- No external igniter required ⚠
- Ideal for outdoor and industrial floodlighting applications

Product ID Code	EAN (Single Pack)	Product Description	W	lm	COLOR		t[h]	d [mm]	l [mm]		PPG
NAVE110	4050300024318	S110I NAV-E 110W	110W	8000	2000K	ES/E27	14,000	76	170	40	35
NAVE210 <sup>1)</sup>	4050300015576	S210I NAV-E 210W	210W	18000	2000K	GES/E40	14,000	91	226	12	35
NAVE350 <sup>1)</sup>	4050300015651	S350I NAV-E 350W	350W	34000	2000K	GES/E40	14,000	122	285	12	35

Perfectly matched with POWERTRONIC® PTo electronic control gear (up to 150W)

1) Banned from 1.4.2015 as per EU phase-out plan

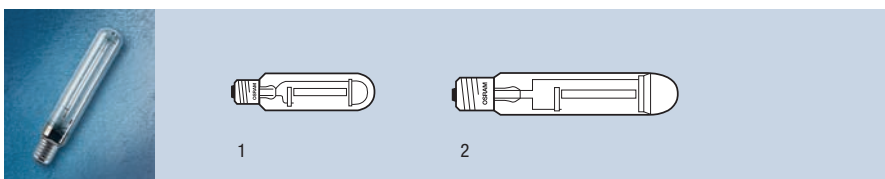

### VIALOX® NAV®-T SUPER 4Y® (SON-T PLUS 4 YEAR) ⚠

- Tubular clear high pressure sodium lamp
- One of the brightest and most economical SON lamps
- 4 year (4Y) relamping cycle
- 20% higher efficiency and direct replacement for NAV®-E Standard and 4Y versions
- Up to 25% longer life
- Without igniter ⚠
- Ideal for street lighting, floodlighting and indoor lighting in heavy industry

Product ID Code	EAN (Single Pack)	Product Description	W	lm	COLOR		t[h]	d [mm]	l [mm]	No.		PPG
NAV750S	4050300024325	S50PT4 NAV-T 50W SUP4Y <sup>1)</sup>	50	4400	2000K	ES/E27	28,000	38	156	1	12	36
NAV70S	4050300015736	S70PT4 NAV-T 70W SUP4Y <sup>1)</sup>	70	6600	2000K	ES/E27	28,000	38	156	1	12	36
NAV7100S4Y	4050300015743	S10PT4 NAV-T 100W SUP4Y <sup>1)</sup>	100	10700	2000K	GES/E40	28,000	47	210	2	12	36
NAV7150S4Y	4050300024400	S15PT4 NAV-T 150W SUP4Y <sup>1)</sup>	150	17500	2000K	GES/E40	28,000	47	210	2	12	36
NAV7250S4Y	4050300024417	S25PT4 NAV-T 250W SUP4Y <sup>1)</sup>	250	33200	2000K	GES/E40	28,000	47	257	2	12	36
NAV7400S4Y	4050300281179	S40PT4 NAV-T 400W SUP4Y <sup>1)</sup>	400	56500	2000K	GES/E40	28,000	47	285	2	12	36
NAV7600S4Y	4050300275772	S60PT4 NAV-T 600W SUP4Y <sup>1)</sup>	600	90000	2000K	GES/E40	28,000	47	285	2	12	36

Perfectly matched with POWERTRONIC® PTo electronic control gear (up to 150W)

1) Important: Before replacing NAV® (SON) standard lamps in existing installations, check that igniters are suitable

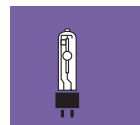

All orders must be multiples of sales pack

High Intensity Discharge Lamps – High Pressure Sodium Lamps



**4 YEARS  
LONGLIFE**

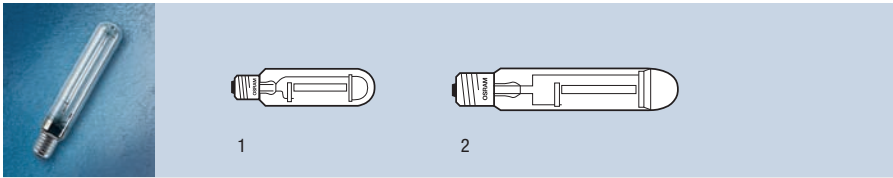

**VIALOX® NAV®-T 4Y® (SON-T 4 YEAR)**

- Tubular clear high pressure sodium lamp
- 4 year (4Y) relamping cycle
- Up to 25% longer life
- Without igniter
- Ideal for street lighting, floodlighting and indoor lighting in heavy industry

Product ID Code	EAN (Single Pack)	Product Description	W	lm	COLOR		t[h]	d [mm]	l [mm]	LCL a [mm]	No.		PPG
NAV704Y <sup>1)</sup>	4050300579061	S70T4Y NAV-T 70W 4Y	70	6000	2000K	ES/E27	28,000	38	156	104	1	12	34
NAV1504Y <sup>1)</sup>	4050300577616	S15T4Y NAV-T 150W 4Y	150	15000	2000K	GES/E40	28,000	47	210	132	2	12	34
NAV2504Y <sup>1)</sup>	4050300577630	S25T4Y NAV-T 250W 4Y	250	28000	2000K	GES/E40	28,000	47	257	158	2	12	34
NAV4004Y <sup>1)</sup>	4050300577654	S40T4Y NAV-T 400W 4Y	400	48000	2000K	GES/E40	28,000	47	285	175	2	12	34

Perfectly matched with POWERTRONIC® PTo electronic control gear (up to 150W)

1) Banned from 1.4.2012 as per EU phase-out plan

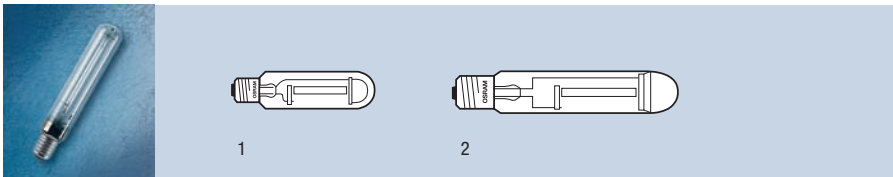
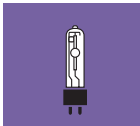

**VIALOX® NAV®-T (STANDARD SON-T)**

- Tubular clear high pressure sodium lamp
- Ideal for economical street lighting and floodlighting

Product ID Code	EAN (Single Pack)	Product Description	W	lm	COLOR		t[h]	d [mm]	l [mm]	LCL a [mm]	No.		PPG
<b>Without igniter</b>													
NAV750	4008321337986	S 50T NAV-T 50W	50	3700	2000K	ES/E27	18,000	38	156	104	1	12	34
NAV70 <sup>1)</sup>	4050300255590	S70T NAV-T 70W	70	6000	2000K	ES/E27	18,000	38	156	104	1	12	34
NAV100 <sup>1)</sup>	4008321087287	S 100T NAV-T 100W	100	9000	2000K	GES/E40	18,000	47	210	132	2	12	34
NAV150 <sup>1)</sup>	4050300015668	S150T NAV-T 150W	150	15000	2000K	GES/E40	18,000	47	210	132	2	12	34
NAV250 <sup>1)</sup>	4050300015675	S250T NAV-T 250W	250	28000	2000K	GES/E40	18,000	47	257	158	2	12	34
NAV400 <sup>1)</sup>	4050300015682	S400T NAV-T 400W	400	48000	2000K	GES/E40	18,000	47	285	175	2	12	34
NAV1000 <sup>1)</sup>	4050300251417	S1KWT NAV-T 1000W 230V	1000	130000	2000K	GES/E40	18,000	66	360	240	2	10	34

**With igniter**

NAV1000 <sup>1)</sup>	4050300287171	S1KWT NAV-T 1000W 400V/l	1000	130000	2000K	GES/E40	18,000	66	360	240	-	12	35
-----------------------	---------------	--------------------------	------	--------	-------	---------	--------	----	-----	-----	---	----	----

Perfectly matched with POWERTRONIC® PTo electronic control gear (up to 150W)

1) Banned from 1.4.2012

**NEW**

All orders must be multiples of sales pack



### High Intensity Discharge Lamps – High Pressure Sodium Lamps



#### VIALOX® NAV®-TS SUPER 4Y® (SON-TS PLUS)

- Double ended high pressure sodium lamp
- One of the brightest and most economical SON lamps
- 4 year (4Y) relamping cycle
- Without igniter
- Ideal for smaller floodlighting applications

Product ID Code	EAN (Single Pack)	Product Description	W	Im	COLOR		t [h]	d [mm]	l [mm]	LCL a [mm]		PPG
NAVTS70S	4050300024301	S70TS NAV-TS 70W SUP 4Y	70	6800	2000K	Rx7s	24,000	20	120	57	12	35
NAVTS150S	4050300281667	S150TS NAV-TS 150W SUP 4Y	150	15000	2000K	Rx7s-24	24,000	23	138	66	12	35

Perfectly matched with POWERTRONIC® electronic control gear (PTo)



#### VIALOX® NAV®-TS (STANDARD SON-TS)

- Double ended high pressure sodium lamp
- Instant hot restart is possible with a special igniter
- Without igniter
- Ideal for lighting bridges, tunnels and railway lines

Product ID Code	EAN (Single Pack)	Product Description	W	Im	COLOR		t [h]	d [mm]	l [mm]	LCL a [mm]		PPG
NAVTS250	4050300015705	S250TS NAV-TS 250W	250	25500	2000K	FC2	24,000	23	206	103	12	35
NAVTS400	4050300015712	S400TS NAV-TS 400W	400	48000	2000K	FC2	24,000	23	206	103	12	35



All orders must be multiples of sales pack

## High Intensity Discharge Lamps – High Pressure Sodium Lamps

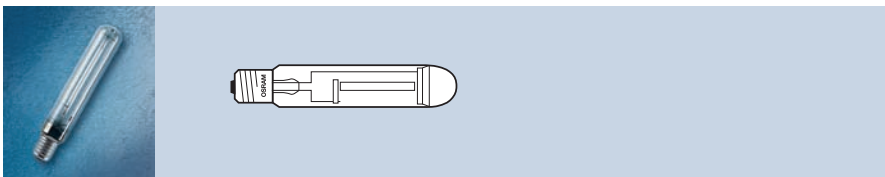

### PLANTASTAR®

- Tubular clear high pressure sodium lamp
- Without igniter
- Ideal for use in professional horticulture

Product ID Code	EAN (Single Pack)	Product Description	W	lm				LCL		PPG
						d (mm)	l (mm)	l (mm)		
PLANTASTARINTER250	4008321240620	PS 250T PLANTASTAR 400W	250	33200	GES/E40	47	257	158	12	35
PLANTASTAR400	4050300620084	PS400T PLANTASTAR 400W <sup>1)</sup>	400	56500	GES/E40	47	285	175	12	35
PLANTASTAR600	4050300620107	PS600T PLANTASTAR 600W <sup>1)</sup>	600	89000	GES/E40	47	285	175	12	35
PLANTASTAR600CG	4008321284303	PS600CGT PLANTASTAR 600W	600	87000	GES/E40	47	285	175	12	35

NEW

1) Lamps require igniters with an ignition voltage of 4 to 5 kVs

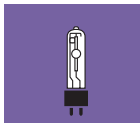

All orders must be multiples of sales pack



## HIGH INTENSITY DISCHARGE LAMPS – LOW PRESSURE SODIUM LAMPS

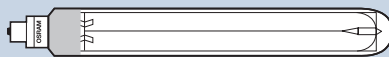

### SOX

- Standard low pressure sodium lamp
- Ideal for streetlighting, amenity and security lighting

Product ID Code	EAN (Single Pack)	Product Description	W	lm		t [h]				PPG
SOX18	4050300015569	SX18 SOX 18W	18	1800	BY22d	16,000	54	216	12	33
SOX180	4050300015552	SX180 SOX 180W	180	32000	BY22d	16,000	68	1120	6	33



### SOX PLUS

- Low pressure sodium lamp
- 12,000 hour guarantee
- Ideal for streetlighting, amenity and security lighting

Product ID Code	EAN (Single Pack)	Product Description	W			PPG
SOX35PLUS	4050300614311	SXP35 SOX PLUS 35W	35	BY22d	12	33
SOX55PLUS	4050300614335	SXP55 SOX PLUS 55W	55	BY22d	12	33
SOX90PLUS	4050300614359	SXP90 SOX PLUS 90W	90	BY22d	12	33
SOX135PLUS	4050300614373	SXP135 SOX PLUS 135W	135	BY22d	12	33

All orders must be multiples of sales pack



## HIGH INTENSITY DISCHARGE LAMPS – MERCURY VAPOUR LAMPS



### HQL® SUPER DE LUXE (MBF SUPER DE LUXE)

- Elliptical high pressure mercury lamp
- With golden brown filter
- Incandescent-like colour appearance
- Ideal for versatile indoor and outdoor lighting applications

Product ID Code	EAN (Single Pack)	Product Description	W	lm		t (h)	d (mm)	l (mm)		PPG
HQL50SDL <sup>1)</sup>	4050300015217	HQ50SD HQL 50W SUPER DL	50	1600	ES/E27	20,000	56	130	40	32
HQL80SDL <sup>1)</sup>	4050300015224	HQ80SD HQL 80W SUPER DL	80	3400	ES/E27	20,000	71	155	40	32
HQL125SDL <sup>1)</sup>	4050300018515	HQ125SD HQL 125W SUPER DL	125	5700	ES/E27	20,000	76	168	40	32

1) Banned from 1.4.2015 as per EU phase-out plan

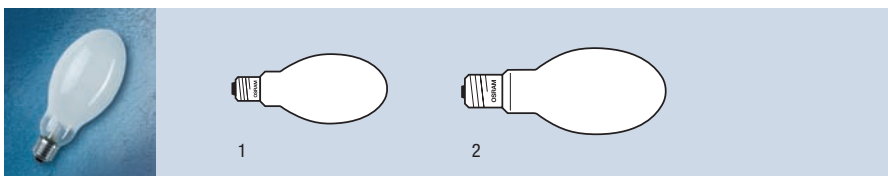

### HQL® DE LUXE (MBF DE LUXE)

- Elliptical high pressure mercury lamp
- Warmer appearance
- Emits more light than a standard HQL®
- Suitable for 4 years of operation in street lighting
- Ideal for versatile indoor and outdoor lighting applications

Product ID Code	EAN (Single Pack)	Product Description	W	lm	COLOR		t (h)	d (mm)	l (mm)		PPG
HQL50DL <sup>1)</sup>	4050300015132	HQ50D HQL 50W DE LUXE	50	2000	3600K	ES/E27	20,000	56	130	40	32
HQL80DL <sup>1)</sup>	4050300015149	HQ80D HQL 80W DE LUXE	80	4000	3400K	ES/E27	20,000	71	155	40	32
HQL125DL <sup>1)</sup>	4050300015156	HQ125D HQL 125W DE LUXE	125	6800	3400K	ES/E27	20,000	76	168	40	32
HQL250DL <sup>1)</sup>	4050300015163	HQ250D HQL 250W DELUXE	250	14000	3400K	GES/E40	20,000	91	226	12	32
HQL400DL <sup>1)</sup>	4050300015170	HQ400D HQL 400W DELUXE	400	24000	3800K	GES/E40	20,000	122	285	12	32

1) Banned from 1.4.2015 as per EU phase-out plan

All orders must be multiples of sales pack



## High Intensity Discharge Lamps – Mercury Vapour Lamps

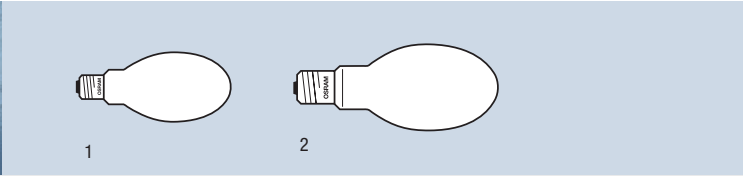

### HQL® Standard (MBF)

- Elliptical high pressure mercury lamp
- Yttrium vanadate phosphor coating
- Neutral white light colour
- Ideal for traffic and factory lighting applications

Product ID Code	EAN (Single Pack)	Product Description	W	lm	COLOR		t [h]	$\varnothing$ [mm]	l [mm]	No.		PPG
HQL50 <sup>1)</sup>	4050300015040	MB50 HQL	50	1800	4200K	ES/E27	20,000	56	130	1	40	31
HQL80 <sup>1)</sup>	4050300012360	MB80 HQL	80	3800	4200K	ES/E27	20,000	71	155	1	40	31
HQL125 <sup>1)</sup>	4050300012377	MB125 HQL	125	6300	4200K	ES/E27	20,000	76	168	1	40	31
HQL250 <sup>1)</sup>	4050300015064	MB250 HQL	250	13000	4000K	GES/E40	20,000	91	226	2	12	31
HQL400 <sup>1)</sup>	4050300015071	MB400 HQL	400	22000	4000K	GES/E40	20,000	122	285	2	12	31
HQL700 <sup>1)</sup>	4050300015088	MB700 HQL	700	40000	4000K	GES/E40	15,000	141	325	2	6	31
HQL1000 <sup>1)</sup>	4050300015095	MB1KLV HQL	1000	57000	4000K	GES/E40	15,000	165	355	2	6	31

1) Banned from 1.4.2015 as per EU phase-out plan

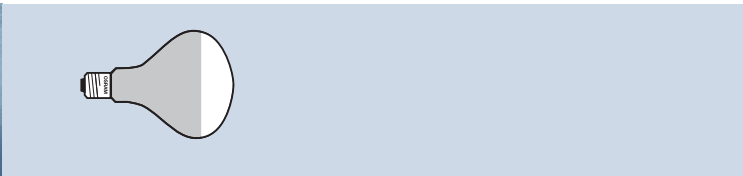

### HQL® R DE LUXE

- Mushroom shaped high pressure mercury lamp with reflector
- Yttrium vanadate phosphor coating
- Provides a warm white light colour
- Ideal for decorative lighting, plant lighting, aquariums

Product ID Code	EAN (Single Pack)	Product Description	W	lm	COLOR		t [h]	$\varnothing$ [mm]	l [mm]	No.		PPG
HQLR80DL <sup>1)</sup>	4050300003290	HQLR80WDELUXE	80	3000	3400K	ES/E27	20,000	125	168	6	31	

1) Banned from 1.4.2015 as per EU phase-out plan

All orders must be multiples of sales pack

LED MODULES

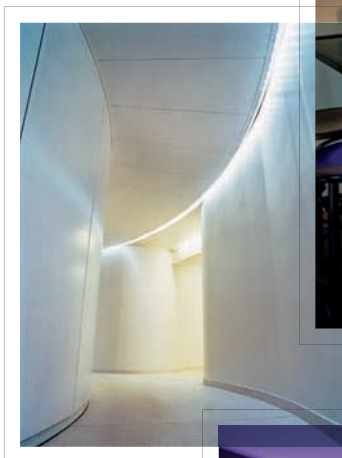
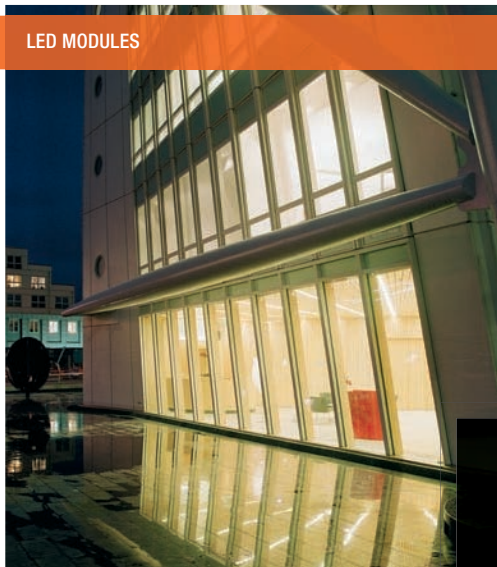



# LED Modules Contents.

STREETlight Module Advanced	152
STREETlight Protect Module	152
PrevaLED™ Core	153
COINlight® Advanced	154
COINlight-OSTAR® Heatsink	154
LINEARlight-DRAGON®	155
CONNECTsystem for LINEARlight-DRAGON®	155
LINEARlight Dragon Slim	156
LINEARlight POWER Flex	157
CONNECTsystem for Flex modules	157
LINEARlight Flex/Eco	158
LINEARlight Flex	159
LINEARlight	160
CONNECTsystem for LINEARlight and EFFECTlight	160
LINEARlight Optics	161
DRAGONeye®	161
DRAGONpuck®	162
DRAGONtape®	162
DRAGONtape® Optics	163
DRAGON-X Plus	163
DRAGON-X	164
COINlight®	164
LINEARlight DRAGON® Colormix	165
CONNECTsystem for LINEARlight DRAGON Colormix	165
DRAGONchain® Colormix	166
LINEARlight Colormix Flex	166
CONNECTsystem for LINEARlight Colormix Flex modules	167
LINEARlight Colormix	167
CONNECTsystem for LINEARlight Colormix	167
COINlight® Colormix	168
BACKlight Protect	168
BACKlight POWER	169
BACKlight BL02	169
Installation aid for BACKlight BL02 and BACKlight BL04	170
DRAGONchain®	170
LEDs DECO® FLEX	171
LINEARlight Track	171

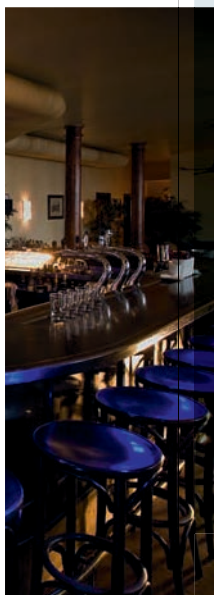

## LED Modules

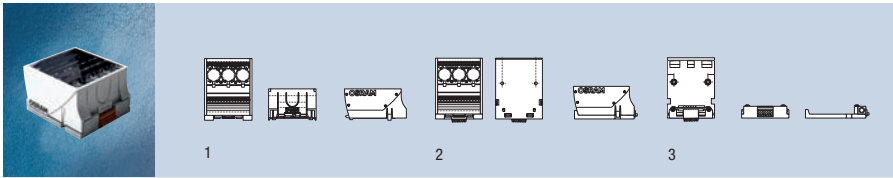

### STREETlight Module Advanced

- Robust street light LED module
- LED illumination of highways and byways
- Optical lens reflector concept using 3 multichip LEDs
- Viewing angle 80° x 140° with 50,000 hours lifetime
- LED replacement without tools

Product ID Code	EAN (Single Pack)	Product Description	W	V/mA	No.	PPG
SLA1L123742	4008321965967	STREETlight Module Advanced 4200K (93,6 x 72,0 x 44,8)	29	24	1	20 38
SLA1L143760	4008321958853	STREETlight Module Advanced 6000K (93,6 x 72,0 x 44,8)	29	24	1	20 38
SLA1L105830	4008321958877	STREETlight Module Advanced 3000K (93,6 x 72,0 x 44,8)	29	24	1	20 38
SLA1SL123742	4008321965981	STREETlight Module Advanced 4200K (98,0 x 72,0 x 50,8)	29	24	2	20 38
SLA1SL143760	4008321960061	STREETlight Module Advanced 6000K (98,0 x 72,0 x 50,8)	29	24	2	20 38
SLA1SL105830	4008321960085	STREETlight Module Advanced 3000K (98,0 x 72,0 x 50,8)	29	24	2	20 38
SLA1SOCKET	4008321958891	STREETlight Module Advanced Socket (96,7 x 72,0 x 20,3)	-	-	3	20 38

Perfectly matched with OPTOTRONIC® OT 75 E

NEW  
NEW  
NEW  
NEW  
NEW  
NEW

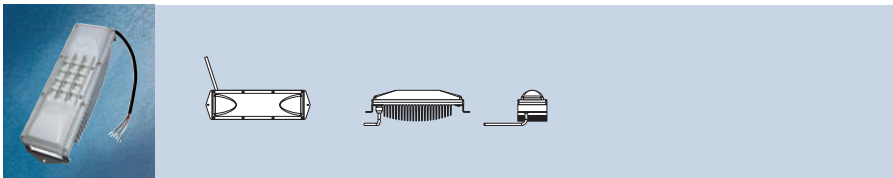

### STREETlight Protect Module

- Robust street light LED module
- Modular solution with 15 high power LEDs
- Integrated heat sink and IP 66 protection

Product ID Code	EAN (Single Pack)	Product Description	W	V/mA	PPG
SLP1W4F765	4008321964755	SLP1 W4F 765 (L75x 130)	23	24	4 38
SLP1W4F854	4008321964748	SLP1 W4F 854 (L75x 130)	23	24	4 38
SLP1W4F840	4008321964731	SLP1 W4F 840 (L75x 130)	23	24	4 38
SLP1W4F830	4008321964724	SLP1 W4F 830 (L75x 130)	23	24	4 38

Perfectly matched with OPTOTRONIC® OT 75 E

NEW  
NEW  
NEW  
NEW

All orders must be multiples of sales pack

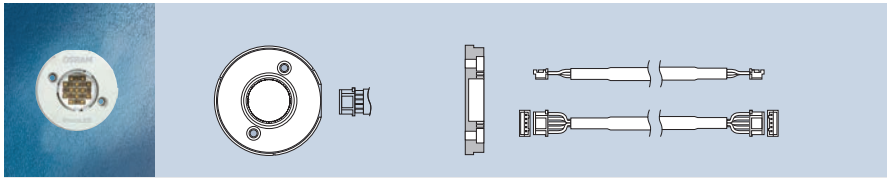

### PrevaLED™ Core

- Up to 3000 lm out of 50mm Ø package, height of 9mm
- Beam angle of 140° for optimum coupling of reflectors
- Flexible module design based on PCB, LED array and protective cover

Product ID Code	EAN (Single Pack)	Product Description	W	lm	PPG	PPG
LEP3000930HDC	4008321966070	LEP-3000-930-HD-C	43	3000	20	38
LEP3000840HDC	4008321966094	LEP-3000-840-HD-C	43	3000	20	38
LEP2100930HDC	4008321963352	LEP-2100-930-HD-C	28	2100	20	38
LEP2100840HDC	4008321963369	LEP-2100-840-HD-C	28	2100	20	38
LEP2100830C	4008321963376	LEP-2100-930-C	38	2100	20	38
LEP2100840C	4008321963383	LEP-2100-840-C	35	2100	20	38
LEP800930HDC	4008321963390	LEP-800-930-HD-C	11	800	20	38
LEP800840HDC	4008321963406	LEP-800-840-HD-C	11	800	20	38

NEW  
NEW  
NEW  
NEW  
NEW  
NEW  
NEW  
NEW

Perfectly matched with OPTOTRONIC® OTp 24V Range



All orders must be multiples of sales pack

## LED Modules

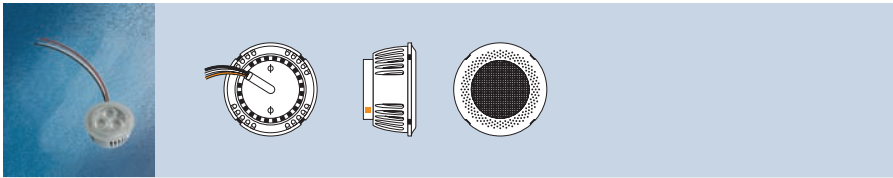

### COINlight® Advanced

- Powered by 3 Golden DRAGON® Plus LEDs
- Integrated 36° optics for wide flood lighting
- Heatsink available for improved lifetime of 80,000 hours
- Ideal for replacing halogen lamps

Product ID Code	EAN (Single Pack)	Product Description	W	V/mA		PPG
CA50051L36854	4008321958952	CA50-051-854-L36 CO AD	7.5	24	25	38
CA50051L36840	4008321958938	CA50-051-840-L36 CO AD	7.5	24	25	38
CA50051L36830	4008321958914	CA50-051-830-L36 CO AD	7.5	24	25	38

Perfectly matched with OPTOTRONIC® OT 24V Range

NEW  
NEW  
NEW

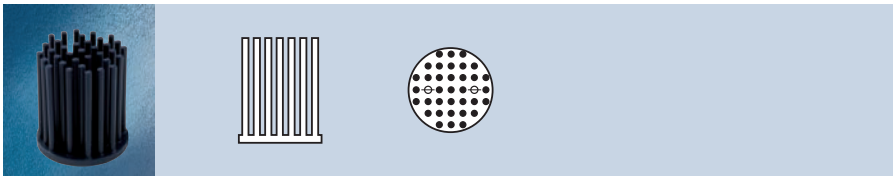

### COINlight-OSTAR® Heatsink

- Accessory for optimised heat dissipation of COINlight-OSTAR®
- Improves life time of the module
- Easy mounting by screwing the heat sink on the module

Product ID Code	EAN (Single Pack)	Product Description		PPG
COHS50	4008321299246	COHS-50 HEAT SINK COINlight-OSTAR	20	38

All orders must be multiples of sales pack

LED Modules

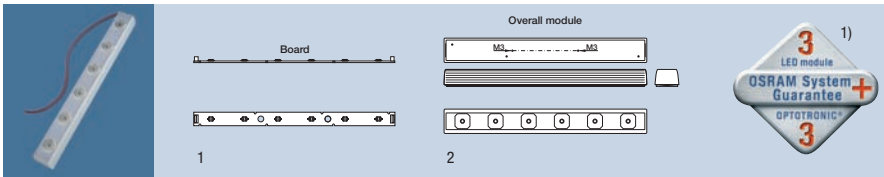

**LINEARlight-DRAGON®**

- Six high power Golden DRAGON® LED on a metal core board
- Complete module includes optics and designer heat sink
- Low profile design
- Plug & Play using CONNECTsystem
- FineWHITE for best colour uniformity
- Ideal for recessed lighting applications and wall washing

Product ID Code	EAN (Single Pack)	Product Description	W	V/mA	No.	PPG
-----------------	-------------------	---------------------	---	------	-----	-----

**Individual boards**

LD06AW3F827LL	4008321940452	LD06-W3F-827 LINEARlight DRAGON FineWHITE 24V 12W 2700k	12	24	1	6	38
-	4008321385757*	LD06B-W4F-830 LINEARlight DRAGON FineWHITE 24V 12W 3000K	12	24	1	6	38
LD06BW4F840LL	4008321395870	LD06B-W4F-840 LINEARlight DRAGON FineWHITE 24V 12W 4000K	12	24	1	6	38
LD06BW4F854LL	4008321395993	LD06B-W4F-854 LINEARlight DRAGON FineWHITE 24V 12W 5400K	12	24	1	6	38

**Complete modules**

LD06A3F827L30LL	4008321940476	LD06 A W3F-827 L30 LINEARlight DRAGON 24V 12W White 2700K	12	24	2	6	38
LD06AW3F854L30LL8	4008321940438	LD06 A W3F-854-L30 LINEARlight DRAGON 24V 8W White 5400K	8	24	2	6	38
-	4008371395290*	LD06B-W4F-854-L30 LINEARLIGHT DRAGON 24V 12W FineWHITE 5400K	12	24	2	6	38
LD06BW4F830L30	4008321394491	LD06B-W4F-830-L30 LINEARLIGHT DRAGON 24V 12W FineWHITE 3000K	12	24	2	6	38
LD06BW4F840L30	4008321394613	LD06B-W4F-840-L30 LINEARLIGHT DRAGON 24V 12W FineWHITE 4000K	12	24	2	6	38

Perfectly matched with OPTOTRONIC® OT 24V Range

1) For more information go to [www.osram.com/system-guarantee](http://www.osram.com/system-guarantee)

\*In preparation at time of print. For further information please contact OSRAM

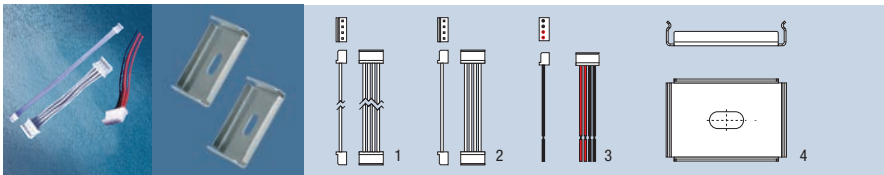

**CONNECTsystem for LINEARlight-DRAGON®**

- Plug and play CONNECTsystem (feeder and connector) enables easy connection of LINEARlight DRAGON®

Product ID Code	EAN (Single Pack)	Product Description	No.	PPG
-----------------	-------------------	---------------------	-----	-----

LD2CONN100	4008321182883	LD-2CONN-100mm	1	10	38
LD2CONN40	4008321182869	LD-2CONN-40mm	2	10	38
LD2PIN	4008321182845	LD-2PIN feeder	3	10	38
<b>LINEARlight DRAGON – Mounting Bracket</b>					
LDMB	4008321225672	LD-MB LINEARlight DRAGON mounting bracket LxWxH 32.5x22x6.6	4	12	38

All orders must be multiples of sales pack

## LED Modules

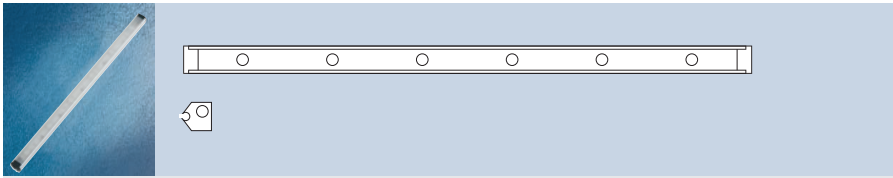

### LINEARlight Dragon Slim

- High Power LED profile
- Contains 6 Hi-flux Golden DRAGON® LED with Thinfilm technology
- Easy plug and play connection
- Ideal for display, cabinet, fridge lighting

Product ID Code	EAN (Single Pack)	Product Description	W	V/mA		PPG
LD06SW4F830	4008321953308	LD06S-W4F-830 LINEARlight DRAGON Slim	7	24	6	38
LD06SW4F840	4008321953322	LD06S-W4F-840 LINEARlight DRAGON Slim	7	24	6	38

NEW  
NEW

Perfectly matched with OPTOTRONIC® OT 24V Range



All orders must be multiples of sales pack

LED Modules

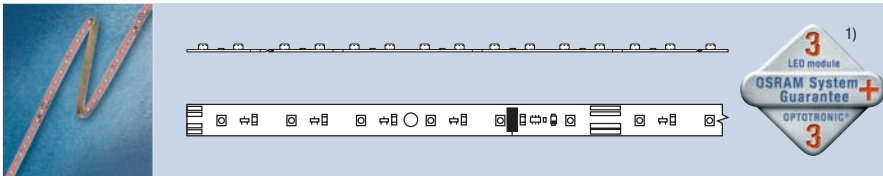

**LINEARlight POWER Flex**

- High output linear LED module on a flexible circuit board
- 3m reel
- FineWHITE for best colour uniformity
- Ideal for edge lighting, cove lighting and linear illumination

Product ID Code	EAN (Single Pack)	Product Description	W	V/mA		PPG
<b>NEW</b> LF06PW4F854	4008321966032	LM06P W4F 854 LINEARlight POWER Flex FineWHITE 5400K	72	24	8	38
<b>NEW</b> LF06PW4F840	4008321966025	LM06P W4F 840 LINEARlight POWER Flex FineWHITE 4000K	72	24	8	38
<b>NEW</b> LF06PW4F830	4008321960528	LM06P W4F 830 LINEARlight POWER Flex FineWHITE 3000K	72	24	8	38
<b>NEW</b> LF06PW4F827	4008321966001	LM06P W4F 827 LINEARlight POWER Flex FineWHITE 2700K	72	24	8	38
LM10PW3F854	4008321215482	LM10P W3F 854 LINEARlight POWER Flex FineWHITE 5400K	48	24	8	38
LM10PW4F854	4008321310798	LM10P W4F 854 LINEARlight POWER Flex FineWHITE 5400K	72	24	8	38
OSLM10PW3F827	4008321940537	LM10P W3F 827 LINEARlight POWER Flex FineWHITE 2700K	72	24	8	38
LM10PW3F830	4008321350565	LM10P W3F 830 LINEARlight POWER Flex 72W 24V	72	24	8	38
LM10PW3F840	4008321350886	LM10P W3F 840 LINEARlight POWER Flex 72W 24V	72	24	8	38

Perfectly matched with OPTOTRONIC® OT 24V Range

1) For more information go to [www.osram.com/system-guarantee](http://www.osram.com/system-guarantee)

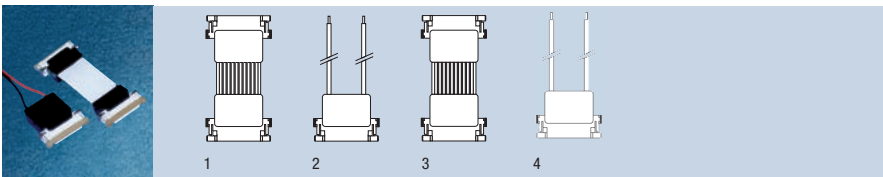

**CONNECTsystem for Flex modules**

- For each attaching and interconnecting of LINEARlight POWER Flex

Product ID Code	EAN (Single Pack)	Product Description	V/mA		No.		PPG
LMCONN10FLEX	4008321916259	LM-CONN 10 Flex	25	1	20x10	38	
LMCONN150FLEX	4008321931375	LM-CONN 150 Flex connect system 10x10	25	2	10x10	38	
LM2PINFLEX	4008321916211	LM-2PIN Flex connect system	25	3	10x10	38	
LMCONN10FLEX	4008321916259	LM-4PIN Flex connect system	25	4	10x10	38	

All orders must be multiples of sales pack

## LED Modules

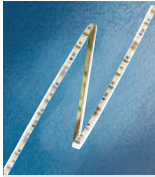

### LINEARlight Flex/Eco

- NEW Generation of linear LED module on a flexible circuit board
- Up to 9.9m long and can be split into units of 5 LEDs
- Adhesive tape on reverse provides easy mounting
- Ideal for lighting complex contours

Product ID Code	EAN (Single Pack)	Product Description	W	V/mA		PPG
<b>9900mm (L) x 8mm (W) x 3mm (H)</b>						
LF05AW3F827	4008321546906	LF05A-W3F-827 LINEARlight Flex/ Eco FineWHITE 2700K	72	24	8	38
OSLF05AW3F830	4008321955371	LF05A-W3F-830 LINEARlight Flex/ Eco FineWHITE 3000K	72	24	8	38
OSLF05AW3F840	4008321955364	LF05A-W3F-840 LINEARlight Flex/ Eco FineWHITE 4000K	72	24	8	38
OSLF5AB3	4008321955388	LF05A-B3 LINEARlight Flex/ Eco Blue	72	24	8	38
<b>6000mm (L) x 8mm (W) x 3mm (H)</b>						
OSLF05EW2F830	4008321955401	LF05E-W2F-830 LINEARlight Flex/ Eco FineWHITE 3000K	24.5	24	8	38
OSLF05EW2F840	4008321955395	LF05E-W2F-840 LINEARlight Flex/ Eco FineWHITE 4000K	24.5	24	8	38
OSLF05EB2	4008321955425	LF05E-B2 LINEARlight Flex/ Eco Blue	24.5	24	8	38
OSLF5ER1	4008321955418	LF05E-R1 LINEARlight Flex/ Eco Red	36	24	8	38
OSLF5EY2	4008321955449	LF05E-T2 LINEARlight Flex/ Eco Green	24.5	24	8	38
OSLF05EY1	4008321955432	LF05E-Y1 LINEARlight Flex/ Eco Yellow	36	24	8	38
<b>CONNECTsystem for 8mm modules</b>						
LF2PINFLEX	4008321955326	LF-2PIN 25V 3A	-	-	10X10	38
LFCONN10FLEX	4008321955333	LF-CONN-10 25V 3A	-	-	20X10	38
LFCONN150FLEX	4008321955340	LF-CONN-150 25V 3A	-	-	10X10	38
LF2TERMFLEX	4008321955357	LF-2TERM	-	-	20X10	38

Perfectly matched with OPTOTRONIC® OT 24V Range

NEW  
NEW  
NEW  
NEW  
NEW  
NEW  
NEW  
NEW  
NEW  
NEW  
NEW



All orders must be multiples of sales pack



## LED Modules

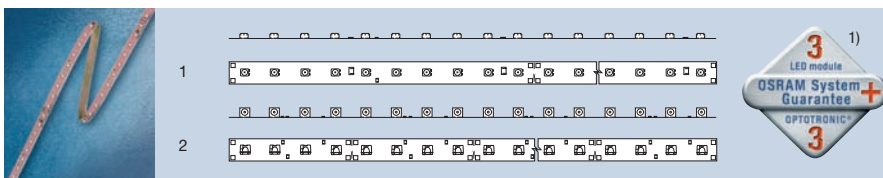

## LINEARlight Flex

- Linear LED module on a flexible circuit board
- TOPLED® version is 8.4m long and can be split into units of 10 LEDs
- SIDELED® version is 4.2m long and can be split into units of 4 LEDs
- Adhesive tape on reverse provides easy installation
- Ideal for lighting complex contours

Product ID Code	EAN (Single Pack)	Product Description	W	V/mA	Light No.	PPG
<b>600 LED TOPLED®</b>						
OSLM10AW3F827	4008321940490	LM10A-W3F-827 LINEARlight Flex White	72	24	1	8 38
OSLM10AW3F830	4008321342874	LM10A-W3F-830 LINEARlight Flex White	72	24	1	8 38
<b>NEW</b> OSLM10AW3F835	4008321938350	LM10A-W3F-835 LINEARlight Flex White	72	24	1	8 38
OSLM10AA2	4008321341990	LM10A-A2 LINEARlight Flex Red	72	24	1	8 38
OSLM10AB2	4008321168818	LM10A-B2 LINEARlight Flex Blue	72	24	1	8 38
OSLM10AY1	4050300946030	LM10A-Y1 LINEARlight Flex Yellow	72	24	1	8 38
<b>300 LED SIDELED®</b>						
OSLM11AW3847	4008321187161	LM11A-W3-847 LINEARlight Flex SIDELED White 4700K	30	10	2	8 38
OSLM11AW3854	4008321187185	LM11A-W3-854 LINEARlight Flex SIDELED White 5400K	30	10	2	8 38
OSLM11AW3865	4008321187208	LM11A-W3-865 LINEARlight Flex SIDELED White 6500K	30	10	2	8 38
OSLM11AA	4008321086952	LM11A-A LINEARlight Flex SIDELED Red	15	10	2	8 38
OSLM11AB	4008321086976	LM11A-B LINEARlight Flex SIDELED Blue	30	10	2	8 38
OSLM11AT	4008321086990	LM11A-T LINEARlight Flex SIDELED Green	30	10	2	8 38
OSLM11AY1	4050300946016	LM11A-Y1 LINEARlight Flex SIDELED Yellow	22.5	10	2	8 38

Perfectly matched with OPTOTRONIC® OT 10V Range

1) For more information go to [www.osram.com/system-guarantee](http://www.osram.com/system-guarantee)

All orders must be multiples of sales pack

## LED Modules

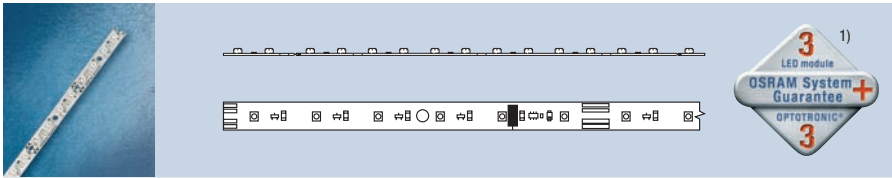
**LINEARlight**

- Linear LED module on a rigid circuit board with 32 LEDs
- 448mm long and can be split into units of 4 LEDs
- Ideal for edge, signage and directional lighting

Product ID Code	EAN (Single Pack)	Product Description	W	V/mA		PPG
OSLM01AA1	4050300887128	LM01A-A1 LINEARlight Red	4	10	10	38
OSLM01AS1	4050300888002	LM01A-S1 LINEARlight Super Red	4	10	10	38
OSLM01AO1	4050300888040	LM01A-O1 LINEARlight Orange	4	10	10	38
OSLM01AB2	4008321313652	LM01A-B2 LINEARlight Blue	4	10	10	38
OSLM01AT2	4050300887845	LM01A-T2 LINEARlight Green	4	10	10	38
OSLM01AY1	4008321015969	LM01A-Y1 LINEARlight Yellow	4	10	10	38
OSLM01AW3F854	4008321387950	LM01A-W3F-854 LINEARlight FineWHITE 5400K	4	10	10	38
OSLM01AW3F827	4008321372390	LM01A-W3F-827 LINEARlight FineWHITE 2700K	4	10	10	38
OSLM01AW3F830	4008321342997	LM01A- W3F 830 LINEARlight FineWHITE 3000K	4	10	10	38
OSLM1AW3F835	4008321938336	LM01A-W3F 835 LINEARlight FineWHITE 3500K	4	10	10	38
OSLM01AW3F840	4008321343413	LM01A -W3F 840 LINEARlight FineWHITE 4000K	4	10	10	38

Perfectly matched with OPTOTRONIC® OT 10V Range

1) For more information go to [www.osram.com/system-guarantee](http://www.osram.com/system-guarantee)

NEW  
NEW  
NEW  
NEW

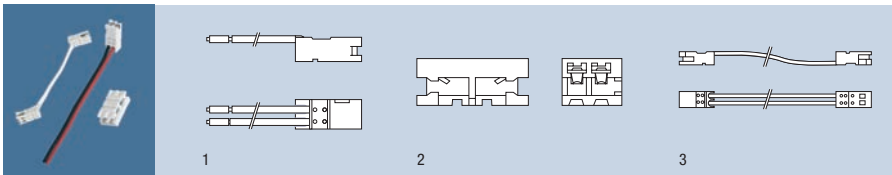
**CONNECTsystem for LINEARlight and EFFECTlight**

- Enables simple connection of LED modules (not suitable for LINEARlight flex)

Product ID Code	EAN (Single Pack)	Product Description	V/mA	No.		PPG
OSLM2CONN	4008321908643	LM-2CONN connector for 2nd gen. single colour	11	1	50X10	38
OSLM2CONN50	4008321908667	LM-2CONN-50mm flexible connector for 2nd gen. single colour	11	2	50X10	38
OSLM2PIN10	4008321908629	LM-2PIN power feed for 2nd gen. single colour	11	3	50X10	38

All orders must be multiples of sales pack

LED Modules

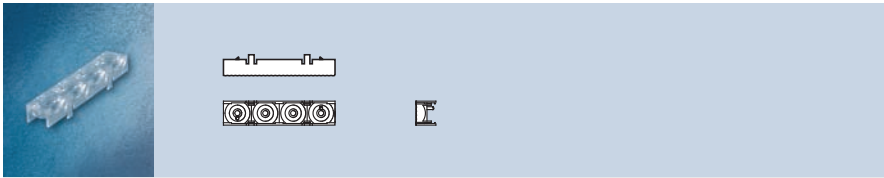

**LINEARlight Optics**

- Snap-on optical lens for LINEARlight
- Reduces viewing angle

Product ID Code	EAN (Single Pack)	Product Description		PPG
OP420	4008321908704	20° optics for LINEARlight module, 26° for white modules	80	38

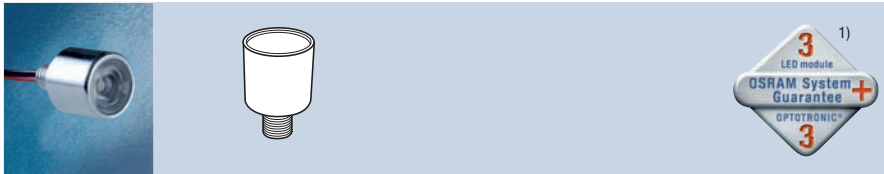

**DRAGONeye®**

- One high power Golden DRAGON® LED in an IP65 housing
- FineWHITE for best colour uniformity
- 22mm diameter, with M10 x 1.5mm thread
- Excellent LED efficiency 42lm/W (White version)
- 200mm pre-wired cables for simple connection
- Ideal for compact LED luminaires

Product ID Code	EAN (Single Pack)	Product Description	W	V/mA		PPG
DE1W4F854	4008321364999	DE1-W4F-854 DRAGON EYE 1.2W FineWHITE 5400K	1.2	350mA	264	38
DE1W3F830	4008321365361	DE1-W3F-830 DRAGON EYE 1.2W FineWHITE 3000K	1.2	350mA	264	38
DE1A2	4008321909732	DE1-A2 DRAGON EYE 0.8W Red	0.8	350mA	264	38
DE1T2	4008321909763	DE1-T2 DRAGON EYE 1.2W Green	1.2	350mA	264	38
DE1Y2	4008321909756	DE1-Y2 DRAGON EYE 0.8W Yellow	0.8	350mA	264	38

Perfectly matched with OPTOTRONIC® OT 350mA Range  
 1) For more information go to [www.osram.com/system-guarantee](http://www.osram.com/system-guarantee)

NEW  
NEW

All orders must be multiples of sales pack

## LED Modules

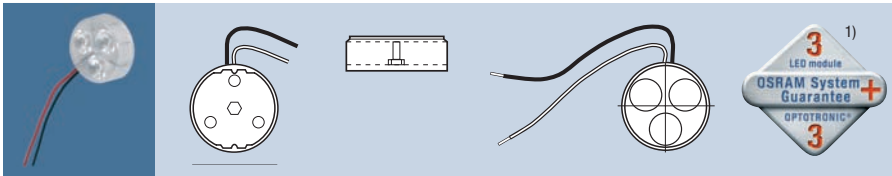
**DRAGONpuck®**

- Three high power Golden DRAGON® LED with a highly efficient optical system
- 35mm diameter
- Only 12mm high
- 200mm pre-wired cables
- Ideal for new LED solutions where a focused light is needed

Product ID Code	EAN (Single Pack)	Product Description	W	V/mA		PPG
OSDP3W3F827	4008321940377	DP3-W3F-827 DRAGONpuck 3.6w 350mA FineWHITE	3.6	350mA	16	38
OSDP3W4F854	4008321940551	DP3-W4F-854 DRAGONpuck 3.6w 350mA FineWHITE 5400K	3.6	350mA	16	38
OSDP3A2	4008321149534	DP3-A2 DRAGONpuck 2.3W 350mA Red	2.3	350mA	16	38
OSDP3T2	4008321149510	DP3-T2 DRAGONpuck 3.4W 350mA True Green	3.4	350mA	16	38

Perfectly matched with OPTOTRONIC® OT 350mA Range

1) For more information go to [www.osram.com/system-guarantee](http://www.osram.com/system-guarantee)

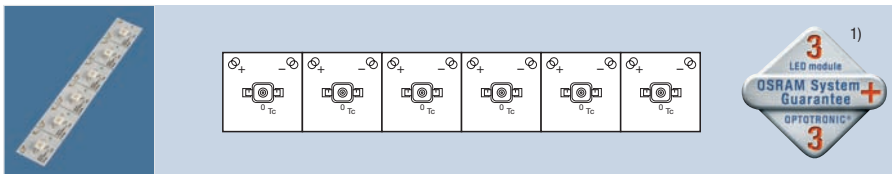
**DRAGONtape®**

- Six series connected high power Golden DRAGON® LEDs on a flexible substrate
- Can be split into units of 1 to 6 LEDs
- Self adhesive backing
- Ideal for shop and furniture luminaires, small signals, effect lighting and industrial applications

Product ID Code	EAN (Single Pack)	Product Description	W	V/mA		PPG
OSDT6B3	4008321365224	DT6-W4F-854 DRAGONtape FineWHITE 5400K	7.2	350mA	25	38
OSDT6B3GB	4008321368461	DT6-W4F-827 DRAGONtape FineWHITE 2700K	7.2	350mA	25	38
OSDT6A1	4008321015747	DT6-A1 DRAGONtape 4.6w Red	4.8	350mA	25	38
OSDT6A2	4008321150141	DT6-A2 DRAGONtape 4.6w Amber	4.8	350mA	25	38
OSDT6B3	4008321277398	DT6-B3 DRAGONtape 4.6w Blue	7.2	350mA	25	38

Perfectly matched with OPTOTRONIC® OT 350mA Range

1) For more information go to [www.osram.com/system-guarantee](http://www.osram.com/system-guarantee)

All orders must be multiples of sales pack

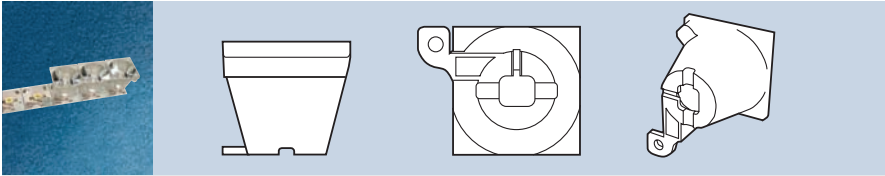

### DRAGONtape® Optics

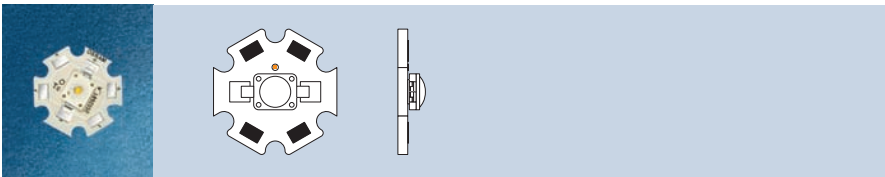

- Optical lens for DRAGONtape®
- 10°, 30° symmetric and 14°x22° asymmetric angles
- Ideal for focussing light from DRAGONtape®

Product ID Code	EAN (Single Pack)	Product Description		PPG
OP1110	4008321909893	10° Optics for DRAGONtape and LINEARlight DRAGON PCB	150	38
OP1130	4008321909770	30° Optics for DRAGONtape and LINEARlight DRAGON PCB	150	38
OP1114	4008321909787	14°x22° Optics for DRAGONtape and LINEARlight DRAGON PCB	150	38



### DRAGON-X® Plus

- Metal core PCB
- 170° viewing angle with optional holder/ lens clip

Product ID Code	EAN (Single Pack)	Product Description	W	V/mA		PPG
 DX01W4F854	4008321960047	DRAGON X PLUS DX01-W4F-854	1.2	350mA	60	38
 DX01W4F830	4008321960023	DRAGON X PLUS DX01-W4F-830	1.2	350mA	60	38

Perfectly matched with OPTOTRONIC® OT 350mA Range

All orders must be multiples of sales pack

## LED Modules

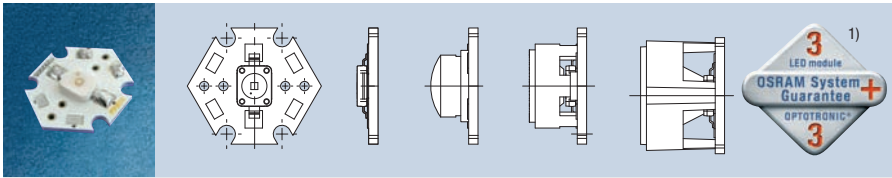

### DRAGON-X®

- One high power Golden DRAGON® LED on a hexagonal metal core board
- Integrated 10°, 30° and 60° optics or 120° without optics
- Without soldering cables
- Ideal for portable, compact, architectural, shop and interior luminaires

Product ID Code	EAN (Single Pack)	Product Description	W	V/mA		PPG
DX1W3733L30	4008321166272	DX1-W3-733-L30 DRAGON X 1.2w White 3300K 30° without cable	1.2	350mA	10	38
DX1W3733L60	4008321166296	DX1-W3-733-L60 DRAGON X 1.2w White 5400K 60° without cable	1.2	350mA	10	38
DX1W3854W	4008321166234	DX1-W3-854-W DRAGON X 1.2w White 5400K 120° without cable	1.2	350mA	10	38
DX1W3854L12	4008321166173	DX1-W3-854-L12W DRAGON X 1.2w White 5400K 12° without cable	1.2	350mA	10	38
DX1W3865W	4008321166159	DX1-W3-865-W DRAGON X White 6500K 120° without cable	1.2	350mA	10	38
DX1W3865L12	4008321166098	DX1-W3-865-L12W DRAGON X 1.2w White 6500K 12° without cable	1.2	350mA	10	38
DX1W3865L30	4008321166111	DX1-W3-865-L30W DRAGON X 1.2w White 6500K 30° without cable	1.2	350mA	10	38

Perfectly matched with OPTOTRONIC® OT 350mA Range

1) For more information go to [www.osram.com/system-guarantee](http://www.osram.com/system-guarantee)

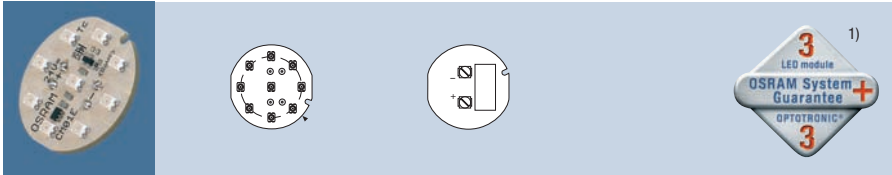

### COINlight®

- Compact round LED module with nine LED
- Ideal for path lighting, recessed wall and floor lighting

Product ID Code	EAN (Single Pack)	Product Description	W	V/mA		PPG
OSCM01EW3	4008321397041	CM01E-W3-854 COINlight White	1.2	24	25	38

Perfectly matched with OPTOTRONIC® OT 24V Range

1) For more information go to [www.osram.com/system-guarantee](http://www.osram.com/system-guarantee)

NEW

All orders must be multiples of sales pack

## LED Modules

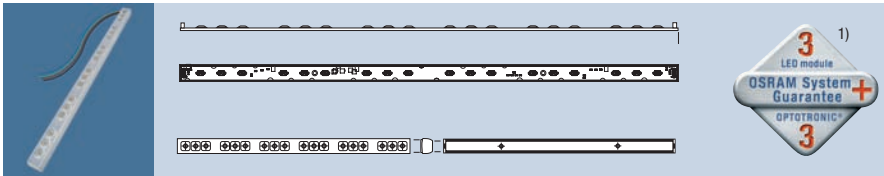
**LINEARlight DRAGON® Colormix**

- Linear high flux RGB module
- Contains 8x high power Golden DRAGON® LEDs, lens holder and heat sink
- 640 lumens of intensive mixed light consuming just 24V of electrical power
- Two versions: an integrated system including heatsink, feeder and optics (LD18A-14X22) and a single board (LD18A)
- Connection via LINEARlight DRAGON® CONNECTsystem
- Up to two modules can be connected in series
- Ideal for creating intensive colour effect and mood lighting

Product ID Code	EAN (Single Pack)	Product Description	W	V/mA		PPG
LD18ARGB1422	4008321251787	LD18A-RGB 14x22 LINEARlight-DRAGON Colormix System with feeder	23	24	6	38
LD18ARGB	4008321248572	LD18A-RGB LINEARlight-DRAGON Colormix Board with feeder	23	24	6	38

Perfectly matched with OPTOTRONIC® OT 24V Range

1) For more information go to [www.osram.com/system-guarantee](http://www.osram.com/system-guarantee)

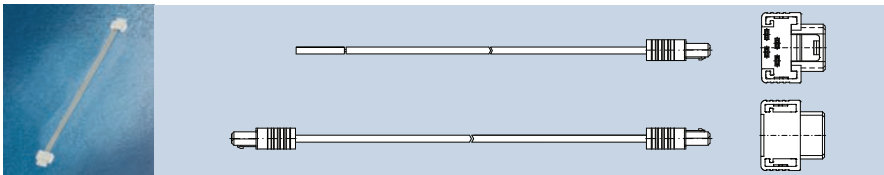
**CONNECTsystem for LINEARlight DRAGON® Colormix**

Product ID Code	EAN (Single Pack)	Product Description	V/mA		PPG
LD4PIN	4008321931337	LD-4PIN power feed for LINEARlight DRAGON Colormix 10mm feeder	25v/2.5mA	10	38
LD4CONN100	4008321931351	LD-4CONN-100mm flexible connector for 2nd gen. single colour 100mm	25v/2.5mA	10	38

All orders must be multiples of sales pack

## LED Modules

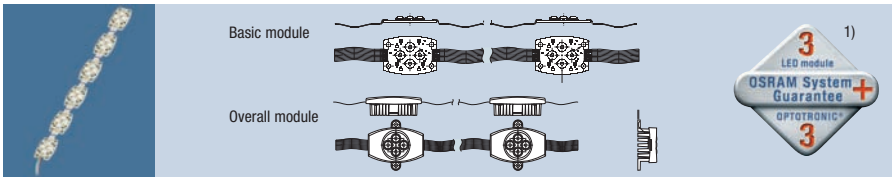

### DRAGONchain® Colormix

- IPx5 LED RGB LED chain suitable for outdoor use
- Consists of 6 metal core boards with 4 high power Golden DRAGON® Argus LEDs
- 2 versions: Basic module:- PCB board; Overall module:- with housing and heatsink
- Ideal for dynamic coloured backlighting, floor mounting, mood lighting large areas

Product ID Code	EAN (Single Pack)	Product Description	W	V/mA	PPG
OSDC24ARGBD	4008321251831	DC24A-RGB DRAGON CHAIN Colormix	23	24	6 38
OSDC24ARGBH	4008321254658	DC24A-RGB-H D CHAIN Colormix Housed version	23	24	6 38

Perfectly matched with OPTOTRONIC® OT 24V Range

1) For more information go to [www.osram.com/system-guarantee](http://www.osram.com/system-guarantee)

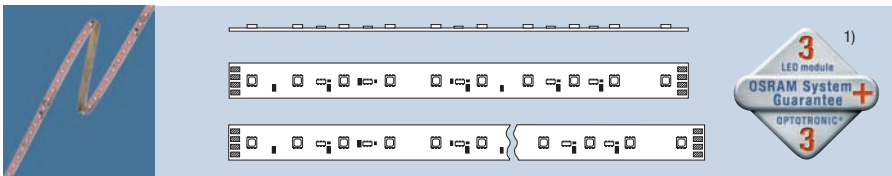

### LINEARlight Colormix Flex

- Red, green and blue flexible colour mixing linear LED module
- 4m long and can be split into units of 10 LEDs
- Ideal for dynamic effect lighting

Product ID Code	EAN (Single Pack)	Product Description	W	V/mA	PPG
OSLF05CERGB1	4008321593375	LF05CE-RGB LINEARlight Colormix Flex	39	24	8 38
OSLM10LRGB2B6	4008321288714	LM10L RGB2 B6 LINEARlight Colormix Flex	41	24	8 38
OSLM10LRGB2B7MIX	4008321285317	LM10L RGB2 B7 LINEARlight Colormix Flex	41	24	8 38
OSLM10LRGBB7	4008321008824	LM10L RGB B7 LINEARlight Colormix Flex	55	24	8 38
OSLF05CARGB3	4008321592644	LF05CA-RGB3 LINEARlight Colormix Flex	72	24	8 38

Perfectly matched with OPTOTRONIC® OT 24V Range

1) For more information go to [www.osram.com/system-guarantee](http://www.osram.com/system-guarantee)

All orders must be multiples of sales pack



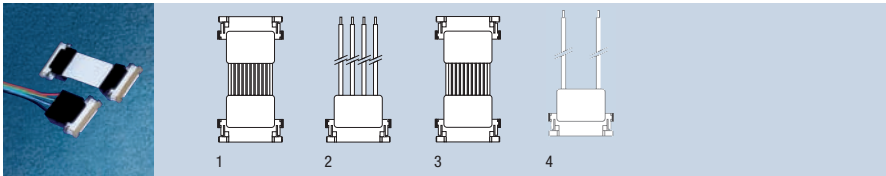

### CONNECTsystem for LINEARlight Colormix Flex modules

Product ID Code	EAN (Single Pack)	Product Description	V/mA	No.	PPG
LMCONN10FLEX	4008321916259	LM-CONN 10 Flex	25	1	20x10 38
LMCONN150FLEX	4008321931375	LM-CONN 150 Flex connect system 10x10	25	2	10x10 38
LM2PINFLEX	4008321916211	LM-2PIN Flex connect system	25	4	10x10 38
LM4PINFLEX	4008321916235	LM-4PIN Flex connect system	25	3	10x10 38

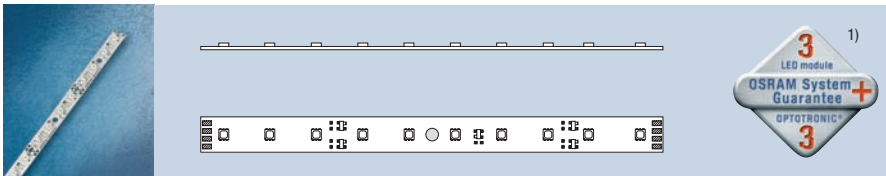

### LINEARlight Colormix

- Red, green and blue colour mixing linear LED module on a rigid circuit board
- 450mm long and can be split into units of 10 LEDs
- Ideal for dynamic effect lighting

Product ID Code	EAN (Single Pack)	Product Description	W	V/mA	PPG
OSLM01MRGBB7	4050300820873	LM01M-RGB-B7 LINEARlight Colormix	8.3	24	10 38

Perfectly matched with OPTOTRONIC® OT 24V Range

1) For more information go to [www.osram.com/system-guarantee](http://www.osram.com/system-guarantee)

NEW

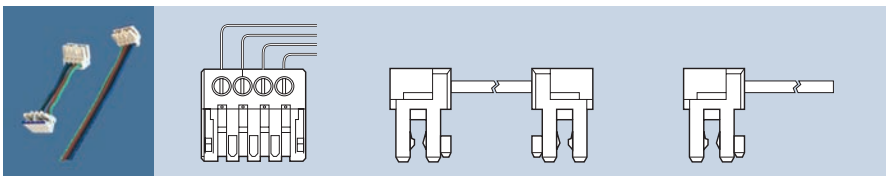

### CONNECTsystem for LINEARlight Colormix

- Enables simple connection of LED modules (not suitable for LINEARlight flex)

Product ID Code	EAN (Single Pack)	Product Description	PPG
OSLM4CONN45	4008321116277	LM-4CONN-45 flexible connector for 2nd gen. single colour	10 38
OSLM4PIN	4008321908681	LM-4PIN power feed for colormix	10 38

All orders must be multiples of sales pack

## LED Modules

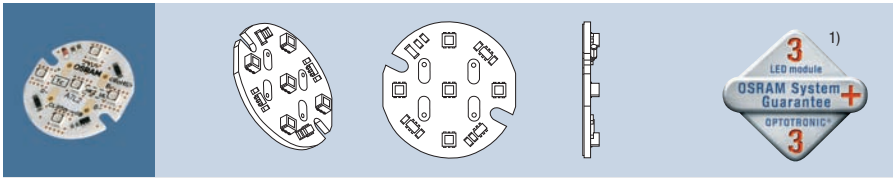

### COINlight® Colormix

- Compact round RGB LED module with 5 MultiLED units
- Ideal for backlighting, accent lighting, recessed wall and floor lighting

Product ID Code	EAN (Single Pack)	Product Description	W	V/mA		PPG
OSCL05ARGB	4008321208262	CL05A-RGB COINlight RGB Colormix	1.2	24	1	38

Perfectly matched with OPTOTRONIC® OT 24V Range

1) For more information go to [www.osram.com/system-guarantee](http://www.osram.com/system-guarantee)

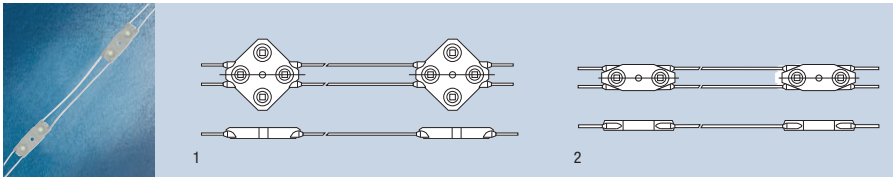

### BACKlight Protect

- NEW: special encapsulation of the LED boards providing maximum robustness
- NEW: Ingress protection IP66 for outdoor application
- Two long, flexible LED chains per module (up to 7.2m)
- New W4F-765 provides double brightness compared to W3F-865
- FineWhite for best colour uniformity
- Long lifetime and maximum reliability
- Ideal for illuminated signs and channel letters

Product ID Code	EAN (Single Pack)	Product Description	W	V/mA	No.		PPG
BL04LPW4F	4008321375650	BL04LP-W4F-765 BACKlight PROTECT FineWHITE	44	10	1	5	38
BL02LPW4F	4008321375414	BL02LP-W4F-765 BACKlight PROTECT FineWHITE	44	10	2	5	38
BL02LPW3F	4008321375537	BL02LP-W3F-830 BACKlight PROTECT Warm White	44	10	2	5	38
OSBL02LP02	4008321403599	BL02LP-02-HE BACKlight PROTECT Orange	22	10	2	5	38
OSBL02LPR2	4008321403575	BL02LP-R2-HE BACKlight PROTECT Red	22	10	2	5	38
OSBL02LPB2	4008321403537	BL02LP-B2-HE BACKlight PROTECT Blue	22	10	2	5	38
OSBL02LPT2	4008321403551	BL02LP-T2-HE BACKlight PROTECT Green	22	10	2	5	38

Perfectly matched with OPTOTRONIC® OT 10V Range

NEW  
NEW  
NEW  
NEW  
NEW  
NEW

All orders must be multiples of sales pack

## LED Modules

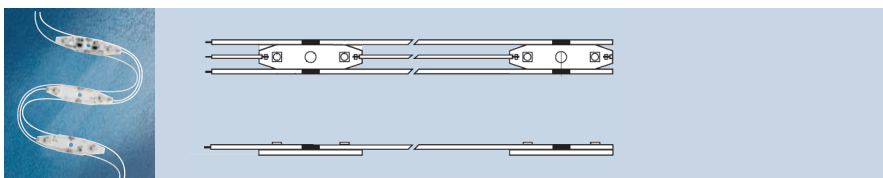
**BACKlight POWER**

- High power LED Module for signage backlighting
- Module efficacy of 60 lm/W with 135° viewing angle

Product ID Code	EAN (Single Pack)	Product Description	V/mA	PPG
BACKLPOW34	4008321534729	BP02A-W4F-765 6500K	24	38

NEW

Perfectly matched with OPTOTRONIC® OT 24V Range

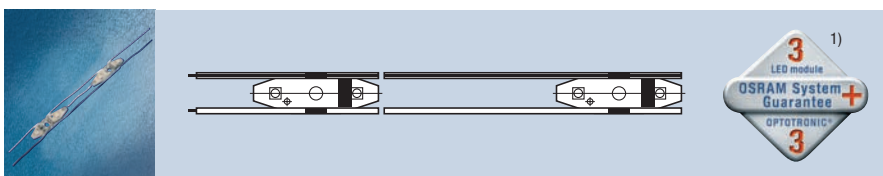
**BACKlight BL02**

- 60 linked circuit boards each holding 2 LED
- Can be operated from one OPTOTRONIC® power supply
- S version is 2 x 4.8m long with 80mm light centre
- L version is 2 x 7.2m long with 120mm light centre
- FineWHITE for best colour uniformity
- Ideal for installation in narrow letter signage

Product ID Code	EAN (Single Pack)	Product Description	W	V/mA	PPG
BACKLIGHT44W	4008321372277	BL02L-W4F-765	44	10	5 38
OSBL02SA1	4008321083715	BL02S-A1 BACKlight 2G Amber	38	10	5 38
OSBL02SA2	4008321174932	BL02S-A2 BACKlight 2G Amber	38	10	5 38

Perfectly matched with OPTOTRONIC® OT 10V Range

1) For more information go to [www.osram.com/system-guarantee](http://www.osram.com/system-guarantee)

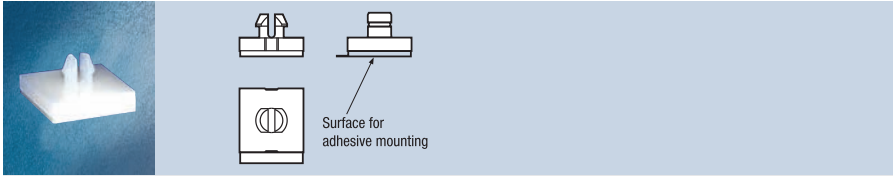

All orders must be multiples of sales pack

## LED Modules



### Installation aid for BACKlight BL02 and BACKlight BL04



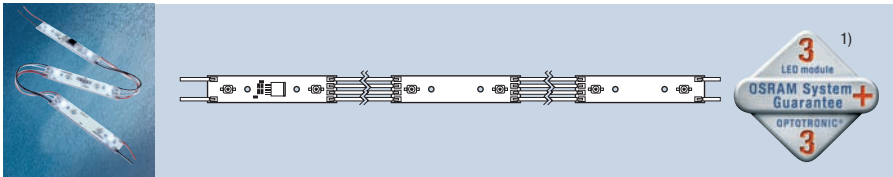

- Self adhesive installation aid

Product ID Code	EAN (Single Pack)	Product Description			
OSBLT	4008321161284	BL-T 5X 60 Installation aid for BACKlight BL02 and BL04	60	38	



### DRAGONchain®

- Module comprising LED Chain of 18 metal boards each with two OSRAM Golden DRAGON® LEDs
- Two modules can be operated on one OT75E OPTOTRONIC® ECG
- Efficient alternative to white neon tubes
- Very long life time - up to 60,000 hours
- FineWHITE for best colour uniformity
- Ideal for signage, illuminated advertising and corporate lighting, backlighting of complex and deep structures

Product ID Code	EAN (Single Pack)	Product Description				
OSDC02BW4F765	4008321338013	DC02B-W4F-765 FineWHITE 6500K	36	24	1	38
OSDC02CW4F765	4008321410757	DC02C-W4F- 765 FineWHITE 6500K	36	24	6	38
OSDC02CW4F830	4008321410962	DC02C-W4F- 830 FineWHITE 3000K	36	24	6	38

Perfectly matched with OPTOTRONIC® OT 24V Range

1) For more information go to [www.osram.com/system-guarantee](http://www.osram.com/system-guarantee)

**NEW**  
**NEW**

All orders must be multiples of sales pack

## LED Modules

**LEDs DECO® FLEX**

- Plug & Play flexible light strip for easy home decoration\*
- 3 x Flexible LED strips with connectors and controller
- Ideal for edge and decorative lighting

Product ID Code	EAN (Single Pack)	Product Description	W	V/mA	PPG	
LEDDECOBASE	4008321524348	LEDS DECO FLEX BASE KIT	36	12	3	38
LEDDECORG	4008321524409	LEDS DECO FLEX ADD ON KIT	-	-	5	38

\*Base kit with European Plug

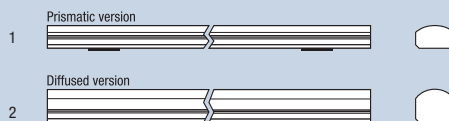
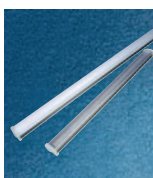
**LINEARlight Track**

- Lightweight aluminium track system for flexible or rigid OSRAM LINEARlight modules
- Two versions: Prismatic version for indirect lighting and diffused version for direct light
- Easy mounting and installation of flexible and rigid LED modules, either individually or as a light strip
- Rails come into two different lengths and can be shortened or extended to desired length
- Brackets and metal pins included
- Provides optimum cooling of the LED modules for long life and maximum reliability

Product ID Code	EAN (Single Pack)	Product Description	Light No.	PPG	
LTH047S	4008321256805	LT-H074-S DIFFS TRACK 464 x 35.5 x 37.5mm LINEARlight track	2	10	38
LTH143S	4008321256829	LT-H143-S DIFFS TRACK 1424 x 35.5 x 37.5mm LINEARlight track	2	6	38
LTH047P	4008321239563	LT-H047-P PRISM TRACK 464 x 35.5 x 26.5mm LINEARlight track	1	10	38
LTH143P	4008321239587	LT-H143-P PRISM TRACK 1424 x 35.5 x 26.5mm LINEARlight track	1	6	38

All orders must be multiples of sales pack

AUTOMOTIVE LAMPS



# Automotive Lamps Contents.

## PREMIUM UPGRADE HEADLAMPS

NIGHT BREAKER® PLUS	174
SILVERSTAR®	175
COOL BLUE®	176
ULTRA LIFE®	177
TRUCKSTAR®	178
XENARC®	179
XENARC® COOL BLUE® INTENSE	180
NIGHT RACER®	180
X-RACER®	181

## ORIGINAL 12V AND 24V BULBS

Original 12V and 24V halogen headlight bulbs	182
Original 12V and 24V headlight bulbs	183
Original Stop, tail and directional 12V and 24V auxiliary bulbs	183
Original Parking and interior 12V and 24V auxiliary bulbs	184
Original Festoon 12V and 24V auxiliary bulbs	184
Original Wedge base 12V and 24V auxiliary bulbs	185
MINIWATT®	186
MINI EUROBOX kits	187



## AUTOMOTIVE – PREMIUM UPGRADE HEADLAMPS

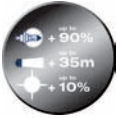
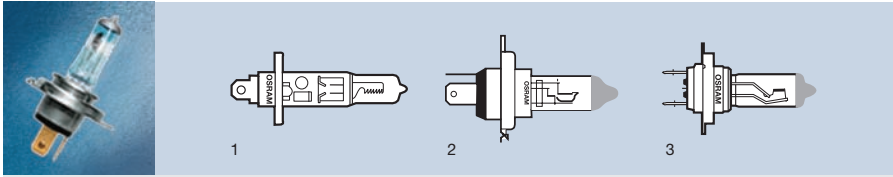

### NIGHT BREAKER® PLUS

- Up to 50% longer lifetime compared to first generation
- Up to 90% more light on the road and a 10% whiter light
- Twin retail DUOPACKS

Product ID Code	EAN (Single Pack)	Product Description	ECE Ref	W	V		No.		PPG
64150NBP	4008321544582	H1 Halogen NIGHT BREAKER PLUS +90%	H1	55	12	P14.5s	1	10x2	38
64193NBP	4008321550798	H4 Halogen NIGHT BREAKER PLUS +90%	H4	60/55	12	P43t	2	10x2	38
64210NBP	4008321548290	H7 Halogen NIGHT BREAKER PLUS +90%	H7	55	12	PX26d	3	10x2	38

Also available in single blister H1, H3, H4, H7 and H11  
 Also available in twin blister H1, H4, and H7

NEW  
NEW  
NEW

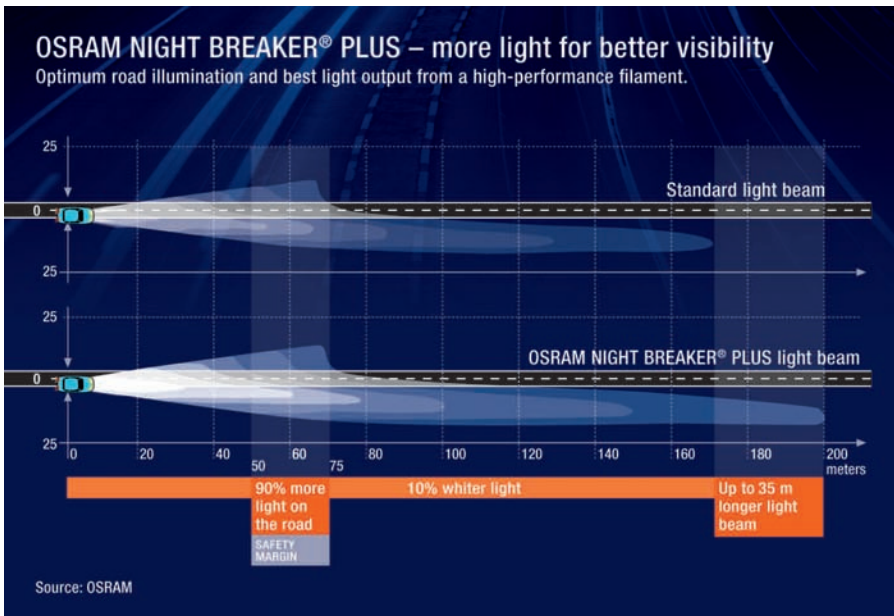
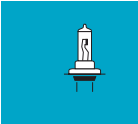

All orders must be multiples of sales pack



Automotive – Premium Upgrade Headlamps

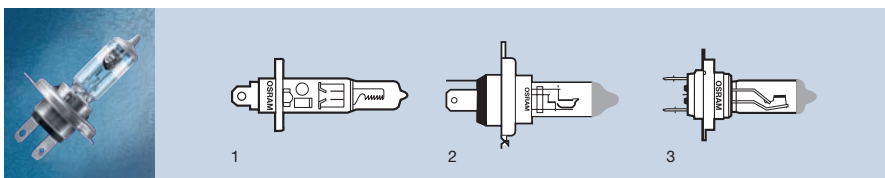

**NIGHT BREAKER®**

- Up to 90% more light on the road and a 10% whiter light
- Twin retail DUOPACKS



Product ID Code	EAN (Single Pack)	Product Description	ECE Ref	W	V			No.		PPG
64150NBR	4008321226747	H1 Halogen NIGHT BREAKER +90%	H1	55	12	P14.5s	1	10x2	38	
64193NBR	4008321227096	H4 Halogen NIGHT BREAKER +90%	H4	60/55	12	P43t	2	10x2	38	
64210NBR	4008321227201	H7 Halogen NIGHT BREAKER +90%	H7	55	12	PX26d	3	10x2	38	

Also available in single blister H1, H3, H4, H7 and H11  
 Also available in twin blister H1, H4, H7

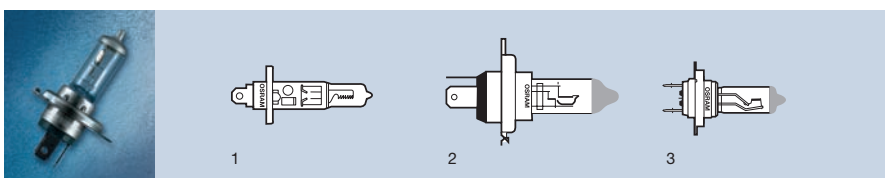

**SILVERSTAR®**

- Up to 50% more light on the road
- Twin retail DUOPACKS



Product ID Code	EAN (Single Pack)	Product Description	ECE Ref	W	V			No.		PPG
64150SVS	4008321144614	H1 Halogen SILVERSTAR +50%	H1	55	12	P14.5s	1	10x2	38	
64193SVS	4008321144737	H4 Halogen SILVERSTAR +50%	H4	60/55	12	P43t	2	10x2	38	
64210SVS	4008321144751	H7 Halogen SILVERSTAR +50%	H7	55	12	PX26d	3	10x2	38	

Also available in single blister H1, H4 and H7  
 Also available in twin blister H1, H4 and H7

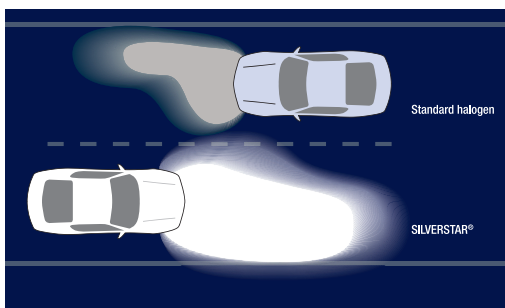
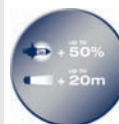

All orders must be multiples of sales pack

## Automotive – Premium Upgrade Headlamps

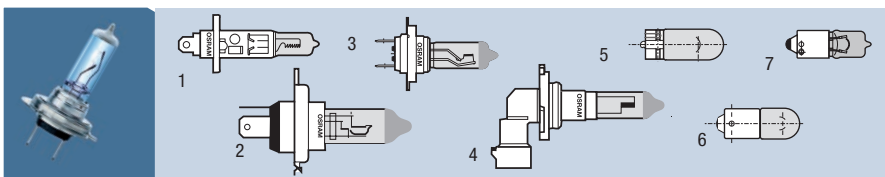

### COOL BLUE®

- Distinctive, crisp bluish-white light
- Up to 20% more light on the road

Product ID Code    EAN (Single Pack)    Product Description    ECE Ref   

### Headlight Bulbs

- Twin retail DUOPACKS

64150CB	4008321144775	H1 Halogen COOL BLUE	H1	55	12	P14.5s	1	10x2	38
64193CB	4008321144799	H4 Halogen COOL BLUE	H4	60/55	12	P43t	2	10x2	38
64210CB	4008321144812	H7 Halogen COOL BLUE	H7	55	12	PX26d	3	10x2	38
9005CB	4008321164490	HB3 Halogen COOL BLUE	HB3	60	12	P20d	4	10x2	38
9006CB	4008321164513	HB4 Halogen COOL BLUE	HB4	60	12	P22d	4	10x2	38

Also available in single blister H1, H4 and H7

Also available in twin blister H1, H4 and H7

### Parking and sidelight bulbs

- Twin blister retail packs

64132CB02B	4050300925820	H6W Halogen COOL BLUE	H6W	6	12	BAX9s	7	20	38
2825HCB02B	4050300925707	W5W Halogen COOL BLUE	W5W	5	12	W2.1x9.5d	5	20	38
2825CB02B	4050300925721	W5W COOL BLUE	W5W	5	12	W2.1x9.5d	5	20	38
3893CB02B	4050300925660	T4W COOL BLUE	T4W	4	12	BA9s	6	20	38

All orders must be multiples of sales pack

## Automotive – Premium Upgrade Headlamps

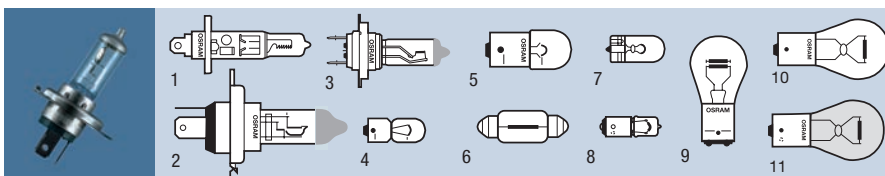

### ULTRA LIFE®

- Extra longlife bulbs with a 3 year guarantee<sup>1)</sup>
- Up to 3 times longer lifetime than standard bulbs
- Designed for day and night operation



Product ID Code	EAN (Single Pack)	Product Description	ECE Ref	W	V		No.		PPG
-----------------	-------------------	---------------------	---------	---	---	--	-----	--	-----

### Headlight Bulbs

- Twin retail DUOPACKS

NEW  
NEW  
NEW  
NEW

64150ULT	4008321416162	H1 ULTRA LIFE	H1	55	12	P14.5s	1	10x2	38
64150D	4008321144836	H1 LIGHT@DAY	H1	55	12	P14.5s	1	10x2	38
64193ULT	4008321416186	H4 ULTRA LIFE	H4	60/55	12	P43t	2	10x2	38
64210ULT	4008321416148	H7 ULTRA LIFE	H7	55	12	PX26d	3	10x2	38

Also available in single blister H1, H4 and H7

Also available in twin blister H1, H4, and H7

1) For more information go to [www.osram.com/system-guarantee](http://www.osram.com/system-guarantee)

### Tail and sidelight bulbs

- Longlife tail and sidelight bulbs
- Twin blister retail packs
- Also available in garage packaging

NEW  
NEW  
NEW  
NEW  
NEW  
NEW  
NEW  
NEW  
NEW  
NEW  
NEW

5007ULT02B	4008321415202	R5W ULTRA LIFE	R5W	5	12	BA15s	5	20	38
5007D02B	4050300925585	R5W LIGHT@DAY	R5W	5	12	BA15s	5	20	38
6418ULT02B	4008321415240	C5W ULTRA LIFE	C5W	5	12	SV8.5-8	6	20	38
6418D02B	4050300773674	C5W LIGHT@DAY	C5W	5	12	SV8.5-8	6	20	38
2825ULT02B	4008321415189	W5W ULTRA LIFE	W5W	5	12	W2.1x9.5d	7	20	38
2825D02B	4050300772936	W5W LIGHT@DAY	W5W	5	12	W2.1x9.5d	7	20	38
64132ULT02B	4008321415325	H6W ULTRA LIFE	H6W	6	12	BAX9s	8	20	38
64132D02B	4050300773339	H6W LIGHT@DAY	H6W	6	12	BAX9s	8	20	38
5008ULT02B	4008321415226	R10W ULTRA LIFE	R10W	10	12	BA15s	5	20	38
5008D02B	4050300773490	R10W LIGHT@DAY	R10W	10	12	BA15s	5	20	38
7528ULT02B	4008321415288	P21/5W ULTRA LIFE	P21/5W	21/5	12	BAY15d	9	20	38
7528D02B	4050300773384	P21/5W LIGHT@DAY	P21/5W	21/5	12	BAY15d	9	20	38
7506ULT02B	4008321415141	P21W ULTRA LIFE	P21W	21	12	BA15s	10	20	38
7507ULT02B	4008321415165	PY21W ULTRA LIFE	PY21W	21	12	BAU15s	11	20	38



All orders must be multiples of sales pack

## Automotive – Premium Upgrade Headlamps

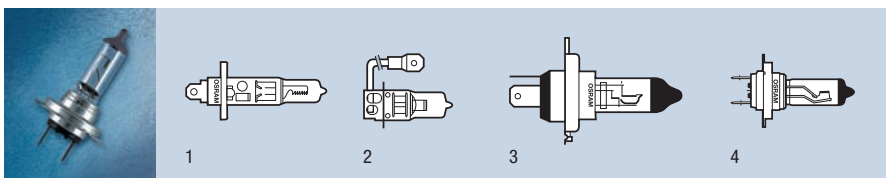
**TRUCKSTAR®**

- Up to 100% more life and up to 100% more light on the road
- Ideal headlamp upgrade for commercial vehicles

Product ID Code	EAN (Single Pack)	Product Description	ECE Ref	W	V		No.		PPG
-----------------	-------------------	---------------------	---------	---	---	--	-----	--	-----

**Headlight Bulbs****Twin retail DUOPACKS**

64155LTS	4008321161062	H1 TRUCKSTAR	H1	70	24	P14.5s	1	10x2	38
64196LTS	4008321161260	H4 TRUCKSTAR	H4	70/75	24	P43t	3	10x2	38
64215LTS	4008321161246	H7 TRUCKSTAR	H7	70	24	PX26d	4	10x2	38

**Single blister retail packs**

64155LTS01B	4008321040596	H1 TRUCKSTAR	H1	70	24	P14.5s	1	10	38
64156LTS01B	4008321040572	H3 TRUCKSTAR	H3	70	24	PK22s	2	10	38
64196LTS01B	4008321155535	H4 TRUCKSTAR	H4	70/75	24	P43t	3	10	38
64215LTS01B	4008321040619	H7 TRUCKSTAR	H7	70	24	PX26d	4	10	38

**Single box carton packs**

64155LTS	4008321004093	H1 TRUCKSTAR	H1	70	24	P14.5s	1	100	38
64156LTS	4008321004123	H3 TRUCKSTAR	H3	70	24	PK22s	2	100	38
64196LTS	4008321133571	H4 TRUCKSTAR	H4	70/75	24	P43t	3	100	38
64215LTS	4008321004246	H7 TRUCKSTAR	H7	70	24	PX26d	4	100	38

**Stop, tail and directional indicator bulbs**

- Previously known as GIGANT® HEAVY DUTY
- Twin blister retail packs
- Also available in carton packs

3930LTS02B	4008321174055	T4W TRUCKSTAR	T4W	4	24	BA9s	–	20	38
5627LTS02B	4008321174017	R5W TRUCKSTAR	R5W	5	24	BA15s	–	20	38
5637LTS02B	4008321174031	R10W TRUCKSTAR	R10W	10	24	BA15s	–	20	38
7511LTS02B	4008321173973	P21W TRUCKSTAR	P21W	21	24	BA15s	–	20	38
7510LTS02B	4008321173997	PY21W TRUCKSTAR	PY21W	21	24	BAU15s Amber	–	20	38

All orders must be multiples of sales pack

## Automotive – Premium Upgrade Headlamps

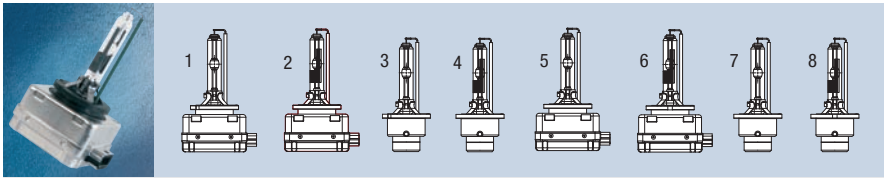
**XENARC®**

- Electronic Gas Discharge Headlight Bulbs
- Produces up to 100% more light output than standard halogen headlight bulbs
- Ideal for vehicles with existing gas discharge headlight systems only



Product ID Code	EAN (Single Pack)	Product Description	ECE Ref	W		No.		PPG
66142	4050300893259	D1S XENARC**	D1S	35	PK32d-2	1	10	38
66152	4008321902719	D1R XENARC**	D1R	35	PK32d-3	2	10	38
66040	4050300357393	D2S XENARC**	D2S	35	P32d-2	3	10	38
66050	4050300433486	D2R XENARC**	D2R	35	P32d-3	4	10	38
66144	4008321184474	D1S XENARC**	D1S	35	PK32d-2	1	10	38
66154	4008321184511	D1R XENARC**	D1R	35	PK32d-3	2	10	38
66240	4008321184573	D2S XENARC**	D2S	35	P32d-2	3	10	38
66250	4008321184634	D2R XENARC**	D2R	35	P32d-3	4	10	38
66340	4008321379627	D3S XENARC**	D3S	35	PK32d-5	5	10	38
66350	4008321129857	D3R XENARC**	D3R	35	PK32d-6	6	10	38
66440	4008321349392	D4S XENARC**	D4S	35	P32d-5	7	10	38
66450	4008321349576	D4R XENARC**	D4R	35	P32d-6	8	10	38

\*\*For use with XENAELECTRON® electronic control gear – available on request

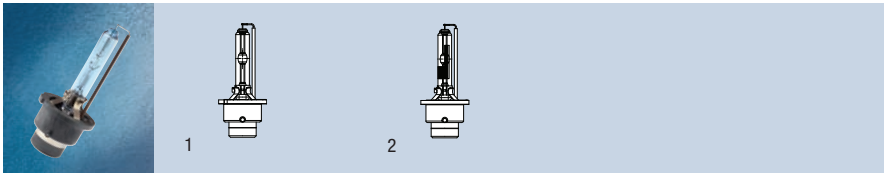
**XENARC® D2 COOL BLUE®**

- Extra blue xenon light with razor sharp contrast

Product ID Code	EAN (Single Pack)	Product Description	ECE Ref	W		No.		PPG
66240CB	4008321213518	D2S XENARC COOL BLUE	D2S	35	P32d-2	1	10	38
66250CB	4008321213532	D2R XENARC COOL BLUE	D2R	35	P32d-3	2	10	38

All orders must be multiples of sales pack

Automotive – Premium Upgrade Headlamps

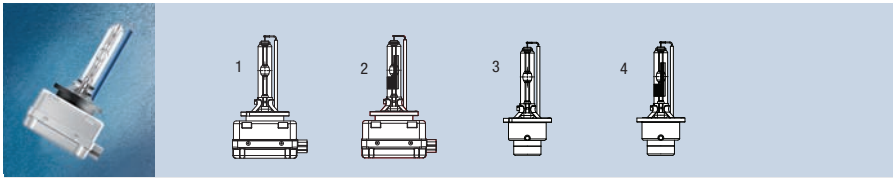

**XENARC® COOL BLUE® INTENSE**

- The new extra blue intense xenon light with razor sharp contrast
- up to 20% more light – 5000 Kelvin

Product ID Code	EAN (Single Pack)	Product Description	ECE Ref	W	V	No.	PPG
66144CBI	4008321401472	D1S XENARC COOL BLUE INTENSE	D1S	35	PK32d-2	1	10 38
66154CBI	4008321401373	D1R XENARC COOL BLUE INTENSE	D1R	35	PK32d-3	2	10 38
66240CBI	4008321401359	D2S XENARC COOL BLUE INTENSE	D2S	35	P32d-2	3	10 38
66250CBI	4008321401533	D2R XENARC COOL BLUE INTENSE	D2R	35	P32d-3	4	10 38
66240CBI	4008321588883	D2S XENARC COOL BLUE INTENSE	D2S	35	P32d-2	3	10X2 38

NEW  
NEW  
NEW  
NEW

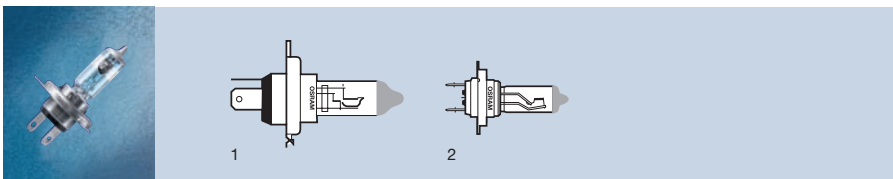

**NIGHT RACER®**

- Up to 90% more light on the road
- 10% whiter light
- See and be seen - for safer riding

Product ID Code	EAN (Single Pack)	Product Description	ECE Ref	W	V	No.	PPG
<b>Headlight Bulbs</b>							
<b>Twin Blister Packs with a special helmet shaped box</b>							
64193NR02B	4008321395672	H4 NIGHT RACER	H4	60/55	12	P43t	1 20 38
64210NR02B	4008321395658	H7 NIGHT RACER	H7	55	12	PX26d	2 20 38

All orders must be multiples of sales pack

Automotive – Premium Upgrade Headlamps

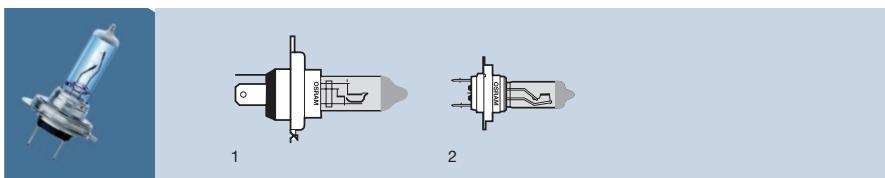

**X-RACER®**

- XTRA Blue light for that look of Xenon
- Up to 4000 Kelvin
- See and be seen – for style concious riders



Product ID Code	EAN (Single Pack)	Product Description	ECE Ref	W	V		No.		PPG
-----------------	-------------------	---------------------	---------	---	---	--	-----	--	-----

**Headlight Bulbs**

Twin Blister Packs with a special helmet shaped box

64193XR02B	4008321395719	H4 X-RACER	H4	60/55	12	P43t	1	20	38
64210XR02B	4008321395696	H7 X-RACER	H7	55	12	PX26d	2	20	38



All orders must be multiples of sales pack

## AUTOMOTIVE – ORIGINAL 12V AND 24V

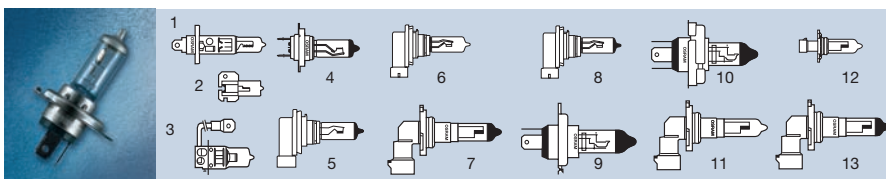

### Original 12V and 24V halogen headlight bulbs



Product ID Code	EAN (Single Pack)	Product Description	ECE Ref	W	V		No.		PPG
<b>12V halogen headlight bulbs</b>									
64150	405030001487	H1 Halogen	H1	55	12	P14.5s	1	100	38
64175	4050300218900	H2 Halogen	H2	70	24	X511	2	100	38
64152	4050300222738	H1 High Performance Halogen*	H1	100	12	PX14.5s	-	100	38
64151	405030001494	H3 Halogen	H3	55	12	PK22s	3	100	38
64153	4050300222837	H3 High Performance Halogen*	H3	100	12	PKY22s	-	100	38
64193	405030001470	H4 Halogen	H4	60/55	12	P43t	9	100	38
64194	4050300225852	H4 High Performance Halogen*	H4	100/80	12	PU43t	-	100	38
64210	4050300332185	H7 Halogen	H7	55	12	PX26d	4	100	38
64217	4050300524399	H7 High Performance Halogen*	H7	65	12	PX26d	-	100	38
64218	4050300526188	H7 Halogen	H7	65	12	PX26d	-	100	38
64212	4050300498751	H8 Halogen	H8	35	12	PGJ19-1	5	100	38
64242	4008321055422	H8B Halogen	H8B	35	12	PGJY19-1	-	100	38
64213	4050300524368	H9 Halogen	H9	65	12	PGJ19-5	6	100	38
64243	4008321055477	H9B Halogen	H9B	65	12	PGJY19-5	-	100	38
9145	4050300186320	H10 Halogen	H10	42	12	PY20d	7	100	38
64211	4050300524313	H11 Halogen	H11	55	12	PGH19-2	8	100	38
64241	4008321054654	H11B Halogen	H11B	55	12	PGJY19-2	-	100	38
9008	4008321939401	H13 Halogen	H13	60/55	12	P26.4t	-	100	38
64176	4008321218391	H15 Halogen	H15	15/55	12	PGJ23t-1	-	100	38
9003L	4050300308975	HB2 Halogen	HB2	60/55	12	P43t	9	100	38
9005	4050300137193	HB3 Halogen	HB3	60	12	P20d	11	100	38
9005XS	0046135320408	HB3A Halogen	HB3A	60	12	P20d	12	100	38
9006	4050300012650	HB4 Halogen	HB4	51	12	P22d	13	100	38
9006XS	4050300532400	HB4A Halogen	HB4A	51	12	P22d	-	100	38
64183	4050300350554	R2 Halogen	R2	45/40	12	P45t	10	100	38
64185	4050300439969	HS1 Halogen	HS1	35/55	12	Px43t	9	100	38
<b>24V halogen headlight bulbs</b>									
64155	4050300016498	H1 Halogen	H1	70	24	P14.5s	1	100	38
64175	4050300218900	H2 Halogen	H2	70	24	X511	2	100	38
64156	4050300016535	H3 Halogen	H3	70	24	PK22s	3	100	38
64196	4050300016542	H4 Halogen	H4	75/70	24	P43t	9	100	38
64215	4050300386522	H7 Halogen	H7	70	24	PX26d	4	100	38

\*For off road use only. These products are not ECE approved and are not for use on public roads.

NEW  
NEW  
NEW  
NEW



All orders must be multiples of sales pack



## Automotive Lamps – Original 12V and 24V

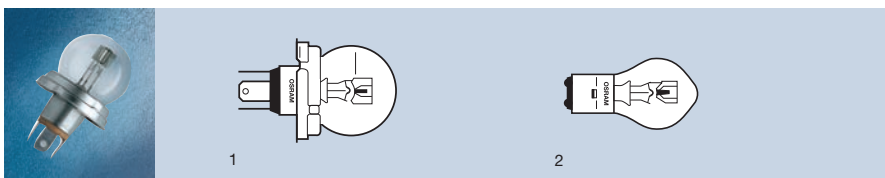

### Original 12V and 24V headlight bulbs

Product ID Code	EAN (Single Pack)	Product Description	ECE Ref	W	V		No.		PPG
7951	4050300001500	R2 12V	R2	45/40	12	P45t	1	100	38
7952	4050300016405	R2 24V	R2	55/50	24	P45t	1	100	38
7326	4050300271248	S1 12V	S1	25/25	12	BA20d	2	100	38
7327	4050300016375	S2 12V	S2	35/35	12	BA20d	2	100	38

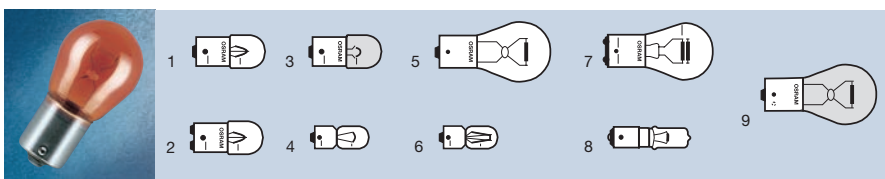

### Original stop, tail & directional 12V and 24V auxiliary bulbs

Product ID Code	EAN (Single Pack)	ECE Ref	W	V		No.		PPG
5627	4050300838335	R5W	5	24	BA15s	1	50	38
5626	4008321095336	-	5	24	BA15d	2	50	38
5007	4050300838427	R5W	5	12	BA15s	1	50	38
3893	4050300838489	T4W	4	12	BA9s	4	50	38
64132	4008321094896	H6W	6	12	BAX9s	-	50	38
64136	4008321095190	H21W	21	12	BAY9s	8	50	38
64138	4008321094988	H21W	21	24	BAY9s	8	50	38
7511	4050300838090	P21W	21	24	BA15s	5	50	38
5008	4050300838212	R10W	10	12	BA15s	1	50	38
5009	4008321095442	RY10W	10	12	BAU15s	3	50	38
5637	4050300831459	R10W	10	24	BA15s	1	50	38
3930	4050300838366	T4W	4	24	BA9s	6	50	38
7528	4050300838069	P21/5W	21/5	12	BAY15d	7	50	38
7537	4050300838038	P21/5W	21/5	24	BAY15d	7	50	38
7506	4050300838120	P21W	21	12	BA15s	5	50	38
7225	4050300891514	P21/4W	21/5	12	BAZ15d	7	50	38
7507	4050300891477	PY21W AMBER	21	12	BAU15s	9	50	38

All orders must be multiples of sales pack

Automotive Lamps – Original 12V and 24V

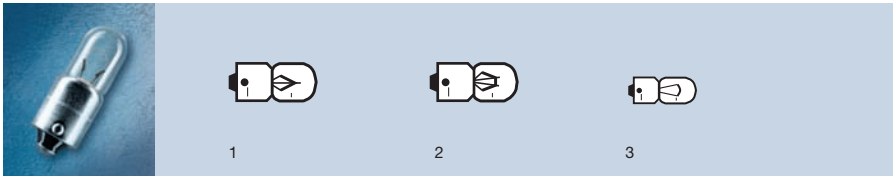

Original Parking & Interior 12V and 24V auxiliary bulbs

Product ID Code	EAN (Single Pack)	W	V		No.		PPG
3796	4050300891309	2	12	BA9s	1	50	38
3797	4050300891668	2	24	BA9s	2	50	38
3860	4008321095756	5	12	BA9s	3	50	38
3894	4008321095725	3	12	BA9s	1	50	38

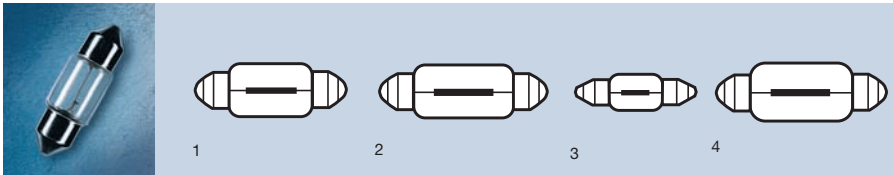

Original Festoon 12V and 24V auxiliary bulbs

Product ID Code	EAN (Single Pack)	ECE Ref	W	V		No.		PPG
6418	4050300838397	C5W	5	12	SV8.5-8	1	50	38
6423	4050300831435	C5W	5	24	SV8.5-8	1	50	38
6428	4008321094384	C3W	3	12	SV7-8	3	50	38
6430	4008321094414	-	3	24	SV7-8	3	50	38
6411	4050300891354	-	10	12	SV8.5-8	2	50	38
6413	4050300891439	-	5	12	SV8.5-8	2	50	38
6421	4008321090768	-	3	24	SV8.5-8	4	50	38
6424	4050300891712	-	5	24	SV8.5-8	4	50	38
6438	4008321094353	-	10	12	SV8.5-8	1	50	38
6461	4008321094261	-	10	12	SV8.5-8	1	50	38
6429	4008321090836	-	10	24	SV8.5-8	4	50	38
6453	4008321094544	-	15	24	SV8.5-8	4	50	38
6475	4008321090874	-	18	12	SV8.5-8	4	50	38
6480	4008321090935	-	18	24	SV8.5-8	4	50	38
6476	4008321090904	C21W	21	12	SV8.5-8	4	50	38



All orders must be multiples of sales pack

Automotive Lamps – Original 12V and 24V

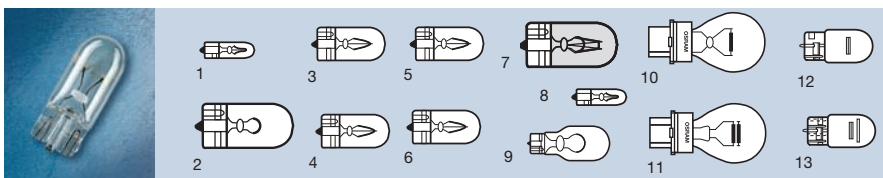

Original Wedge base 12V and 24V auxiliary bulbs

Product ID Code	EAN (Single Pack)	ECE Ref	W	V			PPG
2721	4050300838540	-	1.2	12	W2x4.6d	1	50 38
2825	4050300838632	W5W	5	12	W2.1x9.5d	2	50 38
2821	4050300838663	W3W	3	12	W2.1x9.5d	3	50 38
2840	4008321094698	-	2	24	W2.1x9.5d	4	50 38
2841	4008321094728	W3W	3	24	W2.1x9.5d	5	50 38
2845	4050300891552	W5W	5	24	W2.1x9.5d	6	50 38
2827	4050300891200	WY5W	5	12	W2.1x9.5d AMBER	7	50 38
2741	4050300838519	-	1.2	24	W2x4.6d	8	50 38
921	4008321100948	W16W	16	12	W2.1x9.5d	9	50 38
3156	4008321090621	P27W	27	12	W2.5x16d	10	50 38
3157	4008321090683	P27/7W	27/7	12	W2.5x16q	11	50 38
7505	4008321090652	W21W	21	12	W3x16d	12	50 38
7515	4008321090713	W21/5W	21/5	12	W3x16q	13	50 38

All orders must be multiples of sales pack



## Automotive Lamps – Original 12V and 24V

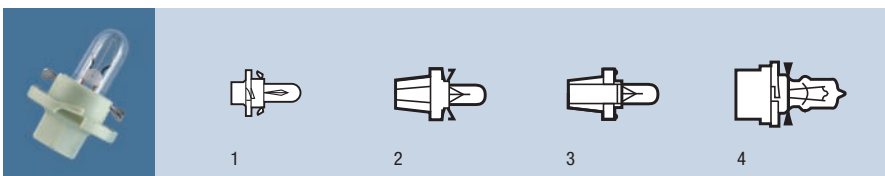

### MINIWATT®

- Colour-coded tacho bulbs
- Sizes available to fit varying printed circuit boards
- Ideal for dashboard lighting

Product ID Code	EAN (Single Pack)	Product Description	W	V			No.		PPG
<b>Suitable for 1.5mm PCB</b>									
2351MFX6	4008321096852	Jet black	1.2	12	BX8.4d	1	50	38	
2352MFX6	4008321097149	Pale green	2	12	BX8.4d	1	50	38	
2452MFX6	4008321097118	Beige	1.5	12	BX8.4d	1	50	38	
2473MFX6	4008321096821	Pastel orange	1.1	12	BX8.4d	1	50	38	
<b>Suitable for 2.0mm PCB</b>									
2721MF	4050300891255	Jet black	1.2	12	B8.5d	2	50	38	■
2722MF	4008321096791	Lime green	2	12	B8.5d	2	50	38	■
2752MF	4008321096760	Beige	1.5	12	B8.5d	2	50	38	■
2741MF	4050300891606	Slate grey	1.2	24	B8.5d	2	50	38	■
64122MF	4008321095107	Copper brown	3	12	B10d	4	50	38	■
64124MF	4008321101471	Jet black	5	12	B10d	4	50	38	■
2721MF8	4008321096388	Jet black	1.2	12	B8.3d	3	50	38	
2741MF8	4008321097170	Slate grey	1.2	24	B8.3d	3	50	38	
2722MF8	4008321096418	White	2	12	B8.3d	3	50	38	





All orders must be multiples of sales pack

## Automotive Lamps – Original 12V and 24V

**MINI EUROBOX Kits**

- Compact spare bulb kit
- Covers all major car types and manufacturers
- Essential for foreign motoring
- Ideal for all road users

Product ID Code	EAN (Single Pack)	Product Description			PPG
CLKM H1	4050300875217	H1 Mini Eurobox car spare bulb kit	12	10	38
CLKM H4	4050300873398	H4 Mini Eurobox car spare bulb kit	12	10	38
CLKM H7	4050300876375	H7 Mini Eurobox car spare bulb kit	12	10	38
■ CLKM H7/H1	4050300873411	H1/H7 Mini Eurobox car spare bulb kit	12	10	38



All orders must be multiples of sales pack

DISPLAY/OPTIC LAMPS



# Display/Optic Lamps Contents.

HMI® single ended metal halide	191
HMI® double ended metal halide	192
HTI® single ended metal halide	193
HTI® double ended metal halide	193
Baby SharXS® HTI® double ended metal halide	194
SharXS® HTI® double ended metal halide	195
Maxi SharXS® HTI® double ended metal halide	195
HTI® metal halide with dichroic reflector	196
HSR® metal halide	196
4ArXS HSD™ metal halide	197
Lok-it!® metal halide lamps	197
EMH™ metal halide lamps (Classic Line)	198
Lampholders	199
Low voltage halogen without reflector (HLX)	200
Low voltage halogen without reflector (Krypton)	201
Halogen reflector lamps – MR11 35mm diameter	202
Halogen reflector lamps – MR16 51mm diameter 8-20V	202
Halogen reflector lamps – MR16 51mm diameter 21-120V	203
Halogen lamps, medium/high voltage single-ended 150-360W	203
Halogen lamps, medium/high voltage single-ended 400-1000W	204
Halogen studio lamps, single ended 300-650W	205
Halogen studio lamps, single ended 750-1000W	206
Halogen studio lamps, single ended 1200-2000W	207
Halogen lamps – double ended	208
HPL® high performance single ended halogen lamps with special bases	209
STUDIOLINE	209
DOT-it Backstage Blue for entertainment	210
aluPAR® 56 halogen lamps	210
aluPAR® 64 halogen lamps	211
Halogen lamps current controlled – single ended	212
Halogen lamps current controlled with PK30d base	213
Halogen reflector current controlled halogen lamps with dichroic coating	214
Halogen lamps current controlled – double ended	215
Electronic control gear for medical applications	216
XBO® Xenon short arc lamps with reflector 75-300W	217
XBO® Xenon short arc lamps with reflector 450-10000W	218
XBO® Classic Line for cinema projection	219
XBO® Xtreme Life for cinema projection	220
XBO® lamps for digital cinema projection	221
XSTAGE® Xenon short arc lamps for entertainment	222
HBO® Mercury short arc lamps 50-200W	222

## CONTENTS

Special lamps for IR applications	223
XERADEX® lamps	223
XIS XERADEX® irradiation system	224
DBD electronic control gear for XERADEX® lamps	224
Micro lithography lamps for i-line systems	225
Micro lithography lamps for LCD systems	226
Other Micro lithography lamps up to 1000W	226
HXP® long life mercury short-arc lamps	227
Lamps without Halogen, low voltage	227
SPECTRAL lamps	228
Lamps for scientific purposes	228
HALOTHERM® Infra-red Halogen lamps	229
RUBYSTAR® Halogen infra-red lamps	230
SICCATHERM® Infra-red lamps	230
THERATHERM® INFRA-RED HEAT LAMPS	231
Fluorescent tubes with black glass bulbs	232
OSRAM DULUX® BLUE AND BLUE UVA	232
HNS® germicidal lamps producing no ozone	233





Display/Optic Lamps

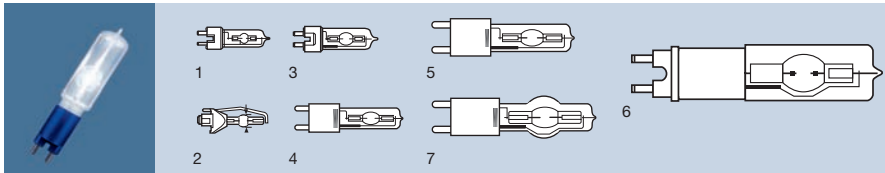

**HMI® single ended metal halide**

- 6000K – daylight colour temperature
- Excellent colour rendering
- Hot restart
- Dimmable
- Ideal for location, stage, studio and TV lighting

Product ID Code	EAN (Single Pack)	Product Description	W	V	lm				PPG
HMI200SE	4008321299444	HMI 200W/SE	200	70	16000	GZY9.5	1	10	38
HMI250SE	4050300239064	HMI 250 W/SE	270	50	16200	FaX1.5	2	1	38
HMI400SE	4008321299468	HMI 400 W/ SE	400	70	33000	GZZ9.5	3	10	38
HMI575SEL	4050300603100	HMI 575 W/SEL XS	575	95	49000	G22	4	10	38
HMI700SEXS	4008321191601	HMI 700 W/SE XS	700	100	56000	G22	4	10	38
HMI1200SEL	4008321062109	HMI 1200 W/SE XS	1200	100	110000	G38	5	1	38
HMI1800SEXS	4008321378453	HMI 1800W/SE XS	1800	140	165000	G38	6	1	39
HMI2500SE	4050300284293	HMI 2500 W/SE XS	2500	115	240000	G38	7	1	38
HMI4000SE	4008321244314	HMI 4000 W/SE XS	4000	200	380000	G38	7	1	38
HMI6000SE	4050300564067	HMI 6000 W/SE XS	6000	123	600000	GX38	6	1	38
HMI12000SE	4050300650418	HMI 12000 W/SE XS	12000	160	1150000	GX38	6	1	38
HMI18000SEGX51	4008321098955	HMI 18000 W/SE/GX51 XS	18000	225	1600000	GX51	6	1	38

W = Watts  
 SE = Single ended  
 XS = eXtreme Seal (max. permissible foil temperature 450° C)



All orders must be multiples of sales pack

Display/Optic Lamps

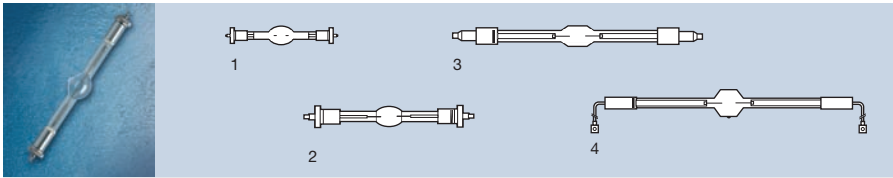

**HMI® double ended metal halide**

- 6000K – daylight colour temperature
- Excellent colour rendering
- Hot restart
- Dimmable
- Ideal for location, stage, studio and TV lighting

Product ID Code	EAN (Single Pack)	Product Description	W	V	lm	A				PPG
HMI575DXS	4008321285102	HMI 575 W/DXS	575	95	49000	7	SFf10	1	1	38
HMI1200DXS	4008321931153	HMI 1200 W/DXS	1200	100	110000	13.8	SFf15.5	2	1	38
HMI2500S	4050300025780	HMI 2500 W/S XS	2500	115	240000	25.6	SFa21	3	1	38
HMI2500DXS	4008321182197	HMI 2500 W/DXS	2500	115	240000	25.6	SFa21	3	1	38
HMI4000DXS	4008321210203	HMI 4000 W/DXS	4000	200	380000	24	SFa21	3	1	38
HMI6000DXS	4008321210210	HMI 6000 W/DXS	6000	123	570000	55	S25.5	4	1	38
HMI12000DXS	4008321210227	HMI 12000 W/DXS	12000	160	1150000	84	S30	4	1	38
HMI18000DXS	4008321210234	HMI 18000 W/DXS	18000	225	1700000	88	S30	4	1	38
HMI24000DXS	4008321355805	HMI 24000W/DXS	24000	280	2300000	86	S30	4	1	38



W = Watts  
 S = Short  
 XS = eXtreme Seal (max. permissible foil temperature 450° C)

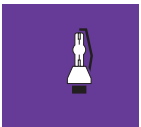

All orders must be multiples of sales pack



Display/Optic Lamps

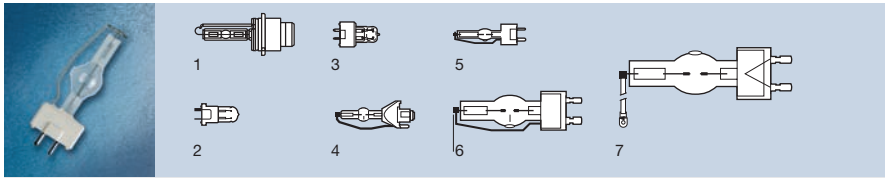

**HTI® single ended metal halide**

- Metal halide lamp similar to HMI
- Short arc technology
- Ideal for fibre optic applications, effect spot lights and slide projectors

Product ID Code	EAN (Single Pack)	Product Description	W	V	Im	A			No.		PPG
HTIS35	4050300503578	HTI S 35/12	35	85	3200	2.2	P32d-2		1	10	38
HTI150	4050300301402	HTI 150 W	150	90	10000	1.8	GY9.5		2	12	38
HTI152	4050300461519	HTI 152 W	150	95	10000	1.8	GY9.5		3	12	38
HTI700SE	4008321061096	HTI 700 W/SE/75 XS	700	70	59000	10	GY9.5		4	1	38
HTI705SE	4050300618074	HTI 705 W/SE XS	700	70	59000	10	GY9.5		5	1	38
HTI1200SE	4050300371153	HTI 1200 W/SE XS	1200	100	105000	13.8	GY22		6	1	38
HTI2500SE	4050300371146	HTI 2500 W/SE XS	2500	115	240000	25.6	GY22 +cable		7	1	38



⏏ = Square-wave AC current  
 XS = eXtreme Seal (max. permissible foil temperature 450° C)

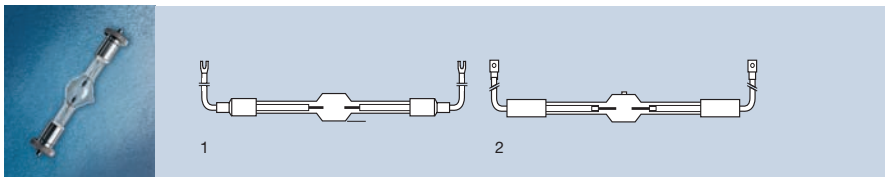

**HTI® double ended metal halide**

- Metal halide lamp similar to HMI
- Short arc technology
- Ideal for fibre optic applications, effect spot lights and slide projectors

Product ID Code	EAN (Single Pack)	Product Description	W	V	Im	A		No.		PPG	
HTI2500DEL	4050300596709	HTI 2500 W/DEL	2500	115	270000	26	Special		1	1	38
HTI4000DE	4050300519845	HTI 4000 W/DE	4000	115	360000	40	S25.5		2	1	38



~ = Sine wave AC current  
 XS = eXtreme Seal (max. permissible foil temperature 450° C)



All orders must be multiples of sales pack

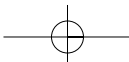

Display/Optic Lamps

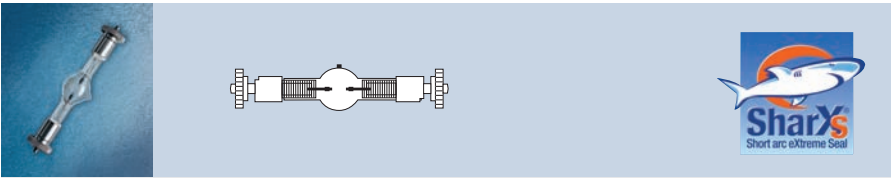

**Baby SharXS® HTI® double ended metal halide**

- 5600K, 5700K, 6000K, 6500K, 7500K & 8000K colour temperature
- Short arc technology
- Excellent colour rendering
- Modular design
- Ideal for location, stage, studio and TV lighting

Product ID Code	EAN (Single Pack)	Product Description	W	V	lm	A			PPG
BSXHHTI250D580	4008321129161	Baby SharXS HTI 250 W/D5/80	250	90	19000	3.2	SFc10-4	1	38
BSXHHTI300D557	4008321129185	Baby SharXS HTI 300 W/D5/57	300	80	20000	4.4	SFc10-4	1	38
BSXHHTI300D565	4008321129208	Baby SharXS HTI 300 W/D5/65	300	100	22000	3.6	SFc10-4	1	38
BSXHHTI575D556	4008321129345	Baby SharXS HTI 575 W/D5/56	575	97	43000	6.9	SFc10-4	1	38



XS = eXtreme Seal (max. permissible foil temperature 450° C)

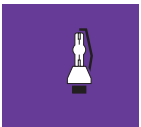

All orders must be multiples of sales pack

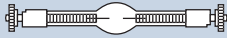

## Display/Optic Lamps

**SharXS® HTI® double ended metal halide**

- 6000K, 7000K & 7500K colour temperature
- Short arc technology
- Excellent colour rendering
- Modular design
- Ideal for location, stage, studio and TV lighting

Product ID Code	EAN (Single Pack)	Product Description	W	V	lm	A			PPG
SXHTI400D375	4008321285157	SharXS HTI 400 W/D3/75	400	49	26000	8.5	SFc10-4	1	38
SXHTI575D475	4008321285195	SharXS HTI 575 W/D4/75	575	64	44000	9	SFc10-4	1	38
SXHTI700D460	4008321285218	SharXS HTI 700 W/D4/60	700	70	59000	10	SFc10-4	1	38
SXHTI700D475	4008321285232	SharXS HTI 700 W/D4/75	700	70	59000	10	SFc10-4	1	38
SXHTI1200D760	4008321285256	SharXS HTI 1200 W/D7/60	1200	95	110000	12.7	SFc10-4	1	38
SXHTI1200D775	4008321285270	SharXS HTI 1200 W/D7/75	1200	95	110000	12.7	SFc10-4	1	38
SXHTI1500D761	4008321285294	SharXS HTI 1200 W/D7/76	1500	110	165000	13.6	SFc10-4	1	38



XS = eXtreme Seal (max. permissible foil temperature 450° C)

**Maxi SharXS® HTI® double ended metal halide**

- A new addition to the SharXS® family
- 6000K colour temperature
- Short arc technology
- Excellent colour rendering
- Modular design
- Ideal for location, stage, studio and TV lighting

Product ID Code	EAN (Single Pack)	Product Description	W	V	lm	A			PPG
MSXHTI2000D1060	4008321334947	Maxi SharXS HTI 2000 W/D10/60	2000	105	200000	19	SFc15.5	1	38



XS = eXtreme Seal (max. permissible foil temperature 450° C)

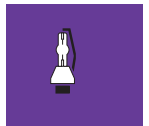

All orders must be multiples of sales pack

Display/Optic Lamps

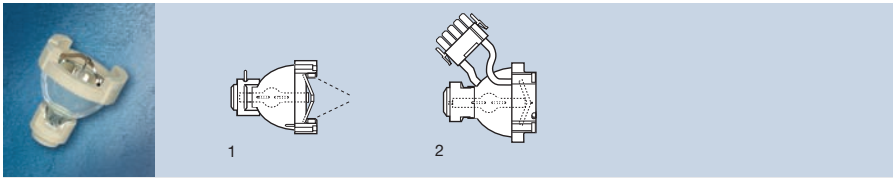

**HTI® metal halide with dichroic reflector**

- HTI lamp with dichroic prefocused reflectors
- Ideal for medical applications and entertainment lighting

Product ID Code	EAN (Single Pack)	Product Description	W	V	A	Light No.	PPG
HTI25022	4050300367781	HTI 250 W/22	270	45	6	1	2 38
HTI25032	4050300226576	HTI 250 W/32	270	45	6	1	2 38
HTI40024	4050300228327	HTI 400 W/24 (with plug & cable)	400	55	7.3	2	2 38
HTI40324	4050300386331	HTI 403 W/24 (with plug & cable)	400	55	7.3	2	2 38

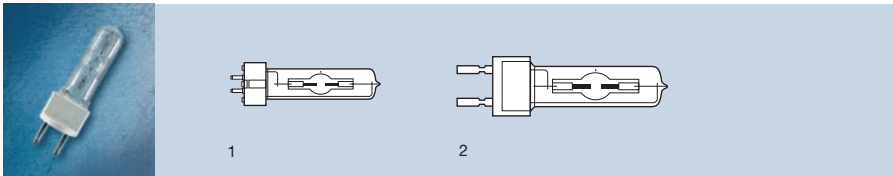

**HSR® metal halide**

- Single ended metal halide lamp similar to HTI lamp
- Fitted with an outer bulb for ease of handling
- Ideal for “architainment” applications

Product ID Code	EAN (Single Pack)	Product Description	W	V	lm	A	Beam	Light No.	PPG
HSR400	4050300315942	HSR 400/60	400	67	33000	6.9	GX9.5	1	10 38
HSR57560	4050300941776	HSR 575/60	575	97.5	49000	7	GX9.5	1	10 38
HSR57572	4050300651187	HSR 575/72	575	97.5	49000	7	GX9.5	1	10 38
HSR120060	4050300526836	HSR 1200/60	1200	100	110000	13.8	G22/28x50	2	20 38



All orders must be multiples of sales pack



Display/Optic Lamps

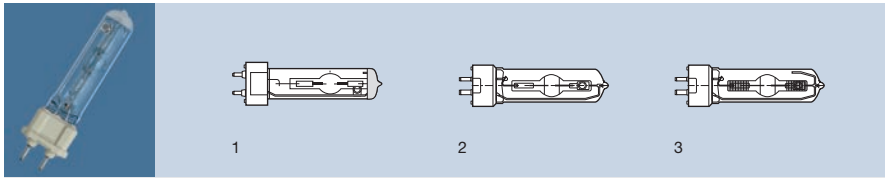

**4ArXS HSD™ metal halide**

- Long life HSR lamp
- Ideal for commercial and architectural applications

Product ID Code	EAN (Single Pack)	Product Description	W	V	lm	A		No.		PPG
HSD15070	4008321202147	4ArXS HSD 150W/70	150	97	12000	1.8	G12	1	10	38
HSD150UL75	4008321202116	4ArXS HSD 150W/UL(751)	150	97	11000	1.8	G12	1	10	38
HSD200	4050300424682	4ArXS HSD 200W/60	200	70	13000	3.3	GY9.5	2	10	38
HSD25060	4050300501925	4ArXS HSD 250W/60	250	90	17000	3.3	GY9.5	2	10	38
HSD25080	4050300808635	4ArXS HSD 250W/80	250	95	17000	3.3	GY9.5	2	10	38
HSD250UL75	4008321083586	4ArXS HSD 250W/UL/75	250	90	15000	3.3	GY9.5	2	10	38
HSD575	4050300593937	4ArXS HSD 575W/72	575	88	45000	7.4	GX9.5	3	10	38

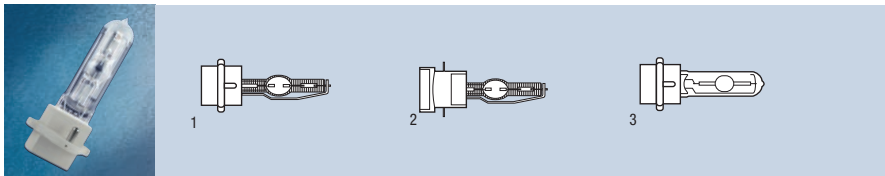

**Lok-it!® metal halide lamps**

- Lamp system with bayonet cap
- Lampholder ensures secure hold during transportation and has a bayonet lock for rapid installation and removal

Product ID Code	EAN (Single Pack)	Product Description	W	V	lm		No.		PPG
HSDLOKIT30080	4008321493989	Lok-it! HSD 300W/80/P28	300	95	27000	PGSx28	1	1	38
HTILOKIT700P50	4008321485205	Lok-it! HTI 700W/75/P50	700	100	50000	PGSx50	2	1	38
HTILOKIT700P28	4008321510549	Lok-it! HTI 700W/75/P28	700	100	50000	PGSx28	3	1	38
HTILOKIT1500	4008321344410	Lok-it! HTI 1500W/60/P50	1500	100	135000	PGSx50	2	1	38
LPHOLDLOCKITOGJX50	4008321404725	Lamp holder Lok-it! PGJX50	1500	250	-	-	-	1	38
LOKITPGJX28	4008321512079	Lamp holder Lok-it! PGJX28	700	250	-	-	-	20	38



NEW  
NEW  
NEW  
NEW  
NEW  
NEW

All orders must be multiples of sales pack

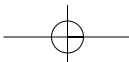

## Display/Optic Lamps

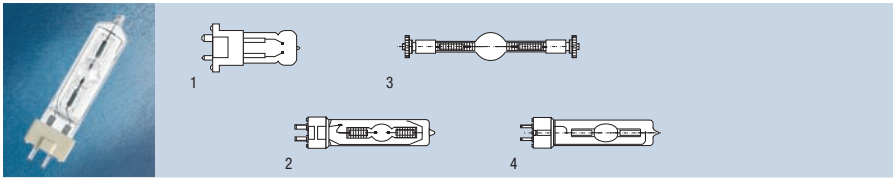
**EMH™ metal halide lamps (Classic Line)**

- Economy Metal Halide short arc lamps
- Economical versions of the most popular metal halide lamps
- For use in enclosed luminaires only
- Ideal for use in clubs, shops and small stages

Product ID Code	EAN (Single Pack)	Product Description	W	V	lm		No.		PPG
EMH150SE70	4008321345004	EMH 150W/SE/70	150	90	8000	GY9.5	1	10	38
-	4008321412294*	EMH 250W/SE/80	250	94	15000	GY9.5	2	30	38
-	4008321412317*	EMH 575W/DE/60	575	95	42000	SFc10-4	3	30	38
EMH575DE75	4008321345066	EMH 575W/DE/75	575	95	42000	SFc10-4	3	10	38
EMH575SE75	4008321345080	EMH 575W/SE/75	575	95	42000	GX9.5	4	10	38
-	4008321412379*	EMH 1200W/DE/60	1200	100	95000	SFc15.5	3	30	38

\* In preparation at time of print. For further information please contact OSRAM.

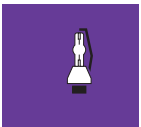

All orders must be multiples of sales pack





## Display/Optic Lamps



## Lampholders

OSRAM lampholders for halogen and discharge lamps

Optimum quality lampholders from the same source as the relevant lamps

Product ID Code	EAN (Single Pack)	Product Description	W	V		PPG
LAMHOLDERSHARXS	4008321189042	Lampholder SharXs SFc1-4	1200	1000	1	38
LPHOLDTP22PAR	4008321335265	Lampholder TP22-H/CE PAR	1000	250	10	38
LPHOLDTP22S4	4008321335241	Lampholder TP22-H/CE	1000	250	10	38
LPHOLDPAR1	4008321355928	Lampholder PAR1	1000	250	10	38
LPHOLDG12	4008321355942	Lampholder G12	150	1000	4	38
LPHOLDG22	4008321355966	Lampholder G22	1200	1000	2	38
LPHOLDG38	4008321355980	Lampholder G38	5000	1000	1	38
LPHOLDGY9	4008321356000	Lampholder GY9.5	500	1000	2	38
LPHOLDS26	4008321388636	Lampholder S26	3000	600	20	38
LPHOLDS26A	4008321388674	Lampholder S26A	3000	600	20	38
LPHOLDTP22XL	4008321388735	Lampholder TP22-XL	1000	250	10	38
LPHOLDTP23H	4008321388711	Lampholder TP23-H	1200	250	20	38
LPHOLDTP61	4008321388698	Lampholder TP61	750	250	25	38

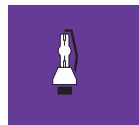

All orders must be multiples of sales pack

## Display/Optic Lamps

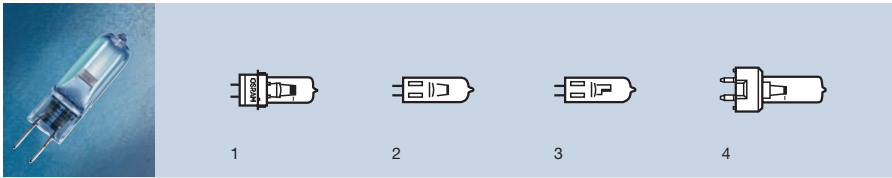
**Low voltage halogen without reflector (HLX)**

- XENOPHOT® (HLX) lamps have a Xenon gas filling
- Up to 10% greater luminous flux than a Krypton gas filled version
- Ideal for stage and studio lighting

Product ID Code	EAN (Single Pack)	ANSI	LIF	W	V	lm				PPG
<b>6V version</b>										
HLX64250	4050300012407	ESB	M30	20	6	460	G4	2	40	38
HLX64251	4050300338316	-	-	20	6	500	PG22	1	30	38
HLX64265	4008321107053	-	-	30	6	765	G4	2	40	38
<b>12V version</b>										
HLX64610	4050300006697	BRL	A1220	50	12	1600	G6.35	2	40	38
HLX64611	4008321107091	-	-	50	12	1350	G6.35	2	40	38
HLX62138	4050300242958	-	-	100	12	2800	G6.35	3	40	38
HLX64621	4050300535531	-	-	100	12	2750	PG22	1	30	38
HLX64623	4050300012018	EVA	M28	100	12	2800	GY6.35	2	40	38
HLX64625	4050300006703	FCR	A1215	100	12	3600	GY6.35	2	40	38
<b>15V Version</b>										
HLX64633	4050300006710	BRJ	A1234	150	15	5600	G6.35	2	40	38
<b>24V Version</b>										
HLX64638	4050300283050	-	-	100	24	2900	G6.35	2	40	38
HLX64640	4050300006727	FCS	A1216	150	24	6000	G6.35	2	40	38
HLX64641	4050300048260	-	-	150	24	2700	G6.35	2	40	38
HLX64642	4050300012025	FDV	M184	150	24	5000	G6.35	2	40	38
HLX64654	4008321241399	-	-	250	24	9000	GY9.5	4	12	38
HLX64655	4050300006734	EHJ	A1223	250	24	10000	G6.35	2	40	38
HLX64657	4050300012001	EVC	M33	250	24	9000	G6.35	2	40	38
HLX64656	4050300023120	FNT	-	275	24	10000	G6.35	2	40	38
<b>36V Version</b>										
HLX64663	4050300006741	EVD	A1239	400	36	16000	G6.35	2	40	38
HLX64664	4008321241474	-	-	400	36	14500	G6.35	2	40	38
HLX64665	4008321099761	-	-	400	36	12200	G6.35	2	12	38

All orders must be multiples of sales pack

## Display/Optic Lamps



1



2



3



4



5

### Low voltage tungsten halogen without reflector (Krypton)

- Krypton gas filling
- Clear finish
- Ideal for stage and studio lighting and industrial applications



Product ID Code	EAN (Single Pack)	ANSI	LIF	W	V	lm		No.		PPG
<b>6V version</b>										
64222	4050300327273	-	-	10	6	150	PG22	1	30	38
64223	4008321107039	-	M43	10	6	150	G4	2	40	38
64225	4050300006758	ESA	M29	10	6	200	G4	2	40	38
64275	4050300258690	-	M137	35	6	760	G4	3	40	38
<b>12V version</b>										
64258	4050300285153	-	-	20	12	350	G4	2	40	38
64259	4008321352569	-	-	20	12	400	G4	2	40	38
64260	4050300099798	-	M185	30	12	800	PG22	1	30	38
64261	4050300220529	-	M130	30	12	750	G6.35	2	40	38
64602	4008321107077	-	M134	50	12	1000	G6.35	2	40	38
64628	4008321099549	FDT	A1261	100	12	3000	GY9.5	4	12	38
<b>22.8V version</b>										
64291	4008321330550	-	-	40	22.8	1200	G6.35	5	40	38
64650	4008321107138	-	-	50	22.8	1150	G6.35	3	40	38
64668	4008321331182	-	-	80	22.8	3050	G6.35	5	40	38
64292XIR	4008321330598	-	-	150	22.8	6000	G6.35	5	40	38
<b>24V version</b>										
64647	4008321107114	-	-	100	24	3600	G6.35	3	40	38
64643	4008321099648	FDS	A1262	150	24	5000	GY9.5	4	12	38

Some lamp models are available as XENOPHOT® versions (type HLX®).

With xenon instead of krypton as the filler gas, a luminous flux up to 10 % higher is achieved with the same electrical lamp data for details refer to page 200

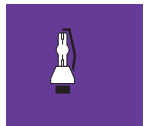

All orders must be multiples of sales pack

### Display/Optic Lamps

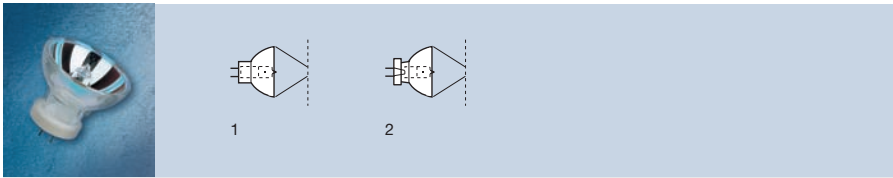

#### Halogen reflector lamps – MR11 35mm diameter

- Compact design
- With prefocused reflector
- Ideal for theatre, film and TV lighting

Product ID Code	EAN (Single Pack)	W	V				PPG
64255	4050300006833	20	8	GZX4	1	20	38
64613	4050300241012	75	12	G5.3-4.8	2	20	38
64617	4050300231211	75	12	G5.3-4.8	2	20	38
64617S	4050300461106	75	12	G5.3-4.8	2	20	38
64624	4050300013916	100	12	G5.3-4.8	2	20	38

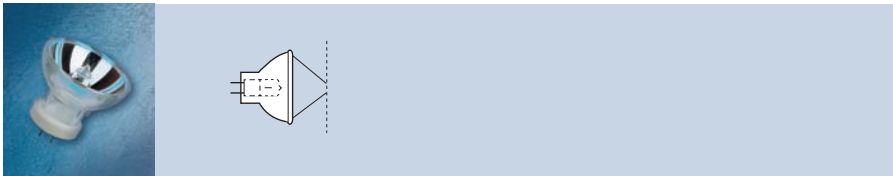

#### Halogen reflector lamps – MR16 51mm diameter 8-20V

- Compact design
- With prefocused reflector
- Ideal for theatre, film and TV lighting

Product ID Code	EAN (Single Pack)	ANSI	LIF	W	V			PPG
64607	4050300006789	EFM	A1229	50	8	GZ6.35	20	38
HLX64615	4050300006796	EFN	A1230	75	12	GZ6.35	20	38
HLX64627	4050300006802	EFP	A1231	100	12	GZ6.35	20	38
64629	4050300943169	-	-	100	12	GZ6.35	20	38
64637	4008321352071	-	A1271	100	12	GZ6.35	20	38
64619 <sup>1)</sup>	4050300017273	EPX	-	90	14.5	GX5.3	50	38
64620	4050300797397	EFR-5	-	150	15	GZ6.35	20	38
HLX64634	4050300006819	EFR	A1232	150	15	GZ6.35	20	38
HLX64635	4050300238807	-	-	150	15	GZ6.35	20	38

1) Available on request. For further information please contact OSRAM

All orders must be multiples of sales pack

## Display/Optic Lamps

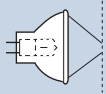

### Halogen reflector lamps – MR16 51mm diameter 21-120V

- Compact design
- With prefocused reflector
- Ideal for theatre, film and TV lighting

Product ID Code	EAN (Single Pack)	ANSI	W	V			PPG
93637	4050300350097	EJV	150	21	GX5.3	24	38
93638	4050300456843	EKE	150	21	GX5.3	24	38
HLX64653	4008321540423	ELC	250	24	GX5.3	20	38
64659	4008321540188	ELC-10	250	24	GX5.3	20	38
93653	4050300636450	ELC-3	250	24	GX5.3	24	38
93506	4050300349930	ENH	250	120	GY5.3	24	38



1

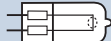

2

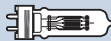

3

### Halogen lamps, medium/high voltage single-ended 150-360W

- Maximum luminous efficacy
- Suitable where colour temperature is required for 3400K sensitised material
- Ideal for TV, video and film studios

Product ID Code	EAN (Single Pack)	ANSI	LIF	W	V				PPG
64501	4050300279237	–	–	150	120	GX6.35	1	25	38
64502	4050300289977	–	–	150	230	GX6.35	1	25	38
64505	4008321098436	–	–	200	230	GX6.35	2	12	38
24064505	4008321098610	–	–	200	240	GX6.35	2	12	38
64512	4008321098634	FNS	–	300	120	GX6.35	2	12	38
64514	4008321098672	–	CP96	300	120	GX6.35	2	12	38
64515	4008321098696	–	–	300	230	GX6.35	2	12	38
24064515	4008321098719	–	–	300	240	GX6.35	2	12	38
64516	4008321098733	–	–	300	230	GX6.35	2	12	38
24064516	4008321098757	–	CP97	300	240	GX6.35	2	12	38
64662	4008321097873	–	M38	300	230	GY9.5	3	12	38

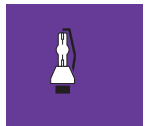

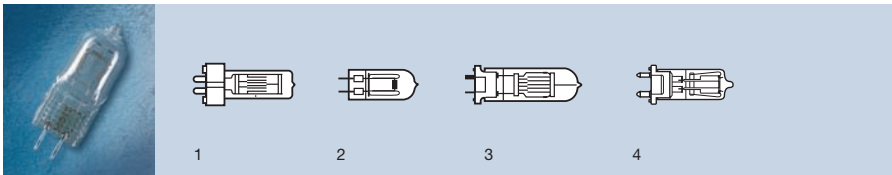

All orders must be multiples of sales pack

## Display/Optic Lamps

**Halogen lamps, medium/high voltage single-ended 400-1000W**

- Maximum luminous efficacy
- Enhanced filament design
- Ideal for theatre, film and TV lighting

Product ID Code	EAN (Single Pack)	ANSI	LIF	W	V		 No.		PPG
24093591	4050300481555	FSY	-	400	240	GY9.5	1	24	38
93592	4050300481531	FSX	-	400	230	GY9.5	1	24	38
64672	4008321098559	-	M/40	500	230	GY9.5	2	12	38
24064672	4008321098535	-	M/40	500	240	GY9.5	2	12	38
64680	4008321098573	-	A1/244	500	230	GY9.5	3	12	38
24064680	4008321098597	-	A1/244	500	240	GY9.5	3	12	38
64540	4008321098818	BVM	P1/13	650	230	GX6.35	2	12	38
24064540	4008321098795	BVM	P1/13	650	240	GX6.35	2	12	38
64686	4008321098498	DYR	A1/233	650	230	GY9.5	4	12	38
24064686	4008321098511	DRY	A1/233	650	240	GY9.5	4	12	38
64573	4008321098832	-	-	1000	120	GX6.35	2	12	38
64575	4008321098856	EGY	P115	1000	230	GX6.35	2	12	38
24064575	4008321098450	EGY	P115	1000	240	GX6.35	2	12	38

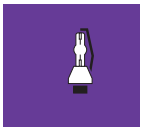

All orders must be multiples of sales pack

Display/Optic Lamps

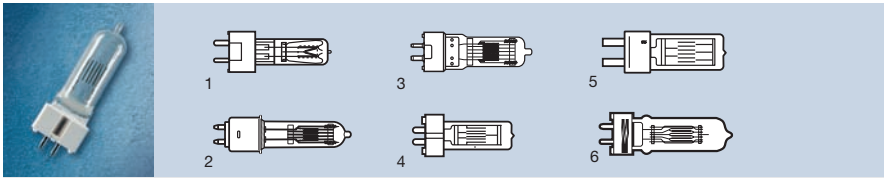

**Halogen studio lamps, single ended 300-650W**

- Maximum luminous efficacy
- Suitable where colour temperature is required for 3200K sensitised material
- Ideal for professional film and TV recordings

Product ID Code	EAN (Single Pack)	ANSI	LIF	W	V	lm		No.		PPG
64673	4008321099785	-	CP81	300	230	7500	GY9.5	1	12	38
24064673	4008321099808	-	CP81	300	230	7500	GY9.5	1	12	38
64670	4050300022536	-	T25	500	230	11000	GY9.5	6	25	38
64674	4008321099822	-	CP82	500	230	13500	GY9.5	1	12	38
24064674	4008321099846	-	CP82	500	240	13500	GY9.5	1	25	38
64716	4050300506494	GKV	-	600	230	14000	G9.5	2	25	38
24064716	4050300506517	GKV	-	600	240	14000	G9.5	2	25	38
64717	4050300296692	FRK	CP89	650	230	16250	GY9.5	3	25	38
24064717	4050300304953	FRK	CP89	650	240	16250	GY9.5	3	25	38
64718	4050300022543	GCT	T27	650	230	14500	GY9.5	3	25	38
24064718	4050300283463	GCT	T27	650	240	14500	GY9.5	3	25	38
64719	4050300019154	-	T12	650	230	12000	GX9.5	4	20	38
64720	4050300017716	-	CP23	650	230	16800	GX9.5	4	20	38
64721	4050300217970	FKH	CP39	650	230	16800	G22	5	20	38



All orders must be multiples of sales pack

## Display/Optic Lamps

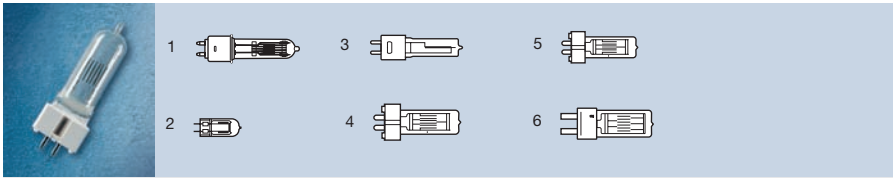

### Halogen studio lamps, single ended 750-1000W

- Maximum luminous efficacy
- Suitable where colour temperature is required for 3200K sensitised material
- Ideal for professional film and TV recordings

Product ID Code	EAN (Single Pack)	ANSI	LIF	W	V				PPG
64678	4050300609102	-	-	800	230	G9.5	1	25	38
64576	4008321099860	-	P217	1000	230	GX6.35	2	12	38
64743	4008321225702	FEL	CP77	1000	120	G9.5	3	20	38
64744	4050300017723	FWP	T19	1000	230	GX9.5	4	20	38
24064744	4050300283333	FWP	T19	1000	240	GX9.5	4	20	38
64745	4050300213262	FVA	CP70	1000	230	GX9.5	5	20	38
24064745	4050300283234	FVA	CP70	1000	240	GX9.5	5	20	38
24064747	4050300283999	FKJ	CP71	1000	240	G22	6	20	38
64748XS	4008321218483	-	-	1000	230	GY9.5	5	25	38
24064748XS	4008321218506	-	-	1000	240	GY9.5	5	25	38
93734	4050300350073	FEL	CP77	1000	240	G9.5	3	12	38



XS = eXtreme Seal (max. permissible foil temperature 450° C)

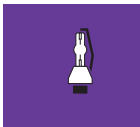



All orders must be multiples of sales pack

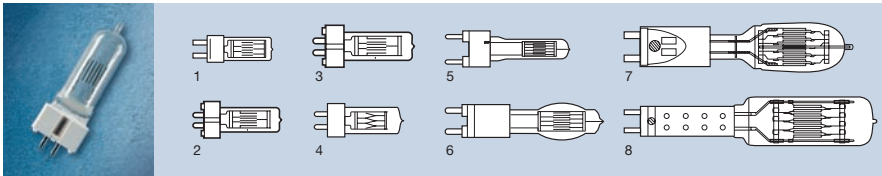

## Display/Optic Lamps

**Halogen studio lamps, single ended 1200-20000W**

- Maximum luminous efficacy
- Suitable where colour temperature is required for 3200K sensitised material
- Ideal for professional film and TV recordings

Product ID Code	EAN (Single Pack)	ANSI	LIF	W	V	lm				PPG
93723	4008321370594	–	CP/110	1200	80	37500	2PIN	1	12	38
64752	4050300296616	FWS	T29	1200	230	28600	GX9.5	2	20	38
24064752	4050300305011	FWS	T29	1200	240	28600	GX9.5	2	20	38
64754	4050300296746	–	CP90	1200	230	30000	GX9.5	3	20	38
64756	4050300296722	–	CP93	1200	230	30000	G22	1	20	38
64777	4050300367682	–	CP92	2000	230	52000	G22	1	20	38
64787	4050300246154	–	CP75	2000	230	52000	G22	1	20	38
64788	4050300213286	FTM	CP72	2000	230	52000	GY16	4	20	38
24064788	4050300283258	FTM	CP72	2000	240	52000	GY16	4	20	38
64789	4050300219103	FKK	CP73	2000	220	52000	G38	5	1	38
24064789	4050300283371	FKK	CP73	2000	240	52000	G38	5	1	38
64796	4050300406428	–	CP91	2500	230	65000	G22	1	20	38
64805	4050300212609	–	CP85	5000	230	135000	G38	6	1	38
24064805	4050300283401	–	CP85	5000	240	135000	G38	6	1	38
64815	4050300780696	ECR	CP83	10000	230	285000	G38	7	1	38
64818	4050300782713	BCM	CP99	20000	230	580000	G38	8	1	38

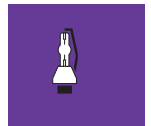

All orders must be multiples of sales pack

## Display/Optic Lamps

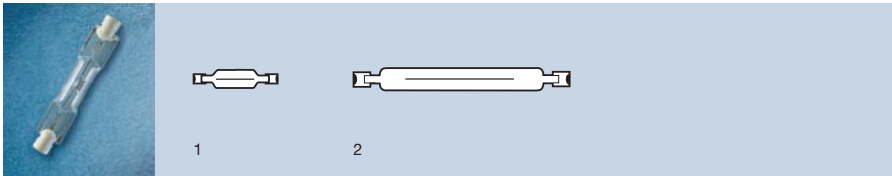
**Halogen lamps – double ended**

- Maximum luminous efficacy
- Suitable where colour temperature is required for 3200K sensitised material
- Ideal for professional film and TV recordings

Product ID Code	EAN (Single Pack)	ANSI	LIF	W	V	lm		No.		PPG
64571	4050300014180	DXX	P213	800	230	21000	R7s	1	50	38
24064571	4050300283388	DXX	P213	800	240	21000	R7s	1	50	38
64572	4008321325181	–	P2/35	1000	230	25000	R7s	2	50	38
64579	4050300014104	FDG	–	1000	120	33000	R7s	2	12	38
64580	4050300006888	–	P112	1000	230	35000	R7s	2	15	38
24064580	4050300283173	–	P112	1000	240	35000	R7s	2	15	38
64583	4050300249094	–	P220	1000	230	27000	R7s	2	12	38
24064583	4050300411477	–	P220	1000	240	27000	R7s	2	12	38
64741	4050300209333	EKM	P27	1000	230	25000	R7s	2	12	38
64751	4050300214641	ELN	P212	1250	230	33500	R7s	2	12	38
24064751	4050300283357	ELN	P212	1250	240	33500	R7s	2	12	38
64781	4050300229997	FEX	P227	2000	230	50000	RX7s	2	12	38
24064781	4050300283500	FEX	P227	2000	240	50000	RX7s	2	12	38



All orders must be multiples of sales pack

Display/Optic Lamps

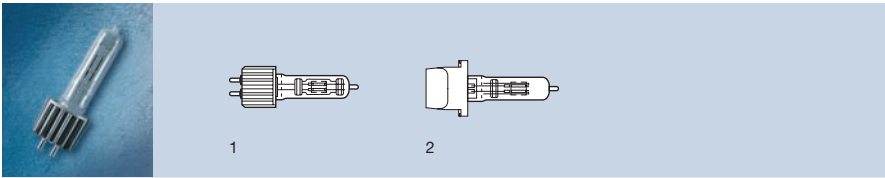

**HPL® high performance single ended halogen lamps with special bases**

- Extended lamp life
- Light output equal to 1000W lamp
- The QXL® halogen lamp with the special bayonet base can be changed without tools and without opening the spotlight
- Ideal for entertainment and architectural applications

Product ID Code	EAN (Single Pack)	W	V	lm				PPG
93728	4050300461816	575	230	14900	2PIN	1	12	38
24093728	4050300461830	575	240	14900	2PIN	1	12	38
93728LL	4008321090102	575	240	11780	2PIN	1	12	38
24093728LL	4008321174444	575	230	11780	2PIN	1	12	38
93729	4050300654201	750	230	19750	2PIN	1	12	38
24093729	4050300654225	750	240	19750	2PIN	1	12	38
93729LL	4008321090324	750	250	15600	2PIN	1	12	38
24093729LL	4008321174468	750	240	15600	2PIN	1	12	38
93721	4008321090195	750	77	22950	Bayonet	2	12	38



XS = eXtreme Seal (max. permissible foil temperature 450° C)

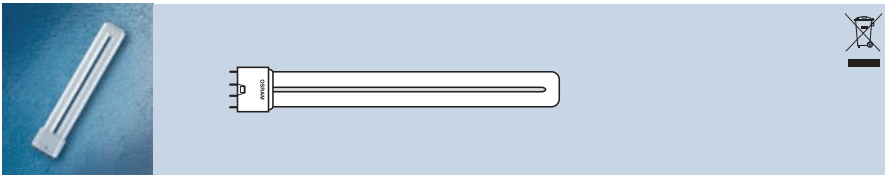

**STUDIOLINE**

- Compact fluorescent lamp
- 3200K or 5600K colour temperature
- Ideal for film and TV lighting

Product ID Code	EAN (Single Pack)	W	lm			PPG
STUDIOLINE55/3200	4050300575292	55	3800	G11	10	38
STUDIOLINE55/5600	4050300575278	55	3800	G11	10	38

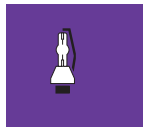

All orders must be multiples of sales pack

## Display/Optic Lamps

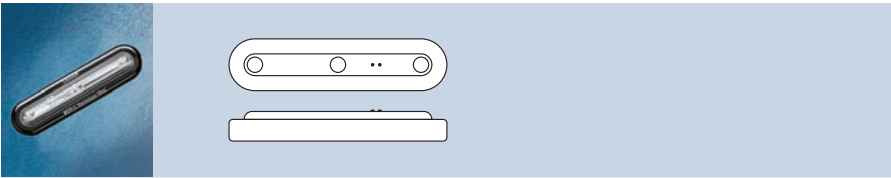

### DOT-it Backstage Blue for entertainment

- Portable LED luminaire with bright blue LEDs
- A mobile light source providing light where its needed
- Ideal for film and TV lighting

Product ID Code	EAN (Single Pack)	Product Description	W	V		PPG
DOTITBACKSTAG	4008321411426	DOT-IT Backstage blue	0.23	4.5	6	38

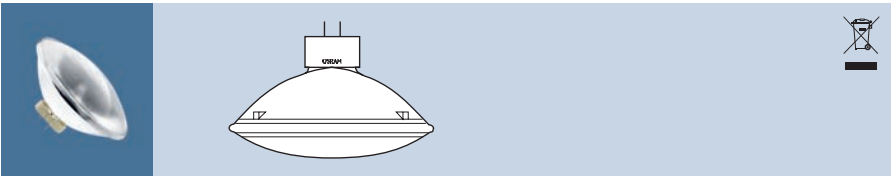

### aluPAR® 56 halogen lamps

- Lightweight aluminium reflector
- Ideal for stage lighting

Product ID Code	EAN (Single Pack)	Product Description	W	V			PPG
120ALUPAR56NSP	4008321369550	aluPAR 56 NSP	300	120	GX16d	6	38
120ALUPAR56MFL	4008321369574	aluPAR 56 MFLL	300	120	GX16d	6	38
120ALUPAR56WFL	4008321369598	aluPAR 56 WFL	300	120	GX16d	6	38
230ALUPAR56NSP	4008321209788	aluPAR 56 NSP	300	230	GX16d	6	38
230ALUPAR56MFL	4008321209863	aluPAR 56 MFLL	300	230	GX16d	6	38
230ALUPAR56WFL	4008321209801	aluPAR 56 WFL	300	230	GX16d	6	38
240ALUPAR300NSP	4008321107947	aluPAR 56 NSP	300	240	GX16d	6	38
240ALUPAR300MFL	4008321107985	aluPAR 56 MFLL	300	240	GX16d	6	38
240ALUPAR56WFL	4008321209887	aluPAR 56 WFL	300	240	GX16d	6	38



All orders must be multiples of sales pack

## Display/Optic Lamps

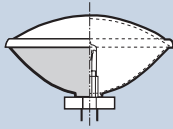

### aluPAR® 64 halogen lamps

- Lightweight aluminium reflector

Product ID Code	EAN (Single Pack)	Product Description	ANSI	LIF	W	V			PPG
ALUPAR64500VNSPCP8	4008321341259	aluPAR 64 VNSP	–	CP86	500	230	GX16d	6	38
ALUPAR64500NSPCP87	4008321341273	aluPAR 64 NSP	–	CP87	500	230	GX16d	6	38
ALUPAR64500MFLCP88	4008321341327	aluPAR 64 MFL	–	CP88	500	230	GX16d	6	38
240ALUPAR64500VNSP	4008321341365	aluPAR 64 VNSP	–	CP86	500	240	GX16d	6	38
240ALUPAR64500NSPC	4008321341389	aluPAR 64 NSP	–	CP87	500	240	GX16d	6	38
240ALUPAR64500MFLC	4008321341402	aluPAR 64 MFL	–	CP88	500	240	GX16d	6	38
ALUPAR64VNSP	4008321205773	aluPAR 64 VNSP	EXC	–	1000	230	GX16d	6	38
ALUPAR64NSP	4008321205797	aluPAR 64 NSP	EXD	CP60	1000	230	GX16d	6	38
ALUPAR64MFL	4008321205858	aluPAR 64 MFL	EXE	CP61	1000	230	GX16d	6	38
ALUPAR641000WFL	4008321341921	aluPAR 64 WFL	EXG	CP62	1000	230	GX16d	6	38
240ALUPAR64VNSP	4008321205872	aluPAR 64 VNSP	EXC	–	1000	240	GX16d	6	38
240ALUPAR64NSP	4008321205896	aluPAR 64 NSP	EXD	–	1000	240	GX16d	6	38
240ALUPAR64MFL	4008321205919	aluPAR 64 MFL	EXE	–	1000	240	GX16d	6	38
240ALUPAR641000WFL	4008321341945	aluPAR 64 WFL	EXG	–	1000	240	GX16d	6	38

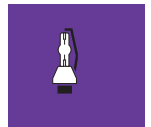

All orders must be multiples of sales pack

## Display/Optic Lamps

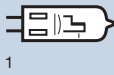

1





2



3

**Halogen lamps, current controlled – single ended**

- To be used in series connected systems
- Emits bright, visual light
- Ideal for airfield lighting

Product ID Code	EAN (Single Pack)	ANSI	LIF	W	A	Im		No.		PPG
64322	4008321100146	EXL	–	30	6.6A	430	GY9.5	1	12	38
64311UK	4008321106346	–	J159	36	6.6A	600	G6.35	2	40	38
64321	4008321106360	–	J157	45	6.6A	900	G6.35	2	40	38
64320	4008321100122	EXM	–	45	6.6A	900	GZ9.5	1	12	38
64346	4008321106384	–	J158	100	6.6A	2300	G6.35	3	40	38
64386	4008321106407	–	J139	200	6.6A	4700	G6.35	3	40	38
58750	4008321100160	EZL	–	200	6.6A	5200	GY9.5	1	12	38



All orders must be multiples of sales pack

Display/Optic Lamps

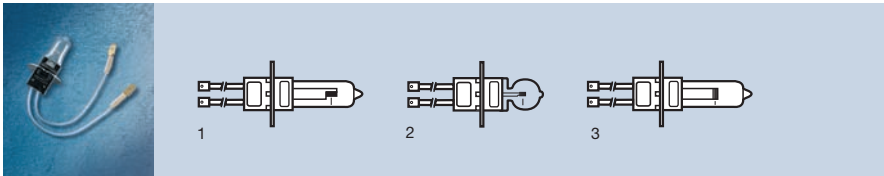

**Halogen lamps, current controlled with PK30d base**

- To be used in series connected systems
- Emits bright, visual light
- Ideal for airfield lighting

Product ID Code	EAN (Single Pack)	Product Description	LIF	W	A	lm				PPG
64323C	4008321391582	64323 C 30-15	-	30	PK30d	300	PKX30d	1	100	38
64317C	4008321345493	64317 C 45-15	J1/76	45	PK30d	800	PKX30d	1	100	38
64317IRCC	4008321340139	64317 IRC-C 45-30	J1/76	45	PK30d	900	PKX30d	2	100	38
64318A	4008321345516	64318 A 45-15	J1/77	45	PK30d	800	PKX30d	1	100	38
64319Z	4008321345578	64319 Z/C 45-15	-	45	PK30d	800	PKX30d	1	100	38
64319IRCA	4008321340153	64319 IRC-A 45-30	-	45	PK30d	900	PKX30d	2	100	38
HLX64328A	4008321345592	64328 HLX-A 65-15	-	65	PK30d	1450	PKX30d	3	100	38
HLX64328Z	4008321345615	64328 HLX-Z/C 65-15	-	65	PK30d	1450	PKX30d	3	100	38
HLX64341A	4008321345639	64341 HLX-A 100-15	J1/79	100	PK30d	2700	PKX30d	3	100	38
HLX64341Z	4008321345653	64341 HLX-Z/C 100-15	J1/79	100	PK30d	2700	PKX30d	3	100	38
HLX64342	4008321345677	64342 HLX-C 100-15	J1/80	100	PK30d	2700	PKX30d	3	100	38
HLX64361A	4008321345691	64361 HLX-A 150-15	J1/83	150	PK30d	3600	PKX30d	3	100	38
HLX64361Z	4008321345714	64361 HLX-Z/C 150-15	J1/83	150	PK30d	3600	PKX30d	3	100	38
HLX64382A	4008321345738	64382 HLX-A 200-15	J1/84	200	PK30d	4800	PKX30d	3	100	38
HLX64382	4008321345752	64382 HLX-C 200-15	J1/84	200	PK30d	4800	PKX30d	3	100	38



All orders must be multiples of sales pack

Display/Optic Lamps

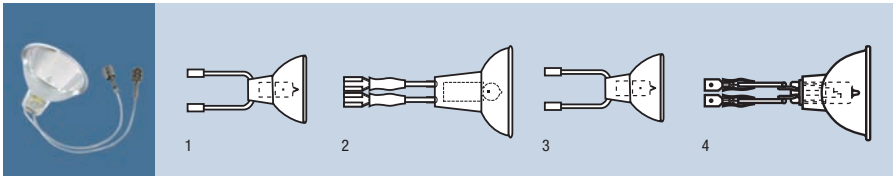

**Halogen lamps, current controlled with reflector**

- To be used in series connected systems
- With dichroic coating for cooler heat projection
- Ideal for airfield lighting

Product ID Code	EAN (Single Pack)	Product Description	W	A			No.		PPG
64331SPA	4008321102560	64331 SP-A 30-10	30	6.6A	Cables	1	20	38	
64333A	4008321166340	64333 A-40-15	40	6.6A	Cables	1	20	38	
64333B	4008321104731	64333 B	40	6.6A	Cables	1	20	38	
64333CUK	4008321104885	64333 C	40	6.6A	Cables	1	20	38	
64337A	4008321102515	64337A45-15	45	6.6A	Cables	1	20	38	
64337B45	4008321104700	64337B45-15	45	6.6A	Cables	1	20	38	
64337A	4008321102737	64337A48-15	48	6.6A	Cables	1	20	38	
64337B48	4008321105226	64337 IRC-LL-B	48	6.6A	Cables	1	20	38	
64337C48	4008321105240	64337C IRC-LL-C	48	6.6A	Cables	1	20	38	
64337IRC-C	4008321102492	64337 IRC-C 48-30	48	6.6A	Cables	2	20	38	
64338A	4008321105301	64338 A 48-10	48	6.6A	Cables	1	20	38	
64337IRC-A	4008321341174	64337 IRC-A 48-30	48	6.6A	Cables	2	20	38	
64336A	4008321186713	64336 A 62-15	62	6.6A	Cables	3	20	38	
64339A	4008321101600	64339-A 105-10	105	6.6A	Cables	4	20	38	
64339	4008321105424	64339-AC 105-10	105	6.6A	Cables	4	20	38	
64339B	4008321105462	64339-B 105-10	105	6.6A	Cables	4	20	38	
64339C	4008321105486	64339-C 105-10	105	6.6A	Cables	4	20	38	



All orders must be multiples of sales pack



Display/Optic Lamps

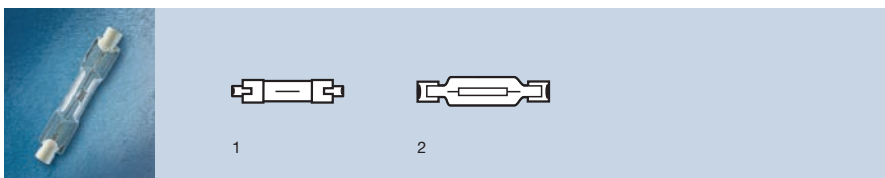

**Halogen lamps, current controlled – double ended**

- To be used in series connected systems
- Emits bright, visual light
- Ideal for airfield lighting

Product ID Code	EAN (Single Pack)	LIF	W	A			No.		PPG
64315	4050300206844	J178	45	6.6A	R7s-15	1	25	38	
64340	4050300017266	J182	100	6.6A	R7s-15	2	25	38	
64380	4050300209944	J140	200	6.6A	R7s-18	2	25	38	



All orders must be multiples of sales pack

Display/Optic Lamps



**Electronic control gear for medical applications**

- Various lamp types (eg HXP® lamps) are designed exclusively for operation with series PT-VIP ECG
- These ECGs operate the lamps in special patented operating modes which benefit lamp life and efficacy

Product ID Code	EAN (Single Pack)	Product Description	W	$\frac{l}{(mm)}$	$\frac{b}{(mm)}$	$\frac{h}{(mm)}$		PPG
PTVIP01XB075	4008321502650	PT-VIP 01 Mega & PT HVI 16kV 5.5A for XBO 75W/AC	75	150	60	30	25	38
PTVIP2AC01DIM	4008321040855	PT-VIP 2AC/380 01 DIM 120	120	150	60	32	25	38
PTVIP4AC03DIM	4008321337276	PT-VIP 4AC/380 03 DIM 206	200	135	50	30	50	38

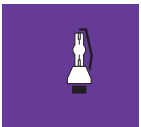

All orders must be multiples of sales pack



Display/Optic Lamps

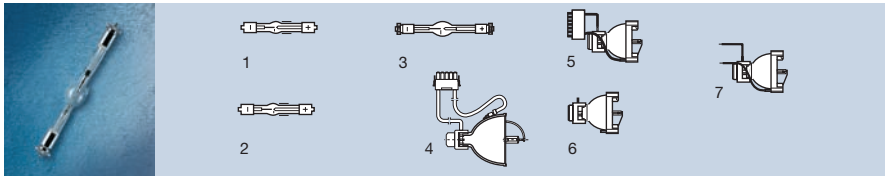

**XBO® Xenon short arc lamps (75-300W)**

- Double ended short arc xenon lamp
- Very high luminance, high colour rendering, dimmable long life lamps
- Ideal for cinema projection

Product ID Code	EAN (Single Pack)	Product Description	W	V	No.	PPG
<b>Without reflector</b>						
XBO752	4050300508801	XBO 75 W/2 DC	75	14	1	38
XBO752OFR	4050300508825	XBO 75W/2 OFR DC	75	14	1	38
XBO100OFR	4008321386328	XBO 100 W/OFR DC	100	14	2	38
XBO150CROFR	4050300508788	XBO 150 W/CR DC	150	16.5	3	38
XBO1501	4050300508344	XBO 150 W/1 DC	150	25	3	38
XBO1501OFR	4050300508368	XBO 150W/1 OFR DC	150	25	3	38
XBO1504	4050300508382	XBO 150W/4 DC	150	25	3	38
<b>With reflector</b>						
XBO75RAC	4008321964816	XBO R 75W/AC 34.5	75	-	4	38
XBOR10045C	4050300367767	XBO R 100W/45 C DC	100	-	5	38
XBOR10045OFR	4050300317205	XBO R 100W/45 OFR DC	100	-	6	38
XBOR10145C	4050300388458	XBO R 101W/45 C OFR DC	101	-	7	38
XBOR18045	4050300432175	XBO R 180 W/45 DC	180	-	6	38
XBOR18045C	4050300432199	XBO R 180W/ 45 C OFR DC	180	-	5	38
XBOR18145C	4050300450872	XBO R 180W/45 C OFR DC	180	-	7	38
XBOR300	4008321137722	XBO R 181W/45 C DC	181	-	4	38



All orders must be multiples of sales pack

Display/Optic Lamps

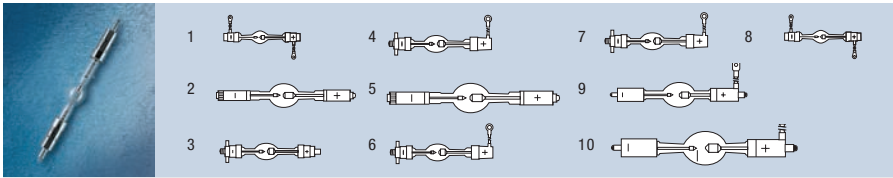

**XBO® Xenon short arc lamps with reflector (450-10000W)**

- Double ended short arc xenon lamp
- Very high luminance, high colour rendering, dimmable long life lamps
- Ideal for cinema projection

Product ID Code	EAN (Single Pack)	Product Description	W	V	No.		PPG
XBO4500FR	4008321082633	XBO 450 W OFR	450	17	1	1	38
XBO450	4008321082640	XBO 450W	450	17	2	1	38
XBO4501	4008321082510	XBO 450 W/1	450	17	2	1	38
XBO4502	4008321082626	XBO 450 W/2 OFR	450	17	1	1	38
XBO4504	4006584412990	XBO 450 W/4	450	17	3	1	38
XBO500HOFR	4008321082503	XBO 500 W/H OFR	500	17	4	1	38
XBO900OFR	4008321081346	XBO 900 W OFR	900	19	5	1	38
XBO1000HSOFR	4008321082114	XBO 1000 W/HS OFR	1000	19	6	1	38
XBO1000HSCOFR	4008321082107	XBO 1000 W/HSC OFR	1000	19	7	1	38
XBO1000HTPOFR	4008321081353	XBO 1000 W/HTP OFR	1000	21	4	1	38
XBO1600CAOFR	4008321064738	XBO 1600 W/CA OFR	1600	24	6	1	38
XBO2000HSOFR	4008321081360	XBO 2000 W/HS OFR	2000	24	10	1	38
XBO2000HTTOFR	4008321064769	XBO 2000 W/HTT OFR	2000	24	8	1	38
XBO2000SHSCOFR	4008321082077	XBO 2000 W/SHSC OFR	2000	27	1	1	38
XBO2000HCCOFR	4008321117250	XBO 2000 W/HCC OFR	2000	28	9	1	38
XBO2500OFR	4008321064783	XBO 2500 W OFR	2500	29	10	1	38
XBO3000HTCOFR	4008321064820	XBO 3000 W/HTC OFR	3000	29	2	1	38
XBO4000HSAOFR	4008321337030	XBO 4000 W/HAS OFR	4000	29	9	1	38
XBO4200CAOFR	4008321337047	XBO 4200 W/CA OFR	4200	29	2	1	38
XBO8000HSOFR	4008321552310	XBO 8000 W/HS OFR	8000	45	1	1	38



All orders must be multiples of sales pack

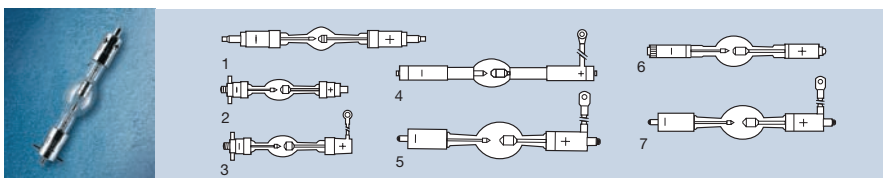

## Display/Optic Lamps

**XBO® Classic Line for cinema projection**

- Double ended short arc xenon lamp
- Very high luminance, high colour rendering, dimmable long life lamps
- Ideal for cinema projection

Product ID Code	EAN (Single Pack)	Product Description	W	V	No.		PPG
XBO1600CLOFR	4008321318022	XBO 1600 W CL OFR	1600	24	1	1	38
XBO1600HSCLOFR	4008321317940	XBO 1600 W/HS CL OFR	1550	23	2	1	38
XBO1600HSCCLOFR	4008321317957	XBO 1600 W/HS CL OFR	1550	23	3	1	38
XBO2000HCL OFR	4008321209566	XBO 2000W/H CL OFR	2000	28	4	1	38
XBO2000HSCLOFR	4008321288653	XBO 2000 W/HS CL OFR	2000	24	6	1	38
XBO2000HTPCL	4008321288646	XBO 2000 W/HTP CL OFR	2000	27	5	1	38
XBO2000SHSCCLOFR	4008321317933	XBO 2000 W/SHSC CL OFR	2000	27	3	1	38
XBO2500HSCLOFR	4008321288660	XBO 2500 W/HS CL OFR	2500	28	6	1	38
XBO3000HCL OFR	4008321209573	XBO 3000 W/H CL/OFR	3000	29	6	1	38
XBO3000HSCLOFR	4008321210265	XBO 3000 W/HS CL OFR	3000	29	7	1	38
XBO3000HTPCL	4008321288677	XBO 3000 W/HTP CL OFR	3000	29	6	1	38
XBO4000HSCLOFR	4008321210272	XBO 4000 W/HS CL OFR	4000	28	6	1	38
XBO4000HTPCL	4008321288684	XBO 4000 W/HTP CL OFR	4000	30	5	1	38
XBO5000HCL OFR	4008321317988	XBO 5000 W/H CL OFR	5000	35	6	1	38
XBO5000HBMCL OFR	4008321317995	XBO 5000 W/HBM CL OFR	5000	34	6	1	38
XBO6000HSCLOFR	4008321318008	XBO 6000 W/HS CL OFR	6000	37	6	1	38
XBO7000HSCLOFR	4008321318015	XBO 7000 W/HS CL OFR	7000	42	6	1	38



All orders must be multiples of sales pack

Display/Optic Lamps

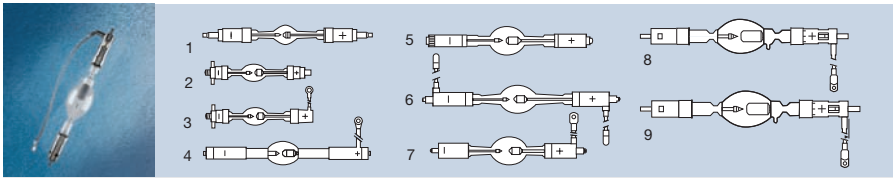

**XBO® Xtreme Life for cinema projection**

- Double ended short arc xenon lamp
- Very high luminance, high colour rendering, dimmable long life lamps
- Ideal for cinema projection

Product ID Code	EAN (Single Pack)	Product Description	W	V	No.	PPG
XBO1600XLOFR	4008321299918	XBO 1600W XL OFR	1600	24	1	38
XBO1600HSXLOFR	4008321299925	XBO 1600W/HS XL OFR	1550	23	2	38
XBO1600HSCXLOFR	4008321299932	XBO 1600W/HSC XL OFR	1550	23	3	38
XBO2000HXLOFR	4008321211781	XBO 2000W/HXL OFR	2000	27	4	38
XBO2000HTPXL	4008321244031	XBO 2000W/HTP XL OFR	2000	28	5	38
XBO2500XLOFR	4008321372789	XBO 2500W XL OFR	2500	29	6	38
XBO2500HSXLOFR	4008321299963	XBO 2500W/HS XL OFR	2500	28	7	38
XBO3000HXLOFR	4008321226174	XBO 3000W/H XL OFR	3000	29	8	38
XBO3000HSXLOFR	4008321330031	XBO 3000W/HS XL OFR	3000	29	5	38
XBO3000HTPXL	4008321244017	XBO 3000 W/HTP XL OFR	3000	29	5	38
XBO4000HSOFR	4008321412812	XBO 4000W/HS XL OFR	4000	30	9	38
XBO4000HTPXL	4008321244024	XBO 4000 W/HTP XL OFR	4000	30	5	38
XBO6000HSXLOFR	4008321299987	XBO 6000 W/HS XL OFR	6000	37	5	38
XBO6000HTPXL OFR	4008321334923	XBO 6000 W/HTP XL OFR	6000	37	5	38
XBO7000HSXLOFR	4008321299970	XBO 7000 W/HS XL OFR	7000	42	5	38
XBO4500HSOFR	4008321412881	XBO 4500W/HS XL OFR	4500	32	5	38
XBO5000HOFR	4008321412829	XBO 5000W/H XL OFR	5000	35	8	38
XBO5000HBM OFR	4008321412836	XBO 5000W/HBM XL OFR	5000	34	-	38
XBO4500HTP OFR	4008321412898	XBO 4500W/HTP XL OFR	4500	32	-	38



All orders must be multiples of sales pack

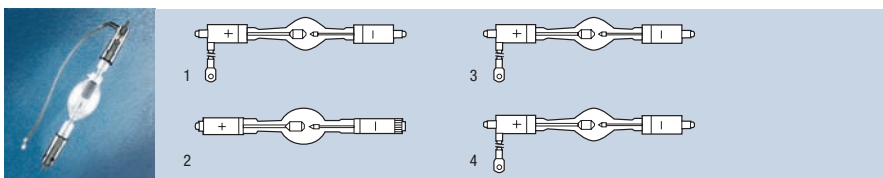

## Display/Optic Lamps

**XBO® lamps for digital cinema projection**

- Double ended short arc xenon lamp
- Very high luminance, high colour rendering, dimmable long life lamps
- Ideal for cinema projection

Product ID Code	EAN (Single Pack)	Product Description	W	V	No.	PPG
<b>DHP</b>						
XB01200DHPOFR	4008321396433	XBO 1200W/DHP OFR	1200	20	1	38
XB02000DHPOFR	4008321244048	XBO 2000W/DHP OFR	2000	25	1	38
XB03000DHPOFR	4008321330048	XBO 3000W/DHP OFR	3000	30	1	38
XB03000DHPCLOFR	4008321309532	XBO 3000W/DHP XL OFR	3000	30	1	38
XB03000DHSOFR	4008321330017	XBO 3000W/DHS OFR	3000	29	1	38
XB04000DHPCLOFR	4008321309686	XBO 4000W/DHP XL OFR	4000	34	1	38
XB04500DHPOFR	4008321372727	XBO 4500W/DHP OFR	4500	30	1	38
XB06000DHPOFR	4008321549693	XBO 6000W/DHP OFR	6000	35	1	38
XB06500DHPOFR	4008321549723	XBO 6500/DHP OFR	6500	37	1	38
XB04000DHPOFR	4008321546272	XBO 4000W/DHP OFR	4000	33	1	38
XB03000DHSOFR	4008321199065	XBO 3000W/DHS OFR	3000	29	1	38
<b>DTP</b>						
XB02000DTPOFR	4008321191533	XBO 2000W/DTP OFR	2000	25	2	38
XB03000DTPOFR	4008321191540	XBO 3000W/DTP OFR	3000	27	2	38
XB04500DTPOFR	4008321372734	XBO 4500W/DTP OFR	4500	32	2	38
<b>HPS</b>						
XB02000HPSOFR	4008321330000	XBO 2000W/HPS OFR	2000	25	3	38
XB03000HPSOFR	4008321330062	XBO 3000W/HPS OFR	3000	29	3	38
XB04200HPSOFR	4008321330086	XBO 4200W/HPS OFR	4200	35	3	38
<b>HSLA</b>						
XB03000HSLAOFR	4008321330079	XBO 3000W/HSLA OFR1)	3000	29	4	38
XB04500HSLAOFR	4008321372710	XBO 4500W/HSLA OFR1)	4500	30	4	38
XB06000HSLAOFR	4008321549716	XBO 6000W/HSLA OFR	6000	35	4	38
XB06500HSLAOFR	4008321549730	XBO 6500W/HSLA OFR	6500	38	4	38
XB08000HSLAOFR	4008321549747	XBO 8000W/HSLA OFR	8000	43	4	38



All orders must be multiples of sales pack

Display/Optic Lamps

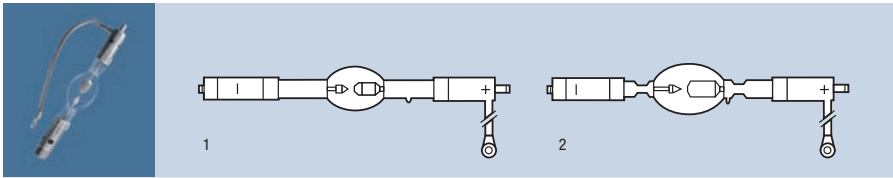

**XSTAGE® Xenon short arc lamps for entertainment**

- Short arc xenon lamp
- Optimised for outdoor use
- Ideal for event and architectural lighting and large scale floodlighting

Product ID Code	EAN (Single Pack)	Product Description	W	V	No.	PPG
XSTAGE2000	4008321288820	Xstage 2000W OFR	2000	23	1	38
XSTAGE3000	4008321199690	Xstage 3000W OFR	3000	30	1	38
XSTAGE4000	4008321199706	Xstage 4000W OFR	4000	30	1	38
XSTAGE7000	4008321199713	Xstage 7000W OFR	7000	40	2	38

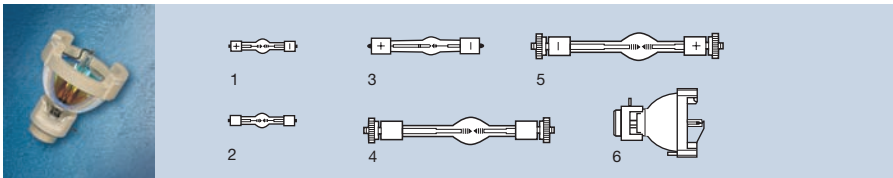

**HBO® Mercury short arc lamps 50-200W**

- Short arc Mercury lamp
- Ideal for UV generation in scientific and technical applications

Product ID Code	EAN (Single Pack)	Product Description	W	No.	PPG
<b>Without reflector</b>					
HBO50ACL2	4050300507118	HBO 50 W/AC L2	50	1	38
HBO50ACL1	4050300507132	HBO 50 W/AC L1	50	1	38
HBO503	4050300506692	HBO 50 W/3 DC	50	2	38
HBO1002	4050300507095	HBO 100 W/2 DC	100	3	38
HBO1032	4050300382128	HBO 103 W/2 DC	103	3	38
HBO2004	4050300506715	HBO 200 W/4 AC	200	4	38
HBO2024	4050300507156	HBO 202 W/4 AC	202	4	38
HBO2002L2	4050300508283	HBO 200 W/2 L2 AC/DC	200	5	38
HBO2002L1	4050300508153	HBO 200 W/2 L1 AC/DC	200	5	38
HBO200DC	4050300506791	HBO 200 W/DC	200	5	38
HBO200DCTM	4008321137623	HBO 200 W/DC TM	200	5	38
<b>With reflector</b>					
HBOR10345	4050300405957	HBO R 103 W/45 DC	103	6	38

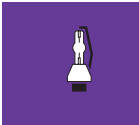

All orders must be multiples of sales pack





## Display/Optic Lamps

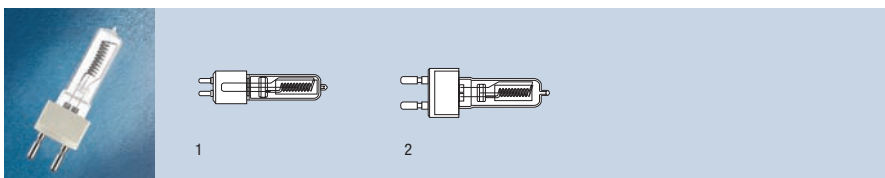

### Special lamps for IR applications

- Short wave halogen infrared lamp developed specifically for fast heating processes

Product ID Code	EAN (Single Pack)	Product Description	ANSI	W	V		No.		PPG
54555	4008321216304	54555	-	1000	120	G9.5	1	12	38
64743HT	4050300506531	64743 HT	FEL	1000	120	G9.5	2	12	38
VIPR120P24I	4050300563084	HXP R120W/ 17C	-	120	82.5	-	-	1	38
HXPR20045MP2	4008321180087	HXP R200W/ 45M	-	200	78	-	-	1	38

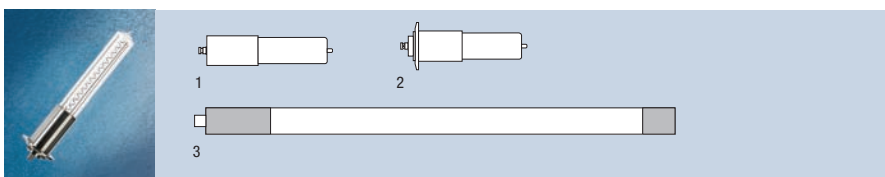

### XERADEX® lamps

- Xenon excimer lamps

Product ID Code	EAN (Single Pack)	Product Description	W		No.		PPG
<b>Single ended</b>							
XERADEX120SB4685	4008321190994	XERADEX L40/120/SB-S46/85	20	1	1	38	
XERADEX120SBKF50	4008321191014	XERADEX L40/120/SB-SX48/KF50	20	2	1	38	
XERADEX120SBKF50HV	4008321211255	XERADEX L40/120/SB-SX48/KF50HV	20	2	1	38	
XERADEX175SB4595	4008321191052	XERADEX L40/175/SB-S45/95	20	1	1	38	
XERADEX175SB4685	4008321191038	XERADEX L40/175/SB-S46/85	20	1	1	38	
XERADEX175SBKF50HV	4008321243713	XERADEX L40/175/SB-SX48/KF50HV	20	2	1	38	
<b>Double ended</b>							
XERADEX375DB	4008321939289	XERADEX L40/375/DB-AZ48/90	60	3	1	38	
XERADEX620DB	4008321939296	XERADEX L40/620/DB-AZ48/90	100	3	1	38	



All orders must be multiples of sales pack

Display/Optic Lamps

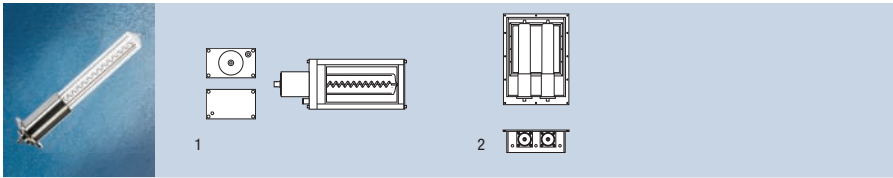

**XIS XERADEX® irradiation system**

- Complete systems that can be used as stand alone units or integrated as part of an installation
- The system comprises XERADEX® 20W lamps, DBD 20 electronic control gear, special VUC compatible reflectors and a quartz front panel

Product ID Code	EAN (Single Pack)	Product Description	l [mm]	b [mm]	h [mm]	No.	PPG
XTU70	4008321216328	XTU 70 30W 110-240V	180	94	56	1	38
XIS170S	4008321158253	XIS 170 60W 110-240V	320	230	75	2	38

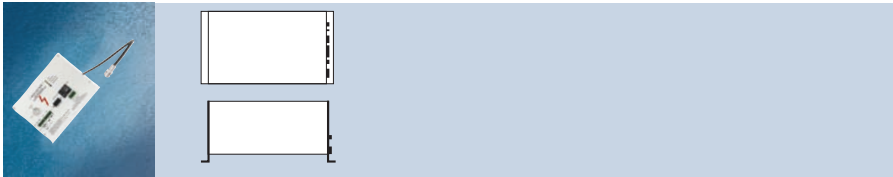

**DBD electronic control gear for XERADEX® lamps**

- DBD electronic control gear designed exclusively for operating XERADEX® lamps

Product ID Code	EAN (Single Pack)	Product Description	V	l [mm]	b [mm]	h [mm]	PPG
DBD20	4050300939469	DBD 20/110-240	110-240	240	17	95	38
DBD300DIM	4008321939357	DBD 300/100-240 DIM	110-240	250	166	125	38

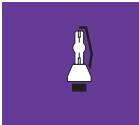

All orders must be multiples of sales pack



Display/Optic Lamps

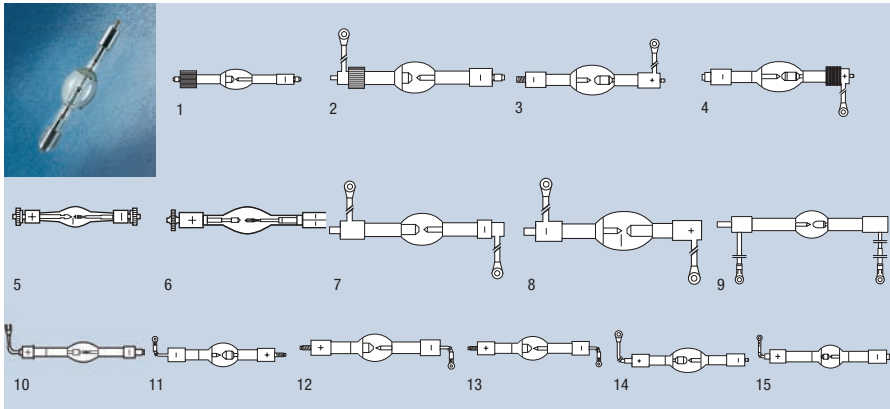

**Microlithography lamps for i-line systems**

Product ID Code	EAN (Single Pack)	Product Description	W	V	No.	PPG
-----------------	-------------------	---------------------	---	---	-----	-----

**For ASML i-line systems**

HBO1003PIL	4050300461380	HBO 1003W/PIL DC	700	27.1	1	8	38
HBO1500PIL	4050300461465	HBO 1500W/PIL DC	1500	23	2	6	38
HBO2100PIL	4050300800431	HBO 2100W/PIL DC	2100	24	2	6	38
HBO2500PIL	4050300947396	HBO 2500W/PIL DC	2500	28	3	1	38
HBO3500PIL	4008321355843	HBO 3500W/PIL DC	3400	23	4	4	38

**For Canon i-line systems**

HBO1000CEL	4050300412627	HBO 1000W/CEL	750	47	5	1	38
HBO1002CEL	4050300412634	HBO 1002W/CEL	750	47	6	1	38
HBO1500CIEL	4050300624037	HBO 1500W/CIEL	1500	23	7	6	38
HBO1500CIEL	4050300538204	HBO 1500W/CIEL	1500	23	7	1	38
HBO2001CIEL	4050300972121	HBO 2001W/CIEL	2000	26	8	4	38
HBO2001CIELX	4008321122735	HBO 2001W/CIELX	2000	24	8	4	38
HBO2001CIL	4050300947235	HBO 2001W/CIL	2000	26	8	4	38
HBO2700CIL	4050300896588	HBO 2700W/CIL	2700	26	9	1	38

**For Nikon i-line systems**

HBO1002NIL	4050300461403	HBO 1002W/NIL	750	25.8	10	8	38
HBO2000NIL	4050300490212	HBO 2000W/NIL	1750	26	11	1	38
HBO2001NIEL	4050300538211	HBO 2001W/NIEL	1750	26	12	1	38
HBO2001NIL	4050300461489	HBO 2001W/NIL	1750	26	12	6	38
HBO2002NIL	4050300772714	HBO 2002W/NIL	1750	26	13	1	38
HBO2011NIL	4050300652641	HBO 2011W/NIL	2000	25	13	6	38
HBO2011NILH	4050300991665	HBO 2011W/NILH	2000	25	13	6	38
HBO2501NIL	4050300628288	HBO 2501W/NIL	2500	23	14	4	38
HBO2510NIL	4050300628400	HBO 2510W/NIL	2500	23	15	4	38

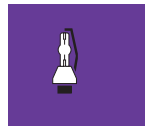

All orders must be multiples of sales pack

Display/Optic Lamps

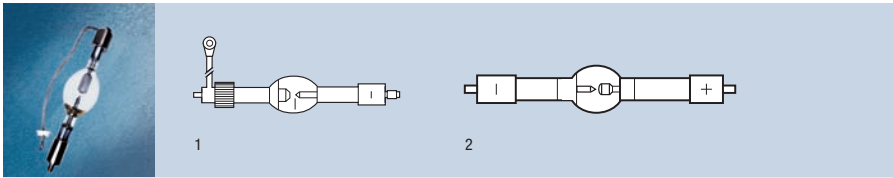

**Microlithography lamps for LCD systems**

Product ID Code	EAN (Single Pack)	Product Description	W	V	No.	PPG
<b>For Canon LCD systems</b>						
HBO8000C	4008321352323	HBO 8000W/C	8000	81	1	4 38
HBO8000CHL	4008321280282	HBO 8000W/CHL	8000	81	1	1 38
<b>For Nikon LCD systems</b>						
HBO4300NHLVS11	4008321281159	HBO 4300W/NHL	4300	54	2	4 38
HBO4300NHL	4008321281142	HBO 4300W/NHL	4300	54	2	1 38

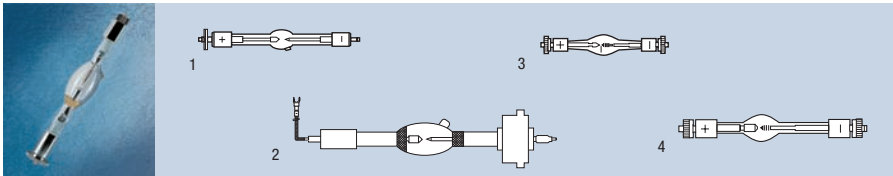

**Other Microlithography lamps up to 1000W**

Product ID Code	EAN (Single Pack)	Product Description	W	V	No.	PPG
HBO250BY	4050300803432	HBO 250W/BY DC	250	40	1	1 38
HBO250LS	4008321336668	HBO 250W/LS DC	250	39	2	1 38
HBO350	4050300351599	HBO 350W DC	350	67.5	3	1 38
HBO350S	4050300258041	HBO 350W/S DC	350	68	3	1 38
HBO1000D	4050300288857	HBO 1000W/D	1000	37.7	4	1 38

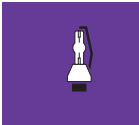

All orders must be multiples of sales pack



Display/Optic Lamps

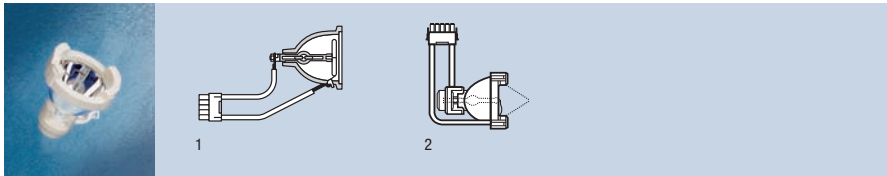

**HXP® long life mercury short-arc lamps**

- Pico 9 base
- Gas filled incandescent lamp
- Ideal for scientific applications

Product ID Code	EAN (Single Pack)	Product Description	W	No.	PPG
HXPR12017CP50	4050300786476	HXP R 120W/17C AC	120	1	38
HXPR12045CVIS	4050300882772	HXP R 120W/45C VIS AC	120	2	38
HXPR12045CUV	4050300666525	HXP R 120W/45C UV AC	120	2	38
HXPR20045M	4008321180070	HXP R 200W/45M AC	200	2	38

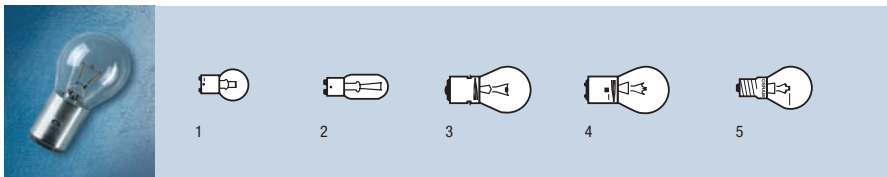

**Lamps without Halogen, low voltage**

- For optical and photo-electronic purposes

Product ID Code	EAN (Single Pack)	W	V	Base	No.	PPG
8013	4050300206356	10	6	BA15d	1	100 38
8014	4050300206370	10	6	BA15s	1	100 38
8017	4050300017327	15	6	B15d	2	100 38
8018	4050300206417	15	6	B15d	2	100 38
8022	4050300206677	50	12	BA20d	3	100 38
8024	4050300013817	40	12	BA20d	4	100 38
8100	4050300342122	5A	6	E14/SES	5	100 38



All orders must be multiples of sales pack

## Display/Optic Lamps

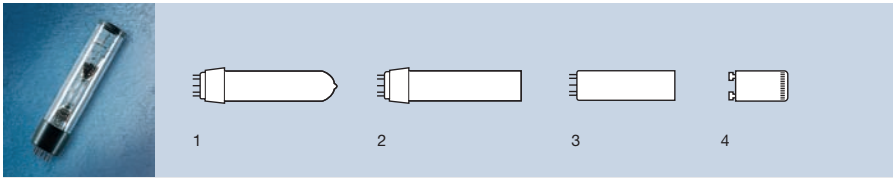

### SPECTRAL lamps

- Pico 9 base
- Gas filled incandescent lamp
- Ideal for scientific applications

Product ID Code	EAN (Single Pack)	AC/DC	Light Bulb Icon	W	No.	Box Icon	PPG
CD10	4050300210353	AC	Cadmium	15	1	1	38
CS10	4050300213842	AC	Caesium	10	1	1	38
HE10	4050300212258	AC	Helium	55	1	1	38
K10	4050300212197	AC	Potassium	10	1	1	38
NA10	4008321417800	AC	Sodium	15	1	1	38
NE10	4050300212210	AC	Neon	30	1	1	38
HG100	4050300231310	AC/DC	Mercury	22	2	1	38
HGCD10	4050300211459	AC	Mercury/ Cadmium	25	1	1	38
RB10	4050300213866	AC	Rubidium	10	1	1	38
TL10	4050300211435	AC	Thallium	15	1	1	38
ZN10	4050300212234	AC	Zinc	15	1	1	38

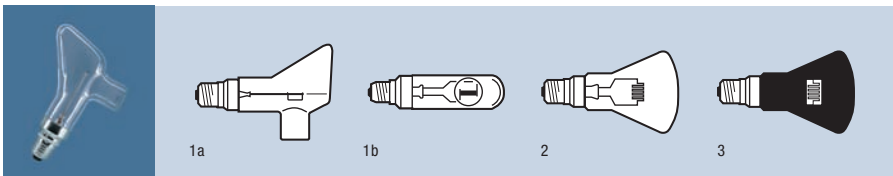

### Lamps for scientific purposes

- Used mainly for scientific purposes as comparison standards and calibration lamps
- Ideal for photometry, colorimetry and physics

Product ID Code	EAN (Single Pack)	Product Description	V	Box Icon	Light Bulb Icon	No.	Box Icon	PPG
WI17G	4050300209104	WI 17/G 9V 16A	9	E27/51X39	1	1	38	
WI40G	4050300206783	WI 40/G 31V 6A 2856K	31	E27/51X39	2	1	38	
WI41G	4050300206806	WI 41/G 31V 6A 2856K	31	E27/51X39	3	1	38	

All orders must be multiples of sales pack

Display/Optic and Special Lamps

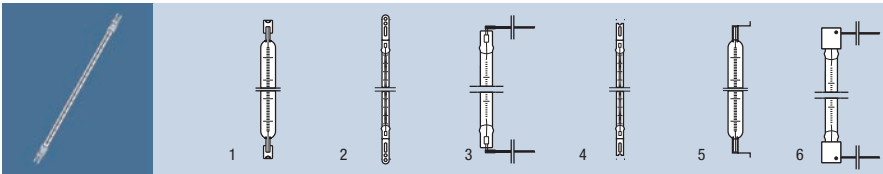

**HALOTHERM® Infra-red halogen lamps**

- Ideal for plastics, paper and printing industries, for drying paint and restaurant food areas

Product ID Code	EAN (Single Pack)	Product Description	W	V	COLOR				PPG
<b>Quartz Clear</b>									
ITT200	4008321203472	HALO ITT 200/235-0170	200	235	Quartz Clear	R7s	1	12	38
ITT350	4008321204219	HALO ITT 350/235-0170	350	235	Quartz Clear	R7s	1	12	38
ITT500CL	4008321203519	HALO ITT 500/235-0170	500	235	Quartz Clear	R7s	1	12	38
ITT500	4008321206701	HALO ITT 500/235-0170 K	500	235	Quartz Clear	R7s	1	12	38
ITT700	4008321203533	HALO ITT 700/235-0170	700	235	Quartz Clear	R7s	1	12	38
ITT1000	4008321203557	HALO ITT 1000/235-0170	1000	235	Quartz Clear	R7s	1	12	38
ITT100001ROL1	4008321555076	HALO ITT 1000/235-01X0	1000	235	Quartz Clear	X	2	12	38
ITT2000ROL1	4008321555137	HALO ITT 2000/235-01Y0 K	2000	235	Quartz Clear	Y	3	12	38
ITT2000	4008321555151	HALO ITT 2000/235-0103 K	2000	235	Quartz Clear	-	4	12	38
ITT2200	4008321555175	HALO ITT 2300/235-0102	2200	235	Quartz Clear	-	4	12	38
ITT3000UNV1	4008321387127	HALO ITT 3000/235-0102 K	3000	235	Quartz Clear	-	4	60	38
400ITT3000	4008321507174	HALO ITT 3000/400-0102 K	3000	400	Quartz Clear	-	4	60	38
ITT3000ROL1	4008321555199	HALO ITT 3000/235-01Y0 K	3000	235	Quartz Clear	Y	3	12	38
ITT3000	4008321206725	HALO ITT 3000/235-01Y0 Z/K	3000	235	Quartz Clear	Y/Z	5	30	38
<b>White reflector</b>									
ITT5000870	4008321206299	HALO ITT 500/235-0870	500	235	White reflector	R7s	1	12	38
ITT50008	4008321555090	HALO ITT 500/235-08X0	500	235	White reflector	X	2	12	38
ITT100008ROL1	4008321555113	HALO ITT 1000/235-08X0	1000	235	White reflector	X	2	12	38
ITT1000S	4008321206275	HALO ITT 1000/235-0826 /S	1000	235	White reflector	K9x15/21	6	12	38
ITT1000CL	4008321259738	HALO ITT 1000/235-0826 /S 600CL	1000	235	White reflector	K9x15/21	6	60	38
ITT2000	4008321206350	HALO ITT 2000/235-0826 K/S	2000	235	White reflector	K9x15/21	6	12	38
ITT2000CL	4008321259790	HALO ITT 2000/235-0826 K/S 600CL	2000	235	White reflector	K9x15/21	6	60	38
ITP2500	4008321252944	HALO ITP 2500/235-0826 K/S	2500	235	White reflector	K9x15/21	6	12	38
ITT2500	4008321206336	HALO ITT 2500/400-0826 K	2500	400	White reflector	K9x15/21	6	12	38
ITT3000CL	4008321206312	HALO ITT 3000/400-0826 K	3000	400	White reflector	K9x15/21	6	12	38

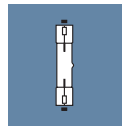

All orders must be multiples of sales pack

## Display/Optic and Special Lamps

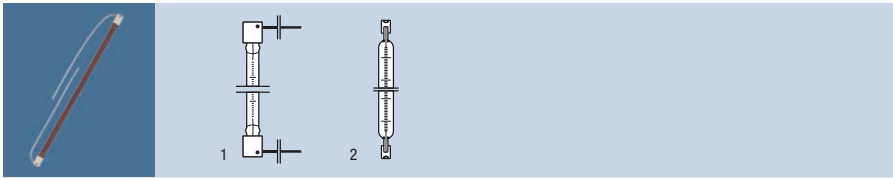

### RUBYSTAR® Halogen Infra-red lamps

- Rubied quartz Infra-red halogen lamp
- Ideal for applications in which visible light would be a distraction

Product ID Code	EAN (Single Pack)	Product Description	W	V	COLOR				PPG
RUBYST120026	4008321204233	RUBYSTAR 1200/235-0026 PH	1200	235	Rubied quartz	K9x15/21	1	12	38
RUBYST130070	4008321203618	RUBYSTAR 1300/235-0070	1300	235	Rubied quartz	R7s	2	12	38
RUBYST150028	4008321196804	RUBYSTAR 1500/235-0028	1500	235	Rubied quartz	K9x15/21	1	12	38
RUBYST200023	4008321196620	RUBYSTAR 1500/235-0023	2000	235	Rubied quartz	K9x15/21	1	12	38

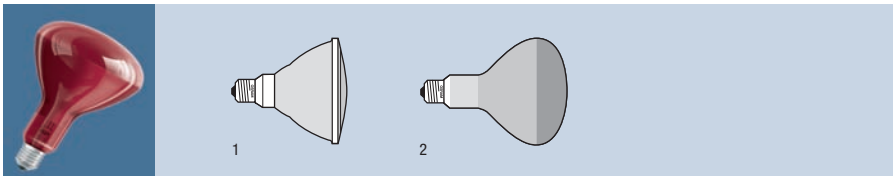

### SICCATHERM® Infra-red lamps

- Infra-red heat lamp
- Ideal for in food processing for pasteurising and drying and keeping food warm

Product ID Code	EAN (Single Pack)	Product Description	W	V	COLOR				PPG
240SICCA100LR	4008321392145	SICCATHERM PAR38 Red 100W	100	240	Red filter	E27	2	12	38
240SICCA150LR	4008321502094	SICCATHERM R125 Red 150W	150	240	Red filter	E27	1	12	38
240SICCA175LR	4008321392190	SICCATHERM PAR38 Red 175W	175	240	Red filter	E27	2	12	38
240SICCA250CL	4008321507051	SICCATHERM R125 CL 250W	250	240	Clear	E27	1	12	38
240SICCA250FR	4008321507037	SICCATHERM R125 FR 250W	250	240	Frosted	E27	1	12	38
240SICCA250LR	4008321507013	SICCATHERM R125 Red 250W	250	240	Red filter	E27	1	12	38
240SICCA275CL	4008321507075	SICCATHERM R125 CL 275W	275	240	Clear	E27	1	12	38
SICCA375	4050300206912	SICCATHERM R125 CL 375W	375	230	Clear	E27	1	12	38

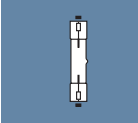

All orders must be multiples of sales pack



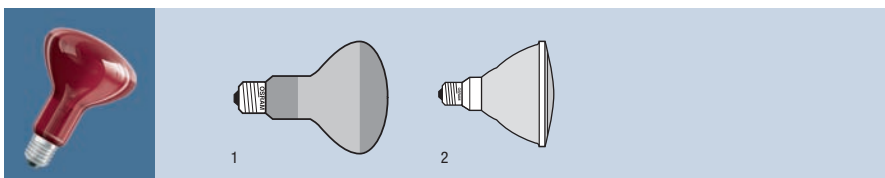

Display/Optic and Special Lamps



**THERATHERM® Infra-red heat lamps**

- Infra-red heat lamp
- Ideal for use in the cosmetic industry and as heat sources in saunas, swimming pools

Product ID Code	EAN (Single Pack)	Product Description	W	V	COLOR		 No.		PPG
THERA150DL	4008321392213	THERA PAR 38 Red DL 150W	150	240	Red filter	E27	2	12	38
THERA250	4008321507099	THERA R125 Red 250W	250	240	Red filter	E27	1	12	38

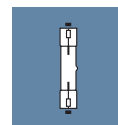

All orders must be multiples of sales pack

Display/Optic and Special Lamps



**Fluorescent tubes with black glass bulbs**

- Fluorescent tube that emits long wave UV radiation
- Ideal for all applications involving fluorescence analysis such as criminal investigation, Food and textiles industry and effect lighting

Product ID Code	EAN (Single Pack)	Product Description	W		I (mm)		PPG
L1873	4008321054685	L 18/73	18	G13	590	25	38
L3673	4008321054715	L 36/73	36	G13	1200	20	38

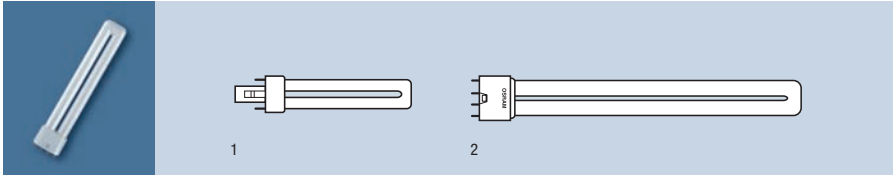

**OSRAM DULUX® BLUE AND BLUE UVA**

- DULUX® Blue: Compact fluorescent lamp approved for use in medical applications
- DULUX® Blue UVA: Compact fluorescent lamp used mainly for curing plastics, dentistry, circuit board manufacture and scientific investigation

Product ID Code	EAN (Single Pack)	Product Description	W		I (mm)	No.		PPG
DS971	4008321198860	DULUX S BLUE	9	G23	167mm	2	50	38
DL1871	4008321198884	DULUX L BLUE	18	2G11	217mm	1	10	38
DS778	4008321198907	DULUX S BLUE UVA	7	G23	137mm	2	50	38
DS978	4008321198938	DULUX S BLUE UVA	9	G23	167mm	2	50	38
DL1878	4008321198990	DULUX L BLUE UVA	18	2G11	217mm	1	10	38

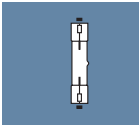

All orders must be multiples of sales pack

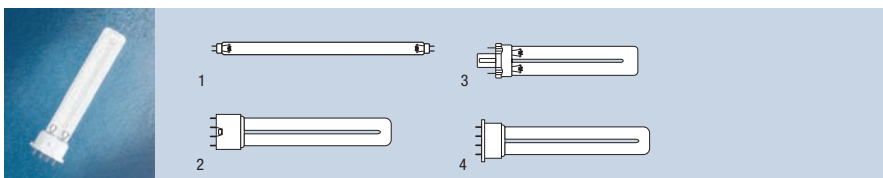

## Display/Optic and Special Lamps

**HNS® germicidal lamps producing no ozone**

- Germicidal lamps producing no ozone
- Ideal for disinfecting water, air and surfaces, water purification in applications such as swimming pools, water treatment systems, drinking water

Product ID Code	EAN (Single Pack)	Product Description	W		L (mm)	No.			PPG
HNS4	4008321378316	HNS 4W G5	4	G5	136	1	25	38	
HNS60FR	4008321378330	HNS 6W G5	6	G5	212	1	25	38	
HNS80FR	4008321378385	HNS 8W G5	8	G5	288	1	25	38	
HNS11G5	4008321468796	HNS 11W G5	11	G5	212	1	25	38	
HNS15G13	4008321398826	HNS 15W G13	15	G13	438	1	20	38	
HNS25G13	4008321398857	HNS 25W G13	25	G13	438	1	20	38	
HNS300FR	4008321398888	HNS 30W G13	30	G13	895	1	10	38	
HNS55G13	4008321398918	HNS 55W G13	55	G13	895	1	10	38	
HNSL18	4008321220431	HNS L 18W 2G11	18	2G11	214	2	10	38	
HNSL24	4008321220561	HNS L 24W 2G11	24	2G11	314	2	10	38	
HNSL36	4008321220684	HNS L 36W 2G11	36	2G11	408	2	10	38	
HNS50FR	4008321229946	HNS S 5W G23	5	G23	108	3	10	38	
HNS70FR	4050300941202	HNS S 7W G23	7	G23	136	3	10	38	
HNS90FR	4050300941226	HNS S 9W G23	9	G23	166	3	10	38	
HNS110FR	4050300941240	HNS S 11W G23	11	G23	236	3	10	38	
HNSSE7	4008321383891	HNS S/E 7W 2G7	7	2G7	112	4	10	38	
HNSSE9	4008321384911	HNS S/E 9W 2G7	9	2G7	142	4	10	38	
HNSSE11	4008321384935	HNS S/E 11W 2G7	11	2G7	212	4	10	38	

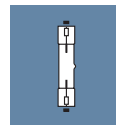

All orders must be multiples of sales pack

ELECTRONIC CONTROL GEAR



# Electronic Control Gear Contents.

## ECG FOR FLUORESCENT AND/OR COMPACT FLUORESCENT LAMPS

QUICKTRONIC® INTELLIGENT QT <sup>i</sup> DALI® DIM for T5 fluorescent tubes	237
QUICKTRONIC® INTELLIGENT QT <sup>i</sup> DALI® DIM for T8 fluorescent tubes	238
QUICKTRONIC® INTELLIGENT QT <sup>i</sup> DALI® DIM for CFL OSRAM DULUX® D/E, T/E	238
QUICKTRONIC® QT DALI® DIM for CFL OSRAM DULUX® T/E HE	239
QUICKTRONIC® INTELLIGENT QT <sup>i</sup> DIM (1-10V) for T5 fluorescent tubes	239
QUICKTRONIC® DE LUXE HF DIM (1-10V) for T8 fluorescent tubes	240
QUICKTRONIC® INTELLIGENT QT <sup>i</sup> DIM (1-10V) for T8 fluorescent tubes	240
QUICKTRONIC® INTELLIGENT QT <sup>i</sup> DIM (1-10V) for CFL OSRAM DULUX® D/E, T/E	241
QUICKTRONIC® INTELLIGENT QT <sup>i</sup> for T5 fluorescent tubes	241
QUICKTRONIC® PROFESSIONAL QTP5 for T5 HE fluorescent tubes	242
QUICKTRONIC® PROFESSIONAL for T5 HO fluorescent tubes	242
QUICKTRONIC® QT for T5 circular fluorescent tubes	243
QUICKTRONIC® PROFESSIONAL for T5 FC and DL lamps	243
QUICKTRONIC® PROFESSIONAL QTP8 for T8 fluorescent tubes	244
QUICKTRONIC® FIT QT-FIT8 for T8 fluorescent tubes	245
QUICKTRONIC® INSTANT START ECONOMIC QTIS E for T8 fluorescent tubes	246
QUICKTRONIC® ECO QT-ECO for CFL OSRAM DULUX® D/E, T/E, FM lamps	247
QUICKTRONIC® PROFESSIONAL QTP-DL for CFL OSRAM DULUX L® and F lamps	248
QUICKTRONIC® PROFESSIONAL for compact fluorescent lamps	249
QUICKTRONIC® QT-TE for CFL OSRAM DULUX® T/E HE	249
DULUXTRONIC®	250
QUICKTRONIC® QT-FM for T2 fluorescent tubes	251
QUICKTRONIC® ECONOMIC QT-ECO for T2 fluorescent tubes	251
QUICKTRONIC® for OSRAM ENDURA®	252
ECG accessories – Protective Casing OUTKIT®	252
ECG accessories – QT Cable Clamp	252

## ECG FOR HID LAMPS

POWERTRONIC® OUTDOOR PTo for HID lamps	253
POWERTRONIC® INTELLIGENT PTi S for HID lamp (without cable clamp)	254
POWERTRONIC® INTELLIGENT PTi for HID lamps (with cable clamp)	255
POWERTRONIC® INTELLIGENT SNAP for HID lamps (with cable clamp)	256
POWERTRONIC® FIT PT-FIT for HID lamps	256
POWERTRONIC® GREENHOUSE	257
EBN-OS Inrush current limiter for POWERTRONIC®	257

## ECG FOR LOW VOLTAGE HALOGEN LAMPS

HALOTRONIC® DALI® for Low Voltage Halogen lamps	258
HALOTRONIC® LONG (HTL) for Low Voltage Halogen lamps	258
HALOTRONIC® HTM MOUSE® for Low Voltage Halogen lamps	259
HALOTRONIC® NANO for Low Voltage Halogen lamps	259
ET-PARROT®	260
Dimming modules for HALOTRONIC®	260



## CONTENTS

### ECG FOR LED MODULES

10V OPTOTRONIC® units for LED modules	261
24V OPTOTRONIC® units for LED modules	261
350mA OPTOTRONIC® units for LED modules	262
700mA OPTOTRONIC® units for LED modules	262
OPTOTRONIC® Dimmers	263
OPTOTRONIC® Units with DALI interfaces	263
OPTOTRONIC® for PrevaLED™	264



# Systematic quality – from a single source

## The multi-level system guarantee from OSRAM

OSRAM introduced the System\* Guarantee for lamp and ECG from a single source more than 6 years ago. The System\* Guarantee is popular with system operators as it provides additional security for using modern energy-efficient systems, especially dimming systems. More than 10 million ECGs throughout the world have already been registered, ranging from industrial facilities and shopping centers to the smallest lighting systems. The System\* Guarantee is in high demand among users particularly for dimming systems and high-intensity discharge lamps.

OSRAM is the only ECG supplier to replace **any** ECG that fails as a result of a material or manufacturing defect.

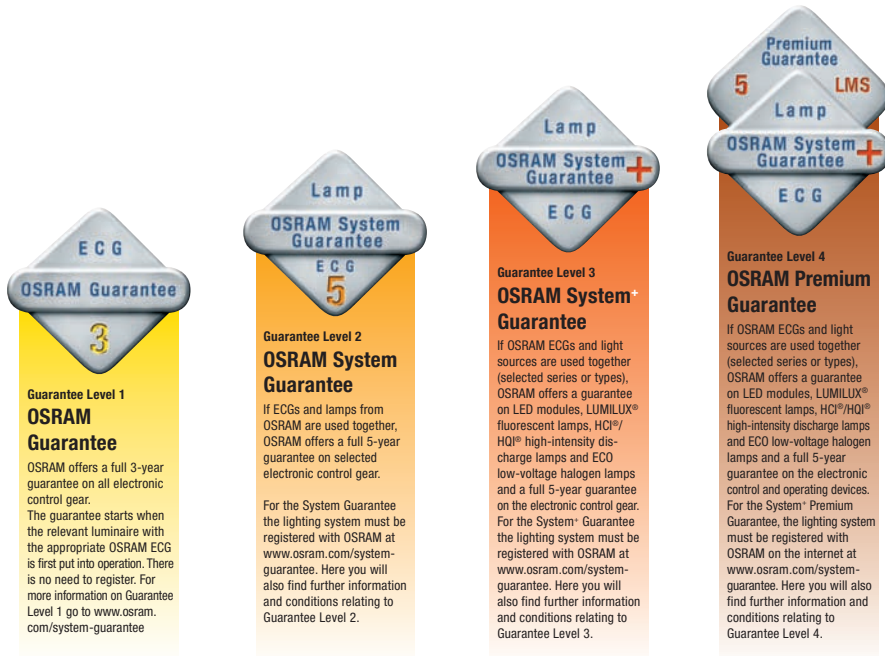

To meet market requirements and demands due to the increasing use of lighting control components OSRAM now offers in addition to a guarantee on lamps and ECGs a System\* Guarantee in connection with OSRAM lighting control components.

**For more information go to**  
[www.osram.com/system-guarantee](http://www.osram.com/system-guarantee)

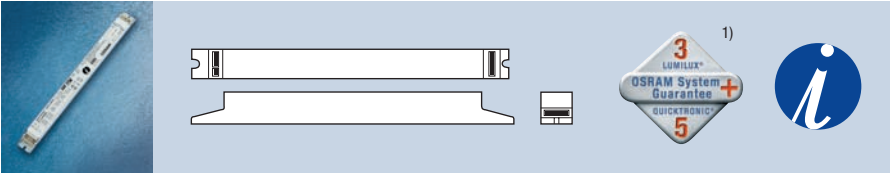
**ELECTRONIC CONTROL GEAR****ECG FOR FLUORESCENT AND/OR COMPACT FLUORESCENT LAMPS****QUICKTRONIC® INTELLIGENT QT<sub>i</sub> DALI® DIM for T5 fluorescent tubes**

- Digital dimmable ECG for T5 HE & HO fluorescent lamps, OSRAM DULUX® L CONSTANT, OSRAM DULUX® T/E IN PLUS
- Intelligent lamp detection and superior dimming from 1 to 100%

Product ID Code	EAN (Single Pack)	Product Description		PPG
<b>Single</b>				
QTIDALI114-24DIM	4050300870380	QT <sub>i</sub> DALI 1x14/24/220-240 DIM	20	39
QTIDALI121-39DIM	4050300870366	QT <sub>i</sub> DALI 1x21/39/220-240 DIM	20	39
QTIDALI128-54DIM	4050300870809	QT <sub>i</sub> DALI 1x28/54/220-240 DIM	20	39
QTIDALI135-80DIM	4050300870342	QT <sub>i</sub> DALI 1x35/49/80/220-240 DIM	20	39
<b>Twin</b>				
QTIDALI214-24DIM	4050300870861	QT <sub>i</sub> DALI 2x14/24/220-240 DIM	20	39
QTIDALI221-39DIM	4050300870489	QT <sub>i</sub> DALI 2x21/39/220-240 DIM	20	39
QTIDALI228-54DIM	4050300870502	QT <sub>i</sub> DALI 2x28/54/220-240 DIM	20	39
QTIDALI235-49DIM	4050300870465	QT <sub>i</sub> DALI 2x35/49/220-240 DIM	20	39
QTIDALI280DIM	4050300870441	QT <sub>i</sub> DALI 2x80/220-240 DIM	20	39
<b>Three &amp; four lamps</b>				
QTIDALI314-24DIM	4008321069955	QT <sub>i</sub> DALI 3x14/24/220-240 DIM	20	39
QTIDALI414-24DIM	4008321070036	QT <sub>i</sub> DALI 4x14/24/220-240 DIM	20	39

1) For more information go to [www.osram.com/system-guarantee](http://www.osram.com/system-guarantee)



All orders must be multiples of sales pack



Electronic Control Gear – ECG for Fluorescent and/or Compact Fluorescent Lamps

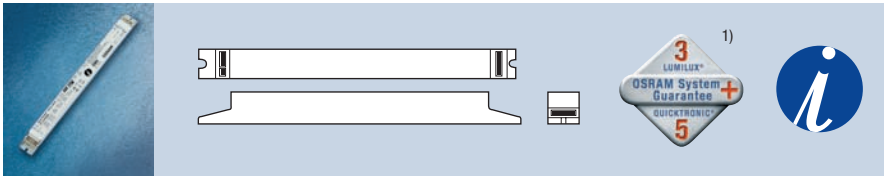

**QUICKTRONIC® INTELLIGENT QT<sub>i</sub> DALI® DIM for T8 fluorescent tubes**

- Digital dimmable ECG for T8 fluorescent lamps
- Intelligent lamp detection and superior dimming from 1 to 100%



Product ID Code	EAN (Single Pack)	Product Description		PPG
<b>Single</b>				
QTIDALI118DIM	4050300870403	QT <sub>i</sub> DALI 1x18/220-240 DIM	20	39
QTIDALI136DIM	4050300870427	QT <sub>i</sub> DALI 1x36/220-240 DIM	20	39
QTIDALI158DIM	4050300870823	QT <sub>i</sub> DALI 1x58/220-240 DIM	20	39
<b>Twin</b>				
QTIDALI218DIM	4050300870526	QT <sub>i</sub> DALI 2x18/220-240 DIM	20	39
QTIDALI236DIM	4050300870885	QT <sub>i</sub> DALI 2x36/220-240 DIM	20	39
QTIDALI258DIM	4050300870847	QT <sub>i</sub> DALI 2x58/220-240 DIM	20	39
<b>Three &amp; four lamps</b>				
QTIDALI318DIM	4008321069979	QT <sub>i</sub> DALI 3x18/220-240 DIM	20	39
QTIDALI418DIM	4008321070050	QT <sub>i</sub> DALI 4x18/220-240 DIM	20	39

1) For more information go to [www.osram.com/system-guarantee](http://www.osram.com/system-guarantee)

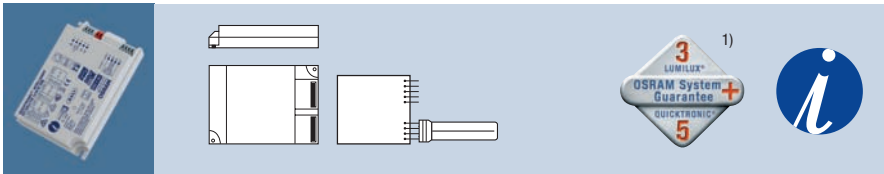

**QUICKTRONIC® INTELLIGENT QT<sub>i</sub> DALI® DIM for CFL OSRAM DULUX® D/E,T/E**

- Intelligent digital dimmable ECG for OSRAM DULUX® D/E and T/E compact fluorescent lamps
- With DALI or 1-10V dimming interface



Product ID Code	EAN (Single Pack)	Product Description		PPG
<b>Single</b>				
QTIDALITE118-57DIM	4008321060808	QT <sub>i</sub> DALI-T/E 1x18-57 DIM	20	39
<b>Twin</b>				
QTIDALITE218-42DIM	4008321060822	QT <sub>i</sub> DALI-T/E 2x18-42 DIM	20	39

1) For more information go to [www.osram.com/system-guarantee](http://www.osram.com/system-guarantee)

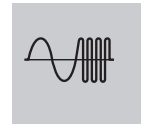

All orders must be multiples of sales pack

Electronic Control Gear – ECG for Fluorescent and/or Compact Fluorescent Lamps



**QUICKTRONIC® QT DALI® DIM for CFL OSRAM DULUX® T/E HE**

- New QT (DALI) T/E 14-17 HE for operating OSRAM DULUX® T/E HE Lamps

Product ID Code	EAN (Single Pack)	Product Description		PPG
QTDALITE114-17DIM	4008321327383	QT DALI T/E 1x14-17 HE DIM	12	39
QTDALITE214-17DIM	4008321327406	QTP DALI T/E 2x14-17 HE DIM	12	39

NEW

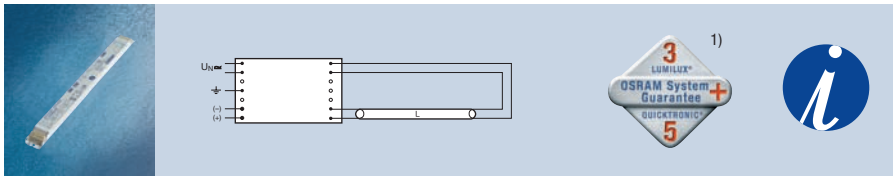

**QUICKTRONIC® INTELLIGENT QT i DIM (1-10V) for T5 fluorescent tubes**

- 1...10V intelligent dimmable ECG for T5 HO and HE fluorescent lamps
- Dimming range 1 to 100%

Product ID Code	EAN (Single Pack)	Product Description		PPG
<b>Single</b>				
QTI114-24DIM	4050300870922	QTI 1x14/24/220-240 DIM	20	39
QTI121-39DIM	4050300870564	QTI 1x21/39/220-240 DIM	20	39
QTI128-54DIM	4050300870588	QTI 1x28/54/220-240 DIM	20	39
QTI135-80DIM	4050300870540	QTI 1x35/49/80/220-240 DIM	20	39
<b>Twin</b>				
QTI214-24DIM	4050300870946	QTI 2x14/24/220-240 DIM	20	39
QTI221-39DIM	4050300870694	QTI 2x21/39/220-240 DIM	20	39
QTI228-54DIM	4050300870717	QTI 2x28/54/220-240 DIM	20	39
QTI235-49DIM	4050300870670	QTI 2x35/49/220-240 DIM	20	39
QTI235DIM	4050300870984	QTI 2x80/220-240 DIM	20	39
<b>Three &amp; four lamps</b>				
QTI314-24DIM	4008321069719	QTI 3x14/24/220-240 DIM	20	39
QTI414-24DIM	4008321069993	QTI 4x14/24/220-240 DIM	20	39

1) For more information go to [www.osram.com/system-guarantee](http://www.osram.com/system-guarantee)

All orders must be multiples of sales pack

## Electronic Control Gear – ECG for Fluorescent and/or Compact Fluorescent Lamps

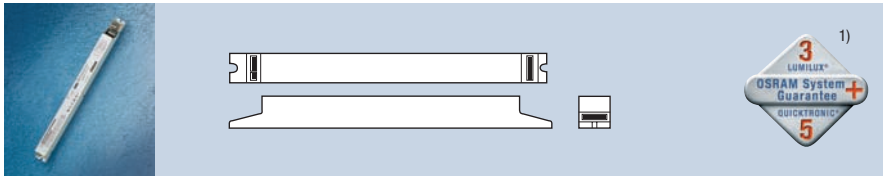
**QUICKTRONIC® DE LUXE HF DIM (1-10V) for T8 fluorescent tubes**

- 1...10V dimming ECG for T8 fluorescent lamps
- Dimming range 1 to 100% (three & four lamp 3 to 100%)

Product ID Code	EAN (Single Pack)	Product Description		PPG
<b>Single</b>				
HF118DIM	4050300319254	HF 1x18/230-240 DIM	20	39
HF136DIM	4050300297705	HF 1x36/230-240 DIM	20	39
HF158DIM	4050300297729	HF 1x58/230-240 DIM	20	39
<b>Twin</b>				
HF218DIM	4050300350950	HF 2x18/230-240 DIM	20	39
HF236DIM	4050300350974	HF 2x36/230-240 DIM	20	39
HF258DIM	4050300350998	HF 2x58/230-240 DIM	20	39

1) For more information go to [www.osram.com/system-guarantee](http://www.osram.com/system-guarantee)

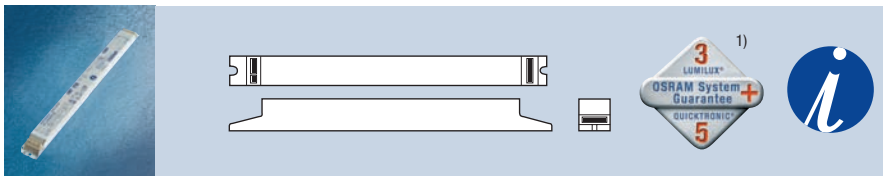
**QUICKTRONIC® INTELLIGENT QT i DIM (1-10V) for T8 fluorescent tubes**

- 1...10V intelligent dimmable ECG for T8 fluorescent lamps
- Dimming range 1 to 100%

Product ID Code	EAN (Single Pack)	Product Description		PPG
<b>Single</b>				
QTI118DIM	4050300870601	QTI 1x18/220-240 DIM	20	39
QTI136DIM	4050300870625	QTI 1x36/220-240 DIM	20	39
QTI158DIM	4050300870908	QTI 1x58/220-240 DIM	20	39
<b>Twin</b>				
QTI218DIM	4050300870960	QTI 2x18/220-240 DIM	20	39
QTI236DIM	4050300870755	QTI 2x36/220-240 DIM	20	39
QTI258DIM	4050300870731	QTI 2x58/220-240 DIM	20	39
<b>Three &amp; four lamps</b>				
QTI318DIM	4008321069931	QTI 3x18/220-240 DIM	20	39
QTI418DIM	4008321070012	QTI 4x18/220-240 DIM	20	39

1) For more information go to [www.osram.com/system-guarantee](http://www.osram.com/system-guarantee)



All orders must be multiples of sales pack

Electronic Control Gear – ECG for Fluorescent and/or Compact Fluorescent Lamps

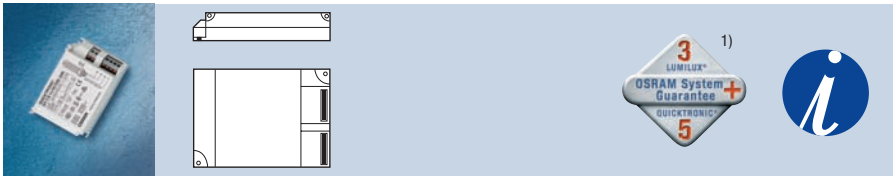

**QUICKTRONIC® INTELLIGENT QT i DIM (1-10V) for CFL OSRAM DULUX® D/E, T/E**

- 1...10V intelligent dimmable ECG for OSRAM DULUX® D/E and T/E compact fluorescent lamps

Product ID Code	EAN (Single Pack)	Product Description		PPG
QTITE118-57DIM	4008321060860	QT i-T/E 1x18-57/ 220-240 DIM	20	39
<b>Twin</b>				
QTITE218-42DIM	4008321060846	QT i-T/E 2x18-42 / 220-240 DIM	20	39

1) For more information go to [www.osram.com/system-guarantee](http://www.osram.com/system-guarantee)

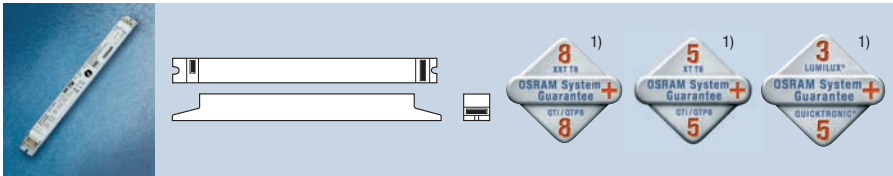

**QUICKTRONIC® INTELLIGENT QT i for T5 fluorescent tubes**

- Intelligent ECG for T5 HO and HE fluorescent lamps
- Higher efficiency, shorter cases

Product ID Code	EAN (Single Pack)	Product Description		PPG
<b>Single</b>				
QT i114	4050300796871	QT i 1x14/24/21/39	20	39
QT i114GII	4008321383334	QT i 1x14/24/21/39 GII	20	39
QT i128	4050300796857	QT i 1x28/54	20	39
QT i128GII	4008321383358	QT i 1x28/54/35/49 GII	20	39
QT i135	4050300796833	QT i 1x35/49/80	20	39
QT i135GII	4008321383372	QT i 1x35/49/80 GII	20	39
<b>Twin</b>				
QT i214	4050300797090	QT i 2x14/24/21/39	20	39
QT i214GII	4008321383396	QT i 2x14/24/21/39 GII	20	39
QT i228	4050300797076	QT i 2x28/54	20	39
QT i228GII	4008321383419	QT i 2x28/54/35/49 GII	20	39
QT i235	4050300796895	QT i 2x35/49	20	39
QT i235-80	4008321174291	QT i 2x35/49/80	20	39

1) For more information go to [www.osram.com/system-guarantee](http://www.osram.com/system-guarantee)

NEW  
NEW  
NEW  
NEW

All orders must be multiples of sales pack

## Electronic Control Gear – ECG for Fluorescent and/or Compact Fluorescent Lamps

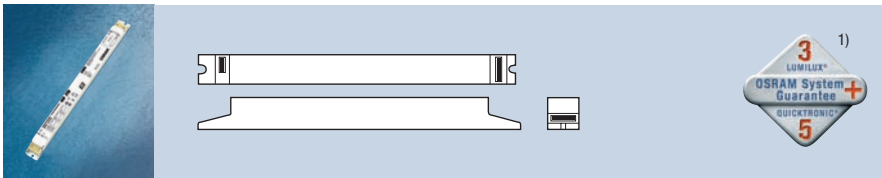
**QUICKTRONIC® PROFESSIONAL QTP5 for T5 HE fluorescent tubes**

- ECG for T5 HE fluorescent lamps including NEW Longlife XT HO T5 tube and DULUX® L 28W HE lamps
- New 2nd generation family offer product life of up to 100,000 hours, suitable for protection class I & II luminaires and are shorter in dimension



Product ID Code	EAN (Single Pack)	Product Description		PPG
<b>Single</b>				
QTP511435	4008321329035	QTP5 1x14-35 2nd generation	20	39
<b>Twin</b>				
QTP521435	4008321329073	QTP5 2x14-35 2nd generation	20	39
<b>Triple</b>				
QTP5314	4008321484598	QTP5 3x14, 4x14	20	39

1) For more information go to [www.osram.com/system-guarantee](http://www.osram.com/system-guarantee)

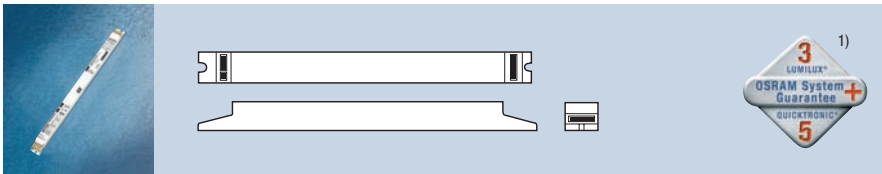
**QUICKTRONIC® PROFESSIONAL for T5 HO fluorescent tubes**

- ECG for T5 HO fluorescent tubes and DULUX® L 55W-80W
- New 2nd generation family offer product life of up to 100,000 hours, suitable for protection class I & II luminaires and are shorter in dimension



Product ID Code	EAN (Single Pack)	Product Description		PPG
<b>Single</b>				
QTP512439	4008321329110	QTP5 1x24-39 2nd generation	20	39
QTP5149	4008321329370	QTP5 1x49 2nd generation	20	39
QTP5154	4008321329394	QTP5 1x54 2nd generation	20	39
QTP5180	4008321329059	QTP5 1x80 2nd generation	20	39
<b>Twin</b>				
QTP522439	4008321329417	QTP5 2 X24-39 2nd generation	20	39
QTP5249	4008321329431	QTP5 2x49 2nd generation	20	39
QTP5254	4008321329097	QTP5 2x54 2nd generation	20	39
QTFQ280CW	4050300825564	QTP5 2x80 2nd generation	20	39

1) For more information go to [www.osram.com/system-guarantee](http://www.osram.com/system-guarantee)

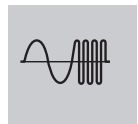

All orders must be multiples of sales pack

## Electronic Control Gear – ECG for Fluorescent and/or Compact Fluorescent Lamps

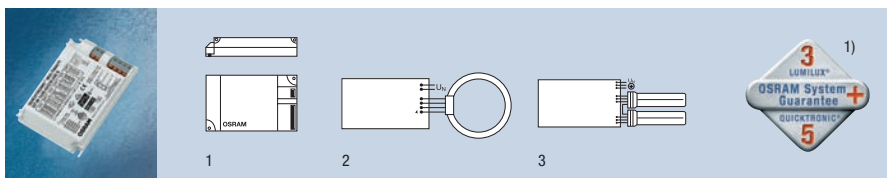

### QUICKTRONIC® QT for T5 circular fluorescent tubes

- ECG for T5 circular fluorescent lamps

Product ID Code	EAN (Single Pack)	Product Description	No.	Light Bulb Icon	PPG
<b>Single</b>					
QTM126-42SE	4050300817699	QT-M 1x26-42/220-240 SE OUTDOOR USE MULTIWATT	1	20	39
QTFC155	4050300526096	QT-FC 1x55/230-240	2	20	39
<b>Twin</b>					
QTM226-32	4050300624969	QT-M 2x26-32/230-240 MULTIWATT	3	20	39
QTM226-42	4008321110022	QT-M 2x26-42/220-240 MULTIWATT	3	20	39

1) For more information go to [www.osram.com/system-guarantee](http://www.osram.com/system-guarantee)

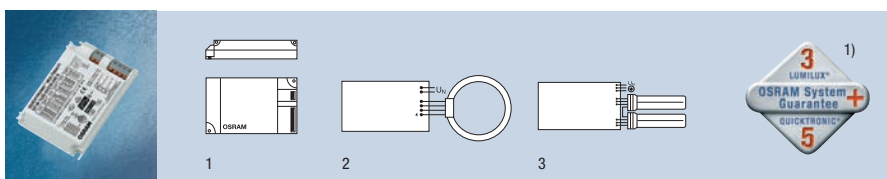

### QUICKTRONIC® PROFESSIONAL for T5 FC and DL lamps

- Suitable for 1xFC 55 and 1xDL 55W lamps
- K2 case (103 x 67 x 31 mm)
- Suitable for optional K2 cable clamp for independent installation
- 50,000 hours lifetime

Product ID Code	EAN (Single Pack)	Product Description	No.	PPG
QTPFC155	4008321537041*	QTP-FC - 1x FC 55 and 1x DL 55	20	39

1) For more information go to [www.osram.com/system-guarantee](http://www.osram.com/system-guarantee)

\*In preparation at time of print. For further information please contact OSRAM

NEW

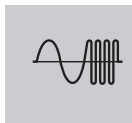

All orders must be multiples of sales pack

Electronic Control Gear – ECG for Fluorescent and/or Compact Fluorescent Lamps

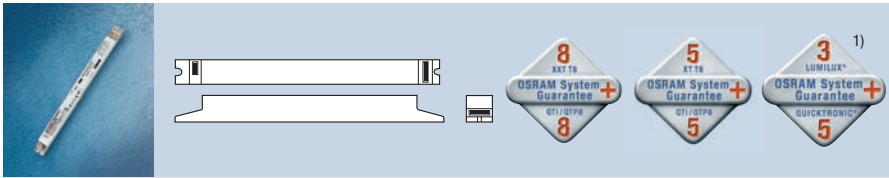

**QUICKTRONIC® PROFESSIONAL QTP8 for T8 fluorescent tubes**

- ECG for T8 fluorescent lamps including the new OSRAM LUMILUX® XXT tube



Product ID Code	EAN (Single Pack)	Product Description		PPG
<b>Single</b>				
QTP8118	4008321131584	QTP8 1x18/230-240	20	39
QTP8136	4008321131621	QTP8 1x36/230-240	20	39
QTP8158	4008321131669	QTP8 1x58/230-240	20	39
<b>Twin</b>				
QTP8218	4008321131607	QTP8 2x18/230-240	20	39
QTP8236	4008321131645	QTP8 2x36/230-240	20	39
QTP8258	4008321131683	QTP8 2x58/230-240	20	39
<b>Three &amp; four lamps</b>				
QTP8318	4008321131706	QTP8 3x18, 4x18/230-240	20	39

1) For more information go to [www.osram.com/system-guarantee](http://www.osram.com/system-guarantee)



All orders must be multiples of sales pack

## Electronic Control Gear – ECG for Fluorescent and/or Compact Fluorescent Lamps

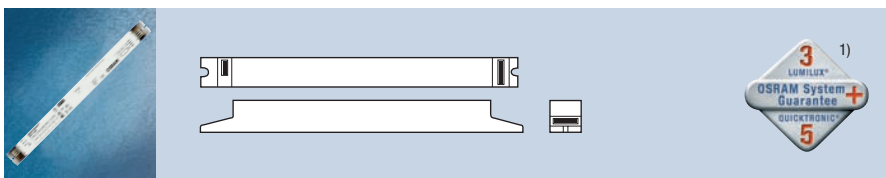
**QUICKTRONIC® FIT QT-FIT8 for T8 fluorescent tubes**

- T8 standard pre-heat ECG for T8 fluorescent tubes
- Up to 25% energy saving and 80% higher lamp life compared to magnetic ballast
- Automatic shutdown at lamp failure and automatic restart after lamp replacement
- High energy efficiency (EEL=A2)
- Long ECG lifetime (50,000 hours) suitable for use with motion sensors

Product ID Code	EAN (Single Pack)	Product Description		PPG
<b>Single</b>				
QTFIT8118	4008321294180	QT-FIT8 1X18	20	39
QTFIT8136	4008321294203	QT-FIT8 1X36	20	39
QTFIT8158	4008321294227	QT-FIT8 1X58-70	20	39
<b>Twin</b>				
QTFIT8218	4008321294241	QT-FIT8 2X18	20	39
QTFIT8236	4008321294265	QT-FIT8 2X36	20	39
QTFIT8258	4008321294289	QT-FIT8 2X58-70	20	39
<b>Three &amp; four lamps</b>				
QTFIT8318	4008321294302	QT-FIT8 3X, 4X18	20	39
QTFIT8336	4008321512055	QT-FIT8 3X36	20	39

1) For more information go to [www.osram.com/system-guarantee](http://www.osram.com/system-guarantee)

NEW



All orders must be multiples of sales pack

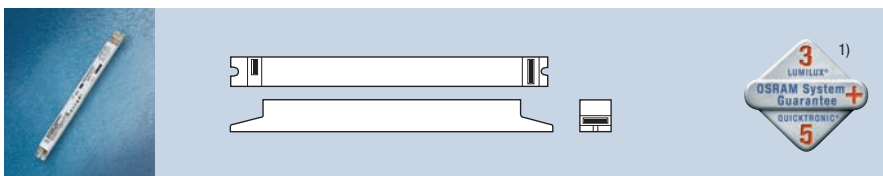

## Electronic Control Gear – ECG for Fluorescent and/or Compact Fluorescent Lamps

**QUICKTRONIC® INSTANT START ECONOMIC QTIS E for T8 fluorescent tubes**

- Economical ECG for T8 fluorescent lamps

Product ID Code	EAN (Single Pack)	Product Description		PPG
<b>Single</b>				
■ QTISE118	4050300775388	QTIS e 1x18/220-240	20	39
■ QTISE136	4050300940649	QTIS e 1x36/220-240	20	39
■ QTISE158	4050300940625	QTIS e 1x58/220-240	20	39
<b>Twin</b>				
■ QTISE218	4050300775401	QTIS e 2x18/220-240	20	39
■ QTISE236	4050300940663	QTIS e 2x36/220-240	20	39
■ QTISE258	4050300940618	QTIS e 2x58/220-240	20	39
<b>Three &amp; four lamps</b>				
■ QTISE418	4050300940670	QTIS e 3x18, 4x18/220-240	20	39
■ QTISE336CW	4008321104687	QTIS e 3x36/220-240	20	39

Will be replaced by QT-FIT8. Please refer to page 246 for further information

1) For more information go to [www.osram.com/system-guarantee](http://www.osram.com/system-guarantee)

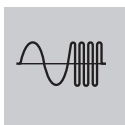

All orders must be multiples of sales pack

## Electronic Control Gear – ECG for Fluorescent and/or Compact Fluorescent Lamps

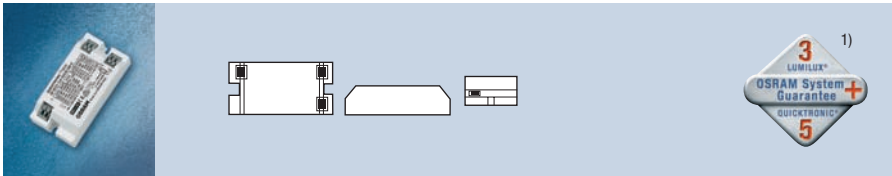
**QUICKTRONIC® ECO QT-ECO for CFL OSRAM DULUX® D/E, T/E, FM lamps**

- ECG with typical dimensions of CCG
- Suitable for compact fluorescent lamps

Product ID Code	EAN (Single Pack)	Product Description		
<b>Single</b>				
QTECO14-16	4050300638584	QT-ECO 1x4-16/220-240 S square	20	39
QTECO14-16L	4050300660370	QT-ECO 1x4-16/220-240 L long	20	39
QTECO118-21	4050300794907	QT-ECO 1x18-21/220-240 S square	20	39
QTECO118-24	4050300638560	QT-ECO 1x18-24/220-240 S square	20	39
QTECO118-24L	4050300660417	QT-ECO 1x18-24/220-240 L long	20	39
QTECO126	4008321065971	QT-ECO 1x26/220-240 S square	20	39
<b>Twin</b>				
QTECO25-11	4050300821504	QT-ECO 2x5-11/220-240 S square	20	39
QTECOTE218	4050300803982	QT-ECO/T/E 2x18/220-240 S square	20	39
QTECOTE226	4050300804002	QT-ECO T/E 2x26/220-240 S square	20	39

1) For more information go to [www.osram.com/system-guarantee](http://www.osram.com/system-guarantee)



All orders must be multiples of sales pack

## Electronic Control Gear – ECG for Fluorescent and/or Compact Fluorescent Lamps

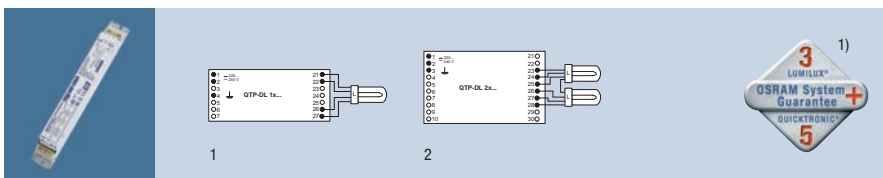

### QUICKTRONIC® PROFESSIONAL QTP-DL for CFL OSRAM DULUX® L and F lamps

- ECG for OSRAM DULUX® L and F compact fluorescent lamps
- 2nd generation version with shorter cases

Product ID Code	EAN (Single Pack)	Product Description	No.	PPG
<b>Single</b>				
QTPDL11824	4008321117861	QTP-DL 1x18-24/220-240	1	20 39
QTPDL13640	4008321117908	QTP-DL 1x36-40/220-240	1	20 39
QTPDL155	4008321117946	QTP-DL 1x55/220-240	1	20 39
QTPDL155GII	4008321390158	QTP-DL 1x55/220-240 GII (2nd Generation)	1	20 39
<b>Twin</b>				
QTPDL21824	4008321117885	QTP-DL 2x18-24/220-240	2	20 39
QTPDL23640	4008321117922	QTP-DL 2x36-40/220-240	2	20 39
QTPDL255	4008321117960	QTP-DL 2x55/220-240	2	20 39
QTPDL255GII	4008321390172	QTP-DL 2x55/220-240 GII (2nd Generation)	2	20 39

1) For more information go to [www.osram.com/system-guarantee](http://www.osram.com/system-guarantee)

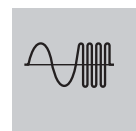

All orders must be multiples of sales pack

## Electronic Control Gear – ECG for Fluorescent and/or Compact Fluorescent Lamps

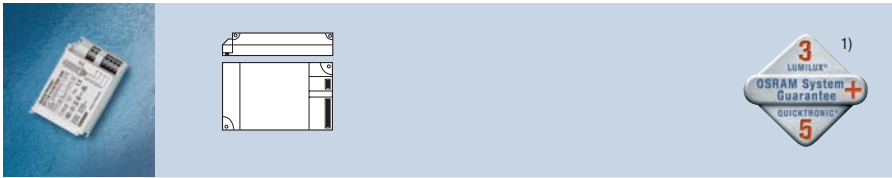
**QUICKTRONIC® PROFESSIONAL for Compact Fluorescent lamps**

- ECG for 4-pin compact fluorescent lamps
- Suitable for OSRAM DULUX® D/E and T/E lamps
- New QTP Multiwatt version suitable for OSRAM DULUX® D/E, T/E, DL, DF and LUMILUX® FC, HO & T8 lamps

Product ID Code	EAN (Single Pack)	Product Description		PPG
<b>Single</b>				
QTPDE110	4008321181572	QTP-D/E 1x10-13/220-240	20	39
QTPTE118	4008321181701	QTP-T/E 1x18-13/220-240	20	39
QTM126-42SE	4050300817699	QT-M 1x26-42/220-240 SE OUTDOOR USE MULTIWATT	20	39
QTPM126-42	4008321329134	QTP-M 1x 26-42/220-240	20	39
<b>Twin</b>				
QTPDE21013	4008321181596	QTP-D/E 2x10-13/220-240	20	39
QTPTE218	4008321181619	QTP-T/E 2x18/220-240	20	39
QTM226-32	4050300624969	QT-M 2x26-32/230-240 MULTIWATT	20	39
QTM226-42	4008321110022	QT-M 2x26-42/220-240 MULTIWATT	20	39
QTPM226-32	4008321329158	QTP-M 2x 26-32/220-240	20	39

1) For more information go to [www.osram.com/system-guarantee](http://www.osram.com/system-guarantee)

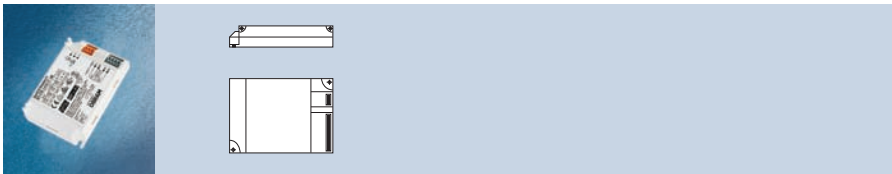
**QUICKTRONIC® QT-TE and QT-T/E HE for CFL OSRAM DULUX® T/E and T/E HE**

QTTE114-17	4008321327345	QT-T/E 1x14-17 HE	12	39
QTTE214-17	4008321327369	QT-T/E 2x14-17 HE	12	39
QTPTE1218	4008321537065	QTP-T/E 1x18, 2x18	20	39
QTPTE1226	4008321537089	QTP-T/E 1x26-42, 2x26	20	39



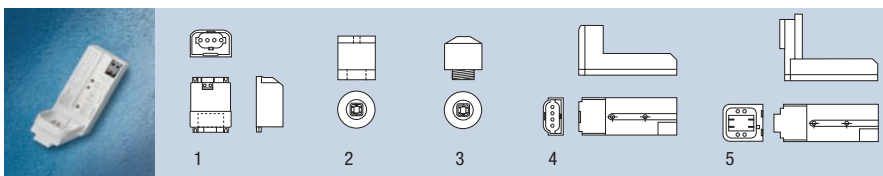

All orders must be multiples of sales pack

## Electronic Control Gear – ECG for Fluorescent and/or Compact Fluorescent Lamps

**DULUXTRONIC®**

- ECG with integral lampholder for pin base compact fluorescent
- Suitable for OSRAM DULUX® S/E, D/E and T/E

Product ID Code	EAN (Single Pack)	Product Description	 No.		PPG
<b>S version</b>					
DTSE511S	4008321181459	DT-S/E 5-11/230-240 S	1	20	39
<b>C version</b>					
DTDE1013C	4008321181510		2	20	39
DTTE18C	4050300421384	DT-T/E 18/230-240 C	2	20	39
<b>P version</b>					
DTDE1013P	4008321181534	DT-D/E 10-13/230-240 P	3	20	39
DTTE18P	4050300421421	DT-T/E 18/230-240 P	3	20	39
<b>L version</b>					
DTSE511L	4008321181473	DT-S/E 5-11/230-240 L	4	20	39
DTDE1013L	4008321181497	DT-D/E 10-13/230-240 L	5	20	39
DTTE18L	4050300406404	DT-T/E 18/230-240 L	5	20	39



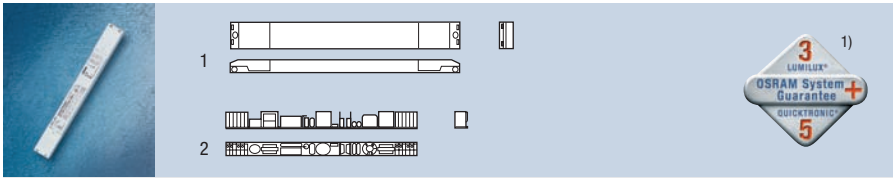

All orders must be multiples of sales pack

Electronic Control Gear – ECG for Fluorescent and/or Compact Fluorescent Lamps



**QUICKTRONIC® QT-FM for T2 fluorescent tubes**

- ECG for FM T2 miniature fluorescent lamps

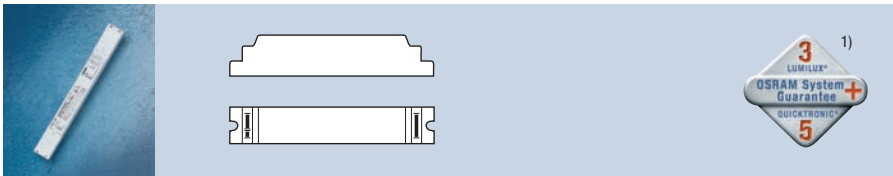

Product ID Code	EAN (Single Pack)	Product Description	  		
<b>With housing</b>					
QTFM16	4050300511139	QT-FM 1x6/230-240 L	1	20	39
QTFM18	4050300511153	QT-FM 1x8/230-240 L	1	20	39
QTFM111	4050300511177	QT-FM 1x11/230-240 L	1	20	39
QTFM113	4050300511191	QT-FM 1x13/230-240 L	1	20	39
<b>Without housing</b>					
QTFM18LB	4050300363523	QT-FM 1x8/230-240 LB	2	20	39
QTFM111LB	4050300363547	QT-FM 1x11/230-240 LB	2	20	39
QTFM113LB	4050300363561	QT-FM 1x13/230-240 LB	2	20	39

1) For more information go to [www.osram.com/system-guarantee](http://www.osram.com/system-guarantee)



**QUICKTRONIC® ECONOMIC QT-ECO for T2 fluorescent tubes**

- ECG for FM T2 miniature fluorescent lamps

Product ID Code	EAN (Single Pack)	Product Description	 	
QTECOFM16-8	4050300797502	QT-ECO FM 1x6-8/220-240	50	39
QTECOFM111-13	4050300799780	QT-ECO FM 1x11-13/220-240	20	39

1) For more information go to [www.osram.com/system-guarantee](http://www.osram.com/system-guarantee)



All orders must be multiples of sales pack

## Electronic Control Gear – ECG for Fluorescent and/or Compact Fluorescent Lamps

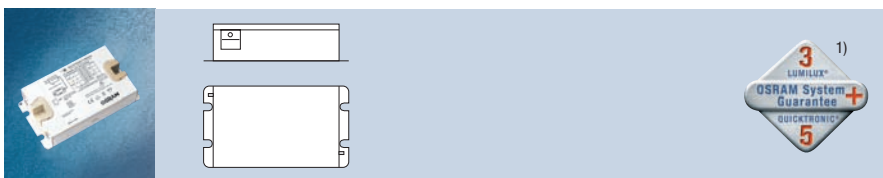

### QUICKTRONIC® for OSRAM ENDURA®

- Electronic control gear for OSRAM ENDURA® lamp

Product ID Code	EAN (Single Pack)	Product Description		PPG
QTENDURA70	4050300804668	QT ENDURA 70-100/120-240 S	1	39
QTENDURA100SUK	4050300662589	QT ENDURA 100-150/120-240 S	1	39

1) For more information go to [www.osram.com/system-guarantee](http://www.osram.com/system-guarantee)

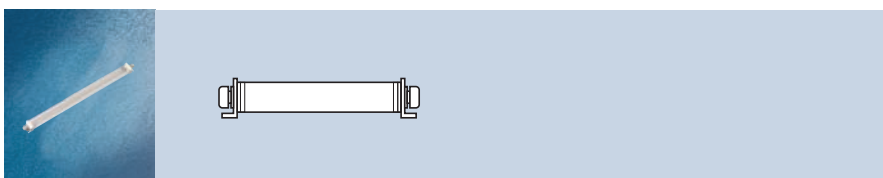

### ECG accessories – Protective Casing OUTKIT®

- IP67 rated ECG housing

Product ID Code	EAN (Single Pack)	Product Description		PPG
OUTKIT30S	4008321159533	Short – for ECG dimensions 360 x 30 x 30mm	20	39
OUTKIT21S	4008321159571	Short – for ECG dimensions 360 x 30 x 21mm	20	39
OUTKIT30L	4008321159557	Long – for ECG dimensions 423 x 30 x 30mm	20	39
OUTKIT21L	4008321159595	Long – for ECG dimensions 423 x 30 x 21mm	20	39

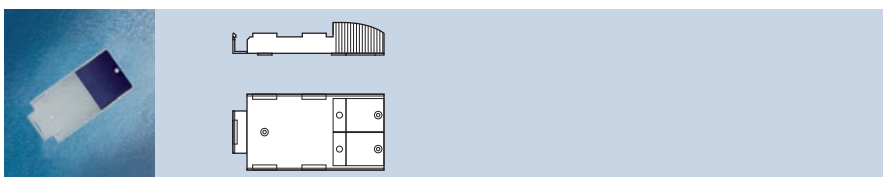

### ECG accessories – QT Cable Clamp

Product ID Code	EAN (Single Pack)	Product Description		PPG
–	4008321907727*	QT CABLE CLAMP K2	10	39
QTCABLECLAMPK3	4008321190741	QT CABLE CLAMP K3	10	39

\*In preparation at time of print. For further information please contact OSRAM

NEW

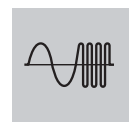

All orders must be multiples of sales pack

## ELECTRONIC CONTROL GEAR

### ECG FOR HID LAMPS

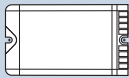

### POWERTRONIC® OUTDOOR PTo for HID lamps

- ECG for metal halide lamps
- New PTo DALI intelligent version for street and outdoor lighting
- PTo 3DIM has 3 dim options
  - 1) DALI control – continual dimming range between 60% and 100% lamp output
  - 2) Step DIM – Two step switching
  - 3) Astro DIM – Two step dimming with an integrated timer control
- Complies with new EMI Standards acc to EN 55015

Product ID Code	EAN (Single Pack)	Product Description		PPG
PT035	4008321956323	PTo 35/220-240	20	39
PT050DIM3	4008321956347	PTo 50/220-240 3 DIM	20	39
PT070DIM3	4008321959355	PTo 70/220-240 3 DIM	20	39
-	4008321956361*	PTo 100/220-240 3 DIM	20	39
-	4008321956385*	PTo 150/220-240 3 DIM	20	39

NEW  
NEW  
NEW  
NEW

1) For more information go to [www.osram.com/system-guarantee](http://www.osram.com/system-guarantee)  
 \*In preparation at time of print. For further information please contact OSRAM

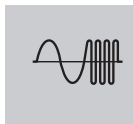

All orders must be multiples of sales pack



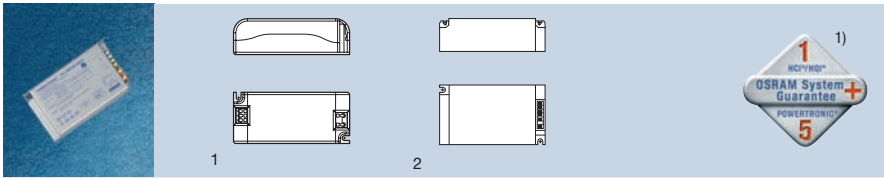

Electronic Control Gear – ECG for HID Lamps



**POWERTRONIC® INTELLIGENT PTi S for HID lamp (without cable clamp)**

- New intelligent versions (PTi) available for single and twin lamps
- PCB version for 20W HID high systems
- Compact dimensions and light designed for small luminaire designs
- Excellent thermal behaviour for very high limit temperatures
- Without cable clamp

Product ID Code	EAN (Single Pack)	Product Description	 No.		PPG
<b>Single</b>					
PTI205	4008321353290	PTi 20/220-240 S without cable clamp	1	20	39
PTI20B	4008321391490	PTi 20/220-240 B (PCB)	–	20	39
PTI35SMINI	4008321955906	PTi 35/220-240 S Mini	–	20	39
PTI35BMINI	4008321955913	PTi 35/220-240 B Mini	–	20	39
PTI35S	4008321073112	PTi 35/220-240 S without cable clamp	2	20	39
PTI2355	4008321372642	PTi 2x35/220-240 S without cable clamp	2	20	39
PTI70S	4008321049629	PTi 70/220-240 S without cable clamp	2	20	39
PTI100S	4008321926630	PTi 100/220-240 S without cable clamp	2	20	39
PTI150S	4008321188090	PTi 150/220-240 S without cable clamp	2	20	39
<b>Twin</b>					
PTI270S	4008321910028	PTi 2x70/220-240 S without cable clamp	2	20	39

1) For more information go to [www.osram.com/system-guarantee](http://www.osram.com/system-guarantee)



All orders must be multiples of sales pack

Electronic Control Gear – ECG for HID Lamps

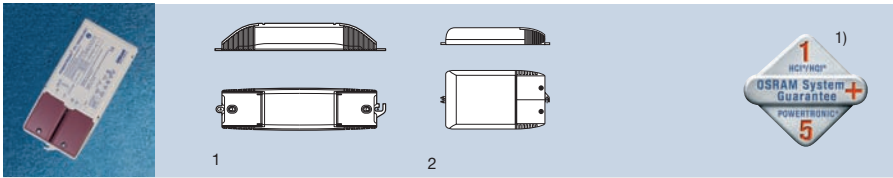

**POWERTRONIC® INTELLIGENT PTi for HID lamps (with cable clamp)**

- New intelligent versions (PTi) available for single and twin lamps
- Extended terminal section enables mains looping
- Screw down cable clamps for reliable strain relief
- Screwless plug in terminals for rapid and accurate cabling

Product ID Code	EAN (Single Pack)	Product Description	No.	PPG
<b>Single</b>				
PTI20I	4008321404763	PTI 20/220-240 I	1	20 39
PTI35I	4008321099488	PTI 35/220-240 I with cable clamp	2	20 39
PTI70I	4008321099501	PTI 70/220-240 I with cable clamp	2	20 39
PTI100I	4008321926654	PTI 100/220-240 I with cable clamp	2	20 39
PTI150I	4008321915535	PTI 150/220-240 I with cable clamp	2	20 39
<b>Twin</b>				
PTI270I	4008321910042	PTI 2x70/220-240 I with cable clamp	2	20 39
PTI35IP	4008321290458	PTI 35/220-240 I ST 18 cap with cable clamp and prewired cable	2	20 39
PTI70IP	4008321290472	PTI 70/220-240 I ST 18 cap with cable clamp and prewired cable	2	20 39
PTODALI70DIM	4008321940612	PTi DALI 70 20/220-240 DIM	2	20 39
PTI150IP	4008321318152	PTI 150/220-240 I ST 18 cap with cable clamp and prewired cable	2	20 39
PTI35IP	4008321543462	PTI 35/220-240 I GST 18 cap with cable clamp and prewired cable	2	20 39
PTI70IP	4008321543943	PTI 70/220-240 I GST 18 cap with cable clamp and prewired cable	2	20 39
<b>Twin lamp</b>				
PTI235S	4008321122247	PTI 2x35/220-240 I with cable clamp	2	20 39

1) For more information go to [www.osram.com/system-guarantee](http://www.osram.com/system-guarantee)

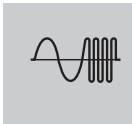

All orders must be multiples of sales pack

Electronic Control Gear – ECG for HID Lamps

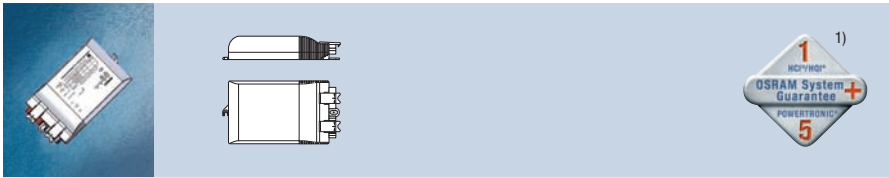

**POWERTRONIC® INTELLIGENT SNAP for HID lamps (with cable clamp)**

- ECG with integrated socket for easy installation
- For all 35W and 70W HID lamps (HQI® and HCl®)
- Luminaire side equipped with ST 18 universal female plug
- Mains side equipped with GST 18 plug
- 40,000 hours ECG lifetime

Product ID Code	EAN (Single Pack)	Product Description			PPG
PTI35SNAP	4008321955920	PTI 35/220 - 240 SNAP	20	39	
PTI70SNAP	4008321955937	PTI 70/220 - 240 SNAP	20	39	

1) For more information go to [www.osram.com/system-guarantee](http://www.osram.com/system-guarantee)

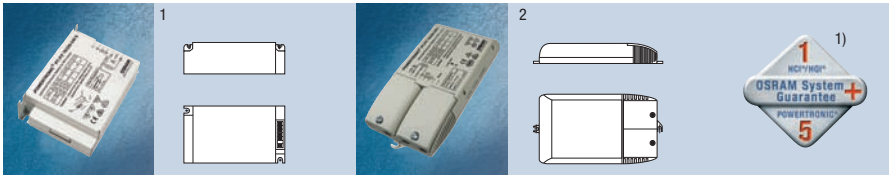

**POWERTRONIC® FIT PT-FIT for HID lamps**

- ECG suitable for standard track and spot lightning fixtures

Product ID Code	EAN (Single Pack)	Product Description			PPG
<b>Without Cable Clamp</b>					
PTFIT35S	4008321386625	PT-FIT 35/220-240 S	1	20	39
PTFIT35	4008321498731	PT-FIT 35/220-240 B	1	20	39
PTFIT70S	4008321386649	PT-FIT 70/ 220-240 S	1	20	39
PTFIT70	4008321498717	PT-FIT 70/ 220-240 B	1	20	39
<b>With Cable Clamp</b>					
PTFIT35I	4008321377661	PT-FIT 35/220-240 I	2	20	39
PTFIT70I	4008321377685	PT-FIT 70/ 220-240 I	2	20	39

1) For more information go to [www.osram.com/system-guarantee](http://www.osram.com/system-guarantee)

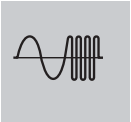

All orders must be multiples of sales pack

## Electronic Control Gear – ECG for HID Lamps



### POWERTRONIC® GREENHOUSE

- PTg – ECG for greenhouse lighting
- Ideal in systems with PLANTASTAR®

Product ID Code	EAN (Single Pack)	Product Description		PPG
PTG1000	4008321956408	PTg 100/400	1	39

NEW



### EBN-OS Inrush current limiter for POWERTRONIC®

- Inrush limiter for PTi and QTi installations
- Enables refurbishment of CCG installations without changing electrical infrastructure
- Ideal for all POWERTRONIC® ECG

Product ID Code	EAN (Single Pack)	Product Description		PPG
EBNOS	4006584548019	EBN-OS	100	39

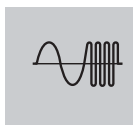

All orders must be multiples of sales pack

## ELECTRONIC CONTROL GEAR

### ECG FOR LOW VOLTAGE HALOGEN LAMPS

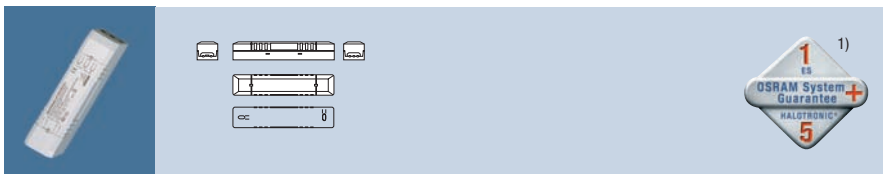

#### HALOTRONIC® DALI® for Low Voltage Halogen lamps

- Low voltage electronic transformers
- Long casing L 140mm x H 34mm x D 44mm
- Fully controllable with DALI® or Touch DIM/ Touch DIM Sensor
- Suitable for 12V halogen lamps

Product ID Code	EAN (Single Pack)	Product Description		PPG
HTI105DALI	4008321420633	HTI DALI 105/220-240 DIM	10	39
<b>Dimmer module for controlling HALOTRONIC® DALI</b>				
HTIDALI150DIM	4050300807782	HTI DALI 150/220-240 DIM	10	39
HTIDALI315DIM	4008321957344	HTI DALI 315 DIM dimming module for controlling HTIDALI	10	39

1) For more information go to [www.osram.com/system-guarantee](http://www.osram.com/system-guarantee)

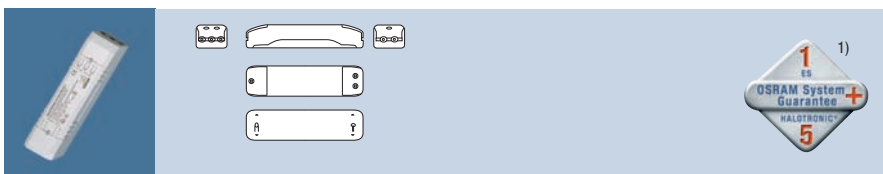

#### HALOTRONIC® LONG (HTL) for Low Voltage Halogen lamps

- Low voltage electronic transformers
- Long casing L 140mm x H 34mm x D 44mm
- Fully dimmable with trailing and leading edge phase dimmer
- Suitable for 12V halogen lamps

Product ID Code	EAN (Single Pack)	Product Description		PPG
HTL105	4008321927019	HTL 105/230-240	10	39
HTL225	4008321927026	HTL 225/230-240	10	39

1) For more information go to [www.osram.com/system-guarantee](http://www.osram.com/system-guarantee)

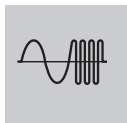

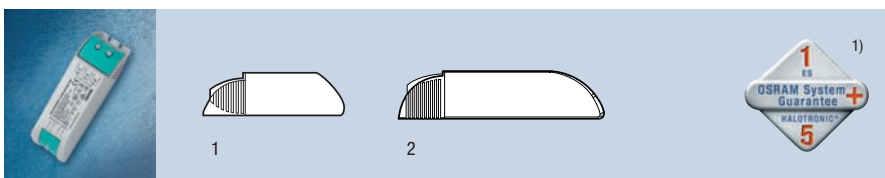

All orders must be multiples of sales pack

## Electronic Control Gear – ECG for Low Voltage Halogen Lamps



### HALOTRONIC® HTM MOUSE® for Low Voltage Halogen lamps

- Low voltage compact electronic transformers
- Fully dimmable with trailing and leading edge phase dimmer
- Suitable for 12V halogen lamps

Product ID Code	EAN (Single Pack)	Product Description	 No.		PPG
<b>With housing</b>					
HTM70	4050300442310	HTM 70/230-240	1	20	39
HTM105	4050300442334	HTM 105/230-240	1	20	39
HTM150	4050300581415	HTM 150/230-240	2	10	39

1) For more information go to [www.osram.com/system-guarantee](http://www.osram.com/system-guarantee)

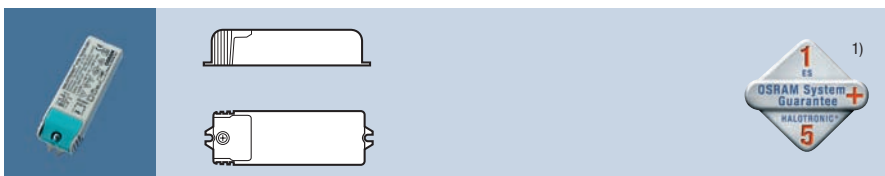

### HALOTRONIC® NANO for Low Voltage Halogen lamps

- Low voltage electronic transformers
- Extremely compact
- Fully dimmable (trailing edge)
- Ideal partner for MINISTAR® low voltage lamps

Product ID Code	EAN (Single Pack)	Product Description		PPG
HTN75I	4008321073037	HTN 75/230-240 I	20	39
HTN75S	4008321909329	HTN 75/230-240 S	20	39

1) For more information go to [www.osram.com/system-guarantee](http://www.osram.com/system-guarantee)

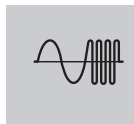

All orders must be multiples of sales pack

### Electronic Control Gear – ECG for Low Voltage Halogen Lamps

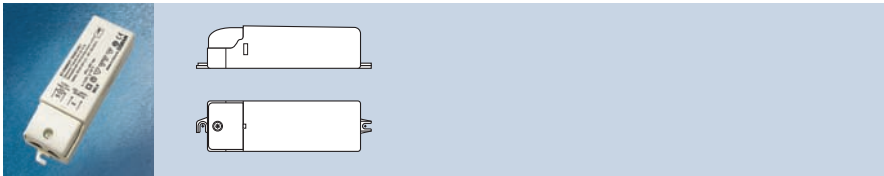

#### ET-PARROT®

- Low voltage compact electronic transformers
- Fully dimmable with trailing and leading edge phase dimmer
- Suitable for 12V halogen lamps

Product ID Code	EAN (Single Pack)	Product Description		PPG
ET70	4008321111593	ET-PARROT 70/220-240 I	50	39
ET105	4008321111579	ET-PARROT 105/220-240 I	50	39

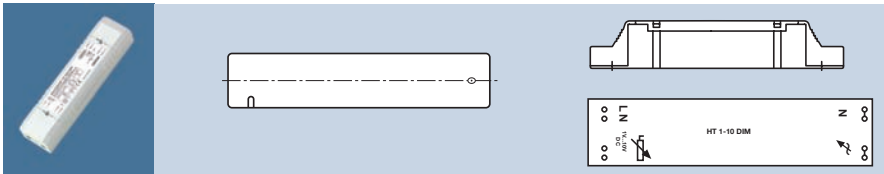

#### Dimming modules for HALOTRONIC®

- For controlling HALOTRONIC® LVTH transformers

Product ID Code	EAN (Single Pack)	Product Description		PPG
HT110DIM	4050300451350	HT 1-10 DIM for controlling HALOTRONIC in 1...10V dimming systems	10	39

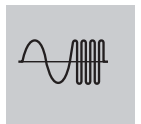

All orders must be multiples of sales pack

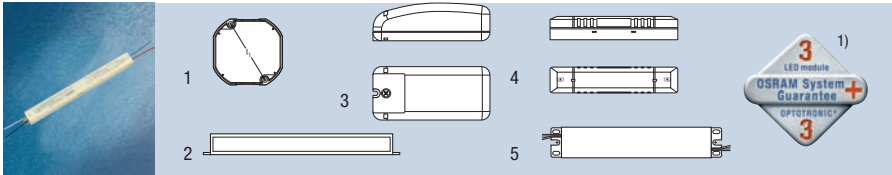

## ELECTRONIC CONTROL GEAR

### ECG FOR LED MODULES



#### 10V OPTOTRONIC® units for LED modules

- Electronic control gear for 10V LED modules
- Ideal for obtaining the optimum performance from LED modules

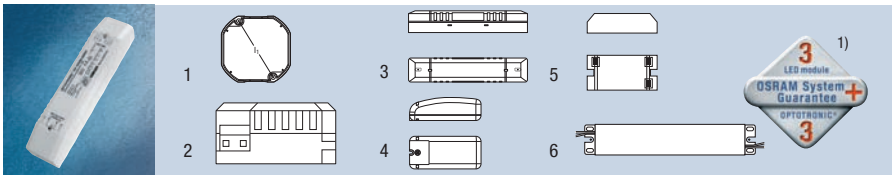

Product ID Code	EAN (Single Pack)	Product Description	 No.		PPG
OT6/240CE	4008321113306	OT 6/200-240/10V CE	1	20	38
OT12LE	4008321174253	OT 12/200-240/10V LE	2	20	38
OT15	4008321391544	OT 15/220-240/10	3	20	38
OT50	4050300817491	OT 50/220-240/10V	4	10	38
OT50E	4008321362452	OT 50/220-240/10V E	5	10	38

1) For more information go to [www.osram.com/system-guarantee](http://www.osram.com/system-guarantee)



#### 24V OPTOTRONIC® units for LED modules

- Electronic control gear for 24V LED modules
- Ideal for obtaining the optimum performance from LED modules

Product ID Code	EAN (Single Pack)	Product Description	 No.		PPG
OT6/240/24CE	4008321113269	OT 6/200-240/24V CE	1	20	38
OT6/120/24CE	4008321129130	OT 6/100-120/24V CE	-	20	38
OT08	4008321040169	OT 8/200-240/24V	5	50	38
OT20S	4050300662626	OT 20/120-240/24V S	2	10	38
OT20	4050300618111	OT 20/230-240/24V	4	30	38
OTEASY60	4008321187796	OT EASY 60/220-240/24 RGB	-	10	38
OT75	4050300817477	OT 75/220-240/24V	3	10	38
OT7SE	4008321362476	OT 75/220-240/24V E	6	10	38

1) For more information go to [www.osram.com/system-guarantee](http://www.osram.com/system-guarantee)

NEW

All orders must be multiples of sales pack



Electronic Control Gear – ECG for LED Modules

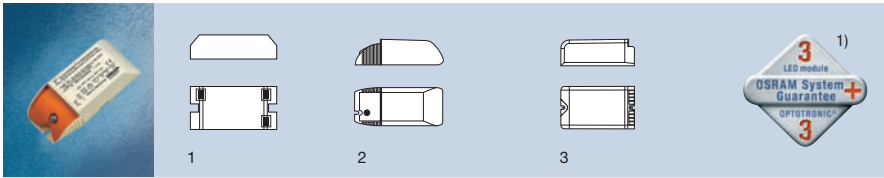

**350mA OPTOTRONIC® units for LED modules**

- Electronic control gear for 350mA LED modules
- Ideal for obtaining the optimum performance from LED modules

Product ID Code	EAN (Single Pack)	Product Description	Light No.	Box	PPG
OT091024350DIM	4050300888897	OT 9/10-24/350mA DIM	1	50	38
OT9/120	4050300888835	OT 9/100-120/350mA E	1	50	38
OT9/350	4050300888262	OT 9/200-240/350mA	1	50	38
OT09350DIM	4008321187321	OT 9/200-240/350mA DIM	2	20	38
OT42	4008321421678	OT 42/220-240/350 E	3	20	38

NEW

1) For more information go to [www.osram.com/system-guarantee](http://www.osram.com/system-guarantee)

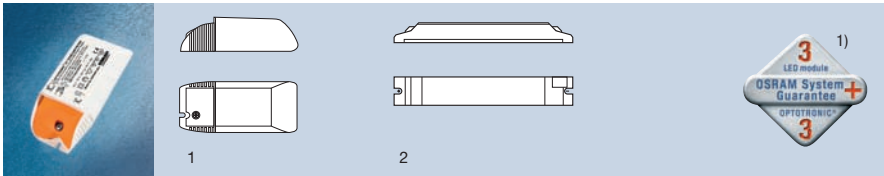

**700mA OPTOTRONIC® units for LED modules**

- Electronic control gear for 700mA LED modules
- Ideal for obtaining the optimum performance from LED modules

Product ID Code	EAN (Single Pack)	Product Description	Light No.	Box	PPG
OT18DIM	4008321139320	OT 18/200-240/700mA DIM	1	20	38
OT35	4008321169365	OT 35/200-240/700mA	2	24	38

1) For more information go to [www.osram.com/system-guarantee](http://www.osram.com/system-guarantee)

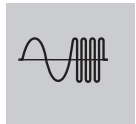

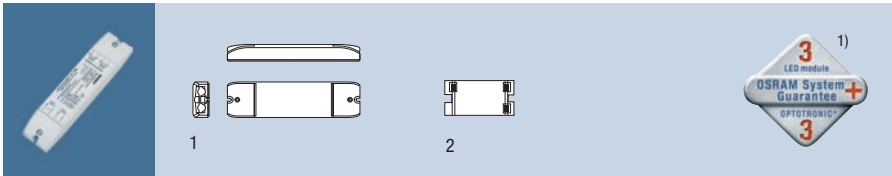

All orders must be multiples of sales pack

## Electronic Control Gear – ECG for LED Modules

**OPTOTRONIC® Dimmers**



- Connect to secondary side of power supplies for dimming
- Dynamic control of LED
- Opens up new applications for LEDs

Product ID Code	EAN (Single Pack)	Product Description	 No.		PPG
OTDIM	4050300943459	OT DIM 1...10V (10V & 24V modules)	1	20	38
OTRGBDIM	4050300793108	OT RGB 3-Channel DIM (10V & 24V modules)	1	20	38
OTRGB	4050300792460	OT RGB Sequencer (10V & 24V modules)	1	20	38
OTDMXRGB1024DIM	4008321160829	OT RGB DMX DIM	1	20	38
OTDMX3X1RGMIDIM	4008321279835	OT RGB DMX DIM 3 X 1	2	10	38

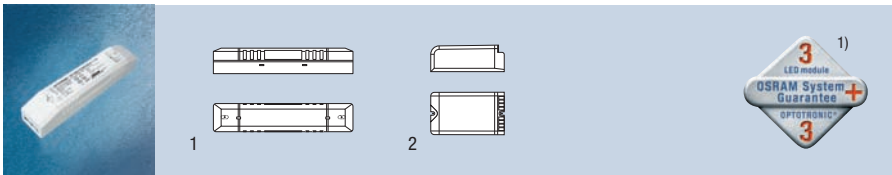
1) For more information go to [www.osram.com/system-guarantee](http://www.osram.com/system-guarantee)

**OPTOTRONIC® Units with DALI interfaces**

- DALI control via DALI Interface
- Integrated Touch DIM function for QT<sub>i</sub> DALI 75 and QT<sub>i</sub> DALI DIM
- 3 DIM version ideal for STREETlight Advance and STREETlight Protect modules

Product ID Code	EAN (Single Pack)	Product Description	 No.		PPG
OTDALI75	4008321371560	OTI DALI 75/220-240/24V 1-4	–	10	38
OTDALIDIM	4008321061195	OTI DALI DIM (10V & 24V modules)	1	20	38
OT65243DIM	4008321964403	OT 65 220-240/24 3 DIM E	–	20	38
OTDALI25	4050300829463	OT DALI 25/220-240/24 RGB (24V modules)	2	20	38

1) For more information go to [www.osram.com/system-guarantee](http://www.osram.com/system-guarantee)

NEW

NEW

All orders must be multiples of sales pack

## Electronic Control Gear – ECG for LED Modules

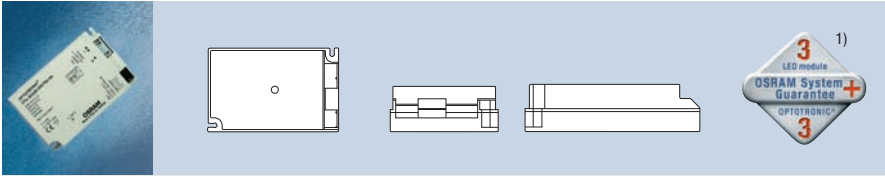
**OPTOTRONIC® for PrevaLED™**

- Electronic control gear for PrevaLED™ LED modules and accessories

Product ID Code	EAN (Single Pack)	Product Description		PPG
<b>NEW</b> OTP45HD	4008321966117	OTp 45/220-240/700 HD	1	38
<b>NEW</b> OTP35HD	4008321963413	OTp DALI 35/220-240/700 HD	1	38
<b>NEW</b> OTP35HD	4008321963420	OTp 35/220-240/700 HD	1	38
<b>NEW</b> OTP35	4008321962218	OTp 35/220-240/700	1	38
<b>NEW</b> OTP15HD	4008321962225	OTp 15/220-240/700 HD	1	38
<b>NEW</b> OTPCABLE	4008321966131	Cable, 40 cm	1	38
<b>NEW</b> OTPCABLE80	4008321590565	Cable, 80 cm	1	38
<b>NEW</b> OTPCABLECLAMP	4008321966155	Cable clamp for OTp 45, OTp DALI, OTp 35	1	38

1) For more information go to [www.osram.com/system-guarantee](http://www.osram.com/system-guarantee)



All orders must be multiples of sales pack

LIGHT MANAGEMENT SYSTEMS

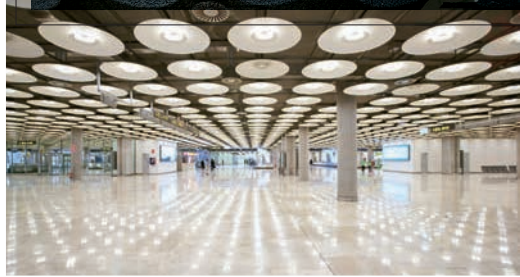
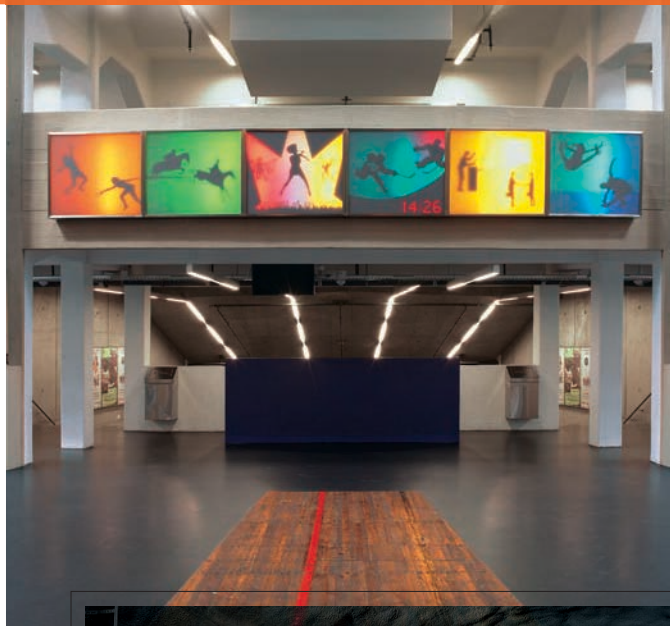

# Light Management Systems Contents.

## ENERGY SAVING

### Mains Switching Sensors

SOLAR	270
Switch RC	270
HIGH BAY motion sensor	271
VISION motion sensor	271
DUO daylight and presence detector	272
Wall Switch	272
OUTDOOR	273

### 1-10V Sensors

DIM PICO	274
DIM MICO	274
DIM MULTI	275

### Touch DIM® System

Touch DIM® WCU	277
Touch DIM® RMC	277
Touch DIM® RC	277
Touch DIM® LS/PD LI	278
Touch DIM® LS LI	278

### MULTIeco and MULTI 3

LS/PD MULTI 3	280
LS/PD MULTI 3 FL	280
LS/PD MULTI 3 B	281
LS/PD MULTI 3 CI	281
DALI MULTIeco	281
DIM MULTIeco	282
MULTIeco	282
DALI MULTI 3	283
DIM MULTI 3	283

## AMBIENCE

### EASY COLOR control

EASY RMC	285
EASY Hybrid Remote	285
EASY Color Drive	286
EASY Touch Panel	286
EASY IR CI	287
EASY IR	287
EASY RC	287
EASY PB Coupler	288
EASY PC Kit	288
EASY SYS CP	288
OT EASY 60 II	289

DALI EASY III	289
EASY DMX 16x4 SO	289
EASY DMX 32x4 SO	290
EASY DMX 64x4 SO	290
OT EASY 32	290

## OT DMX

LED Dimmer OT DMX	291
-------------------	-----

## SCENES

### DALI®/1-10V Manual dimmers

DALI MCU	293
DIM MCU	293

### DALI® BASIC System

DALI WCU 5 BASIC	295
DALI LS/PD BASIC	295
DALI LS/PD BASIC LI	295
DALI RC BASIC SO	296

### DALI® PROFESSIONAL System

DALI PRO Touch Panel	298
Glass touch 6	298
Glass touch 12	299
Glass touch 6 JW	299
E-BUS DALI Gateway	299
DALI PRO PB Coupler	300
DALI PRO Sensor Coupler	300
DALI PRO CONT-4	301

## COMPONENTS

### Interfaces and amplifiers

DALI REPEATER LI	303
DALI REPEATER SO	303
DALI CON 1...10 LI	304
DALI CON 1...10 SO	304
DIM SA	304
LMS DMX CON DALI SO	305

### Accessories

Y-CONNECTOR	306
Y-CONNECTOR SCREW	306
Mounting Adapter	306
SENSOR KIT	307
ECO CI KIT	307
LMS CI BOX	307

## Light Management Systems



### OSRAM – the perfect partner for LMS

Light management products from OSRAM provide the ideal basis for innovative tailor-made lighting concepts – from an individual luminaire to more complex systems. Due to OSRAM's many years of experience and in-depth technical know-how, our wide-ranging product portfolio meets the requirements of an impressive array of applications:

- Energy saving with daylight-dependent and presence-dependent lighting
- Atmospheric and dynamic RGB lighting
- Multifunctional management of lighting groups and lighting scenes

**This is possible through manual or remote control, with a high degree of flexibility.**

**OSRAM lighting management systems can be easily tailored to the specific requirements of the application:**

#### Energy saving



- Light management systems for daylight-dependent and presence-dependent lighting
- Light management systems with maintenance-free EnOcean radio technology
- Sensors for non-system-specific use

#### Ambience



- Light management systems for dynamic RGB lighting
- Light management systems for daylight simulation

#### Scenes



- Light management systems for multifunctional management of lighting groups and lighting scenes
- Simple manual dimming solutions

#### Components

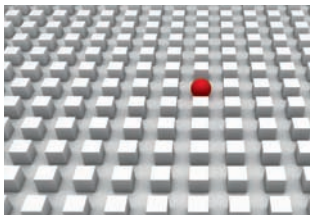

- Non-system-specific components for expanding, connecting or installing light management products

1) Lighting systems which are entitled to receive a System+ Guarantee and are controlled or operated by components of Light Management Systems (LMS components), are also entitled to an additional 5-year guarantee on LMS components from OSRAM. For more information go to [www.osram.com/system-guarantee](http://www.osram.com/system-guarantee)

## LIGHT MANAGEMENT SYSTEMS – ENERGY SAVING

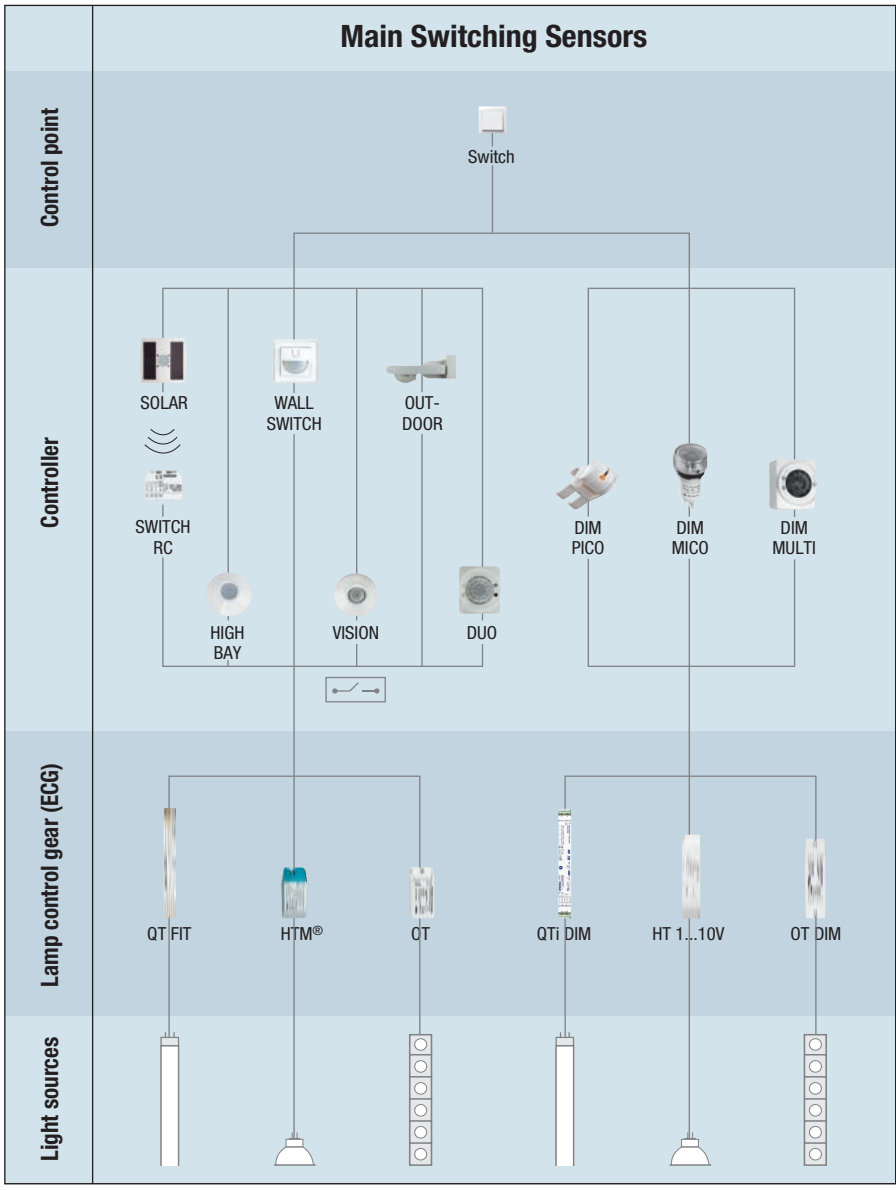

All orders must be multiples of sales pack

## LIGHT MANAGEMENT SYSTEMS – ENERGY SAVING

### Mains Switching Sensors

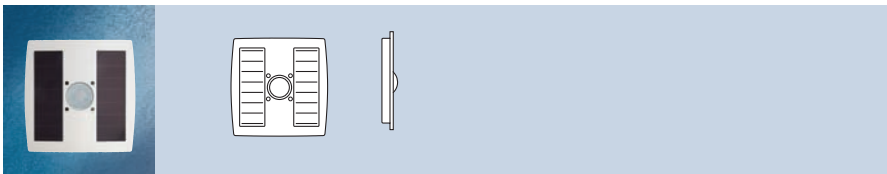

#### SOLAR

- Daylight and presence sensor with transmitter combining EnOcean wireless technology
- Solar powered, wireless, maintenance free
- Energy saving potential up to 45%
- Range up to 30m (up to 5 walls) or 100m (no walls)
- Ideal for new installations or as a retrofit solution for existing lighting systems

Product ID Code	EAN (Single Pack)	Product Description		PPG
SOLARSENSOR	4008321385628	Daylight and presence sensor	20	39

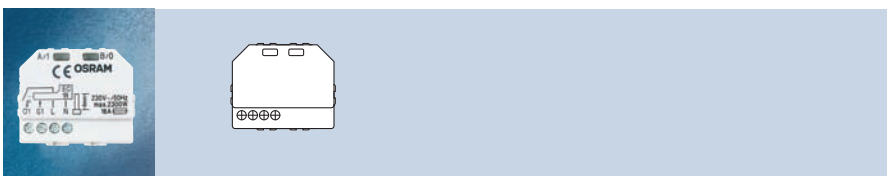

#### Switch RC

- Radio receiver for OSRAM control elements
- Choice of 5 operating modes
- Up to 8 sensors and 8 wall mounted/ hand held transmitters can be trained on one Switch RC
- Up to 14 ECGs can be connected with adjustable switch off delay 1 to 20 mins

Product ID Code	EAN (Single Pack)	Product Description		PPG
SWITCHRCRECEIVER	4008321385642	Radio receiver	20	39



All orders must be multiples of sales pack



Light Management Systems  
Energy Saving – Mains Switching Sensors

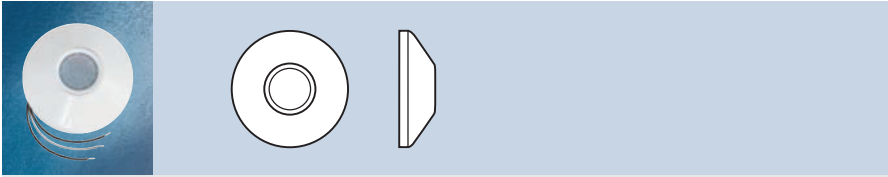

**HIGH BAY motion sensor**

- Motion sensor for ceiling heights up to 13m
- Energy saving potential up to 45% (in combination with daylight sensor)
- Detection zone up to 18 metres
- Ideal for ceiling heights between 3m and 10m to detect motion of people or between 3m and 13m to detect vehicle movement

Product ID Code	EAN (Single Pack)	Product Description		PPG
HIGHBAYSENS	4008321410078	High Bay motion sensor	20	39

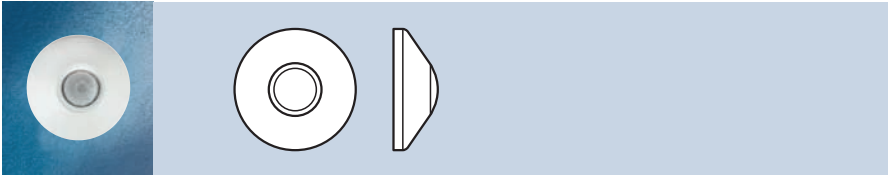

**VISION motion sensor**

- Motion sensor for large areas
- Adjustable switch-off delay 30sec to 20min

Product ID Code	EAN (Single Pack)	Product Description		PPG
VISIONSENSOR	4008321957047	VISION presence detector	20	39

NEW



All orders must be multiples of sales pack

Light Management Systems  
Energy Saving – Mains Switching Sensors

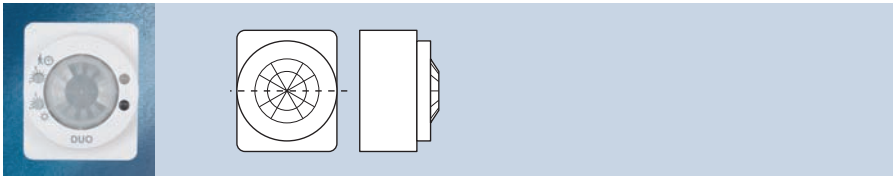

**DUO daylight and presence detector**

- Energy saving solution for non dimmable luminaires/systems
- Daylight and presence detection
- Ceiling mounting or direct luminaire integration
- Energy saving potential up to 45%
- Ideal for office, residential, hospitality, retail, shop and industrial applications

Product ID Code	EAN (Single Pack)	Product Description		PPG
DUOSENSOR	4008321496355	DUO daylight and presence detector	20	39

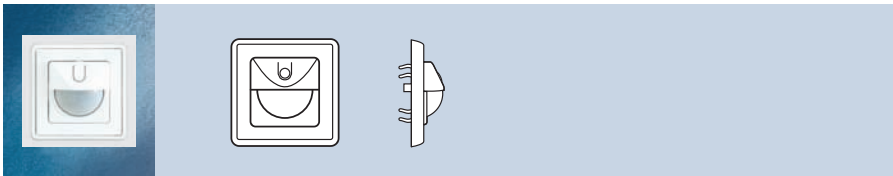

**Wall Switch**

- Motion sensor for recess in wall
- Contactless light switch for installation in pattress boxes
- 180° horizontal or 70° vertical detection angle up to 8 metres
- Energy saving potential up to 45%
- Ideal for new installations or as a retrofit solution for existing lighting systems

Product ID Code	EAN (Single Pack)	Product Description		PPG
WALLSWITCH	4008321467386	Wall switch (81 x 81 x 24mm)	20	39
-	-*	Wall box (71 x 71 x 33mm)	1	39

\*In preparation at time of print. For further information please contact OSRAM

**NEW**



All orders must be multiples of sales pack

Light Management Systems  
Energy Saving – Mains Switching Sensors

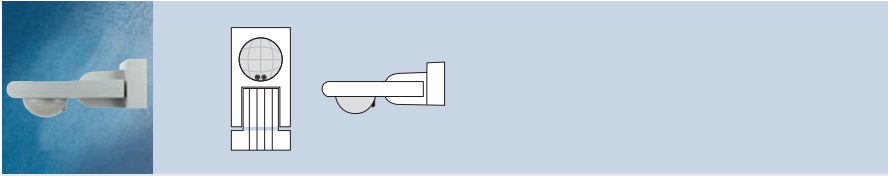

**OUTDOOR**

- Daylight, presence and motion detectors for LMS applications
- Ideal for outdoor LMS installations – IP55 rated

Product ID Code	EAN (Single Pack)	Product Description		
OUTDOOR	4008321957061	OUTDOOR Daylight and Presence Detector	1	39

**NEW**



All orders must be multiples of sales pack

## LIGHT MANAGEMENT SYSTEMS – ENERGY SAVING

### 1-10V Sensors

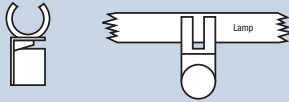

#### DIM PICO

- Clip on sensor for T8 and T5 lamps
- Energy savings up to 30% by compensating for 50% of the incoming daylight
- 1-10V dimming output

Product ID Code	EAN (Single Pack)	Product Description		PPG
HFDIMPICO	4050300554457	DIM PICO clip on mini light sensor for T8 and T5 tubes	1	39

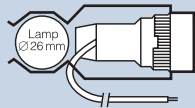

#### DIM MICO

- Clip on sensor for T8 and T5 lamps
- Energy savings up to 40% by compensating for 100% of the incoming daylight
- 1-10V dimming output

Product ID Code	EAN (Single Pack)	Product Description		PPG
HFDIMMICO	4050300464411	DIM MICO mini light sensor for strip lighting	1	39



All orders must be multiples of sales pack

Light Management Systems  
Energy Saving – 1-10V Sensors

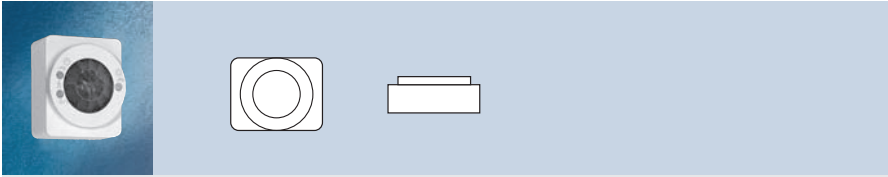

**DIM MULTI**

- Daylight dependent control with switch off delay from 5min to 20min
- Energy savings up to 70% by compensating for 100% of the incoming daylight
- Light and motion sensing
- 1-10V dimming output

Product ID Code	EAN (Single Pack)	Product Description		PPG
HFDIMMULTI	4050300554471	DIM MULTI light sensor/presence detector	1	39



All orders must be multiples of sales pack

## LIGHT MANAGEMENT SYSTEMS – ENERGY SAVING

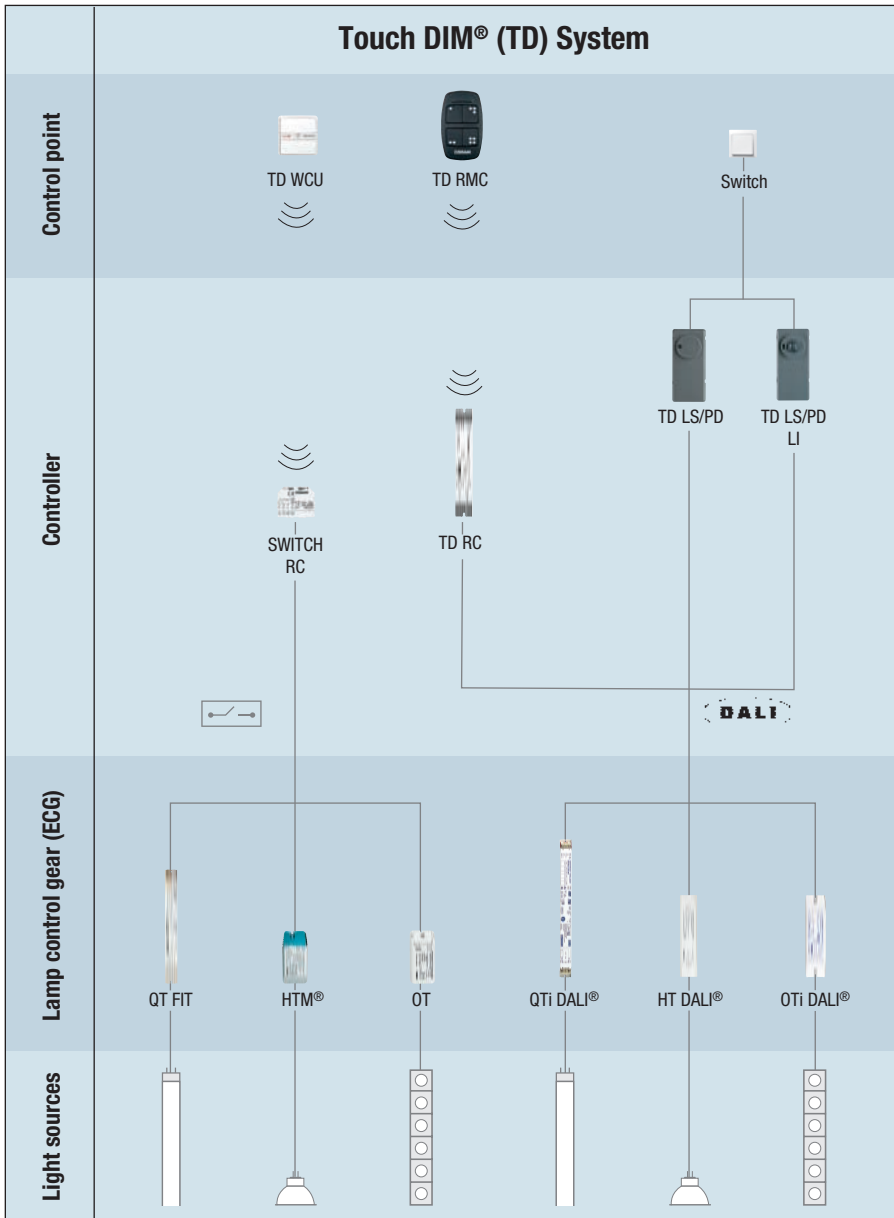

All orders must be multiples of sales pack

## LIGHT MANAGEMENT SYSTEMS – ENERGY SAVING Touch DIM® System

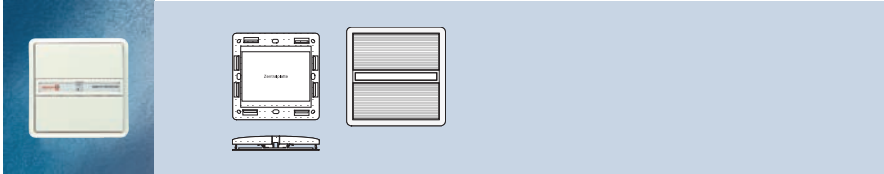

### Touch DIM® WCU

- 2 Channel radio wall transmitter
- No battery required and can be used up to 30m from the receiver in a building

Product ID Code	EAN (Single Pack)	Product Description		PPG
TOUCHDIMWCU	4008321032737	Touch DIM WCU wall switch	25	39

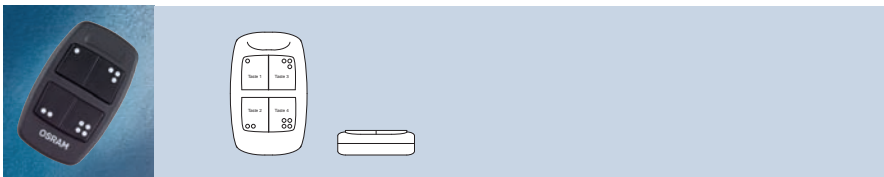

### Touch DIM® RMC

- 4 Channel radio hand held transmitter
- No battery required and can be used up to 30m from the receiver in a building

Product ID Code	EAN (Single Pack)	Product Description		PPG
TOUCHDIMRMC	4008321183033	Touch DIM 4-Channel manual transmitter	20	39

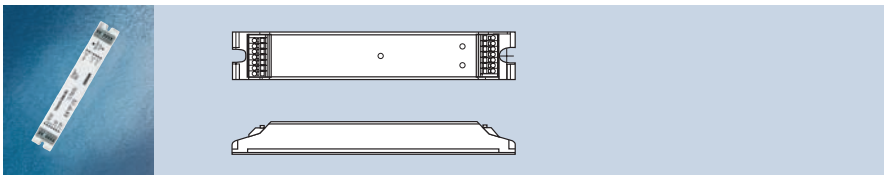

### Touch DIM® RC

- 2 Channel radio receiver module
- Up to 15 QTi DALI® ECGs or HTi® transformers can be connected per output

Product ID Code	EAN (Single Pack)	Product Description		PPG
TOUCHDIMRC	4008321031938	Touch DIM RC receiver module	20	39



All orders must be multiples of sales pack

Light Management Systems  
 Energy Saving – Touch DIM® System

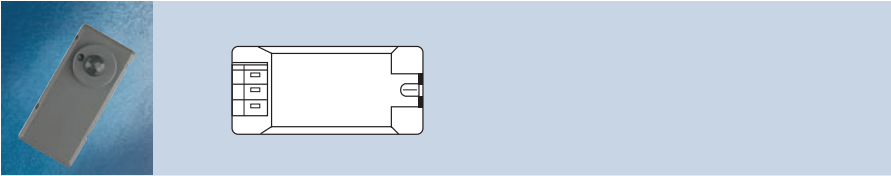

**Touch DIM® LS/PD LI**

- Light and presence detector for luminaire installation
- Up to 4 QTi DALI® ECGs or 4 HTi transformers or 4 OTi DALI® LED dimmers can be connected
- Can be used as a purely presence detector
- Fully automatic operation possible

Product ID Code	EAN (Single Pack)	Product Description		PPG
TOUCHDIMLSPD	4008321023025	Touch DIM LS/PD LI light and motion sensor	25	39

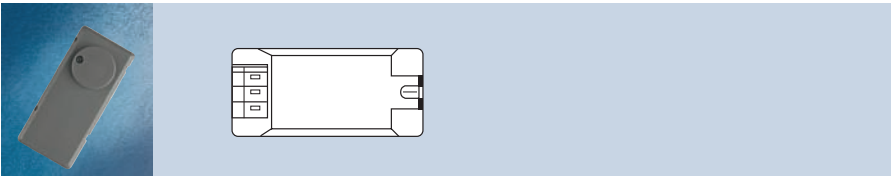

**Touch DIM® LS LI**

- Light sensor for luminaire installation
- Up to 4 QTi DALI® ECGs or 4 HTi transformers or 4 OTi DALI® LED dimmers can be connected
- Daylight dependent control can be set by double clicking

Product ID Code	EAN (Single Pack)	Product Description		PPG
TOUCHDIMLSLI	4008321023087	Touch DIM LS LI light sensor	25	39



All orders must be multiples of sales pack



**LIGHT MANAGEMENT SYSTEMS – ENERGY SAVING**

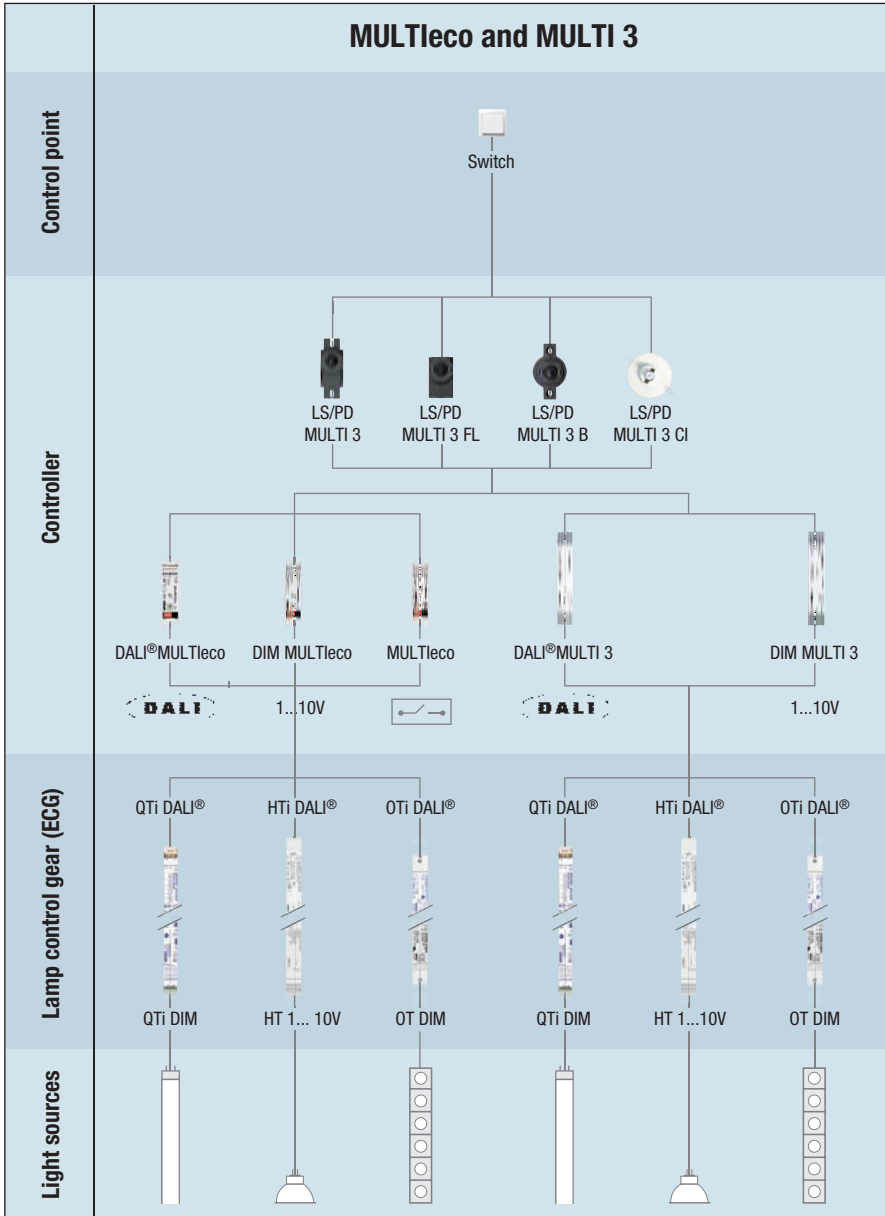

All orders must be multiples of sales pack

## LIGHT MANAGEMENT SYSTEMS – ENERGY SAVING MULTIeco and MULTI 3

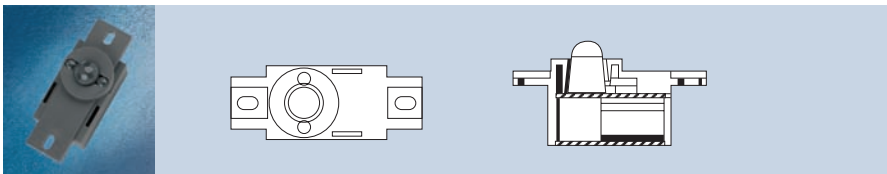

### LS/PD MULTI 3

- Light and presence detector
- For installation in luminaires

Product ID Code	EAN (Single Pack)	Product Description		PPG
LSPDMULTI3	4050300802138	LS/PD MULTI 3 standard light sensor/ motion detector	25	39

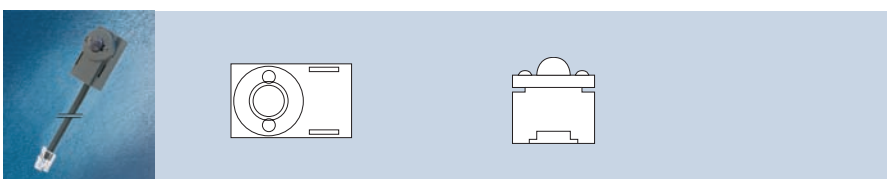

### LS/PD MULTI 3 FL

- Light and presence detector
- Low profile casing
- For installation in luminaires

Product ID Code	EAN (Single Pack)	Product Description		PPG
LSPDMULTI3FL	4008321047342	LS/PD MULTI 3 FL light sensor/motion detector	25	39



All orders must be multiples of sales pack

## Light Management Systems Energy Saving – MULTIEco and MULTI 3

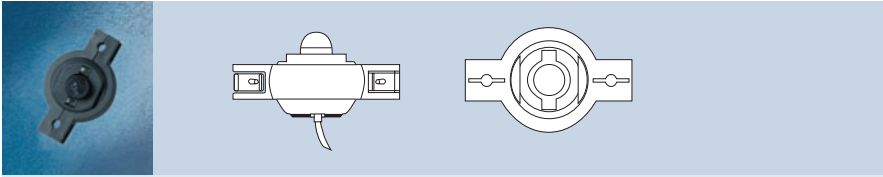

### LS/PD MULTI 3 B

- Light and presence detector with moveable sensor
- For installation in luminaires

Product ID Code	EAN (Single Pack)	Product Description		PPG
LSPDMULTI3B	4050300803081	LS/PD MULTI 3 B movable light sensor/ motion detector	25	39

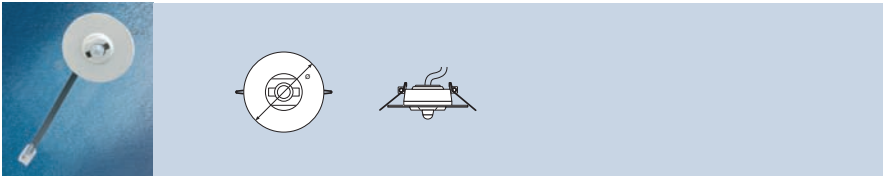

### LS/PD MULTI 3 CI

- Light and presence detector with moveable sensor
- Surface mounting with Sensor kit

Product ID Code	EAN (Single Pack)	Product Description		PPG
LSPDMULTI3CI	4008321916648	LS/PD MULTI 3 CL recessed/surface mount ceiling sensor	10	39

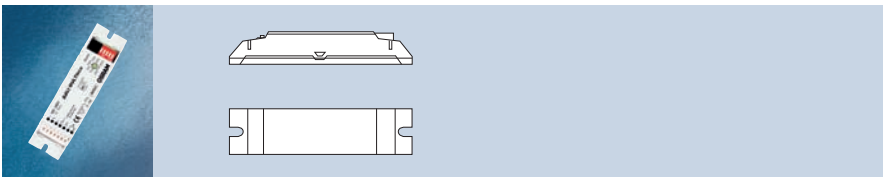

### DALI® MULTIEco

- Suitable for daylight dependent control with presence function
- Up to 2 sensors and up to 6 DALI® ECGs can be connected
- 14 different operating modes can be set via DIP switches
- Up to 3 controllers can be synchronised for central presence function

Product ID Code	EAN (Single Pack)	Product Description		PPG
DALIMULTIECO	4008321371300	DALI MULTIEco 100-240V AC (50...60Hz) /DC	25	39



All orders must be multiples of sales pack

## Light Management Systems

### Energy Saving – MULTieco and MULTI 3

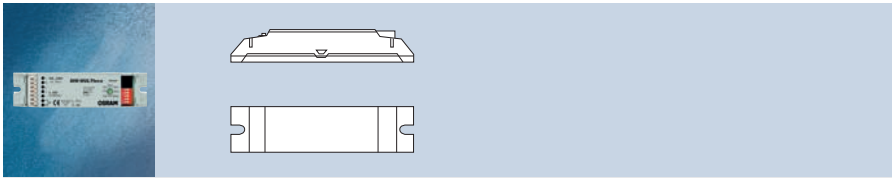

#### DIM MULTieco

- Suitable for daylight dependent switching control with presence function
- Up to 2 sensors and up to six 1...10V ECGs can be connected
- 14 different operating modes can be set via DIP switches
- Up to 3 controllers can be synchronised for central presence function

Product ID Code	EAN (Single Pack)	Product Description		PPG
DIMMULTIECO	4008321507273	DIM MULTieco 100V AC (50...60Hz) /DC	25	39

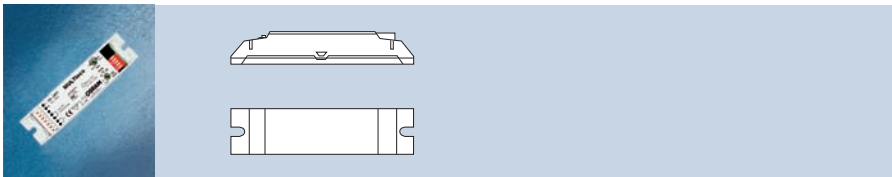

#### MULTieco

- Suitable for daylight dependent switching control with presence function
- Up to 2 sensors and up to 6 ECGs can be connected
- 8 different operating modes can be set via DIP switches
- Up to 3 controllers can be synchronised for central presence function

Product ID Code	EAN (Single Pack)	Product Description		PPG
MULTIECO	4008321405302	MULTieco 100-240V AC (50...60Hz) /DC	25	39



All orders must be multiples of sales pack

Light Management Systems  
Energy Saving – MULTIEco and MULTI 3



**DALI® MULTI 3**

- Suitable for daylight dependent control with presence function
- Up to 4 sensors and up to 32 ECGs can be connected
- Choice of 10 different operating modes can be set

Product ID Code	EAN (Single Pack)	Product Description		PPG
DALIMULTI3	4050300802084	DALI MULTI 3 DALI control unit	25	39



**DIM MULTI 3**

- Suitable for daylight dependent control with presence function
- Up to 4 sensors and up to 32 ECGs can be connected
- Choice of 10 different operating modes from manual control to fully automatic

Product ID Code	EAN (Single Pack)	Product Description		PPG
DIMMULTI3	4050300802107	DIM MULTI 3 1...10V control unit	25	39



All orders must be multiples of sales pack

## LIGHT MANAGEMENT SYSTEMS – AMBIENCE

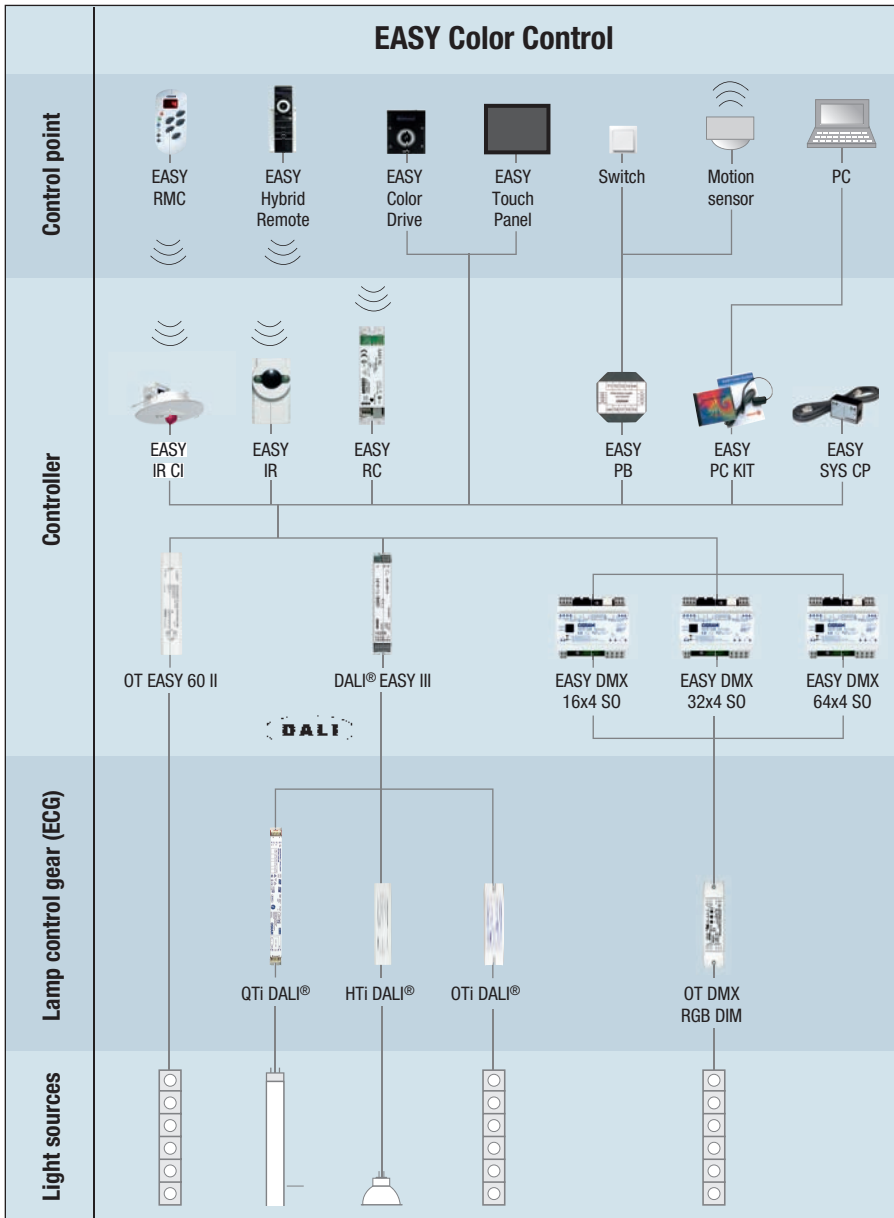

All orders must be multiples of sales pack

## LIGHT MANAGEMENT SYSTEMS – AMBIENCE

### EASY Color Control

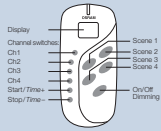

#### EASY RMC

- Infra-red remote control
- Control up to 4 lighting scenes, 4 lighting groups and 1 sequence

Product ID Code	EAN (Single Pack)	Product Description		PPG
DALIEASYRMC	4008321053152	DALI EASY RMC IR remote control	25	39

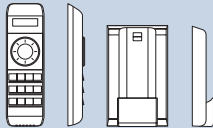

#### EASY Hybrid Remote

- Hybrid technology for digital infra-red and radio remote control
- Control up to 8 lighting scenes, 8 lighting groups and 4 sequences
- LCD display with ability to customise the backlight colour

Product ID Code	EAN (Single Pack)	Product Description		PPG
HYBRIDREMOTE	4008321421739	LMS EASY Hybrid Remote	5	39



All orders must be multiples of sales pack

Light Management Systems  
Ambience – EASY Color Control

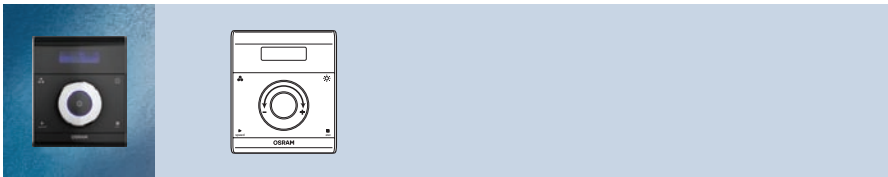

**EASY Color Drive**

- Dual technology for connection via 4 wire signal line or wireless connection via radio transmitter
- Control up to 8 lighting scenes, 8 lighting groups and 4 sequences
- LCD display with ability to customise the backlight colour

Product ID Code	EAN (Single Pack)	Product Description		PPG
COLORDRIVE	4008321421777	LMS EASY Color Drive	5	39

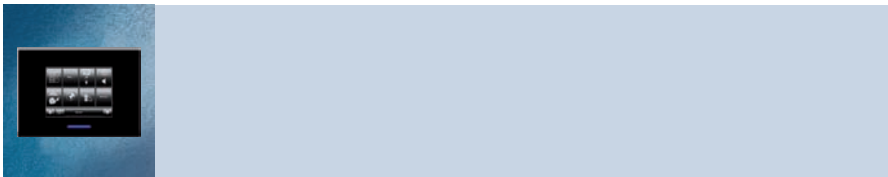

**EASY Touch Panel**

- 5.7" display, 640 x 480 pixels
- Control up to 64 lighting scenes, 16 lighting groups, 4 sequences and 4 switchable loads or 2 louvre blinds
- Up to 32 DALI® ECGs can be directly connected

Product ID Code	EAN (Single Pack)	Product Description		PPG
-	4008321956989*	LMS EASY Touch Panel	1	40

\*In preparation at time of print. For further information please contact OSRAM

**NEW**



All orders must be multiples of sales pack



Light Management Systems  
Ambience – EASY Color Control

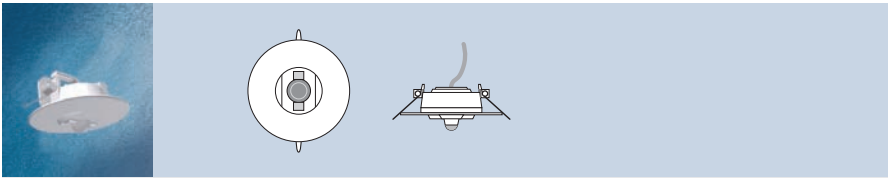

**EASY IR CI**

- Infra-red receiver
- Surface mounting with SENSOR KIT

Product ID Code	EAN (Single Pack)	Product Description		PPG
EASYIR	4008321915573	EASY IR sensor for ceiling installation	10	39

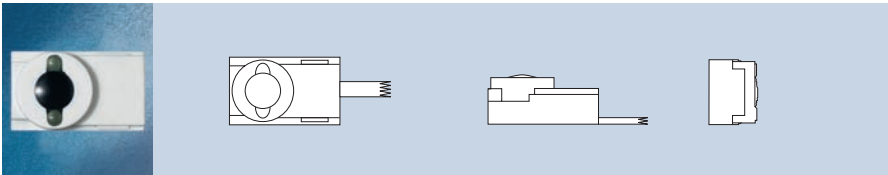

**EASY IR**

- Infra-red receiver
- For installation in luminaires

Product ID Code	EAN (Single Pack)	Product Description		PPG
DALIEASYIR	4008321053138	EASY IR sensor for luminaire installation	25	39

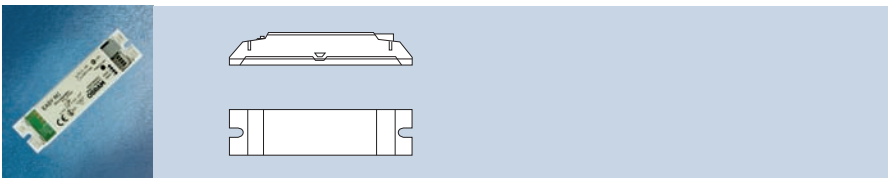

**EASY RC**

- Radio receiver for use with EASY Hybrid Remote and EASY Color Drive
- For installation in luminaires

Product ID Code	EAN (Single Pack)	Product Description		PPG
EASYRC	4008321421753	EASY RC Radio Receiver	18	39



All orders must be multiples of sales pack

Light Management Systems  
Ambience – EASY Color Control



**EASY PB Coupler**

- Push button coupler
- 8 inputs for floating make contacts

Product ID Code	EAN (Single Pack)	Product Description		PPG
EASYPB	4008321915597	EASY PB COUPLER	1	39



**EASY PC Kit**

- Simple creation of scenes and sequences on a PC
- Load, save and duplicate system settings
- Requires Windows PC with USB port

Product ID Code	EAN (Single Pack)	Product Description		PPG
EASYPC	4008321915559	PC Software EASY Color Control with USB Adapter	1	39

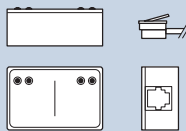

**EASY SYS CP**

- Coupler for connecting EASY systems and expansion to 64 controllers possible

Product ID Code	EAN (Single Pack)	Product Description		PPG
EASYSYSCP	4008321320902	EASY SYSTEM Coupler for extension of up to 64 EASY control units	25	39



All orders must be multiples of sales pack

Light Management Systems  
Ambience – EASY Color Control

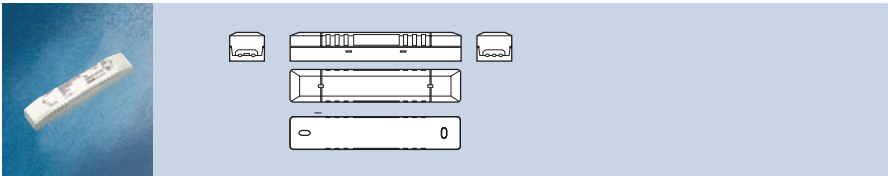

**OT EASY 60 II**

- 60W ECG and configurable LED control unit for static and dynamic lighting applications
- Lighting scenes can be retrieved as sequences or static scenes
- Configuration via software or remote control

Product ID Code	EAN (Single Pack)	Product Description		PPG
OTEASY60	400832118796	OT EASY 60/220-240/24 RGB LED control Unit	10	38

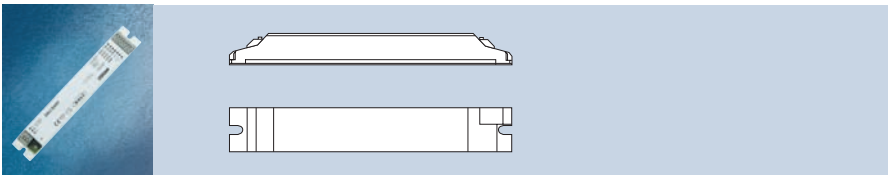

**DALI EASY III**

- Up to 32 DALI® ECGs can be connected
- 4 DALI® outputs
- Lighting scenes can be retrieved as sequences or static scenes
- Configuration via software or remote control

Product ID Code	EAN (Single Pack)	Product Description		PPG
DALIEASY	4008321053046	DALI EASY control unit	25	39

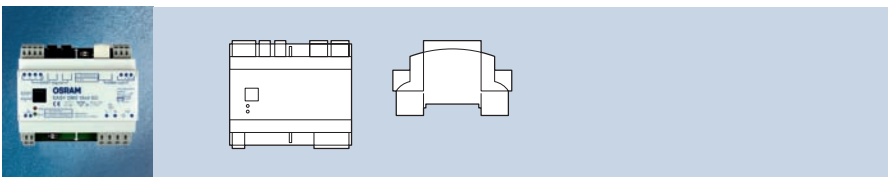

**EASY DMX 16x4 S0**

- Suitable for control of luminaires via 2,3 or 4 DMX addresses
- Individual control of 64 DMX channels
- Up to 64 lighting scenes and 4 sequences can be programmed

Product ID Code	EAN (Single Pack)	Product Description		PPG
EASYDMX16	4008321441522	EASY DMX 16x4 S0 110 – 240 V; 0, 50 – 60 Hz	6	39



All orders must be multiples of sales pack

Light Management Systems  
Ambience – EASY Color Control

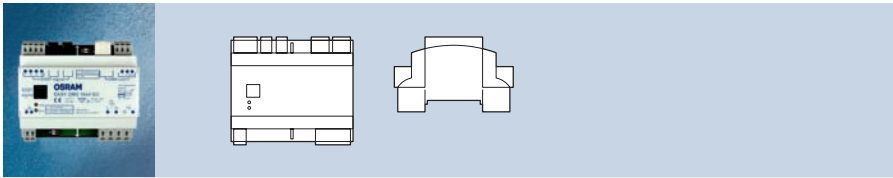

**EASY DMX 32x4 S0**

- Suitable for control of luminaires via 2,3 or 4 DMX addresses
- Individual control of 128 DMX channels
- Up to 64 lighting scenes and 4 sequences can be programmed

Product ID Code	EAN (Single Pack)	Product Description		PPG
EASYDMX32	4008321441546	EASY DMX 32x4 S0 110 – 240 V; 0, 50 – 60 Hz	6	39

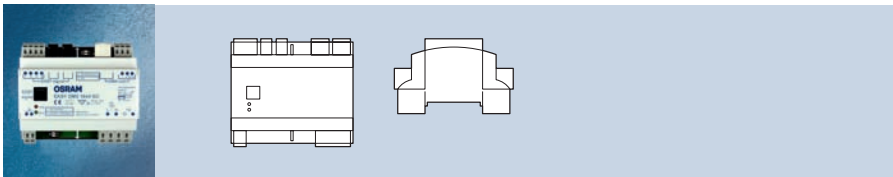

**EASY DMX 64x4 S0**

- Suitable for control of luminaires via 2,3 or 4 DMX addresses
- Individual control of 256 DMX channels
- Up to 64 lighting scenes and 4 sequences can be programmed

Product ID Code	EAN (Single Pack)	Product Description		PPG
EASYDMX64	4008321441560	EASY DMX 64x4 S0 110 – 240 V; 0, 50 – 60 Hz	6	39

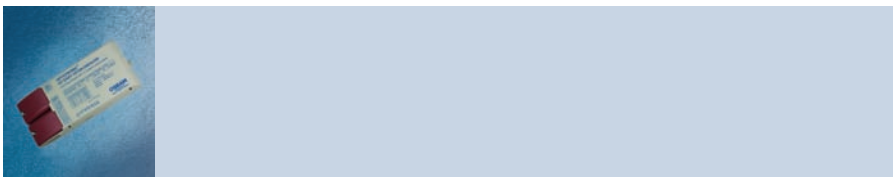

**OT EASY 32**

- EASY control unit for high flux LED requiring 350mA supply
- 4 independent constant current LED output channels

Product ID Code	EAN (Single Pack)	Product Description		PPG
OTEASY 32	4008321547088	OT EASY 32 CC/120-240/350 4CH	20	39

**NEW**

All orders must be multiples of sales pack





## LIGHT MANAGEMENT SYSTEMS – AMBIENCE

### OT DMX



#### LED Dimmer OT DMX

- 3 and 9 channel DMX dimmers for constant voltage LED modules
- DMX output for fast chaining of multiple devices

Product ID Code	EAN (Single Pack)	Product Description		PPG
 OT2DMX3	4008321533265	OT DMX 3x2.5A DIM	10	39
 OT2DMX3PCB	4008321533289	OT DMX 3x2.5A PCB DIM	10	39
 OT2DMX9	4008321533302	OT DMX 9x2A DIM SO	10	39



All orders must be multiples of sales pack

**LIGHT MANAGEMENT SYSTEMS – SCENES**

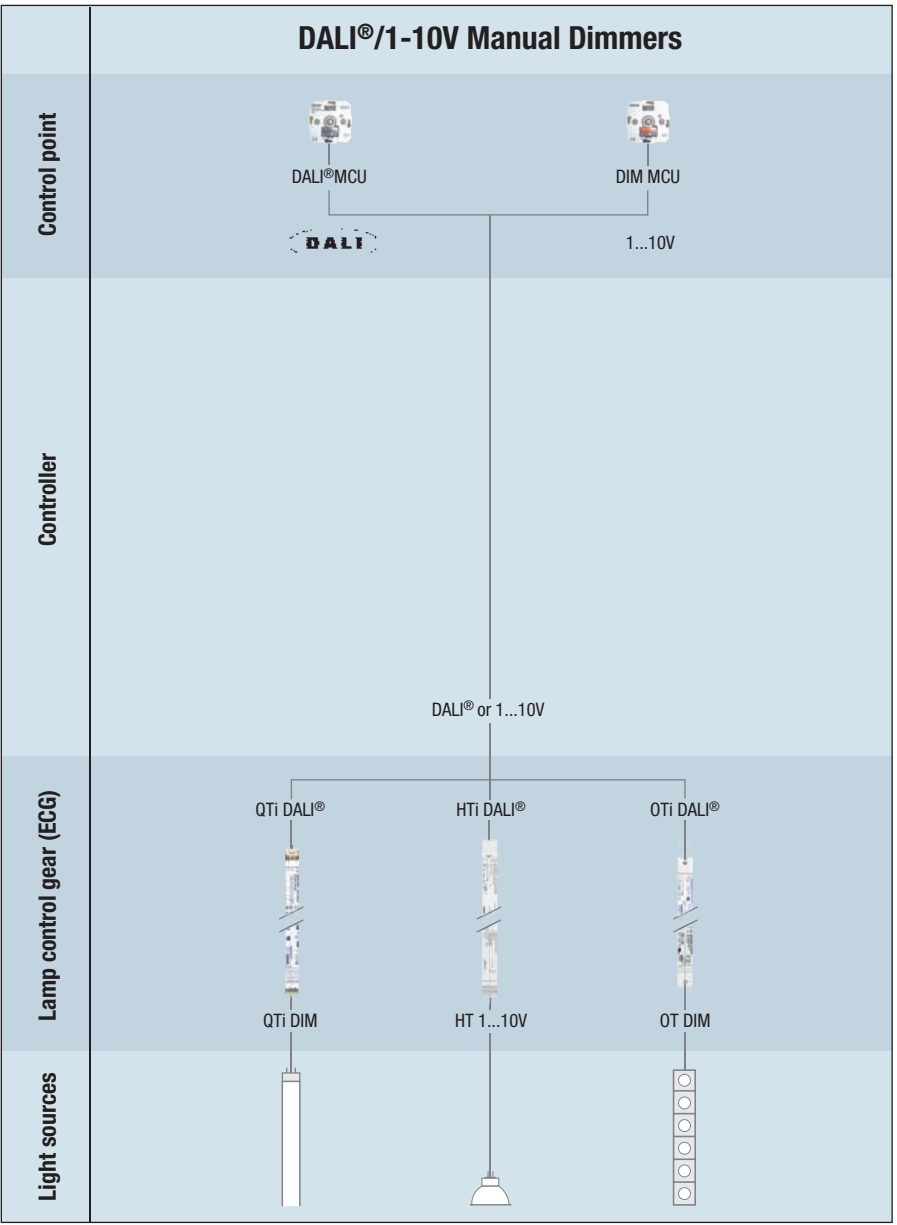

All orders must be multiples of sales pack

## LIGHT MANAGEMENT SYSTEMS – SCENES

### DALI®/1-10V Manual dimmers

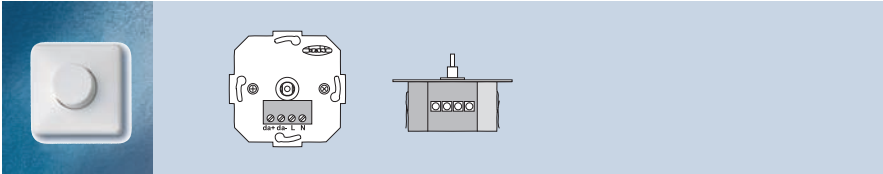

#### DALI MCU

- Up to 25 ECGs can be directly connected
- 4 DALI® MCUs can be connected in parallel – Up to 100 DALI® ECG

Product ID Code	EAN (Single Pack)	Product Description		PPG
DALIMCU	4008321189721	DALI MCU Digital potentiometer	15	39

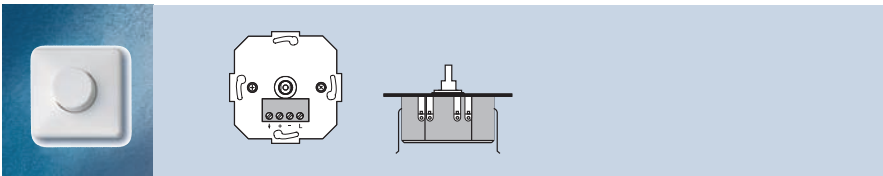

#### DIM MCU

- Up to 100 ECGs can be directly connected

Product ID Code	EAN (Single Pack)	Product Description		PPG
HFDIMMCUP	4050300347424	DIM MCU P manual control unit with cover plate	1	39



All orders must be multiples of sales pack

## LIGHT MANAGEMENT SYSTEMS – SCENES

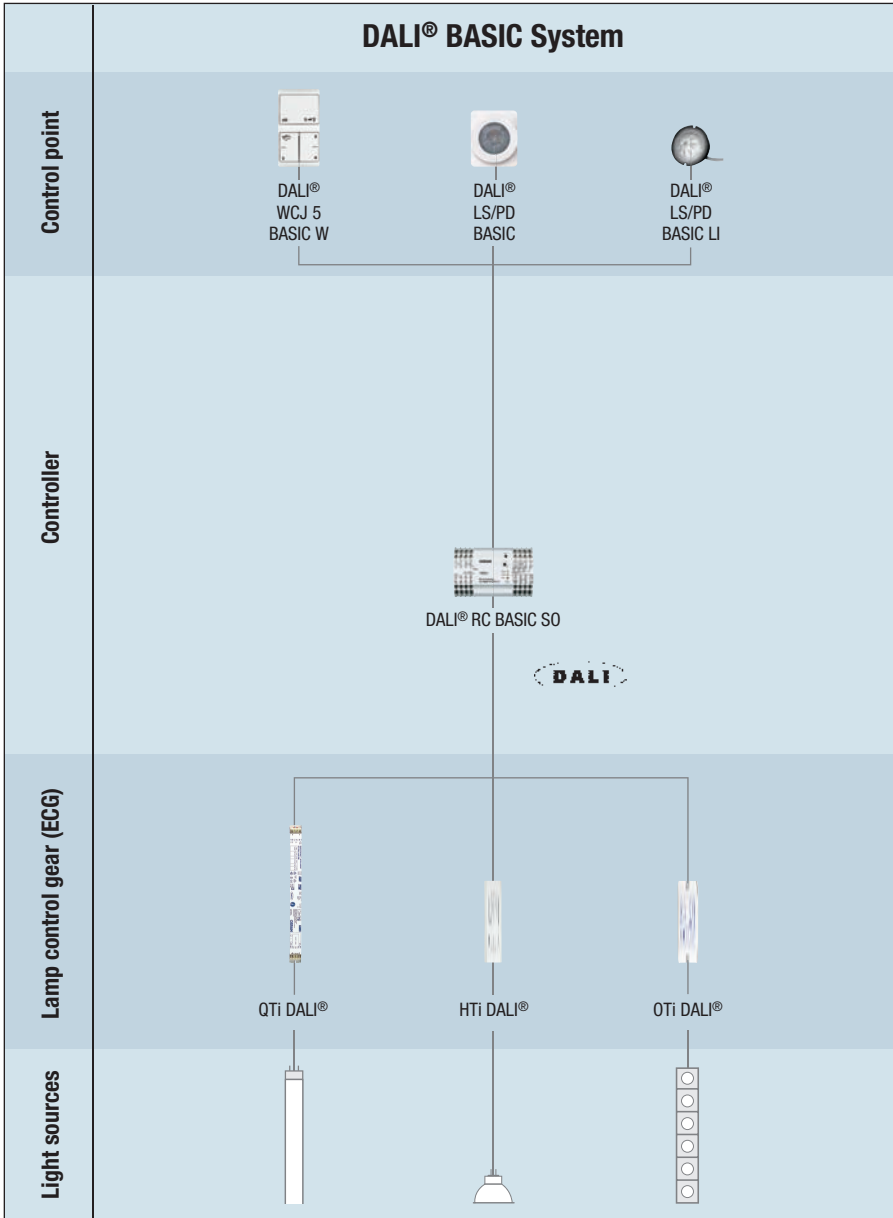

All orders must be multiples of sales pack



## LIGHT MANAGEMENT SYSTEMS – SCENES

### DALI® BASIC System

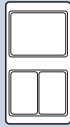

#### DALI® WCU 5 BASIC

- 5 Floating make contacts

Product ID Code	EAN (Single Pack)	Product Description		PPG
DALIWCU5	4050300771106	DALI WCU 5 BASIC W white 5 push button switch array	50	39



#### DALI® LS/PD BASIC

- Light and presence detector

Product ID Code	EAN (Single Pack)	Product Description		PPG
DALILSPD	4050300639949	DALI LS/PD BASIC light sensor/ presence detector for surface mounting	50	39

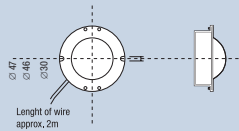

#### DALI® LS/PD BASIC LI

- Light and presence detector

Product ID Code	EAN (Single Pack)	Product Description		PPG
DALILSPDLI	4050300850184	DALI LS/PD LI BASIC light sensor/ presence detector for luminaire installation	20	39



All orders must be multiples of sales pack

Light Management Systems  
 SCENES – DALI® BASIC System



**DALI® RC BASIC SO**

- Up to 64 ECGs can be directly connected
- Control up to 4 lighting scenes, 4 assignable scenes and 3 inputs for 3 light or presence sensors

Product ID Code	EAN (Single Pack)	Product Description		PPG
DALIRC	4050300654973	DALI RC BASIC SO snap on room controller for DIN rail	18	39



All orders must be multiples of sales pack

## LIGHT MANAGEMENT SYSTEMS – SCENES

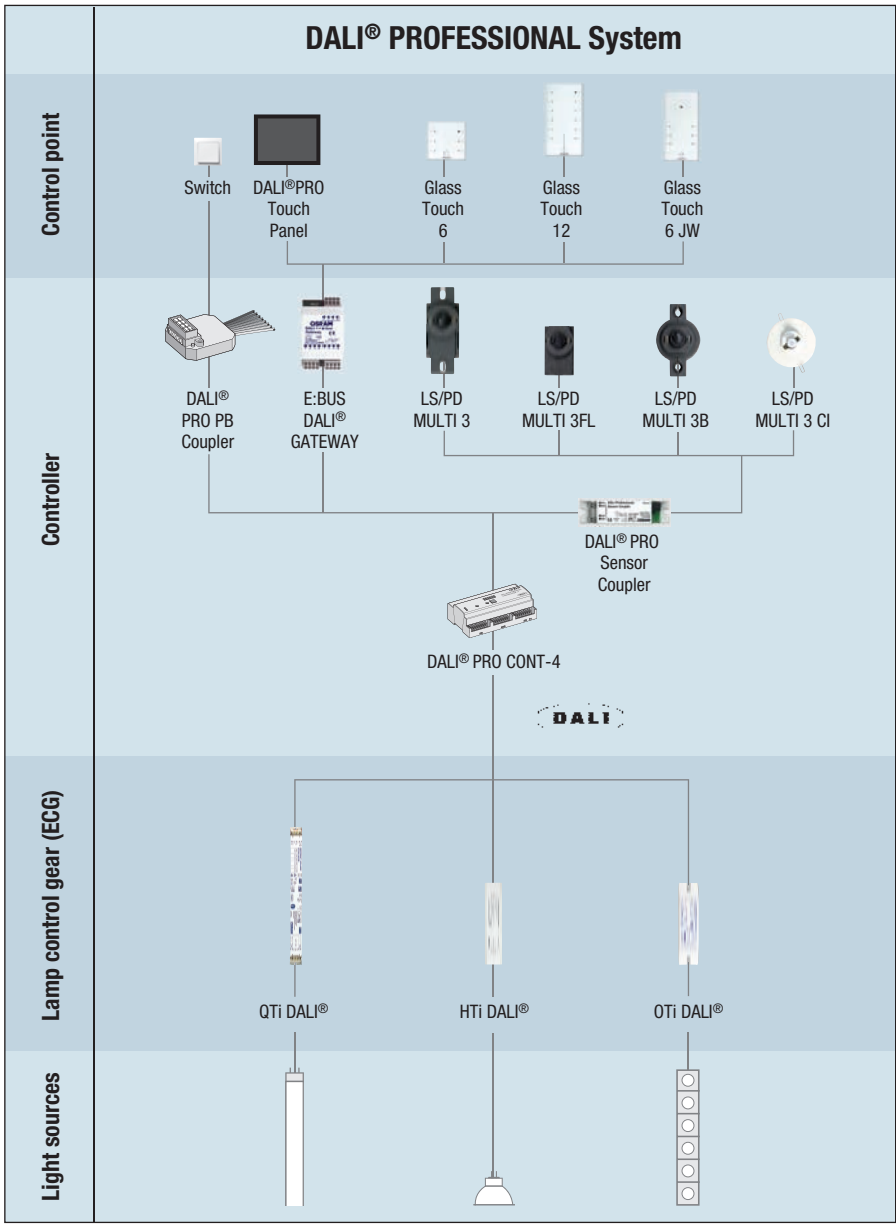

All orders must be multiples of sales pack

## LIGHT MANAGEMENT SYSTEMS – SCENES DALI® PROFESSIONAL System

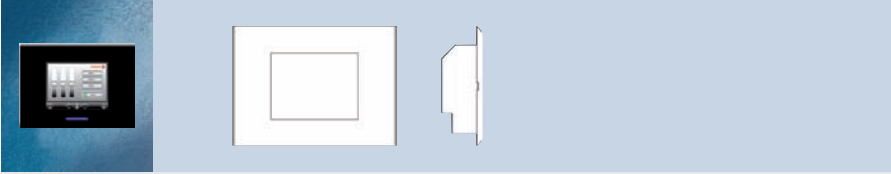

### DALI® PRO Touch Panel

- 5.7" high resolution LCD screen
- All luminaires in system can be switched or dimmed
- Backgrounds, logos, keys can be inserted

Product ID Code	EAN (Single Pack)	Product Description		PPG
–	4008321957092	DALI Pro Touch Panel	1	39

\*In preparation at time of print. For further information please contact OSRAM

NEW

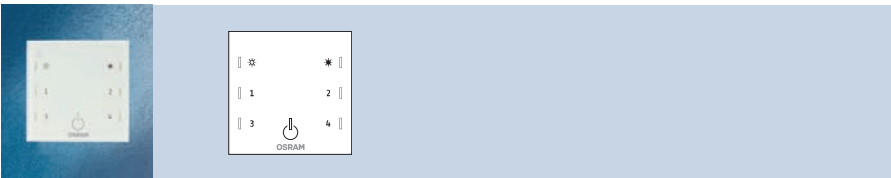

### Glass touch 6

- DALI Pro user interface for lighting management
- 6 Touch sensitive buttons on unit behind smooth glass

Product ID Code	EAN (Single Pack)	Product Description		PPG
GTOUCH6T	4008321957108	Glass Touch 6	4	39

NEW



All orders must be multiples of sales pack



### Glass touch 12

- DALI Pro user interface for lighting management
- 12 Touch sensitive buttons on unit behind smooth glass

Product ID Code	EAN (Single Pack)	Product Description		PPG
GTOUCH12T	4008321957115	Glass Touch 12	4	39

NEW

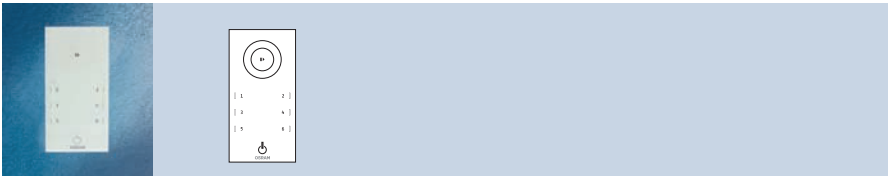

### Glass touch 6 JW

- DALI Pro user interface for lighting management
- 6 Touch sensitive buttons and touch wheel unit behind smooth glass

Product ID Code	EAN (Single Pack)	Product Description		PPG
GTOUCH6TR	4008321957054	Glass Touch 6 JW	4	39

NEW

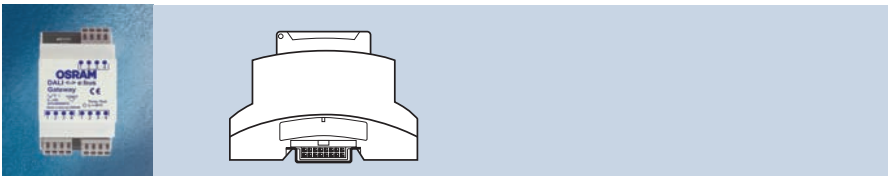

### E:BUS DALI® Gateway

- DIN Rail gateway to communicate between DALI® Pro CONT-4 and e:bus interfaces

Product ID Code	EAN (Single Pack)	Product Description		PPG
DALIGATEWAY	4008321957085	e:bus <-> DALI Gateway	8	39
DALIGATEWAY	4008321555311	PS30/100-240/24S0 power supply for e:bus <-> DALI Gateway	8	39

NEW



All orders must be multiples of sales pack

Light Management Systems  
 SCENES – DALI® PROFESSIONAL System

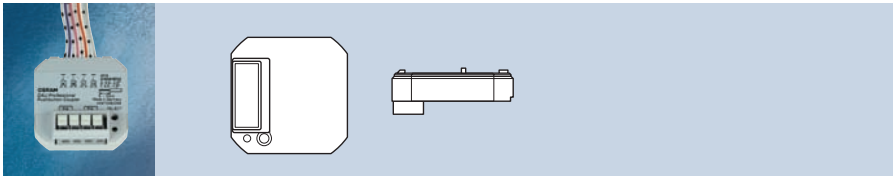

**DALI® PRO PB Coupler**

- Suitable for integrating push buttons for switching, dimming for scene setting
- Switching and dimming of up to 256 DALI® ECGS
- Up to 4 existing push buttons can be integrated

Product ID Code	EAN (Single Pack)	Product Description		PPG
DALIPROFPUSHB	4008321496461	DALI PROFESSIONAL PBcoupler	4	39

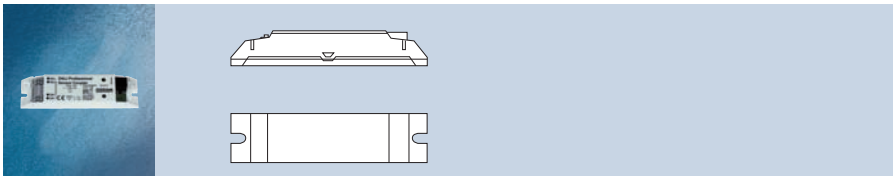

**DALI® PRO Sensor Coupler**

- Suitable for lighting control with light and presence sensors
- Light sensor and presence sensor from the MULTI 3 range can be used

Product ID Code	EAN (Single Pack)	Product Description		PPG
DALIPROFSENS	4008321379269	DALI PROFESSIONAL Sensorcoupler	25	39



All orders must be multiples of sales pack

Light Management Systems  
SCENES – DALI® PROFESSIONAL System

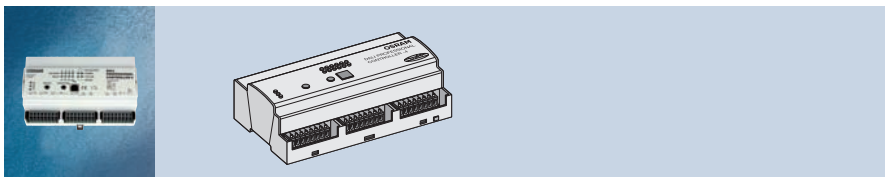

### DALI® PRO CONT-4

- Suitable for room control and daylight dependent control
- Intelligent module for controlling up to 256 ECGs
- 4 programmable switchover relays

Product ID Code	EAN (Single Pack)	Product Description		PPG
DALIPROCON4	4008321478948	DALI PROFESSIONAL CONTROLLER -4	4	39
–	–*	DALI PROFESSIONAL RF coupler	–	39
DALISWITCH	4008321533364	DALI Switch	8	39

\*In preparation at time of print. For further information please contact OSRAM



All orders must be multiples of sales pack

## LIGHT MANAGEMENT SYSTEMS – COMPONENTS

### COMPONENTS



LMS CI BOX

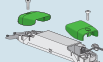

ECO CI KIT



SENSOR KIT



MOUNTING ADAPTER



Y-CONNECTOR SCREW



Y-CONNECTOR



DIM SA



DALI® CON 1...10 SO



DALI® CON 1...10 LI



DALI® REPEATER SO



DALI® REPEATER LI



All orders must be multiples of sales pack



**LIGHT MANAGEMENT SYSTEMS – COMPONENTS**  
**Interfaces and amplifiers**



**DALI® REPEATER LI**

- Addressable signal amplifier for the extension of DALI® and Touch DIM® light control systems
- To control up to 64 DALI® ECG as one group
- Allows expansion of DALI® systems with more than 64 ECG per DALI® Line

Product ID Code	EAN (Single Pack)	Product Description		PPG
DALIREPLI	4008321292599	DALI REPEATER LI Long 100-240V AC DC	25	39

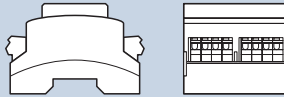

**DALI® REPEATER SO**

- Addressable signal amplifier for the extension of DALI® and Touch DIM® light control systems
- Integrated load contact for disconnecting the ECG supply in standby (Greenswitch)
- Touch DIM® control of 64 DALI® ECGs

Product ID Code	EAN (Single Pack)	Product Description		PPG
DALIREPSO	4008321301093	DALI REPEATER SO Square 100-240V AC DC	25	39



All orders must be multiples of sales pack

Light Management Systems  
 COMPONENTS – Interfaces and amplifiers

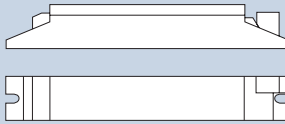

**DALI® CON 1...10 LI**

- Touch DIM® or DALI® control of 1-10V ECGs
- For luminaire installation

Product ID Code	EAN (Single Pack)	Product Description		PPG
DALICNLI	4050300638973	DALI CON 1...10V LI converter for luminaire installation	40	39

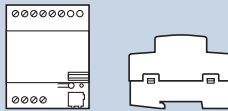

**DALI® CON 1...10 SO**

- Touch DIM® or DALI® control of 1-10V ECGs
- For series installation

Product ID Code	EAN (Single Pack)	Product Description		PPG
DALICNSO	4050300639802	DALI CON 1...10V SO snap on converter	16	39

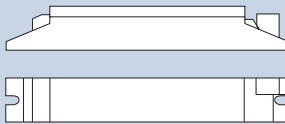

**DIM SA**

- Amplifies 1-10V control signals to operate larger numbers of ECG (up to 100 per unit)

Product ID Code	EAN (Single Pack)	Product Description		PPG
HFDIMSA	4008321097095	DIM SA signal amplifier	1	39



All orders must be multiples of sales pack

Light Management Systems  
 COMPONENTS – Interfaces and amplifiers



**LMS DMX CON DALI® SO**

- Convert DMX signal into DALI®
- 6 DALI® outputs with up to 16 DALI® ballasts per output
- Manual and auto DMX addressing modes
- Automatic amplification of DMX out signal

Product ID Code	EAN (Single Pack)	Product Description		PPG
CONDMX	4008321532336	DMX CON/100-240 DALI SO	10	39

NEW



All orders must be multiples of sales pack

## LIGHT MANAGEMENT SYSTEMS – COMPONENTS

### Accessories



#### Y-CONNECTOR

- Connections: 3 x modular 4p4c- socket
- 2 connecting cables included, modular 4p4c- connector on both ends, 2m long

Product ID Code	EAN (Single Pack)	Product Description		PPG
YCONNECTMULTI3	4050300803135	Y-CONNECTOR MULTI 3	25	39



#### Y-CONNECTOR SCREW

- Connections: 2 x four pin screw terminal and 2 x 4p4c- socket
- 2 connecting cables included, modular 4p4c- connector on both ends, 2m long

Product ID Code	EAN (Single Pack)	Product Description		PPG
YCON	4008321916686	Y-CONNECTOR with screw terminals	25	39

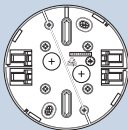

#### Mounting Adapter

- Adapter for surface mounting of sensor elements with a diameter 115.6mm

Product ID Code	EAN (Single Pack)	Product Description		PPG
MOUNTADAPTER	4008321480798	Mounting Adapter	20	39

All orders must be multiples of sales pack

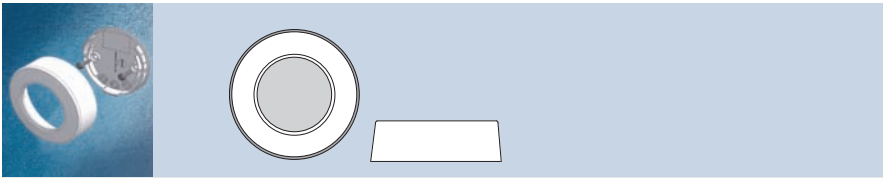

### SENSOR KIT

- Adapter for surface mounting of sensor elements with a diameter of 50 mm

Product ID Code	EAN (Single Pack)	Product Description		PPG
SENSORKIT	4008321916662	Adapter for surface mounting of LS/PD MULTI 3	10	39

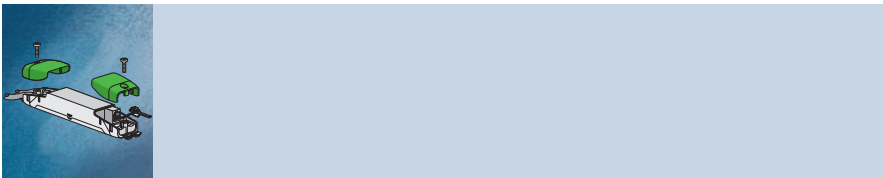

### ECO CI KIT

- Can be used for separate mounting of all OSRAM controllers with dimensions of (l)118mm x (w)30mm x (h)21 mm

Product ID Code	EAN (Single Pack)	Product Description		PPG
ECOCITKIT	4008321392091	ECO CI KIT	1	39

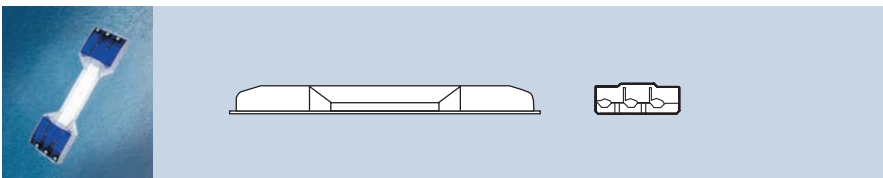

### LMS CI BOX

- Can be used for separate mounting of all OSRAM controllers with dimensions of (l)189mm x (w)30mm x (h)21 mm

Product ID Code	EAN (Single Pack)	Product Description		PPG
LMSCIBOX	4008321083692	LMS CI BOX installation kit	40	39



All orders must be multiples of sales pack

LUMINAIRES

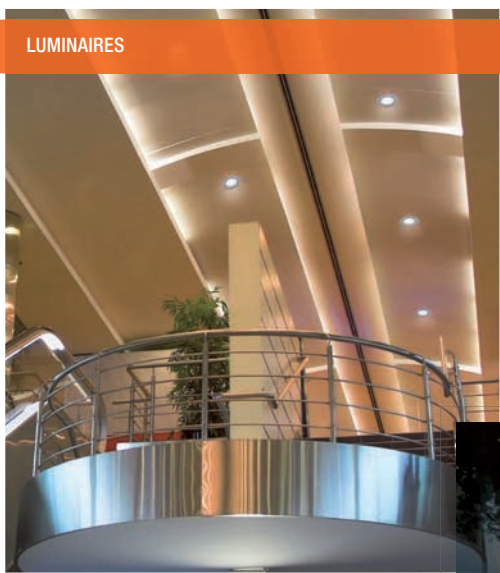

# Luminaires Contents.

## INDOOR LUMINAIRES

### MODULAR SYSTEMS

RFI E	311
PASS II	312

### SURFACE MOUNTED LUMINAIRES

LUMILUX® DUO® T5 F/P	313
LUMILUX® DUO® T5 F/R	313
OSRAM SOFTLITE® EL	314
Pendant kit	314
LUMILUX® FLATLITE® T5 F/P	315
DIADEM®	315
LUMILUX® DUO®EL F/P	316
LUMILUX® DUO®EL F/R	316
SCRIPTUS	317
OSRAM DULUX® RONDEL	317
OSRAM DULUX® CARRE	318

### BATTEN LUMINAIRES

OSRAM ECOPACK®T5 DALI	319
OSRAM ECOPACK®T5 DIM	319
OSRAM ECOPACK®FH DIM	320
OSRAM ECOPACK® T5	320
OSRAM ECOPACK® Louvre	321
OSRAM ECOPACK® FQ	321
OSRAM ECOPACK® FH	322
OSRAM MINI5 ECO	323
LUMILUX® COMBI EL	324
LUMILUX® DECO EL	325
OSRAM ECOPACK® DIM	325
OSRAM ECOPACK®	326
LUMILUX® COMBI EL-N	326
LUMILUX® COMBI EL-F	327
LUMILUX® COMBI EL-N/P	328
LUMILUX® COMBI EL-F/P	328
LUMILUX® COMBI EL-F/D	329
LUMILUX® COMBI EL-F/B	329
LUMILUX® COMBI EL-N	330
LUMILUX® VARIO EL-F	330

### FURNITURE LUMINAIRES

DRAGONPOINT® VARIO KIT	331
DRAGONPOINT® FIX KIT	332
DRAGONPOINT® MOOD KIT	332
DRAGONSPOT®	333
LEDVANCE™ DOWNLIGHT S	334
LEDVANCE™ Polybar	335
LUMINESTRA® LED	336
LUMINESTRA® EL	336
SLIMLITE® EL	337
PICOLINE® EL	337
LUMILUX® VARIO FM	338

### RECESSED LUMINAIRES

LEDVANCE® Downlight M	339
LEDVANCE® Downlight L	340
LEDVANCE® Downlight XL	341
KIT LED PRO	342
DOWNLIGHT KIT HCI® R111	343
KIT DOWNLIGHT HQI®-TS EXCELLENCE	344
DOWNLIGHT KIT HALOSPOT® R111 ECO	345
KIT HALO ECO	346
KIT HALO PRO	346
KIT HALO PRO HYDRO	347
JADE KTI ECO HF	347
OSRAM DEDRA plus® T5 KIT	348
OSRAM DEDRA plus® T8 KIT	349
DELTA	350

### DAMP PROOF LUMINAIRES

ORCA PLUS for T5	351
ORCA PLUS for T8	352
NEPTUNE® POLYCARBONATE	353
IGLOO II	353
AQUALINE™ T5	354

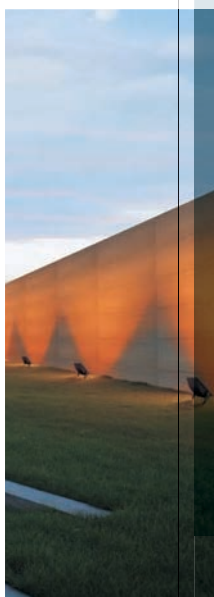

## CONTENTS

### OUTDOOR LUMINAIRES

#### RECESSED LUMINAIRES

AQUALED®	355
AQUALED DRAGON®	356
NAUTILUS® MIDI DR51 INC	356
NAUTILUS® MINI HAL	357

#### SURFACE MOUNTED LUMINAIRES

LUMILUX BRIK® EL	358
OSRAM DULUX BRIK® EL	358

### CONSUMER LUMINAIRES

#### FLASHLIGHTS

SIRIUS Torch Range	359
CROSSER Torch Range	359
LED Clip on Lights	360
LED MULTIFUNCTIONAL	360
LED SAVER LIGHT	361
LED HEADLAMP	361
CAMPING LED	362
CAMPING ENERGY AUTOMATIC	362
CAMPING HALOGEN DIM SI	363

#### NIGHT LIGHTS

SPYLUX™	364
NIGHTLUX™	364

#### FUNCTIONAL DESIGN

LEDstixx™	365
POWERstixx™	365
QOD	366

#### PORTABLE LED LUMINAIRES

DOT-it® CLASSIC	367
DOT-it® VARIO	368
DOT-it® LINEAR VARIO	368
DOT-it® waterproof	369

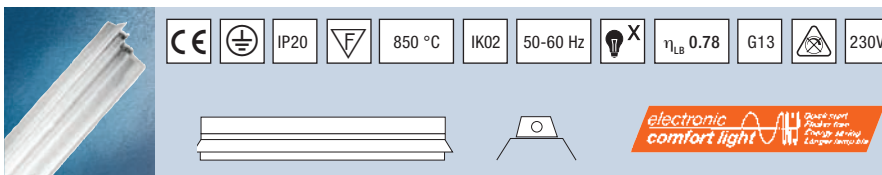

**INDOOR****MODULAR SYSTEMS****RFI E**

- Ready to install thin low profile aluminium reflector
- Equipped with QTIS-E electronic control gear, suitable for LUMILUX® T8 58W tubes
- Ideal for high ceilings, cove lighting industrial and commercial settings

Product ID Code	EAN (Single Pack)	Product Description	FINISH	W	l (mm)	b (mm)	h (mm)		PPG
<b>RFI E – Electronic Control Gear</b>									
SCHUTZGITTER258	4050300117690	RFI E 2 x 58W HE	White	2x58	1523	207	94	1	38
<b>RFI E – Accessories</b>									
SCHUTZGITTER258	4050300117690	RFI E Louvre grid 2 x 58W	White	-	-	-	-	2	38
GRILGYMNOS58	4050300820170	RFI E grid 2 x 58W	White	-	-	-	-	1	38
7ONCTIONS2XRFIE	4008321083456	RFI E connection element	White	-	-	-	-	25 x2	38
FLAQUES2XRFE	4008321083449	RFI E end caps	White	-	-	-	-	25 x2	38



Louvre grid



Grid



Connection element



End caps

All orders must be multiples of sales pack

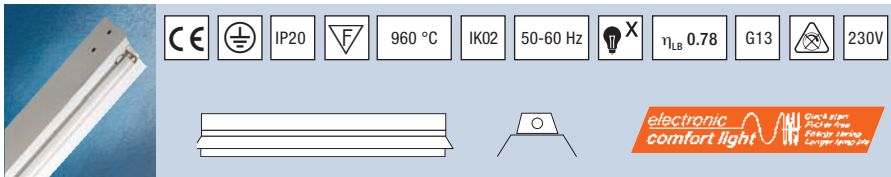

## Indoor – Modular Systems

**PASS II**

- Prewired strip light with bracket and guide rail for ceiling or pendant mounting
- Equipped with QTIS-E electronic control gear, suitable for LUMILUX® T8 58W tubes
- Ideal for general illumination and route lighting in industrial and commercial settings

Product ID Code	EAN (Single Pack)	Product Description	FINISH	W	l [mm]	b [mm]	h [mm]		PPG
<b>PASS II</b>									
PASSIIHFGB1	4050300910444	PASS II 153 1 x 58W HE	White	58	1530	140	60	1	38
PASTICHE	4050300910420	PASS II 153 2 x 58W HE	White	2x58	1530	140	60	1	38
PASSIIHFGB2	4050300910468	PASS II 306 2 x 58W HE	White	2x58	3060	140	60	1	38
PASSIVITY	4050300909455	PASS II 306 4 x 58W HE	White	4x58	3060	140	60	1	38
<b>PASS II – Accessories</b>									
PASSIIETRIER	4050300909264	Bracket for additional suspension	-	-	-	-	-	72	38
PASSII2CAPS	4008321188434	END caps (supplied in pairs)	-	-	-	-	-	18 x2	38
BRANCARDPASS	4008321302816	Connector for cross mounting	-	-	-	-	-	48 x2	38
PASSIICOVERCLE	4050300772844	Zinc-plated end sheet 153	-	-	-	-	-	10	38



Bracket for additional suspension



End caps



Connector for cross mounting



All orders must be multiples of sales pack



## INDOOR

### SURFACE MOUNTED LUMINAIRES

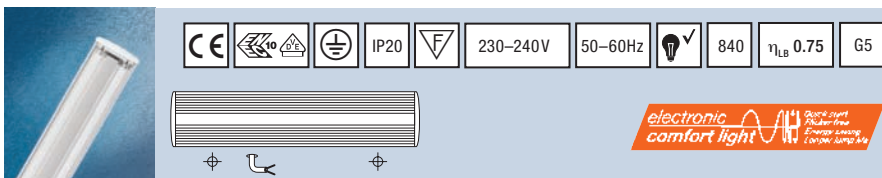

#### LUMILUX® DUO® T5 F/P

- Twin T5 low profile electronic batten with LUMILUX® T5 HE/840 tubes for fixed connection
- Prismatic cover
- High quality casing made from anodised aluminium
- Ideal for strip lighting when used in conjunction with OSRAM ECOPACK® Pendant/suspension kit

Product ID Code	EAN (Single Pack)	Product Description	FINISH	W	l (mm)	b (mm)	h (mm)		PPG
72098	4008321908797	LUMILUX DUO T5 F/P 2x14	Silver	2x14	594	110	42	2	38
72099	4008321908803	LUMILUX DUO T5 F/P 2x21	Silver	2x21	894	110	42	2	38
72100	4008321908810	LUMILUX DUO T5 F/P 2x28	Silver	2x28	1194	110	42	2	38

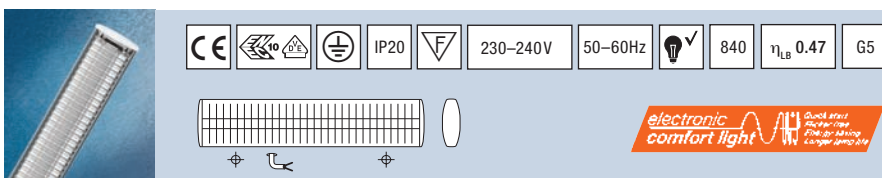

#### LUMILUX® DUO® T5 F/R

- Twin T5 low profile electronic batten with LUMILUX® T5 HE/840 tubes for fixed connection
- Aluminium louvre and highly polished reflector
- High quality casing made from anodised aluminium
- Ideal for strip lighting when used in conjunction with OSRAM ECOPACK® Pendant/suspension kit

Product ID Code	EAN (Single Pack)	Product Description	FINISH	W	l (mm)	b (mm)	h (mm)		PPG
72102	4008321908827	OSRAM DUO T5 F/R 2x14W	Silver	2x14	594	110	50	2	38
72103	4008321908834	OSRAM DUO T5 F/R 2x21W	Silver	2x21	894	110	50	2	38
72104	4008321908841	OSRAM DUO T5 F/R 2x28W	Silver	2x28	1194	110	50	2	38



All orders must be multiples of sales pack



## Indoor – Surface Mounted Luminaires

				850 °C	IK06	230–240 V	50–60 Hz		840
								$\eta_{LB}$ 0.49	G5

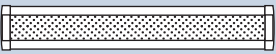



*electronic  
comfort light* Stichtlicht  
Stichtlicht  
Energie sparen  
Lichtleistung  
Lichtleistung

**OSRAM SOFTLITE® EL**

- T5 electronic batten with LUMILUX® T5 HO/ 840 tubes for fixed connection
- Perforated cover for glare free direct/indirect lighting
- QUICKTRONIC® QTP5 electronic control gear
- OSRAM ECOPACK® Pendant/suspension kit available which includes 2 x fixings, adjustable cable holders, steel cable for pendant lengths and cable clamps.

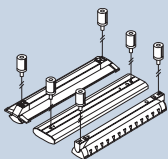
Product ID Code	EAN (Single Pack)	Product Description	FINISH	W	I (mm)	b (mm)	h (mm)		PPG
72535W	4050300535630	OSRAM SOFTLITE EL 24W	White	24	610	155	82	2	38
72536W	4050300535654	OSRAM SOFTLITE EL 39W	White	39	910	155	82	2	38
72537W	4050300535678	OSRAM SOFTLITE EL 54W	White	54	1210	155	82	2	38
72538W	4050300535692	OSRAM SOFTLITE EL 80W	White	80	1510	155	82	2	38



**Pendant kit for LUMILUX® DUO® T5, OSRAM SOFTLITE® and ECOPACK®**

- Kit includes: 2 x fixings, adjustable cable holders, steel cable for pendant lengths up to 2m and cable clamps

Product ID Code	EAN (Single Pack)	Product Description	FINISH	I (mm)		PPG
72097	4050300792200	Pendant Kit	Silver	2000	4	38



All orders must be multiples of sales pack

## Indoor – Surface Mounted Luminaires

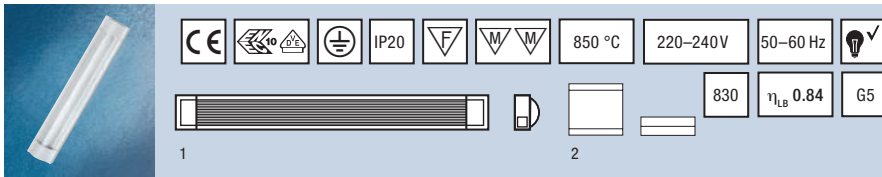
**LUMILUX® FLATLITE® T5 F/P**

- Compact low profile through wired T5 luminaire with high luminous efficacy
- Prismatic cover for glare free light
- Includes LUMILUX® T5 830 HO and integrated QTP5 electronic control gear
- Ideal for general lighting or strip lighting with the appropriate accessory (double cap)

Product ID Code	EAN (Single Pack)	Product Description	FINISH	W	l (mm)	b (mm)	h (mm)	No.	PPG	
72491	4008321908537	LUMILUX FLATLITE T5 F/P 24W 830	White	24	608	105	41	1	4	38
72492	4008321908544	LUMILUX FLATLITE T5 F/P 39W 830	White	39	908	105	41	1	4	38
72493	4008321908551	LUMILUX FLATLITE T5 F/P 54W 830	White	54	1208	105	41	1	4	38
72494	4008321908568	LUMILUX FLATLITE T5 F/P 49W 830	White	49	1508	105	41	1	4	38
7249155	4008321917355	Double Cap for strip lighting LUMILUX FLATLITE T5 F/P	White	-	118	105	38	2	4	38

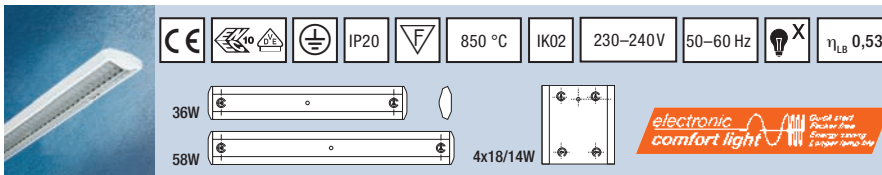
**DIADEM®**

- Attractive economical ceiling mounted luminaire with retaining cable for simple relamping
- Symmetrical V reflector in polished aluminium or white finishes
- Integrated QT-FIT8 or QT-FH 4x14W control gear, suitable for LUMILUX® T8 or T5 tubes
- Ideal for office, conference and amenity lighting

Product ID Code	EAN (Single Pack)	Product Description	FINISH	W	l (mm)	b (mm)	h (mm)	PPG	
DIAD2M2X36VB	4008321413390	DIAD2M 2 x 36W	White	36	1265	210	80	1	38
DIAD2M2X36WT	4008321413406	DIAD2M 2 x 36W	Aluminium	36	1265	210	80	1	38
DIAD2M2X58VB	4008321413413	DIAD2M 2 x 58W	White	58	1565	210	80	1	38
DIAD2M2X58WT	4008321413420	DIAD2M 2 x 58W	Aluminium	58	1565	210	80	1	38
-	4008321926348*	DIAD2M 4 x 18W	White	18	660	610	80	1	38
DIAD4M4X18VA	4008321962355	DIAD4M 4 x 18W	Aluminium	18	660	610	80	1	38
-	4008321926324*	DIAD4M 4 x 14W VBAS	White	14	660	610	80	1	38
DIAD1M58	4008321962331	DIAD4M 4 x 58W ASM	White	58	1565	210	80	1	38

\*In preparation at time of print. For further information please contact OSRAM



All orders must be multiples of sales pack

## Indoor – Surface Mounted Luminaires

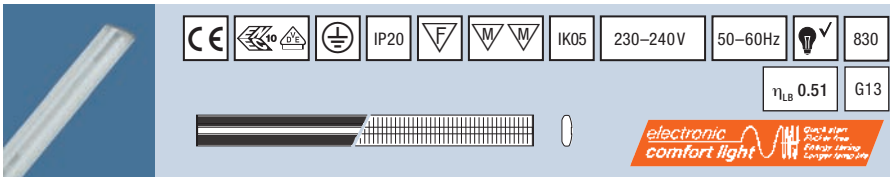
**LUMILUX® DUO® EL F/P**

- Extremely low profile twin T8 electronic batten luminaire with LUMILUX® T8 830 tubes for fixed connection
- Prismatic cover for uniform light
- High quality casing made from anodised aluminium
- Integrated QTP electronic control gear
- Ideal for applications that require high lighting levels

Product ID Code	EAN (Single Pack)	Product Description	FINISH	W	l [mm]	b [mm]	h [mm]		PPG
72085	4050300774206	OSRAM DUO EL F/P 2x18W	Silver	2 x 18	626	140	45	4	38
72086	4050300774237	OSRAM DUO EL F/P 2x36W	Silver	2 x 36	1235	140	45	4	38
72087	4050300774268	OSRAM DUO EL F/P 2x58W	Silver	2 x 58	1535	140	45	4	38

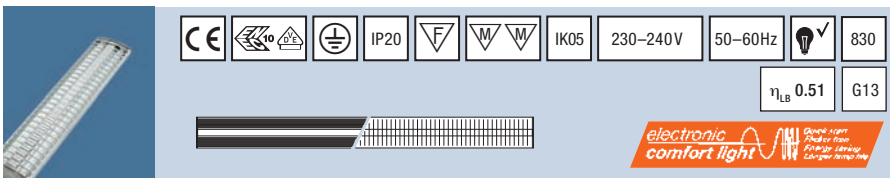
**LUMILUX® DUO® EL F/R**

- Extremely low profile twin T8 electronic batten luminaire with LUMILUX® T8 830 tubes for fixed connection
- Aluminium louvre and highly polished reflector
- High quality casing made from anodised aluminium
- Integrated QTP electronic control gear
- Ideal for applications that require high lighting levels

Product ID Code	EAN (Single Pack)	Product Description	FINISH	W	l [mm]	b [mm]	h [mm]		PPG
72088	4050300774299	OSRAM DUO EL F/R 2x18W	Silver	2 x 18	626	140	50	4	38
72089	4050300774329	OSRAM DUO EL F/R 2x36W	Silver	2 x 36	1235	140	50	4	38
72090	4050300774350	OSRAM DUO EL F/R 2x58W	Silver	2 x 58	1535	140	50	4	38



All orders must be multiples of sales pack

## Indoor – Surface Mounted Luminaires

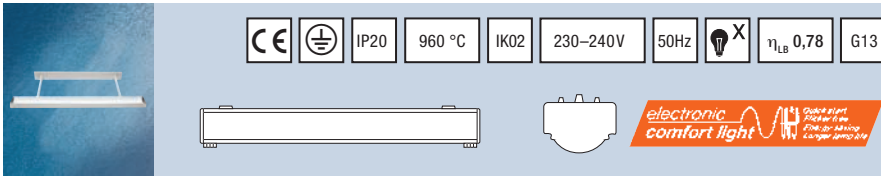
**SCRIPTUS**

- T8 reflector luminaire for wall mounting
- Kit includes integrated ECG, brackets, ceiling rose and two cable routing rods
- Suitable for LUMILUX® T8
- Ideal for illuminating paintings, classroom boards, advertising panels and indirect lighting

Product ID Code	EAN (Single Pack)	Product Description	FINISH	W	l (mm)	b (mm)	h (mm)		PPG
SCRIPTUS1L36C	4050300118185	SCRIPTUS 1x36 HF	White	36	1230	145	74	1	38
SCRIPTUS1L58HF	4050300117638	SCRIPTUS 1x58 HF	White	58	1530	145	74	1	38

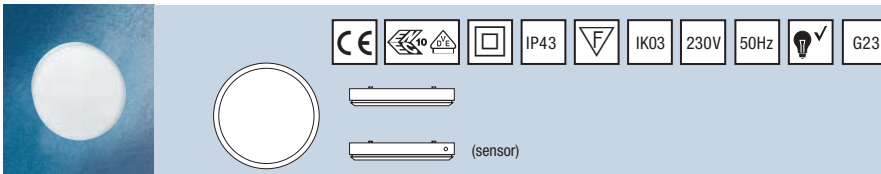
NEW  
NEW**OSRAM DULUX® RONDEL\***

- Super slim round energy saving luminaire suitable for indoors and outdoors (IP43)
- Sensor version available with adjustable dimmer switch
- Equipped with OSRAM DULUX® S compact fluorescent lamps

Product ID Code	EAN (Single Pack)	Product Description	FINISH	W	h (mm)	d (mm)		PPG
<b>OSRAM DULUX RONDEL</b>								
73025W	4050300361543	RONDEL 9W DULUX S 827	White	9	55	230	4x1	38
73030W	4050300328737	RONDEL 2 x 9W DULUX S 827	White	2 x 9	55	270	4x1	38
<b>OSRAM DULUX RONDEL SENSOR</b>								
7302575W	4050300399133	RONDEL SENSOR 9W DULUX S 830	White	9	55	230	4x1	38

\*Changeover to electronic operation in preparation. For further information please contact OSRAM

All orders must be multiples of sales pack

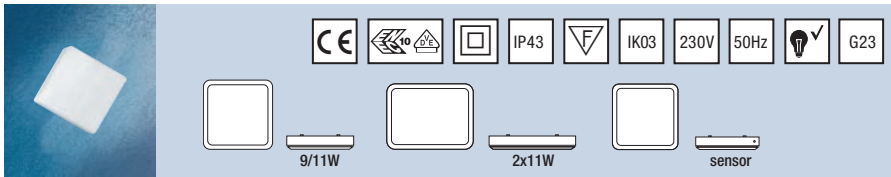

## Indoor – Surface Mounted Luminaires

**OSRAM DULUX® CARRE\***

- Super slim rectangular energy saving luminaire suitable for indoors and outdoors (IP43)
- Sensor version available with adjustable dimmer switch
- Equipped with OSRAM DULUX® S compact fluorescent lamps

Product ID Code	EAN (Single Pack)	Product Description	FINISH	W	l [mm]	b [mm]	h [mm]	PPG
<b>OSRAM DULUX CARRE</b>								
73040W	4050300012117	CARRE 9W DULUX S 827	White	9	200	200	55	4x1 38
73045W	4050300012100	CARRE 11W DULUX S 827	White	11	270	200	55	4x1 38
73050W	4050300314921	CARRE 2x11W DULUX S 827	White	2x11	270	270	55	4x1 38
<b>OSRAM DULUX CARRE SENSOR</b>								
7304075W	4050300424644	CARRE SENSOR 9W DULUX S 830	White	9	200	200	55	4x1 38

\*Changeover to electronic operation in preparation. For further information please contact OSRAM



All orders must be multiples of sales pack

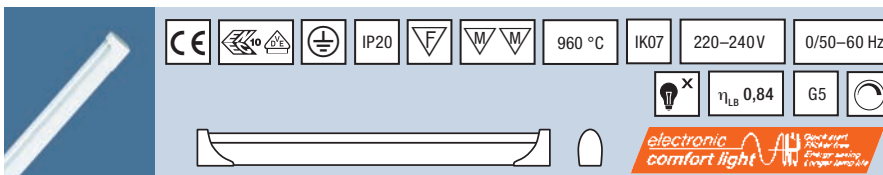

**INDOOR****BATTEN LUMAIRES****OSRAM ECOPACK® T5 DALI®**

- T5 batten luminaires with integrated QUICKTRONIC® QT<sub>i</sub> DALI® electronic control gear
- Large number of different light sources can be used
- For integration in DALI® installations, dimmable from 100% to 1%
- Supplied without cover and T5 lamp for fixed connection

Product ID Code	EAN (Single Pack)	Product Description	FINISH	W	l (mm)	b (mm)	h (mm)		PPG
7262199	4008321259578	OSRAM ECOPACK T5 DALI	White	14/24	584	38	58	4	38
7262299	4008321259592	OSRAM ECOPACK T5 DALI	White	21/39	884	38	58	4	38
7262399	4008321259615	OSRAM ECOPACK T5 DALI	White	28/54	1184	38	58	4	38
7262499	4008321259639	OSRAM ECOPACK T5 DALI	White	35/49/80	1484	38	58	4	38

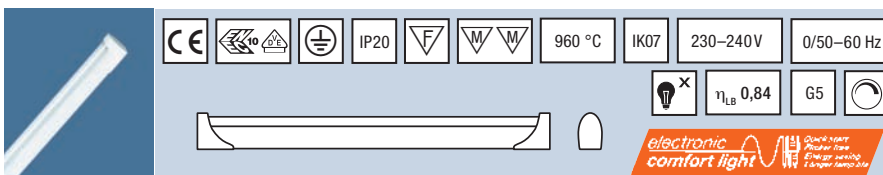
**OSRAM ECOPACK® T5 DIM**

- Dimmable T5 batten luminaire with integrated QUICKTRONIC® QT<sub>i</sub> DIM electronic control gear
- Large number of different light sources can be used
- 1...10V dimmable from 100% to 1%
- Supplied without cover and T5 lamp for fixed connection

Product ID Code	EAN (Single Pack)	Product Description	FINISH	W	l (mm)	b (mm)	h (mm)		PPG
7261199	4008321259493	OSRAM ECOPACK T5 DIM	White	14/24	584	38	58	4	38
7261299	4008321259516	OSRAM ECOPACK T5 DIM	White	21/39	884	38	58	4	38
7261399	4008321259530	OSRAM ECOPACK T5 DIM	White	28/54	1184	38	58	4	38
7261499	4008321259554	OSRAM ECOPACK T5 DIM	White	35/49/80	1484	38	58	4	38



All orders must be multiples of sales pack

## Indoor – Batten Luminaires

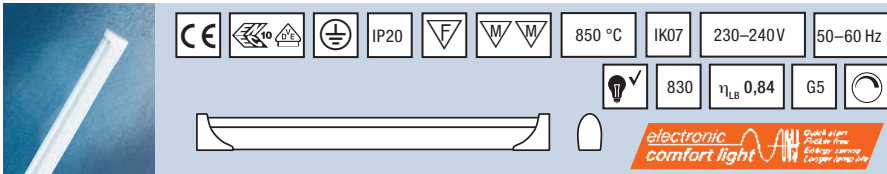
**OSRAM ECOPACK® FH DIM**

- Dimmable T5 batten luminaire equipped with LUMILUX® T5 HE 830 tube for fixed connection
- 1...10V dimmable from 100% to 1%
- Prismatic cover for uniform light
- With QUICKTRONIC® QT DIM electronic control gear

Product ID Code	EAN (Single Pack)	Product Description	FINISH	W	l (mm)	b (mm)	h (mm)	PPG
72611W	4050300659213	OSRAM ECOPACK FH DIM 14W	White	14	584	38	58	4 38
72612W	4050300659237	OSRAM ECOPACK FH DIM 21W	White	21	884	38	58	4 38
72613W	4050300659251	OSRAM ECOPACK FH DIM 28W	White	28	1184	38	58	4 38
72614W	4050300659275	OSRAM ECOPACK FH DIM 35W	White	35	1484	38	58	4 38

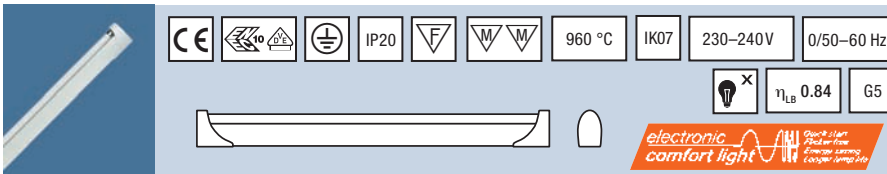
**OSRAM ECOPACK® T5**

- Dimmable T5 batten luminaire with integrated QUICKTRONIC® QT electronic control gear
- Large number of different light sources can be used
- Supplied without cover and T5 lamp for fixed connection

Product ID Code	EAN (Single Pack)	Product Description	FINISH	W	l (mm)	b (mm)	h (mm)	PPG
7260199	4008321257413	OSRAM ECOPACK FH	White	14/24	584	38	58	4 38
7260299	4008321257437	OSRAM ECOPACK FH	White	21/39	884	38	58	4 38
7260399	4008321257451	OSRAM ECOPACK FH	White	28/54	1184	38	58	4 38
-	4008321257479*	OSRAM ECOPACK FH	White	35/49/80	1484	38	58	4 38

\*In preparation at time of print. For further information please contact OSRAM



All orders must be multiples of sales pack

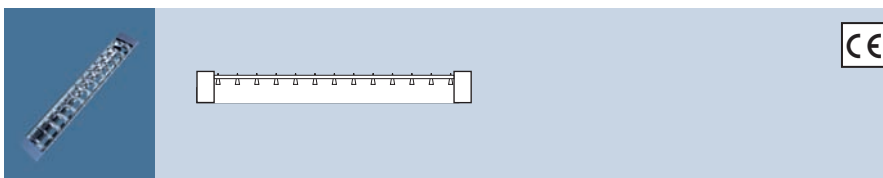

Indoor – Batten Luminaires

**OSRAM ECOPACK® Louvre**

- Double parabolic louvres for all OSRAM ECOPACK® luminaires with or for T5 tubes
- Highly polished, aluminium finish
- Ideal for reducing glare

Product ID Code	EAN (Single Pack)	Product Description	FINISH	W	l (mm)	b (mm)	h (mm)		PPG
72650	4008321079886	OSRAM ECOPACK Louvre for 14/24W	White	14/24	567	88	53	4	38
72651	4008321079909	OSRAM ECOPACK Louvre for 21/39W	White	21/39	867	88	53	4	38
72652	4008321080424	OSRAM ECOPACK Louvre for 28/54W	White	28/54	1167	88	53	4	38
72653	4008321080448	OSRAM ECOPACK Louvre for 35/80W	White	35/49/80	1467	88	53	4	38

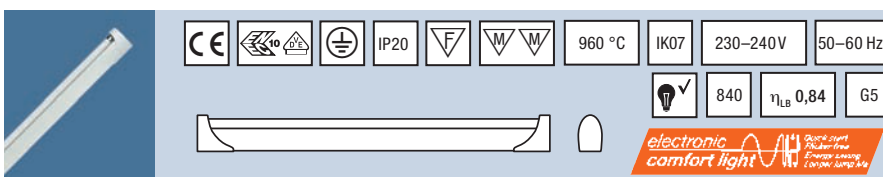
**OSRAM ECOPACK® FQ**

- Extremely bright T5 electronic batten luminaire
- Complete with high output LUMILUX® T5 HO 840 tubes for fixed connection
- Without cover for maximum luminous flux
- With QUICKTRONIC® QT<sub>i</sub> electronic control gear

Product ID Code	EAN (Single Pack)	Product Description	FINISH	W	l (mm)	b (mm)	h (mm)		PPG
72630	4050300797762	OSRAM ECOPACK FQ 24W	White	24	584	38	58	4	38
72631	4050300859187	OSRAM ECOPACK FQ 39W	White	39	884	38	58	4	38
72632	4050300859200	OSRAM ECOPACK FQ 54W	White	54	1184	38	58	4	38
72633	4050300859385	OSRAM ECOPACK FQ 80W	White	80	1484	38	58	4	38



All orders must be multiples of sales pack

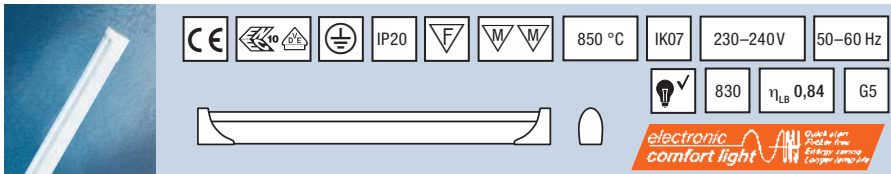

## Indoor – Batten Luminaires

**OSRAM ECOPACK® FH**

- Extremely economical T5 electronic batten luminaire
- Complete with high efficiency LUMILUX® T5 HE 830 tubes for fixed connection
- With prismatic cover for uniform light distribution
- With QUICKTRONIC® QTi electronic control gear

Product ID Code	EAN (Single Pack)	Product Description	FINISH	W	l (mm)	b (mm)	h (mm)	PPG
72601W	4050300513249	OSRAM ECOPACK FH 14W	White	14	584	38	58	4 38
72602W	4050300513263	OSRAM ECOPACK FH 21W	White	21	884	38	58	4 38
72603W	4050300513287	OSRAM ECOPACK FH 28W	White	28	1184	38	58	4 38
72604W	4050300513300	OSRAM ECOPACK FH 35W	White	35	1484	38	58	4 38



All orders must be multiples of sales pack

## Indoor – Batten Luminaires

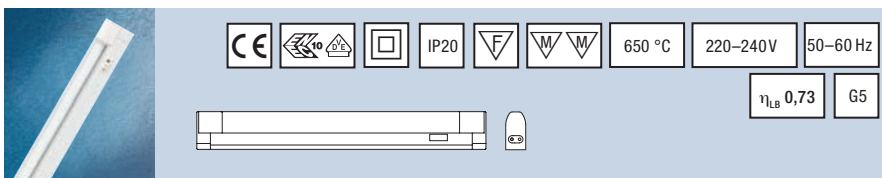
**OSRAM MINI5 ECO**









- Compact pluggable T5 batten luminaire with LUMILUX® T5 tubes
- Equipped with or without LUMILUX® T5 8W/13W or LUMILUX® T5 HE 14W/28W/35W
- With prismatic cover for uniform light distribution
- Developed for installation in tight spaces
- Can be installed separately or combined to create strip lighting

Product ID Code	EAN (Single Pack)	Product Description	FINISH	W	l [mm]	b [mm]	h [mm]	PPG
<b>OSRAM MINI5 ECO – with lamp</b>								
7281027	4008321931399	OSRAM MINI5 ECO 8W 827	White	8	318	24	42	4 38
7281127	4008321931412	OSRAM MINI5 ECO 13W 827	White	13	547	24	42	4 38
7281227	4008321931436	OSRAM MINI5 ECO 14W 827	White	14	579	24	42	4 38
7281327	4008321931450	OSRAM MINI5 ECO 21W 827	White	21	879	24	42	4 38
7281427	4008321931474	OSRAM MINI5 ECO 28W 827	White	28	1179	24	42	4 38
7281527	4008321931498	OSRAM MINI5 ECO 35W 827	White	35	1479	24	42	4 38
7281040	4008321931511	OSRAM MINI5 ECO 8W 840	White	8	318	24	42	4 38
7281140	4008321931535	OSRAM MINI5 ECO 13W 840	White	13	547	24	42	4 38
7281240	4008321931559	OSRAM MINI5 ECO 14W 840	White	14	579	24	42	4 38
7281340	4008321931573	OSRAM MINI5 ECO 21W 840	White	21	879	24	42	4 38
7281440	4008321931597	OSRAM MINI5 ECO 28W 840	White	28	1179	24	42	4 38
7281540	4008321931610	OSRAM MINI5 ECO 35W 840	White	35	1479	24	42	4 38
<b>OSRAM MINI5 ECO – without lamp</b>								
72810	4008321300911	OSRAM MINI5 ECO ex. lamp 8W	White	8	318	24	42	4 38
72811	4008321300935	OSRAM MINI5 ECO ex. lamp 13W	White	14	547	24	42	4 38
72812	4008321300959	OSRAM MINI5 ECO ex. lamp 14W	White	18	579	24	42	4 38
72813	4008321300973	OSRAM MINI5 ECO ex. lamp 21W	White	21	879	24	42	4 38
72814	4008321300997	OSRAM MINI5 ECO ex. lamp 28W	White	28	1179	24	42	4 38
72815	4008321301154	OSRAM MINI5 ECO ex. lamp 35W	White	35	1479	24	42	4 38

All orders must be multiples of sales pack

Indoor – Batten Luminaires

827





**LUMILUX® COMBI EL**

- General purpose T8 electronic batten luminaire
- Equipped with LUMILUX® tube colour 827
- Ready to install with 2m of cable and euro plug

Product ID Code	EAN (Single Pack)	Product Description	FINISH	W	l [mm]	b [mm]	h [mm]	PPG
72032	4050300824765	LUMILUX COMBI EL 827 8W	White	8	323	21	50	4 38
72037	4050300824819	LUMILUX COMBI EL 827 13W	White	13	551	21	50	4 38



All orders must be multiples of sales pack

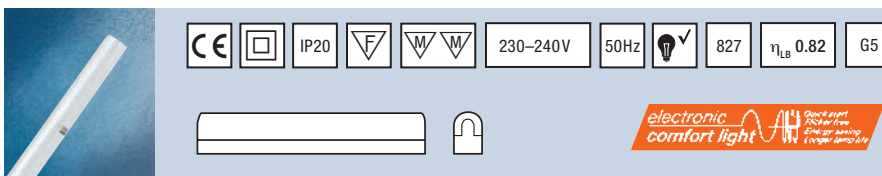

## Indoor – Batten Luminaires

**LUMILUX® DECO EL**

- Wall and mirror T8 batten luminaire for fixed connection
- Prismatic (EL/P) or Opal (EL/D) lamp cover
- Equipped with LUMILUX® T5 fluorescent tube and electronic control gear

Product ID Code	EAN (Single Pack)	Product Description	FINISH	W	l (mm)	b (mm)	h (mm)		PPG
72161W	4050300356846	LUMILUX DECO EL/P 8W Prismatic	White	8	310	42	54	4	38
72165W	4050300356860	LUMILUX DECO EL/P 13W Prismatic	White	13	538	42	54	4	38
7216144	4050300497822	LUMILUX DECO EL/D 8W Opal	White	8	310	42	54	4	38
7216544	4050300497846	LUMILUX DECO EL/D 13W Opal	White	13	538	42	54	4	38

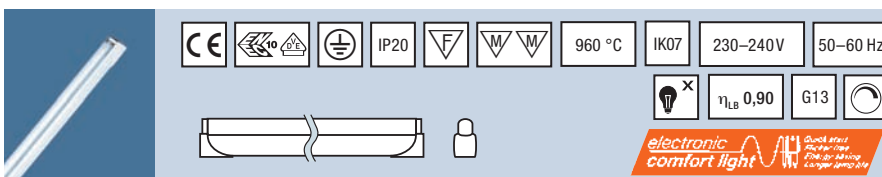
**OSRAM ECOPACK® DIM**

- Low cost dimmable T8 electronic batten luminaire
- 1...10V dimmable from 100% to 1%
- Supplied with QUICKTRONIC® dimmable electronic control gear

Product ID Code	EAN (Single Pack)	Product Description	FINISH	W	l (mm)	b (mm)	h (mm)		PPG
72561W	4050300561981	OSRAM ECOPACK DIM 18W	White	18	618	38	66	4	38
72565W	4050300562025	OSRAM ECOPACK DIM 36W	White	36	1228	38	66	4	38
72567W	4050300562070	OSRAM ECOPACK DIM 58W	White	58	1528	38	66	4	38

All orders must be multiples of sales pack

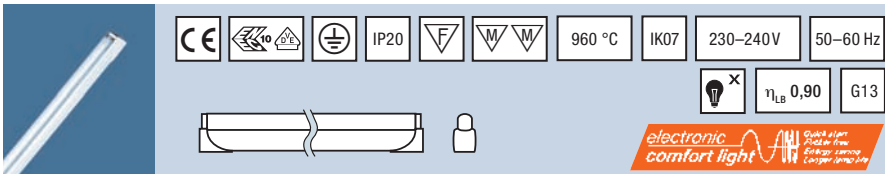

## Indoor – Batten Luminaires

**OSRAM ECOPACK®**

- Low cost electronic T8 batten luminaire
- Supplied with QUICKTRONIC® PROFESSIONAL electronic control gear

Product ID Code	EAN (Single Pack)	Product Description	FINISH	W	l (mm)	b (mm)	h (mm)		PPG
72581W	4050300562124	OSRAM ECOPACK 18W	White	18	618	38	66	4	38
72585W	4050300528359	OSRAM ECOPACK 36W	White	36	1228	38	66	4	38
72587W	4050300528373	OSRAM ECOPACK 58W	White	58	1528	38	66	4	38

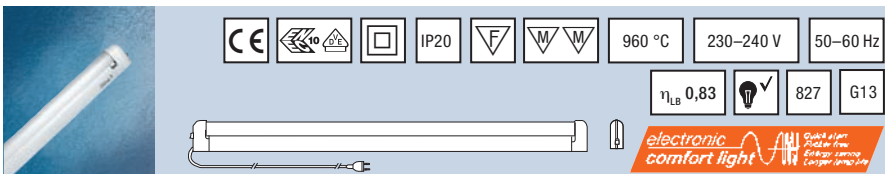
**LUMILUX® COMBI EL-N**

- Low cost general purpose electronic T8 batten luminaire
- Supplied with or without LUMILUX® T8 tubes
- Ready to install with 2m of cable and euro plug

Product ID Code	EAN (Single Pack)	Product Description	FINISH	W	l (mm)	b (mm)	h (mm)		PPG
<b>LUMILUX® COMBI EL-N</b>									
72006W	4050300003443	LUMILUX COMBI EL-N 10W	White	10	501	30	50	4x1	38
72011W	4050300003474	LUMILUX COMBI EL-N 18W	White	18	621	30	50	4x1	38
72016W	4050300002163	LUMILUX COMBI EL-N 30W	White	30	926	30	50	4x1	38
72021W	4050300003511	LUMILUX COMBI EL-N 36W	White	36	1231	30	50	4x1	38
72026W	4050300986517	LUMILUX COMBI EL-N 58W	White	58	1531	30	50	4x1	38
<b>LUMILUX® COMBI EL-N without lamp</b>									
72011	4050300997650	LUMILUX COMBI EL-N ex. lamp 18W	White	18	621	30	50	4x1	38
72016	4050300003504	LUMILUX COMBI EL-N ex. lamp 30W	White	30	926	30	50	4x1	38
72021	4050300148663	LUMILUX COMBI EL-N ex. lamp 36W	White	36	1231	30	50	4x1	38
72026	4050300993973	LUMILUX COMBI EL-N ex. lamp 58W	White	58	1531	30	50	4x1	38



All orders must be multiples of sales pack



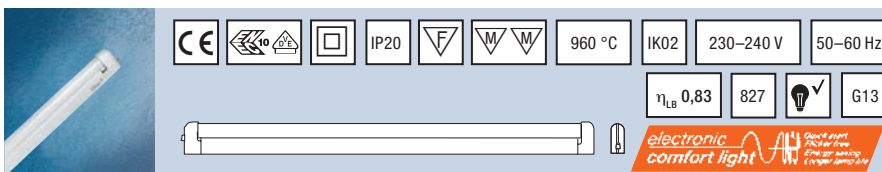

## Indoor – Batten Luminaires

**LUMILUX® COMBI EL-F**

- Electronic general purpose T8 fluorescent batten luminaire
- For fixed connections with central, asymmetrical and side cable insertion
- Integrated switch
- Supplied with or without LUMILUX® T8 tubes

Product ID Code	EAN (Single Pack)	Product Description	FINISH	W	l (mm)	b (mm)	h (mm)	PPG
<b>LUMILUX® COMBI EL-F</b>								
72106W	4050300003542	LUMILUX COMBI EL-F 10W	White	10	501	30	50	4 38
72111W	4050300003573	LUMILUX COMBI EL-F 18W	White	18	621	30	50	4 38
72116W	4050300003597	LUMILUX COMBI EL-F 30W	White	30	926	30	50	4 38
72121W	4050300003634	LUMILUX COMBI EL-F 36W	White	36	1231	30	50	4 38
72126W	4050300005195	LUMILUX COMBI EL-F 58W	White	58	1531	30	50	4 38
<b>LUMILUX® COMBI EL-F – without lamp</b>								
72111	4050300148724	LUMILUX COMBI EL-F – ex. lamp 18W	White	18	621	30	50	4 38
72116	4050300484679	LUMILUX COMBI EL-F – ex. lamp 30W	White	30	926	30	50	4 38
72121	4050300148748	LUMILUX COMBI EL-F – ex. lamp 36W	White	36	1231	30	50	4 38
72126	4050300993959	LUMILUX COMBI EL-F – ex. lamp 58W	White	58	1531	30	50	4 38



All orders must be multiples of sales pack

## Indoor – Batten Luminaires

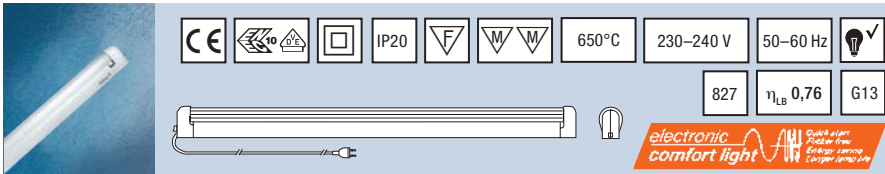
**LUMILUX® COMBI EL-N/P**

- Low cost electronic T8 batten luminaire
- Equipped with LUMILUX® T8 827 tube
- Ready to install with 2m of cable and euro plug

Product ID Code	EAN (Single Pack)	Product Description	FINISH	W	l [mm]	b [mm]	h [mm]	PPG	
72206W	4050300346540	LUMILUX COMBI EL-N/P 10W	White	10	501	33	52	4	38
72211W	4050300346625	LUMILUX COMBI EL-N/P 18W	White	18	621	33	52	4	38
72216W	4050300346663	LUMILUX COMBI EL-N/P 30W	White	30	926	33	52	4	38
72221W	4050300346861	LUMILUX COMBI EL-N/P 36W	White	36	1231	33	52	4	38
72226W	4050300346946	LUMILUX COMBI EL-N/P 58W	White	58	1531	33	52	4	38

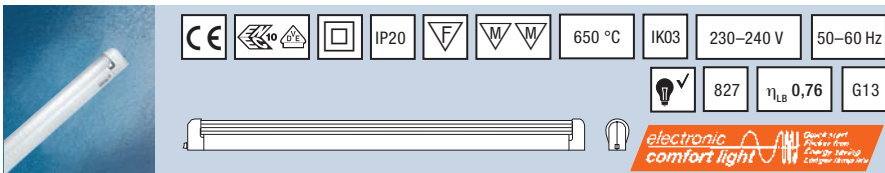
**LUMILUX® COMBI EL-F/P**

- General purpose electronic T8 fluorescent batten
- Equipped with LUMILUX® T8 827 tube
- Prismatic cover provides glare free light
- For fixed connections with central, asymmetrical and side cable insertion
- Integrated switch

Product ID Code	EAN (Single Pack)	Product Description	FINISH	W	l [mm]	b [mm]	h [mm]	PPG	
72306W	4050300346502	LUMILUX COMBI EL-F/P 10W	White	10	501	33	51.5	4	38
72311W	4050300346588	LUMILUX COMBI EL-F/P 18W	White	18	621	33	51.5	4	38
72316W	4050300346700	LUMILUX COMBI EL-F/P 30W	White	30	926	33	51.5	4	38
72321W	4050300346908	LUMILUX COMBI EL-F/P 36W	White	36	1231	33	51.5	4	38
72326W	4050300346984	LUMILUX COMBI EL-F/P 58W	White	58	1531	33	51.5	4	38



All orders must be multiples of sales pack

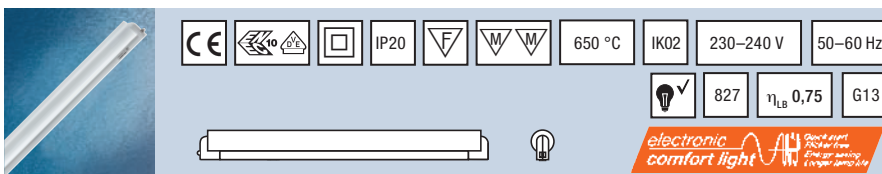

## Indoor – Batten Luminaires

**LUMILUX® COMBI EL-F/D**

- Electronic wall and mirror batten luminaire
- Equipped with LUMILUX® T8 827 tube and QUICKTRONIC® electronic control gear
- With matt diffuser for uniform glare free light
- For fixed connections

Product ID Code	EAN (Single Pack)	Product Description	FINISH	W	l (mm)	b (mm)	h (mm)	PPG
7210644	4008321917454	LUMILUX COMBI EL-F/D 10W	White	10	501	52	64	38
7211144	4008321917478	LUMILUX COMBI EL-F/D 18W	White	18	621	52	64	38
7211644	4008321917492	LUMILUX COMBI EL-F/D 30W	White	30	926	52	64	38
7212144	4008321917515	LUMILUX COMBI EL-F/D 36W	White	36	1230	52	64	38
7212644	4008321917539	LUMILUX COMBI EL-F/D 58W	White	58	1531	52	64	38

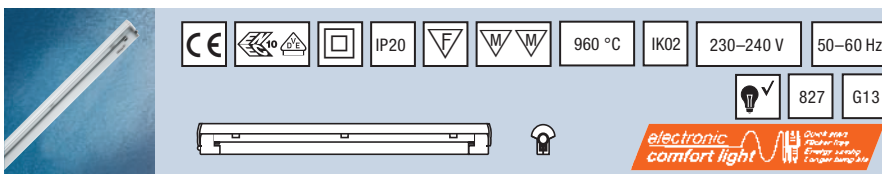
**LUMILUX® COMBI EL-F/B**

- Electronic wall and mirror batten luminaire
- Equipped with LUMILUX® T8 827 tube and QUICKTRONIC® electronic control gear
- With rotary shade for directional or shielded light
- For fixed connections

Product ID Code	EAN (Single Pack)	Product Description	FINISH	W	l (mm)	b (mm)	h (mm)	PPG
7211145	4008321917379	LUMILUX COMBI EL-F/B 18W	White	18	634	52	61	38
7211645	4008321917393	LUMILUX COMBI EL-F/B 30W	White	30	939	52	61	38
7212145	4008321917416	LUMILUX COMBI EL-F/B 36W	White	36	1243	52	61	38
7212645	4008321917430	LUMILUX COMBI EL-F/B 58W	White	58	1544	52	61	38

All orders must be multiples of sales pack



## Indoor – Batten Luminaires

**LUMILUX® VARIO EL-N**

- Flat batten luminaire with special tubular reflector capable of rotating 360° for variable, directional light
- Ready to install with 2m of cable and euro plug
- 40% more light in the main beam direction compared with free burning lamps
- Equipped with LUMILUX® 827 tube and QUICKTRONIC® electronic control gear

Product ID Code	EAN (Single Pack)	Product Description	FINISH	W	l (mm)	b (mm)	h (mm)		PPG
72356	4008321908445	LUMILUX VARIO EL-N 18W	White	18	617	35	59	4	38
72357	4008321908452	LUMILUX VARIO EL-N 30W	White	30	922	35	59	4	38
72358	4008321908469	LUMILUX VARIO EL-N 36W	White	36	1227	35	59	4	38

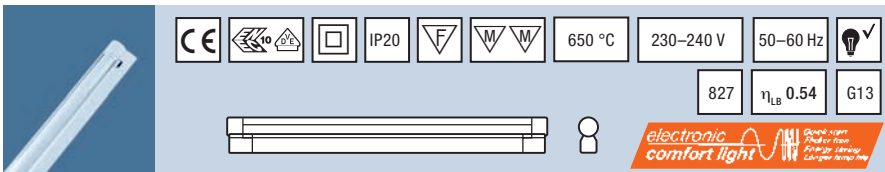
**LUMILUX® VARIO EL-F**

- Flat batten luminaire with special tubular reflector capable of rotating 360° for variable, directional light
- For fixed connection, with central, asymmetrical and side cable insertion
- 40% more light in the main beam direction compared with free burning lamps
- Equipped with LUMILUX® 827 tube and QUICKTRONIC® electronic control gear

Product ID Code	EAN (Single Pack)	Product Description	FINISH	W	l (mm)	b (mm)	h (mm)		PPG
72456	4008321908476	LUMILUX VARIO EL-F 18W	White	18	617	35	59	4	38
72457	4008321908483	LUMILUX VARIO EL-F 30W	White	30	922	35	59	4	38
72458	4008321908490	LUMILUX VARIO EL-F 36W	White	36	1227	35	59	4	38

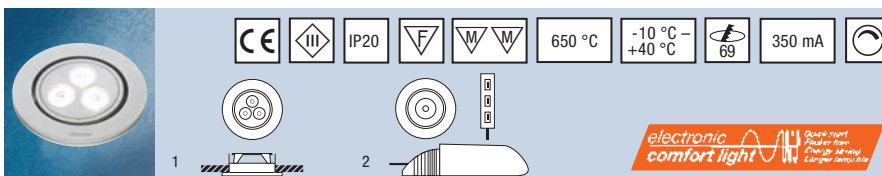

All orders must be multiples of sales pack

**INDOOR****FURNITURE LUMAIRES****DRAGONPOINT® VARIO KIT**

- Built in swivel LED light fixture in an aluminium casing
- Equipped with Golden DRAGON® LED 1.2W
- DRAGONPOINT® 1 LED KIT contains 3 luminaires with 1 LED, OPTOTRONIC® OT9 DIM
- DRAGONPOINT® 3 LED KIT contains 2 luminaires with 3 LED, OPTOTRONIC® OT9 DIM
- Extremely flat and narrow light fixture ideal for emphasising specific detail

Product ID Code	EAN (Single Pack)	Product Description	FINISH		W	h [mm]	d [mm]	No.			PPG
-----------------	-------------------	---------------------	--------	--	---	--------	--------	-----	--	--	-----

**DRAGONPOINT® 2 X 3 LED KIT**

DPVARIOKITL30LED3	4008321368775	DP VARIO KIT 2 X 3 LED 830 L30°	Grey/Alu	30	3.6	32.3	80	1	4	38
8021922	4008321291547	DP VARIO KIT 2 X 3 LED 854 L30°	Grey/Alu	30	3.6	32.3	80	1	4	38
DPVARIOKITL12LED3	4008321368744	DP VARIO KIT 2 X 3 LED 830 L12°	Grey/Alu	12	3.6	32.3	80	1	4	38
8021921	4008321291516	DP VARIO KIT 2 X 3 LED 854 L12°	Grey/Alu	12	3.6	32.3	80	1	4	38

**DRAGONPOINT® 3 X 1 LED KIT**

DPVARIOKITL30	4008321368621	DP VARIO KIT 3 X 1 LED 830 L30°	Grey/Alu	30	1.2	16	52	2	4	38
8021722	4008321291455	DP VARIO KIT 3 X 1 LED 854 L30°	Grey/Alu	30	1.2	16	52	2	4	38
DPVARIOKITL12	4008321368652	DP VARIO KIT 3 X 1 LED 830 L12°	Grey/Alu	12	1.2	16	52	2	4	38
8021721	4008321291578	DP VARIO KIT 3 X 1 LED 854 L12°	Grey/Alu	12	1.2	16	52	2	4	38

**DRAGONPOINT® VARIO PRO 2 X 3 LED KIT (OEM version)**

DPVARIOPRO830L30L3	4008321399663	DP VARIO PRO 3 LED 830 L30°	Grey/Alu	30	3.6	32.3	80	1	4	38
DPVARIOPRO854L30L3	4008321399434	DP VARIO PRO 3 LED 854 L30°	Grey/Alu	30	3.6	32.3	80	1	4	38
DPVARIOPRO830L12L3	4008321399632	DP VARIO PRO 3 LED 830 L12°	Grey/Alu	12	3.6	32.3	80	1	4	38
DPVARIOPRO854L12L3	4008321399403	DP VARIO PRO 3 LED 854 L12°	Grey/Alu	12	3.6	32.3	80	1	4	38

**DRAGONPOINT® VARIO PRO 1 X 3 LED KIT (OEM version)**

DPVARIOPRO830L30L1	4008321399571	DP VARIO PRO 1 LED 830 L30°	Grey/Alu	30	1.2	16	52	2	4	38
DPVARPRO854L30L1	4008321399342	DP VARIO PRO 1 LED 854 L30°	Grey/Alu	30	1.2	16	52	2	4	38
DPVARIOPRO830L12L1	4008321399601	DP VARIO PRO 1 LED 830 L12°	Grey/Alu	12	1.2	16	52	2	4	38
DPVARIOPRO854L12L1	4008321399373	DP VARIO PRO 1 LED 854 L12°	Grey/Alu	12	1.2	16	52	2	4	38



All orders must be multiples of sales pack

Indoor – Furniture Luminaires

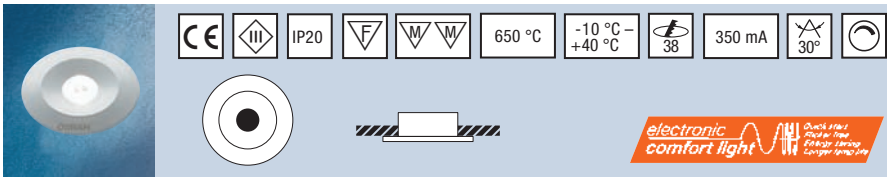

**DRAGONPOINT® FIX KIT**

- LED spotlight in a brushed aluminium casing
- Equipped with 1 Golden DRAGON® LED 1.2W
- Kit contains 3 spotlights, OT 9/200-240V/350 DIM and 1 metre connecting cables
- Ideal for illuminating work surfaces

Product ID Code	EAN (Single Pack)	Product Description	FINISH	△	W	h (mm)	a (mm)	⊞	PPG
DPFIXKITL30	4008321368713	DP FIX KIT 3 X 1 LED 830 L30°	Grey/Alu	30	1.2	19	42	4	38
8021822	4008321291608	DP FIX KIT 3 X 1 LED 854 L30°	Grey/Alu	30	1.2	19	42	4	38
<b>DRAGONPOINT® FIX PRO (OEM version)</b>									
DPFIXPRO830L30L1	4008321400994	DP FIX PRO 1 LED 830 L30°	Grey/Alu	30	1.2	19	42	4	38
DPFIXPRO854L30L1	4008321400901	DP FIX PRO 1 LED 854 L30°	Grey/Alu	30	1.2	19	42	4	38

NEW  
NEW  
NEW  
NEW

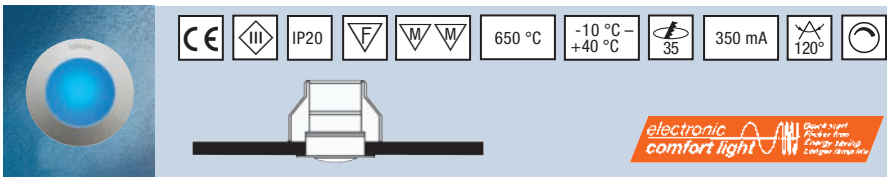

**DRAGONPOINT® MOOD KIT**

- Compact recessed LED luminaire in a brushed aluminium casing
- Equipped with 1 Golden DRAGON® LED in amber or blue light colour
- Kit contains 3 spotlights, OT 9/200-240V power supply and 1 metre connecting cables
- Ideal for accent and background illumination

Product ID Code	EAN (Single Pack)	Product Description	FINISH	△	W	h (mm)	a (mm)	⊞	PPG
8022083	4008321326553	DP MOOD KIT 3 X 1 LED Amber 120°	Grey/Alu	120	1.2	43	42	4	38
8022080	4008321326522	DP MOOD KIT 3 X 1 LED Blue 120°	Grey/Alu	120	1.2	43	42	4	38
<b>DRAGONPOINT® MOOD PRO (OEM version)</b>									
DPMOODPRORED	4008321399540	DP MOOD PRO 1 LED Amber 120°	Grey/Alu	120	1.2	43	42	4	38
DPMOODPROBLUE	4008321399519	DP MOOD PRO 1 LED Blue 120°	Grey/Alu	120	1.2	43	42	4	38



All orders must be multiples of sales pack



Indoor – Furniture Luminaires

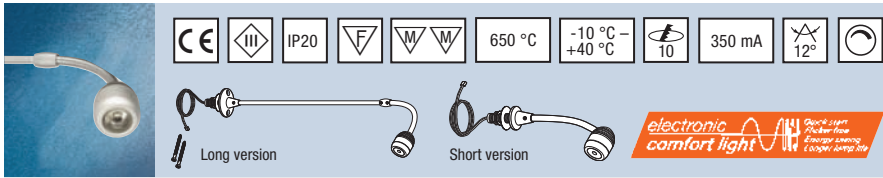

**DRAGONSPOT®**

- Practical, small and lightweight LED luminaire with an adjustable head
- Equipped with Golden DRAGON® LED 1.2W
- Kit contains 1 spotlight and connecting cable
- Accessories available: Connection kit to connect 6 luminaires and OT 9/200-240V DIM power supply
- Ideal as a reading light, accent or directional light source

Product ID Code	EAN (Single Pack)	Product Description	FINISH	°	W	h (mm)	d (mm)	PPG
-----------------	-------------------	---------------------	--------	---	---	--------	--------	-----

**DRAGONSPOT® long version**

NEW

DSPOTLONG	4008321368805	DRAGONSPOT LONG 1 LED 830 L12°	Grey/Alu	12	1.2	380	27	4	38
8022321	4008321326584	DRAGONSPOT LONG 1 LED 854 L12°	Grey/Alu	12	1.2	380	27	4	38

**DRAGONSPOT® short version**

NEW

DSPOTSHORT	4008321368836	DRAGONSPOT SHORT 1 LED 830 L12°	Grey/Alu	12	1.2	130	27	4	38
8022221	4008321326232	DRAGONSPOT SHORT 1 LED 854 L12°	Grey/Alu	12	1.2	130	27	4	38

**DRAGONSPOT® PRO long version (OEM version)**

NEW

NEW

DSPOTLONG830L12L1	4008321399694	DRAGONSPOT PRO LONG 1 LED 830 L12°	Grey/Alu	12	1.2	380	27	4	38
DSPOTLONG854L12L1	4008321399465	DRAGONSPOT PRO LONG 1 LED 854 L12°	Grey/Alu	12	1.2	380	27	4	38

**DRAGONSPOT® PRO short version (OEM version)**

NEW

NEW

DSPOTSHORT830L12L1	4008321399717	DRAGONSPOT PRO SHORT 1 LED 830 L12°	Grey/Alu	12	1.2	130	27	4	38
DSPOTSHORT854L12L1	4008321399489	DRAGONSPOT PRO SHORT 1 LED 854 L12°	Grey/Alu	12	1.2	130	27	4	38

**Accessories for DRAGONSPOT®**

DSPOTCONKIT	4008321326201	DRAGONSPOT Connection kit	-	-	-	-	-	8	38
OT9/350	4050300888262	OPTOTRONIC OT 9/200240/350	-	-	-	-	-	50	38
OT09350DIM	4008321187321	OPTOTRONIC OT 9/200240/350 DIM	-	-	-	-	-	20	38

All orders must be multiples of sales pack

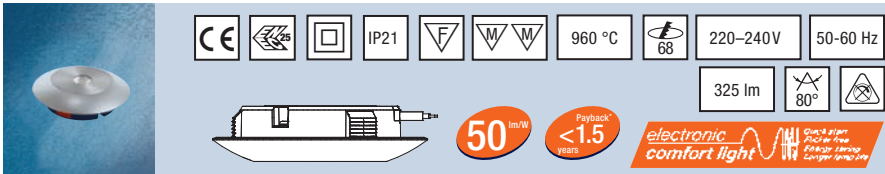

## Indoor – Furniture Luminaires

**LEDVANCE® DOWNLIGHT S**

- LED downlight fitting for replacement of 20W low voltage halogen
- Integrated ECG for direct connection to mains
- Ideal for furniture and under cabinet lighting

Product ID Code	EAN (Single Pack)	Product Description	FINISH		W				PPG
LDVS830	4008321968623	LEDVANCE DOWNLIGHT S 830 L80 AL	Alu	80	6.5	23	88	4	38
LDVS830WT	4008321968630	LEDVANCE DOWNLIGHT S 830 L80 WT	White	80	6.5	23	88	4	38
LDVS840	4008321968647	LEDVANCE DOWNLIGHT S 840 L80 AL	Alu	80	6.5	23	88	4	38
LDVS840WT	4008321968654	LEDVANCE DOWNLIGHT S 840 L80 WT	White	80	6.5	23	88	4	38

NEW  
NEW  
NEW  
NEW



All orders must be multiples of sales pack





Indoor – Furniture Luminaires

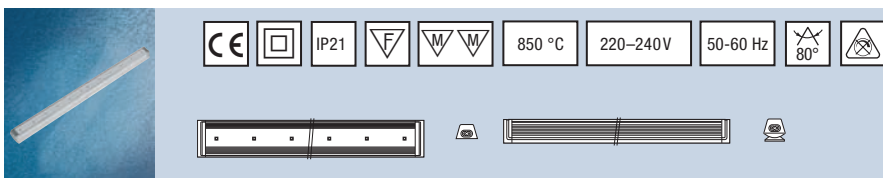

**LEDVANCE® Polybar**

- Modular LED fixture in lengths of 250mm, 500mm, 750mm
- 60° or 120° optics and can be connected up to 20m serially
- Slimline fitting for under shelf and cove lighting

Product ID Code	EAN (Single Pack)	Product Description	FINISH	△°	Im	W	l [mm]	b [mm]	h [mm]	PPG
-----------------	-------------------	---------------------	--------	----	----	---	--------	--------	--------	-----

**LEDVANCE® Polybar – 250mm version**

NEW  
NEW  
NEW

LDVPBS830	4008321963338	LEDVANCE POLYBAR S	Grey/Alu	80	300	6	250	40	26/42	4	38
LDVPBS840	4008321962393	LEDVANCE POLYBAR S	Grey/Alu	80	300	6	250	40	26/42	4	38
LDVPBS854	4008321962423	LEDVANCE POLYBAR S	Grey/Alu	80	300	6	250	40	26/42	4	38

**LEDVANCE® Polybar – 500mm version**

NEW  
NEW  
NEW

LDVPBM830	4008321963345	LEDVANCE POLYBAR M	Grey/Alu	80	600	12	500	40	26/42	4	38
LDVPBM840	4008321962409	LEDVANCE POLYBAR M	Grey/Alu	80	600	12	500	40	26/42	4	38
LDVPBM854	4008321962430	LEDVANCE POLYBAR M	Grey/Alu	80	600	12	500	40	26/42	4	38

**LEDVANCE® Polybar – 750mm version**

NEW  
NEW  
NEW

LDVPBL830	4008321962386	LEDVANCE POLYBAR L	Grey/Alu	80	900	18	750	40	26/42	4	38
LDVPBL840	4008321962416	LEDVANCE POLYBAR L	Grey/Alu	80	900	18	750	40	26/42	4	38
LDVPBL854	4008321962447	LEDVANCE POLYBAR L	Grey/Alu	80	900	18	750	40	26/42	4	38

**LEDVANCE® Polybar – accessories**

NEW  
NEW  
NEW  
NEW  
NEW  
NEW  
NEW  
NEW

LEDVANCE Polybar adjustable base S*	Grey/Alu	-	-	-	-	40	12	4	38
LEDVANCE Polybar adjustable base M*	Grey/Alu	-	-	-	-	40	12	4	38
LEDVANCE Polybar adjustable base L*	Grey/Alu	-	-	-	-	40	12	4	38
LEDVANCE Polybar Entry Cable 2m*	-	-	-	-	2000	-	-	-	38
LEDVANCE Polybar Connection Cable 250mm*	-	-	-	-	250	-	-	-	38
LEDVANCE Polybar Connection Cable 500mm*	-	-	-	-	500	-	-	-	38
LEDVANCE Polybar Connection Cable 1000mm*	-	-	-	-	1000	-	-	-	38
LEDVANCE Polybar On/Off Switch*	-	-	-	-	50	38	28	-	38

\*In preparation at time of print. For further information please contact OSRAM



Adjustable base



Power supply connector



All orders must be multiples of sales pack

## Indoor – Furniture Luminaires

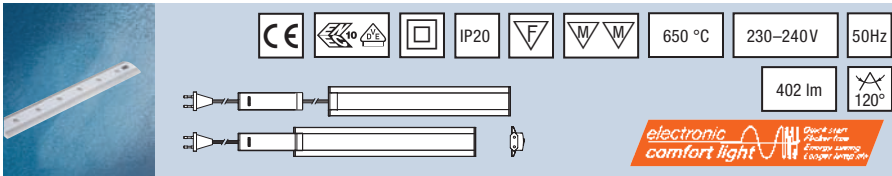
**LUMINESTRA® LED**

- Low profile LED luminaire in an aluminium housing with prismatic cover for glare free light
- Ready to install with 1.6m of cable and euro plug

Product ID Code	EAN (Single Pack)	Product Description	FINISH	△°	W	$\frac{l}{(mm)}$	$\frac{b}{(mm)}$	$\frac{h}{(mm)}$		PPG
73092	4008321524461	LUMINESTRA LED 8W 830	Silver/ White	120	8	448/343	55	24/10	4	38
73093	4008321524485	LUMINESTRA LED 8W 840	Silver/ White	120	8	448/343	55	24/10	4	38

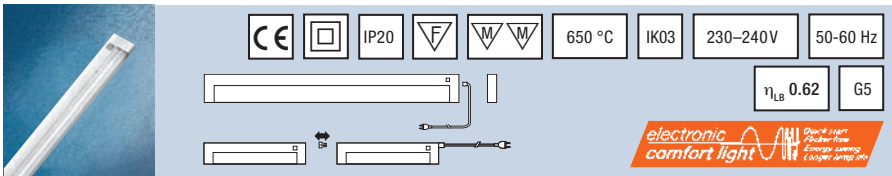
NEW  
NEW**LUMINESTRA® EL**

- Low profile T5 fluorescent luminaire with prismatic cover for glare free light
- Ready to install with 2m of cable and euro plug
- Equipped with LUMILUX® T5 tube and integrated electronic control gear. Also available without lamp
- Up to 10 LUMINESTRA® EL luminaires can be combined to create strip lighting

Product ID Code	EAN (Single Pack)	Product Description	FINISH	W	$\frac{l}{(mm)}$	$\frac{b}{(mm)}$	$\frac{h}{(mm)}$		PPG
<b>LUMINESTRA EL</b>									
73071W	4050300008738	LUMINESTRA LUMILUX T5 8W 827	White	8	342	70	20	4	38
73081W	4050300008745	LUMINESTRA LUMILUX T5 13W 827	White	13	555	70	20	4	38
73271	4008321962690	LUMINESTRA LUMILUX T5 8W 840	White	8	342	70	20	4	38
73281	4008321962706	LUMINESTRA LUMILUX T5 13W 840	White	13	555	70	20	4	38
<b>LUMINESTRA EL – without lamp</b>									
73371	4008321962751	LUMINESTRA without lamp	White	8	342	70	20	4	38
73381	4008321962768	LUMINESTRA without lamp	White	13	555	70	20	4	38



All orders must be multiples of sales pack

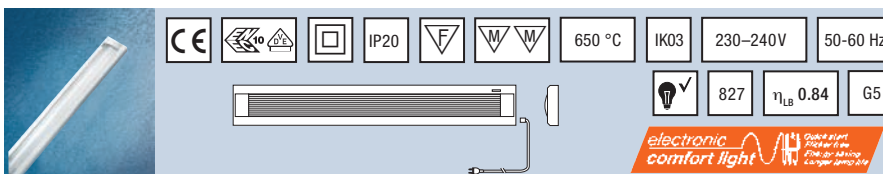

## Indoor – Furniture Luminaires

**SLIMLITE® EL**

- Compact low profile furniture luminaire
- Equipped with LUMILUX® T5 tube
- Ready to install with 2m of cable and euro plug

Product ID Code	EAN (Single Pack)	Product Description	FINISH	W	l [mm]	b [mm]	h [mm]	PPG
73073W	4050300620145	SLIMLITE EL 8W 827	White	8	320	78	26	4 38
73083W	4050300620121	SLIMLITE EL 13W 827	White	13	550	78	26	4 38

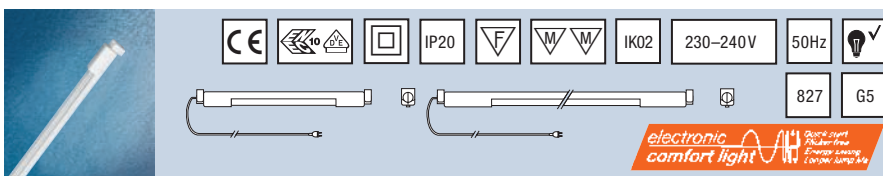
**PICOLINE® EL**

- Miniature furniture luminaire brings light into the tightest of spaces
- Rotates through 360°
- Ready to install with 2m of cable and euro plug
- Equipped with LUMILUX® T5 tube or LUMILUX® T5 HE tube

Product ID Code	EAN (Single Pack)	Product Description	FINISH	W	l [mm]	b [mm]	h [mm]	PPG
72041W	4050300499543	PICOLINE EL 8W LUMILUX T5	White	8	374	21	30	4 38
72042W	4050300499567	PICOLINE EL 13W LUMILUX T5	White	13	602	21	30	4 38
72043W	4050300593975	PICOLINE EL 21W LUMILUX T5 HE	White	21	990	23	30	4 38

All orders must be multiples of sales pack

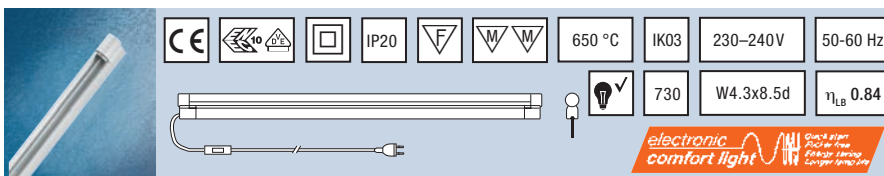

## Indoor – Furniture Luminaires

**LUMILUX® VARIO FM**

- Compact low profile furniture luminaire with integrated QUICKTRONIC® QT-FM electronic control gear
- With 360° rotary tube reflector for variable directional light
- Ready to install with 2m of cable and euro plug
- Equipped with LUMILUX® T2 FM® tube

Product ID Code	EAN (Single Pack)	Product Description	FINISH	W	I (mm)	b (mm)	h (mm)	PPG
72292W	4050300636351	LUMILUX VARIO-FM 8W	White	8	335	23	41	4 38
72293W	4050300636382	LUMILUX VARIO-FM 11W	White	11	437	23	41	4 38
72294W	4050300636405	LUMILUX VARIO-FM 13W	White	13	538	23	41	4 38

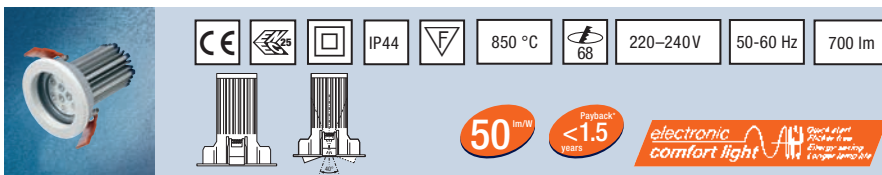

All orders must be multiples of sales pack

**INDOOR****RECESSED LUMINAIRES****LEDVANCE® Downlight M**

- Adjustable LED downlight fitting for replacement of classic MR16 50W low voltage halogen
- Average lifetime 50,000 hours
- 36° or 12° beam angle with external power supply
- Accessories: Decorative rings in anodized aluminium
- Ideal for halogen replacement downlighting

Product ID Code	EAN (Single Pack)	Product Description	FINISH	$\angle$	W	h (mm)	d (mm)		PPG
<b>LEDVANCE® Downlight M</b>									
LDVM830WTL12	4008321968661	LEDVANCE DOWNLIGHT M 830 L12 WT	White	12	13.5	103	80	4	38
LDVM830WTL36	4008321968678	LEDVANCE DOWNLIGHT M 830 L36 WT	White	36	13.5	99	80	4	38
LDVM840WTL12	4008321968685	LEDVANCE DOWNLIGHT M 840 L12 WT	White	12	13.5	103	80	4	38
LDVM840WTL36	4008321968692	LEDVANCE DOWNLIGHT M 840 L36 WT	White	36	13.5	99	80	4	38
<b>LEDVANCE® Downlight M DIM*</b>									
–	4008321968708*	LEDVANCE DOWNLIGHT M 830 L12 WT DIM	White	12	13.5	103	80	4	38
–	4008321968715*	LEDVANCE DOWNLIGHT M 830 L36 WT DIM	White	36	13.5	99	80	4	38
–	4008321968722*	LEDVANCE DOWNLIGHT M 840 L12 WT DIM	White	12	13.5	103	80	4	38
–	4008321968739*	LEDVANCE DOWNLIGHT M 840 L36 WT DIM	White	36	13.5	99	80	4	38
<b>Accessories for LEDVANCE® Downlight M</b>									
LDVMRING	4008321968746	LEDVANCE DOWNLIGHT M RING AL	Aluminium	–	–	8	80	4	38

\*In preparation at time of print. For further information please contact OSRAM

## LEDVANCE™ DOWNLIGHT M

Lighting Association's Domestic  
Product of the Year 2010



All orders must be multiples of sales pack

## Indoor – Recessed Luminaires

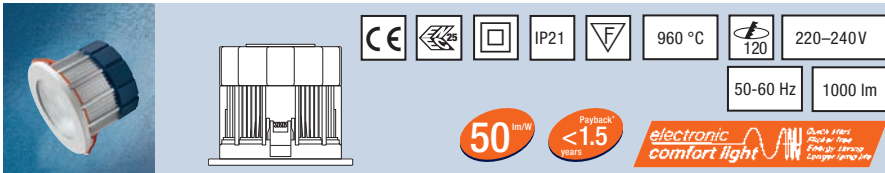
**LEDVANCE® Downlight L**

- Adjustable LED downlight fitting for replacement of 1 x 26W compact fluorescent downlights
- 60° or 100° beam angles with integrated power supply
- Accessories: Decorative rings in anodized aluminium
- Ideal for downlighting

Product ID Code	EAN (Single Pack)	Product Description	FINISH		W	h (mm)	d (mm)		PPG
LDVL830WTL60	4008321968753	LEDVANCE DOWNLIGHT L 830 L60 WT	White	60	20	102	140	4	38
LDVL830WTL100	4008321968760	LEDVANCE DOWNLIGHT L 830 L100 WT	White	100	20	102	140	4	38
LDVL840WTL60	4008321968777	LEDVANCE DOWNLIGHT L 840 L60 WT	White	60	20	102	140	4	38
LDVL840WTL100	4008321968784	LEDVANCE DOWNLIGHT L 840 L100 WT	White	100	20	102	140	4	38
LDVLRING	4008321968791	LEDVANCE DOWNLIGHT L RING AL	Alu	-	-	10	140	4	38
-	4008321968807*	LEDVANCE DOWNLIGHT L RING LA	Anodised Alu	-	-	-	-	4	38
-	4008321968814*	LEDVANCE DOWNLIGHT L RING LB	Black	-	-	-	-	4	38

\*In preparation at time of print. For further information please contact OSRAM

NEW  
NEW  
NEW  
NEW  
NEW



All orders must be multiples of sales pack

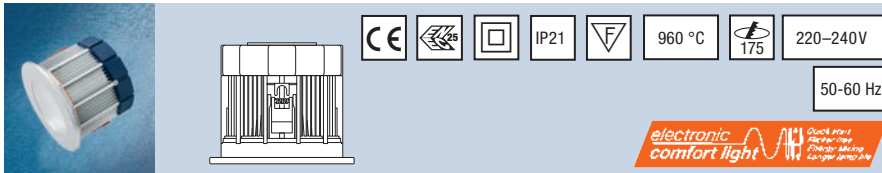

## Indoor – Recessed Luminaires

**LEDVANCE® Downlight XL**

- Adjustable and dimmable LED downlight fitting for replacement of 2 x 26W compact fluorescent downlights
- 60° or 100° beam angles with integrated power supply
- Accessories: Decorative rings in anodized aluminium
- Ideal for downlighting

Product ID Code	EAN (Single Pack)	Product Description	FINISH	△°	lm	W	h (mm)	d (mm)	PPG
<b>LEDVANCE® Downlight XL</b>									
LDVXL830WTL60	4008321968821	LEDVANCE DOWNLIGHT XL 830 L60 WT	White	60	1600	32	150	195	4 38
LDVXL830WTL100	4008321968838	LEDVANCE DOWNLIGHT XL 830 L100 WT	White	100	1600	32	150	195	4 38
LDVXL840WTL60	4008321968845	LEDVANCE DOWNLIGHT XL 840 L60 WT	White	60	1600	32	150	195	4 38
LDVXL840WTL100	4008321968852	LEDVANCE DOWNLIGHT XL 840 L100 WT	White	100	1600	32	150	195	4 38
<b>LEDVANCE® Downlight XL DALI</b>									
–	4008321968869	LEDVANCE DOWNLIGHT XL 830 L60 WT DALI*	White	60	2000	32	150	195	4 38
–	4008321968876	LEDVANCE DOWNLIGHT XL 830 L100 WT DALI*	White	100	2000	32	150	195	4 38
–	4008321968883	LEDVANCE DOWNLIGHT XL 840 L60 WT DALI*	White	60	2000	32	150	195	4 38
–	4008321968890	LEDVANCE DOWNLIGHT XL 840 L100 WT DALI*	White	100	2000	32	150	195	4 38
<b>Accessories for LEDVANCE® Downlight XL</b>									
LDVXLRING	4008321968906	LEDVANCE DOWNLIGHT XL RING AL	Alu	–	–	–	6	195	4 38
–	4008321968913*	LEDVANCE DOWNLIGHT XL RING LA	Anodised Alu	–	–	–	–	–	4 38
–	4008321968920*	LEDVANCE DOWNLIGHT XL RING LB	Black	–	–	–	–	–	4 38

\*In preparation at time of print. For further information please contact OSRAM

50<sup>lm/W</sup>70<sup>lm/W</sup>

Indoor – Recessed Luminaires



Technical specifications and icons for the LED kit:

- CE, IP23, F, 850 °C, IK02, -15 °C – +40 °C, 80, 220–240 V, 50–60 Hz
- 830, 460 cd, 30°, GU10
- electronic comfort light

**KIT LED PRO**

- Ready to install luminaire kit (pre wired luminaire containing lamp and ECG)
- Containing one white GU10 LED PARATHOM® PAR 16 4.5W
- Two versions round or square
- Ideal for interior illumination in retail, hotel and restaurant lighting

Product ID Code	EAN (Single Pack)	Product Description	FINISH	W	l (mm)	b (mm)	h (mm)	d (mm)	PPG	
LEDPROKITRBRN15	4008321963284	KIT LED PRO R 1 X 4.5W	Brushed Nickel	4.5	–	–	90	91	6	38
LEDPROKITSBRN15	4008321963291	KIT LED PRO S 1 X 4.5W	Brushed Nickel	4.5	91	91	90	–	6	38

NEW  
NEW



All orders must be multiples of sales pack





Indoor – Recessed Luminaires

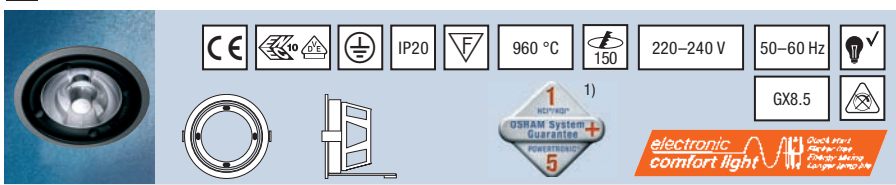

**DOWNLIGHT KIT HCI® R111**

- Ready to install kit containing a downlight, POWERBALL® HCI R111 metal halide lamp and POWERTRONIC® PtI ECG
- Provides flicker free light with brilliant colour rendering
- Simple to install due to twist and lock interlock for the lamp
- Ideal for shoplighting, museums and exhibition lighting

Product ID Code	EAN (Single Pack)	Product Description	FINISH	△°	W	h (mm)	d (mm)	PPG
NEW 7608125	4008321929594	DOWNLIGHT KIT HCI R111 White 35W WDL 10°	White	10	35	90	155	2 38
NEW 7608126	4008321929624	DOWNLIGHT KIT HCI R111 White 35W WDL 24°	White	24	35	90	155	2 38
NEW 7608127	4008321929655	DOWNLIGHT KIT HCI R111 White 35W WDL 40°	White	40	35	90	155	2 38
NEW 7608225	4008321929860	DOWNLIGHT KIT HCI R111 Grey 35W WDL 10°	Grey	10	35	90	155	2 38
NEW 7608226	4008321929891	DOWNLIGHT KIT HCI R111 Grey 35W WDL 24°	Grey	24	35	90	155	2 38
NEW 7608227	4008321929921	DOWNLIGHT KIT HCI R111 Grey 35W WDL 40°	Grey	40	35	90	155	2 38
NEW 7608121	4008321929778	DOWNLIGHT KIT HCI R111 White 35W NDL 10°	White	10	35	90	155	2 38
NEW 7608122	4008321929839	DOWNLIGHT KIT HCI R111 White 35W NDL 24°	White	24	35	90	155	2 38
NEW 7608123	4008321929808	DOWNLIGHT KIT HCI R111 White 35W NDL 40°	White	40	35	90	155	2 38
NEW 7608221	4008321929952	DOWNLIGHT KIT HCI R111 Grey 35W NDL 10°	Grey	10	35	90	155	2 38
NEW 7608222	4008321929983	DOWNLIGHT KIT HCI R111 Grey 35W NDL 24°	Grey	24	35	90	155	2 38
NEW 7608223	4008321930019	DOWNLIGHT KIT HCI R111 Grey 35W NDL 40°	Grey	40	35	90	155	2 38
NEW 7608325	4008321929617	DOWNLIGHT KIT HCI R111 White 70W WDL 10°	White	10	70	90	155	2 38
NEW 7608326	4008321929679	DOWNLIGHT KIT HCI R111 White 70W WDL 24°	White	24	70	90	155	2 38
NEW 7608327	4008321929730	DOWNLIGHT KIT HCI R111 White 70W WDL 40°	White	40	70	90	155	2 38
NEW 7608425	4008321929884	DOWNLIGHT KIT HCI R111 Grey 70W WDL 10°	Grey	10	70	90	155	2 38
NEW 7608426	4008321929945	DOWNLIGHT KIT HCI R111 Grey 70W WDL 24°	Grey	24	70	90	155	2 38
NEW 7608427	4008321930002	DOWNLIGHT KIT HCI R111 Grey 70W WDL 40°	Grey	40	70	90	155	2 38
NEW 7608321	4008321929686	DOWNLIGHT KIT HCI R111 White 70W NDL 10°	White	10	70	90	155	2 38
NEW 7608322	4008321929716	DOWNLIGHT KIT HCI R111 White 70W NDL 24°	White	24	70	90	155	2 38
NEW 7608323	4008321929747	DOWNLIGHT KIT HCI R111 White 70W NDL 40°	White	40	70	90	155	2 38
NEW 7608421	4008321930040	DOWNLIGHT KIT HCI R111 Grey 70W NDL 10°	Grey	10	70	90	155	2 38
NEW 7608422	4008321930071	DOWNLIGHT KIT HCI R111 Grey 70W NDL 24°	Grey	24	70	90	155	2 38
NEW 7608423	4008321930101	DOWNLIGHT KIT HCI R111 Grey 70W NDL 40°	Grey	40	70	90	155	2 38

1) For more information go to [www.osram.com/system-guarantee](http://www.osram.com/system-guarantee)

All orders must be multiples of sales pack

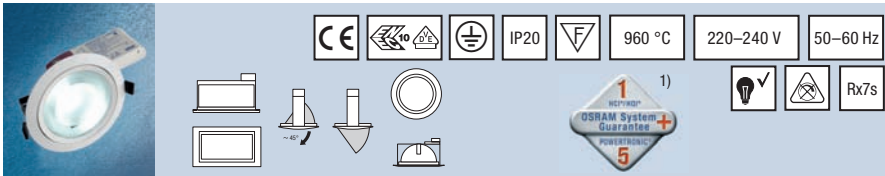

## Indoor – Recessed Luminaires

**KIT DOWNLIGHT HQI®-TS EXCELLENCE**

- Non dimmable luminaire kit consisting of a downlight, POWERSTAR® HQI® TS excellence metal halide lamp and POWERTRONIC® ECG
- In 3 versions: Round, Square and Mini Round in 3 light colours 3000K (WDL), 4200K (NDL) 5600K (D)
- Square version swivels through 45°
- Ideal for shop illumination and foyers

Product ID Code	EAN (Single Pack)	Product Description	FINISH	W	l [mm]	b [mm]	h [mm]	d [mm]	PPG
<b>Square Version</b>									
7609521	4008321391766	KIT DOWNLIGHT HQI-TS EXCELLENCE SQUARE 70W WDL	White	70	240	142	130	-	2 38
7609523	4008321391780	KIT DOWNLIGHT HQI-TS EXCELLENCE SQUARE 70W NDL	White	70	240	142	130	-	2 38
7609525	4008321391803	KIT DOWNLIGHT HQI-TS EXCELLENCE SQUARE 70W D	White	70	240	142	130	-	2 38
7609721	4008321391841	KIT DOWNLIGHT HQI-TS EXCELLENCE SQUARE 150W WDL	White	150	240	142	130	-	2 38
7609723	4008321391865	KIT DOWNLIGHT HQI-TS EXCELLENCE SQUARE 150W NDL	White	150	240	142	130	-	2 38
7609725	4008321391889	KIT DOWNLIGHT HQI-TS EXCELLENCE SQUARE 150W D	White	150	240	142	130	-	2 38
<b>Round Version</b>									
7609121	4008321391605	KIT DOWNLIGHT HQI-TS EXCELLENCE ROUND 70W WDL	White	70	-	-	110	230	2 38
7609123	4008321391629	KIT DOWNLIGHT HQI-TS EXCELLENCE ROUND 70W NDL	White	70	-	-	110	230	2 38
7609125	4008321391643	KIT DOWNLIGHT HQI-TS EXCELLENCE ROUND 70W D	White	70	-	-	110	230	2 38
7609321	4008321391667	KIT DOWNLIGHT HQI-TS EXCELLENCE ROUND 150W WDL	White	150	-	-	110	230	2 38
7609323	4008321391704	KIT DOWNLIGHT HQI-TS EXCELLENCE ROUND 150W NDL	White	150	-	-	110	230	2 38
7609325	4008321391728	KIT DOWNLIGHT HQI-TS EXCELLENCE ROUND 150W D	White	150	-	-	110	230	2 38
<b>Mini Round Version</b>									
7609921	4008321391902	KIT DOWNLIGHT HQI-TS EXCELLENCE MINI ROUND 70W WDL	WDL	70	-	-	93	166	4 38
7609923	4008321391926	KIT DOWNLIGHT HQI-TS EXCELLENCE MINI ROUND 70W NDL	White	70	-	-	93	166	4 38
7609925	4008321391940	KIT DOWNLIGHT HQI-TS EXCELLENCE MINI ROUND 70W D	White	70	-	-	93	166	4 38

1) For more information go to [www.osram.com/system-guarantee](http://www.osram.com/system-guarantee)

NEW  
NEW  
NEW  
NEW  
NEW  
NEW  
NEW  
NEW  
NEW  
NEW  
NEW  
NEW



All orders must be multiples of sales pack

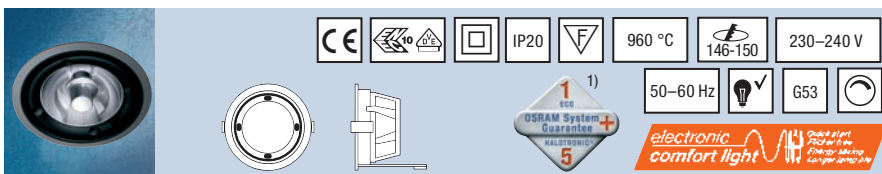

## Indoor – Recessed Luminaires

**DOWNLIGHT KIT HALOSPOT® R111 ECO**

- Downlight Kit containing HALOSPOT® R111 ECO and HALOTRONIC® MOUSE HTM
- Available in 8°, 24°, 45° beam angle
- Two luminaire colours: white and silver grey
- Ideal for accent lighting, shoplighting, museums and exhibitions

Product ID Code	EAN (Single Pack)	Product Description	FINISH		W	h (mm)	d (mm)		PPG
NEW 7608521	4008321330734	DOWNLIGHT KIT HALOSPOT 111 ES 35W, 8°	White	8	35	90	155	2	38
NEW 7608522	4008321335920	DOWNLIGHT KIT HALOSPOT 111 ES 35W, 24°	White	24	35	90	155	2	38
NEW 7608523	4008321335944	DOWNLIGHT KIT HALOSPOT 111 ES 50W, 8°	White	8	50	90	155	2	38
NEW 7608524	4008321335968	DOWNLIGHT KIT HALOSPOT 111 ES 50W, 24°	White	24	50	90	155	2	38
NEW 7608525	4008321335982	DOWNLIGHT KIT HALOSPOT 111 ES 50W, 45°	White	45	50	90	155	2	38
NEW 7608526	4008321336002	DOWNLIGHT KIT HALOSPOT 111 ES 65W, 8°	White	8	65	90	155	2	38
NEW 7608527	4008321336026	DOWNLIGHT KIT HALOSPOT 111 ES 65W, 24°	White	24	65	90	155	2	38
NEW 7608528	4008321336040	DOWNLIGHT KIT HALOSPOT 111 ES 65W, 45°	White	45	65	90	155	2	38
NEW 7608621	4008321330758	DOWNLIGHT KIT HALOSPOT 111 ES 35W, 8°	Silver Grey	8	35	90	155	2	38
NEW 7608622	4008321336064	DOWNLIGHT KIT HALOSPOT 111 ES 35W, 24°	Silver Grey	24	35	90	155	2	38
NEW 7608623	4008321336088	DOWNLIGHT KIT HALOSPOT 111 ES 50W, 8°	Silver Grey	8	50	90	155	2	38
NEW 7608624	4008321336101	DOWNLIGHT KIT HALOSPOT 111 ES 50W, 24°	Silver Grey	24	50	90	155	2	38
NEW 7608625	4008321336125	DOWNLIGHT KIT HALOSPOT 111 ES 50W, 45°	Silver Grey	45	50	90	155	2	38
NEW 7608626	4008321336149	DOWNLIGHT KIT HALOSPOT 111 ES 65W, 8°	Silver Grey	8	65	90	155	2	38
NEW 7608627	4008321336163	DOWNLIGHT KIT HALOSPOT 111 ES 65W, 24°	Silver Grey	24	65	90	155	2	38
NEW 7608628	4008321336187	DOWNLIGHT KIT HALOSPOT 111 ES 65W, 45°	Silver Grey	45	65	90	155	2	38

1) For more information go to [www.osram.com/system-guarantee](http://www.osram.com/system-guarantee)



All orders must be multiples of sales pack

## Indoor – Recessed Luminaires

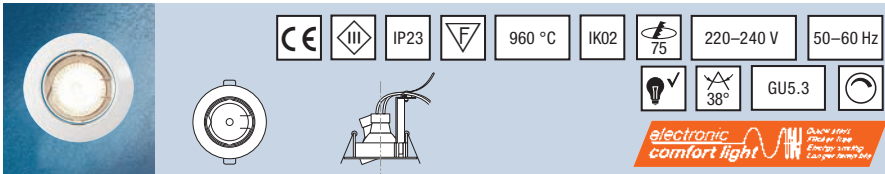
**KIT HALO ECO**

- Cost effective ready to install luminaire kit (Prewired luminaire containing 50W DECOSTAR® standard)
- Lamp swivels through 40°
- Ideal for illuminating shop windows, retail outlets and corridor lighting

Product ID Code	EAN (Single Pack)	Product Description	FINISH	△	W	h (mm)	d (mm)	PPG
HALECOKIT150WT	4008321390806	KIT HALO ECO ROUND 1 X 50W	White	40	50	74	82	24X1 38

NEW

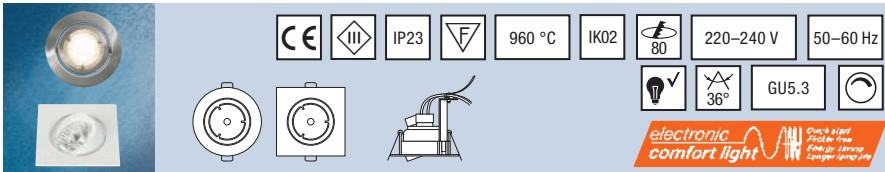
**KIT HALO PRO**

- Ready to install luminaire kit (Pre wired luminaire containing lamp and ECG)
- Containing a halogen DECOSTAR® GU5.3 35W ECO
- Two versions round or square
- Ideal for interior illumination in retail, hotel and restaurant lighting

Product ID Code	EAN (Single Pack)	Product Description	FINISH	△	W	l (mm)	b (mm)	h (mm)	d (mm)	PPG
<b>Round version</b>										
HALPROKITRWT35	4008321398628	KIT HALO PRO R 1 X 35 W	White	36	35	–	–	74	91	6 38
HALOPROKITRWT335	4008321445537	KIT HALO PRO R 3 X 35 W	White	36	35	–	–	74	91	6 38
HALPROKITRBRNI35	4008321398642	KIT HALO PRO R 1 X 35 W	Brushed Nickel	36	35	–	–	74	91	6 38
HALOPROKITRBRNI335	4008321445551	KIT HALO PRO R 3 X 35 W	Brushed Nickel	36	35	–	–	74	91	6 38
<b>Square version</b>										
HALPROKITSWT35	4008321398987	KIT HALO PRO S 1 X 35 W	White	36	35	91	91	74	–	6 38
HALOPROKITSWT335	4008321445575	KIT HALO PRO S 3 X 35 W	White	36	35	91	91	74	–	6 38
HALPROKITSRNI35	4008321399007	KIT HALO PRO S 1 X 35 W	Brushed Nickel	36	35	91	91	74	–	6 38
HALOPROKITSRNI335	4008321445599	KIT HALO PRO S 3 X 35 W	Brushed Nickel	36	35	91	91	74	–	6 38



All orders must be multiples of sales pack

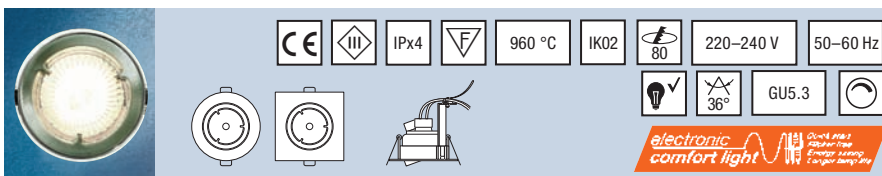

## Indoor – Recessed Luminares

**KIT HALO PRO HYDRO**

- Ready to install luminaire kit (Pre wired luminaire containing lamp and ECG)
- Containing a halogen DECOSTAR® GU5.3 35W 12V energy saver
- New recessed spot for fix illumination in humidity areas
- IP24 rated for humid areas
- Two versions round or square
- Ideal for bathroom lighting, showers, kitchens, changing rooms

Product ID Code	EAN (Single Pack)	Product Description	FINISH	∠°	W	l (mm)	b (mm)	h (mm)	d (mm)	PPG
<b>Round version</b>										
HALHYDROKITRWT35	4008321399045	KIT HP HYDRO R 1 X 35	White	36	35	-	-	74	91	6 38
HALHYDRKITRWT335	4008321445636	KIT HP HYDRO R 3 X 35	White	36	35	-	-	74	91	6 38
HALHYDROKITRBRNI35	4008321399069	KIT HP HYDRO R 1 X 35	Nickel	36	35	-	-	74	91	6 38
HALHYDRKITRBRNI335	4008321445650	KIT HP HYDRO R 3 X 35	Nickel	36	35	-	-	74	91	6 38
<b>Square version</b>										
HALHYDROKITSWT35	4008321399083	KIT HP HYDRO S 1 X 35	White	36	35	91	91	74	-	6 38
HALHYDRKITSWT335	4008321445674	KIT HP HYDRO S 3 X 35	White	36	35	91	91	74	-	6 38
HALHYDROKITSRBNI35	4008321399106	KIT HP HYDRO S 1 X 35	Nickel	36	35	91	91	74	-	6 38
HALHYDRKITSRBNI335	4008321445698	KIT HP HYDRO S 3 X 35	Nickel	36	35	91	91	74	-	6 38
KITHALHYDRO135	4008321552570	KIT HP HYDRO FIX 1x35 IP65	White	36	35	-	-	-	-	6 38

NEW

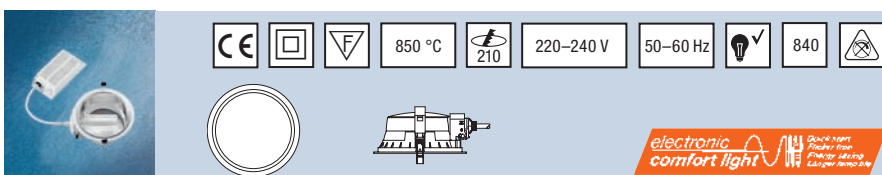
**JADE KIT ECO HF**

- Ready to install low profile luminaire kit
- Containing 1 QT ECO T/E electronic control gear and two OSRAM DULUX® D/E lamps
- Ideal for retail outlets, reception areas, offices and corridors

Product ID Code	EAN (Single Pack)	Product Description	FINISH	W	h (mm)	d (mm)	PPG
JADEKITECO218	4008321963246	JADE KIT ECO WT 2X18W IP20	White	2X18	110	225	2x1 38
JADEKITECO218DIFF	4008321963260	JADE KIT ECO Shield 2X18 IP40	White	2X18	110	225	2x1 38
JADEKITECO226	4008321387660	JADE KIT ECO WT 2X26W IP20	White	2X18	110	225	2x1 38
JADEKITECO226DIFF	4008321391513	JADE KIT ECO Shield 2X26 IP40	White	2X18	110	225	2x1 38



All orders must be multiples of sales pack

## Indoor – Recessed Luminaires

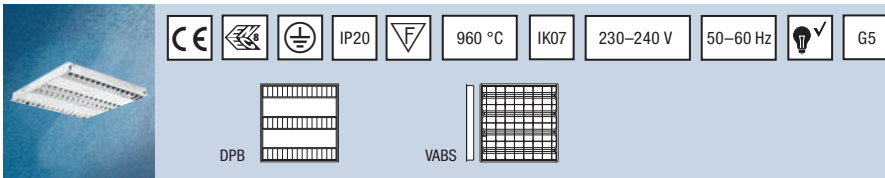
**OSRAM DEDRA plus® T5 KIT**

- Ready to install luminaire kit (Pre wired luminaire containing lamp and ECG)
- Double parabolic optics for a symmetrical reflector
- Available in frosted and polished versions for very low luminance
- Containing three or four LUMILUX® T5 HE high efficiency tubes
- Ideal for background lighting in offices, schools and conference rooms

Product ID Code	EAN (Single Pack)	Product Description	FINISH	W	I (mm)	b (mm)	h (mm)	PPG	
-----------------	-------------------	---------------------	--------	---	--------	--------	--------	-----	--

**DPB DALI version**

- Comprising a symmetrical longitudinal reflector and louvre with a polished finish
- Integrated QTI DALI DIM control gear

DEDT5DPB3X14DALI	4008321380852	DEDRA T5 DPB KIT 3 x 14/840 DALI	White	3x14	596	596	52	1	38
DEDT5DPB4X14DALI	4008321380883	DEDRA T5 DPB KIT 4 x 14/840 DALI	White	4x14	596	596	52	1	38
DEDT5DPB4X14830DALI	4008321533555	DEDRA T5 DPB KIT 4 x 14/830 DALI	White	4x14	596	596	52	1	38

**DPB-C WIELAND version**

- Comprising a symmetrical longitudinal reflector and louvre with a frosted finish
- DPB C kit with WIELAND connector
- Integrated electronic control gear QT-FH 3x14W or 4x14W

DEDT5DPBC3X14WIELA	4008321380890	DEDRA T5 DPB-C kit 3x14W/840 WIELAND Frosted	White	3 x14	596	596	52	1	38
--------------------	---------------	--	-------	-------	-----	-----	----	---	----

**DPB version**

- Comprising a symmetrical longitudinal reflector and louvre in a polished or frosted finish
- Integrated electronic control gear QT-FH 3X14W or 4X14W

DEDT5DPBC3X14840	4008321366696	DEDRA T5 DPB C kit 3x14W/840 – Frosted	White	3x14	596	596	52	1	38
DEDT5DPBC4X14840	4008321366726	DEDRA T5 DPB C kit 4x14W/840 – Frosted	White	4x14	596	596	52	1	38
DEDT5DPB3X14830	4008321366689	DEDRA T5 DPB kit 3x14W/830 – Polished	White	3x14	596	596	52	1	38
DEDT5DPB3X14840	4008321366672	DEDRA T5 DPB kit 3x14W/840 – Polished	White	3x14	596	596	52	1	38
DEDT5DPB4X14830	4008321366719	DEDRA T5 DPB kit 4x14W/830 – Polished	White	4x14	596	596	52	1	38
DEDT5DPB4X14840	4008321366702	DEDRA T5 DPB kit 4x14W/840 – Polished	White	4x14	596	596	52	1	38

**DPB -VABS version**

- Double parabolic optics for a symmetrical V reflector
- Integrated electronic control gear QT-FH 3X14W or 4X14W

DEDT5VABS4X14	4008321380937	DEDRA T5 VABS kit 4x14W/840	White	4x14	596	596	52	1	38
---------------	---------------	-----------------------------	-------	------	-----	-----	----	---	----



All orders must be multiples of sales pack



Indoor – Recessed Luminaire

**OSRAM DEDRA plus® T8 KIT**

- Ready to install luminaire kit (Pre wired luminaire containing lamp and ECG)
- Double parabolic optics for a symmetrical reflector
- Available in frosted and polished versions for very low luminance
- Containing LUMILUX® T8 lamps
- Ideal for background lighting in offices, schools and conference rooms

Product ID Code	EAN (Single Pack)	Product Description	FINISH	W	I (mm)	b (mm)	h (mm)	PPG
-----------------	-------------------	---------------------	--------	---	--------	--------	--------	-----

**OSRAM DEDRA plus® T8 KIT- DPTB**

- Double parabolic optics for a symmetrical reflector
- Integrated electronic control gear QTP 4X18W

DEDT8DPTB4X18830	4008321526502	DEDRA T8 DPTB KIT 4x18/830 polished	White	4x18	596	596	130	1	38
DEDT8DPTB4X18840	4008321526496	DEDRA T8 DPTB KIT 4x18/840 polished	White	4x18	596	596	130	1	38

**OSRAM DEDRA plus® T8 KIT (VATS/VABS/VB)**

- Double parabolic optics for a symmetrical V reflector
- Integrated electronic control gear QTP 4X18W
- Available in brilliant aluminium reflector finish, satin aluminium or white finish

-	4008312526526	DEDRA T8 VATS KIT 4x18W/830 Satin Alu reflector*	White	4x18	596	596	130	1	38
-	4008312526519	DEDRA T8 VATS KIT 4x18W/840 Satin Alu reflector*	White	4x18	596	596	130	1	38
DEDT8VABS4X18830	4008321526540	DEDRA T8 VABS KIT 4x18W/830 Brilliant Alu reflector	White	4x18	596	596	130	1	38
DEDT8VABS4X18840	4008321526533	DEDRA T8 VABS KIT 4x18W/840 Brilliant Alu reflector	White	4x18	596	596	130	1	38
DEDT8VB4X18840	4008321526557	DEDRA T8 VB KIT 4x18W/840 White reflector	White	4x18	596	596	130	1	38

\*In preparation at time of print. For further information please contact OSRAM

NEW  
NEW

All orders must be multiples of sales pack

## Indoor – Recessed Luminaires

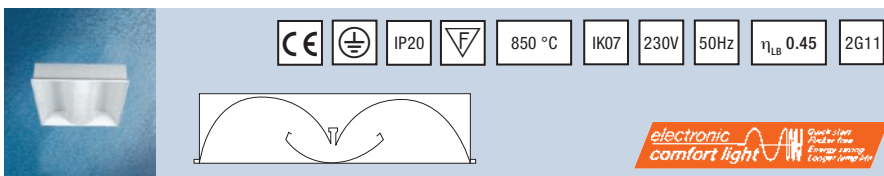
**DELTA**

- Recessed ceiling luminaire with integrated electronic control gear for compact fluorescent lamps
- Suitable for two OSRAM DULUX® L 36W or 55W lamps
- Kit version includes lamps with light colour 840 or 830
- White painted parabolic reflector

Product ID Code	EAN (Single Pack)	Product Description	FINISH	W	I (mm)	b (mm)	h (mm)		PPG
<b>DELTA KIT – with lamp</b>									
DELTAKIT36840	4008321126504	DELTA KIT 2 x 36W Col 840	White	2x36	596	596	118	1	38
DELTAKIT36830	4008321126511	DELTA KIT 2 x 36W Col 830	White	2x36	596	596	118	1	38
DELTAKIT55840	4008321126924	DELTA KIT 2 x 55W Col 840	White	2x55	596	596	118	1	38
DELTAKIT55830	4008321126931	DELTA KIT 2 x 55W Col 830	White	2x55	596	596	118	1	38
<b>DELTA – without lamp</b>									
DELTAII2X36	4050300188850	DELTA 2 x 36W	White	2x36	596	596	118	1	38
DELTAII2X55	4050300188867	DELTA 2 x 55W	White	2x55	596	596	118	1	38
DELTAII2X36DIM	4050300188836	DELTA 2 x 36W DIM	White	2x36	596	596	118	1	38
DELTAII2X55DIM	4050300188843	DELTA 2 x 55W DIM	White	2x55	596	596	118	1	38



All orders must be multiples of sales pack





## INDOOR

### DAMP PROOF LUMINAIRES

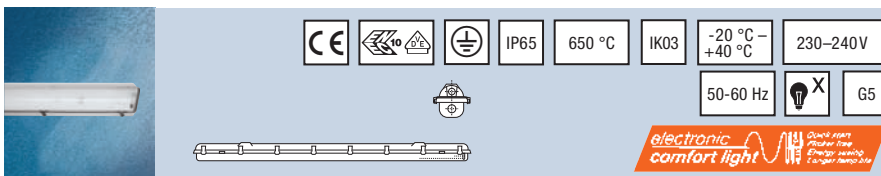

#### ORCA PLUS for T5

- Extremely robust jet proof luminaire for suspended or ceiling mounting
- Suitable for LUMILUX® T5 HO CONSTANT fluorescent lamps and equipped with QTP5 ECG
- Polyester casing with 22% fibre glass, PMMA coating with stainless steel fastenings
- Ideal for functional lighting in wet or damp and dusty rooms such as workshops, garages, swimming pools and petrol stations

Product ID Code	EAN (Single Pack)	Product Description	FINISH	W	l (mm)	b (mm)	h (mm)	PPG
ORCAPMMA1X54	4008321193124	ORCA PLUS for T5 54W	Grey/Transparent	54	1276	115	105	38
ORCAPMMA1X80	4008321193131	ORCA PLUS for T5 80W	Grey/Transparent	80	1576	115	105	38
ORCAPMMA2X54	4008321193148	ORCA PLUS for T5 2 x 54W	Grey/Transparent	2x54	185	185	105	38
ORCAPMMA2X80	4008321193155	ORCA PLUS for T5 2 x 80W	Grey/Transparent	2x80	185	185	105	38



All orders must be multiples of sales pack

## Indoor – Damp Proof Luminaires

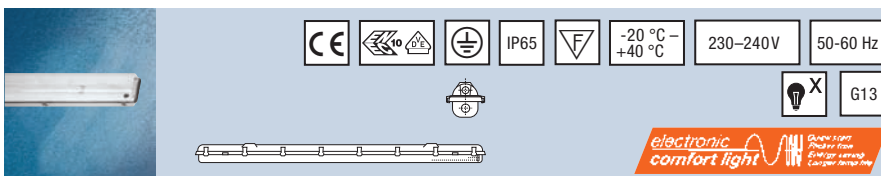
**ORCA PLUS for T8**

- Extremely robust jet proof luminaire for suspended or ceiling mounting
- Suitable for LUMILUX® T8 fluorescent lamps and equipped with QTP8 ECG
- Polyester casing with 22% fibre glass, PMMA coating with stainless steel fastenings
- Ideal for functional lighting in wet or damp and dusty rooms such as workshops, garages, swimming pools and petrol stations



Product ID Code	EAN (Single Pack)	Product Description	FINISH	W	l (mm)	b (mm)	h (mm)		PPG
<b>Polyester Casing</b>									
ORCAPPC1X36	4008321193087	ORCA PLUS for T8 36W Polyester Casing	Grey/Transparent	36	1276	115	105	1	38
ORCAPPC1X58	4008321193094	ORCA PLUS for T8 58W Polyester Casing	Grey/Transparent	58	1576	115	105	1	38
ORCAPPC2X36	4008321193100	ORCA PLUS for T8 2 x 36W Polyester Casing	Grey/Transparent	2x36	185	185	105	1	38
ORCAPPC2X58	4008321193117	ORCA PLUS for T8 2 x 58W Polyester Casing	Grey/Transparent	2x58	185	185	105	1	38
<b>PMMA coating</b>									
ORCAPMMA1X36	4008321193049	ORCA PLUS for T8 36W PMMA coating	Grey/Transparent	36	1276	115	105	1	38
ORCAPMMA1X58	4008321193056	ORCA PLUS for T8 58W PMMA coating	Grey/Transparent	58	1576	115	105	1	38
ORCAPMMA2X36	4008321193063	ORCA PLUS for T8 2 x 36W PMMA coating	Grey/Transparent	2x36	185	185	105	1	38
ORCAPMMA2X58	4008321193070	ORCA PLUS for T8 2 x 58W PMMA coating	Grey/Transparent	2x58	185	185	105	1	38



All orders must be multiples of sales pack



### Indoor – Damp Proof Luminaires

CE

D/E

⊕

IP65

850 °C

IK08

-20 °C – +40 °C

230–240V

50-60 Hz

X

G13



#### NEPTUNE® POLYCARBONATE

- Extremely robust jet proof luminaire providing permanent seals, high resistance with a functional design
- Suitable for LUMILUX® T8 fluorescent lamps and equipped with QTS or QTP ECG
- Ideal for industrial and storage facilities, car parks and underpasses

Product ID Code	EAN (Single Pack)	Product Description	FINISH	W	l (mm)	b (mm)	h (mm)		PPG
<b>NEPTUNE® POLYCARBONATE QTS</b>									
NEPPOLY1X36	4008321910752	NEPTUNE POLY QTS 1x36W	Grey	1x36	1275	104	108	1	38
NEPPOLY2X36	4008321910776	NEPTUNE POLY QTS 2x36W	Grey	2x36	1275	164	108	1	38
NEPPOLY1X58	4008321910790	NEPTUNE POLY QTS 1x58W	Grey	1x58	1575	104	108	1	38
NEPPOLY2X58	4008321910813	NEPTUNE POLY QTS 2x58W	Grey	2x58	1575	164	108	1	38
<b>NEPTUNE® POLYCARBONATE QTP</b>									
NEPTPOLY1X58HFQTP	4008321098108	NEPTUNE POLY QTP 1x58W	Grey	1x58	1575	104	108	1	38
NEPTPOLY2X58HFQTP	4008321098115	NEPTUNE POLY QTP 2x58W	Grey	2x58	1575	164	108	1	38
<b>Accessories for NEPTUNE® POLYCARBONATE</b>									
STAINLESS8	4008321391162	Fastening clips for 36W version	Grey	–	–	–	–	100x8	38
STAINLESS10	4008321391186	Fastening clips for 58W version	Grey	–	–	–	–	100x10	38

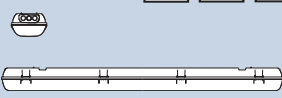
CE

D/E

⊕

IP65

F

850 °C

IK08

-30 °C – +50 °C

230V

50-60 Hz

X

2G11



#### IGLOO II

- Damp proof luminaire for low temperatures down to -30°C
- Suitable for two or four OSRAM DULUX® L SP lamps with integrated QTP ECG
- Ideal for illuminating cold stores and winter sports facilities

Product ID Code	EAN (Single Pack)	Product Description	FINISH	W	l (mm)	b (mm)	h (mm)		PPG
IGLOOIIGR	4050300774626	IGLOO II 2x24W (DULUX)	Grey	2x24	1270	100	102	1	38
IGLOOII	4050300774619	IGLOO II 4x24W (DULUX)	Grey	4x24	1270	100	102	1	38



All orders must be multiples of sales pack

## Indoor – Damp Proof Luminaires

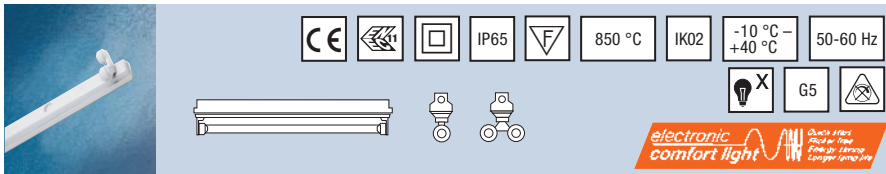
**AQUALINE™ T5**

- Jet proof luminaire for use in damp and dusty environments
- Suitable for LUMILUX® T5 HO CONSTANT fluorescent lamps equipped with QTP5 ECG
- Ideal for industrial and storage facilities, swimming pools, car parks and underpasses

Product ID Code	EAN (Single Pack)	Product Description	FINISH	W	l [mm]	b [mm]	h [mm]		PPG
RTP1X24	4008321173744	AQUALINE 1 x 24W HO CONSTANT	Grey/ Transparent	24	661	65	115	1	38
RTP1X54	4008321173751	AQUALINE 1 x 54W HO CONSTANT	Grey/ Transparent	54	1271	65	115	1	38
RTP1X80	4008321173768	AQUALINE 1 x 80W HO CONSTANT	Grey/ Transparent	80	1571	65	115	1	38
RTP2X54	4008321173799	AQUALINE 2 x 54W HO CONSTANT	Grey/ Transparent	2 x54	1271	117	115	1	38
RTP2X80	4008321173829	AQUALINE 2 x 80W HO CONSTANT	Grey/ Transparent	2x80	1571	117	115	1	38

**Accessories for AQUALINE™ T5**

Product ID Code	EAN (Single Pack)	Product Description	FINISH		PPG
<b>Round protective tube made from PC for IK08</b>					
SLPCR24AQUA	4008321185372	Round PC tube with fastening rings – 24W	Grey	1	38
SLPCR54AQUA	4008321185402	Round PC tube with fastening rings – 54W	Grey	1	38
SLPCR80AQUA	4008321185419	Round PC tube with fastening rings – 80W	Grey	1	38
<b>Oval protective tube made from PMMA with parabolic reflector for IK08</b>					
OVAL24SR	4008321193919	OVAL PMMA tube with fastening rings – 24W	Transparent	1	38
OVAL54SR	4008321193926	OVAL PMMA tube with fastening rings – 54W	Transparent	1	38
OVAL80SR	4008321193971	OVAL PMMA tube with fastening rings – 80W	Transparent	1	38



Round protective tube made from PC



Oval protective tube made from PMMA with parabolic reflector



All orders must be multiples of sales pack



## OUTDOOR

### RECESSED LUMINAIRES



#### AQUALED®

- IP68 LED luminaires for decoration and orientation
- Chrome, granite look or stainless steel finish
- Ideal for outdoor lighting

Product ID Code	EAN (Single Pack)	Product Description	FINISH	W	h (mm)	d (mm)	PPG
<b>AQUALED® White</b>							
4700570	4050300160580	AQUALED White LED	Granite	0.4	84	88	4 38
4700571	4050300160603	AQUALED White LED	Chrome	0.4	84	88	4 38
4700574	4008321100276	AQUALED White LED	Stainless Steel	0.4	84	88	4 38
<b>AQUALED® Blue</b>							
4700572	4050300160566	AQUALED Blue LED	Granite	0.5	84	88	4 38
4700573	4050300160627	AQUALED Blue LED	Chrome	0.5	84	88	4 38
4700575	4008321100290	AQUALED Blue LED	Stainless Steel	0.5	84	88	4 38

#### Accessories for AQUALED®

- ECG for AQUALED®

OT6/240CE	4008321113306	OPTOTRONIC OT 6/200240/10 CE ECG	-	-	-	-	20 38
OT12	4050300609232	OPTOTRONIC OT 12/230240/10 ECG	-	-	-	-	20 38

All orders must be multiples of sales pack

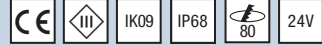

## Outdoor – Recessed Luminaires

**LED****AQUALED DRAGON®**

- IP 68 recessed stainless steel LED luminaire with Golden DRAGON® LED
- Ideal for swimming pools and orientation light

Product ID Code	EAN (Single Pack)	Product Description	FINISH	W	h (mm)	d (mm)		PPG
4700674	4008321213433	OSRAM AQUALED DRAGON White	Inox	1.7	84	88	4	38
4700675	4008321213457	OSRAM AQUALED DRAGON Blue	Inox	1.7	84	88	4	38

**Accessories for AQUALED DRAGON®**

- ECG for AQUALED DRAGON®

OT08	4008321040169	OPTOTRONIC OT8/200240/24 ECG	-	-	-	-	50	38
------	---------------	------------------------------	---	---	---	---	----	----

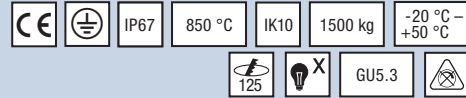
**NAUTILUS® MIDI DR51 INC**

- Decorative recessed spotlights equipped with 1m cable for connecting to ECG
- Suitable for DECOSTAR® 51mm lamps or DRAGONSTAR® 500
- Ideal for architectural illumination, facades and monuments

Product ID Code	EAN (Single Pack)	Product Description	FINISH	W	h (mm)	d (mm)		PPG
NAUTILUSMIDI50	4008321154439	NAUTILUS MIDI DR 51	Grey	10,24,38,60	50	224	147	4 38
KITSECURFIXNAUTMIDI	4008321153470	NAUTILUS MIDI KIT SECURFIX	-	-	-	-	10X2	38



All orders must be multiples of sales pack



Outdoor – Recessed Luminaires

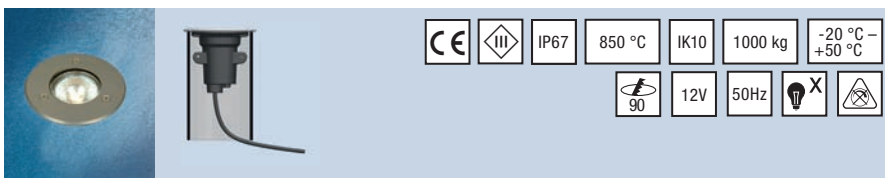

**NAUTILUS® MINI HAL**

- Decorative space saving luminaire
- Suitable for DECOSTAR® halogen lamps
- Ideal for architectural illumination, gardens, facades and monuments

Product ID Code	EAN (Single Pack)	Product Description	FINISH	△	W	h (mm)	d (mm)	PPG
NAUTILUSMINI20	4008321154415	NAUTILUS MINI DR51 FIX	Grey	10,38,60	20	150	100	4 38

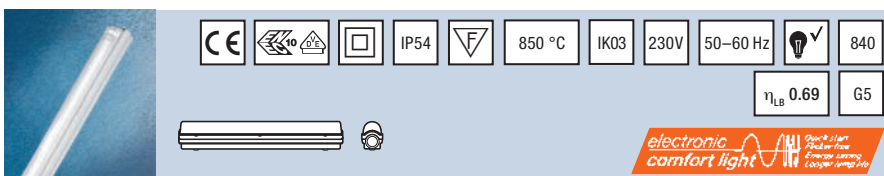

All orders must be multiples of sales pack

**OUTDOOR****SURFACE MOUNTED LUMINAIRES****LUMILUX BRIK® EL**

- Slim splash proof wall and ceiling luminaire
- Ideal for garages and damp locations

Product ID Code	EAN (Single Pack)	Product Description	FINISH	W	l (mm)	b (mm)	h (mm)		PPG
72181GR	4050300440880	72181 LUMILUX BRIK EL 8W	Grey	8	330	42	58	4	38
72185GR	4050300440903	72185 LUMILUX BRIK EL 13W	Grey	13	560	42	58	4	38

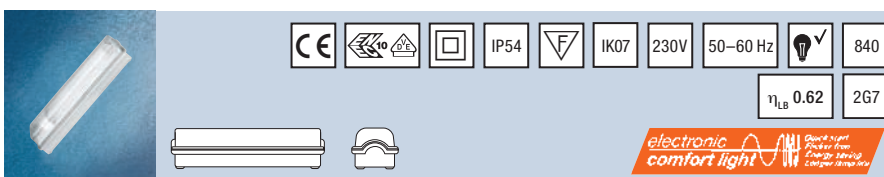
**OSRAM DULUX BRIK® EL**

- Compact energy saving exterior luminaire
- With colour 840 OSRAM DULUX® S/E lamps
- Ideal for garages and damp locations

Product ID Code	EAN (Single Pack)	Product Description	FINISH	W	l (mm)	b (mm)	h (mm)		PPG
74121GR	4050300440927	74121 OSRAM DULUX BRIK EL 9W	Grey	9	224	68	58	4	38
74125GR	4050300440941	74125 OSRAM DULUX BRIK EL 11W	Grey	11	294	68	58	4	38



All orders must be multiples of sales pack





## CONSUMER FLASHLIGHTS



### SIRIUS Torch Range

- High quality aluminium torches
- High Power DRAGON® PLUS LEDs
- Batteries not included

Product ID Code	EAN (Single Pack)	Product Description	FINISH	W	l (mm)	b (mm)	h (mm)		PPG
<b>NEW</b> SIRIUSLARGE	4008321957429	SIRIUS – Large	Aluminium	2.7	278	69	69	6	38
<b>NEW</b> SIRIUSMEDIUM	4008321957399	SIRIUS – Medium	Aluminium	2.2	228	55	55	6	38
<b>NEW</b> SIRIUSSMALL	4008321957368	SIRIUS – Small	Aluminium	1.2	131	48	48	6	38

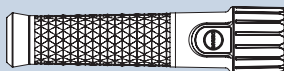

### CROSSER Torch Range

- Robust LED plastic torches
- High Power DRAGON® PLUS LEDs
- Batteries not included

Product ID Code	EAN (Single Pack)	Product Description	FINISH	W	l (mm)	b (mm)	h (mm)		PPG
<b>NEW</b> CROSSERLARGE	4008321957542	CROSSER – Large	Grey plastic	2.7	258	60	60	6	38
<b>NEW</b> CROSSERMEDIUM	4008321957511	CROSSER – Medium	Grey plastic	2.2	217	52	52	6	38
<b>NEW</b> CROSSERSMALL	4008321957481	CROSSER – Small	Grey plastic	1.2	134	42	42	6	38
<b>NEW</b> CROSSERMICRO	4008321957450	CROSSER – Micro	Grey plastic	0.5	73	20	20	6	38
<b>NEW</b> CROSSERTUBE	4008321957603	CROSSER – Tube Camping Lantern	Grey plastic	2.2	150	91	91	6	38
<b>NEW</b> CROSSERMULTIFU	4008321957573	CROSSER – Multifunction	Grey plastic	1.2	134	44	44	6	38
<b>NEW</b> CROSSERSPOTLIG	4008321957634	CROSSER – Spotlight	Grey plastic	3.3	216	135	135	6	38



All orders must be multiples of sales pack

Consumer – Flashlights



**LED Clip on Lights**

- Easy clip on night safety LED light
- With both red and white LED
- Ideal as a personal mobile safety light (children's backpacks, jackets, clothing)

Product ID Code	EAN (Single Pack)	Product Description	FINISH	PPG
80198	4008321371324	LED clip on Lights (Double blister)	6	38

**NEW**



**LED MULTIFUNCTIONAL**

- Versatile LED torch
- Extendable flexible arm with adjustable head
- Button cell batteries included
- Ideal for use as a reading light

Product ID Code	EAN (Single Pack)	Product Description	FINISH	PPG
4648201	4008321040237	LED MULTIFUNCTIONAL (Single blister)	Silver/Blue	6 38



All orders must be multiples of sales pack



Consumer – Flashlights

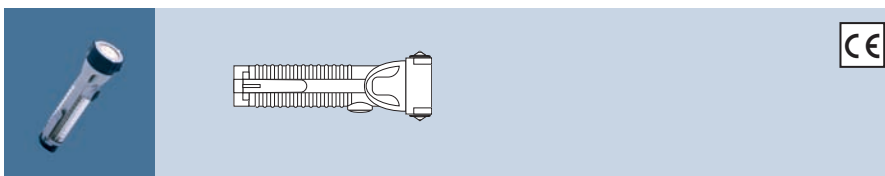

### LED SAVER LIGHT

- Krypton torch
- 12 Flashing Red LEDs in the handle to act as a warning light
- 3 magnets to attach to metal surfaces
- Emergency hammer for breaking windscreens and seat belt cutter
- Ideal accessory for all cars



Product ID Code	EAN (Single Pack)	Product Description	FINISH	PPG
46474	4050300884882	LED SAVER LIGHT (Blister)	Silver/Blue	6 38

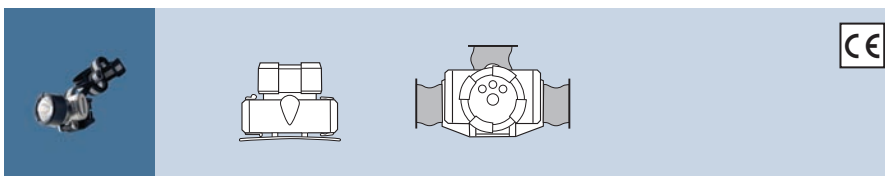

### LED HEADLAMP

- Adjustable headlamp
- Light from three bright white LEDs and one Xenon lamp
- Ideal for providing localised light



Product ID Code	EAN (Single Pack)	Product Description	FINISH	PPG
4645201	4008321047106	LED HEADLAMP (Single blister)	Grey/Black	6 38



All orders must be multiples of sales pack

## Consumer – Flashlights

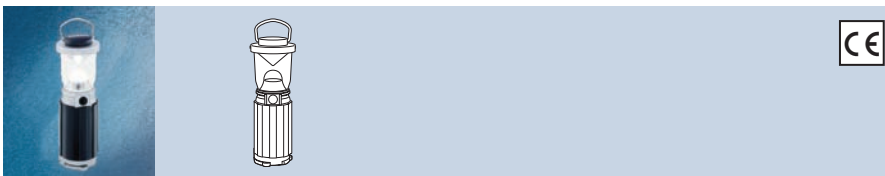
**CAMPING LED**

- Economical compact camping lantern
- Super bright OSRAM Golden DRAGON® LED
- Two brightness levels: 100% and 25%

Product ID Code	EAN (Single Pack)	Product Description	FINISH		PPG
46473	4050300884943	CAMPING LED	Silver/Blue	6	38

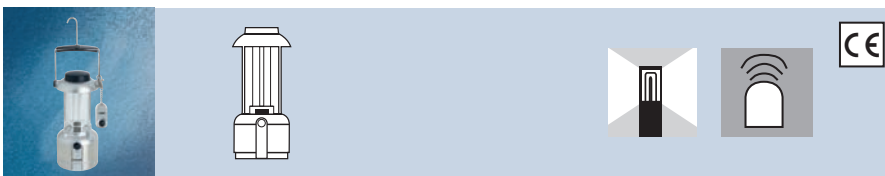
**CAMPING ENERGY AUTOMATIC**

- Energy saving camping lantern
- With 7W energy saving lamp for wide area work light
- Remote control for standby mode
- Robust steel/plastic casing
- Practical carrying handle and hanging hook
- Ideal for camping and picnics

Product ID Code	EAN (Single Pack)	Product Description	FINISH		PPG
46471	4050300776057	CAMPING ENERGY AUTOMATIC	Silver/Blue	6	38



All orders must be multiples of sales pack



Consumer – Flashlights

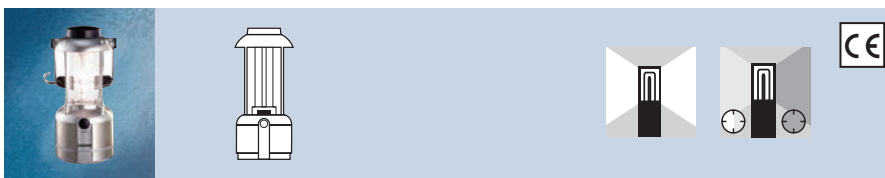

**CAMPING HALOGEN DIM SI**

- Halogen camping lantern
- Four dimming levels: 100%, 70%, 35% and 8%
- Robust steel/plastic casing
- Practical carrying handle and hanging hook
- Ideal for camping and picnics

Product ID Code	EAN (Single Pack)	Product Description	COLOR	PPG
46475	4050300900063	CAMPING HALOGEN DIM	Silver/Blue	6 38



All orders must be multiples of sales pack

**CONSUMER****NIGHT LIGHTS****SPYLUX®**

- Automatic Night time Motion Sensor Mode
- 70° rotational head including 3 LED
- Auto motion features 12 second energy saving timer
- Functions as a stand alone torchlight
- Includes 3 x AAA batteries
- Ideal for outdoor security, sheds, garages, children's rooms

Product ID Code	EAN (Single Pack)	Product Description	FINISH	W	l (mm)	b (mm)	h (mm)	d (mm)	PPG	
80191BL1	4008321935021	SPYLUX	White	0.23	99	68	68	68	6	38
501632EU	4008321935052	SPYLUX Counter display (10 x Blister)	White	-	-	-	-	-	1 (display)	38

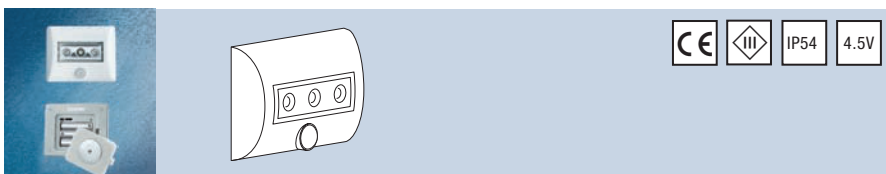
NEW  
NEW**NIGHTLUX®**

- Automatic wireless LED night light
- Turns on at dark when motion sensor is activated
- Directional LED light can rotate up and down 60°
- Functions as a stand alone torchlight
- Includes 3 x AAA batteries
- Ideal as a night time orientation light in the home

Product ID Code	EAN (Single Pack)	Product Description	FINISH	W	l (mm)	b (mm)	h (mm)	d (mm)	PPG	
80193	4008321376596	NIGHTLUX	White	0.6	86	69	28	88	6	38
501689EU	4008321377982	NIGHTLUX Counter display (10 x Blister)	White	-	-	-	-	-	1 (display)	38

NEW  
NEW

All orders must be multiples of sales pack



## CONSUMER

### FUNCTIONAL DESIGN

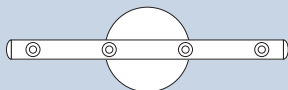

#### LEDstix®

- Multi directional mobile LED light stick
- Equipped with Golden DRAGON® PLUS LEDs
- Numerous mounting options
- Includes X 3 AAA batteries
- Ideal for home decoration, shelf, cupboard and orientation light

Product ID Code	EAN (Single Pack)	Product Description	FINISH	W	l (mm)	b (mm)	h (mm)	d (mm)	PPG	
80189	4008321951236	LEDstix (Blister)	Silver Aluminium	0.3	70	70	225	16	6	38
501687EU	4008321951250	LEDstix Counter display (Blister)	Silver Aluminium	-	-	-	-	-	1 (display)	38

NEW  
NEW



#### POWERstix™

- Modular LED light sticks
- Equipped with four white LEDs
- For fixed or mobile use
- Ideal for home decoration, shelf, cupboard and orientation light

Product ID Code	EAN (Single Pack)	Product Description	FINISH	W	l (mm)	d (mm)	PPG	
40000	4008321962874	POWERSTIXX SET	Silver Aluminium	3x 4.7	750	16	4	38
40001	4008321962898	POWERSTIXX ADD ON	-	4.7	250	16	6	38
PSTIXXPENDANT	4008321960559	POWERSTIXX PENDANT KIT	-	-	-	-	6	38
PSTIXXCONNECTORS	4008321960566	POWERSTIXX CONNECTOR SET	-	-	-	-	6	38

NEW  
NEW  
NEW  
NEW



All orders must be multiples of sales pack

Consumer – Functional design

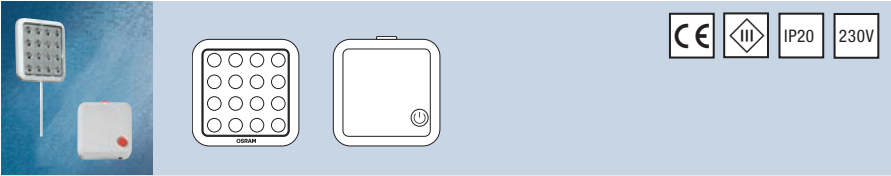

**QOD™**

- Stylish slim LED luminaire
- Includes connector box for up to 5 modules
- Ideal for under shelf and cupboard lighting

Product ID Code	EAN (Single Pack)	Product Description	FINISH	W	l [mm]	b [mm]	h [mm]	PPG	
40012	4008321962911	QOD SET	Silver/Aluminium	3x 3.5	70	70	8	6	38
40013	4008321962935	QOD ADD ON	Silver/Aluminium	3.5	70	70	8	6	38

NEW  
NEW



All orders must be multiples of sales pack





## CONSUMER

### PORTABLE LED LUMINAIRES

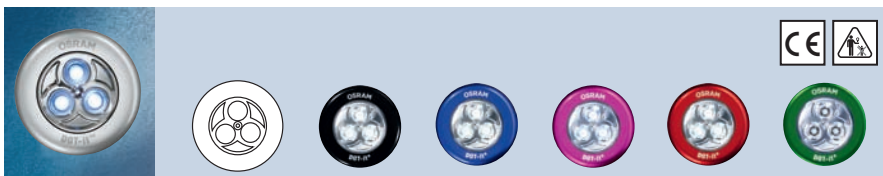

**LED**

#### DOT-it® CLASSIC

- Portable LED light with three white LEDs
- Simple click on/off
- Mounting through adhesive pad, hook and loop pad or magnet
- Three replaceable batteries included
- Counter display version is shelf ready and includes twelve DOT-ITs, 6 x Platinum, 2 X Black/Blue/Red

Product ID Code	EAN (Single Pack)	Product Description	FINISH	W	PPG
80142	4008321930491	DOT-it CLASSIC Platinum	Platinum	0.23 6	38
80143	4008321930521	DOT-it CLASSIC Piano Black	Piano Black	0.23 6	38
80144	4008321930583	DOT-it CLASSIC Oxygen Blue	Oxygen Blue	0.23 6	38
80145*	4008321930613	DOT-it CLASSIC Princess Pink	Princess Pink	0.23 6	38
80146	4008321930644	DOT-it CLASSIC Diva Red	Diva Red	0.23 6	38
80147*	4008321930675	DOT-it CLASSIC Mint Green	Mint Green	0.23 6	38
501606EU	4008321932761	DOT-it CLASSIC Counter display (inc. 12xDOT-it)	Mixed colours	0.23 1 (display)	38

\* Available on request



All orders must be multiples of sales pack

Consumer – Portable LED Luminaires

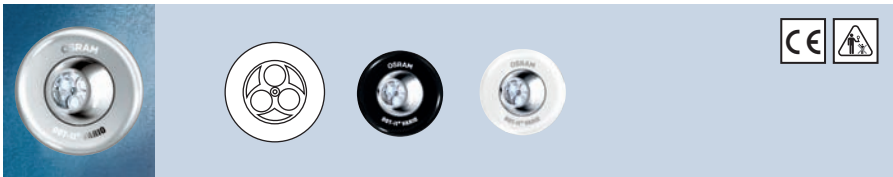

**LED**

**DOT-it® VARIO**

- Portable 360° rotational and tiltable head for directional light
- With three super bright LEDs
- Mounting through adhesive pad, hook and loop pad or magnet
- Three replaceable batteries included

Product ID Code	EAN (Single Pack)	Product Description	FINISH	W		PPG
80160	4008321930705	DOT-it VARIO Platinum	Platinum	0.23	6	38
80161	4008321930736	DOT-it VARIO Piano Black	Piano Black	0.23	6	38
80162	4008321930767	DOT-it VARIO White	White	0.23	6	38

NEW  
NEW  
NEW



**LED**

**DOT-it® LINEAR VARIO**

- Portable linear 360 rotational and tiltable head for directional light
- With three super bright LEDs
- Mounting through adhesive pad, hook and loop pad or magnet
- Three replaceable batteries included

Product ID Code	EAN (Single Pack)	Product Description	FINISH	W		PPG
80170	4008321930880	DOT-it LINEAR VARIO Ice White	Ice White	0.23	6	38
80169	4008321930859	DOT-it LINEAR VARIO Piano Black	Piano Black	0.23	6	38
80168	4008321930828	DOT-it LINEAR VARIO Platinum	Platinum	0.23	6	38

NEW  
NEW  
NEW



All orders must be multiples of sales pack



Consumer – Portable LED Luminaires

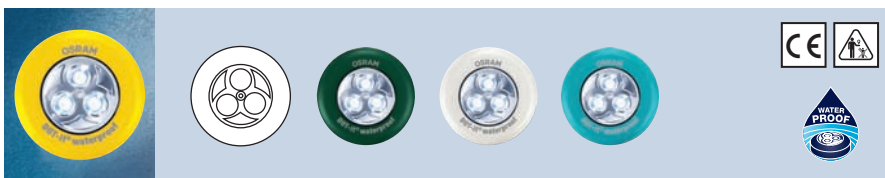

**DOT-it® waterproof**

- Portable waterproof LED light containing 3 LED
- Works up to 2 m / 9ft underwater and also floats
- Mounting through adhesive pad, hook and loop pad or magnet
- Three replaceable batteries included
- Ideal for use both indoors and out such as camping or skiing

**LED**

Product ID Code	EAN (Single Pack)	Product Description	FINISH	W	PPG
80175	4008321930910	DOT-it waterproof Amazon Green	Amazon Green	0.23 6	38
80176	4008321930941	DOT-it waterproof Sunbeam Yellow	Sunbeam Yellow	0.23 6	38
80177	4008321930972	DOT-it waterproof Pepper White	Pepper White	0.23 6	38
80179	4008321931030	DOT-it waterproof Spa Blue	Spa Blue	0.23 6	38

NEW  
NEW  
NEW  
NEW



All orders must be multiples of sales pack



## Double the power for new ideas in lighting: OSRAM and Traxon Technologies.

Traxon Technologies Ltd., the OSRAM joint venture, is a world leader in archtainment installations and LED lighting systems that are marketed through a global partner and sales network. The know-how of a specialist in high-end RGB and white-light installations Traxon and its subsidiary for professional lighting control e:cue, combined with the power of a innovation leader and global player OSRAM results in a portfolio that ranges from innovative LED lighting systems to highly advanced system control solutions. As a leading supplier, the joint venture has the aim of becoming the number one innovator in the world. The expertise can be seen in more than 3000 prestige lighting installations throughout the world – including famous landmarks such as London's Tower Bridge and the Guggenheim Museum in New York.

[www.traxontechnologies.com](http://www.traxontechnologies.com)

# Traxon LED Luminaires Contents.

## ARCHITECTURAL

WALL WASHER XB	372
LINEAR XB	373

## PROFESSIONAL MOOD AND TASK LIGHTING

NANOLINER XB	374
SPOT XB	375
1PXL STRIP	375
1PXL COVE LIGHT XR	376
1PXL BOARD	377
1PXL MODULE	378

## CONTROLS

LIGHT-DRIVE RGB	379
LIGHT-DRIVE JOG	379

## CONNECTION ACCESSORIES

POWER SUPPLIES	380
TX CONNECT Data Cables	380
TX CONNECT XB Cables	381
TX CONNECT SMART Cables	381





## TRAXON LED LUMINAIRES

### ARCHITECTURAL



#### Wall Washer XB

- Stylish, compact high power LED fixture
- Dynamic White™ (3400 K – 6700 K) option allows you to adjust and optimise the colour temperature depending on the current conditions/usage
- Aluminium finish acts as an efficient heatsink for the 700mA high performance LEDs
- IP65 so it can be used in both indoor and outdoor installations
- Integrated thermal management system
- Ideal for creating a rich wall washing effect

Product ID Code	EAN (Single Pack)	Traxon No.	Product Description	FINISH	△°	W		PPG
<b>Wall Washer XB-18</b>								
XB18RGB30DEG	4006584524075	XB.WD.4213100	TX WALLWASHER XB18 OUTDOOR RGB	Aluminium	30°	54	2 X 1	38
XB18RGB10DEG	4006584524051	XB.WD.4211100	TX WALLWASHER XB18 OUTDOOR RGB	Aluminium	10°	54	2 X 1	38
XB18DW30DEG	4006584524211	XB.WD.4283100	TX WALLWASHER XB18 OUTDOOR DW	Aluminium	30°	54	2 X 1	38
XB18DW10DEG	4006584524174	XB.WD.4281100	TX WALLWASHER XB18 OUTDOOR DW	Aluminium	10°	54	2 X 1	38
<b>Wall Washer XB-36</b>								
XB36RGB30DEG	4006584524112	XB.WE.4213100	TX WALLWASHER XB36 OUTDOOR RGB	Aluminium	30°	54	2 X 1	38
XB36RGB10DEG	4006584524099	XB.WE.4211100	TX WALLWASHER XB36 OUTDOOR RGB	Aluminium	10°	54	2 X 1	38
XB36DW30DEG	4006584524297	XB.WE.4283100	TX WALLWASHER XB36 OUTDOOR DW	Aluminium	30°	54	2 X 1	38
XB36DW10DEG	4006584524259	XB.WE.4281100	TX WALLWASHER XB36 OUTDOOR DW	Aluminium	10°	54	2 X 1	38
<b>Accessories</b>								
MOUNTINGBRACKETS	4006584619061	XB.AC.0000500	TX XB MOUNTING BRACKET	-	-	-	20 X 1	38

#### Accessories

##### TX CONNECT™

XI.IC.1000000	XB Interconnection Cable (10m/32.8ft)
XI.IC.2000000	XB Interconnection Cable (20m/65.6ft)
XE.AC.0200000	XB Interconnection Sleeve
XI.AC.0200200	XB Splitter
X1.AC.0200100	XB Coupler
DI.IC.0020000	Data Cable (20cm/0.65ft)
DI.IC.0100000	Data Cable (1m/3.28ft)
DI.IC.0300000	Data Cable (3m/9.84ft)
DI.IC.0500000	Data Cable (5m/16.44ft)
DI.IC.1000000	Data Cable (10m/32.84ft)
DI.IC.2000000	Data Cable (20m/65.6ft)

##### TX POWER

LED Engine XB-SD	
PX.IC.5030100	700mA-108 220V/Input voltage 200-260V
PX.IC.5030200	700mA-108 110V
LED Engine XB Mini	
PX.IB.5010000	700mA-36 90-260V
PX.AC.0000002	PSU 60W 24VDC
PX.AC.0000000	PSU 150W 48VDC
PS.AC.0000x00	AC Power Cord (2m/6.6ft)

For more details refer to pages 379/380 and 381] or contact OSRAM for further information

All orders must be multiples of sales pack



## Traxon LED Luminaires – Architectural

**LINEAR XB**

- High output Linear LED fixture equipped with 700 mA high performance LEDs
- Projects an intense even light spread to brightly colour wash any flat surface
- Dynamic White™ (3400 K – 6700 K) option allows you to adjust and optimise the colour temperature depending on the current conditions/usage
- IP65 rated so it can be used in both indoor and outdoor installations
- Ideal for a variety of lighting applications from floodlighting to display lighting

Product ID Code	EAN (Single Pack)	Traxon No.	Product Description	FINISH	Beam Angle	W	PPG
XB9RGB40X10DEG	4006584524136	XB.LF.4214100	TX LINER XB9 OUTDOOR RGB	Aluminium	40°x10	27	4 X 1 38
XB27RGB40X10DEG	4006584524150	XB.LH.4214100	TX LINER XB27 OUTDOOR RGB	Aluminium	40°x10	81	4 X 1 38
XB9DW40X10DEG	4006584524310	XB.LF.4284100	TX LINER XB9 OUTDOOR DW	Aluminium	40°x10	27	4 X 1 38
XB27DW	4006584524358	XB.LH.4284100	TX LINER XB27 OUTDOOR DW	Aluminium	40°x10	81	4 X 1 38
<b>Accessories</b>							
MOUNTINGBRACKETS	4006584619061	XB.AC.0000500	TX XB MOUNTING BRACKET	-	-	-	20X1 38

RGB = Colour Change  
DW = Dynamic White™

**Accessories****TX CONNECT™**

XI.IC.1000000	XB Interconnection Cable (10m/32.8ft)
XI.IC.2000000	XB Interconnection Cable (20m/65.6ft)
XE.AC.0200000	XB Interconnection Sleeve
XI.AC.0200200	XB Splitter
X1.AC.0200100	XB Coupler
DI.IC.0020000	Data Cable (20cm/0.65ft)
DI.IC.0100000	Data Cable (1m/3.28ft)
DI.IC.0300000	Data Cable (3m/9.84ft)
DI.IC.0500000	Data Cable (5m/16.44ft)
DI.IC.1000000	Data Cable (10m/32.84ft)
DI.IC.2000000	Data Cable (20m/65.6ft)

**TX POWER**

<b>LED Engine XB-SD</b>	
PX.IC.5030100	700mA-108 220V/Input voltage 200-260V
PX.IC.5030200	700mA-108 110V
<b>LED Engine XB Mini</b>	
PX.IB.5010000	700mA-36 90-260V
PX.AC.0000002	PSU 60W 24VDC
PX.AC.0000000	PSU 150W 48VDC
PS.AC.0000x00	AC Power Cord (2m/6.6ft)

For more details refer to pages 379/380 and 381 or contact OSRAM for further information

All orders must be multiples of sales pack





## TRAXON LED LUMINAIRES

### PROFESSIONAL MOOD AND TASK LIGHTING



#### NANO LINER XB

- Slim profile high power linear LED fixtures
- Equipped with 350mA LEDs
- Dynamic White™ (3400K – 6700K) option allows you to adjust and optimise the colour temperature depending on the current conditions/usage
- Available in two different lengths
- Ideal for interior installations with restricted space that require an intense and even light output on walls or other flat surfaces

Product ID Code	EAN (Single Pack)	Traxon No.	Product Description	FINISH	△	W	⊞	PPG
NANOLINERXB9RGB	4006584524631	XB.NF.2114100	TX NANO LINER XB9 INDOOR RGB	Aluminium	40°x10	11	4 X 1	38
NANOLINERXB27RGB	4006584524679	XB.NH.2114100	TX NANO LINER XB27 INDOOR RGB	Aluminium	40°x10	33	4 X 1	38
NANOLINERXB9DW	4006584524877	XB.NF.2184100	TX NANO LINER XB9 INDOOR DW	Aluminium	40°x10	14	4 X 1	38
NANOLINERXB27DW	4006584524891	XB.NH.2184100	TX NANO LINER XB27 INDOOR DW	Aluminium	40°x10	41	4 X 1	38

RGB = Colour Change  
 DW = Dynamic White™  
 WW = Warm White  
 CW = Cool White

#### Accessories

##### TX CONNECT™

XI.IC.1000000	XB Interconnection Cable (10m/32.8ft)
XI.IC.2000000	XB Interconnection Cable (20m/65.6ft)
XI.AC.0200200	XB Splitter
X1.AC.0200100	XB Coupler
DI.IC.0020000	Data Cable (20cm/0.65ft)
DI.IC.0100000	Data Cable (1m/3.28ft)
DI.IC.0300000	Data Cable (3m/9.84ft)
DI.IC.0500000	Data Cable (5m/16.44ft)
DI.IC.1000000	Data Cable (10m/32.84ft)
DI.IC.2000000	Data Cable (20m/65.6ft)

#### TX POWER

LED Engine XB-SD	
PX.IC.5060100	350mA-216 220V/Input voltage 200-260V
PX.IC.5060200	350mA-108 110V
LED Engine XB Mini	
PX.IA.5010000	350mA-36 90-260V
PX.AC.0000002	PSU 60W 24VDC
PX.AC.0000000	PSU 150W 48VDC
PS.AC.0000x00	AC Power Cord (2m/6.6ft)

For more details refer to pages 379/380 and 381 or contact OSRAM for further information



All orders must be multiples of sales pack





## Traxon LED Luminaires – Professional Mood and Task Lighting

**SPOT XB**

- High power LED fixture designed to fit into standard MR16 fittings
- Highly efficient alternative to conventional halogen downlights
- Aluminium finish acts as an efficient heatsink for the 350mA high performance LEDs
- Dynamic White™ (3400K – 6700K) option allows you to adjust and optimise the colour temperature depending on the current conditions/usage
- Controlled by an easy to use plug and play LED engine XB or XB Mini
- Ideal for interior spotlighting applications

Product ID Code	EAN (Single Pack)	Traxon No.	Product Description	FINISH		W		PPG
SPOTXBRGB	4006584922635	XB.SP.2113100	TX SPOT XB RGB INDOOR 350mA	Aluminium	30°	4.7	25X1	38
SPOTXBDW	4006584922673	XB.SP.2183000	TX SPOT XB DW INDOOR 350mA	Aluminium	30°	4.7	25X1	38
SPOTXBWW	4006584922666	XB.SP.2173000	TX SPOT XB WW INDOOR 350mA	Aluminium	30°	4.7	25X1	38
SPOTXBCW	4006584922659	XB.SP.2163000	TX SPOT XB CW INDOOR 350mA	Aluminium	30°	4.7	25X1	38

For a full listing of appropriate accessories please refer to page 372

**1PXL STRIP**

- High performance Linear LED strip equipped with onboard DMX enhancement
- Smart Chip™ technology offers integrated DMX enhancement, including auto addressing and flicker free technology
- Dynamic White™ (3400K – 6700K) option allows you to adjust and optimise the colour temperature depending on the current conditions/usage
- Ideal solution for interior installations with restricted space that require colour changing lighting effects

Product ID Code	EAN (Single Pack)	Traxon No.	Product Description	FINISH		W		PPG
STRIPLIGHTRGB	4006584524594	MB.ST.501000	TX 1PXL STRIPLIGHT RGB	White	120°	6	10X1	38
STRIP24DW	4006584524853	MB.ST.508000	TX 1PXL STRIPLIGHT XR DW 24 LED	White	120°	10	10X1	38
STRIPLIGHT12WW	4006584524839	MB.ST.507000	TX 1PXL STRIPLIGHT XR WW 12 LED	White	120°	5	10X1	38
STRIP12CW	4006584524792	MB.ST.506000	TX 1PXL STRIPLIGHT XR CW 12 LED	White	120°	5	10X1	38

For a full listing of appropriate accessories please refer to page 374



All orders must be multiples of sales pack

## Traxon LED Luminaires – Professional Mood and Task Lighting

**1PXL COVE LIGHT XR**

- High performance RGB LED cove light with onboard DMX capabilities
- 180° free locking rotation
- Smart Chip™ technology offers integrated DMX enhancement, including auto addressing and flicker free technology
- Dynamic White™ (3400K – 6700K) option allows you to adjust and optimise the colour temperature depending on the current conditions/usage
- Ideal decorative solution for highlighting alcoves and other recessed borders in both hospitality and commercial applications

Product ID Code	EAN (Single Pack)	Traxon No.	Product Description	FINISH		W		PPG
COVELIGHTRGB	4006584524532	MB.CL.5010100	TX 1PXL COVELIGHT XR RGB	TRANSPARENT/BEIGE	120°	6	10X1	38
COVELIGHT24DW	4006584524778	MB.CL.5080100	TX 1PXL COVE LIGHT XR DW 24 LED	TRANSPARENT/BEIGE	120°	10	10X1	38
COVELIGHT12WW	4006584524754	MB.CL.5070100	TX 1PXL COVE LIGHT XR WW 12 LED	TRANSPARENT/BEIGE	120°	5	10X1	38
COVELIGHT12CW	4006584524655	MB.CL.5060100	TX 1PXL COVELIGHT XR CW 12 LED	TRANSPARENT/BEIGE	120°	5	10X1	38

**Accessories****TX CONNECT™ SMART**

0000100	Power/Data Injector Box
TI.DO.0000100	Data Extractor Box
TI.PI.0000100	Power Injector Cable 8.20cm/3.15:7.88"
TI.IC.0008000	Interconnection Cable 8cm/3.15"
TI.IC.0030000	Interconnection Cable 30cm/11.82"
TI.IC.0060000	Interconnection Cable 60cm/23.64"
TI.EC.0050000	Extension Cable 0.5m/1.64ft
TI.EC.0100000	Extension Cable 1m/3.28ft
TI.EC.0300000	Extension Cable 3m/9.84ft
TI.EC.0500000	Extension Cable 5m/16.4ft
TI.EC.1000000	Extension Cable 10m/32.8ft
DI.IC.0020000	Data Cable 0.2m/0.65ft
DI.IC.0100000	Data Cable 1m/3.28ft
DI.IC.0300000	Data Cable 3m/9.84ft
DI.IC.0500000	Data Cable 5m/16.4ft
DI.IC.1000000	Data Cable 10m/32.8ft
DI.IC.2000000	Data Cable 20m/65.6ft
DI.AC.0200100	Data (DMX) Active Splitter, Booster and Addresser

**TX POWER**

PS.IA001000	LED Engine Smart 100W Indoor
PS.AC.0000X00	AC Power Cord (2m/6.6ft)

For more details refer to pages 379/380 and 381 or contact OSRAM for further information



All orders must be multiples of sales pack



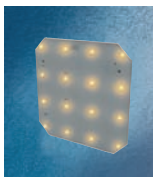

## Traxon LED Luminaires – Professional Mood and Task Lighting



### 1PXL BOARD

- High performance RGB LED board with onboard DMX capabilities
- Can be applied as a backdrop installation
- Smart Chip™ technology offers integrated DMX enhancement, including auto addressing and flicker free technology
- Interconnectable via TX Connect Smart with any other Traxon Smart products
- Dynamic White™ (3400K – 6700K) option allows you to adjust and optimise the colour temperature depending on the current conditions/usage
- Ideal solution for interior design within exhibitions, hospitality, commercial and architectural applications

Product ID Code	EAN (Single Pack)	Traxon No.	Product Description	FINISH		W		PPG
BOARDRGB	4006584524495	MB.BO.5010000	TX 1PXL BOARD RGB	White	120°	9	4X1	38
BOARDDW	4006584524617	MB.BO.5080000	TX 1PXL BOARD DW 32 LED	White	120°	15	4X1	38
BOARDWW	4006584524570	MB.BO.5070000	TX 1PXL BOARD WW 16 LED	White	120°	8	4X1	38
BOARDCW	4006584524556	MB.BO.5060000	TX 1PXL BOARD CW 16 LED	White	120°	8	4X1	38

For a full listing of appropriate accessories please refer to page 374

RGB = Colour Change  
 DW = Dynamic White™  
 WW = Warm White  
 CW = Cool White



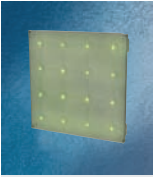

All orders must be multiples of sales pack

## Traxon LED Luminaires – Professional Mood and Task Lighting

**1PXL MODULE**

- High performance RGB LED module with a plastic cover equipped with onboard DMX capabilities
- Design inlays can be inserted behind the protective cover to provide bespoke lighting effects
- Suitable for both temporary and permanent installations due to Quick Clip mounting system
- Smart Chip™ technology offers integrated DMX enhancement, including auto addressing and flicker free technology
- Dynamic White™ (3400K – 6700K) option allows you to adjust and optimise the colour temperature depending on the current conditions/usage
- Ideal solution for front and backlighting applications

Product ID Code	EAN (Single Pack)	Traxon No.	Product Description	FINISH		W		PPG
MODULERGB	4006584524419	MB.MO.5010000	TX 1PXL MODULE RGB	TRANSPARENT/WHITE	120°	9	4x1	38
MODULEDW	4006584524471	MB.MO.5080000	TX 1PXL MODULE DW 32 LED	TRANSPARENT/WHITE	120°	15	4x1	38
MODULEWW	4006584524457	MB.MO.5070000	TX 1PXL MODULE WW 16 LED	TRANSPARENT/WHITE	120°	8	4x1	38
MODULECW	4006584524433	MB.MO.5060000	TX 1PXL MODULE CW 16 LED	TRANSPARENT/WHITE	120°	8	4x1	38

For a full listing of appropriate accessories please refer to page 374

RGB = Colour Change  
 DW = Dynamic White™  
 WW = Warm White  
 CW = Cool White



All orders must be multiples of sales pack



## TRAXON LED LUMINAIRES

### CONTROLS



#### LIGHT-DRIVE RGB

- Innovative plug and play DMX based stand alone controller for RGB LED fixtures
- Wall mounted device in a black or white finish provides direct access to connected fixtures
- Six memory slots allow you to save individual settings
- Use the Light Drive IR remote control to recall all functions on the Light-Drive from a distance
- Tune colour and brightness by the turn of the Light Drive wheel

Product ID Code	EAN (Single Pack)	Traxon No.	Product Description	FINISH		PPG
LIGHTDRIVERGBWT	4006584524198	SC.CD.5000100	TX LIGHT-DRIVE RGB	White	2	38
LIGHTDRIVERGBBK	4006584524037	SC.CD.5000000	TX LIGHT-DRIVE RGB	Black	2	38
LIGHTDRIVERGBIRRM	4006584524396	SC.AC.0100100	TX LIGHT-DRIVE RGB IR REMOTE CONTROL	Black	4	38



#### LIGHT-DRIVE JOG

- DMX based plug and play stand alone controller for RGB or Dynamic White™ LED fixtures
- Wall mounted device in a black or white finish provides direct access to connected fixtures
- Memory function allows you to save two settings (Dynamic White™) or continuous replay of preset colour phases (RGB)
- Tune colour and brightness by the turn of the jog wheel

Product ID Code	EAN (Single Pack)	Traxon No.	Product Description	FINISH		PPG
LIGHTDRIVERGBJOGWT	4006584524273	SC.JD.5010100	TX LIGHT-DRIVE RGB JOG	White	20	38
LIGHTDRIVERGBJOGBK	4006584524235	SC.JD.5010000	TX LIGHT-DRIVE RGB JOG	Black	20	38
LIGHTDRIVEDWJOGWT	4006584524372	SC.JD.5080100	TX LIGHT-DRIVE DW JOG	White	20	38
LIGHTDRIVEDWJOGBK	4006584524334	SC.JD.5080000	TX LIGHT-DRIVE DW JOG	Black	20	38



All orders must be multiples of sales pack



## TRAXON LED LUMINAIRES

### CONNECTION ACCESSORIES



### POWER SUPPLIES

Product ID Code	EAN (Single Pack)	Traxon No.	Product Description	W		PPG
LEXBSD350MA200	4006584525447	PX.IC.5060100	TX LED ENGINE XB-SD 350MA-216 200-260V	-	1	38
LEXBSD700MA200	4006584525454	PX.IC.5030100	TX LED ENGINE XB-SD 700MA-108 200-260V	-	1	38
LEXBMINI350MA110	4006584922710	PX.IA.5010000	TX LED ENGINE XB-MINI 350MA 110-220V	-	1	38
LEXBMINI700MA110	4006584922727	PX.IB.5010000	TX LED ENGINE XB-MINI 700MA 110-220V	-	1	38
XBMINIPSUJ15048	4006584922734	PX.AC.0000000	TX LED ENGINE XB Mini PSU 150W 48 Vdc	150	12	38
XBMINIPSU6048	4006584922741	PX.AC.0000001	TX LED ENGINE XB Mini PSU 60W 48 Vdc	60	18	38
XBMINIPSU6024	4006584922758	PX.AC.0000002	TX LED ENGINE XB Mini PSU 60W 24 Vdc	60	18	38
LESMART100	4006584525423	PX.IA.0010000	TX LED ENGINE SMART 100W INDOOR	100	15	38
LEXBSD700MA108	4006584558513	-	LED ENGINE XB-SD 700MA-108 110V	-	1	38
LEXBSD350MA216	4006584558506	-	LED ENGINE XB-SD 350MA-216 110V	-	1	38
ACPOWERCORDUK	4006584922581	PX.AC.0000300	AC POWER CORD (UK)	-	1	38
ACPOWERCORDEU	4006584922529	PX.AC.0000100	AC POWER CORD (EU)	-	1	38

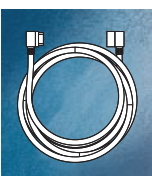

### TX CONNECT Data Cables

Product ID Code	EAN (Single Pack)	Traxon No.	Product Description		PPG
CONDATA0.2M	4006584525102	DI.IC.0020000	TX CONNECT Data Cable 0.2m	10	38
CONDATA1M	4006584525126	DI.IC.0100000	TX CONNECT Data Cable 1m	10	38
CONDATA3M	4006584525140	DI.IC.0300000	TX CONNECT Data Cable 3m	10	38
CONDATA5M	4006584525164	DI.IC.0500000	TX CONNECT Data Cable 5m	10	38
CONDATA10M	4006584525188	DI.IC.1000000	TX CONNECT Data Cable 10m	10	38
CONDATA20M	4006584525201	DI.IC.2000000	TX CONNECT Data Cable 20m	10	38



All orders must be multiples of sales pack



## Traxon LED Luminaires – Connection Accessories

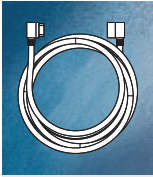

## TX CONNECT XB Cables

Product ID Code	EAN (Single Pack)	Traxon No.	Product Description		PPG
CONXBINTERCON10	4006584525041	XI.IC.1000000	TX CONNECT XB Intercon cable 10m	10	38
CONXBINTERCON20	4006584525065	XI.IC.2000000	TX CONNECT XB Intercon cable 20m	10	38
CONXBCOUPLER	4006584922567	XI.AC.0200100	TX CONNECT XB Coupler	1	38
CONXBSPLITTER	4006584922574	XI.AC.0200200	TX CONNECT XB Splitter	1	38
XBINTERCONSL	4006584922796	XE.AC.0200000	TX XB Interconnection sleeve	1	38

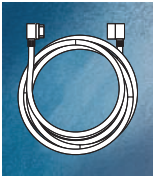

## TX CONNECT SMART Cables

Product ID Code	EAN (Single Pack)	Traxon No.	Product Description		PPG
CONSMARTPOWER8	4006584525089	TI.PI.0000100	TX CONNECT SMART Power cable 8-20cm	10	38
CONSMARTINTERCON8	4006584525249	TI.IC.0008000	TX CONNECT SMART Interconnection cable 8cm	10	38
CONSMARTINTERCON30	4006584525263	TI.IC.0030000	TX CONNECT SMART Interconnection cable 30cm	10	38
CONSMARTINTERCON60	4006584525287	TI.IC.0060000	TX CONNECT SMART Interconnection cable 60cm	10	38
CONSMARTEXT50	4006584525300	TI.EC.0050000	TX CONNECT SMART Extension cable 0.5m	10	38
CONSMARTEXT1	4006584525324	TI.EC.0100000	TX CONNECT SMART Extension cable 1m	10	38
CONSMARTEXT3	4006584525362	TI.EC.0300000	TX CONNECT SMART Extension cable 3m	10	38
CONSMARTEXT5	4006584525386	TI.EC.0500000	TX CONNECT SMART Extension cable 5m	10	38
CONSMARTEXT10	4006584525409	TI.EC.1000000	TX CONNECT SMART Extension cable 10m	10	38
CONSMARTPINJECTOR	4006584922598	TI.ZI.0000100	TX CONNECT SMART Power/Data Injector Box	20	38
CONSMARTTRACTOR	4006584922604	TI.DO.0000100	TX CONNECT SMART Data extractor	20	38
DMXBOOSTSPLITAD	4006584525348	DI.AC.0200100	TX DMX Booster Splitter Addresser	10	38
CONSMARTSPLITTER20	4006584525225	-	TX CONNECT SMART Data cable 20m	10	38



All orders must be multiples of sales pack

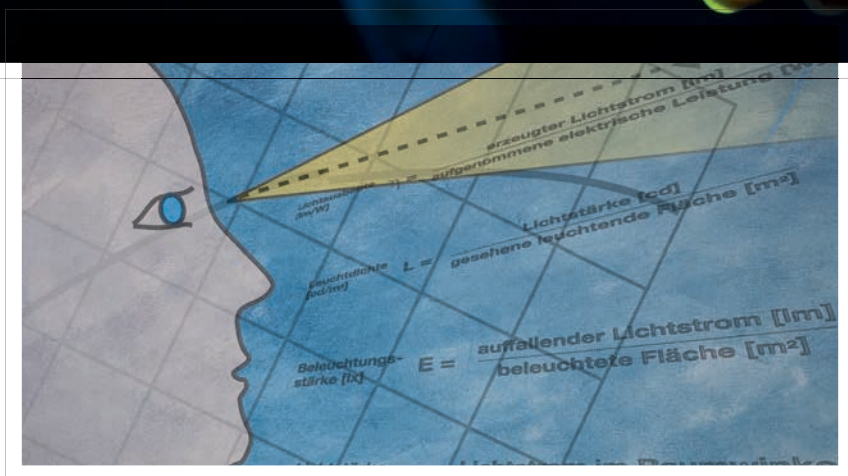
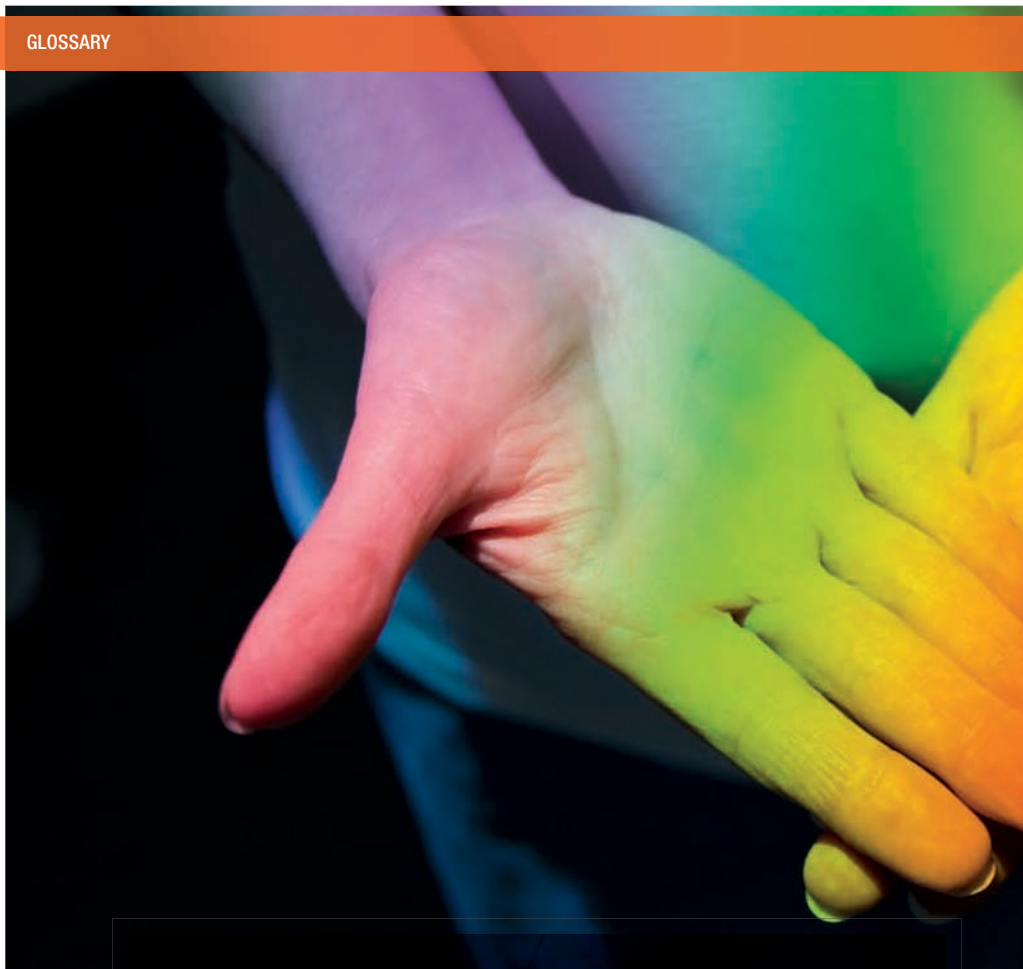





**Glossary of Lighting Terms**  
**Symbols and Abbreviations**  
**Common Lamp caps**  
**Cross Reference Charts**  
**Conditions of Sale.**

# Glossary of the most important lighting terms

As with any technical or scientific discipline, lighting technology has its own special terms and concepts for defining the characteristics of lamps and luminaires and for standardising the units of measurement.

The most important of these are described here.

## Luminous flux $\Phi$

Unit of measurement: lumen [lm]  
 Luminous flux  $\Phi$  is all the radiated power emitted by a light source evaluated with the spectral sensitivity of the eye and the photometric radiation equivalent  $k_m$ .

## Light and radiation

Light is taken to mean the electromagnetic radiation that the human eye perceives as brightness, in other words that part of the spectrum that can be seen. This is the radiation between 360 and 830 nm, a tiny fraction of the known spectrum of electromagnetic radiation.

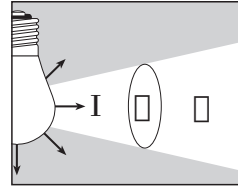

**Luminous intensity I**  
 is a measure of the luminous flux  $\Phi$  emitted in solid angle  $\Omega$ .

## Luminous intensity I

Unit of measurement: candela [cd].  
 Generally speaking, a light source emits its luminous flux  $\Phi$  in different directions and at different intensities.

The visible radiant intensity in a particular direction is called luminous intensity I.

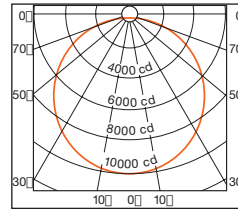

**Polar diagram**

## Illuminance E

Unit of measurement: lux [lx].  
 Illuminance E is the ratio between the luminous flux and the area being illuminated.

An illuminance of 1 lx occurs when a luminous flux of 1 lm is evenly distributed over an area of 1 m<sup>2</sup>.

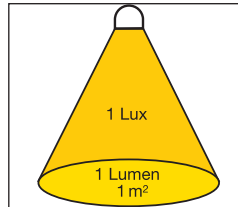

**Illuminance E**

## Luminance L

Unit of measurement: candelas per square metre [cd/m<sup>2</sup>].  
 The luminance L of a light source or an illuminated area is a measure of the brightness.

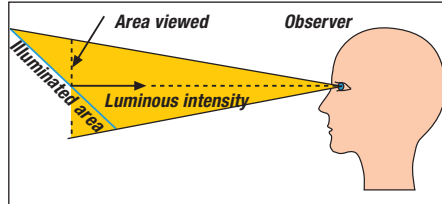

**Luminance L**

**The most important photometric formulae:**

Luminous intensity [cd]	$I$	$\frac{\text{Luminous flux in solid angle}}{\text{Solid angle } \Omega \text{ [sr]}}$	Luminance [cd/m <sup>2</sup> ]	$L$	$\frac{\text{Luminous intensity [cd]}}{\text{Viewed luminous area [m}^2\text{]}}$
Illuminance [lx]	$E$	$\frac{\text{Luminous flux falling on area [lm]}}{\text{Illuminated area [m}^2\text{]}}$	Luminous efficacy [lm/W]	$\eta_l$	$\frac{\text{Generated luminous flux [lm]}}{\text{Electrical power consumed [W]}}$

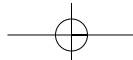
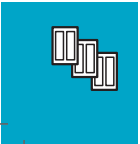

**Luminous efficacy  $\eta$** 

Unit of measurement : lumens per watt [lm/W].

Luminous efficacy  $\eta$  indicates the efficiency with which the electrical power consumed is converted into light.

**Colour temperature**

Unit of measurement : Kelvin [K].

The colour temperature of a light source is defined in comparison with a "black body radiator" and plotted on what is known as the "Planckian curve". The higher the temperature of this "black body radiator" the greater the blue component in the spectrum and the smaller the red component. An incandescent lamp with a warm white light, for example, has a colour temperature of 2700 K, whereas a daylight fluorescent lamp has a colour temperature of 6000 K.

**Colour appearance**

The colour appearance of a lamp can be neatly defined in terms of colour temperature. There are three main categories here:

Warm White < 3300 K

Cool White 3300–5000 K

Daylight > 5000 K

Despite having the same colour appearance, lamps may have very different colour rendering properties owing to the spectral composition of their light.

**Colour rendering**

As a rule, artificial light should enable the human eye to perceive colours correctly, as it would in natural daylight. Obviously, this depends to some extent on the location and purpose for which light is required.

The criterion here is the colour rendering property of a light source. This is expressed as a "general colour rendering index" ( $R_a$ ).

The colour rendering index is a measure of the correspondence between the colour of an object (its "self-luminous colour") and its appearance under a reference light source. To determine the  $R_a$  values, eight test colours defined in accordance with DIN 6169 are illuminated with the reference light source and the light source under test. The smaller the discrepancy, the better the colour rendering property of the lamp being tested.

A light source with an  $R_a$  value of 100 displays all colours exactly as they appear under the reference light source. The lower the  $R_a$  value, the worse the colours are rendered.

**Luminaire efficiency**

Luminaire efficiency (also known as light output ratio) is an important criterion in gauging the energy efficiency of a luminaire. This is the ratio between the luminous flux emitted by the luminaire and the luminous flux of the lamp (or lamps) installed in the luminaire.

For detailed information on indoor lighting with artificial light, see DIN 5035.

**Average life**

The average life of a lamp is an average of the lives of individual lamps operated under standard conditions (50% failure = average life).





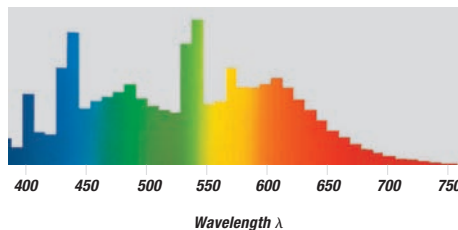
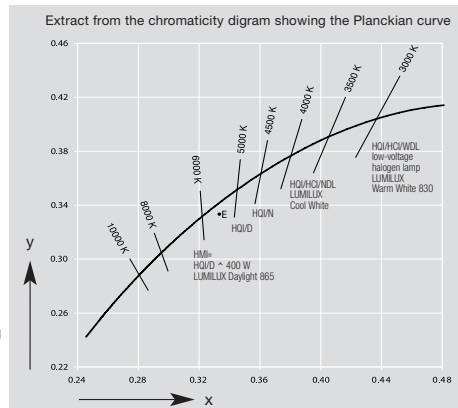
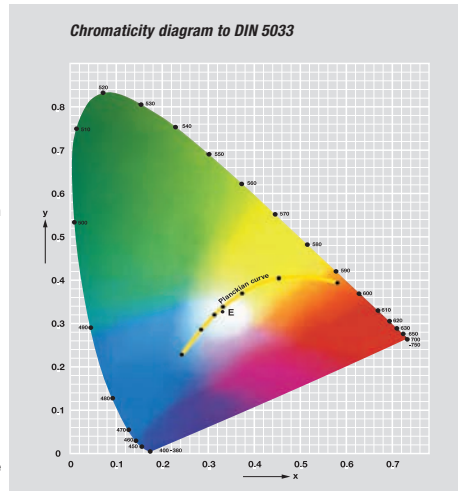

**Service life**

Service life is a simple practical measure of the economical life of a lamp. It is the number of hours of operation after which the system luminous flux (i.e. the product of the relative luminous flux and the relative proportion of lamps still in operation) is still around 80% of the initial value.



**Daylight spectrum of a BIOLUX® fluorescent lamp. The radiation is very evenly distributed over the entire visible range.**

## Symbols and Abbreviations

-  Discontinued items. Please check availability.
-  New and future additions to the OSRAM range of products. Please check availability.
-  Lamps with a reduced UV output.
-  NAV (SON) lamps requiring an external ignitor.
-  NAV (SON) lamps with an internal ignitor.
-  Products affected by the WEEE Directive

## Colour appearance and colour rendering properties of fluorescent tubes, compact fluorescent lamps and LEDs.

OSRAM Colour ref	Colour temp	Colour appearance	Colour rendering group		Lamp type
<b>880</b>	8000 K	Skywhite	Very good	1B	Triphosphor
<b>865</b>	6500 K	Cool Daylight	Very good	1B	Triphosphor
<b>840</b>	4000 K	Cool White	Very good	1B	Triphosphor
<b>835</b>	3500 K	White	Very good	1B	Triphosphor
<b>830</b>	3000 K	Warm White	Very good	1B	Triphosphor
<b>827</b>	2700 K	INTERNA	Very good	1B	Triphosphor
<b>825</b>	2500 K	Warm Comfort light	Very good	1B	CFLi
<b>965</b>	6500 K	Cool Daylight	Excellent	1A	Deluxe Triphosphor
<b>954</b>	5400 K	Daylight	Excellent	1A	Deluxe Triphosphor
<b>940</b>	3800 K	Cool White	Excellent	1A	Deluxe Triphosphor
<b>930</b>	3000 K	Warm White	Excellent	1A	Deluxe Triphosphor
<b>30/530</b>	3000 K	Warm White	Acceptable	3	Basic phosphor
<b>25/740</b>	4000 K	Universal White	Good	2A	Basic phosphor
<b>23/535</b>	3500 K	White	Acceptable	3	Basic phosphor
<b>20/640</b>	4000 K	Cool White	Fair	2B	Basic phosphor
<b>10/765</b>	6500 K	Cool Daylight	Good	2A	Basic phosphor
<b>60</b>	N/A	Red	N/A		
<b>62</b>	N/A	Yellow	N/A		
<b>66</b>	N/A	Green	N/A		
<b>67</b>	N/A	Blue	N/A		
<b>76</b>	N/A	NATURA DELUXE	N/A		
<b>827</b>	2700 K	Fine White	Very good	1B	LED
<b>830</b>	3000 K	Fine White	Very good	1B	LED
<b>835</b>	3500 K	Fine White	Very good	1B	LED
<b>840</b>	4000 K	Fine White	Very good	1B	LED
<b>854</b>	5400 K	Fine White	Very good	1B	LED
<b>727</b>	2700 K	White	Good	2A	LED
<b>730</b>	3000 K	White	Good	2A	LED
<b>733</b>	3300 K	White	Good	2A	LED
<b>847</b>	4700 K	White	Very good	1B	LED
<b>854</b>	5400 K	White	Very good	1B	LED
<b>865</b>	6500 K	White	Very good	1B	LED

	Type of sensor
	No. of Electronic Control Gears
	Color
	Light color
	Rated output in Watts
	Voltage in Volts
	Permitted sinusoidal operating voltage in Volts
	Primary voltage in Volts
	Secondary voltage in Volts
	Rated current in Amperes
	Temperature range
	Type of protection
	Type of reflector
	Luminous intensity in candela
	Color temperature in Kelvins
	Beam angle in degrees
	Diameter d in mm
	Length l in mm
	Width b in mm
	Height h in mm
	Hole spacing a in mm
	No. of LEDs per module
	Electrical appliance class
	Base
	Standard pack/pcs.
	Product Purchase Group

Appliance class	
Type of protection	IP20 IP22 IP23 IP40 IP41 IP43 IP44 IP54 IP65 IP66 IP67 IP68
Flame protection class	
Glowing wire test	650 °C 850 °C 950 °C
Mechanical stress	IK02 IK03 IK04 IK05 IK06 IK07 IK08 IK09 IK10
Load capacity	500 kg 1500 kg
Ambient temperature	-40 °C - +65 °C
Mounting diameter	
Voltage	10V 12V 24V 100-240V 120-277V 200-250V 200-260V 220-240V 220-250V 230V 230-240V
Current	350 mA
Frequency	0-60 Hz 50Hz 50-60 Hz
Dimmable	

Starter	DEOS
Equipped with Lamp	
Light colour	730 827 830 840 RGB
Beam angle	
Base	E27 E40 G4 G5 2G11 G12 G13 GU4 GU5.3 GX8.5 GX24q-6 GY6.35 Rx7s
Approval	

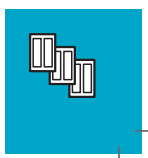

## Common lamp caps

Standard Designation	IEC Designation	Description
BC	B22d	Bayonet Cap
SBC	B15d	Small Bayonet Cap
3 pin BC	B22d-3	Bayonet Cap - 3 pin
ES	E27	Edison Screw
SES	E14	Small Edison Screw
GES	E40	Goliath Edison Screw
-	GU5.3	Bi-pin
-	R7s	Recessed Single Contact
-	G4/GU4/GY4	Small Bi-pin

### Bases – GLS, Halogen, CFLi

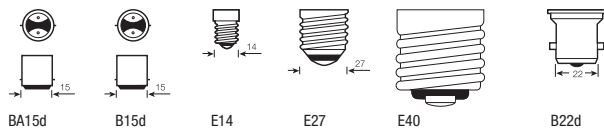

### Bases – Halogen

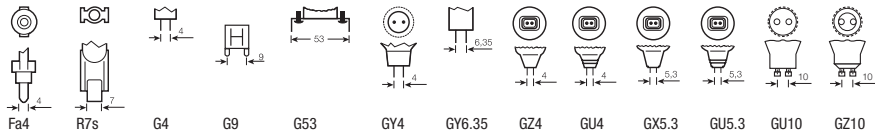

### Bases – CFL

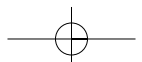
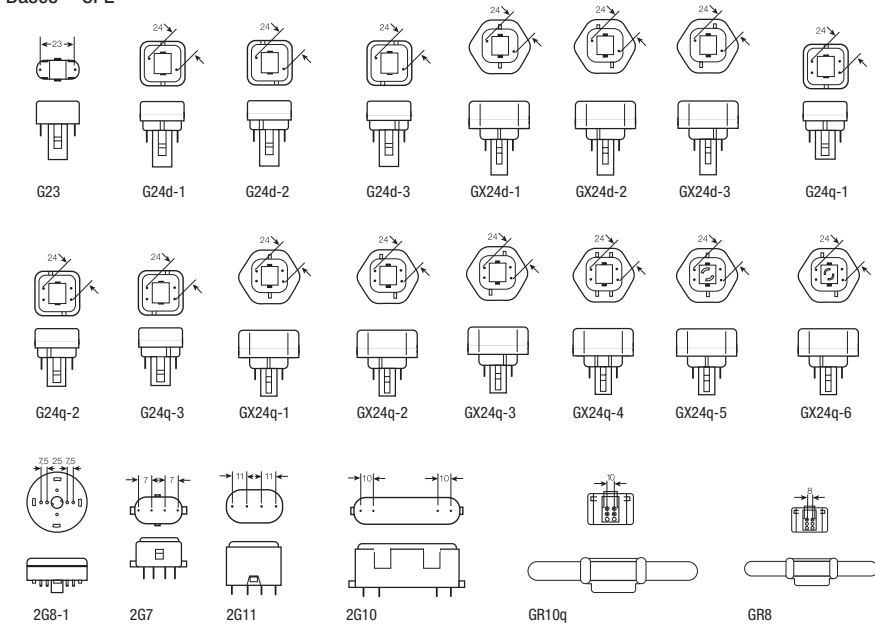

Bases – Fluorescent Tubes

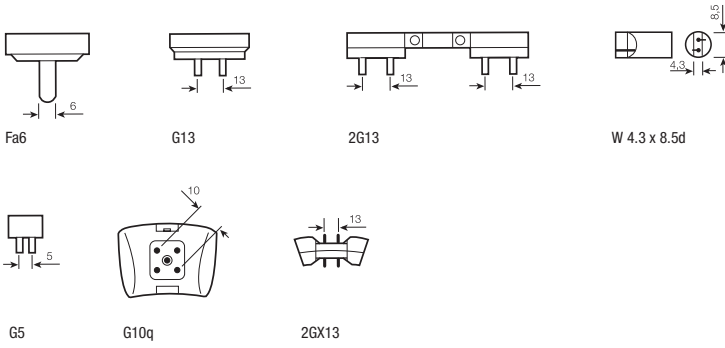

Bases – High Pressure Discharge

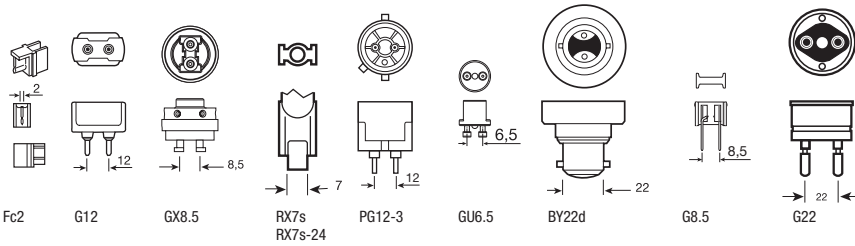

Bases – Special Lamps

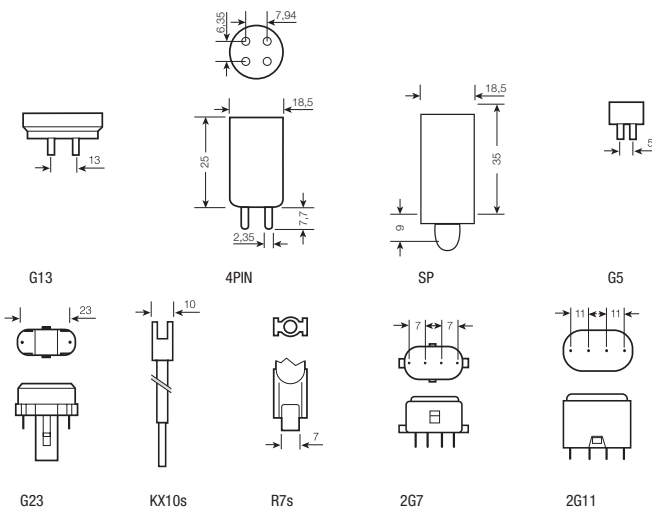

## Lamp Cross Reference Chart

The chart represents the nearest equivalent OSRAM lamp brand to other manufacturers

OSRAM	Philips	GE	SLI
<b>Mains voltage halogen</b> HALOPIN® HALOPAR® 16 HALOPAR® 20 HALOPAR® 30	CLICKline Twistline HalogenA PAR 20 HalogenA PAR 30	Tech PAR 16 PAR 20 PAR 30	– Hi-Spot 50 Hi-Spot 63 Hi-Spot 95
<b>Low voltage halogen</b> DECOSTAR® IRC DECOSTAR® TITAN DECOSTAR® STANDARD DECOSTAR® ALU	Master Line ES Brilliantline Pro Accentline Brilliantline Pro ALU	– Dichrioc Precise Constant Colour MR 16 Precise Standard Precise Alutech	– Superia – Coolfit
<b>Pin-based compact fluorescent</b> OSRAM DULUX® S OSRAM DULUX® S/E OSRAM DULUX® D OSRAM DULUX® D/E OSRAM DULUX® T OSRAM DULUX® T/E OSRAM DULUX® L	PLS PLS PL-C PL-C PL-T PL-T PL-L	Biax S 2pin Biax S/E 4pin Biax D 2pin Biax D/E 4pin Biax T 2pin Biax T/E 4pin Biax L	Lynx-S Lynx-SE Lynx-D Lynx-DE Lynx-S Lynx-TE Lynx-L
<b>Electronic compact fluorescent</b> OSRAM DULUX® EL LONGLIFE OSRAM DULUX® EL ECONOMY OSRAM DULUX® EL CLASSIC OSRAM DULUX® EL ECONOMY CLASSIC	MASTER PL PL Electronic Pro Ambiance Pro Ambiance 6000 hour	Electronic Biax EXTRA MINI Electronic Biax ECO Electronic Biax MINI GLS Electronic GLS	Mini-Lynx Professional Mini-Lynx Economy – Mini-Lynx Ambiance GLS
<b>Linear fluorescent</b> LUMILUX® T5 HE High Efficiency LUMILUX® T5 HO High Output LUMILUX® DE LUXE T5 HO High Output +Triphosphor LUMILUX® T5 FC LUMILUX® T8 LUMILUX® DE LUXE T8 BASIC T8 NATURA FLUORA® SPS UVS	MASTER TL5 MASTER TL5 – Circular TL5 MASTER TL Super 80 De Luxe T8 Standard – – MASTER TLD Secura –	Starcoat T5 HE Starcoat T5 HE – – T8 Polylux T8 Polylux XL T8 Standard – – – –	T5 Miniature T5 Miniature T5 FHO Luxline – – Luxline plus – T8 Standard – – Gro-Lux – –
<b>Ceramic metal halide</b> POWERBALL® HCl®-T POWERBALL® HCl®-TC POWERBALL® HCl®-TS POWERBALL® HCl®-PAR POWERBALL® HCl®-TT POWERBALL® HCl®-E	CDM T CDM TC CDM TD CDM R PAR CDM TT CDM ET	CMH T CMH TC CMH TD CMH PAR CMH TT CMH E	CMI-T CMI-TC CMI-TD – – –
<b>Quartz metal halide</b> POWERSTAR® HQI®-T POWERSTAR® HQI®-TS POWERSTAR® HQI®-E	MHN-T MHN-TD –	ARC T ARC TD –	HSI-T Britelux HSI-TD Britelux HSI-SX
<b>High pressure sodium</b> VIALOX® NAV® (SON) SUPER 4Y VIALOX® NAV® (SON) 4Y VIALOX® (SON) standard	MASTER SON PIA Plus MASTER SON PIA SON Pro	Lucalox Superlife Lucalox XD Lucalox	SHP SUPER SHP SHP Standard



# General Conditions of Sale

Unless otherwise stated by OSRAM LIMITED (the "Company") in writing, the Company's General Conditions of Sale set out below shall apply to all sales of goods by the Company to any other party (the "Customer"):

## 1 General

All quotations are made and all orders are accepted subject to the following terms and conditions and no addition thereto or variation therein shall be made or apply unless agreed in writing.

## 2 Orders

- (2.1) The Company reserves the right to accept or refuse orders. The Company also reserves the right (without prejudice to any other remedy) to cancel any uncompleted order or to suspend delivery in the event of any of the Customer's commitments with the Company not being met or if the Company is of the opinion that such commitment will not be met by the Customer.
- (2.2) With regard to orders for goods which the Company does not stock and therefore makes or procures specifically for the Customer, the Company can accept neither the cancellation of any such order nor the return of any such goods except under Clause 16 (Defects after delivery).

## 3 Validity of quotations

- (3.1) The contract will be on these conditions which shall override any terms and conditions which the Customer purports to apply, including those contained or referred to in the order and shall supersede all prior agreements, offers and discussions (oral or written) between the parties regarding the subject matter of the contract. The order shall be deemed to be an offer by the Customer to purchase goods and/or services subject to these conditions. No order shall be deemed to be accepted by the Company until a written acknowledgement of the order is issued by the Company or (if earlier) the Company delivers goods and/or services to the Customer. These conditions shall be binding on the Customer when the Company accepts the order whether or not the Customer has executed the contract.
- (3.2) Unless expressly agreed in writing to the contrary, these conditions shall apply to all orders placed by the Customer with the Company until further notice from the Company to the Customer.

## 4 Acceptance of quotations

The acceptance of a quotation must be accompanied by sufficient information to enable the Company to proceed with the order forthwith, otherwise the Company will be at liberty to amend the quoted price to cover any increase in cost which has taken place after acceptance. Any sample submitted with the Company's quotation is returnable.

## 5 Catalogues etc

Catalogues, price lists and other advertising matter and descriptions, specifications or samples are only an indication of the type of goods offered and no particulars therein or attributes thereof shall be binding on the Company. All prices quoted therein are subject to alteration or withdrawal from time to time without notice.

## 6 Price

- (6.1) All quotations and orders for the general range of goods in current demand are subject to relevant prices and relevant discounts ruling at date of despatch.
- (6.2) Except as provided in Clause 6.1 above, all prices are based on the cost of material, labour, transport and of conforming to statutory obligations ruling at the date of quotation or tender, and if between that date and the date on which the goods are despatched, variations, either by rise or fall, shall occur in these costs the Company may amend the price to provide for these variations. The Company shall be entitled to charge an additional cost for the impact of specific legislation, coming into force either before or after the contract with the Customer is concluded, such as laws or regulations on waste electrical and electronic equipment, use of hazardous substances, packaging or disposal.
- (6.3) All amounts payable pursuant to the Contract are expressed exclusive of Value Added Tax (VAT) and any VAT shall be paid at the rate applying at the date of the Company's invoice.



## 7 Description of goods

- (7.1) All goods will be supplied as specified subject to reasonable availability to the Company of materials. Where specified materials are not so available the Company reserves the right without further notice to substitute other materials.
- (7.2) All descriptive specifications and drawings, all particulars of weights and dimensions and all forwarding specifications issued by the Company are approximate only.

## 8 Rejection and Return

- (8.1) Unless otherwise agreed in writing, goods rejected by the Customer as not complying with the contract must be rejected within 14 days.
- (8.2) Due to the fragile nature of the goods the Company will not accept goods for return unless previously inspected and confirmed as fit for re-sale by an employee of the Company. For this reason the Company does not operate a "sale or return" option, nor does it operate a stock cleanse facility. Any and all returns may only be made with the full agreement and authorisation of a manager of the Company. The Company will not accept any responsibility for goods returned by the Customer without full authorisation.

## 9 RISK/TITLE

- (9.1) The goods are at the risk of the Customer from the time of delivery.
- (9.2) Ownership of the goods shall not pass to the Customer until the Company has received in full (in cash or cleared funds) all sums due to it in respect of:
- (9.2.1) the goods; and
- (9.2.2) all other sums which are or which become due to the Company from the Customer on any account.
- (9.3) Until ownership of the goods has passed to the Customer, the Customer must:
- (9.3.1) hold the goods on a fiduciary basis as the Company's bailee;
- (9.3.2) store the goods (at no cost to the Company) separately from all other goods of the Customer or any third party in such a way that they remain readily identifiable as the Company's property;
- (9.3.3) not destroy, deface or obscure any identifying mark or packaging on or relating to the goods;
- (9.3.4) maintain the goods in satisfactory condition and keep them insured on the Company's behalf for their full price against all risks to the reasonable satisfaction of the Company. On request the Customer shall produce the policy of insurance to the Company; and
- (9.3.5) hold the proceeds of the insurance referred to in Clause 9.3.4 or of sale of any of the goods on trust for the Company and not mix them with any other money, nor pay the proceeds into any overdrawn bank account.
- (9.4) The Customer's right to possession of the goods shall terminate immediately if:
- (9.4.1) the Customer has a bankruptcy order made against him or makes an arrangement or composition with his creditors, or otherwise takes the benefit of any statutory provision for the time being in force for the relief of insolvent debtors, or (being a body corporate) convenes a meeting of creditors (whether formal or informal), or enters into liquidation (whether voluntary or compulsory) except a solvent voluntary liquidation for the purpose only of reconstruction or amalgamation, or has a receiver and/or manager, administrator or administrative receiver appointed of its undertaking or any part thereof, or a resolution is passed or a petition presented to any court for the winding up of the Customer or for the granting of an administration order in respect of the Customer, or any proceedings are commenced relating to the insolvency or possible insolvency of the Customer; or (9.4.2) the Customer suffers or allows any execution, whether legal or equitable, to be levied on his/its property or obtained against him/it, or fails to observe/performs any of his/its obligations



under the Contract or any other contract between the Company and the Customer, or is unable to pay its debts within the meaning of section 123 of the Insolvency Act 1986 or the Customer ceases to trade; or

- (9.4.3) the Customer encumbers or in any way charges any of the goods.
- (9.5) The Company shall be entitled to recover payment for the goods notwithstanding that ownership of any of the goods has not passed from the Company.
- (9.6) The Customer grants the Company, its agents and employees an irrevocable licence at any time to enter any premises where the goods are or may be stored in order to inspect them, or, where the Customer's right to possession has terminated, to recover them.

## 10 Despatch

Any times quoted for despatch are to be treated as estimates only and the Company shall not be liable in any manner whatsoever for failure to despatch within such time unless the Customer has suffered loss thereby and the amount payable in respect thereof shall have been agreed in writing prior to despatch as liquidated damages, in which case the Company's liability shall be limited to the amount so agreed to be paid. In all cases, whether a time for despatch be quoted or not, the time for despatch shall not be of the essence and shall be extended by a reasonable period and for so long as the Company's having regard to all circumstances if delay in despatch is caused by instructions or lack of instructions or other necessary particulars from the Customer, or by industrial dispute, or by any cause whatsoever beyond the Company's reasonable control.

## 11 Storage

If by reason of instructions or lack of instructions from the Customer or failure of the Customer to accept delivery, despatch in accordance with the contract is delayed for 7 days after the Customer has been notified that the goods are ready for despatch, the risk in the goods shall pass to the Customer who shall take delivery or arrange for storage and for the purposes of Clause 15 (Payment) the goods shall thereupon be deemed to have been delivered. If storage facilities permit, the Company may store the goods and the Customer shall pay a reasonable charge therefor.

## 12 Delivery

- (12.1) Unless otherwise specified the price quoted includes delivery.
- (12.2) The Company reserves the right to choose the method of transport.
- (12.3) The Customer will sign, at the time of delivery, the Delivery Note, International Delivery Note (CMR) or other delivery documentation for receipt of the goods. If the Customer signs "unexamined" or similar, the Company will deem this to be an acknowledgement of receipt of all cartons or packages specified on the Delivery Note.

## 13 Loss or damage in transit

- (13.1) Shortages and/or damages in transit, must be clearly stated by the Customer on the Delivery Note, CMR or other delivery documentation at the time of delivery. The Company undertakes to investigate, and credit where appropriate.
- (13.2) Where shortages and/or damages are not apparent at the time of delivery, the Customer must notify the company, in writing, within 3 working days of receipt of delivery. The Company undertakes to investigate, and credit where appropriate.
- (13.3) Where an entire delivery has not been received, the Customer must notify the company, in writing, within 10 working days of the date of the invoice. The Company undertakes to investigate, and credit where appropriate.

## 14 Packing

Packing cases, pallets, drums and/or packing materials, will be charged extra if not returned in good condition carriage paid to the Company within one month of delivery of the goods if requested by the Company. If no such request is made by the Company, the Customer shall be responsible for proper disposal of such items.



**15 Payment**

- (15.1) Unless otherwise agreed in writing, payment in full is due on or before the last banking day of the calendar month following the month of the invoice.
- (15.2) If the price of the goods is not paid in full by the due date all other sums owing or incurred by the Customer to the Company but not already due for payment shall thereupon become due and immediately payable in full and the Company may suspend any further deliveries due to the Customer.
- (15.3) In the event any amount payable is overdue, the Company may, without prejudice to any other right, charge simple interest on overdue amounts at a rate of 2% per annum above the then current base rate published by Barclays Bank PLC. The Company reserves the right to charge interest at the rate set out in the Late Payment of Commercial Debts (Interest) Act 1998.

**16 Defects after delivery**

The Company will make good, by repair or at the Company's option by the supply of a replacement or refund, defects which, under proper use, appear in the goods within a period of twelve calendar months after the goods have been delivered and arise solely from faulty design, materials or workmanship (other than a design made, furnished or specified by or on behalf of the Customer): provided always that defective parts have been returned to the Company if the Company shall have so required. The Company shall refund the cost of carriage of such returned parts and the repaired or new parts will be delivered by the Company free of charge as provided in Clause 12 (Delivery). The Company shall be under no liability for the fitting or installation of the repaired part or for service charges incurred in respect thereof. In respect of goods not of the Company's manufacture, the Customer is entitled only to such benefits as the Company may receive under any guarantee given to it in respect thereof.

The Company's liability under this clause shall be in lieu of any warranty or condition implied by law as the quality or fitness for any particular purpose of the goods, and save as provided in this clause the Company shall not be under any liability, whether in contract, tort or otherwise, in respect of defects in goods delivered or for any damage or loss resulting from such defects or from any work done in connection therewith. Provided however that nothing in this clause shall operate to exclude any warranty or condition implied by law as to the quality of the goods in the event that the goods when sold by the Customer or when sold by any person or persons to whom the Customer may sell the goods shall become the subject of a consumer sale as defined in the Sale of Goods Act 1979, or any statutory reenactment or modification thereof, except to the extent that any claim under such warranty or condition shall have arisen from any act or omission by the Customer or by any other persons selling the goods by a way of a consumer sale.

**17 Patents etc**

- (17.1) The Company will defend the Customer against any claim of infringement of Letters Patent, Registered Design, Trade Mark or Copyright (published at date of the contract) by the use or sale of any article or material supplied by the Company to the Customer and will indemnify the Customer against all third party costs and damages awarded against the Customer as a result of such claim; provided always that this indemnity shall not apply to any infringement which is due to the Company having followed a design or instruction furnished or given by the Customer or in a foreign country not specified by or disclosed to the Company, or to any infringement which is due to the use of such article or material in association or combination with any article or material not supplied by the Company; and provided also that this indemnity is conditional on the Customer giving to the Company the earliest possible notice in writing of any claim being made or action threatened or brought against the Customer and on the Customer's permitting the Company at the Company's own expense to conduct any litigation that may ensue and all negotiations for a settlement of the claim and giving the Company all reasonable assistance. The Customer on his part warrants that any design or instruction furnished or given by him shall not be such as will cause the Company to infringe any Letters Patent, Registered Design, Trade Mark or Copyright in execution of the Customer's order.

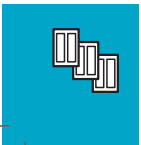

- (17.2) The Customer shall not use any registered or unregistered trade marks, trade names, brand names, product names, images, logos, designs, get-ups or materials of the Company except those provided by the Company to the Customer for the purposes for which they were supplied and shall cease using them if required by the Company in writing at any time.

### **18 Reservation Clause**

The fulfilment of the agreement on the Company's part is subject to the proviso that this shall not be prevented by impediments on the grounds of national and international legal requirements, in particular export control provisions.

### **19 Limitation of Liability**

- (19.1) Nothing in these conditions excludes or limits the liability of the Company:
- (19.1.1) for death or personal injury caused by the Company's negligence; or
  - (19.1.2) under section 2(3), Consumer Protection Act 1987; or
  - (19.1.3) for any matter which it would be illegal for the Company to exclude or attempt to exclude its liability; or
  - (19.1.4) for fraud or fraudulent misrepresentation.
- (19.2) Subject to Clause 19.1:
- (19.1.1) the Company's total liability in contract, tort (including negligence or breach of statutory duty), misrepresentation, restitution or otherwise, arising in connection with the performance or contemplated performance of the contract with the Customer shall be limited to the contract price; and
  - (19.1.1) the Company shall not be liable to the Customer for any pure economic loss, loss of profit, loss of business, depletion of goodwill or otherwise, in each case whether direct, indirect or consequential, or any claims for consequential compensation whatsoever (howsoever caused) which arise out of or in connection with the agreement.

### **20 Legal construction**

The contract shall in all respects be construed and operate as an English contract and in conformity with English law.

(Revised August 2009)

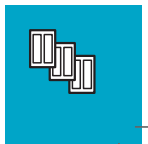

## Notes

### 1. Minimum Order Values

All orders must be in multiples of the Sales Pack detailed for each product.

Orders for part Sales Packs will be rounded up to the next full Sales Pack quantity.

Prices are carriage paid to UK on shore locations subject to a Minimum Order Value of £250 net invoice value (excluding WEEE or other changes).

A Small Order Charge of £10 will be made for freight and handling of orders less than £250 net invoice value.

### 2. CE Marking

In order to show compliance with the EMC Directive (89/336/EEC) and the Low Voltage Directive (73/23/EEC) all OSRAM high frequency electronic control gear, transformers and integrally ballasted compact fluorescent lamps carry the 'CE' mark.

All other lamps that operate above 50V are CE marked to show compliance with the Low Voltage Directive (73/23/EEC)

### 3. Energy Efficiency Classification

Mains operated household lamps (e.g. GLS, TH, integral ballasted CFLs, Fluorescent tubes) are energy labelled to show compliance with the Energy Labelling Directive (98/11/EEC).

The energy label indicates the energy efficiency index of the lamp and is classified on a scale from A (the highest) to G (the lowest).

### 4. Compliance with Standards

Compliance with relevant EN and IEC Standards is a priority in the design, manufacture and quality control of our products.

### 5. OSRAM will, upon request, provide CE Declarations of Conformity.

### 6. All OSRAM products are manufactured and supported under Quality Systems Management designed to meet EN ISO 9001 2000.

### 7. Since July 2006 all OSRAM products are compliant with Directive 2002/95/EC on the restriction of the use of certain hazardous substances in electrical and electronic equipment (RoHS).

### 8. Collection, Disposal and Recycling of End of Life Lamps & Luminaires

From 1st July 2007 The Waste Electrical and Electronic Regulations 2006 – S.I. 2006 No. 3289 (commonly referred to as the WEEE Directive) became effective in the UK. Under the terms of the regulations OSRAM Ltd. is classed as a Producer for OSRAM branded products and is responsible for the financing of the collection, treatment, recovery and disposal of WEEE that we put onto the UK market. As required by the regulations OSRAM Ltd. is registered as a Producer with the Environment Agency, our UK Producer Registration Number (PRN) is WEE/FE0081UW and this will be clearly displayed on all OSRAM Ltd. invoices.

All OSRAM branded products affected by the WEEE Directive are marked with the "crossed out wheelie bin" symbol . These products are also identified within this publication by the same symbol.

To fulfil our obligations OSRAM Ltd. has joined the Recolight Compliance Scheme [www.recolight.co.uk](http://www.recolight.co.uk).

All enquiries or questions relating to the collection, treatment, recovery and recycling of OSRAM branded products affected by the WEEE Directive in the UK should be directed to Recolight Ltd. at [info@recolight.co.uk](mailto:info@recolight.co.uk)

OSRAM strives to achieve the highest possible standards of customer service and to provide a co-ordinated product range.

## Contact Details

### OSRAM Customer Service Centre

OSRAM Ltd.

Neills Road

Bold Industrial Park

St Helens WA9 4XG

Tel: 01744 812221

Fax: 01744 831900

E-mail: [csc@osram.co.uk](mailto:csc@osram.co.uk)



# Notes

