

# *User's Guide*



**plustek**

## *Network Video Recorder*

- **Setup**
- **Configuration**
- **Technical Guides**

©2010. All rights are reserved. No portion of this document may be reproduced without permission. All trademarks and brand names mentioned in this publication are property of their respective owners.

While all efforts have been made to ensure the accuracy of all contents in this manual, we assume no liability for errors or omissions or by statements of any kind in this manual, whether such errors are omissions or statements resulting from negligence, accidents, or any other cause. The contents of this manual are subject to change without notice.

This NVR device is intended to be used in a lawful manner. Certain uses of the NVR device may be prohibited by local laws in some countries or states, such as the surreptitious recording of audio and/or video communications for certain purposes. If you have any question about whether a proposed use of your products is lawful, you should consult a local legal authority before proceeding.

The product is designed and produced to achieve sustainable environmental improvement. We strive to produce products in compliance with global environmental standards. Please consult your local authorities for proper disposal. The product packaging can be recycled.

Attention to recycling (For EU countries only)

Protect your environment! This product should not be thrown into the household waste container. Please give it to the free collecting center in your community.

The screen shots in this guide were made with Windows XP. If you are using Windows 7, Vista or 2000, your screens will look somewhat different but functions are the same.

# Table of Contents

<b>Introduction</b> .....	<b>1</b>
How to Use This Guide.....	1
<i>Conventions of This Guide</i> .....	1
<i>A Note about Icons</i> .....	1
<i>Safety Precautions</i> .....	2
Main NVR Features .....	3
Minimum System Requirements.....	3
Box Contents .....	3
<i>NVR 4000/4200/4300</i> .....	4
<i>NVR Slim240</i> .....	4
<i>NVR 4200V</i> .....	5
Overview.....	6
<i>NVR 4000/4200</i> .....	6
<i>NVR 4300</i> .....	7
<i>NVR Slim240</i> .....	8
<i>NVR 4200V</i> .....	9
<b>Chapter I. Setup the NVR</b> .....	<b>10</b>
Setup the NVR System.....	10
<i>I. Connecting with IP Cameras</i> .....	10
<i>II. Connecting with CCTV Cameras and Video Servers</i> .....	14
<b>Chapter II. Working with the NVR</b> .....	<b>19</b>
Log in the NVR .....	19
<i>Method I. Network Device Search Tool Application</i> .....	19
<i>Method II. IE Address Bar</i> .....	20
Wizard .....	20
<i>Step 1 – System Settings</i> .....	21
<i>Step 2 – WAN Settings</i> .....	21
<i>Step 3 – LAN Settings</i> .....	22
To Add a New IP Camera.....	23
NVR Viewer Windows .....	24
<i>Language</i> .....	24
<i>Live View</i> .....	24
<i>Record View</i> .....	26
<i>Motion Detection</i> .....	29
Log out the NVR .....	30
<b>Chapter III. Advanced NVR Configuration</b> .....	<b>31</b>
Wizard .....	31
<i>Step 1 – System Settings</i> .....	32
<i>Step 2 – WAN Settings</i> .....	32
<i>Step 3 – LAN Settings</i> .....	33
Status .....	34

<i>NVR Status</i> .....	34
<i>IPCam Status</i> .....	35
Network .....	35
<i>WAN</i> .....	35
<i>LAN</i> .....	39
<i>Client List</i> .....	40
IPCam .....	40
<i>Device Management</i> .....	41
<i>Video Settings</i> .....	43
Hard Disk .....	45
System .....	45
<i>Users</i> .....	45
<i>Maintenance</i> .....	46
<i>Log</i> .....	47
<i>System Settings</i> .....	48
<i>Date &amp; Time</i> .....	48
Database .....	49
<i>Management</i> .....	49
<i>Alarm Data Management</i> .....	50
Schedule Settings .....	50
<i>Record Schedule</i> .....	50
<i>Event Schedule</i> .....	51
Security .....	52
<i>Event Settings</i> .....	52
<i>Alarm Notification</i> .....	54
<i>Log</i> .....	55
<b>Chapter IV. Technical Guides</b> .....	<b>56</b>
LED Indicators .....	56
Search Tool .....	56
IP Configuration Information .....	57
Use the NVR with Dynamic IP Address .....	58
Proxy Server .....	59
Reset the NVR .....	61
Turn off the NVR .....	62
<b>Appendix A: Glossary</b> .....	<b>63</b>
<b>Appendix B: Specifications</b> .....	<b>67</b>
<b>Appendix C: Customer Service and Warranty</b> .....	<b>72</b>
Statement of Limited Warranty .....	72
FCC Radio Frequency Statement .....	73
<b>Contacting Plustek</b> .....	<b>75</b>

# Introduction

Thank you for choosing us as your NVR supplier. Like all of our products, your new NVR is thoroughly tested and backed by our reputation for unsurpassed dependability and customer satisfaction. We hope you will continue to turn to us for additional quality products as your computing needs and interests grow.

## How to Use This Guide

This User's Guide provides instructions and illustrations on how to setup and configure your NVR. This guide assumes the user is familiar with Microsoft Windows 7, Vista, XP and 2000 Professional. If this is not the case, we suggest you learn more about Microsoft Windows by referring to your Microsoft Windows manual before using your NVR.

The **Introduction** section of this manual provides an outline of this manual, and describes the minimum system requirements, the main features and box contents.

**Chapter I** describes how to set up basic NVR and IP Camera system in the network environment.

**Chapter II** describes how to log in the NVR interface and get live view of the connected IP cameras.

**Chapter III** provides you with plenty of illustrations and information about advanced configuration of the NVR. You may get familiar with it and try out all functions provided with the NVR.

**Chapter IV** provides useful technical information and usage tips.

**Appendix A** covers the glossary that may help you to know more about the network and network devices.

**Appendix B** contains the specifications of the NVR you purchased.

**Appendix C** contains our customer service, limited warranty agreement and FCC statement.

## Conventions of This Guide

"XXX" — Represents commands or contents on your computer screen.

**Bold** — Represents important notes.

## A Note about Icons

This guide uses the following icons to point out information that deserves special attention.



**Warning:** A procedure that must be followed carefully to prevent injury, or accidents.



**Attention:** Instructions that are important to remember and may prevent mistakes.



**Information:** Optional tips for your reference.

## Safety Precautions

Before using this device, please read the following important information carefully to eliminate or reduce any possibility of causing damage and personal injury.

1. Do use the AC adapter that comes with this device (if it is available). Use of other AC adapter may lead to malfunction, heat up, electrical shock, fire or injury.
2. Keep the space around the adapter clear in case you need to quickly unplug the adapter during emergencies.
3. Do not install near any heat sources such as radiators or other devices.
4. Use only attachments/accessories such as cover and plates specified by the manufacturer.
5. Do not touch the unit or the AC adapter when power on.
6. Unplug the device if you don't need to use for a certain period of time to avoid any risks of causing fire.
7. Do not disassemble the NVR case.
8. Please contact your distributor to obtain compatible IP camera list.
9. Damaged wire could cause fire or electrical shock. Keep the power cord straight and without being twisted, bended, or scraped.
10. Moisture condensation may occur inside this device and cause malfunction at these conditions:
  - When this device is moved directly from a cold to a warm location.
  - After a cold room is heated.
  - When this device is placed in a damp room.

To avoid the moisture condensation, you are recommended to follow the procedure:

- Seal this device in a plastic bag for it to adapt to room conditions.
  - Wait for 1 ~ 2 hours before removing this device from the bag.
11. Avoid excessive smoke, mechanical, dust, or direct sunlight.
  12. Do not replace incorrect type of battery on the Server main board. There is risk of explosion if the battery is replaced by an incorrect type. Dispose of used batteries according to the instructions.



**Information**



The mark shown to the left is in compliance with the Waste Electrical and Electronic Equipment Directive 2002/96/EC (WEEE). The mark indicates the requirement NOT to dispose the equipment as unsorted municipal waste, but use the return and collection systems according to local law. If the batteries, accumulators and button cells included with this equipment, display the chemical symbol Hg, Cd, or Pb, then it means that the battery has a heavy metal content of more than 0.0005% Mercury, or more than 0.002% Cadmium, or more than 0.004% Lead.

## Main NVR Features

---

- Real-time live view supervision
- Scheduled Recording, Manual Recording and Event Triggered Recording
- Record Playback
- Motion Detection
- TCP/IP / SMTP / DNS / DDNS / UPnP Support
- PTZ camera control

## Minimum System Requirements<sup>1</sup>

---

The NVR is recommended to work with personal computer or network that meets the following requirements:

Operation System	Microsoft® Windows® 2000 Professional, XP Home Edition or XP Professional, Vista, 7 compatible
CPU	Intel Pentium® 4 processor or above
Network Protocol	TCP/IP Network protocol installed. (DHCP, Static IP, DDNS, SMTP)
Web Browser	Internet Explorer 6.0 or later <sup>2</sup>
RAM	256 MB (512 MB or higher recommended)
Ethernet Interface	10/100 Mbps Ethernet Card and Category 5 cables for network connections <sup>3</sup>
Others	CD-ROM/DVD Drive, Video card that supports 16-bit color or greater, 800 MB Free Hard Disk Space

## Box Contents<sup>4</sup>

---

Before you start installing your NVR, check the box contents to make sure all parts are included. If any items are damaged or missing, please contact the vendor where you purchased your NVR or our customer service directly.

<sup>1</sup> The system requirements here are only a guideline, as in general the better the computer (motherboard, processor, hard disk, RAM, video graphic card), the better the results.

<sup>2</sup> The program is available with Microsoft Windows and therefore is not included in the Setup/Application CD-ROM of this product.

<sup>3</sup> These parts are not included in the package.

<sup>4</sup> Save the box and packing materials in case you need to transport this NVR in the future. The product packaging can be recycled.

## NVR 4000/4200/4300

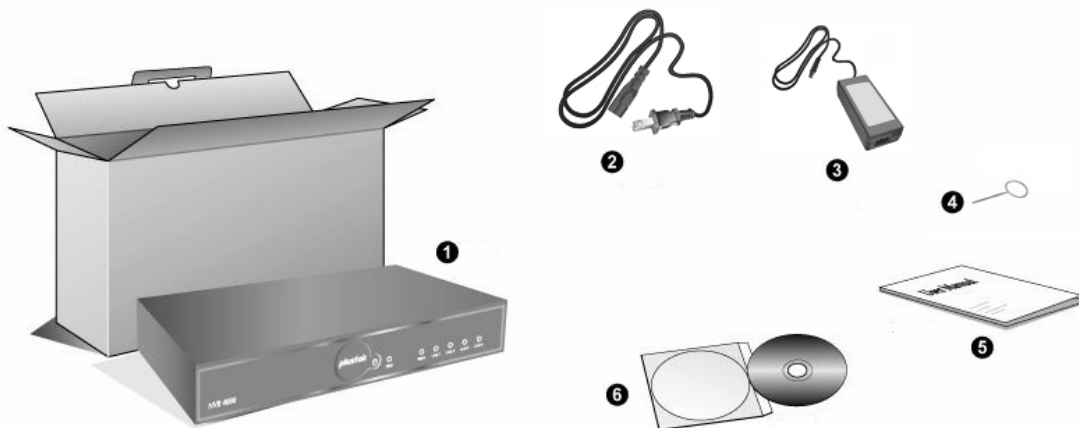

1. NVR
2. Power Cable
3. AC Adapter
4. Reset Pin
5. User's Guide
6. Installation CD

## NVR Slim240

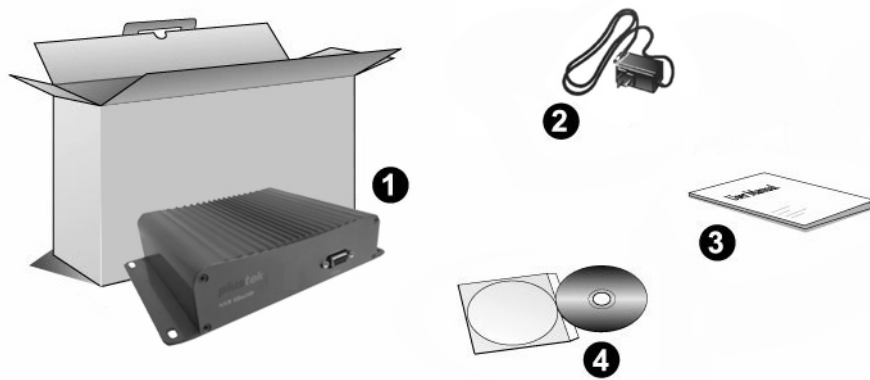

1. NVR
2. AC Adapter
3. User's Guide
4. Installation CD



## NVR 4200V

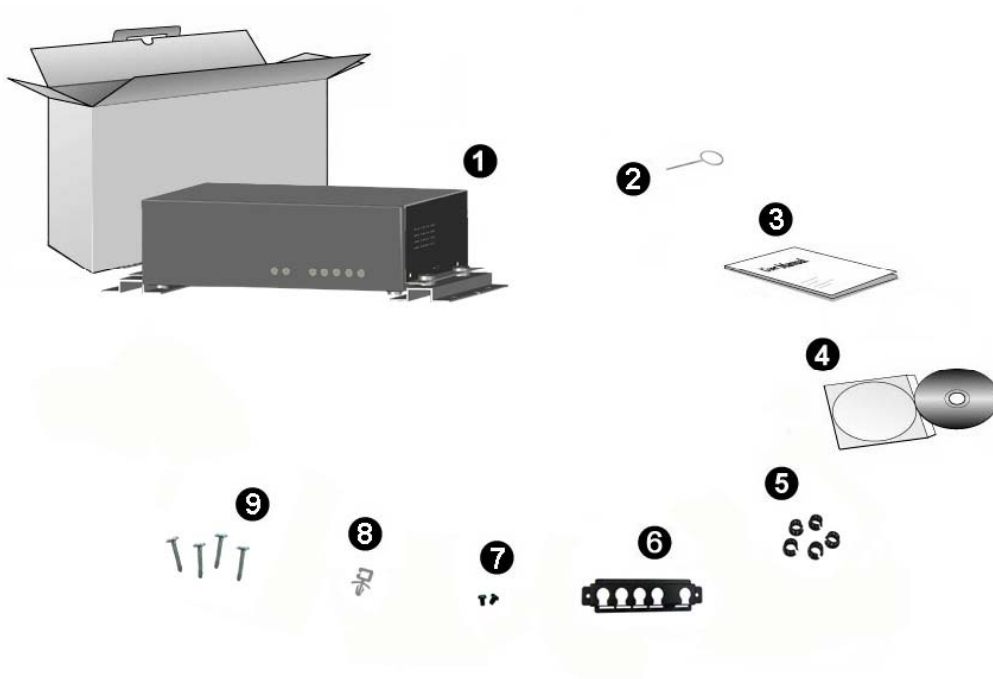

1. NVR
2. Reset Pin
3. User's Guide
4. Installation CD
5. Cable Clasp
6. Cable Stabilizer Rack
7. Rack Screws
8. Power Cord Clasp
9. NVR Screws

# Overview

---

## NVR 4000/4200

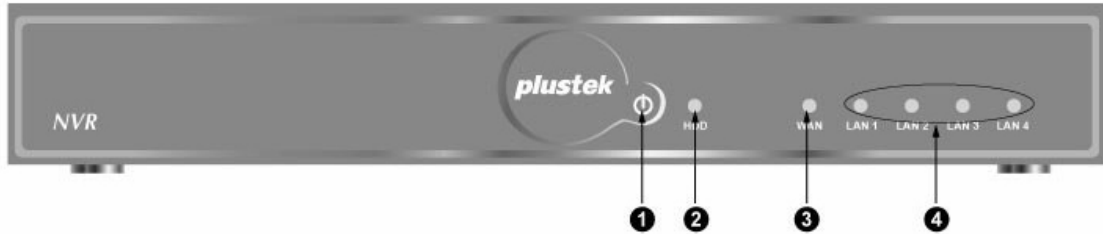

1. Power Indicator
2. HDD Indicator
3. WAN Indicator
4. LAN Indicators

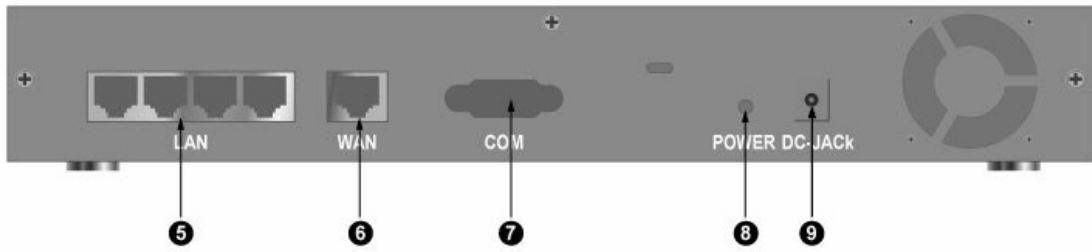

5. 4 LAN Ports
6. WAN Port
7. COM Port
8. Power Hole
9. DC-Jack

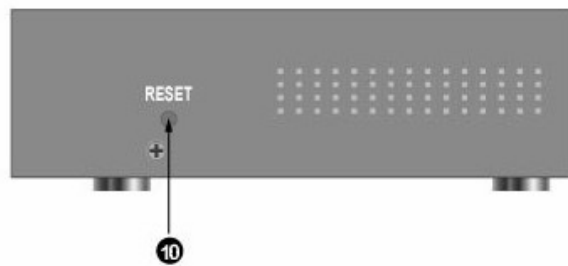

10. RESET Hole

## NVR 4300

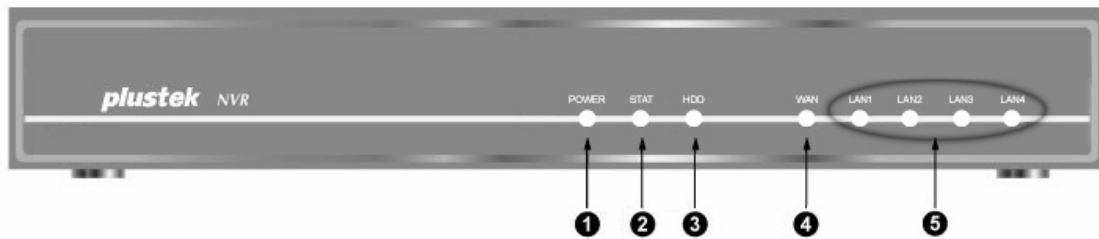

1. Power Indicator
2. Status Indicator
3. HDD Indicator
4. WAN Indicator
5. LAN Indicators

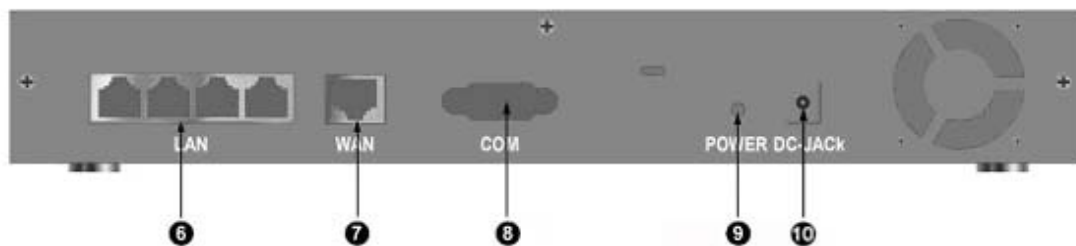

6. 4 LAN Ports
7. WAN Port
8. COM Port
9. Power Hole
10. DC-Jack

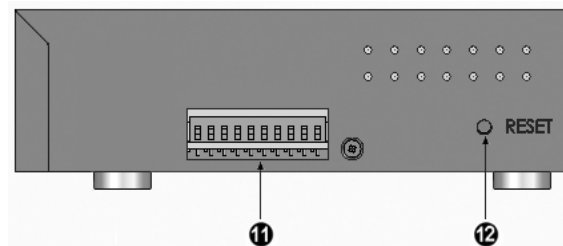

11. I/O Interface<sup>5</sup>
12. RESET Hole

<sup>5</sup> Serious damage to the NVR may result if a device is connected to the I/O Interface that exceeds its electrical capability. The low voltage/current circuit and high voltage/current circuit are in the NVR circuit. Incorrect wiring could damage the NVR.

## NVR Slim240

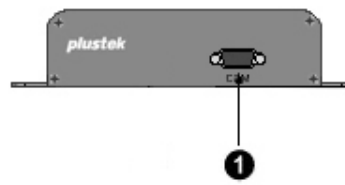

1. COM Port

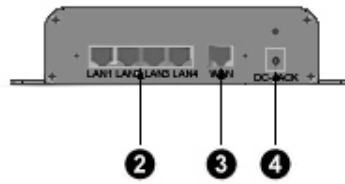

2. 4 LAN Ports

3. WAN Port

4. DC-Jack

## NVR 4200V

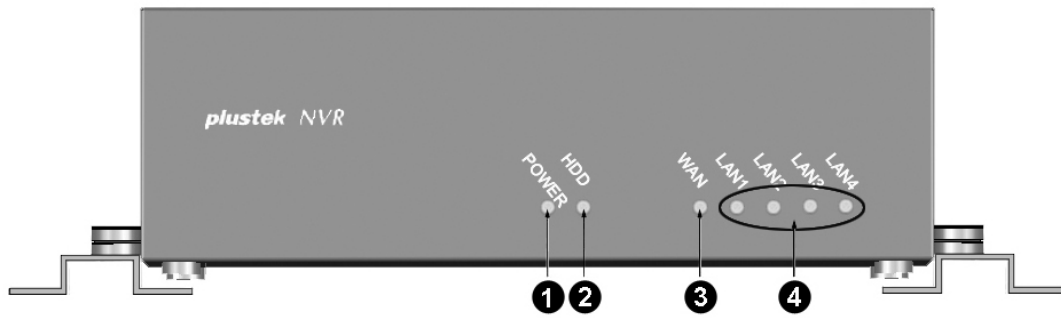

1. Power Indicator
2. HDD Indicator
3. WAN Indicator
4. LAN Indicators

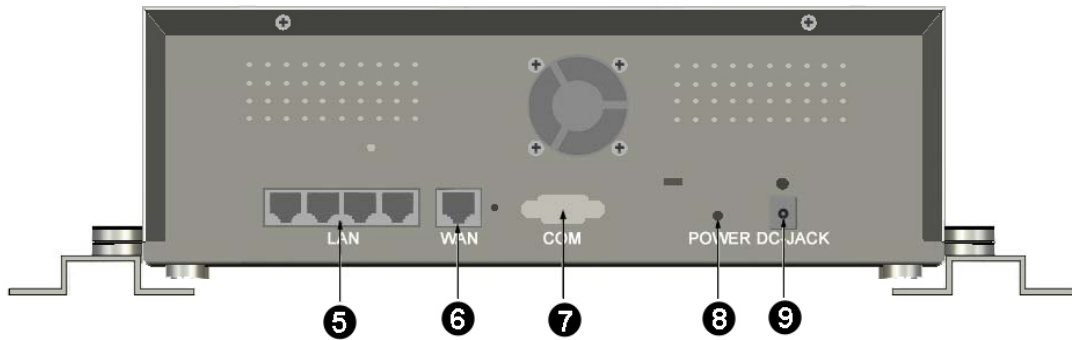

5. 4 LAN Ports
6. WAN Port
7. COM Port
8. Power Hole
9. DC-Jack

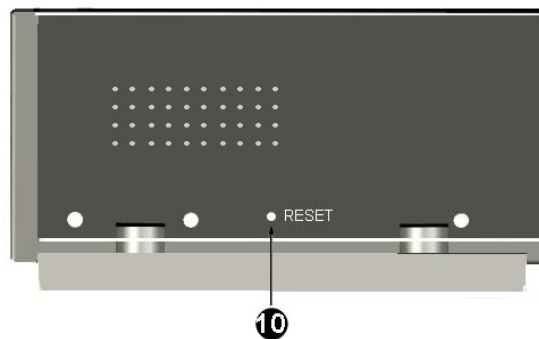

10. RESET Hole

# Chapter I. Setup the NVR

Before you setup the NVR (Network Video Recorder), please make sure all components are available and ready. A list of the package contents is provided in the [Box Contents](#) section of this guide. If any items are damaged or missing, please contact the vendor where you purchased your NVR or our customer service directly.

## Setup the NVR System

### I. Connecting with IP Cameras

#### NVR 4000/4200/4300

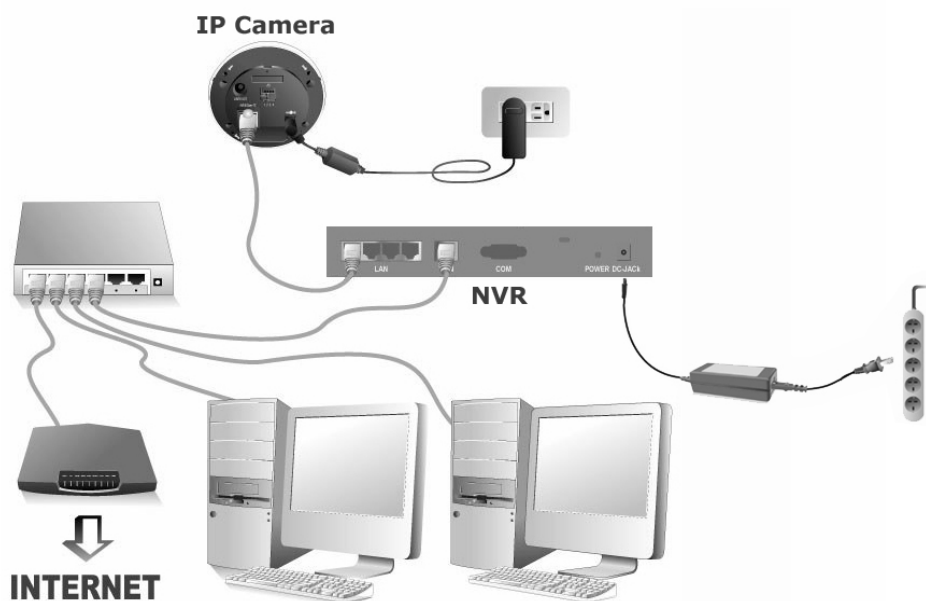

To set up the NVR system in your LAN environment:



#### **Attention**

Please configure the IP address of the IP cameras before connecting to the NVR.

1. Plug the RJ-45 connectors into LAN port of NVR and IP camera RJ-45 port.
2. Plug the RJ-45 connectors into WAN port and Router's LAN port.
3. Turn on the Router (Router with UPnP on/off function is recommended).
4. Plug the AC adapter into the DC-Jack of the NVR. Attach the power cable to the AC adapter. Plug the other end of the power cable into a standard AC power outlet.
5. Connect PC or Laptop with Router LAN port.
6. Insert the Installation CD, included with your NVR, into your CD-ROM drive.
7. Double click the "vcredist\_x86.exe" file in your language on the CD-ROM to install the Microsoft Visual C++ 2005 SP1 Redistributable Package (x86).
8. Run the "Network Device Search Tool" application on the CD-ROM.

9. When the NVR lists in the Network Device Search Tool window, your NVR works properly.

## **NVR Slim240**

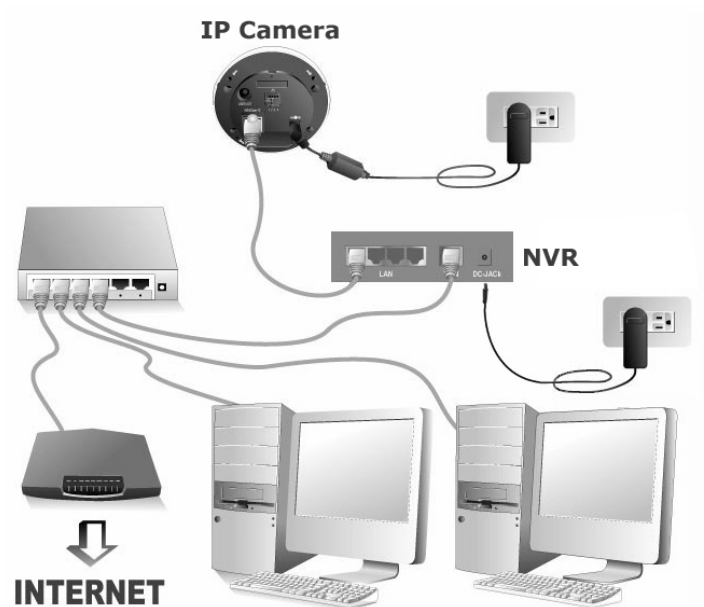

### **To set up the NVR system in your LAN environment:**



#### **Attention**

Please configure the IP address of the IP cameras before connecting to the NVR.

1. Plug the RJ-45 connectors into LAN port of NVR and IP camera RJ-45 port.
2. Plug the RJ-45 connectors into WAN port and Router's LAN port.
3. Turn on the Router (Router with UPnP on/off function is recommended).
4. Plug the AC adapter into the DC-Jack of the NVR. Plug the other end of the power cable into a standard AC power outlet.
5. Connect PC or Laptop with Router LAN port.
6. Insert the Installation CD, included with your NVR, into your CD-ROM drive.
7. Double click the "vcredist\_x86.exe" file in your language on the CD-ROM to install the Microsoft Visual C++ 2005 SP1 Redistributable Package (x86).
8. Run the "Network Device Search Tool" application on the CD-ROM.
9. When the NVR lists in the Network Device Search Tool window, your NVR works properly.

## NVR 4200V

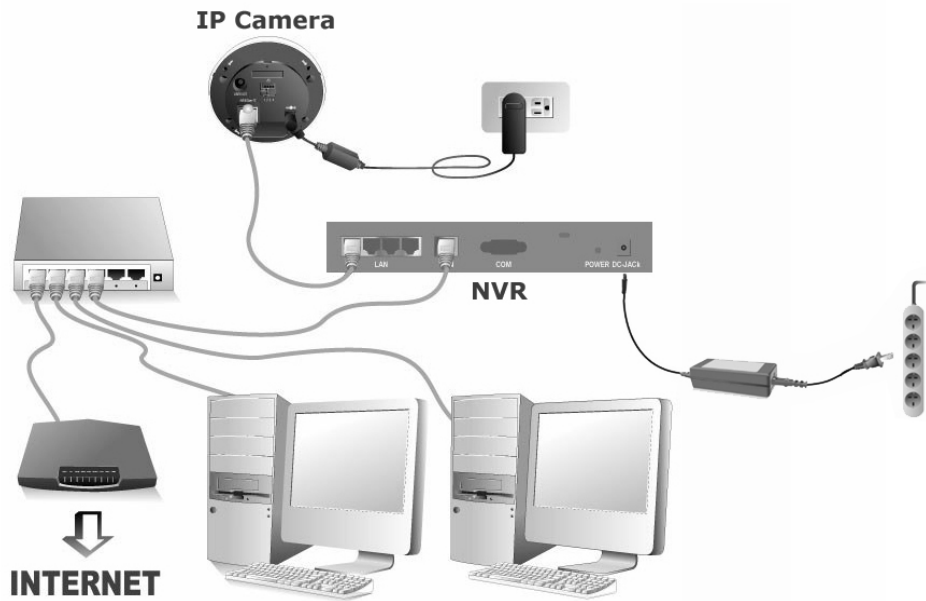

### To set up the NVR system in your LAN environment:



#### **Attention**

Please configure the IP address of the IP cameras before connecting to the NVR.

1. Put the cable clasp onto the RJ-45 cables. Put that end of the cable connectors through the cable stabilizer rack. Clasp the cable clasp into the cable stabilizer rack.

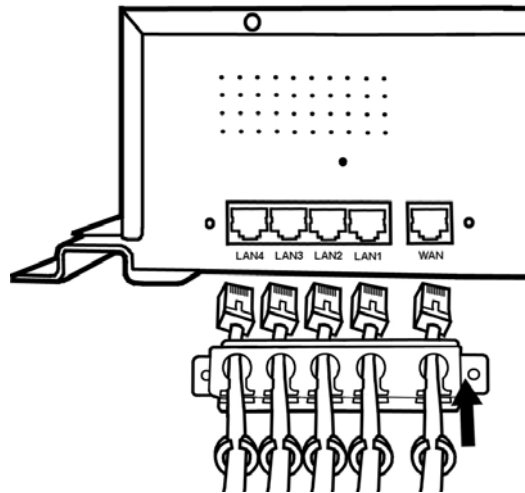

2. Plug the RJ-45 connectors into LAN port of NVR and IP camera RJ-45 port.
3. Plug the RJ-45 connectors into WAN port and Router's LAN port.
4. Fasten the rack screws to fix the cable stabilizer rack on the rear panel of the NVR.



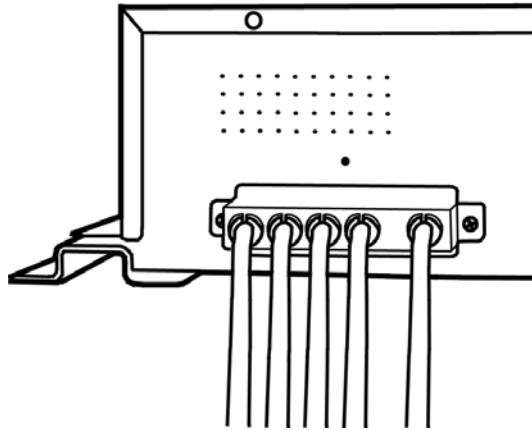

5. Turn on the Router (Router with UPnP on/off function is recommended).
6. Plug the power cord clasp into the hole above the DC-JACK.

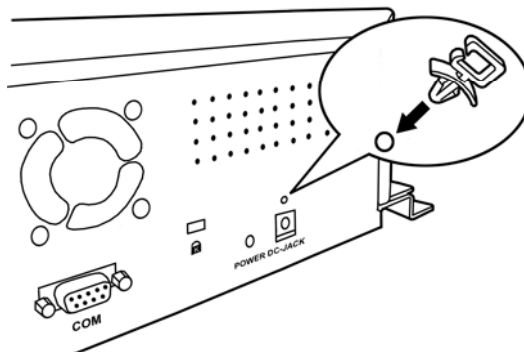

7. Plug your suitable power source cable into the DC-Jack of the NVR. Put the power cord into the power cord clasp.

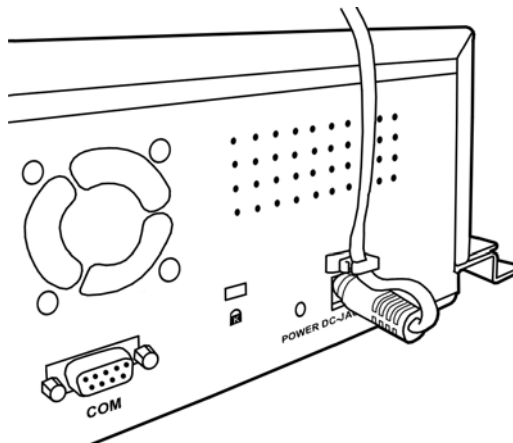

8. Fasten the NVR screws to fix the NVR at the desired position.
9. Connect PC or Laptop with Router LAN port.
10. Insert the Installation CD, included with your NVR, into your CD-ROM drive.
11. Double click the "vcredist\_x86.exe" file in your language on the CD-ROM to install the Microsoft Visual C++ 2005 SP1 Redistributable Package (x86).
12. Run the "Network Device Search Tool" application on the CD-ROM.
13. When the NVR lists in the Network Device Search Tool window, your NVR works properly.

## II. Connecting with CCTV Cameras and Video Servers

### NVR 4000/4200/4300

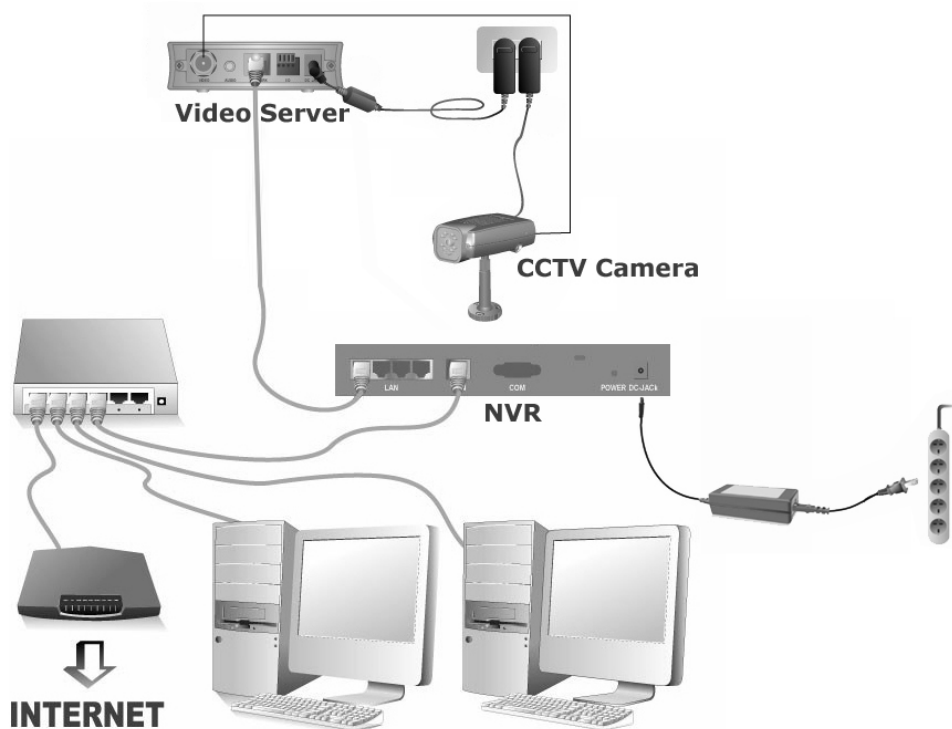

To set up the NVR system in your LAN environment:



#### **Attention**

Please configure the IP address of the Video Server before connecting to the NVR.

1. Connect the AC adapter to the DC IN Jack of the video server.
2. Plug the AC adapter into a standard wall outlet.
3. Connect the coaxial cable to the video input port of the Video Server from the CCTV camera.
4. Connect CCTV power cord to an outlet, if any.
5. Plug the RJ-45 connectors into LAN port of NVR and Ethernet Port of the video server.
6. Plug the RJ-45 connectors into WAN port and Router's LAN port.
7. Turn on the Router (Router with UPnP on/off function is recommended).
8. Plug the AC adapter into the DC-Jack of the NVR. Attach the power cable to the AC adapter. Plug the other end of the power cable into a standard AC power outlet.
9. Connect PC or Laptop with Router LAN port.
10. Insert the Installation CD, included with your NVR, into your CD-ROM drive.
11. Double click the "vcredist\_x86.exe" file in your language on the CD-ROM to install the Microsoft Visual C++ 2005 SP1 Redistributable Package (x86).
12. Run the "Network Device Search Tool" application on the CD-ROM.

13. When the NVR lists in the Network Device Search Tool window, your NVR works properly.

## **NVR Slim240**

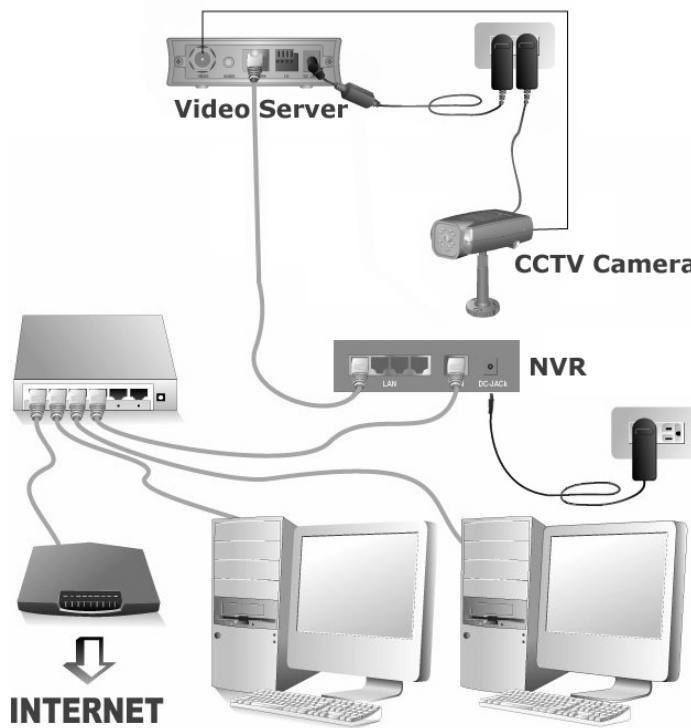

### **To set up the NVR system in your LAN environment:**



Please configure the IP address of the Video Server before connecting to the NVR.

1. Connect the AC adapter to the DC IN Jack of the video server.
2. Plug the AC adapter into a standard wall outlet.
3. Connect the coaxial cable to the video input port of the Video Server from the CCTV camera.
4. Connect CCTV power cord to an outlet, if any.
5. Plug the RJ-45 connectors into LAN port of NVR and Ethernet Port of the video server.
6. Plug the RJ-45 connectors into WAN port and Router's LAN port.
7. Turn on the Router (Router with UPnP on/off function is recommended).
8. Plug the AC adapter into the DC-Jack of the NVR. Plug the other end of the power cable into a standard AC power outlet.
9. Connect PC or Laptop with Router LAN port.
10. Insert the Installation CD, included with your NVR, into your CD-ROM drive.
11. Double click the "vcredist\_x86.exe" file in your language on the CD-ROM to install the Microsoft Visual C++ 2005 SP1 Redistributable Package (x86).
12. Run the "Network Device Search Tool" application on the CD-ROM.

13. When the NVR lists in the Network Device Search Tool window, your NVR works properly.

### **NVR 4200V**

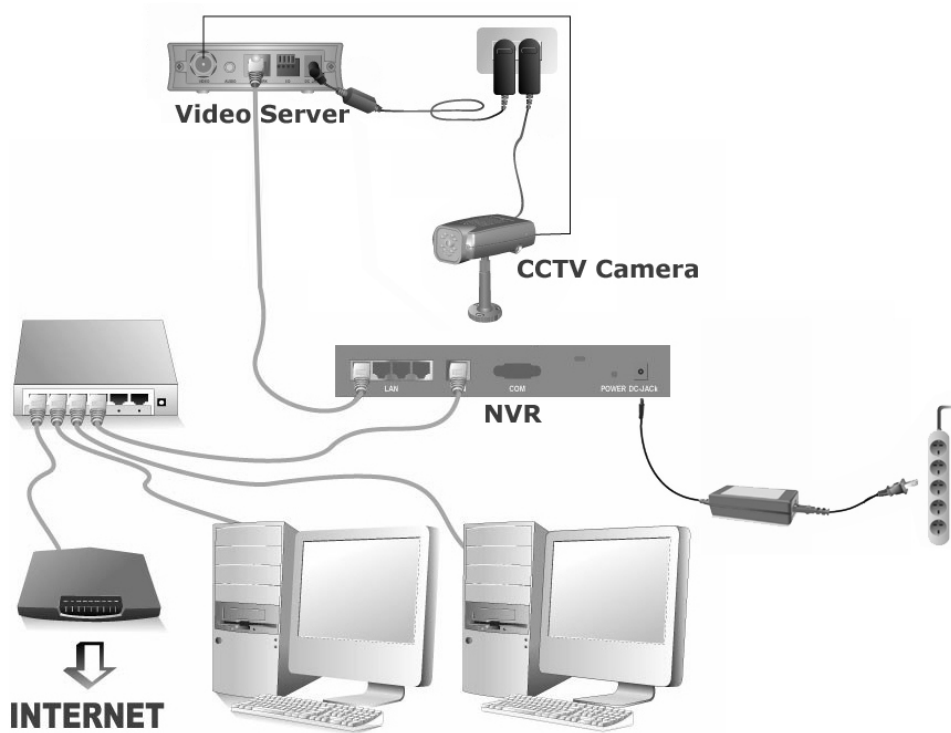

**To set up the NVR system in your LAN environment:**



Please configure the IP address of the Video Server before connecting to the NVR.

1. Connect the AC adapter to the DC IN Jack of the video server.
2. Plug the AC adapter into a standard wall outlet.
3. Connect the coaxial cable to the video input port of the Video Server from the CCTV camera.
4. Connect CCTV power cord to an outlet, if any.
5. Put the cable clasp onto the RJ-45 cables. Put that end of the cable connectors through the cable stabilizer rack. Clasp the cable clasp into the cable stabilizer rack.

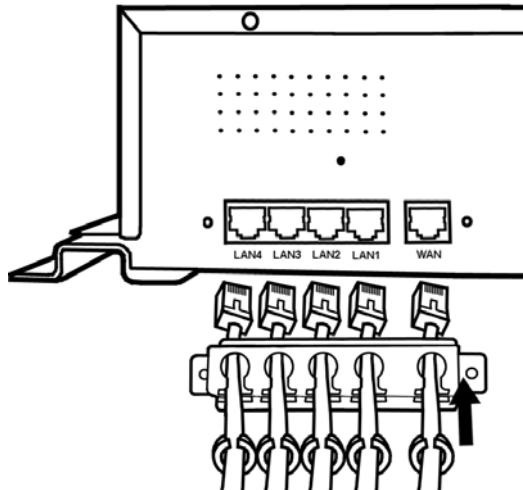

6. Plug the RJ-45 connectors into LAN port of NVR and Ethernet Port of the video server.
7. Plug the RJ-45 connectors into WAN port and Router's LAN port.
8. Fasten the rack screws to fix the cable stabilizer rack on the rear panel of the NVR.

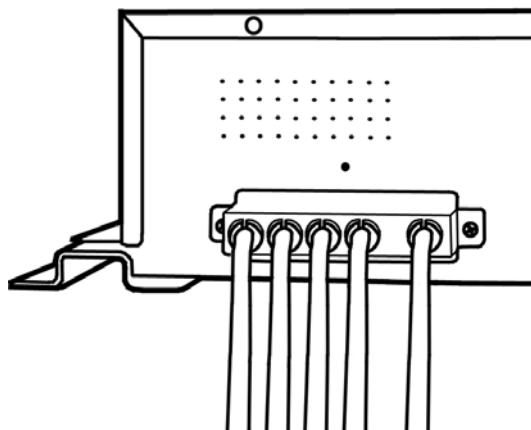

9. Turn on the Router (Router with UPnP on/off function is recommended).
10. Plug the power cord clasp into the hole above the DC-JACK.

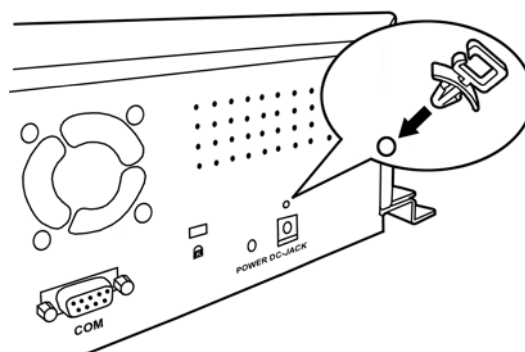

11. Plug your suitable power source cable into the DC-Jack of the NVR. Put the power cord into the power cord clasp.

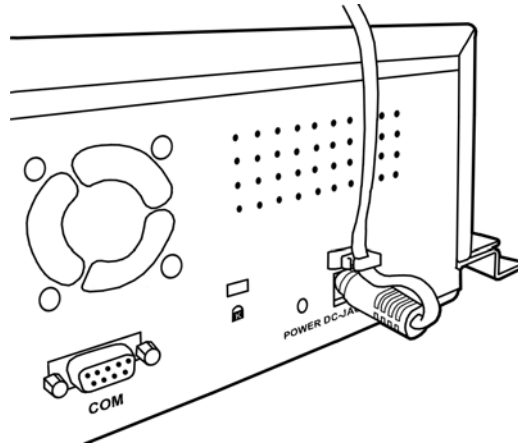

12. Fasten the NVR screws to fix the NVR at the desired position.
13. Connect PC or Laptop with Router LAN port.
14. Insert the Installation CD, included with your NVR, into your CD-ROM drive.
15. Double click the “vcredist\_x86.exe” file in your language on the CD-ROM to install the Microsoft Visual C++ 2005 SP1 Redistributable Package (x86).
16. Run the “Network Device Search Tool” application on the CD-ROM.
17. When the NVR lists in the Network Device Search Tool window, your NVR works properly.

## Chapter II. Working with the NVR

### Log in the NVR

#### Method I. Network Device Search Tool Application

Network Device Search Tool is an application that can detect the network camera(s) and NVR(s) that you connect to an organization's network or your PC.

1. Insert the CD-ROM into the CD-ROM drive of your PC.
2. Double click on the "Plustek Network Device Search Tool" file.
3. The Network Device Search Tool window is displayed.



4. Select and double click on the desired NVR.
5. The System Login page appears on the screen.

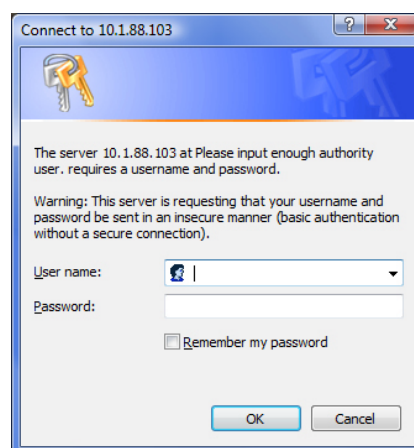

When you use the Internet Explorer to browse the website, ActiveX controls may assure the normal display of images.

- When you log in your NVR for the first time, enter “admin” as your user name and “admin” as your password.
- Click “OK” to send the identification information for recognition.

 <b>Attention</b>	<p>The “admin” and “admin” are the default user name and password for your first login of the NVR as Administrator. Please change the default password as soon as possible. To change the password, please refer to the section “<a href="#">Users</a>”.</p>
---	--

## Method II. IE Address Bar

When you connect the NVR to the Internet with static IP address, you may log in the NVR by directly entering the IP address in the IE Address Bar.

 <b>Information</b>	<p>If you are provided with dynamic IP address in an organization’s network, please refer to the “<a href="#">Use the NVR with Dynamic IP Address</a>” section for more instructions.</p>
---	---

- Start the Internet Explorer, enter the IP address of the NVR in the IE address bar, and press “Enter” on the keyboard to launch the System Login page.



- The System Login page is displayed.

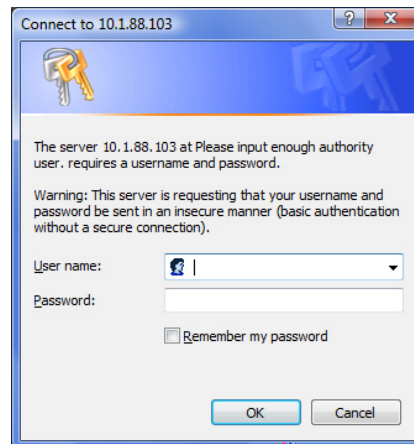

- Enter “admin” as your user name, “admin” as your password and click “OK”.

 <b>Attention</b>	<p>The “admin” and “admin” are the default user name and password for your first login of the NVR as Administrator. Please change the default password as soon as possible. To change the password, please refer to the section “<a href="#">Users</a>”.</p>
---	--

## Wizard

This Wizard will guide you through the basic settings to complete your initial setup fast and easy. You may define the “Device Name” for the NVR you use.



## Step 1 – System Settings

The screenshot shows the 'Step 1 - System Settings' configuration page. It includes a 'System' section with a 'Device Name' field containing 'NVR'. Below is the 'Date & Time' section, which has a 'Time Zone' dropdown menu set to '(GMT-08:00) Pacific Time (US & Canada); Tijuana'. There are two radio buttons: 'Computer Time' (selected) and 'Set manually'. The 'Computer Time' section shows 'Date: 2010 / 3 / 31' and 'Time: 11:56:58'. The 'Set manually' section has empty input fields for Date and Time. At the bottom, there are 'Skip' and 'Next' buttons. A footer note states: '\*Click 'Skip' button to skip wizard, but the settings will not be saved.'

### To set NVR Date & Time:

1. Select Time Zone from the drop-down list.
2. You may set the NVR date and time by any of the following two ways:
  - a. Synchronize the NVR with the computer time.
  - b. Manually set the Date and Time by entering the Date and Time in the blanks.

Click “Next” to continue the settings.

## Step 2 – WAN Settings

The screenshot shows the 'Step 2 - WAN Settings' configuration page. It features two radio buttons: 'Obtain IP via DHCP' (selected) and 'Use the following IP'. Under 'Use the following IP', there are input fields for IP address (10, 1, 100, 24), Subnet mask (255, 255, 0, 0), and Gateway (10, 1, 100, 1). Below is the 'HTTP Port' section with a 'Port number' field set to 80. The 'DNS' section has two radio buttons: 'Obtain a DNS address automatically' (selected) and 'Use the following DNS address'. Under 'Use the following DNS address', there are input fields for Primary DNS address and Secondary DNS address. At the bottom, there are 'Skip', 'Back', and 'Next' buttons. A footer note states: '\*TCP/IP (Transmission Control Protocol) is a set of rules (protocol) used along with the Internet Protocol (IP) to send data in the form of message units between computers over the Internet. While IP takes care of handling the actual delivery of the data, TCP takes care of keeping track of the individual units of data (called packets) that a message is divided into for efficient routing through the Internet. \*DNS(Domain Name System) is service that locates various Internet domain names and translates them into Internet Protocol address. DNS service may increase the responding speed and accuracy of specified web site. \*You can press 'Skip' button to skip wizard, the settings will not be saved.'

### To choose the IP allocation methods:

1. Select either DHCP or static IP:

- If you want your NVR to use a dynamic IP, select the “Obtain IP via DHCP” radio button and your NVR will be assigned with any idle IP address in your organization’s network.
- If you want your NVR to use a static IP, select the “Use the following IP” radio button and fill in the blanks for IP address, subnet mask and Gateway.

2. Enter the HTTP port if needed. The default port is 80.

**To enter the DNS address if needed:**

You may check “Obtain a DNS address automatically” radio button to obtain the DNS address automatically. If you want the NVR to use a host name, you’ll need to enter at least one (Primary) DNS address.

1. Enter the IP address of the “Primary DNS Address” provided by your ISP.
2. Enter the IP address of the “Secondary DNS Address” provided by your ISP.

Click “Next” to continue the settings.

**Step 3 – LAN Settings**

Step3 - LAN Settings				
IP Address	192	168	10	18
Subnet Mask	255	255	255	0
Gateway	192	168	10	254
DHCP Settings				
DHCP Server	<input type="checkbox"/> Enable			
* You can enable DHCP to dynamically allocate IP addresses to your client IPCam.				
IP Pool Starting Address	20			
IP Pool Ending Address	250			
Lease Time	Two hours			
Local Domain Name	NVR-4000			(optional)
<input type="button" value="Skip"/> <input type="button" value="Back"/> <input type="button" value="Finish"/>				
<small>*DHCP(Dynamic Host Configuration Protocol) is communications that lets network administrators manage centrally and automate the assignment of Internet Protocol(IP) address in an organization's network.            *You can press 'Skip' button to skip wizard, the settings will not be saved.</small>				

**To enable NVR as DHCP Server:**

1. Check “Enable” if you want the NVR to serve as a DHCP Server and dynamically allocate IP addresses to the IP Camera(s) connected.
2. Enter the Starting and Ending IP Pool Addresses to define the IP Address range of the IP Camera(s).
3. Enter the “Lease Time”.
4. Enter the “Local Domain Name” for the NVR if you want to visit the NVR by its Local Domain Name within the LAN.

Click “Finish” to complete the settings, it takes about 60 seconds to reboot the system. Follow the on-screen instructions to install all software that your NVR requires.

## To Add a New IP Camera

1. Go to the “Advanced” page and click the menu “IPCam” → “Device Management”.
2. Click the “New” button to enter the “Device Information” window, and the NVR will automatically detect the IP Camera connected with its “Device Name”, “IP Address” and “Port”. You may click “Refresh” button to update connected device information.

Device Information				
<input type="button" value="UPnP"/> <input type="button" value="History"/> <input type="button" value="Manual"/>				
		Device Name	IP Address	Port
1	<input checked="" type="radio"/>	ipcam	192.168.10.214	80
	<input type="radio"/>			
	<input type="radio"/>			
	<input type="radio"/>			

3. To add IP cameras that were not detected, click the “Manual” button in the “Device Information” window to enter the “Add Device” window.

 **Information** There are two other ways to add IP Cameras:

- You may click “UPnP” button to automatically detect the connected IP Cameras, and select the IP Camera by clicking the radio button then click “Next” button to continue the settings.
- You may click “History” button to display the IP Cameras you had added previously in the “Device Management” list, and select the IP Camera by clicking the radio button then click “Next” button to continue the settings.

Add Device	
Device Name	<input type="text" value="ipcam"/>
Name	<input type="text" value="office"/>
User Name	<input type="text" value="admin"/>
Password	<input type="password" value="•••••"/>
Confirm Password	<input type="password" value="•••••"/>
IP Address	<input type="text" value="192"/> <input type="text" value="168"/> <input type="text" value="10"/> <input type="text" value="214"/>
WEB Port	<input type="text" value="80"/>

4. Enter the “Name” for the device and the name will show at the screen banner on “Live View”, “Record View”, “Motion Detection” page; enter the “Device Name”, “IP Address” and “WEB Port” of the IP Camera you’ve seen on the

“Device Information” page; enter the “User Name” and “Password” of the IP Camera. Enter the password again in “Confirm Password”.

5. Click “Next” to add the IP Camera information, and the “Connection Status” window will show the status of the IP Camera you just added.

Connection Status	
Name	office
Device Name	ipcam
IP Address	192.168.10.214:80
Status	PASS
<input type="button" value="close"/>	

## NVR Viewer Windows

### Language

After logging in, the “Live View” page will be displayed. You may choose the system language from the drop-down list.

### Live View

After logging in, the “Live View” page will show four camera screens, displaying the live video stream captured by the cameras. Double-click the bar at the top of desired camera window to display the desired channel.

There're a few buttons for you to control the functions of the camera and NVR.

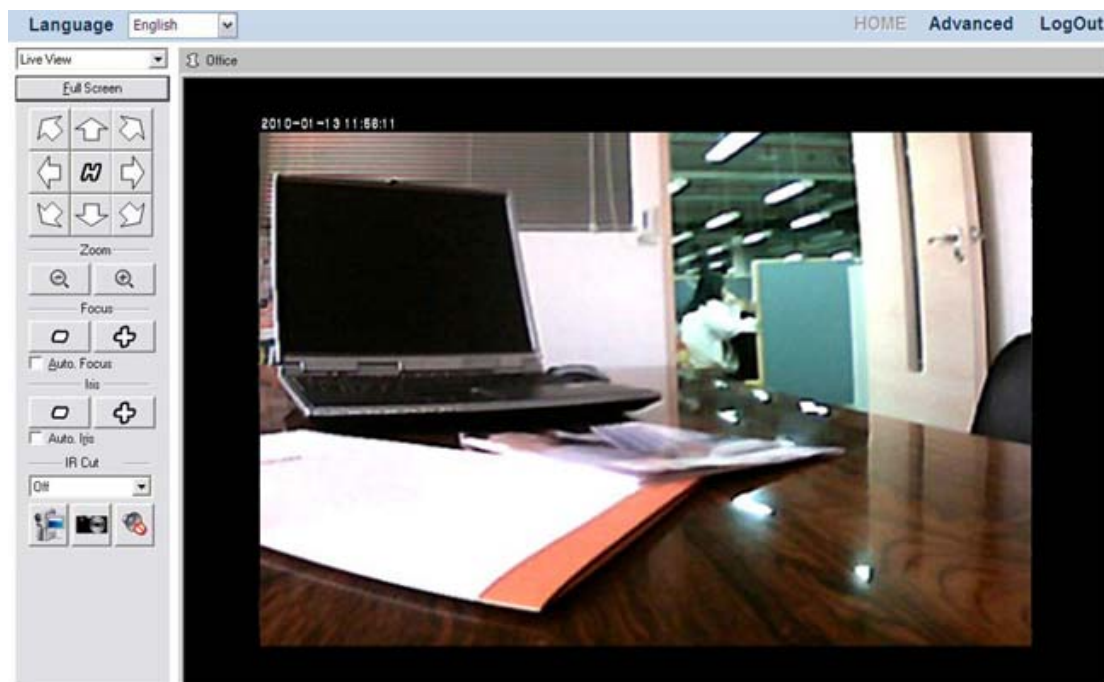



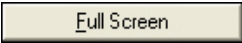







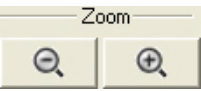

## To maximize the screen



Click on the “Full Screen” button  to maximize the camera window. Press the Alt + Esc buttons on the keyboard to exit the full screen.

## To control the camera viewer<sup>6</sup>

The buttons and their respective functions are shown in the following table:

Button	Function
	If you are using a PTZ network camera, the PTZ Setting button will be activated. Click on the button to make PTZ adjustment of the camera. By PTZ control, you may focus the network camera to a desired position.
	Click these arrow buttons to adjust the direction of the camera lens. Click  to reset the camera to its home position.
	Click  or  to zoom in or zoom out.
	Click  or  to adjust lens focus.
<input type="checkbox"/> <b>Auto. Focus</b>	Tick this checkbox to enable auto lens focus.
	Click  or  to adjust Iris levels.
<input type="checkbox"/> <b>Auto. Iris</b>	Tick this checkbox to enable auto Iris.
	If you set the “IR Cut” to “off”, the image is displayed in black & white. If you set the “IR Cut” to “Auto”, the camera will turn the filter off automatically when the surrounding light falls below the specific requirement.

## To manually record a video

1. Press down on the “Manual Record” button  to start the recording process.
2. Press up on the “Manual Record” button  again to stop the recording process.
3. The recorded video will be saved, and you may enter the “Record View” page by selecting “Record View” from the drop-down list to play the recorded video.

<sup>6</sup> The following functions are available only when the connected IP Camera is built with related functions.

## To take a snapshot

1. Click the “Snapshot” button  to capture the image shown in the current viewer.
2. A note will pop out telling you the saving folder and filename of the snapshot. You may go to the folder and find the snapshot picture. For Windows 7 users, you may browse your disk drives to select a desired saving folder in the dialog that opens.

## To enable Audio function

The “Audio” button  is available only when the connected IP Camera is built with related functions. Go to the “Advanced” page and click the menu “IPCam” → “Video Settings”, if the “Enable Audio” option is checked, you may click on the “Audio” button to enable or disable the audio function.

## Record View

Select “Record View” from the drop-down list to display the page of Record View.

### To select a normal record to play:



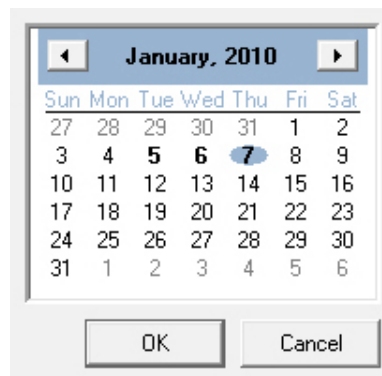

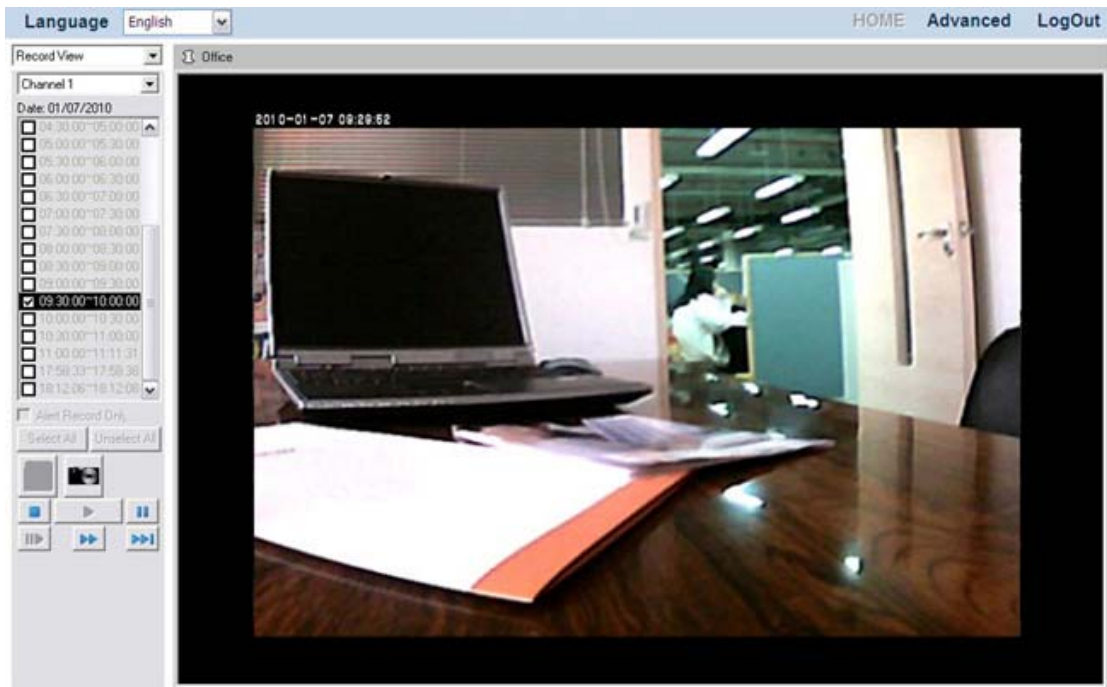

1. Select a desired Channel to configure settings. Click the  button to select a date from the popup window.



2. Click on the date you want to review in the calendar. The dates with video records are displayed in bold fonts. Click “OK” to confirm the selection.
3. Tick the checkbox to select the time period from the list on the left.
4. Click “Select All” to select all records, and click “Unselect All” to unselect all records. Click “PLAY” and the window will play the recorded video one by one.



5. Click the “Snapshot” button  and you may take a snapshot for the image displayed.
6. Click the buttons at the bottom of the Record View dialog to control the play of the videos. The buttons and their respective functions are shown in the following table:

	Play
	Stop
	Pause
	Fast Forward
	Jump to the next section of the recordings selected
	Move forward one image at a time

**To select an alarm record to play:**



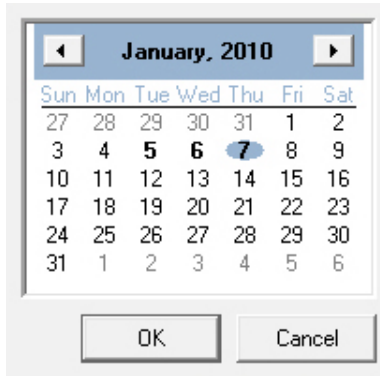

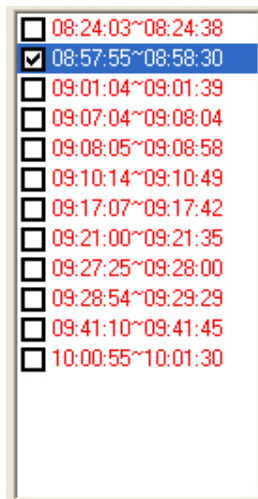

1. Select the “Alert Record Only” option.
2. Select a desired Channel to configure settings. Click the  button to select a date from the popup window.



3. Click on the date you want to review in the calendar. The dates with video records are displayed in bold fonts. Click “OK” to confirm the selection.
4. Tick the checkbox to select the time period from the list on the left.



5. Click “Select All” to select all records, and click “Unselect All” to unselect all records. Click “PLAY” and the window will play the recorded video one by one.
6. Click the “Snapshot” button  and you may take a snapshot for the image displayed.
7. Click the buttons at the bottom of the Record View dialog to control the play of the videos. The buttons and their respective functions are shown in the following table:

	Play
	Stop
	Pause
	Fast Forward
	Jump to the next section of the recordings selected
	Move forward one image at a time



## Motion Detection

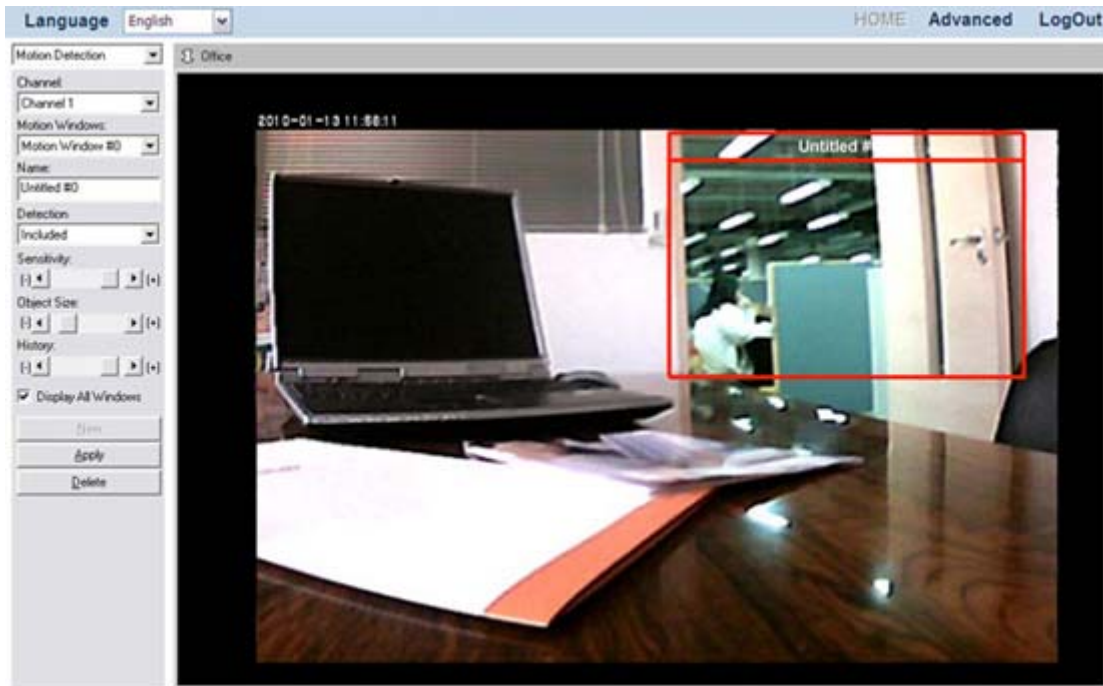

### To set motion detection conditions for each camera:

1. Select "Motion Detection" from the drop-down list to enter the Motion Detection page.
2. "Motion Detection" dialog will display on the left side. Select a desired Channel to configure settings.
3. From the "Motion Detection" dialog, select a desired Motion Window to configure settings.
  - If you don't see any motion detection frame in the camera window, click the "New" button in the "Motion Detection" dialog, and a red motion detection frame will be created with the name "Untitled #0" and you may configure settings for it.
  - If you see motion detection frames in the camera window, select a "Motion Windows" from the drop-down list in the "Motion Detection" dialog, and the motion window will be activated with red borders and you may configure settings for it.
4. Drag the red borders of the active Motion Window to define the window shape, size and position.
5. Enter the "Name" in the dialog.
6. In the "Detection" drop-down list, select "Included" if you want to detect the motion of the area within the frame, or "Excluded" if you want to detect the motion of the area outside the frame.
7. Adjust the sliders to define:
  - The color and luminance difference "Sensitivity" that will trigger the motion detection.

- The “Object Size” that will trigger the motion detection.
  - The “History” – the duration an object appears within the motion detection frame to trigger the motion detection.
8. Check “Display All Windows” to display all the motion windows in the camera view. Uncheck the option if you only want to see the active motion window.
  9. Click the “Delete” button to delete the active motion window.
  10. Please make sure to click the “Apply” button in order to save the changes you’ve made.



**Information**

The Motion Detection settings for a camera won't take effect until you configure Motion Detection as an Event Trigger for the camera. Please refer to the [Event Settings](#) section for more information.



## **Log out the NVR**

---

To exit the NVR page, click the “LogOut” button at the top right corner of the NVR's main page.



**Attention**

Please do NOT click on the  button on the Internet Explorer window to exit the NVR. Clicking on the  button will not change the logged-in status of the user.

## Chapter III. Advanced NVR Configuration

The administrator has the right to access all the NVR functions, and can make advanced configurations for the NVR according to the special needs.



The screenshot displays the PlusTek NVR configuration interface. At the top, there is a language dropdown set to 'English' and navigation links for 'HOME', 'Advanced', and 'LogOut'. The main content area is titled 'NVR IPCam' and is divided into three sections: 'SYSTEM', 'NETWORK', and 'SERVICES'. The 'SYSTEM' section includes fields for Device Name (NVR), Version (2.0.0.5), and IPCAM Driver (Network Camera 2.0.0.2). The 'NETWORK' section shows Connection Type (DHCP), IP Address (10.1.100.24), Subnet Mask (255.255.0.0), Default router (10.1.100.1), Primary DNS (10.1.1.30), and Secondary DNS (10.1.1.11). The 'SERVICES' section lists NTP, DDNS, SMTP, UPnP, and DHCP Server, all set to 'Disable' except for UPnP which is 'Enable'. A 'Hard Disk' section at the bottom shows a size of 320 GB and 20% usage. On the left side, a vertical menu contains buttons for 'Wizard', 'Status', 'Network', 'IPCam', 'Hard Disk', 'System', 'Database', 'Schedule Settings', and 'Security'.

### To enter the Advanced settings page:

1. Click the “Advanced” button on the main page banner to enter the advanced configuration page. On the left of the page shows the configuration menu. There are 9 menus available: “Wizard”, “Status”, “Network”, “IPCam”, “Hard Disk”, “System”, “Database”, “Scheduled Settings” and “Security”.
2. Click on each menu item to enter the submenus. You may configure settings according to your special need.

The following describes the menus individually and the related settings.

## Wizard

This Wizard will guide you through the basic settings to complete your initial setup fast and easy. Go to the “Advanced” page and click the menu “Wizard” to display the page of System Settings. You may define the “Device Name” for the NVR you use.

## Step 1 – System Settings

The screenshot shows the 'Step 1 - System Settings' configuration page. It includes a 'System' section with a 'Device Name' field containing 'NVR'. The 'Date & Time' section has a 'Time Zone' dropdown menu set to '(GMT-08:00) Pacific Time (US & Canada); Tijuana'. There are two radio buttons: 'Computer Time' (selected) and 'Set manually'. The 'Computer Time' section shows 'Date: 2010 / 3 / 31' and 'Time: 11:56:58'. The 'Set manually' section has empty input fields for Date and Time. At the bottom, there are 'Skip' and 'Next' buttons. A footer note states: '\*Click 'Skip' button to skip wizard, but the settings will not be saved.'

### To set NVR Date & Time:

1. Select Time Zone from the drop-down list.
2. You may set the NVR date and time by any of the following two ways:
  - a. Synchronize the NVR with the computer time.
  - b. Manually set the Date and Time by entering the Date and Time in the blanks.

Click “Next” to continue the settings.

## Step 2 – WAN Settings

The screenshot shows the 'Step 2 - WAN Settings' configuration page. It has two radio buttons: 'Obtain IP via DHCP' (selected) and 'Use the following IP'. The 'Use the following IP' section has input fields for IP address (10, 1, 100, 24), Subnet mask (255, 255, 0, 0), and Gateway (10, 1, 100, 1). The 'HTTP Port' section has a 'Port number' field with '80'. The 'DNS' section has two radio buttons: 'Obtain a DNS address automatically' (selected) and 'Use the following DNS address'. The 'Use the following DNS address' section has input fields for Primary DNS address and Secondary DNS address. At the bottom, there are 'Skip', 'Back', and 'Next' buttons. A footer note states: '\*TCP/IP (Transmission Control Protocol) is a set of rules (protocol) used along with the Internet Protocol (IP) to send data in the form of message units between computers over the Internet. While IP takes care of handling the actual delivery of the data, TCP takes care of keeping track of the individual units of data (called packets) that a message is divided into for efficient routing through the Internet. \*DNS(Domain Name System) is service that locates various Internet domain names and translates them into Internet Protocol address. DNS service may increase the responding speed and accuracy of specified web site. \*You can press 'Skip' button to skip wizard, the settings will not be saved.'

### To choose the IP allocation methods:

1. Select either DHCP or static IP:

- If you want your NVR to use a dynamic IP, select the “Obtain IP via DHCP” radio button and your NVR will be assigned with any idle IP address in your organization’s network.
- If you want your NVR to use a static IP, select the “Use the following IP” radio button and fill in the blanks for IP address, subnet mask and Gateway.

2. Enter the HTTP port if needed. The default port is 80.

**To enter the DNS address if needed:**

You may check “Obtain a DNS address automatically” radio button to obtain the DNS address automatically. If you want the NVR to use a host name, you’ll need to enter at least one (Primary) DNS address.

1. Enter the IP address of the “Primary DNS Address” provided by your ISP.
2. Enter the IP address of the “Secondary DNS Address” provided by your ISP.

Click “Next” to continue the settings.

**Step 3 – LAN Settings**

Step3 - LAN Settings				
IP Address	192	168	10	18
Subnet Mask	255	255	255	0
Gateway	192	168	10	254
DHCP Settings				
DHCP Server	<input type="checkbox"/> Enable			
* You can enable DHCP to dynamically allocate IP addresses to your client IPCam.				
IP Pool Starting Address	20			
IP Pool Ending Address	250			
Lease Time	Two hours			
Local Domain Name	NVR-4000			(optional)
<input type="button" value="Skip"/> <input type="button" value="Back"/> <input type="button" value="Finish"/>				
<small>*DHCP(Dynamic Host Configuration Protocol) is communications that lets network administrators manage centrally and automate the assignment of Internet Protocol(IP) address in an organization's network.            *You can press 'Skip' button to skip wizard, the settings will not be saved.</small>				

**To enable NVR as DHCP Server:**

1. Check “Enable” if you want the NVR to serve as a DHCP Server and dynamically allocate IP addresses to the IP Camera(s) connected.
2. Enter the Starting and Ending IP Pool Addresses to define the IP Address range of the IP Camera(s).
3. Enter the “Lease Time”.
4. Enter the “Local Domain Name” for the NVR if you want to visit the NVR by its Local Domain Name within the LAN.

Click “Finish” to complete the settings, it takes about 60 seconds to reboot the system. Follow the on-screen instructions to install all software that your NVR requires.

# Status

---

## NVR Status

SYSTEM	
Device Name	NVR
Version	2.0.0.5 (2010/01/02 19:48:34)
IPCAM Driver	Network Camera 2.0.0.2
NETWORK	
Connection Type	DHCP
IP Address	10.1.100.24
Subnet Mask	255.255.0.0
Default router	10.1.100.1
Primary DNS	10.1.1.30
Secondary DNS	10.1.1.11
SERVICES	
NTP	Disable
DDNS	Disable
SMTP	Disable
UPnP	Enable
DHCP Server	Disable
Hard Disk	
Size	320 GB
Use%	20%

### To view the current NVR status

Go to the “Advanced” page and click the menu “Status” → “NVR”, and the current status of the NVR will display on the right.

You can alter some of the settings shown in this sector from other menu items.

## IPCam Status

Channel 1	
Name	Office
Device name	ipcam
IP address : Port	192.168.10.214:80
Record : Off   Connect : On   Alarm : Off	
Channel 2	
Name	
Device name	
IP address : Port	
Channel 3	
Name	
Device name	
IP address : Port	
Channel 4	
Name	
Device name	
IP address : Port	

### To view the current IPCam status

Go to the “Advanced” page and click the menu “Status” → “IPCam”, and you’ll see the current status of the IP Camera(s) connected to your NVR. The NVR provides up to four channels to connect up to four IP Cameras. The list shows the information of the IP Cameras connected to respective channels.

## Network

---

### WAN

Go to the “Advanced” page and click the menu “Network” → “WAN”. In the WAN menu, you may configure the NVR’s WAN settings according to the network connection conditions and your special needs. You may select desired options from the drop-down list.

## TCP/IP

TCP/IP

Obtain IP via DHCP

Use the following IP

IP address: 10 . 1 . 100 . 24

Subnet mask: 255 . 255 . 0 . 0

Gateway: 10 . 1 . 100 . 1

**HTTP Port**

Port number: 80

**DNS**

Obtain a DNS address automatically

Use the following DNS address

Primary DNS address: [ ] . [ ] . [ ] . [ ]

Secondary DNS address: [ ] . [ ] . [ ] . [ ]

Submit

\*TCP/IP (Transmission Control Protocol) is a set of rules (protocol) used along with the Internet Protocol (IP) to send data in the form of message units between computers over the Internet. While IP takes care of handling the actual delivery of the data, TCP takes care of keeping track of the individual units of data (called packets) that a message is divided into for efficient routing through the Internet.

\*DNS(Domain Name System) is service that locates various Internet domain names and translates them into Internet Protocol address. DNS service may increase the responding speed and accuracy of specified web site.

### To choose the IP allocation methods:

1. Go to the “Advanced” page and click the menu “Network” → “WAN” → “TCP/IP”.
2. Select either DHCP or static IP:
  - If the NVR adopts dynamic IP, check “Obtain IP via DHCP” radio button, and your NVR will be assigned with any idle IP address in your organization’s network.
  - If the NVR uses static IP, check “Use the following IP” radio button, and fill in the blanks of IP address, subnet mask and Gateway.
3. Enter the HTTP port if needed. The default port is 80.

### To enter the DNS address if needed:

You may check “Obtain a DNS address automatically” radio button to obtain the DNS address automatically. If you want the NVR to use a host name, you’ll need to enter at least one (Primary) DNS address.

1. Enter the IP address of the “Primary DNS Address” provided by your ISP.
2. Enter the IP address of the “Secondary DNS Address” provided by your ISP.



## DDNS

DDNS <span>▼</span>	
The NVR acts as DDNS Service	<input type="checkbox"/> Enable
DDNS Server	members.dyndns.org
User Name	<input type="text"/>
Password	<input type="text"/>
Host Name	<input type="text"/>
Status	
<input type="button" value="Submit"/>	

### To configure DDNS settings:

1. Go to the “Advanced” page and click the menu “Network” → “WAN” → “DDNS”.
2. If you want the NVR to act as DDNS Service, click “Enable”.
3. Enter the address of “DDNS Server”, “User Name”, “Password”, and “Host Name”.
4. Click “Submit” to save the setting.

## SMTP

SMTP <span>▼</span>				
Priority		Name	Sender Address	Mail Server
1	<input checked="" type="radio"/>	Mary Lo	marylo@123.com	smtp.123.com
2	<input type="radio"/>			
3	<input type="radio"/>			
4	<input type="radio"/>			
<input type="button" value="Add"/> <input type="button" value="Edit"/> <input type="button" value="Delete"/>				<input type="button" value="UP"/> <input type="button" value="DOWN"/>
<small>*SMTP(Simple Mail Transfer Protocol) is a TCP/IP Protocol used in sending and receiving e-mail. However, since it is limited in its ability to queue messages at the receiving end, it is usually used with one of two other Protocol, POP3 or IMAP, that let the user save messages in server mailbox and download them periodically from the server. In other words, users typically use a program the uses SMTP for sending email and either POP3 or IMAP for receiving e-mail.</small>				

Go to the “Advanced” page and click the menu “Network” → “WAN” → “SMTP”. In this menu you can configure several email addresses. The NVR can automatically send alarm messages from the configured email addresses when an event is triggered. (See [Event Settings](#) for more information about automated email alert.)

### To add email addresses:

1. Go to the “Advanced” page and click the menu “Network” → “WAN” → “SMTP”.
2. Click the “Add” button and enter the SMTP information in this page.

SMTP	
Name	<input type="text" value="Mary Lo"/>
Sender Address	<input type="text" value="marylo@123.com"/>
Mail Server	<input type="text" value="smtp.123.com"/>
User Name	<input type="text" value="marylo"/>
Password	<input type="password" value="••••••"/>
Confirm Password	<input type="password" value="••••••"/>
<input type="button" value="Submit"/> <input type="button" value="Cancel"/>	

3. Enter the “Name”, “Sender Address”, “Mail Server”, “User Name” and “Password” of the email account. Enter the password again in “Confirm Password”.
4. Click “Submit” to save the setting.

**To set the priority for the email addresses:**

1. Go to the “Advanced” page and click the menu “Network” → “WAN” → “SMTP”.
2. When more than one email address has been added, you may click on the radio button in front of a sender address and click “UP” or “DOWN” button to move the email address’s priority in the list.

**FTP**

FTP			
Priority	Name	Server	Directory Path
1	FTP	ftp.xyz.org	NVR
2			
3			
4			

In this page you can configure several FTP servers. The NVR can automatically send recorded images to the configured FTP server when an event is triggered. (See [Event Settings](#) for more information about automated uploading images to the FTP server.)

**To add an FTP Server:**

1. Go to the “Advanced” page and click the menu “Network” → “WAN” → “FTP”.
2. Click “Add” button and enter the FTP server information in this page.

FTP Server	
Connection Name	<input type="text" value="FTP"/>
Server	<input type="text" value="ftp.xyz.org"/>
User Name	<input type="text" value="Mary Lo"/>
Password	<input type="password" value="•••••"/>
Confirm Password	<input type="password" value="•••••"/>
Server Directory	<input type="text" value="NVR"/>
<input type="button" value="Submit"/> <input type="button" value="Cancel"/>	

- Enter the following information:
  - Connection Name: Enter the name for this FTP Server, e.g. FTP.
  - Server: Enter the address of this FTP Server, e.g. [ftp.xyz.org](http://ftp.xyz.org) or 10.1.100.62.
  - User Name: Enter your user name to log in with, e.g. Mary Lo.
  - Password: Enter the password to log in with, e.g. 157639.
  - Confirm Password: Enter the password again.
  - Server Directory: Enter the directory path on the FTP server to save the files in, e.g. NVR.
- Click "Submit" to save the settings.

### To set the priority for the FTP Servers:

- Go to the "Advanced" page and click the menu "Network" → "WAN" → "FTP".
- When more than one FTP Server has been added, you may click on the radio button in front of a FTP Server Name and use "UP" "DOWN" button to change the FTP Server's priority in the list.

## LAN

LAN Settings	
IP Address	<input type="text" value="192"/> <input type="text" value="168"/> <input type="text" value="10"/> <input type="text" value="18"/>
Subnet Mask	<input type="text" value="255"/> <input type="text" value="255"/> <input type="text" value="255"/> <input type="text" value="0"/>
Gateway	<input type="text" value="192"/> <input type="text" value="168"/> <input type="text" value="10"/> <input type="text" value="254"/>
DHCP Settings	
DHCP Server	<input checked="" type="checkbox"/> Enable
* You can enable DHCP to dynamically allocate IP addresses to your client IPCam.	
IP Pool Starting Address	<input type="text" value="192.168.10."/> <input type="text" value="20"/>
IP Pool Ending Address	<input type="text" value="192.168.10."/> <input type="text" value="250"/>
Lease Time	<input type="text" value="Two hours"/> <input type="button" value="v"/>
Local Domain Name	<input type="text" value="NVR-4000"/> (optional)
<input type="button" value="Submit"/>	
<small>*DHCP(Dynamic Host Configuration Protocol) is communications that lets network administrators manage centrally and automate the assignment of Internet Protocol(IP) address in an organization's network.</small>	

### To enable NVR as DHCP Server:

1. Go to the “Advanced” page and click the menu “Network” → “LAN”.
2. Check “Enable” if you want the NVR to serve as a DHCP Server and dynamically allocate IP addresses to the IP Camera(s) connected.
3. Enter the Starting and Ending IP Pool Addresses to define the IP Address range of the IP Camera(s).
4. Enter the “Lease Time”.
5. Enter the “Local Domain Name” for the NVR if you want to visit the NVR by its Local Domain Name within the LAN.

### Client List

ID	IP	MAC	Name
1	192.168.10.4	00:40:8C:78:63:0D	Office

Refresh

### To view the current DHCP Client List

Go to the “Advanced” page and click the menu “Network” → “Client List”, and you’ll see the current list of the IP Camera(s) connected to your NVR via DHCP (dynamic IP). Note that the IP Camera(s) connected to your NVR via fixed IP address will not be listed on this page. The DHCP Client List menu displays the IP addresses, MAC addresses and the names of the IP cameras via the DHCP connection. In addition, after you connect a new IP camera to the NVR via DHCP, you may click “Refresh” in this page to renew the DHCP Client List.

### IPCam

---

In this menu, you can configure the setting for the IP Cameras connected to your NVR.

## Device Management

Channel	Name	Device Name (Source)	IP Address : Port	Status	
1	<input checked="" type="radio"/>	office	ipcam(N)	192.168.10.214:80	Connect
2	<input type="radio"/>				
3	<input type="radio"/>				
4	<input type="radio"/>				

New Edit Delete Restore Restart

### To add a new IP Camera

1. Go to the “Advanced” page and click the menu “IPCam” → “Device Management”.
2. Click the “New” button to enter the “Device Information” window, and the NVR will automatically detect the IP Camera connected with its “Device Name”, “IP Address” and “Port”. You may click “Refresh” button to update connected device information.

Device Information				
UPnP History Manual				
		Device Name	IP Address	Port
1	<input checked="" type="radio"/>	ipcam	192.168.10.214	80
	<input type="radio"/>			
	<input type="radio"/>			
	<input type="radio"/>			

Back Next Cancel Refresh

3. To add IP cameras that were not detected, click the “Manual” button in the “Device Information” window to enter the “Add Device” window.



**Information**

There are two other ways to add IP Cameras:

- You may click “UPnP” button to automatically detect the connected IP Cameras, and select the IP Camera by clicking the radio button then click “Next” button to continue the settings.
- You may click “History” button to display the IP Cameras you had added previously in the “Device Management” list, and select the IP Camera by clicking the radio button then click “Next” button to continue the settings.

Add Device	
Device Name	<input type="text" value="ipcam"/>
Name	<input type="text" value="office"/>
User Name	<input type="text" value="admin"/>
Password	<input type="password" value="*****"/>
Confirm Password	<input type="password" value="*****"/>
IP Address	<input type="text" value="192"/> <input type="text" value="168"/> <input type="text" value="10"/> <input type="text" value="214"/>
WEB Port	<input type="text" value="80"/>
<input type="button" value="Back"/> <input type="button" value="Next"/>	

4. Enter the “Name” for the device and the name will show at the screen banner on “Live View”, “Record View”, “Motion Detection” page; enter the “Device Name”, “IP Address” and “WEB Port” of the IP Camera you’ve seen on the “Device Information” page; enter the “User Name” and “Password” of the IP Camera. Enter the password again in “Confirm Password”.
5. Click “Next” to add the IP Camera information, and the “Connection Status” window will show the status of the IP Camera you just added.

Connection Status	
Name	office
Device Name	ipcam
IP Address	192.168.10.214:80
Status	PASS
<input type="button" value="close"/>	

### To change the IP Camera information

Channel	Name	Device Name (Source)	IP Address : Port	Status
1	<input checked="" type="radio"/> office	ipcam(N)	192.168.10.214:80	Connect
2	<input type="radio"/>			
3	<input type="radio"/>			
4	<input type="radio"/>			
<input type="button" value="New"/> <input type="button" value="Edit"/> <input type="button" value="Delete"/> <input type="button" value="Restore"/> <input type="button" value="Restart"/>				

1. In the Device Management window, you may select the IP Camera by clicking the radio button before its name.
2. You may click the “Edit” button to edit the Name of the IP Camera.
3. You may click the “Delete” button to delete the IP Camera.
4. You may click the “Restore” button to restore the IP Camera to its factory default values.
5. You may click the “Restart” button to restart the IP Camera.

## Video Settings

office ▼	
<b>Image Appearance</b>	
Video format	JPEG ▼
Resolution	4CIF ▼
Quality	High ▼
Rotate image	0 ▼ degrees
Color level	50 [0..100]
Brightness	50 [0..100]
Sharpness	50 [0..100]
<b>Display Setting</b>	
Camera Selection :	Auto ▼ 10 ▼ lux
<b>Audio Settings</b>	
<input checked="" type="checkbox"/> Enable audio	
Source	Line in ▼
<input checked="" type="checkbox"/> Enable microphone power. If your microphone is dynamic or battery powered, this should be off.	
<b>Overlay Settings</b>	
<input checked="" type="checkbox"/> Include date / time	
<input type="checkbox"/> Include text	<input type="text"/>
Place text/date/time at	top ▼ of image
Frame rate	<input type="radio"/> Unlimited <input checked="" type="radio"/> Limited to 10 fps [ 1~30 ]
<input type="button" value="Submit"/> <input type="button" value="Preview"/>	

### To set video display:

1. Go to the “Advanced” page and click the menu “IPCam” → “Video Settings”.
2. Select the camera you want to adjust the video settings for from the drop-down list.
3. In “Image Appearance” section, you may adjust the Video format, Resolution, Quality, Rotation angle, Color saturation, Brightness, and Sharpness for the video image displayed by the camera.
4. In the “Display Setting” section, you can configure the lens operation modes of the connected IP Camera.



#### Attention

The “Display Setting” function is available only when the connected IP Camera is built with related lens functions.

- If you select “Right” from the drop-down list, it displays the image recorded by the right-side lens of the connected IP Camera.
- If you select “Left”, it displays the video recorded by the left-side lens of the connected IP Camera.
- If you select “Both”, it horizontally displays the videos recorded by both lenses of the connected IP Camera.

- If you select “RiL”, the video recorded by the right-side lens of the connected IP Camera is displayed on the full monitor screen while a small video recorded by the left-side lens is displayed in an inset window.
  - If you select “LiR”, the video recorded by the left-side lens of the connected IP Camera is displayed on the full monitor screen while a small video recorded by the right-side lens is displayed in an inset window.
  - If you select “Auto”, the connected IP Camera will be activated to detect the lighting in the environment and determine the “lux” level of the detected light. You can select a desired “lux” level from the “lux” drop-down list.
5. In the “Audio Settings” section, you may adjust the audio settings.



**Attention**

The “Audio Settings” function is available only when the connected IP Camera is built with related functions.

6. In the “Overlay Settings” section, you can add some text information to the video image, such as Date/time and a text title. You may choose Top or Bottom from the drop-down list to display the information at the top or bottom of the image. The text information will be shown in live view, snapshot and recorded video.
7. Enter the camera frame rates. The frame rates may range from 1 to 30 fps.
8. Click “Submit” to save the settings.
9. Click “Preview” to preview the video settings you have made.

**To estimate recording capacity:**

Actual recording capacity may differ depending on the hard disk size, the image quality and the record **Frame rate**. For example, NVR hard disk is 320GB and you want to record one channel 24 hours a day. If you set the image quality at **Normal** quality (the image size is about 48 KB) and the record **Frame rate** at 10 fps, you may approximately record about 7.72 days.

Disk data recording chart (approximately)

Frame rate	Quality (Image quality)	Hard disk capacity (days)						
		250GB	320GB	500GB	750GB	1000GB	1250GB	1500GB
10 fps (frames per second)	<b>High</b> (96KB)	3.02	3.86	6.03	9.04	12.06	15.07	18.08
	<b>Normal</b> (48KB)	6.03	7.72	12.06	18.08	24.11	30.14	36.17
	<b>Low</b> (24KB)	12.06	15.44	24.12	36.16	48.22	60.28	72.34

Notes:

- Recording conditions: 1 channel, recording time: 24 hours/day.
- All above figures are estimates, actual figures may differ depending on the complexity of the real situation.



## Hard Disk

---

Size	320 GB
Status	PASS
<input type="button" value="Format"/>	

Go to the “Advanced” page and click the menu “Hard Disk” to check the size and status of the hard disk.

If you want to format the hard disk, you can click on the “Format” button, but please note that all the data in the hard disk will be formatted.

## System

---

### Users

User ID	User Name	Password	Re-type Password
Administrator	<input type="text" value="admin"/>	<input type="password" value="....."/>	<input type="password" value="....."/>
1 <input type="button" value="Operator"/> ▾	<input type="text" value="operator"/>	<input type="password" value="....."/>	<input type="password" value="....."/>
2 <input type="button" value="General User"/> ▾	<input type="text" value="user"/>	<input type="password" value="....."/>	<input type="password" value="....."/>
3 <input type="button" value="Top User"/> ▾	<input type="text" value="topustr"/>	<input type="password" value="....."/>	<input type="password" value="....."/>
4 <input type="button" value="Operator"/> ▾	<input type="text"/>	<input type="password"/>	<input type="password"/>
5 <input type="button" value="Operator"/> ▾	<input type="text"/>	<input type="password"/>	<input type="password"/>
6 <input type="button" value="Operator"/> ▾	<input type="text"/>	<input type="password"/>	<input type="password"/>
7 <input type="button" value="Operator"/> ▾	<input type="text"/>	<input type="password"/>	<input type="password"/>
8 <input type="button" value="Operator"/> ▾	<input type="text"/>	<input type="password"/>	<input type="password"/>
9 <input type="button" value="Operator"/> ▾	<input type="text"/>	<input type="password"/>	<input type="password"/>
<input type="button" value="Submit"/>			

Go to the “Advanced” page and click the menu “System” → “Users” to display the Users page. We offer an Administrator account with the User Name “admin” and default Password “admin”. Please change the administrator’s password to avoid unauthorized usage.

The “administrator” can add several “General Users”, “Operators” or “Top Users”. A “General User” is only authorized to view the live video of the cameras in the “Live View” page. An “Operator” and a “Top User” are authorized to view the video of the cameras in the “Live View”, “Record View”, “Motion Detection” page and is also allowed to view the settings in “Advanced” pages, but is not allowed to change settings. A “Top User” is allowed to control the camera viewer. The “Administrator” has access right to all the functions of the NVR in the “Live View”, “Record View”, “Motion Detection” and “Advanced” pages.

The following table lists the privilege right of different user accounts:

User Privilege	General User	Operator	Top User	Administrator
View "Live View" page	O	O	O	O
Select "Language"	O	O	O	O
Control camera viewer	X	X	O	O
View "Record View" page	X	O	O	O
View "Motion Detection" page	X	O	O	O
Modify "Motion Detection" page	X	X	X	O
View "Advanced" page	X	O	O	O
Modify "Advanced" page	X	X	X	O

## Maintenance

Current Version : 2.0.1.0 (2010/02/09 17:01:05) www.plustek.com

**Update firmware**

Specify the firmware to upgrade to :

*Note : Do not disconnect power to unit during the upgrade . The unit restarts automatically after the upgrade has completed .*

**Backup settings**

Save all parameters and user-defined scripts to backup file .

**Restore settings**

Use a saved backup file to return the unit to a previous configuration specify the backup file to use :

**Reset to default**

Reset all parameters to the original factory settings

Except network settings (By checking this box, the preset network setting will not be changed.)

**System restart**

Restart the NVR

**Power off**

Shutdown the NVR

Go to the "Advanced" page and click the menu "System" → "Maintenance" to display the Maintenance page. In the Maintenance page, you may update firmware, backup and restore settings, reset, restart, or turn off the NVR system.

### Update firmware

#### To update the NVR firmware:

1. Click on the "Browse" button to find the latest firmware you have downloaded.
2. Click on the "Upgrade" button to load the firmware in your NVR and the upgrade will start automatically.
3. The NVR system will automatically restart after the update is complete.

### Backup settings

#### To backup the current settings:

Click on the “Backup” button to backup all the settings you’ve made in the NVR system, and a window will pop up asking you to save the backup file. You may choose a saving folder for the backup file.

## Restore settings

### To restore previous settings:

You may restore the NVR to previous settings by loading a saved backup file. (See the above [Backup settings](#) section for more information on how to backup system settings.)

1. Click on the “Browse” button to find the backup file you have saved.
2. Click the “Restore” button and the restoration will start automatically.
3. The system will restart after the restoration is complete.

## Reset to default

Click the “Default” button and you will reset the NVR to the default factory settings. If the “Except network settings” option is checked, the settings in both [LAN](#) and the [TCP/IP](#) pages will not be changed to default settings after you reset the NVR.

## System restart

Click the “Restart” button to restart the NVR.

## Power off

You may turn off the NVR by clicking the “Power off” button.

## Log

Time	Information
2010/01/13 15:39:44	admin : Login
2010/01/13 15:39:25	admin : Logout
2010/01/13 15:32:07	admin : Login
2010/01/13 15:24:37	admin : Logout
2010/01/13 15:13:10	admin : Login
2010/01/13 15:13:05	admin : Logout
2010/01/13 14:55:03	guest : Login
2010/01/13 14:55:01	guest : Logout
2010/01/13 14:53:03	admin : Login
2010/01/13 14:52:58	admin : Logout
2010/01/13 14:52:52	admin : Login
2010/01/13 11:59:31	System Boot
2010/01/13 11:56:58	admin : Login
2010/01/13 11:56:52	admin : Logout
2010/01/13 11:51:28	admin : Login
2010/01/13 11:48:47	admin : Logout

Page 1 2 3 4 5 6 7 8 9 10 >|

Go to the “Advanced” page and click the menu “System” → “Log” to display the Log page. The Log page keeps a record on the settings or change made in the NVR system.

## System Settings

Device Name	NVR
<b>UPnP</b>	
The NVR acts as UPnP Service	<input checked="" type="checkbox"/> Enable
<b>Set Time Zone</b>	
Time Zone	(GMT-08:00) Pacific Time (US & Canada); Tijuana
<input type="checkbox"/> Automatically adjust for daylight saving time changes.	
<input type="button" value="Submit"/>	

Go to the “Advanced” page and click the menu “System” → “System Settings” to display the page of System Settings. You may define the “Device Name” for the NVR you use.

### To enable UPnP:

Check “Enable” if you want the NVR to act as UPnP service. And you’ll be able to visit the NVR from “My Network Places”.

### To set Time Zone:

1. Select Time Zone from the drop-down list.
2. Check the “Automatically adjust for daylight saving time changes” option if needed.

Click “Submit” to save the settings.

## Date & Time

System Time	2010/03/31 21:58:33	
Time Zone	(GMT-08:00) Pacific Time (US & Canada); Tijuana	
<b>Time Synchronization Method</b>		
<input checked="" type="radio"/> NTP Time		
	<input checked="" type="radio"/> NTP Server	time.stdtime.gov.tw
	<input type="radio"/> NTP Server	<input type="text"/> (host name or IP address)
<input type="radio"/> Computer Time	Date : 2010 / 4 / 1	Time : 13:57:56
<input type="radio"/> Set manually	Date : <input type="text"/> / <input type="text"/> / <input type="text"/>	Time : <input type="text"/> : <input type="text"/> : <input type="text"/>
<input type="button" value="Submit"/>		

Go to the “Advanced” page and click the menu “System” → “Date & Time” to display the page of Date & Time. You may set the date and time of the NVR. When the time is set, the connected network cameras will automatically synchronize the time with the NVR and will show in four channels interface and recorded videos.

### To set NVR Date & Time:

1. You may set the NVR date and time by any of the following three ways:
  - a. Synchronize the NVR date and time with NTP (Network Time Protocol) time. Select the NTP Server you want to use.
  - b. Synchronize the NVR with the computer time.
  - c. Manually set the Date and Time by entering the Date and Time in the blanks.
2. Click the “Submit” button to save the setting.

## Database

---

### Management

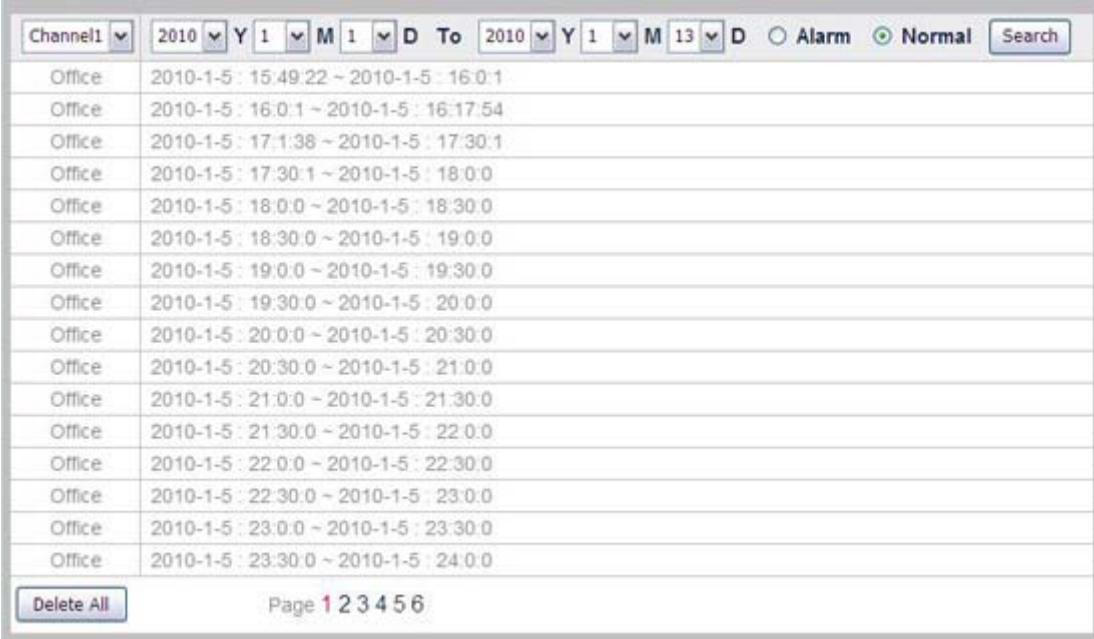

Channel	Date	Time	Alarm/Normal
Office	2010-1-5	15:49:22 ~ 2010-1-5 : 16:0:1	<input type="radio"/> Alarm <input checked="" type="radio"/> Normal
Office	2010-1-5	16:0:1 ~ 2010-1-5 : 16:17:54	<input type="radio"/> Alarm <input checked="" type="radio"/> Normal
Office	2010-1-5	17:1:38 ~ 2010-1-5 : 17:30:1	<input type="radio"/> Alarm <input checked="" type="radio"/> Normal
Office	2010-1-5	17:30:1 ~ 2010-1-5 : 18:0:0	<input type="radio"/> Alarm <input checked="" type="radio"/> Normal
Office	2010-1-5	18:0:0 ~ 2010-1-5 : 18:30:0	<input type="radio"/> Alarm <input checked="" type="radio"/> Normal
Office	2010-1-5	18:30:0 ~ 2010-1-5 : 19:0:0	<input type="radio"/> Alarm <input checked="" type="radio"/> Normal
Office	2010-1-5	19:0:0 ~ 2010-1-5 : 19:30:0	<input type="radio"/> Alarm <input checked="" type="radio"/> Normal
Office	2010-1-5	19:30:0 ~ 2010-1-5 : 20:0:0	<input type="radio"/> Alarm <input checked="" type="radio"/> Normal
Office	2010-1-5	20:0:0 ~ 2010-1-5 : 20:30:0	<input type="radio"/> Alarm <input checked="" type="radio"/> Normal
Office	2010-1-5	20:30:0 ~ 2010-1-5 : 21:0:0	<input type="radio"/> Alarm <input checked="" type="radio"/> Normal
Office	2010-1-5	21:0:0 ~ 2010-1-5 : 21:30:0	<input type="radio"/> Alarm <input checked="" type="radio"/> Normal
Office	2010-1-5	21:30:0 ~ 2010-1-5 : 22:0:0	<input type="radio"/> Alarm <input checked="" type="radio"/> Normal
Office	2010-1-5	22:0:0 ~ 2010-1-5 : 22:30:0	<input type="radio"/> Alarm <input checked="" type="radio"/> Normal
Office	2010-1-5	22:30:0 ~ 2010-1-5 : 23:0:0	<input type="radio"/> Alarm <input checked="" type="radio"/> Normal
Office	2010-1-5	23:0:0 ~ 2010-1-5 : 23:30:0	<input type="radio"/> Alarm <input checked="" type="radio"/> Normal
Office	2010-1-5	23:30:0 ~ 2010-1-5 : 24:0:0	<input type="radio"/> Alarm <input checked="" type="radio"/> Normal

Go to the “Advanced” page and click the menu “Database” → “Management” to display the Management page.

### To view the management records:

The list shows the Management log you have done for a certain channel in a period of time.

1. Select the Channel from the drop-down list.
2. Define the time period by selecting the time period in “Y/M/D To Y/M/D” drop-down lists.
3. Check “Alarm” or “Normal” radio button to display the desired records. Click the “Search” button, and the list below will show the Management log you have done for the channel during that period.

## Alarm Data Management

Retain the data according to the preset time frame.	
Retain the data for	<input type="text" value="30"/> day(s) (10 to 90)
Retain the data according to the available disk space.	
Maximum available hard disk space	<input type="text" value="50"/> GB (5 to 50)
<input type="button" value="Submit"/>	
<p>*Enter the number of days or the amount of hard drive space that you wish to retain your recorded surveillance data up to.</p> <p>*Note : This function is only available for event trigger recordings. Auto-recordings will overlap itself, once the hard disk is full.</p>	

Go to the “Advanced” page and click the menu “Database”→ “Alarm Data Management” and the “Alarm Data Management” page displays. You can decide how to retain the alarm images after a triggered event. Enter the number of days or the amount of hard drive space that you wish to retain your recorded surveillance data up to.

Note: This function is only available for event trigger recordings. Auto-recordings will overlap itself, once the hard disk is full.

### To configure Data Management settings:

1. “Retain the data according to the preset time frame.”: you are able to retain your alarm images for **10-90** days.
2. “Retain the data according to the available disk space.”: set the maximum available hard drive space from **5 to 50** GB. With the increased alarm images, when the available disk space is reaching the value set, the existing alarm images will be deleted from the hard drive.
3. Click “Submit” button to save the settings.

## Schedule Settings

### Record Schedule

<input type="button" value="office"/>		
Schedule	Active	Time Table (00:00 to 24:00)
No 1	<input checked="" type="checkbox"/>	Start Time : <input type="text" value="08"/> h <input type="text" value="30"/> m - End Time : <input type="text" value="17"/> h <input type="text" value="30"/> m <input checked="" type="checkbox"/> Mon <input checked="" type="checkbox"/> Tue <input checked="" type="checkbox"/> Wed <input checked="" type="checkbox"/> Thu <input checked="" type="checkbox"/> Fri <input type="checkbox"/> Sat <input type="checkbox"/> Sun
No 2	<input type="checkbox"/>	Start Time : <input type="text" value="0"/> h <input type="text" value="0"/> m - End Time : <input type="text" value="24"/> h <input type="text" value="0"/> m <input type="checkbox"/> Mon <input type="checkbox"/> Tue <input type="checkbox"/> Wed <input type="checkbox"/> Thu <input type="checkbox"/> Fri <input type="checkbox"/> Sat <input type="checkbox"/> Sun
No 3	<input type="checkbox"/>	Start Time : <input type="text" value="0"/> h <input type="text" value="0"/> m - End Time : <input type="text" value="24"/> h <input type="text" value="0"/> m <input type="checkbox"/> Mon <input type="checkbox"/> Tue <input type="checkbox"/> Wed <input type="checkbox"/> Thu <input type="checkbox"/> Fri <input type="checkbox"/> Sat <input type="checkbox"/> Sun
No 4	<input type="checkbox"/>	Start Time : <input type="text" value="0"/> h <input type="text" value="0"/> m - End Time : <input type="text" value="24"/> h <input type="text" value="0"/> m <input type="checkbox"/> Mon <input type="checkbox"/> Tue <input type="checkbox"/> Wed <input type="checkbox"/> Thu <input type="checkbox"/> Fri <input type="checkbox"/> Sat <input type="checkbox"/> Sun
No 5	<input type="checkbox"/>	Start Time : <input type="text" value="0"/> h <input type="text" value="0"/> m - End Time : <input type="text" value="24"/> h <input type="text" value="0"/> m <input type="checkbox"/> Mon <input type="checkbox"/> Tue <input type="checkbox"/> Wed <input type="checkbox"/> Thu <input type="checkbox"/> Fri <input type="checkbox"/> Sat <input type="checkbox"/> Sun
No 6	<input type="checkbox"/>	Start Time : <input type="text" value="0"/> h <input type="text" value="0"/> m - End Time : <input type="text" value="24"/> h <input type="text" value="0"/> m <input type="checkbox"/> Mon <input type="checkbox"/> Tue <input type="checkbox"/> Wed <input type="checkbox"/> Thu <input type="checkbox"/> Fri <input type="checkbox"/> Sat <input type="checkbox"/> Sun
<input type="button" value="Submit"/> <input type="button" value="clear"/>		

Go to the “Advanced” page and click the menu “Schedule Settings” → “Record Schedule” to configure schedule settings.

**To pre-set the record schedule for each individual camera:**

1. Select the camera from the drop-down list.
2. Select the “Start Time” and “End Time” for the NVR to record during one day. Select the day (or days) of the week. For example, you can enable the recording from 6 pm to 12 pm for every day of the week.
3. Select a preset record schedule setting and click the checkbox of “Active” to activate the record schedule.
4. You may set up to 6 settings from “No 1” to “No 6”.
5. Click the “Submit” button to save the settings for the camera.



For security reasons, you may schedule the recording 24 hours a day and 7 days a week.

**Information**

**Event Schedule**

office ▾		
Schedule	Active	Time Table (00:00 to 24:00)
No 1	<input checked="" type="checkbox"/>	Start Time : 08 h 30 m - End Time : 17 h 30 m <input checked="" type="checkbox"/> Mon <input checked="" type="checkbox"/> Tue <input checked="" type="checkbox"/> Wed <input checked="" type="checkbox"/> Thu <input checked="" type="checkbox"/> Fri <input type="checkbox"/> Sat <input type="checkbox"/> Sun
No 2	<input type="checkbox"/>	Start Time : 0 h 0 m - End Time : 24 h 0 m <input type="checkbox"/> Mon <input type="checkbox"/> Tue <input type="checkbox"/> Wed <input type="checkbox"/> Thu <input type="checkbox"/> Fri <input type="checkbox"/> Sat <input type="checkbox"/> Sun
No 3	<input type="checkbox"/>	Start Time : 0 h 0 m - End Time : 24 h 0 m <input type="checkbox"/> Mon <input type="checkbox"/> Tue <input type="checkbox"/> Wed <input type="checkbox"/> Thu <input type="checkbox"/> Fri <input type="checkbox"/> Sat <input type="checkbox"/> Sun
No 4	<input type="checkbox"/>	Start Time : 0 h 0 m - End Time : 24 h 0 m <input type="checkbox"/> Mon <input type="checkbox"/> Tue <input type="checkbox"/> Wed <input type="checkbox"/> Thu <input type="checkbox"/> Fri <input type="checkbox"/> Sat <input type="checkbox"/> Sun
No 5	<input type="checkbox"/>	Start Time : 0 h 0 m - End Time : 24 h 0 m <input type="checkbox"/> Mon <input type="checkbox"/> Tue <input type="checkbox"/> Wed <input type="checkbox"/> Thu <input type="checkbox"/> Fri <input type="checkbox"/> Sat <input type="checkbox"/> Sun
No 6	<input type="checkbox"/>	Start Time : 0 h 0 m - End Time : 24 h 0 m <input type="checkbox"/> Mon <input type="checkbox"/> Tue <input type="checkbox"/> Wed <input type="checkbox"/> Thu <input type="checkbox"/> Fri <input type="checkbox"/> Sat <input type="checkbox"/> Sun
<input type="button" value="Submit"/> <input type="button" value="clear"/>		

Go to the “Advanced” page and click the menu “Schedule Settings” > “Event Schedule” to configure schedule settings.

**To pre-set the event schedule for each individual camera:**

1. Select the camera from the drop-down list.
2. Select the “Start Time” and “End Time” for the NVR to record the configured events during one day. Select the day (or days) of the week. For example, you can enable the event settings from 6 pm to 12 pm for every day of the week.
3. Select a preset event schedule setting and click the checkbox of “Active” to activate the event schedule.
4. You may set up to 6 settings from “No 1” to “No 6”.

5. Click "Submit" button to save the settings for the camera.



For security reasons, you may schedule the recording 24 hours a day and 7 days a week.

### Information

## Security

### Event Settings

In the Event Settings menu, you may configure the event the IP Camera responds to and the output reaction the IP Camera will trigger.

#### To add an event

Add Event Settings	
<input checked="" type="checkbox"/> Enable	
Name	<input type="text"/>
Priority	Low <input type="button" value="v"/>
Triggered Source	
<input checked="" type="radio"/> Motion Detection	
In	Untitled #0 <input type="button" value="v"/> when motion detection <input type="button" value="starts"/> <input type="button" value="v"/>
<input type="radio"/> Input Ports	
In	1 <input type="button" value="v"/> When Input <input type="button" value="Active"/> <input type="button" value="v"/>
When Triggered	
<input checked="" type="checkbox"/> Activate output port.	
	1 <input type="button" value="v"/>
<input checked="" type="radio"/> Keep active during event.	
<input type="radio"/> Keep active for	5 second(s) <input type="button" value="v"/>
<input checked="" type="checkbox"/> Send e-mail notification.	
Subject	<input type="text"/>
Send to	<input type="text"/> <input type="button" value="Add"/>
	<input type="text"/> <input type="button" value="Delete"/>
<input checked="" type="checkbox"/> Send image to FTP Server	
File Name Prefix	NVR- <input type="text"/>
Upload for	3 second(s)
Desired image frequency :	
<input checked="" type="radio"/> Maximum possible	
<input type="radio"/> 1 frame per second	
<input checked="" type="checkbox"/> Auto Record	
Limited to	30 [10-99]sec
<input type="button" value="Save"/>	<input type="button" value="Cancel"/>



1. Go to the “Advanced” page and click the menu “Security” → “Event Settings” to enter the Event Settings window.
2. Click the “Add” button to enter “Add Event Settings” page.
3. Check “Enable” to make the Event Settings effective.
4. Define a name for the event setting, and choose the event’s “Priority” from the drop-down list.
5. Choose the “Triggered Source” you want to respond to by clicking the radio button of Motion Detection or Input Ports.

- For “Motion Detection” event, you’ll need to configure Motion Detection settings for the camera (Please refer to [Motion Detection](#) for more information). Choose the Motion Detection window from the drop-down list and the motion detection event as “starts”, “stops” or “starts-stops”.



**Attention**

This function is available only when the connected IP Camera is built with related functions.

- For “Input Ports” event, you’ll need to connect an external sensor or device to the camera in the camera’s input port. Choose the input event from the drop-down list as “active”, “inactive” or “change”.
6. You may activate the Output Port by checking the “Activate Output Port” option. When an event is triggered, the output port will enable the IP Camera to send alarm signal to external sensor or device. (Please refer to the camera’s manual for more information on External Input/Output Interface.)  
 Select the active time period of the output port. The port can be kept activated during the whole event or for a period after the event is triggered.
  7. If you want to send an alert email to your desired email address when an event is triggered, check the “Send e-mail notification” option.
    - a. Type in the “Subject” of the email.
    - b. Enter the email address you want to send notice in the “Send to” blank and click the “Add” button to add the address into the mailing list. A sender’s email address should be pre-set in the SMTP menu to make the auto-mailing effective. (Please refer to the [SMTP](#) section for more information.)
  8. If you want to send recorded images to the desired FTP server when an event is triggered, check the “Send Image to FTP Server” option. A FTP server should be pre-set in the FTP list to enable this feature. (Please refer to the [FTP](#) section for more information.)
    - a. File Name Prefix: Enter the prefix for the recorded image files, e.g. NVR-.
    - b. Upload seconds: The default value is 3 seconds. For example, if you set 3 seconds in this field, the NVR uploads the recorded images within the 3 seconds to the selected FTP server.
    - c. Desired image frequency:
      - (i) **Maximum possible:** When an event is triggered, the number of the image frames that the NVR uploads to the FTP Server is determined by the “Frame rate” setting in the “Video Settings”

page. (Please refer to [Video Settings](#) for more information). The NVR is able to upload up to **15** image frames.

For example:

You set the NVR to upload the recorded images for **3** seconds, set the “Frame rate” as **15** fps in the “Video Settings” page, and click the “Maximum possible” option. When an event is triggered, the NVR maximum uploads 45 recorded image frames to the FTP server within the 3 seconds.

- (ii) **1 frame per second:** This option sets the NVR to upload one image to the selected FTP server per second within the pre-set time period.

For example:

You set the NVR to upload the recorded images for **3** seconds and click the “1 frame per second” option. When an event is triggered, the NVR transmits a recorded image frame to the FTP server per second. After the 3 seconds ends, a total of 3 image frames are transmitted to the FTP server.

- 9. Check “Auto Record” to record the event when triggered. You can enter the record time from 10 to 99 seconds.

### To edit or delete an event

In the Event Settings window, select an existing event and click the “Edit” button to edit the event or click the “Delete” button to delete the event.

Event List				
office ▼				
		Name	Triggered Source	When Triggered
1	<input checked="" type="radio"/>	Office	Input Port	"Auto Record"
2	<input type="radio"/>			
3	<input type="radio"/>			
4	<input type="radio"/>			

### Alarm Notification

Enable e-mail notification to administrator.

When device disconnect.

When available FTP server space is full.

Subject

Send to

Go to the “Advanced” page, click the menu “Security”→ “Alarm Notification”, and the “Alarm Notification” page displays. You can configure to notify the related personnel via e-mail when there is a connection failure between the NVR and the IP Camera or available FTP server space is full.

1. If you want to send an email to notify the administrator when the device is disconnected or the available FTP server space is full, tick the checkbox before the options.
2. Type in the “Subject” of the email.
3. Enter the email address you want to send the notice in the “Send to” blank and click “Add” button to add the address into the mailing list. To delete an added email address, select the email address and click “Delete”.
4. Click “Submit” to save the settings.

## Log

Go to the “Advanced” page and click the menu “Security” → “Log” to display the Alarm page. If you have made effective settings in the Event Settings menu, the Alarm list will keep a record on the events that have been triggered.

Time	Information
2010/01/13 15:39:44	office:Untitled #0: testevent1
2010/01/13 15:39:25	office:Untitled #0: testevent1
2010/01/13 15:32:07	office:Untitled #0: testevent1
2010/01/13 15:24:37	office:Untitled #0: testevent1
2010/01/13 15:13:10	office:Untitled #0: testevent1
2010/01/13 15:13:05	office:Untitled #0: testevent1
2010/01/13 14:55:03	office:Untitled #0: testevent1
2010/01/13 14:55:01	office:Untitled #0: testevent1
2010/01/13 14:53:03	office:Untitled #0: testevent1
<input type="button" value="Delete All"/>	

## Chapter IV. Technical Guides

This chapter covers plenty of useful technical information on using the NVR, which will help you get more familiar with this network device. For further information about network, you may read their definition or explanation in [Appendix A: Glossary](#) of this guide.

### LED Indicators<sup>7</sup>

The LED indicators at the front of the NVR indicate the status of the NVR, as described below:

LED	Status	Indications
Power	On	The NVR is powered on.
	Off	The NVR is powered off.
STAT	On	The system is ready.
	Off	The system is not ready.
HDD	Off	No data are being written in NVR Hard Disk.
	Flashing	Data are being written in NVR Hard Disk.
WAN	Off	The WAN cable is not successfully connected yet.
	On	The WAN cable is successfully connected but the NVR is not being visited.
	Flashing	The WAN cable is successfully connected and the NVR is being visited.
LAN	Off	The LAN cable is not successfully connected yet.
	On	The LAN cable is successfully connected but the NVR is not being visited.
	Flashing	The LAN cable is successfully connected and the NVR is being visited.

### Search Tool

Search Tool is an application that can detect the IP Camera(s) and NVR(s) that you connect to a company network.

<sup>7</sup> This function may or may not be available depending on the NVR model you purchase.



Search Tool application may detect all the NVRs that you have connected successfully to your company network or community network. The NVR list is displayed in the white pane of the window. You may select one of the NVRs to configure for your surveillance needs if you are the authorized user of that NVR.

1. Name the selected NVR in “Name” section.
2. Type the correct IP address of the NVR if you have “STATIC” checked. If you have “DHCP” checked, please jump to Step 5.



**Information** The NVR should have the same IP configuration information of your PC except IP address. Please refer to [“IP Configuration Information”](#) section to get the correct subnet mask and gateway of your PC.

3. Type the subnet mask of your network in Submask option.
4. Type in the Gateway of your network.
5. Type “80” in Http Port option.
6. Click the “Submit“ button to apply the settings.
7. Click the “Update” button to refresh the list in the white pane of this window.

## IP Configuration Information

You may get the IP configuration information of your PC by following the steps described as below:

1. Click “Start” → “All Programs” → “Accessories” → “Command Prompt”, and access the Command Prompt window.
2. Type in “ipconfig” after “C:\>”.
3. Write down the information including IP Address, Subnet Mask and Gateway for IP configuration of the NVR.

```
Command Prompt
Microsoft Windows 2000 [Version 5.00.2195]
(C) Copyright 1985-2000 Microsoft Corp.

C:\>ipconfig

Windows 2000 IP Configuration

Ethernet adapter Local Area Connection:

    Connection-specific DNS Suffix  . : RDehina
    IP Address . . . . . : 10.2.0.106
    Subnet Mask . . . . . : 255.0.0.0
    Default Gateway . . . . . : 10.2.1.2

C:\>_
```

 **Information** When you connect the NVR to your community network, the PC IP configuration information is for your reference to revise the last number and specify a unique IP address for the NVR.

## Use the NVR with Dynamic IP Address

In some organization's network, you may be provided with dynamic IP address. That is, each time your network device is connected to the network, it will be assigned with a different IP address.

When you need to deploy the NVR in such a network, you need to configure the NVR before connection.

You may follow the steps described below:

1. Connect the NVR to the network via Ethernet switching hub.

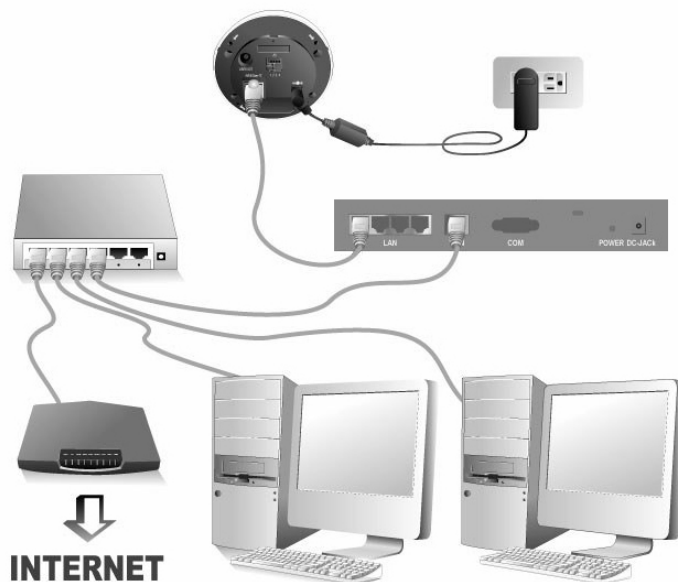

2. Insert the installation CD into the CD-ROM drive and run Search Tool application by double clicking the "Plustek Network Device Search Tool". The NVR that you connected to your network will be displayed in the opened window.



3. If you choose the “STATIC” option, please fill the Submask and Gateway in the Search Tool window, revise the last number of your PC IP address to create a new unique IP address for the NVR, type “80” in Http Port option, and click the “Submit” button to apply the changes.

 Please refer to the [“IP Configuration Information”](#) section to get IP address, Submask and Gateway of your PC.

4. Click the “Update” button in the Search Tool window to update the information in the left pane of the window and double click the NVR to log in.
5. You may log in by simply typing the Host Name in the IE address bar after completing the above configuration.

## Proxy Server

Proxy server is generally used to connect to the Internet directly in order to maintain the security of a network in some corporate environment. When your NVR is connected to such a network, the proxy server may prevent you from accessing the NVR. Please consult your network administrator or ISP for any details on disusing proxy server in your corporate environment.

You may follow the following steps to disuse the proxy server:

1. Start up the Internet Explorer, and click “Tools” to choose “Internet Options” from the drop-down menu.



2. Click the "LAN Settings" button in the Connections tab.

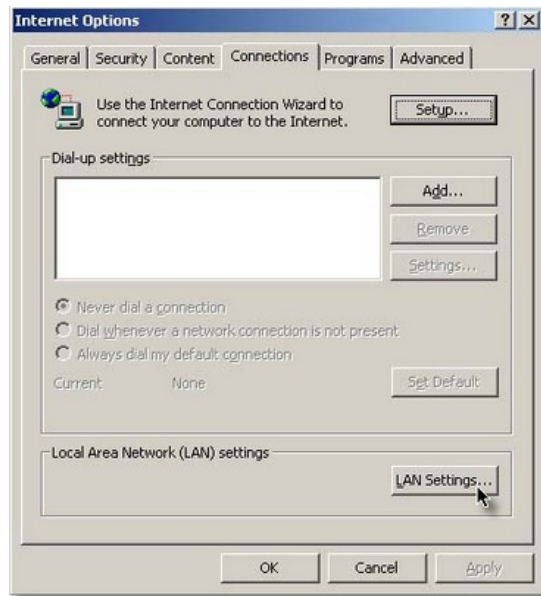

3. You may uncheck the "Use a proxy server" option, and click the "OK" button in the window. Or click the "Advanced..." button in the LAN Settings window and follow Step a and Step b.

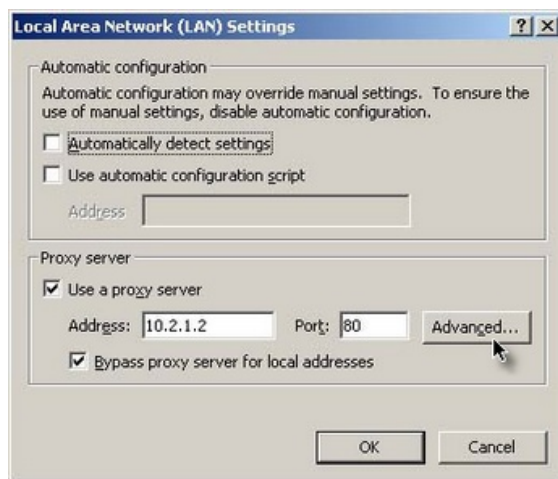

- a. Enter the specified IP address in this page.
- b. Click the "OK" button in the Proxy Setting window to confirm the settings.



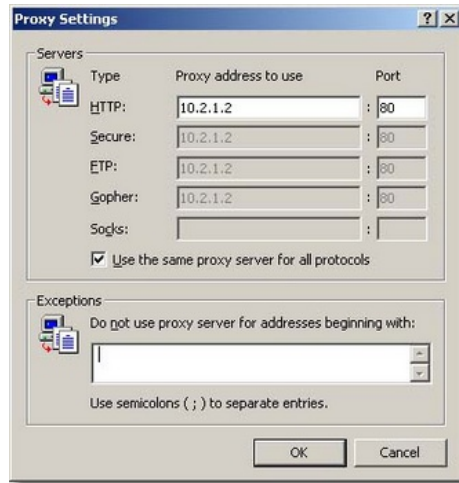

Please consult your network administrator or ISP for the IP address.

## Reset the NVR<sup>8</sup>

The RESET function of the NVR allows you to set the NVR to its factory default settings.

To reset the NVR, please keep your NVR connected to your network and follow the steps:

1. Insert the reset pin into the RESET hole at the side of the NVR.
2. Stab the RESET button with the pin for 5 seconds.

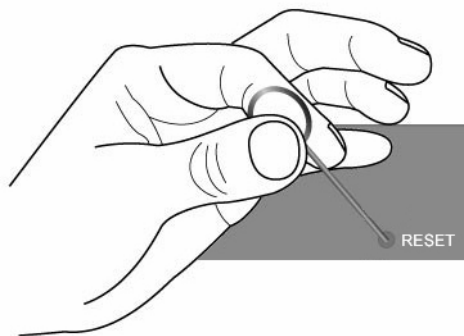

3. All settings are reset to their factory default settings.



**Attention**

All the settings you've configured in the NVR will be lost after resetting. Please make sure to [Backup settings](#) you need before resetting.

<sup>8</sup> This function may or may not be available depending on the NVR model you purchase.

## Turn off the NVR<sup>9</sup>

---

To turn off the NVR, please follow the steps:

1. Insert the pin into the Power hole at the rear side of the NVR.
2. Stab the Power hole with the pin for 5 seconds.
3. The NVR will be turned off.

---

<sup>9</sup> This function may or may not be available depending on the NVR model you purchase.

## Appendix A: Glossary

You may read through the below definitions for better understanding of the network environment, and this may probably help you to deal with the network problems when using any network devices. However, the knowledge covered in the chapter won't fail you to setup and use the NVR.

For more information about those definitions, you may study them in relevant books on network or network device.

### **ADSL**

ADSL (Asymmetric Digital Subscriber Line) is a technology for transmitting digital information at a high bandwidth on existing phone lines to homes and businesses. Unlike regular dialup phone service, ADSL provides an "always on line" connection.

### **ActiveX controls**

An ActiveX control is a component program object that can be re-used by many application programs within a computer or among computers in a network. The technology for creating ActiveX controls is part of Microsoft's overall ActiveX set of technologies, chief of which is the Component Object Model (COM). When you use Internet Explorer to browse website, ActiveX controls may assure the normal displaying of images.

### **DHCP**

DHCP (Dynamic Host Configuration Protocol) is a communications protocol that lets network administrators manage centrally and automate the assignment of Internet Protocol (IP) addresses in an organization's network.

### **DNS**

DNS (Domain Name System) is a service that locates various Internet domain names and translates them into Internet Protocol addresses. DNS service may increase the responding speed and accuracy of a specified web site.

### **HTTP**

HTTP (Hypertext Transfer Protocol) is a standard protocol used widely on World Wide Web, and all files (text, graphic images, sound, video, and other multimedia files) transferred on WWW follow this protocol. As soon as a Web user opens their Web browser, the user is indirectly making use of HTTP.

### **FTP**

File Transfer Protocol (FTP), a standard Internet protocol, is the simplest way to exchange files between computers on the Internet. FTP is commonly used to download and upload files (the formats includes: \*.txt, \*.exe, \*.pdf, \*.doc, \*.mp3, \*.zip, \*.rar and ect.) between two computers. When uploading or downloading, one computer can be regarded as FTP sever, the other is client terminal.

## **Gateway**

A gateway is a network point that acts as an entrance to another network. In a network for an enterprise, a computer server acts as a gateway node, and also a proxy server and a firewall server.

## **IP address**

An IP address is a 32-bit number that identifies each sender or receiver of information that is sent in packets across the Internet. An IP address has two parts: the identifier of a particular network on the Internet and an identifier of the particular device (which can be a server or a workstation) within that network.

## **Internet Protocol**

The Internet Protocol (IP) is the method or protocol by which data is sent from one computer to another on the Internet. When you send or receive data (for example, an e-mail note or a Web page), the message gets divided into little chunks called packets. Each of these packets contains both the sender's Internet address and the receiver's address. The Internet Protocol just delivers them.

## **IMAP**

IMAP (Internet Message Access Protocol) is a standard protocol for accessing e-mail from your local server. IMAP requires continual access to the server during the time that you are working with your mail. IMAP provides the user more capabilities for retaining e-mail on the server and for organizing it in folders on the server. IMAP can be thought of as a remote file server.

## **MAC address**

In a local area network (LAN) or other network, the MAC (Media Access Control) address is your computer's unique hardware number. (On an Ethernet LAN, it's the same as your Ethernet address.)

## **LAN**

A local area network (LAN) is a group of computers and associated devices that share a common communications line or wireless link and typically share the resources of a single processor or server within a small geographic area (for example, within an office building).

## **JPEG**

JPEG (pronounced "jay-peg") is a format that is commonly used for color images displayed on the Internet. JPEG reduces the file size of an image by discarding some of the non-critical data of the image. JPEG retains all of the color information of an image and offers varying degrees of compression.

## **Network**

In information technology, a network is a series of points or nodes interconnected by communication paths. Networks can interconnect with other networks and contain sub networks.

### **NTP**

NTP (Network Time Protocol) is a protocol designed to synchronize the clocks of computers over a network.

### **POP3**

POP3 is a client/server protocol in which e-mail is received and held for you by your Internet server. POP can be thought of as a "store-and-forward" service. POP and IMAP deal with the receiving of email, and SMTP is a protocol for simply transferring email across the Internet.

### **Port number**

In programming, a port (noun) is a "logical connection place" and specifically, using the Internet's protocol, TCP/IP, the way a client program specifies a particular server program on a computer in a network. For the HTTP service, port 80 is defined as a default and it does not have to be specified in the Uniform Resource Locator (URL).

### **PPPOE**

PPPOE (Point-to-Point Protocol over Ethernet) is a specification for connecting multiple computer users on an Ethernet local area network to a remote site through common customer premises equipment, which is the telephone company's term for a modem and similar devices. PPPOE can be used to have an office or building-full of users share a common Digital Subscriber Line (DSL), cable modem, or wireless connection to the Internet. PPPOE combines the Point-to-Point Protocol (PPP), commonly used in dialup connections, with the Ethernet protocol, which supports multiple users in a local area network. The PPP protocol information is encapsulated within an Ethernet frame.

### **Proxy Server**

A proxy server is associated with or part of a gateway server that separates the enterprise network from the outside network and a firewall server that protects the enterprise network from outside intrusion. To the user, the proxy server is invisible.

### **SMTP**

SMTP (Simple Mail Transfer Protocol) is a TCP/IP protocol used in sending and receiving e-mail. However, since it is limited in its ability to queue messages at the receiving end, it is usually used with one of two other protocols, POP3 or IMAP, that let the user save messages in a server mailbox and download them periodically from the server. In other words, users typically use a program that uses SMTP for sending e-mail and either POP3 or IMAP for receiving e-mail.

### **Subnet Mask**

Once a packet has arrived at an organization's gateway or connection point with its unique network number, it can be routed within the organization's internal gateways using the subnet number as well. The subnet mask allows router know whether two IP addresses belong to the same subnet.

### **TCP/IP**

TCP (Transmission Control Protocol) is a set of rules (protocol) used along with the Internet Protocol (IP) to send data in the form of message units between computers over the Internet. While IP takes care of handling the actual delivery of the data, TCP takes care of keeping track of the individual units of data (called packets) that a message is divided into for efficient routing through the Internet.

### **WEP**

WEP is the short form of Wired Equivalent Privacy. It is a security protocol for wireless local area networks (WLANs) defined in the 802.11b standard. With less secure physical structure than LAN, WLANs are more vulnerable to tampering. WEP is to provide security by encrypting data over radio waves from one end point to another.

## Appendix B: Specifications<sup>10</sup>

### NVR 4000

<b>Interface</b>	10 / 100 Mbps Ethernet 4 LAN / 1 WAN
<b>Number of IPCameras</b>	4 x via LAN
<b>Resolution</b>	VGA, up to 2 MegaPixel
<b>Frames Per Second (fps)</b>	up to 60 fps
<b>Protocol</b>	TCP / IP, HTTP, UPnP, SNTP, DHCP Server / Fixed IP, DHCP Client / TETP, CLI, SMTP, FTP Client, DDNS
<b>Hard Disk</b>	1 X 3.5" IDE HDD
<b>Memory</b>	8MB Flash / 64MB DRAM
<b>Compression Format</b>	MJPEG
<b>Power</b>	12V / 5A
<b>Consumption of Electricity</b>	14.4W (max.)
<b>Alarm</b>	E-Mail, Browser pop up warning, Push Service (optional)
<b>Dimensions (WxDxH)</b>	300mm x 152mm x 44mm
<b>Weight</b>	1.95 KG/4.31 lbs (HDD included)
<b>Operating Environments</b>	Temperature: - 20°C ~ + 40°C Humidity: 20% ~ 80% R.H.
<b>Certification</b>	CE, FCC
<b>Software</b>	Recording in MJPEG, timer recording, system security, dual mode (recording and playback), IPcam search tool, Back up, Motion detection, Language selection, alarm FTP function, permanent alarm recording, up to 4 IPcams in 60fps in VGA: 640x480 dpi, 120fps in CIF: 320x240 dpi, 120fps in QCIF(QQVGA) 160x120 dpi
<b>Models</b>	Compatible with Axis, Panasonic, Mobotix, Sony, Pelco, and Vivotek IP Cameras

<sup>10</sup> Hardware specifications may change at any time without prior notice.

## NVR 4200

<b>Interface</b>	10 / 100 Mbps Ethernet 4 LAN / 1 WAN
<b>Number of IPCameras</b>	4 x via LAN
<b>Resolution</b>	VGA, up to 2 MegaPixel
<b>Frames Per Second (fps)</b>	up to 60 fps
<b>Protocol</b>	TCP / IP, HTTP, UPnP, SNTP, DHCP Server / Fixed IP, DHCP Client / TFTP, CLI, SMTP, FTP Client, DDNS
<b>Hard Disk</b>	1 x 3.5" SATA HDD
<b>Memory</b>	8MB Flash / 64MB DRAM
<b>Compression Format</b>	MJPEG, MPEG4, H.264
<b>Power</b>	12V / 5A
<b>Consumption of Electricity</b>	14.4W (max.)
<b>Alarm</b>	E-Mail, Browser pop up warning, Push Service (optional)
<b>Dimensions (WxDxH)</b>	300mm x 152mm x 44mm
<b>Weight</b>	1.60 KG/3.54 lbs (HDD included)
<b>Operating Environments</b>	Temperature: - 20°C ~ + 40°C Humidity: 20% ~ 80% R.H.
<b>Certification</b>	CE, FCC
<b>Software</b>	Recording in MJPEG, MPEG4, or H.264, timer recording, system security, dual mode (recording and playback), IPcam search tool, Back up, Motion detection, Language selection, alarm FTP function, permanent alarm recording, up to 16 IPcams in 60fps in VGA: 640x480 dpi, 120fps in CIF: 320x240 dpi, 120fps in QCIF(QQVGA) 160x120 dpi
<b>Models</b>	Compatible with Axis, Panasonic, Mobotix, Sony, Pelco, and Vivotek IP Cameras



## NVR 4300

<b>Interface</b>	Dual Giga LAN 4 LAN / 1 WAN
<b>Number of IPCameras</b>	8 x via 4 LAN, Switch
<b>Resolution</b>	VGA, up to 2 MegaPixel
<b>Frames Per Second (fps)</b>	up to 120 fps
<b>Protocol</b>	TCP / IP, HTTP, UPnP, SNTP, DHCP Server / Fixed IP, DHCP Client / TFTP, CLI, SMTP, FTP Client, DDNS
<b>Hard Disk</b>	1 x 3.5" SATA HDD
<b>Memory</b>	8MB Flash / 64MB DRAM
<b>Compression Format</b>	MJPEG, MPEG4, H.264
<b>Power</b>	12V / 5A
<b>Consumption of Electricity</b>	14.4W (max.)
<b>Alarm</b>	E-Mail, Browser pop up warning, Push Service (optional)
<b>Dimensions (WxDxH)</b>	320mm x 152mm x 44mm
<b>Weight</b>	1.74 KG/ 3.84 lbs (HDD included)
<b>Operating Environments</b>	Temperature: - 20°C ~ + 40°C Humidity: 20% ~ 80% R.H.
<b>Certification</b>	CE, FCC
<b>Software</b>	Recording in MJPEG, MPEG4, or H.264, timer recording, system security, dual mode (recording and playback), IPcam search tool, Back up, Motion detection, Language selection, alarm FTP function, permanent alarm recording, up to 16 IPcams in 120fps in VGA: 640x480 dpi, 240fps in CIF: 320x240 dpi, 240fps in QCIF(QQVGA) 160x120 dpi
<b>Models</b>	Compatible with Axis, Panasonic, Mobotix, Sony, Pelco, and Vivotek IP Cameras

## NVR Slim240

<b>Interface</b>	10 / 100 Mbps Ethernet 4 LAN / 1 WAN
<b>Number of IPCameras</b>	4 x via LAN
<b>Resolution</b>	VGA, up to 2 MegaPixel
<b>Frames Per Second (fps)</b>	up to 60 fps
<b>Protocol</b>	TCP / IP, HTTP, UPnP, SNTP, DHCP Server / Fixed IP, DHCP Client / TFTP, CLI, SMTP, FTP Client, DDNS
<b>Hard Disk</b>	1 x 2.5" SATA HDD
<b>Memory</b>	8MB Flash / 64MB DRAM
<b>Compression Format</b>	MJPEG, MPEG4, H.264
<b>Power</b>	5V / 3A
<b>Consumption of Electricity</b>	8W~10W (max.)
<b>Alarm</b>	E-Mail, Browser pop up warning, Push Service (optional)
<b>Dimensions (WxDxH)</b>	152mm x 125mm x 45mm
<b>Weight</b>	785 g / 1.73 lbs (HDD included)
<b>Operating Environments</b>	Temperature: - 30°C ~ + 50°C Humidity: 20% ~ 80% R.H.
<b>Certification</b>	CE, FCC
<b>Software</b>	Recording in MJPEG, MPEG4, or H.264, timer recording, system security, dual mode (recording and playback), IPcam search tool, Back up, Motion detection, Language selection, alarm FTP function, permanent alarm recording, up to 16 IPcams in 60fps in VGA: 640x480 dpi, 120fps in CIF: 320x240 dpi, 120fps in QCIF(QQVGA) 160x120 dpi
<b>Models</b>	Compatible with Axis, Panasonic, Mobotix, Sony, Pelco, and Vivotek IP Cameras

## NVR 4200V

<b>Interface</b>	10 / 100 Mbps Ethernet 4 LAN / 1 WAN
<b>Number of IPCameras</b>	4 x via LAN
<b>Resolution</b>	VGA, up to 2 MegaPixel
<b>Frames Per Second (fps)</b>	up to 60 fps
<b>Protocol</b>	TCP / IP, HTTP, UPnP, SNTP, DHCP Server / Fixed IP, DHCP Client / TFTP, CLI, SMTP, FTP Client, DDNS
<b>Hard Disk</b>	1 x 3.5" SATA HDD
<b>Memory</b>	8MB Flash / 64MB DRAM
<b>Compression Format</b>	MJPEG, MPEG4, H.264
<b>Power</b>	12V / 5A (NP 240 -24V Power Unit) (NP 120 -12V Power Unit)
<b>Consumption of Electricity</b>	14.4W (max.)
<b>Alarm</b>	E-Mail, Browser pop up warning, Push Service (optional)
<b>Dimensions (WxDxH)</b>	200mm x 304mm x 88mm
<b>Weight</b>	4.15 KG/ 9.14 lbs (HDD included)
<b>Operating Environments</b>	Temperature: - 20°C ~ + 50°C (NVR Unit) - 40°C ~ + 70°C (Power Controller Unit)  Humidity: 20% ~ 80% R.H.
<b>Certification</b>	E-mark (E4), ISO 16750-3, IEC 60571, EN 50155, CE, and FCC Test Acceleration-Operating Mode: 1G (m/S <sup>2</sup> ) Test Acceleration-Non-Operating Mode: 5G
<b>Software</b>	Recording in MJPEG, MPEG4, or H.264, timer recording, system security, dual mode (recording and playback), IPcam search tool, Back up, Motion detection, Language selection, alarm FTP function, permanent alarm recording, up to 16 IPcams in 60fps in VGA: 640x480 dpi, 120fps in CIF: 320x240 dpi, 120fps in QCIF(QQVGA) 160x120 dpi
<b>Models</b>	Compatible with Axis, Panasonic, Mobotix, Sony, Pelco, and Vivotek IP Cameras

## Appendix C: Customer Service and Warranty

If you encounter problems with your NVR, please review the installation instructions and operation suggestions contained in this guide.

For further assistance call our customer support phone number listed on the last page of this guide. One of our representatives will be happy to assist you from Monday through Friday during office working hours as shown below:

Europe	9:00 a.m. – 5:30 p.m. (CET)
Other Countries or Areas	9:00 a.m. – 6:00 p.m. Taiwan Time

To avoid delays, please have the following information available before calling:

- NVR name and model number
- NVR serial number (Located at the bottom of the NVR)
- A detailed description of the problem
- Your computer manufacturer and its model number
- The speed of your CPU (Pentium 4, etc.)
- Your current operating system and BIOS (optional)
- Name of software package(s), version or release number and manufacturer of the software
- Other USB devices installed

### Statement of Limited Warranty

---

This Statement of Limited Warranty applies only to the options you originally purchase for your use, and not for resale, from an authorized reseller.

The manufacturer warranty includes all parts and labor, and is not valid without the receipt of original purchase. To obtain warranty service, you may contact the authorized dealer or distributor, or visit our website to check out the available service information, or send a request via E-mail for further help.

If you transfer this product to another user, warranty service is available to that user for the remainder of the warranty period. You should give your proof of purchase and this statement to that user.

We warrant that this machine will be in good working order and will conform to its functional descriptions in the documentation provided. Upon provision of proof of purchase, replacement parts assume the remaining warranty of the parts they replace.

Before presenting this product for warranty service, you must remove all programs, data and removable storage media. Products returned without guides and software will be replaced without guides and software.

This Limited Warranty service does not provide for carry-in exchange when the problem results from accident, disaster, vandalism, misuse, abuse, unsuitable environment, program modification, another machine or non-vendor modification for this product.

If this product is an optional feature, this Limited Warranty applies only when the feature is used in a machine for which it was designed.

If you have any questions about your Limited Warranty, contact the approved retailer from whom you bought the product or the manufacturer.

THIS LIMITED WARRANTY REPLACES ALL OTHER WARRANTIES, EXPRESS OR IMPLIED, INCLUDING, BUT NOT LIMITED TO, THE IMPLIED WARRANTIES OF MERCHANTABILITY AND FITNESS FOR A PARTICULAR PURPOSE. HOWEVER, SOME LAWS DO NOT ALLOW THE EXCLUSION OF IMPLIED WARRANTIES. IF THESE LAWS APPLY, THEN ALL EXPRESS AND IMPLIED WARRANTIES ARE LIMITED IN DURATION TO THE WARRANTY PERIOD. NO OTHER WARRANTIES APPLY AFTER THAT PERIOD.

Some jurisdictions do not allow limitations on how long an implied warranty lasts, so the above limitation may not apply.

Under no circumstances are we liable for any of the following:

1. Third party claims against you for losses or damages.
2. Loss of, or damage to, your records or data; or
3. Economic consequential damages (including lost profits or savings) or incidental damages, even if we are informed of their possibility.

Some jurisdictions do not allow the exclusion or limitations of incidental or consequential damages, so the above limitation or exclusion may not apply to you.

This Limited Warranty gives you specific legal rights, and you may also have other rights that vary from jurisdiction to jurisdiction.

## **FCC Radio Frequency Statement**

This is a Class A product. In a domestic environment this product may cause radio interference in which case the user may be required to take adequate measures.

This equipment generates, uses and can radiate radio frequency energy and, if not installed and used in accordance with the instructions, may cause harmful interference to radio communications. However, there is no guarantee that interference will not occur in a particular television reception (which can be determined by turning the equipment off and on), the user is encouraged to try to correct the interference by one or more of the following measures:

- Reorient or relocate the receiving antenna.
- Increase the separation between the equipment and receiver.
- Connect the equipment to an outlet on a circuit different from that which the receiver is connected.
- Shielded interconnect cables and shielded power cord which are supplied with this equipment must be employed with this equipment to ensure compliance with the pertinent RF emission limits governing this device.
- Consult the dealer or an experienced radio/TV technician for help if the conditions persist.
- Changes or modifications not expressly approved by the manufacturer or authorized service center could void the user's authority to operate this equipment.

This device complies with Part 15 of the FCC Rules. Operation is subject to the

following two conditions: (1) this device may not cause harmful interference, and (2) this device must accept any interference received, including interference that may cause undesired operation.

## Contacting Plustek

**Europe:** Plustek Technology GmbH  
An der Strusbek 60-62  
22926 Ahrensburg  
Germany  
Tel.: +49-4102-8913-0  
Fax: +49-4102-8913-500/508  
E-mail: [support@plustek.de](mailto:support@plustek.de)  
Website: [www.plustek.de](http://www.plustek.de)

**North America:** Plustek Technology Inc.  
17517 Fabrica Way, Suite B  
Cerritos, CA 90703  
U.S.A.  
Tel: +1 -714-670-7713  
Fax: +1 -714-670-7756  
E-mail: [supportusa@plustek.com](mailto:supportusa@plustek.com)

**Worldwide except  
Europe & North America:** Plustek Inc.  
13F-1, No.3 (Building F), Yuan Qu Street  
115 Nankang, Taipei  
Taiwan  
Tel: +886-2-2655 7866  
Fax: +886-2-2655 7833  
Website: [www.plustek.com](http://www.plustek.com)

**Visit our website**

<http://www.plustek.com/support/support.htm>

**for more customer service information.**