



Surgical Instruments
www.frimed.com







Tobias Schwoy

Managing Director
Frimed Medizintechnik GmbH

Sehr geehrter Geschäftsfreund, sehr geehrter Kunde,

ich freue mich sehr Ihnen unseren neuen komplett überarbeiteten Hauptkatalog chirurgischer Instrumente der verschiedensten Disziplinen vorstellen zu dürfen. Bei der Auswahl der Produkte in den verschiedenen Disziplinen, sind wir mit der größtmöglichen Sorgfalt bezüglich der Aktualität der Instrumente vorgegangen. Es besteht in allen gängigen chirurgischen Disziplinen die Möglichkeit, sich die Instrumente selbst zusammen zu stellen, oder aber, Sie können sich auch von uns, auf Anforderung, Instrumentensätze zusammenstellen lassen, die uns für Ihre jeweils spezifischen Aufgaben als geeignet erscheinen. Ich für meinen Teil, wünsche Ihnen auf jeden Fall, viel Erfolg in Ihrer täglichen Arbeit und würde mich freuen, wenn Sie uns und unserem Instrumentarium auch in Zukunft weiterhin die Treue halten würden.

Dear business associate and/or customer,

I am very pleased to present you our new, completely revised main catalogue of surgical instruments for the various disciplines. When selecting the products for the various disciplines, we took extreme care to ensure that the instruments are up to date. In all common surgical procedures, it is possible to assemble the instrument sets yourself at your request, or to have us assemble sets of instruments that we judge to be suitable for your specific tasks. For my part, I would like to wish you every success in your daily work and would very much appreciate your continued loyalty to us and our range of instruments in the future.

Estimado corresponsal, estimado cliente,

me alegra poder presentarles nuestro nuevo catálogo general de instrumentos quirúrgicos para las diferentes especialidades, completamente revisado. Para la selección de los productos en las diferentes especialidades hemos procedido con el máximo esmero posible en relación a la actualidad de los instrumentos. En todas las especialidades quirúrgicas existe la posibilidad de agrupar por sí mismo los instrumentos, o bien Ud. también puede solicitar que nosotros agrupemos juegos de instrumentos apropiados para sus tareas específicas. Por mi parte les deseo mucho éxito en su trabajo diario y me alegraría si en el futuro continuáran manteniendo la confianza en nosotros y en nuestros instrumentos.

Gentile socio d'affari, Gentile cliente,

sono lieto di poterle presentare il nostro nuovo catalogo generale di Strumenti chirurgici delle più diverse discipline, completamente rielaborato. Per la scelta dei prodotti nelle diverse discipline abbiamo proceduto con massima accuratezza in riguardo all'attualità degli strumenti. È possibile assortire in modo individuale gli strumenti in tutte le discipline chirurgiche correnti, oppure, su richiesta, Le possiamo anche proporre un assortimento di set di strumenti, che ci sembrano appropriati di volta in volta ai Suoi compiti specifici. Da parte mia Le auguro, in ogni caso, di poter svolgere il Suo lavoro quotidiano con successo e sarei lieta di poterla ancora annoverare tra i nostri clienti, assicurando così, a noi e ai nostri strumenti, il Suo apprezzamento anche in futuro.

Tobias Schwoy
Managing Director



Die Fertigung unserer Produkte ist eine Symbiose aus langjähriger handwerklicher Tradition und modernsten Fertigungsabläufen mittels CNC gesteuerter Fertigungszentren, welches einen hochwertigen Funktions- und Qualitätsstandard unserer Produkte sicher stellt.

Our product manufacturing is a symbiosis of many years of tradition in craftsmanship combined with the most modern production processes using CNC-controlled manufacturing centres, which ensures the highest standard in terms of both functioning and quality for our products.

La fabricación de nuestros productos es la simbiosis de una larga tradición artesanal y modernos procesos de fabricación mediante CNC, lo que asegura un elevado estándar de funcionamiento y calidad de nuestros productos.

La lavorazione dei nostri prodotti è una simbiosi tra la tradizione artigiana pluriennale e i più moderni processi di produzione attraverso centri di lavoro a CNC, che assicurano ai nostri prodotti un alto standard di qualità e di funzionamento.



Bereits bei der Vorauswahl und Materialprüfung der verwendeten Werkstoffe, hauptsächlich korrosionsbeständige Chromstähle, halten wir uns an die uns selbst auferlegten strengen Qualitätsmaßstäbe die sich kontinuierlich über den ganzen Fertigungsprozess hindurch fortsetzen, wodurch wir eine sehr hohe und immer wiederkehrende Produkt- und Modelltreue erzielen.

We adhere to strict quality standards that we impose on ourselves as early as during the preselection and testing of the materials of construction used, which are mainly corrosion-resistant chrome steels. These standards apply throughout the entire manufacturing process, thus ensuring a very high and very repeatable degree of product and model consistency.

Ya en la preselección y control de los materiales utilizados, esencialmente aceros al cromo resistentes a la corrosión, cumplimos nuestras exigentes normas de calidad que se propagan de forma continua en todo el proceso de fabricación, alcanzando siempre un producto de alta calidad y exacto al modelo.

Già nella selezione anticipata e nel controllo dei materiali utilizzati, generalmente acciai al cromo resistenti alla corrosione, ci atteniamo alle severe misure di qualità da noi stessi fissate, che vengono continuamente applicate a tutto il processo di lavorazione, pur ottenendo comunque un'alta e sempre ricorrente fedeltà al modello del prodotto.



Jeder Einzelne unserer hoch qualifizierten und hoch motivierten Mitarbeiter und Mitarbeiterinnen engagiert sich tagtäglich auf das Neue und sieht in der Erfüllung der Bedürfnisse und Wünsche unserer Kunden seine oberste Pflicht.

All our highly qualifield and highly motivated employees do their utmost every single day and dedicate themselves to fulfilling the needs and wishes of our customers.

Cada uno de nuestros colaboradores, altamente calificado y motivado, se compromete a diario de nuevo y considera su obligación en la satisfacción de las necesidades y deseos de nuestros clientes.

Ogni nostro singolo collaboratore, altamente qualificato e motivato, è disponibile ogni giorno a nuove sfide e s'impone come dovere assoluto la soddisfazione dei bisogni e delle richieste dei clienti.



Im Mittelpunkt unserer Firmenphilosophie stehen der Kunde und der Anwender mit ihrem berechtigten Interesse an der Qualität unserer Instrumente. Ein perfekt auf alle Unternehmensbereiche abgestimmtes Qualitäts Management System regelt die kundenorientierten Abläufe, beginnend bei der Produktion bis hin zu der Rückverfolgbarkeit aller Produkt- und Kundenrelevanten Daten. Alle von uns gelieferten Instrumente sind mit dem CE Kennzeichen versehen.

The focus of our company philosophy is the customer and user with their justified interest in the quality of our instruments. A Quality Management System that is ideally adapted for all company areas controls the customer oriented processes, starting with production and continuing right through to the after-sales service.

Como centro de la filosofía de la empresa se encuentra el cliente y los usuarios, con su merecido interés en la calidad de nuestros instrumentos. Un perfecto sistema de control de calidad en todas las áreas de la empresa regula los ciclos orientados al cliente, comenzando en la producción hasta la trazabilidad de todos los datos relevantes sobre los productos y clientes. Todos los instrumentos fabricados por nosotros poseen la marca CE.

Al centro della filosofia della nostra ditta si trovano il cliente e l'utente con il Loro giustificato interesse alla qualità dei nostri strumenti. Un sistema di gestione in perfetta armonia con tutti i settori aziendali regola i processi orientati al cliente, a cominciare dalla produzione fino a la tracciabilità di tutti i dati pertinenti sui prodotti e clienti. Tutti gli strumenti da noi forniti sono provvisti con il marchio CE.





Frimed befindet sich zwischen Stuttgart und Zürich in unmittelbarer Nähe zu der Autobahn A 81 Abfahrt Tunningen, inmitten von Tuttlingen dem weithin bekannten Weltzentrum der Medizintechnik. Besucher sind jederzeit recht herzlich willkommen.

La empresa Frimed se encuentra entre Stuttgart y Zurich, en la cercanía de la autopista A81 Salida - Tunningen, en el centro de Tuttlingen, el conocido centro mundial de la técnica médica. Los visitantes son siempre bienvenidos.

Frimed is located between Stuttgart and Zurich right beside the exit 'Tunningen' on the A81 motorway, in the centre of Tuttlingen, the well-known world centre for medical technology. Visitors always are very welcome.

Frimed si trova fra Stoccarda e Zurigo nelle immediate vicinanze dell'autostrada A 81 uscita Tunningen, nel bel mezzo di Tuttlingen, centro conosciuto a livello mondiale per la tecnica medica. I visitatori sono sempre benvenuti.

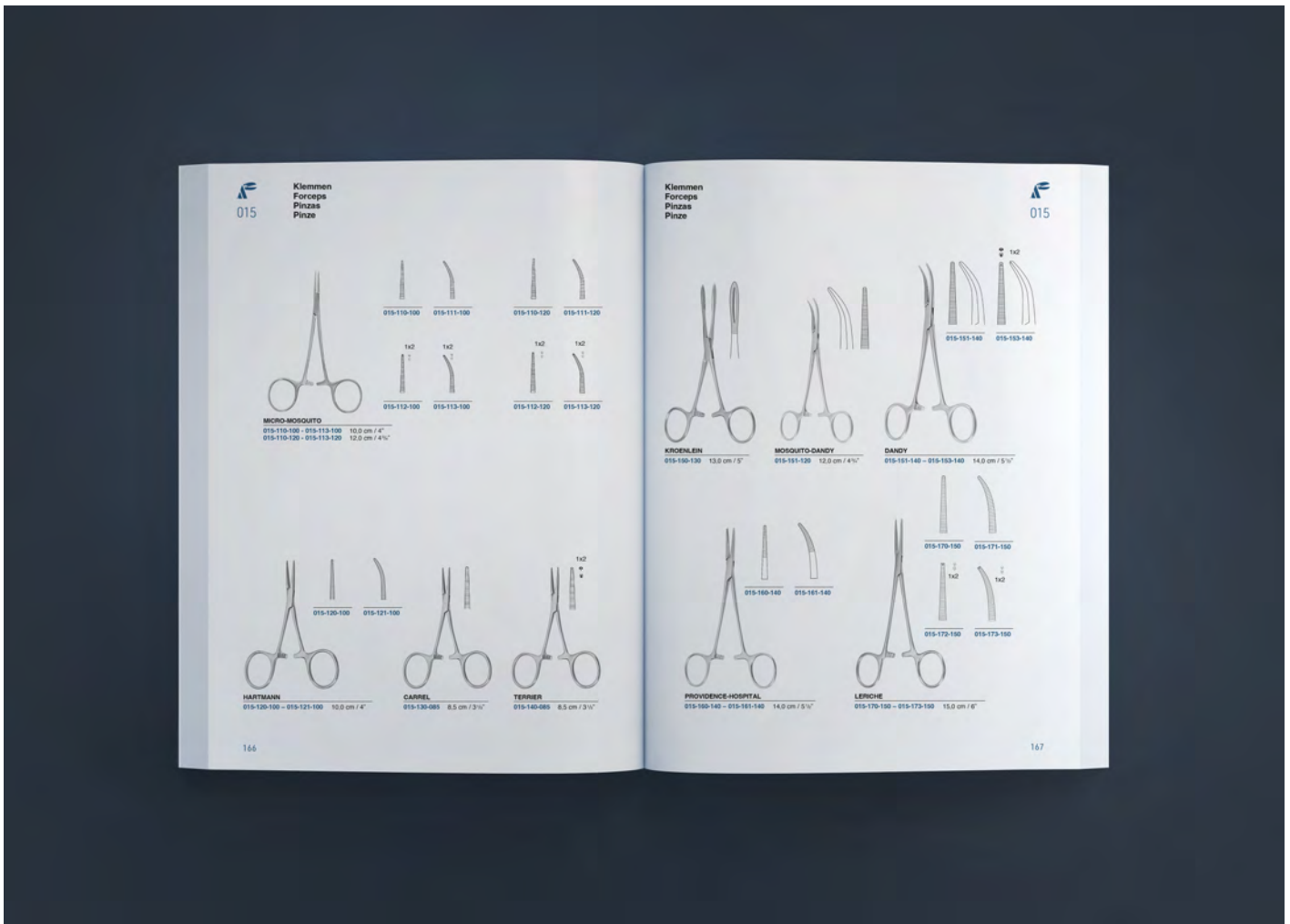

Der Aufbau des Frimed Hauptkataloges erfolgte in numerisch aufsteigender Reihenfolge. Damit ist jede Artikelnummer jederzeit sofort auffindbar. Die Artikelnummer gibt Auskunft über die Artikelgruppe/Details des Artikels wie Größe und/oder Figur des Instrumentes.

The Frimed main catalogue is structured in numerical order, starting with the lowest numbers. This means that every article number can be quickly located at any time. The article number provides information about the article group and details concerning the article such as size and/or the form of the instrument.

El catálogo general de Frimed está estructurado numéricamente de forma ascendente. De esta forma, cada número de artículo se encuentra rápido y en cualquier momento. El número de artículo informa sobre el grupo/detalles del mismo, como por ejemplo tamaño y/o figura del instrumento

La struttura del catalogo generale Frimed è in successione numerica ascendente. In questo modo ogni numero di articolo è rintracciabile subito in ogni momento. Il numero di articolo offre informazioni sul gruppo di articoli/dettagli riguardanti l'articolo così come la grandezza e/o l'immagine dello strumento



012-722-210

Artikelgruppe / Disziplin
Product Group / Discipline
Grupo de artículo / Disciplina
Gruppo di articolo / Disciplina

Laufende Nummer innerhalb der Artikelgruppe
Current catalogue number within the group
Número ordinal dentro del grupo
Numero progressivo all'interno del gruppo

Größe / Figur des Instruments
Size / Shape of the instrument
Tamaño / Forma del instrumento
Dimensione / Forma dello strumento

Artikel-Nummer
Item number
Nº del artículo
Codice articolo

Autor
Author
Autor
Autore

Arbeitsende
Detail des Instruments

Working end /
Detail of the instrument

Extremo funcional
Detalle del instrumento

Estremidad funcional
Dettaglio dello strumento

Maße
Dimensions
Dimensiones
Dimensioni

012

Chirurgische Scheren mit Hartmetallschneiden
Surgical Scissors with tungsten carbide edges
Tijeras para cirugía con filos de carburo tungsteno
Forbici per chirurgia con lame in carburo di tungsteno

Brand	Item Number	Dimensions
LEXER	012-722-160	16,0 cm / 6 1/4"
	012-722-210	21,0 cm / 8 1/4"
METZENBAUM	012-730-115 - 012-731-115	11,5 cm / 4 1/2"
	012-730-145 - 012-731-145	14,5 cm / 5 1/2"

56



Inhalt / Content / Tabla / Indice

010	Skalpelle und Messer	1-14
	Scalpes and Knives	1-14
	Bisturías y Cuchillos	1-14
	Bisturi e Coltelli	1-14
011	Mikro-Scheren	15-20
	Micro Scissors	15-20
	Micro Tijeras	15-20
	Micro Forbici	15-20
012	Scheren	21-76
	Scissors	21-76
	Tijeras	21-76
	Forbici	21-76
013	Pinzetten - anatomische, chirurgische, Mikro.	77-100
	Forceps - anatomics, surgicals, Micro	77-100
	Pinzas - anatómicas, quirúrgicas, Micro.	77-100
	Pinze - anatomiche, chirurgici, Micro	77-100
014	Aneurysmen Gefäß Clips	101-158
	Aneurysm Vessel Clips	101-158
	Clips de aneurisma	101-158
	Clips per aneurisma	101-158
015	Arterienklemmen, Korn- und Tupferzangen	159-210
	Artery Forceps, Dressing and Sponge Forceps	159-210
	Pinzas hemostáticas, Pinzas para torundo y vendajes	159-210
	Pinze emostatiche, Pinze per medicatura e tamponi.	159-210
016	Wundhaken, Wundspreizer, Bauchdeckenhalter	211-280
	Retractors, Self-retaining Retractors, Abdominal Retractors	211-280
	Separadores, Separadores autoestáticos, Separadores abdominales	211-280
	Divaricatori, Divaricatori autostatici, Divaricatori addominali	211-280
017	Sonden, Aspiration	281-304
	Probes, Aspiration.	281-304
	Sondas, Aspiración	281-304
	Sonde, Aspirazione	281-304
018	Diagnostik, Narkose	305-344
	Diagnostics, Anaesthesia.	305-344
	Diagnóstico, Anestesia.	305-344
	Diagnóstica, Anestesia	305-344



Inhalt / Content / Tabla / Indice

019	Naht	345-398
	Suture	345-398
	Sutura	345-398
	Sutura	345-398
020	Verband, Gips	399-408
	Dressing, Plaster	399-408
	Vendajes, Escayolas	399-408
	Bendaggi, Gessatura	399-408
021	Knochenchirurgie	409-436
	Bone Surgery	409-436
	Cirugía ósea	409-436
	Chirurgia ossea	409-436
024	Knochenchirurgie	437-528
	Bone Surgery	437-528
	Cirugía ósea	437-528
	Chirurgia ossea	437-528
025	Thorax, Cardiovascular-Chirurgie	529-600
	Thorax, Cardiovascular Surgery	529-600
	Torácio, Cirugía cardiovascular	529-600
	Torace, Chirurgia cardiovascolare	529-600
026	Neurochirurgie, Laminektomie	601-660
	Neurosurgery, Laminectomy	601-660
	Neurocirugía, Laminectomía	601-660
	Neurochirurgia, Laminectomia	601-660
027	Magen, Darm, Urologie	661-704
	Stomach, Intestines, Urology	661-704
	Estómago, Intestinos, Urología	661-704
	Stomaco, Intestini, Urologia	661-704
030	Gynäkologie, Geburtshilfe	705-760
	Gynecology, Obstetrics	705-760
	Ginecología, Ostetricia	705-760
	Ginecologia, Ostetricia	705-760
032	Ophthalmologie	761-784
	Ophthalmology	761-784
	Oftalmología	761-784
	Ophtalmologia	761-784



Inhalt / Content / Tabla / Indice

034	Otologie.....	785-820
	Otology.....	785-820
	Otología.....	785-820
	Otologia.....	785-820
035	Rhinologie.....	821-868
	Rhinology.....	821-868
	Rinología.....	821-868
	Rinologia.....	821-868
037	Mund-, Kiefer- und Gesichtschirurgie.....	869-910
	Oral Maxillo-Facial Surgery.....	869-910
	Cirugía oral y maxilofacial.....	869-910
	Chirurgia maxillo-facciale.....	869-910
046	Dermatologie.....	911-918
	Dermatology.....	911-918
	Dermatología.....	911-918
	Dermatologia.....	911-918
085	Sterilisation, Hygiene, Aufbewahrung.....	919-948
	Sterilisation, Hygiene, Storage.....	919-948
	Esterilización, Higiene, Almacenaje.....	919-948
	Sterilizzazione, Magazzinaggio.....	919-948
Index	Inhaltsverzeichnis.....	949-959
	Alphabetical Index.....	960-969
	Indice alfabético.....	970-981
	Indice alfabetico.....	982-989



010

Skalpelle und Messer
Scalpes and Knives
Bisturies y Cuchillos
Bisturi e Coltelli



010

Anatomische Skalpelle
Dissecting knives
Bisturies para disección
Bisturi per dissezione

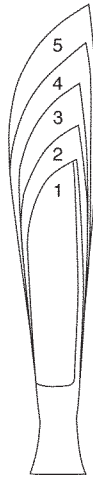

- 010-100-001 Fig. 1
- 010-100-002 Fig. 2
- 010-100-003 Fig. 3
- 010-100-004 Fig. 4
- 010-100-005 Fig. 5

mit Metallheft
with metal handle
con mango metálico
con manico di metallo



- 010-100-006 Fig. 6
- 010-100-007 Fig. 7
- 010-100-008 Fig. 8
- 010-100-009 Fig. 9
- 010-100-010 Fig. 10

010-100-001 - 010-100-005 15,0 cm / 6"

010-100-006 - 010-100-010 15,0 cm / 6"

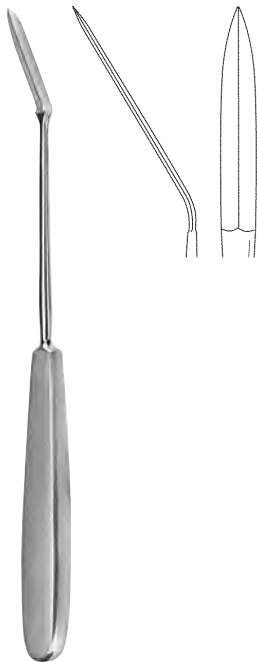

AYRE

010-110-235 23,5 cm / 9 1/4"

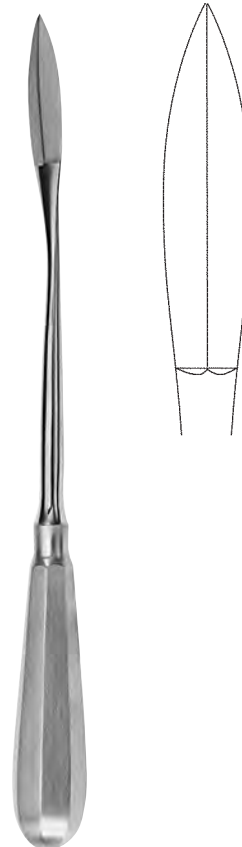

SEGOND

010-120-270 27,0 cm / 10 1/2"

**Seziermesser, Knorpelmesser,
Autopsy knives, Cartilage knives
Cuchillos para autopsia, cuchillos para cartilago
Coltelli per autopsia, coltelli per cartilagini**



010

Mit Holzheft
with wooden handle
con mango de madera
con manico di legno

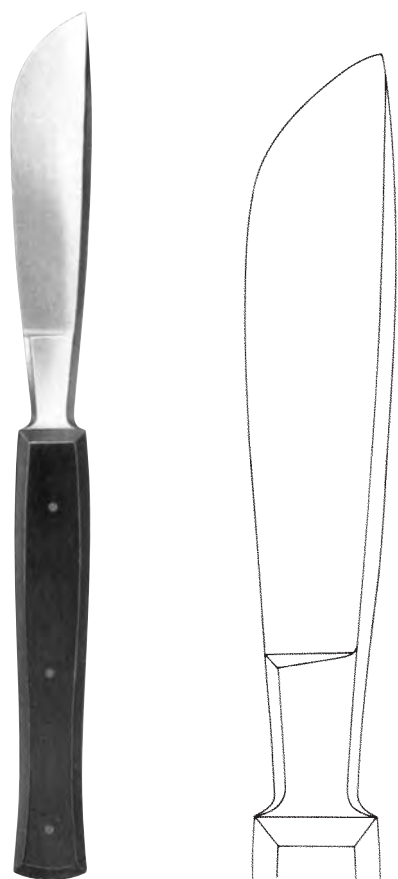

VIRCHOW

010-130-210 21,0 cm / 8 1/4"

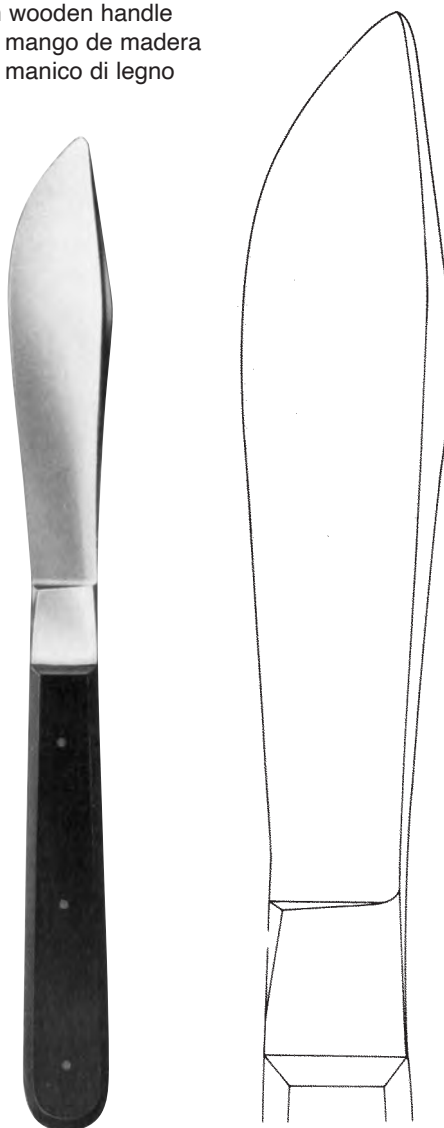

010-140-255 25,5 cm / 10"



010

Organmesser, Messer
Post mortem knife, Knife
Cuchillos para órganos
Coltelli

Mit Metallheft
with metal handle
con mango metálico
con manico di metallo

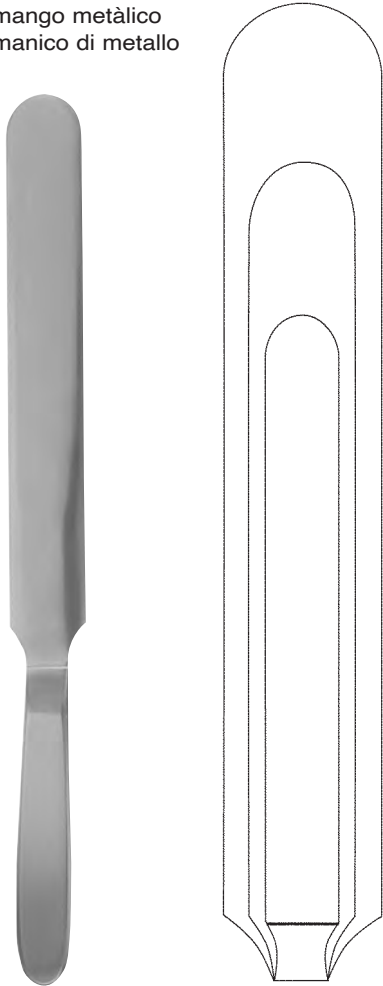

VIRCHOW

010-150-160	16,0 cm, 6 ¹ / ₄ "
010-150-200	20,0 cm, 8"
010-150-240	24,0 cm, 9 ¹ / ₂ "

Mit Holzheft
with wooden handle
con mango de madera
con manico di legno

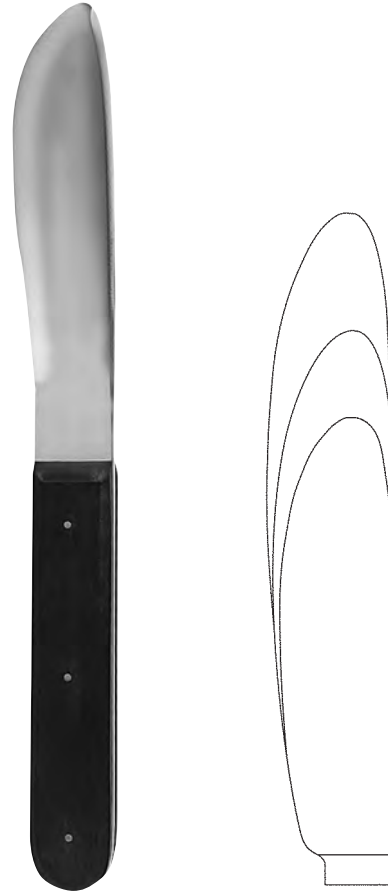

WALB

010-160-110	11,0 cm, 4 ¹ / ₃ "
010-160-140	14,0 cm, 5 ¹ / ₂ "
010-160-170	17,0 cm, 6 ⁴ / ₃ "



massiv
 solid
 macizo
 pieno

STANDARD Nr. 3

010-200-003 12,0 cm / 4³/₄"



massiv
 solid
 macizo
 pieno

mit cm - Graduierung
 with cm - graduiation
 graduado en cm
 graduato in cm

Nr. 3

010-202-003 12,0 cm / 4³/₄"



massiv
 solid
 macizo
 pieno

STANDARD Nr. 4

010-210-004 12,0 cm / 4³/₄"



massiv
 solid
 macizo
 pieno

 gerade
 straight
 recto
 retto

Nr. 3L

010-204-003 21,5 cm / 8¹/₂"

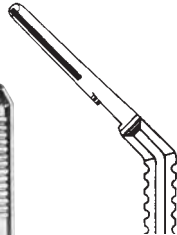

massiv
 solid
 macizo
 pieno

 abgewinkelt
 angled
 acodado
 angolare

Nr. 3L

010-205-003 21,0 cm / 8¹/₄"



Nr. 3

010-206-003 21,5 cm / 8¹/₂"



Nr. 3

010-207-003 21,5 cm / 8¹/₂"



010

**Skalpelli
Scalpel Handles
Mangos de Bisturi
Manici per bisturi**



massiv
solid
macizo
pieno

Doppelgriff
Double Hand
Mango doble
Manico doppio

Nr. 3 + 4
010-212-034 16,0 cm / 6 1/4"



massiv
solid
macizo
pieno

gerade
straight
recto
retto

Nr. 4L
010-214-004 21,5 cm / 8 1/2"



massiv
solid
macizo
pieno

abgewinkelt
angled
acodado
angolare

Nr. 4L
010-215-004 21,0 cm / 8 1/4"



Nr. 4
010-216-004 22 cm / 8 3/4"



massiv
solid
macizo
pieno

Nr. 7
010-220-007 16 cm / 6 1/4"



massiv
solid
macizo
pieno

Nr. 7K
010-222-017 12,5 cm / 5"



hohl, rund
hollow, round
hueco, redondo
vuoto, rotondo

010-230-003 15,5 cm / 6"

steril
 serile
 estériles
 sterile



Fig. 10
 010-260-010



Fig. 11
 010-260-011



Fig. 12
 010-260-012



Fig. 13
 010-260-013



Fig. 14
 010-260-014



Fig. 15
 010-260-015

passend für Skalpellgriffe / for scalpel handles / compatible para mangos / per i manici
 010-210-014, 010-220-007, 010-220-008, 010-220-009, 010-220-010, 010-220-011, 010-220-012, 010-220-013, 010-220-014, 010-220-015, 010-220-016, 010-220-017, 010-220-018, 010-220-019, 010-220-020, 010-220-021, 010-220-022, 010-220-023, 010-220-024, 010-220-025, 010-220-026, 010-220-027, 010-220-028, 010-220-029, 010-220-030, 010-220-031, 010-220-032, 010-220-033, 010-220-034, 010-220-035, 010-220-036, 010-220-037, 010-220-038, 010-220-039, 010-220-040, 010-220-041, 010-220-042, 010-220-043, 010-220-044, 010-220-045, 010-220-046, 010-220-047, 010-220-048, 010-220-049, 010-220-050, 010-220-051, 010-220-052, 010-220-053, 010-220-054, 010-220-055, 010-220-056, 010-220-057, 010-220-058, 010-220-059, 010-220-060, 010-220-061, 010-220-062, 010-220-063, 010-220-064, 010-220-065, 010-220-066, 010-220-067, 010-220-068, 010-220-069, 010-220-070, 010-220-071, 010-220-072, 010-220-073, 010-220-074, 010-220-075, 010-220-076, 010-220-077, 010-220-078, 010-220-079, 010-220-080, 010-220-081, 010-220-082, 010-220-083, 010-220-084, 010-220-085, 010-220-086, 010-220-087, 010-220-088, 010-220-089, 010-220-090, 010-220-091, 010-220-092, 010-220-093, 010-220-094, 010-220-095, 010-220-096, 010-220-097, 010-220-098, 010-220-099, 010-220-100

steril
 serile
 estériles
 sterile



Fig. 17
 010-260-016



Fig. 17
 010-260-017



Fig. 12d
 010-261-012



Fig. 15c
 010-261-015

* doppelschneidig
 double cutting edge
 dos filos de corte
 Filo doppio

discontinued item



010

**Skalpellklingen
Scalpel Blades
Hojas de bisturi
Lame per bisturi**

steril
serile
estériles
sterile

passend für Skalpellgriffe / for scalpel handles / para mangos / per i manici .
010-210-004, 010-210-014, 010-210-024, 010-210-034

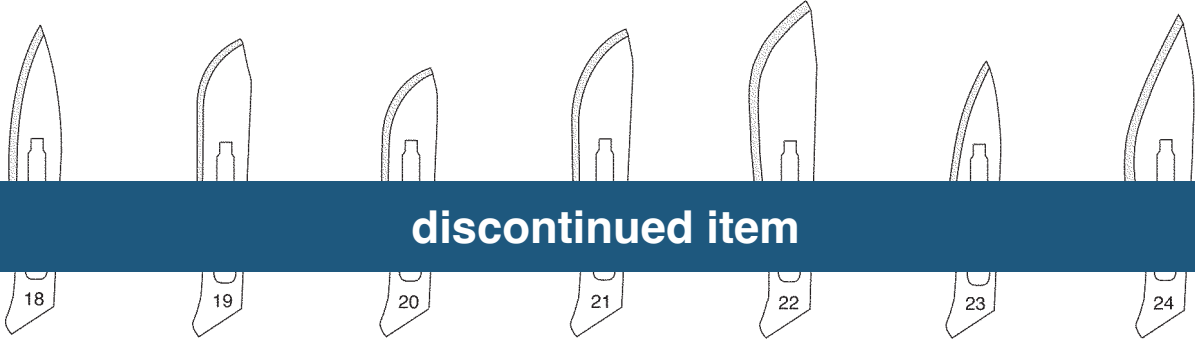

discontinued item

Fig. 18
010-260-018

Fig. 19
010-260-019

Fig. 20
010-260-020

Fig. 21
010-260-021

Fig. 22
010-260-022

Fig. 23
010-260-023

Fig. 24
010-260-024

steril
serile
estériles
sterile

* doppelschneidig
double cutting edge
dos filos de corte
Filo doppio

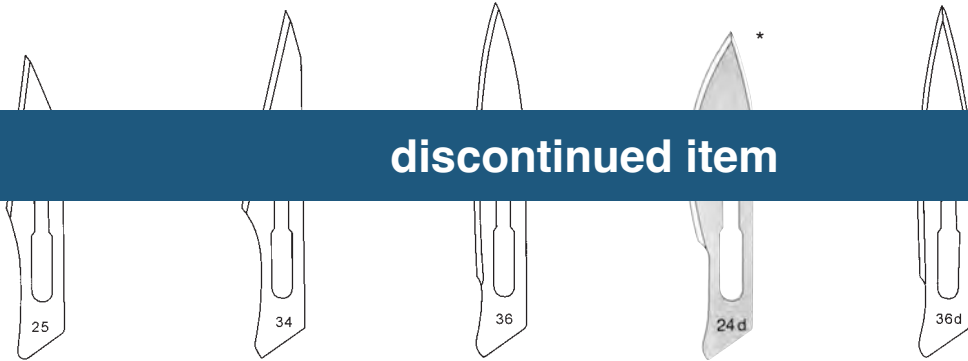

discontinued item

Fig. 25
010-260-025

Fig. 34
010-260-034

Fig. 36
010-260-036

Fig. 24d
010-261-024

Fig. 36d
010-261-036

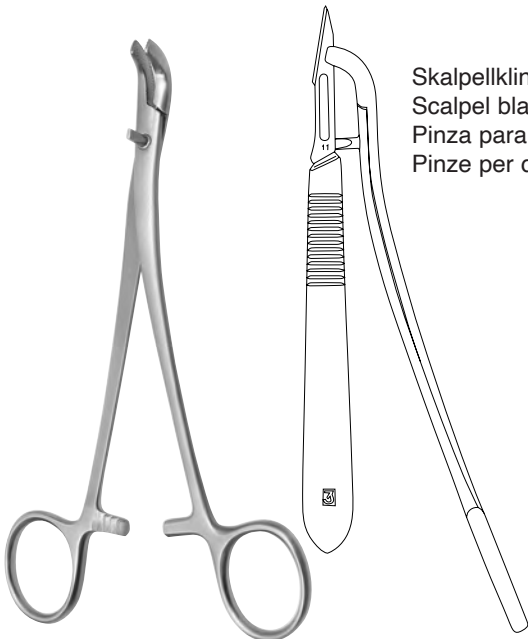

Skalpellklingen-Entfernungszange
Scalpel blade removing forceps
Pinza para quitar hojas de bisturías
Pinze per distribuire lame die bisturi



Skalpellklingen-Entferner
Scalpel-Blade Remover
Quita hojas
Distributore lame

010-280-000

010-271-160 16 cm / 6 1/4"

Einmal-Skalpelle steril
Disposable Scalpels sterile
Bisturíes para uso único, esteriles
Bisturi mono uso, sterile



010

steril
serile
estériles
sterile



010-290-018



010-290-019



010-290-020



010-290-021

steril
serile
estériles
sterile



010-290-022



010-290-023



010-290-024



010-290-025

discontinued item



010

Einmal-Skalpelle steril
Disposable Scalpels sterile
Bisturios para uso único, esteriles
Bisturi mono uso, sterile

steril
 serile
 estériles
 sterile



010-300-010



010-300-011



010-300-012



010-300-013

einzel verpackt Packung
 mit 10 Stk.

single packed package
 with 10 pos.

envase individual paquete
 con 10 unidades.

bustina individuale
 scatola di 10 bisturi

discontinued item



010-300-015



010-301-012



010-301-015

* doppelschneidig
 double cutting edge
 dos filos de corte
 Filo doppio



Dermatom, einstellbar von 0,1 bis 2,0 mm, komplett, mit 1 auswechselbarer Klinge und 2 Spannplatten.
 Dermeatome, adjustable from 0,1 to 2,0 mm, compl., with 1 interchangeable blade and 2 skin straightening blades
 Dermatomo, graduable de 0,1 hasta 2,0 mm, completo, con 1 hoja intercambiable y 2 placas para extender la piel
 Dermatomi regolabile da 0,1 a 2,0 mm, completo con 2 placche per stendere la pelle ed una lama.

Ersatzklinge
 Spare blade
 Hoja de repuesto
 Lama di ricambio

Spannplatte allein
 Skin straightening plate only
 Placa para extender la piel
 Placca per stendere la pelle

discontinued item



SCHINK

010-350-000 31,0 cm / 12 1/4"

010-350-001

010-350-002



für handelsübliche Rasierklinge
 for razor blades standard model in trade
 para hojas de afeitar de uso corriente en el comercio
 Per lamette da barba normali

SILVER

010-351-000 19,0 cm / 7 1/2"



discontinued item

Ersatzklinge
 Spare blade
 Hoja de repuesto
 Lama di ricambio

010-352-001

HUMBY

010-352-000 32,0 cm / 12 1/2"



010

Amputationsmesser, Resektionsmesser
Amputating knives, Resection knives
Cuchillos para amputación y resección
Coltelli per amputazione e resezione



COLIN	A
010-400-130	13,0 cm / 5 ¹ / ₈ "
010-400-160	16,0 cm / 6 ¹ / ₄ "
010-400-190	19,0 cm / 7 ¹ / ₂ "
010-400-220	22,0 cm / 8 ¹ / ₂ "
010-400-280	28,0 cm / 11 ¹ / ₄ "

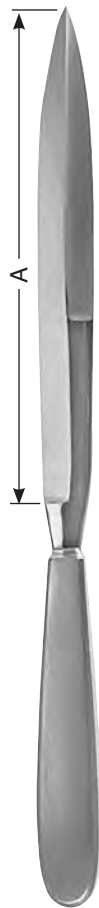

CATLIN	A
010-402-160	16,0 cm / 6 ¹ / ₄ "
010-402-190	19,0 cm / 7 ¹ / ₂ "
010-402-220	22,0 cm / 8 ³ / ₄ "



LISTON	A
010-404-170	17,0 cm / 6 ³ / ₄ "
010-404-200	20,0 cm / 8"



010

Rasierklingenhalter und -brecher, Rasierklingen
Blade Holders / Blade Breakers, Razorblades
Porta hojas / Rompe hojas de afeitar, Hojas para afeitar
Pinze per afferare e rompere le lamette de rasoio, Lamette de rasoio

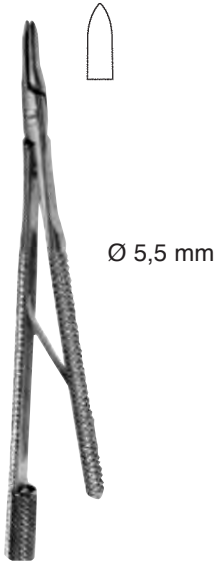

TROUTMAN-CHRIS

010-450-090 9,0 cm / 3 1/2"



TROUTMAN-CHRIS

010-451-090 9,0 cm / 3 1/2"



CASTROVIEJO

010-452-110 11,0 cm / 4 1/2"



CASTROVIEJO

010-454-130 13,0 cm / 5 1/4"

Rasierklingen, brechbar, rostfrei, in Packungen zu 10 Stück.

Razor blades, breakable, stainless steel, in packages of 10 pieces.

Hojas de afeitar, rompibles de acero inoxidable, en paquetes de 10 piezas.

Lamette di rasoio, per rompere, acciaio inossidabile, scatola di 10 pezzi



discontinued item

010-460-010

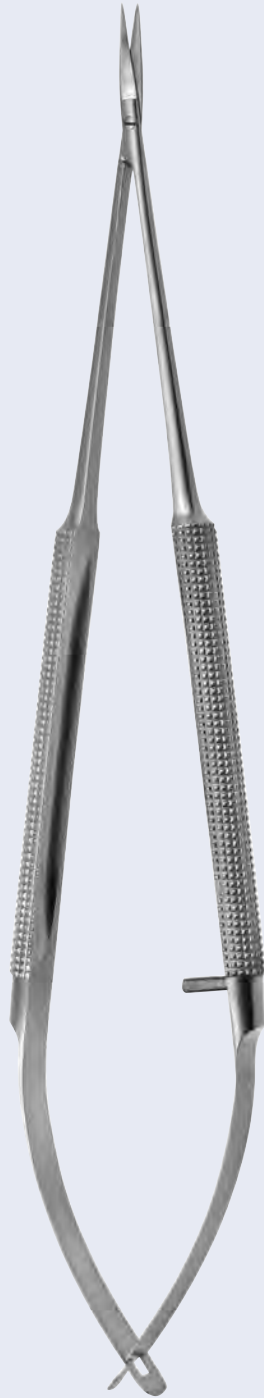
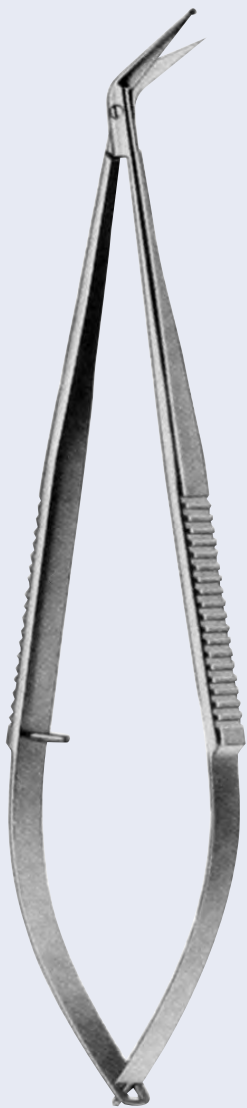

011

Mikro-Scheren
Micro Scissors
Micro Tijeras
Micro Forbici



011

Mikro-Scheren
Micro Scissors
Micro Tijeras
Micro Forbici

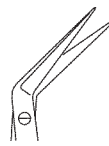

011-100-185

011-101-185

011-103-185

011-105-185

aufgebogen
curved
curva
curve in alto

abgebogen
cur. downward
curva hacia abajo
curve basso

abgewinkelt
angled
acodada
angolato

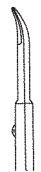
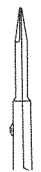

011-106-185

011-107-185

011-100-185 – 011-107-185 18,5 cm / 7 1/2"



JACOBSON
011-100-225

POTTS
011-101-225

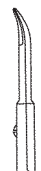
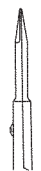

011-106-225

011-107-225

011-100-225 – 011-107-225 22,5 cm / 8 3/4"



011-110-185

011-111-185



011-113-185

011-110-185 – 011-113-185 18,5 cm / 7 1/2"

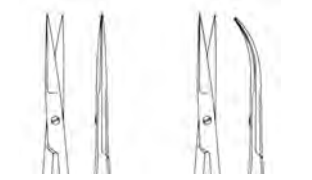

011-120-115 **011-121-115**

WESTCOTT

011-120-115 11,5 cm / 8³/₄"
011-121-115 11,5 cm / 8³/₄"

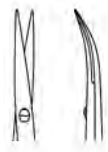

011-201-110 11,0 cm / 4¹/₂"



011-204-120 12,0 cm / 5"

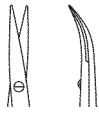

GOMEL

011-211-140 14,0 cm / 5¹/₂"
011-211-180 18,0 cm / 6¹/₄"

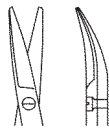

HEPP/SCHIEDEL

011-221-140 14,0 cm / 5¹/₂"
011-221-160 16,0 cm / 6¹/₄"

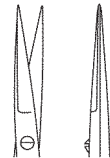

011-230-090



011-231-090

011-230-090 9,0 cm / 3¹/₂"
011-231-090 9,0 cm / 3¹/₂"



011

Mikro-Scheren
Micro Scissors
Micro Tijeras
Micro Forbici

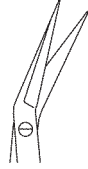

011-251-025

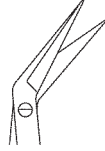

011-251-045

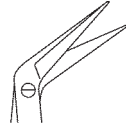

011-251-060



011-251-090

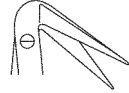

011-251-125

011-251-025 – 011-251-125 18,0 cm / 7"



011-261-025

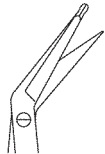

011-261-045

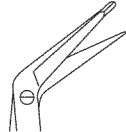

011-261-060



011-261-090

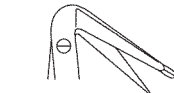

011-261-125

- 1 Blatt geknöpft
- 1 probe-pointed blade
- 1 hoja botonada
- 1 lama bottonuta

011-261-025 – 011-261-125 18,0 cm / 7"

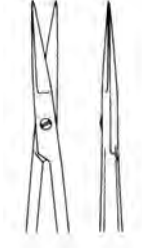

011-270-140

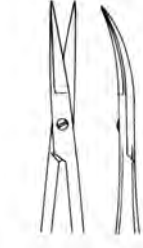

011-271-155



REILL

011-273-155

- 1 Blatt gezahnt
- 1 blade saw edge
- 1 hoja dentada
- 1 lama dentata

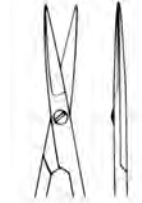

011-280-180



011-282-180

- 1 Blatt gezahnt
- 1 blade saw edge
- 1 hoja dentada
- 1 lama dentata

- 011-270-140** 14 cm / 5 1/2"
- 011-271-155** 15,5 cm / 6"
- 011-273-155** 15,5 cm / 6"

- 011-280-180** 18,0 cm / 7 1/4"
- 011-282-180** 18,0 cm / 7 1/4"

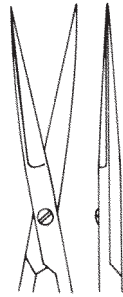
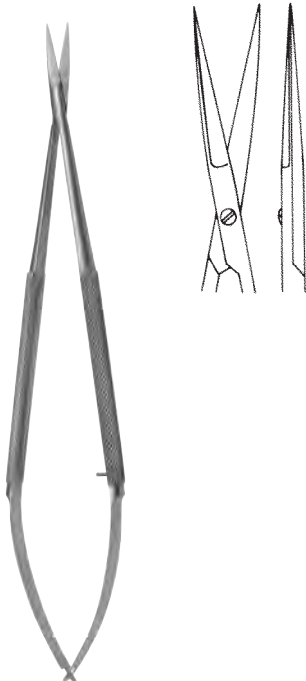

HEPP/SCHIEDEL

011-290-180 18,0 cm / 7 1/4"



011-291-180 18,0 cm / 7 1/4"



HEPP/SCHIEDEL

011-293-180 18,0 cm / 7 1/4"



011



012

Scheren
Scissors
Tijeras
Forbici



012

Chirurgische Scheren
Surgical Scissors
Tijeras para cirugía
Forbici per chirurgia

gerade • straight • rectas • retto



STANDARD

012-100-105	10,5 cm / 4 1/4"
012-100-115	11,5 cm / 4 1/2"
012-100-130	13,0 cm / 5 1/8"
012-100-145	14,5 cm / 5 3/4"
012-100-155	15,5 cm / 6"
012-100-165	16,5 cm / 6 1/2"
012-100-175	17,5 cm / 7"
012-100-185	18,5 cm / 7 1/4"
012-100-200	20,0 cm / 8"

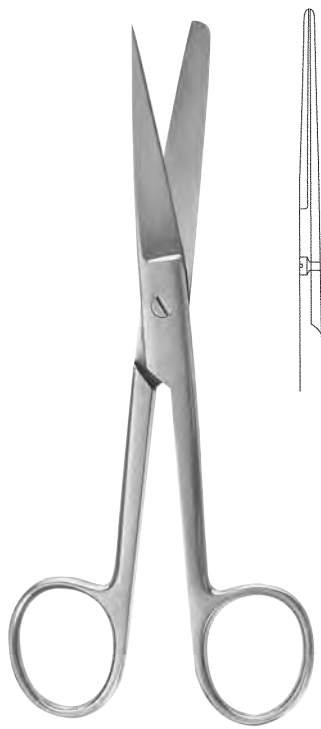

STANDARD

012-102-105	10,5 cm / 4 1/4"
012-102-115	11,5 cm / 4 1/2"
012-102-130	13,0 cm / 5 1/8"
012-102-145	14,5 cm / 5 3/4"
012-102-155	15,5 cm / 6"
012-102-165	16,5 cm / 6 1/2"
012-102-175	17,5 cm / 7"
012-102-185	18,5 cm / 7 1/4"
012-102-200	20,0 cm / 8"

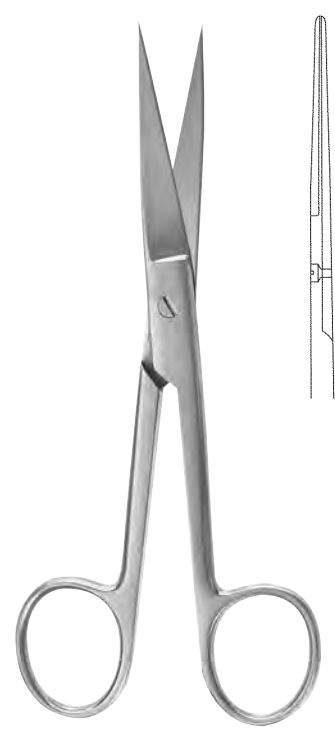

STANDARD

012-104-105	10,5 cm / 4 1/4"
012-104-115	11,5 cm / 4 1/2"
012-104-130	13,0 cm / 5 1/8"
012-104-145	14,5 cm / 5 3/4"
012-104-155	15,5 cm / 6"
012-104-165	16,5 cm / 6 1/2"
012-104-175	17,5 cm / 7"
012-104-185	18,5 cm / 7 1/4"
012-104-200	20,0 cm / 8"

gebogen • curved • curvas • curve



STANDARD

012-101-115	11,5 cm / 4 1/2"
012-101-130	13,0 cm / 5 1/8"
012-101-145	14,5 cm / 5 3/4"
012-101-155	15,5 cm / 6"
012-101-165	16,5 cm / 6 1/2"
012-101-175	17,5 cm / 7"
012-101-185	18,5 cm / 7 1/4"
012-101-200	20,0 cm / 8"



STANDARD

012-103-115	11,5 cm / 4 1/2"
012-103-130	13,0 cm / 5 1/8"
012-103-145	14,5 cm / 5 3/4"
012-103-155	15,5 cm / 6"
012-103-165	16,5 cm / 6 1/2"
012-103-175	17,5 cm / 7"
012-103-185	18,5 cm / 7 1/4"
012-103-200	20,0 cm / 8"

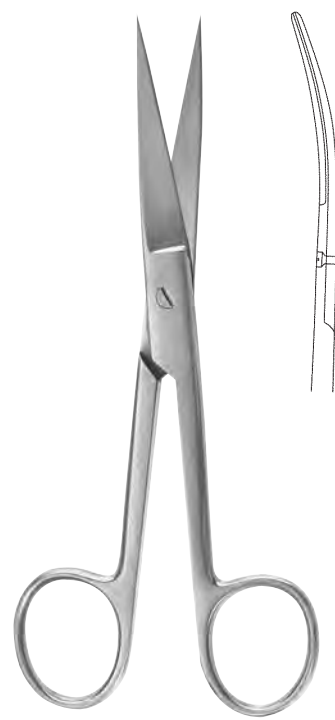

STANDARD

012-105-115	11,5 cm / 4 1/2"
012-105-130	13,0 cm / 5 1/8"
012-105-145	14,5 cm / 5 3/4"
012-105-155	15,5 cm / 6"
012-105-165	16,5 cm / 6 1/2"
012-105-175	17,5 cm / 7"
012-105-185	18,5 cm / 7 1/4"
012-105-200	20,0 cm / 8"



012

Chirurgische Scheren
Surgical Scissors
Tijeras para cirugía
Forbici per chirurgia



GRAZIL

012-110-130 13,0 cm / 5 1/8"
012-110-145 14,5 cm / 5 3/4"



GRAZIL

012-111-130 13,0 cm / 5 1/8"
012-111-145 14,5 cm / 5 3/4"



GRAZIL

012-112-130 13,0 cm / 5 1/8"
012-112-145 14,5 cm / 5 3/4"



GRAZIL

012-113-130 13,0 cm / 5 1/8"
012-113-145 14,5 cm / 5 3/4"



GRAZIL

012-114-130 13,0 cm / 5 1/8"
012-114-145 14,5 cm / 5 3/4"



GRAZIL

012-115-130 13,0 cm / 5 1/8"
012-115-145 14,5 cm / 5 3/4"



INCISION

012-120-130 13,0 cm / 5 1/8"
012-120-145 14,5 cm / 5 3/4"



DEAVER

012-130-140 14,0 cm / 5 1/2"

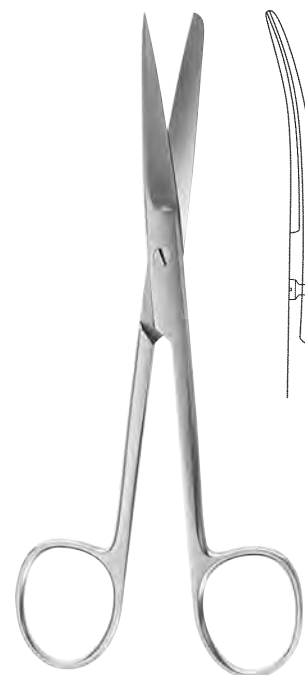

DEAVER

012-131-140 14,0 cm / 5 1/2"

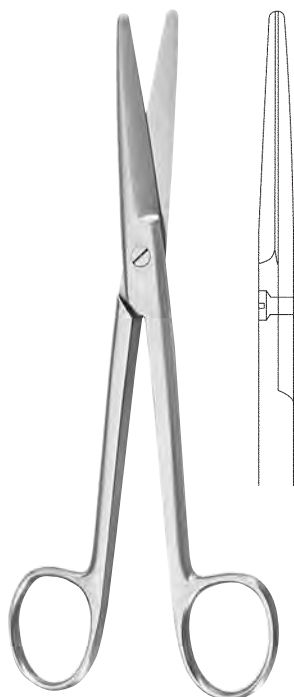

MAYO

012-140-145 14,5 cm / 5 3/4"
012-140-155 15,5 cm / 6"
012-140-170 17,0 cm / 6 3/4"
012-140-230 23,0 cm / 9"

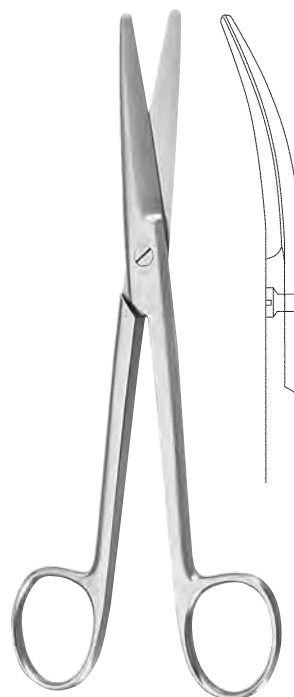

MAYO

012-141-145 14,5 cm / 5 3/4"
012-141-155 15,5 cm / 6"
012-141-170 17,0 cm / 6 3/4"
012-141-230 23,0 cm / 9"



012

Chirurgische Scheren
Surgical Scissors
Tijeras para cirugía
Forbici per chirurgia

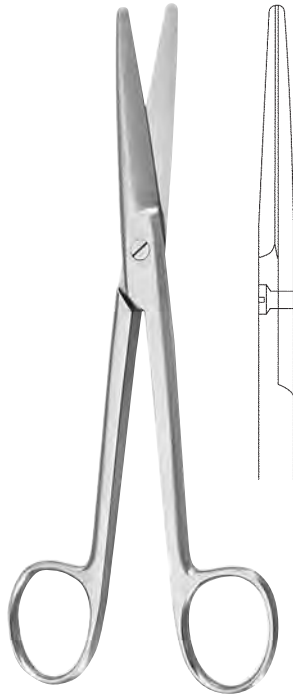

MAYO-HARRINGTON

012-142-225 22,5 cm / 9"

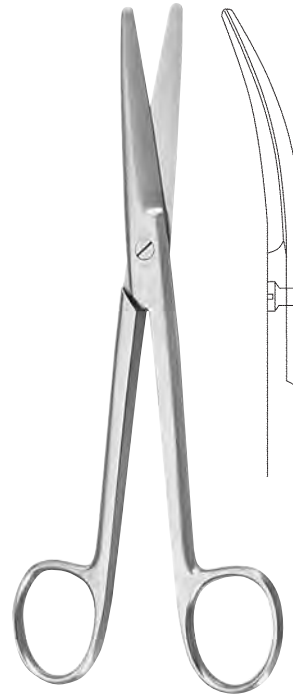

MAYO-HARRINGTON

012-143-225 22,5 cm / 9"
012-143-280 28,0 cm / 11"

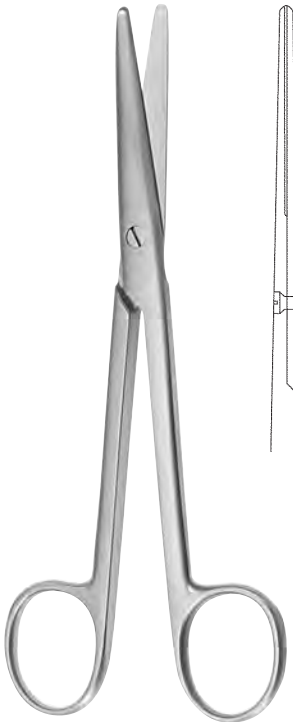

MAYO-STILLE

012-150-150 15,0 cm / 6"
012-150-170 17,0 cm / 6³/₄"
012-150-190 19,0 cm / 7¹/₂"
012-150-210 21,0 cm / 8¹/₄"



MAYO-STILLE

012-151-150 15,0 cm / 6"
012-151-170 17,0 cm / 6³/₄"
012-151-190 19,0 cm / 7¹/₂"
012-151-210 21,0 cm / 8¹/₄"

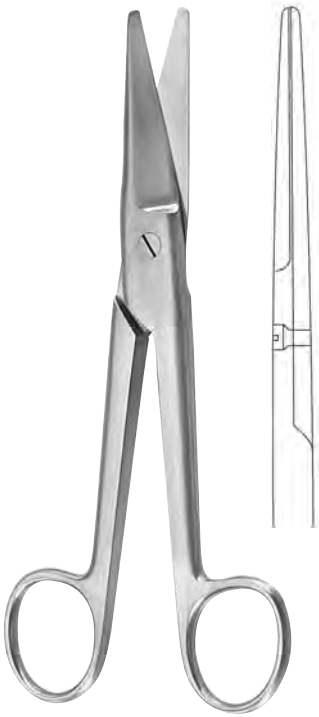

MAYO-NOBLE

012-154-170 17,0 cm / 6³/₄"



MAYO-NOBLE

012-155-170 17,0 cm / 6³/₄"

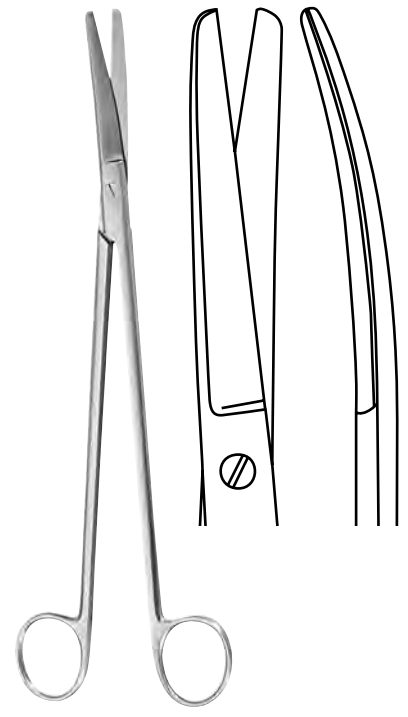

WERTHEIM

012-159-145 14,5 cm / 5¹/₂"
012-159-195 19,5 cm / 7³/₄"
012-159-225 22,5 cm / 9"

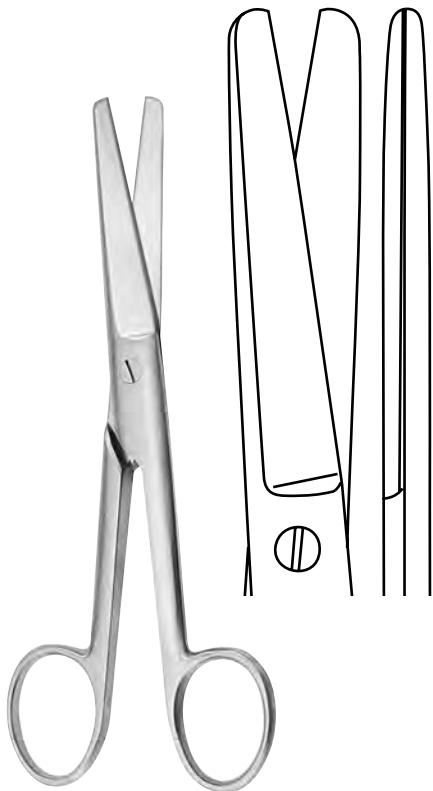

DOYEN

012-160-175 17,5 cm / 7"

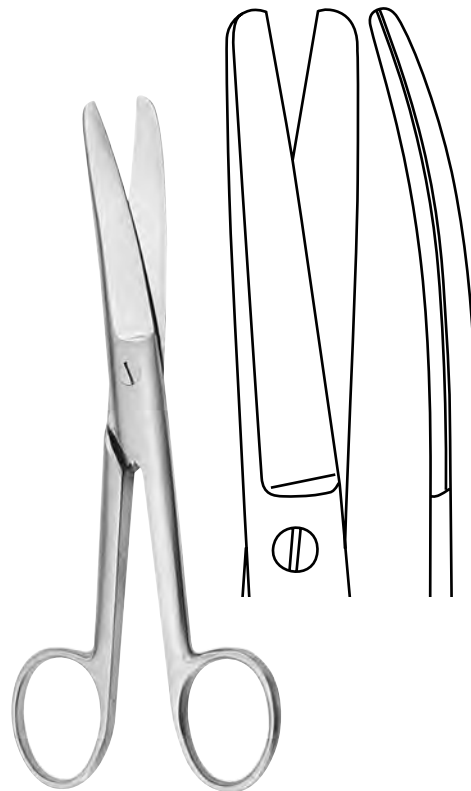

DOYEN

012-161-175 17,5 cm / 7"



012

Gynäkologische Scheren
Gynecological Scissors
Tijeras para ginecología
Forbici per ginecologia

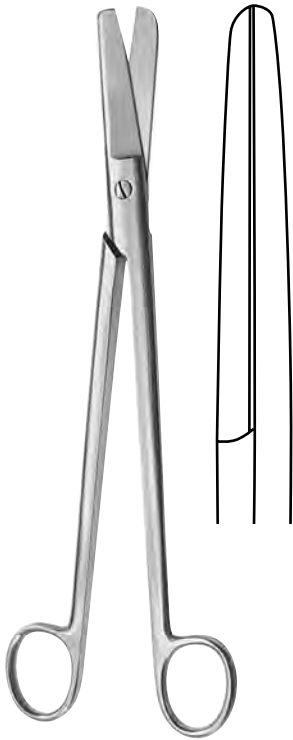

DUBOIS

012-160-270 27,0 cm / 10⁵/₈"

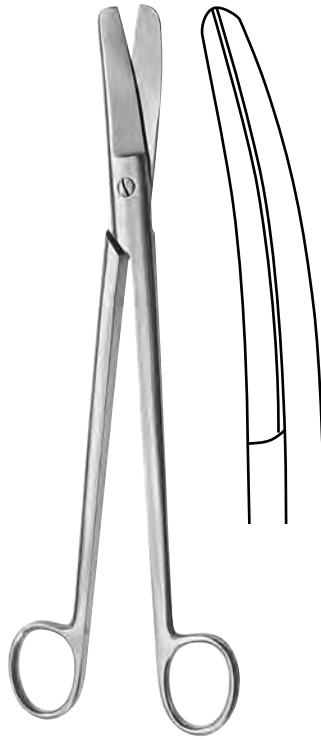

DUBOIS

012-161-270 27,0 cm / 10⁵/₈"



BOZEMANN

012-163-220 22,0 cm / 8³/₄"



SIEBOLD

012-165-240 24,0 cm / 9¹/₂"

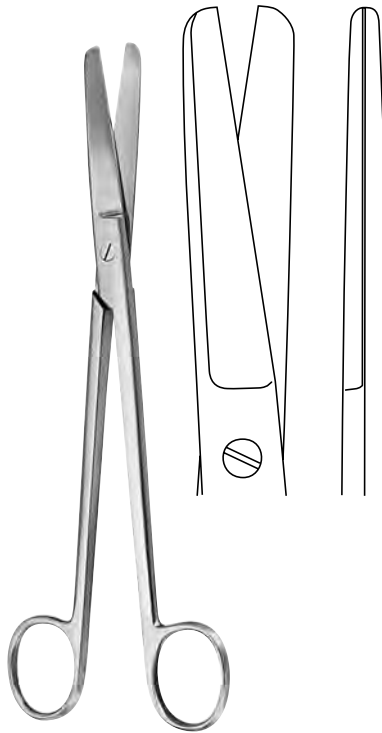

SIMS

012-166-200 20,0 cm / 8"
012-166-230 23,0 cm / 9"

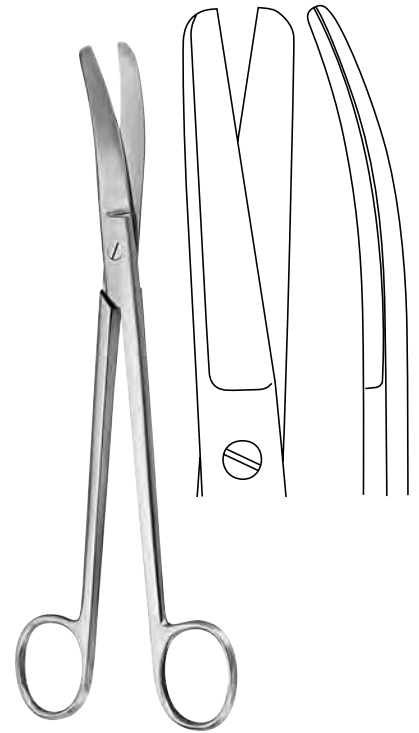

SIMS

012-167-200 20,0 cm / 8"
012-167-230 23,0 cm / 9"

Gynäkologische Scheren / Nabelschnurscheren
 Gynecological Scissors / Umbilical Scissors
 Tijeras para ginecología / Tijeras umbilicales
 Forbici per ginecologia / Forbici ombelicali



012



BRAUN-STADLER

012-169-140 14,0 cm / 5 1/2"
012-169-220 22,0 cm / 8 3/4"



BUSCH

012-171-130 13,0 cm / 5 1/8"
012-171-160 16,0 cm / 6 1/4"



MOD. USA

012-173-105 10,5 cm / 4 1/8"



SCHUMACHER

012-175-160 16,0 cm / 6 1/4"



WALDMANN

012-177-180 18,0 cm / 7"

Episiotomiescheren
 Episiotomy scissors
 Tijeras para episiotomía
 Forbici per episiotomia



Episiotomiescheren
 Episiotomy scissors
 Tijeras para episiotomía
 Forbici per episiotomia

gezahnt
 toothed
 dentada
 dentate

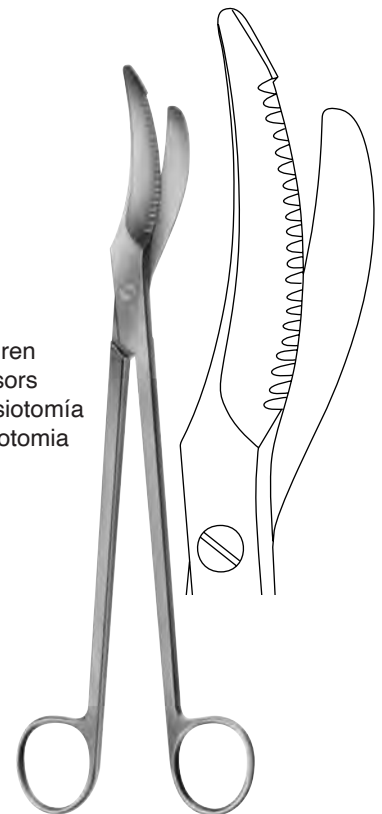

012-181-240 24,0 cm / 9 1/2"



012

**Präparierscheren
Dissecting Scissors
Tijeras de disección
Forbici per dissezione**



METZENBAUM-BABY

012-200-115 11,5 cm / 4 1/2"



METZENBAUM-BABY

012-201-115 11,5 cm / 4 1/2"



012-202-145



012-203-145

METZENBAUM

012-202-145 – 012-203-145 14,5 cm / 5 1/2"

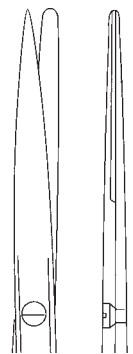

012-204-145

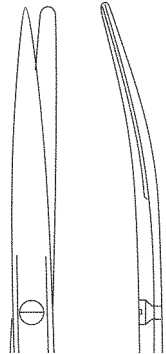

012-205-145

METZENBAUM

012-204-145 – 012-205-145 14,5 cm / 5 1/2"



012-206-145

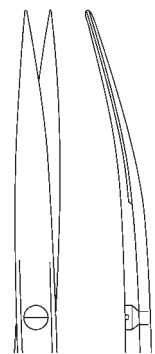

012-207-145

METZENBAUM

012-206-145 – 012-207-145 14,5 cm / 5 1/2"



METZENBAUM-NELSON

012-210-180	18,0 cm / 7"
012-210-200	20,0 cm / 8"
012-210-230	23,0 cm / 9"
012-210-250	25,0 cm / 10"
012-210-280	28,0 cm / 11"
012-210-300	30,0 cm / 12"

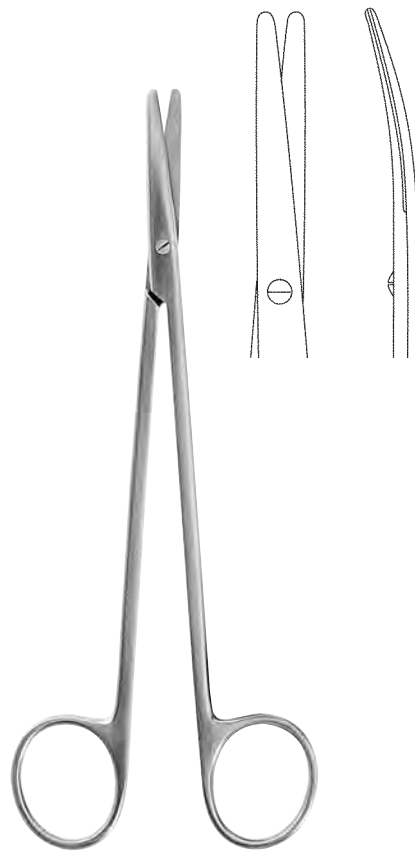

METZENBAUM-NELSON

012-211-180	18,0 cm / 7"
012-211-200	20,0 cm / 8"
012-211-230	23,0 cm / 9"
012-211-250	25,0 cm / 10"
012-211-280	28,0 cm / 11"
012-211-300	30,0 cm / 12"



012

Präparierscheren
Dissecting Scissors
Tijeras de disección
Forbici per dissezione

Nerv-Präparierscheren • Nerve-Dissecting Scissors
Tijeras para disección de nervios • Forbici per nervi



012-214-150 15,0 cm / 6"



012-215-150 15,0 cm / 6"

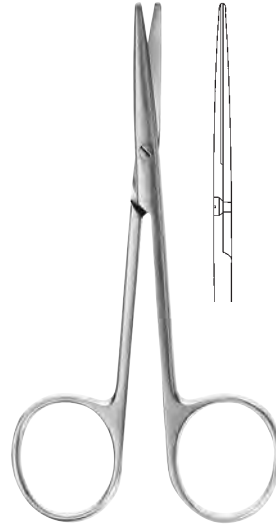

LEXER-BABY
012-220-100 10,0 cm / 4"

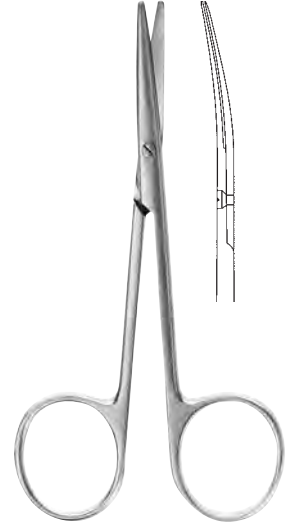

LEXER-BABY
012-221-100 10,0 cm / 4"

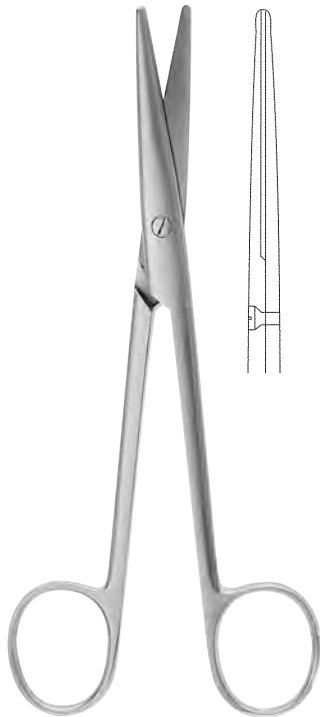

LEXER
012-220-160 16,0 cm / 6 1/4"
012-220-210 21,0 cm / 8 1/4"



LEXER
012-221-160 16,0 cm / 6 1/4"
012-221-210 21,0 cm / 8 1/4"

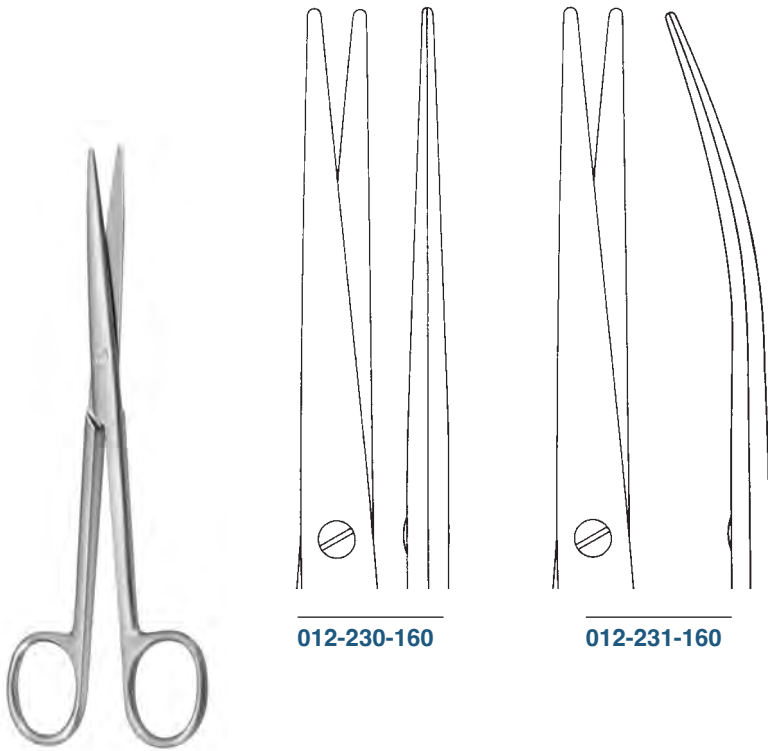

012-230-160

012-231-160

LEXER-FINO

012-230-160 – 012-231-160 16,0 cm / 6 1/4"



012-240-145

012-241-145

012-242-145

012-243-145

METZENBAUM-FINO

012-240-145 – 012-241-145 14,5 cm / 5 3/4"

METZENBAUM-FINO

012-242-145 – 012-243-145 14,5 cm / 5 3/4"



012

Präparierscheren
Dissecting Scissors
Tijeras para disección
Forbici per dissezione

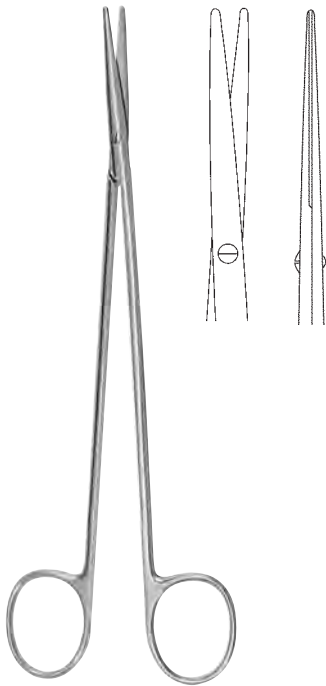

METZENBAUM-FINO

- 012-244-180** 18,0 cm / 7"
- 012-244-200** 20,0 cm / 8"
- 012-244-230** 23,0 cm / 9"

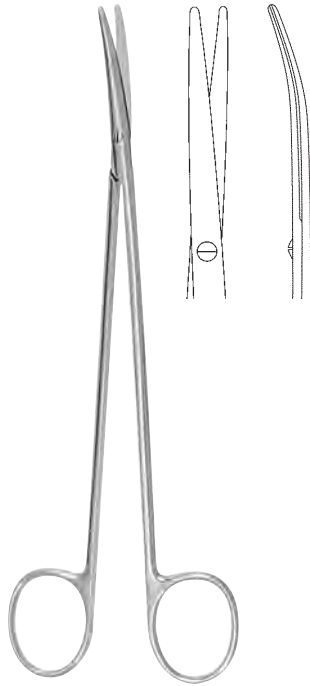

METZENBAUM-FINO

- 012-245-180** 18,0 cm / 7"
- 012-245-200** 20,0 cm / 8"
- 012-245-230** 23,0 cm / 9"

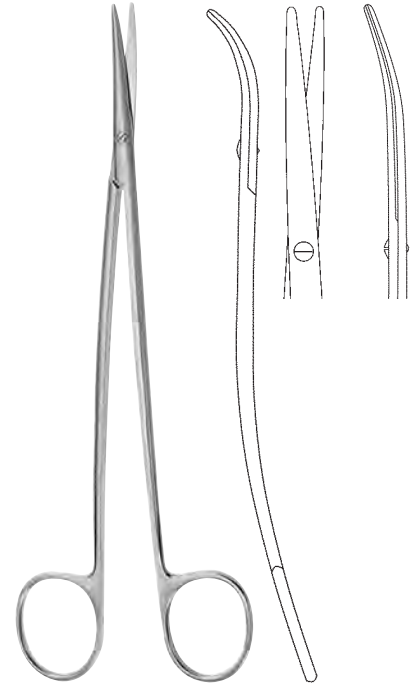

METZENBAUM-FINO S

- 012-247-180** 18,0 cm / 7"
- 012-247-200** 20,0 cm / 8"
- 012-247-230** 23,0 cm / 9"



THOREK

- 012-251-190** 19,0 cm / 7 1/2"

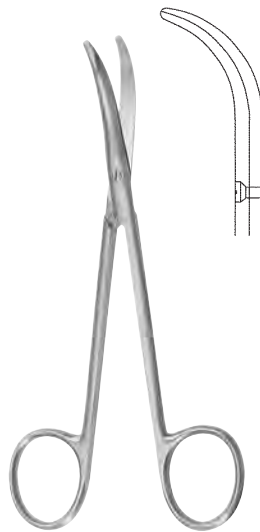

FOMON

- 012-253-135** 13,5 cm / 5 1/8"



ENUCLEATION

- 012-255-110** 11,0 cm / 4 3/8"

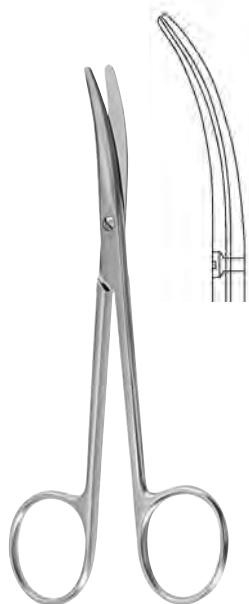

LANDOLT

012-257-125 12,5 cm / 5"



LANDOLT

012-259-125 12,5 cm / 5"



KILNER

012-261-120 12,0 cm / 4³/₄"
012-261-150 15,0 cm / 6"

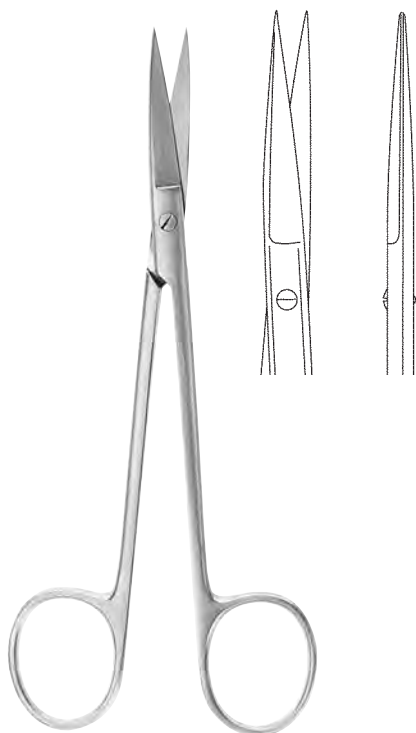

JOSEPH

012-262-140 14,0 cm / 5¹/₂"

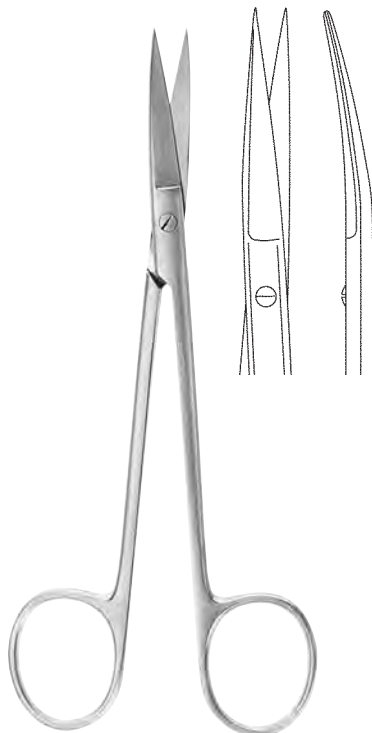

JOSEPH

012-263-140 14,0 cm / 5¹/₂"



012

Feine chirurgische Scheren
Delicate Surgical Scissors
Tijeras finas para cirugía
Forbici fine per chirurgia



BROPHY-SULLIVAN

012-264-140 14,0 cm / 5 1/2"



BROPHY-SULLIVAN

012-265-140 14,0 cm / 5 1/2"

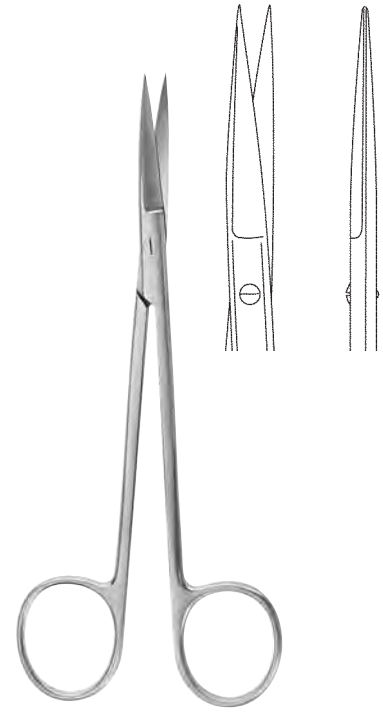

SANVENERO

012-266-140 14,0 cm / 5 1/2"

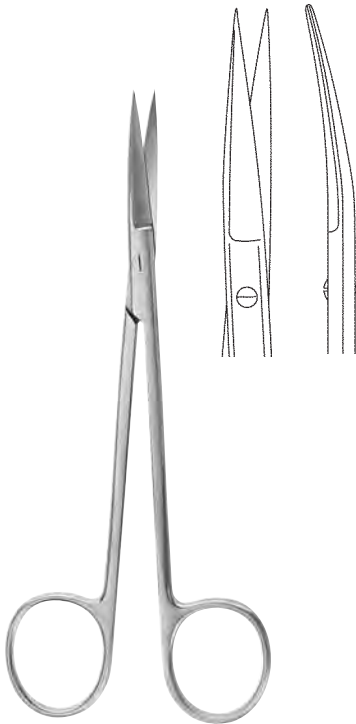

SANVENERO

012-267-140 14,0 cm / 5 1/2"

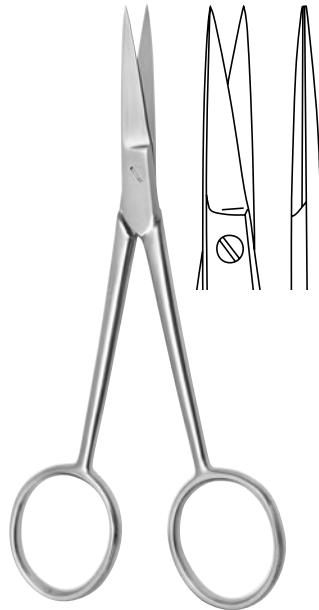

012-268-110 11,0 cm / 4 3/8"

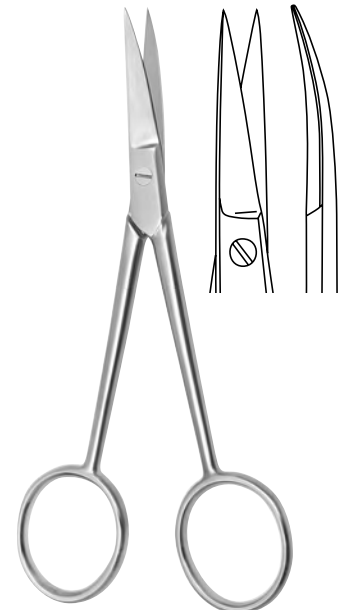

012-269-110 11,0 cm / 4 3/8"

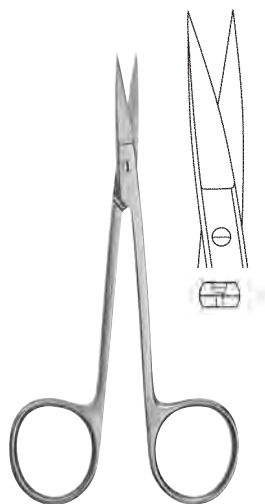

IRIS

- 012-270-090** 9,0 cm / 3 1/2"
- 012-270-105** 10,5 cm / 4 1/8"
- 012-270-115** 11,5 cm / 4 1/2"

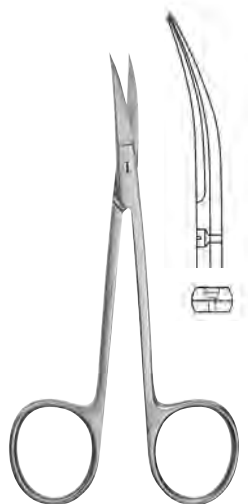

IRIS

- 012-271-090** 9,0 cm / 3 1/2"
- 012-271-105** 10,5 cm / 4 1/8"
- 012-271-115** 11,5 cm / 4 1/2"



- 012-273-115** 11,5 cm / 4 1/2"



- 012-275-115** 11,5 cm / 4 1/2"

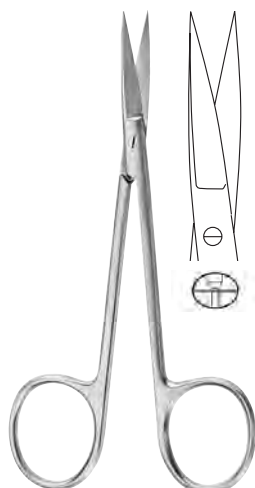

IRIS

- 012-276-090** 9,0 cm / 3 1/2"
- 012-276-105** 10,5 cm / 4 1/8"
- 012-276-115** 11,5 cm / 4 1/2"

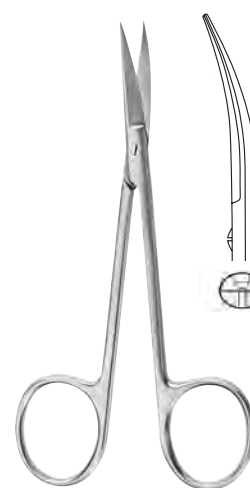

IRIS

- 012-277-090** 9,0 cm / 3 1/2"
- 012-277-105** 10,5 cm / 4 1/8"
- 012-277-115** 11,5 cm / 4 1/2"

Feine chirurgische Scheren
Delicate Surgical Scissors
Tijeras finas para cirugía
Forbici fine per chirurgia



STEVENS
012-280-115 11,5 cm / 4 1/2"



STEVENS
012-281-115 11,5 cm / 4 1/2"



STEVENS
012-282-115 11,5 cm / 4 1/2"

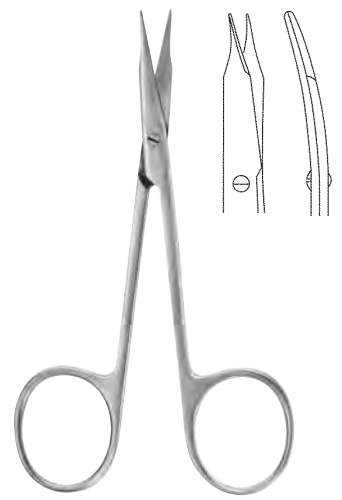

STEVENS
012-283-115 11,5 cm / 4 1/2"



MOD. BONN
012-284-080 8,0 cm / 3 1/4"

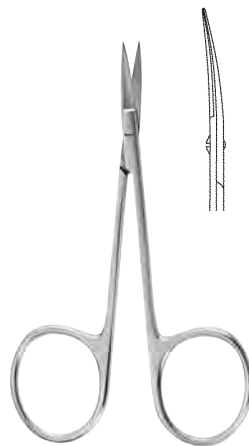

MOD. BONN
012-285-080 8,0 cm, 3 1/4"

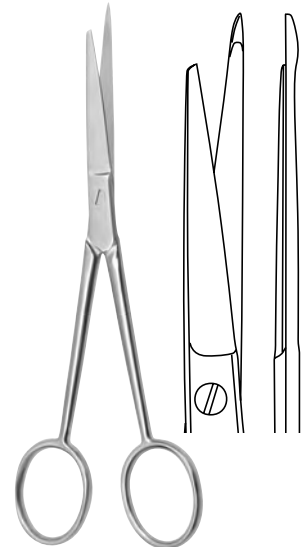

012-286-145 14,5 cm / 5 3/4"

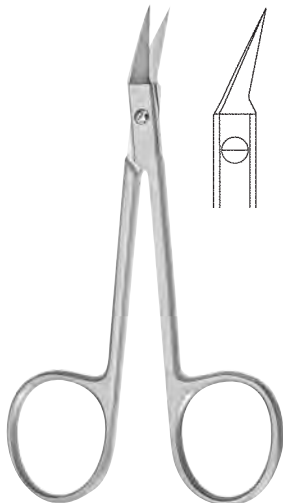

O'BRIAN
012-287-095 9,5 cm / 3 3/4"



STRABISMUS
012-288-115 11,5 cm / 4 1/2"



STRABISMUS
012-289-115 11,5 cm / 4 1/2"



WAGNER

012-290-120 12,0 cm / 4 3/4"



WAGNER

012-291-120 12,0 cm / 4 3/4"

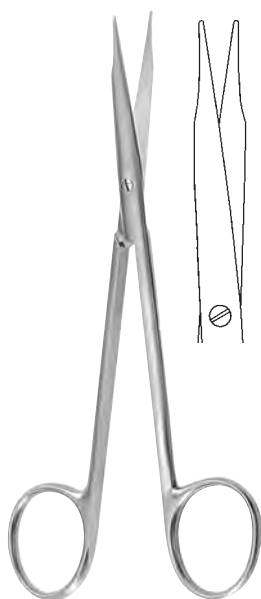

REYNOLDS

012-292-150 15,0 cm / 6"

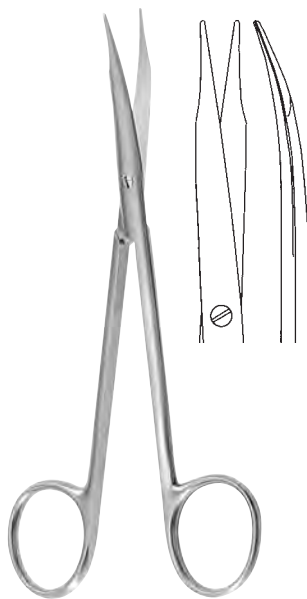

REYNOLDS

012-293-150 15,0 cm / 6"
012-293-175 17,5 cm / 6"

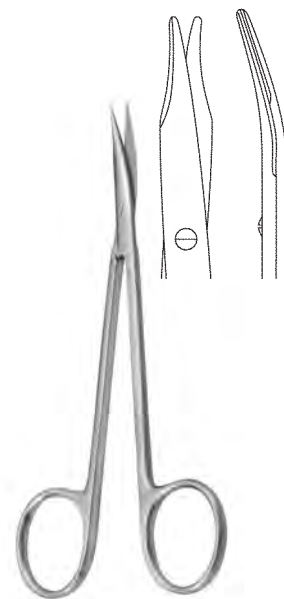

JAMESON

012-295-150 15,0 cm / 6"



012

Feine chirurgische Scheren, Gefäßscheren
Delicate Surgical Scissors, Vascular Scissors
Tijeras finas para cirugía, Tijeras vasculares
Forbici fine per chirurgia, Forbici vascolari

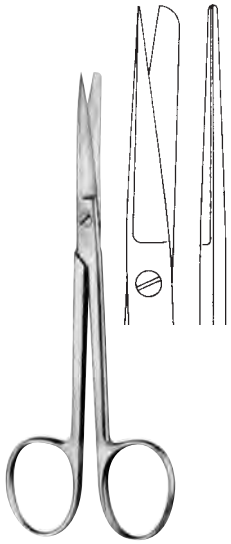

012-296-120 12,0 cm / 4³/₄"

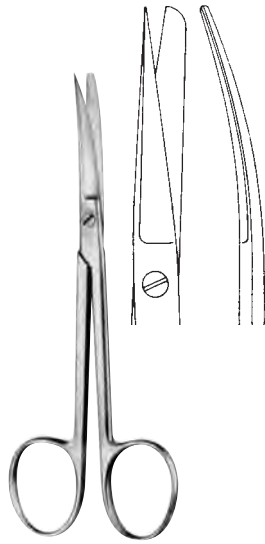

012-297-120 12,0 cm / 4³/₄"

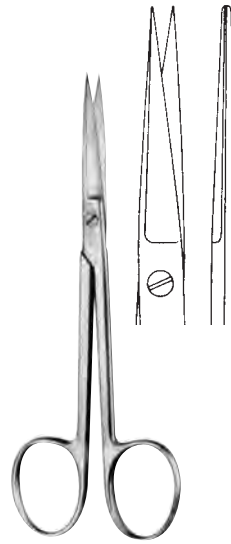

012-298-120 12,0 cm / 4³/₄"

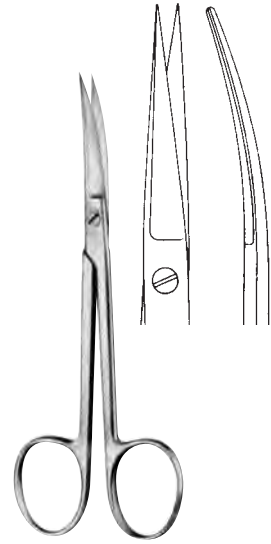

012-299-120 12,0 cm / 4³/₄"

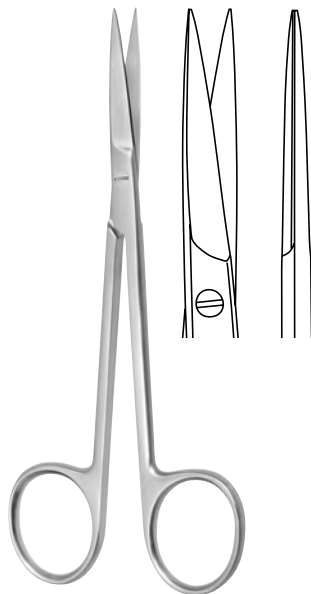

012-298-130 13,0 cm / 5¹/₈"

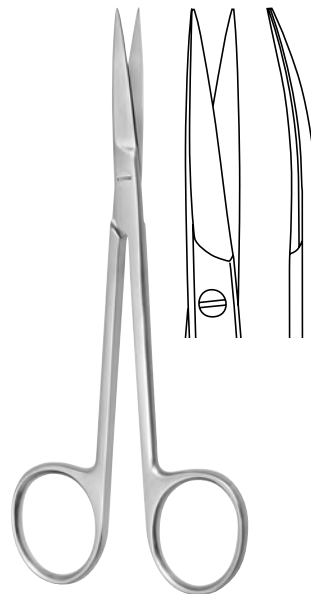

012-299-130 13,0 cm / 5¹/₈"

Gefäßscheren, Darmscheren, Lungenlappenscheren
 Vascular Scissors, Enterotomy Scissors, Lobectomy Scissors
 Tijeras vasculares, Tijeras enterótomos, Tijeras para lobectomia
 Forbici vascolari, Forbici per enterotomia, Forbici per lobo polmonare



012

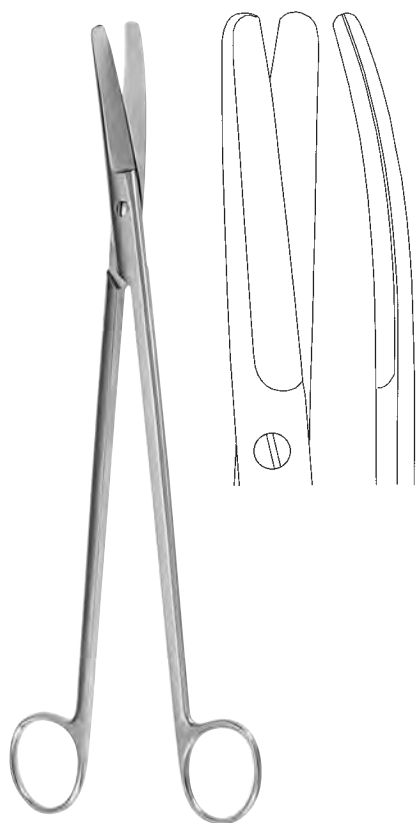

CRAFOORD

012-301-300 30,0 cm / 12"

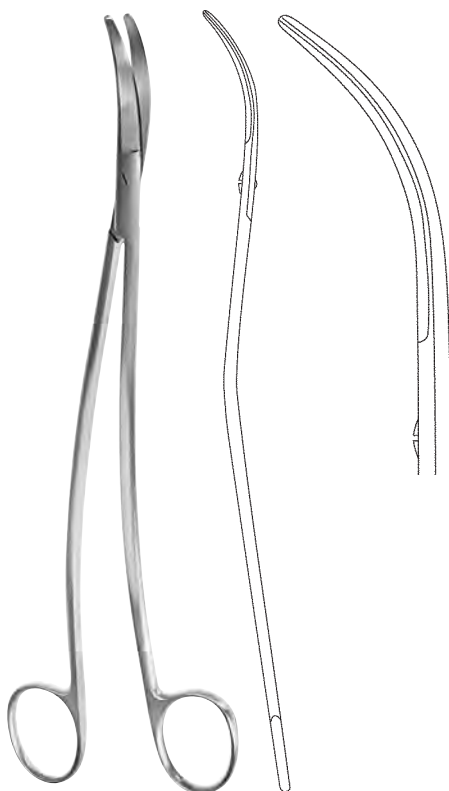

SATINSKY

012-303-245 24,5 cm / 9³/₄"

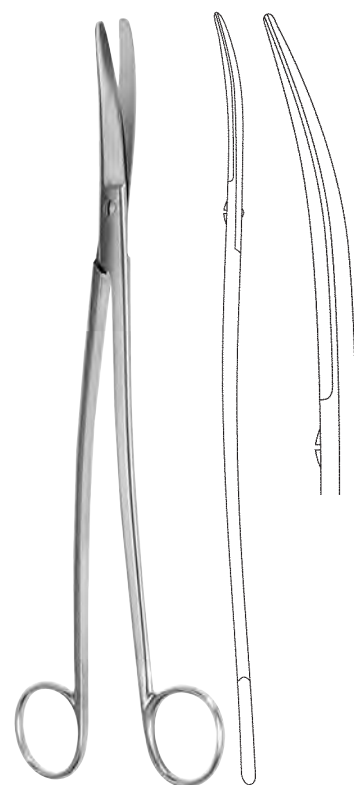

KLINGENBERG-LOTH

012-305-230 23,0 cm / 9"

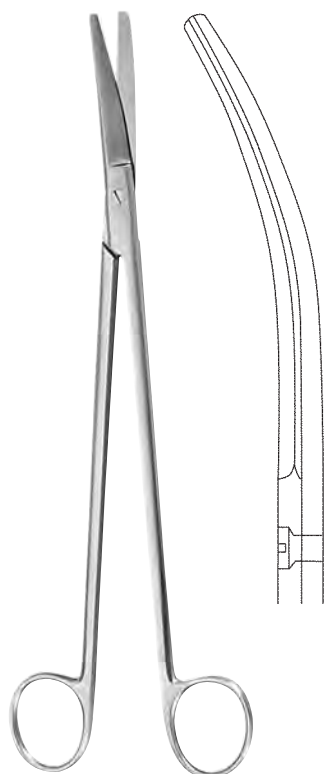

LLOYD-DAVIS

012-311-270 27,0 cm / 10⁵/₈"

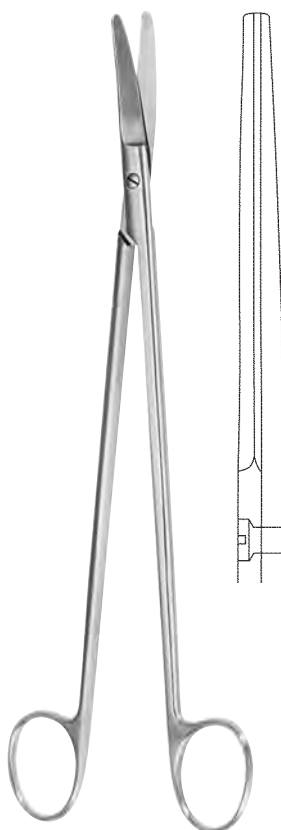

STELZNER

012-312-310 31,0 cm / 12¹/₄"

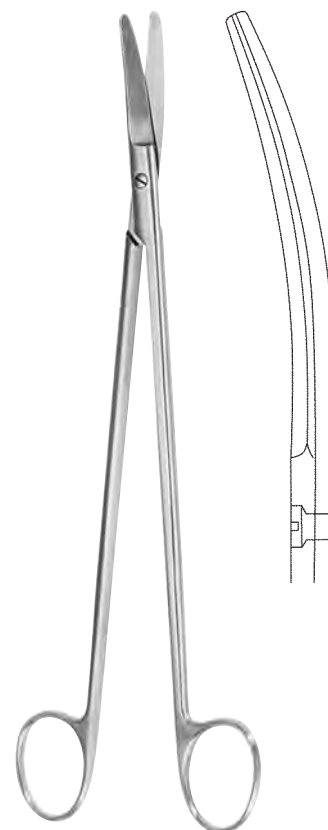

STELZNER

012-313-310 31,0 cm / 12¹/₄"



012

Lungenlappen- und Rektumscheren
Lobectomy and Rectal Scissors
Tijeras para lobectomía y recto
Forbici per lobo polmonare e per il retto

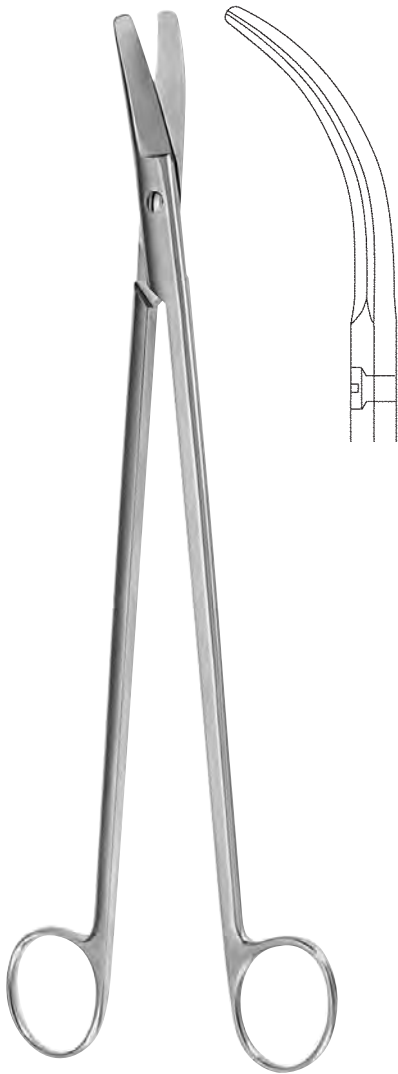

RECTAL

012-315-325 32,5 cm / 12³/₄"



FINOCHIETTO

012-317-270 27,0 cm / 10⁵/₈"

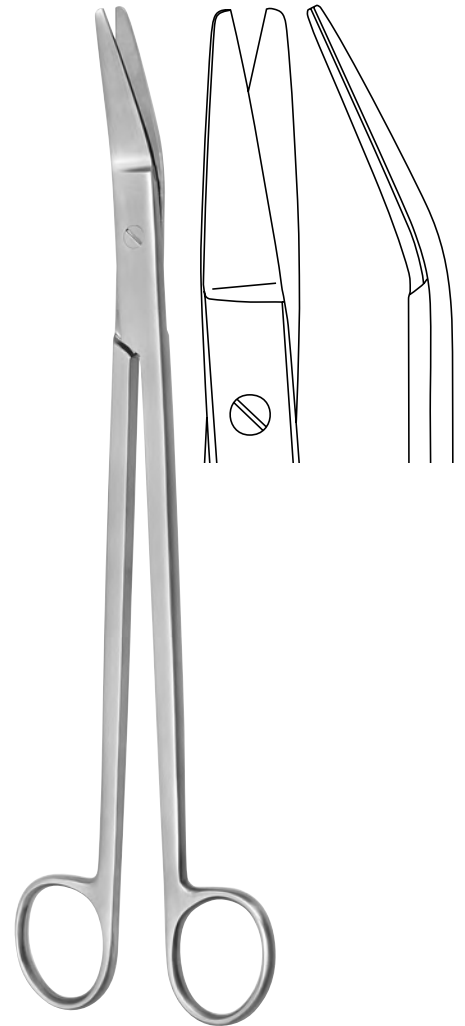

RESANO

012-319-250 25,0 cm / 9³/₄"

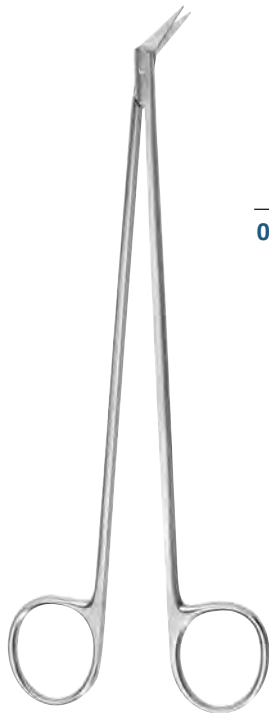

012-331-025



012-331-045

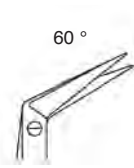

012-331-060

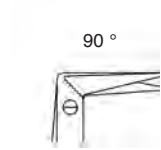

012-331-090



012-331-125

DIETRICH

012-331-025 - 012-331-125 19,0 cm / 7 1/2"



DIETRICH-HEGEMANN

012-333-125 19,0 cm / 7 1/2"

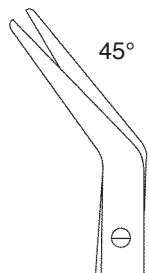
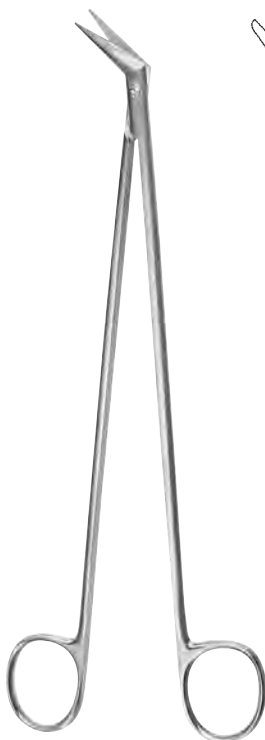

012-335-045

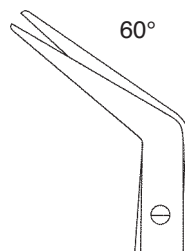

012-335-060

DE BAKEY

012-335-045 16,5 cm / 6 1/2"
 012-335-060 16,0 cm / 6 1/4"



012

Gefäßscheren
Vascular Scissors
Tijeras vasculares
Forbici vascolari

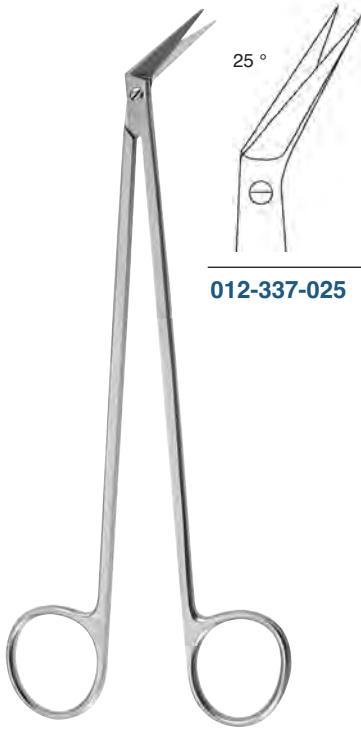

012-337-025

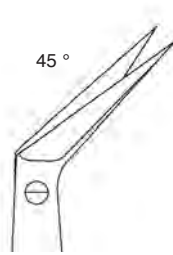

012-337-045

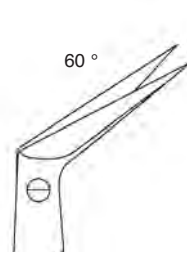

012-337-060

POTTS-SMITH

012-337-025 – 012-337-060 19,0 cm / 7 1/2"

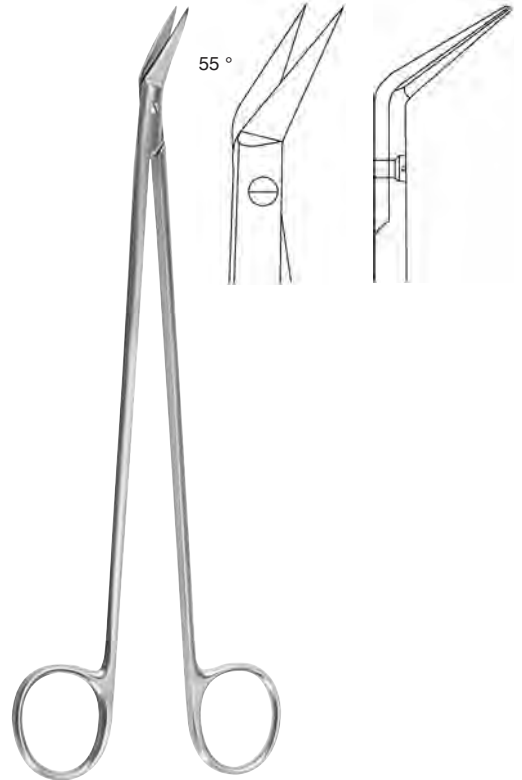

POTTS-SMITH

012-339-055 18,0 cm / 7"

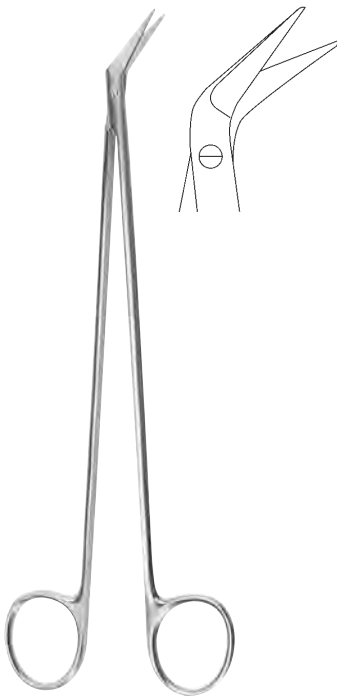

POTTS DE MARTEL

012-441-210 21,0 cm / 8 1/4"
012-441-240 24,0 cm / 9 1/2"

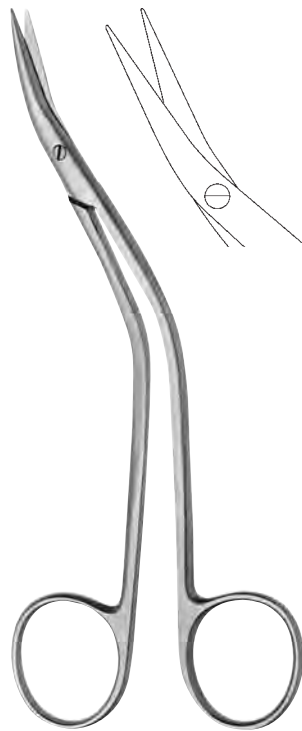

DE BAKEY

012-443-155 15,5 cm / 6"

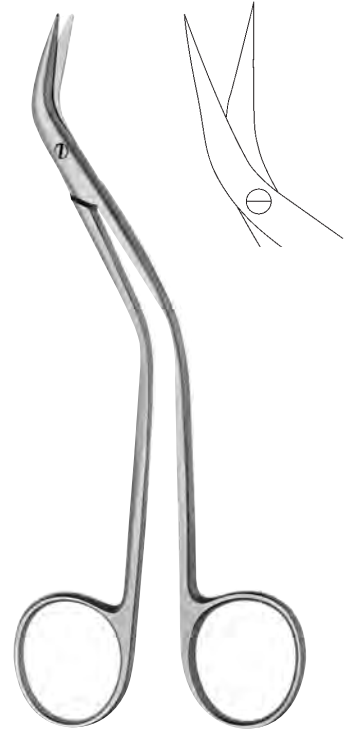

DE BAKEY

012-445-155 15,5 cm / 6"

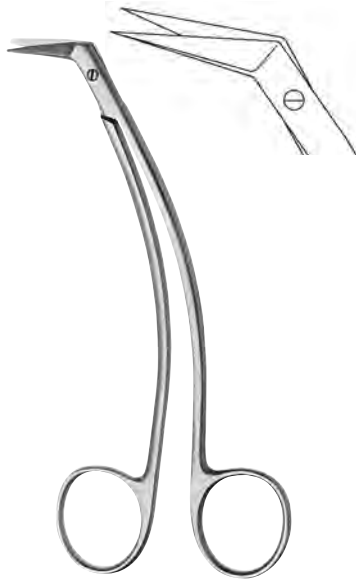

FAVALORO

012-447-155 15,5 cm / 6"

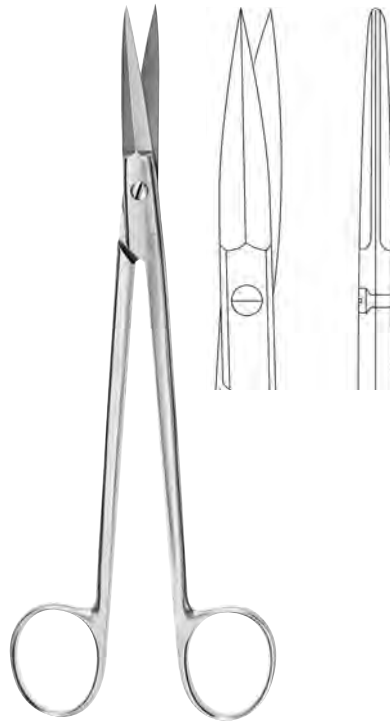

MC INDOE

012-448-190 19,0 cm / 7 1/2"



geknöpftes Blatt
 probe-pointed blade
 punta botonada
 lame bottonuta

012-450-115 11,5 cm / 4 1/2"

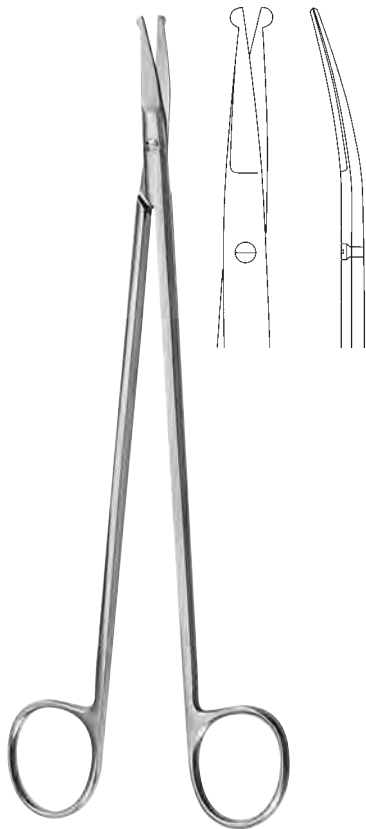

STRULLY

012-461-220 22,0 cm / 8 5/8"

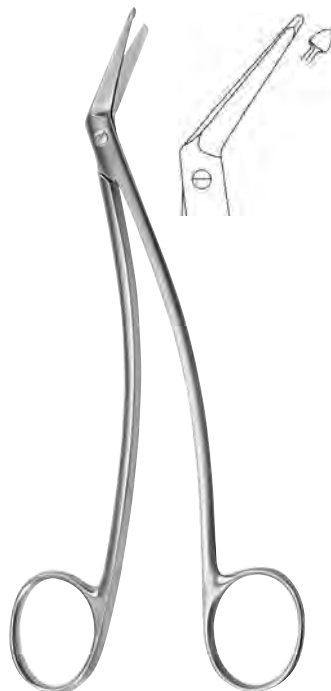

SCHMIEDEN-TAYLOR

012-463-170 17,0 cm / 6 3/4"

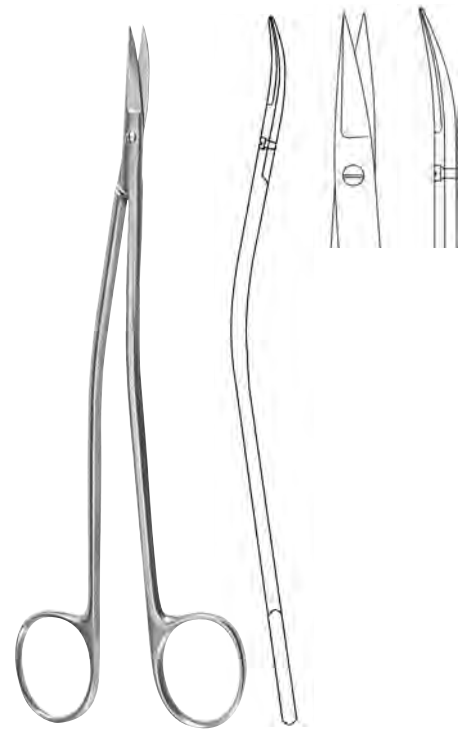

DANDY

012-465-170 17,0 cm / 6 3/4"



012

Gefäßscheren
Vascular Scissors
Tijeras vasculares
Forbici vascolari



012-466-180

012-467-180

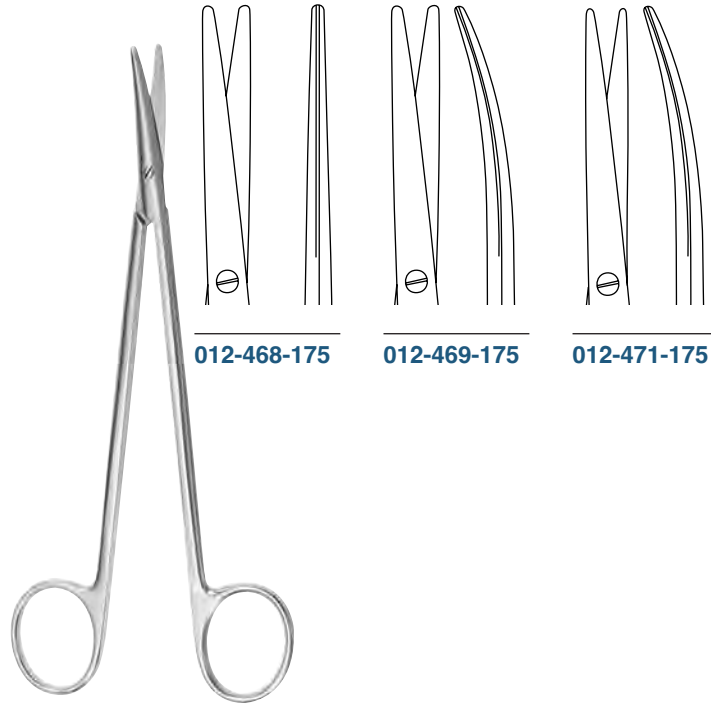

012-468-175

012-469-175

012-471-175

TOENNIS

012-466-180 – 012-467-180 18,0 cm / 7"

TOENNIS-ADSON

012-468-175 – 012-471-175 17,5 cm / 7"



OLIVECRONA

012-473-230 23,0 cm / 9"

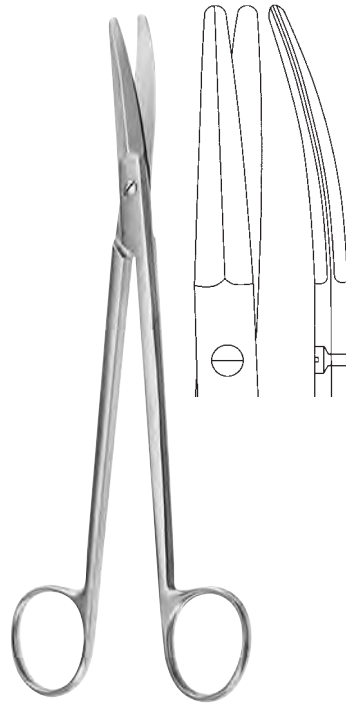

BOETTCHER

012-501-180 18,0 cm / 7"

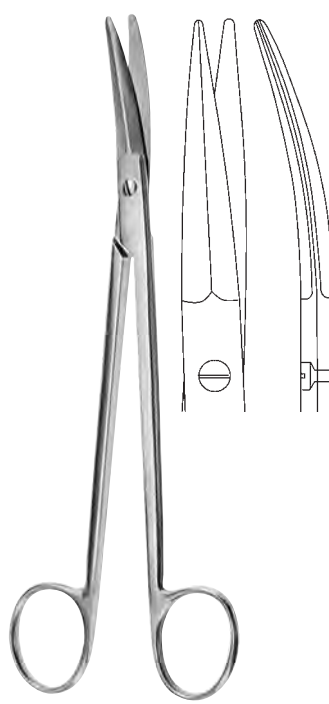

PRINCE

012-503-175 17,5 cm / 7"

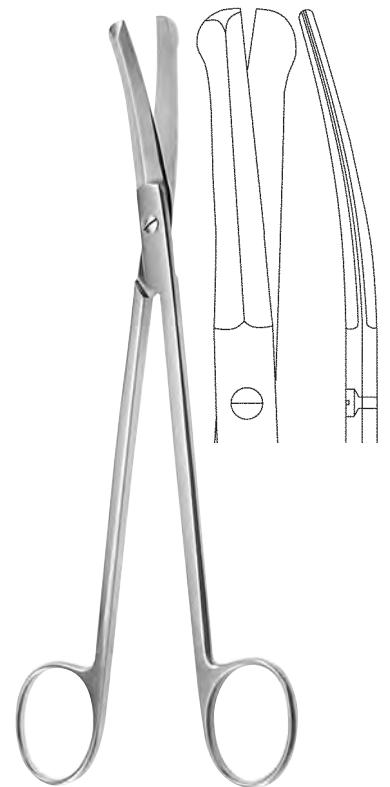

GOOD

012-505-190 19,0 cm / 7 1/2"

Tonsillenscheren, Nasenscheren
Tonsil Scissors, Nasal Scissors
Tijeras para amígdalas, Tijeras para el tabique nasal
Forbici per tonsille, Forbici per il setto nasale



012



HEYMANN

012-507-180 18,0 cm / 7"

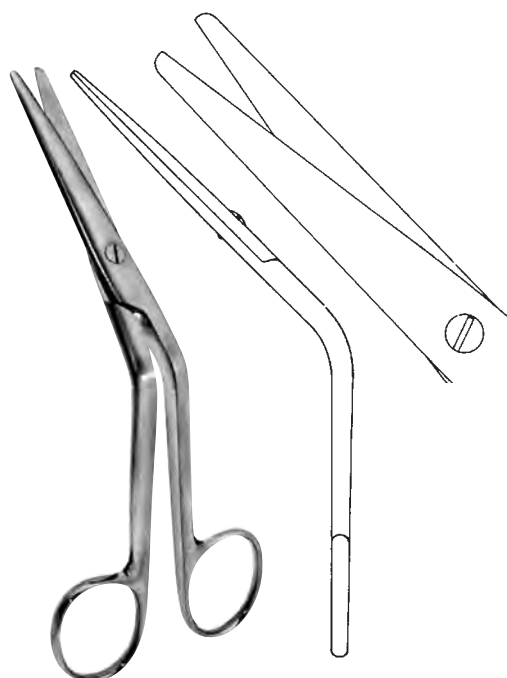

COTTLE

012-509-160 16,0 cm / 6 1/4"

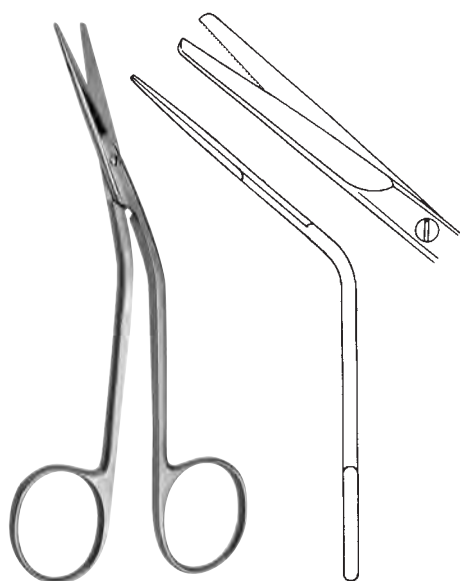

FOMON

012-511-150 15,0 cm / 6"

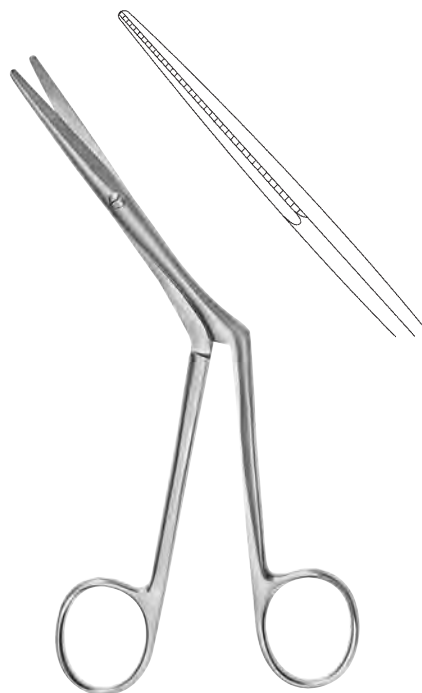

KIRSTEIN

012-513-180 18,0 cm / 7"



012

**Zahnfleischscheren
Gum Scissors
Tijeras para encías
Forbici per gengiva**



012-550-160

012-551-160

KELLY

012-550-160 – 012-551-160 16,0 cm / 6¹/₄"

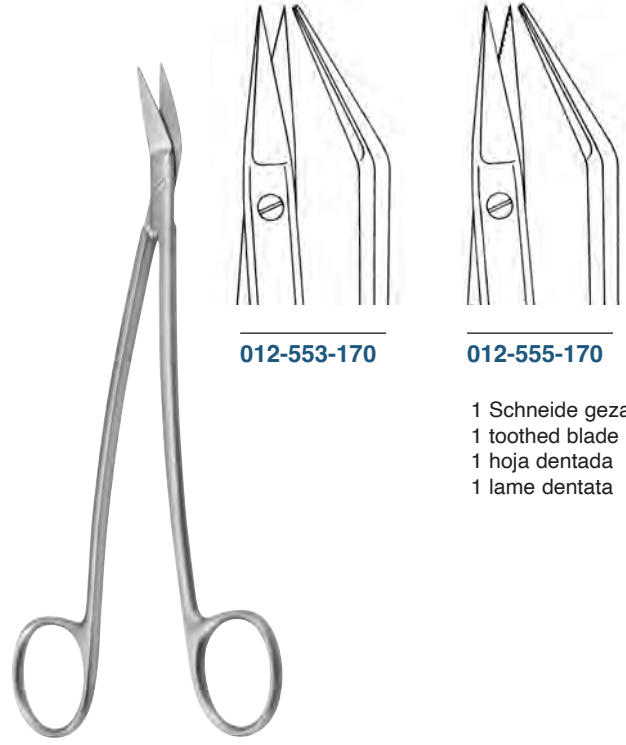

012-553-170

012-555-170

DEAN

012-553-170 – 012-555-170 17,0 cm / 6³/₄"

1 Schneide gezahnt
1 toothed blade
1 hoja dentada
1 lame dentata

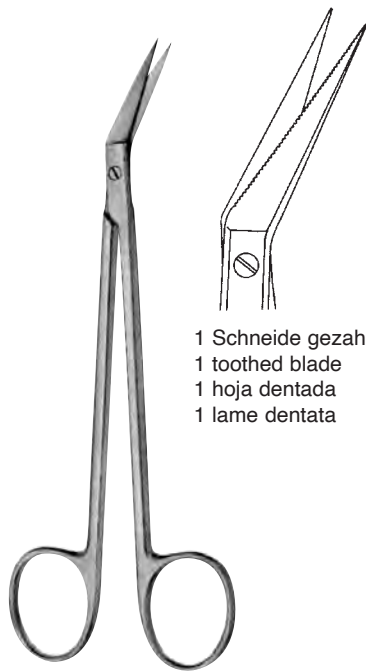

1 Schneide gezahnt
1 toothed blade
1 hoja dentada
1 lame dentata

LOCKLIN

012-557-160 16,0 cm / 6¹/₄"

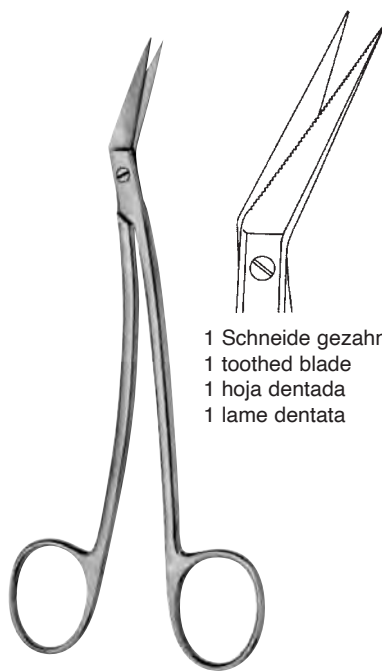

1 Schneide gezahnt
1 toothed blade
1 hoja dentada
1 lame dentata

LOCKLIN

012-559-160 16,0 cm / 6¹/₄"



QUINBY

012-561-125 12,5 cm / 5"

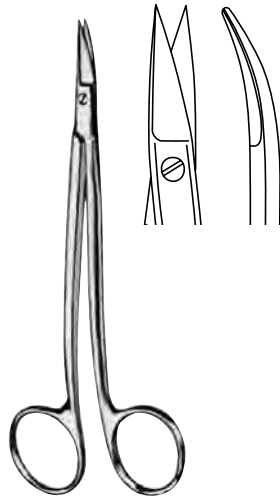

NEUMANN

012-563-125 12,5 cm / 5"

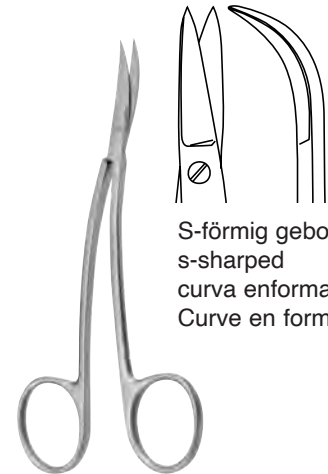

S-förmig gebogen
 s-sharped
 curva en forma S
 Curve en forma S

LA GRANGE

012-565-115 11,5 cm / 4 1/2"



012-566-130

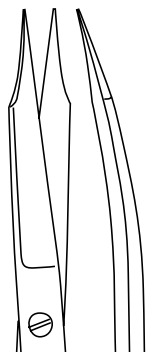

012-567-130

GOLDMANN-FOX

012-566-130 – 012-567-130 13,0 cm / 5 1/8"

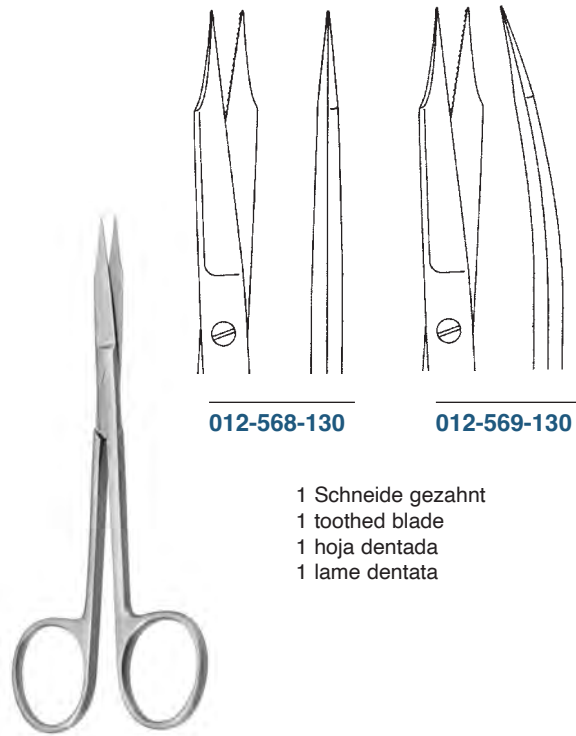

012-568-130

012-569-130

1 Schneide gezahnt
 1 toothed blade
 1 hoja dentada
 1 lame dentata

GOLDMANN-FOX

012-568-130 – 012-569-130 13,0 cm / 5 1/8"



012

Drahtscheren
Wire Cutting Scissors
Cizallas corta-alambres
Forbici taglia cavo



012-570-105

012-571-105

BEEBEE

012-570-105 – 012-571-105

10,5 cm / 4 1/4"



012-572-105

012-573-105

BEEBEE

012-572-105 – 012-573-105

10,5 cm / 4 1/4"

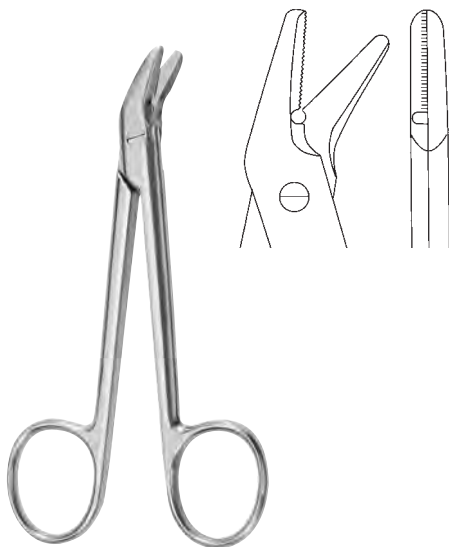

UNIVERSAL

012-575-120 12,0 cm / 4 3/4"



012-580-210 21,0 cm / 8 1/4"



012-582-210 21,0 cm / 8 1/4"



012-584-210 21,0 cm / 8 1/4"



012

Ligaturscheren
Ligature Scissors
Tijeras para ligaduras
Forbici per legature



SPENCER

- 012-590-090** 9,0 cm / 3 1/2"
- 012-590-105** 11,0 cm / 4 1/4"
- 012-590-130** 13,0 cm / 5 1/8"



NORTHBENT

- 012-591-090** 9,0 cm / 3 1/2"
- 012-591-125** 12,5 cm / 5"



LITTAUER

- 012-592-140** 14,0 cm / 5 1/2"



BUCK

- 012-594-145** 14,5 cm / 5 3/4"
- 012-594-180** 18,0 cm / 7"

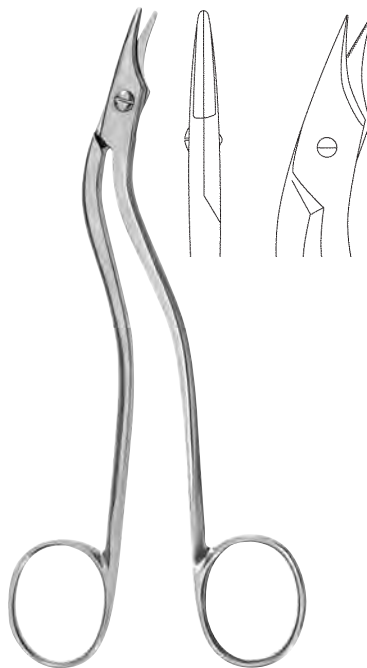

HEATH

- 012-595-160** 16,0 cm / 6 1/4"



EISELSBERG

- 012-596-120** 12,0 cm / 4 3/4"

Chirurgische Scheren mit Hartmetallschneiden
Surgical Scissors with tungsten carbide edges
Tijeras para cirugía con filos de carburo tungsteno
Forbici per chirurgia con lame in carburo di tungsteno



012

- lange Lebensdauer
- hohe Wirtschaftlichkeit
- hervorragende Schnitthaltigkeit
- glatter weicher Schnitt
- durchgehend gehärtet
- vergoldete Ringe zur schnellen Identifikation

-
- long lasting performance
 - economical
 - excellent cutting action
 - smooth cutting
 - fully tempered
 - goldplated rings for easy identification

-
- larga duración
 - gran economía
 - corte de máxima agudeza
 - suave filo
 - completamente templado
 - anillos dorados para su identificación

-
- prestazioni die lunga durata
 - risparmi sul costo
 - eccellente accuratezza del taglio
 - taglio liscio
 - completamente temperato
 - anelli bagnati in oro permettono una piú semplice identificazione





012

Chirurgische Scheren mit Hartmetallschneiden
Surgical Scissors with tungsten carbide edges
Tijeras para cirugía con filos de carburo tungsteno
Forbici per chirurgia con lame in carburo di tungsteno



STANDARD

012-700-145 14,5 cm / 5³/₄"



STANDARD

012-701-145 14,5 cm / 5³/₄"



STANDARD

012-702-145 14,5 cm / 5³/₄"



STANDARD

012-703-145 14,5 cm / 5³/₄"



STANDARD

012-704-145 14,5 cm / 5³/₄"



STANDARD

012-705-145 14,5 cm / 5³/₄"

Chirurgische Scheren mit Hartmetallschneiden
Surgical Scissors with tungsten carbide edges
Tijeras para cirugía con filos de carburo tungsteno
Forbici per chirurgia con lame in carburo di tungsteno



012

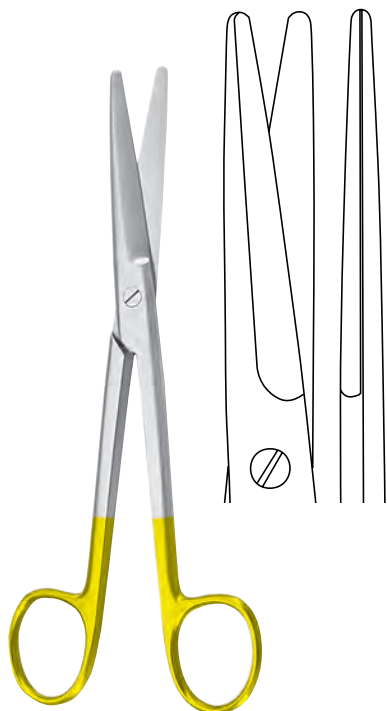

MAYO

- 012-710-145** 14,5 cm / 5³/₄"
- 012-710-170** 17,0 cm / 6³/₄"
- 012-710-230** 23,0 cm / 9"

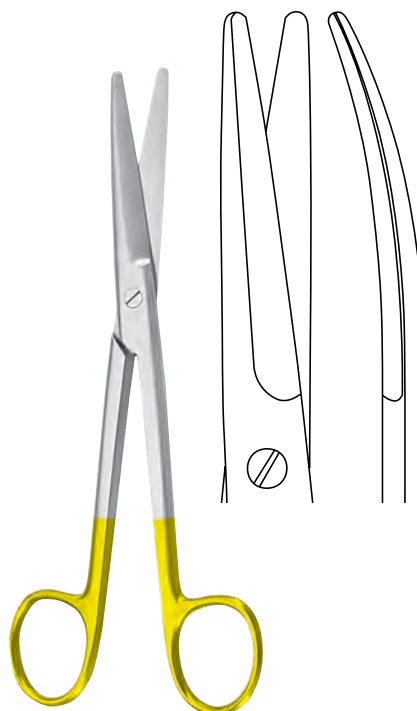

MAYO

- 012-711-145** 14,5 cm / 5³/₄"
- 012-711-170** 17,0 cm / 6³/₄"
- 012-711-230** 23,0 cm / 9"

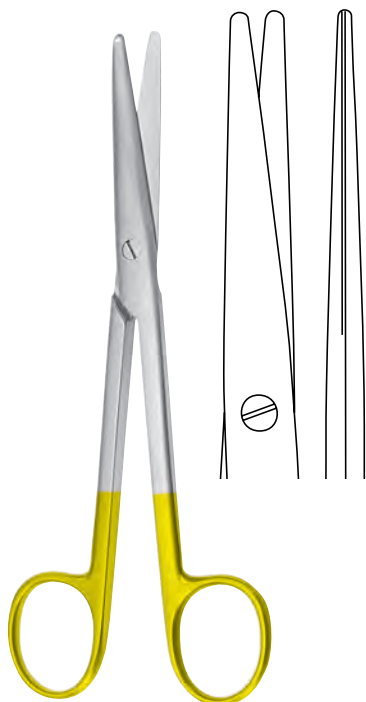

MAYO-STILLE

- 012-714-150** 15,0 cm / 6"
- 012-714-170** 17,0 cm / 6³/₄"

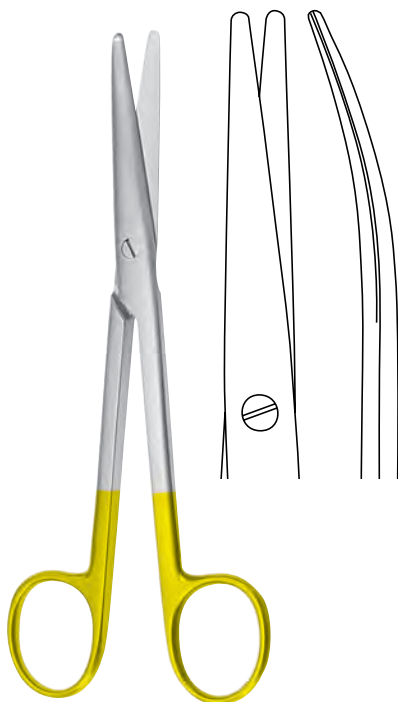

MAYO-STILLE

- 012-715-150** 15,0 cm / 6"
- 012-715-170** 17,0 cm / 6³/₄"

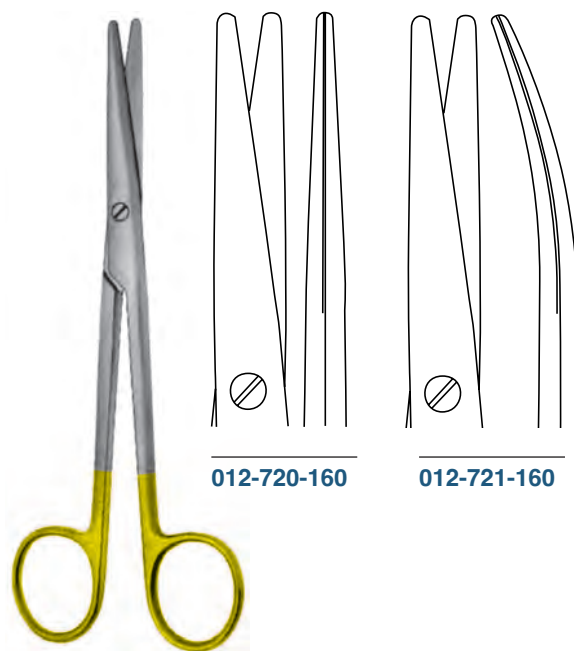

MAYO-LEXER

- 012-720-160 – 012-721-160** 16,0 cm / 6¹/₄"



012

Chirurgische Scheren mit Hartmetallschneiden
Surgical Scissors with tungsten carbide edges
Tijeras para cirugía con filos de carburo tungsteno
Forbici per chirurgia con lame in carburo di tungsteno



LEXER

012-722-160 16,0 cm / 6 1/4"
012-722-210 21,0 cm / 8 1/4"



LEXER

012-723-160 16,0 cm / 6 1/4"
012-723-210 21,0 cm / 8 1/4"



012-730-115

012-731-115

METZENBAUM

012-730-115 – 012-731-115 11,5 cm / 4 1/2"



012-730-145

012-731-145

METZENBAUM

012-730-145 – 012-731-145 14,5 cm / 5 1/2"

Präparierscheren mit Hartmetallschneiden
Dissecting Scissors with tungsten carbide edges
Tijeras para disección con filos de carburo tungsteno
Forbici per dissezione con lame in carburo di tungsteno



012



METZENBAUM

012-730-180	18,0 cm / 7"
012-730-200	20,0 cm / 8"
012-730-230	23,0 cm / 9"
012-730-250	25,0 cm / 10"
012-730-280	28,0 cm / 11"
012-730-300	30,0 cm / 12"

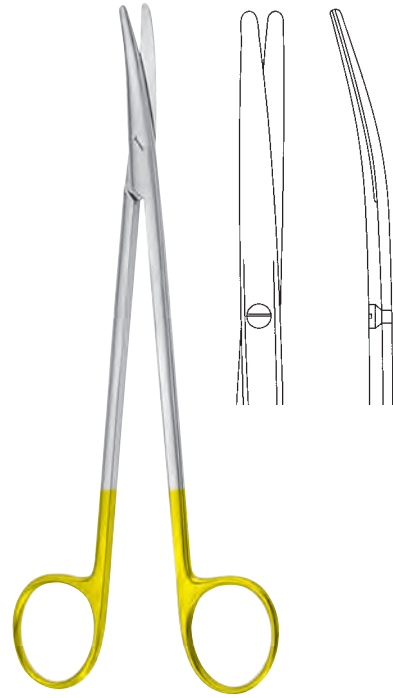

METZENBAUM

012-731-180	18,0 cm / 7"
012-731-200	20,0 cm / 8"
012-731-230	23,0 cm / 9"
012-731-250	25,0 cm / 10"
012-731-280	28,0 cm / 11"
012-731-300	30,0 cm / 12"

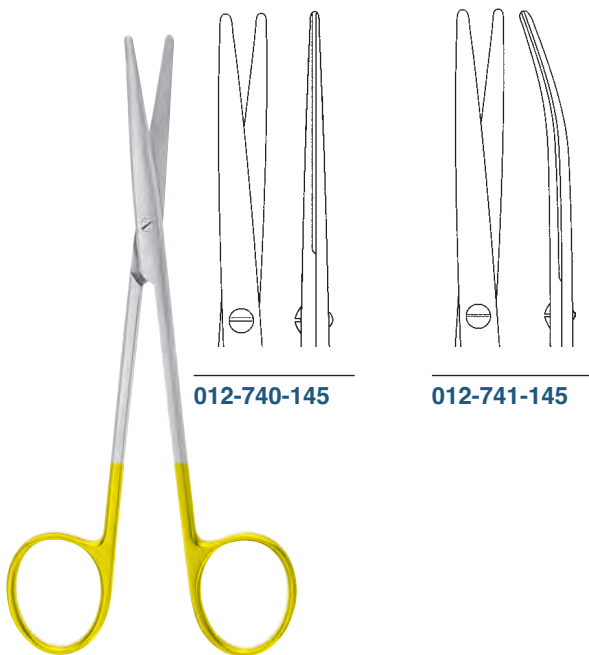

012-740-145

012-741-145

METZENBAUM-FINO

012-740-145 – 012-741-145	14,5 cm / 5 1/2"
----------------------------------	------------------

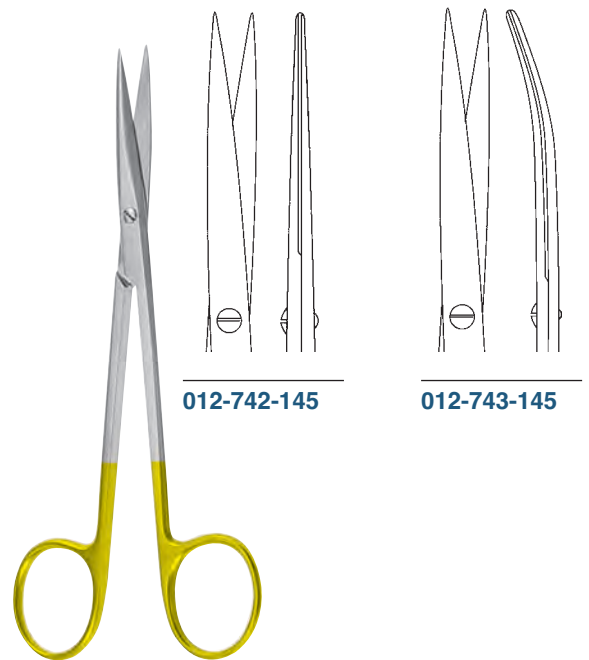

012-742-145

012-743-145

METZENBAUM-FINO

012-742-145 – 012-743-145	14,5 cm / 5 1/2"
----------------------------------	------------------



012

Präparierscheren mit Hartmetallschneiden
Dissecting Scissors with tungsten carbide edges
Tijeras para disección con filos de carburo tungsteno
Forbici per dissezione con lame in carburo di tungsteno

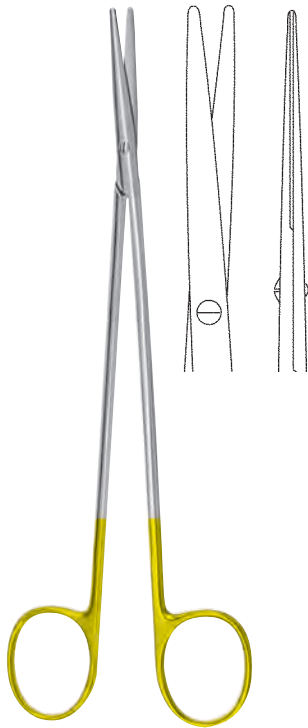

METZENBAUM-FINO

012-740-180	18,0 cm / 7"
012-740-200	20,0 cm / 8"
012-740-230	23,0 cm / 9"
012-740-250	25,0 cm / 10"
012-740-280	28,0 cm / 11"

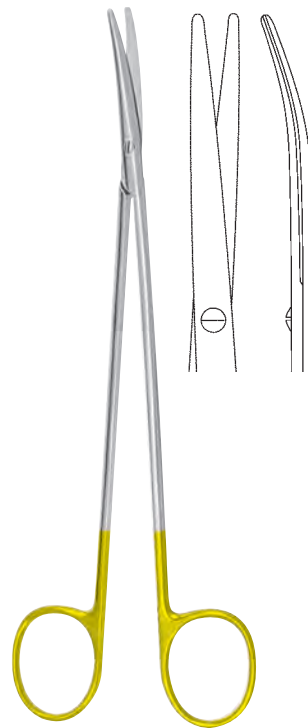

METZENBAUM-FINO

012-741-180	18,0 cm / 7"
012-741-200	20,0 cm / 8"
012-741-230	23,0 cm / 9"
012-741-250	25,0 cm / 10"
012-741-280	28,0 cm / 11"

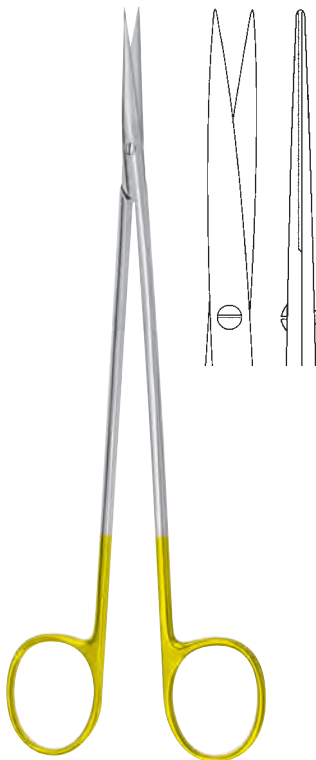

METZENBAUM-FINO

012-742-180	18,0 cm / 7"
012-742-200	20,0 cm / 8"
012-742-230	23,0 cm / 9"

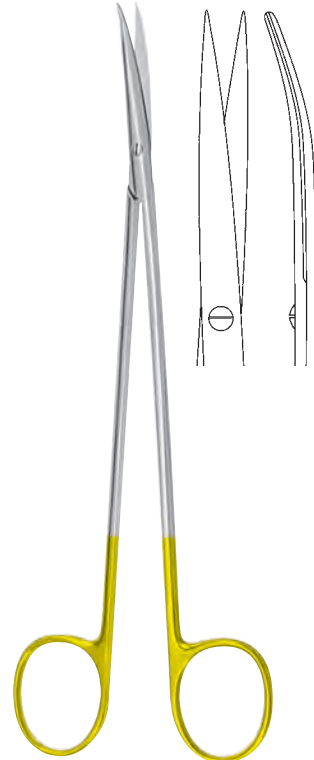

METZENBAUM-FINO

012-743-180	18,0 cm / 7"
012-743-200	20,0 cm / 8"
012-743-230	23,0 cm / 9"

Präparierscheren mit Hartmetallschneiden
Dissecting Scissors with tungsten carbide edges
Tijeras para disección con filos de carburo tungsteno
Forbici per dissezione con lame in carburo di tungsteno



012

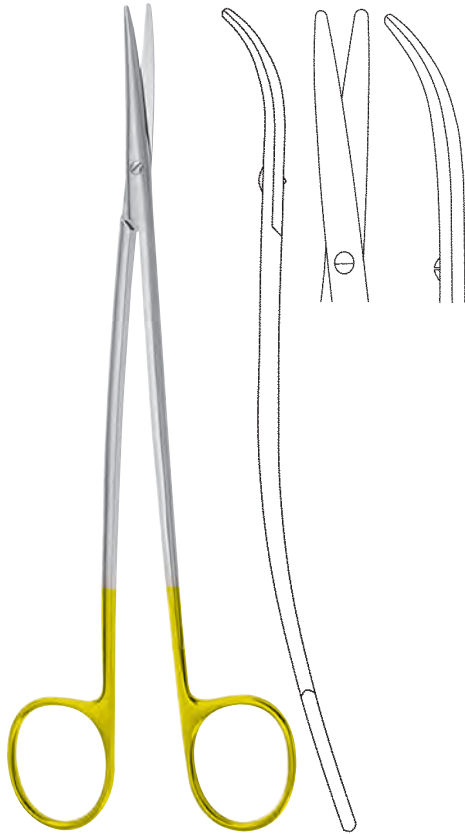

METZENBAUM-FINO S

012-745-180	18,0 cm / 7"
012-745-200	20,0 cm / 8"
012-745-230	23,0 cm / 9"

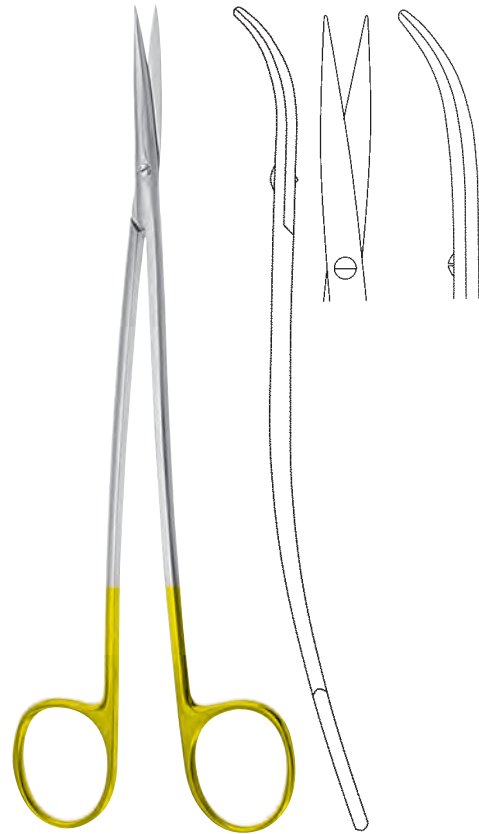

METZENBAUM-FINO S

012-747-180	18,0 cm / 7"
012-747-200	20,0 cm / 8"
012-747-230	23,0 cm / 9"

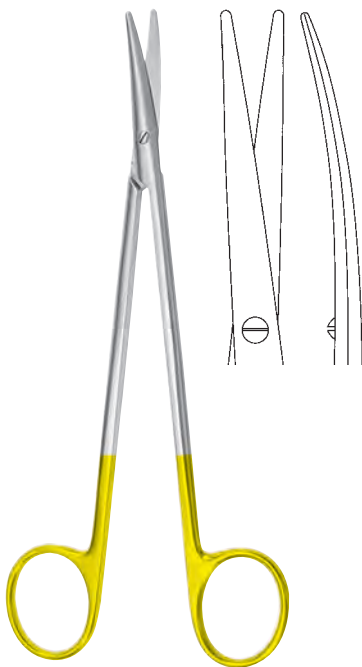

TOENNIS-ADSON

012-749-175	17,5 cm / 7"
--------------------	--------------



012

Gefäßscheren mit Hartmetallschneiden
Vascular Scissors with tungsten carbide edges
Tijeras vasculares con filos de carburo tungsteno
Forbici vascolari con lame in carburo di tungsteno



25 °

012-761-025

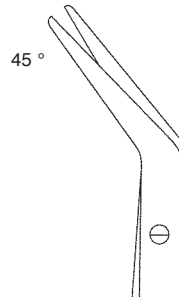

45 °

012-761-045

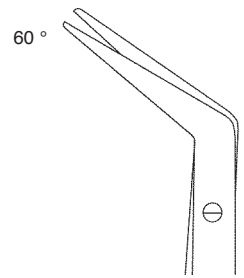

60 °

012-761-060

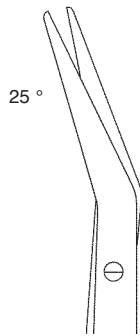

25 °

012-763-025

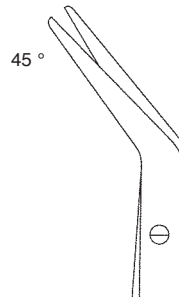

45 °

012-763-045

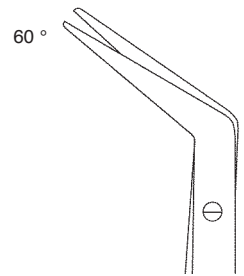

60 °

012-763-060

DE BAKEY

012-761-025 – 012-761-060 18,0 cm / 7"
012-763-025 – 012-763-060 23,0 cm / 9"

Gynäkologische Scheren mit Hartmetallschneiden
 Gynecology Scissors with tungsten carbide edges
 Tijeras para ginecología con filos de carburo tungsteno
 Forbici per ginecologia con lame in carburo di tungsteno



012

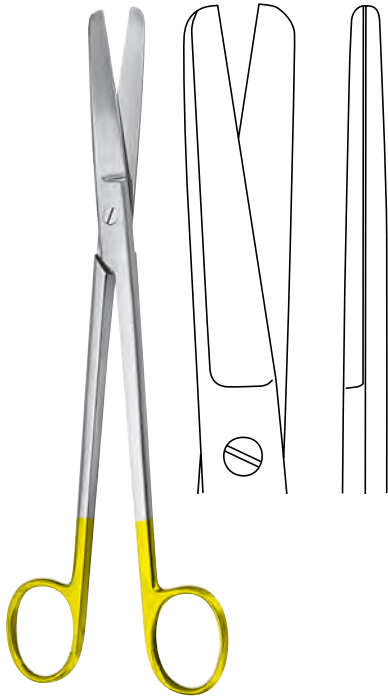

SIMS

012-770-200 20,0 cm / 8"
012-770-230 23,0 cm / 9"

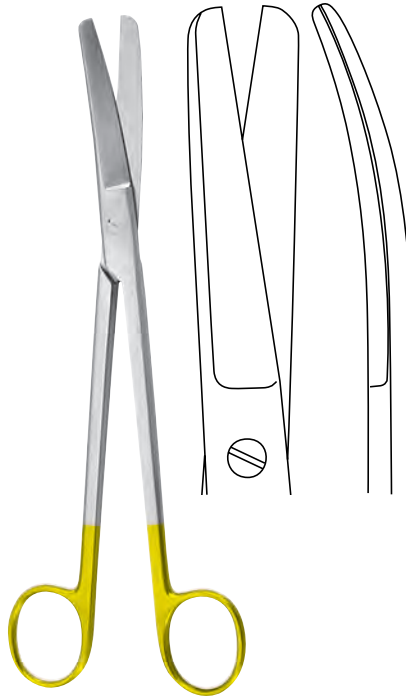

SIMS

012-771-200 20,0 cm / 8"
012-771-230 23,0 cm / 9"

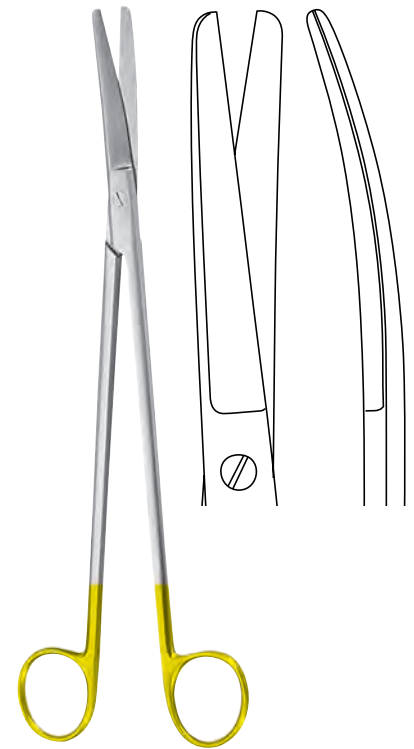

WERTHEIM

012-773-225 22,5 cm / 8³/₄"

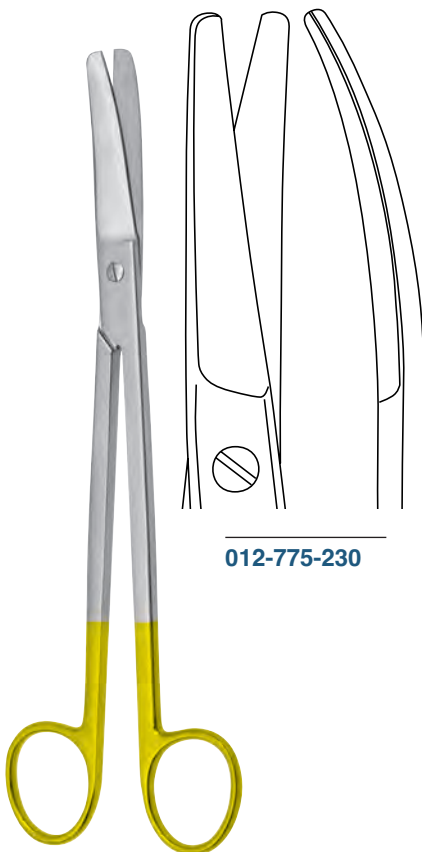

012-775-230

PARAMETRIUM

012-775-225 22,5 cm / 8³/₄"
012-775-230 23,0 cm / 9"

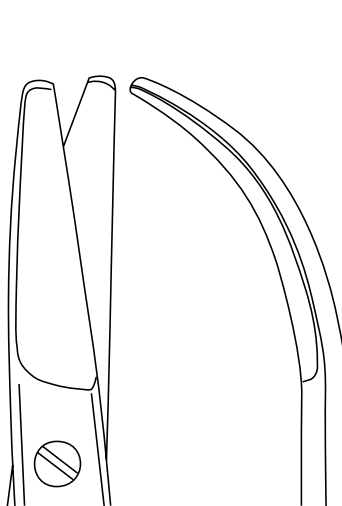

012-775-225

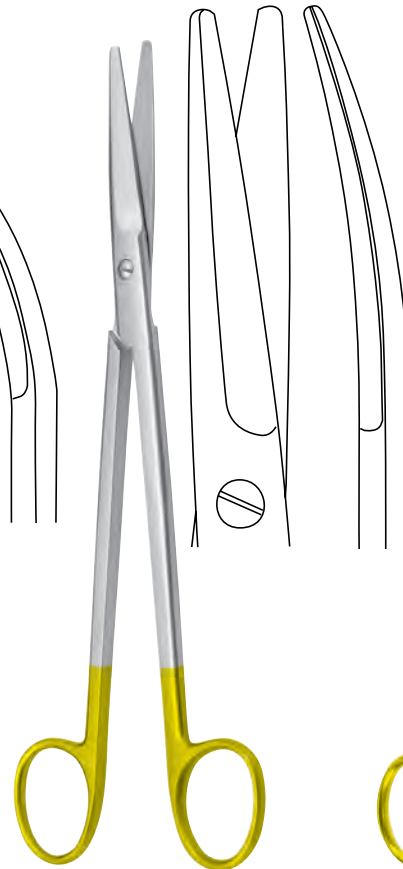

MAYO-HARRINGTON

012-777-280 28,0 cm / 11"



012-778-195 19,5 cm / 7³/₄"



012

Scheren mit Hartmetallschneiden
Scissors with tungsten carbide edges
Tijeras con filos de carburo tungsteno
Forbici con lame in carburo di tungsteno



IRIS
012-780-115 11,5 cm / 4 1/2"



IRIS
012-781-115 11,5 cm / 4 1/2"

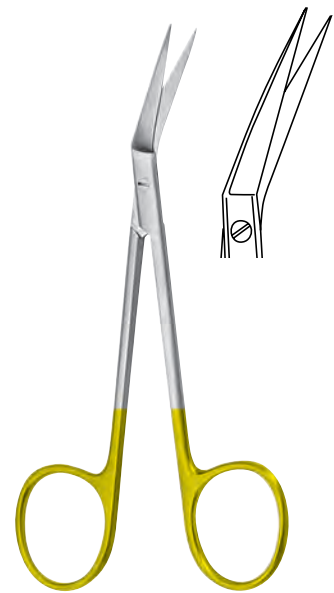

IRIS
012-783-115 11,5 cm / 4 1/2"

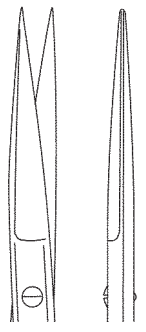

012-784-140

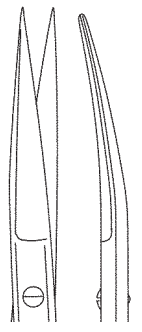

012-785-140

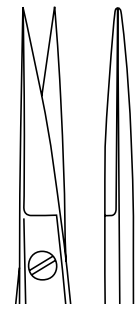

012-786-160

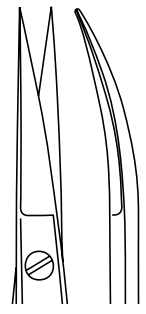

012-787-160



JOSEPH
012-784-140 – 012-785-140 14,0 cm, 5 1/2"



KELLY
012-786-160 – 012-787-160 16,0 cm / 6 1/4"

Scheren mit Hartmetallschneiden
Scissors with tungsten carbide edges
Tijeras con filos de carburo tungsteno
Forbici con lame in carburo di tungsteno



012

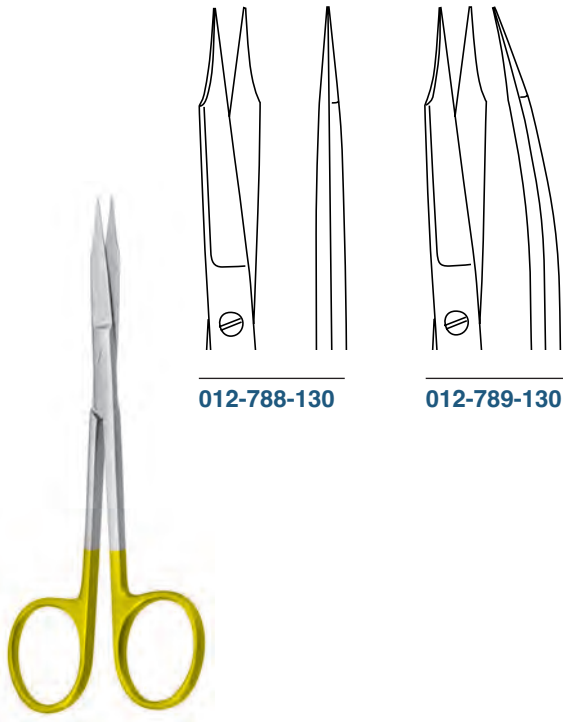

012-788-130

012-789-130

GOLDMANN-FOX

012-788-130 – 012-789-130 13,0 cm / 5 1/8"

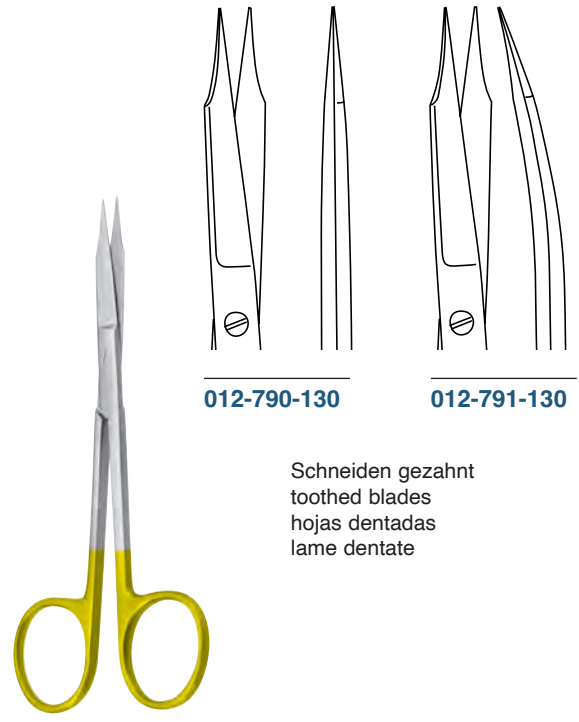

012-790-130

012-791-130

Schneiden gezahnt
 toothed blades
 hojas dentadas
 lame dentate

GOLDMANN-FOX

012-790-130 – 012-791-130 13,0 cm / 5 1/8"

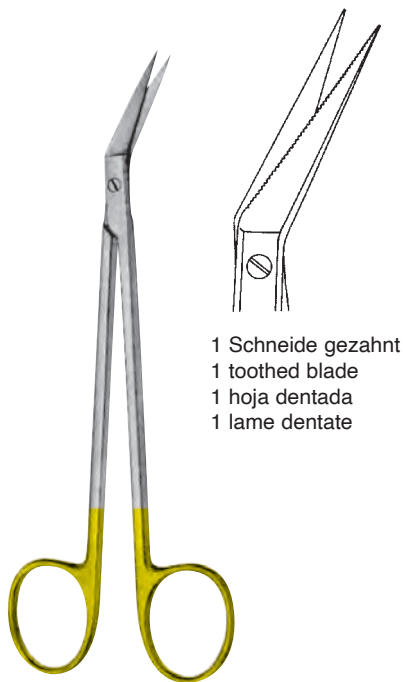

1 Schneide gezahnt
 1 toothed blade
 1 hoja dentada
 1 lame dentate

LOCKLIN

012-793-160 16,0 cm / 6 1/4"

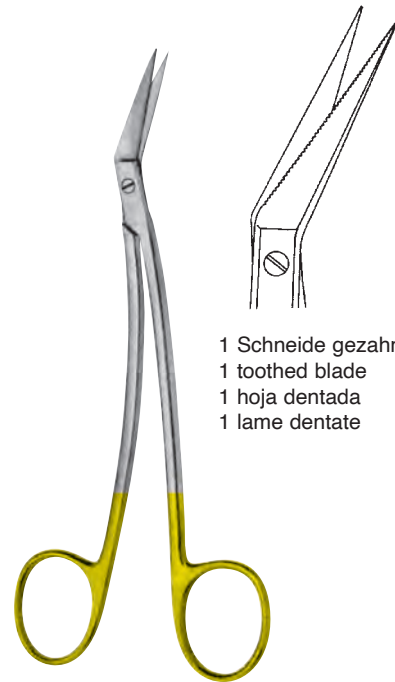

1 Schneide gezahnt
 1 toothed blade
 1 hoja dentada
 1 lame dentate

LOCKLIN

012-795-160 16,0 cm / 6 1/4"



012

Scheren mit Hartmetallschneiden
Scissors with tungsten carbide edges
Tijeras con filos de carburo tungsteno
Forbici con lame in carburo di tungsteno



RAGNELL (KILLNER)

012-797-120 12,0 cm / 4³/₄"

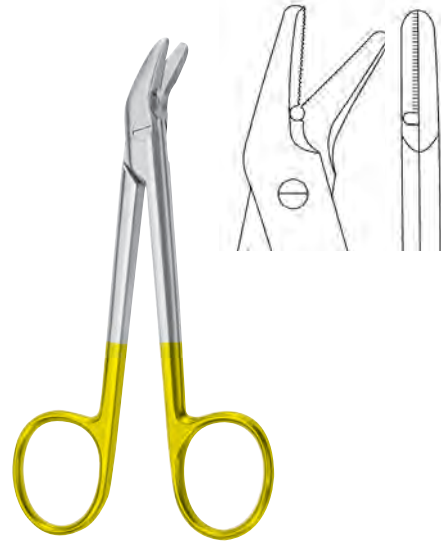

UNIVERSAL

012-799-120 12,0 cm / 4³/₄"

Super Cut

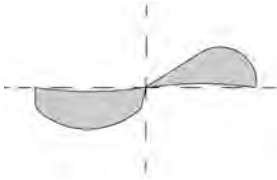

Standard

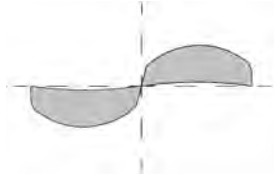

- Messerschiff für optimalen Schnitt
- 1 gezahntes Blatt verhindert das Herausgleiten des Gewebes
- schwarze Ringe

-
- Knife blade sharpness for optimum cutting
 - 1 serrated blade prevents tissue from slipping out
 - black-plated rings

-
- Filo tipo cuchillo para un corte óptimo
 - 1 hoja dentada impide el deslizamiento del tejido
 - anillos negros

-
- affilatura speciale per un ottimo taglio
 - Lama a denti micro
 - anelli neri





012

Super-Cut Scheren
Super-Cut Scissors
Tijeras Super-Cut
Forbici Super-Cut



STANDARD

012-850-145 14,5 cm / 5³/₄"



STANDARD

012-851-145 14,5 cm / 5³/₄"

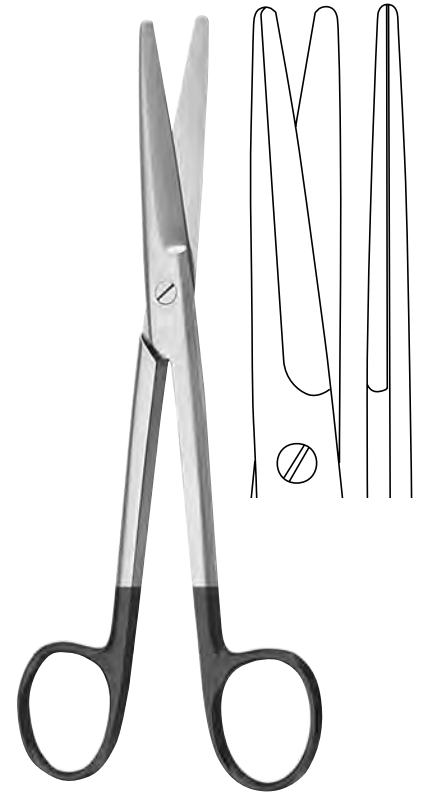

MAYO

012-852-145 14,5 cm / 5³/₄"
012-852-170 17,0 cm / 6³/₄"
012-852-230 23,0 cm / 9"



MAYO

012-853-145 14,5 cm / 5³/₄"
012-853-170 17,0 cm / 6³/₄"
012-853-230 23,0 cm / 9"

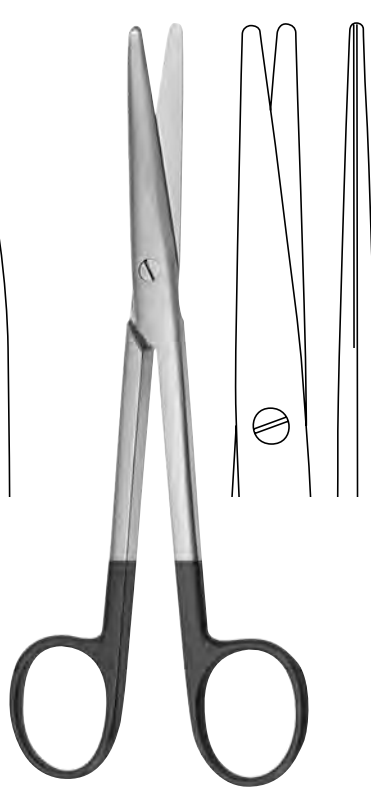

MAYO-STILLE

012-854-150 15,0 cm / 6"
012-854-170 17,0 cm / 6³/₄"

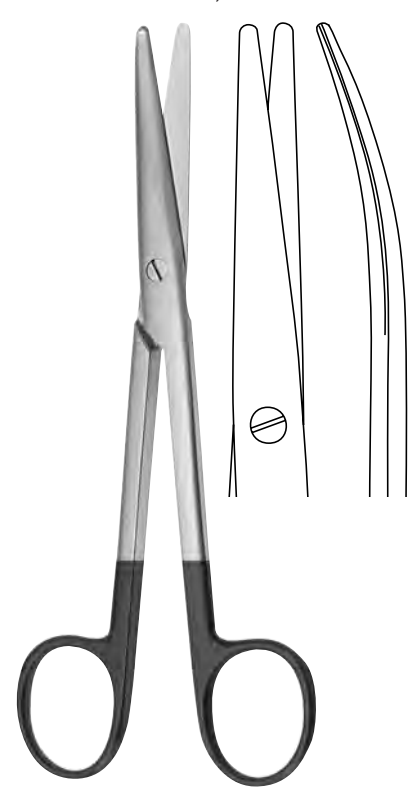

MAYO-STILLE

012-855-150 15,0 cm / 6"
012-855-170 17,0 cm / 6³/₄"



012-860-115

012-861-115

METZENBAUM

012-860-115 – 012-861-115 11,5 cm / 4 1/2"



012-860-145

012-861-145

METZENBAUM

012-860-145 – 012-861-145 14,5 cm / 5 1/2"

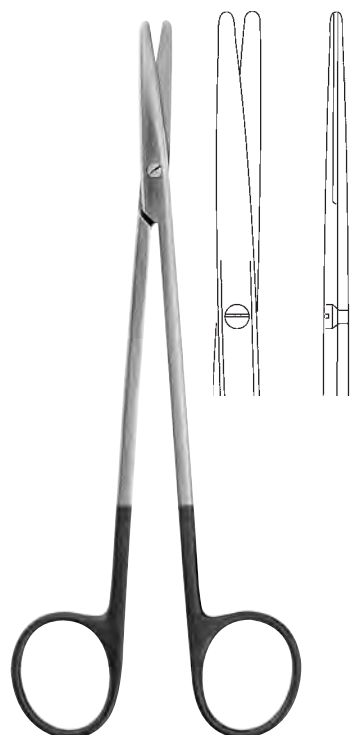

METZENBAUM-NELSON

012-860-180 18,0 cm / 7"
 012-860-200 20,0 cm / 8"
 012-860-230 23,0 cm / 9"



METZENBAUM-NELSON

012-861-180 18,0 cm / 7"
 012-861-200 20,0 cm / 8"
 012-861-230 23,0 cm / 9"



012

Super-Cut Scheren
Super-Cut Scissors
Tijeras Super-Cut
Forbici Super-Cut



012-864-115

012-865-115

STRABISMUS

012-864-115 – 012-865-115 11,5 cm / 4 1/2"

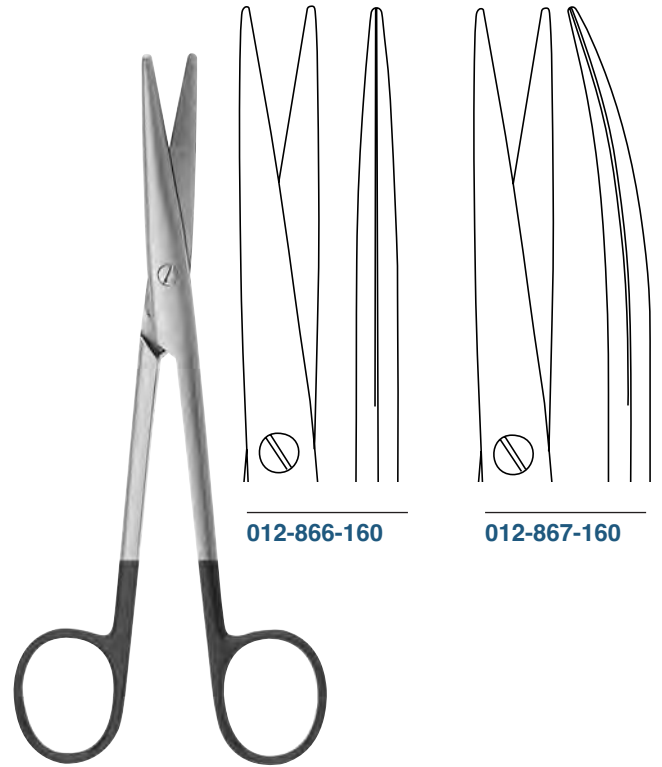

012-866-160

012-867-160

LEXER

012-866-160 – 012-867-160 16,0 cm / 6 1/4"



012-870-145

012-871-145

METZENBAUM-FINO

012-870-145 – 012-871-145 14,5 cm / 5 1/2"

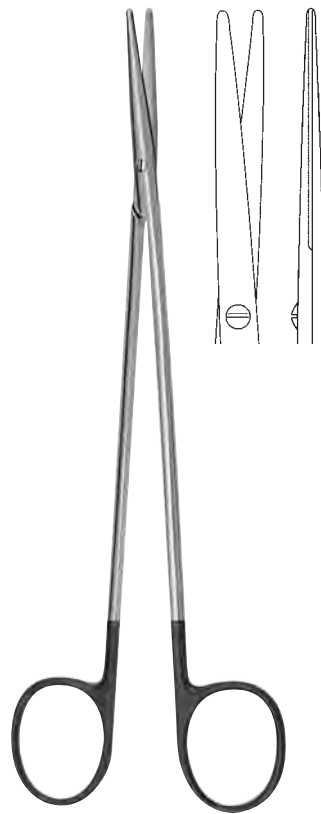

METZENBAUM-FINO

012-870-180 18,0 cm / 7"
012-870-200 20,0 cm / 8"
012-870-230 23,0 cm / 9"

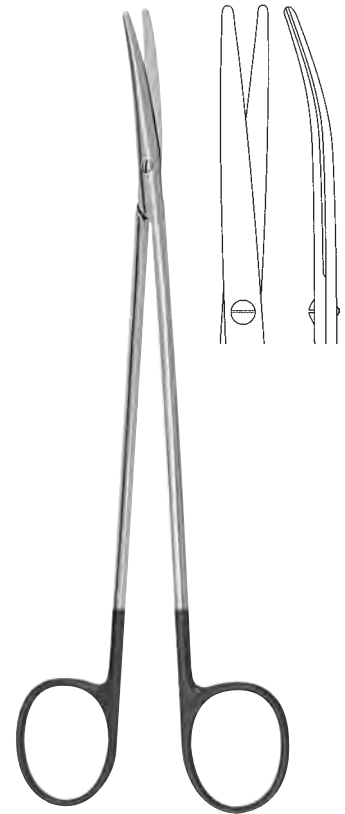

METZENBAUM-FINO

012-871-180 18,0 cm / 7"
012-871-200 20,0 cm / 8"
012-871-230 23,0 cm / 9"

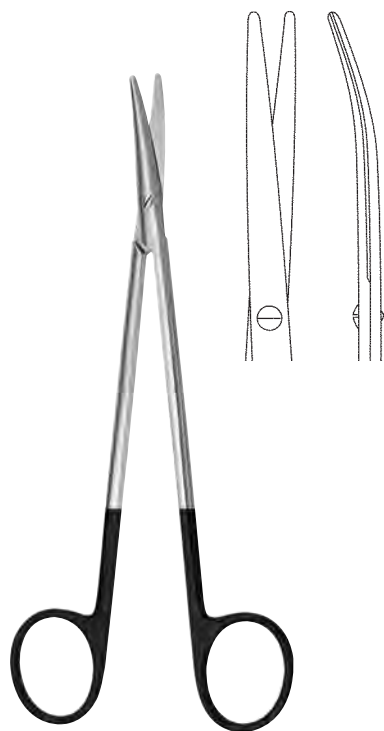

TOENNIS-ADSON

012-873-175 17,5 cm / 7"

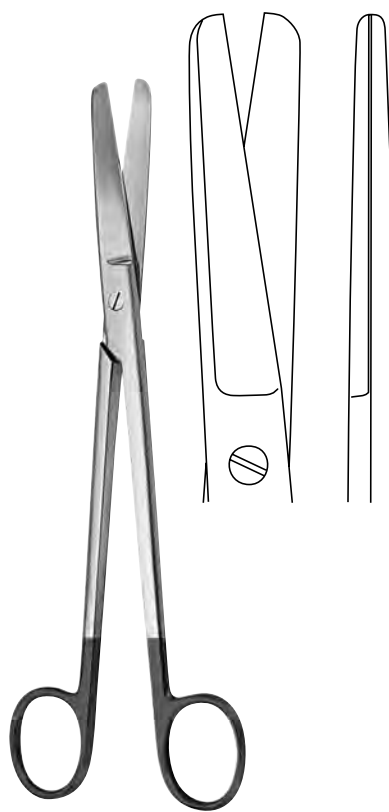

SIMS

012-880-200 20,0 cm / 8"

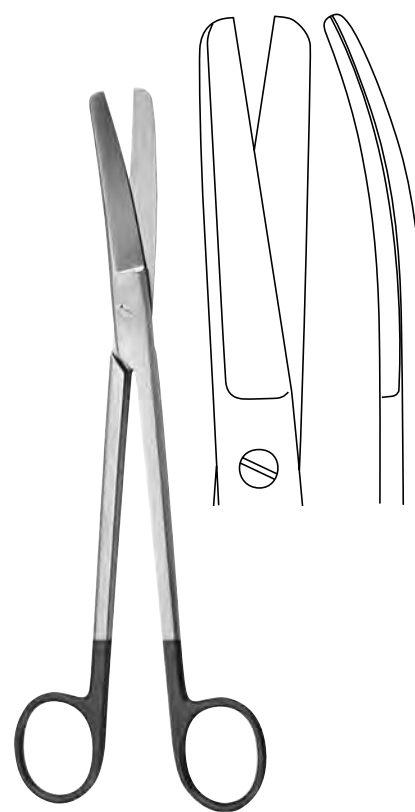

SIMS

012-881-200 20,0 cm / 8"
012-881-230 23,0 cm / 9"



SIEBOLD

012-883-240 24,0 cm / 9 1/2"



WALDMANN

012-885-180 18,0 cm / 7"

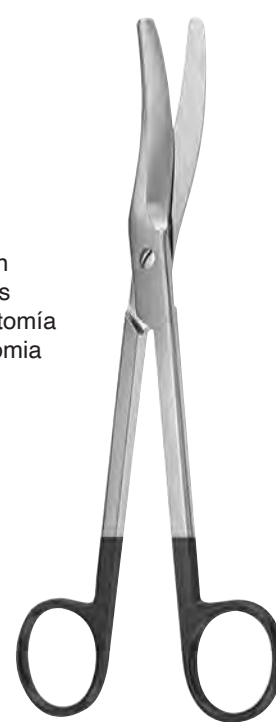

012-887-200 20,0 cm / 8"

Episiotomiescheren
 Episiotomy scissors
 Tijeras para episiotomía
 Forbici per episiotomia



012

Super-Cut Scheren
Super-Cut Scissors
Tijeras Super-Cut
Forbici Super-Cut

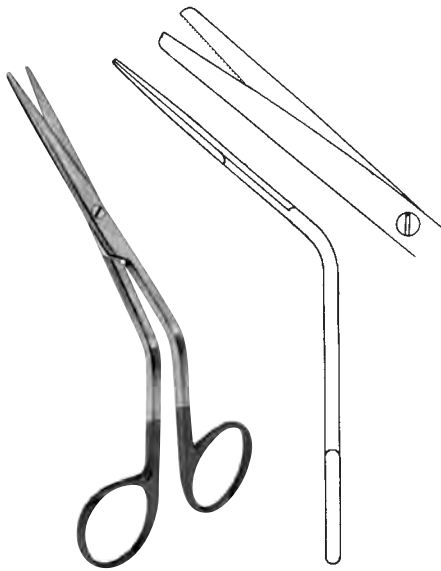

FOMON

012-891-135 13,5 cm, 5 1/4"

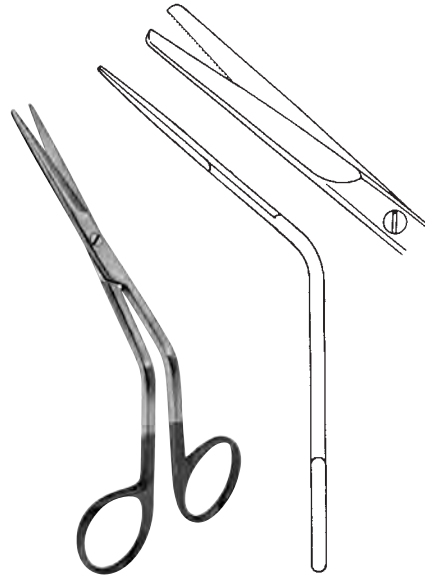

FOMON

012-893-145 14,5 cm, 5 3/4"

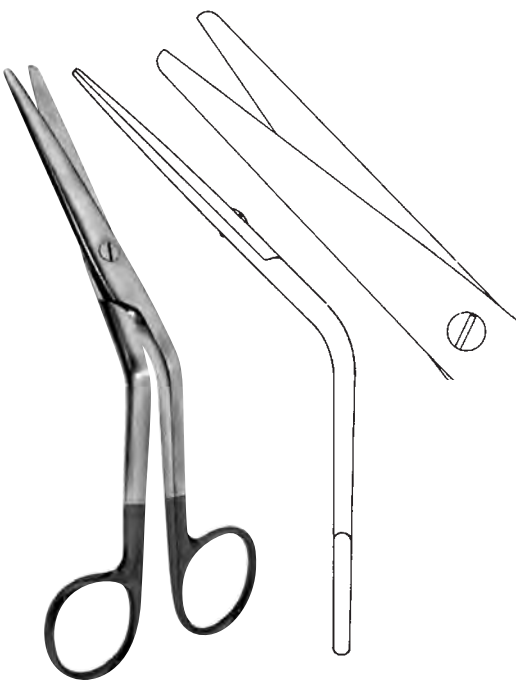

COTTLE

012-895-160 16,0 cm / 6 1/4"



HEYMANN

012-897-180 18,0 cm / 7"

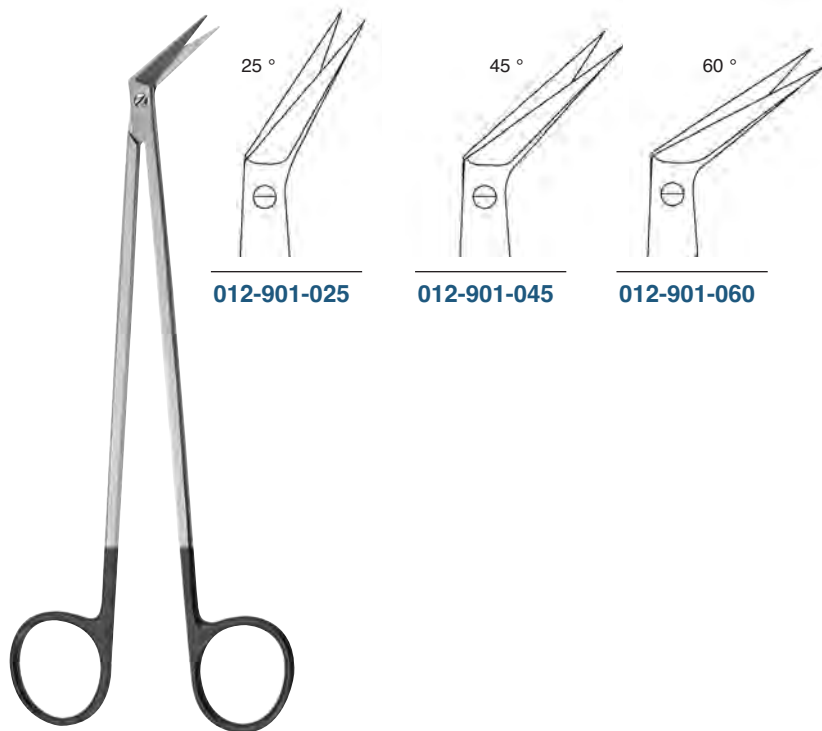

POTTS-SMITH

012-901-025 – 012-901-060 19,0 cm / 7 1/2"

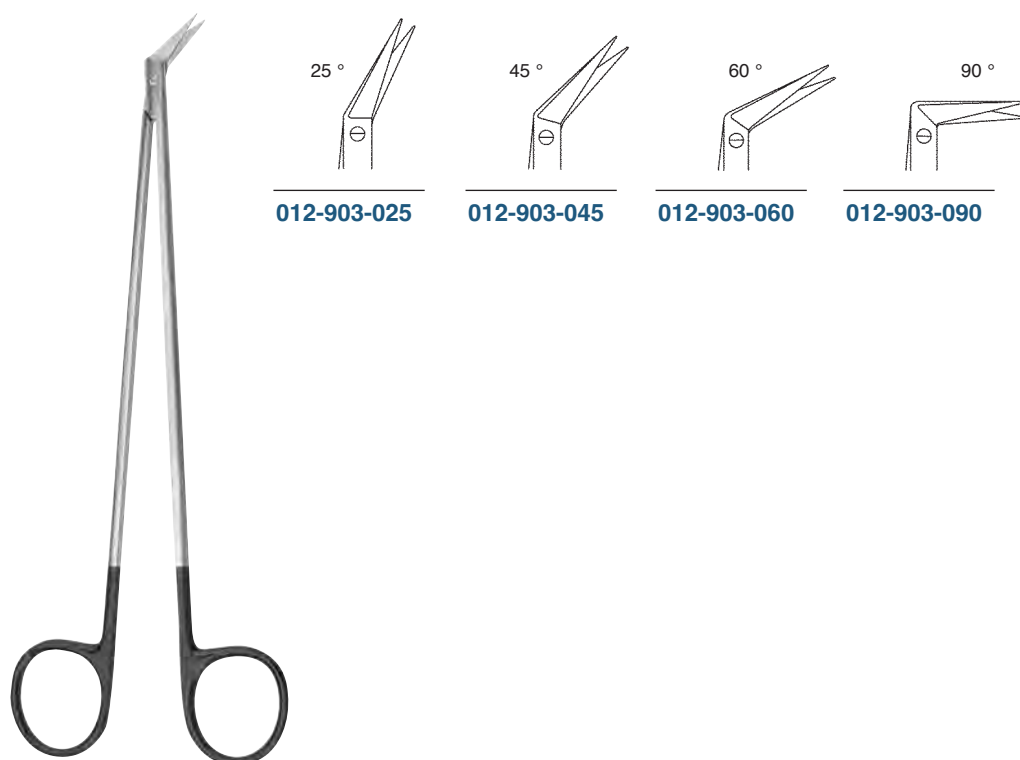

DIETRICH

012-903-025 – 012-903-090 19,0 cm / 7 1/2"



012

Super-Cut Scheren
Super-Cut Scissors
Tijeras Super-Cut
Forbici Super-Cut



012-910-160

012-911-160

Fistelscheren
Fistula scissors
Tijeras para fistulas
Forbici per fistole

KELLY

012-910-160 – 012-911-160 16,0 cm / 6 1/4"



012-912-140

012-913-140

JOSEPH

012-912-140 – 012-913-140 14,0 cm, 5 1/2"

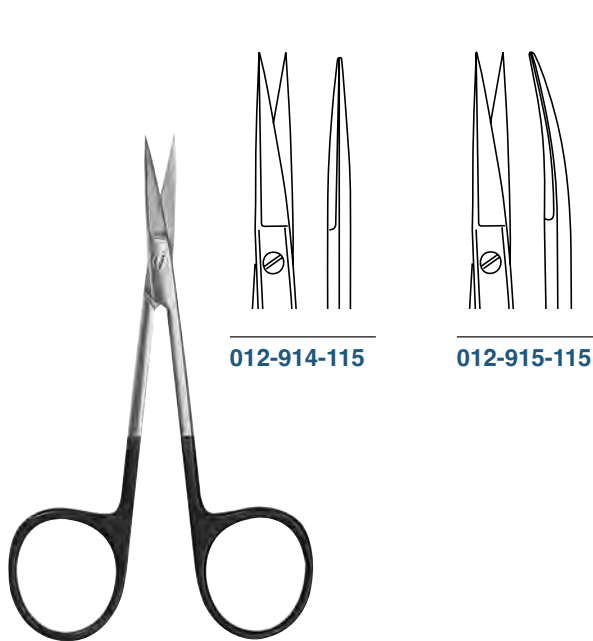

012-914-115

012-915-115

IRIS

012-914-115 – 012-915-115 11,5 cm / 4 1/2"



012-916-120

012-917-120

WAGNER

012-916-120 – 012-917-120 12,0 cm / 4 3/4"

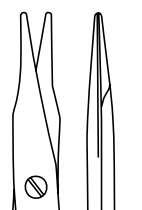
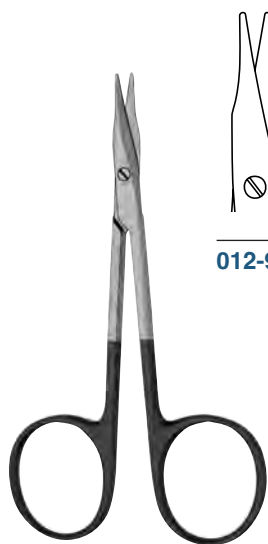

012-920-115



012-921-115

STEVENS

012-920-115 – 012-921-115

11,5 cm / 4 1/2"

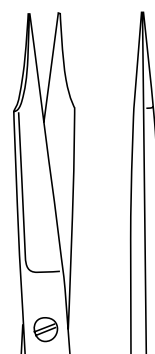
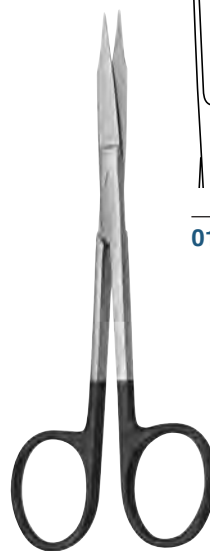

012-922-130

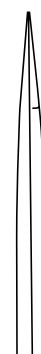

012-923-130

GOLDMANN-FOX

012-922-130 – 012-923-130

13,0 cm / 5 1/8"

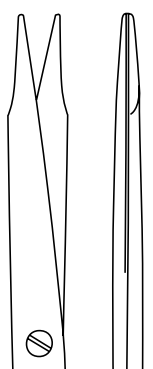

012-924-150

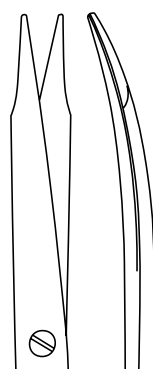

012-925-150

REYNOLDS

012-924-150 – 012-925-150

15,0 cm / 6"

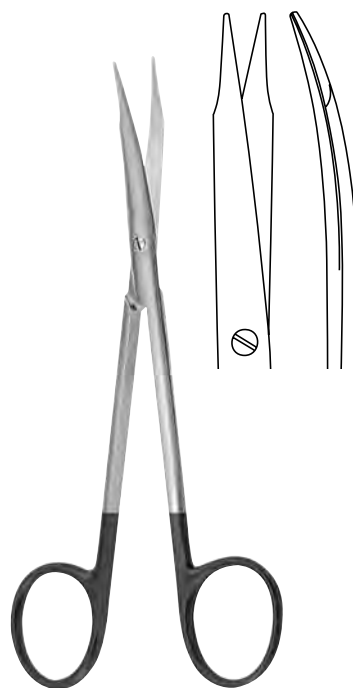

REYNOLDS

012-925-175 17,5 cm / 7"



012

Super-Cut Scheren
Super-Cut Scissors
Tijeras Super-Cut
Forbici Super-Cut

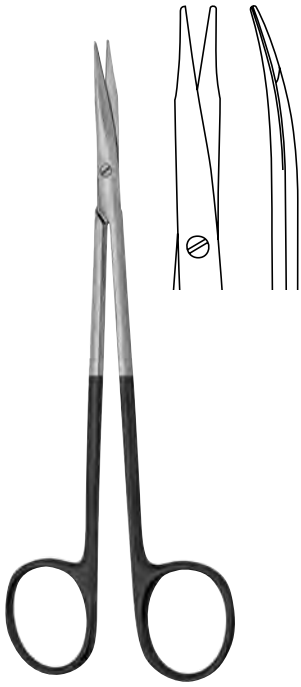

JAMESON

012-927-150 15,0 cm / 6"

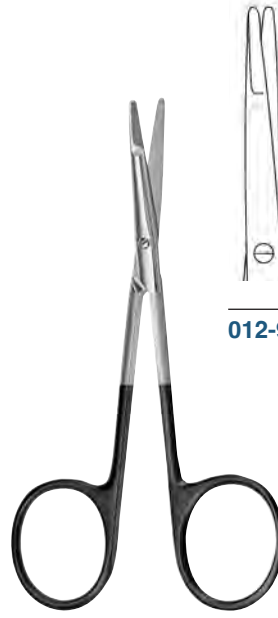

PAR-TYPE

012-930-120 – 012-931-120 12,0 cm / 4 3/4"

012-930-120

012-931-120



KAYE FACE LIFT

012-933-150 15,0 cm / 6"
012-933-190 19,0 cm / 7 1/2"



GORNEY

012-934-190 – 012-935-190 19,0 cm / 7 1/2"

012-934-190

012-935-190

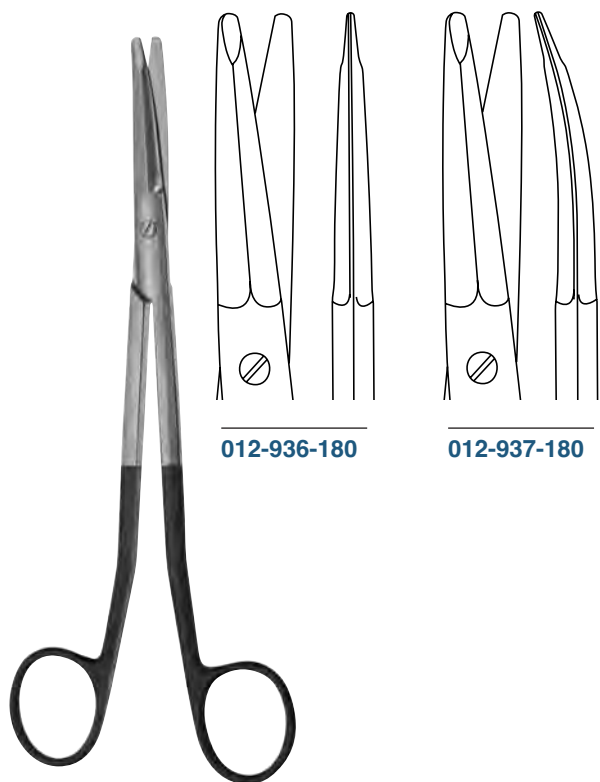

012-936-180

012-937-180

FREEMANN-KAYE

012-936-180 – 012-937-180 18,0 cm / 7"

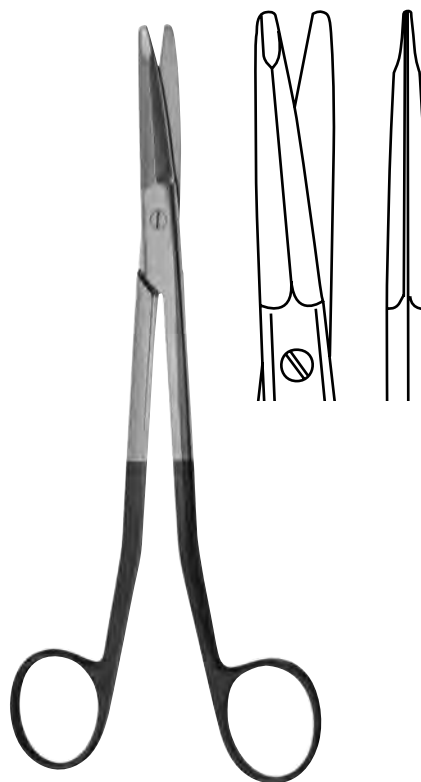

FREEMANN-GORNEY

012-938-190 19,0 cm / 7 1/2"
 012-938-230 23,0 cm / 9"

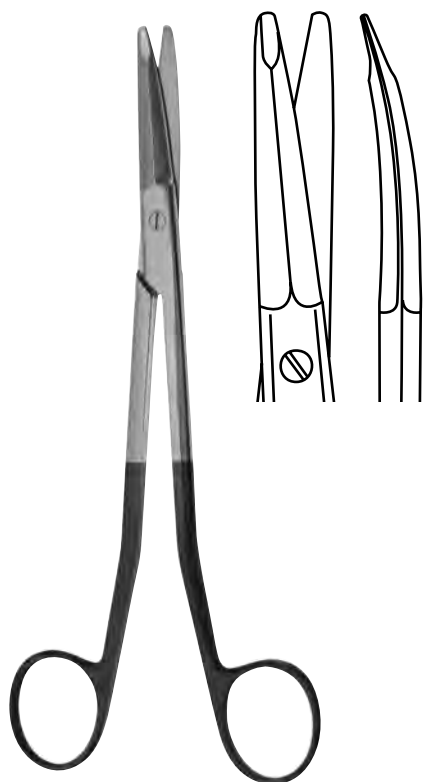

FREEMANN-GORNEY

012-939-190 19,0 cm / 7 1/2"
 012-939-230 23,0 cm / 9"

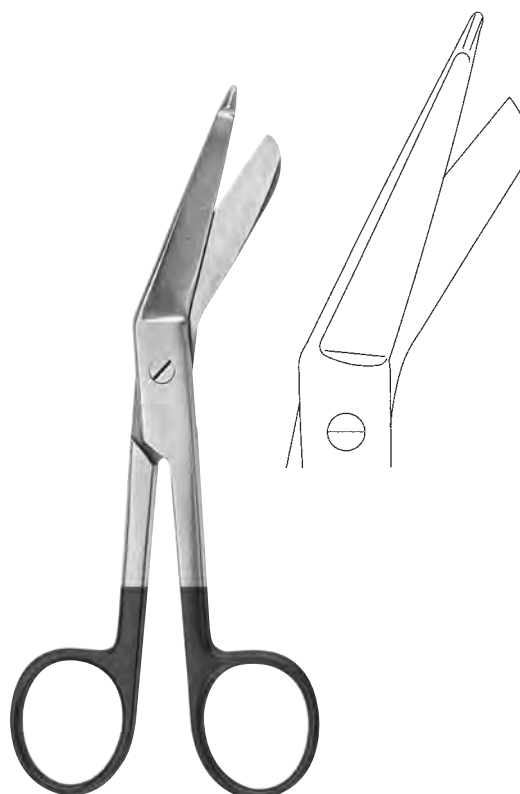

LISTER

012-951-140 14,0 cm / 5 1/2"
 012-951-180 18,0 cm / 7"
 012-951-200 20,0 cm / 8"



012

Super-Cut Scheren
Super-Cut Scissors
Tijeras Super-Cut
Forbici Super-Cut



013

Pinzetten - anatomische,
chirurgische, Mikro
Forceps - anatomics,
surgicals, Micro
Pinzas - anatómicas,
quirurgicas, Micro
Pinze - anatomiche, chi-
rurgici, Micro



013

Anatomische Pinzetten
Dissecting Forceps
Pinzas de disección
Pinze anatomiche per dissezione



STANDARD

013-100-105	10,5 cm / 4 1/8"
013-100-115	11,5 cm / 4 1/2"
013-100-130	13,0 cm / 5"
013-100-145	14,5 cm / 5 3/4"
013-100-160	16,0 cm / 6 1/4"
013-100-180	18,0 cm / 7"
013-100-200	20,0 cm / 8"
013-100-250	25,0 cm / 10"
013-100-300	30,0 cm / 12"



schmal
narrow
estrecha
stretti

STANDARD

013-110-115	11,5 cm / 4 1/2"
013-110-130	13,0 cm / 5"
013-110-145	14,5 cm / 5 3/4"
013-110-160	16,0 cm / 6 1/4"
013-110-180	18,0 cm / 7"
013-110-200	20,0 cm / 8"
013-110-250	25,0 cm / 10"
013-110-300	30,0 cm / 12"



MOD. USA

013-130-120	12,0 cm / 4 3/4"
013-130-130	13,0 cm / 5"
013-130-145	14,5 cm / 5 3/4"
013-130-155	15,5 cm / 6"
013-130-180	18,0 cm / 7"
013-130-210	21,0 cm / 8"
013-130-250	25,0 cm / 10"
013-130-310	31,0 cm / 12"



schmal
narrow
estrecha
stretti

MOD. USA

013-140-120	12,0 cm / 4 3/4"
013-140-130	13,0 cm / 5"
013-140-145	14,5 cm / 5 3/4"
013-140-155	15,5 cm / 6 1/8"



ADSON

013-150-120	12,0 cm / 4 3/4"
013-150-150	15,0 cm / 6"



MICRO-ADSON

013-152-120	12,0 cm / 4 3/4"
013-152-150	15,0 cm / 6"

Anatomische Pinzetten
Dissecting Forceps
Pinzas de disección
Pinze anatomiche per dissezione



013



MC INDOE

013-156-150 15,0 cm / 6"



SEMKEN

013-158-125 12,5 cm / 5"
013-158-150 15,0 cm / 6"



POTTS-SMITH

013-160-180 18,0 cm / 7"
013-160-210 21,0 cm / 8 1/4"
013-160-250 25,0 cm / 10"



POTTS-SMITH

013-161-180 18,0 cm / 7"
013-161-210 21,0 cm / 8 1/4"
013-161-250 25,0 cm / 10"



BROPHY

013-164-200 20,0 cm / 8"



BROPHY

013-165-200 20,0 cm / 8"



TAYLOR

013-168-175 17,5 cm / 7"



TAYLOR

013-169-175 17,5 cm / 7"

Dissektor Ende
dissector end
cabo disecador
dissettore



013

Anatomische Pinzetten
Dissecting Forceps
Pinzas de disección
Pinze anatomiche per dissezione



CUSHING
013-176-175 17,5 cm / 7"



CUSHING
013-177-175 17,5 cm / 7"



GERALD
013-178-180 18,0 cm / 7"



GERALD
013-179-180 18,0 cm / 7"



englische Modelle
 english patterns
 modelos ingleses
 modelli inglese

013-180-125 12,5 cm / 5"
013-180-155 15,5 cm / 6 1/8"



DUEHRSEN
013-184-200 20,0 cm / 8"



RAMSEY
013-186-180 18,0 cm / 7"



1x2



2x3



3x4

STANDARD

013-200-105	10,5 cm / 4 1/8"
013-200-115	11,5 cm / 4 1/2"
013-200-130	13,0 cm / 5"
013-200-145	14,5 cm / 5 3/4"
013-200-160	16,0 cm / 6 1/4"
013-200-180	18,0 cm / 7"
013-200-200	20,0 cm / 8"
013-200-250	25,0 cm / 10"
013-200-300	30,0 cm / 12"

013-210-115	11,5 cm / 4 1/2"
013-210-130	13,0 cm / 5"
013-210-145	14,5 cm / 5 3/4"
013-210-160	16,0 cm / 6 1/4"
013-210-180	18,0 cm / 7"
013-210-200	20,0 cm / 8"
013-210-250	25,0 cm / 10"
013-210-300	30,0 cm / 12"

013-220-130	13,0 cm / 5"
013-220-145	14,5 cm / 5 3/4"
013-220-160	16,0 cm / 6 1/4"



4x5



schmal
narrow
estrecha
stretti

1x2



1x2

013-230-130	13,0 cm / 5"
013-230-145	14,5 cm / 5 3/4"
013-230-160	16,0 cm / 6 1/4"

013-240-115	11,5 cm / 4 1/2"
013-240-130	13,0 cm / 5"
013-240-145	14,5 cm / 5 3/4"
013-240-160	16,0 cm / 6 1/4"
013-240-180	18,0 cm / 7"
013-240-200	20,0 cm / 8"

013-241-130	13,0 cm / 5"
013-241-145	14,5 cm / 5 3/4"



013

Chirurgische Pinzetten
Tissue Forceps
Pinzas quirúrgicas
Pinze per chirurgia



1x2

USA MODELL

- 013-250-120** 12,0 cm / 4³/₄"
- 013-250-130** 13,0 cm / 5"
- 013-250-140** 14,5 cm / 5³/₄"
- 013-250-155** 15,5 cm / 6"
- 013-250-180** 18,0 cm / 7"
- 013-250-210** 21,0 cm / 8¹/₄"
- 013-250-250** 25,0 cm / 9³/₄"
- 013-250-310** 31,0 cm / 12¹/₄"



2x3

USA MODELL

- 013-260-130** 13,0 cm / 5"
- 013-260-145** 14,5 cm / 5³/₄"
- 013-260-155** 15,5 cm / 6"



1x2

STILLE

- 013-270-150** 15,0 cm / 6"



2x3

STILLE

- 013-272-150** 15,0 cm / 6"



1x2

ADSON

- 013-280-120** 12,0 cm / 4³/₄"
- 013-280-150** 15,0 cm / 6"



1x2

MIKRO-ADSON

- 013-282-120** 12,0 cm / 4³/₄"
- 013-282-150** 15,0 cm / 6"



1x2

ADSON

- 013-284-120** 12,0 cm / 4³/₄"



7x7

ADSON-BROWN

- 013-286-120** 12,0 cm / 4³/₄"



STONE

013-288-150 15,0 cm / 6"



LERCHE

013-290-150 15,0 cm / 6"



ADLERKREUTZ

013-292-150 15,0 cm / 6"
013-292-200 20,0 cm / 8"



ADLERKREUTZ

013-294-150 15,0 cm / 6"
013-294-200 20,0 cm / 8"



GILLIES

013-296-150 15,0 cm / 6"



SEMKEN

013-298-125 12,5 cm / 5"
013-298-150 15,0 cm / 6"



TAYLOR

013-300-175 17,5 cm / 7"



TAYLOR

013-301-175 17,5 cm / 7"



013

Chirurgische Pinzetten
Tissue Forceps
Pinzas quirúrgicas
Pinze per chirurgia



↔ 1x2

GERALD

013-302-175 17,5 cm / 7"



↔ 1x2

GERALD

013-303-175 17,5 cm / 7"



↔ 1x2

CUSHING

013-304-175 17,5 cm / 7"



↔ 1x2

CUSHING

013-305-175 17,5 cm / 7"



↔ 1x2

POTTS-SMITH

013-310-180 18,0 cm / 7"

013-310-210 21,0 cm / 8 1/4"

013-310-250 25,0 cm / 10"



↔ 1x2

POTTS-SMITH

013-311-180 18,0 cm / 7"

013-311-210 21,0 cm / 8 1/4"

013-311-250 25,0 cm / 10"



↔ 1x2

BROPHY

013-314-200 20,0 cm / 8"



↔ 1x2

BROPHY

013-315-200 20,0 cm / 8"



WAUGH

013-318-200 20,0 cm / 8"



DUEHRSEN

013-320-200 20,0 cm / 8"



STILLE-BARRAYA

013-322-180 18,0 cm / 7"
013-322-200 20,0 cm / 8"
013-322-250 25,0 cm / 10"



013-326-180

FERRIS-SMITH

013-326-180 - 013-328-180 18,0 cm / 7"



013-328-180



LANE

013-330-145 14,5 cm / 5³/₄"
013-330-175 17,5 cm / 7"



LANE

013-332-145 14,5 cm / 5³/₄"
013-332-175 17,5 cm / 7"

Chirurgische Pinzetten
Tissue Forceps
Pinzas quirúrgicas
Pinze per chirurgia

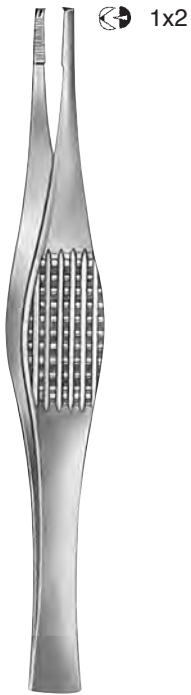

RAMSEY
013-334-180 18,0 cm / 7"

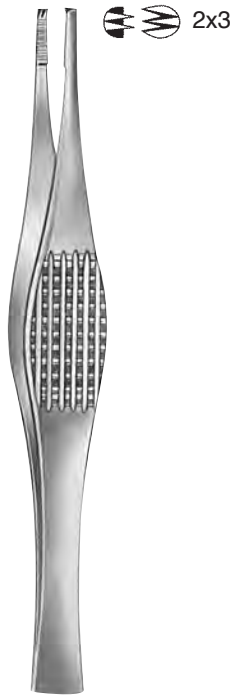

RAMSEY
013-336-180 18,0 cm / 7"



BONNEY
013-338-180 18,0 cm / 7"



BONNEY
013-340-180 18,0 cm / 7"



TREVES
013-342-130 13,0 cm / 5"
013-342-150 15,0 cm / 6"



BROWN
013-344-150 15,0 cm / 6"



DURANTE
013-350-145 14,5 cm / 5³/₄"
013-350-160 16,0 cm / 6¹/₄"
013-350-200 20,0 cm / 8"



RUSS. MODELL
013-360-150 15,0 cm / 6"
013-360-200 20,0 cm / 8"
013-360-250 25,0 cm / 10"



NELSON
 013-400-230 23,0 cm / 9"



DUVAL
 013-402-140 14,0 cm / 5 1/2"



FIG. 1
 013-404-001

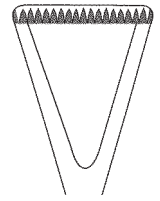

FIG. 2
 013-404-002

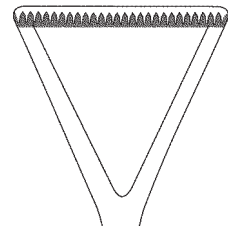

FIG. 3
 013-404-003

COLLIN-DUVAL
 013-404-001 - 013-404-003 20,0 cm / 8"



SINGLEY-TUTTLE
 013-406-230 23,0 cm / 9"



DENIS-BROWNE
 013-408-200 20,0 cm / 8"



013

Mikro-Pinzetten
Micro Forceps
Pinzas para microscopia
Pinze per microscopia



GRAEFE
013-500-100 10,0 cm / 4"



GRAEFE
013-501-100 10,0 cm / 4"



GRAEFE
013-503-100 10,0 cm / 4"

↔ 1x2



GRAEFE
013-504-100 10,0 cm / 4"

↔ 1x2



GRAEFE
013-505-100 10,0 cm / 4"

↔ 1x2



GRAEFE
013-507-100 10,0 cm / 4"

Splitterpinzetten, Mikro-Pinzetten
Splinter Forceps, Micro Forceps
Pinzas para espinas, Pinzas para microscopia
Pinze per schegge, Pinze per microscopia



013



ohne Stift
without pin
sin perno
senza perno



mit Stift
with pin
con perno
con perno



013-510-080 8,0 cm / 3 1/4"
013-510-090 9,0 cm / 3 1/2"
013-510-105 10,5 cm / 4 1/8"
013-510-115 11,5 cm / 4 1/2"
013-510-125 12,5 cm / 5"

013-511-080 8,0 cm / 3 1/4"
013-511-090 9,0 cm / 3 1/2"
013-511-105 10,5 cm / 4 1/8"
013-511-115 11,5 cm / 4 1/2"
013-511-125 12,5 cm / 5"

013-512-080 8,0 cm / 3 1/4"
013-512-090 9,0 cm / 3 1/2"
013-512-105 10,5 cm / 4 1/8"
013-512-115 11,5 cm / 4 1/2"
013-512-125 12,5 cm / 5"

013-513-080 8,0 cm / 3 1/4"
013-513-090 9,0 cm / 3 1/2"
013-513-105 10,5 cm / 4 1/8"
013-513-115 11,5 cm / 4 1/2"
013-513-125 12,5 cm / 5"



HUNTER
013-520-105 10,5 cm / 4 1/4"

HUNTER
013-521-105 10,5 cm / 4 1/4"

WALTER-CARMALT
013-522-105 10,5 cm / 4 1/4"

WALTER-CARMALT
013-523-105 10,5 cm / 4 1/4"



013

Splitterpinzetten, Mikro-Pinzetten
Splinter Forceps, Micro Forceps
Pinzas para espinas, Pinzas para microscopia
Pinze per schegge, Pinze per microscopia



013-524-100 10,0 cm / 4"



013-525-100 10,0 cm / 4"



013-526-100 10,0 cm / 4"



FEILCHENFELD

- 013-530-075** 7,5 cm / 3 1/8"
- 013-530-090** 9,0 cm / 3 1/2"
- 013-530-115** 11,5 cm / 4 1/2"



SHAAF

013-550-090 9,0 cm / 3 1/2"



LITTAUER

013-552-085 8,5 cm / 3 1/3"



013-554-090 9,0 cm / 3 1/2"



DOUGLAS

013-556-090 9,0 cm / 3 1/2"



DOUGLAS
013-558-090 9,0 cm / 3 1/2"



BEER
013-560-090 9,0 cm / 3 1/2"



BARRAQUER
013-562-105 10,5 cm / 4 1/4"



FIG. 3
013-600-003 11,5 cm / 4 3/4"



FIG. 4
013-600-004 11,0 cm / 4 3/8"



FIG. 5
013-600-005 11,0 cm / 4 3/8"



FIG. 7
013-600-007 11,5 cm / 4 3/8"



013

Mikro-Pinzetten
Micro Forceps
Pinzas para microscopia
Pinze per microscopia

0,3 mm



9 mm

013-610-001 11,0 cm / 4³/₈"

0,3 mm x 90°



9 mm

013-610-002 11,0 cm / 4³/₈"

0,3 mm x 45°



9 mm

013-610-003 11,0 cm / 4³/₈"

0,3 mm x 45°



9 mm

diamantbeschichtet
diamond coated
diamantado
diamantato

013-610-004 11,0 cm / 4³/₈"

0,3 mm



9 mm

013-620-120 12,0 cm / 4³/₄"

0,3 mm x 45°



9 mm

013-623-135 13,5 cm / 5¹/₄"

Tumor- und Gewebefäßpinzetten
Tumor and Tissue Grasping Forceps
Pinzas de agarre para tejido y tumor
Pinze per afferare tessuti e tumori



013



Ø 3 mm
013-651-003

Ø 5 mm
013-651-005

YASARGIL

013-651-003 - 013-651-005 22,0 cm / 8³/₄"



Ø 3 mm
013-653-003

Ø 5 mm
013-653-005

YASARGIL

013-653-003 - 013-653-005 22,0 cm / 8³/₄"



Ø 3 mm
013-655-003

Ø 5 mm
013-655-005

HEIFETZ

013-655-003 - 013-655-005 22,0 cm / 8³/₄"

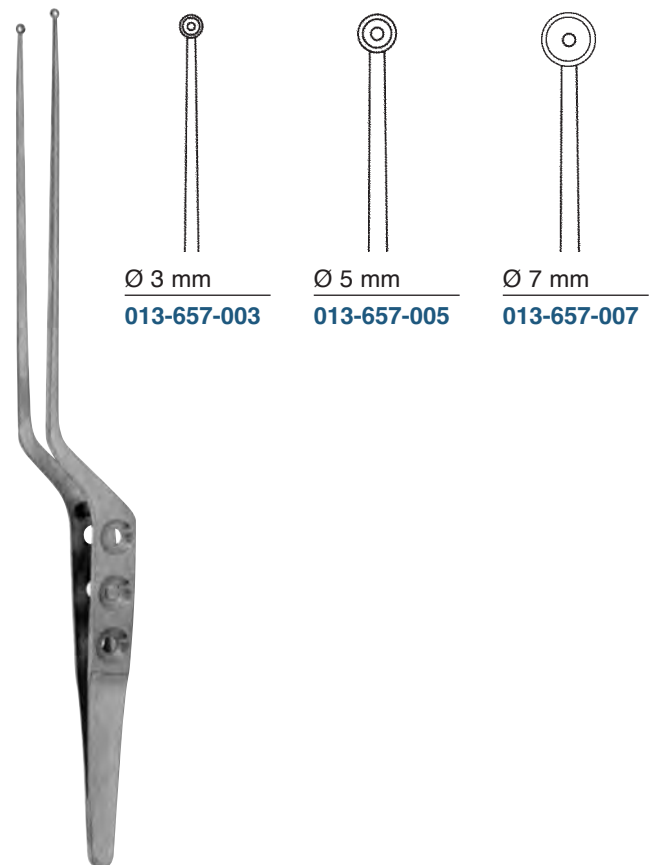

Ø 3 mm
013-657-003

Ø 5 mm
013-657-005

Ø 7 mm
013-657-007

YASARGIL-SAMI

013-657-003 - 013-657-007 24,0 cm / 9¹/₂"

Tumor- und Gewebefaßpinzetten, Mikro-Pinzetten
Tumor and Tissue Grasping Forceps, Micro-Forceps
Pinzas de agarre para tejido y tumor, Micro-Pinzas
Pinze per afferare tessuti e tumori, Micro-Pinze



SAMI
013-675-230 23,0 cm / 9"



SAMI
013-677-230 23,0 cm / 9"



HUNT
013-679-200 20,0 cm / 8"



YASARGIL
013-681-180 18,0 cm / 7"
013-681-200 20,0 cm / 8"
013-681-220 22,0 cm / 8³/₄"
013-681-240 24,0 cm / 9¹/₂"



YASARGIL
013-683-180 18,0 cm / 7"
013-683-200 20,0 cm / 8"
013-683-220 22,0 cm / 8³/₄"
013-683-240 24,0 cm / 9¹/₂"



YASARGIL
013-685-180 18,0 cm / 7"

Mikro-Knüpppinzetten
Micro Suture Tying Forceps
Micro Pinzas de ligadura
Micro Pinze per legature



013

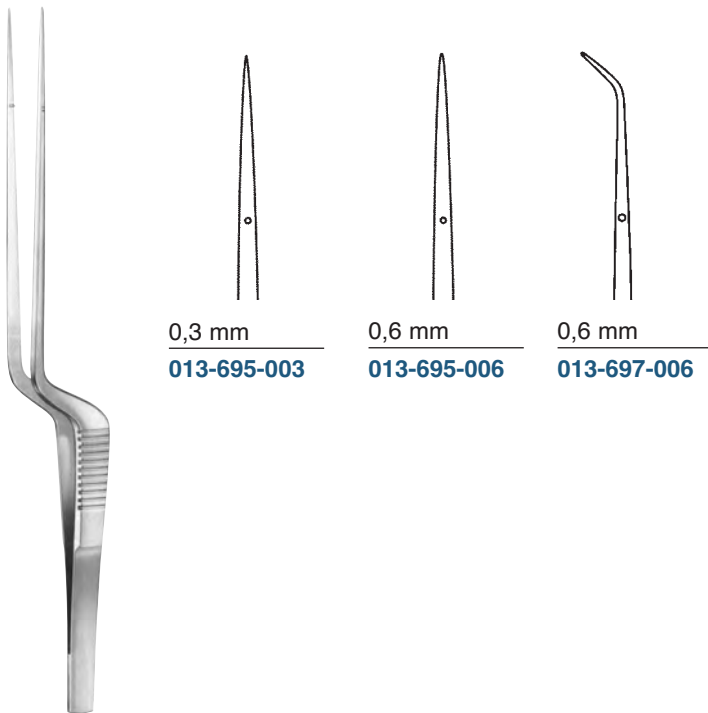
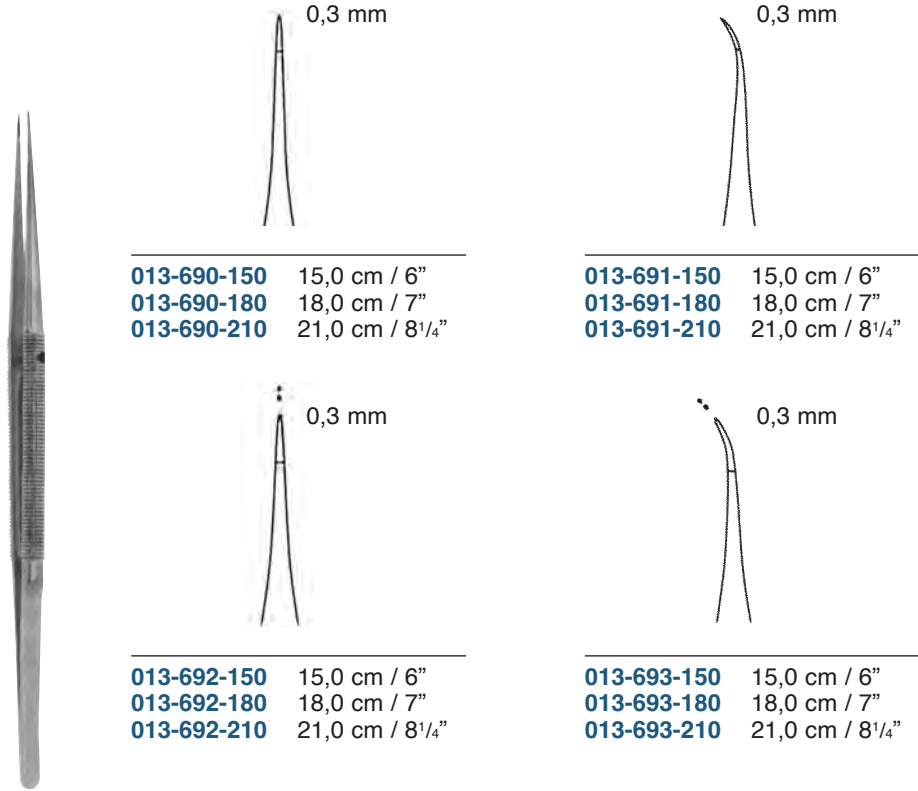

013-695-003 - 013-697-006 18,5 cm / 7¼"



013

Mikro-Knüpfpinzetten
Micro Suture Tying Forceps
Micro-pinzas de ligadura
Micro-pinze per legature



AUSTIN
013-698-140 14,0 cm / 5 1/2"

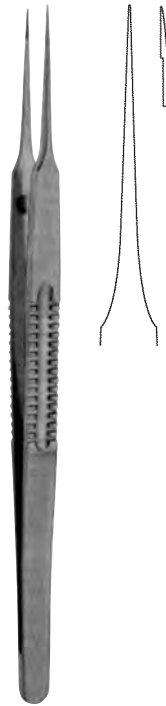

013-700-185 18,5 cm / 7 1/4"

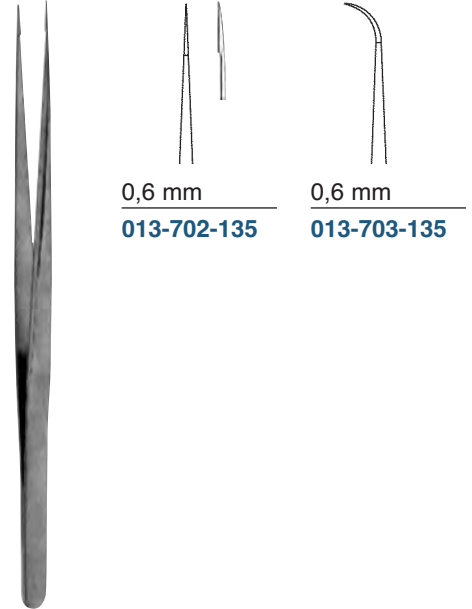

VISE
013-702-135 - 013-703-135 13,5 cm / 5 1/4"

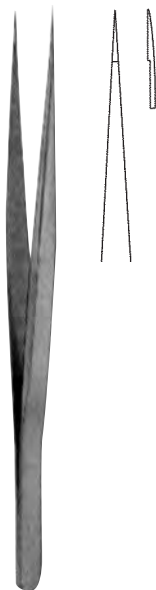

013-704-120 12,0 cm / 4 3/4"

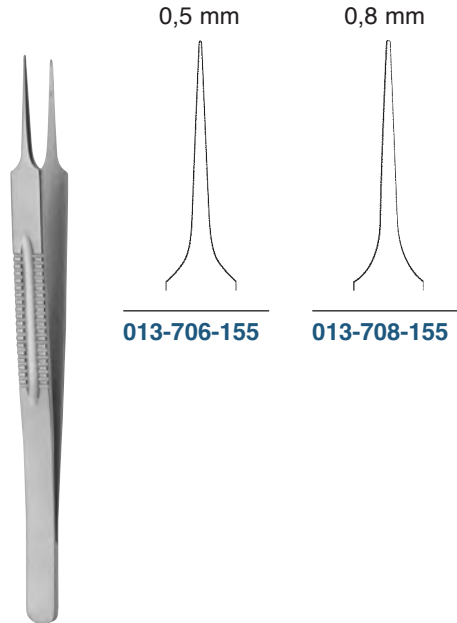

LAZAR
013-706-155 - 013-708-155 15,5 cm / 6 1/8"

Pinzetten mit Hartmetalleinlagen
Forceps with tungsten carbide inserts
Pinzas con bocas de carburo tungsteno
Pinze con morsi in carburo di tungsteno



013



Profil
Serration
Perfil
Profilo

0,4 mm

ADSON

013-800-120 12,0 cm / 4³/₄"
013-800-150 15,0 cm / 6"



Profil
Serration
Perfil
Profilo

0,4 mm

MICRO-ADSON

013-802-120 12,0 cm / 4³/₄"
013-802-150 15,0 cm / 6"

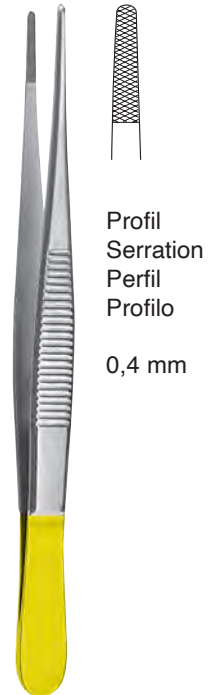

Profil
Serration
Perfil
Profilo

0,4 mm

STANDARD

013-810-145 14,5 cm / 5³/₄"
013-810-160 16,0 cm / 6¹/₄"
013-810-180 18,0 cm / 7"
013-810-200 20,0 cm / 8"
013-810-250 25,0 cm / 10"

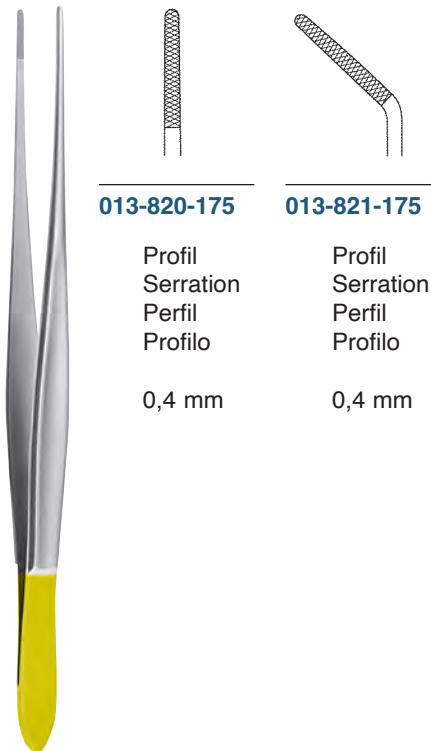

013-820-175

Profil
Serration
Perfil
Profilo

0,4 mm

013-821-175

Profil
Serration
Perfil
Profilo

0,4 mm

CUSHING

013-820-175 - 013-821-175 17,5 cm / 7"

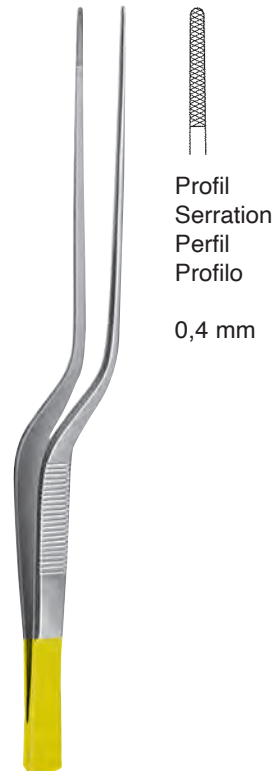

Profil
Serration
Perfil
Profilo

0,4 mm

CUSHING-TAYLOR

013-823-180 18,0 cm / 7"



013

Pinzetten mit Hartmetalleinlagen
Forceps with tungsten carbide inserts
Pinzas con bocas de carburo tungsteno
Pinze con morsi in carburo di tungsteno

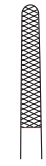

Profil
Serration
Perfil
Profilo
0,4 mm

POTTS-SMITH

- 013-840-150** 15,0 cm / 6"
- 013-840-180** 18,0 cm / 7"
- 013-840-200** 20,0 cm / 8"
- 013-840-230** 23,0 cm / 9"
- 013-840-250** 25,0 cm / 10"



Profil
Serration
Perfil
Profilo
0,4 mm

SEMKEN

- 013-850-150** 15,0 cm / 6"



Profil
Serration
Perfil
Profilo
0,4 mm

MC INDOE

- 013-860-150** 15,0 cm / 6"



Profil
Serration
Perfil
Profilo
0,5 mm

WANGENSTEEN

- 013-880-150** 15,0 cm / 6"
- 013-880-230** 23,0 cm / 9"
- 013-880-250** 25,0 cm / 10"

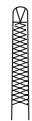

Profil
Serration
Perfil
Profilo
0,4 mm

ADSON

- 013-900-120** 12,0 cm / 4³/₄"
- 013-900-150** 15,0 cm / 6"



Profil
Serration
Perfil
Profilo
0,4 mm

MICRO-ADSON

- 013-902-120** 12,0 cm / 4³/₄"
- 013-902-150** 15,0 cm / 6"



Profil
Serration
Perfil
Profilo
0,4 mm

ADSON-BROWN

- 013-905-120** 12,0 cm / 4³/₄"

Pinzetten mit Hartmetalleinlagen
Forceps with tungsten carbide inserts
Pinzas con bocas de carburo tungsteno
Pinze con morsi in carburo di tungsteno



013

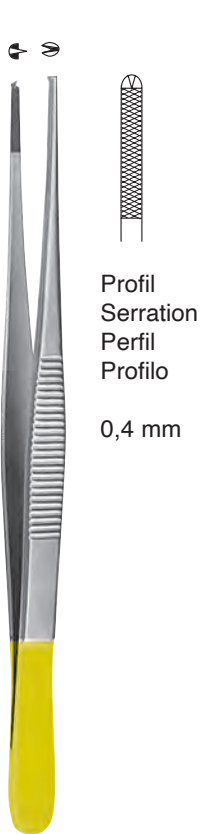

Profil
Serration
Perfil
Profilo
0,4 mm

OEHLER

- 013-910-140** 14,0 cm / 5 1/2"
- 013-910-160** 16,0 cm / 6 1/4"
- 013-910-180** 18,0 cm / 7"
- 013-910-200** 20,0 cm / 8"
- 013-910-250** 25,0 cm / 10"
- 013-910-300** 30,0 cm / 12"



BONNEY

- 013-920-180** 18,0 cm / 7"

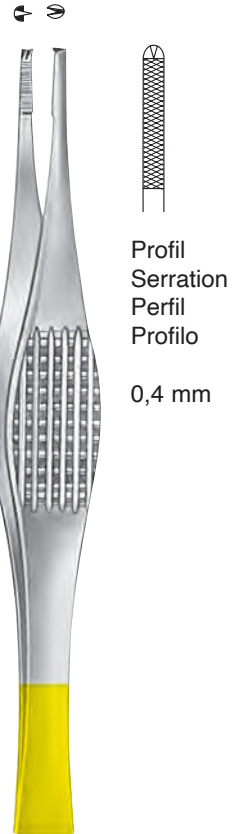

Profil
Serration
Perfil
Profilo
0,4 mm

FERRIS-SMITH

- 013-930-180** 18,0 cm / 7"

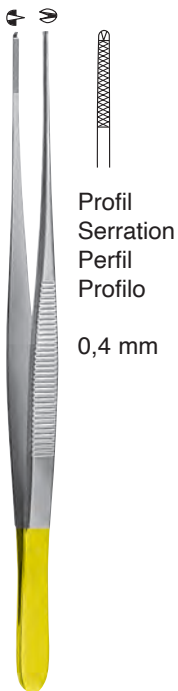

Profil
Serration
Perfil
Profilo
0,4 mm

SEMKEN

- 013-950-150** 15,0 cm / 6"

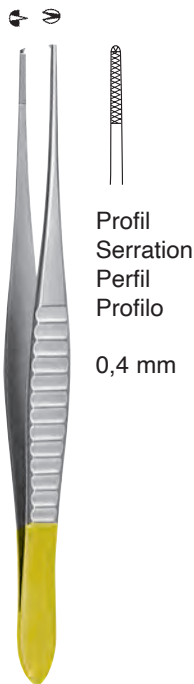

Profil
Serration
Perfil
Profilo
0,4 mm

GILLIES

- 013-960-150** 15,0 cm / 6"



DEBAKEY

- 013-980-150 - 013-982-150** 15,0 cm / 6"
- 013-980-190 - 013-982-190** 19,0 cm / 7 1/2"
- 013-980-240 - 013-982-240** 24,0 cm / 9 1/2"



- 013-980-150**
- 013-980-190**
- 013-980-240**



- 013-982-150**
- 013-982-190**
- 013-982-240**



013

Splitter-Zangen
Splinter Forceps
Pinzas para espinas
Pinze per achegge



013-990-135

013-991-135



013-992-135

013-993-135

STIEGLITZ

013-990-135 - 013-991-135

13,5 cm / 5 1/4"

STIEGLITZ

013-992-135 - 013-993-135

13,5 cm / 5 1/4"



PEET

013-995-115 11,5 cm / 4 1/2"



013-998-150

013-999-150

RALK (VIRTUS)

013-998-150 - 013-999-150

15,0 cm / 6"



015

Klemmen, Korn- und
Tupferzangen
Forceps, Dressing and
Sponge Forceps
Pinzas, Pinzas para torundo y
vendajes
Pinze, Pinze per medicatura
e tamponi



015

Klemmen
Clamps
Pinzas
Pinze



TITANIUM VENA

015-020-030	30 mm
015-020-035	35 mm
015-020-040	40 mm
015-020-050	50 mm



015-020-030



015-020-035



015-020-040



015-020-050

discontinued item



015-021-030



015-021-035



015-021-040



015-021-050

TITANIUM VENA

015-021-030	30 mm
015-021-035	35 mm
015-021-040	40 mm
015-021-050	50 mm



015-030-030



015-030-035



015-030-040



015-030-050



TITANIUM ARTERIA

015-030-030	30 mm
015-030-035	35 mm
015-030-040	40 mm
015-030-050	50 mm

discontinued item



015-031-030



015-031-035



015-031-040

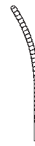

015-031-050



TITANIUM ARTERIA

015-031-030	30 mm
015-031-035	35 mm
015-031-040	40 mm
015-031-050	50 mm



015

Klemmen
Clamps
Pinzas
Pinze



015-023-030
015-033-030



015-023-035
015-033-035



015-023-040
015-033-040



015-023-050
015-033-050



TITANIUM VENA

015-023-030	30 mm
015-023-035	35 mm
015-023-040	40 mm
015-023-050	50 mm

TITANIUM ARTERIA

015-033-030	30 mm
015-033-035	35 mm
015-033-040	40 mm
015-033-050	50 mm

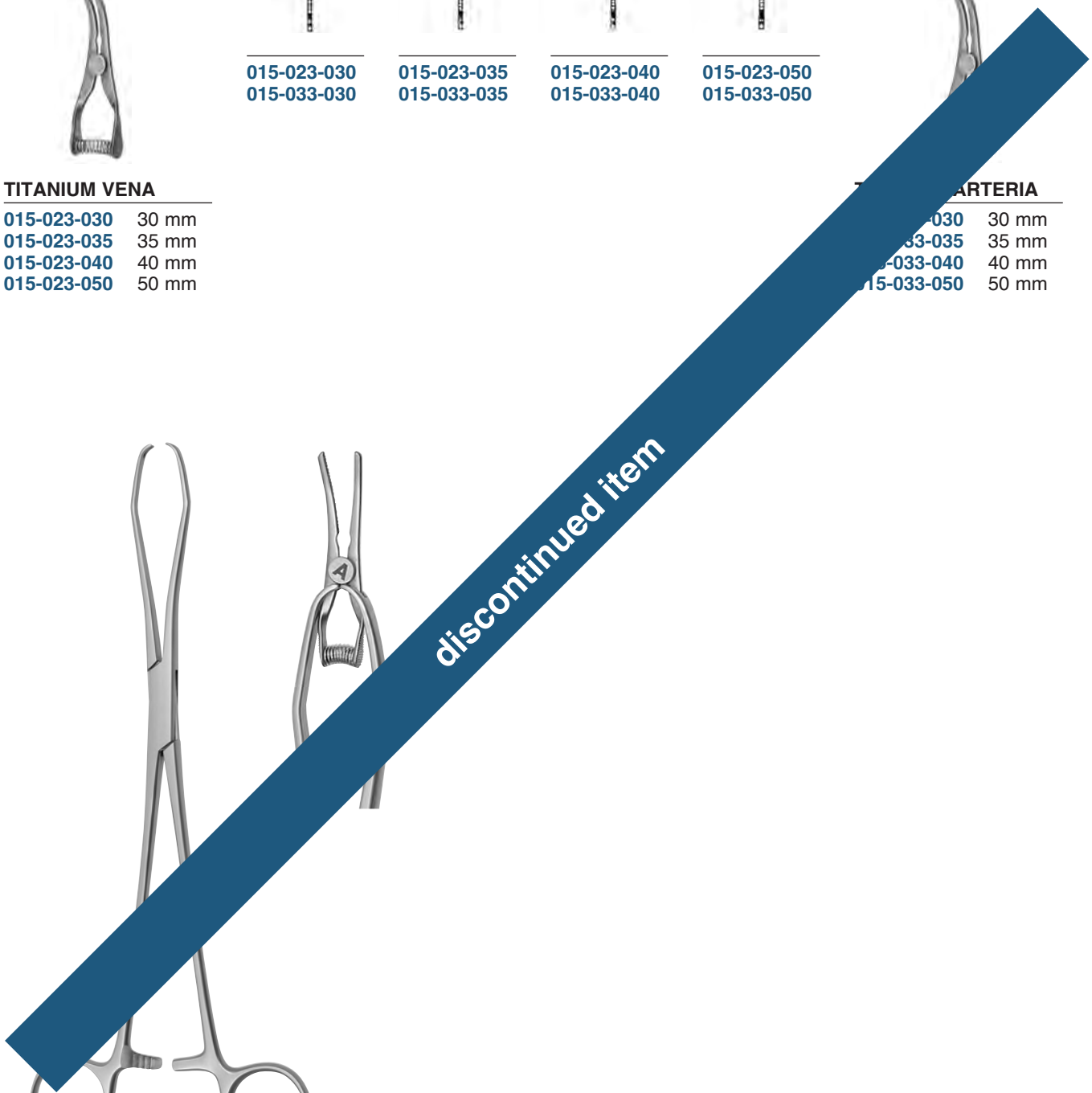

discontinued item

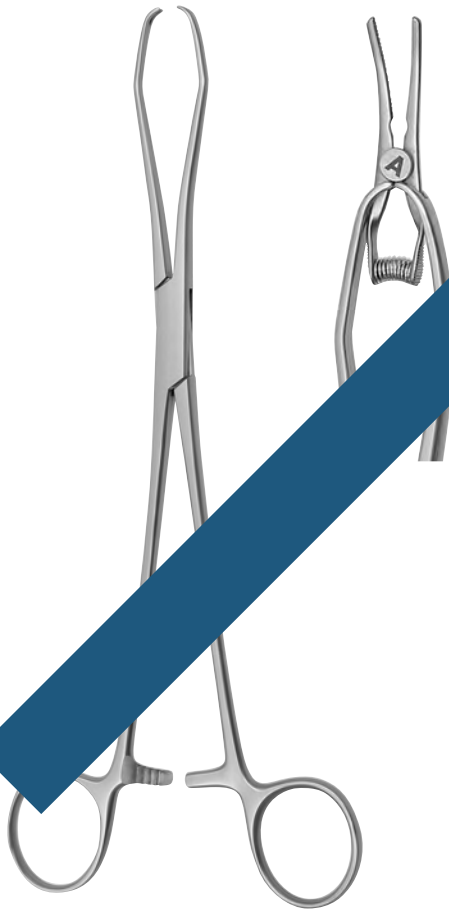

015-036-240 24,0 cm / 9 1/2"



015-040-008



015-040-012

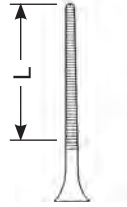

015-040-020



015-041-008



015-041-012



015-041-020

DIETRICH

015-040-008	8 mm (L)
015-040-012	12 mm (L)
015-040-020	20 mm (L)
015-041-008	8 mm (L)
015-041-012	12 mm (L)
015-041-020	20 mm (L)



015-044-010



015-044-014

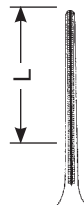

015-044-020



015-045-010



015-045-014



015-045-020

DEBAKEY-DIETRICH

015-044-010	10 mm (L)
015-044-014	14 mm (L)
015-044-020	20 mm (L)
015-045-010	10 mm (L)
015-045-014	14 mm (L)
015-045-020	20 mm (L)



015

**Klemmen
Clamps
Pinzas
Pinze**



015-050-035



015-050-050

DIEFENBACH

015-050-035 3,5 cm / 1 1/2"
015-050-050 5,0 cm / 2"



015-051-035



015-051-050

DIEFENBACH

015-051-035 3,5 cm / 1 1/2"
015-051-050 5,0 cm / 2"

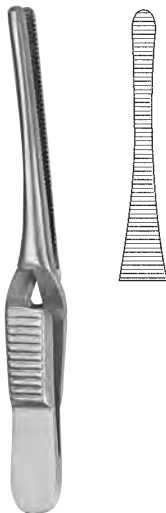

JOHNS-HOPKINS

015-060-050 5,0 cm / 2"
015-060-065 6,5 cm / 2 1/2"
015-060-075 7,5 cm / 3"

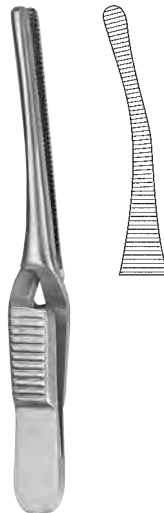

JOHNS-HOPKINS

015-061-050 5,0 cm / 2"
015-061-065 6,5 cm / 2 1/2"
015-061-075 7,5 cm / 3"



HESS

L

015-071-020 20 mm
015-071-030 30 mm



HALSTED-MOSQUITO

015-100-125 - 015-103-125 12,5 cm / 5"
015-100-140 - 015-103-140 14,0 cm / 5 1/2"

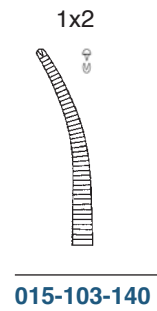
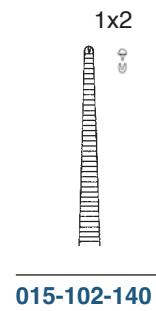
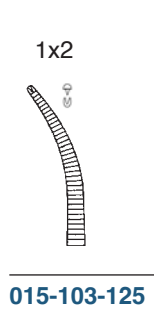
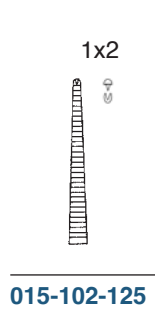
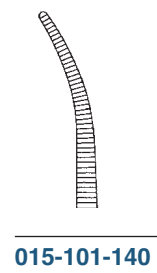
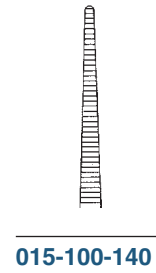
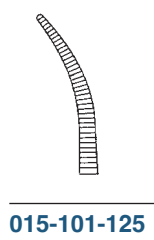
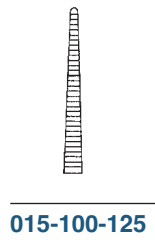

HALSTED-MOSQUITO

015-100-180 - 015-103-180 18,0 cm / 7"
015-100-210 - 015-103-210 21,0 cm / 8 1/4"

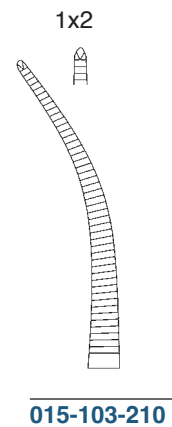
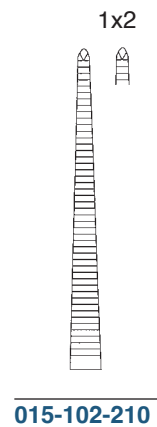
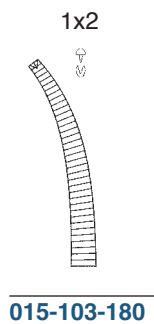
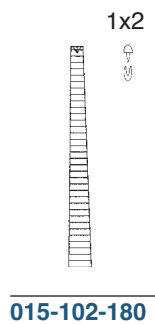
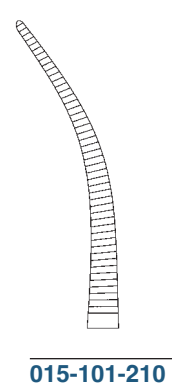
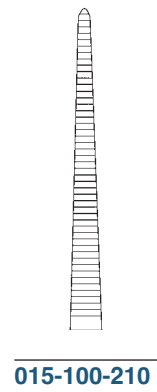
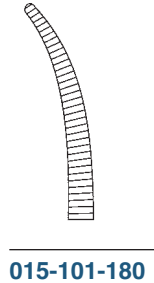
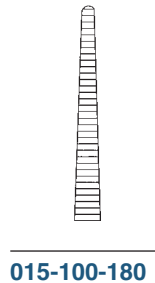



015

**Klemmen
Forceps
Pinzas
Pinze**



015-110-100



015-111-100



015-110-120



015-111-120

1x2



015-112-100

1x2



015-113-100

1x2



015-112-120

1x2



015-113-120

MICRO-MOSQUITO

015-110-100 - 015-113-100 10,0 cm / 4"

015-110-120 - 015-113-120 12,0 cm / 4 3/4"

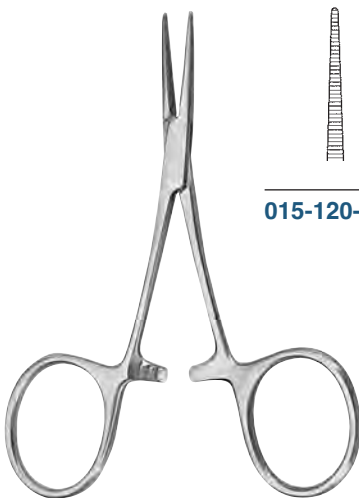

015-120-100

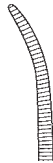

015-121-100

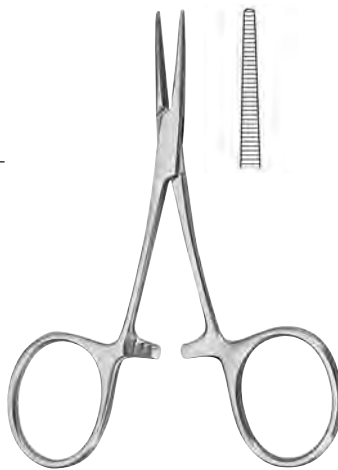

CARREL

015-130-085 8,5 cm / 3 1/3"



1x2

TERRIER

015-140-085 8,5 cm / 3 1/3"



KROENLEIN
015-150-130 13,0 cm / 5"

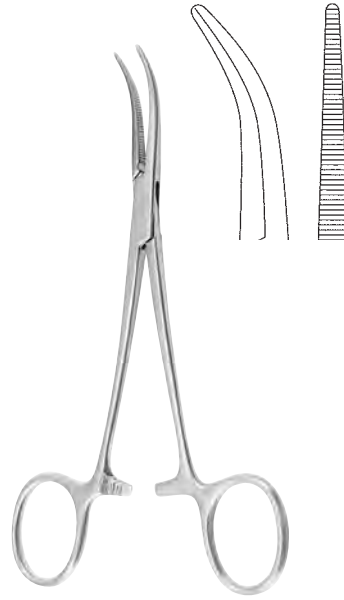

MOSQUITO-DANDY
015-151-120 12,0 cm / 4³/₄"

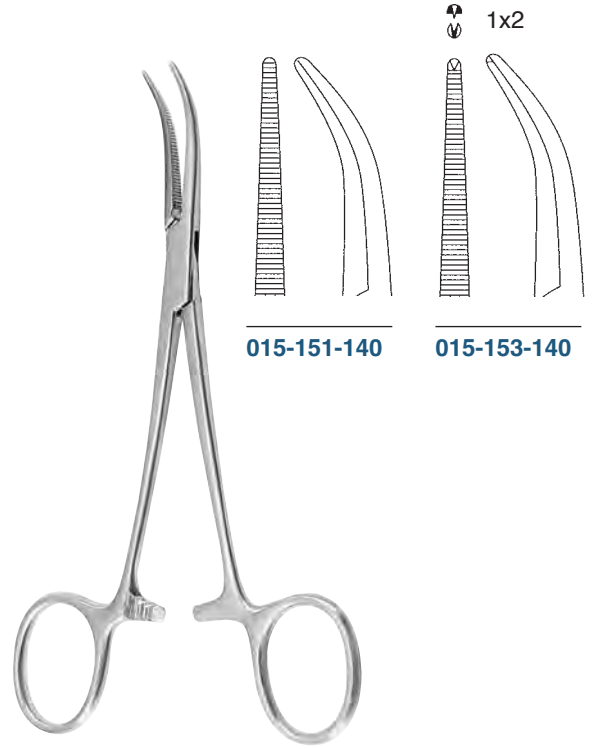

DANDY
015-151-140 – 015-153-140 14,0 cm / 5¹/₂"



PROVIDENCE-HOSPITAL
015-160-140 – 015-161-140 14,0 cm / 5¹/₂"

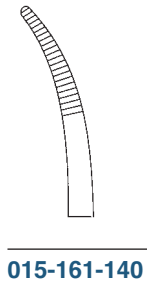

015-161-140

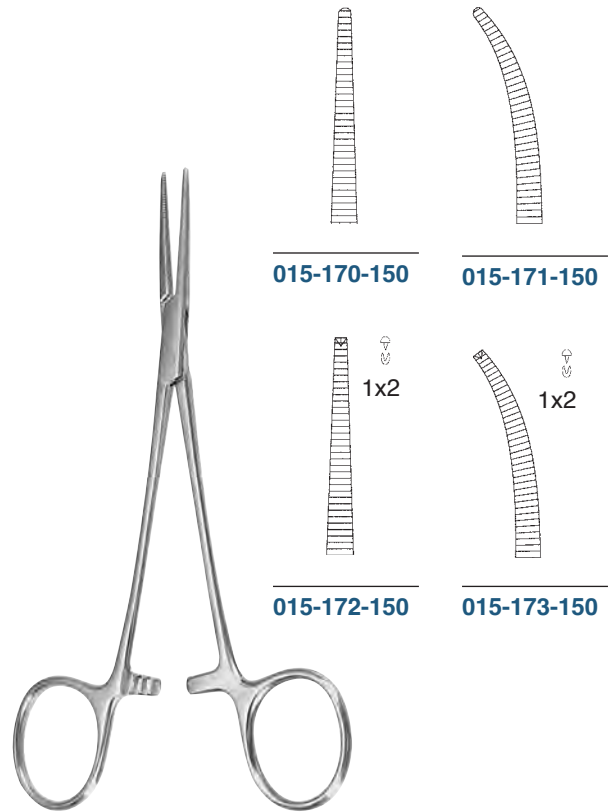

LERICHE
015-170-150 – 015-173-150 15,0 cm / 6"

015-170-150

015-171-150

015-172-150

015-173-150



015

**Klemmen
Forceps
Pinzas
Pinze**

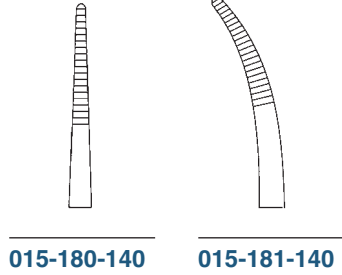

015-180-140

015-181-140

KELLY

015-180-140 – 015-181-140 14,0 cm / 5 1/2"

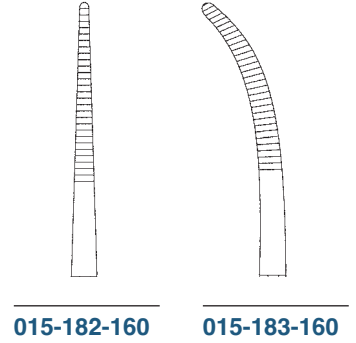

015-182-160

015-183-160

KELLY-RANKIN

015-182-160 – 015-183-160 16,0 cm / 6 1/4"

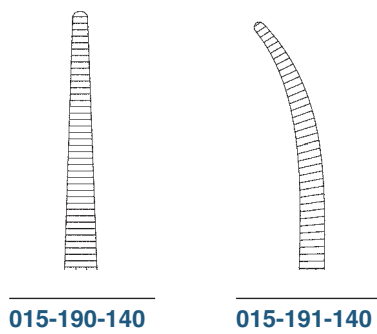
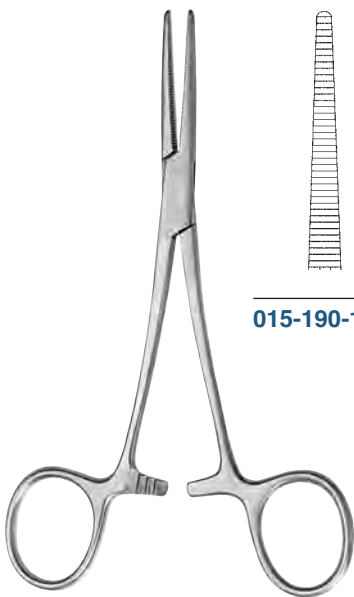

015-190-140

015-191-140

1x2

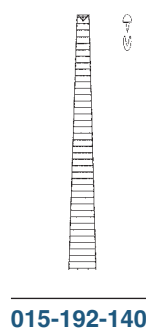

015-192-140

1x2

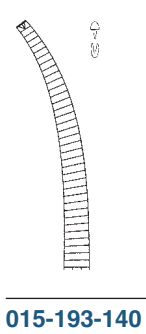

015-193-140

CRILE

015-190-140 – 015-193-140 14,0 cm / 5 1/2"

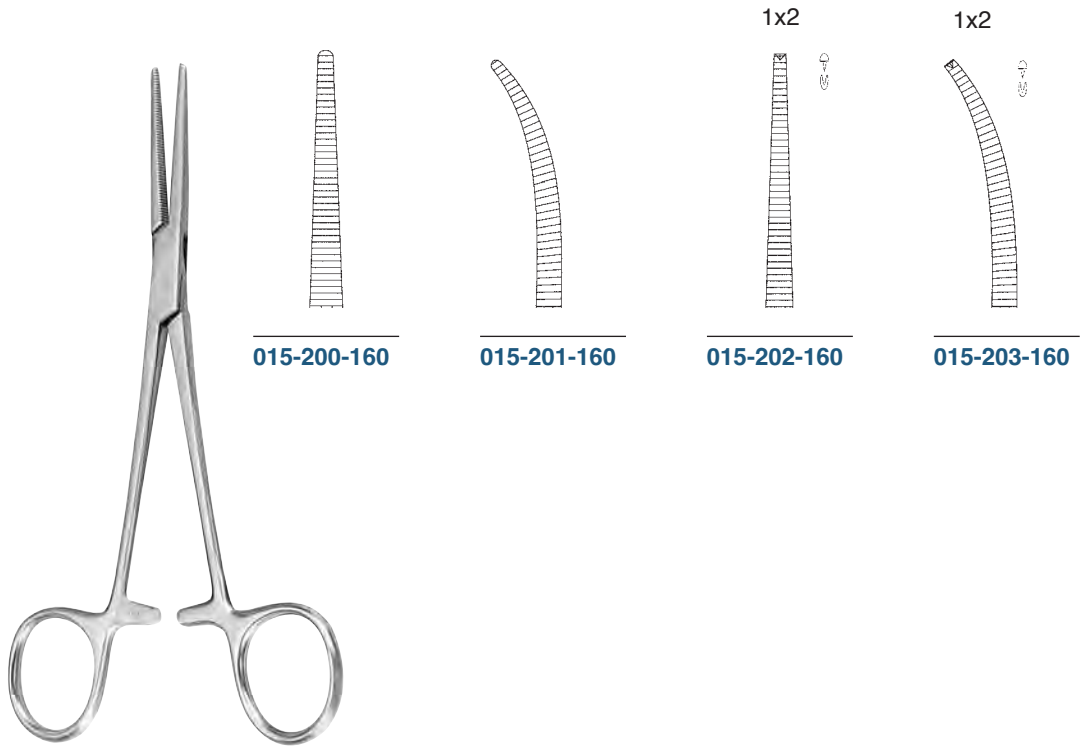

CRILE-RANKIN

015-200-160 – 015-203-160 16,0 cm / 6¹/₄"



BABY-OVERHOLT

015-211-135 13,5 cm / 5¹/₄"

DIXON-LOVELACE

015-220-150 – 015-222-150 15,0 cm / 6"



015

**Klemmen
Forceps
Pinzas
Pinze**



015-230-130



015-230-150



015-230-180



015-230-200



015-230-230

SPENCER-WELLS

- 015-230-130 13,0 cm / 5 1/8"
- 015-230-150 15,0 cm / 6"
- 015-230-180 18,0 cm / 7"
- 015-230-200 20,0 cm / 8"
- 015-230-230 23,0 cm / 9"

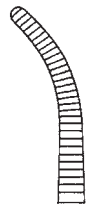

015-231-130



015-231-150

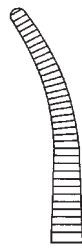

015-231-180

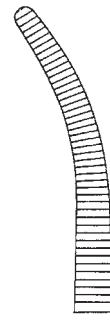

015-231-200

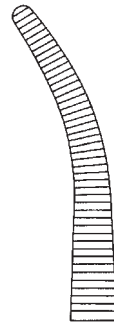

015-231-230

SPENCER-WELLS

- 015-231-130 13,0 cm / 5 1/8"
- 015-231-150 15,0 cm / 6"
- 015-231-180 18,0 cm / 7"
- 015-231-200 20,0 cm / 8"
- 015-231-230 23,0 cm / 9"

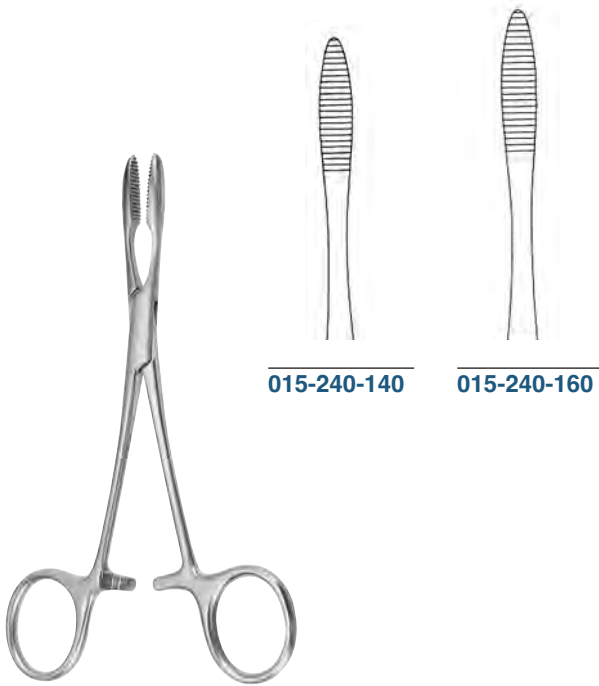

015-240-140

015-240-160

PEAN

015-240-140 14,0 cm / 5 1/2"
 015-240-160 16,0 cm / 6 1/4"



015-250-130

015-250-140

015-250-160

015-251-130

015-251-140

015-251-160

PEAN-DELICATE

015-250-130 13,0 cm / 5 1/8"
 015-250-140 14,0 cm / 5 1/2"
 015-250-160 16,0 cm / 6 1/4"

PEAN-DELICATE

015-251-130 13,0 cm / 5 1/8"
 015-251-140 14,0 cm / 5 1/2"
 015-251-160 16,0 cm / 6 1/4"



015

**Klemmen
Forceps
Pinzas
Pinze**



ROCHESTER-PEAN

015-260-140	14,0 cm / 5 1/2"
015-260-160	16,0 cm / 6 1/4"
015-260-180	18,0 cm / 7"
015-260-200	20,0 cm / 8"
015-260-220	22,0 cm / 8 3/4"
015-260-240	24,0 cm / 9 1/2"
015-260-260	26,0 cm / 10 1/4"
015-260-280	28,0 cm / 11"
015-260-300	30,0 cm / 11 3/4"



015-260-140



015-260-160



015-260-180

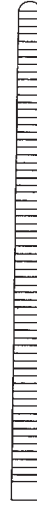

015-260-200



015-260-220

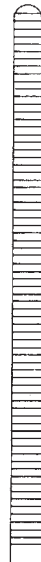

015-260-240

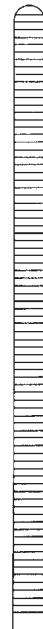

015-260-260



015-260-280



015-260-300

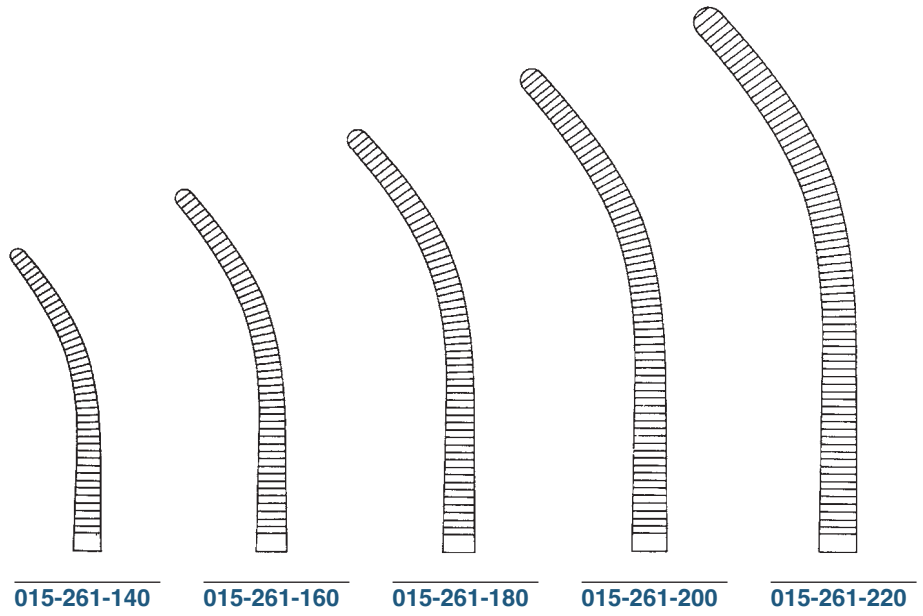

ROCHESTER-PEAN

015-261-140	14,0 cm / 5 1/2"
015-261-160	16,0 cm / 6 1/4"
015-261-180	18,0 cm / 7"
015-261-200	20,0 cm / 8"
015-261-220	22,0 cm / 8 3/4"
015-261-240	24,0 cm / 9 1/2"
015-261-260	26,0 cm / 10 1/4"
015-261-280	28,0 cm / 11"
015-261-300	30,0 cm / 11 3/4"

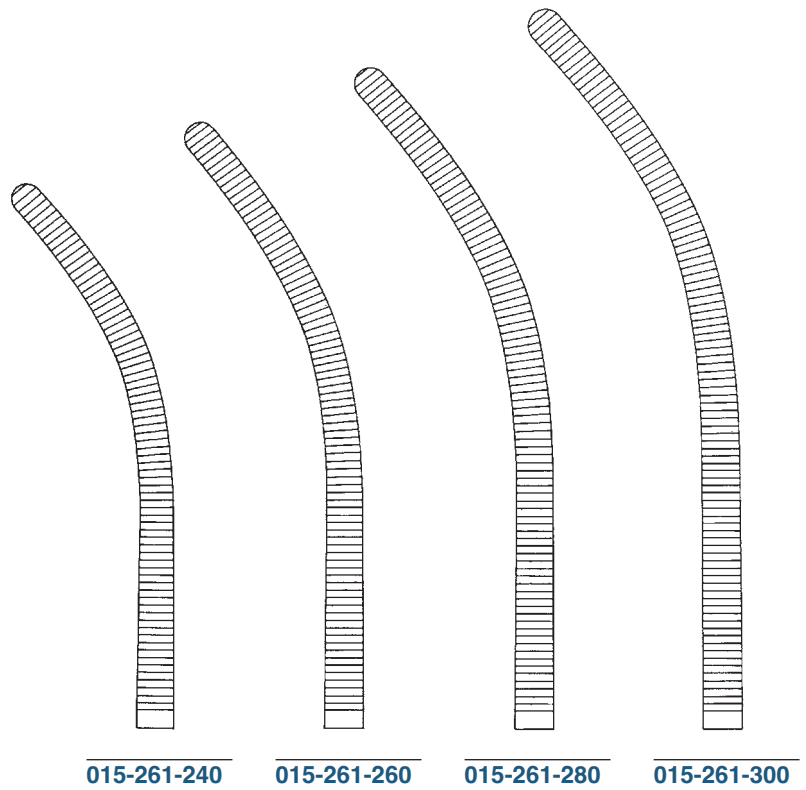



015

**Klemmen
Forceps
Pinzas
Pinze**

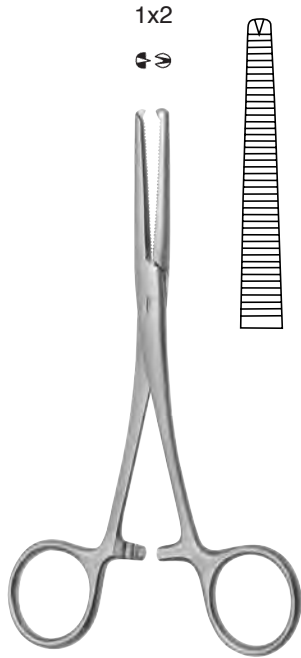

KOCHER

015-266-145 14,5 cm / 5³/₄"



KOCHER DELICATE

015-270-130 13,0 cm / 5¹/₈"
015-270-140 14,0 cm / 5¹/₂"
015-270-160 16,0 cm / 6¹/₄"

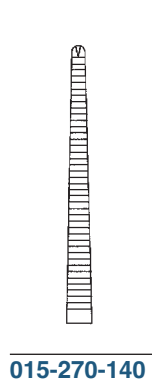

015-270-140

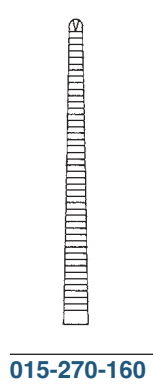

015-270-160

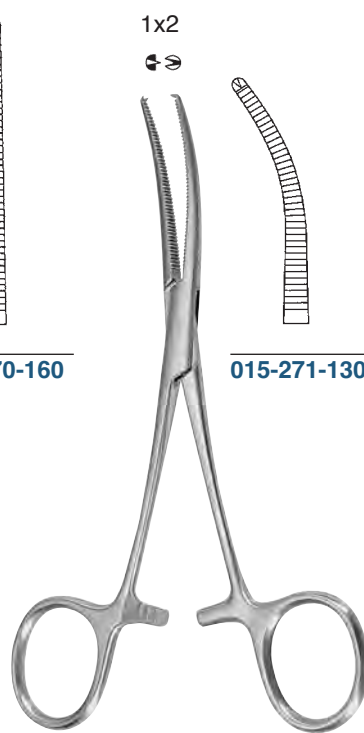

KOCHER DELICATE

015-271-130 13,0 cm / 5¹/₈"
015-271-140 14,0 cm / 5¹/₂"
015-271-160 16,0 cm / 6¹/₄"

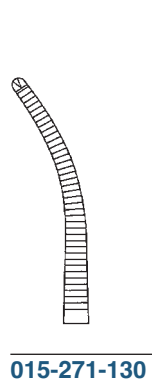

015-271-130

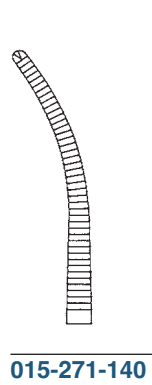

015-271-140

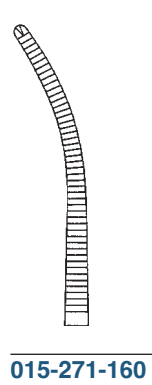

015-271-160



KOCHER-OCHSNER

015-280-130	13,0 cm / 5 1/8"
015-280-140	14,0 cm / 5 1/2"
015-280-160	16,0 cm / 6 1/4"
015-280-180	18,0 cm / 7"
015-280-200	20,0 cm / 8"
015-280-220	22,0 cm / 8 3/4"
015-280-240	24,0 cm / 9 1/2"
015-280-260	26,0 cm / 10 1/4"
015-280-300	30,0 cm / 11 3/4"



015-280-130



015-280-140



015-280-160

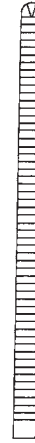

015-280-180



015-280-200



015-280-220



015-280-240

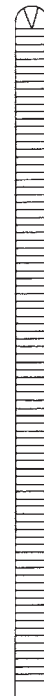

015-280-260



015-280-300



015

**Klemmen
Forceps
Pinzas
Pinze**

1x2



KOCHER-OCHSNER

015-281-130	13,0 cm / 5 1/8"
015-281-140	14,0 cm / 5 1/2"
015-281-160	16,0 cm / 6 1/4"
015-281-180	18,0 cm / 7"
015-281-200	20,0 cm / 8"
015-281-220	22,0 cm / 8 3/4"
015-281-240	24,0 cm / 9 1/2"
015-281-260	26,0 cm / 10 1/4"
015-281-300	30,0 cm / 11 3/4"

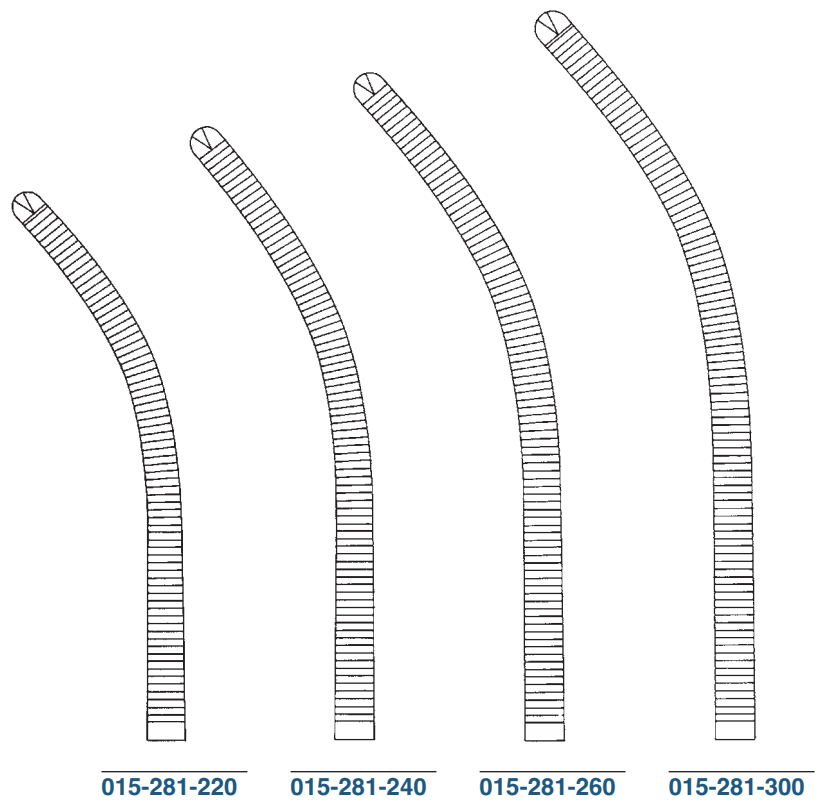
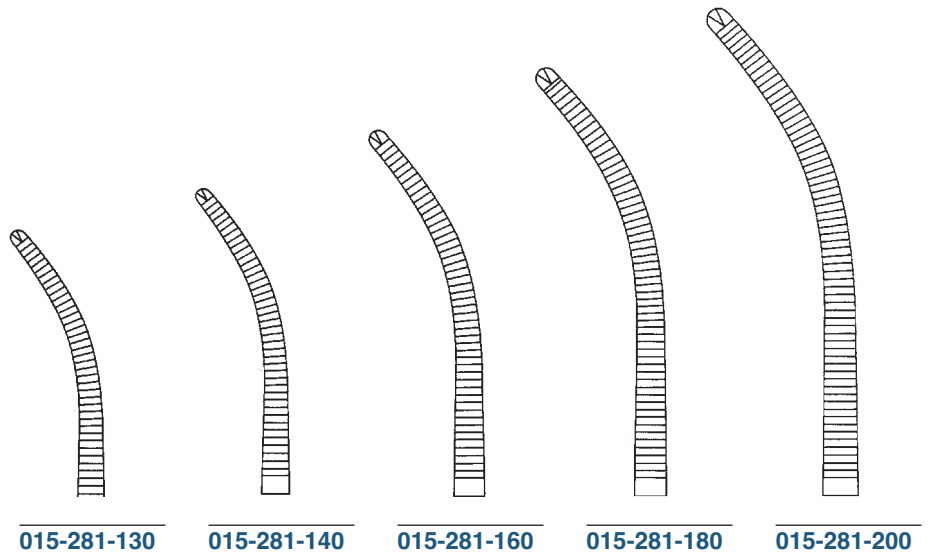

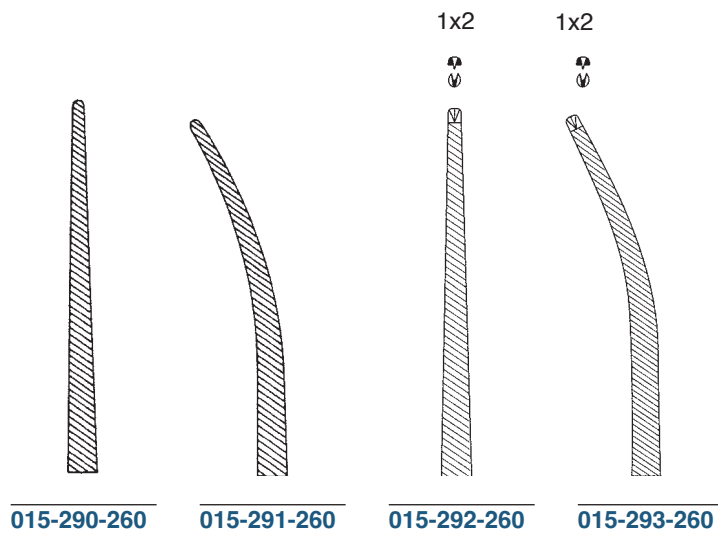
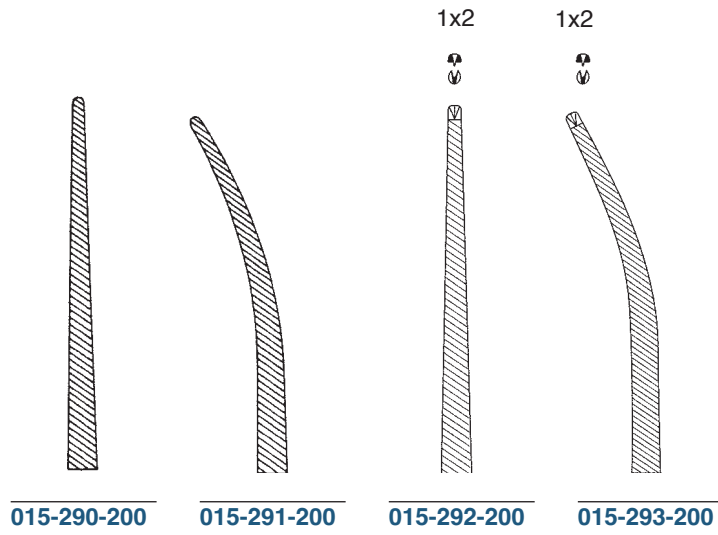

BENGOLEA

015-290-200 – 015-293-200 20,0 cm / 8"
 015-290-260 – 015-293-260 26,0 cm / 10¹/₄"



015

Gewebefäßzangen
Tissue Grasping Forceps
Pinzas para tejidos
Pinze da presa per tessuti



CHAPUT

015-300-130 13,0 cm / 5 1/8"



TUFFIER

015-310-130 13,0 cm / 5 1/8"



PENNINGTON

015-320-155 15,5 cm / 6 1/8"
015-320-200 20,0 cm / 8"

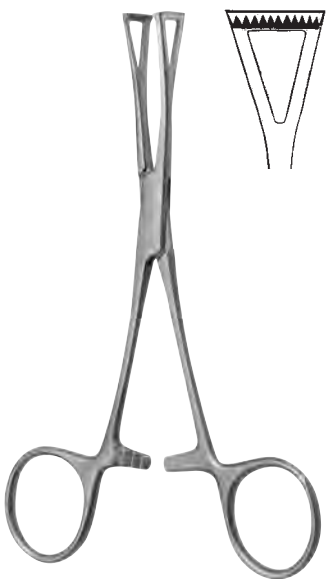

COLLIN

015-322-140 14,0 cm / 5 1/2"



COLLIN

015-330-160 – 015-332-160 16,0 cm / 6 1/4"

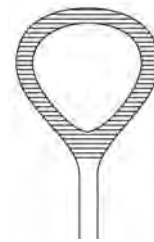

015-330-160



015-332-160



BUIE

015-335-210 21,0 cm / 8 1/4"



PRATT

015-338-150 15,0 cm / 6"



MARTEL

015-340-140 14,0 cm / 5 1/2"

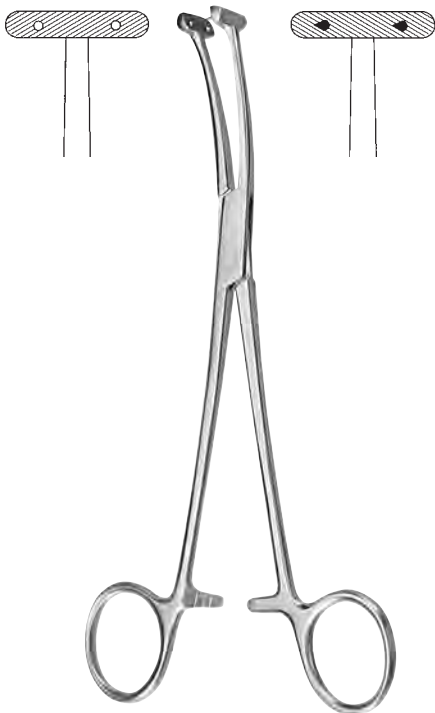

WILLET-MARTEL

015-345-190 19,0 cm / 7 1/2"

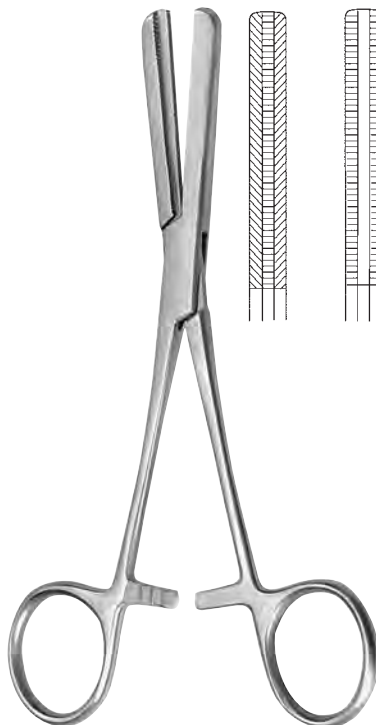

FERGUSON

015-350-160 16,0 cm / 6 1/4"
015-350-200 20,0 cm / 8"

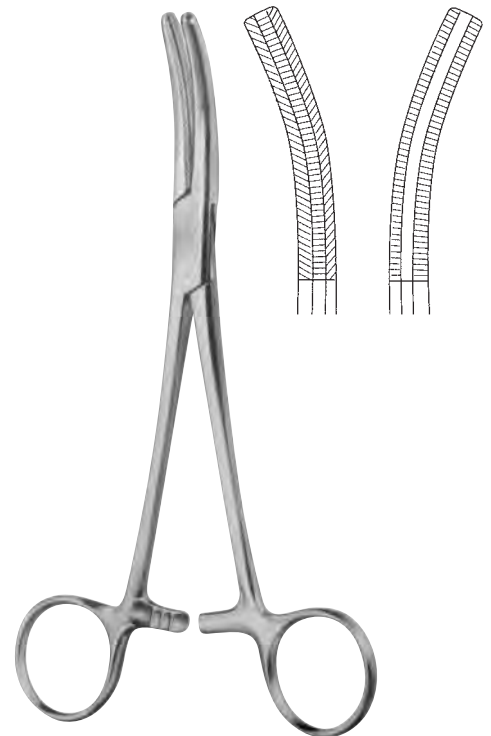

FERGUSON

015-351-160 16,0 cm / 6 1/4"
015-351-200 20,0 cm / 8"



015

**Klemmen
Forceps
Pinzas
Pinze**

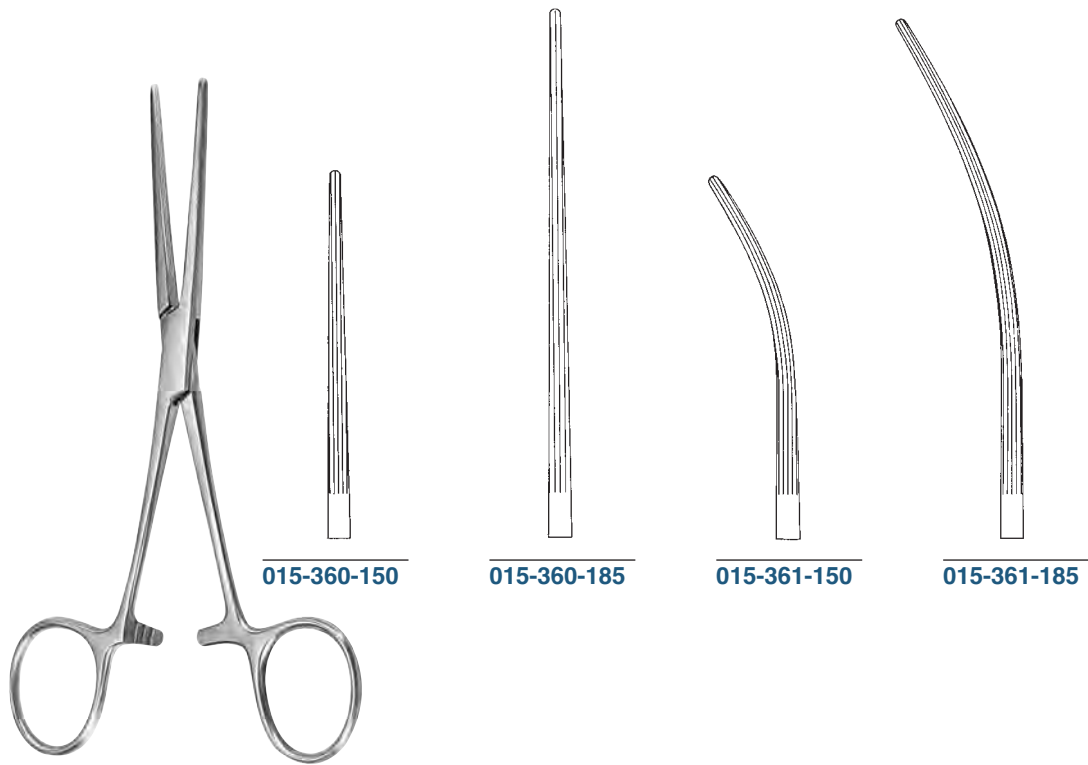

BAINBRIDGE

015-360-150 – 015-361-150 15,0 cm / 6"
015-360-185 – 015-361-185 18,5 cm / 7 1/4"

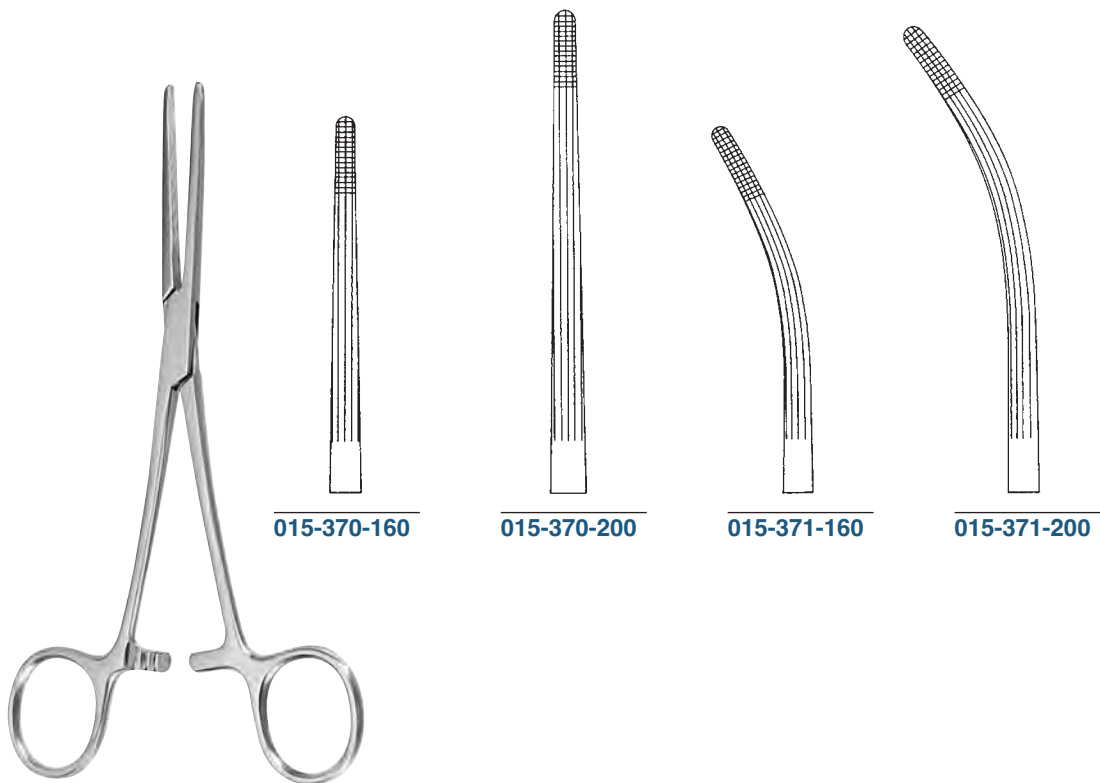

ROCHESTER-CARMALT

015-370-160 – 015-371-160 16,0 cm / 6 1/4"
015-370-200 – 015-371-200 20,0 cm / 8"



015-381-140

015-383-140

BABY-MIXTER

015-381-140 – 015-383-140 14,0 cm / 5 1/2"



BABY-MIXTER

015-385-180 18,0 cm / 7"

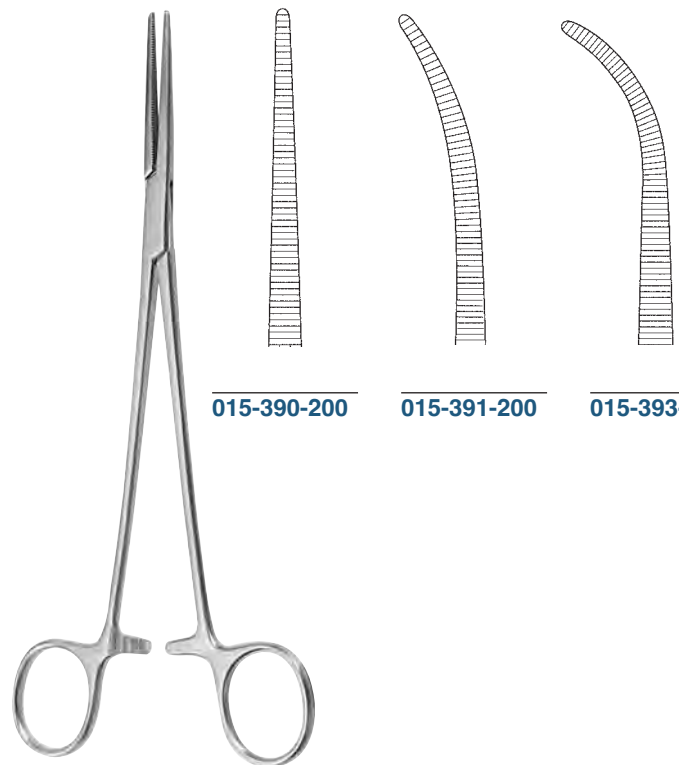

015-390-200

015-391-200

015-393-200

HEISS

015-390-200 – 015-393-200 20,0 cm / 8"



015

**Klemmen
Forceps
Pinzas
Pinze**



015-401-190



015-403-190

SCHNIDT

015-401-190 - 015-403-190 19,0 cm / 7 1/2"



015-410-180

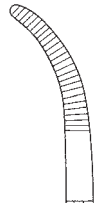

015-411-180

ADSON

015-410-180 - 015-411-180 18,5 cm / 7 1/4"

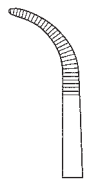

015-421-140

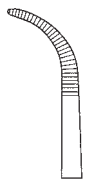

015-421-180

BABY-ADSON

015-421-140 14,0 cm / 5 1/2"
015-421-180 18,0 cm / 7"



MIKRO-ADSON

015-423-140 14,0 cm / 5 1/2"



OVERHOLT-MIXTER

015-431-210 21,0 cm / 8¹/₄"

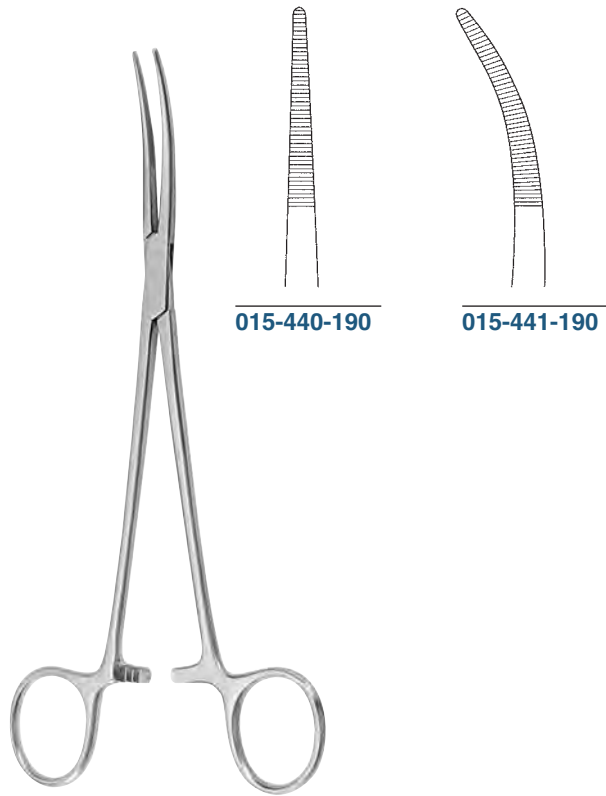

BIRKETT

015-440-190 – 015-441-190 19,0 cm / 7¹/₂"

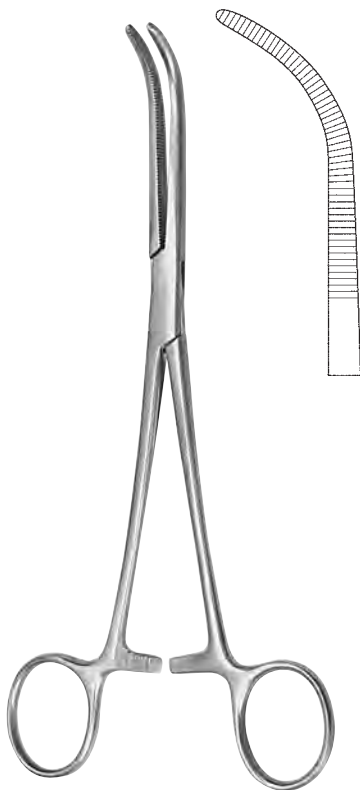

JOHNS HOPKINS

015-451-200 20,0 cm / 8"

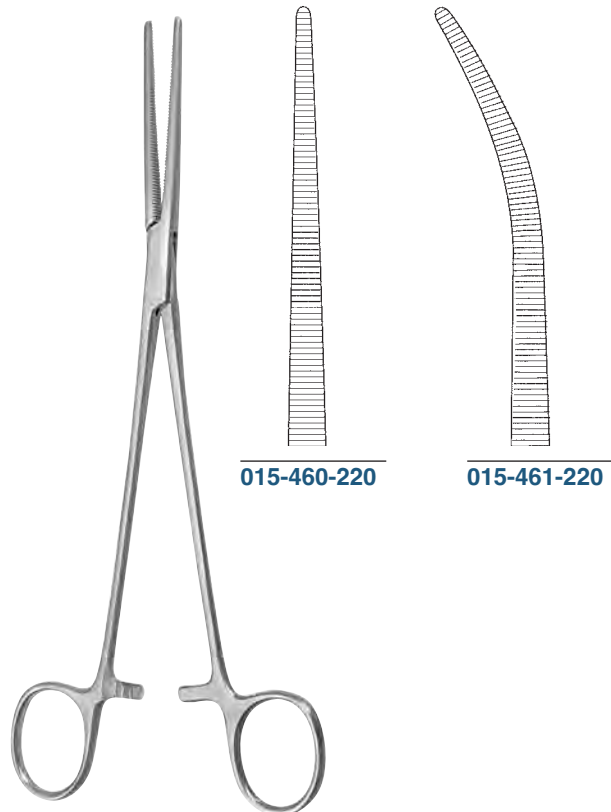

ROBERTS

015-460-220 – 015-461-220 22,0 cm / 8³/₄"



015

**Klemmen
Forceps
Pinzas
Pinze**



015-470-240

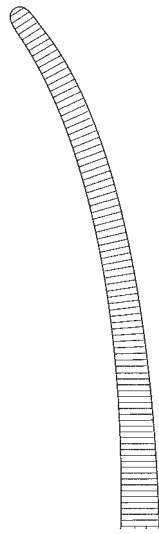

015-471-240

SAROT

015-470-240 – 015-471-240 24,0 cm / 9 1/2"

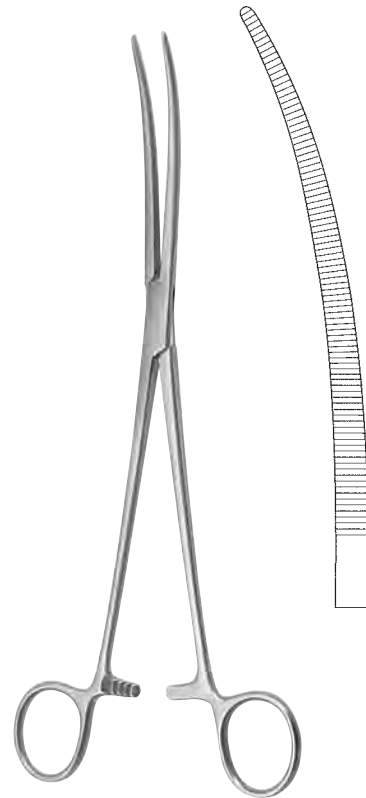

CRAFOORD

015-481-240 24,0 cm / 9 1/2"

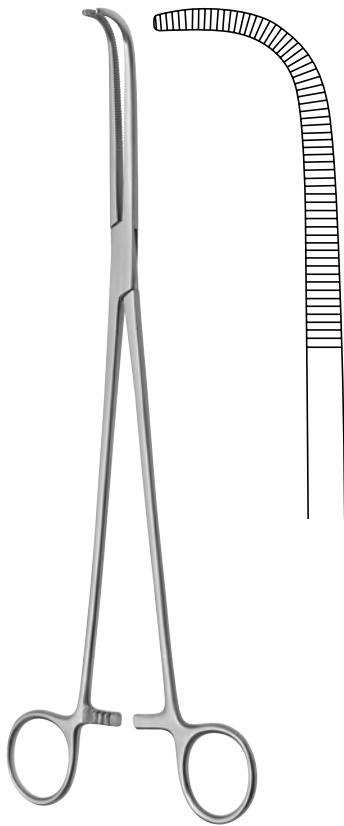

MIXTER-CRAFOORD

015-483-270 27,0 cm / 10 3/4"



CRAFOORD-SELLORS

015-485-220 22,0 cm / 8 3/4"
015-485-230 23,0 cm / 9"
015-485-240 24,0 cm / 9 1/2"

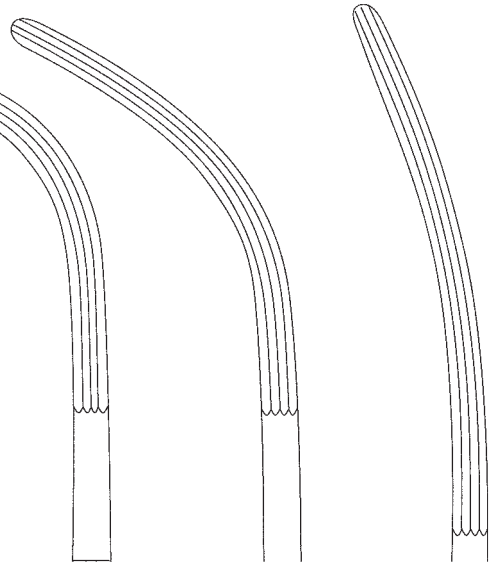

015-485-220

015-485-230

015-485-240

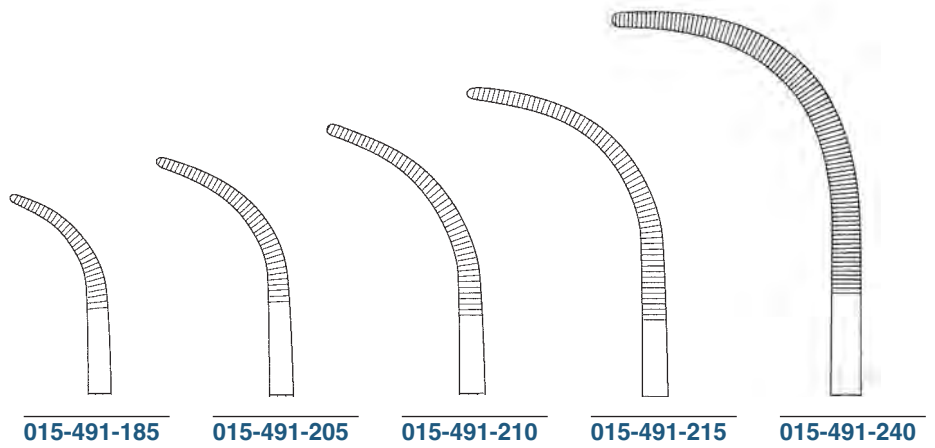
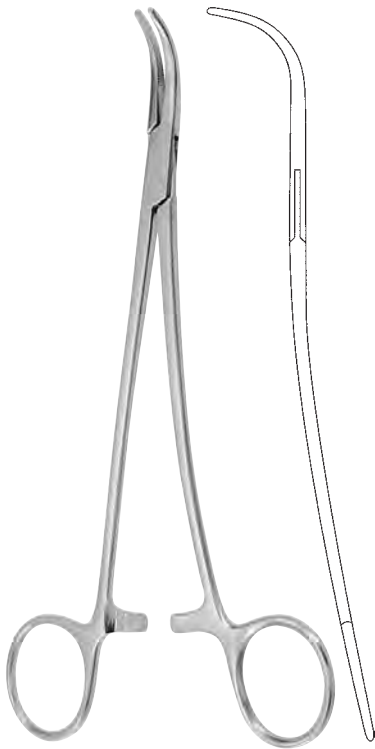

OVERHOLT

015-491-185	18,5 cm / 7 ¹ / ₄ "
015-491-205	20,0 cm / 8"
015-491-210	21,0 cm / 8 ¹ / ₄ "
015-491-215	21,5 cm / 8 ¹ / ₂ "
015-491-240	24,0 cm / 9 ¹ / ₂ "

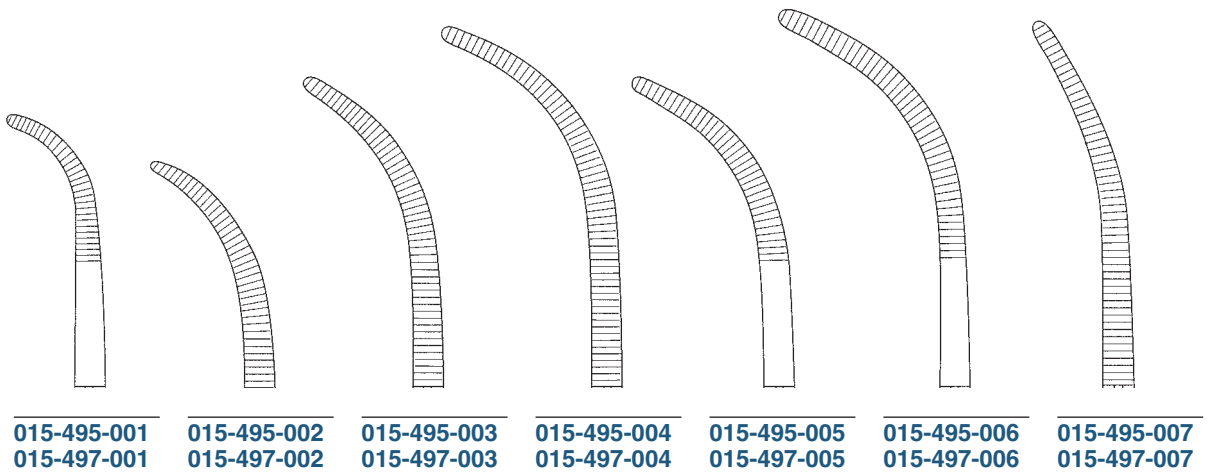

OVERHOLT-GEISSENDOERFER

015-495-001 – 015-495-007	21,0 cm / 8 ¹ / ₄ "
015-497-001 – 015-497-007	27,0 cm / 10 ³ / ₄ "



015

**Klemmen
Forceps
Pinzas
Pinze**

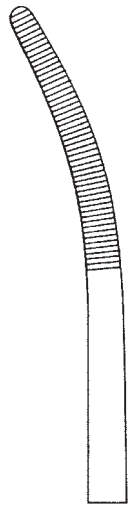

015-501-001

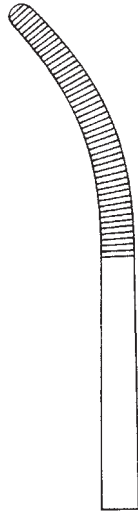

015-501-002

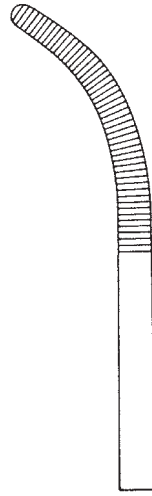

015-501-003

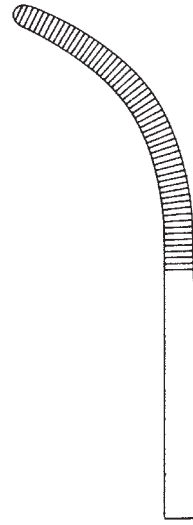

015-501-004

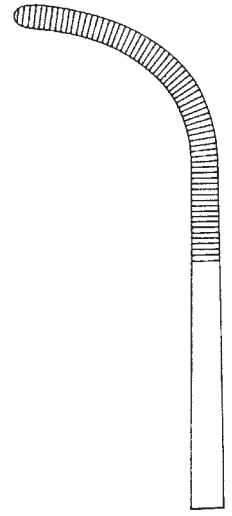

015-501-005

RUMEL

015-501-001 – 015-501-005 23,0 cm / 9"

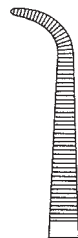

015-511-180



015-511-220



015-511-250

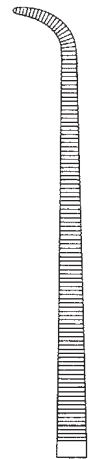

015-511-280

MINI-GEMINI

015-511-180 18,0 cm / 7"
015-511-220 22,0 cm / 8³/₄"
015-511-250 25,0 cm / 9³/₄"
015-511-280 28,0 cm / 11"

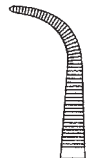

015-521-130



015-521-160



015-521-180

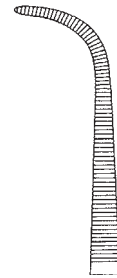

015-521-200

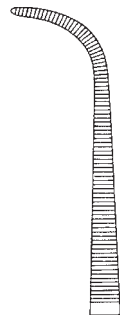

015-521-230

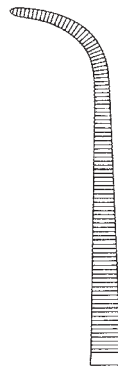

015-521-250

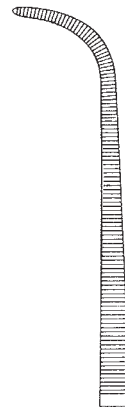

015-521-280



GEMINI

015-521-130	13,0 cm / 5 ¹ / ₈ "
015-521-160	16,0 cm / 6 ¹ / ₄ "
015-521-180	18,0 cm / 7"
015-521-200	20,0 cm / 8"
015-521-230	23,0 cm / 9"
015-521-250	25,0 cm / 9 ³ / ₄ "
015-521-280	28,0 cm / 11"



015

**Klemmen
Forceps
Pinzas
Pinze**



**015-530-210
015-530-260**

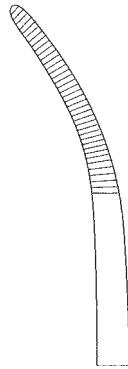

**015-531-210
015-531-260**



**015-532-210
015-532-260**

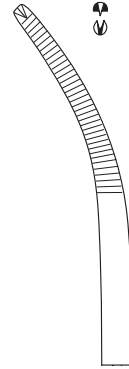

**015-533-210
015-533-260**

TOENNIS

015-530-210 – 015-533-210 21,0 cm / 8 1/4"
015-530-260 – 015-533-260 26,0 cm / 10 1/4"

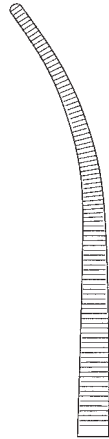

**015-541-190
015-541-220
015-541-240**



**015-543-190
015-543-220
015-543-240**



**015-545-190
015-545-220
015-545-240**

KELLY

015-541-190 – 015-545-190 19,0 cm / 7 1/2"
015-541-220 – 015-545-220 22,0 cm / 8 3/4"
015-541-240 – 015-545-240 24,0 cm / 9 1/2"



ZENKER

015-551-001 – 015-551-002 29,5 cm / 11⁵/₈"

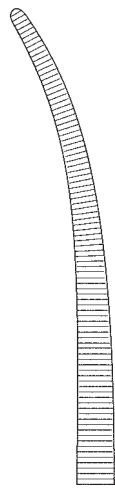

015-551-001

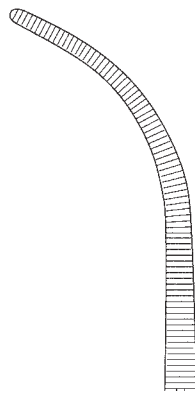

015-551-002



MEEKER

015-553-180 18,0 cm / 7"
015-553-275 27,5 cm / 10³/₄"

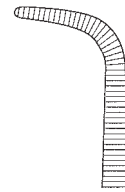

015-553-180

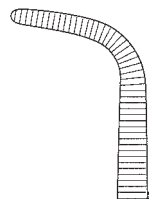

015-553-275



015

**Klemmen
Forceps
Pinzas
Pinze**



KANTROWITZ

- 015-561-190** 19,0 cm / 7 1/2"
- 015-561-240** 24,0 cm / 9 1/2"
- 015-561-265** 26,5 cm / 10 1/2"

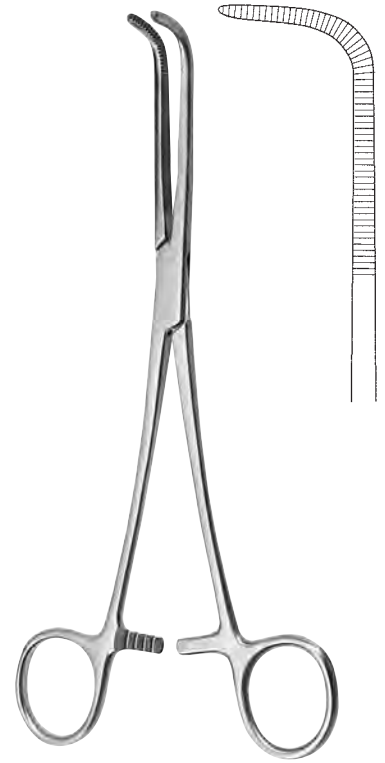

WIRKSTROEM

- 015-565-210** 21,0 cm / 8 1/4"
- 015-565-240** 24,0 cm / 9 1/2"

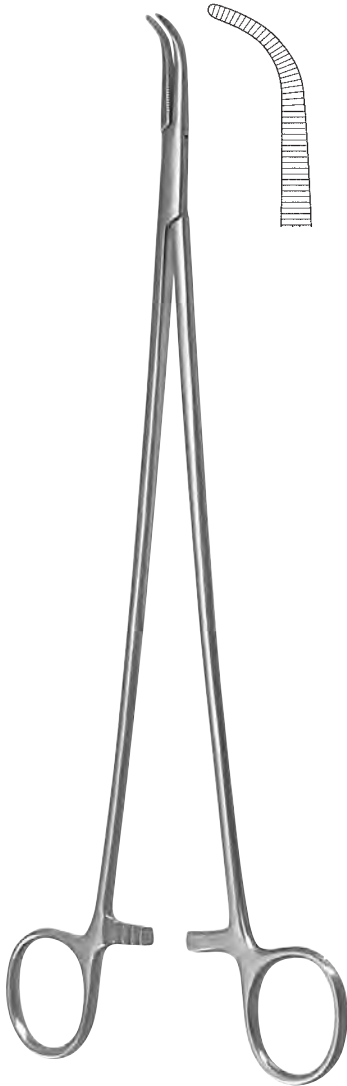

LAWRENCE

- 015-555-275** 27,5 cm / 10 3/4"



MIXTER

- 015-571-145** 14,5 cm / 5 3/4"
- 015-571-155** 15,5 cm / 6 1/8"
- 015-571-190** 19,0 cm / 7 1/2"



MIXTER-O'SHAUGNESSY

- 015-575-155** 15,5 cm / 6 1/8"
- 015-575-190** 19,0 cm / 7 1/2"



MIXTER

015-577-220 22,0 cm / 8³/₄"



MIXTER

015-579-230 23,0 cm / 9"

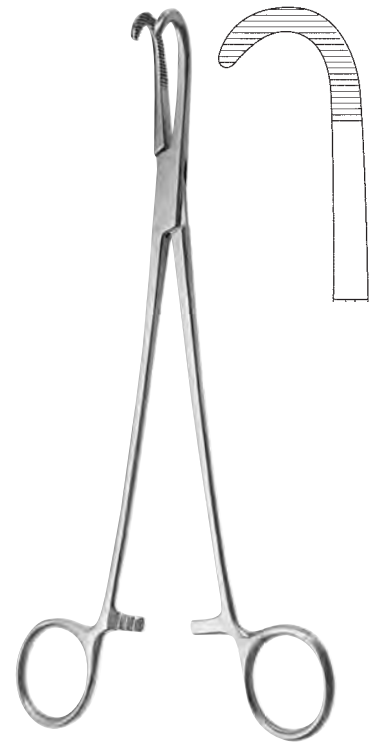

DESJARDINS

015-585-210 21,0 cm / 8¹/₄"



NEGUS

015-587-190 – 015-589-190 19,0 cm / 7¹/₂"

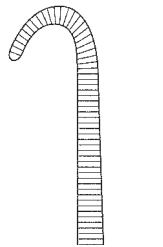

015-589-190

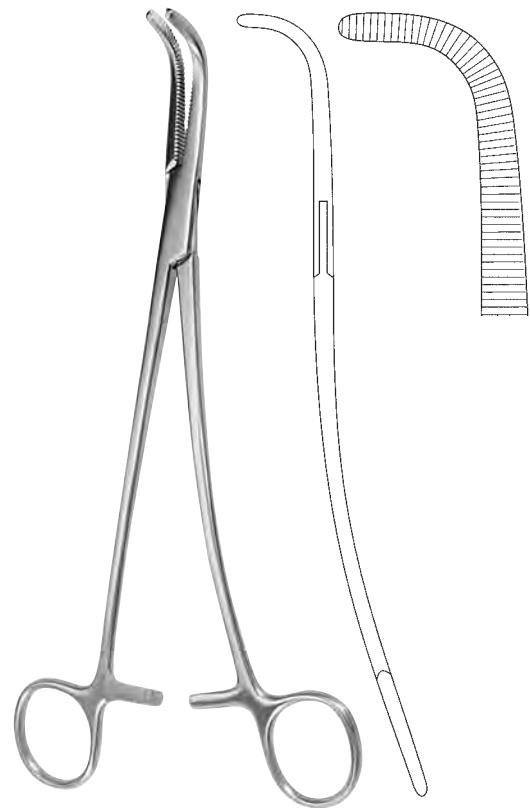

GRAY

015-593-220 22,0 cm / 8³/₄"
015-593-230 23,0 cm / 9"



015

**Klemmen
Forceps
Pinzas
Pinze**



015-601-220

015-601-250

015-601-280



LOWER

015-603-180 18,0 cm / 7"

MIXTER

015-601-220 22,0 cm / 8³/₄"

015-601-250 25,0 cm / 9³/₄"

015-601-280 28,0 cm / 11"



015-605-190

015-605-230

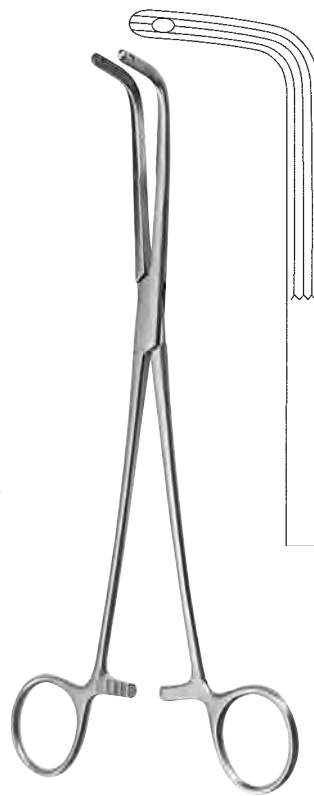

FINOCCHIETTO

015-607-240 24,0 cm / 9¹/₂"

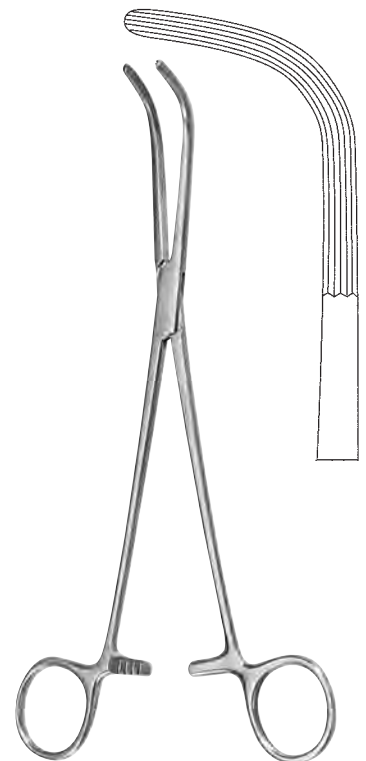

MC QUIGG-MIXTER

015-609-220 22,0 cm / 8³/₄"

LAHEY

015-605-190 19,0 cm / 7¹/₂"

015-605-230 23,0 cm / 9"

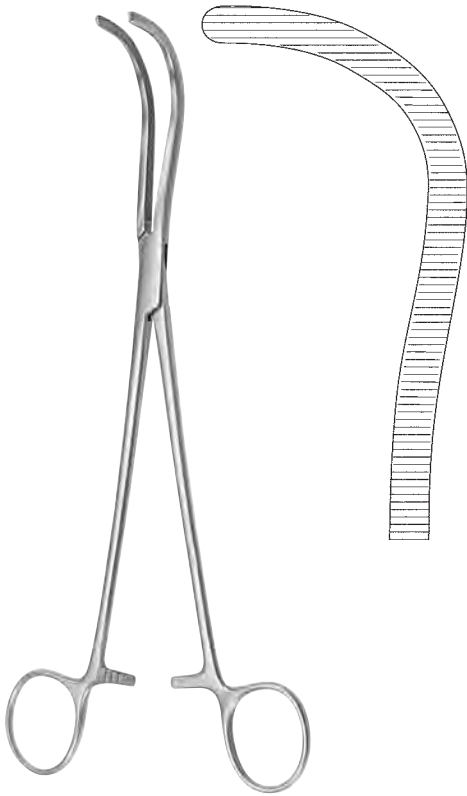

GUYON

015-621-230 23,0 cm / 12 1/2"



GUYON-ATRAUMA

015-627-230 23,0 cm / 9"

015-627-240 24,0 cm / 9 1/2"

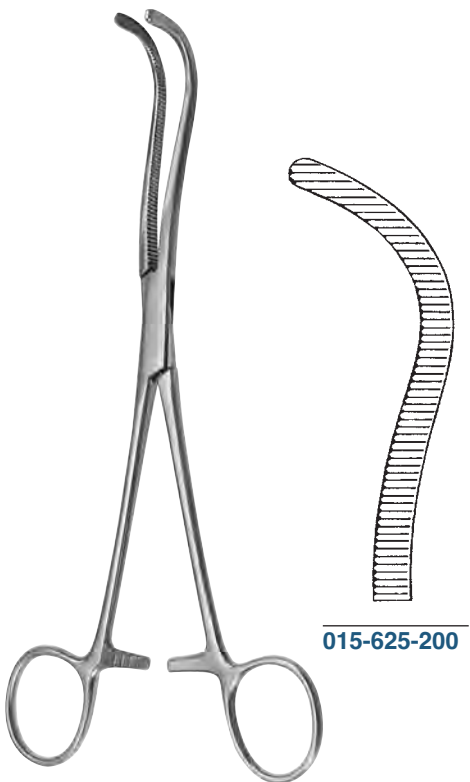

015-625-200

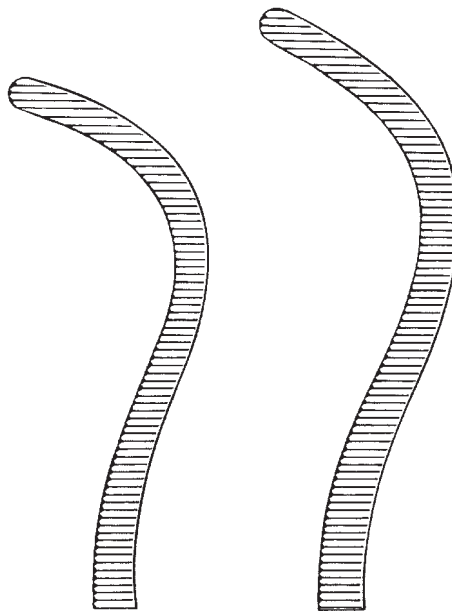

015-625-220

015-625-240

GUYON

015-625-200 20,0 cm / 8"

015-625-220 22,0 cm / 8 3/4"

015-625-240 24,0 cm / 9 1/2"



015

**Klemmen
Forceps
Pinzas
Pinze**

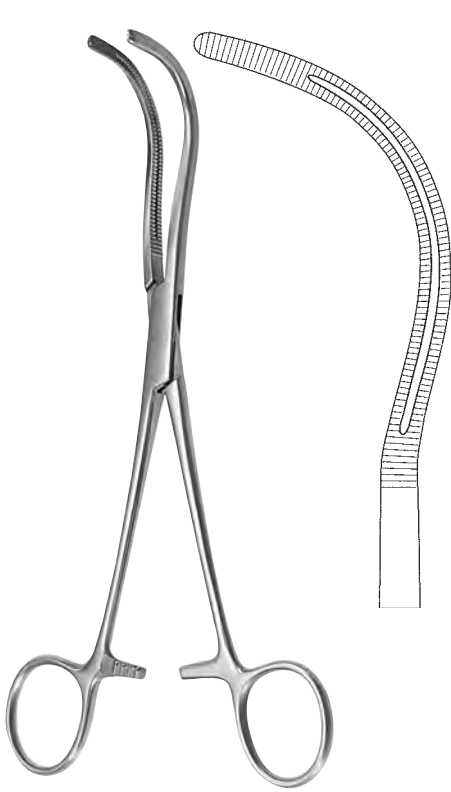

STILLE
015-631-230 23,0 cm / 9"

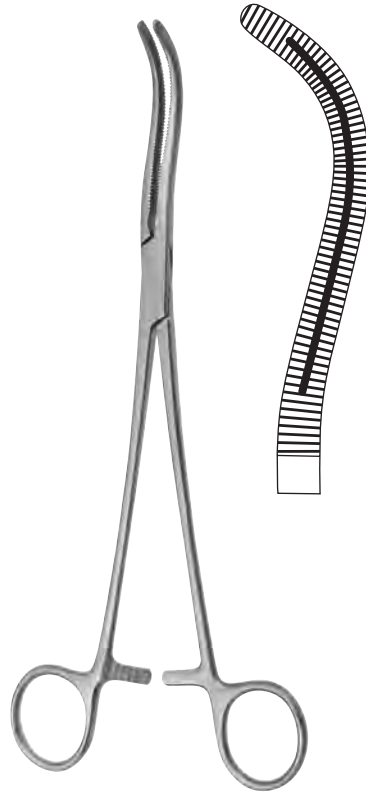

STILLE
015-633-230 23,0 cm / 9"

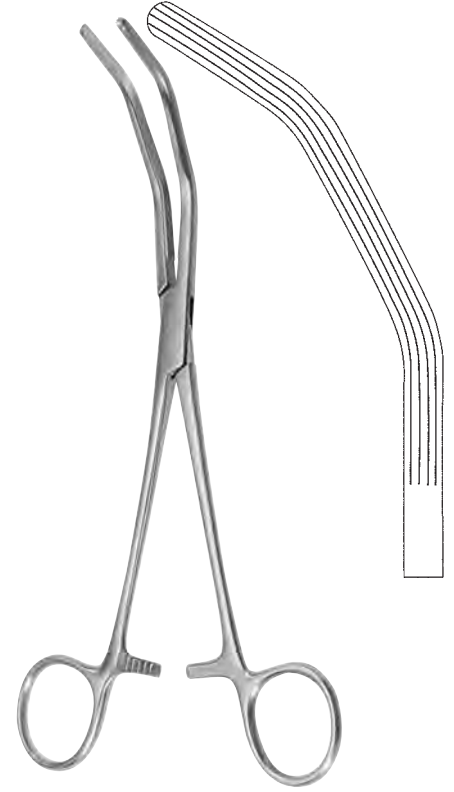

HERRICK
015-635-230 23,0 cm / 9"

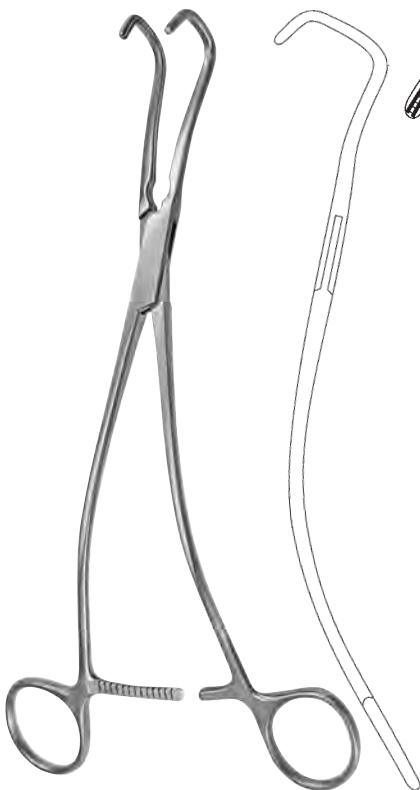

URO-TANGENTIAL
015-639-230 23,0 cm / 9"
015-639-240 24,0 cm / 9 1/2"

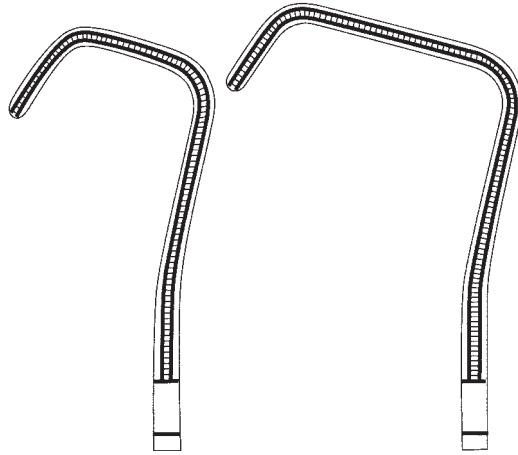

015-639-230

015-639-240

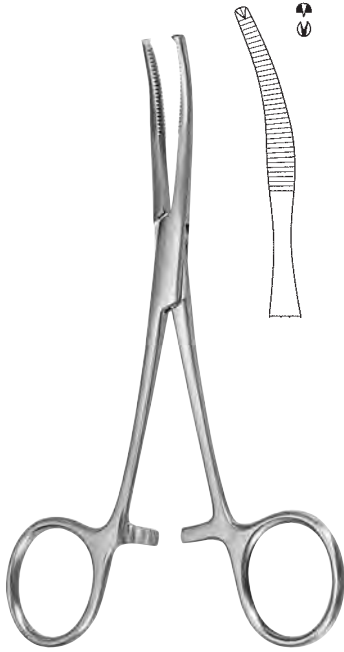

BABY-MIKULICZ
 015-641-140 14,0 cm / 5³/₄"

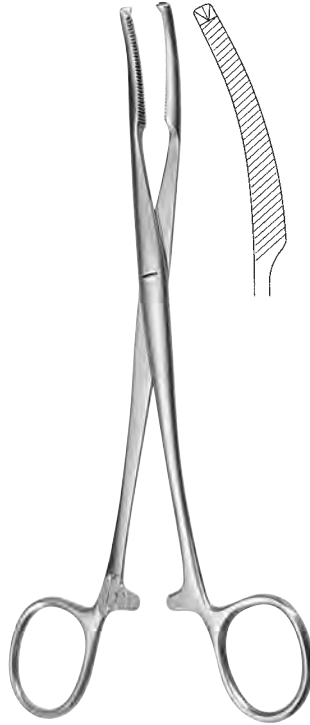

MIKULICZ
 015-643-180 18,0 cm / 7"
 015-643-200 20,0 cm / 8"

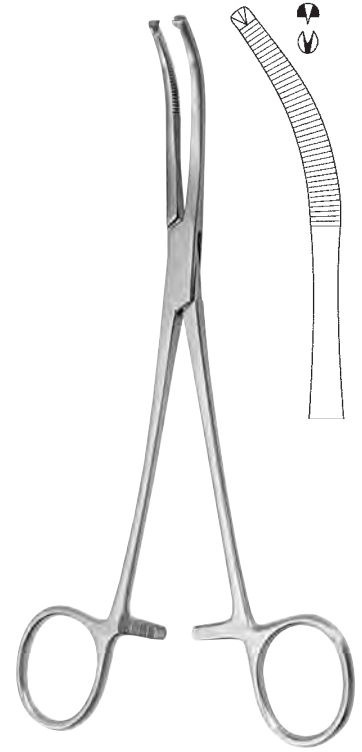

MIKULICZ
 015-645-180 18,0 cm / 7"
 015-645-200 20,0 cm / 8"

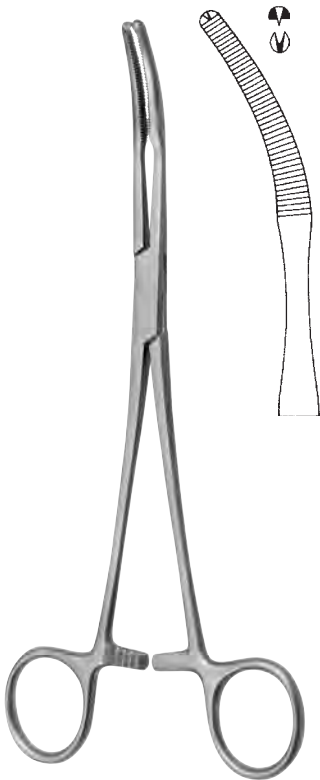

MIKULICZ
 015-647-200 20,0 cm / 8"



MIKULICZ
 015-649-205 20,5 cm / 8"



FAURE
 015-651-200 – 015-653-200 20,0 cm / 8"

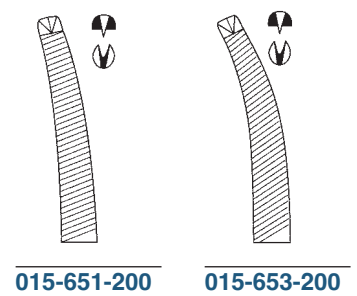

015-651-200 015-653-200



015

**Klemmen
Forceps
Pinzas
Pinze**

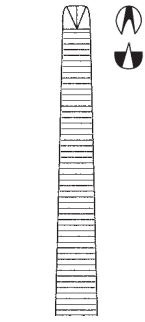

015-656-215

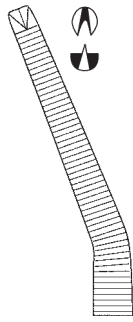

015-657-215

PHANEUF

015-656-215 – 015-657-215 21,5 cm / 8 1/2"



015-661-230



015-663-230

WERTHEIM

015-661-230 – 015-663-230 23,0 cm / 9"

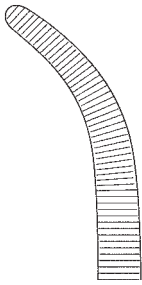

015-665-230

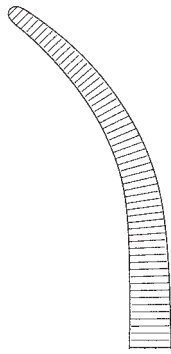

015-667-240

MOYNIHAN

015-665-230 23,0 cm / 9"
015-667-240 24,0 cm / 9 1/2"

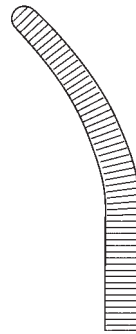

WERTHEIM

015-669-250 25,0 cm / 10"

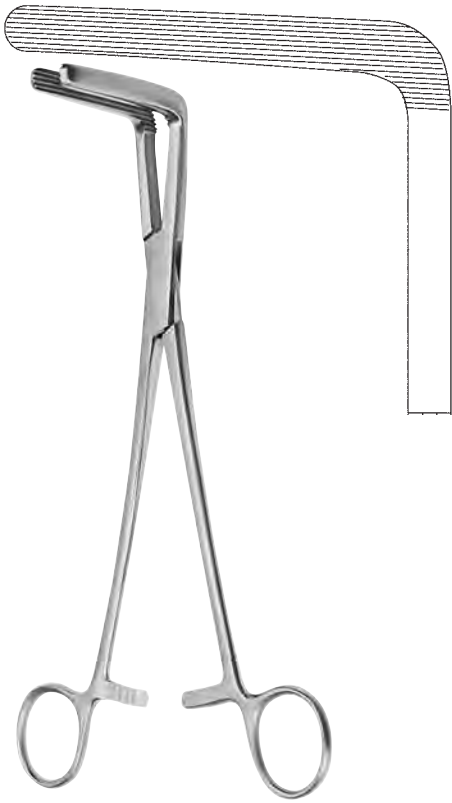

WERTHEIM-CULLEN

015-671-215 21,5 cm / 8½"

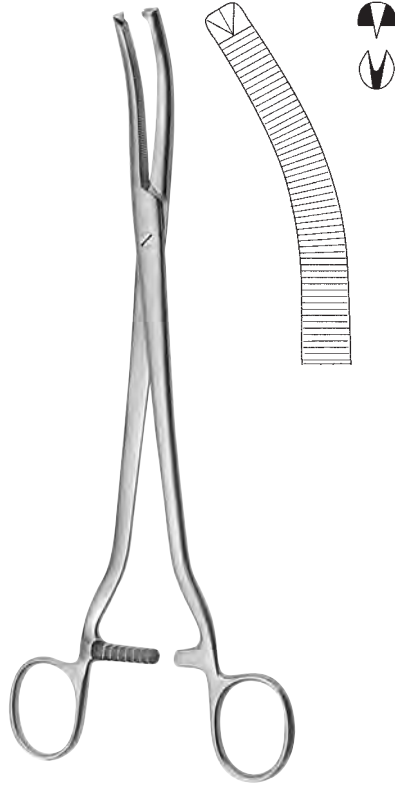

WERTHEIM

015-671-240 24,0 cm / 9½"



WERTHEIM

015-673-235 23,5 cm / 9¼"



WERTHEIM

015-675-235 23,5 cm / 9¼"

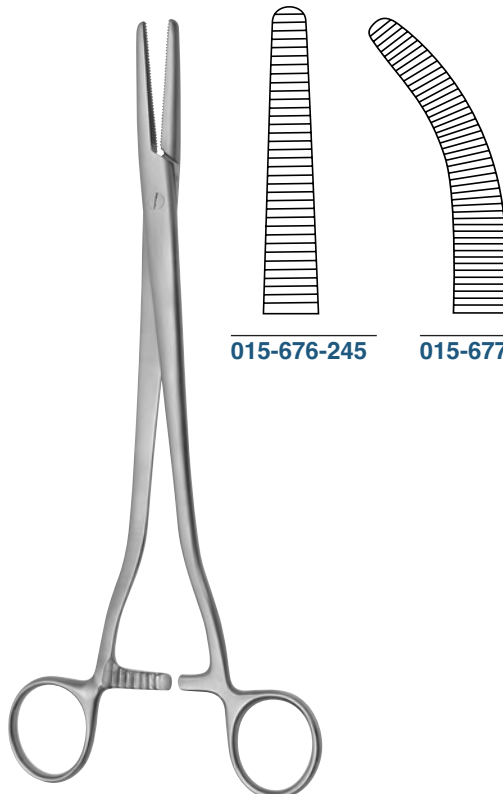

SEGOND-LANDAU

015-676-245 24,5 cm / 9⅔"
015-677-240 24,0 cm / 9½"

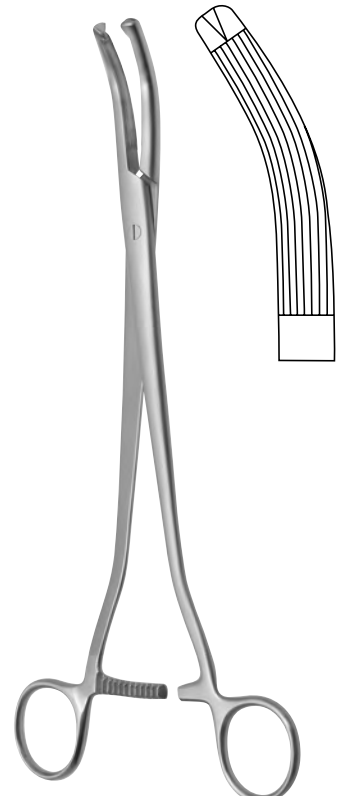

MIKULICZ

015-679-245 24,5 cm / 9⅔"



015

**Klemmen
Forceps
Pinzas
Pinze**

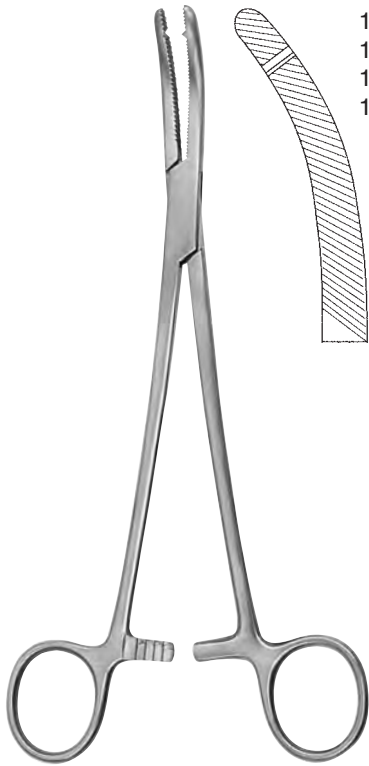

1 Zahn
1 tooth
1 diente
1 dente

HEANEY

015-681-195 19,5 cm / 7³/₄"
015-681-210 21,0 cm / 8¹/₄"
015-681-230 23,0 cm / 9"

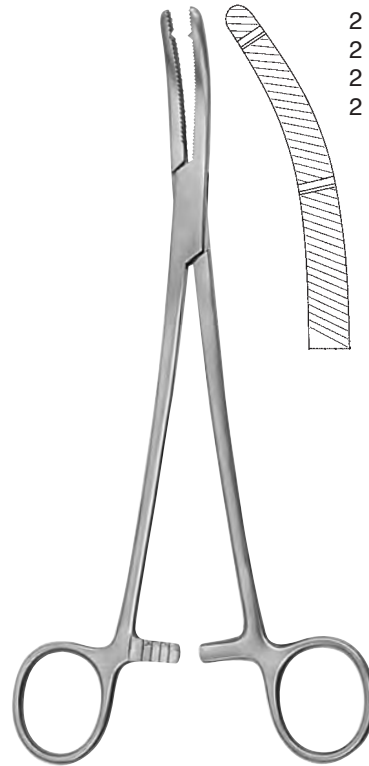

2 Zähne
2 teeth
2 dientes
2 denti

HEANEY

015-683-195 19,5 cm / 7³/₄"
015-683-210 21,0 cm / 8¹/₄"
015-683-230 23,0 cm / 9"



HEANEY-REZEK

015-684-210 21,0 cm / 8¹/₄"

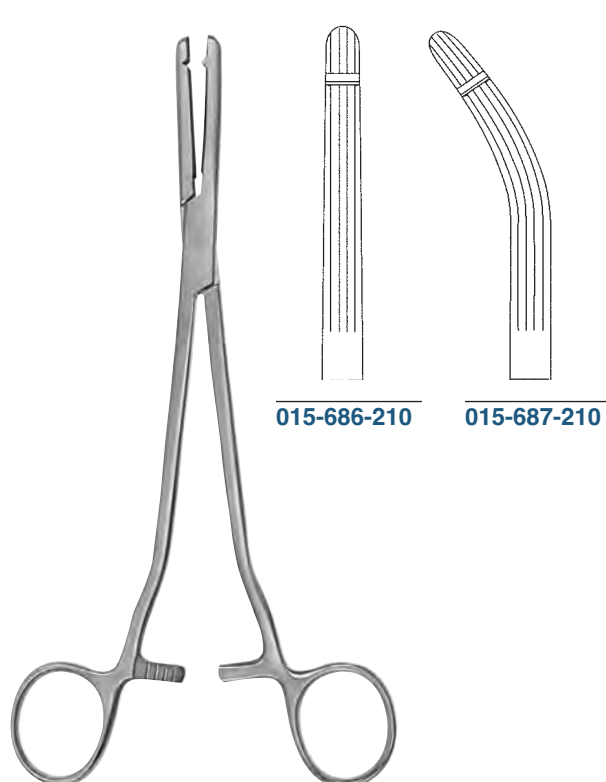

015-686-210

015-687-210

HEANEY-BALLENTINE

015-686-210 – 015-687-210 21,0 cm / 8¹/₄"

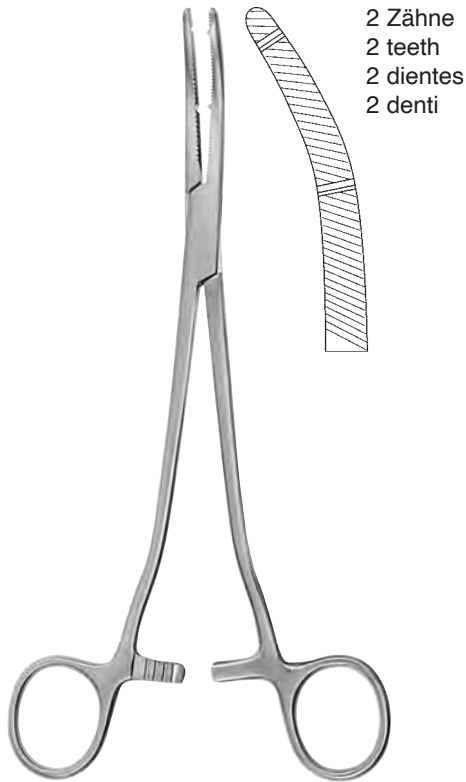

HEANEY-KANTER

015-689-210 21,0 cm / 8¹/₄"

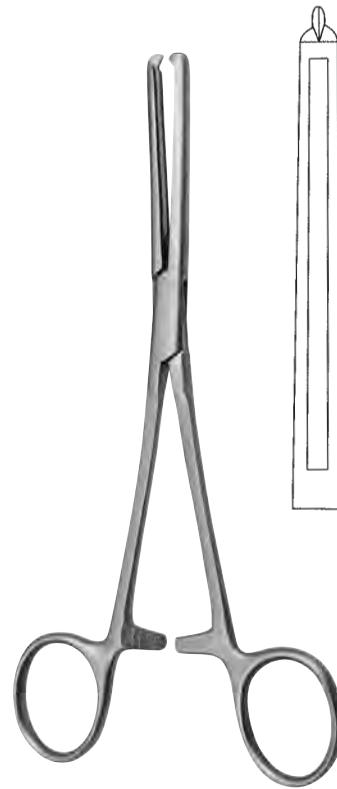

MAINGOT

015-690-200 20,0 cm / 8"

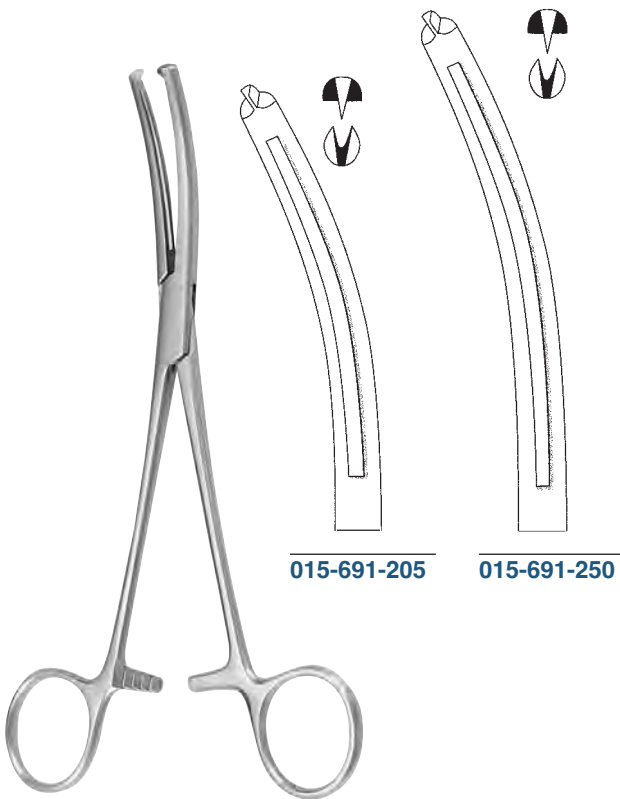

015-691-205

015-691-250

MAINGOT

015-691-205 20,5 cm / 8"

015-691-250 25,0 cm / 10"



015

**Klemmen
Forceps
Pinzas
Pinze**

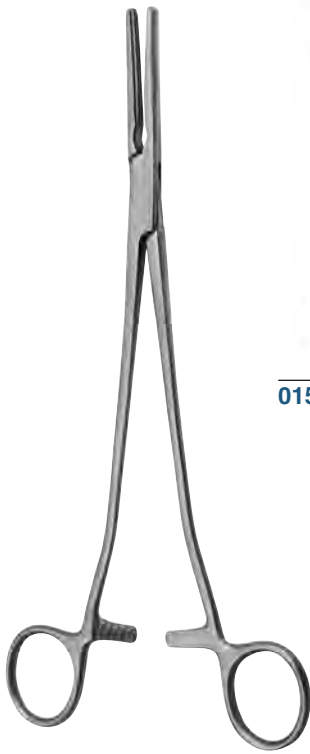

015-693-001



015-693-002



015-693-003

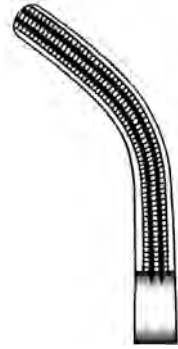

015-693-004

ROGERS

015-693-001	21,5 cm / 8 1/2"
015-693-002	21,0 cm / 8 1/4"
015-693-003	20,5 cm / 8"
015-693-004	20,0 cm / 8"



015-695-001



015-695-002

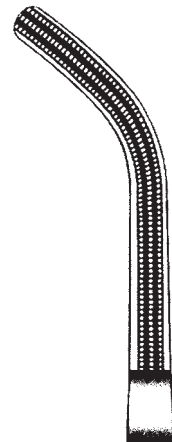

015-695-003

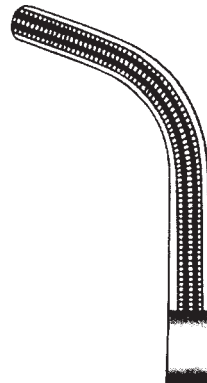

015-695-004

ROGERS

015-695-001	25,0 cm / 9 3/4"
015-695-002	25,0 cm / 9 3/4"
015-695-003	24,5 cm / 9 2/3"
015-695-004	23,0 cm / 9 1/4"



SCHAEDEL

015-701-090 9,0 cm / 3 1/2"



ENGL. MODELL

015-703-090 9,0 cm / 3 1/2"



JONES

015-705-050 5,0 cm / 2"
015-705-090 9,0 cm / 3 1/2"

mit Schlauch- oder Kabelhalter
 with clip for tubing or cable
 con porta-tubo o porta-cable
 con porta-tubo o porta-cavo



mit Schlauchhalter
 with tube holder
 con porta-tubo
 con porta-tubo

JONES-FRIMED

015-707-090 9,0 cm / 3 1/2"

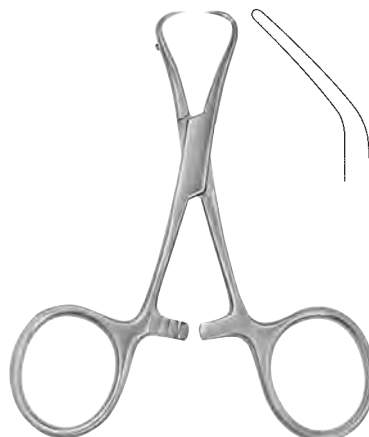

BACKHAUS

015-711-080 8,0 cm / 3 1/8"
015-711-110 11,0 cm / 4 3/8"
015-711-130 13,0 cm / 5 1/8"
015-711-150 15,0 cm / 6"



015-713-110 11,0 cm / 4 3/8"



ROEDER

015-715-130 13,0 cm / 5 1/8"
015-715-150 15,0 cm / 6"



LORNA

015-721-100 10,0 cm / 4"
015-721-130 13,0 cm / 5"



015-721-100



015-721-130



BERNHARD

015-724-165 16,5 cm / 6 1/2"



LANE

015-726-150 15,0 cm / 6"
015-726-180 18,0 cm / 7"
015-726-200 20,0 cm / 8"



BALL + SOCKET

015-731-115 11,5 cm / 4 1/2"
015-731-130 13,0 cm / 5 1/3"

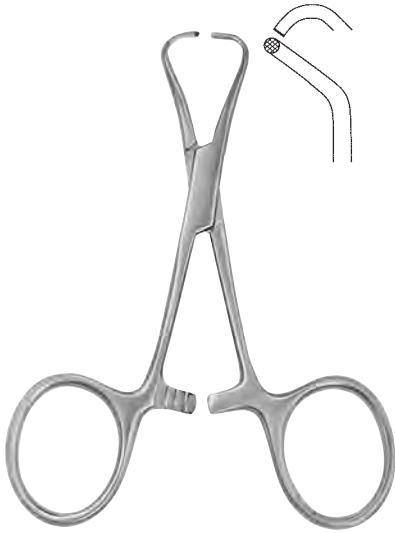

TOHOKU

015-733-100 10,0 cm / 4"
015-733-130 13,0 cm / 5 1/8"



PEERS

015-735-145 14,5 cm / 5 3/4"



015-737-100 10,0 cm / 4"
015-737-130 13,0 cm / 5 1/8"



HOFF

015-739-110 11,0 cm / 4 3/8"
015-739-145 14,5 cm / 5 3/4"



für Kabel bis Ø 5 mm
for cables up to Ø 5 mm
para cables hasta Ø 5 mm
per cavo fino a Ø 5 mm

ROBIN

015-741-135 13,5 cm / 5 1/4"

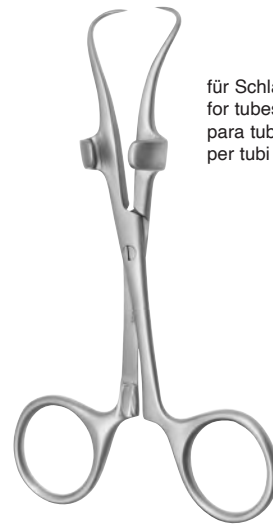

für Schläuche bis Ø 13 mm
for tubes up to Ø 13 mm
para tubos hasta Ø 13 mm
per tubi fino a Ø 13 mm

ROBIN

015-743-135 13,5 cm / 5 1/4"



015

**Klemmen
Clamps
Pinzas
Pinze**

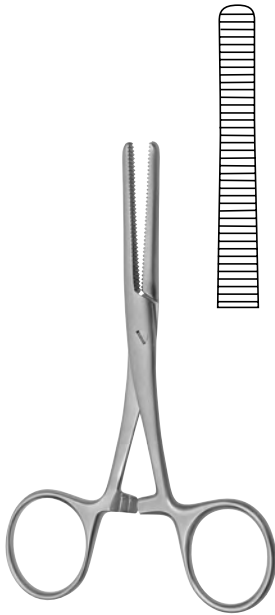

PEAN

015-750-125 12,5 cm / 5"



BERLIN

015-760-145 14,5 cm / 5³/₄"



glatt
smooth
lisa
liscio

PRESBYTERIAN

015-770-160 16,0 cm / 6¹/₄"

015-770-180 18,0 cm / 7"

015-770-200 20,0 cm / 8"



015-780-155 15,5 cm / 6 1/8"
015-780-180 18,0 cm / 7"
015-780-200 20,0 cm / 8"

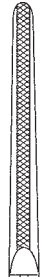

015-780-155

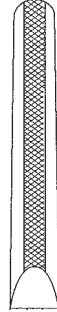

015-780-180



015-780-200



015-790-155 15,5 cm / 6 1/8"
015-790-180 18,0 cm / 7"
015-790-200 20,0 cm / 8"

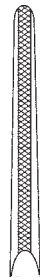

015-790-155



015-790-180

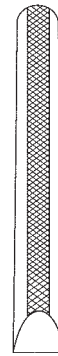

015-790-200

mit Schutzbügel
with safety guard
con estribo de protección
con protezione

Korn- und Tupferzangen
Sponge and Dressing Forceps
Pinzas para vendajes y torundas
Pinze per medicatura e tamponi



015-800-200
015-800-265

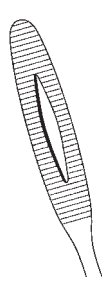

015-801-200
015-801-265

GROSS-MAIER

015-800-200 – 015-801-200 20,0 cm / 8"
 015-800-265 – 015-801-265 26,5 cm / 10½"



015-804-180

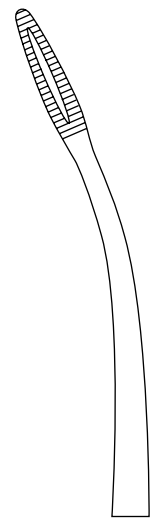

015-805-180

GROSS

015-804-180 – 015-805-180 18,0 cm / 7"



015-806-180

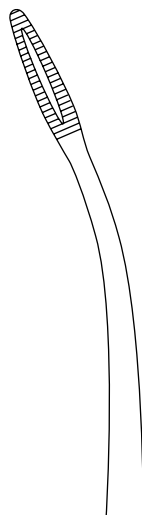

015-807-180

GROSS

015-806-180 – 015-807-180 18,0 cm / 7"

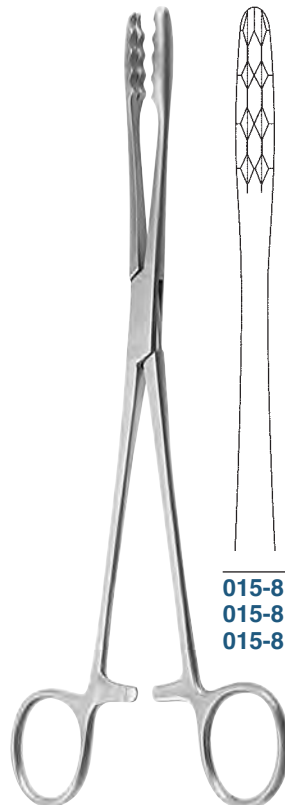

015-810-220
015-810-250
015-810-270

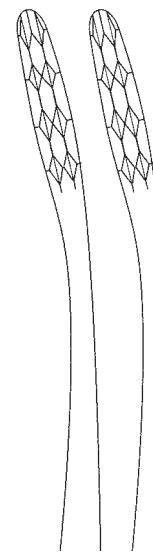

015-811-220
015-811-250
015-811-270

ULRICH

015-810-220 – 015-811-220 22,0 cm / 8¾"
 015-810-250 – 015-811-250 25,0 cm / 9¾"
 015-810-270 – 015-811-270 27,0 cm / 10¾"

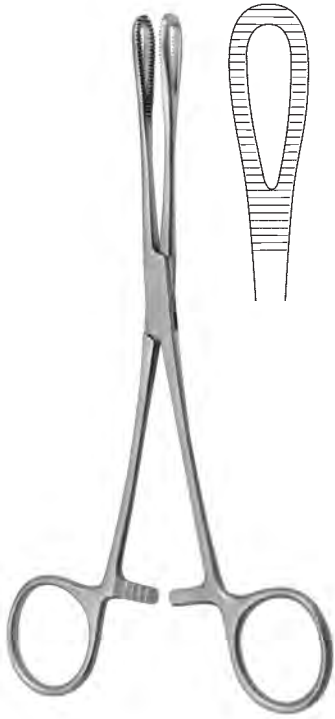

RAMPLEY

015-820-180 18,0 cm / 7"
015-820-250 25,0 cm / 9³/₄"

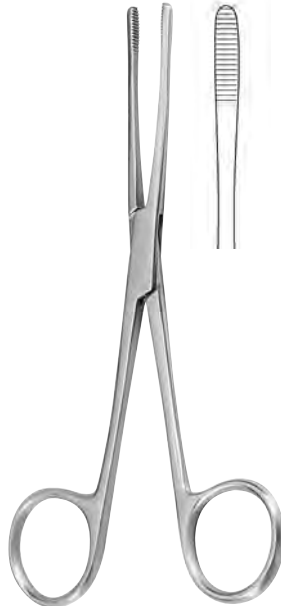

LISTER

015-830-130 13,0 cm / 5¹/₈"
015-830-160 16,0 cm / 6¹/₄"
015-830-180 18,0 cm / 7"



BRYANT

015-831-130 13,0 cm / 5¹/₈"



SIMS-MAIER

015-836-280 – 015-837-280 28,0 cm / 11"

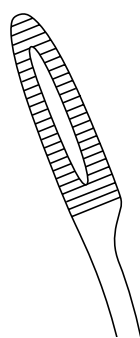

015-837-280

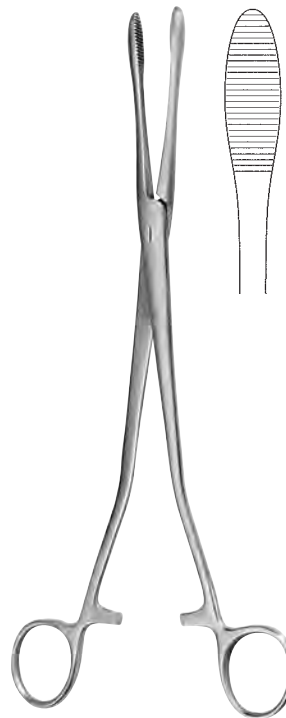

COLLIN

015-840-250 25,0 cm / 9³/₄"

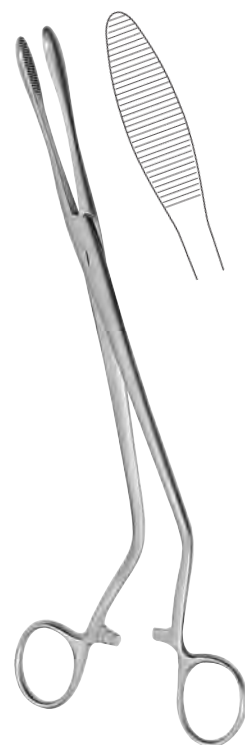

CHERON

015-841-250 25,0 cm / 9³/₄"



015

Korn- und Tupferzangen
Sponge and Dressing Forceps
Pinzas para vendajes y torundas
Pinze per medicatura e tamponi

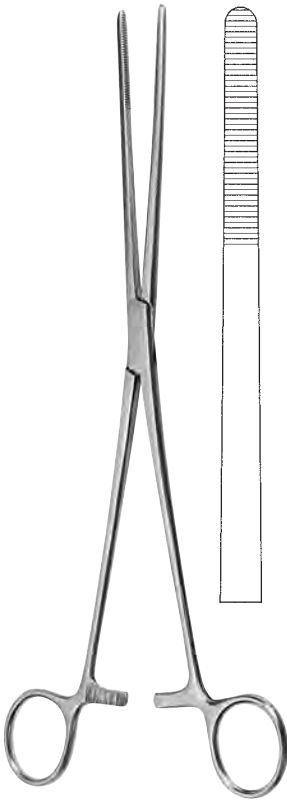

BOZEMANN
015-850-260 26,0 cm / 10 1/4"

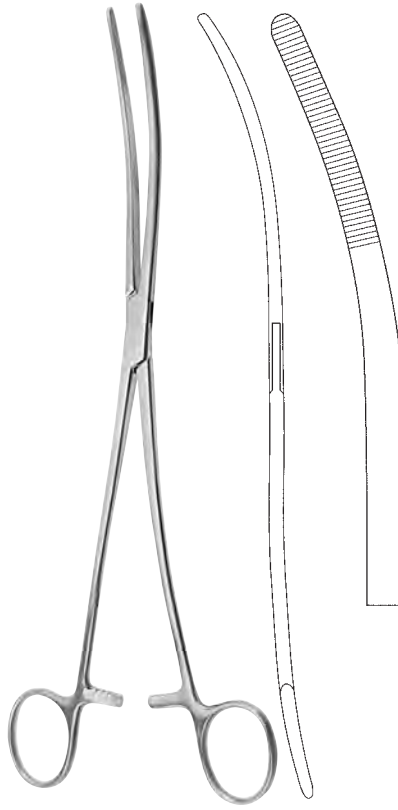

BOZEMANN
015-851-260 26,0 cm / 10 1/4"

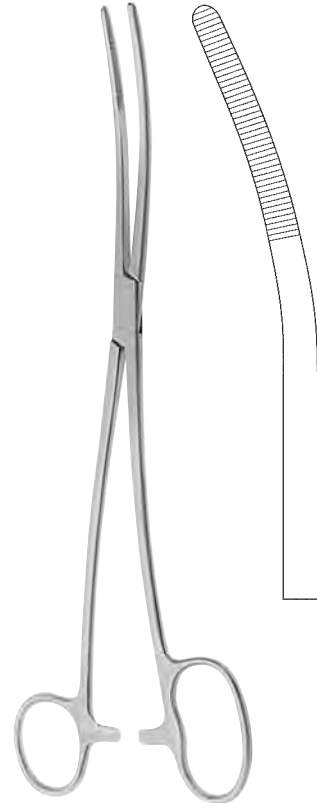

BOZEMANN-DOUGLAS
015-855-260 26,0 cm / 10 1/4"



FOERSTER
015-860-180 – 015-871-180 18,0 cm / 7"
015-860-200 – 015-871-200 20,0 cm / 8"
015-860-250 – 015-871-250 25,0 cm / 9 3/4"

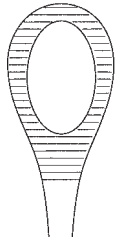

015-860-180
015-860-200
015-860-250

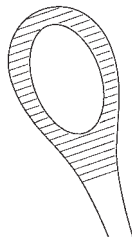

015-861-180
015-861-200
015-861-250



015-870-180
015-870-200
015-870-250

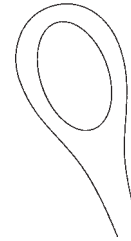

015-871-180
015-871-200
015-871-250

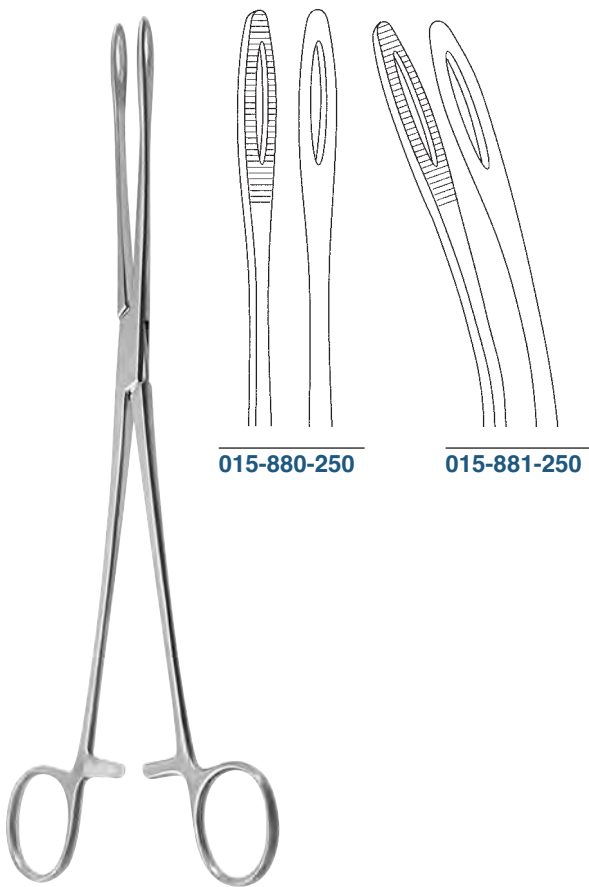

015-880-250

015-881-250

FOERSTER

015-880-250 – 015-881-250 25,0 cm / 9³/₄"



RAMPLEY

015-890-250 25,0 cm / 9³/₄"



015

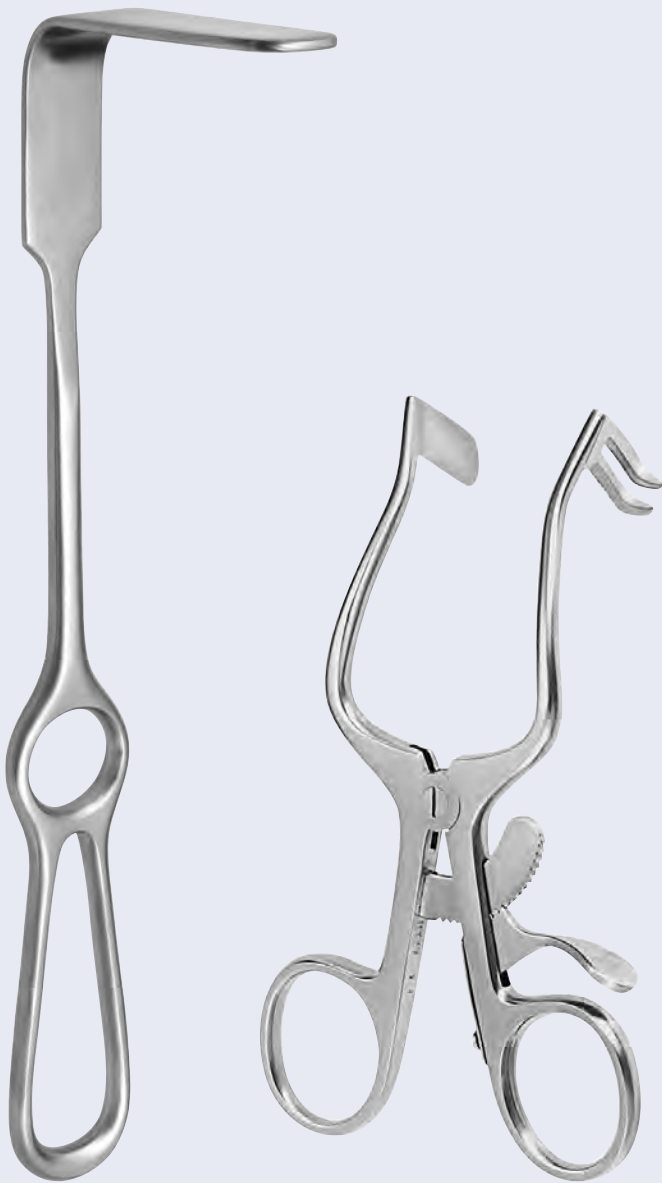

016

Wundhaken,
Wundspreizer,
Bauchdeckenhalter
Retractors, Self-retaining
Retractors, Abdominal
Retractors
Separadores, Separadores
autoestáticos,
Separadores abdominales
Divaricatori, Divaricatori
autostatici, Divaricatori
addominali



016

**Wundhaken
Retractors
Separadores
Divaricatori**



016-010-001



016-010-002



016-010-003



016-010-004

016-010-001 - 016-010-004 16,0 cm / 6 1/4"



016-020-001

scharf
sharp
agudo
acuto



016-020-002

stumpf
blunt
romo
smusso

GRAEFE

016-020-001 - 016-020-002 15,0cm / 6"



016-022-001



016-022-002

scharf
sharp
agudo
acuto

GUTHRIE

016-022-001 - 016-022-002 15,5 cm / 6 1/4"



O'CONNOR

016-024-160 16,0 cm / 6 1/4"



scharf
sharp
agudo
acuto

halbscharf
semi-sharp
semi-agudo
semi-acuto

stumpf
blunt
romo
smusso

016-030-001 - 016-034-004 16,0 cm / 6¹/₄"

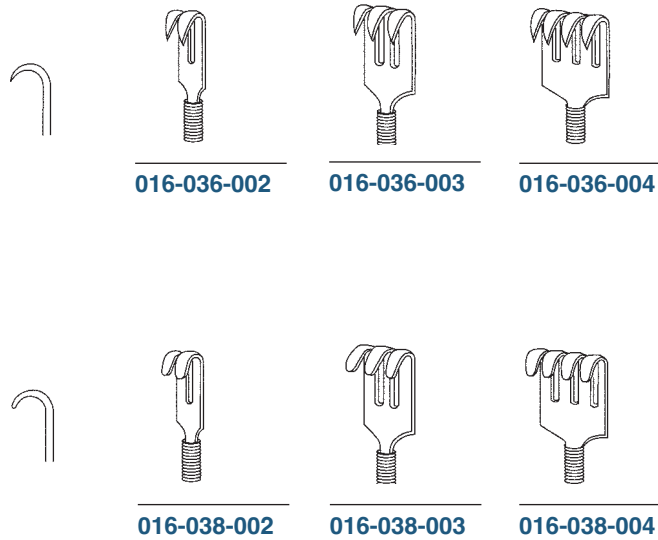

scharf
sharp
agudo
acuto

stumpf
blunt
romo
smusso

flexibel, flexible, flexibles, flessibili

016-036-002 - 016-038-004 16,0 cm / 6¹/₄"



016

Wundhaken Retractors Separadores Divaricatori



016-040-001 Fig.1

scharf
sharp
agudo
acuto



016-040-002 Fig.2

stumpf
blunt
romo
smusso



KNAPP

016-040-001 - 016-040-002 13,0 cm / 5"



016-050-008 8,0 mm



016-050-010 10,0 mm



016-050-012 12,0 mm

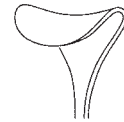

016-050-014 14,0 mm

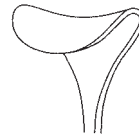

016-050-016 16,0 mm

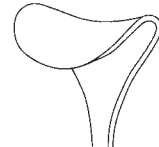

016-050-018 18,0 mm

DESMARRES

016-050-008 - 016-050-018 16,0 cm / 6 1/4"

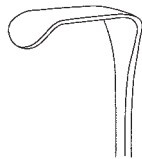

016-056-001 10x6 mm

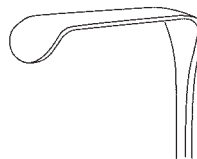

016-056-002 17x5 mm

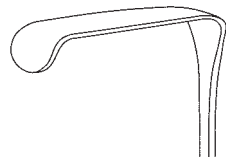

016-056-003 20x6 mm

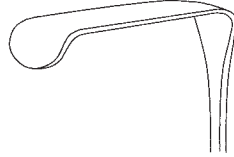

016-056-004 22x8 mm

MINI-LANGENBECK

016-056-001 - 016-056-004 16,0 cm, 6 1/4"



016-058-160 14x8 mm

stumpf
blunt
romo
smusso

16,0 cm, 6¹/₄"

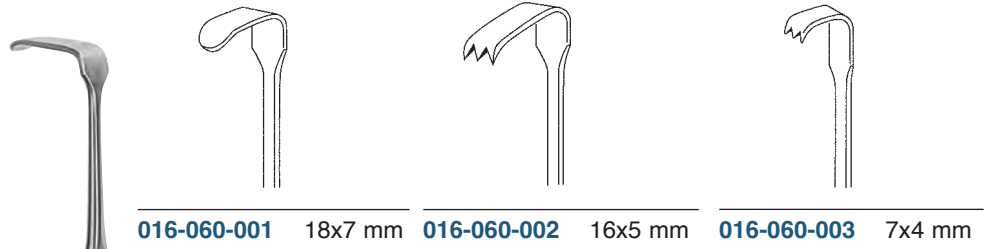

016-060-001 18x7 mm

016-060-002 16x5 mm

016-060-003 7x4 mm

016-060-004 10x3 mm

016-060-005 7x4 mm

016-060-006 10x4 mm

MEYERDING

016-060-001 - 016-060-006 16,0 cm / 6¹/₄"

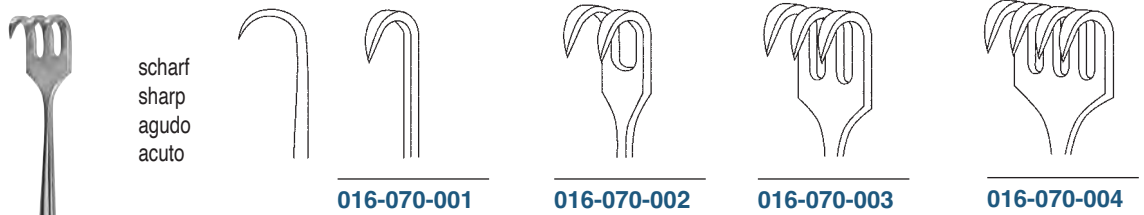

scharf
sharp
agudo
acuto

016-070-001

016-070-002

016-070-003

016-070-004

Kehlengriff
serrated handle
mango serrado
manico striate

stumpf
blunt
romo
smusso

016-071-001

016-071-002

016-071-003

016-071-004

016-070-001 - 016-071-004 16,5 cm, 6¹/₂"



016

**Wundhaken
Retractors
Separadores
Divaricatori**

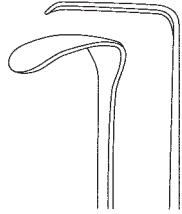

016-072-001 16x6 mm

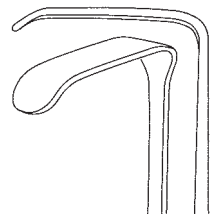

016-072-002 24x6 mm

LANGENBECK-GREEN

016-072-001 - 016-072-002 15,0 cm / 6"



016-074-001 10x6 mm

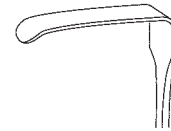

016-074-002 20x6 mm

016-074-001 - 016-074-002 15,0 cm / 6"



RAGNELL-DAVIS

016-076-140 14,0 cm / 5 1/2"



RAGNELL

016-078-150 15,0 cm / 6"

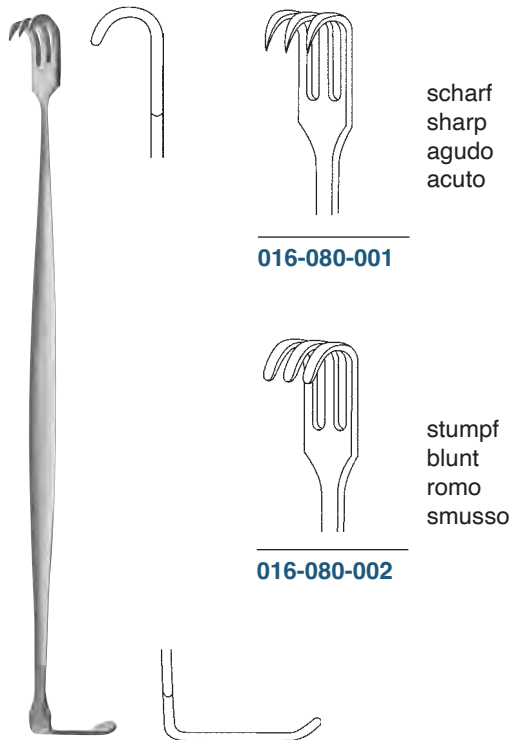

scharf
sharp
agudo
acuto

016-080-001

stumpf
blunt
romo
smusso

016-080-002

SENN-MILLER

016-080-001 - 016-080-002 16,0 cm / 6 1/4"

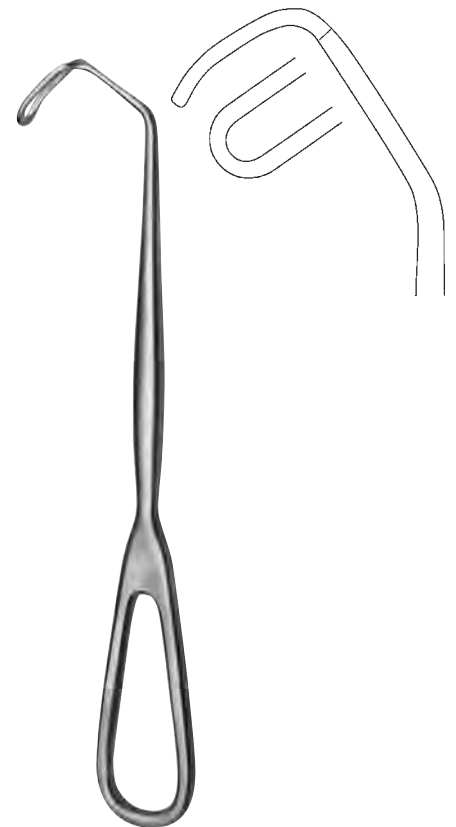

CUSHING

016-090-200 20,0 cm / 8"

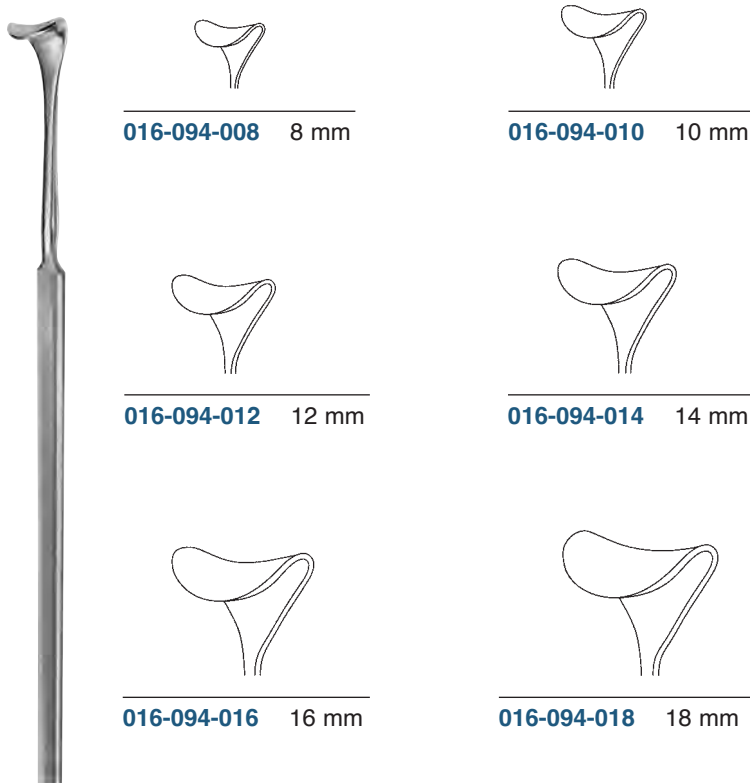

016-094-008 8 mm

016-094-010 10 mm

016-094-012 12 mm

016-094-014 14 mm

016-094-016 16 mm

016-094-018 18 mm

CUSHING

016-094-008 - 016-094-018 20,0 cm / 8"



016

**Wundhaken
Retractors
Separadores
Divaricatori**



016-096-008 8 mm



016-096-010 10 mm



016-096-012 12 mm

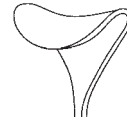

016-096-014 14 mm

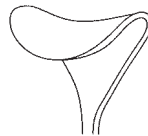

016-096-016 16 mm

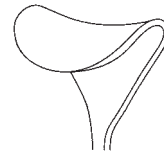

016-096-018 18 mm

CUSHING

016-096-008 - 016-096-018 24,0 cm / 9¹/₂"



GIL-VERNET

016-100-008 - 016-100-023 24,0 cm / 9¹/₂"



016-110-001

Fig. 1
glatt
smooth
lisa
liscio

016-110-002

Fig. 2
gezahnt
toothed
dentado
dentate



CUSHING

016-114-215 21,5 cm / 8¹/₂"

STRANDELL-STILLE

016-110-001 - 016-110-002 19,0 cm / 7¹/₂"



016

**Wundhaken
Retractors
Separadores
Divaricatori**



016-120-001
scharf
sharp
agudo
acuto



016-120-002



016-120-003



016-120-004

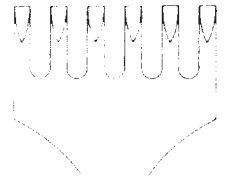

016-120-006



016-122-001
stumpf
blunt
romo
smusso



016-122-002

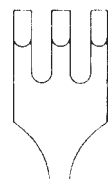

016-122-003

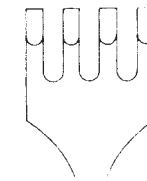

016-122-004

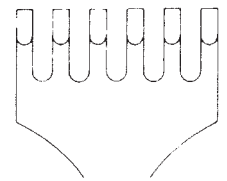

016-122-006

VOLKMANN

016-120-001 - 016-122-006

21,5 cm / 8 1/2"

scharf
sharp
agudo
acuto

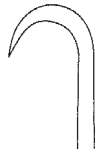

016-130-001



016-130-002 9x8 mm



016-130-003 9x13 mm



016-130-004 9x19 mm

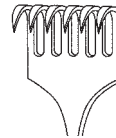

016-130-006 9x29 mm

VOLKMANN

016-130-001 - 016-130-006

22,0 cm / 8 1/2"

halbscharf
semi-sharp
semi-agudo
semi-acuto

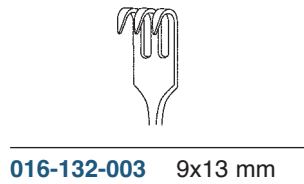
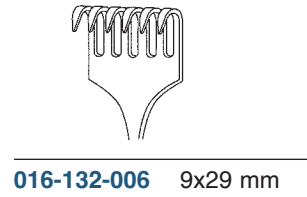
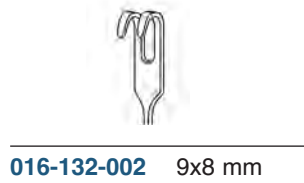
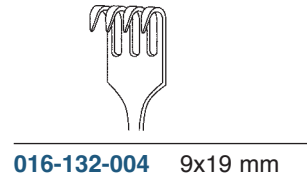
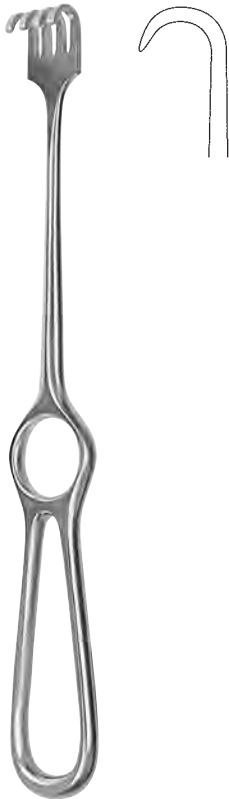

VOLKMANN

016-132-001 - 016-132-006 22,0 cm / 8³/₄"

stumpf
blunt
romo
smusso

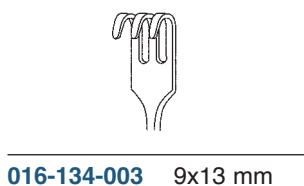
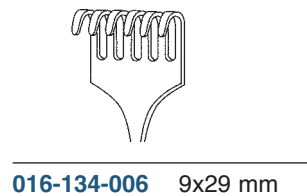
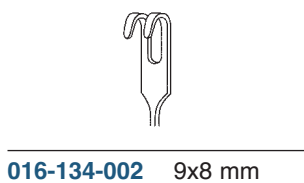
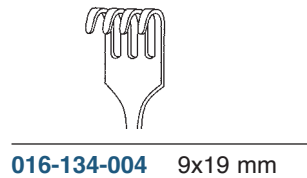

VOLKMANN

016-134-001 - 016-134-006 22,0 cm / 8³/₄"

**Wundhaken
Retractors
Separadores
Divaricatori**

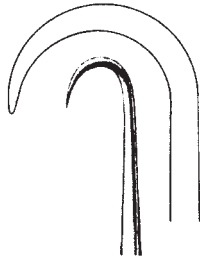

016-136-001
scharf
sharp
agudo
acuto

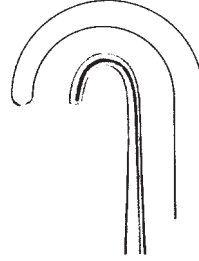

016-136-002
stumpf
blunt
romo
smusso

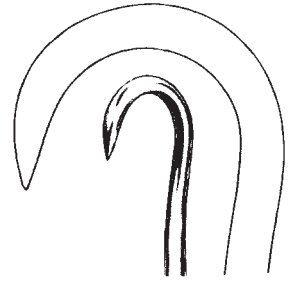

016-137-001
scharf
sharp
agudo
acuto

VOLKMANN

016-136-001 - 016-137-001 21,5 cm / 8½"

scharf
sharp
agudo
acuto

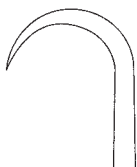

016-140-001



016-140-004 15x20 mm



016-140-002 9x8 mm

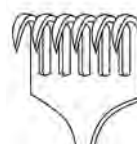

016-140-006 15x30 mm

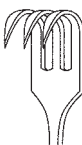

016-140-003 15x15 mm

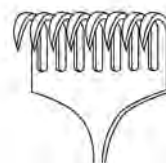

016-140-008 15x40 mm

KOCHER

016-140-001 - 016-140-008 22,0 cm / 8⅝"

halbscharf
semi-sharp
semi-agudo
semi-acuto



016-142-001



016-142-004 15x20 mm

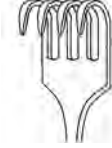

016-142-002 9x8 mm

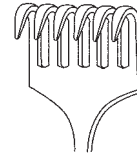

016-142-006 15x30 mm



016-142-003 15x15 mm

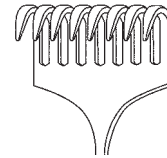

016-142-008 15x40 mm

KOCHER

016-142-001 - 016-142-008 22,0 cm / 8⁵/₈"

stumpf
blunt
romo
smusso

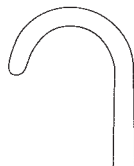

016-144-001

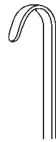

016-144-004 15x20 mm

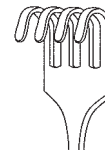

016-144-002 9x8 mm

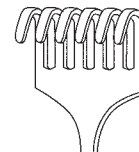

016-144-006 15x30 mm



016-144-003 15x15 mm

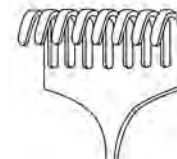

016-144-008 15x40 mm

KOCHER

016-144-001 - 016-144-008 22,0 cm / 8⁵/₈"



016

**Wundhaken
Retractors
Separadores
Divaricatori**



OLLIER

016-150-004 23,0 cm / 9" 36x35 mm

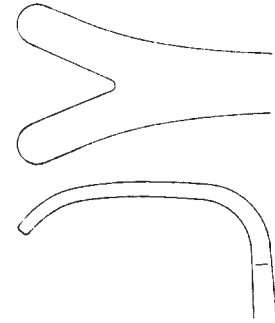

OLLIER

016-150-003 23,0 cm / 9" 36x60 mm

WASSMUND

016-155-002 20,5 cm / 8" 33x21 mm

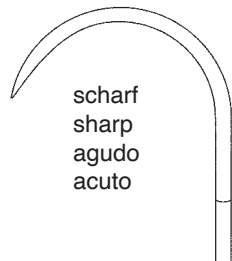

scharf
sharp
agudo
acuto

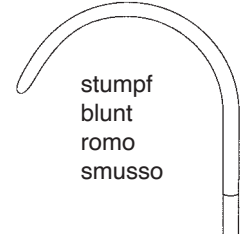

stumpf
blunt
romo
smusso

KOERTE

016-160-008 24,0 cm / 9½"

KOERTE

016-161-008 24,0 cm / 9½"



stumpf
blunt
romo
smusso

ISRAEL

016-166-040 - 016-166-070 25,0 cm / 9³/₄"

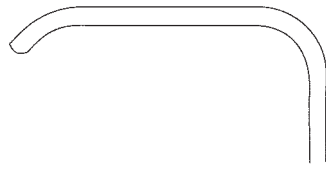

016-166-040 40x40 mm

4 Zähne
4 teeth
4 dientes
4 denti



016-166-050 45x50 mm

5 Zähne
5 teeth
5 dientes
5 denti



016-166-060 50x60 mm

6 Zähne
6 teeth
6 dientes
6 denti



016-166-070 70x70 mm

6 Zähne
6 teeth
6 dientes
6 denti

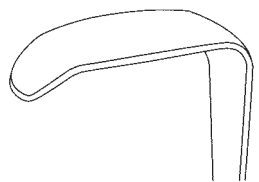

016-170-001 30x11 mm

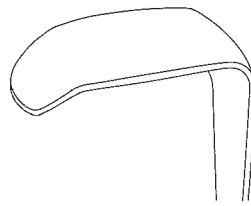

016-170-002 30x14 mm

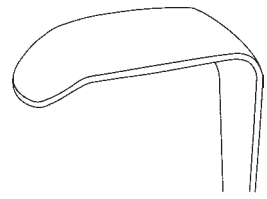

016-170-003 30x16 mm

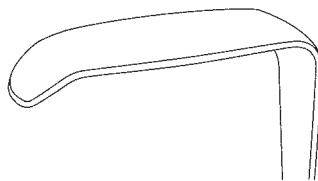

016-170-004 40x11 mm

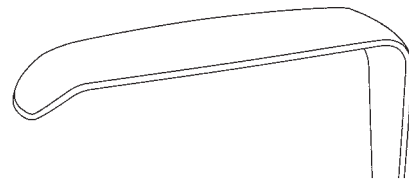

016-170-005 50x11 mm

LANGENBECK

016-170-001 - 016-170-005 22,5 cm / 9"



016

**Wundhaken
Retractors
Separadores
Divaricatori**

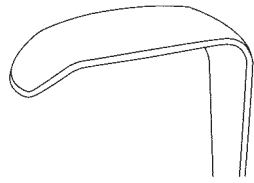

016-180-001 30x11 mm

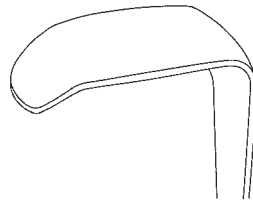

016-180-002 30x14 mm

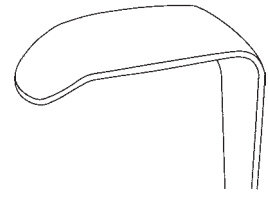

016-180-003 30x16 mm

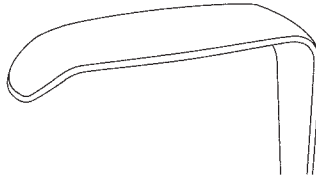

016-180-004 40x11 mm

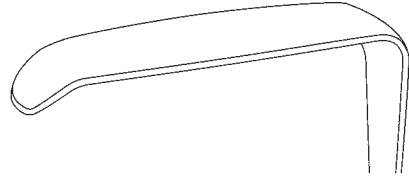

016-180-005 50x11 mm

LANGENBECK

016-180-001 - 016-180-005 22,0 cm / 8⁵/₈"



85x15 mm



60x20 mm



LANGENBECK

016-182-210 21,0 cm / 8¹/₄"



LANGENBECK

016-183-210 22,5 cm / 9"



LAHEY
016-190-190 19,0 cm / 7½"



LITTLE
016-192-200 20,0 cm / 8"



016

**Wundhaken
Retractors
Separadores
Divaricatori**



KOCHER-LANGENBECK

016-200-001 - 016-200-010 21,5 cm / 8¹/₂"



016-200-001 25x6 mm



016-200-002 30x11 mm

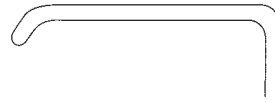

016-200-003 35x8 mm



016-200-004 35x11 mm

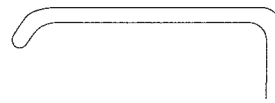

016-200-005 35x15 mm



016-200-006 40x11 mm

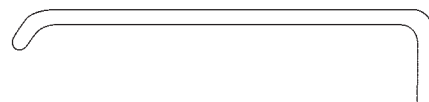

016-200-007 55x11 mm

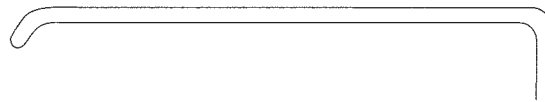

016-200-008 70x15 mm



016-200-009 80x12 mm

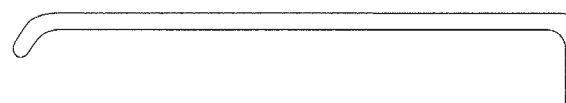

016-200-010 80x15 mm



KOCHER

016-210-018 - 016-210-040 21,0 cm / 8¹/₄"



016-210-018 40x18 mm



016-210-020 60x20 mm



016-210-025 60x25 mm



016-210-030 75x30 mm

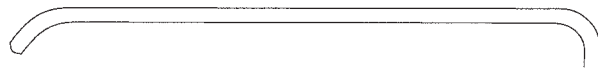

016-210-040 75x40 mm



SAUERBRUCH

016-220-001 - 016-220-003 22,5 cm / 8³/₄"

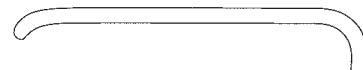

016-220-001 50x15 mm

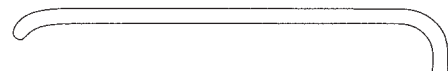

016-220-002 63x23 mm



016-220-003 80x20 mm



016

**Wundhaken
Retractors
Separadores
Divaricatori**



ZENKER

016-230-001	25,0 cm / 9 ³ / ₄ "
016-230-002	26,0 cm / 10"
016-230-003	27,5 cm / 10 ³ / ₄ "

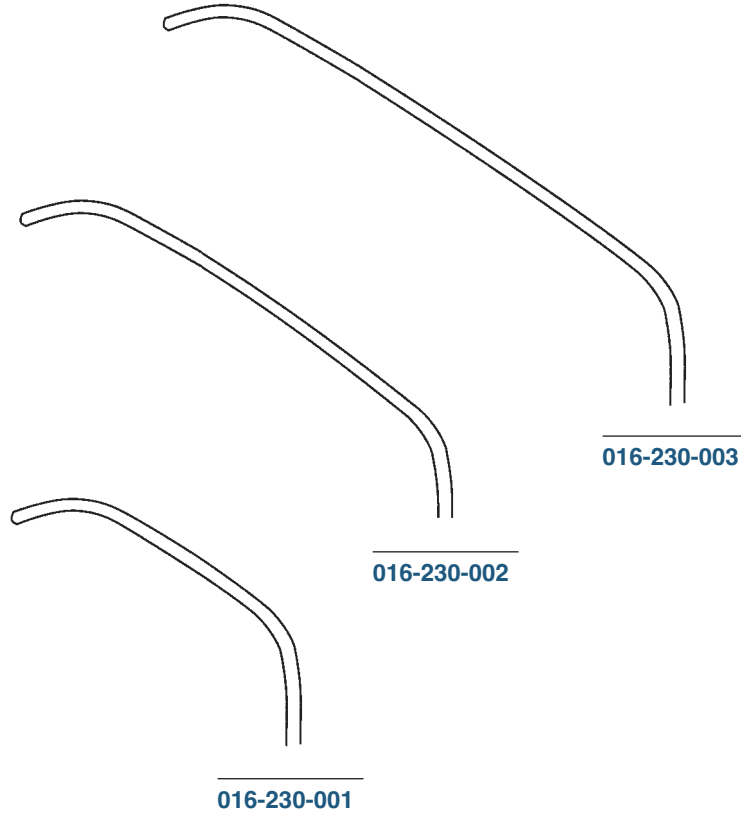

KOCHER

016-240-012	19,0 cm / 7 ¹ / ₂ "	19 x 12 mm
016-240-014	19,0 cm / 7 ¹ / ₂ "	21 x 14 mm



KOCHER

016-250-010	22 cm / 8 ⁵ / ₈ "	42x10 mm
016-250-015	22 cm / 8 ⁵ / ₈ "	42x15 mm
016-250-020	22 cm / 8 ⁵ / ₈ "	43x20 mm



016-260-001 18x17 mm

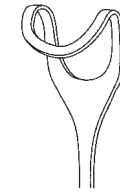

016-260-002 25x22 mm

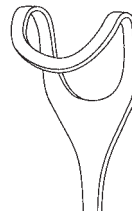

016-260-003 31x30 mm

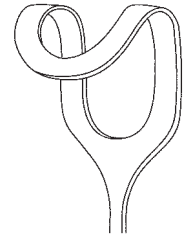

MIDDELDORPF

016-260-001	21,5 cm / 8 ¹ / ₂ "
016-260-002	23,0 cm / 9"
016-260-003	24,5 cm / 9 ² / ₃ "



016-262-001 14x17 mm



016-262-002 20x22 mm

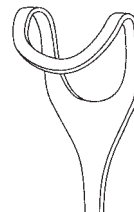

016-262-003 26x30 mm

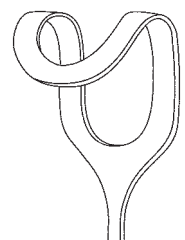

MIDDELDORPF

016-262-001	21,5 cm / 8 ¹ / ₂ "
016-262-002	22 cm / 8 ⁵ / ₈ "
016-262-003	23,5 cm / 9 ¹ / ₂ "

**Wundhaken
Retractors
Separadores
Divaricatori**



RICHARDSON-EASTMAN

016-270-000	Fig. 1+2	27,0 cm / 10 ³ / ₄ "
016-270-001	Fig. 1	26,0 cm / 10 ¹ / ₄ "
016-270-002	Fig. 2	27,0 cm / 10 ³ / ₄ "



RICHARDSON

016-272-001 - 016-272-004	24,0 cm / 9 ¹ / ₂ "
----------------------------------	---



016-272-001 30x21 mm

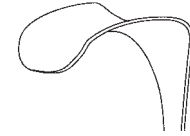

016-272-002 37x29 mm

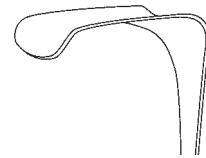

016-272-003 45x40 mm

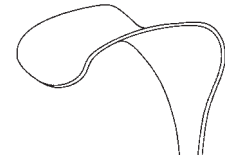

016-272-004 53x22 mm

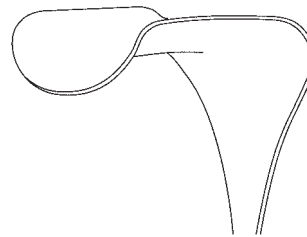

KELLY

016-274-001	26,0 cm / 10 ¹ / ₄ "	62 x 50 mm
--------------------	--	------------

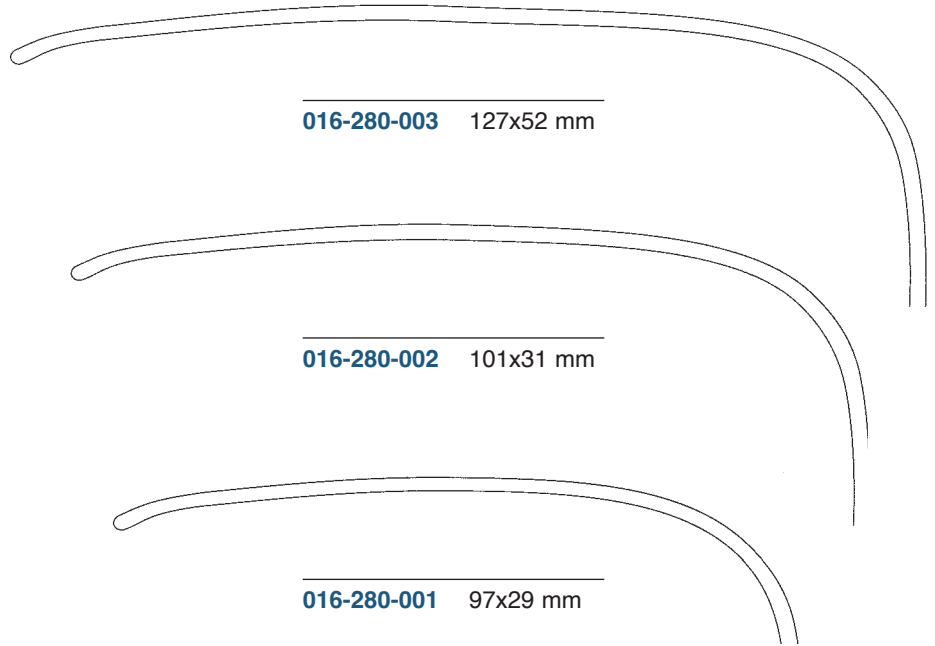

DOYEN-STILLE

016-280-001 - 016-280-003 26,0 cm / 10¹/₄"

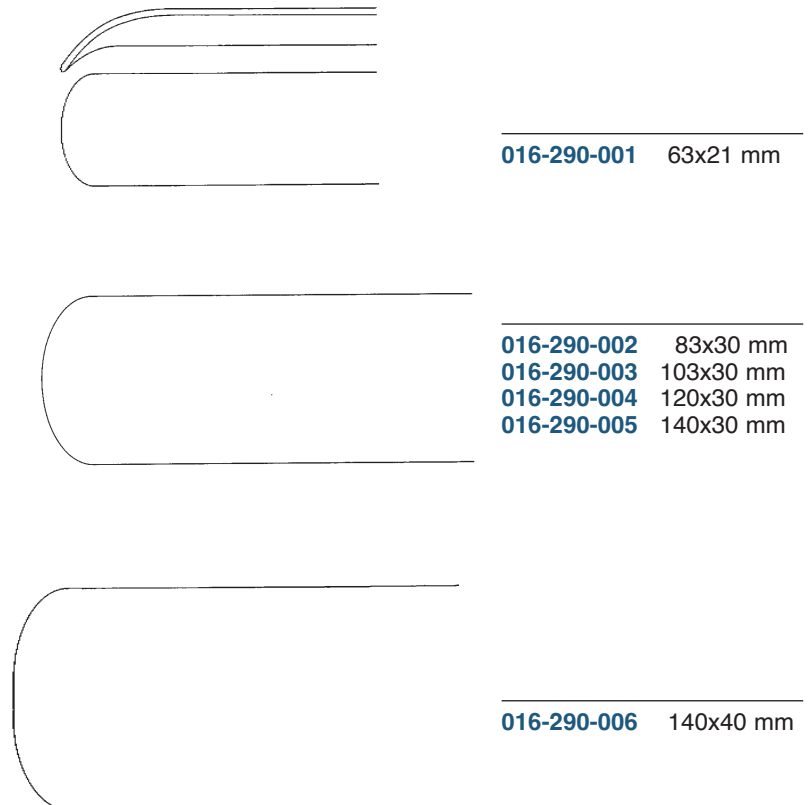
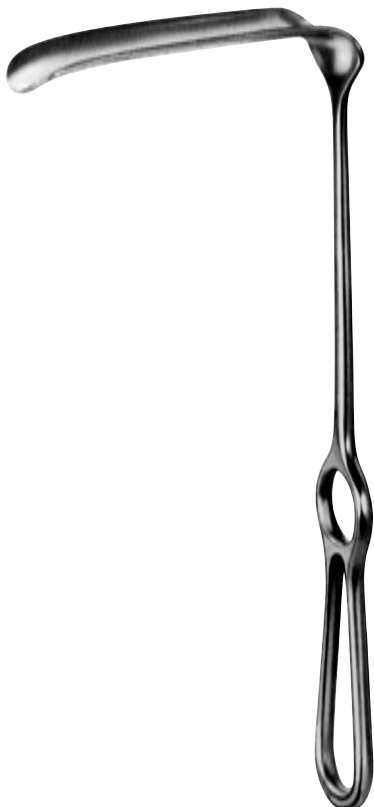

HÖSEL

016-290-001 - 016-290-006 26,0 cm / 10¹/₄"

**Wundhaken
Retractors
Separadores
Divaricatori**

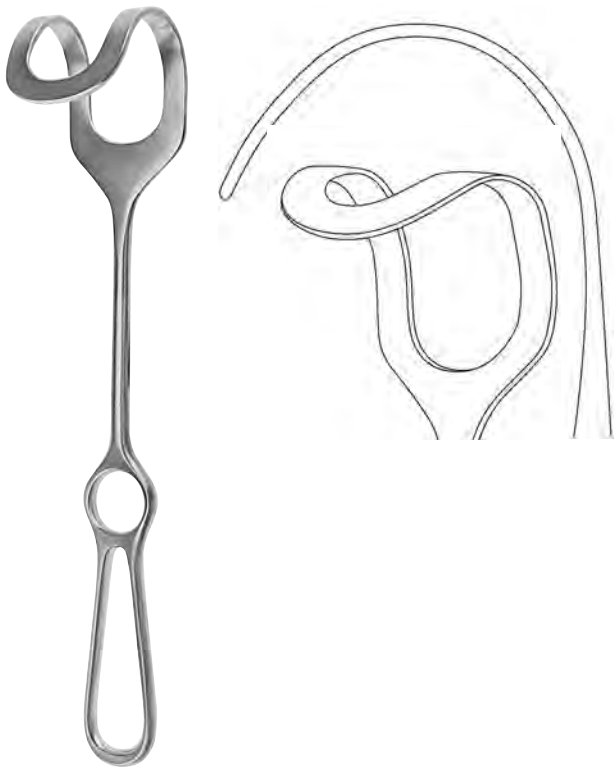

MIDDELDORPF

016-300-001	27,0 cm / 10 ³ / ₄ "	48x45 mm
016-300-002	27,0 cm / 10 ³ / ₄ "	52x50 mm
016-300-003	28,0 cm / 11"	60x70 mm



FRITSCH

016-310-000	23,5 cm / 9 ¹ / ₄ "	30x30 mm
016-310-001	24,0 cm / 9 ¹ / ₂ "	32x40 mm
016-310-002	25,0 cm / 9 ³ / ₄ "	40x50 mm
016-310-003	25,0 cm / 9 ³ / ₄ "	40x60 mm
016-310-004	25,5 cm / 10"	45x75 mm
016-310-005	26,5 cm / 10 ¹ / ₂ "	65x85 mm



DOYEN

016-320-250	25,0 cm / 10"
--------------------	---------------

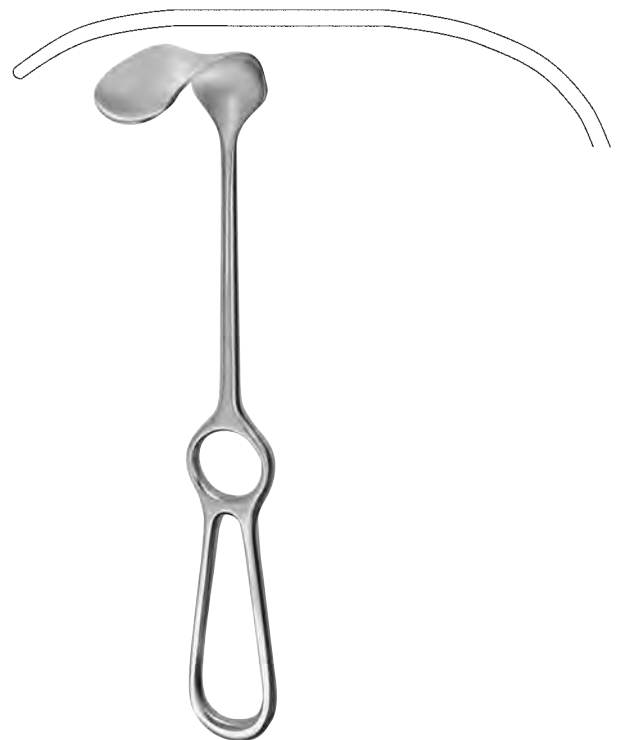

KOCHER

016-324-025	25,0 cm / 10"	70x25 mm
016-324-045	25,0 cm / 10"	80x45 mm
016-324-055	25,0 cm / 10"	80x55 mm
016-324-065	25,0 cm / 10"	80x65 mm

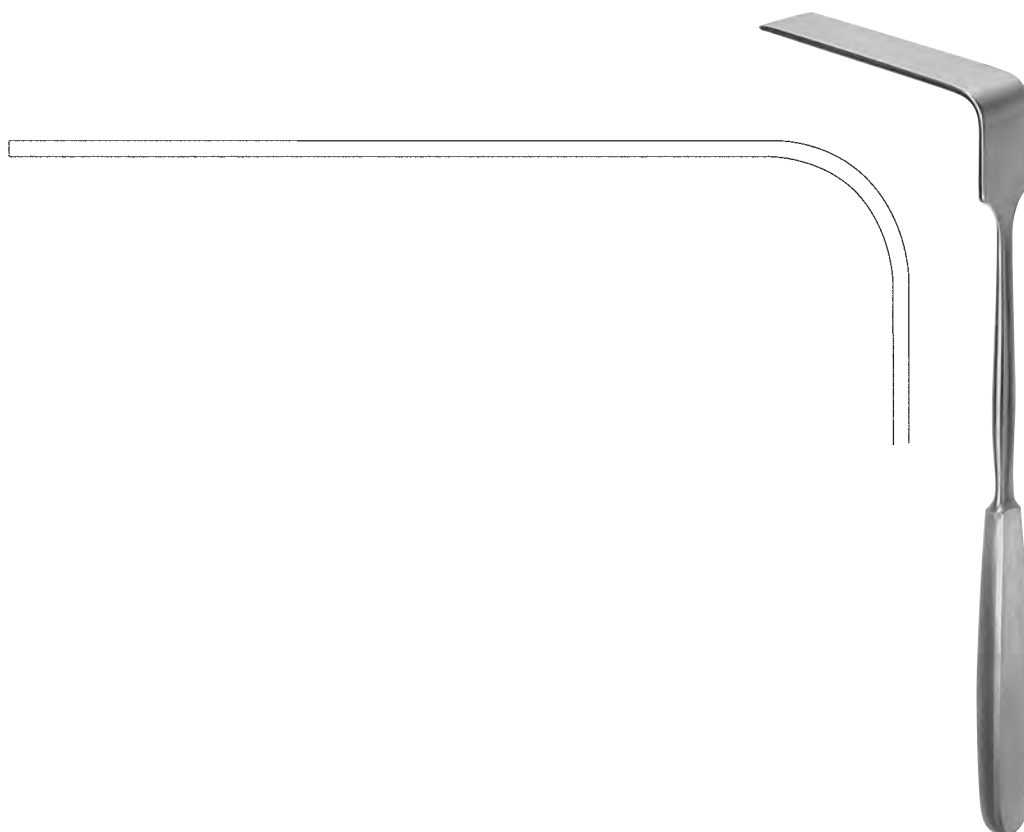

SIMON

016-326-022	28,0 cm / 11"	115x22 mm
016-326-027	28,0 cm / 11"	115x27 mm

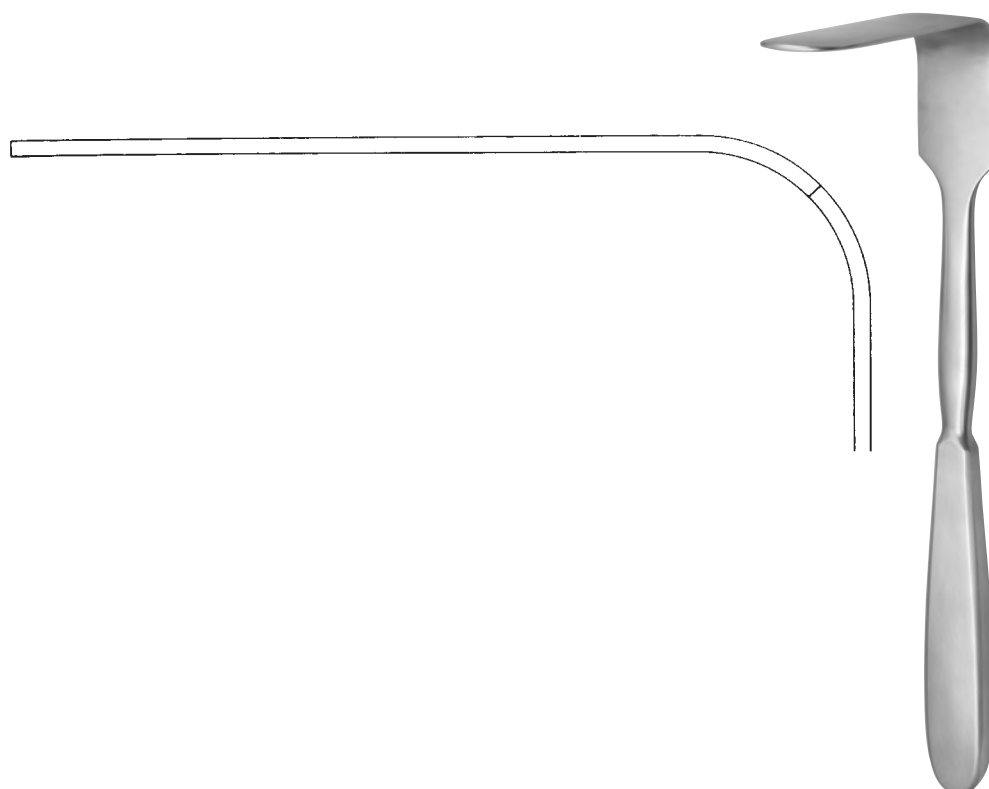

MARTIN

016-328-027	26,0 cm / 10"	110 x 27 mm
--------------------	---------------	-------------



016

**Wundhaken
Retractors
Separadores
Divaricatori**

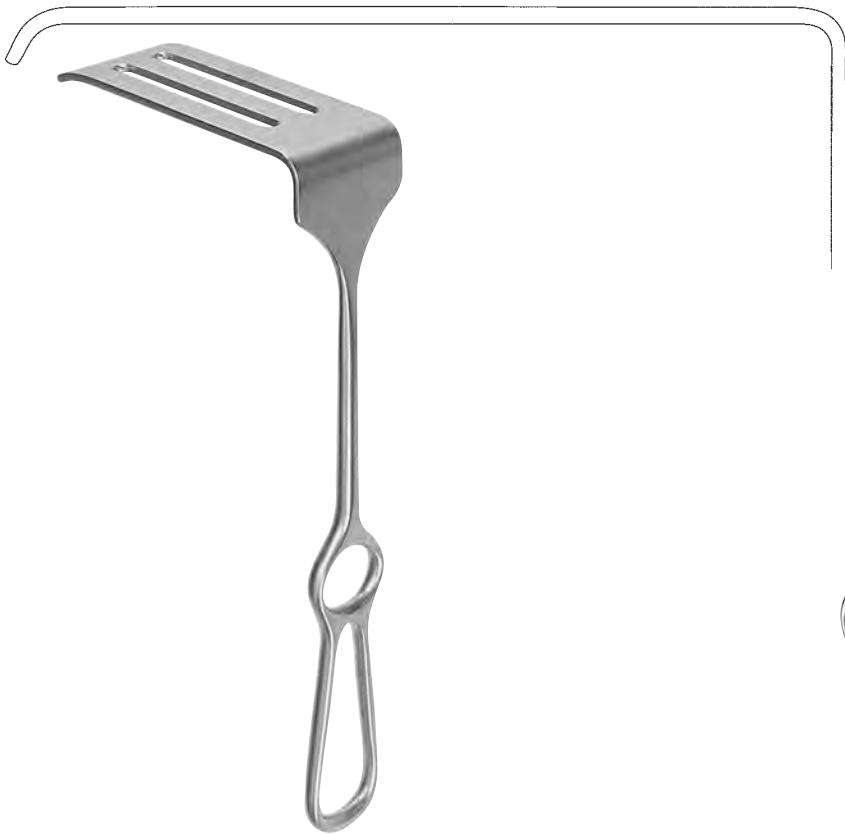

CORYLLOS

016-330-001	24,0 cm / 9 1/2"	85x22 mm
016-330-002	24,0 cm / 9 3/4"	108x43 mm
016-330-003	24,0 cm / 9 3/4"	119x65 mm



DAVIDSON

016-340-001	19,0 cm / 6 1/4"	80x54 mm
016-340-002	18,5 cm / 6 1/4"	80x95 mm



SAUERBRUCH

016-344-250	25,5 cm / 10"	127x38 mm
--------------------	---------------	-----------

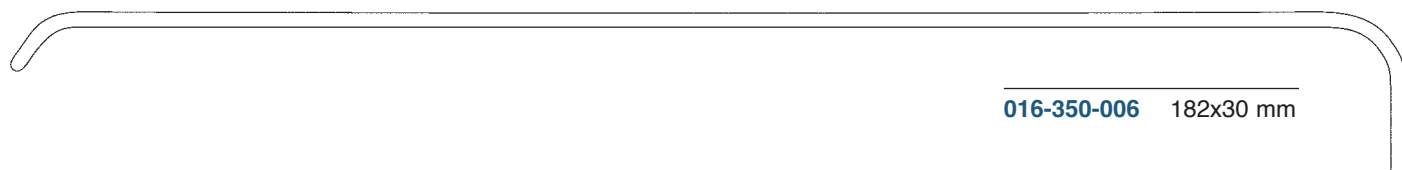

016-350-006 182x30 mm

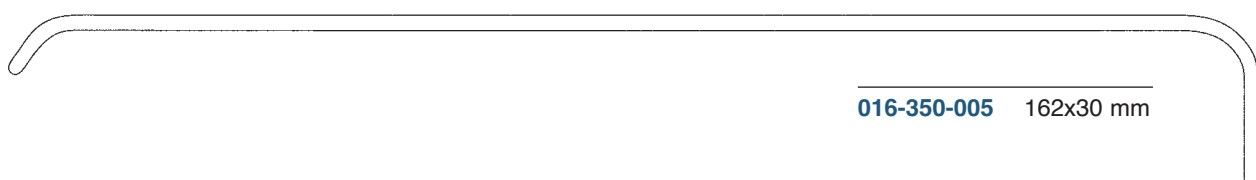

016-350-005 162x30 mm

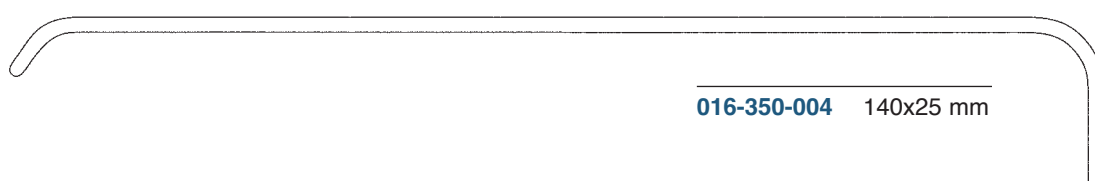

016-350-004 140x25 mm

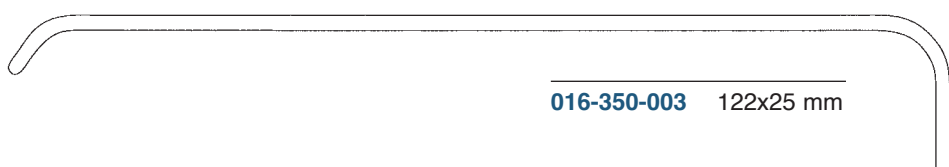

016-350-003 122x25 mm

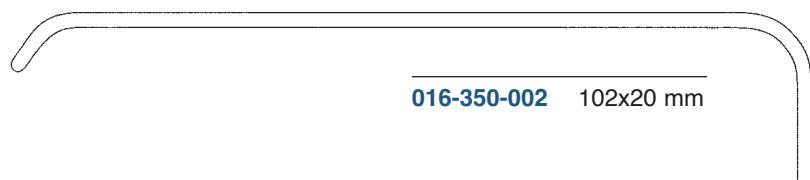

016-350-002 102x20 mm



016-350-001 82x20 mm



BRUNNER

016-350-001 - 016-350-006 25,0 cm / 9³/₄"



016

**Wundhaken
Retractors
Separadores
Divaricatori**

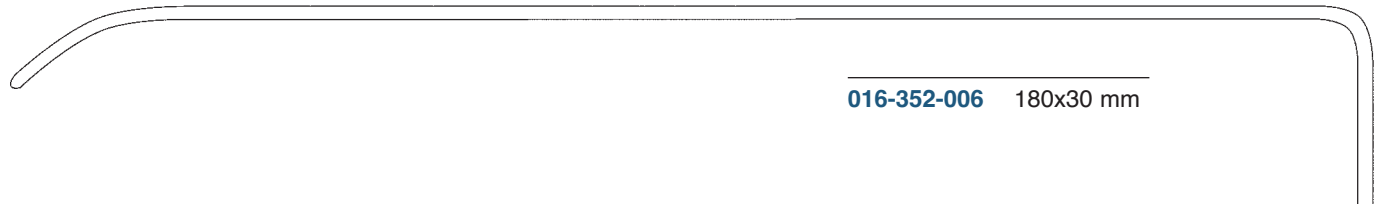

016-352-006 180x30 mm



016-352-005 160x30 mm

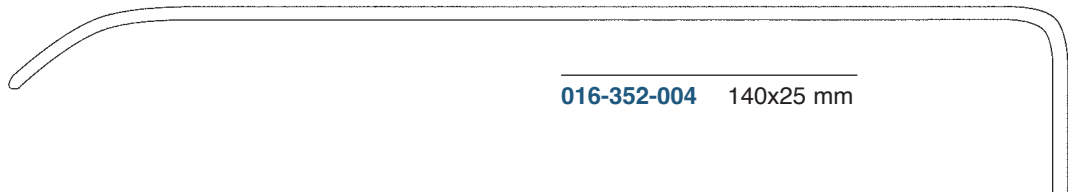

016-352-004 140x25 mm



016-352-003 120x25 mm

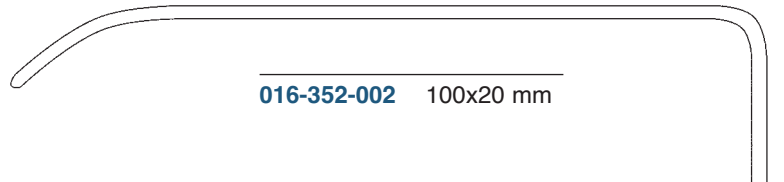

016-352-002 100x20 mm

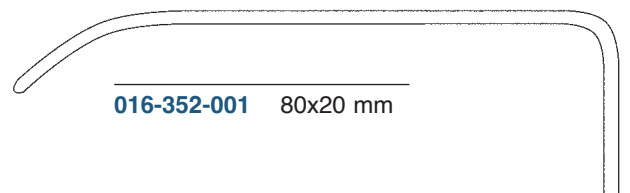

016-352-001 80x20 mm

BRUNNER

016-352-001 - 016-352-006 25,0 cm / 9³/₄"

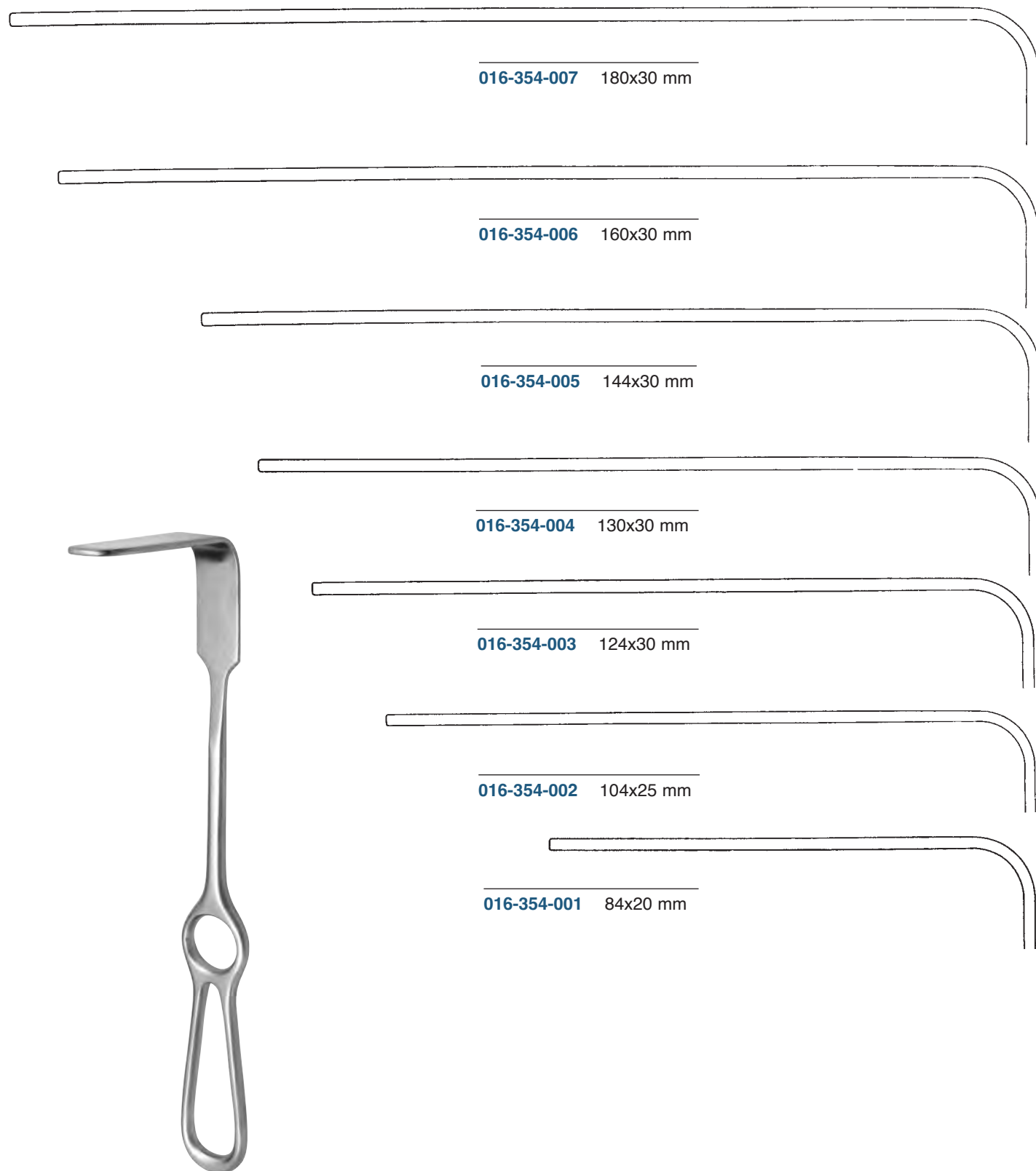

016-354-007 180x30 mm

016-354-006 160x30 mm

016-354-005 144x30 mm

016-354-004 130x30 mm

016-354-003 124x30 mm

016-354-002 104x25 mm

016-354-001 84x20 mm

BRUNNER

016-354-001 - 016-354-007 25,5 cm / 10"

**Wundhaken
Retractors
Separadores
Divaricatori**

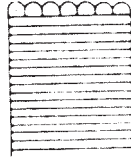

016-358-001 15x15 mm

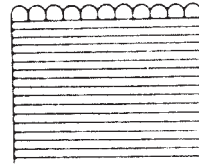

016-358-002 15x23 mm

CRAWFORD

016-358-001 - 016-358-002 19,0 cm / 7¹/₂"



016-360-001 Fig. 1



016-360-002 Fig. 2



016-360-003 Fig. 3



016-360-004 Fig. 4



016-360-005 Fig. 5



016-360-006 Fig. 6

ROSS

016-360-001 - 016-360-006 25,0 cm / 9³/₄"

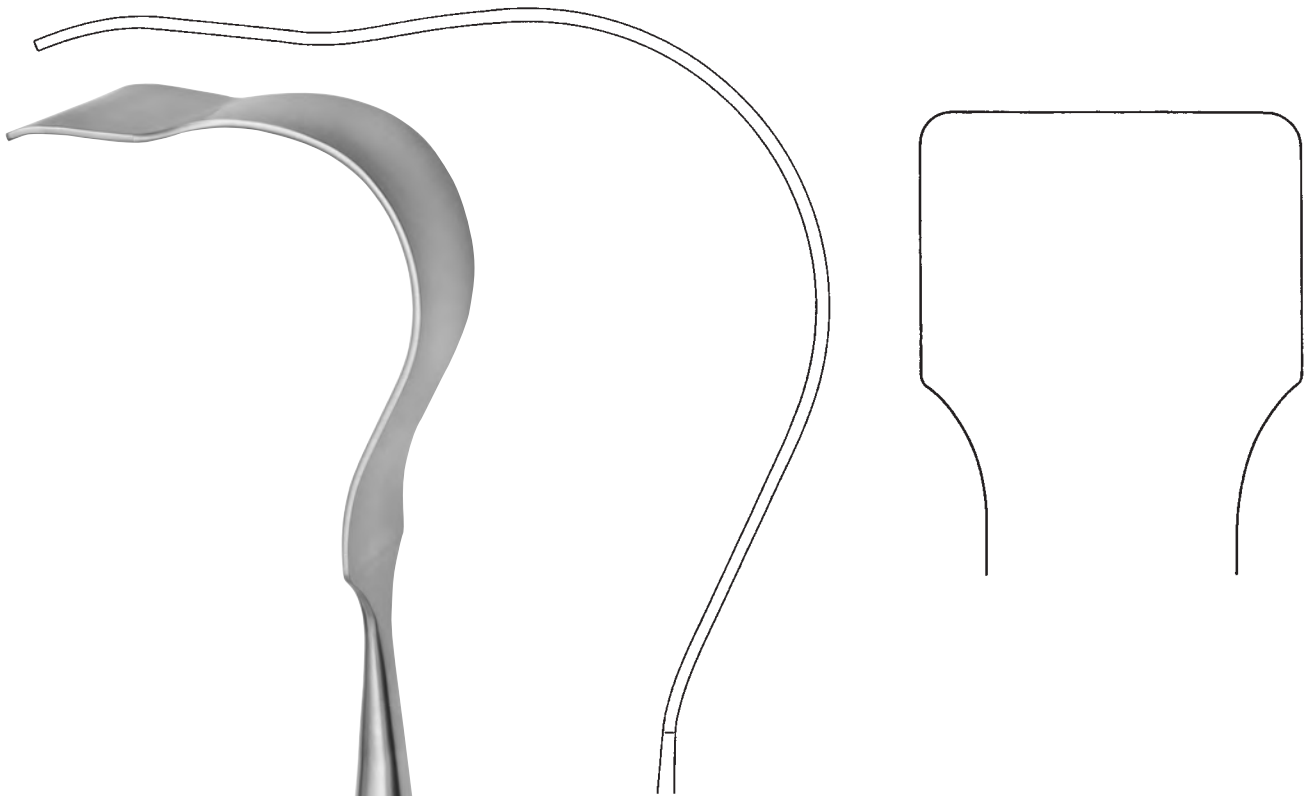

POLLOSON

016-366-001 29,0 cm / 11¹/₂"



POLLOSON

016-366-002 27,0 cm / 10³/₄"



016

**Wundhaken
Retractors
Separadores
Divaricatori**



HARRINGTON

016-370-001	31,5 cm / 12 ¹ / ₂ "	137x44 mm
016-370-002	31,5 cm / 12 ¹ / ₂ "	137x65 mm

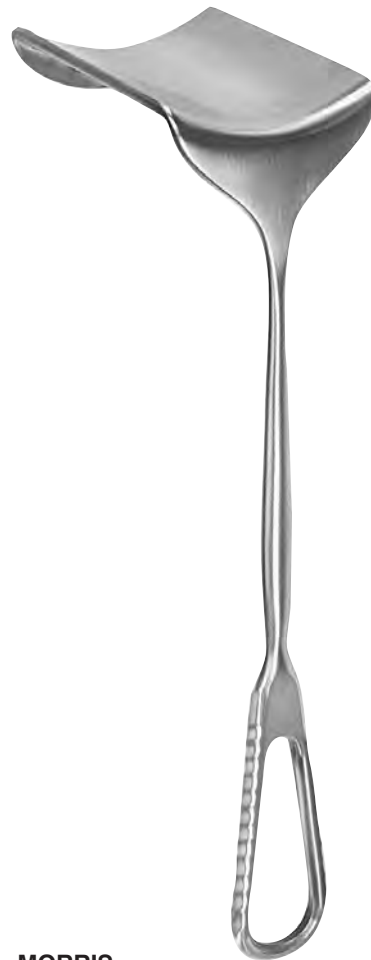

MORRIS

016-380-040	24,5 cm / 9 ² / ₃ "	70x40 mm
016-380-050	24,5 cm / 9 ² / ₃ "	70x50 mm
016-380-065	24,5 cm / 9 ² / ₃ "	70x65 mm



MEYERDING

016-390-001 - 016-390-003 23 cm / 8³/₄"

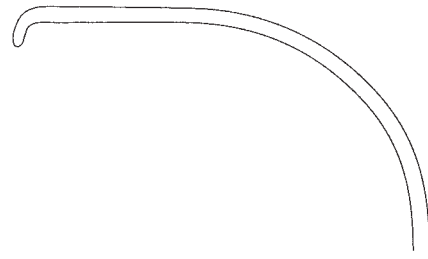

016-390-001 50x16 mm 23,0 cm

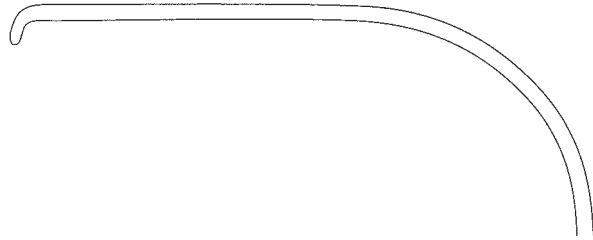

016-390-002 75x25 mm 23,0 cm

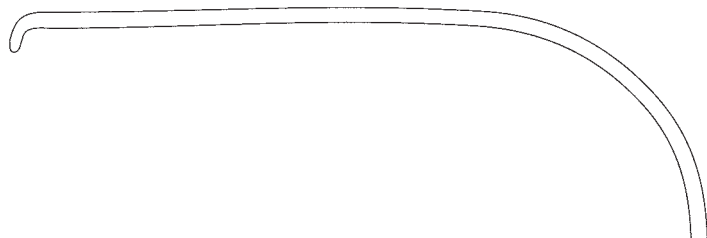

016-390-003 90x50 mm 25,5 cm



19 mm

DEAVER

016-400-001 18,0 cm / 7"



22 mm

DEAVER

016-400-002 21,5 cm / 8¹/₂"



25 mm

DEAVER

016-400-003 25,0 cm / 9³/₄"



016

**Wundhaken
Retractors
Separadores
Divaricatori**



25 mm

DEAVER

016-400-004 31,0 cm / 12¹/₄"



25 mm

DEAVER

016-400-005 33,0 cm / 13"



25 mm

DEAVER

016-400-006 36,0 cm / 14¹/₈"



38 mm

DEAVER

016-400-007 30,0 cm / 11³/₄"



50 mm

DEAVER

016-400-008 31,0 cm / 12¹/₄"



75 mm

DEAVER

016-400-009 31,5 cm / 12¹/₂"



DEAVER

016-402-025	31,5 cm / 12 ¹ / ₂ "	25 mm
016-402-038	31,5 cm / 12 ¹ / ₂ "	38 mm
016-402-050	31,5 cm / 12 ¹ / ₂ "	50 mm
016-402-075	31,0 cm / 12 ¹ / ₄ "	75 mm



48 x 48 mm
rechts
right
derecho
destra

COOLEY

016-410-001 25,0 cm / 9³/₄"



48 x 48 mm
rechts gerieft
right serrated
derecho, estriado
destra, con striatura

COOLEY

016-410-002 25,0 cm / 9³/₄"



30 x 48 mm
links
left
izquierdo
sinistra

COOLEY

016-410-003 27,0 cm / 10³/₄"



016

**Wundhaken
Retractors
Separadores
Divaricatori**

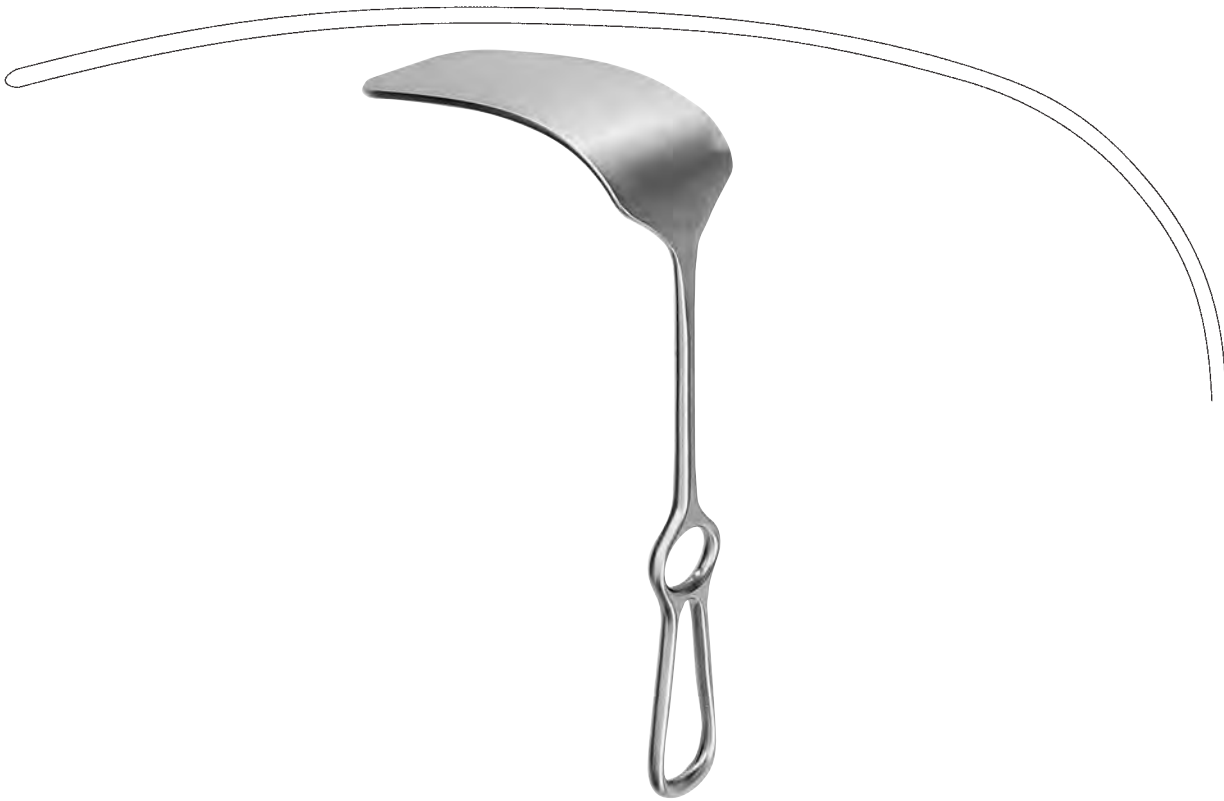

MIKULICZ

016-414-001	25,0 cm / 9 ³ / ₄ "	90x35 mm
016-414-002	25,0 cm / 9 ³ / ₄ "	125 x50 mm
016-414-003	25,0 cm / 9 ³ / ₄ "	160 x50 mm

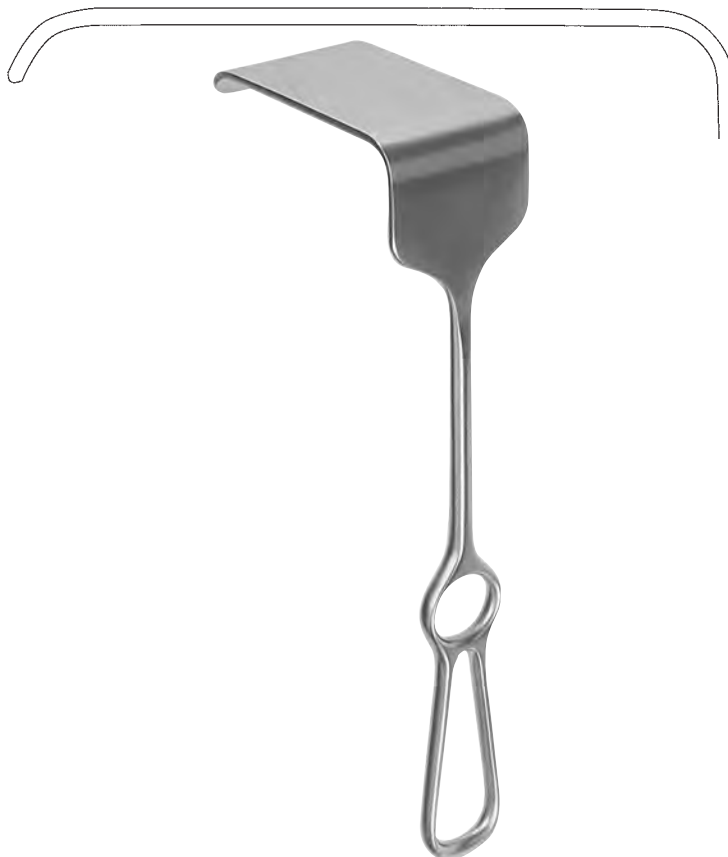

MIKULICZ

016-416-260	26,0 cm / 10 ¹ / ₄ "	90 x 55 mm
--------------------	--	------------



KELLY

016-420-001	27,0 cm /10 ³ / ₄ "	160x38 mm
016-420-002	27,0 cm /10 ³ / ₄ "	160x57 mm
016-420-003	27,0 cm /10 ³ / ₄ "	190x38 mm
016-420-004	27,0 cm /10 ³ / ₄ "	190x57 mm



016-422-001	29,0 cm /11 ¹ / ₂ "	124x60 mm
016-422-002	33,0 cm /13"	174x60 mm
016-422-003	33,0 cm /13"	178x60 mm

ST. MARKS

016-422-001 - 016-422-003



016

**Wundhaken
Retractors
Separadores
Divaricatori**

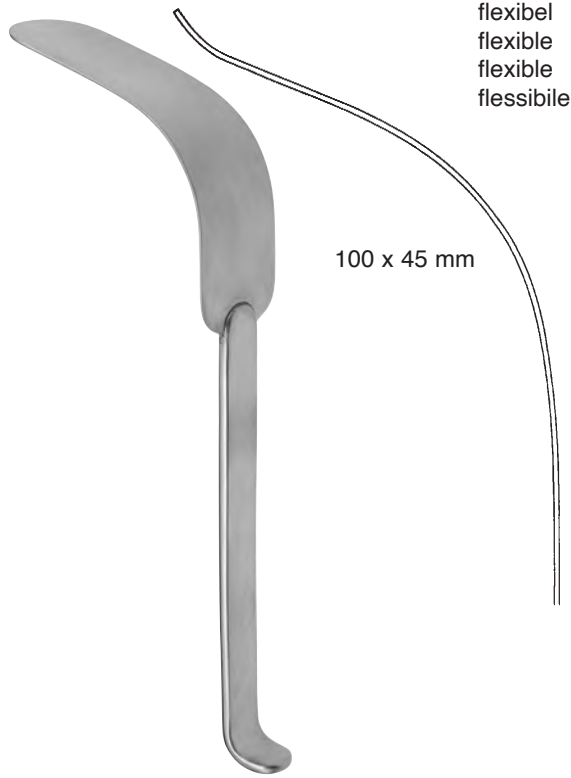

flexibel
flexible
flexible
flessibile

100 x 45 mm

KUEMMEL

016-426-280 28,0 cm / 11"

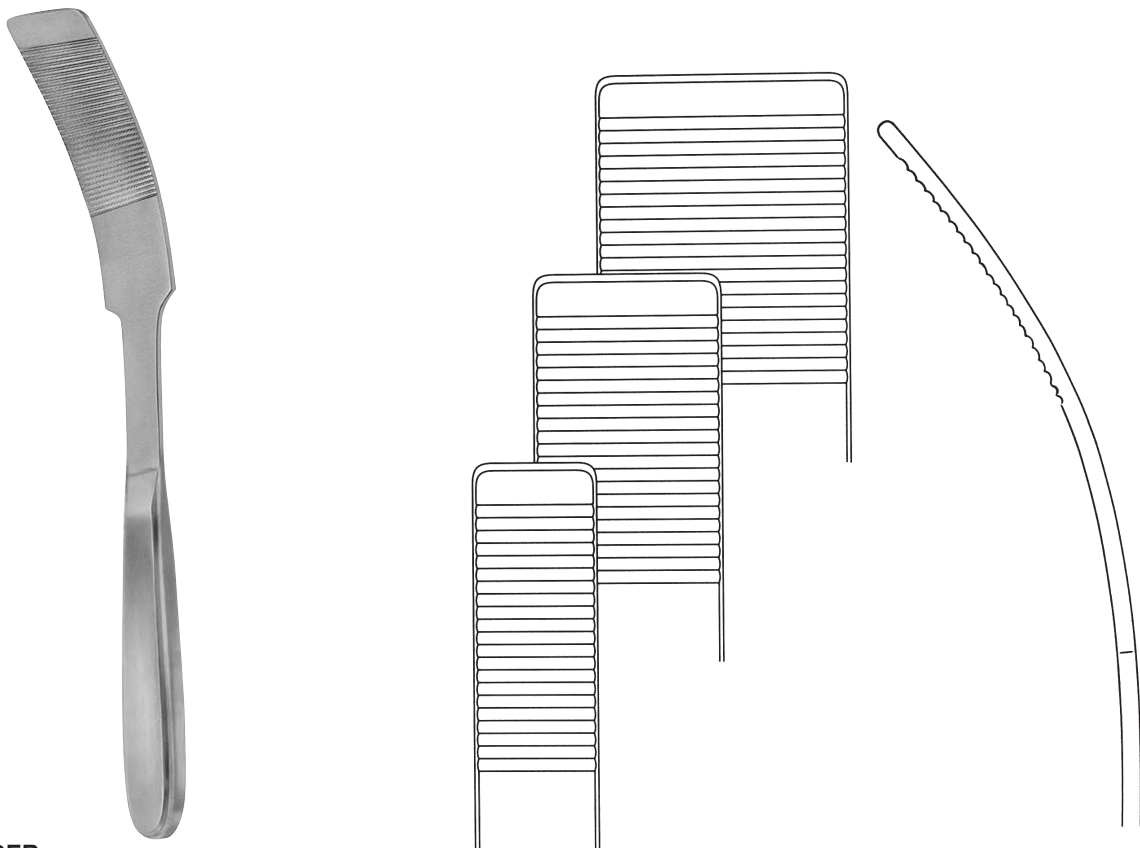

KADER

016-430-020	28,0 cm / 11"	20 mm
016-430-030	28,0 cm / 11"	30 mm
016-430-040	28,0 cm / 11"	40 mm



Fig.1 24x20 mm
Fig.2 29x26 mm
mmFig.333x29 mm

Satz, Fig. 1-3
Set, fig. 1-3
Juego, fig. 1-3
Serie, fig. 1-3

Fig.1 30x28 mm
Fig.2 36x36 mm
mmFig.338x43 mm

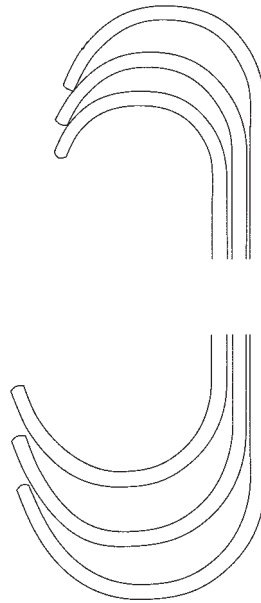

ROUX

016-450-000	17,0 cm / 6 ³ / ₄ "	Fig.1-3
016-450-001	14,0 cm / 5 ¹ / ₂ "	Fig.1
016-450-002	15,0 cm / 6"	Fig.2
016-450-003	17,0 cm / 6 ³ / ₄ "	Fig.3



Fig.2 30x10 mm
Fig.1 26x10 mm

Fig.1 30x13 mm
Fig.2 34x13 mm

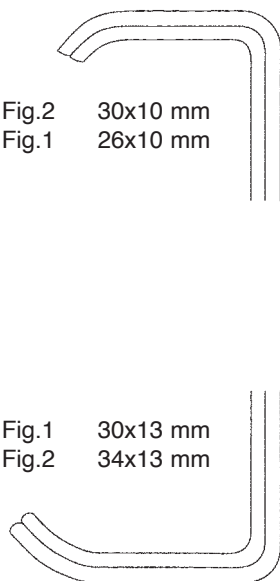

FARABEUF

016-454-000	11,5 cm / 4 ¹ / ₄ "	Fig.1-2
016-454-001	11,5 cm / 4 ¹ / ₄ "	Fig.1
016-454-002	11,5 cm / 4 ¹ / ₄ "	Fig.2



Fig.1 23x16 mm
Fig.2 27x16 mm

Fig.1 26x16 mm
Fig.2 30x16 mm



FARABEUF

016-456-000	15,0 cm / 6"	Fig.1-2
016-456-001	15,0 cm / 6"	Fig.1
016-456-002	15,0 cm / 6"	Fig.2



016

**Wundhaken
Retractors
Separadores
Divaricatori**



MINI-ROUX

016-458-140 14,0 cm / 5 1/2"

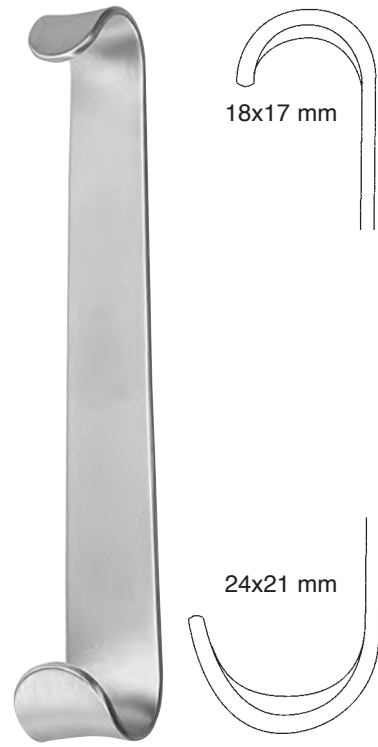

BABY-ROUX

016-460-130 13,0 cm / 5"

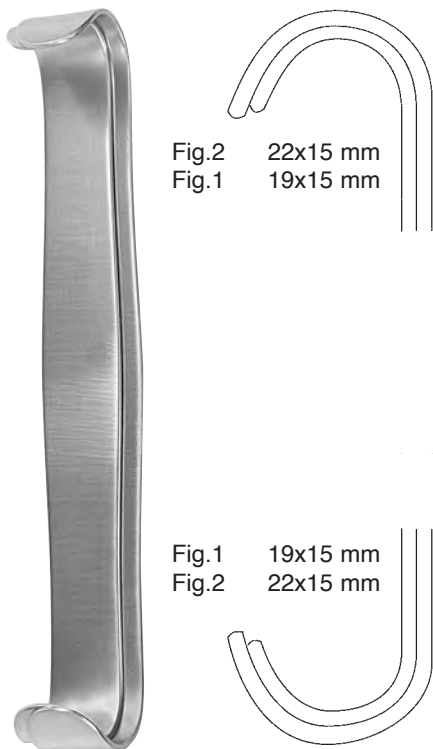

PARKER

016-464-000	13,5 cm / 5 1/4"	Fig.1-2
016-464-001	13,5 cm / 5 1/4"	Fig.1
016-464-002	13,5 cm / 5 1/4"	Fig.2

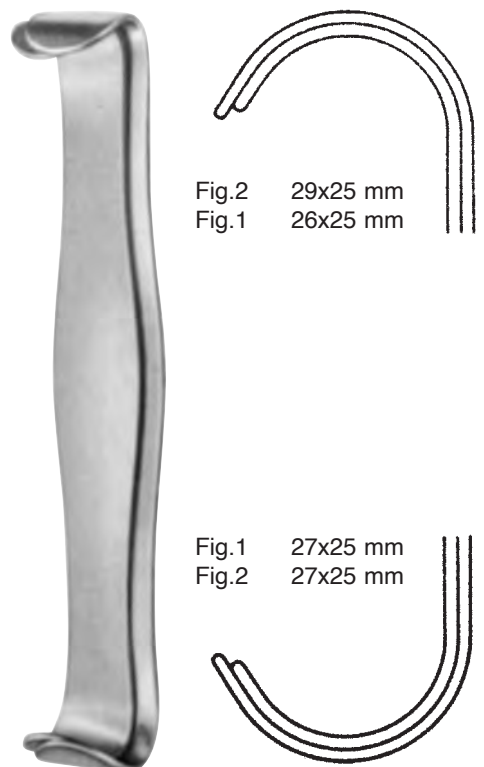

PARKER

016-466-000	17,5 cm / 7 "	Fig.1-2
016-466-001	17,5 cm / 7 "	Fig.1
016-466-002	17,5 cm / 7 "	Fig.2

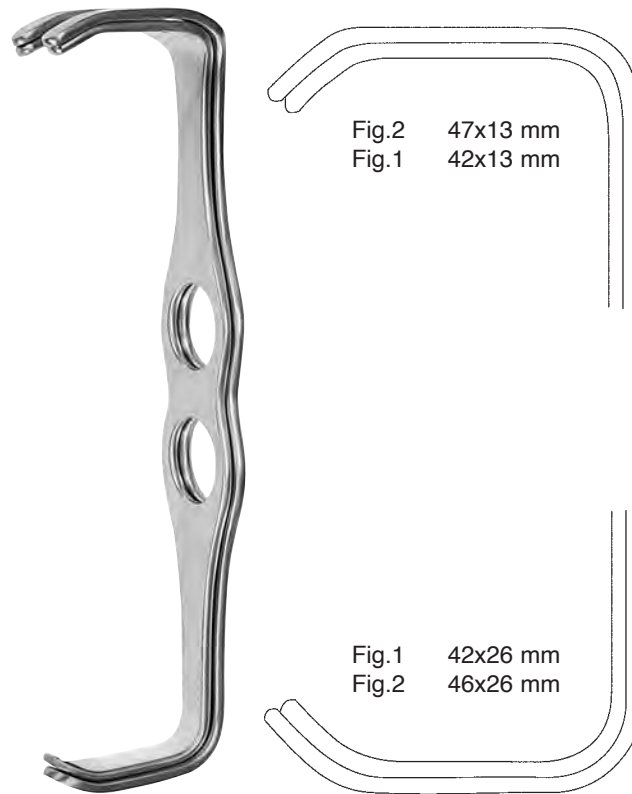

MATHIEU

016-470-000	20,0 cm / 8"	Fig. 1-2
016-470-001	20,0 cm / 8"	Fig. 1
016-470-002	20,0 cm / 8"	Fig. 2



GOELET

016-472-190	19,0 cm / 7½"
--------------------	---------------

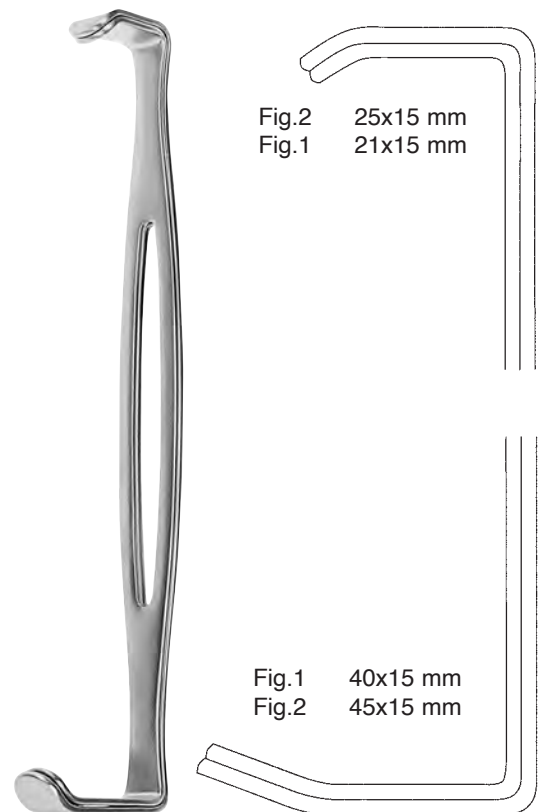

PARKER-LANGENBECK

016-474-000	21,5 cm / 8½"	Fig. 1-2
016-474-001	21,5 cm / 8½"	Fig. 1
016-474-002	21,5 cm / 8½"	Fig. 2



016

**Wundhaken
Retractors
Separadores
Divaricatori**

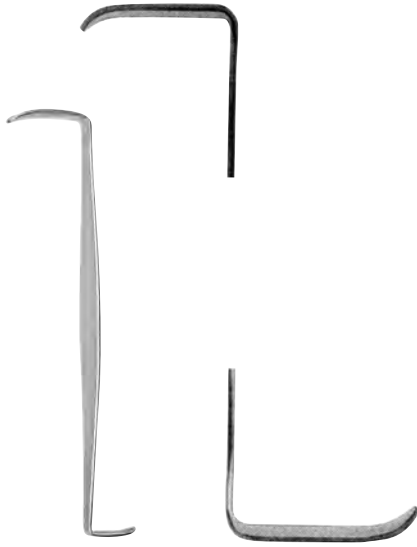

CRILE

016-478-110 11,0 cm / 4¹/₄"



LUER

016-479-110 11,0 cm / 4¹/₄"



COLLIN

016-480-145 14,5 cm / 5³/₄"



REVERDIN

016-485-290 29,0 cm / 11 1/2"



REVERDIN

016-486-280 28,5 cm / 11"



biegsam
malleable
maleable
malleabile

RIBBON

016-490-030 330x30 mm
016-490-040 330x40 mm
016-490-050 330x50 mm



biegsam
malleable
maleable
malleabile

HABERER

016-492-200 200x17/25 mm
016-492-280 280x25/30 mm
016-492-300 300x37/45 mm



biegsam
malleable
maleable
malleabile

RIBBON

016-494-012 200x12 mm
016-494-017 200x17 mm
016-494-025 200x25 mm

Wundspreizer
Self-Retaining Retractors
Separadores autoestáticos
Divaricatori autostatici



FINSEN

016-500-005 - 016-501-005 5,0 cm / 2"
016-500-007 - 016-501-007 7,0 cm / 2³/₄"

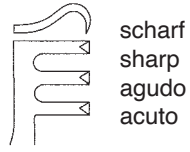

scharf
sharp
agudo
acuto

016-500-005

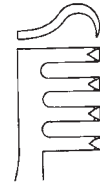

scharf
sharp
agudo
acuto

016-500-007

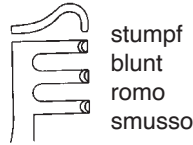

stumpf
blunt
romo
smusso

016-501-005

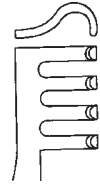

stumpf
blunt
romo
smusso

016-501-007



FINSEN

016-504-007 - 016-505-007 7,0 cm / 2³/₄"

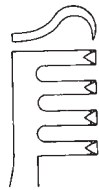

016-504-007

scharf
sharp
agudo
acuto

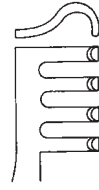

016-505-007

stumpf
blunt
romo
smusso

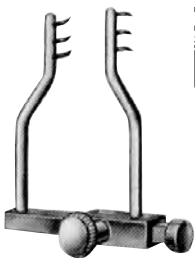

LOGAN

016-506-004 4,0 cm / 1¹/₂"

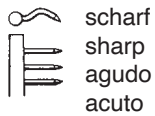

scharf
sharp
agudo
acuto



BUCKLEY

016-508-006 6,0 cm / 2¹/₄"



scharf
sharp
agudo
acuto

Wundspreizer
Self-Retaining Retractors
Separadores autoestáticos
Divaricatori autostatici



016

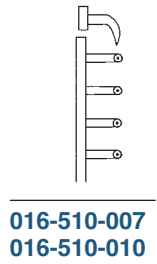

scharf
sharp
agudo
acuto

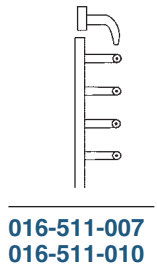

stumpf
blunt
romo
smusso

ALM

016-510-007 - 016-511-007 7,0 cm / 2³/₄"
 016-510-010 - 016-511-010 10,0 cm / 4"



ALLPORT

016-512-095 9,5 cm / 3³/₄"



scharf
sharp
agudo
acuto

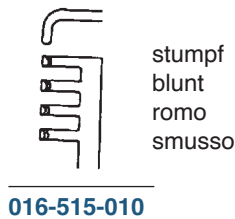

stumpf
blunt
romo
smusso

HOLZHEIMER

016-514-010 - 016-515-010 10,0 cm / 4"



JANSEN

016-520-010 - 016-521-010 10,0 cm / 4"

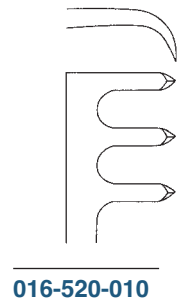

scharf
sharp
agudo
acuto

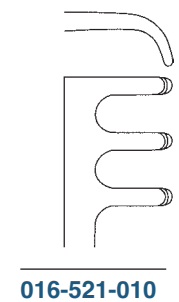

stumpf
blunt
romo
smusso

Wundspreizer
Self-Retaining Retractors
Separadores autoestáticos
Divaricatori autostatici

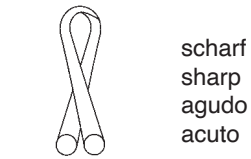

016-524-140

scharf
sharp
agudo
acuto



016-525-140

stumpf
blunt
romo
smusso

SCALP-CONTOUR

016-524-140 - 016-525-140

14,0 cm / 5 1/2"

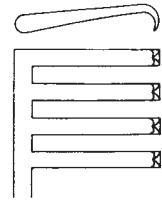

scharf
sharp
agudo
acuto

ANDERSON-ADSON

016-530-195 20,0 cm / 8"



016-532-265

scharf
sharp
agudo
acuto



016-533-265

stumpf
blunt
romo
smusso

ADSON

016-532-265 - 016-533-265

26,5 cm / 10 1/2"



016-538-105

scharf
sharp
agudo
acuto



016-539-105

stumpf
blunt
romo
smusso

WEITLANER-LOKTITE

016-538-105 - 016-539-105

10,5 cm / 4 1/8"

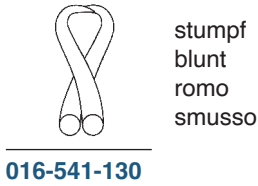
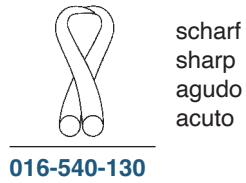

WEITLANER

016-540-130 - 016-541-130 13,0 cm / 5 1/8"

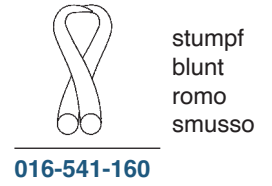
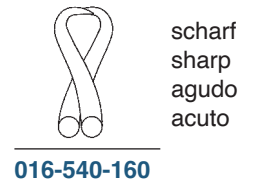

WEITLANER

016-540-160 - 016-541-160 16,0 cm / 6 1/4"

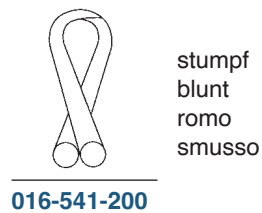
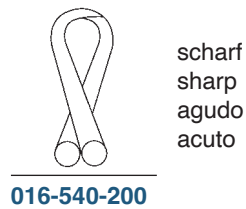

WEITLANER

016-540-200 - 016-541-200 20,0 cm / 8"



WEITLANER

016-540-240 - 016-541-240 24,0 cm / 9 1/2"



016

Wundspreizer
Self-Retaining Retractors
Separadores autoestáticos
Divaricatori autostatici



scharf
sharp
agudo
acuto

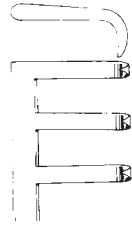

016-544-130

stumpf
blunt
romo
smusso

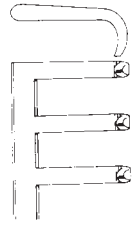

016-545-130

WEITLANER-WULLSTEIN

016-544-130 - 016-545-130 13,0 cm / 5"



scharf
sharp
agudo
acuto

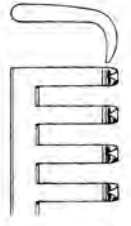

MOLLISON

016-550-155 15,5 cm / 6"



scharf
sharp
agudo
acuto



016-554-130

stumpf
blunt
romo
smusso



016-555-130

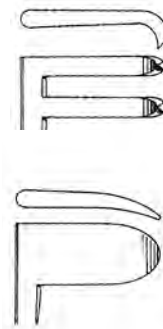

PLESTER

016-556-110 11,0 cm / 4³/₈"



PLESTER

016-557-110 11,0 cm / 4³/₈"

PLESTER

016-554-130 - 016-555-130 13,0 cm / 5"

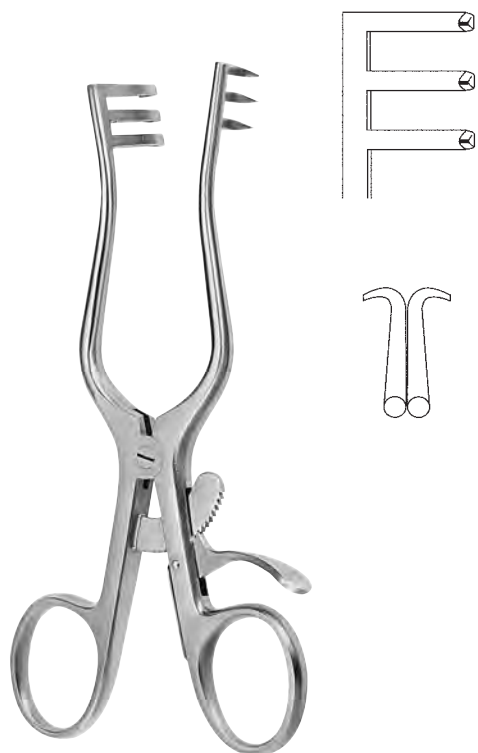

stumpf
 blunt
 romo
 smusso

MILLIGAN

016-560-130 13,0 cm / 5"

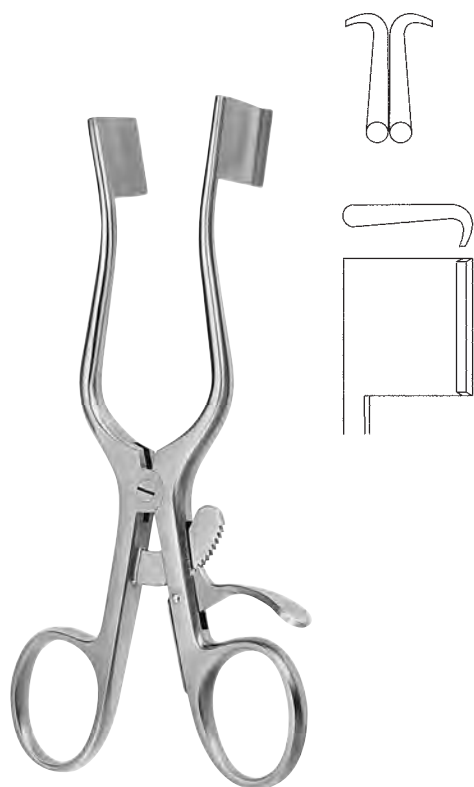

WEITLANER-BABY

016-562-130 13,0 cm / 5"



scharf
 sharp
 agudo
 acuto

016-564-125

stumpf
 blunt
 romo
 smusso

016-565-125

SCHUKNECHT

016-564-125 - 016-565-125 12,5 cm / 5"

**Wundspreizer
Self-Retaining Retractors
Separadores autoestáticos
Divaricatori autostatici**

scharf
sharp
agudo
acuto

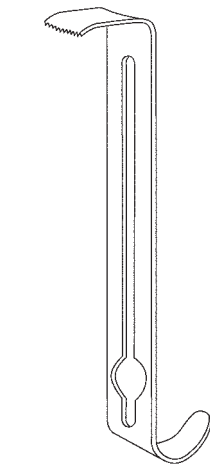

016-572-019 19x16 mm

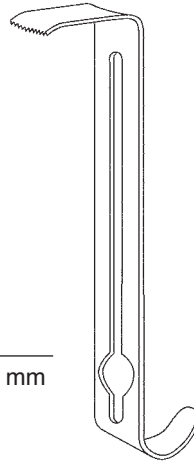

016-572-025 25x16 mm

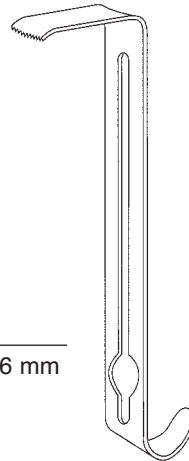

016-572-032 32x16 mm

stumpf
blunt
romo
smusso



HENLEY

016-570-000 16,0 cm / 6 1/4"

HENLEY

016-571-000 16,0 cm / 6 1/4"

HENLEY

016-570-000

komplett, bestehend aus:

- 1 Sperrer mit Seitenvalven, scharf (016-570-001)
- 1 Mittelvalve 19 x 16 mm (016-572-019)
- 1 Mittelvalve 25 x 16 mm (016-572-025)
- 1 Mittelvalve 32 x 16 mm (016-572-032)

complete, consisting of:

- 1 Spreader with lateral valves, sharp (016-570-001)
- 1 Central valve 19 x 16 mm (016-572-019)
- 1 Central valve 25 x 16 mm (016-572-025)
- 1 Central valve 32 x 16 mm (016-572-032)

completo, compuesto de:

- 1 Separador con valvas laterales, agudas (016-570-001)
- 1 Valva central 19 x 16 mm (016-572-019)
- 1 Valva central 25 x 16 mm (016-572-025)
- 1 Valva central 32 x 16 mm (016-572-032)

completo, composto da:

- 1 Divaricatore con valve laterali, acuto (016-570-001)
- 1 Valva centrale 19 x 16 mm (016-572-019)
- 1 Valva centrale 25 x 16 mm (016-572-025)
- 1 Valva centrale 32 x 16 mm (016-572-032)

HENLEY

016-571-000

komplett bestehend aus:

- 1 Sperrer mit Seitenvalven, stumpf (016-571-001)
- 1 Mittelvalve 19 x 16 mm (016-572-019)
- 1 Mittelvalve 25 x 16 mm (016-572-025)
- 1 Mittelvalve 32 x 16 mm (016-572-032)

complete consisting of:

- 1 Spreader with lateral valves, blunt (016-571-001)
- 1 Central valve 19 x 16 mm (016-572-019)
- 1 Central valve 25 x 16 mm (016-572-025)
- 1 Central valve 32 x 16 mm (016-572-032)

completo, compuesto de:

- 1 Separador con valvas laterales, romas (016-571-001)
- 1 Valva central 19 x 16 mm (016-572-019)
- 1 Valva central 25 x 16 mm (016-572-025)
- 1 Valva central 32 x 16 mm (016-572-032)

completo, composto da:

- 1 Divaricatore con valve laterali, smusso (016-571-001)
- 1 Valva centrale 19 x 16 mm (016-572-019)
- 1 Valva centrale 25 x 16 mm (016-572-025)
- 1 Valva centrale 32 x 16 mm (016-572-032)



scharf
sharp
agudo
acuto

ADSON

016-580-130 13,5 cm / 5¹/₄"
016-580-160 16,5 cm / 6¹/₂"

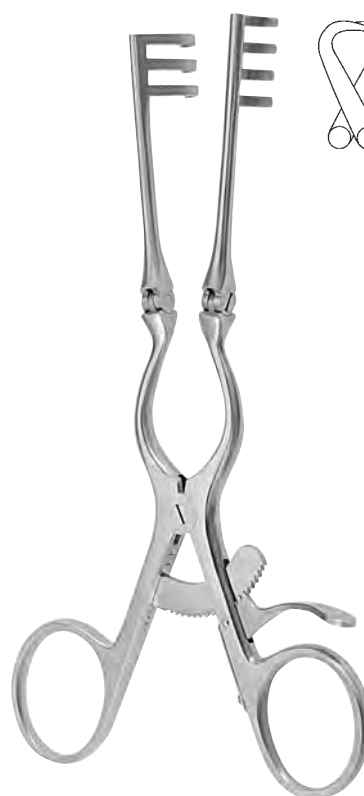

stumpf
blunt
romo
smusso

ADSON

016-581-130 13,5 cm / 5¹/₄"
016-581-160 16,5 cm / 6¹/₂"



016

Wundspreizer
Self-Retaining Retractors
Separadores autoestáticos
Divaricatori autostatici

scharf
sharp
agudo
acuto

stumpf
blunt
romo
smusso



ADSON

016-580-200 20,0 cm / 8"
016-580-260 26,0 cm / 10¹/₄"

ADSON

016-581-200 20,0 cm / 8"
016-581-260 26,0 cm / 10¹/₄"

scharf
sharp
agudo
acuto

stumpf
blunt
romo
smusso

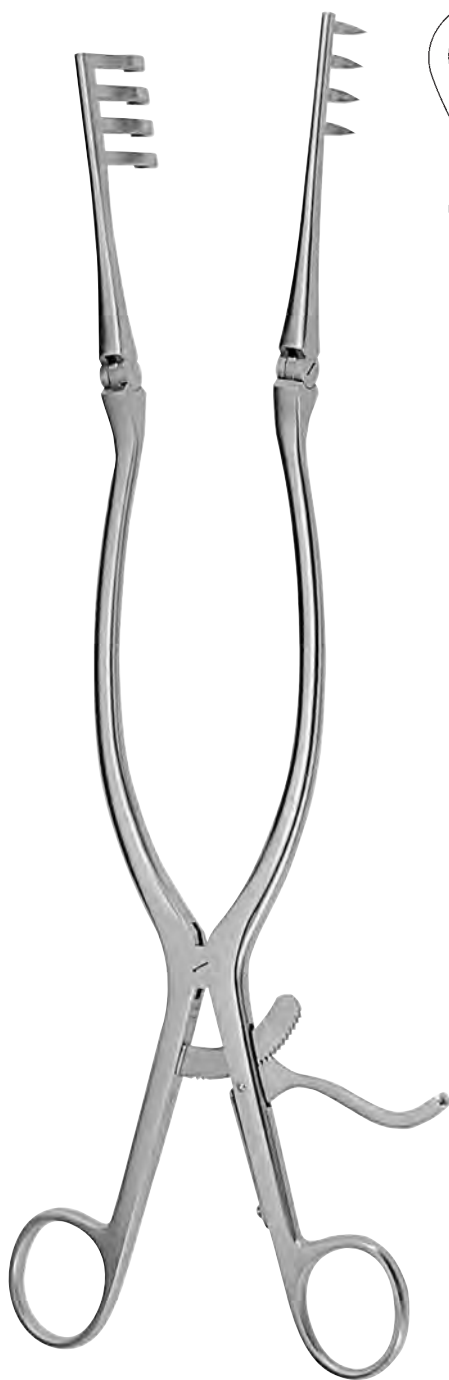

BECKMANN

016-590-320 32,0 cm / 12 1/2"

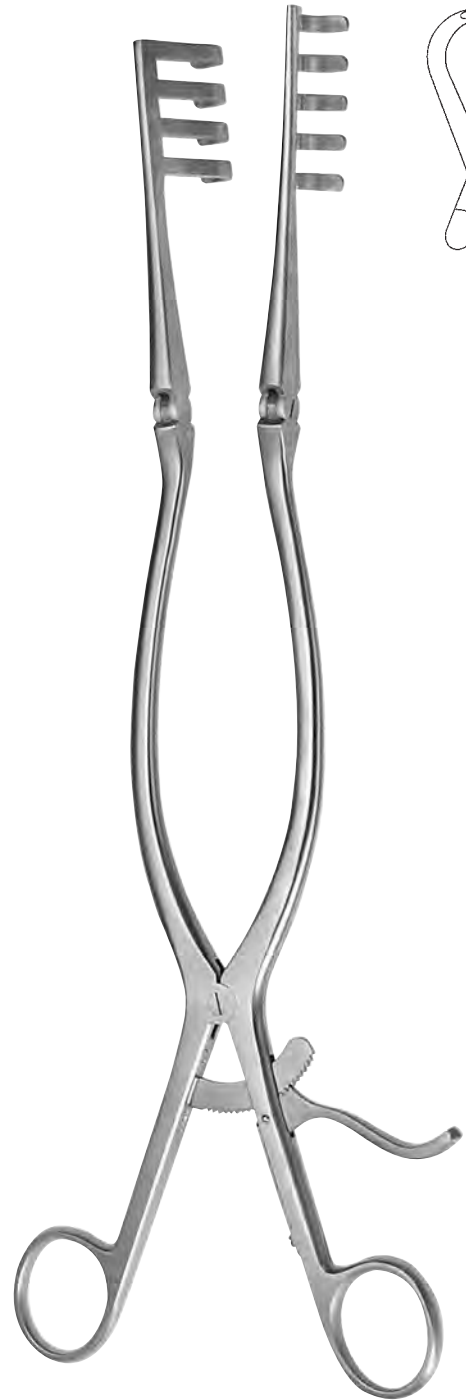
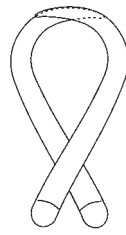

ADSON

016-592-330 33,0 cm / 13"

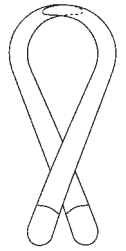

Wundspreizer
Self-Retaining Retractors
Separadores autoestáticos
Divaricatori autostatici

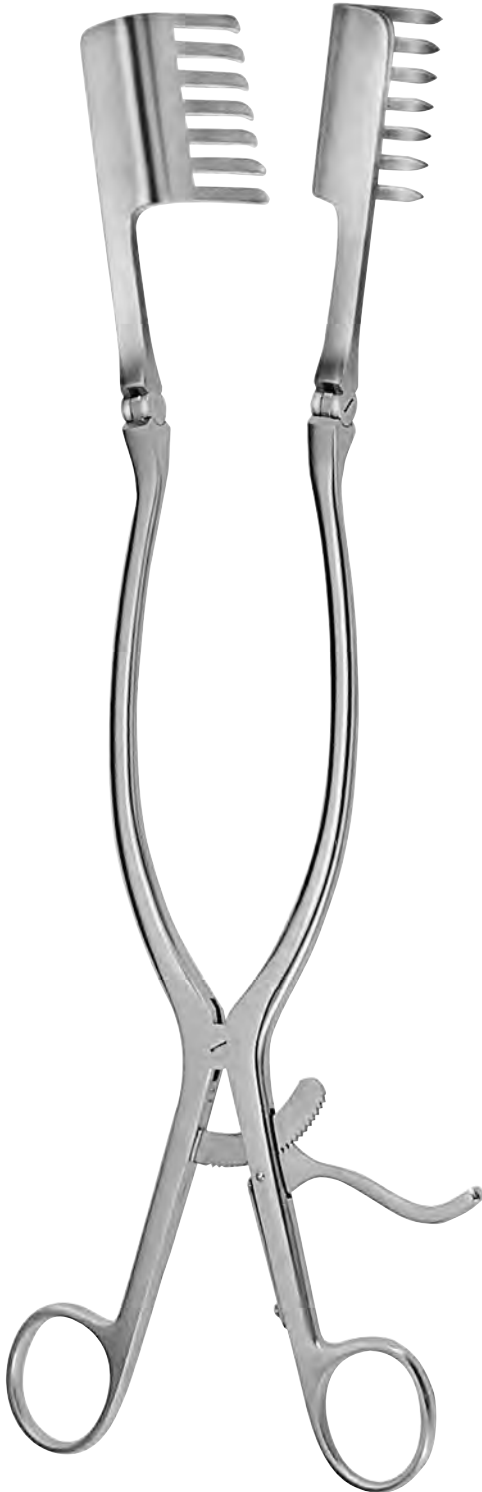

BECKMANN-EATON

016-594-320 32,0 cm / 12¹/₂"

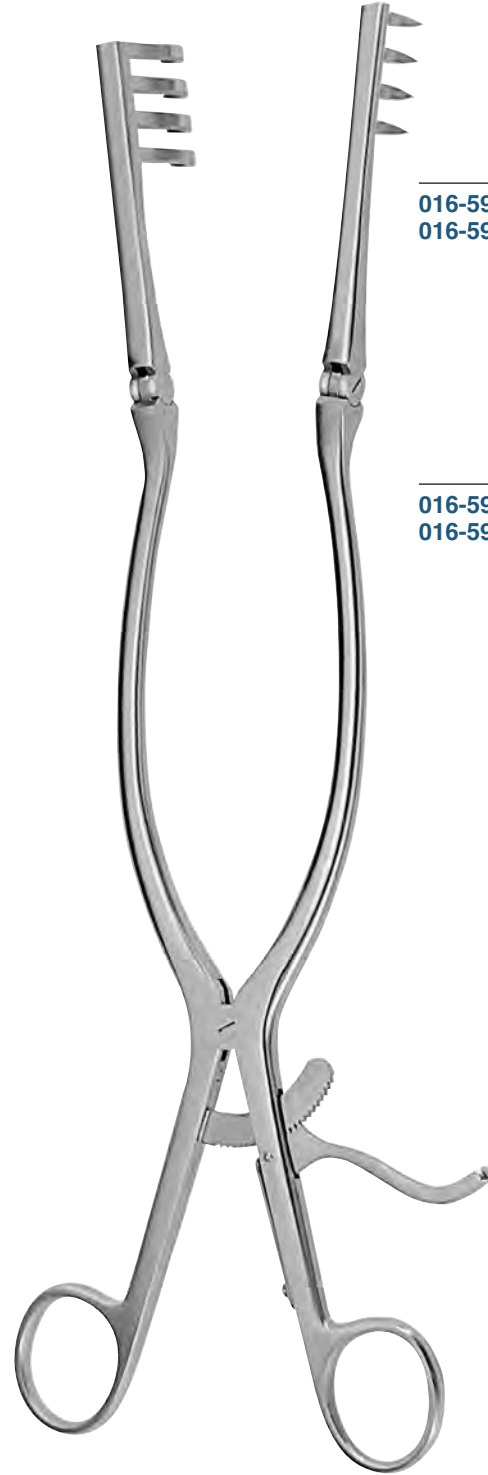

BECKMANN-ADSON

016-596-001 - 016-598-002 30,5 cm / 12¹/₄"



scharf
 sharp
 agudo
 acuto

016-596-001 25x25 mm
016-598-001 25x45 mm



stumpf
 blunt
 romo
 smusso

016-596-002 25x25 mm
016-598-002 25x45 mm



NORFOLK AND NORWICH
016-600-220 22,0 cm / 8³/₄"



RICHTER
016-620-170 17,0 cm / 6³/₄"

Wundspreizer
Self-Retaining Retractors
Separadores autoestáticos
Divaricatori autostatici



MAYO-ADAMS

016-622-165 16,5 cm / 6 1/2"



RIGBY

016-626-180 18,0 cm / 7"



JOLL (FRIEDMAN)

016-630-155 15,5 cm / 6"



GELPI

016-640-090 9,0 cm / 3 1/2"
016-640-110 11,0 cm / 4 3/8"



GELPI

016-640-130 13,0 cm / 5 1/8"



GELPI

016-640-160 16,0 cm / 6 1/4"
016-640-180 18,0 cm / 7"



GELPI-LOKTITE

016-641-180 18,0 cm / 7"

Wundspreizer für die cervicale Wirbelsäule
Retractors for cervical spine
Separadores para la columna cervical
Divaricatori per colonna cervicale



016-650-040 40x15-23 mm (axb)



016-650-045 45x15-23 mm (axb)



016-650-050 50x15-23 mm (axb)



016-650-055 55x15-23 mm (axb)



016-650-060 60x15-23 mm (axb)

CLOWARD

016-650-000

Wundspreizer, komplett, bestehend aus:

- 1 Sperrer (016-650-001)
- 2 gezahnten Seitenvalven 40x15 - 23 mm (016-650-040)
- 2 gezahnten Seitenvalven 45x15 - 23 mm (016-650-045)
- 2 gezahnten Seitenvalven 50x15 - 23 mm (016-650-050)
- 2 gezahnten Seitenvalven 55x15 - 23 mm (016-650-055)
- 2 gezahnten Seitenvalven 60x15 - 23 mm (016-650-060)

Self-retaining retractor, complete, consisting of:

- 1 Spreader (016-650-001)
- 2 Lateral valves, serrated, 40x15 - 23 mm (016-650-040)
- 2 Lateral valves, serrated, 45x15 - 23 mm (016-650-045)
- 2 Lateral valves, serrated, 50x15 - 23 mm (016-650-050)
- 2 Lateral valves, serrated, 55x15 - 23 mm (016-650-055)
- 2 Lateral valves, serrated, 60x15 - 23 mm (016-650-060)

Separador, completo, compuesto de:

- 1 Separador (016-650-001)
- 2 Valvas laterales, dentadas, 40x15 - 23 mm (016-650-040)
- 2 Valvas laterales, dentadas, 45x15 - 23 mm (016-650-045)
- 2 Valvas laterales, dentadas, 50x15 - 23 mm (016-650-050)
- 2 Valvas laterales, dentadas, 55x15 - 23 mm (016-650-055)
- 2 Valvas laterales, dentadas, 60x15 - 23 mm (016-650-060)

Divaricatore, completo, composto da:

- 1 Divaricatore (016-650-001)
- 2 Valve laterale, dentellata, 40x15 - 23 mm (016-650-040)
- 2 Valve laterale, dentellata, 45x15 - 23 mm (016-650-045)
- 2 Valve laterale, dentellata, 50x15 - 23 mm (016-650-050)
- 2 Valve laterale, dentellata, 55x15 - 23 mm (016-650-055)
- 2 Valve laterale, dentellata, 60x15 - 23 mm (016-650-060)



CLOWARD

016-650-001 25,0 cm / 9³/₄"

Wundspreizer für die cervicale Wirbelsäule
Retractors for cervical spine
Separadores para la columna cervical
Divaricatori per colonna cervicale



016

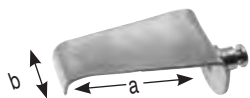

016-660-040 40x15-23 mm (axb)



016-660-045 45x15-23 mm (axb)



016-660-050 50x15-23 mm (axb)



016-660-055 55x15-23 mm (axb)



016-660-060 60x15-23 mm (axb)

CLOWARD

016-660-000

Wundspreizer, komplett, bestehend aus:

- 1 Sperrer (016-660-001)
- 2 stumpfen Seitenvalven 40x15 - 23 mm (016-660-040)
- 2 stumpfen Seitenvalven 45x15 - 23 mm (016-660-045)
- 2 stumpfen Seitenvalven 50x15 - 23 mm (016-660-050)
- 2 stumpfen Seitenvalven 55x15 - 23 mm (016-660-055)
- 2 stumpfen Seitenvalven 60x15 - 23 mm (016-660-060)

Self-retaining retractor, complete, consisting of:

- 1 Spreader (016-660-001)
- 2 Lateral valves, blunt, 40x15 - 23 mm (016-660-040)
- 2 Lateral valves, blunt, 45x15 - 23 mm (016-660-045)
- 2 Lateral valves, blunt, 50x15 - 23 mm (016-660-050)
- 2 Lateral valves, blunt, 55x15 - 23 mm (016-660-055)
- 2 Lateral valves, blunt, 60x15 - 23 mm (016-660-060)

Separador, completo, compuesto de:

- 1 Separador (016-660-001)
- 2 Valvas laterales, romas, 40x15 - 23 mm (016-660-040)
- 2 Valvas laterales, romas, 45x15 - 23 mm (016-660-045)
- 2 Valvas laterales, romas, 50x15 - 23 mm (016-660-050)
- 2 Valvas laterales, romas, 55x15 - 23 mm (016-660-055)
- 2 Valvas laterales, romas, 60x15 - 23 mm (016-660-060)

Divaricatore, completo, composto da:

- 1 Divaricatore (016-660-001)
- 2 Valve laterale, smussa, 40x15 - 23 mm (016-660-040)
- 2 Valve laterale, smussa, 45x15 - 23 mm (016-660-045)
- 2 Valve laterale, smussa, 50x15 - 23 mm (016-660-050)
- 2 Valve laterale, smussa, 55x15 - 23 mm (016-660-055)
- 2 Valve laterale, smussa, 60x15 - 23 mm (016-660-060)



CLOWARD

016-660-001 15,0 cm /6"

Wundspreizer, Bauchdeckenhalter
Self-Retaining Retractors, Abdominal Retractors
Separadores autoestáticos, Separadores abdominales
Divaricatori autostatici, Divaricatori addominali



016-670-030 30x44 mm

016-670-023 23x44 mm

Wechselvalven
 Exchangeable blades
 Valvas intercambiables
 Valve intercambiabili

BABY-COLLIN

016-670-000 18,0 cm / 7"



COLLIN

016-680-000 22,5 cm / 9"



COLLIN

016-682-000 22,5 cm / 9 1/4"

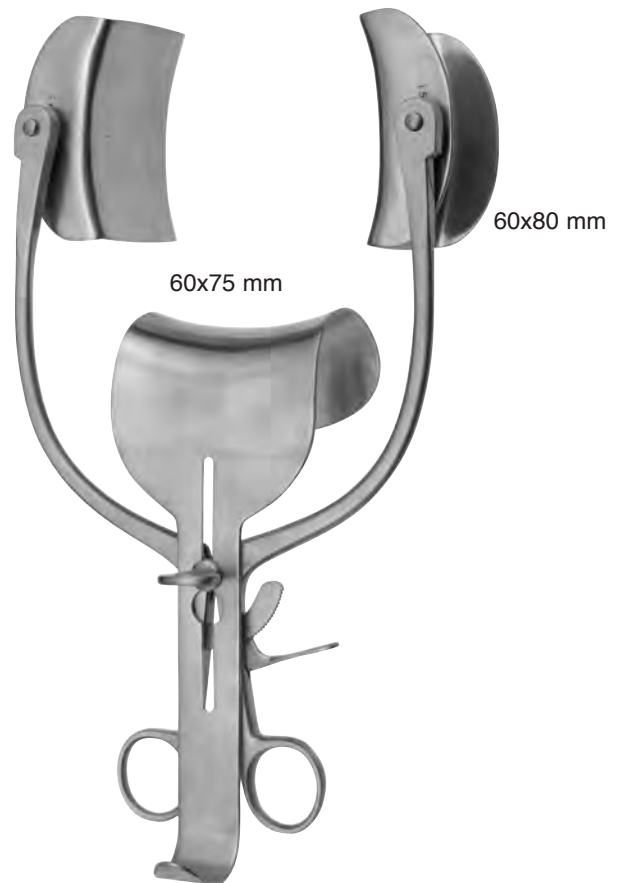

COLLIN-LOKTITE

016-684-000 31,0 cm / 12 1/4"

Wundspreizer, Bauchdeckenhalter
Self-Retaining Retractors, Abdominal Retractors
Separadores autoestáticos, Separadores abdominales
Divaricatori autostatici, Divaricatori addominali



016

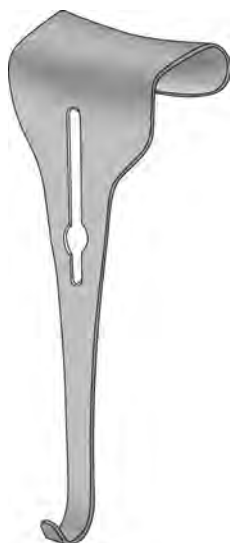

COLLIN

016-686-055	55x55 mm
016-686-065	55x65 mm
016-686-075	55x75 mm

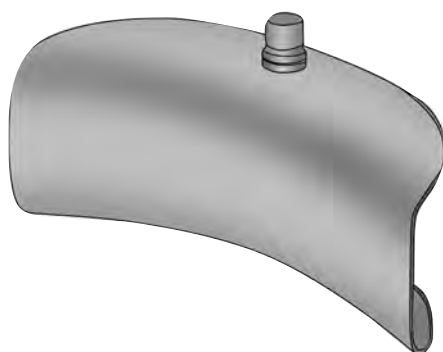

016-688-001	32x 62 mm
016-688-002	38x 80 mm
016-688-003	38x100 mm

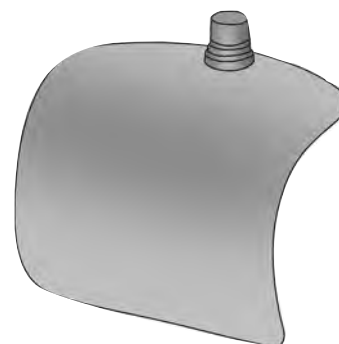

016-688-004	60x80 mm
--------------------	----------

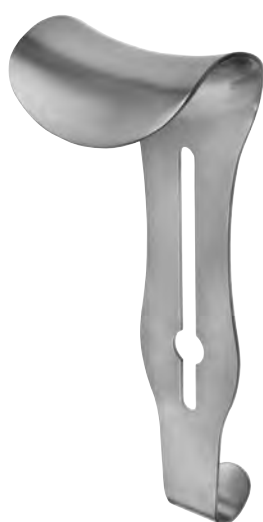

RICARD

016-711-001	55x70 mm
016-711-002	90x80 mm



016-713-050	50x58 mm
016-713-060	60x80 mm
016-713-072	72x85 mm

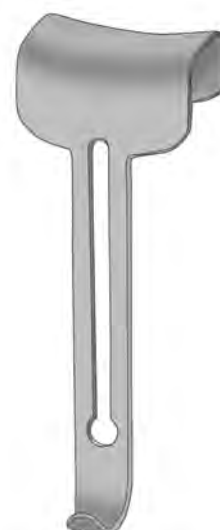

ROBIN-MASSE

016-721-001	40x64 mm
--------------------	----------



016

Wundspreizer, Bauchdeckenhalter
Self-Retaining Retractors, Abdominal Retractors
Separadores autoestáticos, Separadores abdominales
Divaricatori autostatici, Divaricatori addominali

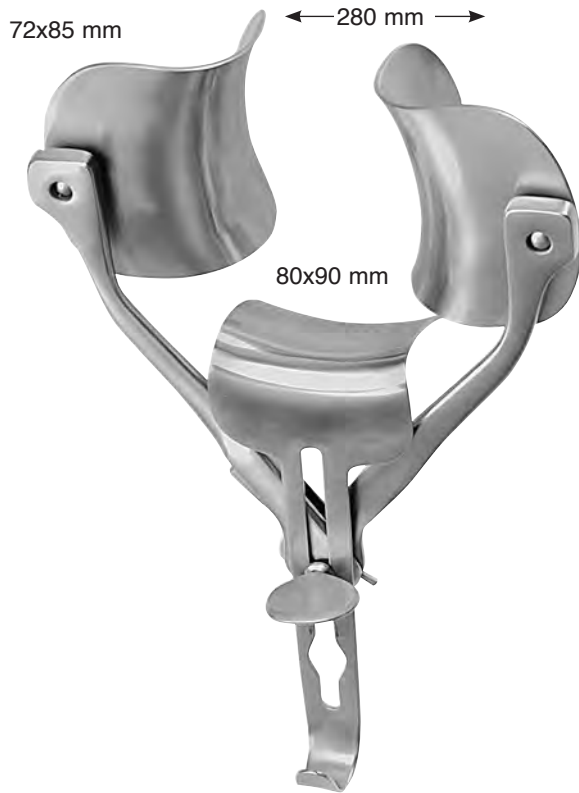

RICARD

016-700-280 28,0 cm / 11"

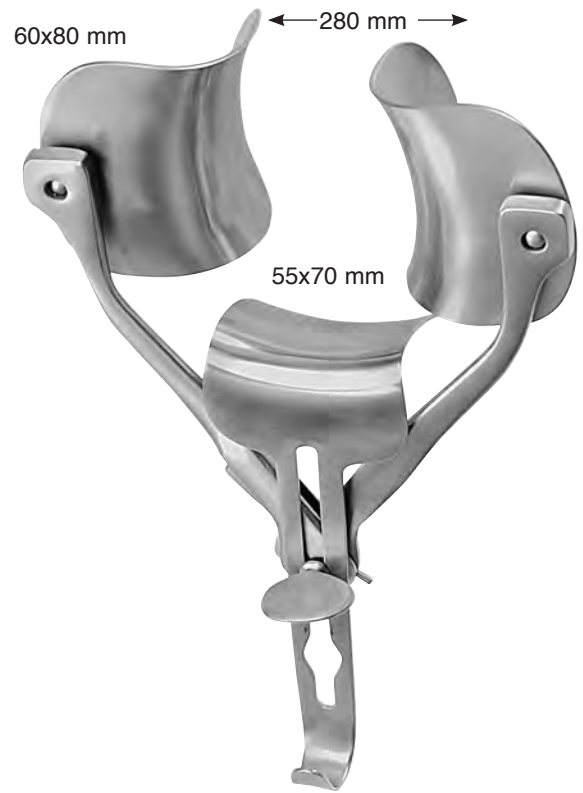

RICARD

016-710-300 30,0 cm / 12"

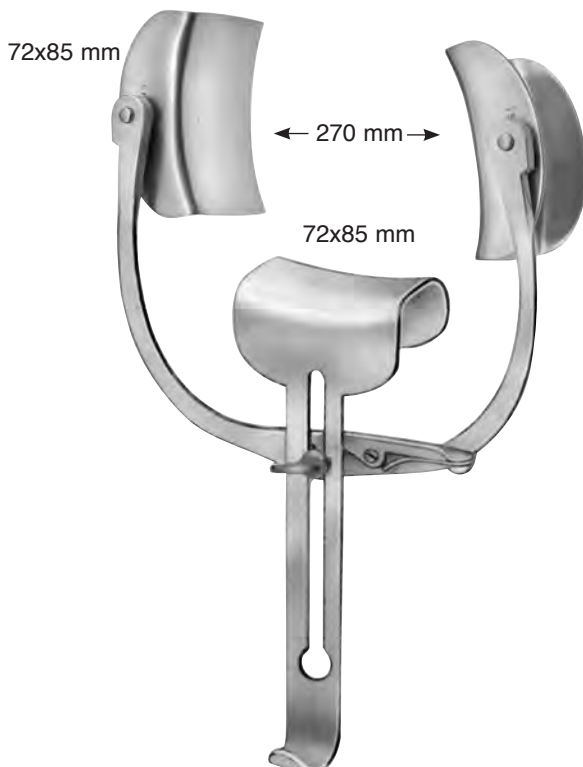

ROBIN-MASSE

016-720-270

Bauchdeckenhalter
Abdominal Retractors
Separadores abdominales
Divaricatori addominali



016

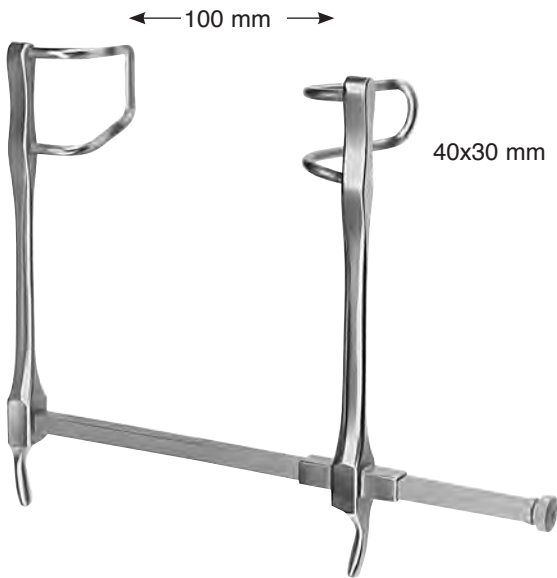

GOSSET
016-730-100

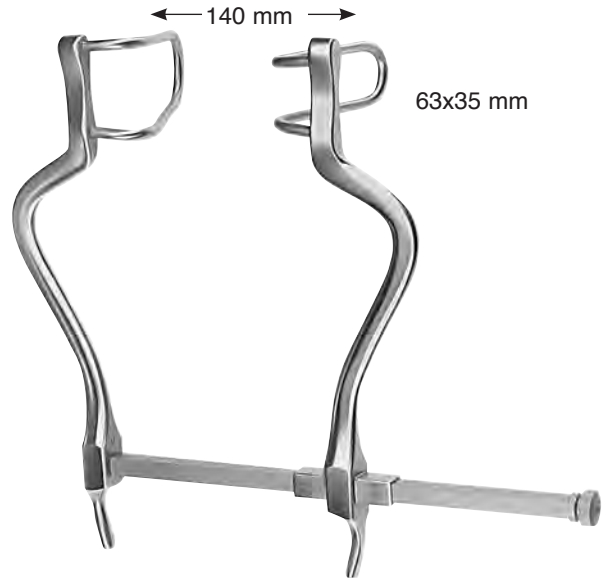

GOSSET
016-730-140

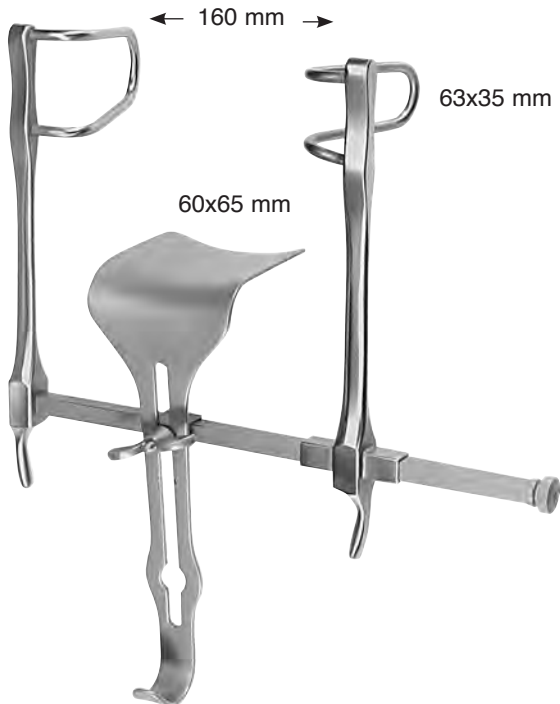

GOSSET
016-730-160

016-731-060 60x65 mm
Mittelvalve
Central blade
Valva central
Valva centrale

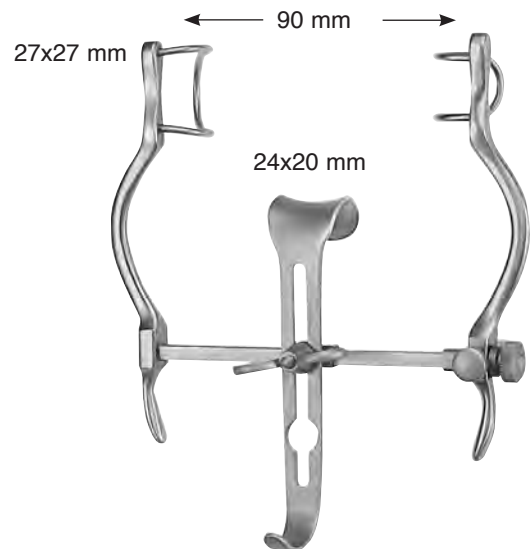

BABY-BALFOUR
016-740-090



016

Bauchdeckenhalter
Abdominal Retractors
Separadores abdominales
Divaricatori addominali

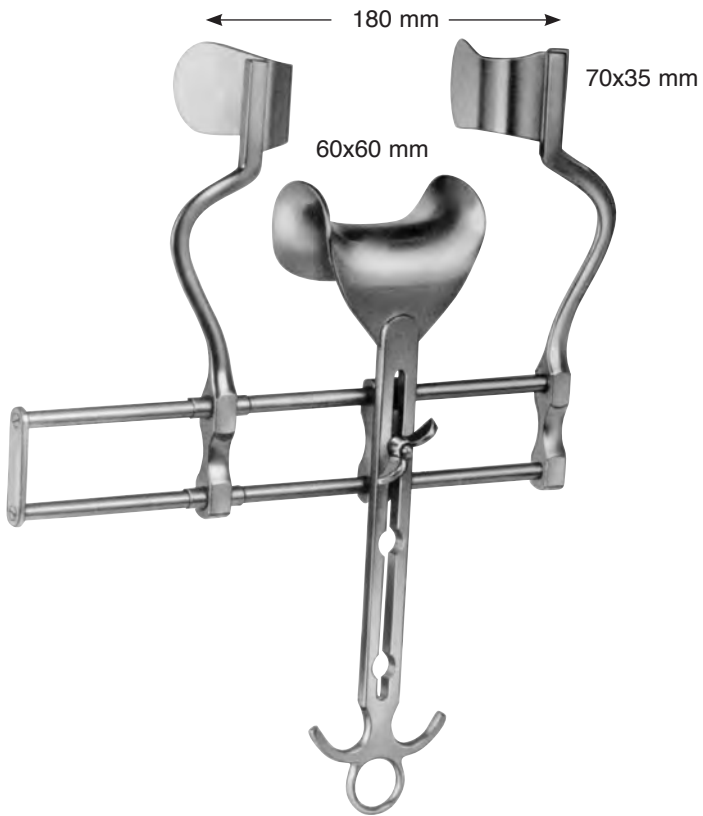

BALFOUR
016-746-180

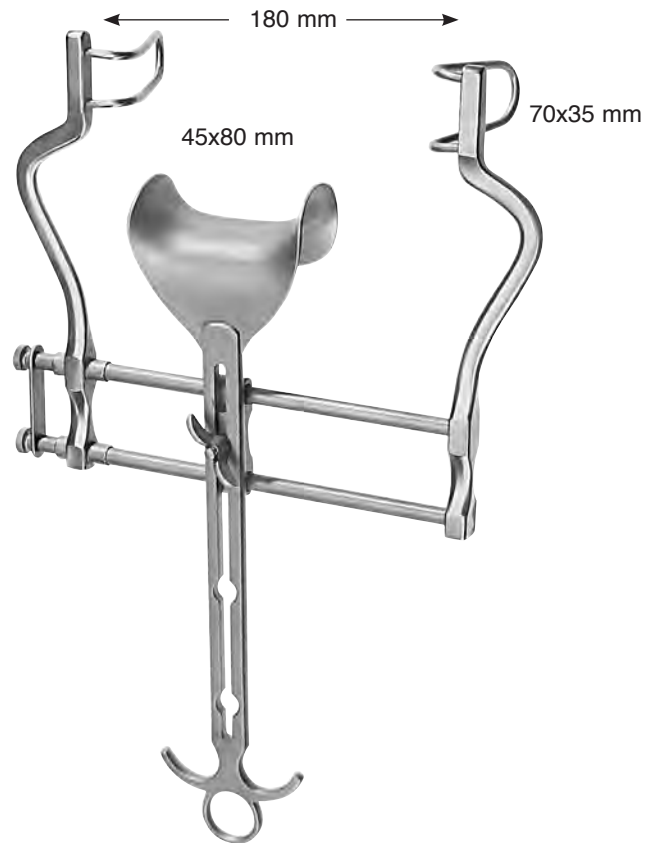

BALFOUR
016-750-180

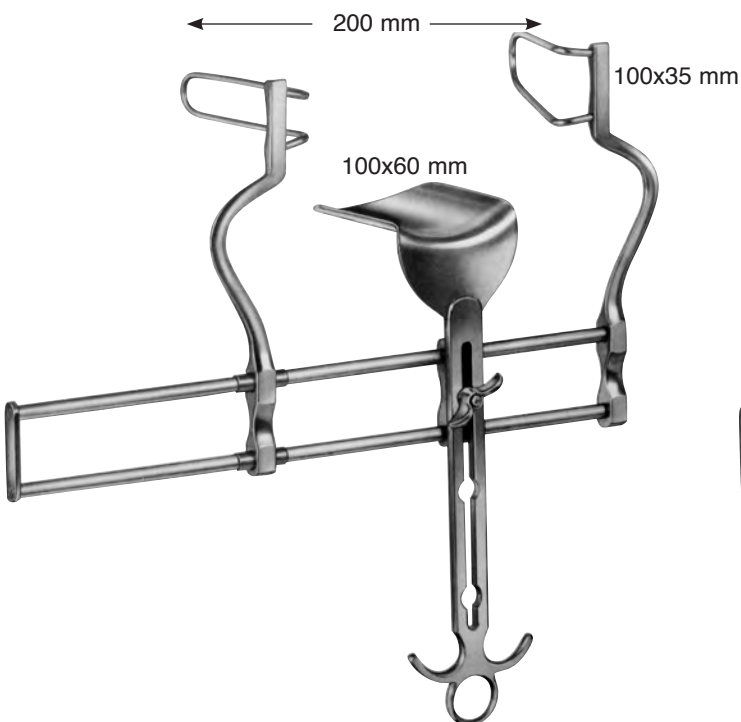

BALFOUR
016-750-200

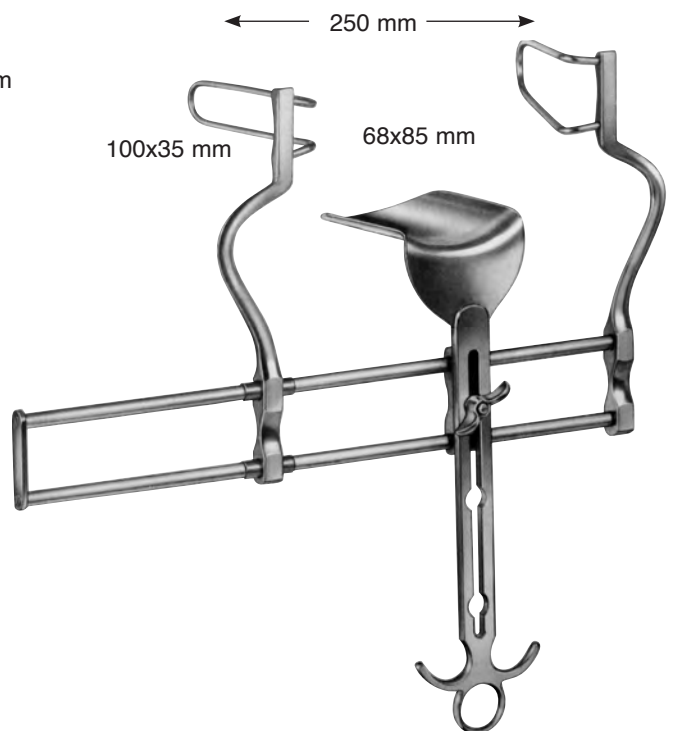

BALFOUR
016-750-250

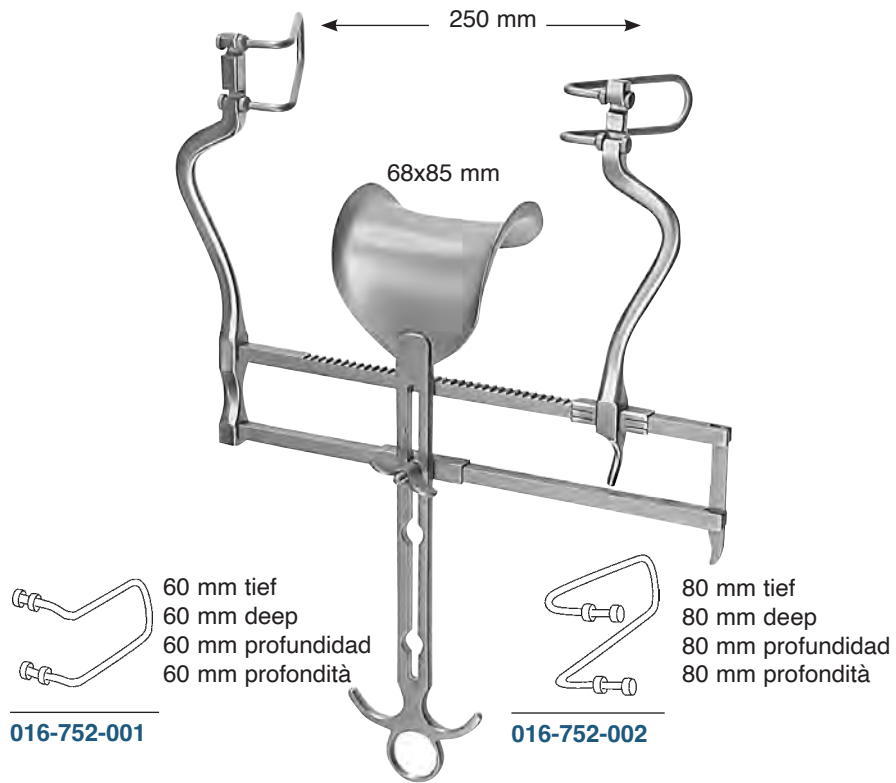

BALFOUR US-TYPE
016-752-000

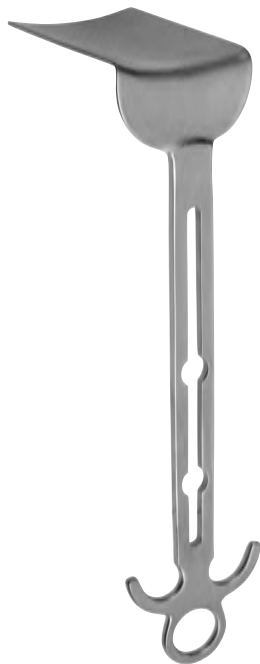

BALFOUR
016-756-100 100x60 mm



BALFOUR
016-758-001 45x80 mm
016-758-002 68x85 mm

Bauchdeckenhalter
Abdominal Retractors
Separadores abdominales
Divaricatori addominali

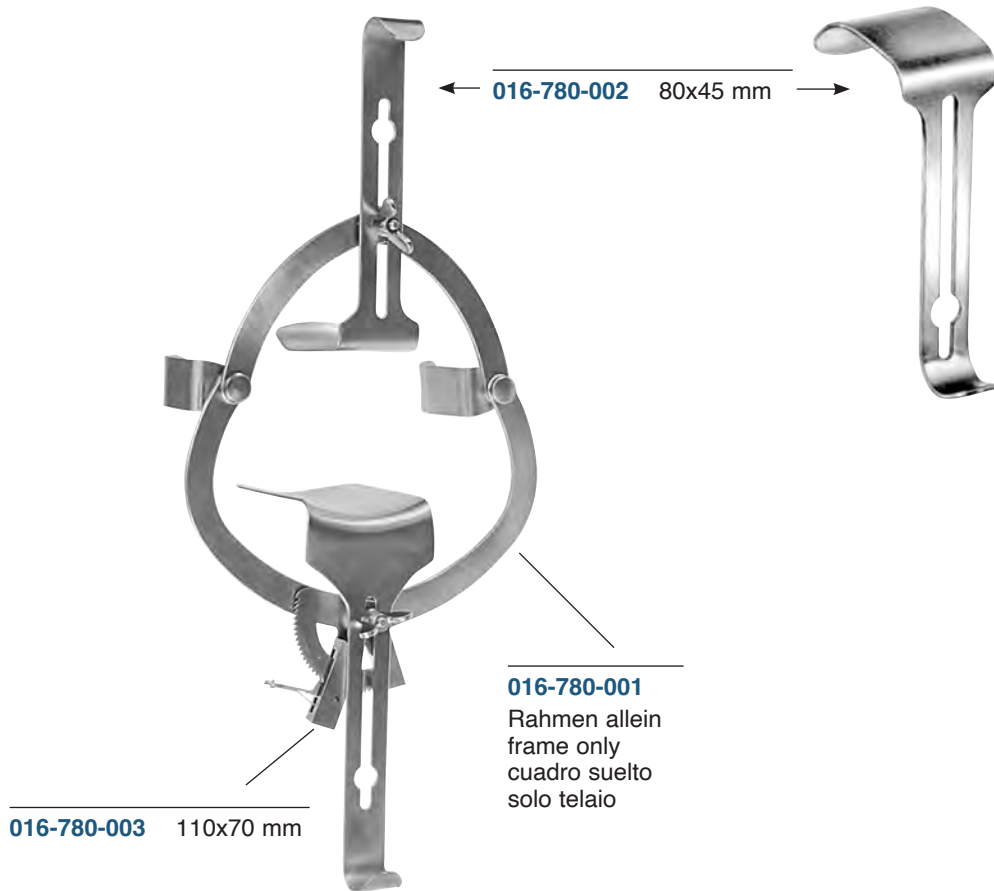

016-780-003 110x70 mm

016-780-002 80x45 mm

016-780-001
 Rahmen allein
 frame only
 cuadro suelto
 solo telaio

O`SULLIVAN-O`CONNOR

016-780-000

komplett, complete, completo, completo
 1 x 016-780-001
 2 x 016-780-002
 1 x 016-780-003

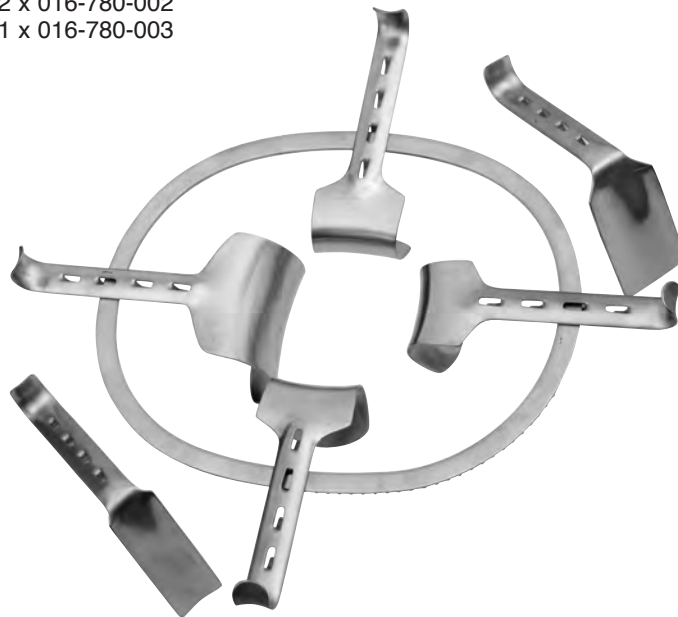

KIRSCHNER

016-800-000

komplett, complete, completo, completo
 1 x 016-800-001
 3 x 016-811-002
 1 x 016-811-003
 1 x 016-813-001
 1 x 016-813-002

016-800-001 300 x 240 mm

Rahmen allein
 frame only
 cuadro suelto
 telaio solo

Bauchdeckenhalter
Abdominal Retractors
Separadores abdominales
Divaricatori addominali



016

016-811-002 50x65 mm

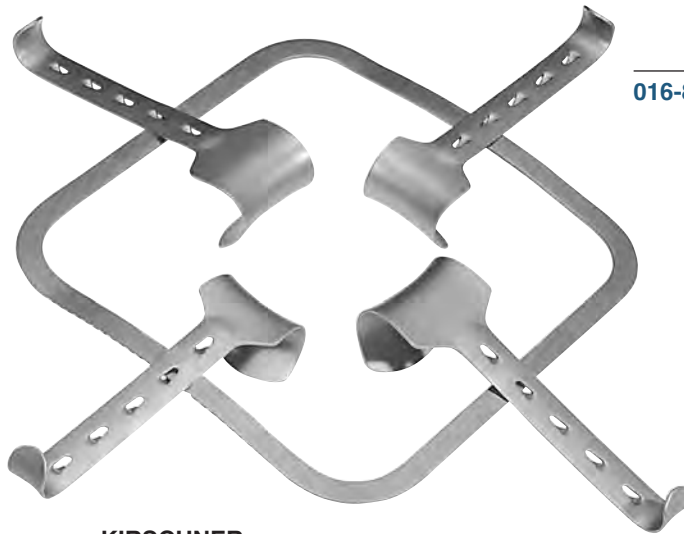

016-811-001 40x55 mm

016-810-001 240x240 mm

Rahmen allein
 frame only
 cuadro suelto
 telaio solo

KIRSCHNER

016-810-000

komplett, complete, completo, completo

1 x 016-810-001

2 x 016-811-001

2 x 016-811-002



KIRSCHNER

016-811-003 80x90 mm

016-811-004 90x65 mm



KIRSCHNER

016-811-005 60x85 mm



KIRSCHNER-BALFOUR

016-811-010 80x80 mm



KIRSCHNER

016-813-001 98x50 mm

016-813-002 105x35 mm

KIRSCHNER

016-814-000 270x270 mm

komplett, complete, completo, completo

1 x 016-814-001

2 x 016-811-001

2 x 016-811-002

016-814-001 270x270 mm

zusammenlegbarer Rahmen, allein

folding frame, only

cuadro plegable, suelto

telaio pieghevole, solo

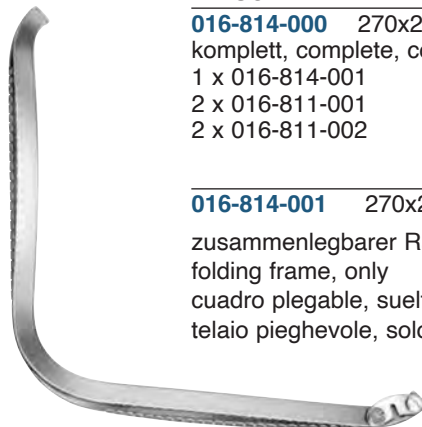

Bauchdeckenhalter
Abdominal Retractors
Separadores abdominales
Divaricatori addominali

016-820-005 45x57 mm



016-820-004 83x94 mm

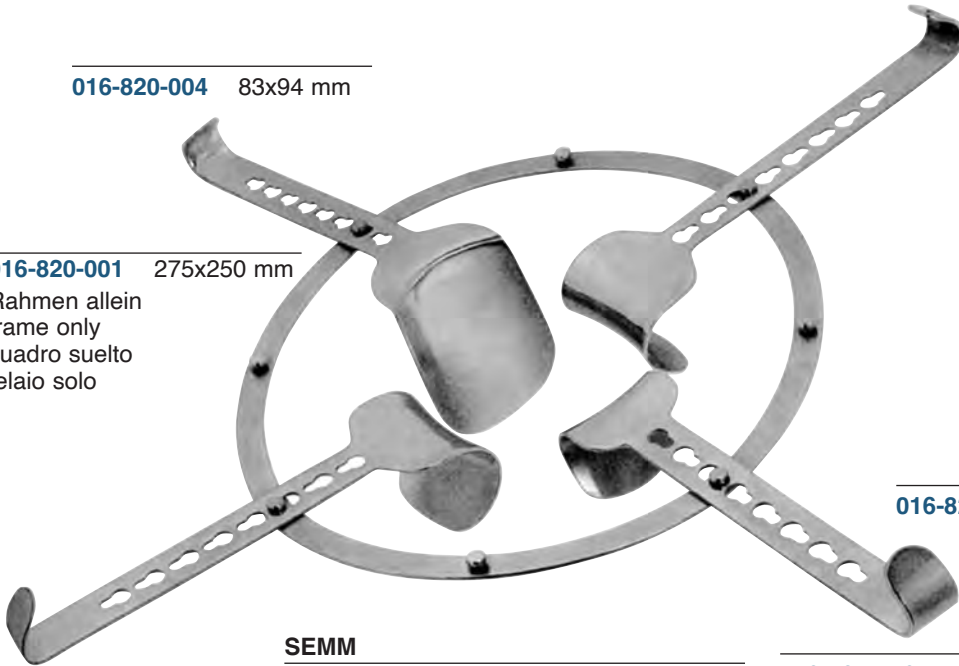

016-820-001 275x250 mm

Rahmen allein
 frame only
 cuadro suelto
 telaio solo

016-820-002 98x50 mm

016-820-003 105x35 mm

SEMM

016-820-000

komplett, complete, completo, completo

1 x 016-820-001

1 x 016-820-002

1 x 016-820-003

1 x 016-820-004

2 x 016-820-005

1 x 016-820-006

016-820-006 50x54 mm

016-832-004 40x40 mm

016-832-003 40x30 mm

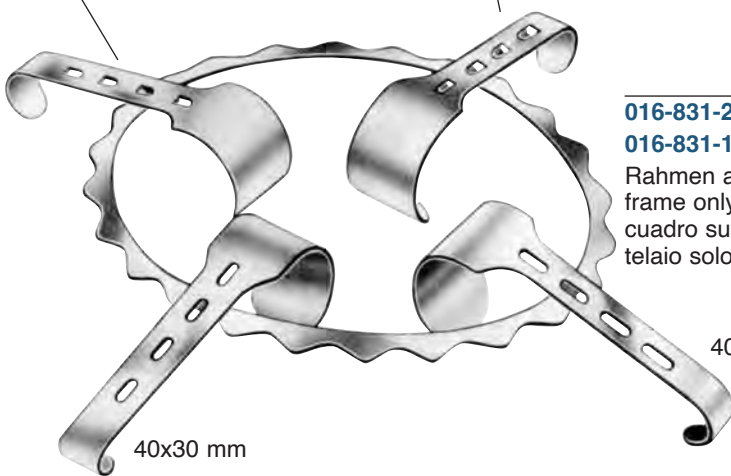

016-831-255 255x180 mm

016-831-150 150x180 mm

Rahmen allein
 frame only
 cuadro suelto
 telaio solo

40x40 mm

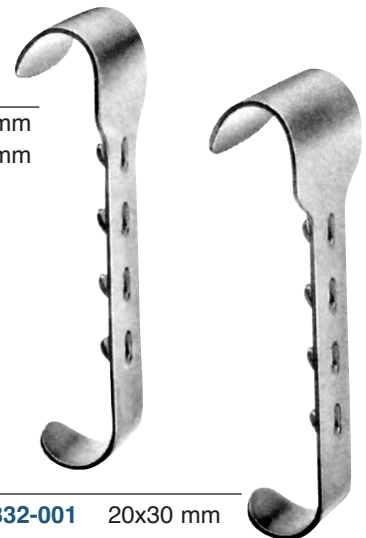

016-832-001 20x30 mm

016-832-002 20x40 mm

DENIS-BROWNE

016-830-150

1 x 016-831-150

2 x 016-832-003

2 x 016-832-004

DENIS-BROWNE

016-830-255

1 x 016-831-255

2 x 016-832-003

2 x 016-832-004

Bauchdeckenhalter
Abdominal Retractors
Separadores abdominales
Divaricatori addominali



016

016-840-004 40x60 mm



016-840-002 48x56 mm

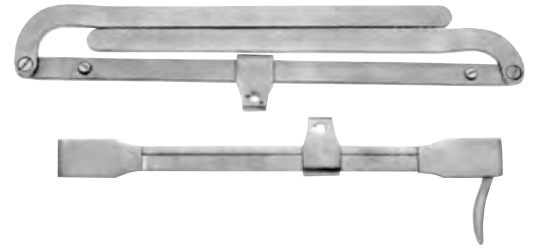

016-840-001 220x220 mm
 zusammenlegbarer Rahmen, allein
 folding frame, only
 cuadro plegable, suelto
 telaio piegabile, solo

FRANZ

016-840-000

komplett, complete, completo, completo
 1 x 016-840-001
 2 x 016-840-002
 2 x 016-840-004

FRANZ

016-842-000

komplett, complete, completo, completo
 1 x 016-840-001
 2 x 016-840-002
 2 x 016-840-003
 2 x 016-840-004
 2 x 016-840-005



016-840-004 40x60 mm
016-840-005 40x80 mm

016-840-002 48x56 mm
016-840-003 50x85 mm



Kette mit Gewicht
 Chain with weight
 Cadena con peso
 Catena con peso

DOYEN

016-850-001 28,0 cm /11" 90x50 mm
016-850-002 28,0 cm /11" 105x50 mm
016-850-003 28,0 cm /11" 120x50 mm
016-850-004 28,0 cm /11" 135x50 mm

016-851-000 79,0 cm /31"

Bauchdeckenhalter
Abdominal Retractors
Separadores abdominales
Divaricatori addominali



ROCHARD
016-860-000



ROCHARD
016-870-000



ROCHARD
016-871-001 19,0 cm /11"

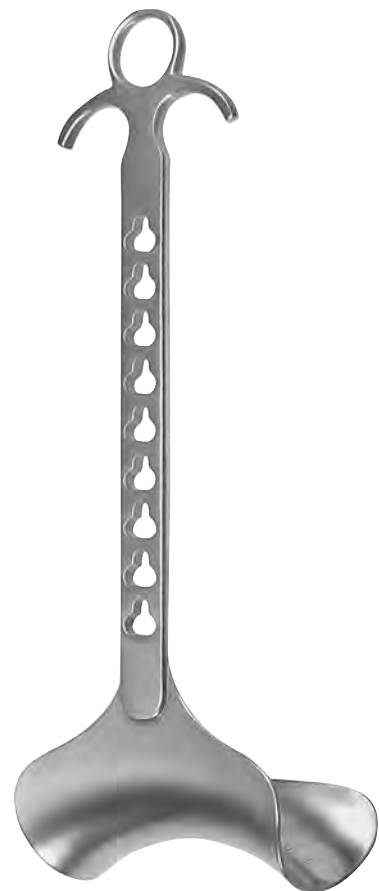

ROCHARD

016-871-002	28,0 cm /11"	95x50 mm
016-871-003	28,0 cm /11"	105x50 mm
016-871-004	28,0 cm /11"	120x60 mm
016-871-005	28,0 cm /11"	135x60 mm
016-871-006	28,0 cm /11"	155x60 mm

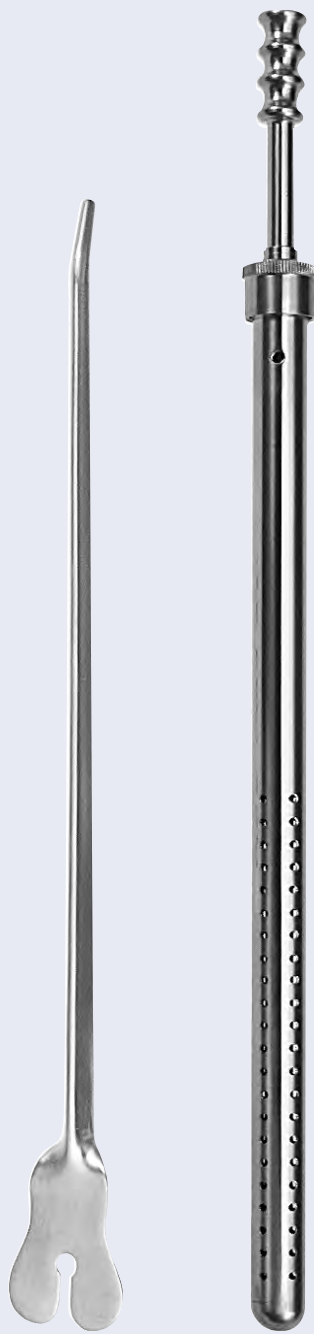

017

Sonden, Aspiration
Probes, Aspiration
Sondas, Aspiración
Sonde, Aspirazione



017

**Sonden
Probes
Sondas
Sonde**



ø 1,0 mm	ø 1,5 mm	ø 2,0 mm	
017-010-115	017-012-115	017-014-115	11,5 cm / 4 1/2"
017-010-130	017-012-130	017-014-130	13,0 cm / 5"
017-010-145	017-012-145	017-014-145	14,5 cm / 5 3/4"
017-010-160	017-012-160	017-014-160	16,0 cm / 6 1/4"
017-010-180	017-012-180	017-014-180	18,0 cm / 7"
017-010-200	017-012-200	017-014-200	20,0 cm / 8"
	017-012-250	017-014-250	25,0 cm / 9 3/4"
		017-014-300	30,0 cm / 11 3/4"

ø 2,0 mm	
017-020-115	11,5 cm / 4 1/2"
017-020-130	13,0 cm / 5"
017-020-145	14,5 cm / 5 3/4"
017-020-160	16,0 cm / 6 1/4"
017-020-180	18,0 cm / 7"
017-020-200	20,0 cm / 8"
017-020-250	25,0 cm / 9 3/4"

Ø 1,0 mm



Silber
Silver
Plata
argento

**STACKE**

017-030-105 10,5 cm / 4 1/8"

ø 1,5 mm	ø 2,0 mm	ø 3,5 mm	
-	017-040-130	017-050-115	11,5 cm / 4 1/2"
017-035-145	017-040-145	017-050-130	13,0 cm / 5"
-	017-040-160	017-050-145	14,5 cm / 5 3/4"
-	017-040-180	017-050-160	16,0 cm / 6 1/4"
-	017-040-200	017-050-180	18,0 cm / 7"
		017-050-200	20,0 cm / 8"



ø 3,3 mm

- 017-060-130** 13,0 cm / 5"
- 017-060-145** 14,5 cm / 5³/₄"
- 017-060-160** 16,0 cm / 6¹/₄"
- 017-060-180** 18,0 cm / 7"
- 017-060-200** 20,0 cm / 8"



DOYEN

- 017-071-145** 14,5 cm / 5³/₄"



NELATON

- 017-073-160** 16,0 cm / 6¹/₄"



BRODIE

- 017-080-200** 20,0 cm / 8"



LOCKHARD-MUMMERY

- 017-090-001** 16,5 cm / 6¹/₂"

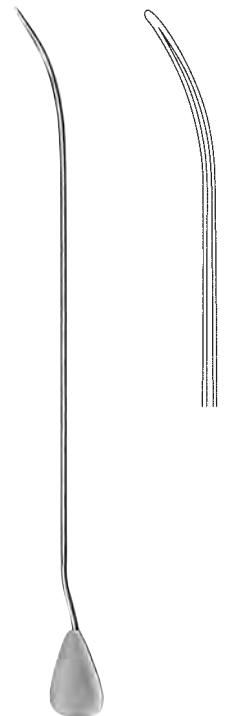

LOCKHARD-MUMMERY

- 017-090-002** 16,5 cm / 6¹/₂"



017

**Sonden, Phlebo-dissektor
Probes, Phlebo-dissectors
Sondas, Flebodisecadores
Sonde, Flebo-dissettori**

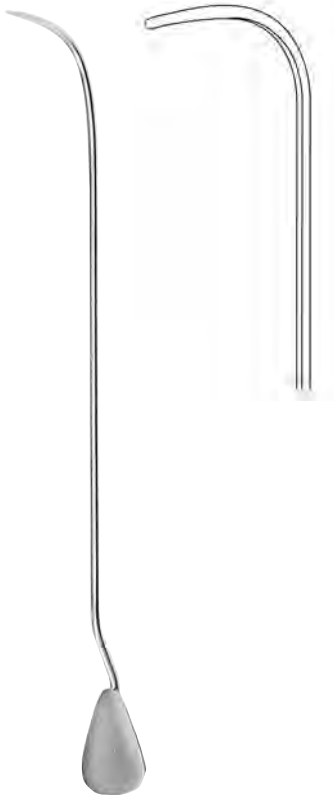

LOCKHARD-MUMMERY

017-090-003 16,5 cm / 6 1/2"

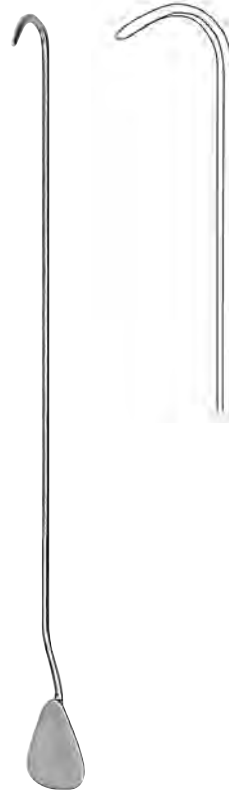

LOCKHARD-MUMMERY

017-090-004 16,5 cm / 6 1/2"

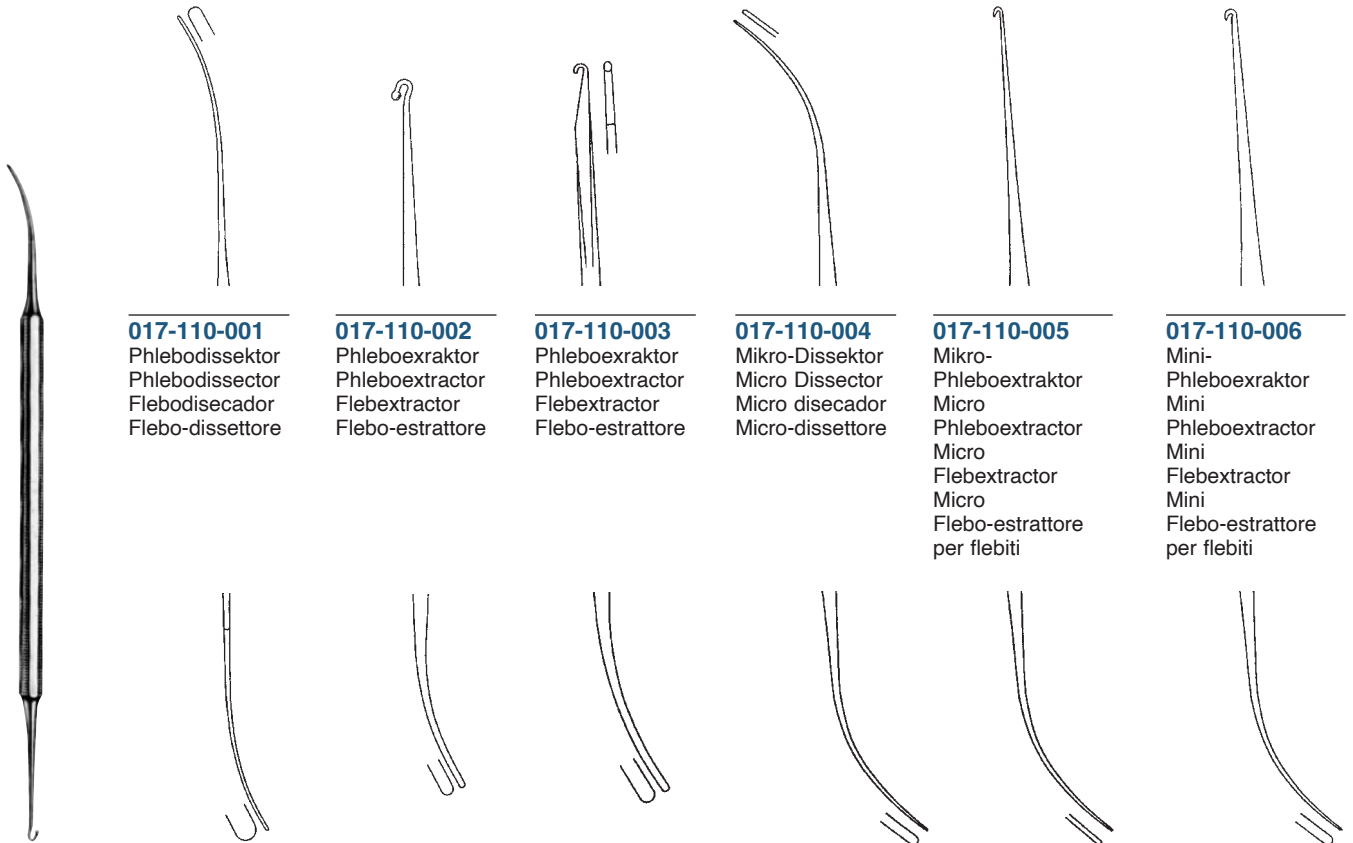

017-110-001

Phlebo-dissektor
Phlebo-dissector
Flebodisecador
Flebo-dissetttore

017-110-002

Phleboexraktor
Phleboextractor
Flebextractor
Flebo-estrattore

017-110-003

Phleboexraktor
Phleboextractor
Flebextractor
Flebo-estrattore

017-110-004

Mikro-Dissektor
Micro Dissector
Micro disecador
Micro-dissetttore

017-110-005

Mikro-
Phleboexraktor
Micro
Phleboextractor
Micro
Flebextractor
Micro
Flebo-estrattore
per flebiti

017-110-006

Mini-
Phleboexraktor
Mini
Phleboextractor
Mini
Flebextractor
Mini
Flebo-estrattore
per flebiti

VARADY

017-110-001 - 017-110-006 18,0 cm / 7"

Krampfader-Besteck
Varicose Vein Probe Set
Juego para várices
Astuccio per varici



017



017-100-001 135x100x25 mm

Metalletui
 Metal case
 Estuche de metal
 Scatola in metallo

NABATOFF

017-100-000

komplett
 complete
 completo
 completo



017-100-003
 Ø 3,0 mm



017-100-006
 Ø 6,0 mm



017-100-009
 Ø 9,0 mm

017-100-021

Zugseil
 Cable
 Cable
 Fune

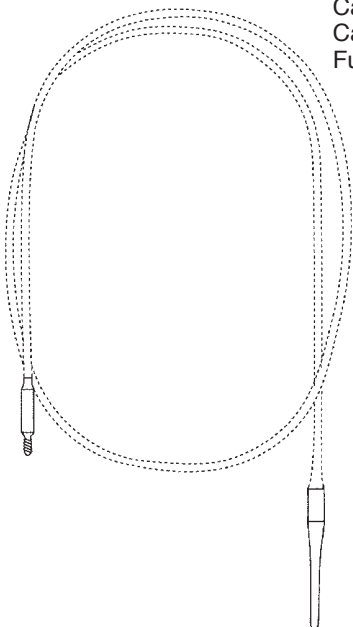

017-100-012
 Ø 12,0 mm

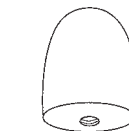

017-100-015
 Ø 15,0 mm

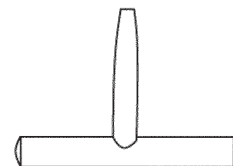

017-100-020
 Handgriff
 Handle
 Mango
 Manico

017-100-002

Kunststoff-Sondenspitze
 Plastic probe tip
 Punta de sonda de plastico
 Punta di sonda di plastica

**Sonden, Phlebotomier
Probes, Phlebotomizers
Sondas, Flebotomizadores
Sonde, Flebo-dissettori**

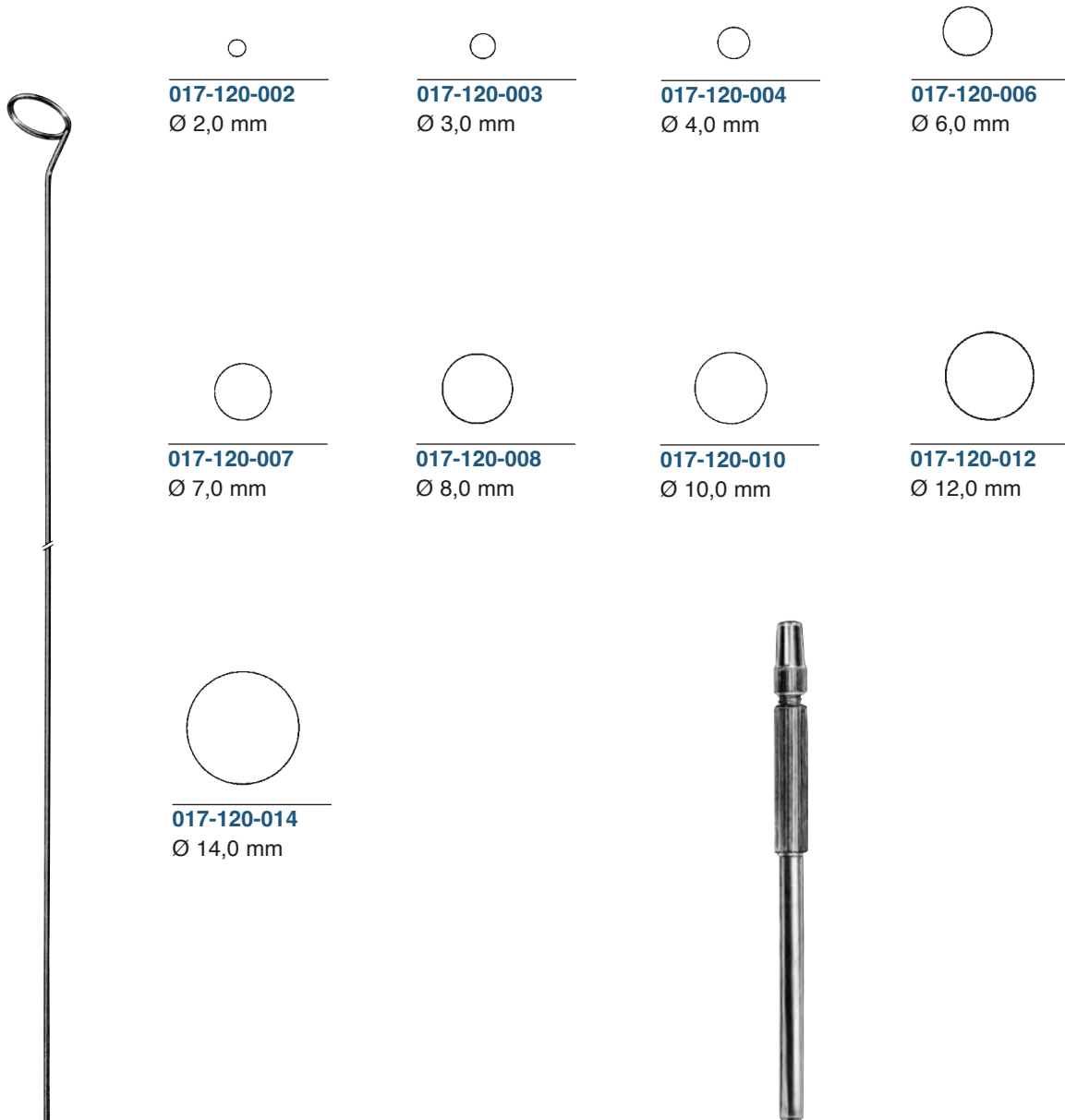

017-120-002
Ø 2,0 mm

017-120-003
Ø 3,0 mm

017-120-004
Ø 4,0 mm

017-120-006
Ø 6,0 mm

017-120-007
Ø 7,0 mm

017-120-008
Ø 8,0 mm

017-120-010
Ø 10,0 mm

017-120-012
Ø 12,0 mm

017-120-014
Ø 14,0 mm

VOLLMAR

017-120-002 - 017-120-012 50 cm / 19³/₄"

017-122-120 12,0 cm / 4²/₃"

Handgriff für Ringstripper nach Vollmar
Handle for Vollmar Ring Stripper
Mango para Vollmar fleboextractor
Manico per stripper anello di Vollmar



JOBSON-HORNE

017-150-180 18,0 cm / 7"

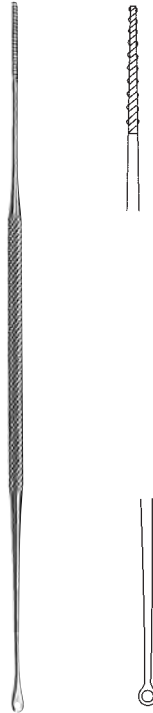

UCKERMANN

017-154-160 16,0 cm / 6 1/4"



FARRELL

017-160-120	Ø 0,9 mm	12,0 cm / 4 3/4"
017-160-140	Ø 0,9 mm	14,0 cm / 5 1/2"
017-160-160	Ø 1,1 mm	16,5 cm / 6 1/2"
017-160-180	Ø 1,2 mm	18,0 cm / 7"



FARRELL

017-170-120	Ø 0,9 mm	12,0 cm / 4 3/4"
017-170-140	Ø 0,9 mm	14,0 cm / 5 1/2"
017-170-160	Ø 1,1 mm	16,5 cm / 6 1/2"
017-170-180	Ø 1,2 mm	18,0 cm / 7"

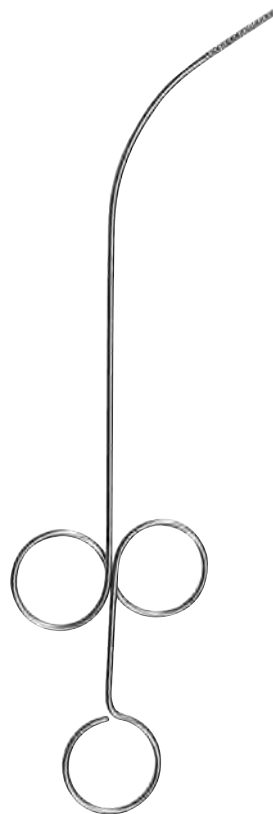

FEIN

017-180-280 28,0 cm / 11"

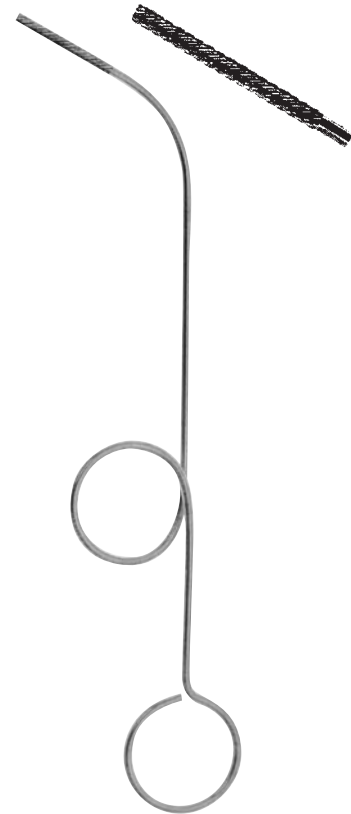

PELTESON

017-184-230 23,0 cm / 9"



017

**Trokare
Trocars
Trócares
Trequarti**

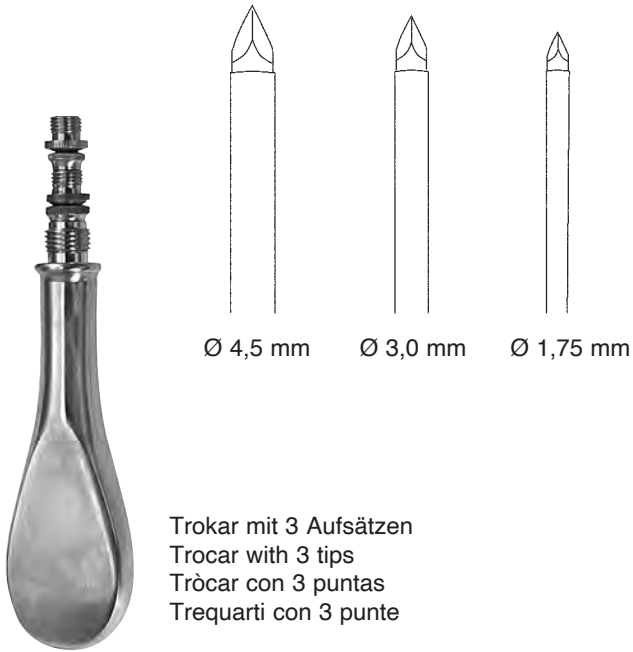

Trokar mit 3 Aufsätzen
Trocar with 3 tips
Tròcar con 3 puntas
Trequarti con 3 punte

UNIVERSAL
017-200-003

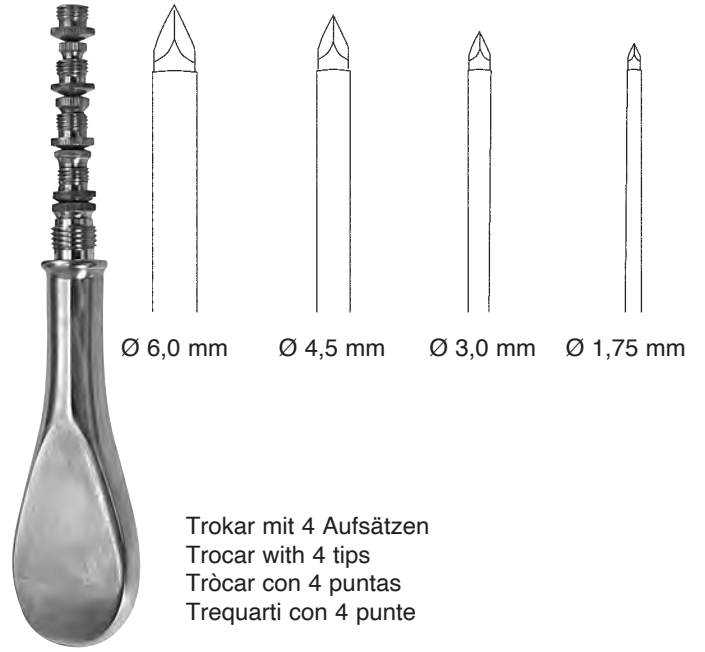

Trokar mit 4 Aufsätzen
Trocar with 4 tips
Tròcar con 4 puntas
Trequarti con 4 punte

UNIVERSAL
017-200-004



STANDARD

017-210-030	Ø 3,0 mm
017-210-035	Ø 3,5 mm
017-210-040	Ø 4,0 mm
017-210-045	Ø 4,5 mm
017-210-050	Ø 5,0 mm
017-210-055	Ø 5,5 mm
017-210-060	Ø 6,0 mm

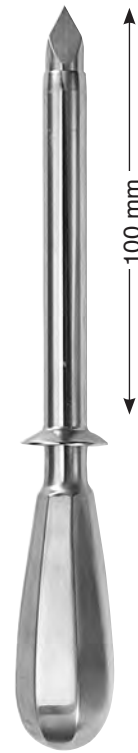

NELSON

017-220-075	Ø 7,5 mm
017-220-090	Ø 9,0 mm
017-220-110	Ø 11,0 mm

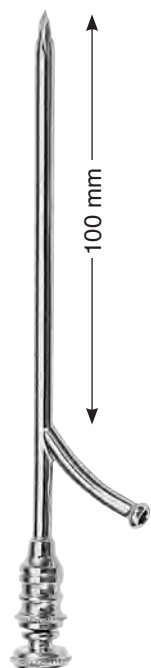

OCHSNER

017-230-040 Ø 4,0 mm
017-230-055 Ø 5,5 mm
017-230-065 Ø 6,5 mm



Kieferhöhlentrokare
Antrum trocars
Trócares para el seno maxilar
Trequarti per puntura del seno
mascellare

LICHTWITZ

017-240-190 19,0 cm / 7½"



DOUGLAS

017-250-110 Ø 3,0 mm



KRAUSE

017-260-040 Ø 4,0 mm
017-260-055 Ø 5,5 mm



PIERCE

017-265-040 Ø 4,0 mm



BUELAU

017-270-080 Ø 8,0 mm



017

Trokare, Saugrohre
Trocars, Suction Tubes
Trócares, Tubos para aspiración
Trequarti, Tubi aspirazione



Ø 2,0 mm

LANDAU

017-280-160 16,0 cm / 6 1/4"



Ø 2,3 mm

COAKLEY

017-290-140 14,0 cm / 5 1/4"



Ø 4,0 mm

ADSON

017-300-210 21,0 cm / 8 1/4"



Ø 3,0 mm

ADSON

017-301-165 16,5 cm / 6 1/2"



FRAZIER

017-310-010 Charr. 10 20,0 cm / 8"



FRAZIER

017-311-006	Charr. 6	19,0 cm / 7 1/2"
017-311-007	Charr. 7	19,0 cm / 7 1/2"
017-311-008	Charr. 8	19,0 cm / 7 1/2"
017-311-009	Charr. 9	19,0 cm / 7 1/2"
017-311-010	Charr. 10	19,0 cm / 7 1/2"
017-311-011	Charr. 11	19,0 cm / 7 1/2"
017-311-012	Charr. 12	19,0 cm / 7 1/2"



POPEN

017-320-006	Charr. 6	13,0 cm / 5"
017-320-008	Charr. 8	13,0 cm / 5"
017-320-010	Charr. 10	13,0 cm / 5"
017-320-012	Charr. 12	13,0 cm / 5"



PLESTER

017-340-015	Ø 1,5 mm	19,5 cm / 7 7/8"
017-340-020	Ø 2,0 mm	19,5 cm / 7 7/8"
017-340-025	Ø 2,5 mm	19,5 cm / 7 7/8"
017-340-030	Ø 3,0 mm	19,5 cm / 7 7/8"



LEMPERT

017-350-020	Ø 2,0 mm	20,0 cm / 8"
017-350-030	Ø 3,0 mm	20,0 cm / 8"



017

Sauginstrumente
Aspirating Instruments
Instrumentos de aspiración
Strumenti per aspirazione



COGSWELL

017-375-230 23,0 cm / 9"



Präpariersauger
Suction raspatory
Aspirador para preparacion
Aspiratore per preparazione

LANDOLT

017-380-200 20,0 cm / 8"

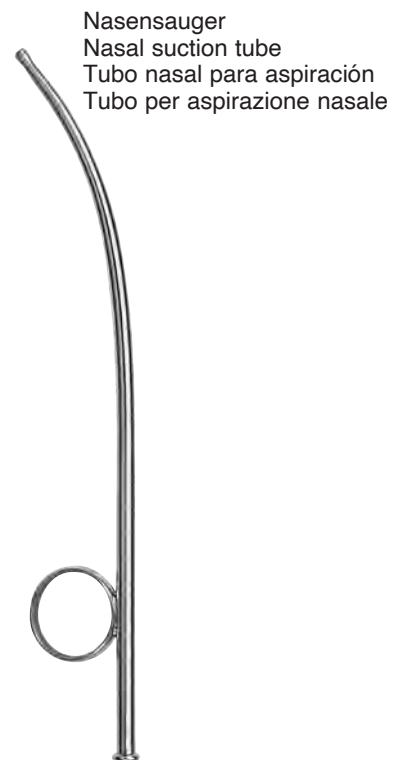

Nasensauger
Nasal suction tube
Tubo nasal para aspiración
Tubo per aspirazione nasale

KILNER

017-390-190 19,0 cm / 7½"

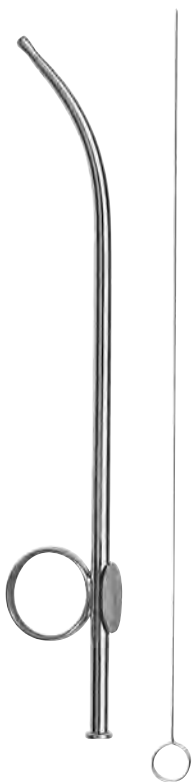

MAGILL

- 017-400-030** Ø 3,0 mm 24,5 cm / 6,9"
- 017-400-035** Ø 3,5 mm 24,5 cm / 6,9"
- 017-400-040** Ø 4,0 mm 24,5 cm / 6,9"

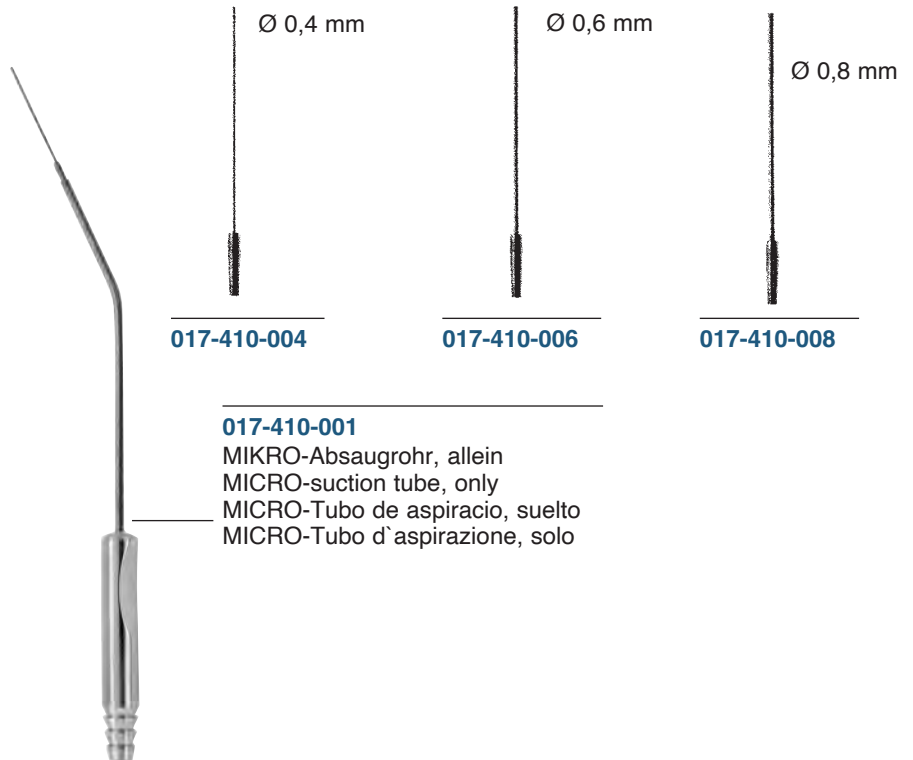

017-410-004

017-410-006

017-410-008

017-410-001

MIKRO-Absaugrohr, allein
 MICRO-suction tube, only
 MICRO-Tubo de aspiración, suelto
 MICRO-Tubo d'aspirazione, solo

WULLSTEIN

017-410-000 17,0 cm / 6³/₄"

- Komplett bestehend aus: 1 MIKRO-Absaugrohr mit LUER-Bohrung (017-410-001) und
 3 MIKRO-Saugkanülen Ø 0,4 mm - Ø 0,8 mm (017-410-004, -006 und -008)
- Complete consisting of: 1 MICRO-Suction tube with LUER hub (017-410-001) and
 3 MICRO-Suction cannulas Ø 0,4 mm - Ø 0,8 mm (017-410-004, -006 und -008)
- Completo compuesto de: 1 MICRO-Tubo de aspiración con cono LUER (017-410-001) y
 3 MICRO-cánulas para aspiración Ø 0,4 mm - Ø 0,8 mm (017-410-004, -006 und -008)
- Completo composto da: 1 MICRO-Tubo d'aspirazione, perforazione LUER (017-410-001) e
 3 MICRO-cannule d'aspirazione Ø 0,4 mm - Ø 0,8 mm (017-410-004, -006 und -008)

017-420-001

MIKRO-Absaugrohr, allein
 MICRO-suction tube, only
 MICRO-Tubo de aspiración, suelto
 MICRO-Tubo d'aspirazione, solo

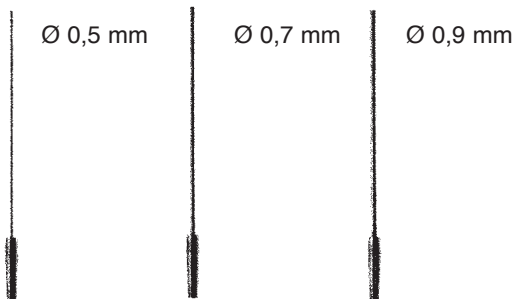
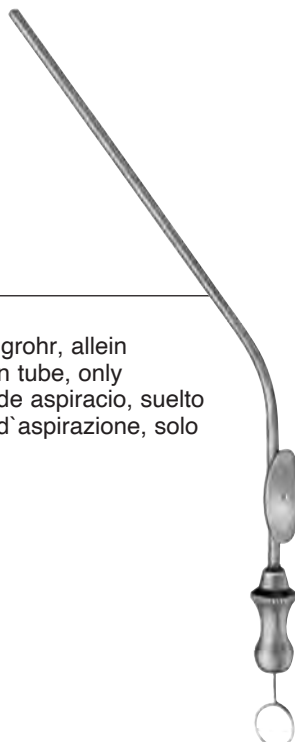

017-420-005

017-420-007

017-420-009

BELLUCCI

017-420-000 15,5 cm / 6"

- Komplett bestehend aus: 1 MIKRO-Absaugrohr mit LUER-Bohrung (017-420-001) und
 3 MIKRO-Saugkanülen Ø 0,5 mm - Ø 0,9 mm (017-420-005, -007 und -009)
- Complete consisting of: 1 MICRO-Suction tube with LUER hub (017-420-001) and
 3 MICRO-Suction cannulas Ø 0,5 mm - Ø 0,9 mm (017-420-005, -007 und -009)
- Completo compuesto de: 1 MICRO-Tubo de aspiración con cono LUER (017-420-001) y
 3 MICRO-Cánulas para aspiración Ø 0,5 mm - Ø 0,9 mm (017-410-005, -007 und -009)
- Completo composto da: 1 MICRO-Tubo d'aspirazione, perforazione LUER (017-420-001) e
 3 MICRO-Cannule d'aspirazione Ø 0,5 mm - Ø 0,9 mm (017-420-005, -007 und -009)

Sauginstrumente
Aspirating Instruments
Instrumentos de aspiración
Strumenti per aspirazione



SCHUKNECHT

-
- 017-430-005** Ø 0,5 mm 13,0 cm / 5¹/₈"
 - 017-430-009** Ø 0,9 mm 13,0 cm / 5¹/₈"



BARRON

-
- 017-440-010** Ø 1,0 mm 10,0 cm / 4"
 - 017-440-023** Ø 2,3 mm 10,0 cm / 4"



ZÖLLNER

-
- 017-451-005** Ø 0,5 mm
 - 017-451-007** Ø 0,7 mm
 - 017-451-009** Ø 0,9 mm
 - 017-451-012** Ø 1,2 mm

ZÖLLNER

-
- 017-450-180** 18,0 cm / 7"



HOUSE

-
- 017-460-009** Ø 0,9 mm/0,7 mm
 - 017-460-012** Ø 1,2 mm/0,9 mm
 - 017-460-015** Ø 1,5 mm/1,2 mm

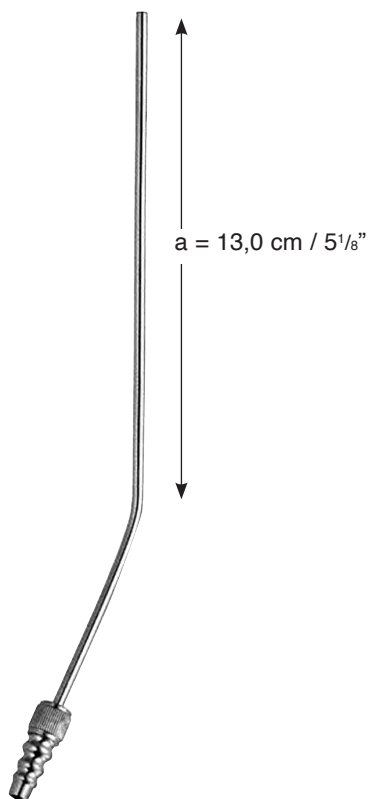

YASARGIL

- 017-470-015 Ø 1,5 mm
- 017-470-020 Ø 2,0 mm
- 017-470-025 Ø 2,5 mm
- 017-470-035 Ø 3,5 mm

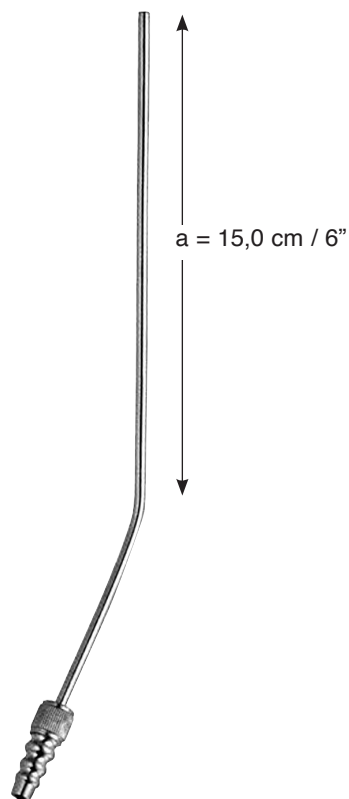

YASARGIL

- 017-472-015 Ø 1,5 mm
- 017-472-020 Ø 2,0 mm
- 017-472-025 Ø 2,5 mm
- 017-472-035 Ø 3,5 mm

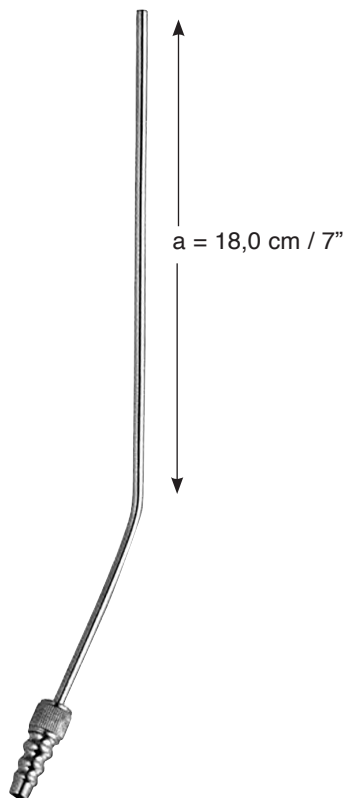

YASARGIL

- 017-474-015 Ø 1,5 mm
- 017-474-020 Ø 2,0 mm
- 017-474-025 Ø 2,5 mm
- 017-474-035 Ø 3,5 mm

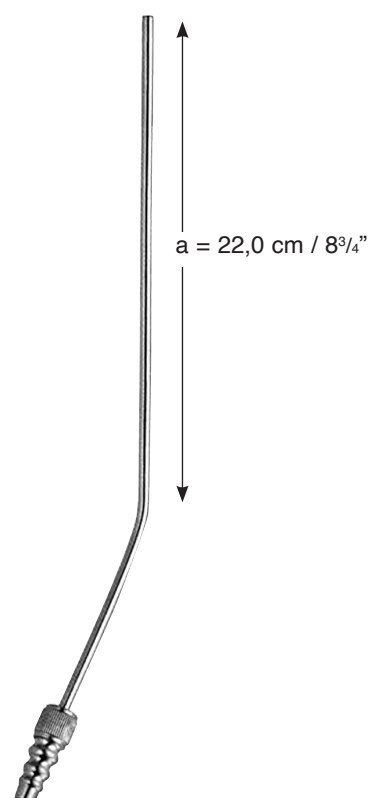

YASARGIL

- 017-476-015 Ø 1,5 mm
- 017-476-020 Ø 2,0 mm
- 017-476-025 Ø 2,5 mm
- 017-476-035 Ø 3,5 mm



017

Saug- und Spülinstrumente
Aspirating and Irrigating Instruments
Instrumentos de aspiración y de lavado
Strumenti per aspirazione e lavaggio

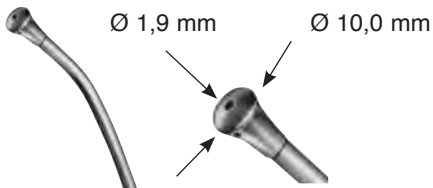

017-480-271
 Saugkopf allein
 Tip head only
 Cabeza de succión sola
 Testa di aspirazione solo

YANKAUER
017-480-270 27,0 cm / 10³/₄"

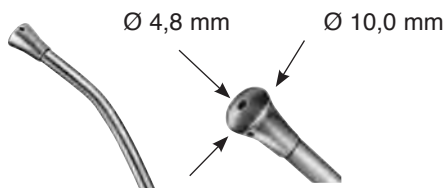

YANKAUER
017-490-285 28,5 cm / 11¹/₄"



ANDREWS-PYNCHON
017-500-240 24,0 cm / 9¹/₂"



POOLE
017-510-220 22,0 cm / 8⁵/₈"



POOLE
017-511-220 22,0 cm / 8⁵/₈"

Ø 8,0 mm



COOLEY

017-521-350 35,0 cm / 13³/₄"

Ø 7,0 mm



COOLEY

017-523-300 30,0 cm / 11³/₄"

Ø 3,5 mm



017-531-035

Ø 3,5 mm

Ø 10,0 mm



COOLEY

017-525-310 31,0 cm / 11³/₄"

Ø 8,0 mm



COOLEY

017-527-330 33,0 cm / 13"



COUPLAND

017-530-170

17,0 cm / 6³/₄"



017

Spezialkanülen
Special Needles
Agujas especiales
Aghi speciali

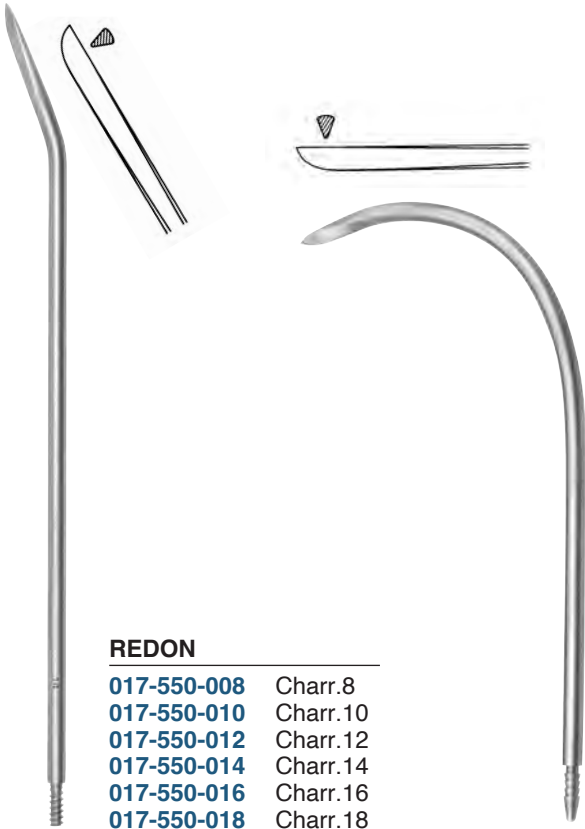

REDON

- 017-550-008 Charr.8
- 017-550-010 Charr.10
- 017-550-012 Charr.12
- 017-550-014 Charr.14
- 017-550-016 Charr.16
- 017-550-018 Charr.18

REDON

- 017-560-008 Charr.8
- 017-560-010 Charr.10
- 017-560-012 Charr.12
- 017-560-014 Charr.14
- 017-560-016 Charr.16
- 017-560-018 Charr.18



REDON

- 017-570-008 Charr.8
- 017-570-010 Charr.10
- 017-570-012 Charr.12
- 017-570-014 Charr.14
- 017-570-016 Charr.16
- 017-570-018 Charr.18



REDON

- 017-580-008 Charr.8
- 017-580-010 Charr.10
- 017-580-012 Charr.12
- 017-580-014 Charr.14
- 017-580-016 Charr.16
- 017-580-018 Charr.18



IOWA

- 017-610-140 14,0 cm / 5 1/4"



- 017-611-001



017-620-012 Ø 1,20x80 mm
017-620-015 Ø 1,50x80 mm



Kanülen zur Leberblindpunktion
 Liver blind puncture needles
 Aguja para punción ciega del hígado
 Aghi per la punture cieca del fegato

MENGHINI

- 017-630-001** Ø 1,00x 35 mm
- 017-630-002** Ø 1,00x 70 mm
- 017-630-003** Ø 1,20x 70 mm
- 017-630-004** Ø 1,20x100 mm
- 017-630-005** Ø 1,40x 70 mm
- 017-630-006** Ø 1,40x100 mm
- 017-630-007** Ø 1,60x 70 mm
- 017-630-008** Ø 1,60x100 mm



QUINKE

- 017-650-001** Ø 1,20x 76 mm
- 017-650-002** Ø 1,20x 89 mm
- 017-650-003** Ø 1,00x 76 mm
- 017-650-004** Ø 1,00x 89 mm
- 017-650-005** Ø 0,70x 76 mm
- 017-650-007** Ø 0,70x 89 mm



Kanülen zur Lumbalpunktion
 Lumbar puncture needles
 Aguja para punción lumbar
 Aghi per punture lombari

MENGHINI

- 017-640-014** Ø 1,40x168 mm
- 017-640-018** Ø 1,80x168 mm

Spezialkanülen
Special Needles
Agujas especiales
Aghi speciali



Kanülen zur Lumbalpunktion
 Lumbar puncture needles
 Aguja para punción lumbar
 Aghi per punture lombari

TUOHY

- | | |
|--------------------|--------------|
| 017-660-012 | Ø 1,20x76 mm |
| 017-660-014 | Ø 1,40x76 mm |
| 017-660-016 | Ø 1,60x76 mm |



BIER

- | | |
|--------------------|-------------|
| 017-670-014 | Ø 1,4x80 mm |
| 017-670-016 | Ø 1,6x80 mm |
| 017-670-018 | Ø 1,8x80 mm |
| 017-670-020 | Ø 2,0x80 mm |

- | | |
|--------------------|--------------|
| 017-672-014 | Ø 1,4x100 mm |
| 017-672-016 | Ø 1,6x100 mm |
| 017-672-018 | Ø 1,8x100 mm |
| 017-672-020 | Ø 2,0x100 mm |



VERRES

- | | |
|--------------------|---------------|
| 017-680-100 | Ø 2,00x100 mm |
| 017-680-120 | Ø 2,00x120 mm |
| 017-680-150 | Ø 2,00x150 mm |

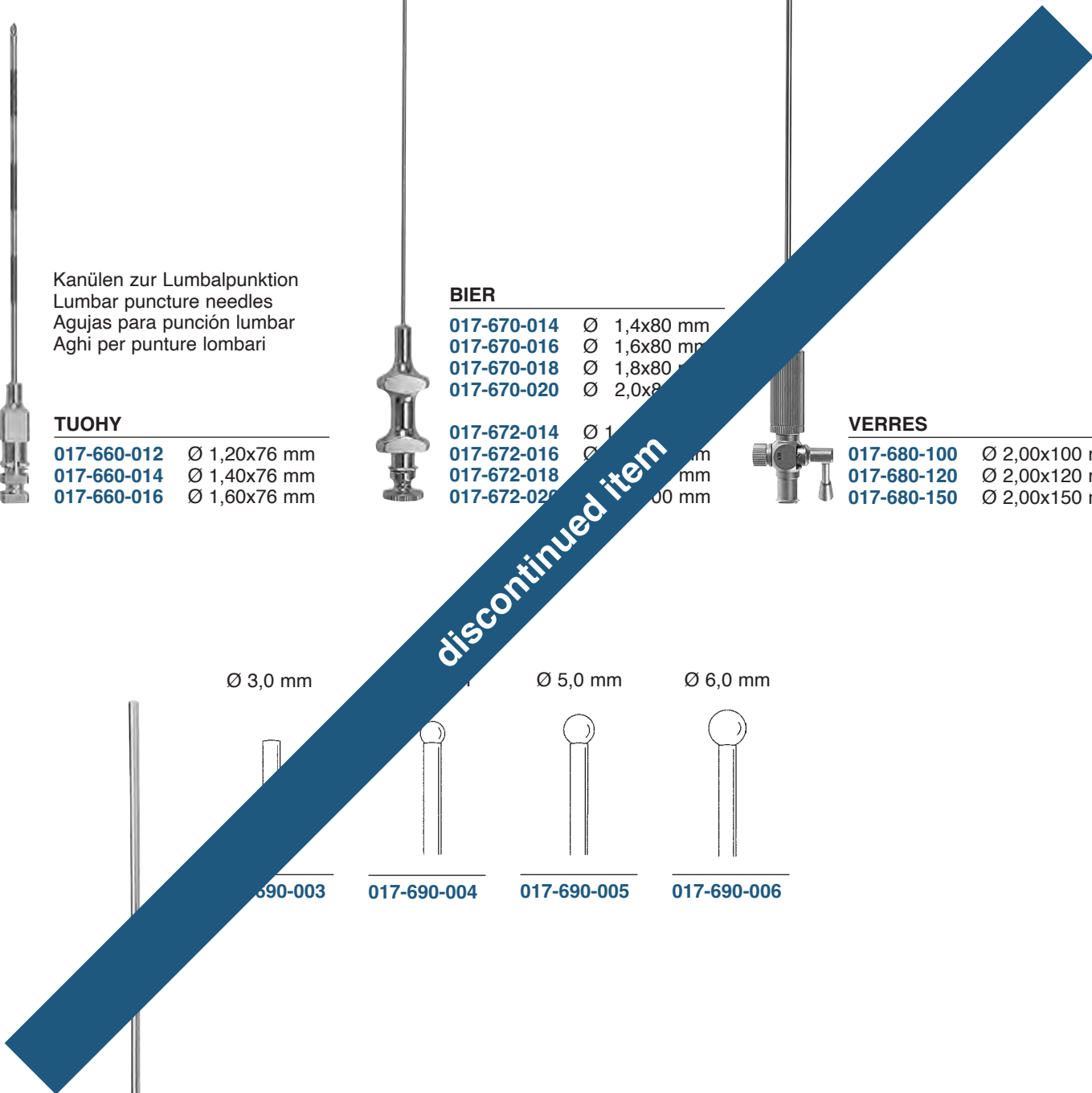

Ø 3,0 mm

Ø 5,0 mm

Ø 6,0 mm



017-690-003

017-690-004

017-690-005

017-690-006

Gefäßspülkanülen, biegsam
 Vascular irrigation cannulae, malleable
 Cánulas vasculares para irrigación, maleables
 Aghi vascolari per irrigazione, malleabili

SCHMID

- 017-690-003 - 017-690-006** 15,0 cm / 6"



discontinued item

Kanülen zur Sternalpunktion
Sternum puncture needles
Agujas para la punción del esternón
Aghi per puntura dello sterno

KLIMA-ROSSEGGER

017-720-016 Ø 1,60x40 mm

Verbindungsstücke, Hähne
Connecting Pieces, Stopcocks
Piezas de conexión, Llaves
Raccordi, Rubinetti

Zwischenstück, LUER-LOCK weiblich, record männlich
 Connecting piece, LUER-LOCK female, record male
 Pieza de conexión, LUER-LOCK hembra, record masculino
 Raccordo, LUER-LOCK femmina, record maschio



017-750-000

Zwischenstück, LUER-LOCK männlich
 Connecting piece, LUER-LOCK male
 Pieza de conexión, LUER-LOCK masculino
 Raccordo, LUER-LOCK maschio



017-755-000

Zwischenstück, LUER-LOCK weiblich, record männlich
 Connecting piece, LUER-LOCK female, record male
 Pieza de conexión, LUER-LOCK hembra, record masculino
 Raccordo, LUER-LOCK femmina, record maschio



017-760-006 Ø 6 mm
 017-760-008 Ø 8 mm

Zwischenstück, LUER-LOCK weiblich
 Connecting piece, LUER-LOCK female
 Pieza de conexión, LUER-LOCK hembra
 Raccordo, LUER-LOCK femmina



017-750-000

Durchflußhahn, LL männl. - LL weibl.
 Stopcock, LL male - LL female
 Llave, LL masculino - LL hembra
 Rubinetto, LL maschio - LL femmina



017-780-000

Durchflußhahn, LL weibl.
 Stopcock, LL female
 Llave, LL hembra
 Rubinetto, LL femmina



017-781-000

Dreiweghahn, 1 LL männl. - 2 LL weibl.
 Three-way-stopcock, 1 LL male - 2 LL female
 Llave de 3 vías, 1 LL masculino - 2 LL hembra
 Rubinetto a tre vie, 1 LL maschio - 2 LL femmina



017-790-000

discontinued item

Spritzen, Ersatzzylinder
Syringes, Spare barrel
Jeringas, Cilindro de repuesto
Siringhe, Cilindro di ricambio



017



LUER

017-800-001	1 ml
017-800-002	2 ml
017-800-005	5 ml
017-800-010	10 ml
017-800-020	20 ml
017-800-050	50 ml



LUER-LOCK

017-810-001	1 ml
017-810-002	2 ml
017-810-005	5 ml
017-810-010	10 ml
017-810-020	20 ml
017-810-050	50 ml



LUER-LOCK

017-820-002	2 ml
017-820-005	5 ml
017-820-010	10 ml



017-801-001	1 ml
017-801-002	2 ml
017-801-005	5 ml
017-801-010	10 ml
017-801-020	20 ml
017-801-050	50 ml



017-811-001	1 ml
017-811-002	2 ml
017-811-005	5 ml
017-811-010	10 ml
017-811-020	20 ml
017-811-050	50 ml



017-821-002	2 ml
017-821-005	5 ml
017-821-010	10 ml

Spritzen, Ersatzzylinder
Syringes, Spare barrel
Jeringas, Cilindro de repuesto
Siringhe, Cilindro di ricambio



TUBERKULIN LUER LOCK
017-840-001 1 ml



JANET
017-850-050 50 ml
017-850-100 100 ml
017-850-150 150 ml
017-850-200 200 ml



LUER-LOCK
017-860-010 10 ml
017-860-020 20 ml
017-860-030 30 ml
017-860-050 50 ml



017-841-001 1 ml



017-851-050 50 ml
017-851-100 100 ml
017-851-150 150 ml
017-851-200 200 ml



017-861-010 10 ml
017-861-020 20 ml
017-861-030 30 ml
017-861-050 50 ml

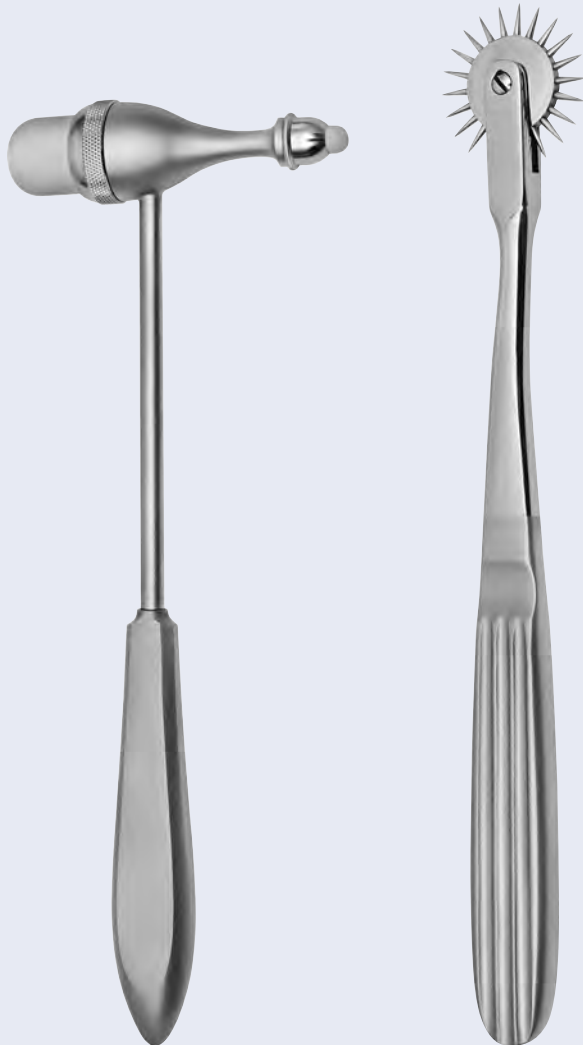

018

Diagnostik, Narkose
Diagnostics, Anaesthesia
Diagnóstico, Anestesia
Diagnóstica, Anestesia

Perkussionshämmer
Percussion Hammers
Martillos para reflejos
Martelli percussori



TROEMMER
018-100-240 24,0 cm / 9½"



DEJERINE
018-110-200 20,0 cm / 8"



DEJERINE
018-120-210 21,0 cm / 8¼"

mit Nadel
with needle
con aguja
con ago



TAYLOR
018-130-180 18,0 cm / 7"
018-130-200 20,0 cm / 8"



BERLINER
018-140-170 17,0 cm / 6¾"
018-140-200 20,0 cm / 8"



BABINSKI

018-150-220 22,0 cm / 8³/₄"



BABINSKI

018-152-220 22,0 cm / 8³/₄"

mit Nadel
 with needle
 con aguja
 con ago



RABINER

018-160-230 23,0 cm / 9"

mit Nadel und Pinsel
 with needle and pencil
 con aguja y pincel
 con ago e pennello



BUCK

018-170-180 18,0 cm / 7"

mit Nadel und Pinsel
 with needle and pencil
 con aguja y pincel
 con ago e pennello



BUCK

018-172-180 18,0 cm / 7"

Teleskopgriff
 telescope handle
 mango telescópico
 manico telescopico

mit Nadel und Pinsel
 with needle and pencil
 con aguja y pincel
 con ago e pennello

Sensibilitätsinstrument, Stethoskope
Sensitivity-Instrument, Stethoscopes
Instrumento para examinar sensibilidad, Estetoscopios
Strumento per misurare sensibilità, Stetoscopi



Algesimeter
 Pinwheel
 Rueda de espigas
 Algesimetro

WARTENBERG

018-200-190 19,0 cm / 7 1/2"



Holz
 Wooden
 Madera
 Legno

PINARD

018-210-180 18,0 cm / 7"



Aluminium
 Aluminium
 Aluminio
 Alluminio

PINARD

018-220-150 15,0 cm / 6"

ALUMINIUM



DUPLEX
018-250-047



Ø 47 mm



BABY-DUPLEX
018-255-037



Ø 37 mm



ANESTOPHON
018-260-047



Ø 47 mm

discontinued item



018

Messinstrumente
Measuring Instrument
Instrumentos de medición
Strumenti per misurare



FRIMED VIGORIMETER

018-280-000

018-280-003

Ersatz-Gummibälle
Spare Rubber Balls
Peras de goma
Palloni di ricambio

Satz mit 3 Größen
Set with 3 sizes
Juego con 3 tamaños
Set in 3 misure



CAROLL
 018-300-140 14,0 cm / 5½"



MOELTGEN
 018-310-000 23,0 cm / 9"



BERTILLON
 018-320-000 32,0 cm / 12½"

mit KG-Einteilung für Erwachsene
 with kilogram scale for adults
 con graduacion en kgs para adultos
 con graduazione in kg per adulti



COLLIN
 018-330-110 11,0 cm / 4¾"

mit lbs-Einteilung für Erwachsene
 with lbs scale for adults
 con graduacion en lbs para adultos
 con graduazione in lbs per adulti



COLLIN
 018-331-110 11,0 cm / 4¾"

discontinued item

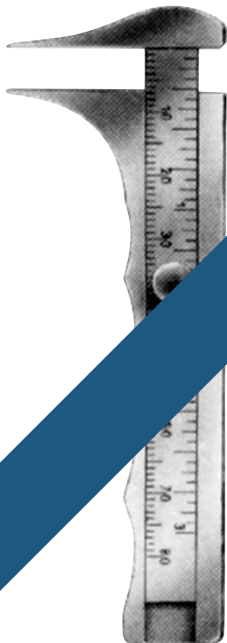

Einteilung in mm und Zoll
graduated in mm and inches
graduado en mm y pulgadas
graduato in mm e pollici

JAMESON

018-340-000

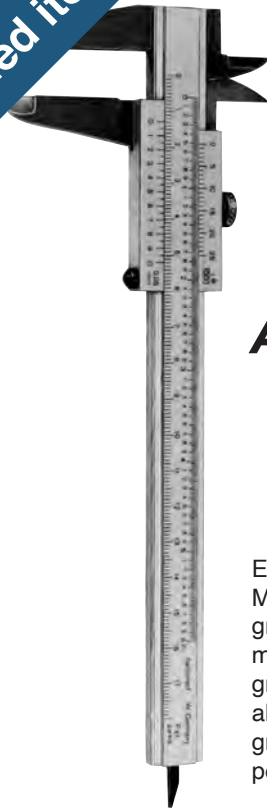

ALUMINIUM

Einteilung in mm und Zoll
Messbereich bis 200 mm
graduated in mm and inches
measuring range up to 200 mm
graduado en mm y pulgadas
alcance de medición hasta 200 mm
graduato in mm e pollici
per misurare fino a 200 mm

018-360-200

discontinued item



018-380-150 150 mm
018-380-200 200 mm
018-380-300 300 mm
018-380-500 500 mm



018-390-500 500 mm

Diagnostik-Bestecke
Diagnostic-Sets
Juegos para diagnóstico
Sets per diagnostica



OTOSKOP BESTECK
018-400-000

discontinued item

Otoskopbesteck komplett in Etui bestehend aus:

- 1 Griff Typ C für 2 Batterien oder 1 Accu (ohne Batterien/Accu)
- 1 Otoskopkopf mit Halogenbirne 2,5 V
- je 1 wiederverwendbarer Ohrtrichter ø 2,0 mm, 3,0 mm, 4,0 mm und 5,0 mm, schwarz
- je 3 Einwegohrtrichter ø 2,0 mm und 4,0 mm, blau
- 1 Operationslinse, 4-fach vergrößernd
- 1 Ersatzbirnchen, Halogen 2,5 V

- Otoskopkopf aus robustem Kunststoff
- Fiberoptik für optimale Bündelung und Leitung der Lichtstrahlen
- Nach beiden Seiten schwenkbare Glasoptik mit 3-facher Vergrößerung
- Operationslinse mit 4-fach Vergrößerung und Glasmini-Optik aus Glas für erleichterte Instrumentenführung
- Mit einfach zu bedienender Spektula-Auswurfmechanik
- Mit Trichteraufnahme für Spektula und vergrößerte Durchgangsöffnung für Instrumente
- Geeignet zur Durchführung pneumatischer Tests (Lieferung ohne Ball)

Juego para Otoscopia completo en estuche compuesto de:

- 1 mango de pila (o con 2 pilas)
- 1 cabeza de otoscopio con bombilla de halógeno 2,5 V
- 1 de c. u. reutilizables auriculares reutilizables ø 2,0 mm, 3,0 mm, 4,0 mm y 5,0 mm, negro
- 3 de espejos auriculares desechables ø 2,0 mm y 4,0 mm, azules
- 1 lente para operaciones, aumento 4 x
- 1 bombilla de repuesto, halógena 2,5 V

- Cabeza de otoscopio de plástico robusto
- Fibra óptica para una focalización y conducción óptima de la luz
- Óptica de vidrio de 3 aumentos, orientable hacia ambos lados
- Lupa quirúrgica de 4 aumentos, con óptica miniaturizada para facilitar la inserción de los instrumentos
- Con expulsión de espejos de uso fácil
- Con acogimiento para espejos y mayor abertura de acceso para instrumentos
- Adecuado para realizar pruebas neumáticas (se suministra sin la pera)

Otoskopbesteck komplett in case consisting of:

- 1 handle type C (without batteries)
- 1 otoscope head with halogen bulb 2,5 V
- each reusable ear specula ø 2,0 mm, 3,0 mm, 4, mm and 5,0 mm black
- 3 each disposable ear specula ø 2,0 mm and 4,0 mm, blue
- 1 magnifying lens for operations 4 x
- 1 spare bulb, halogen, 2,5 V

- Oscope head made of robust plastic material
- Fiberoptics for optimal beaming and transmission of the light
- Bi-directional swivelling optical glass with 3-fold magnification
- Operation lens with 4-fold magnification and glass mini optic ease the insertion of instruments
- Easy-to-operate specula ejection device
- Fitting for specula and enlarged conduit for instruments
- Suitable for pneumatic tests (supplied without ball)

Set per Otoscopia completo in astuccio composto de:

- 1 manico per pila tipo C (senza pila)
- 1 testa di otoscopio con lampadina alogena 2,5 V
- 1 ognuno specolo auricolare riutilizzabile ø 2,0 mm, 3,0 mm, 4,0 mm e 5,0 mm, nero
- 3 ognuno specoli auricolari monouso ø 2,0 mm e 4,0 mm azzurro
- 1 lente per operazione ingrandimento 4 x
- 1 lampadina di ricambio, alogena 2,5V

- Testa di otoscopio di materia plastica robusta
- Fibra ottica per raggiante e conduzione ottimale della luce
- Ottica di vetro da 3 ingrandimento, in due lati orientabile
- Lente per operazione da 4 ingrandimento, con ottica di vetro minimizza per facilitare la introduzione delle strumenti
- Con espulsione degli specoli da uso facile
- Con accoglienza per specoli è ingrandiva apertura del accesso per strumenti
- Appropriato per realizzare test pneumatico (consegna senza pallone)



OPHTHALMOSKOP

018-410-000

Ophthalmoskopbesteck komplett in Etui bestehend aus:

- 1 Griff Typ C für 2 Batterien oder 1 Accu (ohne Batterien/Accu)
- 1 Ophthalmoskop mit Halogenbirne 2,5 V
- 1 Lupe, 5-fach vergrößernd
- 1 Ersatzbirnchen, Halogen, 2,5 V

- Ophthalmoskopkopf aus robustem Kunststoff
- Dioptrienscheibe mit 29 Korrekturlinsen
Plus 1-10, 12, 15, 20, 40
Minus 1-10, 15, 20, 25, 30, 35
- Mit leicht bedienbarem Blendenstellrad mit Halbkreis, kleiner/mittlerer/großer Kreisblende, Fixierstern und Spalte
- Inklusive zu allen Blenden zuschaltbares Filterrad mit Symbolanzeige, Rotfreifilter, Blaufilter und Polarisationsfilter
- Optimierte Hochleistungsoptik mit asphärischer Kondensatorlinse
- Paralleler Strahlengang
- Staubgeschützt

Juego para oftalmología completa en estuche compuesto de:

- 1 mango de pilas tipo C (sin pilas)
- 1 oftalmoscopio con bombilla de halógeno 2,5 V
- 1 lupa, aumento 5x
- 1 bombilla de repuesto, halógeno 2,5 V

- cabeza de oftalmoscopio de plástico robusto
- Rueda de lentes con 29 lentes correctoras
D+ 1-10, 12, 15, 20, 40
D- 1-10, 15, 20, 25, 30, 35
- Con carrucola de diafragma de fácil uso, diafragma circular pequeño/mediano/grande, estrella de fijación y rendija
- Incluye una rueda de filtros aplicable a todos los diaframas con indicador de símbolos, filtro azul, de polarización y exento de rojo
- Óptica de alto rendimiento con lente condensadora asférica
- Trayectoria paralela del haz
- Protección contra el polvo

Ophthalmoskopbesteck komplett in case consisting of:

- 1 battery type C (without batteries)
- 1 ophthalmoscope with halogen bulb 2,5 V
- 1 magnifying lens, 5x
- 1 spare bulb, halogen 2,5 V

- Ophthalmoscope head made of robust plastic material
- Diopter wheel with 29 corrective lenses
Plus 1-10, 12, 15, 20, 40
Minus 1-10, 15, 20, 25, 30, 35
- Easy-to-operate aperture hand-wheel with semi-circle, small/medium/large circle, fixation star and slit
- Includes filter wheel engageable for all apertures with symbol display, red-free filter, blue filter and polarization filter
- Optimized high-performance optics with aspherical condenser lens
- Parallel beam path
- Dust-proof

Set per oftalmologia completo in astuccio composto da:

- 1 manico per pila tipo C (senza pila)
- 1 oftalmoscopio con lampadina alogena 2,5 V
- 1 lente, ingrandimento 5x
- 1 lampadina di ricambio, alogena 2,5 V

- testa di oftalmoscopio di materia plastica robusta
- Carrucola da lente con 29 lenti correttive
D+ 1-10,12,15,20,40
D- 1-10, 15, 20, 25, 30, 35
- Con carrucola da diaframma e semicerchio da uso facile, diaframma circolare piccolo/medio/largo stella per fissare e fessura
- Include carrucola da filtri appropriato a tutti diaframma con indicatore da simboli, filtri azzurro, di polarizzazione e libero da rosso
- Ottica di alto rendimento con lente condensadora asferica
- Percorso di raggio parallelo
- Protezione contra il polvere

discontinued item

Diagnostik-Bestecke
Diagnostic-Sets
Juegos para diagnóstica
Sets per diagnóstica



KOMBINATIONS-SET
018-430-000

discontinued item

Diagnostikbesteck kombiniert, komplett in Etui bestehend aus... Diagnostic Set, combined, complete in case consisting of:

- | | |
|---|--|
| <ul style="list-style-type: none"> 1 Griff Typ C für 2 Batterien oder 1 Accu (ohne Batterien) 1 Ophthalmoskop mit Halogenbirne 2,5 V 1 Otoskopkopf mit Halogenbirne 2,5 V je 1 wiederverwendbarer Ohrtrichter ø 2,0 mm, 3,0 mm, 4,0 mm und 5,0 mm, schwarz je 3 Einwegohrtrichter ø 2,0 mm und 4,0 mm, blau 1 Operationslinse, 4-fach vergrößert 2 Ersatzbirnchen, Halogen 2,5 V | <ul style="list-style-type: none"> 1 battery handly (without batteries) 1 ophthalmoscope with halogen bulb 2,5 V 1 otoscope head with halogen bulb 2,5 V 1 each reusable ear specula ø 2,0 mm, 3,0 mm, 4,0 mm and 5,0 mm, black 3 each disposable ear specula ø 2,0 mm and 4,0 mm, blue 1 magnifying lens for operations, 4 x 2 spare bulb, halogen 2,5 V |
|---|--|

Juego Diagnóstico, combinado, completo en estuche compuesto de:

- 1 mango de pilas tipo C (senza pilas)
- 1 oftalmoscopio con lampadina de halógeno 2,5 V
- 1 cabeza de otoscopio con bombilla de halógeno 2,5 V
- 1 de c. u. espejos auriculares reutilizables ø 2,0 mm, 3,0 mm, 4,0 mm e 5,0 mm, negros
- 3 de espejos auriculares desechables ø 2,0 mm y 4,0 mm, azules
- 1 lente para operaciones, aumento 4 x
- 2 bombillas de repuesto, halógeno 2,5 V

Set per diagnostica, combinato, completo in astuccio composto da:

- 1 manico per pila tipo C (senza pila)
- 1 oftalmoscopio con lampadina alogena 2,5 V
- 1 testa di otoscopio con lampadina alogena 2,5 V
- 1 ognuno specoli auricolari riutilizzabili ø 2,0 mm, 3,0 mm, 4,0 mm e 5,0 mm, nero
- 3 ognuno specoli auricolari ø 2,0 mm e 4,0 mm, azzurro
- 1 lente per operazione, ingrandimento 4 x
- 2 lampadina di ricambio, alogena 2,5 V



Packung á 100 St.



Packung á 10 St.

discontinued item

für/for/para/per		
018-440-020	Ø 2,0 mm	Ohr/ear/oido/orecchia
018-440-030	Ø 3,0 mm	Ohr/ear/oido/orecchia
018-440-040	Ø 4,0 mm	Ohr/ear/oido/orecchia
018-440-050	Ø 5,0 mm	Ohr/ear/oido/orecchia
018-440-090	Ø 9,0 mm	Nase/nose/nariz/naso
blau	zum Einmalgebrauch	
blue	disposable	
azul	desechable	
azzurro	monouso	

für/for/para/per		
018-441-020	Ø 2,0 mm	Ohr/ear/oido/orecchia
018-441-030	Ø 3,0 mm	Ohr/ear/oido/orecchia
018-441-040	Ø 4,0 mm	Ohr/ear/oido/orecchia
018-441-050	Ø 5,0 mm	Ohr/ear/oido/orecchia
018-441-090	Ø 9,0 mm	Nase/nose/nariz/naso
schwarz	wiederverwendbar	
black	reusable	
negro	reutilizable	
nero	riutilizzabile	



018-442-001

Batteriehandgriff
 Battery Handle
 Mango de batería
 Manico per pile



018-442-010

Otoskopkopf mit Halogenbirne 2,5 V
 Otoscope head with halogen bulb 2,5 V
 Cabeza de otoscopio con bombilla de halógeno 2,5 V
 Testa di otoscopio con lampadina alogena 2,5 V



Packung á 6 St.
 Package of 6 pcs.
 Paquete de 6 piezas
 Confezione da 6 pezzi

018-443-001

2,5 V

Ersatzbirnchen, Halogen für Otoskop
 Spare bulb, halogen for otoscope
 Bombilla de repuesto, halógeno para otoscopio
 Lampadina di ricambio, alogeno per otoscopio



Packung á 6 St.
 Package of 6 pcs.
 Paquete de 6 piezas
 Confezione da 6 pezzi

018-444-001

2,5 V

Ersatzbirnchen, Halogen für Ophthalmoskop
 Spare bulb, halogen for ophthalmoscope
 Bombilla de repuesto, halógeno para oftalmoscopio
 Lampadina di ricambio, alogeno per oftalmoscopio



018-442-020

Ophthalmoskopkopf mit Halogenbirne 2,5 V
 Ophthalmoscope head with halogen bulb 2,5 V
 Cabeza de oftalmoscopio con bombilla de halógeno 2,5 V
 Testa di oftalmoscopio con lampadina alogena 2,5 V

**Stirnspiegel
Head Mirrors
Espejos frontales
Specchi frontali**



ZIEGLER

018-450-090 Ø 90 mm

Stirnspiegel mit schwarzem
Plasikband
Head mirror with black plastic
head band
Espejo frontal con banda de
plastico negro
Specchio frontale con fascia di
plastica nera

ZIEGLER

018-452-090 Ø 90 mm

Stirnspiegel mit weißem
Plasikband
Head mirror with white
head band
Espejo frontal con banda de
plastico blanco
Specchio frontale con fascia di
plastica bianca



ZIEGLER

018-453-090 Ø 90 mm

weißes Celluloid
white celluloid
celoloido blanco
celloloide bianco

discontinued item



ZIEGLER

018-454-000 schwarz/black/
negra/nera

018-455-000 weiß/white/
blanca/bianca

018-461-111

Ersatz-Schaumgummipolsterung für Stirnband
Spare foam rubber pad for head band
Almohadilla de espuma de repuesto para cinta frontal
Imbottitura frontale per fascia frontale

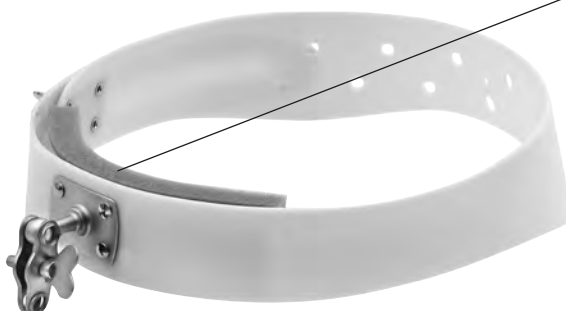

018-456-000

018-461-111

Ersatz-Schaumgummipolsterung für Stirnband
 Spare foam rubber pad for head band
 Almohadilla de espuma de repuesto para cinta frontal
 Imbottitura frontale per fascia frontale



CLAR
 018-460-006 6 Volt



mit Fassung
 with socket
 con montura
 con montatura

CLAR
 018-461-055 Ø 55 mm

discontinued item

weißes Celluloid
 white celluloid
 celoloido blanco
 celloido



018-461-110



018-462-006 6 Volt

Stirnlampen
Head lamps
Lamparas frontales
Lampade frontali

018-461-111

Ersatz-Schaumgummipolsterung für Stirnband
 Spare foam rubber pad for head band
 Almohadilla de espuma de repuesto para cinta frontal
 Imbottitura frontale per fascia frontale



CLAR

018-470-006 6 Volt



Spiegel, allein
 mirror, only
 espejo, suelto
 specchio, solo

CLAR

018-471-100 Ø 100 mm

weißes Celluloid
 white celluloid
 celoloido blanco
 celloloide bianco



10



018-462-006 6 Volt

stufenlos regulierbar 0-10 Volt
 continuously adjustable 0-10 volt
 regulacion continua 0-10 voltios
 regolazione continua 0-10 Volt

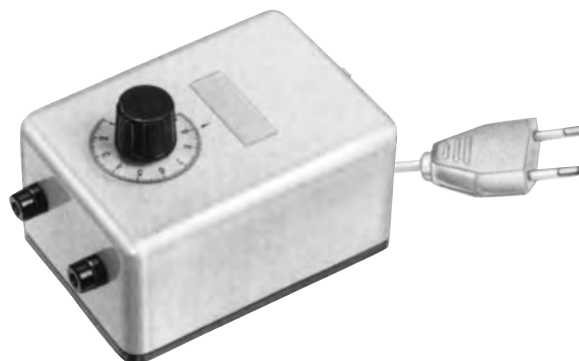

018-475-000

discontinued item



BERGER
018-480-000

binokular
 auswechselbare Linsen,
 aufklappbar
 Vergrößerung 2,5 x
 interchangeable lenses.
 housing
 magnifying power 2,5 x
 binocular lentes intercambiables,
 regulable
 aumento 2,5 x
 binoculare lenti intercambiabili,
 regolabili
 ingrandimento 2,5 x

discontinued item



BERGER	Binokular, Arbeitsabstand binocular, free working distance binocular, distancia de trabajo binoculare, distanza di osservazione	Vergrößerung magnifying power aumento ingrandimento
018-481-015	220 mm = 4,0 Diop.	1,5 x
018-481-020	170 mm = 5,5 Diop.	2,0 x
018-481-025	130 mm = 7,0 Diop.	2,5 x
018-481-030	100 mm = 8,5 Diop.	3,0 x

Blutdruckmeßgeräte
Blood Pressure Manometers
Manómetros
Sfigmomanometri

018-500-000

Tischmodell - mit Nylon-Klettmanchette (018-502-000),
 Quecksilberröhre 300 mm

Desk Model - with nylon velcro cuff (018-502-000),
 mercury tube 300 mm

Modelo-Sobremesa - con brazalet de nylon con velcro
 (018-502-00), tubo de mercurio 300 mm

Modello tavolo - con bracciale velcro-nylon (018-502-000),
 tubo a mercurio 300 mm



018-502-000

Nylon-Klettmanchette für Erwachsene mit
 Latexschläuch, 54,5 cm x 14,5 cm
 Nylon velcro cuff for adults with 2-tube latex
 bladder 54,5 cm x 14,5 cm

Brazalet de nylon-velcro para adultos con
 cámara de látex de 2 tubos 54,5 cm x 14,5 cm
 Bracciale velcro-nylon per adulti con camera
 d'aria in lattice a 2 tubi, 54,5 cm x 14,5 cm

discontinued item

018-512-000

Nylon-Klettmanchette für Erwachsene mit
 Latexpolster, 1-Schlauch, 54,5 cm x 14,5 cm
 Nylon velcro cuff for adults with 1-tube latex
 bladder 54,5 cm x 14,5 cm

Brazelete de nylon-velcro para adultos con
 bolsa de látex de 1 tubos 54,5 cm x 14,5 cm
 Bracciale velcro-nylon per adulti con camera
 d'aria in lattice a 1 tubi, 54,5 cm x 14,5 cm



018-510-000

in Tasche - mit Nylon-Klettmanchette (018-512-000)

in bag - with nylon velcro cuff (018-512-000)

en bolso - con brazelete de nylon con velcro (018-512-000)

in borsa - con bracciale velcro-nylon (018-512-000)



018-513-000

Manometer mit Gummiball
Manometer with rubber bulb
Manómetro con pera de goma
Manometro con pallone in gomma



018-520-000

Wandmodell - mit Nylon-Klettmanschette
(018-502-000), Quecksilberröhre 300 mm

Wall Model - with nylon velcro cuff
(018-502-000), mercury tube 300 mm

Modelo pared - con brazelete de nylon co
(018-502-000), tubo de mercurio 300 mm

Modello parete - con bracciale velcro
(018-502-000), tubo a mercurio 300 mm

discontinued item



018

Katheter-Einführungszangen
Catheter Introducing Forceps
Pinzas para introducir catéteres
Pinze introduttrici di cateteri



018-601-150



018-601-170



018-601-200



018-601-250

MAGILL

018-601-150	15,0 cm / 6"
018-601-170	17,0 cm / 6 ³ / ₄ "
018-601-200	20,0 cm / 8"
018-601-250	25,0cm / 9 ³ / ₄ "

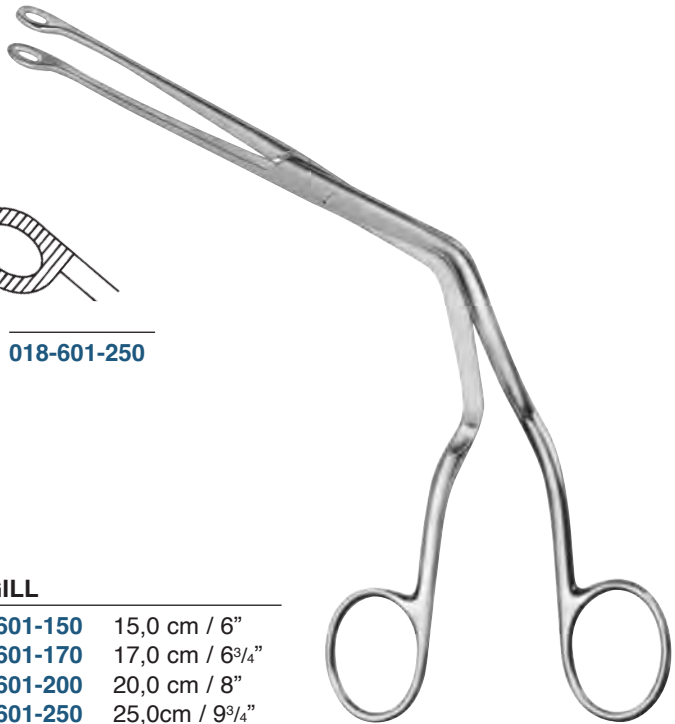



MILLER-BABY

018-610-002

mit Batterie-Handgriff (ohne Batterien)
und zwei Laryngoskopspatel Fig. 0 und 1,
komplett, in Etui

with battery handle (without batteries)
and two laryngoscope blades fig. 0 and 1,
complete, in case

con mango de pilas (sin pilas) y dos
hojas de laringoscopia fig. 0 y 1
completo, en estuche

con manico a pila (senza pila) é due
spatole per laringoscopia fig. 0 é 1,
completo, in scatola

MILLER

018-610-003

mit Batterie-Handgriff (ohne Batterien)
und drei Laryngoskopspatel Fig. 1 bis 3,
komplett, in Etui

with battery handle (without batteries)
and three laryngoscope blades fig. 1 to 3,
complete, in case

con mango de pilas (sin pilas) y tres
hojas de laringoscopia fig. 1 a 3
completo, en estuche

con manico a pila (senza pila) é tre
spatole per laringoscopia fig. 1 a 3,
completo, in scatola

MILLER

018-610-004

mit Batterie-Handgriff (ohne Batterien)
und vier Laryngoskopspatel Fig. 1 bis 4,
komplett, in Etui

with battery handle (without batteries)
and four laryngoscope blades fig. 1 to 4,
complete, in case

con mango de pilas (sin pilas) y cuatro
hojas de laringoscopia fig. 1 a 4
completo, en estuche

con manico a pila (senza pila) é quattro
spatole per laringoscopia fig. 1 a 4,
completo, in scatola



018

Laryngoskope und Zubehör
Laryngoscopes and Accessories
Laringoscopios y accesorios
Laringoscopi ed accessori



MILLER

018-615-000

Fig.0
für Säuglinge
for babies
para bebès
per neonati

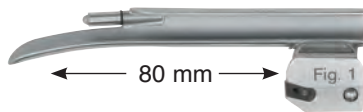

MILLER

018-615-001

Fig.1
für Kinder
for children
para niños
per bambini

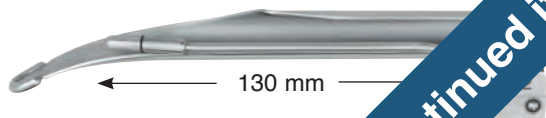

MILLER

018-615-002

Fig.2
für Jugendliche
for adolescent
para adolescentes
per adolescenti



MILLER

018-615-003

Fig.3
für Frauen
for women
para mujeres
per donne

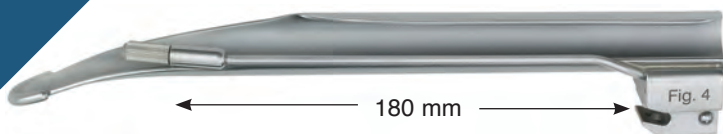

MILLER

018-615-004

Fig.4
für Männer
for men
para hombres
per uomini

discontinued item



GUEDEL-NEGUS

018-620-003

mit Batterie-Handgriff (ohne Batterien) und drei Laryngoskopspatel Fig. 2 bis 4, komplett, in Etui

with battery handle (without batteries) and three laryngoscope blades fig. 2 to 4, complete, in case

con mango de pilas (sin pilas) y tres hojas de laringoscopia fig. 2 a 4 completo, en estuche

con manico a pila (senza pila) e tre spatole per laringoscopia fig. 2 a 4 completo, in scatola

GUEDEL-NEGUS

018-620-004

mit Batterie-Handgriff (ohne Batterien) und zwei Laryngoskopspatel Fig. 1 bis 4, komplett, in Etui

with battery handle (without batteries) and two laryngoscope blades fig. 1 to 4, complete, in case

con mango de pilas (sin pilas) y dos hojas de laringoscopia fig. 1 a 4 completo, en estuche

con manico a pila (senza pila) e due spatole per laringoscopia fig. 1 a 4, completo, in scatola

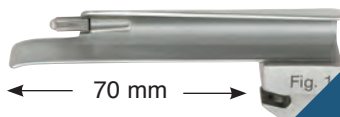

018-625-001

Fig.1
für Kinder
for children
para niños
per bambini

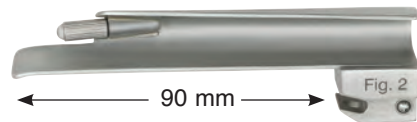

018-625-002

Fig.2
für Jugendliche
for adolescent
para adolescentes
per adolescenti

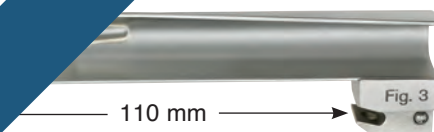

018-625-003

Fig.3
für Frauen
for women
para mujeres
per donne



018-625-004

Fig.4
für Männer
for men
para hombres
per uomini

discontinued item

Laryngoskope und Zubehör
Laryngoscopes and Accessories
Laringoscopios y accesorios
Laringoscopi ed accessori



MC INTOSH

018-630-003

mit Batterie-Handgriff (ohne Batterien) und drei Laryngoskopspatel Fig. 1 bis 3, komplett, in Etui

with battery handle (without batteries) and three laryngoscope blades fig. 1 to 3, complete, in case

con mango de pilas (sin pilas) y tres hojas de laringoscopio fig. 1 a 3, completo, en estuche

con manico a pila (senza pile) e due spatole per laringoscopia fig. 1 a 3, completo, in etui

MC INTOSH

018-635-003

mit Batterie-Handgriff (ohne Batterien) und zwei Laryngoskopspatel Fig. 1 bis 4, komplett, in Etui

with battery handle (without batteries) and two laryngoscope blades fig. 1 to 4, complete, in case

con mango de pilas (sin pilas) y dos hojas de laringoscopio fig. 1 a 4, completo, en estuche

con manico a pila (senza pile) e due spatole per laringoscopia fig. 1 a 4, completo, in scatola

discontinued item



018-635-000

Fig.0
für Säuglinge
for babies
para bebés
per bambini



018-635-001

Fig.1
für Kinder
for children
para niños
per bambini



018-635-002

Fig.2
für Jugendliche
for adolescent
para adolescentes
per adolescenti



018-635-003

Fig.3
für Frauen
for women
para mujeres
per donne



018-635-004

Fig.4
für Männer
for men
para hombres
per uomini



FOREGGER

018-640-003

mit Batterie-Handgriff (ohne Batterien) und drei Laryngoskopspatel Fig.1 bis 3, komplett, in Etui

with battery handle (without batteries) and three laryngoscope blades fig. 1 to 3, complete, in case

con mango de pilas (sin pilas) y tres hojas de laringoscopia fig. 1 a 3, completo, en estuche

con manico a pila (senza pila) e due spatole per laringoscopia fig. 1 a 3, completo, in scatola

FOREGGER

018-645-004

mit Batterie-Handgriff (ohne Batterien) und zwei Laryngoskopspatel Fig. 0 bis 3, komplett, in Etui

with battery handle (without batteries) and two laryngoscope blades fig. 0 to 3, complete, in case

con mango de pilas (sin pilas) y dos hojas de laringoscopia fig. 0 a 3, completo, en estuche

con manico a pila (senza pila) e due spatole per laringoscopia fig. 0 a 3, completo, in scatola

discontinued item



018-645-000

Fig.0
 für Kinder
 for children
 para niños
 per bambini

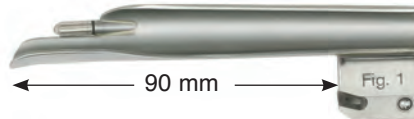

018-645-001

Fig.1
 für Jugendliche
 for adolescent
 para adolescentes
 per adolescenti

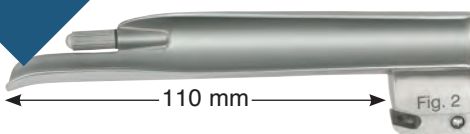

018-645-002

Fig.2
 für Frauen
 for women
 para mujeres
 per donne



018-645-003

Fig.3
 für Männer
 for men
 para hombres
 per uomini

Laryngoskope und Zubehör
Laryngoscopes and Accessories
Laringoscopios y accesorios
Laringoscopi ed accessori



018-650-000
 Batteriehandgriff
 Battery Handle
 Mango de pilas
 Manico per pila



018-660-000
 Batteriehandgriff
 Battery Handle
 Mango de pilas
 Manico per pila



018-670-000
 Batteriehandgriff
 Battery Handle
 Mango de pilas
 Manico per pila

discontinued item



018-680-001 2,5V
 Ersatzlampe klein
 für Spatel Fig. 0 bis 1
 Spare Bulb small,
 for blades fig. 0 to 1
 Bombilla de recambio pequeño,
 para hojas fig. 0 á 1
 Lampadina di ricambio piccolo,
 per spatola fig. 2 fino a 4



018-680-004 2,5 V
 Ersatzlampe groß
 für Spatel Fig. 2 bis 4
 Spare Bulb large,
 for blades fig. 2 to 4
 Bombilla de recambio grande,
 para hojas fig. 2 á 4
 Lampadina di ricambio grande,
 per spatola fig. 2 fino a 4



verstellbar
adjustable
ajustable
regolabili

018-690-000

Fig. 2 – 4

Der Teleskop-Laryngoskopspatel ist die Konsequenz aus den Erfahrungen mehrjähriger Notärzte mit der Intubationstechnik. Die Notwendigkeit der Intubation ergibt sich nur bei einem kleinen Prozentsatz der Einsatzfälle. Sie muss sie jedoch schnell und sicher erfolgen können! Die bisherige Methode mit mehreren Laryngoskopspatelgrößen benötigt viel Volumen in Rettungskoffern ein und trägt erheblich zu dessen Gewicht bei.

Wird dem Notarzt bei der Intubation der falsche (insbesondere zu kleine) Laryngoskopspatel zur Verfügung gestellt, muss evtl. nach frustriertem Intubationsversuch, ein relativ zeitraubender Spatelwechsel erfolgen.

Jetzt besteht das Hauptrisiko für Hypoxämie und Aspiration für den Patienten!
Der Teleskop-Laryngoskopspatel erlaubt die sichere Intubation mit sofortiger Anpassung der Spatellänge durch den Notarzt. Sein Volumen- und Gewichtsanteil im Rettungskoffer ist definitiv niedriger. Dies führt zur Steigerung der Einsatzfähigkeit des Rettungsteams bei der Boden-, See- und insbesondere auch bei der Luftrettung.

The Telescope Laryngoscope Blade is the consequence of the experiences of emergency doctor for years. An intubation is only necessary at a small percentage of the emergency cases. But then it has to be effected quickly and safe! The present method with various sizes of Laryngoscope blades needs many space in the rescue suitcase and it makes it very heavy.

If the emergency doctor gets the wrong blade at the emergency (especially if the blade is too small) a change of blades has to be effected, probably after a futile trial of intubation, which is very time consuming.

Now is the main risk for hypoxemia and aspiration for the patient!

With the Telescope Laryngoscope Blade the emergency doctor is able to make a safe intubation with the possibility of an immediate adjustment of the length of the blade. The volume and the weight of the rescue suitcase is definitely lower.

This aspect diate adjustment of the length of the blade. The volume and the weight of the rescue suitcase is definitely lower. This aspect leads to an increase of the capacity of the rescue team on ground, at sea and especially in the air.

El Laringoscopio telescopico es la consecuencia de las experiencias de medicos de urgencias durante años.

Una intubación es sólo necesaria en un pequeño porcentaje de los casos de emergencia. El método presente con varios tamaños de hojas de Laringoscopio necesita mucho espacio en la maleta de rescate y esto la hace muy pesada.

Si se le entrega al medico de urgencias la hoja incorrecta para la intubación (sobre todo si la hoja es demasiado pequeña) un cambio de hoja tiene que ser efectuado, probablemente tras un intento vano de intubación que requiere mucho tiempo.

Ahora es el riesgo principal para hipoxemia y aspiración para el paciente!

El Laringoscopio telescopico permite al medico de urgencias una intubación segura con la posibilidad de un ajuste inmediato de la longitud de la hoja. El volumen y el peso de la maleta de rescate son definitivamente inferiores. Este aspecto conduce a un aumento de la capacidad del equipo de rescate sobre la tierra, en el mar y sobre todo en el aire.

Il Laringoscopio telescopico è la conseguenza dalle esperienze di dottori di emergenza per anni. Una intubazione è solamente necessaria in una piccola percentuale dei casi di emergenza. Il metodo presente con le varie taglie delle lame di Laringoscopio ha bisogno di molto spazio nella valigia di liberazione e lo fa molto pesante. Se il dottore di emergenza trova la lama sbagliata all'intubazione (specialmente se la lama è troppo piccola) un cambio di lame doveva essere effettuato, probabilmente dopo un triale futile di intubazione che richiede molto tempo.

Ora è il rischio principale per hipoxemia e l'aspirazione per il paziente!

Col il Laringoscopio telescopico il dottore di emergenza è capace di fare un'intubazione sicura con la possibilità di una rettifica immediata della lunghezza della lama. Il volume ed il peso della valigia di liberazione sono definitivamente più bassi. Questo aspetto conduce ad un aumento della capacità della squadra di soccorso su terra, a mare e specialmente nell'aria.



018

Kaltlicht-Laryngoskope und Zubehör
Fiber Optic Laryngoscopes and Accessories
Laringoscopios de luz fria y accesorios
Laringoscopi di luce fredda ed accessori



Laryngoskopiebestecke Kaltlicht
 Laryngoscope Sets fiber optic
 Juegos de laringoscopios luz fria
 Set per laringoscopia luce fredda

MILLER

018-710-003

mit Batterie-Handgriff (ohne Batterie)
 und drei Laryngoskopspatel
 Fig. 1 bis 3, komplett, in Etui
 with battery handle (without batteries)
 and three laryngoscope blades
 fig. 1 to 3, complete, in case
 con mango de pilas (sin pilas)
 y tres hojas de laringoscopia
 fig. 1 a 3 completo, en estuche
 con manico a pila (senza pila)
 è tre spatole per laringoscopia
 fig. 1 fino a 3, complete, in scatola

MILLER

018-

mit Batterie-Handgriff (ohne Batterie)
 und vier Laryngoskopspatel
 Fig. 1 bis 4, komplett, in Etui
 with battery handle (without batteries)
 and four laryngoscope blades
 fig. 1 to 4, complete, in case
 con mango de pilas (sin pilas)
 y cuatro hojas de laringoscopia
 fig. 1 a 4 completo, en estuche
 con manico a pila (senza pila)
 è quattro spatole per laringoscopia
 fig. 1 fino a 4, complete, in scatola

discontinued item

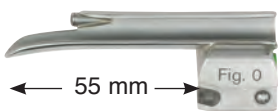

MILLER
018-715-000
 Fig.0
 für Säuglinge
 for babies
 para bebés
 per neonati

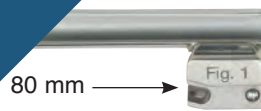

MILLER
018-715-001
 Fig.1
 für Kinder
 for children
 para niños
 per bambini

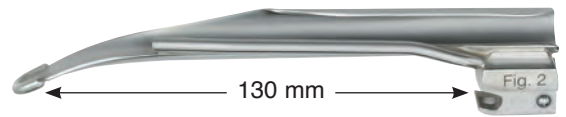

MILLER
018-715-002
 Fig.2
 für Jugendliche
 for adolescent
 para adolescentes
 per adolescenti



MILLER
018-715-003
 Fig.3
 für Frauen
 for women
 para mujeres
 per donne



MILLER
018-715-004
 Fig.4
 für Männer
 for men
 para hombres
 per uomini

Laryngoskopiebestecke Kaltlicht
Laryngoscope Sets fiber optic
Juegos de laringoscopios luz fria
Set per laringoscopia luce fredda



MCINTOSH

018-730-003

mit Batterie-Handgriff (ohne Batterie)
und drei Laryngoskopspatel
Fig. 1 bis 3,
komplett, in Etui

with battery handle (without batteries)
and three laryngoscope blades
fig. 1 to 3,
complete, in case

con mango a pila (senza pile)
y tres hojas de
laringoscopia fig. 1 a 3
completo, en estuche

con manico a pila (senza pila)
è quattro spatole per
laringoscopia fig. 1 fino a 3,
completo, in scatola

MCINTOSH

018-730-004

mit Batterie-Handgriff (ohne Batterie)
und vier Laryngoskopspatel
Fig. 1 bis 4,
komplett, in Etui

with battery handle (without batteries)
and four laryngoscope blades
fig. 1 to 4,
complete, in case

con mango de pilas (sin pilas)
y cuatro hojas de
laringoscopia fig. 1 a 4
completo, en estuche

con manico a pila (senza pila)
è quattro spatole per
laringoscopia fig. 1 fino a 4,
completo, in scatola

Kaltlicht-Laryngoskope und Zubehör
Fiber Optic Laryngoscopes and Accessories
Laringoscopios de luz fria y accesorios
Laringoscopi di luce fredda ed accessori

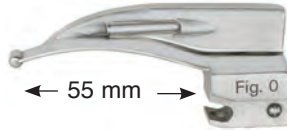

MCINTOSH
018-735-000

Fig.0
für Säuglingen
for babies
para bebés
per neonati

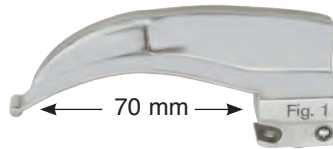

MCINTOSH
018-735-001

Fig.1
für Kinder
for children
para niños
per bambini



MCINTOSH
018-735-002

Fig.2
für Jugendliche
for adolescent
para adolescentes
per adolescenti

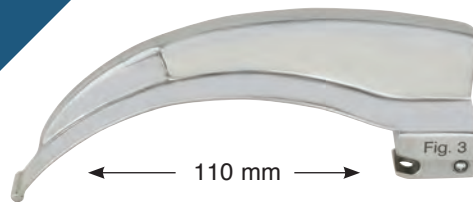

MCINTOSH
018-735-003

Fig.3
für Frauen
for women
para mujeres
per donne

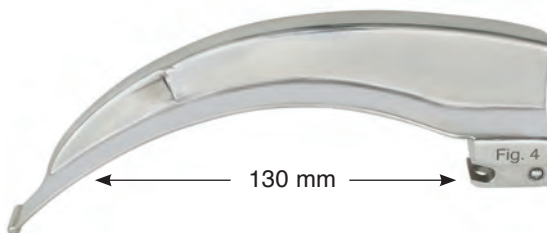

MCINTOSH
018-735-004

Fig.4
für Männer
for men
para hombres
per uomini

discontinued item

Laryngoskopiebestecke Kaltlicht
Laryngoscope Sets fiber optic
Juegos de laringoscopios luz fria
Set per laringoscopia luce fredda



FOREGGER

018-740-003

mit Batterie-Handgriff (mit Batterie)
und drei Laryngoskopspateln
Fig. 2 bis 4,
komplett, in Etui

with battery handle (without batteries)
and three laryngoscope blades
fig. 2 to 4,
complete, in case

con mango de pilas (sin pilas)
y tres hojas de
laringoscopio fig. 2 a 4
completo, en estuche

con manico a pila (senza pila)
è tre spatole per
laringoscopia fig. 2 fino a 4,
completo, in scatola

FOREGGER

018-740-004

mit Batterie-Handgriff (ohne Batterie)
und vier Laryngoskopspatel
Fig. 1 bis 4,
komplett, in Etui

with battery handle (without batteries)
and four laryngoscope blades
fig. 1 to 4,
complete, in case

con mango de pilas (sin pilas)
y cuatro hojas de
laringoscopio fig. 1 a 4
completo, en estuche

con manico a pila (senza pila)
è quattro spatole per
laringoscopia fig. 1 fino a 4,
completo, in scatola

Kaltlicht-Laryngoskope und Zubehör
Fiber Optic Laryngoscopes and Accessories
Laringoscopios de luz fria y accesorios
Laringoscopi di luce fredda ed accessori

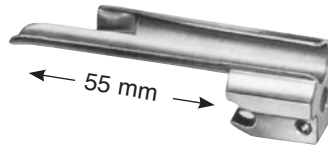

FOREGGER

018-745-000

Fig.0
für Säuglingen
for babies
para bebés
per neonati

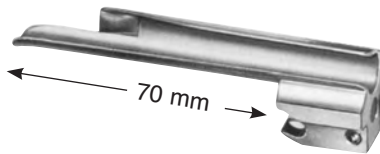

FOREGGER

018-745-001

für Kinder
for children
para niños
per bambini



FOREGGER

018-745-002

Fig.2
für Jugendliche
for adolescent
para adolescentes
per adolescenti

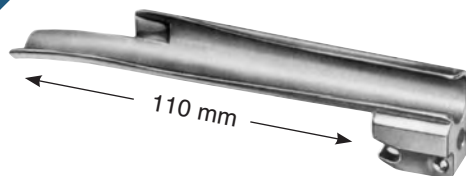

FOREGGER

018-745-003

Fig.3
für Frauen
for women
para mujeres
per donne

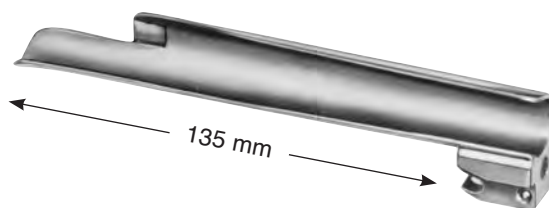

FOREGGER

018-745-004

Fig.4
für Männer
for men
para hombres
per uomini

discontinued item



018-750-000

Batteriehandgriff (ohne Batterie)
 mit Halogenlampe und grünem Ring

Battery handle (without batteries)
 with halogen bulb and green ring

Mango de pilas (sin pila)
 con bombilla de halogeno y anillo verde

Manico a pila (senza pila)
 con lampadina di alogeno e anello verde



018-760-000

Batteriehandgriff (ohne Batterie)
 mit Halogenlampe und grünem Ring

Battery handle (without batteries)
 with halogen bulb and green ring

Mango de pilas (sin pilas)
 con bombilla de halogeno y anillo verde

Manico a pila (senza pila)
 con lampadina di alogeno e anello verde



018-770-025

Ersatzlampe
 Spare Bulb
 Bombilla de recambio
 Lampadina di ricambio
 Krypton 2,5 V



018-774-025

Ersatzlampe
 Spare Bulb
 Bombilla de recambio
 Lampadina di ricambio
 Xenon 2,5 V



018-778-025

Ersatzlampe
 Spare Bulb
 Bombilla de recambio
 Lampadina di ricambio
 Halogen 2,5 V

discontinued item



018

Kaltlicht-Griff mit Ladestation
Fiber Optic Handle with charging station
Mango para luz fria con cargador
Manico per luce fredda con caricatore

018-790-000

Kaltlichtgriff mit LED-Beleuchtung
Fiber optic Handle with LED-illumination
Mango con iluminaci3n LED para luz fria
Manico con illuminazione LED per luce fredda



discontinued item

018-791-000 220 V

Ladestation für Kaltlichtgriff 018-790-000
Charging station for Fiberoptic handle 018-790-000
Cargador para mango para luz fria 018-790-000
Caricatore per manico per luce fredda 018-790-000

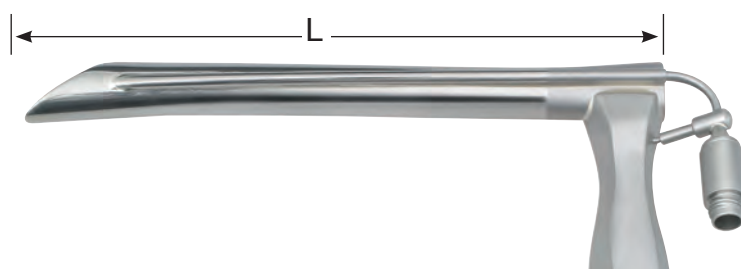

discontinued item



HOLINGER	L	
018-800-171	171 mm	018-801-001
018-800-180	180 mm	018-801-002
		Ersatz-Lichtträger Spare light carriers Portadores de luz de repuesto Supporte per illuminazione di ricambio

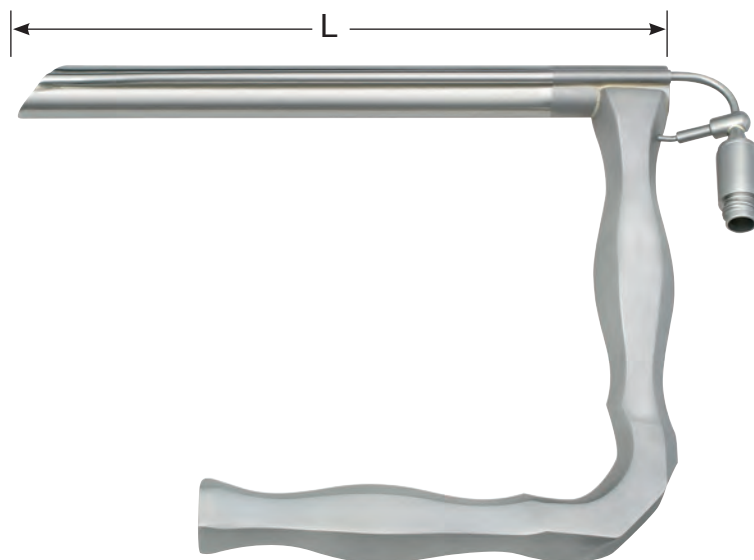

JACKSON	L	
018-802-120	120 mm	018-803-001
018-802-170	170 mm	018-803-002
018-802-180	180 mm	018-803-003
		Ersatz-Lichtträger Spare light carriers Portadores de luz de repuesto Supporte per illuminazione di ricambio

Operations-Laryngoskope mit Fiberglas-Lichtr ager
Operating Laryngoscopes with Fiber Optic Light Carrier
Laringoscopios para operaciones con portadores de luz fibra  ptica
Laringoscopi a sospensione con supporto per illuminazione fibra ottica

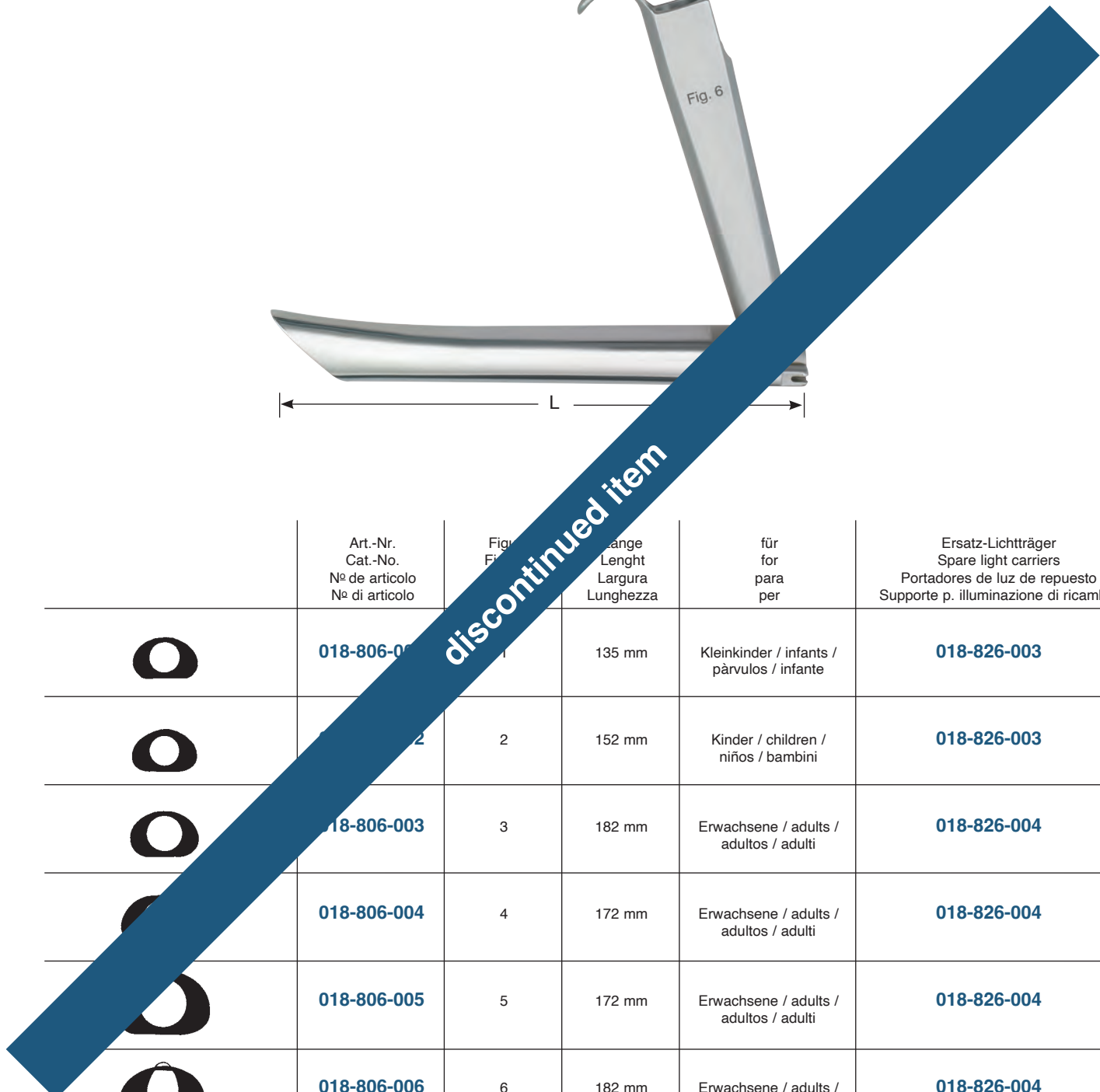

	Art.-Nr. Cat.-No. N� de articulo N� di articolo	Fig. Fig.	Blade Length Largura Lunghezza	f�r for para per	Ersatz-Lichtr�ager Spare light carriers Portadores de luz de repuesto Supporte p. illuminazione di ricambio
	018-806-001	1	135 mm	Kleinkinder / infants / p�rvulos / infante	018-826-003
	018-806-002	2	152 mm	Kinder / children / ni�os / bambini	018-826-003
	018-806-003	3	182 mm	Erwachsene / adults / adultos / adulti	018-826-004
	018-806-004	4	172 mm	Erwachsene / adults / adultos / adulti	018-826-004
	018-806-005	5	172 mm	Erwachsene / adults / adultos / adulti	018-826-004
	018-806-006	6	182 mm	Erwachsene / adults / adultos / adulti	018-826-004
	018-806-007	7	222 mm	Erwachsene / adults / adultos / adulti	018-826-005

Operations-Laryngoskope mit Fiberglas-Lichtrager
Operating Laryngoscopes with Fiber Optic Light Carrier
Laringoscopios para operaciones con portadores de luz fibra ptica
Laringoscopi a sospensione con supporto per illuminazione fibra ottica



018

spreizbar
spreadable
plegable
divaricabile



	Art.-Nr. Cat.-No N de articolo N di articolo	Figur Figure Figura Figura	Figura Figura Figura Figura	fr for para per	Ersatz-Lichtrager Spare light carriers Portadores de luz de repuesto Supporte p. illuminazione di ricambio
	018-816-001		135 mm	Kleinkinder / infants / prvulos / infante	018-826-003
	018-816-002	2	152 mm	Kinder / children / nios / bambini	018-826-003
	018-816-003	3	182 mm	Erwachsene / adults / adultos / adulti	018-826-004
	018-816-004	4	172 mm	Erwachsene / adults / adultos / adulti	018-826-004
	018-816-005	5	172 mm	Erwachsene / adults / adultos / adulti	018-826-004
	018-816-006	6	182 mm	Erwachsene / adults / adultos / adulti	018-826-004
	018-816-007	7	222 mm	Erwachsene / adults / adultos / adulti	018-826-005

discontinued item

Operations-Laryngoskope mit Fiberglas-Lichtträger, Zubehör
Operating Laryngoscopes with Fiber Optic Light Carrier, Accessorie
Laringoscopios para operaciones con portadores de luz fibra òptica, Accesorios
Laringoscopi a sospensione con supporto per illuminazione fibra ottica, Accessori



mit innenliegendem Rauchabsaugrohr
 with smoke suction tube inside
 con tubo extractor de humo al interior
 con tubo aspiratore di fumo nell'interno

← L →
 ← L →
018-817-007 Fig.7 140 mm



← L →
018-819-001 34,0 cm
 Bruststütze mit Laryngoskophalter
 Chest support with laryngoscope holder
 Soporte de pecho con porta-laringoscopio
 Supporto sternale con porta-laringoscopi

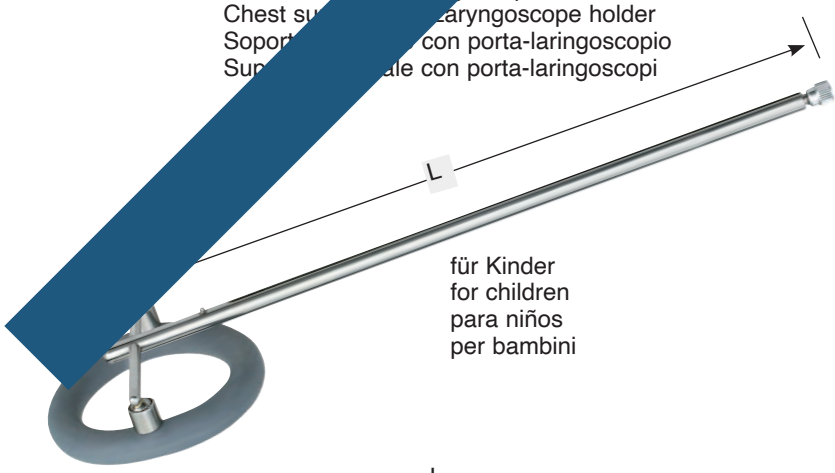

← L →
018-819-002 24,0 cm
 Bruststütze, allein
 Chest support, only
 Soporte de pecho, suelto
 Supporto sternale, solo

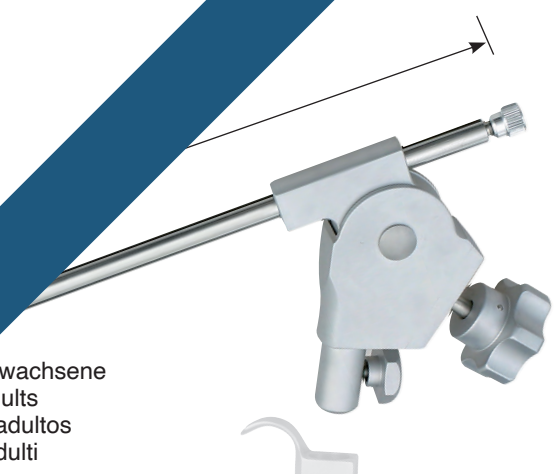

← L →
 für Erwachsene
 for adults
 para adultos
 per adulti



← L →
018-819-003
 Laryngoskophalter, allein
 Laryngoscope holder, only
 Porta-laringoscopio, suelto
 Porta-laringoscopi, solo



018-826-003

Fiberglaslichtträger, klein, für Laryngoskope Fig. 1+ 2
Fiber optic Light carrier, small, for Laryngoscopes Fig. 1+ 2
Portador de luz fibra óptica, pequeño, para laringoscopios Fig. 1 + 2
Supporte per illuminazione, piccolo, per laringoscopi Fig. 1 + 2



018-826-004

Fiberglaslichtträger, mittel, für Laryngoskope Fig. 3 bis 6
Fiber optic Light carrier, medium, for Laryngoscopes Fig. 3 bis 6
Portador de luz fibra óptica, mediano, para laringoscopios Fig. 3 hasta 6
Supporte per illuminazione, mezziano, per laringoscopi Fig. 3 a 6



018-826-005

Fiberglaslichtträger, groß, für Laryngoskope Fig. 7
Fiber optic Light carrier, large, for Laryngoscopes Fig. 7
Portador de luz fibra óptica, grande, para laringoscopios Fig. 7
Supporte per illuminazione, grande, per laringoscopi Fig. 7



018-826-006

Rauchabsaugrohr für Laryngoskope Fig. 3 bis 7
Smoke Suction tube for Laryngoscopes Fig. 3 to 7
Tubo extractor de humo para laringoscopios Fig. 3 hasta 7
Tubo aspiratore di fumo per laringoscopi Fig. 3 a 7

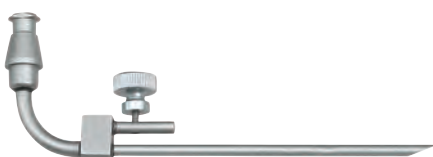

018-826-007

Injektionskanüle für Laryngoskope Fig. 3 bis 7
Injections Drain tube for Laryngoscopes Fig. 3 to 7
Injector para canulas para laringoscopios Fig. 3 hasta 7
Iniettore per cannule mezziano, per laringoscopi Fig. 3 a 7

discontinued item



018



019

Naht
Suture
Sutura
Sutura



019

Chirurgische Nadeln
Surgical Needles
Agujas quirúrgicas
Aghi chirurgici

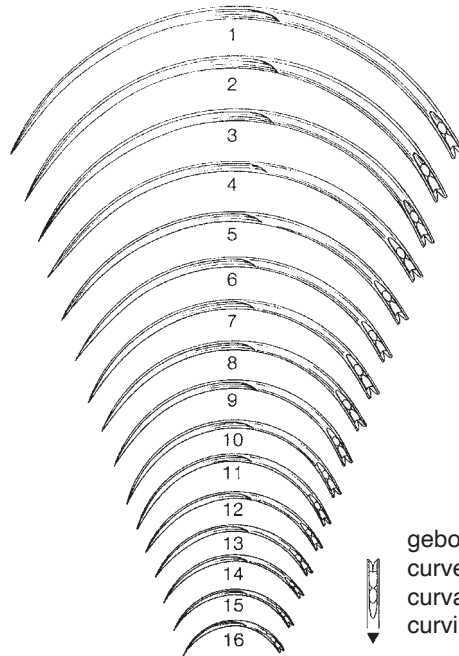
**B**

019-001-001	Fig. 1
019-001-002	Fig. 2
019-001-003	Fig. 3
019-001-004	Fig. 4
019-001-005	Fig. 5
019-001-006	Fig. 6
019-001-007	Fig. 7
019-001-008	Fig. 8
019-001-009	Fig. 9
019-001-010	Fig. 10
019-001-011	Fig. 11
019-001-012	Fig. 12
019-001-013	Fig. 13
019-001-014	Fig. 14
019-001-015	Fig. 15
019-001-016	Fig. 16

gebogen 3/8 Kreis
 curved 3/8 circle
 curvas 3/8 circulo
 curvi 3/8 circolo

*in Packungen zu 12 Stück
 *in packages of 12 pieces
 *en paquets de 12 piezas
 *in confezione da 12 pezzi

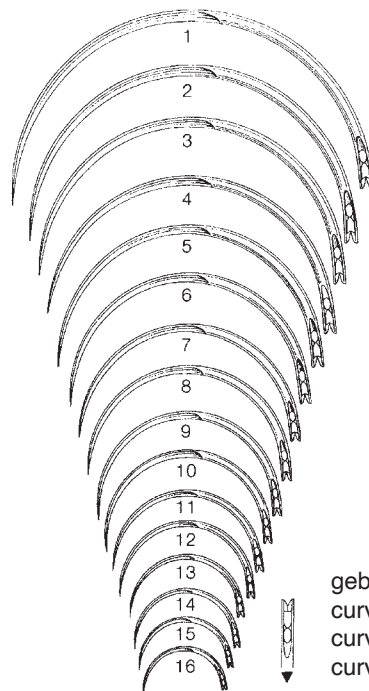
**G**

019-003-001	Fig. 1
019-003-002	Fig. 2
019-003-003	Fig. 3
019-003-004	Fig. 4
019-003-005	Fig. 5
019-003-006	Fig. 6
019-003-007	Fig. 7
019-003-008	Fig. 8
019-003-009	Fig. 9
019-003-010	Fig. 10
019-003-011	Fig. 11
019-003-012	Fig. 12
019-003-013	Fig. 13
019-003-014	Fig. 14
019-003-015	Fig. 15
019-003-016	Fig. 16

gebogen 1/2 Kreis
 curved 1/2 circle
 curvas 1/2 circulo
 curvi 1/2 circolo

*in Packungen zu 12 Stück
 *in packages of 12 pieces
 *en paquets de 12 piezas
 *in confezione da 12 pezzi

*Mindestbestellmenge 5 Dutzend
 *Minimum order quantity 5 dozen
 *Cantidad mínima de pedido 5 docenas
 *Quantità di ordine minimo 5 dozzine

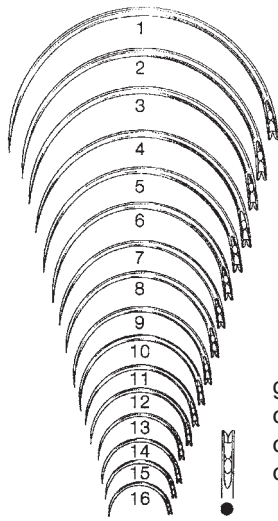

gebogen 1/2 Kreis
 curved 1/2 circle
 curvas 1/2 círculo
 curvi 1/2 circolo

Gr

019-005-001	Fig. 1
019-005-002	Fig. 2
019-005-003	Fig. 3
019-005-004	Fig. 4
019-005-005	Fig. 5
019-005-006	Fig. 6
019-005-007	Fig. 7
019-005-008	Fig. 8
019-005-009	Fig. 9
019-005-010	Fig. 10
019-005-011	Fig. 11
019-005-012	Fig. 12
019-005-013	Fig. 13
019-005-014	Fig. 14
019-005-015	Fig. 15
019-005-016	Fig. 16

*in Packungen zu 12 Stück
 *in packages of 12 pieces
 *en paquetes de 12 piezas
 *in confezione da 12 pezzi

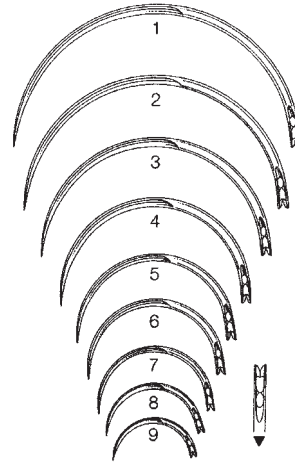

gebogen 1/2 Kreis
 curved 1/2 circle
 curvas 1/2 círculo
 curvi 1/2 circolo

Ga

019-007-001	Fig. 1
019-007-002	Fig. 2
019-007-003	Fig. 3
019-007-004	Fig. 4
019-007-005	Fig. 5
019-007-006	Fig. 6
019-007-007	Fig. 7
019-007-008	Fig. 8
019-007-009	Fig. 9

*in Packungen zu 12 Stück
 *in packages of 12 pieces
 *en paquetes de 12 piezas
 *in confezione da 12 pezzi

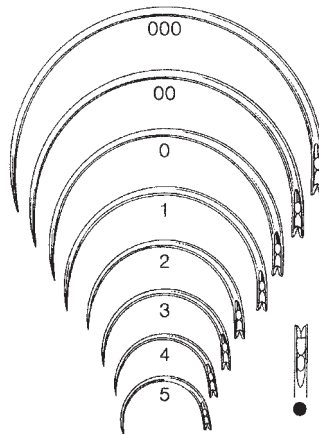

gebogen 1/2 Kreis
 curved 1/2 circle
 curvas 1/2 círculo
 curvi 1/2 circolo

E

019-011-010	Fig. 0
019-011-020	Fig. 00
019-011-030	Fig. 000
019-013-001	Fig. 1
019-013-002	Fig. 2
019-013-003	Fig. 3
019-013-004	Fig. 4
019-013-005	Fig. 5

*in Packungen zu 12 Stück
 *in packages of 12 pieces
 *en paquetes de 12 piezas
 *in confezione da 12 pezzi

*Mindestbestellmenge 5 Dutzend
 *Minimum order quantity 5 dozen
 *Cantidad mínima de pedido 5 docenas
 *Quantità di ordine minimo 5 dozzine

Chirurgische Nadeln, Darmnadeln
Surgical Needles, Intestinal Needles
Agujas quirúrgicas, Agujas intestinales
Aghi chirurgici, Aghi intestinali

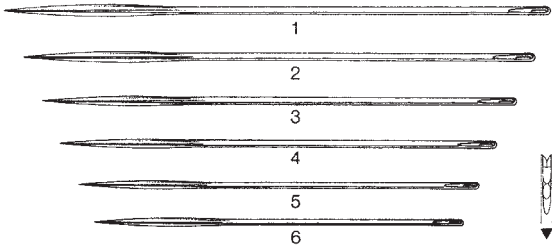

KEITH

- | | | |
|--------------------|--------|----------------------------|
| 019-016-001 | Fig. 1 | *in Packungen zu 12 Stück |
| 019-016-002 | Fig. 2 | *in packages of 12 pieces |
| 019-016-003 | Fig. 3 | *en paquetes de 12 piezas |
| 019-016-004 | Fig. 4 | *in confezione da 12 pezzi |
| 019-016-005 | Fig. 5 | |
| 019-016-006 | Fig. 6 | |

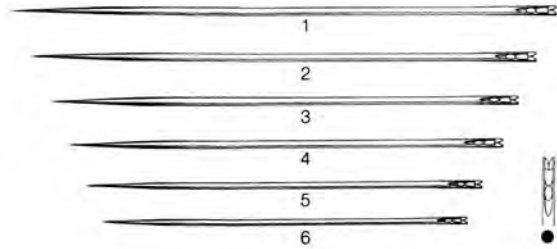

KEITH

- | | | |
|--------------------|--------|----------------------------|
| 019-018-001 | Fig. 1 | *in Packungen zu 12 Stück |
| 019-018-002 | Fig. 2 | *in packages of 12 pieces |
| 019-018-003 | Fig. 3 | *en paquetes de 12 piezas |
| 019-018-004 | Fig. 4 | *in confezione da 12 pezzi |
| 019-018-005 | Fig. 5 | |
| 019-018-006 | Fig. 6 | |

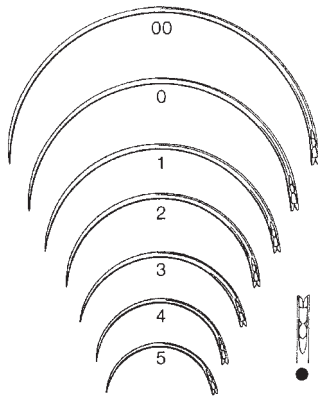

gebogen 1/2 Kreis
 curved 1/2 circle
 curvas 1/2 círculo
 curvi 1/2 circolo

Pb

- | | | |
|--------------------|---------|----------------------------|
| 019-021-010 | Fig. 0 | *in Packungen zu 12 Stück |
| 019-021-020 | Fig. 00 | *in packages of 12 pieces |
| 019-023-001 | Fig. 1 | *en paquetes de 12 piezas |
| 019-023-002 | Fig. 2 | *in confezione da 12 pezzi |
| 019-023-003 | Fig. 3 | |
| 019-023-004 | Fig. 4 | |
| 019-023-005 | Fig. 5 | |

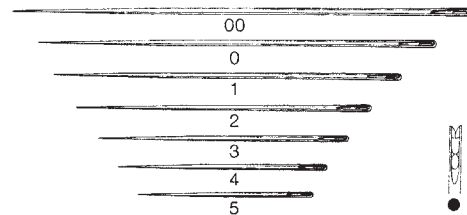

Pc

- | | | |
|--------------------|---------|----------------------------|
| 019-024-010 | Fig. 0 | *in Packungen zu 12 Stück |
| 019-024-020 | Fig. 00 | *in packages of 12 pieces |
| 019-026-001 | Fig. 1 | *en paquetes de 12 piezas |
| 019-026-002 | Fig. 2 | *in confezione da 12 pezzi |
| 019-026-003 | Fig. 3 | |
| 019-026-004 | Fig. 4 | |
| 019-026-005 | Fig. 5 | |

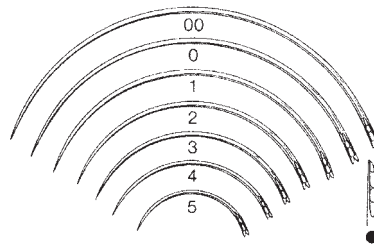

gebogen 3/8 Kreis
 curved 3/8 circle
 curvas 3/8 círculo
 curvi 3/8 circolo

Pd

- | | | |
|--------------------|---------|----------------------------|
| 019-027-010 | Fig. 0 | *in Packungen zu 12 Stück |
| 019-027-020 | Fig. 00 | *in packages of 12 pieces |
| 019-029-001 | Fig. 1 | *en paquetes de 12 piezas |
| 019-029-002 | Fig. 2 | *in confezione da 12 pezzi |
| 019-029-003 | Fig. 3 | |
| 019-029-004 | Fig. 4 | |
| 019-029-005 | Fig. 5 | |

*Mindestbestellmenge 5 Dutzend
 *Minimum order quantity 5 dozen
 *Cantidad mínima de pedido 5 docenas
 *Quantità di ordine minimo 5 dozzine

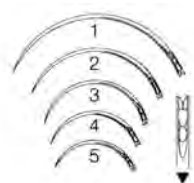

gebogen 3/8 Kreis
 curved 3/8 circle
 curvas 3/8 círculo
 curvi 3/8 circolo

Ob

- 019-031-001** Fig. 1
- 019-031-002** Fig. 2
- 019-031-003** Fig. 3
- 019-031-004** Fig. 4
- 019-031-005** Fig. 5

*in Packungen zu 12 Stück
 *in packages of 12 pieces
 *en paquetes de 12 piezas
 *in confezione da 12 pezzi

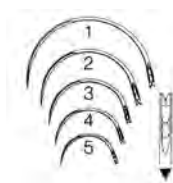

gebogen 1/2 Kreis
 curved 1/2 circle
 curvas 1/2 círculo
 curvi 1/2 circolo

Og

- 019-033-001** Fig. 1
- 019-033-002** Fig. 2
- 019-033-003** Fig. 3
- 019-033-004** Fig. 4
- 019-033-005** Fig. 5

*in Packungen zu 12 Stück
 *in packages of 12 pieces
 *en paquetes de 12 piezas
 *in confezione da 12 pezzi

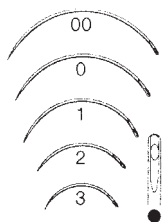

gebogen 3/8 Kreis
 curved 3/8 circle
 curvas 3/8 círculo
 curvi 3/8 circolo

KALT

- 019-035-010** Fig. 0
- 019-035-020** Fig. 00
- 019-037-001** Fig. 1
- 019-037-002** Fig. 2
- 019-037-003** Fig. 3

*in Packungen zu 12 Stück
 *in packages of 12 pieces
 *en paquetes de 12 piezas
 *in confezione da 12 pezzi

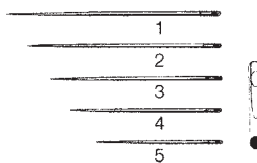

PAYR

- 019-040-001** Fig. 1
- 019-040-002** Fig. 2
- 019-040-003** Fig. 3
- 019-040-004** Fig. 4
- 019-040-005** Fig. 5

*in Packungen zu 12 Stück
 *in packages of 12 pieces
 *en paquetes de 12 piezas
 *in confezione da 12 pezzi

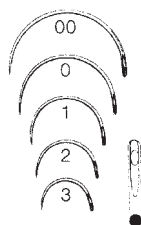

gebogen 1/2 Kreis
 curved 1/2 circle
 curvas 1/2 círculo
 curvi 1/2 circolo

PAYR

- 019-043-010** Fig. 0
- 019-043-020** Fig. 00
- 019-045-001** Fig. 1
- 019-045-002** Fig. 2
- 019-045-003** Fig. 3

*in Packungen zu 12 Stück
 *in packages of 12 pieces
 *en paquetes de 12 piezas
 *in confezione da 12 pezzi

*Mindestbestellmenge 5 Dutzend
 *Minimum order quantity 5 dozen
 *Cantidad mínima de pedido 5 docenas
 *Quantità di ordine minimo 5 dozzine



019

Nadelkassetten
Needle Cases
Estuches para agujas
Scatole per aghi



019-070-001 150x95x13 mm



019-070-002 150x95x13 mm
perforierter Deckel und Boden
perforated lid and bottom
tapa y fondo perforado
coperchio e fondo perforati



019-070-003 150x95x13 mm
perforierter Boden
perforated bottom
fondo perforado
fondo perforato



019-070-005 150x95x13 mm



019-070-006 150x95x13 mm

perforierter Deckel und Boden
perforated lid and bottom
tapa y fondo perforado
coperchio e fondo perforati



019

Nadelkassetten
Needle Cases
Estuches para agujas
Scatole per aghi

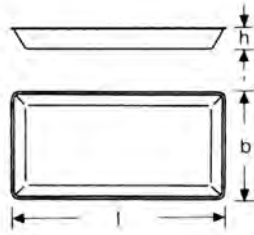

019-074-050 50x25x4,5 mm
019-074-065 65x42x8,0 mm
019-074-075 75x25x4,5 mm

019-076-050 50x25x4,5 mm
019-076-065 65x42x8,0 mm
019-076-075 75x25x4,5 mm



019-080-001 Ø 62x13 mm
Innendose allein, perforiert
Interior box, perforated
Caja interior, perforada
Scatola interiore, perforati

019-080-000 Ø 65x15 mm



KALT

019-100-140 14,0 cm / 5½"



019-104-140

019-105-140

ARRUGA

019-104-140 - 019-105-140 14,0 cm / 5½"



019-106-160

019-107-160

ARRUGA

019-106-160 - 019-107-160 16,0 cm / 6¼"



019

Mikro-Nadelhalter
Micro Needle Holders
Micro Porta-agujas
Micro Portaghi

Maul 0,5 mm
jaw 0,5 mm
boca 0,5 mm
muso 0,5 mm



019-108-100



019-109-100



ohne Sperre
without ratchet
sin cierre
senza chiusura

Maul 0,5 mm
jaw 0,5 mm
boca 0,5 mm
muso 0,5 mm



019-110-100



019-111-100



mit Sperre
with ratchet
con cierre
con chiusura

BARRAQUER-TROUTMAN

019-108-100 - 019-109-100 10,0 cm / 4"

BARRAQUER-TROUTMAN

019-110-100 - 019-111-100 10,0 cm / 4"

Maul 1,0 mm
jaw 1,0 mm
boca 1,0 mm
muso 1,0 mm

glatt
smooth
liso
liscio



019-112-115



019-112-130



019-112-140



019-113-115



019-113-130



019-113-140



ohne Sperre
without ratchet
sin cierre
senza chiusura

Maul 1,0 mm
jaw 1,0 mm
boca 1,0 mm
muso 1,0 mm

glatt
smooth
liso
liscio



019-114-115



019-114-130



019-114-140



019-115-115



019-115-130



019-115-140



mit Sperre
with ratchet
con cierre
con chiusura

BARRAQUER

019-112-115 - 019-113-115 11,5 cm / 4 1/2"
019-112-130 - 019-113-130 13,0 cm / 5 1/8"
019-112-140 - 019-113-140 14,0 cm / 5 1/2"

BARRAQUER

019-114-115 - 019-115-115 11,5 cm / 4 1/2"
019-114-130 - 019-115-130 13,0 cm / 5 1/8"
019-114-140 - 019-115-140 14,0 cm / 5 1/2"

Mikro-Nadelhalter
Micro Needle Holders
Micro Porta-agujas
Micro Portaghi



019

Maul 1,0 mm
 jaw 1,0 mm
 boca 1,0 mm
 muso 1,0 mm



glatt
 smooth
 liso
 liscio

mit Sperre
 with ratchet
 con cierre
 con chiusura

Maul 1,0 mm
 jaw 1,0 mm
 boca 1,0 mm
 muso 1,0 mm



glatt
 smooth
 liso
 liscio

mit Sperre
 with ratchet
 con cierre
 con chiusura

BARRAQUER

019-120-150 15,0 cm / 6"
019-120-180 18,0 cm / 6"
019-120-210 21,0 cm / 8 1/4"

BARRAQUER

019-121-150 15,0 cm / 6"
019-121-180 18,0 cm / 6"
019-121-210 21,0 cm / 8 1/4"

Maul 1,0 mm
 jaw 1,0 mm
 boca 1,0 mm
 muso 1,0 mm

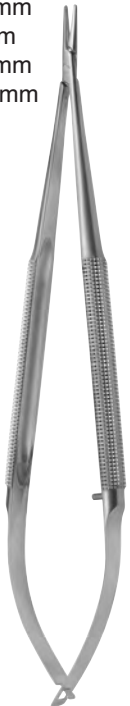

glatt
 smooth
 liso
 liscio

ohne Sperre
 without ratchet
 sin cierre
 senza chiusura

Maul 1,0 mm
 jaw 1,0 mm
 boca 1,0 mm
 muso 1,0 mm



glatt
 smooth
 liso
 liscio

ohne Sperre
 without ratchet
 sin cierre
 senza chiusura

BARRAQUER

019-124-150 15,0 cm / 6"
019-124-180 18,0 cm / 6"
019-124-210 21,0 cm / 8 1/4"

BARRAQUER

019-125-150 15,0 cm / 6"
019-125-180 18,0 cm / 6"
019-125-210 21,0 cm / 8 1/4"

glatt
 smooth
 liso
 liscio

gebogen
 curved
 curva
 curva

ohne Sperre
 without ratchet
 sin cierre
 senza chiusura

GOMEL

019-127-140 14,0 cm / 5 1/2"



019

Mikro-Nadelhalter
Micro Needle Holders
Micro Porta-agujas
Micro Portaghi



019-130-140



019-131-140

mit Sperre
with ratchet
con cierre
con chiusura



019-132-140



019-133-140

ohne Sperre
without ratchet
sin cierre
senza chiusura

CASTROVIEJO

019-130-140 - 019-131-140 14,0 cm / 5 1/2"

CASTROVIEJO

019-132-140 - 019-133-140 14,0 cm / 5 1/2"



019-136-140



019-137-140

mit Sperre
with ratchet
con cierre
con chiusura



019-138-140



019-139-140

ohne Sperre
without ratchet
sin cierre
senza chiusura

CASTROVIEJO

019-136-140 - 019-137-140 14,0 cm / 5 1/2"

CASTROVIEJO

019-138-140 - 019-139-140 14,0 cm / 5 1/2"



mit Sperre
with ratchet
con cierre
con chiusura

CASTROVIEJO (JACOBSON)

019-144-180 18,0 cm / 7"
019-144-210 21,0 cm / 8 1/4"



mit Sperre
with ratchet
con cierre
con chiusura

CASTROVIEJO (JACOBSON)

019-145-180 18,0 cm / 7"
019-145-210 21,0 cm / 8 1/4"



mit Sperre
with ratchet
con cierre
con chiusura

CASTROVIEJO (JACOBSON)

019-146-180 18,0 cm / 7"
019-146-210 21,0 cm / 7"



mit Sperre
with ratchet
con cierre
con chiusura

CASTROVIEJO (JACOBSON)

019-147-180 18,0 cm / 7"
019-147-210 21,0 cm / 7"



ohne Sperre
without ratchet
sin cierre
senza chiusura

CASTROVIEJO (JACOBSON)

019-148-180 18,0 cm / 7"
019-148-210 21,0 cm / 7"



ohne Sperre
without ratchet
sin cierre
senza chiusura

CASTROVIEJO (JACOBSON)

019-149-180 18,0 cm / 7"
019-149-210 21,0 cm / 7"



ohne Sperre
without ratchet
sin cierre
senza chiusura

CASTROVIEJO (JACOBSON)

019-150-180 18,0 cm / 7"
019-150-210 21,0 cm / 7"



ohne Sperre
without ratchet
sin cierre
senza chiusura

CASTROVIEJO (JACOBSON)

019-151-180 18,0 cm / 7"
019-151-210 21,0 cm / 7"



019

Mikro-Nadelhalter
Micro Needle Holders
Micro Porta-agujas
Micro Portaghi



glatt
smooth
liso
liscio

ohne Sperre
without ratchet
sin cierre
senza chiusura

YASARGIL

019-170-200 20,0 cm / 8"
019-170-225 22,5 cm / 9"
019-170-245 24,5 cm / 9²/₃"



glatt
smooth
liso
liscio

ohne Sperre
without ratchet
sin cierre
senza chiusura

YASARGIL

019-171-200 20,0 cm / 8"
019-171-225 22,5 cm / 9"
019-171-245 24,5 cm / 9²/₃"



glatt
smooth
liso
liscio

CASTROVIEJO

019-186-130 13,0 cm / 5¹/₈"



glatt
smooth
liso
liscio

CASTROVIEJO

019-187-130 13,0 cm / 5¹/₈"



DERF
019-200-125 13,0 cm / 5 1/8"



DERF
019-202-125 12,5 cm / 5"



COLLIER
019-204-125 12,5 cm / 5"

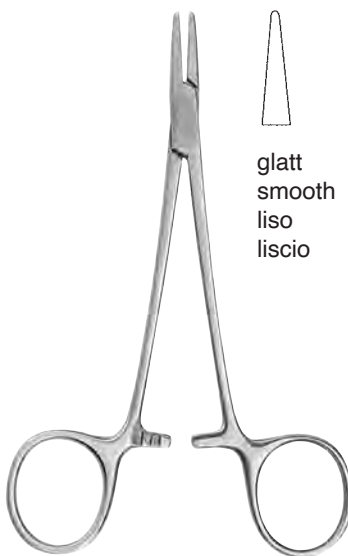

glatt
smooth
liso
liscio

WEBSTER
019-210-130 13,0 cm / 5"

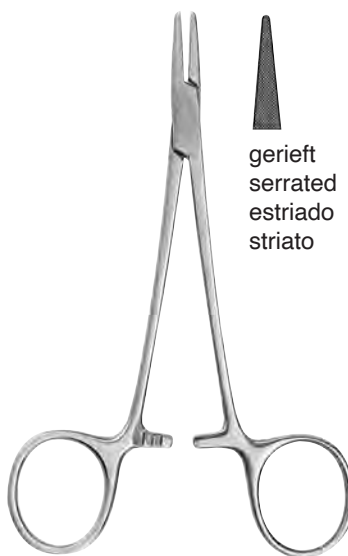

gerieft
serrated
estriado
striato

WEBSTER
019-212-130 13,0 cm / 5"



glatt
smooth
liso
liscio

HALSEY
019-216-115 11,5 cm / 4"
019-216-130 13,0 cm / 5 1/8"

**Nadelhalter
Needle Holders
Porta-agujas
Portaghi**



HALSEY

019-218-130 13,0 cm / 5 1/8"



glattes Maul mit Spezialkehlung
smooth jaw, special groove
boca lisa, especialmente acanalada
mors lisse, avec stries spéciales
morso liscio con scannellatura speciale

NEIVERT

019-220-130 13,0 cm / 5 1/8"



BAUMGARTNER

019-224-140 14,0 cm / 5 1/2"

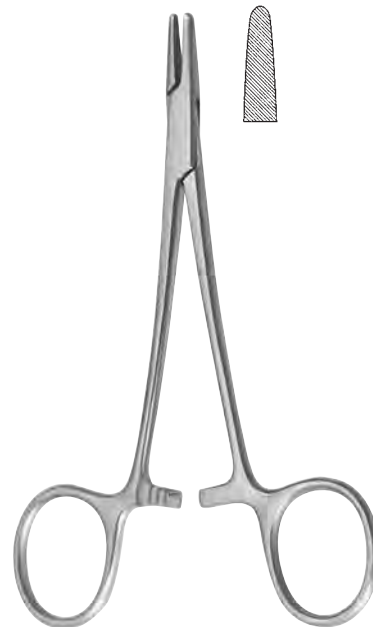

BROWN

019-226-130 13,0 cm / 5 1/8"
019-226-180 18,0 cm / 7"



CRILE MURRAY

019-228-150 15,0 cm / 6"



CRILE WOOD

019-230-150 15,0 cm / 6"
019-230-180 18,0 cm / 7"
019-230-200 20,0 cm / 8"



ADSON

019-232-180 18,0 cm / 7"



METZENBAUM

019-234-180 18,0 cm / 7"



MASS.-GENERAL-HOSPITAL

019-236-170 17,0 cm / 6³/₄"

**Nadelhalter
Needle Holders
Porta-agujas
Portaghi**



019-240-125



019-240-140



019-240-160



019-240-180



019-240-200

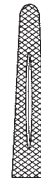

019-240-240



019-240-260



019-240-300

MAYO-HEGAR

019-240-125	12,5 cm / 5"
019-240-140	14,0 cm / 5½"
019-240-160	16,0 cm / 6¼"
019-240-180	18,0 cm / 7"
019-240-200	20,0 cm / 5½"
019-240-240	24,0 cm / 9½"
019-240-260	26,0 cm / 10¼"
019-240-300	30,0 cm / 11¾"



019-242-160



019-242-180



019-242-200

schlankes Modell
delicate pattern
modelo delgado
modello gracile

MAYO HEGAR

019-242-160	16,0 cm / 6¼"
019-242-180	18,0 cm / 7"
019-242-200	20,0 cm / 8"



HEANEY

019-245-210 21,0 cm / 8¹/₄"

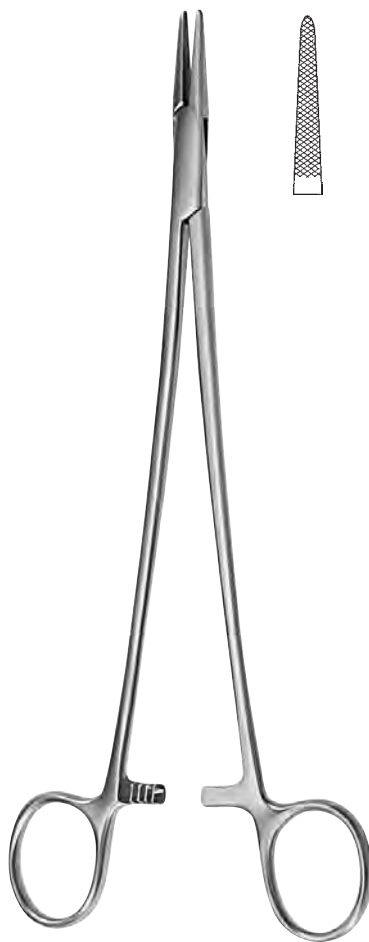

JAMISON

019-248-235 23,5 cm / 9¹/₄"



MASSON

019-250-270 27,0 cm / 10¹/₂"



019

**Nadelhalter
Needle Holders
Porta-agujas
Portaghi**



FINOCHIETTO

019-253-270 27,0 cm / 10¹/₂"



WANGENSTEEN

019-256-270 27,0 cm / 10¹/₂"



JOHNSON

019-257-270 27,0 cm / 10¹/₂"

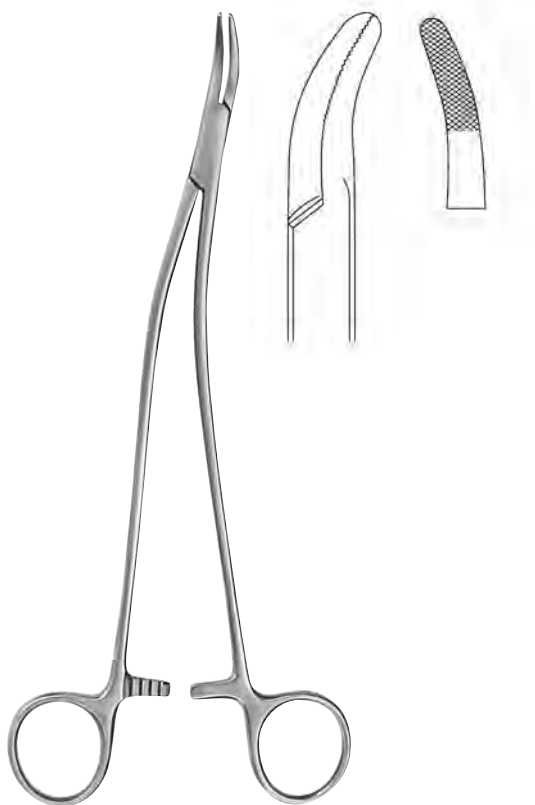

STRATTE

019-259-230 23,0 cm / 9"

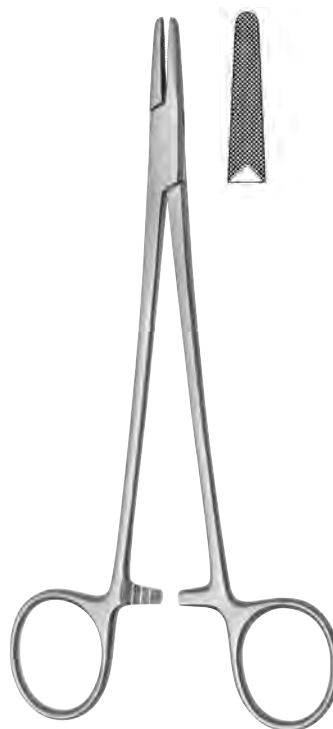

MAYO-HEGAR

019-260-165 16,5 cm / 6½"
019-260-190 19,0 cm / 7½"



HEGAR

019-262-150 15,0 cm / 6"
019-262-175 17,5 cm / 7"
019-262-205 20,5 cm / 8"

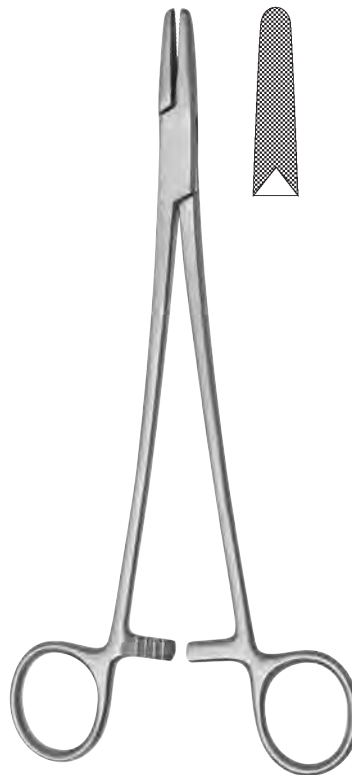

HEGAR

019-264-205 20,5 cm / 8"

**Nadelhalter
Needle Holders
Porta-agujas
Portaghi**



OLSEN-HEGAR

019-270-115 11,5 cm / 4½"
019-270-140 14,0 cm / 5½"



OLSEN-HEGAR

019-272-185 18,5 cm / 7¼"

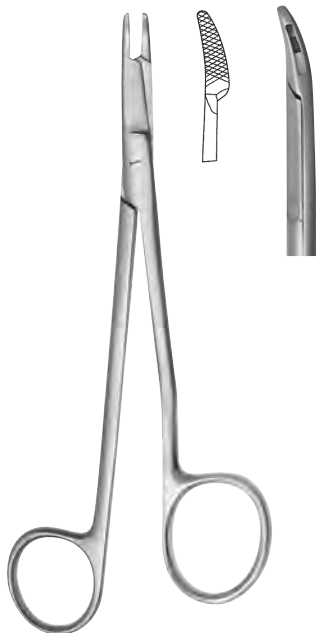

BABY-GILLIES

019-274-150 15,0 cm / 6"

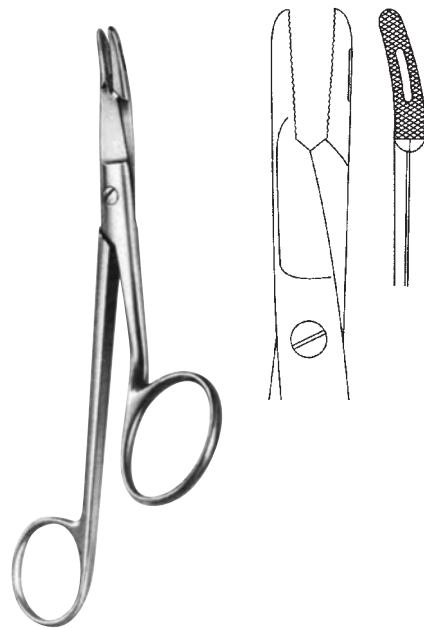

GILLIES

019-276-160 16,0 cm / 6¼"

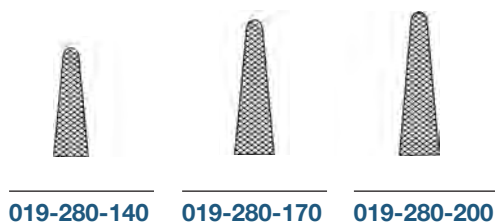

019-280-140

019-280-170

019-280-200

MATHIEU

- 019-280-140 14,0 cm / 5 1/2"
- 019-280-170 17,0 cm / 6 3/4"
- 019-280-200 20,0 cm / 8"

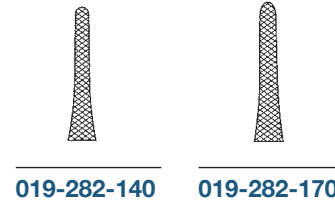

019-282-140

019-282-170

MATHIEU-KOCHER

- 019-282-140 14,0 cm / 5 1/2"
- 019-282-170 17,0 cm / 6 1/4"



MATHIEU-RYDER

- 019-286-140 14,0 cm / 5 1/2"



TOENNIS

- 019-290-180 18,0 cm / 7"



LICHTENBERG

- 019-292-200 20,0 cm / 8"

Nadelhalter mit Hartmetalleinlagen
Needle Holders with tungsten carbide inserts
Porta-agujas con bocas de carburo tungsteno
Portaghi con morsi in carburo di tungsteno

Hartmetalleinlagen mit präzise gearbeitetem Pyramidenprofil garantieren einen sicheren Halt der Nadel.

Tungsten carbide inserts with precisely worked out structure guarantee to grip the needle securely.

Capas intermedias de carburo tungsteno con perfil amoldado piramidal que garantiza un sujeto seguro de la aguja.

Inserti in carburo di tungsteno che garantiscono una perfetta tenuta dell'ago.

Gebrochene Kanten verhindern ein Verfangen des Nahtmaterials.

Bevelled edges to prevent catching of suture material.

Bordes quebrados evitan que se enrede el material de sutura.

I bordi squadri evitano che si impigliano i fili di sutura.

Vergoldete Ringe als leichte Kennzeichnung.

Gold-plated rings for easy identification.

Anillos dorados para fácil identificación

Anelli dorata permette una facile identificazione.

Leichtgängige Sperre ermöglicht eine sichere Arbeitsweise.

Soft working catch provides safe handling.

El cierre suave facilita un manejo seguro.

Il bloccaggio leggero e preciso facilita un uso sicuro.

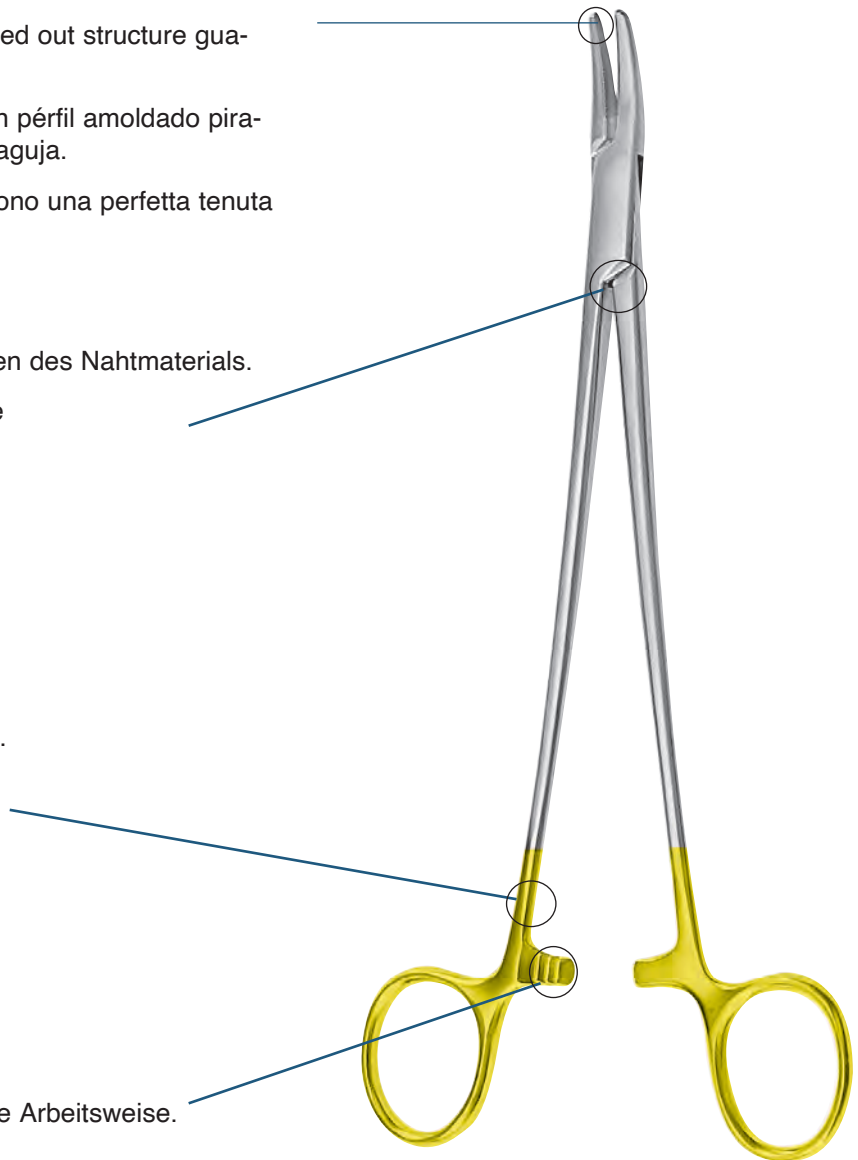

Nadelhalter mit Hartmetalleinlagen
Needle Holders with tungsten carbide inserts
Porta-agujas con bocas de carburo tungsteno
Portaghi con morsi in carburo di tungsteno



019

Je nach Anwendungsgebiet stehen für TC Nadelhalter unterschiedliche Hartmetalleinlagen zur Verfügung:
According to the field of application, there are various types of tungsten carbide inserts for TC needle holders:
Según campo de aplicación, disponemos de TC porta-agujas con varias capas intermedias:
A seconda delle necessità disponiamo di TC portaghi con varie capacità intermedie:

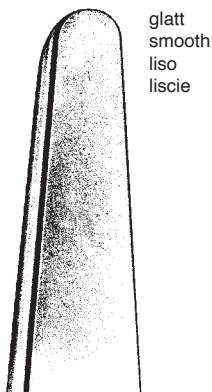

Zum Halten von extrem feinem Nahtmaterial.
For holding the smallest suture sizes.
Para sujetar suturas muy finas.
Per lavorare con suture sottilissime

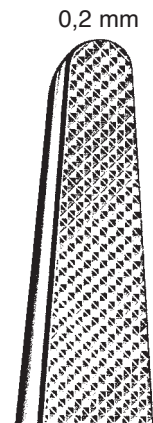

Zum Halten von Nahtmaterial der Stärken 7/0 bis 10/0.
For holding the suture sizes from 7/0 to 10/0.
Para sujetar suturas de gruesas 7/0 hasta 10/0.
Per lavorare con suture da 7/0 a 10/0.

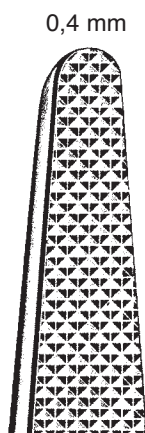

Zum Halten von Nahtmaterial der Stärken 4/0 bis 6/0.
For holding the suture sizes from 4/0 to 6/0.
Para sujetar suturas de gruesas 4/0 hasta 6/0.
Per lavorare con suture da 4/0 a 6/0.

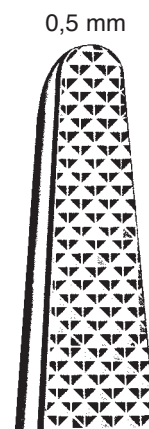

Zum Halten von Nahtmaterial der Stärke 3/0 und kräftiger.
For holding the suture size 3/0 and larger.
Para sujetar suturas de 3/0 y más gruesas.
Per lavorare con suture da 3/0 in poi.



019

Nadelhalter mit Hartmetalleinlagen
Needle Holders with tungsten carbide inserts
Porta-agujas con bocas de carburo tungsteno
Portaghi con morsi in carburo di tungsteno



KALT

019-300-140 14,0 cm / 5½"



019-304-160

019-305-160



ARRUGA

019-304-160 – 019-305-160 16,0 cm / 6¼"



BOYTON

019-310-120 12,0 cm / 4¾"

Nadelhalter mit Hartmetalleinlagen
Needle Holders with tungsten carbide inserts
Porta-agujas con bocas de carburo tungsteno
Portaghi con morsi in carburo di tungsteno



019



ohne Sperre
without ratchet
sin cierre
senza chiusura

CASTROVIEJO (JACOBSON)

019-320-140 14,0 cm / 5¹/₂"
019-320-180 18,0 cm / 7"
019-320-220 22,0 cm / 8³/₄"



ohne Sperre
without ratchet
sin cierre
senza chiusura

CASTROVIEJO (JACOBSON)

019-321-140 14,0 cm / 5¹/₂"
019-321-180 18,0 cm / 7"
019-321-220 22,0 cm / 8³/₄"



ohne Sperre
without ratchet
sin cierre
senza chiusura

CASTROVIEJO (JACOBSON)

019-330-140 14,0 cm / 5¹/₂"
019-330-180 18,0 cm / 7"
019-330-220 22,0 cm / 8³/₄"



ohne Sperre
without ratchet
sin cierre
senza chiusura

CASTROVIEJO (JACOBSON)

019-331-140 14,0 cm / 5¹/₂"
019-331-180 18,0 cm / 7"
019-331-220 22,0 cm / 8³/₄"



mit Sperre
with ratchet
con cierre
con chiusura

CASTROVIEJO (JACOBSON)

019-340-140 14,0 cm / 5¹/₂"
019-340-180 18,0 cm / 7"
019-340-220 22,0 cm / 8³/₄"



mit Sperre
with ratchet
con cierre
con chiusura

CASTROVIEJO (JACOBSON)

019-341-140 14,0 cm / 5¹/₂"
019-341-180 18,0 cm / 7"
019-341-220 22,0 cm / 8³/₄"



019

Nadelhalter mit Hartmetalleinlagen
Needle Holders with tungsten carbide inserts
Porta-agujas con bocas de carburo tungsteno
Portaghi con morsi in carburo di tungsteno



CASTROVIEJO (JACOBSON)

- 019-350-140** 14,0 cm / 5½"
- 019-350-180** 18,0 cm / 7"
- 019-350-220** 22,0 cm / 8¾"



CASTROVIEJO (JACOBSON)

- 019-351-140** 14,0 cm / 5½"
- 019-351-180** 18,0 cm / 7"
- 019-351-220** 22,0 cm / 8¾"



019-360-180



019-361-180



BARRAQUER

- 019-370-180** 18,0 cm / 7"



BARRAQUER

- 019-371-140** 14,0 cm / 5½"
- 019-371-180** 18,0 cm / 7"

BARRAQUER

- 019-360-180 – 019-361-180** 18,0 cm / 7"

Nadelhalter mit Hartmetalleinlagen
Needle Holders with tungsten carbide inserts
Porta-agujas con bocas de carburo tungsteno
Portaghi con morsi in carburo di tungsteno



019



BARRAQUER

019-380-180 18,0 cm / 7"
019-380-210 21,0 cm / 8 1/4"



BARRAQUER

019-381-180 18,0 cm / 7"
019-381-210 21,0 cm / 8 1/4"



BARRAQUER

019-390-180 18,0 cm / 7"
019-390-210 21,0 cm / 8 1/4"



BARRAQUER

019-391-140 14,0 cm / 5 1/2"
019-391-180 18,0 cm / 7"
019-391-210 21,0 cm / 8 1/4"



diamantbeschichtet
 diamond coated
 capa de diamante
 strato di diamante

YASARGIL

019-400-225 22,5 cm / 9"



diamantbeschichtet
 diamond coated
 capa de diamante
 strato di diamante

ohne Sperre
 without ratchet
 sub cierre
 senza chiusura

YASARGIL

019-401-225 22,5 cm / 9"



019

Nadelhalter mit Hartmetalleinlagen
Needle Holders with tungsten carbide inserts
Porta-agujas con bocas de carburo tungsteno
Portaghi con morsi in carburo di tungsteno



DIETHRICH

019-410-160	16,0 cm / 6 ¹ / ₄ "
019-410-180	18,0 cm / 7"
019-410-200	20,0 cm / 8"
019-410-230	23,0 cm / 9"
019-410-250	25,0 cm / 9 ³ / ₄ "



DIETHRICH

019-420-160	16,0 cm / 6 ¹ / ₄ "
019-420-180	18,0 cm / 7"
019-420-200	20,0 cm / 8"
019-420-230	23,0 cm / 9"
019-420-250	25,0 cm / 9 ³ / ₄ "



HEPP-SCHEIDEL

019-430-180	18,0 cm / 7"
--------------------	--------------



DERF

019-500-120	12,0 cm / 4 ³ / ₄ "
--------------------	---

Nadelhalter mit Hartmetalleinlagen
Needle Holders with tungsten carbide inserts
Porta-agujas con bocas de carburo tungsteno
Portaghi con morsi in carburo di tungsteno



019

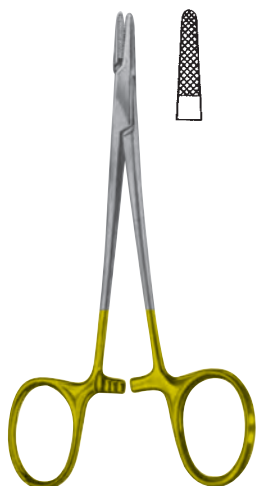

CONVERSE

019-504-120 12,0 cm / 4³/₄"

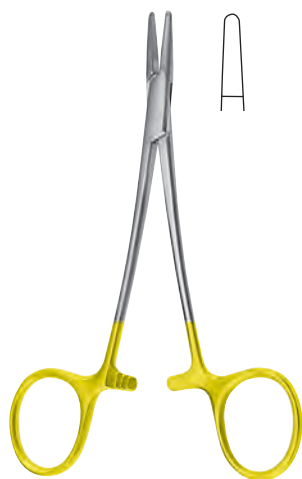

WEBSTER

019-510-115 11,5 cm / 4¹/₂"
019-510-130 13,0 cm / 5¹/₈"



WEBSTER

019-511-130 13,0 cm / 5¹/₈"



HALSEY

019-520-130 13,0 cm / 5¹/₈"



HALSEY

019-522-115 11,5 cm / 4¹/₂"
019-522-130 13,0 cm / 5¹/₈"



NEIVERT

019-530-130 13,0 cm / 5¹/₈"



019

Nadelhalter mit Hartmetalleinlagen
Needle Holders with tungsten carbide inserts
Porta-agujas con bocas de carburo tungsteno
Portaghi con morsi in carburo di tungsteno

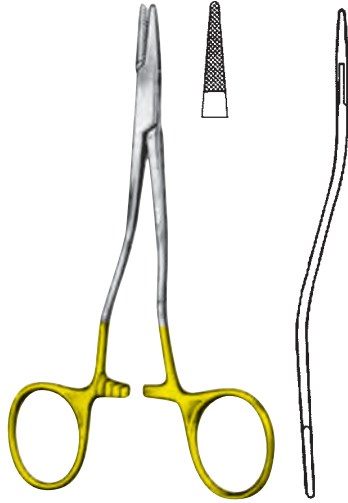

KILNER

019-535-135 13,5 cm / 5¹/₄"



BAUMGARTNER

019-540-125 12,5 cm / 5"
019-540-140 14,0 cm / 5¹/₂"



019-550-140



019-550-160



019-550-180



019-550-200



019-550-240



019-550-260



019-550-300



MAYO-HEGAR

019-550-140 14,0 cm / 5¹/₂"
019-550-160 16,0 cm / 6¹/₄"
019-550-180 18,0 cm / 7"
019-550-200 20,0 cm / 8"
019-550-240 24,0 cm / 9¹/₂"
019-550-260 26,0 cm / 10¹/₄"
019-550-300 30,0 cm / 11³/₄"

Nadelhalter mit Hartmetalleinlagen
Needle Holders with tungsten carbide inserts
Porta-agujas con bocas de carburo tungsteno
Portaghi con morsi in carburo di tungsteno



019

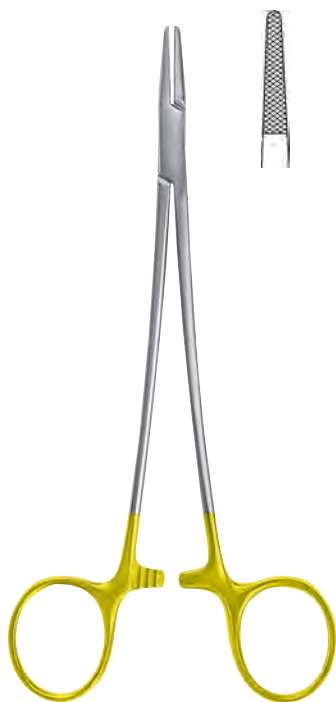

MAYO-HEGAR - SLENDER PATTERN

019-552-180 18,0 cm / 7"
019-552-200 20,0 cm / 8"



MAYO-HEGAR - HEAVY PATTERN

019-554-180 18,0 cm / 7"



HEGAR

019-556-200 20,0 cm / 8"
019-556-240 24,0 cm / 9⁵/₈"



MAYO-HEGAR (HEANEY)

019-557-200 20,0 cm / 8"
019-557-240 24,0 cm / 9⁵/₈"
019-557-260 26,0 cm / 10¹/₄"

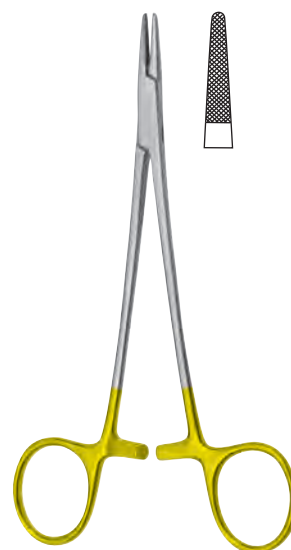

CRILE-WOOD BABY

019-560-150 15,0 cm / 6"



019

Nadelhalter mit Hartmetalleinlagen
Needle Holders with tungsten carbide inserts
Porta-agujas con bocas de carburo tungsteno
Portaghi con morsi in carburo di tungsteno

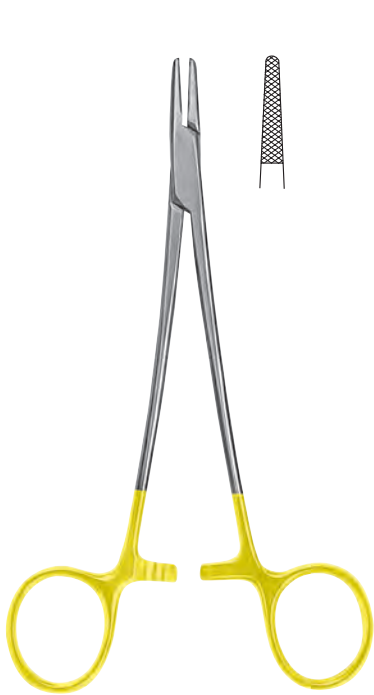

CRILE-WOOD

- 019-570-150** 15,0 cm / 6"
- 019-570-180** 18,0 cm / 7"
- 019-570-200** 20,0 cm / 8"
- 019-570-230** 23,0 cm / 9"
- 019-570-260** 26,0 cm / 10¹/₄"

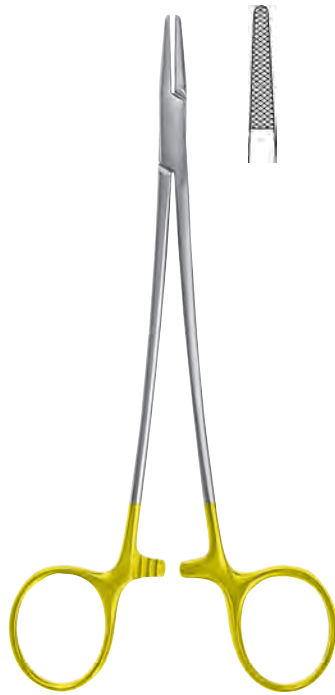

DEBAKEY

- 019-580-150** 15,0 cm / 6"
- 019-580-165** 16,5 cm / 6¹/₂"
- 019-580-180** 18,0 cm / 7"
- 019-580-200** 20,0 cm / 8"
- 019-580-230** 23,0 cm / 9"
- 019-580-260** 26,0 cm / 10¹/₄"
- 019-580-310** 31,0 cm / 12¹/₄"



MIKRO-SLIM

- 019-586-150** 15,0 cm / 6"
- 019-586-180** 18,0 cm / 7"
- 019-586-200** 20,0 cm / 8"
- 019-586-230** 23,0 cm / 9"

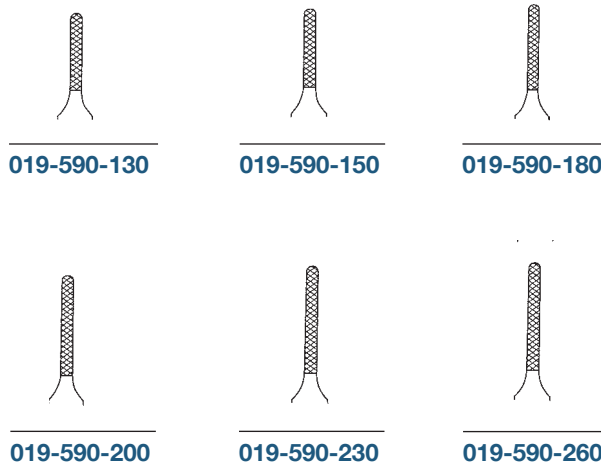
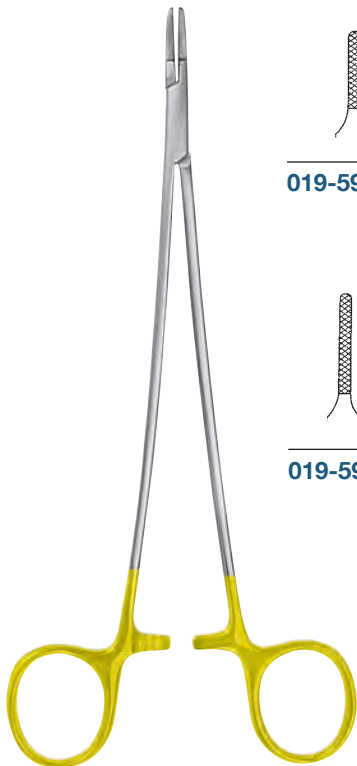

RYDER-FRENCH EYE

- 019-590-130** 13,0 cm / 5¹/₈"
- 019-590-150** 15,0 cm / 6"
- 019-590-180** 18,0 cm / 7"
- 019-590-200** 20,0 cm / 8"
- 019-590-230** 23,0 cm / 9"
- 019-590-260** 26,0 cm / 10¹/₄"

Nadelhalter mit Hartmetalleinlagen
Needle Holders with tungsten carbide inserts
Porta-agujas con bocas de carburo tungsteno
Portaghi con morsi in carburo di tungsteno



019

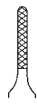

019-600-130



019-600-150



019-600-180



019-600-200

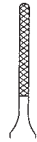

019-600-230

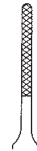

019-600-260

RYDER-MINI

019-600-130	13,0 cm / 5 ¹ / ₈ "
019-600-150	15,0 cm / 6"
019-600-180	18,0 cm / 7"
019-600-200	20,0 cm / 8"
019-600-230	23,0 cm / 9"
019-600-260	26,0 cm / 10 ¹ / ₄ "

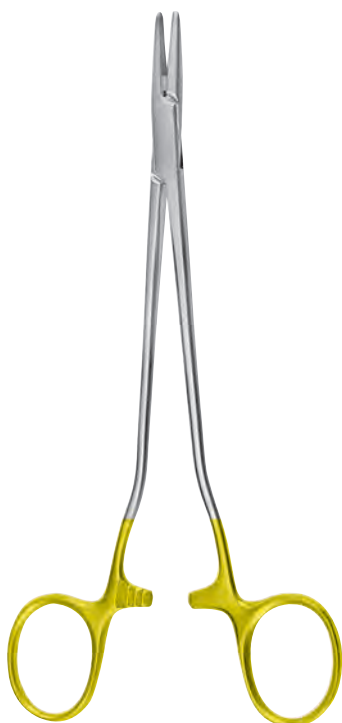

019-610-140



019-610-180



019-610-200



019-610-230

HEGAR-VASCULAR

019-610-140	14,0 cm / 5 ¹ / ₂ "
019-610-180	18,0 cm / 7"
019-610-200	20,0 cm / 8"
019-610-230	23,0 cm / 9"



019

Nadelhalter mit Hartmetalleinlagen
Needle Holders with tungsten carbide inserts
Porta-agujas con bocas de carburo tungsteno
Portaghi con morsi in carburo di tungsteno

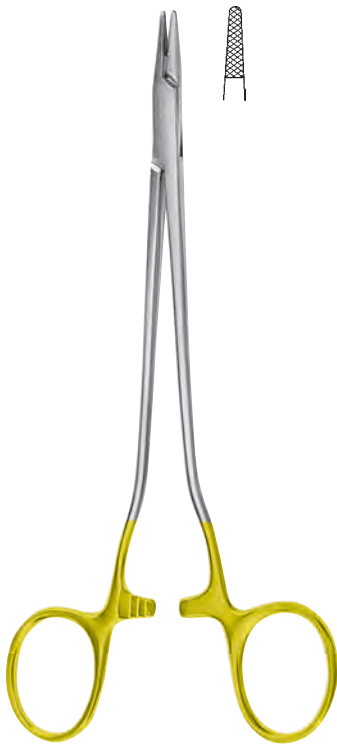

SENNING

- 019-620-150** 15,0 cm / 6"
- 019-620-170** 17,0 cm / 6³/₄"
- 019-620-200** 20,0 cm / 8"

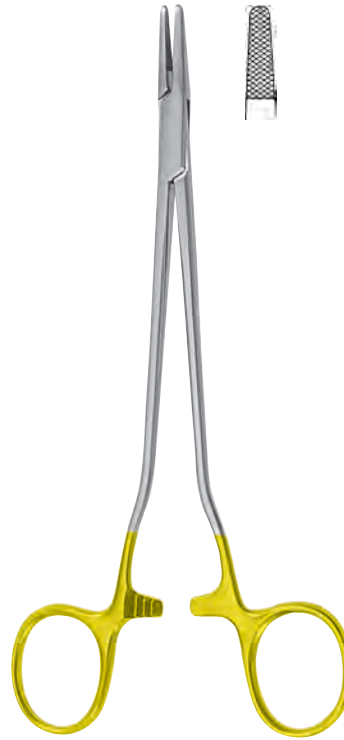

SAROT

- 019-630-180** 18,0 cm / 7"
- 019-630-200** 20,0 cm / 8"
- 019-630-230** 23,0 cm / 9"
- 019-630-260** 26,0 cm / 10¹/₄"

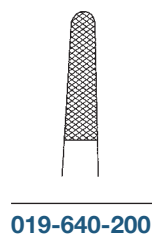
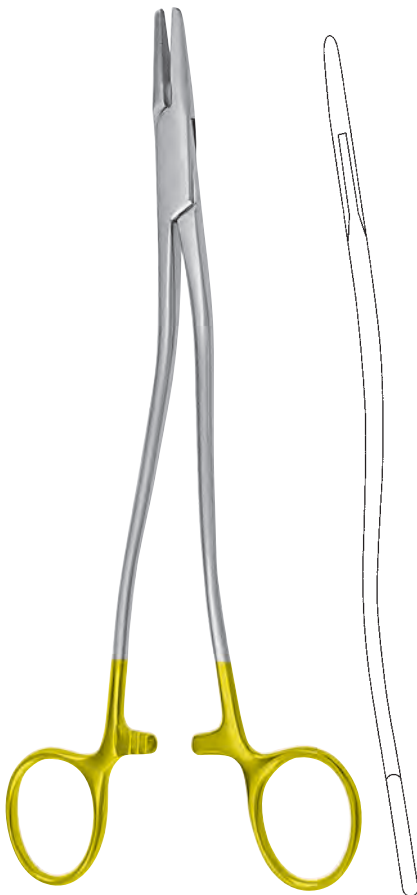

019-640-200

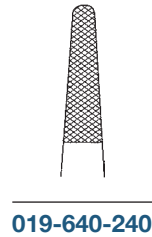

019-640-240

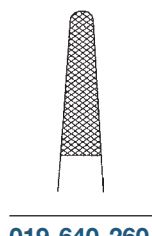

019-640-260

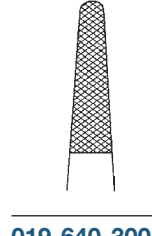

019-640-300

BOZEMANN

- 019-640-200** 20,0 cm / 8"
- 019-640-240** 24,0 cm / 9¹/₂"
- 019-640-260** 26,0 cm / 10¹/₄"
- 019-640-300** 30,0 cm / 11³/₄"

Nadelhalter mit Hartmetalleinlagen
Needle Holders with tungsten carbide inserts
Porta-agujas con bocas de carburo tungsteno
Portaghi con morsi in carburo di tungsteno



019

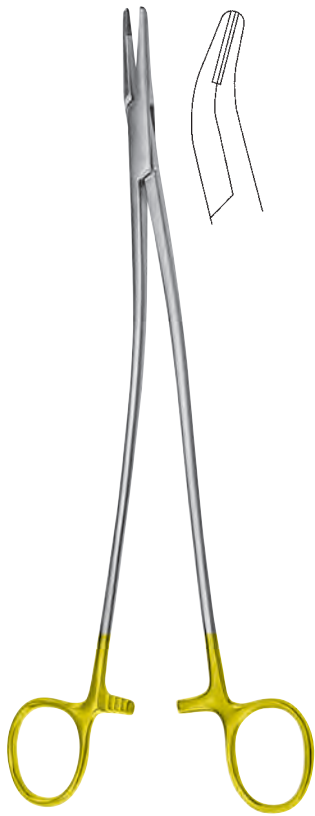

019-644-210



019-644-230



STRATTE

019-644-210 21,0 cm / 8¹/₄"
 019-644-230 23,0 cm / 9"

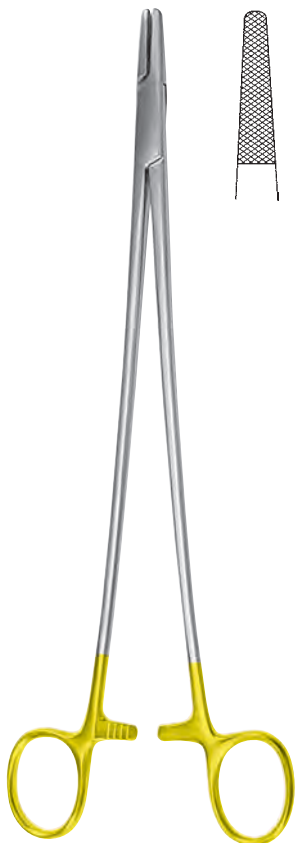

MASSON

019-650-270 27,0 cm / 10¹/₄"

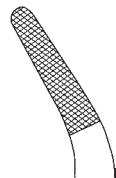

FINOCHIETTO

019-651-270 27,0 cm / 10¹/₄"

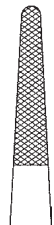
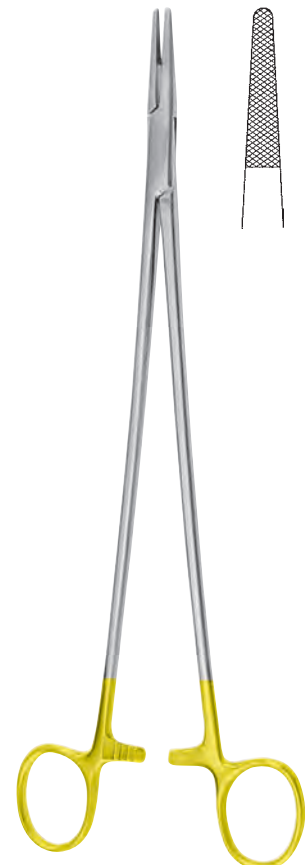

WANGENSTEEN

019-654-270 28,0 cm / 11"

Nadelhalter mit Hartmetalleinlagen
Needle Holders with tungsten carbide inserts
Porta-agujas con bocas de carburo tungsteno
Portaghi con morsi in carburo di tungsteno

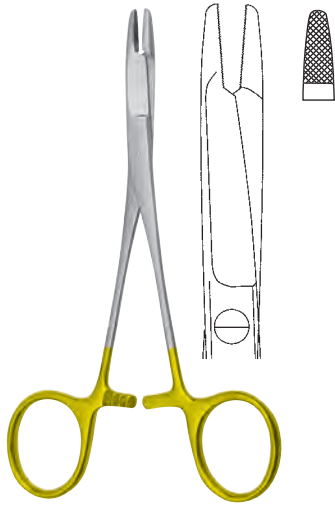

OLSEN-HEGAR

- 019-660-115** 11,5 cm / 4¹/₂"
- 019-660-140** 14,0 cm / 5¹/₂"
- 019-660-170** 17,0 cm / 6³/₄"
- 019-660-185** 18,5 cm / 7¹/₄"

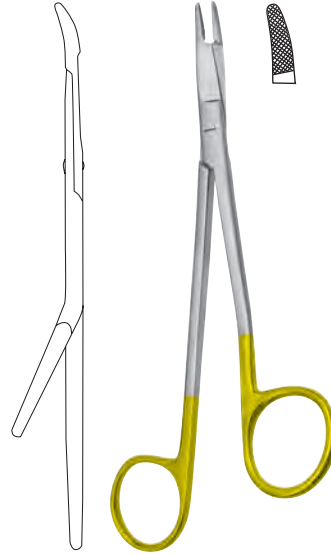

BABY-GILLIES

- 019-662-150** 15,0 cm / 6"



GILLIES

- 019-664-160** 16,0 cm / 6¹/₄"

Nadelhalter mit Hartmetalleinlagen
Needle Holders with tungsten carbide inserts
Porta-agujas con bocas de carburo tungsteno
Portaghi con morsi in carburo di tungsteno



019



019-670-140

019-670-170

019-670-200

019-670-240

MATHIEU

- | | |
|--------------------|---|
| 019-670-140 | 14,0 cm / 5 ¹ / ₂ " |
| 019-670-170 | 17,0 cm / 6 ³ / ₄ " |
| 019-670-200 | 20,0 cm / 8" |
| 019-670-240 | 24,0 cm / 6 ¹ / ₂ " |

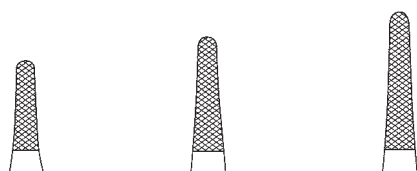

019-672-140

019-672-170

019-672-200

MATHIEU-KOCHER

- | | |
|--------------------|---|
| 019-672-140 | 14,0 cm / 5 ¹ / ₂ " |
| 019-672-170 | 17,0 cm / 6 ³ / ₄ " |
| 019-672-200 | 20,0 cm / 8" |



019

Nadelhalter mit Hartmetalleinlagen
Needle Holders with tungsten carbide inserts
Porta-agujas con bocas de carburo tungsteno
Portaghi con morsi in carburo di tungsteno



019-674-140



019-674-170



019-674-200



019-680-140



019-680-170



019-680-200

MATHIEU-RYDER

- 019-674-140 14,0 cm / 5¹/₂"
- 019-674-170 17,0 cm / 6³/₄"
- 019-674-200 20,0 cm / 8"

MATHIEU

- 019-680-140 14,0 cm / 5¹/₂"
- 019-680-170 17,0 cm / 6³/₄"
- 019-680-200 20,0 cm / 8"



019-690-160



019-690-180



019-690-200

LANGENBECK

- 019-690-160 16,0 cm / 6¹/₄"
- 019-690-180 18,0 cm / 7"
- 019-690-200 20,0 cm / 8"

Nadelhalter mit Hartmetalleinlagen
Needle Holders with tungsten carbide inserts
Porta-agujas con bocas de carburo tungsteno
Portaghi con morsi in carburo di tungsteno



019



CRILE

019-696-150 15,0 cm / 6"



TOENNIS

019-696-180 18,0 cm / 7"



LICHTENBERG

019-700-170 17,0 cm / 6³/₄"
019-700-200 20,0 cm / 8"



LICHTENBERG

019-701-170 17,0 cm / 6³/₄"



mit langem Hals
with long neck
con cuello largo
con collo lungo

HÖSEL

019-710-200 20,0 cm / 8"



019

Nadelhalter mit Hartmetalleinlagen
Needle Holders with tungsten carbide inserts
Porta-agujas con bocas de carburo tungsteno
Portaghi con morsi in carburo di tungsteno



019-714-200



019-714-230

ZWEIFEL

019-714-200 20,0 cm / 8"
019-714-230 23,0 cm / 9"



mit langem Hals
with long neck
con cuello largo
con collo lungo

HÖSEL

019-720-260 26,0 cm / 10³/₄"

Unterbindungsnadeln
Ligature Needles
Agujas para ligaduras
Aghi per legatura



019

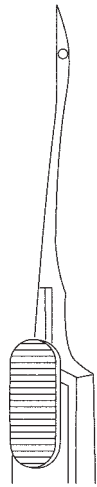

019-750-001

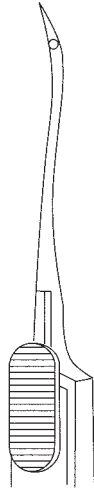

019-750-002

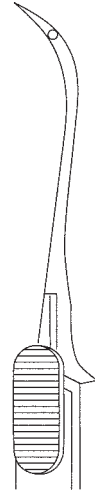

019-750-003

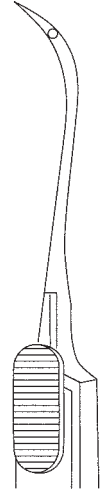

019-750-004

REVERDIN

019-750-001 - 019-750-004 14,0 cm / 5 1/2"

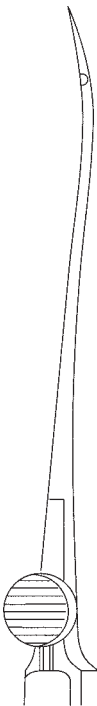

019-752-001
019-754-001

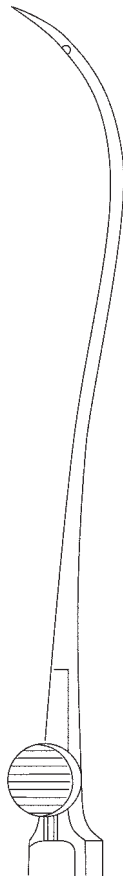

019-752-002
019-754-002

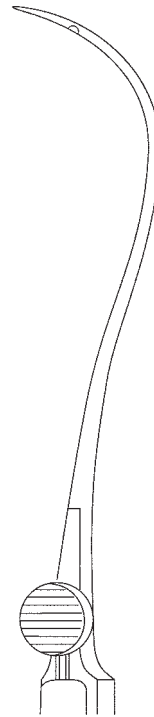

019-752-003
019-754-003

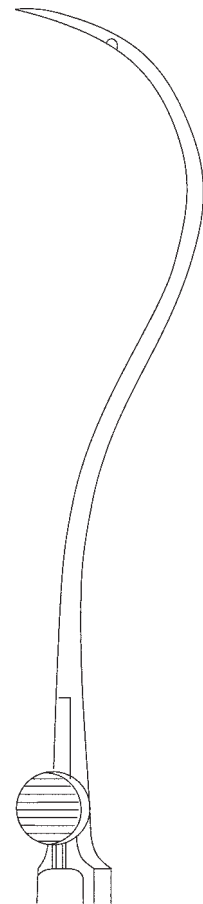

019-752-004
019-754-004

REVERDIN

019-752-001 - 019-752-004 19,0 cm / 7 1/2"
019-754-001 - 019-754-004 23,0 cm / 9"

**Unterbindungsnadeln
Ligature Needles
Agujas para ligaduras
Aghi per legatura**



Fig. 1
019-761-001

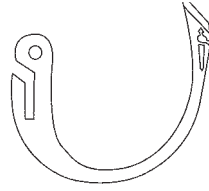

Fig. 2
019-761-002

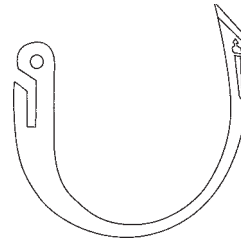

Fig. 3
019-761-003

komplett mit Nadel Fig.1
complete with needle Fig.1
completo con aguja Fig.1
completo con ago Fig.1

YOUNG

019-760-240 24,0 cm / 9 1/2"



SCHMIEDEN

019-771-240 24,0 cm / 9 1/2"

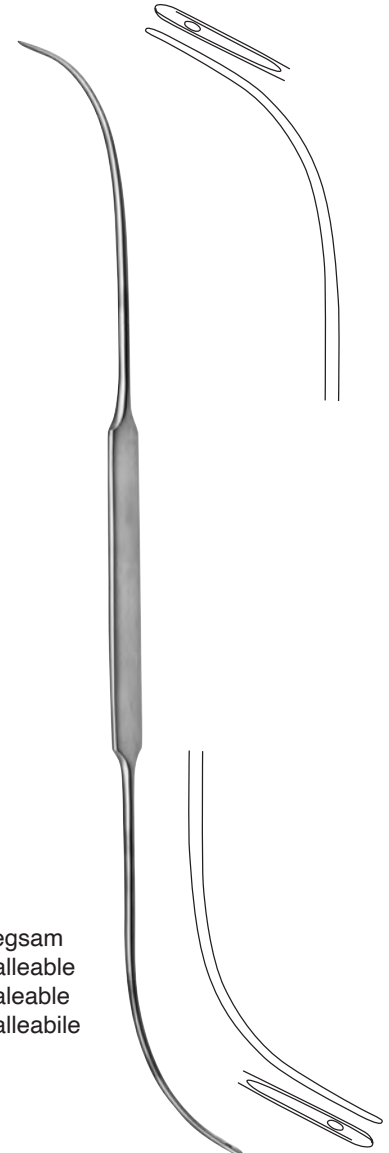

biegsam
malleable
maleable
malleabile

SCHMIEDEN-DICK

019-773-300 30,0 cm / 11 3/4"

Unterbindungsnadeln
Ligature Needles
Agujas para ligaduras
Aghi per legatura



019

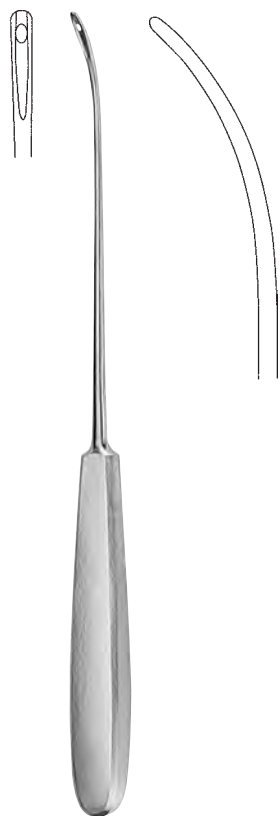

019-781-200 20,0 cm / 8"

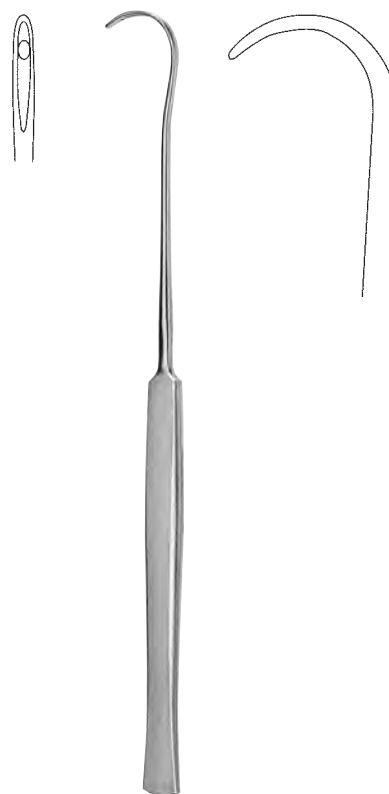

COOPER
019-783-190 19,0 cm / 7½"



fein
 für die rechte Hand
 delicate
 for right hand
 fina
 para la mano derecha
 fino
 per la mano destra

KRONECKER
019-785-130 13,0 cm / 5⅓"

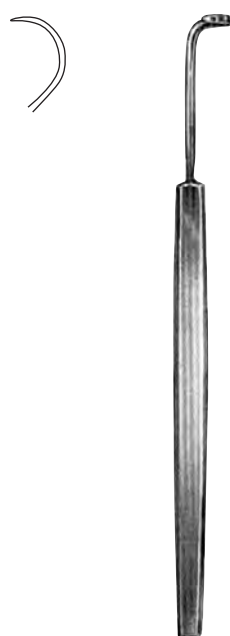
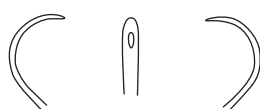

fein
 für die linke Hand
 delicate
 for left hand
 fina
 para la mano izquierda
 fino
 per la mano sinistra

KRONECKER
019-787-130 13,0 cm / 5⅓"



019

**Unterbindungsnadeln
Ligature Needles
Agujas para ligaduras
Aghi per legatura**

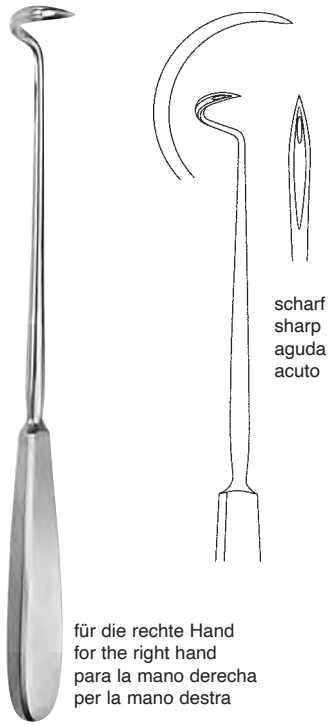

scharf
sharp
aguda
acuto

für die rechte Hand
for the right hand
para la mano derecha
per la mano destra

DESCHAMPS

019-800-200 20,0 cm / 8"

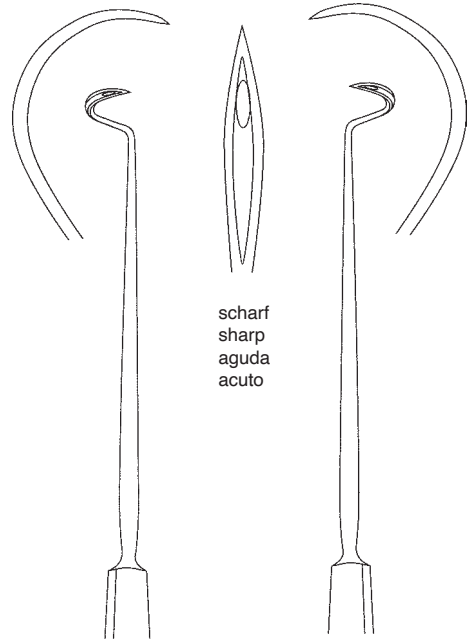

scharf
sharp
aguda
acuto

019-800-210
019-800-270

für die rechte Hand
for the right hand
para la mano derecha
per la mano destra

019-801-210
019-801-270

für die linke Hand
for the left hand
para la mano izquierda
per la mano sinistra

DESCHAMPS

019-800-210 - 019-801-210 21,0 cm / 8 1/4"
019-800-270 - 019-801-270 27,0 cm / 10 1/4"

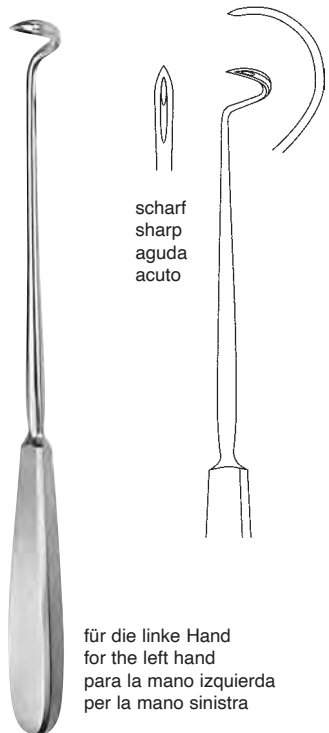

scharf
sharp
aguda
acuto

für die linke Hand
for the left hand
para la mano izquierda
per la mano sinistra

DESCHAMPS

019-801-200 20,0 cm / 8"

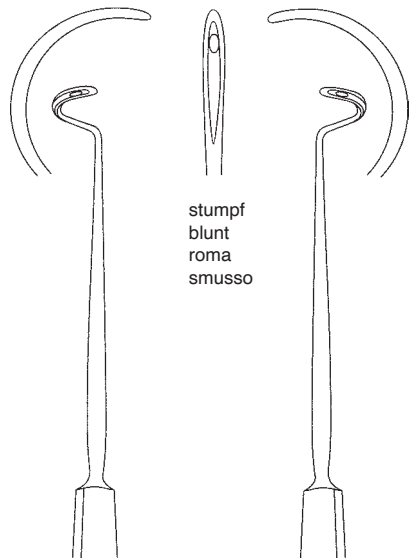

stumpf
blunt
roma
smusso

019-810-200
für die rechte Hand
for the right hand
para la mano derecha
per la mano destra

019-811-200
für die linke Hand
for the left hand
para la mano izquierda
per la mano sinistra

DESCHAMPS

20,0 cm / 8"

Unterbindungsnadeln
Ligature Needles
Agujas para ligaduras
Aghi per legatura



019

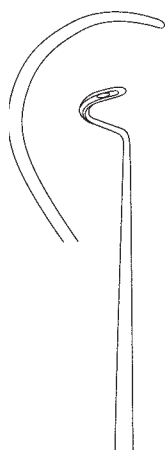

stumpf
 blunt
 roma
 smusso

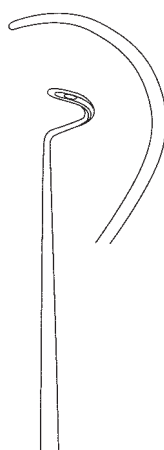

019-810-210
019-810-240

für die rechte Hand
 for the right hand
 para la mano derecha
 per la mano destra

019-811-210
019-811-240

für die linke Hand
 for the left hand
 para la mano izquierda
 per la mano sinistra

DESCHAMPS

019-810-210 - 019-811-210 21,0 cm / 8¹/₄"
019-810-240 - 019-811-240 24,0 cm / 9¹/₂"

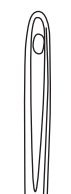
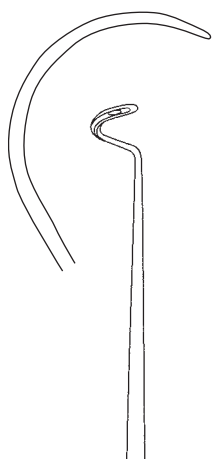

stumpf
 blunt
 roma
 smusso

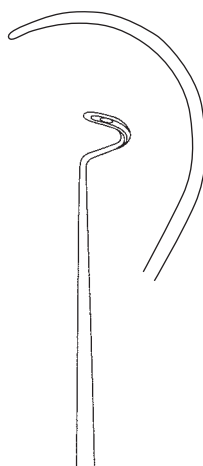

019-810-270
019-810-280

für die rechte Hand
 for the right hand
 para la mano derecha
 per la mano destra

019-811-270
019-811-280

für die linke Hand
 for the left hand
 para la mano izquierda
 per la mano sinistra

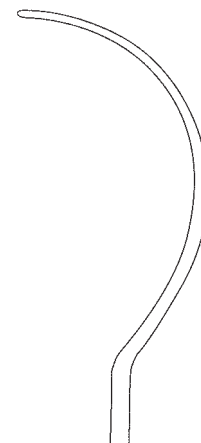

019-820-001

019-820-002

DESCHAMPS

019-810-270 - 019-811-270 24,0 cm / 9¹/₂"
019-810-280 - 019-811-280 28,0 cm / 11"

BRUNNER

019-820-001 - 019-820-002 30,0 cm / 11³/₄"

Unterbindungsnadeln, Führungshohlsonden
Ligature Needles, Ligature Conductors
Agujas para ligaduras, Sondas conductoras
Aghi per legatura, Sonde conduttrici



019-824-001

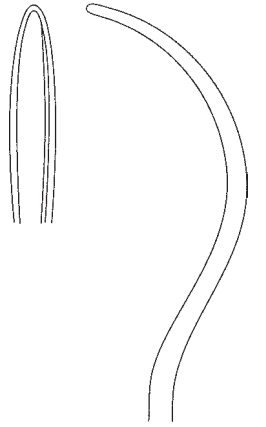

019-824-002

BRUNNER

019-824-001 - 019-824-002 30,0 cm / 11³/₄"

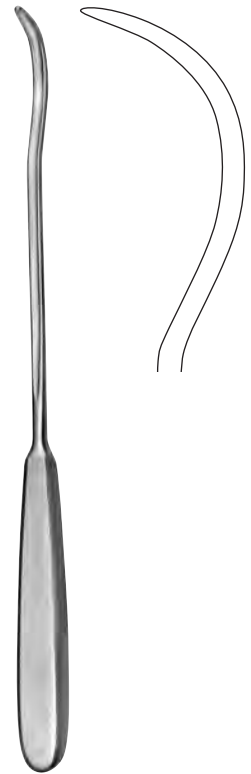

KIRSCHNER

019-829-255 25,5 cm / 10"

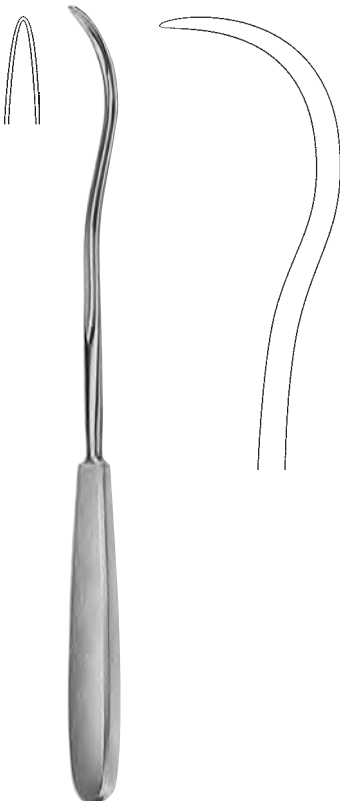

KIRSCHNER

019-829-280 28,0 cm / 11"

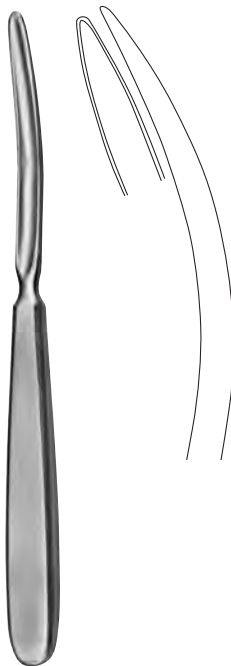

FRIMED

019-833-195 19,5 cm / 7³/₄"



KÖNIG

019-841-001 19,5 cm / 7³/₄"

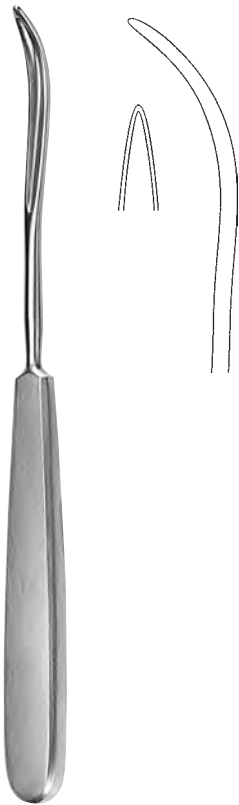

KÖNIG

019-841-002 19,5 cm / 7³/₄"



KÖNIG

019-841-003 19,5 cm / 7³/₄"

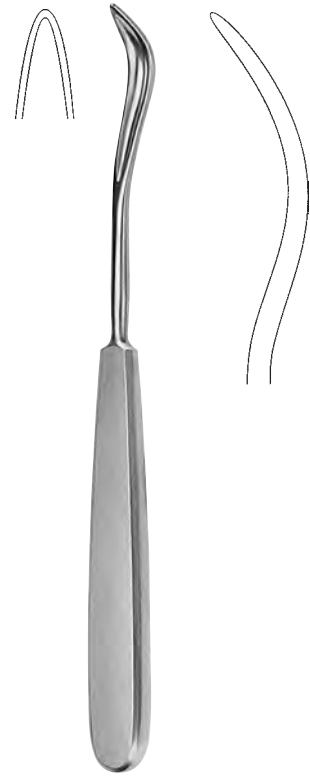

SCHMIEDEN

019-845-190 19,0 cm / 7¹/₂"

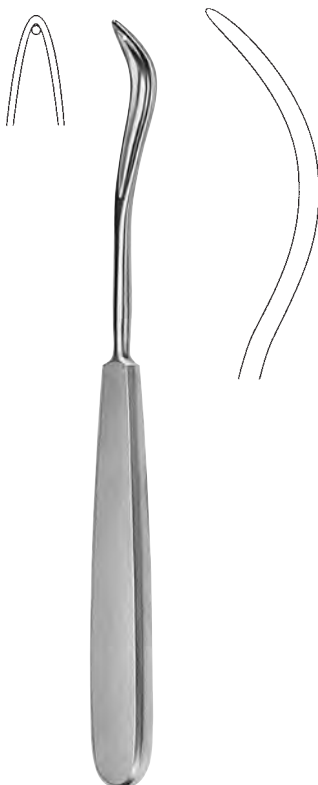

SCHMIEDEN-PAYR

019-847-190 19,0 cm / 7¹/₂"



PAYR

019-850-220 22,0 cm / 8⁵/₈"



PAYR

019-851-220 22,0 cm / 8⁵/₈"



019

Führungshohlsonden
Ligature Conductors
Sondas conductoras
Sonde conduttrici



MOD. WIEN

019-856-235 23,5 cm / 9¹/₄"



BOZEMANN

019-858-210 21,0 cm / 8¹/₄"



FRIMED

019-860-230 23,0 cm / 9"



BRUNNER

019-871-180 18,0 cm / 7"
019-871-270 27,0 cm / 10³/₄"



KIRSCHNER

019-873-270 27,0 cm / 10³/₄"



FERROZELL

019-875-190 19,0 cm / 7¹/₂"



FERROZELL

019-877-185 18,5 cm / 7¹/₄"



FERROZELL

019-878-240 24,0 cm / 9¹/₂"



kräftig, mit Klammerschiene
heavy pattern, with clip holder
modelo fuerte, con porta-agrafas
modello forte, con porta-agrafas

CHILDE

019-901-180 18,0 cm / 7"



MICHEL

019-902-120 12,0 cm / 4³/₄"



019

Wundklammerpinzetten, Wundklammerzangen

Clip Applying Forceps

Pinzas aplicadoras para agrafes

Pinze per applicare le agrafe

zum Anlegen und Abnehmen der Klammern
for applying and removal of clips
para aplicar y quitar agrafes
per applicare e togliere le agrafe



HEGENBARTH

019-904-120 12,0 cm / 4³/₄"



WACHENFELDT

019-906-125 12,5 cm / 5"



MICHEL

019-910-120 12,0 cm / 4³/₄"



langes Maul
long jaw
boca larga
morso lungo

MOD. MICHEL

019-912-120 12,0 cm / 4³/₄"

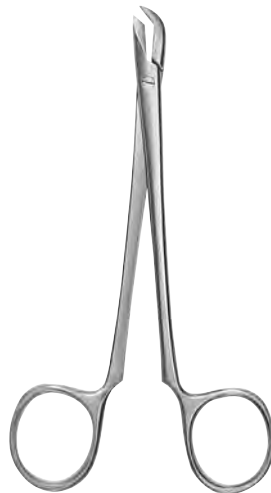

COLLIN

019-914-130 13,0 cm / 5"

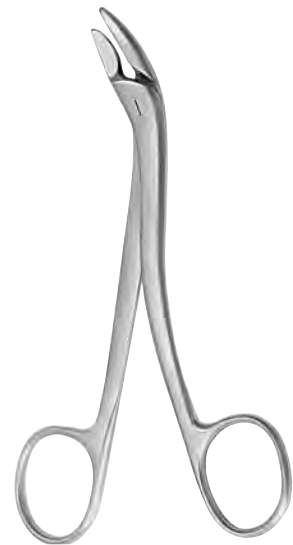

RICHTER-HEATH

019-915-140 14,0 cm / 5¹/₂"

Wundklammern, Wundklammernbesteck
Suture Clips, Suture Clip Set
Agrafes de sutura, Estuche para suturas
Agrafe, Set per sutura



019



MICHEL

019-920-007 7,5 x 1,75 mm



MICHEL

019-920-011 11,0 x 2,0 mm



MICHEL

019-920-012 12,0 x 3,0 mm



MICHEL

019-920-014 14,0 x 3,0 mm



MICHEL

019-920-016 16,0 x 3,0 mm



MICHEL

019-920-018 18,0 x 3,0 mm



019-920-020 20,0 x 3,0 mm



MICHEL

019-920-022 22,0 x 3,0 mm

Verkaufseinheit: 1000 Stück
 (10 Packungen mit je 100 Stück)

Sales Unit: 1000 pieces
 (10 packages with 100 each)

Unidad de venta: 1000 piezas
 (10 paquetes con 100 piezas)

Unità di vendita: 1000 pezzi
 (10 pacchetti con 100 pezzi)

discontinued item

019-930-000 130x45x18 mm

Wundklammer-Besteck, komplett, im Metalltui,
 bestehend aus:

- 1 Michel Wundklammerzängchen
- 1 Wachenfeldt Wundrand-Faßpinzette,
mit Klammerhalter
- 50 Michel Wundklammern, 14 x 3 mm
- 1 Plastikschatztasche

Suture Clip Set, complete, in metal case,
 consisting of:

- 1 Michel suture clip forceps
- 1 Wachenfeldt approximation forceps,
with clip holder
- 50 Michel suture clips, 14 x 3 mm
- 1 protection pouch, plastic

Estuche de agrafes, completo, en caja metálica,
 compuesto de:

- 1 Michel pinza para agrafes
- 1 Wachenfeldt pinza aproximadora
con porta-agrafas
- 50 Michel agrafes, 14 x 3 mm
- 1 bolsa de protección, plástico

Set per sutura cutanea, completo, in contenitore
 metallico

- composto di:
- 1 pinza per agrafes Michel
 - 1 pinza Wachenfeldt per avvicinare i
margini della ferita, con port'agrafas
 - 50 agrafes Michel, 14 x 3 mm
 - 1 busta protettiva in plastica

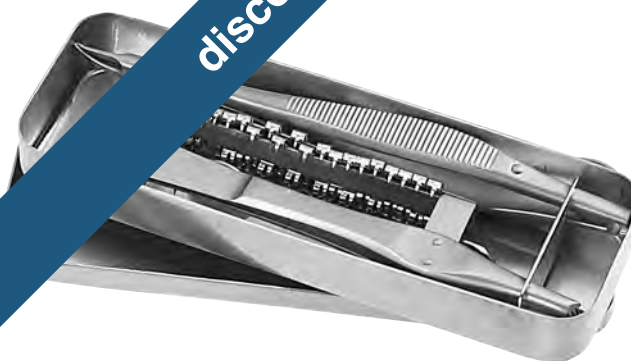



019

Wundklammernbesteck
Suture Clip Set
Estuche para suturas
Set per sutura



CLIP SET MINI ASSISTENT

019-940-000

Taschenbesteck "Mini-Assistent" komplett, in Metalletui bestehend aus:

- 1 Mathieu Nadelhalter, 14 cm
- 1 Packung mit Nähseide, steril
- 3 Stück Nähnadeln, verschiedene Größen
- 1 Nadeldose 50 x 25 mm, gelocht
- 1 Michel Wundklammerzängchen
- 20 Michel Wundklammern 14 x 3 mm, auf Halter
- 1 Skalpelli Griff, No. 4
- 3 Skalpellklingen, verschiedene Größen
- 1 Chirurgische Schere, gerade spitz/stumpf, 13 cm
- 1 Anatomische Pinzette, fein, 12,5 cm
- 1 Plastikschiutztasche

Pocket Set "Mini-Assistent" completo, in metal case consisting of:

- 1 Mathieu needle holder, 14 cm
- 1 package of suture thread, sterile
- 3 suture needles, different sizes
- 1 needle case 50 x 25 mm, perforated
- 1 Michel clip forceps
- 20 Michel wire clips 14 x 3 mm, on clip holder
- 1 scalpel handle, no. 4
- 3 scalpel blades, different sizes
- 1 operating scissors, straight, sharp/blunt 13 cm
- 1 dressing forceps, delicate, 12,5 cm
- 1 protection pouch, plastic

Estuche para suturas "Mini-Assistent", completo en metalletui compuesto de:

- 1 portaghi para agujas, 14 cm
- 1 flacone de seda, estéril
- 3 agujas para suturas, diferentes tamaños
- 1 caja perforada para agujas 50 x 25 mm
- 1 Michel pinza para agrafes
- 20 Michel agrafes 14 x 3 mm, en dispositivo
- 1 mango de bisturi, no.4
- 3 hojas de bisturi, diferentes tamaños
- 1 tijera, recta, aguda/roma, 13 cm
- 1 pinza de disección, fina, 12,5 cm
- 1 bolsa de protección, plástico

Set per sutura cutanea "Mini-Assistent", completo, in contenitore metallico composto di:

- 1 portaghi Matthieu, 14 cm
- 1 flacone di seta sutura, sterile
- 3 aghi assortiti per sutura
- 1 astuccio per aghi, 50 x 25 mm
- 1 pinza per agrafes Michel
- 20 agrafes Michel 14 x 3 mm, con supporto
- 1 manico per bisturi no.4
- 3 lame per bisturi, assortite
- 1 forbice chirurgica, retta, smussa/appuntita, 13 cm
- 1 pinza anatomica, fina, 12,5 cm
- 1 busta protettiva in plastica

discontinued item



020

Verband, Gips
Dressing, Plaster
Vendajes, Escayolas
Bendaggi, Gessatura



020

**Verbandsscheren
Bandage Scissors
Tijeras de vendajes
Cesoie per bendaggi**

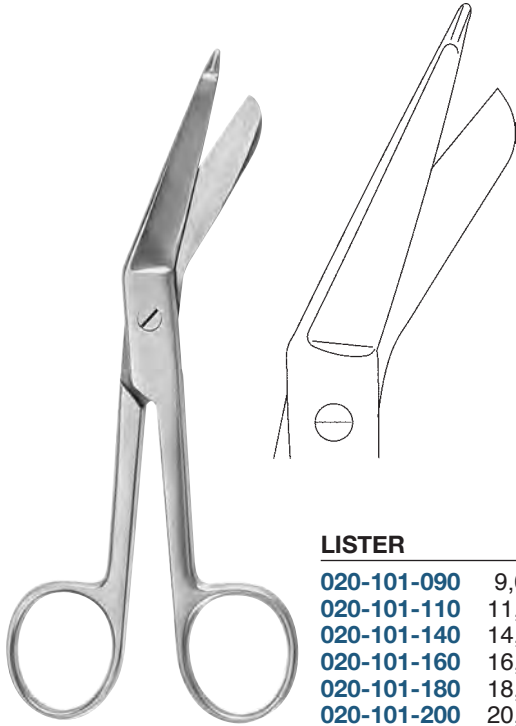

LISTER

020-101-090	9,0 cm / 3 1/2"
020-101-110	11,0 cm / 4 3/8"
020-101-140	14,0 cm / 5 1/2"
020-101-160	16,0 cm / 6 1/4"
020-101-180	18,0 cm / 7"
020-101-200	20,0 cm / 8"

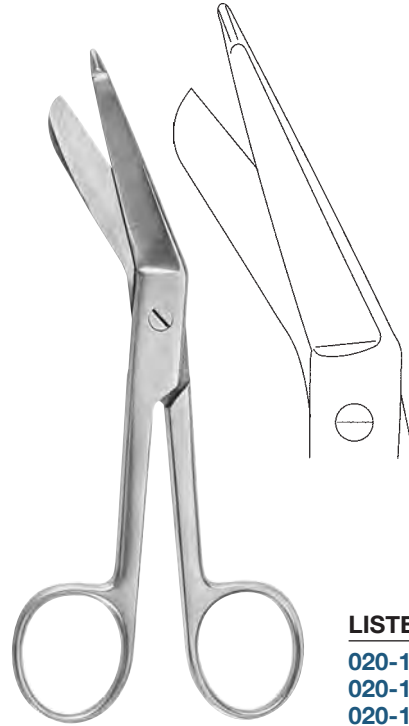

für Linkshänder
for left-handed
para zurdos
per mancini

LISTER

020-111-140	14,0 cm / 5 1/2"
020-111-180	18,0 cm / 7"
020-111-200	20,0 cm / 8"

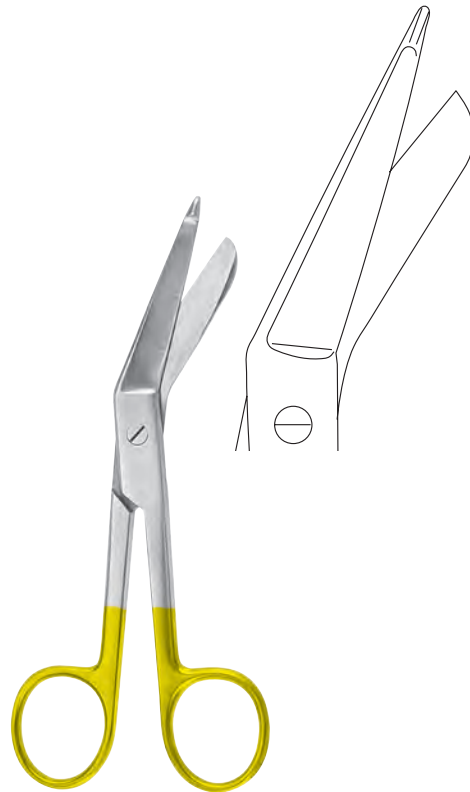

LISTER

020-115-140	14,0 cm / 5 1/2"
020-115-180	18,0 cm / 7"



LISTER

020-121-150 15,0 cm / 6"
020-121-180 18,0 cm / 7"



LISTER

020-131-150 15,0 cm / 6"
020-131-180 18,0 cm / 7"



LISTER

020-141-150 15,0 cm / 6"
020-141-180 18,0 cm / 7"



LISTER

020-151-150 15,0 cm / 6"
020-151-180 18,0 cm / 7"



LISTER

020-161-150 15,0 cm / 6"
020-161-180 18,0 cm / 7"



020

Verbandsschere
Bandage Scissors
Tijeras para vendajes
Cesoie per bendaggi



LISTER

020-171-200 20,0 cm / 8"



EXCENTRIC

020-181-160 16 cm / 5 1/2"



KNOWLES

020-190-140 14,0 cm / 5 1/2"



KNOWLES

020-191-140 14,0 cm / 5 1/2"

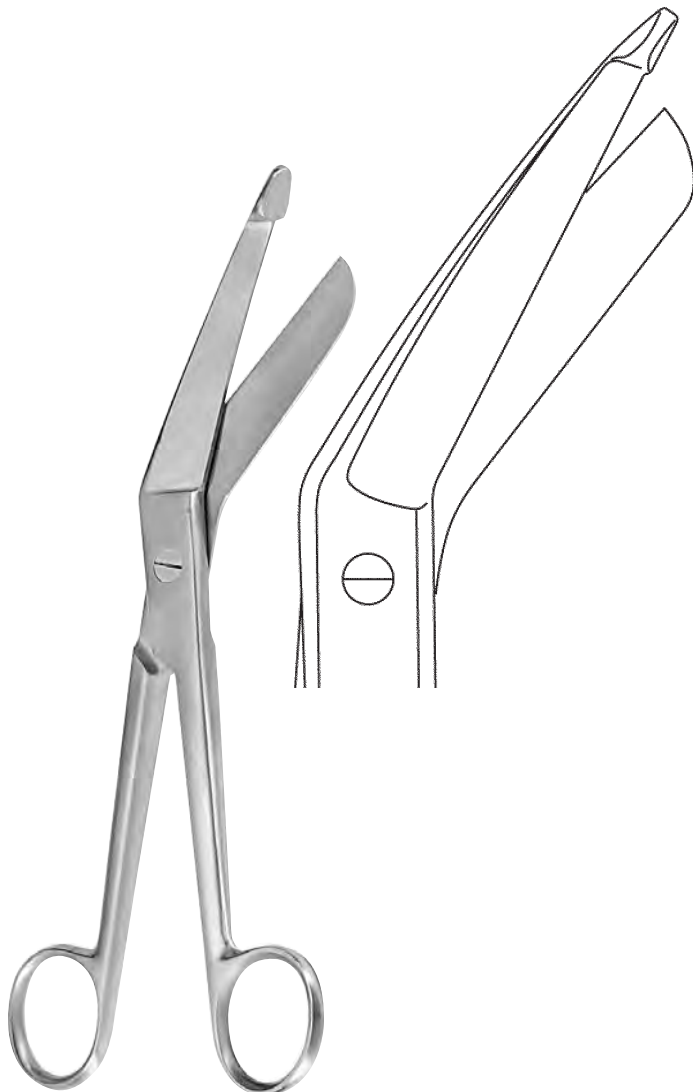

BERGMANN

020-201-230 23,0 cm / 9"



LORENZ

020-211-230 23,0 cm / 9"



020

Verbandsschere
Bandage Scissors
Tijeras para vendajes
Cesoie per bendaggi

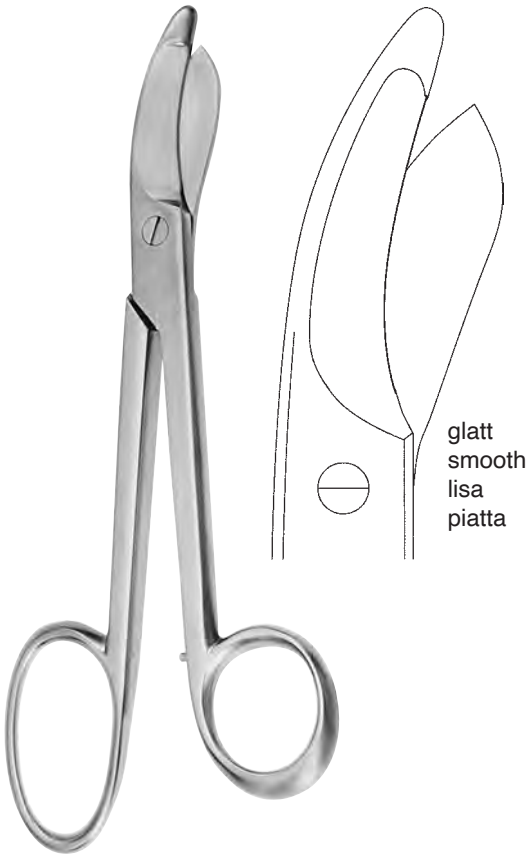

glatt
smooth
lisa
piatta

BRUNS

020-221-240 24,0 cm / 9½"

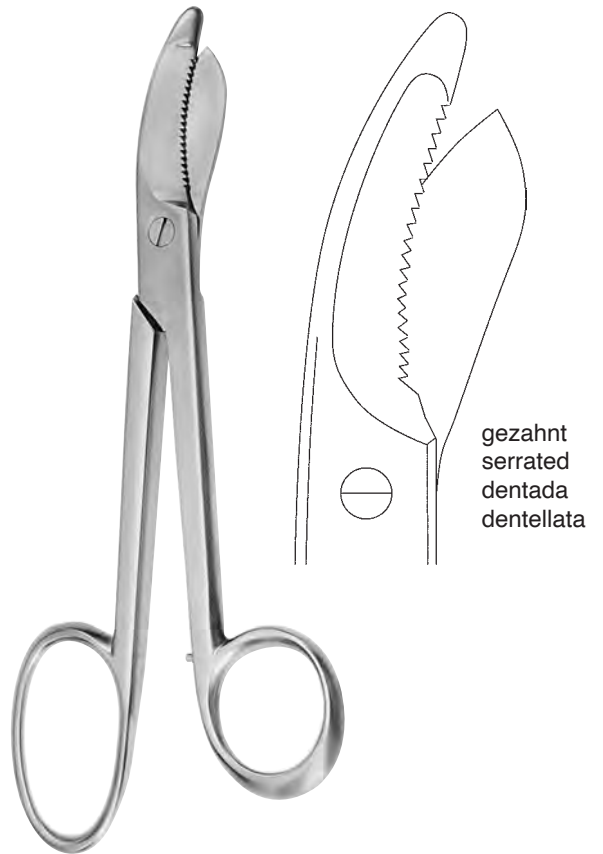

gezahnt
serrated
dentada
dentellata

BRUNS

020-231-240 24,0 cm / 9½"

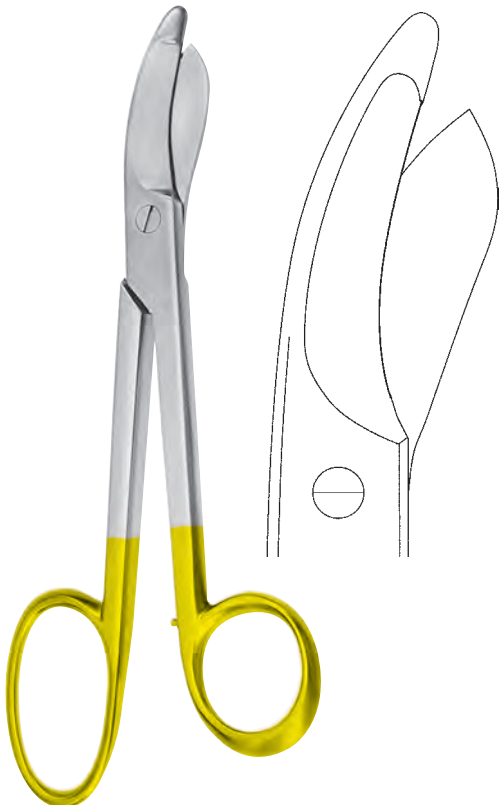

BRUNS

020-233-240 24,0 cm / 9½"

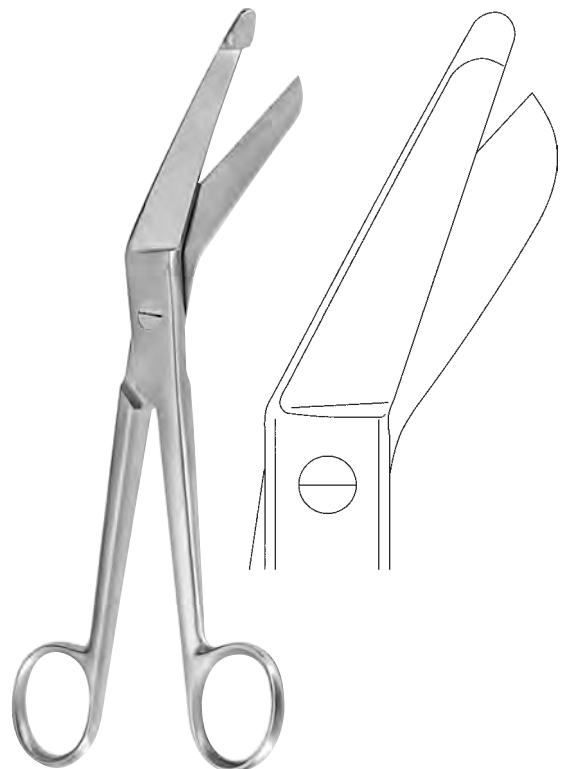

ESMARCH

020-241-200 20,0 cm / 8"
020-241-220 22,0 cm / 8¾"

Verbandsscheren
Bandage Scissors
Tijeras para vendajes
Cesioie per bendaggi



020



SEUTIN

020-251-230 23,0 cm / 9"

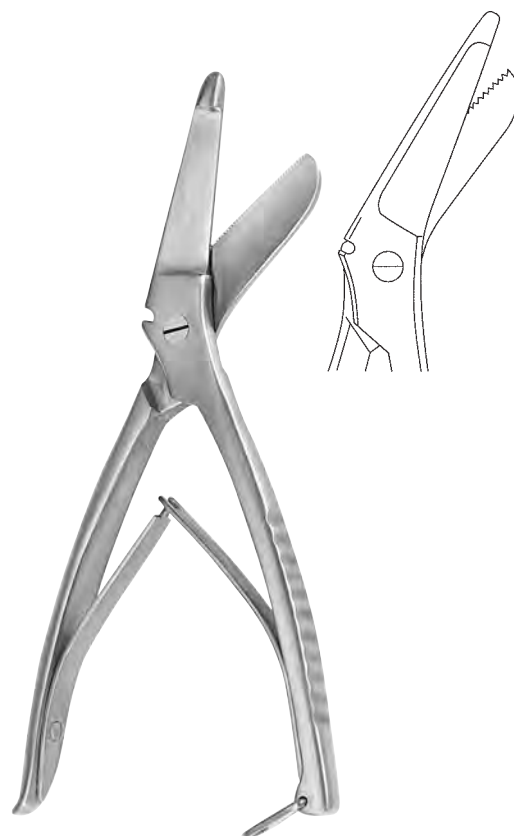

020-261-200 20,0 cm / 8"



STILLE

020-271-240 24,0 cm / 9½"



STILLE

020-281-230 23,0 cm / 9"
020-281-260 26,0 cm / 10¼"
020-281-370 37,0 cm / 14½"

Gipsmesser, Gipssägen
Plaster Knives , Plaster Saws
Cuchillos para escayolas, Sierras para escayolas
Coltelli per gessi, Seghe per gessi

**ENGEL**

020-301-140 14,0 cm / 5½"**BERGMANN**

020-311-180 18,0 cm / 7"**HOPKINS**

020-320-200 20,0 cm / 8"**ESMARCH**

020-330-180 18,0 cm / 7"**REINER**

020-341-185 18,5 cm / 7¼"



MOD. USA

020-400-230 23,0 cm / 9"



HENNIG

020-410-280 28,0 cm / 11"



WOLFF

020-421-180 18,0 cm / 7"
020-421-240 24,0 cm / 9½"



020-421-180



020-421-240



020

Oszillierende Gipssäge
Oscillating Plaster Saw
Sierra oscilante para escayolas
Sega oscillante per gessi



020-500-110 110 Volt
020-500-230 230 Volt

komplett, mit 2 Spannschlüsseln (**020-530-000**),
 1 Sägeblatt (**020-510-065**) und 1 Sägeblatt (**020-510-050**).

complete, with 2 spanners (**020-530-000**),
 1 sawblade (**020-510-065**) and 1 sawblade (**020-510-050**).

completo, con 2 llaves (**020-530-000**),
 1 hoja (**020-510-065**) y 1 hoja (**020-510-050**).

completo, con 2 chiavi (**020-530-000**),
 1 lama (**020-510-065**) y 1 lama (**020-510-050**).

020-530-000

Spannschlüssel
 Spanners
 Llaves inglesas
 Chiavi inglese



020-510-050 Ø 50 mm

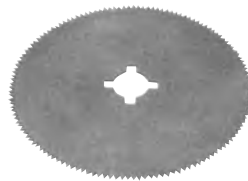

020-510-065 Ø 65 mm



020-520-050 Ø 50 mm

Spezialgehärtet
 Special hardness
 templada especial
 temprata speciale

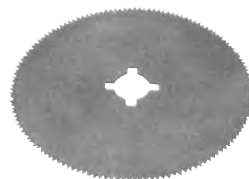

020-520-065 Ø 65 mm

Spezialgehärtet
 Special hardness
 templada especial
 temprata speciale



021

Knochenchirurgie
Bone Surgery
Cirugía ósea
Chirurgia ossea

Amputations- und Resektionssägen
Amputation and Resection Saws
Sierras para amputación y resección
Seghe per amputazione e resezione



021-010-004 4 mm



021-010-006 6 mm

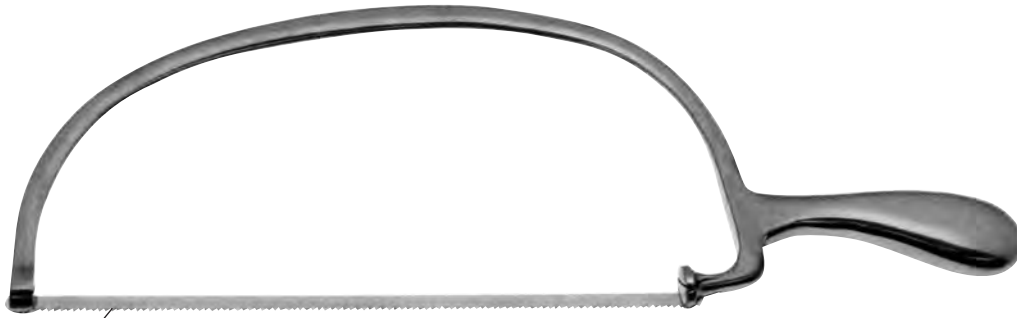

021-010-008 8 mm

BIER

021-010-000 40,5 cm / 16"

komplett
 complete
 completo
 completo



021-020-012 12 mm



021-020-008 8 mm



021-020-006 6 mm

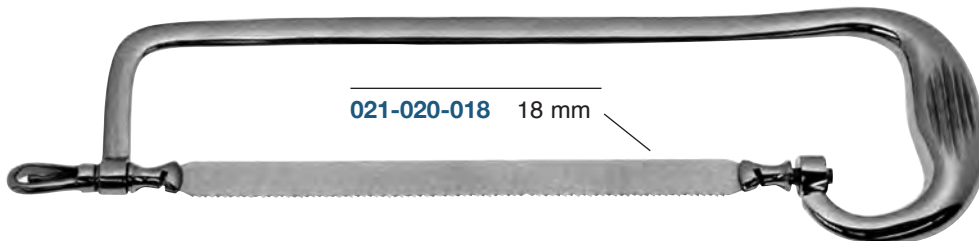

021-020-018 18 mm

RUST

021-020-000 39,0 cm / 15 1/2"

komplett mit 4 Sägeblättern (1 x 021-020-006, 1 x 021-020-008, 2 x 021-020-012)
 complete with 4 Saw blades (1 x 021-020-006, 1 x 021-020-008, 2 x 021-020-012)
 completo con 4 hojas de sierra (1 x 021-020-006, 1 x 021-020-008, 2 x 021-020-012)
 completo con 4 lame di seghe (1 x 021-020-006, 1 x 021-020-008, 2 x 021-020-012)

Amputations- und Resektionssägen
Amputation and Resection Saws
Sierras para amputación y resección
Seghe per amputazione e resezio



021



021-030-012 12 mm

021-030-015 15 mm

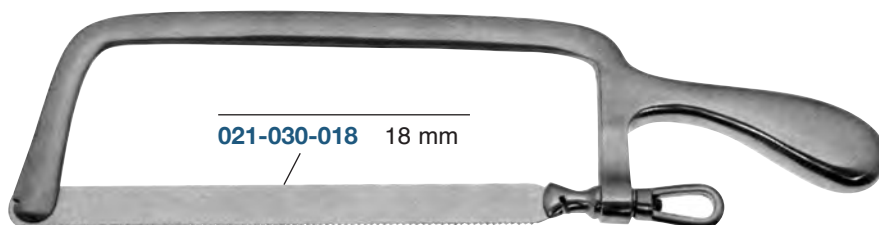

021-030-018 18 mm

CHARRIÉRE

021-030-000 35,0 cm / 13³/₄"

komplett
 complete
 completo
 completo



LANGENBECK

021-032-235 23,5 cm / 9¹/₄"



CHARRIÉRE

021-037-001 20,0 cm / 8"

Ersatzblatt für 021-036-300
 Spareblade for 021-036-300
 hoja de repuesto para 021-036-300
 Lama di ricambio per 021-036-300

021-034-270 27,0 cm / 10³/₄"

021-036-300 30,0 cm / 11³/₄"

021-035-001 15,0 cm / 6"

Ersatzblatt für 021-034-270
 Spareblade for 021-034-270
 hoja de repuesto para 021-034-270
 Lama di ricambio per 021-034-270

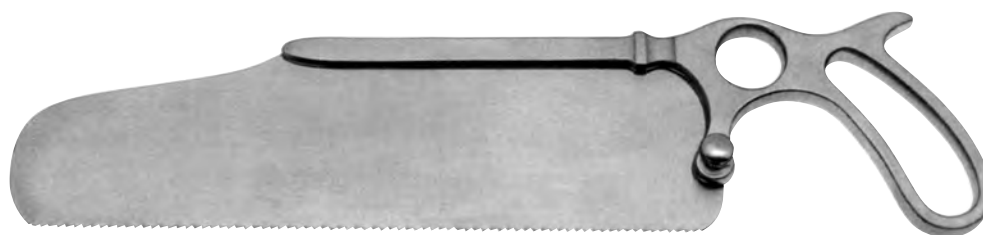

SATTERLEE

021-040-290 29,0 cm / 11¹/₄"

021-041-001 20,0 cm / 8"

Ersatzblatt
 Spareblade
 hoja de repuesto
 Lama di ricambio

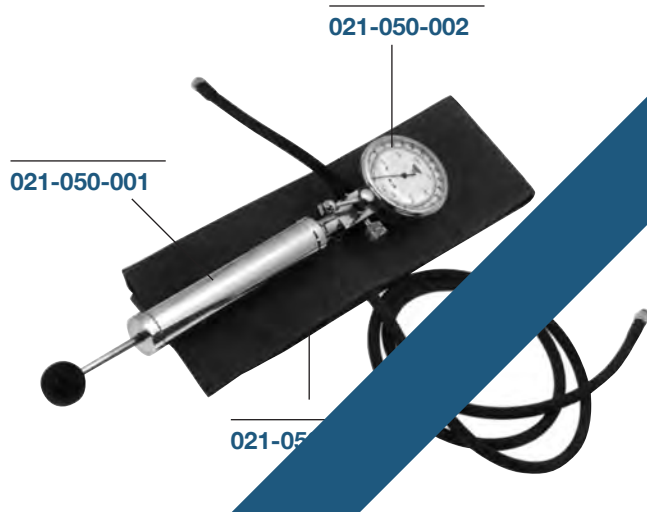

021-050-000

Komprimeter zur Erzeugung einer Blutleere in den Extremitäten, Manometer mit Meßbereich bis 700 mm Hg, komplett, bestehend aus:
Luftpumpe (021-050-001) mit Manometer (021-050-002)
Oberschenkel-Manschette (021-050-003) 960 x 130 mm
Oberarm-Manschette (021-050-004) 570 x 90 mm

021-050-000

Comprimeter, Compression apparatus for producing a local blood stasis in the extremities, Manometer registers up to 700 mm Hg. Complete, consisting of:
Pump (021-050-001) with manometer (021-050-002)
Cuff for the leg (021-050-003) 960 x 130 mm
cuff for the upper arm (021-050-004) 570 x 90 mm

021-050-000

Torniquete para producir un estancamiento local en las extremidades, Manómetro con rango de medida hasta 700 mm Hg, completo, compuesto de:
Bomba de aire (021-050-001) con manómetro (021-050-002)
Brazaletes para el muslo (021-050-003) 960 x 130 mm
Brazaletes para el brazo (021-050-004) 570 x 90 mm

021-050-000

Apparecchio per arrestare il sangue nelle estremita, Manometro con campo di misura fino a 700 mm Hg, completo, composto da:
Pompa (021-050-001) con manometro (021-050-002)
Poliambra (021-050-003) 960 x 130mm
Poliambra (021-050-004) 570 x 90 mm

discontinued item

discontinued item



ESMARCH

021-052-500 500 x 6 cm

Staubinde
Compression bandage
Venda-compresiòn
Fascia per ischemia

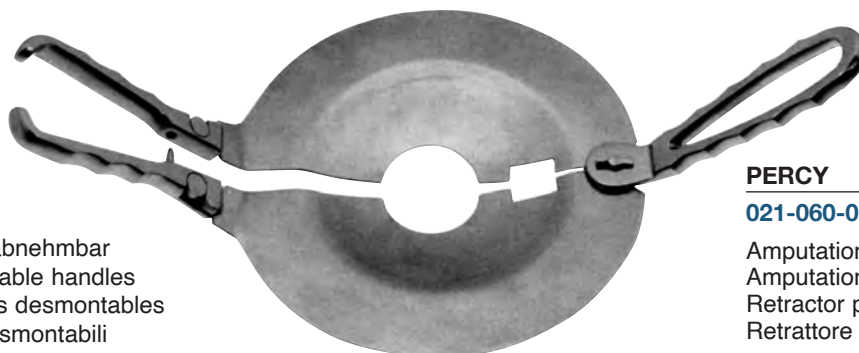

Griffe abnehmbar
Removable handles
Mangos desmontables
manici smontabili

PERCY

021-060-000

Amputationsretraktor
Amputation Retractor
Retractor para amputaciòn
Retrattore per amputazione

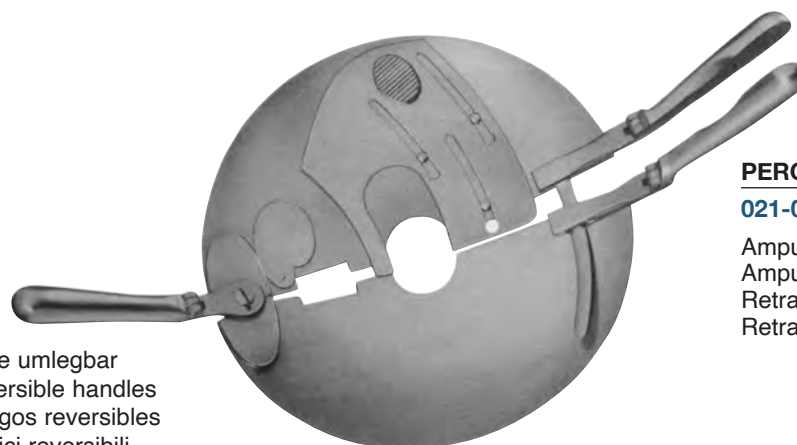

Griffe umlegbar
Reversible handles
Mangos reversibles
Manici reversibili

PERCY

021-062-000

Amputationsretraktor
Amputation Retractor
Retractor para amputaciòn
Retrattore per amputazione



021

**Reibahlen
Reamers
Escariadores
Punteruoli**



021-100-140 14,0 cm / 5½"
021-100-160 16,0 cm / 6¼"



PERTHES

021-110-180 18,0 cm / 7"



PERTHES

021-120-215 21,5 cm / 8½"



021-130-140 14,0 cm / 5½"



021-150-001

Handbohrapparat, allein
 Hand Bone Drill, only
 Perforadore de mano, suelta
 Trapano a mano per ossa, solo

STILLE

021-150-000

komplett mit 4 Bohrer, 4 Fräsern, 1 Trepine
 complete with 4 drills, 4 burrs, 1 trephine
 completo con 4 taladros, 4 fresas, 1 trepano
 completo con 4 punte, 4 frese sferica, 1 fresa



021-151-010 Ø 1,0 mm



021-151-015 Ø 1,5 mm



021-151-020 Ø 2,0 mm



021-151-025 Ø 2,5 mm



021-151-030 Ø 3,0 mm



021-151-035 Ø 3,5 mm



021-151-040 Ø 4,0 mm



021-152-010 Ø 10,0 mm



021-154-005 Ø 5,0 mm



021-154-008 Ø 8,0 mm



021-154-012 Ø 12,0 mm



021-154-016 Ø 16,0 mm

**Handbohrapparate
Hand Bone Drills
Perforadores de mano
Trapani a mano per ossa**



HUDSON

021-160-001

Handbohrapparat mit Schnellverschluß, allein
Hand Bone Drill with quick lock, only
Perforador de mano con cierre rapido, suelto
Trapano a mano con chiusura presta, solo

HUDSON

021-160-000

(021-160-001 + 021-160-002 + 021-162-009 + 021-162-014 + 021-162-016)

komplett mit Verlängerungsstück und 4 Fräsern
complete with extension piece and 4 burrs
completo con pieza de prolongacion y 4 fresas
completo con giunto di prolungamento e 4 frese



021-160-002

Verlängerungsstück
Extension piece
Pieza de prolongación
Giunto di prolungamento



021-162-009 Ø 9,0 mm



021-162-014 Ø 14,0 mm



021-162-016 Ø 16,0 mm



021-162-022 Ø 22,0 mm



CUSHING

021-164-013 Ø 13,0 mm



ADSON

021-165-024 Ø 2,4 mm



MC KENZIE

021-166-013 Ø 13,0 mm



D'ERRICO

021-167-016 Ø 16,0 mm

021-171-000

Spannschlüssel, allein
Wrench, only
Llave, suelta
Chiave, sola



021-170-160 16,0 cm / 6¼"



BUNNELL

021-180-000

längsdurchgebohrt, zur Aufnahme von Bohrdrähten und Nägeln
cannulated, for taking wire drills and nails
barrenado oblongo, para agujas y clavos
tubolare, per inserire fili e chiodi



021-171-000

Spannschlüssel, allein
Wrench, only
Llave, suelta
Chiave, sola

RALK

021-190-000

längsdurchgebohrt, zur Aufnahme von Bohrdrähten und Nägeln
cannulated, for taking wire drills and nails
barrenado oblongo, para agujas y clavos
tubolare, per inserire fili e chiodi



021

Knochenhalteklammern
Bone Holding Clamps
Grapas porta-huesos
Tenaglie per ossa

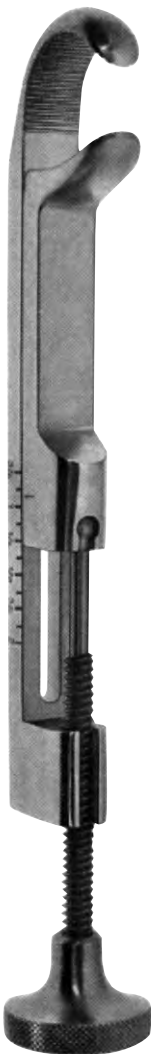

LOWMAN

021-200-120	12,0 cm / 4 ³ / ₄ "	a = 19,0 mm
021-200-180	18,0 cm / 7"	a = 25,0 mm
021-200-200	20,0 cm / 8"	a = 29,0 mm

LOWMAN

021-210-120	12,0 cm / 4 ³ / ₄ "	a = 19,0 mm
021-210-180	18,0 cm / 7"	a = 25,0 mm
021-210-200	20,0 cm / 8"	a = 29,0 mm
021-210-220	22,0 cm / 8 ³ / ₄ "	a = 31,0 mm



a = 29,0 mm



LOWMAN-LAMBERT

021-220-210 21,0 cm // 8 1/4"



a = 25,0 mm

1 Maulteil beweglich
 1 jaw swiveled
 1 boca movable
 1 musso mobile

LOWMAN-HOGLUND

021-230-180 18,0 cm // 7"

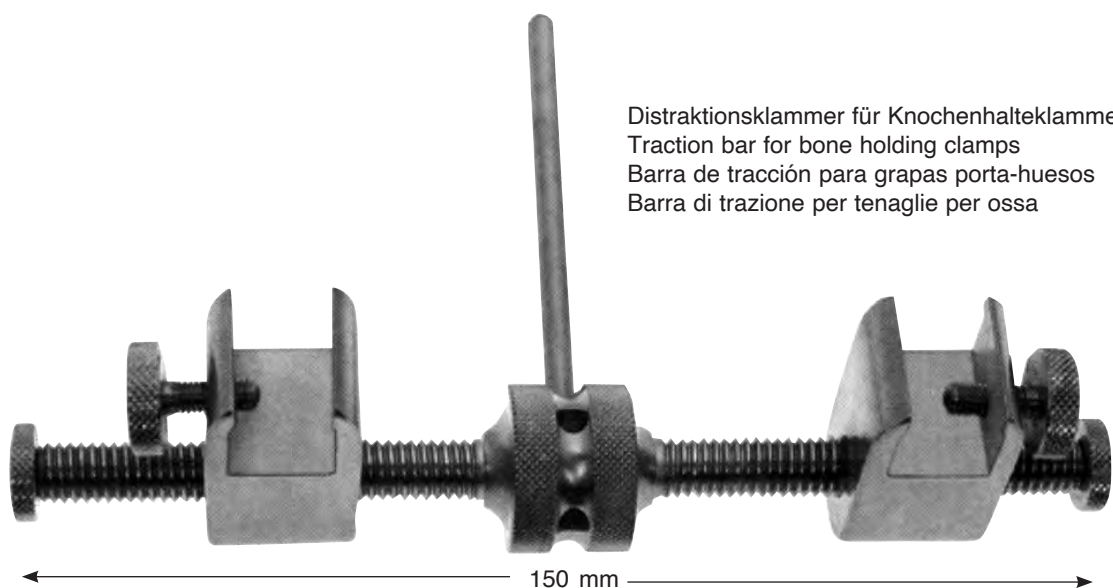

Distraktionsklammer für Knochenhalteklammern
 Traction bar for bone holding clamps
 Barra de tracción para grapas porta-huesos
 Barra di trazione per tenaglie per ossa

150 mm

GERSTER

021-240-150



021

Drahtspannzangen mit Hartmetalleinlagen
Wire Twisting Forceps with tungsten carbide inserts
Pinzas cierra-hilos con bocas de carburo tungsteno
Pinze gira cavo con morsi in carburo di tungsteno

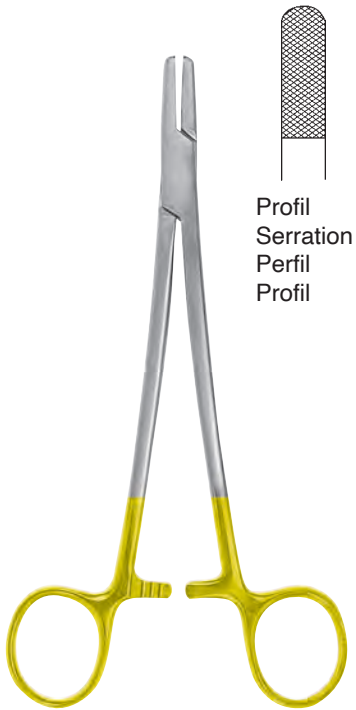

Profil
 Serration
 Perfil
 Profil

BARRY-STERNDAL

021-250-185 18,5 cm / 7 1/4"

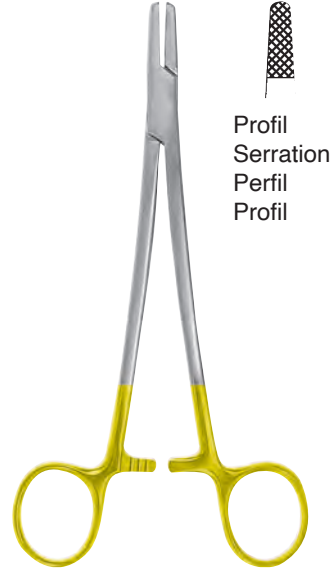

Serration
 Profil
 Profil

021-260-150 15,0 cm / 6"
021-260-200 20,0 cm / 8"

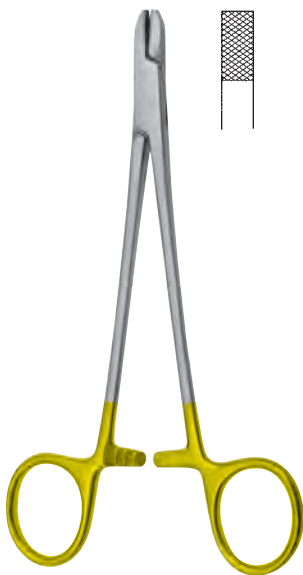

021-270-150 15,0 cm / 6"
021-270-200 20,0 cm / 8"

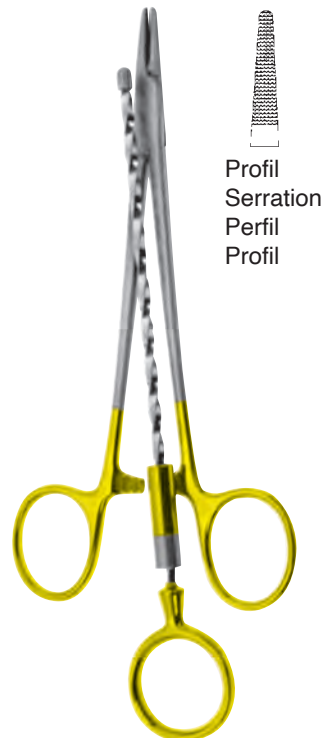

Profil
 Serration
 Perfil
 Profil

CROWIN-HEGAR

021-280-160 16,0 cm / 6 1/4"

Drahtfasszangen, Flachzangen
Wire Holding Forceps, Flat Nose Pliers
Alicates para extraer alambres, Alicates de pico plano
Tenaglie porta cavo, Tenaglie piatte



021

mit Längsrille
 with longitudinal groove
 con ranura longitudinal
 con scannelatura longitudinale



021-300-140 14,0 cm / 5 1/4"



021-304-140 14,0 cm / 5 1/4"



HACKSTOCK
021-306-160 16,0 cm / 6 1/4"



021-310-180 18,0 cm / 7"



021-320-180 18,0 cm / 7"

Drahtfasszangen, Flachzangen
Wire Holding Forceps, Flat Nose Pliers
Alicates para extraer alambres, Alicates de pico plano
Tenaglie porta cavo, Tenaglie piatte



021-330-001 17,0 cm / 6³/₄"



mit Kreuzrille
 with crosswire groove
 con ranura en forma de cruz
 con scannalatura a croce

021-330-002 17,0 cm / 6³/₄"

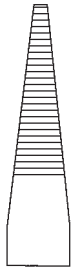

021-340-190 19,0 cm / 7¹/₂"



021-350-150 15,0 cm / 6"

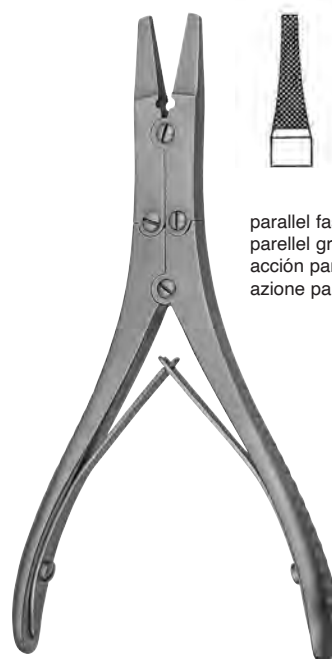

parallel fassend
 parallel grip
 acción paralela
 azione parallela

021-378-145 14,5 cm / 5³/₄"

Drahtfasszangen
Wire Holding Forceps
Alicates para extraer alambres
Tenaglie porta cavo



021



Fig. 1
021-380-001



Fig. 2
021-380-002



Fig. 3
021-380-003

Parallelschluß
 Parallel action
 Acciòn paralela
 Azione parallela

021-380-001 - 021-380-003 18,0 cm / 7"



021-382-180 18,0 cm / 7"

TC



Fig. 1
021-390-001



Fig. 2
021-390-002



Fig. 3
021-390-003

Parallelschluß
 Parallel action
 Acciòn paralela
 Azione parallela

021-390-001 - 021-390-003 18,0 cm / 7"

Drahtkneifzangen
Wire Cutting Pliers
Alicates corta-alambres
Tegnalie tagliafili



für weiche Drähte bis 2,4 mm Ø
 for soft wires up to 2,4 mm Ø
 para alambres blandos hasta 2,4 mm Ø
 per fili molli fino a 2,4 mm Ø

für harte Drähte bis 1,6 mm Ø
 for hard wires up to 1,6 mm Ø
 para alambres duros hasta 1,6 mm Ø
 per fili metallici duri fino a 1,6 mm Ø

021-400-185 18,5 cm / 7 1/4"



Kopfschneider
 Wire Cutter, front action
 Alicates frontal para corta alambre
 Tenaglie tagliafili frontali

für weiche Drähte bis 2,2 mm Ø
 for soft wires up to 2,2 mm Ø
 para alambres blandos hasta 2,2 mm Ø
 per fili molli fino a 2,2 mm Ø

für harte Drähte bis 2,0 mm Ø
 for hard wires up to 2,0 mm Ø
 para alambres duros hasta 2,0 mm Ø
 per fili metallici duri fino a 2,0 mm Ø

FRIMED-DIAMANT

021-410-160 16,0 cm / 6 1/4"



für weiche Drähte bis 0,6 mm Ø
 for soft wires up to 0,6 mm Ø
 para alambres blandos hasta 0,6 mm Ø
 per fili molli fino a 0,6 mm Ø

für harte Drähte bis 0,4 mm Ø
 for hard wires up to 0,4 mm Ø
 para alambres duros hasta 0,4 mm Ø
 per fili metallici duri fino a 0,4 mm Ø

TC



021-420-125 12,5 cm / 5"



021-420-470 47,0 cm / 18 1/4"

Bolzenschneider zum Abzwicken von Drähten, Schrauben und Nägeln bis Ø 6 mm
 Cutters for cutting of wires, screws and pins up to diam, 6 mm
 Alicates corta-alambres, tornillos y clavos hasta Ø 6 mm
 Cesovia per cavi, viti e perni, con Ø superiore a 6 mm

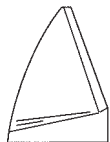

für weiche Drähte bis 2,0 mm Ø
 for soft wires up to 2,0 mm Ø
 para alambres blandos hasta 2,0 mm Ø
 per fili molli fino a 2,0 mm Ø

für harte Drähte bis 1,7 mm Ø
 for hard wires up to 1,7 mm Ø
 para alambres duros hasta 1,7 mm Ø
 per fili metallici duri fino a 1,7 mm Ø

021-430-185 18,5 cm / 7¹/₄"

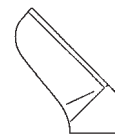

021-440-175

für weiche Drähte bis 2,0 mm Ø
 for soft wires up to 2,0 mm Ø
 para alambres blandos hasta 2,0 mm Ø
 per fili molli fino a 2,0 mm Ø

für harte Drähte bis 1,7 mm Ø
 for hard wires up to 1,7 mm Ø
 para alambres duros hasta 1,7 mm Ø
 per fili metallici duri fino a 1,7 mm Ø

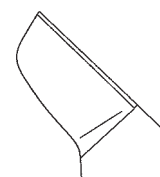

021-440-220

für weiche Drähte bis 2,8 mm Ø
 for soft wires up to 2,8 mm Ø
 para alambres blandos hasta 2,8 mm Ø
 per fili molli fino a 2,8 mm Ø

für harte Drähte bis 2,2 mm Ø
 for hard wires up to 2,2 mm Ø
 para alambres duros hasta 2,2 mm Ø
 per fili metallici duri fino a 2,2 mm Ø

021-440-175 17,5 cm / 7"
021-440-220 22,0 cm / 8³/₄"



Kopf- und Seitenschneider
 Wire Cutting Plier
 Alicates para cortar alambre
 Tenaglia tagliafili

für weiche Drähte bis 2,0 mm Ø
 for soft wires up to 2,0 mm Ø
 para alambres blandos hasta 2,0 mm Ø
 per fili molli fino a 2,0 mm Ø

für harte Drähte bis 1,7 mm Ø
 for hard wires up to 1,7 mm Ø
 para alambres duros hasta 1,7 mm Ø
 per fili metallici duri fino a 1,7 mm Ø

021-450-180 18,0 cm / 7"

TC-Drhtkneifzangen
TC-Wire Cutting Pliers
TC-Alicates corta-alambres
TC-Tenaglie tagliafili



für harte Drähte bis 2,2 mm Ø
 for hard wires up to 2,2 mm Ø
 para alambre duros hasta 2,2 mm Ø
 per fill duri fino a 2,2 mm Ø

021-460-180 18,0 cm / 7"



021-460-230

für harte Drähte bis 3,0 mm Ø
 for hard wires up to 3,0 mm Ø
 para alambre duros hasta 3,0 mm Ø
 per fill duri fino a 3,0 mm Ø

021-460-280

für harte Drähte bis 2,5 - 4,0 mm Ø
 for hard wires up to 2,5 - 4,0 mm Ø
 para alambre duros hasta 2,5 - 4,0 mm Ø
 per fill duri fino a 2,5 - 4,0 mm Ø

021-460-230 23,0 cm / 9"

021-460-280 28,0 cm / 11"

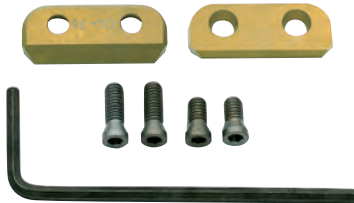

Ersatzteilset: 1 Paar TC-Ersatzschneiden,
 2 Paar Schrauben, 1 Inbusschlüssel
Spare Part Set: 1 pair of TC-blades, 2 pairs
 of screws, 1 Allen key
Juego de recambio: 1 par de placas de
 Tungsteno, 2 pares de tornillos, 1 llave
 Hexagonal
Set di ricambio: 1 paio di lami di TC,
 2 paio di viti, 1 chiave a brugola

021-461-001 für/for/para/per 021-460-180

021-461-002 für/for/para/per 021-460-230 und -280



Ersatzteilset: 1 Paar Gummibacken,
 1 Paar Schrauben, 1 Schraubendreher
Spare Part Set: 1 pair of rubber jaws,
 1 pair of screws, 1 Screwdriver
Juego de recambio: 1 par de bocas de
 goma, 1 par de tornillos, 1 destornillador
Set di ricambio: 1 paio di guance
 di plastica, 1 Cacciavite

021-461-003 für/for/para/per 021-460-180,
 021-460-230 und -280



für weiche Drähte bis 3,0 mm Ø
 for soft wires up to 3,0 mm Ø
 para alambre blandos hasta 3,0 mm Ø
 per fili molli fino a 3,0 mm Ø

für harte Drähte bis 2,0 mm Ø
 for hard wires up to 2,0 mm Ø
 para alambre duros hasta 2,0 mm Ø
 per fili duri fino a 2,0 mm Ø

021-470-220 22,0 cm / 8³/₄"

Drähte, Drahtspanner, Drahtspannzange
Bone Wires, Wire Tightener, Wire Twisting Forceps
Alambres para huesos, Tensor cierra-hilo, Pinza cierra-hilo
Fili per ossa, Trenditore serra filo, Pinza gira cavo



021

Cerclage-Drähte, weich, in Ringen zu 10 m
Bone wires, soft, in coils of 10 m
Hilos de cerclaje, blandos, en rollos de 10 m
Filo per ossa, leggero, in rotolo di 10 m



021-500-002 Ø 0,2 mm

021-500-003 Ø 0,3 mm

021-500-004 Ø 0,4 mm

discontinued item

021-500-008 Ø 0,8 mm

021-500-009 Ø 0,9 mm

021-500-010 Ø 1,0 mm

021-500-012 Ø 1,2 mm

021-500-015 Ø 1,5 mm



Drahtspanner mit an der Spitze
eingebauter beweglicher Drahtspannbüchse
für Cerclage-Drähte bis ø 1 mm

Wire tightener, with movable tip, for wires up
to 1,0 mm diam.

Teñsor cierra-hilo con manguito movable en la
punta, para hilos de cerclaje hasta ø 1 mm

Trenditore serra filo con manico mobile sulla
punta, per fili di cerchiaggio da 1 mm, di ø

LOUTE

021-510-210 21,0 cm / 8¹/₄"



DEMEL

021-520-270 27,0 cm / 10³/₄"

Drahtumführungsadeln
Wire Guides
Agujas pasa-hilos
Aghi passafili

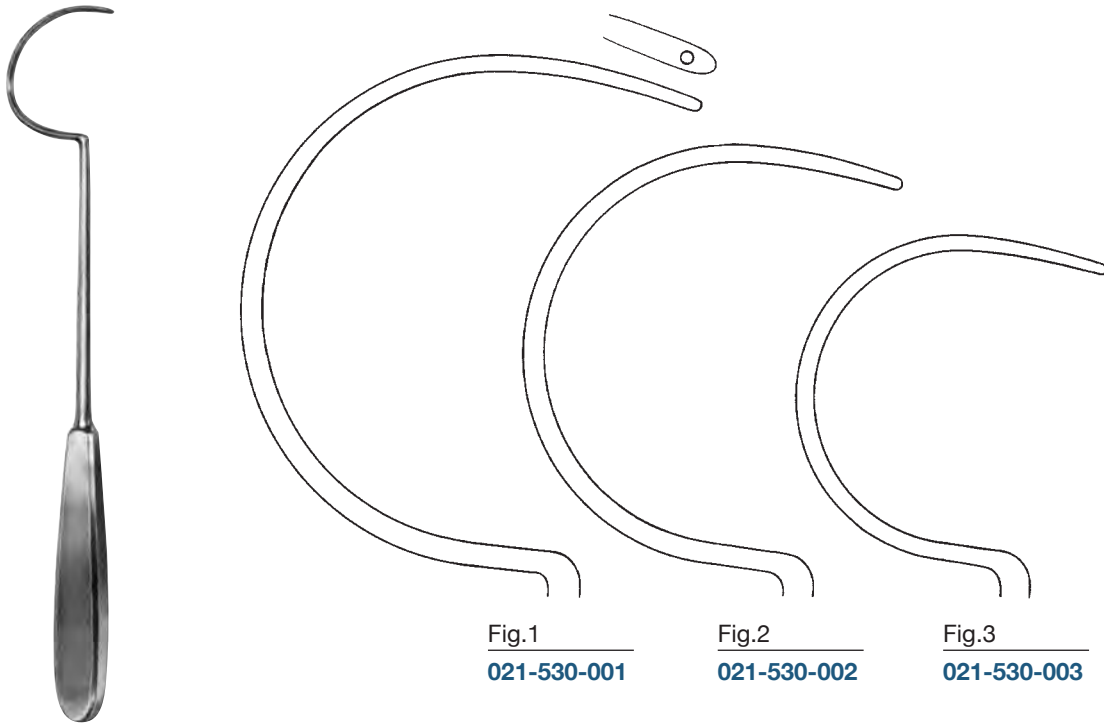

Fig.1
021-530-001

Fig.2
021-530-002

Fig.3
021-530-003

DEMEL

- 021-530-001** 31,0 cm / 12¹/₄"
- 021-530-002** 29,0 cm / 11¹/₄"
- 021-530-003** 28,0 cm / 11"

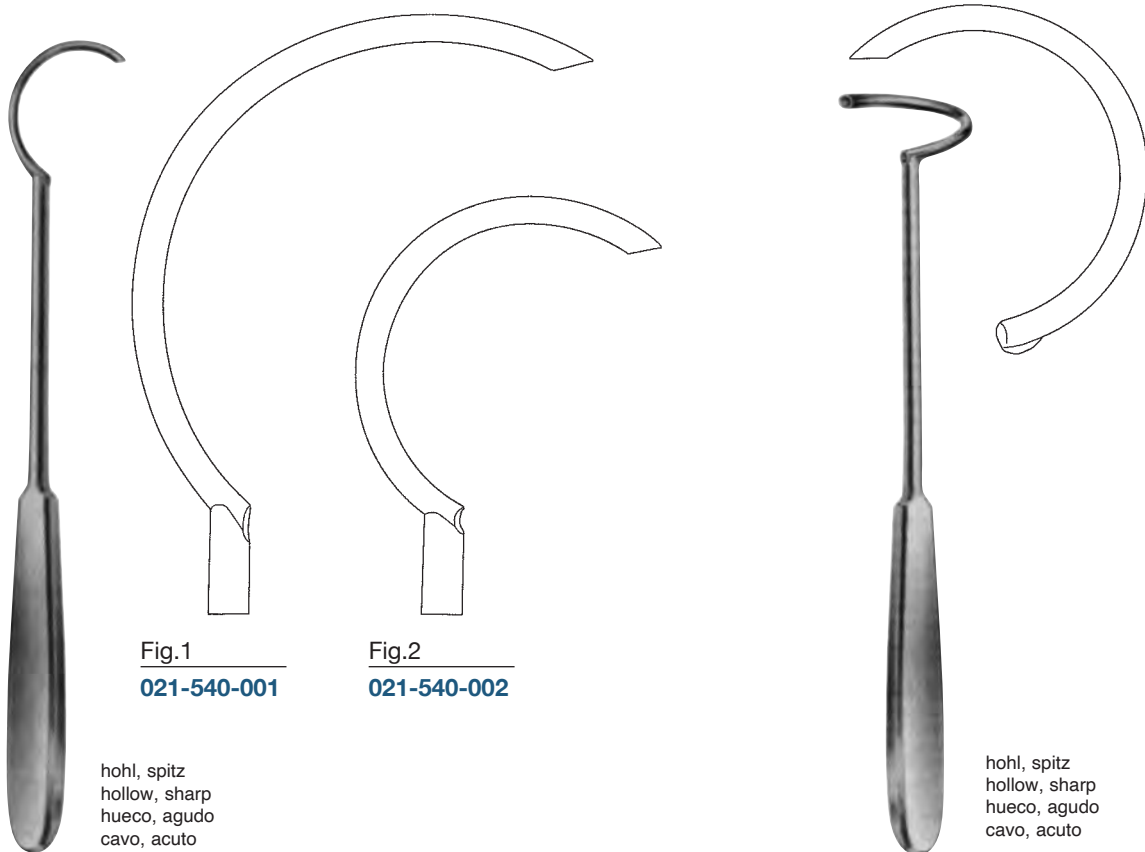

Fig.1
021-540-001

Fig.2
021-540-002

hohl, spitz
 hollow, sharp
 hueco, agudo
 cavo, acuto

hohl, spitz
 hollow, sharp
 hueco, agudo
 cavo, acuto

- 021-540-001** 27,0 cm / 10³/₄"
- 021-540-002** 24,0 cm / 9¹/₂"

- 021-544-225** 22,5 cm / 9"

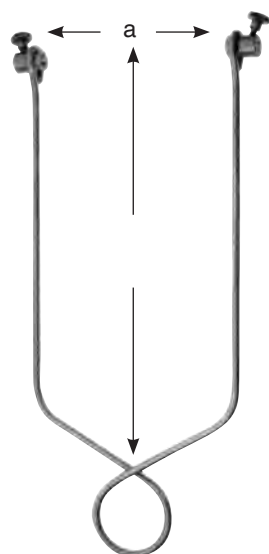

komplett mit STEINMANN Nagel Ø 4 mm
 complete with STEINMANN pin, Ø 4 mm
 completo con clavo STEINMANN Ø 4 mm
 completo con chiodo STEINMANN, Ø 4 mm

BÖHLER

	a	b	
021-550-001	90 mm	160 mm	für Arm / for arm / para brazo / p
021-550-002	110 mm	210 mm	für Oberschenkel und Knie / für femur und Knie / para fémur y rodilla / per femore e ginocchio
021-550-003	150 mm	210 mm	für Oberschenkel und Knie / für femur und Knie / para fémur y rodilla / per femore e ginocchio

discontinued item



Extensionsbügel mit 1 Zughaken, zur Verwendung mit KIRSCHNER Drähten
 bis Ø 1,6 mm (021-570-001), Ø 2,0 mm (021-570-002), Ø 2,5 mm
 (021-570-003), verstellbar, selbsthemmend.

Wire traction bow with 1 traction hook, to be used with KIRSCHNER wires up
 to Ø 1,6 mm (021-570-001), Ø 2,0 mm (021-570-002), Ø 2,5 mm
 (021-570-003), adjustable, holds wire securely.

Estribo para extensión con 1 gancho de tracción, para agujas de KIRSCHNER
 hasta Ø 1,6 mm (021-570-001), Ø 2,0 mm (021-570-002), Ø 2,5 mm
 (021-570-003), ajustable, sujeto seguro de la aguja.

Archi per trazione con 1 ganci di trazione, da impiegarsi con fili KIRSCHNER
 superiori a Ø 1,6 mm (021-570-001), Ø 2,0 mm (021-570-002), Ø 2,5 mm
 (021-570-003), regolabile, fili in sicurezza.

KIRSCHNER

	a	b
021-570-001	0-105 mm	80-95 mm
021-570-002	0-160 mm	90-120 mm
021-570-003	0-200 mm	140-170 mm

Zubehör für Extensionsbügel
Accessories for Wire Traction Bows
Accesorios para estribos para extensión
Accessori per archi per trazione



Extensionsbügel mit 3 Zughaken, zur Verwendung mit KIRSCHNER Drähten bis Ø 2,5 mm (großes Modell), und Ø 2,0 mm (kleines Modell), verstellbar.

Wire traction bow with 3 traction hooks, to be used with KIRSCHNER wires up to 2,5 mm Ø (large size), and up to 2,0 mm Ø (small size), adjustable.

Estribo para extensión con 3 ganchos de tracción, para agujas de KIRSCHNER hasta Ø 2,5 mm (modelo grande), y Ø 2,0 mm (modelo pequeño), ajustable.

Archi per trazione con 3 ganci di trazione, da impiegarsi con fili KIRSCHNER superiori a 2,5 mm di Ø (misura grande), e 2,0 mm di Ø (misura piccola), regolabile.

	a	b
021-580-001	40-130 mm	100 mm
021-580-002	80-260 mm	150 mm



Zughaken, klein
 Traction Hook, small
 Gancho de tracción, pequeño
 Ganci di trazione, piccolo

021-590-001



Zughaken, groß
 Traction Hook, large
 Gancho de tracción, grande
 Ganci di trazione, largo

021-590-002



Begrenzungsplatte, paar
 Fixation disc, pair
 Disco fijador, par
 Disco di fissaggio, paio

021-592-000



Fixierscheiben, paar
 Fixation discs, pair
 Discos fijadores, par
 Dischi di fissaggio, paio

021-593-000



021-594-000

Bohrhandgriff
Drill handle
Perforador de mano
Perforatore a mano



021



VICKERS-EASYDRIVER

021-598-140 14,0 cm / 5 1/2"



021

Cerclage-Drähte, STEINMANN Nägel
Bone wires, STEINMANN Pins
Hilos de cerclaje, Clavos STEINMANN
Filo per ossa, Chiodi STEINMANN

**STEINMANN**

021-600-080	Ø 4,0 x 80 mm
021-600-100	Ø 4,0 x 100 mm
021-600-120	Ø 4,0 x 120 mm
021-600-140	Ø 4,0 x 140 mm
021-600-150	Ø 4,0 x 150 mm
021-600-160	Ø 4,0 x 160 mm
021-600-180	Ø 4,0 x 180 mm
021-600-200	Ø 4,0 x 200 mm
021-600-210	Ø 4,0 x 210 mm
021-600-250	Ø 4,0 x 250 mm

Spannschlüssel mit Klemmzange
 Wire tightener, with clamping jaws
 Tensor de alambres con mordaza
 Strumento per allungare con morso a presa



021-661-000

discontinued item

Extensionsbügel mit 3 Zughaken, zur Verwendung
 mit KIRSCHNER Drähten bis Ø 2,5 mm.

Wire traction bows with 3 Traction hooks, to be used
 with KIRSCHNER wires up to 2,5 mm diam.

Estribos para extensión con 3 ganchos de tracción,
 para agujas de KIRSCHNER hasta Ø 2,5 mm.

Archi per trazione con 3 ganci di trazione, da impiegarsi
 con fili KIRSCHNER superiori a 2,5 mm di Ø.

KIRSCHNER

	a	b	
021-660-001	95 mm	70 mm	für Arm und Ellenbogen / for arm and elbow / para brazo y codo / per braccio e gomito
021-660-002	95 mm	110 mm	für Fersenbein / for clacaneus / para calcáneo / per calcagno
021-660-003	105 mm	100 mm	für Knie / for knee / para rodilla / per ginocchio
021-660-004	120 mm	120 mm	für Knie / for knee / para rodilla / per ginocchio
021-660-005	135 mm	130 mm	für Knie / for knee / para rodilla / per ginocchio
021-660-006	155 mm	155 mm	für Oberschenkel / for femur / para fémur / per femore
021-660-007	200 mm	155 mm	für Hüfte / for hip / para coxa / per anca



Bohrdrähte mit beidseitiger Trokarspitze, in Packungen zu 10 Stk.
 Wire drills with trocar point on each end, in packages of 10 pieces
 Aguas con dos puntas trocar, en paquete de 10 piezas
 Punte trequarti a punta ciascun lato, in confezioni da 10 pezzi

KIRSCHNER

6,0 cm / 2 1/2"	10,0 cm / 4"	12,0 cm / 4 3/4"	14,0 cm / 4 3/4"	16,0 cm / 6 1/4"	31,0 cm / 12 1/4"	
021-700-008	021-702-008	021-704-008	021-706-008	021-708-008	021-710-008	Ø 0,8 mm
021-700-010	021-702-010	021-704-010	021-706-010	021-708-010	021-710-010	Ø 1,0 mm
021-700-012	021-702-012	021-704-012	021-706-012	021-708-012	021-710-012	Ø 1,2 mm
021-700-014	021-702-014	021-704-014	021-706-014	021-708-014	021-710-014	Ø 1,4 mm
021-700-015	021-702-015	021-704-015	021-706-015	021-708-015	021-710-015	Ø 1,5 mm
021-700-016	021-702-016	021-704-016	021-706-016	021-708-016	021-710-016	Ø 1,6 mm
021-700-018	021-702-018	021-704-018	021-706-018	021-708-018	021-710-018	Ø 1,8 mm
021-700-020	021-702-020	021-704-020	021-706-020	021-708-020	021-710-020	Ø 2,0 mm
021-700-022	021-702-022	021-704-022	021-706-022	021-708-022	021-710-022	Ø 2,2 mm
021-700-025	021-702-025	021-704-025	021-706-025	021-708-025	021-710-025	Ø 2,5 mm
021-700-030	021-702-030	021-704-030	021-706-030	021-708-030	021-710-030	Ø 3,0 mm



Bohrdrähte mit Trokarspitze und rundem Schaftende, in Packungen zu 10 Stk.
 Wire drills with trocar point and round shaft end, in packages of 10 pieces
 Aguas con punta trocar y cabo redondo, en paquetes de 10 piezas
 Punte trequarti a punta, estremita rotonda, in confezioni da 10 pezzi

KIRSCHNER

6,0 cm / 2 1/2"	10,0 cm / 4"	12,0 cm / 4 3/4"	14,0 cm / 4 3/4"	16,0 cm / 6 1/4"	31,0 cm / 12 1/4"	
021-720-008	021-722-008	021-724-008	021-726-008	021-728-008	021-730-008	Ø 0,8 mm
021-720-010	021-722-010	021-724-010	021-726-010	021-728-010	021-730-010	Ø 1,0 mm
021-720-012	021-722-012	021-724-012	021-726-012	021-728-012	021-730-012	Ø 1,2 mm
021-720-014	021-722-014	021-724-014	021-726-014	021-728-014	021-730-014	Ø 1,4 mm
021-720-015	021-722-015	021-724-015	021-726-015	021-728-015	021-730-015	Ø 1,5 mm
021-720-016	021-722-016	021-724-016	021-726-016	021-728-016	021-730-016	Ø 1,6 mm
021-720-018	021-722-018	021-724-018	021-726-018	021-728-018	021-730-018	Ø 1,8 mm
021-720-020	021-722-020	021-724-020	021-726-020	021-728-020	021-730-020	Ø 2,0 mm
021-720-022	021-722-022	021-724-022	021-726-022	021-728-022	021-730-022	Ø 2,2 mm
021-720-025	021-722-025	021-724-025	021-726-025	021-728-025	021-730-025	Ø 2,5 mm
021-720-030	021-722-030	021-724-030	021-726-030	021-728-030	021-730-030	Ø 3,0 mm

für Drähte mit
 for wires with
 para agujas con
 per punte con

discontinued item



021

KIRSCHNER Bohrdrähte und Bohrdrahtspender
KIRSCHNER Wire Drills and Wire Drill Dispenser
Brocas filiformes KIRSCHNER y dispensadores para brocas filiformes
Punte filiformi di KIRSCHNER è distributore per punte filiformi

- Bohrdrähte mit Trokarspitze und flachem Schaftende, in Packungen zu 10 Stk.
Wire drills with trocar point and flat shaft end, in packages of 10 pieces
Agujas con punta trocar y cabo plano, en paquetes de 10 piezas
Punte trequarti a punta, in confezioni da 10 pezzi



für Drähte mit
for wires with
para agujas con
per punte con

KIRSCHNER

6,0 cm / 2 1/2"	10,0 cm / 4"	12,0 cm / 4 3/4"	14,0 cm / 4 3/4"	16,0 cm / 6 1/4"	31,0 cm / 12 1/4"	
021-740-008	021-742-008	021-744-008	021-746-008	021-748-008	021-750-008	Ø 0,8 mm
021-740-010	021-742-010	021-744-010	021-746-010	021-748-010	021-750-010	Ø 1,0 mm
021-740-012	021-742-012	021-744-012	021-746-012	021-748-012	021-750-012	Ø 1,2 mm

discontinued item

021-740-016	021-742-016	021-744-016	021-746-016	021-748-016	021-750-016	Ø 1,6 mm
021-740-020	021-742-020	021-744-020	021-746-020	021-748-020	021-750-020	Ø 2,0 mm
021-740-022	021-742-022	021-744-022	021-746-022	021-748-022	021-750-022	Ø 2,2 mm
021-740-025	021-742-025	021-744-025	021-746-025	021-748-025	021-750-025	Ø 2,5 mm
021-740-030	021-742-030	021-744-030	021-746-030	021-748-030	021-750-030	Ø 3,0 mm

□



für Drähte mit
for wires with
para agujas con
per punte con

KIRSCHNER

021-762-008	Ø 0,8 mm	10,0 cm / 4"
021-762-010	Ø 1,0 mm	10,0 cm / 4"

- Bohrdraht mit Lanzettenspitze, flaches Schaftende, in Packungen zu 10 Stk.
Wire drill with lancet point, flat shaft end, in packages of 10 pieces
Aguja con punta de lancetta, cabo plano, en paquetes de 10 piezas

discontinued item

021-762-016	Ø 1,6 mm	10,0 cm / 4"
021-762-018	Ø 1,8 mm	10,0 cm / 4"
021-762-020	Ø 2,0 mm	10,0 cm / 4"
021-762-022	Ø 2,2 mm	10,0 cm / 4"
021-762-025	Ø 2,5 mm	10,0 cm / 4"
021-762-030	Ø 3,0 mm	10,0 cm / 4"



mit Metall-Deckel
with metal lid
con tapa metalica
con coperchio metallico

für Drähte mit
for wires with
para agujas con
per punte con

mit Kunststoff-Deckel
with plastic lid
con tapa de plastico
con coperchio in plastico

für Drähte mit
for wires with
para agujas con
per punte con

10,0 cm / 4"	16,0 cm / 6 1/4"	31,0 cm / 12 1/4"		10,0 cm / 4"	16,0 cm / 6 1/4"	31,0 cm / 12 1/4"	
021-900-008	021-902-008	021-904-008	Ø 0,8 mm	021-901-008	021-903-008	021-905-008	Ø 0,8 mm
021-900-010	021-902-010	021-904-010	Ø 1,0 mm	021-901-010	021-903-010	021-905-010	Ø 1,0 mm
021-900-012	021-902-012	021-904-012	Ø 1,2 mm	021-901-012	021-903-012	021-905-012	Ø 1,2 mm
021-900-014	021-902-014	021-904-014	Ø 1,4 mm	021-901-014	021-903-014	021-905-014	Ø 1,4 mm
021-900-015	021-902-015	021-904-015	Ø 1,5 mm	021-901-015	021-903-015	021-905-015	Ø 1,5 mm
021-900-016	021-902-016	021-904-016	Ø 1,6 mm	021-901-016	021-903-016	021-905-016	Ø 1,6 mm
021-900-018	021-902-018	021-904-018	Ø 1,8 mm	021-901-018	021-903-018	021-905-018	Ø 1,8 mm
021-900-020	021-902-020	021-904-020	Ø 2,0 mm	021-901-020	021-903-020	021-905-020	Ø 2,0 mm
021-900-022	021-902-022	021-904-022	Ø 2,2 mm	021-901-022	021-903-022	021-905-022	Ø 2,2 mm
021-900-025	021-902-025	021-904-025	Ø 2,5 mm	021-901-025	021-903-025	021-905-025	Ø 2,5 mm
021-900-030	021-902-030	021-904-030	Ø 3,0 mm	021-901-030	021-903-030	021-905-030	Ø 3,0 mm

Mehrfach-Bohrdrahtspender
Multiple Wire Drill Dispenser
Dispensador multiple para brocas filiformes
Distributore multiplo per punte filiformi



021

- Vier verschiedene Bohrdrähte in einem Spender.
- Eindeutige Kennzeichnung der verschiedenen Durchmesser auf dem Spender.
- Sterilisation und Aufbewahrung im Spender.

- Four different wire drills from one dispenser.
- Clear size markings on the dispenser.
- Sterilization and storage in the dispenser.

- Cuatro agujas distintas en un sólo dispensador.
- El dispensador está marcado claramente con los diferentes diámetros.
- Esterilización y almacenaje dentro del mismo dispensador.

- 4 Differenti punte filiformi e un solo contenitore
- Distributore marcato con i vari diametri.
- Sterilizzazione e conservazione nello stesso distributore.



021-916-310 Ø 1,0 / 1,2 / 1,4 / 1,6 mm x 310 mm
021-918-310 Ø 1,8 / 2,0 / 2,2 / 2,5 mm x 310 mm

021-912-160 Ø 1,0 / 1,2 / 1,4 / 1,6 mm x 160 mm
021-914-160 Ø 1,8 / 2,0 / 2,2 / 2,5 mm x 160 mm

Bohrdraht-Lagergestelle
Wire Drill racks
Soportes para brocas filiformes
Telaio per punte filiformi



-
- 021-920-100** für 10,0 cm Draht / for 10,0 cm wire / para agujas de 10,0 cm / per punte filiformi 10,0 cm
021-920-150 für 15,0 cm Draht / for 15,0 cm wire / para agujas de 15,0 cm / per punte filiformi 15,0 cm

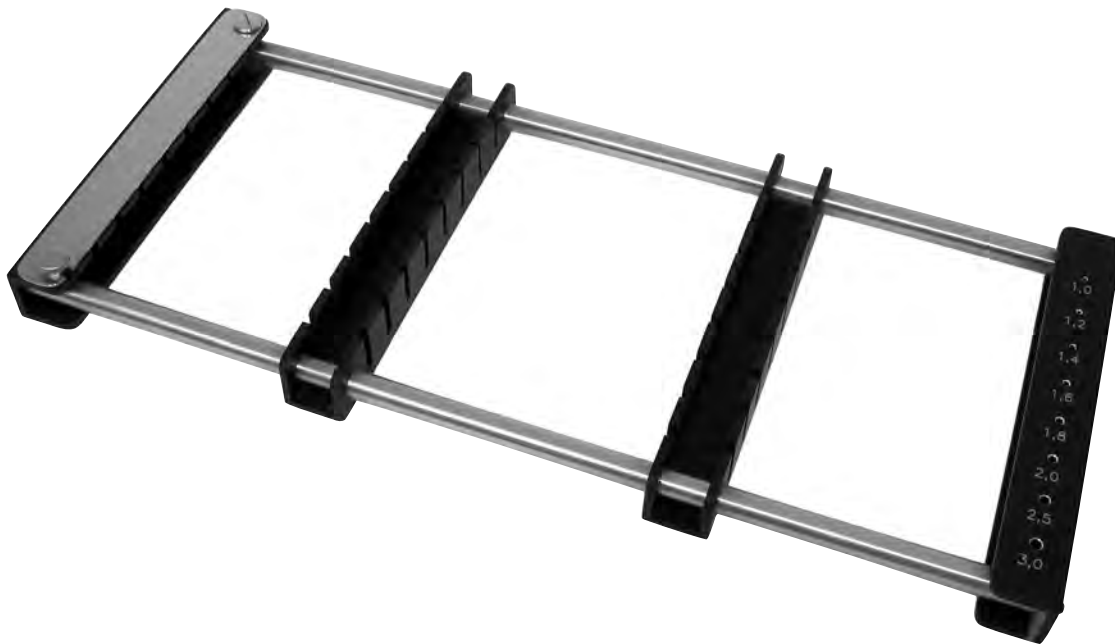

-
- 021-922-310** für 31,0 cm Draht / for 31,0 cm wire / para agujas de 31,0 cm / per punte filiformi 31,0 cm



024

Knochenchirurgie
Bone Surgery
Cirugía ósea
Chirurgia ossea





024

Flachmeißel, Hohlmeißel, Osteotome
Chiseles, Gouges, Osteotomes
Cinceles, Gubias, Osteótomos
Scalpelli, Sgorbie, Osteotomi

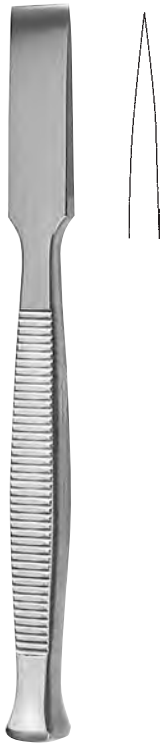

024-010-008	8 mm	13,5 cm / 5 ³ / ₈ "
024-010-010	10 mm	13,5 cm / 5 ³ / ₈ "
024-010-012	12 mm	13,5 cm / 5 ³ / ₈ "
024-010-014	14 mm	13,5 cm / 5 ³ / ₈ "
024-010-016	16 mm	13,5 cm / 5 ³ / ₈ "

024-012-008	8 mm	13,5 cm / 5 ³ / ₈ "
024-012-010	10 mm	13,5 cm / 5 ³ / ₈ "
024-012-012	12 mm	13,5 cm / 5 ³ / ₈ "
024-012-014	14 mm	13,5 cm / 5 ³ / ₈ "
024-012-016	16 mm	13,5 cm / 5 ³ / ₈ "

024-014-008	8 mm	13,5 cm / 5 ³ / ₈ "
024-014-010	10 mm	13,5 cm / 5 ³ / ₈ "
024-014-012	12 mm	13,5 cm / 5 ³ / ₈ "
024-014-014	14 mm	13,5 cm / 5 ³ / ₈ "
024-014-016	16 mm	13,5 cm / 5 ³ / ₈ "



PARTSCH

024-020-002	2 mm	13,5 cm / 5 ³ / ₈ "
024-020-003	3 mm	13,5 cm / 5 ³ / ₈ "
024-020-004	4 mm	13,5 cm / 5 ³ / ₈ "
024-020-005	5 mm	13,5 cm / 5 ³ / ₈ "
024-020-006	6 mm	13,5 cm / 5 ³ / ₈ "

PARTSCH

024-022-002	2 mm	17,0 cm / 6 ³ / ₄ "
024-022-003	3 mm	17,0 cm / 6 ³ / ₄ "
024-022-004	4 mm	17,0 cm / 6 ³ / ₄ "
024-022-005	5 mm	17,0 cm / 6 ³ / ₄ "
024-022-006	6 mm	17,0 cm / 6 ³ / ₄ "
024-022-007	7 mm	17,0 cm / 6 ³ / ₄ "

PARTSCH

024-024-002	2 mm	13,5 cm / 5 ³ / ₈ "
024-024-003	3 mm	13,5 cm / 5 ³ / ₈ "
024-024-004	4 mm	13,5 cm / 5 ³ / ₈ "
024-024-005	5 mm	13,5 cm / 5 ³ / ₈ "
024-024-006	6 mm	13,5 cm / 5 ³ / ₈ "

Flachmeißel, Hohlmeißel, Osteotome
Chiseles, Gouges, Osteotomes
Cinceles, Gubias, Osteótomos
Scalpelli, Sgorbie, Osteotomi



024



PARTSCH

024-026-002	2 mm	17,0 cm / 6 ³ / ₄ "
024-026-003	3 mm	17,0 cm / 6 ³ / ₄ "
024-026-004	4 mm	17,0 cm / 6 ³ / ₄ "
024-026-005	5 mm	17,0 cm / 6 ³ / ₄ "
024-026-006	6 mm	17,0 cm / 6 ³ / ₄ "
024-026-007	7 mm	17,0 cm / 6 ³ / ₄ "



ALEXANDER

024-030-004	4 mm	18,0 cm / 7"
024-030-006	6 mm	18,0 cm / 7"
024-030-008	8 mm	18,0 cm / 7"
024-030-010	10 mm	18,0 cm / 7"
024-030-012	12 mm	18,0 cm / 7"
024-030-014	14 mm	18,0 cm / 7"



ALEXANDER

024-032-004	4 mm	18,0 cm / 7"
024-032-006	6 mm	18,0 cm / 7"
024-032-008	8 mm	18,0 cm / 7"
024-032-010	10 mm	18,0 cm / 7"
024-032-012	12 mm	18,0 cm / 7"
024-032-014	14 mm	18,0 cm / 7"



STILLE

024-040-010	10 mm	20,0 cm / 8"
024-040-015	15 mm	20,0 cm / 8"
024-040-020	20 mm	20,0 cm / 8"
024-040-025	25 mm	20,0 cm / 8"



STILLE

024-042-010	10 mm	20,0 cm / 8"
024-042-015	15 mm	20,0 cm / 8"
024-042-020	20 mm	20,0 cm / 8"
024-042-025	25 mm	20,0 cm / 8"



STILLE

024-044-010	10 mm	20,0 cm / 8"
024-044-015	15 mm	20,0 cm / 8"
024-044-020	20 mm	20,0 cm / 8"
024-044-025	25 mm	20,0 cm / 8"



024

Osteotome
Osteotomes
Osteótomos
Osteotomi

**MINI-LAMBOTTE**

024-050-002	2 mm	12,5 cm / 5"
024-050-003	3 mm	12,5 cm / 5"
024-050-004	4 mm	12,5 cm / 5"
024-050-006	6 mm	12,5 cm / 5"
024-050-008	8 mm	12,5 cm / 5"
024-050-010	10 mm	12,5 cm / 5"
024-050-012	12 mm	12,5 cm / 5"
024-050-015	15 mm	12,5 cm / 5"

**MINI-LAMBOTTE**

024-052-003	3 mm	17,0 cm / 6 ³ / ₄ "
024-052-004	4 mm	17,0 cm / 6 ³ / ₄ "
024-052-006	6 mm	17,0 cm / 6 ³ / ₄ "
024-052-008	8 mm	17,0 cm / 6 ³ / ₄ "
024-052-010	10 mm	17,0 cm / 6 ³ / ₄ "
024-052-012	12 mm	17,0 cm / 6 ³ / ₄ "
024-052-015	15 mm	17,0 cm / 6 ³ / ₄ "

**LAMBOTTE**

024-054-004	4 mm	24,0 cm / 9 ¹ / ₂ "
024-054-006	6 mm	24,0 cm / 9 ¹ / ₂ "
024-054-008	8 mm	24,0 cm / 9 ¹ / ₂ "
024-054-010	10 mm	24,0 cm / 9 ¹ / ₂ "
024-054-012	12 mm	24,0 cm / 9 ¹ / ₂ "
024-054-015	15 mm	24,0 cm / 9 ¹ / ₂ "
024-054-020	20 mm	24,0 cm / 9 ¹ / ₂ "
024-054-025	25 mm	24,0 cm / 9 ¹ / ₂ "
024-054-030	30 mm	24,0 cm / 9 ¹ / ₂ "
024-054-038	38 mm	24,0 cm / 9 ¹ / ₂ "
024-054-044	44 mm	24,0 cm / 9 ¹ / ₂ "
024-054-050	50 mm	24,0 cm / 9 ¹ / ₂ "

**LAMBOTTE**

024-056-004	4 mm	24,0 cm / 9 ¹ / ₂ "
024-056-006	6 mm	24,0 cm / 9 ¹ / ₂ "
024-056-008	8 mm	24,0 cm / 9 ¹ / ₂ "
024-056-010	10 mm	24,0 cm / 9 ¹ / ₂ "
024-056-012	12 mm	24,0 cm / 9 ¹ / ₂ "
024-056-015	15 mm	24,0 cm / 9 ¹ / ₂ "
024-056-020	20 mm	24,0 cm / 9 ¹ / ₂ "
024-056-025	25 mm	24,0 cm / 9 ¹ / ₂ "
024-056-030	30 mm	24,0 cm / 9 ¹ / ₂ "
024-056-038	38 mm	24,0 cm / 9 ¹ / ₂ "
024-056-044	44 mm	24,0 cm / 9 ¹ / ₂ "
024-056-050	50 mm	24,0 cm / 9 ¹ / ₂ "



SMITH-PETERSON

024-060-006	6 mm	20,0 cm / 8"
024-060-009	9 mm	20,0 cm / 8"
024-060-013	13 mm	20,0 cm / 8"
024-060-016	16 mm	20,0 cm / 8"
024-060-019	19 mm	20,0 cm / 8"
024-060-025	25 mm	20,0 cm / 8"
024-060-032	32 mm	20,0 cm / 8"



SMITH-PETERSON

024-061-006	6 mm	20,0 cm / 8"
024-061-009	9 mm	20,0 cm / 8"
024-061-013	13 mm	20,0 cm / 8"
024-061-016	16 mm	20,0 cm / 8"
024-061-019	19 mm	20,0 cm / 8"
024-061-025	25 mm	20,0 cm / 8"
024-061-032	32 mm	20,0 cm / 8"



SMITH-PETERSON

024-064-009	9 mm	20,0 cm / 8"
024-064-014	14 mm	20,0 cm / 8"
024-064-019	19 mm	20,0 cm / 8"
024-064-025	25 mm	20,0 cm / 8"

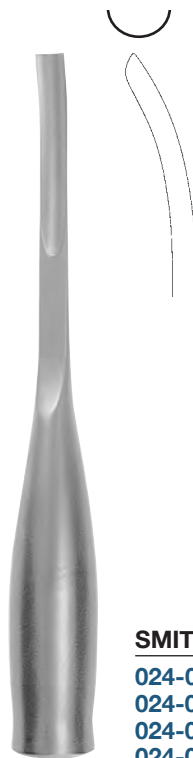

SMITH-PETERSON

024-065-009	9 mm	20,0 cm / 8"
024-065-014	14 mm	20,0 cm / 8"
024-065-019	19 mm	20,0 cm / 8"
024-065-025	25 mm	20,0 cm / 8"



024

**Flachmeißel, Hohlmeißel, Osteotome
Chiseles, Gouges, Osteotomes
Cinceles, Gubias, Osteótomos
Scalpelli, SGorbie, Osteotomi**



HOKE

024-068-003	3 mm	17,0 cm / 6 ³ / ₄ "
024-068-005	5 mm	17,0 cm / 6 ³ / ₄ "
024-068-006	6 mm	17,0 cm / 6 ³ / ₄ "
024-068-008	8 mm	17,0 cm / 6 ³ / ₄ "
024-068-009	9 mm	17,0 cm / 6 ³ / ₄ "



HIBBS

024-070-006	6 mm	24,0 cm / 9 ¹ / ₂ "
024-070-013	13 mm	24,0 cm / 9 ¹ / ₂ "
024-070-019	19 mm	24,0 cm / 9 ¹ / ₂ "
024-070-025	25 mm	24,0 cm / 9 ¹ / ₂ "
024-070-032	32 mm	24,0 cm / 9 ¹ / ₂ "

Flachmeißel, Hohlmeißel, Osteotome
 Chiseles, Gouges, Osteotomes
 Cinceles, Gubias, Osteótomos
 Scalpelli, Sgorbie, Osteotomi



024



HIBBS

024-072-006	6 mm	24,0 cm / 9½"
024-072-013	13 mm	24,0 cm / 9½"
024-072-019	19 mm	24,0 cm / 9½"
024-072-025	25 mm	24,0 cm / 9½"
024-072-032	32 mm	24,0 cm / 9½"



HIBBS

024-073-006	6 mm	24,0 cm / 9½"
024-073-013	13 mm	24,0 cm / 9½"
024-073-019	19 mm	24,0 cm / 9½"
024-073-025	25 mm	24,0 cm / 9½"
024-073-032	32 mm	24,0 cm / 9½"



HIBBS

024-076-006	6 mm	24,0 cm / 9½"
024-076-013	13 mm	24,0 cm / 9½"
024-076-019	19 mm	24,0 cm / 9½"
024-076-025	25 mm	24,0 cm / 9½"
024-076-032	32 mm	24,0 cm / 9½"



HIBBS

024-077-006	6 mm	24,0 cm / 9½"
024-077-013	13 mm	24,0 cm / 9½"
024-077-019	19 mm	24,0 cm / 9½"
024-077-025	25 mm	24,0 cm / 9½"
024-077-032	32 mm	24,0 cm / 9½"



024

**Stößel
Tampers
Pisón
Punzoni**



024-080-002 ø 2 mm



024-080-003 ø 3 mm



024-080-004 ø 4 mm



024-080-005 ø 5 mm



024-080-006 ø 6 mm



024-080-008 ø 8 mm



024-080-010 ø 10 mm

024-080-002 – 024-080-010 15,5 cm / 6"



024-090-003 ø 3 mm



024-090-005 ø 5 mm



024-090-008 ø 8 mm



024-090-012 ø 12 mm

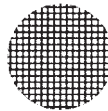

024-090-014 ø 14 mm

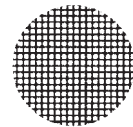

024-090-016 ø 16 mm

024-090-003 – 024-090-016 20,0 cm / 8"

Flachmeißel, Hohlmeißel und Osteotome mit Ferrozellgriff
Chisels, Gouges and Osteotomes with handle from artificial wood
Cinceles, Gubias y Osteótomos con mango de madera artificial
Scalpelli, Sgorbie e Osteotomi con manico in legno artificiale



024



024-100-180 18,0 cm / 7"



024-108-001

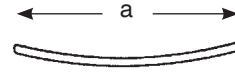

Hohlmeißel
Gouges
Gubias
Sgorbie

024-102-050 a = 50 mm
024-102-060 a = 60 mm
024-102-070 a = 70 mm

Flachmeißel
Chisels
Cinceles
Scalpelli

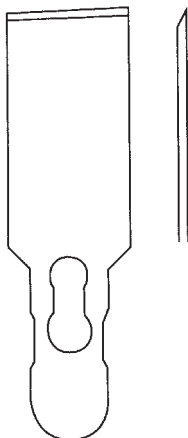

024-104-005 5,0 mm
024-104-010 10,0 mm
024-104-016 16,0 mm
024-104-025 25,0 mm

Osteotome
Chisels
Cinceles
Scalpelli

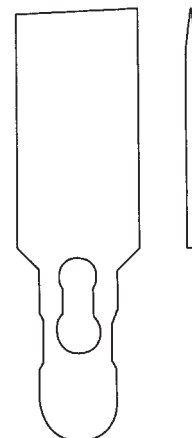

024-106-005 5,0 mm
024-106-010 10,0 mm
024-106-016 16,0 mm
024-106-025 25,0 mm

Flachmeißel, Hohlmeißel und Osteotome mit Ferrozellgriff
Chisels, Gouges and Osteotomes with handle from artificial wood
Cinceles, Gubias y Osteótomos con mango de madera artificial
Scalpelli, Sgorbie e Osteotomi con manico in legno artificiale



Osteotome
 Chisels
 Cinceles
 Scalpelli

MINI-LEXER

024-110-004	4 mm	18,0 cm / 7"
024-110-006	6 mm	18,0 cm / 7"
024-110-008	8 mm	18,0 cm / 7"
024-110-010	10 mm	18,0 cm / 7"
024-110-012	12 mm	18,0 cm / 7"



Hohlmeißel
 Gouges
 Gubias
 Sgorbie

MINI-LEXER

024-112-004	4 mm	18,0 cm / 7"
024-112-006	6 mm	18,0 cm / 7"
024-112-008	8 mm	18,0 cm / 7"
024-112-010	10 mm	18,0 cm / 7"
024-112-012	12 mm	18,0 cm / 7"



Hohlmeißel
 Gouges
 Gubias
 Sgorbie

LEXER

024-114-005	5 mm	25,0 cm / 9 ³ / ₄ "
024-114-010	10 mm	25,0 cm / 9 ³ / ₄ "
024-114-015	15 mm	25,0 cm / 9 ³ / ₄ "



Hohlmeißel
 Gouges
 Gubias
 Sgorbie

LEXER

024-115-005	5 mm	25,0 cm / 9 ³ / ₄ "
024-115-010	10 mm	25,0 cm / 9 ³ / ₄ "
024-115-015	15 mm	25,0 cm / 9 ³ / ₄ "

Flachmeißel, Hohlmeißel und Osteotome mit Ferrozellgriff
Chisels, Gouges and Osteotomes with handle from artificial wood
Cinceles, Gubias y Osteótomos con mango de madera artificial
Scalpelli, Sgorbie e Osteotomi con manico in legno artificiale



024



Osteotome
Chisels
Cinceles
Scalpelli



Hohlmeißel
Gouges
Gubias
Sgorbie

LEXER

024-116-005	5 mm	22,0 cm / 8 ³ / ₄ "
024-116-007	7 mm	22,0 cm / 8 ³ / ₄ "
024-116-010	10 mm	22,0 cm / 8 ³ / ₄ "
024-116-015	15 mm	22,0 cm / 8 ³ / ₄ "
024-116-020	20 mm	22,0 cm / 8 ³ / ₄ "
024-116-025	25 mm	22,0 cm / 8 ³ / ₄ "
024-116-030	30 mm	22,0 cm / 8 ³ / ₄ "

LEXER

024-118-005	5 mm	22,0 cm / 8 ³ / ₄ "
024-118-007	7 mm	22,0 cm / 8 ³ / ₄ "
024-118-010	10 mm	22,0 cm / 8 ³ / ₄ "
024-118-015	15 mm	22,0 cm / 8 ³ / ₄ "
024-118-020	20 mm	22,0 cm / 8 ³ / ₄ "
024-118-025	25 mm	22,0 cm / 8 ³ / ₄ "
024-118-030	30 mm	22,0 cm / 8 ³ / ₄ "



Hohlmeißel
Gouges
Gubias
Sgorbie



Osteotome
Chisels
Cinceles
Scalpelli

LEXER

024-120-007	7 mm	28,5 cm / 11 ¹ / ₄ "
024-120-010	10 mm	28,5 cm / 11 ¹ / ₄ "

LEXER

024-123-010	10 mm	27,5 cm / 10 ³ / ₄ "
024-123-015	15 mm	27,5 cm / 10 ³ / ₄ "

Flachmeißel, Hohlmeißel und Osteotome mit Ferrozellgriff
Chisels, Gouges and Osteotomes with handle from artificial wood
Cinceles, Gubias y Osteótomos con mango de madera artificial
Scalpelli, Sgorbie e Osteotomi con manico in legno artificiale



Hohlmeißel
 Gouges
 Gubias
 Sgorbie

LEXER

024-125-010	10 mm	27,5 cm / 10 ³ / ₄ "
024-125-015	15 mm	27,5 cm / 10 ³ / ₄ "



Hohlmeißel
 Gouges
 Gubias
 Sgorbie

ZIELKE

024-127-005	5,5 mm	23,0 cm / 9"
024-127-009	9,0 mm	23,0 cm / 9"



Flachmeißel
 Chisels
 Cinceles
 Scalpelli

024-130-010	10 mm	16,0 cm / 6 ¹ / ₄ "
024-130-015	15 mm	16,0 cm / 6 ¹ / ₄ "



Flachmeißel
 Chisels
 Cinceles
 Scalpelli

024-132-010	10 mm	20,0 cm / 8"
024-132-015	15 mm	20,0 cm / 8"
024-132-020	20 mm	20,0 cm / 8"

Flachmeißel, Hohlmeißel und Osteotome mit Ferrozellgriff
Chisels, Gouges and Osteotomes with handle from artificial wood
Cinceles, Gubias y Osteótomos con mango de madera artificial
Scalpelli, Sgorbie e Osteotomi con manico in legno artificiale



024



Flachmeißel
Chisels
Cinceles
Scalpelli

-
- 024-133-010** 10,0 mm 20,0 cm / 8"
 - 024-133-015** 15,0 mm 20,0 cm / 8"
 - 024-133-020** 20,0 mm 20,0 cm / 8"



Flachmeißel
Chisels
Cinceles
Scalpelli

-
- 024-136-020** 20,0 mm 24,5 cm / 9³/₄"



Flachmeißel
Chisels
Cinceles
Scalpelli

-
- 024-137-016** 16,0 mm 26,5 cm / 10¹/₂"



Hohlmeißel
Gouges
Gubias
Sgorbie

-
- 024-140-220** 9,0 mm 22,0 cm / 8³/₄"



024

Flachmeißel, Hohlmeißel und Osteotome mit Ferrozellgriff
Chisels, Gouges and Osteotomes with handle from artificial wood
Cinceles, Gubias y Osteótomos con mango de madera artificial
Scalpelli, Sgorbie e Osteotomi con manico in legno artificiale



Hohlmeißel
Gouge
Gubia
Sgorbie

COBB

024-142-275 8,0 mm 27,5 cm / 10³/₄"



Hohlmeißel
Gouge
Gubia
Sgorbie

COBB

024-143-270 8,0 mm 27,0 cm / 10³/₄"



Hohlmeißel
Gouge
Gubia
Sgorbie

COBB

024-145-270 8,0 mm 27,0 cm / 10³/₄"

Hohlmeißel und Osteotome mit Ferrozellgriff
Gouges and Osteotomes with handle from artificial wood
Gubias y Osteótomos con mango de madera artificial
Sgorbie e Osteotomi con manico in legno artificiale



024



DAHMEN

024-150-004	4 mm	30,0 cm / 11 ³ / ₄ "
024-150-005	5 mm	30,0 cm / 11 ³ / ₄ "
024-150-006	6 mm	30,0 cm / 11 ³ / ₄ "
024-150-008	8 mm	30,0 cm / 11 ³ / ₄ "
024-150-010	10 mm	30,0 cm / 11 ³ / ₄ "
024-150-012	12 mm	30,0 cm / 11 ³ / ₄ "
024-150-015	15 mm	30,0 cm / 11 ³ / ₄ "
024-150-020	20 mm	30,0 cm / 11 ³ / ₄ "
024-150-022	22 mm	30,0 cm / 11 ³ / ₄ "
024-150-025	25 mm	30,0 cm / 11 ³ / ₄ "

DAHMEN

024-154-004	4 mm	30,0 cm / 11 ³ / ₄ "
024-154-005	5 mm	30,0 cm / 11 ³ / ₄ "
024-154-006	6 mm	30,0 cm / 11 ³ / ₄ "
024-154-008	8 mm	30,0 cm / 11 ³ / ₄ "
024-154-010	10 mm	30,0 cm / 11 ³ / ₄ "
024-154-012	12 mm	30,0 cm / 11 ³ / ₄ "
024-154-015	15 mm	30,0 cm / 11 ³ / ₄ "
024-154-020	20 mm	30,0 cm / 11 ³ / ₄ "
024-154-022	22 mm	30,0 cm / 11 ³ / ₄ "
024-154-025	25 mm	30,0 cm / 11 ³ / ₄ "

Flachmeißel und Hohlmeißel mit Ferrozellgriff
Chisels and Gouges with handle from artificial wood
Cinceles y Gubias con mango de madera artificial
Scalpelli e Sgorbie con manico in legno artificiale



DAHMEN

024-155-004	4 mm	30,0 cm / 11 ³ / ₄ "
024-155-005	5 mm	30,0 cm / 11 ³ / ₄ "
024-155-006	6 mm	30,0 cm / 11 ³ / ₄ "
024-155-008	8 mm	30,0 cm / 11 ³ / ₄ "
024-155-010	10 mm	30,0 cm / 11 ³ / ₄ "
024-155-012	12 mm	30,0 cm / 11 ³ / ₄ "
024-155-015	15 mm	30,0 cm / 11 ³ / ₄ "
024-155-020	20 mm	30,0 cm / 11 ³ / ₄ "
024-155-022	22 mm	30,0 cm / 11 ³ / ₄ "
024-155-025	25 mm	30,0 cm / 11 ³ / ₄ "

DAHMEN

024-159-004	4 mm	30,0 cm / 11 ³ / ₄ "
024-159-005	5 mm	30,0 cm / 11 ³ / ₄ "
024-159-006	6 mm	30,0 cm / 11 ³ / ₄ "
024-159-008	8 mm	30,0 cm / 11 ³ / ₄ "
024-159-010	10 mm	30,0 cm / 11 ³ / ₄ "
024-159-012	12 mm	30,0 cm / 11 ³ / ₄ "
024-159-015	15 mm	30,0 cm / 11 ³ / ₄ "
024-159-020	20 mm	30,0 cm / 11 ³ / ₄ "
024-159-022	22 mm	30,0 cm / 11 ³ / ₄ "
024-159-025	25 mm	30,0 cm / 11 ³ / ₄ "



WILLIGER

024-200-300	300 g	ø 26 mm	24,0 cm / 9 ¹ / ₂ "
024-200-340	340 g	ø 28 mm	24,0 cm / 9 ¹ / ₂ "
024-200-400	400 g	ø 30 mm	24,0 cm / 9 ¹ / ₂ "



DOYEN

024-202-120	120 g	ø 25 mm	19,5 cm / 7 ³ / ₄ "
024-202-180	180 g	ø 30 mm	19,5 cm / 7 ³ / ₄ "
024-202-260	260 g	ø 35 mm	21,0 cm / 8 ¹ / ₄ "



024

**Hammer
Mallets
Martillos
Martelli**



COLLIN

024-204-220 220 g ø 30 mm 20,0 cm / 8"



LUCAE

024-206-230 230 g ø 19 mm 19,5 cm / 7³/₄"
024-206-260 260 g ø 25 mm 19,5 cm / 7³/₄"



COTTLE

024-208-350 350 g ø 30 mm 19,0 cm / 7½"



WILLIGER

024-210-140 140 g ø 20 mm 16,5 cm / 6½"



mit auswechselbaren Backen
(024-214-001)

with interchangeable disks
(024-214-001)

con tapas intercambiables
(024-214-001)

con piastre intercambiabili
(024-214-001)

MEAD

024-212-320 320 g ø 26 mm 19,0 cm / 7½"



PARTSCH

024-216-200 200 g ø 22 mm 19,0 cm / 7½"



024

**Hammer
Mallets
Martillos
Martelli**



HAJEK

024-218-200 200 g ø 27 mm 20,0 cm / 8"



GERZOG

024-220-270 270 g ø 25 mm 19,5 cm / 7 1/2"



KIRK

024-222-650 650 g ø 38 mm 21,0 cm / 8 1/4"



BERGMANN

024-224-490 490 g ø 45 mm 25,0 cm / 9 3/4"



BERGMANN

024-226-400 400 g ø 30 mm 24,5 cm / 9²/₈"



OMBREDANNE

024-228-700 700 g ø 40 mm 24,0 cm / 9¹/₂"



HEATH

024-230-700 700 g ø 40 mm 18,5 cm / 7¹/₄"

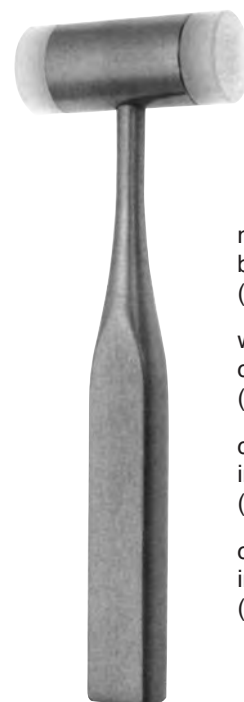

mit auswechselbaren Backen
(**024-233-001**)

with interchangeable disks
(**024-233-001**)

con tapas intercambiables
(**024-233-001**)

con piastre intercambiabili
(**024-233-001**)

024-232-240 240 g ø 25 mm 18,5 cm / 7¹/₄"



024

**Hammer
Mallets
Martillos
Martelli**



aus Ferrozell
from artificial wood
de madera artificial
in legno artificiale



KIRK

024-234-180	180 g	ø 35 mm	26,0 cm / 10 ¹ / ₄ "
024-234-250	250 g	ø 42 mm	26,0 cm / 10 ¹ / ₄ "
024-234-350	350 g	ø 50 mm	26,0 cm / 10 ¹ / ₄ "

024-236-340	340 g	ø 42 mm	26,0 cm / 10 ¹ / ₄ "
--------------------	-------	---------	--



024-238-675	675 g	ø 30 mm	26,5 cm / 10 ¹ / ₂ "
--------------------	-------	---------	--



024-240-530	530 g	ø 42/30 mm	26,0 cm / 10 ¹ / ₄ "
--------------------	-------	------------	--



024-242-480 480 g ø 30 mm 24,0 cm / 9½"



024-245-001

Ersatzbacken (Paar) Kunststoff
Spare Facings (pair) plastic
Tapas de repuesto (par) plástico
Placche di ricambio (paio) plastica

024-244-370 370 g ø 37 mm 24,0 cm / 9½"



024-246-450 450 g ø 30 mm 26,5 cm / 10½"



024-246-900 900 g ø 50 mm 26,5 cm / 10½"





024

Scharfe Löffel
Bone Curettes
Cucharillas cortantes
Curette per ossa





Fig. 0000
024-300-040



Fig. 000
024-300-030



Fig. 00
024-300-020

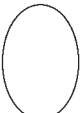

Fig. 0
024-300-010



Fig. 1
024-300-001

Fig. 2
024-300-002

Fig. 3
024-300-003

Fig. 4
024-300-004

Fig. 5
024-300-005



Fig. 6
024-300-006

VOLKMANN

024-300-001 - 024-300-040 17,5 cm / 7"





Fig. 0000
024-302-040

Fig. 000
024-302-030

Fig. 00
024-302-020

Fig. 0
024-302-010

Fig. 1
024-302-001





Fig. 2
024-302-002

Fig. 3
024-302-003

Fig. 4
024-302-004

Fig. 5
024-302-005

Fig. 6
024-302-006

VOLKMANN

024-302-001 - 024-302-040 28,0 cm / 11"

Scharfe Löffel
Bone Currettes
Cucharillas cortantes
Curette per ossa



024



Fig. 000
024-304-030

Fig. 1
024-304-001

Fig. 00
024-304-020

Fig. 2
024-304-002

Fig. 0
024-304-010

Fig. 3
024-304-003

Fig. 4
024-304-004

SCHEDE

024-304-001 - 024-304-030 17,0 cm / 6³/₄"



Fig. 0000
024-306-040

Fig. 0
024-306-010

Fig. 3
024-306-003

Fig. 000
024-306-030

Fig. 1
024-306-001

Fig. 4
024-306-004

Fig. 6
024-306-006

Fig. 00
024-306-020

Fig. 2
024-306-002

Fig. 5
024-306-005

VOLKMANN

024-306-001 - 024-306-040 17,0 cm / 6³/₄"



024

Scharfe Löffel
Bone Curettes
Cucharillas cortantes
Curette per ossa



Fig. 0000
024-308-040

Fig. 000
024-308-030

Fig. 00
024-308-020

Fig. 0
024-308-010

Fig. 1
024-308-001

Fig. 2
024-308-002

Fig. 3
024-308-003

Fig. 4
024-308-004

Fig. 5
024-308-005

Fig. 6
024-308-006

BRUNS

024-308-001 - 024-308-040 17,0 cm / 6³/₄"



Fig. 000
024-310-030

Fig. 00
024-310-020

Fig. 0
024-310-010

Fig. 1
024-310-001

Fig. 2
024-310-002

Fig. 3
024-310-003

Fig. 4
024-310-004

Fig. 5
024-310-005

SPRATT

024-310-001 - 024-310-030 17,0 cm / 6³/₄"

Scharfe Löffel
 Bone Currettes
 Cucharillas cortantes
 Curette per ossa





024





 Fig. 000
 024-312-030



 Fig. 00
 024-312-020



 Fig. 0
 024-312-010



 Fig. 1
 024-312-001

 Fig. 2
 024-312-002

 Fig. 3
 024-312-003

 Fig. 4
 024-312-004

 Fig. 5
 024-312-005

 Fig. 6
 024-312-006

BRUNS

024-312-001 - 024-312-030 23,0 cm / 9"



SCOVILLE

024-314-250 25,0 cm / 9³/₄"



SCOVILLE

024-315-250 25,0 cm / 9³/₄"



SCOVILLE

024-317-250 25,0 cm / 9³/₄"



024

Scharfe Löffel
Bone Currettes
Cucharillas cortantes
Curette per ossa

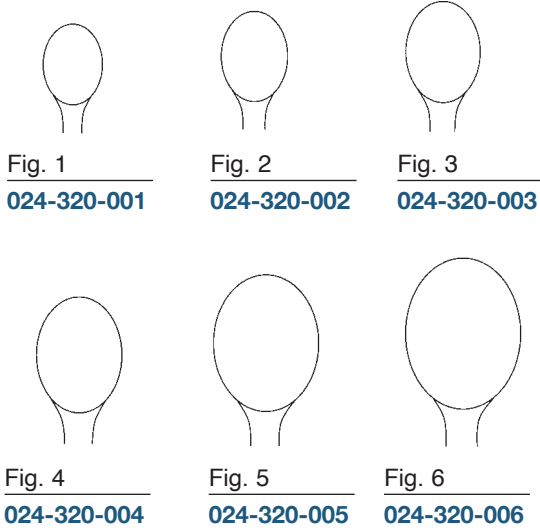

Fig. 1
024-320-001

Fig. 2
024-320-002

Fig. 3
024-320-003

Fig. 4
024-320-004

Fig. 5
024-320-005

Fig. 6
024-320-006

SIMON

024-320-001 - 024-320-006

25,0 cm / 9³/₄"

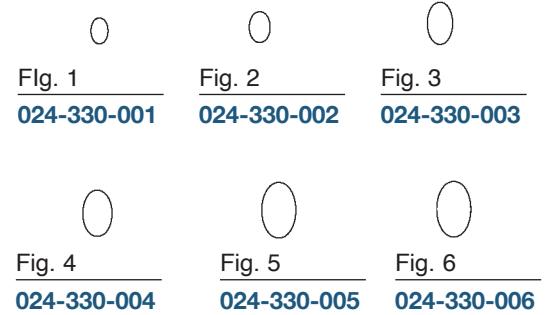

Fig. 1
024-330-001

Fig. 2
024-330-002

Fig. 3
024-330-003

Fig. 4
024-330-004

Fig. 5
024-330-005

Fig. 6
024-330-006

MOD. USA

024-330-001 - 024-330-006

16,0 cm / 6¹/₄"

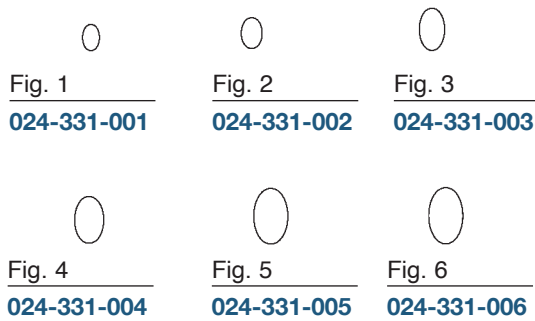

Fig. 1
024-331-001

Fig. 2
024-331-002

Fig. 3
024-331-003

Fig. 4
024-331-004

Fig. 5
024-331-005

Fig. 6
024-331-006

MOD. USA

024-331-001 - 024-331-006

15,5 cm / 6"

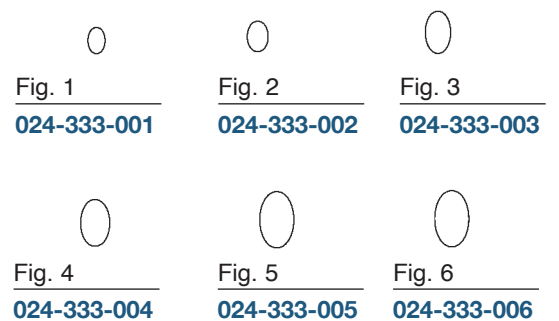

Fig. 1
024-333-001

Fig. 2
024-333-002

Fig. 3
024-333-003

Fig. 4
024-333-004

Fig. 5
024-333-005

Fig. 6
024-333-006

MOD. USA

024-333-001 - 024-333-006

15,5 cm / 6"

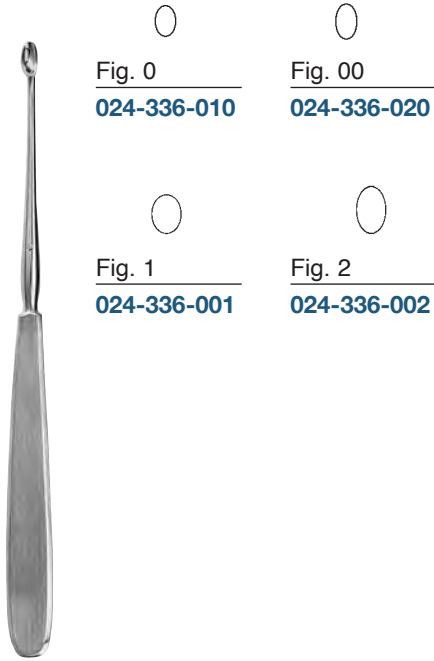

Fig. 0
 024-336-010

Fig. 00
 024-336-020

Fig. 1
 024-336-001

Fig. 2
 024-336-002

WILLIGER
 024-336-001 - 024-336-020 17,0 cm / 6³/₄"

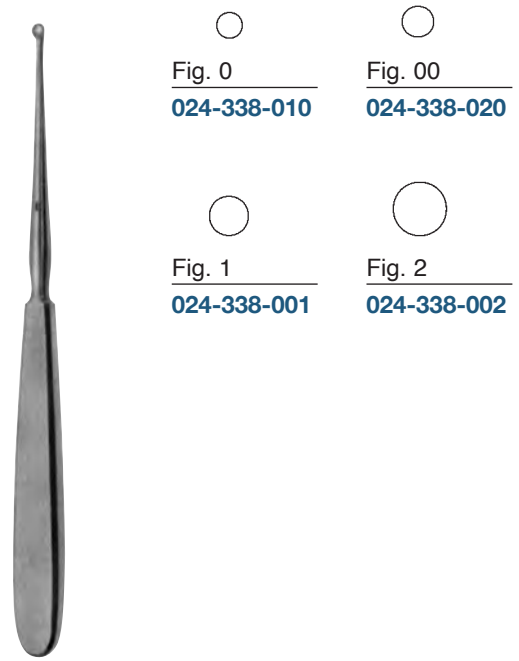

Fig. 0
 024-338-010

Fig. 00
 024-338-020

Fig. 1
 024-338-001

Fig. 2
 024-338-002

WILLIGER
 024-338-001 - 024-338-020 17,5 cm / 7"

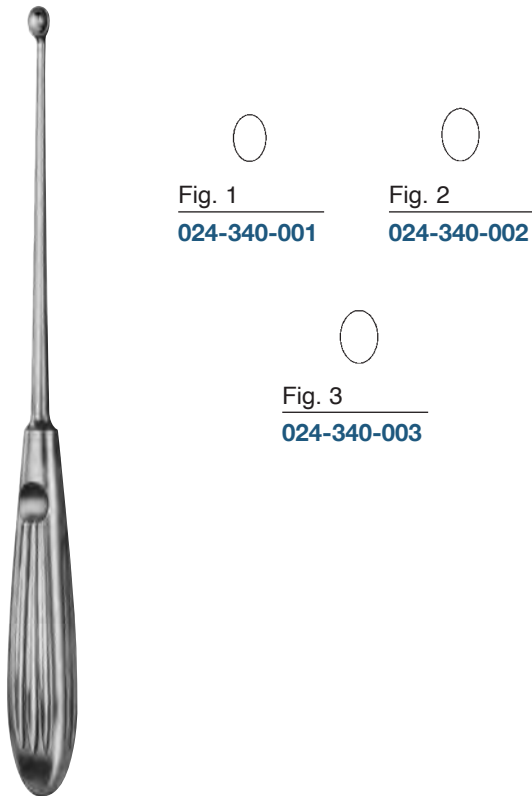

Fig. 1
 024-340-001

Fig. 2
 024-340-002

Fig. 3
 024-340-003

HALLE
 024-340-001 - 024-340-003 21,0 cm / 8¹/₄"



024

Scharfe Löffel
Bone Currettes
Cucharillas cortantes
Curette per ossa

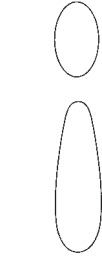

024-342-130



024-342-140



024-342-170

VOLKMANN

- 024-342-130 13,0 cm / 5"
- 024-342-140 14,0 cm / 5 1/2"
- 024-342-170 17,0 cm / 6 3/4"



024-344-130



024-344-160



024-344-200



VOLKMANN

- 024-344-130 13,0 cm / 5"
- 024-344-160 16,0 cm / 6 1/4"
- 024-344-200 20,0 cm / 8"



024-346-210 21,0 cm / 8 1/4"



Scharfe Löffel
Bone Currettes
Cucharillas cortantes
Curette per ossa



024



Fig. 00/0

024-348-000



Fig. 0/1

024-348-010



Fig. 1/2

024-348-012

WILLIGER

024-348-000 - 024-348-012

13,5 cm / 5 1/4"



Fig. 00/00

024-350-000



Fig. 0/1

024-350-010



Fig. 1/1

024-350-012

WILLIGER

024-350-000 - 024-350-012

16,0 cm / 6 1/4"



Fig. 00/0

024-352-000



Fig. 0/1

024-352-010



Fig. 1/2

024-352-012

MARTINI

024-352-000 - 024-352-012

13,5 cm / 5 1/4"



Fig. 1 R/L

024-360-001



Fig. 2 R/L

024-360-002



Fig. 3 R/L

024-360-003



HEMMINGWAY

024-360-001 - 024-360-003

18,0 cm / 7"



024

Scharfe Löffel
Bone Currettes
Cucharillas cortantes
Curette per ossa

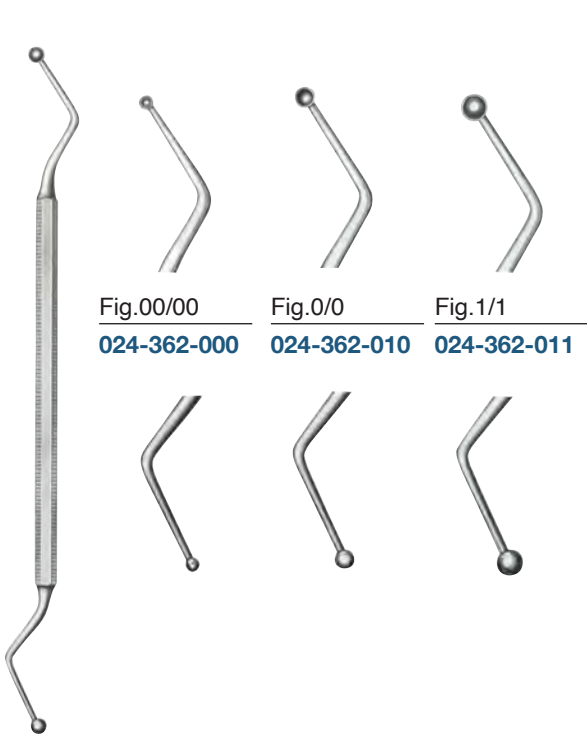

Fig.00/00 Fig.0/0 Fig.1/1
024-362-000 **024-362-010** **024-362-011**

HEMMINGWAY

024-362-000 - 024-362-011 18,0 cm / 7"

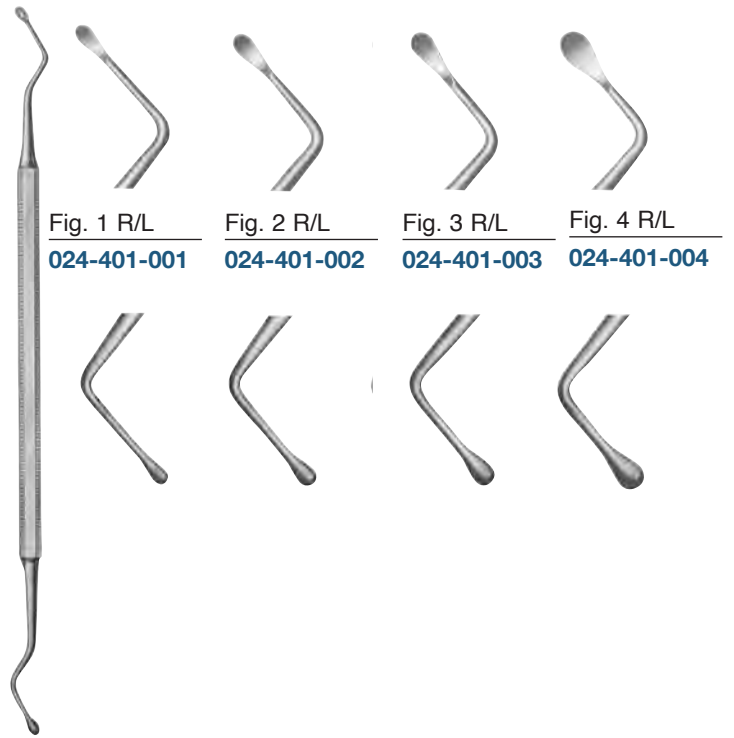

Fig. 1 R/L Fig. 2 R/L Fig. 3 R/L Fig. 4 R/L
024-401-001 **024-401-002** **024-401-003** **024-401-004**

HEMMINGWAY

024-401-001 - 024-401-004 18,0 cm / 7"

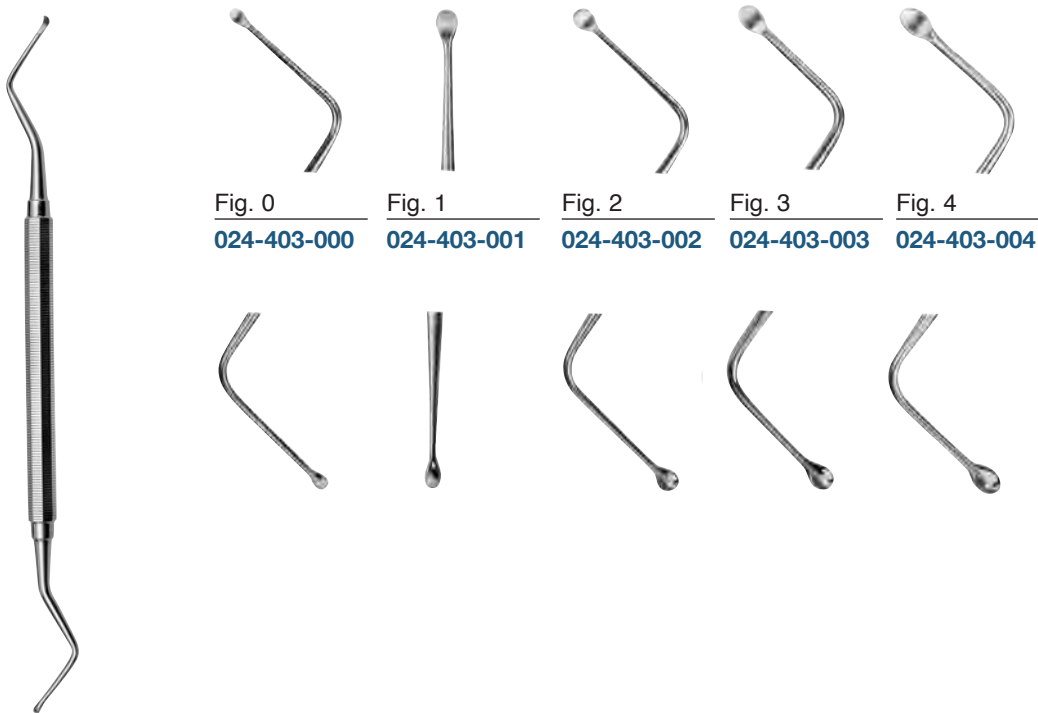

Fig. 0 Fig. 1 Fig. 2 Fig. 3 Fig. 4
024-403-000 **024-403-001** **024-403-002** **024-403-003** **024-403-004**

MILLER-COLBURN

024-403-000 - 024-403-004 17,0 cm / 6³/₄"

Raspatorien mit Ferrozellgriff
Raspatories with handle from artificial wood
Periostótomos con mango de madera artificial
Periostotomi con manico in legno artificiale



024



024-406-200 20,0 cm / 8"



024-407-190 19,0 cm / 7½"

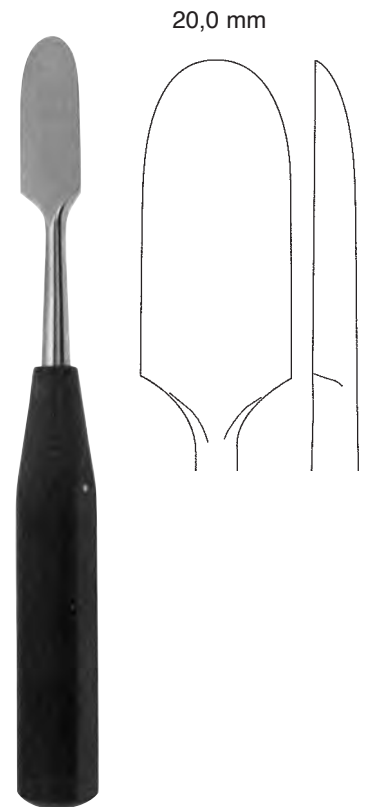

024-408-200 20,0 cm / 8"



024-409-190 19,0 cm / 7½"



024-410-180 18,0 cm / 7"



024-411-180 18,0 cm / 7"



024

Raspatorien mit Ferrozellgriff
Raspatories with handle from artificial wood
Periostótomos con mango de madera artificial
Periostotomi con manico in legno artificiale



024-413-180 18,0 cm / 7"



024-415-180 18,0 cm / 7"

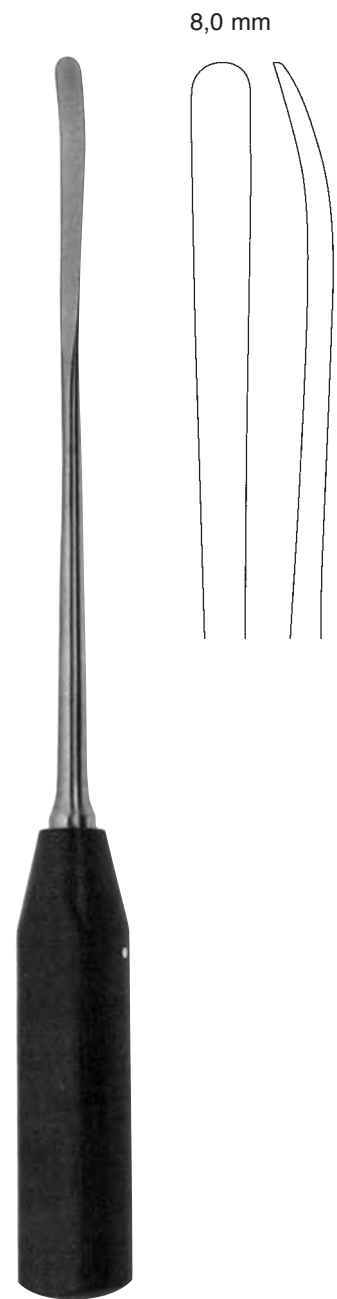

WAGNER
024-417-008 33,0 cm / 13"

Raspatorien mit Ferrozellgriff
Raspatories with handle from artificial wood
Periostótomos con mango de madera artificial
Periostotomi con manico in legno artificiale



024

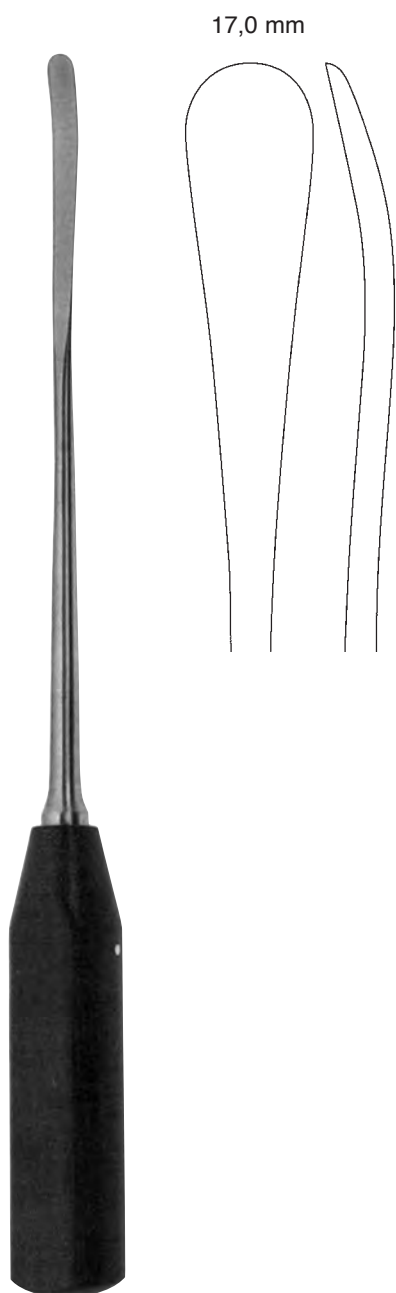

WAGNER

024-417-017 33,0 cm / 13"

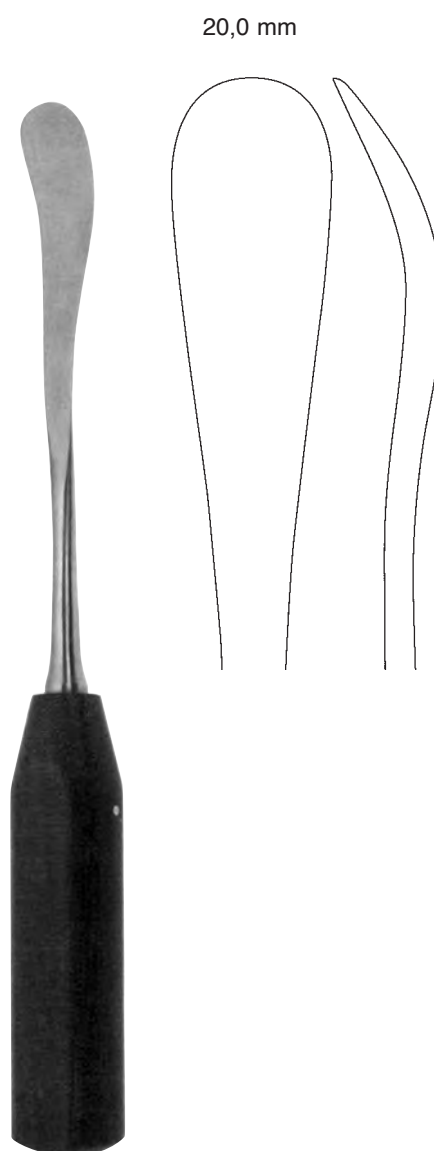

024-419-275 27,5 cm / 10³/₄"



024

Raspatorien
Raspatories
Periostótomos
Periostotomi



024-421-010 10,0 mm



024-425-010 10,0 mm

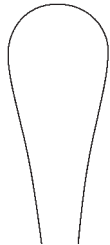

024-421-013 13,0 mm



024-425-013 13,0 mm

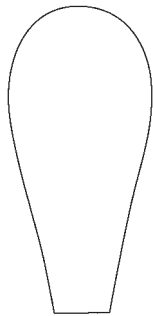

024-421-019 19,0 mm

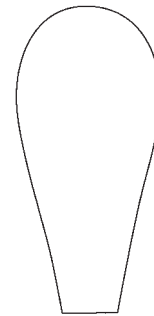

024-425-019 19,0 mm

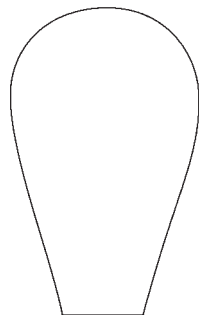

024-421-025 25,0 mm

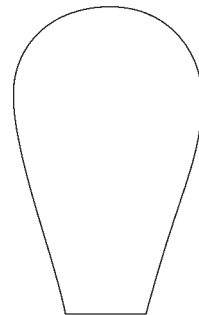

024-425-025 25,0 mm

COBB

024-421-010 - 024-421-025 25,0 cm / 10"

COBB

024-425-010 - 024-425-025 28,0 cm / 11"

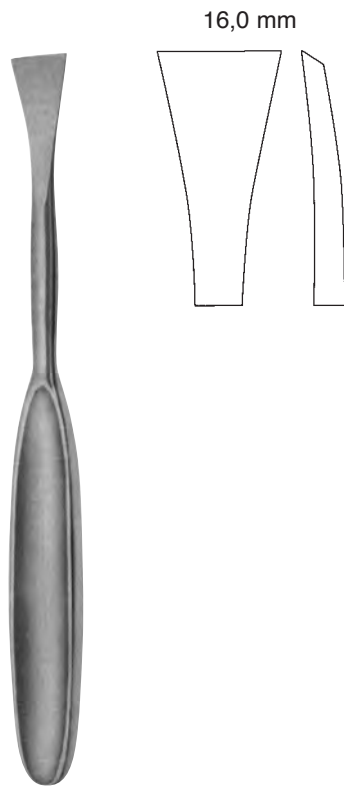

LANGENBECK

024-427-190 19,0 cm / 7½"

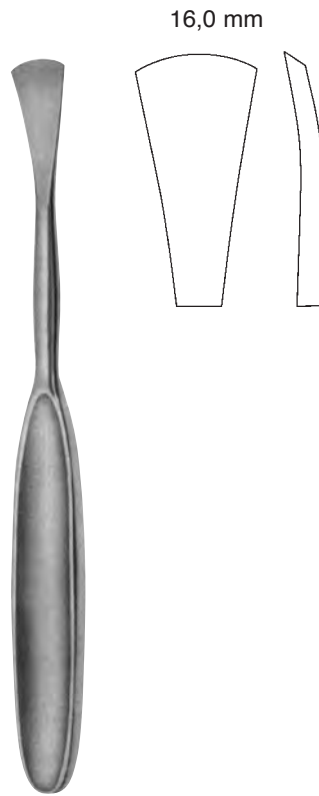

LANGENBECK

024-429-190 19,0 cm / 7½"

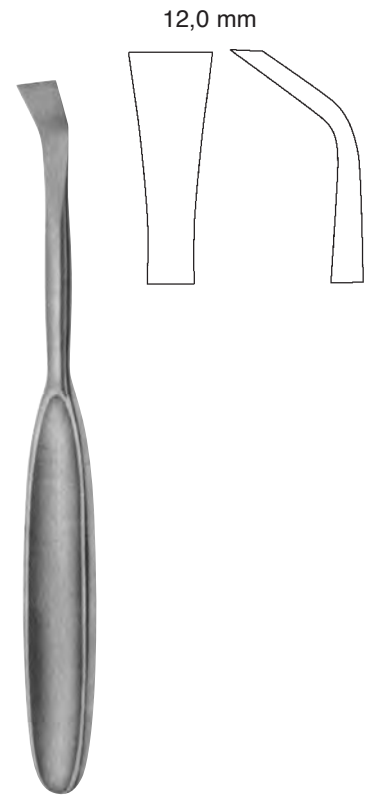

LANGENBECK

024-431-185 18,5 cm / 7¼"

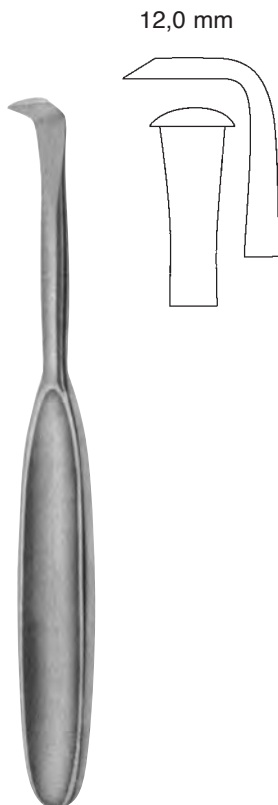

LANGENBECK

024-433-180 18,0 cm / 7"

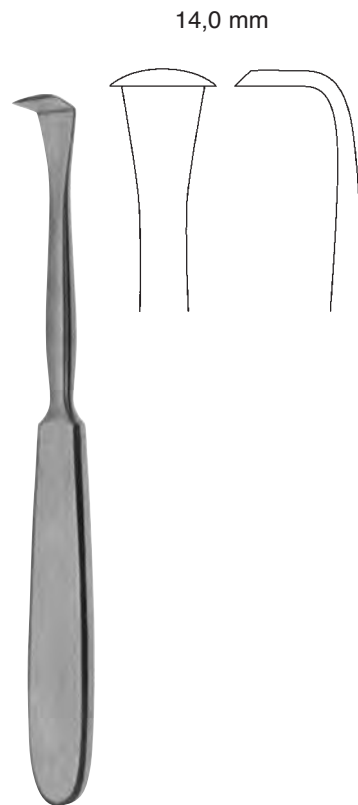

LANGENBECK

024-435-180 18,0 cm / 7"



LANGENBECK

024-437-190 19,0 cm / 7½"



024

**Raspatorien
Raspatories
Periostótomos
Periostotomi**

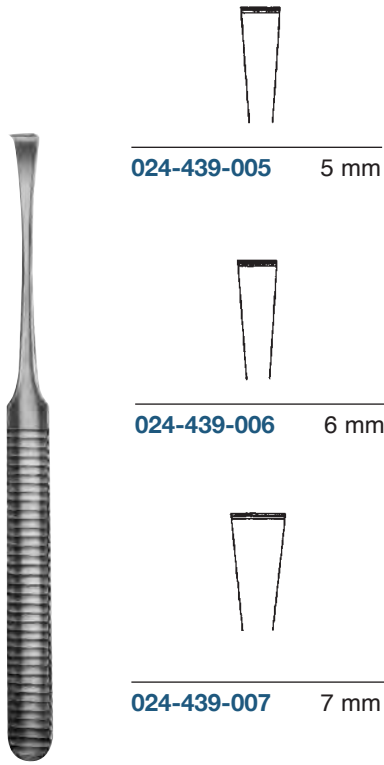

024-439-005 5 mm

024-439-006 6 mm

024-439-007 7 mm

024-439-005 - 024-439-007 16,0 cm / 6¹/₄"

12,5 mm



FARABEUF

024-440-150 15,0 cm / 6"

12,5 mm

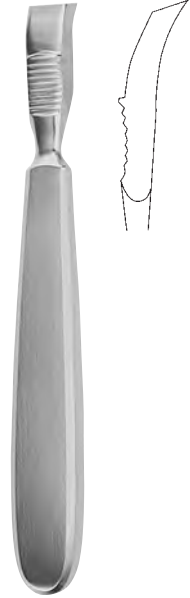

FARABEUF

024-441-150 15,0 cm / 6"

15,0 mm



SEDILOT

024-443-210 21,0 cm / 8¹/₄"

4,0 mm

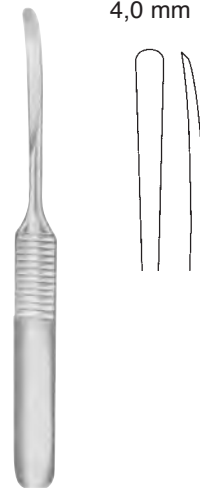

WILLIGER

024-445-140 14,0 cm / 5¹/₂"

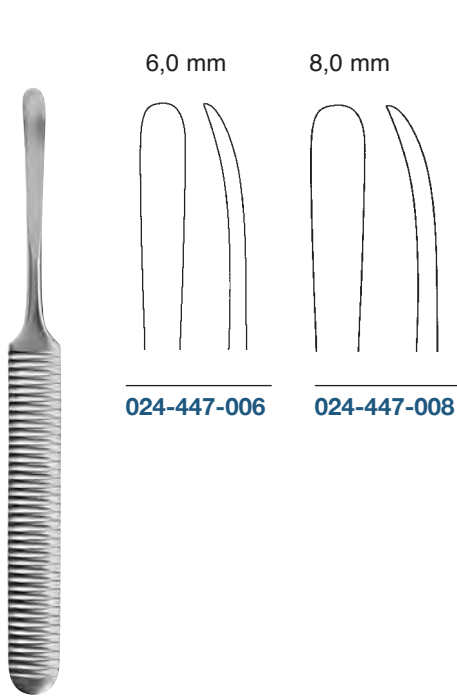

WILLIGER

024-447-006 - 024-447-008 16,0 cm / 6¹/₄"

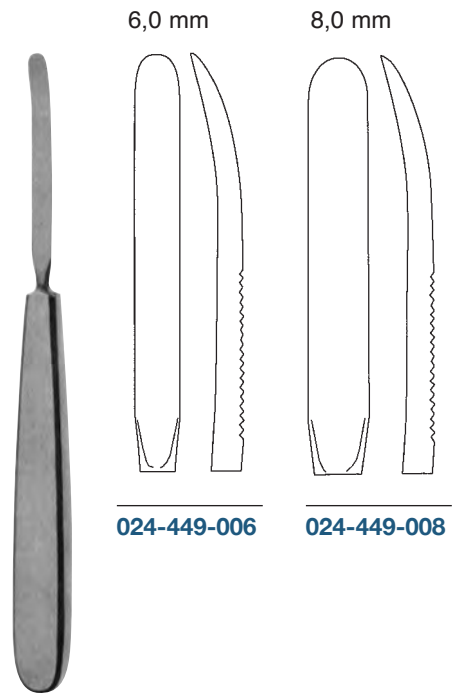

024-449-006 - 024-449-008 17,0 cm / 6³/₄"



DOYEN

024-451-170 17,0 cm / 6³/₄"



DOYEN

024-453-170 17,0 cm / 6³/₄"



024

Raspatorien
Raspatories
Periostótomos
Periostotomi



Für Erwachsene
for adults
para adultos
per adulti

DOYEN

024-455-170 17,0 cm / 6³/₄"

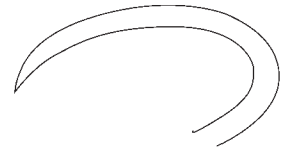

Für Erwachsene
for adults
para adultos
per adulti

DOYEN

024-457-170 17,0 cm / 6³/₄"



10,0 mm

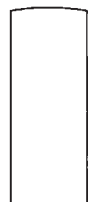

024-461-010

15,0 mm

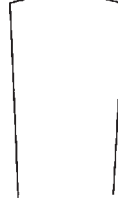

024-461-015

20,0 mm

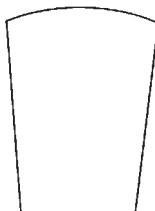

024-461-020

25,0 mm

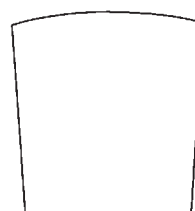

024-461-025

LAMBOTTE

024-461-010 - 024-461-025 21,0 cm / 8¹/₄"

12,0 mm

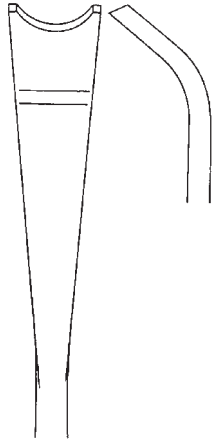

Fig. 1

024-463-001 19,0 cm / 7½"

12,0 mm

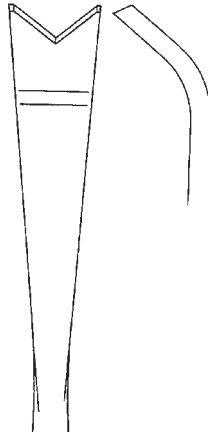

Fig. 2

024-463-002 23,0 cm / 9"

13,0 mm

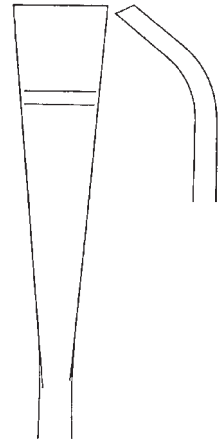

Fig. 3

024-463-003 23,0 cm / 9"



13,0 mm



Fig. 4

024-463-004 23,0 cm / 9"

16,0 mm

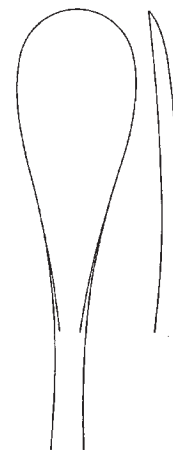

Fig. 5

024-463-005 23,0 cm / 9"

SEMB

024-463-001 - 024-463-005



024

Raspatorien
Raspatories
Periostótomos
Periostotomi

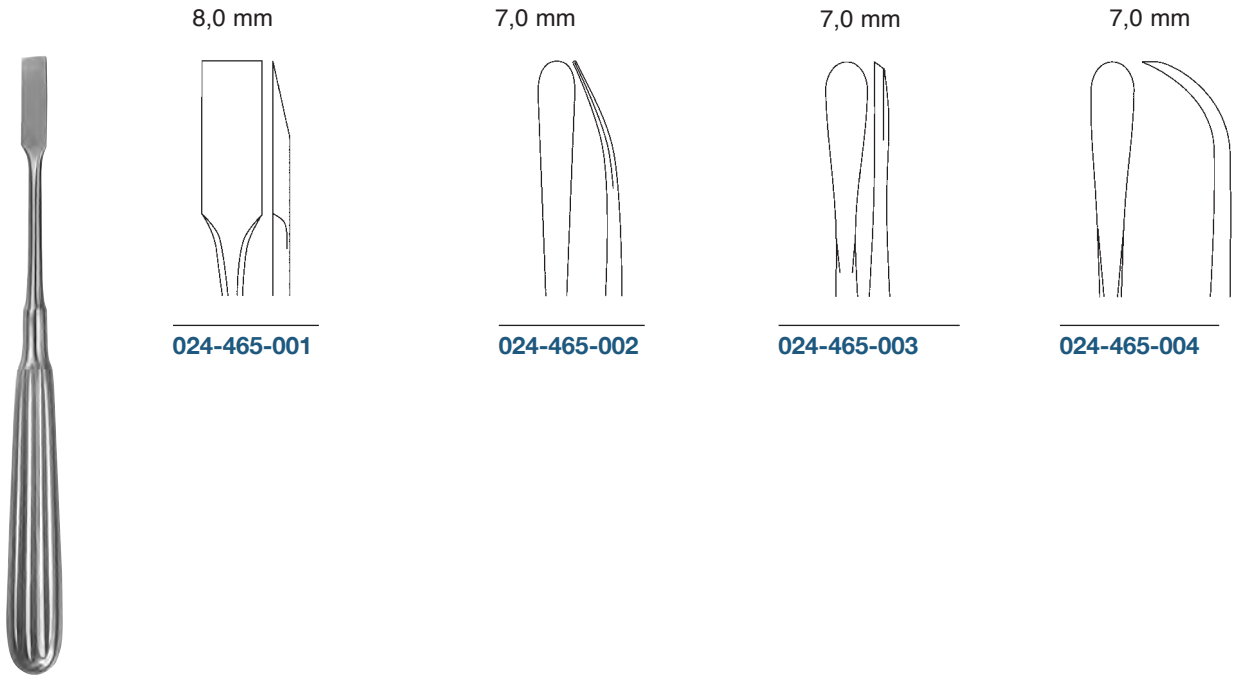

ADSON

024-465-001 - 024-465-004 17,0 cm / 6³/₄"

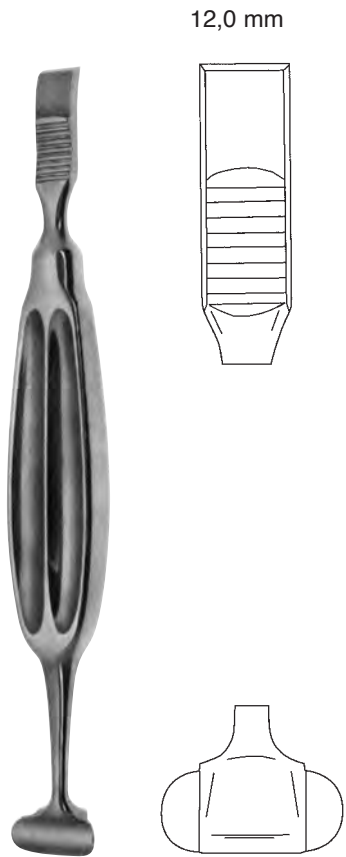

ALEXANDER

024-467-210 21,0 cm / 8¹/₄"

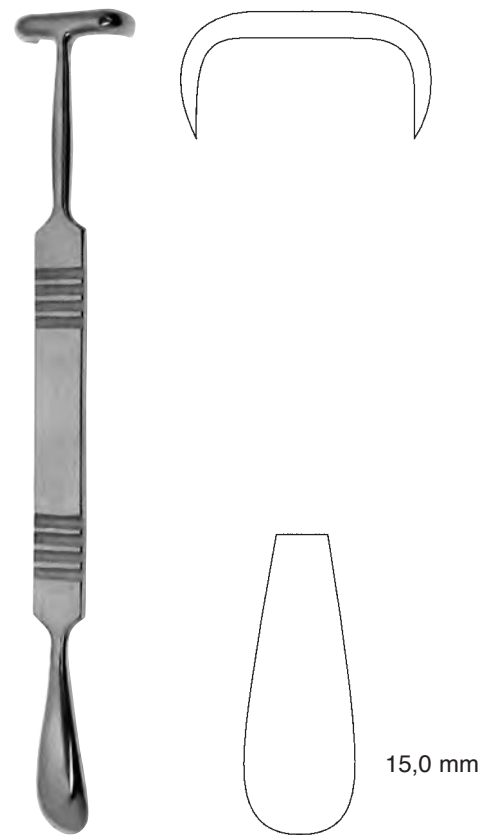

MATSON

024-469-220 22,0 cm / 8³/₄"

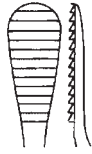

Fig. 1
024-501-001

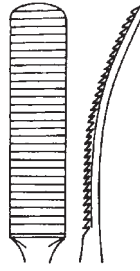

Fig. 2
024-501-002

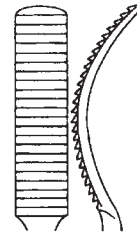
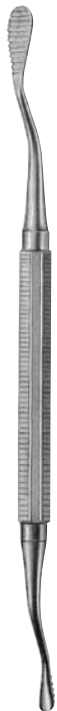
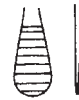
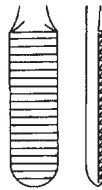
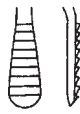

Fig. 3
024-501-003



abwärts schneidend
downwards cutting
corte abajo
tagliente in basso

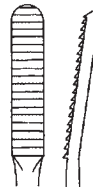

Fig. 4
024-501-004

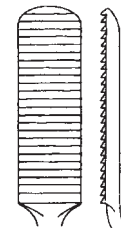
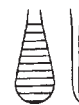

Fig. 5
024-501-005



MILLER-COLBURN

024-501-001 - 024-501-005

18,0 cm / 7"



024

Knochenfeilen
Bone files
Limas para huesos
Lima per ossa

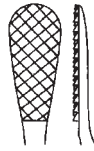

Fig. 1

024-503-001

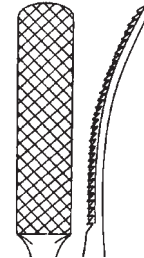

Fig. 2

024-503-002

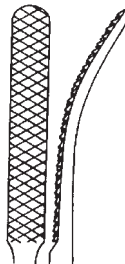

Fig. 3

024-503-003



Fig. 4

024-503-004

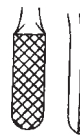

Kreuzhieb
cross cut
picado en cruz
tagleinte a croce

MILLER-COLBRUN

024-503-001 - 024-503-004

18,0 cm / 7"

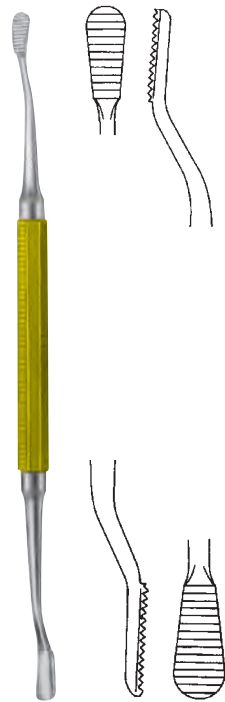

TC-MILLER-COLBRUN

024-505-185 18,5 cm / 7¹/₄"



TC-MILLER-COLBRUN

024-507-185 18,5 cm / 7¹/₄"



024-510-280 28,0 cm / 11"



024-511-245 24,5 cm / 9²/₃"



024-512-220 22,0 cm / 8³/₄"



024

Knochenfeilen
Bone files
Limas para huesos
Lima per ossa



PUTTI

024-515-300 30,0 cm / 12"



PUTTI

024-517-270 27,0 cm / 10³/₄"



LANGENBECK

024-551-008 - 024-551-010 20,0 cm / 8"

8,0 mm

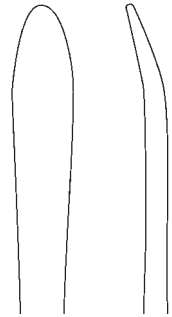

024-551-008

10,0 mm

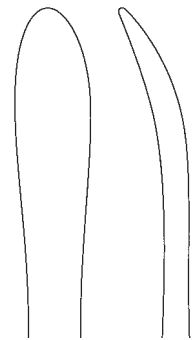

024-551-010

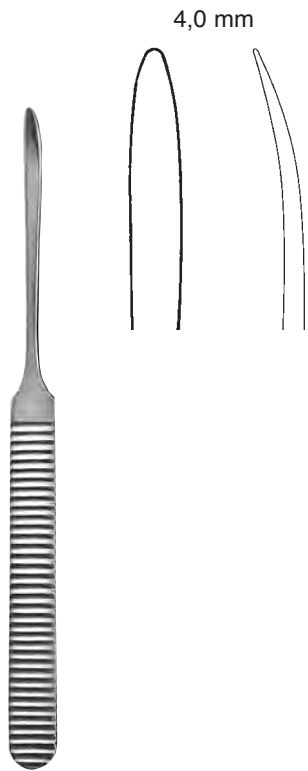

WILLIGER
 024-553-170 17,0 cm / 6³/₄"

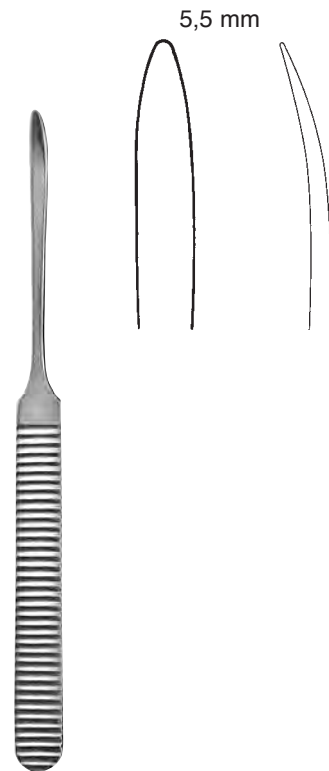

WILLIGER
 024-555-160 16,0 cm / 6¹/₄"

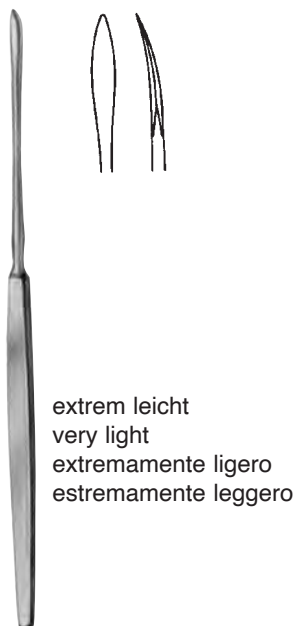

extrem leicht
 very light
 estremamente ligero
 estremamente leggero

024-557-170 17,0 cm / 6³/₄"



Mikro-Elevatorium
 Micro-Elevator
 Micro-Elevador
 Micro-Elevatorio

024-559-160 16,0 cm / 6¹/₄"

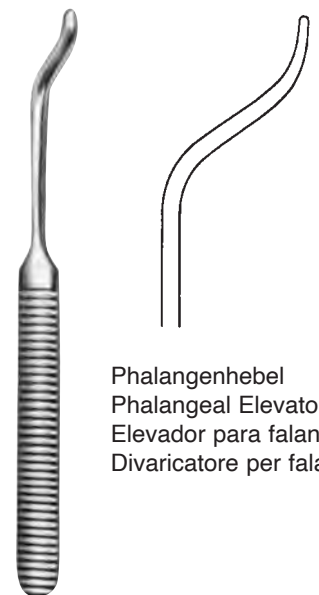

Phalangenhebel
 Phalangeal Elevator
 Elevador para falanges
 Divaricatore per falanghe

024-561-160 16,0 cm / 6¹/₄"



024

Dissektoren, Elevatorien
Dissectors, Elevators
Disectores, Elevadores
Dissettori, Elevatori

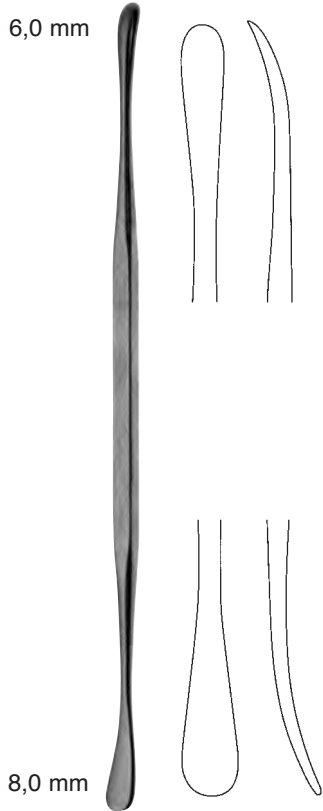

ALDERDYCE

024-563-210 21,0 cm / 8¹/₄"

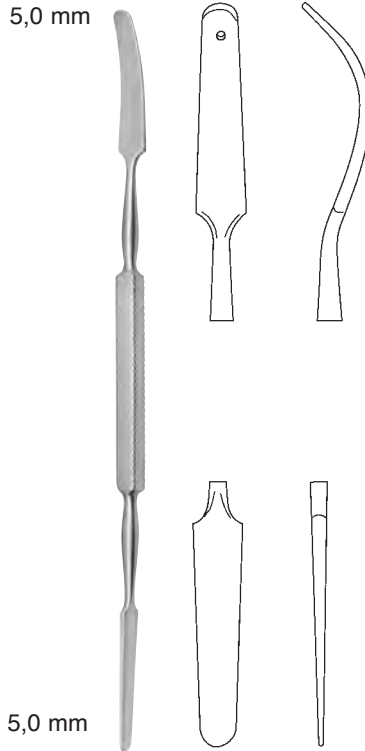

MC DONALD

024-565-190 19,0 cm / 7¹/₂"

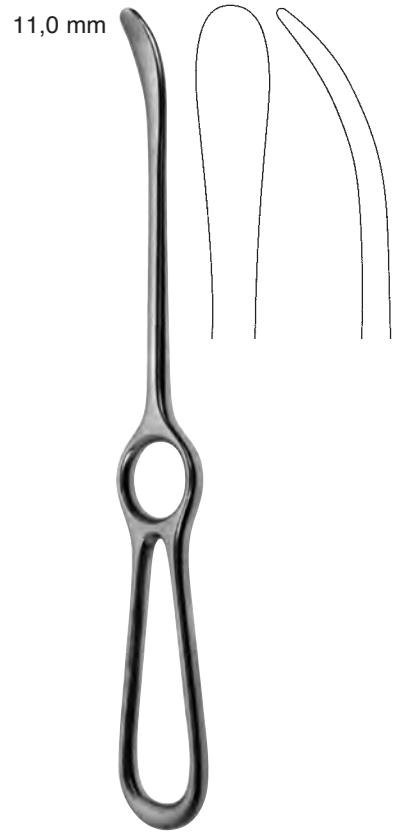

LANGENBECK

024-567-230 23,0 cm / 9"

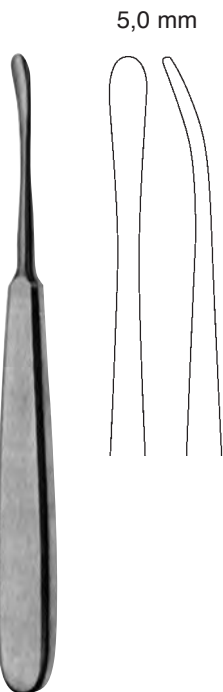

SEBILEAU

024-569-170 17,0 cm / 6³/₄"

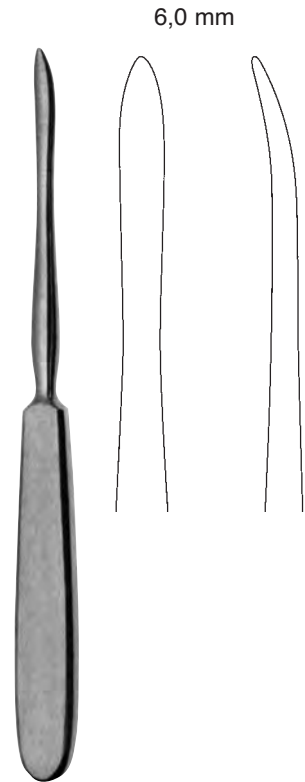

QUERVAIN

024-571-195 19,5 cm / 7³/₄"

2,8 mm

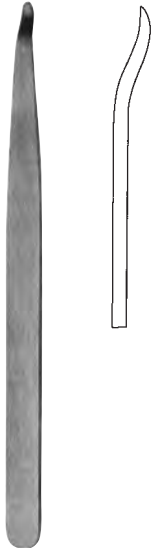

024-601-140 14,0 cm / 5 1/2"

5,0 mm

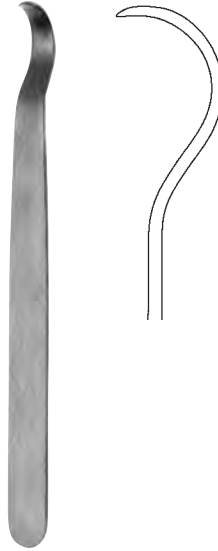

024-603-150 15,0 cm / 6"

7,0 mm

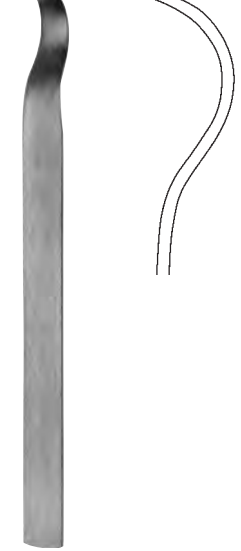

024-605-150 15,0 cm / 6 "

2,0 mm

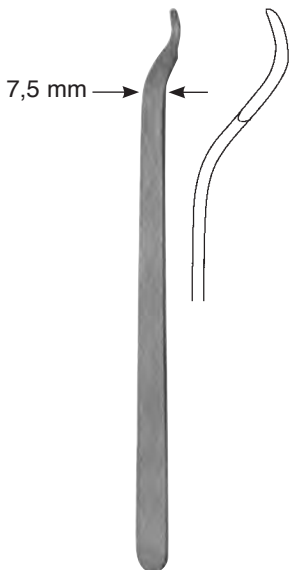

BUCK-GRAMCKO
024-607-150 15,0 cm / 6"

2,0 mm

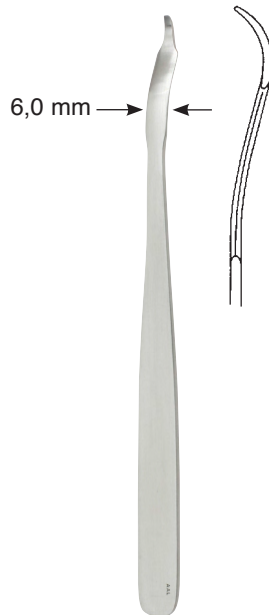

MINI-HOHMANN
024-609-006 16,0 cm / 6 1/4"

2,0 mm

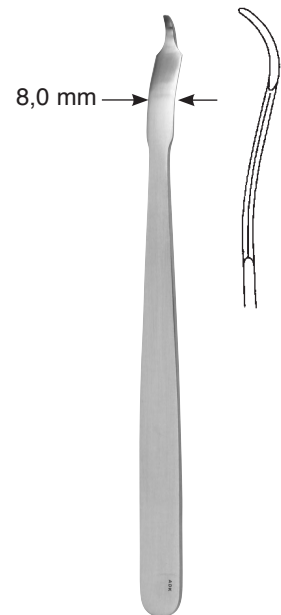

MINI-HOHMANN
024-609-008 16,0 cm / 6 1/4"



024

Knochenheber
Bone Levers
Elevadores para huesos
Leve per ossa

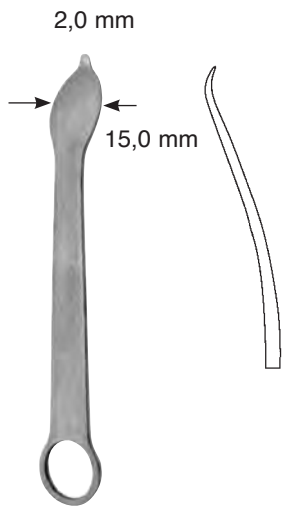

KNOCHENHEBEL

024-611-125 12,5 cm / 5"

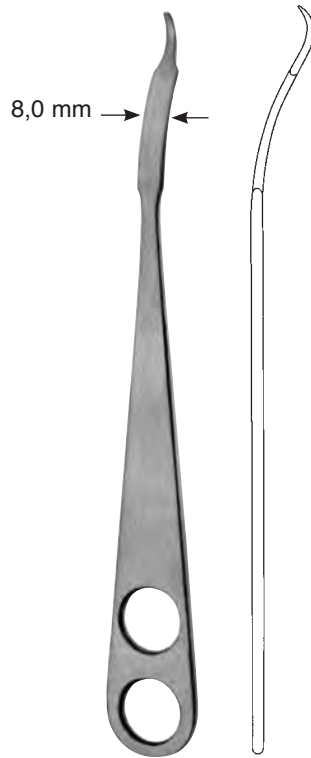

HOHMANN

024-613-220 22,0 cm / 8³/₄"



HOHMANN

024-615-235 23,5 cm / 9¹/₄"

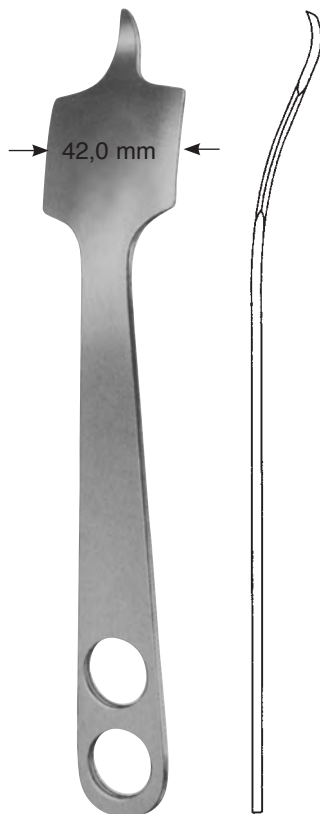

HOHMANN

024-617-240 24,0 cm / 9¹/₄"

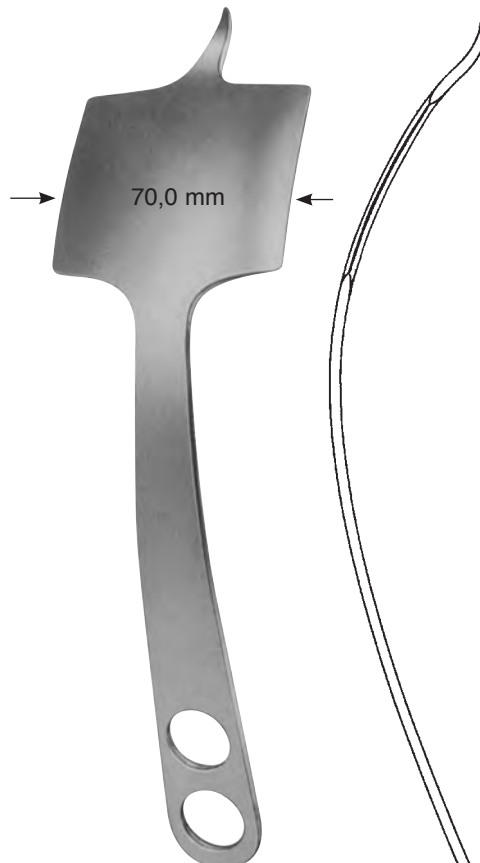

HOHMANN

024-619-250 25,0 cm / 9³/₄"

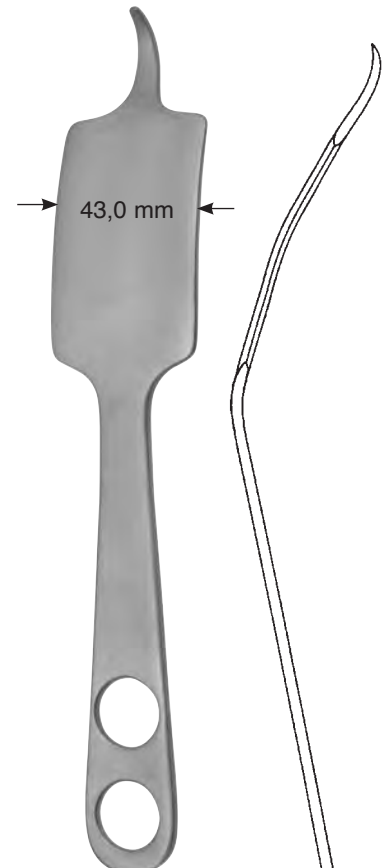

HOHMANN

024-621-235 23,5 cm / 9¹/₄"

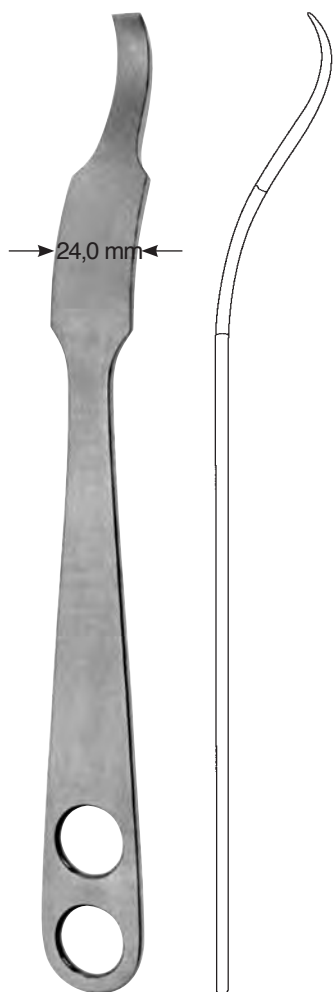

HOHMANN
024-623-260 26,0 cm / 10¹/₄"

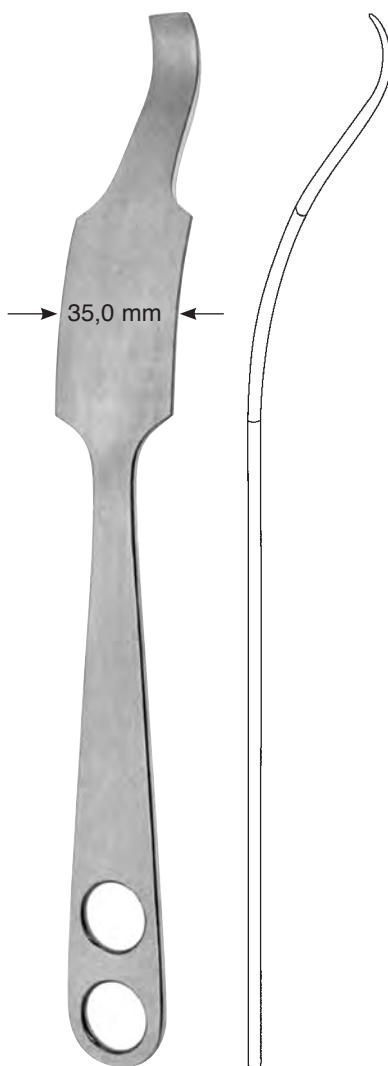

HOHMANN
024-625-290 29,0 cm / 11¹/₄"

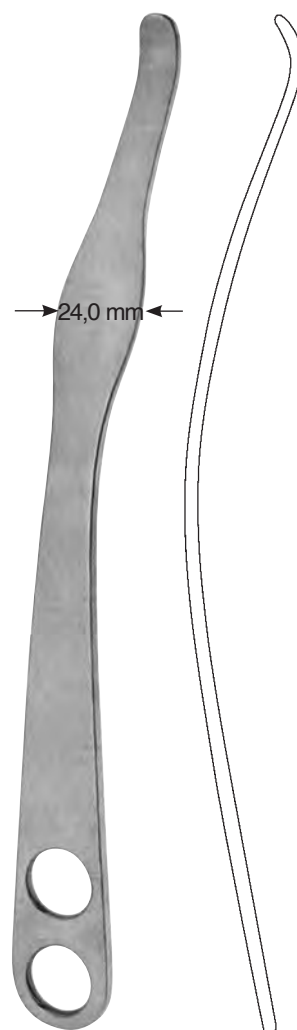

HOHMANN
024-627-275 27,5 cm / 10³/₄"



024

Knochenheber
Bone Levers
Elevadores para huesos
Leve per ossa

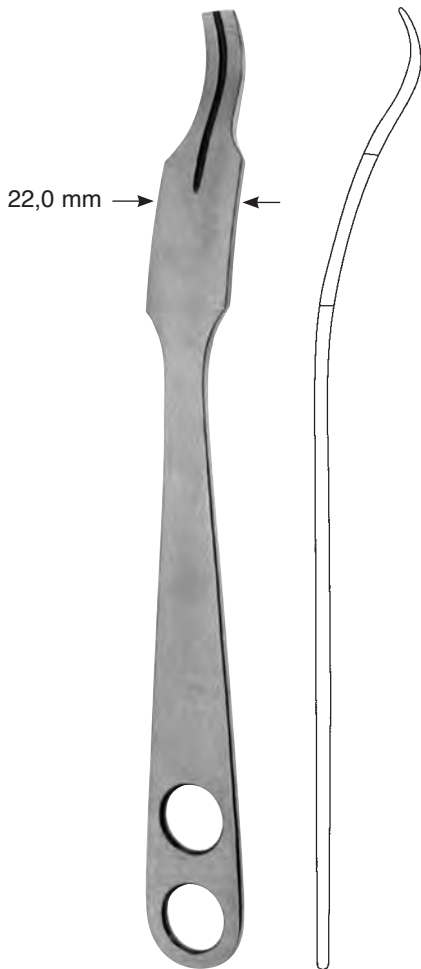

LANGE-HOHMANN

024-629-250 25,0 cm / 9³/₄"

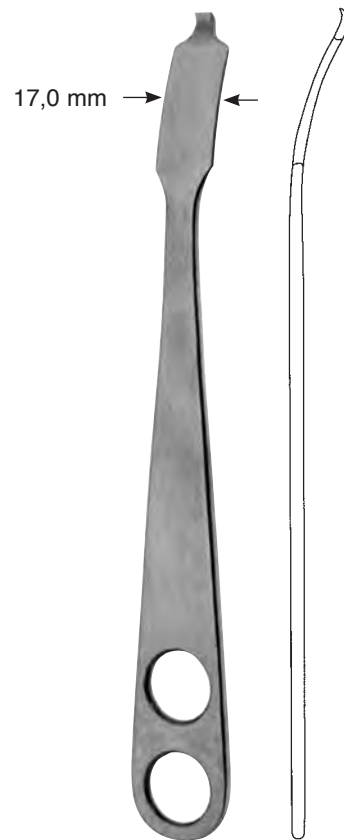

WAGNER

024-631-220 22,0 cm / 8³/₄"

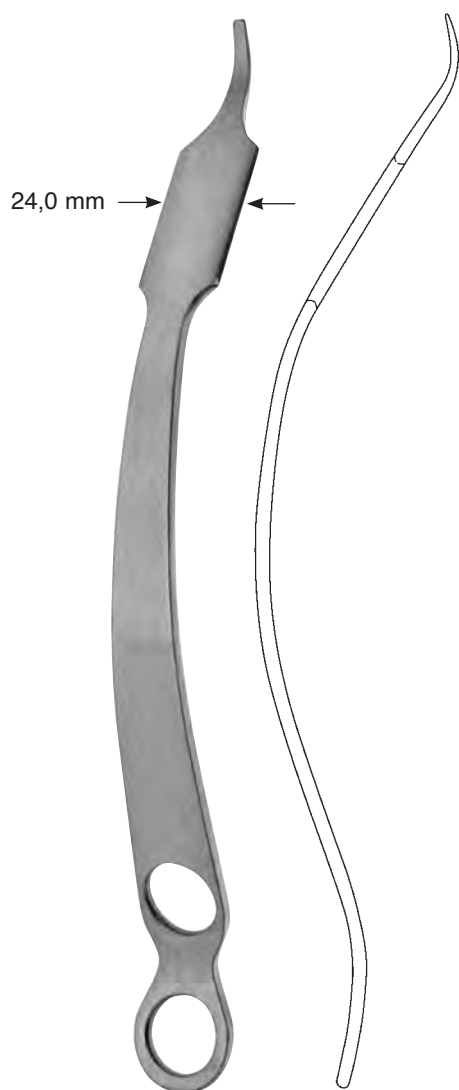

HOHMANN-ALDINGER

024-633-280 28,0 cm / 11"

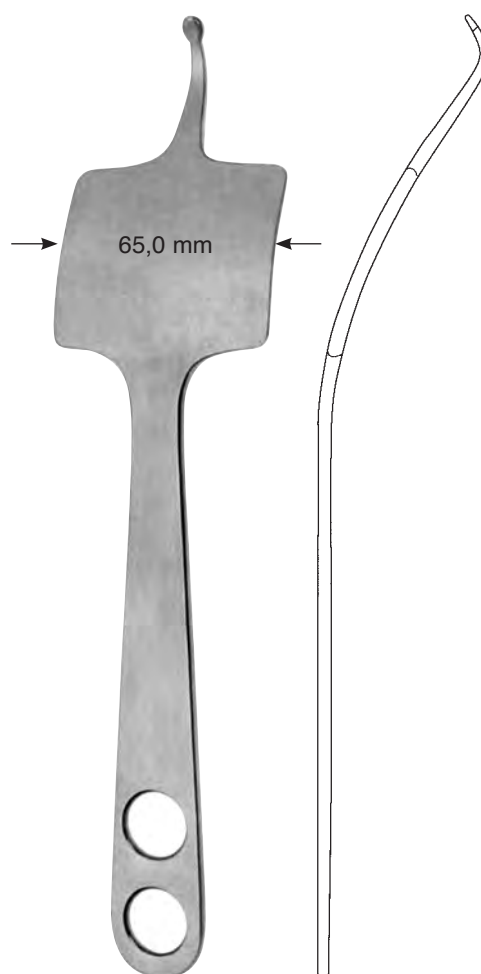

MÜLLER-VERBRUGGE

024-635-255 25,5 cm / 10"



024

Knochenheber
Bone Levers
Elevadores para huesos
Leve per ossa

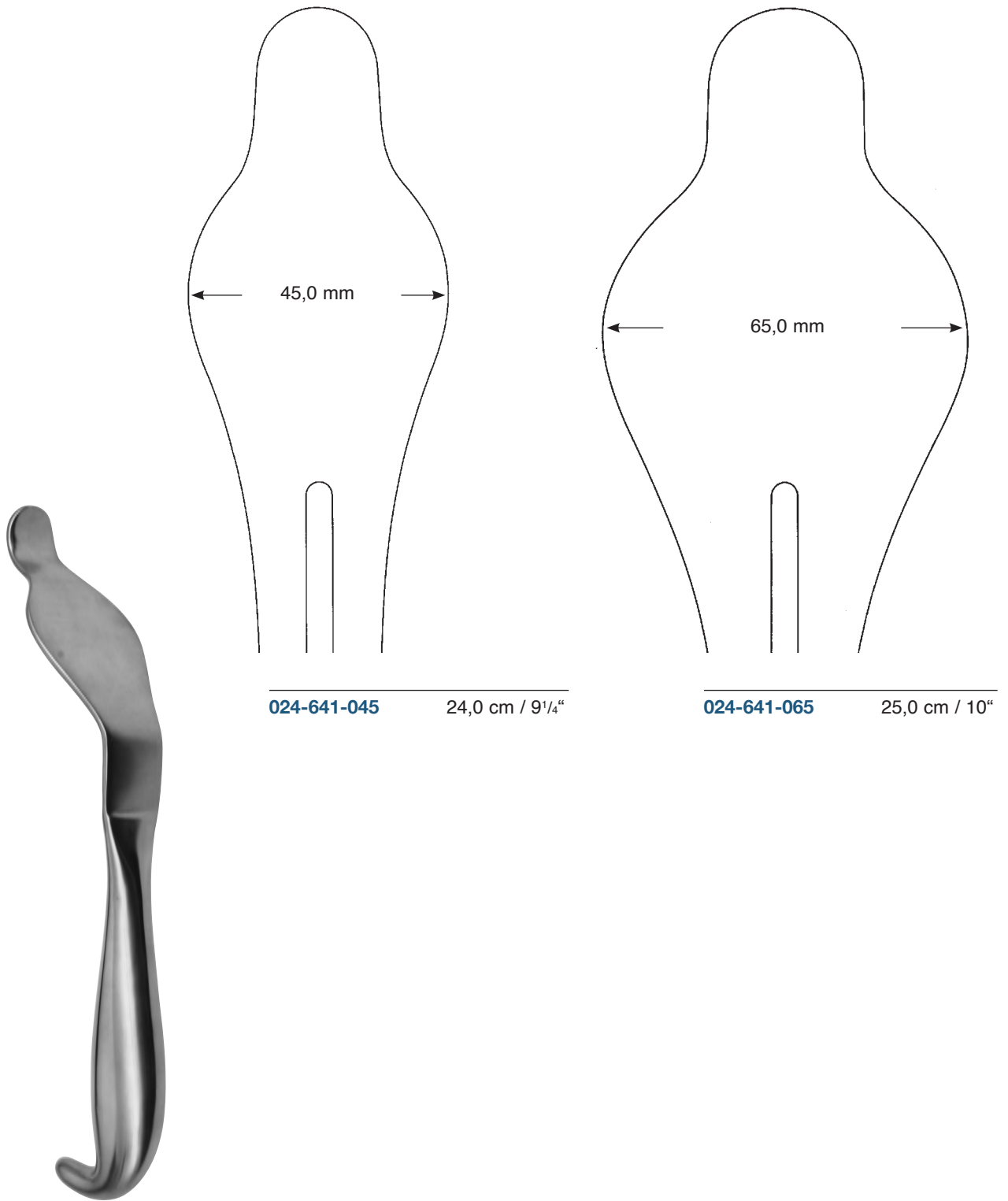

BENNET

024-641-045 - 024-641-065

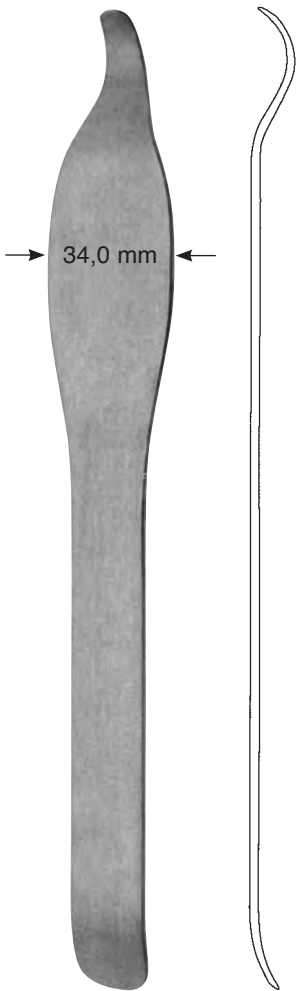

BLOUNT

024-643-260 26,0 cm / 10¹/₄"

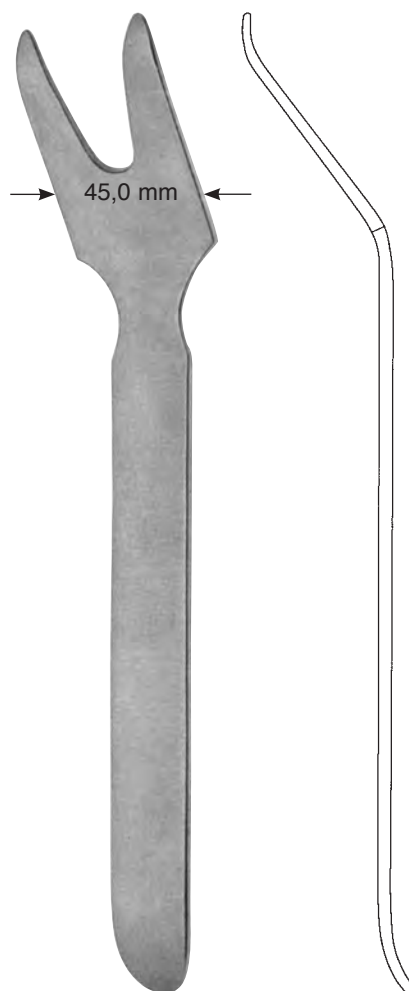

BLOUNT

024-645-260 26,0 cm / 10¹/₄"

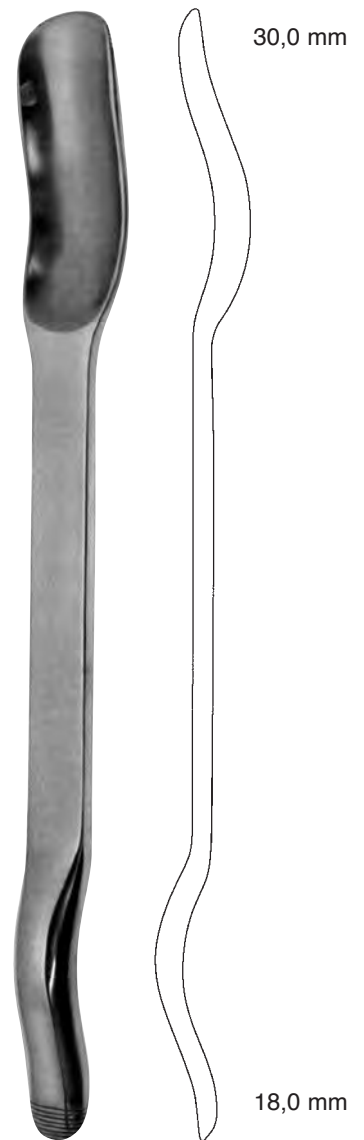

MURPHY-LANE

024-647-300 30,0 cm / 12"



024

Wund- und Meniskushaken
Retractor for Knee
Separadores para rodilla
Retrattori per ginocchio



40 x 4 mm

BLOUNT

024-649-175 17,5 cm / 7"

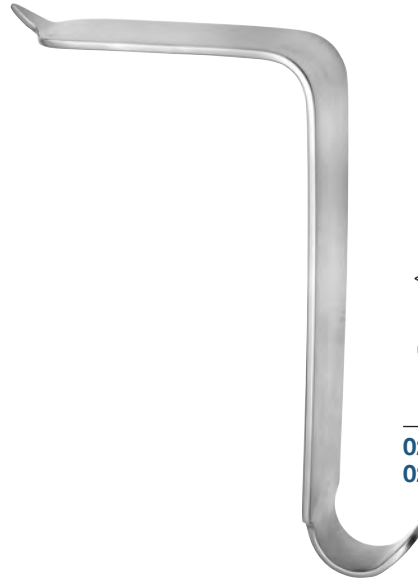

024-651-160 75 x 30 mm
024-653-160 100 x 30 mm

TAYLOR

024-651-160 - 024-653-160 16,0 cm / 6¹/₂"



56 x 10 mm

024-655-170 17,0 cm / 6³/₄"

Wund- und Meniskushaken
 Retractor for Knee
 Separadores para rodilla
 Retrattori per ginocchio



024

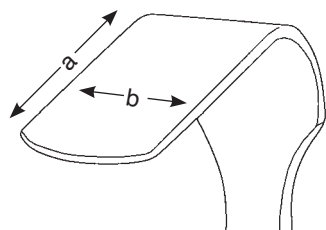

024-657-001 32 x 19 mm (a x b)

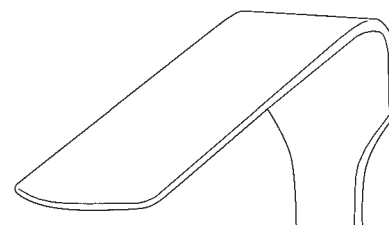

024-657-002 48 x 19 mm (a x b)

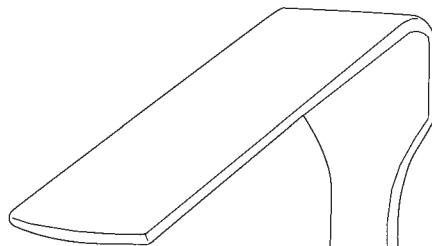

024-657-003 57 x 19 mm (a x b)

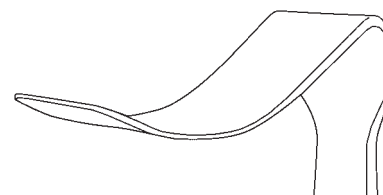

024-657-004 52 x 13 mm (a x b)



SMILLIE

024-657-001 - 024-657-005 14,0 cm / 5 1/2"

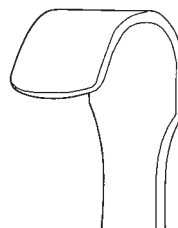

024-657-005 17 x 13 mm (a x b)



38 x 9 mm

024-659-210 21,0 cm / 8 1/4"



024

Meniskusmesser
Meniscus Knives
Bisturries para menisco
Bisturi per menisco

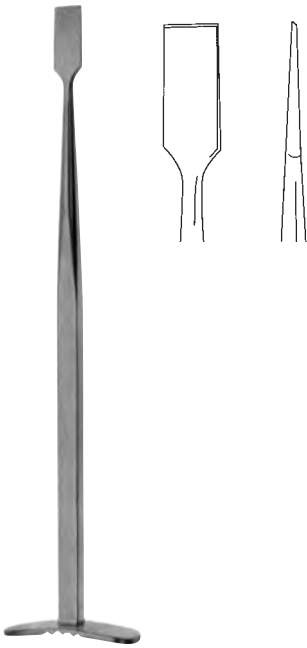

SMILLIE

024-660-170 17,0 cm / 6³/₂"

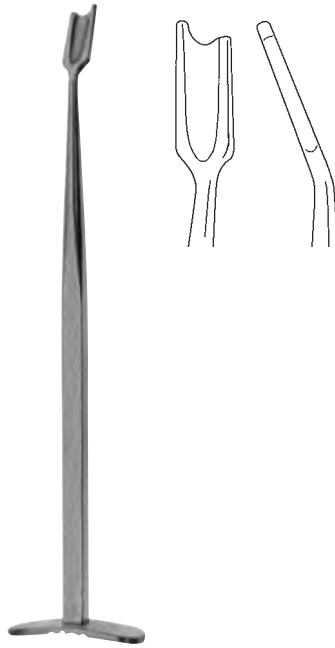

SMILLIE

024-661-170 17,0 cm / 6³/₄"

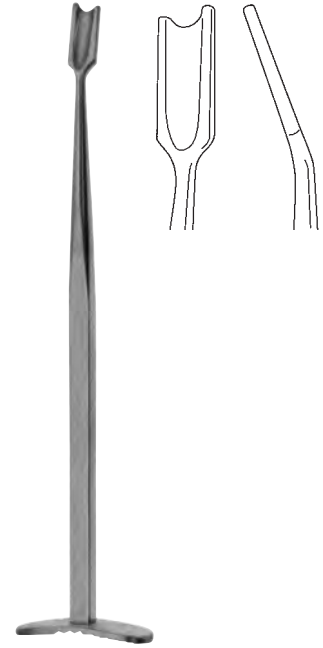

SMILLIE

024-663-170 17,0 cm / 6³/₄"



BIRCHER

024-665-001 19,0 cm / 7¹/₂"



BIRCHER

024-665-002 19,0 cm / 7¹/₂"

Meniskusmesser
Meniscus Knives
Bisturìes para menisco
Bisturi per menisco



024



NEFF

024-667-001 20,5 cm / 8"



NEFF

024-667-002 20,5 cm / 8"



SALENIUS

024-669-001 22,0 cm / 8³/₄"

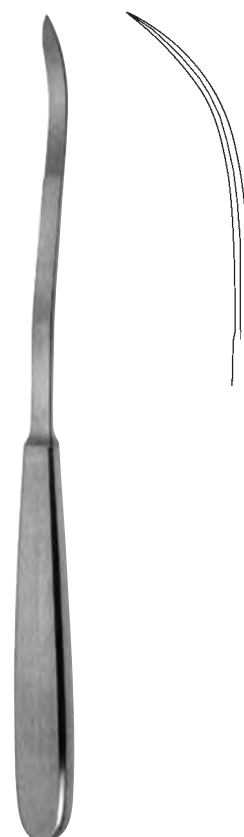

SALENIUS

024-669-002 22,0 cm / 8³/₄"



024

Sehnenführer, Sehnenschäler
Tendon Passing Instruments, Tendon Strippers
Conductor de tendónes, Mondador de tendónes
Guida per tendine, Enucleatore per tendine



024-671-180 18,0 cm / 7"





024-674-003 Ø 3,0 mm

024-674-004 Ø 4,0 mm

024-674-005 Ø 5,0 mm

024-674-006 Ø 6,0 mm

024-674-007 Ø 7,0 mm

BUNNELL

024-674-003 - 024-674-007 15,0 cm / 6"



024-676-004 Ø 4,0 mm

024-676-005 Ø 4,5 mm

024-676-006 Ø 5,5 mm

flexibler Schaft
flexible shaft
vástago flexible
gambo flessibile

024-676-004 - 024-676-006 23,0 cm / 9"

Sehnenführer, Sehnenschäler
Tendon Passing Instruments, Tendon Strippers
Conductor de tendones, Mondador de tendones
Guida per tendine, Enucleatore per tendine



024

Ø 4,0 mm



FISCHER
024-680-310 31,0 cm / 12¹/₄"

Ø 5,0 mm



BUNNELL
024-682-230 23,0 cm / 9"

Sehnenführungszangen und Sehnenfaßzangen
Tendon Holding Forceps and Tendon Seizing Forceps
Pinzas-conductoras de tendones y Pinzas para agarrar tendones
Pinze ferma tendine e Pinze per la presa del tendine



BRAND

- 024-704-150 15,0 cm / 6"
- 024-704-190 19,0 cm / 7½"
- 024-704-240 24,0 cm / 9½"

BRAND

- 024-705-150 15,0 cm / 6"
- 024-705-190 19,0 cm / 7½"
- 024-705-240 24,0 cm / 9½"

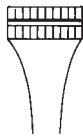

STEINMANN

- 024-702-160 16,0 cm / 6¼"



- 024-708-205 – 024-709-205 20,5 cm / 8"

Sehneneinflechtzangen, Sehnedurchziehzangen
 Tendon Interlacing Forceps, Tendon Passing Forceps
 Pinzas para entrelazar tendones, Pinzas para pasar tendones
 Pinze per allacciare tendini, Pinze passa tendine



024



CAROLL

024-711-110 11,0 cm / 4³/₈"

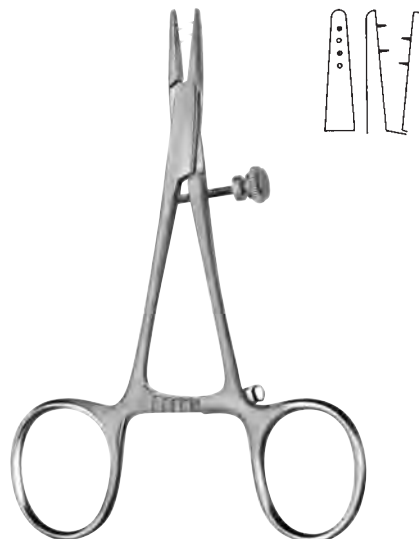

024-716-115 11,5 cm / 4¹/₂"



KLEINERT-KUTZ

024-720-020 Ø 2,0 mm 20,5 cm / 8"
024-720-025 Ø 2,5 mm 20,5 cm / 8"



024-724-150 15,0 cm / 6"

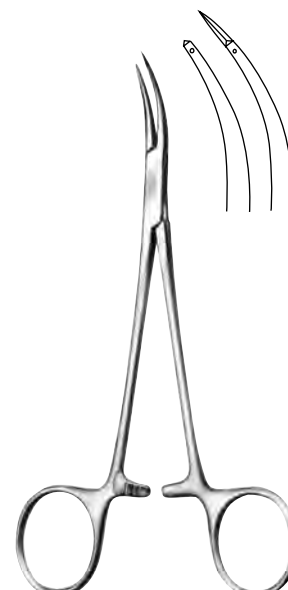

024-725-150 15,0 cm / 6"

Knorpelfasszangen
Cartilage Seizing Forceps
Pinzas para cartilago
Pinze per cartilagine

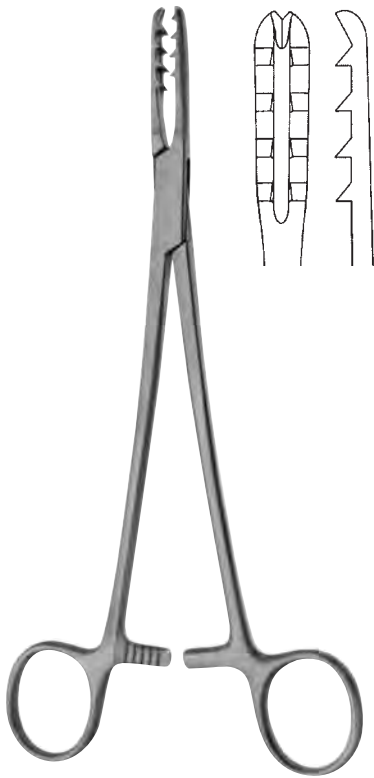

BIRCHER-GANSKE

024-730-205 20,5 cm / 8"



BIRCHER-GANSKE

024-731-205 20,5 cm / 8"

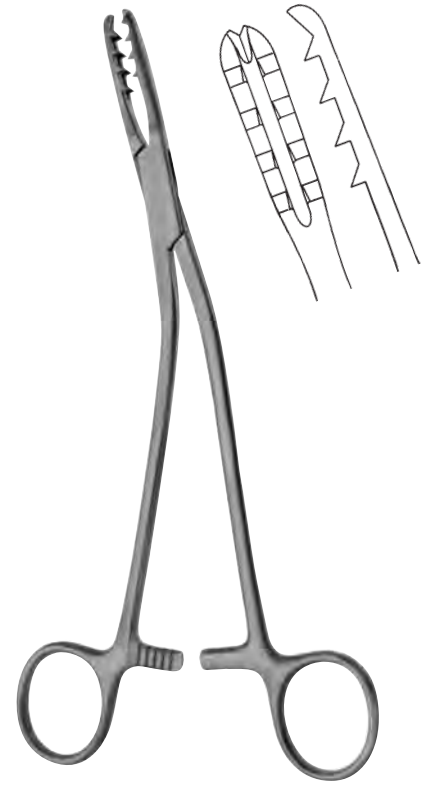

BIRCHER-GANSKE

024-733-200 20,0 cm / 8"



024-735-140 14,0 cm / 5 1/4"



DINGMANN

024-737-185 18,5 cm / 7 1/4"



MARTIN

024-740-185 18,5 cm / 7 1/4"

Repositionszangen, Knochenhaltezangen
 Reposition Forceps, Bone Holding Forceps
 Pinzas para reposición, Pinzas para hueso
 Pinze per riposizioni, Tenaglie per ossa



024

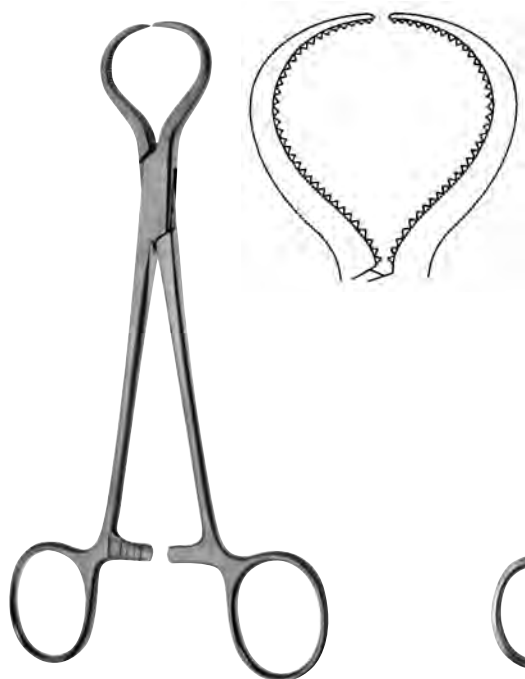

LEWIN

024-742-180 18,0 cm / 7"



024-745-140 14,0 cm / 5 1/2"



024-748-140 14,0 cm / 5 1/2"



lange Sperre, scharf
 long ratchet, pointed
 cremallera larga, aguda
 cremagliera lunga, acuta

024-749-135 13,5 cm / 5 1/4"



024-751-205 20,5 cm / 8"

Sequesterzangen, Knochenhaltezangen
Sequestrum Forceps, Bone Holding Forceps
Pinzas para secuestro; Pinzas para huesos
Pinze per frammento osseo, Tenaglie per ossa



024-760-200 20,0 cm / 8"



024-761-200 20,0 cm / 8"



VAN BUREN
024-763-230 23,0 cm / 9"



LANGENBECK
024-766-210 21,0 cm / 9"



FERGUSON
024-768-210 21,0 cm / 8 1/4"

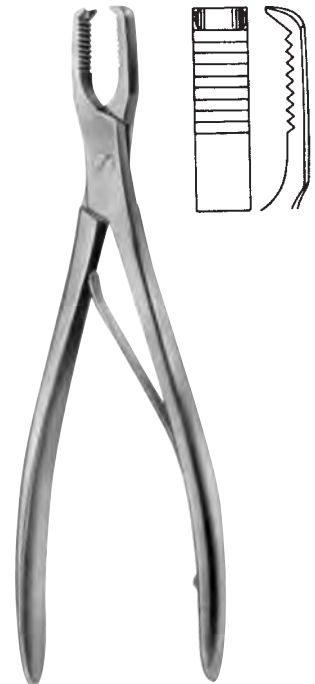

FROSCH
024-770-180 18,0 cm / 7"

Knochenhaltezangen
Bone Holding Forceps
Pinzas para huesos
Tenaglie per ossa



024



LANGENBECK

024-772-200 20,0 cm / 8"



024-775-160

024-775-240

024-775-160 16,0 cm / 6¹/₄"
024-775-240 24,0 cm / 9¹/₂"



BABY-KERN

024-780-150 15,0 cm / 6"

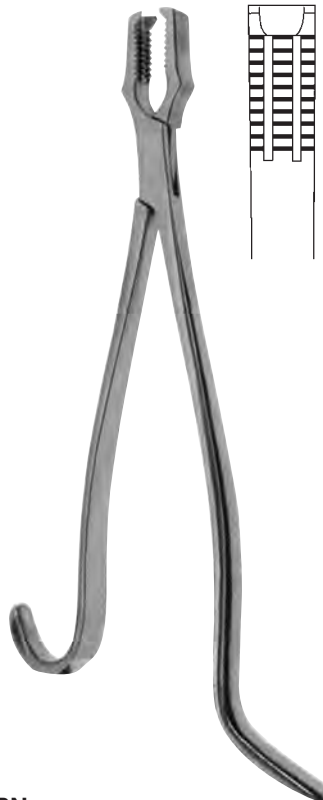

KERN

024-780-170 17,0 cm / 6³/₄"
024-780-210 21,0 cm / 8¹/₄"

Knochenhalte­zangen
Bone Holding Forceps
Pinzas para huesos
Tenaglie per ossa



BABY-KERN

024-782-150 15,0 cm / 6"



KERN

024-782-170 17,0 cm / 6³/₄"
024-782-210 21,0 cm / 8¹/₄"



SEMB

024-785-190 19,0 cm / 7³/₄"



FARABEUF

024-790-230 23,0 cm / 9"
024-790-260 26,0 cm / 10¹/₄"

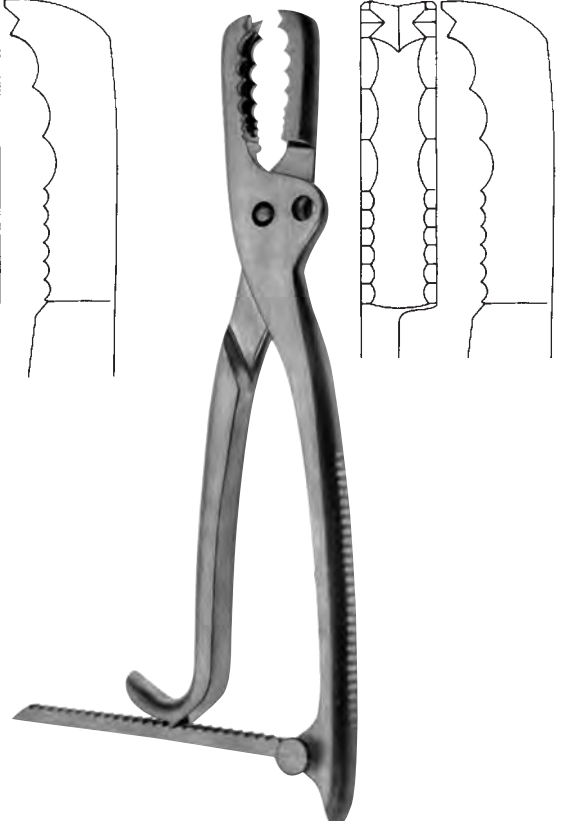
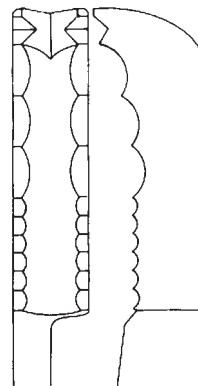

FARABEUF-LAMBOTTE

024-792-260 26,0 cm / 10"

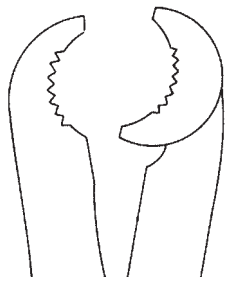

024-796-220

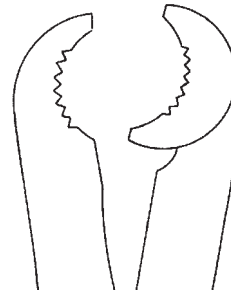

024-796-270

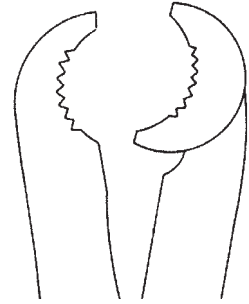

024-796-300

LAMBOTTE

- 024-796-220 22,0 cm / 8³/₄"
- 024-796-270 27,0 cm / 10³/₄"
- 024-796-300 30,0 cm / 11³/₄"

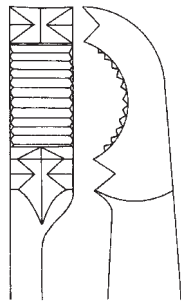

TUFFIER

024-794-270 27,0 cm / 10³/₄"

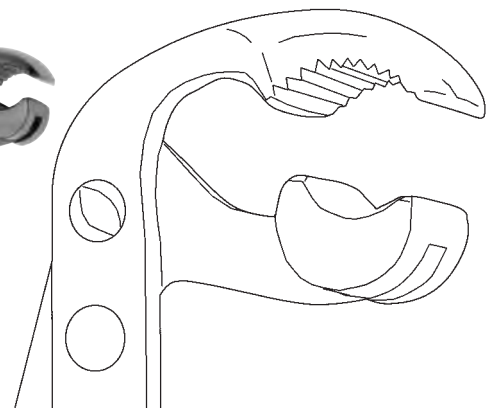

LAMBOTTE

024-799-190 19,0 cm / 7¹/₂"



024

Knochenhaltezangen
Bone Holding Forceps
Pinzas para huesos
Tenaglie per ossa



LANE

024-800-330 33,0 cm / 13"
024-800-450 45,0 cm / 17³/₄"

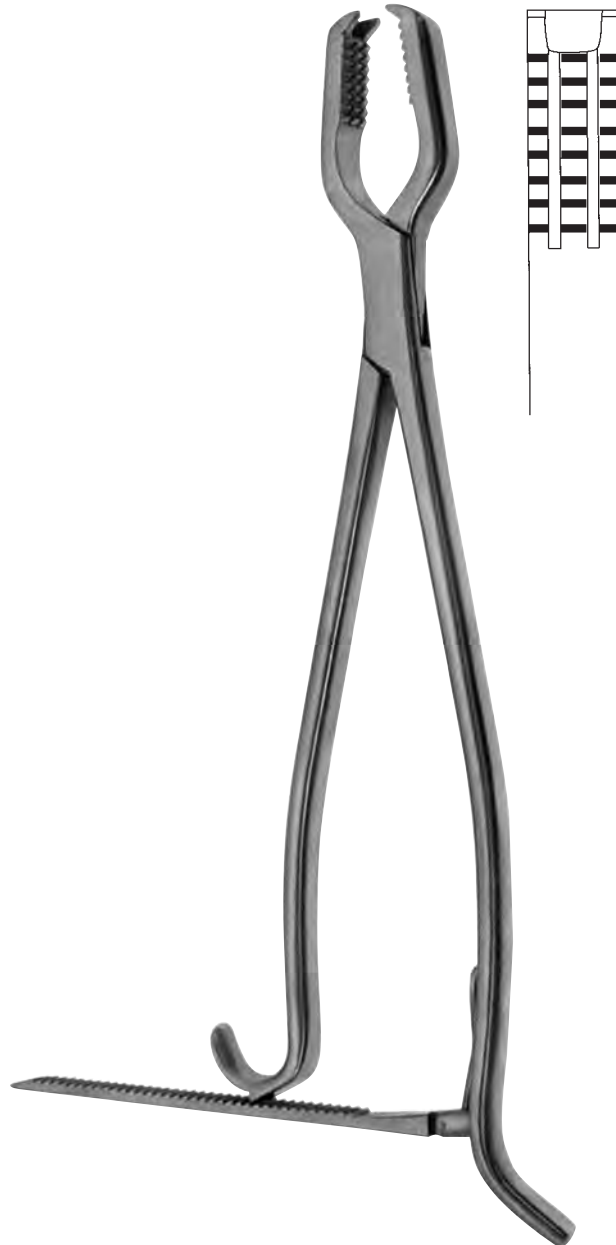

LANE

024-802-330 33,0 cm / 13"
024-802-450 45,0 cm / 17³/₄"

Knochenhalte­zangen
Bone Holding Forceps
Pinzas para huesos
Tenaglie per ossa



024

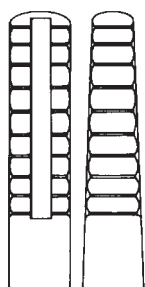

5,0 mm

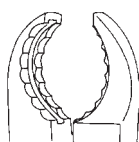

024-810-180

7,5 mm

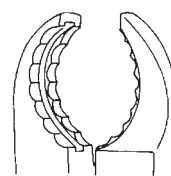

024-810-230

8,0 mm

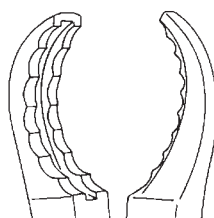

024-810-250

8,5 mm

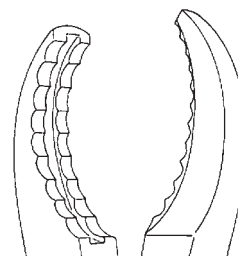

024-810-280

ULRICH

024-810-180	18,0 cm / 7"
024-810-230	23,0 cm / 9"
024-810-250	25,0 cm / 10"
024-810-280	28,0 cm / 11"



024

Knochenhaltezangen
Bone Holding Forceps
Pinzas para huesos
Tenaglie per ossa

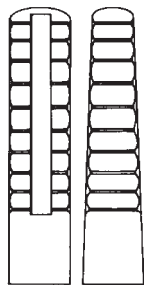

5,0 mm

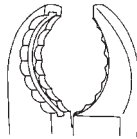

024-811-180

7,5 mm

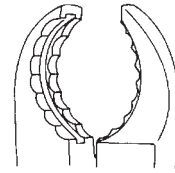

024-811-230

8,0 mm

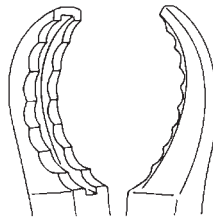

024-811-250

8,5 mm

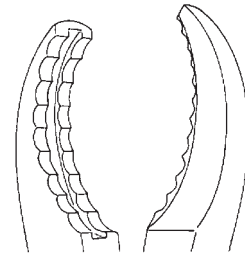

024-811-280

ULRICH

024-811-180 18,0 cm / 7"

024-811-230 23,0 cm / 9"

024-811-250 25,0 cm / 10"

024-811-280 28,0 cm / 11"

Knochenhaltezangen
Bone Holding Forceps
Pinzas para huesos
Tenaglie per ossa



024

2,5 mm

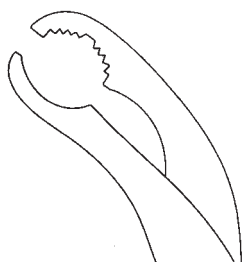

024-815-150

6,5 mm

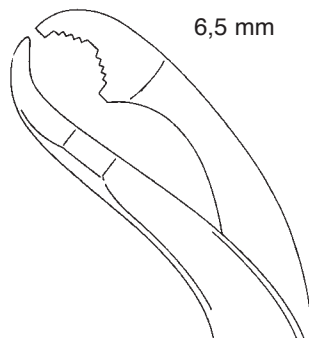

024-815-190

selbstzentrierend mit Gewindesperre
 self-centering forceps with thread fixation
 autocentrante con cremallera de rosca
 pinze autocentranti con blocco di filettatura

9,5 mm

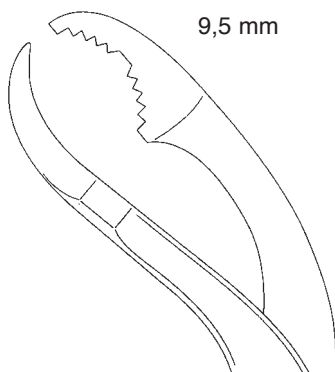

024-815-240

10,0 mm

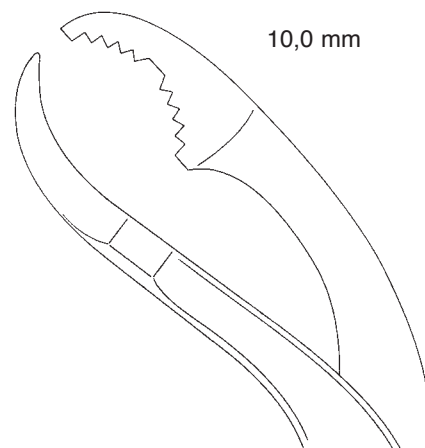

024-815-260



11,0 mm

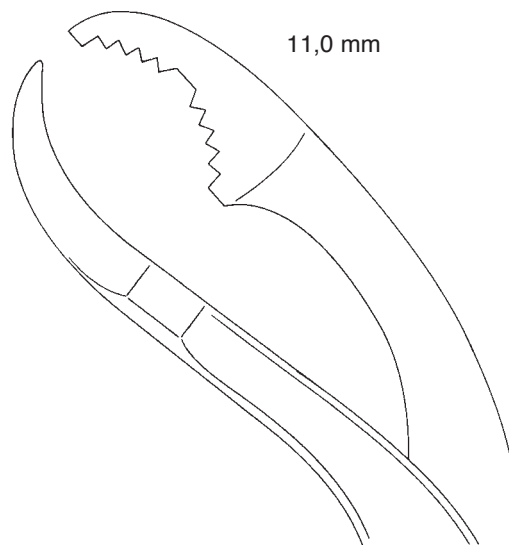

024-815-280

024-815-150	15,0 cm / 6"
024-815-190	19,0 cm / 7 1/2"
024-815-240	24,0 cm / 9 1/2"
024-815-260	26,0 cm / 10 1/4"
024-815-280	28,0 cm / 11"



024

Knochenhalte­zangen
Bone Holding Forceps
Pinzas para huesos
Tenaglie per ossa

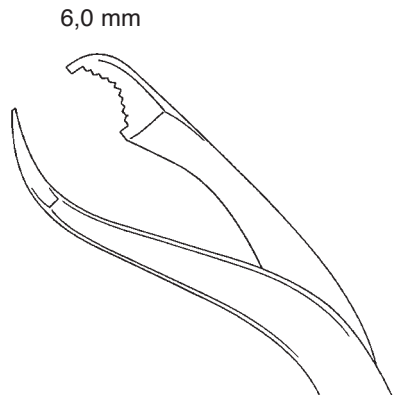

6,0 mm

024-819-175

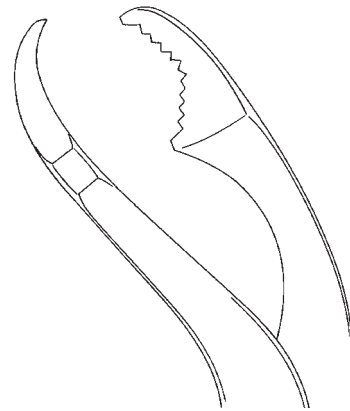

9,0 mm

024-819-250

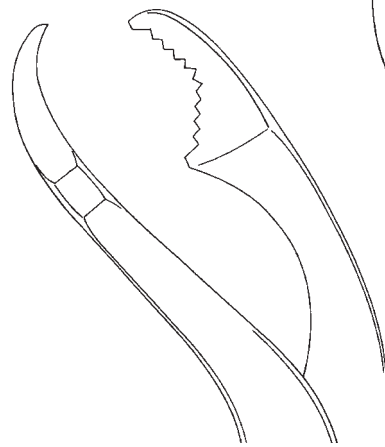

11,5 mm

024-819-260

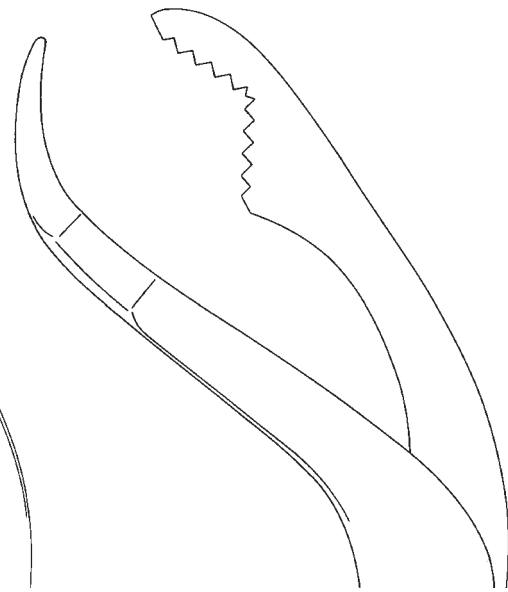

12,5 mm

024-819-270

VERBRUGGE

024-819-175	17,5 cm / 7"
024-819-250	25,0 cm / 10"
024-819-260	26,0 cm / 10 ¹ / ₄ "
024-819-270	27,0 cm / 10 ³ / ₄ "

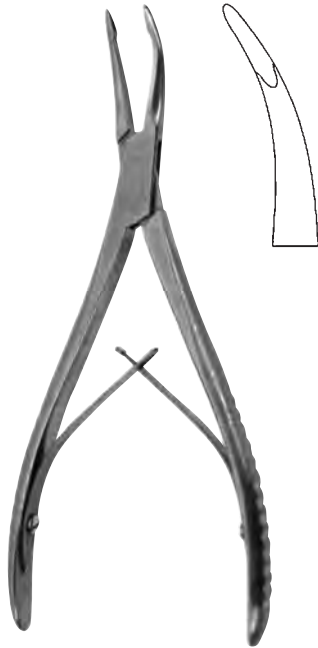

STELLBRINK

024-851-001 17,5 cm / 7"

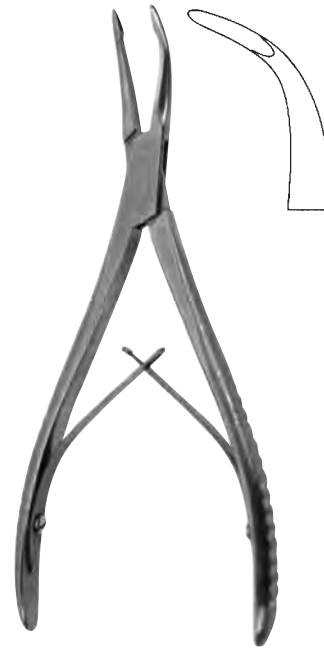

STELLBRINK

024-851-002 17,5 cm / 7"

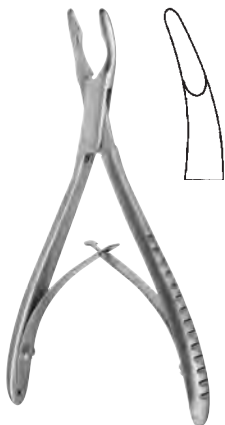

MINI-FRIEDMANN

024-853-120 12,0 cm / 4³/₄"

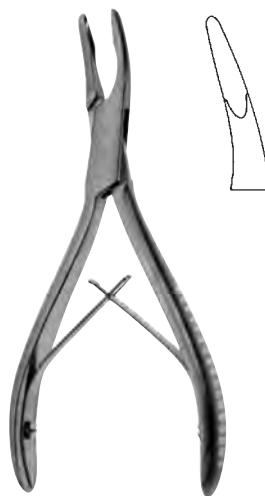

FRIEDMANN

024-855-140 14,0 cm / 5¹/₂"

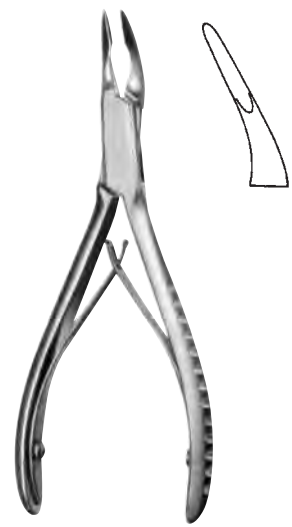

FRIEDMANN-VICKERS

024-857-140 14,0 cm / 5¹/₂"

Hohlmeißelzangen
Bone Rongeurs
Pinzas-gubias
Pinze per ossa



CLEVELAND
024-859-140 14,0 cm / 5½"



CLEVELAND
024-859-170 17,0 cm / 6¾"



MEAD
024-861-165 16,5 cm / 6½"



HARTMANN
024-863-180 18,0 cm / 7"



JANSEN
024-866-180 18,0 cm / 7"
024-867-180 18,0 cm / 7"
024-869-180 18,0 cm / 7"

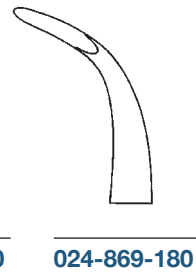
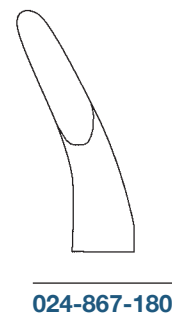
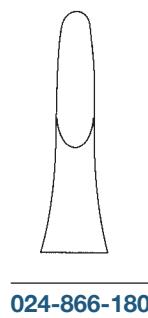

Hohlmeißelzangen
 Bone Rongeurs
 Pinzas-gubias
 Pinze per ossa



024

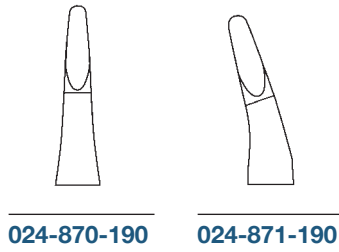

LEMPERT

024-870-190 – 024-871-190 19,0 cm / 7 1/2"

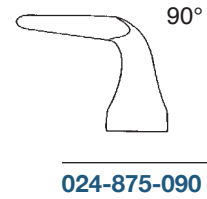
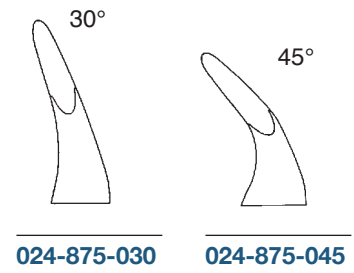

BLUMENTHAL

024-875-030 – 024-875-090 15,5 cm / 6"

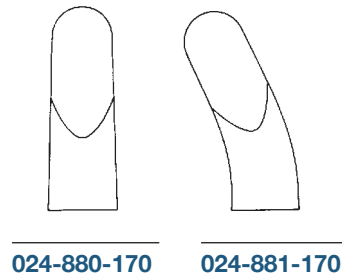

LUER

024-880-170 17,0 cm / 6 3/4"
 024-881-170 17,0 cm / 6 3/4"

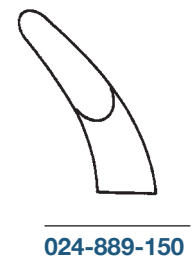
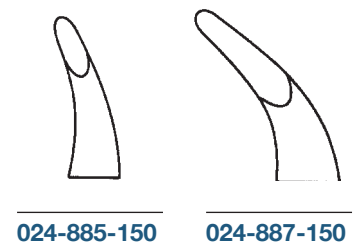

LUER

024-885-150 – 024-889-150 14,5 cm / 5 3/4"

Hohlmeißelzangen
Bone Rongeurs
Pinzas-gubias
Pinze per ossa

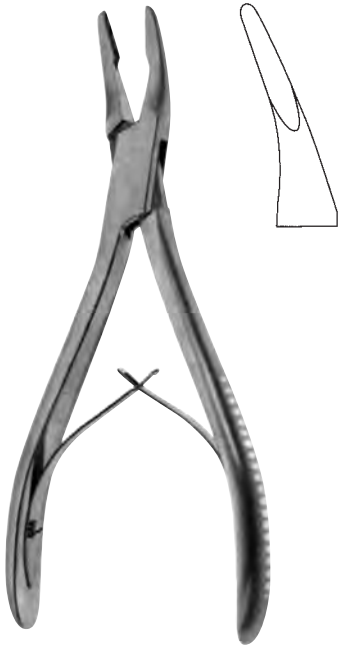

BEYER
024-891-180 18,0 cm / 7"

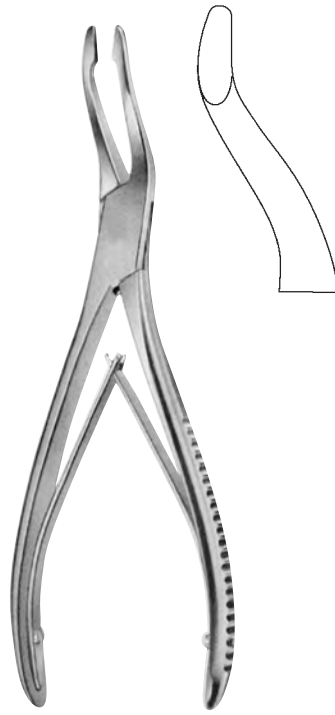

JANSEN
024-893-190 19,0 cm / 7½"

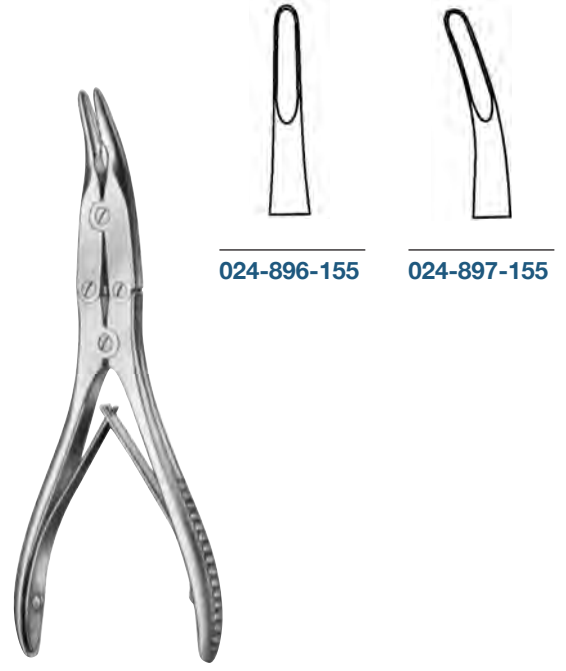

BÖHLER
024-896-155 – 024-897-155 15,5 cm / 6"



BEYER
024-899-180 18,0 cm / 7"



ZAUFAL-JANSEN
024-901-180 18,0 cm / 7"



MAYFIELD
024-903-175 17,5 cm / 7"



MARQUARDT
 024-905-200 20,0 cm / 8"



RUSKIN
 024-907-180 18,0 cm / 7"



RUSKIN
 024-909-240 24,0 cm / 9½"

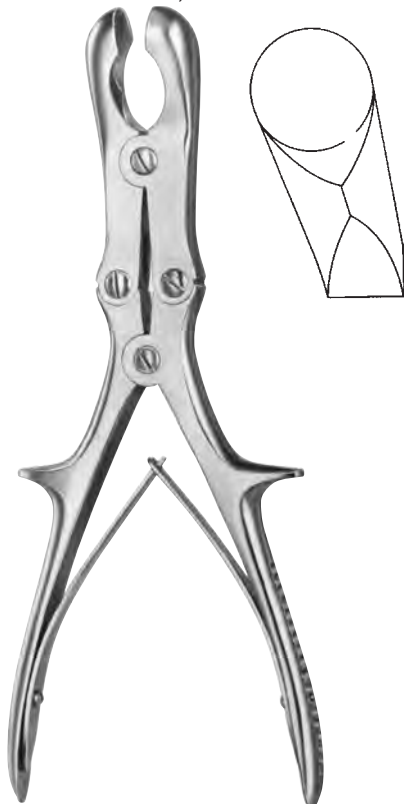

SEMB
 024-911-235 23,5 cm / 9¼"

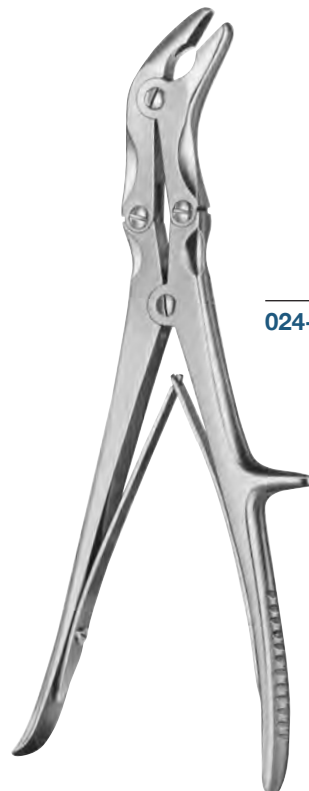

STILLE
 024-913-004 – 024-913-008 23,0 cm / 9"



024-913-004



024-913-006

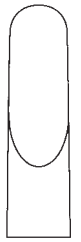

024-913-008

2,0 mm

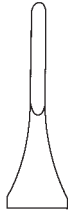

024-915-002

3,0 mm



024-915-003

4,0 mm



024-915-004



ECHLIN

024-915-002 – 024-915-004

23,0 cm / 9"



STILLE RUSKIN

024-917-230

23,0 cm / 9"

3,0 mm



024-919-003

5,0 mm



024-919-005

8,0 mm



024-919-008

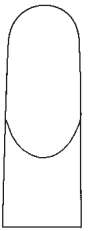

024-922-220

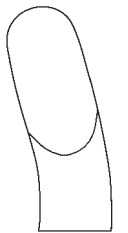

024-923-220

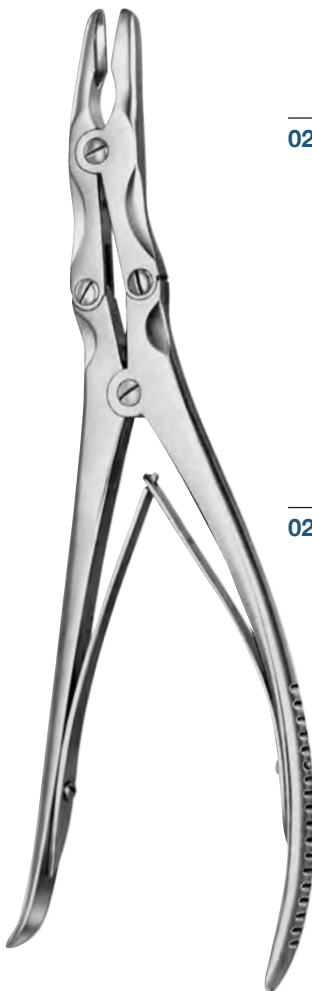

LEKSELL-STILLE

024-919-003 – 024-919-008 24,5 cm / 9³/₄“

FRYKHOLM

024-921-240 24,5 cm / 9³/₄“

STILLE-LUER

024-922-220 - 024-923-220 22,0 cm / 8³/₄“



024

Hohlmeißelzangen
Bone Rongeurs
Pinzas-gubias
Pinze per ossa



024-924-230
024-924-270



024-926-300

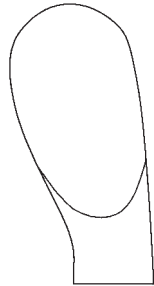

024-925-230
024-925-270



024-928-300



STILLE-LUER

024-924-230 – 024-925-230 23,0 cm / 9"
024-924-270 – 024-925-270 27,0 cm / 10³/₄"



SAUERBRUCH

024-926-300 – 024-928-300 30,0 cm / 11³/₄"

Knochensplitterzangen
Bone Cutting Forceps
Pinzas cortantes para huesos
Cesoie per ossa



024

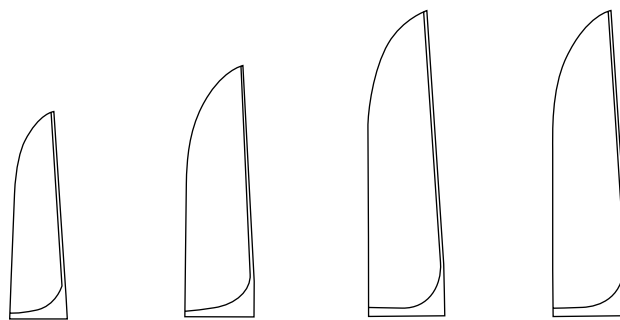

024-934-140

024-934-170

024-934-190

024-934-220

LISTON

024-934-140	14,0 cm / 5 ¹ / ₂ "
024-934-170	17,0 cm / 6 ³ / ₄ "
024-934-190	19,0 cm / 7 ¹ / ₂ "
024-934-220	22,0 cm / 8 ³ / ₄ "

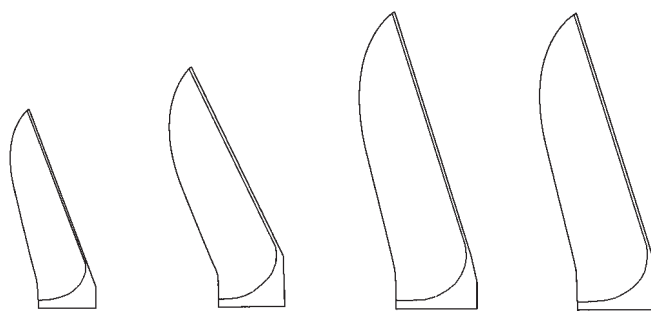

024-935-140

024-935-170

024-935-190

024-935-220

LISTON

024-935-140	14,0 cm / 5 ¹ / ₂ "
024-935-170	17,0 cm / 6 ³ / ₄ "
024-935-190	19,0 cm / 7 ¹ / ₂ "
024-935-220	22,0 cm / 8 ³ / ₄ "

Knochensplitterzangen
Bone Cutting Forceps
Pinzas cortantes para huesos
Cesoie per ossa



MARKWALDER
024-931-200 20,0 cm / 8"

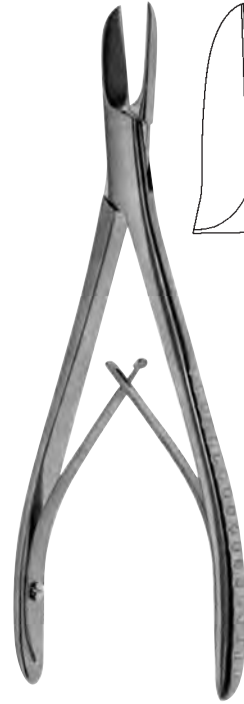

COTTLE-KAZANJIAN
024-932-190 19,0 cm / 7½"

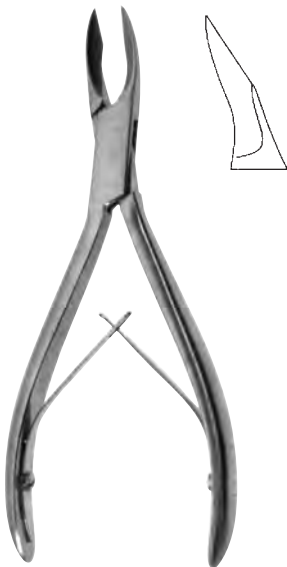

CLEVELAND
024-937-150 15,0 cm / 6"

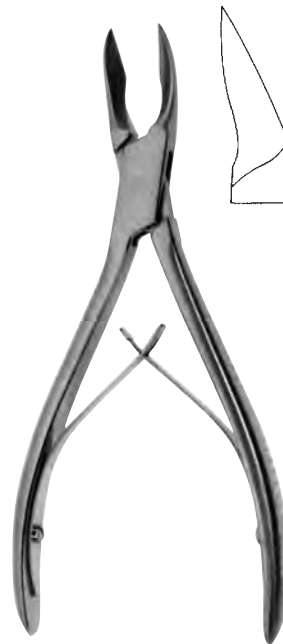

CLEVELAND
024-937-170 17,0 cm / 6¾"

Knochensplitterzangen
Bone Cutting Forceps
Pinzas cortantes para huesos
Cesoie per ossa



024



BÖHLER

024-938-150 15,0 cm / 6"



BÖHLER

024-939-150 15,0 cm / 6"



RUSKIN

024-940-180 18,0 cm / 7"



RUSKIN

024-941-180 18,0 cm / 7"



MC INDOE

024-943-175 17,5 cm / 6³/₄"



024

Knochensplitterzangen
Bone Cutting Forceps
Pinzas cortantes para huesos
Cesoie per ossa



STILLE-LISTON

024-945-270 27,0 cm / 10³/₄"



STILLE-LISTON

024-948-270 27,0 cm / 10³/₄"



STILLE-LISTON

024-949-240 24,0 cm / 9¹/₂"



STILLE-LISTON

024-949-270 27,0 cm / 10³/₄"



024

Knochensplitterzangen
Bone Cutting Forceps
Pinzas cortantes para huesos
Cesoie per ossa



LISTON-KEY

024-951-270 27,0 cm / 10³/₄"



SEMB

024-953-240 24,0 cm / 9¹/₂"



Bleihände. Durch Umbiegen der Lappen werden Hand und Finger in Operationslage festgehalten und durch das Gewicht der Bleihand zusätzlich immobilisiert.

Lead hands. Hand and fingers are secured by bending the lateral fixator into position and further fixed by weight of lead hand.

Manos de plomo. Doblando los lóbulos se sujeta la mano y los dedos en la posición para operar y además se queda inmóvil por el peso de la mano de plomo.

Mano di piombo. Legando i lobi, la mano e le dita vengono fissate in posizione da poter operare grazie al peso della mano di piombo.

024-960-001 24,5 cm / 9³/₄"
für Kinder
for children
para niños
per bambine

024-960-002 37,0 cm / 14¹/₂"
für Erwachsene
for adults
para adultos
per adulti

discontinued item



Zur schnellen und sicheren Fixierung der Hand.

To hold the hand quickly and efficiently in any desired position.

Para mantener la mano en cualquier posición deseada, eficiente y rápidamente.

Per una rapida e sicura fissazione alla mano in qualsiasi posizione desiderata.

MARTIN-VICKERS

024-962-000 27,0 cm / 10³/₄"

Kompressorium, Fingernagelbohrer
Tourniquet, Finger Nail Drill
Compresor, Perforador para uñas
Compressorio, Perforatore per unghie



024-964-011

Band allein
 Band only
 Tomo solo
 Nastro solo

FELDHEIM

024-964-010 10,0 cm / 4"

Nagelbohrer
 finger nail drill
 Taladro para uñas
 Ghiaccia unghie



024-968-001

024-968-002

024-968-003

MARTIN-IDEAL

024-968-030

Satz mit 3 Bohrern
 Set of 3 drills
 Juego de 3 brocas
 Set con 3 punte

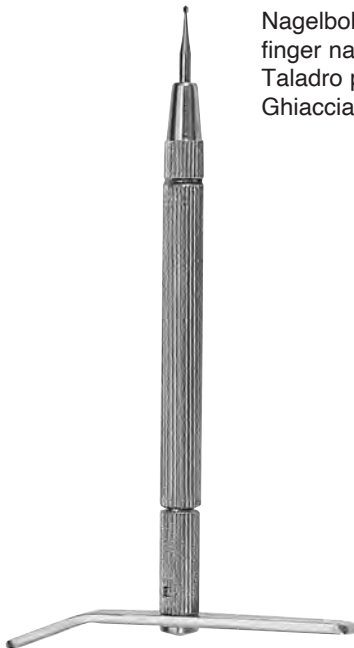

MARTIN-IDEAL

024-966-000

komplett
 complet
 completo
 completo

Fingerringsägen, Nagelextraktionszangen
Finger Ring Saws, Nail Extracting Forceps
Sierras para abrir anillos, Pinzas para arrancar uñas
Seghe per anelli, Pinze per la lacerazione delle unghie



024



024-971-001

Ersatzsägeblatt
 Spare saw black
 Hoja de repuesto para sierra
 Lame di ricambio per sega

MOD. MARTIN

024-970-170 17,0 cm / 6³/₄"



024-973-001

Ersatzsägeblatt
 Spare saw black
 Hoja de repuesto para sierra
 Lame di ricambio per sega

WALTON

024-972-160 16,0 cm / 6¹/₄"



024-976-001

Ersatzsägeblatt
 Spare saw black
 Hoja de repuesto para sierra
 Lame di ricambio per sega

024-975-170 17,0 cm / 6³/₄"



RADOLF

024-978-135 13,5 cm / 5³/₈"



024



025

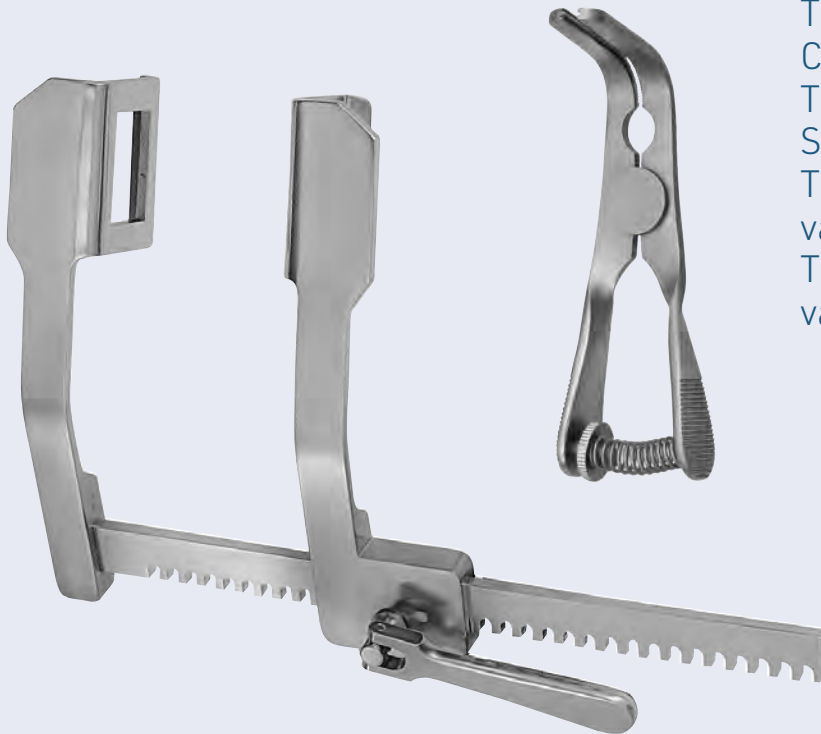

Thorax, Cardiovascular-
Chirurgie
Thorax, Cardiovascular
Surgery
Torácio, Cirugía cardio-
vascular
Torace, Chirurgia cardio-
vascolare



025

Rippenscheren
Rib Shears
Costòtomos
Costotomi



025-100-230 23,0 cm / 9"



025-104-230 23,0 cm / 9"



GLUCK
025-106-220 22,0 cm / 8"

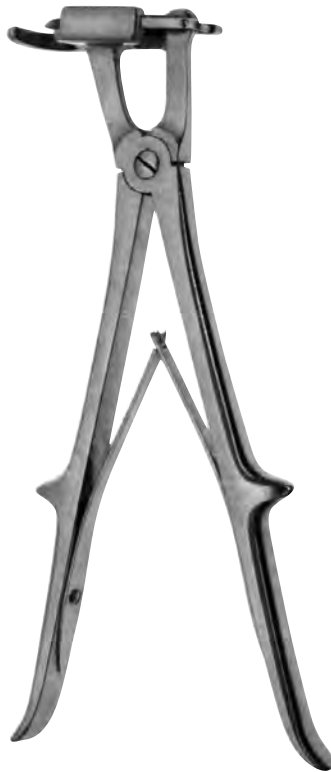

SAUERBRUCH
025-110-260 26,0 cm / 10³/₄"



GIERTZ-STILLE
025-111-270 27,0 cm / 10³/₄"

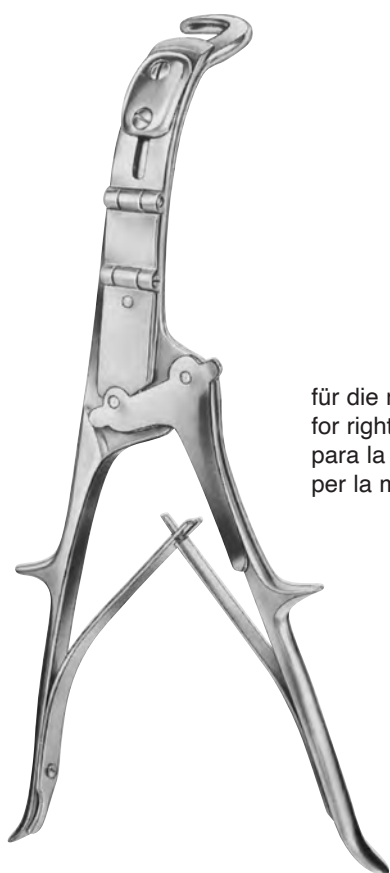

für die rechte Hand
for right hand
para la mano derecha
per la mano destra

BRUNNER

025-113-320 32,0 cm / 12½"

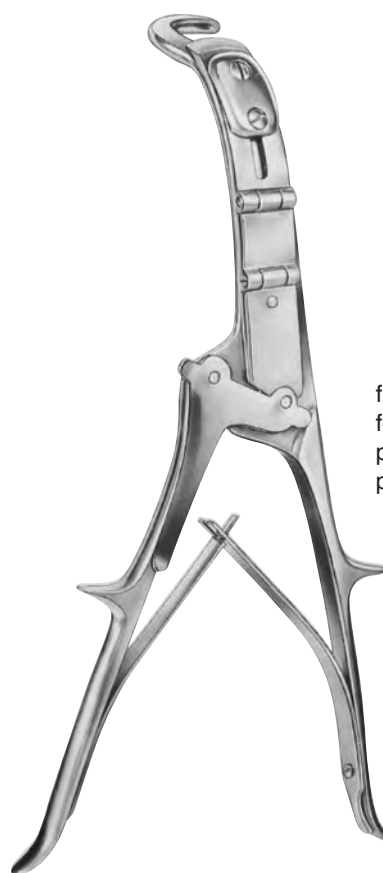

für die linke Hand
for left hand
para la mano izquierda
per la mano sinistra

BRUNNER

025-115-320 32,0 cm / 12½"



025

Rippenscheren
Rib Shears
Costòtomos
Costotomi



BETHUNE

025-117-340 34,0 cm / 13³/₄"



LEBSCHÉ

025-119-245 24,5 cm / 10"

ALUMINIUM

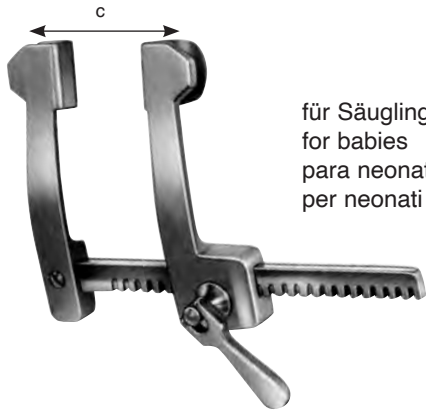
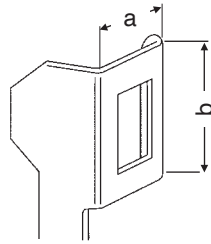

für Säuglinge
 for babies
 para neonatales
 per neonati

COOLEY	a x b	c
025-150-085	12 x 16 mm	85 mm



für Kinder
 for children
 para niños
 per bambini

COOLEY	a x b	c
025-150-115	15 x 30 mm	115 mm



für Erwachsene
 for adults
 para adultos
 per adulti

COOLEY	a x b	c
025-152-140	20 x 45 mm	140 mm
025-152-185	35 x 50 mm	185 mm



025

Rippensperrer
Rib Retractors
Separadores costales
Divaricatori costali

ALUMINIUM

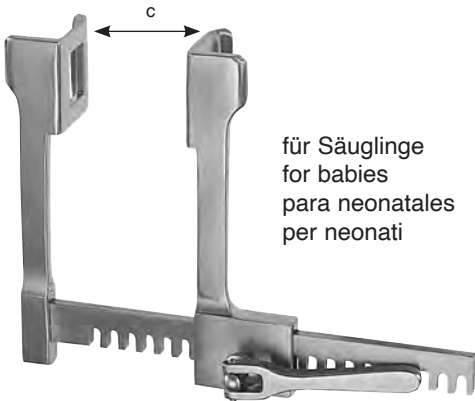

für Säuglinge
 for babies
 para neonatales
 per neonati

FINOCHIETTO BABY	a x b	c
025-160-001	15 x 15 mm	75 mm



für Kinder
 for children
 para niños
 per bambini

FINOCHIETTO INFANT	a x b	c
025-162-001	31 x 31 mm	100 mm

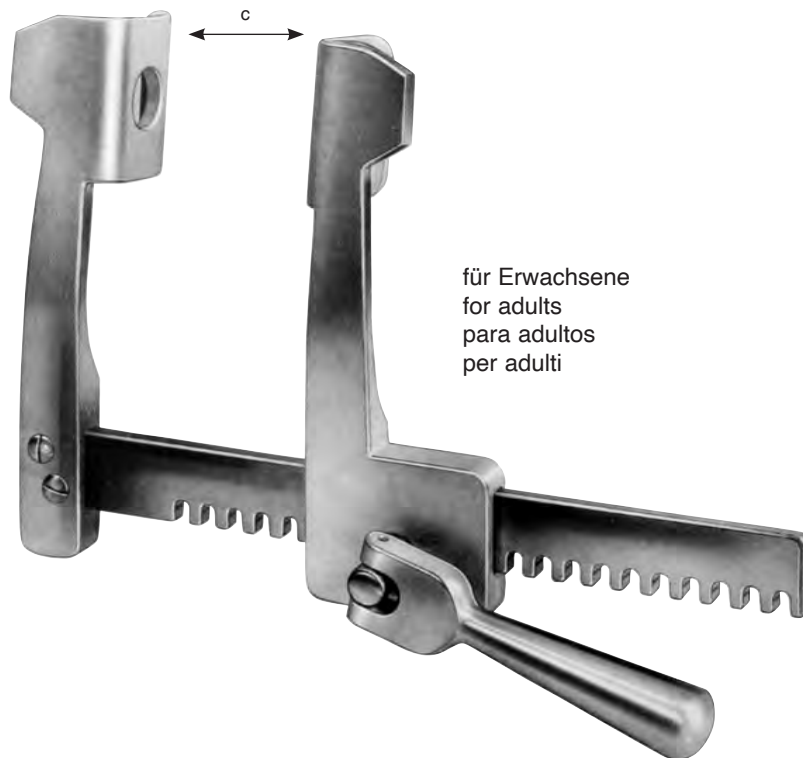

für Erwachsene
 for adults
 para adultos
 per adulti

FINOCHIETTO	a x b	c
025-164-001	40 x 45 mm	135 mm
025-164-002	52 x 62 mm	175 mm
025-164-003	85 x 65 mm	175 mm

ALUMINIUM

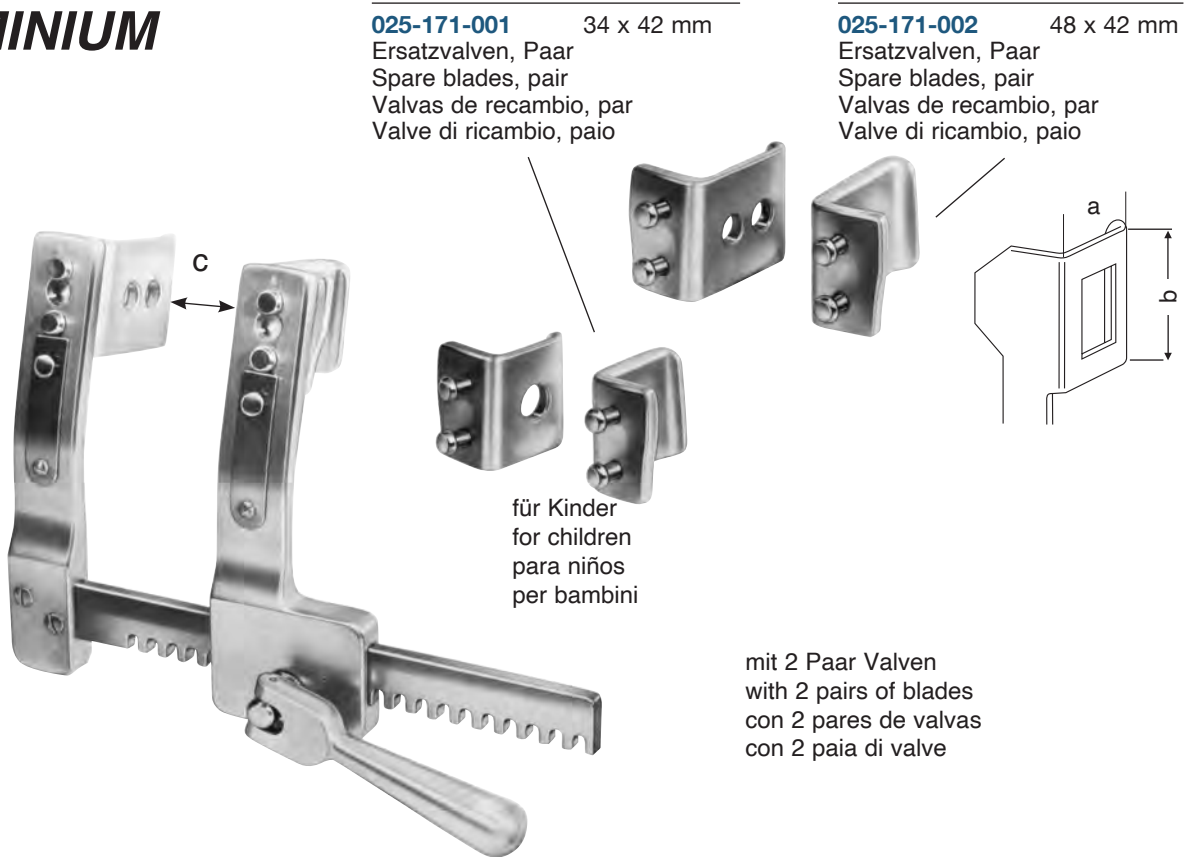

BURFORD

025-170-001

a x b

48 x 42 mm + 34 x 42 mm

c

135 mm

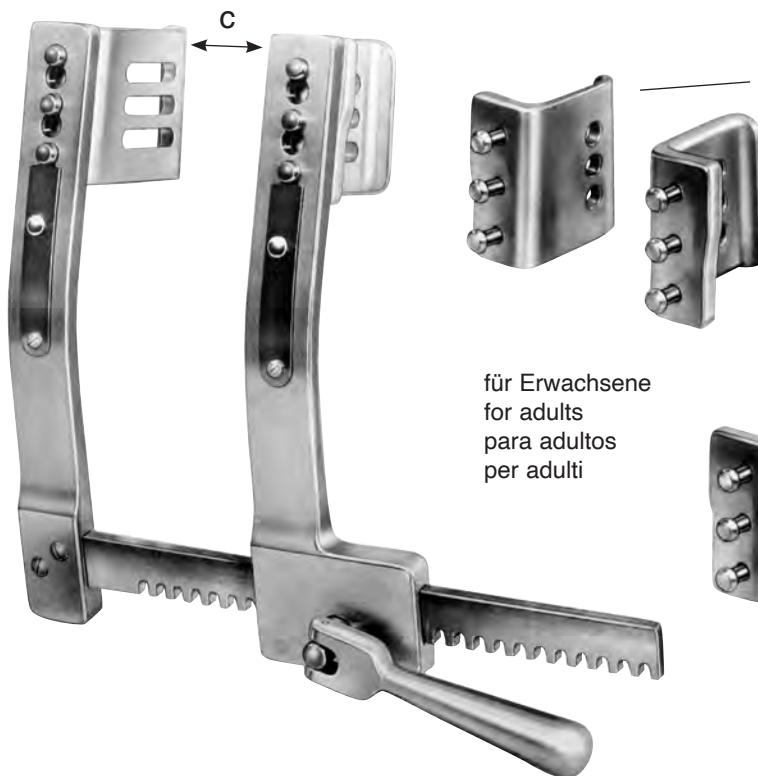

025-173-001

47 x 62 mm

Ersatzvalven, Paar
Spare blades, pair
Valvas de recambio, par
Valve di ricambio paio

025-173-002

65 x 62 mm

Ersatzvalven, Paar
Spare blades, pair
Valvas de recambio, par
Valve di ricambio paio

mit 2 Paar Valven
with 2 pairs of blades
con 2 pares de valvas
con 2 paia di valve

BURFORD

025-172-001
025-172-002
025-172-003

a x b

47 x 62 mm + 65 x 62 mm
47 x 62 mm + 65 x 62 mm
47 x 62 mm + 65 x 62 mm

c

200 mm
260 mm
300 mm



025

Rippensperrer
Rib Retractors
Separadores costales
Divaricatori costali

ALUMINIUM

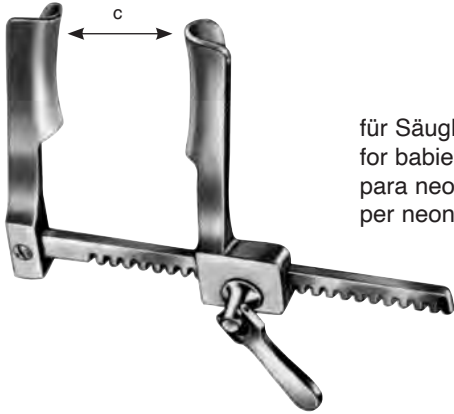
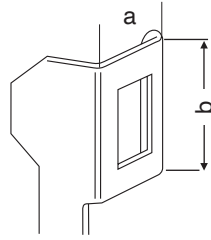

für Säuglinge
 for babies
 para neonatales
 per neonati



für Kleinkinder
 for infants
 para bebes
 per piccoli

CASTAÑEDA	a x b	c
025-180-001	10,5 x 32 mm	65 mm

CASTAÑEDA	a x b	c
025-180-002	12 x 45 mm	70 mm



für Kinder
 for children
 para niños
 per bambini

CASTAÑEDA	a x b	c
025-180-003	15 x 60 mm	120 mm

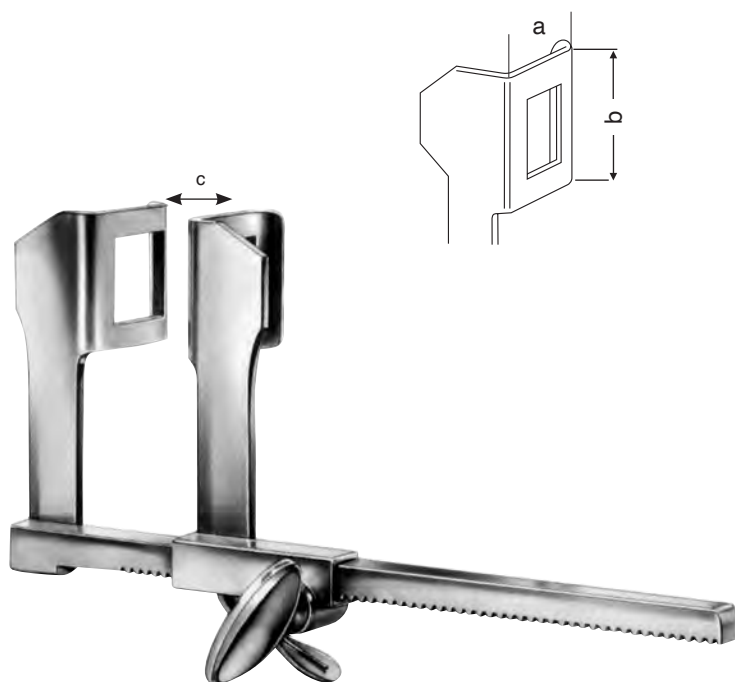

HAIGHT	a x b	c
025-184-001	30 x 30 mm	120 mm



TUFFIER	a x b	c
025-186-001	45 x 45 mm	160 mm



025

Rippensperrer
Rib Retractors
Separadores costales
Divaricatori costali

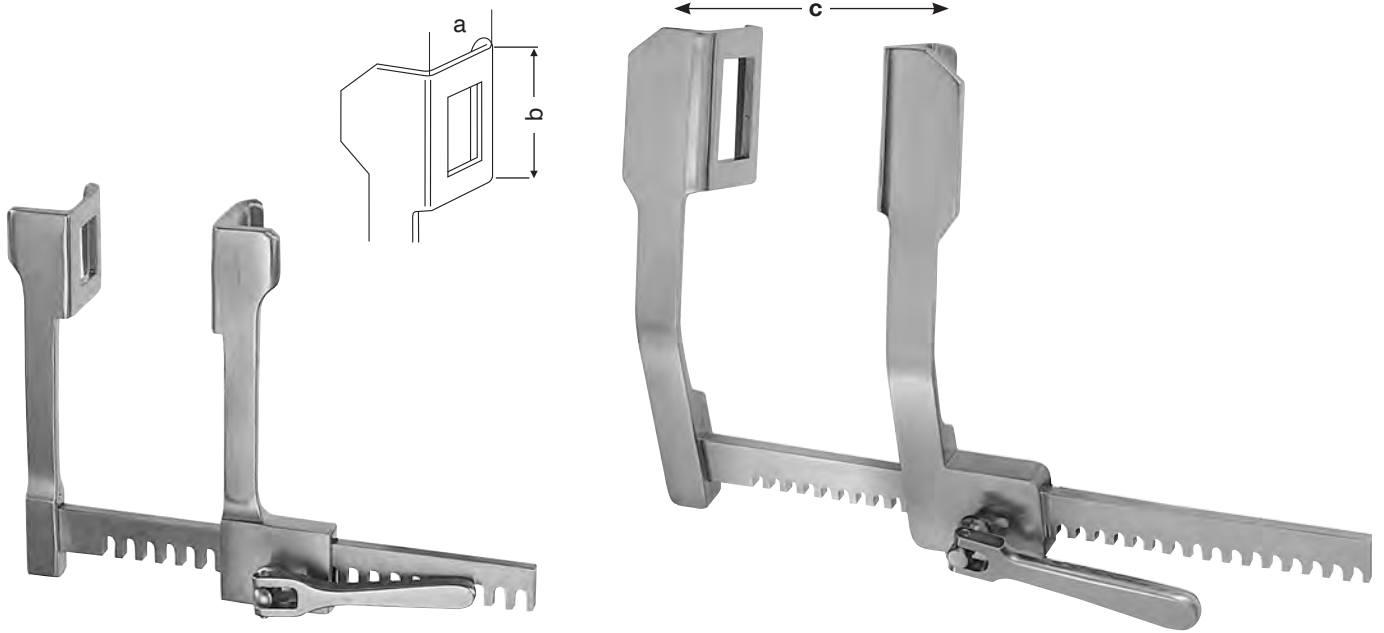

FINOCHIETTO BABY	a x b	c
025-190-001	14 x 15 mm	75 mm

FINOCHIETTO	a x b	c
025-192-001	40 x 40 mm	165 mm
025-192-002	45 x 65 mm	200 mm
025-192-003	70 x 65 mm	250 mm



ALUMINIUM

FINOCHIETTO (MODIF.)	a x b	c
025-194-001	14 x 15 mm	120 mm

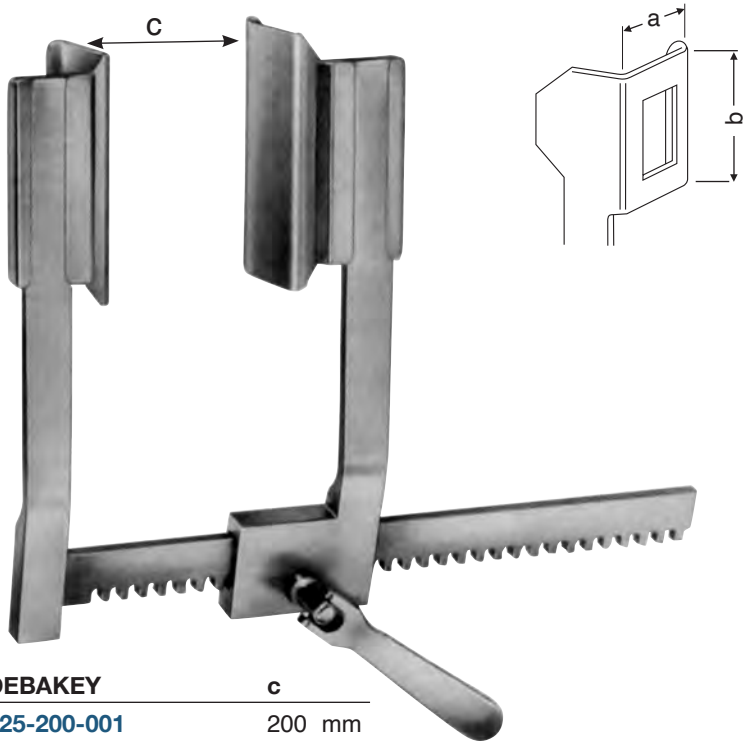

DEBAKEY

025-200-002

Sperrer allein
 Retractor only
 Separador suelto
 Divaricatore solo

DEBAKEY
025-200-001 **c**
 200 mm



025-201-001 60 x 60 mm

025-201-002 50 x 80 mm

025-201-003 40 x 100 mm

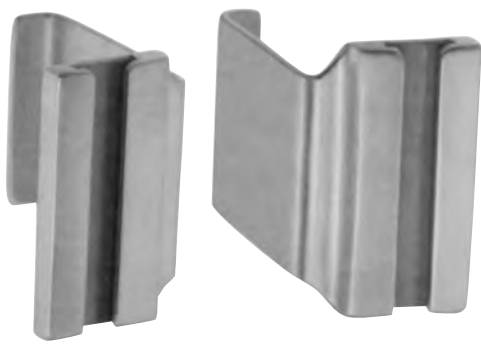

025-201-004 80 x 60 mm



025-201-005 50 x 66 mm



025

Rippensperrer
Rib Retractors
Separadores costales
Divaricatori costali

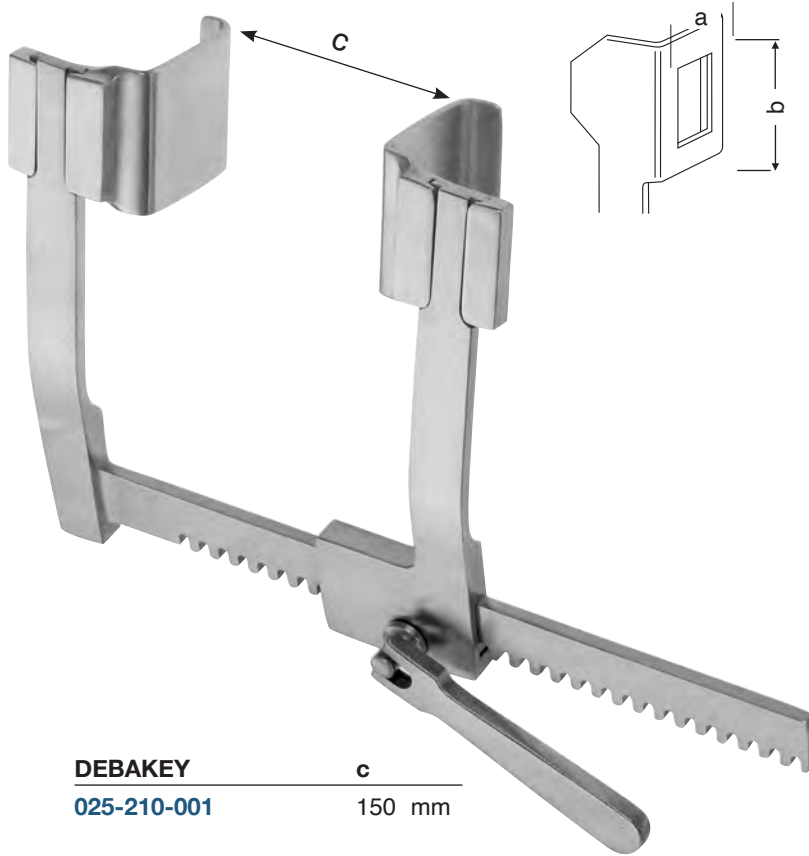

DEBAKEY

025-210-002

Sperrer allein
Retractor only
Separador suelto
Divaricatore solo

DEBAKEY **c**
025-210-001 150 mm



025-211-001 30 x 30 mm

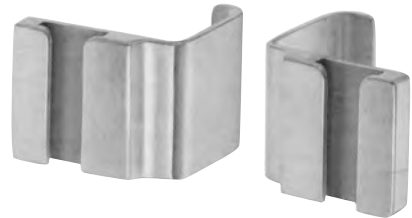

025-211-002 40 x 40 mm

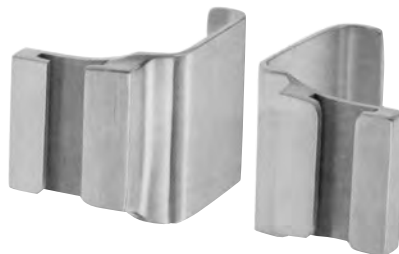

025-211-003 50 x 50 mm

Sternumspreizer
Sternal Retractors
Separadores esternales
Divaricatori per sterno



025

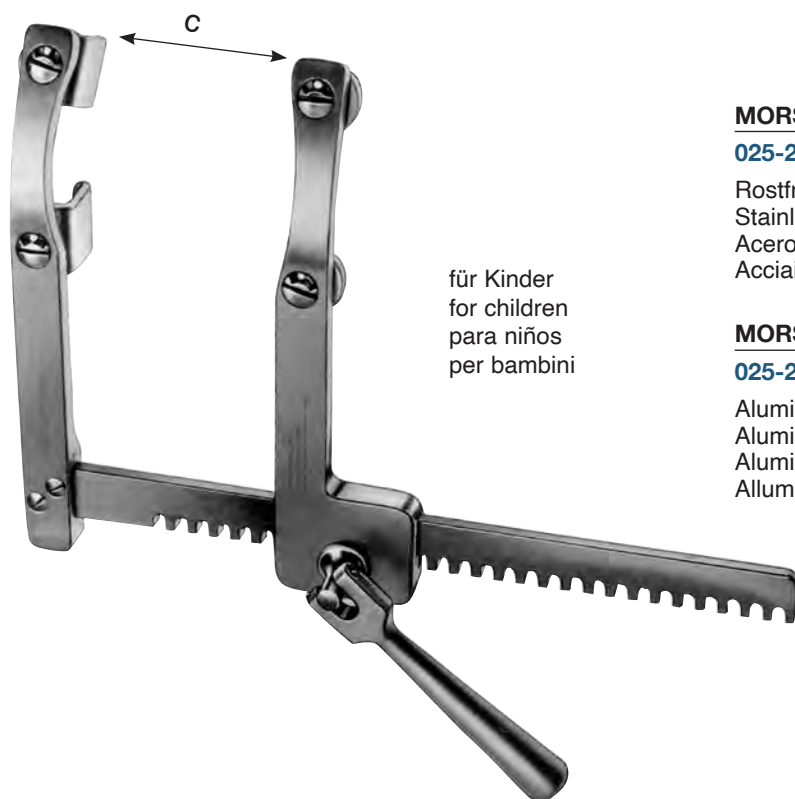

für Kinder
 for children
 para niños
 per bambini

MORSE-FAVALORO	a x b	c
025-220-001	17 x 22 mm	160 mm
Rostfreier Stahl Stainless Steel Acero inoxidable Acciaio inossidabile		

MORSE-FAVALORO	a x b	c
025-224-001	17 x 22 mm	160 mm
Aluminium Aluminium Aluminio Alluminio		

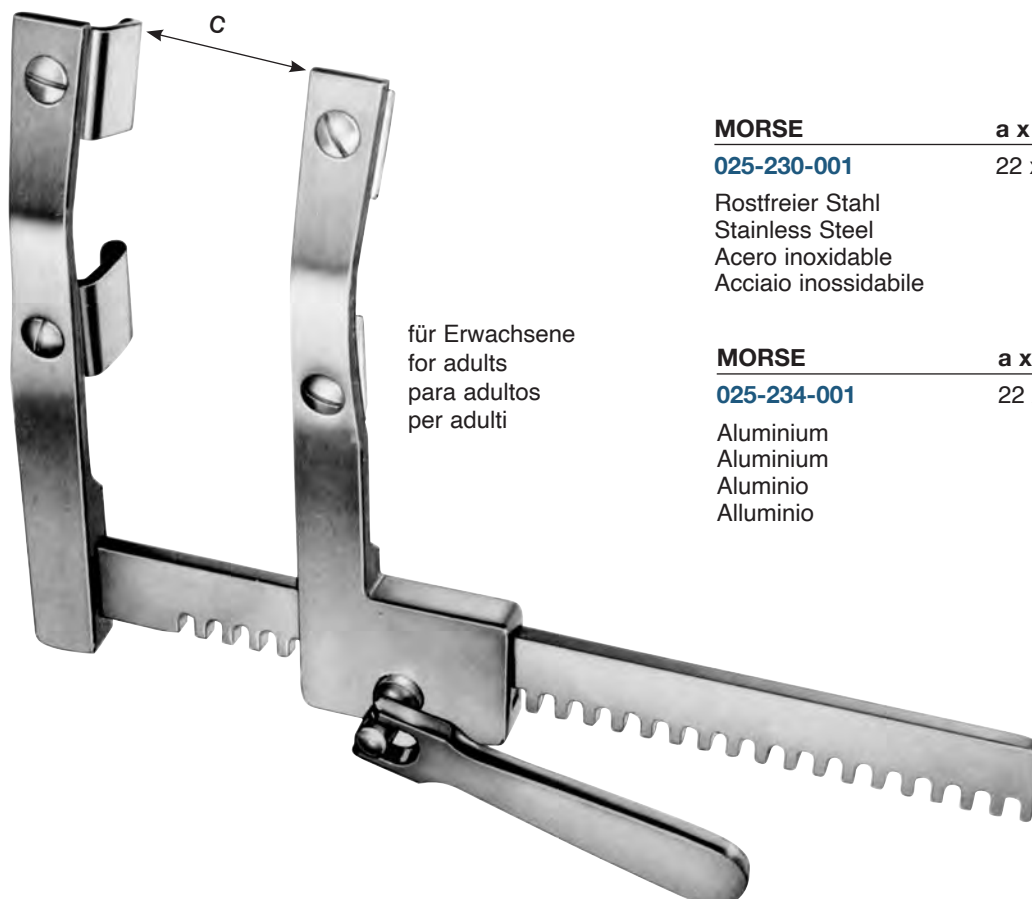

für Erwachsene
 for adults
 para adultos
 per adulti

MORSE	a x b	c
025-230-001	22 x 27 mm	200 mm
Rostfreier Stahl Stainless Steel Acero inoxidable Acciaio inossidabile		

MORSE	a x b	c
025-234-001	22 x 27 mm	200 mm
Aluminium Aluminium Aluminio Alluminio		



025

Thoraxsperrer
Thoracic Retractor
Separador torácico
Divaricatore per il torace



MERCEDES

025-240-001

komplett
complete
completo
completo

MERCEDES

025-240-002

Sperrer allein
Retractor only
Separador suelto
Divaricatore solo



025-241-001

48 x 68 mm



025-241-002

70 x 75 mm



BABY-BAILEY

025-252-155 15,5 cm / 6"



BAILEY

025-254-200 20,0 cm / 8"



BAILEY-GIBBON

025-256-200 20,0 cm / 8"



025

**Lungenspatel
Lung Spatulas
Espátulas pulmonares
Spatole per pulmone**



ALLISON

025-261-300	30,0 cm / 11 ³ / ₄ "	40 mm
025-261-320	32,0 cm / 12 ¹ / ₂ "	54 mm



PRICE-THOMAS

025-271-220	22,0 cm / 8 ³ / ₄ "
--------------------	---



025-273-220

025-275-220

PRICE-THOMAS

025-273-220 - 025-275-220	22,0 cm / 8 ³ / ₄ "
----------------------------------	---

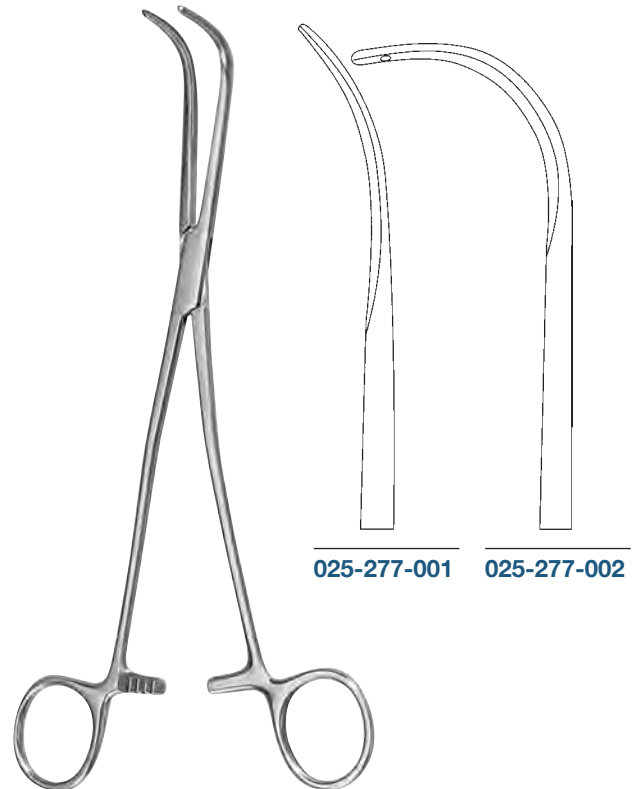

025-277-001

025-277-002

SEMB

025-277-001 - 025-277-002	24,0 cm / 9 ¹ / ₂ "
----------------------------------	---

Lungenfaßzangen
Lung Grasping Forceps
Pinzas para coger el pulmón
Pinze per afferrare polmone



025



LOVELACE
025-278-200 20,0 cm / 8"



LOVELACE
025-279-200 20,0 cm / 8"

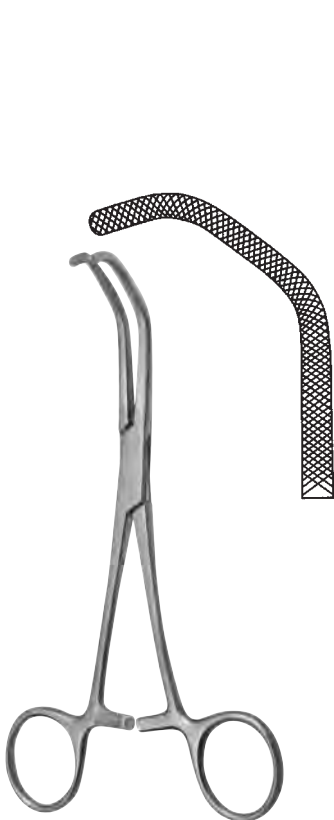

BABY-SATINSKY
025-281-150 15,0 cm / 6"



SATINSKY
025-283-001 – 025-283-02 26,5 cm / 10 1/2"

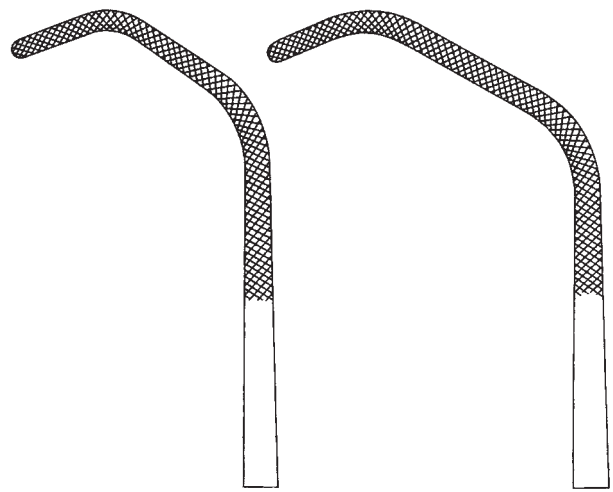

025-283-001

025-283-002



025

**Klemmen
Clamps
Pinzas
Pinze**

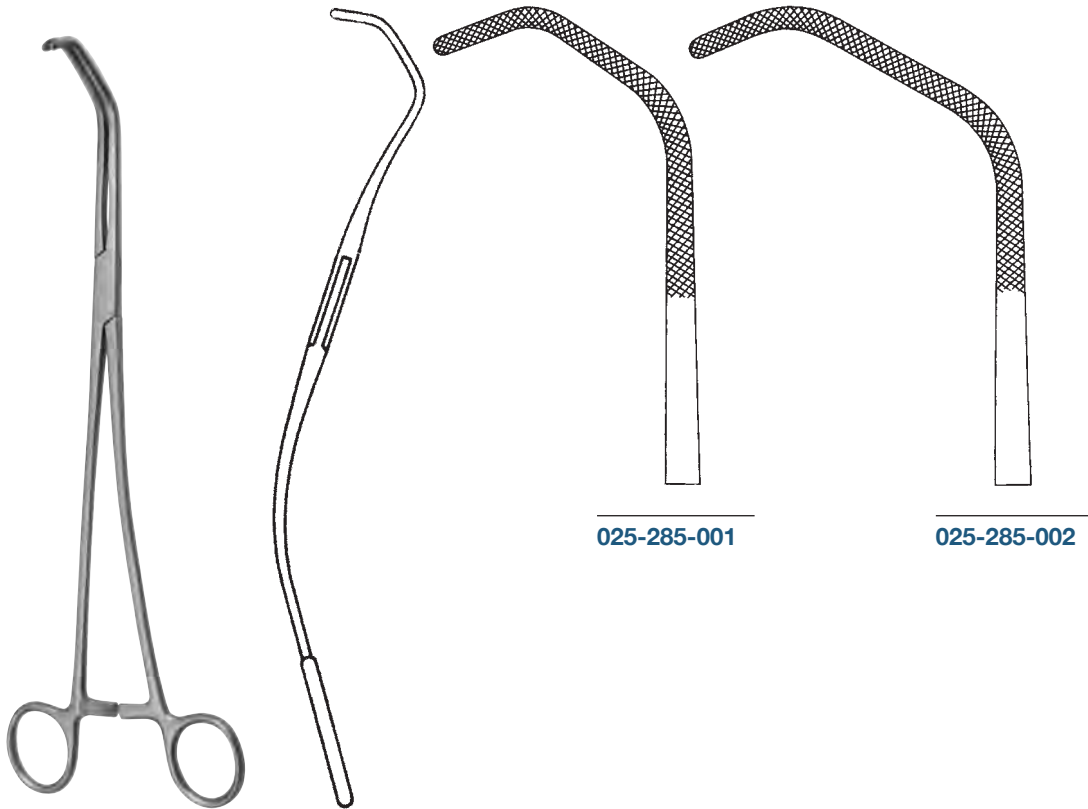

SATINSKY

025-285-001 – 025-285-002 26,5 cm / 10¹/₂"

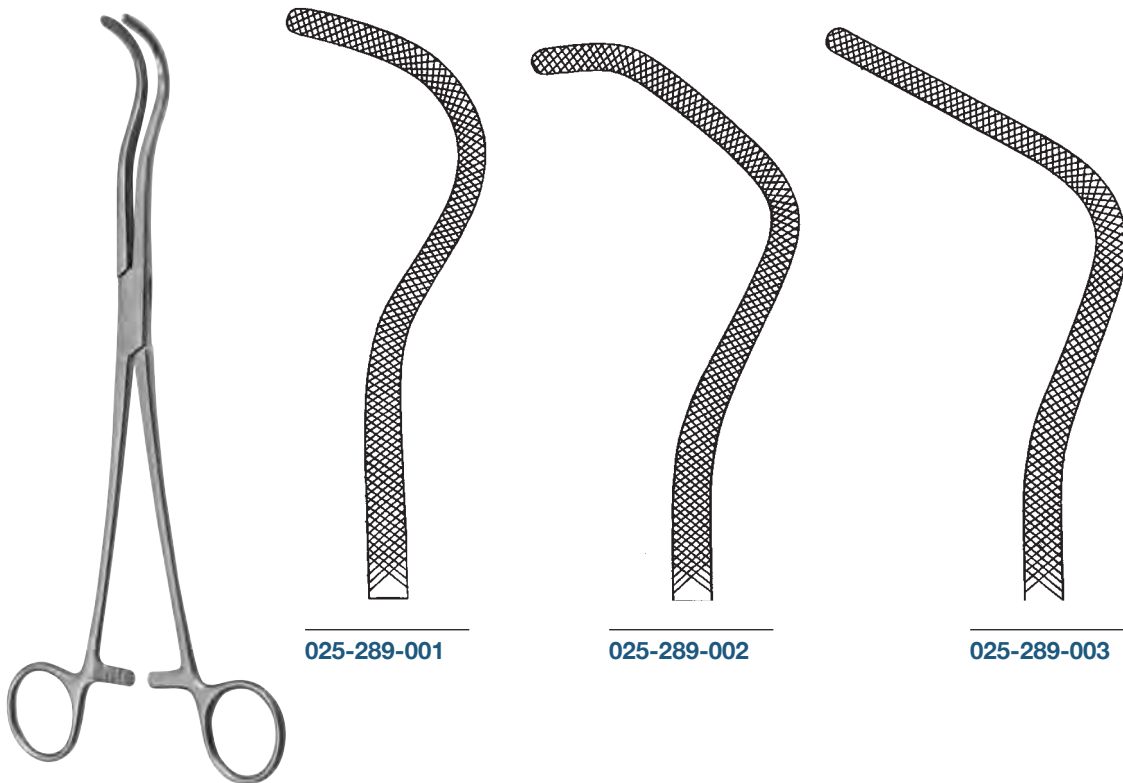

HARKEN

025-289-001 – 025-289-003 24,0 cm / 9¹/₂"

ATRAUMA

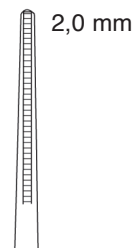
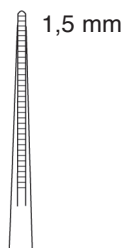

025-300-160 16,0 cm / 6¹/₄"
025-300-200 20,0 cm / 8"
025-300-240 24,0 cm / 9¹/₂"

025-302-160 16,0 cm / 6¹/₄"
025-302-200 20,0 cm / 8"
025-302-240 24,0 cm / 9¹/₂"
025-302-300 30,0 cm / 12"

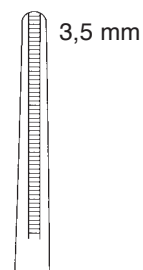
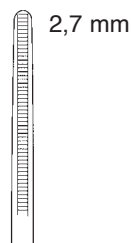

025-304-160 16,0 cm / 6¹/₄"
025-304-200 20,0 cm / 8"
025-304-240 24,0 cm / 9¹/₂"
025-304-300 30,0 cm / 12"

025-306-160 16,0 cm / 6¹/₄"
025-306-200 20,0 cm / 8"
025-306-240 24,0 cm / 9¹/₂"
025-306-300 30,0 cm / 12"

DEBAKEY

025-300-160 - 025-306-300

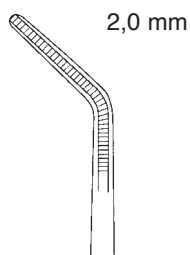

025-309-160 16,0 cm / 6¹/₄"
025-309-200 20,0 cm / 8"
025-309-240 24,0 cm / 9¹/₂"
025-309-300 30,0 cm / 12"

DEBAKEY

025-309-160 - 025-309-300



025

Klemmen mit DEBAKEY-Zahnung
Clamps with Toothing DEBAKEY
Clamps con dentado DEBAKEY
Pinze con dentatura DEBAKEY

ATRAUMA



DEBAKEY

025-320-075	7,5 cm / 3"
025-320-085	8,5 cm / 3 1/4"
025-320-105	10,5 cm / 4 1/8"
025-320-120	12,0 cm / 4 3/4"

L

2,5 cm / 1"
3,5 cm / 1 3/8"
5,0 cm / 2"
6,8 cm / 2 3/4"



DEBAKEY

025-321-070	7,5 cm / 3"
025-321-080	8,5 cm / 3 3/8"
025-321-100	9,5 cm / 3 3/4"
025-321-115	11,0 cm / 4 3/8"

L

2,5 cm / 1"
3,5 cm / 1 3/8"
5,0 cm / 2"
6,8 cm / 2 3/4"

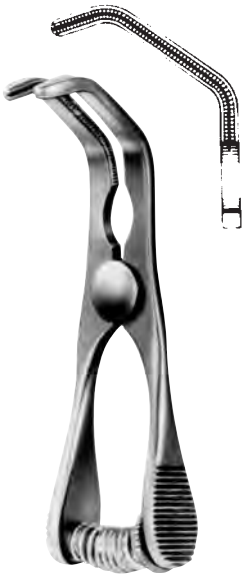

DEBAKEY-SATINSKY

025-323-070	7,0 cm / 2 3/4"
--------------------	-----------------



DEBAKEY-SATINSKY

025-325-090	9,0 cm / 3 1/2"
--------------------	-----------------



DEBAKEY-SATINSKY

025-327-100	10,0 cm / 4"
--------------------	--------------

ATRAUMA



025-329-235 23,5 cm / 9¹/₄"



GLOVER

025-330-060	6,0 cm / 2 ³ / ₈ "
025-330-070	7,0 cm / 2 ³ / ₄ "
025-330-090	9,0 cm / 3 ³ / ₄ "
025-330-110	11,0 cm / 4 ³ / ₈ "



GLOVER

025-331-055	5,5 cm / 2 ¹ / ₃ "
025-331-070	7,0 cm / 2 ¹ / ₂ "
025-331-085	8,5 cm / 3 ¹ / ₂ "
025-331-105	10,5 cm / 4 ³ / ₈ "



025

Klemmen mit DEBAKEY-Zahnung
Clamps with Toothing DEBAKEY
Clamps con dentado DEBAKEY
Pinze con dentatura DEBAKEY

ATRAUMA



GLOVER

025-333-060

6,0 cm / 2¹/₄"



SANTULLI

025-335-070

7,0 cm / 2³/₄"

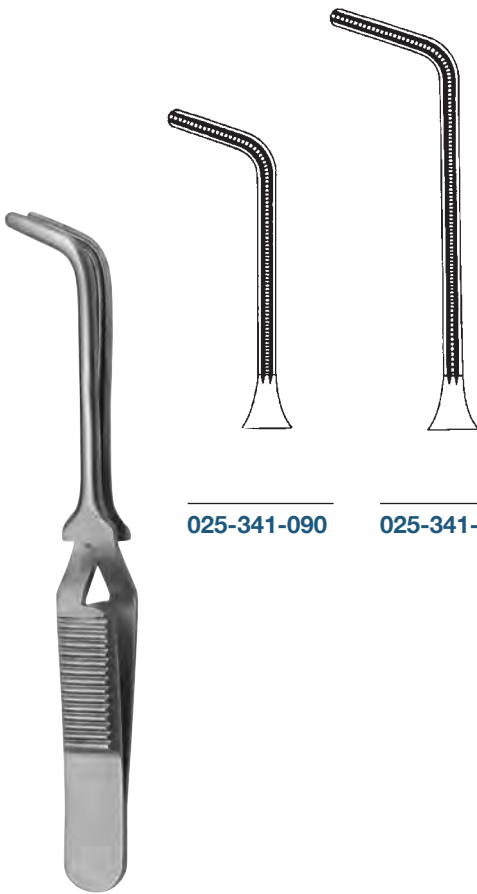

025-341-090

025-341-110

GREGORY SOFT

025-341-090 9,0 cm / 3¹/₂"

025-341-110 11,0 cm / 4¹/₄"



025-343-105

rechts
right
derecho
destro

025-345-105

links
left
izquierdo
sinistro

GREGORY

025-343-105 – 025-345-105

10,5 cm / 4"

ATRAUMA



MOSQUITO-DEBAKEY

025-350-125 – 025-351-125 12,5 cm / 5"

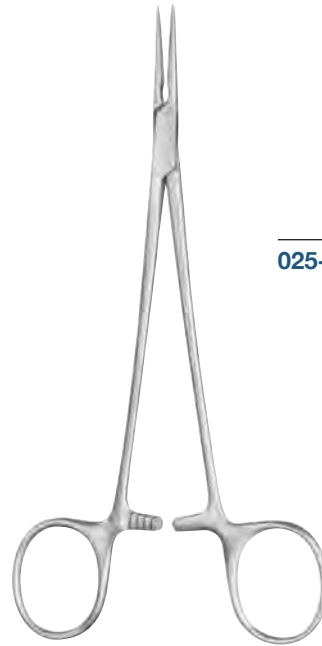

MOSQUITO-DEBAKEY

025-350-150 – 025-351-150 15,0 cm / 6"

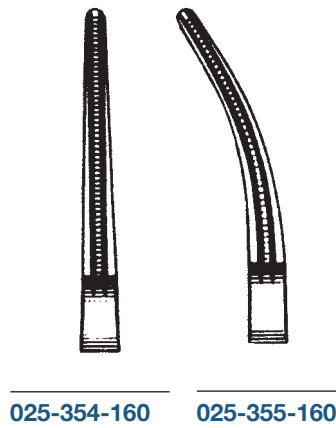
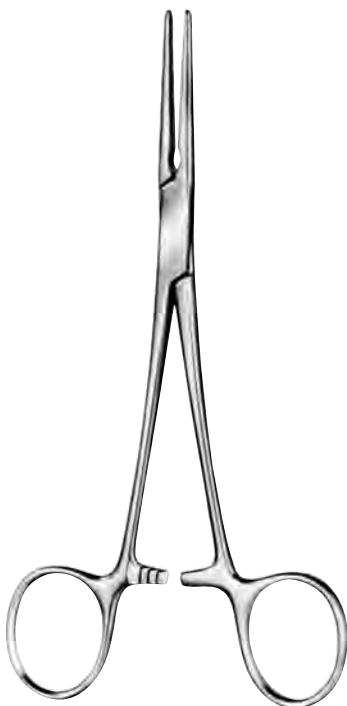

DE-BAKEY-RANKIN

025-354-160 – 025-355-160 16,0 cm / 6 1/4"



025

Klemmen mit DEBAKEY-Zahnung
Clamps with Toothing DEBAKEY
Pinzas-clamps con dentado DEBAKEY
Pinze con dentatura DEBAKEY

ATRAUMA



PEAN-DEBAKEY
025-360-145 - 025-360-205



025-360-145
14,5 cm / 5³/₄"

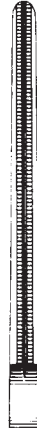

025-360-165
16,5 cm / 6¹/₂"

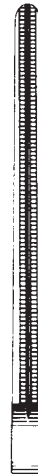

025-360-185
18,5 cm / 7¹/₄"



025-360-205
20,5 cm / 8"

ATRAUMA



PEAN-DEBAKEY

025-361-145 - 025-361-205

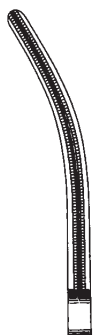

025-361-145
14,5 cm / 5³/₄"

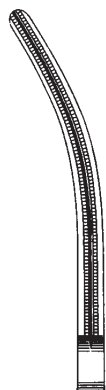

025-361-165
16,5 cm / 6¹/₂"

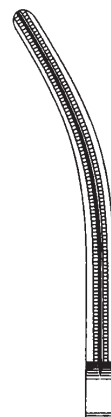

025-361-185
18,5 cm / 7¹/₄"

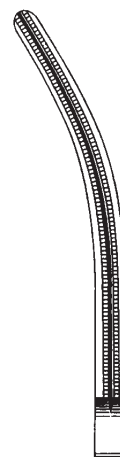

025-361-205
20,5 cm / 8"



025

Klemmen mit DEBAKEY-Zahnung
Clamps with Toothing DEBAKEY
Pinzas-clamps con dentado DEBAKEY
Pinze con dentatura DEBAKEY

ATRAUMA



025-370-150
 15,0 cm / 6"



025-370-185
 18,5 cm / 7 1/4"

BAINBRIDGE

025-370-150 - 025-370-185

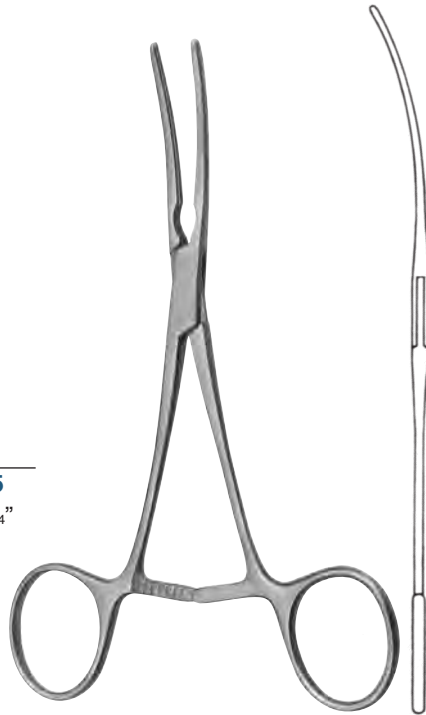

BAINBRIDGE

025-371-150 - 025-371-185



025-371-150
 15,0 cm / 6"

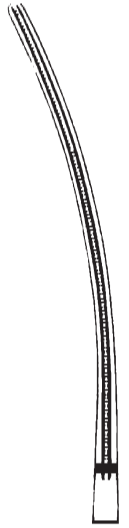

025-371-185
 18,5 cm / 7 1/4"



025-380-210
 21,0 cm / 8 1/4"



025-380-225
 22,5 cm / 8 3/4"

POTTS

025-380-210 - 025-380-225

ATRAUMA



025-381-210
21,0 cm / 8¹/₄"

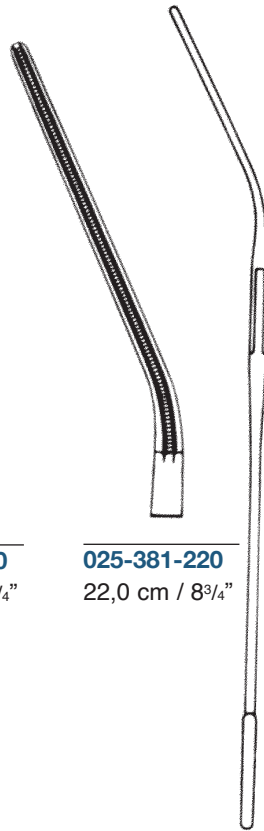

025-381-220
22,0 cm / 8³/₄"

POTTS

025-381-210 - 025-381-220



POTTS

025-383-210 - 025-383-220

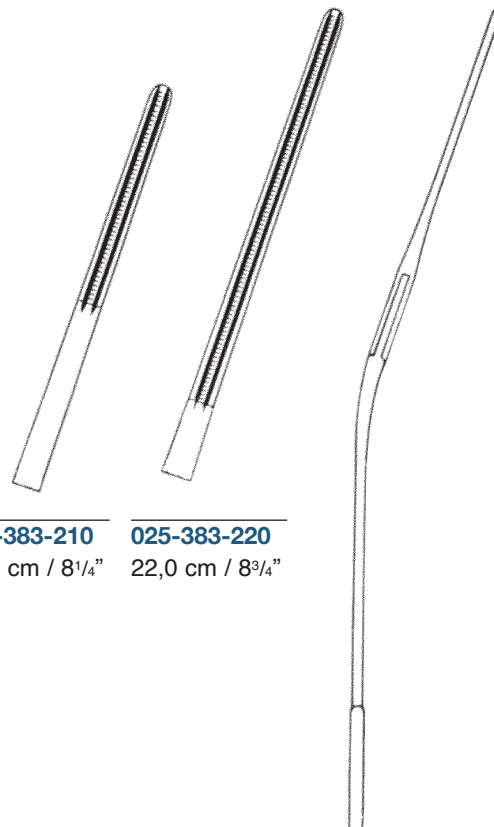

025-383-210
21,0 cm / 8¹/₄"

025-383-220
22,0 cm / 8³/₄"



025

Klemmen mit DEBAKEY-Zahnung
Clamps with Toothing DEBAKEY
Pinzas-clamps con dentado DEBAKEY
Pinze con dentatura DEBAKEY

ATRAUMA



POTTS-GLOVER
 025-385-215 21,5 cm / 8½"



POTTS
 025-387-220 22,0 cm / 2¾"

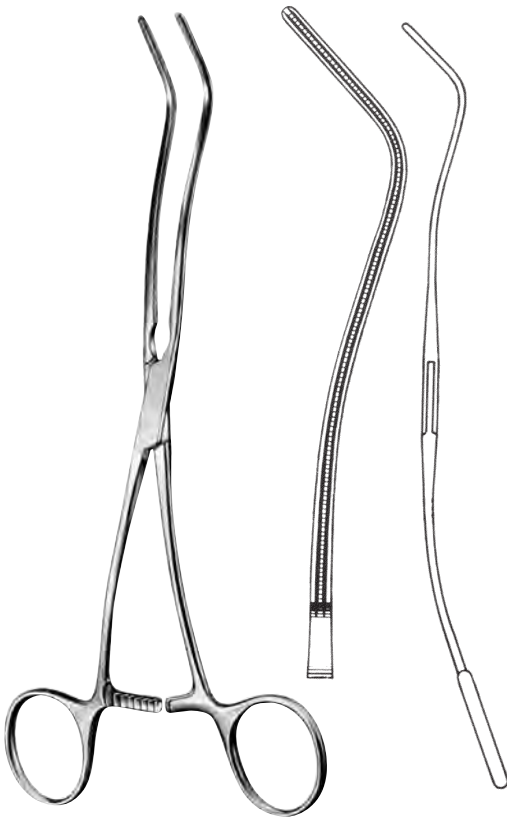

DEBAKEY
 025-391-200 20,0 cm / 8"



025-395-190
 19,0 cm / 7½"

025-395-240
 24,0 cm / 9½"

DEBAKEY
 025-395-190 - 025-395-240

ATRAUMA



DEBAKEY

025-401-160

16,0 cm / 6¹/₄"

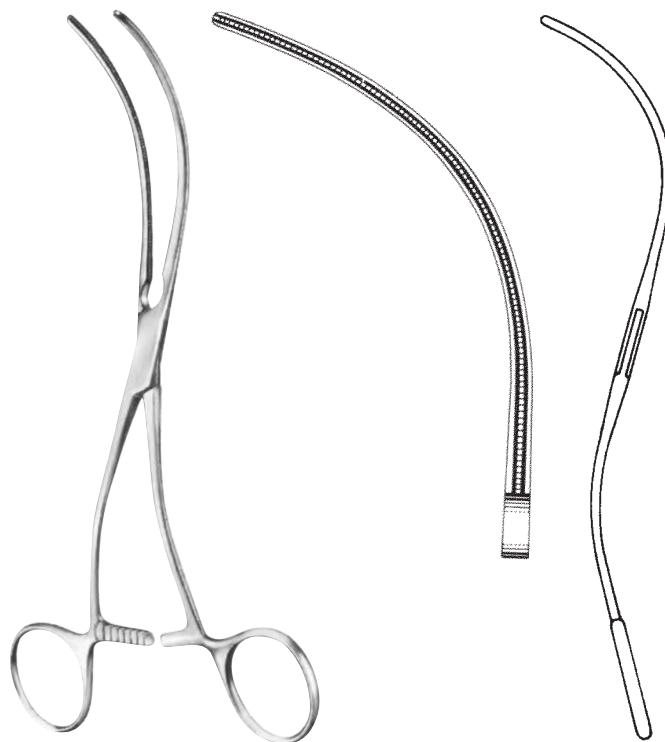

DEBAKEY

025-403-190

19,0 cm / 7¹/₂"



DEBAKEY

025-405-200

20,0 cm / 8"



025

Klemmen mit DEBAKEY-Zahnung
Clamps with Toothing DEBAKEY
Pinzas-clamps con dentado DEBAKEY
Pinze con dentatura DEBAKEY

ATRAUMA



LELAND-JONES
025-411-180 18,0 cm / 7"

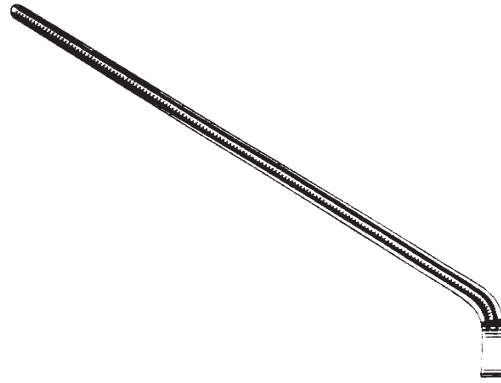

LELAND-JONES
025-411-190 19,0 cm / 7½"

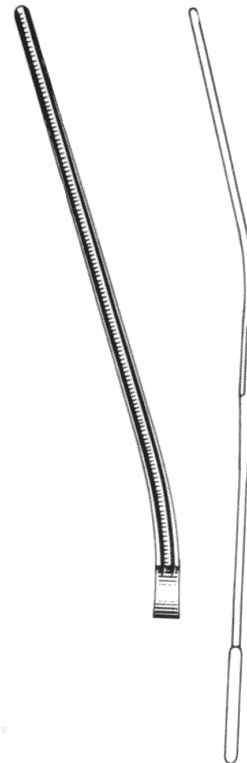

LELAND-JONES
025-411-200 20,0 cm / 8"

ATRAUMA



025-421-260
26,0 cm / 10¹/₄"

025-421-270
27,0 cm / 10³/₄"

025-421-310
31,0 cm / 12¹/₄"

025-421-330
33,0 cm / 13,0"

DEBAKEY

025-421-260 - 025-421-330



025

Klemmen mit DEBAKEY-Zahnung
Clamps with Toothing DEBAKEY
Pinzas-clamps con dentado DEBAKEY
Pinze con dentatura DEBAKEY

ATRAUMA

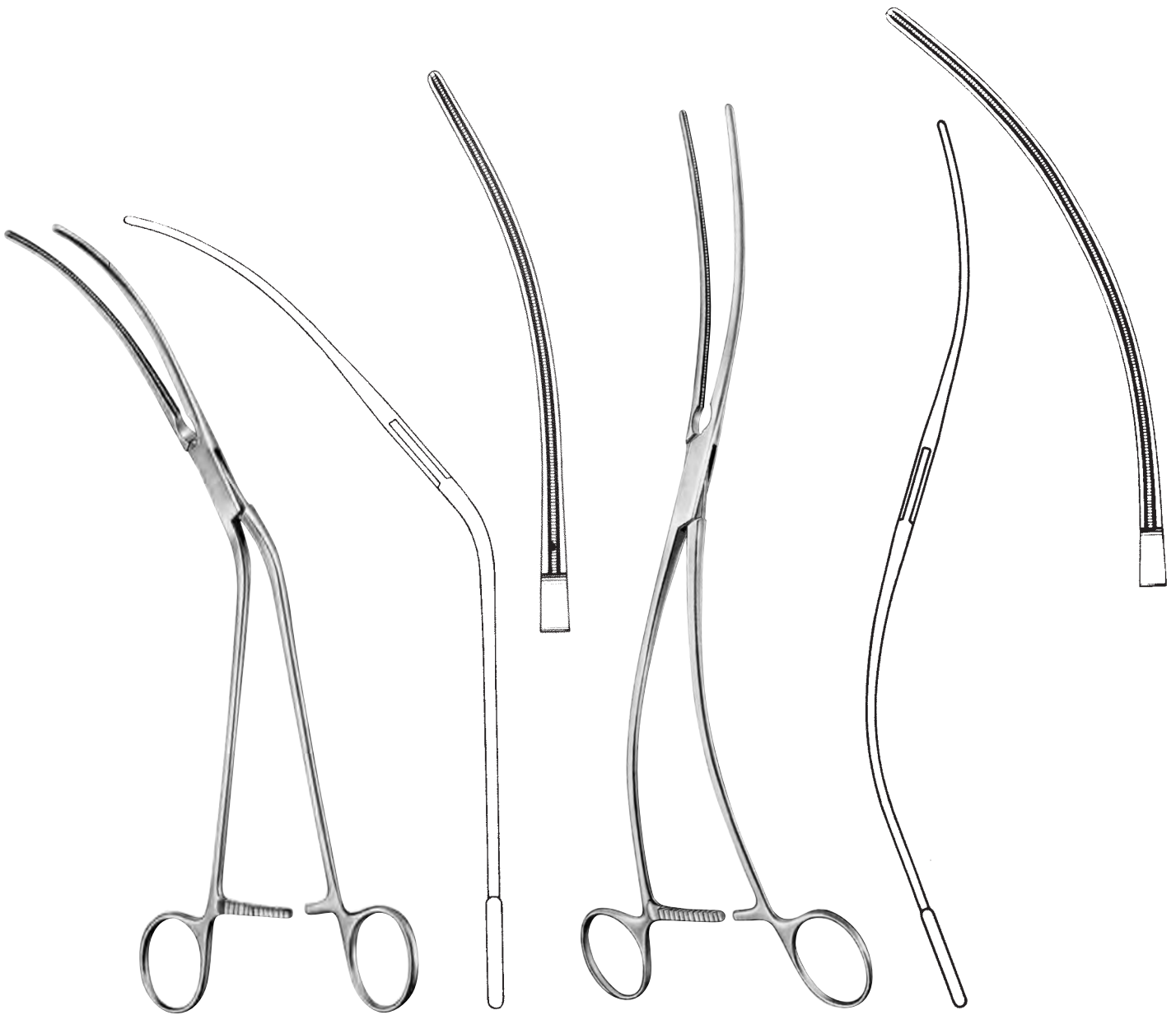

DEBAKEY

025-423-280

28,0 cm / 11"

DEBAKEY

025-425-300

30,0 cm / 11³/₄"

ATRAUMA

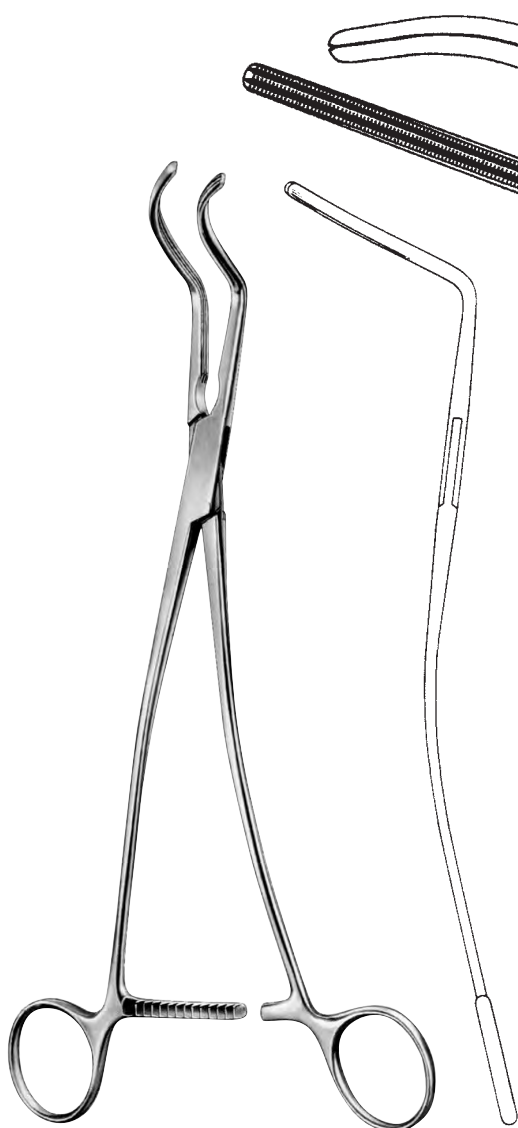

DEBAKEY

025-427-270

27,0 cm / 10³/₄"

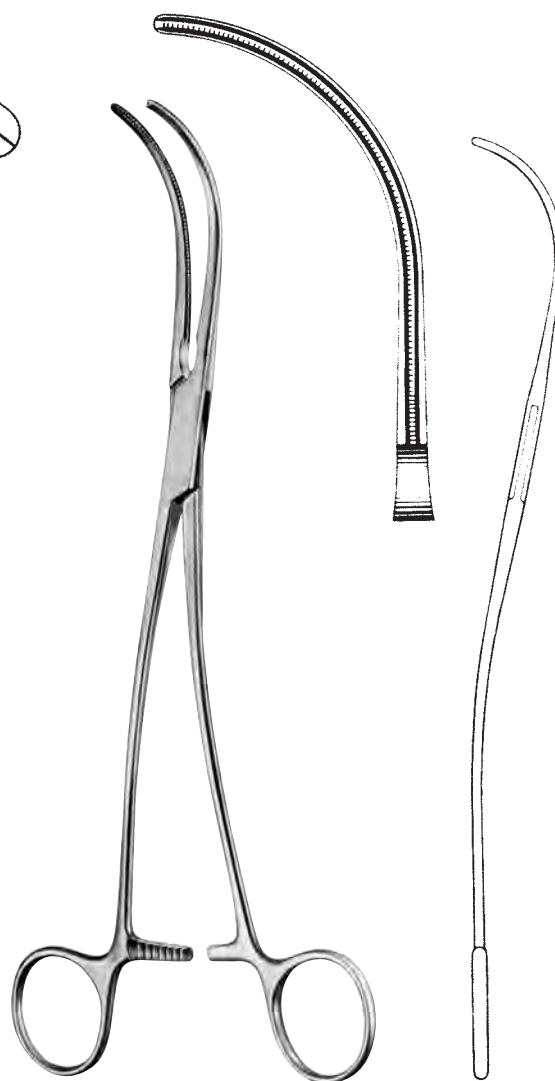

DEBAKEY

025-429-245

24,5 cm / 9³/₄"



025

Klemmen mit DEBAKEY-Zahnung
Clamps with Toothing DEBAKEY
Pinzas-clamps con dentado DEBAKEY
Pinze con dentatura DEBAKEY

ATRAUMA

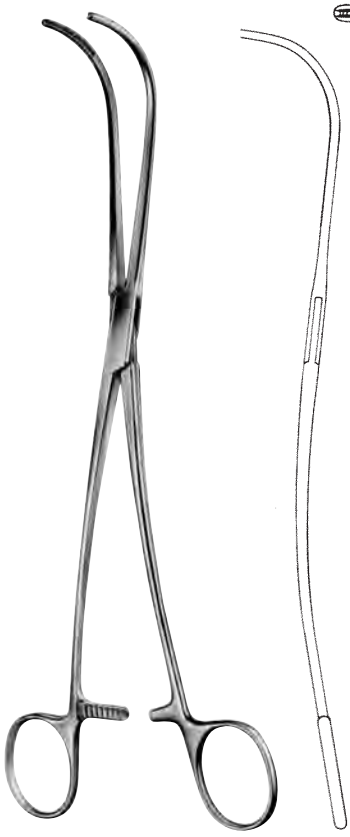

DEBAKEY

025-431-245

24,5 cm / 9³/₄"

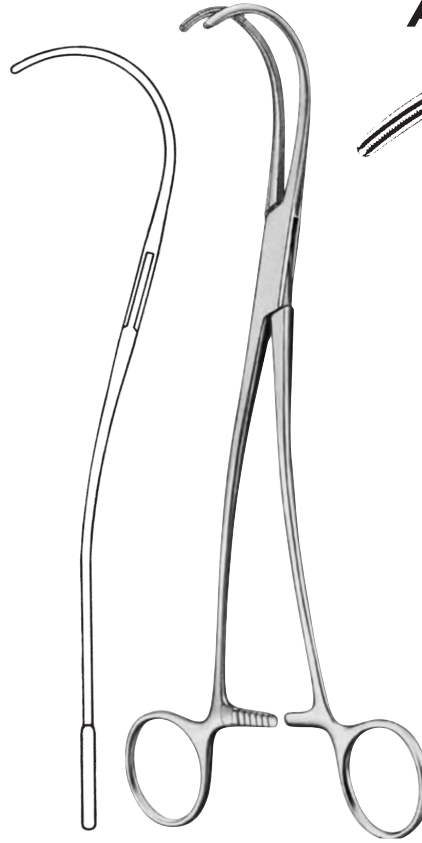

DEBAKEY

025-433-270

27,0 cm / 10¹/₂"



DEBAKEY

025-435-270

27,0 cm / 10¹/₂"

ATRAUMA



WEBER

025-441-001

24,0 cm / 9½"



WEBER

025-441-002

24,0 cm / 9½"



025

Klemmen mit DEBAKEY-Zahnung
Clamps with Toothing DEBAKEY
Pinzas-clamps con dentado DEBAKEY
Pinze con dentatura DEBAKEY

ATRAUMA



025-451-220 22,0 cm / 8³/₄"



025-451-260 26,0 cm / 10¹/₄"

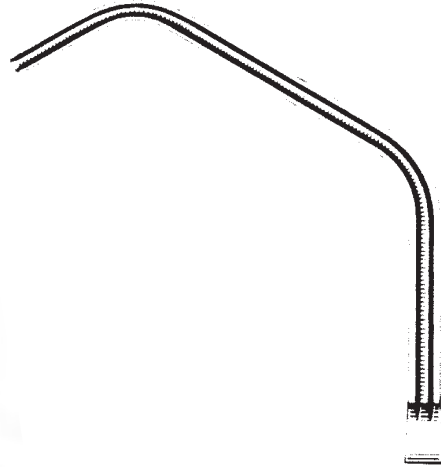

025-451-265 26,5 cm / 10¹/₂"



SATINSKY

025-451-220 - 025-451-285

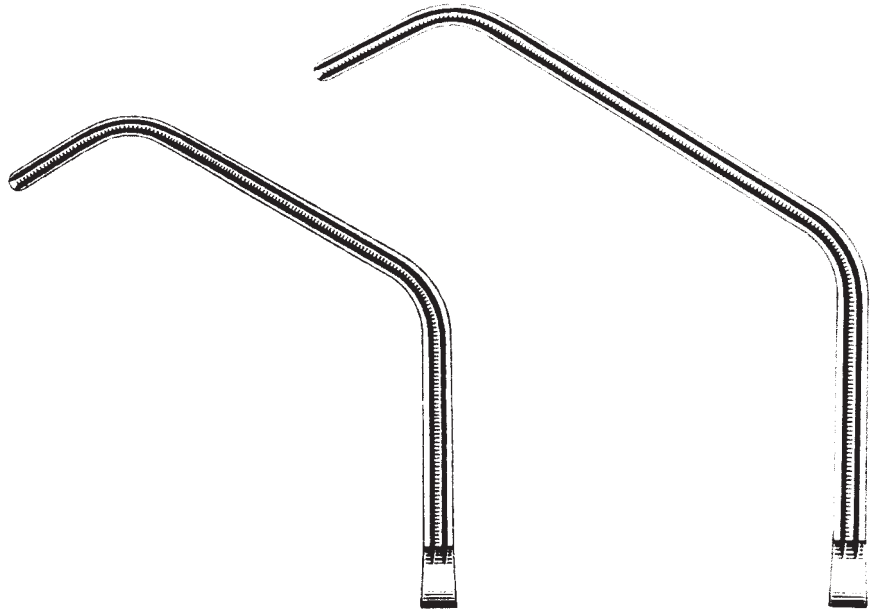

025-451-275 27,5 cm / 10³/₄"

025-451-285 28,5 cm / 11¹/₄"

ATRAUMA

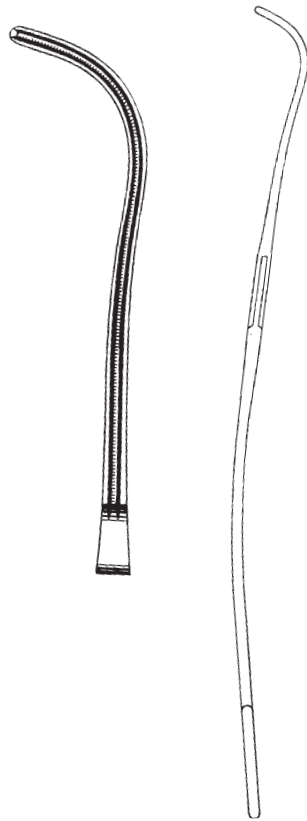

025-461-001 24,5 cm / 9³/₄"

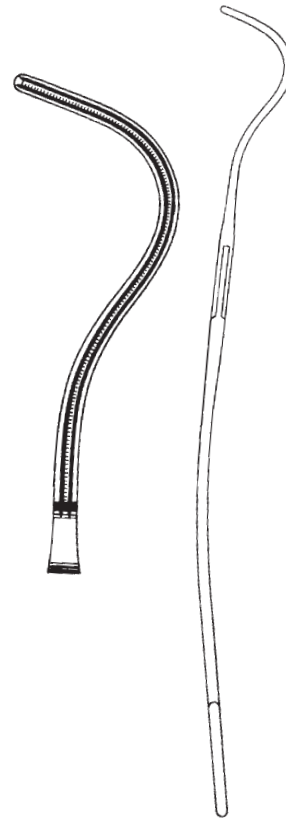

025-461-002 24,0 cm / 9¹/₂"



HARKEN

025-461-001 - 025-461-004

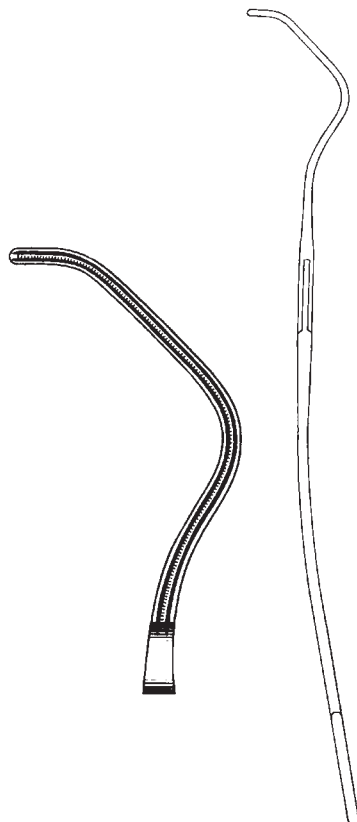

025-461-003 23,0 cm / 9"

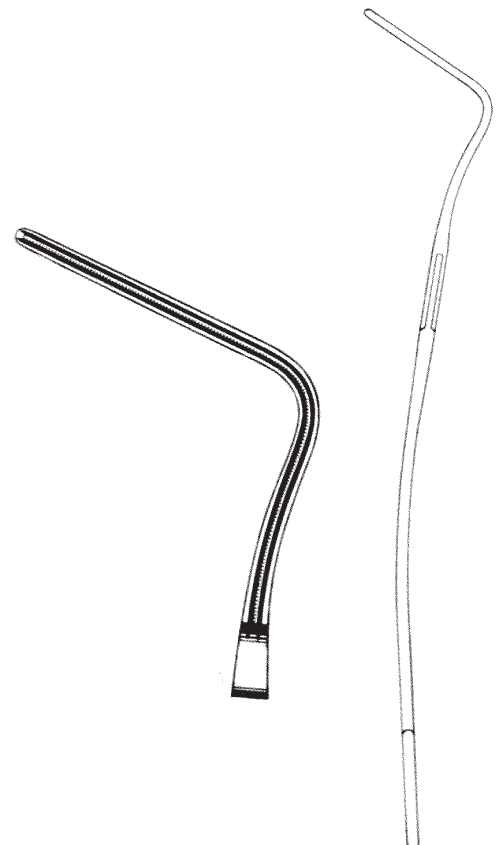

025-461-004 23,5 cm / 9¹/₄"



025

Klemmen mit DEBAKEY-Zahnung
Clamps with Toothing DEBAKEY
Pinzas-clamps con dentado DEBAKEY
Pinze con dentatura DEBAKEY

ATRAUMA



LEES

025-471-230 - 025-471-255

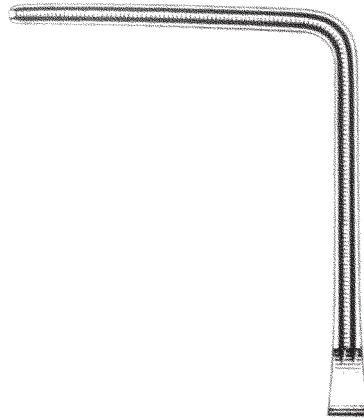
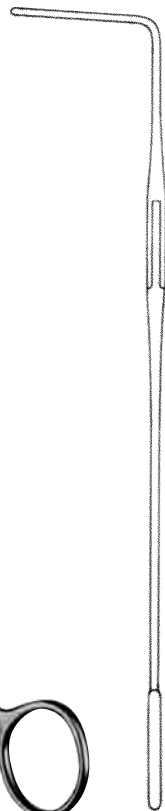

025-471-230 23,0 cm / 9"

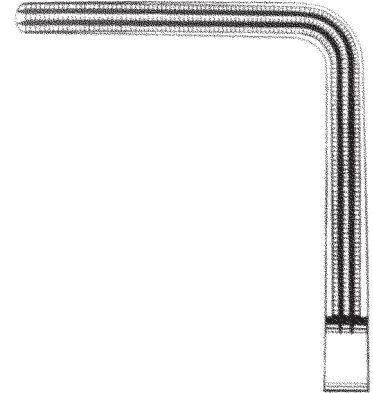

025-471-255 25,5 cm / 10"



LEES

025-473-250 25,0 cm / 9³/₄"

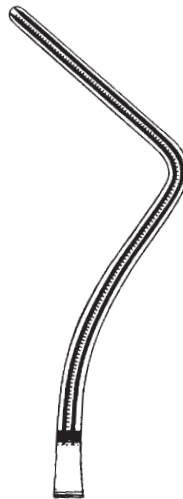
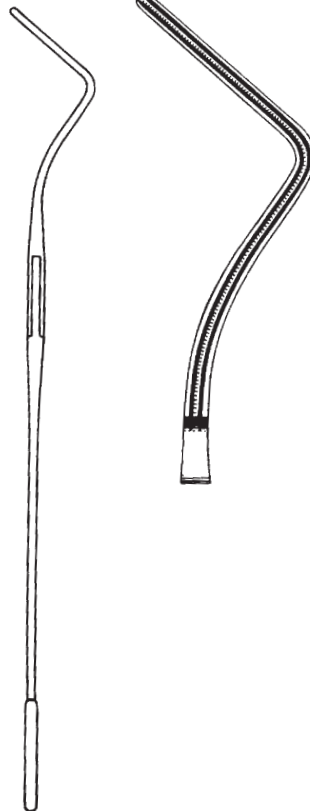

ATRAUMA



025-481-001



025-481-002

LAMBERT-KAY

025-481-001 - 025-481-002 22,5 cm / 8³/₄"

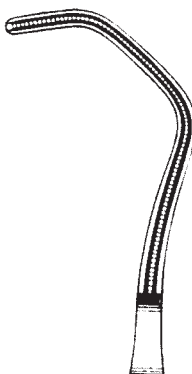

DEBAKEY

025-491-170 17,0 cm / 6³/₄"



025

Klemmen mit DEBAKEY-Zahnung
Clamps with Toothing DEBAKEY
Pinzas-clamps con dentado DEBAKEY
Pinze con dentatura DEBAKEY

ATRAUMA



025-493-180 18,0 cm / 7"

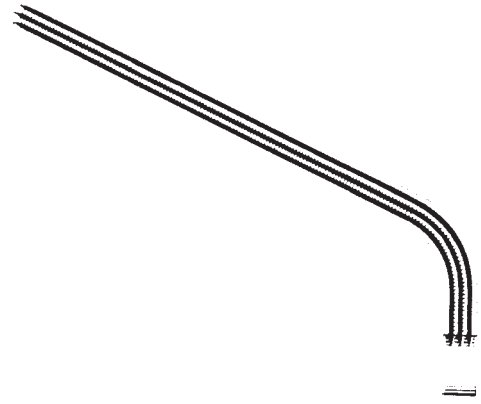

025-493-200 20,0 cm / 8"

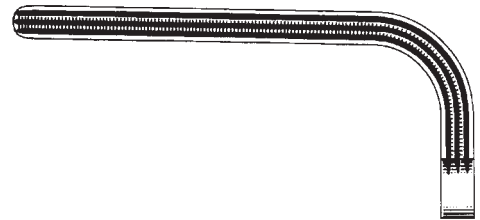

025-493-240 24,0 cm / 9½"

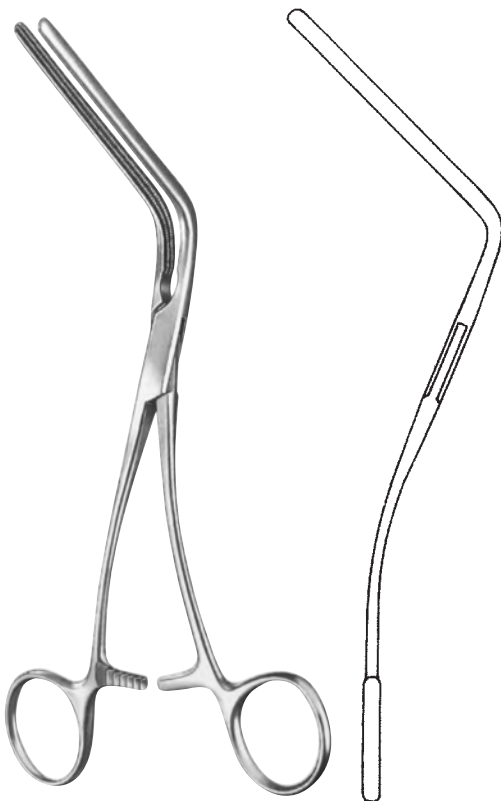

MORRIS-DEBAKEY

025-493-180 - 025-493-260

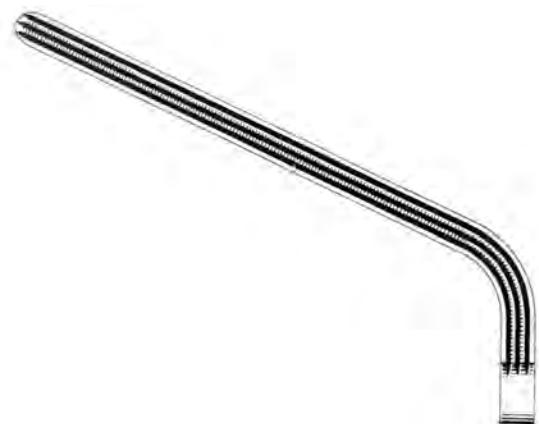

025-493-260 26,0 cm / 10¼"

ATRAUMA

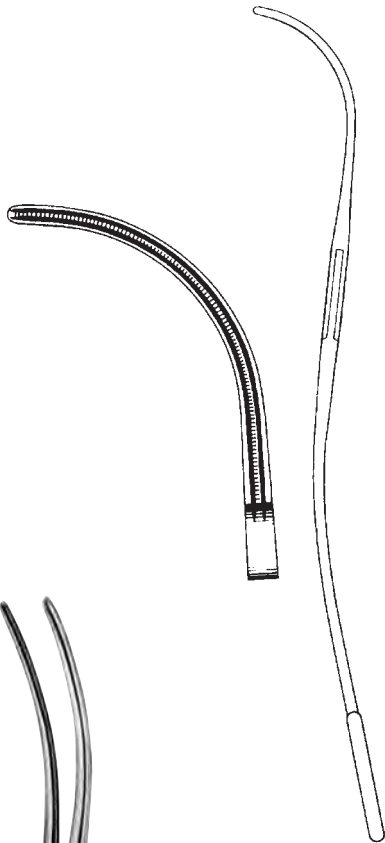

025-495-235 23,5 cm / 9¹/₄"

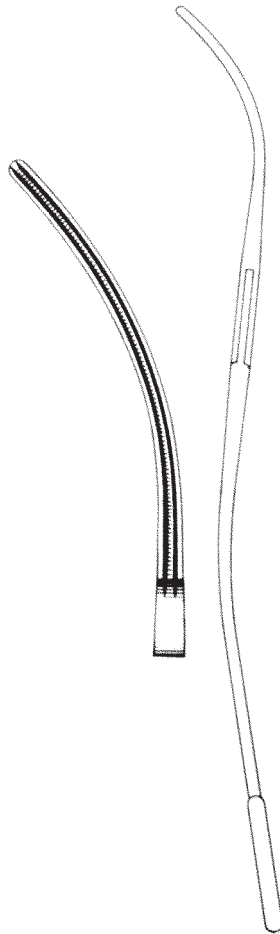

025-495-245 24,5 cm / 9¹/₂"

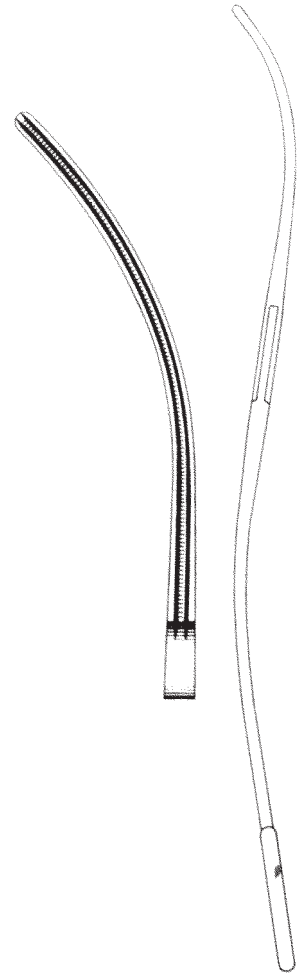

025-495-255 25,5 cm / 10"



BAHNSON-DEBAKEY

025-495-235 - 025-495-255

Klemmen mit DEBAKEY-Zahnung
Clamps with Toothing DEBAKEY
Pinzas-clamps con dentado DEBAKEY
Pinze con dentatura DEBAKEY

ATRAUMA



POTTS

025-500-215 - 025-500-310



025-500-215
21,5 cm / 8½"



025-500-235
23,5 cm / 9¼"



025-500-270
27,0 cm / 10¾"



025-500-310
31,0 cm / 12¼"



POTTS

025-501-210 - 025-501-305



025-501-210
21,0 cm / 8¼"



025-501-230
23,0 cm / 9"



025-501-260
26,0 cm / 10¼"

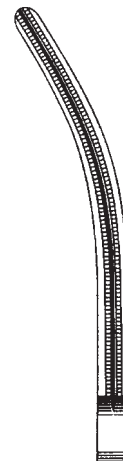

025-501-305
30,5 cm / 12"

ATRAUMA

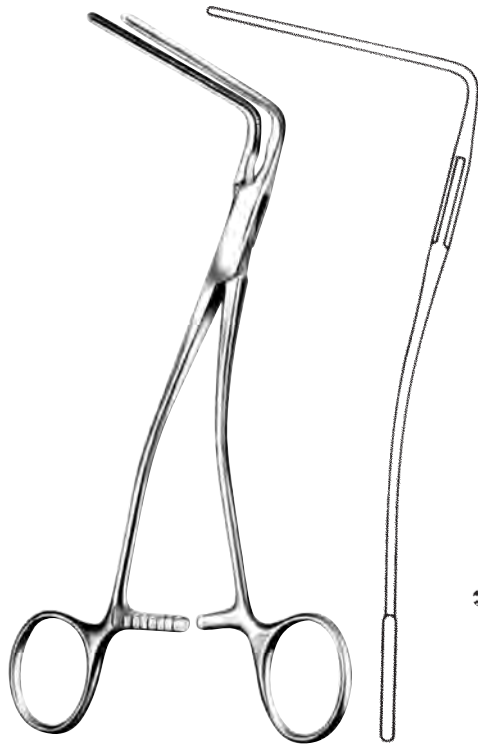

DEBAKEY

025-511-180 - 025-511-255

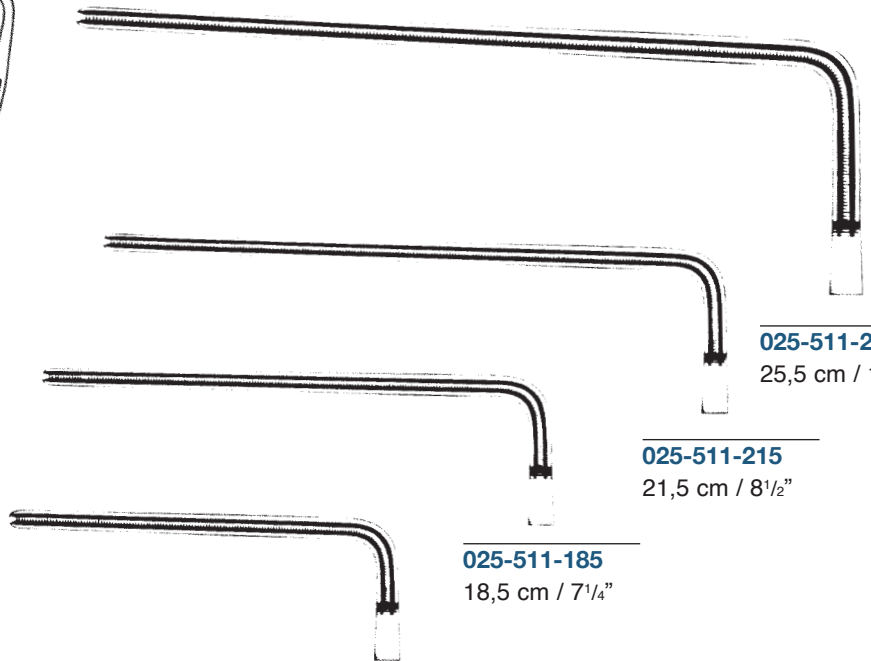

025-511-255
 25,5 cm / 10"

025-511-215
 21,5 cm / 8½"

025-511-185
 18,5 cm / 7¼"

025-511-180
 18,0 cm / 7"



DEBAKEY

025-513-210 - 025-513-310

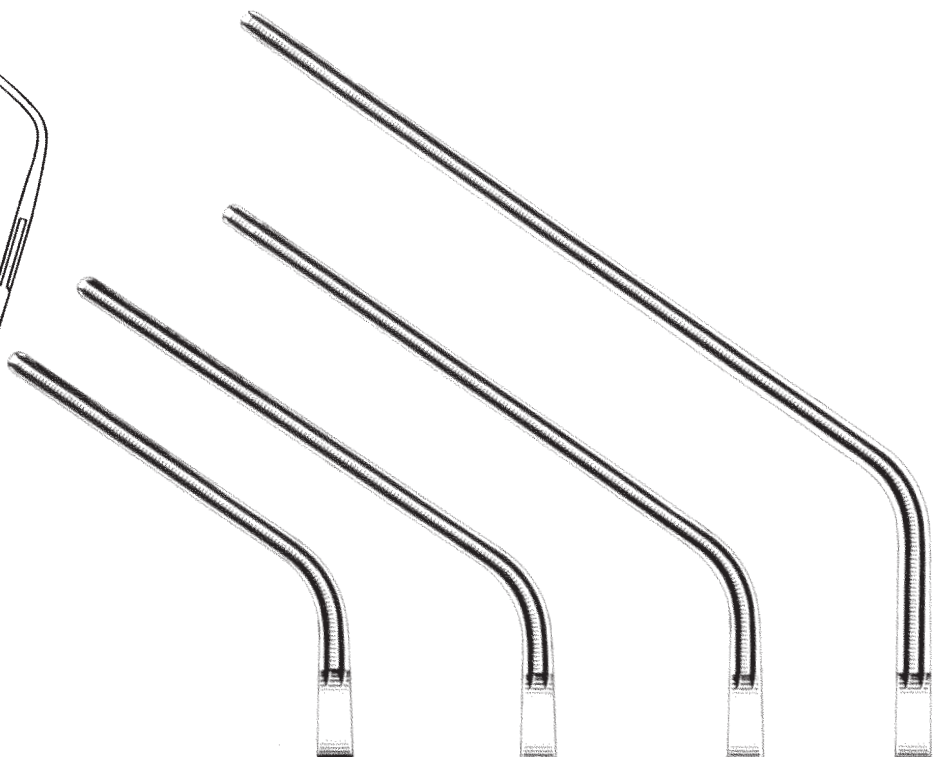

025-513-210
 21,0 cm / 8¼"

025-513-220
 22,0 cm / 8¾"

025-513-260
 26,0 cm / 10¼"

025-513-310
 31,0 cm / 12¼"



025

Klemmen mit DEBAKEY-Zahnung
Clamps with Toothing DEBAKEY
Pinzas-clamps con dentado DEBAKEY
Pinze con dentatura DEBAKEY

ATRAUMA



DEBAKEY
025-520-170 17,0 cm / 6³/₄"

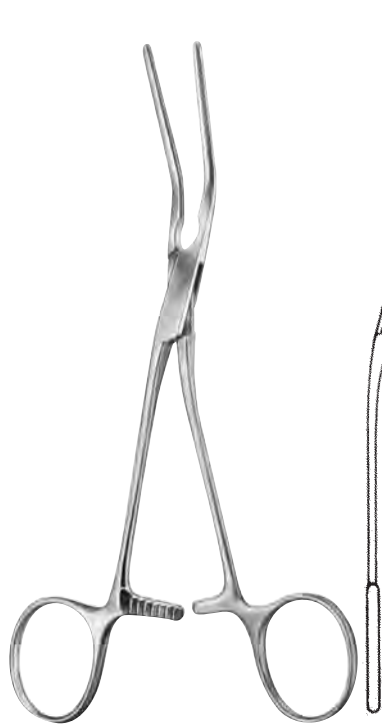

DEBAKEY
025-521-165 16,5 cm / 6¹/₂"



DEBAKEY
025-523-160 16,0 cm / 6¹/₄"



DEBAKEY
025-525-145 14,5 cm / 5³/₄"



DEBAKEY
025-527-165 16,5 cm / 6¹/₂"

ATRAUMA



GLOVER

025-531-170

17,0 cm / 6³/₄"



GLOVER

025-533-175

17,5 cm / 7"



DEBAKEY

025-541-001 - 025-541-002

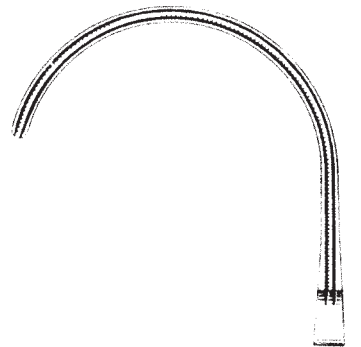

025-541-001

16,5 cm / 6¹/₂"

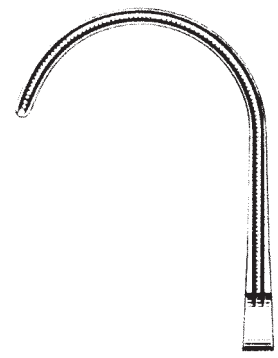

025-541-002

17,0 cm / 6³/₄"



025

Klemmen mit DEBAKEY-Zahnung
Clamps with Toothing DEBAKEY
Pinzas-clamps con dentado DEBAKEY
Pinze con dentatura DEBAKEY

ATRAUMA



DERRA

025-551-165 - 025-551-180

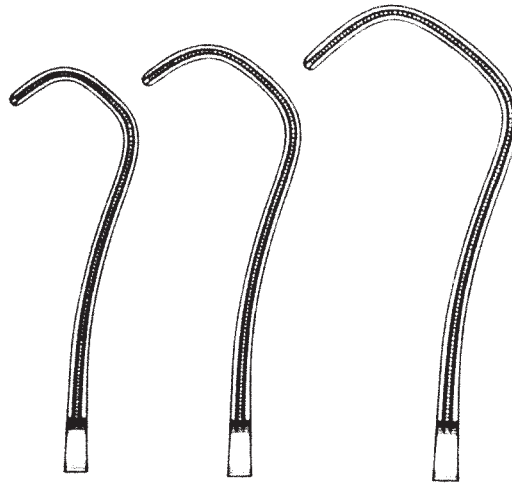

Fig. 1

025-551-165

16,5 cm / 6 1/2"

Fig. 2

025-551-170

17,0 cm / 6 3/4"

Fig. 3

025-551-180

18,0 cm / 7"



BECK

025-561-170 17,0 cm / 6 3/4"

ATRAUMA



OCHSNER

025-571-235

23,5 cm / 9¹/₄"



DIETRICH

025-573-220

22,0 cm / 8³/₄"



025

Klemmen mit DEBAKEY-Zahnung
Clamps with Toothing DEBAKEY
Pinzas-clamps con dentado DEBAKEY
Pinze con dentatura DEBAKEY

ATRAUMA



025-581-140
14,0 cm / 5½"

025-581-160
16,0 cm / 6¼"

025-581-180
18,0 cm / 7"

GREGORY

025-581-140 - 025-581-180

ATRAUMA

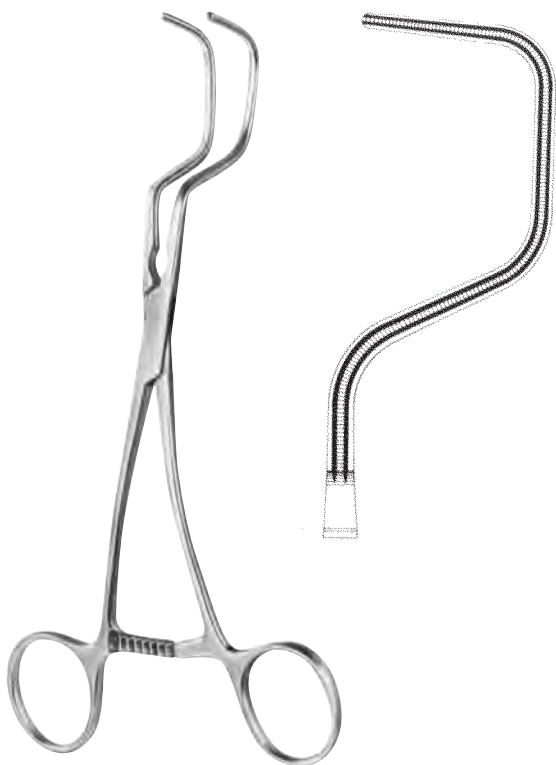

DALE

025-591-180 18,0 cm / 7"

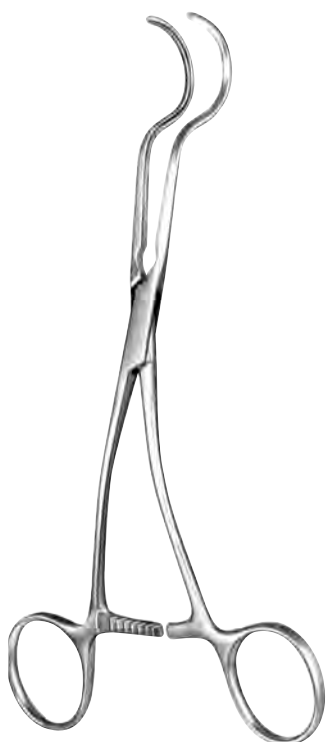

025-593-175
17,5 cm / 6³/₄"

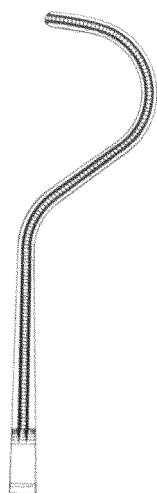

025-593-180
18,0 cm / 7"

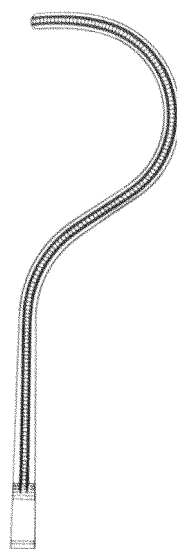

025-593-190
19,0 cm / 7¹/₂"

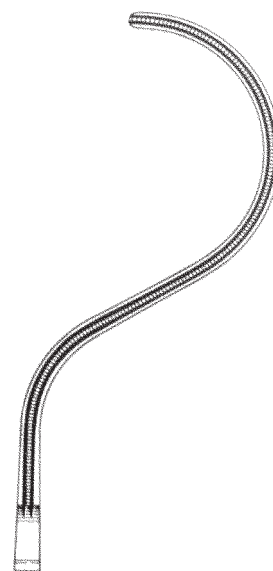

DALE

025-593-175 - 025-593-190



025

Klemmen mit DEBAKEY-Zahnung
Clamps with Toothing DEBAKEY
Pinzas-clamps con dentado DEBAKEY
Pinze con dentatura DEBAKEY

ATRAUMA

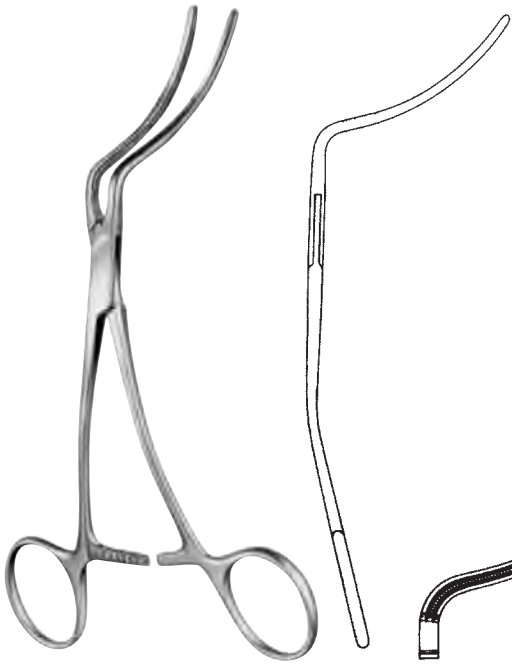

MARTIN

025-601-160

16,0 cm / 6¼"

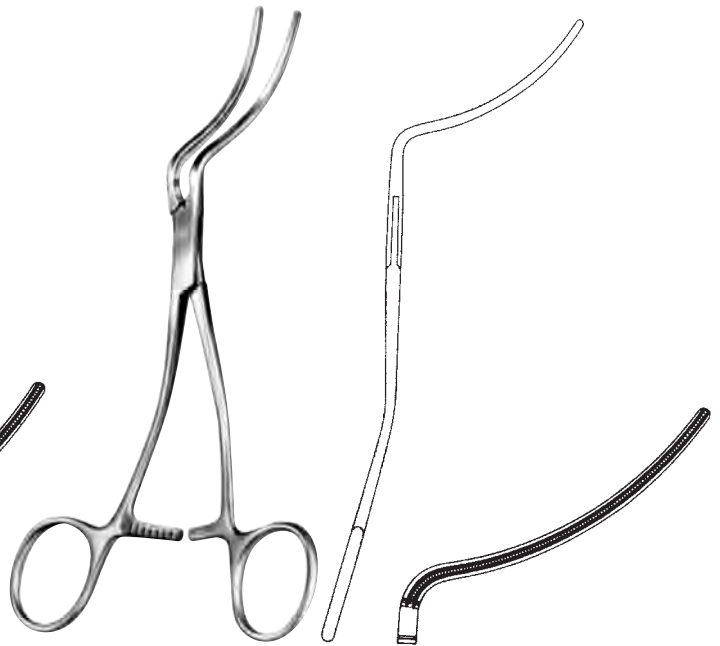

MARTIN

025-601-165

16,5 cm / 6½"



MARTIN

025-601-180

18,0 cm / 7"



MARTIN

025-601-195

19,5 cm / 7¾"

ATRAUMA



HUSFELDT

025-611-175

17,5 cm / 7"



HUSFELDT

025-613-180

18,0 cm / 7"



HUSFELDT

025-615-170

17,0 cm / 6³/₄"



025

Klemmen mit DEBAKEY-Zahnung
Clamps with Toothing DEBAKEY
Pinzas-clamps con dentado DEBAKEY
Pinze con dentatura DEBAKEY

ATRAUMA

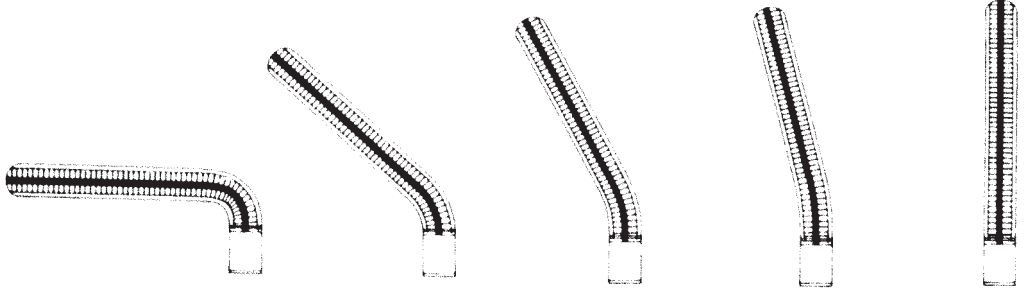

025-621-090 15,0 cm / 5 1/2" 90°	025-621-045 15,0 cm / 5 1/2" 45°	025-621-030 15,0 cm / 5 1/2" 30°	025-621-015 15,0 cm / 5 1/2" 15°	025-622-150 15,0 cm / 5 1/2"
---	---	---	---	--

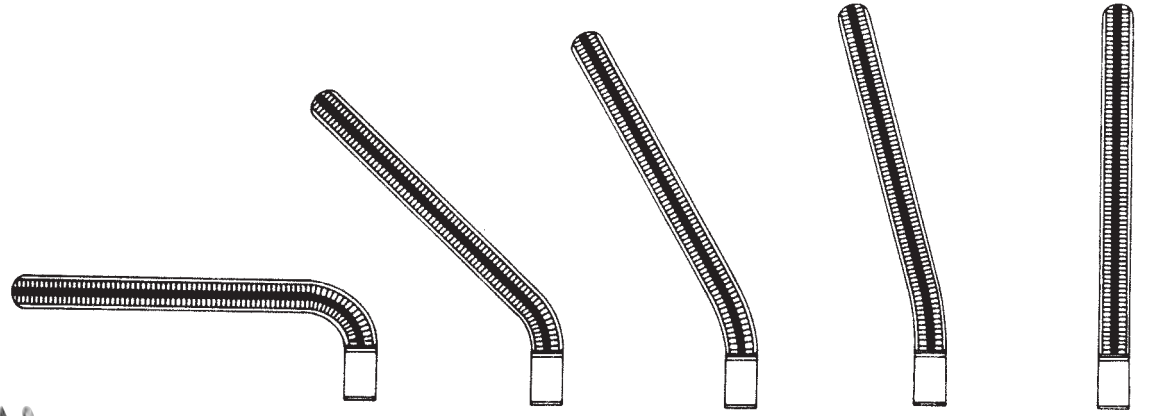

025-623-090 17,0 cm / 6 1/2" 90°	025-623-045 17,0 cm / 6 1/2" 45°	025-623-030 17,0 cm / 6 1/2" 30°	025-623-015 17,0 cm / 6 1/2" 15°	025-624-170 17,0 cm / 6 1/2"
---	---	---	---	--



DARDIK

025-621-090 - 025-622-150	15,0 cm / 5 1/2"
025-623-090 - 025-624-170	17,0 cm / 6 1/2"

ATRAUMA

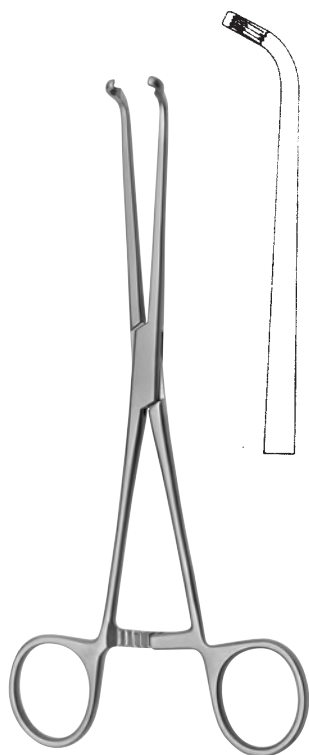

JAVID
025-631-175 17,5 cm / 7"

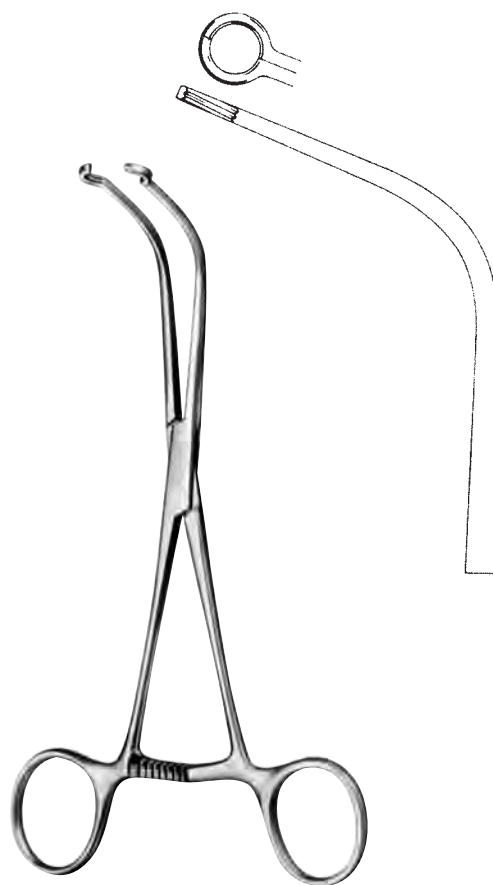

JAVID
025-633-190 19,0 cm / 7½"



025

Klemmen mit DEBAKEY-Zahnung
Clamps with Toothing DEBAKEY
Pinzas-clamps con dentado DEBAKEY
Pinze con dentatura DEBAKEY

ATRAUMA



135°

SUBRAMANIAN-MINIATURE

025-651-155 15,5 cm / 6"

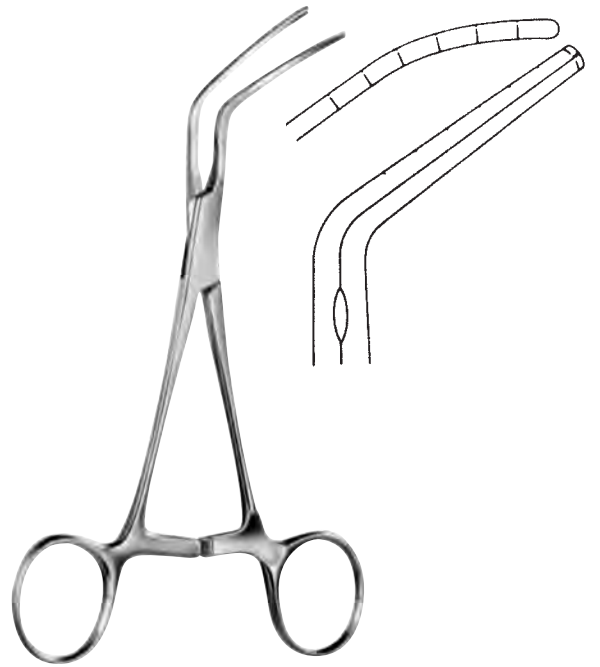

SUBRAMANIAN

025-653-160 16,0 cm / 6 1/4"

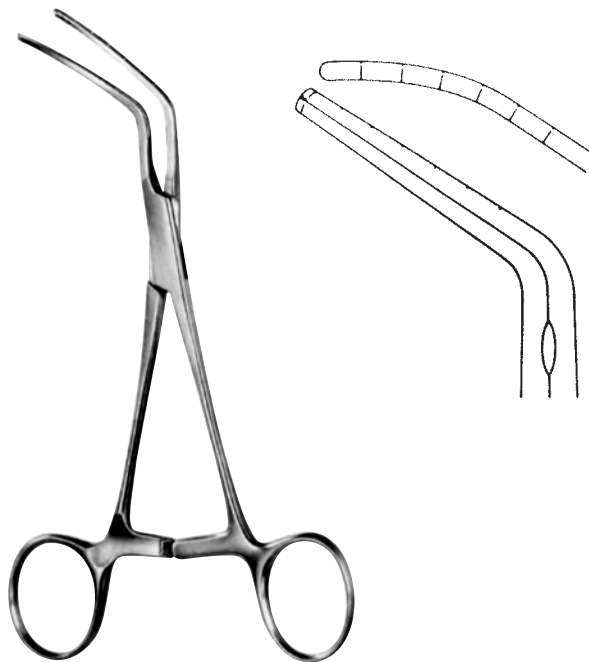

SUBRAMANIAN

025-655-160 16,0 cm / 6 1/4"

ATRAUMA



COOLEY

025-700-170 17,0 cm / 6³/₄"



COOLEY

025-701-220 22,0 cm / 8³/₄"



COOLEY

025-703-200 20,0 cm / 8"



025

Klemmen mit COOLEY-Zahnung
Clamps with Toothing COOLEY
Pinzas con dentado COOLEY
Pinze con dentatura COOLEY

ATRAUMA

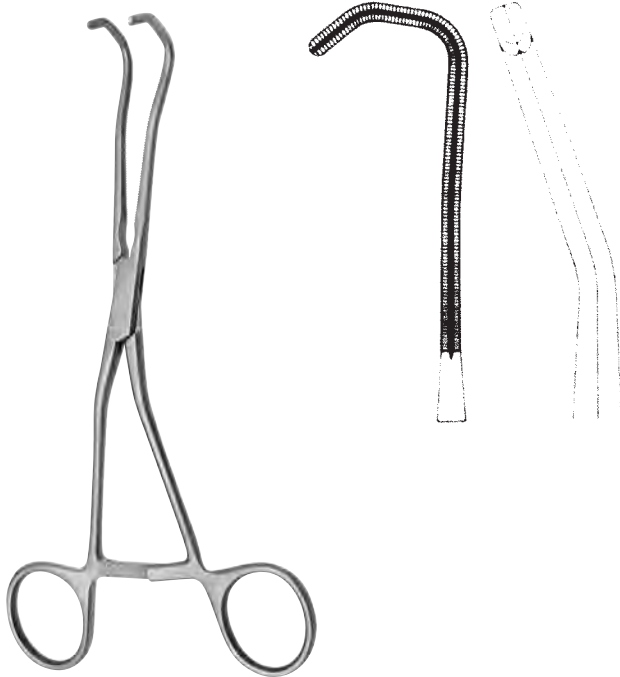

COOLEY

025-711-170

17,0 cm / 6³/₄"



COOLEY

025-713-160

16,0 cm / 6¹/₄"



COOLEY

025-721-140

14,0 cm / 5¹/₂"



COOLEY

025-721-160

16,0 cm / 6¹/₄"

ATRAUMA

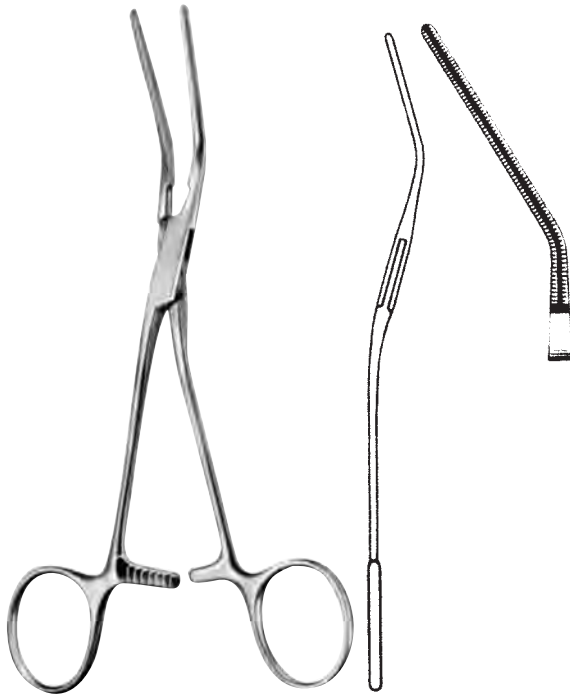

COOLEY
025-721-170 17,0 cm / 6³/₄"



COOLEY
025-723-170 17,0 cm / 6³/₄"



COOLEY
025-725-170 17,0 cm / 6³/₄"



025

Klemmen mit COOLEY-Zahnung
Clamps with Toothing COOLEY
Pinzas con dentado COOLEY
Pinze con dentatura COOLEY

ATRAUMA



COOLEY

025-727-175

17,5 cm / 7"

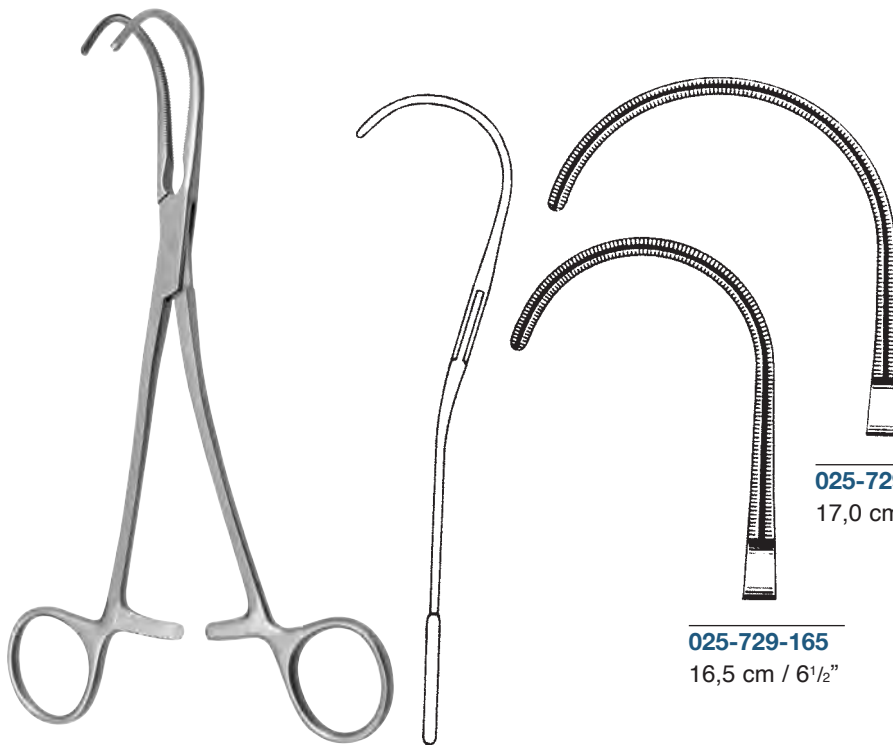

025-729-170

17,0 cm / 6³/₄"

025-729-165

16,5 cm / 6¹/₂"

COOLEY

025-729-165 - 025-729-170

ATRAUMA

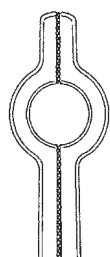

025-741-001
16,0 cm / 6¹/₄"
24 Charr.

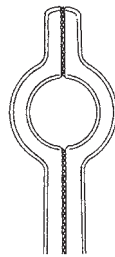

025-741-002
16,0 cm / 6¹/₄"
26 Charr.

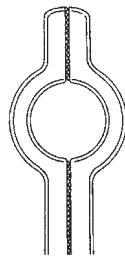

025-741-003
20,0 cm / 8"
28 Charr.

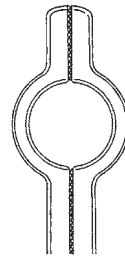

025-741-004
20,0 cm / 8"
30 Charr.

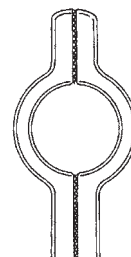

025-741-005
20,0 cm / 8"
32 Charr.

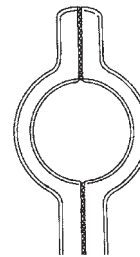

025-741-007
20,0 cm / 8"
36 Charr.

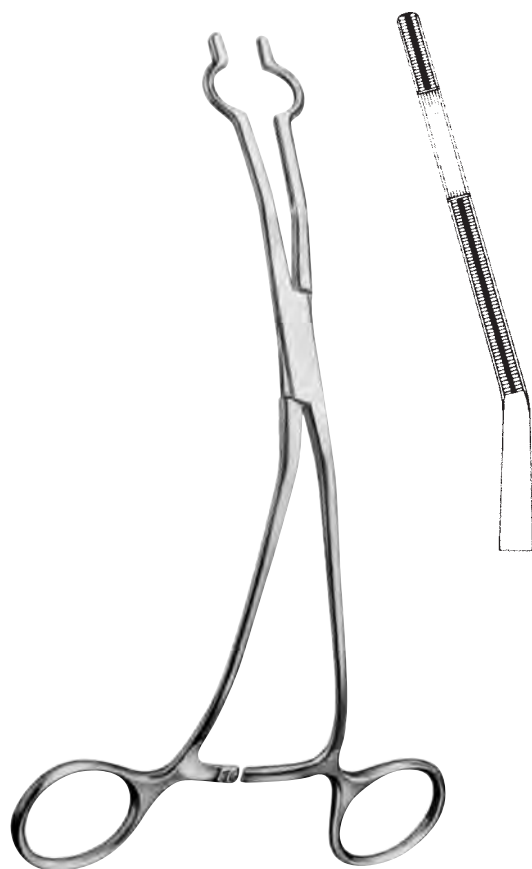

COOLEY

025-741-001 - 025-741-007



025

Klemmen mit COOLEY-Zahnung
Clamps with Toothing COOLEY
Pinzas con dentado COOLEY
Pinze con dentatura COOLEY

ATRAUMA

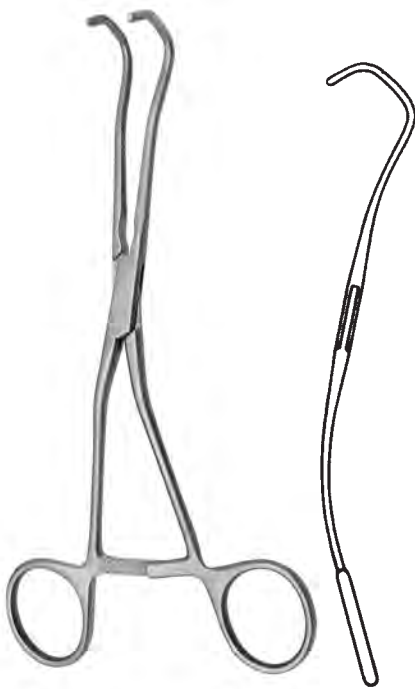

COOLEY-DERRA

025-751-165 - 025-751-175

025-751-165
16,5 cm / 6 $\frac{1}{2}$ "

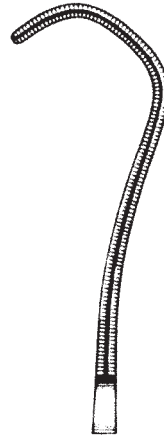

025-751-170
17,0 cm / 6 $\frac{3}{4}$ "

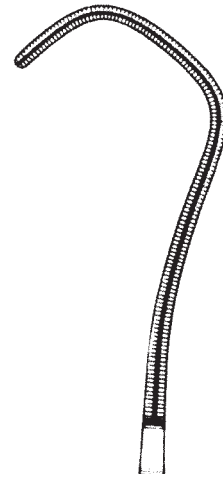

025-751-175
17,5 cm / 7"



COOLEY-BECK

025-761-170 17,0 cm / 6 $\frac{3}{4}$ "

ATRAUMA



DEBAKEY
 025-800-130 13,0 cm / 5"

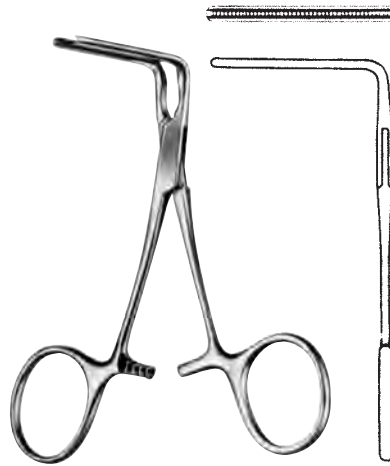

DEBAKEY
 025-801-100 10,0 cm / 4"

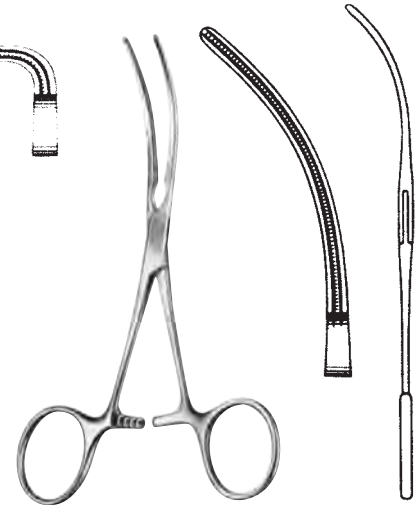

DEBAKEY
 025-803-125 12,5 cm / 5"



DEBAKEY
 025-805-125 12,5 cm / 5"



DEBAKEY
 025-807-125 12,5 cm / 5"



025

Klemmen mit COOLEY-Zahnung
Clamps with Toothing COOLEY
Pinzas con dentado COOLEY
Pinze con dentatura COOLEY

ATRAUMA

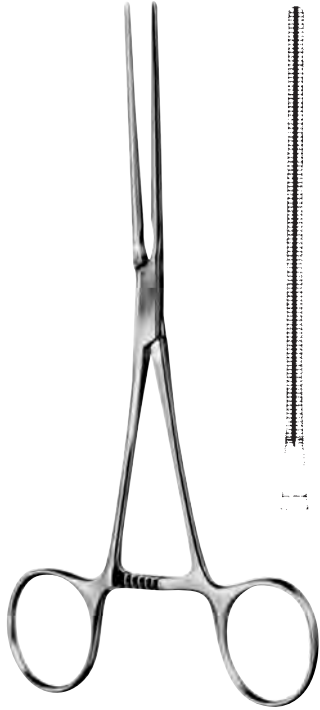

COOLEY
025-820-165

16,5 cm / 6 1/2"



COOLEY
025-821-160

16,0 cm / 6 1/4"

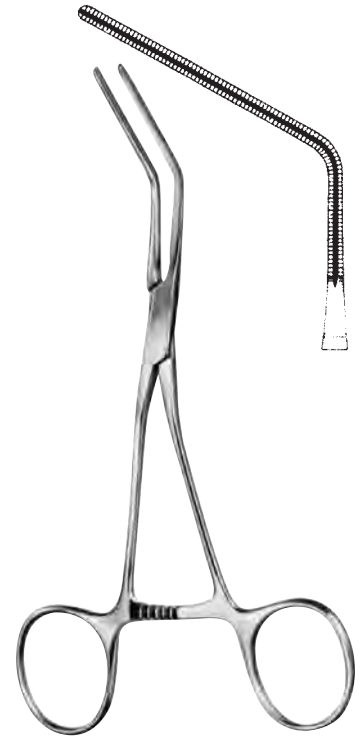

COOLEY
025-823-155

15,5 cm / 6"



COOLEY
025-825-155

15,5 cm / 6"

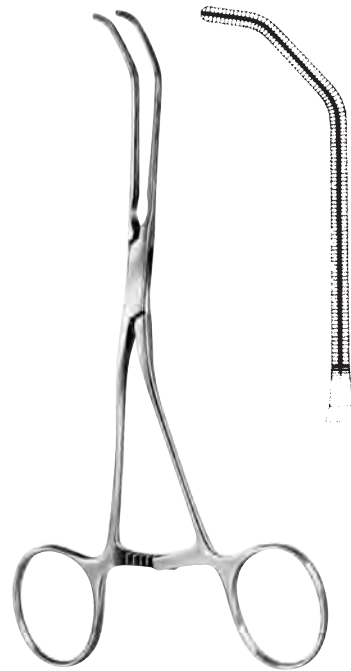

COOLEY
025-827-160

16,0 cm / 6 1/4"

ATRAUMA



025-830-140



025-831-140

COOLEY

025-830-140 - 025-831-140 14,0 cm / 5 1/2"

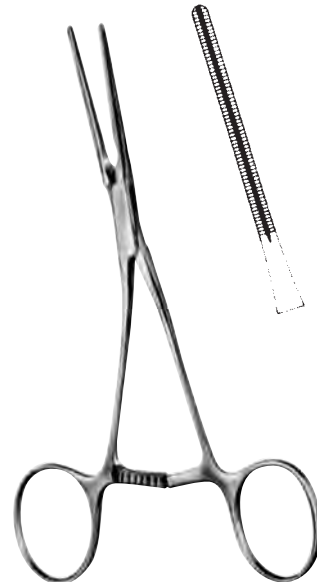

COOLEY

025-833-140 14,0 cm / 5 1/2"



COOLEY

025-835-140 14,0 cm / 5 1/2"



COOLEY

025-837-140 14,0 cm / 5 1/2"



025

Klemmen mit COOLEY-Zahnung
Clamps with Toothing COOLEY
Pinzas con dentado COOLEY
Pinze con dentatura COOLEY

ATRAUMA



Fig.1
025-840-001
13,5 cm / 5¼"

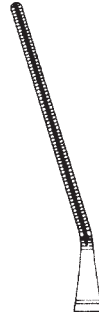

Fig.2
025-840-002
13,5 cm / 5¼"

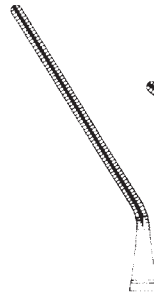

Fig.3
025-840-003
14,0 cm / 5½"

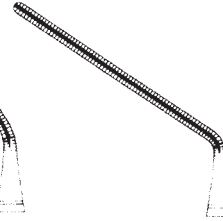

Fig.4
025-840-004
13,5 cm / 5¼"



Fig.5
025-840-005
13,5 cm / 5¼"

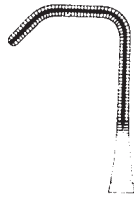

Fig.6
025-840-006
12,5 cm / 5"

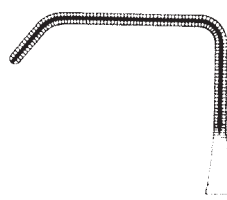

Fig.7
025-840-007
13,0 cm / 5"

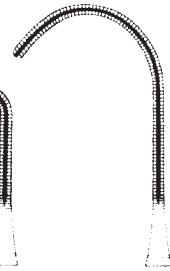

Fig.8
025-840-008
13,5 cm / 5¼"



Fig.9
025-840-009
13,0 cm / 5"



COOLEY

025-840-001 - 025-840-009

Klemmen mit CASTA—EDA-Zahnung
Clamps with Toothing CASTA—EDA
Pinzas con dentado CASTA—EDA
Pinze con dentatura CASTA—EDA



025

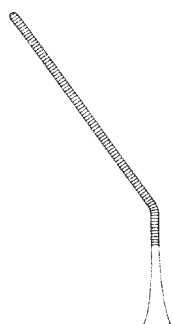

Fig.1
025-851-001
 12,5 cm / 5"

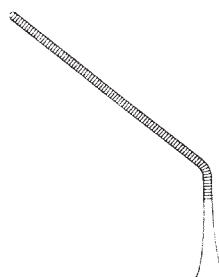

Fig.2
025-851-002
 11,5 cm / 4½"



Fig.3
025-851-003
 11,0 cm / 4¼"

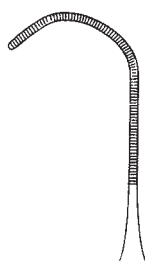

Fig.1
025-853-001
 11,5 cm / 4½"

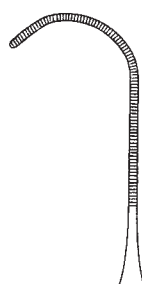

Fig.2
025-853-002
 12,0 cm / 4¾"



Fig.3
025-853-003
 12,0 cm / 4¾"

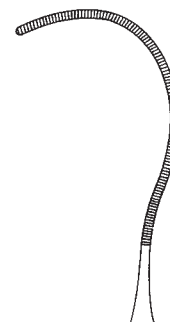

Fig.4
025-853-004
 12,0 cm / 4¾"



CASTAÑEDA
 025-851-001 - 025-853-004



025

**Dilatatoren
Dilators
Dilatadores
Dilatatori**

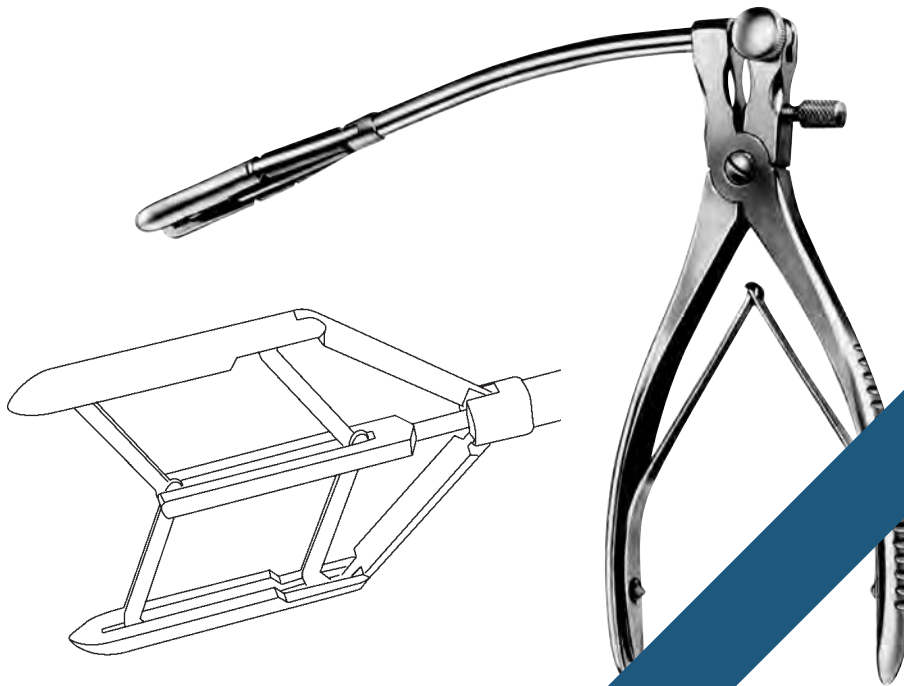

für Mitralstenosen
for mitral stenosis
para estenosis mitral
per stenosi mitrali

Spreizweite 8-42 mm, mit Feststellschraube
spreading 8-42 mm, with foxatopm screw
abertura 8-42 mm, con tornillo de ajuste
apertura totale 8-42 mm, con vite di fissazione

TUBBS

025-901-000

discontinued item

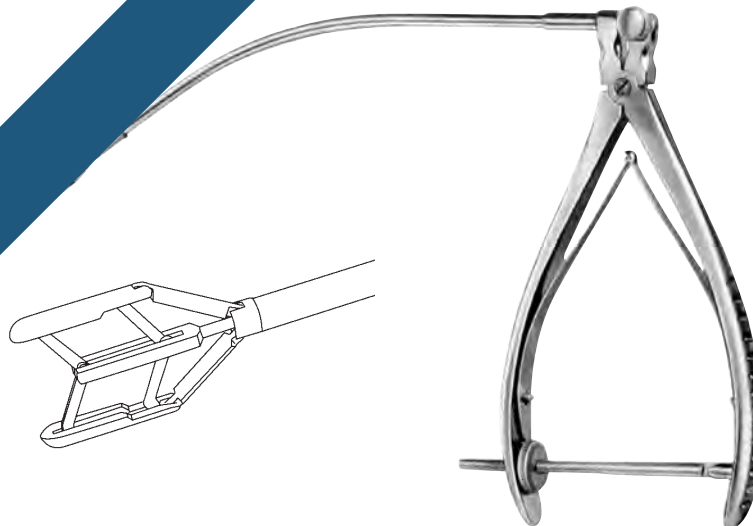

für Mitralstenosen
for mitral stenosis
para estenosis mitral
per stenosi mitrali

Spreizweite 8-15 mm, mit Gewindesperre
spreading 8-15 mm, with thread fixation
abertura 8-15 mm, con fijación de rosca
apertura totale 8-15 mm, con fissazione a filettatura

COOLEY

025-903-000

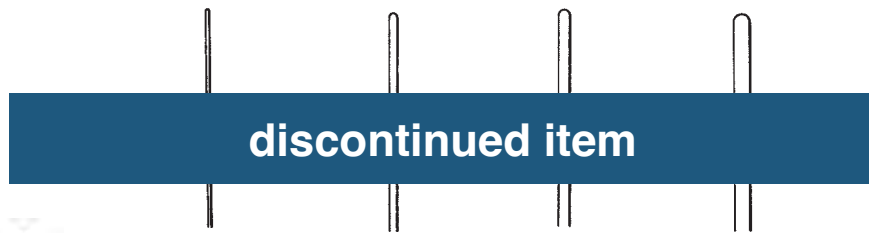

025-910-005 0,5 mm Ø	025-910-010 1,0 mm Ø	025-910-015 1,5 mm Ø	025-910-020 2,0 mm Ø
--------------------------------	--------------------------------	--------------------------------	--------------------------------

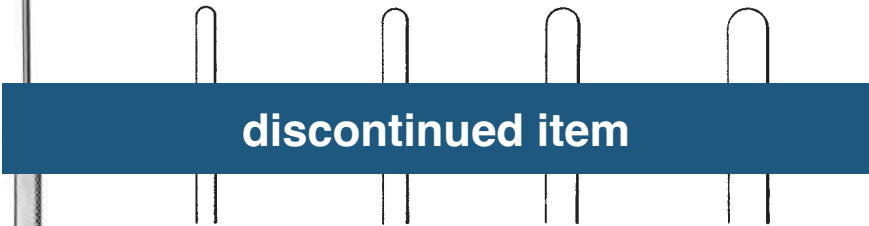

025-910-025 2,5 mm Ø	025-910-030 3,0 mm Ø	025-910-040 4,0 mm Ø	025-910-050 5,0 mm Ø
--------------------------------	--------------------------------	--------------------------------	--------------------------------

COOLEY

025-910-005 - 025-910-050 13,0 cm / 5"

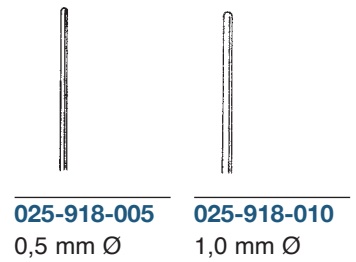

025-918-005 0,5 mm Ø	025-918-010 1,0 mm Ø
--------------------------------	--------------------------------



025-918-015 1,5 mm Ø	025-918-020 2,0 mm Ø
--------------------------------	--------------------------------

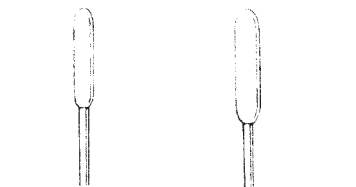

025-918-025 2,5 mm Ø	025-918-030 3,0 mm Ø
--------------------------------	--------------------------------

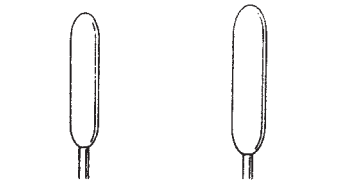

025-918-035 3,5 mm Ø	025-918-040 4,0 mm Ø
--------------------------------	--------------------------------

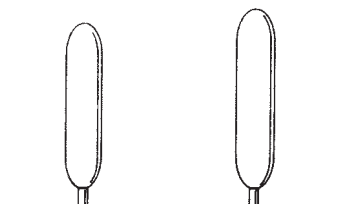

025-918-045 4,5 mm Ø	025-918-050 5,0 mm Ø
--------------------------------	--------------------------------

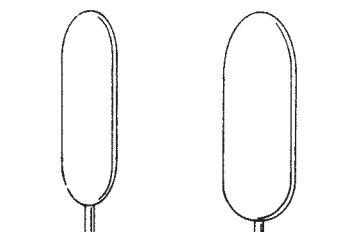

025-918-070 7,0 mm Ø	025-918-090 9,0 mm Ø
--------------------------------	--------------------------------

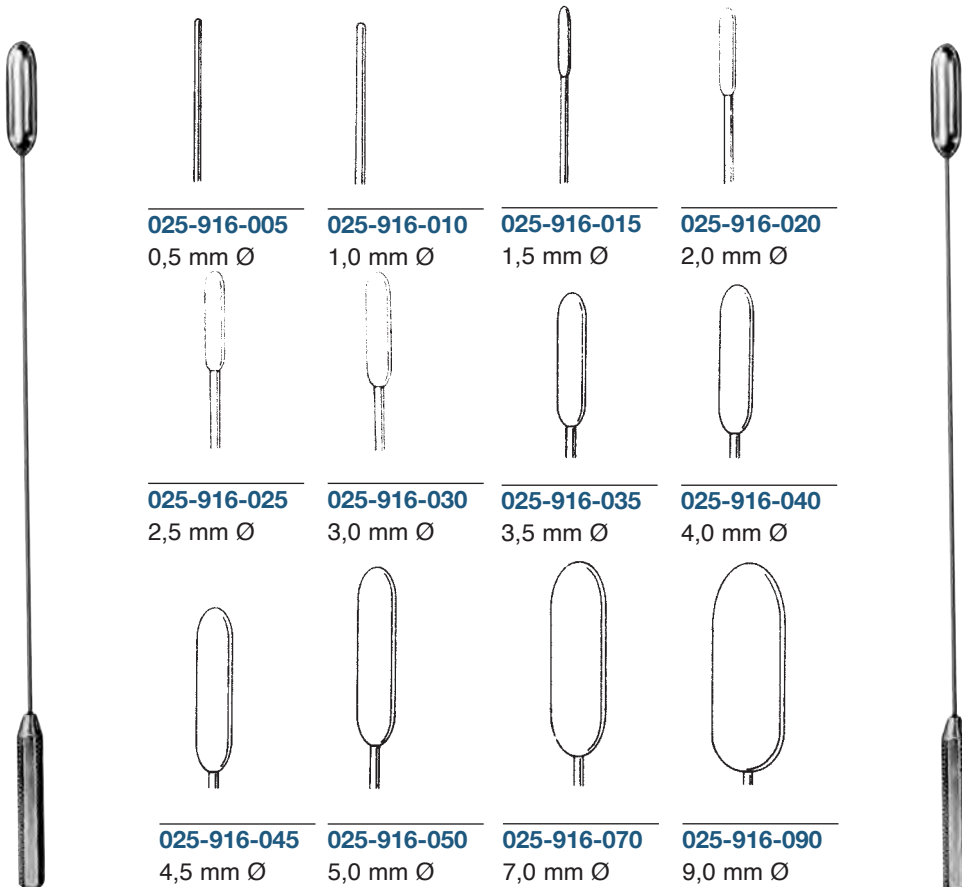

025-916-005 0,5 mm Ø	025-916-010 1,0 mm Ø	025-916-015 1,5 mm Ø	025-916-020 2,0 mm Ø
--------------------------------	--------------------------------	--------------------------------	--------------------------------

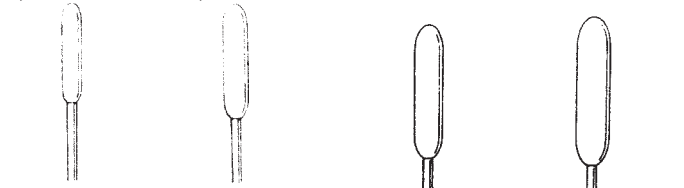

025-916-025 2,5 mm Ø	025-916-030 3,0 mm Ø	025-916-035 3,5 mm Ø	025-916-040 4,0 mm Ø
--------------------------------	--------------------------------	--------------------------------	--------------------------------

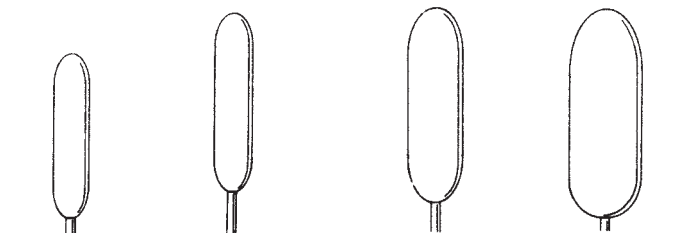

025-916-045 4,5 mm Ø	025-916-050 5,0 mm Ø	025-916-070 7,0 mm Ø	025-916-090 9,0 mm Ø
--------------------------------	--------------------------------	--------------------------------	--------------------------------

DEBAKEY

025-916-005 - 025-916-090 19,0 cm / 7 1/2"

DEBAKEY

025-918-005 - 025-918-090 35,0 cm / 13 3/4"



025

Tunnelier-Set
Tunneling Set
Juego para tunelar
Set per tunnelare



Tunnelierschäfte
Tunneling Shafts
Vástagos para tunelar
Gambi per tunnelare

gebogen
curved
curva
curvo

gerade
straight
recto
diritto

gebogen
curved
curva
curvo

discontinued item

MARTIN

025-920-000

Satz komplett mit 3 Schäften, 2 Griffen und 12 Aufsätzen im Lagerungsbehälter
complete set with 3 shafts, 2 handles and 12 tips in storage case

juego completo con 3 vástagos, 2 manijas y 12 Cabezas en caja metálica

Set completo, con 3 gambi, 2 maniglie e 12 raccordi in contenitore metallico

025-920-001

Halteplatte für Tunnelierschäfte
Plate for Tunneling Shafts
Soporte para vástagos
Supporto per gambi

025-920-002

Lagerungsbehälter
Storage Case
Caja metálica
Contenitore metallico

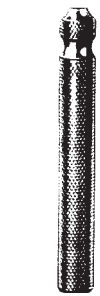

025-921-001
12,5 cm / 5"

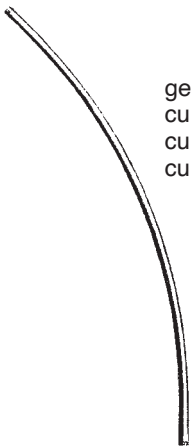

025-922-002
24,5 cm



025-922-003
24,5 cm



025-922-006
6,0 mm Ø
Schraubolive
Screw Olive
Oliva
Oliva



025-922-008
8,0 mm Ø
Schraubolive
Screw Olive
Oliva
Oliva



025-922-020

Schraubadapter für Venen
Vein Tip
Cabeza para venas
Tata adattatore veni

mit Knopf, Luer-Lock Ansatz
with button, Luer Lock cone
con botón, cono Luer-Lock
con bottone, cono Luer-Lock



025-922-022

Luer-Schraubadapter
Luer Adaptor
Adaptador Luer
Adattatore Luer

Luer-Lock Ansatz
Luer-Lock cone
cono Luer-Lock
cono Luer-Lock



025-922-030

Schraubenschlüssel
Wrench
Llave horquilla
Giravite

10,0 cm / 4"



025-922-004

Tunnelierschaft
Tunneling Shaft
Vástago para tunelar
Gambo per tunnelare

gebogen
curved
curvo
curvo



025-922-010
10,0 mm Ø
Schraubolive
Screw Olive
Oliva
Oliva



025-922-012
12,0 mm Ø
Schraubolive
Screw Olive
Oliva
Oliva

Intimaspatel, Gefäßdissektoren
Intima Spatulas, Vascular Dissectors
Espátulas para la íntima, Disecadores vasculares
Spatole per intima, Dissettori vascolari



025

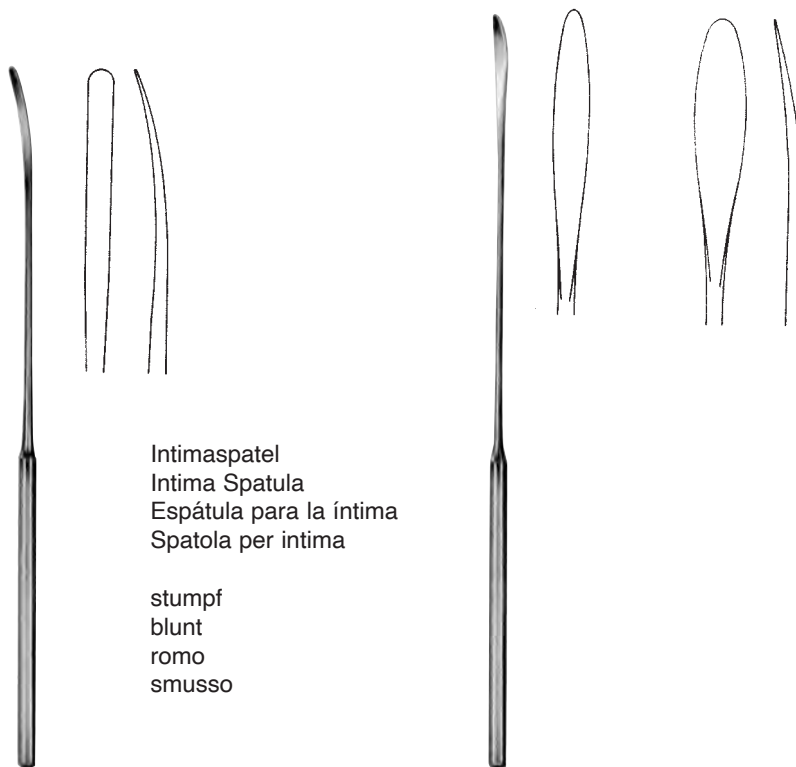

Intimaspatel
Intima Spatula
Espátula para la íntima
Spatola per intima

stumpf
blunt
romo
smusso

025-941-185 18,5 cm / 7¹/₄"
025-941-215 21,5 cm / 8¹/₂"

025-943-140 14,0 cm / 5¹/₂"
025-943-235 23,5 cm / 9¹/₄"



025

Intimaspatel, Gefäßdissektoren
Intima Spatulas, Vascular Dissectors
Espátulas para la íntima, Disecadores vasculares
Spatole per intima, Dissettori vascolari

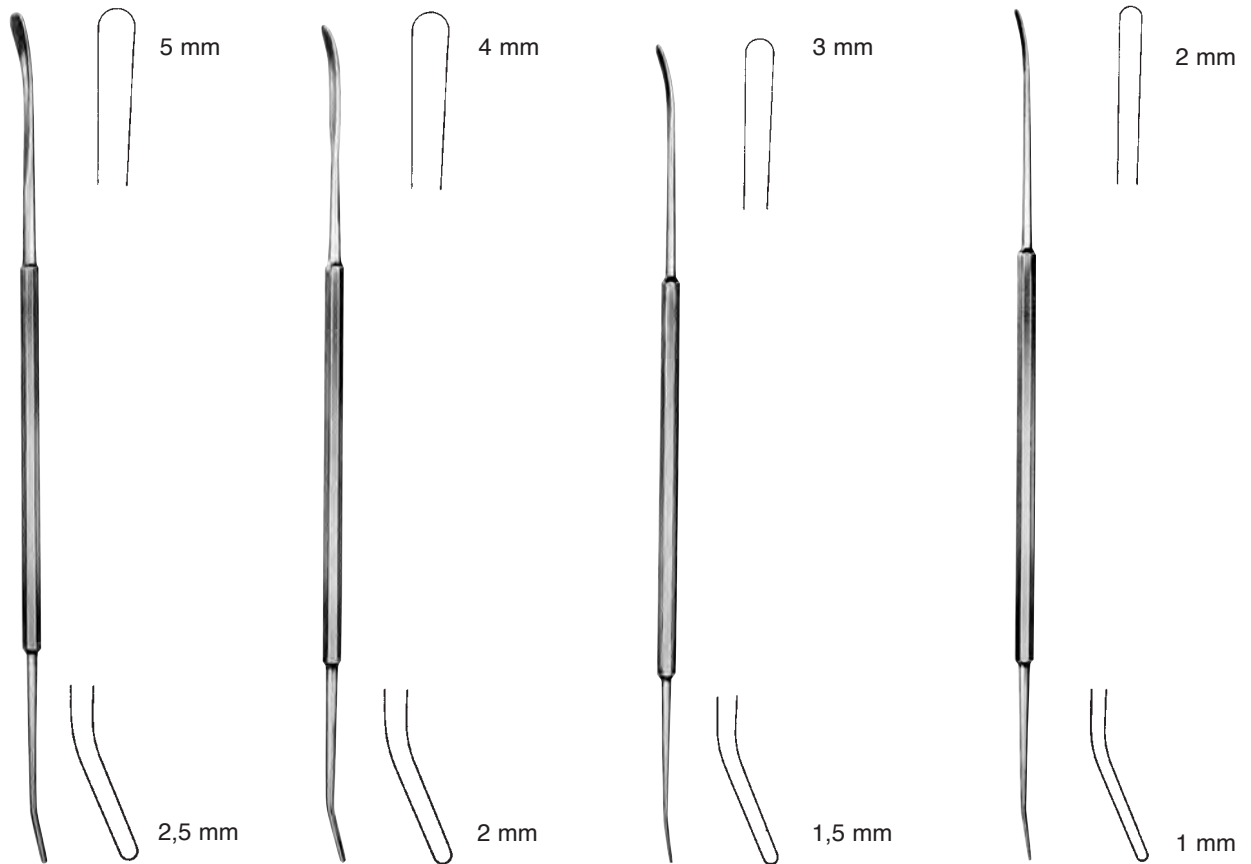

ROBB

025-945-001 24,0 cm / 9½"
Fig. 1

ROBB

025-945-002 24,0 cm / 9½"
Fig. 2

ROBB

025-945-003 24,0 cm / 9½"
Fig. 3

ROBB

025-945-004 24,0 cm / 9½"
Fig. 4

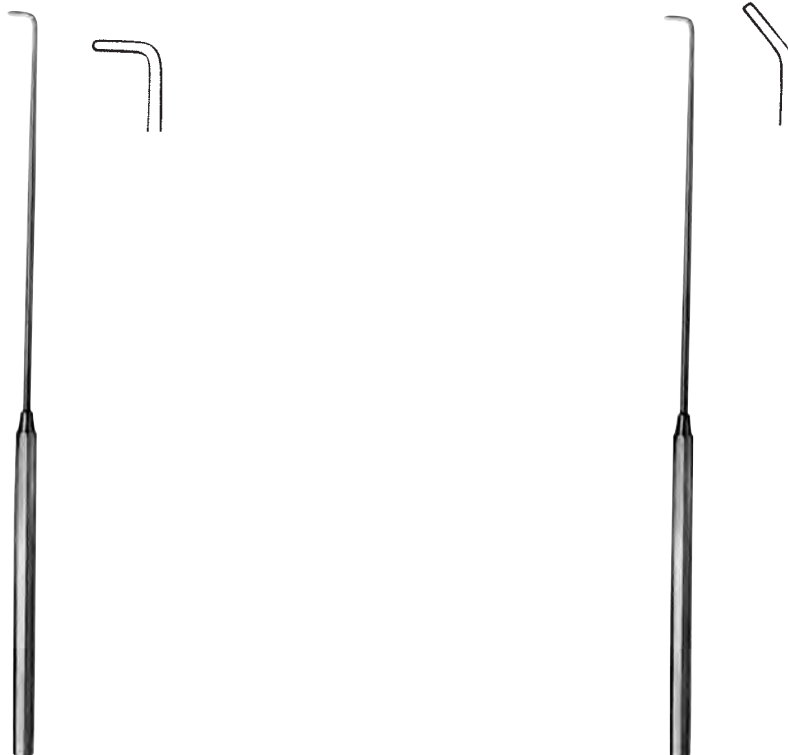

CRILE

025-947-200 20,0 cm / 8"

CRILE

025-949-205 20,5 cm / 10¼"

Nervhäkchen, Tourniquets
Nerve Hooklets, Tourniquets
Ganchitos para nervios, Tourniquetes
Uncini per nerve, Tornichetti



025



025-960-015
1,5 mm



025-960-020
2,0 mm



025-960-025
2,5 mm



025-960-030
3,0 mm



RUMEL-BELMONT

025-970-270 27,0 cm / 10³/₄" 3,2 mm Ø
025-970-330 33,0 cm / 13" 6,4 mm Ø

025-960-015 - 025-960-030 26,0 cm / 10"



025



026

Neurochirurgie,
Laminektomie
Neurosurgery,
Laminectomy
Neurocirugía,
Laminectomía
Neurochirurgia,
Laminectomia

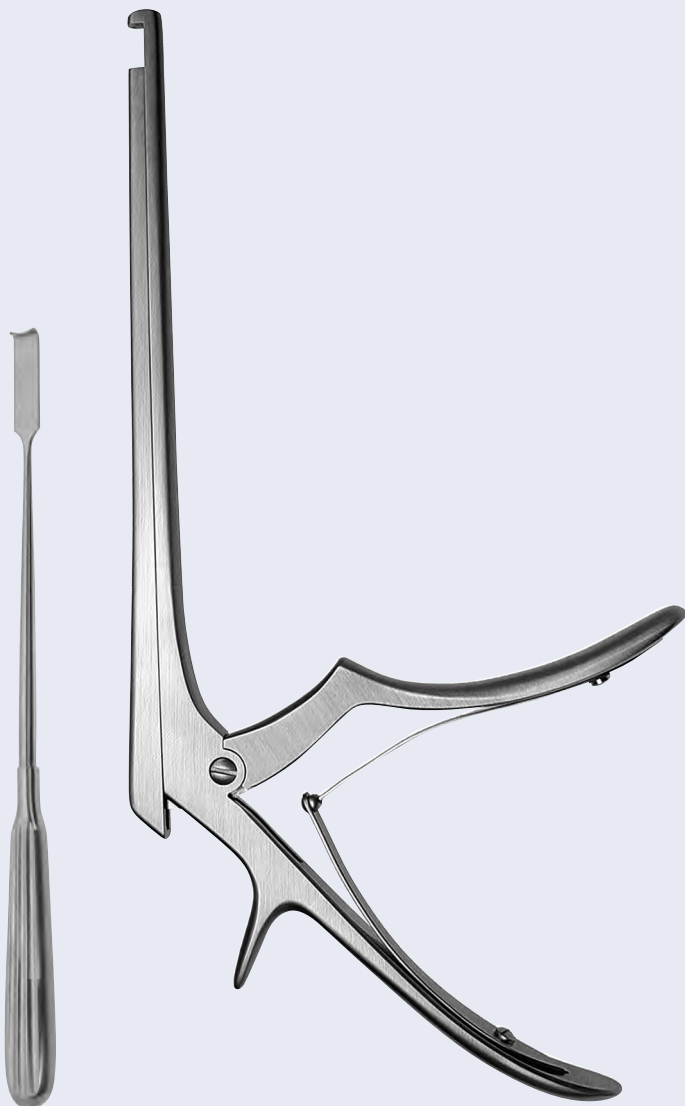

Instrumente zur Schädelöffnung
Instruments for cranial Opening
Instrumentos para apertura craneana
Strumenti per apertura del cranio

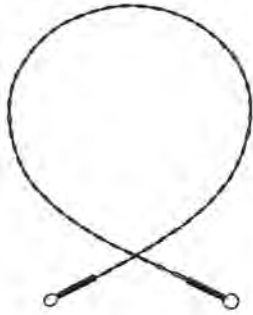

2-teilig
 2 wires twisted
 2 vueltas de hilo
 2-girate

OLIVECRONA

- 026-010-300 30,0 cm / 12"
- 026-010-400 40,0 cm / 16"
- 026-010-500 50,0 cm / 20"
- 026-010-600 60,0 cm / 24"
- 026-010-700 70,0 cm / 28"

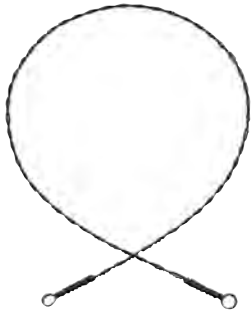

fein, 6-teilig
 fine, 6 wires twisted
 fina, 6 vueltas de hilo
 fino, 6-girate

GIGLIW

- 026-014-300 30,0 cm / 12"
- 026-014-400 40,0 cm / 16"
- 026-014-500 50,0 cm / 20"



GIGLI

- 026-015-007 7,0 cm / 2 1/4"

Einführungsinstrument für Drahtsägen
 Conductor for wire saws
 Conductor para sierras de hilo
 Introduttore per fili per sega



DE MARTEL

- 026-020-330 33,0 cm / 13"

Schädelhalter
Cervical Traction Tongs
Estribos de tracción craneal
Pinze per trazione craniale



026

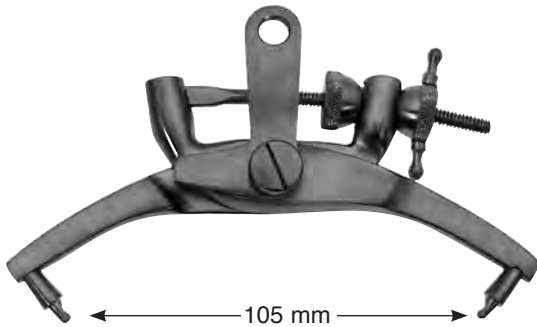

CRUTCHFIELD
026-030-105

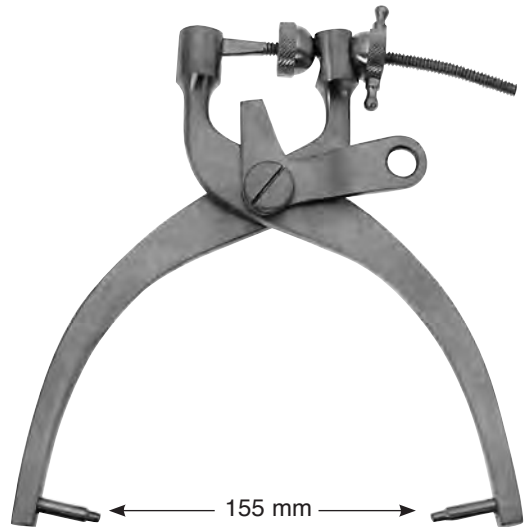

CRUTCHFIELD
026-030-155



CRUTCHFIELD
026-032-035 Ø 3,5 mm



CRUTCHFIELD
026-032-050 Ø 5,0 mm

Vorböhrer für CRUTCHFIELD-Schädelhalter
 Drill point for CRUTCHFIELD cervical traction tongs
 Perforador inicial para pinzas de tracción craneal CRUTCHFIELD
 Alesatore per pinze per trazione craniale di CRUTCHFIELD



026-035-001
 Ersatzdorn
 Spare pin
 Espina de repuesto
 Punta di ricambio

026-034-175

Schädelhalter für Extension der Halswirbel,
 großes Modell, Dorne verstellbar, deshalb
 Vorbohren nicht erforderlich

Cervical traction tongs, for extension of the
 neck vertebrae, large size, pins adjustable
 hence no initial drilling

Pinza de tracción craneal para la extensión
 de las vertebrae de cuello, tamaño grande,
 puntas ajustables suprimiendo perforaciones
 iniciales

Pinza per trazione craniale e l'estensione delle
 vertebre del collo, modello grande, punte
 regolabili al fine di evitare la perforazione iniziale

Schädelstanzen
Cranial Rongeur Forceps
Pinzas sacabocados craneales
Pinze per ossa del cranio



DAHLGREN
026-040-200 20,0 cm / 8"



026-041-001

Schädelstanze
 Cranial rongeur
 Pinza saca-bocado craneal
 Pinza per cranio

Schädelstanzzange
 Cranial punch rongeur
 Pinza saca-bocados craneal
 Pinza per cranio



CONE
026-048-225 22,5 cm / 9"



DE VILBISS
026-044-210 21,0 cm / 8 1/4"

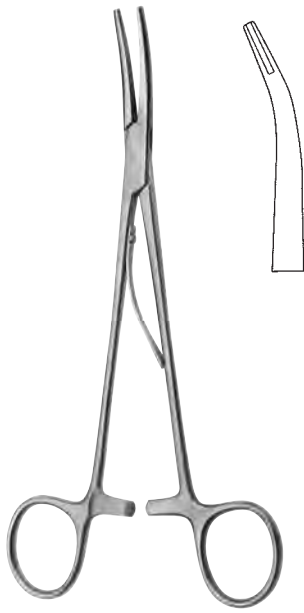

Fig. 4
026-045-004



Fig. 5
026-045-005

Schädelstanze
 Cranial rongeur
 Pinza saca-bocado craneal
 Pinza per cranio



MC KENZIE

026-051-155 15,5 cm / 6"
026-051-185 18,5 cm / 7 1/4"

Klammer-Anlegezange für Silberklammern
 Clip applying forceps for silver clips
 Pinza para aplicar las grapas de plata
 Pinza per applicare le agrafe in argento

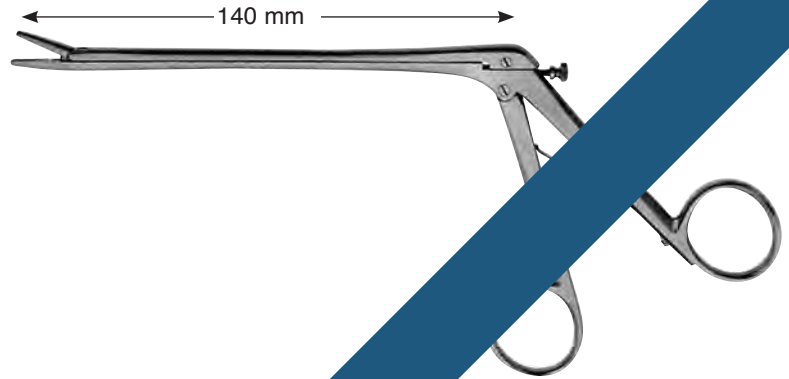

LIVECRONA-TOENNIS

026-052-140

discontinued item



MC KENZIE

026-054-001 166 mm

Klammerblock mit Klammernbügel und
 1 Schieber
 Silver clips with 1 clip holding rack and
 1 sliding cover
 Blocco grapas con 1 riel para grapas y
 1 cubierta deslizante
 Gruppo porta-agrafe, con 1 fila di agrafe
 e 1 copertura a scorrimento



MC KENZIE

026-054-002

Silberklammern in Plastikbehälter,
 zu 100 Stück
 Silver clips in plastic vial,
 comprising 100 pieces
 Grapas de plata en tubo de plástico,
 conteniendo 100 piezas
 Agrafe di argento, contenuti in piccoli tubi
 di materiale plastico,
 100 pezzi per tubo

Klammerinstrumentarium, Galeahaken
Clip Instruments, Galea Hooks
Instrumental para grapar, Gancho para galea
Strumenti per mettere i punti, Ganci galea



discontinued item

026-056-001

Kopfhautklammern, in Packungen zu 50 Stück
 Scalp hemostasis clips, in packages of 50 pieces
 Grapa hemostática para cuero cabelludo, en paquetes de 50 piezas
 Agrafes emostatici per cuoio capelluto in confezioni da 50 pezzi



RANEY

026-058-001

Kopfhautklammern
 Scalp hemostasis clips
 Grapa hemostática para cuero cabelludo
 Agrafes emostatici per cuoio capelluto

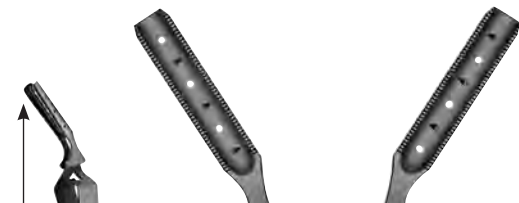

discontinued item

YASARGIL	L
026-071-310	31,0 cm / 12 ¹ / ₄ "
026-071-410	41,0 cm / 16 ¹ / ₄ "



RANEY

026-062-160 16,0 cm / 6¹/₄"

Anlege- und Abnehmezange für Kopfhautklammern
 Applying an removing forceps for scalp hemostasis clips
 Pinza para aplicar y quitar clips hemostáticas de cuero cabelludo
 Pinza per applicare e togliere le agrafes emostatiche al cuoio capelluto

Federhaken zur Galea-Fixation mit Bulldog-klemme zum Befestigen am Abdecktuch.
 Spring hooks for galea fixation with bulldog clamp, to be fastened to covering drape.
 Ganchos con muelle para la fijación de la galea, con pinza de bulldog para agarrar tela
 Ganci a molla per fissare la galea con clamp bulldog, da applicare al telo di copertura

Retraktoren zur Fixation am Schädel
Self-Retaining Retractors, for Skull Mounting
Separadores para la fijación del cráneo
Autofissator per retrattori, per il supporto del cranio



026



discontinued item

LEYLA

026-100-001

Selbsthaltender Spatel mit 1 Spannarm, komplett, bestehend aus:

- 1 Spannarm, flexibel (026-100-010)
- 1 Fixiervorrichtung für 1 Spannarm (026-100-020)
- 1 Spatelhalter für flache Spatel (026-100-031)

Self-retaining retractor with 1 arm, complete, consisting of:

- 1 Flexible arm (026-100-010)
- 1 Fixation base for 1 arm (026-100-020)
- 1 Support for flat spatulas (026-100-031)

Separador automático con 1 brazo, completo, compuesto de:

- 1 Brazo, flexible (026-100-010)
- 1 Fijador para 1 brazo (026-100-020)
- 1 Porta-espátula para espátulas planas (026-100-031)

Autofissatore per retrattore con 1 braccio, completo, composto da:

- 1 Braccio flessibile (026-100-010)
- 1 Base di fissaggio per 1 braccio (026-100-020)
- 1 Supporto per spatole cervicali piatte (026-100-031)

LEYLA

026-100-002

Selbsthaltender Spatel mit 2 Spannarm, komplett, bestehend aus:

- 2 Spannarm, flexibel (026-100-020)
- 1 Fixiervorrichtung für 2 Spannarme (026-100-021)
- 2 Spatelhalter für flache Spatel (026-100-031)

Self-retaining retractor with 2 arm, complete, consisting of:

- 2 Flexible arms (026-100-010)
- 1 Fixation base for 2 arms (026-100-021)
- 2 Supports for flat spatulas (026-100-031)

Separador automático con 2 brazos, completo, compuesto de:

- 2 Brazos, flexible (026-100-010)
- 1 Fijador para 2 brazos (026-100-021)
- 2 Porta-espátula para espátulas planas (026-100-031)

Autofissatore per retrattore con 2 bracci, completo, composto da:

- 2 Bracci flessibili (026-100-010)
- 1 Base di fissaggio per 2 bracci (026-100-021)
- 2 Supporti per spatole cervicali piatte (026-100-031)



026

Zubehör zu LEYLA-Retraktoren
Accessories for LEYLA Self-Retaining Retractors
Accesorios para separadores automáticos de LEYLA
Accessori per autofissatori di retrattori di LEYLA



LEYLEA

026-100-010

Spannarm
Flexible arm
Brazo flexible
Braccio flessibile

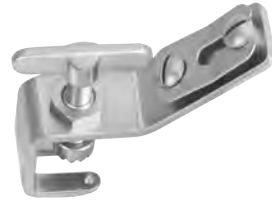

LEYLEA

026-100-020

Fixiervorrichtung für 1 Spannarm
Fixation base for 1 arm
Fijador para 1 brazo
Base di fissaggio per 1 braccio



LEYLEA

026-100-021

Fixiervorrichtung für 2 Spannarme
Fixation base for 2 arms
Fijador para 2 brazos
Base di fissaggio per 2 bracci



LEYLEA

026-100-022

Fixiervorrichtung für 1 Spannarm
Fixation base for 1 arm
Fijador para 1 brazo
Base di fissaggio per 1 braccio



LEYLEA

026-100-030

Spatelhalter
Support
Porta-espátula
Supporto



LEYLEA

026-100-031

Spatelhalter
Support
Porta-espátula
Supporto

discontinued item

Retraktoren zur Fixation am OP-Tisch
Self-Retaining Retractors, Fixation to Operating Table
Separadores para fijación a la mesa de operaciones
Autofissatori per retrattori, da fissare alla tavola operatoria



026



LEYLA

026-110-001

Selbsthaltender Spatel mit 1 Spannarm, komplett, bestehend aus:

- 1 Kugelgelenkkloben (026-110-010)
- 1 Haltearm (026-110-020)
- 1 Kupplungskopf (026-110-030)
- 1 Spannarm (026-100-010)
- 1 Spatelhalterung für Spatel mit rundem Griff (026-100-030)

Self-retaining retractor with 1 flexible arm, complete, consisting of:

- 1 Ball and socket joint (026-110-010)
- 1 Holding rod (026-110-020)
- 1 Coupling head (026-110-030)
- 1 Flexible arm (026-100-010)
- 1 Support, for spatulas with round shaft (026-100-030)

Separador automático con 1 brazo, completo, compuesto de:

- 1 Articulación esférica (026-110-010)
- 1 Brazo de apoyo (026-110-020)
- 1 Acoplamiento (026-110-030)
- 1 Brazo (026-100-010)
- 1 Porta-espátula para espátulas con mangos redondos (026-100-030)

Autofissatore per retrattori con 1 braccio flessibile completo, composto da:

- 1 Giunto a sfera ad incastro (026-110-010)
- 1 Porta asta (026-110-020)
- 1 Testa accoppiamento (026-110-0310)
- 1 Braccio flessibile (026-100-010)
- 1 Supporto per spatola con albero rotondo (026-100-030)

LEYLA

026-110-002

Selbsthaltender Spatel mit 2 Spannarmen, komplett, bestehend aus:

- 1 Kugelgelenkkloben (026-110-010)
- 1 Haltearm (026-110-020)
- 1 Kupplungsköpfe (026-110-030)
- 2 Spannarme (026-100-010)
- 1 Spatelhalterung, für flache Spatel (026-100-031)
- 1 Spatel (026-127-009)
- 1 Spatel (026-127-012)

Self-retaining retractor with 2 flexible arms, complete, consisting of:

- 1 Ball and socket joint (026-110-010)
- 1 Holding rod (026-110-020)
- 1 Coupling heads (026-110-030)
- 2 Flexible arms (026-100-010)
- 2 Supports, for flat spatulas (026-100-31)
- 1 spatulas (026-127-009)
- 1 spatulas (026-127-012)

Separador automático con 2 brazos, completo, compuesto de:

- 1 Articulación esférica (026-110-010)
- 1 Brazo de apoyo (026-110-020)
- 1 Acoplamientos (026-110-030)
- 2 Brazos (026-100-010)
- 2 Porta-espátula, para espátula planas (026-100-31)
- 1 Espatula (026-127-009)
- 1 Espatula (026-127-012)

Autofissatore per retrattori con 2 bracci flessibili completo, composto da:

- 1 Giunto a sfera ad incastro (026-110-010)
- 1 Porta asta (026-110-020)
- 1 Testa accoppiamento (026-110-030)
- 2 Bracci flessibili (026-100-010)
- 2 Supporti per spatola piatta (026-100-031)
- 1 Spatola (026-127-009)
- 1 Spatola (026-127-012)

discontinued item

Zubehör zu LEYLA-Retraktoren
Accessories for LEYLA Self-Retaining Retractors
Accesorios para separadores automáticos de LEYLA
Accessori per autofissatori di retrattori di LEYLA

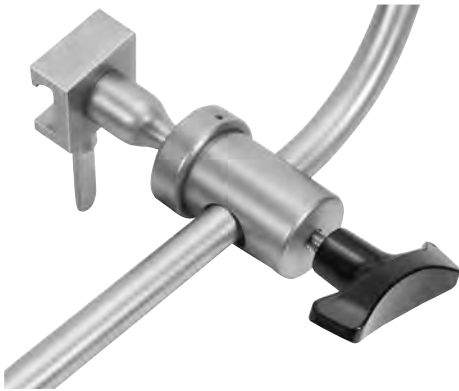

LEYLE
026-110-010
 Kugelgelenkkloben
 Ball and socket joint
 Articulación esférica
 Giunto a sfera ad incastro



LEYLE
026-110-020
 Haltearm
 Holding rod
 Brazo
 Porta asta



LEYLE
026-110-030
 Kupplungskopf
 Coupling head
 Acoplamiento
 Testa accoppiamento



LEYLE
026-110-031
 Kupplungskopf, drehbar
 Coupling head, turnable
 Acoplamiento, girable
 Testa accoppiamento, girabile

discontinued item

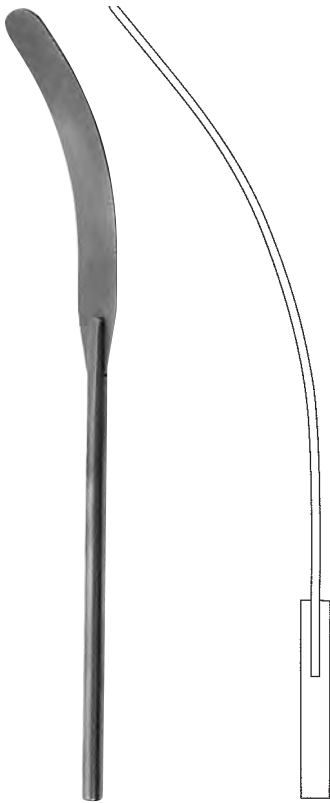

HEIFETZ

026-121-008	8 x 200 mm
026-121-011	11 x 200 mm
026-121-014	14 x 200 mm
026-121-017	17 x 200 mm
026-121-020	20 x 200 mm



HEIFETZ

026-122-008	8 x 155mm
026-122-011	11 x 155 mm
026-122-014	14 x 155 mm
026-122-017	17 x 155 mm



biegsam
malleable
maleable
flessibile

DAVIS

026-125-013	13 x 190 mm
026-125-016	16 x 190 mm



biegsam / gerieft
malleable / serrated
maleable / acanalada
flessibile / scannalato

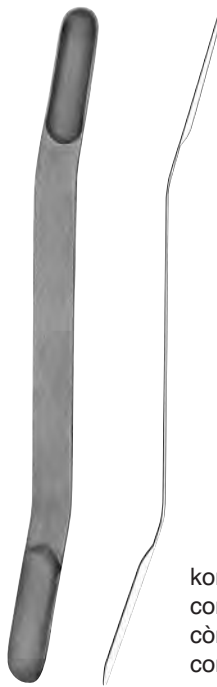

konkav
concave
còncava
concava

OLIVECRONA

026-127-009	9 x 200 mm
026-127-012	12 x 200 mm

026-131-001	7+ 9 mm x 180 mm
026-131-002	11+13 mm x 180 mm
026-131-003	15+18 mm x 180 mm
026-131-004	19+21 mm x 180 mm

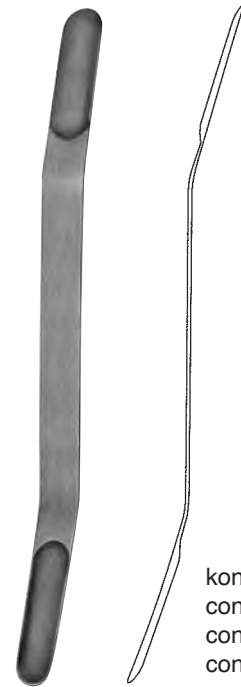

konvex
convex
convexa
convessa

OLIVECRONA

026-133-001	7+ 9 mm x 180 mm
026-133-002	11+13 mm x 180 mm
026-133-003	15+18 mm x 180 mm
026-133-004	19+21 mm x 180 mm



026

Nervwurzelnhaken
Nerve Root Retractors
Separadores para la raíz de nervios
Seperatori pr le radici dei nervi



SCOVILLE

026-140-230 23,0 cm / 9"



SCOVILLE

026-141-200 20,0 cm / 8"

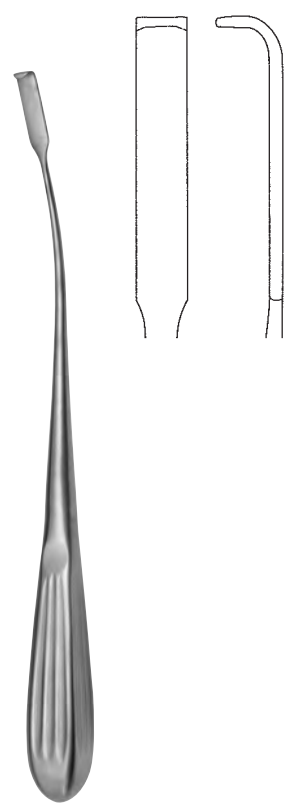

HOLSHER

026-143-240 24,0 cm / 9 1/2"



LOVE

026-146-190 19,0 cm / 7 1/2"

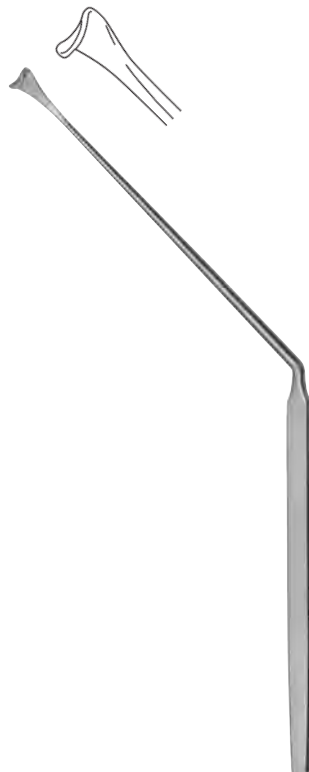

LOVE

026-147-180 18,0 cm / 7"

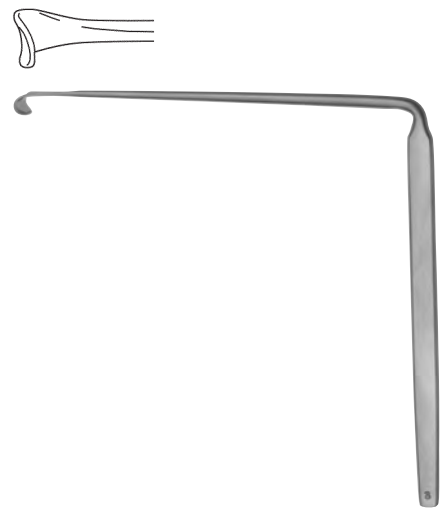

LOVE

026-149-140 14,0 cm / 5 1/2"

Nervwurzelhaken
Nerve Root Retractors
Separadores para la raíz de nervios
Seperatori per le radici dei nervi



026



026-153-001

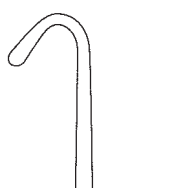

026-153-002

GRONINGEN

026-153-001 - 026-153-002 26,0 cm / 10¹/₄"



stumpf
blunt
romo
smusso

CUSHING

026-155-190 19,0 cm / 7¹/₂"
 026-155-280 28,0 cm / 11"



stumpf
blunt
romo
smusso

CUSHING

026-157-190 19,0 cm / 7¹/₂"
 026-157-280 28,0 cm / 11"



026

Dura-Separatoren
Dura Separators
Disecadores para dura-madre
Dissettori per la dura-madre



DANDY

026-159-200 20,0 cm / 8 1/2"

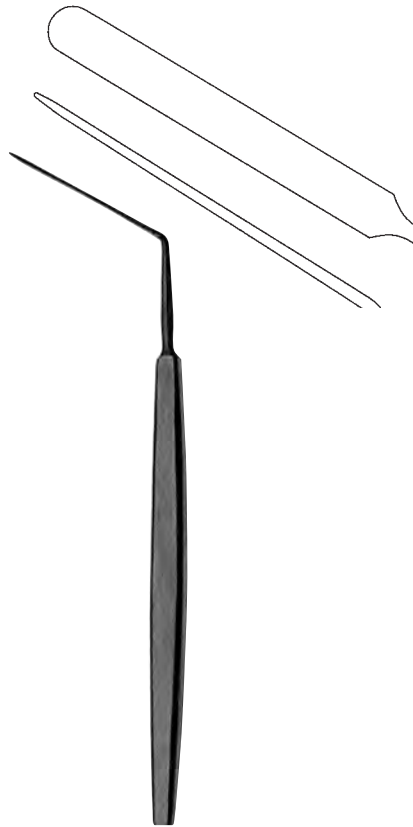

HORSLEY

026-161-200 20,0 cm / 7 1/4"

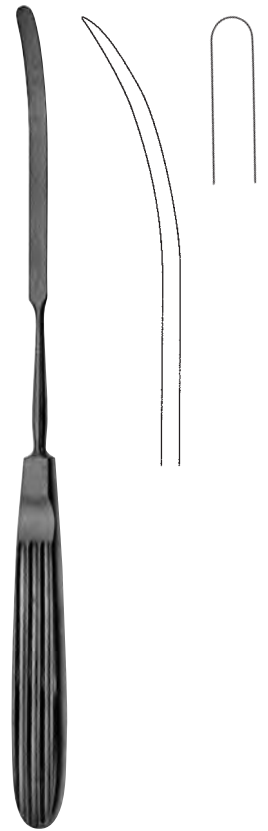

SACHS

026-163-210 21,0 cm / 9"



SACHS

026-165-210 21,0 cm / 8"

scharf
sharp
agudo
acuto

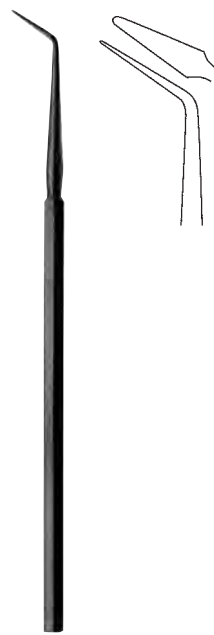

FRAZIER

026-167-165 16,5 cm / 6 1/2"



MILLIGAN

026-169-210 21,0 cm / 8 1/4"

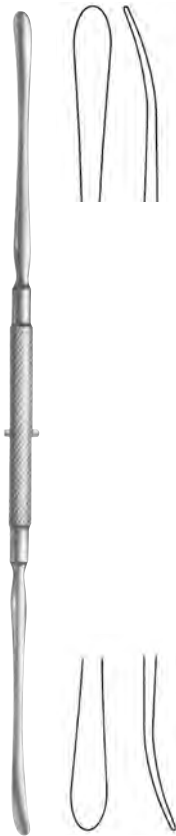

DAVIS

026-170-245 24,5 cm / 9²/₃"



PENFIELD

026-171-001 17,5 cm / 7"



PENFIELD

026-171-002 19,5 cm / 7³/₄"

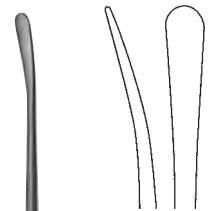

PENFIELD

026-171-003 19,5 cm / 7³/₄"



PENFIELD

026-171-215 21,5 cm / 8¹/₂"



PENFIELD

026-171-290 29,0 cm / 11¹/₂"



026

**Dissektoren
Dissectors
Disecadores
Dissettori**



**schmal
small
estrecho
stretto**

TOENNIS

026-173-001 24,0 cm / 9 1/2"



**breit
large
ancho
largo**

TOENNIS

026-173-002 24,0 cm / 9 1/2"

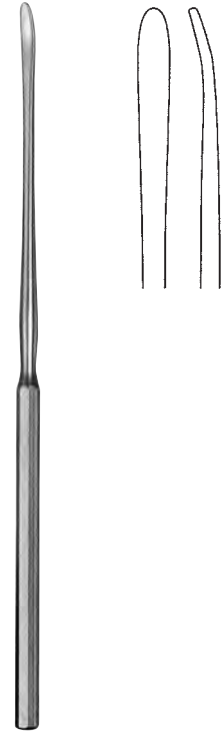

DAVIS

026-175-190 19,0 cm / 7 1/2"



**schmall
small
estrecho
stretto**

OLIVECRONA

026-177-180 18,0 cm / 7"
026-177-240 24,0 cm / 9 1/2"



**breit
large
ancho
largo**

OLIVECRONA

026-179-195 19,5 cm / 7 3/4"
026-179-240 24,0 cm / 9 1/2"

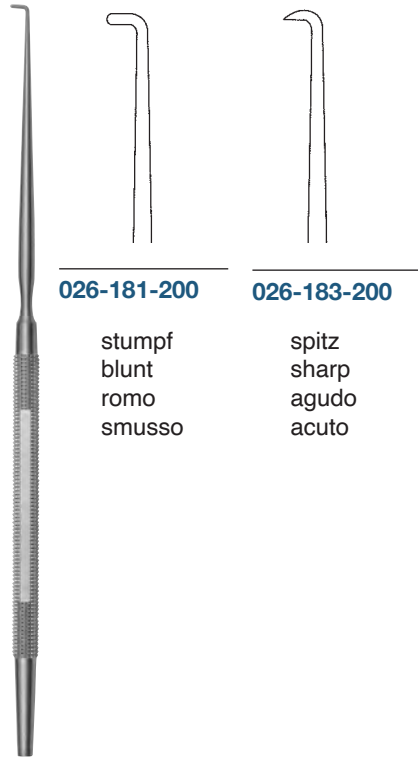

026-181-200

stumpf
blunt
romo
smusso

026-183-200

spitz
sharp
agudo
acuto

ADSON

026-181-200 - 026-183-200 20,0 cm / 8"

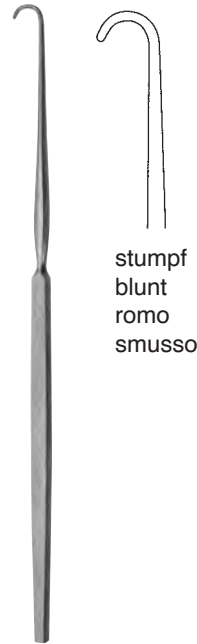

stumpf
blunt
romo
smusso

GRAHAM

026-185-165 16,5 cm / 6³/₄"

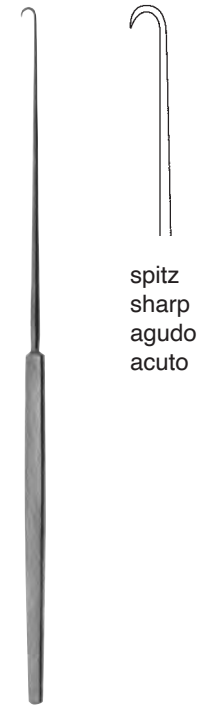

spitz
sharp
agudo
acuto

SACHS

026-187-185 18,5 cm / 7¹/₄"



spitz
sharp
agudo
acuto

FRAZIER

026-189-130 13,0 cm / 5"
026-189-180 18,0 cm / 7"



stumpf
blunt
romo
smusso

FRAZIER

026-190-130 13,0 cm / 5"

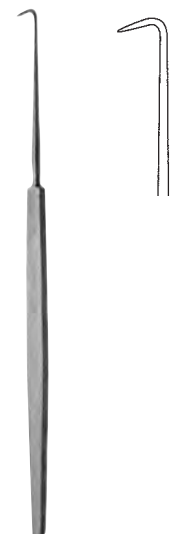

CUSHING

026-191-140 14,0 cm / 5¹/₂"



026

Messer, Haken
Knives, Hooks
Cuchillos, Ganchos
Bisturi, Uncini



TOENNIS

026-193-130 13,0 cm / 5 1/8"



TOENNIS

026-193-190 19,0 cm / 7 1/2"



HALLE

026-195-200 20,0 cm / 8 1/4"

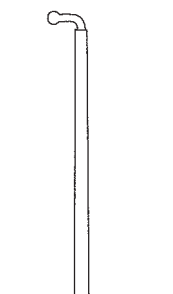

026-201-001

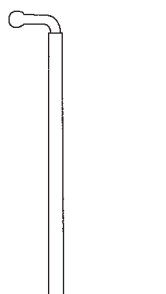

026-201-002

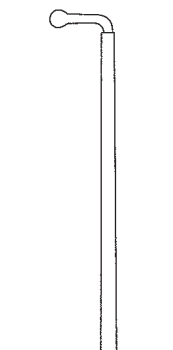

026-201-003

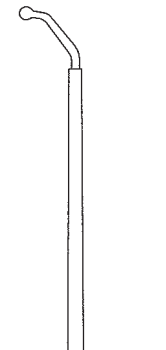

026-201-004

CASPAR

026-201-001 - 026-201-004 25,0 cm / 10"



026-203-020



026-203-025



026-203-030



026-203-035



KRAYENBÜHL

026-203-020 - 026-203-035 18,5 cm / 7 1/4"

Spekula für trans-sphenoidale Hypophysektomie
 Specula for trans-sphenoidal hypophysectomy
 Espéculo para la hipofisectomía trans-sfenoidal
 Speculo per ipofisectomia trans-sfenoidale



**LANDOLT-
CUSHING**

026-210-070 ø 15 mm x 70 mm
026-210-090 ø 15 mm x 90 mm

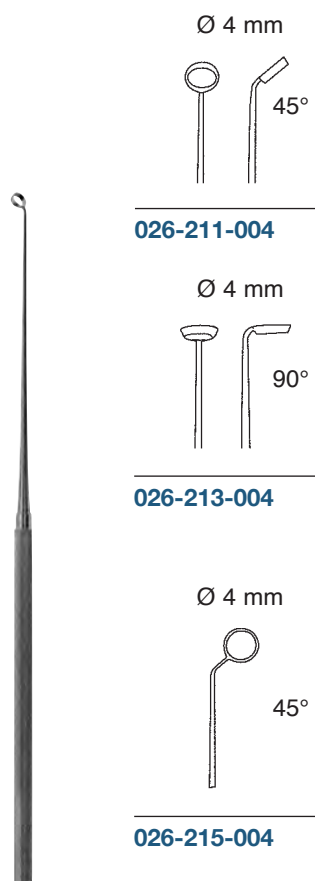

RAY

026-211-004 - 026-215-004 19,0 cm / 7 1/2"

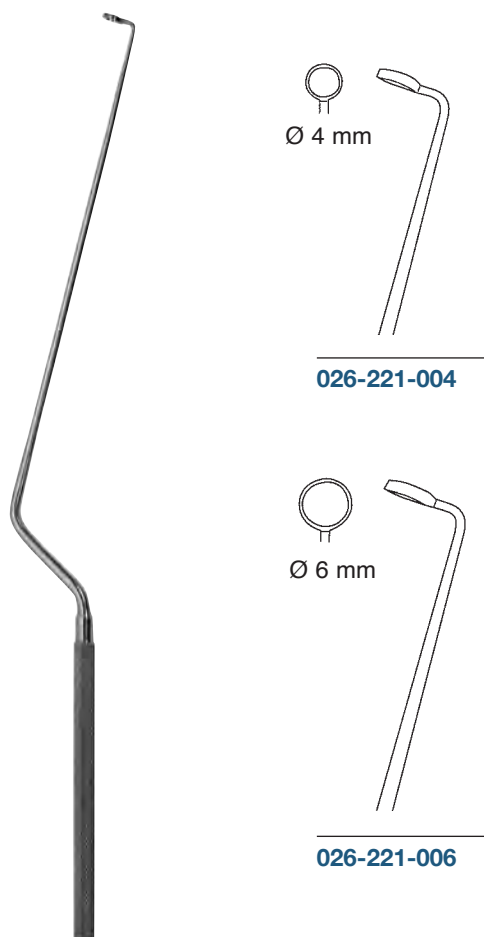

HARDY

026-221-004 - 026-221-006 26,0 cm / 10 1/4"

Küretten, horizontal 90°, biegsam
 Currettes, horizontal 90°, malleable
 Curetas, horizontal 90°, maleable
 Curette, orizzontale 90°, malleabile



026

Hypophysektomie-Instrumente
Pituitary Instruments
Instrumentos para la hipofisectomía
Strumenti per ipofisi

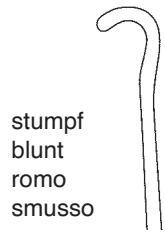

HARDY
 026-231-001

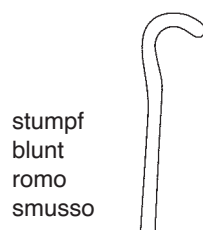

HARDY
 026-231-002



HARDY
 026-233-001

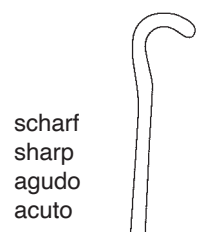

HARDY
 026-233-002



HARDY
 026-236-245



HARDY-FAHLBUSCH
 026-237-001



HARDY-FAHLBUSCH
 026-237-002

026-231-001 - 026-237-002 24,5 cm / 9³/₄"



YASARGIL
 026-251-001



YASARGIL
 026-251-002



YASARGIL
 026-251-003



YASARGIL
 026-251-004



YASARGIL
 026-251-005



JACOBSON
 026-251-006

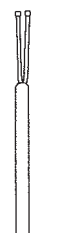

JACOBSON
 026-251-007

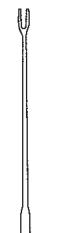

YASARGIL
 026-251-008

026-251-001 - 026-251-008 19,0 cm / 7¹/₂"



026-261-001 - 026-267-002 19,0 cm / 7 1/4"

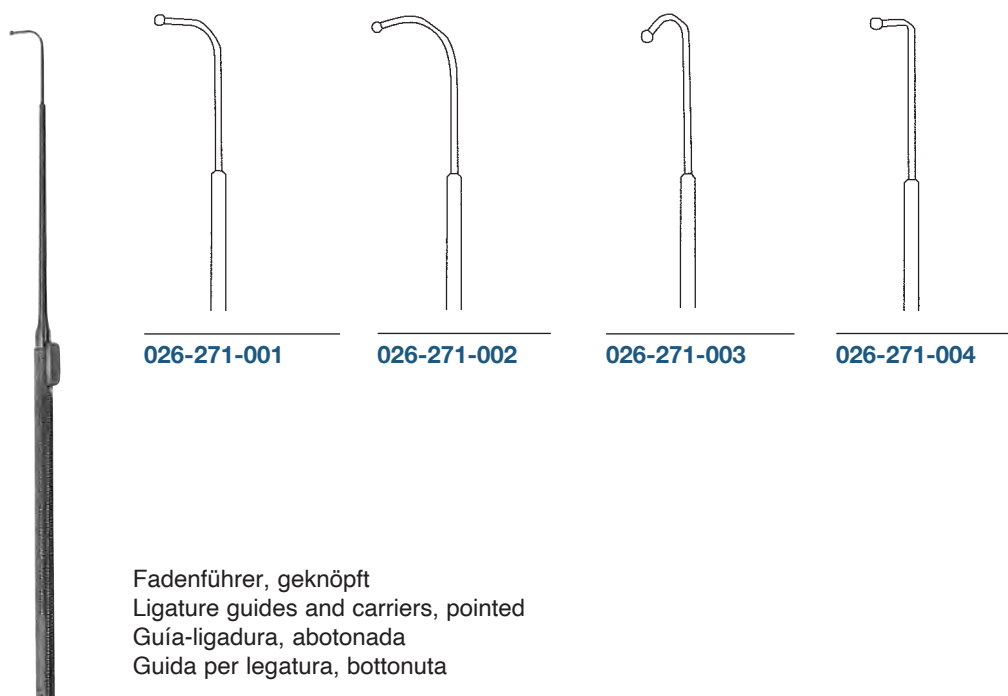

Fadenführer, geknöpft
 Ligature guides and carriers, pointed
 Guía-ligadura, abotonada
 Guida per legatura, bottonuta

YASARGIL
 026-271-001 - 026-271-004 18,5 cm / 7 1/4"



026

Mikro Instrumente
Micro Instruments
Instrumentos para microcirugia
Strumenti per microchirurgia



026-280-001



026-280-002



026-291-001

Dissektor
Dissector
Disecador
Dissettore

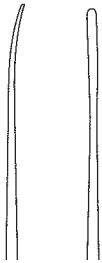

026-281-001



026-281-002



026-291-002

Dissektor
Dissector
Disecador
Dissettore

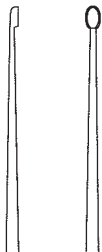

026-284-001



026-284-002



026-291-003

Raspatorium
Raspatory
Legra
Periostotomo



026-285-001

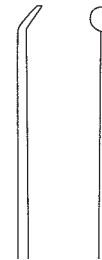

026-285-002



026-280-001 - 026-285-002 23,0 cm / 9"

026-291-001 - 026-291-003 23,0 cm / 9"

Hypophysektomie-Instrumente
Pituitary Instruments
Instrumentos para la hipofisectomía
Strumenti per ipofisi



026

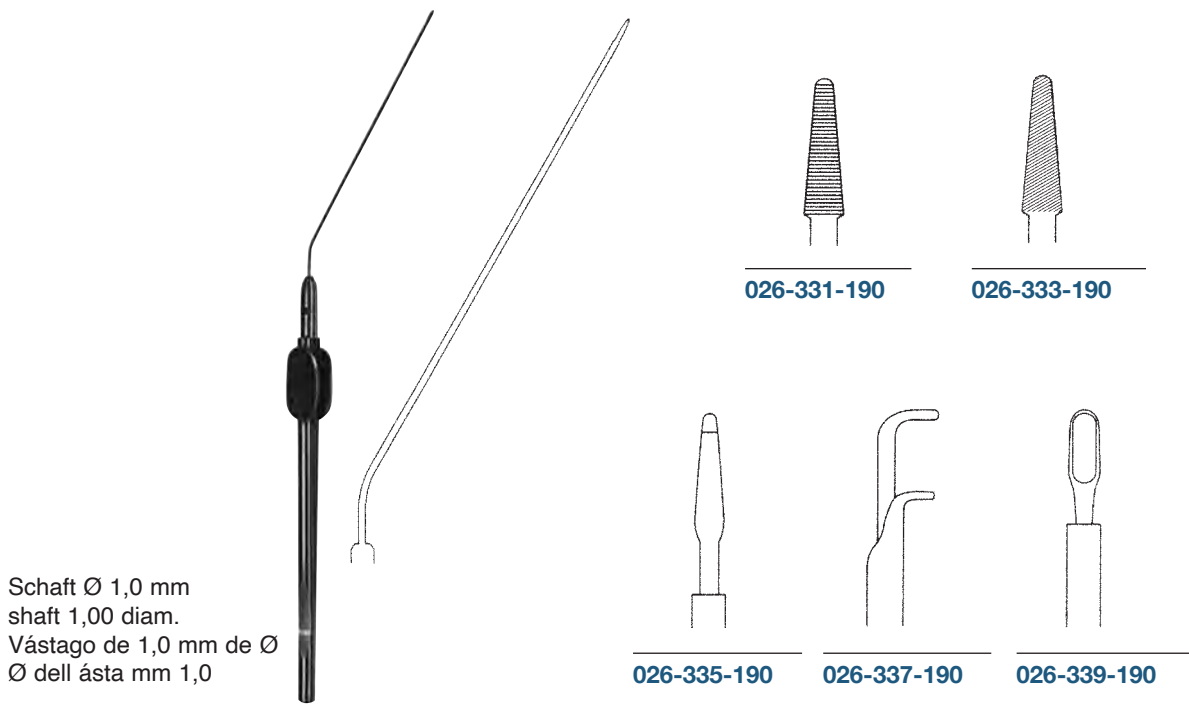

026-331-190 - 026-339-190 19,0 cm / 7½"

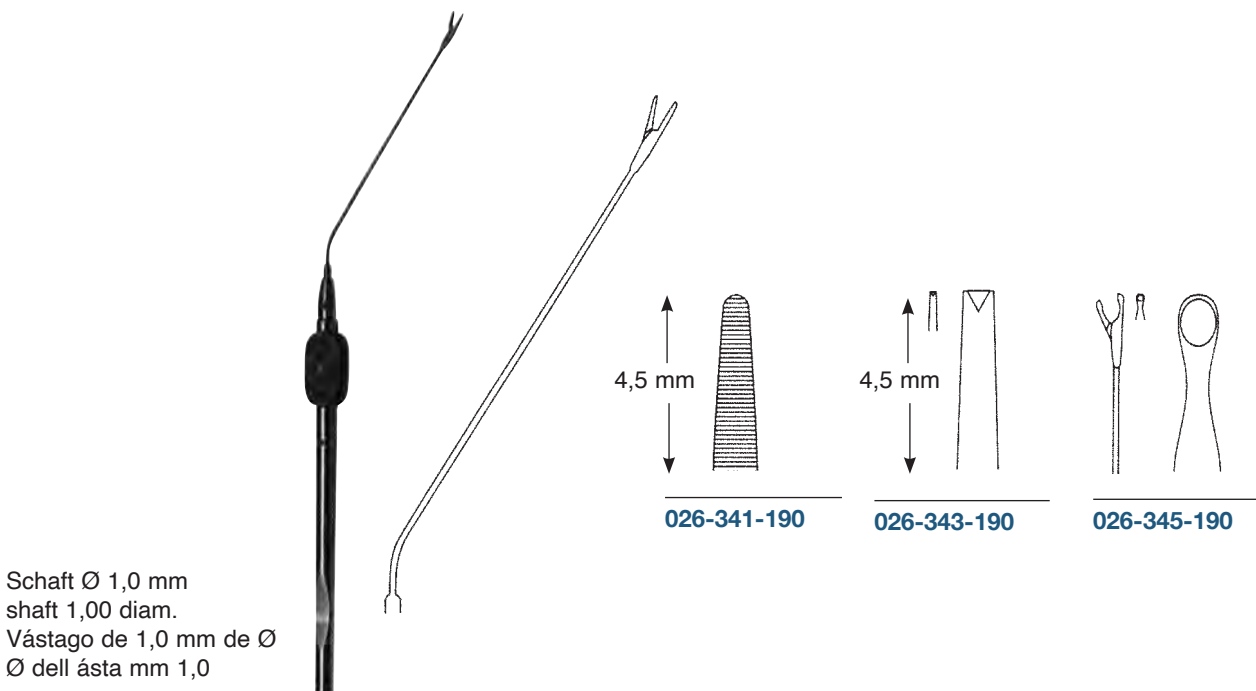

026-341-190 - 026-345-190 19,0 cm / 7½"

Laminektomie-Spreizer
Laminectomy Retractors
Separadores para laminectomía
Divaricatori per laminectomia

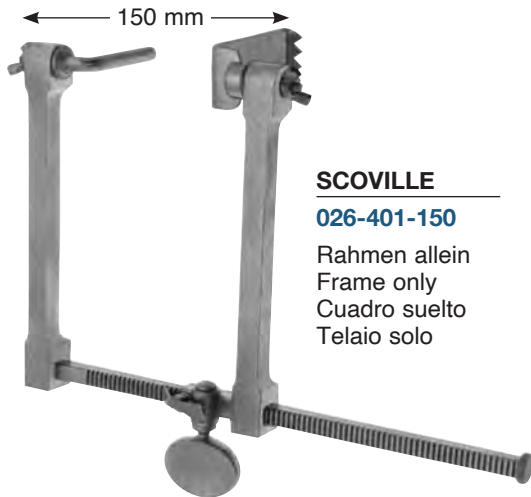

SCOVILLE

026-401-150

Rahmen allein
 Frame only
 Cuadro suelto
 Telaio solo

SCOVILLE

026-400-150

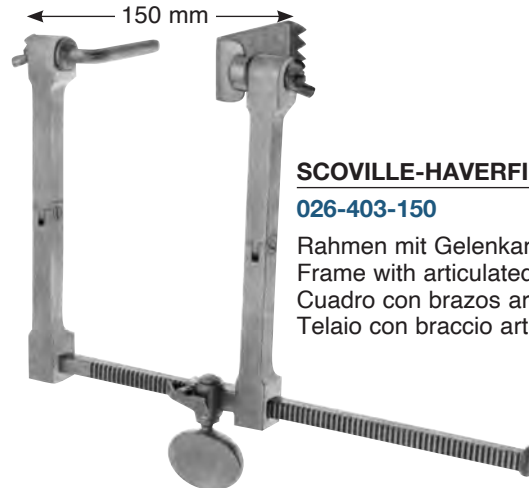

SCOVILLE-HAVERFIELD

026-403-150

Rahmen mit Gelenkarmen, allein
 Frame with articulated arms, only
 Cuadro con brazos articulados, suelto
 Telaio con braccio articolato, solo

SCOVILLE-HAVERFIELD

026-402-150

Wundspreizer, komplett, bestehend aus:

- 1 Rahmen (026-401-150)
- 1 Haken 50 mm (026-403-050)
- 1 Seitenvalve 63 x 25 mm (a x b) (026-405-001)

Self-retaining retractor, complete, consisting of:

- 1 Frame (026-401-150)
- 1 Hook 50 mm (026-403-050)
- 1 Lateral valve 63 x 25 mm (a x b) (026-405-001)

Separador, completo, compuesto de:

- 1 Cuadro (026-403-050)
- 1 Gancho 50 mm (026-403-050)
- 1 Valva lateral 63 x 25 mm (a x b) (026-405-001)

Divaricatore, completo, composto da:

- 1 Telaio (026-403-050)
- 1 Divaricatore 50 mm (026-403-050)
- 1 Valva laterale 63 x 25 mm (a x b) (026-405-001)

Wundspreizer, komplett, bestehend aus:

- 1 Rahmen (026-403-150)
- 1 Haken 50 mm (026-403-050)
- 1 Seitenvalve 63 x 25 mm (a x b) (026-405-001)

Self-retaining retractor, complete, consisting of:

- 1 Frame (026-403-150)
- 1 Hook 50 mm (026-403-050)
- 1 Lateral valve 63 x 25 mm (a x b) (026-405-001)

Separador, completo, compuesto de:

- 1 Cuadro (026-403-150)
- 1 Gancho 50 mm (026-403-050)
- 1 Valva lateral 63 x 25 mm (a x b) (026-405-001)

Divaricatore, completo, composto da:

- 1 Telaio (026-403-150)
- 1 Divaricatore 50 mm (026-403-050)
- 1 Valva laterale 63 x 25 mm (a x b) (026-405-001)



SCOVILLE

026-403-050 50,0 mm
026-403-075 75,0 mm

Haken für Wundspreizer
 (026-400-150 und 026-402-150)

Hooks for self-retaining retractors
 (026-400-150 und 026-402-150)

Ganchos para separadores
 (026-400-150 und 026-402-150)

Gancio per divaricatori
 (026-400-150 und 026-402-150)

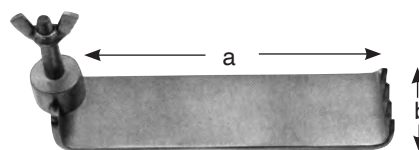

SCOVILLE

026-405-001 63 x 25 mm (a x b)
026-405-002 64 x 50 mm (a x b)
026-405-003 88 x 25 mm (a x b)

Seitenvalven für Wundspreizer
 (026-400-150 und 026-402-150)

Lateral valves for self-retaining
 (026-400-150 und 026-402-150)

Valvas laterales para separadores
 (026-400-150 und 026-402-150)

Valve laterali per divaricatori
 (026-400-150 und 026-402-150)

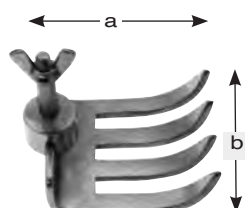

SCOVILLE

026-407-038 41 x 38 mm (a x b)
026-407-044 67 x 44 mm (a x b)

Seitenvalven für Wundspreizer
 (026-400-150 und 026-402-150)

Lateral valves for self-retaining
 (026-400-150 und 026-402-150)

Valvas laterales para separadores
 (026-400-150 und 026-402-150)

Valve laterali per divaricatori
 (026-400-150 und 026-402-150)

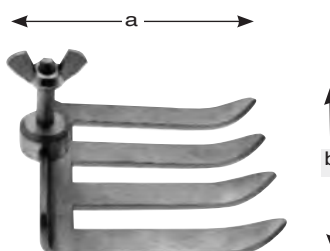

TAYLOR

026-409-001 48 x 50 mm (a x b)
026-409-002 64 x 64 mm (a x b)
026-409-003 80 x 57 mm (a x b)

Seitenvalven für Wundspreizer
 (026-400-150 und 026-402-150)

Lateral valves for self-retaining
 (026-400-150 und 026-402-150)

Valvas laterales para separadores
 (026-400-150 und 026-402-150)

Valve laterali per divaricatori
 (026-400-150 und 026-402-150)



026

Laminektomie-Spreizer
Laminectomy Retractors
Separadores para laminectomía
Divaricatori per laminectomia

Wundspreizer, Seitenvalven 52 x 44 mm (a x b)
Self-retaining retractor, lateral valves 52 x 44 mm (a x b)
Separador, valvas laterales 52 x 44 mm (a x b)
Divaricatore, Valve laterali 52 x 44 mm (a x b)

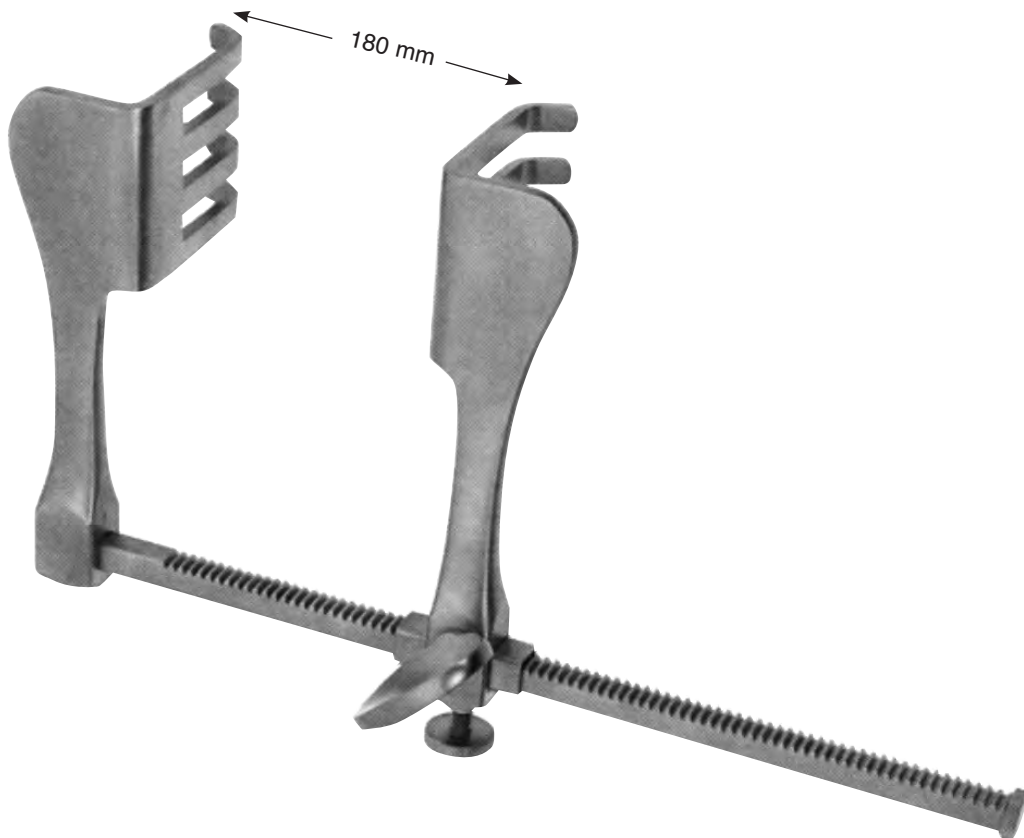

BADGLEY
026-410-180

Laminektomie-Spreizer
Laminectomy Retractors
Separadores para laminectomía
Divaricatori per laminectomia



026

Lumbal, thorakal und cervical einzusetzen!
 For use of lumbar, thoracic and cervical!
 Útil para lumbar, toracal y cervical!
 Per impiego lombare, toracico e cervicale



CASPAR
026-420-145

Wundspreizer mit Gelenkarmen und Kugelschnellverschluss, für Laminektomie und Hemi-Laminektomie, komplett, bestehend aus:

- 1 Rahmen (026-421-145)
- 1 Drehschlüssel (026-422-001)
- 1 Haken 38 mm (026-423-038)
- 1 Seitenvlase 37 x 22 mm (026-425-037)
- 1 Seitenvlase 43 x 22 mm (026-425-043)
- 1 Seitenvlase 47 x 22 mm (026-425-047)
- 1 Seitenvlase 52 x 22 mm (026-425-052)
- 1 Seitenvlase 57 x 22 mm (026-425-057)

Separador con brazos articulados y cierre rápido esférico, para laminectomía y hemilaminectomía, completo, compuesto de:

- 1 Cuadro (026-421-145)
- 1 Llave (026-422-001)
- 1 Gancho 38 mm (026-423-038)
- 1 Valva lateral 37 x 22 mm (026-425-037)
- 1 Valva lateral 43 x 22 mm (026-425-043)
- 1 Valva lateral 47 x 22 mm (026-425-047)
- 1 Valva lateral 52 x 22 mm (026-425-052)
- 1 Valva lateral 57 x 22 mm (026-425-057)

026-421-145

Rahmen mit Gelenkarmen, allein
 Frame with articulated arms, only
 Cuadro con brazos articulados, suelto
 Telaio con braccio articolato, solo

Self-retaining retractor with articulated arms and ball snap closure, for laminectomy and hemi-laminectomy, complete, consisting of:

- 1 Frame (026-421-145)
- 1 Key (026-422-001)
- 1 Hook 38 mm (243-351-38)
- 1 Lateral valve 37 x 22 mm (026-425-037)
- 1 Lateral valve 43 x 22 mm (026-425-043)
- 1 Lateral valve 47 x 22 mm (026-425-047)
- 1 Lateral valve 52 x 22 mm (026-425-052)
- 1 Lateral valve 57 x 22 mm (026-425-057)

Divaricatore con braccio articolato a chiusura istantanea, per laminectomia e emi-laminectomia, completo, composto da:

- 1 Telaio (026-421-145)
- 1 Chiave (026-422-001)
- 1 Gancio 38 mm (243-351-38)
- 1 Valva laterale 37 x 22 mm (026-425-037)
- 1 Valva laterale 43 x 22 mm (026-425-043)
- 1 Valva laterale 47 x 22 mm (026-425-047)
- 1 Valva laterale 52 x 22 mm (026-425-052)
- 1 Valva laterale 57 x 22 mm (026-425-057)



026-423-038 38,0 mm



026-425-037 37 x 22 mm (a x b)

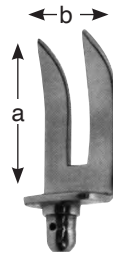

026-425-043 43 x 22 mm (a x b)



026-425-047 47 x 22 mm (a x b)



026-425-052 52 x 22 mm (a x b)



026-425-057 57 x 22 mm (a x b)

026-422-001

Drehschlüssel
 Key
 Llave
 chiave

Haken, Seitenvalven
Hooks, Lateral Valves
Ganchos, Valvas laterales
Ganci, Valve laterali



026-423-038 38,0 mm
026-423-058 58,0 mm

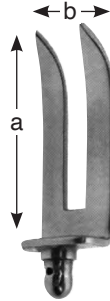

026-425-032 32 mm x 22 mm (a x b)
026-425-037 37 mm x 22 mm (a x b)
026-425-043 43 mm x 22 mm (a x b)
026-425-047 47 mm x 22 mm (a x b)
026-425-052 52 mm x 22 mm (a x b)
026-425-057 57 mm x 22 mm (a x b)
026-425-062 62 mm x 22 mm (a x b)
026-425-067 67 mm x 22 mm (a x b)



026-427-032 32 mm x 37 mm (a x b)
026-427-037 37 mm x 37 mm (a x b)
026-427-043 43 mm x 37 mm (a x b)
026-427-047 47 mm x 37 mm (a x b)
026-427-052 52 mm x 37 mm (a x b)
026-427-057 57 mm x 37 mm (a x b)
026-427-062 62 mm x 37 mm (a x b)
026-427-067 67 mm x 37 mm (a x b)



026-429-032 32 mm x 52 mm (a x b)
026-429-037 37 mm x 52 mm (a x b)
026-429-043 43 mm x 52 mm (a x b)
026-429-047 47 mm x 52 mm (a x b)
026-429-052 52 mm x 52 mm (a x b)
026-429-057 57 mm x 52 mm (a x b)
026-429-062 62 mm x 52 mm (a x b)
026-429-067 67 mm x 52 mm (a x b)



026-430-115 11,5 cm / 4 1/2"
 Pinzette zum Valvenwechsel bei Kugelschnellverschluß-System
 Valve ejector for changing the valves with ball snap closure system
 Pinza para el cambio de valvas con el sistema de cierre rapido esférico
 Pinza per il cambio delle valve a chiusura istantanea

CASPAR

026-440-090



Wundspreizer mit Gelenkarmen und Kugelschnellverschluß, komplett, bestehend aus:
 1 Rahmen (026-441-090)
 1 medialen Valve 40 x 23 mm (026-443-040)
 1 medialen Valve 45 x 23 mm (026-443-045)
 1 medialen Valve 50 x 23 mm (026-443-050)
 1 medialen Valve 55 x 23 mm (026-443-055)
 1 medialen Valve 60 x 23 mm (026-443-060)
 1 lateralen Valve 40 x 23 mm (026-445-040)
 1 lateralen Valve 45 x 23 mm (026-445-045)
 1 lateralen Valve 50 x 23 mm (026-445-050)
 1 lateralen Valve 55 x 23 mm (026-445-055)
 1 lateralen Valve 60 x 23 mm (026-445-060)

Self-retaining retractor with articulated arms and ball snap closure, complete, consisting of:
 1 Frame (026-441-090)
 1 Medial valve 40 x 23 mm (026-443-040)
 1 Medial valve 45 x 23 mm (026-443-045)
 1 Medial valve 50 x 23 mm (026-443-050)
 1 Medial valve 55 x 23 mm (026-443-055)
 1 Medial valve 60 x 23 mm (026-443-060)
 1 Lateral valve 40 x 23 mm (026-445-040)
 1 Lateral valve 45 x 23 mm (026-445-045)
 1 Lateral valve 50 x 23 mm (026-445-050)
 1 Lateral valve 55 x 23 mm (026-445-055)
 1 Lateral valve 60 x 23 mm (026-445-060)

Separador con brazos articulados y cierre rápido esférico, completo, compuesto de:
 1 Cuadro (026-441-090)

Divaricatore con braccio articolato a chiusura istantanea, completo, composto da:
 1 Telaio (026-441-090)

026-441-090

Rahmen mit Gelenkarmen, allein
 Frame with articulated arms, only
 Cuadro con brazos articulados, suelto
 Telaio con braccio articolato, solo

1 Valva mediana 40 x 23 mm (026-443-040)
 1 Valva mediana 45 x 23 mm (026-443-045)
 1 Valva mediana 50 x 23 mm (026-443-050)
 1 Valva mediana 55 x 23 mm (026-443-055)
 1 Valva mediana 60 x 23 mm (026-443-060)
 1 Valva lateral 40 x 23 mm (026-445-040)
 1 Valva lateral 45 x 23 mm (026-445-045)
 1 Valva lateral 50 x 23 mm (026-445-050)
 1 Valva lateral 55 x 23 mm (026-445-055)
 1 Valva lateral 60 x 23 mm (026-445-060)

1 Valva media 40 x 23 mm (026-443-040)
 1 Valva media 45 x 23 mm (026-443-045)
 1 Valva media 50 x 23 mm (026-443-050)
 1 Valva media 55 x 23 mm (026-443-055)
 1 Valva media 60 x 23 mm (026-443-060)
 1 Valva laterale 40 x 23 mm (026-445-040)
 1 Valva laterale 45 x 23 mm (026-445-045)
 1 Valva laterale 50 x 23 mm (026-445-050)
 1 Valva laterale 55 x 23 mm (026-445-055)
 1 Valva laterale 60 x 23 mm (026-445-060)

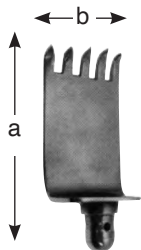

026-443-040

40 x 23 mm (a x b)



026-443-045

45 x 23 mm (a x b)



026-443-050

50 x 23 mm (a x b)



026-443-055

55 x 23 mm (a x b)



026-443-060

60 x 23 mm (a x b)



026-445-040

40 x 23 mm (a x b)



026-445-045

45 x 23 mm (a x b)



026-445-050

50 x 23 mm (a x b)



026-445-055

55 x 23 mm (a x b)



026-445-060

60 x 23 mm (a x b)

Wundspreizer für die cervicale Wirbelsäule
Retractors for cervical spine
Separadores para la columna cervical
Divaricatori per colonna cervicale

← 85 mm →



026-451-085

Sperrer allein
 Spreader only
 Seperador suelto
 Divaricatore solo

CASPAR

026-450-085 10,5 cm / 4¹/₄"

Wundspreizer mit Gelenkarmen und Kugelschnellverschluß-komplett, bestehend aus:

- 1 Sperrer (026-451-085)
- 1 stumpfe Valve 45 x 23 mm (026-463-045)
- 1 stumpfe Valve 50 x 23 mm (026-463-050)
- 1 stumpfe Valve 55 x 23 mm (026-463-055)
- 1 stumpfe Valve 60 x 23 mm (026-463-060)
- 1 stumpfe Valve 65 x 23 mm (026-463-065)

Seperador con brazos articulados y cierre rápido esférico, completo compuesto de:

- 1 Separador (026-451-085)
- 1 Valva roma 45 x 23 mm (026-463-045)
- 1 Valva roma 50 x 23 mm (026-463-050)
- 1 Valva roma 55 x 23 mm (026-463-055)
- 1 Valva roma 60 x 23 mm (026-463-060)
- 1 Valva roma 65 x 23 mm (026-463-065)

Self-retaining retractor with articulated arms and ball snap closure, complete, consisting of:

- 1 Spreader (026-451-085)
- 1 Blunt valve 45 x 23 mm (026-463-045)
- 1 Blunt valve 50 x 23 mm (026-463-050)
- 1 Blunt valve 55 x 23 mm (026-463-055)
- 1 Blunt valve 60 x 23 mm (026-463-060)
- 1 Blunt valve 65 x 23 mm (026-463-065)

Divaricatore con braccio articolato a chiusura istantanea, completo, composto da:

- 1 Divaricatore (026-451-085)
- 1 Valva smussa 45 x 23 mm (026-463-045)
- 1 Valva smussa 50 x 23 mm (026-463-050)
- 1 Valva smussa 55 x 23 mm (026-463-055)
- 1 Valva smussa 60 x 23 mm (026-463-060)
- 1 Valva smussa 65 x 23 mm (026-463-065)

In Wirbelsäulen-Längsachse zu verwenden!

To be used for up and down retraction!

Útil para el eje longitudinal de la columna vertebra!

Da impiegarsi per la trazione e la compressione della colonna!

← 90 mm →



026-461-090

Sperrer allein
 Spreader only
 Seperador suelto
 Divaricatore solo

CASPAR

026-460-090 16,5 cm / 6¹/₂"

Wundspreizer mit Gelenkarmen und Kugelschnellverschluß-komplett, bestehend aus:

- 1 Sperrer (026-461-090)
- 1 stumpfe Valve 45 x 23 mm (026-463-045)
- 1 stumpfe Valve 50 x 23 mm (026-463-050)
- 1 stumpfe Valve 55 x 23 mm (026-463-055)
- 1 stumpfe Valve 60 x 23 mm (026-463-060)
- 1 stumpfe Valve 65 x 23 mm (026-463-065)

Seperador con brazos articulados y cierre rápido esférico, completo compuesto de:

- 1 Separador (026-461-090)
- 1 Valva roma 45 x 23 mm (026-463-045)
- 1 Valva roma 50 x 23 mm (026-463-050)
- 1 Valva roma 55 x 23 mm (026-463-055)
- 1 Valva roma 60 x 23 mm (026-463-060)
- 1 Valva roma 65 x 23 mm (026-463-065)

Self-retaining retractor with articulated arms and ball snap closure, complete, consisting of:

- 1 Spreader (026-461-090)
- 1 Blunt valve 45 x 23 mm (026-463-045)
- 1 Blunt valve 50 x 23 mm (026-463-050)
- 1 Blunt valve 55 x 23 mm (026-463-055)
- 1 Blunt valve 60 x 23 mm (026-463-060)
- 1 Blunt valve 65 x 23 mm (026-463-065)

Divaricatore con braccio articolato a chiusura istantanea, completo, composto da:

- 1 Divaricatore (026-461-090)
- 1 Valva smussa 45 x 23 mm (026-463-045)
- 1 Valva smussa 50 x 23 mm (026-463-050)
- 1 Valva smussa 55 x 23 mm (026-463-055)
- 1 Valva smussa 60 x 23 mm (026-463-060)
- 1 Valva smussa 65 x 23 mm (026-463-065)

Valven, stumpf
Valves, blunt
Valvas, romas
Valve, smusso



026

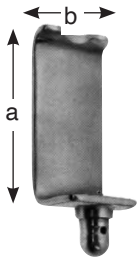

026-463-045
45 x 23 mm (a x b)



026-463-050
50 x 23 mm (a x b)



026-463-055
55 x 23 mm (a x b)



026-463-060
60 x 23 mm (a x b)



026-463-065
65 x 23 mm (a x b)



026-465-050
50 x 25 mm (a x b)



026-465-060
60 x 25 mm (a x b)

Wundspreizer für die lumbale Wirbelsäule
Retractors for lumbar spine
Separadores para la columna lumbar
Divaricatori per colonna lombo



Oberfläche geschwärzt
 Surface black-finish
 Superficie negra
 Superficie nera

026-471-060

Rahmen mit Gelenkarmen, allein
 Frame with articulated arms, only
 Cuadro con brazos articulados, suelto
 Relais con braccio articolato, solo

CASPAR

026-470-060

Wundspreizer mit Gelenkarmen und Kugelschnellverschluß-komplett, bestehend aus:

- 1 Rahmen (026-471-060)
- 1 Seitenvalve 35 x 12 mm (026-473-035)
- 1 Seitenvalve 40 x 13 mm (026-473-040)
- 1 Seitenvalve 45 x 13 mm (026-473-045)
- 1 Seitenvalve 50 x 14 mm (026-473-050)
- 1 Seitenvalve 55 x 14 mm (026-473-055)
- 1 Seitenvalve 60 x 15 mm (026-473-060)

Seperador con brazos articulados y cierre rápido esférico, completo compuesto de:

- 1 Cuadro (026-471-060)
- 1 Valva lateral 35 x 12 mm (026-473-035)
- 1 Valva lateral 40 x 13 mm (026-473-040)
- 1 Valva lateral 45 x 13 mm (026-473-045)
- 1 Valva lateral 50 x 14 mm (026-473-050)
- 1 Valva lateral 55 x 14 mm (026-473-055)
- 1 Valva lateral 60 x 15 mm (026-473-060)

Self-retaining retractor with articulated arms and ball snap closure, complete, consisting of:

- 1 Frame (026-461-060)
- 1 Lateral valve 35 x 12 mm (026-473-035)
- 1 Lateral valve 40 x 13 mm (026-473-040)
- 1 Lateral valve 45 x 13 mm (026-473-045)
- 1 Lateral valve 50 x 14 mm (026-473-050)
- 1 Lateral valve 55 x 14 mm (026-473-055)

Divaricatore con braccio articolato a chiusura istantanea, completo, composto da:

- 1 Telaio (026-461-060)
- 1 Valva laterale 35 x 12 mm (026-473-035)
- 1 Valva laterale 40 x 13 mm (026-473-040)
- 1 Valva laterale 45 x 13 mm (026-473-045)
- 1 Valva laterale 50 x 14 mm (026-473-050)
- 1 Valva laterale 55 x 14 mm (026-473-055)



026-473-035

35 x 12 mm (a x b)

026-473-040

40 x 13 mm (a x b)

026-473-045

45 x 13 mm (a x b)

026-473-050

50 x 14 mm (a x b)

026-473-055

55 x 14 mm (a x b)

026-473-060

60 x 15 mm (a x b)

Spekula für lumbale Bandscheibenoperationen
Specula for lumbar vertebral operations
Espéculos para la cirugía lumbar vertebral
Speculi per chirurgia lombo vertebrale



026



Oberfläche geschwärzt
 Surface black-finish
 Superficie negra
 Superficie nera

CASPAR

026-481-040 - 026-481-060 15,0 cm / 6"

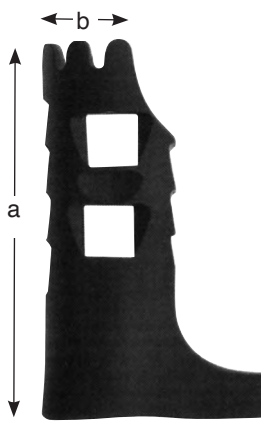

026-481-040
 40 x 18 mm (a x b)



026-481-045
 45 x 18 mm (a x b)



026-481-050
 50 x 18 mm (a x b)



026-481-055
 55 x 18 mm (a x b)



026-481-060
 60 x 18 mm (a x b)

Wirbelkörperspreizer
Lamina Spreadors
Separadores para cuerpos vertebrales
Separatori per vertebre

Spreizweite 18 mm
 Blade opening 18 mm
 Abertura de la hoja 18 mm
 Apertura lame 18 mm



CLOWARD

026-491-130 13,0 cm / 5 1/8"

Spreizweite 18 mm
 Blade opening 18 mm
 Abertura de la hoja 18 mm
 Apertura lame 18 mm



CLOWARD

026-493-160 16,0 cm / 6 1/4"

Spreizweite 38 mm
 Blade opening 38 mm
 Abertura de la hoja 38 mm
 Apertura lame 38 mm



INGE

026-495-160 16,0 cm / 6 1/4"



INGE

026-497-270 27,0 cm / 10 1/2"

Laminektomie-Stanzen nicht zerlegbar
Laminectomy Punches non detachable
Pinzas cortantes para laminectomía non desmontable
Pinze per laminectomia non smontabile



026

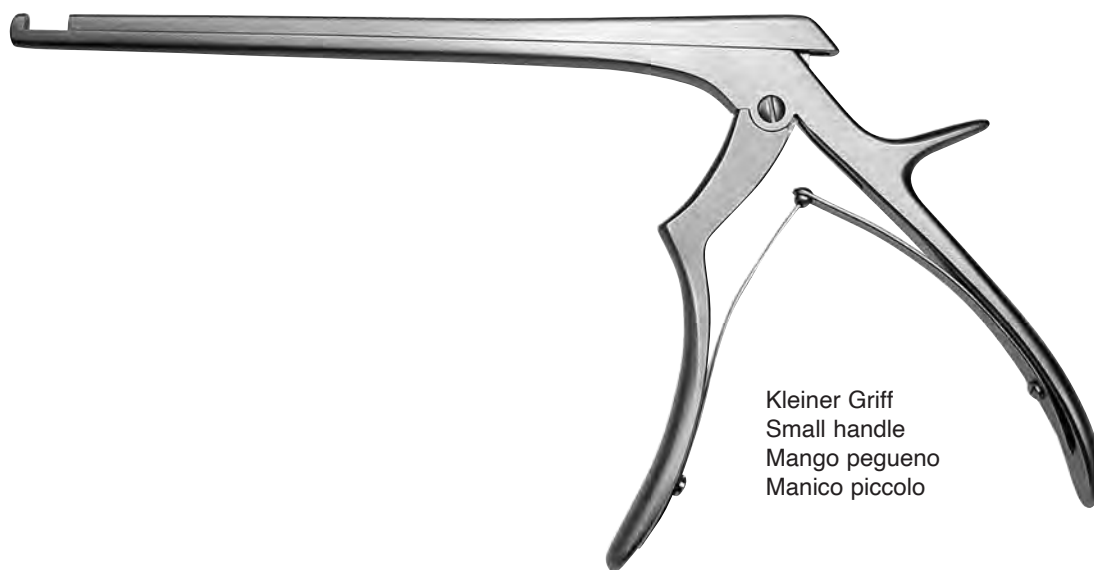

Kleiner Griff
 Small handle
 Mango pegueno
 Manico piccolo

KERRISON

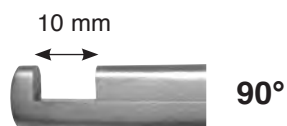

Schaftlänge Length of shaft Longitud del vástago Lunghezza dell'asta	Bissbreite / Width of bite / Anchura de la boca / Larghezza del morso					
	1 mm	2 mm	3 mm	4 mm	5 mm	6 mm
180 mm	026-550-001	026-550-002	026-550-003	026-550-004	026-550-005	026-550-006
200 mm	026-552-001	026-552-002	026-552-003	026-552-004	026-552-005	026-552-006
230 mm	–	026-554-002	026-554-003	026-554-004	026-554-005	–

Laminektomie-Stanzen nicht zerlegbar
Laminectomy Punches non detachable
Pinzas cortantes para laminectomía non desmontable
Pinze per laminectomia non smontabile

Dünnfuß (Mikro)
 Thin footplate (Micro)
 Lámin de punzonar estrecha (Micro)
 Battente sottile (Micro)

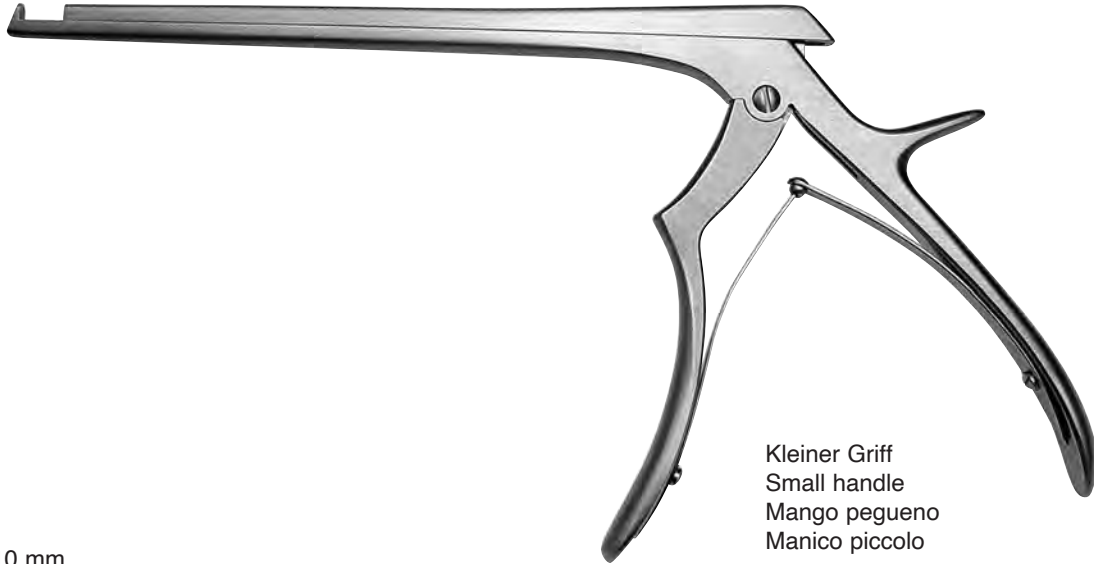

Kleiner Griff
 Small handle
 Mango pegueno
 Manico piccolo

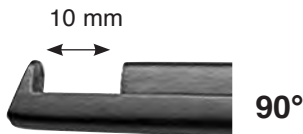

KERRISON

Schaftlänge Length of shaft Longitud del vástago Lunghezza dell' asta	Bissbreite / Width of bite / Anchura de la boca / Larghezza del morso				
	2 mm	3 mm	4 mm	5 mm	6 mm
180 mm	026-560-002	026-560-003	026-560-004	026-560-005	026-560-006
200 mm	026-562-002	026-562-003	026-562-004	026-562-005	026-562-006
230 mm	026-564-002	026-564-003	026-564-004	026-564-005	—

Laminektomie-Stanzen nicht zerlegbar
Laminectomy Punches non detachable
Pinzas cortantes para laminectomía non desmontable
Pinze per laminectomia non smontabile



026



KERRISON

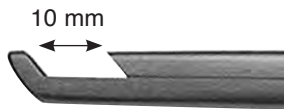

discontinued item

Schaftlänge Length of shaft Longitud del vástago Lunghezza dell'asta	Bissbreite / Width of bite / Anchura de la boca / Larghezza del morso					
		2 mm	3 mm	4 mm	5 mm	6 mm
180 mm	026-570-001	026-570-002	026-570-003	026-570-004	026-570-005	026-570-006
200 mm	026-572-001	026-572-002	026-572-003	026-572-004	026-572-005	026-572-006
230 mm		026-574-002	026-574-003	026-574-004	026-574-005	-

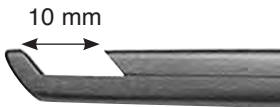

130° (40°)

mit Auswerfer
with ejector
con espulsore
con espulsore

Schaftlänge Length of shaft Longitud del vástago Lunghezza dell'asta	Bissbreite / Width of bite / Anchura de la boca / Larghezza del morso		
	3 mm	4 mm	5 mm
180 mm	026-580-003	026-580-004	026-580-005
200 mm	026-582-003	026-582-004	026-582-005

Laminektomie-Stanzen nicht zerlegbar
Laminectomy Punches non detachable
Pinzas cortantes para laminectomía non desmontable
Pinze per laminectomia non smontabile

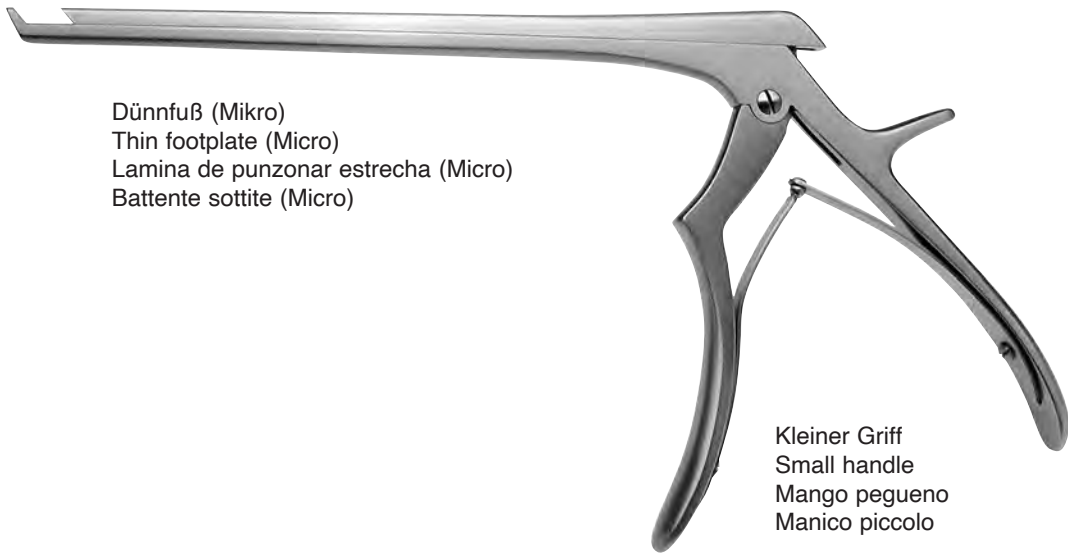

Dünnfuß (Mikro)
 Thin footplate (Micro)
 Lamina de punzonar estrecha (Micro)
 Battente sottile (Micro)

Kleiner Griff
 Small handle
 Mango pequeño
 Manico piccolo

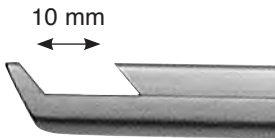

130° (40°)

KERRISON

Schaftlänge Length of shaft Longitud del vástago Lunghezza dell'asta	Bissbreite / Width of bite / Anchura de la boca / Larghezza del morso				
	2 mm	3 mm	4 mm	5 mm	6 mm
180 mm	026-590-002	026-590-003	026-590-004	026-590-005	026-590-006
200 mm	026-592-002	026-592-003	026-592-004	026-592-005	026-592-006
230 mm	026-594-002	026-594-003	026-594-004	026-594-005	-

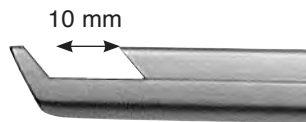

130° (40°)

mit Auswerfer
 with ejector
 con espulsor
 con espulsore

Schaftlänge Length of shaft Longitud del vástago Lunghezza dell'asta	Bissbreite / Width of bite / Anchura de la boca / Larghezza del morso		
	3 mm	4 mm	5 mm
180 mm	026-600-003	026-600-004	026-600-005
200 mm	026-602-003	026-602-004	026-602-005

Laminektomie-Stanzen nicht zerlegbar
Laminectomy Punches non detachable
Pinzas cortantes para laminectomía non desmontable
Pinze per laminectomia non smontabile



026



Kleiner Griff
 Small handle
 Mango pegueno
 Manico piccolo

KERRISON



Standardfuß
 Standard footplate
 Lámin de punzonar standard
 Battente standard

Schaftlänge Length of shaft Longitud del vástago Lunghezza dell'asta	Bissbreite / Width of bite / Anchura de la boca / Larghezza del morso			
	2 mm	3 mm	4 mm	5 mm
180 mm	026-610-002	026-610-003	026-610-004	026-610-005
200 mm	026-612-002	026-612-003	026-612-004	026-612-005



Dünnpfuß (Mikro)
 Thin footplate (Micro)
 Lámina de punzonar estrecha (Micro)
 Battente sottile

Schaftlänge Length of shaft Longitud del vástago Lunghezza dell'asta	Bissbreite / Width of bite / Anchura de la boca / Larghezza del morso			
	2 mm	3 mm	4 mm	5 mm
180 mm	026-620-002	026-620-003	026-620-004	026-620-005
200 mm	026-622-002	026-622-003	026-622-004	026-622-005

Laminektomie-Stanzen nicht zerlegbar
Laminectomy Punches non detachable
Pinzas cortantes para laminectomía non desmontable
Pinze per laminectomia non smontabile

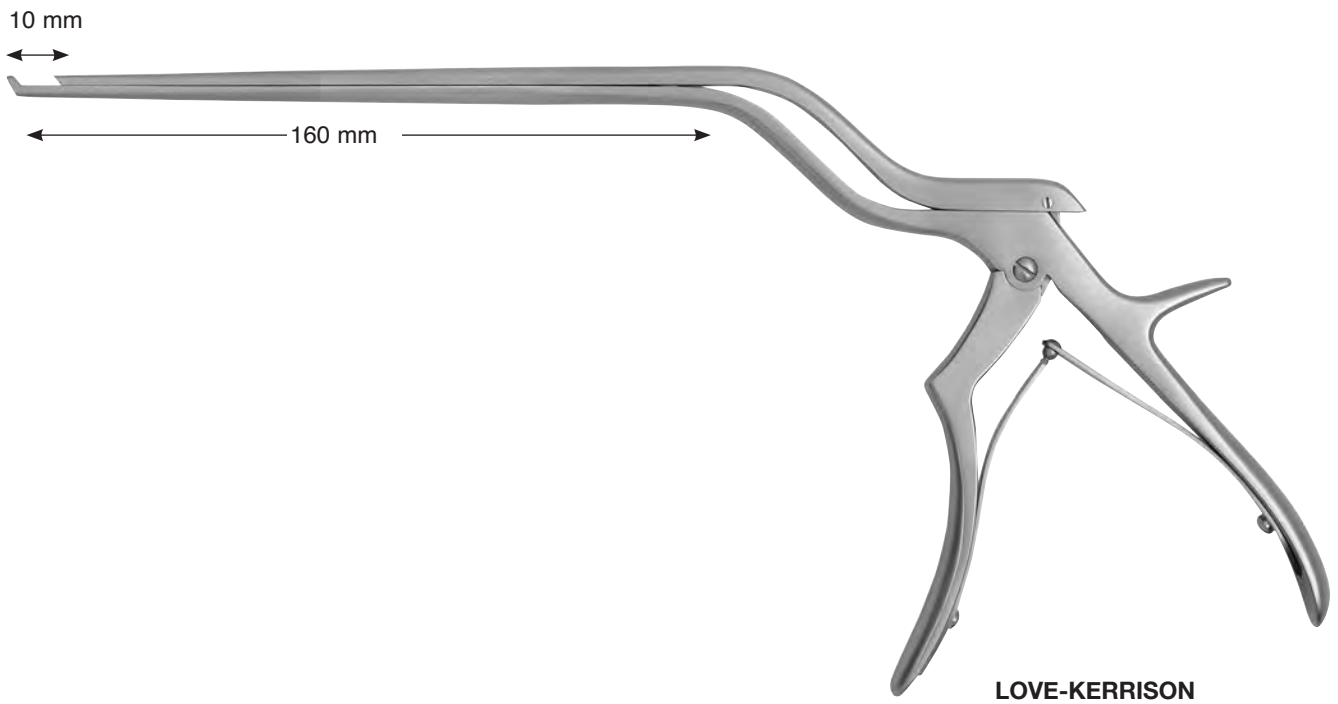

Standardfuß
 Standard footplate
 Lámin de punzonar standard
 Battente standard

Schaftlänge Length of shaft Longitud del vástago Lunghezza dell' asta	Bissbreite / Width of bite / Anchura de la boca / Larghezza del morso			
	2 mm	3 mm	4 mm	5 mm
160 mm	026-630-002	026-630-003	026-630-004	026-630-005



Dünnfuß (Mikro)
 Thin footplate (Micro)
 Lámina de punzonar estrecha (Micro)
 Battente sottile

Schaftlänge Length of shaft Longitud del vástago Lunghezza dell' asta	Bissbreite / Width of bite / Anchura de la boca / Larghezza del morso			
	2 mm	3 mm	4 mm	5 mm
160 mm	026-640-002	026-640-003	026-640-004	026-640-005

Laminektomie-Stanzen nicht zerlegbar
 Laminectomy Punches non detachable
 Pinzas cortantes para laminectomía non desmontable
 Pinze per laminectomia non smontabile



026

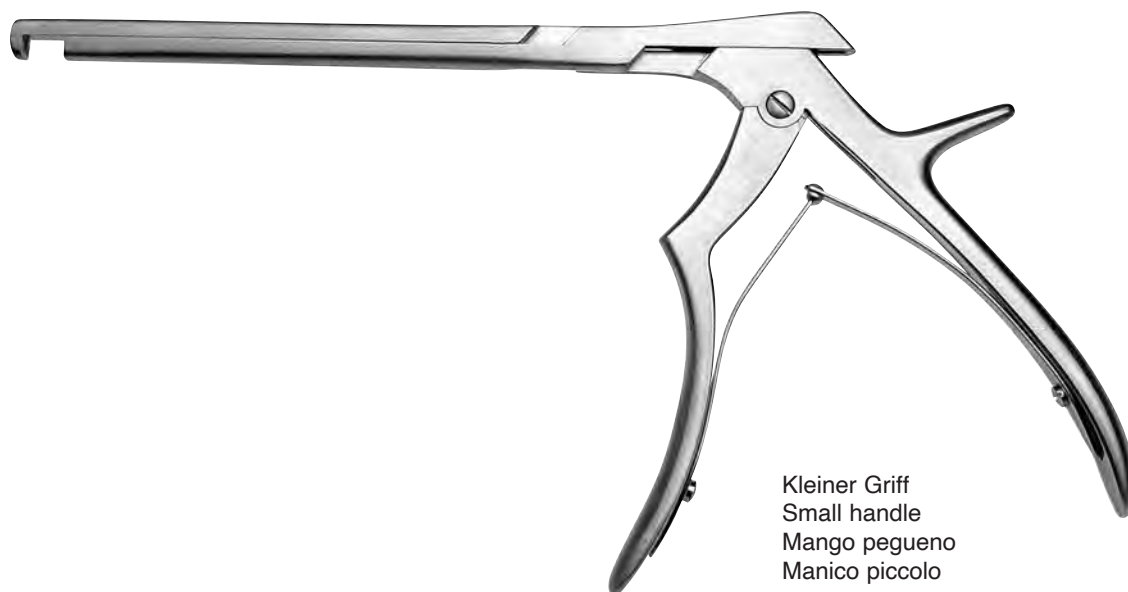

Kleiner Griff
 Small handle
 Mango pegueno
 Manico piccolo

KERRISON



Schaftlänge Length of shaft Longitud del vástago Lunghezza dell'asta	Bissbreite / Width of bite / Anchura de la boca / Larghezza del morso				
	2 mm	3 mm	4 mm	5 mm	6 mm
180 mm	026-650-002	026-650-003	026-650-004	026-650-005	026-650-006
200 mm	026-652-002	026-652-003	026-652-004	026-652-005	026-652-006



026

Laminektomie-Stanzen nicht zerlegbar
Laminectomy Punches non detachable
Pinzas cortantes para laminectomía non desmontable
Pinze per laminectomia non smontabile



KERRISON



10 mm

130° (40°)

Schaftlänge Length of shaft Longitud del vástago Lunghezza dell'asta	Bissbreite / Width of bite / Anchura de la boca / Larghezza del morso			
	2 mm	3 mm	4 mm	5 mm
180 mm	026-670-002	026-670-003	026-670-004	026-670-005

- ein Teil
- einfach zu demontieren
- einfach zu reinigen
- einfach zusammenzufügen

Demontage Disassembly



Zuerst den Griff schließen ...
First close the handle ...



dann den Riegel nach unten drücken ...
then push the lever downwards ...

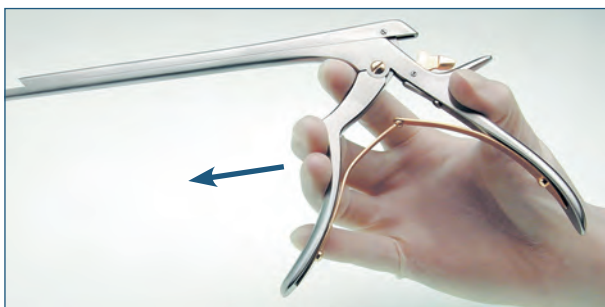

nun den Griff wieder öffnen ...
now open the handle ...

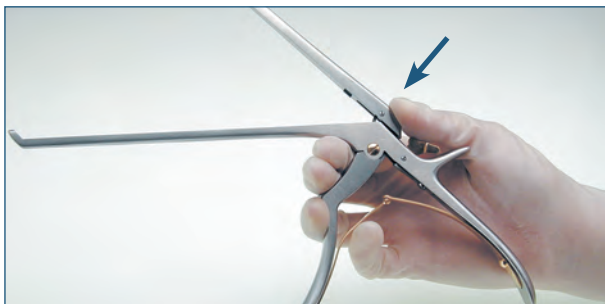

und hinten auf den Schaft drücken.
and push downwards at the end of shaft.

- one piece
- easy to disassemble
- easy to clean
- easy to assemble

Zusammenfügen Assembly



Zuerst Schaftteile ineinandersetzen ...
 First push shaft parts into one other ...

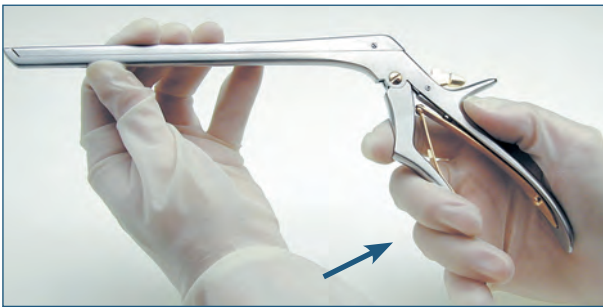

dann den Griff schließen ...
 than close the handle ...

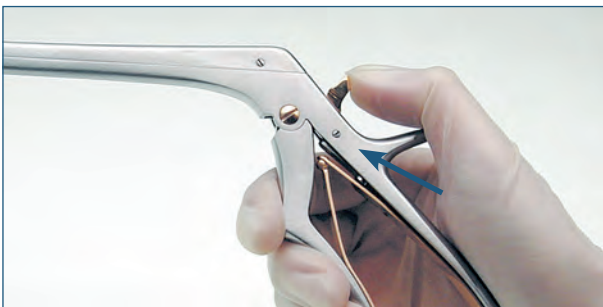

nun den Riegel nach oben drücken ...
 now push the lever upwards ...

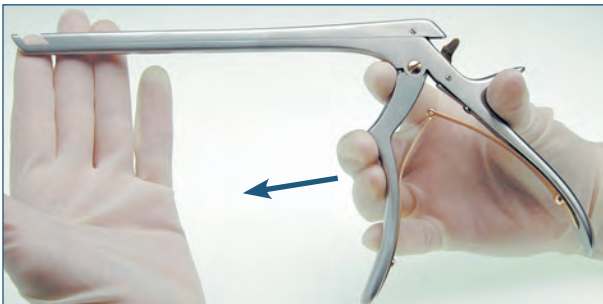

und den Griff wieder öffnen.
 and finally open the handle.

Laminektomie-Stanzen zerlegbar
 Laminectomy Punches detachable
 Pinzas cortantes para laminectomía desmontable
 Pinze per laminectomia smontabile



026

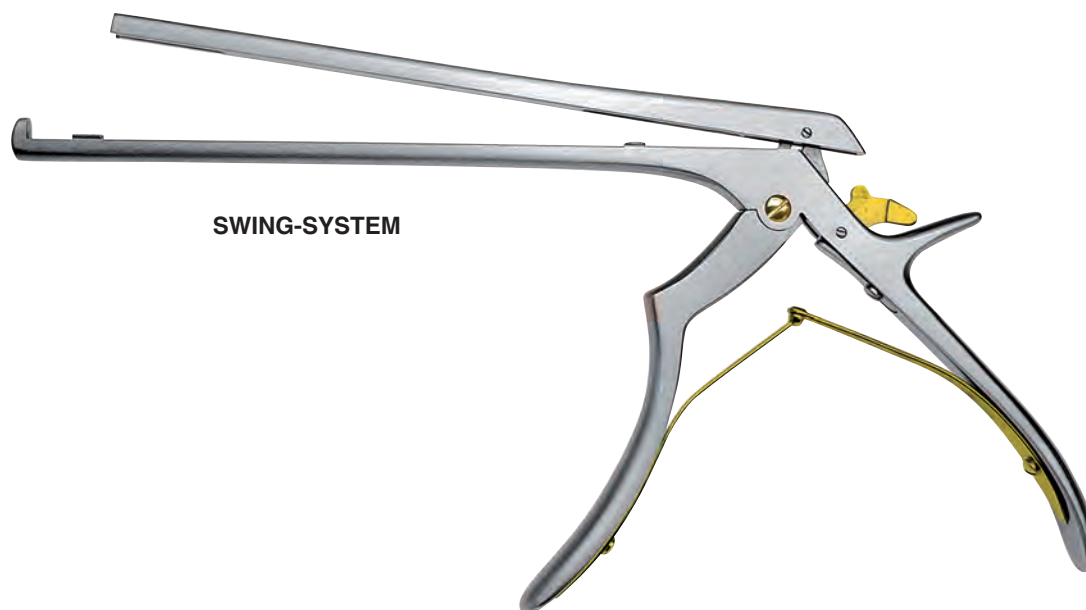

KERRISON

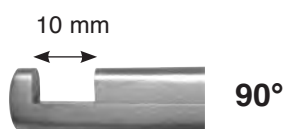

discontinued item

Schaftlänge Length of shaft Longitud del vástago Lunghezza dell'asta		Bissbreite / Width of bite / Anchura de la boca / Larghezza del morso				
		2 mm	3 mm	4 mm	5 mm	6 mm
180 mm	001	026-700-002	026-700-003	026-700-004	026-700-005	026-700-006
200 mm	001	026-702-002	026-702-003	026-702-004	026-702-005	026-702-006
230 mm	001	026-704-002	026-704-003	026-704-004	026-704-005	026-704-006



026

Laminektomie-Stanzen zerlegbar
Laminectomy Punches detachable
Pinzas cortantes para laminectomía desmontable
Pinze per laminectomia smontabile

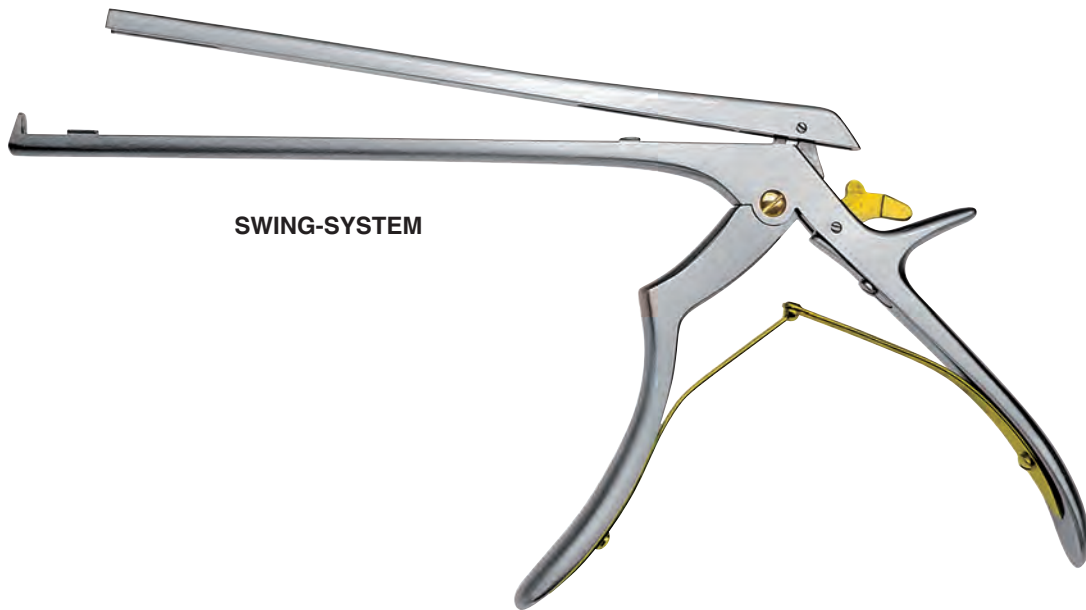

SWING-SYSTEM

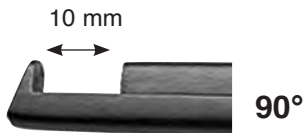
KERRISON

10 mm

90°

Dünnpfuss (Mikro)
 Thin footplate (Micro)
 Lámina de punzonar estrecha (Micro)
 Battente sottile

Schaftlänge Length of shaft Longitud del vástago Lunghezza dell'asta	Bissbreite / Width of bite / Anchura de la boca / Larghezza del morso				
	2 mm	3 mm	4 mm	5 mm	6 mm
180 mm	026-710-002	026-710-003	026-710-004	026-710-005	026-710-006
200 mm	026-712-002	026-712-003	026-712-004	026-712-005	026-712-006
230 mm	026-714-002	026-714-003	026-714-004	026-714-005	026-714-006

Laminektomie-Stanzen zerlegbar
Laminectomy Punches detachable
Pinzas cortantes para laminectomía desmontable
Pinze per laminectomia smontabile



026

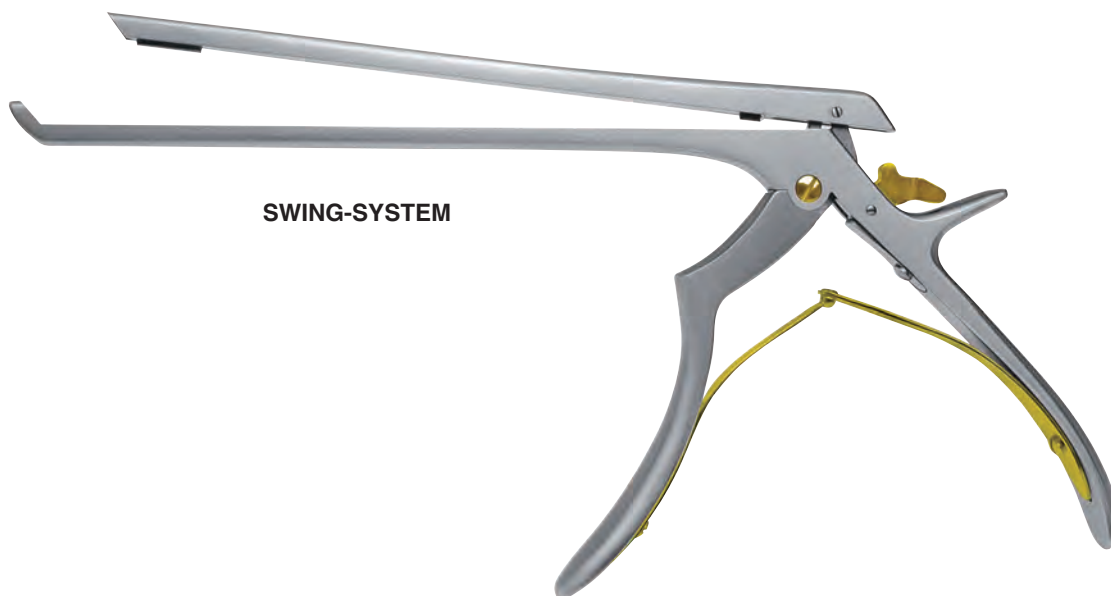

SWING-SYSTEM

KERRISON

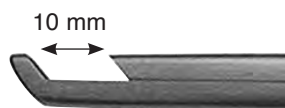

130° (40°)

Schaftlänge Length of shaft Longitud del vástago Lunghezza dell'asta	discontinued item	Bissbreite / Width of bite / Anchura de la boca / Larghezza del morso				
		2 mm	3 mm	4 mm	5 mm	6 mm
180 mm	026-720-001	026-720-002	026-720-003	026-720-004	026-720-005	026-720-006
200 mm	026-722-001	026-722-002	026-722-003	026-722-004	026-722-005	026-722-006
230 mm	026-724-001	026-724-002	026-724-003	026-724-004	026-724-005	026-724-006

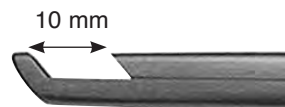

130° (40°)

mit Auswerfer
with ejector
con espulsor
con espulsore

Schaftlänge Length of shaft Longitud del vástago Lunghezza dell'asta	Bissbreite / Width of bite / Anchura de la boca / Larghezza del morso			
	3 mm	4 mm	5 mm	6 mm
180 mm	026-730-003	026-730-004	026-730-005	026-730-006
200 mm	026-732-003	026-732-004	026-732-005	026-732-006
230 mm	026-734-003	026-734-004	026-734-005	026-734-006

Laminektomie-Stanzen zerlegbar
Laminectomy Punches detachable
Pinzas cortantes para laminectomía desmontable
Pinze er laminectomia smontabile

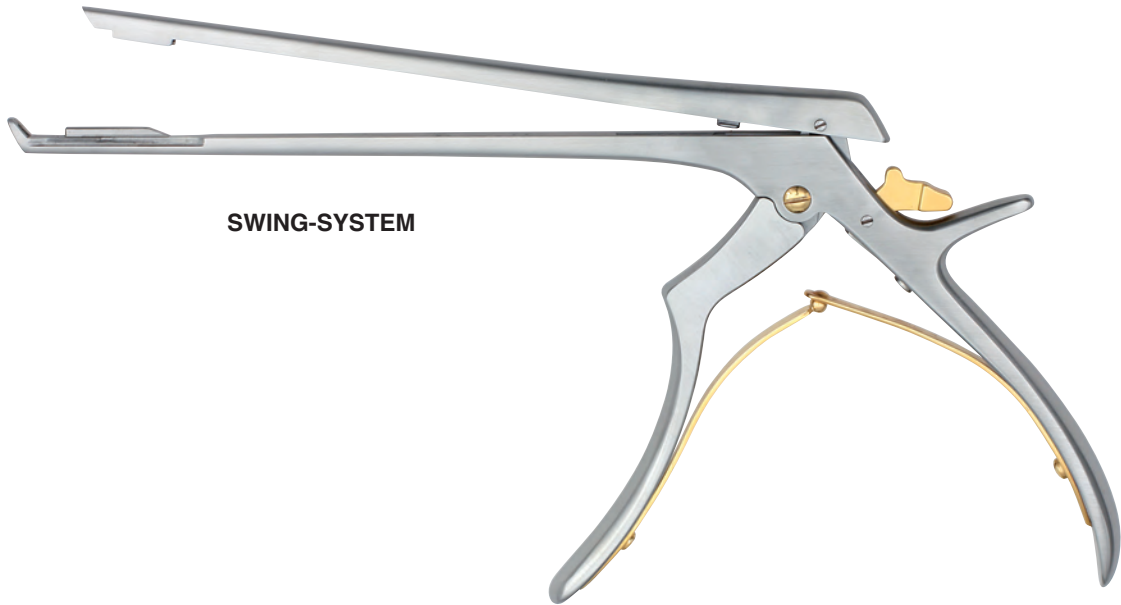

KERRISON

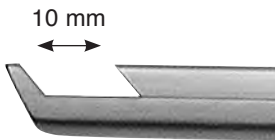

130° (40°)

Dünnpfuß (Mikro)
 Thin footplate (Micro)
 Lámina de punzonar estrecha (Micro)
 Battente sottile

Schaftlänge Length of shaft Longitud del vástago Lunghezza dell'asta	discontinued item	Bissbreite / Width of bite / Anchura de la boca / Larghezza del morso				
		2 mm	3 mm	4 mm	5 mm	6 mm
180 mm	026-740-001	026-740-002	026-740-003	026-740-004	026-740-005	026-740-006
200 mm	026-742-001	026-742-002	026-742-003	026-742-004	026-742-005	026-742-006
230 mm	026-744-001	026-744-002	026-744-003	026-744-004	026-744-005	026-744-006

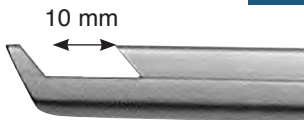

130° (40°)

Dünnpfuß (Mikro)
 Thin footplate (Micro)
 Lámina de punzonar estrecha (Micro)
 Battente sottile

mit Auswerfer
 with ejector
 con espulsore
 con espulsore

Schaftlänge Length of shaft Longitud del vástago Lunghezza dell'asta	Bissbreite / Width of bite / Anchura de la boca / Larghezza del morso			
	3 mm	4 mm	5 mm	6 mm
180 mm	026-750-003	026-750-004	026-750-005	026-750-006
200 mm	026-752-003	026-752-004	026-752-005	026-752-006
230 mm	026-754-003	026-754-004	026-754-005	026-754-006

Laminektomie-Stanzen
Laminectomy Punches
Pinzas cortantes para laminectomía
Pinze per laminectomia



026

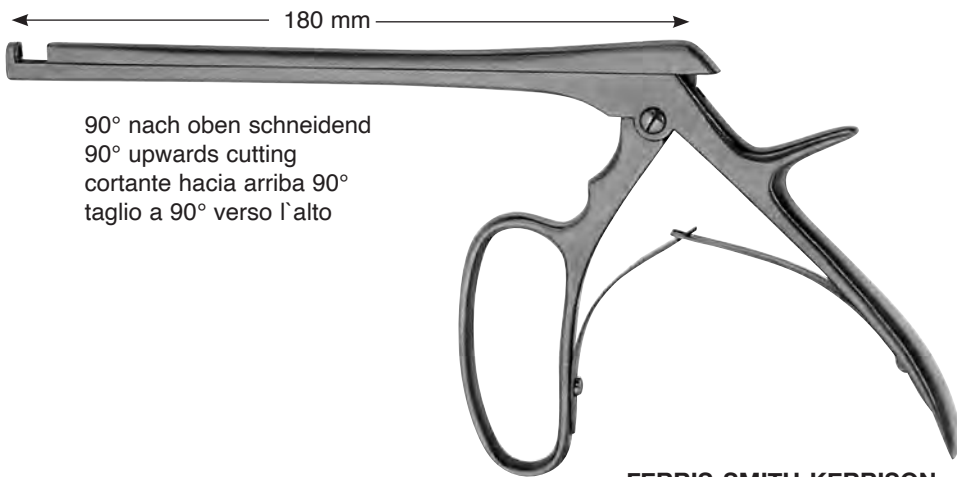

90° nach oben schneidend
 90° upwards cutting
 cortante hacia arriba 90°
 taglio a 90° verso l'alto

FERRIS-SMITH-KERRISON

- | | | |
|--------------------|--------|--|
| 026-790-003 | 3,0 mm | |
| 026-790-005 | 5,0 mm | |

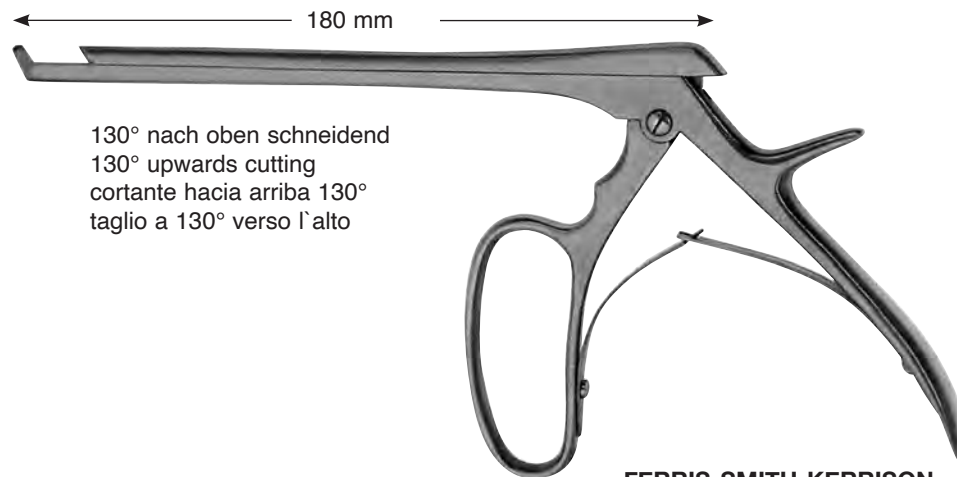

130° nach oben schneidend
 130° upwards cutting
 cortante hacia arriba 130°
 taglio a 130° verso l'alto

FERRIS-SMITH-KERRISON

- | | | | |
|--------------------|--------------------|--------|--|
| a = 180 mm | a = 200 mm | | |
| 026-792-003 | 026-794-003 | 3,0 mm | |
| 026-792-005 | 026-794-005 | 5,0 mm | |

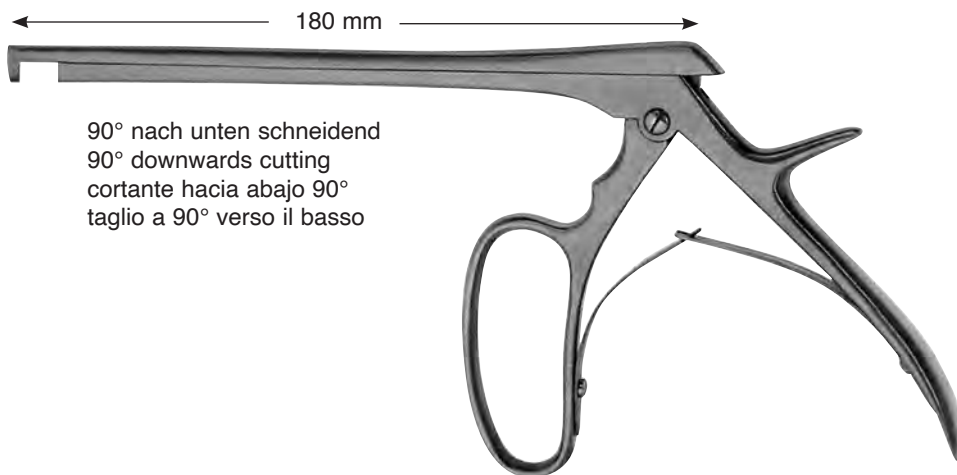

90° nach unten schneidend
 90° downwards cutting
 cortante hacia abajo 90°
 taglio a 90° verso il basso

FERRIS-SMITH-KERRISON

- | | | |
|--------------------|--------|--|
| 026-796-003 | 3,0 mm | |
| 026-796-005 | 5,0 mm | |

Laminektomie-Zangen
Laminectomy Rongeurs
Pinzas cortantes para laminectomía
Pinze per laminectomia

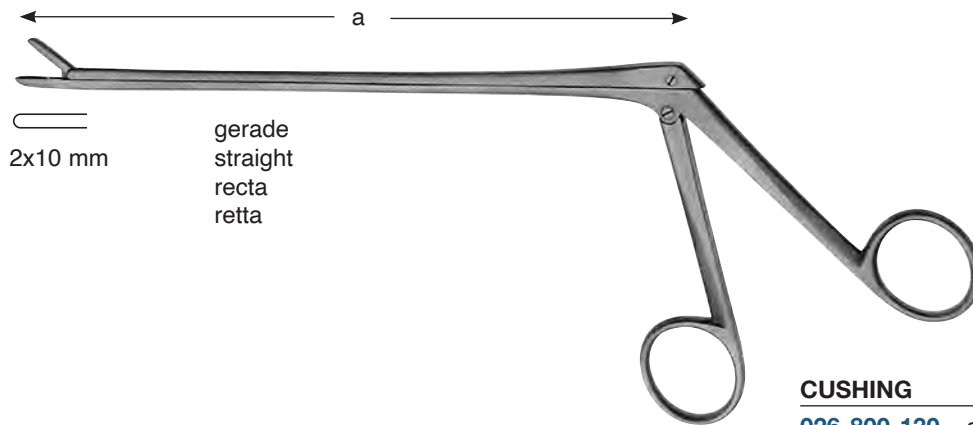

2x10 mm
 gerade
 straight
 recta
 retta

CUSHING

- 026-800-130** a = 130 mm
- 026-800-150** a = 150 mm
- 026-800-180** a = 180 mm

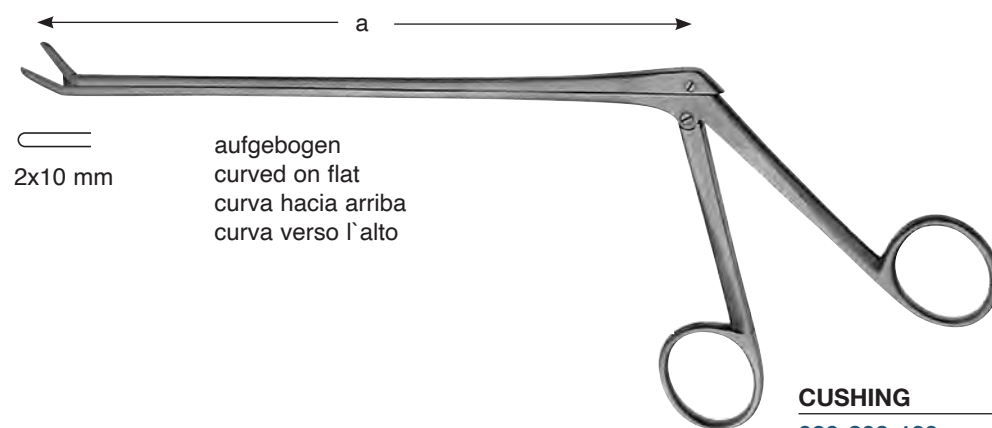

2x10 mm
 aufgebogen
 curved on flat
 curva hacia arriba
 curva verso l'alto

CUSHING

- 026-802-130** a = 130 mm
- 026-802-150** a = 150 mm
- 026-802-180** a = 180 mm

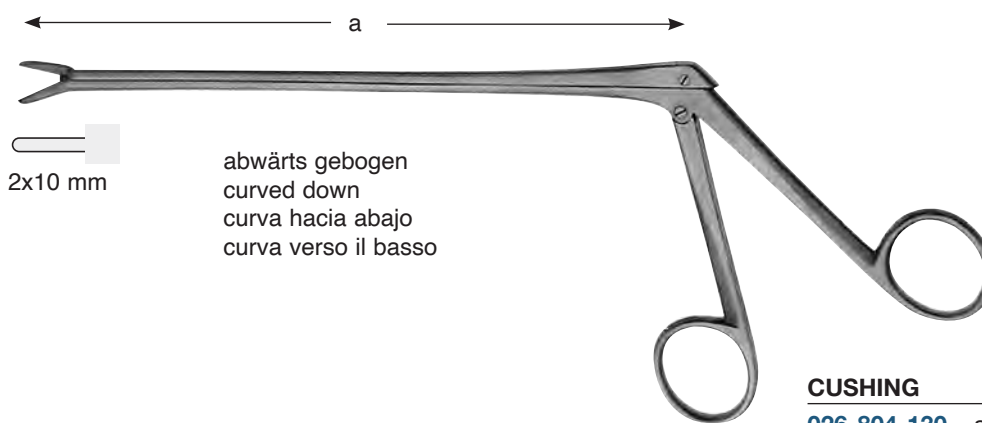

2x10 mm
 abwärts gebogen
 curved down
 curva hacia abajo
 curva verso il basso

CUSHING

- 026-804-130** a = 130 mm
- 026-804-150** a = 150 mm
- 026-804-180** a = 180 mm

Laminektomie-Zangen
Laminectomy Rongeurs
Pinzas cortantes para laminectomía
Pinze per laminectomia



026

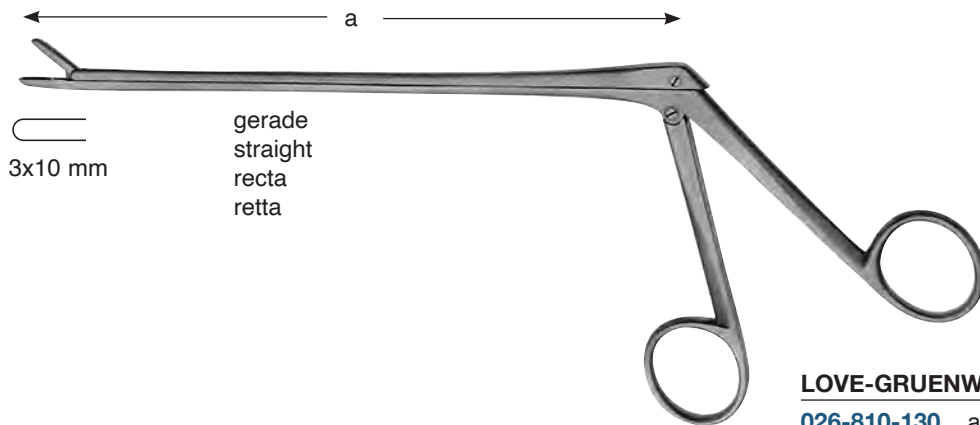

LOVE-GRUENWALD

026-810-130 a = 130 mm
026-810-150 a = 150 mm
026-810-180 a = 180 mm

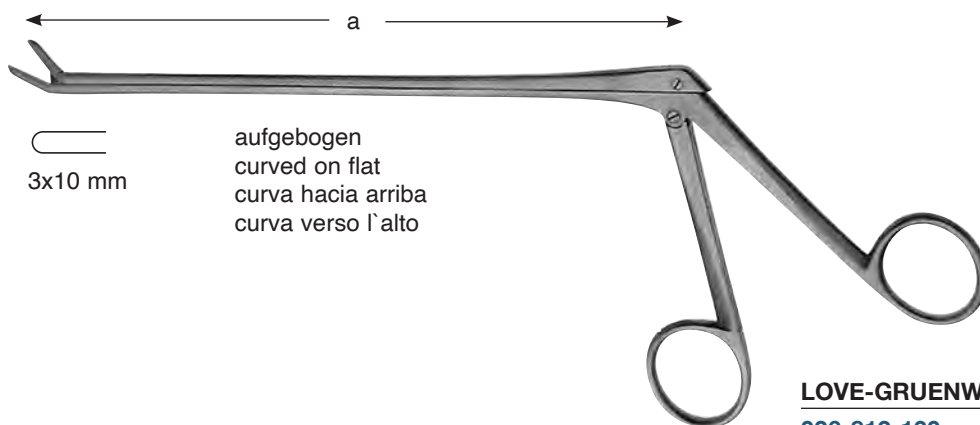

LOVE-GRUENWALD

026-812-130 a = 130 mm
026-812-150 a = 150 mm
026-812-180 a = 180 mm

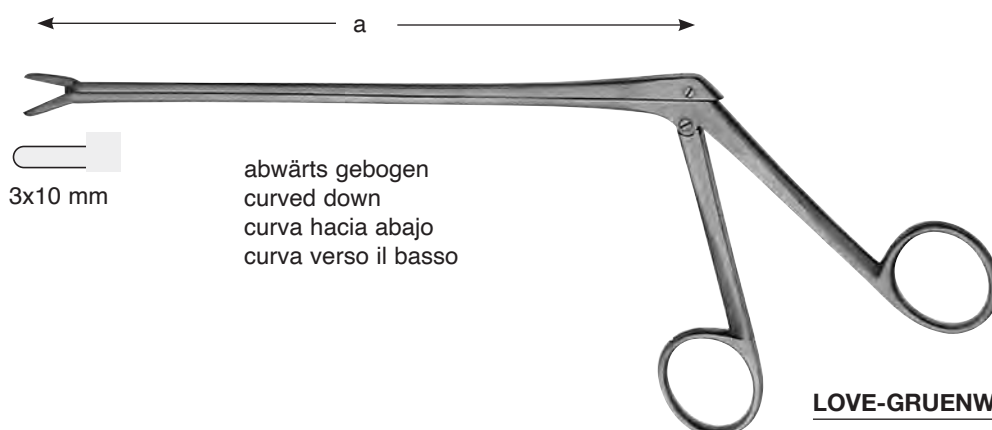

LOVE-GRUENWALD

026-814-130 a = 130 mm
026-814-150 a = 150 mm
026-814-180 a = 180 mm

Laminektomie-Zangen
Laminectomy Rongeurs
Pinzas cortantes para laminectomía
Pinze per laminectomia

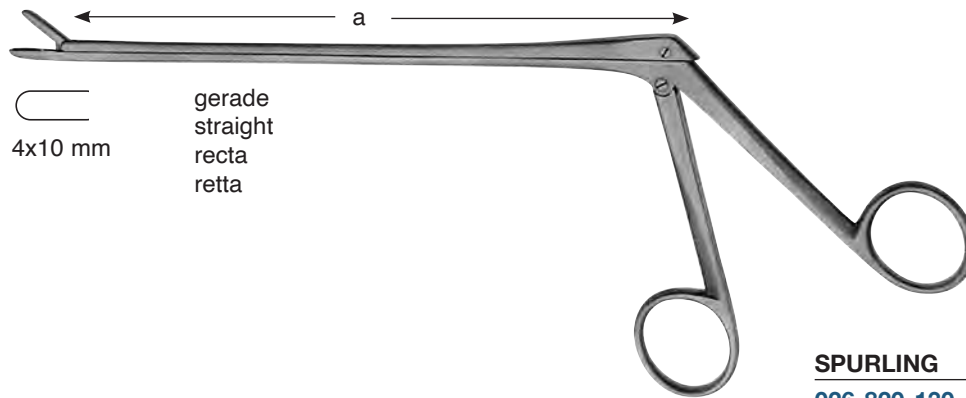

SPURLING

- 026-820-130** a = 130 mm
026-820-150 a = 150 mm
026-820-180 a = 180 mm

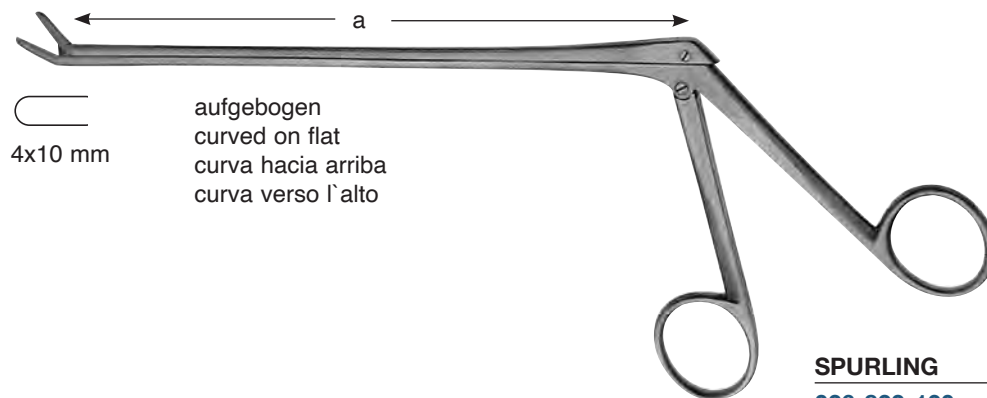

SPURLING

- 026-822-130** a = 130 mm
026-822-150 a = 150 mm
026-822-180 a = 180 mm



SPURLING

- 026-824-130** a = 130 mm
026-824-150 a = 150 mm
026-824-180 a = 180 mm

Laminektomie-Zangen
Laminectomy Rongeurs
Pinzas cortantes para laminectomía
Pinze per laminectomia



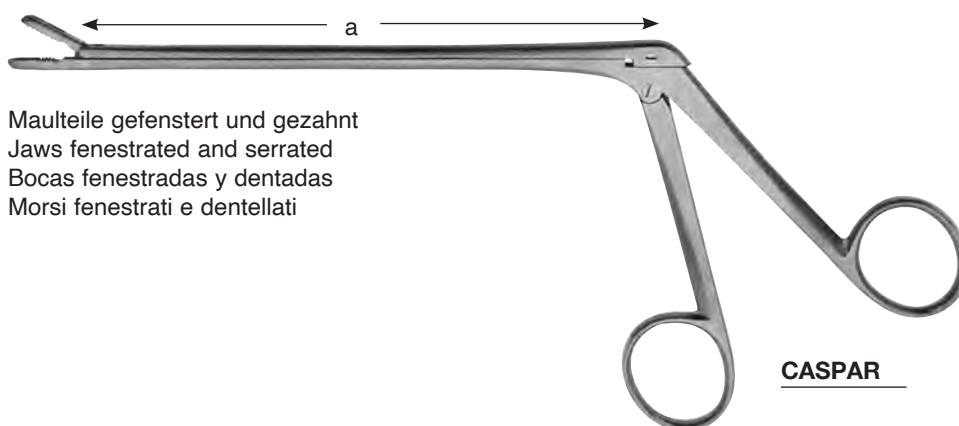

026



Maulteile gefenstert und gezahnt
 Jaws fenestrated and serrated
 Bocas fenestradas y dentadas
 Morsi fenestrati e dentellati

CASPAR

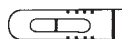
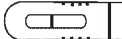
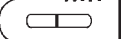
Schaftlänge Length of shaft Longitud del vástago Lunghezza dell' asta	Bissbreite / Width of bite / Anchura de la boca / Larghezza del morso				
					
2,0 x 12,0 mm	3,0 x 12,0 mm	4,0 x 14,0 mm	5,0 x 14,0 mm	6,0 x 16,0 mm	
a = 140 mm	026-830-140	026-832-140	026-834-140	026-836-140	026-838-140
a = 160 mm	026-830-160	026-832-160	026-834-160	026-836-160	026-838-160
a = 185 mm	026-830-185	026-832-185	026-834-185	026-836-185	026-838-185

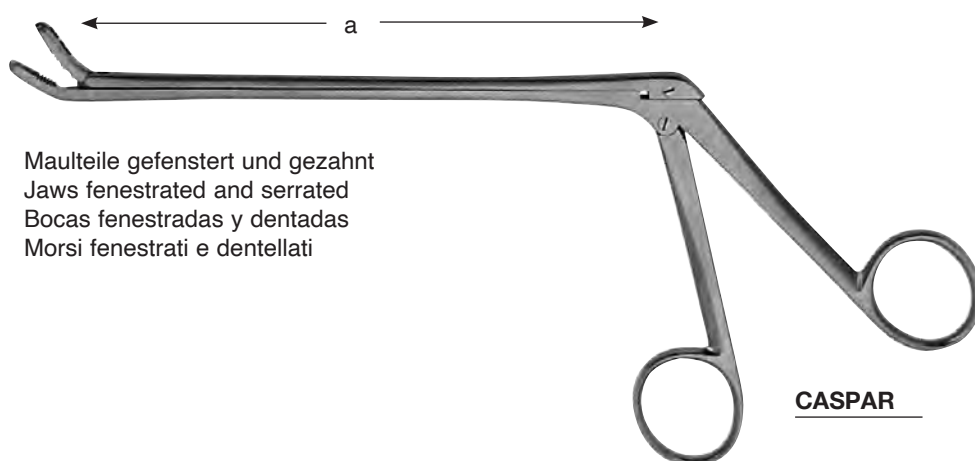

Maulteile gefenstert und gezahnt
 Jaws fenestrated and serrated
 Bocas fenestradas y dentadas
 Morsi fenestrati e dentellati

CASPAR

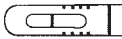
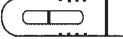
Schaftlänge Length of shaft Longitud del vástago Lunghezza dell' asta	Bissbreite / Width of bite / Anchura de la boca / Larghezza del morso		
			
3,0 x 12,0 mm	4,0 x 14,0 mm	5,0 x 14,0 mm	
a = 140 mm	026-842-140	026-844-140	026-846-140
a = 160 mm	026-842-160	026-844-160	026-846-160
a = 185 mm	026-842-185	026-844-185	026-846-185

Laminektomie-Zangen
Laminectomy Rongeurs
Pinzas cortantes para laminectomía
Pinze per laminectomia

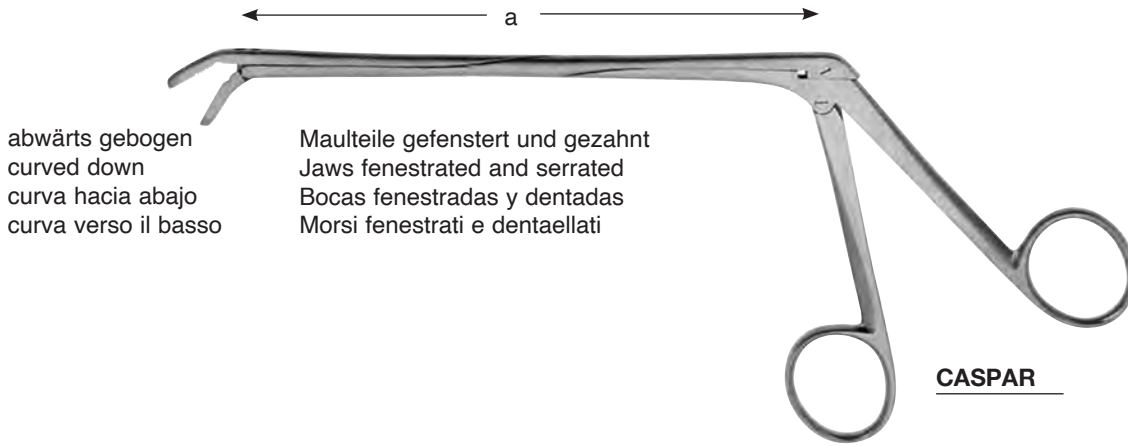

abwärts gebogen
 curved down
 curva hacia abajo
 curva verso il basso

Maulteile gefenestert und gezahnt
 Jaws fenestrated and serrated
 Bocas fenestradas y dentadas
 Morsi fenestrati e dentaellati

Schaftlänge Length of shaft Longitud del vástago Lunghezza dell'asta	Bissbreite / Width of bite / Anchura de la boca / Larghezza del morso	
	3,0 x 12,0 mm	4,0 x 14,0 mm
a = 140 mm	026-852-140	026-854-140
a = 160 mm	026-852-160	026-854-160
a = 185 mm	026-852-185	026-854-185

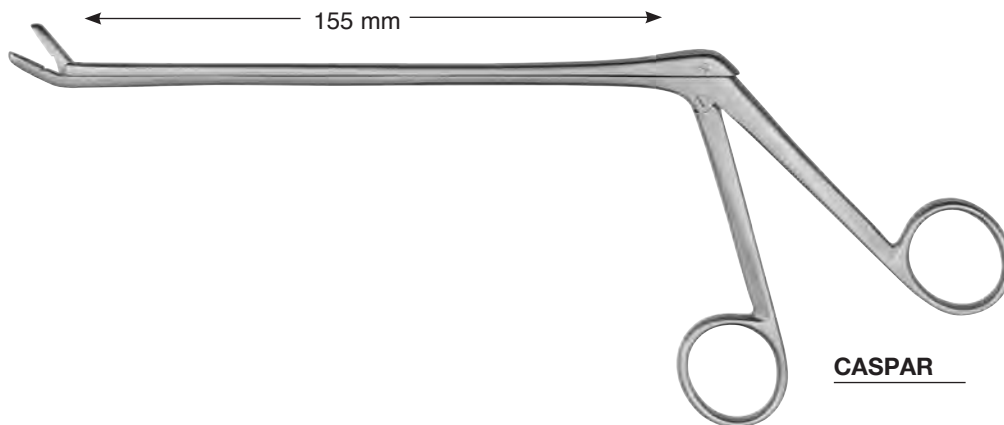

	Bissbreite / Width of bite / Anchura de la boca / Larghezza del morso			
	2,0 x 12,0 mm	3,0 x 13,0 mm	4,0 x 14,0 mm	5,0 x 14,0 mm
	026-860-002	026-860-003	026-860-004	026-860-005
	026-862-002	026-862-003	026-862-004	026-862-005
	026-864-002	026-864-003	026-864-004	026-864-005

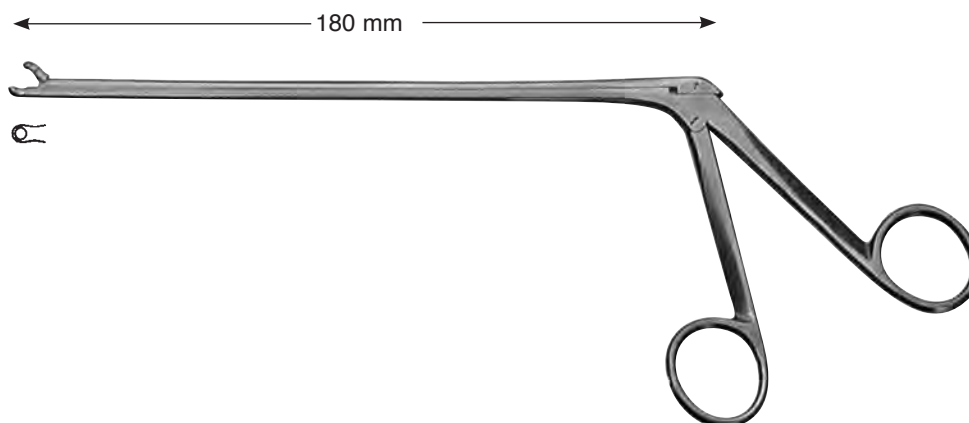

YASARGIL

026-870-180 Ø 2,0 mm

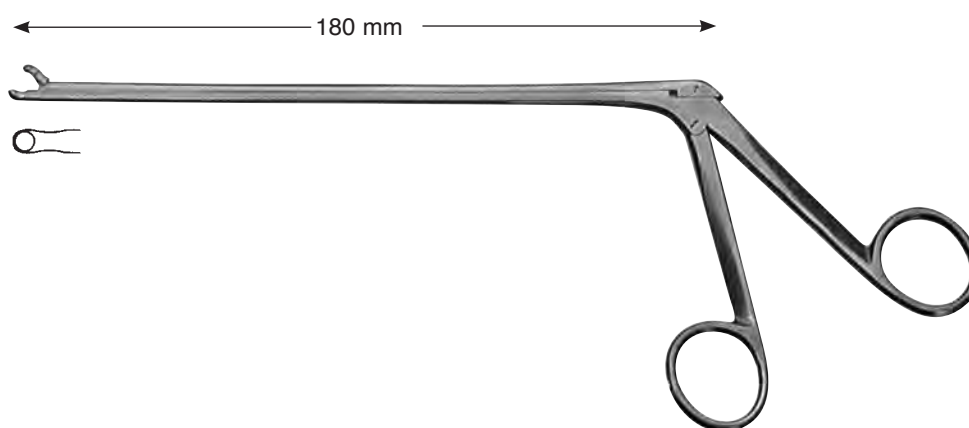

OLDBERG

026-872-180 Ø 3,5 mm

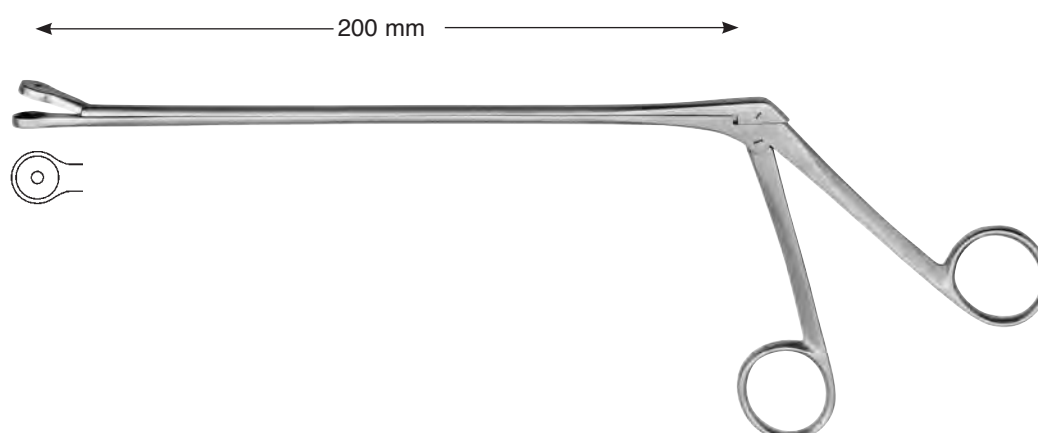

LANDOLT





026-874-200 Ø 9,0 mm

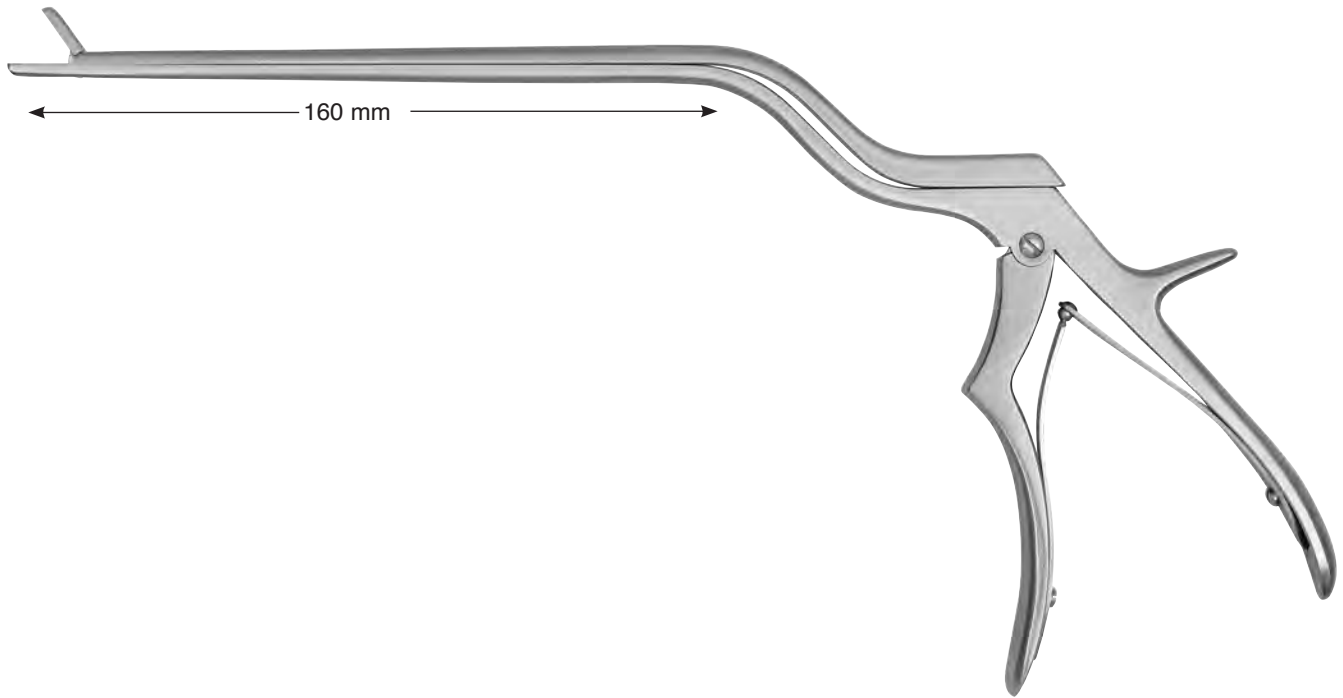

026

Laminektomie-Zangen
Laminectomy Rongeurs
Pinzas cortantes para laminectomía
Pinze per laminectomia



	Bissbreite / Width of bite / Anchura de la boca / Larghezza del morso		
			
	2,0 x 8,0 mm	3,0 x 9,0mm	4,0 x 10,0 mm
	026-880-002	026-880-003	026-880-004
	026-882-002	026-882-003	026-882-004

Laminektomie-Zangen
Laminectomy Rongeurs
Pinzas cortantes para laminectomía
Pinze per laminectomia



026

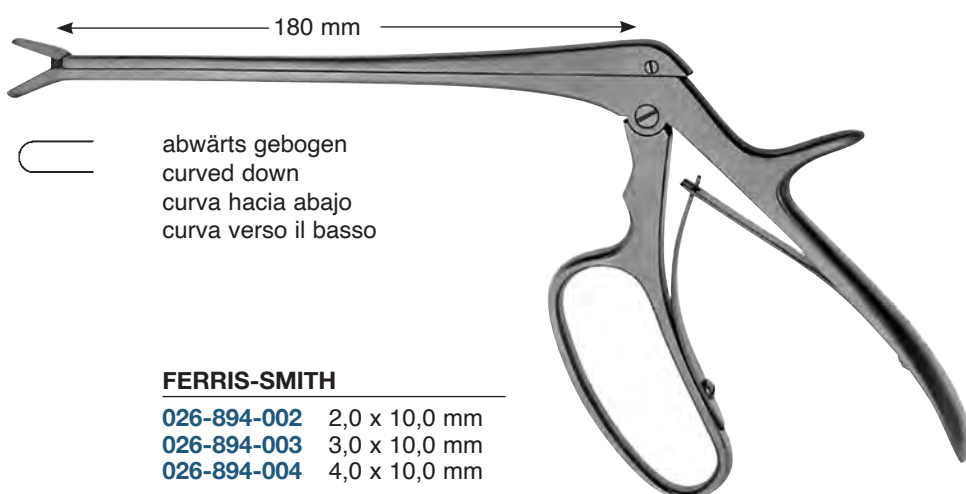
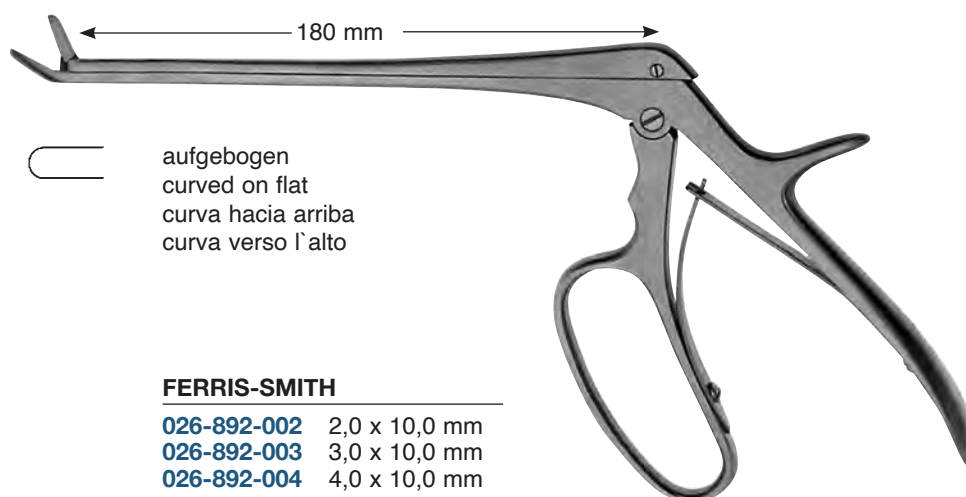
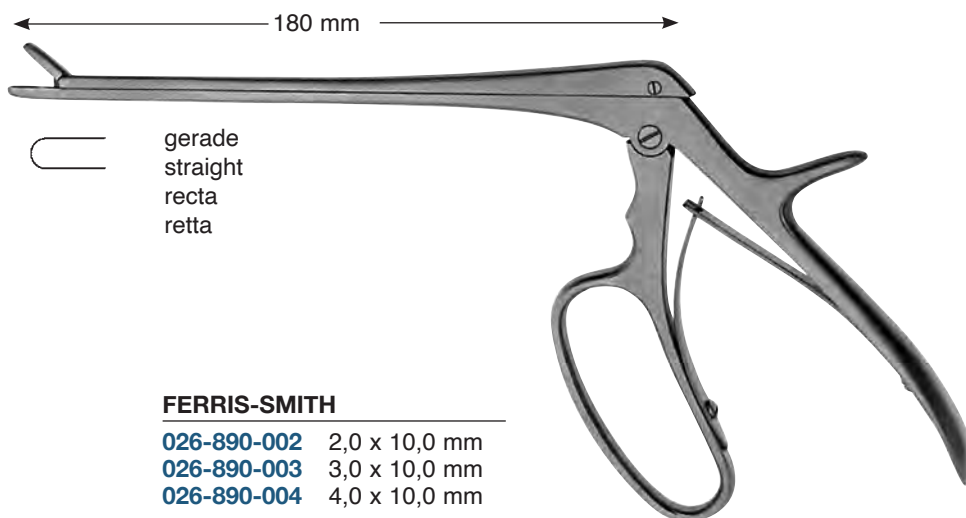

Mikro-Zangen für Neurochirurgie
Micro Forceps for Neurosurgery
Micro Pinzas para Neurocirugía
Micro Pinze per Neurochirurgia

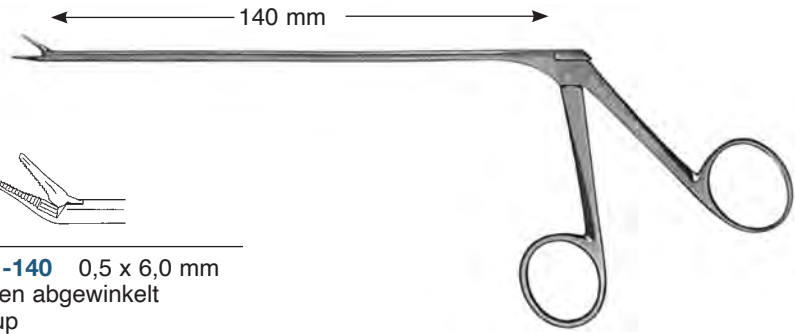

026-900-140 0,5 x 6,0 mm
gerade
straight
recta
retta

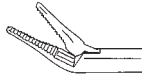

026-901-140 0,5 x 6,0 mm
nach oben abgewinkelt
angled up
angulada hacia arriba
angolata in alto



026-903-140 0,5 x 6,0 mm
nach rechts gebogen
curved to right
curva a la derecha
curve a destra



026-905-140 0,5 x 6,0 mm
nach links gebogen
curved to left
curva a la izquierda
curve a sinistra

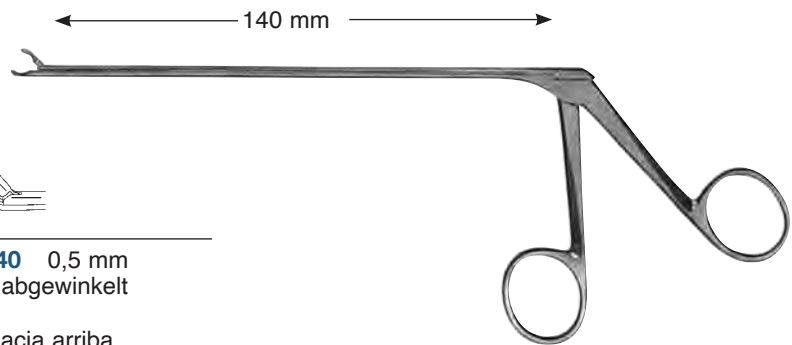

026-910-140 0,5 mm
026-920-140 1,0 mm
gerade
straight
recta
retta



026-911-140 0,5 mm
nach oben abgewinkelt
angled up
angulada hacia arriba
angolata in alto



026-913-140 0,5 mm
026-923-140 1,0 mm
nach rechts gebogen
curved to right
curva a la derecha
curve a destra





026-915-140 0,5 mm
026-925-140 1,0 mm
nach links gebogen
curved to left
curva a la izquierda
curve a sinistra

Mikro-Zangen für Neurochirurgie
Micro Forceps for Neurosurgery
Micro Pinzas para Neurocirugía
Micro Pinze per Neurochirurgia

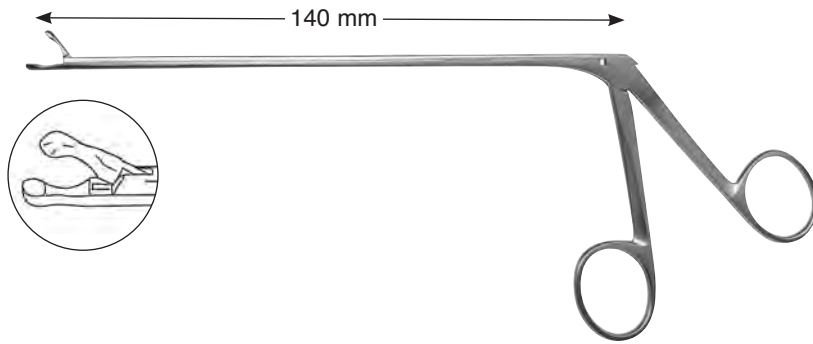

026



- | | | |
|--------------------|----------|---|
| 026-930-140 | Ø 2,0 mm |  |
| 026-932-140 | Ø 3,0 mm |  |

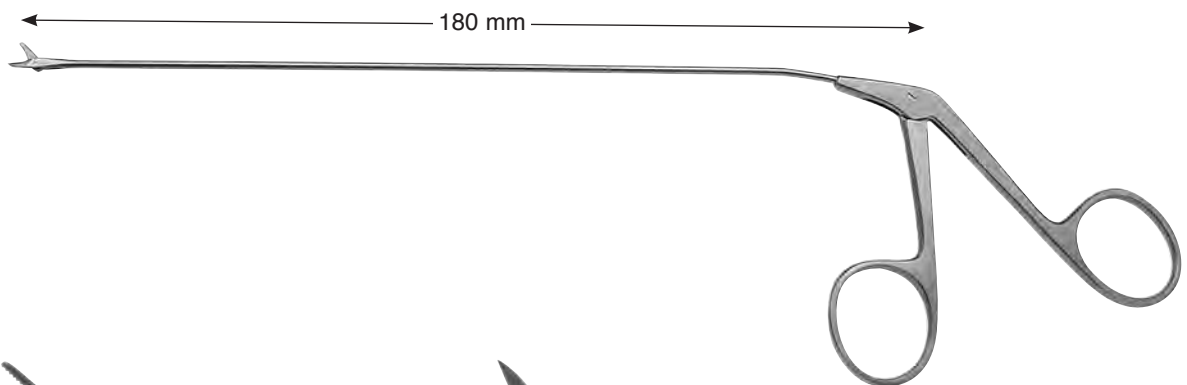

YASARGIL
026-940-180 Ø 2,0 mm



NICOLA
026-942-180 Ø 2,0 mm



NICOLA
026-944-180 Ø 2,0 mm



026

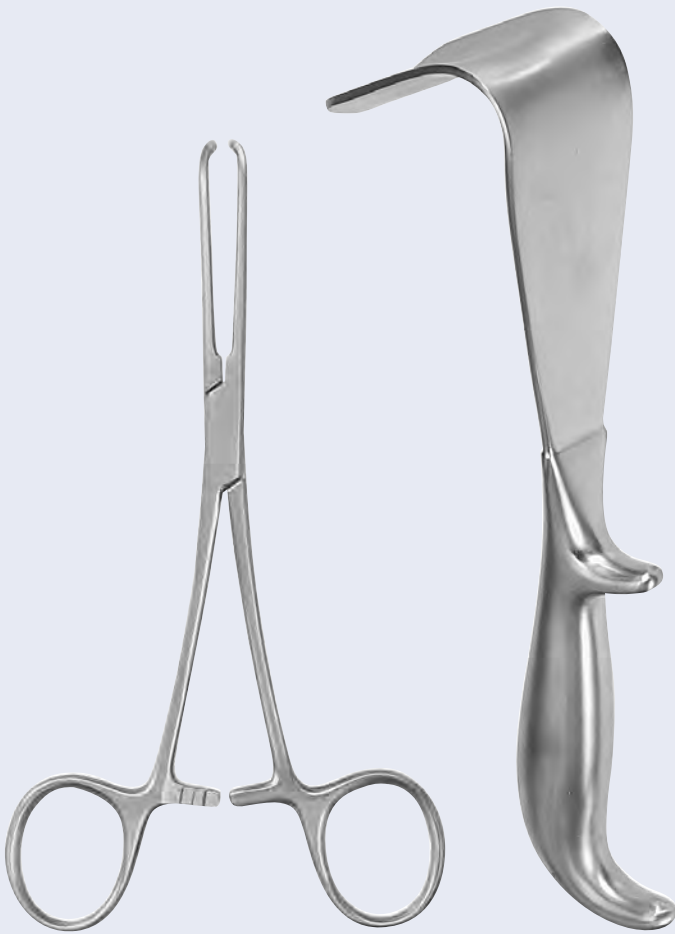

027

Magen, Darm, Urologie
Stomach, Intestines, Urology
Estómago, Intestinos,
Urología
Stomaco, Intestini, Urologia

Darm- und Gewebefäßzangen
Intestinal and Tissue Grasping Forceps
Pinzas intestinales y para tejidos
Pinze da presa per intestino e tessuti

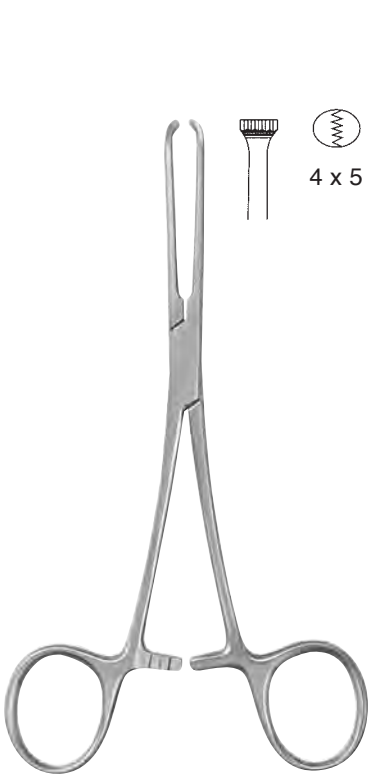

ALLIS-BABY

- 027-100-120** 12,0 cm / 4³/₄"
- 027-100-140** 14,0 cm / 5¹/₂"



ALLIS

- 027-110-150** 15,0 cm / 6"
- 027-110-190** 19,0 cm / 7¹/₂"



ALLIS

- 027-120-150** 15,0 cm / 6"
- 027-120-190** 19,0 cm / 7¹/₂"
- 027-120-220** 22,0 cm / 8³/₄"
- 027-120-250** 25,0 cm / 9³/₄"

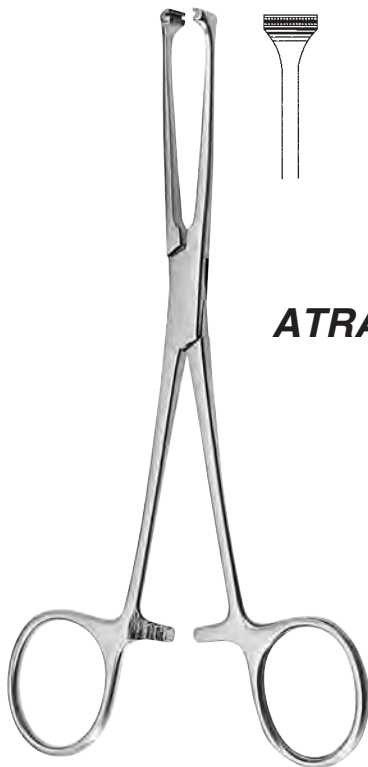

ATRAUMA

ALLIS

- 027-122-160** 16,0 cm / 6¹/₄"
- 027-122-200** 20,0 cm / 8"
- 027-122-250** 25,0 cm / 9³/₄"
- 027-122-300** 30,0 cm / 11¹/₄"



ALLIS-ADAIR

- 027-130-155** 15,5 cm / 6"

Darm- und Gewebefäßzangen
Intestinal and Tissue Grasping Forceps
Pinzas intestinales y para tejidos
Pinze da presa per intestino e tessuti



027



BOYS-ALLIS

027-132-150 15,0 cm / 6"



JUDD-ALLIS

027-134-150 15,0 cm / 6"
027-134-190 19,0 cm / 7½"



THOMS-ALLIS

027-140-200 20,0 cm / 8"



ALLIS

027-142-200 20,0 cm / 8"

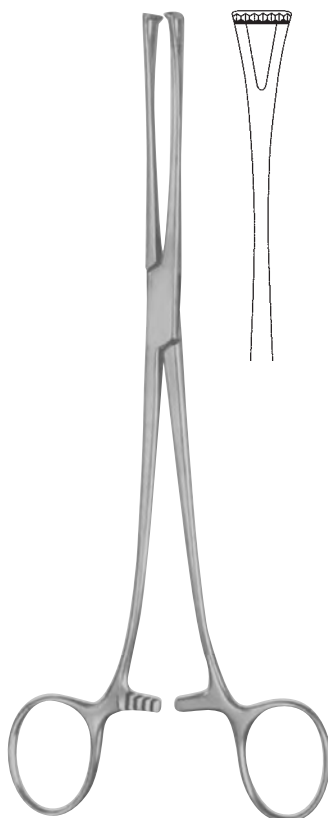

LOCKWOOD-ALLIS

027-144-200 20,0 cm / 8"

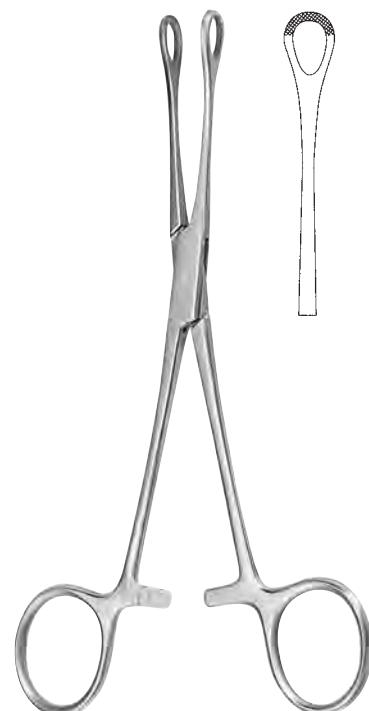

WILLIAMS

027-146-160 16,0 cm / 6¼"

Darm- und Gewebefäßzangen
Intestinal and Tissue Grasping Forceps
Pinzas intestinales y para tejidos
Pinze da presa per intestino e tessuti



2 x 3

LITTLEWOOD

027-152-185 18,5 cm / 7¹/₄"

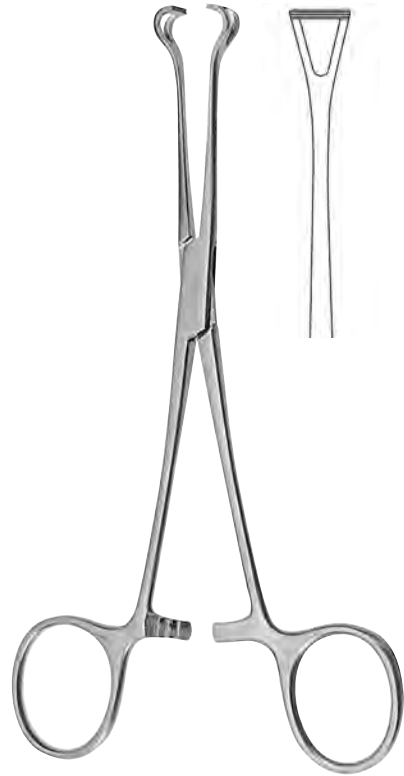

BABCOCK

- 027-160-140** 14,0 cm / 5¹/₂"
- 027-160-160** 16,0 cm / 8"
- 027-160-180** 18,0 cm / 7"
- 027-160-200** 20,0 cm / 8"
- 027-160-240** 24,0 cm / 9¹/₂"

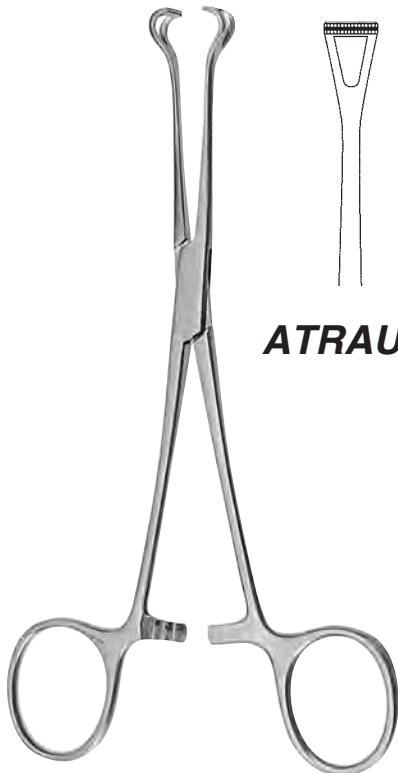

ATRAUMA

BABCOCK

- 027-162-160** 16,0 cm / 6¹/₄"
- 027-162-200** 20,0 cm / 8"

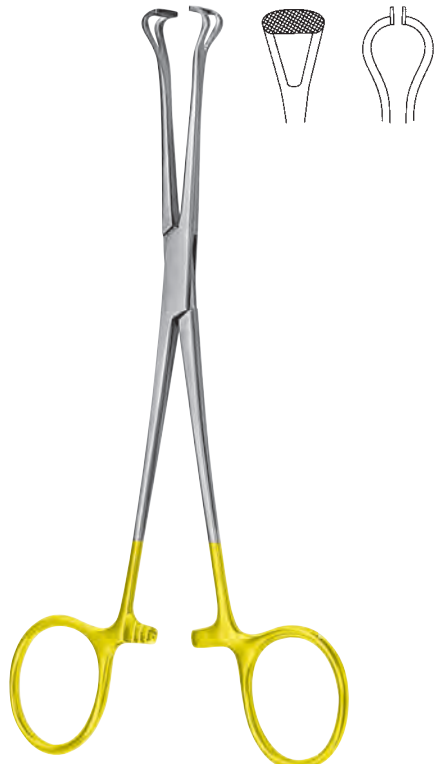

BABCOCK-TC

- 027-164-160** 16,0 cm / 6¹/₄"
- 027-164-200** 20,0 cm / 8"

Darm- und Gewebefäßzangen
Intestinal and Tissue Grasping Forceps
Pinzas intestinales y para tejidos
Pinze da presa per intestino e tessuti



027



DUVAL

027-170-180 18,0 cm / 7"
027-170-200 20,0 cm / 8"



DUVAL

027-172-200 20,0 cm / 8"
027-172-230 23,0 cm / 9"



DUVAL-TC

027-174-200 20,0 cm / 8"

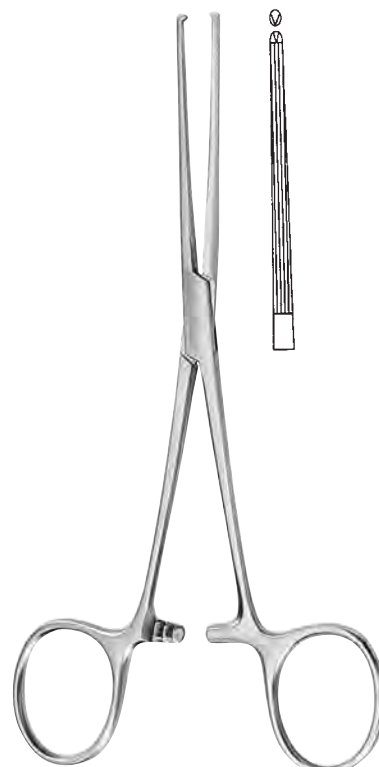

ALLEN

027-200-155 15,5 cm / 6"

Darm- und Gewebefäßzangen
Intestinal and Tissue Grasping Forceps
Pinzas intestinales y para tejidos
Pinze da presa per intestino e tessuti

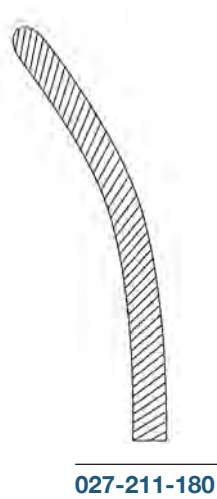
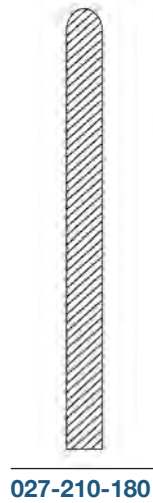

BABY-DOYEN

027-210-180 - 027-211-180 18,0 cm / 7"

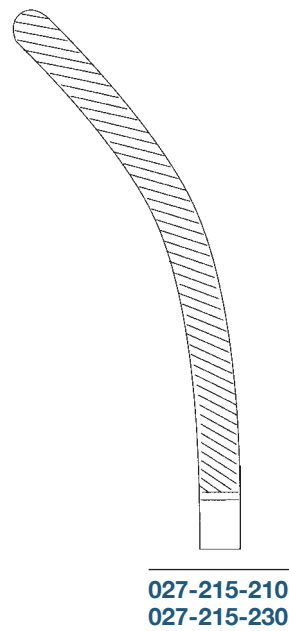
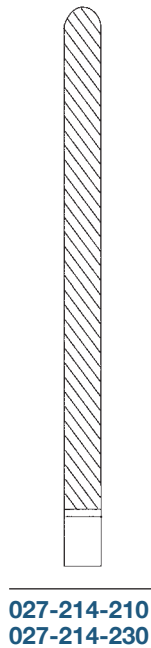

DOYEN

027-214-210 - 027-215-210 21,0 cm / 8¹/₄"
 027-214-230 - 027-215-230 23,0 cm / 9"

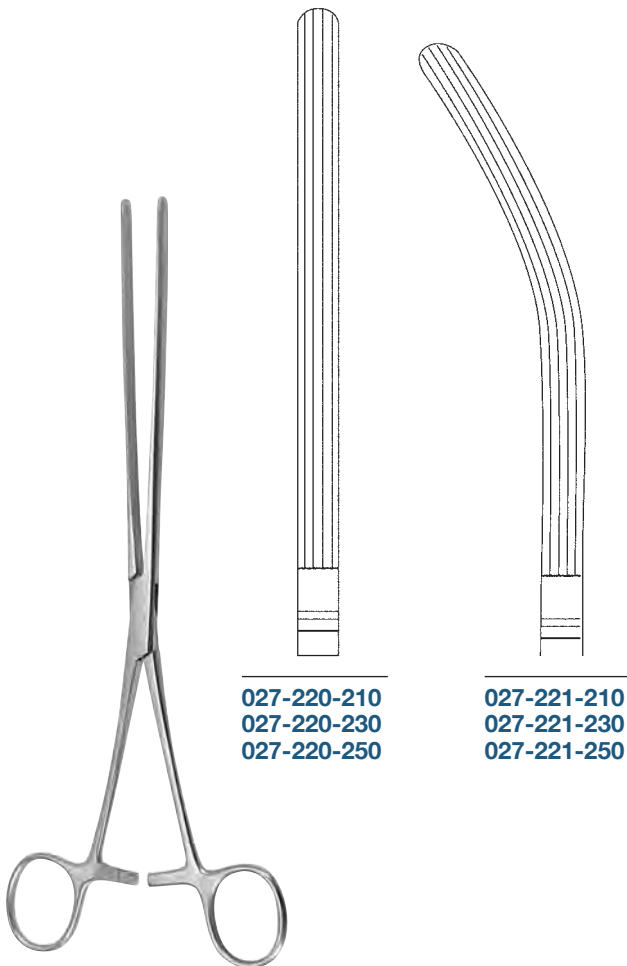

027-220-210
027-220-230
027-220-250

027-221-210
027-221-230
027-221-250

MAYO-ROBSON

027-220-210 - 027-221-210	21,0 cm / 8 ¹ / ₄ "
027-220-230 - 027-221-230	23,0 cm / 9"
027-220-250 - 027-221-250	25,0 cm / 9 ³ / ₄ "

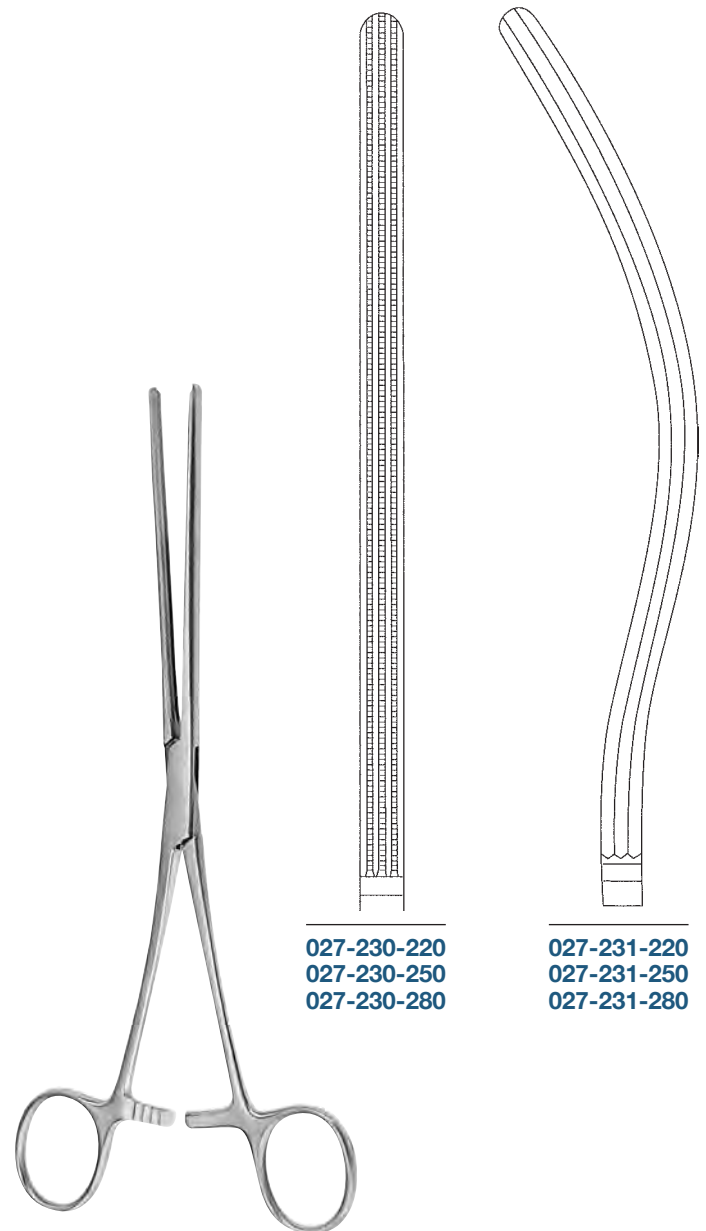

027-230-220
027-230-250
027-230-280

027-231-220
027-231-250
027-231-280

KOCHER

027-230-220 - 027-231-220	22,0 cm / 8 ³ / ₄ "
027-230-250 - 027-231-250	25,0 cm / 9 ³ / ₄ "
027-230-280 - 027-231-280	28,0 cm / 11"



027

**Klemmen
Clamps
Pinzas
Pinze**



027-232-330

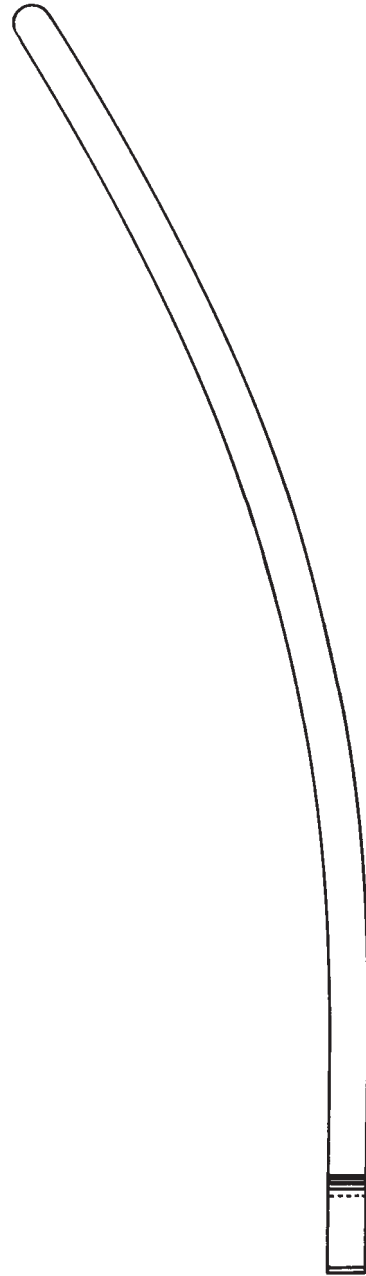

027-233-330

SCUDDER

027-232-330 - 027-233-330

33,0 cm / 13"

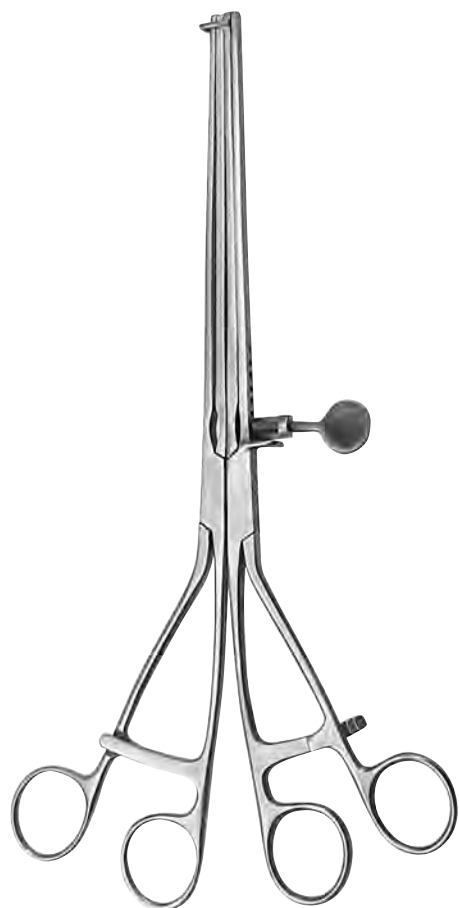

027-234-300

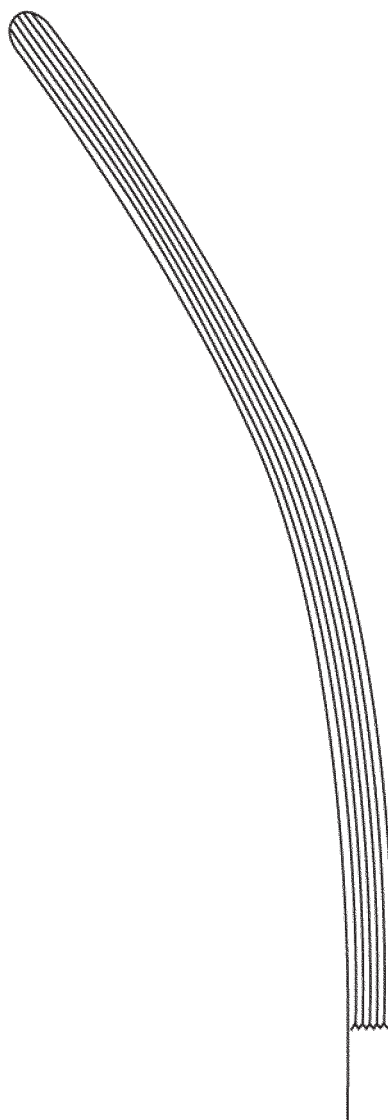

027-235-300

LANE

027-234-300 - 027-235-300

30,0 cm / 11³/₄"



027

**Klemmen
Clamps
Pinzas
Pinze**



**027-236-250
027-236-300**

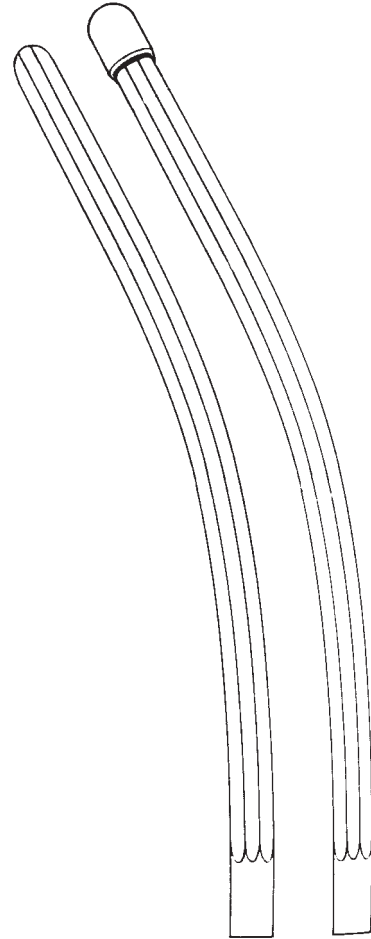

**027-237-250
027-237-300**

NUSSBAUM

027-236-250 - 027-237-250 25,0 cm / 9³/₄"
027-236-300 - 027-237-300 30,0 cm / 11³/₄"

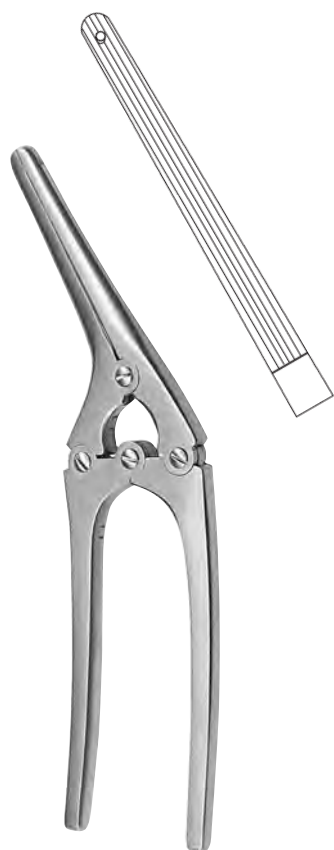

PAYR-BABY

027-240-150 15,0 cm / 6"

mit Stift
with pin
con espiga
con perno

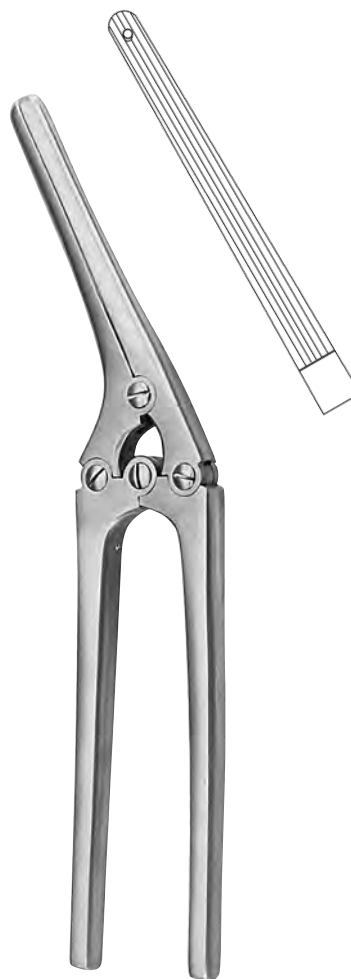

PAYR

027-250-210 21,0 cm / 8¹/₄"
027-250-290 29,0 cm / 11¹/₃"
027-250-350 35,0 cm / 13³/₄"

mit Stift
with pin
con espiga
con perno



027

**Klemmen
Clamps
Pinzas
Pinze**

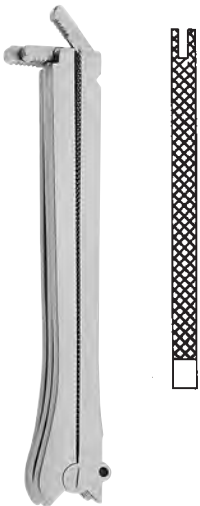

DE MARTEL-WOLFSON

027-260-005 5,0 cm / 2"
027-260-007 7,0 cm / 2 1/2"
027-260-100 10,0 cm / 4"



DE MARTEL-WOLFSON

027-261-260 26,0 cm / 10 1/4"

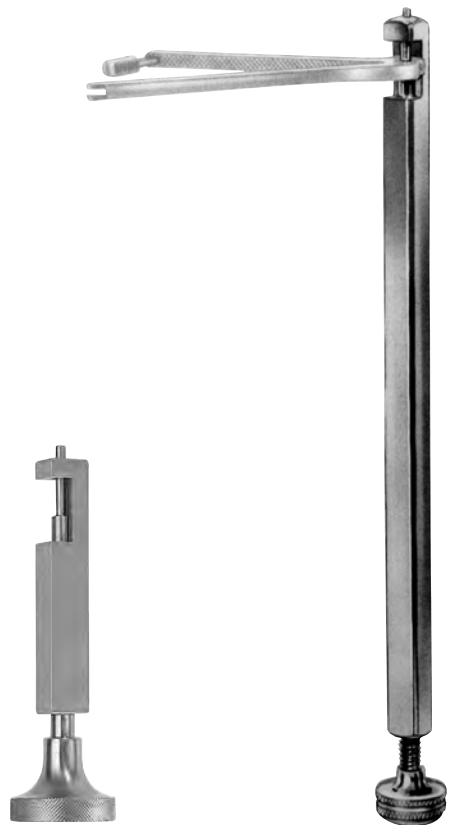

DE MARTEL-WOLFSON

027-270-085 8,5 cm / 3 1/2"

DE MARTEL-WOLFSON

027-270-230 23,0 cm / 9"

ATRAUMA

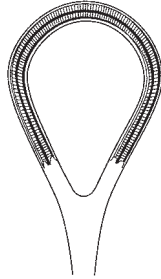

027-300-250 25,0 cm / 9³/₄"

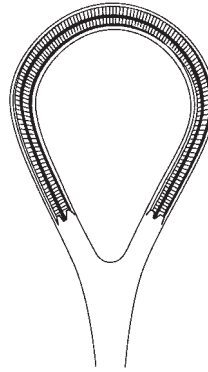

027-300-260 26,0 cm / 10¹/₄"

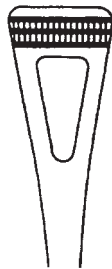

027-304-180 18,0 cm / 7"

schmal
narrow
estrecho
stretto

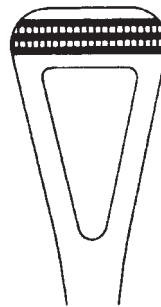

027-304-205 20,5 cm / 8"

mittel
medium
mediano
medio

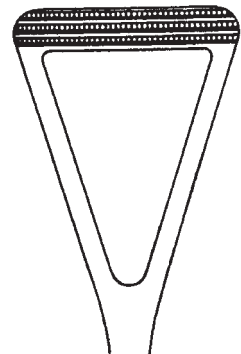

027-304-230 23,0 cm / 9"

breit
wide
ancho
largo

SCHEIBE



027

Darm- und Gewebefäßzangen
Intestinal and Tissue Grasping Forceps
Pinzas intestinales y para tejidos
Pinze da presa per intestino e tessuti

ATRAUMA



027-310-130

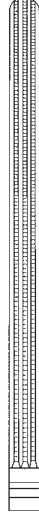

027-310-160

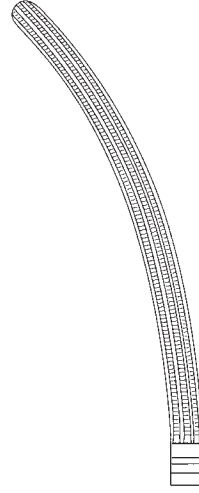

027-311-130

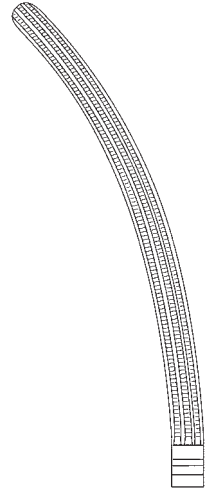

027-311-160

BABY-DOYEN

027-310-130 - 027-311-130	13,0 cm / 5 ¹ / ₈ "
027-310-160 - 027-311-160	16,0 cm / 6 ¹ / ₄ "



027-314-180



027-314-210



027-314-230

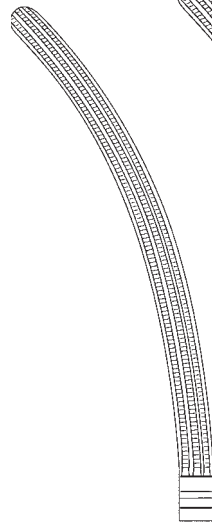

027-315-180

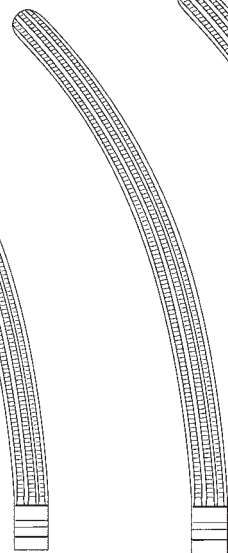

027-315-210

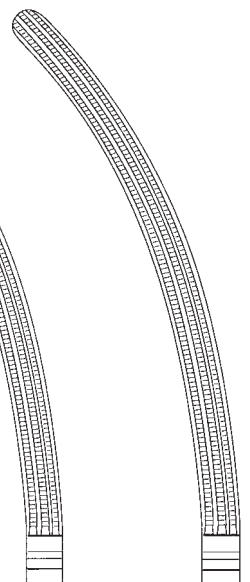

027-315-230

DOYEN

027-314-180 - 027-315-180	18,0 cm / 7"
027-314-210 - 027-315-210	21,0 cm / 8 ¹ / ₄ "
027-314-230 - 027-315-230	23,0 cm / 9"

ATRAUMA

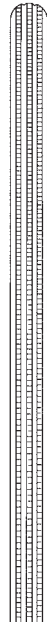

027-320-250

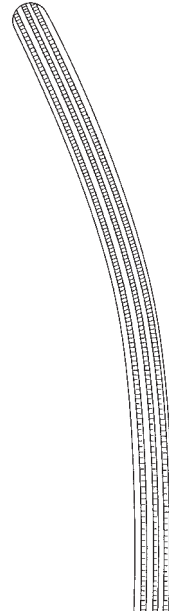

027-321-250

MAYO-ROBSON

027-320-250 - 027-321-250

25,0 cm / 9³/₄"

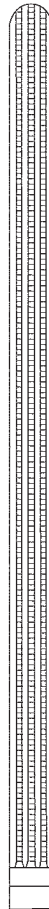

027-330-220 22,0 cm / 8³/₄"
027-330-250 25,0 cm / 9³/₄"
027-330-280 28,0 cm / 11"

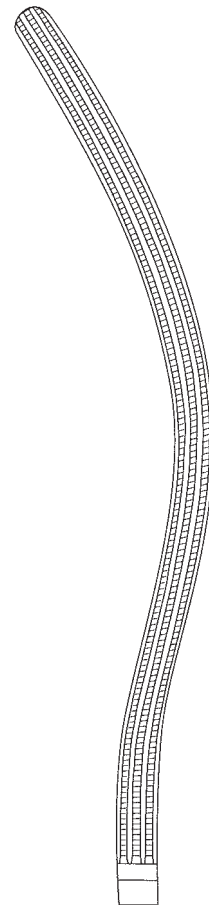

027-331-220 22,0 cm / 8³/₄"
027-331-250 25,0 cm / 9³/₄"
027-331-280 28,0 cm / 11"

KOCHER



027

Klemmen
Clamps
Pinzas
Pinze

ATRAUMA

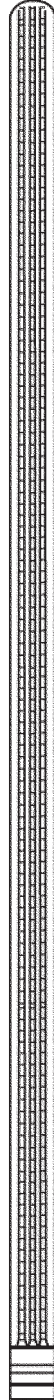

027-340-330

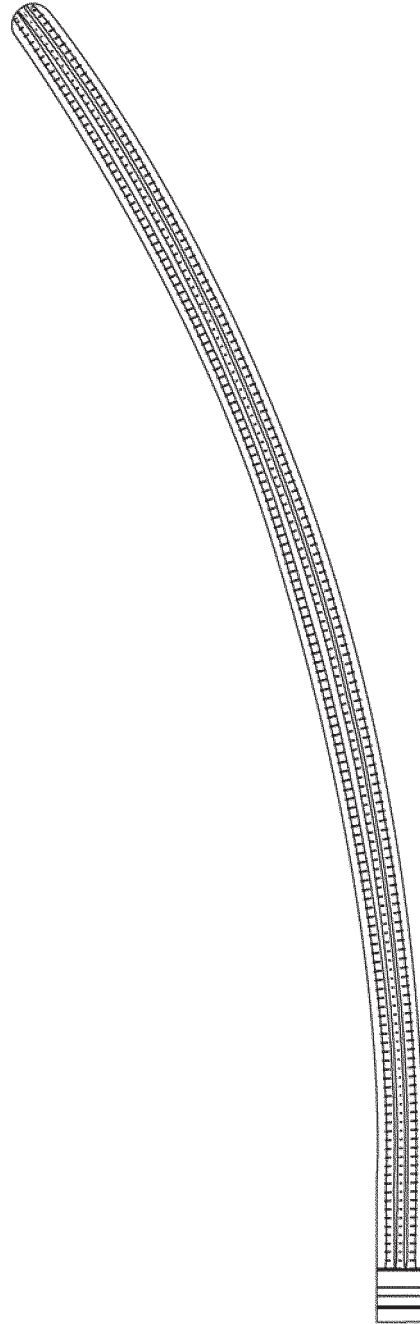

027-341-330

SCUDDER

027-340-330 - 027-341-330

33,0 cm / 13"

ATRAUMA



BRUNNER

027-345-240 24,0 cm / 9 1/2"

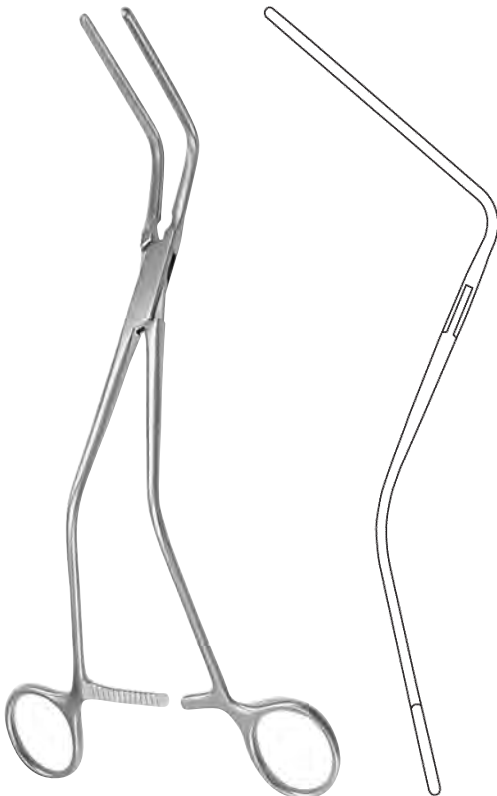
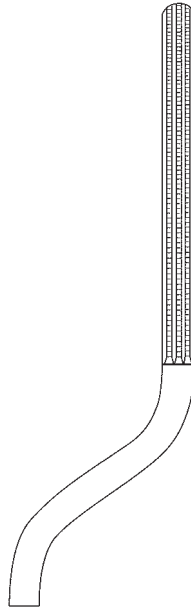

HAYES

027-349-260 - 027-349-280

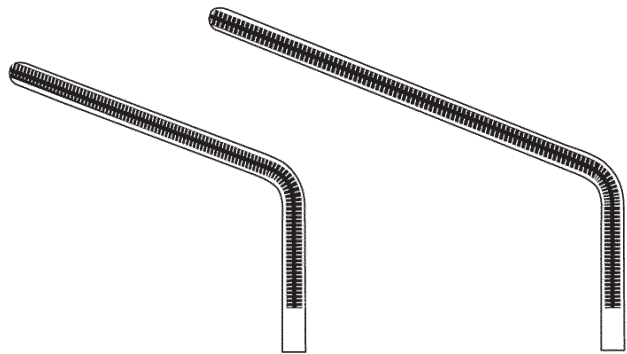

027-349-260 26,0 cm / 10"

027-349-280 28,0 cm / 11"



027

Klemmen
Forceps
Pinzas
Pinze

ATRAUMA

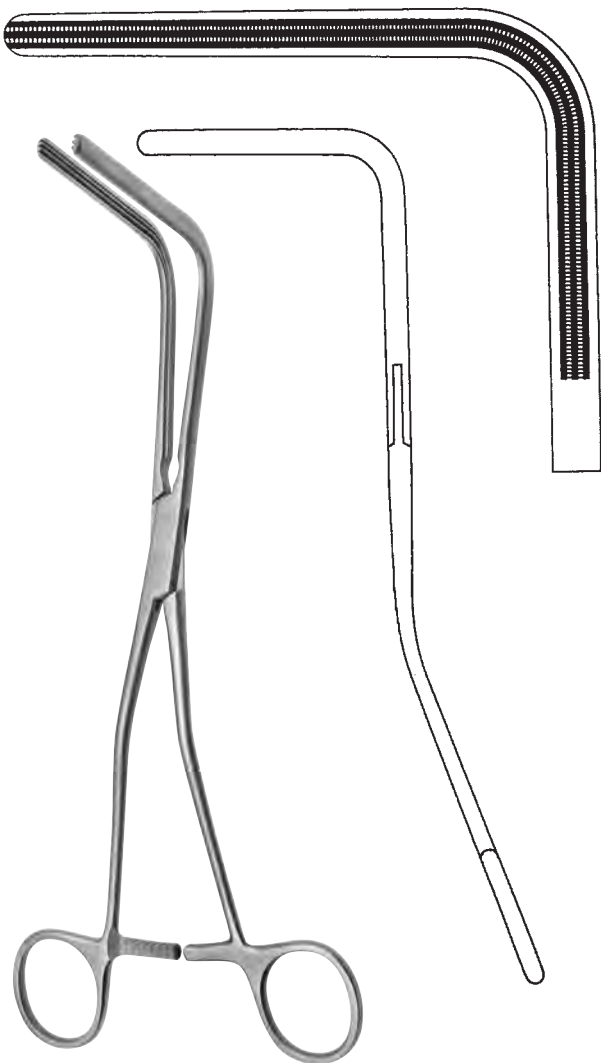

VEIDENHEIMER

027-351-250 25,0 cm / 9³/₄"

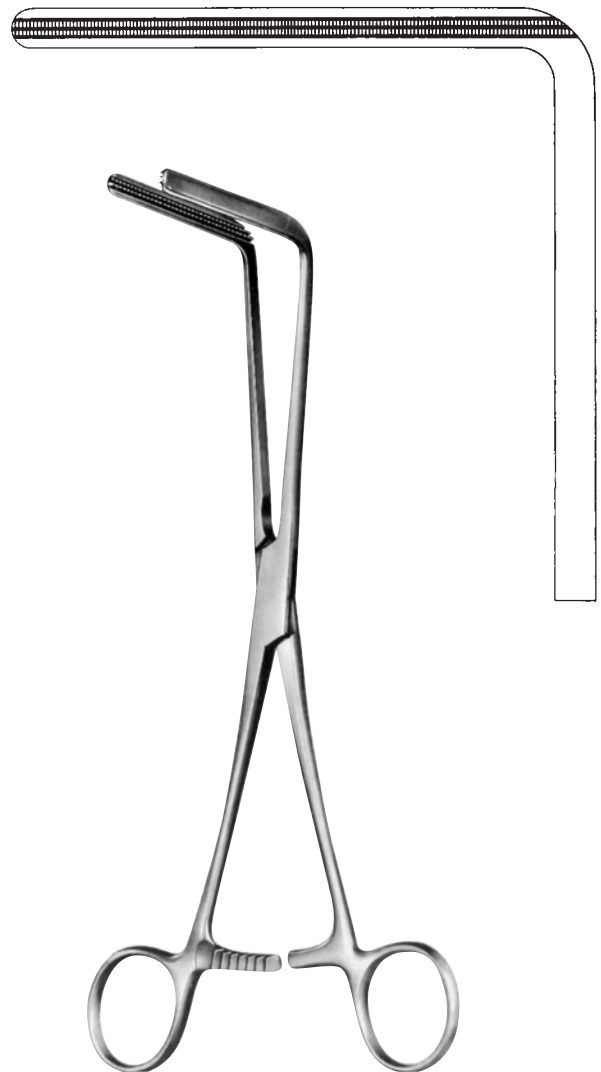

FEHLAND

027-353-240 24,0 cm / 9¹/₂"

ATRAUMA

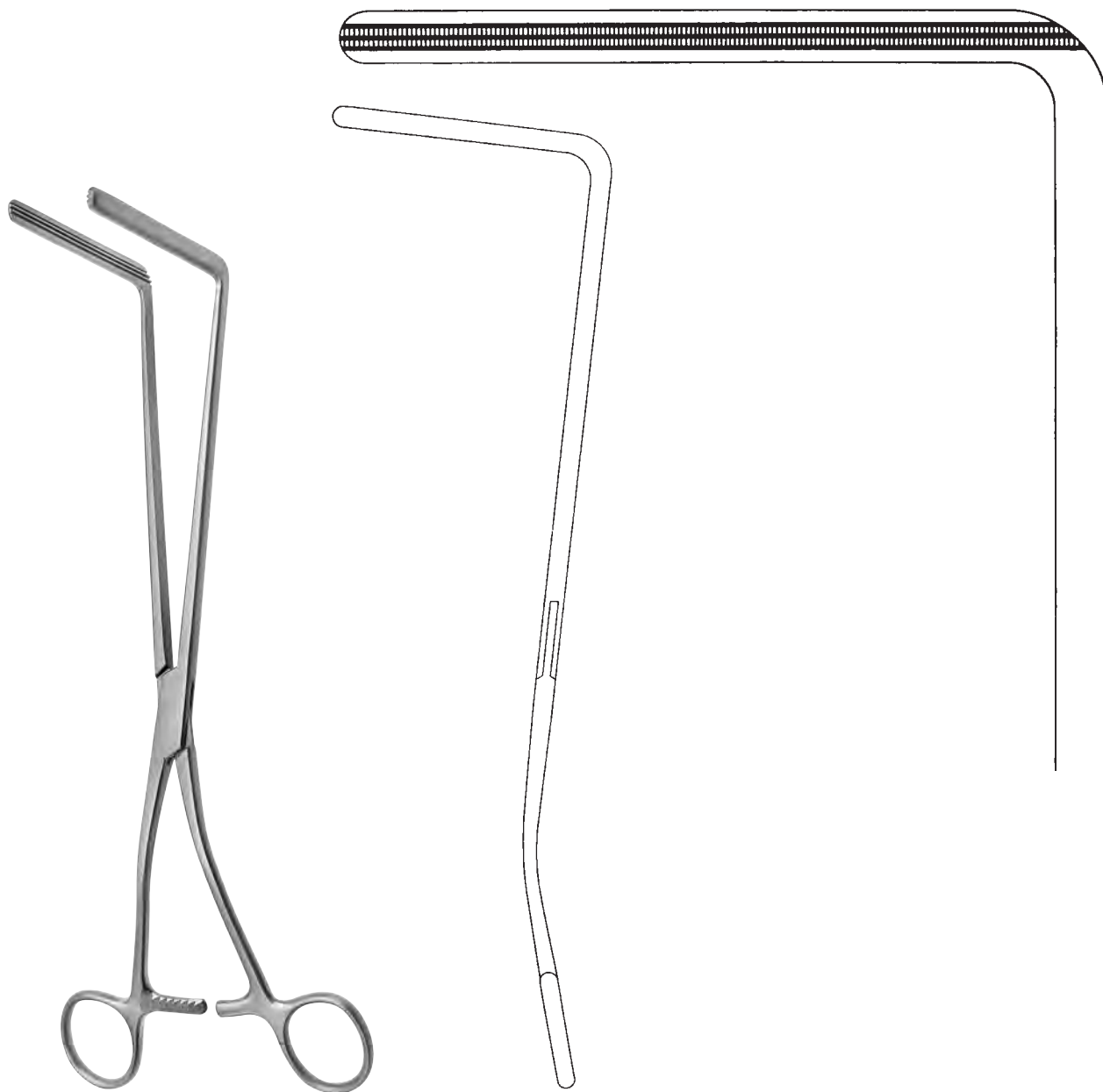

RESANO

027-355-300 30,0 cm / 11"



027

Mastdarm-Rektum-Spekula
Rectal Specula
Espéculos para el recto
Speculi rectali



CZERNY

027-400-220 22,0 cm / 9 1/2"



SIMS

027-402-150 15,0 cm / 6"



BODENHAMMER

027-404-150 15,0 cm / 6"



PRATT

027-408-200 20,0 cm / 8"



70 x 22 mm

BARR

027-410-170 17,0 cm / 6³/₄"

Mastdarm-Rektum-Spekula
Rectal Specula
Espéculos para el recto
Speculi rettali



MATHIEU
027-414-210 21,0 cm / 8¼"



SMITH BUIE
027-426-150 15,0 cm / 6"



SCHULZE-BERGMANN
027-420-060 - 027-420-125

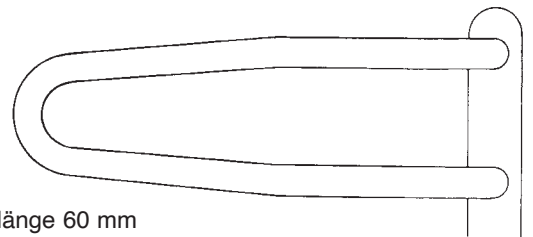

Valvenlänge 60 mm
 Length of Blades 60 mm
 Largo de valvas 60 mm
 Lunghezza di valvi 60 mm

027-420-060

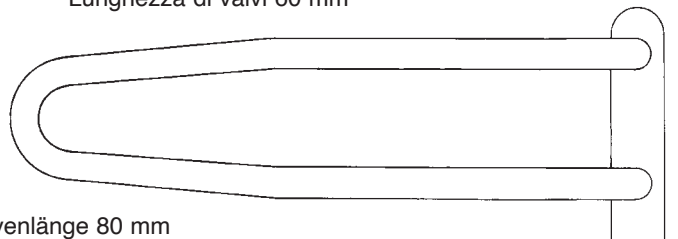

Valvenlänge 80 mm
 Length of Blades 80 mm
 Largo de valvas 80 mm
 Lunghezza di valvi 80 mm

027-420-080

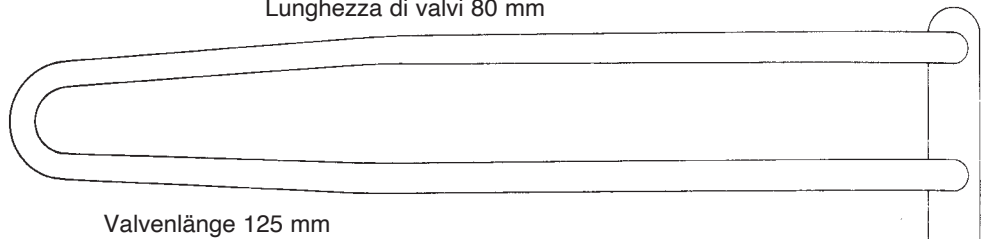

Valvenlänge 125 mm
 Length of Blades 125 mm
 Largo de valvas 125 mm
 Lunghezza di valvi 125 mm

027-420-125

Analspreizer, Sphinkteroskope, Anuskope
Rectal Retractor, Sphincteroscopes, Anoscopes
Separadores para el recto, Esfinteroscopios, Anoscopios
Dilatatori per l'ano e il retto, Sfinteroscopi, Anoscopi



027

027-430-075 22 x 75 mm

027-430-095 22 x 95 mm

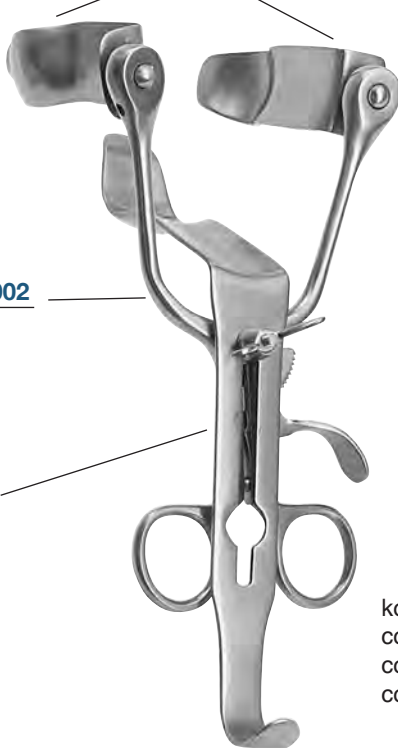

027-430-002

027-430-003
25 x 95 mm

ALAN PARKS

027-430-001 13,5 cm / 5³/₈"
 komplett mit Kaltlichtträger
 complete with cold light carrier
 completo con portador para luz fria
 completo con supporto per luce fredda

komplett ohne Kaltlichtträger
 complete without cold light carrier
 completo sin portador para luz fria
 completo senza supporto per luce fredda

ALAN PARKS

027-430-000 13,5 cm / 5¹/₄"



ohne Kaltlichtträger
 without cold light carrier
 sin portador para luz fria
 senza supporto per luce fredda

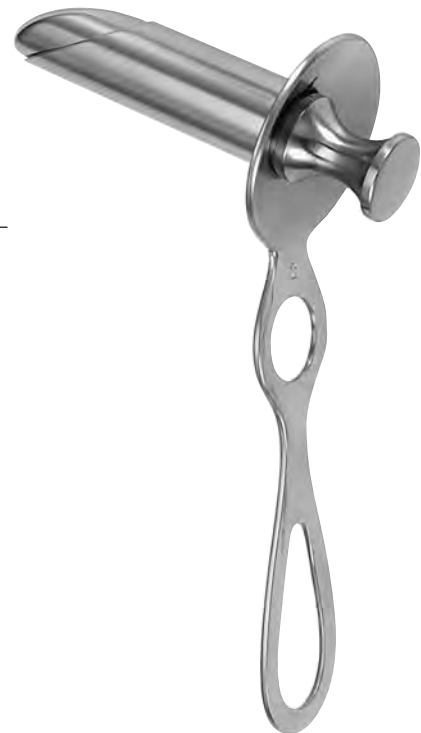

027-440-003

Kunststoffobturator allein
 Obturator of plastic only
 Obturador de plastico suelto
 Otturatore di plastica solo

mit Kaltlichtträger
 with cold light carrier
 con portador para luz fria
 con supporto per luce fredda

IVES FANSLER

027-440-001 Ø 22 mm

IVES FANSLER

027-440-002 Ø 22 mm

HIRSCHMANN

027-444-001 Ø 16 x 65 mm
027-444-002 Ø 19 x 65 mm
027-444-003 Ø 22 x 70 mm



027

Analspreizer, Sphinkteroskope, Anuskope
Rectal Retractor, Sphincteroscopes, Anoscopes
Separadores para el recto, Esfinteroscopios, Anoscopios
Dilatatori per l'ano e il retto, Sfinteroscopi, Anoscopi



KELLY

027-452-021 Ø 21 x 50 mm
027-452-027 Ø 27 x 50 mm



FANSLER

027-454-025 Ø 25 x 65 mm
027-454-029 Ø 29 x 65 mm
027-454-038 Ø 38 x 70 mm



PRATT

21,0 cm / 8¼"



027-460-001



027-460-002



027-460-003

Mastdarm-Biopsiezangen
Rectal Biopsy Forceps
Pinzas sacabocado para biopsia rectal
Pinze taglienti per biopsia rettale



027



027-470-280 28,0 cm / 11"
027-470-350 35,0 cm / 13³/₄"
027-470-420 42,0 cm / 16¹/₂"

027-472-280 28,0 cm / 11"
027-472-350 35,0 cm / 13³/₄"
027-472-420 42,0 cm / 16¹/₂"

YEOMAN



027-476-280 28,0 cm / 11"
027-476-350 35,0 cm / 13³/₄"
027-476-420 42,0 cm / 16¹/₂"

027-478-280 28,0 cm / 11"
027-478-350 35,0 cm / 13³/₄"
027-478-420 42,0 cm / 16¹/₂"

Haemorrhoiden-Ligator mit Ladekonus
 Haemorrhoidal ligator with loading attachment
 Ligador para hemorroides con cono de carga
 Legatori emorroidali con carica a cono

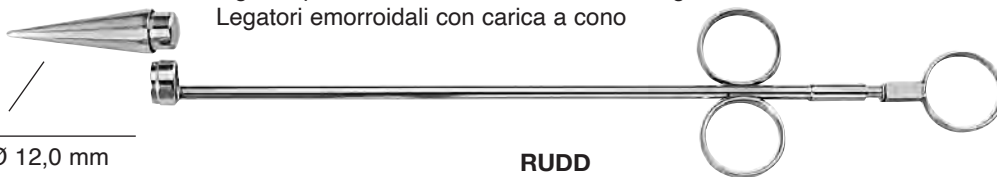

027-486-012 Ø 12,0 mm

RUDD
027-486-000

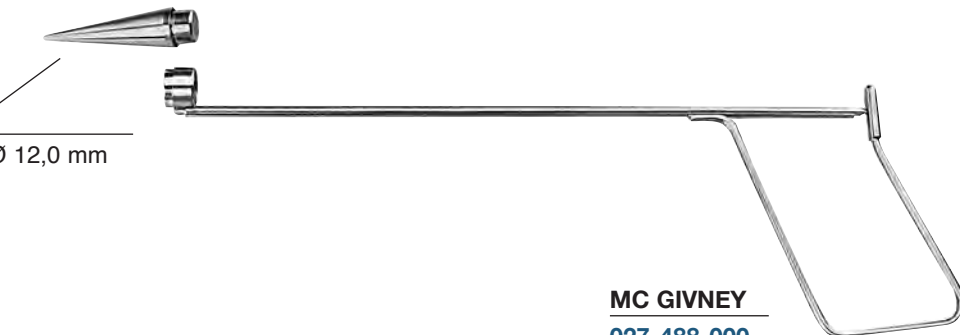

027-486-012 Ø 12,0 mm

MC GIVNEY
027-488-000



027-488-100
 Gummiringe 100
 Stück
 Rubber rings 100 pieces
 Anillos de goma 100 unidades
 Anelli di gomma 100 pezzi

Polypenfasszangen
Polypus Grasping Forceps
Pinzas para coger pólipos
Pinze per afferrare polipi

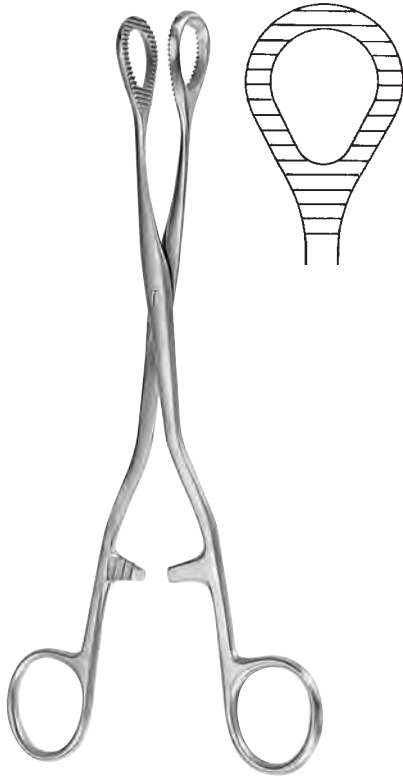

HEYWOOD-SMITH

027-490-210 21,0 cm / 8¹/₄"
027-490-250 25,0 cm / 9³/₄"

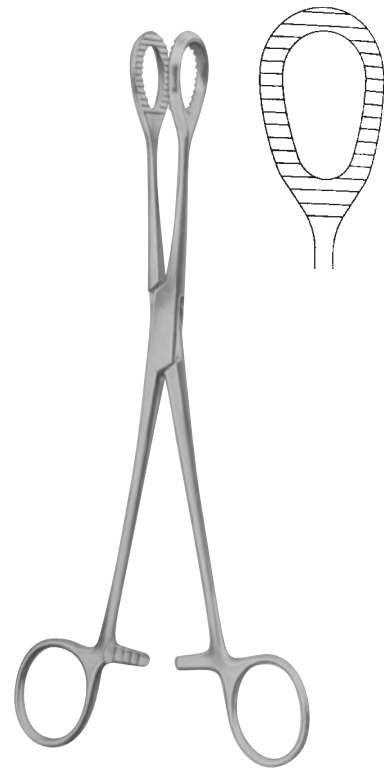

HEYWOOD-SMITH

027-492-210 21,0 cm / 8¹/₄"
027-492-250 25,0 cm / 9³/₄"

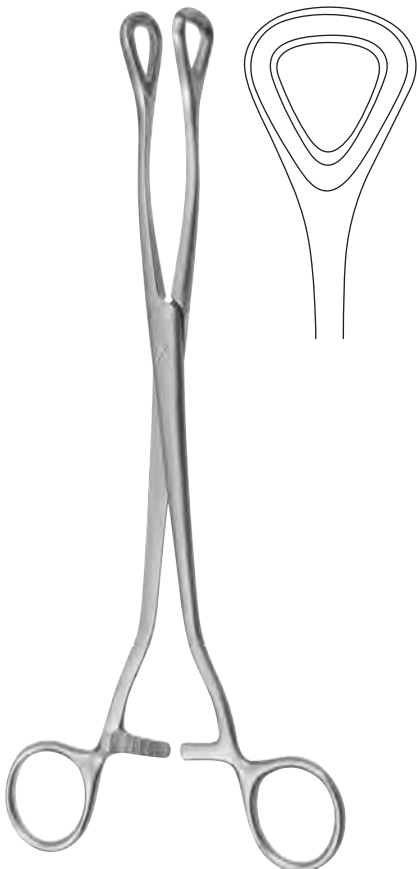

LUER

027-494-245 24,5 cm / 9²/₃"



MC GIVNEY

027-495-190 19,0 cm / 7¹/₂"



MC GIVNEY

027-497-190 19,0 cm / 7¹/₂"

Nierensteinzangen
Kidney Stone Forceps
Pinzas para los cálculos renales
Pinze per calcoli renali



027

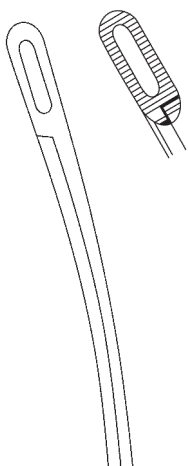

027-531-001 23,0 cm / 9"

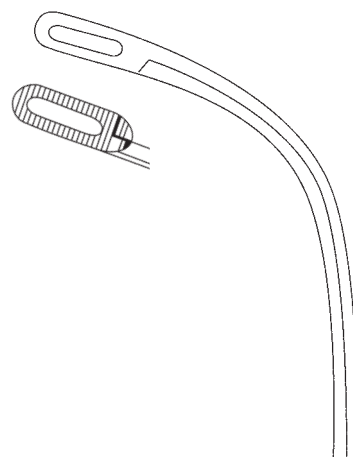

027-531-002 22,0 cm / 8⁵/₈"



RANDALL

027-531-001 - 027-531-004

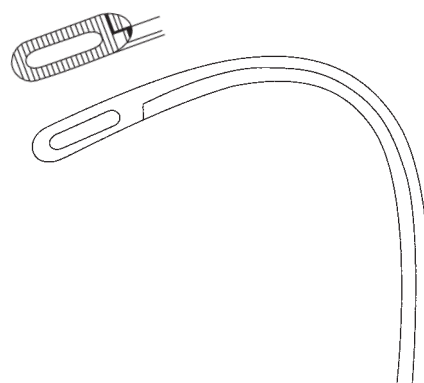

027-531-003 19,0 cm / 7¹/₂"

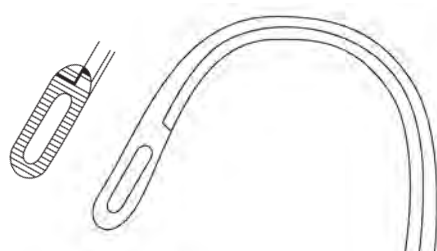

027-531-004 19,0 cm / 7¹/₂"

Nierensteinzangen, Gallensteinzangen
Kidney Stone Forceps, Gall Stone Forceps
Pinzas para los cálculos renales, Pinzas para los cálculos biliares
Pinze per calcoli renali, Pinze per calcoli biliari

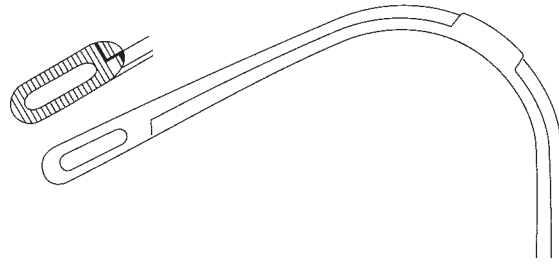

027-531-005

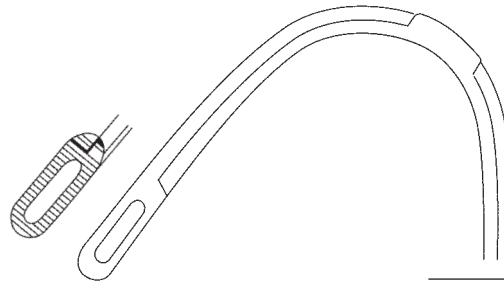

027-531-006

RANDALL

027-531-005 - 027-531-006 19,0 cm / 7 1/2"

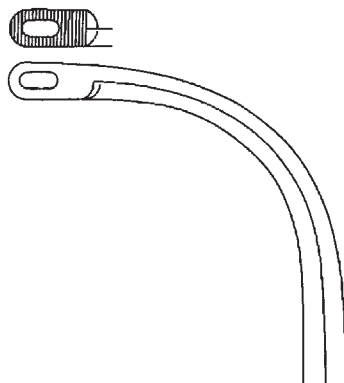

027-535-160 16,0 cm / 6 1/4"



027-535-170 17,0 cm / 6 3/4"

HEIMING

027-535-160 - 027-535-170

Nierenfistelzangen
Nephrostomy Forceps
Pinzas para nefrostomía
Pinze per nefrostomia



027

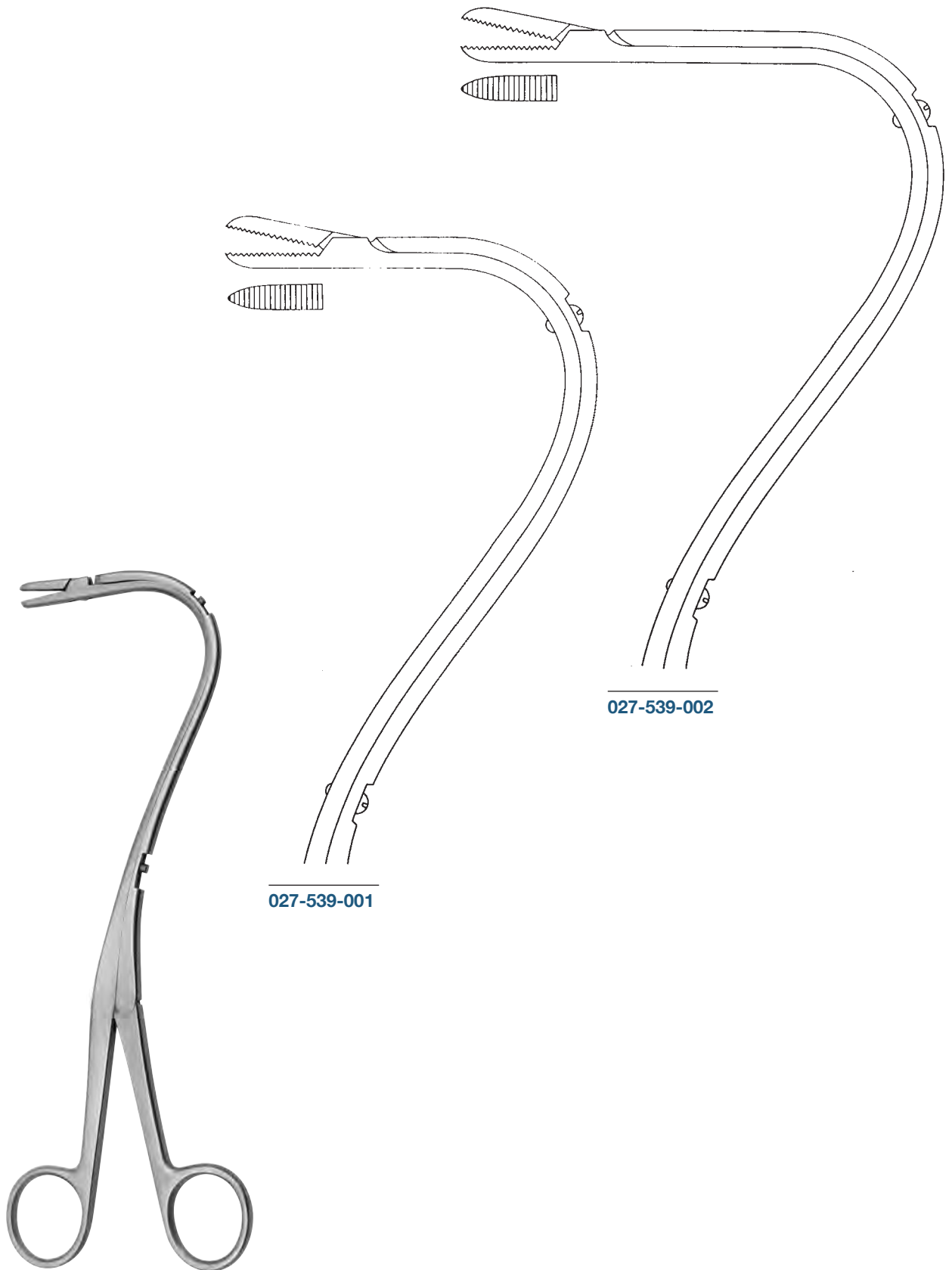

027-539-001

027-539-002

ELSÄSSER

027-539-001 - 027-539-002 21,0 cm / 8 1/4"



027

Gallengang Dilatoren
Common Bile Duct Dilators
Dilatadores para el conducto biliar
Dilatatori per coledoco



027-540-001 Ø 1,0 mm



027-540-002 Ø 2,0 mm



027-540-003 Ø 3,0 mm



027-540-004 Ø 4,0 mm



027-540-005 Ø 5,0 mm



027-540-006 Ø 6,0 mm



027-540-007 Ø 7,0 mm



027-540-008 Ø 8,0 mm



027-540-009 Ø 9,0 mm



027-540-010 Ø 10,0 mm



027-540-011 Ø 11,0 mm



027-540-012 Ø 12,0 mm



027-540-013 Ø 13,0 mm



biegsamer Schaft
 malleable shaft
 vastago maleabile
 asta malleabile

027-540-000

Satz à 9 Stück ø 3,0 -11,0 mm
 set of 9 pieces ø 3,0 -11,0 mm
 juego de 9 piezas ø 3,0 -11,0 mm
 set di 9 pezzi ø 3,0 -11,0 mm

BAKES

027-540-001 - 027-540-013 30,0 cm / 11³/₄"

Gallensteinlöffel, Gallengangsonden
Gall Stone Scoops, Gall Duct Probes

Cucharilla para los cálculos biliares, sondas para el conducto biliar
Cucchiai per calcoli biliari, Dilatatori per condotti biliari



027

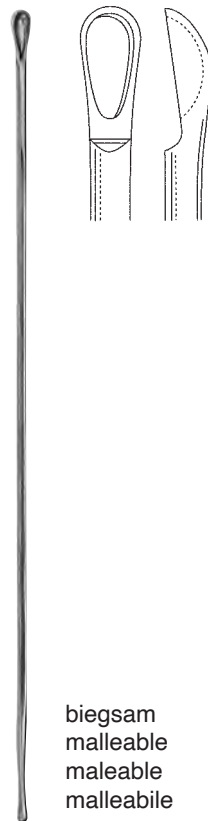

biegsam
 malleable
 maleable
 malleabile

MOYNIHAN

027-544-340 34,0 cm / 13³/₄"



027-546-013 13 Charr.



027-546-018 18 Charr.



027-546-021 21 Charr.

federnd
 flexible
 flexible
 flessibile

DESJARDINS

027-546-013 - 027-546-021 28,0 cm / 11"



biegsam
 malleable
 maleable
 malleabile

MAYO

027-548-320 32,0 cm / 12¹/₂"



027

Gallensteinzangen
Gall Stone Forceps
Pinzas para los cálculos biliares
Pinze per calcoli biliari



CZERNY

027-551-245 24,5 cm / 9⁵/₈"



TURNER-WARWICK

027-553-180 18,0 cm / 7"
027-553-190 19,0 cm / 7¹/₂"

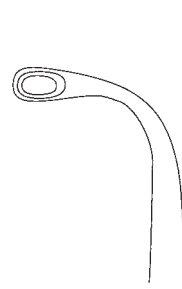

027-553-180

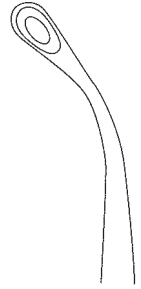

027-553-190



BLAKE

027-556-200 - 027-557-200 20,0 cm / 8"

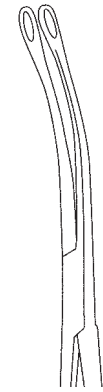

027-557-200



MAYO-BLAKE

027-560-200 - 027-561-200 20,0 cm / 8"



027-561-200

Gallensteinzangen, Gallensteinlöffel
 Gall Stone Forceps, Gall Stone Scoops
 Pinzas para cálculos biliares, Cucharas para cálculos biliares
 Pinze per calcoli biliari, Cucchiari per calcoli biliari



027



MIXTER

027-563-220 22,0 cm / 8³/₄"



DESJARDINS

027-565-001 - 027-565-002 23,0 cm / 9"



STILLE

027-567-245 24,5 cm / 9²/₈"

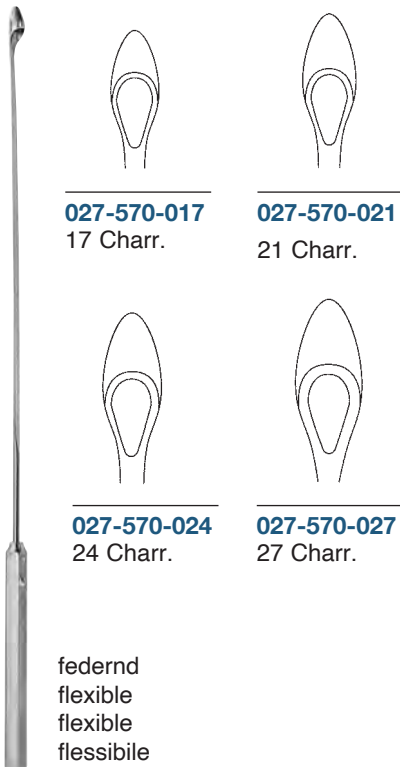

DESJARDINS

027-570-017 - 027-570-027 30,0 cm / 11³/₄"

federnd
flexible
flexible
flessibile

027-570-017
17 Charr.

027-570-021
21 Charr.

027-570-024
24 Charr.

027-570-027
27 Charr.

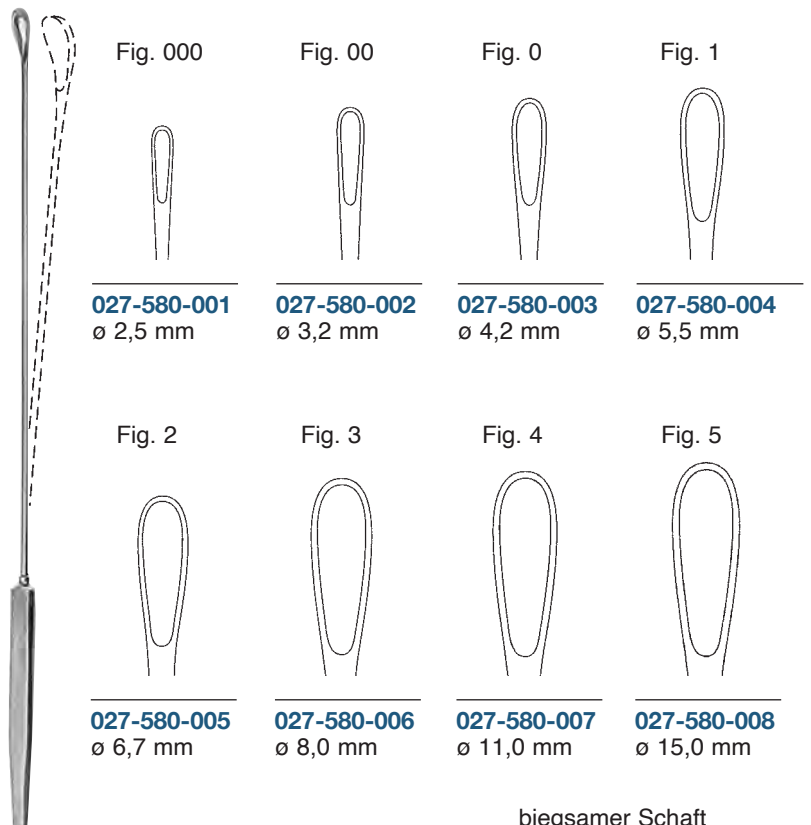

LUER-KÖRTE

027-580-001 - 027-580-008 32,0 cm / 12¹/₂"

biegsamer Schaft
malleable shaft
vastago malleabile
asta malleabile

Fig. 000

027-580-001
ø 2,5 mm

Fig. 00

027-580-002
ø 3,2 mm

Fig. 0

027-580-003
ø 4,2 mm

Fig. 1

027-580-004
ø 5,5 mm

Fig. 2

027-580-005
ø 6,7 mm

Fig. 3

027-580-006
ø 8,0 mm

Fig. 4

027-580-007
ø 11,0 mm

Fig. 5

027-580-008
ø 15,0 mm



027

Gallensteinlöffel
Gall Stone Scoops
Cucharillas para los cálculos biliares
Cucchiai per calcoli biliari



Gallenblasenlöffel
Gall bladder scoope
Cucharilla para la vesicula biliar
Cucchiaio pre colecisti

MOORE

027-582-300 30,0 cm / 12"



MAYO

027-584-280 28,0 cm / 11"



FERGUSSON

027-586-215 21,5 cm / 8 1/2"

Prostatahaken, Blasenspatel
Prostatic Retractors, Bladder Retractor
Separadores para la prostata, Separadores vesicales
Retrattori prostatici, Divaricatori vescicali



027



YOUNG

027-701-210 21,0 cm / 8¹/₄"



YOUNG

027-703-220 22,0 cm / 8⁵/₈"



YOUNG

027-705-210 21,0 cm / 8¹/₄"

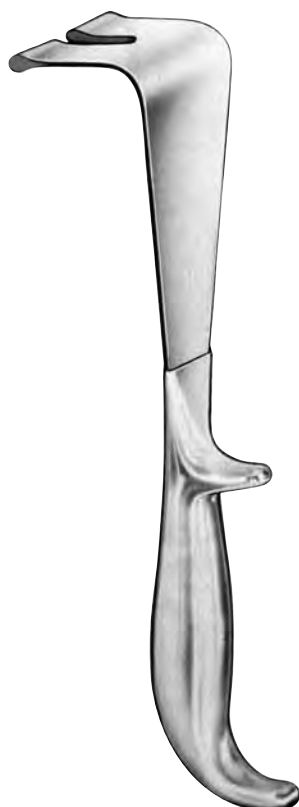

YOUNG

027-707-220 22,0 cm / 8⁵/₈"



YOUNG

027-710-200 20,0 cm / 8"

Instrumente für Prostatektomie
Prostatectomy Instruments
Instrumentos para la prostatectomía
Strumenti per operazioni della prostata



ATRAUMA



MILLIN

027-711-240 24,0 cm / 9 1/2"



ATRAUMA



MILLIN

027-713-240 24,0 cm / 9 1/2"

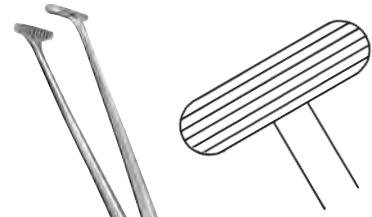

MILLIN

027-715-240 24,0 cm / 9 1/2"

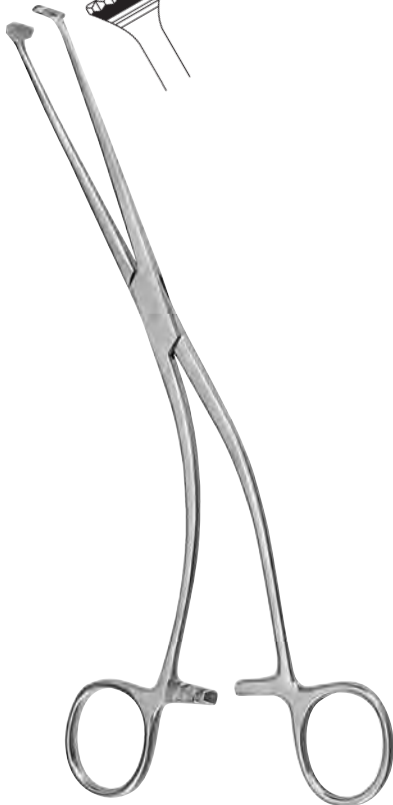

MILLIN

027-717-230 23,0 cm / 9"

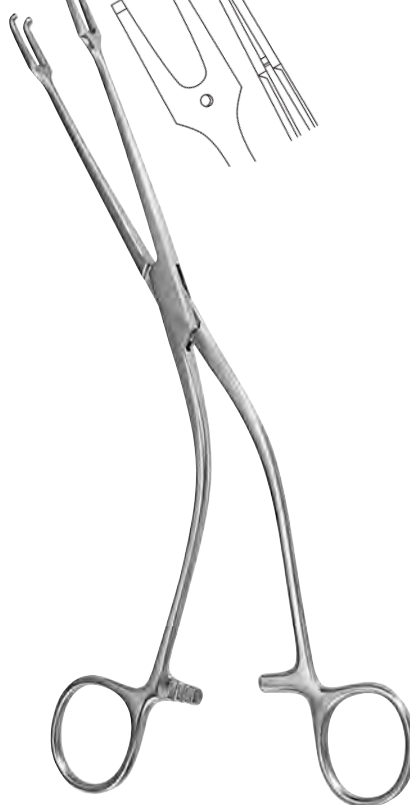
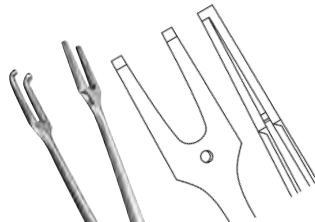

MILLIN

027-719-240 24,0 cm / 9 1/2"



discontinued item

MILLIN

027-725-285 28,5 cm / 11 1/4"

Blasenwundspreizer
Bladder Retractors
Separadores para la vejiga
Divaricatori vescicali



027

JUDD-MASSON

027-740-000

ohne Mittelblatt
 without central blade
 sin valva central
 senza valva centrale

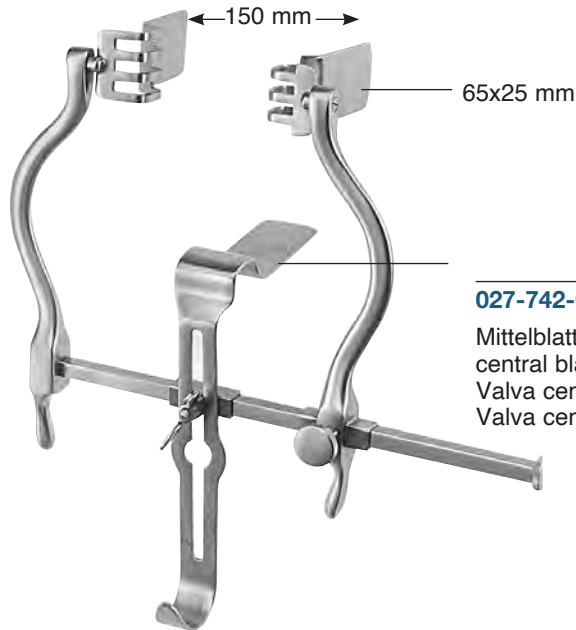

JUDD-MASSON

027-742-000

mit Mittelblatt
 with central blade
 con valva central
 con valva centrale

027-742-001

75x25 mm

Mittelblatt
 central blade
 Valva central
 Valva centrale

JUDD-MASSON

027-750-003

Seitenvalven
 lateral blades
 Valvas laterales
 Valva laterale

027-750-002

Seitenvalven
 lateral blades
 Valvas laterales
 Valva laterale

80x25 mm

57x25 mm

120x45 mm

027-750-001

Rahmen allein
 Frame only
 Cuadro suelto
 telaio solo

027-750-004

Mittelblatt
 central blade
 Valva central
 Valva centrale

120x45 mm

80x25 mm

027-754-001

Kaltlichtaufsatz
 cold light carrier
 portador para luz fria
 supporto per luce fredda

MILLIN

027-750-000

MILLIN

027-754-000



027

Prostatahaken, Blasenspatel
Prostatic Retractors, Bladder Spatulas
Separadores para la prostata, Espátulas vesicales
Retrattori prostatici, Spatole vescicali

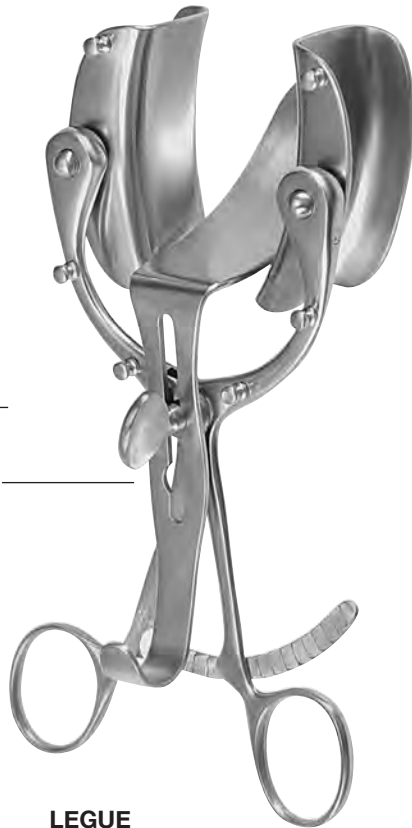

027-760-001 28 x 60 mm
Seitenvalven
lateral blades
Valvas laterales
Valva laterale

027-760-002 70 x 32 mm
Mittelvalve
center blade
Valva central
Valva centrale

LEGUE
027-760-000



35 mm

LEGUEU
027-765-270 30,0 cm / 11¹/₄"



67 mm

KOCHER
027-767-270 27,0 cm / 10³/₄"

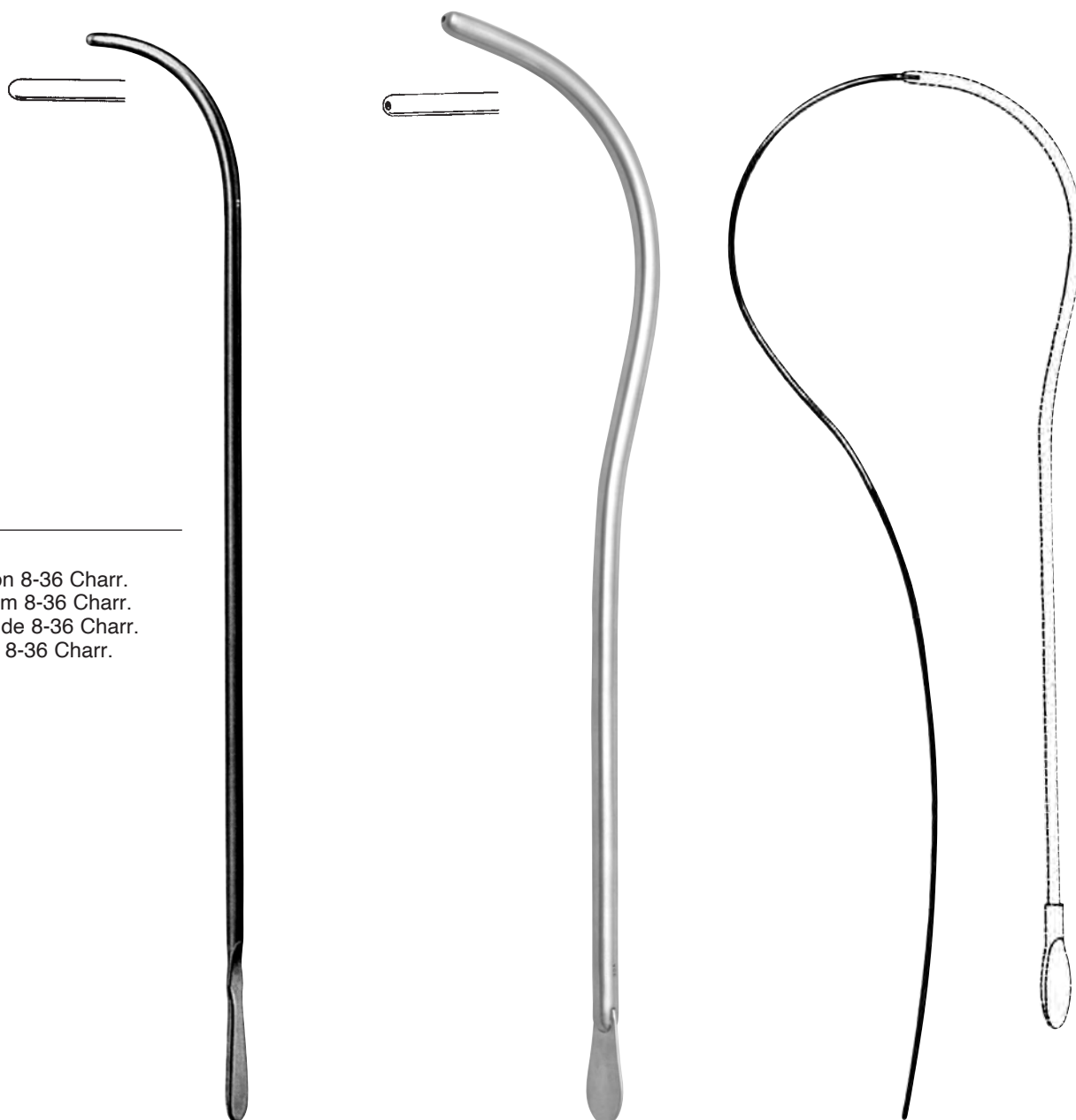

027-781-000

Satz komplett von 8-36 Charr.
Set complete from 8-36 Charr.
Juego completo de 8-36 Charr.
Set completo da 8-36 Charr.

VAN BUREN

027-781-008	Ø 2 ² / ₃ mm	Char. 8
027-781-010	Ø 3 ¹ / ₃ mm	Char. 10
027-781-012	Ø 4 mm	Char. 12
027-781-014	Ø 4 ² / ₃ mm	Char. 14
027-781-016	Ø 5 ¹ / ₃ mm	Char. 16
027-781-018	Ø 6 mm	Char. 18
027-781-020	Ø 6 ² / ₃ mm	Char. 20
027-781-022	Ø 7 ¹ / ₃ mm	Char. 22
027-781-024	Ø 8 mm	Char. 24
027-781-026	Ø 8 ² / ₃ mm	Char. 26
027-781-028	Ø 9 ¹ / ₃ mm	Char. 28
027-781-030	Ø 10 mm	Char. 30
027-781-032	Ø 10 ² / ₃ mm	Char. 32
027-781-034	Ø 11 ¹ / ₃ mm	Char. 34
027-781-036	Ø 12 mm	Char. 36

GUYON

027-791-012	Ø 4 mm	Char. 12
027-791-013	Ø 4 ¹ / ₃ mm	Char. 13
027-791-014	Ø 4 ² / ₃ mm	Char. 14
027-791-015	Ø 5 mm	Char. 15
027-791-016	Ø 5 ¹ / ₃ mm	Char. 16
027-791-017	Ø 5 ² / ₃ mm	Char. 17
027-791-018	Ø 6 mm	Char. 18
027-791-019	Ø 6 ¹ / ₃ mm	Char. 19
027-791-020	Ø 6 ² / ₃ mm	Char. 20
027-791-021	Ø 7 mm	Char. 21
027-791-022	Ø 7 ¹ / ₃ mm	Char. 22
027-791-023	Ø 7 ² / ₃ mm	Char. 23
027-791-024	Ø 8 mm	Char. 24
027-791-025	Ø 8 ¹ / ₃ mm	Char. 25
027-791-026	Ø 8 ² / ₃ mm	Char. 26
027-791-027	Ø 9 mm	Char. 27
027-791-028	Ø 9 ¹ / ₃ mm	Char. 28
027-791-029	Ø 9 ² / ₃ mm	Char. 29
027-791-030	Ø 10 mm	Char. 30

FILIFORM

027-793-003	Char. 3
027-793-004	Char. 4
027-793-005	Char. 5
027-793-006	Char. 6



027

Metallkatheter
Metal Catheters
Sondas metalicas
Cateteri metalliche



für Männer
for male
para hombres
per uomini

27,0 cm / 10³/₄"

027-801-008	Char. 8	ø 2 ² / ₃ mm
027-801-010	Char. 10	ø 3 ¹ / ₃ mm
027-801-012	Char. 12	ø 4 mm
027-801-014	Char. 14	ø 4 ² / ₃ mm
027-801-016	Char. 16	ø 5 ¹ / ₃ mm
027-801-018	Char. 18	ø 6 mm
027-801-020	Char. 20	ø 6 ² / ₃ mm
027-801-022	Char. 22	ø 7 ¹ / ₃ mm
027-801-024	Char. 24	ø 8 mm



für Frauen
for female
para mujeres
per donne

15,0 cm / 6"

027-811-006	Char. 6	ø 2 mm
027-811-007	Char. 7	ø 2 ¹ / ₃ mm
027-811-008	Char. 8	ø 2 ² / ₃ mm
027-811-009	Char. 9	ø 3 mm
027-811-010	Char. 10	ø 3 ¹ / ₃ mm
027-811-011	Char. 11	ø 3 ² / ₃ mm
027-811-012	Char. 12	ø 4 mm
027-811-013	Char. 13	ø 4 ¹ / ₃ mm
027-811-014	Char. 14	ø 4 ² / ₃ mm
027-811-015	Char. 15	ø 5 mm
027-811-016	Char. 16	ø 5 ¹ / ₃ mm
027-811-018	Char. 18	ø 6 mm
027-811-020	Char. 20	ø 6 ² / ₃ mm
027-811-022	Char. 22	ø 7 ¹ / ₃ mm
027-811-024	Char. 24	ø 8 mm



OTIS

027-820-000

komplett im Holzetui
mit dilatator, 2 Messer und 3 Ansätzen
complete in wooden case
with dilator, 2 knives 3 tips
completo en caja de madera
con dilatador, 2 cuchillos y 3 puntas
completo in contenitore di legno
con dilatatore, 2 coltelli e 3
punte



OTIS

027-825-000

Ersatzmesser
Replacement knife
cuchillo de repuesto
Coltello di ricambio

Urethrographie- und Circumcisions-Instrumente
Urethrography- and Circumcisions Instruments
Instrumentos para uretrografia y circuncisiòn
Strumenti per uretrografia e circoncisione



COMCO

- 027-830-008** ø 8,0 mm
- 027-830-011** ø 11,0 mm
- 027-830-013** ø 13,0 mm
- 027-830-016** ø 16,0 mm
- 027-830-021** ø 21,0 mm
- 027-830-026** ø 26,0 mm
- 027-830-032** ø 32,0 mm



KNUTSON

027-840-000

KNUTSON-KOCH

027-842-000

- Konus
- Cone
- Cono
- Cono



MOGEN

027-846-075 7,5 cm / 3"



GUYON

027-850-390 39,0 cm / 16"

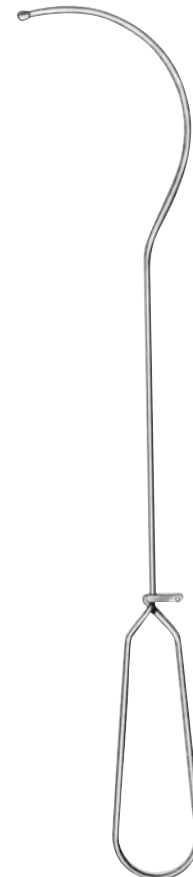

GUYON

027-851-350 35,0 cm / 13³/₄"



STRAUSS

027-860-110 11,0 cm / 4¹/₃"



STOCKMANN

027-862-080 8,0 cm / 3¹/₄"



MATHIEU

027-870-200 20,0 cm / 8"
027-870-280 28,0 cm / 11"



027

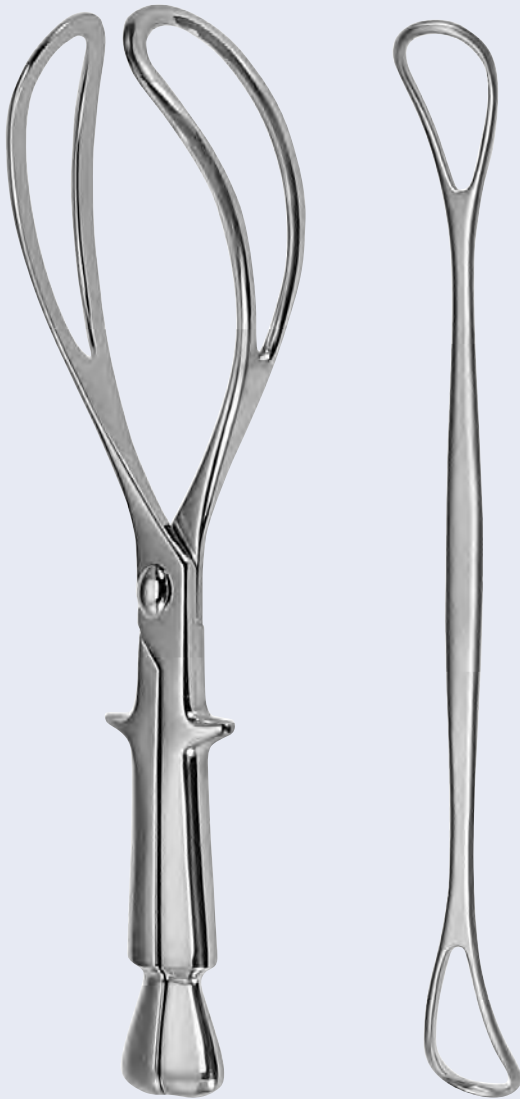

030

Gynäkologie, Geburtshilfe
Gynecology, Obstetrics
Ginecología, Ostetricia
Ginecologia, Ostetricia



030

Scheidenspekula
Vaginal Specula
Espéculos vaginales
Specoli vaginali



Schweizer Modell
Swiss pattern
Modelo suizo
Modello svizzero

CUSCO

- 030-010-001** 80x22 mm
- 030-010-002** 100x25 mm
- 030-010-003** 105x27 mm

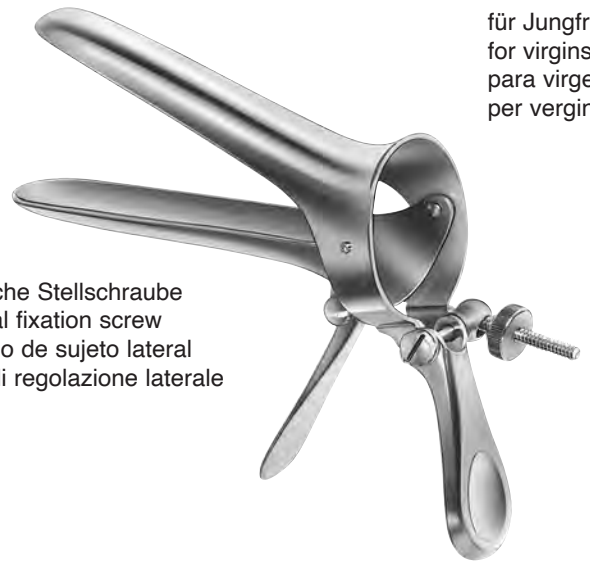

für Jungfrauen
for virgins
para vírgenes
per vergini

seitliche Stellschraube
lateral fixation screw
tornillo de sujeto lateral
vite di regolazione laterale

CUSCO

- 030-012-001** 75x17 mm



zentrale Stellschraube
central fixation screw
tornillo de sujeto central
vite di regolazione centrale

CUSCO

- 030-020-001** 75x32 mm
- 030-020-002** 85x35 mm
- 030-020-003** 100x37 mm



seitliche Stellschraube
lateral fixation screw
tornillo de sujeto lateral
vite di regolazione laterale

CUSCO

- 030-030-001** 75x32 mm
- 030-030-002** 85x35 mm
- 030-030-003** 100x35 mm



CUSCO STANDARD

030-040-001	80x24 mm
030-040-002	80x32 mm
030-040-003	85x36 mm
030-040-004	110x37 mm



für Kinder
 for children
 para niñas
 per bambini

COLLIN

030-050-001	55x10 mm
--------------------	----------



COLLIN

030-052-001	55x10 mm
030-052-002	65x20 mm

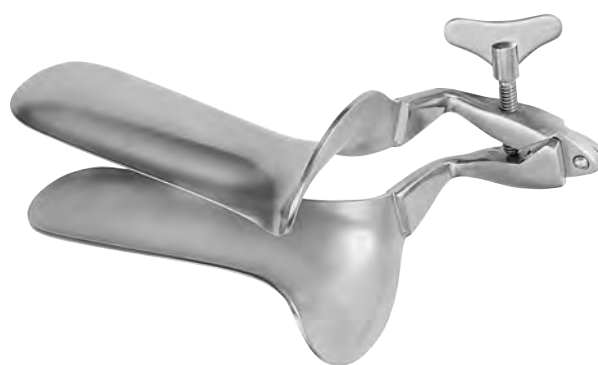

COLLIN

030-054-001	85x30 mm
030-054-002	100x35 mm
030-054-003	110x40 mm



030

Scheidenspekula
Vaginal Specula
Espéculos vaginales
Specoli vaginali



GRAVE

030-060-001	75x20 mm
030-060-002	95x35 mm
030-060-003	115x35 mm



PEDERSON

030-070-001	75x13 mm
030-070-002	100x22 mm
030-070-003	120x25 mm



SEMM

030-075-001	90x14-18 mm
030-075-002	100x17-20 mm
030-075-003	100x25-30 mm



SEYFFERT

030-080-001	100x17 mm	Fig.1
030-080-002	110x33 mm	Fig.2



TRELAT

030-085-001	85x33 mm	Fig.1
030-085-002	95x35 mm	Fig.2
030-085-003	115x43 mm	Fig.3



JACKSON

030-090-001	75x35 mm	Fig.1
030-090-002	90x35 mm	Fig.2
030-090-003	100x35 mm	Fig.3



JACKSON

030-092-001	75x40 mm	Fig.1
030-092-002	90x40 mm	Fig.2
030-092-003	100x40 mm	Fig.3



EASTMAN

030-094-001	75x35 mm	Fig.1
030-094-002	90x35 mm	Fig.2
030-094-003	100x35 mm	Fig.3



EASTMAN

030-096-001	75x40 mm	Fig.1
030-096-002	90x40 mm	Fig.2
030-096-003	100x40 mm	Fig.3



030

**Scheidenspekula
Vaginal Specula
Espéculos vaginales
Specoli vaginali**



SIMS

030-100-000

Satz
Set
Juego
Set



60x30 mm

60x25 mm

SIMS

030-100-001 12,5 cm / 5"



70x35 mm

70x30 mm

SIMS

030-100-002 15,0 cm / 6"



80x40 mm

80x35 mm

SIMS

030-100-003 17,5 cm / 7"



SIMS

030-102-001	Fig.1	70x25 mm
030-102-002	Fig.2	85x30 mm
030-102-003	Fig.3	100x40 mm



KRISTELLER

030-110-001	70x27 mm
030-110-002	75x30 mm
030-110-003	90x36 mm



KRISTELLER

030-111-001	75x23 mm
030-111-002	80x26 mm
030-111-003	95x32 mm



KRISTELLER Satz/Set/juego/set

030-115-001	70x27 mm + 75x23 mm
030-115-002	75x30 mm + 80x26 mm
030-115-003	90x36 mm + 95x32 mm

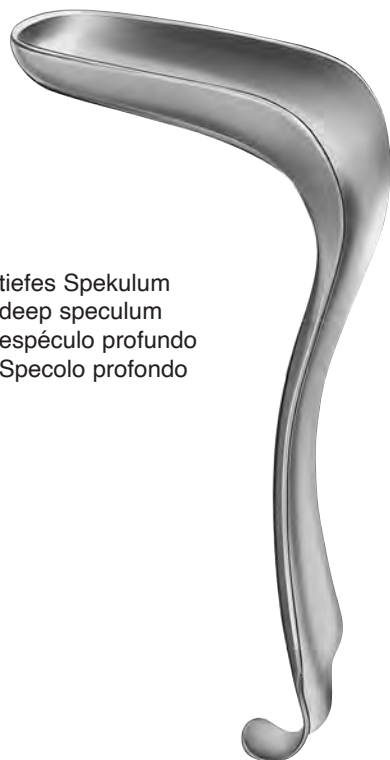

tiefes Spekulum
 deep speculum
 espéculo profundo
 Specolo profondo

KRISTELLER

030-120-001	110x27 mm
030-120-002	110x30 mm
030-120-003	110x36 mm



KRISTELLER

030-121-001	115x23 mm
030-121-002	115x26 mm
030-121-003	115x32 mm



KRISTELLER

030-125-001	110x27 mm + 115x23 mm
030-125-002	110x30 mm + 115x26 mm
030-125-003	110x36 mm + 115x32 mm



030

Scheidenspekula
Vaginal Specula
Espéculos vaginales
Specoli vaginali

flaches Spekulum
flat speculum
espéculo plano
specolo piatto

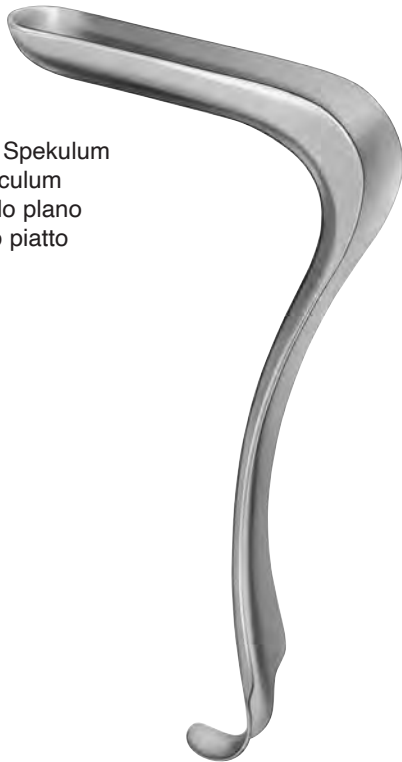

KRISTELLER

030-130-001 110x27 mm
030-130-002 110x30 mm
030-130-003 110x36 mm



KRISTELLER

030-131-001 115x23 mm
030-131-002 115x26 mm
030-131-003 115x32 mm



KRISTELLER Satz/Set/juego/set

030-135-001 110x27 mm + 115x23 mm
030-135-002 110x30 mm + 115x26 mm
030-135-003 110x36 mm + 115x32 mm



KRISTELLER

030-140-001 110x18 mm
030-140-002 110x21 mm



KRISTELLER

030-141-001 115x14 mm
030-141-002 115x17 mm



KRISTELLER Satz/Set/juego/set

030-145-001 110x18 mm + 115x14 mm
030-145-002 110x21 mm + 115x17 mm



030

Scheidenspekula
Vaginal Specula
Espéculos vaginales
Specoli vaginali



KRISTELLER
030-150-001 130x40 mm



KRISTELLER
030-151-001 135x36 mm



KRISTELLER Satz/Set/juego/set
030-155-001 130x40 mm + 135x36 mm



KRISTELLER
030-160-001 70x15 mm



KRISTELLER
030-161-001 75x10 mm



KRISTELLER Satz/Set/juego/Set
030-165-001 70x15 mm + 75x10 mm



030

Scheidenspekula
Vaginal Specula
Espéculos vaginales
Specoli vaginali



KALLMORGEN

030-170-001 70x40 mm
030-170-002 90x40 mm

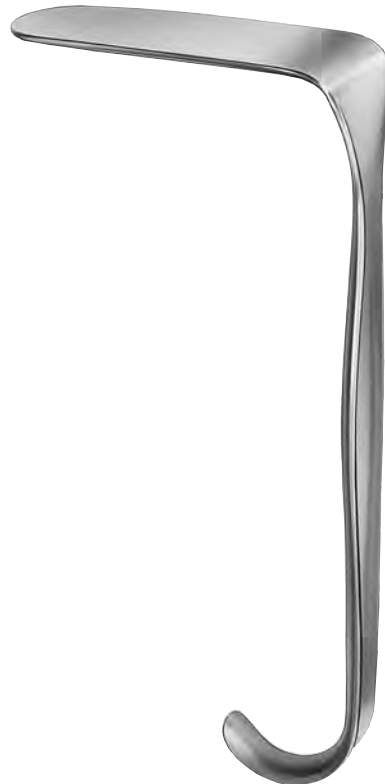

KALLMORGEN

030-171-001 70x33 mm
030-171-002 90x33 mm



KALLMORGEN Satz/Set/juego/set

030-175-001 70x40 mm + 70x33 mm
030-175-002 90x40 mm + 90x33 mm

Spekulum allein
 Speculum only
 Espéculo suelto
 Specolo solo



MATHIEU

030-180-001 95x16-26 mm
030-180-002 95x16-30 mm

Halter allein
 Retractor only
 Valva suelta
 Valva sola

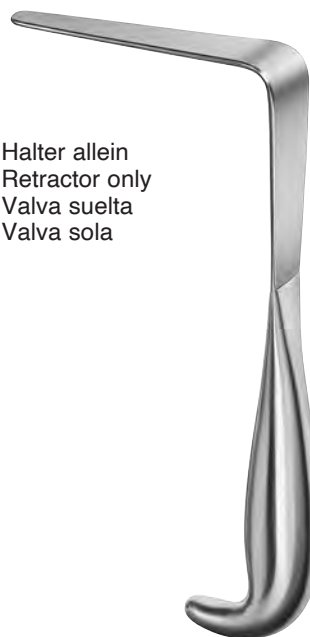

MATHIEU

030-181-001 100x11/21 mm
030-181-002 100x14/27 mm

leicht hohl
 slightly concave
 ligeramente cóncavo
 leggermente concavo



DOYEN

030-190-001	55x35	mm	Fig.1	24,0 cm / 9 1/2"
030-190-002	85x35	mm	Fig.2	24,0 cm / 9 1/2"
030-190-003	115x35	mm	Fig.3	24,0 cm / 9 1/2"
030-192-001	55x45	mm	Fig.1	24,0 cm / 9 1/2"
030-192-002	85x45	mm	Fig.2	24,0 cm / 9 1/2"
030-192-003	115x45	mm	Fig.3	24,0 cm / 9 1/2"
030-192-004	160x45	mm	Fig.4	24,0 cm / 9 1/2"
030-194-001	55x60	mm	Fig.1	24,0 cm / 9 1/2"
030-194-002	85x60	mm	Fig.2	24,0 cm / 9 1/2"
030-194-003	115x60	mm	Fig.3	24,0 cm / 9 1/2"
030-194-004	160x60	mm	Fig.4	24,0 cm / 9 1/2"

Scheidenspekula
Vaginal Specula
Espéculos vaginales
Specoli vaginali



030-200-001

Griff allein
 Handle only
 Mango soelto
 Manico solo

030-200-400 400g
030-200-800 800g

Gewicht
 Weight
 Peso
 Peso

SCHERBAK

030-200-000

komplett
 complete
 completo
 completo

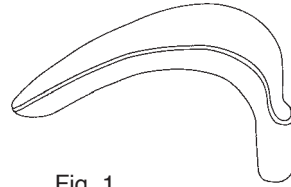

Fig. 1

030-200-030 80x30 mm



Fig. 2

030-200-035 85x35 mm

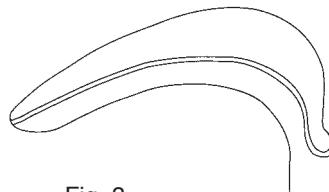

Fig. 3

030-200-040 90x40 mm

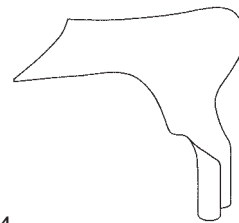

Fig. 4

030-200-060 55x40/60 mm

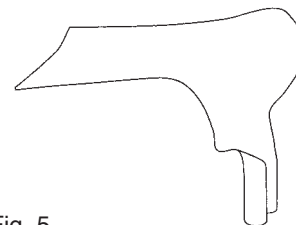

Fig. 5

030-200-070 70x45/70 mm

Scheidenspekula
Vaginal Specula
Espéculos vaginales
Specoli vaginali



030

mit festem Gewicht
with fixed weight
con peso fijo
con peso fisso



AUVARD

030-210-000 90x45 mm

mit abnehmbarem Gewicht
with detachable weight
con peso desmontable
con peso smontabile



AUVARD

030-212-000 80x38 mm

80x42 mm

mit abnehmbarem Auffangsieb
with removable strainer
con tamiz desmontable
con filtro smontabile



WEISSBARTH

030-216-000 21,0 cm / 8 1/4"



030

Scheidenspekula
Vaginal Specula
Espéculos vaginales
Specoli vaginali



BREISKY

030-221-020	100x20 mm	30,0 cm / 12"
030-221-025	100x25 mm	30,0 cm / 12"
030-221-030	100x30 mm	30,0 cm / 12"
030-221-035	100x35 mm	30,0 cm / 12"
030-221-040	100x40 mm	30,0 cm / 12"
030-223-020	130x20 mm	32,0 cm / 12 ³ / ₄ "
030-223-025	130x25 mm	32,0 cm / 12 ³ / ₄ "
030-223-030	130x30 mm	32,0 cm / 12 ³ / ₄ "
030-223-035	130x35 mm	32,0 cm / 12 ³ / ₄ "
030-223-040	130x40 mm	32,0 cm / 12 ³ / ₄ "
030-225-040	155x40 mm	35,0 cm / 14"

LANDAU

030-229-028	100x28 mm	29,0 cm / 11 ¹ / ₂ "
030-229-038	100x38 mm	29,0 cm / 11 ¹ / ₂ "

DOYEN

030-231-250	25,0 cm / 9"
--------------------	--------------



HEGAR

030-240-001	Ø 1,0 mm	18,5 cm / 7 ¹ / ₄ "
030-240-002	Ø 2,0 mm	18,5 cm / 7 ¹ / ₄ "
030-240-003	Ø 3,0 mm	18,5 cm / 7 ¹ / ₄ "
030-240-004	Ø 4,0 mm	18,5 cm / 7 ¹ / ₄ "
030-240-005	Ø 5,0 mm	18,5 cm / 7 ¹ / ₄ "
030-240-006	Ø 6,0 mm	18,5 cm / 7 ¹ / ₄ "
030-240-007	Ø 7,0 mm	18,5 cm / 7 ¹ / ₄ "
030-240-008	Ø 8,0 mm	18,5 cm / 7 ¹ / ₄ "
030-240-009	Ø 9,0 mm	18,5 cm / 7 ¹ / ₄ "
030-240-010	Ø 10,0 mm	18,5 cm / 7 ¹ / ₄ "
030-240-011	Ø 11,0 mm	18,5 cm / 7 ¹ / ₄ "
030-240-012	Ø 12,0 mm	18,5 cm / 7 ¹ / ₄ "
030-240-013	Ø 13,0 mm	18,5 cm / 7 ¹ / ₄ "
030-240-014	Ø 14,0 mm	18,5 cm / 7 ¹ / ₄ "
030-240-015	Ø 15,0 mm	18,5 cm / 7 ¹ / ₄ "
030-240-016	Ø 16,0 mm	18,5 cm / 7 ¹ / ₄ "
030-240-017	Ø 17,0 mm	18,5 cm / 7 ¹ / ₄ "
030-240-018	Ø 18,0 mm	18,5 cm / 7 ¹ / ₄ "
030-240-019	Ø 19,0 mm	18,5 cm / 7 ¹ / ₄ "
030-240-020	Ø 20,0 mm	18,5 cm / 7 ¹ / ₄ "
030-240-021	Ø 21,0 mm	18,5 cm / 7 ¹ / ₄ "
030-240-022	Ø 22,0 mm	18,5 cm / 7 ¹ / ₄ "
030-240-023	Ø 23,0 mm	18,5 cm / 7 ¹ / ₄ "
030-240-024	Ø 24,0 mm	18,5 cm / 7 ¹ / ₄ "
030-240-025	Ø 25,0 mm	18,5 cm / 7 ¹ / ₄ "
030-240-026	Ø 26,0 mm	18,5 cm / 7 ¹ / ₄ "
030-240-027	Ø 27,0 mm	18,5 cm / 7 ¹ / ₄ "
030-240-028	Ø 28,0 mm	18,5 cm / 7 ¹ / ₄ "
030-240-029	Ø 29,0 mm	18,5 cm / 7 ¹ / ₄ "
030-240-030	Ø 30,0 mm	18,5 cm / 7 ¹ / ₄ "

HEGAR

030-241-015	Ø 1,5 mm	18,5 cm / 7 ¹ / ₄ "
030-241-025	Ø 2,5 mm	18,5 cm / 7 ¹ / ₄ "
030-241-035	Ø 3,5 mm	18,5 cm / 7 ¹ / ₄ "
030-241-045	Ø 4,5 mm	18,5 cm / 7 ¹ / ₄ "
030-241-055	Ø 5,5 mm	18,5 cm / 7 ¹ / ₄ "
030-241-065	Ø 6,5 mm	18,5 cm / 7 ¹ / ₄ "
030-241-075	Ø 7,5 mm	18,5 cm / 7 ¹ / ₄ "
030-241-085	Ø 8,5 mm	18,5 cm / 7 ¹ / ₄ "
030-241-095	Ø 9,5 mm	18,5 cm / 7 ¹ / ₄ "
030-241-105	Ø 10,5 mm	18,5 cm / 7 ¹ / ₄ "
030-241-115	Ø 11,5 mm	18,5 cm / 7 ¹ / ₄ "
030-241-125	Ø 12,5 mm	18,5 cm / 7 ¹ / ₄ "
030-241-135	Ø 13,5 mm	18,5 cm / 7 ¹ / ₄ "
030-241-145	Ø 14,5 mm	18,5 cm / 7 ¹ / ₄ "
030-241-155	Ø 15,5 mm	18,5 cm / 7 ¹ / ₄ "
030-241-165	Ø 16,5 mm	18,5 cm / 7 ¹ / ₄ "
030-241-175	Ø 17,5 mm	18,5 cm / 7 ¹ / ₄ "



030

**Uterus-Dilatatoren
Uterine Dilators
Dilatadores uterinos
Dilatatori uterini**



HEGAR

030-240-140 Ø 4,0 - Ø 17,0 mm

Satz, in Metalletui
Set, in metal case
Juego, en caja metalica
Set, in scatola metallica
(14 dilators)

HEGAR

030-240-260 Ø 1,0 - Ø 26,0 mm

Satz, in Metalletui
Set, in metal case
Juego, en caja metalic
Set, in scatola metallica
(26 dilators)



HEGAR

030-245-140 Ø 4,0 - Ø 17,0 mm

Satz, in Lederetui
Set, in leather pouch
Juego, en estuche de piel
Set, in scatola de pelle
(14 dilators)

HEGAR

030-245-260 Ø 1,0 - Ø 26,0 mm

Satz, in Lederetui
Set, in leather pouch
Juego, en estuche de piel
Set, in scatola de pelle
(26 dilators)



HEGAR

030-250-002	Ø 1,0/ 2,0 mm	20,0 cm / 8"
030-250-004	Ø 3,0/ 4,0 mm	20,0 cm / 8"
030-250-006	Ø 5,0/ 6,0 mm	20,0 cm / 8"
030-250-008	Ø 7,0/ 8,0 mm	20,0 cm / 8"
030-250-010	Ø 9,0/10,0 mm	20,0 cm / 8"
030-250-012	Ø 11,0/12,0 mm	20,0 cm / 8"
030-250-014	Ø 13,0/14,0 mm	20,0 cm / 8"
030-250-016	Ø 15,0/16,0 mm	20,0 cm / 8"
030-250-018	Ø 17,0/18,0 mm	20,0 cm / 8"
030-250-020	Ø 19,0/20,0 mm	20,0 cm / 8"
030-250-022	Ø 21,0/22,0 mm	20,0 cm / 8"
030-250-024	Ø 23,0/24,0 mm	20,0 cm / 8"
030-250-026	Ø 25,0/26,0 mm	20,0 cm / 8"

HEGAR

030-250-080 Ø 3,0/4,0-Ø 17,0/18,0 mm (8 dilators)
030-250-130 Ø 1,0/2,0-Ø 25,0/26,0 mm (13 dilators)

Satz ohne auskochbare Stoffrolltasche
 Set without bilable canvas roll
 Juego sin bolsa de tela esterilizable por ebullición
 Set senza busta di tela sterilizzabile

HEGAR

030-252-080 Ø 3,0/4,0-Ø 17,0/18,0 mm (8 dilators)
030-252-130 Ø 1,0/2,0-Ø 25,0/26,0 mm (13 dilators)

Satz in auskochbare Stoffrolltasche
 Set in bilable canvas roll
 Juego en bolsa de tela esterilizable por ebullición
 Set in busta di tela sterilizzabile



HEGAR

030-254-080 Ø 3,0/4,0-Ø 17,0/18,0 mm

Satz in Metalletui
 Set in metalcase
 Juego en caja metalica
 Set in scatola metallica
 (8 dilators)



030

Uterus-Dilatatoren
Uterine Dilators
Dilatadores uterinos
Dilatatori uterini



HANK

030-260-010	Ø 4,5/ 5,0 mm	Fig. 9/10
030-260-012	Ø 5,5/ 6,0 mm	Fig.11/12
030-260-014	Ø 6,5/ 7,0 mm	Fig.13/14
030-260-016	Ø 7,5/ 8,0 mm	Fig.15/16
030-260-018	Ø 8,5/ 9,0 mm	Fig.17/18
030-260-020	Ø 9,5/10,0 mm	Fig.19/20



HANK

030-260-060 Ø 4,5/5,0-Ø 9,5/10,0 mm (6 dilators)

Satz in auskochbarer Stoffrolltasche

Set in boilable canvas roll

Juego en bolsa de tela esterilizable por ebullición

Set in busta di tela sterilizzabile



PRATT

030-270-005	Ø 4,5/ 5,0 mm	Charr. 13/15
030-270-006	Ø 5,5/ 6,0 mm	Charr. 17/19
030-270-008	Ø 7,5/ 8,0 mm	Charr. 21/23
030-270-009	Ø 8,5/ 9,0 mm	Charr. 25/27
030-270-010	Ø 9,5/10,0 mm	Charr. 29/31
030-270-012	Ø 11,5/12,0 mm	Charr. 33/35
030-270-013	Ø 12,5/13,0 mm	Charr. 37/39
030-270-014	Ø 13,5/14,0 mm	Charr. 41/43

030-270-080 Ø 3,0/4,0-Ø 17,0/18,0 mm (8 dilators)

Satz in auskochbarer Stoffrolltasche

Set in boilable canvas roll

Juego en bolsa de tela esterilizable por ebullición

Set in busta di tela sterilizzabile



030

Uterussonden, Zentimereinteilung
Uterine Probes, graduated in centimeters
Histerómetros, graduado en centímetros
Isterometri, graduato in cm



biegsam
malleable
maleable
malleabile

SIMS

030-281-320 32,0 cm / 12 1/2"



starr
rigid
rigido
rigido

SIMS

030-283-320 32,0 cm / 12 1/2"



biegsam
malleable
maleable
malleabile

MARTIN

030-285-320 32,0 cm / 12 1/2"



graduiert
graduated
graduado
graduato

COLLIN

030-287-280 28,0 cm / 11"



VALLEIX

030-289-295 25,0 cm / 10"



BRAUN

030-291-280 28,0 cm / 11"

Hakenzangen
Uterine Tenaculum Forceps
Pinzas para coger el cuello del útero
Pinze per abbassare il collo dell'utero



030



STAUDE-MOORE

030-300-170 17,0 cm / 6³/₄"

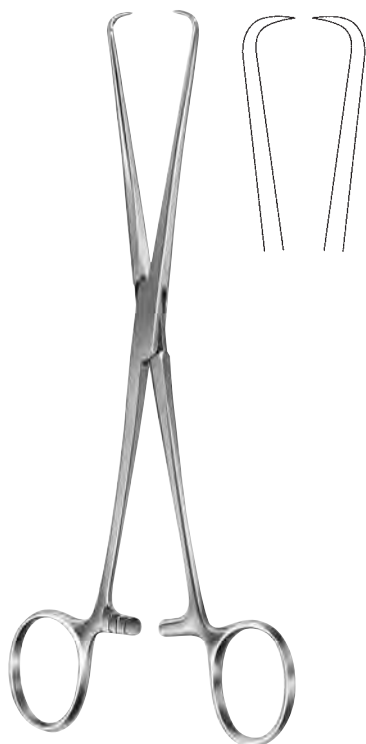

BARRETT

030-304-180 18,0 cm / 7"

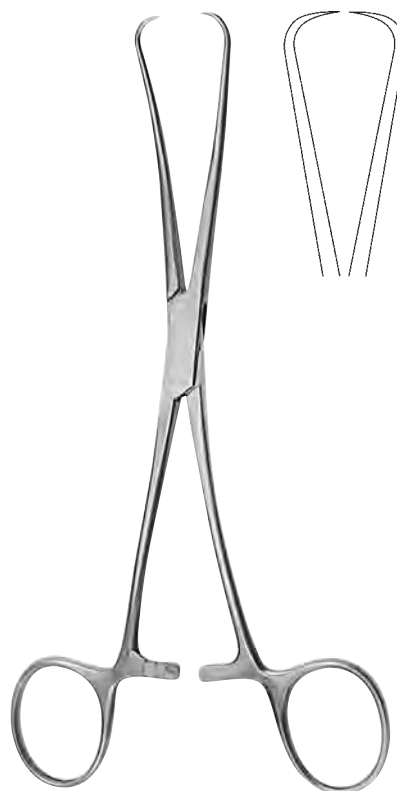

JARCHO

030-307-200 20,0 cm / 8"



030

Hakenzangen
Uterine Tenaculum Forceps
Pinzas para coger el cuello del útero
Pinze per abbassare il collo del'utero



SCHROEDER
030-310-250 25,0 cm / 9³/₄"

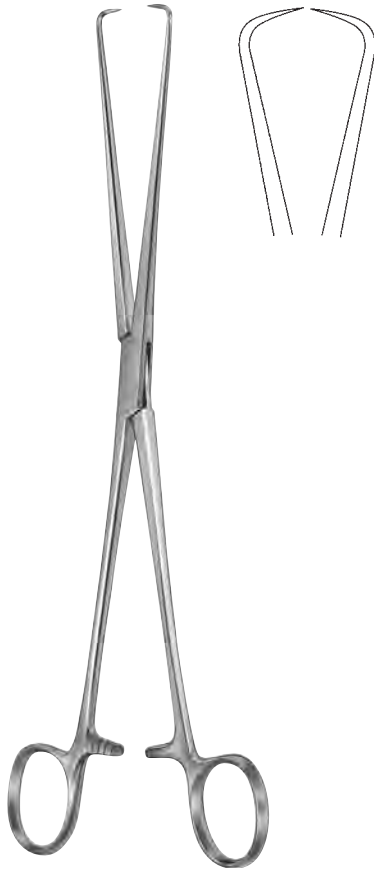

BRAUN
030-312-250 25,0 cm / 9³/₄"

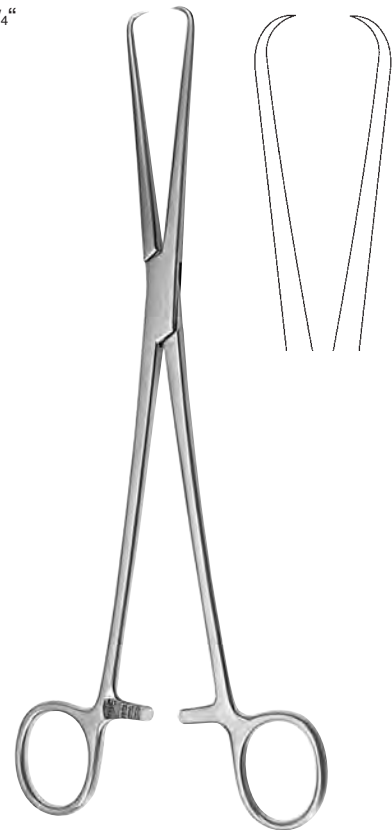

POZZI
030-314-255 25,5 cm / 10¹/₄"

Hakenzangen
Uterine Tenaculum Forceps
Pinzas para coger el cuello del útero
Pinze per abbassare il collo dell'utero



030

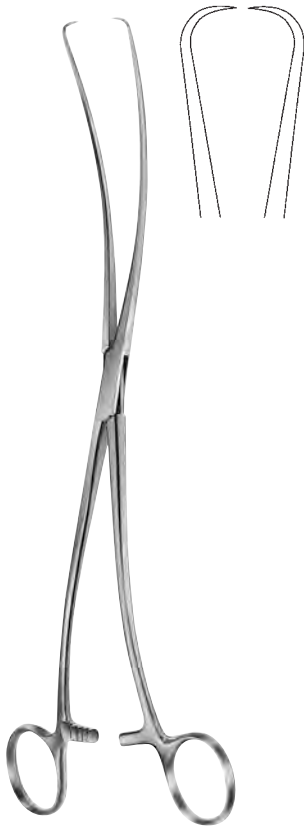

DUPLAY
030-317-280 28,0 cm / 11"

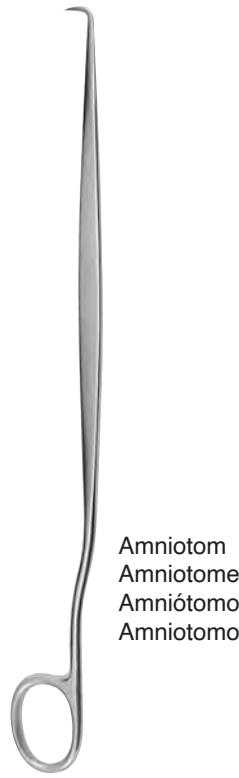

Amniotom
 Amniotome
 Amniótomo
 Amniotomo

BEACHAM
030-320-260 26,0 cm / 10¹/₄"

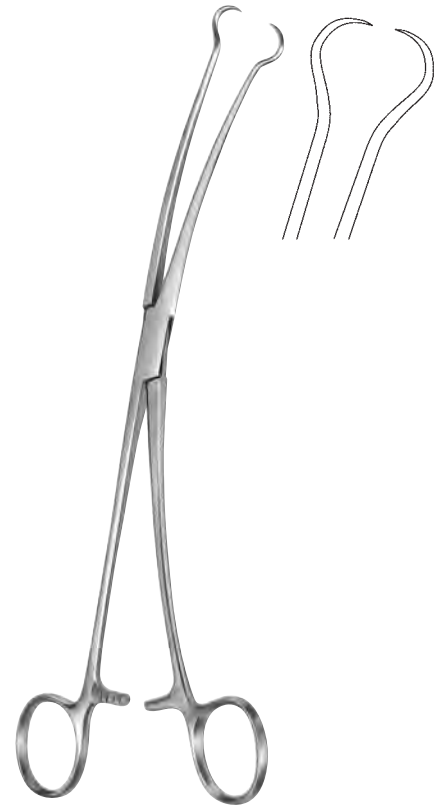

SKENE
030-323-240 24,0 cm / 9¹/₂"



SCHROEDER
030-326-250 25,0 cm / 9³/₄"



SCHROEDER
030-327-250 25,0 cm / 9¹/₂"



3x4 Zähne
 3x4 teeth
 3x4 dientes
 3x4 denti

TEALE
030-329-230 23,0 cm / 9"



030

Hakenzangen
Uterine Tenaculum Forceps
Pinzas para coger el cuello del útero
Pinze per abbassare il collo del'utero

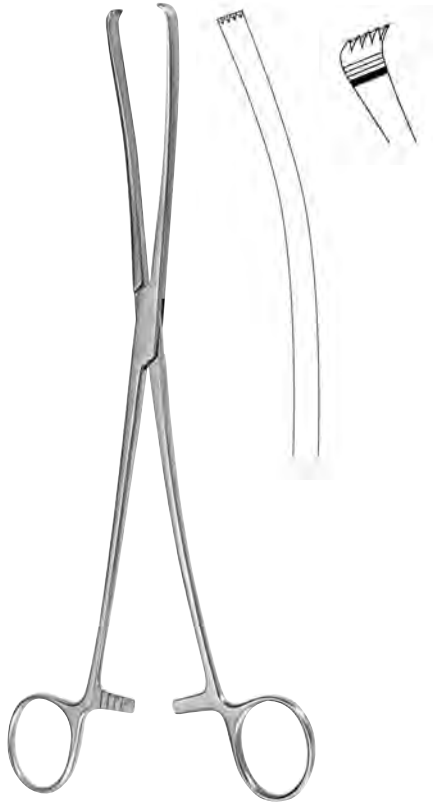

IOWA
030-331-260 26,0 cm / 10¼"



6 mm
030-340-006

8 mm
030-340-008

10 mm
030-340-010

MUSEUX
030-340-006 – 030-340-010 24,0 cm / 9½"



6 mm
030-341-006

8 mm
030-341-008

10 mm
030-341-010

MUSEUX
030-341-006 – 030-341-010 24,0 cm / 9½"



JACOBS
030-344-210 21,0 cm / 8¼"



JACOBS
030-345-210 21,0 cm / 8¼"

Hakenzangen
Uterine Tenaculum Forceps
Pinzas para coger el cuello del útero
Pinze per abbassare il collo dell'utero



030

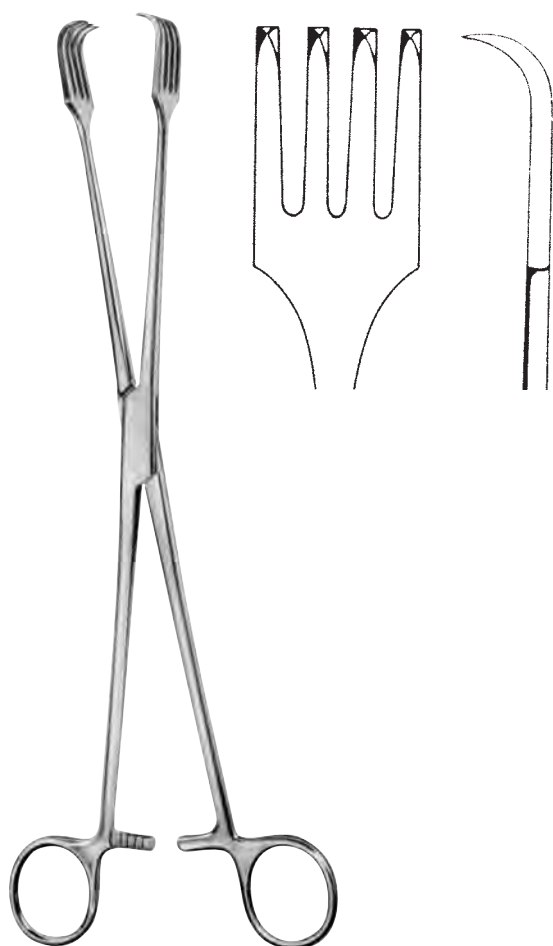

030-350-260 26,0 cm / 10¹/₄"

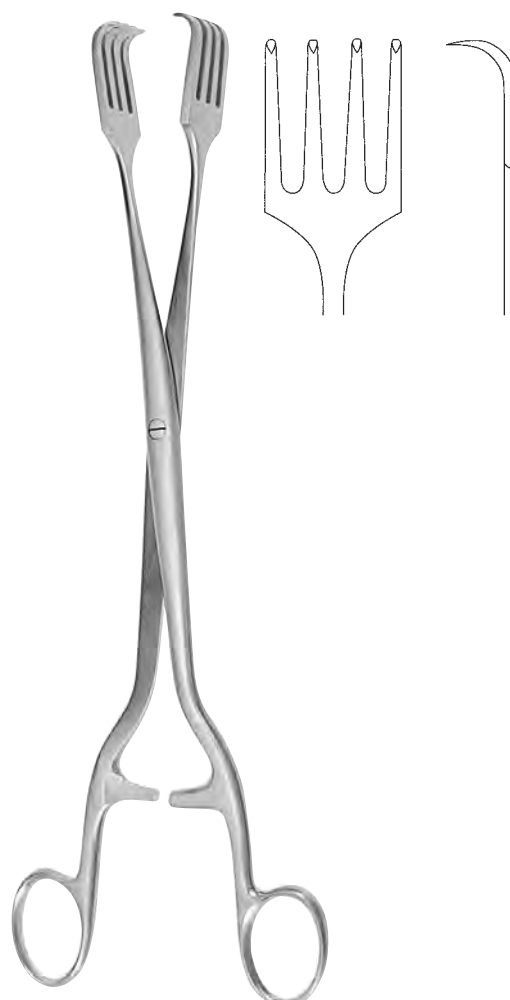

PRATT
030-352-280 28,0 cm / 11"

Hakenzangen, Polypen- und Ovarienzangen
Uterine Tenaculum Forceps, Polypus and Ovum Forceps
Pinzas para coger el cuello del útero, Pinzas para pólipos uterinos y ovarios
Pinze per abbassare il collo del'utero, Pinze per polipi e ovaie

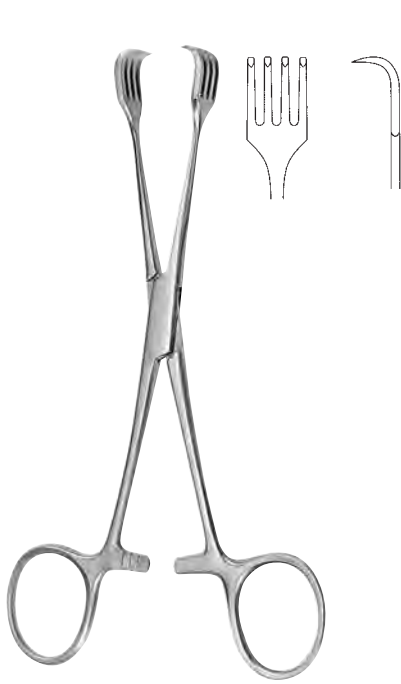

BRAUN
030-354-155 15,5 cm / 6"

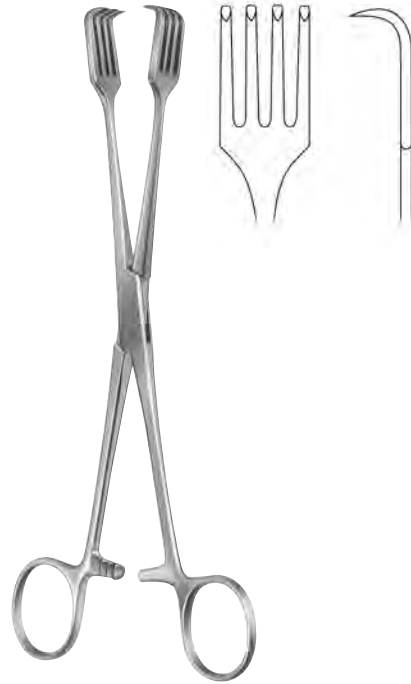

CZERNY
030-356-205 20,5 cm / 8"

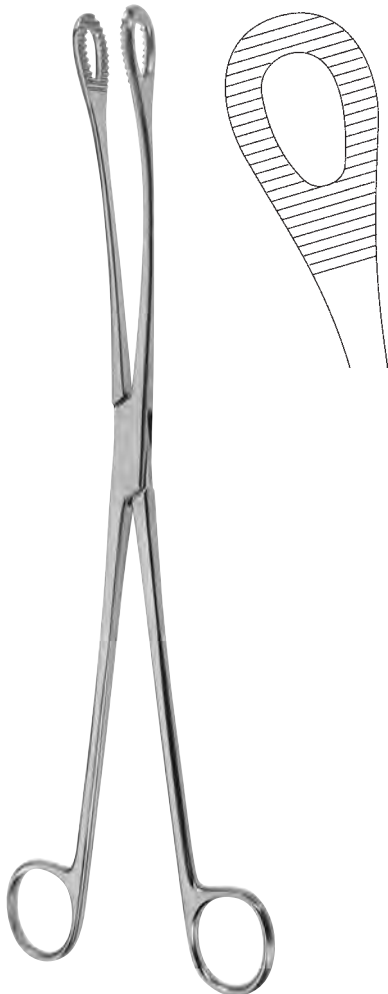

KELLY
030-359-320 32,0 cm / 12 1/2"

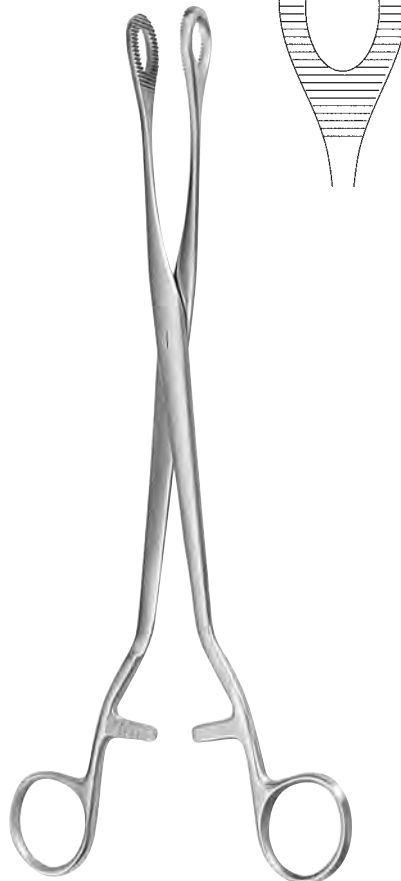

NOTO
030-360-270 27,0 cm / 10 5/8"



DOYEN
030-362-200 20,0 cm / 8"

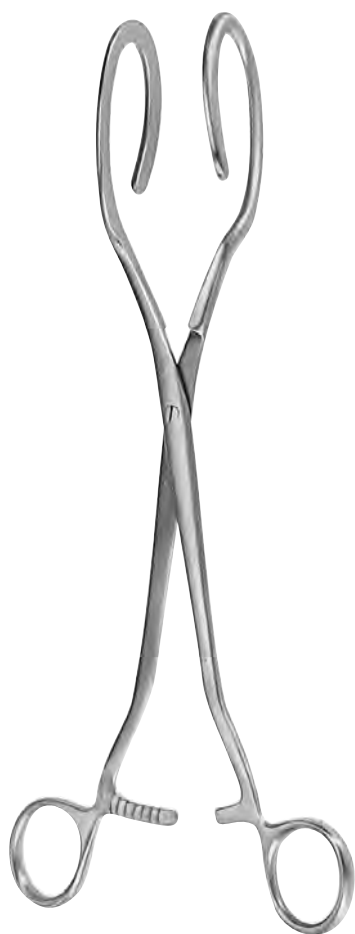

DARTIGUES

030-370-270 27,0 cm / 10³/₄"



SOMER

030-373-230 23,0 cm / 9"



COLLIN

030-376-250 25,0 cm / 9³/₄"



030

Myominstrumente, Fistelhaken
Myoma instruments, Fistula Hooks
Instrumentos para mioma, Ganchos para fistulas
Strumenti per fibroma, Uncini per fistole

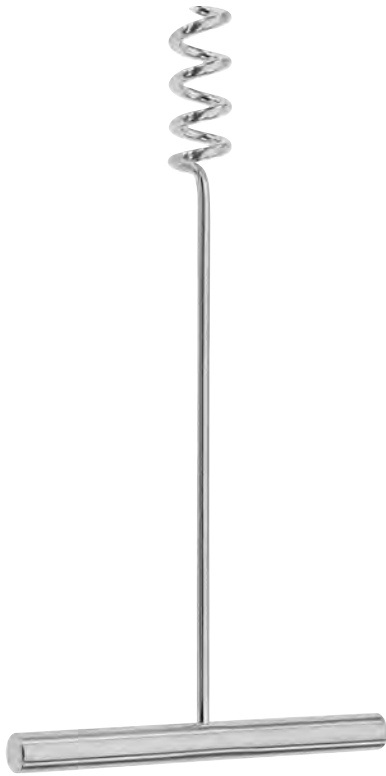

DOYEN
030-380-170 17,0 cm / 6³/₄"



DOYEN
030-382-170 17,0 cm / 6³/₄"



030-384-001



030-384-002



030-384-003



030-384-004



030-384-005

EMMET
030-384-001 - 030-384-005 22,0 cm / 8³/₄"

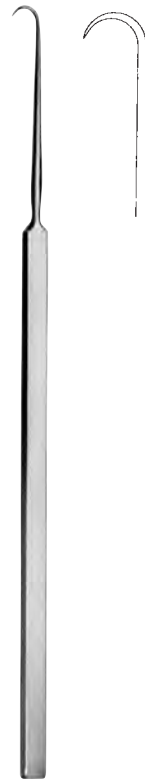

SIMON
030-386-220 22,0 cm / 8³/₄"



SIMON
030-388-220 22,0 cm / 8³/₄"



KOGAN

030-391-006 24,0 cm / 9½"



KOGAN

030-393-006 24,0 cm / 9½"

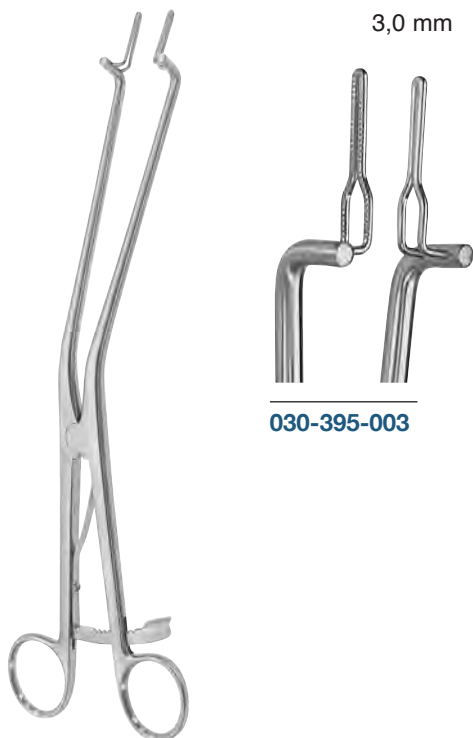

030-395-003



030-395-004



030-395-006

KOGAN

030-395-003 - 030-395-006 28,0 cm / 11"



030

Endospekula
Endospecula
Endospéculos
Endospecoli



GOODELL

030-397-340 34,0 cm / 13 1/2"

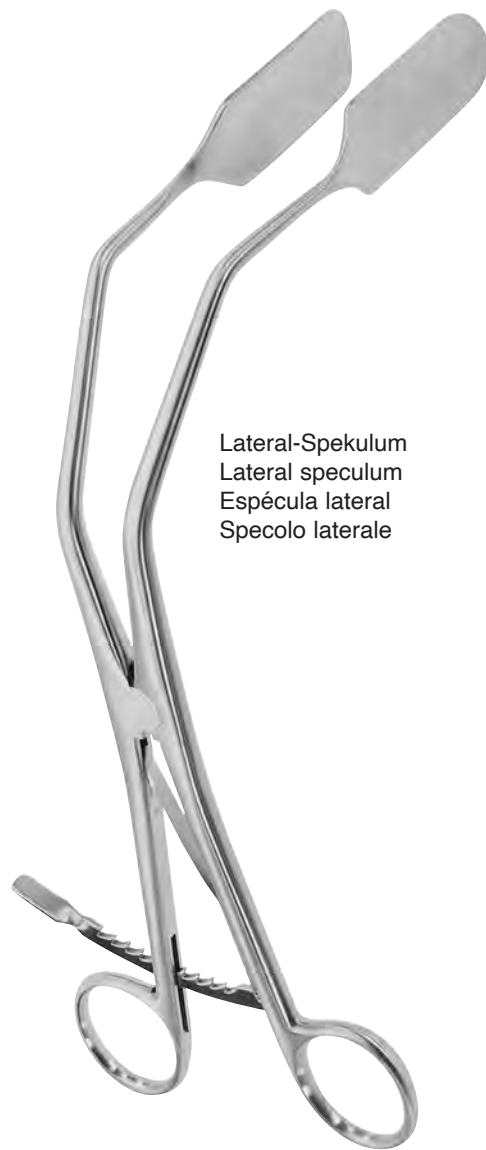

Lateral-Spekulum
Lateral speculum
Espécula lateral
Specolo laterale

030-399-060 60x22 mm 25,0 cm / 10"
030-399-072 72x22 mm 25,0 cm / 10"

Biopsieküretten
Biopsy Curettes
Curetas para biopsia
Curette per biopsia



030

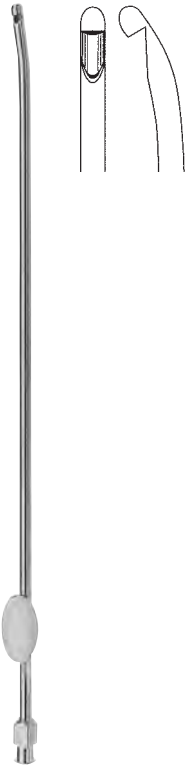

RANDALL
030-451-230 23,0 cm / 9" Ø 4,0 mm



NOVAK
030-453-002 23,0 cm / 9" Ø 2 mm
030-453-004 23,0 cm / 9" Ø 4 mm



KEVORKIAN
030-456-300 30,0 cm / 12"



KEVORKIAN
030-458-300 30,0 cm / 12"



KEVORKIAN
030-460-300 30,0 cm / 12"



030

Probeexzisionszangen
Uterine Biopsy Forceps
Pinzas para biopsia
Pinze per biopsia



GELLHORN

030-501-230 23,0 cm / 9"



FAURE

030-503-210 21,0 cm / 8 1/4"



SCHUBERT

030-506-210 21,0 cm / 8 1/4"
030-506-290 29,0 cm / 11 1/2"

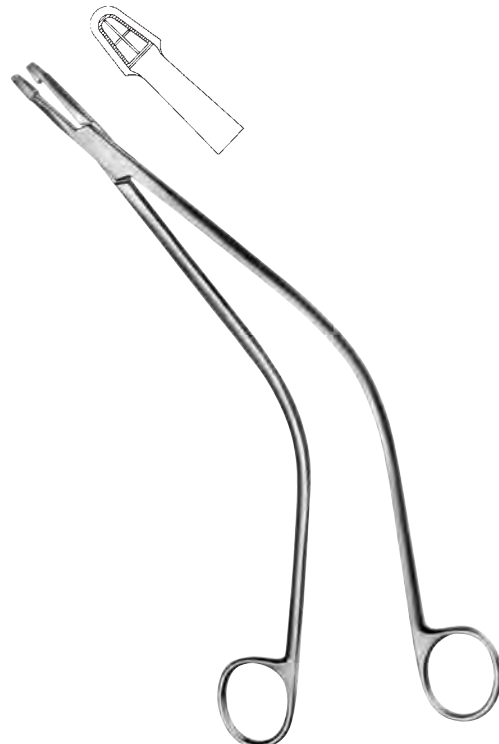

SCHUBERT

030-509-260 26,0 cm / 10 1/4"



THOMS-GAYLOR

030-511-220 22,0 cm / 8³/₄"
030-511-240 24,0 cm / 9¹/₂"

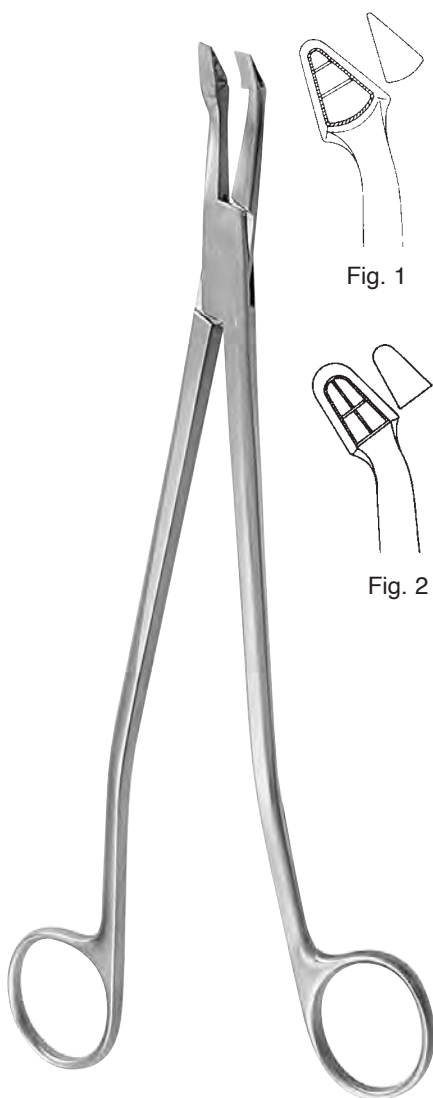

VAN DOREN

030-515-001 25,0 cm / 9³/₄" Fig. 1
030-515-002 25,0 cm / 9³/₄" Fig. 2



VAN DOREN

030-517-002 25,5 cm / 10"



030

Uterus Biopsiezangen
Cervical Biopsy and Specimen Forceps
Pinzas saca-bocados para biopsia
Pinze per la biopsia cervicale e da prelievo

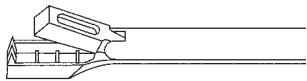
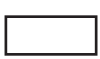
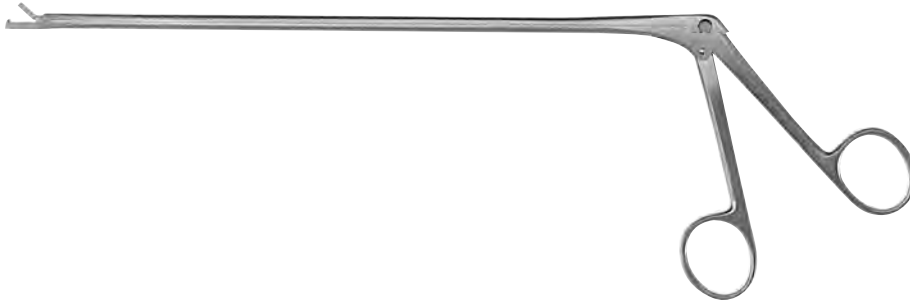

KEVORKIAN

030-520-250 25,0 cm / 10" 3x9 mm

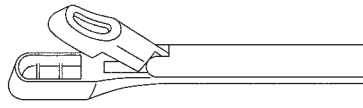

EPPENDORFER

030-524-200 20,0 cm / 8" 4x8 mm



ALEXANDER

030-526-280 28,0 cm / 11"

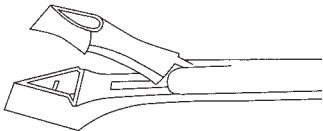

SCHUMACHER

030-530-001 24,0 cm / 9½" 4,5x7 mm

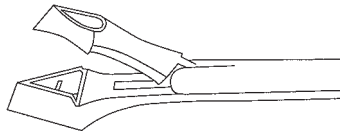

SCHUMACHER

030-530-002 24,0 cm / 9½" 6x9 mm

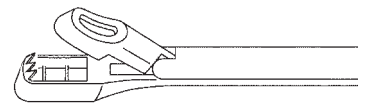

WITTNER

030-532-230 23,0 cm / 9" 4,5x8 mm

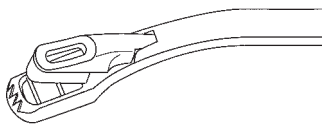

WITTNER

030-533-230 23,0 cm / 9" 4,5x8 mm

Uterus Biopsiezangen
Cervical Biopsy and Specimen Forceps
Pinzas saca-bocados para biopsia
Pinze per la biopsia cervicale e da prelievo



030

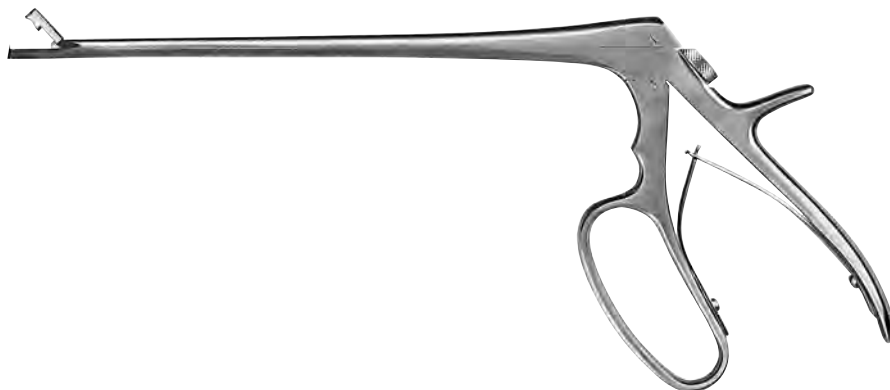

TISCHLER-MORGAN

030-550-210 21,0 cm / 8¹/₄" 7x3 mm
030-550-250 25,0 cm / 9³/₄" 7x3 mm



MINI-TOWNSEND

030-552-210 21,0 cm / 8¹/₄" 2,3x5 mm



BABY-TISCHLER

030-554-210 21,0 cm / 8¹/₄" 2,3x5 mm



TISCHLER-KEVORKIAN

030-556-210 21,0 cm / 8¹/₄" 3x9 mm



KEVORKIAN-PACIFIC

030-558-210 21,0 cm / 8¹/₄" 3x8 mm

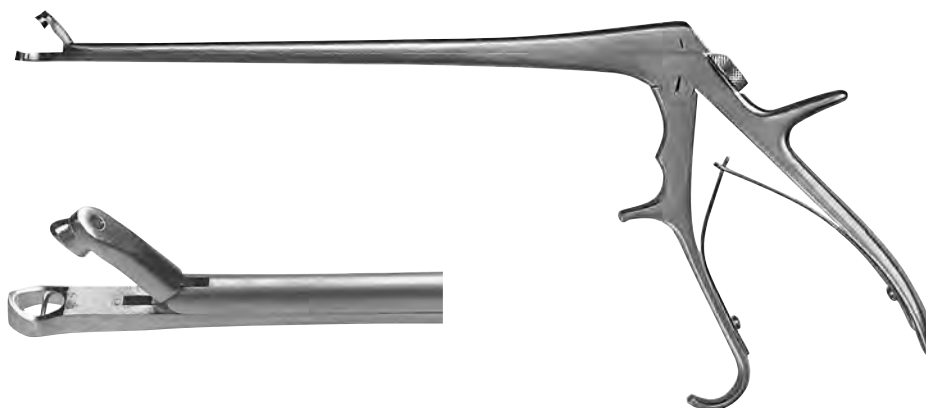

BURKE

030-560-210 21,0 cm / 8¹/₄" 7x5 mm



030

Biopsiezangen
Biopsy Specimen Forceps
Pinzas sacabocado para biopsia
Pinze per biopsia



030-572-000

Griff allein
handle only
manico solo
mango suelto

Aufsätze allein
Tips only
Puntas sueltas
Punti solo

030-570-001 Fig.1
030-570-003 Fig.3
030-570-004 Fig.4
030-570-005 Fig.5
komplett
complete
completo
completo



TISCHLER MORGAN
030-571-001 Fig.1



TOWNSEND
030-571-003 Fig.3



KEVORKIAN
030-571-004 Fig.4



**MINI-TOWNSEND
(BABY-TISCHLER)**
030-571-005 Fig.5

Probeexzisionszangen, IUP-Fasszangen
Uterine Biopsy Forceps, IUP Grasping Forceps
Pinza para biopsia, Pinzas para coger intra-uterinos
Pinze per biopsia, Pinze intra-uterine



030



flexibler Schaft
felxible shaft
vastago flexible
asta flessibile

SERPENTINE

030-580-220 22,0 cm / 8³/₄"
030-580-285 28,5 cm / 11¹/₄"



SCHUMACHER

030-586-001

Aufsatz allein
Tip only
Punta suelta
Punta, sola

SCHUMACHER

030-586-000 25,0 cm / 9³/₄"

komplett
complete
completo
completo



030

**Uteruslöffel
Uterine Scoopes
Cucharillas uterinas
Curette uterine**



scharf, fest
sharp, rigid
cortante, rigido
tagliente, rigido



030-600-001

Fig.1



030-600-002

Fig.2



030-600-003

Fig.3

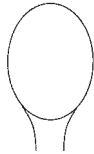

030-600-004

Fig.4



030-600-005

Fig.5

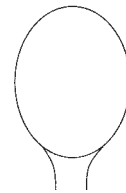

030-600-006

Fig.6

SIMON

030-600-001 - 030-600-006 25,0 cm / 9³/₄"



scharf, fest
sharp, rigid
cortante, rigido
tagliente, rigido



030-602-001

Fig.1



030-602-002

Fig.2



030-602-003

Fig.3



030-602-004

Fig.4

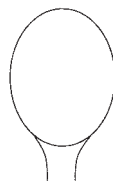

030-602-005

Fig.5

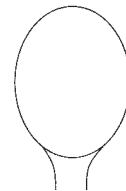

030-602-006

Fig.6

SCHROEDER

030-602-001 - 030-602-006 30,0 cm / 11³/₄"

scharf, fest
 sharp, rigid
 cortante, rigido
 tagliente, rigido

scharf, biegsam
 sharp, malleable
 cortante, maleabile
 tagliente, malleabile



RECAMIER

030-650-045	Fig.00	31,0 cm / 12 ¹ / ₄ "
030-650-075	Fig.0	31,0 cm / 12 ¹ / ₄ "
030-650-085	Fig.1	31,0 cm / 12 ¹ / ₄ "
030-650-105	Fig.2	31,0 cm / 12 ¹ / ₄ "
030-650-120	Fig.3	31,0 cm / 12 ¹ / ₄ "
030-650-140	Fig.4	31,0 cm / 12 ¹ / ₄ "
030-650-150	Fig.5	31,0 cm / 12 ¹ / ₄ "
030-650-165	Fig.6	31,0 cm / 12 ¹ / ₄ "
030-650-180	Fig.7	31,0 cm / 12 ¹ / ₄ "
030-650-195	Fig.8	31,0 cm / 12 ¹ / ₄ "
030-650-215	Fig.9	31,0 cm / 12 ¹ / ₄ "
030-650-235	Fig.10	31,0 cm / 12 ¹ / ₄ "

RECAMIER

030-652-085	Fig.1	31,0 cm / 12 ¹ / ₄ "
030-652-105	Fig.2	31,0 cm / 12 ¹ / ₄ "
030-652-120	Fig.3	31,0 cm / 12 ¹ / ₄ "
030-652-140	Fig.4	31,0 cm / 12 ¹ / ₄ "
030-652-150	Fig.5	31,0 cm / 12 ¹ / ₄ "
030-652-165	Fig.6	31,0 cm / 12 ¹ / ₄ "
030-652-180	Fig.7	31,0 cm / 12 ¹ / ₄ "
030-652-195	Fig.8	31,0 cm / 12 ¹ / ₄ "



030

Uterusküretten
Uterine Curettes
Curetas uterinas
Curette uterine



stumpf, fest
blunt, rigid
romo, rigida
smusso, rigido



4,5 mm
Fig.00



7,5 mm
Fig.0



8,5 mm
Fig.1



10,5 mm
Fig.2



12,0 mm
Fig.3



14,0 mm
Fig.4



15,0 mm
Fig.5

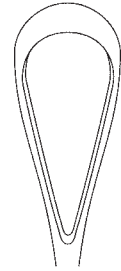

16,5 mm
Fig.6



18,0 mm
Fig.7

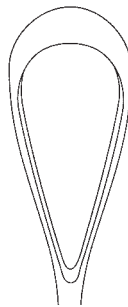

19,5 mm
Fig.8

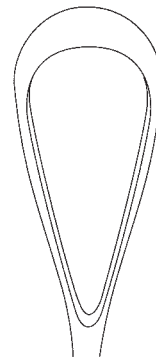

21,5 mm
Fig.9

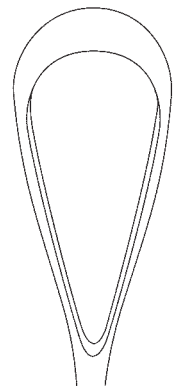

23,5 mm
Fig.10

RECAMIER

030-654-045	Fig.00	31,0 cm / 12 ¹ / ₄ "
030-654-075	Fig.0	31,0 cm / 12 ¹ / ₄ "
030-654-085	Fig.1	31,0 cm / 12 ¹ / ₄ "
030-654-105	Fig.2	31,0 cm / 12 ¹ / ₄ "
030-654-120	Fig.3	31,0 cm / 12 ¹ / ₄ "
030-654-140	Fig.4	31,0 cm / 12 ¹ / ₄ "
030-654-150	Fig.5	31,0 cm / 12 ¹ / ₄ "
030-654-165	Fig.6	31,0 cm / 12 ¹ / ₄ "
030-654-180	Fig.7	31,0 cm / 12 ¹ / ₄ "
030-654-195	Fig.8	31,0 cm / 12 ¹ / ₄ "
030-654-215	Fig.9	31,0 cm / 12 ¹ / ₄ "
030-654-235	Fig.10	31,0 cm / 12 ¹ / ₄ "

Uterusküretten
Uterine Curettes
Curetas uterinas
Curette uterine



030

scharf, fest
 sharp, rigid
 cortante, rigido
 tagliente, rigido

scharf, biegsam
 sharp, malleable
 cortante, malleable
 tagliente, malleable

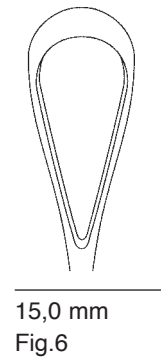
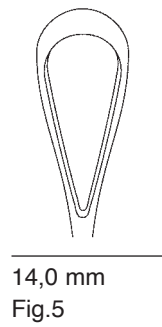
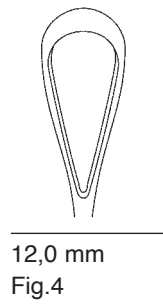
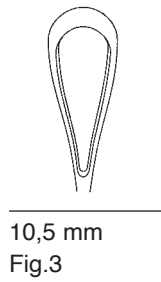
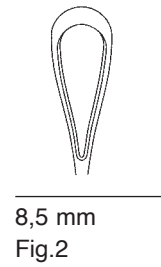
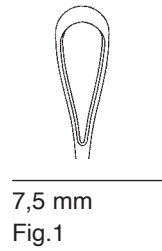
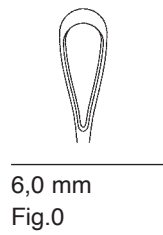
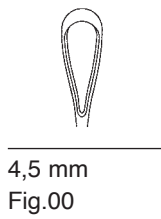

SIMS

030-660-045	Fig.00	28,0 cm / 11"
030-660-060	Fig.0	28,0 cm / 11"
030-660-075	Fig.1	28,0 cm / 11"
030-660-085	Fig.2	28,0 cm / 11"
030-660-105	Fig.3	28,0 cm / 11"
030-660-120	Fig.4	28,0 cm / 11"
030-660-140	Fig.5	28,0 cm / 11"
030-660-150	Fig.6	28,0 cm / 11"

SIMS

030-662-075	Fig.1	28,0 cm / 11"
030-662-085	Fig.2	28,0 cm / 11"
030-662-105	Fig.3	28,0 cm / 11"
030-662-120	Fig.4	28,0 cm / 11"
030-662-140	Fig.5	28,0 cm / 11"
030-662-150	Fig.6	28,0 cm / 11"



030

Uterusküretten
Uterine Currettes
Curetas uterinas
Curette uterine

stumpf, fest
blunt, rigid
romo, rigida
smusso, rigido



4,5 mm
Fig.00



6,0 mm
Fig.0



7,5 mm
Fig.1



8,5 mm
Fig.2



10,5 mm
Fig.3



12,0 mm
Fig.4



14,0 mm
Fig.5



15,0 mm
Fig.6

SIMS

030-664-045	Fig.00	28,0 cm / 11"
030-664-060	Fig.0	28,0 cm / 11"
030-664-075	Fig.1	28,0 cm / 11"
030-664-085	Fig.2	28,0 cm / 11"
030-664-105	Fig.3	28,0 cm / 11"
030-664-120	Fig.4	28,0 cm / 11"
030-664-140	Fig.5	28,0 cm / 11"
030-664-150	Fig.6	28,0 cm / 11"

stumpf, fest
 blunt, rigid
 romo, rigida
 smusso, rigido

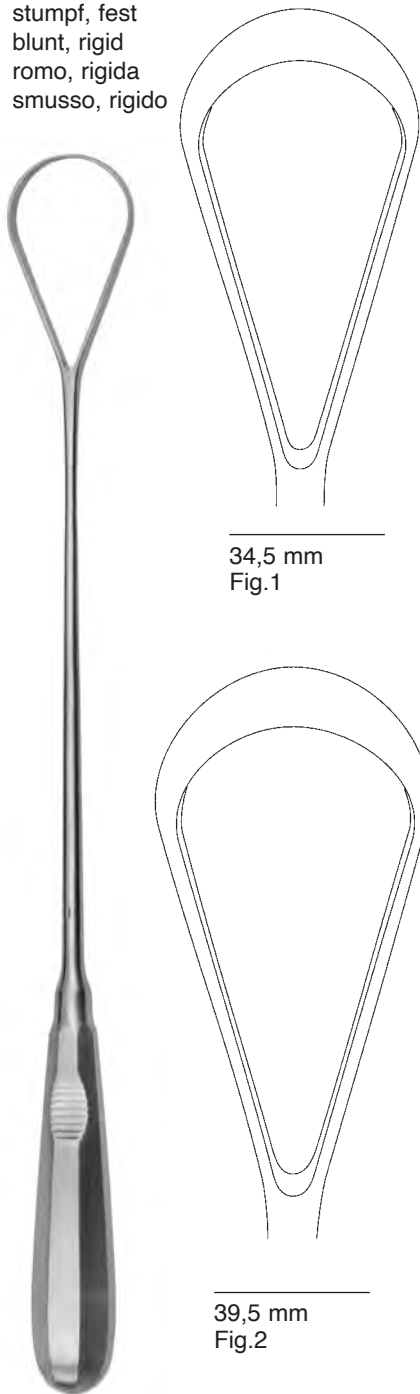

34,5 mm
 Fig.1

39,5 mm
 Fig.2

RECAMIER

030-674-345 36,0 cm / 14¹/₄" Fig.1
030-674-395 36,0 cm / 14¹/₄" Fig.2

scharf, biegsam
 sharp, malleable
 cortante, maleable
 tagliente, malleabile

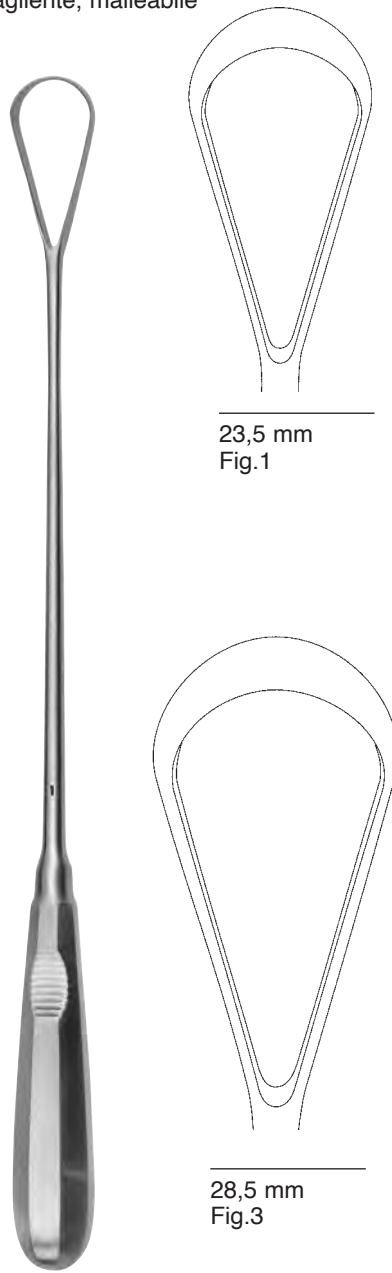

23,5 mm
 Fig.1

28,5 mm
 Fig.3

BUMM

030-682-235 31,0 cm / 12¹/₄" Fig.1
030-682-285 31,0 cm / 12¹/₄" Fig.3

stumpf, biegsam
 blunt, malleable
 romo, maleable
 smusso, malleabile

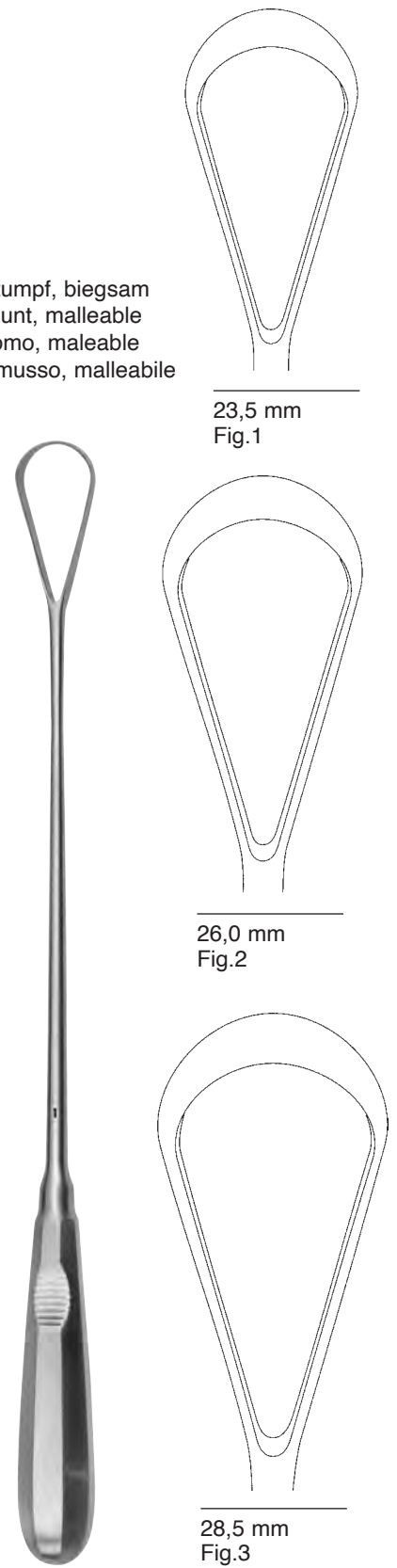

23,5 mm
 Fig.1

26,0 mm
 Fig.2

28,5 mm
 Fig.3

BUMM

030-686-235 31,0 cm / 12¹/₄" Fig.1
030-686-260 31,0 cm / 12¹/₄" Fig.2
030-686-285 31,0 cm / 12¹/₄" Fig.3



030

Uteruslöffel
Uterine Scoopes
Curetas uterinas
Curette uterine

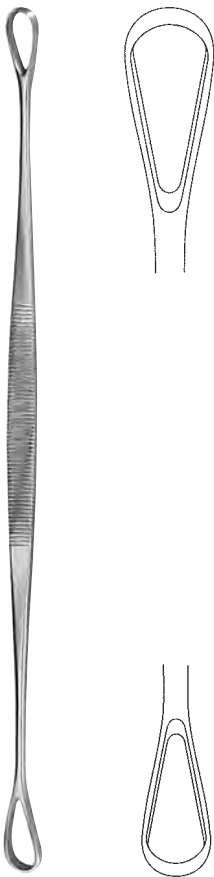

scharf/stumpf
sharp/blunt
cortante/romo
tagliente/smusso

BLAKE

030-697-270 27,0 cm / 10³/₄"

Absaugküretten
Suction Curettes
Curetas aspiradoras
Curette per aspirazione



030



030-701-003 Ø 3,0 mm



030-701-004 Ø 4,5 mm



030-701-006 Ø 6,0 mm



030-701-008 Ø 8,0 mm



030-701-010 Ø 10,0 mm



030-701-012 Ø 12,0 mm

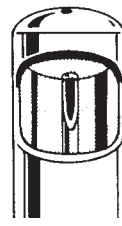

030-701-014 Ø 14,0 mm

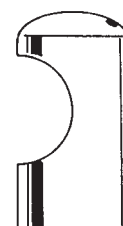

030-701-120 12,0 cm, 4³/₄"

Kupplungsstück
 Coupling Piece
 Pieza de acoplamiento
 Pezzo di collegamento

030-701-200

Dichtungsring (Paar) für Kupplungsstück
 Gasket rings (pair) for coupling piece
 Anillos de cierre (par) para pieza de acoplamiento
 Anelli di tenuta (paio) per pezzo di collegamento

030-701-003 - 030-701-014 29,0 cm / 11¹/₂"



030

Salpingograph
Salpingograph
Salpingógrafo
Salpingógrafo



discontinued item

SCHULTZE

030-710-000

Komplett im Holzetui
Complete in wooden case
Completo en estuche de madera
Completo in scatola di legno



discontinued item

SCHULTZE

030-710-001



DRUCK

030-710-002

Manometer allein
Manometer only
Manometro solo
Manometro solo



MARTIN
030-900-340 34,0 cm / 13³/₈"

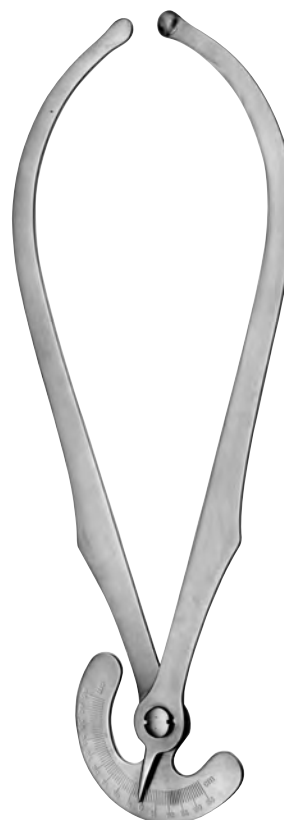

COLLIN
030-902-350 35,0 cm / 13³/₄"



COLLYER
030-904-300 30,0 cm / 13³/₄"



030

Geburtszangen
Obstetrical Forceps
Fórceps para obstétrica
Forcipi per ostetricia



WRIGLEY

030-911-280 28,0 cm / 11"



SIMPSON

030-913-230 23,0 cm / 9"
030-913-300 30,0 cm / 11³/₄"



SIMPSON-BRAUN

030-915-360 36,0 cm / 14¹/₄"



DE LEE

030-917-360 36,0 cm / 14¹/₄"



MCLEAN-TUCKER

030-919-390 39,0 cm / 15½"



MCLEAN-LUIKART

030-921-390 39,0 cm / 15½"



NAEGELE

030-923-360 36,0 cm / 14¼"
030-923-400 40,0 cm / 16"



KIELLAND

030-925-410 41,0 cm / 16½"

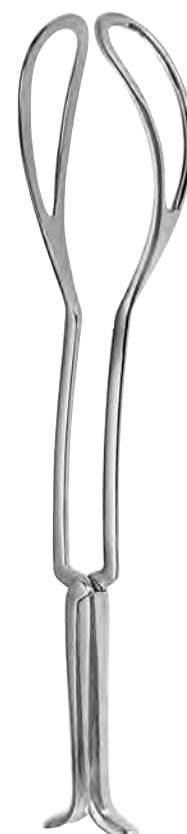

PIPER

030-927-440 44,0 cm / 17¼"



030

Abortuszangen
Placenta and Ovum Forceps
Pinzas para aborto
Pinze per placenta e per ovaie



SELLHEIM

030-939-280 28,0 cm / 11"



GREEN-ARMYTAGE

030-940-210 21,0 cm / 8¹/₄"

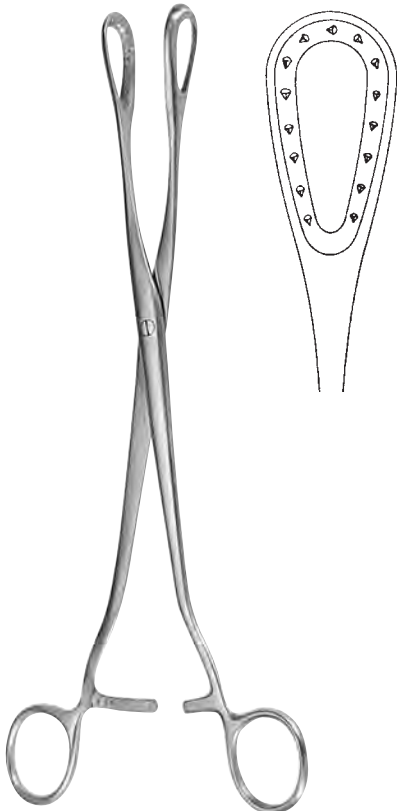

SAENGER

030-942-270 27,0 cm / 10³/₄"

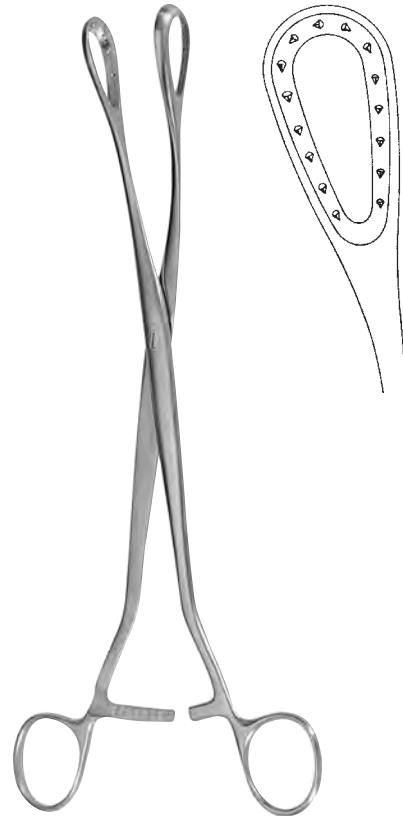

SAENGER

030-943-270 27,0 cm / 10³/₄"

Plazenta- und Abortuszangen
Placenta and Ovum Forceps
Pinzas para aborto y placenta
Pinze per pacenta e per ovaie



030

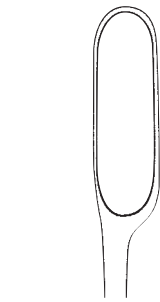
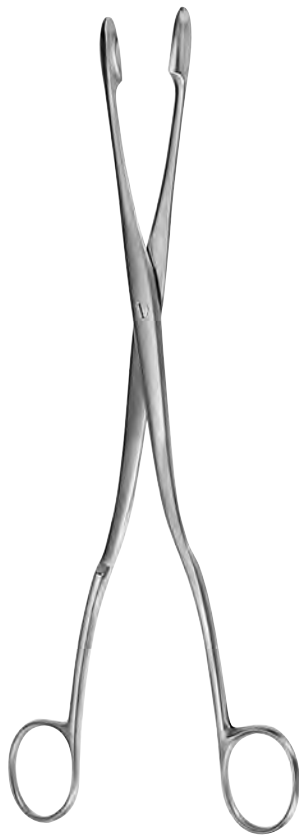

030-950-001 Fig.1



030-950-002 Fig.2

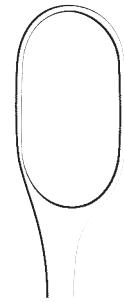

030-950-003 Fig.3



030-951-001 Fig.1



030-951-002 Fig.2



030-951-003 Fig.3

WINTER

030-950-001 - 030-951-003 28,0 cm / 11"

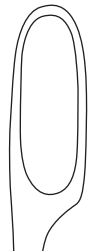

030-955-002 Fig.2

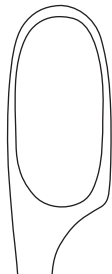

030-955-003 Fig.3

WINTER

030-955-002 - 030-955-003 28,0 cm / 11"



14 mm



Fig.1

030-961-001

18 mm



Fig. 2

030-961-002

20 mm



Fig. 3

030-961-003

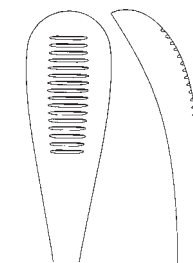

stumpf, Rückseite gerieft
 blunt, backside serrated
 romo, dorso estriado
 smusso, dorso scanalato

CUZZI

030-961-001 - 030-961-003 30,0 cm / 11³/₄"



030

Abortuslöffel, Nabelschnurklemmen
Placenta scoops, Umbilical cord clamps
Cucharillas para aborto, Clamps umbilicales
Cucchiai per placenta e ovaie, Clamps ombelicali

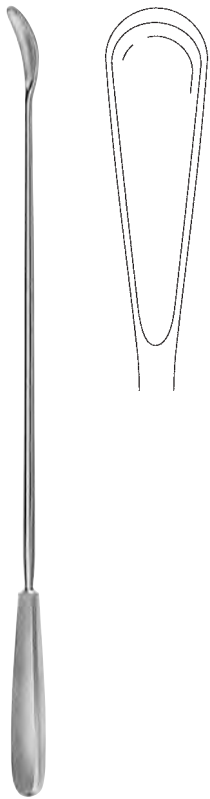

WALLICH

030-963-420 42,0 cm / 17"

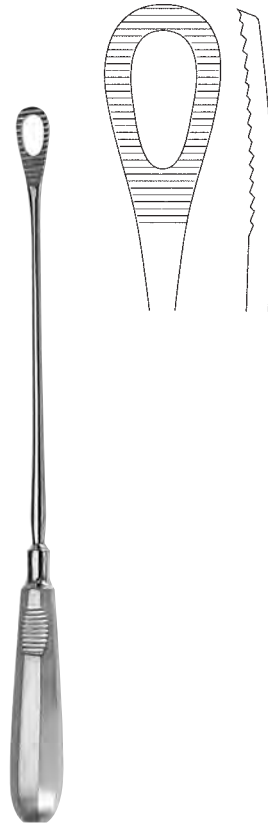

PESTALOZZA

030-965-300 30,0 cm / 11³/₄"

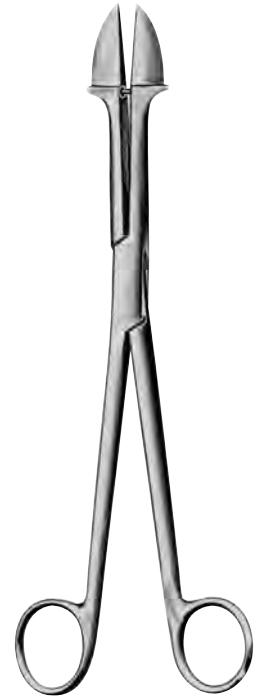

SMELLIE

030-970-250 25,0 cm / 10"



BRAUN

030-971-300 30,0 cm / 11³/₄"



COLLIN

030-975-090 9,0 cm / 3¹/₂"



KANE

030-977-085 8,5 cm / 3¹/₄"



BRAUN

030-981-420 42,0 cm / 16½"

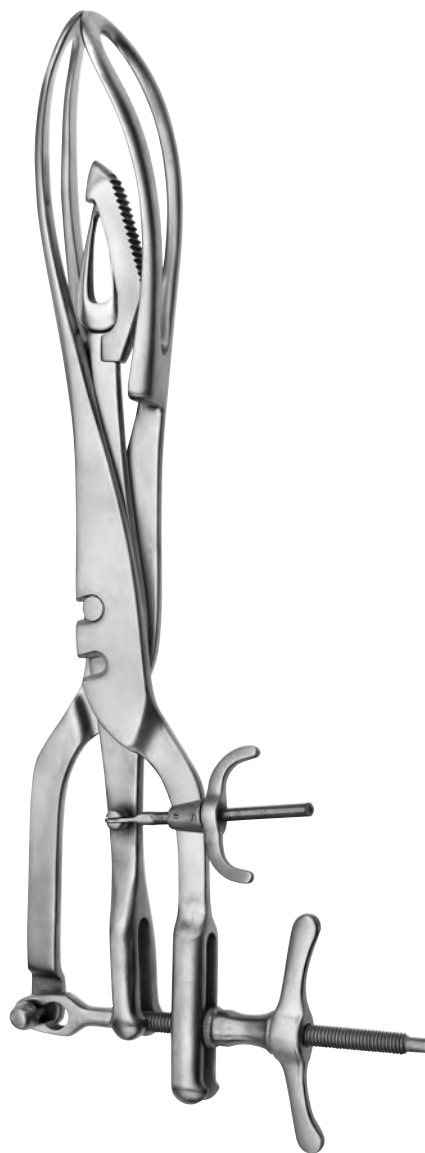

TARNIER

030-983-460 46,0 cm / 18"



030



032

Ophthalmologie
Ophthalmology
Oftalmología
Ophthalmologia

Tonometer, Sperrelevatoren
Tonometer, Eye Specula
Tonómetros, Blefarostatos
Tonometri, Blefarostati

ungeeicht
 un calibrated
 no calibrado
 non calibrato



SCHIOETZ

032-010-000

mit gerader Skala
 with straight scale
 con escala recta
 con scala retta

032-011-000

mit gebogener Skala
 with curved scale
 con escala inclinada
 con scala inclinata



BARRAQUER (COLIBRI)

032-021-003 3,0 cm / 1 1/4"

für Kinder
 for children
 para niños
 per bambini

BARRAQUER (COLIBRI)

032-021-004 4,0 cm / 1 1/2"

für Erwachsene
 for adults
 para adultos
 per adulti



BOWMAN

032-023-007 7,0 cm / 2 3/4"



MELLINGER

032-051-005 5,0 cm / 2"

für Kinder
 for children
 para niños
 per bambin

MELLINGER

032-051-007 7,0 cm / 2 3/4"

für Erwachsene
 for adults
 para adultos
 per adulti



MELLINGER-AXENFELD

032-053-007 7,0 cm / 2 3/4"



MELLINGER-AXENFELD

032-055-007 7,0 cm / 2 3/4"



CASTROVIEJO

032-059-008 8,0 cm / 3 1/8"

Lidinstrumente, Nahtspatel
Lid Instruments, Suturing Spatula
Instrumentos para párpados, Espátula para sutura
Strumenti per palpebra, Spatole per sutura



032



DESMARRES

032-100-009 13,0 cm / 5¹/₈"

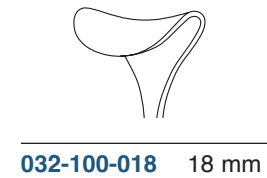
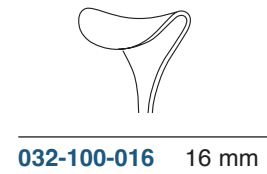
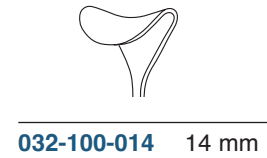
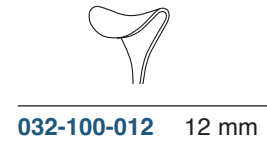

DESMARRES

032-100-012 - 032-100-018 13,0 cm / 5¹/₈"



032-102-012 12 mm



032-102-014 14 mm



032-102-016 16 mm



032-102-018 18 mm



DESMARRES

032-102-012 - 032-102-018 13,0 cm / 5¹/₈"



JAEGER

032-110-110 11,0 cm / 4¹/₂"



032

**Starmesser
Cataract Knives
Cuchillos para catarata
Coltelli per cataratta**



FIG.0
032-120-000



FIG.1
032-120-001



FIG.2
032-120-002



FIG.3
032-120-003

GRAEFE

032-120-000 - 032-120-003 13,0 cm / 5 1/8"



FIG.1
032-150-001



FIG.2
032-150-002

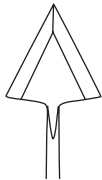

FIG.3
032-150-003



JAEGER-GRIESHABER

032-150-001 - 032-150-003



032-160-001



032-160-002



032-160-003



KNAPP

032-160-001 - 032-160-003

Verschiedene Augenmesser
Varios Eye Knives
Varios cuchillos oculares
Diversi coltelli per oculistica



032

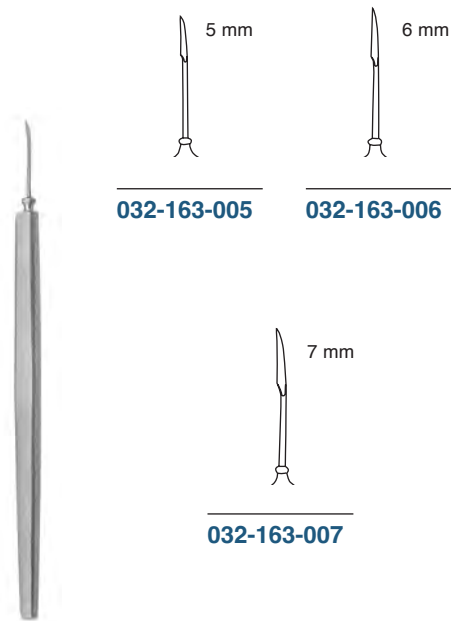

032-163-005

032-163-006

032-163-007

ZIEGLER

032-163-005 - 032-163-007

13,0 cm / 5¹/₈"

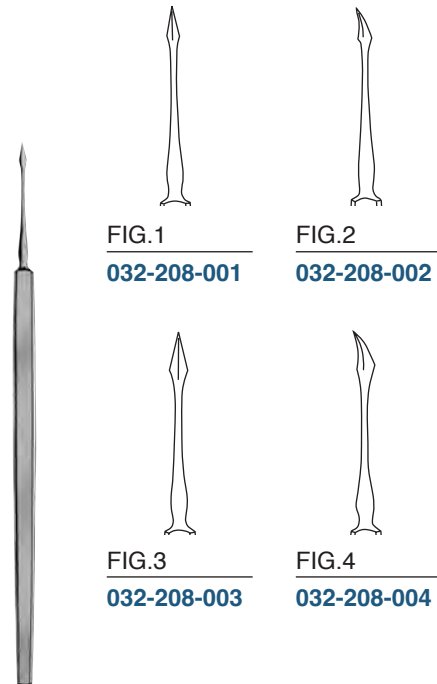

FIG.1

032-208-001

FIG.2

032-208-002

FIG.3

032-208-003

FIG.4

032-208-004

032-208-001 - 032-208-004

13,0 cm / 5¹/₈"

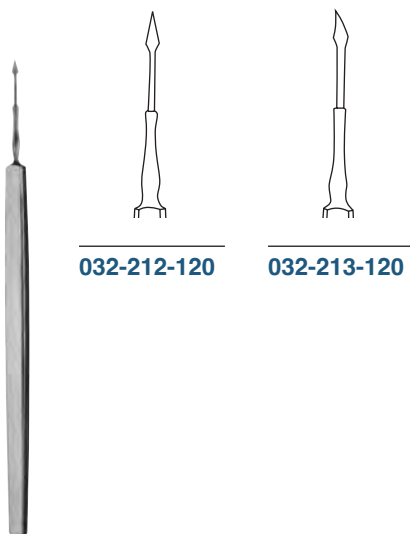

032-212-120

032-213-120

BOWMAN

032-212-120 - 032-213-120

12,0 cm / 4³/₄"

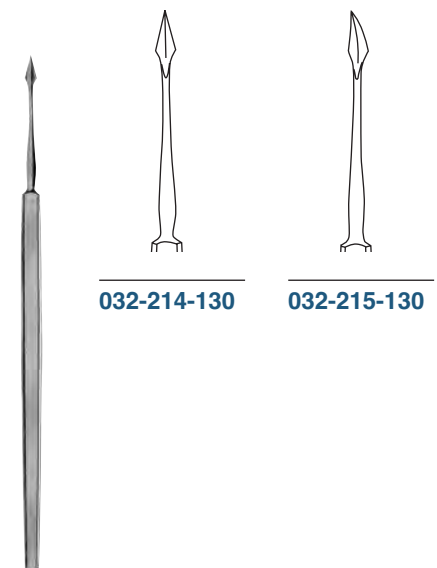

032-214-130

032-215-130

032-214-130 - 032-215-130

13,0 cm / 5¹/₈"

Fremdkörper-Instrumente, Cystotome
Foreign Body Instruments, Cystotomes
Instrumentos para cuerpos extraños, Quistótomos
Strumenti per corpi estranei, Cistitome



WALTON
032-232-120



WALTON
032-234-120

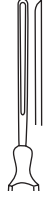

MEYER
032-236-120

032-232-120 - 032-236-120 12,0 cm / 4³/₄"

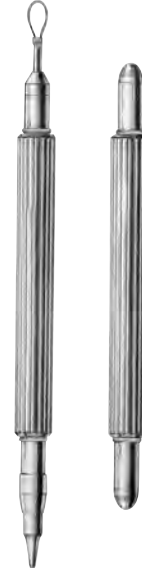

STANDARD
032-244-120

Fremdkörperschlinge und Magnet
in Umsteckhülse

Foreign Body Remover and Magnetic
Eye Probe, in reversible handle

Lazo para cuerpos extraños e Imàn,
en mango reversible

Laccio per corpi estranei e Calamita,
in manico reversibile



032-246-130



032-247-130



032-249-130

GRAEFE
032-246-130 - 032-249-130 13,0 cm / 5¹/₈"



032-253-120
scharf
shap
agudo
acuto



032-255-120
stumpf
blunt
romo
smusso

GRAEFE
032-253-120 - 032-255-120 12,0 cm / 4³/₄"

Feine Wundhäkchen
Fine Hooklets
Ganchos y Ganchitos finos
Uncini sottile



032

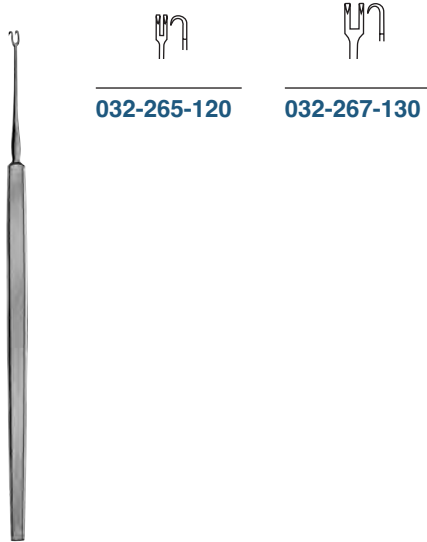

032-265-120

032-267-130

GUTHRIE

032-265-120 12,0 cm / 4³/₄"
 032-267-130 13,0 cm / 5¹/₈"

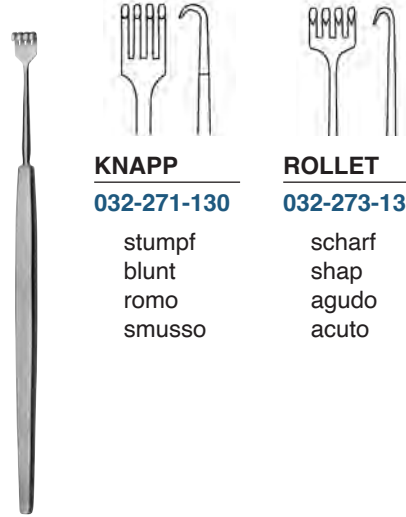

KNAPP
 032-271-130

stumpf
 blunt
 romo
 smusso

ROLLET
 032-273-130

scharf
 shap
 agudo
 acuto

032-271-130 - 032-273-130 13,0 cm / 5¹/₈"

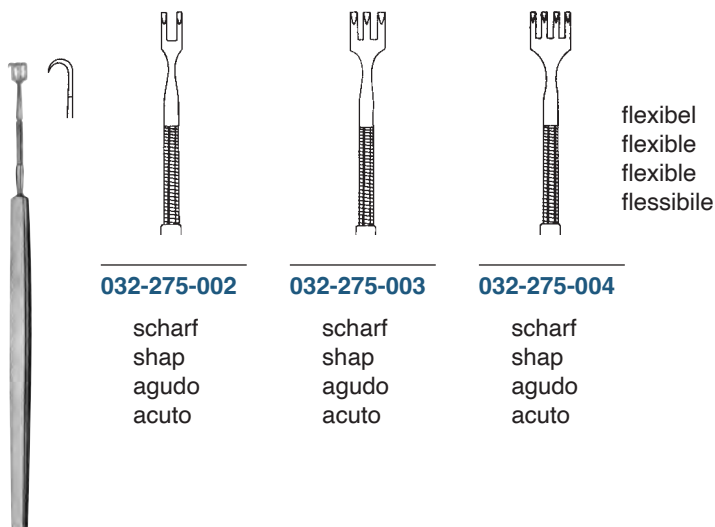

032-275-002

032-275-003

032-275-004

scharf
 shap
 agudo
 acuto

scharf
 shap
 agudo
 acuto

scharf
 shap
 agudo
 acuto

flexibel
 flexible
 flexible
 flessibile

KNAPP-ROLLET

032-275-002 - 032-275-004 13,0 cm / 5¹/₈"



032

Feine Wundhäkchen
Fine Hooklets
Ganchos y Ganchitos finos
Uncini sottile



032-277-002

scharf
shap
agudo
acuto

032-279-002

stumpf
blunt
romo
smusso

032-281-003

scharf
shap
agudo
acuto

032-283-003

stumpf
blunt
romo
smusso

AXENFELD

032-277-002 - 032-283-003

15,0 cm / 6"

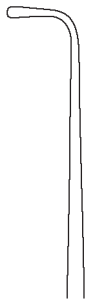

032-297-130

032-297-140

032-297-150

GRAEFE

032-297-130 13,0 cm / 5 1/8"
032-297-140 14,0 cm / 5 1/2"
032-297-150 15,0 cm / 6"

Spatelbreite
 Width of spatula
 anchura de espátula
 larghezza della spatola

0,5 mm



032-317-008 8 mm



032-317-010 10 mm

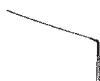

032-317-012 12 mm

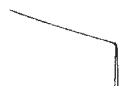

032-317-014 14 mm



032-317-016 16 mm

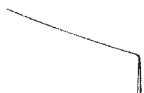

032-317-018 18 mm



CASTROVIEJO-BARRAQUER
032-317-008 - 032-317-018

Spatelbreite
 Width of spatula
 anchura de espátula
 larghezza della spatola

1,0 mm



032-319-008 8 mm



032-319-010 10 mm



032-319-012 12 mm



032-319-014 14 mm



032-319-016 16 mm



032-319-018 18 mm



CASTROVIEJO-BARRAQUER
032-319-008 - 032-319-018



032

**Starschlingen, Chalazionlöffel
 Lens Scoops, Chalazion Curettes
 Asas, Cucharillas para chalazion
 Anse, Cucchiari per calazio**



ELSCHNIG
 032-321-130

CASTROVIEJO
 032-323-130

CASTROVIEJO
 032-323-140

032-321-130 - 032-323-130 13,0 cm / 5 1/8"
 032-323-140 14,0 cm / 5 1/2"

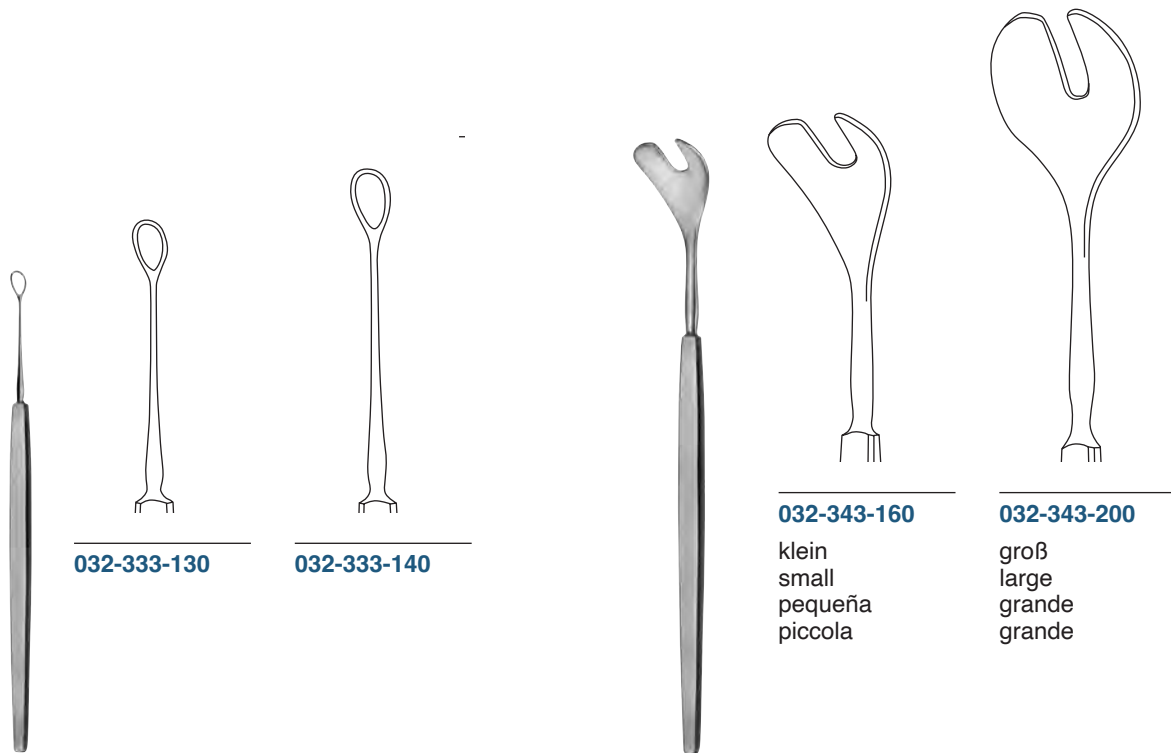

032-333-130

032-333-140

032-343-160

klein
 small
 pequeña
 piccola

032-343-200

groß
 large
 grande
 grande

WEBER

032-333-130 13,0 cm / 5 1/8"
 032-333-140 14,0 cm / 5 1/2"

WELLS

032-343-160 16,0 cm / 6 1/4"
 032-343-200 20,0 cm / 8"

Chalationslöffel
Chalazion Currettes
Cucharillas para chalaziòn
Cucchiai per calazio



032

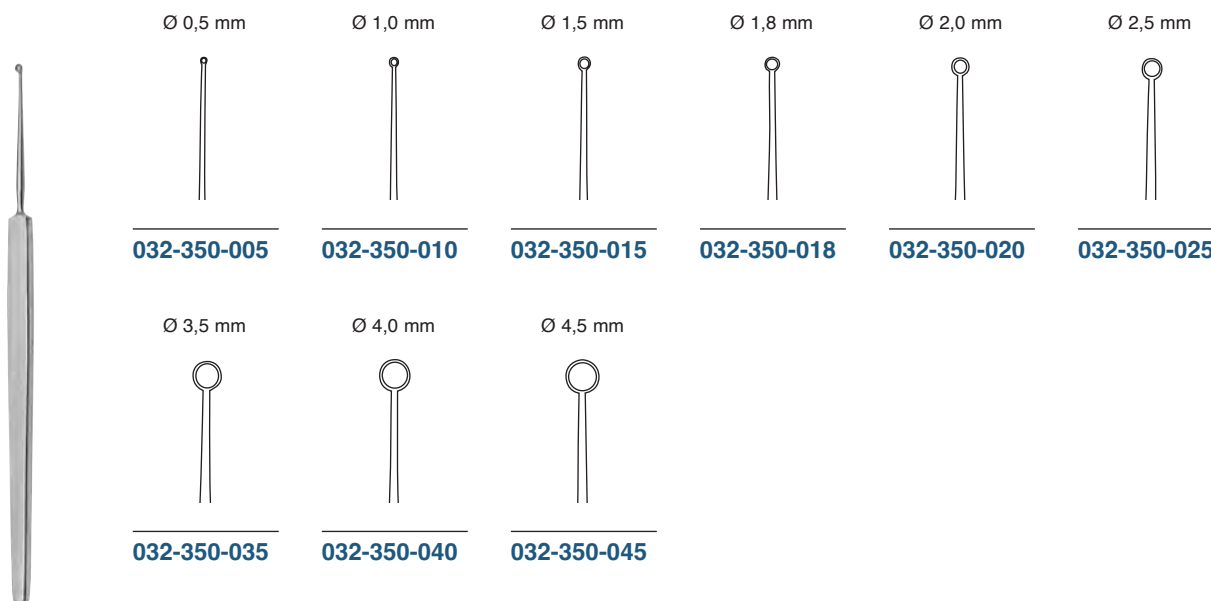

MEYHOEFER

032-350-005 - 032-350-045

13,0 cm / 5 1/8"

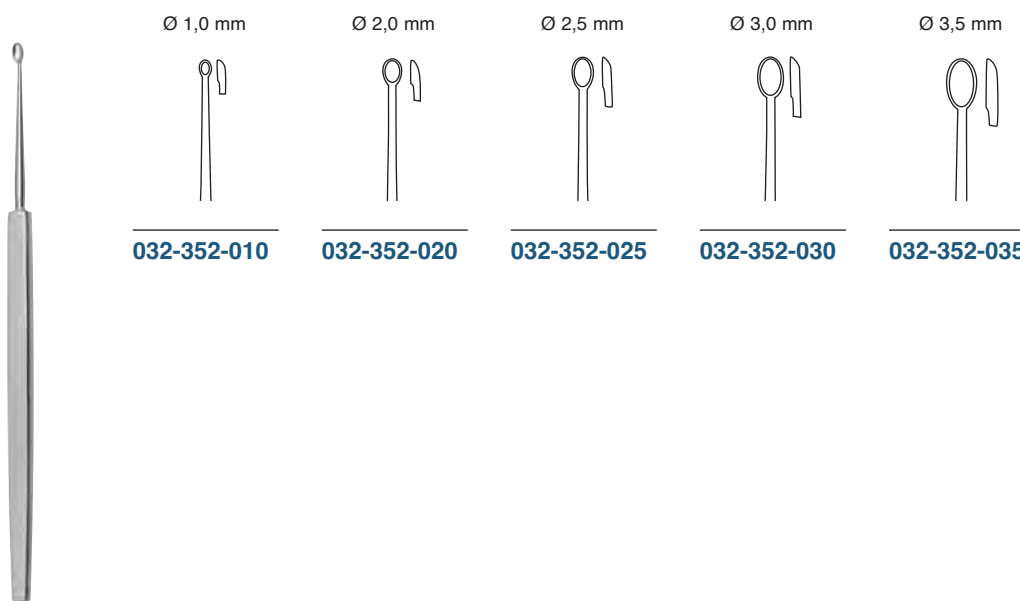

HEBRA

032-352-010 - 032-352-035

13,0 cm / 5 1/8"

Kanülen, Hornhautbohrer, Hornhauttrephinen
Cannulas, Corneal Burrs and Trephines
Cánulas, Fresas y Trépanos corneales
Cannule, Fresa e Trapani corneali

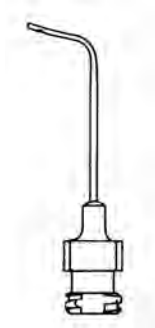

CASTROVIEJO

032-361-010 1,0 mm

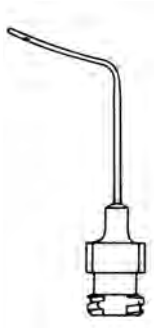

CASTROVIEJO

032-361-015 1,5 mm



LUER LOCK

032-363-027 27 Gauch

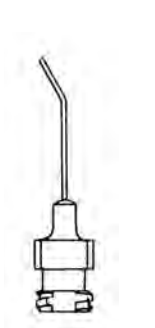

LUER LOCK

032-363-030 30 Gauch



032-420-010

Griff allein
 Handle only
 Mango suelto
 Manico solo

Ø 1,5 mm



032-420-015

Ø 2,0 mm



032-420-020

ELLIOT

032-420-000

Satz komplett bestehend aus:

- 1 Griff Art.-Nr. 032-420-010
- 2 Trephinen Ø 1,5 mm, Art.-Nr. 032-420-015
- 2 Trephinen Ø 2,0 mm, Art.-Nr. 032-420-020

Juego completo compuesto de.

- 1 Griff Ref.-No. 032-420-010
- 2 Trépanos Ø 1,5 mm, Ref.-No. 032-420-015
- 2 Trépanos Ø 2,0 mm, Ref.-No. 032-420-020

Set complete consisting of:

- 1 Handle Ref.-No. 032-420-010
- 2 Trephines Ø 1,5 mm, Ref.-No. 032-420-015
- 2 Trephinen Ø 2,0 mm, Ref.-No. 032-420-020

Set completo composto da:

- 1 Manico Ref.-No. 032-420-010
- 2 Trapani Ø 1,5 mm, Ref.-No. 032-420-015
- 2 Trapani Ø 2,0 mm, Ref.-No. 032-420-020



HOLTH

032-441-090 9,0 cm / 3 1/2"



WEST

032-442-160 16,0 cm / 6 1/4"



WEST

032-444-160 16,0 cm / 6 1/4"



CASTROVIEJO

032-450-015

Meßbereich: 15 mm
 Measuring Range: 15 mm
 Alcance de medición: 15 mm
 Campo di misura: 15 mm



CASTROVIEJO

032-450-020

Meßbereich: 20 mm
 Measuring Range: 20 mm
 Alcance de medición: 20 mm
 Campo di misura: 20 mm

Tränenkanal-Dilatatoren
Lachrymal Dilators
Dilatadores para canal lagrimal
Dilatatori per canale lacrimale

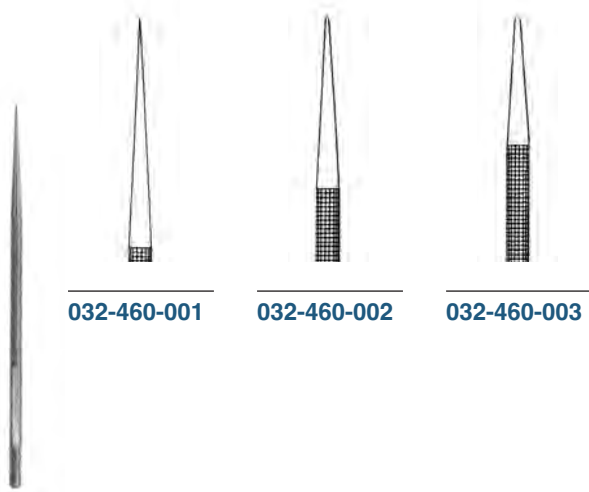

WILDER
 032-460-001 - 032-460-003

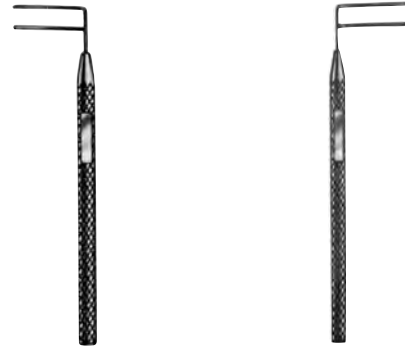

HARMS
 032-465-001

links
 left
 izquierda
 sinistra

HARMS
 032-465-002

rechts
 right
 derecha
 destra



zylindrisch/geknöpft
 cylindrical/pointed
 cilíndrico/abotonado
 cilindrico/abbottonato

Neusilber
 German silver
 plata alemana
 in argerto

BOWMAN	FIG.	
032-470-000	0/0	0,8 mm
032-470-011	1/1	0,9 mm
032-470-022	2/2	1,1 mm
032-470-033	3/3	1,3 mm
032-470-044	4/4	1,4 mm
032-470-055	5/5	1,5 mm
032-470-066	6/6	1,6 mm
032-470-077	7/7	1,8 mm
032-470-088	8/8	1,9 mm



zylindrisch
 cylindrical
 cilíndrico
 cilindrico

Neusilber
 German silver
 plata alemana
 in argerto

BOWMAN	FIG.	
032-472-000	00/0	0,7/0,8 mm
032-472-001	0/1	0,8/0,9 mm
032-472-012	1/2	0,9/1,1 mm
032-472-023	2/3	1,1/1,3 mm
032-472-034	3/4	1,3/1,4 mm
032-472-045	4/5	1,4/1,5 mm
032-472-056	5/6	1,5/1,6 mm
032-472-067	6/7	1,6/1,8 mm
032-472-078	7/8	1,8/1,9 mm



geknöpft
 pointed
 abotonado
 abbottonato

Neusilber
 German silver
 plata alemana
 in argerto

BOWMAN	FIG.	
032-474-000	00/0	0,7/0,8 mm
032-474-001	0/1	0,8/0,9 mm
032-474-012	1/2	0,9/1,1 mm
032-474-023	2/3	1,1/1,3 mm
032-474-034	3/4	1,3/1,4 mm
032-474-045	4/5	1,4/1,5 mm
032-474-056	5/6	1,5/1,6 mm
032-474-067	6/7	1,6/1,8 mm
032-474-078	7/8	1,8/1,9 mm

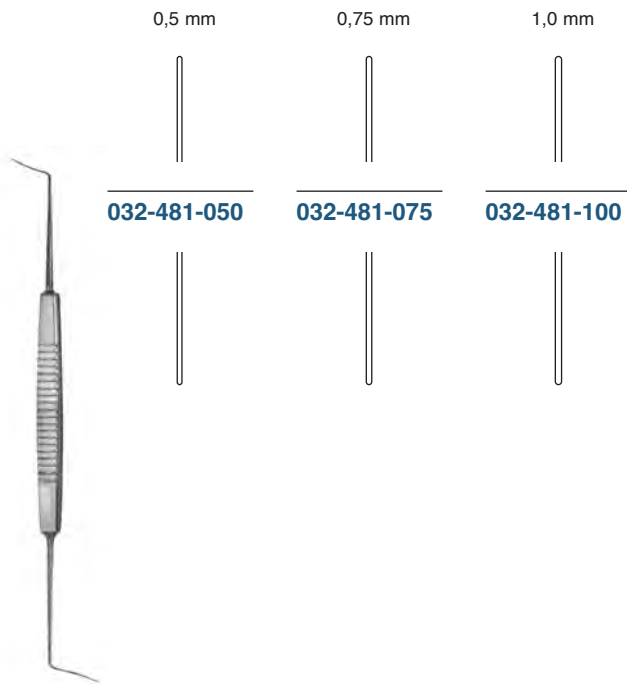

0,5 mm 0,75 mm 1,0 mm

032-481-050 **032-481-075** **032-481-100**

CASTROVIEJO

032-481-050 - 032-481-100



Flachmeißel
 Chisel
 Cincel
 Scalpello

DIX

032-490-120 12,0 cm / 4³/₄"



Hohlmeißel
 Gouge
 Gubia
 Sgorbie

DIX

032-492-120 12,0 cm / 4³/₄"

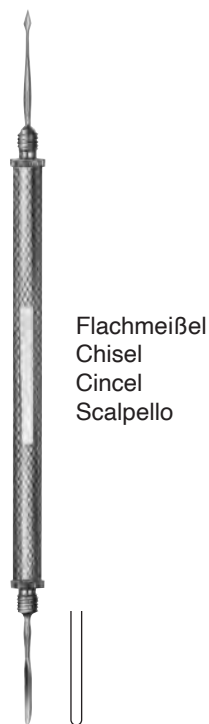

Flachmeißel
 Chisel
 Cincel
 Scalpello

032-494-130 13,0 cm / 5¹/₈"

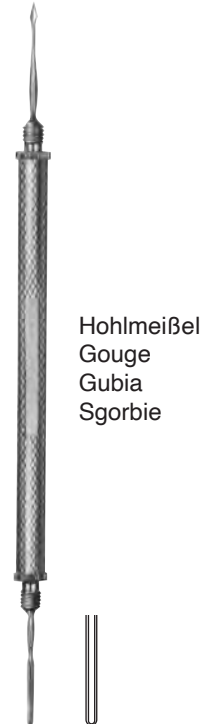

Hohlmeißel
 Gouge
 Gubia
 Sgorbie

032-496-130 13,0 cm / 5¹/₈"



032

Irispinzetten
Iris Forceps
Pinzas para iris
Pinze per iride

1,0 mm



032-500-010



032-501-010



1x2

032-504-010



1x2

032-505-010

GRAEFE

032-500-010 - 032-505-010

7,0 cm / 2³/₄"



032-510-105



032-511-105

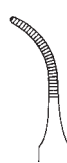

032-513-105



1x2

032-514-105



1x2

032-515-105



1x2

032-517-105

STEVENS

032-510-105 - 032-517-105

10,5 cm / 4¹/₂"

Irispinzetten, Fixierpinzetten
Iris Forceps, Fixation Forceps
Pinzas para iris, Pinzas de fijación
Pinze per iride, Pinze per fissare



032



MOD. BONN

032-542-070 7,0 cm / 2³/₄"
032-542-100 10,0 cm / 4"



BISHOP-HARMAN

032-544-085 - 032-550-085 8,5 cm / 3¹/₂"

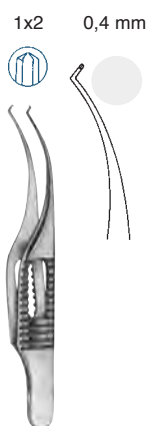
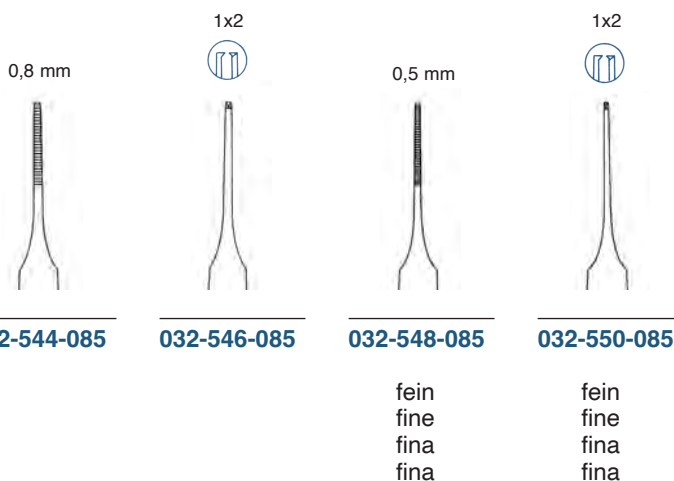

BARRAQUER-KATZIN

032-553-070 7,0 cm / 2³/₄"

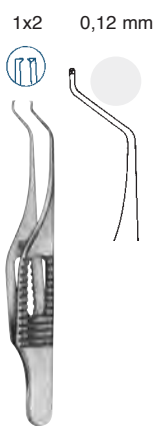

TROUTMAN (COLIBRI)

032-555-075 7,5 cm / 3"



BARRAQUER (COLIBRI)

032-557-070 7,0 cm / 2³/₄"



BARRAQUER-KATZIN (COLIBRI)

032-559-070 7,0 cm / 2³/₄"



032

Fixierpinzetten, Faßpinzetten
Fixation Forceps, Tissue Forceps
Pinzas de fijación, Pinzas con dientes
Pinze per fissare, Pinze con denti

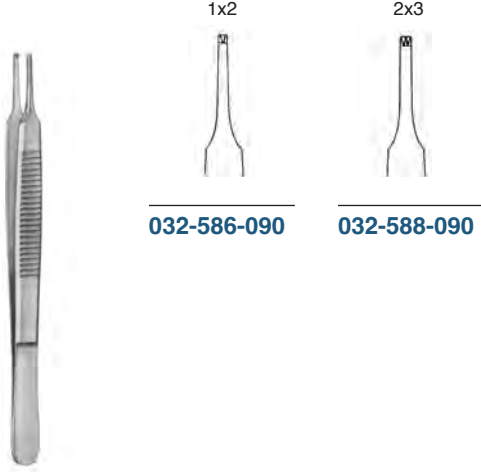

032-586-090

032-588-090

LESTER

032-586-090 - 032-588-090 9,0 cm / 3 1/2"

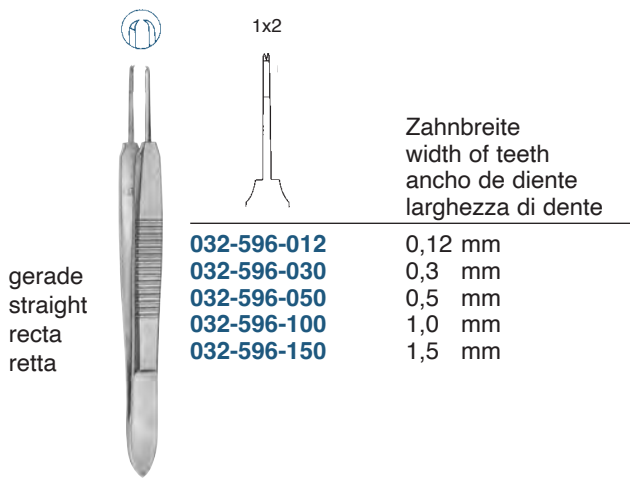

gerade
 straight
 recta
 retta

- 032-596-012
- 032-596-030
- 032-596-050
- 032-596-100
- 032-596-150

Zahnbreite
 width of teeth
 ancho de diente
 larghezza di dente

0,12 mm
 0,3 mm
 0,5 mm
 1,0 mm
 1,5 mm

CASTROVIEJO

032-596-012 - 032-596-150 10,0 cm / 4"

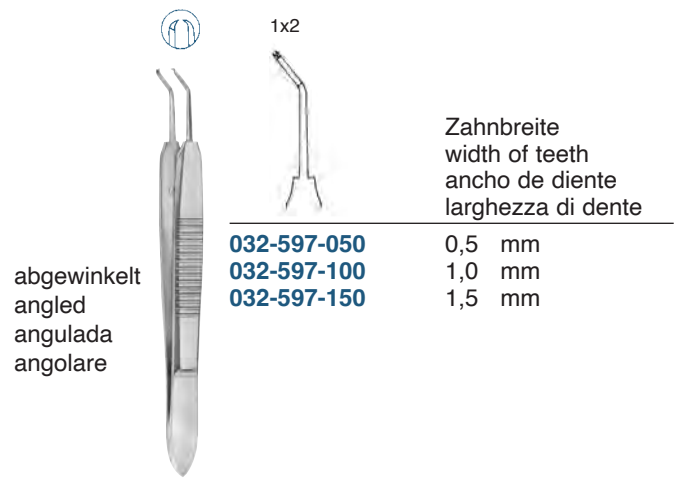

abgewinkelt
 angled
 angulada
 angolare

- 032-597-050
- 032-597-100
- 032-597-150

Zahnbreite
 width of teeth
 ancho de diente
 larghezza di dente

0,5 mm
 1,0 mm
 1,5 mm

CASTROVIEJO

032-597-050 - 032-597-150 10,0 cm / 4"

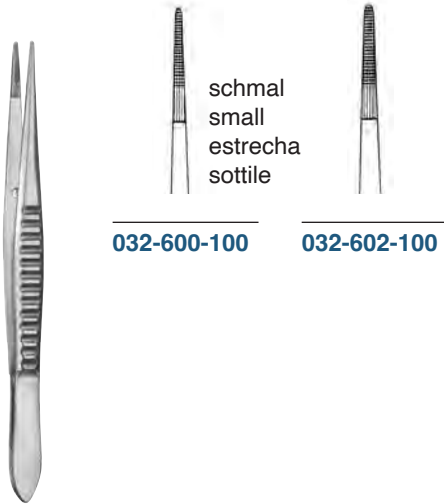

032-600-100

032-602-100

schmal
small
estrecha
sottile

BONACCOLTO

032-600-100 - 032-602-100

10,0 cm / 4"

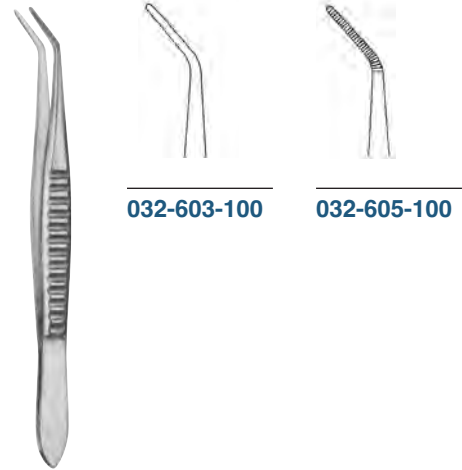

032-603-100

032-605-100

NUGENT

032-603-100 - 032-605-100

10,0 cm / 4"



SNELLEN

032-625-100

10,0 cm / 4"



SNELLEN

032-627-100

10,0 cm / 4"



032

Chalazionpinzetten
Chalazion Forceps
Pinzas de chalazión
Pinze per calazio

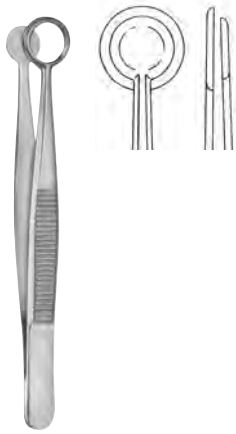

AYER

032-630-090 9,0 cm / 3 1/2"

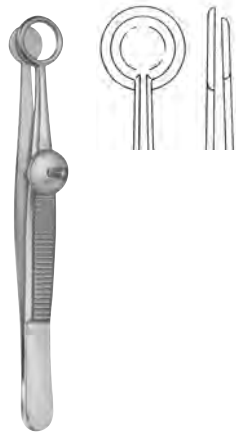

AYER

032-632-090 9,0 cm / 3 1/2"



LAMBERT

032-634-090 9,0 cm / 3 1/2"



DESMARRES

032-636-001 - 032-636-003 9,0 cm / 3 1/2"

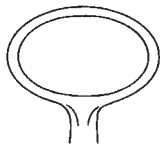

032-636-001

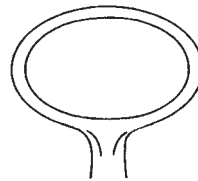

032-636-002

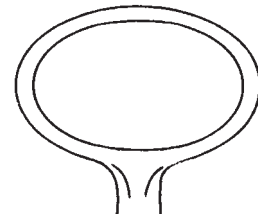

032-636-003



links
 left
 izquierda
 sinistra

KATZIN-BARRAQUER

032-701-100 10,0 cm / 4"



rechts
 right
 derecha
 destro

KATZIN-BARRAQUER

032-703-100 10,0 cm / 4"



032-704-100



032-705-100

032-704-100 - 032-705-100

10,0 cm / 4"



CASTROVIEJO

032-707-100 10,0 cm / 4"



CASTROVIEJO

032-709-100 10,0 cm / 4"



AEBLI

032-711-100 10,0 cm / 4"



032

**Iridektomiescheren,
Iridectomy Scissors
Pinzas-Tijeras para iridectomia
Forbici per iridectomia**

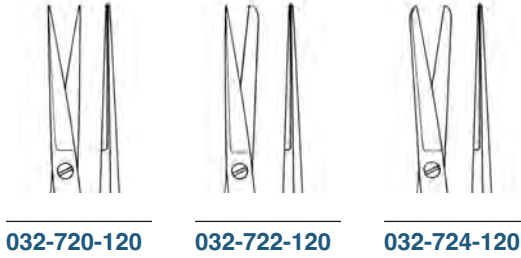

032-720-120

032-722-120

032-724-120

NOYES

032-720-120 - 032-724-120

12,0 cm / 4³/₄"

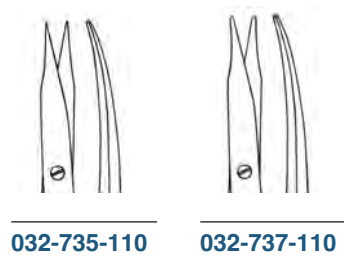

032-735-110

032-737-110

spitz
pointed
aguda
acuto

stumpf
blunt
roma
smusso

WESTCOTT

032-735-110 - 032-737-110

11,0 cm / 4¹/₂"



CASTROVIEJO

032-743-090 9,0 cm / 3¹/₂"

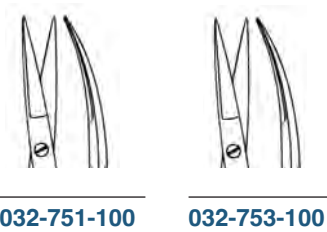

032-751-100

032-753-100

spitz
pointed
aguda
acuto

stumpf
blunt
roma
smusso

CASTROVIEJO

032-751-100 - 032-753-100 10,0 cm / 4"

**Iridektomiescheren,
Iridectomy Scissors
Tijeras para iridectomia
Forbici per iridectomia**



032

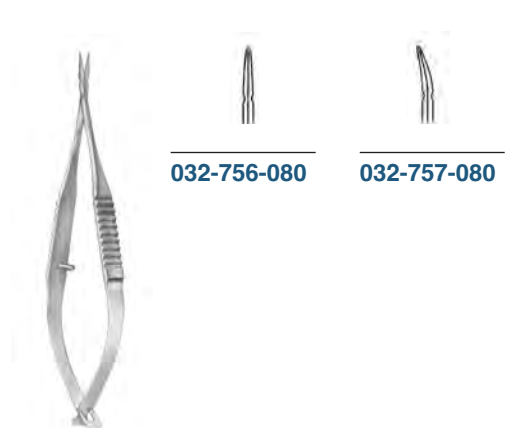

032-756-080

032-757-080

VANNAS

032-756-080 - 032-757-080

8,0 cm / 3 1/4"



032-760-085

032-761-085

032-763-085

VANNAS-MOD. TÜBINGEN

032-760-085 - 032-763-085

8,5 cm / 3 1/2"

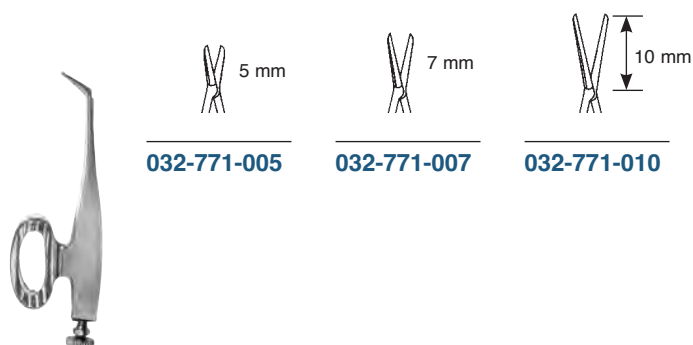

032-771-005

032-771-007

032-771-010

BARRAQUER

032-771-005 - 032-771-010

5,5 cm / 2 1/4"



032

Feine Augenscheren, Hornhautscheren
Delicate Eye Scissors, Corneal Scissors
Tijeras finas, Tijeras para còrnea
Forbici fine, Forbici corneali

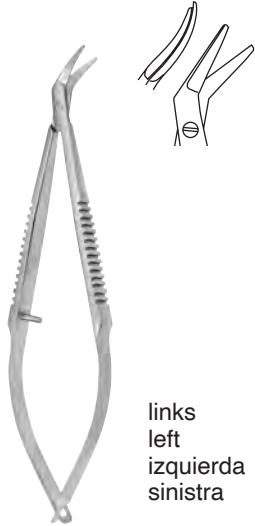

links
left
izquierda
sinistra

CASTROVIEJO

032-781-100 10,0 cm / 4"



rechts
right
derecha
destra

CASTROVIEJO

032-783-100 10,0 cm / 4"



links
left
izquierda
sinistra

CASTROVIEJO

032-785-110 11,0 cm / 4 1/2"



rechts
right
derecha
destra

CASTROVIEJO

032-787-110 11,0 cm / 4 1/2"

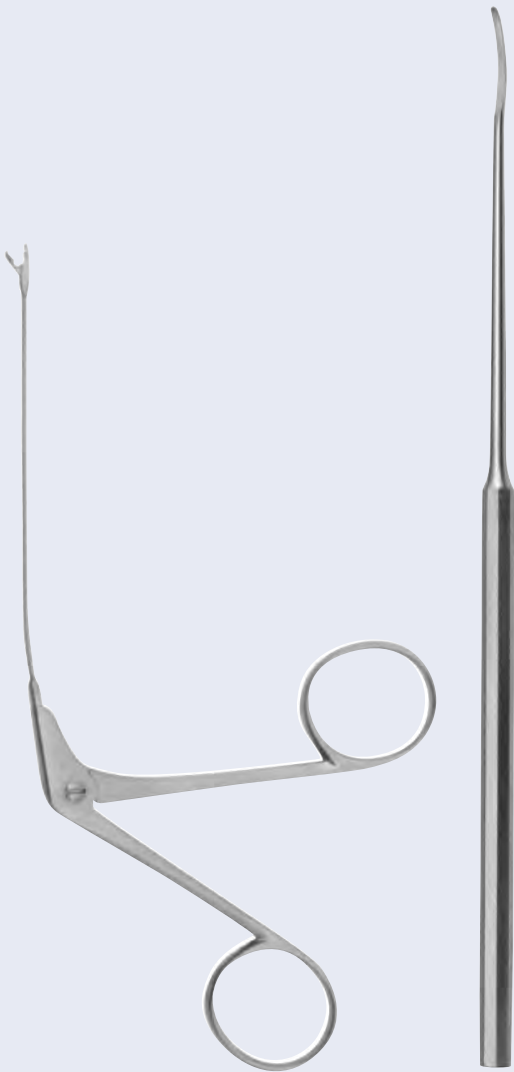

034

Otologie
Otology
Otología
Otologia

Mikro-Ohrzängchen
Micro Ear Forceps
Micro Pinzas auriculares
Micro Pinze auricolari



WULLSTEIN
034-002-040 - 034-007-040

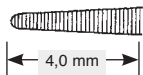
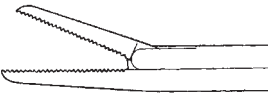
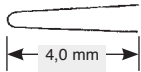
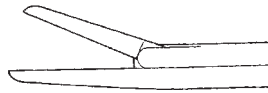

034-010-040 - 034-017-040



034-002-040



034-003-040



034-005-040



034-007-040



034-010-040



034-012-040



034-013-040

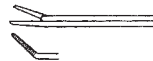

034-015-040

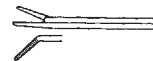

034-017-040

4,0 mm x 1,0 mm
geriefte Maulteile, gerade
serrated jaws, straight
bocas estriadas, recta
morsi scanalati, rette

4,0 mm x 1,0 mm
geriefte Maulteile, aufgebogen
serrated jaws, curved up
bocas estriadas, curva hacia arriba
morsi scanalati, curve verso l'alto

4,0 mm x 1,0 mm
geriefte Maulteile, rechts gebogen
serrated jaws, curved to the right
bocas estriadas, curva a la derecha
morsi scanalati, curve verso destra

4,0 mm x 1,0 mm
geriefte Maulteile, links gebogen
serrated jaws, curved to the left
bocas estriadas, curva a la izquierda
morsi scanalati, curve verso sinistra

4,0 mm x 0,8 mm
glatt, gerade
smooth, straight
lisa, recta,
liscia, retta

4,0 mm x 0,8 mm
gerieft, gerade
serrated, straight
estriada, recta,
con scanalura, retta

4,0 mm x 0,8 mm
aufgebogen, gerieft
bent upwards, serrated
curva por arriba, estriada
curva in alto, con scanallatura

4,0 mm x 0,8 mm
rechts, gerieft
right, serrated
derrecha, estriada
estra, con scanallatura

4,0 mm x 0,8 mm
links, gerieft
left, serrated
izquierda, estriada
sinistra, con scanallatura

Mikro-Ohrzangchen
Micro Ear Forceps
Micro Pinzas auriculares
Micro Pinze auricolari



034

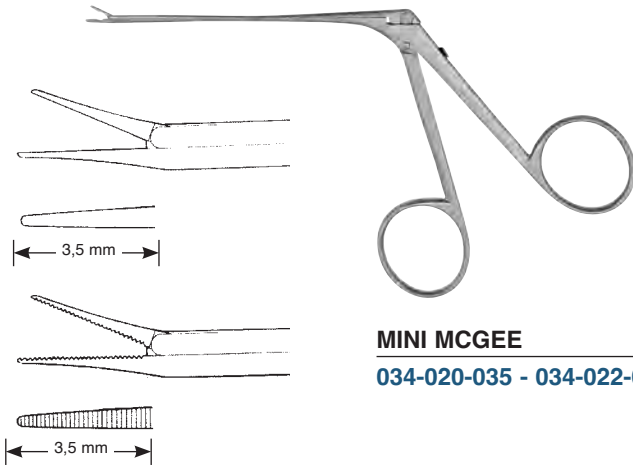

MINI MCGEE

034-020-035 - 034-022-035



034-020-035

3,5 mm x 0,6 mm
 glatt, gerade
 smooth, straight
 lisa, recta
 liscia, retta



034-022-035

3,5 mm x 0,6 mm
 gerieft, gerade
 serrated, straight
 estriada, recta
 con scanalatura, retta

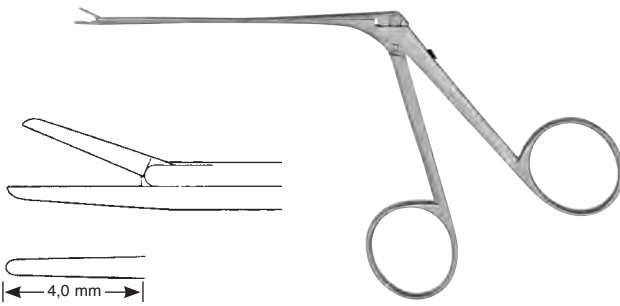

034-030-040

4,0 mm x 0,6 mm
 glatt, gerade
 smooth, straight
 lisa, recta
 liscia, retta

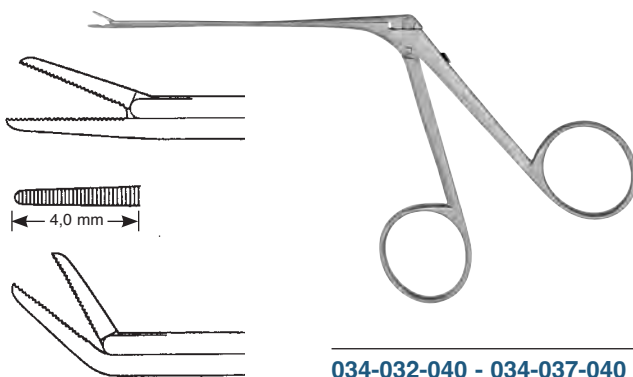

034-032-040 - 034-037-040



034-032-040

4,0 x 0,6 mm
 gerieft, gerade
 serrated, straight
 estriada, recta,
 con scanalura, retta

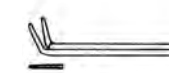

034-033-040

4,0 x 0,6 mm
 aufgebogen, gerieft
 bent upwards, serrated
 curva por arriba, estriada
 curva in alto, con scanallatura



034-035-040

4,0 x 0,6 mm
 rechts, gerieft
 righth, serrated
 derrecha, estriada
 estra, con scanallatura



034-037-040

4,0 x 0,6 mm
 links, gerieft
 left, serrated
 izquierda, estriada
 sinistra, con scanallatura

Mikro-Ohrzängchen
Micro Ear Forceps
Micro Pinzas auriculares
Micro Pinze auricolari

1,0 x 0,9 mm
 Löffel
 cup
 cucharilla
 cucchiaio



034-040-040 - 034-047-040

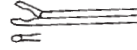

4,0 mm
 gerade
 straight
 recta
 retta

034-040-040



4,0 mm
 aufgebogen
 curved up
 curva por arriba
 curva in alto

034-043-040



4,0 mm
 rechts
 right
 derecha
 destra

034-045-040

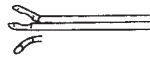

4,0 mm
 links
 left
 izquierda
 sinistra

034-047-040

0,6 x 0,5 mm
 Löffel
 cup
 cucharilla
 cucchiaio

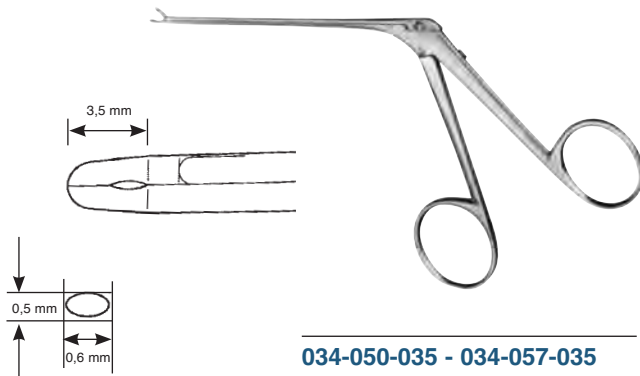

034-050-035 - 034-057-035



3,5 mm
 gerade
 straight
 recta
 retta

034-050-035



3,5 mm
 aufgebogen
 curved up
 curva por arriba
 curva in alto

034-053-035



3,5 mm
 rechts
 right
 derecha
 destra

034-055-035



3,5 mm
 links
 left
 izquierda
 sinistra

034-057-035

Mikro-Ohrscheren
Micro Ear Scissors
Micro Tijeras auriculares
Micro Forbici auricolari



034

sehr fein
 very fine
 muy fina
 molto delicata

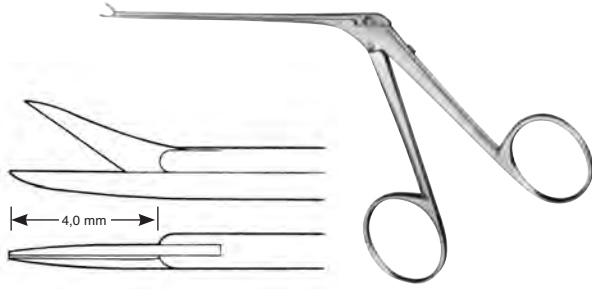

BELLUCCI
 034-060-040 - 034-067-040



gerade
 straight
 recta,
 retta

034-060-040



aufgebogen
 curved up
 curva por arriba
 curva in alto

034-063-040



rechts
 right
 derecha
 destra

034-065-040



links
 left
 izquierda
 sinistra

034-067-040

0,8 mm
 Schaft
 shaft
 vastago
 gambo

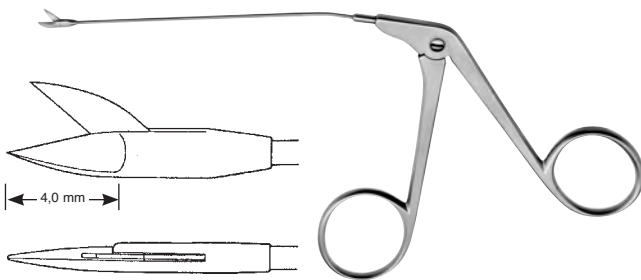

WULLSTEIN
 034-070-040 - 034-077-040

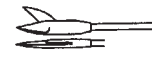

gerade
 straight
 recta
 retta

034-070-040



aufgebogen
 curved up
 curva por arriba
 curva in alto

034-073-040

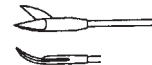

rechts
 right
 derecha
 destra

034-075-040

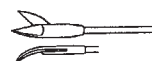

links
 left
 izquierda
 sinistra

034-077-040

Mikro-Ohrzängchen
Micro Ear Forceps
Micro Pinzas auriculares
Micro Pinze auricolari

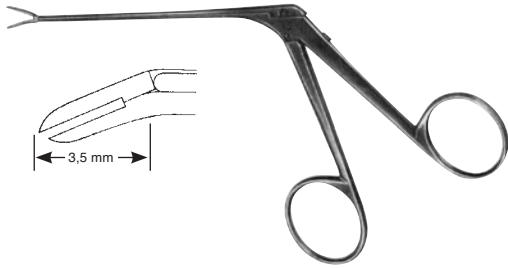

MC GEE
034-081-035 - 034-081-060



3,5 x 0,8 mm
 abgebogen
 curved downward
 curva por abajo
 curva in basso

034-081-035



6,0 x 0,8 mm
 abgebogen
 curved downward
 curva por abajo
 curva in basso

034-081-060



WULLSTEIN
034-082-010 - 034-087-010



runde Maulteile, ø 1,0 mm, gerade
 round cup jaws, ø 1,0 mm, straight
 copas redondas, ø 1,0 mm, recta
 morsi rotondi, ø 1,0 mm, retta

034-082-010



runde Maulteile, ø 1,0 mm, aufgebogen
 round cup jaws, ø 1,0 mm, curved up
 copas redondas, ø 1,0 mm, curva hacia arriba
 morsi rotondi, ø 1,0 mm, curve verso l'alto

034-083-010



runde Maulteile, ø 1,0 mm, rechts gebogen
 round cup jaws, ø 1,0 mm, curved to the right
 copas redondas, ø 1,0 mm, curva a la derecha
 morsi rotondi, ø 1,0 mm, curve verso destra

034-085-010



runde Maulteile, ø 1,0 mm, links gebogen
 round cup jaws, ø 1,0 mm, curved to the left
 copas redondas, ø 1,0 mm, curva a la izquierda
 morsi rotondi, ø 1,0 mm, curve verso sinistra

034-087-010

Hammerkopfzängchen
 Malleus Nipper
 Pinza para cabezal del malèolo
 Pinz per testa del martelletto

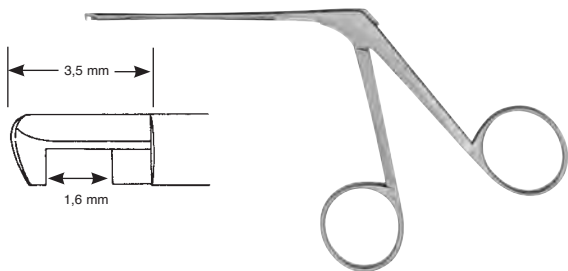

HOUSE-DIETER
034-091-035 - 034-093-035

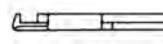

3,5 x 1,6 mm
 oben schneidend
 up-cutting
 corte arriba
 tagliente in alto

034-091-035

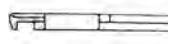

3,5 x 1,6 mm
 unten schneidend
 down-cutting
 corte abajo
 tagliente in basso

034-093-035

Mikro-Ohrzängchen
Micro Ear Forceps
Micro Pinzas auriculares
Micro Pinze auricolari



034

Hammerkopfzängchen
 Malleus Nipper
 Pinza para cabezal del malèolo
 Pinz per testa del martelletto

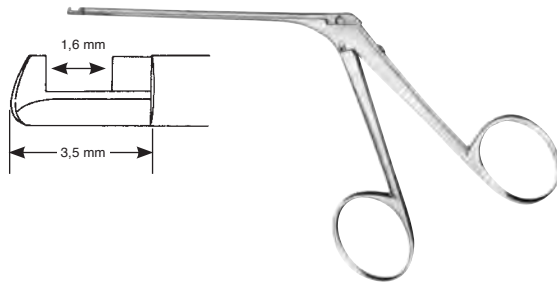

HOUSE-DIETER
 034-095-035 - 034-097-035

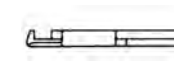

3,5 mm x 1,6 mm
 rechts schneidend
 right-cutting
 corte derecho
 tagliente a destra

034-095-035

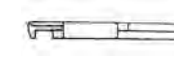

3,5 mm x 1,6 mm
 links schneidend
 left-cutting
 corte izquierdo
 tagliente a sinistra

034-097-035

Einführungszängchen
 Introducing Forceps
 Pinza para introducir
 Pinza per introduzione

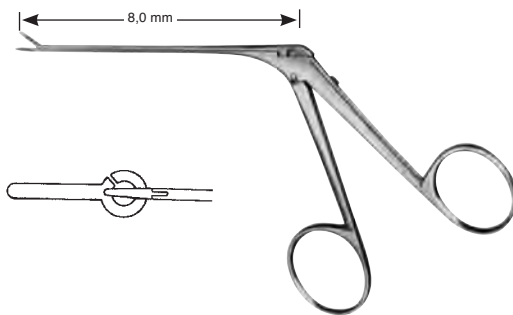

FULLER
 034-100-080



ovale Maulteile, ø 1,0 mm, gerade
 oval cup jaws, ø 1,0 mm, straight
 copas ovales, ø 1,0 mm, recta
 morsi ovali, ø 1,0 mm, retta

034-102-010



ovale Maulteile, ø 1,0 mm, aufgebogen
 oval cup jaws, ø 1,0 mm, curved up
 copas ovales, ø 1,0 mm, curva hacia arriba
 morsi ovali, ø 1,0 mm, curve verso l'alto

034-103-010



ovale Maulteile, ø 1,0 mm, rechts gebogen
 oval cup jaws, ø 1,0 mm, curved to the right
 copas ovales, ø 1,0 mm, curva a la derecha
 morsi ovali, ø 1,0 mm, curve verso destra

034-105-010



ovale Maulteile, ø 1,0 mm, links gebogen
 oval cup jaws, ø 1,0 mm, curved to the left
 copas ovales, ø 1,0 mm, curva a la izquierda
 morsi ovali, ø 1,0 mm, curve verso sinistra

034-107-010



WULLSTEIN
 034-102-010 - 034-107-010



034

Mikro-Ohrmesser
Micro Ear Knives
Micro Cuchillos auriculares
Micro Coltelli



SCHUKNECHT

034-111-160 16,0 cm / 6 1/4"

Rollenmesser
Rotary Knife
Cuchillo redondo
Coltello rotondo



SCHUKNECHT

034-113-160 16,0 cm / 6 1/4"

Sichelmesser
Sickle Knife
Cuchillos de hoz
Coltello falcato come sinechia



WULLSTEIN

034-115-160 16,0 cm / 6 1/4"

Sichelmesser
Sickle Knife
Cuchillos de hoz
Coltello falcato come sinechia



TABB

034-117-160 16,0 cm / 6 1/4"

Schleimhautmesser
Mucosa Knife
Cuchillo para mucosa
Coltello per mucosa



PLESTER

034-119-160 16,0 cm / 6 1/4"

Lappenmesser
Flap Knife
Cuchillo para lóbulos
Coltello per lobi

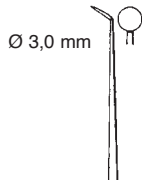

FIG. 1
034-121-001

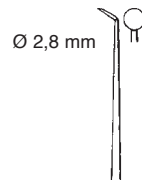

FIG. 2
034-121-002

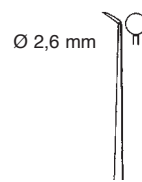

FIG. 3
034-121-003

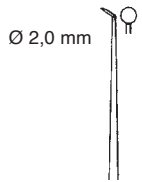

FIG. 4
034-121-004

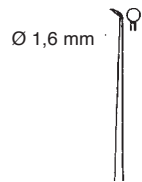

FIG. 5
034-121-005

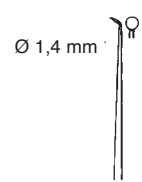

FIG. 6
034-121-006

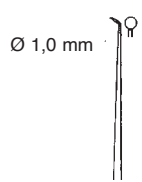

FIG. 7
034-121-007

ROSEN

034-121-001 - 032-121-007 16,0 cm / 6 1/4"

Rundschnittmesser
Circular Cut Knives
Cuchillos para cortes redondos
Coltelli circolari

Mikro-Ohrnadeln, Mikro-Ohrhäkchen
Micro Ear Needles, Micro Ear Hooks
Micro Aguja auriculares, Mirco Ganchitos auriculares
Micro Aghi auricolari, Micro Uncini auricolari



034



BARBARA
034-125-001



BARBARA
034-125-002



BARBARA
034-125-003



ROSEN
034-125-004



25°

BARBARA
034-131-003 0,3 mm
034-131-006 0,6 mm
034-131-010 1,0 mm



45°

BARBARA
034-133-003 0,3 mm
034-133-006 0,6 mm
034-133-010 1,0 mm
034-133-012 1,2 mm
034-133-015 1,5 mm
034-133-020 2,0 mm
034-133-025 2,5 mm



90°

BARBARA
034-135-003 0,3 mm
034-135-006 0,6 mm
034-135-010 1,0 mm
034-135-012 1,2 mm
034-135-015 1,5 mm
034-135-020 2,0 mm
034-135-025 2,5 mm



BARBARA
034-137-005 0,5 mm
034-137-010 1,0 mm



034-125-001 - 034-137-010 16,0 cm / 6 1/4"



034

Mikro-Ohrnadeln, Mikro-Ohrhäkchen
Micro Ear Needles, Micro Ear Hooks
Micro Aguja auriculares, Mirco Ganchitos auriculares
Micro Aghi auricolari, Micro Uncini auricolari



90°

034-139-003 0,3 mm
034-139-006 0,6 mm
034-139-010 1,0 mm



90°

034-141-003 0,3 mm
034-141-006 0,6 mm
034-141-010 1,0 mm



MC GEE

034-143-005 0,5 mm
034-143-010 1,0 mm



MC GEE

034-145-005 0,5 mm
034-145-010 1,0 mm



BARBARA

034-147-155



ROSEN

034-149-155

034-139-003 - 034-149-155 15,5 cm / 6"

Mikro-Ohrhäkchen
Micro Ear Hooks
Micro Ganchitos auriculares
Micro Uncini auricolari



034

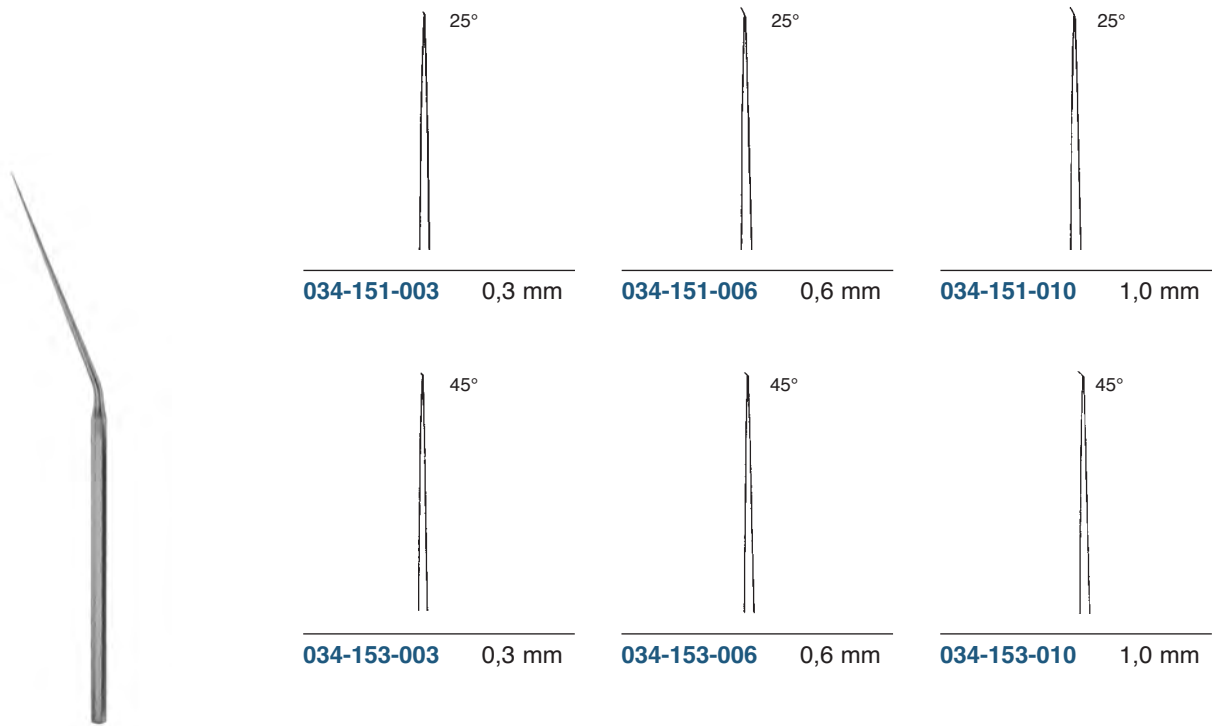

034-151-003 - 034-153-010 15,5 cm / 6"

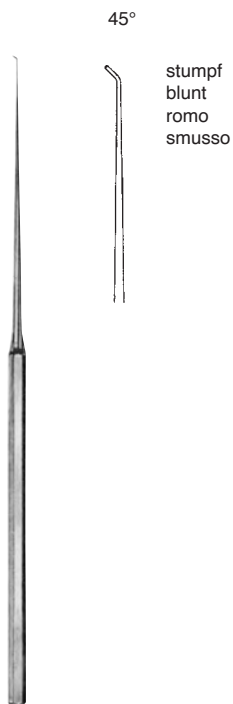

SHEA

034-155-020 2,0 mm

Sondierhaken
 Exploring Hook
 Ganchito explorador
 Uncino di sondaggio

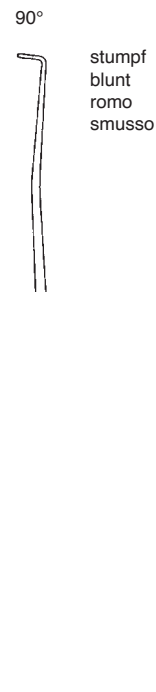

AUSTIN

034-157-030 3,0 mm

Attikusdissektor
 Attic Dissector
 Disecador para el ático
 Dissettore per l'attico



034

Mikro-Ohrhäkchen
Micro Ear Hooks
Micro Ganchitos auriculares
Micro Uncini auricolari



nach rechts abgewinkelt
 angled to right
 angulada por derecha
 angulata a destra

034-161-001

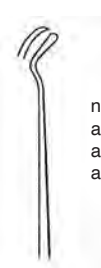

nach links abgewinkelt
 angled to left
 angulada por izquierda
 angulata a sinistra

034-161-002

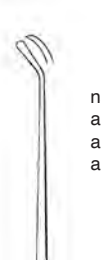

nach rechts abgewinkel
 angled to right
 angulada por derecha
 angulata a destra

034-163-001

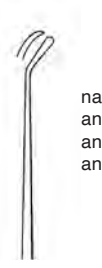

nach links abgewinkelt
 angled to left
 angulada por izquierda
 angulata a sinistra

034-163-002

FISCH

034-161-001 - 034-163-002

15,5 cm / 6"



2,0 mm

ROSEN

034-165-155 15,5 cm / 6"

Mikro-Ohrraspatorium
 Micro Ear Periosteal Elevator
 Micro legra auricular
 Micro Raspatore auricolare



034-170-035

3,5 mm



034-170-040

4,0 mm



034-170-045

4,5 mm



034-170-050

5,0 mm

HOUSE

034-170-035 - 034-170-050

15,5 cm / 6"

Mikro-Messsonde
 Micro Measuring Rod
 Micro sonda para medir
 Micro Sonda per misurare

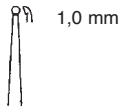

034-180-001

034-180-002

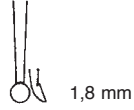
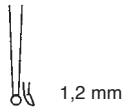

HOUSE

034-180-001 - 034-180-002 15,0 cm / 6"



034-181-001

034-181-002

stark abgewinkelt
 strong angled
 angulada fuerte
 angulata forte

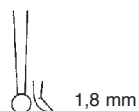

HOUSE

034-181-001 - 034-181-002 15,0 cm / 6"

Ohrspekula
Ear Specula
Espéculos auriculares
Specoli auricolari



HARTMANN Fig. 0-2

034-201-003 3,6 cm / 1 1/2"

Ohrspekula, Satz für Kinder
 Ear Specula, set for children
 Spéculums auriculares, juego para niños
 Specoli auricolari, set per bambini

Fig. 0
034-200-030 3,0 mm

Fig. 1
034-200-040 4,0 mm

Fig. 2
034-200-050 5,0 mm

Fig. 3
034-200-060 6,0 mm

Fig. 4
034-200-075 7,5 mm



HARTMANN Fig. 2-4

034-202-003 3,6 cm / 1 1/2"

HARTMANN Fig. 1-4

034-202-004 3,6 cm / 1 1/2"

Ohrspekula, Satz für Erwachsene
 Ear Specula, set for adults
 Spéculums auriculares, juego para adultos
 Specoli auricolari, set per adulti



TOYNBEE Fig. 2-4

034-211-003 3,6 cm / 1 1/2"

TOYNBEE Fig. 1-4

034-211-004 3,6 cm / 1 1/2"

Ohrspekula, Satz für Erwachsene
 Ear Specula, set for adults
 Spéculums auriculares, juego para adultos
 Specoli auricolari, set per adulti



schwarz
 black
 negro
 nero

FARRIOR Fig. 1-7

034-221-007 3,6 cm / 1 1/2"

Ohrspekula, Satz bestehend aus 7 Stück
 Ear Specula, set consisting of 7 pieces
 Spéculums auriculares, juego consiste de 7 piezas
 Specoli auricolari, set composto di 7 pezzi

Fig. 1
034-210-040 4,0 mm

Fig. 2
034-210-050 5,0 mm

Fig. 3
034-210-060 6,0 mm

Fig. 4
034-210-075 7,5 mm

Fig. 1
034-220-055 5,5 mm

Fig. 3
034-220-075 7,5 mm

Fig. 5
034-220-095 9,5 mm

Fig. 7
034-220-115 11,5 mm

Fig. 2
034-220-065 6,5 mm

Fig. 4
034-220-085 8,5 mm

Fig. 6
034-220-105 10,5 mm

Ohrspekula
Ear Specula
Espéculos auriculares
Specoli auricolari



034



oval, schwarz
 oval, black
 ovalado, negro
 ovale, nero

ZÖLLNER Fig. 1-6

034-231-006 3,8 cm / 1 1/2"

Ohrspekula, Satz bestehend aus 6 Stück
 Ear Specula, set consisting of 6 pieces
 Spéculums auriculares, juego consiste de 6 piezas
 Specoli auricolari, set composto di 6 pezzi

Fig. 1
034-230-065 5,5 x 6,5 mm

Fig. 2
034-230-075 6,5 x 7,5 mm

Fig. 3
034-230-085 7,5 x 8,5 mm

Fig. 4
034-230-095 8,5 x 9,5 mm

Fig. 5
034-230-105 9,5 x 10,5 mm

Fig. 6
034-230-115 10,5 x 11,5 mm

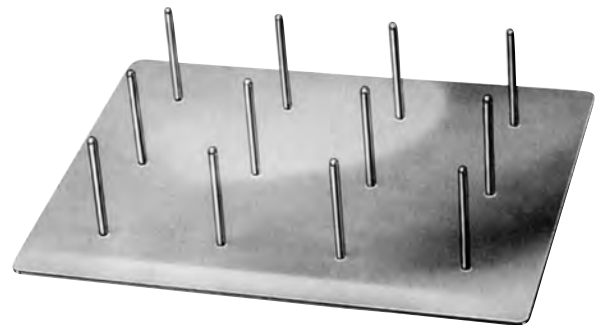

034-244-012

Ohrspekulaständer
 Ear Specula Storage Rack
 Soporte para espéculos auriculares
 Supporto per specoli auricolari



BOUCHERON Fig. 1-4

034-241-004

Ohrspekula, Satz bestehend aus 4 Stück
 Ear Specula, set consisting of 4 pieces
 Spéculums auriculares, juego consiste de 4 piezas
 Specoli auricolari, set composto di 4 pezzi

Fig. 1
034-240-042 4,2 mm

Fig. 2
034-240-052 5,2 mm

Fig. 3
034-240-062 6,2 mm

Fig. 4
034-240-072 7,2 mm



034

Stimmgabeln Tuning Forks Diapasones Diapason

ALUMINIUM

034-301-005

Alu-Stimmgabel-Satz komplett im Etui bestehend aus 034-300-001 bis 034-300-005

Set of Tuning Forks (Alu) complete in case consisting of 034-300-001 till 034-300-005

Juego de diapasones (aluminio) completo en estuche compuesto de 034-300-01 hasta 034-300-005

Set da diapason (alluminio) completo in astuccio composto da 034-300-001 fino a 034-300-005

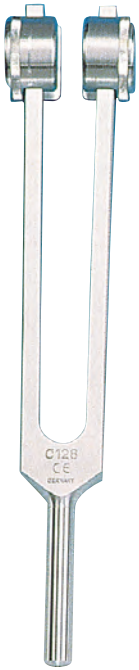

ALUMINIUM

034-300-001 c128



ALUMINIUM

034-300-002 C256



ALUMINIUM

034-300-003 C512



ALUMINIUM

034-300-004 C1024



ALUMINIUM

034-300-005 C2048



HARTMANN

034-304-001 c128



HARTMANN

034-304-002 c1256



HARTMANN

034-304-003 c2512



HARTMANN

034-304-004 c31024



HARTMANN

034-304-005 c42048



HARTMANN

034-305-005

Stimmgabel-Satz komplett im Etui bestehend aus 034-304-001 bis 034-304-005

Set of Tuning forks complete in case consisting of 034-304-001 till 034-304-005

Juego de diapasones completo en estuche compuesto de 034-304-001 hasta 034-304-005

Set da diapason completo in astuccio composito da 034-304-001 fino a 034-304-005



HARTMANN

034-310-001 c128



HARTMANN

034-310-002 c'256



HARTMANN

034-310-003 c⁵4096



HARTMANN

034-312-001 C64



034

Stimmgabeln Tuning Forks Diapasones Diapason



LUCAE
034-320-001 c128



LUCAE
034-320-002 c1256



LUCAE
034-320-003 c2512



LUCAE
034-320-004 c31024



LUCAE
034-320-005 c2048



LUCAE
034-320-006 c54096

verschiebbar bis h 240
movable up to h 240
regulable hasta h 240
regolabile fino a h 240

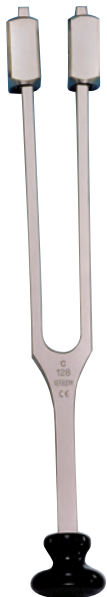

LUCAE
034-322-001 c128

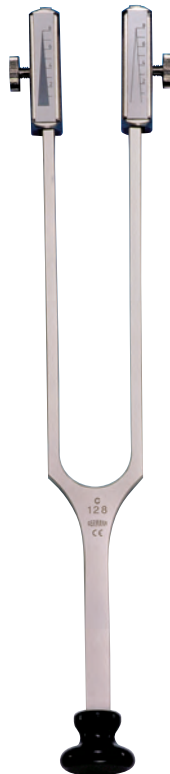

RYDEL-SEIFFERT
034-324-001 C64/c128

auch für Neurologie
also for neurology
para neurología
per neurologia

mit Dämpfer = C64
with Dampers = C64
con sordinas = C64
con sordine = C64

ohne Dämpfer = c128
without dampers = c128
sin sordinas = c128
senza sordine = c128

ALUMINIUM-STIMMGABEL mit Perkussionshammer,
Nadelrad, Nadel und Pinsel im Etui

ALUMINIUM-Tuning Fork with Percussion hammer,
pin wheel, needle and brush in case

ALUMINIO-Diapason con martillo para percusion,
rueda de agujas, aguja y pincel en festuche

ALLUMINIO-Diapason con martello di riflesso, ruota
per l'ago, ago è pennello in astuccio



NEURO
034-326-001

Stimmgabeln, Lärmtrommel
Tuning Forks, Noise Apparatus
Diapasones, Ensordecdor
Diapason, Assordatore



034

verschiebbar bis g194
movable up to g194
regulable hasta g194
regolabile fino a g194

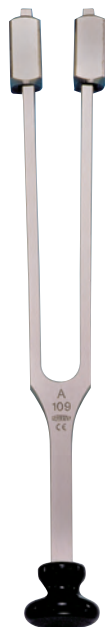

KÖNIG

034-328-001 A109



034-330-001 a:440



BARANY

034-340-000

034-340-001

Ohrolive, allein
Ear piece, only
Oliva, suelta
Oliva, sola

Ohrkatheter, Polypenschnürer
Ear Catheters, Polypus Snares
Sondas auriculares, Polipótomos
Sonde auricolari, Serranodi per polipi



- 
 Fig. 1
034-349-001
- 
 Fig. 2
034-349-002
- 
 Fig. 3
034-349-003

HARTMANN

034-349-001 - 034-349-003 15,0 cm / 6"



offenes Ende
 open tip
 punta abierta
 punta aperta

KRAUSE

034-351-185 18,5 cm / 7 1/4"

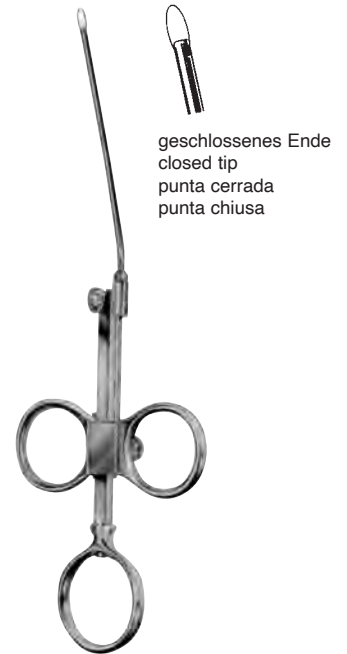

geschlossenes Ende
 closed tip
 punta cerrada
 punta chiusa

KRAUSE-VOSS

034-353-185 18,5 cm / 7 1/4"

Schnürerschlingen, Bündel mit 12 Stück
 Snare loops, bundle with 12 pieces
 Asas de alambre, manojo de 12 piezas
 Lacci di filo di metallo, manello die 12 pezzi



7,5 cm

- 034-355-020** Ø 0,20 mm
- 034-355-025** Ø 0,25 mm
- 034-355-030** Ø 0,30 mm



TROELTSCH (WILDE)
034-375-120 12,0 cm / 4³/₄"



TROELTSCH (WILDE)
034-381-120 12,0 cm / 4³/₄"



LUCAE
034-391-140 14,0 cm / 5¹/₂"



LUCAE
034-391-160 16,0 cm / 6¹/₄"

Ohrpolypenzangen
Ear Polypus Forceps
Pinzas para pólipos auriculares
Pinze per polipi auricolari



TILLEY
034-401-140 14,0 cm / 5½"

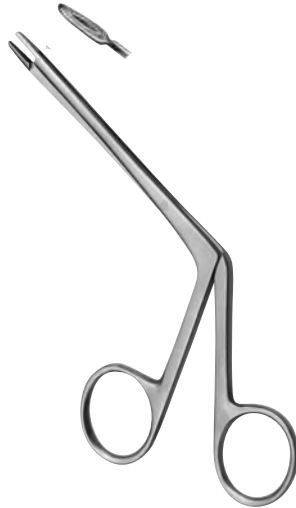

LITTAUER
034-403-120 12,0 cm / 4¾"

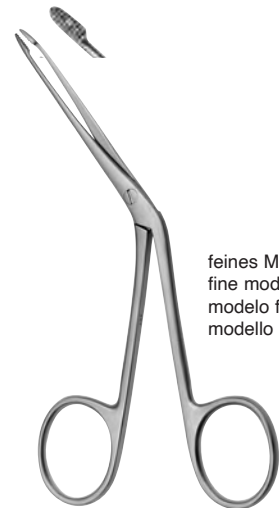

feines Modell
 fine model
 modelo fino
 modello fino

HARTMANN
034-405-120 12,0 cm / 4¾"



HARTMANN
034-407-140 14,0 cm / 5½"

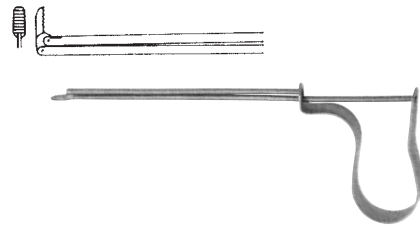

QUIRE
034-410-100 10,0 cm / 4⅜"

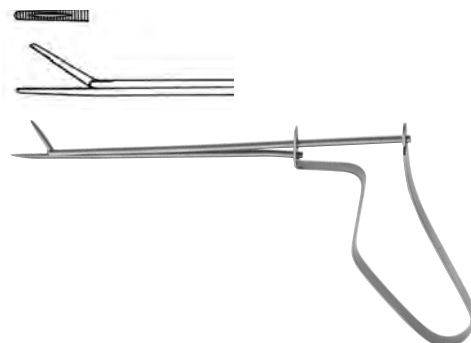

BUCK
034-412-110 11,0 cm / 4⅜"

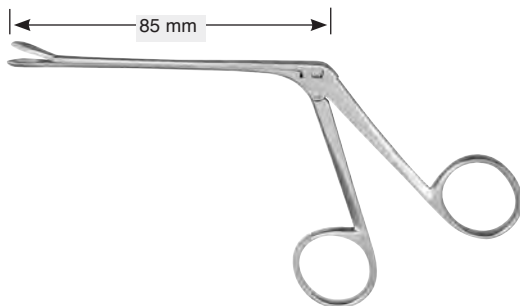
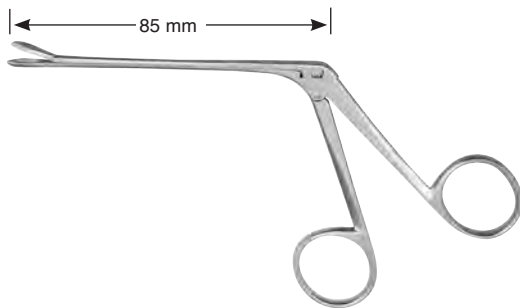

HARTMANN-WULLSTEIN
034-420-085 8,5 cm

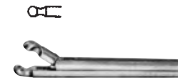

HARTMANN-WULLSTEIN
034-422-085 Ø 1,0 mm/ 8,5 cm



HARTMANN
034-424-085 8,5 cm



HARTMANN
034-426-085 8,5 cm

HARTMANN
034-424-140 14,0 cm / 5 1/2"

Schaftlänge 140 mm
 Shaft length 140 mm
 longitud del vástago 140 mm
 lunghezza del gambo 140 mm

HARTMANN
034-426-140 14,0 cm / 5 1/2"

Schaftlänge 140 mm
 Shaft length 140 mm
 longitud del vástago 140 mm
 lunghezza del gambo 140 mm

HARTMANN
034-424-160 16,0 cm / 6 1/4"

Schaftlänge 160 mm
 Shaft length 160 mm
 longitud del vástago 160 mm
 lunghezza del gambo 160 mm



ø 2,0 mm
HARTMANN
034-430-020 8,5 cm / 3 1/4"



STRÜMPEL
034-434-085 8,5 cm / 3 1/4"



ø 2,5 mm
HARTMANN
034-430-025 8,5 cm / 3 1/4"



HARTMANN-HOFFMANN
034-438-085 8,5 cm / 3 1/4"



ø 3,0 mm
HARTMANN
034-430-030 8,5 cm / 3 1/4"



034

Ohr-Knochenstanzen
 Mastoid Rongeurs
 Pinzas cortantes para huesos
 Pinze osteomi



034-450-015 1,5 mm



034-450-020 2,0 mm



034-450-030 3,0 mm

CITELLI

034-450-015 - 034-450-030 17,0 cm / 6³/₄"



1 mm Schnitt
1 mm cut
corte 1 mm
taglio 1 mm

BEYER

034-452-001 14,0 cm / 5¹/₂"



2 mm Schnitt
2 mm cut
corte 2 mm
taglio 2 mm

BEYER

034-452-002 19,0 cm / 7¹/₂"

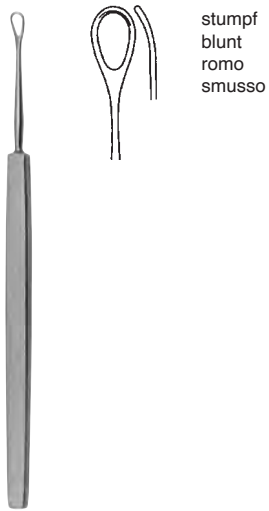

stumpf
 blunt
 romo
 smusso

LANGENBECK

034-501-130 13,0 cm / 5"

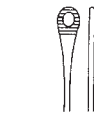

034-503-001



034-503-002

SHAPLEIGH

034-503-001 - 034-503-002 15,0 cm / 6"



gerade stumpf
 straight blunt
 recto romo
 retto smusso



BUCK

034-510-002 - 034-512-015



FIG. 00

034-510-002



FIG. 0

034-510-010



FIG. 1

034-510-011



FIG. 2

034-510-012



FIG. 3

034-510-013



FIG. 4

034-510-014



FIG. 5

034-510-015



FIG. 00

034-512-002



FIG. 0

034-512-010



FIG. 1

034-512-011



FIG. 2

034-512-012



FIG. 3

034-512-013



FIG. 4

034-512-014



FIG. 5

034-512-015



gerade scharf
 straight sharp
 recto agudo
 retto acuto



034

Ohrküretten
Ear Currettes
Curetas auriculares
Curette auricolari



gebogen stumpf
curved blunt
curva romo
curvo smusso



FIG. 00
034-515-002



FIG. 0
034-515-010



FIG. 1
034-515-011



FIG. 2
034-515-012



FIG. 3
034-515-013



FIG. 4
034-515-014



FIG. 5
034-515-015



gebogen scharf
curved sharp
curva agudo
curvo acuto



FIG. 00
034-517-002



FIG. 0
034-517-010



FIG. 1
034-517-011



FIG. 2
034-517-012



FIG. 3
034-517-013



FIG. 4
034-517-014



FIG. 5
034-517-015



BUCK
034-515-002 - 034-517-015



JANSEN
034-521-150 15,0 cm / 6"

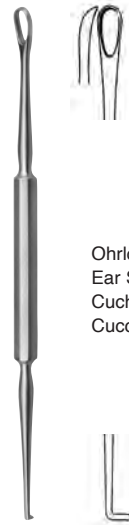

Ohrlöffel und Hähchen
Ear Scoop/Hook
Cucharilla/ganchito auricular
Cucchiaio auricolare

GROSS
034-523-120 12,0 cm / 4³/₄"



klein
small
pequeño
piccolo

034-530-001



mittel
medium
mediano
medio

034-530-002



groß
large
grande
grande

034-530-003

BILLEAU

034-530-001 - 034-530-003

16,0 cm / 6¹/₄"

Ohrschlinge
Ear Loop
Asa auricular
Ansa auricolare



Fig.0

034-532-000



Fig.1

034-532-001



Fig.2

034-532-002

WEBER-LOCH

034-532-000 - 034-532-002

14,5 cm / 5³/₄"

Ohrschlinge
Ear Loop
Asa auricular
Ansa auricolare



MOLDENHAUER

034-541-165

16,5 cm / 6¹/₂"

Fremdkörperhebel
Foreign Body Lever
Elevador para cuerpos extraños
Leva per corpi estranei



ZAUFAL

034-543-160

16,0 cm / 6¹/₂"

Fremdkörperhebel
Foreign Body Lever
Elevador para cuerpos extraños
Leva per corpi estranei



HARTMANN

034-545-160

16,0 cm / 6"

Ohrhäkchen
Ear Hooklet
Ganchito auricular
Uncino auricolare



034

Fremdkörperinstrumente, Ohrhäkchen
Foreign Body Instruments, Ear Hooks
Instrumentos para cuerpos extraños, Ganchitos auriculares
Strumenti per corpi estranei, Uncini auricolare

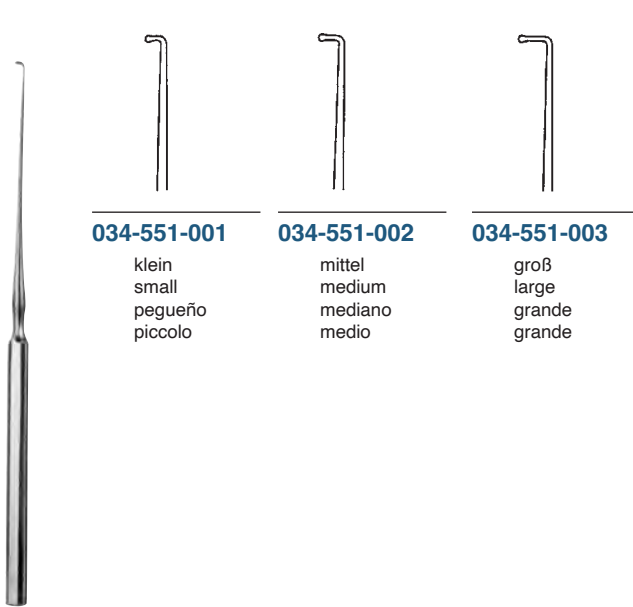

034-551-001

klein
small
pequeño
piccolo

034-551-002

mittel
medium
mediano
medio

034-551-003

groß
large
grande
grande

LUCAE

034-551-001 - 034-551-003

14,0 cm / 5½"

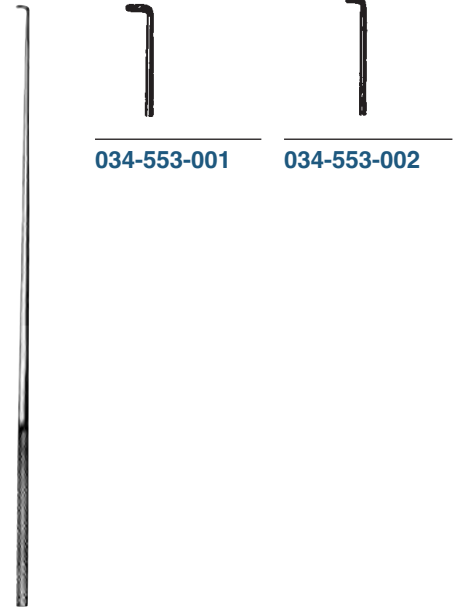

034-553-001

034-553-002

DAY

034-553-001 - 034-553-002

16,0 cm / 6¾"

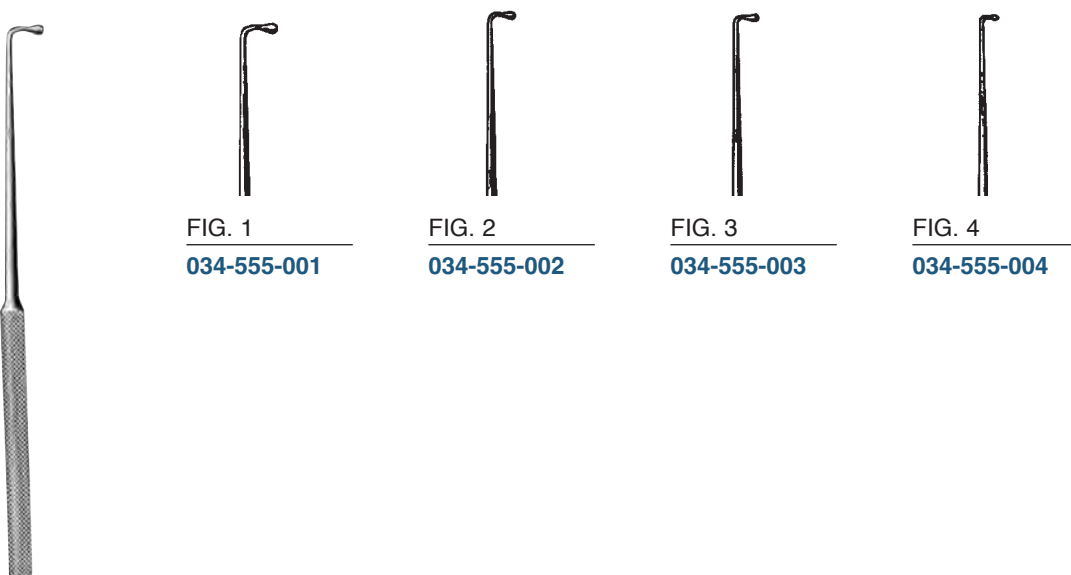

FIG. 1

034-555-001

FIG. 2

034-555-002

FIG. 3

034-555-003

FIG. 4

034-555-004

WAGNER

034-555-001 - 034-555-004

14,0 cm / 5½"

Trommelfellnadeln
Tympanum Needles
Agujas para tímpano
Aghi per timpano



034



POLITZER
034-561-160 16,0 cm / 6¹/₂"



POLITZER
034-563-160 16,0 cm / 6¹/₄"

Nadel quergestellt
 needle horizontally
 aguja en posición horizontal
 ago orizzontale



POLITZER
034-565-150 15,0 cm / 6"
 Furunkelmesser
 Furuncle Knife
 cuchillo para furúnculos
 Coltello per foruncoli



POLITZER
034-566-180 18,0 cm / 7"



LUCAE
034-571-180 18,0 cm / 7"



LUCAE
034-573-180 18,0 cm / 7"



034

Ohrraspatorien, Ohrlöffel
Ear Periosteal Elevators, Ear Scoops
Legras auriculares, Cucharillas auriculares
Raspatori auricolari, Curette auricolari



LEMPERT
034-581-205 20,5 cm / 8"



LEMPERT
034-583-180 18,0 cm / 7"



- | | | | | |
|---|---|---|---|---|
|  |  |  |  |  |
| FIG. 0 | FIG. 00 | FIG. 1 | FIG. 2 | FIG. 3 |
| 034-590-010 | 034-590-020 | 034-592-001 | 034-592-002 | 034-592-003 |
| Ø 2,0 mm | Ø 1,7 mm | Ø 2,4 mm | Ø 2,7 mm | Ø 3,0 mm |

LEMPERT
034-590-010 - 034-592-003 20,0 cm / 8"



034-600-011 11,0 cm / 4"

Ohrkanüle
Ear cannula
Cánula auricular
Cannula auricolare



034-600-013 13,0 cm / 5"

Ohrkanüle
Ear cannula
Cánula auricular
Cannula auricolare



034-600-008 8,0 cm / 3 1/8"

Ohrkanüle
Ear cannula
Cánula auricular
Cannula auricolare

034-600-020

Ventilball
Valve Rubber Bulb
Pera de goma con
Pallone in gomma

034-600-001 30 ccm

Flasche
Bottle
Botella
Bottiglia di ricambio

KABIERSKE

034-600-000

komplett mit 3 Kanülen und Gummiball
complete with 3 cannulas and rubber bulb
completo con 3 cánulas y pera de goma
completo con 3 cannule e pera di gomma

discontinued item



UNIVERSAL

034-620-000

Komplett mit beweglicher Düse, Nasenolive, Schraubflasche und Gebläse
Complete with moveable tube, Nose Olive, screw bottle and rubber bulb
Completo con tubo móvil, oliva nasal, botella con rosca y pera de goma
Completo con tubo mobile, oliva nasale, bottiglia con filettatura e pera di gomma



034

Luftdusche
Air Bags
Insufladores de aire
Insoffiatore d'aria



POLITZER

034-630-000

komplett mit 3 Nasenoliven Art.-Nr. 034-630-015 - 034-630-022
complete with 3 nasal olives ref. 034-630-015 - 034-630-022
completo con 3 olivas nasales ref. 034-630-015 - 034-630-022
completo con 3 olive nasali rif. 034-630-015 - 034-630-022



034-630-001

Einsteckkonus
Connecting Nozzle
Cono de conexiòn
Cono di connessione



Ø 4 mm

034-630-004

Ohrolive
Ear olive
Oliva auricular
Oliva auricolare



Ø 15 mm

034-630-015

Nasenolive
Nose Olive
Oliva nasal
Oliva nasale



Ø 17 mm

034-630-017

Nasenolive
Nose Olive
Oliva nasal
Oliva nasale



Ø 22 mm

034-630-022

Nasenolive
Nose Olive
Oliva nasal
Oliva nasale

discontinued item



POLITZER

034-632-000

komplett mit 4 Nasenoliven Art.-Nr. 034-630-004 - 034-630-022 in Kunststoffbox
complete with 4 nasal olives ref. 034-630-004 - 034-630-022 in plastic box
completo con 4 olivas nasales ref. 034-630-004 - 034-630-022 en caja plástica
completo con 4 olive nasali rif. 034-630-004 - 034-630-022 in scatola di plastica



034-640-050 50 ml

komplett mit Teller und 2 Ansätzen
complete with protection disc and 2 tips
completo con disco protector y 2 puntas
completo con disco protettivo e 2 punte



034-640-075 75 ml

komplett mit Teller und 2 Ansätzen
complete with protection disc and 2 tips
completo con disco protector y 2 puntas
completo con disco protettivo e 2 punte



034-640-100 100 ml

komplett mit Teller und 2 Ansätzen
complete with protection disc and 2 tips
completo con disco protector y 2 puntas
completo con disco protettivo e 2 punte

034-640-150 150 ml

komplett mit Teller und 2 Ansätzen
complete with protection disc and 2 tips
completo con disco protector y 2 puntas
completo con disco protettivo e 2 punte

Ohrspritzen
Ear Syringes
Jeringas auriculares
Siringhe auricolari

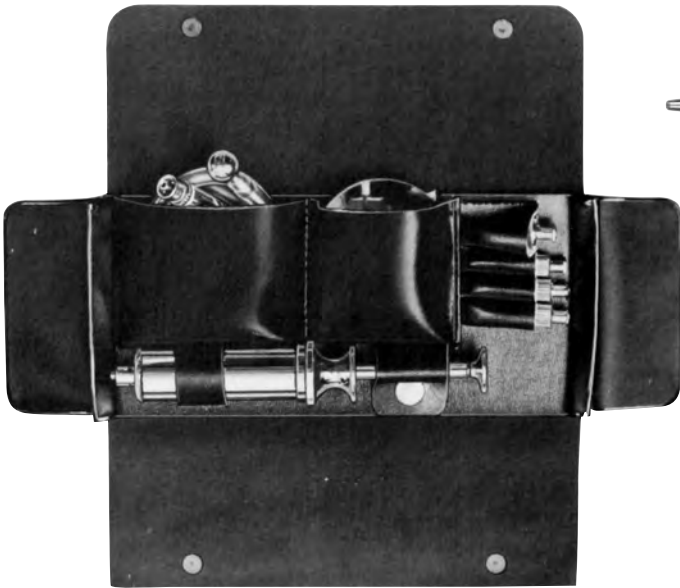

034-650-000 10 ml

selbstfüllend in Kunststofftasche
 self filling in plastic pouch
 auto-rellena en bolsa plástica
 auto-riempente in borsa di plastica



034-650-001
 Verbindungsschlauch komplett mit Ventilaufsatz
 Verbindungsgansatz
 Connection Tube complete with Valve attachment
 and suction nozzle
 Tubo de conexión completo con Válvula de
 conexión y pieza de succión
 Tubo di connessione, completo con valvola
 diconnessione e aspiratore



034-650-002
 Ventilator
 Valve attachment
 Valvola di connessione
 Valvola di connessione



034-650-003
 Saugansatz
 Suction Nozzle
 Pieza de succión
 Aspiratore



034-650-004
 Schutzteller
 Protecting Disc
 Disco protector
 Disco protettivo



034-650-005
 Metallolive
 Metal Olive
 Oliva metálica
 Oliva in metallo



034-650-006
 Konischer Ansatz
 Conical Tip
 Punta cónica
 Punta conica



034-650-007
 Geknöpfte Ansatz
 Button ended Tip
 Punta de botón
 Punta a bottone



034-650-008
 Gewindeansatz
 Threaded Tip
 Punta de rosca
 Punta filettata

discontinued item

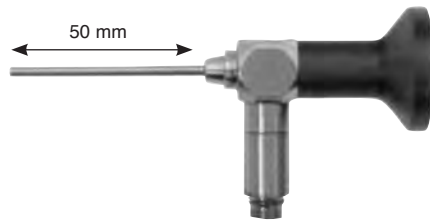

034-700-050 Ø 4,0 x 50 mm

Autoklavierbare Geradeausblick-Optik.
Blickrichtung 0°/ Bildwinkel ca. 60°. Sterilisation:
Gas- oder Kalt- bzw. Flüssigkeitssterilisation

Autoclavable forward telescope,
viewing direction 0°/ viewing angle 60° approx.
Sterilization: Gas sterilization or cold respectively
liquid sterilization.

Òptica recta autoclavable, direcció de vista 0°/
àngulo de la imatge aprox. 60°. Esterilización:
Esterilización por gas o con un líquido.

Ottica autoclavabile a visione retta 0°/
angolo 60° ca. Sterilizzazione: sterilizzabile a
gas e con tutte le soluzioni sterilizzanti a freddo.

034-702-050 Ø 4,0 x 50 mm

Autoklavierbare Vorausblick-Optik.
Blickrichtung 30°/ Bildwinkel ca. 60°. Sterilisation:
Gas- oder Kalt- bzw. Flüssigkeitssterilisation

Autoclavable forward-oblique telescope,
viewing direction 30°/ viewing angle 60° approx.
Sterilization: Gas sterilization or cold respectively
liquid sterilization.

Òptica recta-oblicua autoclavable,
direcció de vista 30°/ àngulo de la imatge aprox. 60°.
Esterilización: Esterilización por gas o con un líquido.

Ottica autoclavabile a visione obliqua 30°/
angolo 60° ca. Sterilizzazione: sterilizzabile a
gas e con tutte le soluzioni sterilizzanti a freddo.

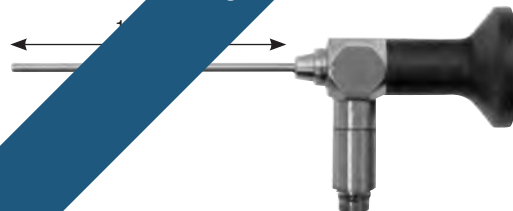

034-710-100 Ø 2,7 x 100 mm

Autoklavierbare Geradeausblick-Optik
Blickrichtung 0°/ Bildwinkel ca. 80°.
Sterilisation: Dampfsterilisation bei 2 bar
Überdruck (134°C).

Autoclavable forward telescope,
viewing direction 0°/ viewing angle 80° approx.
Sterilization: Sterilizable in the autoclave at 2 bar
overpressure (134°C)..

Òptica recta autoclavable,
direcció de vista 0°/ àngulo de la imatge aprox. 80°
Esterilización: Esterilizable en autoclave a 2 bar
sobrepresión (134°C)..

Ottica autoclavabile a
visione retta 0°/ angolo 80° ca.
Sterilizzazione: in autoclave a 2 bar di
superpressione (134°C).

034-712-100 Ø 2,7 x 100 mm

Autoklavierbare Vorausblick-Optik
Blickrichtung 30°/Bildwinkel ca. 80°.
Sterilisation: Dampfsterilisation bei 2
bar Überdruck (134°C).

Autoclavable forward-oblique telescope,
viewing direction 0°/ viewing angle 80° approx.
Sterilization: Sterilizable in the autoclave at 2
bar overpressure (134°C)..

Òptica recta-oblicua autoclavable,
direcció de vista 0°/ àngulo de la imatge aprox. 80°
Esterilización: Esterilizable en autoclave a 2 bar
sobrepresión (134°C)..

Ottica autoclavabile a
visione obliqua 30°/ angolo 80° ca.
Sterilizzazione: in autoclave a 2 bar
di superpressione (134°C).

discontinued item

**Optiken
Telescopes
Òpticas
Ottiche**

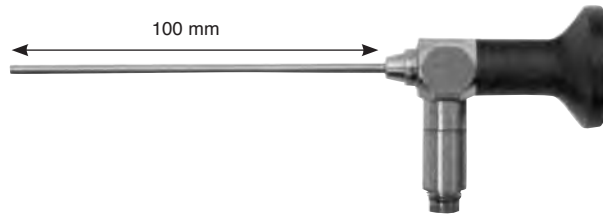

034-720-100 Ø 1,9 x 100 mm

Autoklavierbare Geradeausblick-Optik
Blickrichtung 0°/Bildwinkel ca. 65°. Sterilisation:
Dampfsterilisation bei 2 bar Überdruck (134°C).

Autoclavable forward telescope, viewing direction 0°/
viewing angle 65° approx. Sterilization: Sterilizable in
the autoclave at 2 bar overpressure (134°C).

Òptica recta autoclavable, direcció de vista 0°/
àngulo de la imatge aprox. 65°. Esterilizació:
Esterilizable en autoclave a 2 bar sobrepresió
(134°C).

Ottica autoclavabile a visione retta 0°/
angolo 65° ca. Sterilizzazione: in autoclave
a 2 bar di superpressione (134°C).

034-722-100 Ø 1,9 x 100 mm

Autoklavierbare Vorausblick-Optik Blickrichtung
30°/Bildwinkel ca. 65°. Sterilisation:
Dampfsterilisation bei 2 bar Überdruck (134°C).

Autoclavable forward-oblique telescope, viewing direction
0°/ viewing angle 65° approx. Sterilization: Sterilizable in
the autoclave at 2 bar overpressure (134°C).

Òptica autoclavable hacia adelante, direcció de vista
0°/ àngulo de la imatge aprox. 65°. Esterilizació:
Esterilizable en autoclave a 2 bar sobrepresió
(134°C).

Ottica autoclavabile a visione obliqua 30°/
angolo 65° ca. Sterilizzazione: in autoclave
a 2 bar di superpressione (134°C).

discontinued item



035-950-100 10,0 cm / 4"

Handgriff, flach, fü Ø 2,7 mm Optiken
Flat handle for Ø 2,7 mm telescopes
Mango plano para òpticas de Ø 2,7 mm
Manico piatto per ottiche di Ø 2,7 mm



035-952-100 10,0 cm / 4"

Handgriff, rund, fü Ø 2,7 mm Optiken
Round handle for Ø 2,7 mm telescopes
Mango redondo para òpticas de Ø 2,7 mm
Manico rotondo per ottiche di Ø 2,7 mm



035-954-100 10,0 cm / 4"

Handgriff, flach, fü Ø 4,0 mm Optiken
Flat handle for Ø 4,0 mm telescopes
Mango plano para òpticas de Ø 4,0 mm
Manico piatto per ottiche di Ø 4,0 mm

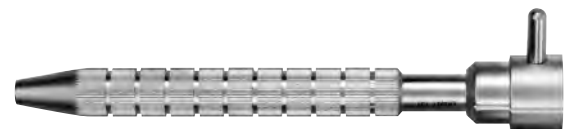

035-956-100 10,0 cm / 4"

Handgriff, rund, fü Ø 4,0 mm Optiken
Round handle for Ø 4,0 mm telescopes
Mango redondo para òpticas de Ø 4,0 mm
Manico rotondo per ottiche di Ø 4,0 mm



035

Rhinologie
Rhinology
Rinología
Rinologia

Nasenspekula
Nasal Specula
Espèculos nasales
Specoli nasali



Fig.1
035-100-001 21,0 x 9,5 mm



Fig.2
035-100-002 21,0 x 10,5 mm



GOLDSMITH (THUDICHUM)
035-100-001 - 035-100-003 6,5 cm / 2 1/2"

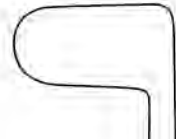

Fig.3
035-100-003 21,0 x 11,5 mm



FIG. 1
035-110-001

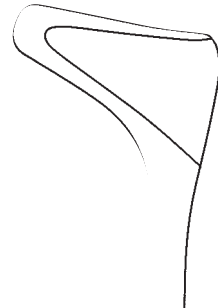

FIG. 2
035-110-002



HARTMANN-HALLE
035-110-001 - 035-110-003 15,0 cm / 6"

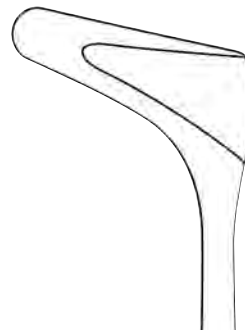

FIG. 3
035-110-003

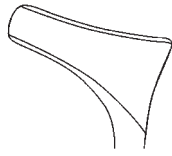

Fig.1

035-120-001

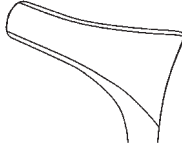

Fig.2

035-120-002

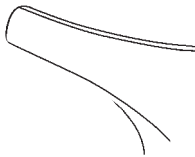

Fig.3

035-120-003

HARTMANN

035-120-001 - 035-120-003

15,0 cm / 6"



Fig.1

035-130-001

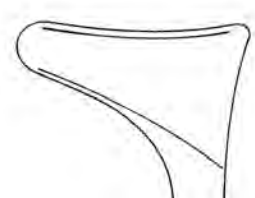

Fig.2

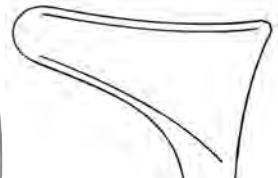

Fig.3

035-130-003

MOD. WIEN

035-130-001 - 035-130-003

14,5 cm / 5 1/4"

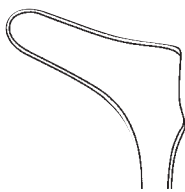
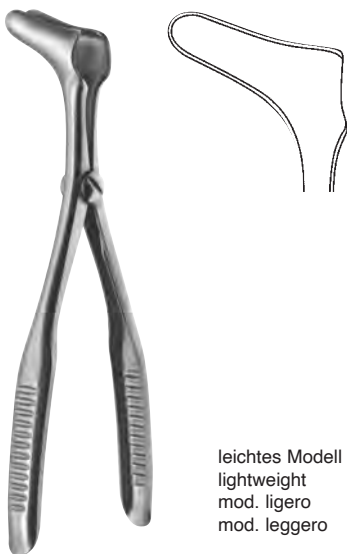

leichtes Modell
 lightweight
 mod. ligero
 mod. leggero

MOD. WIEN

035-132-135 13,5 cm / 5 1/4"



Fig.1

035-140-001



Fig.2

035-140-002

TIECK-HALLE

035-140-001 - 035-140-002

13,0 cm / 5 1/8"

Nasenspekula
Nasal Specula
Espèculos nasales
Specoli nasali

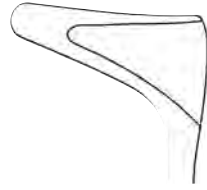

FIG. 1
035-150-001 35 mm

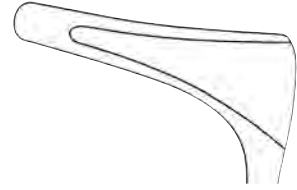

FIG. 2
035-150-002 50 mm

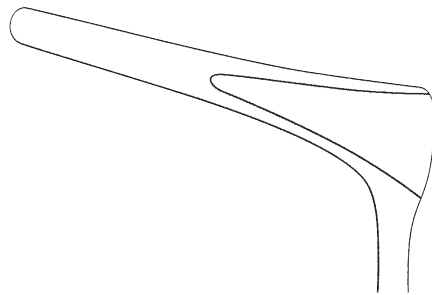

FIG. 3
035-150-003 75 mm

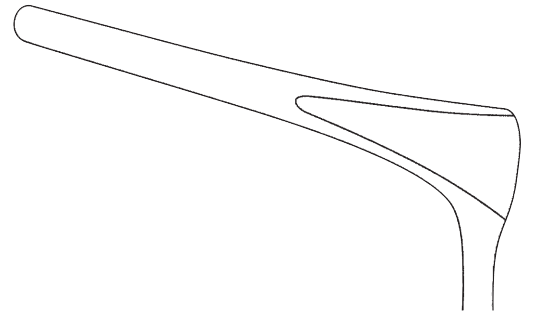

FIG. 4
035-150-004 90 mm

KILIAN

035-150-001 - 035-150-003 13,0 cm / 5 1/8"

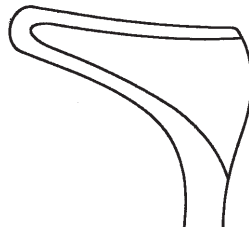

FIG. 1
035-160-001 35 mm

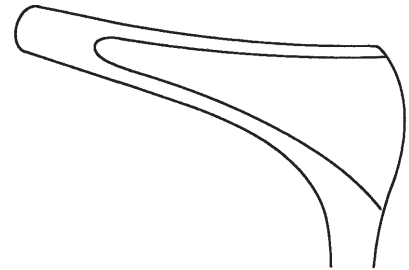

FIG. 2
035-160-002 50 mm



FIG. 3
035-160-003 75 mm

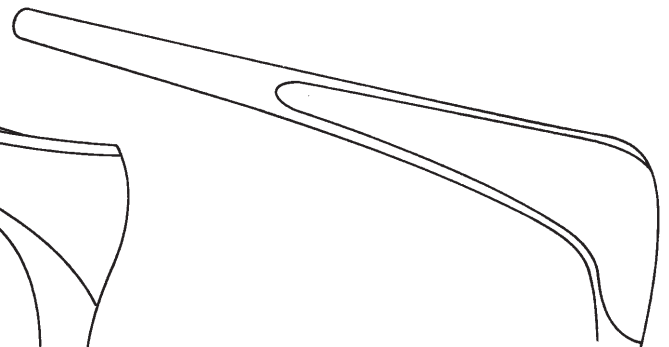

FIG. 4
035-160-004 90 mm

COTTLE

035-160-001 - 035-160-004 13,5 cm / 5 1/4"



BECKMANN Fig.1
035-164-001 13,0 cm / 5 1/8"



BECKMANN Fig.2
035-164-002 14,0 cm / 5"



Schaft Ø 3 mm
 Shaft Ø 3 mm
 vástago Ø 3mm
 gambo Ø 3 mm

KRAUSE
035-171-260 26,0 cm / 10 1/4"



Schaft Ø 3 mm
 Shaft Ø 3 mm
 vástago Ø 3mm
 gambo Ø 3 mm

KRAUSE-VOSS
035-173-260 26,0 cm / 10 1/4"

mit 2 Ansätzen
 with 2 caps
 con 2 apliques
 con 2 punta

Schnürschlingen Ø 0,30 mm
 Bündel mit 12 Stück
 Snare loops Ø 0,30 mm
 Bundle with 12 pieces
 Asas de alambre Ø 0,30 mm
 Manojó de 12 piezas
 Lacci di filo di metallo Ø 0,30 mm
 Manello di 12 pezzi



035-175-003 10,0 cm

Nasentamponpinzetten, Nasenpolypenzangen
Nasal Tampon Forceps, Nasal Polypus Forceps
Pinzas para taponamiento, Pinzas para pólipos nasales
Pinze per medicature, Pinze per polipi nasali



TRÖLTSCH
035-181-150 15,0 cm / 6"



TRÖLTSCH
035-181-180 18,0 cm / 7"



JANSEN (GRÜNWALD)
035-185-180 18,0 cm / 7"
035-185-200 20,0 cm / 8"



WESTMACOTT
035-201-200 20,0 cm / 8"

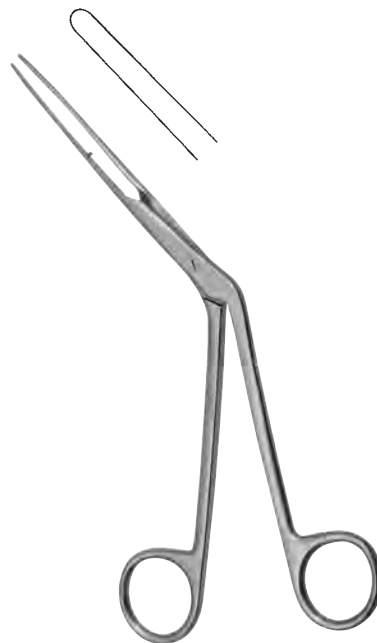

LUBET-BARBON
035-203-185 18,5 cm / 7 1/4"



HARTMANN
035-205-160 16,0 cm / 6 1/4"

Nasenpolypenzangen, Septumzangen
Nasal Polypus Forceps, Septum Forceps
Pinzas para pólipos nasales, Pinzas para tabique nasal
Pinze per polipi nasali, Pinze per il setto nasale



035



HARTMANN

035-207-200 20,0 cm / 8"

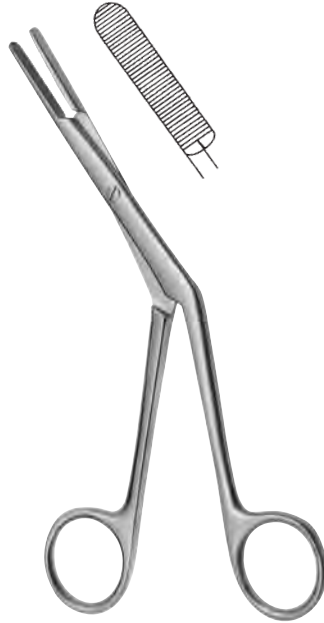

KILLIAN

035-209-170 17,0 cm / 6³/₄"



HEYMANN

035-221-180 18,0 cm / 7"

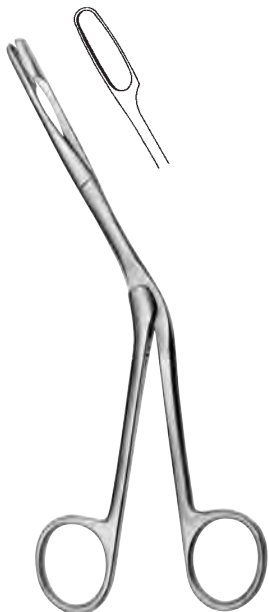

KNIGHT

035-223-180 18,0 cm / 7"

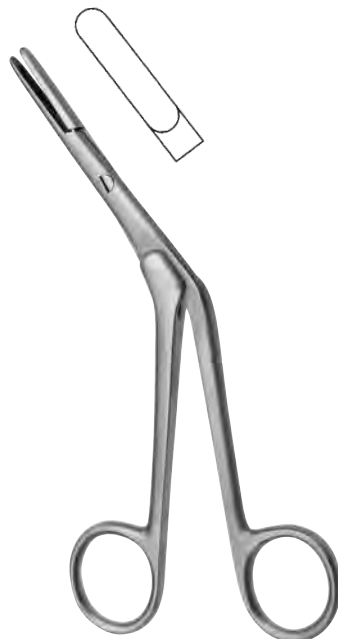

CRAIG

035-225-160 16,0 cm / 6¹/₄"



035-229-001

links gebogen
 left curved
 curva por izquierda
 curva a sinistra



035-229-002

rechts gebogen
 right curved
 curva por derecha
 curva a destra

035-229-001 - 035-229-002

16,0 cm / 6¹/₄"

**Septumzangen, scharfe Nasenzangen
 Septum Forceps, Nasal Cutting Forceps
 Pinzas para tabique nasal, Pinzas nasales cortantes
 Pinze per il setto nasale, Pinze nasale taglienti per il naso**

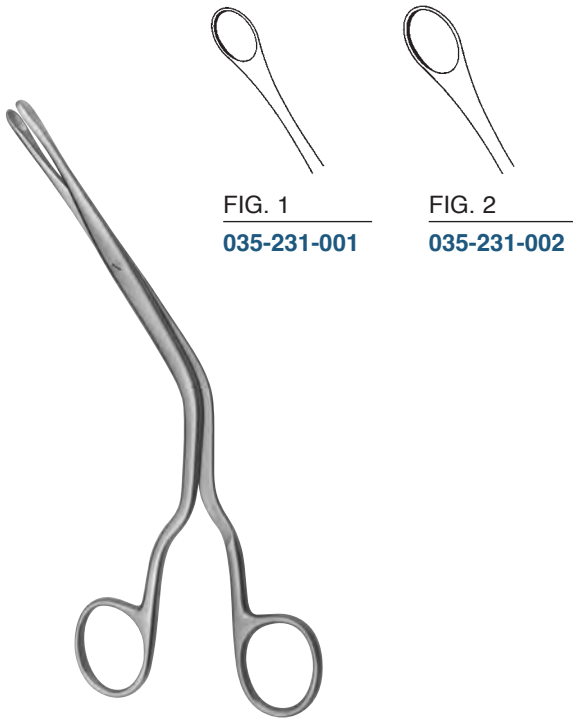

FIG. 1
 035-231-001

FIG. 2
 035-231-002

LUC
 035-231-001 - 035-231-002 20,0 cm / 8"

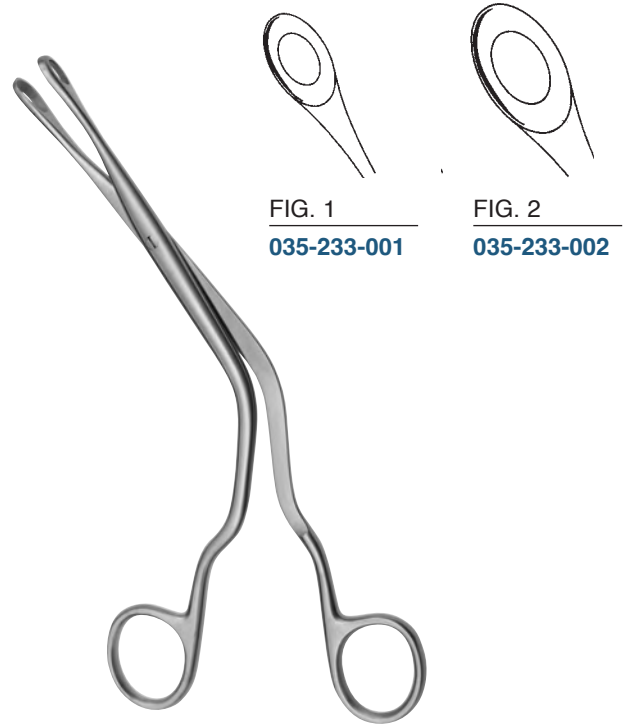

FIG. 1
 035-233-001

FIG. 2
 035-233-002

LUC
 035-233-001 - 035-233-002 19,0 cm / 7 1/2"



FIG. 1
 035-235-001

FIG. 2
 035-235-002

FIG. 3
 035-235-003

FIG. 4
 035-235-004

BRUENINGS
 035-235-001 - 035-235-004 19,0 cm / 7 1/2"

Siebbeinzangen, scharfe Nasenzangen
Ethmoid Bone Forceps, Nasal Cutting Forceps
Pinzas para etmoides, Pinzas nasales cortantes
Pinze etmoidali, Pinze taglienti per il naso



035

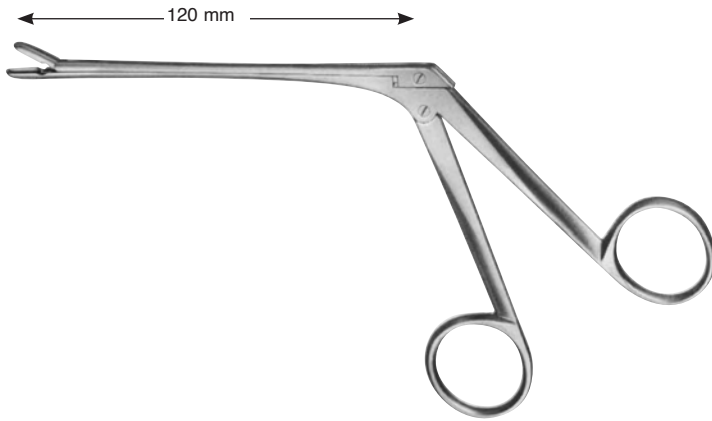

3 x 8 mm



035-240-190

gerade
straight
recto
retto

3 x 8 mm



035-241-190

aufgebogen
bent upwards
curva por arriba
curva in alto

TAKAHASHI

035-240-190 - 035-241-190

19,0 cm / 7 1/2"

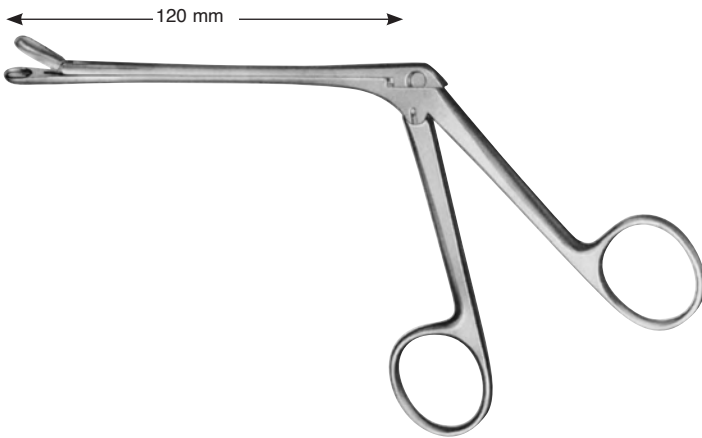

WATSON-WILLIAMS

035-243-190

gerade
straight
recto
retto



035-245-190

gerade
straight
recto
retto

035-243-190 - 035-245-190

19,0 cm / 7 1/2"

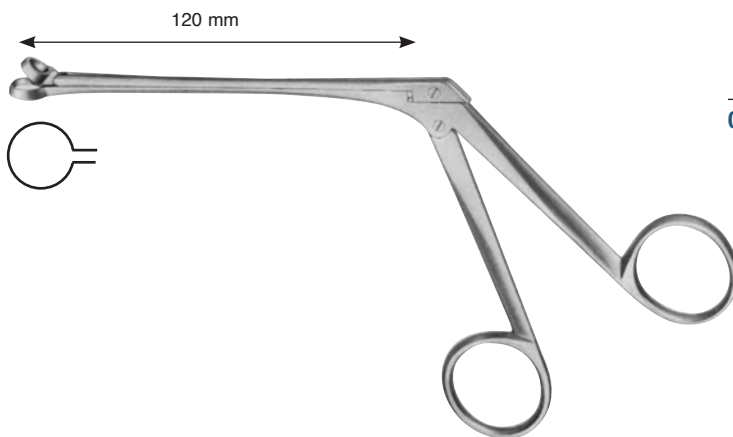

035-251-005 Ø 5 mm



035-251-007 Ø 7 mm



035-251-009 Ø 9 mm



035-251-011 Ø 11 mm

HARTMANN

035-251-005 - 035-251-011

19,0 cm / 7 1/2"

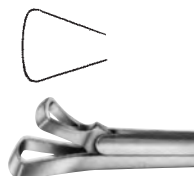

SCHMEDEN

035-253-190

19,0 cm / 7 1/2"

Maulbreite 8,0 mm
jaw width 8,0 mm
anchura de la boca 8,0 mm
larghezza della bocca 8,0 mm

Scharfe Nasenzangen
Nasal Cutting Forceps
Pinzas nasales cortantes
Pinze taglienti per il naso

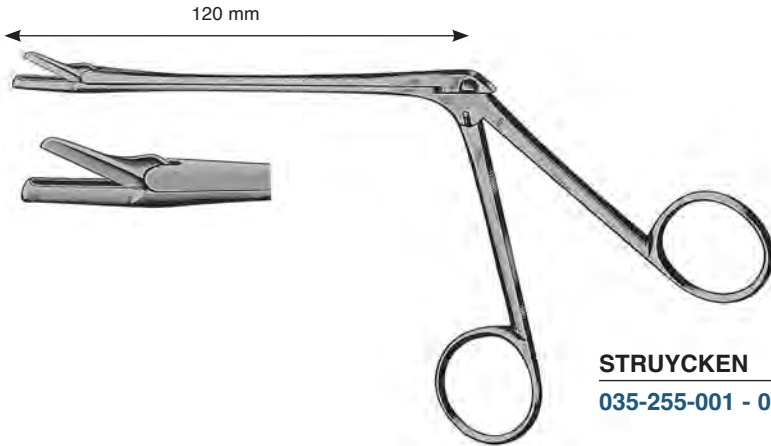

STRUYCKEN

035-255-001 - 035-255-002

19,0 cm / 7 1/2"

FIG. 1

035-255-001

Maulbreite 1,0 mm
 jaw width 1,0 mm
 anchura de la boca 1,0 mm
 larghezza della bocca 1,0 mm

FIG. 2

035-255-002

Maulbreite 1,5 mm
 jaw width 1,5 mm
 anchura de la boca 1,5 mm
 larghezza della bocca 1,5 mm

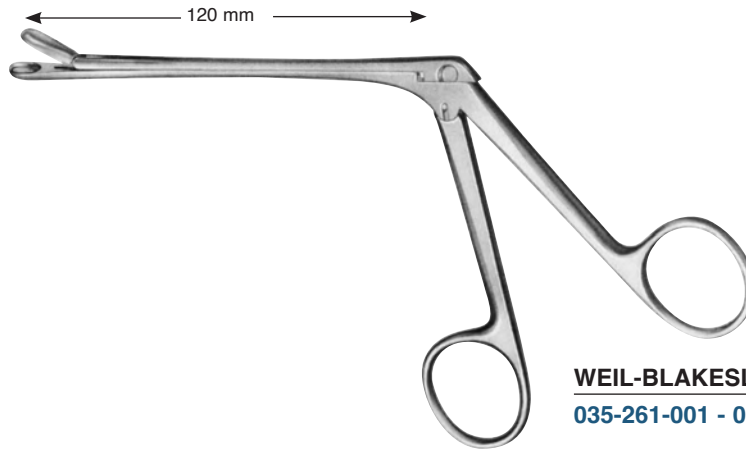

WEIL-BLAKESLEY

035-261-001 - 035-262-005

19,0 cm / 7 1/2"



FIG. 1

035-261-001

Maulbreite 3,0 mm
 jaw width 3,0 mm
 anchura de la boca 3,0 mm
 larghezza della bocca 3,0 mm



FIG. 2

035-261-002

Maulbreite 3,5 mm
 jaw width 3,5 mm
 anchura de la boca 3,5 mm
 larghezza della bocca 3,5 mm



FIG. 3

035-261-003

Maulbreite 4,5 mm
 jaw width 4,5 mm
 anchura de la boca 4,5 mm
 larghezza della bocca 4,5 mm



FIG. 4

035-261-004

Maulbreite 5,0 mm
 jaw width 5,0 mm
 anchura de la boca 5,0 mm
 larghezza della bocca 5,0 mm



FIG. 5

035-261-005

Maulbreite 5,5 mm
 jaw width 5,5 mm
 anchura de la boca 5,5 mm
 larghezza della bocca 5,5 mm



mit Hals
 with neck
 con cuello
 con collo



FIG. 1

035-262-001

Maulbreite 3,0 mm
 jaw width 3,0 mm
 anchura de la boca 3,0 mm
 larghezza della bocca 3,0 mm



FIG. 2

035-262-002

Maulbreite 3,5 mm
 jaw width 3,5 mm
 anchura de la boca 3,5 mm
 larghezza della bocca 3,5 mm



FIG. 3

035-262-003

Maulbreite 4,5 mm
 jaw width 4,5 mm
 anchura de la boca 4,5 mm
 larghezza della bocca 4,5 mm



FIG. 4

035-262-004

Maulbreite 5,0 mm
 jaw width 5,0 mm
 anchura de la boca 5,0 mm
 larghezza della bocca 5,0 mm



FIG. 5

035-262-005

Maulbreite 5,5 mm
 jaw width 5,5 mm
 anchura de la boca 5,5 mm
 larghezza della bocca 5,5 mm

Scharfe Nasenzangen
Nasal Cutting Forceps
Pinzas nasales cortantes
Pinze taglienti per il naso



035

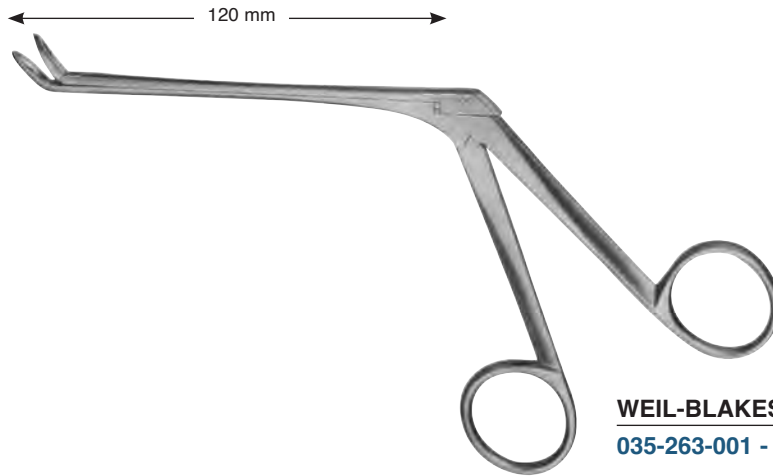

WEIL-BLAKESLEY

035-263-001 - 035-263-004

19,0 cm / 7 1/2"

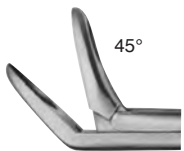

FIG. 1

035-263-001

Maulbreite 3,0 mm
 jaw width 3,0 mm
 anchura de la boca 3,0 mm
 larghezza della bocca 3,0 mm



FIG. 2

035-263-002

Maulbreite 3,5 mm
 jaw width 3,5 mm
 anchura de la boca 3,5 mm
 larghezza della bocca 3,5 mm



FIG. 3

035-263-003

Maulbreite 4,5 mm
 jaw width 4,5 mm
 anchura de la boca 4,5 mm
 larghezza della bocca 4,5 mm



FIG. 4

035-263-004

Maulbreite 5,0 mm
 jaw width 5,0 mm
 anchura de la boca 5,0 mm
 larghezza della bocca 5,0 mm

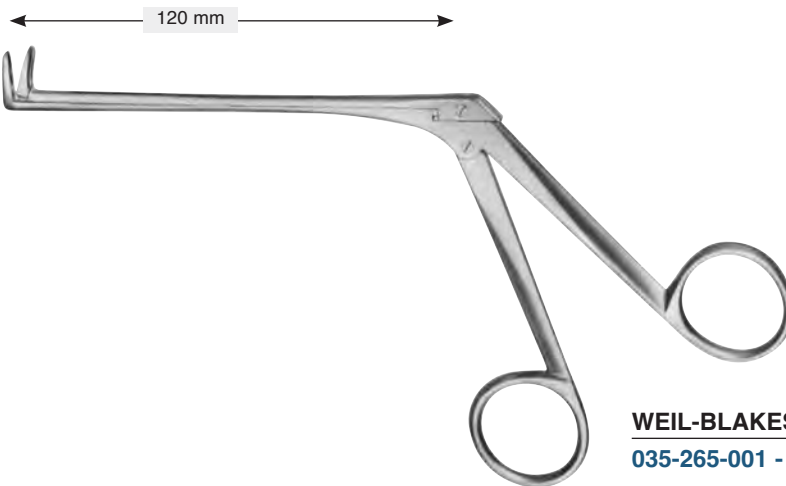

WEIL-BLAKESLEY

035-265-001 - 035-265-004

19,0 cm / 7 1/2"

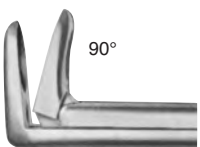

FIG. 1

035-265-001

Maulbreite 3,0 mm
 jaw width 3,0 mm
 anchura de la boca 3,0 mm
 larghezza della bocca 3,0 mm



FIG. 2

035-265-002

Maulbreite 3,5 mm
 jaw width 3,5 mm
 anchura de la boca 3,5 mm
 larghezza della bocca 3,5 mm

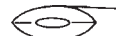

FIG. 3

035-265-003

Maulbreite 4,5 mm
 jaw width 4,5 mm
 anchura de la boca 4,5 mm
 larghezza della bocca 4,5 mm



FIG. 4

035-265-004

Maulbreite 5,0 mm
 jaw width 5,0 mm
 anchura de la boca 5,0 mm
 larghezza della bocca 5,0 mm



035

Scharfe Nasenzangen
Nasal Cutting Forceps
Pinzas nasales cortantes
Pinze taglienti per il naso

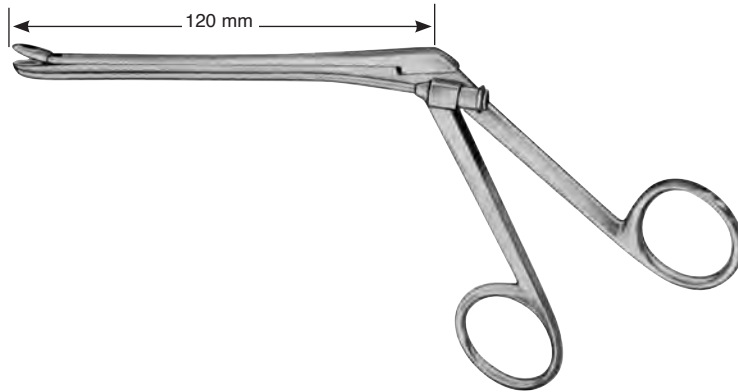

WEIL-BLAKESLEY

035-271-001 - 035-279-003

19,0 cm / 7 1/2"

gerade
 straight
 recta
 retta



035-271-001 2,5 mm



035-271-002 3,6 mm



035-271-003 4,8 mm

45° aufgebogen
 45° up curved
 45° curva arriba
 45° curva in alto



035-273-001 2,5 mm



035-273-002 3,6 mm



035-273-003 4,8 mm

90° aufgebogen
 90° up curved
 90° curva arriba
 90° curva in alto



035-275-001 2,5 mm

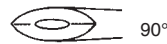

035-275-002 3,6 mm



035-275-003 4,8 mm

rechts gebogen
 right curved
 curva por derecha
 curva a destra



035-277-001 2,5 mm



035-277-002 3,6 mm



035-277-003 4,8 mm

links gebogen
 left curved
 curva por izquierda
 curva a sinistra



035-279-001 2,5 mm



035-279-002 3,6 mm



035-279-003 4,8 mm

Scharfe Nasenzangen, Antrumstanzen
Nasal Cutting Forceps, Antrum Punches
Pinzas nasales cortantes, Pinzas sacabocados para seno maxilar
Pinze taglienti per il naso, Pinze tagliente per seno mascellare



035

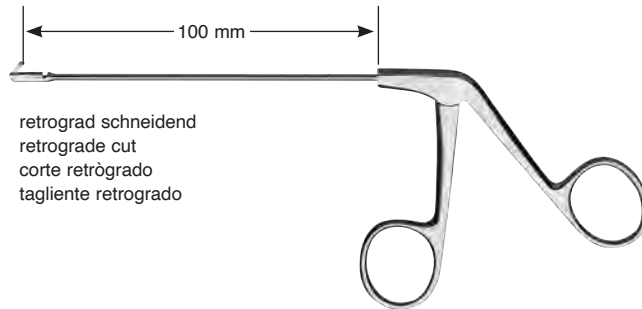

retrograd schneidend
 retrograde cut
 corte retrògrado
 tagliente retrogrado

STAMMBERGER

035-291-001 - 035-291-003

Antrumstanze
 Antrum Punch
 Pinza saca-bocado para seno maxilar
 Pinza tagliente per seno mascellare

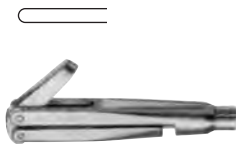

035-291-001 2 mm

oben schneidend
 up cutting
 cortante por arriba
 tagliente in alto



035-291-002 2 mm

rechts schneidend
 righth cutting
 cortante a la derecha
 tagliente a destra



035-291-003 2 mm

links schneidend
 left cutting
 cortante a la izquierda
 tagliente a sinistra

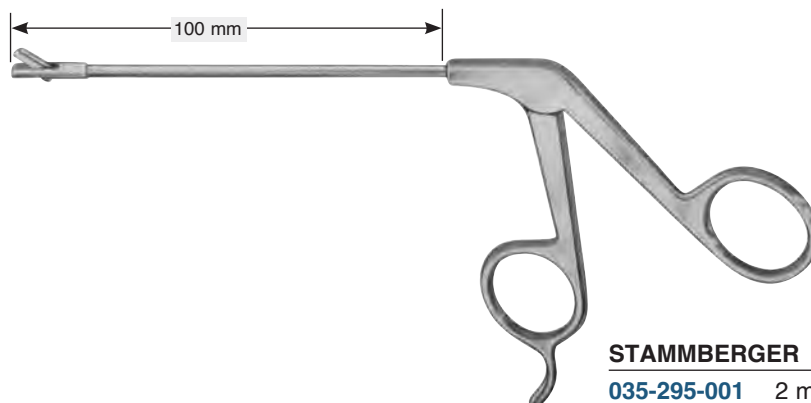

STAMMBERGER

035-295-001 2 mm



035

Nasenscheren
Nasal scissors
Tijeras nasales
Forbici nasale

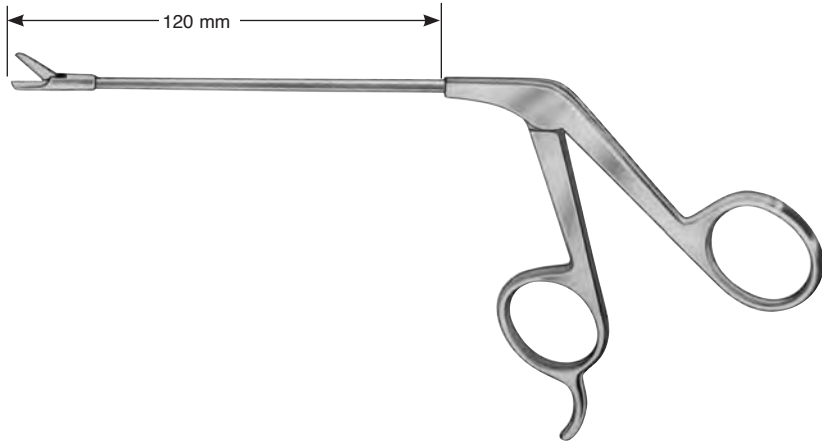

035-301-001 - 035-301-003



035-301-001 Ø 5 mm

gerade schneidend
straight cutting
cortante recto
tagliente retto

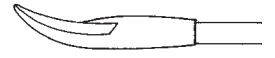

035-301-002 Ø 5 mm

rechts gebogen schneidend
right curved cutting
cortante curva derecha
tagliente curva destra



035-301-003 Ø 5 mm

links gebogen schneidend
left curved cutting
cortante curva izquierda
tagliente curva sinistra

MICRO

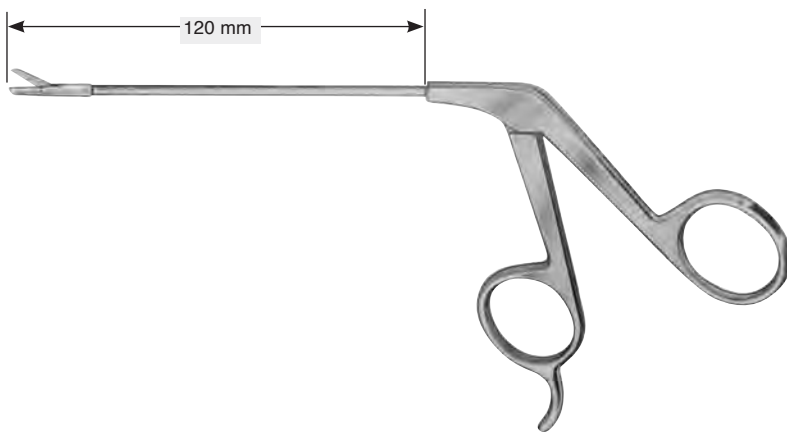

035-305-001 - 035-305-003



035-305-001 Ø 3,5 mm

gerade schneidend
straight cutting
cortante recto
tagliente retto



035-305-002 Ø 3,5 mm

rechts gebogen schneidend
right curved cutting
cortante curva derecha
tagliente curva destra

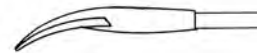

035-305-003 Ø 3,5 mm

links gebogen schneidend
left curved cutting
cortante curva izquierda
tagliente curva sinistra

Septumzangen
Septum Forceps
Pinzas para tabique nasal
Pinze per il setto nasale



035

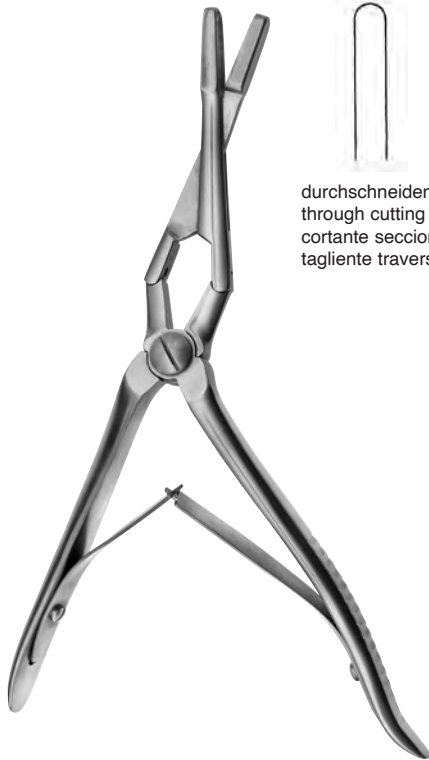

durchschneidend
 through cutting
 cortante seccional
 tagliente trasverso

MIDDLETON-JANSEN

035-321-190 19,0 cm / 7½"



MIDDLETON-JANSEN

035-323-190 19,0 cm / 7½"



eine Schneide gezahnt
 one toothed cutting edge
 una hoja dentada
 una lama dentata

CAPLAN

035-325-200 20,0 cm / 8"



035-328-001

Schutzkappe
 Protection Cap
 Caperuza protectora
 Calotta protettiva

RUBIN

035-327-210 21,0 cm / 8¼"

Keilbeinstanzen
Sphenoid Bone Punches
Pinzas sacabocadas para esfenoides
Pinze taglienti per seno sfenoidale

140 mm



035-340-040

oben schneidend
 up cutting
 cortante por arriba
 tagliente in alto

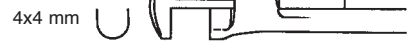

035-342-040

unten schneidend
 down cutting
 cortante por abajo
 tagliente in basso

HAJEK

035-340-040 - 035-342-040

14,0 cm / 5 1/2"

140 mm



035-344-035

oben schneidend
 up cutting
 cortante por arriba
 tagliente in alto



035-346-035

unten schneidend
 down cutting
 cortante por abajo
 tagliente in basso

HAJEK-KOFLER

035-344-035 - 035-346-035

14,0 cm / 5 1/2"

Antrumstanzen, Keilbeinstanzen
Antrum Punches, Sphenoid Bone Punches

Pinzas sacabocadas para seno maxilar, Pinzas sacabocados para esfenoides
Pinze taglianti per seno mascellare, Pinze taglianti per seno sfenoidale



035



3x3 mm



035-350-033

oben schneidend
up cutting
cortante por arriba
tagliante in alto

4x4 mm



035-350-044

oben schneidend
up cutting
cortante por arriba
tagliante in alto

5x5 mm



035-350-055

oben schneidend
up cutting
cortante por arriba
tagliante in alto

6x6 mm



035-350-066

oben schneidend
up cutting
cortante por arriba
tagliante in alto

KERRISON

035-350-033 - 035-350-066

17,0 cm / 6³/₄"



034-450-015 1,5 mm



034-450-020 2,0 mm



034-450-030 3,0 mm

CITELLI

034-450-015 - 034-450-030

17,0 cm / 6³/₄"



035

Rhinoplastik-Messer
Rhinoplastic Knives
Cuchillos para rinoplástica
Bisturi per plastica nasale

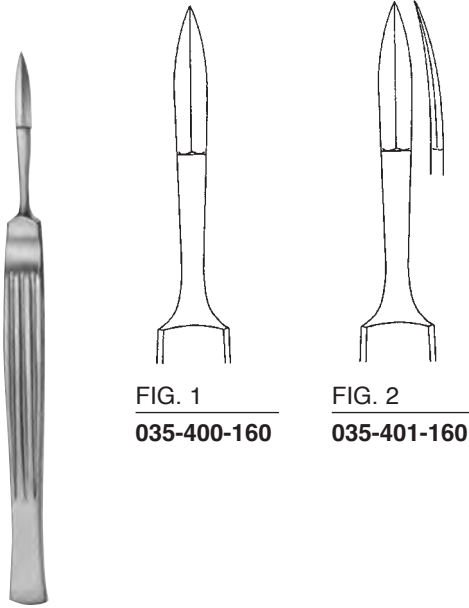

FIG. 1
 035-400-160

FIG. 2
 035-401-160

JOSEPH

035-400-160 - 035-401-160 16,0 cm / 6 1/4"

FOMON

035-405-160 16,0 cm / 6 1/4"

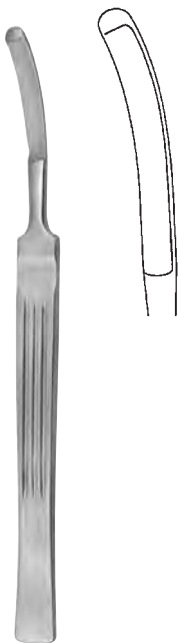

CONVERSE

035-407-160 16,0 cm / 6 1/4"



JOSEPH

035-408-150 15,0 cm / 6"



COTTLE

035-410-150 15,0 cm / 6"

Septummesser
Septum Knives
Cuchillos para tabique nasal
Bisturi per il setto nasale



035



Mukosamesser
Mucosa Knife
cuchillo para mucosa
Bisturi per mucosa

FREER

035-420-165 16,5 cm / 6¹/₂"

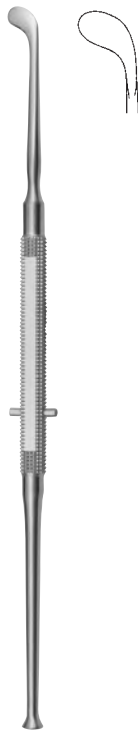

FREER

035-423-190 19,0 cm / 7¹/₂"

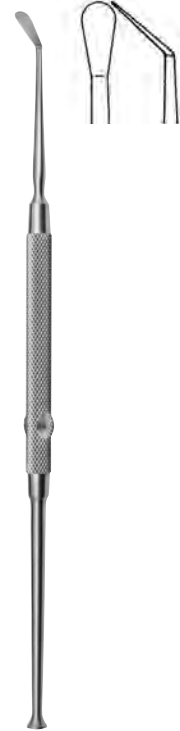

FREER

035-425-190 19,0 cm / 7¹/₂"



035

Septummesser, Schwingmesser
Septum Knives, Swivel Knives
Cuchillos para tabique nasal
Bisturi per il setto nasale



035-430-003 3,0 mm



035-430-004 4,0 mm



035-430-005 5,0 mm

BALENGER

035-430-003 - 035-430-005 21,0 cm / 8¹/₄"



035-431-003 3,0 mm



035-431-004 4,0 mm



035-431-005 5,0 mm

BALENGER

035-431-003 - 035-431-005 21,0 cm / 8¹/₄"

**Septumelevatoren
Septum Elevators
Elevadores para tabique nasal
Elevatori per il setto nasale**



035



Septummesser
Septum Knife
Cuchillo para tabique nasal
Bisturi per il setto nasale

BRUENINGS

035-435-165 16,5 cm / 6 1/2"



4 mm

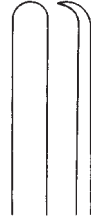

035-441-004

5 mm

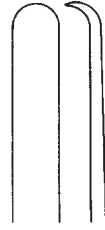

035-441-005

MC KENTY

035-441-004 - 035-441-005 15,0 cm / 6"

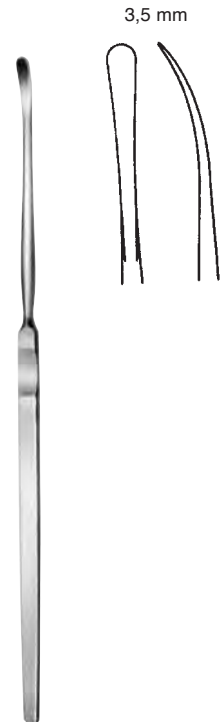

3,5 mm



HALLE

035-443-160 16,0 cm / 6 1/4"



4 mm



JOSEPH

035-445-160 16,0 cm / 6 1/4"



5 mm



035-449-190

scharf
sharp
agudo
acuto

6 mm



035-451-190

stumpf
blunt
romo
smusso

FREER

035-449-190 - 035-451-190 19,0 cm / 7 1/2"



5 mm

scharf / stumpf
sharp / blunt
agudo / romo
acuto / smusso

FREER

035-455-180 18,0 cm / 7"

5 mm





035

Septumelevatoren
Septum Elevators
Elevadores para tabique nasal
Elevatori per il setto nasale

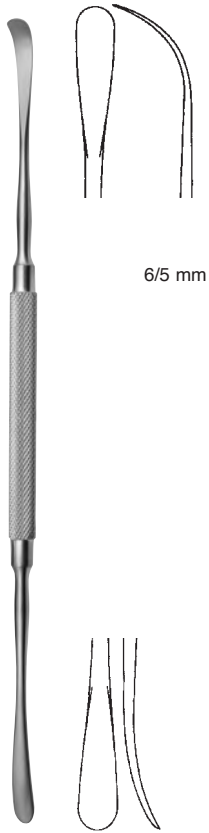

6/5 mm

FREER

035-457-205 20,5 cm / 8"



4 / 4 mm

MC KENTY

035-459-220 22,0 cm / 8³/₄"

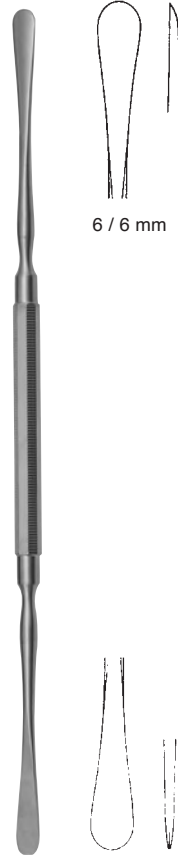

6 / 6 mm

BALLENGER-HAJEK

035-460-220 22,0 cm / 8³/₄"



5 / 5 mm

COTTLE

035-463-235 23,5 cm / 9¹/₄"

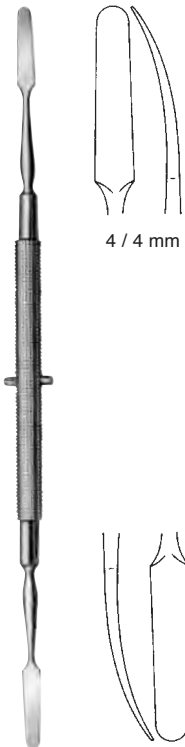

4 / 4 mm

KILIAN

035-465-180 18,0 cm / 7"

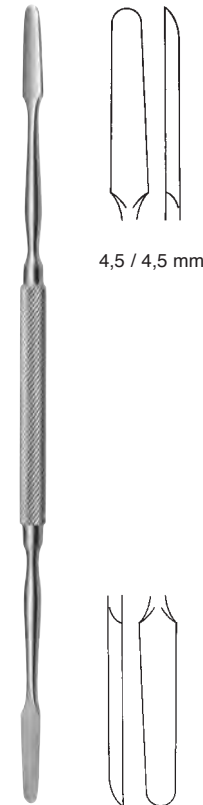

4,5 / 4,5 mm

KILIAN

035-468-220 22,0 cm / 8³/₄"

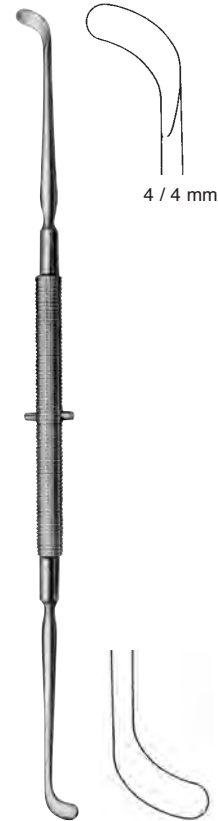

4 / 4 mm

PENNINGTON

035-469-215 21,5 cm / 7¹/₄"

Periostelevatorien
Periosteal Elevators
Legras para periostio
Elevatori per il perisoto



035



4 / 4 mm

ROGER

035-481-195 19,5 cm / 7³/₄"



4 mm

JOSEPH-MASING

035-483-215 21,5 cm / 8¹/₂"

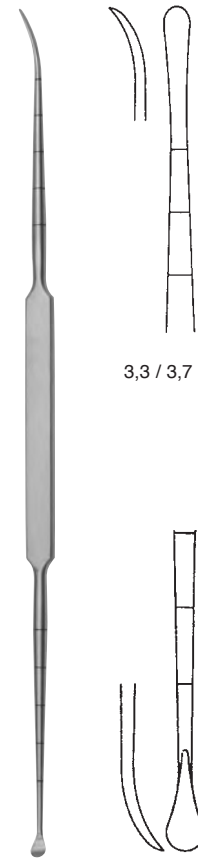

3,3 / 3,7 mm

COTTLE

035-485-220 22,0 cm / 8³/₄"

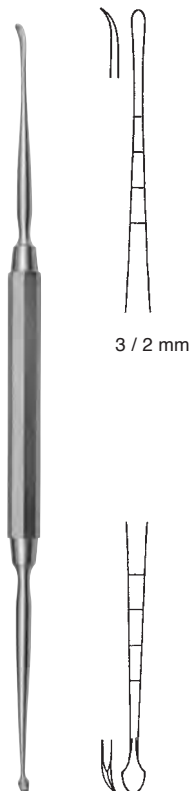

3 / 2 mm

MASING

035-487-210 21,0 cm / 8¹/₄"



4,5 / 4,5 mm

COTTLE

035-489-210 21,0 cm / 8¹/₄"

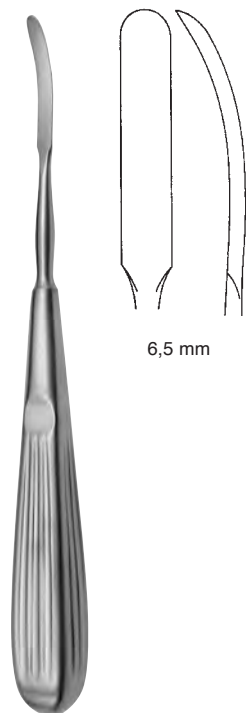

6,5 mm

JOSEPH

035-493-160 16,0 cm / 8¹/₄"



035

Septummeißel
Septum Chisels
Cinceles para tabique nasal
Scalpello per il setto nasale



4 mm

FREER

035-500-160 16,0 cm / 6¹/₄"



4 mm

FREER

035-501-160 16,0 cm / 6¹/₄"

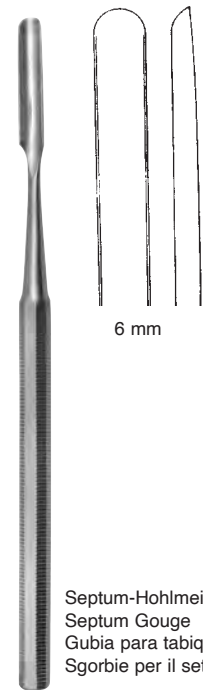

6 mm

Septum-Hohlmeißel
Septum Gouge
Gubia para tabique nasal
Sgorbie per il setto nasale

FREER

035-510-150 15,0 cm / 6"

Septum-Hohlmeißel
 Septum Gouges
 Gubias para tabique nasal
 Sgorbie per il setto nasale



035



035-520-002 2 mm



035-520-004 4 mm



035-520-006 6 mm

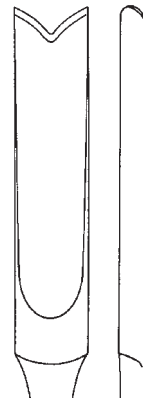

035-520-008 8 mm

BALLENGER

035-520-002 - 035-520-008 15,0 cm / 6"



5 mm

KILLIAN

035-525-160 16,0 cm / 6 1/4"

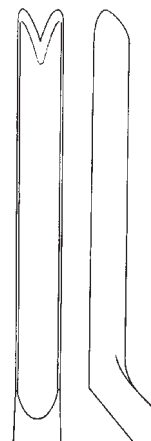

5 mm

KILLIAN

035-529-160 16,0 cm / 6 1/4"



035

**Osteotome
Osteotomes
Osteótomos
Osteotomi**



035-530-004 4 mm



035-530-007 7 mm



035-530-009 9 mm



035-530-012 12 mm

COTTLE

035-530-004 - 035-530-012 18,0 cm / 7"

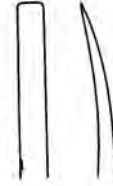

6 mm

COTTLE

035-535-006 18,0 cm / 7"



035-540-004 4 mm



035-540-007 7 mm



035-540-009 9 mm

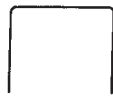

035-540-012 12 mm

COTTLE

035-540-004 - 035-540-012 18,0 cm / 7"

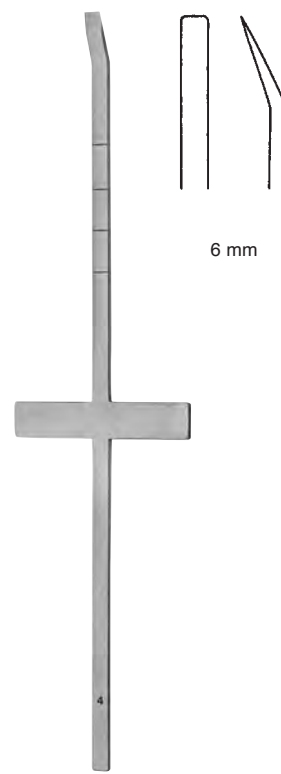

6 mm

COTTLE

035-543-006 18,0 cm / 7"

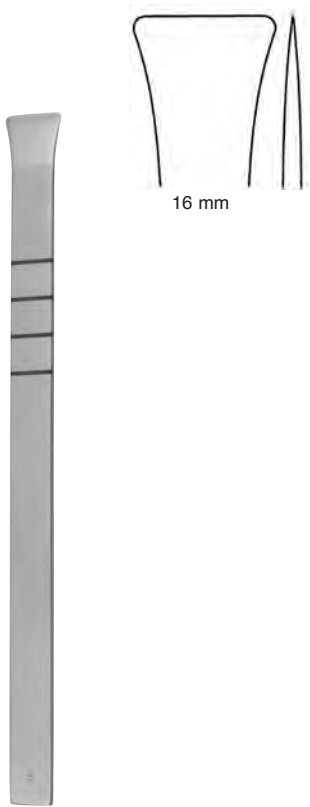

16 mm

COTTLE

035-546-016 18,0 cm / 7"

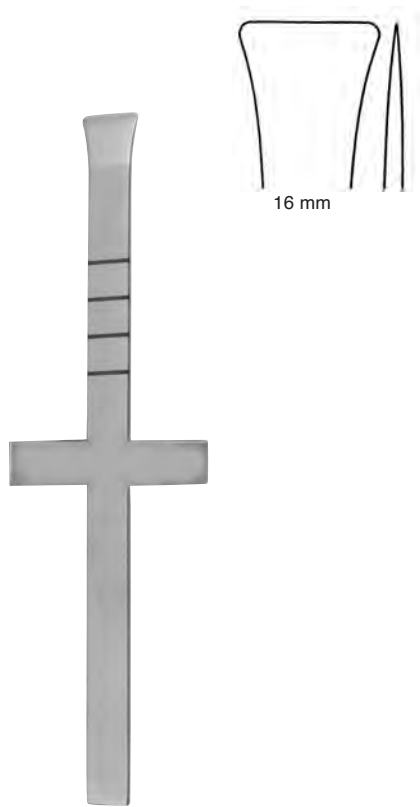

16 mm

COTTLE

035-548-016 18,0 cm / 7"

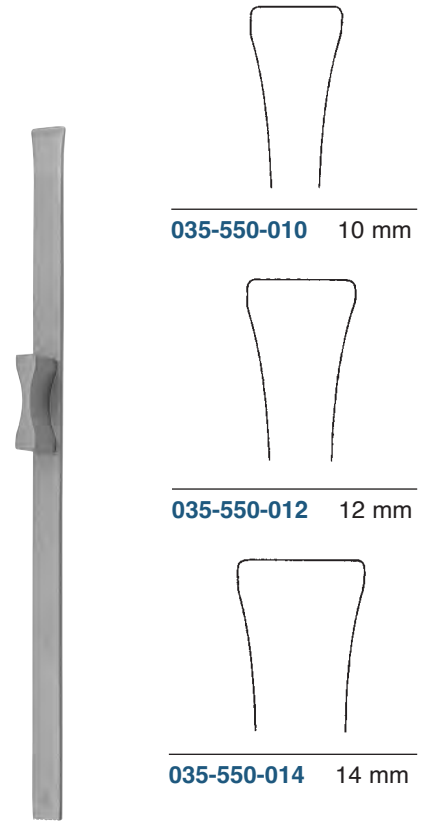

035-550-010 10 mm

035-550-012 12 mm

035-550-014 14 mm

RUBIN

035-550-010 - 035-550-014 18,0 cm / 7"

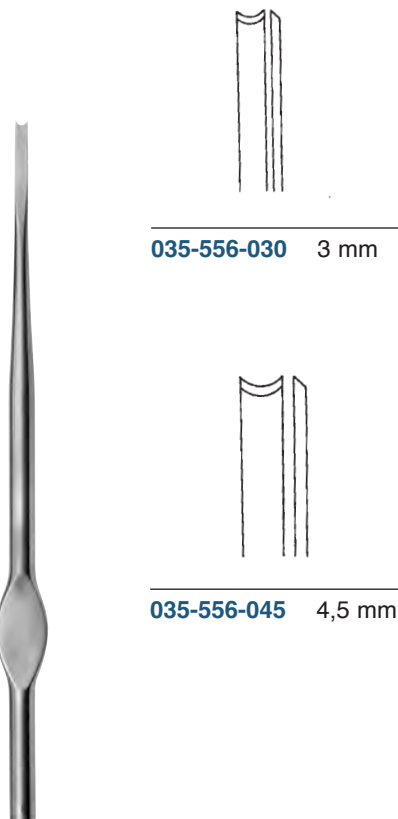

035-556-030 3 mm

035-556-045 4,5 mm

WALTER

035-556-030 - 035-556-045 19,0 cm / 7½"

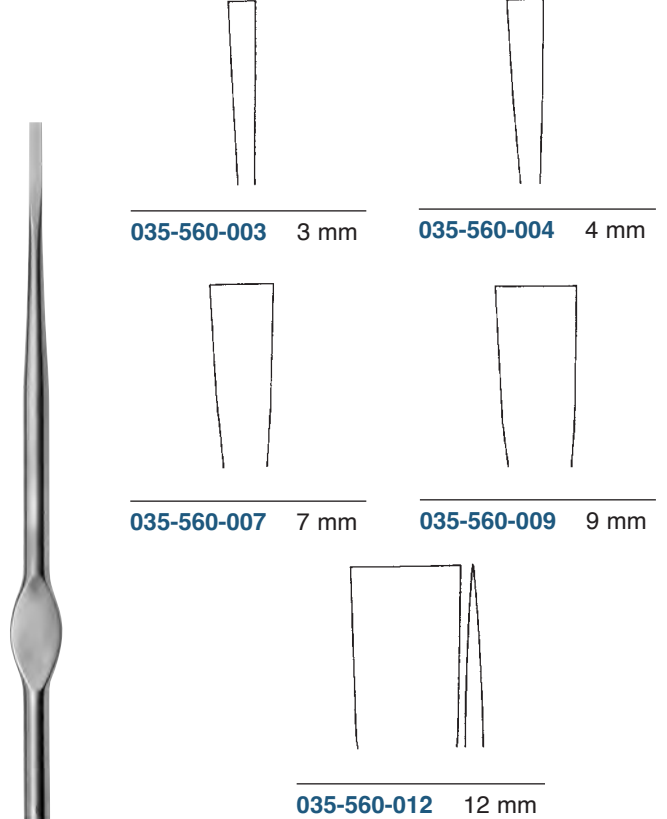

035-560-003 3 mm

035-560-004 4 mm

035-560-007 7 mm

035-560-009 9 mm

035-560-012 12 mm

WALTER

035-560-003 - 035-560-012 19,0 cm / 7½"



035

**Osteotome
Osteotomes
Osteótomos
Osteotomi**

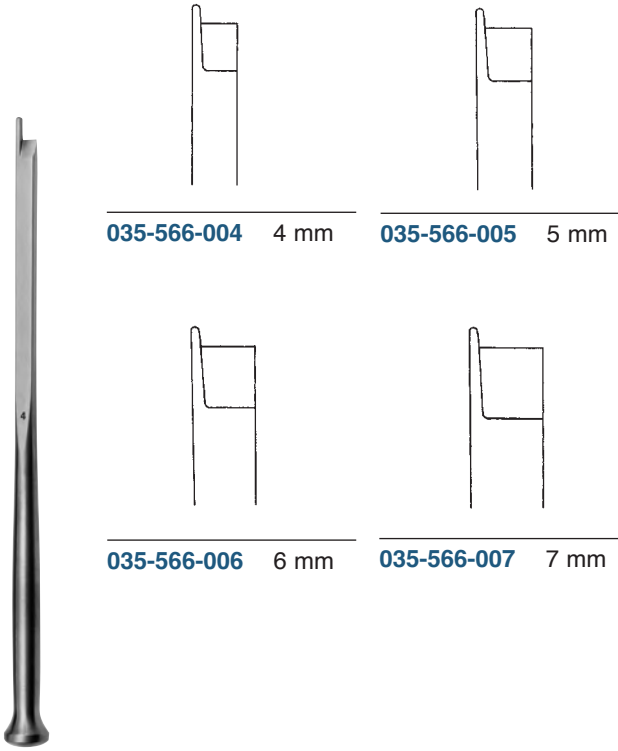

035-566-004 4 mm

035-566-005 5 mm

035-566-006 6 mm

035-566-007 7 mm

FOMON

035-566-004 - 035-566-007 16,0 cm / 6 1/4"

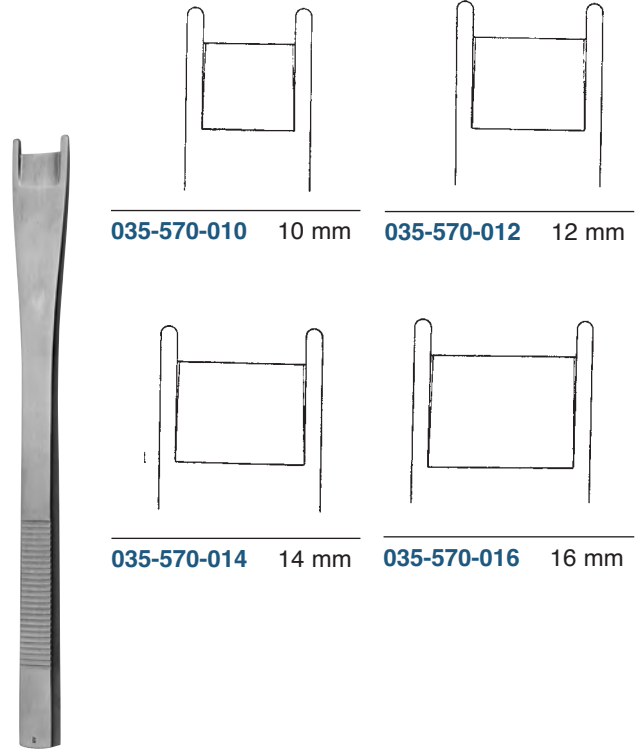

035-570-010 10 mm

035-570-012 12 mm

035-570-014 14 mm

035-570-016 16 mm

CINELLI

035-570-010 - 035-570-016 16,0 cm / 6 1/4"

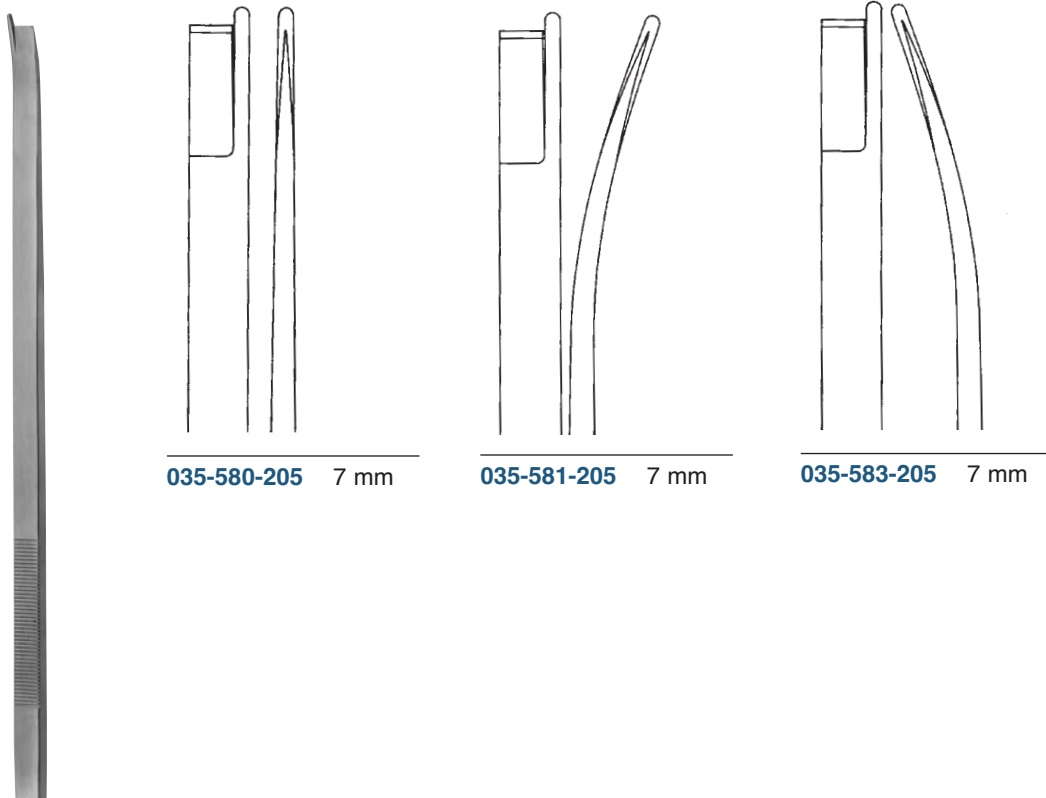

035-580-205 7 mm

035-581-205 7 mm

035-583-205 7 mm

NEIVERT-ANDERSON

035-580-205 - 035-583-205 20,5 cm / 8"



035-590-002 2 mm



035-590-003 3 mm



035-50-004 4 mm



035-590-005 5 mm



035-590-006 6 mm



035-590-007 7 mm



035-590-008 8 mm



035-590-010 10 mm

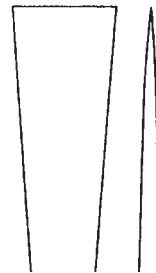

035-590-012 12 mm

SHEEHAN

035-590-002 - 035-590-012 15,0 cm / 6"



035

**Osteotome
Osteotomes
Osteótomos
Osteotomi**



5 mm

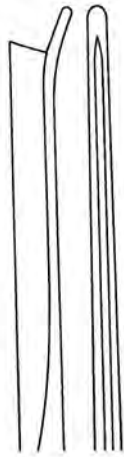

035-594-001

gerade
straight
recto
retto

5 mm

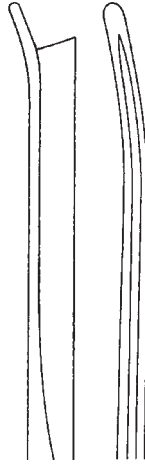

035-594-002

rechts
right
derecho
destra

5 mm

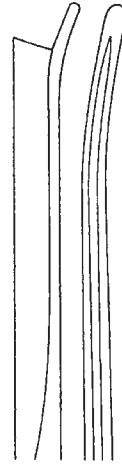

035-594-003

links
left
izquierdo
sinistra

SILVER

035-594-001 - 035-594-003

18,0 cm / 7"

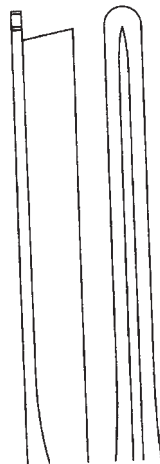

PARKES

035-596-160 16,0 cm / 6 1/4"



links abgewinkelt
 angeled to left
 angulado por izquierdo
 anguato a sinistra

JOSEPH

035-611-001 17,0 cm / 6³/₄"



rechts abgewinkelt
 angeled to right
 angulado por derecho
 anguato a destra

JOSEPH

035-611-002 17,0 cm / 6³/₄"

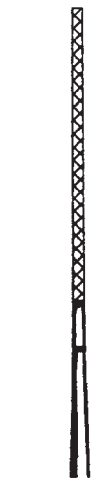

035-620-190

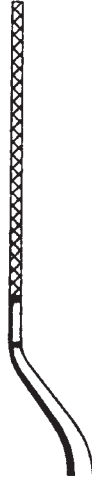

035-621-190



035-623-190

Arbeitslänge 40 mm
 working length 40 mm
 longitud de la punta 40 mm
 lunghezza utile 40 mm

JOSEPH

035-620-190 - 035-623-190 19,0 cm / 7¹/₂"

Knorpelquetsche
 Cartilage Crusher
 Machacadora
 Torchio per cartilagine

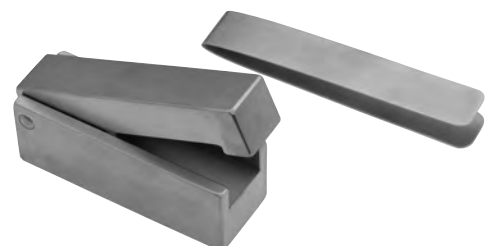

COTTLE

035-630-000

Nasenraspeln, Knochenfeilen, Antrumraspeln
Nasal Rasps, Bone Files, Antrum Rasps
Escofinas nasales, Limas para huesos, Escofinas para el antro
Raspe nasali, Lime per ossa, Raspe per seno mascellare

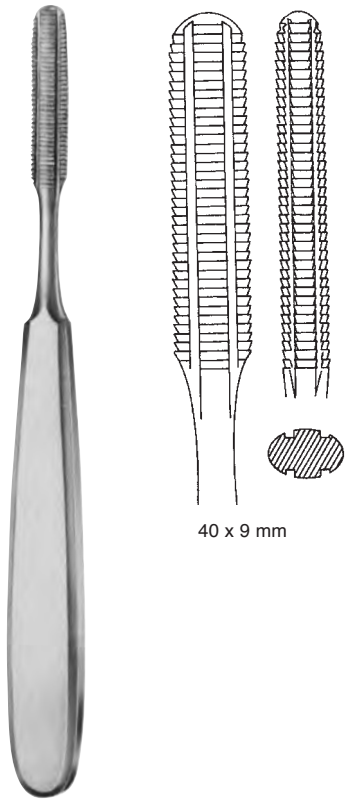

40 x 9 mm

MALTZ

035-650-175 17,5 cm / 7"

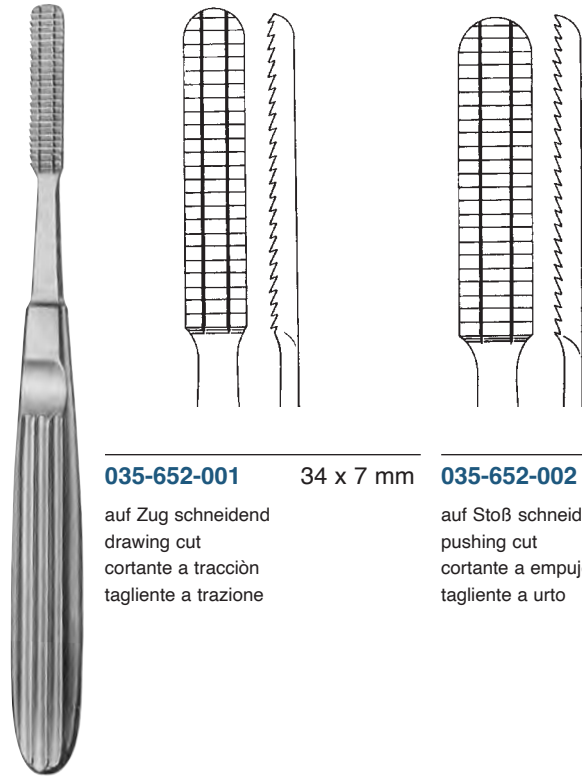

035-652-001 34 x 7 mm

auf Zug schneidend
drawing cut
cortante a traccion
tagliante a trazione

035-652-002 34 x 7 mm

auf Stoß schneidend
pushing cut
cortante a empuje
tagliante a urto

MALTZ

035-652-001 - 035-652-002 17,0 cm / 6³/₄"

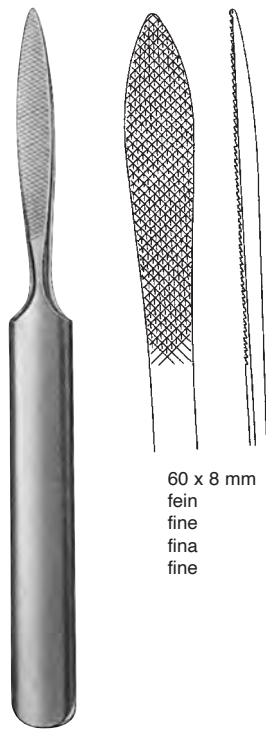

60 x 8 mm
fein
fine
fina
fine

JOSEPH

035-654-160 16,0 cm / 6¹/₄"

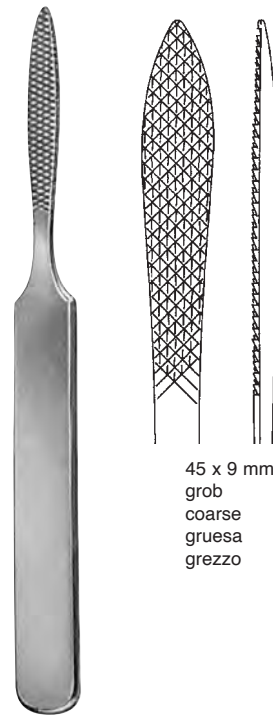

45 x 9 mm
grob
coarse
gruesa
grezzo

JOSEPH

035-655-160 16,0 cm / 6¹/₄"

Nasenraspeln, Knochenfeilen, Antrumraspeln
Nasal Rasps, Bone Files, Antrum Rasps
Escofinas nasales, Limas para huesos, Escofinas para el antro
Raspe nasali, Lime per ossa, Raspe per seno mascellare



035

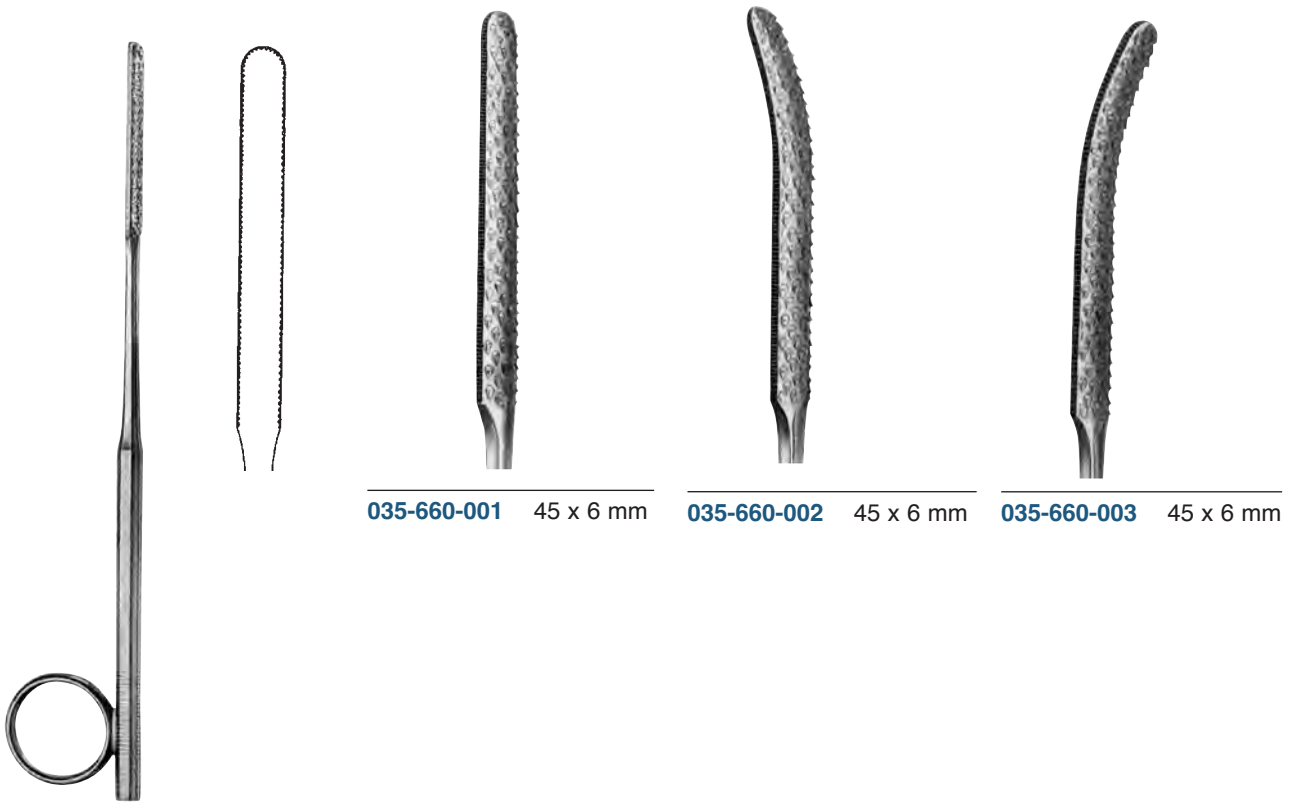

035-660-001 45 x 6 mm

035-660-002 45 x 6 mm

035-660-003 45 x 6 mm

GALLAHER

035-660-001 - 035-660-003 17,0 cm / 6³/₄"

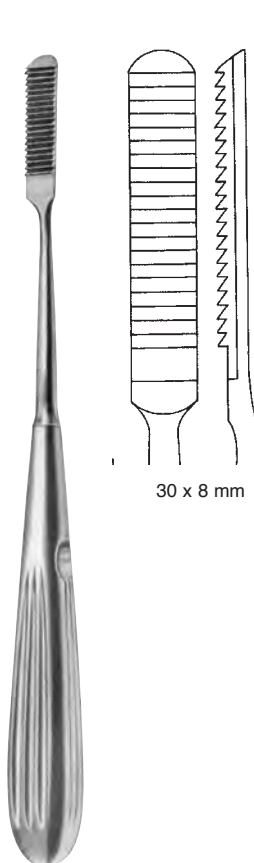

30 x 8 mm

COTTLE

035-664-210 21,0 cm / 8¹/₄"

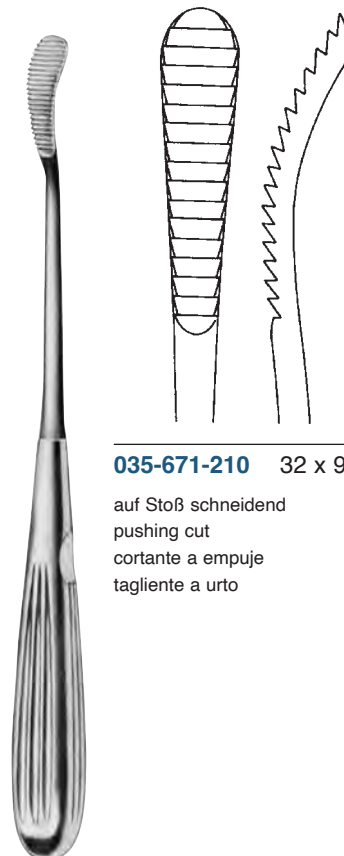

035-671-210 32 x 9 mm

auf Stoß schneidend
 pushing cut
 cortante a empuje
 tagliente a urto

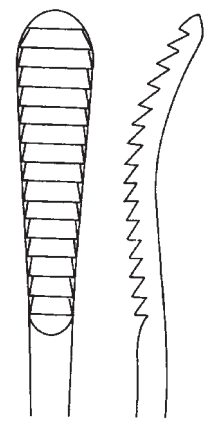

035-673-210 32 x 9 mm

auf Zug schneidend
 drawing cut
 cortante a traccion
 tagliente a trazione

AUFRIECHT

035-671-210 - 035-673-210 21,0 cm / 8¹/₄"



035

Nasenraspeln
Nasal Rasps
Escofinas nasales
Raspe nasali

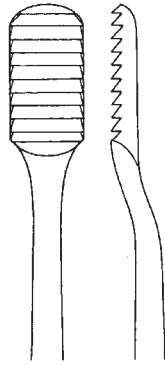

035-674-190

auf Zug schneidend
drawing cut
cortante a traccion
tagliente a trazione

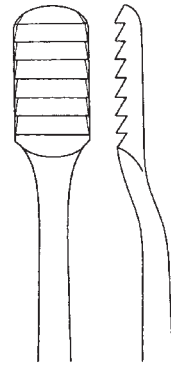

035-676-190

auf Zug schneidend
drawing cut
cortante a traccion
tagliente a trazione

LEWIS

035-674-190 - 035-676-190 19,0 cm / 7 1/2"



fein / grob
fine / coarse
fina / gruesa
fino / grezzo

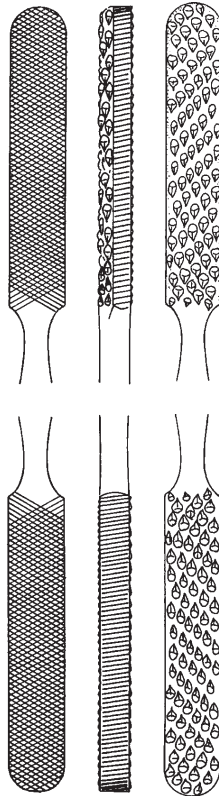

30 x 8 mm

FOMON

035-680-210 21,0 cm / 8 1/4"

TC

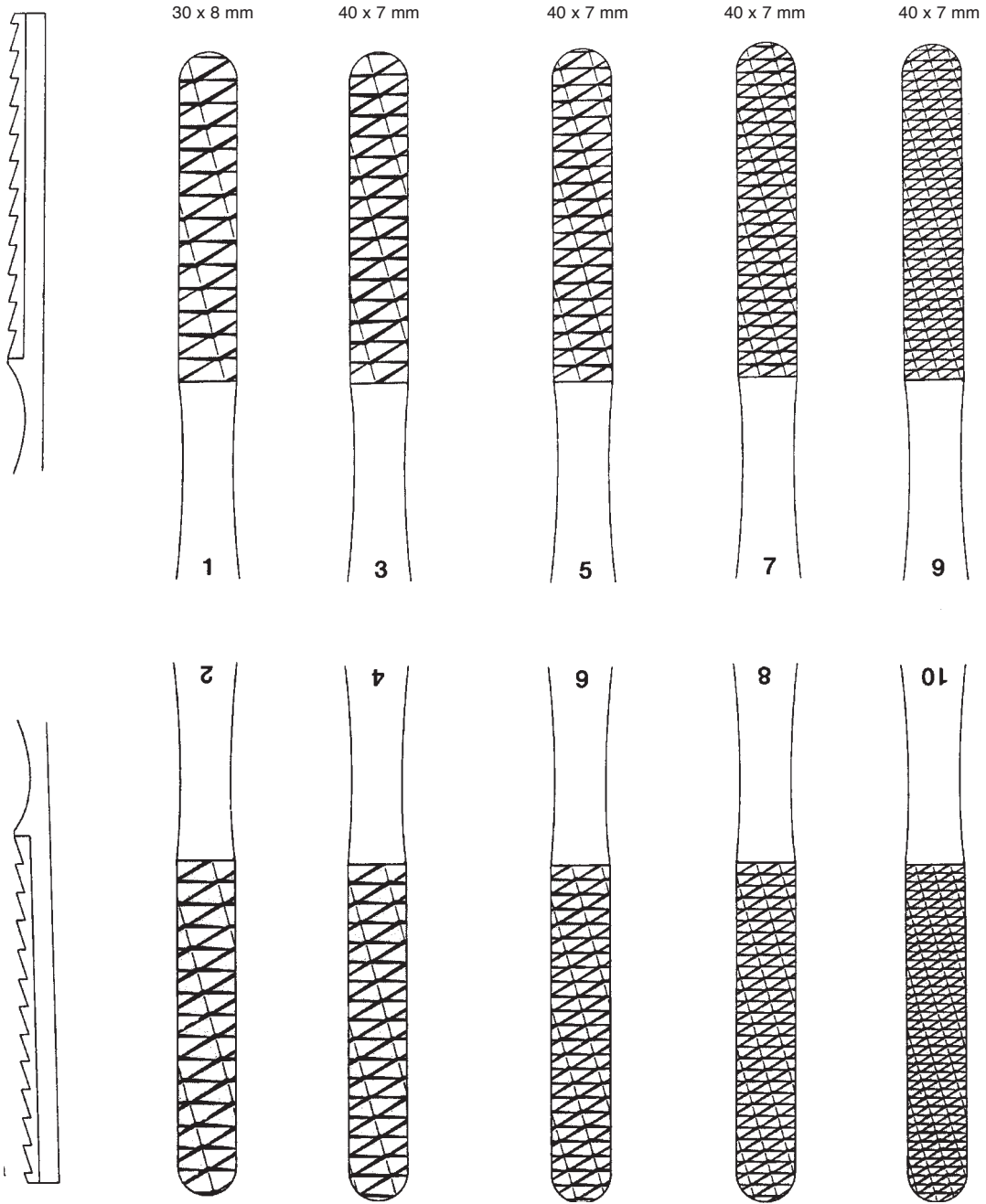

Fig. 1/2
 035-690-012

Fig. 3/4
 035-690-034

Fig. 5/6
 035-690-056

Fig. 7/8
 035-690-078

Fig. 9/10
 035-690-090

FOMON

035-690-012 - 035-690-090

20,5 cm / 8"



035

Nasenhäkchen, Nasenhaken
Nasal Hooks, Nasal Retractors
Ganchitos nasales, Separadores nasales
Uncini nasali, Divaricatori nasali



scharf
sharp
agudo
acuto

COTTLE

035-701-170 17,0 cm / 6³/₄"



035-703-001

scharf
sharp
agudo
acuto



035-703-002

scharf
sharp
agudo
acuto



035-703-003

scharf
sharp
agudo
acuto

COTTLE

035-703-001 - 035-703-003 14,5 cm / 5³/₄"



Knopfende
button end
punta abotonada
fine abbottonato

LANGE

035-705-220 22,0 cm / 8³/₄"

Nasenflügelhäkchen
Alar Hooklet
Ganchito para alas de nariz
Uncino per le inne
nasali

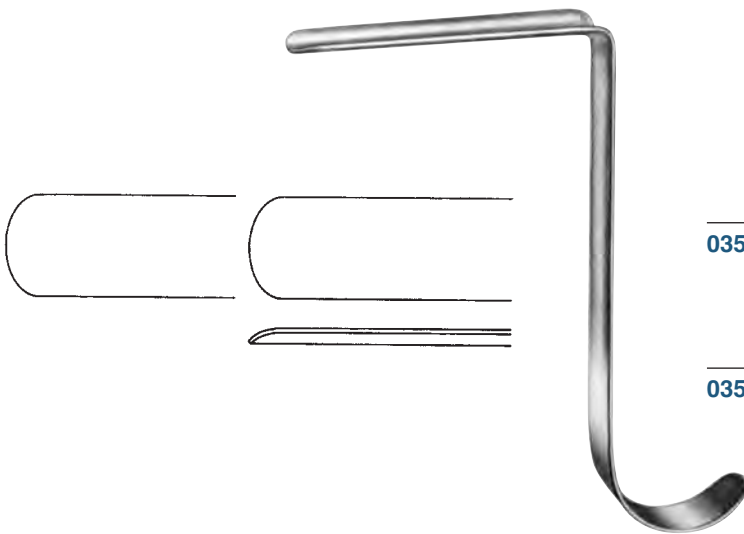

035-709-001 20 x 9 mm

035-709-002 28 x 13 mm

035-709-003 41 x 13 mm

035-709-004 60 x 14 mm

CONVERSE

035-709-001 - 035-709-004 9,0 cm / 3¹/₂"



FOMON

035-711-170 17,0 cm / 7¹/₂"

Nasenflügelhäkchen
Alar Hooklet
Ganchito para alas de nariz
Uncino per le inne
nasali

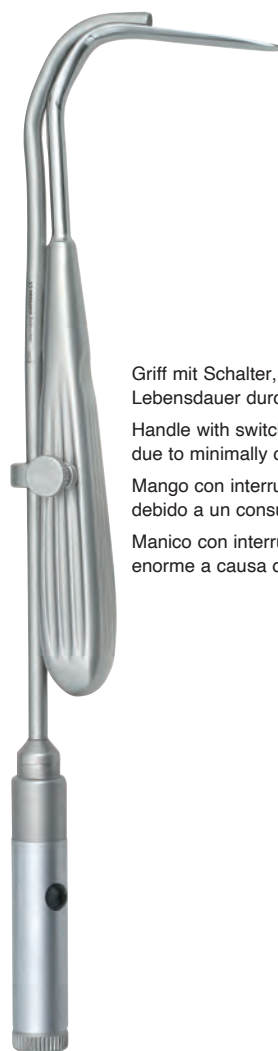

Griff mit Schalter, integrierter Batterie. Extrem lange Lebensdauer durch minimale Stromaufnahme.

Handle with switch, included battery. Substandard lifetime due to minimally current consumption.

Mango con interruptor, batería incluida. Enorme vida útil debido a un consumo mínimo de corriente.

Manico con interruttore, batteria inclusa. La vita utile ed enorme a causa di un minimo consumo di corrente.

035-716-215 21,5 cm / 8¹/₂"

Nasentrückenhaken mit Fiberglas-Lichtträger
Nasal retractor with fiber optic light carrier
Separador nasal con portador de luz fibra óptica
Divaaricatore nasale con supporto per illuminazione fibra ottica

Nasenhäkchen
Nasal Hooks
Ganchitos nasales
Uncini nasali

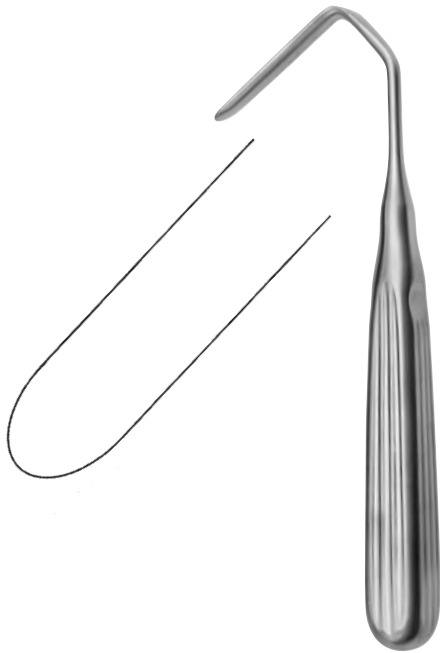

AUFRICHT
035-715-160 16,0 cm / 6¹/₄"



KILNER
035-717-080 8,0 cm / 3¹/₂"

Nasenflügelhäkchen
 Alar Hooklet
 Ganchito para alas de nariz
 Uncino per le inne
 nasali

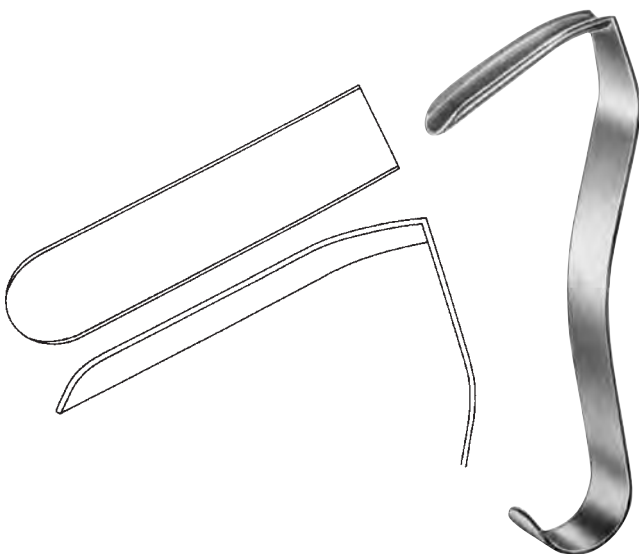

Blatt 45 x 10 mm
 blade 45 x 10 mm
 hoja 45 x 10 mm
 lama 45 x 10 mm

CONVERSE
035-719-105 10,5 cm / 4"

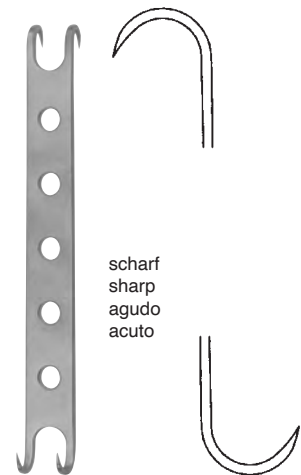

scharf
 sharp
 agudo
 acuto

CONVERSE
035-721-115 12cm / 4³/₄"

Nasenflügelhäkchen
 Alar Hooklet
 Ganchito para alas de nariz
 Uncino per le inne
 nasali



scharf
 sharp
 agudo
 acuto

FREER

035-723-150 15,0 cm / 6"



JOSEPH

035-725-001 15,0 cm / 6"

Schleimhauthäkchen
 Mucosa Hooklet
 Ganchito para mucosa
 Uncino per mucosa



JOSEPH

035-725-002 - 035-725-010 16,0 cm / 6 1/4"



035-725-002

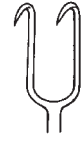

035-725-005



035-725-007



035-725-010

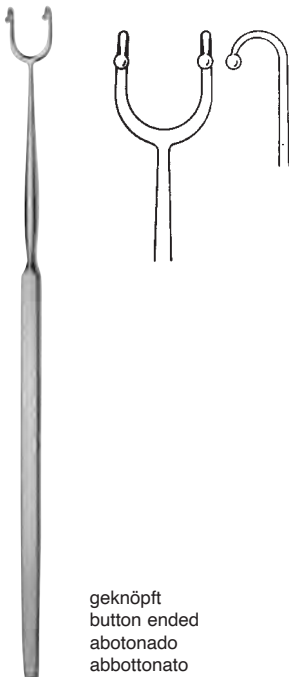

geknöpft
 button ended
 abotonado
 abbottonato

FOMON

035-729-160 16,0 cm / 6 1/4"



geknöpft
 button ended
 abotonada
 abbottonato

COTTLE-NEIVERT

035-731-200 20,0 cm / 8"



035-733-001

scharf
 sharp
 agudo
 acuto



035-733-002

geknöpft / scharf
 button end / sharp
 abotonado / agudo
 abbotto nato / acuto



035-733-003

scharf / geknöpft
 sharp / button end
 agudo / abotonado
 acuto / abbottonato

COTTLE

035-733-001 - 035-733-003 14,5 cm / 5 3/4"



035

Nasenflügelhäkchen
Alar Hooklets
Ganchitos para alas de nariz
Uncini per le pinne nasali

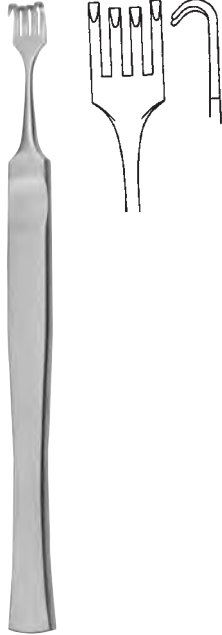

COTTLE
035-735-140 14,0 cm / 5 1/2"



NEIVERT
035-737-170 17,0 cm / 6 3/4"



COTTLE
035-741-140 14,0 cm / 5 1/2"

Sattelhäkchen
 Saddle Hook
 Separador en forma de silla
 Elevatori in forma di sella



COTTLE
035-743-160 16,0 cm / 6 1/4"



Blatt
 blade
 hoja
 lama
 60 x 6,5 mm

stumpf
 blunt
 romo
 smusso

AUFRICHT
035-745-120 12,0 cm / 4 3/4"

Septumzangen, Septumrichtzangen, Hautfasspinzetten
 Septum Forceps, Septum Straightening Forceps, Skin Grasping Forceps
 Pinzas para tabique nasal, Pinzas para enderezar el tabique nasal, Pinzas para piel
 Pinze per il setto nasale, Pinze per raddizzare il setto nasale, Pinze per afferrare la pelle



035

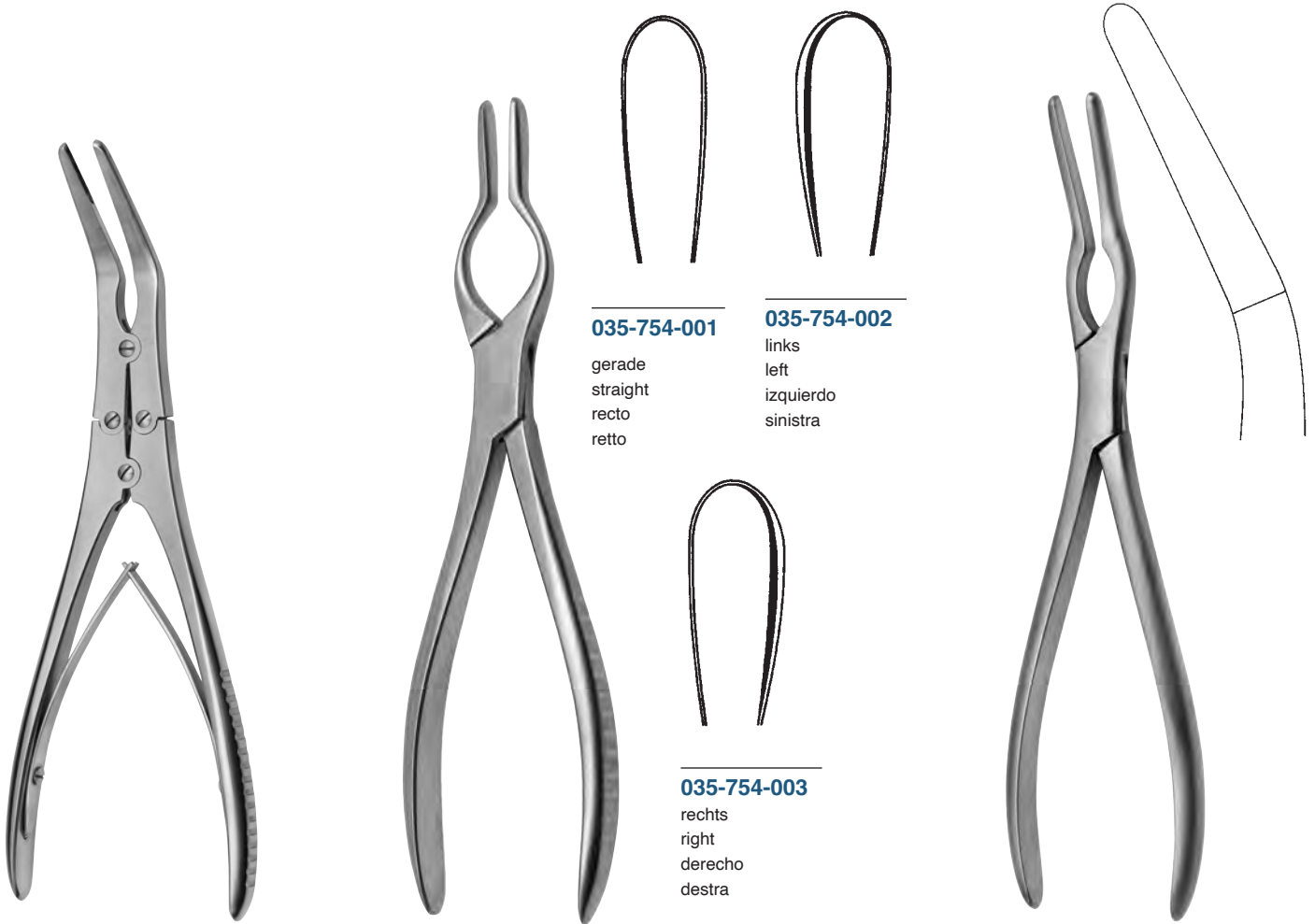

KRESSNER
 035-751-210 21,0 cm / 8¹/₄"

COTTLE-WALSHAM
 035-754-001 - 035-754-003 23,0 cm / 9"

ASCH
 035-757-225 22,5 cm / 8³/₄"

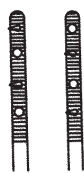

1,7 mm breit mit Zähnen
 1,7 mm wide with teeth
 1,7 mm de ancho con dientes
 largo 1,7 mm con denti

COTTLE
 035-765-140 14,0 cm / 5¹/₂"

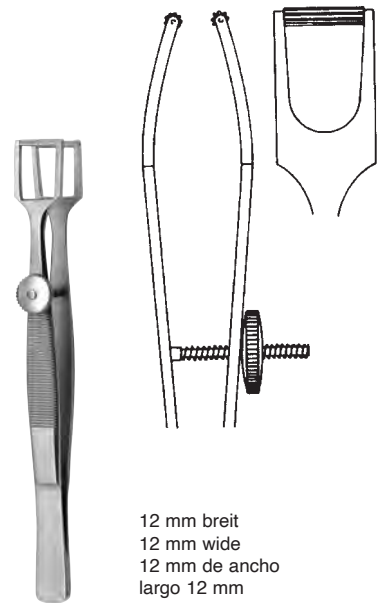

12 mm breit
 12 mm wide
 12 mm de ancho
 largo 12 mm

COTTLE
 035-766-110 11,0 cm / 4¹/₄"



035

Ringmesser
Adenoid Currettes
Cuchillos para adenoides
Coltelli per vegetazioni adenoidee



FAULKNER

035-781-210 21,0 cm / 8¹/₄"



COAKLEY

035-785-001 - 035-785-006 17,0 cm / 6³/₄"



035-785-001



035-785-002



035-785-003



035-785-004



035-785-005



035-785-006



BECKMANN

035-800-001 - 035-800-006 22,0 cm / 8³/₄"



FIG. 1

035-800-001 10 mm



FIG. 2

035-800-002 12 mm

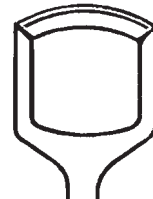

FIG. 3

035-800-003 14 mm

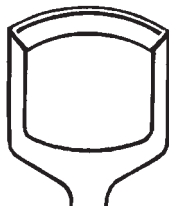

FIG. 4

035-800-004 16 mm

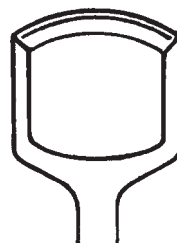

FIG. 5

035-800-005 20 mm

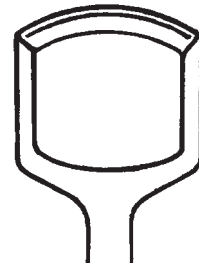

FIG. 6

035-800-006 22 mm

Ringmesser
Adenoid Currettes
Cuchillos para adenoides
Coltelli per vegetazioni adenoidee



035



trapezförmig gefenstert
 trapezoidal fenestrated
 fenestrado trapecialmente
 fenestrato a forma di trapezio

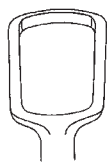

FIG. 1
035-810-001 10 mm

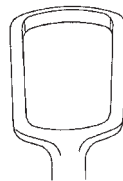

FIG. 2
035-810-002 14 mm

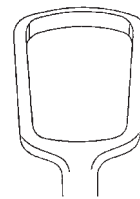

FIG. 3
035-810-003 16 mm

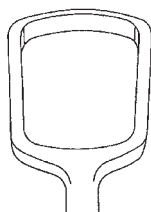

FIG. 4
035-810-004 18 mm

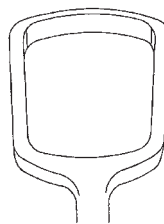

FIG. 5
035-810-005 20 mm

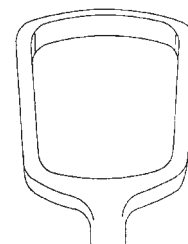

FIG. 6
035-810-006 22 mm

BECKMANN

035-810-001 - 035-810-006 22,0 cm / 8³/₄"



FIG. 1
035-820-001 16 mm



FIG. 2
035-820-002 18 mm

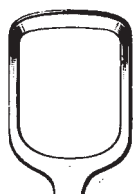

FIG. 3
035-820-003 20 mm



FIG. 4
035-820-004 23 mm

BARNHILL

035-820-001 - 035-820-004 21,0 cm / 8¹/₄"



035

Ringmesser
Adenoid Curettes
Cuchillos para adenoides
Coltelli per vegetazioni adenoidee

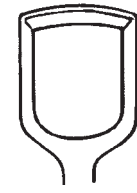

FIG. 1
 035-830-001

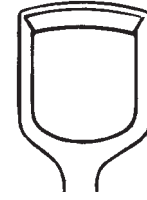

FIG. 2
 035-830-002

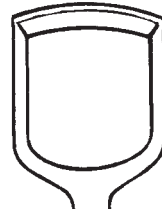

FIG. 3
 035-830-003

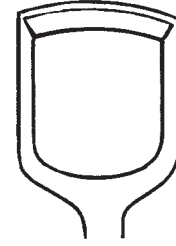

FIG. 4
 035-830-004

ST. CLAIR-THOMSON

035-830-001 - 035-830-004 21,0 cm / 8 1/4"



FIG. 1
 035-840-001



FIG. 2
 035-840-002

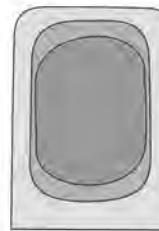

FIG. 3
 035-840-003

mit gelochter Klinge
 with perforated blade
 con hoja perforada
 con lama forato

Ersatzklingen
 Spare Blades
 Hojas de repuesto
 Lame di ricambio

FIG. 1
 035-841-001

FIG. 2
 035-841-002

FIG. 3
 035-841-003

LA FORCE

035-840-001 - 035-840-003 25,0 cm / 10"

Spülkatheter, Sinus-Dilatatoren
Antrum Irrigation Cannulas, Frontal Sinus Dilators
Catéteres lavadores , Dilatadores para el seno
Cateteri per lavaggio, Dilatatori per il seno frontale



035



EICKEN-KILLIAN

035-851-140 14,0 cm / 5 1/2"



GUILLEN

035-857-190 19,0 cm / 7 1/2"

Saugraspatorium
 Suction Raspatory
 Legra de succión
 Raspatorio con aspiratore

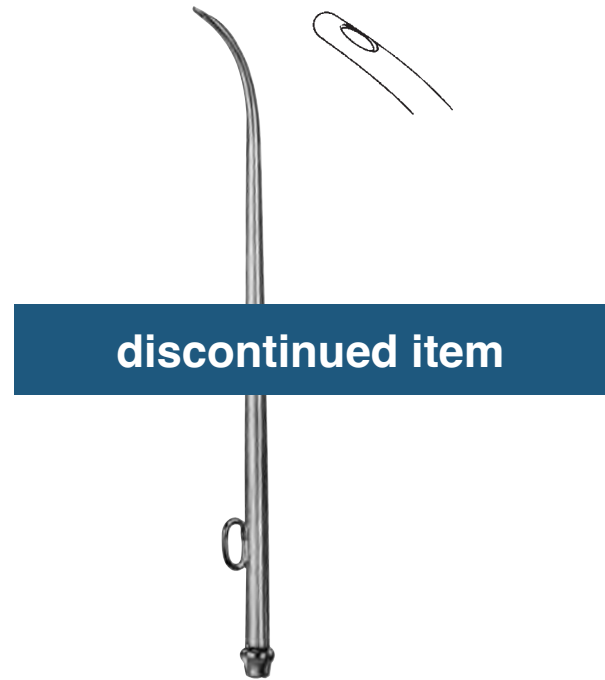

SIEBENMANN

035-855-015	15,0 cm / 6"	Ø 1,5 mm
035-855-017	15,0 cm / 6"	Ø 1,7 mm
035-855-020	15,0 cm / 6"	Ø 2,0 mm
035-855-025	15,0 cm / 6"	Ø 2,5 mm
035-855-030	15,0 cm / 6"	Ø 3,0 mm



RITTER-HALLE

035-859-025	14,5 cm / 5 3/4"	Ø 2,5 mm
035-859-030	14,5 cm / 5 3/4"	Ø 3,0 mm
035-855-040	14,5 cm / 5 3/4"	Ø 4,0 mm
035-859-050	14,5 cm / 5 3/4"	Ø 5,0 mm



035

**Zerstäuber
Atomizers
Atomizadores
Polverizzatori**



UNIVERSAL

035-870-000

mit beweglicher Düse, Flasche und Halbgebläse
with adjustable nozzle bottle and rubber bulb
con tobera mòvil frasco y per de goma
con ugello mobile bottiglia e pera

discontinued item



035-870-002

Ersatzflasche
Spare Bottle
Frasco de repuesto
Bottiglia di ricambio

UNIVERSAL

035-870-001

wie Art.-Nr. 035-870-000 jedoch ohne Halbgebläse
as ref. 035-870-000 without rubber bulb
como ref. 035-870-000 pero sin pera de goma
come rif. 035-870-001 però senza pera di gomma

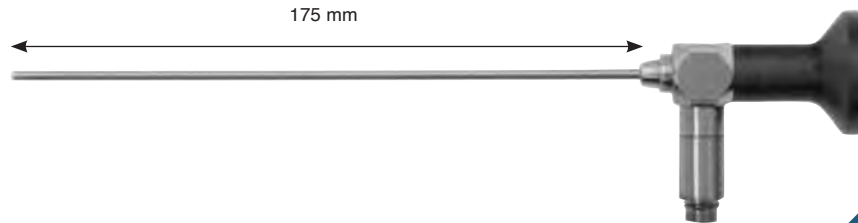

035-910-175 Ø 4,0 x 175 mm

Autoklavierbare Weitwinkel-Geradeausblick-Optik
Blickrichtung 0°/Bildwinkel ca. 105°.

Sterilisation: Dampfsterilisation bei 2 bar
Überdruck (134°C).

Autoclavable wide-angle forward telescope,
viewing direction 0°/ viewing angle 105° approx.
Sterilization: Sterilizable in the autoclave at 2 bar
overpressure (134°C)..

Òptica recta autoclavable gran angular recta,
direcció de vista 0°/ àngulo de la imagen aprox. 105°
Esterilizació: Esteriizable en autoclave a 2 bar
sobrepresió (134°C)..

Ottica grand angolare autoclavabile a
visione retta 0°/ angolo 105° ca.
Sterilizzazione: in autoclave a 2 bar di
superpressione (134°C).

035-912-175 Ø 4,0 x 175 mm

Autoklavierbare Weitwinkel-Geradeausblick-Optik
Blickrichtung 30°/Bildwinkel ca. 105°.

Sterilisation: Dampfsterilisation bei 2 bar
Überdruck (134°C).

Autoclavable wide-angle forward telescope,
viewing direction 30°/ viewing angle 105° approx.
Sterilization: Sterilizable in the autoclave at 2 bar
overpressure (134°C)..

Òptica recta autoclavable gran angular vertical,
direcció de vista 30°/ àngulo de la imagen aprox. 105°
Esterilizació: Esteriizable en autoclave a 2 bar
sobrepresió (134°C)..

Ottica grand angolare autoclavabile a
visione retta 30°/ angolo 105° ca.
Sterilizzazione: in autoclave a 2 bar di
superpressione (134°C).

035-911-175 Ø 4,0 x 175 mm

Autoklavierbare Weitwinkel-Steilblick-Optik
Blickrichtung 70°/Bildwinkel ca. 105°.

Sterilisation: Dampfsterilisation bei 2 bar
Überdruck (134°C).

Autoclavable wide-angle lateral telescope,
viewing direction 70°/ viewing angle 105° approx.
Sterilization: Sterilizable in the autoclave at 2 bar
overpressure (134°C)..

Òptica recta autoclavable granangular vertical,
direcció de vista 70°/ àngulo de la imagen aprox. 105°
Esterilizació: Esteriizable en autoclave a 2 bar
sobrepresió (134°C)..

Ottica grand angolare autoclavabile a
visione verticale 70°/ angolo 105° ca.
Sterilizzazione: in autoclave a 2 bar di
superpressione (134°C).

discontinued item

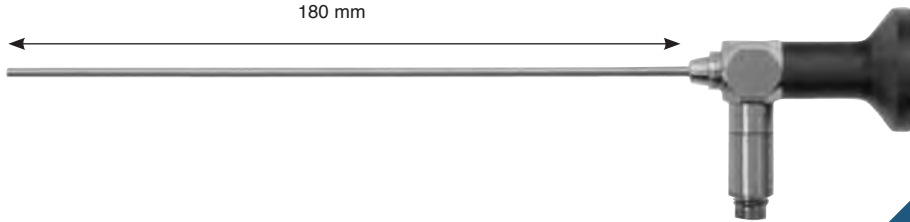

035-920-180 Ø 2,7 x 180 mm

Autoklavierbare Weitwinkel-Geradeausblick-Optik
Blickrichtung 0°/Bildwinkel ca. 80°.
Sterilisation: Dampfsterilisation bei 2 bar
Überdruck (134°C).

Autoclavable wide-angle forward telescope,
viewing direction 0°/ viewing angle 80° approx.
Sterilization: Sterilizable in the autoclave at 2 bar
overpressure (134°C)..

Òptica recta autoclavable gran angular recta,
dirección de vista 0°/ ángulo de la imagen aprox. 80°
Esterilización: Esterilizable en autoclave a 2 bar
sobrepresión (134°C)..

Ottica grand angolare autoclavabile a
visione retta 0°/ angolo 80° ca.
Sterilizzazione: in autoclave a 2 bar di
superpressione (134°C).

035-922-180 Ø 2,7 x 180 mm

Autoklavierbare Weitwinkel-Vierfeld-Optik
Blickrichtung 30°/Bildwinkel ca. 80°.
Sterilisation: Dampfsterilisation bei 2 bar
Überdruck (134°C).

Autoclavable wide-angle four-field telescope,
viewing direction 30°/ viewing angle 80° approx.
Sterilization: Sterilizable in the autoclave at 2 bar
overpressure (134°C)..

Òptica gran angular autoclavable hacia adelante,
de vista 30°/ ángulo de la imagen aprox. 80°
Esterilización: Esterilizable en autoclave a 2 bar
sobrepresión (134°C)..

Ottica grand angolare autoclavabile a
visione obliqua 30°/ angolo 80° ca.
Sterilizzazione: in autoclave a 2 bar di
superpressione (134°C).

discontinued item



035-954-100 10,0 cm / 4"

Handgriff, flach, fü Ø 2,7 mm Optiken
Flat handle for Ø 2,7 mm telescopes
Mango plano para ópticas de Ø 2,7 mm
Manico piatto per ottiche di Ø 2,7 mm

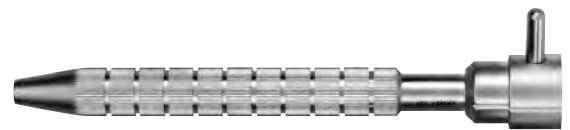

035-952-100 10,0 cm / 4"

Handgriff, rund, fü Ø 2,7 mm Optiken
Round handle for Ø 2,7 mm telescopes
Mango redondo para ópticas de Ø 2,7 mm
Manico rotondo per ottiche di Ø 2,7 mm



035-954-100 10,0 cm / 4"

Handgriff, flach, fü Ø 4,0 mm Optiken
Flat handle for Ø 4,0 mm telescopes
Mango plano para ópticas de Ø 4,0 mm
Manico piatto per ottiche di Ø 4,0 mm

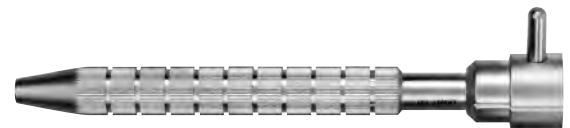

035-956-100 10,0 cm / 4"

Handgriff, rund, fü Ø 4,0 mm Optiken
Round handle for Ø 4,0 mm telescopes
Mango redondo para ópticas de Ø 4,0 mm
Manico rotondo per ottiche di Ø 4,0 mm



037

Mund-, Kiefer- und
Gesichtschirurgie
Oral Maxillo-Facial
Surgery
Cirugía oral y maxilofacial
Chirurgia maxillo-facciale



037

Serviettenhalter, Fingerschützer, Mundkeile
Napkin Holder Finger, Protector Mouth Gags
Porta servilletas, Dedales, Abrebocas
Porta-salviette, Protettore per dita, Apribocca



ADAMS
037-101-001



LANGENBECK
037-105-001



LANGENBECK
037-105-002



LANGENBECK
037-105-003

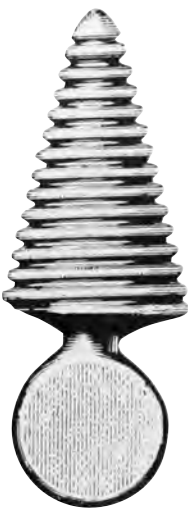

MAUNDER
037-108-100 10,0 cm / 4"



PITHA
037-111-001



HEISTER

037-120-130 13,0 cm / 5"



MOLT / DOYEN-JANSEN

037-123-110 11,0 cm / 4 1/2"



MOLT / DOYEN-JANSEN

037-123-140 14,0 cm / 5 1/2"



DENHART

037-125-120 12,0 cm / 4 3/4"

DENHART

037-126-002

Silikonbacken, allein (Paar)
 Silicon jaws, only (pair)
 Bocas de silicona, sueltas (par)
 Bocca da silicona, sola (paio)

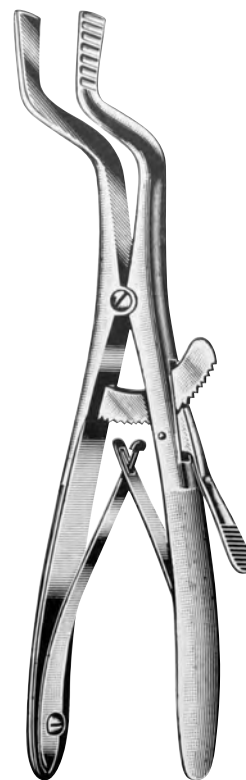

ROER-KÖNIG

037-127-160 16,0 cm / 6 1/4"
037-127-200 20,0 cm / 8"



037

**Mundsperrer
Mouth Gags
Abrebocas
Apribocca**



Bruststütze mit Band
Chest support with band
Soporte de pecho con cinta
Supporto per petto con filo



NEGUS
037-140-000



FIG. 1 29 x 70 mm
037-142-001 13,5 cm / 5 1/4"



FIG. 2 34 x 80 mm
037-142-002 13,5 cm / 5 1/4"

037-142-010
Mundsperrer-Rahmen
Frame for Mouth Gag
Bastidor para abrebooca
Telaio per apribocca

KILNER-DOUGHTY
037-142-000

komplett, bestehend aus Rahmen und 3 Zungenspatel Fig. 1 bis 3, 2 Zahnplatten und 1 Gaumenplatte
complete, consisting of frame and 3 tongue depressors no. 1 to 3, 2 tooth plates and 1 palate plate
completo, consiste de bastidor y 3 babajalenguas no. 1 hasta 3, 2 placas para dientes y 1 placa paladar
completo, composto di telaio e 3 abassalingua no. 1 fino a 3, 2 placche per denti e 1 placa per palato



FIG. 3 38 X 85 mm
037-142-003 13,5 cm / 5 1/4"

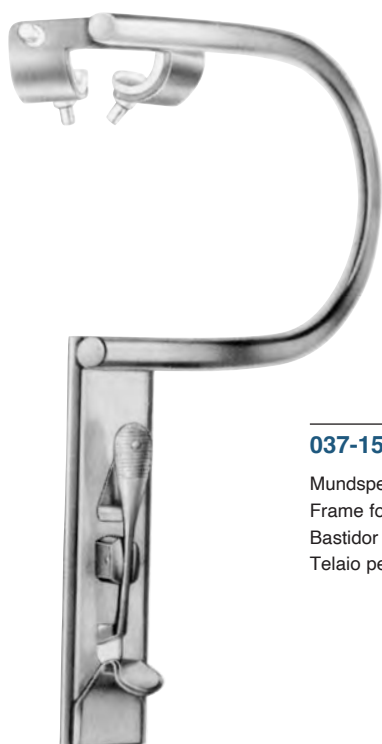

037-150-010

Mundsperrer-Rahmen
 Frame for Mouth Gag
 Bastidor para abrebooca
 Telaio per apribocca



DAVIS-BOYLE

037-150-001 13,5 cm / 5 1/4" 25 x 108 mm

Zungenspatel mit fester Absaugung
 Tongue Depressor with fixed suction tube
 Bajalengua con tubo de succión fijo
 Abassalingua con tubo di aspirazione fisso

DAVIS-BOYLE

037-150-000

komplett, bestehend aus Rahmen und fünf Zungenspatel Fig. 1 bis 5
 complete, consisting of frame and five tongue depressors no. 1 to 5
 completo, consiste de bastidor y cinco babajalenguas no. 1 hasta 5
 completo, composto di telaio e cinque abassalingua no. 1 fino a 5



DAVIS-BOYLE

037-150-002 13,5 cm / 5 1/4" 25 x 95 mm

Zungenspatel mit fester Absaugung
 Tongue Depressor with fixed suction tube
 Bajalengua con tubo de succión fijo
 Abassalingua con tubo di aspirazione fisso



DAVIS-BOYLE

037-150-003 13,5 cm / 5 1/4" 24 x 80 mm

Zungenspatel mit fester Absaugung
 Tongue Depressor with fixed suction tube
 Bajalengua con tubo de succión fijo
 Abassalingua con tubo di aspirazione fisso



DAVIS-BOYLE

037-150-004 13,5 cm / 5 1/4" 23 x 65 mm

Zungenspatel mit fester Absaugung
 Tongue Depressor with fixed suction tube
 Bajalengua con tubo de succión fijo
 Abassalingua con tubo di aspirazione fisso



DAVIS-BOYLE

037-150-005 13,5 cm / 5 1/4" 20 x 30 mm

Zungenspatel ohne Absaugung
 Tongue Depressor without suction tube
 Bajalengua sin tubo de succión fijo
 Abassalingua senza tubo di aspirazione fisso



037

**Mundsperrer
Mouth Gags
Abrebocas
Apribocca**



MC IVOR

037-160-010

Mundsperrer-Rahmen
Frame for Mouth Gag
Bastidor para abrebooca
Telaio per apribocca

MC IVOR

037-160-000

komplett mit drei Zungenspatel
complete with three tongue depressors
completo con tres babajalenguas
completo e tre abassalingua



MC IVOR

037-160-001 13,5 cm / 5 1/2" 26 x 100 mm

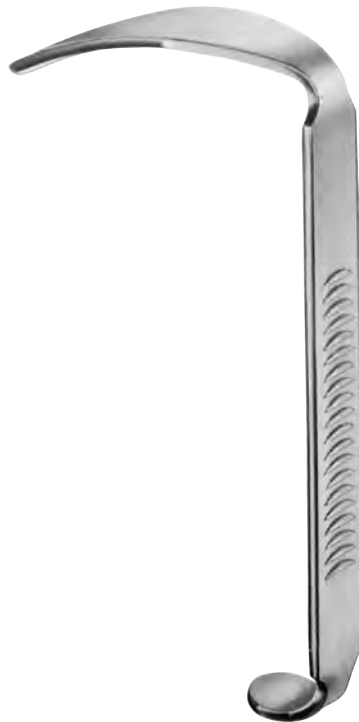

MC IVOR

037-160-002 13,5 cm / 5 1/2" 25 x 85 mm

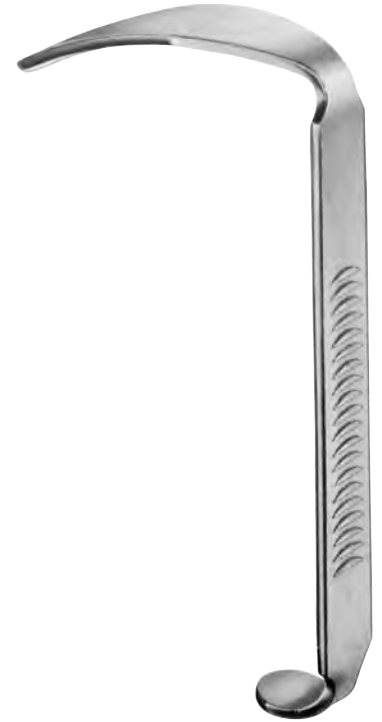

MC IVOR

037-160-003 13,5 cm / 5 1/2" 23 x 75 mm



DINGMANN

037-170-010

Mundsperrer-Rahmen
Frame for Mouth Gag
Bastidor para abreboca
Telaio per apribocca

DINGMANN

037-170-000

komplett mit Rahmen, 3 Zungenspateln und 2 beweglichen Seitenvalven
Complete with frame, 3 tongue depressors and 2 adjustable lateral blades
Completo con bastidor, 3 bajalenguas y 2 valvas laterales ajustables
completo con telaio, 3 abassalingua e 2 valve laterali movibili

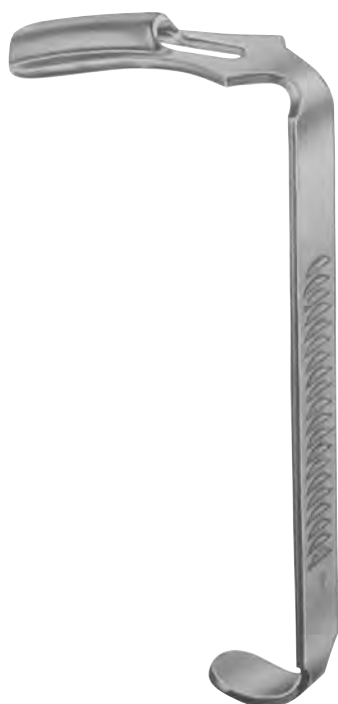

DINGMANN

037-170-001 13,5 cm / 5 1/2" 25 x 65 mm



DINGMANN

037-170-002 13,5 cm / 5 1/2" 29 x 70 mm

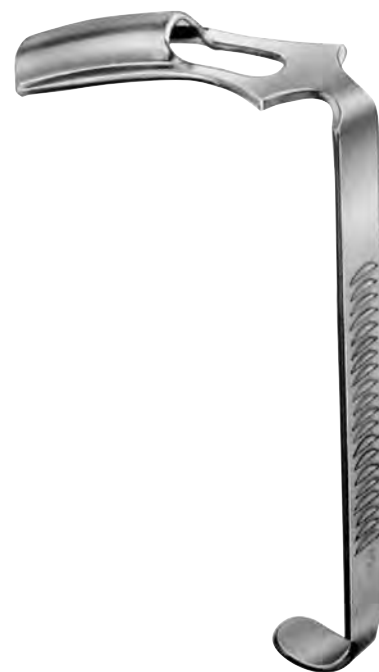

DINGMANN

037-170-003 13,5 cm / 5 1/2" 32 x 80 mm



037

**Mundsperrer
Mouth Gags
Abrebocas
Apribocca**



WHITEHEAD

037-173-110	11,0 cm / 4 ¹ / ₄ "
037-173-130	13,0 cm / 5"
037-173-150	15,0 cm / 6"

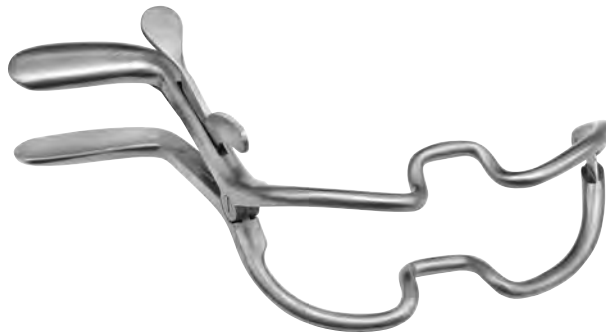

JENNINGS

037-175-090	9,0 cm / 3 ¹ / ₂ "
037-175-110	11,0 cm / 4 ¹ / ₄ "
037-175-130	13,0 cm / 5"
037-175-150	15,0 cm / 6"



SIMPLEX

037-183-110 11,0 cm / 4¹/₂"



STERNBERG

037-185-120 12,0 cm / 4³/₄"

037-185-140 14,0 cm / 5¹/₂"

037-185-160 16,0 cm / 6¹/₄"



037-187-190 19,0 cm / 7¹/₂"

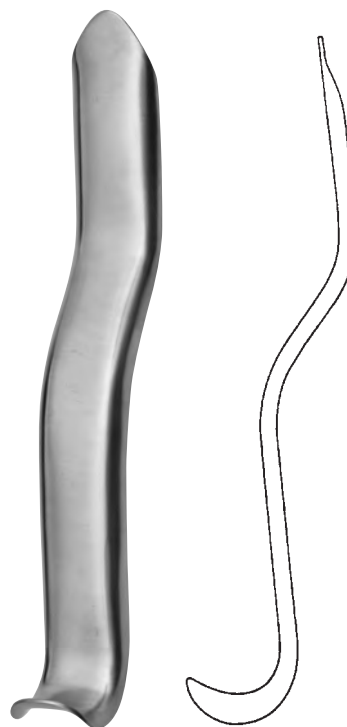

CAWOOD-MINNESOTA

037-191-155 15,5 cm / 6"

Wangen- und Lippenhalter, Zungendrucker
Cheek and Lip Retractors, Tongue Depressors
Separadores para mejillas y labios, Abajalenguas
Divaricatori per guanci e labbra, Abbassalingua

83x25 mm

80x25 mm



HARTMANN
037-193-150 15,0 cm / 6"



TOBOLD
037-195-145 14,5 cm / 5 1/2"



TOBOLD
037-197-145 14,5 cm / 5 1/2"

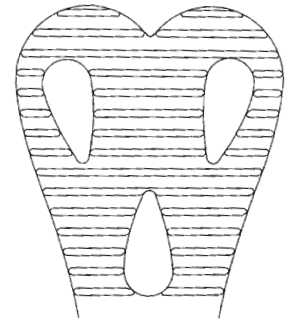

037-201-001 14,0 cm / 5 1/2"

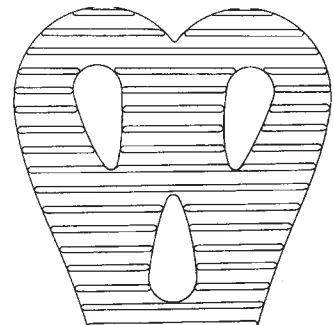

037-201-002 15,0 cm / 6"



ANDREW
037-199-110 11,0 cm / 4 3/8"



WIEDER
037-201-001 - 037-201-002

discontinued item

Packung á 100 Stk.
package of 100 pcs.
paquete con 100 piezas
confezione di 100 pezzi



aus Holz
from wood
de madera
di legno

037-210-160 16,0 cm / 6¹/₄"

Packung á 100 Stk.
package of 100 pcs.
paquete con 100 piezas
confezione di 100 pezzi



aus Kunststoff
from plastic
de plástico
di plastica

037-212-150 15,0 cm / 6"



BUCHWALD

037-215-170 19,0 cm / 7¹/₂"



BRUENINGS

037-217-190 19,0 cm / 7¹/₂"



037-219-145 14,5 cm / 5³/₄"



037

Zungenzangen
Tongue Holding Forceps
Pinzas tira-lengua
Pinze per lingua



COLLIN

037-220-160 16,0 cm / 6¹/₄"
037-220-180 18,0 cm / 7"



037-224-002

Gummibacken, allein (Paar)
Rubber inserts, only (pair)
Bocas de goma, sueltas (par)
Cuscino di gomma, soli (paio)

YOUNG

037-223-160 16,0 cm / 6¹/₄"

Weichteilhaken
Soft Tissue Retractors
Separadores para partes blandas
Separatori per tessuti molli



037



OBWEGESER

037-251-040 - 037-251-080 22,0 cm / 8³/₄"



037-251-040 11 x 40 mm



037-251-055 11 x 55 mm



037-251-080 16 x 80 mm



037

**Ramushaken
Ramus Retractors
Separadores para el ramo
Separatore per ramo**



OBWEGESER

037-253-220 22,0 cm / 8³/₄" 10 x 45 mm

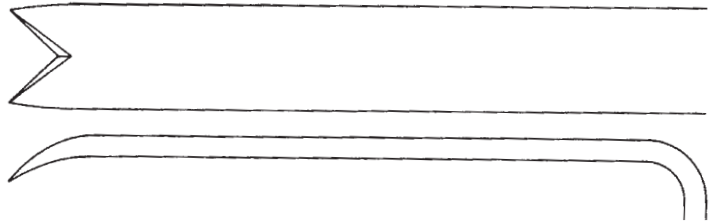

OBWEGESER

037-255-220 22,0 cm / 8³/₄" 11 x 70 mm



OBWEGESER

037-257-160 16,0 cm / 6¹/₂"



OBWEGESER

037-259-008 17,0 cm / 6³/₄" 8 mm
037-259-010 17,0 cm / 6³/₄" 10 mm



037

Raspatorien
Periosteal Elevators
Legras
Elevatori periosteo



037-265-006 6 mm



037-265-007 7 mm



037-265-009 9 mm



037-265-011 11 mm

OBWEGESER

037-265-006 - 037-265-011 17,5 cm / 7¹/₄"



037-267-005 5 mm



037-267-007 7 mm

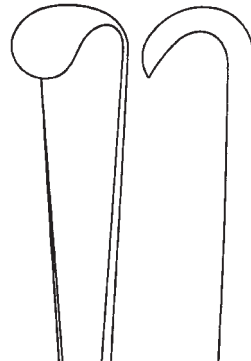

037-267-009 9 mm

OBWEGESER

037-267-005 - 037-267-009 20,0 cm / 8"

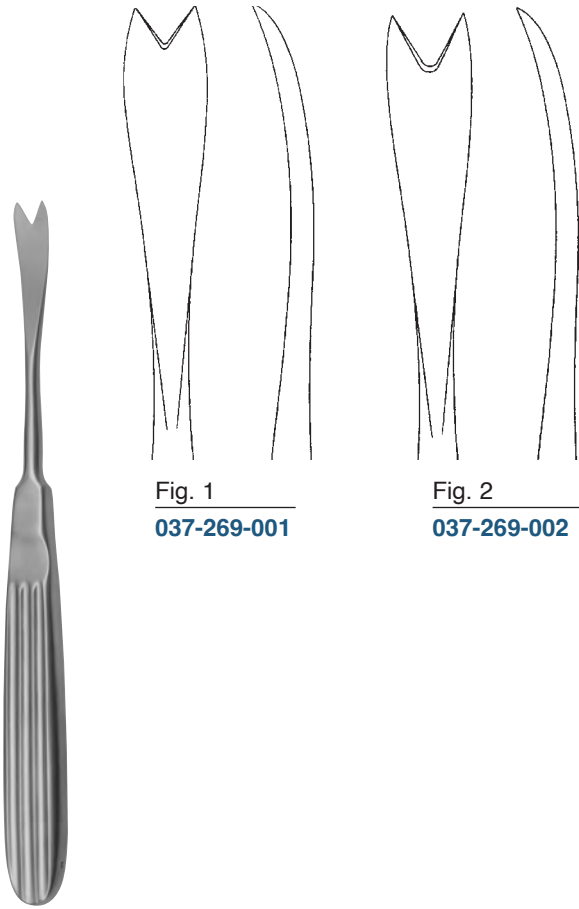
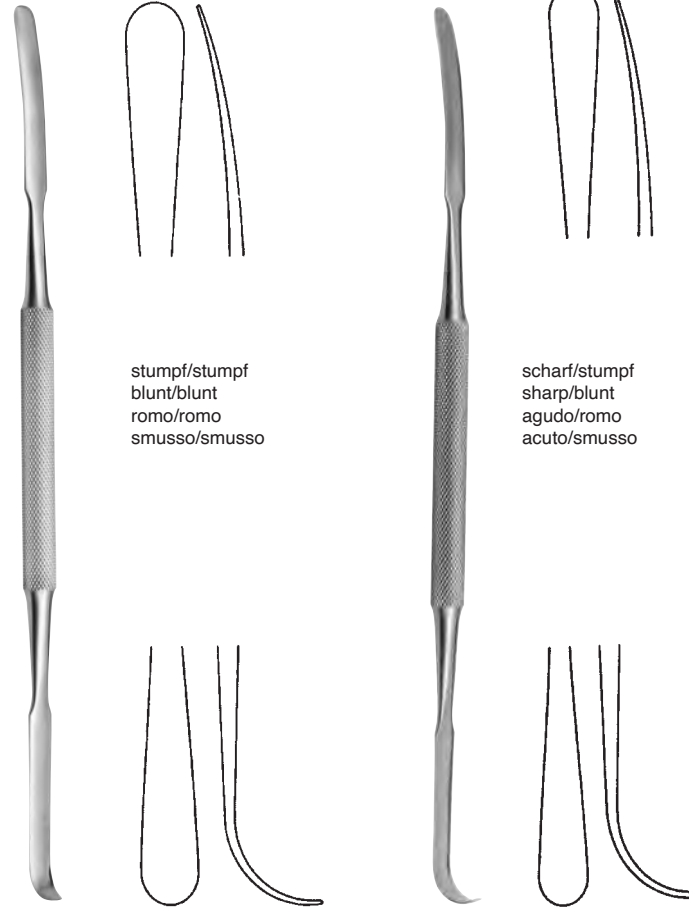

Fig. 1
 037-269-001

Fig. 2
 037-269-002

OBWEGESER
 037-269-001 - 037-269-002 17,5 cm / 7"



stumpf/stumpf
 blunt/blunt
 romo/romo
 smusso/smusso

scharf/stumpf
 sharp/blunt
 agudo/romo
 acuto/smusso

OBWEGESER Fig. 1
 037-271-210 21,0 cm / 8 1/2"

OBWEGESER Fig. 2
 037-273-210 21,0 cm / 8 1/2"

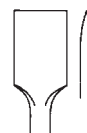

037-276-025 2,5 mm 037-276-040 4,0 mm 037-276-065 6,5 mm

OBWEGESER
 037-276-025 - 037-276-065 15,0 cm / 6"



037

Raspatorien, Osteotome, Ahlen
Raspatories, Osteotomes, Awls
Legras, Osteótomos, Leznas
Periostotomi, Osteotomi, Lesine

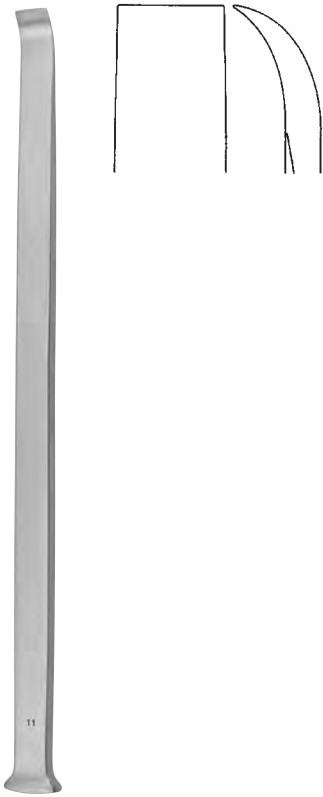

OBWEGESER

037-279-235 23,5 cm / 9¹/₄"



037-281-185



037-283-185

OBWEGESER

037-281-185 - 037-283-185 18,5 cm / 7¹/₄"



OBWEGESER

037-291-180 18,0 cm / 7"



OBWEGESER

037-293-140 14,0 cm / 5¹/₂"



OBWEGESER

037-295-230 23,0 cm / 9"

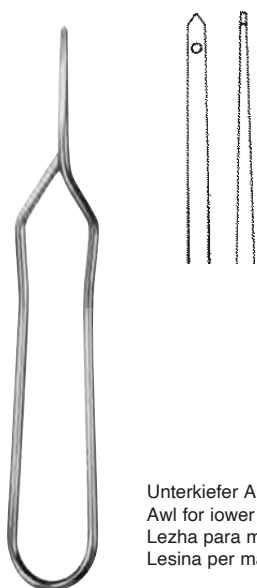

Unterkiefer Ahle
Awl for lower jaw
Lezha para maxilar inferior
Lesina per mascella inferiore

KELSEY-FRY

037-297-150 15,0 cm / 6"

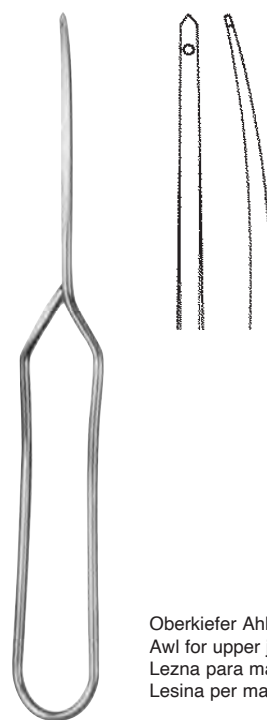

Oberkiefer Ahle
Awl for upper jaw
Lezna para maxilar superior
Lesina per mascella superiore

KELSEY-FRY

037-299-180 18,0 cm / 7¹/₄"



037

Repositionszangen
Reposition Forceps
Pinzas para reposición
Pinze per riposizione

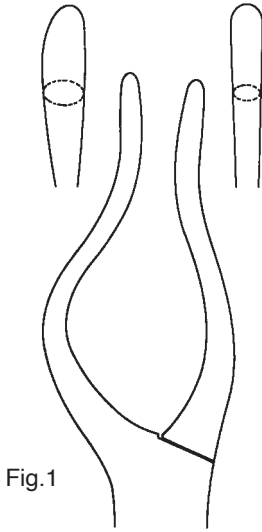

Fig.1

für Babys
for babies
para bebés
per neonati

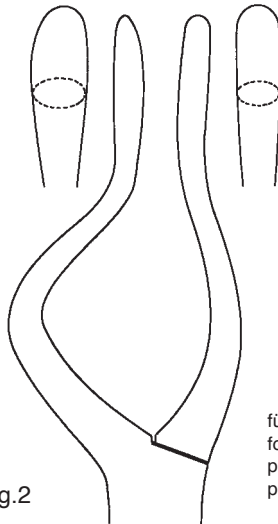

Fig.2

für Kinder
for children
para niños
per bambini

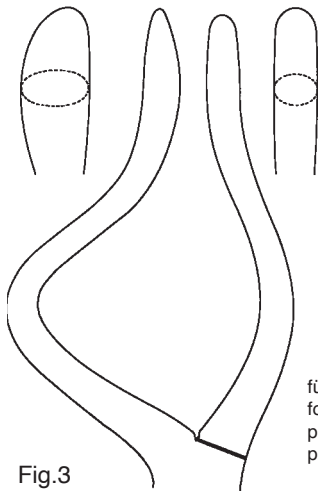

Fig.3

für Erwachsene
for adults
para adultos
per adulti



links
left
izquierda
sinistra



rechts
right
derecha
destra

ROWE

037-301-001	Fig. 1	22,5 cm
037-301-002	Fig. 2	23,5 cm
037-301-003	Fig. 3	24,0 cm

ROWE

037-303-001	Fig. 1	22,5 cm
037-303-002	Fig. 2	23,5 cm
037-303-003	Fig. 1	24,0 cm

Nadeln zur Gaumennaht, Tonsillennadeln
Cleft Palate Needles, Tonsil Needles
Agujas para sutura del paladar, agujas para amígdalas
Aghi per sutura del palato, Aghi per tonsille



037



für rechte Hand
 for right hand
 para mano derecha
 per mano destra



für linke Hand
 for left hand
 para mano izquierda
 per mano sinistra



für rechte Hand
 for right hand
 para mano derecha
 per mano destra



für linke Hand
 for left hand
 para mano izquierda
 per mano sinistra

HURD

037-321-210 21,0 cm / 8¹/₄"

HURD

037-323-210 21,0 cm / 8¹/₄"

DUPUY WEISS

037-325-220 22,0 cm / 8³/₄"

DUPUY WEISS

037-327-220 22,0 cm / 8³/₄"



037

Tonsillennmesser
Tonsil Knives
Cuchillos para amígdalas
Bisturi per tonsille



FISCHER

037-345-225 22,5 cm / 9"



ABRAHAM

037-347-210 21,0 cm / 8¹/₄"



BRUENINGS

037-349-230 23,0 cm / 9"

Tonsillendissektoren
Tonsil Dissectors
Disector para amígdalas
Disettori per tonsille



037



CARPENTER

037-355-250 25,0 cm / 10"



CARPENTER

037-357-240 24,0 cm / 9 1/2"



HURD

037-359-225 22,5 cm / 9"



037

Tonsillendissektoren
Tonsil Dissectors
Disector para amígdalas
Disettori per tonsille



HENKE
037-361-230 23,0 cm / 9"

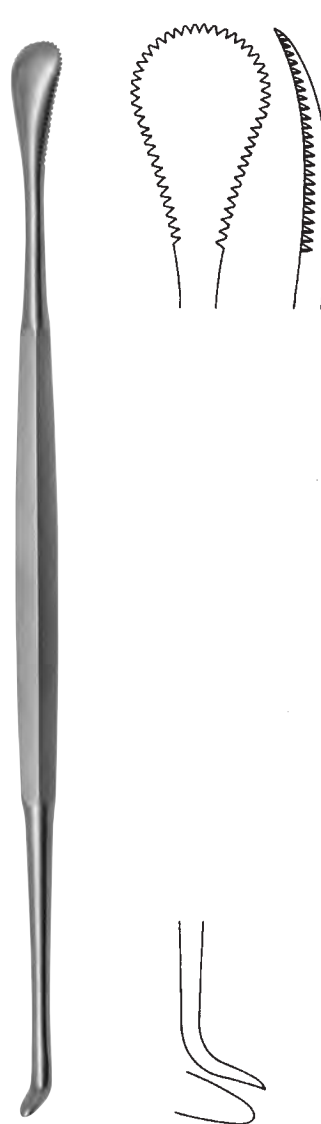

HENKE
037-363-230 23,0 cm / 9"

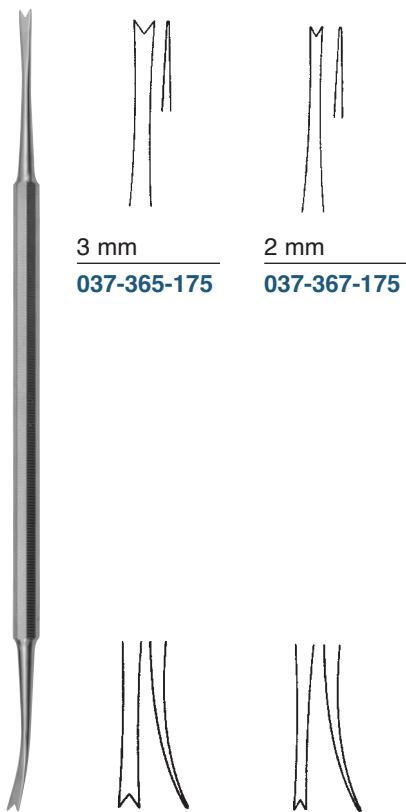

LUNIATSCHEK

037-365-175 - 037-367-175

17,5 cm / 6³/₄"

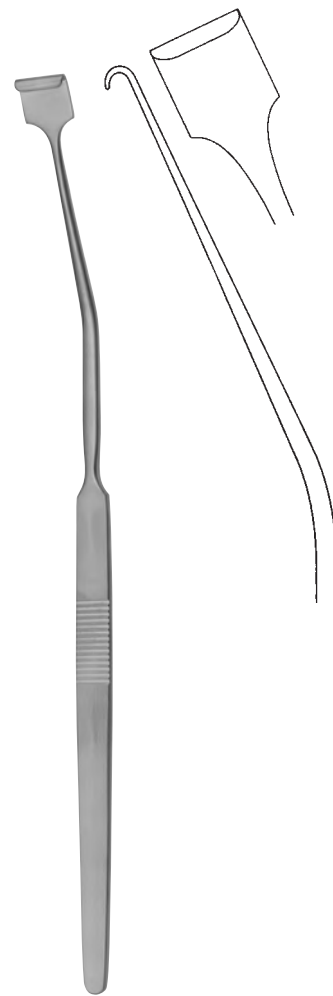

NAGER

037-369-240

24,0 cm / 9"

Tonsillenzangen
Tonsil Forceps
Pinzas para amígdalas
Pinze per tonsille

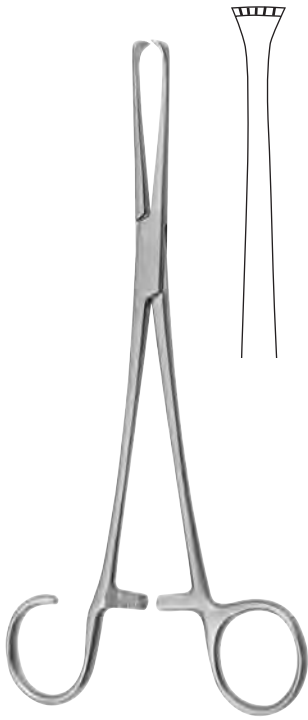

WHITE (COLVER)
037-378-190 19,0 cm / 7½"



WHITE (COLVER)
037-379-180 18,0 cm / 7"



WHITE
037-381-180 18,0 cm / 7"
037-381-230 23,0 cm / 9"

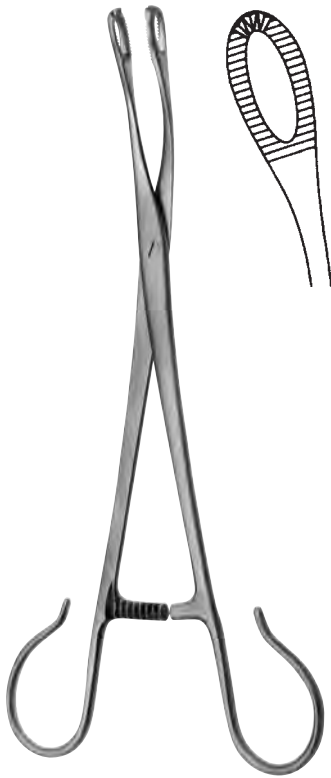

BLOHMKE
037-383-200 20,0 cm / 8"

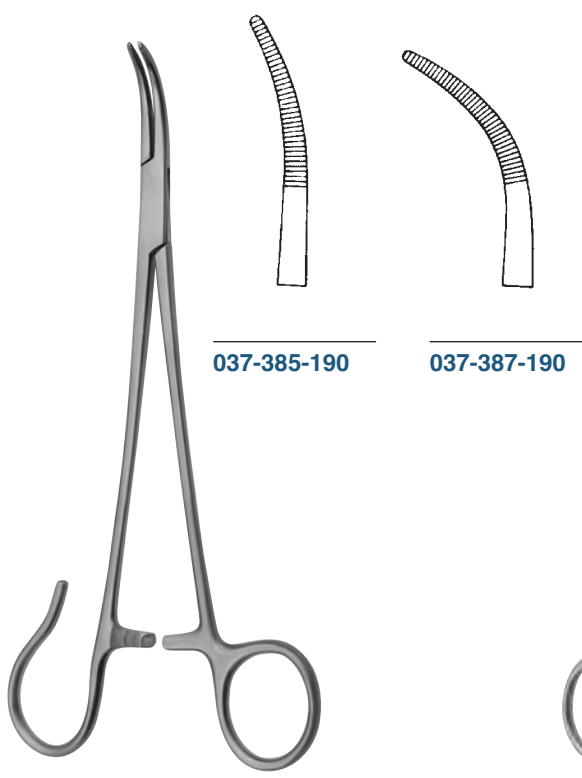

SCHNIDT
037-385-190 - 037-387-190 19,0 cm / 7½"

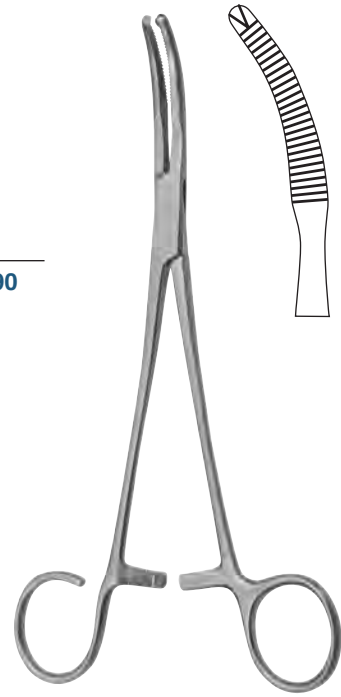

MIKULICZ
037-389-185 18,5 cm / 7¼"

Tonsillenschnürer
Tonsil Snares
Cierra - nudos para amígdalas
Serranodi per tonsille



037



Packung à 100 Stk.
 package with 100 pcs.
 paquete de 100 piezas
 confezione di 100 pezzi



Bündel mit 12 Stk.
 bundle with 12 pcs.
 manajo de 12 piezas
 manello di 12 pezzi

037-400-040 40 mm
037-400-050 50 mm

037-401-035 Ø 0,35 mm
037-401-040 Ø 0,40 mm
037-401-045 Ø 0,45 mm
037-401-050 Ø 0,50 mm



EVES

037-410-280 28,0 cm / 11"



EVES

037-412-280 28,0 cm / 11"

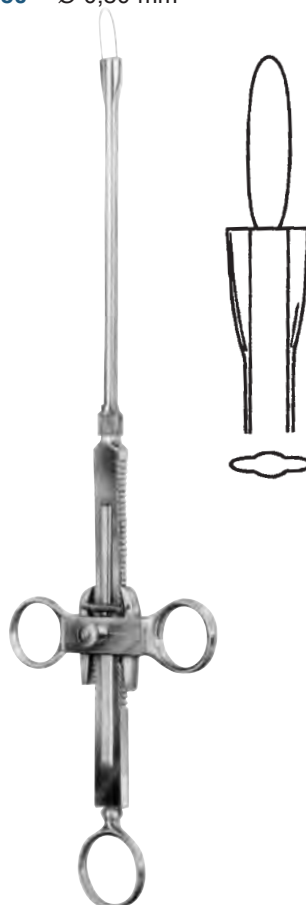

BRUENINGS

037-414-280 28,0 cm / 11"



RÖDER

037-416-265 26,5 cm / 10 1/2"

**Tonsillotome
Tonsillectomes
Amigdalòtomos
Tonsillotomi**

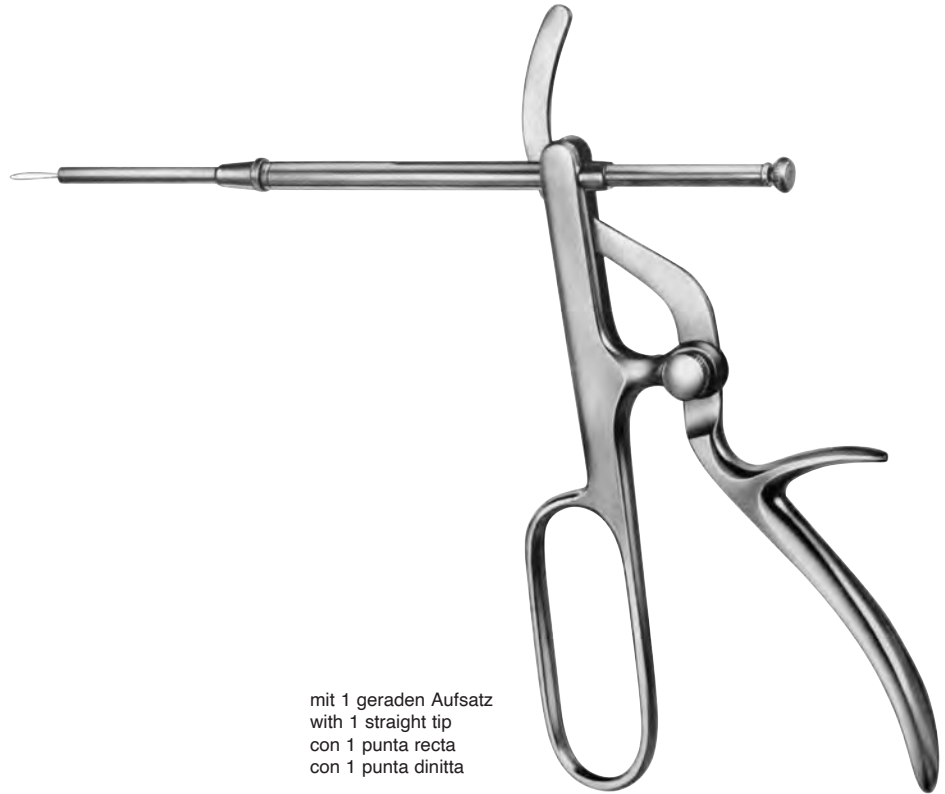

mit 1 geraden Aufsatz
with 1 straight tip
con 1 punta recta
con 1 punta dritta

TYDING
037-420-001

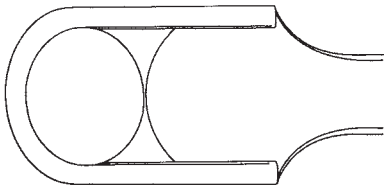

SLUDDER-BALLENGER
037-431-001 Fig.1

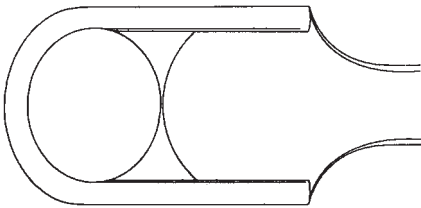

SLUDDER-BALLENGER
037-431-002 Fig.2

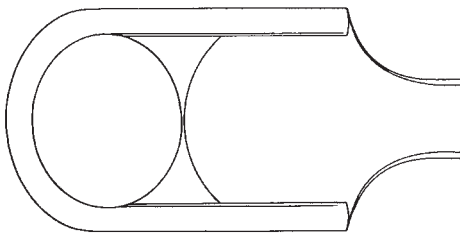

SLUDDER-BALLENGER
037-431-003 Fig.3



SLUDDER-BALLENGER
037-430-010

Griff alleine
handle only
mango suelto
manico solo

SLUDDER-BALLENGER
037-430-003

komplett mit 3 Aufsätzen
complete with 3 tips
completo con 3 puntas
completo con 3 punti

Tonsillenzange
Tonsil Punches
Pinzas para amígdalas
Pinze per tonsille



037

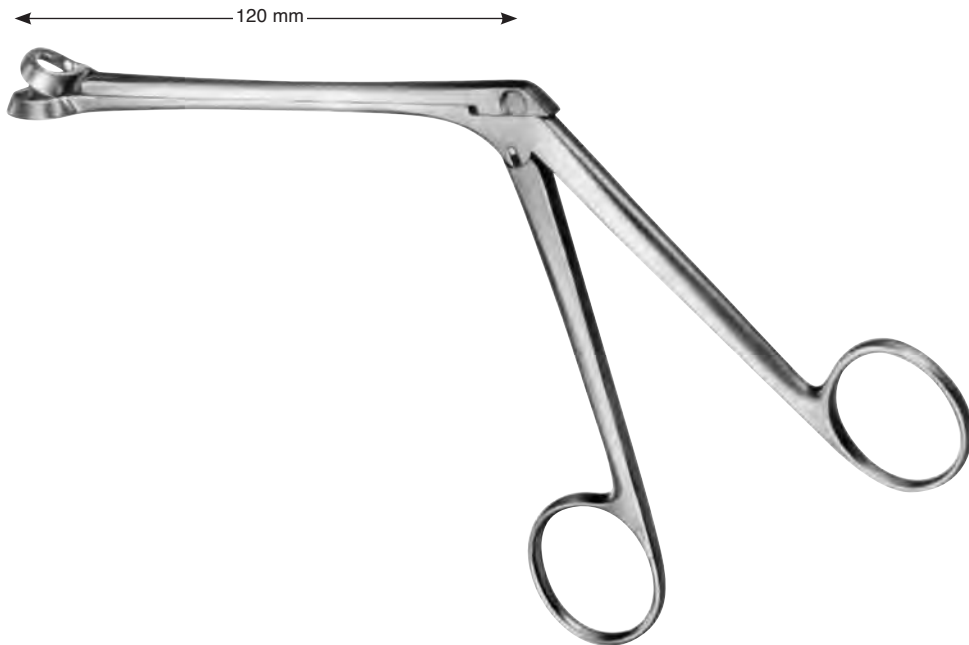

HARTMANN

037-435-013 - 037-435-017

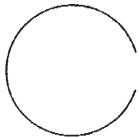

037-435-013 Ø 13 mm

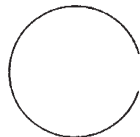

037-435-015 Ø 15 mm

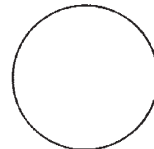

037-435-017 Ø 17 mm

Broncho-Oesophaguskopiezangen
Broncho-Esophagoscopy Forceps
Pinzas para Bronco-Esofagoscopia
Pize per Broncho-Esofagoscopia



CHEVALIER-JACKSON

037-440-300 - 037-446-600



Fig. 1

037-440-300	30,0 cm
037-440-400	40,0 cm
037-440-500	50,0 cm
037-440-600	60,0 cm



Fig. 2

037-441-300	30,0 cm
037-441-400	40,0 cm
037-441-500	50,0 cm
037-441-600	60,0 cm



Fig. 3

037-442-300	30,0 cm
037-442-400	40,0 cm
037-442-500	50,0 cm
037-442-600	60,0 cm

ø 4 mm



Fig. 4

037-443-300	30,0 cm
037-443-400	40,0 cm
037-443-500	50,0 cm
037-443-600	60,0 cm



Fig. 5

037-444-300	30,0 cm
037-444-400	40,0 cm
037-444-500	50,0 cm
037-444-600	60,0 cm



Fig. 6

037-445-300	30,0 cm
037-445-400	40,0 cm
037-445-500	50,0 cm
037-445-600	60,0 cm

ø 4 mm



Fig. 7

037-446-300	30,0 cm
037-446-400	40,0 cm
037-446-500	50,0 cm
037-446-600	60,0 cm



HUBER

037-450-001

Universal-Griff
 Universal Handle
 Mango universal
 Manico universale



BRUENINGS

037-452-200	20,0 cm / 8"
037-452-300	30,0 cm / 12"
037-452-400	40,0 cm / 16"

Verlängerungsrohr für Handgriff Art.-Nr. 037-450-001
 Interchangeable Tube for handle ref. 037-450-001
 Tubo de extensión para mango ref. 037-450-001
 Tube allunghi per manico rif..037-450-001

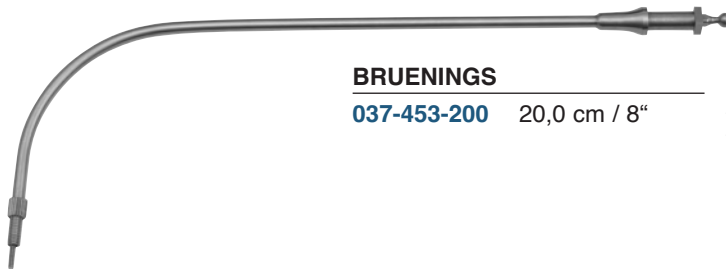

BRUENINGS

037-453-200	20,0 cm / 8"
--------------------	--------------

Verlängerungsrohr gebogen für Handgriff Art.-Nr. 037-450-001
 Interchangeable Tube, curved for handle ref. 037-450-001
 Tubo de extensión, curva para mango ref. 037-450-001
 Tube allunghi, curva per manico rif..037-450-001

Auswechselbare Zangenaufsätze
Exchangeable Forceps Tips
Pinzas intercambiables
Pinze intercambiabili



037



FRAENKEL
 037-456-001



SEIFFERT
 037-458-001



FRAENKEL
 037-460-001



SCHEINMANN
 037-461-001



SCHEINMANN
 037-463-001



BRUENINGS
 037-464-003
 037-464-004



BRUENINGS
 037-466-002
 037-466-003



LANGE
 037-468-001



KRAUSE
 037-470-001
 037-470-002



KRAUSE
 037-472-001



CORDES
 037-474-001
 037-474-002
 037-474-003
 037-474-004



SCHUMACHER
 037-476-001



CORDES
 037-478-001
 037-478-002



CORDES
 037-480-001



ROSENBERG
 037-482-001



037

Kehlkopfpolypenzange, Deckenhalter
Laryngeal Polypus Forceps, Epiglottis Retractor
Pinza para pólipos laringeos, Depresor para epíglotis
Pinze per polipi laringei, Depressore per epiglottide



037-485-001

nach rechts öffnend
 opening to right side
 abriendo hacia la derecha
 aprente verso destra



037-485-002

nach links öffnend
 opening to left side
 abriendo hacia la izquierda
 aprente verso sinistra



037-485-003

nach unten öffnend
 opening down-ward
 abriendo hacia abajo
 aprente in basso



037-485-004

nach oben öffnend
 opening up-ward
 abriendo hacia arriba
 aprente in alto

JURASZ

037-485-001 - 037-485-004

23,0 cm / 9"



REICHERT

037-487-240 24,0 cm / 9 1/2"

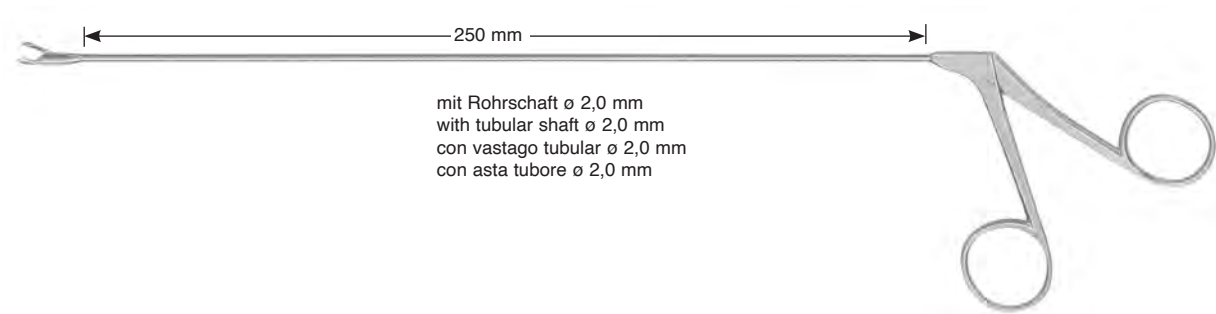

037-490-001 - 037-494-004



gerade
 straight
 recta
 retta

037-490-001

Löffel rund ø 2,5 mm
 round cup ø 2,5 mm
 Cuchara redonda ø 2,5 mm
 Cucchiaino rotondo ø 2,5 mm



links gebogen
 curved left
 curva izquierda
 curva sinistra

037-490-002

Löffel rund ø 2,5 mm
 round cup ø 2,5 mm
 Cuchara redonda ø 2,5 mm
 Cucchiaino rotondo ø 2,5 mm



rechts gebogen
 curved right
 curva derecha
 curva destra

037-490-003

Löffel rund ø 2,5 mm
 round cup ø 2,5 mm
 Cuchara redonda ø 2,5 mm
 Cucchiaino rotondo ø 2,5 mm



aufgebogen
 angled upward
 curva hacia arriba
 curva in alto

037-490-004

Löffel rund ø 2,5 mm
 round cup ø 2,5 mm
 Cuchara redonda ø 2,5 mm
 Cucchiaino rotondo ø 2,5 mm



gerade
 straight
 recta
 retta

037-492-001



links gebogen
 curved left
 curva izquierda
 curva sinistra

037-492-002



rechts gebogen
 curved right
 curva derecha
 curva destra

037-492-003



gerade
 straight
 recta
 retta

037-494-001



links gebogen
 curved left
 curva izquierda
 curva sinistra

037-494-002



rechts gebogen
 curved right
 curva derecha
 curva destra

037-494-003



aufgebogen
 angled upward
 curva hacia arriba
 curva in alto

037-494-004

Kehlkopfspiegel, Spiegelgriffe
Laryngeal Mirrors, Mirror Handles
Espejos laringeales, Mangos para espejos
Specchi laringei, Manico per specchi



mit festem Handgriff
 with fixed handle
 con mango fijo
 con manico fisso

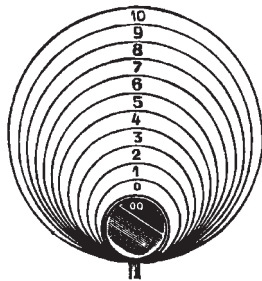

ohne Handgriff
 without handle
 sin mango
 senza manico

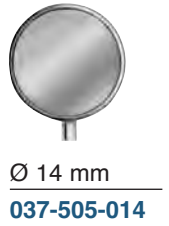

037-501-008	Fig. 00 = 8 mm Ø	037-503-008
037-501-010	Fig. 0 = 10 mm Ø	037-503-010
037-501-012	Fig. 1 = 12 mm Ø	037-503-012
037-501-014	Fig. 2 = 10 mm Ø	037-503-014
037-501-016	Fig. 3 = 16 mm Ø	037-503-016
037-501-018	Fig. 4 = 18 mm Ø	037-503-018
037-501-020	Fig. 5 = 20 mm Ø	037-503-020
037-501-022	Fig. 6 = 22 mm Ø	037-503-022
037-501-024	Fig. 7 = 24 mm Ø	037-503-024
037-501-026	Fig. 8 = 26 mm Ø	037-503-026
037-501-028	Fig. 9 = 28 mm Ø	037-503-028
037-501-030	Fig. 10 = 30 mm Ø	037-503-030

MICHEL

25,0 cm / 10"



037-506-100 10,0 cm



037-510-120 12,0 cm

Tracheal-Trokare, -Dilatatoren
 Tracheotomy Trocars, Tracheal Dilators
 Traqueótomos, Dilatadores traqueales
 Tracheotomi, Dilatatori



037

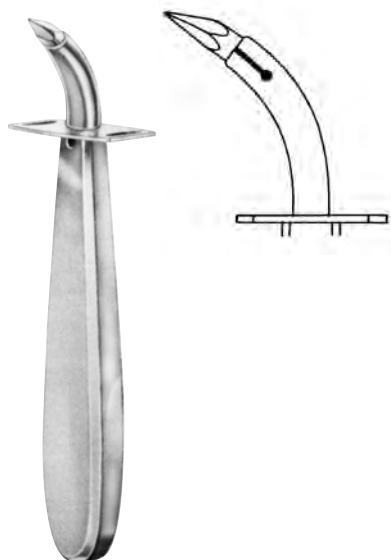

UECKERMANN
 13,0 cm / 5"



037-601-075 Ø 7,5 mm



037-601-090 Ø 9 mm



LABORDE
037-605-140 14,0 cm / 5½"



TROUSSEAU
037-609-120 12,0 cm / 4¾"
037-609-140 14,0 cm / 5½"

Tracheal-Häkchen
Tracheal Hooks
Ganchos traqueales
Uncini tracheali



037-621-170



037-623-170

ITERSON

17,0 cm / 6¹/₄"



links
left
izquierda
sinistra

scharf
sharp
agudo
acuto

BOSE

037-625-160 16,0 cm / 6¹/₄"



rechts
right
derecha
destra

BOSE

037-627-160 16,0 cm / 6¹/₄"

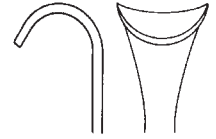

ROSE

037-629-135 13,5 cm / 5"

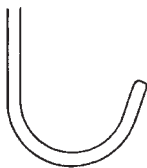
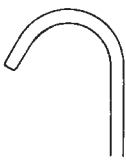

LUER

037-631-110 11,0 cm / 4¹/₂"



JACKSON

037-635-150 15,0 cm / 6"

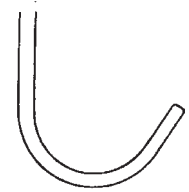
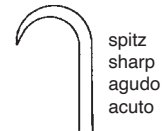

037-637-150 15,0 cm / 6"

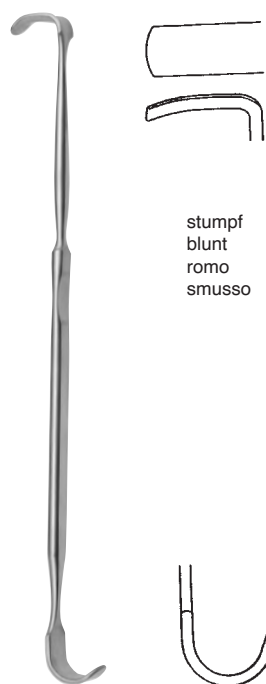

stumpf
 blunt
 romo
 smusso

LUKENS

037-641-170 17,0 cm / 6³/₄"



JACKSON

037-643-170 17,0 cm / 6³/₄"

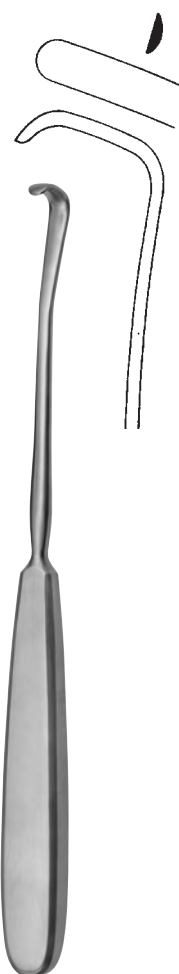

SCHOENBORN

037-645-210 21,0 cm / 8¹/₄"

Tracheal-Kanülen
Tracheal Tubes
Cánulas traqueales
Cannule tracheali

Material: Edelstahl
 Material: Stainless Steel
 Material: acero inoxidable
 Materiale: acciaio inossidabile

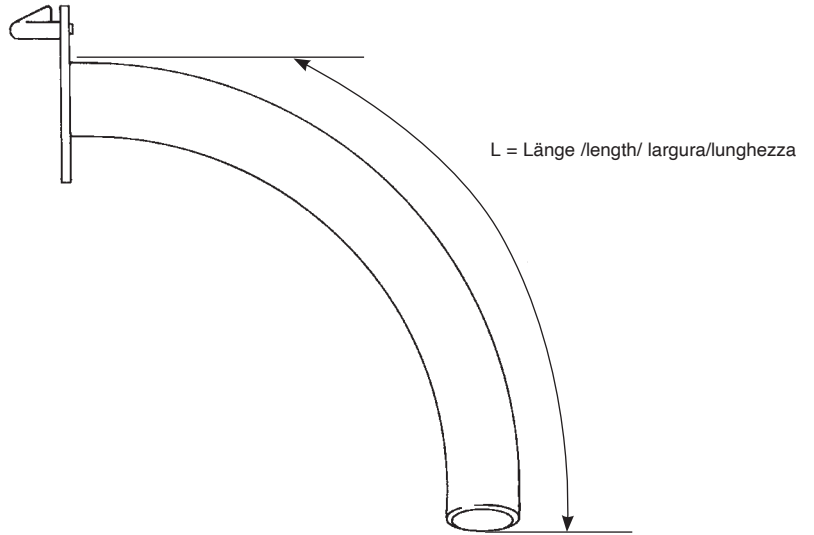

LUER		L	
037-701-004	Fig. 0	Ø 4 mm	45 mm
037-701-005	Fig. 1	Ø 5 mm	50 mm
037-701-006	Fig. 2	Ø 6 mm	55 mm
037-701-007	Fig. 3	Ø 7 mm	60 mm
037-701-008	Fig. 4	Ø 8 mm	65 mm
037-701-009	Fig. 5	Ø 9 mm	70 mm
037-701-010	Fig. 6	Ø 10 mm	75 mm
037-701-011	Fig. 7	Ø 11 mm	80 mm
037-701-012	Fig. 8	Ø 12 mm	85 mm
037-701-013	Fig. 9	Ø 13 mm	90 mm



CHEVALIER-JACKSON		L	
037-711-004	Fig. 0	Ø 4 mm	45 mm
037-711-005	Fig. 1	Ø 5 mm	50 mm
037-711-006	Fig. 2	Ø 6 mm	55 mm
037-711-007	Fig. 3	Ø 7 mm	60 mm
037-711-008	Fig. 4	Ø 8 mm	65 mm
037-711-009	Fig. 5	Ø 9 mm	70 mm
037-711-010	Fig. 6	Ø 10 mm	75 mm
037-711-011	Fig. 7	Ø 11 mm	80 mm
037-711-012	Fig. 8	Ø 12 mm	85 mm
037-711-013	Fig. 9	Ø 13 mm	90 mm

Tracheotomie-Besteck
Tracheotomy Set
Juego para traqueotomía
Set per tracheotomia



037



200 x 105 x 30 mm

037-802-000

Plastik-Schutztasche für Etui
 Plastic Pouch for Case
 Bolsa de plástico para estuche
 Plastic Pouch for Case

TRACHEOTOMIE-BESTECK

037-800-000

komplett im Metall-Etui, mit 2 gelochten Einlagen aus Edelstahl,
 bestehend aus:

- 010-210-004 1 Skalpellgriff Nr. 4 mit 1 Klinge Fig. 20
- 010-210-004 1 Skalpellgriff Nr. 4 mit 1 Klinge Fig. 23
- 013-100-130 1 anatom. Pinzette gerade, 13,0 cm
- 013-200-130 2 chir. Pinzetten gerade, 1x2 Zähne, 13,0 cm
- 015-250-130 2 Pean-Klemmen, 13,0 cm
- 017-050-130 1 Hohlsonde, 13,0 cm
- 016-505-007 1 Finsen Wundsperrer stumpf, 7,0 cm
- 037-623-170 2 Iterson Trachealhäkchen stumpf, 17,0 cm
- 037-625-160 1 Bose Trachealhäkchen scharf, links, 16,0 cm
- 037-627-160 1 Bose Trachealhäkchen scharf, rechts, 16,0 cm
- 037-701-007 1 Luer Trachealkanüle NEUSILBER Fig. 3, Ø 7 mm
- 037-701-008 1 Luer Trachealkanüle NEUSILBER Fig. 4, Ø 8 mm
- 037-820-260 1 Reinigungsbürste Ø 12 mm, 26,0 cm
- 037-802-000 1 Plastik-Schutztasche für Etui

JUEGO PARA TRAQUEOTOMIA

037-800-000

en estuche de metal, con 2

- 010-210-004 1 Manico de bisturi No. 4 con hoja fig. 20
- 010-210-004 1 Manico de bisturi No. 4 con hoja fig. 23
- 013-100-130 1 Pinza para disección recta, 13,0 cm
- 013-200-130 2 Pinzas para disección rectas, 1x2 dientes, 13,0 cm
- 015-250-130 2 Pinzas hemostáticas, 13,0 cm
- 017-050-130 1 Sonda scanalada, 13,0 cm
- 016-505-007 1 Finsen Separador romo, 7,0 cm
- 037-623-170 2 Iterson Separadores traqueales romos, 17,0 cm
- 037-625-160 1 Bose Separador traqueal agudo, lado izquierdo, 16,0 cm
- 037-627-160 1 Bose Separador traqueal agudo, lado derecho, 16,0 cm
- 037-701-007 1 Luer Cánula traqueal PLATA ALEMANA fig. 3, Ø 7 mm
- 037-701-008 1 Luer Cánula traqueal PLATA ALEMANA fig. 4, Ø 8 mm
- 037-820-260 1 Cepillo de limpieza Ø 12 mm, 26,0 cm
- 037-802-000 1 Bolsa de plástico para estuche

TRACHEOTOMY SET

037-800-000

in metal case, consisting of:

- 010-210-004 1 Handle No. 4 with blade Fig. 20
- 010-210-004 1 Handle No. 4 with blade Fig. 23
- 013-100-130 1 Dressing Forcep straight, 13,0 cm
- 013-200-130 2 Tissue Forceps straight, 1x2 teeth, 13,0 cm
- 015-250-130 2 Pean Artery Forceps, 13,0 cm
- 017-050-130 1 Grooved Director, 13,0 cm
- 016-505-007 1 Finsen Retractor blunt, 7,0 cm
- 037-623-170 2 Iterson Trachea Retractors blunt, 17,0 cm
- 037-625-160 1 Bose Trachea Retractor sharp, left hand side, 16,0 cm
- 037-627-160 1 Bose Trachea Retractor sharp, right hand side, 16,0 cm
- 037-701-007 1 Luer Trachea tube GERMAN SILVER Fig. 3, Ø 7 mm
- 037-701-008 1 Luer Trachea tube GERMAN SILVER Fig. 4, Ø 8 mm
- 037-820-260 1 Cleaning Brush Ø 12 mm, 26,0 cm
- 037-802-000 1 Plastic Pouch for case

SET PER TRACHEOTOMIA

037-800-000

in scatola di metallo, contenente:

- 010-210-004 1 Manico di bisturi No. 4 con lama fig. 20
- 010-210-004 1 Manico di bisturi No. 4 con lama fig. 23
- 013-100-130 1 Pinza per dissezione retta, 13,0 cm
- 013-200-130 2 Pinze per dissezione retta con denti 1x2, 13,0 cm
- 015-250-130 2 Pean Pinze emostatiche, 13,0cm
- 017-050-130 1 Sonda scanalata, 13,0 cm
- 016-505-007 1 Finsen Divaricatore smusso, 7,0 cm
- 037-623-170 2 Iterson Uncini tracheali smussi, 17,0 cm
- 037-625-160 1 Bose Uncino tracheale acuto, lato sinistro, 16,0 cm
- 037-627-160 1 Bose Uncino tracheale acuto, lato destro, 16,0 cm
- 037-701-007 1 Luer Cannula tracheale ARGENTONE fig. 3, Ø 7 mm
- 037-701-008 1 Luer Cannula tracheale ARGENTONE fig. 4, Ø 8 mm
- 037-820-260 1 Spazzolino per pulire Ø 12 mm, 26,0 cm
- 037-802-000 1 Cartoccio di plastica per scatola



037-820-260 26,0 cm / 10 1/4" Ø 12 mm

Tracheotomie-Besteck
Tracheotomy Set
Juego para traqueotomía
Set per tracheotomia

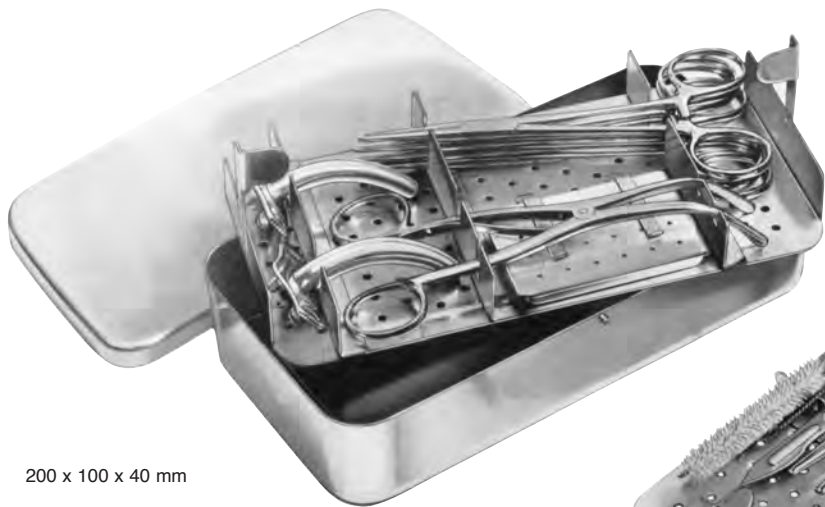

200 x 100 x 40 mm



037-812-000

Plastik-Schutztasche für Etui
 Plastic Pouch for case
 Bolsa de plástico para estuche
 Cartoccio di plastica per scatola

TRACHEOTOMIE-BESTECK

037-810-000

komplett im Metall-Etui, mit 2 gelochten Einlagen aus Edelstahl, bestehend aus:

- 010-210-004 1 Skalpellgriff Nr. 4 mit 1 Klinge Fig. 23
- 010-260-018 – 3 Skalpellklingen, auswechselbar, sortiert,
- 010-260-022 in gelochter Dose
- 019-076-050 1 Dose für Klingen, gelocht
- 013-100-130 1 anatom. Pinzette gerade, 13,0 cm
- 013-200-130 2 chir. Pinzetten gerade, 1x2 Zähne, 13,0 cm
- 015-190-140 4 Crile Klemmen gerade, 14,0 cm
- 017-050-130 1 Hohlsonde, 13,0 cm
- 037-609-140 1 Trousseau Trachealdilatator, 14,0 cm
- 037-623-170 2 Iterson Trachealhäkchen stumpf, 17,0 cm
- 037-625-160 1 Bose Trachealhäkchen scharf, link
- 037-627-160 1 Bose Trachealhäkchen scharf, r
- 037-701-006 1 Luer Trachealkanüle NEUSILVER Fig. 2, Ø 6 mm
- 037-701-008 1 Luer Trachealkanüle NEUSILVER Fig. 4, Ø 8 mm
- 037-820-260 1 Reinigungsbürste Ø 12 mm, 26,0 cm
- 037-812-000 1 Plastik-Schutztasche

JUEGO PARA TRACHEOTOMIA

037-810-000

Completo en estuche de metal con 2 bandejas perforadas de acero, compuesto de:

- 010-210-004 1 Manico de bisturios No. 4 con hoja fig. 23
- 010-260-018 – 3 Lame de bisturios, surtidas, en cajita
- 010-260-022 en bandeja perforada de metal
- 019-076-050 1 Cajita para hojas de bisturios, perforada
- 013-100-130 1 Pinza de disección recta, 13,0 cm
- 013-200-130 2 Pinzas de disección rectas, 1x2 dientes, 13,0 cm
- 015-190-140 4 Crile hemostáticas rectas, 14,0 cm
- 017-050-130 1 Sonda acanalada, 13,0 cm
- 037-609-140 1 Trousseau Dilatador traqueal, 14,0 cm
- 037-623-170 2 Iterson Separadores traqueales romos, 17,0 cm
- 037-625-160 1 Bose Separador traqueal agudo, lado izquierdo, 16,0 cm
- 037-627-160 1 Bose Separador traqueal agudo, lado derecho, 16,0 cm
- 037-701-006 1 Luer Cánula traqueal PLATA ALEMANA fig. 2, Ø 6 mm
- 037-701-008 1 Luer Cánula traqueal PLATA ALEMANA fig. 4, Ø 8 mm
- 037-820-260 1 Cepillo de limpieza Ø 12 mm, 26,0 cm
- 037-812-000 1 Bolsa de plástico para estuche

TRACHEOTOMY SET

037-810-000

metal-case, with 2 perforated trays of stainless steel, consisting of:

- 010-210-004 1 Scalpel Handle No. 4 with blade Fig. 23
- 010-260-018 – 3 Scalpel blades, assorted, in perforated
- 010-260-022 small case
- 019-076-050 1 Small case for above Scalpel blades, perforated
- 013-100-130 1 Dressing Forcep straight, 13,0 cm
- 013-200-130 2 Tissue Forceps straight, 1x2 teeth, 13,0 cm
- 015-190-140 4 Crile Forceps straight, 14,0 cm
- 017-050-130 1 Grooved Director, 13,0 cm
- 037-609-140 1 Trousseau Trachea Dilator, 14,0 cm
- 037-623-170 2 Iterson Trachea Retractors blunt, 17,0 cm
- 037-625-160 1 Bose Trachea Retractor sharp, left hand side, 16,0 cm
- 037-627-160 1 Bose Trachea Retractor sharp, right hand side, 16,0 cm
- 037-701-006 1 Luer Trachea tube GERMAN SILVER Fig. 2, Ø 6 mm
- 037-701-008 1 Luer Trachea tube GERMAN SILVER Fig. 4, Ø 8 mm
- 037-820-260 1 Cleaning Brush Ø 12 mm, 26,0 cm
- 037-812-000 1 Plastic Pouch for case

SET PER TRACHEOTOMIA

037-810-000

completo in scatola di metallo, con 2 supporti perforati di acciaio; composto de:

- 010-210-004 1 Manico di bisturi No. 4 con lama fig. 23
- 010-260-018 – 3 Lame per bisturi, assortite, contenuto in
- 010-260-022 scatoletta perforata
- 019-076-050 1 Scatoletta per lame
- 013-100-130 1 Pinza per dissezione retta, 13,0 cm
- 013-200-130 2 Pinze per dissezione rette con denti 1x2, 13,0 cm
- 015-190-140 4 Crile emostatiche rette, 14,0 cm
- 017-050-130 1 Sonda scanalata, 13,0 cm
- 037-609-140 1 Trousseau Dilatore per tracheotomia, 14,0 cm
- 037-623-170 2 Iterson Uncini tracheali smussi, 17,0 cm
- 037-625-160 1 Bose Uncino tracheale acuto, lato sinistro, 16,0 cm
- 037-627-160 1 Bose Uncino tracheale acuto, lato destro, 16,0 cm
- 037-701-006 1 Luer Cannula tracheale ARGENTONE fig. 2, Ø 6 mm
- 037-701-008 1 Luer Cannula tracheale ARGENTONE fig. 4, Ø 8 mm
- 037-820-260 1 Spazzolino per pulire Ø 12 mm, 26,0 cm
- 037-812-000 1 Cartoccio di plastica per scatola

discontinued item



037-851-150



037-853-150

KOCHER

037-851-150 - 037-853-150 15,0 cm / 6"



KOCHER

037-855-180 18,0 cm / 7"



037

**Kropffäßzangen, Klemme
 Goitre Grasping Forceps, Clamps
 Pinzas para coger el bocio, Clamp para musculos
 Pinze per gozzo, Pinza**



3x3
 037-860-150

3x3
 037-860-200

LAHEY

037-860-150 15,0 cm / 6"
 037-860-200 20,0 cm / 8"

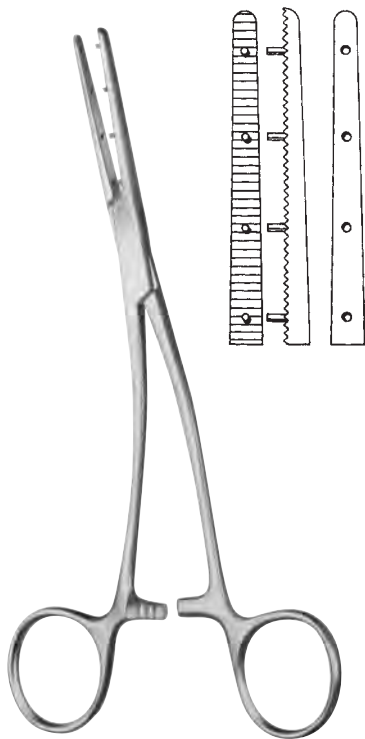

MASTIN

037-865-170 17,0 cm / 7"

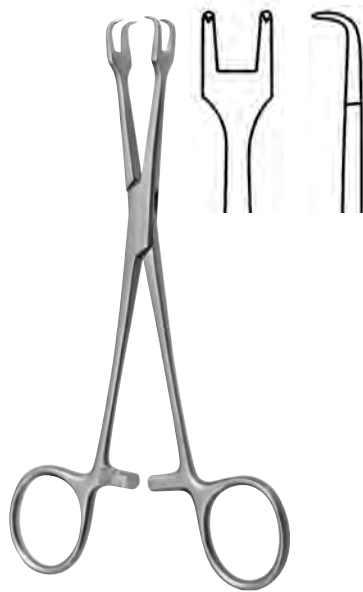

LAHEY

037-868-150 15,0 cm / 6"



BRAUN

037-870-150 15,0 cm / 6"

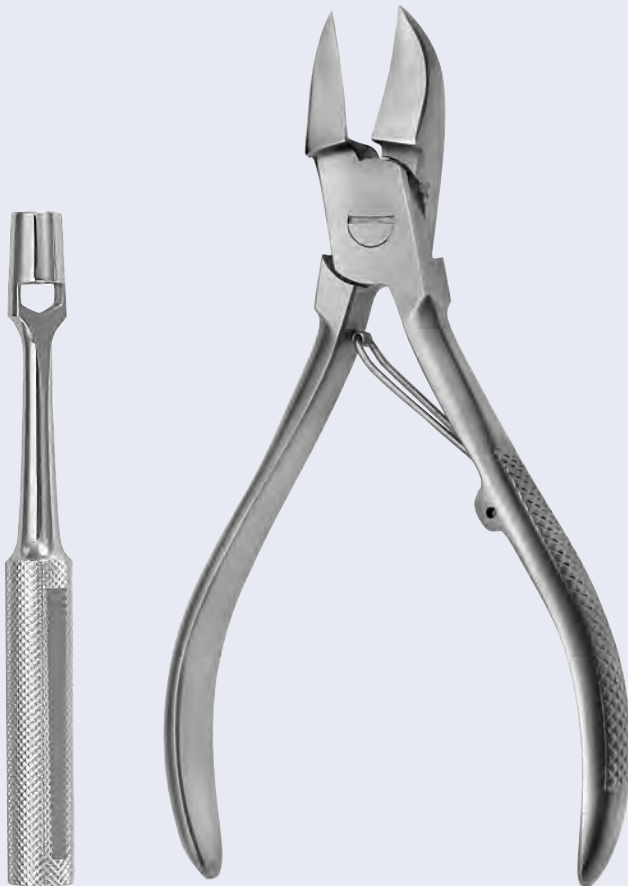

046

Dermatologie
Dermatology
Dermatología
Dermatologia



046

Lupusküretten, Hauthäkchen
Lupus Currettes, Skin Hooklets
Curetas para lupus, Ganchitos para piel
Curette per lupus, Uncini cutanei



Lupusschaber
 Lupus Scraper
 Rascador para lupus
 Raschiatoio per lupus

VIDAL

046-111-140 14,0 cm / 5 1/2"



3,0 mm

4,0 mm



Fig.1

Fig.2

046-120-001

046-120-002

5,0 mm

6,0 mm



Fig.3

Fig.4

046-120-003

046-120-004

FOX

046-120-001 - 046-120-004 14,0 cm / 5 1/2"



Fig.1

046-130-001



Fig.2

046-130-002



Fig.3

046-130-003



Fig.4

046-130-004



Fig.5

046-130-005



Fig.6

046-130-006



scharf
 sharp
 agudo
 acuto

KILNER

046-140-150 15,0 cm / 6"

Hauthäkchen, Face-Lift-Haken, Hauttrephinen
Skin Hooklets, Dermal Punches
Ganchitos para piel, Trépanos para piel
Uncini cutanei, Trefine cutanee



046

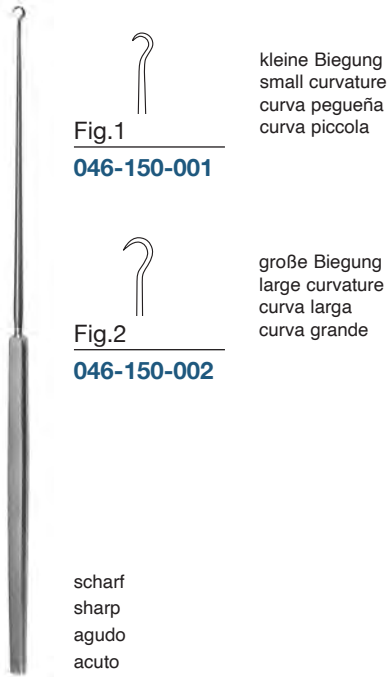

Fig.1
 kleine Biegung
 small curvature
 curva pegueña
 curva piccola
046-150-001

Fig.2
 große Biegung
 large curvature
 curva larga
 curva grande
046-150-002

scharf
 sharp
 agudo
 acuto

GILLIES

046-150-001 - 046-150-002 18,0 cm / 7"

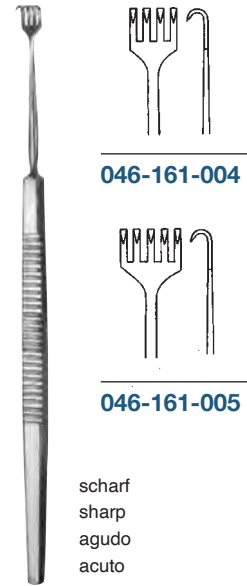

046-161-004

046-161-005

scharf
 sharp
 agudo
 acuto

KAYE

046-161-004 - 046-161-005 13,0 cm / 5"

Trephinensatz komplett auf Platte mit Griff und 6 auswechselbaren Trephinen

Punch Set complete on plate with handle and 6 exchangeable Punches

Juego de trepanos para piel completo en chapa con mango y 6 trépanos cambiables

Serie di trefine cutanee completo in lastra con manico e 6 trefine cambiabile

046-170-001

Griff allein
 Handle only
 Mango suelto
 Manico solo

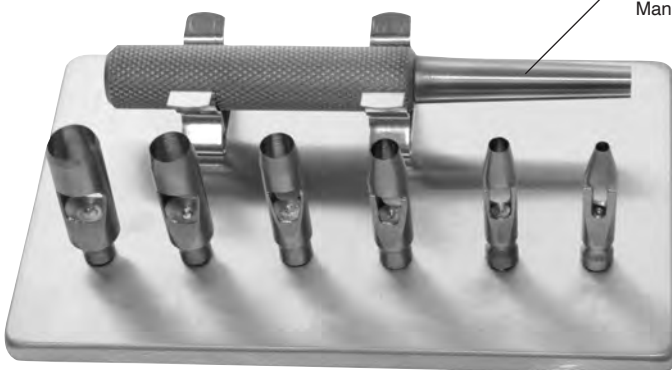

KEYES

046-170-000

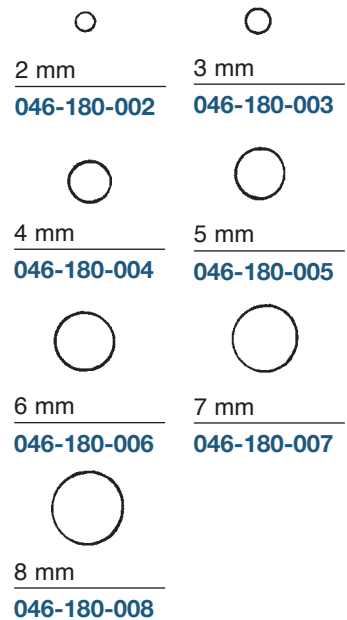
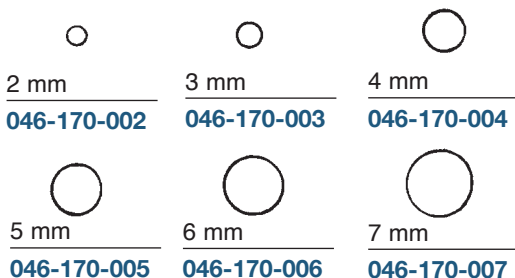

KEYES

046-180-002 - 046-180-008 12,0 cm / 4³/₄"



046

Komedoneninstrumente
Comedone Extractors
Extractores para comedones
Tiracomedoni

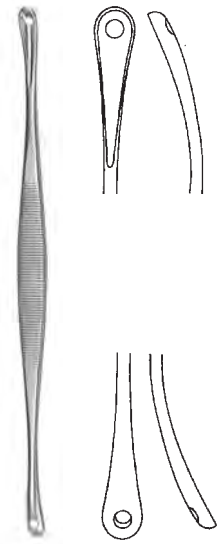

UNNA
046-201-140 14,0 cm / 5½"



UNNA
046-203-140 14,0 cm / 5½"



SAALFELD
046-205-100 10,0 cm / 4"



SAALFELD
046-207-140 14,0 cm / 5½"

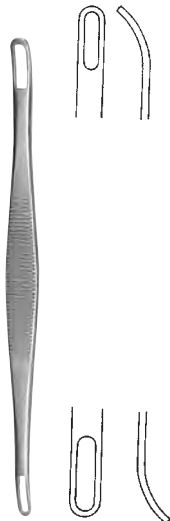

SCHAMBERG
046-209-100 10,0 cm / 4"



KATSCH
046-211-140 14,0 cm / 5½"

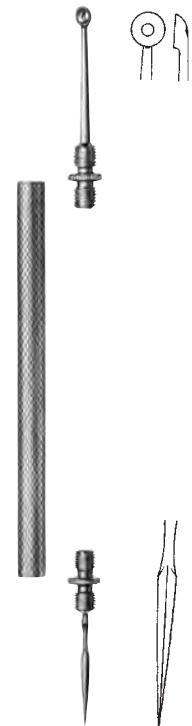

UNNA-VIDAL
046-215-115 11,5 cm / 4½"

Nagelscheren
Nail scissors
Tijeras para uñas
Forbici per unghie



046



046-410-110 11,0 cm / 4¹/₃"

Feile alleine
 file only
 lima suelta
 lima sola

046-303-500 50,0 cm / 19¹/₂"

Kette alleine
 chain only
 cadena suelta
 catena sola

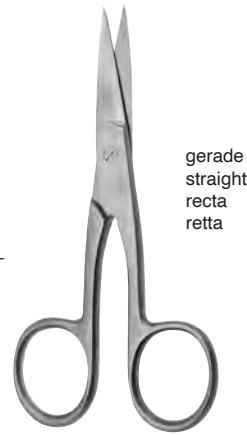

gerade
 straight
 recta
 retta

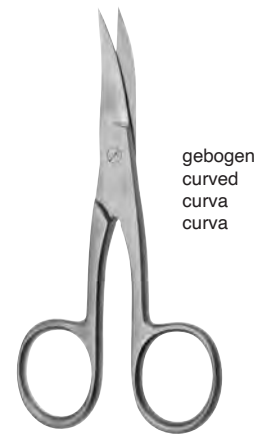

gebogen
 curved
 curva
 curva

046-304-100 10,0 cm / 4"

046-305-090 9,0 cm / 3¹/₂"
046-305-100 10,0 cm / 4"

046-301-110

Schwesterngarnitur, bestehend aus Nagelschere (gebogen) und Nagelfeile, mit Kette

Hospital Nurse Set, consisting of nail scissors (curved) and nail file, with chain

Juego de manicura para enfermeras, compuesto de tijeras (curva) y lima para uñas, con cadena

Set di manicura per infermieri, composto di forbici (curva) e lima per unghie, con catena

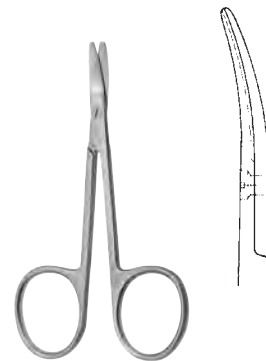

046-307-085 8,5 cm / 3¹/₂"



046-310-095

046-311-095

046-311-105



046-310-095 - 046-311-095 9,5 cm / 3³/₄"
046-311-105 10,5 cm / 4¹/₄"



046

Nagelzangen
Nail Nippers
Pinzas para cortar uñas
Tronchesine per unghie



046-321-140 14,0 cm / 5½"



046-324-140 14,0 cm / 5½"

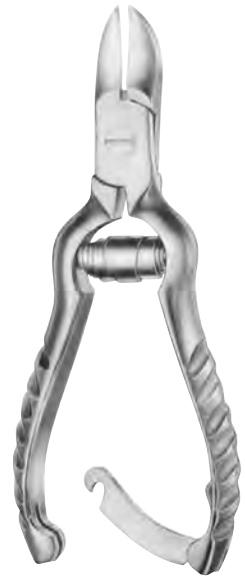

TURNBULL

046-325-110 11,0 cm / 4⅜"
046-325-130 13,0 cm / 5"



046-329-130 13,0 cm / 5"



046-331-120 12,0 cm / 4¾"

Nageleckenzangen, Nagelhautzangen, Nagelfeilen
Nail Nippers, Cuticle Nippers, Nail Files
Pinzas para cortar uñas, Pinzas cuticulares, Limas para uñas
Tronchesine per unghie, Tronchesine per pelle, Lime per unghi



046



gerade Schneiden
 straight cutting edges
 hojas cortantes rectas
 parte tagliente diritta

046-334-110 11,0 cm / 4¹/₂"
046-334-130 13,0 cm / 5"
046-334-150 15,0 cm / 6"



046-335-110 11,0 cm / 4¹/₂"

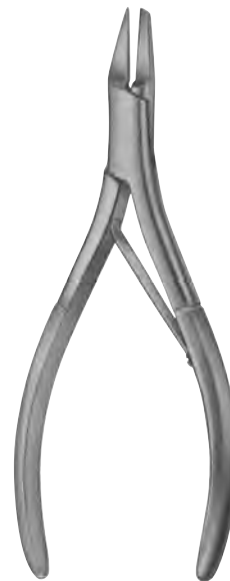

046-338-135 13,5 cm / 5¹/₄"

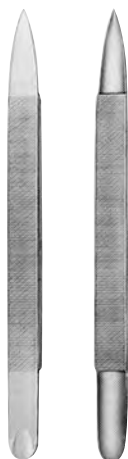

046-400-120 12,0 cm / 4³/₄"



046-410-110 11,0 cm / 4¹/₂"



mit Saphirbelag
 with sapphire coating
 con recubrimiento de zafiro
 con rivestimento in zaffiro

046-420-160 16,0 cm / 6¹/₄"



046



085

Sterilisation, Hygiene,
Aufbewahrung
Sterilisation, Hygiene,
Storage
Esterilización, Hiegiene,
Almacenaje
Sterillizzazione,
Magazzinaggio



085

Handwaschbürste, Bürstenspender
Hand and nail brush, brush dispenser
Cepillo para uñas, dispensadores de cepillos
Spazzola per unghie, Distributore per spazzole

mehr als 400 x autoclavierbar
more than 400 x autoclavable
más que 400 x autoclavable
sterilizzabile più di 400 volte in autoclave



ASEPTIC

085-100-001

Kunststoff
plastic
plástico
plastico

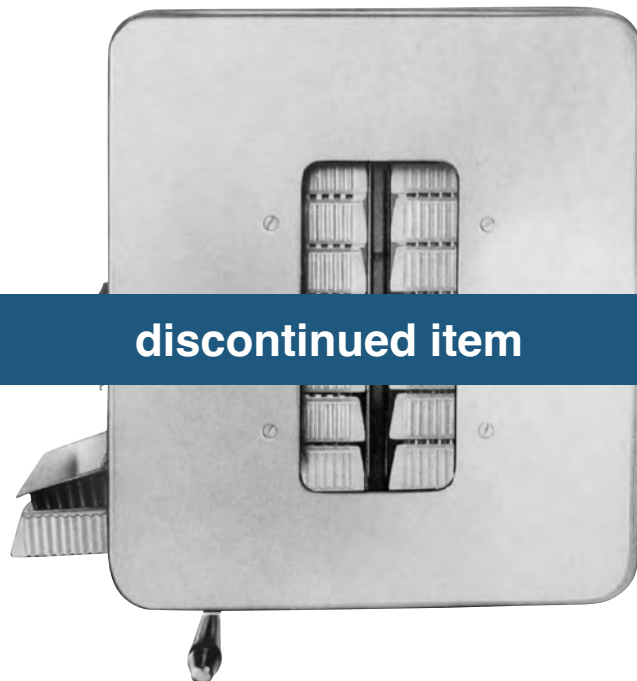

mit Aufhängevorrichtung
with suspension
con suspension
con sospensione

MARTIN

085-110-020

für 20 Bürsten (ohne Bürsten)
for 20 brushes (without brushes)
para 20 cepillos (sin cepillos)
per 20 spazzole (senza spazzole)



085-120-025

Ersatzglas, Kunststoff
Spare Glass, plastic
Vidrio de repuesto, plástico
Vetro di sostituzione, plastica

discontinued item



085-122-020

Aufhängevorrichtung, für großen Bürstenspender
suspension, for large brush dispenser
suspensión, para dispensador de cepillos grande
Suspensione, per distributore di spazzole grande



085

Bürstenabwurfbehälter, Bürstenablagekorb
Brush Collecting box, brush collecting basket
Recipiente de descarga para cepillos, Cestilla para cepillos
Contenitore per spazzole usate, Cestello per spazzole



085-130-025

Aufhängevorrichtung, für Bürstenabwurfbehälter
Suspension, for brush collecting box
Suspensión, para recipiente de descarga para cepillos
Suspensione, per contenitore per spazzole usate

discontinued item



085-132-200 200 x 180 x 135 mm

mit Aufhängevorrichtung
with suspension
con suspensión
con suspensioe

085-134-200 200 x 180 x 135 mm

ohne Aufhängevorrichtung
without suspension
sin suspensión
senza suspensioe

Kappenzangen
Dressing Forceps in jar with cap
Pinza en tarro con tapa
Pinza-coperchio



085



085-150-250 25,0 cm / 9³/₄"

Standgefäß 20,5 cm hoch
mit 25 cm langer Kornzange

jar 20,5 cm high
with 25 cm long dressing forceps

tarro 20,5 de altura
con pinza de vendaje de 25 cm

contenitore 20,5 cm di altezza
con pinza per medicatura die 25 cm di lunghezza



085-150-320 32,0 cm / 12¹/₂"

Standgefäß 25,5 cm hoch
mit 32 cm langer Kornzange

jar 25,5 cm high
with 32 cm long dressing forceps

tarro 25,5 de altura
con pinza de vendaje de 32 cm

contenitore 25,5 cm di altezza
con pinza per medicatura die 32 cm di lunghezza

Sterilisierzangen
Sterilizing Forceps
Pinzas para esterilización
Pinze per strumenti sterilizzati



CHEATTLE
085-155-270 27,0 cm / 10½"



085-158-200 20,0 cm / 8"
085-158-300 30,0 cm / 11¾"



ROGGE
085-160-235 23,5 cm / 9¼"

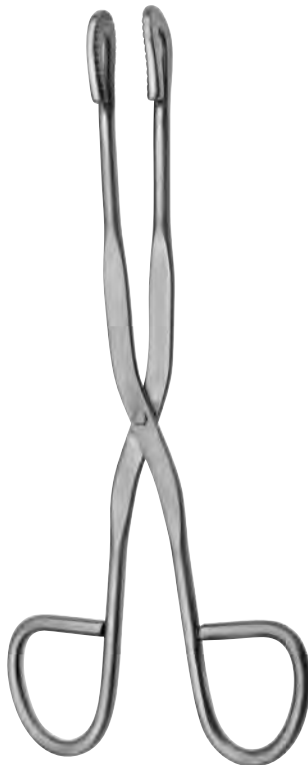

UNIVERSAL
085-164-200 20,0 cm / 8"
085-164-280 28,0 cm / 11"



UNIVERSAL
085-165-200 20,0 cm / 8"
085-165-280 28,0 cm / 11"

Sterilisierklammern, Schlauchklemmen, Quetschhähne
Safety Pins, Pinchcocks, Tubing clamps
Imperdibles para esterilización, Cierra-tubos
Spilli di sicurezza per sterilizzazione, Morsetti per tubi



085



BUNT

085-170-120 12,0 cm / 4³/₄"



MAYO

085-172-140 14,0 cm / 5¹/₂"



HOFFMANN

085-184-013 13 mm
085-184-017 17 mm
085-184-020 20 mm
085-184-025 25 mm
085-184-030 30 mm
085-184-040 40 mm



MOHR

085-187-040 40 mm
085-187-050 50 mm
085-187-060 60 mm
085-187-070 70 mm
085-187-080 80 mm



DEPONETTE

085-200-035 245 x 135 x 35 mm

Boden perforiert, mit Textilfilter (085-207-230)
 perforated bottom, with textile filter (085-207-230)
 fondo perforado, con filtro de tejido (085-207-230)
 fondo perforato, con filtri tessili (085-207-230)

discontinued item



DEPONETTE

085-200-050 245 x 135 x 50 mm

Boden perforiert, mit Textilfilter (085-207-230)
 perforated bottom, with textile filter (085-207-230)
 fondo perforado, con filtro de tejido (085-207-230)
 fondo perforato, con filtri tessili (085-207-230)

Bereitschaftsboxen
Storing Cases
Cajas para almacenaje
Scatole per magazzino



085

Deckel und Boden perforiert, mit Scharnierdeckel
 perforated lid and bottom, with hinged lid
 tapa y fondo perforado, con tapa de bisagra
 coperchio e fondo perforati, con coperchio a cerniera



Behälter Cases Cajas Scatole	Abmessung Sizes Tamaños Dimensione	Ersatz-Textilfilter, Packung mit 5 Paar Spare Textile Filters, package of 5 pairs Filtros de tejido de recambio, paquete con 5 pares Filtri di tessuti di ricambio, pacchetto con 5 paia
085-202-230	230 x 130 x 50 mm	085-207-230
085-202-260	260 x 150 x 50 mm	085-207-260
085-202-275	275 x 235 x 50 mm	085-207-275
085-202-300	300 x 200 x 50 mm	085-207-300
085-202-325	325 x 275 x 50 mm	085-207-325
085-202-420	420 x 175 x 50 mm	085-207-420
085-204-230	230 x 130 x 75 mm	085-207-230
085-204-260	260 x 150 x 75 mm	085-207-260
085-204-300	300 x 200 x 75 mm	085-207-300
085-204-325	325 x 275 x 75 mm	085-207-325
085-204-420	420 x 175 x 75 mm	085-207-420



085

Silikonmatten
Silicone Mats
Alfombras de silicona
Stuoia in silicone

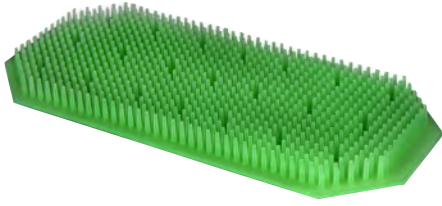

099-210-270 270 x 125 mm

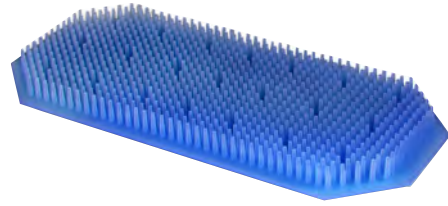

099-211-270 270 x 125 mm

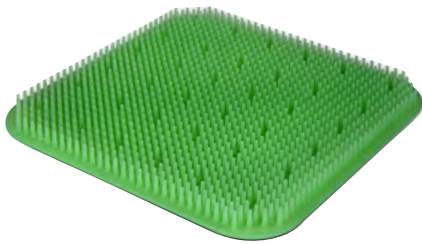

099-212-245 245 x 245 mm

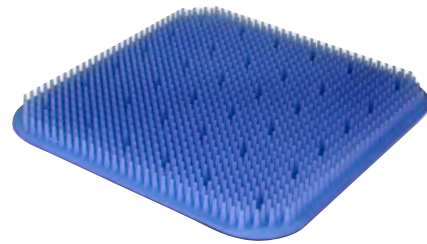

099-213-245 245 x 245 mm

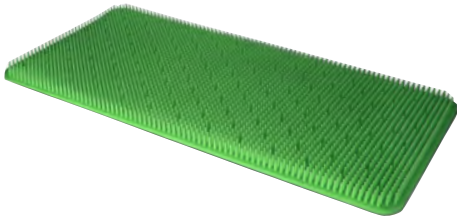

099-214-220 220 x 230 mm
099-214-380 380 x 230 mm
099-214-440 440 x 230 mm
099-214-520 520 x 230 mm

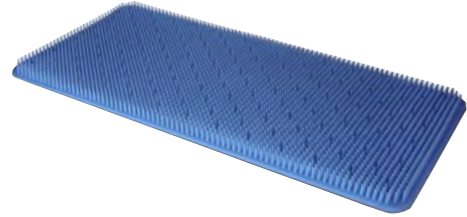

099-215-220 220 x 230 mm
099-215-380 380 x 230 mm
099-215-440 440 x 230 mm
099-215-520 520 x 230 mm

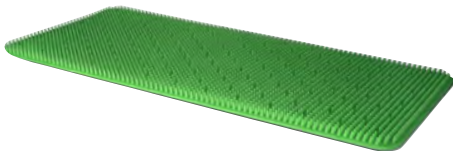

099-216-150 300 x 150 mm
099-216-300 300 x 300 mm

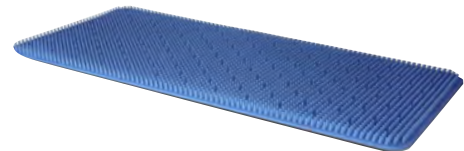

099-217-150 300 x 150 mm
099-217-300 300 x 300 mm



099-218-545 545 x 255 mm

Die Matte kann auf das gewünschte Maß zugeschnitten werden
The mat can be cut to the desired dimensions
La alfombra se puede cortar hasta la medida deseada
La stuoia può essere tagliato a misura desiderata

Rückseite
Back side
Dorso
Retro



Drahtgeflecht
wire mesh
malla de alambre
griglia in metallo

095-220-030	540 x 255 x 30 mm
095-220-050	540 x 255 x 50 mm
095-220-070	540 x 255 x 70 mm
095-220-100	540 x 255 x 100 mm

Drahtgeflecht
wire mesh
malla de alambre
griglia in metallo

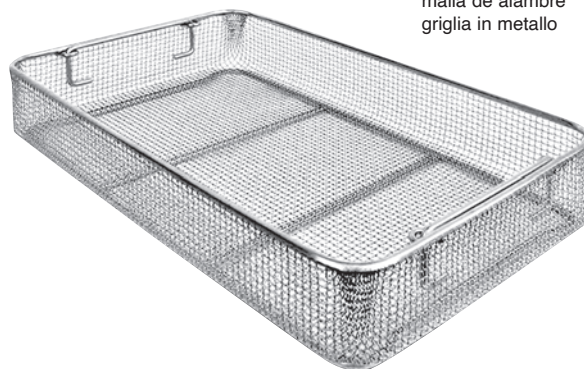

Drahtgeflecht
wire mesh
malla de alambre
griglia in metallo

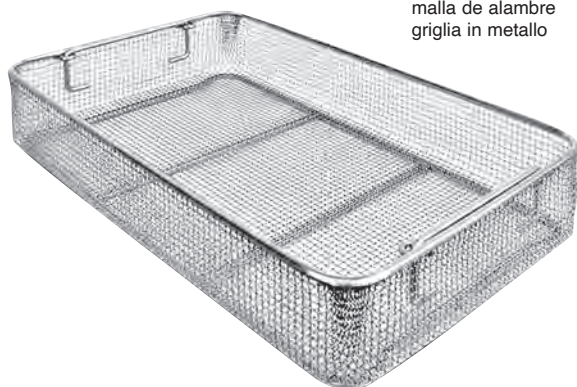

095-222-030	485 x 255 x 30 mm
095-222-050	485 x 255 x 50 mm
095-222-070	485 x 255 x 70 mm
095-222-100	485 x 255 x 100 mm

Drahtgeflecht
wire mesh
malla de alambre
griglia in metallo

095-224-030	405 x 255 x 30 mm
095-224-050	405 x 255 x 50 mm
095-224-070	405 x 255 x 70 mm
095-224-100	405 x 255 x 100 mm



095-226-030	255 x 245 x 30 mm
095-226-050	255 x 245 x 50 mm
095-226-070	255 x 245 x 70 mm
095-226-100	255 x 245 x 100 mm



085

Sterilisierkörbe
Sterilizing Baskets
Cestas para esterilización
Cestelli per sterilizzazione

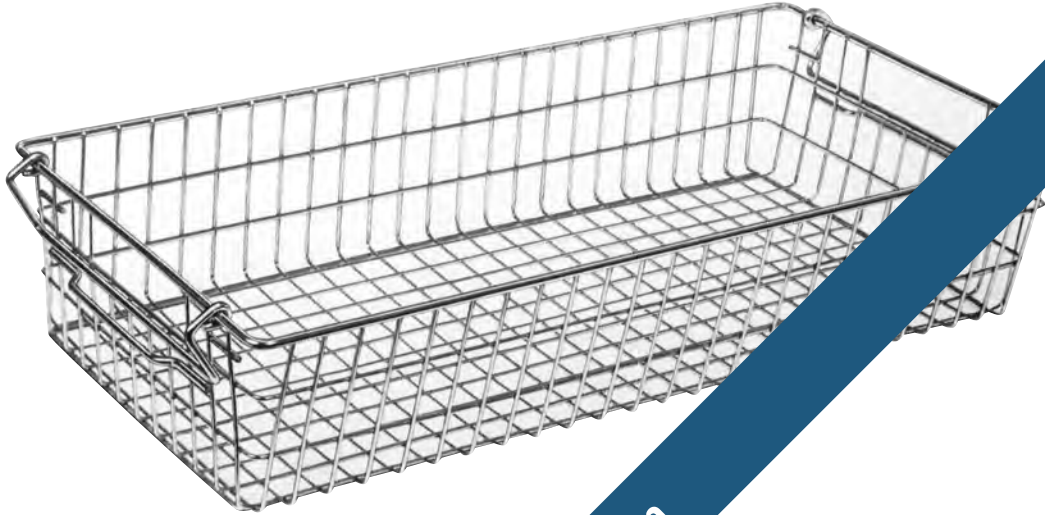

085-230-130 600 x 130 mm



085-230-260 600 x 300 x 260 mm

discontinued item

Metallschalen, Rundschalen, Flachschen, Messbecher
Stainless Steel Bowls, Round Dishes, Flat Dishes, Measurers
Cubetas de acero inoxidable, Cubetas redondas, Cubetas planas, Vaso-medidas
Scodelle di acciaio inossidabile, Scodelle rotonde, Scodelle piatte, Bicchieri graduati



085

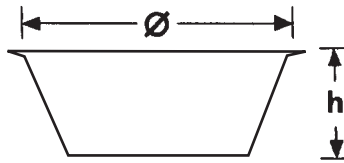

Ø x h

085-300-005	Ø 40 x 19 mm	0,05 l
085-300-007	Ø 61 x 30 mm	0,07 l
085-300-014	Ø 80 x 40 mm	0,14 l
085-300-035	Ø 116 x 50 mm	0,35 l
085-300-045	Ø 128 x 55 mm	0,45 l
085-300-070	Ø 147 x 65 mm	0,70 l
085-300-110	Ø 167 x 75 mm	1,10 l
085-300-160	Ø 187 x 85 mm	1,60 l



Ø x h

085-310-030	Ø 116 x 35 mm	0,30 l
085-310-040	Ø 128 x 38 mm	0,40 l
085-310-050	Ø 147 x 40 mm	0,50 l
085-310-075	Ø 157 x 45 mm	0,75 l
085-310-100	Ø 187 x 45 mm	1,00 l



Ø x h

085-312-015	Ø 110 x 28 mm	0,15 l
--------------------	---------------	--------



Ø x h

085-314-010	100 ccm	0,1 l
--------------------	---------	-------

innen graduert
 graduated inside
 graduado en el interior
 graduato all'interno



innen graduert
 graduated inside
 graduado en el interior
 graduato all'interno

085-320-025	0,25 l
085-320-050	0,50 l
085-320-100	1,00 l
085-320-200	2,00 l



085

Runde Schüsseln, Flachschen
Round bowls, Flat Dishes
Cubetas redondas, Cubetas planas
Scodelle rotonde, Scodelle piatte

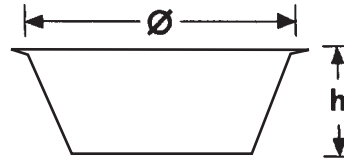

Ø x h

085-330-075	Ø 150 x 74 mm	0,75 l
085-330-100	Ø 160 x 65 mm	1,00 l
085-330-200	Ø 220 x 70 mm	2,00 l
085-330-300	Ø 240 x 95 mm	3,00 l
085-330-450	Ø 260 x 130 mm	4,50 l
085-330-600	Ø 300 x 105 mm	6,00 l
085-330-850	Ø 320 x 140 mm	8,50 l
085-334-380	Ø 380 x 125 mm	11,00 l
085-334-400	Ø 400 x 150 mm	14,00 l



Ø x h

085-342-020	Ø 110 x 27 mm	0,20 l
085-342-030	Ø 110 x 40 mm	0,30 l



Ø x h

085-340-600	Ø 330 x 90 mm	6,00 l
085-340-800	Ø 330 x 115 mm	8,00 l

Mehrzweckschalen, Instrumententabletts
Universal Trays, Instrument Trays
Bandejas universales, Bandejas para instrumentos
Bacinelle universali, Bacinelle per strumenti



085

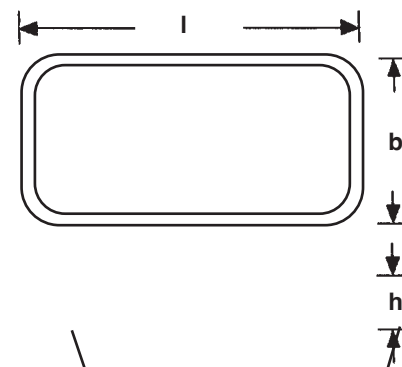

l x b x h

085-350-155	230 x 155 x 30 mm
085-350-175	300 x 175 x 30 mm
085-352-175	300 x 175 x 40 mm
085-352-240	350 x 240 x 36 mm
085-352-300	400 x 300 x 50 mm



l x b x h

085-354-160	210 x 160 x 10 mm
085-354-180	240 x 180 x 10 mm
085-356-150	310 x 150 x 10 mm
085-356-210	310 x 210 x 10 mm
085-356-240	350 x 240 x 10 mm
085-356-270	400 x 270 x 20 mm
085-356-280	420 x 280 x 10 mm



085

Mehrzweckschalen, Runde Schüsseln, Standgefäße
Universal Trays, Round Bowls, Metal Jars
Bandejas universales, Cubetas redondas, Tarros metálicos
Bacinelle universali, Scodelle rotonde, Recipienti metallici

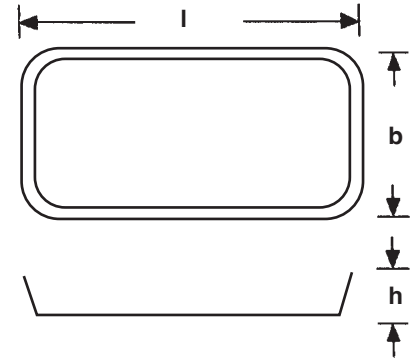

l x b x h

085-358-235 235 x 190 x 40 mm

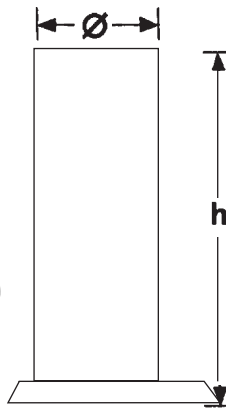

Deckel allein, geschlossen
 Lid only, closed
 Tapa suelta, cerrada
 Coperchio solo, chiuso

085-376-050 Ø 50 mm
085-376-075 Ø 75 mm
085-376-100 Ø 100 mm



Deckel allein, mit dreieckiger Aussparung
 Lid only, with triangular opening

Ø x h

085-370-090 Ø 30 x 90 mm
085-370-100 Ø 50 x 100 mm
085-370-130 Ø 50 x 130 mm
085-370-175 Ø 50 x 175 mm
085-372-100 Ø 75 x 100 mm
085-372-130 Ø 75 x 130 mm
085-372-175 Ø 75 x 175 mm
085-374-175 Ø 100 x 175 mm
085-374-200 Ø 100 x 200 mm

discontinued item

085-378-050 Ø 50 mm
085-378-075 Ø 75 mm
085-378-100 Ø 100 mm



mit Knopfdeckel
 lid with knob
 tapa con botòn
 con coperchio a bottone



Deckel ohne Knopf
 lid without knob
 tapa sin botòn
 coperchio senza bottone

I x b x h

085-400-165	165 x 85 x 35 mm
085-400-200	200 x 100 x 35mm
085-402-200	200 x 100 x 50 mm
085-402-230	230 x 130 x 50 mm
085-402-260	260 x 150 x 50 mm
085-402-270	270 x 235 x 50 mm
085-402-300	300 x 200 x 50 mm
085-402-325	325 x 275 x 50 mm

I x b x h

085-410-165	165 x 85 x 35 mm
085-410-200	200 x 100 x 35 mm
085-412-200	200 x 100 x 50 mm
085-412-230	230 x 130 x 50 mm
085-412-260	260 x 150 x 50 mm
085-412-270	270 x 235 x 50 mm
085-412-300	300 x 200 x 50 mm
085-412-325	325 x 275 x 50 mm

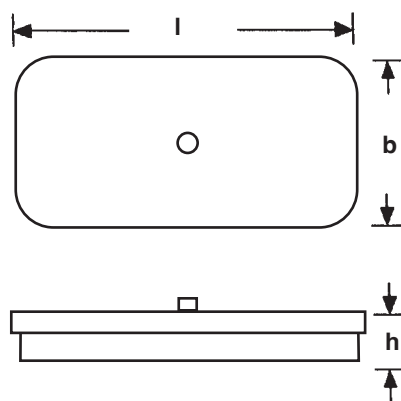

Runde Metalldosen, Medizinbecher
Round Metal Boxes, Medicine cups
Cajas metálicas redondas, Vasos medicinales
Scatole per strumenti, Bicchieri per medicina



mit Knopfdeckel
 lid with knob
 tapa con botón
 con coperchio a bottone

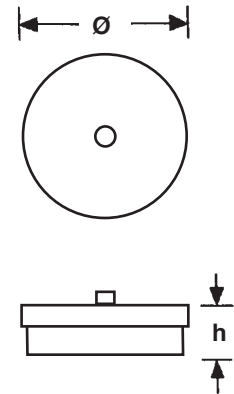

Ø x h

085-420-060	Ø 75 x 60 mm
085-420-075	Ø 75 x 75 mm
085-422-060	Ø 100 x 60 mm
085-422-100	Ø 100 x 100 mm
085-424-080	Ø 125 x 80 mm
085-424-125	Ø 125 x 125 mm
085-426-150	Ø 150 x 150 mm



085-430-025 25 ccm

innen graduert
 graduated inside
 graduado en el interior
 graduato all'interno



085-432-050 50 ccm

innen graduert
 graduated inside
 graduado en el interior
 graduato all'interno



085-434-020 20 ccm

Medizinlöffel
 Medicine Spoon
 Cuchara medicinal
 Cucchiaino per medicina

innen graduert
 graduated inside
 graduado en el interior
 graduato all'interno



Ø x h

085-436-075 Ø 75 x 12 mm

Tablettenschale
 Tablet Tray
 Bandejita para tabletas
 Bacinella per compresse



085-450-090 Ø 90 x 90 mm

Mundbecher
 Metal cup
 Vaso metalico
 Biocchiere metallico



085-452-080 Ø 75 x 80 mm

Sputumbecher
 Sputum cup
 Escupidera
 Sputacciera



METHOD

085-464-075 Ø 50 x 75 mm

mit Deckel
 with lid
 con tapa
 con coperchio



METHOD

085-466-075 Ø 50 x 75 mm

ohne Deckel
 without lid
 sin tapa
 senza coperchio



METHOD

085-468-075 Ø 50 x 75 mm

ohne Deckel
 without lid
 sin tapa
 senza coperchio



Kunststoff
 plastic
 plastico
 materiale plastico

METHOD

085-470-055 Ø 45 x 55 mm

Einsatz
 Insert
 Inserto
 Inserto



085

Nierenschalen, Stechbecken
Kidney Dishes, Bed Pans
Riñoneras, Silletas
Bacinelle reniformi, Padelle



l x b x h

085-500-170	170 x 100 x 35 mm
085-500-250	250 x 140 x 40 mm
085-500-275	275 x 150 x 45 mm

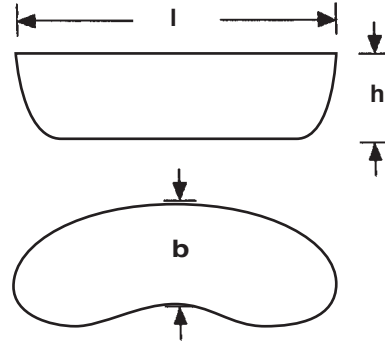

085-511-235	Ø 235 mm
085-511-310	Ø 310 mm

Knopfdeckel, allein
Lid knob, only
Tapa con boton, suelta
Coperchio a bottone, solo

085-510-235	Ø 235 mm
085-510-310	Ø 310 mm

Dreieckschalen, Plazentabecken, Spirituslampen
Triangular Basins, Placenta Pan, Spirit lamps
Cubetas triangulares, cubeta para placenta, lámparas de alcohol
Bacinelle triangolari, Bacinella per placenta, Lampade a spirito



085



085-520-600

innen graduert bis 600 ml, mit Griff
 graduated inside up to 600 ml, with handle
 graduado en el interior hasta 600 ml, con mango
 graduato all'interno fino a 600 ml, con manico

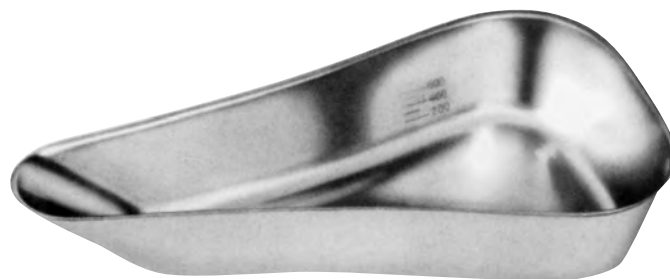

085-522-600

innen graduert bis 600 ml, ohne Griff
 graduated inside up to 600 ml, without handle
 graduado en el interior hasta 600 ml, sin mango
 graduato all'interno fino a 600 ml, senza manico



085-540-120 120 ccm



085-542-100 12 mm

Ersatzdocht, flach per Meter
 Spare Wick, flat, per meter
 Mecha de repuesto, plana, por metro
 Lucignolo di ricambio, piatto, per metro

085-544-012 12 mm

Ersatzdocht, flach, 12 cm lang
 Spare Wick, flat, 12 cm long
 Mecha de repuesto, plana, 12 cm de largo
 Lucignolo di ricambio, piatto, 12 cm di lunghezza



085

Wasserstrahl-Reinigungspistole
Water jet pistol
Pistola-lavatoria de chorro de agua
Pistola lavatrice a getto d'acqua



AQUAJET

085-600-000

komplett mit 9 Aufsätzen 085-602-001 bis 085-602-009,
1 m Druckschlauch, Haken und Schelle

complete, with 9 tips 085-602-001 to 085-602-009,
1 m pressure tube, strap and suspension hook

completa, con 9 toberas 085-602-001 a 085-602-009,
1 m tubo de presión, abrazadera y gancho

completa, con 9 raccordi 085-602-001 a 085-602-009,
1 m tubo ad alta pressione, graffa e fibbia

Aufsätze siehe nächste Seite
tips see next page
toberas véase siguiente página
raccordi vedi pagina accanto

AQUAJET

085-601-000

ohne Aufsätze
without tips
sin toberas
senza raccordi

discontinued item

Aufsätze Wasserstrahl-Reinigungspistole
Tips for water jet pistol
Toberas para pistola-lavatoria de chorro de agua
Raccordi per pistola lavatrice a getto d'acqua



085



Fig. 1

085-602-001

für Flaschen
for bottles
para botellas
per bottiglie



Fig. 2

085-602-002

für Record-Spritzen Konen
for cones of record syringes
para conos de jeringas Record
per coni di siringhe Record



Fig. 3

085-602-003

für Katheter
for catheters
para catèteres
per cateteri



Fig. 4

085-602-004

für Drainageschläuche
for drainage tubings
para tubos de drenaje
per tubi di drenaggio



Fig. 4

085-602-005

für Hohlkatheter
for hollow catheters
para catèteres
per cateteri



Fig. 4

085-602-006

für Kanülen mit Record-Konus
for hypodermic needles with
Record-cone
para agujas de inyección con
cono Record
per aghi ipodermici con cono
record

discontinued item



Fig. 7

085-602-007

für Kanülen mit
für hypodermic needles
with Luer cone
para agujas de inyección con
cono Luer
par aghi ipodermici con
con Luer



Fig. 8

085-602-008

für Meß- und Vollpipetten
for measuring and volumetric
pipettes
para pipetas de medida y
volumétricas
per pipette comuni e
graduate

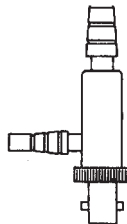

Fig. 9

085-602-009

für feine Pipetten
for fine pipettes
para pipetas finas
per pipette fine



Fig. 10

085-604-310

Reinigungsaufsatz
31 cm, gerade
cleansing tip,
31 cm, straight
tobera de limpeza
31 cm, recta
per lavaggio, 31 cm
retto

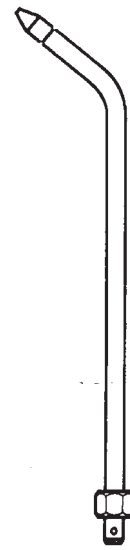

Fig. 11

085-605-310

Reinigungsaufsatz
30 cm, abgebogen
cleansing tip,
30 cm, curved
tobera de limpeza
30 cm, curva
per lavaggio, 30 cm
curvo



085-610-034

Überwurfmutter, 3/4 Zoll
Coupling, 3/4 inch
Tuerca-hembra, 3/4 pulgada
Dado premistoppa, 3/4 pollici



085

**Instrumentenspray
Instrument Spray Oil
Lubricante para instrumentos
Spray lubrificante per strumentario**



085-650-000

Instrumentenspray
Instrument Spray Oil
Lubricante para instru
Spray lubrificante p

discontinued item



a x b x c

085-700-003 245 x 65 x 3 mm



a x b x c

085-702-003 420 x 65 x 3 mm



a x b x c

085-704-008 270 x 65 x 8 mm

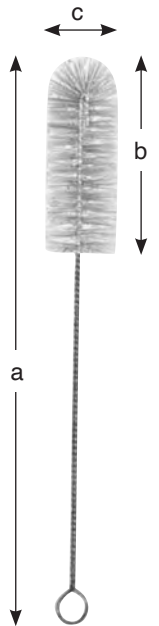

a x b x c

085-706-007 285 x 75 x 7 mm



a x b x c

085-710-012 270 x 65 x 12 mm



a x b x c

085-710-013 215 x 60 x 13 mm



085

Reinigungsbürsten
Cleaning Brushes
Cepillos de limpieza
Spazzole per pulire



a x b x c

085-710-015 215 x 70 x 15 mm



a x b x c

085-710-020 215 x 65 x 20 mm



a x b x c

085-710-025 215 x 65 x 25 mm



a x b x c

085-710-030 215 x 65 x 30 mm



085-720-000

Satz mit 5 Bürsten bestehend aus 085-710-013 -085-710-030
Set of 5 brushes consisting of 085-710-013 -085-710-030
juego de 5 cepillos compuesto de 085-710-013 -085-710-030
set a 5 spazzole composto da 085-710-013 -085-710-030

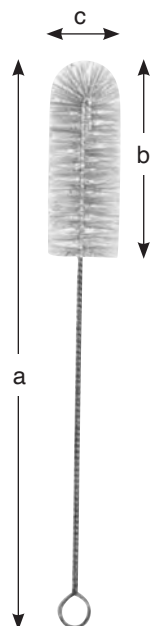



a x b x c

085-730-012 275 x 65 x 12 mm



a x b x c

085-730-015 275 x 80 x 15 mm



a x b x c

085-730-030 300 x 120 x 30 mm



a x b x c

085-730-050 320 x 130 x 50 mm



a x b x c

085-732-035 360 x 140 x 35 mm

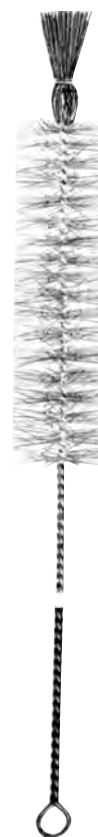

a x b x c

085-734-040 420 x 180 x 40 mm



085

Reinigungsbürsten
Cleaning Brushes
Cepillos de limpieza
Spazzole per pulire

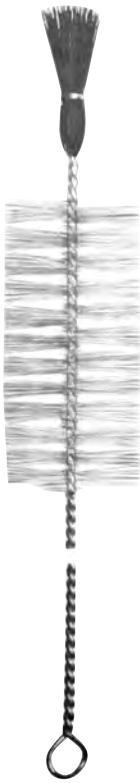

a x b x c

085-736-060 500 x 180 x 60 mm

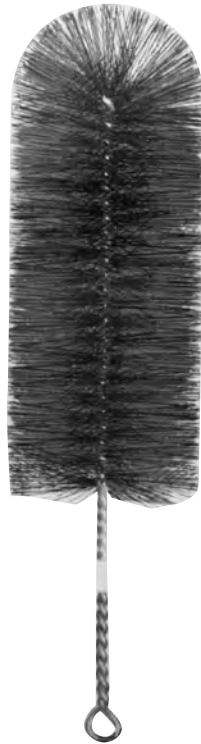

a x b x c

085-740-080 490 x 180 x 80 mm



a x b x c

085-741-060 450 x 180 x 60 mm



a x b x c

085-742-075 420 x 130 x 75 mm



a x b x c

085-746-050 330 x 130 x 50 mm

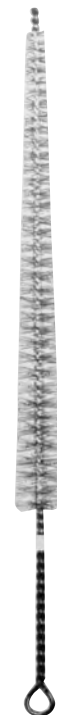

konisch
conical
cónico
conico

a x b x c

085-748-020 400 x 190 x 8/20 mm



konisch
 conical
 cónico
 conico

a x b x c

085-750-033 300 x 110 x 18/33 mm



konisch
 conical
 cónico
 conico

a x b x c

085-752-025 320 x 70 x 15/25 mm



konisch
 conical
 cónico
 conico

a x b x c

085-754-015 420 x 60 x 8/15 mm



a x b x c

085-756-016 1000 x 180 x 16 mm



085-758-095 210 x 95 mm



085

Abfalleimer, Abfallzangen
Waste Bucket, Waste Forceps
Cubo para desechos, Pinzas para desechos
Secchi per rifiuti, Pinze per rifiuti



085-800-325 Ø 325 mm

Inhalt 15l
capacity 15l
capacidad 15l
capacità 15l



085-802-325

Deckel
Lid
tapa
coperchi



085-810-580 58,0 cm / 22³/₄"



SAUERBRUCH

085-820-550 55,0 cm / 22"



Inhaltsverzeichnis
Alphabetical Index
Índice alfabético
Índice alfabético



D

Inhaltsverzeichnis

Alphabetical Index

Indice alfabético

Indice alfabetico

A

Abfallzange	948
Abfalleimer	948
ABRAHAM Tonsillennmesser	890
ADAMS Serviettenhalter	870
ADLERKREUTZ Chirurgische Pinzette	83
ADSON Anatomische Pinzette	78
ADSON Chirurgische Pinzette	82
ADSON Dura Haken	617
ADSON Klemme	182
ADSON MIKRO-Anatomische Pinzette	78
ADSON MIKRO-Chirurgische Pinzette	82
ADSON Nadelhalter	361
ADSON Raspatorium	478
ADSON Saugrohr	290
ADSON Spiralbohrer	416
ADSON Wundsperrerr	256,261,262
ADSON-BROWN Chirurgische Pinzette	82
AEBLI MICRO-Augenschere	781
ALAN-PARKS Analspreizer	683
ALAN-PARKS Mittelvalve	683
ALAN-PARKS Seitenvlve	683
ALDERDYCE Elevator	484
ALEXANDER Biopsiezange	740
ALEXANDER Flachmeißel	439
ALEXANDER Hohlmeißel	439
ALEXANDER Rippen-Raspatorium	478
ALLEN Darm- und Gewebefaßzange	665
ALLIS ATRAUMA Klemme	662
ALLIS Darmfaßklemme	662
ALLIS-ADAIR Darmfaßklemme	662
ALLIS-BABY Darmfaßklemme	662
ALLISON Lungenspatel	544
ALLPORT Retractor	255
ALM Wundsperrerr	255
Amputationskomprimeter	412
Amputationsmesser	12,13
Anatomische Pinzette	78-80
Anatomische Pinzette Iris (GRAEFE)	88
Anatomische Pinzette USA MODELL	78
Anatomische Pinzetten, fein	89
Anatomisches Skalpell	2
ANDERSON-ADSON Wundspreizer	256
ANDREW Zungendrucker	878
ANDREWS-PYNCHON Saugrohr	296
Anestophon Stethoskop	309
Anlegezange für Bulldogklemme	549
Anlegezange für TITAN- Bulldogklemme	162
Ansatz mit konischem Gewinde	818
Ansatz, Olivförmig	818
AQUAJET Aufsatz für Reinigungspistole	941
AQUAJET Reinigungspistole komplett	940
ARRUGA Nadelhalter	353
ARTERIENKLEMMEN	165-184
ASCH Septumzange	861
ASEPTIC Handwaschbürste	920
Aufhängevorrichtungen	921,922
AUFRICHT (WIENER) Nasenraspel	853
AUFRICHT Nasenhaken	858,86
Augennadel	349
AUSTIN MIKRO-Attikus-Dissektor	795
AUSTIN MIKRO-Knüpppinzette	96
AUVARD Spekulum	719
AXENFELD Tränenrüsennähkchen	768
AYER Chalazionspinzette	780
AYRE Konsiationsmesser	2

B

BABCOCK ATRAUMA Klemme	664
------------------------	-----

BABCOCK Darmfaßklemme	664
BABINSKI Hammer	307
BABY-ADSON Klemme	182
BABY-BABCOCK Darmfaßklemme	664
BABY-BAILEY Rippensperrerr	543
ADAMS Gallensteindilatator	273
BABY-COLLIN Seitenvlve	270
BABY-COLLIN Wundsperrerr komplett	270
BABY-DOYEN Darmklemme	666
BABY-DUPLEX Stethoskop	309
BABY-GILLIES Nadelhalter	366
BABY-KERN Knochenhaltezange	503
BABY-MIXTER Klemme	181
BABY-Nagelschere	915
BABY-OVERHOLT Klemme	169
BABY-ROUX Wundhaken	250
BABY-SATINSKY Gefäßklemme	545
BABY-TISCHLER Biopsiezange	741
BACKHAUS Tuchklemme	201
BADGLEY Laminikotomie-Spreizer	626
BAILEY Rippensperrerr	543
BAILEY-GIBBON Rippensperrerr	543
BAINBRIDGE ATRAUMA Klemme	554
BAINBRIDGE Klemme	180
BAKES Gallenkanaldilatator	690
BAKES Gallensteindilatator Satz	690
BALFOUR Bauchdeckenhalter	274
BALFOUR Drahtvlve	275
BALFOUR Mittelvlve	275
BALL-SOCKET Papier-Tuchklemme	202
BALLENGER Schwingmesser	840
BALLENGER Septum-Hohlmeißel	845
BALLENGER-HAJEK Septum Elevator	842
BARANY Lärmtrommel mit Ohrolive	803
BARANY Ohr Olive	803
BARBARA MIKRO-Ohrnadel	793
BARBARA Ohrnadel	794
BARNHILL Ringmesser	863
BARR Mastdarmspekulum	681
BARRAQUER (COLIBRI) Augendisperrerr	762
BARRAQUER Cilienpinzette	91
BARRAQUER Hornhautschere	783
BARRAQUER Nadelhalter	354-355
BARRAQUER-COLIBRI Fixierpinzette	777
BARRAQUER-KATZIN Fixierpinzette	777
BARRAQUER-TROUTMAN Nadelhalter	354
BARRET Hakenzange	727
BARRON Saugkanüle	294
Batteriegriff	330,337
Batteriegriff für Diagnostikbestecke	317
Batteriegriff für Kaltlicht mit LED-Beleuchtung	338
Bauchdeckenhalter	270-280
Bauchspatel	253
BAUMGARTNER Nadelhalter	360
BEACHAM Amniotom	729
BECK ATRAUMA Gefäßklemme	574
BECKMANN Nasenspekulum	825
BECKMANN Ringmesser	862,863
BECKMANN Wundsperrerr	263
BECKMANN-ADSON Wundsperrerr	264
BECKMANN-EATON Wundsperrerr	264
BEEBEE Drahtschere	50
BEER Cilienpinzette	91
Begrenzungsplatten mit Schlitz	430
BELLUCCI MIKRO-Absaugrohr komplett	293
BELLUCCI MIKRO-Ohrschere	789
BELLUCCI MIKRO-Saugkanüle	293
BENGOLEA Klemme	177
BENNETT Knochenhebel	490
Bereitschaftskasten	927
BERGER Linse	321

BERGER Stirnlupe komplett	321
BERGMANN Gipsäge	406
BERGMANN Hammer	456
BERGMANN Verbandschere	403
BERLIN Schlauchklemme	204
BERLINER Hammer	306
BERNHARD Tuchklemme	202
BERTILLON Schädel Meßzirkel	311
BETHUNE Rippenschere	532
BEYER Hohlmeißelzange	514
BEYER Ohrstanze	808
BIEMER Anlegepinzette	156
BIEMER Approximator	156,157
BIEMER Approximator-Set	156,157
BIEMER Gefäßclipps	151
BIEMER Schlüssel	157
BIEMER-MÜLLER Approximator	155
BIER Amputationssäge	410
BIER Ersatz-Sägeblatt	410
BIER Kanüle	300
BILLEAU Ohrschlinge	811
BIRCHER Meniskusmesser	494
BIRCHER-GANSKE Meniskusmlemme	500
BIRKETT Klemme	183
BISHOP-HARMAN Iris Pinzette	777
BISHOP-HARMAN MIKRO-Pinzette	777
BLAKE Galleinsteinzange	692
BLAKE Kürette	750
Bleihand für Erwachsene	525
Bleihand für Kinder	525
BLOHMKE Tonsillenzange	894
BLOUNT Knie-und Wundhaken	492
BLOUNT Knochenhebel	491
BLUMENTHAL Hohlmeißelzange	513
Blutdruckmessapparat	322
Blutdruckmessapparat Wandmodell	323
BODENHAMMER Mastdarmspekulum	680
BOETTCHER Schere	46
BÖHLER Extensionsbügel für Arm	429
BÖHLER Extensionsbügel für Oberschenkel	429
BÖHLER Hohlmeißelzange	514
BÖHLER Knochensplitterzange	521
Bohrdraht Lagergestell für Drähte	436
Bohrdrahtspender, mehrfach	435
Bohrdrahtspender mit Kunststoff-Deckel	434
Bohrdrahtspender mit Metall-Deckel	434
Bohrfutter mit T-Griff komplett	416
Bolzenschneider	424
BONACCOLTO Nahtpinzette	779
BONN MOD. Iris Pinzette	777
BONN MOD. Schere	38
BONNEY Chirurgische Pinzette	86
BOSE Trachealhähkchen	904
BOUCHERON Ohrspekulum	799
BOWMAN Augensonde	774
BOWMAN Diszisionsnadel	765
BOWMAN Sperrelevator	762
BOYS-ALLIS Gewebefaßzange	663
BOZEMANN Schlingendreher	394
BOZEMANN Tupferzange	208
BOZEMANN Uterusschere	28
BOZEMANN-DOUGLAS Schwammzange	208
BRAND Sehnenfaßzange	498
BRAUN Hakenzange	732
BRAUN Krianioklast	759
BRAUN Kröpfzange	910
BRAUN Uterus Depressor	726
BRAUN-STADLER Schere	29
BREISKY Spekulum	720
BRODIE Sonde	283
BROPHY Anatomische Pinzette	79

Inhaltsverzeichnis
Alphabetical Index
Indice alfabético
Indice alfabético



D

BROPHY Chirurgische Pinzette	84	CASTROVIEJO Nahtpinzette	778	COOLEY Rippensperrer	533
BROPHY-SULLIVAN Schere	36	CASTROVIEJO Rasierklingsenbrecher und -halter	14	COOLEY Saugrohr	297
BROWN Chirurgische Pinzette	86	CASTROVIEJO Zykloklialspatel	770,775	COOLEY Wundhaken	245
BROWN Nadelhalter	360	CASTROVIEJO-BARRAQUER Spatel	769	COOLEY-BECK ATRAUMA Gefäßklemme	588
BRUENINGS Brochosaufsatz	899	CATLIN Amputationsmesser	12	COOLEY-DERRA ATRAUMA Gefäßklemme	588
BRUENINGS Mundspatel	879	CAWOOD-MINNESOTA Wangen- und Lippenhalter	877	COOPER Unterbindungsnadel	389
BRUENINGS Scharfe Nasenzange	828	Cerclage Draht	427	CORDES Bronchos Aufsatz	899
BRUENINGS Septummesser komplett	841	CHAPUT Tumorfäßklemme	178	CORYLLOS Wundhaken	236
BRUENINGS Tonsillennmesser	890	CHARRIERE Amputationssäge	411	COTTLE Columella Pinzette	861
BRUENINGS Tonsillenschnürer	895	CHARRIERE Ersatzsägeblatt	411	COTTLE Hammer	455
BRÜNINGS Verlängerungsrohr	898	CHEATTLE Sterilisierzange	924	COTTLE Hautfaßpinzette	861
BRUNNER ATRAUMA Klemme	677	CHERON Tupferzange	208	COTTLE Knorpelquetsche mit Fasspinzette	851
BRUNNER Ferrozell Führungshohlsonde	394	CHEVALIER-JACKSON Bronchoszange	898	COTTLE Meißel	846,847
BRUNNER Führungshohlsonde	392	CHEVALIER-JACKSON Trachealkanüle	906	COTTLE Nasenfeile	853
BRUNNER Rippen und Sternumschere	531	CHILDE Nahtpinzette	395	COTTLE Nasenhäkchen	856
BRUNNER Unterbindungsnadel	391	Chirurgische Nadel	346,347	COTTLE Nasenhaken	860
BRUNNER Wundhaken	237-239	Chirurgische Nadel gebogen	347-348	COTTLE Nasenmeißel	846
BRUNS Gipschere	404	Chirurgische Pinzette	81-88	COTTLE Nasenmesser	838
BRUNS Scharfer Löffel	462,463	Chirurgische Pinzette RUSS. MODELL	86	COTTLE Nasenspekulum	824
Bruststütze	342	Chirurgische Pinzette USA MODELL	82	COTTLE Periostelevator	843
Bruststütze mit Laryngoskophalter	342	Chirurgische Schere, grazil	24	COTTLE Raspator	842
BRYANT Korn- und Tupferzange	207	Cilienpinzette	90,91	COTTLE Sattelhäkchen	860
BUCHWALD Zungenspatel	879	CINELLI Nasenmeißel	848	COTTLE Schere	47
BUCK Hammer	307	Circumcisionsinstrument	702	COTTLE-KAZANJIAN Knochensplitterzange	520
BUCK Ligaturschere	52	CITELLI Antrum Stanze	808, 837	COTTLE-NEIVERT Nasenhaken	859
BUCK Ohrhebel	806	CLAR Stirnlampe	319,32	COTTLE-WALSHAM Septumzange	861
BUCK Ohrkürette	809,81	CLEVELAND Hohlmeißelzange	512	COUPLAND Aufsatz	298
BUCK-GRAMCKO Knochenhebel	485	CLEVELAND Knochensplitterzange	520	COUPLAND Saugerhandgriff	297
BUCKLEY Wundsperrer	254	Clip-Set MINI-Assistent	398	CRAFOORD Klemme	184
BUJE Klemme	179	CLOVER ATRAUMA Bulldogklemme	549	CRAFOORD Schere	41
BULEAU Trokar	289	CLOWARD Sperrer	268	CRAFOORD-SELLORS Klemme	184
Bulldog-Gefäßclip	148	CLOWARD Valve	269	CRAIG Nasenpolypenzange	827
Bulldogklemme	160-164	CLOWARD Wirbelkörperspreizer	634	CRAWFORD Aorta Wundhaken	240
BUMENTAL Hohlmeißelzange	513	CLOWARD Wundsperrer	269	CRILE Klemme	168
BUMM Uterus Kürette	749	COAKLEY Kiefer Trokar	290	CRILE Nervhäkchen	599
BUNELL Handbohrapparat	417	COAKLEY Kürette	862	CRILE Wundhaken	252
BUNNELL Sehnenfächer	496	COBB Hohlmeißel	450	CRILE-MURRAY Nadelhalter	361
BUNNELL Sehnenbruchzugsonde	497	COBB Raspatorium	472	CRILE-RANKIN Klemme	169
BUNT Sterilisierklammer	925	COGSWELL Saugrohr	292	CRILE-WOOD Nadelhalter	361
BURFORD Rippensperrer aus ALUMINIUM	535	COLLIER Nadelhalter	359	CRUTCHFIELD Schädelhalter	603
BURKE Biopsiezange	741	COLLIN Bauchdeckenhalter	270	CUSCO Scheidenspekulum	706,707
Bürstenabwurfbehälter	922	COLLIN Dynamometer	311	CUSHING Anatomische Pinzette	80
BUSCH Nabelschnurschere	29	COLLIN Faßzange	178	CUSHING Bohrer	416
		COLLIN Hammer	454	CUSHING Chirurgische Pinzette	84
		COLLIN Mittelvalve	271	CUSHING Dura Haken	617
C		COLLIN Nabelschnurklemme	758	CUSHING Laminektomiezange	650
		COLLIN Pelvimeter	753	CUSHING Nervenaken	613
CAPLAN Nasenschere	835	COLLIN Scheidenspekulum	707	CUSHING Venenhaken	217
CAROLL Finger Goniometer	311	COLLIN Seitenvlve	271	CUSHING Wundhaken	217,218
CAROLL Sehnenfaßinstrument	499	COLLIN Tupferzange	207	CUZZI Abortuslöffel	757
CARPENTER Tonsillennmesser / Dissektor	891	COLLIN Uterus Sonde	726	CZERNY Gallensteinzange	692
CASPAR Drehschlüssel, allein	627	COLLIN Uterusfaßzange	733	CZERNY Hakenzange	732
CASPAR Durahaken	618	COLLIN Wundhaken	252	CZERNY Mastdarmspekulum	680
CASPAR Haken mit Kungelschnellverschluss	627, 628	COLLIN Wundklammerzängchen	396		
CASPAR Laminektomie-Spreizer	629	COLLIN Zungenzange	880	D	
CASPAR Laminektomie-Spreizer komplett	627-632	COLLIN-DUVAL Faßpinzette	87	D'ERRICO Bohrer	416
CASPAR Laminektomiezange	653,654	COLLIN-LOKITE Wundsperrer	270	DAHLGREN Ersatzmesser	604
CASPAR Pinzette	628	COLLYER Pelvimeter	753	DAHLGREN Schädelöffnungsinstrument	604
CASPAR Rahmen	627-632	COMCO Circumcisionsgerät	702	DAHMEN Hohlmeißel	451,452
CASPAR Seitenvlve	627,628,632	CONE Schädelöffnungsinstrument	604	DAHMEN Osteotom	451,452
CASPAR Spekulum	633	Container für Anlegezangen	146	DALE ATRAUMA Peripheral-Gefäßklemme	577
CASPAR Sperrer	630	Container für Gefäßclips	145,146	DANDY Klemme	167
CASPAR Valve	629	CONVERSE Nasenflügelhäkchen	856,858	DANDY Nervenaken	614
CASTA—EDA ATRAUMA Neonatal-Gefäßklemme	593	CONVERSE Nasenmesser	838	DANDY Schere	45
CASTA—EDA Rippensperrer aus ALUMINIUM	536	COOLEY ATRAUMA Anastomosenklemme	583-586	DARDIK ATRAUMA Gefäßklemme	580
CASTROVIEJO Augenlidsperrer	762	COOLEY ATRAUMA Cardiovascular Klemme	584	Darmschere	51
CASTROVIEJO Augenschere	781,782	COOLEY ATRAUMA Carotisklemme	583	DARTIGUES Uterusfaßzange	733
CASTROVIEJO Augenzirkel	773	COOLEY ATRAUMA Iliaca-Klemme	583	DAVIDSON Wundhaken	236
CASTROVIEJO Hornhautschere	784	COOLEY ATRAUMA Katheterklemme	587	DAVIS Dura Dissektor	616
CASTROVIEJO Kanüle	772	COOLEY ATRAUMA Kindergefäßklemme	590-592	DAVIS Spatel biegsam	611
CASTROVIEJO MIKRO-Nadelhalter	356-358	COOLEY Gefäßdilator	5,94,595		
CASTROVIEJO(JACOBSON) MIKRO-Nadelhalter	357				



D

Inhaltsverzeichnis Alphabetical Index Indice alfabético Indice alfabético

DAVIS-BOYLE Mundsperrerr	873	DOYEN Kette mit Gewicht	279	FAULKNER Kürette	862
DAY Ohrhäkchen	812	DOYEN Myomheber	734	FAURE Biopsiezange	738
DE LEE Geburtszange	754	DOYEN Rahmenhaken	279	FAURE Peritoneumklemme	195
DE MARTEL Einführungsinstrument	602	DOYEN Raspatorium	475,476	FAVALORO Gefäßschere	45
DE MARTEL-WOLFSON Anastomosenklemme	672	DOYEN Scheidenspekulum	720	FEHLAND ATRAUMA Rektum Klemme	678
DE MARTEL-WOLFSON Klemmenhalter	672	DOYEN Schere	27	FEILCHENFELD Splitterpinzette	90
DE MARTEL-WOLFSON Klemmschließzange	672	DOYEN Spekulum	717	FEIN Watteträger	287
DE VILBISS Ersatzmesser	604	DOYEN Uterus Zange	732	Feine Anatomische Pinzette	89
DE VILBISS Schädelöffnungsinstrument	604	DOYEN-JANSEN (MOLT) Mundsperrerr	871	FELDHEIM Band	526
DEAN Schere	48	DOYEN-STILLE Wundhaken	233	FELDHEIM Finger Instrument	526
DEAVER Schere	25	Draht-Fasszange	421-423	FERGUSON Gallensteinlöffel	694
DEAVER Wundhaken	243-245	Draht-Flachzange	421-423	FERGUSON Klemme	179
DEBAKEY ATRAUMA Aortaklemmen	562-568	Draht-Kneifzange	424	FERGUSON Knochenhalte zange	502
DEBAKEY ATRAUMA Bulldogklemme	548-550	Drahtumführungs nadel	428	FERRIS-SMITH Laminektomie zange	657
DEBAKEY ATRAUMA Gefäßklemme	551-582	Druck-Manometer	752	FERRIS-SMITH-KERRISON Laminektomie stanze	649
DEBAKEY ATRAUMA Pinzette	547	DUBOIS Schere	28	Ferrozellbacken für Hammer, allein (Paar)	455,457
DEBAKEY Gefäßdilator	595	DUEHRSEN Anatomische Pinzette	80	Ferrozellgriff für auswechselbare Meißelklinge	445
DEBAKEY Gefäßschere	44	DUEHRSEN Chirurgische Pinzette	85	Ferrozellhammer	458
DEBAKEY Rippensperrerr	539,540	DUPLAY Hakenzange	729	FILIFORM Gleitsonde	699
DEBAKEY Seitenvulve	539-540	DUPLEX Stethoskop	309	Feine Schere	40
DEBAKEY-DIETHRICH Bulldogklemme	163	DUPUY-WEISS Tonsillennadel	889	Fingerring-Sägezange	527
DEBAKEY-SATINSKY ATRAUMA Bulldogklemme	548	DURANTE Chirurgische Pinzette	86	FINOCHIETTO (mod.) Rippensperrerr	538
Deckel für Abfalleimer	948	DUVAL Chirurgische Pinzette	87	FINOCHIETTO BABY Rippensperrerr	534,538
Deckel für Lagerungstray	146	DUVAL Darmfaßklemme	665	FINOCHIETTO INFANT Rippensperrerr	534
Deckel für Nierenschale	938			FINOCHIETTO Klemme	192
Deckel mit dreieckiger Aussparung	934			FINOCHIETTO Nadelhalter	364
Deckel mit Knopf für Stechbecken	938			FINOCHIETTO Rektumschere	42
Deckel, allein	934			FINSIN Wundsperrerr	254
DEJERINE Hammer	306	E		FISCH Ohr Dissektor	796
DEMEL Drahtspannzange	427	EASTMAN Spekulum	709	FISCHER Sehnenschäler	497
DEMEL Drahtumführungs nadel	428	EASTMAN Spekula groß	709	FISCHER Tonsillennmesser	890
DEMEL Drahtumführungs nadel	428	ECHLIN Hohlmeißelzange	516	Fixierscheiben für Bohrdrähte	430
DENHARDT Mundsperrerr	871	EICKEN-KILLIAN Nasenspülkanüle	865	Flachmeißel mit Ferrozellgriff	448,449
DENHARDT Silikonbacken	871	Einnalskalpelle	9,10	Flachmeißelklinge	445
DENIS-BROWNE Bauchdeckenhalter	278	EISELSBERG Fadenschere	52	Flachzange	421,422
DENIS-BROWNE Fußpinzette	87	Elevator	483	FOERSTER Schwammzange	208,209
DENIS-BROWNE Rahmen	278	ELLIOT Griff	772	FOMON Haken	859
DENIS-BROWNE Rahmenhaken	278	ELLIOT Hornhauttrephine komplett in Etui	772	FOMON Nasenfeile	854
DEPONETTE Bereitschaftsbox	926	ELLIOT Trephine	772	FOMON Nasenhaken	857
DERF Nadelhalter	359	ELSÄSSER Nierenfistelzange	689	FOMON Nasenmeißel	848
DERRA ATRAUMA Gefäßklemme	574	EMMET Fistelhaken	734	FOMON Nasenplastikmesser	838
DESCHAMPS Unterbindungsnadel	390,391	ENGEL Gipsäge	406	FOMON Nasenraspel	855
DESJARDINS Gallensteinlöffel	693	ENGL. MODELL Anatomische Pinzette	80	FOMON Schere	34,47
DESJARDINS Gallensteinsonde	691	ENGL. MODELL Tuchklemme	201	FOREGGER Laryngoskopbesteck	329-336
DESJARDINS Gallensteinzange	693	Enucleationsschere	34	FOX Lupus Kürette	912
DESJARDINS Ligatur Klemme	191	Episiotomie-Schere	29	FRAENKEL Bronchosaufsatz	899
DESMARRES Chalazionspinzette	780	EPENDORFER Biopsiezange	740	FRANZ Bauchdeckenhalter	279
DESMARRES Lid Wundhaken	763	Ersatzbacke aus FERROZELL	459	FRANZ Rahmen	279
DESMARRES Wundhaken	214	Ersatzdochte für Spirituslampe	939	FRANZ Rahmenhaken	279
Diagnostik-Besteck	316	Ersatzdorn	603	FRANZ Valve	279
Dichtungsring	751	Ersatzklinge allein	11	FRAZIER Dura Dissektor	614
DIEFFENBACH Bulldogklemme	164	Ersatzklinge für LA FORCE Ringmesser	864	FRAZIER Dura Haken	617
DIETHRICH ATRAUMA Aortaklemme	575	Ersatzlampe für Kaltlicht-Laryngoskope	337	FRAZIER Saugrohr	290
DIETHRICH Bulldogklemme	163	Ersatz-Lichtträger	343	FREER Mukosamesser	839
DIETHRICH Gefäßschere	43	Ersatz-Sägeblatt	527	FREER Schleimhauthäkchen	859
DINGMANN Knochenhalte zange	500	Ersatz-Textil Spezialfilter	927	FREER Septum Elevator	841,842
DINGMANN Mundsperrerr	875	ESMARCH Gipsmesser	406	FREER Septum-Messer	839
DINGMANN Zungenspatel	875	ESMARCH Staubbinde	413	FREER Septum-Hohlmeißel	844
DIX Doppelschiebeinstrument	775	ESMARCH Verbandschere	404	Fremdkörperschlinge und Sugenmagnet	766
DIXON-LOVELACE Klemme	169	EVES Tonsillenschnürer	895	FRIEDMANN Hohlmeißelzange	511
Doppelinstrument umschraubbar	775	EXCENTRIC Verbandsschere	402	FRIEDMANN-VICKERS Hohlmeißelzange	511
Doppelknopfsonde	282	Extensionsbügel	430	FRIMED Fadenfänger	394
Doppelöffel	466			FRIMED Führungshohlsonde	392
DOUGLAS Cilienpinzette	90	F		FRIMED-DIAMANT Kopfschneider	424
DOUGLAS Trokar	289	Fadenfänger für Tourniquet RUMEL-BELMONT	599	FRIMED-VIGORIMETER Kraftmesser	310
DOYEN Raspatorium	475	FANSLER Rektoskop	684	FRITSCHE Wundhaken	234
DOYEN ATRAUMA Darmklemme	674	FARABEUF Knochenhalte zange	504	FROSCH Knochenhalte zange	502
DOYEN Bauchdeckenhaken	234	FARABEUF Raspatorium	474	FRYKHOLM Hohlmeißelzange	517
DOYEN Darmklemme	666	FARABEUF Wundhaken	249	Führungshohlsonde, Ferrozell	395
DOYEN Hammer	454	FARABEUF-LAMBOTTE Knochenhalte zange	504	FULLER MIKRO-Ohrzängchen	791
DOYEN Hohlsonde	283	FARRELL Watteträger	287		
		FARRIOR Ohrspekulum	798		

G

GALLAHER Nasenraspel 853
 Gallenkanal- und Niernstielklemme 193,194
 Gefäßschere 45
GELLHORN Biopsiezange 738
GELPI Wundspreizer 267
GEMINI Präparier- und Ligaturklemme 187
GERALD Anatomische Pinzette 80
GERALD Chirurgische Pinzette 84
GERSTER Knochenhalteklammer 419
GERZOG Hammer 456
GIERTZ-STILLE Sternumschere 530
GIGLI Drahtsäge 602
GIGLI Griff für Drahtsäge 602
GILLIES Chirurgische Pinzette 83
GILLIES Hauthäkchen 913
GILLIES Nadelhalter 366
GIL-VERNET Type Wundhaken 219
GLOVER ATRAUMA Bulldogklemme 549,55
GLOVER ATRAUMA Gefäßklemme 573
GLUCK Rippenschere 530
GOELET Wundhaken 251
GOLDMANN-FOX Schere 49
GOLDSMITH (THUDICHUM) Nasenspekulum 822
GOMEL MIKRO-Schere 17
GOMEL Nadelhalter 355
GOOD Gefäßschere 46
GOODELL (SIMS) Uterus Dilator 736
GOSSET Bauchdeckenhalter 273
GOSSET Mittelvalve 273
GRAEFE Irishäkchen 766
GRAEFE Strabismushäkchen 768
GRAEFE (Iris) Anatomische Pinzette 88
GRAEFE Augenstarmesser 764
GRAEFE Cystotom 766
GRAEFE Iris Häkchen 212,766
GRAEFE Iris Pinzette 776
GRAEFE Strabismushäkchen 768
GRAHAM Dura Haken 617
GRAVE Spekulum 708
GRAY Präparierklemme 191
GREEN-ARMYTAGE Uterusklemmzange 756
GREGORY ATRAUMA Carotisklemme 550
GREGORY ATRAUMA Profundaklemme 576
GREGORY SOFT ATRAUMA Carotisklemme 550
 Griff für Biopsiezange 742
 Griff für Ringstripper 286
GRONINGEN Nervenhaken 613
GROSS Ohrlöffel und Häkchen 810
GROSS-MAIER Kornzange 206
GUEDEL-NEGUS Laryngoskopbesteck 327
GULEN Saugraspatorium 865
 Gummibacken für YOUNG Zungenzange 880
 Gummiringe für Hämorrhoidal Ligatur 685
GUTHRIE Doppelfixierhäkchen 767
GUTHRIE Häkchen 212
GUYON ATRAUMA Niernstielklemme 193
GUYON Harnröhrenbougie 699
GUYON Katheter 702
GUYON Klemme 193

H

HABERER Bauchspatel 253
HACKSTOCK Flachzange 421
HAIGHT Rippensperrerr 537
HAJEK Hammer 456
HAJEK Keilbeinstanze 836
HAJEK-KOFLER Keilbeinstanze 836
 Hakenzange 731

HALLE Dura Messer 618
HALLE Scharfer Löffel 465
HALLE Septum Elevator 841
HALSEY Nadelhalter 360
HALSTEAD-MOSQUITO Klemme 165
 Halteplatte für Tunnelier-Aufsätze 596
 Hammer 454-459
 Hammer mit Kunststoffgriff 458
 Hammer, Rückschlagfrei mit Kunststoffgriff 458
 Handgriff, flach, für Optiken Ø 2,7 mm 820,868
HANK Uterus Dilator 724
HARDY Eukleator 620
HARDY Hypophysen MIKRO-Kürette 619
HARDY Implantationsgabel 620
HARDY-FAHLBUSCH MIKRO-Dissektor 620
HARKEN ATRAUMA Gefäßklemme 565
HARKEN Gefäßklemme 546
HARMS Trabekularsonde 774
HARRINGTON Wundhaken 242
HARTMANN Arterienklemme 166
HARTMANN Hohlmeißelzange 512
HARTMANN Nasenspekulum 823
HARTMANN Nasentamponzange 826
HARTMANN Ohrhäkchen 811
HARTMANN Ohrkatheter 804
HARTMANN Ohrlöffelzängchen 807
HARTMANN Ohrspekulum 798
HARTMANN Ohrzängchen 806,807
HARTMANN Scharfe Nasenzange 829
HARTMANN Stimmgabel 801,802
HARTMANN Tonsillenzange 897
HARTMANN Zungendrücken 878
HARTMANN-HALLE Nasenspekulum 822
HARTMANN-HOFFMANN Ohrlöffelzängchen 807
HARTMANN-WULLSTEIN Ohrzängchen 807
HAYES ATRAUMA Klemme 677
HEANEY Klemme 198
HEANEY Nadelhalter 363
HEANEY-BALLENTINE Hysterektomieklammer 198
HEANEY-KANTER Hysterektomieklammer 199
HEANEY-REZEK Hysterektomieklammer 198
HEATH Hammer 457
HEATH Ligaturschere 52
HEBRA Chalazionslöffel 771
HEGAR Nadelhalter 365
HEGAR Uterine Dilator 721-723
HEGENBARTH Nahtpinzette 396
HEIFETZ Spatel 611
HEIFETZ Tumorzange 93
HEIMING Nierensteinzange 688
HEISS Klemme 181
HEISTER Mundsperrerr 871
HEMINGWAY Doppellkürette 467,468
HENKE Tonsillendisektor 892
HENLEY Mittelvalve 260
HENLEY Wundspreizer 260
HENNING Gipspreizer 407
HEPP-SCHIEDL MIKRO-Schere 17,19
HERRIK Niernstielklemme 194
HESS Bulldogklemme 164
HEYMANN Scharfe Nasenzange 827
HEYMANN Schere 47
HEYWOOD-SMITH Polypenfasszange 686
HIBBS Hohlmeißel 443
HIBBS Meißel 443
HIBBS Osteotom 442,443
HIRSCHMANN Rektoskop 683
HOFF Tuckklemmen 203
HOFFMANN Schlauchklemme 925
 Hohlmeißel 438
 Hohlmeißelklinge auswechselbar 445

Hohlsonde 282,283
 Hohlsonde mit Knopf 283
HOHMANN Knochenheber 486-489
HOKE Meißel 442
HOLINGER Operations-Laryngoskope 339
HOLSHER Nervwurzelhaken 612
HOLTH Kapselstanze 773
HOLZ Mundspatel 879
HOLZHEIMER Wundspreizer 255
HOPKINS Gipsmesser 406
HORSLEY Dura Dissector 614
HÖSEL Wundhaken 233
HOUSE Kürette 797
HOUSE MIKRO-Messsonde 796
HOUSE Saugkanüle 294
HOUSE-DIETER Ohrzängchen 790,791
HUBER Universal Griff 898
HUDSON Bohraparat 416
HUDSON Fräser 416
HUMBY Dermatome Ersatzklinge 11
HUMBY Dermatome 11
HUNT Tumorzange 94
HUNTER Splitterpinzette 89
HURD Tonsillendisektor 891
HURD Tonsillennadel 889
HUSFELDT ATRAUMA Peripherale-Gefäßklemme 579

I

Incisions-Schere 25
INGE Wirbelkörperspreizer 634
 Innendose, Deckel und Boden 352
 Instrumentenbehälter 935
 Instrumentenkasten 935
 Instrumentenspray 942
 Instrumententablett 933
 Intima Spatel 598
IOWA Blasenlange 730
IOWA Kanüle 298
 Iris (GRAEFE) Anatomische Pinzette 88
 Iris Schere 37
ISRAEL Wundhaken 225
ITERSON Trachealhäkchen 904
IUP-Fasszange 743
IVES-FANSLER Kunststoff-Obturator 683
IVES-FANSLER Rektoskop 683

J

JACKSON Operations-Laryngoskope 339
JACKSON Scheidenspekulum 709
JACKSON Trachealhäkchen 904,905
JACOBS Hakenzange 730
JACOBSON Doppelsonde 620
JACOBSON MIKRO-Schere 16
JAEGER Lidplatte 763
JAEGER-GRIESHABER Lanzenmesser 764
JAMESON Meßschieber mit Einteilung 312
JAMESON Präparierschere 39
JAMISON Nadelhalter 363
JANET Wund- und Blasenpritze 304
JANET Zylinder 304
JANSEN (GRUENWALD) Nasentamponpinzette 826
JANSEN Hohlmeißelzange 512,514
JANSEN Ohrkürette 810
JANSEN Wundsperrerr 255
JARCHO Hakenzange 727
JAVID ATRAUMA Carotis-Shuntklemme 581
JENNINGS Mundsperrerr 876
JOBSON HORNE Watteträger 287
JOHNS-HOPKINS Bulldogklemme 164



D

Inhaltsverzeichnis Alphabetical Index Indice alfabético Indice alfabético

JOHNS-HOPKINS Klemme	183	KIRSCHNER Bohrdrähte	433-434	LAMBERT-KAY ATRAUMA Gefäßklemme	567
JOHNSON Nadelhalter	364	KIRSCHNER Extensionsbügel	429,432	LAMBOTTE Knochenhaltezange	505
JOLL (FRIEDMANN) Wundspreizer	266	KIRSCHNER Ferrozell Führungshohlsonde	394	LAMBOTTE Osteotom	440
JONES Tuchklemme	201	KIRSCHNER Führungshohlsonde	392	LAMBOTTE Raspatorium	476
JOSEPH Nasenfeile	852	KIRSCHNER Rahmen	276	LANDAU Scheidenspekulum	720
JOSEPH Nasenmesser	838	KIRSCHNER Rahmenhaken	277	LANDAU Trokar	290
JOSEPH Nasenplastikmesser	838	KIRSCHNER-BALLFOUR Rahmenhaken	277	LANDOLT Präpariersauger	292
JOSEPH Nasensäge	851	KIRSTEIN Nasenschere	47	LANDOLT Schere	35
JOSEPH Raspator	843	KLEINERT-KUTZ Sehnenfaßzange	499	LANDOLT Tumorfasszange	655
JOSEPH Schere	35	KLEINERT-KUTZ Stirnlampe	320	LANDOLT-CUSHING Hypophysektomie Spekulum	619
JOSEPH Schleimhauthäkchen	859	Klettmanschette	322	LANE Chirurgische Pinzette	85
JOSEPH Septum Elevator	841	KLIMA-ROSSEGGER Kanüle	301	LANE Knochenhaltezange	506
JOSEPH-MASING Septum Elevator	843	KLINGENBERG-LOTH Gefäßschere	41	LANE Magenwillingsklemme	669
JUDD-ALLIS Darmfaßklemme	663	KNAPP Augenmesser	764	LANE Tuchklemme	202
JUDD-MASSON Blasenspreizer	697	KNAPP Augenhäkchen	767	LANGE Brochosaufsatz	899
JUDD-MASSON Mittelblatt	697	KNAPP Wundhäkchen	214	LANGE Nasenflügelhaken	856
JURASZ Kehlkopfpolypenzange	900	KNAPP-ROLLET Häkchen	767	LANGE-HOHMANN Knochenhebel	488
K					
KABIERSKE Ersatzflasche	815	KNIGHT Scharfe Nasenzange	827	LANGENBECK Amputationsmesser	13
KABIERSKE Ohrkanüle	815	Knochenfeile	481	LANGENBECK Elevator	482,484
KABIERSKE Pulverbläser komplett	815	Knochenhalte- zange, selbstzentrierend	509	LANGENBECK Fingerschützer	870
KABIERSKE Ventilball	815	Knochenhalte- zange	500-509	LANGENBECK Knochenhalte- zange	502
KADER Spatel	248	Knochenhebel	485,486	LANGENBECK Nadelhalter	384
KALLMORGEN Spekulum	716	Knochenmeißel	438	LANGENBECK Ohrkürette	809
KALLMORGEN Halter	716	Knopfsonde	282	LANGENBECK Raspatorium	473
KALT Gefäßnadel	349	KNOWLES Verbandschere	402	LANGENBECK Säge	411
KALT Nadelhalter	353	Knüpfpinzette	95	LANGENBECK Wundhaken	225,226,228
Kaltlichtgriff	338	KNUTSON Urethrographieinstrument	702	LANGENBECK-GREEN Wundhaken	216
KANE Nabelschnurklemme	758	KNUTSON-KOCH Kanüle	702	Laryngoskop-Ersatzlampe	330
KANTROWITZ Ligatur Klemme	190	KOCHER ATRAUMA Darmklemme	675	Lateral Vaginal Spekulum	736
Kanüle zum Einbinden in die Vene	299	KOCHER Blasenhaken	698	LAWRENCE Präparier und Ligatur Klemme	190
Kappenzange mit Standzylinder	923	KOCHER Darmklemme	667	LAZAR MIKRO-Knüpfpinzette	96
KATSCH Komedonenquetscher	914	KOCHER Klemme	174-176	LEBSCHKE Sternummeißel	532
KATZIN-BARRAQUER Augenschere	781	KOCHER Klemmen, grazil	174	LEES ATRAUMA Gefäßklemme	566
KAYE Hauthäkchen	913	KOCHER Kropfsonde	909	LEGUE Blasenhaken	698
Kehlkopfspiegel	902	KOCHER Wundhaken	222,223,228-234	LEGUE Blasenspreizer	698
Kehlkopfspiegelgriff	902	KOCHER-LANGENBECK Wundhaken	228	LEGUE Mittelvalve	698
KEITH Chirurgische Darmnadel	348	KOERTE Wundhaken	224	LEGUE Seitenvalven	698
KELLY Klemmen	168	KOGAN Vaginal Spekulum	735	LEKSELL-STILLE Hohlmeißelzange	517
KELLY Ligatur Klemme	188	KÖLNER Sparklammer	606	LELAND-JONES ATRAUMA Klemme	558
KELLY Proktoskop	684	KÖNIG Führungshohlsonde	392	LEMPERT Elevator	814
KELLY Schere	48	KÖNIG Stimmgabel	803	LEMPERT Hohlmeißelzange	513
KELLY Uterusfaßzange	732	KOOS MIKRO-Instrument	621	LEMPERT Ohrlöffel	814
KELLY Wundhaken	232,247	Korn- und Tupferzange	206-209	LEMPERT Saugrohr	291
KELLY-RANKIN Klemme	168	KRAUS MIKRO- Instrument	621	LERCHE Chirurgische Pinzette	83
KELSEY-FRY Kiefer-Ahle	887	KRAUSE Bronchosaufsatz	899	LERICHE Klemme	167
KERN Knochenhalte- zange	503,504	KRAUSE Nasenpolypenschnürer	825	LESTER Fasspinzette	778
KERRISON Antrumstanze	837	KRAUSE Ohrpolypenschnürer	804	LEWIN Knochenhalte- zange	501
KERRISON Laminektomi- stanze	635-656	KRAUSE Trokar	289	LEWIS Nasenraspel	854
Kette, allein für Schwestern- garnitur	915	KRAUSE-VOSS Nasenpolypenschnürer	825	LEXER Hohlmeißel	447,448
KEVORKIAN Biopsie Aufsatz	742	KRAUSE-VOSS Ohrpolypenschnürer	804	LEXER Osteotome	447
KEVORKIAN Biopsiekürette	737	KRAYENBÜHL Nerv- und Gefäßhäkchen	618	LEXER Schere	32
KEVORKIAN Biopsiezange	740	KRESSNER Septumzange	861	LEXER Spongiosa Osteotom	446
KEVORKIAN-PACIFIC Biopsiezange	741	KRISTELLER Halter	711-715	LEXER-BABY Schere	32
KEYES Griff	913	KRISTELLER Scheidenspekulum	711-715	LEXER-FINO Schere	33
KEYES Stanze	913	KRONECKER Nadel	389	LEYLA Fixiervorrichtung	607, 608
KEYES Trephinensatz komplett auf Platte	913	KUEMMEL Spatel	248	LEYLA Haltearm zu Fixation	609, 610
KIELLAND Geburtszange	755	Kunststoffbacken für Aluminium- Hammer, allein (Paar)	457	LEYLA Kugelgelenkkloben	609, 610
KILLIAN Elevator	842	Kunststoff-Mundspatel	879	LEYLA Kupplungskopf	609, 610
KILLIAN Nasenspekulum	824	Kupplungsstück	751	LEYLA Selbsthaltender Spatel	607,609
KILLIAN Nasentamponzange	827	L			
KILLIAN Septum-Hohlmeißel	845	LA FORCE Ringmesser	864	LEYLA Spannarm	607, 608, 609
KILLIAN-CLAUS Septum-Hohlmeißel	845	LA GRANGE Schere	49	LEYLA Wundhaken	367
KILNER Hauthäkchen	912	LABORDE Tracheal Dilatator	903	LICHTWITZ Trokar	289
KILNER Nasenflügelhäkchen	858	Ladekonus für Hämorrhoidal Ligatur	685	LISTER (Sinus) Korn- und Tupferzange	207
KILNER Scheren	35	Ladestation für Kaltlichtgriff	338	LISTER Verbandschere	400-402
KILNER-DOUGHTY Mundsperrerr	872	LAHEY Klemme	192	LISTON Amputationsmesser	12
KIRK Hammer	456	LAHEY Kropffaßzange	910	LISTON Knochensplitterzange	519
KIRSCHNER Bauchdeckenhalter	276,277	LAHEY Wundhake	227	LITTAUER Cilienspinzette	90
		LAMBERT Chalazionspinzette	780	LITTAUER Ligaturschere	52
				LITTAUER Ohrzänge	806
				LITTLE Wundhaken	227

LITTLEWOOD Darm- und Gewebefaßzange	664	MATHIEU Wundhaken	251	MICHEL Zängchen	396
LLOYD-DAVIS Gefäßschere	41	MATHIEU-RYDER Nadelhalter	367	MIDDELDORPF Wundhaken	231,234
LOCKHARD-MUMMERY Hohlsonde	283,284	MATSON Rippen-Raspatorium	478	MIDDELTON-JANSEN Septumzange	835
LOCKLIN Schere	48	MAUNDER Mundkeil	870	MIKRO- Raspatorium	622
LOCKWOOD-ALLIS Darmfaßklemme	663	MAYFIELD Hohlmeißelzange	514	MIKRO- Wundhaken	246
LOGAN Wundsperrerr	254	MAYO Gallensteinlöffel	694	MIKRO-ADSON Klemme	182
LORENZ Verbandschere	403	MAYO Schere	25	MIKRO- Augenschere	781
LORNA Tuchklemme	202	MAYO Sonde	691	MIKRO- Dissektor für Hypophysektomie	622
LOUTE Drahtspanner	427	MAYO Sterilisierklammer	925	MIKRO- Elevator	483
LOVE Nerv Wurzelhaken	612	MAYO Wundspreizer	266	MIKRO- Fasszängchen für Hypophysektomie	623
LOVE-GRUENWALD Laminektomiezange	651	MAYO-BLAKE Gallensteinzange	692	MIKRO- Fasszange	658,659
LOVE-KERRISON Laminektomie-Stanze	640	MAYO-HARRINGTON Schere	26	MIKRO- Gefäßschere	18
LOVELACE Klemme	169	MAYO-HEGAR Nadelhalter	362,365	MIKRO- Häckchen für Hypophysektomie	622
LOVELACE Lungenfasszange	545	MAYO-NOBLE Schere	27	MIKRO- Knüppelpinzette	95,96
LOVELACE Lungenfasszange	545	MAYO-ROBSON ATRAUMA Darmklemme	675	MIKRO- Laryngeal Faßzange	901
LOWER Klemme	192	MAYO-ROBSON Darmklemme	667	MIKRO- Löffel für Hypophysektomie	622
LOWMAN Knochenhalteklammer	418	MAYO-STILLE Schere	26	MIKRO- Nadelhalter	355
LOWMAN-HOGLUND Knochenhalteklammer	419	MC DONALD Elevator	484	MIKRO- Nasenschere	834
LOWMAN-LAMBERT Knochenhalteklammer	419	MC GEE MIKRO-Ohrhäkchen	794	MIKRO- Ohrhäkchen	794,795
LUBET-BARBON Nasentamponzange	826	MC GEE MIKRO-Ohrzängchen	790	MIKRO- Ohrzängchen	786,787
LUC Scharfe Nasenzange	828	MC GIVNEY Fasszange	686	MIKRO- Ohrzängchen, Löffel-förmig	788
LUCAE Hammer	454	MC GIVNEY Hämorrhoidal Ligatur	685	MIKRO- Pinzette	91,92
LUCAE Ohrhäkchen	812	MC INDOE Anatomische Pinzette	79	MIKRO- Präparierschere	17
LUCAE Pinzette	805	MC INDOE Gefäßschere	45	MIKRO- Schere	16,17,19
LUCAE Stimmgabel	802	MC INDOE Knochensplitterzange	521	MIKRO- Tonsillenzange	894
LUER Hohlmeißelzange	513	MC INTOSH Laryngoskopspatel	328-336	MIKRO- Wundsperrerr	259
LUER Insulin Spritze	303	MC IVOR Mundsperrerr	874	MIKULICZ Peritoneumklemme	195
LUER Polypenfasszange	686	MC IVOR Mundsperrerr-Rahmen	874	MILLER Laryngoskopbesteck	325-332
LUER Schraubadapter	596	MC IVOR Zungenspatel	874	MILLER-COLBURN Doppellkürette	468
LUER Trachealhäkchen	904	MC KENTY Septum Elevator	841,842	MILLER-COLBURN Knochenfeile	480,479
LUER Trachealkanüle	906	MC KENZIE Clips und Anlegezange	605	MILLIGAN Dura Dissektor	614
LUER Wundhaken	252	MC KENZIE Klammerblock	605	MILLIN ATRAUMA Prostataktomieklammer	696
LUER-KOERTE Gallensteinlöffel	693	MC KENZIE Silberklammer	605	MILLIN Blasenhalsspreizer	696
LUER-LOCK Dreiweghahn	302	MC KENZIE Spiralbohrer	416	MILLIN Blasenspreizer	697
LUER-LOCK Kanüle	772	MC QUIGG-MIXTER Klemme	192	MILLIN Fadenführungszange U-Form	696
LUER-LOCK Wund- und Blasen-spritze	304	MCLEAN-LUIKART Geburtszange	755	MILLIN Kaltlichtaufsatz für Fiberoptik	697
LUER-LOCK Zwischenstück	302	MCLEAN-TUCKER Geburtszange	755	MILLIN Mittelblatt	697
Luftpumpe für Komprimeter	412	MEAD Hammer	455	MILLIN Prostataklammer Allis-Form	696
LUKENS Tymushaken	905	MEAD Hohlmeißelzange	512	MILLIN Prostataklammer T-Form	696
LUNIATSCHEK Tamponstopfer	893	MEDHORN Gefäßclip	150	MILLIN Rahmen allein	697
		Medizinbecher	936	MILLIN Seitenvalve	697
M		MEEKER Präparier und Ligatur Klemme	189	MINI-FRIEDMANN Hohlmeißelzange	511
MAGILL Katheterzange	324	Mehrzweckschale	933	MINI-GEMINI Präparier- und Ligaturklemme	186
MAGILL Saugrohr	293	MELLINGER Augensplerrerr	762	MINI-HOHMANN Knochenhebel	485
MAINGOT Hysterektomieklammer	199	MELLINGER-AXENFELD Sperr-Elevator	762	MINI-LAMBOTTE Meißel	440
MALTZ Nasenraspel	852	MENGHINI Kanüle	299	MINI-LANGENBECK Wundhaken	214
Manometer für Komprimeter	412	Meniskusmesser	496	MINI-LEXER Hohlmeißel	446
Manometer mit Gummiball	323	MERCEDES Seitenvalve	542	MINI-LEXER Meißel	446
MARKWALDER Knochensplitterzange	520	MERCEDES Sperrerr	542	MINI-MC GEE Alligator Ohrzängchen	787
MARTEL Klemme	179	MERCEDES Thorax Sperrerr	542	MINI-ROUX Wundhaken	250
MARTIN ATRAUMA Peripheral-Gefäßklemme	578	Meßbecher	931	MINI-TOWNSEND (BABY-TISCHLER) Biopsiezange	742
MARTIN Beckenzirkel	753	Meßschieber	312	MINI-TOWNSEND (BABY-TISCHLER) Biopsiezangen-Aufsatz	742
MARTIN Bürstenspender	920	Meßstab	313	MINI-TOWNSEND Biopsiezange	741
MARTIN Ersatzsägeblatt für Fingersäge	527	Metallbehälter für Tunnelier-Set	596	MIXTER Gallensteinzange	693
MARTIN Fingerringssäge	527	Metallhammer	459	MIXTER Klemme	190-192
MARTIN Knochenhaltezange	500	Metall-Kathteter für Frauen	700	MIXTER-CRAFOORD Ligaturklemme	184
MARTIN Tunnelier-Set	596	Metall-Kathteter für Männer	700	MIXTER-O' SHAUGNESSY Klemme	190
MARTIN Uterus Sonde	726	Metallolive	818	MOELTGEN Winkelmesser	311
MARTIN Wundhaken	235	METHOT Watteabfallbehälter	937	MOGEN Beschneidungsinstrument	702
MARTINI Doppellöffel	467	METHOT Wattespender	937	MOHR Quetschhahn	925
MARTIN-IDEAL Finger- und Zehennagelbohrer	526	METZENBAUM Nadelhalter	361	MOLDENHAUER Fremdkörperhebel	811
MARTIN-VICKERS Handhalter	525	METZENBAUM Schere	30-34	MOLLISON Wundsperrerr	258
MASING Raspatorium	843	METZENBAUM-NELSON Schere	31	MOORE Gallensteinlöffel	694
MASSON Nadelhalter	363	MEYER Fremdkörperhohlmeißel	766	MORRIS Wundhaken	242
MASTIN Muskelklemme	910	MEYERDING Wundhaken	215,243	MORSE Sternumspreitzer	541
MATHIEU Fremdkörperzange	703	MEYHOEFER Chalazionslöffel	771	MORSE-FAVALORO Sternumspreitzer	541
MATHIEU Halter	717	MGH-MASS-GENERAL-HOSPITAL Nadelhalter	361	MOSQUITO-DEBAKEY ATRAUMA Klemme	551
MATHIEU Mastdarmspekulum	682	MICHEL Kehlkopfspiegel	902	MOYNIHAN Gallensteinsonde und -löffel	691
MATHIEU Nadelhalter	367	MICHEL MOD. Zängchen	396	MOYNIHAN Hysterektomieklammer	196
MATHIEU Spekula	717	MICHEL Nahtpinzette	395	MÜLLER Approximator	154
		MICHEL Wundklammern	397	MÜLLER Gefäßclip	152



D

Inhaltsverzeichnis Alphabetical Index Indice alfabético Indice alfabético

MÜLLER-VERBRUGGE Knochenheber	489	OLIVECRONA-TOENNIS Clip- und Anlegezange	605	POTTS-SMITH Anatomische Pinzette	79
Mundbecher	937	OLLIER Wundhaken	224	POTTS-SMITH Chirurgische Pinzette	84
MURPHY-LANE Luxationsheber	491	OLSEN-HEGAR Nadelhalter	366	POTTS-SMITH Gefäßschere	44
MUSEUX Hakenzange	730	OMBREDANNE Hammer	457	POZZI Hakenzange	728
Myrtenblattsonde	282	Ophtalmoskop-Ersatzbirnchen	317	Präparier- und Ligatruerklemme	185-192
N		Ophtalmoskop-Besteck	315	PRATT Cystikus Haken	684
NABATOFF Handgriff allein	285	Ophtalmoskop-Griff	317	PRATT Hakenzange	731
NABATOFF Krampfadern Besteck	285	Optik, starr	819,820,868	PRATT Klemme	179
NABATOFF Kunststoff Sondenspitze	285	Organfaßzange ATRAUMA	673	PRATT Mastdarmspekulum	681
NABATOFF Metalletui	285	Osteotomeklänge auswechselbar	445	PRATT Uterus Dilator	725
NABATOFF Olive	285	Oszillierende Gipsäge	408	PRESBYTERIAN Schlauchklemme	204
NABATOFF Zugseil, flexibles rostfrei	285	OTIS Ersatzmesser für Urethrotom	701	PRICE-THOMAS Bronchusklemme	544
Nadeldose	350-352	OTIS Urethrotom	701	PRINCE Schere	46
NAEGELE Geburtszange	755	Otoskop-Besteck	314	Probe- und Absaugkürette	751
Nagelbohrer	526	Otoskop-Ersatzbirnchen	317	PROVIDENCE-HOSPITAL Klemme	167
Nagelfeile	917	Otoskopkopf	317	Punktionstrephe für CHAMPY	453
Nagelhautzange	917	OVERHOLT Ligatur Klemme	185	PUTTI Raspel	482
Nagelschere	915	OVERHOLT-GEISSENDOERFER Klemme	185	Q	
Nagelzange	916,917	OVERHOLT-MIXTER Klemme	183	QUERVIAN Elevator	484
NAGER Tonsillenhaken	893	P		QUINBY Schere	49
Nasenhaken	857	Papier-Tuchklemme	203	QUINKE Kanüle	299
Nasenschere	834	PARKER Wundhaken	250	QUIRE Ohrheber	806
NEFF Meniskusmesser	495	PARKER-LANGENBECK Wundhaken	251	R	
NEGUS Bruststütze	872	PARKES Nasenplastikmeißel	850	RABINER Hammer	307
NEGUS Tonsillen Klemme	191	PARTSCH Hammer	455	RADOLF Nagelausreißzange	527
NEIVERT Nadelhalter	360	PARTSCH Hohlmeißel	438,439	RAGNELL Wundhaken	216
NEIVERT Nasenflügelhaken	860	PARTSCH Meißel	438	RAGNELL-DAVIS Wundhaken	216
NEIVERT-ANDERSON Osteotom	848	PARTSCH Führungshohlsonde	393	RALK (VIRTUS) Splitterzange	100
NELATON Hohlsonde	283	PAYR Gefäßnadel	349	RALK Handbohrapparat	417
NELSON Fußpinzette	87	PAYR Magen-Darmquetschzange	671	RAMPLEY Schwammzange	207,209
NELSON Trokar	288	PAYR-BABY Magen-Darmquetschzange	671	RAMSEY Anatomische Pinzette	80
NEUMANN Schere	49	PEAN Klemmen grazil	171	RAMSEY Chirurgische Pinzette	86
NICOLA MIKRO -Fasszange	659	PEAN Klemmen kurzfassend	171	RANDALL Biopsiekürette	737
NICOLA MIKRO -Schere	659	PEAN Tuchklemme	204	RANDALL Nierenstielklemme	687,688
Nierenschale	938	PEAN-DEBAKEY ATRAUMA Klemme	552,553	RANEY Anlege- und Abnehmezange	606
NORFOLK AND NORWICH Wundspreizer	265	PEDERSON Spekulum	708	RANEY Kopfhautklammer	606
NORTHBENT Ligaturschere	52	PEERS-BERTRAM Tuchklemme	203	RANKIN-DEBAKEY ATRAUMA Klemme	551
NOTO Uteruspolypenzange	732	PEET Splitterzange	100	Rasierklingen, brechbar	14
NOVAK Biopsiekürette	737	PELTESON Watteträger	287	Rasierklingenbrecher	14
NOYES Augenschere	782	PENFIELD Dura Dissektor	615	Raspatorium	469-475
NUGENT Nahtpinzette	779	PENNINGTON Elevator	842	RAY Hypophysen Kürette	619
NUSSBAUM Magenklemme	670	PENNINGTON Klemmen	178	RECAMIER Kürette	745,746,749
O		PERCY Amputationschild	413	Rectal Schere	42
O'CONNOR SULLIVAN Bauchdeckenhalter	276	PERCY Amputationsretraktor	413	REDON Nadeln	298
O'CONNOR Wundhäkchen	212	Peritoneumklemme, Hysterektomieklammer	195-200	Reibahle mit T-Griff	414
O'BRIAN Schere	38	PERTHES Reibahle	414	Reibahle	414
Oberarm-Manschette für Komprimeter	412	PESTALOZZA Abortuslöffel	758	REICHERT Deckenhalter	900
Oberschenkel-Manschette für Komprimeter	412	PHANEUF Hysterektomieklammer	196	REIL MIKRO-Schere	19
OBWEGESER Kiefer Ahle	886	PIERCE Antrum Trokar	289	REINER Gipsmesser	406
OBWEGESER Kinnhalter	883	PINARD Stethoskop, ALUMINIUM	308	REINER Ohrspritze	817
OBWEGESER Osteotom	885,886	PINARD Stethoskop, Holz	308	Reinigungsbürste	907,943-947
OBWEGESER Progeniehalter	883	Pinzette	78-99	Repositionszange	501
OBWEGESER Ramushaken	882	PIPER Geburtszange	755	RESANO ATRAUMA Rektum Klemme	679
OBWEGESER Raspatorium	884,885	PITHA Mundkeil	870	RESANO Rektumschere	42
OBWEGESER Wundhaken	881	Plastik-Schutztasche für Trachealbesteck	907	REVERDIN Bauchspatel	253
OCHSNER ATRAUMA Aortaklemme	575	Plazentabecken	939	REVERDIN Nadel	387
OCHSNER Klemme	174-176	PLESTER Lappenmesser	792	REYNOLDS Schere	39
OCHSNER Trokar	289	PLESTER Saugrohr	291,292	RIBBON Bauchspatel	253
Ohrspekulum, Einmalgebrauch	317	PLESTER Wundspreizer	258	RICARD Bauchdeckenhalter	272
Ohrspekulum, wiederverwendbar	317	POLITZER Einsteckkonus mit Deckplatte	816	RICARD Mittelblatt	271
Ohrspritze	818	POLITZER Furunkelmesser	813	RICARD Seitenvolve	271
Ohrtrichter	317	POLITZER Luftdusche	816	RICHARDSON Wundhaken	232
OLDBERG Laminektomie zange	655	POLLOSON Wundhaken	241	RICHARDSON-EASTMAN Wundhaken	232
OLIVECRONA Drahtsäge	602	POOLE Saugrohr	296	RICHTER Wundspreizer	265
OLIVECRONA Dura Dissektor	616	POPPEN Saugrohr	291	RICHTER-HEATH Zängchen	396
OLIVECRONA Spatel	611	POTTS ATRAUMA Gefäßklemme	554-556,570	RIGBY Retraktor	266
OLIVECRONA Schere	46	POTTS DE MARTEL Gefäßschere	44	Rippenschere	530
		POTTS MIKRO-Schere	16		
		POTTS-GLOVER ATRAUMA Gefäßklemme	556		

Inhaltsverzeichnis
Alphabetical Index
Indice alfabético
Indice alfabetico



D

RITTER-HALLE Dilatationssonde	865	SCHERBAK Valve	718	SERPENTINE IUP-Fasszange	743
ROBB Gefäßdissektor	598	Schere	16-75	SEUTIN Verbandschere	405
ROBERTS Klemme	183	SCHINK Dermatom	11	SEYFFERT Scheidenspekulum	708
ROBIN Tuchklemme mit Halter	203	SCHIOETZ Tonometer	762	Seziermesser	3
ROBIN-MASSE Mittelvalve	271	Schlauchklemme	204,205	SHAAF Cilienpinzette	90
ROCHARD Befestigungsgestell	280	Schlingen für Nasenpolypenschnürer	825	SHAPLEIGH Ohrkürette	809
ROCHARD Fixiervorrichtung	280	Schlingen für Ohrpolypenschnürer	804	SHEA MIKRO-Sondierhäkchen	795
ROCHARD Rahmenhaken	280	SCHMEDEN Scharfe Nasenzange	829	SHEEHAN Osteotom	849
ROCHESTER-CARMALT Klemme	180	SCHMID Gefäßspülkanüle	300	SIEBENMANN Kieferhöhlen-Spülkatheter	865
ROCHESTER-PEAN Klemme	172,173	SCHMIEDEN Führungshohlsonde	393	SIEBOLD Schere	23
RÖDER Binder / Tonsillenschnürer	895	SCHMIEDEN Unterbindungsnadel	388	Silikonmatte	928
ROEDER Tuchklemme	202	SCHMIEDEN-DICK Unterbindungsnadel	388	SILVER Dermatom	11
ROGER Septum Elevator	843	SCHMIEDEN-PAYR Führungshohlsonde	393	SILVER Nasenplastikmeißel	850
ROGERS Hysterektomie ATRAUMA Klemme	200	SCHMIEDEN-TAYLOR Dura Schere	45	SIMON Fistelhaken	734
ROGGE Sterilisierzange	924	SCHNIDT Klemme	182	SIMON Löffel	464,744
ROLLET Augenhäkchen	767	SCHNIDT Tonsillenzange	894	SIMON Wundhaken	235
Röntgen-Meßstab	313	SCHOENBORN Schilddrüsenhaken	905	SIMPLEX Mundsperrer	877
ROSE Hyosterektomie ATRAUMA Klemme	200	Schraubaufsatz für Tunnelier-Set	596	SIMPSON Geburtszange	754
ROSEN MIKRO-Ohrraspatorium	796	Schraubenschlüssel für Tunnelier-Set	596	SIMPSON-BRAUN Geburtszange	754
ROSEN MIKRO-Rundschnittmesser	792	Schraubolive	596	SIMS Vaginalspekulum	710
ROSEN Ohrnadel	794	SCHROEDER Hakenzange	728	SIMS Kürette	747,748
ROSENBERG Bronchosaufsatz	899	SCHROEDER Uteruslöffel	744	SIMS Mastdarmspekulum	680
ROSER-KÖNIG Mundsperrer	871	SCHUBERT Biopsiezangen	738	SIMS Schere	28
ROSS Aorta Wundhaken	240	SCHUKNECHT Rollenmesser	792	SIMS Spekulum	710
ROUX Wundhaken	249	SCHUKNECHT Saugkanüle	294	SIMS Uterus Sonde	726
ROWE Repositionszange	888	SCHUKNECHT Sichelmesser	792	SIMS-MAIER Korn- und Tupferzange	207
RUBIN Nasenmeißel	847	SCHUKNECHT Wundspreizer	259	SINGLEY-TUTTLE Faßpinzette	87
RUBIN Septumzange	835	SCHULTZE Salpingograph	752	Skalpellgriffe	5,6
RUDD Hämorrhoidal Ligator	685	SCHULZE-BERGMANN Mastdarm Spekula	682	Skalpellklinge	7,8
RUMEL Präpr./Ligatur Klemmen	186	SCHUMACHER Biopsie Aufsatz	743	Skalpellklängen-Abnehmer	8
RUMEL-BELMONT Torniquet flexibel	599	SCHUMACHER Biopsiezange	740,743	Skalpellklängen-Entfernungszange	8
Runde Misch-Schale	931	SCHUMACHER Bronchosaufsatz	899	SKEENE Hakenzange	729
Runde Schale	931	SCHUMACHER Nabelschnurschere	29	SLUDDER-BALLENGER Aufsatz	896
RUSKIN Hohlmeißelzange	515	Schutzkappe für Septumzange RUBIN	835	SLUDDER-BALLENGER Griff	896
RUSKIN Knochensplitterzange	521	Schutzteller	818	SLUDDER-BALLENGER Tonsillotom	896
RUSS MODELL Chirurgische Pinzette	86	SCHWARTZ Anlegezange	153	SMELLIE Perforatorium	758
RUST Amputationsäge	410	SCHWARTZ Gefäßclips	153	SMILLIE Meniskotom	494
RUST Ersatz-Sägeblatt	410	Schwenkschale	934	SMILLIE Meniskushaken	493
RYDEL-SEIFFERT Stimmgabel	802	Schwestern-Garnitur mit Kette	915	SMITH PETERSON Hohlmeißel	441
S					
SAALFELD Komedonenquetscher	914	SCOVILLE Haken	624, 625	SMITH PETERSON Osteotom	441
SACHS Dura Dissektor	614	SCOVILLE Laminektomie-Spreizer	624	SMITH-BUIE Anal Spreizer	682
SACHS Dura Haken	617	SCOVILLE Nervwurzelhaken	612	SNELLEN Chalazionspinzette	779
SAENGER Abortuszange	756	SCOVILLE Rahmen	624	SOMER Uterusfaßzange	733
Sägeblatt für Oszilierende Gipsäge	408	SCOVILLE Scharfer Löffel	463	Spannplatte, allein	11
SAMMII Tumorzange	94	SCOVILLE Seitenvalve für Wundspreizer	624, 625	Spannschlüssel	408
SANTULLI ATRAUMA Bulldogklemme	550	SCOVILLE-HAVERFIELD Rahmen	624	Spatel	611
SANVENERO Schere	36	SCUDDER ATRAUMA Klemme	676	SPENCER Ligaturschere	52
SAROT Klemme	184	SCUDDER Darm- und Magenklemme	668	SPENCER-WELLS Klemme	170
SATINSKY ATRAUMA Klemme	564	SEBILEAU Elevator	484	Spirituslampe	939
SATINSKY Gefäßklemme	546	SEDILOT Raspatorium	474	Splitterpinzette	89,90
SATINSKY Gefäßschere	41	SEGOND Myommesser	2	Splitterzange	100
SATTERLEE Amputationssäge	411	SEGOND-LANDAU Hysterektomieklammer	197	SPRATT Scharfer Löffel	462
SATTERLEE Sägeblatt	411	Sehnen-Faßinstrument	498,499	Spülschale	932
SAUERBRUCH Abfallzange	948	Sehnen-Flechtklemme	499	SPURLING Laminektomie zange	652
SAUERBRUCH Hohlmeißelzange	518	SEIFFERT Bronchosaufsatz	899	Sputumbeker mit Klappdeckel	937
SAUERBRUCH Sternumschere	530	SELLHEIM Geburtslöffel	756	ST.CLAIR-THOMSON Ringmesser	864
SAUERBRUCH Wundhaken	229,236	SEMB Bronchusklemme	544	ST.MARKS Pelvishaken	247
Saugansatz	818	SEMB Hohlmeißelzange	515	STACKE Sonde	282
SCALP-CONTOUR Wundsperrer	256	SEMB Knochenhalte zange	504	STAMMBERGER Antrumstanze	833
Schädelhalter	603	SEMB Knochensplitterzange	524	Ständer für 12 Ohrspekula	799
SCHAEDEL Tuchklemme	201	SEMB Raspatorium	477	Stanzylinder	934
SCHAMBERG Komedonenquetscher	914	SEMKEN Anatomische Pinzette	79	Starnadel	765
SCHAEDE Scharfer Löffel	461	SEMKEN Chirurgische Pinzette	83	Starre Optik	819,820,868
SCHIEBE ATRAUMA Organfaßzange	673	SEMM Bauchdeckenhalter	278	STAUDE-MOORE Hakenzange	727
SCHIEBENMANN Bronchosaufsatz	899	SEMM Rahmen	278	Stechbecken	938
SCHERBACK Spekulum	718	SEMM Rahmenhaken	278	STEINMANN Nagel	432
SCHERBAK Gewicht für Scheidenspekulum	718	SEMM Scheidenspekulum	708	STEINMANN Sehnenfaßzange	498
SCHERBAK Griff für Scheidenspekulum	718	Sempumzange	827	STELLBRINK Hohlmeißelzange	511
		SENN-GREEN Wundhaken	216	STELZNER Gefäßschere	41
		SENN-MILLER Wundhaken	217	Sterilisier- und Lagerungscontainer	147
		Sequesterzange	502	Sterilisier-Korb	930



D

Inhaltsverzeichnis

Alphabetical Index

Indice alfabético

Indice alfabetico

Sterilisier-Siebschale	929
Sterilisierzange	924
STERNBERG Wangen- und Lippenhalter	877
STEVENS Iris Pinzette	776
STEVENS Schere	38
STIEGLITZ Splitterzange	100
STILLE Chirurgische Pinzette	82
STILLE Gallensteinzange	693
STILLE Gipsschere	405
STILLE Handbohrapparat	415
STILLE Hohlmeißel	439
STILLE Hohlmeißelzange	515
STILLE Kugelfräser	415
STILLE Meißel	439
STILLE Nierenklemme	194
STILLE Osteotom	439
STILLE Spiralbohrer	415
STILLE Trephine	415
STILLE-BARRAYA Chirurgische Pinzette	85
STILLE-LISTON Knochensplitterzange	522,523
STILLE-LUER Hohlmeißelzange	517,518
STILLE-RUSKIN Hohlmeißelzange	516
Stimmgabel	800
STOCKMANN Pennisklemme	703
STONE Chirurgische Pinzette	83
Stößel mit Ferrozellgriff	444
Stößel mit Metallgriff	444
Strabismus Schere	38
STRANDELL-STILLE Wundhaken	219
STRATTE Nadelhalter	365
STRAUSS Penisklemme	703
STRUEMPER Ohrzängchen	807
STRULLY Schere	45
STRUYCKEN Scharfe Nasenzangen	830
Stumpfer Mandrin für CHAMPY	453
SUBRAMANIAN ATRAUMA Aortaklemme	582
SUPERCUT COTTLE Schere	70
SUPERCUT DIETHRICH Gefäßschere	71
SUPERCUT Episiotomie-Schere	69
SUPERCUT FOMON Schere	70
SUPERCUT FREEMANN-GORNEY Schere	75
SUPERCUT FREEMANN-KAYE Schere	75
SUPERCUT GOLDMANN-FOX Schere	73
SUPERCUT GORNEY Schere	74
SUPERCUT HEYMANN Schere	70
SUPERCUT Iris Schere	72
SUPERCUT JAMESON Präparierschere	74
SUPERCUT JOSEPH Schere	72
SUPERCUT KAYE FACE LIFT Schere	74
SUPERCUT KELLY Schere	72
SUPERCUT LEXER Schere	68
SUPERCUT LISTER Verbandsschere	75
SUPERCUT MAYO Schere	66
SUPERCUT MAYO-STILLE Schere	66
SUPERCUT METZENBAUM Schere	67
SUPERCUT METZENBAUM-FINO Schere	68
SUPERCUT METZENBAUM-NELSON Schere	67
SUPERCUT PAR-TYPE Schere	74
SUPERCUT POTTS-SMITH Gefäßschere	71
SUPERCUT REYNOLDS Schere	73
SUPERCUT Schere	66-75
SUPERCUT SIEBOLD Schere	69
SUPERCUT SIMS Schere	69
SUPERCUT STEVENS Schere	73
SUPERCUT Strabismus Schere	68
SUPERCUT TOENNIS-ADSON Gefäßschere	69
SUPERCUT WAGNER Schere	72
SUPERCUT WALDMANN Episiotomie Schere	69

T

TABB Schleimhautmesser	792
Tablettenschale	936
TAKAHASHI Siebbeinzange	829
TARNIER Kranioklast	759
TAYLOR Anatomische Pinzette	79
TAYLOR Chirurgische Pinzette	83
TAYLOR Hammer	306
TAYLOR Seitenvalve für Wundspreizer	625
TAYLOR Spinalhaken	492

TC

TC-ADSON Anatomische Pinzette	97
TC-ADSON Chirurgische Pinzette	98
TC-ADSON MIKRO-Pinzette	97,98
TC-ADSON-BROWN Chirurgische Pinzette	98
TC-ARRUGA MIKRO-Nadelhalter	370
TC-BABCOCK Gewebefassklemme	664
TC-BABY-GILLIES Nadelhalter	382
TC-BARRAQUER Nadelhalter gebogen	372,373
TC-BARRY-STERNDAL Drahtspannzange	420
TC-BAUMGARTNER Nadelhalter	376
TC-BOYNTON MIKRO-Nadelhalter	370
TC-BOZEMANN Nadelhalter	380
TC-BRUNS Schere	404
TC-CASTROVIEJO (JACOBSON) Nadelhalter	371,372
TC-CONVERSE Nadelhalter	375
TC-CORWIN-HEGAR Drahtspannzange	420
TC-CRILE Nadelhalter	385
TC-CRILE-WOOD BABY Nadelhalter	377
TC-CRILE-WOOD Nadelhalter	378
TC-CUSHING Anatomische Pinzette	97
TC-CUSHING-TAYLOR Anatomische Pinzette	97
TC-DEBAKEY Nadelhalter	378
TC-DEBAKEY Pinzette	99
TC-DEBAKEY Schere	60
TC-DERF Nadelhalter	374
TC-DIETHRICH Nadelhalter	374
TC-DIETHRICH-RYDER Nadelhalter	374
TC-DRAHTFAßZANGE	423
TC-Drahtkneifzange	424,425,426
TC-Drahtspannzange	420
TC-DUVAL Gewebefassklemme	665
TC-Episiotomie Schere	61
TC-FERRIS-SMITH Chirurgische Pinzette	99
TC-FINOCCHIETTO Nadelhalter	381
TC-FOMON Nasenfeile	855
TC-GILLIES Chirurgische Pinzette	99
TC-GILLIES Nadelhalter	382
TC-GOLDMAN-FOX Schere	63
TC-HALSEY Nadelhalter	375
TC-HEGAR Nadelhalter starkes Modell	377
TC-HEGAR VASCULAR Nadelhalter	379
TC-HEPP-SCHIEDER Nadelhalter	374
TC-HÖSEL Nadelhalter	385
TC-Iris Schere	62
TC-JOSEPH Schere	62
TC-KALT MIKRO-Nadelhalter	370
TC-KELLY Schere	62
TC-KILNER Nadelhalter	376
TC-Kopf- und Seitenschneider	425
TC-LANGENBECK Nadelhalter	384
TC-LEXER Schere	56
TC-LICHTENBERG Nadelhalter	385
TC-LISTER Schere	400
TC-LOCKLIN Schere	63
TC-MASSON Nadelhalter	381
TC-MATHIEU Nadelhalter	383,384
TC-MATHIEU-KOCHER Nadelhalter	383

TC-MATHIEU-RYDER Nadelhalter	384
TC-MAYO Schere	55
TC-MAYO-HARRINGTON Schere	61
TC-MAYO-HEGAR (HEANEY) Nadelhalter	377
TC-MAYO-HEGAR Nadelhalter	376,377
TC-MAYO-LEXER Schere	55
TC-MAYO-STILLE Schere	55
TC-MC INDOE Anatomische Pinzette	98
TC-METZENBAUM Schere	56,57
TC-METZENBAUM-FINO Schere	57-59
TC-MILLER-COLLBURN Knochenfeile	481
TC-NEIVERT Nadelhalter	375
TC-OEHLER Chirurgische Pinzette	99
TC-OLSEN-HEGAR MINI Nadelhalter	382
TC-PARAMETRIUM Hysterektomieschere	61
TC-Pinzette	97-99
TC-POTTS-SMITH Anatomische Pinzette	98
TC-RAGNELL (KILNER) Schere	64
TC-RYDER MINI Nadelhalter	379
TC-RYDER-FRENCH EYE Nadelhalter	378
TC-SAROT Nadelhalter	380
TC-Schere	54-64
TC-SEMKEN Anatomische Pinzette	98
TC-SEMKEN Chirurgische Pinzette	99
TC-SENNING Nadelhalter	380
TC-SIMS Schere	61
TC-SLIM MIKRO-Nadelhalter	378
TC-STANDARD Anatomische Pinzette	97
TC-STANDARD Schere	54
TC-STRATTE Nadelhalter	381
TC-TOENNIS Nadelhalter	385
TC-TOENNIS-ADSON Schere	59
TC-Universal Schere	64
TC-WANGENSTEEN Nadelhalter	381
TC-WANGENSTEEN Pinzette	98
TC-WEBSTER Nadelhalter	375
TC-WERTHEIM Gynäkologie Schere	61
TC-ZWEIFEL Nadelhalter	386
TC-ZWEIFEL Nadelhalter	386

TEALE Hakenzange	729
TELESCOPE -Laryngoskopspatel	331
THOMS GAYLOR Biopsiezange	739
THOMS-ALLIS Darmfaßklemme	663
THOREK Schere	34
TIECK-HALLE Nasenspekulum	823
TILLEY Ohrzängchen	806
TISCHLER-KEVORKIAN Biopsiezange	741
TISCHLER-MORGAN Biopsie Aufsatz	742
TISCHLER-MORGAN Biopsiezange	741
TITAN Bulldogklemme Vena	160-162
TITAN Bulldogklemme Arteria	160-162
TITAN-YASARGIL Aneurysmen Gefäßclip MINI120,121,136	
TITAN-YASARGIL Aneurysmen Gefäßclip STANDARD108-133	
TITAN-YASARGIL Anlegezange Aneurysmen Gefäß Clip 140-144	
TOBOLD Mundspatel	878
TOENNIS Arterienklemme	188
TOENNIS Dura Dissektor	616
TOENNIS Dura Messer	618
TOENNIS Gefäßschere	46
TOENNIS Nadelhalter	367
TOENNIS-ADSON Gefäßschere	46
TOHOKU Tuchklemme	203
Tonsillen-Drahtschlinge	895
TOWNSEND Biopsie Aufsatz	742
TOWNSEND Biopsiezange	742
TOWNSEND-MINI (BABY-TISCHLER) Biopsie Aufsatz 742	
TOWNSEND-MINI (BABY-TISCHLER) Biopsiezange	742
TOWNSEND-MINI Biopsiezange	741
TOYNEE Ohrspekula	798
Tracheal-Besteck	907,908

Tracheal-Häkchen 213,215,904
TRELAT Vaginal Spekulum 709
TREVES Chirurgische Pinzette 86
TROELTSCH (WILDE) Ohr Pinzette 805
TROELTSCH Nasentamponpinzette 826
TROEMMER Hammer 306
Trokar 288
Trokarhülse für CHAMPY 453
TROUSSEAU Tracheal Dilatator 903
TROUTMAN-COLIBRI Fixierpinzette 777
TROUTMANN-CHRIS Rasierklingenthaler 14
TUBBS Cardiovascular Dilatator 594
TUBERKULIN-LUER Spritze 304
Tuchklemme 201-203
Tuchklemme ENGL. MODELL 201
TUFFIER Knochenhaltezange 505
TUFFIER Rippensperrer 537
TUFFIER Tupferzange 178
TUOHY Kanüle zur Lumbalpunktion 300
Tunnelierschaft 596
TURNBULL Nagelzange 916
TURNER-WARWICK Gallensteinzange 692
TYDING Tonsillenschnürer 896

U

UCKERMANN Sonde 287
UECKERMANN Tracheal Trokar 903
ULRICH Knochenhaltezange 507,508
ULRICH Tupferzange 206
Umbilical Schere MOD.
USA 29
UNIVERSAL Ersatzflasche 866
UNIVERSAL Pulverbläser 815
UNIVERSAL Schere 50
UNIVERSAL Sterilisierzangen 924
UNIVERSAL Trokar 288
UNIVERSALGRIFF für Tunnelier-Set 596
UNNA Komedonenquetscher 914
UNNA-VIDAL Komedonenquetscher 914
Unterbindungsnadeln 389
URO-TANGENTIAL ATRAUMA Klemmen 194
USA MOD. Gipsspreizer 407
USA MOD. Scharfer Löffel 464

V

VALLEIX Uterus Sonde 726
VAN BUREN Harnröhrenbougie 699
VAN BUREN Sequesterzange 502
VAN DOREN Biopsiezange 739
VANNAS MOD.TÜBINGEN Nachstarschere 783
VARADY Phlebodissektor 284
VEIDENHEIMER ATRAUMA Klemme 678
Ventilaufsatz allein 818
Verbindungsschlauch 818
VERBRUGGE Knochenhaltezange 510
VERRES Insufflationskanüle 300
VICKERS Easidriver Bohrhandgriff 431
VIDAL Lupus Schaber 912
VIGORIMETER Gummibälle, allein 310
VIRCHOW Messer 4
VIRCHOW Knorpelmesser 3
WISE MIKRO-Knüpfpinzetten 96
VOLKMANN Scharfer Löffel 460,461
VOLKMANN Scharfer Löffel d/e 466
VOLKMANN Wundhaken 220-222
VOLLMAR Ringstripper 286
Vorböhrer für Chrutchfield 603

W

WACHENFELDT Nahtpinzette 396
WAGENER Ohrhäkchen 812
WAGNER Knochenheber 488
WAGNER Raspatorium 470
WAGNER Scheren 39
WALB Organmesser 4
WALDMANN Episiotomie-Schere 29
WALLICH Abortuslöffel 758
WALTER Nasenhohlmeißel 847
WALTER Nasenmeißel 847
WALTER-CARMALT Splitterpinzette 89
WALTON Ersatzsägeblatt für Fingersäge 527
WALTON Fingerringsäge 527
WALTON Fremdkörperhohlmeißel 766
Wangenhalter 877
WANGENSTEEN Nadelhalter 364
WARTENBERG Sensibilitäts-Instrument 308
Waschschüssel 932
WASSMUND Wundhaken 224
WATSON-WILLIAMS Scharfe Nasenzange 829
Wattedose mit Knopfdeckel 936
WAUGH Chirurgische Pinzette 85
WEBER ATRAUMA Klemme 563
WEBER Drahtschlinge 770
WEBER-LOCH Ohrschlinge 811
WEBSTER Nadelhalter 359
WEIL-BLAKESLEY Nasenzange 830-832
WEISSBARTH Vaginal Spekulum 719
WEITLANER Wundsperrer 257-259
WELLS Chalazionlöffel 770
WERTHEIM Hysterektomieklammer 196,197
WERTHEIM Schere 27
WERTHEIM-CULLEN Hysterektomieklammer 197
WEST Flachmeißel 773
WEST Hohlmeißel 773
WESTCOTT MIKRO-Schere 17
WESTCOTT Sehnenschere 782
WESTMACOTT Nasentamponzange 826
WHITE Tonsillenzange 894
WHITEHEAD Mundsperrer 876
WIEDER Zungendrucker 878
WIEN Fadenknoten 394
WIEN Nasenspekulum 823
WILDER Tränenkanal Dilatator 774
WILLET-MARTEL Kopfklemme 179
WILLIAMS Darmfaßklemme 663
WILLIGER Doppellöffel 467
WILLIGER Hammer 454
WILLIGER Raspatorium 474
WILLIGER Scharfe Löffel 465
WILLIGER Septum Elevator 483
WINTER Abortuszange 757
WIRKSTROEM Klemmen 190
WITTNER Biopsiezangen 740
WOLFF Gipsabreißzange 407
WOLFF Lupus Kürette 912
WRIGLEY Geburtszange 754
WULLSTEIN MIKRO-Ohrscheren 789
WULLSTEIN MIKRO-Ohrzängchen 786-791
WULLSTEIN MIKRO-Saugkanüle 293
WULLSTEIN Ohr-Sichelmesser 792
Wund- und Meniskushaken 492,493
Wundhäkchen 212-215
Wundhaken 215-252
Wundnaht-Besteck in Metall-Etui 397
Wundspreizer 254-272

Y

YANKAUER Saugrohr 296
YASARGIL Aneurysmen Gefäßclip MINI . . . 120,121,136
YASARGIL Aneurysmen Gefäßclip STANDARD 108-133
YASARGIL Anlegezange für Aneurysmen Gefäßclip . 138-144
YASARGIL Anlegezangen 138-144
YASARGIL Fadenführer 621
YASARGIL Fadengabel 620
YASARGIL Galea Haken 606
YASARGIL Gefäßclips 108-137
YASARGIL Hypophysenzange 655
YASARGIL MIKRO-Fasszange 659
YASARGIL MIKRO-Instrumente 620,621
YASARGIL MIKRO-Messer 621
YASARGIL MIKRO-Pinzetten 94
YASARGIL Nadelhalter 358,373
YASARGIL Saugrohr 295
YASARGIL Scharfer Löffel 621
YASARGIL Tumorpinzetten 93
YASARGIL-SAMMI Tumorpinzetten 93
YEOMAN Rektum Biopsiefasszange 685
YOUNG Ersatznadel 388
YOUNG Nahtinstrument 388
YOUNG Prostatahaken 695
YOUNG Zungenzange 880

Z

ZAUFAL Fremdkörperheber 811
ZAUFAL-JANSEN Hohlmeißelzange 514
ZENKER Klemmen 189
ZENKER Wundhaken 230
ZIEGLER Augenmesser 765
ZIEGLER Stirnspiegel mit Stirnreif 318
ZIELKE Hohlmeißel 448
ZÖLLNER Ohrspekulum schwarz eloxiert 799
ZÖLLNER Saugkanüle 294
Zughaken für Extensionsbügel, groß 430
Zughaken für Extensionsbügel, klein 430
Zungendrucker 879



E

Inhaltsverzeichnis Alphabetical Index Indice alfabético Indice alfabético

A

Abdominal Spatula	253
ABRAHAM Tonsil Knife	890
ADAMS Napkin Holder	870
ADLERKREUTZ Tissue Forceps	83
ADSON Dressing Forceps	78
ADSON Dura Hook	617
ADSON Forceps	182
ADSON MICRO-Forceps	78,82
ADSON Needle Holder	361
ADSON Raspatory	478
ADSON Retractor	256-263
ADSON Suction Tube	290
ADSON Tissue Forceps	82
ADSON Twist Drill	416
ADSON-BROWN Tissue Forceps	82
AEBLI Corneal Scissors	781
ALAN-PARKS Central blade	683
ALAN-PARKS Lateral blade	683
ALAN-PARKS Rectal Spreader	683
ALDERDYCE Elevator	484
ALEXANDER Biopsy Forceps	740
ALEXANDER Chisel	439
ALEXANDER Gouge	439
ALEXANDER Rip-Raspatory	478
ALLEN Intestinal Forceps	665
ALLIS ATRAUMA Tissue Forceps	662
ALLIS Intestinal Forceps	662,663
ALLIS-ADAIR Intestinal Forceps	662
ALLIS-BABY Intestinal Forceps	662
ALLISON Lung Spatula	544
ALLPORT Retractor	255
ALM Retractor	255
Amputating Knife	12,13
Amputation Comprimeter	412
ANDERSON-ADSON Retractor	256
ANDREW Tongue Depressor	878
ANDREWS-PYNCHON Suction Tube	296
Anestophon Stethoscope	309
Applying and Removing Forceps	162
Applying Forceps for Bulldog Clamp	549
AQUAJET	941
AQUAJET Water Jet Pistol complete	940
ARRUGA Needle Holder	353
ASCH Septum Forceps	861
ASEPTIC Nailbrush	920
ASPIRATING Curette	751
ATRAUMA Cardiovascular Forceps	573
ATRAUMA Organ Grasping Forceps	673
AUFRICHT (WIENER) Nasal Rasp	853
AUFRICHT Nasal Retractor	858,86
AUSTIN MICRO-Attic Dissector	795
AUSTIN MICRO-Suture Tying Forceps	96
Autopsy Knife heavy pattern	3
AUVARD Speculum	719
AXENFELD Hook	768
AYER Chalazion Forceps	780
AYRE Cone Knife	2

B

BABCOCK ATRAUMA Tissue Forceps	664
BABCOCK Intestinal Forceps	664
BABINSKY Hammer	307
BABY-ADSON Forceps	182
BABY-BABCOCK Intestinal Forceps	664
BABY-BAILEY Rip Retractor	543
BABY-BALFOUR Abdominal Retractor	273
BABY-COLLIN Abdominal Retractor	270
BABY-COLLIN Lateral Blade	270

BABY-DOYEN Intestinal Forceps	666
BABY-DUPLEX Stethoscope	309
BABY-GILLIES Needle Holder	366
BABY-KERN Bone Holding Forceps	503,504
BABY-MAGILL Catheter Forceps	324
BABY-MIKULICZ Peritoneal	195
BABY-MIXTER Forceps	181
BABY-Nail Scissors	915
BABY-OVERHOLT Forceps	169
BABY-ROUX Retractor	250
BABY-SATINSKY Blood Vessel Clamp	545
BABY-TISCHLER Biopsy Forceps	741
BACKHAUS Towel Forceps	201
BADGLEY Laminectomy Retractor	626
BAILEY Rib Retractor	543
BAILEY-GIBBON Rip Retractor	543
BAINBRIDGE ATRAUMA Forceps	554
BAINBRIDGE Forceps	180
BAKES Gall Duct Dilator	690
BALFOUR Abdominal Retractor	274,275
BALFOUR Central Blade	275
BALFOUR Lateral Blade	275
BALL+SOCKET Paper Clamp	202
BALLENGER Septum Gouge	845
BALLENGER Septum Knife	840
BALLENGER-HAJEK Septum Elevator	842
BANDAGE Scissors	405
BARANY Ear Piece	803
BARANY Noise Apparatus	803
BARBARA Ear Hook	793
BARBARA Ear Needle	793,794
BARBARA MICRO-Ear Needle	793
BARNHILL Adenoid Curette	863
BARR Rectal Speculum	681
BARRAQUER (COLIBRI) Eye Lid Speculum	762
BARRAQUER Cilia Forceps	91
BARRAQUER Corneal Scissors	783
BARRAQUER Needle Holder	354-355
BARRAQUER-COLIBRI Fixation Forceps	777
BARRAQUER-KATZIN Fixation Forceps	777
BARRAQUER-KATZIN Fixation Forceps	777
BARRAQUER-TROUTMAN Needle Holder	354
BARRET Tenaculum Forceps	727
BARRON Suction Tube	294
Battery Handle (without battery)	330,337
Battery Handle for fiber optic with LED-illumination	338
BAUMGARTNER Needle Holder	360
BEACHAM Amniotom	729
BECK ATRAUMA Vascular Clamp	574
BECKMANN Adenoid Curette	862,863
BECKMANN Nasal Speculum	825
BECKMANN Retractor	263
BECKMANN-ADSON Retractor	264
BECKMANN-EATON Retractor	264
Bed Pan	938
BEEBEE Scissors	50
BEER Cilia Forceps	91
BELLUCCI MICRO-Ear Scissors	789
BELLUCCI MICRO-Suction Tube	293
BENGOLEA Forceps	177
BENNETT Bone Lever	490
BERGER Head Loupe	321
BERGER Lens	321
BERGMANN Bandage Scissors	403
BERGMANN Mallet	456
BERGMANN Plaster Saw	406
BERLIN Tubing Clamp	204
BERLINER Hammer	306
BERNHARD Towel Forceps	202
BERTILLON Caliper	311
BETHUNE Rib Shears	532

BEYER Bone Rongeur Forceps	514
BEYER Ear Punch	808
BIEMER Applying Forceps	156
BIEMER Approximator	156
BIEMER Approximator for temporary occlusion	156,157
BIEMER Vessel Clip	151
BIEMER-MÜLLER Approximator	155
BIER Amputation Saw	410
BIER Lumbar Puncture Needles	300
BIER Spare Saw Blade	410
BILLEAU Ear Loop	811
Biopsy Trephine for CHAMPY	453
BIRCHER Gensky Knife	494
BIRCHER-MANISKE Meniscotomy Forceps	500
BIRKETT Forceps	183
BISHOP-HARMAN Iris Forceps	777
BLAKE Gall Stone Forceps	692
BLAKE Uterus Curette	750
BLOHMKE Tonsil Forceps	894
Blood Pressure Manometer	322,323
BLOUNT Bone Lever	491
BLOUNT Retractor	492
BLUMENTHAL Bone Rongeur Forceps	513
Blunt Obturator for CHAMPY	453
BODENHAMMER Rectal Speculum	680
BOETTCHER Scissors	46
BÖHLER Bone Cutting Forceps	521
BÖHLER Bone Rongeur Forceps	514
BÖHLER Extension Bow	429
BONACCOLTO Suture Forceps	779
Bone Chisel	438
Bone Curette	466
Bone File	481
Bone Gouge	438
Bone Holding Forceps	500-509
Bone Holding Forceps, self-centering	509
Bone Lever	485,486
Bone Wire	427
BONN MOD. Iris Forceps straight	777
BONN MOD. Scissors	38
BONNEY Tissue Forceps	86
BOSE Tracheal Hook	904
BOUCHERON Ear Speculum	799
BOWMAN Discissions Needle	765
BOWMAN Eye Lid Speculum	762
BOWMAN Lachrymal Probe	774
BOYS-ALLIS Tissue Forceps	663
BOZEMANN Knot Tier	394
BOZEMANN Swab Forceps	208
BOZEMANN Uterus Scissors	28
BOZEMANN-DOUGLAS Swab Forceps	208
BRAND Tendon holding Forceps	498
BRAUN Cranioclast	759
BRAUN Goitre Forceps	910
BRAUN Tenaculum Forceps	732
BRAUN Uterus Depressor	726
BRAUN-STADLER Scissors	29
BREISKY Speculum	720
BRODIE Director	283
BROPHY Dressing Forceps	79
BROPHY Tissue Forceps	84
BROPHY-SULLIVAN Scissors	36
BROWN Needle Holder	360
BROWN Tissue Forceps	86
BRUENINGS Nasal Cutting Forceps	828
BRUENINGS Septum Knife	841
BRUENINGS Tongue Depressor	879
BRUENINGS Tonsil Knife	890
BRUENINGS Tonsil Snare	895
BRÜNING Broncho Forceps	899
BRÜNING Broncho Forceps Tip	899

Inhaltsverzeichnis
Alphabetical Index
Indice alfabético
Indice alfabetico



E

BRÜNNINGS Laryngeal Tube	898	CHAPUT Tumor Seizing Forceps	178	CORYLLOS Retractor	236
BRUNNER ATRAUMA Intestinal Forceps	677	Charging Station	338	COTTLE Nasal File	853
BRUNNER Ferrozell Ligature Conductor	394	CHARRIERE Amputations Saw	411	COTTLE Cartilage Crusher	851
BRUNNER Ligature Needle	391,392	CHARRIERE Spare Blade	411	COTTLE Chisel	846,847
BRUNNER Retractor	237-239	CHEATTLE Sterilizing Forceps	924	COTTLE Columella Forceps	861
BRUNNER Rib and Sternum Scissors	531	CHEEK Retractor	877	COTTLE Elevator	843
BRUNS Plaster Cast Shear	404	CHERON Dressing Forceps	208	COTTLE Mallet	455
BRUNS Bandage Scissors	404	Chest Support for children	342	COTTLE Nasal Chisel	846
BRUNS Bone Curette	462,463	CHEVALIER-JACKSON Broncho-Esophagoscopy	898	COTTLE Nasal Hook	856
Brush Collecting Box	922	CHEVALIER-JACKSON Trachea Tube	906	COTTLE Nasal Knife	838
BRYANT Polypus Forceps	207	CHILDE Suture Forceps	395	COTTLE Nasal Retractor	859,86
BUCHWALD Tongue Depressor	879	Chisel Blade	445	COTTLE Nasal Speculum	824
BUCK Ear Curette	809,81	Chisel with handle from artificial wood	448,449	COTTLE Nasal Tissue Forceps	861
BUCK Foreign Body Lever	806	Cilia Forceps serrated	90	COTTLE Saddle Hook	860
BUCK Hammer	307	CINELLI Nasal Chisel	848	COTTLE Scissors	47
BUCK Ligatur Scissors	52	Cip-Set MINI-Assistent	398	COTTLE Septum Elevator	842
BUCK-GRAMCKO Bone Lever	485	CITELLI Antrum Punch Forceps	808, 837	COTTLE Septum Raspatory	843
BUCKLEY Retractor	254	CLAR Head Light	319,32	COTTLE-KAZANJIAN Bone Cutting Forceps	520
BUIE Forceps	179	Cleaning Brush	907,943-947	COTTLE-NEIVERT Nasal Retractor	859
BULEAU Trocar	289	Cleaning Brushes Set	944	COTTLE-WALSHAM Septum Forceps	861
Bulldog Clamp	160	CLEVELAND Bone Cutting Forceps	520	COUPLAND Suction Tube	297
Bulldog Vessel Clip	148	CLEVELAND Bone Rongeur Forceps	512	Coupling Piece	751
BUMM Uterine Curette	749	CLOVER ATRAUMA Bulldog Clamp	549	CRAFOORD Forceps	184
BUNELL Hand Bone Drill	417	CLOWARD Lamina Spreader	634	CRAFOORD Torax Scissors	41
BUNNEL Tendon Passer	497	CLOWARD Retractor complete	268,289	CRAFOORD-SELLORS Forceps	184
BUNNEL Tendon Stripper	496	CLOWARD Valve	268,269	CRAIG Nasal Septum Forceps	827
BUNT Safety pin	925	COAKLEY Antrum Trocar	290	CRAWFORD Aorta Retractor	240
BURFORD Rip Spreader	535	COAKLEY Curette	862	CRILE Forceps	168
BURKE Biopsy Forceps	741	COBB Gouge	450	CRILE Nerve Hooklet	599
BUSCH Umbilical Scissors	29	COBB Raspatory	472	CRILE Retractor	252
C					
Caliper ALUMINIUM	312	COGSWELL Suction Canula	292	CRILE WOOD Needle Holder	361
Canula for Vein	299	COLLIER Needle Holder	359	CRILE-MURRAY Needle Holder	361
CAPLAN Nasal Cutting Scissors	835	COLLIN Abdominal Retractor	270	CRILE-RANKIN Forceps	169
CAROLL Finger Goniometer	311	COLLIN Center Blade	271	CRUTCHFIELD Cervical Traction Tong	603
CAROLL Tendon Holding Forceps	499	COLLIN Dressing Forceps	207	CUSCO Vaginal Speculum	706,707
CARPENTER Tonsil Knife / Disector	891	COLLIN Dynamometer	311	CUSCO Vaginal Speculum, Swiss pattern	706
CARREL Artery Forceps	166	COLLIN Hammer	454	CUSHING Dressing Forceps	80
CASPAR Exploration Hook	618	COLLIN Holding Forceps	178	CUSHING Drill	416
CASPAR Frame	627-632	COLLIN Lateral Blade	271	CUSHING Dura Hook	617
CASPAR Hook	627, 628	COLLIN Pelvimeter	753	CUSHING Laminectomy Rongeur	650
CASPAR Key	627	COLLIN Retractor	252	CUSHING Nerv Hook	613
CASPAR Laminectomy Retractor	627-632	COLLIN Speculum	707	CUSHING Retractor	217-219
CASPAR Laminectomy Rongeur	653,654	COLLIN Suture Forceps	396	CUSHING Tissue Forceps	84
CASPAR Lateral Valve	627, 632	COLLIN Tongue Forceps	880	CUZZI Abortus Scoop	757
CASPAR Medial Valve	629	COLLIN Tongue Holding Forceps	178	CZERNY Gall Stone Forceps	692
CASPAR Specula	633	COLLIN Tumor Seizing Forceps	178	CZERNY Rectal Speculum	680
CASPAR Spreader	630	COLLIN Umbilical Clamp	758	CZERNY Tenaculum Forceps	732
CASPAR Valve blunt	631	COLLIN Uterine Elevating Forceps	733	D	
CASPAR Valve Ejector	628	COLLIN Uterus Sounds	726	D'ERRICO Drill	416
CASTA—EDA ATRAUMA Cardiovascular Clamp	593	COLLIN Vaginal Speculum	707	DAHLGREN Cranial Rongeur	604
CASTA—EDA Rib Spreader	536	COLLIN-DUVAL Tubal Seizing Forceps	87	DAHLGREN Spare Blade for Cranial Rongeur	604
CASTROVIEJO Corneal Scissors	781,784	COLLYER Pelvimeter	753	DAHMEN Bone chisel	451,452
CASTROVIEJO Cyclodialyse Spatula	770,775	COMCO Circumcision Instrument	702	DAHMEN Gouge	451,452
CASTROVIEJO Cyclodialysis	775	CONE Cranial Rongeur	604	DALElamp ATRAUMA Peripheral Vascular Clamp	577
CASTROVIEJO Eye Cannula	772	CONVERSE Alar Hooklet	856,858	DANDY Forceps	167
CASTROVIEJO Eye Lid Speculum	762	CONVERSE Nasal Knife	838	DANDY Nerv Hook	614
CASTROVIEJO Eye Scissors	782	COOLEY ATRAUMA Anastomosis Clamp	583-586	DANDY Scissors	45
CASTROVIEJO Marker	773	COOLEY ATRAUMA Cardiovascular Forceps	584	DARDIK ATRAUMA Vascular Clamp	580
CASTROVIEJO MICRO-Needle Holder	356-358	COOLEY ATRAUMA Carotid Clamp	583	DARTIGUES Uterine Elevating Forceps	733
CASTROVIEJO(JACOBSON) MICRO-Needle Holder	357	COOLEY ATRAUMA Catheter Clamp	587	DAVIDSON Retractor	236
CASTROVIEJO Razor Blade Holder / Blade Breaker	14	COOLEY ATRAUMA Pediatric Vascular Clamp	590-592	DAVIS Spatula	611
CASTROVIEJO-BARRAQUER Spatula	769	COOLEY Cardiovascular Dilator	594	DAVIS Dura Dissector	616
Cataract Needle	765	COOLEY Retractor	245	DAVIS-BOYLE Mouth Gag	873
CATLIN Amputating Knife	12	COOLEY Rib Spreader	533	DAY Ear Hook	812
CAWOOD-MINNESOTA Check Retractor	877	COOLEY Suction Tube	297	DE LEE Obsterical Forceps	754
Cervical Traction Tong	603	COOLEY Vascular Dilatator	595	DE MARTEL Conductor for Wire Saw	602
Chain for nurse set	915	COOLEY-BECK ATRAUMA Cardiovascular Clamp	588	DE MARTEL-WOLFSON Anastomosis Clamp	672
		COOLEY-DERRA ATRAUMA Cardiovascular Clamp	588	DE MARTEL-WOLFSON Clamp Closing Forceps	672
		COOPER Ligatur Needle	389	DE MARTEL-WOLFSON Clamp Holder	672
		CORDES Broncho Forceps	899		



Inhaltsverzeichnis

Alphabetical Index

Indice alfabético

Indice alfabético

DE VILBISS Cranial Rongeur	604	Drill Point for Cervical traction Tong	603	Finger Ring Saw	527
DE VILBISS Spare Blade for Cranial Rongeur	604	DUBOIS Scissors	28	FINOCHIETTO (mod.) Rib Retractor	538
DEAN Scissors	48	DUEHRSEN Dressing Forceps	80	FINOCHIETTO BABY Rib Retractor	534,538
DEAVER Retractor	243-245	DUEHRSEN Tissue Forceps	85	FINOCHIETTO Forceps	192
DEAVER Scissors	25	DUPLAY Tenaculum Forceps	729	FINOCHIETTO INFANT Rib Retractor	534
DEBAKEY ATRAUMA Aortic Clamp	562-568	DUPLEX Stethoscope	309	FINOCHIETTO Needle Holder	364
DEBAKEY ATRAUMA Bulldog Clamp	548-550	DUPUY-WEISS Tonsil Needle	889	FINOCHIETTO Rectal Scissors	42
DEBAKEY ATRAUMA Vascular Clamp	551-582	DURANTE Tissue Forceps	86	FINSEN Retractor	254
DEBAKEY Lateral Blades	539-540	DUVAL Intestinal Forceps	665	FISCH Ear Dissector	796
DEBAKEY Rib Retractor	539,540	DUVAL Tissue Forceps	87	FISCHER Tendon Stripper	497
DEBAKEY Vascular Dilatator	595	E		FISHER Tonsil Knife	890
DEBAKEY Vascular Scissors	43,44			Fixation Discs	430
DEBAKEY-DIETHRICH Bulldog Clamp	163			Flat Nose Pliers	421-423
DEBAKEY-SATINSKY ATRAUMA Bulldog Clamp 548				Flexible Tube complete	818
DEJERINE Hammer	306	Ear Speculum disposable	317	FOERSTER Sponge Forceps	208,209
Delicate Scissors	36,38,40	Ear Speculum for diagnostic sets	317	FOMON Nasal Chisel	848
DEMEL Wire Guide	428	Ear Speculum reusable	317	FOMON Nasal File	854,855
DEMEL Wire Twisting Forceps	427	Ear Syringe	818	FOMON Nasal Hook	857
DENHARDT Mouth Gag	871	EASTMAN Speculum	709	FOMON Nasal Plastic Knife	838
DENHARDT Silicon jaws	871	EASTMAN Speculum large	709	FOMON Nasal Retractor	859
DENIS-BROWNE Abdominal Retractor	278	ECHLIN Bone Rongeur Forceps	516	FOMON Scissors	34,47
DENIS-BROWNE Grasping Forceps	87	EICKEN-KILLIAN Nasal Canula	865	Forceps, fine Pattern	89
DENIS-BROWNE Hook on Retractor	278	EISELSBERG Ligatur Scissors	52	Forceps, Nasal Gouge	845
DEPONETTE Storing Case	926	Elevator and Bone Lever	483	FOREGGER Laryngoscope	336
DERF Needle Holder	359	ELLIOT Corneal Trephine	772	Foreign Body Remover and Magnetic Eye Probe	766
DERRA ATRAUMA Vascular Clamp	574	ELLIOT Trephine	772	FOX Lupus curette	912
DESCHAMPS Ligatur Needle	390,391	ELSÄSSER Nephrostomy Forceps	689	FRAENKEL Broncho Forceps	899
DESJARDIN Dissecting Forceps	191	EMMET Fistula Hook	734	FRAENKEL Crasping Forceps	899
DESJARDINS Gall Duct Scoop	693	ENGEL Plaster Cast Saw	406	FRAENZ Abdominal Retractor	279
DESJARDINS Gall Stone Forceps	693	ENGL. MODELL Dressing Forceps	80	FRAZIER Dura Dissector	614
DESJARDINS Gall Stone Probe	691	ENGL. MODELL Towel Clamp	201	FRAZIER Dura Hook	617
DESJARDINS Gall Stone Probe flexible	691	ENTEROTOMY Scissors	51	FRAZIER Suction Tube	290
DESMARRES Chalazons Forceps	780	Enucleation Scissors	34	FREER Mucosa Hooklet	859
DESMARRES Lid Retractor	763	Episiotomy Scissors	29	FREER Mucosa Knife	839
DESMARRES Retractor	214	EPENDORFER Biopsy Forceps	740	FREER Septum Chisel	844
Diagnostic-Set in case, combined	316	ESMARCH Bandage Scissors	404	FREER Septum Elevator	841,842
DIEFFENBACH Bulldog Clamp	164	ESMARCH Compression Bandage	413	FREER Septum Gouge	844
DIETHRICH ATRAUMA Aortic Clamp	575	ESMARCH Plaster Knife	406	FREER Septum Knife	839
DIETHRICH Bulldog Clamp	163	EVES Tonsil Snare	895	FRIEDMANN Bone Rongeur Forceps	511
DIETHRICH Vascular Scissors	43	Excentric Bandage and Cloth Scissors	402	FRIEDMANN-VICKERS Bone Rongeur Forceps	511
DIETHRICH-HEGEMANN Vascular Scissors	43	Eye Needle	349	FRIMED Ligatur Conductor	392
DINGMANN Bone Holding Forceps	500	F		FRIMED Ligature Adjuster	394
DINGMANN Mouth Gag	875			FRIMED-DIAMANT Wire Cutter	424
DINGMANN Tounge Depressor	875	Falt Nose Plier	421-423	FRIMED-VIGORIMETER Dynamometer	310
Disposable Scalpel	9,10	FARABEUF Bone Holding Forceps	504	FRITSCH Retractor	234
Dissecting Knife	2	FARABEUF Periosteal Raspatory	474	FROSCH Bone Forceps	502
Dissecting Scissors	36	FARABEUF Retractor	249	FRYKHOLM Bone Rongeur Forceps	517
DIX Double Instrument	775	FARABEUF-LAMBOTTE Bone Holding Forceps	504	FULLER MICRO- Ear Introduction Forceps	791
DIXON LOVELACE Forceps	169	FARRELL Cotton Applicator	287	G	
Double Instrument	775	FARRIOR Ear Speculum	798		
Double Scalpel Handles No. 3 + 4	6	FAULKNER Curette	862	GALLAHER Nasal Rasp	853
DOUGLAS Cilia Forceps	90,91	FAURE Biopsy Forceps	738	Gasket Ring	751
DOUGLAS Trocar	289	FAURE Peritoneal Clamp	195	GELLHORN Biopsy Forceps	738
DOYEN Abdominal Retractor	234	FAVALORO Vascular Scissors	45	GELPI Perineal Retractor	267
DOYEN ATRAUMA Intestinal Forceps	674	FEHLAND ATRAUMA Rectum Forceps	678	GELPI-LOKTITE Perineal Retractor	267
DOYEN Chain with weight	279	FEILCHENFELD Splitter Forceps	90	GEMINI Dissecting and Ligature Forceps	187
DOYEN Grooved Director	283	FEIN Cotton Applicator	287	GERALD Thumb Dressing Forceps	80
DOYEN Hook	279	FELDHEIM Band	526	GERALD Tissue Forceps	84
DOYEN Intestinal Forceps	666	FELDHEIM Finger Nail Instrument	526	GERSTER Bone Holding Clamp	419
DOYEN Mallet	454	FERGUSSON Bone Holding Forceps	502	GERZOG Mallet	456
DOYEN Myoma Screw	734	FERGUSSON Forceps	179	GIERTZ-STILLE Sternum Scissors	530
DOYEN Raspator	476	FERGUSSON Gall Duct Scoop	694	GIGLI Drahtsägen	602
DOYEN Scissors	27	FERRIS-SMITH Laminectomy Rongeur	657	GIGLI Handle for Wire Saw	602
DOYEN Speculum	717,720	FERRIS-SMITH Tissue Forceps	85	GILLIES Hooklet	913
DOYEN Uterus Forceps	732	FERRIS-SMITH-KERRISON Laminectomy-Punch 649		GILLIES Needle Holder	366
DOYEN Xostal Periosteal	475	FERROZELL Cheek for mallet	455,457	GILLIES Tissue Forceps	83
DOYEN-JANSEN (MOLT) Mouth Gag	871	FERROZELL Handle	445	GIL-VERNET Type Retractor	219
DOYEN-STILLE Retractor	233	FERROZELL Ligature Conductor	394,395	GLOVER ATRAUMA Bulldog Clamp	549,55
Dressing Forceps	78	Fiber Optic Light Carrier	343	GLOVER ATRAUMA Cardiovascular Forceps	573
Dressing Forceps in jar	923	FILIFORM Bougie	699	GLUCK Rib Shear	530
Drill Chuck with T-Handle complete	416	Fine Scissors	40		

Inhaltsverzeichnis
Alphabetical Index
Indice alfabético
Indice alfabético



E

GOLDMANN-FOX Scissors	49	HARTMANN Nasal Speculum	823	Injections Dain Tube	343
GOLDSMTH (THUDICHUM) Nasal Speculum	822	HARTMANN Nasal Tampon Forceps	826	Instrument Box	352,935
GOLLET Retractor	251	HARTMANN Tongue Depressor	878	Instrument Spray Oil	942
GOMEL MICRO-Scissors	17	HARTMANN Tonsil Punch Forceps	897	Instrument Tray	933
GOMEL Needle Holder	355	HARTMANN Tuning Fork	800,801	Intima Spatula	598
Good Tonsil Scissors	46	HARTMANN-HALLE Nasal Speculum	822	Intima Spatula blunt curved 18,5 cm	598
GOODELL (SIMS) Uterine Dilator	736	HARTMANN-HOFFMANN Ear Spoon Forceps	807	IOWA canula	298
GOSSET Abdominal Retractor	273	HARTMANN-WULLSTEIN Ear Forceps	807	IOWA Vusellum Forceps	730
GOSSET Central Blade	273	HAYES ATRAUMA Intestinal Forceps	677	Iris (GRAEFE) Dressing Forceps	88
GOUGE Blade interchangeable	445	Head Band of black plastic	318,32	Iris Scissors	37
GRAEFE (Iris) Dressing Forceps	88	HEANEY Forceps	198	ISRAEL Retractor	225
GRAEFE Cataract Knife	764	HEANEY Needle Holder	363	ITERSON Tracheal Hook	904
GRAEFE Cystotome	766	HEANEY-KANTER Forceps	199	IVES-FANSLER Anoscope	683
GRAEFE Iris Forceps	776	HEANEY-REZEK Hysterectomy Forceps	198		
GRAEFE Iris Hook	766,768	HEANY-BALLENTINE Hysterectomy Forceps	198	J	
GRAEFE Iris Hooklet	212,766	HEATH Ligatur Scissors	52	JACKSON Operating Laryngoscope	339
GRAHAM Dura Hook	617	HEATH Mallet	457	JACKSON Trachea Tube	906
GRAVE Speculum	708	HEBRA Chalazion Curette	771	JACKSON Tracheal Hook	904
GRAY Dissecting Forceps	191	HEGAR Needle Holder	365	JACKSON Vaginal Speculum	709
Grazil Surgical Scissors	24	HEGAR Uterine Dilator	721-723	JACOBS Tenaculum Forceps	730
GREEN-ARMYTAGE Uterine Clamp	756	HEGENBARTH Suture Forceps	396	JACOBSON MICRO- Instrument	620
GREGORY ATRAUMA Carotid Clamp	550	HEIFETZ Spatula	611	JACOBSON MICRO-Scissors	16
GREGORY ATRAUMA Profunda-Clamp	576	HEIFETZ Tumor Forceps	93	JACOBSON Twin Probe	620
GRONINGEN Nerv Hook	613	HEIMING Kidney Stone Forceps	688	JAEGER Lid Plate	763
Grooved Director	282,283	HEISS Forceps	181	JAEGER-GRIESHABER Keratome	764
GROSS Ear Spoon and Hhook	810	HEISTER Mouth Gag	871	JAMESON Caliper	312
GROSS modif. Dressing Forceps	206	HEMINGWAY Double Curette	467,468	JAMESON Dissecting Scissors	39
GROSS-MAIER Dressing Forceps	206	HENKE Tonsil Dissector	892	JAMISON Needle Holder	363
GUEDEL-NEGUS Laryngoscope	327	HENLEY Central valve	260	JANET Barrel	304
GUILLEN Suction Raspatory	865	HENLEY Retractor	260	JANET Wound and Bladder Syringe	304
GUTHRIE Double Hooklet	212	HENNING Plaster Spreader	407	JANSEN (GRUENWALD) Nasal Forceps	826
GUTHRIE Fixation Hook	767	HEPP-SCHIEDEL MICRO-Scissors	17,19	JANSEN Bone Rongeur Forceps	512,514
GUYON ATRAUMA Kidney Pedicle	193	HERRIK Kidney Pedicle Clamp	194	JANSEN Ear Scoop	810
GUYON Catheter	702	HESS Bulldog Clamp	164	JANSEN Retractor	255
GUYON Forceps	193	HEYMANN Nasal Cutting Forceps	827	JARCHO Tenaculum Forceps	727
GUYON Urethral Sound	699	HEYMANN Scissors	47	JAVID ATRAUMA Carotid Shunt Clamp	581
H		HEYWOOD-SMITH Forceps	686	JENNINGS Mouth Gag	876
HABERER Spatula	253	HIBBS Bone Chisel	442,443	JOBSON HORNE Cotton Applicator	287
HACKSTOCK Wire Forceps	421	HIBBS Bone Gouge	443	JOHNS-HOPKINS Bulldog Clamp	164
HAIGHT Rip Spreader	537	HIRSCHMANN Anoscope	683,684	JOHNS-HOPKINS Forceps	183
HAJEK Antrum Punch Forceps	836	HOFF Towel Forceps	203	JOHNSON Needle Holder	364
HAJEK Mallet	456	HOFFMANN Tubing Clamp	925	JOLL (FRIEDMANN) Retractor	266
HAJEK-KOFLER Antrum Punch Forceps	836	HOHMANN Bone Lever	486	JONES Towel Clip	201
HALLE Bone Curette	465	HOHMANN-ALDINGER Bone Lever	489	JOSEPH Mucosa Hooklet	859
HALLE Dura Knife	618	HOKE Chisel	442	JOSEPH Nasal File	852
HALLE Septum Elevator	841	HOLINGER Operating Laryngoscope	339	JOSEPH Nasal Hook	859
HALSEY Needle Holder	359,36	HOLSHER Nerv Root Retractor	612	JOSEPH Nasal Knife	838
HALSTEAD-MOSQUITO Forceps	165	HOLTZ Punch	773	JOSEPH Nasal Saw	851
Handle for Biopsy Forceps	742	HOLZHEIMER Retractor	255	JOSEPH Raspator	843
Handle for Ring Stripper	286	HOPKINS Plaster Knife	406	JOSEPH Scissors	35
Handle with LED-Illumination	338	HORSLEY Dura Dissector	614	JOSEPH Septum Elevator	841
Handle, Ferrozell	445	HÖSEL Retractor	233	JOSEPH Septum Elevator	843
Handle, flat, for Telescopes	820, 868	HOUSE Curette	797	JUDD-ALLIS Intestinal Forceps	663
HANK Uterine Dilator	724	HOUSE MICRO-Measuring Rod	796	JUDD-MASSON Bladder Retractor	697
HARDY Enuclator for Pituitary	620	HOUSE Suction Tube	294	JURASZ Laryngeal Polypus Forceps	900
HARDY Pituitary MICRO-Curette	619	HOUSE-DIETER Ear Introction Forceps	790		
HARDY-FAHLBUSCH MICRO-Dissector	620	HUBER Broncho Handle	898	K	
HARKEN ATRAUMA Forceps	565	HUDSON Burr	416	KABIERSKE Ear Cannula	815
HARKEN Blood Vessel Clamp	546	HUDSON Extension Piece	416	KABIERSKE Powder Blower	815
HARMS Trabecular Probe	774	HUDSON Hand Bone Drill	416	KABIERSKE Spare Bottle	815
HARRINGTON Retractor	242	HUMBY Dermatome	11	KABIERSKE Valve Rubber bulb	815
HARTMANN Bone Rongeur Forceps	512	HUNT Tumor Forceps	94	KADER Spatula	248
HARTMANN Ear Catheter	804	HUNTER Splitter Forceps	89	KALLMORGAN Retractor	716
HARTMANN Ear Forceps	806,807	HURD Tonsil Dissector	891	KALT Needle Holder	353
HARTMANN Ear Hook	811	HURD Tonsil Needle	889	KALT Vascular Suture Needle	349
HARTMANN Ear Speculum	798	HUSFELDT ATRAUMA Peripheral Vascular Clamp579		KANE Umbilical Clamp	758
HARTMANN Forceps	166			KANTROWITZ Dissecting and Ligature Forceps	190
HARTMANN Haemostatic Forceps	166	I		KATSCH Comedone Extractor	914
HARTMANN Nasal Cutting Forceps	829	Incision-Scissors	25	KATZIN-BARRAQUER Corneal Scissors	781
		INGE Lamina Spreader	634		



Inhaltsverzeichnis

Alphabetical Index

Indice alfabético

Indice alfabetico

KAYE Skin Hooklet	913	KRISTELLER Retractor	711-714	LEYLA Ball and Socket joint	609, 610
KEITH Surgical Intestinal-needle	348	KRISTELLER Specula	711-715	LEYLA Coupling head	609, 610
KELLY Anoscope	684	KROENLEIN Tumor Seizing Forceps	167	LEYLA Fixation base	607,608
KELLY Forceps	168	KRONECKER Needle	389	LEYLA Holding rod	609, 610
KELLY Ligatur Forceps	188	KUEMMEL Spatula	248	LEYLA Self-retaining Retractor	607,609
KELLY Retractor	247			LEYLA Support for Spatulas	608, 609
KELLY Scissors	48	L		LICHTENBERG Needle Holder	367
KELLY Uterus Polypus Forceps	732			LICHTWITZ Trocar	289
KELLY-RANKIN Forceps	168	LA FORCE Adenoid Curette	864	Lid for Storage Tray	146
KELSEY-FRY Awl for upper jaw	887	LA GRANGE Scissors	49	Lid for Waste bucket	948
KERN Bone Holding Forceps	503,504	LAHEY Forceps	192	Lid Knob for bed pan	938
KERRISON Antrum Punch	837	LAHEY Gouitre Forceps	910	Lid, only, for Kidney Bowl	938
KERRISON Laminectomy Rongeur	635-648,656	LAHEY Retractor	227	Lid, only, for Metal Jar	934
KEVORKIAN Biopsy Curette	737	LAMBERT Chalazions Forceps	780	Lid, only, with triangular opening	934
KEVORKIAN Biopsy Forceps	740	LAMBERT-KAY ATRAUMA Forceps	567	Ligature Catcher for RUMEL-BELMONT	599
KEVORKIAN Biopsy Tip	742	LAMBOTTE Bone Chisel	440	Ligature Conductor, Ferrozell	394,395
KEVORKIAN-PACIFIC Biopsy Forceps	741	LAMBOTTE Bone Holding Forceps	505	Ligature Needle flexible	389
Key for Interchangeable Blades	445	LAMBOTTE Raspatorium	476	LISTER (sinus) Swab Forceps	207
KEYES Punch	913	LANDAU Trocar	290	LISTER Bandage Scissors	400-402
KIDNEY Bowl	938	LANDAU Vaginal Speculum	720	LISTON Amputating Knife	12
KIELLAND Obsterical Forceps	755	LANDOLT Dissecting Suction Tube	292	LISTON Bone Cutting Forceps	519
KILLIAN Elevator	842	LANDOLT Scissors	35	LISTON-KEY Bone Cutting Forceps	524
KILLIAN Nasal Speculum	824	LANDOLT Tumor Grasping Forceps	655	LITTAUER Cilia Forceps	90
KILLIAN Nasal Tampon Forceps	827	LANDOLT-CUSHING Speculum	619	LITTAUER Ear Forceps	806
KILLIAN Raspator	842	LANE Bone Holding Forceps	506	LITTAUER Ligatur Forceps	52
KILLIAN Septum Gouge	845	LANE Stomach Clamp Forceps	669	LITTLE Retractor	227
KILLIAN-CLAUS Septum Gouge	845	LANE Tissue Forceps	85	LITTLEWOOD Tissue Grasping Forceps	664
KILNER Alar Hooklet	858	LANE Towel Clamp	202	LLOYD-DAVIS Vascular Scissors	41
KILNER Hooklet	912	LANGE Alar Hooklet	856	Loading Cone for Haemorrhoidal Ligator	685
KILNER Scissors	35	LANGE Broncho Forceps Tip	899	LOCKHARD-MUMMERY Grooved Director	283,284
KILNER-DOUGHTY Frame for Mouth Gag	872	LANGE-HOHMANN Bone Lever	488	LOCKLIN Scissors	48
KIRK Mallet	456	LANGENBECK Amputation and Resecting Saws	411	LOGAN Retractor	254
KIRSCHNER Abdominal Retractor	276,277	LANGENBECK Amputating Knife	13	LOOKWOOD-ALLIS Intestinal Forceps	663
KIRSCHNER Extension Bow	429	LANGENBECK Bone Holding Forceps	502	LORENZ Bandage Scissors	403
KIRSCHNER Ligature Conductor	392,394	LANGENBECK Ear Curette	809	LORNA Towel Forceps	202
KIRSCHNER Wire Drill	433,434	LANGENBECK Elevator	484	LOUTE Wire-Tightener	427
KIRSCHNER Wire traction bow	432	LANGENBECK Finger Protector	870	LOVE Nerv Hook	612
KIRSCHNER-BALLFOUR Hook on Retractor	277	LANGENBECK Needle Holder	384	LOVE-GRUENWALD Laminectomy Rongeur	651
KIRSTEIN Nasal Scissors	47	LANGENBECK Raspatory	473	LOVE-KERRISON Laminectomy Punch	640
KLEINERT-KUTZ Tendon Holding Forceps	499	LANGENBECK Retractor	225-228	LOVELACE Forceps	169
KLIMA-ROSEGGER Sternum Puncture Needle	301	LANGENBECK-GREEN Retractor	216	LOVELACE Tissue Holding Forceps	545
KLINGENBERG-LOTH Vascular Scissors	41	LARBORDE Tracheal Dilator	903	LOWER Forceps	192
KNAPP Discission Knife	764	Laryngeal Handle	902	LOWMAN Bone Holding Clamp	418
KNAPP Hook	767	Laryngeal Mirror	902	LOWMAN-HOGLUND Bone Holding Clamp	419
KNAPP Retractor	214	Laryngoscope Holder	342	LOWMAN-LAMBERT Bone Holding Clamp	419
KNAPP-ROLLET Hook	767	Laryngoscope Spare Bulb	330	LUBET-BARBON Nasal Tampon Forceps	826
KNIGHT Nasal Cutting Forceps	827	Laterral Vaginal Speculum	736	LUC Nasal Cutting Forceps	828
KNOWLES Bandage Scissors	402	LAWRENCE Dissecting and Ligature Forceps	190	LUCAE Ear Hook	812
KNUTSON Urethrography Instrument	702	LAZAR MICRO-Surture Tying Forceps	96	LUCAE Forceps	805
KNUTSON-KOCH Cannula	702	Lead Hand	525	LUCAE Mallet	454
KOCHER (OCHSNER) Forceps	174-176	LEBSCH Sternum Chisel	532	LUCAE Tuning Fork	802
KOCHER ATRAUMA Intestinal Forceps	675	LEES ATRAUMA Cardiovascular Forceps	566	LUER Adaptor for Tunneling Set	596
KOCHER Bladder Retractor	698	Leg-Cuff for Comprimeter	412	LUER Barrel	303
KOCHER Goitre Director	909	LEGUE Bladder Retractor	698	LUER Bone Rongeur Forceps	513
KOCHER Intestinal Forceps	667	LEKSELL-STILLE Bone Rongeur Forceps	517	LUER Hämorrhoidal Forceps	686
KOCHER Retractor	222-234	LELAND-JONES ATRAUMA Forceps	558	LUER Insulin Barrel	303
KOCHER-LANGENBECK Retractor	228	LEMPERT Bone Rongeur Forceps	513	LUER Insulin Syringe	303
KOERTE Retractor	224	LEMPERT Ear Curette	814	LUER Retractor	252
KOGAN Endocervical Speculum	735	LEMPERT Elevator	814	LUER Syringes	303
KÖLNER Scalp Hemostasis Clip	606	LEMPERT Suction Canula	291	LUER Trachea Tube	906
KÖNIG Ligature Conductor	392,393	LERCHE Tissue Forceps	83	LUER Tracheal Hook	904
KÖNIG Tuning Fork	803	LERICHE Forceps	167	LUER-KOERTE Gall Duct Scoop	693
KOOS MICRO-Instrument	621	LESTER Tissue Forceps	778	LUER-LOCK Barrel	303,304
KRAUS MICRO-Instrument	621	LEWIN Bone Holding Forceps	501	LUER-LOCK Connecting Piece	302
KRAUSE Broncho Forceps Tip	899	LEWIS Nasal Rasp	854	LUER-LOCK Eye Cannula	772
KRAUSE Ear Polypus Snare	804	LEXER Bone Chisel	447	LUER-LOCK Stopcock	302
KRAUSE Nasal Polypus Snare	825	LEXER Gouges	447,448	LUER-LOCK Syringe	303
KRAUSE Trocar	289	LEXER Scissors	32	LUER-LOCK Three way Stopcock	302
KRAUSE-VOSS Ear Polypus Snare	804	LEXER Spongiosa Osteotom	446	LUER-LOCK Wound and Bladdersyringe	304
KRAYENBÜHL Nerv and Vessel Hook	618	LEXER-BABY Scissors	32	LUKENS Tymus Hook	905
KRESSNER Septum Forceps	861	LEXER-FINO Scissors	33	LUNIATSCHEK Tonsil Gauze Packer	893

Inhaltsverzeichnis
Alphabetical Index
Indice alfabético
Indice alfabetico



E

M

MAGILL Catheter Forceps 324
MAGILL Suction Tube..... 293
MAINGOT Hysterectomy Forceps..... 199
Mallet 454-459
Mallet blow-back proof 458,459
MALTZ Nasal Rasp 852
Manometer for Comprimeter 412
Manometer with luminous dial 752
Manometer with rubber bulb 323
MARKWALDER Bone Cutting Forceps 520
MARQUARDT Bone Rongeur Forceps 515
MARTEL Forceps 179
MARTIN ATRAUMA Peripheral Vascular Clamp 578
MARTIN Bone Holding Forceps 500
MARTIN Brush Dispenser 920
MARTIN Finger Ring Saw 527
MARTIN Pelvimeter 753
MARTIN Retractor 235
MARTIN Spare Saw Blade 527
MARTIN Tunneling-Set 596
MARTIN Uterus Sound 726
MARTINI Double Curette 467
MARTIN-IDEAL Finger and foot nail Drill 526
MARTIN-VICKERS Hand Restrainer 525
MASING Septum Raspatory 843
MASSON Needle Holder 363
MASTIN Muscular Clamp 910
MATHIEU Foreign Body Forceps 703
MATHIEU Needle Holder 367
MATHIEU Rectal Speculum 682
MATHIEU Retractor 251,717
MATHIEU Speculum 717
MATHIEU-RYDER Needle Holder 367
MATSON Rip-Raspatory 478
MAUNDER Mouth Oral Screw 870
MAYFIELD Bone Rongeur Forceps 514
MAYO Gall Duct Probe 691
MAYO Gall Duct Scoop 694
MAYO Safety pin 925
MAYO Scissors 25,66
MAYO-ADAMS Retractor 266
MAYO-BLAKE Gall Stone Forceps 692
MAYO-HARRINGTON Scissors 26
MAYO-HEGAR Needle Holder 362,365
MAYO-NOBLE Scissors 27
MAYO-ROBSON ATRAUMA Intestinal Forceps 675
MAYO-ROBSON Intestinal Forceps 667
MAYO-STILLE Scissors 26
MC DONALD Elevator 484
MC GEE MICRO-Ear Hook 794
MC GEE MICRO-Ear Wire Closure Forceps 790
MC GIVNEY Forceps 686
MC GIVNEY Haemorrhoidal Ligator 685
MC INDOE Bone Cutting Forceps 521
MC INDOE Dressing Forceps 79
MC INDOE Vascular Scissors 45
MC INTOSH Laryngoscope 328,333,334
MC IVOR Frame 874
MC IVOR Mouth Gag complete 874
MC IVOR Tounge Depressor 874
MC KENTY Septum Elevator 841,842
MC KENZIE Clips and Applying Forceps 605
MC KENZIE Silver 605
MC KENZIE Silver Clip Carrier 605
MC KENZIE Twist Drill 416
MC QUIGG-MIXTER Forceps 192
MCCLEAN-LUIKART Obsteric Forceps 755
MCCLEAN-TUCKER Obsterical Forceps 755

MEAD Bone Rongeur Forceps 512
MEAD Mallet 455
Measurers graduated 931
Medicine Cup 936
Medicine Spoon 936
MEEKER Dissecting and Ligature Forceps 189
MEHDORN Vessel Clip 150
MEHDORN Applying Forceps for Vessel Clip 150
MELLINGER Eye Speculum 762
MELLINGER-AXENFELD Eye Lid Speculum 762
MENGHINI Liver Blind Puncture 299
MENGHINI Needle 299
Menicus Knife 496
MERCEDES Blade 542
MERCEDES Retractor 542
Metal Case for Tunneling-Set 596
Metal Catheter 700
Metal Cup 937
Metal Jar 934
Metal Mallet 459
Metal Olive 818
METHOT Cotton Dispenser 937
METZENBAUM Needle Holder 361
METZENBAUM Scissors 30-34
METZENBAUM-NELSON Scissors 31
MEYER Foreign Body Gouge 766
MEYERDING Retractor 215,243
MEYHOEFER Chalazion Curette 771
MGH-MASS-GENERAL-HOSPITAL Needle Holder 361
MICHEL Laryngeal Mirror 902
MICHEL MOD. Suture Forceps 396
MICHEL Suture Clip 397
MICHEL Suture Forceps 396
MICRO-ADSON Dissecting Forceps 78
MICRO-ADSON Forceps 182
MICRO-Corneal Scissors 781
MICRO-Dissecting Scissors 17
MICRO-Dissector for Pituitary 622
MICRO-Ear Cup-shaped Forceps 788
MICRO-Ear Forceps 786,787
MICRO-Ear Hook 794,795
MICRO-Elevator 483
MICRO-Forceps 91,92
MICRO-Grasping Forceps 658,659
MICRO-Holding Forceps 623
MICRO-Hook 622
MICRO-Laryngeal Grasping Forceps 901
MICRO-MOSQUITO Forceps 166
MICRO-Needle Holder 355
MICRO-Raspatory 622
MICRO-Scissors 16-19
MICRO-Scissors, nasal 834
MICRO-Scissors, vascular 18
MICRO-Scoop 622
MICRO-Suture Tying Forceps 95,96
MIDDELDORPF Retractor 231,234
MIDDELTON-JANSEN Septum Forceps 835
MIKULICZ Forceps 195,197
MIKULICZ Peritoneal Clamp 195
MIKULICZ Retractor 246
MIKULICZ Tonsil Forceps 894
MILLER Laryngoscope 325-332
MILLER-BABY Laryngoscope-Set 325
MILLER-COLBURN Double Curette 468
MILLER-COLBURN Bone file 480,479
MILLIGAN Dura Dissector 614
MILLIGAN Retractor 259
MILLIN Bladder Retractor 697
MILLIN ATRAUMA Grasping Forceps 696
MILLIN Bladder neck spreader 696
MILLIN Central blade 697

MILLIN Fiber Optic light carrier 697
MILLIN Frame only 697
MILLIN Grasping Forceps 696,697
MILLIN Lateral Blade 697
Mini Transformer for Head lamp 320
MINI-FRIEDMANN Bone Rongeur Forceps 511
MINI-GEMINI Dissecting and Ligature Forceps 186
MINI-HOHMANN Bone Lever 485
MINI-LAMBOTTE Bone Chisel 440
MINI-LANGENBECK Retractor 214
MINI-LEXER Chisel 446
MINI-LEXER Gouges 446
MINI-MC GEE Alligator Ear Forceps 787
MINI-ROUX Retractor 250
MINI-TOWNSEND (BABY-TISCHLER) Biopsy Forceps 742
MINI-TOWNSEND (BABY-TISCHLER) Biopsy Tip 742
MINI-TOWNSEND Biopsy Forceps 741
MIXTER Forceps 190-192
MIXTER Gall Stone Forceps 693
MIXTER-BABY Forceps 181
MIXTER-CRAFOOD Dissecting Forceps 184
MIXTER-O'SHAUGNESSY Forceps 190
MOELTGEN Goniometer 311
MOGEN Circumcision Instrument 702
MOHR Pinchcock 925
MOLDENHAUER Foreign Body Lever 811
MOLLISON Retractor 258
MOORE Gall Duct Scoop 694
MORRIS Retractor 242
MORSE-FAVALORO Sternal Retractor 541
MOSQUITO-DANDY Forceps 167
MOSQUITO-DEBAKEY ATRAUMA Forceps 551
MOYNIHAN Gall Stone Probe and Scoop 691
MOYNIHAN Hysterectomy Forceps 196
MÜLLER Approximator 154
MÜLLER Vessel clip 152
MÜLLER-VERBRUGGE Bone Lever 489
MURPHY-LANE Luxation Lever 491
Muscular Needle 347,348
MUSEUX Tenaculum Forceps 730
Myrtenblade Probe 282

N

NABATOFF Cable 285
NABATOFF Handle 285
NABATOFF Metalcase 285
NABATOFF Olive 285
NABATOFF Probe tip 285
NABATOFF Varicose Vein Probe 285
NAEGELE Osterical Forceps 755
NAGER Tonsil Retractor 893
Nail Cuticle Nipper 917
Nail Drill 526
Nail File 917
Nail Nipper 916,917
Nail Scissors 915
Nail Splitter Forceps 917
Nasal Retractors 857
Nasal Scissors 834
NELATON Grooved Director 283
Needle Case 350-352
NEFF Meniscotomy Knife 495
NEGUS Chest Support 872
NEGUS Tonsillen Forceps 191
NEIVERT Nasal Retractor 860
NEIVERT Needle Holder 360
NEIVERT-ANDERSON Osteotom 848
NELSON Trocar 288
NELSON Tuttle Forceps 87
Nerve Dissecting Scissors 32



Inhaltsverzeichnis

Alphabetical Index

Indice alfabético

Indice alfabetico

NEUMANN Scissors	49	PENNINGTON Elevator	842	RAY Pituitary Curette	619
Neurological Tuning Fork, ALUMINIUM	802	PENNINGTON Forceps	178	RAY Pituitary Curette Ø 4 mm / 90°	619
NICOLA MICRO -Forceps	659	PERCY Amputating Retractor	413	Razorblade, breakable	14
NICOLA MICRO -Scissors	659	PERTHES Reamer	414	Reamer	414
NORFOLK AND NORWICH Retractor	265	PESTALOZZA Abortus Scoop	758	RECAMIER Uterine Curette	745,746,749
NORTHBENT Ligatur Scissors	52	PHANEUF Hysterectomy Forceps	196	Rectal Scissors	42
NOTO Uterus Polypus Forceps	732	PIERCE Antrum Trocar	289	REDON Needle	298
NOVAK Biopsy Curette	737	PINARD Stethoscope	308	REICHERT Epiglottis Retractor	900
NOYES Eye Scissors	782	PIPER Obstetrical Forceps	755	REIL MICRO -Scissors	19
NUGENT Suture Forceps	779	PITHA Mouth Rubber Wedge	870	REINER Ear Syringe	817
Nurse Hospital-Set with Chain	915	Placenta Pan	939	REINER Plaster Knife	406
NUSSBAUM Stomach Clamp Forceps	670	Plastic Pouch for Tracheotomy	907,908	Repositions Forceps	501
O				Plate for Tunneling-Tips	596
O'BRIAN Scissors	38	PLESTER Flap Knife	792	RESANO ATRAUMA Rectum Forceps	679
O'CONNOR Retractor	212	PLESTER Retractor	258	RESANO Cartilage Scissors	42
O'SULLIVAN-O'CONNOR Abdominal Retractor	276	PLESTER Suction Cannula	291	Retractor	212-252
OBWEGESER Awl	886	POLITZER Air Bag	816	Retractor for knee	492,493
OBWEGESER Channelled Retractor	883	POLITZER Connecting nozzle	816	REVERDIN Needle	387
OBWEGESER Chin Retractor	883	POLITZER Ear and Nasal tip	816	REVERDIN Spatula	253
OBWEGESER Osteotom	885,886	POLITZER Ear Needle	813	REYNOLDS Dissecting Scissors	39
OBWEGESER Periosteal Elevator	884,885	POLITZER Furuncle Knife	813	Rib Shear	530
OBWEGESER Ramus Retractor	881,882	POLLOSON Retractor	241	RIBBON Spatula	253
OCHSNER ATRAUMA Aortic Clamp	575	POOLE Suction Tube	296	RICARD Abdominal Retractor	272
OCHSNER Trocar	289	POPPE Suction Tube	291	RICARD Center Blade	271
OLDBERG Laminectomy Rongeur	655	POTTS ATRAUMA Cardiovascular Forceps	554-556,570	RICARD Lateral Blade	271
OLIVECRONA Spatula	611	POTTS DE MARTEL Vascular Scissors	44	RICHARDSON Retractor	232
OLIVECRONA Dura Dissector	616	POTTS MICRO -Scissors	16	RICHARDSON-EASTMAN Retractor	232
OLIVECRONA Wire Saw	602	POTTS-GLOVER ATRAUMA Forceps	556	RICHTER Retractor	265
OLIVECRONA-TOENNIS (SCOVILLE) Clip and Applying Forceps	605	POTTS-SMITH Dressing Forceps	79	RICHTER-HEATH Forceps	396
OLIVERCRONA Scissors	46	POTTS-SMITH Tissue Forceps	84	RIGBY Retractor	266
OLLIER Retractor	224	POTTS-SMITH Vascular Scissors	44	Rigid Telescope	819,820,868
OLSEN-HEGAR Needle Holder	366	POZZI Tenaculum Forceps	728	RITTER-HALLE Frontal Sinus Dilator	865
OMBREDANNE Mallet	457	PRATT Cystic Hook	684	ROBB Vascular Dissector	598
Operating Laryngoscope	340-342	PRATT Forceps	179	ROBERTS Forceps	183
Ophthalmoscope-Head	317	PRATT Rectal Specula	681	ROBIN Towel Clamp	203
Ophthalmoscope-Set	315	PRATT Uterine Dilator	725	ROBIN-MASSÉ Center Blade	271
Ophthalmoscope-Spare Bulb	317	PRATT Vusellum Forceps	731	ROCHARD Fixation device	280
Oscillating Plaster Saw	408	PRESBYTERIAN Tubing Clamp	204	ROCHARD Hook on Retractor	280
Osteotome Blade	445	PRICE-THOMAS Bronchus Forceps	544	ROCHARD Mouting frame for operating table	280
OTIS Replacement Knife	701	PRINCE Scissors	46	ROCHESTER-CARMALT Forceps	180
OTIS Urethrotome complete	701	Probe buttoned	282	ROCHESTER-PEAN Forceps	172,173
Otoscope-Head	317	Protecting Disc	818	RÖDER Ligatur Carrier	895
Otoscope-Set	314	Protection Cap	835	ROEDER Towel Forceps	202
Otoscope-Spare Bulb	317	PROVIDENCE-HOSPITAL Forceps	167	ROGER Septum Elevator	843
OVERHOLT Forceps	185	Pump for Comprimeter	412	ROGERS ATRAUMA Hysterectomy Forceps	200
OVERHOLT-GEISSENDOERFER	185	PUTTI Rasp	482	ROGGE Sterilizing Forceps	924
OVERHOLT-MIXTER Forceps	183	Q			
P				QUERVIAN Elevator	484
Paper Towel Clamp	203	QUINBY Scissors	49	QUINKE Lumbar Puncture Needles	299
Pare Wick for Spirit Lamp	939	QUINKE Lumbar Puncture Needles	299	QUIRE Ear Foreign Body Lever	806
PARKER Retractor	250	R			
PARKER-LANGENBECK Retractor	251	RABINER Hammer	307	RADOLF Nail Extractin Forceps	527
PARKER Nasal Plastic Chisel	850	RAGNELL Retractor	216	RAGNELL Retractor	216
PARTSCH Chisel	438	RAGNELL-DAVIS Retractor	216	RALK (VIRTUS) Splinter Forceps	100
PARTSCH Gouge	439	RALK Hand Bone Drill	417	RAMPLEY Swab Forceps	207,209
PARTSCH Mallet	455	RAMSEY Dressing Forceps	80	RAMSEY Tissue Forceps	86
PAYR Intestinal and Stomach Clamp	671	RANDALL Biopsy Curette	737	RANDALL Biopsy Curette	737
PAYR Ligatur Conductor	393	RANDALL Kidney Stone Forceps	687,688	RANEY Applying und Removing Forceps	606
PAYR Vascular Suture Needle	349	RANEY Applying und Removing Forceps	606	RANEY Scalp Hemostasis Clip	606
PAYR-BABY Intestinal and Stomach Clamp	671	RANKIN-DEBAKEY ATRAUMA Forceps	551	RANKIN-DEBAKEY ATRAUMA Forceps	551
PEAN Forceps	171,204	Raspatory	469-475		
PEAN-DEBAKEY ATRAUMA Forceps	552,553				
PEDERSON Speculum	708				
PEERS-BERTRAM Towel Forceps	203				
PEET Splinter Forceps	100				
PELTESON Cotton Applicator	287				
PENFIELD Dura Dissector	615				

Inhaltsverzeichnis
Alphabetical Index
Indice alfabético
Indice alfabetico



E

S

SAALFELD Comdome Extractor	914	SEIFFERT Broncho Forceps Tip.	899	Spatula	611
SACHS Dura Dissector	614	Self Centering Bone Holding Forceps.	509	SPENCER Ligatur Scissors	52
SACHS Dura Hook	617	SELLHEIM Obsteric Elevating Spoon.	756	SPENCER-WELLS Forceps	170
SAENGER Placenta and Ovum	756	SEMB Bone Cutting Forceps	524	Spirit Lamp	939
SAMMII Tumor Forceps	94	SEMB Bone Holding Forceps	504	Splinter Forceps	90
SANTULLI ATRAUMA Bulldog Clamp	550	SEMB Bone Rongeur	515	SPRATT Bone Curette	462
SANVENERO Scissors	36	SEMB Brochus Forceps	544	SPURLING Laminectomy Rongeur.	652
SAROT Forceps	184	SEMB Raspatory.	477	Sputum Cup.	937
SATINSKY ATRAUMA Tangential Occlusion Clamp.	564	SEMKEN Dressing Forceps	79	ST. CLAIR-THOMSON Adenoid Curette	864
SATINSKY Blood Vessel Clamp.	545	SEMKEN Tissue Forceps	83	ST. MARKS Pelvis Retractor	247
SATINSKY Vascular Scissors	41	SEMM Abdominal Retractor	278	STACKE Probe	282
SATTERLEE Amputation Saw	411	SEMM Frame	278	STAMMBERGER Antrum Punch	833
SATTERLEE Saw Blade.	411	SEMM Hook	278	STAUDE-MOORE Tenaculum Forceps	727
SAUERBRUCH Bone Rongeur Forceps.	518	SEMM Vaginal Speculum	708	STEINMANN Nail	432
SAUERBRUCH Retractor	229,236	SENN-GREEN Retractor.	216	STEINMANN Tendon Seizing Forceps	498
SAUERBRUCH Sternum Scissors	530	SENN-MILLER Retractor	217	STELLBRINK Bone Rongeur	511
SAUERBRUCH Waste Forceps	948	Septum Forceps	827	STELZNER Vascular Scissors	41
Sawblade for Oscilating Plaster Saw.	408	SEQUESTRUM Forceps	502	Sterilizing Forceps.	924
SCALP-CONTOUR Retractor	256	SERPENTINE Grasper for IUD (Intra Uterine Device)	743	Sterilizing Trays.	929,93
Scalpel-Blade Remover.	8	SEUTIN Bandage Scissors	405	STERNBERG Lip Retractor	877
Scalpel-Blades.	7,8	SEYFFERT Vaginal Speculum	708	STEVENS Iris Forceps	776
Scalpel-Handle	5,6	SHAAF Cilia Forceps	90	STEVENS Scissors	38
SCHAEDEL Towel Clips	201	SHAPLEIGH Ear Curette	809	STIEGLITZ Splinter Forceps	100
SCHAMBERG Comedone Extractor.	914	SHEA MICRO-Exploring Hook	795	STILLE Bone Chisel	439
SCHEDE Bone Curette	461	SHEEHAN Osteotom	849	STILLE Bone Gouge	439
SCHIEBE ATRAUMA Organ Grasping Forceps	673	SIEBENMANN Maxillary Antrum Irrigation	865	STILLE Bone Rongeur Forceps	515
SCHNEIMANN Broncho Forceps Tip	899	SIEBOLD Uterus Scissors	23	STILLE Gall Duct Forceps	693
SCHERBACK Specula Set.	718	Silicone Mat	928	STILLE Hand Bone Drill	415
SCHINK Dermatome	11	SILVER Dermatome	11	STILLE Kidney Clamp.	194
SCHIOETZ Tonometer	762	SILVER Nasal Plastic Chisel	850	STILLE Plaster cast shear	405
SCHMEDEDEN Nasal Cutting Forceps	829	SIMON Bone curette	464	STILLE Spherical burr f. Hand Bone Drill	415
SCHMID Vascular irrigation.	300	SIMON Fistula Hook	734	STILLE Tissue Forceps.	82
SCHMIEDEN Ligatur Conductor	393	SIMON Retractor.	235	STILLE Trephine for Hand Bone Drill	415
SCHMIEDEN Ligatur Needle.	388	SIMON Uterus Scoop	744	STILLE Twist Drill for Hand Bone Drill	415
SCHMIEDEN-DICK Ligatur Needle.	388	SIMPLEX Lip Retractors	877	STILLE-BARRAYA Tissue Forceps	85
SCHMIEDEN-PAYR Ligatur Conductor	393	SIMPSON Obsterical Forceps.	754	STILLE-LISTON Bone Cutting Forceps	522,523
SCHMIEDEN-TAYLOR Dura Scissors	45	SIMPSON-BRAUN Obsterical Forceps.	754	STILLE-LUER Bone Rongeur Forceps.	517,518
SCHNIDT Forceps.	182	SIMS Rectal Specula.	680	STILLE-RUSKIN Bone Rongeur Forceps.	516
SCHNIDT Tonsil Forceps	894	SIMS Speculum.	710	STOCKMANN Penis Clamp	703
SCHOENBORN Tyroid Gland Retractor	905	SIMS Uterine Curette	747,748	STONE Tissue Forceps.	83
SCHROEDER Tenaculum Forceps.	728,729	SIMS Uterus Scissors	28	Storage Rack for Ear Specula	799
SCHROEDER Uterus Scoop.	744	SIMS Uterus Sound.	726	Storage Tray for Applier	146
SCHUBERT Biopsy Forceps.	738	SIMS-MAIER Dressing Forceps	207	Storing Case	927
SCHUKNECHT Retractor	259	SINGLEY-TUTTLE Grasping Forceps	87	STRANDELL-STILLE Retractor	219
SCHUKNECHT Rotary Knife	792	SKEENE Tenaculum Forceps.	729	STRATTE Needle Holder	365
SCHUKNECHT Sickle Knife	792	Skin Straightening Plate	11	STRAUSS Penis Forceps	703
SCHUKNECHT Suction Tube	294	SLUDDER-BALLENGER Handle.	896	STRUEMPPEL Ear Forceps	807
SCHULTZE Salpingograph.	752	SLUDDER-BALLENGER Tip	896	STRULLY Scissors	45
SCHULZE-BERGMANN Rectal Specula	682	SLUDDER-BALLENGER Tonsilectom.	896	STRUYCKEN Nasal Cutting Forceps	830
SCHUMACHER Biopsy Forceps.	743	SMELLIE Perforator	758	Strabismus Scissors.	38
SCHUMACHER Biopsy Tip.	743	SMILLIE Meniscotomy Knife.	494	SUBRAMANIAN ATRAUMA Aortic Clamp	582
SCHUMACHER Broncho Forceps Tip	899	SMILLIE Retractor.	493	Suction Nozzle.	818
SCHUMACHER Umbical Scissors	29	SMITH-BUIE Rectal Spreader.	682	SUPERCUT COTTLE Scissors.	70
SCHWARTZ Applying Forceps for Vessel Clips.	153	SMITH-PETERSON Bone Chisel	441	SUPERCUT DIETHRICH Vascular Scissors.	71
SCHWARTZ Vessel Clip.	153	SMITH-PETERSON Gouge.	441	SUPERCUT Episiotomy-Scissors	69
SCOVILLE Bone Curette	463	Smoke Suction Tube	343	SUPERCUT FOMON Scissors	70
SCOVILLE Laminectomy Retractor complete.	624	Snare Loops for Ear Snare	804	SUPERCUT FREEMANN-GORNEY Scissors	75
SCOVILLE Lateral Valve for Self-retaining Retractor	624, 625	Snare Loops for Nasal Snare	825	SUPERCUT FREEMANN-KAYE Scissors	75
SCOVILLE Nerv Root Retractor	612	SNELLEN Chalazion Forceps.	779	SUPERCUT GOLDMANN-FOX Scissors	73
SCOVILLE-HAVERFIELD Frame.	624	Solution Bowl.	932	SUPERCUT GORNEY Scissors	74
Screw Olive	596	SOMER Uterine Elevating Forceps.	733	SUPERCUT HEYMANN Scissors	70
SCUDDER ATRAUMA Intestinal Forceps.	676	Spanner.	408	SUPERCUT Iris Scissors	72
SCUDDER Intestinal Forceps.	668	Spare Blade.	11	SUPERCUT JAMESON Dissecting Scissors	74
SEBILEAU Elevator	484	Spare Bulb.	319, 320	SUPERCUT JOSEPH Scissors	72
SEDILOT Raspatory	474	Spare Bulb for Fiber Optic.	337	SUPERCUT KAYE FACE LIFT Scissors.	74
SEGOND Hysterectomy Forceps	197	Spare Facing.	459	SUPERCUT KELLY Scissors	72
SEGOND Myom Knife.	2	Spare Foam Rubber Pad.	318, 319, 320	SUPERCUT LEXER Scissors	68
SEGOND-LANDAU Hysterectomy Forceps	197	Spare Glass.	921	SUPERCUT LISTER Bandage Scissors.	75
		Spare Pin.	603	SUPERCUT MAYO -Scissors	66
		Spare Sawblade	527	SUPERCUT MAYO-STILLE Scissors	66
		Spare Textl Filter.	927	SUPERCUT METZENBAUM Scissors	67



Inhaltsverzeichnis Alphabetical Index Indice alfabético Indice alfabético

SUPERCUT METZENBAUM-FINO Scissors	68	TC-HEGAR-VASCULAR Needle Holder	379	TISCHLER-MORGAN Biopsy Tip only	742
SUPERCUT METZENBAUM-NELSON Scissors	67	TC-HEPP-SCHIEDEL Needle Holder	374	Tissue Forceps	81
SUPERCUT PAR-TYPE Scissors	74	TC-HÖSEL Needle Holder	385,386	TITANIUM Bulldog Clamp Arteria	161,162
SUPERCUT POTTS-SMITH Vascular Scissors	71	TC-Iris Scissors	62	TITANIUM Bulldog Clamp Vena	161,162
SUPERCUT REYNOLDS Scissors	73	TC-JOSEPH Scissors	62	TITANIUM YASARGIL Applying Forceps for aneurysm Vessel Clip140-144	
SUPERCUT SIEBOLD Scissors	69	TC-KALT MICRO-Needle Holder	370	TITANIUM YASARGIL Vessel Clip for aneurysm MINI 120,121,136	
SUPERCUT SIMS Scissors	69	TC-KELLY Scissors	62	TITANIUM YASARGIL Vessel Clip for aneurysm STAN-	
SUPERCUT STEVENS Scissors	73	TC-KILNER Needle Holder	376	DARD	108-133
SUPERCUT Strabismus Scissors	68	TC-LANGENBECK Needle Holder	384	TOBOLD Tongue Depressor	878
SUPERCUT Surgical Scissors	66	TC-LEXER Scissors	56	TOENNIS Artery Forceps	188
SUPERCUT TOENNIS-ADSON Vascular Scissors	69	TC-LICHTENBERG Needle Holder	385	TOENNIS Dura Dissector	616
SUPERCUT WAGNER Scissors	72	TC-LISTER Scissors	400	TOENNIS Dura Knife	618
SUPERCUT WALDMANN Episiotomy Scissors	69	TC-LOCKLIN Scissors	63	TOENNIS Needle Holder	367
Surgical needle	346,347	TC-MAYO Needle Holder	381	TOENNIS Vascular Scissors	46
Surgical Scissors	22-23	TC-MATHIEU Needle Holder	383,384	TOENNIS-ADSON Vascular Scissors	46
Surgical Scissors, grazil	24	TC-MATHIEU-KOCHER Needle Holder	383	TOHOKU Towel Forceps	203
Suspension for brush	921,922	TC-MATHIEU-RYDER Needle Holder	384	Tongue Spatula	879
Suture Clip Set	397	TC-MAYO Scissors	55	Tonsil Wire Loop	895
T		TC-MAYO-HARRINGTON Scissors	61	Tounge Depressor	879
TABB Mucosa Knife	792	TC-MAYO-HEGAR (HEANEY) Needle Holder	377	Towel Clamp	201-203
Table Tray	936	TC-MAYO-HEGAR Needle Holder	376,377	TOWNSEND Biopsy Forceps	742
TAKAHASHI Ethmoid Bone Forceps	829	TC-MAYO-LEXER Scissors	55	TOWNSEND Biopsy Tip	742
Tamper	444	TC-MAYO-STILLE Scissors	55	TOWNSEND-MINI (BABY-TISCHLER) Biopsy Forceps	742
TARNIER Cranioclast	759	TC-MC INDOE Dressing Forceps	98	TOWNSEND-MINI (BABY-TISCHLER) Biopsy Tip	742
TAYLOR Dressing Forceps	79	TC-METZENBAUM Scissors	56,57	TOWNSEND-MINI Biopsy Forceps	741
TAYLOR Hammer	306	TC-METZENBAUM-FINO Scissors	57-59	TOYNBEE Ear Specula	798
TAYLOR Lateral Valve	625	TC-MILLER-COLLBURN Bone file	481	Tracheal Hook	904
TAYLOR Spinal Retractor	492	TC-NEIVERT Needle Holder	375	Tracheal Retractor	213,215
TAYLOR Tissue Forceps	83	TC-OEHLER Tissue Forceps	99	Tracheotomy Set	907,908
TC		TC-OLSEN-HEGAR Needle Holder	382	Traction Hook for Extension Bow	430
TC-ADSON Dressing Forceps	97	TC-PARAMETRIUM Hysterectomy Scissors	61	TRELAT Vaginal Specula	709
TC-ADSON MICRO-Dressing Forceps	97,98	TC-POTTS-SMITH Dressing Forceps	98	TREVES Tissue Forceps	86
TC-ADSON Tissue Forceps	98	TC-RAGNELL (KILLNER) Scissors	64	Trocar	288
TC-ADSON-BROWN Tissue Forceps	98	TC-RYDER MINI Needle Holder	379	Trocar Cannulafor CHAMPY	453
TC-ARRUGA MICRO-Needle Holder	370	TC-RYDER-FRENCH EYE Needle Holder	378	TROELTSCH Nasal Forceps	826
TC-BABCOCK Tissue Seizing Forceps	664	TC-SAROT Needle Holder	380	TROEMMER Hammer	306
TC-BABY-GILLIES Needle Holder	382	TC-SEMKEN Dressing Forceps	98	TROUSSEAU Tracheal Dilator	903
TC-BARRAQUER Needle Holder	372,373	TC-SEMKEN Tissue Forceps	99	TROUTMAN-COLIBRI Fixation Forceps	777
TC-BARRY-STERNDAL Wire Twisting Forceps	420	TC-SENNING Needle Holder	380	TROUTMANN-CHRIS Razor Blade Holder	14
TC-BAUMGARTNER Needle Holder	376	TC-SIMS Scissors	61	TUBBS Cardiovascular Dilator	594
TC-BONNEY Tissue Forceps	99	TC-SLIM MICRO-Needle Holder	378	TUBERKULIN-LUER Barrel	304
TC-BOYNTON Micro Needle Holder	370	TC-STANDARD Dressing Forceps	97	TUBERKULIN-LUER Syringe	304
TC-BOZEMANN Needle Holder	380	TC-STANDARD Scissors	54	Tubing Clamp	205
TC-BRUNS Scissors	404	TC-STRATTE Needle Holder	381	TUFFIER Bone Holding Forceps	505
TC-CASTROVIEJO (JACOBSON) Needle Holder	371,372	TC-TOENNIS Needle Holder	385	TUFFIER Rib Spreader	537
TC-CONVERSE Needle Holder	375	TC-TOENNIS-ADSON Scissors	59	TUFFIER Tumor Seizing Forceps	178
TC-CORWIN-HEGAR Wire Twisting Forceps	420	TC-UNIVERSAL Scissors	64	TUOHY Lumbar Puncture Needle	300
TC-CRILE Needle Holder	385	TC-WANGENSTEEN Forceps	98	Tuning Fork ALUMINIUM	800
TC-CRILE-WOOD BABY Needle Holder	377	TC-WANGENSTEEN Needle Holder	381	Tuning Fork with foot	803
TC-CRILE-WOOD Needle Holder	378	TC-WEBSTER Needle Holder	375	Tunneling Shaft	596
TC-CUSHING Dressing Forceps	97	TC-WERTHEIM Gynecology Scissors	61	Turnbull Nail Nipper	916
TC-CUSHING-TAYLOR Dressing Forceps	97	TC-Wire Cutting Forceps	424-426	TURNER-WARWICK Gall Stone Forceps	692
TC-DEBAKEY Forceps	99	TC-Wire Holding Forceps	421-423	TYDING Tonsil Snare	896
TC-DEBAKEY Needle Holder	378	TC-Wire Twisting Forceps	420	U	
TC-DEBAKEY Scissors	60	TC-ZWEIFEL Needle Holder	386	UBBER Rings for Haemorrhoidal Ligator	685
TC-DERF Needle Holder	374	TEALE Vusellum Forceps	729	UCKERMANN Cotton Applicator	287
TC-DIETHRICH Needle Holder	374	Telescope-Laryngoscope Blade	331	UECKERMANN Tracheal Trocar	903
TC-DIETHRICH-RYDER Needle Holder	374	Tenaculum Forceps	731	ULRICH Bone Holding Forceps	507,508
TC-DUVAL Tissue Seizing Forceps	665	Tendon Interlacing Forceps	499	ULRICH Swab Forceps	206
TC-Episiotomy Scissors	61	Tendon Seizing Instrument	498,499	Umbilical Scissors MOD. USA	29
TC-FERRIS-SMITH Tissue Forceps	99	TERRIER Artery Forceps	166	Universal Atomizer	815,866
TC-FINOCCHIETTO Needle Holder	381	THOMS-ALLIS Intestinal Forceps	663	Universal Handle for Tunneling-Set	596
TC-GILLIES Needle Holder	382	THOMS-GAYLOR Biopsy Forceps	739	Universal Scissors	50
TC-GILLIES Tissue Forceps	99	THOREK Dissecting Scissors	34	Universal Spare Bottle	866
TC-GOLDMAN-FOX Scissors	63	TIECK-HALLE Nasal Speculum	823	Universal Sterilizing Forceps	924
TC-HALSEY Needle Holder	375	Tightening Wrench for Extension Bow	430	Universal Tray	933
TC-HEGAR Needle Holder	377	TILLEY Ear Forceps	806	Universal Trocar Set	288

Inhaltsverzeichnis
Alphabetical Index
Indice alfabético
Indice alfabético



E

Upper Arm-Cuff for Comprimeter	412	WELLS Enuclation Scoop	770	ZENKER Forceps	189
Uro-Tangential ATRAUMA Clamp Forceps.	194	WERTHEIM Hysterectomy Forceps	196,197	ZENKER Retractor	230
USA MOD. Bone Curette	464	WERTHEIM Scissors	27	ZIEGLER Iris Knife	765
USA MOD. Dressing Forceps	78	WERTHEIM-CULLEN Hysterectomy Forceps	197	ZIEGLER Head Mirror	318
USA MOD. Plaster Spreader.	407	WEST Chisel	773	ZIELKE Gouges	448
USA MOD. Tissue Forceps	82	WEST Gouge	773	ZÖLLNER Ear Speculum	799
Utility Tray	145-146	WESTCOTT Corneal Scissors	782	ZÖLLNER Suction Tube	294
V					
VALLEIX Uterus Sound	726	WESTCOTT MICRO-Scissors.	17		
Valve Attachment	818	WESTMACOTT Nasal Tampon Forceps	826		
VAN BUREN Sequesterum Forceps.	502	WHITE (COLVER) Tonsil Forceps	894		
VAN BUREN Urethral Sound	699	WHITE Tonsil Forceps	894		
VAN DOREN Biopsie Forceps	739	WHITEHEAD Mouth Gag	876		
VANNAS Eye Scissors	783	WIEDER Tongue Depressor	878		
VANNAS MOD.TÜBINGEN Eye Scissors	783	WIEN MOD. Ligature Catcher	394		
VARADY MICRO- Phlebextractor	284	WIEN MOD. Nasal Speculum	823		
VARADY MICRO-Dissector	284	WILDE (TROELTSCH) Ear Forceps	805		
Vascular Scissors	45	WILDER Lachrymal Dilator	774		
VEIDENHEIMER ATRAUMA Intestinal Forceps.	678	WILLET-MARTEL Forceps	179		
Vein Cannula	299	WILLIAMS Intestinal Forceps	663		
Vein Tip for Tunneling-Set.	596	WILLIGER Bone Curette.	465,467		
Velcro Cuff.	322	WILLIGER Mallet	454,455		
VERBRUGGE Bone Holding Forceps.	510	WILLIGER Raspatory	474,475		
VERRES Insufflation canula	300	WILLIGER Septum Elevator	483		
VICKERS EASIDRIVER Handle	431	WINTER Abortus and Ovum	757		
VIDAL Lupus Scraper	912	Wire Cutting Pliers.	424		
VIGORIMETER Rubber Bulb, only	310	Wire Drill Dispender.	434,435		
VIRCHOW Knife	4	Wire Drill Rack	436		
VIRCHOW Cartilage Knife.	3	Wire Guides.	428		
VISE MICRO-Suture Tying Forceps.	96	Wire Holding Forceps	421-423		
VOLKMANN Bone Curette	460,461	Wire Tightener	432		
VOLKMANN Bone Curette d/e.	466	Wire Traction Bow	430		
VOLKMANN Retractor	220-222	WIRKSTROEM Forceps	190		
VOLLMAR Ring Stripper.	286	WITTNER Biopsy Forceps	740		
W					
WACHENFELDT Suture Forceps.	396	WOLFF Lupus Curette	912		
WAGENER Ear Hook	812	WOLFF Plaster Cast Breaker	407		
WAGNER Bone Lever	488	Wrench for Tunneling Set	596		
WAGNER Raspatory.	470,471	WRIGLEY Obstetrical Forceps.	754		
WAGNER Scissors	39	WULLSTEIN MICRO-Ear Forceps	786,790,791		
WALB Organ Knife	4	WULLSTEIN MICRO-Ear Scissors	789		
WALDMANN Episiotomy Scissors	29	WULLSTEIN MICRO-Suction Tube	293		
WALLICH Abortus Scoop	758	WULLSTEIN Sickle Knife	792		
WALTER Nasal Chisel	847	Y			
WALTER Nasal Gouge	847	YANKAUER Suction Tube	296		
WALTER-CARMALT Splitter Forceps	89	YASARGIL Applying Forceps for aneurysm Vessel Clip 138-144			
WALTON Finger Ring Saw	527	YASARGIL Archnoid Knife	621		
WALTON Foreign Body Gouge.	766	YASARGIL Galea Hook	606		
WALTON Spare Saw	527	YASARGIL Ligature Guides	621		
WANGENSTEEN Needle Holder	364	YASARGIL MICRO-Forceps.	94		
WARTENBERG Pinwheel.	308	YASARGIL MICRO-Forceps for Neuro-Surgery.	659		
Wash Bowl.	932	YASARGIL MICRO-Instrument.	620-621		
WASSMUND Retractor.	224	YASARGIL Needle Holder	358,373		
Waste Bucket	948	YASARGIL Pituitary Rongeur.	655		
Waste Forceps	948	YASARGIL Scoop.	621		
WATSON-WILLIAMS Nasal Cutting Forceps.	829	YASARGIL Suction Tube	295		
WAUGH Tissue Forceps.	85	YASARGIL Suture Pusher	620		
WEBER ATRAUMA Cardiovascular Forceps	563	YASARGIL Tumor Forceps.	93		
WEBER Lens Scoop.	770	YASARGIL Vessel Clip for aneurysm MINI 120,121,136			
WEBER-LOCH Ear Loop	811	YASARGIL Vessel Clip for aneurysm STANDARD 108-133			
WEBSTER Needle Holder	359	YASARGIL-SAMMII Tumor Forceps	93		
WEIL-BLAKESLEY Nasal Cutting Forceps	830-832	YEOMAN Rectal Biopsy Forceps	685		
WEISSBARTH Vaginal Speculum	719	YOUNG Needle Holder	388		
WEITLANER Retractor	257	YOUNG Prostaic Retractor	695		
WEITLANER-BABY Retractor	259	YOUNG Spare Needle	388		
WEITLANER-LOKTITE Retractor	256	YOUNG Tongue Forceps	880		
WEITLANER-WULLSTEIN Retractor.	258	Z			
		ZAUFAL Foreign Body Lever	811		
		ZAUFAL-JANSEN Bone Rongeur Forceps	514		

A

ABRAHAM Cuchillo para amígdalas 890
ADAMS Porta-servilletas 820, 868
ADLERKREUTZ Pinza quirúrgica..... 83
ADSON Gancho para duramadre 617
ADSON MICRO-Pinza de diseccion 78
ADSON MICRO-Pinza quirúrgica 82
ADSON Perostotomo 478
ADSON Pinza de diseccion..... 78
ADSON Pinza hemostática 182
ADSON Pinza quirúrgica..... 82
ADSON Porta-agujas 361
ADSON Separador 256,261-263
ADSON Taladro espiral, suelto 416
ADSON Tubo para aspiración..... 290
ADSON-BROWN Pinza quirúrgica 82
AEBLI MICRO-Tijera 781
Aguja muscular 347,348
Aguja ocular 349
Aguja para catarata 765
Aguja para cataratas 765
Aguja para ligadura 389
Aguja pasa-hilo 428
Aguja quirúrgica..... 346
ALAN-PARKS Separador 683
ALAN-PARKS Valva central 683
ALDERDYCE Elevador..... 484
ALEXANDER Cincel 439
ALEXANDER Legra costal 478
ALEXANDER Pinza para biopsia 740
Alfombra de silicona 928
Alicate corta-alambre 424
Alicate de pico plano 421-423
Alicate para extraer alambres 421-423
ALLEN Pinza intestinal 665
ALLIS ATRAUMA Pinza para intestinos y tejidos..... 662
ALLIS Pinza para intestinos y tejidos 663
ALLIS-ADAIR Pinza para intestinos y tejidos..... 662
ALLIS-BABY Pinza para intestinos y tejidos 662
ALLISON Espátula 544
ALLPORT Separador 255
ALM Separador..... 255
Almohadilla de espuma 318, 319, 320
ANDERSON-ADSON Separador 256
ANDREW Abajalengua 878
ANDREWS-PYNCHON Tubo para aspiración 296
ANESTOPHON Estetoscopio 309
Anillo de cierre para pieza de acoplamiento 751
Anillo de gomma 685
AQUAJET Pistola-lavatoria completa 941
ARRUGA Porta-agujas 353
Asas de alambre para polipotomo 805
Asas de alambre, abiertas 895
ASCH Pinza para enderezar 861
ASEPTIC Cepillo 920
AUFRIEHT (WIENER) Escofina nasal 853
AUFRIEHT Separador nasal 859
AUSTIN MICRO-Disecador 795
AUSTIN MICRO-Pinza para ligadura 96
AUVARD Espéculo vaginal 719
AXENFELD Gancho 768
AYER Pinza de chalazión 780
AYRE Bisturí 2

B

BABCOCK ATRAUMA Pinza para intestinos y tejidos664
BABCOCK Pinza para intestinos y tejidos intestinal 664
BABINSKY Martillo 307
BABY Tijera para uñas 915

BABY-ADSON Pinza hemostática 182
BABY-BAILEY Separador 543
BABY-BALFOUR Separador abdominal 273
BABY-COLLIN Separador 270
BABY-DOYEN Pinza intestinal 666
BABY-DUPLEX Estetoscopio 309
BABY-GILLIES Porta-agujas 366
BABY-KERN Pinza para huesos 504
BABY-MIKULICZ Pinza-clamp 195
BABY-MIXTER Pinza hemostática 181
BABY-OVERHOLT Pinza hemostática..... 169
BABY-ROUX Separador 250
BABY-SATINSKY Pinza vascular 545
BABY-TISCHLER Pinza para biopsia 741
BACKHAUS Pinza de campo 201
BADGLEY Separador para laminectomia..... 626
BAILEY Separador 543
BAILEY-GIBBON Separador 543
BAINBRIDGE ATRAUMA Ppinza vascular..... 554
BAINBRIDGE Pinza hemostática 180
BAKES Dilatador 691
BALFOUR Separador abdominal 274
BALFOUR Valva central 275
BALL+SOCKET Pinza para paños de papel 202
BALLENGER Cuchillo 840
BALLENGER Gubia 845
BALLENGER-HAJEK Elevador 842
Bandeja para agujas 351
Bandeja para esterilización 930
Bandeja universal 934
Bandejita para tabletas 936
BARANY Ensordecedor 803
BARBARA Aguja auricular 794
BARBARA Gancho auricular 793
BARBARA MICRO-Aguja auricular 794
BARNHILL Cuchillo para adenoides..... 863
BARR Espéculo rectal 681
BARRAQUER (COLIBRI) Blefarostato 762
BARRAQUER Pinza depilatoria 91
BARRAQUER Porta-agujas 354-355
BARRAQUER Tijera para cornea 783
BARRAQUER-COLIBRI Pinza de fijación 777
BARRAQUER-KATZIN Pinza de fijación 777
BARRAQUER-TROUTMAN Porta-agujas 354
BARRETT Pinza para cuello uterino 727
BARRON Cánula de aspiración 294
BAUMGARTNER Porta-agujas 360
BEACHAM Amniotomo 729
BECK ATRAUMA Pinza cardiovascular 574
BECKMANN Cuchillo para adenoides 863
BECKMANN Espéculo nasal 825
BECKMANN Separador 263
BECKMANN-ADSON Separador 264
BECKMANN-EATON Separador 264
BEEBEE Tijera 50
BEER Pinza depilatoria 91
BELLUCCI MICRO-Cánula para aspiración 293
BELLUCCI MICRO-Tijera 789
BENGOLEA Pinza hemostática 177
BENNETT Elevador 490
BERGER Lentas 321
BERGMANN Martillo 456
BERGMANN Sierra 406
BERGMANN Tijera 403
BERLIN Pinza para tubos 204
BERLINER Martillo 306
BERNHARD Pinza de campo 202
BERTILLON Cefalometro 311
BETHUNE Costotomo 532
BEYER Pinza cortante para huesos 808
BEYER Pinza gubia 514

BIEMER Agujas de repuesto para Aproximador..... 157
BIEMER Aproximador 156
BIEMER Clip vascular 151
BIEMER Juego-Aproximador 156
BIEMER Llave para Aproximadores 157
BIEMER Pinza aplicadora para Aproximador 156
BIEMER-MÜLLER Aproximador..... 155
BIER Agujas 300
BIER Hoja de recambio 410
BIER Sierra para amputacion 410
BILLEAU Asa auricular 811
BIRCHER Cuchillo 494
BIRCHER-GANSKE Pinza para huesos..... 500
BIRKETT Pinza hemostática..... 183
BISHOP-HARMAN Pinza para iridectomia..... 777
Bisturí para diseccion 2,3
Bisturí para uso unico 9,10
BLAKE Cureta 750
BLAKE Pinza para cálculos biliares 692
BLOHMKE Pinza para amígdalas 894
BLOUNT Elevador 491
BLOUNT Separador 492
BLUMENTHAL Pinza gubia 513
Bocas de goma 880
BODENHAMMER Espéculo 680
BOEHLER Estribo de extension 429
BOETTCHER Tijera 46
BÖHLER Pinza cortante 521
BÖHLER Pinza gubia 514
Bolsa de plástico para estuche de juego 907,908
Bomba de aire para torniquete 412
Bombilla de recambio para lamparas frontales 319, 320
Bombilla de recambio, sola 330,337
BONACCOLTO Pinza para sutura 779
BONN MOD. Pinza para iridectomia 777
BONN MOD. Tijera 38
BONNEY Pinza quirúrgica 86
BOSE Gancho traqueal 904
BOUCHERON Espéculo auricular 799
BOWMAN Aguja para discision 765
BOWMAN Blefarostato 762
BOWMAN Estilete 774
BOYS-ALLIS Pinza para intestino 663
BOZEMANN Pinza para tapones 208
BOZEMANN Tijera para ginecologia 28
BOZEMANN Tuerce-lazos 394
BOZEMANN-DOUGLAS Pinza para pólipos 208
BRAND Pinza para coger tendones 498
BRAUN Craneoclasto 759
BRAUN Depresor uterino 726
BRAUN Pinza para coger el bocio 910
BRAUN Pinza para cuello uterino 732
BRAUN-STADLER Tijera 29
Brazaletes de velcro-nylon 322
Brazaletes para brazo 412
BREISKY Espéculo 720
BRODIE Sonda acanalada 283
BROPHY Pinza de diseccion 79
BROPHY Pinza quirúrgica 84
BROPHY-SULLIVAN Tijera 36
BROWN Pinza quirúrgica 86
BROWN Porta-agujas 360
BRUENINGS Sierra-nudo para amígdalas..... 895
BRUENINGS Cuchillo para amígdalas 890
BRUENINGS Cuchillo para tabique nasal 841
BRUENINGS Espátula lingual 879
BRUENINGS Pinza nasal cortante 828
BRUENINGS Pinza para broncoscopia 899
BRÜNINGS Pinza para broncoscopia..... 899
BRÜNINGS Tubo de extension 898
BRUNNER Sonda, Ferrozell 394

Inhaltsverzeichnis
Alphabetical Index
Índice alfabético
Indice alfabetico



BRUNNER Aguja para ligadura	391	Cesta para esterilizacion	930	COTTLE Pinza para columela	861
BRUNNER ATRAUMA Pinza intestinal.	677	CHAPUT Pinza Hemostática.	178	COTTLE Separdor	860,906
BRUNNER Separador	237-239	CHARRIERE Hoja de sierra	411	COTTLE Tijera	47
BRUNNER Sonda conductora	392	CHEATTLE Pinza para esterilizacion	924	COTTLE-KAZANJIAN Pinza cortante para huesos	520
BRUNNER Tijera de costilla y esternon	531	CHERON Pinza para vendajes	208	COTTLE-NEIVERT Ganchito para alas de nariz	859
BRUNS Cucharilla cortante	462,463	CHEVALIER-JACKSON Cánula traqueal.	906	COTTLE-WALSHAM Pinza para tabique nasal	861
BRUNS Tijera para vendajes	404	CHEVALIER-JACKSON Pinza para bronco-esofagoscopia	897,898	COUPLAND Tubo para aspiración	297,298
BRYANT Pinza para vendajes	207	CHILDE Pinza para sutura	395	CRAFOORD Pinza hemostática	184
BUCHWALD Espátula	879	Ciinta frontal de celoide blanco	318-320	CRAFOORD Tijera	41
BUCK Cureta auricular	809,810	Cinzel con mango de madera artificial	448,449	CRAFOORD-SELLORS Pinza hemostática	184
BUCK Martillo	307	Cinzel para huesos	438	CRAIG Pinza para tabique nasal	827
BUCK Pinza para cuerpos extraños	806	CINELLI Cinzel nasal	848	CRAWFORD Separador	240
BUCK Tijera para ligadura	52	CITELLI Pinza osteotomo	808, 837	CRILE Ganchito para nervios	599
BUCK-GRAMCKO Elevador para huesos	485	Clamp Bulldog	160	CRILE Pinza hemostática	168,169
BUCKLEY Separador	254	CLAR Lampara frontal	319,320	CRILE Separador	252
BUELAU Trócar	289	CLEVELAND Pinza cortante	520	CRILE-MURRAY Porta-agujas	361
BUJE Pinza-clamp	179	CLEVELAND Pinza gubia.	512	CRILE-RANKIN Pinza hemostática	169
BULLDOG Clip vascular	148	Clip-Set MINI-Assistent	398	CRILE-WOOD Porta-gubia	361
BUMM Cureta uterina	749	CLOWARD Separador	268,269	CRUTCHFIELD Estribo de traccion craneal	603
BUNELL Perforador de mano	417	CLOWARD Separador para cuerpo vertebral.	634	Cubeta para soluciones.	932
BUNNEL Mondador de tendones	496	CLOWARD Valva	268,269	Cubeta redonda	931
BUNNEL Sonda conductora de tendones.	497	COAKLEY Cureta	862	Cubo para desechos	948
BUNT Imperdible para esterilización.	925	COAKLEY Trócar para el antro	290	Cuchara medicinal	936
BURFORD Separador	535	COBB Gubia con mango de madera artificial.	450	Cucharilla doble extremo.	466
BURKE Pinza para biopsia	741	COBB Periostotomo	472	Cuchillo para amputacion	12,13
BUSCH Tijera umbilical.	29	COGSWELL Tubo para aspiración.	292	Cuchillo para menisco	496
C		COLLIER Porta-agujas	359	Cureta aspiradora	751
Cabeza para venas, juego para tunelar	596	COLLIN Clamp umbilical	758	CUSCO Espéculo vaginal	706,707
Cadena para juego de manicura	915	COLLIN Dinamometro	311	CUSHING Gancho para duramadre	617
Caja metalica para juego para tunelar.	596	COLLIN Espéculo	707	CUSHING Pinza cortante para laminectomia	650
Caja para almacenaje	927	COLLIN Histerolabo	733	CUSHING Pinza de diseccion.	80
Caja para instrumentos	935	COLLIN Histerometro	726	CUSHING Pinza quirúrgica	84
Caja redonda, metalica.	936	COLLIN Martillo.	454	CUSHING Separador	217-219
Calibrador, ALUMINIO.	312	COLLIN Pelvimetro	753	CUSHING Taladro.	416
Cánula para venas	299	COLLIN Pinza para sacar tumores	178	CUZZI Cucharilla para aborto	757
Cánula trócar para CHAMPY	453	COLLIN Pinza para sutura	396	CZERNY Espéculo rectal	680
Caperuza protectora para pinza RUBIN	835	COLLIN Pinza para taponés	207	CZERNY Pinza para cálculos biliares	692
CAPLAN Pinza par tabique nasal.	835	COLLIN Pinza para tejidos	178	CZERNY Pinza para cuello uterino.	732
Captador de hilos, RUMEL-BELMONT	599	COLLIN Pinza tira-lengua	879,880	D	
Cargador para mango con iluminacion	338	COLLIN Separador	270	D'ERRICO Taladro	416
CAROLL Goniometro	311	COLLIN Separador, juego	252	DAHLGREN Hoja de recambio.	604
CAROLL Pinza para coger tendones	499	COLLIN Valva central	271	DAHMEN Gubia	451,452
CARPENTER Cuchillo	890,891	COLLIN-DUVAL Pinza quirúrgica.	87	DAHMEN Osteotomo	451,452
CARREL Pinza hemostáticas	166	COLLIN-LOKTITE Separador.	270	DALE ATRAUMA Pinza para la profunda.	576,577
CASPAR Cuadro con brazos articulados	627,629,632	COLLYER Pelvimetro	753	DANDY Gancho para nervios	614
CASPAR Espéculo para la cirugía lumbar	633	COMCO Instrumento para circuncision.	702	DANDY Pinza hemostática	167
CASPAR Gancho	618,627, 628	Cona de carga para ligador para hemorroides	685	DANDY Tijera	45
CASPAR Llave	627	CONE Pinza sacabocado	604	DARDIK ATRAUMA Pinza vascular	580
CASPAR Pinza cortante para laminectomia.	653,654	Contenedor para almacenaje	145-147	DARTIGUES Histerolabo	733
CASPAR Pinza para el cambio de valvas.	628	CONVERSE Cuchillo nasal	838	DASTOOR Pinza para sutura	778
CASPAR Separador	627-630	CONVERSE Ganchito.	856,858	DAVIDSON Separador	236
CASTA—EDA ATRAUMA Pinza cardiovascular	593	COOLEY ATRAUMA Pinza cardiovascular.	583-592	DAVIS Disecador	615,616
CASTA—EDA Separador	536	COOLEY Dilatador	594,595	DAVIS Espátula	611
CASTROVIEJO Blefarostato.	762	COOLEY Separador	533	DAVIS Taladro	615,616
CASTROVIEJO Cánula	772	COOLEY Tubo de aspiración	297	DAVIS-BOYLE Abreboca	872,873
CASTROVIEJO Compaso	773	COOLEY-BECK ATRAUMA Pinza cardiovascular	588	DAY Ganchito auricular.	812
CASTROVIEJO Espátula	770,775	COOLEY-DERRA ATRAUMA Pinza cardiovascular	588	DE LEE Forceps obstétricos	754
CASTROVIEJO MICRO-Porta-agujas	356-358	COOPER Aguja para ligadura.	389	DE MARTEL Conductor	602
CASTROVIEJO MICRO-Porta-agujas 357	357	CORDES Pinza para broncoscopia	899	DE MARTEL-WOLFSON Pinza para anastomosis.	672
CASTROVIEJO MICRO-Tijera	781	CORYLLOS Separador.	236	DE MARTEL-WOLFSON Pinza para cerrar grapas	672
CASTROVIEJO Pinza para sutura	778	Costotomo	530	DE MARTEL-WOLFSON Porta-clamps	672
CASTROVIEJO Porta-hoja / Rompe-hoja de afeitár.	14	COTTLE Cinzel	843	DE VILBISS Hoja de recambio	604
CASTROVIEJO Tijera para cornea.	784	COTTLE Cuchillo nasal	838	DEAN Tijera	48
CASTROVIEJO Tijera para iridectomia	782	COTTLE Elevador para tabique nasal	842,843	DEAVER Separador	243-245
CASTROVIEJO-BARRAQUER Espátula.	769	COTTLE Espéculo nasal.	824	DEAVER Tijera	25
CATLIN Cuchillo	12	COTTLE Ganchito nasal	856,859	DEBAKEY ATRAUMA Pinza aórtica	562-568
CAWOOD-MINNESOTA Separador.	877	COTTLE Lima nasal	853	DEBAKEY ATRAUMA Pinza Clamp Bulldog	548-550
Cepillo de limpieza	907,943-947	COTTLE Machacadora con pinza.	851	DEBAKEY ATRAUMA Pinza Vascular	551-582
		COTTLE Martillo	455	DEBAKEY Dilatador vascular.	595
		COTTLE Osteotomo	846,847	DEBAKEY Separador	539,540

DEBAKEY Tijera vascular.....	43,44
DEBAKEY Valva lateral.....	539,540
DEBAKEY-DIETHRICH Clamp Bulldog.....	163
DEBAKEY-SATINSKY ATRAUMA Clamp Bulldog.....	548
DEJERINE Martillo.....	306
DEMEL Aguja pasa-hilo.....	427,428
DENHARDT Bocas de silicona.....	871
DENHART Abreboca.....	871
DENIS-BROWNE Cuadro, suelto.....	278
DENIS-BROWNE Gancho-separador.....	278
DENIS-BROWNE Pinza quirúrgica.....	87
DENIS-BROWNE Separador.....	278
DEPONETTE Caja para almacenaje.....	926
DERF Porta-agujas.....	359
DERRA ATRAUMA Pinza cardiovascular.....	573,574
DESCHAMPS Aguja para ligadura.....	390,391
DESJARDIN Pinza para preparación.....	191
DESJARDINS Cuchara para cálculos biliares.....	693
DESJARDINS Sonda para cálculos biliares.....	691
DESMARRES Pinza de chalazion.....	780
DESMARRES Retractor.....	763
DESMARRES Separador.....	214
DEVILBISS Pinza sacabocado craneal.....	604
Diapason con pie.....	803
Diapason neurologico, ALUMINIO.....	802
Diapason, ALUMINIO.....	800
Diapason, juego completo, ALUMINIO.....	800
DIEFFENBACH Clamp.....	163,164
DIETHRICH ATRAUMA Pinza Clamp para aorta.....	575
DIETHRICH Tijera vascular.....	43
DIETHRICH-HEGEMANN Tijera vascular.....	43
DINGMANN Abreboca.....	874
DINGMANN Bajalengua.....	875
DINGMANN Pinza para huesos.....	500
Disco protector.....	818
Discos fijadores con hendidura, pár.....	430
Dispensador de brocas filiformes.....	434
Dispensador multiple para brocas.....	435
DIX Instrumento.....	775
DIXON-LOVELACE Pinza hemostática.....	169
DOUGLAS Pinza depilatoria.....	90,91
DOUGLAS Trócar.....	289
DOYEN ATRAUMA Pinza intestinal.....	674
DOYEN Cadena con peso para Gancho-separador.....	279
DOYEN Espéculo vaginal.....	717,720
DOYEN Gancho-separador.....	279
DOYEN Martillo.....	454
DOYEN Periototomo.....	475,476
DOYEN Pinza intestinal.....	666
DOYEN Pinza uterina.....	732
DOYEN Separador abdominal.....	234
DOYEN Sonda acanalada.....	283
DOYEN Tijera.....	27
DOYEN Tirabuzón para fibroma.....	734
DOYEN-JANSEN (MOLT) Abreboca.....	871
DOYEN-STILLE Separador.....	233
DUBOIS Tijera.....	28
DUEHRSEN Pinza de diseccion.....	80,85
DUPLAY Pinza para cuello uterino.....	729
DUPLEX Estetoscopio.....	309
DUPUY-WEISS Aguja para amígdalas.....	889
DURANTE Pinza quirúrgica.....	86
DUVAL Pinza intestinal.....	665
DUVAL Pinza quirúrgica.....	87

E

EASTMAN Espéculo.....	709
ECHLIN Pinza gubia.....	516
EICKEN-KILLIAN Cánula nasal.....	865
EISELSBERG tijeras.....	52

Elevador.....	483
Elevador para huesos.....	485,486
ELLIOT Mango para trepano corneal.....	772
ELLIOT Trepano.....	772
ELSÄSSER Pinza para nefrostomia.....	689
ELSCHNIG Espátula para ciclodialisis.....	769
EMMET Gancho para fistolas.....	734
ENGEL Sierra.....	406
ENGL. MODELL Pinza de campo.....	201
ENGL. MODELL Pinza de diseccion.....	80
EPPENDORFER Pinza para biopsia.....	740
Escariador con mango transversal.....	414
Escupidera con tapa plegable.....	937
ESMARCH Chuchillo para yeso.....	406
ESMARCH Tijera.....	404
ESMARCH Venda para compresion.....	413
Espátula abdominal flexible.....	253
Espátula maleable.....	611
Espátula lingual de madera.....	878
Espátula lingual de plastico.....	879
Espátula para la intima.....	598
Espátula para lengua.....	879
Espéculo auricular.....	317
Espéculo lateral vaginal.....	736
Espejo laringeo.....	901,902
Espejo laringeo.....	902
Espina de repuesto para CRUTCHFIELD.....	603
Estilete botonado.....	282
Estribo de extension.....	430
Estribo de traccion craneal.....	603
Estuche para agujas.....	350-352
Estuche para sutura en caja de metal.....	397
EVES Cierra-nudos para amígdalas.....	895

F

FARABEUF Periostotomo.....	474
FARABEUF Pinza para huesos.....	504
FARABEUF Separador.....	249
FARABEUF-LAMBOTTE Pinza para huesos.....	504
FARREL Porta-algodón.....	287
FARRIOR Espectulo auricular.....	798
FAULKNER Cureta.....	862
FAURE Pinza para biopsia.....	738
FAURE Pinza-clamp para peritoneo.....	195
FAVALORO Tijera vascular.....	45
FEHLAND ATRAUMA Pinza para anastomoses rectales.....	678
FEILCHENFELD Pinza para espina.....	90
FEIN Porta-algodón.....	287
FELDHEIM Instrumento para dedo.....	526
FERGUSSON Cuchara para cálculos biliares.....	694
FERGUSSON Pinza de pression progresiva.....	179
FERGUSSON Pinza para huesos.....	502
FERRIS-SMITH Pinza para laminectomia.....	657
FERRIS-SMITH Pinza quirúrgica.....	85
FERRIS-SMITH-KERRISON Pinza cortante.....	649
FERROZELL Sonda conductora.....	394,395
FERROZELL Tapa para martillo, sola (par).....	455,457
FILIFORM Sonda.....	699
Filtros de intercambio de tejidos.....	927
FINOCHIETTO (modif.) Separador costal.....	538
FINOCHIETTO BABY Separador costal.....	534,538
FINOCHIETTO INFANT Separador costal.....	534
FINOCHIETTO Pinza hemostática.....	192
FINOCHIETTO Porta-agujas.....	364
FINOCHIETTO Tijera.....	42
FINSEN Mod.Martin Separador.....	254
FINSEN Separador.....	254
FISCH MICRO-Disecador auricular.....	796
FISCHER Mondador de tendones.....	497
FISHER Cuchillo para amígdalas.....	889

FOERSTER Pinza para esponjas.....	208,209
FOMON Cincel nasal.....	848
FOMON Cuchillo para rinoplástica.....	838
FOMON Escofina nasal.....	854
FOMON Ganchito nasal.....	859
FOMON Ganchito para alas de nariz.....	857
FOMON Tijera.....	34,47
FOREGGER Hoja de laringoscopia.....	329,335,336
FOX Cureta para lupus.....	912
FRAENKEL Pinza para broncoscopia.....	898,899
FRANZ Cuadro plegable.....	279
FRANZ Gancho-separador.....	279
FRANZ Separador abdominal completo.....	279
FRANZ Valva.....	279
FRAZIER Disecador.....	614
FRAZIER Gancho para duramadre.....	617
FRAZIER Tubo para aspiración.....	290
FREER Cincel para tabique nasal.....	844
FREER Cuchillo paraa tabique nasal.....	839
FREER Elevador.....	841,842
FREER Ganchito para mucosa.....	859
FREER Gubia.....	844
FRIEDMANN Pinza gubia.....	511
FRIEDMANN-VICKERS Pinza gubia.....	511
FRIMED Horquilla de hilos.....	394
FRIMED Sonda conductora.....	392
FRIMED-DIAMANT Alicata corta-alambre.....	424
FRIMED-VIGORIMETER Dinamómetro completo.....	310
FRITSCH Separador.....	234
FROSCHE Pinza para huesos.....	502
FRTISCH Separador.....	234
FRYKHOLM Pinza gubia.....	517
FULLER MICRO-Pinza para introducir.....	791

G

GALLAHER Escofina nasal.....	853
Gancho de tracción para estribo.....	430
Gancho traqueal fino.....	904
GELLHORN Pinza para biopsia.....	738
GELPI Separador.....	267
GEMINI Pinza para preparación y ligadura.....	187
GERALD Pinza de diseccion.....	80,84
GERSTER Pinza para huesos.....	419
GERZOG Martillo.....	456
GIERTZ-STILLE Costotomo.....	530
GIGLI Mango para sierra de hilo.....	602
GIGLI Sierra de hilo.....	602
GILLIES Ganchito para piel.....	913
GILLIES Pinza quirúrgica.....	83
GILLIES Porta-agujas.....	366
GIL-VERNET Type Separador.....	219
GLOVER ATRAUMA Clamp Bulldog.....	549,550
GLOVER ATRAUMA Pinza cardiovascular.....	572,573
GLUCK Costotomo.....	530
GOLDMANN-FOX Tijera.....	49
GOLDSMITH (THUDICHUM) Espéculo nasal.....	822
GOLLET Separador para iridectomia.....	251
GOMEL MICRO-Tijera.....	17
GOMEL Porta-agujas.....	355
GOOD Tijera para amígdalas.....	46
GOODELL (SIMS) Dilatador uterino.....	736
GOSSET Separador abdominal.....	273
GRAEFE Cuchillo para catarata.....	764
GRAEFE Gancho para estrabismo.....	768
GRAEFE Gancho para iridectomia.....	766
GRAEFE Pinza para iridectomia.....	776
GRAEFE Quistotomo.....	766
GRAEFE Separador.....	212
GRAHAM Gancho para duramadre.....	617
GRAVE Espéculo.....	708

GRAY Pinza para preparación	191	HEMINGWAY Cucharilla de doble extremo	467,468	JACOBSON Instrumento para MICRO-cirugía	620
GREEN-ARMYTAGE Pinza uterina para hemostasis	756	HENKE Disector para amígdalas	891,892	JACOBSON MICRO-Tijera	16
GREGORY ATRAUMA Clamp para carotis	550	HENLEY Separador	260	JACOBSON Sonda	620
GREGORY ATRAUMA Pinza aortica	575,576	HENLEY Valva central	260	JAEGER Placa para parpados	763
GRONINGEN Gancho para nervios	613	HENNIG Separador	407	JAEGER-GRIESHABER Cuchillo para catarata	764
GROSS Cucharilla y ganchito	810	HEPP-SCHEIDEL MICRO-Tijera	17,19	JAMESON Calibrador	312
GROSS MAIER Pinza para pólipos	206	HERRIK Pinza-clamp	194	JAMESON Tijera	39
Gubia para huesos	438	HESS Clamp Bulldog	164	JAMISON Porta-agujas	363
GUEDEL-NEGUS Hoja de laringoscopio	327	HEYMANN Pinza nasal	827	JANET Cilindro	304
GUEDEL-NEGUS Laringoscopio, juego completo .	326,327	HEYMANN Tijera	47	JANET Jeringa	304
GUTHRIE Gancho fijador	767	HEYWOOD-SMITH Pinza para coger pólipos	686	JANSEN (GRUENWALD) Pinza para taponamiento	826
GUTHRIE Separador	212	HIBBS Cinsel	443	JANSEN Cucharilla auricular	810
GUYON ATRAUMA Pinza-clamp para pedúnculo renal	193	HIBBS Gubia	443	JANSEN Pinza gubia	512,514
GUYON Bujía uretral	699	HIBBS Osteotomo	442,443	JAMESON Separador	255
GUYON Mandril para cateteres	702	Hilos de cerclaje, blando	427	JARCHO Pinza para cuello uterino	727
GUYON Pinza-clamp para pedúnculo renal	193	HIRSCHMANN Anoscopio	683,684	JAVID ATRAUMA Pinza para shunt carótido	581
H		HOFF Pinza de campo	203	JENNINGS Abreboca	876
HABERER Espátula abdominal	253	HOFFMANN Cierra-tubo	925	Jeringa auricular auto-rellena completa	818
HACKSTOCK Alicata plano	421	HOHMANN Elevador para huesos	486,487	JOBSON HORNE Porta-algodón	287
HAIGHT Separador	537	HOHMANN-ALDINGER Elevador para huesos	489	JOHNS-HOPKINS Clamp Bulldog	164
HAJEK Martillo	456	Hoja de afeitar	14	JOHNS-HOPKINS Pinza hemostática	183
HAJEK Pinza sacabocado	836	Hoja de bisturí, esteril	7,8	JOHNSON Porta-agujas	364
HAJEK-KOFLER Pinza sacabocado	836	Hoja de cincel, intercambiable	445	JOLL (FRIEDMANN) Separador	266
HALLE Cucharilla cortante	465	Hoja de gubia, intercambiable	445	JONES Pinza de campo	201
HALLE Cuchillo para duramadre	618	Hoja de osteotomo, intercambiable	445	JOSEPH Cuchillo nasal	838
HALLE Elevador	841	Hoja de recambio para dermatomo	11	JOSEPH Elevador para tabique nasal	841,843
HALSEY Porta-agujas	359,360	Hoja de recambio para PINZA-SIERRA	527	JOSEPH Ganchito para mucosa	859
HALSTED-MOSQUITO Pinza hemostática	165	Hoja de recambio, esteril	7	JOSEPH Lima nasal	852
HANK Dilatador uterino	724	Hoja de repuesto, perfodora	864	JOSEPH Sierra nasal	851
HARDY Enuclador	620	Hoja de sierra para SIERRA OSCILANTE	408	JOSEPH Tijera quirúrgica	35
HARDY Horquilla para pituitaria	620	Hoja telescópica de laringoscopio	330	JOSEPH-MASING Elevador para tabique nasal	843
HARDY MICRO-Cureta pituitaria	619	HOKE Cinsel	442	JUDD-ALLIS Pinza ara intestino	663
HARDY-FAHLBUSCH Disecador para pituitaria	620	HOLINGER Laringoscopio	338,339	JUDD-MASSON Dilatador para cuello vesical	697
HARKEN ATRAUMA Pinza cardiovascular	565	HOLINGER Soporte de luz fibra optica	339	Juego de cepillos de limpieza	944
HARKEN Pinza vascular	546	HOLSHER Separador	612	Juego de manicura para enfermeras	915
HARMS Sonda trabecular	774	HOLTH Pinza sacabocado para capsuloiridotomía	773	Juego de oftalmología, completo	315
HARRINGTON Separador	242	HOLZHEIMER Separador	255	Juego de otoscopia en estuche	314
HARTMANN Abajalengua	877	HOPKINS Chuchillo para escayolas	406	Juego de recambio para alicates corta-alembre	426
HARTMANN Diapason	800,801	HORSLEY Disecador duramadre	614	Juego diagnostico en estuche	316
HARTMANN Espéculo auricular	798	HÖSEL Separador	233	Juego traqueal completo	907,908
HARTMANN Espéculo nasal	823	HOUSE Cannula de aspiración	294	JURASZ Pinza para pólipos laringeos	899,900
HARTMANN Ganchito auricular	811	HOUSE MICRO-Cucharilla	797	K	
HARTMANN Pinza auricular	806,807	HOUSE MICRO-Sonda para medir	796	KABIERSKE Cánula auricular	815
HARTMANN Pinza gubia	512	HOUSE-DIETER Pinza para cabezal del maleólo .	790,791	KABIERSKE Frasco de recambio	815
HARTMANN Pinza hemostática	166	HUBER Mango universal	898	KABIERSKE Pera de goma con valva	815
HARTMANN Pinza nasal cortante	829	HUDSON Fresa cónica	416	KABIERSKE Pulverizador completo	815
HARTMANN Pinza para amígdalas	896,897	HUMBY Dermatomo	11	KADER Espátula	248
HARTMANN Pinza para taponamiento	826,827	HUNT Pinza para tumor	94	KALLMORGAN Valva vaginal	716
HARTMANN Sonda auricular	804	HUNTER Pinza para espina	89	KALLMORGEN Espéculo	716
HARTMANN-HALLE Espéculo nasal	822	HURD Aguja para sutura del paladar	889	KALT Aguja vascular	349
HARTMANN-HOFFMANN Pinza para pólipos auriculares	807	HURD Disector para amígdalas	891	KALT Porta-agujas	353
HARTMANN-WULLSTEIN Pinza auricular, aligador	807	HUSFELDT ATRAUMA Pinza para vasos perifericos	579	KANE Clamp umbilical	758
HAYES ATRAUMA Pinza intestinal	677	I		KANTROWITZ Pinza para preparación	190
HEANEY Pinza-clamp	198	INGE Separador	634	KATSCH Extractor para comedones	914
HEANEY Porta-agujas	363	Injector para cánula para laringoscopios	343	KATZIN-BARRAQUER MICRO-Tijera	781
HEANEY-BALLENTINE Pinza para histerectomía	198	Instrumento doble	775	KAYE Ganchito para piel	913
HEANEY-KANTER Pinza-clamp	199	IOWA Pinza para cuello uterino	730	KEITH Aguja quirúrgica	348
HEANEY-REZEK Pinza para histerectomía	198	IOWA Tubo completo	298	KELLY Pinza hemostática	168
HEATH Martillo	457	IRIS (GRAEFE) Pinza de diseccion	88	KELLY Pinza ligadura	188
HEATH Tijera	52	ISRAEL Separador	225	KELLY Pinza para pólipos uterinos	732
HEBRA Cuchara para chalazion	771	ITERSON Gancho traqueal	903,904	KELLY Proctoscopio	684
HEGAR Dilatador uterino	721-723	IVES FANSLER Anoscopio	683	KELLY Separador	247
HEGAR Porta-agujas modelo fuerte	365	J		KELLY Tijera	48
HEGENBARTH Pinza para sutura	396	JACKSON Espéculo vaginal	709	KELLY-RANKIN Pinza hemostática	168
HEIFETZ Espátula	611	JACKSON Gancho traqueal	904,905	KELSEY-FRY Lezna mandibular	887
HEIFETZ Pinza para tumores	93	JACKSON Laringoscopio	339	KERN Pinza para huesos	503,504
HEIMING Pinza para cálculos renales	688	JACOBS Pinza para cuello uterino	730	KERRISON Pinza cortante	635-646
HEISS Pinza hemostática	181			KERRISON Pinza para laminectomía	656
HEISTER Abreboca	870			KERRISON Pinza sacabocado para seno maxilar . .	837

KEVORKIAN Cureta para biopsia	737	LAMBERT Pinza de chalazion	780	Llave para hojas intercambiables	445
KEVORKIAN Pinza para biopsia	740	LAMBERT-KAY ATRAUMA Pinza para anastomosis	567	Llave tensora para estribo de extension	430
KEVORKIAN Punta para biopsia, suelta	742	LAMBOTTE Osteotomo	440	Llave, suelta	408
KEVORKIAN-PACIFIC Pinza para biopsia.	741	LAMBOTTE Periostotomo	476	LLOYD-DAVIS Tijera vascular	41
KEYES Juego de trépano	913	LAMBOTTE Pinza para huesos	505	LOCKHARD-MUMMERY Sonda acanalada	283,284
KEYES Mango para inserto trépano.	913	Lampara de alcohol.	939	LOCKLIN Tijera.	48
KEYES Trépano	913	LANDAU Espéculo vaginal	720	LOCKWOOD-ALLIS Pinza para intestinos.	663
KIELLAND Forceps obstétricos	755	LANDAU Trócar	290	LOGAN Separador	254
KILLIAN Elevador	842	LANDOLT Pinza para coger tumores	655	LORENZ Tijera para vendajes	403
KILLIAN Espéculo nasal.	824	LANDOLT Tijera	35	LORNA Pinza de campo	202
KILLIAN Gubia	845	LANDOLT Tubo para diseccion	292	LOUTE Tensor cierra-hilo	427
KILLIAN Pinza para taponamiento	827	LANDOLT-CUSHING Espéculo	619	LOVE Separador para raiz de nervio	612
KILLIAN-CLAUS Gubia	845	LANE Pinza clamp estomacal.	669	LOVE-GRUENWALD Pinza para laminectomia	651
KILLNER Tijera	35	LANE Pinza de campo	202	LOVE-KERRISON Pinza cortante.	640
KILNER Ganchito	858,913	LANE Pinza para huesos	506	LOVELACE Pinza hemostática.	170
KILNER-DOUGHTY Abreboca	872	LANE Pinza quirúrgica	85	LOVELACE Pinza para coger pulmón	545
KIRK Martillo	456	LANGE Ganchito para alas de nariz.	856	LOWER Pinza hemostática.	192
KIRSCHNER Broca filiforme	433,434	LANGE Pinza para broncoscopia.	899	LOWMAN Grapa para huesos	418
KIRSCHNER Cuadro, suelto	276	LANGE-HOHMANN Elevador	488	LOWMAN-HOGLUND Grapa porta-huesos	419
KIRSCHNER Cuadro, suelto, plegable	277	LANGENBECK Cuchillo para resección.	13	LOWMAN-LAMBERT Grapa porta-huesos	419
KIRSCHNER Estribo de extension	429,432	LANGENBECK Cureta auricular.	809	LUBET-BARBON Pinza para taponamiento.	826
KIRSCHNER Gancho-separador	277	LANGENBECK Dedal	870	Lubricante en bote pulverizador	942
KIRSCHNER Separador abdominal	276,277	LANGENBECK Elevador	482,484	LUC Pinza nasal cortante	828
KIRSCHNER Sonda conductora.	392	LANGENBECK Periostotomo.	473	LUCAE Diapason con pie	802
KIRSCHNER Sonda, Ferrozell	394	LANGENBECK Pinza para huesos	502	LUCAE Ganchito auricular	812
KIRSCHNER-BALLFOUR Gancho-separador.	277	LANGENBECK Separador	226-228	LUCAE Martillo	454
KIRSTEIN Tijera	47	LANGENBECK Sierra de amputación	411	LUCAE Pinza auricular	805
KLEINERT-KUTZ Pinza para coger tendones	499	LANGENBECK-GREEN Separador	216	LUER Adaptador para juego de tunelar	596
KLIMA-ROSSEGGER Aguja especial	301	Laringoscopio para operaciones	339-342	LUER Cánula traqueal	905,906
KLINGENBERG-LOTH Tijera vascular.	41	LAWRENCE Pinza hemostática para preparación y ligadura	190	LUER Cilindro	303
KNAPP Cuchillo para catarata	764	LAZAR MICRO -Pinza de ligadura	96	LUER Gancho traqueal	904
KNAPP Separador	214,767	Lazo para cuerpos extraños e iman	766	LUER Jeringa Insulina.	303
KNAPP-ROLLET Gancho.	767	LEBSCHKE Cíncel para esternón	532	LUER Pinza gubia.	513
KNIGHT Pinza nasal	827	LEES ATRAUMA Pinza cardiovascular	566	LUER Pinza hemorroidal con tornillo	686
KNOWLE Tijera	402	LEGUEU Dilatador para cuello vesical	698	LUER Separador.	252
KNUTSON Instrumento para circuncisión.	702	LEGUEU Separador vesical	698	LUER-KOERTE Cuchara para cálculos biliares	693
KNUTSON-KOCH Cánula regulable.	702	LEGUEU Valva central	698	LUER-LOCK Cánula.	772
KOCHER Separador	223-234	LEKSELL-STILLE Pinza gubia.	517	LUER-LOCK Cilindro	303,304
KOCHER (OCHSNER) Pinza hemostática	175,176	LELAND-JONES ATRAUMA Pinza vascular	558	LUER-LOCK Jeringa.	303,304
KOCHER ATRAUMA Pinza intestinal	675	LEMPERT Cureta auricular.	814	LUER-LOCK Llave	302
KOCHER Pinza hemostática, fina.	174	LEMPERT Elevador auricular	814	LUER-LOCK Pieza de conexión.	302
KOCHER Pinza intestinal	667	LEMPERT Pinza gubia	513	LUKENS Separador para timo	905
KOCHER Separador vesical	698	LEMPERT Tubo para aspiración.	291	LUNIATSCHEK Taponeador	893
KOCHER Sonda para bocio	909	LERCHE Pinza quirúrgica.	83		
KOCHER-LANGENBECK Separador.	228	LERICHE Pinza hemostática	167	M	
KOERTE Separador	224	LESTER Pinza de fijación	778	MAGILL Pinza para catéteres.	323
KOGAN Espéculo endocervical	735	LEWIN Pinza para huesos	501	MAGILL Tubo para aspiración	293
KÖLNER Grapa hemostática	606	LEWIS Escofina nasal	854	MAINGOT Pinza-clamp para histerctomia	199
KÖNIG Diapason con pie	803	LEXER CÍNCEL	446,447	MALTZ Escofina nasal	852
KÖNIG Sonda conductora.	392	LEXER Gubia	447,448	Mandril con mango forma-T, completo	416
KOOS Instrumento para MICRO-cirugia.	621	LEXER Osteotomo	447	Mandrin, romo para Instrumento CHAMPY.	453
KRAUS Instrumento para MICRO-cirugia.	621	LEXER Tijera	32	Mango de bisturi	5,6
KRAUSE Pinza parar broncoscopia	899	LEXER-BABY Tijera.	32	Mango de Ferrozell	445
KRAUSE Polipotomo	804,825	LEXER-FINO Tijera.	33	Mango de pila (sin pilas) delgado, para.	330,337
KRAUSE Trócar	289	LEYLA Acoplamiento	607-610	Mango laringeo	902
KRAUSE-VOSS Polipotomo	804,825	LICHTENBERG Porta-agujas	367	Mango para flebodisecador.	286
KRAYENBÜHL Ganchito para nervios y vasos	618	LICHTWITZ Trócar	289	Mango para luz fría con iluminación LED	338
KRESSNER Pinza para tabique nasal	861	Lima para huesos	481	Mango para Pinza para biopsia.	742
KRISTELLER Espéculo	711-715	Lima para uñas	917	Mango plano, para optica	820, 868
KROENLEIN Pinza para sacar tumores	167	Lima para uñas	917	Mango universal para juego para tunelar	596
KRONECKER Aguja para ligadura.	389	LISTER Pinza para vendajes	207	Mannómetro con pera de goma	322
KUEMMELE Espátula	248	LISTER Tijera	400-402	Manómetro con escala luminosa	752
L		LISTON Cuchillo para amputacion	12	Manómetro para torniquete	412
LA FORCE Adenotomo.	864	LISTON Pinza cortante para huesos.	519	Manopla de plomo	525
LA GRANGE Tijera.	49	LITTON-KEY Pinza cortante para huesos	524	MARITN-IDEAL juego de 3 brocas.	526
LABORDE Dilatador traqueal	903	LITTAUER Pinza depilatoria	90	MARKWALDER Pinza cortante para huesos	520
LAHEY Pinza hemostática	192	LITTAUER Pinza para pólipos auriculares	806	MARQUARDT Pinza gubia.	515
LAHEY Pinza para coger el bocio.	910	LITTAUER Tijera.	52	MARQUARDT Pinza para intestinos	664
LAHEY Separador	227	LITTLEWOOD Pinza para intestinos	664	MARTEL Pinza hemostática pericraneos	179
		Llave horquilla para juego de tunelar	596	Martillo	454-459
				Martillo de madera artificial	458

Inhaltsverzeichnis
Alphabetical Index
Indice alfabético
Indice alfabetico



ES

Martillo de metal con mango de plastico	459	MEYHOEFFER Cuchara para chalazion	771	MORSE-FAVALORO Separador	541
Martillo sin rechazo con mango de plastico	458	MGH-MASS-GENERAL-HOSPITAL Porta-agujas	361	MOSQUITO-DANDY Pinza hemostática	167
MARTIN ATRAUMA Pinza para vaso periférico	578	MICHEL Agrafe de sutura	397	MOSQUITO-DEBAKEY ATRAUMA Pinza-clamp vascular	551
MARTIN Dispensador	920	MICHEL Espejo laringeo	902	MOYNIHAN Pinza histerectomia	196
MARTIN Histerometro	726	MICHEL MOD. Pinza para sutura	396	MOYNIHAN Sonda y cucharilla	691
MARTIN Juego para tunelar, set completo	596	MICHEL Pinza para sutura	395,396	MÜLLER Aproximador	154
MARTIN MOD. Sierra para abrir anillos	527	MICRO-ADSON Pinza de disección	78	MÜLLER Clip vascular	152
MARTIN Pelvimetro	753	MICRO-ADSON Pinza hemostática	182	MÜLLER-VERBRUGGE Elevador para huesos	489
MARTIN Pinza para huesos	500	MICRO -Cucharilla cortante para pituitaria	622	MURPHY-LANE Elevador para luxacion	491
MARTIN Separador	235	MICRO -Disecador para pituitaria	622	MUSEUX Pinza para cuello uterino	730
MARTINI Cucharilla	467	MICRO -Elevador	483		
MARTIN-IDEAL Perforador	526	MICRO -Ganchito auricular	794,795	N	
MARTIN-VICKERS Sujetador de mano	525	MICRO -Gancho para pituitaria	622	NABATOFF Juego para varices	285
MASING Juego para tabique nasal	843	MICRO -Legra para pituitaria	622	NAEGELE Forceps obstétricos	755
MASSON Porta-agujas	363	MICRO -MOSQUITO Pinza hemostática	166	NAGER Separador para amígdalas	893
MASTIN pinza p. musculos	910	MICRO -Pinza	91,92	NELATON Sonda acanalada	283
MATHIEU Espéculo	717	MICRO -Pinza auricular	786-788	NEFF Cuchillo para menisco	495
MATHIEU Espéculo rectal	682	MICRO -Pinza de ligadura	95,96	NEGUS Pinza hemostática amígdalas	191
MATHIEU Pinza para cuerpos extraños	703	MICRO -Pinza laringea	900,901	NEGUS Soporte de pecho	871
MATHIEU Porta-agujas	367	MICRO -Pinza para neuro-cirugía	658,659	NEIVERT Ganchito para alas de nariz	860
MATHIEU Separador	251	MICRO -Pinza para pituitaria	623	NEIVERT Porta-agujas	360
MATHIEU Valva vaginal	717	MICRO -Porta-agujas	355	NEIVERT-ANDERSON Osteotomo	848
MATHIEU-RYDER Porta-agujas	367	MICRO -Tijera	16-19	NELSON Pinza para disección	87
MATSON Legra costales	478	MICRO -Tijera laringea	901	NELSON Trócar	288
MAUNDER Abreboca de madera	870	MICRO -Tijera nasal	834	NEUMANN Tijera	49
MAYFIELD Pinza gubia	514	MICRO -Tijera ocular	781	NICOLA MICRO-Pinza	659
MAYO Cuchara para cálculos biliares	691,694	MIDDELDORPF Separador	231,234	NORFOLK AND NORWICH Separador	265
MAYO Imperdible para instrumentos	925	MIDDELTON-JANSEN Pinza para tabique	835	NORTHBENT Tijera	52
MAYO Tijera	25	MIKULICZ Pinza-clamp	195,197	NOTO Pinza para pólipos uterinos	732
MAYO-ADAMS Separador	266	MIKULICZ Pinza-clamp para amígdalas	894	NOVAK Cureta para biopsia	737
MAYO-BLAKE Pinza para cálculos biliares	692	MIKULICZ Pinza-clamp peritoneo	195	NOYES Tijera	782
MAYO-HARRINGTON Tijera	26	MIKULICZ Separador	246	NUGENT Pinza para sutura	779
MAYO-HEGAR Porta-agujas	362,365	MILLER Hoja de laringoscopio	324-332	NUSSBAUM Pinza clamp	670
MAYO-NOBLE Tijera	27	MILLER-COLBURN Cureta	468		
MAYO-ROBSON ATRAUMA Pinza intestinal	675	MILLER-COLBURN Lima para huesos	479,480	O	
MAYO-ROBSON Pinza intestinal	667	MILLIGAN Disecador duramadre	614	O'BRIAN Tijera	38
MAYO-STILLE Tijera	26	MILLIGAN Separador	259	O'CONNOR Separador	212
MC DONALD Elevador	484	MILLIN ATRAUMA Pinza capsular	696	O'SULLIVAN- O'CONNOR Cuadro, suelto	276
MC GEE Ganchito auricular	794	MILLIN Cuadro, suelto	697	O'SULLIVAN- O'CONNOR Separador abdominal	276
MC GEE MICRO-Pinza para plegar alambre	790	MILLIN Dilatador para cuello vesical	696	O'SULLIVAN- O'CONNOR Valva	276
MC GIVNEY Ligador para hemorroides	685	MILLIN Pinza capsular forma-ALLIS	696	OBWEGESER Elevador	885
MC GIVNEY Pinza hemorroidal	686	MILLIN Pinza capsular forma-T	696	OBWEGESER Gancho	882
MC INDOE Pinza cortante para huesos	521	MILLIN Pinza porta-ligadura forma-U	696	OBWEGESER Legra	884
MC INDOE Pinza de disección	79	MILLIN Portador para luz fría	697	OBWEGESER Lezna	886
MC INDOE Tijera	45	MILLIN Separador vesical completo	697	OBWEGESER Osteotomo	885,886
MC INTOSH Hoja de laringoscopio	327,328-334	MILLIN Valva	697	OBWEGESER Separador	880-882
MC IVOR Abreboca completo	873	MINI-FRIEDMANN Pinza gubia	511	OCHSNER ATRAUMA Pinza aórtica	574
MC IVOR Bajalengua	874	MINI-GEMINI Pinza para preparación y ligadura	186	OCHSNER Trócar	289
MC KENTY Elevador para tabique nasal	841,842	MINI-HOHMANN Elevador para huesos	485	OFTALMOSCOPIO , cabeza con bombilla	317
MC KENZIE Grapas de plata en tubo	605	MINI-LAMBOTTE Cíncel	440	OLDBERG Pinza cortante para laminectomia	655
MC KENZIE Pinza clipadora y aplicadora	605	MINI-LANGENBECK Separador	214	Oliva metalica, suelta	818
MC KENZIE Porta-grapas	605	MINI-LEXER Cíncel	446	Oliva, suelta	596
MC KENZIE Taladro espiral	416	MINI-LEXER Gubia	446	OLIVECRONA Disecador	616
MC QUIGG-MIXTER Pinza para preparación	192	MINI-MCGEE Pinza auricular	787	OLIVECRONA Espátula	611
MCLEAN-LUIKART Forceps obstétricos	755	MINI-ROUX Separador	250	OLIVECRONA Sierra	602
MCLEAN-TUCKER Forceps obstétricos	755	MINI-TOWNSEND (BABY-TISCHLER) Pinza para biopsia	742	OLIVECRONA Tijera	46
MEAD Martillo	455,457	MINI-TOWNSEND (BABY-TISCHLER) Punta para biopsia	742	OLIVECRONA-TOENNIS Pinza para colocar grapas	605
MEAD Pinza gubia	512	MINI-TOWNSEND Pinza para biopsia	741	OLLIER Separador	224
Mecha de repuesto para lampara	939	MIXTER Pinza hemostática	190-192	OLSEN-HEGAR Porta-agujas	366
MEEKER Pinza para preparación y ligadura	189	MIXTER Pinza para cálculos biliares	693	OMBREDANNE Martillo	457
MEHDORN Pinza aplicadora para Clips	150	MIXTER-BABY Pinza hemostática	181	Optica, rigida	819,820,868
MELLINGER Blefarostato	762	MIXTER-CRAFOORD Pinza para preparación	184	OTIS Uretrótomo completo en caja de madera	701
MELLINGER-AXENFELD Blefarostato	762	MIXTER-O' SHAUGNESSY Pinza hemostática	190	Otoscopio, cabeza con bombilla	317
MENGHINI Aguja para puncion	299	MOELTGEN Goniometro	311	OVERHOLT Pinza hemostática	185
MERCEDES Separador	542	MOGEN Instrumento para circuncisión	702	OVERHOLT-GEISSENDOERFER Pinza de disección y liga- dura	185
METHOT Dispensador de algodón	937	MOHR Sierra-tubo	925	OVERHOLT-MIXTER Pinza hemostática	183
METZENBAUM Porta-agujas	361	MOLDENHAUER Elevador para cuerpos extraños	811		
METZENBAUM Tijera	30-34	MOLLISON Separador	258		
METZENBAUM-NELSON Tijera	31	MOORE Cuchara para cálculos biliares	694		
MEYER Cíncel	766	MOORFIELD Pinza para sutura	778		
MEYERDING Separador	215,243	MORRIS Separador	242		

P

Palangana 932
PARKER Separador 250
PARKER-LANGENBECK Separador 251
PARKES Cíncel nasal 850
PARTSCH Cíncel 438
PARTSCH Gubia 439
PARTSCH Martillo 455
PAYR Aguja vascular 349
PAYR Pinza-clamp gastro-intestinal 671
PAYR Sonda conductora 393
PAYR-BABY Pinza-clamp gastro-intestinal 671
PEAN Pinza hemostática 171,204
PEAN-DEBAKEY ATRAUMA Pinza cardiovascular 552,553
PEDERSON Espéculo 708
PEERS-BERTRAM Pinza de campo 203
PEET Pinza para espinas 100
PELTESON Porta-algodón 287
PENFIELD Disecador 615
PENNINGTON Elevador 842
PENNINGTON Pinza hemostática 178
PERCY Retractor para Amputacion 413
 Perforador para estribo para traccion 603
 Perforador para uñas 526
 Periototomo 469-475
PERTHES Escariador 414
PESTALOZZA Cucharilla para aborto 758
PHANEUF Pinza para histerectomía 196
PIERCE Trócar 289
 Pieza de acoplamiento 751
 Pieza de succión 818
 Pinza para tubos 205
PINARD Estetoscopio 308
 Pinza de rosca, suelta 818
 Pinza Aplicadora para clamps Bulldog 549
 Pinza ATRAUMA para coger órganos 673
 Pinza con tapa, en tarro 923
 Pinza cuticular 917
 Pinza de campo 201-203
 Pinza de disección 78
 Pinza depilatoria 90
 Pinza fina 89
 Pinza para coger tendones 498
 Pinza para coger tendones 498,499
 Pinza para cortar uñas 916,917
 Pinza para cortar uñas 915-916
 Pinza para cuello uterino 731
 Pinza para desechos 948
 Pinza para entrelazar tendones 499
 Pinza para espinas 90
 Pinza para esterelización 924
 Pinza para huesos 500-509
 Pinza para huesos, autocentrante 509
 Pinza para poner y quitar TITANIO-clamps 162
 Pinza para quitar hojas de bisturíes 8
 Pinza para reposición 501
 Pinza para reposición 501
 Pinza para secuestro 502
 Pinza para tabique nasal 827
 Pinza para tubos 205
 Pinza para uñas 916,917
 Pinza quirúrgica 81
 Pinza-sierra para abrir anillos 527
PIPER Forceps obstétricos 755
 Pisón con mango 444
PITHA Abreboca 870
 Placa para extender la piel 11
 Placenta cubeta 939
PLESTER MICRO-Cuchillo auricular 792
PLESTER Separador 258

PLESTER Tubo para aspiración 291,292
POLITZER Aguja para tímpano 813
POLITZER Cono de conexión 816
POLITZER Cuchillo para furúnculos 813
POLITZER Insuflador de aire 816
POLLOSON Separador 241
POOLE Tubo para aspiración 296
POPPE Tubo para aspiración 291
 Portador de luz fibra óptica 343
 Porta-laringoscopio 342
POTTS ATRAUMA Pinza cardiovascular 554-556,570
POTTS MICRO-Tijera 16
POTTS-DE-MARTEL Tijera vascular 44
POTTS-GLOVER ATRAUMA Pinza vascular 556
POTTS-SMITH Pinza de disección 79
POTTS-SMITH Pinza quirúrgica 84
POTTS-SMITH Tijera vascular 44
POZZI Pinza para cuello uterino 728
PRATT Dilatador uterino 725
PRATT Espéculo rectal 681
PRATT Gancho 684
PRATT Pinza hemostática 179
PRATT Pinza para cuello uterino 731
PRESBYTERIAN Pinza para tubos 204
PRICE-THOMAS Pinza bronquial 544
PRINCE Tijera 46
PROVIDENCE-HOSPITAL Pinza hemostática 167
 Punta cónica, suelta 818
 Punta de oliva, suelta 818
PUTTI Escofina 482

Q

QUERVIAN Elevador 484
QUINBY Tijera 49
QUINKE Aguja 299
QUIRE Elevador para cuerpos extraños 806
 Quita hojas de bisturíes 8

R

RABINER Martillo 307
RADOLF Pinza para arrancar uñas 527
RAGNELL Separador 216
RAGNELL-DAVIS Separador 216
RALK (VIRTUS) Pinza para espinas 100
RALK Perforador de mano 417
RAMPLEY Pinza para esponjas 207,209
RAMSEY Pinza anatómica / Pinza quirúrgica 80,86
RANDALL Cureta para biopsia 737
RANDALL Pinza para cálculos renales 687,688
RANEY Grapa hemostática 606
RANEY Pinza para aplicar 606
RANKIN-DEBAKEY ATRAUMA Pinza-clamp vascular 551
RAY Cureta pituitaria 619
RECAMIER Cureta uterina 745,746,749
 Recipiente de descarga 922
RECTAL Tijera para el recto 42
REDON Aguja 298
 Regla graduada en mm y pulgadas 313
REICHERT Depresor para epiglotis 900
REIL MICRO-Tijera 19
REINER Chuchillo para escayolas 406
RESANO ATRAUMA Pinza para anastomosis rectales 679
RESANO Tijera 42
REVERDIN Aguja 387
REVERDIN Espátula abdominal 253
REYNOLDS Tijera para disección 39
RIBBON Espátula abdominal 253
RICARD Separador abdominal 271,272
RICHARDSON Separador 232

RICHARDSON-EASTMAN Separador 232
RICHTER Separador 265
RICHTER-HEATH Pinza para sutura 396
RIGBY Separador 266
 Riñonera 938
RITTER-HALLE Dilatador 865
ROBB Disecador vascular 598
ROBERTS Pinza hemostática 183
ROBIN Pinza de campo 203
ROBIN-MASSE Valva central 271
ROCHARD Bastidor 280
ROCHARD Dispositivo de fijación 280
ROCHARD Gancho-separador 280
ROCHESTER-CARMALT Pinza hemostática 180
ROCHESTER-PEAN Pinza hemostática 172,173
RÖDER Porta-ligadura 895
ROEDER Pinza de campo 202
ROGER Elevador para periostio 843
ROGERS ATRAUMA Pinza histerectomía 200
ROGGE Pinza para esterilización 924
ROLLET Separador 767
ROSE Gancho traqueal 904
ROSEN Aguja auricular 794
ROSEN MICRO-Cuchillo auricular 792,793
ROSEN MICRO-Legra auricular 796
ROSENBERG Pinza para broncoscopia 899
ROSER-KÖNIG Abreboca 871
ROSS Separador 240
ROUX Separador 249
ROWE Pinza para reposición 887,888
RUBIN Osteotomo 847
RUBIN Pinza para tabique nasal 835
RUDD Ligador para hemorroides 685
RUMEL Pinza para preparación y ligadura 186
RUMEL-BELMONT Tourniquete 599
RUSKIN Pinza cortante para huesos 521
RUSKIN Pinza gubia 515
RUSS.MODELL Pinza quirúrgica 86
RUST Hoja de recambio 410
RUST Sierra para amputación 410
RYDEL-SEIFFERT Diapason 802

S

SAALFELD Extractor para comedones 914
SACHS Disecador 614
SACHS Gancho 617
SAENGER Pinza para aborto y placenta 756
SAMMII Pinza para tumores 94
SANTULLI ATRAUMA Clamp Bulldog 550
SANVENERO Tijera 36
SAROT Pinza hemostática 184
SATINSKY ATRAUMA Pinza-clamp 564
SATINSKY Pinza para anastomosis 545,546
SATINSKY Tijera vascular 41
SATTERLEE Hoja de sierra 411
SATTERLEE Sierra para amputación 411
SAUERBRUCH Costotomo 530
SAUERBRUCH Pinza gubia 518
SAUERBRUCH Pinza para desechos 948
SAUERBRUCH Separador 229,236
SCALP-CONTOUR Separador 256
SCHAEDEL Pinza de campo 201
SCHAMBERG Extractor para comedones 914
SCHADE Cucharilla 461
SCHIBE ATRAUMA Pinza para coger órganos 673
SCHINMANN Pinza para broncoscopia 899
SCHERBAK Espéculo 718
SCHINK Dermotomo 11
SCHIOETZ Tonómetro 762
SCHMEDEN Pinza nasal 829

SCHMID Tubo vascular.....	300	SIMON Gancho	734	STRUEMPPEL Pinza de copas.....	807
SCHMIEDEN Aguja para ligadura.....	388	SIMON Separadores	235	STRULLY Tijera	45
SCHMIEDEN Sonda conductora.....	393	SIMPLEX Separador	876	STRUYCKEN Pinza nasal	830
SCHMIEDEN-DICK Aguja para ligadura.....	388	SIMPSON Forceps obstétricos	754	SUBRAMANIAN ATRAUMA Pinza clamp	582
SCHMIEDEN-PAYR Sonda conductora	393	SIMPSON-BRAUN Forceps obstétricos	754	SUPERCUT COTTLE Tijera	70
SCHMIEDEN-TAYLOR Tijera.....	45	SIMS Cureta uterina	747,748	SUPERCUT DIETHRICH Tijera	71
SCHNIDT Pinza hemostática	182	SIMS Espéculo rectal	680	SUPERCUT FOMON Tijera	70
SCHNIDT Pinza para amígdalas.....	894	SIMS Espéculo vaginal	710	SUPERCUT FREEMANN-GORNEY Tijera.....	75
SCHOENBORN Separador.....	905	SIMS Histerometro	726	SUPERCUT FREEMANN-KAYE Tijera.....	75
SCHROEDER Cucharilla uterina.....	744	SIMS Tijera	28	SUPERCUT GOLDMANN-FOX Tijera	73
SCHROEDER Pinza para cuello uterino.....	728,729	SIMS-MAIER Pinza para pólipos	207	SUPERCUT GORNEY Tijera	74
SCHUBERT Pinza para biopsia	738	SINGLEY-TUTTLE Pinza de disección.....	87	SUPERCUT HEYMANN Tijera	70
SCHUKNECHT Cánula de aspiración.....	294	SKENE Pinza para cuello uterino	729	SUPERCUT JAMESON Tijera	74
SCHUKNECHT MICRO-Cuchillo auricular	792	SLUDDER-BALLENGER Amigdalótomo	896	SUPERCUT JOSEPH Tijera	72
SCHUKNECHT Separador	259	SMELLIE Perfora-craneos	758	SUPERCUT KAYE FACE LIFT Tijera	74
SCHULTZE Salpingografo	752	SMILLIE Cuchillo para menisco	494	SUPERCUT KELLY Tijera	72
SCHULZE-BERGMANN Espéculo	682	SMILLIE Separador	493	SUPERCUT LEXER Tijera	68
SCHUMACHER Pinza para biopsia	740,743,899	SMITH-BUIE Separador rectal	682	SUPERCUT LISTER tijera	75
SCHUMACHER Punta para biopsia	743	SMITH-PETERSEN Gubia	441	SUPERCUT MAYO Tijera	66
SCHUMACHER Tijera umbilical	29	SMITH-PETERSEN Osteotomo	441	SUPERCUT MAYO-STILLE Tijera	66
SCHWARTZ Clip vascular	153	SNELLEN Pinza entropion	779	SUPERCUT METZENBAUM Tijera	67,68
SCHWARTZ Pinza aplicadora	153	SOMER Histerolabo	733	SUPERCUT METZENBAUM-NELSON Tijera.....	67
SCOVILLE Cuadro	624	Sonda conductora, Ferrozell	394,395	SUPERCUT PAR-TYPE Tijera	74
SCOVILLE Cucharilla cortante	463	Sonda de metal para mujeres	700	SUPERCUT POTTS-SMITH Tijera vascular.....	71
SCOVILLE Gancho.....	624, 625	Sonda forma mirto	282	SUPERCUT REYNOLDS Tijera	73
SCOVILLE Separador completo	624	Sonda metálica para hombres.....	700	SUPERCUT SIEBOLD Tijera	69
SCOVILLE Separador para raiz de nervio	612	Sonda metálica para mujeres	700	SUPERCUT SIMS Tijera	69
SCOVILLE Valva lateral	624, 625	Sonda para mirto	282	SUPERCUT STEVENS Tijera	73
SCOVILLE-HAVERFIELD Cuadro	624	Sondda acanalada	282,283	SUPERCUT Tijera para episiotomía	69
SCUDDER ATRAUMA Pinza intestinal	676	Soporte de pecho para niños, suelto.....	342	SUPERCUT Tijera para iridectomía	72
SCUDDER Pinza intestinal	668	Soporte para 12 Espéculo auriculares	799	SUPERCUT Tijera para strabismo	68
SEBILEAU Elevador.....	484	Soporte para brocas filiformes.....	436	SUPERCUT Tijera quirúrgica	66
SEDILLOT Periestotomo	474	Soporte para cabezas para tunelar	596	SUPERCUT TOENNIS-ADSON Tijera	69
SEGOND Cuchillo para fibroma	2	SPENCER Tijera para ligadura.....	52	SUPERCUT WAGNER Tijera	72
SEGOND Pinza para histerectomía	197	SPENCER-WELLS Pinza hemostática.....	170	SUPERCUT WALDMANN Tijera.....	69
SEGOND-LANDAU Pinza histerectomía	197	SPRATT Cucharilla	462	Suspension para dispensador de cepillos.....	921,922
SEIFFERT Pinza para broncoscopia	899	SPURLING Pinza cortante para laminectomía	652	Sutura-Estuche en caja de metal	397
SELLHEIM Elevador obstetrico.....	756	ST. CLAIR-THOMSON Cuchillo para adenoides.....	864		
SEMB Periestotomo	477	ST. MARKS Retractor de pelvis.....	247		
SEMB Pinza bronquial	544	STACKE Sonda	282		
SEMB Pinza cortante para huesos	524	STAMMBERGER Pinza sacabocado	833	TABB Cuchillo para mucosa.....	792
SEMB Pinza gubia	515	STAUDE-MOORE Pinza para el cuello uterino.....	727	TAKAHASHI Pinza para etmoides	829
SEMB Pinza para huesos	504	STEINMANN Clavo	432	Tapa con boton para sielleta	938
SEMKEN Pinza de disección	79	STEINMANN Pinza para coger tendones	498	Tapa de repuesto	459
SEMKEN Pinza quirúrgica	83	STELLBRINK Pinza gubia	511	Tapa para contenedor para almacenaje	146
SEMM Cuadro solo	278	STELZNER Tijera para ligadura.....	41	Tapa para cubo para desechos.....	948
SEMM Espéculo vaginal	708	STERNBERG Separador	877	Tapa para rinoneras	938
SEMM Gancho-separador.....	278	STEVENS Pinza para iridectomía	776	Tapa suelta con abertura triangular.....	934
SEMM Separador abdominal completo.....	278	STEVENS Tijera	38	Tapa suelta, cerrada, para tarro metalico	934
SENN-GREEN Separador	216	STIEGLITZ Pinza para espinas.....	100	TARNIER Craneoclasto	759
SENN-MILLER Separador	217	STILLE Cincel.....	439	Tarro metalico	934
Separador	212-252	STILLE Fresa	415	TAYLOR Martillo	306
Separador nasal	857	STILLE Gubia	439	TAYLOR Pinza de disección.....	79
Separador para mejilla	877	STILLE Osteotomo	439	TAYLOR Pinza quirúrgica	83
Separador para rodilla para rodilla	492,493	STILLE Perforador	415	TAYLOR Separador	492
Separador traqueal	213,215	STILLE Pinza gubia	515	TAYLOR Valva lateral para separador	625
SERPENTINE-GRASPER Pinza para coger intra uterino ..	743	STILLE Pinza para cálculos biliares	693		
SEUTIN Tijera para vendajes	405	STILLE Pinza para pedúnculo	194		
SEYFFERT Espéculo vaginal	708	STILLE Pinza quirúrgica	82		
SHAAF Pinza depilatoria	90	STILLE Taladro espiral	415		
SHAPLEIGH Cureta auricular.....	809	STILLE Tijera	405	TC	
SHEA MICRO-Ganchito	795	STILLE Trépano	415	TC-ADSON MICRO-Pinza	97,98
SHEEHAN Osteotomo	849	STILLE-BARRAYA Pinza quirúrgica	85	TC-ADSON Pinza de disección.....	97
SIEBENMANN Catéter lavador.....	865	STILLE-LISTON Pinza cortante para huesos	522,523	TC-ADSON Pinzas quirúrgica	98
SIEBOLD Tijera para ginecología	23	STILLE-LUER Pinza gubia	517,518	TC-ADSON-BROWN Pinza quirúrgica	98
Sierra oscilante para escayolas	408	STILLE-RUSKIN Pinza gubia	516	TC-Alicate corta-alambres.....	424-426
Silleta con tapa con boton	938	STOCKMANN Clamp para pene.....	703	TC-Alicate para extraer alambres	423
SILVER Cincel nasal	850	STONE Pinza quirúrgica	83	TC-ARRUGA MICRO- Porta-agujas	370
SILVER Dermatomo	11	STRANDELL-STILLE Separador	219	TC-BABCOCK Pinza para tejidos.....	664
SIMON Cucharilla cortante	464	STRATTE Porta-agujas	365	TC-BABY-GILLIES Porta-agujas	382
SIMON Cucharilla uterina	744	STRAUSS Clamp para pene.....	703	TC-BARRAQUER Porta-agujas	372,373
				TC-BARRY-STERNDAL Pinza cierra-hilos	420
				TC-BAUMGARTNER Porta-agujas.....	376

TC-BONNEY Pinza quirúrgica	99	TC-TOENNIS-ADSON Tijera	59	TUOHY Aguja para puncion lumbar	300
TC-BOYNTON MICRO -Porta-agujas	370	TC-UNIVERSAL Tijera	64	TURNBULL Pinza para cortar uñas	916
TC-BOZEMANN Porta-agujas	380	TC-WANGENSTEEN Pinza	98	TURNER-WARWICK Pinza para cálculos biliares	692
TC-BRUNS Tijera	404	TC-WANGENSTEEN Porta-agujas	381	TYDING Cierra-nudos para amígdalas	895
TC-CASTROVIEJO (JACOBSON) Aorta-agujas	371,372	TC-WEBSTER Porta-agujas	375		
TC-CONVERSE Porta-agujas	375	TC-ZWEIFEL Porta-agujas	386	U	
TC-CORWIN-HEGAR Pinza para torcer hilos	420			UCKERMANN Porta-algodón	287
TC-CRILE Porta-agujas	385	TEALE Pinza para cuello uterino	729	UECKERMANN Traqueótomo	902,903
TC-CRILE-WOOD Porta-agujas	377	Tensiómetro en bolso con brazelete	322,323	ULRICH Pinza para tapones	206
TC-CRILE-WOOD BABY Porta-agujas	378	Tensor de alambres con mordaza	432	ULRICH Pinza prensora para huesos	507,508
TC-CUSHING Pinza de disección	97	TERRIER Pinza hemostática	166	UNIVERSAL Atomizador completo	865
TC-CUSHING-TAYLOR Pinza de diseccion	97	THOMS-ALLIS Pinza para intestinos	663	UNIVERSAL Frasco de recambio	866
TC-DEBAKEY Pinza	99	THOMS-GAYLOR Pinza para biopsia	739	UNIVERSAL Pinza para esterilización	924
TC-DEBAKEY Porta-agujas	378	THOREK Tijera	34	UNIVERSAL Pulverizador completo	815
TC-DEBAKEY Tijera	60	TIECK-HALLE Espéculo nasal	823	UNIVERSAL Tijera	50
TC-DERF Porta-agujas	374	Tijera fina	38,40	UNIVERSAL Trócar	288
TC-DIETHRICH Porta-agujas	374	Tijera nasal con vastago tubular	834	UNNA Extractor para comedones	914
TC-DIETHRICH-RYDER Porta-agujas	374	Tijera para diseccion de nervios	32	UNNA-VIDAL Extractor para comedones	915
TC-DUVAL Pinza para tejidos	665	Tijera para disección	36	URO-TANGENTIAL ATRAUMA Pinza-clamp	194
TC-FERRIS-SMITH Pinza quirúrgica	99	Tijera para enterotomía	51	USA MOD. Cucharilla	464
TC-FINOCCHIETTO Porta-agujas	381	Tijera para enucleacion	34	USA MOD. Pinza de diseccion	78
TC-FOMON Escofina nasal	855	Tijera para episiotomía, dentada	29	USA MOD. Pinza quirúrgica	82
TC-GILLIES Pinza quirúrgica	99	Tijera para estrabismo	38	USA MOD. Separador para yeso	407
TC-GILLIES Porta-agujas	382	Tijera para incision	25	USA MOD. Tijera umbilical	29
TC-GOLDMAN-FOX Tijera	63	Tijera para iridectomia	37		
TC-HALSEY Porta-agujas	375	Tijera para uñas	915	V	
TC-HEGAR Porta-agujas	377	Tijera para uñas	915	VALLEIX Histerometro	726
TC-HEGAR-VASCULAR Porta-agujas	379	Tijera para vendajes	402	Válvula de conexión	818
TC-HEPP-SCHIEDL Porta-agujas	374	Tijera para vendajes con ceradura	405	VAN BUREN Bujía uretral	699
TC-HÖSEL Porta-agujas	386	Tijera quirúrgica	22,23	VAN BUREN Pinza para secuestro	502
TC-JOSEPH Tijera	62	Tijera quirúrgica, gracil	24	VAN DOREN Pinza para biopsia	739
TC-KALT MICRO-Porta-agujas	370	Tijera vascular	45	VANNAS MOD. TÜBINGEN Tijera para iridectomia	783
TC-KELLY Tijera	62	TILLEY Pinza auricular	806	VANNAS Tijera para iridectomia	783
TC-KILNER Porta-agujas	376	TISCHLER-KEVORKIAN Pinza para biopsia	741	VARADY Flebextractor	284
TC-LANGENBECK porta-agujas	384	TISCHLER-MORGAN Pinza para biopsia	741,742	VARADY MICRO-disecador	284
TC-LEXER Tijera	56	TITANIO Clamps Bulldog Arteria	161,162	Vaso medicinal	936,937
TC-LICHTENBERG Porta-agujas	385	TITANIO Clamps Bulldog Vena	161,162	Vaso para medidas graduado	931
TC-LISTER Tijera para vendajes	400	TITANIO YASARGIL Clip vascular para aneurisma MINI120,121,136	108-133	Vastago para tunelar	596
TC-LOCKLIN Tijera	63	TITANIO YASARGIL Clip vascular para aneurisma STANDARD	140-144	VEIDENHEIMER ATRAUMA Pinza intestinal	678
TC-MASSON Porta-agujas	381	TITANIO YASARGIL Pinza Aplicadora para Clips vasculares	140-144	VERBRUGGE Pinza para huesos	510
TC-MATHIEU Porta-agujas	383,384	TOBOLD Abajalengua	878	VERRES Aguja para insuflación	300
TC-MATHIEU-KOCHER Porta-agujas	383	TOENNIS Cuchillo para duramadre	618	VICKERS EASIDRIVER Mango	431
TC-MATHIEU-RYDER Porta-agujas	384	TOENNIS Disecador	616	VIDAL Rascador para lupus	912
TC-MAYO Tijera	55	TOENNIS Pinza hemostática	188	Vidrio de repuesto	921
TC-MAYO-HARRINGTON Tijera	61	TOENNIS Porta-agujas	367	VIGORIMETER Pera de goma, suelta	310
TC-MAYO-HEGAR (HEANEY) Porta-agujas	376,377	TOENNIS Porta-vascular	46	VIRCHOW Cuchillo	3,4
TC-MAYO-LEXER Tijera	55	TOENNIS-ADSON Tijera vascular	46	VISE MICRO-Pinza de ligadura	96
TC-MAYO-STILLE Tijera	55	TOHOKU Pinza de campo	203	VOLKMANN Cucharilla	460,461
TC-McINDOE Pinzas de disección	98	Torniquete para amputación	412	VOLKMANN Cucharilla doble extremo	466
TC-METZENBAUM Tijera	56-59	TOWNSEND Pinza para biopsia	742	VOLKMANN Separador	220,221
TC-MICRO-SLIM Porta-agujas	378	TOWNSEND Punta para biopsia	742	VOLLMAR Flebodisecador	286
TC-MILLER-COLLBURN Lima para huesos	481	TOWNSEND-MINI (BABY-TISCHLER) Pinza para biopsia	742		
TC-NEIVERT Porta-agujas	375	TOWNSEND-MINI (BABY-TISCHLER) Punta para biopsia	742	W	
TC-OEHLER Pinza quirúrgica	99	TOWNSEND-MINI Pinza para biopsia	741	WACHENFELDT Pinza para sutura	396
TC-OLSEN-HEGAR Porta-agujas	382	TOYNBEE Espéculo auricular	798	WAGENER Ganchito auricular	812
TC-PARAMETRIUM Tijera para histerectomía	61	Transformador pequeño	320	WAGNER Elevador para huesos	488
TC-Pinza cierra hilos	420	TRELAT Espéculo vaginal	709	WAGNER Periotostomo	470,471
TC-POTTS-SMITH Pinza de diseccion	98	Trepano para biopsia para CHAMPY	453	WAGNER Tijera	39
TC-RAGNELL (KILLNER) Tijera	64	TREVES Pinza quirúrgica	86	WALB Cuchillo pars órganos	4
TC-RYDER-FRENCH EYE Porta-agujas	378,379	TROELTSCH Pinza para taponamiento	826	WALDMANN Tijera para episiotomia	29
TC-SAROT Porta-agujas	380	TROEMMER Martillo	306	WALLICH Cucharilla para aborto	758
TC-SEMKEN Pinza de diseccion	98	TROUSSEAU Dilatador traqueal	903	WALTER Cincel nasal	847
TC-SEMKEN Pinza quirúrgica	99	TROUTMAN-CHRIS Porta-hoja / Rompe-hoja de afeitar	14	WALTER Gubia nasal	847
TC-SENNING Porta-agujas	380	TROUTMAN-COLIBRI Pinza de fijación	777	WALTER-CARMALT Pinza para espinas	89
TC-SIMS Tijera	61	TUBBS Dilatador aortico	594	WALTON Cincel para cuerpos	766
TC-STANDARD Pinza de diseccion	97	TUBERKULIN-LUER Jeringa	304	WALTON Sierra para abrir anillos	527
TC-STANDARD Tijera quirúrgica	54	Tubo de conexión completo	818	WANGENSTEEN Porta-agujas	364
TC-STRATTE Porta-agujas	381	Tubo extractor de humo	343	WARTENBERG Instrumento para examinar	308
TC-Tijera para episiotomía	61	TUFFIER Pinza para huesos	505		
TC-Tijera para iridectomia	62	TUFFIER Pinza para sacar tumores	178		
TC-TOENNIS Porta-agujas	385	TUFFIER Separador	537		

Inhaltsverzeichnis
Alphabetical Index
Indice alfabético
Indice alfabetico

WASSMUND Separador	224	YOUNG Separador	695
WATSON-WILLIAMS Pinza para etmoides	829		
WAUGH Pinza quirúrgica	85	Z	
WEBER Asa grande	770	ZAUFAL Elevador para cuerpos extraños	811
WEBER ATRAUMA Pinza cardiovascular	563	ZAUFAL-JANSEN Pinza gubia	514
WEBER-LOCH Asa auricular	811	ZENKER Pinza para preparación y ligadura	189
WEBSTER Porta-agujas	359	ZENKER Separador	230
WEIL-BLAKESLEY Pinza para etmoides	830-832	ZIEGLER Cuchillo	765
WEISSBARTH Espéculo vaginal	719	ZIEGLER Espejo frontal	318
WEITLANER Separado	257	ZIELKE Gubia	448
WEITLANER-BABY Separador	259	ZÖLLNER Cánula de aspiración	294
WEITLANER-LOKTITE Separador	256	ZÖLLNER Espéculo auricular	799
WEITLANER-WULLSTEIN Separador	258		
WELLS Cuchara para enucleación	770		
WERTHEIM Pinza para histerectomía	196-197		
WERTHEIM Tijera	27		
WERTHEIM-CULLEN Pinza para histerectomía	197		
WEST Cíncel	773		
WEST Gubia	773		
WESTCOTT MICRO-Tijera	17		
WESTCOTT Tijera para tendones	782		
WESTMACOTT Pinza para taponamiento	826		
WHITE Pinza para amígdalas	893,894		
WHITEHEAD Abreboca	875		
WIEDER Abajalengua	878		
WIEN MOD. Captador de hilos	394		
WIEN MOD. Espéculo	823		
WIENER (AUFRIEHT) Escofina nasal	853		
WILDE (TROELTSCH) Pinza auricular	805		
WILDER Dilatador para canal lacrimonasal	774		
WILLET-MARTEL Pinza hemostática	179		
WILLIAMS Pinza para intestinos	663		
WILLIGER Cucharilla	465,467		
WILLIGER Elevador	483		
WILLIGER Martillo	454,455		
WILLIGER Periostotomo	474,475		
WINTER Pinza para aborto y placenta	757		
WIRKSTROEM Pinza preparación	190		
WITTNER Pinza para biopsia	740		
WOLFF Cureta para lupus	912		
WOLFF Pinza para yesos	407		
WRIGLEY Forceps obstétricos	754		
WULLSTEIN Cuchillo de hoz	792		
WULLSTEIN MICRO Pinza auricular	786-792		
WULLSTEIN MICRO -Cánula para aspiración	293		
WULLSTEIN MICRO -Tijera auricular	789		
Y			
YANKAUER Tubo para aspiración	296		
YASARGIL Clip vascular de aneurisma MINI120,121,136			
YASARGIL Clip vascular de aneurisma STANDARD108-133			
YASARGIL Cucharilla cortante	621		
YASARGIL Empujador de sutura	620		
YASARGIL Gancho para galea	606		
YASARGIL Guia-ligadura, abotonada	621		
YASARGIL Instrumento para micro-cirugía	620,621		
YASARGIL MICRO -Pinza para agarre	94		
YASARGIL MICRO -Pinza para neuro-cirugía	659		
YASARGIL Pinza aplicadora	138-144		
YASARGIL Pinza cortante para hipofisis	655		
YASARGIL Pinza para tumor	93		
YASARGIL Porta-agujas	358		
YASARGIL Porta-agujas	373		
YASARGIL Tubo de aspiración	295		
YASARGIL-SAMMII Pinza para tumor	93		
YEOMAN Pinza para biopsia rectal	685		
YOUNG Aguja de repuesto	388		
YOUNG Instrumento para sutura	388		
YOUNG Pinza para prostata	695		
YOUNG Pinza tira-lengua	880		



Inhaltsverzeichnis

Alphabetical Index

Indice alfabético

Indice alfabético

A

ABRAHAM Bisturi per Tonsille	890
ADAMS Porta salviette	870
ADLERKREUTZ Pinza chirurgia.....	83
ADSON Divaricatore	256,261-263
ADSON MICRO-Pinza anatomica	78
ADSON MICRO-Pinza per chirurgia	82
ADSON Periostotomo	478
ADSON Pinza anatomica	78
ADSON Pinza emostatica	182
ADSON Pinza per chirurgia	82
ADSON Portaghi	361
ADSON Punta a spirale sola	416
ADSON Tubo per aspirazione.....	290
ADSON Uncino per dura-madre	617
ADSON-BROWN Pinza per chirurgia	82
AEBLI MICRO-Forbice oculare	781
Ago muscolare	347,348
Ago oftalmico, ago piatto	349
Ago passafili	428
Ago per cataratta	765
Ago per chirurgia	346,347
ALAN-PARKS Divaricatore rettale.....	683
ALAN-PARKS Valva centrale.....	683
ALAN-PARKS Valva laterale	683
ALDERDYCE Elevatore	484
Alesatore per Pinza per Trazione Craniale	603
ALEXANDER Periostotomo	478
ALEXANDER Pinza per biopsia	740
ALEXANDER Scalpello.....	439
ALEXANDER Sgorbia.....	439
ALLEN Pinza per intestino	665
ALLIS ATRAUMA Pinza per afferrare tessuti	662
ALLIS Pinza per afferrare intestino	662
ALLIS-ADAIR Pinza per intestino	662
ALLISON Spatole per polmone	544
ALLPORT Divaricatore	255
ALM Divaricatore.....	255
ANDERSON-ADSON Divaricatore	256
ANDREW Abassalingua	878
ANDREWS-PYNCHON Tubo per aspirazione	296
Anello di gomma per Lefattore Emorroidale	685
Aneloi di Tenuta	751
Anestophon Stetoscopio	309
Apparecchio per Arrestatare	412
AQUAJET Pistola lavatrice	940,941
Arco per Trazione	430
ARRUGA Portaghi	353
ASCH Pinza per raddizzare il setto nasale	861
Aseptic Spazzola per Unghie	920
Aspiratore, solo	818
AUFRIEHT (WIENER) Raspa nasale	853
AUFRIEHT Divaricatore	858,86
AUSTIN MICRO-Dissettore	795
AUSTIN MICRO-Pinza	96
AUVARD Specolo vaginale	719
AXENFELD Uncino.....	768
AYER Pinza per calazio	780
AYRE Bisturi	2

B

BABCOCK ATRAUMA Pinza per intestino	664
BABCOCK Pinza per intestino	664
BABINSKY Martello	307
BABY-ADSON Pinza emostatica	182
BABY-BABCOCK Pinza per intestino	664
BABY-BAILEY Divaricatore	543
BABY-BALFOUR Divaricatore addominale	273

BABY-COLLIN Divaricatore addominale	270
BABY-COLLIN Valva laterale.....	270
BABY-DOYEN Pinza per intestino	666
BABY-DUPLEX Stetoscopio	309
BABY-GILLIES Portaghi.....	366
BABY-KERN Tenaglia per ossa	503,504
BABY-MIKULICZ Pinza peritoneo	195
BABY-MIXTER Pinza emostatica	181
BABY-OVERHOLT Pinza emostatica	169
BABY-ROUX Divaricatore.....	250
BABY-SATINSKY Pinza per afferrare	545
BABY-TISCHLER Pinza per biopsia.....	741
Bacinella per aghi	351
Bacinella per compresse	936
Bacinella per placenta	939
Bacinella per Strumenti	933
Bacinella reniforme	938
Bacinella universale.....	933
BACKHAUS Pinza fissateli	201
BADGLEY Divaricatore per laminectomia	626
BAILEY Divaricatore	543
BAILEY-GIBBON Divaricatore	543
BAINBRIDGE ATRAUMA Pinza vascolare.....	554
BAINBRIDGE Pinza emostatica	180
BAKES Dilatatore	690
BAKES Pinza per calcolo biliare.....	692
BALFOUR Divaricatore addominale.....	274,275
BALFOUR Valva a filo	275
BALFOUR Valva centrale	275
BALL+SOCKET Pinza per copertura	202
BALLENGER Bisturi per il setto nasale	840
BALLENGER Sgorbia per setto nasale	845
BALLENGER-HAJEK Elevatore.....	842
BARANY Assortatore.....	803
BARBARA Ago.....	793,794
BARBARA Uncino auricolare	793
BARNHILL Coltello per adenoidee	863
BARR Specolo rettale	681
BARRAQUER (COLIBRI) Blefarostato	762
BARRAQUER Forbice	783
BARRAQUER Pinza	91
BARRAQUER Portaghi.....	354-355
BARRAQUER-COLIBRI Pinza	777
BARRAQUER-KATZIN Pinza	777
BARRAQUER-TOUTMAN Portaghi	354
BARRETT Pinza	727
BARRON Cannula	294
BAUMGARTNER Portaghi	360
BEACHAM Amniotomo	729
BECK ATRAUMA Pinza cardiovascolare	574
BECKMANN Coltello per adenoidee.....	862,863
BECKMANN Divaricatore	263
BECKMANN Specolo nasale	825
BECKMANN-ADSON Divaricatore	264
BECKMANN-EATON Divaricatore	264
BEEBEE Forbice.....	50
BEER Pinze	91
BELLUCCI MICRO-Cannula.....	293
BELLUCCI MICRO-Forbice	789
BENGOLEA Pinza emostatica	177
BENNETT Elevatore	490
BERGER Lente frontale completo.....	321
BERGMANN Forbice	403
BERGMANN Martello	456,457
BERGMANN Sega per gessi	406
BERLIN Pinza per Tubo	204
BERLINER Martello	306
BERNHARD Pinza per fissare	202
BERTILLON Cefalometro	311
BETHUNE Costotome	532
BEYER Pinza osteotomo	808

BEYER Pinza sgorbia	514
Bicchiere Graduati	931
Bicchiere Metallico	936,937
BIEMER Ago di ricambio per approssimatore.....	157
BIEMER Applicatore per approssimatore	156
BIEMER Applicatore per Clip	151
BIEMER Approssimatore	156,157
BIEMER Clip vascolare per occlusione	151
BIEMER-MÜLLER Approssimatore	155
BIER Ago.....	300
BIER Lama di ricambio	410
BIER Sega per amputazione.....	410
BILLEAU Ansa auricolare.....	811
BIRCHER Meniscotomo	494
BIRCHER-GANSKE Tenaglia per ossa	500
BIRKETT Pinza emostatica	183
BISHOP-HARMAN Pinza per iridectomia.....	777
Bisturi monouso sterile	9,1
Bisturi per disezione	2,3
BLAKE Curetta	750
BLAKE Pinza per calcolo biliare	692
BLOHMKE Pinza per tonsille	894
BLOUNT Elevatore per ossa	491
BLOUNT Retrattore.....	492
BLUMENTHAL Pinza sgorbia	513
BODENHAMMER Specolo rettale	680
BOETTCHER Forbice	46
BÖHLER Arco per estensione	429
BÖHLER Cesoa per ossa	521
BÖHLER Pinza sgorbia	514
BONACCOLTO Pinza per sutura	779
BONN MOD. Forbice	38
BONN MOD. Pinza per iride	777
BONNEY Pinza per chirurgia	86
BOSE Uncino tracheali	904
BOUCHERON Specolo auricolare	799
BOWMAN Ago per discisione	765
BOWMAN Blefarostato	762
BOWMAN Specillo	774
BOYS-ALLIS Pinza per intestino	663
BOZEMANN Forbice	28
BOZEMANN Pinza per tampone.....	208
BOZEMANN Torcifilo	394
BOZEMANN-DOUGLAS Pinza per polipo	208
Bracciale per apparecchio di compressione	412
Bracciale Velcro-Nylon	322
BRAND Pinza per afferrare tendine	498
BRAUN Cranioclaste	759
BRAUN Depressore uterino	726
BRAUN Pinza per collo dell'utero	732
BRAUN Pinza per gozzo	910
BRAUN-STADLER Forbice	29
BREISKY Specolo	720
BRODIE Sonda	283
BROPHY Pinza anatomica	79
BROPHY Pinza per chirurgia	84
BROPHY-SULLIVAN Forbice	36
BROWN Pinza per chirurgia	86
BROWN Portaghi	360
BRUENINGS Bisturi per il setto nasale.....	841
BRUENINGS Bisturi per tonsille	890
BRUENINGS Pinza nasale tagliente	828
BRUENINGS Pinza per bronchoscopia	899
BRUENINGS Serranodi per tonsille	895
BRUENINGS Spatola per lingua	879
BRÜNING Pinza per bronchoscopia	899
BRÜNING Tubo allunghi.....	898
BRUNNER Ago per legatura	391
BRUNNER ATRAUMA Pinza intestinale.....	677
BRUNNER Divaricatore	237-239
BRUNNER Forbice di costola	531

Inhaltsverzeichnis
Alphabetical Index
Indice alfabético
Indice alfabetico



BRUNNER Sonda conduttrice	392	CHEATTLE Pinza per strumenti	924	COTTLE Pinza per columella	861
BRUNNER Sonda Ferrozol	394	CHERON Pinza per tamponi	208	COTTLE Scalpello	843
BRUNS Curetta tagliente	462,463	CHEVALIER-JACKSON Canulla tracheale	906	COTTLE Specolo nasale	824
BRUNS Forbice per bendaggi	404	CHEVALIER-JACKSON Pinza per broncho-esofagoscopia	898	COTTLE Torchio per cartilagine	851
BRYANT Pinze per medicatura e tamponi	207	Chiave per arco per Trazione	430	COTTLE Uncino nasale	859,860
BUCHWALD Spatola per lingua	879	CLAR Lampada frontale	319,320	COTTLE Uncino nasale	856
BUCK Curetta auricolare	809,810	CHILDE Pinza per sutura	395	COTTLE Uncino nasale abbottonato / acuto	859
BUCK Forbice legature	52	CINELLI Scalpello nasale	848	COTTLE-KAZANJIAN Cesoa per ossa	520
BUCK Martello	307	CITELLI Pinza osteotomo	808, 837	COTTLE-NEIVERT Uncino per le inne nasali	859
BUCK Pinza per corpi estranei	806	CLAR Lampada frontale	319,320	COTTLE-WALSHAM Pinza per setto nasale	861
BUCK-GRAMCKO Leve per ossa	485	CLEVELAND Cesoa per ossa	520	COTTLE-WALSHAM Pinza universale	861
BUCKLEY Divaricatore	254	CLEVELAND Pinza sgorbia	512	COUPLAND Tubo per aspirazione	297,298
BUIE Pinza	179	Clip-Set MINI-Assistent completo	398	CRAFOORD Forbice	41
BULEAU Trequarto	289	CLOWARD Divaricatore	268,269	CRAFOORD Pinza emostatica	184
BULLDOG Clip vascolare	148	CLOWARD Separatore	634	CRAFOORD-SELLORS Pinza emostatica	184
BUMM Curetta uterine	749	CLOWARD Valva	268,289	CRAIG Pinza per il setto nasale	827
BUNELL Trapano a mano per ossa	417	COAKLEY Antrum Trequarto	290	CRAWFORD Divicatore	240
BUNNEL Enucleatore	496	COAKLEY Curetta	862	CRILE Divaricatore	252
BUNNEL Sonda conduttrice per tendine	497	COBB Periostotomo	472	CRILE Pinza emostatica	168
BUNT Spilla di sicurezza per sterilizzazione	925	COBB Sgorbia con manico in legno artificiale	450	CRILE Uncino	599
BURFORD Divaricatore costale	535	COGSWELL Tubo per aspirazione	292	CRILE WOOD Portaghi	361
BURKE Pinza per biopsia	741	COLLIER Portaghi	359	CRILE-MURRAY Portaghi	361
BUSCH Forbice	29	COLLIN Clamp ombelicale	758	CRILE-RANKIN Pinza emostatica	169
C					
Calibro, ALLUMINIO graduato	312	COLLIN Dinamometro	311	CRUTCHFIELD Pinza per trazione craniale	603
Calotta protettiva per Pinza	835	COLLIN Divaricatore	252,270	Cucchiaio per Medicina	936
Camicia Trequari CHAMPY	453	COLLIN Forcipe per sutura	396	Curetta per aspirazione	751
Cannule	299	COLLIN Isterometro	726	Curreta per Aspirazione	751
CAPLAN Pinza per il setto nasale	835	COLLIN Martello	454	Curreta doppio Fondo	466
Carica a cono per legatore emorroidale	685	COLLIN Pelvimetro	753	Cuscino di Gomma per Pinze YOUNG	880
Caricatore per manico con illuminazione	338	COLLIN Pinza isterolabo	733	CUSCO Specolo vaginale	706
CAROLL Goniometro	311	COLLIN Pinza per afferrare lingua	178	CUSHING Divaricatore	217,218
CAROLL Pinza per afferrare tendini	499	COLLIN Pinza per afferrare tumori	178	CUSHING Pinza anatomiche	80
CARPENTER Bisturi	891	COLLIN Pinza per lingua	880	CUSHING Pinza per chirurgia	84
CARREL Pinza emostatica	166	COLLIN Pinza per tamponi	207	CUSHING Pinza tagliente per laminectomia	650
CASPAR Chiave	627	COLLIN Specolo vaginale	707	CUSHING Punta, sola	416
CASPAR Divaricatore	629-632	COLLIN Valva centrale	271	CUSHING Uncino	613,617
CASPAR Gancio con chiusura istantanea	627, 628	COLLIN-DUVAL Pinze per afferrare	87	CUZZI Cucchiaio	757
CASPAR Pinza per laminectomia	653,654	COLLIN-LOKITTE Divaricatore	270	CZERNY Pinza per calcolo biliare curva	692
CASPAR Specolo per chirurgia	633	COLLYER Pelvimetro	753	CZERNY Pinza per collo dell'utero	732
CASPAR Uncino per esplorazione	618	Coltello per Amputazione	12,13	CZERNY Specolo	680
CASPAR Valva laterale con chiusura	627, 628	COMCO Strumento per circoncisione	702	D	
CASPAR Valva media con chiusura	629,631	CONE Pinza per cranio	604	D'ERRICO Punta, sola	416
CASTA—EDA ATRAUMA Pinza	593	Contenitore	146,147	DAHLGREN Lama di ricambio	604
CASTA—EDA Divaricatore	536	Contenitore Metallico	596	DAHMEN Osteotomo	451,452
CASTROVIEJO Blefarostato	762	Contenitore per Spazzole usate	922	DAHMEN Sgorbia	451,452
CASTROVIEJO Cannula	772	CONVERSE Bisturi nasale	838	DALE ATRAUMA Pinza	577
CASTROVIEJO Compasso	773	CONVERSE Uncino per le inne nasali	856,858	DANDY Forbice	45
CASTROVIEJO Forbice	781-784	COOLEY ATRAUMA Pinza	583-592	DANDY Pinza emostatica	167
CASTROVIEJO MICRO-Portaghi	356-358	COOLEY ATRAUMA Pinza per catetere	587	DANDY Uncino per nervi	614
CASTROVIEJO Pinza per afferrare e rompere le lamette da rasoio	14	COOLEY Dilatore	594,595	DARDIK ATRAUMA Pinza	580
CASTROVIEJO Pinza per sutura	778	COOLEY Divaricatore	245	DARTIGUES Pinza isterolabo	733
CASTROVIEJO Spatola	770,775	COOLEY Divaricatore costale	533	DAVIDSON Divaricatore	236
CASTROVIEJO Standard Portaghi	356	COOLEY Tubo per aspirazione	297	DAVIS Dissettore	616
CASTROVIEJO-BARRAQUER Spatola	769	COOLEY-BECK ATRAUMA Pinza cardiovascolare	588	DAVIS Spatole	611
Cataratta, ago	765	COOLEY-DERRA ATRAUMA Pinza	588	DAVIS-BOYLE Abassalingua con tubo	873
Catena per Set di Manicura	915	COOPER Ago per legatura	389	DAY Uncino auricolare	812
Catetere Metalicho per donne	700	Coperchio a bottone per padelle	938	DE LEE Forcipe per ostetricia	754
Catetere Metalicho per uomini	700	Coperchio per bacinelle reniformi	938	DE MARTEL Introduttore per fili sega	602
Catetere metalicho per donne	700	Coperchio per contenitore per magazzino	146	DE MARTEL-WOLFSON Porta-Pinza	672
CATLIN Coltello per amputazione	12	Coperchio per secchi per rifiuti	934,948	DE MARTEL-WOLFSON Pinza anastomosa	672
Catoccio di Plastica	907	CORDES Pinza per bronchoscopia	899	DE MARTEL-WOLFSON Serrapinza	672
CAWOOD-MINNESOTA Separatore	877	CORYLLOS Divaricatore	236	DE VILBISS Lama di ricambio	604
Cesoa per Cavi	424	Costostomo	530	DEAN Forbice	48
Cestello per Sterelizzazione	929,930	COTTLE Bisturi nasale	838	DEAVER Divaricatore	243-245
CHAPUT Pinza per afferrare tumori	178	COTTLE Elevatore forma di sella	842,843	DEAVER Forbice	25
CHARRIERE Lama da sega	411	COTTLE Elevatore forma di sella	860	DEBAKEY ATRAUMA Pinza per aorta	562-568
CHARRIERE Segna per amputazione	411	COTTLE Forbice	47	DEBAKEY ATRAUMA Pinza Bulldog	548-550
		COTTLE Lima nasale	853	DEBAKEY ATRAUMA Pinza vascolare	551-582
		COTTLE Martello	455	DEBAKEY Divaricatore	539,540
		COTTLE Osteotome	846,847		
		COTTLE Pinza per afferrare pelle	861		



Inhaltsverzeichnis

Alphabetical Index

Indice alfabético

Indice alfabético

DEBAKEY Forbice vascolare	43,44
DEBAKEY Valva laterale	539,540
DEBAKEY-DIETHRICH Pinza Bulldog	163
DEBAKEY-SATINSKY ATRAUMA Bulldog Clamp.	548
DEJERINE Martello	306
DEMEL Ago passafilo	428
DEMEL Pinza gira cavo per fili	427
DENHART Apribocca	871
DENIS-BROWNE Divaricatore	278
DENIS-BROWNE Pinza per chirurgia	87
DENIS-BROWNE Telaio, solo	278
DEPONETTE Scatola per magazzinaggio	926
DERF Portaghi	359
DERRA ATRAUMA Pinza cardiovascolare	574
DESCHAMPS Ago per legatura	390,391
DESJARDIN Pinza per preparazione	191
DESJARDINS Sonda per calcolo biliare	691
DESMARRES Divaricatore	214
DESMARRES Divaricatore per palpebra	763
DESMARRES Pinza per calazio	780
DEVILBISS Pinza per craniectomia	604
Diagnostica-Set in astuccio combinato	316
Diapason ALLUMINIO	800,802
DIEFFENBACH Pinza Bulldog	164
DIETHRICH ATRAUMA Pinza per aorta	575
DIETHRICH Forbice vascolare	43
DIETHRICH Pinza Bulldog	163
DIETHRICH-HEGEMANN Forbice vascolare	43
DINGMANN Abassalingua	875
DINGMANN Tenaglia per ossa	500
Disco di fissaggio	430
Disco protettivo	818
Distributore multiplo per fili	435
Distributore per lame	8
Distributore per punte Filiformi	434
Divaricatore	212-252
Divaricatore nasale	857
Divaricatore tracheale	213,215
DIX Strumento doppio ago / cincelo	775
DIXON-LOVELACE Pinza emostatica	169
DOUGLAS Pinze depilatoria	90,91
DOUGLAS Trequarto	289
DOYEN ATRAUMA Pinza intestinale	674
DOYEN Divaricatore addominale	234
DOYEN Forbice	27
DOYEN Gancio-Divaricatore	279
DOYEN Martello	454
DOYEN Periostotomo	475,476
DOYEN Pinza per intestino	666
DOYEN Sonda scanalata	283
DOYEN Specolo	717,720
DOYEN Tiramiomo	734
DOYEN-JANSEN (MOLT) Apribocca	871
DOYEN-STILLE Divaricatore	233
DUBOIS Forbice	28
DUEHRSEN Pinza anatomiche	80
DUEHRSEN Pinza chirurgia	85
DUPLAY Pinza per collo dell'utero	729
DUPLEX Stetoscopio	309
DUPUY-WEISS Ago per tonsille	889
DURANTE Pinza chirurgia	86
DUVAL Pinza chirurgia	87
DUVAL Pinza per intestino	665
E	
EASTMAN Specolo	709
ECHLIN Pinza sgorbia	516
EICKEN-KILLIAN Cannula nasale	865
EISELSBERG Forbice	52
Elevatore	483
Elevatore estremamente leggero	483
Elevatore per ossa	485,486
ELLIOT Manico per trapani	772
ELSÄSSER Pinza per nefrostomia	689
EMMET Uncino per fistole	734
ENGEL Segna	406
ENGL. MODELL Pinza anatomica	80
ENGL. MODELL Pinza fissare le compresse	201
EPPENDORFER Pinza per biopsia	740
ESMARCH Coltello per gessati	406
ESMARCH Fascia per ischemia	413
ESMARCH Forbice per bendaggi	404
EVES Serranodi per tonsille	895
F	
FANSLER-IVES Anoscope	683
FARABEUF Divaricatore	249
FARABEUF Periostotomo	474
FARABEUF Tenaglia per ossa	504
FARABEUF-LAMBOTTE Tenaglia per ossa	504
FARREL Portacotone	287
FARRIOR Specolo auricolare	798
Fascia Frontale di celluloido bianco	318-320
FAULKNER Curetta	862
FAURE Pinza per biopsia	738
FAURE Pinza peritoneo	195
FAVALORO Forbice vascolare	45
FEHLAND ATRAUMA Pinza rettale	678
FEILCHENFELD Pinza per schegge	90
FEIN Portacotone	287
FELDHEIM Strumento per dita	526
FERGUSON Cucchiaino	694
FERGUSON Pinza per pressione progressiva	179
FERGUSON Tenaglia per ossa	502
FERRIS-SMITH Pinza chirurgia	85
FERRIS-SMITH Pinza per laminectomia	657
FERRIS-SMITH-KERRISON Pinza tagliente	649
FERROZELL Placche per martello	455,457
FERROZELL Sonda	394,395
Filiform Candeletta	699
Filo per ossa	427
Filtro di ricambio di tessuti	927
FINOCHIETTO (mod.) Divaricatore costale	538
FINOCHIETTO BABY Divaricatore costale	534,538
FINOCHIETTO Divaricatore costale	534,538
FINOCHIETTO Forbice	42
FINOCHIETTO INFANT Divaricatore costale	534
FINOCHIETTO Pinza emostatica	192
FINOCHIETTO Portaghi	364
FINSEN Divaricatore	254
FISCH MICRO-Dissettore auricolare	796
FISCHER Sonda Enucliatore	497
FISHER Bisturi per tonsille	890
FOERSTER Pinza per spugne	208
FOMON Bisturi per plastica nasale	838
FOMON Forbice	34,47
FOMON Raspa nasale	854,855
FOMON Scalpello nasale	848
FOMON Uncino nasale	857,859
Forbice dentate per episiotomia	29
Forbice fine	40
Forbice fine per chirurgia	36,38,40
Forbice gracile per chirurgia	24
Forbice nasale con asta tubolare	834
Forbice per bendaggi	405
Forbice per chirurgia	22,23
Forbice per enterotomia	51
Forbice per enucleazione	34
Forbice per il retto	42
Forbice per incisioni	25
Forbice per nervi	32
Forbice per strabismo	38
Forbice per unghie	915
Forbice vascolare	45
FOREGGER Laringoscopio	329,335,336
FOX Curetta	912
FRAENKEL Pinza per bronchoscopia	899
FRANZ Divaricatore addominale	279
FRANZ Gancio-Divaricatore	279
FRANZ Valva	279
FRAZIER Dissettore dura-madre	614
FRAZIER Tubo per aspirazione	290
FRAZIER Uncino per dura-madre	617
FREER Bisturi	839
FREER Elevatore	841,842
FREER Scalpello	844
FREER Uncino	859
FRIEDMANN Pinza sgorbia	511
FRIEDMANN-VICKERS Pinza sgorbia	511
FRIMED Forchetta da sutura	394
FRIMED Sonda conduttrice	392
FRIMED-DIAMANT Tenaglia	424
FRIMED-VIGORIMETER Dinamometro	310
FRITSCH Divaricatore	234
FROSCH Tenaglie per ossa	502
FRYKHOLM Pinza sgorbia	517
FULLER MICRO-Pinza	791
G	
GALLAHER Raspa nasale	853
Gambo per tunnelare	596
Gancio di trazione	430
GELLHORN Pinza per biopsia	738
GELPI Divaricatore	267
GELPI-LOKITE Divaricatore	267
GEMINI Pinza per preparazione e legature	187
GERALD Pinza anatomica	80,84
GERSTER Tenaglia per ossa	419
GERZOG Martello	456
GIERTZ-STILLE Costotome	530
GIGLI Fili sega	602
GIGLI Manico	602
GILLIES Pinza per chirurgia	83
GILLIES Portaghi	366
GILLIES Uncinetto	913
GIL-VERNET Type Divaricatore	219
Giravite per Set per tunnelare	596
GLOVER ATRAUMA Bulldog Clamp	549,550
GLOVER ATRAUMA Pinza cardiovascolare	573
GLUCK Costotome	530
GOLDMANN-FOX Forbice	49
GOLDSMITH (THUDICHUM) Specolo nasale	822
GOLLET Divaricatore	251
GOMEL MICRO-Forbice	17
GOMEL Portaghi	355
Good Forbice	46
GOODELL (SIMS) Dilatatore uterino	736
GOSSET Divaricatore addominale	273
GOSSET Valva	273
GRAEFE (IRIS) Pinza per iridectomia	88
GRAEFE Cistitomo	766
GRAEFE Coltello per cataratta	764
GRAEFE Divaricatore	212
GRAEFE Pinza per iride	776
GRAEFE Uncino per strabismo	766,768
GRAHAM Uncino per dura-madre	617
GRAVE Specolo	708
GRAY Pinza per preparazione	191
GREEN-ARMYTAGE Pinza emostatica	756
GREGORY ATRAUMA Pinza per profonda	576

Inhaltsverzeichnis
Alphabetical Index
Indice alfabético
Indice alfabetico



GREGORY ATRAUMA Pinze per carotis	550	HEPP-SCHEIDEL MICRO-Forbice	17,19	JARCHO Pinza per collo dell'utero	727
GRONINGEN Uncino per nervi	613	HERRIK Pinza peduncoli renali	194	JAVID ATRAUMA Pinza per carotis	581
GROSS Cucchiaino auricolare	810	HESS Pinza Bulldog	164	JENNINGS Apribocca	876
GROSS modif. Pinza per polipi	206	HEYMANN Forbice	47	JOBSON HORNE Portacotone	287
GROSS-MAIER Pinza per polipi	206	HEYMANN Pinza nasale	827	JOHNS-HOPKINS Pinza Bulldog	164
GUEDEL-NEGUS Laringoscopia-Set	327	HEYWOOD-SMITH Pinza per afferrare polipi	686	JOHNS-HOPKINS Pinze emostatica	183
GUILLEN Raspatorio con aspiratore	865	HIBBS Osteotomo	442,443	JOHNSON Portaghi	364
GUTHRIE Divaricatore	212	HIBBS Scalpello	443	JOLL (FRIEDMANN) Divaricatore	266
GUTHRIE Uncino per fissare	767	HIBBS Sgorbia	443	JONES Pinza fissateli	201
GUYON ATRAUMA Pinze per peduncolo	193	HIBBS Sgorbia	443	JOSEPH Bisturi nasale	838
GUYON Candeletta dilatatrice	699	HIRSCHMANN Anoscopio	683,684	JOSEPH Elevator per periosto	843
GUYON Mandrino per sonda uretale	702	HOFF Pinza fissateli	203	JOSEPH Elevatore per setto nasale	841
GUYON Pinza	193	HOFFMANN Morsetto per tubi	925	JOSEPH Forbice	35
H					
HABERER Spatole addominale	253	HOHMANN Elevatore	486,487	JOSEPH Lima nasale	852
HACKSTOCK Tenaglia	421	HOHMANN-ALDINGER Elevatore per ossa	489	JOSEPH Segna nasale	851
HAIGHT Divaricatore	537	HOKE Scalpello	442	JOSEPH Uncino	859
HAJEK Martello	456	HOLINGER Laringoscopia per operazione	339	JOSEPH-MASING Elevatore	843
HAJEK Pinza tagliente	836	HOLINGER Supporto per illuminazione fibra ottica	339	JUDD-ALLIS Pinza per intestino	663
HAJEK-KOFLER Pinza tagliente	836	HOLSHER Uncino	612	JUDD-MASSON Divaricatore	697
HALLE Bisturi per dura-madre	618	HOLTH Pinza punch	773	JUDD-MASSON Valva centrale	697
HALLE Curetta tagliente	465	HOLZHEIMER Divaricatore	255	JURASZ Pinza per polipi	900
HALLE Elevatore	841	HOPKINS Coltello per gessati	406	K	
HALSEY Portaghi	359,360	HORSLEY Dissettore dura-madre	614	KABIERSKE Bottiglia di ricambio	815
HALSTED-MOSQUITO Pinza emostatica	165	HÖSEL Divaricatore	233	KADER Spatole	248
HANK Dilatatore uterino	724	HOUSE Cannula per aspirazione	294	KALLMORGAN Valva vaginale	716
HARDY Enucleatore per ipofisi	620	HOUSE Cucchiaino	797	KALLMORGEN Specolo	716
HARDY Forchetta per impiantare	620	HOUSE MICRO-Sonda per misurare	796	KALT Agoi	349
HARDY MICRO-Curetta	619	HOUSE-DIETER Pinza auricolare	790,791	KALT Portaghi	353
HARDY-FAHLBUSCH MICRO-Dissettore	620	HUBER Manico universale	898	KANE Clamp ombelicale	758
HARKEN ATRAUMA Pinza	565	HUDSON Fresca, sola	416	KANTROWITZ Pinza per preparazione	190
HARKEN Pinza vascolare	546	HUMBY Dermatomo	11	KATSCHE Tiracomodone	914
HARMS Specillo trabecolare	774	HUNT Pinza per tumore	94	KATZIN-BARRAQUER MICRO-Forbice	781
HARRINGTON Divaricatore	242	HUNTER Pinza per schegge	89	KAYE Uncino cutanei	913
HARTMANN Abassalingua	878	HURD Ago per sutura di palato destra	889	KEITH Ago	348
HARTMANN Diapason inossidabile	800,801	HURD Dissettore per tonsille	891	KELLY Divaricatore	232,247
HARTMANN Pinza auricolare	806,807	HUSFELDT ATRAUMA Pinza vascolare	579	KELLY Forbice per gengiva	48
HARTMANN Pinza emostatica	166	I			
HARTMANN Pinza nasale tagliente	829	Imbottitura frontale per fascia frontale	318, 319, 320	KELLY Pinza emostatica	168
HARTMANN Pinza per tamponamenti	826	Infirmeri -Set di manicura	915	KELLY Pinza per polipi uterino	732
HARTMANN Pinza per tonsille tagliente	897	INGE Separatore	634	KELLY Pinza per preparazione	188
HARTMANN Pinza sgorbia	512	INGLESE MODELLO Pinze anatomiche	80	KELLY Protoscope	684
HARTMANN Sonda auricolare	804	Iniettore per Cannule	343	KELLY-RANKIN Pinza emostatica	168
HARTMANN Specolo auricolare	798	IOWA Cannula	298	KELSEY-FRY Lesina per mascella	887
HARTMANN Specolo nasale	823	IOWA Pinza per collo dell'utero	730	KERN Tenaglia per ossa	503,504
HARTMANN Uncino auricolare	811	IRIS (GRAEFE) Pinza per iridectomia	88	KERRISON Pinza per laminectomia	635-656,837
HARTMANN-HALLE Specolo nasale	822	IRIS Forbice per iridectomia	37	KEVORKIAN Curetta per biopsia	737
HARTMANN-HOFFMANN Pinza cucchiaino auricolare 807		ISRAEL Divaricatore	225	KEVORKIAN Pinza per biopsia	740,742
HARTMANN-WULLSTEIN Pinza aligatore auricolare 807		ITERSON Uncino tracheali	904	KEVORKIAN-PACIFIC Pinza per biopsia	741
HAYES ATRAUMA Pinza intestinale	677	IVES-FANSLER Anoscope	683	KEYES Manico	913
HEANEY Pinza emostatica	198	J			
HEANEY Portaghi	363	JACKSON Laringoscopia	339	KEYES Trefina	913
HEANEY-BALLENTINE Pinza emostatica	198	JACKSON Specolo vaginale	709	KIELLAND Forcipe ostetrica	755
HEANEY-KANTER Pinza emostatica	199	JACKSON Supporto	339	KILLIAN Elevatore	842
HEATH Forbice	52	JACKSON Uncino tracheali	904,905	KILLIAN Pinza per tamponamenti	827
HEATH Martello	457	JACOBS Pinza per collo dell'utero	730	KILLIAN Sgorbia	845
HEBRA Cucchiaino	771	JACOBSON MICRO-Forbice	16	KILLIAN Specolo nasale	824
HEGAR Dilatatore	721-723	JACOBSON Sonda	620	KILLIAN-CLAUS Sgorbia per setto nasale	845
HEGAR Portaghi	365	JACOBSON Strumento per MICRO-chirurgia	620	KILNER Divaricatore	858
HEGENBARTH Pinze per sutura	396	JAEGER Placca per palpebre	763	KILNER Forbice	35
HEIFETZ Pinze per tumore	93	JAEGER-GRIESHABER Coltello per cataratta	764	KILNER Uncinetto	912
HEIFETZ Spatola	611	JAMESON Calibro	312	KILNER-DOUGHTY Abassalingua	872
HEIMING Pinza per calcoli renali	688	JAMISON Forbice	39	KIRK Martello	456
HEISS Pinza emostatica	181	JAMISON Portaghi	363	KIRSCHNER Arco per estensione	429,432
HEISTER Apribocca	871	JANET Siringa	304	KIRSCHNER Arco per trazione	432
HEMINGWAY Curetta	467,468	JANSEN Pinza sgorbia	512,514	KIRSCHNER Divaricatore addominale piegabile 276,277	
HENKE Dissettore per tonsille	892	JANSEN (GRUENWALD) Pinza per tamponamento 826		KIRSCHNER Gancio-Divaricatore	277
HENLEY Divaricatore	260	JANSEN Curetta auricolare	810	KIRSCHNER Punta filiforme	433,434
HENNIG Divaricatore per gessati	407	JANSEN Divaricatore	255	KIRSCHNER Sonda conduttrice	392



Inhaltsverzeichnis

Alphabetical Index

Indice alfabético

Indice alfabetico

KIRSTEIN Forbice.....	47	LANE Pinza.....	85	LORNA Pinza fissateli.....	202
KLEINERT-KUTZ Pinza per afferrare tendoni.....	499	LANE Pinza clamp stomacale.....	669	LOUTE Trenditore serra.....	427
KLIMA-ROSSEGGER Ago.....	301	LANE Pinza fissateli.....	202	LOVE Uncino per radici di nervi.....	612
KLINGENBERG-LOTH Forbice.....	41	LANE Pinze chirurgia.....	85	LOVE-GRUENWALD Pinza per laminectomia.....	651
KNAPP Coltello per occhio.....	764	LANE Tenaglia per ossa.....	506	LOVE-KERRISON Pinza tagliente.....	640
KNAPP Divaricatore.....	214,767	LANGE Pinza per bronchoscopia.....	899	LOVELACE Pinza emostatica.....	169
KNAPP-ROLLET Uncino.....	767	LANGE Uncino.....	856	LOVELACE Pinza polmonare.....	545
KNIGHT Pinza nasale.....	827	LANGE-HOHMANN Elevatore per ossa.....	488	LOWER Pinza emostatica.....	192
KNOWLES Forbice.....	402	LANGENBECK Elevatore per ossa.....	482,484	LOWMAN Tenaglia per ossa.....	418
KNUTSON Strumento per uretrografia.....	702	LANGENBECK Curetta.....	809	LOWMAN-HOGLUND Tenaglia per ossa.....	419
KNUTSON-KOCH Cannula.....	702	LANGENBECK Diletatore tracheotomia.....	809	LOWMAN-LAMBERT Tenaglia per ossa.....	419
KOCHER (OCHSNER) Pinza emostatica.....	175,176	LANGENBECK Divaricatore.....	225-228	LUBET-BARBON Pinza per tamponamenti.....	826
KOCHER ATRAUMA Pinza intestinale.....	675	LANGENBECK Elevatore.....	482,484	LUC Pinza Nasale tagliente.....	828
KOCHER Divaricatore.....	223-234	LANGENBECK Periostotomo.....	473	LUCAE Diapason con piede.....	802
KOCHER Divaricatore vescicale.....	698	LANGENBECK Protettore.....	870	LUCAE Martello, acciaio massiccio.....	454
KOCHER Pinza intestinale.....	667	LANGENBECK Sega.....	411	LUCAE Pinza auricolare.....	805
KOCHER Pinze emostatica.....	174	LANGENBECK Tenaglia per ossa.....	502	LUCAE Uncino auricolare.....	812
KOCHER Sonda per gozzo.....	909	LANGENBECK-GREEN Divaricatore.....	216	Lucignolo di ricambio per lampade a spirito.....	939
KOCHER-LANGENBECK Divaricatore.....	228	LARBORDE Diletatore tracheotomia.....	903	LUER Adattatore per Set per tunnelare.....	596
KOERTE Divaricatore.....	224	LARINGEO Specchio con manico.....	902	LUER Canulla Tracheale argentone.....	906
KOGAN Endospecolo.....	735	Laringoscopio per operazione.....	340-342	LUER Cilindro.....	303
KÖLNER Agrafe.....	606	LAWRENCE Pinae emostatiche disezioni e legature.....	190	LUER Divaricatore.....	252
KÖNIG Diapason.....	803	LAZAR MICRO-Pinza per legature.....	96	LUER Pinza per emorroidi.....	686
KÖNIG Sonda.....	392,393	LEBSCHÉ Scalpello sterno.....	532	LUER Pinza sgorbia.....	513
KOOS Strumento per MICRO-Chirurgia.....	621	LEES ATRAUMA Pinza cardiovascolare.....	566	LUER Siringa.....	303
KRAUSE Pinza per bronchoscopia.....	899	LEGUEU Divaricatore vescicale.....	698	LUER Uncino tracheali doppio.....	904
KRAUSE Serranodi.....	804	LEGUEU Valva centrale.....	698	LUER-KOERTE Cucchiaino per calcolo biliare.....	693
KRAUSE Serranodi per polipi.....	825	LEGUEU Valva laterale.....	698	LUER-LOCK Ago della siringa.....	772
KRAUSE Trequarto.....	289	LEKSELL-STILLE Pinza sgorbia.....	517	LUER-LOCK Cilindro.....	303,304
KRAUSE-VOSS Serranodi auricolare.....	825	LELAND-JONES ATRAUMA Pinza vascolare.....	558	LUER-LOCK Raccordo.....	302
KRAUSE-VOSS Serranodi nasale.....	804	LEMPERT Curetta auricolare acuta.....	814	LUER-LOCK Rubinetto.....	302
KRAYENBÜHL Uncino.....	618	LEMPERT Elevatore auricolare.....	814	LUER-LOCK Siringa.....	303
KRESSNER Pinza.....	861	LEMPERT Pinza sgorbia.....	513	LUER-LOCK Siringa per vescica e ferite.....	304
KRISTELLER Specolo.....	711-715	LEMPERT Tubo per aspirazione.....	291	LUKENS Divaricatore per timo, doppio.....	905
KROENLEIN Pinze.....	167	LERCHE Pinza chirurgia.....	83	LUNIATSCHEK Tamponatore.....	893
KRONECKER Ago.....	389	LERICHE Pinza emostatica.....	167		
KUEMMEL Spatole.....	248	LESTER Pinza dentata.....	778		
		LEWIN Tenaglia per ossa.....	501		
L		LEWIS Raspa nasale.....	854	M	
LA FORCE Adenotomo.....	864	LEXER Forbice.....	32	MAGILL Pinza per cannule.....	324
LA GRANGE Forbice.....	49	LEXER Osteotomo.....	447	MAGILL Tubo per aspirazione.....	293
Laccio di filo aperti.....	895	LEXER Sgorbia.....	447,448	MAINGOT Pinza per isterectomia.....	199
Laccio di filo di Metallo per serradoni.....	804,825	LEXER-BABY Forbice.....	32	MALTZ Raspa nasale.....	852
Laccio per corpi strani e calamita.....	766	LEXER-FINO Forbice.....	33	Mandrino con manico forma-T completo.....	416
LAHEY Divaricatore.....	227	LEYLA Base die fissaggio.....	607, 608	Manico a pila (senza pila) per laringoscopi.....	330,337
LAHEY Pinza emostatica.....	192	LEYLA Braccio flessibile.....	607, 608, 609	Manico a pila (senza pila) per laringoscopi di luce fredda.....	337
LAHEY Pinza per gozzo.....	910	LEYLA Giunto a sfera ad incastro.....	609, 610	Manico con illuminazione LED per laringoscopi di luce fredda.....	338
Lama di ricambio.....	11	LEYLA Porta asta per il fissaggio.....	609, 610	Manico di Ferrozell per lame.....	445
Lama di ricambio per sega per aprire anelli.....	527	LEYLA Retrattore cervicale.....	607,609	Manico laringei	902
Lama di sega per sega oscillante.....	408	LEYLA Supporto per spatola cervicale.....	607, 608	Manico per bisturi	5,6
Lama per bisturi sterile.....	7,8	LEYLA Testa accoppiamento.....	609, 610	Manico per stripper anello.....	286
Lama per Osteotomo.....	445	LICHTENBERG Portaghi.....	367	Manico piatto, per ottica	820, 868
Lama per Scalpello intercambiabile.....	445	LICHTWITZ Trequarto per seno masscellare.....	289	Manico universale per Set per tunnelare	596
Lama ricambio, forata, per Coltello LA FORCE.....	864	Lima per ossa.....	481	Mano di Piombo per adulti	525
Lama, sola sterile.....	7	Lima per unghie.....	917	Mano di Piombo per bambini	525
Lamatta di rasoio.....	14	Lima per unghie.....	917	Manometro con pallone in gomma, solo	323
LAMBERT Pinza.....	780	LISTER (sinus) Pinza per medicatura e tamponi.....	207	Manometro con scala luminosa, solo	752
LAMBERT-KAY ATRAUMA Pinza.....	567	LISTER Forbice per bendaggi.....	400-402	Manometro per apparecchio di compressione	412
LAMBOTTE Osteotomo.....	440	LISTON Cesioia per ossa.....	519	MARKWALDER Cesioia per ossa.....	520
LAMBOTTE Periostotomo.....	476	LISTON Coltello per amputazione.....	12	MARQUARDT Pinza sgorbia.....	515
LAMBOTTE Tenaglia per ossa.....	505	LISTON-KEY Cesioia per ossa.....	524	MARTEL Pinza emostatica.....	179
Lampade a spirito.....	939	LITTAUER Forbice legature.....	52	Martello	454-459
Lampadina di ricambio per lampade frontali.....	319, 320	LITTAUER Pinza depilatoria.....	90	Martello con manico in plastica	458,459
Lampadina di ricambio per laringoscopi.....	330,337	LITTAUER Pinza per polipi auricolare.....	806	Martello di metallo con manico in legno	459
LANDAU Specolo vaginale.....	720	LITTLE Divaricatore.....	227	Martello di metallo con manico in plastico	459
LANDAU Trequarto.....	290	LITTLEWOOD Pinza per intestino.....	664	Martello in Legno artificiale	458
LANDOLT Forbice.....	35	LLOYD-DAVIS Forbice vascolare.....	41	Martello senza rinculo con manico	458
LANDOLT Pinza.....	655	LOCKHARD-MUMMERY Sonda scanalata.....	283,284	Martello, ALLUMINIO	457
LANDOLT Tubo per aspirazione.....	292	LOCKLIN Forbice.....	48	MARTIN ATRAUMA Pinza vascolare periferale.....	578
LANDOLT-CUSHING Speculo.....	619	LOCKWOOD-ALLIS Pinza per affare intestino.....	663	MARTIN Distributore per spazzole.....	920
		LOGAN Divaricatore.....	254	MARTIN Divaricatore.....	235
		LORENZ Forbice per bendaggi.....	403	MARTIN Isterometro grad. malleabile.....	726



MARTIN MOD. Lame di ricambio per Seghe	527	MEYERDING Divaricatore.....	215,243	MOSQUITO-DANDY Pinza emostatica.....	167
MARTIN Pelvimetro con scala in cm.....	753	MEYHOEFER Cucchiaino per calazio	771	MOSQUITO-DEBAKEY ATRAUMA Pinza vascolare	551
MARTIN Set per tunnelare completo	596	MGH-MASS-GENERAL-HOSPITAL Portaghi.....	361	MOYNIHAN Pinza per isterectomia	196
MARTIN Tenaglia per ossa	500	MICHEL Agrafes per sutura	397	MOYNIHAN Sonda con cucchiaino	691
MARTINI Curetta doppio fondo	467	MICHEL Forcipe per sutura	396	MÜLLER Approssimatore	154
MARTIN-IDEAL Perforatore per unghie	526	MICHEL MOD. Forcipe per sutura	396	MÜLLER Clip vascolare	152
MARTIN-VICKERS Fissatore per mano	525	MICHEL Pinza per sutura	395	MÜLLER-VERBRUGGE Elevatore per ossa	489
MASING Scalpello per setto nasale doppio	843	MICHEL Specchio laringeo	902	MURPHY-LANE Leva per lussazione.....	491
MASSON Portaghi	363	MICRO-ADSON Pinza emostatica	182	MUSEUX Pinza per collo dell'utero	730
MASTIN Pinza muscolare.....	910	MICRO-Curetta tagliente	622		
MATHIEU Divaricatore	251	MICRO-Elevatore	483	N	
MATHIEU Pinza per corpi estranei	703	MICRO-Forbice	17	NABATOFF Manico, solo	285
MATHIEU Portaghi	367	MICRO-Forbice nasale	834	NABATOFF Oliva	285
MATHIEU Specolo rettale.....	682	MICRO-Forbice oculistiche	781	NABATOFF Punta di sonda in materia plastica	285
MATHIEU Specolo vaginale	717	MICRO-Forbice per preparazione	16,17,19	NABATOFF Scatola in metallo, sola.....	285
MATHIEU Valva vaginale	717	MICRO-Forbice vascolare	18	NABATOFF Set di sonde per varici	285
MATHIEU-RYDER Portaghi	367	MICRO-MOSQUITO Pinza emostatica	166	NAEGELE Forcipe ostetrica	755
MATSON Periototomo costale, doppio fino.....	478	MICRO-Periototomo per ipofisi	622	NAGER Retrattore per tonsille	893
MAUNDER Apribocca di legno	870	MICRO-Pinza	91,92	NELATON Sonda scanalata	283
MAYFIELD Pinza sgorbia	514	MICRO-Pinza auricolare	786,787	NEFF Meniscotomo	495
MAYO Cucchiaino per calcolo biliare	694	MICRO-Pinza auricolare, cucchiaino	788	NEGUS Pinza per tonsille	191
MAYO Cucchiaino per calcolo biliare graduato.....	691	MICRO-Pinza con asta tubolare	901	NEGUS Supporto per petto	872
MAYO Forbice	25	MICRO-Pinza per ipofisi	623	NEIVERT Portaghi	360
MAYO Spillo di Sicurezza per sterilizzazione	925	MICRO-Pinza per legature	95,96	NEIVERT Uncino per pinne nasale	860
MAYO-ADAMS Divaricatore	266	MICRO-Pinza per Neurochirurgia	658,659	NEIVERT-ANDERSON Osteotomo.....	848
MAYO-BLAKE Pinza per calcolo biliare	692	MICRO-Portaghi	355	NELSON Pinza per afferrare	87
MAYO-HARRINGTON Forbice	26	MICRO-Uncino auricolare	794,795	NELSON Trequarto	288
MAYO-HEGAR Portaghi	362,365	MICRO-Uncino per ipofisi	622	NEUMANN Forbice	49
MAYO-NOBLE Forbice	27	MIDDELTON-JANSEN Pinza per il setto	835	NICOLA MICRO-Forbice.....	659
MAYO-ROBSON ATRAUMA Pinza intestinale.....	675	MIDDELTORPF Divaricatore	231,234	NICOLA MICRO-Pinza, forma cucchiaino	659
MAYO-ROBSON Pinza pintestinale	667	MIDDELTON-JANSEN Pinza per il setto	835	NORFOLK AND NORWICH Divaricatore	265
MAYO-STILLE Forbice	26	MIKULICZ Divaricatore	246	NORTHBENT Forbice per legature.....	52
MC DONALD Elevatore doppio	484	MIKULICZ Pinza	195,197	NOTO Pinza per polipi uterini	732
MC GEE MICRO-Pinza auricolare	790	MIKULICZ Pinza per tonsille.....	894	NOVAK Curetta per biopsia	737
MC GEE MICRO-Uncino auricolare	794	MIKULICZ Pinza peritoneo	195	NOYES Forbice per iridectomia	782
MC GIVNEY Legatore emorroidale.....	685	MILLER Laringoscopio ed accessori.....	325-332	NUGENT Pinza per sutura	779
MC GIVNEY Pinza per emorroidi	686	MILLER-COLBURN Curetta doppio fondo	468	NUSSBAUM Pinza clamp stomacale	670
MC INDOE Cesoaia per ossa	521	MILLER-COLBURN Lima per ossa	479,480		
MC INDOE Forbice vascolare	45	MILLIGAN Dissettore dura-madre	614	O	
MC INDOE Pinza anatomiche	79	MILLIGAN Divaricatore smusso	259	O'BRIAN Forbice	38
MC INTOSH Spatola per laringoscopia	328-336	MILLIN ATRAUMA Pinza per afferrare capsule	696	O'CONNOR Divaricatore	212
MC IVOR Abassalingua	874	MILLIN Divaricatore per collo vescicale	696	O'SULLIVAN- O'CONNOR Divaricatore addominale	276
MC IVOR Apribocca completo	874	MILLIN Divaricatore per collo vescicale	697	O'SULLIVAN- O'CONNOR Telaio, solo	276
MC IVOR Telaio per apribocca	874	MILLIN Pinza porta-filo forma-U	696	O'SULLIVAN- O'CONNOR Valva	276
MC KENTY Elevatore per setto nasale.....	841,842	MILLIN Supporto per luce fredda	697	OBWEGESER Elevatore doppio.....	885
MC KENZIE Agrafe di argento	605	MILLIN Telaio solo	697	OBWEGESER Elevatore per periosteo.....	884
MC KENZIE Pinza per applicare agrafe	605	MILLIN Valva centrale	697	OBWEGESER Guancio per mento	883
MC KENZIE Porta-agrafe	605	MILLIN Valve laterale	697	OBWEGESER Lesina	886
MC KENZIE Punta a spirale	416	MINI-FRIEDMANN Pinza sgorbia	511	OBWEGESER Osteotomo	885,886
MC QUIGG-MIXTER Pinza per preparazione.....	192	MINI-GEMINI Punta per preparazione e legature.....	186	OBWEGESER Separatore	881
MCLEAN-LUIKART Forcipe ostetrica	755	MINI-HOHMANN Elevatore per ossa	485	OBWEGESER Separatore mandibulare.....	883
MCLEAN-TUCKER Forcipe ostetrica	755	MINI-LAMBOTTE Osteotomo	440	OBWEGESER Separatore per ramo	882
MEAD Martello con placche in plastica	455	MINI-LANGENBECK Divaricatore	214	OCHSNER ATRAUMA Pinza per aorta	575
MEAD Martello con placche in plastica.....	457	MINI-LEXER Scalpello	446	OCHSNER Trequarto	289
MEAD Pinza sgorbia	512	MINI-MC GEE Pinza alligatore auricolare	787	Oftalmologia-Set completo in astuccio	315
MEDHORN Clip vascolare	150	MINI-ROUX Divaricatore	250	OLDBERG Pinza tagliente per laminectomia	655
MEEKER Pinza per preparazione e legature	189	MINI-TOWNSEND (BABY-TISCHLER) Pinza per biopsia.....	742	Oliva	596
MEHDORN Applicatore per Clips vascolari.....	150	MINI-TOWNSEND (BABY-TISCHLER) Punta per biopsia.....	742	Oliva in metallo, sola	818
MELLINGER Blefarostato	762	MINI-TOWNSEND Pinza per biopsia	741	OLIVECRONA Dissettore dura-madre	616
MELLINGER-AXENFELD Blefarostato.....	762	MIXTER Pinza emostatica.....	190-192	OLIVECRONA Fili sega	602
MENGHINI Ago per puntura	299	MIXTER Pinza per calcolo biliare	693	OLIVECRONA Forbice	46
Meniscotomo	496	MIXTER-BABY Pinza emostatica	181	OLIVECRONA Spatola	611
MERCEDES Divaricatore per il torace, completo	542	MIXTER-CRAFOORD Pinza emostatica	184	OLIVECRONA-TOENNIS Pinza per applicare agrafe in argento.....	605
MERCEDES Divaricatore, solo	542	MIXTER-O' SHAUGNESSY Pinza emostatica	190	OLLIER Divaricatore	224
MERCEDES Valva laterale, solo paio.....	542	MOELTGEN Goniometro p. membra	311	OLSEN-HEGAR Portaghi	366
METHOT Distributore di cotone	937	MOEN Strumento per circoncisione	702	OMBREDANNE Martello, acciaio massiccio.....	457
METHOT Portarifiuti di cotone	937	MOHR Morsetto per tubo	925	Ophtalmoscopio, lampadina di ricambio	317
METZENBAUM Forbice	30-34	MOLDENHAUER Leva per corpi estranei.....	811	Ophtalmoscopio, testa con lampadina	317
METZENBAUM Portaghi	361	MOLLISON Divaricatore	258	OTIS Coltello di ricambio per Uretrotomo	701
METZENBAUM-NELSON Forbice	31	MOORE Cucchiaino per calcolo biliare.....	694		
MEYER Sgorbia per corpi estranei	766	MORRIS Divicatore	242		
		MORSE-FAVALORO Divaricatore per sterno.....	541		



Inhaltsverzeichnis

Alphabetical Index

Indice alfabético

Indice alfabetico

Otoscoopia-Set in astuccio completo	314
OtoscoPIO, lampadina di ricambio	317
OtoscoPIO, testa con lampadina alogena	317
Ottica, rigida	819,820,868
Otturatore per Strumento CHAMPY	453
OVERHOLT Pinza per preparazioni e legature	185
OVERHOLT-GEISSENDOERFER Pinza per preparazioni e legature	185
OVERHOLT-MIXTER Pinza emostatica	183

P

Padelle con coperchio a bottone e manico	938
PARKER Divaricatore	250
PARKER-LANGENBECK Divaricatore	251
PARKES Scalpello nasale	850
PARTSCH Martello ripieno di piombo	455
PARTSCH Sgorbia	438,439
PAYR Agho vascolare	349
PAYR Pinza-clamp per intestino e stomaco	671
PAYR Sonda conduttrice	393
PAYR-BABY Pinza-clamp per intestino e stomaco	671
PEAN Pinz per tubo	204
PEAN Pinza emostatica fina	171
PEAN-DEBAKEY ATRAUMA Pinza cardiovascolare	552,553
PEDERSON Specolo	708
PEERS-BERTRAM Pinza fissateli	203
PEET Pinza per schegge	100
PELTESON Portacotone	287
PENFELD Dissettore dura-madre	615
PENNINGTON Elevatore	842
PENNINGTON Pinze	178
PERCY Retrattore per amputazione	413
Perforatore per unghie	526
Periostotomo con manico in legno	469-475
PERTHES Punteruolo	414
PESTALOZZA Cucchiaino per aborto	758
Pezzo di collegamento	751
PHANEUF Pinza per isterectomia	196
PIERCE Trequarto	289
PINARD StetoscoPIO	308
Pinza anatomica fina	89
Pinza anatomica con dissezione	78-80
Pinza ATRAUMA per afferare organi	673
Pinza ATRAUMA per posizionare Clamps Bulldog	549
Pinza Bulldog	160
Pinza depilatoria	90
Pinza fissateli	203
Pinza per afferare tendini	498
Pinza per afferare tendini	498
Pinza per chirurgia	81-88
Pinza per collo dell utero	731
Pinza per distribuire lame die bisturi	8
Pinza per fissare le compresse	201-203
Pinza per frammento osseo	502
Pinza per il setto nasale	827
Pinze per rifiuti	948
Pinza per riposizione	501
Pinza per riposizione con cremagliera lunga	501
Pinza per rompere lamette	14
Pinza per schegge	90
Pinza per strumenti sterilizzati	924
Pinza per trazione craniale	603
Pinza per tubi	205
Pinza per tubi	205
Pinza-Coperchio en contenitore	923
PIPER Forcipe ostetrica	755
PITHA Apribocca, silicena con catena	870
Placca di ricambio in legno artificiale	459
Placca per stendere la pelle, sola	11
PLESTER Coltello per lobi	792
PLESTER Divaricatore	258

PLESTER Tubo per aspirazione	291
POLITZER Ago per timpano	813
POLITZER Cono di connessione	816
POLITZER Insoffiatore d'aria completo	816
POLITZER Oliva auricolare	816
POLLOSON Divaricatore	241
Pompa aria per apparecchio di compressione	412
POOLE Tubo per aspirazione	296
Porta-laringoscPIO con supporto sternale	342
Porta-laringoscPIO, solo	342
Porta-llegature per RUMEL-BELMONT	599
POTTS ATRAUMA Pinza cardiovascolare	554-556,570
POTTS DE MARTEL Forbice vascolare	44
POTTS MICRO-Forbice	16
POTTS-GLOVER ATRAUMA Pinza vascolare	556
POTTS-SMITH Forbice vascolare	44
POTTS-SMITH Pinza anatomica	79
POTTS-SMITH Pinza per chirurgia	84
POZZI Pinza per collo dell utero	728
PRATT Dilatatore uterino doppio	725
PRATT Pinza emostatica	179
PRATT Pinza per collo dell utero	731
PRATT Specolo rettale	681
PRATT Uncino rettale	684
PRESBYTERIAN Pinza per tubi	204
PRICE-THOMAS Pinza per bronchi	544
PRINCE Forbice	46
PROVIDENCE-HOSPITAL Pinza emostatica	167
Punta conica, sola	818
Punta di ricambio, sola	603
Punta filettata, sola	818
Punta Oliva, sola	818
Punteruolo	414
Punzone	444
PUTTI Raspa per ossa	482

Q

QUERVIAN Elevatore	484
QUINBY Forbice	49
QUINKE Ago per puntura lombale	299
QUIRE Leva per corpi estranei	806

R

RABINER Martello	307
RADOLF Pinza per la cerazione delle unghie	527
RAGNELL Divaricatore	216
RAGNELL-DAVIS Divaricatore	216
RALK (VIRTUS) Pinza per schegge	100
RALK Trapano a mano per ossa	417
RAMPLEY Pinza per spugne	207,209
RAMSEY Pinza anatomica	80
RAMSEY Pinza per chirurgia	86
RANDALL Curetta per biopsia	737
RANDALL Pinza per calcoli renali	687,688
RANEY Agrafe emostatica per cuoio capelluto	606
RANEY Pinza per applicare e togliere le graffe	606
RANKIN-DEBAKEY ATRAUMA Pinza vascolare	551
RAY Curetta per ipofisi	619
RECAMIER Curetta uterina	745,746,749
Recipiente Metallico	934
REDON Ago conduttore	298
REICHERT Depressore per epiglottide	900
REIL MICRO-Forbice	19
REINER Coltello per gesso	406
REINER Siringa auricolare completa	817
RESANO ATRAUMA Pinza anastomosi retтали	679
RESANO Forbice	42
Retrattore per ginocchio	492,493
REVERDIN Ago	387

REVERDIN Spatola addominale	253
REYNOLDS Forbice per disezione	39
RIBBON Spatola addominale	253
RICARD Divaricatore addominale	272
RICARD Valva centrale, sola	271
RICARD Valva laterale, sola	271
RICHARDSON Divaricatore	232
RICHARDSON-EASTMAN Divaricatore	232
RICHTER Divaricatore autostatico	265
RICHTER-HEATH Forcipe per sutura	396
Riga graduata in mm e pollici	313
RIGBY Divaricatore	266
RITTER-HALLE Dilatatore per il seno	865
ROBB Dissettore vascolare	598
ROBERTS Pinza emostatica	183
ROBIN Pinza per fissare le compresse	203
ROBIN-MASS Valva centrale, sola	271
ROCHARD Dispositivo di fissaggio	280
ROCHARD Gancio-divaricatore	280
ROCHARD Telaio di supporto per tavolo	280
ROCHESTER-CARMALT Pinza emostatica	180
ROCHESTER-PEAN Pinza emostatica	172,173
RÖDER Porta-ligatura	895
ROEDER Pinza fissateli	202
ROGER Elevatore per periostio	843
ROGERS ATRAUMA Pinza per isterectomia	200
ROGGE Pinza per strumenti sterilizzati	924
ROLLET Divaricatore	767
ROSE Uncino tracheale	904
ROSEN Ago auricolare	794
ROSEN MICRO-Coltello circolare	792
ROSEN MICRO-Raspatore auricolare	796
ROSENBERG Pinza per broncoscopia	899
ROSER-KÖNIG Apribocca	871
ROSS Divicatore per aorta	240
ROUX Divaricatore	249
ROWE Pinza per riposizione	888
RUBIN Osteotomo	847
RUBIN Pinza per il setto nasale	835
RUDD Legatore emorroidale	685
RUMEL Pinza per preparazione e legature	186
RUMEL-BELMONT Tornichette	599
RUSKIN Cesoaia per ossa	521
RUSKIN Pinza sgorbia	515
RUSS-MODELL Pinza per chirurgia	86
RUST Lama di ricambio	410
RUST Sega per amputazione	410
RYDEL-SEIFFERT Diapason con piede	802

S

SAALFELD Tiracomedone	914
SACHS Dissettore dura-madre	614
SACHS Uncino per dura-madre	617
SAENGER Pinza per placenta	756
SAMMII Pinza per tumore	94
SANTULLI ATRAUMA Pinza Bulldog	550
SANVENERO Forbice	36
SAROT Pinza emostatica	184
SATINSKY ATRAUMA Pinza vascolare	564
SATINSKY Forbice vascolare	41
SATINSKY Pinza per anastomosi	545,546
SATTERLEE Lama di sega, sola	411
SATTERLEE Sega per amputazione	411
SAUERBRUCH Costotomo	530
SAUERBRUCH Divaricatore	229
SAUERBRUCH Divaricatore	236
SAUERBRUCH Pinza per rifiuti	948
SAUERBRUCH Pinza sgorbia	518
SCALP-CONTOUR Divaricatore	256
Scalpello	438

Inhaltsverzeichnis
Alphabetical Index
Indice alfabético
Indice alfabetico



Scalpello con manico in legno artificiale	448,449	SEMM Gancio-divaricatore	278	STACKE Sonda auricolare	282
Scatola per aghi	350-352	SEMM Specolo vaginale	708	STAMMBERGER Pinza tagliente per seno	833
Scatola per magazzino	927	SEMM Telaio solo	278	STAUE-MOORE Pinza per collo dell'utero	727
Scatola per strumenti	935	SENN-GREEN Divaricatore	216	STEINMANN Chiodo per ossa	432
Scatola rotonda metallica	936	SENN-MILLER Divaricatore	217	STEINMANN Pinza per afferrare tendine	498
SCHAEDEL Pinza fissateli	201	Separatore per guancia con valva flessibile	877	STELLBRINK Pinza sgorbia	511
SCHAMBERG Tiracomedone	914	SERPENTINE-GRASPER Pinza intra-uterina flessibile	743	STELZNER Forbice vascolare	41
SCHUDE Curetta tagliente	461	Set con 3 punte per ghiaccia unghie	526	STERNBERG Separatore per labbra	877
SCHIEBE ATRAUMA Pinza per afferrare organi	673	Set di ricambio per TC-Tenaglie taglafili	426	STEVENS Forbice	38
SCHNEIMANN Pinza per broncoscopia	899	Set di spazzole per pulire	944	STEVENS Pinza per iride	776
SCHERBAK Manico per specolo vaginale	718	Set per sutura in astuccio metallico	397	STIEGLITZ Pinza per schegge	100
SCHERBAK Peso per specolo vaginale, solo	718	Set per tracheotomia completo	907,908	STILLE Forbice per gesso	405
SCHERBAK Specolo completo	718	SEUTIN Forbice per bendaggio	405	STILLE Fresca per Trapano	415
SCHERBAK Valva	718	SEYFFERT Specolo vaginale	708	STILLE Osteotom	439
SCHINK Dermatomo	11	Sfigmomanometro	322	STILLE Pinza chirurgia	82
SCHIOETZ Tonometro	762	Sfigmomanometro, modello murale	323	STILLE Pinza per calcolo biliare	693
SCHMEDE Pinza nasale tagliente	829	Sgorbia	438	STILLE Pinza per chirurgia	82
SCHMED Ago vascolare	300	SHAAF Pinza depilatoria	90	STILLE Pinza per peduncoli renali	194
SCHMIEDEN Ago per legatura	388	SHAPLEIGH Curetta auricolare	809	STILLE Pinza sgorbia	515
SCHMIEDEN Sonda conduttrice	393	SHEA MICRO-Uncino	795	STILLE Punta a spirale per trapano	415
SCHMIEDEN-DICK Ago per legatura	388	SHEEHAN Osteotome	849	STILLE Scalpello	439
SCHMIEDEN-PAYR Sonda conduttrice	393	SIEBENMANN Catetere per lavaggio	865	STILLE Trapano a mano	415
SCHMIEDEN-TAYLOR Forbice dura-madre	45	SIEBOLD Forbice per ginecologia	23	STILLE-BARRAYA Pinze per chirurgia	85
SCHNIDT Pinza emostatica	182	SILVER Dermatomo	11	STILLE-LISTON Cesoaia per ossa	523
SCHNIDT Pinza per tonsille	894	SILVER Scalpello nasale	850	STILLE-LISTON Cesoaia per ossa	522,523
SCHROEDER Divaricatore per ghiandola	905	SIMON cucchiaino uterino	744	STILLE-LUER Pinza sgorbia	517,518
SCHROEDER Cucchiaino uterino	744	SIMON Curetta tagliente	464	STILLE-RUSKIN Pinza sgorbia	516
SCHROEDER Pinza per collo dell'utero	728	SIMON Divaricatore	235	STOCKMANN Serrapene	703
SCHUBERT Pinza per biopsia	738	SIMON Uncino per fistole	734	STONE Pinza per chirurgia	83
SCHUKNECHT Cannula per aspirazione	294	SIMPLEX Separatore per labbra	877	STRANDELL-STILLE Divaricatore	219
SCHUKNECHT Coltello falcato	792	SIMPSON Forcipe ostetrica	754	STRATTE Portaghi	365
SCHUKNECHT Coltello rotondo	792	SIMPSON-BRAUN Forcipe ostetrica	754	STRAUSS Serrapene	703
SCHUKNECHT Divaricatore	259	SIMS Isterometro	726	STRUEMPEL Pinza per polipi auricolare	807
SCHUKNECHT Tubo per aspirazione	294	SIMS Curetta uteina	747,748	STRULLY Forbice	45
SCHULTZE Salpingografo completo	752	SIMS Forbice	28	Strumento doppio	775
SCHULZE-BERGMANN Specolo rettale	682	SIMS Specolo rettale	680	Strumento tenditore	432
SCHUMACHER Forbice ombelicale	29	SIMS Specolo vaginale	710	STRUYCKEN Pinza nasale tagliente	830
SCHUMACHER Perno per biopsia, solo	743	SIMS-MAIER Pinza per medicatura e tamponi	207	Stuoia in silicone	928
SCHUMACHER Pinza per biopsia	740,743	SINGLEY-TUTTLE Pinza per dissezione	87	SUBRAMANIAN ATRAUMA Pinza per aorta	582
SCHUMACHER Pinza per broncoscopia	899	Siringa auricolare	818	SUPERCUT COTTLE Forbice	70
SCHWARTZ Applicatore per Clips vascolari	153	SKENE Pinza per collo dell'utero	729	SUPERCUT DIETHRICH Forbice vascolare	71
SCHWARTZ Clip vascolare	153	SLUDDER-BALLENGER Manico, solo	896	SUPERCUT FOMON Forbice	70
Scodella per soluzione	932	SLUDDER-BALLENGER Punta, sola	896	SUPERCUT Forbice per chirurgia	66
Scodella rotonda	931	SMELLIE Spezzacrano	758	SUPERCUT Forbice per episiotomia	69
SCOVILLE Curetta tagliente	463	SMILLIE Meniscotomo	494	SUPERCUT Forbice per iridectomia	72
SCOVILLE Divaricatore	624	SMILLIE Retrattore per ginocchio	493	SUPERCUT Forbice per strabismo	68
SCOVILLE Gancio per divaricatore	624, 625	SMITH-BUIE Divaricatore rettale	682	SUPERCUT FREEMANN-GORNEY Forbice	75
SCOVILLE Telaio solo	624	SMITH-PETERSEN Osteotomo	441	SUPERCUT FREEMANN-KAYE Forbice	75
SCOVILLE Uncino per radici di nervi	612	SMITH-PETERSEN Sgorbia	441	SUPERCUT GOLDMANN-FOX Forbice	73
SCOVILLE Valve laterale per divaricatore	624, 625	SNELLEN Pinza entropio	779	SUPERCUT GORNEY Forbice	74
SCOVILLE-HAVERFIELD Telaio con braccio	624	SOMER Pinza afferrare l'utero	733	SUPERCUT HEYMANN Forbice	70
SCUDDER ATRAUMA Pinza intestinale	676	Sonda bottonuta	282	SUPERCUT JAMESON Forbice dissezione	74
SCUDDER Pinza per intestino	668	Sonda scanalata bottonuta	282,283	SUPERCUT JOSEPH Forbice curve 14,0 cm	72
SEBILEAU Elevatore	484	Sonda, FERROZELL	394,395	SUPERCUT JOSEPH Forbice rette 14,0 cm	72
Secchio per rifiuti	948	Spatola flessibile, scannalato	611	SUPERCUT KAYE FACE LIFT Forbice curve	74
SEDILLOT Periostotomo	474	Spatola per intima	598	SUPERCUT KAYE FACE LIFT Forbice curve	74
Sega oscillante per gesso	408	Spatola per lingua	879	SUPERCUT KELLY Forbice	72
Sega per aprire anelli	527	Spatole addominali malleabili	253	SUPERCUT LEXER Forbice	68
SEGOND Bisturi per fibromi	2	Spatole telescopico per laringoscopia	331	SUPERCUT LISTER Forbice	75
SEGOND Hysterectomy Forceps	197	Spazzole per pulire	907,943-947	SUPERCUT MAYO Forbice	66
SEGOND-LANDAU Hysterectomy Forceps	197	Specchio laringeo	902	SUPERCUT MAYO-STILLE Forbice	66
SEIFFERT Pinza per broncoscopia	899	Specolo auricolare	317	SUPERCUT METZENBAUM Forbice rette	67
SELLHEIM Leva ostetrica	756	Specolo Laterale vaginale	736	SUPERCUT METZENBAUM-FINO Forbice	68
SEMB Cesoaia per ossa	524	SPENCER Forbic per legature	52	SUPERCUT METZENBAUM-NELSON Forbice	67
SEMB Periostotomo	477	SPENCER-WELLS Pinza emostatica	170	SUPERCUT PAR-TYPE Forbice	74
SEMB Pinza per bronchi	544	SPRATT Curetta tagliente	462	SUPERCUT POTTS-SMITH Forbice vascolare	71
SEMB Pinza sgorbia	515	Spray lubrificante per strumentario	942	SUPERCUT REYNOLDS Forbice per dissezione	73
SEMB Tenaglia per ossa	504	SPURLING Pinza tagliente per laminectomia	652	SUPERCUT SIEBOLD Forbice	69
SEMKEN Pinza anatomica	79	Sputacchiera con coperchio ribaltabile	937	SUPERCUT SIMS Forbice	69
SEMKEN Pinza per chirurgia	83	ST. CLAIR-THOMSON Coltello per adenoidee	864	SUPERCUT STEVENS Forbice	73
SEMM Divaricatore addominale	278	ST. MARKS Divaricatore per pelvis	247	SUPERCUT TOENNIS-ADSON Forbice vascolare	69



Inhaltsverzeichnis

Alphabetical Index

Indice alfabético

Indice alfabético

SUPERCUT WAGNER Forbice	72	TC-LISTER Forbice per bendaggi	400	TOWNSEND Punta per biopsia	742
SUPERCUT WALDMANN Forbice	69	TC-LOCKLIN Forbice	63	TOWNSEND-MINI (BABY-TISCHLER) Pinza per biopsia	742
Supporto per illuminazione fibra ottica	343	TC-MASSON Portaghi	381	TOWNSEND-MINI (BABY-TISCHLER) Punta per biopsia	742
Supporto per punte per tunnelare	596	TC-MATHIEU Portaghi	383,384	TOWNSEND-MINI Pinza per biopsia	741
Supporto specoli auricolari	799	TC-MAYO Forbice	55	TOYNBEE Specolo auricolare	798
Supporto sternale, solo	342	TC-MAYO-HARRINGTON Forbice	61	Trasformatore piccolo per lampade frontali	320
Suspensione per contenitore per spazzole	922	TC-MAYO-HEGAR (HEANEY) Portaghi	377	Trapano a mano	415
Sutura-Set in astuccio metallico	397	TC-MAYO-HEGAR Portaghi	376,377	Trapano per biopsia per strumento CHAMPY	453
T		TC-MAYO-LEXER Forbice	55	TRELAT Specolo vaginale	709
TAKAHASHI Pinza etmoidale	829	TC-MAYO-STILLE Forbice	55	Trequarto	288
TARNIER Cranioclaste	759	TC-MC INDOE Pinza anatomica	98	TREVES Pinza per chirurgia	86
Tata, Adattatore veni per tunnelare	596	TC-METZENBAUM Forbice	56,57	TROELTSCH Pinza per medicature	826
TAYLOR Divaricatore spinaei	492	TC-METZENBAUM-FINO Forbice	57-59	TROEMMER Martello	306
TAYLOR Martello	306	TC-MILLER-COLLBURN Lima per ossa	481	Tronchesione per pelle	917
TAYLOR Pinza anatomica	79	TC-NEIVERT Portaghi	375	Tronchesione per unghie	916,917
TAYLOR Pinza per chirurgia	83	TC-OEHLER Pinza per chirurgia	99	TROUSSEAU Dilatatore per tracheotomia	903
TAYLOR Valva laterale per divaricatore	625	TC-OLSEN-HEGAR MINI Portaghi	382	TROUTMAN-CHRIS Pinza per afferrare e rompere lamette da rasoi	14
TC		TC-PARAMETRIUM Forbice per isterectomia	61	TROUTMAN-COLIBRI Pinza per fissare	777
TC-ADSON MICRO-Pinza	97,98	TC-Pinza gira cavo	420	TUBBS Dilatatore aortico	594
TC-ADSON Pinza anatomica	97	TC-POTTS-SMITH Pinza anatomica	98	TUBERKULIN-LUER Cilindro	304
TC-ADSON Pinze per chirurgia	98	TC-RAGNELL (KILLNER) Forbice	64	TUBERKULIN-LUER Siringa	304
TC-ADSON-BROWN Pinza per chirurgia	98	TC-RYDER MINI Portaghi	379	Tube aspiratore di fumo per laringoscopi	343
TC-ARRUGA MICRO-Portaghi	370	TC-RYDER-FRENCH EYE Portaghi	378	Tube di connessione completo	818
TC-BABCOCK Pinza per afferrare tessuti	664	TC-SAROT Portaghi	380	TUFFIER Divaricatore costale di acciaio	537
TC-BABY-GILLIES Portaghi	382	TC-SEMKEN Pinza anatomica	98	TUFFIER Pinza per afferrare tumore	178
TC-BARRAQUER Portaghi	372,373	TC-SEMKEN Pinza per chirurgia	99	TUFFIER Tenaglia per ossa	505
TC-BARRY-STERNDAL Pinza gira cavo	420	TC-SENNING Portaghi	380	TUOHY Ago per puntura lombale	300
TC-BAUMGARTNER Portaghi	376	TC-SIMS Forbice	61	TURNBULL Tronchesioe per unghie	916
TC-BONNEY Pinza per chirurgia	99	TC-SLIM MICRO-Portaghi	378	TURNER-WARWICK Pinza per calcolo biliare	692
TC-BOYNTON MICRO-Pportaghi	370	TC-STANDARD Forbice	54	TYDING Serrandi per tonsille	896
TC-BOZEMANN Portaghi	380	TC-STANDARD Pinza anatomica	97	U	
TC-BRUNS Forbice	404	TC-STRATTE Portaghi	381	UCKERMANN Portacotone	287
TC-CASTROVIEJO (JACOBSON) Portaghi	371,372	TC-Tenaglia porta cavo	421-423	UECKERMANN Trequarto per tracheotomia	903
TC-CONVERSE Portaghi	375	TC-Tenaglia tagliafilo	424-426	ULRICH Pinza per tamponi	206
TC-CORWIN-HEGAR Pinza gira cavo	420	TC-TOENNIS Portaghi	385	ULRICH Tenaglia per ossa	507,508
TC-CRILE Portaghi	385	TC-TOENNIS-ADSON Forbice	59	Uncino tracheale	904
TC-CRILE-WOOD BABY Portaghi	377	TC-UNIVERSAL Forbice	64	UNIVERSAL Bottiglia di ricambio, sola	866
TC-CRILE-WOOD Portaghi	378	TC-WANGENSTEEN Pinza per dissezione	98	UNIVERSAL Forbice	50
TC-CUSHING Pinza anatomica	97	TC-WANGENSTEEN Portaghi	381	UNIVERSAL Insoffiatore	815
TC-CUSHING-TAYLOR Pinza anatomica	97	TC-WEBSTER Portaghi	375	UNIVERSAL Pinza per strumenti per sterilizzazione	924
TC-DEBAKEY Forbice	60	TC-ZWEIFEL Portaghi	386	UNIVERSAL Polverizzatore	866
TC-DEBAKEY Pinza per dissezione	99	TEALE Pinza per collo dell'utero	729	UNIVERSAL Trequarto	288
TC-DEBAKEY Portaghi	378	Telaio per punte filiformi	436	UNNA Tiracomedone	914
TC-DERF Portaghi	374	Tenaglia per ossa	500-509	UNNA-VIDA Tiracomedone cambiabile	914
TC-DIETHRICH Portaghi	374	Tenaglia per ossa, autocentraggio	509	URO-TANGENTIAL ATRAUMA Pinza tangenziale	194
TC-DIETHRICH-RYDER Portaghi	374	Tenaglia piatta	421-423	USA MOD. Curetta tagliente	464
TC-DUVAL Pinza per tessuti	665	Tenaglia porta cavo	421-423	USA MOD. Divaricatore per gessati	407
TC-FERRIS-SMITH Pinza per chirurgia	99	Tenaglia tagliafilo	424	USA MOD. Forbice ombelicale	29
TC-FINOCCHIETTO Portaghi	381	TERRIER Pinza emostatica	166	USA MOD. Pinza anatomica gracile	78
TC-FOMON Raspa nasale	855	THOMS-ALLIS Pinza per intestino	663	USA MOD. Pinza per chirurgia	82
TC-Forbice per ginecologia	61	THOMS-GAYLOR Pinza per biopsia	739		
TC-Forbice per iridectomia	62	THOREK Forbice	34		
TC-GILLIES Pinza per chirurgia	99	TIECK-HALLE Specolo nasale	823		
TC-GILLIES Portaghi	382	TILLEY Pinza auricolare	806		
TC-GOLDMAN-FOX Forbice	63	TISCHLER-KEVORKIAN Pinza per biopsia	741		
TC-HALSEY Portaghi	375	TISCHLER-MORGAN Pinza per biopsia	741		
TC-HEGAR Portaghi modello forte	377	TISCHLER-MORGAN Punta per biopsia, sola	742		
TC-HEGAR Portaghi vascolare	379	TITANIO Pinza Bulldog Arteria	161,162		
TC-HEPP-SCHUIDEL Portaghi	374	TITANIO Pinza Bulldog Vena	161,162		
TC-HÖSEL Portaghi	386	TITANIO YASARGIL Applicatore per Clips vascolari per aneurisma 140-144	140-144		
TC-JOSEPH Forbice	62	TITANIO YASARGIL Clip vascolare per aneurisma STANDARD 108-133	108-133		
TC-KALT MICRO-Portaghi	370	TITANIO YASARGIL Clip vascolare per aneurisma MINI 120,121,136	120,121,136		
TC-KELLY Forbice	62	TOBOLD Abassalingua	878		
TC-KILNER Portaghi	376	TOENNIS Bisturi per dura-madre	618		
TC-LANGENBECK Portaghi	384	TOENNIS Forbice vascolare	46		
TC-LEXER Forbice	56	TOENNIS Pinza emostatica	188		
TC-LICHTENBERG Portaghi	385	TOENNIS Portaghi	367		
		TOENNIS-ADSON Forbice vascolare	46		
		TOHOKU Pinza fissateli	203		
		TOWNSEND Pinza per biopsia	742		

Inhaltsverzeichnis
Alphabetical Index
Indice alfabético
Indice alfabetico



VIRCHOW Coltello 3
WISE MICRO-Pinza per legature 96
VOLKMANN Curetta doppio fondo 466
VOLKMANN Curetta tagliente 460,461
VOLKMANN Divaricatore 220-222
VOLLMAR Stripper anello 286

W

WACHENFELDT Pinza per sutura 396
WAGENER Uncino auricolare 812
WAGNER Elevatore per ossa 488
WAGNER Forbice 39
WAGNER Periostotomo 470
WALB Coltello per organi 4
WALDMANN Forbice per episiotomia 29
WALLICH Cucchiaino per aborto 758
WALSHAM Pinza per setto nasale 861
WALTER Scalpello nasale 847
WALTER Sgorbia nasale 847
WALTER-CARMALT Pinza per schegge 89
WALTON Lama di ricambio per Seghe 527
WALTON Sega per anelli 527
WALTON Sgorbia per corpi estranei 766
WANGENSTEEN Portaghi 364
WARTENBERG Strumento per misurare 308
WASSMUND Divaricatore 224
WATSON-WILLIAMS Pinza etmoidale 829
WAUGH Pinza per chirurgia 85
WEBER Ansa 770
WEBER ATRAUMA Pinza cardiovascolare 563
WEBER-LOCH Ansa auricolare 811
WEBSTER Portaghi 359
WEBSTER Portaghi 359
WEIL-BLAKESLEY Pinza etmoidale 830-832
WEISSBARTH Specolo vaginale 719
WEITLANER Divaricatore 257
WEITLANER-BABY Divaricatore 259
WEITLANER-LOKTITE Divaricatore 256
WEITLANER-WULLSTEIN Divaricatore 258
WELLS Cucchiaino per calazio 770
WELLS Spatola per enucleazione 770
WERTHEIM Forbice 27
WERTHEIM Pinza per isterectomia 196,197
WERTHEIM-CULLEN Pinza per isterectomia 197
WEST Scalpello 773
WEST Sgorbia 773
WESTCOTT Forbice per tendini 782
WESTCOTT MICRO-Forbice 17
WESTMACOTT Pinza per tamponamento 826
WHITE Pinza per tonsille 894
WHITE (COLVER) Pinza per tonsille 894
WHITEHEAD Apribocca 876
WIEDER Abassalingua 878
WIEN MOD. Portalegature 394
WIEN MOD. Specolo nasale 823
WILDER Dilatatore per canale lacrimale 774
WILLDE (TROELTSCH) Pinza auricolare 805
WILLET-MARTEL Pinza cuoio capelluto 179
WILLIAMS Pinza per intestino 663
WILLIGER Curetta tagliente 465,467
WILLIGER Elevatore per septum 483
WILLIGER Martello 454,455
WILLIGER Periostotomo 474,475
WINTER Pinza para placenta e ovaie 757
WIRKSTROEM Pinza per preparazione 190
WITTNER Pinza per biopsia 740
WOLFF Curetta per lupus 912
WOLFF Pinze per gesso 407
WRIGLEY Forcipe ostetrica 754
WULLSTEIN Coltello falcato come sinechia 792

WULLSTEIN MICRO Pinza auricolare 786,790,791
WULLSTEIN MICRO-Cannula d'aspirazione 293
WULLSTEIN MICRO-Forbice auricolare 789

Y

YANKAUER Tubo per aspirazione 296
YASARGIL Applicatore per Clips vascolari per aneurisma 138-144
YASARGIL Cannula per aspirazione 295
YASARGIL Clip vascolare per aneurisma STANDARD 108-133
YASARGIL Clip vascolare per aneurisma MINI120,121,136
YASARGIL Coltello per aracnoide 621
YASARGIL Ganci per galea 606
YASARGIL Guida per legatura, bottonuta 621
YASARGIL MICRO-Pinza per Neurochirurgia 659
YASARGIL Micro-Pinze 0,6 mm, 18,0 cm 94
YASARGIL Pinza tagliente per ipofisi 655
YASARGIL Pinze per tumore 93
YASARGIL Portaghi 358,373
YASARGIL Strumento per MICRO-chirurgia 620
YASARGIL Tubo per aspirazione 295
YASARGIL-SAMMII Pinza per tumore 93
YEOMAN Pinza per biopsia rettale 685
YOUNG Ago di ricambio 388
YOUNG Divaricatore prostatico 695
YOUNG Pinza per lingua 880
YOUNG Pinza prostatica 695
YOUNG Strumento per sutura 388

Z

ZAUFAL Leva per corpi estranei 811
ZAUFAL-JANSEN Pinza sgorbia 514
ZENKER Pinza per preparazione e legature 189
ZENKER Divaricatore 230
ZENKER Pinza per preparazione e legature 189
ZIEGLER Coltello per iride 765
ZIEGLER Specchio frontale con fascia 318
ZIELKE Sgorbia 448
ZÖLLNER Cannula per aspirazione 294
ZÖLLNER Specolo auricolare 799





FRIMED GMBH
Junkersstraße 1
78532 Tuttlingen
Germany

Telefon +49 74 61 9 66 18 30
Telefax +49 74 61 9 66 18 50
E-Mail info@frimed.de
Web www.frimed.com