

Operation Instructions 16-channel switching actuator 8-channel shutter actuator

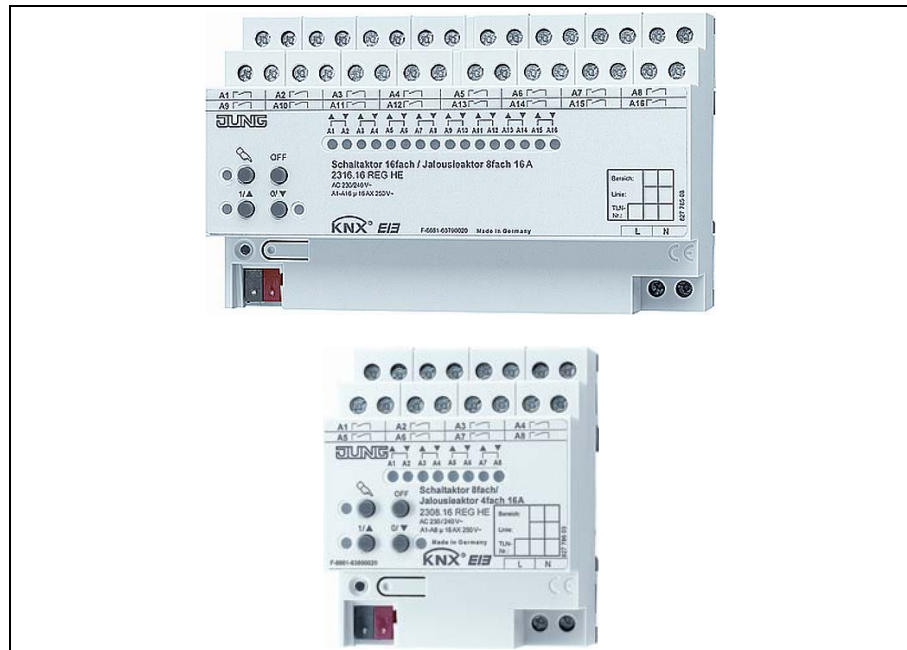

1. Safety instructions

Electrical equipment must be installed and fitted by qualified electricians only. Failure to observe the instructions may cause damage to the device and result in fire or other hazards. The device is not suited for safe disconnection of the mains supply. The device is not suited for SELV/PELV or FELV. For parallel connection of several drives to an output it is indispensable to observe the corresponding instructions of the manufacturers. There is otherwise risk of irreparable damage to the drives. Use only blinds/shutters with mechanical or electronic limit switches. Check the limit switches for correct adjustment. Do not connect three-phase AC motors to the actuator. These operating instruction are part of the product and must be left with the final customer.

2. System information

This device is a product of the KNX-system and complies with KNX directives. Technical knowledge obtained in KNX training courses is a prerequisite to proper understanding. The functionality of this device depends on the software. Detailed information on loadable software and attainable functionality as well as the software itself can be obtained from the manufacturer's product database. Planning, installation and commissioning of the unit is effected by means of KNX-certified software. The full functionality with KNX commissioning software from version ETS3.0d. onwards.

The product database, technical descriptions and conversion programs and other utilities are available in the Internet at www.jung.de.

3. Device components

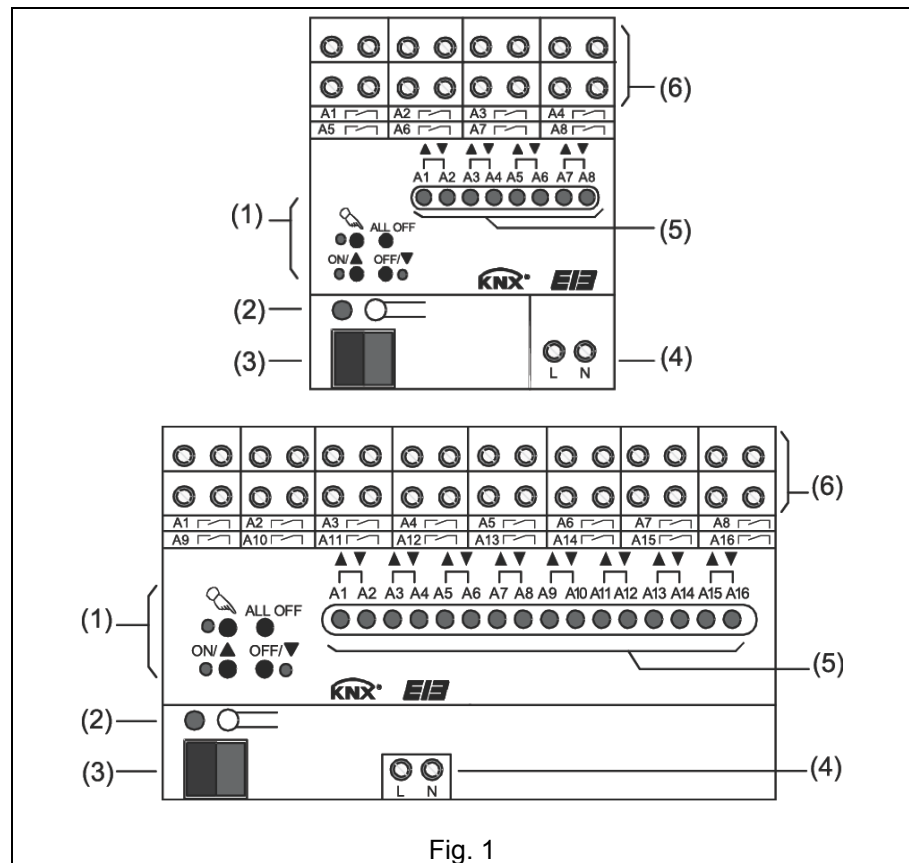

Fig. 1

- (1) buttons for manual control
- (2) programming button and LED
- (3) KNX bus connection
- (4) mains supply connection
- (5) output status LEDs
- (6) consumer connection

4. Designated use

- Switching of electrical consumers AC 230 V with potential-free contacts
- Switching of electrically operated blinds, shutters, awnings and similar devices.
- Installation on DIN rail in small distribution boards

4.1. Product features

- Manual output control, provisional operation
- Checkback in the manual control mode and in bus operation
- Scene function
- Disabling of individual outputs by hand or via the bus possible

4.2. Characteristics as switching actuator

- Operation with break or make contacts
- Logic operation and forced-control functions
- Checkback function
- Central switching function with group checkback
- Time functions: ON-delay, OFF-delay, staircase lighting timer with early-warning function

4.3. Characteristics as shutter actuator

- Suitable for AC motors 230 V
- Direct control of blind/shutter position
- Direct control of slat position
- Checkback of run state, blind/shutter position and slat position
- Forced-control position from primary control
- Safety function: 3 independent wind alarms, rain alarm, frost alarm
- Sun protection function

5. Operation

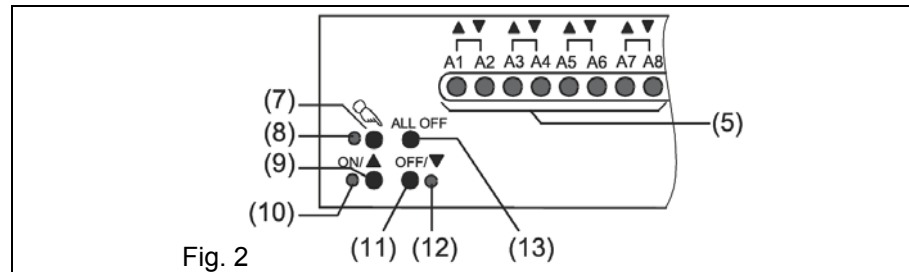

- (5) output status LEDs
- (7) Key Manual control
- (8) LED on: permanent manual control mode active:
- (9) Key **ON/▲** switching on or raising the blind/shutter / stop
- (10) LED **ON/▲** on: switched on or blind/shutter moving upwards, manual control mode
- (11) Key **OFF/▼** switching off or moving the blind/shutter downwards, stop
- (12) LED **OFF/▼** on: switched off or blind/shutter moving down, manual control mode
- (13) Key **ALL OFF** all outputs off and drives stopped

5.1. Status display

The status LEDs **A1...A8** and **A1...A16** (Figs. 2, 5) indicate the states of the outputs.

- Off: output is off
- On: Output is on
- Flashing slowly: Output in manual control mode
- Flashing fast: output disabled in permanent manual control mode

6. Modes of operation

- Bus operation: operation from touch sensors or other bus devices
 - Temporary manual control mode: manual operation locally with keyboard, automatic return to bus operation
 - Permanent manual control mode: only manual operation locally on device
- ① Bus operation in manual control mode disabled.
 - ① Manual operation in the event of bus failure enabled.
 - ① After failure and return of bus voltage, the device switches over to the bus mode.
 - ① After failure and return of mains voltage, the device switches over to the bus mode.
 - ① Manual control mode can be disabled in operation via bus telegram.

Blind/shutter control priorities

- Highest priority: manual control
- 2. priority: forced-control position
- 3. priority: safety function
- 4. priority: sun protection
- Lowest priority: bus operation: raising / lowering, slat adjustment, scenes, positioning

6.1. Activating the temporary manual control mode

Keypad operation is programmed and not disabled.

- Press  the key briefly < 1 s,
LED A1 flashing, LED remains off.
- ① After 5 s without key-press, the actuator returns automatically to the bus mode.

6.2. Deactivating the temporary manual control mode



The device is in the temporary manual control mode.

- No key-press for 5s.
- or -
- Press  the key briefly < 1 s several times until the actuator quits the temporary manual mode.
LEDs A1...A8 oder A1...A16 are no longer flashing, but indicating the output status.

Switching outputs: Depending on programming, the relay outputs are switched over to the position active at the time of deactivation of the manual control mode, e.g. forced control, logic operation
Shutter outputs: Depending on programming, the blinds/shutter move to the position active at the time of deactivation of the manual control mode, e.g. forced-control position, safety or sun protection position.



6.3. Activating the permanent manual control mode

Keypad operation is programmed and not disabled.

- Press  the key for at least 5 s.
LED  is on, LEDs A1 is flashing, permanent manual control mode is activated.

6.4. Deactivating the permanent manual control mode

The device is in the permanent manual control mode.

- Press  the key for at least 5 s.
LED  is off, bus operation is on.

Switching outputs: On deactivation of the manual control mode the output relays are switched - depending on programming - over to the position then active, e.g. forced control, logic operation.
Shutter outputs: Depending on programming, the blinds/shutters move to the position active at the time of deactivation of the manual control mode, e.g. forced-control position, safety or sun protection position.

7. Operating the outputs

The device is in the permanent or temporary manual control mode.

- Press the  key briefly < 1 s several times until the desired output is selected.
- The LED of the selected output **A1...A8** or **A1...A16** is flashing.
- The LEDs **ON/▲** and **OFF/▼** indicate the status.
- Operate the output with the **ON/▲** or **OFF/▼** key.

Switching outputs: switching on or off

Shutter outputs:

Brief press: blind/shutter stop.

Long press: raising/lowering the blind/shutter

The selected output executes the respective commands.

The LEDs **ON/▲** and **OFF/▼** indicate the status.

- ① Temporary manual control mode: After all outputs have been selected one after another, the device quits the manual control mode with the next brief press.

7.1. All outputs are shut off; all blinds/shutters are stopped.

The device is in the permanent manual control mode.

- Press the **ALL OFF** key
- All outputs are shut off; all blinds/shutters are stopped.

7.2. Disabling individual outputs

The device is in the permanent manual control mode.

- Press the  key briefly, < 1 s several times until the desired output is selected.
- The LED of the selected output **A1...A8** oder **A1...A16** is flashing.
Press the keys **ON/▲** and **OFF/▼** simultaneously for at least 5 s. The selected output is disabled. The status LEDs of the selected output **A1...A8** oder **A1...A16** are flashing fast.
- Activate the bus mode (deactivate the permanent manual control mode).

- ① A disabled output can be operated in the manual control mode.
- ① If a disabled output is selected in the manual control mode, the LEDs are flashing twice briefly at intervals.

7.3. Re-enabling the outputs

The device is in the permanent manual control mode.

- Press the  key briefly < 1 s several times. The status LED of the selected output **A1...A8** or **A1...A16** is flashing twice briefly at intervals.
- Press the **ON/▲** and **OFF/▼** keys simultaneously for at least 5 s. The selected output **A1...A8** or **A1...A16** is enabled. The LED of the selected output **A1...A8** or **A1...A16** is flashing slowly.

KNX

16-channel switching actuator

8-channel shutter actuator 16A /

Ref.-no.: 2316.16 REGHE, 2308.16REGHE

- Activate the bus mode (deactivate the permanent manual control mode).

8. Information for qualified electricians

⚠ DANGER!

Electric shock in case of accidental contact with live parts. Electric shocks may be fatal. Before working on the device, cut out the mains supply and cover up live parts in the surroundings.

8.1. Fitting and electrical connection

Fitting the device

Observe the temperature range (Technical data). Ensure sufficient cooling.

Fit the device by snap-fastening on a mounting rail in acc. With DIN EN 60715. The connecting terminals must be at the top (Fig. 3).

Connecting the device (Fig. 3)

- Connect the bus line to the bus terminal.
- Connect the mains voltage supply.

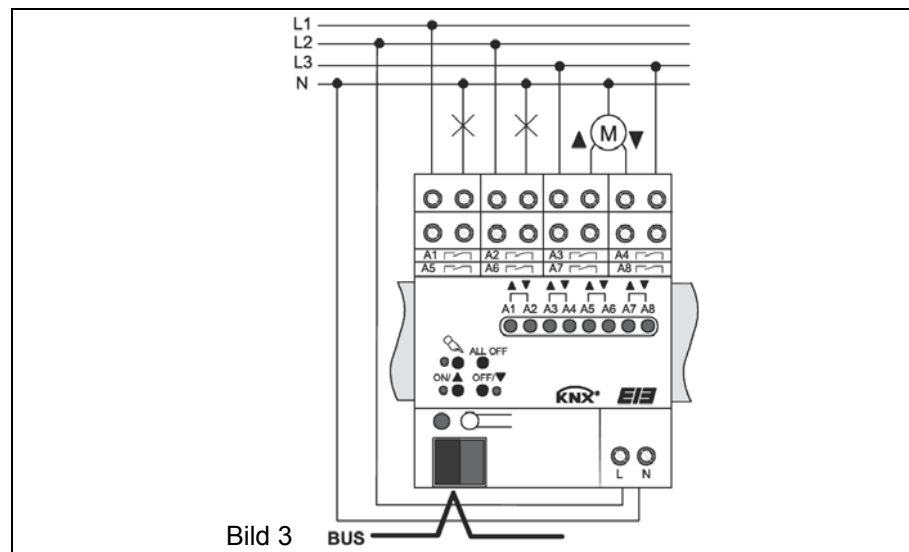

⚠ CAUTION!

Inadmissible temperature rise in the event of device overload. The device itself and the connected wires may be damaged at the terminals. The maximum load current rating per device must not be exceeded.

- Connect the loads as described in the following chapters.

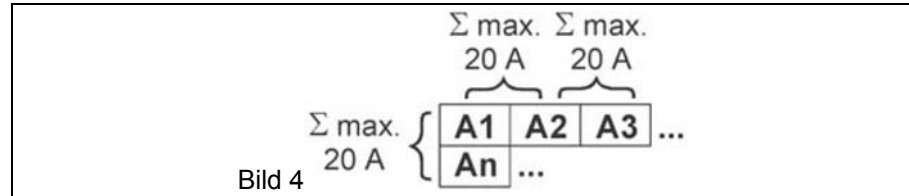

- ① State of delivery: provisional operation, output control via keypad possible. All outputs are configured as shutter outputs.

Connecting switched loads

Observe the admissible load rating (Technical data).

The output is parameterized as switching output.

- Connecting switched loads (Fig. 5).

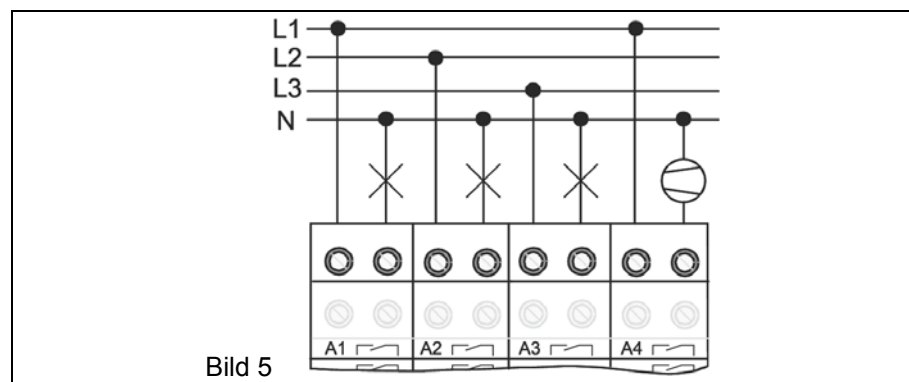

Connecting blind/shutter drives

For blind/shutter operation, two adjacent relay outputs are used as a blind/shutter output. The left relay output **A1, A3,...** is intended for the upward direction and the right relay output **A2, A4, ...** for the downward direction. Observe the admissible load rating (Technical data). The output is parameterized as shutter output.

⚠ CAUTION!
Risk of irreparable damage if several drives are connected in parallel to one output. Limit switch contacts can weld together and drives, blinds/shutters and the shutter actuator can be irreparably damaged. Use an isolating relay.

- Connect the drives (Fig. 6).

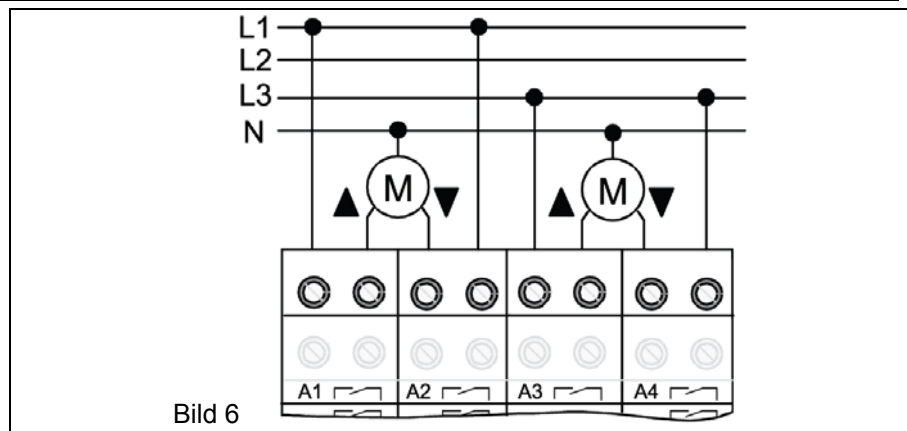

8.2. Sliding on the protective cap

To protect the bus lines against dangerous voltages at the connecting terminal, slide on the protective cap.

- Lead out the bus line at the rear of the device.
- Slide the cap over the bus terminal (Fig. 6 A) until it is heard to engaged.

8.3. Abdeckkappe entfernen

- Press the sides of cap and withdraw (Fig. 6 B).

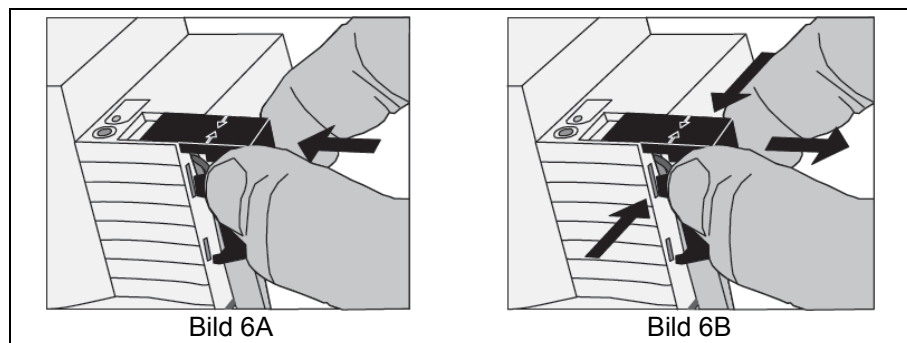

9. Commissioning

9.1. Measuring the blind/shutter and slat running times

The blind/shutter running time is important for positioning and scene moves. With Venetian blinds, the slat adjusting time is for technical reasons part of the overall running time of blinds/shutters. The opening angle of the slats is therefore defined as the running time required between the 'open' and 'closed' positions. The upward move is generally longer than the downward move and is accounted for as running time prolongation in percent.

- Measure the 'up' and 'down' running times of the blind/shutter.
- Measure the slat adjusting time.
- Enter the measured values into the parameter settings list.

9.2. Loading the address and the application software

- Switch on the bus voltage
- Allocate the physical address and load the application software into the device.

Appendix

10. Technical data

KNX medium:	TP1
Mode of commissioning:	S-Mode
KNX supply:	21...32 V DC
KNX power consumption:	max. 150 mW
Mains supply:	AC 230/240 V \pm 10%
Mains frequency:	50/60 Hz
Total dissipated power:	max. 4.5 W (16/8-channel); max. 3 W (8/4-channel)

Connection

KNX:	connecting terminal:
230 V supply and outputs:	screw terminals
single-wire:	1.5...4 mm ² or 2 x 1.5...2.5 mm ²
stranded wire without ferrule:	0.75...4 mm ²
stranded wire with ferrule:	0.5...2.5 mm ²
Screw terminal tightening torque:	max. 0.8 Nm
Output contact type:	potential-free n.o. contact (μ -contact)
Switching voltage AC:	AC 230/240 V \pm 10%, 50/60 Hz
Switching capacity AC 230/240 V per output:	16 A AC1/ 16 AX

Current load rating per device

16/8-channel:	Sum A1...A16 max. 160 A
8/4-channel:	Sum A1...A8 max. 80 A

Loads per Output

Resistive load:	3000 W
Capacitive load:	16 A, max. 140 μ F
Motors (shutter or fan):	1380 VA
Max. inrush current	800 A / 200 μ s 165 A / 20 ms

Lamps load

Incandescent lamps:	3000 W
230 V halogen lamps:	2500 W
LV halogen lamps with Tronic transformers:	1500 W
LV halogen lamps with inductive transformers:	1200 W
Fluorescent lamps T5/T8 non-compensated :	1000 W
parallel compensated:	1160 W / 140 μ F
Lead-lag circuit:	2300 W / 140 μ F

Compact Fluorescent Lamps

non-compensated:	1000 W
parallel compensated:	1160 W / 140 μ F

Mercury vapour lamps

non-compensated:	1000 W
parallel compensated:	1160 W / 140 µF

Electronic ballasts List of types see product documentation

Ambient temperature:	-5 °C...+45 °C
Storage temperature:	-25 °C...+70 °C
Mounting width:	144 mm (8 modules); 72 mm (4 modules)
Weight:	approx. 460 g (16/8- channel);approx. 290 g (8/4- channel)

11. Help in case of trouble

Manual control with keypad not possible

Cause 1: manual control mode not programmed.

- Program the device for manual control.

Cause 2: manual control mode disabled from bus.

- Enable the manual control mode.

Output control not possible

Cause 1: output disabled.

- Re-enable the output.

No output operational

Cause 1: all outputs are disabled.

- Re-enable the outputs.

Cause 2: permanent manual control mode active.

- Deactivate the permanent manual control mode (switch this mode off).

Cause 3: application software stopped, programming LED flashing.

- Make a reset: disconnect the device from the bus, reconnect after 5 seconds.

Cause 4: no or faulty application software.

- Check programming and rectify.

Shutter outputs non operational

Cause: Forced position, safety function or sun protection active.

No control operation possible for this output as long as primary functions are active for a shutter output.

Positioning and scene moves are not executed or executed only incorrectly

Cause 1: sun protection, safety function, forced-control position or manual control mode active.

No positioning or scene moves possible as long as primary functions are active

Blind/shutter does not move to limit position, positioning or scene moves faulty

Cause: blind/shutter running time adjustment incorrect.

- Correct the blind/shutter running time.

Blind/shutter moves upward before a positioning scene moves

Cause: No position stored, e.g. because of mains failure.

Blind/shutter performs a reference run. Do not stop the moving blind/shutter.

12. Accessoires

Cap:	Art.-no.: REG KAP
Isolating relay AP:	Art.-no.: TR-S
Isolating relay REG:	Art.-no.: TR-S REG
Isolating relay UP:	Art.-Nr.: TR-S UP

13. Garantie

Our products are under guarantee within the scope of the statutory provisions.

Please return the unit postage paid to our central service department giving a brief description of the fault:

ALBRECHT JUNG GMBH & CO. KG
Service-Center
Kupferstr. 17-19
D-44532 Lünen
Service-Line: +(49) 23 55 . 80 65 51
Telefax: +(49) 23 55 . 80 61 89
E-Mail: mail.vka@jung.de

General equipment

Service-Line: +(49) 23 55 . 80 65 55
Telefax: +(49) 23 55 . 80 62 55
E-Mail: mail.vkm@jung.de

KNX equipment

Service-Line: +(49) 23 55 . 80 65 56
Telefax: +(49) 23 55 . 80 62 55
E-Mail: mail.vkm@jung.de

 The CE-Sign is a free trade sign addressed exclusively to the authorities and does not include any warranty of any properties.