

Brochure



Original HP large format printing materials & supplies

For graphics & technical applications - Fall 2013



HP large format printing materials

Consistently outstanding image quality – that’s what you see with HP large format printing materials. And with so many options in finish, size, and style, it’s easy to find the ideal paper for almost any printing application.

Original HP printing materials are designed to work with the complete system – together with HP printing supplies and the HP Designjet printer – to provide uncompromising quality, consistency, performance, durability, and value every time.



Ongoing HP innovation includes printing materials with ColorPRO Technology that perform to a strict set of specifications to meet industry-leading performance standards. All products with ColorPRO Technology utilize advanced technologies which have been designed together with Original HP inks and HP printers to optimize printing system performance.

Explore the wide range of different types of printing materials, specifically designed to meet the demands of graphics and technical professionals.

Original HP inks and HP printing materials—good chemistry



Original HP inks and HP printing materials are designed together to provide image quality, durability, and consistency you can rely on. Reliable results enable increased productivity and reduced costs.

Original HP inks are more than just ink and HP large format printing materials are far more than just paper. It’s the chemical makeup of each, together with the carefully engineered interaction between the two, that make exceptional results possible. Image quality and consistency so predictable, it’s almost cliché. Print permanence that’s measured in generations, not months or years. Breakthrough innovations that give you real alternatives to traditional materials that, by nature, must trade off quality, durability, even environmental considerations. The unique chemistry between HP inks and HP large format printing materials changes all that – among the broad array of materials offered in the HP large format printing materials portfolio, you can have it all.



Science & technology

HP Thermal Inkjet technology

Inkjet is a digital printing technology that uses small drops of ink to form an image on a printed media. Drop-on-demand is one type of inkjet technology and it comes in two forms: Piezoelectric and Thermal. Piezoelectric inkjet technology uses mechanical means to eject ink. Thermal Inkjet technology uses heat to vaporize a thin layer of ink to form a bubble that expels a small drop of ink through an orifice or nozzle. These nozzles form part of a customer-replaceable printhead, which receives ink from ink cartridges via ink tubes.

In 1984, HP introduced the first inkjet printer, the 'Thinkjet.' This technology, initially introduced with small-format printers, was quickly adopted for the HP Designjet large format line of printers.

Firing a nozzle with HP Thermal Inkjet technology

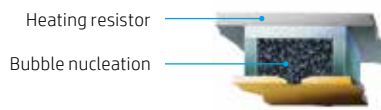

A quick energy pulse is delivered to the resistor causing it to heat up. Then, bubble nucleation starts in the layer of ink next to the resistor.



The ink vapor bubble rapidly grows, forcing the ink meniscus to expand and it begins to form into a drop at the nozzle.

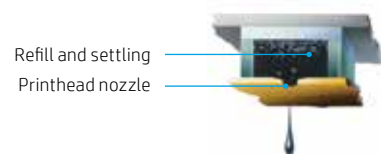

When the ink drop ejects, the ink vapor bubble collapses and ink flows into the firing chamber, refilling it.

HP Thermal Inkjet inks

Traditional water-based inks (dye- or pigment-based) use water as the primary ink vehicle.

Dye-based inks

These inks contain colorant that provides extremely vivid colors, and are compatible with all inkjet coatings.

Pigment-based inks

Pigment-based inks contain finely ground pieces of a colored material. Due to their larger size, they are much more fade resistant than dye-based inks.

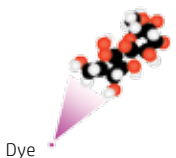
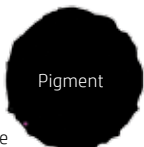
Traditional water-based inks		
	Dye-based inks	Pigment-based inks
	 <p>Dye</p>	 <p>Pigment</p>
Size	<10 nanometers	20-200 nanometers
Physical state	Dissolved in water	Dispersed in water
HP Designjet printers	T series (colored inks)	T series (black ink only) Z series



Inkjet receptive coatings

HP develops inkjet receptive coatings for print media such as paper, photo papers, films, and canvas. HP coatings are designed together with HP inks and printers in order to achieve optimum image quality and durability. The components of these coatings are determined by the properties of the media, the customer’s workflow, and the large format printer.

Currently, HP offers more than 30 different types of large format printing materials, most of which are coated materials. The coating can be of a porous nature (typically used in matte fiber-based papers) or it can be swellable (used in traditional inkjet photo papers and films). Each coating formulation may have up to 15 ingredients. HP may develop up to 100 different formulations before the final definitive one is chosen.

Cross section of an HP photo paper

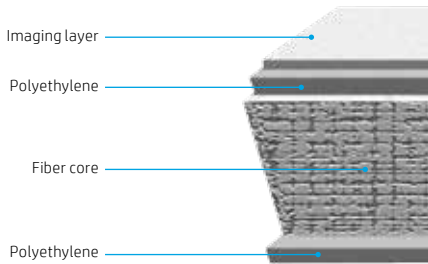

Photo papers

A traditional photo paper is made of several layers, including the paper base (fiber core), a top and bottom extruded polyethylene layer, and a light-sensitive coating. Photo papers used in inkjet printers have a similar structure, but the light-sensitive coating is replaced by a transparent coating capable of absorbing the water-based inks: the imaging layer. These coatings can be of a swellable or nano-porous nature.

Swellable coatings, optimized for Original HP dye-based inks

The swellable coating inflates (swells) as the ink is absorbed, then shrinks as water evaporates. This drying process may take some time and the dye is trapped inside the coating. Swellable coatings are only compatible with dye-based inks and they offer excellent fade resistance when designed together with dye-based inks.

Swellable coatings subject the dye to light fade only

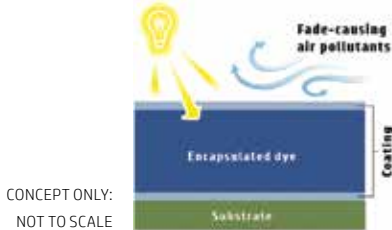

Advantages:

- Permanence (dyes are protected inside polymers)
- Image quality
- Gloss uniformity

Limitations:

- Dry time
- Water resistance
- Pigment compatibility

Porous coatings subject the dye to light and air fade

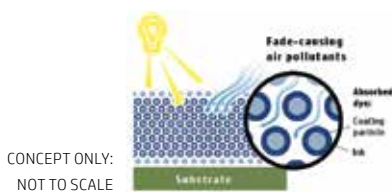

Porous coatings, optimized for Original HP pigment-based inks

Also known as porous or instant-dry, these coatings consist of microscopic particles that are bonded together. These particles form an open, porous structure. The ink is drawn into these open spaces by the capillary action of the coating which occurs during the printing process. These coatings are compatible with both dye- and pigment-based inks. However, when used with dye-based inks, it is important to protect the print (i.e., with lamination), if durability is desired.

Advantages:

- Dry time
- Water resistance
- Gloss uniformity with dyes

Limitations:

- Permanence with dyes
- Scratch resistance with pigments
- Gloss uniformity with pigments

Swellable HP large format photo papers:

- HP Universal Gloss Photo Paper
- HP Universal Satin Photo Paper
- HP Premium Gloss Photo Paper*
- HP Premium Satin Photo Paper*

HP Designjet large format printers using Original HP dye-based inks:

- HP Designjet 5000 Printer series
 - HP Designjet 4000 Printer series
 - HP Designjet 500 Printer series
 - HP Designjet 130 Printer series
 - HP Designjet 111 Printer series
 - HP Designjet T120 ePrinter series
 - HP Designjet T520 ePrinter series
 - HP Designjet T610 Printer series
 - HP Designjet T620 Printer series
 - HP Designjet T770 Printer series
 - HP Designjet T790 ePrinter series
 - HP Designjet T920 ePrinter series
 - HP Designjet T1100 Printer series
 - HP Designjet T1200 Printer series
 - HP Designjet T1300 ePrinter series
 - HP Designjet T1500 ePrinter series
 - HP Designjet T2300 eMFP series
 - HP Designjet T2500 eMFP series
 - HP Designjet T7100 Printer series
- *FSC®-certified papers

Porous HP large format photo papers:

- HP Everyday Instant-dry Gloss Photo Paper*
- HP Everyday Instant-dry Satin Photo Paper*
- HP Universal Instant-dry Gloss Photo Paper*
- HP Universal Instant-dry Satin Photo Paper*
- HP Premium Instant-dry Gloss Photo Paper*
- HP Premium Instant-dry Satin Photo Paper*
- HP Professional Instant-dry Satin Photo Paper
- HP Premium Matte Photo Paper

HP Designjet large format printers using Original HP pigment-based inks:

- HP Designjet Z2100 Printer series
 - HP Designjet Z3100 Printer series
 - HP Designjet Z3200 Printer series
 - HP Designjet Z5200 Printer series
 - HP Designjet Z5400 PostScript® ePrinter
 - HP Designjet Z6100 Printer series
 - HP Designjet Z6200 Photo Printer series
 - HP Designjet 5000 Printer series using HP UV inks
- *FSC®-certified papers

Note: For specific printer compatibility for the HP printing materials listed above, see the "Compatibility and Availability Chart," page 19.

Value proposition

Value proposition of HP printing materials: image quality

Original HP large format printing materials make use of advanced HP-engineered coatings to take the guesswork out of producing high-quality, long-lasting prints. Designed together as a complete printing system, HP large format printers, Original HP inks, and HP printing materials deliver exceptional quality.

To achieve the best print quality results for every type of HP printing material, check for new 'paper presets' frequently at hp.com/go/paperpresets.



Printing materials with ColorPRO Technology perform to a strict set of specifications to meet industry-leading performance standards. The specific technology behind media with ColorPRO Technology varies from product to product, however all products with ColorPRO Technology utilize advanced technologies which have been designed together with Original HP inks and HP printers to optimize printing system performance.





Value proposition of HP printing materials: permanence

Permanence refers to properties that define the ability of both the media and the printed image to resist light, air and humidity, fading, thermal degradation, and shelf-life issues.

HP designs and tests all of its inks and large format printing material combinations for optimal durability, knowing that different applications require different test requirements:

- Indoor, home and office display
- Indoor, commercial in-window display
- Outdoor display

HP performs all testing at HP facilities (San Diego, CA; Corvallis, OR; Barcelona, Spain; Singapore). In many cases, Wilhelm Imaging Research (WIR) verifies image permanence results. WIR has become a world-renowned, industry-leading third-party durability test facility for inkjet and other print technologies.

For example, Original HP Photo Inks (pigment-based inks), together with HP Professional Instant-dry Satin Photo Paper provide a display performance behind glass, indoors away from direct sunlight of up to 200 years (as per Wilhelm Imaging Research testing). In similar conditions, HP Premium Photo Papers (Gloss and Satin) printed with Original HP 711 inks last up to 70 years.

For more information, see hp.com/go/supplies/printpermanence.

Value proposition of HP printing materials: reliability

HP large format printing materials are designed and tested together with the HP printer and Original HP inks to provide a trouble-free printing experience. All Original HP printing materials are covered by an HP warranty. And in some cases, HP offers warranties tailored to specific sign and display application needs. For more information, see hp.com/go/HPMediaWarranties.

Mechanical characteristics

The mechanical/physical properties of HP printing materials have a direct impact on printing reliability. HP designs and tests our printing materials to provide optimal media loading and paper advancement, which helps to avoid everyday printing issues, such as printhead crashes. Other important considerations during the design process are shown in the photo below:



Imaging characteristics

The imaging characteristics of the inkjet receptive layer developed by HP determine imaging properties as well as fade resistance and water resistance.



Value proposition of HP printing materials: environmental

1. Responsible sourcing and management

FSC®-certified HP printing materials (hp.com/go/FSCcertified) carry the Forest Stewardship Council (FSC) Mix label, signifying that these media support the development of responsible forest management worldwide.



- HP Universal Bond Paper
- HP Bright White Inkjet Paper
- HP Universal Coated Paper
- HP Universal Heavyweight Coated Paper
- HP Universal Instant-dry Gloss Photo Paper
- HP Universal Instant-dry Satin Photo Paper
- HP Everyday Instant-dry Gloss Photo Paper
- HP Everyday Instant-dry Satin Photo Paper
- HP Premium Instant-dry Gloss Photo Paper
- HP Premium Instant-dry Satin Photo Paper
- HP Premium Gloss Photo Paper
- HP Premium Satin Photo Paper

The PEFC™ label demonstrates that certified HP papers come from forests that are managed sustainably.

- HP Coated Paper
- HP Heavyweight Coated Paper



Note: Not all FSC®- and PEFC™-certified products are available in all regions.





2. Recyclability and reuse

Many HP large format printing materials are recyclable through commonly available recycling programs. In addition, many other printing materials are eligible for free, convenient return and recycling through the HP Large Format Media take-back program¹ (see hp.com/recycle) including the following printing materials:

- HP Clear Film
- HP Matte film
- HP Premium Vivid Color Backlit Film
- HP Durable Banner with DuPont™ Tyvek®, 2 Pack
- HP Everyday Matte Polypropylene, 2 Pack
- HP Premium Matte Polypropylene, 2 Pack

3. Carbon footprint improvement

Customers can reduce the carbon footprint of their banner printing materials—by over 80% using 170 g/m² (5-ounce) HP HDPE Reinforced Banner² and by over 75% using 200 g/m² (6-ounce) HP Double-sided HDPE Reinforced Banner³—compared to using a performance-equivalent 440 g/m² (13-ounce) PVC scrim banner material.

Value proposition of HP printing materials: consistency

Original HP large format printing materials, Original HP ink supplies, and HP Designjet large format printers are designed together as a system to provide uncompromising image quality, consistency, performance, durability, and value every time.

¹ HP Large Format Media take-back program availability varies. Some recyclable HP papers can be recycled through commonly available recycling programs. Recycling programs may not exist in your area. See hp.com/recycle for details.

² Calculation by the HP IPG Environmental Technology Platform Team (and confirmed by an independent environmental life cycle assessment firm), based on the activities associated with the manufacturing of the product, and comparing 170 g/m² (5-ounce) HP HDPE Reinforced Banner to a traditional 440 g/m² (13-oz) PVC scrim product using the Swiss Center for Life Cycle Inventories Ecoinvent 2.0 database and model IPCC 2007 version 1.02; primarily for the category of PVC/PET/HDPE, and measuring materials extraction, transportation to the manufacturing site, and greenhouse gas emissions generated during manufacturing.

³ Calculation by the HP IPG Environmental Technology Platform Team (and confirmed by an independent environmental life cycle assessment firm), based on the activities associated with the manufacturing of the product, and comparing 200 g/m² (6-ounce) HP Double-sided HDPE Reinforced Banner to a traditional 440 g/m² (13-oz) PVC scrim product using the Swiss Center for Life Cycle Inventories Ecoinvent 2.2 database and model IPCC 2007 version 1.02; primarily for the category of PVC/PET/HDPE, and measuring materials extraction, transportation to the manufacturing site, and greenhouse gas emissions generated during manufacturing.

Consistency is one key property considered during the manufacturing of HP printing materials. HP implements strict product qualification processes and Plan of Control (PoC) during the paper manufacturing and coating processes. This enables consistent and accurate results time after time. HP Super Heavyweight Plus Matte Paper is one example of this consistency. Its thick inkjet receptive layer is capable of uniformly holding all the ink during the printing process. This ability to uniformly hold the ink over the full width and length of the roll, as well as the paper's constant grammage across different rolls and manufacturing runs, is key. It enables a consistently high color gamut on this matte coated paper, plot to plot, roll to roll.

**Cross section of
HP Super Heavyweight Plus Matte Paper**

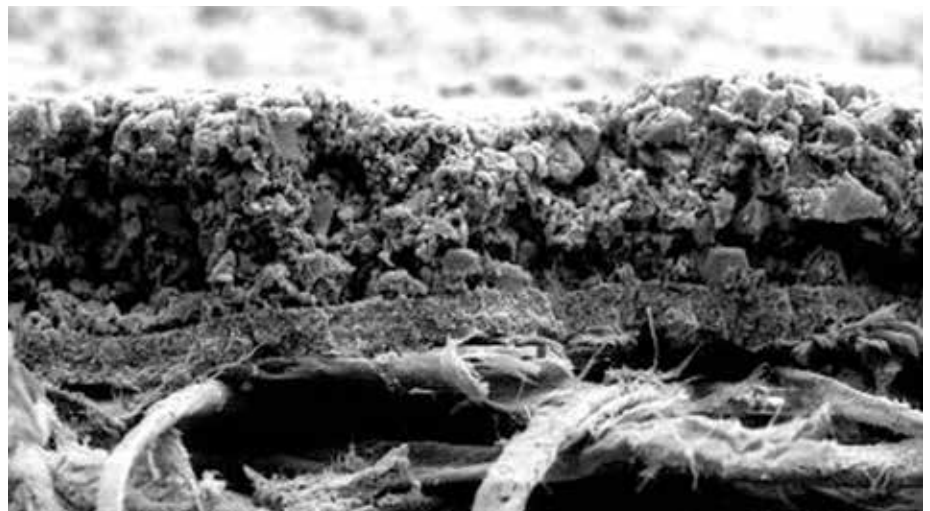



Designjet Portfolio overview

HP Designjet Printers, MFPs, and Scanner for CAD & GIS

For AEC, GIS, and MCAD professional users and work groups who want to print maps, technical drawings, posters, and renders with precise, accurate line quality, and crisp text.

HP Designjet ePrinters & eMFP

HP Designjet T2500 eMultifunction Printer series
Newly designed, two-roll, web-connected ePrinter with scan and copy capabilities



36 inch (910 mm)

HP Designjet T1500 ePrinter series
Newly designed, web-connected ePrinter for demanding teams



36 inch (910 mm)

HP Designjet T920 ePrinter series
Newly designed, web-connected ePrinter with breakthrough usability



36 inch (910 mm)

HP Designjet T790 ePrinter series
High-quality, web-connected, 24-in ePrinter for high printing volumes



24 inch (610 mm)

HP Designjet T520 ePrinter series
Professional, web-connected, 24- and 36-inch printers



24 inch (610 mm)
36 inch (910 mm)

HP Designjet T120 ePrinter
An easy-to-use, web-connected 24-inch printer



24 inch (610 mm)

HP Designjet Printers (Specialty)

HP Designjet T1200 ND Multifunction Printer
Do and offer more - process, print, scan, and copy

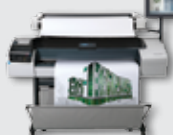

44 inch (1118 mm)

HP Designjet T1300 PostScript® ePrinter
Reliable, web-connected, 44-inch PostScript® ePrinter for GIS



44 inch (1118 mm)

HP Designjet HD Scanner
In-house scanning/copying at the touch of a button



42 inch (1067 mm)

HP Designjet Printers for Production

For print service providers and repro-houses who want to print anything from simple CAD drawings to complex color documents with high speed and outstanding image quality.

HP Designjet T7100 Printer
Color production printer with LED speed at breakthrough TCO



42 inch (1067 mm)

HP Designjet Z6200 Photo Printer series
The fastest production printer* for graphics with unrivaled print quality



42 inch (1067 mm)
60 inch (1523 mm)

HP Designjet Z5400 PostScript® ePrinter
The first multi-roll ePrinter for graphics to produce high-quality, long-lasting prints efficiently



44 inch (1118 mm)

HP Designjet Z5200 Photo Printer
Professional 8-ink PostScript printer is designed for outstanding graphic applications



44 inch (1118 mm)

HP Designjet Printers for Graphics

For copy shops, digital print service providers, professional photographers, and graphic designers who want to create high-impact indoor prints consistently and accurately.

HP Designjet Z6200 Photo Printer Series
The fastest production printer* for graphics with unrivaled print quality



42 inch (1067 mm)
60 inch (1523 mm)

HP Designjet Z5400 PostScript® ePrinter
The first multi-roll ePrinter for graphics to produce high-quality, long-lasting prints efficiently



44 inch (1118 mm)

HP Designjet Z5200 Photo Printer
Professional 8-ink PostScript printer is designed for outstanding graphic applications



44 inch (1118 mm)

HP Designjet Z3200 Photo Printer series
The most advanced 12-ink printer* for gallery-quality prints



24 inch (610 mm)
44 inch (1118 mm)

HP Designjet Z2100 Photo Printer series
HP's affordable 8-ink printer to produce durable prints



24 inch (610 mm)
44 inch (1118 mm)

Legend

- Personal
- Small to medium workgroup
- Medium to large workgroup

CAD and GIS

- Architecture, engineering, and construction**
 - Architecture studios
 - MEP (Mechanical, Electrical, and Plumbing) engineering teams
 - Construction — general contracting departments
 - Construction — trade subcontractors and suppliers
 - Topography studios
 - Public works departments
 - Property management/real estate agencies
- Infrastructure, utilities, and telecommunications**
 - Geographical data suppliers
 - Commercial cartography services
 - Environmental/conservation companies
 - Oil & gas exploration companies
 - Utilities (electricity, water/wastewater, gas distribution, telecommunication, etc.) companies

Manufacturing, automotive, and transportation

- Industrial design departments
- Automotive and transportation design, engineering, and manufacturing departments
- Aerospace design, engineering, and manufacturing departments
- Ship building design, engineering, and manufacturing departments

Public Sector and Corporate

- SME businesses
- Corporate businesses
- Multi-national corporations
- Banking institutions
- Associations
- Public institutions
- Government

Graphic Design, Photography, and Fine Art

- Graphic design**
 - Graphic design studios
 - Advertising and marketing agencies and departments
- Photography**
 - Social, wedding, and portrait photographers
 - Commercial photographers
 - Fine art
- Fine art**
 - Artists
 - Photographers
 - Fine art reproduction
 - Museum shops

Print Service Providers

- Repro-houses and copy shops**
 - High Street copy shops
 - Signmakers
 - Digital printers
- Repro-houses
- Copy shops
- Photo labs
- Commercial printers
- Print shops

Retail

- Retail**
 - Large department stores
 - Food retail stores
 - Do-it-yourself stores
 - Hypermarkets/supermarkets
- Furniture stores
- Clothing stores
- Garage forecourts
- Garden centers

Education

- Education**
 - Associations
 - Schools
 - Colleges and universities
- Youth groups
- Special needs

¹ Compared to large-format inkjet printers under \$25,000 for graphic applications. Based on the fastest rated color speeds as published by manufacturers as of January 2010. Test methods vary.

² The 12-ink HP Designjet Z3200 Photo Printer is the most advanced printer compared with other HP Z-series printers.







HP large format graphics & technical printing materials

Designed together with Original HP inks and the printer

HP offers a broad printing materials portfolio specifically designed to meet the needs of graphics, photography, and technical professionals. All products deliver vivid, high-quality prints and offer excellent price-to-performance ratios.

Key large format applications

-  CAD & GIS
-  GRAPHIC DESIGN & PHOTOGRAPHY
-  PRINT SERVICE PROVIDERS
-  RETAIL
-  EDUCATION

Print with the environment in mind

As you and your customers become increasingly concerned with the environmental impact of printing, look to HP for large format printing materials that reflect responsible sourcing practices and offer recycling options. FSC®- and PEFC™-certified papers support the development of responsible forest management worldwide. Many HP graphics and technical printing materials are recyclable through commonly available recycling programs and select materials, optimized for sign and display applications, can be recycled through the free, convenient HP Large Format Media take-back program.⁴



The mark of responsible forestry



⁴ HP Large Format Media take-back program availability varies. Some recyclable HP papers can be recycled through commonly available recycling programs. Recycling programs may not exist in your area. See hp.com/recycle for details.

HP bond & coated papers



Bond papers

HP Universal Bond Paper FSC® certified

HP Universal Bond Paper with ColorPRO Technology delivers professional quality and striking results at production speed. See more striking colors, crisper text and graphics, and higher-contrast blacks.

Weight: **80 g/m² (21 lbs)** Thickness/caliper: **106 microns/4.2 mil** Whiteness: **160⁶** Brightness: **110⁷** Opacity: **91%⁸**

HP Bright White Inkjet Paper FSC® certified

HP Bright White Inkjet Paper with ColorPRO Technology is our brightest white bond paper. This cost-effective paper is ideal for everyday black and color line drawings. See the ColorPRO difference with high-impact graphics and an extended range of colors.

Weight: **90 g/m² (24 lbs)** Thickness/caliper: **119 microns/4.7 mil** Whiteness: **168⁶** Brightness: **113⁷** Opacity: **93%⁸**

Coated papers

HP Coated Paper PEFC™ certified

Do more with this versatile premium bright white paper—from working comps and design proofs to fine line drawings and illustrations. This premium bright white paper is easy to handle and provides high-quality, consistent results.

Weight: **90 g/m² (24 lbs)** Thickness/caliper: **114 microns/4.5 mil** Whiteness: **145⁹** Brightness: **89%¹⁰** Opacity: **93%¹¹**

HP Universal Coated Paper FSC® certified

HP Universal Coated Paper is an economical material ideal for a variety of technical and graphics applications from working comps and design proofs to POP signage and special event posters.

Weight: **90 g/m² (24 lbs)** Thickness/caliper: **124 microns/4.9 mil** Whiteness: **117¹²** Brightness: **89%¹⁰** Opacity: **89%¹¹**

HP Universal Heavyweight Coated Paper FSC® certified

This economical printing material is ideal for a variety of medium ink-density graphics and technical applications including presentations, indoor signs, and posters that are frequently replaced.

Weight: **125 g/m² (33 lbs)** Thickness/caliper: **165 microns/6.5 mil** Whiteness: **130¹²** Brightness: **>95%¹⁰** Opacity: **>90%¹¹**

HP Heavyweight Coated Paper PEFC™ certified

HP Heavyweight Coated Paper is ideal for durable, long-term applications such as signs and posters. The bright, matte inkjet paper makes colorful, light ink-density images look crisp and smooth.

Weight: **130 g/m² (35 lbs)** Thickness/caliper: **167 microns/6.6 mil** Whiteness: **144¹²** Brightness: **89%¹⁰** Opacity: **96%¹¹**

HP Super Heavyweight Plus Matte Paper

HP Super Heavyweight Plus Matte Paper is a best-in-class graphics display media that delivers sharp image quality and ripple-free prints, even with high ink density. Enhance productivity with broad application versatility, instant dry time, and excellent film laminate compatibility. See a rich, distinctive look and feel with the ultra-white matte finish.

Weight: **210 g/m² (55 lbs)** Thickness/caliper: **264 microns/10.4 mil** Whiteness: **130¹²** Brightness: **91%¹⁰** Opacity: **98%¹¹**

HP technical papers



HP Special Inkjet Paper

HP Special Inkjet Paper is an economical everyday paper, ideal for high-resolution presentation graphics.

Weight: **90 g/m²** Thickness/caliper: **109 microns/4.3 mil** Whiteness: **110¹²** Brightness: **96%¹⁰** Opacity: **91%¹¹**

HP Natural Tracing Paper

HP Natural Tracing Paper is designed for reproducible final drawings that are highly durable.

Weight: **90 g/m²** Thickness/caliper: **76 microns/3 mil** Whiteness: **N/A** Brightness: **61%¹⁰** Opacity: **25%¹¹**

HP Translucent Bond Paper

This economical alternative to vellum is ideal for reproducible drawings and check prints.

Weight: **67 g/m²** Thickness/caliper: **76 microns/3 mil** Whiteness: **73¹²** Brightness: **70%¹⁰** Opacity: **70%¹¹**



- ⁵ Can be recycled through commonly available recycling programs.
- ⁶ Per ISO 11475 Test Method.
- ⁷ Per ISO 2470-2 Test Method.
- ⁸ Per ISO 2471 Test Method.
- ⁹ Per CIE Whiteness ISO 11475 D65/10° Outdoor Daylight Test Method.
- ¹⁰ Per TAPPI T-452 Test Method.
- ¹¹ Per TAPPI T-425 Test Method.
- ¹² Per CIE Ganz 82 Test Method.





HP films (graphics & technical)



HP Clear Film ¹³

HP Clear Film is ideal for multiple overlays and transparent images. This optically clear film provides excellent ink adhesion and bleed control as well as bright, vivid colors.

Weight: **174 g/m²** Thickness/caliper: **132 microns/5.2 mil** Whiteness: **N/A** Brightness: **N/A** Opacity: **8%¹⁴**

HP Matte Film ¹³

Keep track of changes during the review process. Redraw in pen, pencil, or marker on the erasable side, write with pen on the traditional drafting coating on the opposite side. This smear-resistant, archivable, and recyclable¹³ film produces sharp black and color lines and uniform solid areas and is ideal for original and high-volume reproducible drawings.

Weight: **160 g/m²** Thickness/caliper: **127 microns/5 mil** Whiteness: **N/A** Brightness: **72%¹⁵** Opacity: **34%¹⁶**

HP photographic papers



Optimized for Original HP dye-based inks

HP Universal Gloss Photo Paper

HP Universal Gloss Photo Paper is an economical and versatile choice for presentation graphics, displays, and color presentations.

Weight: **190 g/m²** Thickness/caliper: **167 microns/6.6 mil** Whiteness: **105¹⁷** Brightness: **89%¹⁸** Opacity: **95%¹⁴**

HP Universal Satin Photo Paper

HP Universal Satin Photo Paper is a versatile, economical satin-finish paper that provides excellent image quality and vivid color for presentation graphics, displays, and presentations.

Weight: **190 g/m²** Thickness/caliper: **167 microns/6.6 mil** Whiteness: **105¹⁷** Brightness: **89%¹⁸** Opacity: **95%¹⁴**

HP Premium Gloss Photo Paper FSC® certified

This FSC®-certified premium glossy photo paper delivers both excellent image quality and long-lasting display permanence. With an excellent color gamut and consistent gloss, see accurate color and color stability in less than one hour. Photo-realistic prints achieve up to 60 years indoor display permanence.¹⁹

Weight: **240 g/m²** Thickness/caliper: **248 microns/9.8 mil** Whiteness: **>or = to 99¹⁷** Brightness: **>or = to 87%¹⁸** Opacity: **>or = to 93%¹⁶**

HP Premium Satin Photo Paper FSC® certified

This FSC®-certified premium satin photo paper delivers both excellent image quality and long-lasting display permanence. With an excellent color gamut, see accurate color and color stability in less than one hour. Photo-realistic prints achieve up to 70 years indoor display permanence.²¹

Weight: **240 g/m²** Thickness/caliper: **248 microns/9.8 mil** Whiteness: **>or = to 99¹⁷** Brightness: **>or = to 87%¹⁷** Opacity: **>or = to 93%¹⁶**

Optimized for Original HP pigment-based inks

HP Everyday Instant-dry Gloss Photo Paper ²⁰ FSC® certified

Designed for maximum ink absorption, this everyday gloss-finish photo paper includes a porous surface that enables higher ink density, speeds dry time, and achieves vibrant, long-lasting color. And this FSC®-certified paper is recyclable through commonly available recycling programs.²⁰

Weight: **235 g/m²** Thickness/caliper: **231 microns/9.1 mil** Whiteness: **90²¹** Brightness: **90%^{18,16}** Opacity: **96%^{14,22}**

HP Everyday Instant-dry Satin Photo Paper ²⁰ FSC® certified

Designed for maximum ink absorption, this everyday satin-finish photo paper includes a porous surface that enables higher ink density, speeds dry time, and achieves vibrant, long-lasting color. And this FSC®-certified paper is recyclable through commonly available recycling programs.²⁰

Weight: **235 g/m²** Thickness/caliper: **231 microns/9.1 mil** Whiteness: **90²¹** Brightness: **90%^{18,16}** Opacity: **96%^{14,22}**

¹³ HP Large Format Media take-back program availability varies. Recycling programs may not exist in your area. See hp.com/recycle for details.

¹⁴ Per TAPPI T-425 Test Method.

¹⁵ Per ISO 2469 Test Method.

¹⁶ Per ISO 2470 Test Method.

¹⁷ Per CIE Ganz 82 Test Method.

¹⁸ Per TAPPI T-452 Test Method.

¹⁹ Display permanence rating for interior displays/away from direct sunlight, under glass by HP Image Permanence Lab. For more information, see hp.com/go/supplies/printpermanence.

²⁰ In North America and Asia (including Japan), recyclable in consumer collection systems that can accept mixed paper (may not be recyclable in your area); in Europe recyclable in consumer collection systems that accept liquid packaging.

²¹ Per ISO 11476 Test Method.

²² Per ISO 2471 Test Method.

HP Universal Instant-dry Gloss Photo Paper  ²³ FSC® certified

This economical gloss-finish photo paper has been improved, now offering even higher image quality with deeper blacks and more vivid colors. Prints dry instantly for immediate handling and lamination. And indoor displays on this FSC®-certified paper provide exceptional display permanence.²⁴

Weight: **200 g/m²** Thickness/caliper: **195 microns/7.7 mil** Whiteness: **99²⁵** Brightness: > **92%²⁶** Opacity: > **94.5%²⁷**

HP Universal Instant-dry Satin Photo Paper  ²³ FSC® certified

This economical satin-finish photo paper has been improved, now offering even higher image quality with deeper blacks and more vivid colors. Prints dry instantly for immediate handling and lamination. And indoor displays on this FSC®-certified paper provide exceptional display permanence.²⁴

Weight: **200 g/m²** Thickness/caliper: **200 microns/7.9 mil** Whiteness: **99²⁵** Brightness: > **92%²⁶** Opacity: > **94.5%²⁷**

HP Premium Instant-dry Gloss Photo Paper  ²³ FSC® certified

This premium gloss-finish photo paper has been improved to offer unrivaled image quality for brilliant photos and high-impact display graphics—from posters and presentations to retail graphics. Prints dry instantly for immediate handling and lamination. And indoor displays on this FSC®-certified paper provide exceptional display permanence.²⁵

Weight: **260 g/m²** Thickness/caliper: **261 microns/10.3 mil** Whiteness: **105²⁸** Brightness: **92%²⁶** Opacity: **97%²⁹**

HP Premium Instant-dry Satin Photo Paper  ²³ FSC® certified

This premium satin-finish photo paper has been improved to offer unrivaled image quality for brilliant photos and high-impact display graphics—from posters and presentations to retail graphics. Prints dry instantly for immediate handling and lamination. And indoor displays on this FSC®-certified paper provide exceptional display permanence.²⁴

Weight: **260 g/m²** Thickness/caliper: **261 microns/10.3 mil** Whiteness: **104²⁸** Brightness: **92%²⁶** Opacity: **97%²⁹**

HP Professional Instant-dry Satin Photo Paper

This professional, satin-finish photo paper is ideal for printing photographs with vivid, true-to-life colors, realistic skin tones, rich blacks, and sharp details. The professional-grade weight adds a gallery-ready look and feel and enables easier handling of large-size exhibition prints. Long-lasting display prints provide exceptional display permanence.²⁴

Weight: **300 g/m²** Thickness/caliper: **287 microns/11.3 mil** Whiteness: > **115²⁸** Brightness: > **91%^{26,30}** Opacity: > **97%²⁹, >95%²⁷**

HP Premium Matte Photo Paper  ²³

This premium photo paper features a smooth matte surface together with a sturdy 210-g/m² weight ideal for producing professional, ripple-free prints. Instant-dry prints enable immediate lamination.

Weight: **210 g/m²** Thickness/caliper: **264 microns/10.4 mil** Whiteness: **130²⁸** Brightness: **91%²⁶** Opacity: **98%²⁹**



²³ In North America and Asia (including Japan), recyclable in consumer collection systems that can accept mixed paper (may not be recyclable in your area); in Europe recyclable in consumer collection systems that accept liquid packaging.

²⁴ Indoor display permanence ratings by HP Image Permanence Lab and/or by Wilhelm Imaging Research, Inc. on a range of HP media. For more information, see hp.com/go/supplies/printpermanence.

²⁵ Per ISO 11476 Test Method.

²⁶ Per TAPPI T-452 Test Method.

²⁷ Per ISO 2471 Test Method.

²⁸ Per CIE Ganz 82 Test Method.

²⁹ Per TAPPI T-425 Test Method.

³⁰ Per ISO 2470 Test Method.

HP backlit materials



HP Premium Vivid Color Backlit Film ³¹

With a porous coating on the printable front side, HP Premium Vivid Color Backlit Film enhances image definition and provides excellent color contrast. A thick, stiff construction enables easy handling. Designed together with Original HP pigment inks, this film produces fast-dry prints with excellent indoor, in-window display permanence.³²

Weight: **285 g/m²** Thickness/caliper: **220 microns/8.7 mil** Whiteness: **115³³, 110³⁴** Brightness: **>or = to 86%³⁵** Opacity: **>or = to 77%³⁶**
>or = to 74%³⁷



³¹ HP Large Format Media take-back program availability varies. Recycling programs may not exist in your area. See hp.com/recycle for details.

³² Interior in-window display ratings by HP Image Permanence Lab on a range of HP media. HP predictions based on test data under Xenon-Arc illuminant—calculation assumes 6,000 Lux/12 hr day. For more information, see hp.com/go/supplies/printpermanence.

³³ Per CIE Ganz 82 Test Method.

³⁴ Per ISO 11476 Test Method.

³⁵ Per TAPPI T-452 Test Method.

³⁶ Per TAPPI T-425 Test Method.

³⁷ Per ISO 2471 Test Method.

HP self-adhesive materials



HP Universal Adhesive Vinyl, 2 Pack

An economical, everyday adhesive vinyl ideal for both indoor and outdoor applications. HP Universal Adhesive Vinyl is easy to use and produces long-lasting, eye-catching displays.

Weight:	Thickness/caliper:	Whiteness:	Brightness:	Opacity:
Without liner: 150 g/m²	Without liner: 139 microns (5.5 mil)	With liner: 115³⁸, 141³⁹	With liner: >95%⁴⁰, >96%⁴¹	With liner: >96%^{42,43}
With liner: 290 g/m²	With liner: 289 microns (11.4 mil)			

HP Colorfast Adhesive Vinyl, 2 Pack

HP Colorfast Adhesive Vinyl is a presentation-quality vinyl with a pressure-sensitive adhesive that sticks where it's needed, for as long as it's needed—without cracking or peeling. The white-matte finish makes colors sharp and crisp.

Weight:	Thickness/caliper:	Whiteness:	Brightness:	Opacity:
Without liner: 190 g/m²	Without liner: 160 microns (6.3 mil)	With liner: 112³⁸, 130³⁹	With liner: >90%⁴⁰, >92%⁴¹	With liner: >95%⁴², >96%⁴³
With liner: 345 g/m²	With liner: 325 microns (12.8 mil)			

HP Everyday Adhesive Matte Polypropylene, 2 Pack

A versatile and durable polypropylene film that produces quality prints with excellent color vibrancy at an everyday price. Ideal for both indoor and outdoor applications.

Weight:	Thickness/caliper:	Whiteness:	Brightness:	Opacity:
Without liner: 120 g/m²	Without liner: 180 microns (7.1 mil)	With liner: 150³⁹	With liner: >101%⁴¹	With liner: >96%^{42,43}
With liner: 168 g/m²	With liner: 215 microns (8.5 mil)			

HP Everyday Adhesive Gloss Polypropylene, 2 Pack

This self-adhesive polypropylene film produces glossy prints with excellent color vibrancy and brilliant, photo-realistic images. Tear-resistant and easy to handle, its strong adhesive ensures secure, reliable mounting.

Weight:	Thickness/caliper:	Whiteness:	Brightness:	Opacity:
Without liner: 120 g/m²	Without liner: 180 microns (7.1 mil)	With liner: 99%^{38,39}	With liner: 87.5%⁴⁰, 90%⁴¹	With liner: >95%⁴², >96%⁴³
With liner: 168 g/m²	With liner: 215 microns (8.5 mil)			



³⁸ Per ISO 11476 Test Method.
³⁹ Per ISO 11475 Test Method.
⁴⁰ Per TAPPI T-452 Test Method.
⁴¹ Per ISO 2470 Test Method.
⁴² Per TAPPI T-425 Test Method.
⁴³ Per ISO 2471 Test Method.

HP banner & sign materials



HP Opaque Scrim

HP Opaque Scrim is a matte, opaque PVC banner with a tear-resistant polyester fabric embedded between two white vinyl layers. It is an easy-to-use, high-quality material for banners, decorating, and indoor and outdoor signs.

Weight: **460 g/m²** Thickness/caliper: **340 microns/13.4 mil** Whiteness: **140⁴⁴** Brightness: **92%⁴⁵** Opacity: **100%⁴⁶**

HP Premium Matte Polypropylene, 2 Pack

This versatile, durable matte polypropylene film is water-⁴⁸ and tear-resistant, making it ideal for both indoor and outdoor applications full of brilliant color and edge definition. And it's recyclable.⁴⁷

Weight: **140 g/m²** Thickness/caliper: **231 microns (9.1 mil)** Whiteness: **120⁴⁹, 154⁵⁰** Brightness: **>99%⁴⁵, 105%⁵¹** Opacity: **>96%⁴⁶, 98%⁵²**

HP Everyday Matte Polypropylene, 2 Pack

Produce high-impact signs with this versatile, durable matte polypropylene film. This tear-resistant substrate is easy to use and handle, and is ideal for both indoor and outdoor applications.

Weight: **120 g/m²** Thickness/caliper: **203 microns/8 mil** Whiteness: **>113⁴⁹** Brightness: **>101%⁵¹** Opacity: **>96%⁴⁶**

HP Durable Semi-gloss Display Film

HP Durable Semi-gloss Display Film is an opaque, white inkjet-compatible coated PET film designed for pop-up display and roll-up indoor presentation systems. No backside lamination is needed, and this film is resistant to stress from rolling and unrolling.

Weight: **265 g/m²** Thickness/caliper: **198 microns/7.8 mil** Whiteness: **N/A** Brightness: **119%⁵³** Opacity: **>99%⁵⁴**

HP Durable Banner with DuPont™ Tyvek®, 2 Pack

HP Durable Banner with DuPont™ Tyvek® is durable, water resistant, and easy-to-handle. Grommetable, stitchable, tear resistant, and strong, it's the ideal solution for long-term quality and durability.

Weight: **133 g/m²** Thickness/caliper: **299 microns/11.8 mil** Whiteness: **125⁴⁹, 154⁵⁰** Brightness: **>99%⁴⁵, 102%⁵¹** Opacity: **>96%⁴⁶, 52**

⁴⁴ Per CIE Ganz 82 Test Method.

⁴⁵ Per TAPPI T-452 Test Method.

⁴⁶ Per TAPPI T-425 Test Method.

⁴⁷ HP Large Format Media take-back program availability varies. Recycling programs may not exist in your area. See hp.com/recycle for details.

⁴⁸ With HP 83 UV pigment inks. Water resistance testing by HP Image Permanence Lab on a range of HP media and follows ISO 18935 method. For more information, see hp.com/go/supplies/printpermanence.

⁴⁹ Per ISO 11476 Test Method.

⁵⁰ Per ISO 11475 Test Method.

⁵¹ Per ISO 2470 Test Method.

⁵² Per ISO 2471 Test Method.

⁵³ Per ISO 2470-1 Test Method.

⁵⁴ Per DIN 53146 Test Method.



HP fine art printing materials



HP Matte Litho-realistic Paper

HP Matte Litho-realistic Paper delivers outstanding results with the look, feel, and longevity of a heavy, matte offset paper. This natural-white paper is ideal for high-quality poster art and other cost-effective art reproductions.

Weight: **270 g/m²** Thickness/caliper: **330 microns/13 mil** Whiteness: **>75⁵⁵** Brightness: **>87%⁵⁶** Opacity: **>98%⁵⁷**

HP Universal Matte Canvas

HP Universal Matte Canvas is an economical artist stretch canvas that delivers high quality for price-sensitive applications. See true artistic quality and long-lasting results on the slightly textured, matte surface.

Weight: **350 g/m²** Thickness/caliper: **457 microns/18 mil** Whiteness: **117⁵⁸, 127⁵⁹, 125⁵⁵** Brightness: **92%⁶⁰, 101%⁵⁶** Opacity: **>98%⁶¹**

HP Artist Matte Canvas

HP Artist Matte Canvas is ideal for printing high-quality, fine art reproductions and photographs at an affordable price. This mid-grade artist canvas features a bright-white coating.

Weight: **380 g/m²** Thickness/caliper: **457 microns/18 mil** Whiteness: **120⁵⁸, 125⁵⁹, 123⁵⁵** Brightness: **92%⁶⁰, 100%⁵⁶** Opacity: **>98%⁶¹**

HP Collector Satin Canvas

HP Collector Satin Canvas offers a larger color gamut ideal for producing long-lasting, museum-quality prints. A more consistent base fabric and a smooth, even brighter white satin finish helps reduce scrap.⁶² A flexible finish resists cracking for easier mounting. And broad laminate compatibility includes water-based liquid laminates.

Weight: **400 g/m²** Thickness/caliper: **558 microns/22 mil** Whiteness: **105^{58,55}, 107⁵⁹** Brightness: **95%⁶⁰** Opacity: **>98%⁶¹**

HP Professional Matte Canvas

HP Professional Matte Canvas now offers a more consistent base fabric. Museum-quality, matte-finish prints achieve vivid, accurate color reproduction with a bright white surface and improved color gamut ideal for fine art and photographs.⁶² Long-lasting, water-resistant⁶³ prints preserve your work. A flexible finish resists cracking for easier mounting. And broad laminate compatibility includes water-based liquid laminates.

Weight: **430 g/m²** Thickness/caliper: **558 microns/22 mil** Whiteness: **110⁵⁸, 131⁵⁹, 130⁵⁵** Brightness: **96%⁶⁰, 106%⁵⁶** Opacity: **>98%⁶¹, 100%⁵⁶**



⁵⁵ Per ISO 11475 Test Method.

⁵⁶ Per ISO 2470 Test Method.

⁵⁷ Per DIN 53146 Test Method.

⁵⁸ Per CIE Ganz 82 Test Method.

⁵⁹ Per ISO 11476 Test Method.

⁶⁰ Per TAPPI T-452 Test Method.

⁶¹ Per TAPPI T-425 Test Method.

⁶² Compared to the previous version.

⁶³ With Original HP 70 and HP 91 Photo Inks and HP 771 Vivid Photo Inks. Water resistance testing by HP Image Permanence Lab on a range of HP media and follows ISO 18935 method. For more information, see hp.com/go/supplies/printpermanence.

HP graphics and technical printing materials for HP large format printers

Compatibility and Availability Information

Original HP inks and HP printing materials—system chemistry

Original HP inks and printing materials are designed together to provide image quality, durability, and consistency you can rely on. Reliable results enable increased productivity and reduced costs.

Original HP inks are more than just ink and HP large format printing materials are far more than just paper. It's the chemical makeup of each, together with the carefully engineered interaction between the two, that make exceptional results possible. Image quality and consistency so predictable, it's almost cliché. Print permanence that's measured in generations, not months or years. Breakthrough innovations that give you real alternatives to traditional materials that, by nature, must trade-off quality, durability, even environmental considerations. The unique chemistry between HP inks and HP large format printing materials changes all that – among the broad array of materials offered in the HP large format printing materials portfolio, you can have it all.

Original HP inks and printheads

Original HP printing supplies feature intelligent technology, built into the ink cartridges, printheads, and the printer. These critical system components communicate interactively to provide automatic and continuous adjustments that optimize print quality and maximize printhead life. Individually-replaceable printheads enable easy, low-maintenance, cost-effective printing.

Designed with the environment in mind

Many HP graphics and technical printing materials are recyclable through commonly available recycling programs. And in some cases, HP offers the free, convenient HP Large Format Media take-back program.¹ And the HP Planet Partners program provides easy, convenient return and recycling of most Original HP Designjet ink cartridges and printheads.²

Compatibility & Availability Chart

HP Graphics and Technical Printing Materials

Printer availability varies by region.
North America includes the United States and Canada.

Part number	Metric size (mm x cm)	Imperial size (in x ft)	Region availability																				HP Designjet Printer/ePrinter/eMultifunction/Photo Printer Compatibility and Ink Technology																
			North America	Latin America	Japan	Asia (not Japan)	Europe	HP pigment inks							HP dye color inks																								
			Designjet Z3100	Designjet Z3100	Designjet Z3200	Designjet Z5200	Designjet Z5400	Designjet Z6100	Designjet Z6200	Designjet 5000 UV	Designjet 5500 UV	Designjet 5000 Dye	Designjet 5500 Dye	Designjet T120	Designjet T520	Designjet T610	Designjet T770	Designjet T790	Designjet T1100	Designjet T1120	Designjet T1200	Designjet T1300	Designjet T2300 eMFP	Designjet T1920	Designjet T1500	Designjet T2500 eMFP	Designjet T620	Designjet T7100	Designjet 4000	Designjet 4020	Designjet 4500	Designjet 4520	Designjet 500	Designjet 510	Designjet 111	Designjet 130			
HP Bond and Coated Papers																																							
HP Universal Bond Paper (FSC® certified)* 🌱	Q1396A	610 x 45,7	24 x 150	●	●	●	●	●	●	●	●	●	●	●	●	●	●	●	●	●	●	●	●	●	●	●	●	●	●	●	●	●	●	●	●	●	●	●	
	Q1397A	914 x 45,7	36 x 150	●	●	●	●	●	●	●	●	●	●	●	●	●	●	●	●	●	●	●	●	●	●	●	●	●	●	●	●	●	●	●	●	●	●	●	
	Q1398A	1067 x 45,7	42 x 150	●	●	●	●	●	●	●	●	●	●	●	●	●	●	●	●	●	●	●	●	●	●	●	●	●	●	●	●	●	●	●	●	●	●	●	●
	Q8751A	914 x 175	36 x 57,4	●	●	●	●	●	●	●	●	●	●	●	●	●	●	●	●	●	●	●	●	●	●	●	●	●	●	●	●	●	●	●	●	●	●	●	●
	Q8003A	(A1) 594 x 45,7				●	●			●	●				●	●					●	●				●	●												
HP Bright White Inkjet Paper (FSC® certified)* 🌱	Q8004A	(A1) 594 x 91,4				●	●			●	●				●	●					●	●				●	●												
	Q8005A	(A0) 841 x 91,4				●	●			●	●				●	●					●	●				●	●												
	C1860A	610 x 45,7	24 x 150	●	●					●	●				●	●					●	●				●	●												
	C1861A	914 x 45,7	36 x 150	●	●					●	●				●	●					●	●				●	●												
	C6035A	610 x 45,7				●	●			●	●				●	●					●	●				●	●												
	C6036A	914 x 45,7				●	●			●	●				●	●					●	●				●	●												
	C6810A	914 x 91,4	36 x 300	●	●					●	●				●	●					●	●				●	●												
HP Universal Coated Paper (FSC® certified)* 🌱	Q1446A	(A2) 420 x 45,7				●	●			●	●				●	●					●	●				●	●												
	Q1445A	(A1) 594 x 45,7				●	●			●	●				●	●					●	●				●	●												
	Q1444A	(A0) 841 x 45,7				●	●			●	●				●	●					●	●				●	●												
	Q1404A	610 x 45,7	24 x 150	●	●					●	●				●	●					●	●				●	●												
	Q1405A	914 x 45,7	36 x 150	●	●					●	●				●	●					●	●				●	●												
HP Coated Paper (PEFC™ certified)* 🌱	Q1406A	1067 x 45,7	42 x 150	●	●					●	●				●	●					●	●				●	●												
	Q1408A	1524 x 45,7	60 x 150	●	●					●	●				●	●					●	●				●	●												
	C6019B	610 x 45,7	24 x 150	●	●					●	●				●	●					●	●				●	●												
	C6020B	914 x 45,7	36 x 150	●	●					●	●				●	●					●	●				●	●												
	C6567B	1067 x 45,7	42 x 150	●	●					●	●				●	●					●	●				●	●												
	C6568B	1372 x 45,7	54 x 150	●	●					●	●				●	●					●	●				●	●												
	C6980A	914 x 91,4	36 x 300	●	●					●	●				●	●					●	●				●	●												
Q1443A	(A2) 420 x 45,7				●	●			●	●				●	●					●	●				●	●													
Q1442A	(A1) 594 x 45,7				●	●			●	●				●	●					●	●				●	●													
Q1441A	(A0) 841 x 45,7				●	●			●	●				●	●					●	●				●	●													

Original HP printing supplies

ColorPRO CAD/GA Printer series

Ink Cartridges	Color	Ink Volume
HP 10		
C4841A	Cyan	28 ml
C4842A	Yellow	28 ml
C4843A	Magenta	28 ml
C4844A	Black	69 ml

Printheads	Color
HP 10	
C4800A	Black
C4801A	Cyan
C4802A	Magenta
C4803A	Yellow



HP Designjet 10ps/20ps/50ps/120 Printer series

Ink Cartridges	Color	Ink Volume
HP 11		
C4836A	Cyan	28 ml
C4837A	Magenta	28 ml
HP 82		
C4913A	Yellow	69 ml
HP 84		
C5016A	Black	69 ml
C5017A	Light Cyan	69 ml
C5018A	Light Magenta	69 ml

Printheads	Color
HP 11	
C4811A	Cyan
C4812A	Magenta
C4813A	Yellow
HP 84	
C5019A	Black
C5020A	Light Cyan
C5021A	Light Magenta



HP Designjet 30/90/130 Printer series

Ink Cartridges	Color	Ink Volume
HP 84		
C5016A	Black	69 ml
HP 85		
C9425A	Cyan	28 ml
C9426A	Magenta	28 ml
C9427A	Yellow	69 ml
C9428A	Light Cyan	69 ml
C9429A	Light Magenta	69 ml

Printheads	Color
HP 84	
C5019A	Black
HP 85	
C9420A	Cyan
C9421A	Magenta
C9422A	Yellow
C9423A	Light Cyan
C9424A	Light Magenta



HP Designjet 70/100/100 Plus/110/110 Plus Printer series

Ink Cartridges	Color	Ink Volume
HP 10		
C4844A	Black	69 ml
HP 11		
C4836A	Cyan	28 ml
C4837A	Magenta	28 ml
C4838A	Yellow	28 ml

Printheads	Color
HP 11	
C4810A	Black
C4811A	Cyan
C4812A	Magenta
C4813A	Yellow



HP Designjet 111 Printer series

Ink Cartridges	Color	Ink Volume
HP 11		
C4836A	Cyan	28 ml
C4837A	Magenta	28 ml
C4838A	Yellow	28 ml
HP 82		
CH565A	Black	69 ml

Printheads	Color
HP 11	
C4810A	Black
C4811A	Cyan
C4812A	Magenta
C4813A	Yellow





HP Designjet 200/220 Printer series

Inkjet Print Cartridge (printhead included)	Color	Ink Volume
---	-------	------------

HP 26		
51626A	Black	40 ml

HP Designjet 230/250C Printer series

Inkjet Print Cartridge (printhead included)	Color	Ink Volume
---	-------	------------

HP 40		
51640A	Black	42 ml



HP Designjet 330/430 Printer series

Inkjet Print Cartridge (printhead included)	Color	Ink Volume
---	-------	------------

HP 40		
51640A	Black	42 ml

HP Designjet 350C/450C/455CA/488CA Printer series

Inkjet Print Cartridge (printhead included)	Color	Ink Volume
---	-------	------------

HP 40		
51640A	Black	42 ml

HP 44		
51644C	Cyan	42 ml

51644M	Magenta	42 ml
--------	---------	-------

51644Y	Yellow	42 ml
--------	--------	-------

HP Designjet 500 Monochrome Printer series

Ink Cartridge	Color	Ink Volume
---------------	-------	------------

HP 10		
C4844A	Black	69 ml

Printhead	Color
-----------	-------

HP 11	
C4810A	Black



HP Designjet 500/500 Plus/500PS Printer series

Ink Cartridges	Color	Ink Volume
----------------	-------	------------

HP 10		
C4844A	Black	69 ml

HP 82		
C4911A	Cyan	69 ml

C4912A	Magenta	69 ml
--------	---------	-------

C4913A	Yellow	69 ml
--------	--------	-------

CH566A	Cyan	28 ml
--------	------	-------

CH567A	Magenta	28 ml
--------	---------	-------

CH568A	Yellow	28 ml
--------	--------	-------

Printheads	Color
------------	-------

HP 11	
C4810A	Black

C4811A	Cyan
--------	------

C4812A	Magenta
--------	---------

C4813A	Yellow
--------	--------

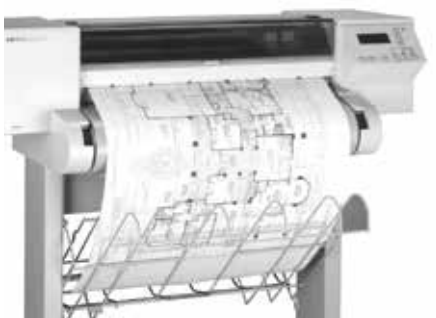

HP Designjet 510 Printer series

Ink Cartridges	Color	Ink Volume
----------------	-------	------------

HP 82		
C4911A	Cyan	69 ml

C4912A	Magenta	69 ml
--------	---------	-------

C4913A	Yellow	69 ml
--------	--------	-------

CH565A	Black	69 ml
--------	-------	-------

CH566A	Cyan	28 ml
--------	------	-------

CH567A	Magenta	28 ml
--------	---------	-------

CH568A	Yellow	28 ml
--------	--------	-------

Printheads	Color
------------	-------

HP 11	
C4810A	Black

C4811A	Cyan
--------	------

C4812A	Magenta
--------	---------

C4813A	Yellow
--------	--------

¹ Available in Asia Pacific only.



HP Designjet 600 Printer series

Inkjet Print Cartridge (printhead included)	Color	Ink Volume
HP 26		
51626A	Black	40 ml

HP Designjet 650C Printer series

Inkjet Print Cartridge (printhead included)	Color	Ink Volume
HP 40		
51640A	Black	42 ml



HP Designjet 700 Printer series

Inkjet Print Cartridge (printhead included)	Color	Ink Volume
HP 45		
51645A	Black	42 ml

HP Designjet 750C/750C Plus/755CM Printer series

Inkjet Print Cartridges (printhead included)	Color	Ink Volume
HP 44		
51644C	Cyan	42 ml
51644M	Magenta	42 ml
51644Y	Yellow	42 ml
HP 45		
51645A	Black	42 ml



HP Designjet 800 Printer series and HP Designjet 815/820 MFPs

Ink Cartridges	Color	Ink Volume
HP 10		
C4844A	Black	69 ml
HP 82		
C4911A	Cyan	69 ml
C4912A	Magenta	69 ml
C4913A	Yellow	69 ml

Printheads	Color
HP 11	
C4810A	Black
C4811A	Cyan
C4812A	Magenta
C4813A	Yellow



HP Designjet 1000 Printer series

Ink Cartridges	Color	Ink Volume
HP 80		
C4846A	Cyan	350 ml
C4847A	Magenta	350 ml
C4848A	Yellow	350 ml
C4871A	Black	350 ml
C4872A	Cyan	175 ml
C4873A	Yellow	175 ml
C4874A	Magenta	175 ml

Printheads/ printhead cleaners	Color
HP 80	
C4820A	Black
C4821A	Cyan
C4822A	Magenta
C4823A	Yellow



HP Designjet 4000/4500 Printer series and HP Designjet 4500 Multifunction Printer

Ink Cartridges	Color	Ink Volume
HP 90		
C5058A	Black	400 ml
C5059A	Black	775 ml
C5060A	Cyan	225 ml
C5061A	Cyan	400 ml
C5062A	Magenta	225 ml
C5063A	Magenta	400 ml
C5064A	Yellow	225 ml
C5065A	Yellow	400 ml

Ink Cartridges 3 Pack	Color	Ink Volume
HP 90		
C5083A	Cyan	3 x 400 ml
C5084A	Magenta	3 x 400 ml
C5085A	Yellow	3 x 400 ml
C5095A	Black	3 x 775 ml

Printheads/ printhead cleaners	Color
HP 90	

C5096A	Black
C5054A	Black
C5055A	Cyan
C5056A	Magenta
C5057A	Yellow

HP Designjet 5000/5500 Printer series

Ink Cartridges	Color	Ink Volume
HP 81		
C4930A	Black	680 ml
C4931A	Cyan	680 ml
C4932A	Magenta	680 ml
C4933A	Yellow	680 ml
C4934A	Light Cyan	680 ml
C4935A	Light Magenta	680 ml

Ink Cartridges 3 Pack	Color	Ink Volume
HP 81		
C5066A	Black	3 x 680 ml
C5067A	Cyan	3 x 680 ml
C5068A	Magenta	3 x 680 ml
C5069A	Yellow	3 x 680 ml
C5070A	Light Cyan	3 x 680 ml
C5071A	Light Magenta	3 x 680 ml

HP 83 UV		
C4940A	Black	680 ml
C4941A	Cyan	680 ml
C4942A	Magenta	680 ml
C4943A	Yellow	680 ml
C4944A	Light Cyan	680 ml
C4945A	Light Magenta	680 ml

HP 83 UV		
C5072A	Black	3 x 680 ml
C5073A	Cyan	3 x 680 ml
C5074A	Magenta	3 x 680 ml
C5075A	Yellow	3 x 680 ml
C5076A	Light Cyan	3 x 680 ml
C5077A	Light Magenta	3 x 680 ml

Printheads/ printhead cleaners	Color
HP 81	

C4950A	Black
C4951A	Cyan
C4952A	Magenta
C4953A	Yellow
C4954A	Light Cyan
C4955A	Light Magenta

HP 83 UV	
C4960A	Black
C4961A	Cyan
C4962A	Magenta
C4963A	Yellow
C4964A	Light Cyan
C4965A	Light Magenta





HP Designjet 5100 Printer series⁶⁴

Ink Cartridges	Color	Ink Volume
HP 705		
CD959A	Black	680 ml
CD960A	Cyan	680 ml
CD961A	Magenta	680 ml
CD962A	Yellow	680 ml
CD963A	Light Cyan	680 ml
CD964A	Light Magenta	680 ml

Printheads/printhead cleaner kits	Color
HP 705	
CD953A	Black
CD954A	Cyan
CD955A	Magenta
CD956A	Yellow
CD957A	Light Cyan
CD958A	Light Magenta



HP Designjet T120/T520 ePrinter series

Ink Cartridges	Color	Ink Volume
HP711		
CZ129A	Black	38 ml
CZ130A	Cyan	29 ml
CZ131A	Magenta	29 ml
CZ132A	Yellow	29 ml
CZ133A	Black	80 ml

Ink Cartridges 3 Pack	Color	Ink Volume
HP711		
CZ134A	Cyan	29 ml
CZ135A	Magenta	29 ml
CZ136A	Yellow	29 ml

Printhead	Color
HP711	
C1Q10A	Printhead Replacement Kit

HP Designjet T610/T620/T770/T1100/T1120 Printer series, HP Designjet T1200 HD Multifunction Printer, HP Designjet T790/T1300 ePrinter series, HP Designjet T2300 eMultifunction Printer series

Ink Cartridges	Color	Ink Volume
HP 72		
C9370A	Photo Black	130 ml
C9371A	Cyan	130 ml
C9372A	Magenta	130 ml
C9373A	Yellow	130 ml
C9374A	Gray	130 ml
C9397A	Photo Black	69 ml
C9398A	Cyan	69 ml
C9399A	Magenta	69 ml
C9400A	Yellow	69 ml
C9401A	Gray	69 ml
C9403A	Matte Black	130 ml
HP 726		
CH575A ⁶⁵	Matte Black	300 ml

Printheads	Color
HP 72	
C9380A	Gray and Photo Black
C9383A	Magenta and Cyan
C9384A	Matte Black and Yellow



HP Designjet T7100 Monochrome Printer

Ink Cartridges	Color	Ink Volume
HP 761		
CM991A ⁶⁶	Matte Black	400 ml
CM996A ⁶⁶	Dark Gray	400 ml
CM997A ⁶⁶	Matte Black	775 ml
HP 763		
CN072A ⁶⁷	Matte Black	775 ml
CN073A ⁶⁷	Dark Gray	775 ml

Ink Cartridges 3 Pack	Color	Ink Volume
HP 761		
CR274A ⁶⁸	Dark Gray	400 ml
CR275A ⁶⁸	Matte Black	775 ml

Printheads	Color
HP 761	
CH648A	Matte Black and Matte Black
HP 762	
CN074A	Dark Gray
CM998A	Black Maintenance Cartridge



⁶⁴ Available in Asia Pacific only.
⁶⁵ Compatible with HP Designjet T1200 HD Multifunction Printer, HP Designjet T1300 ePrinter series, and HP Designjet T2300 eMultifunction Printer series only.
⁶⁶ Not compatible with emerging printers.
⁶⁷ Compatible with emerging printers only.
⁶⁸ Available only in Europe, Middle East, and Africa.

HP Designjet T7100 Printer series

Ink Cartridges	Color	Ink Volume
HP 761		
CM991A ⁶⁹	Matte Black	400 ml
CM992A	Yellow	400 ml
CM993A	Magenta	400 ml
CM994A	Cyan	400 ml
CM995A	Gray	400 ml
CM996A ⁶⁹	Dark Gray	400 ml
CM997A ⁶⁹	Matte Black	775 ml

Printheads	Color
HP 761	
CH645A	Yellow
CH646A	Magenta and Cyan
CH647A	Gray and Dark Gray
CH648A	Matte Black and Matte Black
CH649A	Maintenance Cartridge

HP Designjet T920/T1500 ePrinter series and HP Designjet T2500 eMultifunction series

Ink Cartridges	Color	Ink Volume
HP 727		
C1Q11A	Matte Black	69 ml
B3P13A	Cyan	40 ml
B3P14A	Magenta	40 ml
B3P15A	Yellow	40 ml
B3P17A	Photo Black	40 ml
B3P18A	Gray	40 ml
B3P19A	Cyan	130 ml
B3P20A	Magenta	130 ml
B3P21A	Yellow	130 ml
B3P22A	Matte Black	130 ml
B3P23A	Photo Black	130 ml
B3P24A	Gray	130 ml
C1Q12A	Matte Black	300 ml

Ink Cartridges	Color	Ink Volume
3 Pack ⁷⁰		
HP 761		
CR270A	Yellow	3 x 400 ml
CR271A	Magenta	3 x 400 ml
CR272A	Cyan	3 x 400 ml
CR273A	Gray	3 x 400 ml
CR274A	Dark Gray	3 x 400 ml
CR275A	Matte Black	3 x 775 ml

Printhead
HP 727
B3P06A Printhead Replacement Kit



HP Designjet Z2100 Photo Printer series and HP Designjet Z5200 PostScript Printer

Ink Cartridges	Color	Ink Volume
HP 70		
C9448A	Matte Black	130 ml
C9449A	Photo Black	130 ml
C9451A	Light Gray	130 ml
C9452A	Cyan	130 ml
C9453A	Magenta	130 ml
C9454A	Yellow	130 ml
C9455A	Light Magenta	130 ml
C9390A	Light Cyan	130 ml

Printheads	Color
HP 70	
C9404A	Matte Black and Cyan
C9405A	Light Magenta and Light Cyan
C9406A	Magenta and Yellow
C9407A	Photo Black and Light Gray

HP 772 (for the HP Designjet Z5200 PostScript Printer only)		
CN629A	Magenta	300 ml
CN630A	Yellow	300 ml
CN631A	Light Magenta	300 ml
CN632A	Light Cyan	300 ml
CN633A	Photo Black	300 ml
CN634A	Light Gray	300 ml
CN635A	Matte Black	300 ml
CN636A	Cyan	300 ml



⁶⁹ Not compatible with emerging printers.

⁷⁰ Available only in Europe, Middle East, and Africa.

HP Designjet Z3100 Photo Printer series

Ink Cartridges	Color	Ink Volume
HP 70		
C9448A	Matte Black	130 ml
C9449A	Photo Black	130 ml
C9450A	Gray	130 ml
C9451A	Light Gray	130 ml
C9453A	Magenta	130 ml
C9454A	Yellow	130 ml
C9455A	Light Magenta	130 ml
C9456A	Red	130 ml
C9457A	Green	130 ml
C9458A	Blue	130 ml
C9459A	Gloss Enhancer	130 ml
C9390A	Light Cyan	130 ml

HP Designjet Z3200 Photo Printer series

Ink Cartridges	Color	Ink Volume
HP 70		
C9448A	Matte Black	130 ml
C9449A	Photo Black	130 ml
C9450A	Gray	130 ml
C9451A	Light Gray	130 ml
C9453A	Magenta	130 ml
C9454A	Yellow	130 ml
C9455A	Light Magenta	130 ml
C9457A	Green	130 ml
C9458A	Blue	130 ml
C9459A	Gloss Enhancer	130 ml
C9390A	Light Cyan	130 ml
HP 73		
CD951A	Chromatic Red	130 ml

HP Designjet Z5400 PostScript® ePrinter

Ink Cartridges	Color	Ink Volume
HP 772		
CN629A	Magenta	300 ml
CN630A	Yellow	300 ml
CN633A	Photo Black	300 ml
CN634A	Light Gray	300 ml
CN635A	Matte Black	300 ml
CN636A	Cyan	300 ml
HP 70		
C9448A	Matte Black	130 ml
C9449A	Photo Black	130 ml
C9451A	Light Gray	130 ml
C9453A	Magenta	130 ml
C9454A	Yellow	130 ml
C9452A	Cyan	130 ml

HP Designjet Z6100 Printer series

Ink Cartridges	Color	Ink Volume
HP 91		
C9464A	Matte Black	775 ml
C9465A	Photo Black	775 ml
C9466A	Light Gray	775 ml
C9467A	Cyan	775 ml
C9468A	Magenta	775 ml
C9469A	Yellow	775 ml
C9470A	Light Cyan	775 ml
C9471A	Light Magenta	775 ml

Printheads	Color
HP 70	
C9405A	Light Magenta and Light Cyan
C9406A	Magenta and Yellow
C9407A	Photo Black and Light Gray
C9408A	Blue and Green
C9409A	Matte Black and Red
C9410A	Gloss Enhancer and Gray

Printheads	Color
HP 70	
C9405A	Light Magenta and Light Cyan
C9406A	Magenta and Yellow
C9407A	Photo Black and Light Gray
C9408A	Blue and Green
C9410A	Gloss Enhancer and Gray
HP 73	
CD949A	Matte Black and Chromatic Red

Printheads	Color
HP 70	
C9404A	Matte Black and Cyan
C9406A	Magenta and Yellow
C9407A	Photo Black and Light Gray

Printheads	Color
HP 91	
C9460A	Matte Black and Cyan
C9461A	Magenta and Yellow
C9462A	Light Magenta and Light Cyan
C9463A	Photo Black and Light Gray
C9518A	Maintenance Cartridge





HP Designjet Z6200 Photo Printer series

Ink Cartridges			Color	Ink Volume
HP771A ⁷¹	HP771B ⁷²	HP771C ⁷³		
B6Y15A	B6X99A	B6Y07A	Matte Black	775 ml
B6Y16A	B6Y00A	B6Y08A	Chromatic Red	775 ml
B6Y17A	B6Y01A	B6Y09A	Magenta	775 ml
B6Y18A	B6Y02A	B6Y10A	Yellow Light	775 ml
B6Y19A	B6Y03A	B6Y11A	Magenta	775 ml
B6Y20A	B6Y04A	B6Y12A	Light Cyan	775 ml
B6Y21A	B6Y05A	B6Y13A	Photo Black	775 ml
B6Y22A	B6Y06A	B6Y14A	Light Gray	775 ml

Ink Cartridges, 3 Pack			Color	Ink Volume
HP771A ⁷¹	HP771B ⁷²	HP771C ⁷³		
B6Y39A	B6Y23A	B6Y31A	Matte Black	3 x 775 ml
B6Y40A	B6Y24A	B6Y32A	Chromatic Red	3 x 775 ml
B6Y41A	B6Y25A	B6Y33A	Magenta	3 x 775 ml
B6Y42A	B6Y26A	B6Y34A	Yellow Light	3 x 775 ml
B6Y43A	B6Y27A	B6Y35A	Magenta	3 x 775 ml
B6Y44A	B6Y28A	B6Y36A	Light Cyan	3 x 775 ml
B6Y45A	B6Y29A	B6Y37A	Photo Black	3 x 775 ml
B6Y46A	B6Y30A	B6Y38A	Light Gray	3 x 775 ml

Printheads	Color
HP 771	
CE017A	Matte Black and Chromatic Red
CE018A	Magenta and Yellow
CE019A	Light Magenta and Light Cyan
CE020A	Photo Black and Light Gray
CH644A	Maintenance Cartridge

⁷¹ North America and Latin America only.
⁷² Asia Pacific and Oceania only.
⁷³ Europe, Middle East, and Africa only.

HP Large Format Graphics & Technical Printing Materials



Portfolio overview



Bond and coated

Bond

Z T

- HP Universal Bond Paper
- HP Bright White Inkjet Paper

Coated

Z T

- HP Universal Coated Paper
- HP Coated Paper

Heavyweight

Z T

- HP Universal Heavyweight Coated Paper
- HP Heavyweight Coated Paper
- HP Super Heavyweight Plus Matte Paper



Photographic

Technical photo

T

- HP Universal Gloss Photo Paper
- HP Universal Satin Photo Paper
- HP Premium Gloss Photo Paper
- HP Premium Satin Photo Paper

Matte finish

Z T

- HP Premium Matte Photo Paper

Instant dry

Z T

- HP Universal Instant-dry Gloss Photo Paper
- HP Universal Instant-dry Satin Photo Paper
- HP Premium Instant-dry Gloss Photo Paper
- HP Premium Instant-dry Satin Photo Paper
- HP Professional Instant-dry Satin Photo Paper

Instant dry

Z

- HP Everyday Instant-dry Gloss Photo Paper
- HP Everyday Instant-dry Satin Photo Paper



Technical

T

- HP Special Inkjet Paper
- HP Natural Tracing Paper
- HP Translucent Bond Paper



Backlit

Z

- HP Premium Vivid Color Backlit Film



Films

T

- HP Clear Film
- HP Matte Film



Fine art

Z

- HP Matte Litho-realistic Paper
- HP Universal Matte Canvas
- HP Artist Matte Canvas
- HP Collector Satin Canvas
- HP Professional Matte Canvas



Self-adhesive

Z T

- HP Universal Adhesive Vinyl, 2 Pack
- HP Colorfast Adhesive Vinyl, 2 Pack
- HP Everyday Adhesive Gloss Polypropylene, 2 Pack
- HP Everyday Adhesive Matte Polypropylene, 2 Pack



Banner & sign

Z T

- HP Opaque Scrim
- HP Premium Matte Polypropylene, 2 Pack
- HP Everyday Matte Polypropylene, 2 Pack
- HP Durable Semi-gloss Display Film
- HP Durable Banner with DuPont™ Tyvek®, 2 Pack

Legend

- T** Optimized for Original HP dye-based inks
- T** Compatible with Original HP dye-based inks with image permanence limitations
- Z** Optimized for Original HP pigment-based inks

More information
about HP LFP
materials here



Est. 1991
DESIGNSUPPLY 
supporting creativity
0800 018 23 23
sales@designsupply.com

© 2013 Hewlett-Packard Development Company, L.P. The information contained herein is subject to change without notice. The only warranties for HP products and services are set forth in the express warranty statements accompanying such products and services. Nothing herein should be construed as constituting an additional warranty. HP shall not be liable for technical or editorial errors or omissions contained herein.

