



The Solutionists®

Fiber Instrument Sales, Inc.

**2020**  
44<sup>th</sup> Edition

# Telecommunications Fiber Optic Product Catalog

Providing Fiber Optic Solutions  
For Over 35 Years

**5G**  
SUPPORTING PRODUCTS

Desk Reference



**FIBER OPTIC  
ENCLOSURES**

See Pages 10 - 15



**SPLICE-ON  
CONNECTORS**

Starting At Page 71



**ZEUS FTTx  
SOLUTION**

See Pages 144 - 145



**FIBER OPTIC  
ASSEMBLIES**

See Pages 26-39

Sales Representatives Are Waiting For Your Call!

**1-800-5000-FIS(347)**

[www.fiberinstrumentsales.com](http://www.fiberinstrumentsales.com)

FOR OUR FULL LINE OF PRODUCT OFFERINGS

# FTTx PRODUCTS & SOLUTIONS

# PRESIDENT'S MESSAGE

## *Dear Valued Customer,*

Technical support and quick delivery from huge inventories continues to be our focus.

This changing fiber optic market place provides new opportunities for us to better serve you. In expanding our engineering department capabilities and utilizing our already existing manufacturing infrastructure, we are now in hot pursuit of your product requirements, whether they are big, medium or small.

FIS is prepared to explore development of equivalent replacement(s) of your discontinued staple items, or items that are incurring unacceptable price increases. Our capabilities include designing and building equivalent breakout boxes or even creating a new design that incorporates your special requirements.

Modification of our manufactured test equipment or designing a new testing apparatus you require is within our capabilities. See in our 2020 catalog our recently released MPO Tester and Dual Visual Light Source. Soon to be released is our new MPO Visual Light Polarity Checker.

Cable assemblies, FTTX and general supplies such as SOC's continue to be our area of expertise.

Our goal is to continue our unsurpassed customer service, value and fast delivery. Again, we thank you for your patronage and I welcome your feedback that can easily be delivered by using "Ask the President" button on our website.

Best wishes for a successful 2020!



*Frank Giotto*

Frank Giotto  
President and CEO

# Investing In Our Customers

Throughout its 35 year history, FIS has reinvested much of its revenue back into the company. We created new programs and expanded our capabilities to fulfill a wide range of customer needs.

**Fiber Optic Manufacturing** - FIS manufactured products include fiber optic cable, interconnect boxes, connectors and custom cable assemblies. To our knowledge, FIS is the largest cable assembly house in the U.S.

**Full-Service Manufacturing** - FIS now offers plastics injection molding, CNC machining and metal bending/fabrication. We employ over 425 dedicated employees and our products are "Proudly Made in the USA."

**FIS University** - FIS has one of the longest running fiber optic training programs in the industry. We have trained over 10,000 technicians.

**Innovative Tech Support** - FIS Sales and Technical Staff are highly trained and eager to serve you. Our video conference room is the newest addition to our Tech Support Team.

**Product Availability** - FIS maintains a \$10 million product inventory, including network test and installation equipment from the world's leading manufacturers.

**Network Solutions** - FIS, The Solutionists, has the experience, size and resources to provide the solutions you need. Customers call it Safety of the Buy.



# FIBER INSTRUMENT SALES SALES TEAM · SERVICE · SUPPORT

## SALES MANAGEMENT TEAM



**Kirk Donley**  
Sr. Vice President  
Ext. 2104  
kdonley@fissales.com



**John Bruno**  
Vice President of  
Technical Services  
Ext. 2157  
jbruno@fissales.com



**Cindy Marino**  
Vice President of  
Government Sales  
Ext. 2140  
cmarino@fissales.com



**Steve Casaletta**  
Corporate Sales Director,  
PLM Fusion Splicing  
Products  
Ext. 2166  
scasalletta@fissales.com



**Anthony Russo**  
FTTx Sales Manager,  
PLM Fiber FTTx  
Products  
Ext. 2173  
arusso@fissales.com



**Steve Ermacor**  
PLM Fiber Optic  
Interconnects  
Ext. 2123  
sermacor@fissales.com



**Robert Licari**  
Product Line Manager  
Test Equipment  
FIS University Instructor  
Ext. 2192  
rlicari@fissales.com



**Jim Fasano**  
FTTx Program  
Development  
Ext. 2143  
jfasano@fissales.com



**Ric Lamb**  
Product Line Manager  
Fiber Fence  
Ext. 2151  
rlamb@fissales.com

\* PLM - Product Line Manager

## CORPORATE ACCOUNTS SALES TEAM

## INTERNATIONAL

## INTERNET RENTALS & SALES — CALIBRATIONS



**Sue Muraca**  
Corporate Accounts  
Manager  
Ext. 2160  
smuraca@fissales.com



**Sally Fenton**  
Corporate Accounts  
Manager  
Ext. 2181  
sfenton@fissales.com



**John DeMetro**  
Corporate Accounts  
Manager  
Ext. 2131  
jdemetro@fissales.com



**Trevor Francis**  
International Sales  
Manager  
Ext. 2125  
tfrancis@fissales.com



**Shaun Murray**  
Sr Intl. Sales Associate  
Ext. 2186  
smurray@fissales.com



**Kayla Angelhow**  
Intl. Sales Associate  
Ext. 2111  
kangelhow@fissales.com



**Casner Chapoteau**  
Intl. Sales Associate  
Ext. 2116  
cchapoteau@fissales.com



**John Russo**  
Sales Associate /  
Internet Sales  
Ext. 2161  
jrusso@fissales.com



**Jesse Simonds**  
Calibration Services  
Ext. 2114  
jsimonds@fissales.com



**Jeff Phillips**  
Rental Services  
Ext. 2176  
jphillips@fissales.com

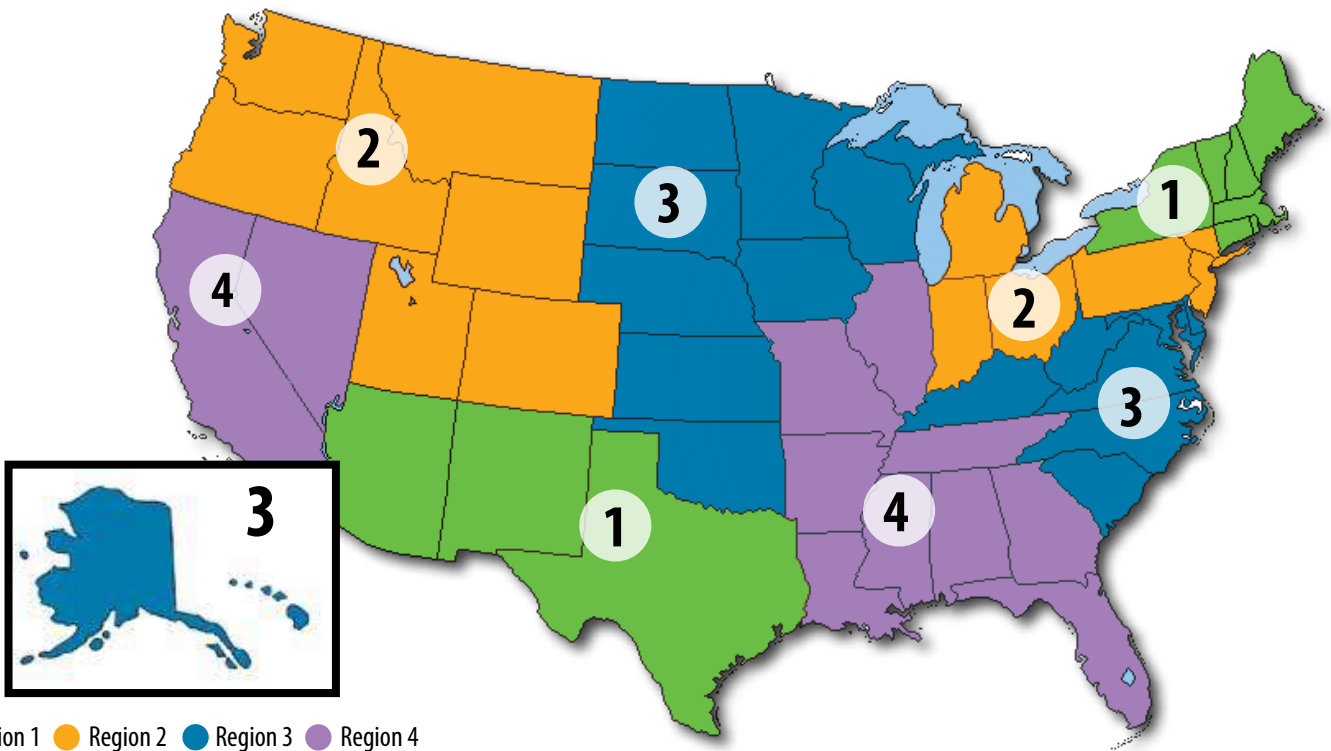

## REGION 1 & REGION 2

## REGION 3 & REGION 4



**Trista Piccione**  
Sr. Account Executive  
Ext. 2189  
tpiccione@fissales.com



**Jennifer Stinger**  
Sales Associate  
Ext. 2185  
jstinger@fissales.com



**Mary Sokolowski**  
Sales Associate  
Ext. 2164  
msokolowski@fissales.com

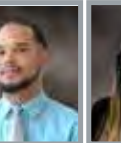

**Calvin Lang Jr.**  
Sales Associate  
Ext. 2146  
clang@fissales.com



**Sierra Quinn**  
Sales Associate  
Ext. 2119  
squinn@fissales.com



**Adam Norsen**  
Sales Associate  
Ext. 2139  
anorsen@fissales.com



**Ruth Mittiga**  
Sr. Account Executive  
Ext. 2128  
rmittiga@fissales.com



**Alicia Aldi**  
Account Executive  
Ext. 2149  
aaldidi@fissales.com



**Phil Kamp**  
Sales Associate  
Ext. 2154  
pkamp@fissales.com



**Brandon Schmidt**  
Sales Associate  
Ext. 2145  
bschmidt@fissales.com



**Amber Coirigliano**  
Sales Associate  
Ext. 2103  
acorigliano@fissales.com



**Casey Weissmuller**  
Sales Associate  
Ext. 2113  
cweissmuller@fissales.com



**PROUDLY  
MADE IN THE  
USA**

## **Custom Manufactured Fiber Optic Products with Fiber Instrument Sales**

*Fiber Instrument Sales is a leading manufacturer of fiber optic products and accessories. Rack and wall mount interconnects, custom cable assemblies, connectors, and test equipment. We also offer custom fiber optic cable, plastic injection molding, CNC machining and metal bending/fabrication. FIS is a trusted American manufacturer who stands behind their product and who provides excellent technical support through their highly trained sales associates and product line managers. FIS products are 100% made in the USA at our facilities located in central upstate New York.*



**CALL FOR CUSTOM QUOTES!  
1-800-5000-FIS(347)**

### **INTERESTED IN SAVING MONEY?**

#### **LET FIS SAVE YOU MONEY BY REPAIRING DAMAGED ASSEMBLIES, PULSE BOXES AND SPLITTERS.**

Fiber Instrument Sales is now offering repair services for Fiber Optic Assemblies, Pulse Boxes, and Splitters. We at FIS know that providing options for our customers to save time and money is critical for business growth. By utilizing our repair service your used products can often be repaired for a fraction of the cost of new.

Our service begins with an evaluation of every product to determine if a repair can be accomplished. FIS will communicate the suggested repair information and begin work with your approval. Documentation and Testing will be provided for all repairs.

*Note: Not every product is repairable, in the case of a product that cannot be repaired the Evaluation fee will be billed accordingly.*



**Call and speak with a Sales Representative Today**

**1-800-5000-FIS(347)**



# 2020 NEW PRODUCTS

**FIS  
ThunderBolt OTDR**  
pg. 40



**FIS Ruggedized  
MPO Test Units**  
pg. 68



**FIS CA6 Core Alignment  
Fusion Splicer**  
pg. 69



**FTTx Fiber Optic  
Interconnect  
Enclosures**  
pg. 145



**FIS Dual Source VFL**  
pg. 67



**AFL 90S  
Core Alignment  
Fusion Splicer**  
pg. 72



**AFL 90R  
Mass Fusion  
Splicer**  
pg. 73

**EXFO Optical  
Wave Expert**  
pg. 42



**FIS Launch Pod and  
Launch Pod Plus  
Pulse Suppressor**  
pg. 57



**AFL FOCIS FLEX  
FIBER OPTIC  
CONNECTOR INSPECTION  
SYSTEM**  
pg. 65



**VIAVI - WDM OTDRs  
T-BERD/MTS-4000 V2  
Optical Test Platform**  
pg. 46



**FIS Flat SST Drop  
Cable**  
pgs. 91 & 145



**FIS MPO Encircled Flux  
Reference Cord**  
pg. 68



# Continuing to be Your **Fiber-Optic Information Source**

## Website

[www.fiberinstrumentsales.com](http://www.fiberinstrumentsales.com)

In addition to online shopping, the FIS website offers a wealth of information to make your job easier and more productive. Spec sheets, white papers, training videos, and Communicator Newsletter – all are accessible online.



## Live Tech Help

Our sales people and tech support are available by phone as well as online, via our website. You can even access our President and CEO, Frank Giotto. Just click on the link, "Ask the President."



## Tutorial Videos

Fusion splicing, fiber termination and network testing are just a few of the informative FIS videos available to you. Videos can be accessed through the FIS Website. Clear and concise, FIS tutorial videos are the next best thing to receiving classroom training.



## We have a Connection!

With the addition of a new Video Conference Room FIS is able to provide training and technical support to our customers with ease. This support includes several different types of equipment such as fusion splicers, OTDRs, connector termination kits, and optical loss test sets and much more. **Let us know if you're interested in setting up a video conference call**



## You will love our new Configurator

Today's network installations sometimes require customized solutions and here at FIS we are ready to put together a solution that will make your job easier. Do you need to connect a piece of equipment that is further away from the enclosure than a standard length patch cable? Let us build you a custom length patch cable! Our standard turnaround time is 2 to 4 business days. Let's make your custom solution together!



## Communicator Newsletter

This six-month publication is a great tool for helping you make informed purchase decisions. For example, various issues of Communicator have provided guidance in selecting the right fusion splicer, OTDR, splice closure and more. Refer to these Communicator "buying guides" when making important purchase decisions. All issues are available in the Communicator Archives on the FIS website.





# TABLE OF CONTENTS

## Services

Equipment Rentals	8
Calibration	9

## Enclosures (Indoor)

Rack Mount Enclosures	10
Wall Mount Enclosures	12
Adapter Panels	16
Pigtails / Snap Packs	17
Custom Enclosures	18
Coupler/Splitter Modules	21
Splice Trays	22
Racks	24
Cable Management	25

## Assemblies

Singlemode, ClearCurve®	26
Multimode 10 Gig OM3 / OM4	28
Multimode OM2 / OM1	29
MTP Cable Assemblies	30
Custom Assemblies	32
Mode Conditioning	34
Specialty Optical Assemblies	34
Couplers/Splitters	35
Broadcast/Military	36

## Test Equipment

OTDRs	40
Wireless Test Equipment	50
Testing Accessories	56
Pulse / Test Boxes	57
Fiber Optic Identifiers	58
Power Meter & Light Sources	60
Fiber Inspection	64
Fault Locators	66

## Splicing

Fusion Splicers	69
Splice-On Connectors	71
Cleavers	80
Mechanical Splices	82
Splice Protection Sleeves	83

## Cable

250µm / 900µm / Large Core	85
Simplex / Duplex	86
Distribution	88
Indoor/Outdoor	89
Outdoor	90
Furcation Tube	92
Breakout / Fanout Kits	93
Air Blown Fiber / Innerduct	94

## Connectivity

Splice-On Connectors	71
Quick Termination	95
Small Form Factor Connectors	98
Standard Connectors	100
Boots & Accessories	102
Adapters	104
Attenuators	109
Drilled Connectors	111

## Consumables

Wipes	112
Cleaning Solutions	113
Dry Cleaners	116
Swabs	118
Cleaning Kits	119
Epoxy	120
Connector Ovens	121
Polishing	122

## Tools

Tool Kits	126
Stripping & Tools	130
Hand Tools	131
Slitting Tools	131
MidAccess Tools	133
Scribes & Crimpers	134
Cable Pulling	137
Tie Wraps & Accessories	138
Marking and Labeling	139
Trailers / Tents	141

## FIBER FENCE Security 142

## ZEUS FTTx Solution 144

## Enclosures (Outdoor)

Outdoor Enclosures	146
ADSS Hardware	152
Snowshoes	153
NIDs	154

## Copper

Category 5e, 6 / Cable	156
Copper Testing	157
Wall Plates / Jacks	158
Patch Panels	158

## Network Equipment

SFPs	159
Media Converters & Switches	162
Harsh Environment	164
Video TX & RX	165

## FIS University

Training Classes	166
Training Material	167



Go to  
page 144 for  
Zeus™ Solution  
Components

# Driving Your Fiber Optic Business Forward with Zeus™ FTTx Solution

- ▶ This diagram is a representation of what the Zeus™ FTTx Solution is all about in a Home application.

Request  
your free  
informational  
Zeus™ FTTx  
brochure

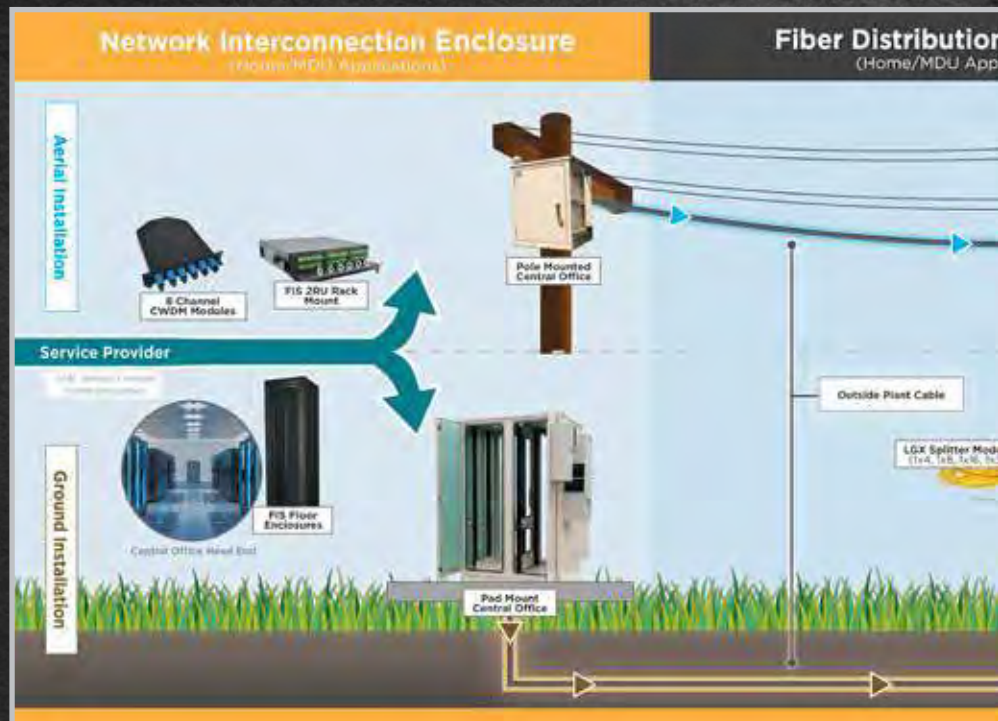

[www.zeusfttx.com](http://www.zeusfttx.com)



# The FTTx Solution

Today, telecommunication companies, CATVs and hundreds of Tier 2 and Tier 3 companies are planning or building FTTx networks. The demand is there, but it has to be harvested with a solid line of FTTx product solutions and support. FIS is serving this growing market through its Zeus FTTx Solutions program.

- ▶ Identify and source the components that best fit your needs and budgetary requirements.
- ▶ Select from a vast array of network components and products manufactured by the most recognized leaders in the FTTx industry.
- ▶ Ensure product interchangeability, compatibility, network expansion and design "portability".
- ▶ Our expert system architects can assist in all key phases of network design, planning and execution.

*Call or E-mail our product specialist today for assistance with your FTTx project*



**Anthony Russo**  
FTTx Sales Manager,  
PLM Fiber FTTx Products  
(315) 737-2173  
arusso@fissales.com

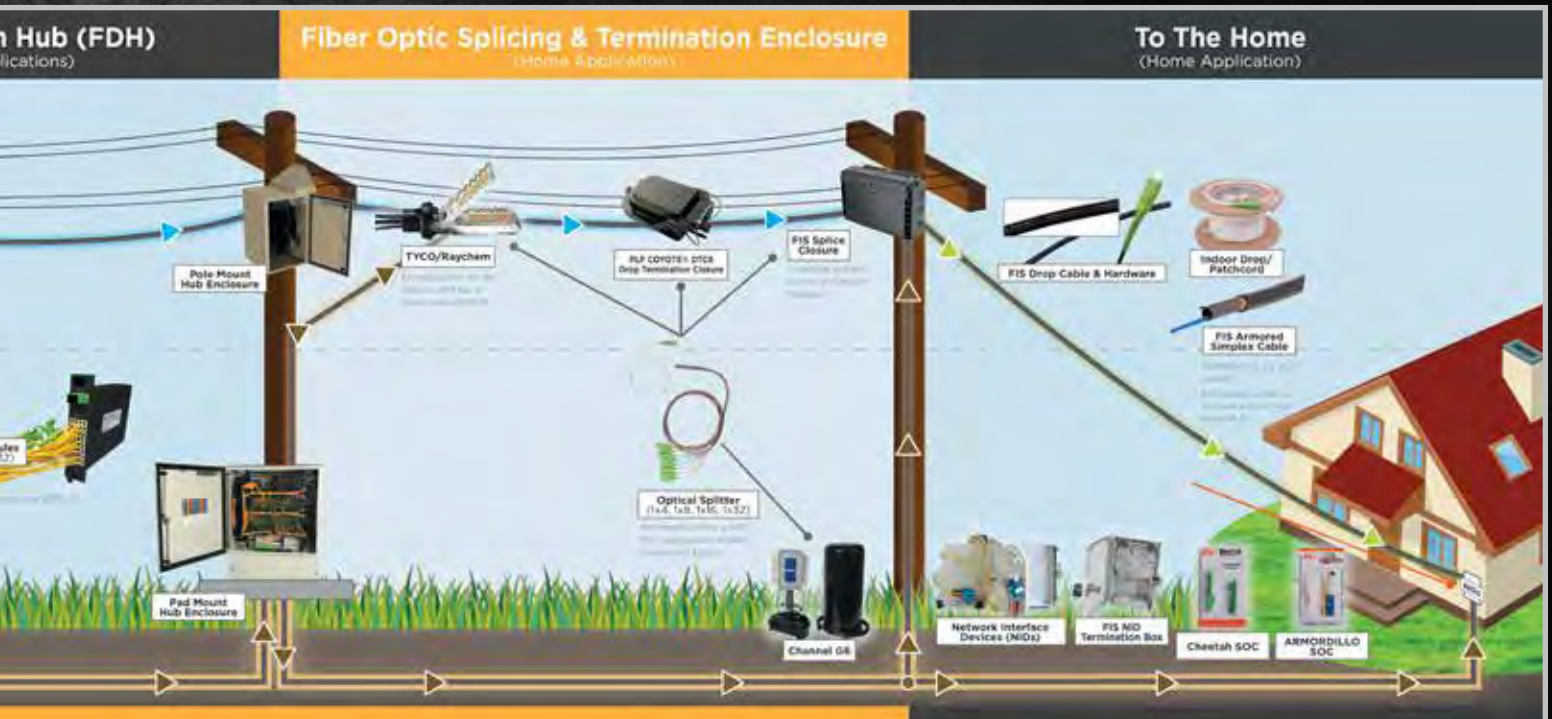

**CALL US TODAY 1-800-5000-FIS(347)**

Call 1.800.5000.FIS (347)  
Ask For Our Rental Department!



### OTDR RENTAL RATES

Launch cable required



	1 Week	2 Weeks	1 Month
AFL FLEXSCAN SM	\$510.00	\$675.00	\$850.00
EXFO MAX-720/730	\$750.00	\$925.00	\$1,250.00
FIS THUNDER BOLT	\$375.00	\$450.00	\$575.00
EXFO TK1V2DC740C OTDR Kit 18 CWDM Wavelengths VFL PM RF <b>NEW</b>	\$2,008.00	\$2,678.00	\$3,348.00

**WE RENT ANRITSU, EXFO, VIAVI, AFL AND FIS**

### FUSION SPLICER RENTAL RATES

Includes cleaver, 1 spare set of electrodes, battery and charge cord



	1 Week	2 Weeks	4 Weeks
<b>V-GROOVE (Clad Alignment)</b>			
AFL or SUMITOMO <b>Cheetah SOC Compatible</b>	\$290.00	\$385.00	\$480.00
<b>ACTIVE V-GROOVE (Clad Alignment)</b>			
FITEL or SUMITOMO <b>Cheetah SOC Compatible</b>	\$510.00	\$680.00	\$850.00
<b>MASS FUSION SPLICER (12 FIBER)</b>			
AFL or SUMITOMO	\$1,095.00	\$1,460.00	\$1,825.00
<b>CORE ALIGNMENT</b>			
FIS CA3 <b>Cheetah SOC Compatible</b>	\$540.00	\$720.00	\$900.00
<b>CORE ALIGNMENT</b>			
AFL, FITEL or SUMITOMO <b>Cheetah SOC Compatible</b>	\$750.00	\$1,000.00	\$1,250.00

### TEST EQUIPMENT RATES

Patch Cord required for EXFO FOT-945 Max Tester and AFL SMLP5-5



	1 Week	2 Weeks	4 Weeks
<b>EXFO MAX-945</b>			
MaxTester (pair) (Quad)	\$695.00	\$850.00	\$1,150.00
<b>AFL / SMLP5-5</b>			
PM and LS (Singlemode or Multimode, Downloadable Power Meter)	\$175.00	\$235.00	\$295.00
<b>FLUKE NETWORKS</b>			
VERSIV DSX-8000 (Copper Cable Analyzer)	\$425.00	\$550.00	\$695.00
<b>FLUKE NETWORKS</b>			
VERSIV DSX-5000 (w/OLTS Modules, Copper and Fiber Analyzer)	\$1,100.00	\$1,400.00	\$1,850.00



## LONG TERM RENTALS "Buy" Now Pay Later!

FIS offers a Long Term Rental program to finance any new or used equipment selling for \$1,000 or more. You can rent for 6 to 24 months and at any time during the term of the contract get a used price to purchase the equipment. We also give you a used buy-out price to purchase equipment after you make the last rent payment.



FIS CA3



AFL-70S



EXFO FTB 1



FIS THUNDER BOLT

EQUIP. COST	MONTHLY TERMS	6 MOS.	12 MOS.	18 MOS.	24 MOS.
\$1,000	Monthly Rent	\$175.00	\$90.00	\$61.00	\$47.00
	Value when due	\$200.00	\$180.00	\$160.00	\$140.00
\$5,000	Monthly Rent	\$872.00	\$445.00	\$302.00	\$231.00
	Value when due	\$1,000.00	\$900.00	\$800.00	\$700.00
\$10,000	Monthly Rent	\$1,743.00	\$889.00	\$604.00	\$461.00
	Value when due	\$2,000.00	\$1,800.00	\$1,600.00	\$1,400.00
\$20,000	Monthly Rent	\$3,484.00	\$1,776.00	\$1,207.00	\$922.00
	Value when due	\$4,000.00	\$3,600.00	\$3,200.00	\$2,800.00
\$35,000	Monthly Rent	\$6,097.00	\$3,107.00	\$2,111.00	\$1,612.00
	Value when due	\$7,000.00	\$6,300.00	\$5,600.00	\$4,900.00

For transactions over \$100,000, please call for rates. Payments shown are subject to state and local taxes. Subject to credit approval.

## Save Money! FIS NEW-2-YOU PROGRAM / FIS UPGRADE PROGRAM



Fiber Instrument Sales can save you money by providing a selection of pre-owned test and splicer equipment. We have demo models, overstock items, rental inventory, and an occasional trade-in all available at 20% to 60% off the original price.

Fiber Instrument Sales is also looking to purchase well kept, up to date used splicers and OTDRs. If you have a unit you are interested in selling and that unit is in working order (no repairs needed) please contact us for possible quote.

Contact your FIS sales representative for more information on New-2-You / New-2-Us products. You may also contact FIS Services at 800-500-0347 extension 2176 and 2114; or at: rentals@fissales.com.



Stay compliant with industry standards by taking advantage of our full service calibration lab. All equipment is inspected, calibrated to NIST traceable standards, and verified to be in conformance with the manufacturer's specifications. All calibration services include a calibration / verification certificate. Turn around time is typically 10 business days or less for standard services. All calibration services include a NIST traceable calibration certificate. Units are available to rent for extended service or repairs. E-mail us with any questions [calibration@fissales.com](mailto:calibration@fissales.com).

Visit us on our website at [www.fiberinstrumentsales.com/calibration/](http://www.fiberinstrumentsales.com/calibration/)

### All Verifications come with the following Service Features

- All calibration and/or verification services include a NIST traceable calibration certificate
- Ensure correct operation and performance
- Verification of conformance with the manufacturer's specifications



### OTDR VERIFICATION

	PRICE
FIS Handheld OTDR	\$300.00
EXFO Handheld OTDR	350.00
AFL Handheld OTDR	350.00
Anritsu Handheld OTDR	500.00
Platform OTDR and 1 Module	850.00
Additional Modules (Price Each)	350.00
Other Manufacturers - Call for pricing	

### TEST SET KIT VERIFICATION

	PRICE
FIS	\$140.00
EXFO	200.00
AFL	300.00
Anritsu	300.00
Other Manufacturers - Call for pricing	

### POWER METER AND LIGHT SOURCES VERIFICATION

	PRICE
FIS	\$75.00
EXFO	100.00
AFL	150.00
Anritsu	150.00
Other Manufacturers - Call for pricing	

### CLEAVER MAINTENANCE

	PRICE
Cleaver Maintenance and Evaluation, Blade Adjustment, Adjust Blade Height, Verify Proper Performance, and Replacement Blade*	\$150.00
Without Replacement Blade	\$75.00

\*Subject to Program Availability

### FUSION SPLICER MAINTENANCE

	PRICE
Splicer Maintenance and Evaluation Replace Electrodes, Clean Optical Components, Detailed Cleaning, and Diagnostic and Performance Tests	\$250.00



The FIS Rack Mount Enclosures are designed for low or high density patching applications. This sturdy 14 gauge rack enclosure is available in 1, 2, 4, and 8RU versions. This unit provides a removable door with front and back access to the slide-out tray. The FIS Enclosures accommodate 19" or 23" racks. Purchase 6, 8, 12 or 24 pack adapter panels. Standard color is Black, simply attach suffix to Rack Mount Enclosures for Off-White (-BW), ex. F1RM2RU4X-BW. All adapter plates are sold separately. Ask us to quote your rack mount loaded with adapter plates, splice trays, pigtails and patch cords.

### FIS Rack Mount Fiber Optic Swing-Out Patch Panels



F1-RMS01RU2X

Closed

#### 1RU SWING-OUT PATCH PANEL - ACCOMMODATES (2) ADAPTER PLATES

The 1RU FIS Swing Out Patch Panel accommodates (2) LGX adapter plates, modules or cassettes. The swing-out design offers easy access to the patch and splice bay. Multiple cable retention brackets and tie down spots allow for convenient cable management. These units can be flush mounted or mounted with 3.5" protrusion from the rack with no additional accessories. Rack mount installs into a standard 19" rack with included mounting hardware. Adapter plates and 23" mounting brackets are sold separately.

PART #	DESCRIPTION	(HxWxD)	PRICE
F1RMS01RU2X	1RU Swing Out Enclosure, 2 Plates, Black, Unloaded	1.75" x 17" x 11.5"	\$70.00
F1RMS01RU2X-BW	1RU Swing Out Enclosure, 2 Plates, Off White, Unloaded	1.75" x 17" x 11.5"	\$70.00

#### 2RU SWING-OUT PATCH PANEL - ACCOMMODATES (4) ADAPTER PLATES

The 2RU FIS Swing Out Patch Panel accommodates (4) LGX adapter plates, modules or cassettes. The swing-out design offers easy access to the patch and splice bay. Multiple cable retention brackets and tie down spots allow for convenient cable management. These units can be flush mounted or mounted with 3.5" protrusion from the rack with no additional accessories. Rack mount installs into a standard 19" rack with included mounting hardware. Adapter plates and 23" mounting brackets are sold separately.

PART #	DESCRIPTION	(HxWxD)	PRICE
F1RMS02RU4X	2RU Swing Out Enclosure, 4 Plates, Black, Unloaded	3.5" x 17" x 11.5"	\$95.00
F1RMS02RU4X-BW	2RU Swing Out Enclosure, 4 Plates, Off White, Unloaded	3.5" x 17" x 11.5"	95.00



F1-RMS02RU4X

Closed

### FIS Rack Mount Fiber Optic Flush Mount Patch Panel Frame



F1-FM1RU3X

Loaded  
(Panels & Cassettes sold separately)

#### 1RU FLUSH MOUNT PATCH PANEL FRAME - ACCOMMODATES (3) ADAPTER PLATES

The 1RU FIS Flush Mount Patch Panel Frame accommodates (3) LGX adapter plates, modules or cassettes. The flush mount design attaches flat against the rack to save space in compact applications. Patch panel frame installs into a standard 19" rack with included mounting hardware. Adapter plates sold separately.

PART #	DESCRIPTION	(HxW)	PRICE
F1FM1RU3X	1RU Flush Mount Frame, 3 Plates, 19", Black, Unloaded	1.75" x 19"	\$20.00

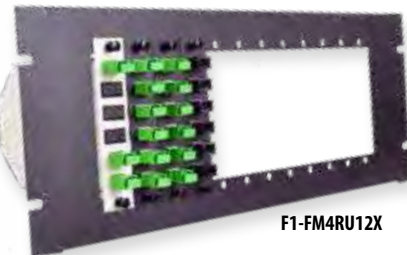

F1-FM4RU12X

#### 4RU FLUSH MOUNT PATCH PANEL FRAME - ACCOMMODATES (12) ADAPTER PLATES

The 4RU FIS Flush Mount Patch Panel Frame accommodates (12) LGX adapter plates, modules or cassettes. The flush mount design attaches flat against the rack to save space in compact applications. Patch panel frame installs into a standard 19" rack with included mounting hardware. Adapter plates sold separately.

PART #	DESCRIPTION	(HxW)	PRICE
F1FM4RU12X	4RU Flush Mount Frame, 12 Plates, 19", Black, Unloaded	7" x 19"	\$39.95

### FIS Rack Mount Fiber Optic Patch and Splice Panel Frame



F1-RMSP4RU4X

#### 4RU PATCH AND SPLICE PANEL - ACCOMMODATES (4) ADAPTER PLATES

The 4RU FIS Patch and Splice Panel accommodates (4) LGX adapter plates, modules or cassettes. The 2 sliding trays on the top and bottom of the enclosure allow for easy access to both patch and splice bays. Multiple cable retention brackets, splice tray mounts and tie down spots allow for convenient cable management. Rack mount installs into a standard 19" rack with included mounting hardware. Adapter plates, splice trays and 23" mounting brackets are sold separately.

PART #	DESCRIPTION	(HxWxD)	PRICE
F1RMSP4RU4X	4RU Patch and Splice Enclosure, 4 Plates, Black, Unloaded	7.125" x 17" x 14"	\$200.00
F1RMSP4RU4X-BW	4RU Patch and Splice Enclosure, 4 Plates, Off White, Unloaded	7.125" x 17" x 14"	200.00



F1-RMSP8RU12X

#### 8RU PATCH AND SPLICE PANEL - ACCOMMODATES (12) ADAPTER PLATES

The 8RU FIS Patch and Splice Panel accommodates (12) LGX adapter plates, modules or cassettes. The 2 sliding trays on the top and bottom of the enclosure allow for easy access to both patch and splice bays. Multiple cable retention brackets, splice tray mounts and tie down spots allow for convenient cable management. Rack mount installs into a standard 19" rack with included mounting hardware. Adapter plates, splice trays and 23" mounting brackets are sold separately.

PART #	DESCRIPTION	(HxWxD)	PRICE
F1RMSP8RU12X	8RU Patch and Splice Enclosure, 12 Plates, Black, Unloaded	14" x 17" x 14"	\$265.00



**1RU CABLE MANAGEMENT ENCLOSURE**

The FIS 1RU Slack Cable Management Enclosure provides a secure, dedicated space for fiber optic cable slack storage. The slide out tray and removable doors provide easy access when managing fiber. Comfortably route and store up to 25 meters of 3.0mm simplex fiber around the semi-circular slack management rings.

PART #	DESCRIPTION	(HxWxD)	PRICE
F1RM1RUSCM	1RU Slack Cable Management Enclosure, Black	1.75" x 17" x 14"	\$99.95



**FIS Rack Mount Fiber Optic Distribution Interconnects**

**1RU RACK MOUNT - ACCOMMODATES (3) ADAPTER PLATES**

The 1RU FIS Rack Mount Enclosure accommodates (3) LGX adapter plates, modules or cassettes. Slide out trays and removable front and back doors allow easy access to the patch bay. Multiple cable retention brackets and tie down spots allow for convenient cable management. Spring loaded stop latches keep the tray securely in place when retracted. Rack mount installs into a standard 19" rack. Adapter plates, 23" mounting brackets and 19" flush mounting brackets are sold separately.

PART #	DESCRIPTION	(HxWxD)	PRICE
F1RM1RU3X	1RU Rack Mount, 3 Plates, Solid Front/Rear Doors, Black, Unloaded	1.75" x 17" x 14"	\$99.95
F1RM1RU3X-BW	1RU Rack Mount, 3 Plates, Solid Front/Rear Doors, Off White, Unloaded	1.75" x 17" x 14"	99.95



**F1-RM1RU3X**  
(3) Six packs = 18 Port  
(3) Twelve packs = 36 Port

**2RU RACK MOUNT - ACCOMMODATES (4) ADAPTER PLATES**

The 2RU FIS Rack Mount Enclosure, accommodates (4) LGX adapter plates, modules or cassettes. Slide out trays and removable front and back doors allow easy access to the patch bay. Multiple cable retention brackets and tie down spots allow for convenient cable management. A smoked Lexan front door is available to provide visibility into the enclosure. Rack mount installs into a standard 19" rack. Adapter plates, 23" mounting brackets and 19" flush mounting brackets are sold separately.

PART #	DESCRIPTION	(HxWxD)	PRICE
F1RM2RU4X	2RU Rack Mount, 4 Plates, Solid Front/Rear Doors, Black, Unloaded	3.5" x 17" x 14"	\$130.00
F1RM2RU4XL	2RU Rack Mount, 4 Plates, Lexan Front and Solid Rear Door, Black, Unloaded	3.5" x 17" x 14"	130.00
F1RM2RU4X-BW	2RU Rack Mount, 4 Plates, Solid Front/Rear Doors, Off White, Unloaded	3.5" x 17" x 14"	130.00
F1RM2RU4XL-BW	2RU Rack Mount, 4 Plates, Lexan Front and Solid Rear Door, Off White, Unloaded	3.5" x 17" x 14"	130.00



**F1-RM2RU4X**  
(4) Six packs = 24 Port  
(4) Twelve packs = 48 Port

**2RU RACK MOUNT - ACCOMMODATES (6) ADAPTER PLATES**

The 2RU FIS Rack Mount Enclosure, accommodates (6) LGX adapter plates, modules or cassettes. Slide out trays and removable front and back doors allow easy access to the patch bay. Multiple cable retention brackets and tie down spots allow for convenient cable management. A smoked Lexan front door is available to provide visibility into the enclosure. Rack mount installs into a standard 19" rack. Adapter plates, 23" mounting brackets and 19" flush mounting brackets are sold separately.

PART #	DESCRIPTION	(HxWxD)	PRICE
F1RM2RU6X	2RU Rack Mount, 6 Plates, Solid Front/Rear Doors, Black, Unloaded	3.5" x 17" x 14"	\$145.00
F1RM2RU6XL	2RU Rack Mount, 6 Plates, Lexan Front and Solid Rear Door, Black, Unloaded	3.5" x 17" x 14"	145.00
F1RM2RU6X-BW	2RU Rack Mount, 6 Plates, Solid Front/Rear Doors, Off White, Unloaded, Unloaded	3.5" x 17" x 14"	145.00
F1RM2RU6XL-BW	2RU Rack Mount, 6 Plates, Lexan Front and Solid Rear Door, Off White, Unloaded	3.5" x 17" x 14"	145.00



**F1-RM2RU6X**  
(6) Six Packs = 36 port  
(6) Twelve packs = 72 port

**4RU RACK MOUNT - ACCOMMODATES (12) ADAPTER PLATES**

The 4RU FIS Rack Mount Enclosure accommodates (12) LGX adapter plates, modules or cassettes. Slide out trays and removable front and back doors allow easy access to the patch bay. Multiple cable retention brackets and tie down spots allow for convenient cable management. A smoked Lexan front door is available to provide visibility into the enclosure. Rack mount installs into a standard 19" rack. Adapter plates and 23" mounting brackets are sold separately.

PART #	DESCRIPTION	(HxWxD)	PRICE
F1RM4RU12X	4RU Rack Mount, 12 Plates, Solid Front/Rear Doors, Black, Unloaded	7.125" x 17" x 14"	\$185.00
F1RM4RU12XL	4RU Rack Mount, 12 Plates, Lexan Front and Solid Rear Door, Black, Unloaded	7.125" x 17" x 14"	185.00
F1RM4RU12X-BW	4RU Rack Mount, 12 Plates, Solid Front/Rear Doors, Off White, Unloaded	7.125" x 17" x 14"	185.00
F1RM4RU12XL-BW	4RU Rack Mount, 12 Plates, Lexan Front and Solid Rear Door, Off White, Unloaded	7.125" x 17" x 14"	185.00



**F1-RM4RU12X**  
(12) Six Packs = 72 port  
(12) Twelve packs = 144 port

**8RU RACK MOUNT - ACCOMMODATES (24) ADAPTER PLATES**

The 8RU FIS Rack Mount Enclosure accommodates (24) LGX adapter plates, modules or cassettes. Slide out trays and removable front and back doors allow easy access to the patch bay. Multiple cable retention brackets and tie down spots allow for convenient cable management. A smoked Lexan front door is available to provide visibility into the enclosure. Rack mount installs into a standard 19" rack. Adapter plates and 23" mounting brackets are sold separately.

PART #	DESCRIPTION	(HxWxD)	PRICE
F1RM8RU24X	8RU Rack Mount, 24 Plates, Solid Front/Rear Doors, Black, Unloaded	14" x 17" x 14"	\$299.95
F1RM8RU24XL	8RU Rack Mount, 24 Plates, Lexan Front and Solid Rear Door, Black, Unloaded	14" x 17" x 14"	299.95
F1RM8RU24X-BW	8RU Rack Mount, 24 Plates, Solid Front/Rear Doors, Off White, Unloaded	14" x 17" x 14"	299.95
F1RM8RU24XL-BW	8RU Rack Mount, 24 Plates, Lexan Front and Solid Rear Door, Off White, Unloaded	14" x 17" x 14"	299.95



**F1-RM8RU24X**  
(24) Six packs = 144 Port  
(24) Twelve packs = 288 Port



## FIS Wall Mount Fiber Optic Enclosures

### FIS MINI WALL MOUNT ENCLOSURE

The FIS Mini Wall Mount has capacity for (1) or (2) LGX style adapter plates, depending on the size of the enclosure chosen. Ideal for patching smaller quantities of fibers in a compact form factor. Fiber enters and exits from the bottom of the closure, and a cable spool and tie down stance provide fiber management options. A single door is removable and lockable with a padlock (sold separately).



F1-MW2X

PART #	DESCRIPTION	(HxWxD)	PRICE
F1-MW1X	1 Plate Mini (Unloaded) Black	9.18" x 6.38" x 2.625"	\$48.95
F1-MW1X-BW	1 Plate Mini (Unloaded) Off White	9.18" x 6.38" x 2.625"	48.95
F1-MW2X	2 Plate Mini (Unloaded) Black	9.18" x 6.38" x 2.625"	55.00
F1-MW2X-BW	2 Plate Mini (Unloaded) Off White	9.18" x 6.38" x 2.625"	55.00

### FIS ECONOMY WALL MOUNT ENCLOSURES

The FIS Economy Wall Mount has capacity for (2) or (4) LGX style adapter plates depending on the size of the enclosure chosen. It features a cable spool, bridge stances and a mounting stud and nut to secure splice trays. The lockable inner door (lock/key included) provides safe storage of incoming cable while allowing the technician to manipulate outgoing fiber patches. The outer door is removable and lockable with a padlock (sold separately). Accommodates QTY (2) splice trays approximately 7"L x 4"W (Ex. F1-SPL12). Ask an FIS sales associate about pre-loading the enclosure with fiber pigtailed, splice trays and adapter plates.



F1-EW2X

PART #	DESCRIPTION	(HxWxD)	PRICE
F1-EW2X	2 Plate Economy (Unloaded) Black	10.33" x 12.12" x 3.81"	\$78.95
F1-EW2X-BW	2 Plate Economy (Unloaded) Off White	10.33" x 12.12" x 3.81"	78.95
F1-EW4X	4 Plate Economy (Unloaded) Black	12.24" x 12.12" x 3.81"	81.95
F1-EW4X-BW	4 Plate Economy (Unloaded) Off White	12.24" x 12.12" x 3.81"	81.95

### FIS DELUXE WALL MOUNT ENCLOSURES

The FIS Deluxe Wall Mount has capacity for (2), (4), or (8) LGX style adapter plates depending on the size of the enclosure chosen. It features a larger splicing bay and more cable spooling brackets than the Economy version. Bridge stances and a splice tray mounting stud and nut are also included for easy installation of splice trays. The two front doors are removable to give unrestricted access during installation, and each door is also lockable with a padlock (sold separately) to provide security when in use. Accommodates QTY (2) splice trays approximately 7"L x 4"W (Ex. F1-SPL12) or 11.72"L x 4"W (Ex. F1-SPL24). Ask an FIS sales associate about pre-loading the enclosure with fiber pigtailed, splice trays and adapter plates.



F1-DW2X

PART #	DESCRIPTION	(HxWxD)	PRICE
F1-DW2X	2 Plate Deluxe (Unloaded) Black	13.16" x 14.44" x 3.06"	\$80.95
F1-DW2X-BW	2 Plate Deluxe (Unloaded) Off White	13.16" x 14.44" x 3.06"	80.95
F1-DW4X	4 Plate Deluxe (Unloaded) Black	13.16" x 14.44" x 3.06"	95.00
F1-DW4X-BW	4 Plate Deluxe (Unloaded) Off White	13.16" x 14.44" x 3.06"	95.00
F1-DW8X	8 Plate Deluxe (Unloaded) Black	13.16" x 14.51" x 5.60"	155.00
F1-DW8X-BW	8 Plate Deluxe (Unloaded) Off White	13.16" x 14.51" x 5.60"	155.00
F1-DW12X	12 Plate Deluxe (Unloaded) Black	14.51" x 19.38" x 5.60"	175.00
F1-DW12X-BW	12 Plate Deluxe (Unloaded) Off White	14.51" x 19.38" x 5.60"	175.00
F1-DW12XEXT	12 Plate Deluxe Extended (Unloaded) Black	14.51" x 25.63" x 5.60"	190.00

### FIS PATCH AND SPLICE WALL MOUNT ENCLOSURE

The FIS Patch and Splice Wall Mount enclosure is lightweight and easy to install. There is capacity for (2), (4), or (8) LGX style adapter plates depending on the size of the enclosure chosen. This unit features a lockable (lock/key included) compact housing that allows both splicing and connecting of fiber optic cables. FF-WM012 accommodates QTY (1) splice tray approximately 7"L x 4"W (Ex. F1-SPL12). FF-WM024 accommodates QTY (2) splice trays approximately 7"L x 4"W (Ex. F1-SPL12). FF-WM048 accommodates QTY (4) splice trays approximately 7"L x 4"W (Ex. F1-SPL12) or 11.72"L x 4"W (Ex. F1-SPL24).



FF-WM012BLK

PART #	DESCRIPTION	(HxWxD)	PRICE
FF-WM012	2 Plate Patch and Splice (Unloaded) Off White	6" x 12" x 4.5"	\$135.00
FF-WM012-BLK	2 Plate Patch and Splice (Unloaded) Black	6" x 14" x 4.5"	145.00
FF-WM024	4 Plate Patch and Splice (Unloaded) Off White	11" x 14" x 4.5"	145.00
FF-WM024-BLK	4 Plate Patch and Splice (Unloaded) Black	11" x 12" x 4.5"	160.00
FF-WM048	8 Plate Patch and Splice (Unloaded) Off White	16" x 20" x 6.5"	215.00
FF-WM048-BLK	8 Plate Patch and Splice (Unloaded) Black	16" x 20" x 6.5"	220.00

### FIS WALL MOUNT SPLICE ENCLOSURE

The FIS Wall Mount Splice Enclosure provides a secure splice bay for up to (12) splice trays. Cable entry and exit holes are now located on the tops and sides of the unit, and are protected by 1.25" dust-proof grommets. Both doors are removable for easy access and lockable for added security. Cable management rings are moveable within the unit and cable tie-downs are located throughout the unit. Constructed from lightweight, sturdy 16 gauge steel for easy installation. Recommended splice tray is 11.72"L x 4"W (Ex. F1-SPL24). Splice trays not included.

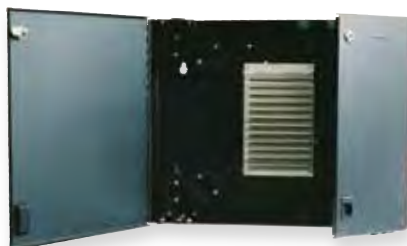

F1-SW12T

PART #	DESCRIPTION	DIMENSIONS (HxWxD)	PRICE
F1-SW12T	FIS Wall Mount Splice Enclosure, 12 Trays, Top/Side Entry	17.25" x 21.25" x 4.68"	\$205.00



## MOLEX COMPACT WALL MOUNT

This low profile wall mount enclosure is constructed of white rugged plastic and provides internal fiber management options. It accepts up to eight fusion or mechanical splices. The included accessory kit contains mounting screws, an identification label and two cable ties.

PART #	DESCRIPTION	(HxWxD)	PRICE
WFR-00010-02	6 Port, ST, SM/MM, Loaded	7.25" x 5" x 1.5"	\$40.00
WFR-00030-02	6 Port, Simplex SC, Unloaded	7.25" x 5" x 1.5"	30.00
WFR-00028-02	8 Ports, Duplex SC, MM, Loaded	7.25" x 5" x 1.5"	58.95
WFR-00029-02	8 Ports, Duplex SC, SM, Loaded	7.25" x 5" x 1.5"	82.95



WFR-00030-02

## FIS COMPACT WALL BOX

Utilize this compact wall mount box for fusion splice sleeve storage or direct connector termination. Simply place two small cable ties through the back of the box, slide the cable (max 5mm OD) into the box and secure. Next use the small cable management spool to store some slack prior to splicing or termination. There are two knock-out slots on each side of the box for (2) SC simplex or LC duplex adapters. There are also two knock-out slots on each side of the box for (1) SC duplex or LC quad adapter. Adapters without flanges are required. Built in splice sleeve holders accommodate up to two 40mm heat shrink splice sleeves.

PART #	DESCRIPTION	(HxWxD)	PRICE
F1-CWB02	FIS Compact Wall Box, White	4" x 3.25" x 1"	\$10.95



F1-CWB02

## FIS SPLICE ENCLOSURE

The splice enclosure unit utilizes a 12 position molded splice chip to secure splices. It is wall mountable and recommended for installation within controlled environments. Cable entry grommets secure incoming and outgoing cable with up to 12mm outside diameter. Inside clamps provide the ability to coil excess cable.

PART #	DESCRIPTION	(HxWxD)	PRICE
F1-4868-FSS	Fusion Splice Enclosure (up to 7mm cable diameter)	6.75" x 4.75" x 2.125"	\$39.00
F1-4868-MSS	Mechanical Splice Enclosure (up to 7mm cable diameter)	6.75" x 4.75" x 2.125"	39.00
F1-4868-FLL	Fusion Splice Enclosure (7mm to 12mm cable diameter)	6.75" x 4.75" x 2.125"	39.00
F1-4868-MLL	Mechanical Splice Enclosure (up to 7mm cable diameter)	6.75" x 4.75" x 2.125"	39.00



F1-4868FSS

## FIS 4 Port Wall Mount

The FIS 4 Port Wall Mount box is a compact design ideal for data center applications. It can be wall mounted or placed in a floor box, and will house up to 4 fibers, inline adapters and pigtails. Cables are easily terminated or spliced together. This wall mount box also has options for incoming fiber to be presented via mini-trunking grommets. Adapters and splice chip sold separately.

PART #	DESCRIPTION	(HxWxD)	PRICE
F1-WM4PW	4 Port, Holds (4) ST/FC/SMA/D4 Adapters, Unloaded	6.5" x 5" x 1.5"	\$13.75
F1-WM4S	8 or 16 Port, Holds (4) Duplex SC or (4) Quad LC Adapters, Unloaded	6.5" x 5" x 1.5"	16.95



F1-WM4PW

## PLP COYOTE WALL MOUNT MULTI-PURPOSE CLOSURE (MPC)

A versatile high performance demarcation closure for indoor or outdoor applications. With its unique interior grid pattern the MPC allows for custom configuration and mounting of a wide array of components. NEMA 4 rated and supplied with knockouts for up to 8 entry points. Contact an FIS sales representative for custom configurations. Bulkhead kit is compatible with PLP adapter plates (not LGX compatible).

PART #	DESCRIPTION	(HxWxD)	PRICE
COYMPC-000	COYOTE Standard MPC (Empty)	16" x 14" x 4"	\$94.00
COYMPC-D000	COYOTE Deep MPC (Empty)	16" x 14" x 8"	139.00
80808618	Stepped Grommet Kit, Bag of 4 (.07" - 1.0")		13.99
80808916	Empty Bulkhead Kit for Standard or Deep MPC, Accepts 2 Adapter Modules		10.35
80808960	Empty Bulkhead Kit for Deep MPC ONLY - Accepts 4 Adapter Modules		13.65
8003814	Splice Platform for Single Fusion splices		11.30



Standard MPC

## CCS ENVIRONMENTAL DISTRIBUTION CENTER (EDC)

Corning Cable Systems EDC product family continues to set the standard for the future of interconnect hardware. These units are designed for the protection of fiber optic connections and splices in indoor or outdoor environments; the EDC is ideal for industrial, marine, security, or traffic control applications. The EDC series accepts CCH panels and splice trays. Does not accept CCH cassettes. No entry holes provided on EDC series cabinets. NEMA 4X Rated. Also Available in Stainless Steel.

PART #	DESCRIPTION	(HxWxD)	PRICE
EDC-02PNH	Accepts 2 CCH Adapter Panels	12.5" x 10.5" x 6.25"	\$370.00
EDC-06PNH	Accepts 6 CCH Adapter Panels	16.5" x 14.5" x 8.3"	489.00
EDC-12PNH	Accepts 12 CCH Adapter Panels	18.6" x 16.6" x 10.3"	595.00
EDC-2N4-KIT	Two NEMA 4 Rated Conduit Fittings for Two-Inch Conduit		95.00
EDC-2EC-KIT	Two Non-Rated Conduit Fittings for Two-Inch Conduit		29.95
EDC-2WT-KIT	Two Watertight Compression Fittings (not intended to mate with conduit)		40.95
HDWR-GRND-KIT	Hardware Grounding Kit: Includes Two Ground Wires, Sheath Ground Clip and Bus		39.95

CORNING



EDC-12PNH

Also Suitable for Outdoor Use!

EDC-02PNH



5R1UL-F03  
Includes Covers  
(Not Shown)



5F100-2LC



5F100-2IL



WME-02



FM001029-BE



FM001038-BE



FM003465



FM003420

### LEVITON OPT-X SDX RACK AND WALL ENCLOSURES

Leviton OPT-X SDX Rack and Wall Mount Enclosures are ideal for fiber applications requiring patching, cross-connect, and/or splicing of singlemode or multimode fibers while utilizing a minimum of space. OPT-X 500i SDX rack mount enclosures feature a flush-mount bulkhead for 19" wide racks. Recommended splice trays are 7"L x 4"W (Ex. F1-8735C). All enclosures are sold empty; order loaded SDX adapter plates separately.

PART #	DESCRIPTION	(HxWxD)	PRICE
5R1UL-F03	OPT-X 500i Flush Mount Rack, 1RU, Holds (3) Splice Trays and (3) SDX Adapter Plates	1.75" x 19" x 12"	\$92.00
5R2UL-F06	OPT-X 500i Flush Mount Rack, 2RU, Holds (6) Splice Trays and (6) SDX Adapter Plates	3.5" x 19" x 12"	115.00
5WSML-02C	OPT-X Small Wall Mount, Holds (2) Splice Trays and (2) SDX Adapter Plates	14" x 12" x 2.16"	92.50
5WMED-04C	OPT-X Medium Wall Mount, Holds (4) Splice Trays and (4) SDX Adapter Plates	12" x 14" x 3.64"	140.50
5WLRG-12C	OPT-X Large Wall Mount, Holds (12) Splice Trays and (12) SDX Adapter Plates	17.22" x 16.50" x 6.18"	263.00
5L000-LOK	Lock & Key Kit for OPT-X SDX Wall Mount Enclosures		8.50

### LEVITON SDX ADAPTER PLATES

Leviton SDX fiber adapter plates are used in conjunction with SDX panels or enclosures. SDX fiber adapter plates are offered in LC, SC, and ST versions. *\*Eight pack adapter plates and other configurations available.*

PART #	DESCRIPTION	PRICE
5F100-6MT	SDX Adapter Plate, Simplex ST, SM/MM, 6 Fiber, Black	\$29.50
5F100-2IC	SDX Adapter Plate, Duplex SC, MM, 12 Fiber, Beige	58.50
5F100-2LC	SDX Adapter Plate, Duplex SC, SM, 12 Fiber, Blue	64.25
5F100-2VC	SDX Adapter Plate, Duplex SC/APC, SM, 12 Fiber, Green	64.25
5F100-2IL	SDX Adapter Plate, Duplex LC, MM, 12 Fiber, Beige	63.75
5F100-2LL	SDX Adapter Plate, Duplex LC, SM, 12 Fiber, Blue	73.00
5F100-2QL	SDX Adapter Plate, Duplex LC, MM (OM3 and OM4), 12 Fiber, Aqua	73.00
5F100-4QL	SDX Adapter Plate, Quad LC, MM (OM3 and OM4), 24 Fiber, Aqua	114.00
5F100-PLT	SDX Adapter Plate, Blank, No Holes, Black	4.90
5F100-6MP	SDX Adapter Plate, MTP 6 Pack, Key Up-Key Down, Black	98.25

### AFL WALL MOUNT ENCLOSURES

AFL's wall mount interconnect enclosures provide a convenient convergence point for interconnecting and/or splicing in wall mount applications. Provisioned for LGX compatible adapter plates or optical modules, the enclosure features a well-engineered solution for fiber and cable management on both the ingress and egress openings of the enclosure. All WME series enclosures feature discrete access doors for provider and customer access which are independently lockable with a common pad-lock or tube-style key lock.

PART #	DESCRIPTION	(HxWxD)	PRICE
WME-02	AFL Wall Mount Enclosure, Holds up to (2) LGX Adapter Plates	12.0" x 14.0" x 2.5"	\$95.00
WME-04	AFL Wall Mount Enclosure, Holds up to (4) LGX Adapter Plates	12.0" x 14.0" x 3.63"	135.00

### AFL FIBER TERMINATION PATCH AND SPLICE PANELS

AFL's fiber termination panels are designed for use as a rack mount interconnect panel and feature universal 19/23" EIA/TIA rack compatibility. They are LGX compatible with industry standard adapter plates and cassettes. Patch and splice panels are sold empty for complete field configuration.

PART #	DESCRIPTION	(HxWxD)	PRICE
FM001038-BE	AFL Patch Panel, 1RU, Holds up to (3) LGX Adapter Plates	1.75" x 17" x 13.51"	\$120.95
FM001029-BE	AFL Patch Panel, 2RU, Holds up to (6) LGX Adapter Plates	3.5" x 17" x 13.51"	165.00
C211372-BE	AFL Patch Panel, 4RU, Holds up to (12) LGX Adapter Plates	7" x 17" x 11"	262.00
C211615-BE	AFL Patch and Splice, 7RU (4RU + 3RU Splice), Holds up to (12) LGX Adapter Plates and (3) AFL 48F Splice Tray Kits	11" x 17" x 12.25"	450.00

### AFL LGX ADAPTER PLATES

AFL adapter plates are compatible with LGX industry standard platforms allowing for easy upgrades within existing panels. Adapter plates come preloaded with mating sleeves and are available in 6, 8 and 12 pack configurations.

PART #	DESCRIPTION	PRICE
FM003104	LGX Adapter Plate, Simplex ST, MM, 6 Fiber	\$25.00
FM003126	LGX Adapter Plate, Duplex ST, SM, 12 Fiber	45.00
FM003096	LGX Adapter Plate, Simplex SC, MM, 6 Fiber	31.00
FM003100	LGX Adapter Plate, Simplex SC, SM, 6 Fiber	35.00
FM003293	LGX Adapter Plate, Duplex SC, MM, 12 Fiber	46.00
FM003297	LGX Adapter Plate, Duplex SC, SM, 12 Fiber	48.00
FM003295	LGX Adapter Plate, Duplex SC, MM (OM3 and OM4), 12 Fiber	48.00
FM003420	LGX Adapter Plate, Simplex FC, SM/MM, 6 Fiber	35.00
FM003110	LGX Adapter Plate, Duplex LC, MM, 12Fiber	53.00
FM003465	LGX Adapter Plate, Duplex LC, SM, 12 Fiber	53.00
FM003208	LGX Adapter Plate, Quad LC, SM, 24 Fiber	98.00
FM003206	LGC Adapter Plate, Quad LC, MM (OM3 and OM4), 24 Fiber	102.25



CORNING

**CORNING CABLE SYSTEMS WALL MOUNT ENCLOSURES**

These metal cabinet units are suitable for loose tube and tight-buffered fiber optic cables. Enclose your fiber optic connections and, for extra protection, locking kits are available for purchase. Accepts CCH cassettes and panels only. Does not accept M67 splice trays or holders. \*Adapter Panels and Cassettes not included.

PART #	DESCRIPTION	(HxWxD)	PRICE
SPH-01P	6 Fiber Wall Mount (1) CCH Adapter Panel	6.3" x 5.5" x 2.0"	\$60.00
WCH-02P	12 Fiber Wall Mount, Up to (2) CCH Adapter Panels	9.25" x 13.25" x 3.25"	83.95
WCH-04P	24 Fiber Wall Mount, Up to (4) CCH Adapter Panels	13.5" x 16" x 4"	165.00
WCH-06P	48 Fiber Wall Mount, Up to (6) CCH Adapter Panels	13.5" x 16" x 4"	225.00
WCH-CLSSC12P	144 Fiber Wall Mount, Up to (12) CCH Adapter Panels	13.5" x 22.5" x 5"	310.95
CCHCS	CCH Splicing Cassette accepts one CCH panel and up to 24 single-fiber or six ribbon heat-shrink splice protectors		135.00
HDWR-LOCK-KIT	Hardware Lock Kit for LANscape Enclosures, Includes One Lock and Two Keys		22.95
HDWR-GRND-KIT	Grounding Kit For LANscape Hardware		39.95
CCHA-LOCK-KIT	Hardware Lock Kit (For CCH and WCH Only)		26.00



WCH-02P

**CORNING CABLE SYSTEMS WALL MOUNT SPLICE HOUSINGS**

The Corning Cable Systems WSH is designed to store fibers being spliced within the unit. The front door doubles as a work surface that can support the weight of a fusion splicer. Multiple cable entry/exit ports are provided on each side in addition to top and bottom. Grounding kits are available for purchase separately.

PART #	DESCRIPTION	(HxWxD)	PRICE
WSH-11SPTF	Wall Mount Splice Housing, Up to 11 Trays (Type 4S, 4R or 4A)	13.5" x 22.5" x 5.2"	\$295.00
WSH-16SPT	Wall Mount Splice Housing, Up to 16 Trays (Type 2S, 2R or 2M)	13.5" x 22.5" x 5.2"	255.00



WSH-16SPT

**CORNING CABLE SYSTEMS PRETIUM™ CONNECTOR HOUSING**

These Corning housings are 4-inches deeper than the standard CCH housings for installing the splice tray holding option. The PCH-04 series contains an integral hinged jumper manager on the front of the housing. The PCH-01U housing has a removable top that slides forward with simple release providing access to interior components.

Accepts CCH cassettes and panels \*Adapter Panels and Cassettes not included.

PART #	DESCRIPTION	(HxWxD)	PRICE
PCH-01U	12 Fiber, 1U - accepts (2) CCH panels	1.75" x 17" x 16"	\$300.00
PCH-02U	24 Fiber 2U - accepts (4) CCH panels	3.5" x 17" x 16.5"	410.00
PCH-04U	72 Fiber, 4U - accepts (12) CCH panels	7" x 17" x 16"	485.00
PC1-SPLC-04R	Splice Tray Bracket for PCH-01U, accepts (4) type 2S trays or (2) type 4R trays.		39.95
PC2-SPLC-6SR	Splice Tray Bracket for PCH-02U, accepts (6) 2R/2S or (3) 4R/4S trays.		41.95
PC4-SPLC-12SR	Splice Tray Bracket for PCH-04U, accepts (12) type 2S or (7) type 4S trays.		153.00



PCH-04U

**CORNING CABLE SYSTEMS ADAPTER PANELS FOR CCH, WCH AND EDC SERIES**

The Closet Connector Housing (CCH) panels are available in a variety of adapter styles for use with the LANscape® hardware products. Manufactured from steel, they are designed to be robust. Choose from the selection below or ask an FIS representative for other configurations.

PART #	DESCRIPTION	PRICE
CCH-CP06-15T	Six ST MM, Ceramic Insert	\$45.00
CCH-CP06-19T	Six ST SM, Ceramic Insert	50.50
CCH-CP12-15T	Twelve ST MM, Ceramic Insert	75.00
CCH-CP12-19T	Twelve ST SM, Ceramic Insert	85.00
CCH-CP06-56	Six SC MM, Metal Insert	48.95
CCH-CP06-3C	Six SC SM, Ceramic Insert	63.00
CCH-CP06-59	Three Duplex SC SM, Ceramic Insert	48.00
CCH-CP12-91	Six Duplex SC MM, Metal Insert	73.25
CCH-CP12-59	Six Duplex SC SM, Ceramic Insert	97.50
CCH-CP12-E7	Six Duplex SC, 10 Gig - Aqua	95.00
CCH-CP06-11	Six FC MM/SM, Ceramic Insert	62.25
CCH-CP12-A8	Six Duplex LC MM, Ceramic Inserts	100.00
CCH-CP12-A9	Six Duplex LC SM, UPC, Ceramic Insert	113.00
CCH-CP24-A9	Twelve Duplex LC SM, UPC, Ceramic Insert	173.95
CCH-CP12-E4	Six Duplex LC, 10 Gig - Aqua	85.00
CCH-CP24-E4	Twelve Duplex LC, 10 Gig - Aqua	185.00

CCH-CP24-A8



CCH-CP12-91

**CORNING CABLE SYSTEMS SPLICE TRAYS**

PART #	DESCRIPTION	PRICE
M67-081	Splice Tray, Type 2S, Twelve Heat Shrink Sleeves	\$36.95
M67-110	Splice Tray, Type 4R, Twelve Heat Shrink or 6 Ribbon Shrink, For LANscape Wall Mounts	35.95
M67-112	Splice Tray, Type 2S, Twenty Four Heat Shrink Sleeves	36.95
M67-087	Splice Tray, Type 4S, Twelve Mechanical Camsplice Splices	42.95
M67-076	Splice Tray, Type 4S, Twelve Fusion Splices, For LANscape Rack Mountable Housings	42.50
M67-048	Splice Tray, Type 2S, Twelve Fusion Splices, For LANscape Splice Closures	42.50
SCFST077	Corning Universal Splice Tray	35.95



M67-081

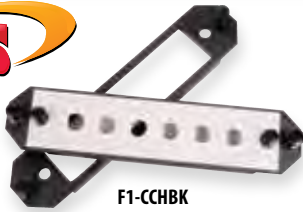

F1-CCHBK

## FIS UNIVERSAL MOUNTING BRACKET FOR CORNING WCH AND CCH BOXES

FIS offers a Universal Mounting Bracket that allows installers to use LGX style adapter plates in Corning CCH and PCH series closures. When original manufacturers' plates are not available, technicians can install this universal mounting bracket and utilize an LGX adapter plate.

PART #	DESCRIPTION	PRICE
F1-CCHBK	Universal Mounting Bracket for Corning PCH and CCH Boxes (LGX Adapter Plate Not Included)	\$3.99



## FIS LGX ADAPTER PLATES

All FIS Adapter Plates are LGX compatible. An LGX adapter plate measures 5.1" long by 1.13" wide with an on center post width of 4.64".



F1-SC6APCUL45



F1-LC24BLSUL



F1-SC8BKSUL



F1-SC6DBKAPCUL



F1-LC6DBKMUL



F1-SC8BKAPCUL



F1-ST8BKSUL

OFF WHITE PART #	BLACK PART #	DESCRIPTION	PRICE
F1-SC6APCUL45	F1-SC6APCBKUL45	SC 6 Pack, Loaded, Angled Plate, Singlemode, APC, Green Adapters	\$22.00
F1-LC6DAQUL45	F1-LC6DAQBKUL45	LC Duplex 6 Pack, Loaded, Angled Plate, Multimode, OM3, Aqua Adapters, 12 Fibers	27.00
F1-BLANKU	F1-BLANKUBK	Blank Plate, Unloaded, No Holes	2.75
F1-SC6U	F1-SC6IUBK	SC 6 Pack, Unloaded	2.75
F1-SC6MUL	F1-SC6IBKMUL	SC 6 Pack, Loaded, Multimode, Beige Adapters	12.50
F1-SC6SUL	F1-SC6IBKSUL	SC 6 Pack, Loaded, Singlemode, Blue Adapters	15.50
F1-SC6APCUL	F1-SC6IBKAPCUL	SC 6 Pack, Loaded, Singlemode, APC, Green Adapters	15.50
F1-SC8U	F1-SC8UBK	SC 8 Pack, Unloaded	2.75
F1-SC8MUL	F1-SC8BKMUL	SC 8 Pack, Loaded, Multimode, Beige Adapters	14.50
F1-SC8SUL	F1-SC8BKSUL	SC 8 Pack, Loaded, Singlemode, Blue Adapters	16.50
F1-SC8APCUL	F1-SC8BKAPCUL	SC 8 Pack, Loaded, Singlemode, APC, Green Adapters	16.50
F1-SC6DMUL	F1-SC6DBKMUL	SC Duplex 6 Pack, Loaded, Multimode, Beige Adapters, 12 Fibers	17.50
F1-SC6DAQUL	F1-SC6DAQBKUL	SC Duplex 6 Pack, Loaded, Multimode, OM3, Aqua Adapters, 12 Fibers	17.50
F1-SC6DSUL	F1-SC6DBKSUL	SC Duplex 6 Pack, Loaded, Singlemode, Blue Adapters, 12 Fibers	18.50
F1-SC6DAPCUL	F1-SC6DBKAPCUL	SC Duplex 6 Pack, Loaded, Singlemode, APC, Green Adapters, 12 Fibers	18.50
F1-DSC6U	F1-DSC6IUBK	SC Duplex 6 Pack, Unloaded	2.75
F1-LC6DMUL	F1-LC6DBKMUL	LC Duplex 6 Pack, Loaded, Multimode, Beige Adapters, 12 Fibers, Square Adapter	15.00
F1-LC6DSUL	F1-LC6DBKSUL	LC Duplex 6 Pack, Loaded, Singlemode, Blue Adapters, 12 Fibers, Square Adapter	17.50
F1-LC6DAPCUL	F1-LC6DBKAPCUL	LC Duplex 6 Pack, Loaded, Singlemode, APC, Green Adapters, 12 Fibers	17.50
F1-LC6DAQUL	F1-LC6DBKAQUL	LC Duplex 6 Pack, Loaded, Multimode, OM3, Aqua Adapters, 12 Fibers	15.00
F1-LC24MUL	F1-LC24BKMUL	LC Quad 6 Pack, Loaded, Multimode, Beige Adapters, 24 Fibers	35.00
F1-LC24AQUL	F1-LC24AQBKUL	LC Quad 6 Pack, Loaded, Multimode, OM3, Aqua Adapters, 24 Fibers	35.00
F1-LC24SUL	F1-LC24BKSUL	LC Quad 6 Pack, Loaded, Singlemode, Blue Adapters, 24 Fibers	45.00
F1-LC6U	F1-LC6UBK	LC Duplex 6 Pack, Unloaded, Square Adapters Only	2.75
F1-MTP6MUL	F1-MTP6BKMUL	MTP 6 Pack, Loaded, MM, Black Adapters, Style A (Key Up-Key Down)	50.00
F1-MTP6SUL	F1-MTP6BKSUL	MTP 6 Pack, Loaded, SM, Green Adapters, Style A (Key Up-Key Down)	60.00
F1-ST6U	F1-ST6UBK	ST 6 Pack, Unloaded	2.75
F1-ST6LMUL	F1-ST6BKMUL	ST 6 Pack, Loaded, Multimode	12.50
F1-ST6LSUL	F1-ST6BKSUL	ST 6 Pack, Loaded, Singlemode	15.50
F1-ST8U	F1-ST8UBK	ST 8 Pack, Unloaded	2.75
F1-ST8LMUL	F1-ST8BKMUL	ST 8 Pack, Loaded, Multimode	16.25
F1-ST8LSUL	F1-ST8BKSUL	ST 8 Pack, Loaded, Singlemode	17.25
F1-ST12UL	F1-ST12BKUL	ST 12 Pack, Loaded, Singlemode	20.00
F1-FC6U	F1-FC6UBK	FC 6 Pack, Unloaded	2.75
F1-FC6MUL	F1-FC6BKMUL	FC 6 Pack, Loaded, Multimode	14.50
F1-FC6SUL	F1-FC6BKSUL	FC 6 Pack, Loaded, Singlemode	16.50
F1-FC6APCUL	F1-FC6BKAPCUL	FC 6 Pack, Loaded, Singlemode, APC	16.50



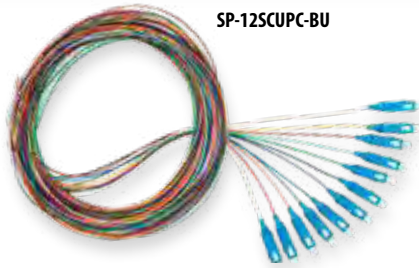

SP-12SCUPC-BU

**Quantity Pricing Available!**

**Multimode Pigtails Available**



DS-P12LCUPC-BU

**LC/APC Pigtails Now Available**

**900UM FIBER PIGTAILS - 6 AND 12 PACKS**

These 900µm Tight Buffer pigtails are designed for high fiber count splicing applications and are color coded to TIA-598-A industry standards for ease of use. Pigtails are available in Singlemode or Multimode, 6-packs or 12-packs, and your choice of connectors. All pigtails feature low insertion loss, low back reflection and are made with Corning® fiber. Standard length of 3 meters.

PART #	DESCRIPTION	PRICE
SP-6SCUPC-BU	6 Fiber SC/UPC 900µm Style Pigtail, SM, Blue Boots	\$14.95
SP-12SCUPC-BU	12 Fiber SC/UPC 900µm Style Pigtail, SM, Blue Boots	21.80
SP-6SCAPC-GR	6 Fiber SC/APC 900µm Style Pigtail, SM, Green Boots	15.95
SP-12SCAPC-GR	12 Fiber SC/APC 900µm Style Pigtail, SM, Green Boots	23.75
SP-6SCMM-BG	6 Fiber SC/PC 900µm Style Pigtail, MM 62.5µm, Beige Boots	14.50
SP-12SCMM-BG	12 Fiber SC/PC 900µm Style Pigtail, MM 62.5µm, Beige Boots	21.45
SP-6SCMM50-BLK	6 Fiber SC/PC 900µm Style Pigtail, MM 50µm, Black Boots	14.50
SP-12SCMM50-BLK	12 Fiber SC/PC 900µm Style Pigtail, MM 50µm, Black Boots	21.45
SP-6SCMM50G-AQ	6 Fiber SC/PC 900µm Style Pigtail, OM3 MM 50µm, Aqua Boots	16.25
SP-12SCMM50G-AQ	12 Fiber SC/PC 900µm Style Pigtail, OM3 MM 50µm, Aqua Boots	24.90
SP-6LCUPC-BU	6 Fiber LC/UPC 900µm Style Pigtail, SM, Blue Boots	16.30
SP-12LCUPC-BU	12 Fiber LC/UPC 900µm Style Pigtail, SM, Blue Boots	24.30
SP-6LCMM-BG	6 Fiber LC/PC 900µm Style Pigtail, MM 62.5µm, Beige Boots	15.90
SP-12LCMM-BG	12 Fiber LC/PC 900µm Style Pigtail, MM 62.5µm, Beige Boots	23.70
SP-6LCMM50-BLK	6 Fiber LC/PC 900µm Style Pigtail, MM 50µm, Black Boots	15.90
SP-12LCMM50-BLK	12 Fiber LC/PC 900µm Style Pigtail, MM 50µm, Black Boots	23.70
SP-12LCMM50G-AQ	12 Fiber LC/PC 900µm Style Pigtail, OM3 MM 50µm, Aqua Boots	27.20
SP-6STUPC-BU	6 Fiber ST/UPC 900µm Style Pigtail, SM, Blue Boots	14.50
SP-12STUPC-BU	12 Fiber ST/UPC 900µm Style Pigtail, SM, Blue Boots	14.50
SP-6STMM-BG	6 Fiber ST/PC 900µm Style Pigtail, MM 62.5µm, Beige Boots	21.45
SP-12STMM-BG	12 Fiber ST/PC 900µm Style Pigtail, MM 62.5µm, Beige Boots	21.45
SP-6STMM50-BLK	6 Fiber ST/PC 900µm Style Pigtail, MM 50µm, Black Boots	15.95
SP-12STMM50-BLK	12 Fiber ST/PC 900µm Style Pigtail, MM 50µm, Black Boots	21.80

**DISTRIBUTION FIBER PIGTAILS - 6 AND 12 PACKS**

These Distribution fiber pigtails feature a durable outer jacket ensuring strength and protection during installations. The distribution fiber fans out into 900µm tight buffered fibers. These pigtails are available in Singlemode or Multimode, 6-packs or 12-packs, and your choice of connectors. All pigtails feature low insertion loss, low back reflection and are made with Corning® fiber. Standard length of 3 meters: 1 meter 900µm 'fan out' and 2 meter distribution 'tail'.

PART #	DESCRIPTION	PRICE
DS-P6SCUPC-BU	6 Fiber SC/UPC Distribution Style Pigtail, SM, Blue Boots	\$14.95
DS-P12SCUPC-BU	12 Fiber SC/UPC Distribution Style Pigtail, SM, Blue Boots	21.80
DS-P6SCAPC-GR	6 Fiber SC/APC Distribution Style Pigtail, SM, Green Boots	15.95
DS-P12SCAPC-GR	12 Fiber SC/APC Distribution Style Pigtail, SM, Green Boots	23.80
DS-P6LCUPC-BU	6 Fiber LC/UPC Distribution Style Pigtail, SM, Blue Boots	16.30
DS-P12LCUPC-BU	12 Fiber LC/UPC Distribution Style Pigtail, SM, Blue Boots	24.30
DS-P6LCAPC-GR	6 Fiber LC/APC Distribution Style Pigtail, SM, Green Boots	17.50
DS-P12LCAPC-GR	12 Fiber LC/APC Distribution Style Pigtail, SM, Green Boots	26.00
DS-P6SCMM50G-AQ	6 Fiber SC/UPC Distribution Style Pigtail, MM, 50µm, OM3 Aqua Boots	16.25
DS-P12SCMM50G-AQ	12 Fiber SC/UPC Distribution Style Pigtail, MM, 50µm, OM3 Aqua Boots	21.80
DS-P6LCMM50G-AQ	6 Fiber LC/UPC Distribution Style Pigtail, MM, 50µm, OM3 Aqua Boots	24.90
DS-P12LCMM50G-AQ	12 Fiber LC/UPC Distribution Style Pigtail, MM, 50µm, OM3 Aqua Boots	27.20

**RIBBON FAN-OUT PACKS**

These Ribbon fiber pigtails fan out into 900µm tight buffered fibers, color coded to TIA-598-A industry standards. Applications include terminating ribbon fiber to patch panels and enclosures, as well as V-Groove and array applications. All fan out kits feature low insertion loss, low back reflection and are made with Corning® fiber. Standard length of 3 meters: 1 meter 900µm 'fan out' and 2 meter ribbon 'tail'.

PART #	DESCRIPTION	PRICE
RF-3-BU-P-S-3-FIS-12	SM, SC/UPC - Pigtail, 3 Meters 36" Fan-out, 2 Meter Tail, 12 Fiber	\$65.00
RF-3-BA-P-S-3-FIS-12	SM, SC/APC - Pigtail, 3 Meters 36" Fan-out, 2 Meter Tail, 12 Fiber	75.00
RF-3-AU-P-S-3-FIS-12	SM, FC/UPC - Pigtail, 3 Meters 36" Fan-out, 2 Meter Tail, 12 Fiber	65.00
RF-3-AA-P-S-3-FIS-12	SM, FC/APC - Pigtail, 3 Meters 36" Fan-out, 2 Meter Tail, 12 Fiber	75.00

**FIS SNAP PACKS™**

These pre-terminated "Snap Pack" adapter panels provide convenience to technicians splicing into fiber distribution frames. Adapter panels are LGX compatible and can be ordered in a black or off white color. Available in 6 or 12 fiber bundles and color coded to TIA-598-A industry standards, these fiber bundles provide cable management from patch panels to splice bays. Custom lengths and various connector styles are available, contact your FIS sales associate for more information.

PART # (Off White)	PART # (Black)	DESCRIPTION	PRICE
F1-SC6LS-SPN	F1-SC6LS-SPN-BLK	(6) Adapters, SC/UPC, 6 Fiber Pigtail, Singlemode, 3 Meters	\$60.00
F1-DSC6LS-SPN	F1-DSC6LS-SPN-BLK	(6) Duplex Adapters, SC/UPC, 12 Fiber Pigtail, Singlemode, 3 Meters	120.00
F1-SC6APC-SPN	F1-SC6APC-SPN-BLK	(6) Adapters, SC/APC, 6 Fiber Pigtail, Singlemode 3 Meters	65.00
F1-DSC6IAPC-SPN	F1-DSC6IAPC-SPN-BLK	(6) Duplex Adapters, SC/APC, 12 Fiber Pigtails, Singlemode, 3 Meters	130.00
F1-SC6LM-SPN	F1-SC6LM-SPN-BLK	(6) Adapters, SC/PC, 6 Fiber Pigtails, 62.5/125µm, 3 Meters	50.00
F1-DSC6LM-SPN	F1-DSC6LM-SPN-BLK	(6) Duplex Adapters, SC/PC, 12 Fiber Pigtail, 62.5/125µm OM1, 3 Meters	80.00
F1-DSC6LM50-SPN	F1-DSC6LM50-SPN-BLK	(6) Duplex Adapters, SC/PC, 12 Fiber Pigtails, 50/125µm, 3 Meters	50.00
F1-DSC6LM50G-SPN	F1-DSC6LM50G-SPN-BLK	(6) Duplex Adapters, SC/PC, 12 Fiber Pigtails, 50/125µm OM3 10G, 3 Meters	50.00
F1-LC6DL-SPN	F1-LC6DL-SPN-BLK	(6) Duplex Adapters, LC/UPC, 12 Fiber Pigtail, Singlemode, 3 Meters	120.00
F1-LC6DLM-SPN	F1-LC6DLM-SPN-BLK	(6) Duplex Adapters, LC/PC, 12 Fiber Pigtails, 62.5/125µm, 3 Meters	80.00
F1-LC6DLM50-SPN	F1-LC6DLM50-SPN-BLK	(6) Duplex Adapters, LC/PC, 12 Fiber Pigtails, 50/125µm OM2, 3 Meters	80.00
F1-LC6DLM50G-SPN	F1-LC6DLM50G-SPN-BLK	(6) Duplex Adapters, LC/PC, 12 Fiber Pigtails, OM3 10G, 3 Meters	80.00
F1-LC6QDAPC-SPN	F1-LC6QDAPC-SPN-BLK	(6) Quad Adapters, LC/APC, 24 Fiber Pigtails, Singlemode, 3 Meters	195.00
F1-ST6LS-SPN	F1-ST6LS-SPN-BLK	(6) Adapters, ST, 6 Fiber Pigtail, Singlemode, 3 Meters	60.00
F1-ST6LM-SPN	F1-ST6LM-SPN-BLK	(6) Adapters, ST, 6 Fiber Pigtail, 62.5/125µm OM1, 3 Meters	50.00



RF-3-BU-P-S-3-FIS-12



F1-SC6LS-SPN



# FIS Custom Manufactured Interconnects

Complete fiber optic solutions, right out of the box.

OEM  
Printing and  
Decals

Unique  
Color Options

Custom  
Designed  
Interconnects

Pre-Installed  
Fiber Optic  
Components

Cold Rolled Steel,  
Stainless Steel or  
Aluminum

MADE IN THE



U.S.A.

*FIS is proud to offer fiber optic Interconnects that are both engineered at our FIS facility and "Made in the USA".*





# High Density Breakout Cassettes and Enclosures



The High Density Breakout Cassette provides 'plug and play' solutions for data center infrastructure and similar high density applications. It offers a secure patch or breakout point from multi-fiber MPO trunk cables to duplex LC patch cables. This modular platform provides a convenient, rapid deployment solution when installing MPO trunk cables and breakout positions within a network. Accommodates a total of 96 or 144 fibers loaded into the matching 1RU enclosure. Both 3X and 4X 1RU enclosures are designed to fit into standard 19" racks. Mounting adapter brackets extend out past the front and back of the enclosure to assist with incoming fiber management. Both front and rear doors are easily removable and provide uninhibited access to the cassette's fiber connections.

## Part Number Configurator

MODULE STYLE	FIBER COUNT	FIBER TYPE	Rear connector (MPO/MTP)	FERRULE QUALITY	FRONT CONNECTOR	POLARITY
F1HDMTP	48	OS2	MT12	E	LU	A
F1HDMTP = 3X HD Cassette F1SHD = 4X SHD Cassette	24 = 24 Fibers 48 = 48 Fibers	OM3 = 50µm OM3, MM OM4 = 50µm OM4, MM OS2 = 9µm OS2, SM	MT12 = MPO 12 Fiber Male MF12 = MPO 12 Fiber Female MT24 = MPO 24 Fiber Male MF24 = MPO 24 Fiber Female	S = Standard E = Elite	L = LC/PC (Aqua or Magenta) LU = LC/UPC (Blue) LA = LC/APC (Green)	A = Type A B = Type B

## Part # Example: F1HDMTP-48-OS2-MT12-E-LU-A

3X HD Breakout Cassette, 48 Fiber, 9µm OS2 SM, (4) 12F Elite MPO/Male to (24) Duplex LC/UPC Blue, Polarity Type A

### 3X HD ENCLOSURE

PART #	DESCRIPTION	PRICE
F1RM1RU3XHD	1RU Rack Mount, 3X HD Cassette Enclosure, Unloaded, Off-White, Empty	\$130.00

### 3X HD CASSETTES

PART #	DESCRIPTION	PRICE
F1HDMTP48OM3MT12ELA	3X HD Cassette, 48 Fiber, OM3, (24) Duplex LC/PC to (4) 12F MPO Male, Polarity Type A	\$470.00
F1HDMTP48OM4MT12ELA	3X HD Cassette, 48 Fiber, OM4, (24) Duplex LC/PC to (4) 12F MPO Male, Polarity Type A	472.50
F1HDMTP48OS2MT12ELUA	3X HD Cassette, 48 Fiber, SM, (24) Duplex LC/UPC to (4) 12F MPO Male, Polarity Type A	532.50
F1HDMTP48OS2MT12ELAA	3X HD Cassette, 48 Fiber, SM, (24) Duplex LC/APC to (4) 12F MPO Male, Polarity Type A	550.00
F1HDMTP48OM3MT12ELB	3X HD Cassette, 48 Fiber, OM3, (24) Duplex LC/PC to (4) 12F MPO Male, Polarity Type B	470.00
F1HDMTP48OM4MT12ELB	3X HD Cassette, 48 Fiber, OM4, (24) Duplex LC/PC to (4) 12F MPO Male, Polarity Type B	472.50

### 4X SHD ENCLOSURE

PART #	DESCRIPTION	PRICE
F1RM1RU4XHD	1RU Rack Mount, 4X SHD Cassette Enclosure, Unloaded, Black	\$130.00

### 4X SHD CASSETTES

PART #	DESCRIPTION	PRICE
F1SHD24OS2MT24ELUA	4X SHD Cassette, 24 Fiber, SM, (12) Duplex LC/UPC to (1) 24F MPO Male, Polarity Type A	\$253.00
F1SHD24OS2MT12ELUA	4X SHD Cassette, 24 Fiber, SM, (12) Duplex LC/UPC to (2) 12F MPO Male, Polarity Type A	259.50
F1SHD24OM3/4MT24ELUB	4X SHD Cassette, 24 Fiber, OM3/4, (12) Duplex LC/UPC to (1) 24F MPO Male, Polarity Type B	186.00
F1SHD24OM3/4MT12ELUB	4X SHD Cassette, 24 Fiber, OM3/4, (12) Duplex LC/UPC to (2) 12F MPO Male, Polarity Type B	283.50

### 4X SHD ADAPTER PLATES

PART #	DESCRIPTION	PRICE
F1SHDMPO6A	MTP 6 Pack, 4X SHD Adapter Plate, Polarity Type A, Color Black	\$55.00
F1SHDMPO12A	MTP 12 Pack, 4X SHD Adapter Plate, Black Type A, Polarity Type A, Color Black	\$86.95
F1SHDBLANK	4X SHD Blank Adapter Plate, Unloaded, No Holes	\$4.85

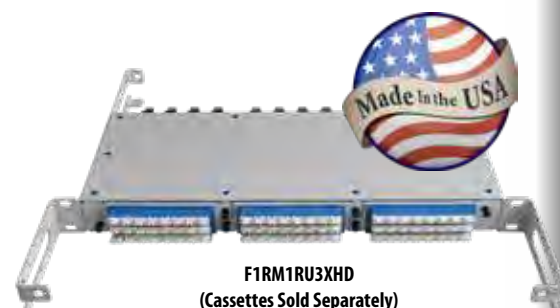

F1RM1RU3XHD  
(Cassettes Sold Separately)  
(Front and Back Doors Not Shown)



F1HDMTP48OS2MT12ELUA



F1RM1RU4XHD  
(Cassettes Sold Separately)



F1SHD24OS2MT24ELUA

# MPO/MTP PRE-TERMINATED SYSTEMS

**MPO Trunk  
Cables  
pg 30 and 31**

The FIS MPO/MTP Module is a pre-terminated, pre-tested, rack mount module system allowing for a simple installation of MPO/MTP backbone cables with a transition to standard LC or SC connections. The FIS modules are designed to fit into enclosures with LGX slot configurations. Using a pre-terminated cable assembly in conjunction with modules within a rack allows for easier installation and simpler cable management. Contact your FIS sales representative today for further details or use the part numbers and configurator below to construct the proper combination to meet any requirement.

## BUILD YOUR OWN CUSTOM MPO/MTP MODULE

Use this chart to build a MPO/MTP module to your exact specifications.

MODULE STYLE	FIBER COUNT	FIBER TYPE	REAR CONNECTOR (MPO/MTP)	FERRULE QUALITY (MPO/MTP)	FRONT CONNECTOR	MTP CASSETTE POLARITY
F1-MTP	12	OS2	MT12	S	LU	A
F1-MTP = MPO/MTP Cassette, LGX, Black	8 = 8 Fiber 12 = 12 Fiber 16 = 16 Fiber 24 = 24 Fiber 32 = 32 Fiber	OM1 = 62.5µm OM1, MM OM2 = 50µm OM2, MM OM3 = 50µm OM3, MM OM4 = 50µm OM4, MM OM5 = 50µm OM5, MM OS2 = 9µm OS2, SM	MT8 = MTP 8 Fiber Male MT12 = MTP 12 Fiber Male MT16 = MTP 16 Fiber Male MT24 = MTP 24 Fiber Male MT32 = MTP 32 Fiber Male MF8 = MTP 8 Fiber Female MF12 = MTP 12 Fiber Female MF16 = MTP 16 Fiber Female MF24 = MTP 24 Fiber Female MF32 = MTP 32 Fiber Female	S = Standard E = Elite	Y = SC/PC YU = SC/UPC YA = SC/APC L = LC/PC LU = LC/UPC LA = LC/APC	A = Type A B = Type B C = Type C D = 24 Fiber Type A E = 24 Fiber Type B U = Other (User Defined)

**Part # Example:**

**F1-MTP-12-OS2-MT12-S-LU-A**

Translates to: MPO/MTP Cassette, 12 Fiber, SM, 1 Male MTP  
Standard Ferrule to LC/UPC Duplex, Type A Polarity

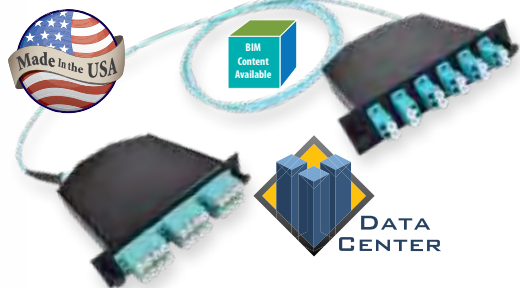

## MPO/MTP STOCK BREAKOUT MODULE SOLUTION

PART #	DESCRIPTION	PRICE
F1-MTP-M-SC-OM3-12	12-fiber 50µm OM3, 1 rear MTP/male port, 6 front SC/duplex ports	\$150.00
F1-MTP-M-SC-OS2-12	12-fiber SM, 1 rear MTP/male port, 6 front SC/duplex ports	190.00
F1-MTP-M-LC-OM3-12	12-fiber 50µm OM3, 1 rear MTP/male port, 6 front LC/duplex ports	150.00
F1-MTP-M-LC-OS2-12	12-fiber SM, 1 rear MTP/male port, 6 front LC/duplex ports	190.00
F1-MTP-M-LC-OM3-24	24-fiber 50µm OM3, 2 rear MTP/male ports, 6 front LC/quad ports	270.00
F1-MTP-M-LC-OS2-24	24-fiber SM, 2 rear MTP/male ports, 6 front LC/quad ports	350.00

**\*\* Also available with MTP / Female Ports and/or SC ports \*\***

# MPO/MTP Module Connectivity Diagrams

**Note:** Below the input Rx/Tx and outputs Tx/Rx are consistent for each diagram when different cable arrays A, B and C (see page 31) are implemented. This is achieved by position locations of patchcord fibers to the adapter plate. There must be a pair-wise flipping that takes place at some point in the link.

CONNECTIVITY METHOD "A"

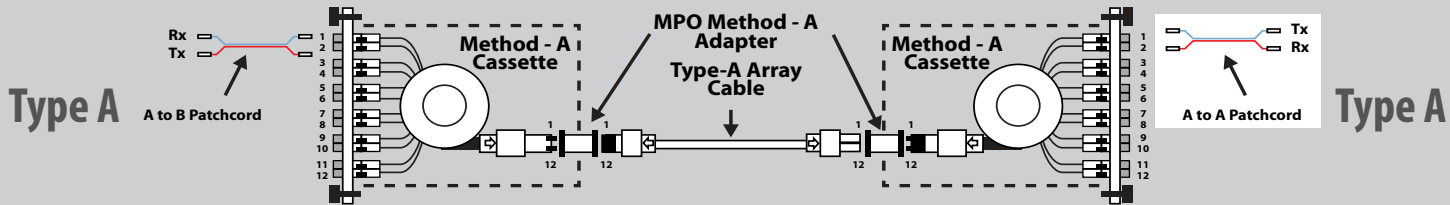

CONNECTIVITY METHOD "B"

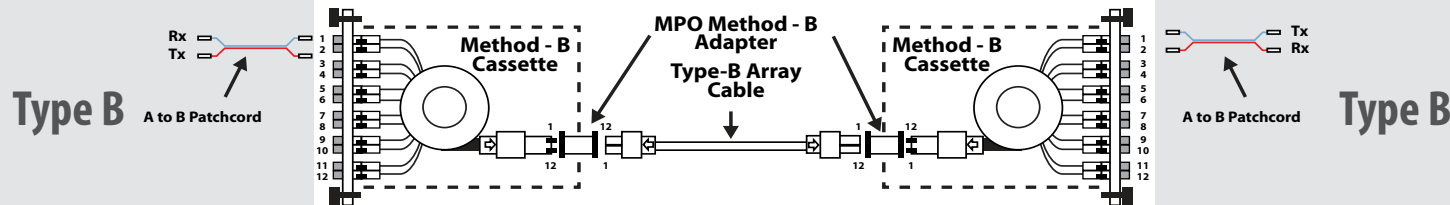

CONNECTIVITY METHOD "C"

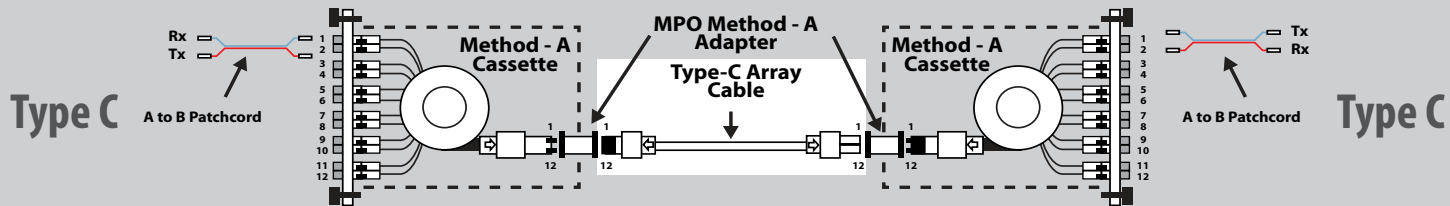



# SPLITTER AND CWDM PRE-TERMINATED SYSTEMS

## BUILD YOUR OWN CUSTOM SPLITTER OR CWDM MODULE

Use this chart to build a Splitter or CWDM module to your exact specifications.

BOX STYLE	CORE/CLAD SIZE	DEVICE	CONFIGURATION	SPLIT RATIO / CHANNELS	CONN. TYPE (INPUT)	CONN. TYPE (OUTPUT)	OPTIONS
RMC	3	CWDM		BC	YU	YU	EXP
RMC = LGX Style Rack Mount RSC = Ruggedized Style Splitter PNC = Special Package BC = No Box, Standard Package RU = 1 RU Panel P4 = F1-400 Enclosure P6 = F1-600 Enclosure P8 = F1-800 Enclosure	1=50/125µm - OM2 2=62.5/125µm - OM1 3=8-9/125µm - OS2 8=50µm10Gig - OM3 10=50µm10Gig - OM4 12=50µm10Gig - OM5	S - Splitter/Coupler W - WDM D - DWDM CWDM=CWDM	2-1x2 3-1x3 4-1x4 5-1x5 6-1x6 7-1x7 8-1x8 12-1x12 16-1x16 32-1x32 64-1x64	01= 01/99 05= 05/95 10= 10/90 20= 20/80 25= 25/75 30= 30/70 40= 40/60 50= 50/50 EV= Even AC-1291-1351 BC-1471-1531 CC-1511-1571 DC-1551-1611 EC- 1271-1611 LC-1471-1611	7= FC/PC 7U= FC/UPC 7A= FC/APC 8= ST/PC 8U= ST/UPC L - LC/PC LU - LC/UPC LA - LC/APC Y=SC/PC YU= SC/UPC YA= SC/APC	7= FC/PC 7U= FC/UPC 7A= FC/APC 8= ST/PC 8U= ST/UPC L - LC/PC LU - LC/UPC LA - LC/APC Y=SC/PC YU= SC/UPC YA= SC/APC	1 - 250µm Bare Fiber 2 - Ruggedized 2mm Jacket 3 - Ruggedized 3mm Jacket 4 - Tree Coupler (Cascade) 5 - 900µm Buffered Fiber 6 - Single Module 7 - Double Module 8 - 1U Rack Mount 9 - PLC Package UPG - CWDM Upgrade EXP - CWDM Express TST - CWDM Test

### Part # Example:

### RMC-3-CWDM-BC-YU-YU-6-EXP

Translates to: Rack Mount Coupler Module, Singlemode, CWDM Mux/Demux, 1471-1531nm, SC/UPC Input and Output, Single Module, with CWDM Express Port.

### SPLITTER TAP LGX STYLE MODULES

These LGX modules are loaded with completely passive optical splitter packages and are configured to meet specific Test Access Point (TAP) requirements. They provide monitor access to live network links without disrupting service on the network. Custom configurations, split ratios and connector styles are available.

PART #	DESCRIPTION	PRICE
RMC-3-S-2-50-YU-YU-6	LGX Style Module, 1x2, 50/50 split, SC/UPC	\$175.00
RMC-3-S-2-50-YA-YA-6	LGX Style Module, 1x2, 50/50 split, SC/APC	185.00
RMC-3-S-2-35-YU-YU-6	LGX Style Module, 1x2, 65/35 split, SC/UPC	175.00
RMC-3-S-2-20-YA-YA-6	LGX Style Module, 1x2, 80/20 split, SC/APC	185.00
RMC-3-S-2-10-YA-YA-6	LGX Style Module, 1x2, 90/10 split, SC/APC	185.00



RMC3S250YAYA6

### CWDM LGX STYLE MODULES

FIS CWDM LGX modules provide the most economic and efficient wavelength division multiplexing solution and are available in 4, 8 and 16 channel packages. All CWDM filters are bi-directional, eliminating the need for a separate Mux versus Demux module. CWDM modules are also available with an EX (Express) port that allows for the addition of future channels or for testing the network. The module is configurable, with a separate UPG (Upgrade) 1310nm port to support an existing active link. All channels have 20nm separation.

PART #	DESCRIPTION	PRICE
RMC-3-CWDM-BC-YA-YA-6	CWDM 1U LGX Module, 4 Channel, 1471-1531nm, Mux/DeMux, SC/APC Adapters	\$316.00
RMC-3-CWDM-DC-YA-YA-6	CWDM 1U LGX Module, 4 Channel, 1551-1611nm, Mux/DeMux, SC/APC Adapters	316.00
RMC-3-CWDM-BC-YA-YA-6-EXP-UPG	CWDM 1U LGX Module, 4 Channel, 1471-1531nm, Mux/DeMux, SC/APC Adapters, EXP and UPG Ports	395.00
RMC-3-CWDM-BC-YA-YA-6-EXP	CWDM 1U LGX Module, 4 Channel, 1471-1531nm, Mux/DeMux, SC/APC Adapters, EXP Port	336.00
RMC-3-CWDM-LC-YA-YA-6	CWDM 1U LGX Module, 8 Channel, 1471-1611nm, Mux/DeMux, SC/APC Adapters	632.00
RMC-3-CWDM-LC-YA-YA-6-EXP	CWDM 1U LGX Module, 8 Channel, 1471-1611nm, Mux/DeMux, SC/APC Adapters, EXP Port	652.00
RMC-3-CWDM-EC-YA-YA-7	CWDM 2U LGX Module, 16 Channel, 1271 - 1611nm, Mux/Demux, SC/APC Adapters	1,290.00



Picture represents visual footprint



## Factory Preloaded Fiber Interconnects

### We Stock Enclosures, Pigtails, Splice Trays, & Adapter Plates

- Swing-out Rack Mounts
- Slide-out Rack Mounts
- Economy Wall Mounts
- Deluxe Wall Mounts

#### Advantages

- Faster Field Installations
- Quick Turnaround
- Small or Large Quantity Orders
- Save Labor in the Field
- Technical Drawings Available



1,2 & 4 RU Slide-Out Rack Mounts



Economy and Deluxe Wall Mounts

**48 Hour Turnaround**  
On Select Stock Interconnects

Sales Representatives Are Waiting For Your Call!

1-800-5000-FIS(347)

www.fiberinstrumentsales.com  
FOR OUR FULL LINE OF PRODUCT OFFERINGS



**FIS ALUMINUM SPLICE TRAYS**

The FIS aluminum splice trays are compact, lightweight, and available with a variety of splice holding chips and cover options. All trays are pre-configured for standard heat shrink fusion splices unless otherwise stated. Any stocked splice holder chip can be pre-loaded into this splice tray. See splice holding chip options below. Each splice tray features a mounting hole to fasten the tray down using a mounting stud and nut. Self adhesive Velcro dots are included with F1-SPL12, F1-SPL24 and F1-6707 to secure the tray in place.

PART #	DESCRIPTION	PRICE
F1-SPL12	Aluminum Splice Tray, 12 Position, Fusion Splice Chip, Rigid (6.5"L x 4.68"W x .42"H)	\$16.95
F1-SPL24	Aluminum Splice Tray, 24 Position, Fusion Splice Chip, Rigid (11.72"L x 3.99"W x .41"H)	17.95
F1-SPL24-8.5	Aluminum Splice Tray, 24 Position, Fusion Splice Chip, Rigid (8.5"L x 5"W x .42"H)	15.95
F1-8735C	Aluminum Splice Tray, 12 Position, Clear Plastic Cover, Fusion Splice Chip, Rigid (7.13"L x 4.13"W x .38"H)	11.95
F1-8729G	Aluminum Splice Tray, 12 Position, Clear Plastic Cover, Fusion Splice Chip, Rigid (11.75"L x 4"W x .38"H)	15.95
F1-6707BLKF	Aluminum Splice Tray, 12 Position, Fusion Splice Chip, Soft (7.5"L x 4"W x .63"H)	13.95
F1-6707BLKM	Aluminum Splice Tray, 12 Position, Mechanical Splice Chip, Soft (7.5"L x 4"W x .63"H)	13.95
F1-6707BLKR	Aluminum Splice Tray, 12 Position, Bare Fiber Splice Chip, Rigid (7.5"L x 4"W x .63"H)	13.95
F1-6707BLKH	Aluminum Splice Tray, 6 Position, Fusion Splice Chip, Rigid (7.5"L x 4"W x .63"H)	13.95

**FIS PLASTIC SPLICE TRAYS**

The FIS Splice Tray is injection molded using UL94 fire retardant material. The tray is designed to fit in most splice closures and can accommodate 12 fusion, mechanical, or bare fiber splices. Any stocked splice holder chip can be pre-loaded into this splice tray. See splice holding chip options below. Features include: Fiber routing molded into the tray, fiber tie down holes, snap or slide together construction, designation label, self adhesive Velcro dots to secure the tray in place, and nylon cable tie wraps.

PART #	DESCRIPTION	DIMENSIONS (LxWxH)	PRICE
F1-6808	Plastic Splice Tray, 12 Position, Fusion Splice Chip, Rigid	7.1" x 4.25" x .48"	\$9.95
F1-6808M	Plastic Splice Tray, 12 Position, Mechanical Splice Chip, Soft	7.1" x 4.25" x .48"	9.95
F1-6808BA	Plastic Splice Tray, 12 Position, Bare Fiber Fusion Splice Chip, Rigid	7.1" x 4.25" x .48"	9.95

**STARFIGHTER SPLICE TRAYS**

Starfighter Splice Trays are designed for use with the Multilink Starfighter series of closures. Each splice tray can accommodate single fusion, bare fusion and ribbon fusion protection sleeves as well as mechanical splices. Starfighter splice trays are durable to protect and hold your splice with confidence.

PART #	DESCRIPTION	DIMENSIONS (LxWxH)	PRICE
1120-SSTA	Aluminum Splice Tray, 12 Position, For 1120-F Closure	6.5" x 4.75" x 0.5"	\$20.50
1120-SSTP	Plastic Splice Tray, 12 Position, For 1120-F Closure	5.13" x 6.5" x 0.5"	15.80
2000-SSTA	Aluminum Splice Tray, 24 Position, For 2000-F Closure	4" x 11.75" x 0.5"	28.95
3000-SSTA	Aluminum Splice Tray, 24 Position, For 3000F Closure	6" x 7.75" x 0.5"	29.60
3030-SSTP	Plastic Splice Tray, 24 Position, For 3000-F Closure	5.75" x 8.25" x 0.5"	25.00
4048-SSTP	Plastic Splice Tray, 24 Position, For 4000-D Closure	9.75" x 4.5" x 0.5"	21.00



**FIS SPLICE BRIDGES**

The FIS splice support bridge is available in two basic designs. The 4 way splice bridge will accept 4 fusion or mechanical splices. It is compatible with the FIS 4 Port Wall Mount (P/N F1-WM4PW and F1-WM4S). The 24 way splice bridge will accept up to 12 mechanical or 24 fusion splices. It is supplied with a protective lid that includes a designation label. Both splice bridges have adhesive backings.

PART #	DESCRIPTION	DIMENSIONS (LxWxH)	PRICE
F1-8730	Plastic Splice Bridge, 4 Way, Accepts 4 Fusion or Mechanical Splices, Adhesive Backing	1.25" x 1.75" x .68"	\$2.95
F1-8731	Plastic Splice Bridge, 24 Way, Accepts 12 Mechanical or 24 Fusion Splices, Adhesive Backing	3.85" x 2.53" x .63"	4.25

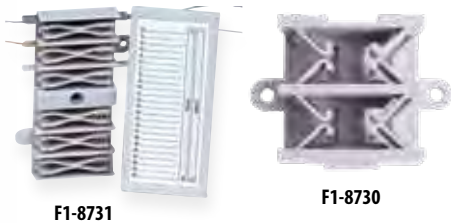

**FIS FUSION AND MECHANICAL SPLICE HOLDING CHIPS**

FIS offers several styles of splice holding chips to secure splice sleeves. For chips with non-adhesive backing, use double sided tape or epoxy to adhere to mounting surfaces. Upon request FIS will install any stock splice chip in your FIS splice tray.

PART #	DESCRIPTION	PRICE
F1-6707FCM	Fusion Splice Chip, 12 Position, Soft, Non-Adhesive Backing (1)	65¢
F1-6707MCM	Mechanical Splice Chip, 12 Position, Soft, Non-Adhesive Backing (2)	65¢
USC-HS	Heat Shrink Splice Chip, 6 Position, Rigid, For Standard/Slim Sleeves, Adhesive Backing (3)	1.10
FSH-LDR	Fusion Splice Chip, 12 Position, Plastic, Adhesive Backing (5)	2.55
F1-105612	Bare Fiber Fusion Splice Chip, 12 Position, Rigid, Adhesive Backing, 12/pack (4)	53.75
275897-000	Raychem/Tyco Splice Chip, 12 Position, Plastic, For Use In FOSC Trays (6)	1.65

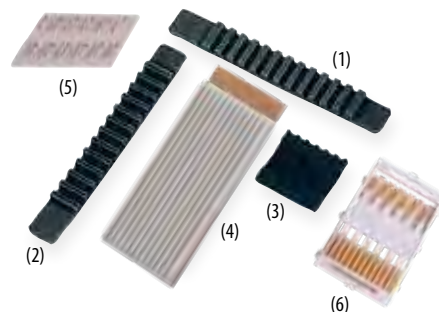



**19" FLUSH MOUNT ADAPTER BRACKETS**

Use these 19" Flush Mount Adapter Brackets to adjust the orientation of FIS enclosures. When installed, these brackets move the enclosure 3.5" back in the rack, so the front of the enclosure sits flush against the rack opening. Compatible with FIS rack mount enclosures.

PART #	DESCRIPTION	PRICE
1RURACKADP19FLUSH	1RU 19" Flush Mount Rack Adapter, Black	\$14.95
1RURACKADP19FLUSHBW	1RU 19" Flush Mount Rack Adapter, Off White	14.95
2RURACKADP19FLUSH	2RU 19" Flush Mount Rack Adapter, Black	14.95
2RURACKADP19FLUSHBW	2RU 19" Flush Mount Rack Adapter, Off White	14.95
4RURACKADP19FLUSH	4RU 19" Flush Mount Rack Adapter, Black	14.95
4RURACKADP19FLUSHBW	4RU 19" Flush Mount Rack Adapter, Off White	14.95

**23" MOUNTING BRACKETS**

Use these 23" Mounting Brackets to adapt enclosures to fit in a 23" wide rack. Compatible with FIS rack mount enclosures, select the appropriate size for the enclosure. Two 4RU sets are required for the 8RU rack mount enclosure.

PART #	DESCRIPTION	PRICE
1RURACKADP23	1RU 23" Rack Adapter, Black	\$14.95
1RURACKADP23BW	1RU 23" Rack Adapter, Off White	14.95
2RURACKADP23	2RU 23" Rack Adapter Black	14.95
2RURACKADP23BW	2RU 23" Rack Adapter, Off White	14.95
2RURACKADP23FLUSH	2RU 23" Flush Mount Rack Adapter, Black	14.95
2RURACKADP23FLUSHBW	2RU 23" Flush Mount Rack Adapter, Off White	14.95
4RURACKADP23	4RU 23" Rack Adapter Black	14.95
4RURACKADP23BW	4RU 23" Rack Adapter, Off White	14.95

**CABLE MANAGEMENT SPOOLS**

These Cable Management Spools come in a pair of two and are compatible with FIS rack and wall mount enclosures. Ideal for storing slack cable and managing incoming and outgoing fibers.

PART #	DESCRIPTION	PRICE
F1MCMB	Metal Cable Management Spool	\$16.25
F1PCM100	Plastic Cable Manager Spool, 1" Height	10.00
F1PCM084	Plastic Cable Manager Spool, 0.84" Height	10.00

**CABLE TIE MOUNTING BASES**

These Cable Tie Mounting Bases are used with T18 through T50 series cable ties to provide stability when securing bundles. The mounts are installed using the adhesive backing and/or by securing two or four screws. The 4 way opening allows the cable ties to be inserted parallel or perpendicular to the wire bundles. Max cable tie width is 0.18". Dimensions of mounting base: 1.12"L x 1.12"W x.22"H

PART #	DESCRIPTION	PRICE
MB4A10H4	Cable Tie Mounting Bases, White, 10 Pack	\$7.00
MB4A0H4	Cable Tie Mounting Bases, Black, 10 Pack	7.00

**CABLE RETENTION RINGS**

Use these Cable Retention Rings to manage incoming and outgoing fibers on the front of FIS rack mount enclosures.

PART #	DESCRIPTION	PRICE
F113187	Cable Retention Rings, White, 10 Pack, 1RU & 2RU, .75" Inside	\$3.95
F113189	Cable Retention Rings, White, 10 Pack, 4RU & 8RU, 1.0" Inside	\$3.95

**AIA GROUNDING KIT**

This grounding and bonding kit provides a grounding point for aluminum interlocking armor cable. It uses a 6 AWG insulated, high-flex grounding wire at 18" long. The included grounding clamps fit cables with an outside diameter ranging from 11.5mm to 16.0mm.

PART #	DESCRIPTION	PRICE
F1-GRBOKIT	FIS Aluminum Interlocking Armor Grounding and Bonding Kit	\$19.95

**SERVICE VACUUMS**

Portable Express Vacuum is just four pounds, easy to operate and comes with ESD safe hose, dust brush, goose neck and service tool. Powerful Omega Vacuum is the quietest, most powerful, with 6ft ESD safe hose, 16in wand and crevice tool.

PART #	DESCRIPTION	PRICE
VACEXP-04	Express Vacuum, ESD Safe, 120v, HEPA Filter	\$199.00
VACEXP-04F	Express Vacuum, ESD Safe, 230v, HEPA Filter	222.00
VACEXP-HEPA	Single Pack HEPA Filter	47.95
VACOMEGASLFH	Omega Supreme HEPA Vacuum, 120v	325.50
VACOMEGAS220FCT	Omega Supreme HEPA Vacuum, 230v	321.50

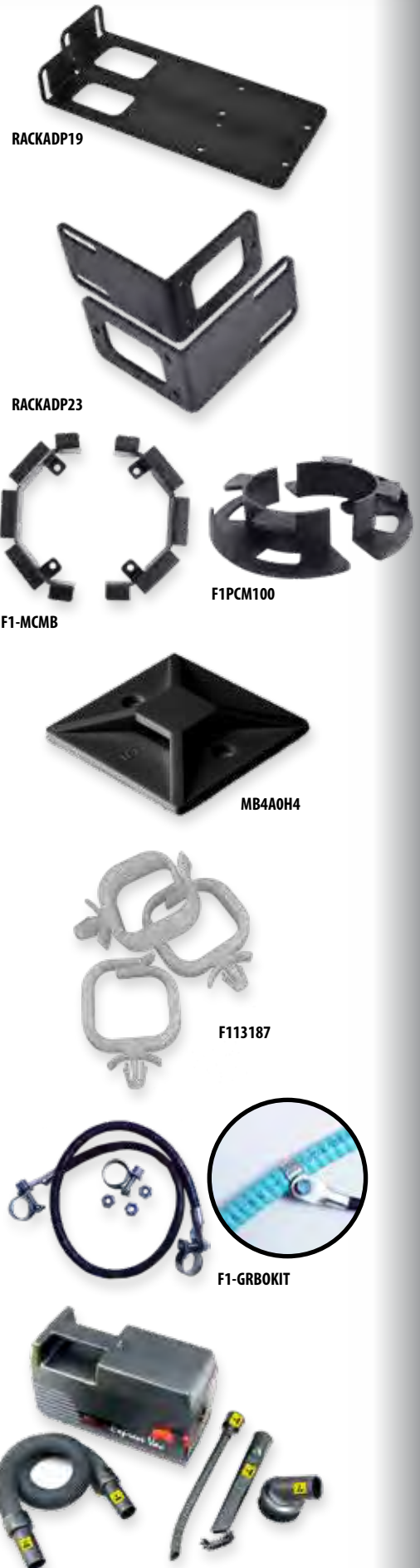



SFR Series

## SWING FRAME RACK

This 19" Wall Mount Swing Frame Rack features an open-back wall mount design ideal for mounting over existing equipment and physical obstacles (conduit, telephone equipment, etc.). Use for mounting patch panels, hubs and switches in a secure room or closet. Rugged steel construction with 100lb weight capacity. Ships ready to assemble.

PART #	DESCRIPTION	OVERALL DIMENSIONS (HxWxD)	PRICE
SFR-12-18	12RU x18"D, Wall Mount, Swing Frame Rack	21" x 19" x 16"	\$175.00
SFR-12-24	12RU x24"D, Wall Mount, Swing Frame Rack	21" x 19" x 18"	235.00
SFR-20-18	20RU x18"D, Wall Mount, Swing Frame Rack	35" x 19" x 16"	225.00
SFR-20-24	20RU x24"D, Wall Mount, Swing Frame Rack	35" x 19" x 18"	300.00
SFR-25-18	25RU x18"D, Wall Mount, Swing Frame Rack	43.75" x 19" x 16"	300.00
SFR-25-24	25RU x24"D, Wall Mount, Swing Frame Rack	43.75" x 19" x 18"	348.75

\* Note: the SFR series does not include the patch panels, shelf, cables, or UPS shown in the pictures



WM Series

## WALL-MOUNT RELAY RACKS

This 19" Wall Mount Rack is self-squaring and allows for virtually any data or telecommunications component to be installed. Ideal for wall mounting fiber-optic equipment, its fixed design prevents kinking or breaking of glass fibers. Rugged steel construction; includes rack screws. Ships ready to assemble.

PART #	DESCRIPTION	OVERALL DIMENSIONS (HxWxD)	PRICE
WM-8-12	8RU x 12"D, Wall Mount, Rack	14" x 19" x 12"	\$135.00
WM-15-12	15RU x 12"D, Wall Mount, Rack	26.25" x 19" x 12"	135.00
WM-30-12	30RU x 12"D, Wall Mount, Rack	52.5" x 19" x 12"	235.00
WM-8-18	8RU x 18"D, Wall Mount, Rack	14" x 19" x 18"	149.00
WM-15-18	15RU x 18"D, Wall Mount, Rack	26.25" x 19" x 18"	165.00
WM-30-18	30RU x 18"D, Wall Mount, Rack	52.5" x 19" x 18"	181.00



F1-FR19074502



## 19" ALUMINUM OPEN FRAME RACK

These 2-Post Floor Mount Racks offer space saving convenience for mounting data and telecommunications equipment. Racks are numbered with rack units and tapped for #12-24 mounting screws. Additional units are available in 3ft and 4ft. heights. Call your FIS sales representative for details on shipping and racks not listed below.

PART #	DESCRIPTION	OVERALL DIMENSIONS (HxWxD)	PRICE
F1-FR19074502	45RU x 19"W, Floor Mount Open Frame Rack, Two Post	84" x 21" x 14"	\$150.25

## QUEST MANUFACTURING FLOOR ENCLOSURES

Quest Manufacturing Floor Enclosures offer a vented steel mesh front door, a dual vented locking rear door, adjustable cage nut rails, dual pre-installed cooling fans, and 3 removable bottom panels for easy access to raised floors or for mounting equipment directly to the floor. Specify preferred shipment style: Fully Assembled or Knockdown. Additional enclosures are available with 31", 34" and 42" depths. Call your FIS sales representative for details on shipping and enclosures not listed below.

PART #	DESCRIPTION	OVERALL DIMENSIONS (HxWxD)	PRICE
FE7019-34-02	34U Steel Mesh Front Door Floor Enclosure, Black	69" x 23" x 23"	\$878.50
FE7019-42-02	40U Steel Mesh Front Door Floor Enclosure, Black	80" x 23" x 23"	1,008.75
FE7019-45-02	45U Steel Mesh Front Door Floor Enclosure, Black	88" x 23" x 23"	1,035.25



FE7019-34-02



WW3019-07-02

## QUEST MANUFACTURING WALL MOUNT ENCLOSURES

Quest Manufacturing Wall Mount Enclosures offer a locking front door that is reversible for left or right side opening. Its swing out feature allows easy access to the back of equipment with a key lock to prevent tampering. Enclosures have vented fixed side panels for better air flow and pre-installed 110VAC 80CFM cooling fans to keep equipment running cool. It also includes adjustable cage nut rails and cage nuts with standard #12-24 mounting screws. Rails are marked with RU space index. Enclosure ships fully assembled. Additional enclosures are available with 20RU and 28RU heights. Call your FIS sales representative for details on shipping and enclosures not listed below.

PART #	DESCRIPTION	OVERALL DIMENSIONS (HxWxD)	PRICE
WM-3019-07-02	7RU Swing Out Wall Mount Enclosure, Black	15" x 20.5" x 23.5"	\$258.50
WM-3019-09-02	9RU Swing Out Wall Mount Enclosure, Black	18.5" x 20.5" x 23.5"	278.75
WM-3019-11-02	11RU Swing Out Wall Mount Enclosure, Black	22" x 20.5" x 23.5"	297.75
WM-3019-14-02	14RU Swing Out Wall Mount Enclosure, Black	27" x 20.5" x 23.5"	329.79
WM-3019-16-02	16RU Swing Out Wall Mount Enclosure, Black	30.5" x 20.5" x 23.5"	352.50



EZ190902

## QUEST MANUFACTURING EZ ASSEMBLY 600 SERIES WALL MOUNT ENCLOSURES

Quest Manufacturing EZ Assembly 600 Series Wall Mount Enclosures offer many convenient features. Locking front door is reversible for left or right side opening. Enclosures have vented fixed side panels for better air flow and pre-installed 110VAC 80CFM cooling fans keep equipment running cool. Also includes adjustable cage nut rails and cage nuts with standard #12-24 mounting screws. Rails are marked with RU space index. Ships in Knockdown Box

PART #	DESCRIPTION	OVERALL DIMENSIONS (HxWxD)	PRICE
EZ190702	7RU EZ Assembly Wall Mount Enclosure, Black	15" x 20.5" x 20"	\$174.75
EZ190902	9RU EZ Assembly Wall Mount Enclosure, Black	18" x 20.5" x 20"	190.75
EZ191102	11RU EZ Assembly Wall Mount Enclosure, Black	22" x 20.5" x 20"	211.75



**VERTICAL CABLE MANAGEMENT**

PART #	DESCRIPTION	PRICE
VF-04-100	Vertical Dual Sided Finger Duct Style Cable Manager, Floor Enclosure Style, Black, 48"H x 1.6"W x 4"D	\$34.25
VF-07-100	Vertical Dual Sided Finger Duct Style Cable Manager, Floor Enclosure Style, Black, 72"H x 1.6"W x 4"D	55.25
VF-07-140	Vertical Dual Sided Finger Duct Style Cable Manager, Floor Enclosure Style Black, 72"H x 2.2"W x 6.4"D	81.25
VR-07-140	Vertical Dual Sided Finger Duct Style Cable Manager, 2 Post Rack Style Black, 72"H x 2.2"W x 6.4"D	81.25

VF-04-100

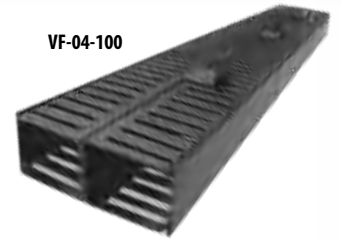

**HORIZONTAL CABLE MANAGEMENT**

PART #	DESCRIPTION	PRICE
HF19-01-040	Horizontal Single Sided Finger Duct Style Cable Manager, Black, 1.75"H x 1.6"W x 2"D	\$17.75
HF19-02-200	Horizontal Single Sided Finger Duct Style Cable Manager, Black, 3.5"H x 3.2"W x 3.2"D	21.75
HF19-02-200D	Horizontal Dual Sided Finger Duct Style Cable Manager, Black, 3.5"H x 3.2"W x 6.4"D	38.75



HF19-01-040

**COOPER B LINE CABLE HOOKS AND CABLE TO BEAM FASTENERS**

Cable hooks or J-hooks are an excellent solution for supporting cables of all types. Cable to Beam fasteners rotate 360 degrees to allow cable to run in any direction and they do accept cable ties. The exclusive Qwik-Latch cable retainers provide secure containment of cables.

PART #	DESCRIPTION	PRICE
BCH21	1-5/16" Cable Hook or J-Hook, Box of 50	\$152.95
BCH32-50	2" Cable Hook or J-Hook, Box of 50	203.75
BCH64	4" Cable Hook or J-Hook, Box of 25	365.50
BCH21C2	1 5/16" Cable to Beam Fastener, Box of 50	292.95
BCH32-C2-50	2" Cable to Beam Fastener, Box of 50	335.00

BCH64



VD00034

**DATA CABLE ACCESSORIES**

Utilize plastic distribution rings or "D" rings, attach to a backboard, ceiling or a wall to support voice and data cables. The plastic rings feature rounded edges that will prevent damage to the wire and cable in addition to allowing for easier "pull." Available in 2", 3" or 5" sizes.

PART #	DESCRIPTION	PRICE
F1-PDR2	Plastic Distribution Ring (2")	\$1.50
F1-PDR3	Plastic Distribution Ring (3")	1.95
F1-PDR5	Plastic Distribution Ring (5")	2.25
VD00034	Vertical D-Ring Cable Manager for open frame racks, Depth 3.25" - 10 per pack	35.50
VD00070	Vertical D-Ring Cable Manager for open frame racks, Depth 5.7 - 10 per pack	35.25

VD00070

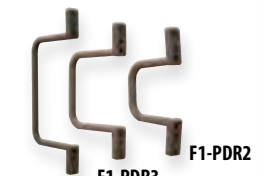

F1-PDR5

F1-PDR3

F1-PDR2

# Custom Interconnect Solutions

FIS' extensive resources facilitate a fast concept-to-product development cycle. FIS will design, manufacture and customize products to meet the needs of your large or special projects.

Any enclosure, either stock or custom built, can be loaded with fiber, connectors, and cable management solutions. CWDM modules, high count fiber couplers, and MTP assemblies are all configurable and can easily be pre-installed within the enclosure.

Feature your unique brand on FIS enclosures by taking advantage of customized silk screened logos, vivid laser etched designs, and a variety of powder coat colors.

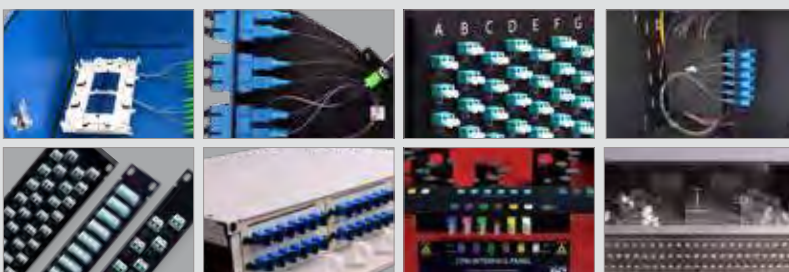

- Individual Logos  
*Laser Etching, Silk Screening, High Tack Stickers*
- Unique Colors  
*Electrostatic Powder Coating Available in Any Color*
- Construction Materials  
*Aluminum or Steel*
- Pre-Loaded Ports  
*LGX Adapter Panels, Pigtailed, Snap Packs, Cassettes*



**3mm ST-ST UPC SIMPLEX**

PART #	LENGTH	PRICE
S98U8US1FISCU	1 Meter	\$5.00
S98U8US2FISCU	2 Meters	5.15
S98U8US3FISCU	3 Meters	5.30
S98U8US5FISCU	5 Meters	5.60
S98U8US10FISCU	10 Meters	6.35



**3mm ST-SC UPC SIMPLEX**

PART #	LENGTH	PRICE
S98UYUS1FISCU	1 Meter	\$5.00
S98UYUS2FISCU	2 Meters	5.15
S98UYUS3FISCU	3 Meters	5.30
S98UYUS5FISCU	5 Meters	5.60
S98UYUS10FISCU	10 Meters	6.35



**3mm SC-SC UPC SIMPLEX**

PART #	LENGTH	PRICE
S9YUYUS1FISCU	1 Meter	\$5.00
S9YUYUS2FISCU	2 Meters	5.15
S9YUYUS3FISCU	3 Meters	5.30
S9YUYUS5FISCU	5 Meters	5.60
S9YUYUS10FISCU	10 Meters	6.35



**1.6mm LC-LC UPC SIMPLEX**

PART #	LENGTH	PRICE
Y9LULUS1FISCU	1 Meter	\$5.65
Y9LULUS2FISCU	2 Meters	5.85
Y9LULUS3FISCU	3 Meters	5.95
Y9LULUS5FISCU	5 Meters	6.30
Y9LULUS10FISCU	10 Meters	7.00



**1.6mm LC-SC UPC SIMPLEX**

PART #	LENGTH	PRICE
Y9LUYUS1FISCU	1 Meter	\$5.65
Y9LUYUS2FISCU	2 Meters	5.85
Y9LUYUS3FISCU	3 Meters	5.95
Y9LUYUS5FISCU	5 Meters	6.30
Y9LUYUS10FISCU	10 Meters	7.00



**3mm FC-FC UPC SIMPLEX**

PART #	LENGTH	PRICE
S97U7US1FISCU	1 Meter	\$5.00
S97U7US2FISCU	2 Meters	5.15
S97U7US3FISCU	3 Meters	5.30
S97U7US5FISCU	5 Meters	5.60
S97U7US10FISCU	10 Meters	6.35

### CORNING® SMF-28® ULTRA FIBER SM PATCH CABLES



**1.6mm LC-SC UPC DUPLEX**

PART #	LENGTH	PRICE
X9LUYUS1FISCU	1 Meter	\$11.25
X9LUYUS2FISCU	2 Meters	11.35
X9LUYUS3FISCU	3 Meters	11.65
X9LUYUS5FISCU	5 Meters	12.30
X9LUYUS10FISCU	10 Meters	13.80



**1.6mm LC-LC UPC DUPLEX**

PART #	LENGTH	PRICE
X9LULUS1FISCU	1 Meter	\$11.25
X9LULUS2FISCU	2 Meters	11.35
X9LULUS3FISCU	3 Meters	11.65
X9LULUS5FISCU	5 Meters	12.30
X9LULUS10FISCU	10 Meters	13.80



**3mm SC-SC UPC DUPLEX**

PART #	LENGTH	PRICE
D9YUYUS1FISCU	1 Meter	\$9.75
D9YUYUS2FISCU	2 Meters	10.00
D9YUYUS3FISCU	3 Meters	10.30
D9YUYUS5FISCU	5 Meters	10.85
D9YUYUS10FISCU	10 Meters	12.20



**3mm ST-ST UPC DUPLEX**

PART #	LENGTH	PRICE
D98U8US1FISCU	1 Meter	\$9.75
D98U8US2FISCU	2 Meters	10.00
D98U8US3FISCU	3 Meters	10.30
D98U8US5FISCU	5 Meters	10.85
D98U8US10FISCU	10 Meters	12.20



**3mm ST-SC UPC DUPLEX**

PART #	LENGTH	PRICE
D98UYUS1FISCU	1 Meter	\$9.75
D98UYUS2FISCU	2 Meters	10.00
D98UYUS3FISCU	3 Meters	10.30
D98UYUS5FISCU	5 Meters	10.85
D98UYUS10FISCU	10 Meters	12.20



**3mm FC-FC UPC DUPLEX**

PART #	LENGTH	PRICE
D97U7US1FISCU	1 Meter	\$9.75
D97U7US2FISCU	2 Meters	10.00
D97U7US3FISCU	3 Meters	10.30
D97U7US5FISCU	5 Meters	10.85
D97U7US10FISCU	10 Meters	12.20





**1.6mm LC-LC APC SIMPLEX**

PART #	LENGTH	PRICE
Y9LALAS1FISCU	1 Meter	\$6.10
Y9LALAS2FISCU	2 Meters	6.25
Y9LALAS3FISCU	3 Meters	6.40
Y9LALAS5FISCU	5 Meters	6.75
Y9LALAS10FISCU	10 Meters	7.50



**3mm SC-SC APC SIMPLEX**

PART #	LENGTH	PRICE
S9YAYAS1FISCU	1 Meter	\$5.55
S9YAYAS2FISCU	2 Meters	5.70
S9YAYAS3FISCU	3 Meters	5.85
S9YAYAS5FISCU	5 Meters	6.25
S9YAYAS10FISCU	10 Meters	6.90



**3mm FC-FC APC SIMPLEX**

PART #	LENGTH	PRICE
S97A7AS1FISCU	1 Meter	\$5.55
S97A7AS2FISCU	2 Meters	5.70
S97A7AS3FISCU	3 Meters	5.85
S97A7AS5FISCU	5 Meters	6.25
S97A7AS10FISCU	10 Meters	6.90



**1.6mm LC-LC APC DUPLEX**

PART #	LENGTH	PRICE
X9LALAS1FISCU	1 Meter	\$12.00
X9LALAS2FISCU	2 Meters	12.30
X9LALAS3FISCU	3 Meters	13.00
X9LALAS5FISCU	5 Meters	13.25
X9LALAS10FISCU	10 Meters	14.75



**3mm SC-SC APC DUPLEX**

PART #	LENGTH	PRICE
D9YAYAS1FISCU	1 Meter	\$10.80
D9YAYAS2FISCU	2 Meters	11.10
D9YAYAS3FISCU	3 Meters	11.40
D9YAYAS5FISCU	5 Meters	12.00
D9YAYAS10FISCU	10 Meters	13.55

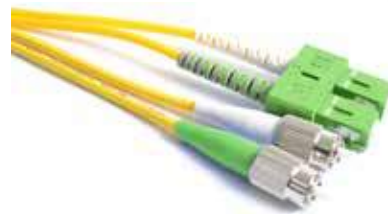

**3mm FC-SC APC DUPLEX**

PART #	LENGTH	PRICE
D9YAYAS1FISCU	1 Meter	\$10.80
D9YAYAS2FISCU	2 Meters	11.10
D9YAYAS3FISCU	3 Meters	11.40
D9YAYAS5FISCU	5 Meters	12.00
D9YAYAS10FISCU	10 Meters	13.55

**CORNING® SMF-28® ULTRA FIBER SM PATCH CABLES**



**1.6mm SC/APC - LC/UPC SIMPLEX**

PART #	LENGTH	PRICE
Y9YALUS1FISCU	1 Meter	\$6.10
Y9YALUS2FISCU	2 Meters	6.25
Y9YALUS3FISCU	3 Meters	6.40
Y9YALUS5FISCU	5 Meters	6.75
Y9YALUS10FISCU	10 Meters	7.50



**1.6mm LC-SC APC SIMPLEX**

PART #	LENGTH	PRICE
Y9YALAS1FISCU	1 Meter	\$6.10
Y9YALAS2FISCU	2 Meters	6.25
Y9YALAS3FISCU	3 Meters	6.40
Y9YALAS5FISCU	5 Meters	6.75
Y9YALAS10FISCU	10 Meters	7.50



**3mm FC-SC APC SIMPLEX**

PART #	LENGTH	PRICE
S9YA7AS1FISCU	1 Meter	\$5.55
S9YA7AS2FISCU	2 Meters	5.70
S9YA7AS3FISCU	3 Meters	5.85
S9YA7AS5FISCU	5 Meters	6.25
S9YA7AS10FISCU	10 Meters	6.90



**1.6mm LC/APC - SC/UPC DUPLEX**

PART #	LENGTH	PRICE
X9LAYUS1FISCU	1 Meter	\$12.00
X9LAYUS2FISCU	2 Meters	12.30
X9LAYUS3FISCU	3 Meters	13.00
X9LAYUS5FISCU	5 Meters	13.25
X9LAYUS10FISCU	10 Meters	14.75



**1.6mm LC-LC UPC UNI-BOOT DUPLEX**

PART #	LENGTH	PRICE
X9LULUS1FISCUNI	1 Meter	\$16.35
X9LULUS2FISCUNI	2 Meters	16.65
X9LULUS3FISCUNI	3 Meters	16.95
X9LULUS5FISCUNI	5 Meters	17.55
X9LULUS10FISCUNI	10 Meters	19.25



**1.6mm LC-LC APC UNI-BOOT DUPLEX**

PART #	LENGTH	PRICE
X9LALAS1FISCUNI	1 Meter	\$17.55
X9LALAS2FISCUNI	2 Meters	17.85
X9LALAS3FISCUNI	3 Meters	18.20
X9LALAS5FISCUNI	5 Meters	18.75
X9LALAS10FISCUNI	10 Meters	20.25



### 1.6mm SC-SC PC SIMPLEX - 50µm OM3

PART #	LENGTH	PRICE
Y8YYM1FISC	1 Meter	\$4.80
Y8YYM2FISC	2 Meters	5.15
Y8YYM3FISC	3 Meters	5.45
Y8YYM5FISC	5 Meters	6.25
Y8YYM10FISC	10 Meters	8.00



### 1.6mm LC-LC PC SIMPLEX - 50µm OM3

PART #	LENGTH	PRICE
Y8LLM1FISC	1 Meter	\$5.35
Y8LLM2FISC	2 Meters	5.75
Y8LLM3FISC	3 Meters	6.10
Y8LLM5FISC	5 Meters	6.80
Y8LLM10FISC	10 Meters	8.60



### 1.6mm ST-ST PC SIMPLEX - 50µm OM3

PART #	LENGTH	PRICE
Y888M1FISC	1 Meter	\$4.80
Y888M2FISC	2 Meters	5.15
Y888M3FISC	3 Meters	5.45
Y888M5FISC	5 Meters	6.25
Y888M10FISC	10 Meters	8.00



### 1.6mm LC-SC PC SIMPLEX - 50µm OM3

PART #	LENGTH	PRICE
Y8LYM1FISC	1 Meter	\$5.35
Y8LYM2FISC	2 Meters	5.75
Y8LYM3FISC	3 Meters	6.10
Y8LYM5FISC	5 Meters	6.80
Y8LYM10FISC	10 Meters	8.60



### 1.6mm SC-ST PC SIMPLEX - 50µm OM3

PART #	LENGTH	PRICE
Y8Y8M1FISC	1 Meter	\$4.80
Y8Y8M2FISC	2 Meters	5.15
Y8Y8M3FISC	3 Meters	5.45
Y8Y8M5FISC	5 Meters	6.25
Y8Y8M10FISC	10 Meters	8.00



### 1.6mm LC-ST PC SIMPLEX - 50µm OM3

PART #	LENGTH	PRICE
Y8L8M1FISC	1 Meter	\$5.35
Y8L8M2FISC	2 Meters	5.75
Y8L8M3FISC	3 Meters	6.10
Y8L8M5FISC	5 Meters	6.80
Y8L8M10FISC	10 Meters	8.60



### 1.6mm ST-ST PC DUPLEX - 50µm OM3

PART #	LENGTH	PRICE
X888M1FISC	1 Meter	\$9.30
X888M2FISC	2 Meters	10.00
X888M3FISC	3 Meters	10.75
X888M5FISC	5 Meters	12.25
X888M10FISC	10 Meters	15.75



### 1.6mm SC-ST PC DUPLEX - 50µm OM3

PART #	LENGTH	PRICE
X8Y8M1FISC	1 Meter	\$9.30
X8Y8M2FISC	2 Meters	10.00
X8Y8M3FISC	3 Meters	10.75
X8Y8M5FISC	5 Meters	12.25
X8Y8M10FISC	10 Meters	15.75



### 1.6mm LC-ST PC DUPLEX - 50µm OM3

PART #	LENGTH	PRICE
X8L8M1FISC	1 Meter	\$10.50
X8L8M2FISC	2 Meters	11.20
X8L8M3FISC	3 Meters	11.95
X8L8M5FISC	5 Meters	13.30
X8L8M10FISC	10 Meters	16.95



### 1.6mm SC-SC PC DUPLEX - 50µm OM3

PART #	LENGTH	PRICE
X8YYM1FISC	1 Meter	\$9.30
X8YYM2FISC	2 Meters	10.00
X8YYM3FISC	3 Meters	10.75
X8YYM5FISC	5 Meters	12.25
X8YYM10FISC	10 Meters	15.75



### 1.6mm LC-LC PC DUPLEX - 50µm OM3

PART #	LENGTH	PRICE
X8LLM1FISC	1 Meter	\$10.50
X8LLM2FISC	2 Meters	11.20
X8LLM3FISC	3 Meters	11.95
X8LLM5FISC	5 Meters	13.30
X8LLM10FISC	10 Meters	16.95



### 1.6mm LC-SC PC DUPLEX - 50µm OM3

PART #	LENGTH	PRICE
X8LYM1FISC	1 Meter	\$10.50
X8LYM2FISC	2 Meters	11.20
X8LYM3FISC	3 Meters	11.95
X8LYM5FISC	5 Meters	13.30
X8LYM10FISC	10 Meters	16.95

### 1.6mm SC-SC PC DUPLEX - 50µm OM4

PART #	LENGTH	PRICE
X10YYM1FISC	1 Meter	\$9.65
X10YYM2FISC	2 Meters	10.75
X10YYM3FISC	3 Meters	11.85
X10YYM5FISC	5 Meters	14.00
X10YYM10FISC	10 Meters	19.30

### 1.6mm LC-LC PC DUPLEX - 50µm OM4

PART #	LENGTH	PRICE
X10LLM1FISC	1 Meter	\$10.85
X10LLM2FISC	2 Meters	11.95
X10LLM3FISC	3 Meters	13.00
X10LLM5FISC	5 Meters	15.15
X10LLM10FISC	10 Meters	20.00

### 1.6mm LC-SC PC DUPLEX - 50µm OM4

PART #	LENGTH	PRICE
X10LYM1FISC	1 Meter	\$10.85
X10LYM2FISC	2 Meter	11.95
X10LYM3FISC	3 Meter	13.00
X10LYM5FISC	5 Meter	15.15
X10LYM10FISC	10 Meter	20.00



**3MM ST-ST SIMPLEX - 50µm OM2**

PART #	LENGTH	PRICE
S188M1FISC	1 Meter	\$4.70
S188M2FISC	2 Meters	4.85
S188M3FISC	3 Meters	5.10
S188M5FISC	5 Meters	5.50
S188M10FISC	10 Meters	6.55

**3MM ST-ST SIMPLEX - 62.5µm OM1**

S288M1FISC	1 Meter	\$4.70
S288M2FISC	2 Meters	4.85
S288M3FISC	3 Meters	5.10
S288M5FISC	5 Meters	5.50
S288M10FISC	10 Meters	6.55



**3MM SC-SC SIMPLEX - 50µm OM2**

PART #	LENGTH	PRICE
S1YYM1FISC	1 Meter	\$4.70
S1YYM2FISC	2 Meters	4.85
S1YYM3FISC	3 Meters	5.10
S1YYM5FISC	5 Meters	5.50
S1YYM10FISC	10 Meters	6.55

**3MM SC-SC SIMPLEX - 62.5µm OM1**

S2YYM1FISC	1 Meter	\$4.70
S2YYM2FISC	2 Meters	4.85
S2YYM3FISC	3 Meters	5.10
S2YYM5FISC	5 Meters	5.50
S2YYM10FISC	10 Meters	6.55



**1.6MM LC-LC SIMPLEX - 50µm**

PART #	LENGTH	PRICE
Y1LLM1FISC	1 Meter	\$5.25
Y1LLM2FISC	2 Meters	5.45
Y1LLM3FISC	3 Meters	5.65
Y1LLM5FISC	5 Meters	6.05
Y1LLM10FISC	10 Meters	7.10

**1.6MM LC-LC SIMPLEX - 62.5µm OM1**

Y2LLM1FISC	1 Meter	\$5.25
Y2LLM2FISC	2 Meters	5.45
Y2LLM3FISC	3 Meters	5.65
Y2LLM5FISC	5 Meters	6.05
Y2LLM10FISC	10 Meters	7.10



**3MM ST-ST DUPLEX - 50µm OM2**

PART #	LENGTH	PRICE
D188M1FISC	1 Meter	\$8.95
D188M2FISC	2 Meters	9.45
D188M3FISC	3 Meters	9.85
D188M5FISC	5 Meters	10.65
D188M10FISC	10 Meters	12.85

**3MM ST-ST DUPLEX - 62.5µm OM1**

D288M1FISC	1 Meter	\$8.95
D288M2FISC	2 Meters	9.45
D288M3FISC	3 Meters	9.85
D288M5FISC	5 Meters	10.65
D288M10FISC	10 Meters	12.85

**3MM SC-SC DUPLEX - 50µm OM2**

PART #	LENGTH	PRICE
D1YYM1FISC	1 Meter	\$8.95
D1YYM2FISC	2 Meters	9.45
D1YYM3FISC	3 Meters	9.85
D1YYM5FISC	5 Meters	10.65
D1YYM10FISC	10 Meters	12.85

**3MM SC-SC DUPLEX - 62.5µm OM1**

D2YYM1FISC	1 Meter	\$8.95
D2YYM2FISC	2 Meters	9.45
D2YYM3FISC	3 Meters	9.85
D2YYM5FISC	5 Meters	10.65
D2YYM10FISC	10 Meters	12.85

**1.6MM LC-LC DUPLEX - 50µm OM2**

PART #	LENGTH	PRICE
X1LLM1FISC	1 Meter	\$10.25
X1LLM2FISC	2 Meters	10.60
X1LLM3FISC	3 Meters	11.00
X1LLM5FISC	5 Meters	11.90
X1LLM10FISC	10 Meters	14.00

**1.6MM LC-LC DUPLEX - 62.5µm OM1**

X2LLM1FISC	1 Meter	\$10.25
X2LLM2FISC	2 Meters	10.60
X2LLM3FISC	3 Meters	11.00
X2LLM5FISC	5 Meters	11.90
X2LLM10FISC	10 Meters	14.00

**CUSTOM LENGTHS AVAILABLE**

**QUANTITY PRICING IN STOCK**

**HYBRID PATCH CABLE**



**3MM ST-SC SIMPLEX - 62.5µm OM1**

PART #	LENGTH	PRICE
S28YM1FISC	1 Meter	\$4.70
S28YM2FISC	2 Meters	4.85
S28YM3FISC	3 Meters	5.10
S28YM5FISC	5 Meters	5.50
S28YM10FISC	10 Meters	6.55

**1.6MM ST-LC SIMPLEX - 62.5µm OM1**

PART #	LENGTH	PRICE
Y28LM1FISC	1 Meter	\$5.25
Y28LM2FISC	2 Meters	5.45
Y28LM3FISC	3 Meters	5.65
Y28LM5FISC	5 Meters	6.05
Y28LM10FISC	10 Meters	7.10

**1.6MM SC-LC SIMPLEX - 62.5µm OM1**

PART #	LENGTH	PRICE
Y2YLM1FISC	1 Meter	\$5.25
Y2YLM2FISC	2 Meters	5.45
Y2YLM3FISC	3 Meters	5.65
Y2YLM5FISC	5 Meters	6.05
Y2YLM10FISC	10 Meters	7.10

**3MM ST-SC DUPLEX - 50µm OM2**

PART #	LENGTH	PRICE
D18YM1FISC	1 Meter	\$8.95
D18YM2FISC	2 Meters	9.45
D18YM3FISC	3 Meters	9.85
D18YM5FISC	5 Meters	10.65
D18YM10FISC	10 Meters	12.85

**1.6MM ST-LC DUPLEX - 50µm OM2**

PART #	LENGTH	PRICE
X18LM1FISC	1 Meter	\$10.25
X18LM2FISC	2 Meters	10.60
X18LM3FISC	3 Meters	11.00
X18LM5FISC	5 Meters	11.90
X18LM10FISC	10 Meters	14.00

**1.6MM SC-LC DUPLEX - 50µm OM2**

PART #	LENGTH	PRICE
X1YLM1FISC	1 Meter	\$10.25
X1YLM2FISC	2 Meters	10.60
X1YLM3FISC	3 Meters	11.00
X1YLM5FISC	5 Meters	11.90
X1YLM10FISC	10 Meters	14.00

**3MM ST-SC DUPLEX - 62.5µm OM1**

D28YM1FISC	1 Meter	\$8.95
D28YM2FISC	2 Meters	9.45
D28YM3FISC	3 Meters	9.85
D28YM5FISC	5 Meters	10.65
D28YM10FISC	10 Meters	12.85

**1.6MM ST-LC DUPLEX - 62.5µm OM1**

X28LM1FISC	1 Meter	\$10.25
X28LM2FISC	2 Meters	10.60
X28LM3FISC	3 Meters	11.00
X28LM5FISC	5 Meters	11.90
X28LM10FISC	10 Meters	14.00

**1.6MM SC-LC DUPLEX - 62.5µm OM1**

X2YLM1FISC	1 Meter	\$10.25
X2YLM2FISC	2 Meters	10.60
X2YLM3FISC	3 Meters	11.00
X2YLM5FISC	5 Meters	11.90
X2YLM10FISC	10 Meters	14.00

## CUSTOM MPO/MTP TRUNK CABLE ASSEMBLY CONFIGURATOR:

Use this chart to build cable you need to your exact specifications.

CABLE STYLE	FIBER	CONN. #1	CONN. #2	MODE	LENGTH (IN METERS)	FERRULE QUALITY	FIBER COUNT	POLARITY	BUILD UP BREAKOUT	JACKET	P/E
M	8	MF12	YU	M	1	S	12	A	X	PL	X
MD = Micro Distribution R = Ribbon	1 = 50µm MM - OM2 2 = 62.5µm MM - OM1 3 = 9µm SM - OS2 8 = 50µm 10Gig - OM3 10 = 50µm 10Gig - OM4 12 = 50µm 10Gig - OMS	MT8 = MTP 8 Fiber Male MT12 = MTP 12 Fiber Male MT16 = MTP 16 Fiber Male MT24 = MTP 24 Fiber Male MT32 = MTP 32 Fiber Male MF8 = MTP 8 Fiber Female MF12 = MTP 12 Fiber Female MF16 = MTP 16 Fiber Female MF24 = MTP 24 Fiber Female MF32 = MTP 32 Fiber Female	YU = SC/UPC YA = SC/APC LU = LC/UPC LA = LC/APC 8U = ST/UPC 7U = FC/UPC 7A = FC/APC  MT8 = MTP 8 Fiber Male MT12 = MTP 12 Fiber Male MT16 = MTP 16 Fiber Male MT24 = MTP 24 Fiber Male MT32 = MTP 32 Fiber Male	S = Singlemode M = Multimode		S = Standard E = Elite	12 = 12-fiber 24 = 24 fiber 32 = 32 fiber 36 = 36 fiber 48 = 48 fiber 72 = 72 fiber 144 = 144 fiber	A = Type A B = Type B C = Type C D = 24 Fiber Type A E = 24 Fiber Type B U = Other (User Defined)	Z9 = 900 Z2 = 2mm Z3 = 3mm X = None	R = Riser PL = Plenum	P/E = Pulling Eye

See Page 99 For MTP Connectors



See Page 20 For MTP Modules



F1-MTP/F-LC-051-12

### MPO/MTP TRUNK AND BREAKOUT CABLE ASSEMBLIES

PART #	DESCRIPTION	TERMINATION PRICE	CABLE PRICE
M3MF12MF12S1S12AXPL	12 Fiber, 9/125µm SM MTP(F)-MTP(F) Plenum	\$85.00	\$1.35/Mtr.
M8MF12MF12M1S12AXPL	12 Fiber, 50µm 10Gig OM3 MM MTP(F)-MTP(F) Plenum	75.00	2.68/Mtr.
M8MF12MF12M1S24AXPL	24 Fiber, 50µm 10Gig OM3 MM MTP(F)-MTP(F) Plenum	145.00	5.60/Mtr.
M8MF12MF12M1S48AXPL	48 Fiber, 50µm 10Gig OM3 MM MTP(F)-MTP(F) Plenum	285.00	11.10/Mtr.

\*\* Trunk cable pricing = termination + per meter cable \*\*  
Example: 50 meter 12-fiber SM cable: \$85.00 (termination) + \$67.50 (\$1.35 x 50 meters) = \$152.50 total

### MPO/MTP RIBBON CABLE ASSEMBLIES AND PIGTAILS

PART #	DESCRIPTION	PRICE
R3MT12MT12S1S12AZ9R	12 Fiber Ribbon, 9µm SM MTP(M)-MTP(M) 1 Meter Riser	\$110.00
R3MT12YUS1S12AZ9R	12 Fiber Ribbon, 9µm SM MTP(M)-SC/UPC 1 Meter Riser	110.00
R3YUPS3FIS12C	12 Fiber Ribbon, 9µm SM SC/UPC 3 Meter Pigtail Fanout Kit	55.00
R3LUPS3FIS12C	12 Fiber Ribbon, 9µm SM LC/UPC 3 Meter Pigtail Fanout Kit	55.00

## MPO/MTP PRE TERMINATED MULTI-FIBER CABLE SOLUTIONS

Help your data transmission initiatives stay future-proof.

### STANDARD vs. ELITE MTP FERRULES

The USCONEC MTP connector is available in both Standard and Elite versions (Singlemode and Multimode). Please indicate Elite or Standard when using the MTP configurator to determine your cable's part number.

### UNDERSTANDING MPO/MTP POLARITY

MPO/MTP polarity has recently become a confusing fiber related issue. Generally there are three accepted 'Industry Standard' wiring methods (A, B and C) for 12 fiber MPO/MTP optical connectors. It is important to know which standard you need for your MPO/MTP assembly. You may also have the need for 'Vendor Specific' MPO/MTP wiring patterns that differ from the 'Industry Standards'. MPO/MTP connectors are also available in a 24 fiber configuration. Fiber Instrument Sales can build your MPO/MTP cable assembly to any of the 'Standards' or fiber counts that you require.

24 FIBER MPO/MTP STRAIGHT POLARITY

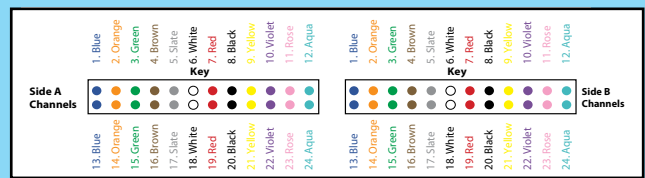
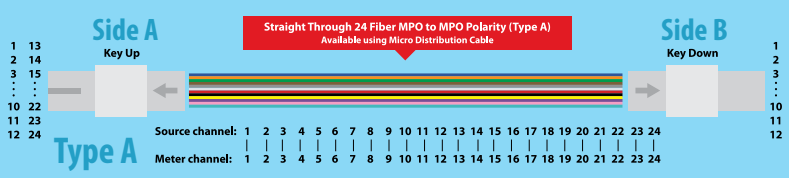

24 FIBER MPO/MTP TYPE - B REVERSED POLARITY

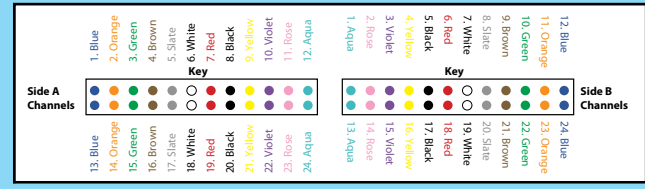
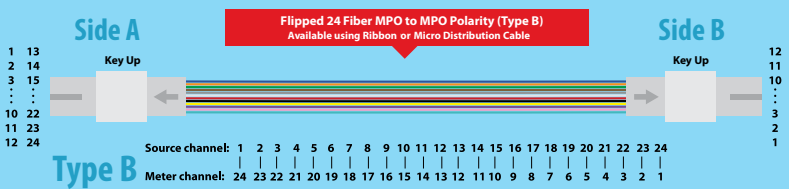

# CUSTOM MPO/MTP TRUNK CABLE ASSEMBLY DIAGRAMS

Use these diagrams to help build the cable you need to your exact specifications.

## Type A

**Straight Through 12 Fiber MPO to MPO Polarity (Type A)**  
Available using Ribbon or Micro Distribution Cable

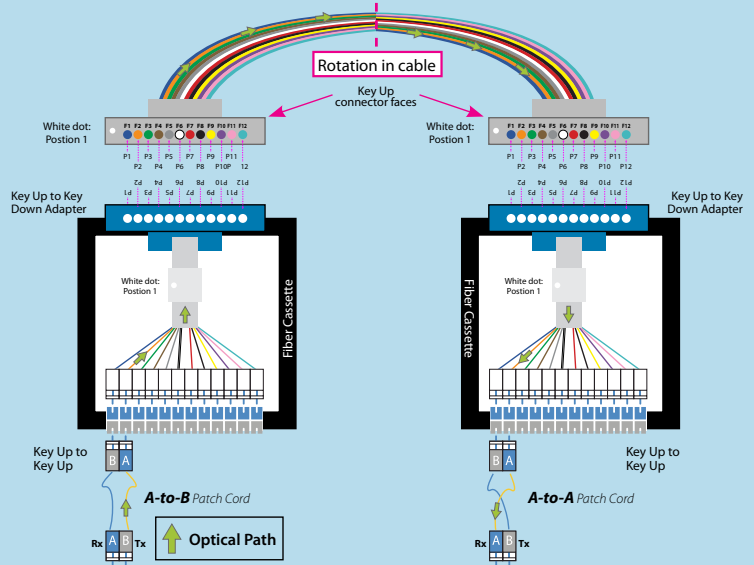

12 FIBER TYPE A MPO/MTP POLARITY

## Type B

**Reversed 12 Fiber MPO to MPO Polarity (Type B)**  
Available using Ribbon or Micro Distribution Cable

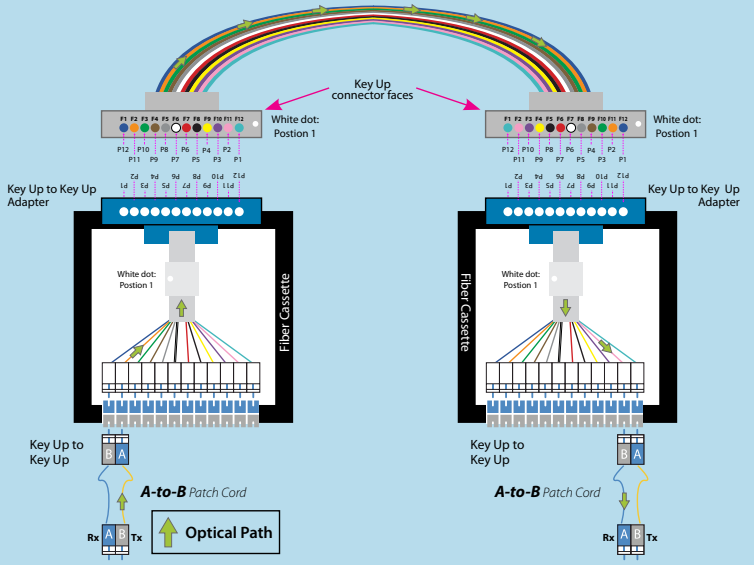

12 FIBER TYPE B MPO/MTP POLARITY

## Type C

**Flipped Pairs 12 Fiber MPO to MPO Polarity (Type C)**  
Available using Micro Distribution Cable

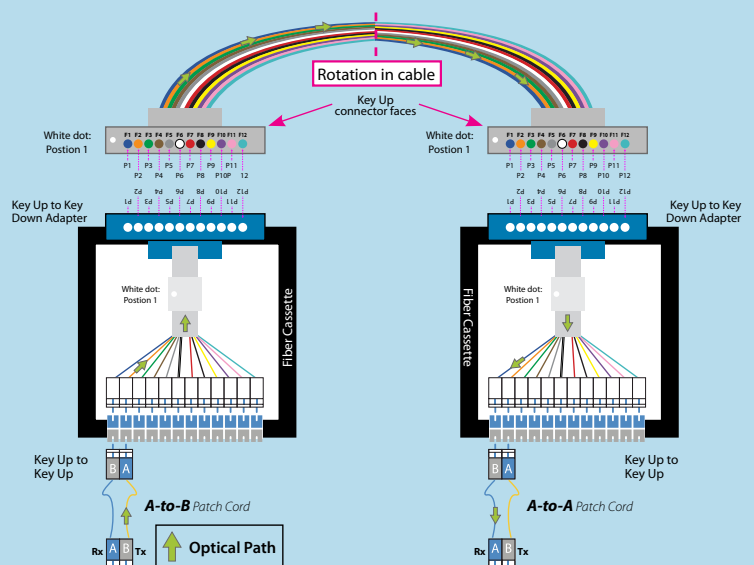
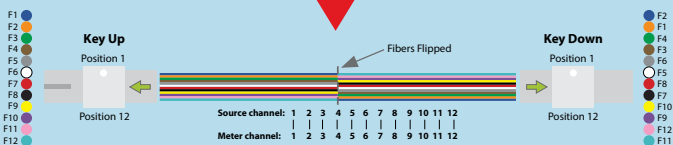

12 FIBER TYPE C MPO/MTP POLARITY



# WHY IS FIS A LEADING SUPPLIER OF CUSTOM FIBER OPTIC ASSEMBLIES...

## 1. FLEXIBILITY

- Wide Selection of components from leading manufacturers
- Ability to build to Engineering specifications or drawings
- From a quantity of 1 or 1,000's FIS can deliver

## 2. FAST DELIVERY / HIGH QUALITY

- Cables are ready to ship nationwide and internationally in as little as 2-4 days
- 100% inspection and tested to industry standards
- ISO 9001-2015 Certified
- Over 30 years of cable assembly experience

## 3. ADDITIONAL SERVICES

- Termination of Customer Supplied Materials
- Creation of engineer drawings of assemblies
- Custom packaging, labeling
- Experienced engineering team to help design an assembly for any application

## SPECIFICATIONS

### LENGTH

#### SIMPLEX/DUPLEX

TOTAL LENGTH = -0/+3" (> 5 MTRS), -0/+10% (< 5 MTRS)  
 BREAKOUT = N/A  
 MAXIMUM CONNECTOR TO CONNECTOR = 1.5"

### TESTING

#### INSERTION LOSS

MULTIMODE = <math>\leq 0.4\text{ dB}</math> (TYPICAL)  
 SINGLEMODE = <math>\leq 0.3\text{ dB}</math> (TYPICAL)

## STANDARD CONFIGURATIONS

Standard configurations (typical lead-time 2-4 days) – Convert your next project to “plug n’ go” by having your cable assemblies pre-terminated by FIS. Our expert technicians prepare assemblies from a 1-fiber patch cable to 144-fiber assemblies, while offering a wide array of components for you to create the perfect assembly for your application.

## CUSTOM CONFIGURATIONS

Custom configurations (typical lead-time 3-5 days) – FIS has the ability to manufacture a variety of custom configurations. Our custom abilities include but are not limited to labeling, packaging, testing requirements, and building to customer supplied specifications and drawings.

#### MULTIFIBER

TOTAL LENGTH = -0/+3" (> 5 MTRS), -0/+10% (< 5 MTRS)  
 BREAKOUT = 1 MTR (-0/+3")  
 MAXIMUM CONNECTOR TO CONNECTOR = 1.5"

#### RETURN LOSS

PC = <math>\leq -25\text{ dB}</math>  
 UPC = <math>\leq -55\text{ dB}</math>  
 APC = <math>\leq -60\text{ dB}</math>

## CUSTOM FIBER OPTIC CABLE ASSEMBLY CONFIGURATOR:

CABLE TYPE	FIBER TYPE	CONNECTOR SIDE A	CONNECTOR SIDE B	MODE
S	3	7A	8U	S
S=Simplex 3.0mm D=Duplex 3.0mm B=Breakout C=Distribution G=GGP Fiber Cable L=Loose Tube I=Indoor/Outdoor R=Ribbon X=Duplex 1.6mm E=250µm Bare Fiber Y=Simplex 1.6mm T=Simplex 2.0mm V=Duplex 2.0mm LA=Loosetube Armored A=Armored Cable PM=Polarization Maintaining RF=Ribbon Fan-Out ENC=Epoxy Node Cable N=900µm Buffered Fiber DB=Dry Block Cable Specialty MD=Micro-Distribution IG= Indoor/Outdoor Rated (250µm) BA=Breakout Cable w/Interlocking Armor TB= Tactical/Broadcast Cable DA= Outdoor Gel Free Armored Cable LZ=LSZH Cable RA=Ribbon Interlocking Armored Cable AER= Aerial RD= Round Duplex F= 1.8mm Simplex H= 1.8mm Duplex FD= Flat Drop Cable Z=1.2mm Simplex	1=50/125µm - OM2 2=62.5/125µm - OM1 3=8-9/125µm - OS2 4=Other 5=100/140µm 6=200/230µm 7=960/1000µm (plastic) 8=BI 50µm 10Gig - OM3 9=BI Singlemode (Ultra) 10=BI 50µm 10Gig - OM4 12=50µm10Gig - OM5	1=SMA905 2=SMA906 4=FC/Stainless Alloy 5=ST/Stainless Alloy 6=D4 7=FC/PC 7U=FC/UPC 7A=FC/APC 8=ST/PC 8A=ST/APC 8U=ST/UPC Y=SC/PC YU=SC/UPC YA=SC/APC D=SC Duplex w/ Clips L=LC/PC LU=LC/UPC LA=LC/APC C=LC Duplex w/ Clips	F=Ferrule Only M=MU/PC MU=MU/UPC 9A=PM-FC/APC 9U=PM-FC/UPC P=Pigtail AA=High Performance FC/APC BA=High Performance SC/APC EU=E2000/UPC EA=E2000/APC MJ=MTRJ (no pins) MP=MTRJ (w/pins) MT12=MTP 12 Fiber Male MF12=MTP 12 Fiber Female MT24 = MTP 24 Fiber Male MF24 = MTP 24 Fiber Female SLA = Short Boot LC/APC SYA = Short Boot SC/APC SLU = Short Boot LC/UPC SYU = Short Boot SC/UPC	S= Singlemode M= Multimode H= Hybrid P= PM Fiber

Note: Choose connector styles from either Connector Side A or Connector Side B column for Side A or Side B categories.

## DID YOU KNOW... THE DIFFERENCE BETWEEN RISER (ONFR) AND PLENUM (ONFP)

- **PLENUM (ONFP)** – refers to a specific fire code rating of cables that are resistant to fire and do not emit toxic fumes or smoke when burned. Plenum-rated cables are primarily used in pathways for either heated, cooled or return airflows.
- **RISER (ONFR)** – is constructed of PVC and may emit toxic fumes when burned and is to be run in non-plenum areas. Plenum cable can always replace riser cable, but riser cable cannot replace plenum cable in plenum spaces.



# CONFIGURATION ILLUSTRATION



**CLIPPED DUPLEX PATCH CABLE**  
Standard Polarity A to B / B to A



**SIMPLEX PATCH CABLE**

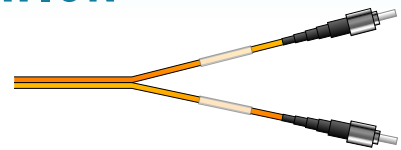

**UNCLIPPED DUPLEX PATCH CABLE**



**NODE CABLE ASSEMBLY**

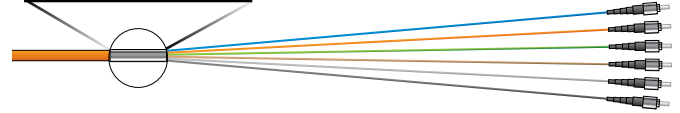
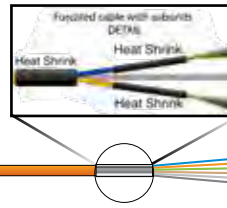

**DISTRIBUTION - INDOOR/OUTDOOR ASSEMBLY**  
2-144 Fiber (ex. 6 Fiber Assembly)

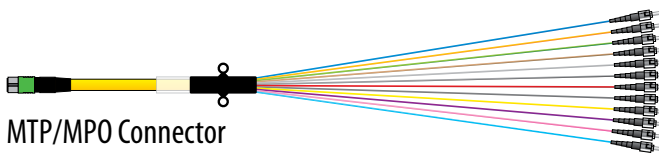

**RIBBON FANOUT ASSEMBLY**

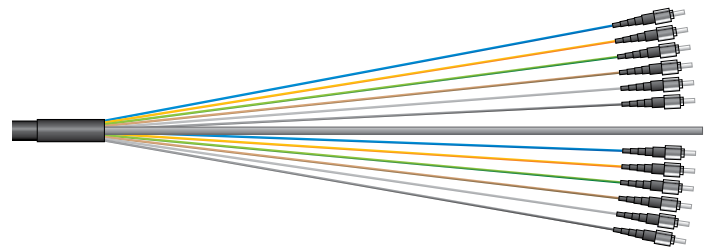

**LOOSE TUBE CABLE ASSEMBLY**

## USE THIS CHART TO BUILD CABLE YOU NEED TO YOUR EXACT SPECIFICATIONS.

LENGTH (IN METERS)	CABLE RATING	FIBER COUNT (Multi Fiber Only)	BREAKOUT BUILD-UP (Multi Fiber Only)	PULLING EYE INSTALLED
X	RI	04	Z3	PE
	NP= No Preference RI= OFNR (Riser) PL= OFNP (Plenum) LZ= LSZH (Low Smoke) UV= Polyethylene/Outdoor	04=4 Fiber 06=6 Fiber 12=12 Fiber 24=24 Fiber 48=48 Fiber 72=72 Fiber 96=96 Fiber 144=144 Fiber *Specify Fiber Count not listed	Z9=900µm Z1=1.8mm Z2=2mm Z3=3mm	PE= Outside End Only PBE= Both Ends



**Part # Example:**  
**S-3-7A-8U-S-3-RI-PE**

Translates to: Simplex 9/125 FC/APC - ST/UPC singlemode, 3 meter, riser patch cable with pulling eye

## CABLE CONSTRUCTION TYPES

**SIMPLEX** - A single fiber cable that may consist of a 900µm coated fiber or a combination of a 900µm coated fiber surrounded by an aramid yarn strength member with an outer jacket diameter varying from 3, 2, 1.8 and 1.6mm.

**DUPLEX** - A two-fiber cable that consists of a combination of two 900µm coated fibers surrounded by an aramid yarn strength member with an outer jacket diameter varying from 3, 2, 1.8 and 1.6mm. Also can choose 900µm duplex cable where the two 900µm buffers are joined together. (Limited offering from manufacturers.)

**BREAKOUT** - Packages multiple 2.5-3.0mm jacketed fibers and surrounds these sub-units with an aramid yarn strength member and outer jacket. Fiber counts typically are 2-24 fibers. Primarily used in application where a rugged or robust cable is required.

**DISTRIBUTION** - Packages multiple 900µm tight buffered fibers, surrounded by aramid yarn strength member, in a larger outer jacket. Fiber counts typically range from 2 - 144 fibers. Primarily used indoors and popular with interlocking armor for extra protection. Often referred to as MIC cable construction by other manufacturers.

**MICRO-DISTRIBUTION** - Packages multiple 250µm buffered bare fibers of different colors within sub-units to minimize the outer jacket size. Fan-out kits or furcation tube often required to terminate connectors. Popular for indoor use with MTP/MPO connector and Fan-out assemblies in Data Center applications.

**BARE FIBER** - A single glass fiber typically consisting of a core, cladding and 250µm acrylate coating.

**TIGHT BUFFER** - A single bare fiber with an outer coating that is typically 900µm in diameter.

**LOOSE TUBE** - Packages 250µm buffered fibers amongst each other in gel filled sub units typically 2.0-2.5mm. The gel filled tubes provide superior protection against changing temperatures and water filled conduits. Outer jacket is UV and moisture resistant.

**LOOSE TUBE ARMORED** - Packages 250µm buffered fibers amongst each other in gel filled sub units typically 2.0-2.5mm. The gel filled tubes provide superior protection against changing temperatures and water filled conduits. The outer jacket is extruded over corrugated coated steel tape offering rodent proof protection, the jacket is UV and moisture resistant.

**OUTDOOR DRY (GEL FREE) CABLE** - Packages 250µm buffered fibers within super absorbent polymer or water blocking aramid yarn. Dry loose tube design improves ease of termination without gel filled tubes. Recommended for installation in ducts, underground conduit or aerial/lashing applications not intended for direct burial. Armored version of cable utilizes corrugated coated steel tape for rodent protection, with extruded UV resistant jacket.

**DISTRIBUTION INTERLOCKING ARMORED** - Available with Riser or Plenum rated outer jacket this cable houses 900µm buffered fibers surrounded by aramid yarn with interlocking aluminum armor then extruded outer flame resistant jacket. Intended for harsh indoor environments requiring heavy duty protection.

**TACTICAL CABLE** - Packages typically multiple 2.0-2.5mm jacketed subunits surrounded by aramid yarn with epoxy/fiberglass strength member. Rugged design for heavy duty applications such as TV cameras, mining/harsh environments and military/commercial field re-deployable communications. Tactical Distribution packages 900µm fiber rather than larger subunits.

**NEW  
Lower  
Price**



S-4-9U-9U-S-1-FIS



E2000/APC

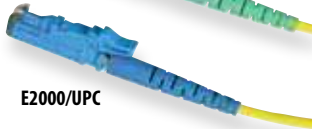

E2000/UPC



F1-MCP-1-2-SC-SC



NC-3-BA-P-S-15-FIS-6



F1-2071



F1-3071

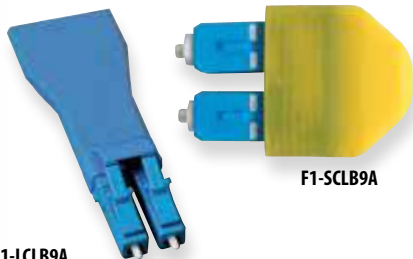

F1-SCLB9A

F1-LCLB9A

## POLARIZATION MAINTAINING PATCH CABLE

For polarization-sensitive applications, FIS offers PM patch cables with UPC or APC connector finishes. Available in 900µm and 3mm jacketed versions. Important specifications need to be discussed with FIS Sales Associate upon ordering, such as: Alignment (slow or fast axis) Fiber Specifications, Cable Jacket (900µm buffer or 3.0mm), whether or not the purchased PM assemblies will be used for splicing. Contact FIS for additional specifications and pricing on PM jumpers of various lengths. **Specify Fibercore Limited PM fiber or Corning PM Fiber.**

PART #	DESCRIPTION	PRICE
S-4-9A-9A-S-1-FIS	Simplex FC/APC - FC/APC, Slow Axis, 3.0mm Jacketed, Blue, 1 Meter	\$95.00
S-4-9U-9U-S-1-FIS	Simplex FC/UPC - FC/UPC, Slow Axis, 3.0mm Jacketed, Blue, 1 Meter	95.00
S-4-9U-9A-S-1-FIS	Simplex FC/UPC - FC/APC, Slow Axis, 3.0mm Jacketed, Blue, 1 Meter	95.00

## E2000 PATCH CABLE AND MATING SLEEVES

FIS offers Singlemode E2000 2.8mm cable assemblies. The E2000 comes with an integrated shutter system to protect the user from high-power laser emissions, and protects the connector from contamination.

**Call for other configurations and lengths.**

PART #	MFG	DESCRIPTION	PRICE
S-3-EU-EU-S-1-FISC	FIS	Simplex 9/125 E2000/UPC to E2000/UPC 1 Meter	\$26.95
S-3-EU-EU-S-3-FISC	FIS	Simplex 9/125 E2000/UPC to E2000/UPC 3 Meter	27.65
S-3-EU-EU-S-5-FISC	FIS	Simplex 9/125 E2000/UPC to E2000/UPC 5 Meter	28.35
S-3-EA-EA-S-1-FISC	FIS	Simplex 9/125 E2000/APC to E2000/APC 1 Meter	27.95
S-3-EA-EA-S-3-FISC	FIS	Simplex 9/125 E2000/APC to E2000/APC 3 Meter	28.65
F1-E2000	FIS	E2000 to E2000 Singlemode Adapter Ceramic Sleeve	12.00
F1-E2000APC	FIS	E2000/APC to E2000/APC Singlemode Adapter Ceramic Sleeve	15.00

## MODE CONDITIONING PATCH CABLE

Mode Conditioning Patch Cable is used in conjunction with laser transmitters or VCSEL's for 1 Gb transmissions over FDDI fiber in fiber optic links to improve the transition bandwidth by the reduction of modal dispersion. These cords can be assembled in various configurations to meet your specific needs. Contact your FIS sales representative for pricing and delivery. Improve the performance of your network today.

### LC-SC MCP MULTIMODE 62.5/125µm

PART #	LENGTH	PRICE
F1-MCP-1-2-LC-SC	1 Meter	\$68.00
F1-MCP-3-2-LC-SC	3 Meters	70.00
F1-MCP-5-2-LC-SC	5 Meters	73.00
F1-MCP-10-2-LC-SC	10 Meters	78.00

### LC-ST MCP MULTIMODE 62.5/125µm

PART #	LENGTH	PRICE
F1-MCP-1-2-LC-ST	1 Meter	\$68.00
F1-MCP-3-2-LC-ST	3 Meters	70.00
F1-MCP-5-2-LC-ST	5 Meters	73.00
F1-MCP-10-2-LC-ST	10 Meters	78.00

## FIS COMPACT NODE CABLES (SERVICE CABLES)

Fiber Instrument Sales' Compact Node is an epoxy based optical node cable assembly. Designed for HFC applications and with the flexibility to fit aerial, pedestal and vault applications. Available in various custom configurations up to 12 fibers.

PART #	DESCRIPTION	PRICE
NC-3-BA-P-S-15-FIS-2	Node Cable 2 Fiber Loosetube Cable SM SC/APC - Pigtail, 15 Meters	\$105.00
NC-3-BA-P-S-15-FIS-4	Node Cable 4 Fiber Loosetube Cable SM SC/APC - Pigtail, 15 Meters	136.00
NC-3-BA-P-S-15-FIS-6	Node Cable 6 Fiber Loosetube Cable SM SC/APC - Pigtail, 15 Meters	170.00
NC-3-BU-P-S-15-FIS-2	Node Cable 2 Fiber Loosetube Cable SM SC/UPC - Pigtail, 15 Meters	99.00
NC-3-BU-P-S-15-FIS-4	Node Cable 4 Fiber Loosetube Cable SM SC/UPC - Pigtail, 15 Meters	130.00
NC-3-BU-P-S-15-FIS-6	Node Cable 6 Fiber Loosetube Cable SM SC/UPC - Pigtail, 15 Meters	164.00

## FIS FIBER OPTIC TERMINATOR CONNECTORS

Low Reflection Terminators are designed for use in unused ports and to reduce back reflection into fiber optic systems. Each connector is environmentally sealed for protection. Back Reflection APC = -65dB UPC = -55dB

PART #	DESCRIPTION	PRICE
F1-0071	FIS ST/UPC Terminator Connector	\$6.95
F1-2071	FIS FC/UPC Terminator Connector	6.95
F1-3071	FIS SC/UPC Terminator Connector	6.95
F1-2072	FIS FC/APC Terminator Connector	7.95
F1-3072	FIS SC/APC Terminator Connector	7.95
F1-4071	FIS LC/UPC Terminator Connector	6.95
F1-4072	FIS LC/APC Terminator Connector	7.95

## FIS LOOPBACK MODULES

Loopbacks are designed for testing, engineering and the burn-in stage of boards or other equipment. They provide system test engineers a simple but effective way of testing the transmission capability and receiver sensitivity of network equipment.

PART #	DESCRIPTION	PRICE
F1-SCLB9A	SC Loopback SM 9/125µm Fiber	\$13.95
F1-SCLB62A	SC Loopback MM 62.5/125µm Fiber	13.95
F1-LCLB9A	LC Loopback SM 9/125µm Fiber	13.95
F1-LCLB62A	LC Loopback MM 62.5/125µm Fiber	13.95
F1-LCLB50A	LC Loopback MM 50/125µm Fiber	13.95



FIS couplers and Wave Division Multiplexers (WDM's) are designed, manufactured, and tested to meet a variety of high performance and environmental requirements. Our high quality couplers are available in single wavelength and dual window varieties in an assortment of split ratios. Our WDM's feature low insertion loss in combination with high isolation. All device types are available in bare fiber, 900µm, or 3mm ruggedized versions and can be terminated with your choice of connectors or installed in a variety of modules.



## SINGLEMODE DUAL WINDOW COUPLERS/SPLITTERS

PART #	DESCRIPTION	PRICE
<b>250µm</b>		
SDW13550122UC	1x2 (1310/1550nm) 50/50 Ratio	\$19.95
SDW13510122UC	1x2 (1310/1550nm) 10/90 Ratio	19.95
SDW13520122UCTS	1x2 (1310/1550nm) 20/80 Ratio	19.95
SDW13530122UCTS	1x2 (1310/1550nm) 30/70 Ratio	19.95
SDW13540122UCTS	1x2 (1310/1550nm) 40/60 Ratio	19.95
SDW13550222UC	2x2 (1310/1550nm) 50/50 Ratio	19.95
<b>900µm</b>		
SDW13550129UCTS	1x2 (1310/1550nm) 50/50 Ratio	\$21.95
SDW13510129UCTS	1x2 (1310/1550nm) 10/90 Ratio	21.95
SDW13520129UCTS	1x2 (1310/1550nm) 20/80 Ratio	21.95
SDW13530129UCTS	1x2 (1310/1550nm) 30/70 Ratio	21.95
SDW13540129UCTS	1x2 (1310/1550nm) 40/60 Ratio	21.95
SDW13550229UCTS	2x2 (1310/1550nm) 50/50 Ratio	21.95
SDW1351X3333333129CTS	1x3 (1310/1550nm) 33/33/33 Ratio	53.00

## MULTIMODE COUPLERS/SPLITTERS (800-1600nm)

PART #	DESCRIPTION	PRICE
<b>250µm</b>		
MMC28550122CTS	1x2 62.5/125µm Coupler 50/50 Ratio 250µm Fiber	\$29.95
MMC38550122CTS	1x2 50/125µm Coupler 50/50 Ratio 250µm Fiber	29.95
<b>900µm</b>		
MMC28550129CTS	1x2 62.5/125µm Coupler 50/50 Ratio 900µm Fiber	\$31.95
MMC28550229C	2x2 62.5/125µm Coupler 50/50 Ratio 900µm Fiber	31.95
MMC38550129CTS	1x2 50/125µm Coupler 50/50 Ratio 900µm Fiber	31.95

## WAVELENGTH DIVISION MULTIPLEXERS

A Wave Division Multiplexer (WDM) is a coupler that enables you to channel a signal to multiple devices operating at different wavelengths.

PART #	DESCRIPTION	PRICE
<b>250µm</b>		
WDM13550122UCTS	1x2 5m Dual Window (1310/1550nm) WDM 250µm Fiber	\$19.95
<b>900µm</b>		
WDM13500129UC	1x2 5m Dual Window (1310/1550nm) WDM 900µm Fiber	\$21.95
WDM13500229UC	2x2 5m Dual Window (1310/1550nm) WDM 900µm Fiber	21.95

## PLANAR LIGHTWAVE CIRCUIT COUPLERS/SPLITTERS

Today's high-port-count applications for broadband system applications demand the best performance and the highest reliability under the most adverse of environments. Planar Lightwave Circuit Splitters deliver on all these requirements. FIS provides a variety of PLC's pre-terminated with SC/UPC, SC/APC or the connector of choice.

PART #	DESCRIPTION	PRICE
F1PLC04	1x4 PLC Unconnectorized	\$35.00
F1PLC08	1x8 PLC Unconnectorized	45.00
F1PLC16	1x16 PLC Unconnectorized	65.00
F1PLC32	1x32 PLC Unconnectorized	100.00
F1-PLC-04-SCU	1x4 PLC with Fan Out and SC/UPC Connectors	41.25
F1-PLC-08-SCU	1x8 PLC with Fan Out and SC/UPC Connectors	55.00
F1-PLC-16-SCU	1x16 PLC with Fan Out and SC/UPC Connectors	75.00
F1-PLC-32-SCU	1x32 PLC with Fan Out and SC/UPC Connectors	115.00
F1-PLC-04-SCA	1x4 PLC with Fan Out and SC/APC Connectors	48.00
F1-PLC-08-SCA	1x8 PLC with Fan Out and SC/APC Connectors	65.00
F1-PLC-16-SCA	1x16 PLC with Fan Out and SC/APC Connectors	90.00
F1-PLC-32-SCA	1x32 PLC with Fan Out and SC/APC Connectors	140.00

## RUGGEDIZED 2mm/3mm JACKETED COUPLERS/SPLITTERS

Install these ruggedized splitters into outdoor or indoor enclosures. The 2mm or 3mm furcated fiber legs offer extra protection when technicians are working in compact areas. The splitter/couplers are housed in a small plastic case; furcated fiber legs are attached with or without connectors installed. **Custom size jacketing/split ratios/connector styles available.**

PART #	DESCRIPTION	PRICE
RSC-3-S-2-50-YA-YA-2	Ruggedized Splitter, SM, 1 x 2, 50/50 split, SC/APC-SC/APC, 2mm jacketing	\$86.00
RSC-3-S-2-45-YA-YA-2	Ruggedized Splitter, SM, 1 x 2, 55/45 split, SC/APC-SC/APC, 2mm jacketing	86.00
RSC-3-S-2-40-YA-YA-2	Ruggedized Splitter, SM, 1 x 2, 60/40 split, SC/APC-SC/APC, 2mm jacketing	86.00
RSC-3-S-2-30-YA-YA-2	Ruggedized Splitter, SM, 1 x 2, 70/30 split, SC/APC-SC/APC, 2mm jacketing	86.00
RSC-3-S-2-05-YA-YA-2	Ruggedized Splitter, SM, 1 x 2, 90/5 split, SC/APC-SC/APC, 2mm jacketing	86.00
RSC-1-S-2-50-Y-Y-3	Ruggedized Splitter, 50µm, 1 x 2, 50/50 split, SC/PC-SC/PC, 3mm jacketing	90.00
RSC-1-S-2-40-Y-Y-3	Ruggedized Splitter, 50µm, 1 x 2, 60/40 split, SC/PC-SC/PC, 3mm jacketing	90.00

## PACKAGED NETWORK COUPLER AND TREE COUPLER

Housed and connectorized with your specified connector are 1X2 or 1X4 Multimode or Singlemode splitters. Also available in same packaging is Singlemode 1310/1550nm Wave Division Multiplexer (WDM). Specify core/clad size, connector style, and split ratio. (Highest port count available is 1X4.) **Other Configurations Available - Call FIS Representative.**

PART #	DESCRIPTION	PRICE
PNC-3-S-2-50-YU-YU	Packaged Network Coupler Box, Singlemode, 50/50 split, 1x2 SC/UPC Adapters	\$150.00
PNC-3-S-2-10-YU-YU	Packaged Network Coupler Box, Singlemode, 90/10 split, 1x2, SC/UPC Adapters	150.00
PNC-3-S-4-EV-YU-YU	Packaged Network Coupler Box, Singlemode, Even split, 1x4, SC/UPC Adapters	239.00
SSCA1X435259C	SM Tree Coupler Module, 1x4, 1310/1550nm 900µm	65.00





**Please Call For Additional Pricing.**

FIS Blue provides specialized assemblies to the Military and Broadcast Industries. Count on us for custom broadcast or military grade tactical fiber optic cable assemblies with up to 24 fibers, in cables that are crush-resistant, resilient and with a thick layer of aramid strength members. The reinforced Kevlar jacket is strong enough to withstand the weight of a truck, making these assemblies ideal for temporary field production, sporting events, and military operations. Call us today for more information and detailed specifications. Our cable assemblies can be terminated with a variety of specialized connectors such as Expanded Beam, TFOCA II® or SMPTE Connectors. These specialized connectors can also be paired with standard connectors (SC, LC, FC, ST, etc.).



**LEMO®**  
**LEANARE**

**SMPTE 311M CABLE ASSEMBLIES**

These rugged stainless steel out shelled SMPTE connectors ensure a very long product life. Cable assemblies utilize two Singlemode fiber contacts, two power contacts and two signal contacts. Cable assemblies are available with multiple configurations including panel mount receptacles and plugs.

- Quick Push-Pull Self Latching System
- Stainless Steel for Harsh Environment
- Complies with SMPTE Signal Requirements
- Popular HDTV Connection on Cameras and Panels

PART #	DESCRIPTION	PRICE
BC-3-FUW-PUW-S-100-FISB-2	LEMO SMPTE Assembly PUW (receptacle) to FUW (plug) 100 feet	\$973.00

\*For other lengths add or subtract cable @ \$1.15 per foot

**QSEAL 2 & 4 CHANNEL CONNECTOR**

The Qseal 2 and 4 Channel Connector is intermateable with Neutrik's opticalCON\* DUO and QUAD connectors. With its metal LC Style insert, and IP67 rating, the Qseal is a more rugged alternative.

Key features include a field installable system, which allow for the customer and end user to build, maintain and troubleshoot their own assemblies. The shutter free design allows for easy inspect and cleaning.

- Intermateable with Neutrik opticalCON\* DUO and QUAD Connector
- No shutters: easy to inspect and clean
- Ruggedized all metal connector design
- Aluminum body with durable black anodize finish
- Resistant to vibration, shock, environmental effects and debris
- Low optical insertion loss
- Singlemode and Multimode operation
- Field installable
- Environmentally sealed to IP67, dust sealed and water immersion to 1meter
- Alternate materials and finishes available (for example stainless steel)

\*opticalCon DUO and QUAD is a registered trademark of Neutrik

PART #	DESCRIPTION	PRICE
T-3-QP-QP-S-1-FISB-2	Qseal 2-channel Plug to Plug Singlemode 1 Foot	\$650.94
T-3-QP-QP-S-1-FISB-4	Qseal 4-channel Plug to Plug Singlemode 1 Foot	750.48

\* add \$0.48 per foot for longer cables utilizing FIS Blue 2-Fiber Tactical cable / \* add \$0.52 per foot for longer cables utilizing FIS Blue 4-Fiber Tactical cable



**DELPHI 4 AND 12 CHANNEL HERMAPHRODITIC CABLE ASSEMBLIES**

Delphi's 4 and 12 Channel Hermaphroditic Connectors are both Single and Multimode compatible in the same connector. They are designed to withstand crush, impact, cable twist, bending movement, water and mud immersion, as well as many other harsh environments. They will link to identical connectors without regard to connector gender.

PART #	DESCRIPTION	PRICE
T-3-DP-DP-S-1-FISB-4	Delphi 4-channel Plug to Plug Singlemode 1 Foot	\$823.00
T-3-DP-DP-S-1-FISB-12	Delphi 12-channel Plug to Plug Singlemode 1 Foot	2,683.00

\* add \$0.52 per foot for longer cables utilizing FIS Blue 4-Fiber Tactical cable / \* add \$0.87 per foot for longer cables utilizing FIS Blue 12-Fiber Tactical cable



**QPC EXPANDED BEAM CABLE ASSEMBLIES**

Our Expanded Beam connectors are designed to the MIL83526/20 Mil-Spec. They are available in 2 and 4 channels, multimode or singlemode. There is also a Mini Expanded Beam version that is available in 2 and 4 channels, multimode or singlemode. All connectors utilize a hermaphroditic interconnection with advanced expanded beam technology. The expanded beam connectors are a very rugged design.

PART #	DESCRIPTION	PRICE
T-3-EP-EP-S-1-FISB-2	Expanded Beam Plug to Plug 2-channel Singlemode 1 Foot	\$1,015.00
T-3-EP-EP-S-1-FISB-4	Expanded Beam Plug to Plug 4-channel Singlemode 1 Foot	1,140.00

\* add \$0.48 per foot for longer cables utilizing FIS Blue 2-Fiber Tactical cable / \* add \$0.52 per foot for longer cables utilizing FIS Blue 4-Fiber Tactical cable

**FISCHER 4 CHANNEL RUGGED CABLE ASSEMBLIES**

Fischer Fiber Optic push-pull connector solutions are purpose built to withstand the elements of rugged and harsh environments, providing virtually faultless performance. Extreme Environmental Robustness: IP68 ingress protection when mated or with caps and IP67 sealing even unmated. Connectors and assemblies are available in 2 and 4 channels, Singlemode and Multimode.

PART #	DESCRIPTION	PRICE
T-3-FP-FP-S-100-FISB-4	Fischer 4-channel Plug to Plug Singlemode 100 Feet	Call For Pricing
T-3-FB-8U-S-2-FISB-4	Fischer 4-channel Jam-Nut Receptacle to ST Singlemode 2 Feet	Call For Pricing

**TFOCA-II Cable Assemblies**

Amphenol Fiber Systems International TFOCA II® connectors are designed to withstand repeated handling and mating cycles typically required for rapid fiber optic cable deployment and retrieval in a tactical environment. TFOCA II is the replacement for US Army and US Marine Corps legacy systems with TFOCA (AT&T).

PART #	DESCRIPTION	PRICE
T-3-T2P-T2P-S-100-FISB-4	TFOCA-II Plug to Plug Singlemode 4-channel 100 feet	\$1,090.00
T-3-T2P-T2P-S-100-FISB-12	TFOCA-II Plug to Plug Singlemode 12-channel 100 feet	2,808.00

\* add \$0.52 per foot for longer cables utilizing FIS Blue 4-Fiber Tactical cable / \* add \$0.87 per foot for longer cables utilizing FIS Blue 12-Fiber Tactical cable



**SHANE**  
**INDUSTRIES**

**FIS BLUE TACTICAL FIBER OPTIC CABLE**

FIS Blue Broadcast/Tactical Cable consists of a polyurethane outer jacket with your choice of 2, 4, 6, 12 or 24 900µm Hytrel tight buffered fibers surrounded by aramid yarn and an aramid ripcord. Polyurethane jacket makes the cable highly flexible and rugged, so it can also be used in direct burial applications. Tactical fiber optic cables are designed for harsh outdoor environments where maximum performance and reliability is essential.

PART #	FIBER COUNT	DESCRIPTION	PRICE
FB-SMTACCABLE2	2	2-fiber Singlemode Tactical Cable	\$1.57 /Mtr.
FB-SMTACCABLE4	4	4-fiber Singlemode Tactical Cable	1.71 /Mtr.
FB-SMTACCABLE6	6	6-fiber Singlemode Tactical Cable	1.80 /Mtr.
FB-SMTACCABLE12	12	12-fiber Singlemode Tactical Cable	2.85 /Mtr.
FB-OM4TACCABLE2	2	2-fiber 50µm OM4 Tactical Cable	\$2.20 /Mtr.
FB-OM4TACCABLE4	4	4-fiber 50µm OM4 Tactical Cable	3.12 /Mtr.
FB-OM4TACCABLE6	6	6-fiber 50µm OM4 Tactical Cable	4.30 /Mtr.
FB-OM4TACCABLE12	12	12-fiber 50µm OM4 Tactical Cable	7.45 /Mtr.



**MICRO ARMORED TAC CABLE**

Super strong steel armored micro cable.



- Flexible
- Special Compact Design
- High Tensile Strength
- High Resistant Outer Jacket

PART #	FIBER COUNT	DESCRIPTION	PRICE
SOLID2.2-1-FRHF	1	1-fiber Singlemode, 2.2mm OD	\$3.81/Mtr.
FLEX4.1-4-FRHF	4	4-fiber Singlemode, 4.1mm OD	2.30/Mtr.
FLEX5.6-12-FR	12	6-fiber Singlemode, 5.6mm OD	3.64/Mtr.
SOLID2.2-1-FRHF-OM3	1	1-fiber 50µm OM3, 2.2mm OD	\$3.84/Mtr.
FLEX4.1-4-FRHF-OM3	4	4-fiber 50µm OM3, 4.1mm OD	2.99/Mtr.
FLEX5.6-12-FR-OM3	12	6-fiber 50µm OM3, 5.6mm OD	6.17/Mtr.

\*Higher fiber counts available upon request

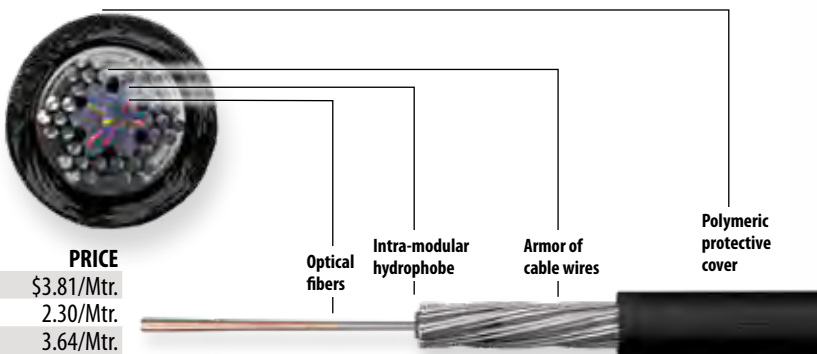

**SMPTE EXTRACTION TOOLS**

For inserting and removing contact sleeves for SMPTE connectors. Choose from LEMO or Canare branded tool.

PART #	DESCRIPTION	PRICE
DCSF2035PN	LEMO Extraction Tool	\$35.00
ASPT-1	Canare Extraction Tool	15.75



**HAVE SOMETHING THAT NEEDS FIXING? LET FIS BLUE DIAGNOSE AND REPAIR.**

Our repair service is perfect if you want to save time and money. Some tactical cable assemblies cost thousands of dollars, so it's smart to know your options. You can ship your SMPTE or tactical cable assembly to us and we can repair it for a fraction of what it might cost you to replace it.

Our service includes evaluation, repair, and testing to make sure your cable assembly is going to do the job right for you.





# TERMINI

FIS Blue offers a full line of fiber optic termini.

We carry all types of termini under the M29504 Mil-Spec designation. In addition, we stock ARINC 801 and SMPTE termini.

**Quantity Pricing Available**



## M29504/04 and /05 Termini, STYLE 1



### SOCKETS

Mil-Spec STYLE 1	Ferrule ID	Fiber Type	Price
M29504/05-4237	125.5µm	9/125µm	\$32.57
M29504/05-4238	126.0µm	9/125µm	62.00
M29504/05-4239	126.0µm	50 & 62.5/125µm	32.57
M29504/05-4046	127.0µm	50 & 62.5/125µm	32.57
M29504/05-4049	142.0µm	100/140µm	34.23
M29504/05-4243	236.0µm	200/233µm	130.42

### PINS

Mil-Spec STYLE 1	Ferrule ID	Fiber Type	Price
M29504/04-4208	125.5µm	9/125µm	\$18.17
M29504/04-4209	126.0µm	9/125µm	18.17
M29504/04-4210	126.0µm	50 & 62.5/125µm	18.17
M29504/04-4040	127.0µm	50 & 62.5/125µm	18.17
M29504/04-4043	142.0µm	100/140µm	19.83
M29504/04-4214	236.0µm	200/233µm	107.58

[ ARINC 801, SMPTE and other termini available upon request ]

## M29504/04 and /05 Termini, STYLE 2



### SOCKETS

Mil-Spec STYLE 2	Ferrule ID	Fiber Type	Price
M29504/05-4248	126.0µm	9/125µm	\$31.38
M29504/05-4249	126.0µm	50 & 62.5/125µm	31.38
M29504/05-4250	127.0µm	50 & 62.5/125µm	31.38

### PINS

Mil-Spec STYLE 2	Ferrule ID	Fiber Type	Price
M29504/04-4219	126.0µm	9/125µm	\$18.92
M29504/04-4220	126.0µm	50 & 62.5/125µm	18.92
M29504/04-4221	127.0µm	50 & 62.5/125µm	18.92



## M29504/14 and /15 Termini

### SOCKETS

PART #	Ferrule ID	Fiber Type	Price
M29504/15-4180	125.0µm	9/125µm	CALL
M29504/15-4181	126.0µm	9/125µm	\$25.00
M29504/15-4171	126.0µm	50 & 62.5/125µm	25.00
M29504/15-4172	127.0µm	50 & 62.5/125µm	CALL
M29504/15-4175	142.0µm	100/140µm	CALL

### PINS

PART #	Ferrule ID	Fiber Type	Price
M29504/14-4140	125.0µm	9/125µm	CALL
M29504/14-4141	126.0µm	9/125µm	\$25.00
M29504/14-4131	126.0µm	50 & 62.5/125µm	25.00
M29504/14-4132	127.0µm	50 & 62.5/125µm	CALL
M29504/14-4135	142.0µm	100/140µm	CALL

### DUMMY

M29504/03-4038	\$8.00
----------------	--------

**Connectors Are Also Available For Purchase. Please Call For Pricing.**

**Non-Hazardous Ships Air!**



FB-BASMPTE-KIT-CTY

### BASIC SMPTE, DELPHI AND MILITARY CLEANING KITS

FIS Blue's Basic SMPTE and Military Tool and Cleaning Kits include all the items needed to properly clean and maintain SMPTE, TFOCA and Delphi, Expanded Beam connectors, plus the standard ST/FC/SC/LC type connectors. In addition there are some basic tools for maintaining and working with the connectors.

PART #	DESCRIPTION	PRICE
FB-BASMPTE-KIT	Basic SMPTE Cleaning and Tool Kit	\$345.00
FB-BAMIL-KIT	Basic Military Cleaning and Tool Kit	290.00
FB-BASMPTE-KIT-CTY	Basic SMPTE (LEMO/Canare, SMPTE 304M) Kit with Continuity Tester	965.00
FB-BAMIL-KIT-TFCTY	Basic Military (TFOCA-II - M29504/16) Kit with Continuity Tester	995.00
FB-BAMIL-KIT-DLCTY	Basic Military (Delphi, M29504/14 /15) Kit with Continuity Tester	995.00
FB-BAMIL-KIT-EBSMCTY	Basic Military (Expanded Beam, SM) Kit with Continuity Tester	1,475.00
FB-BAMIL-KIT-EB50CTY	Basic Military (Expanded Beam, 50um) Kit with Continuity Tester	1,295.00
FB-BAMIL-KIT-EB62CTY	Basic Military (Expanded Beam, 62.5um) Kit with Continuity Tester	1,295.00

## NuGen SMPTE TEST SET

FIS Blue's Ruggedized SMPTE Test Set is designed for harsh work conditions where handheld units are not appropriate. The SMPTE Test Set utilizes a remote loopback unit for single ended testing of both optical fibers as well as power for the built-in copper conductor tests. The set checks all 4 copper conductors for continuity and shorts as well as verifying the integrity of the grounding shield in the cable with simple pass/fail audible and visual indicators. The main control unit houses the optical fiber power meter readout, copper conductor test indicators, and the SMPTE fixed plug connector. The Remote Unit contains the SMPTE fixed socket connector.



### FEATURES

- Single Test Checks Both Fibers for Loss and all 4 Copper Conductors for Continuity, Short Circuits and Ground Braid Integrity
- Simple Audible and Visual Pass/Fail Indicators for Copper Tests
- Designed for Harsh Environments in Ruggedized Housing
- Rechargeable NiMH Batteries
- Tests 1310nm Wavelength
- Integrated VFL
- New polarity and short testing for copper lines
- Most complete SMPTE Test Set in the industry
- Made In USA

PART #	DESCRIPTION	PRICE
FB-ST501NG	SMPTE Test Set	\$2,695.00

## BROADCAST AND TACTICAL CABLE REELS

Specially designed steel cable reels to transport or store your broadcast fiber optic cable assemblies. Stack them on your truck or in your warehouse or roll them wherever you like. Please ask about getting your next custom cable assembly on a reel.

PART #	DIMENSIONS	PRICE
YHP009C	480(L) x 450(W) x 535(H) mm (18.9 x 17.7 x 21.1in)	\$392.00
YHP009B	570(L) x 450(W) x 535(H) mm (22.4 x 17.7 x 21.1in)	457.00
YHP009A	720(L) x 450(W) x 535(H) mm (29.5 x 17.7 x 21.1in)	475.00
GT310RM	Schill GT-310 Cable Reel With RM Cable Flange Support	141.00
GT380RM	Schill GT-380 Cable Reel With RM Cable Flange Support	296.00
HT485RM	Schill HT-485 Cable Reel With RM Cable Flange Support	413.00
OXREEL-SM	Telecast Stackable Small OX Reel, 6" Hub	1,186.00
OXREEL-MD	Telecast Stackable Meidum OX Reel, 6" Hub	820.00



## FIS BLUE MODULAR BROADCAST SYSTEM

FIS Blue has created a revolutionary new system for broadcast fiber optic and copper patching. This convenient modular system utilizes a single frame or a throw-down box. This single frame allows users to load a variety of flat, angled, and loaded modules into the same rack. The complete offering of plates and modules cover most fiber optic and many copper applications. **Please Call For Pricing.**

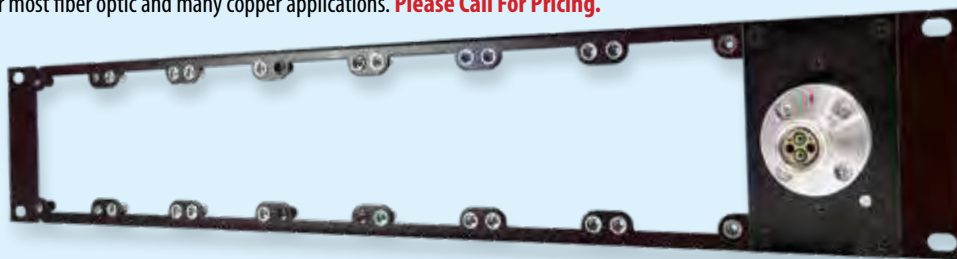

Flat Plates



Angled Plates

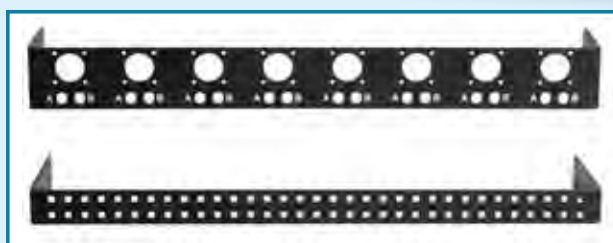

Rear Plates



Modular Throw-down Box



Loaded Modules



Loaded Modules

This modular throw-down box can be used anywhere; temporarily or permanently. Utilizes the same plates and modules as the single frame rack system.

It can hold up to three adapter plates or modules of your choice on each side.

# TEST EQUIPMENT

# THUNDERBOLT OTDR

Fiber Optic Test Equipment



Starting at  
**\$3,995**

## FEATURES:

- Singlemode, Multimode, or Quad (SM/MM) Versions Available
- 36dB Dynamic Range
- Trace Overlay
- Real time Test Mode
- 9 Pulse Widths
- Bluetooth and Wi-Fi Capability
- HDMI Output
- 4 Gigs of Storage
- 6.5" Color LCD Screen
- Available with SC, ST, or FC port

## 1 UNIT – 7 CRITICAL FIBER OPTIC TESTS

A certification solution for contractors, supporting FIS FTTx Zeus Solution

This easy to use fiber optic test unit will exceed your expectations. Fiber Instrument Sales takes pride to be able to provide you a test equipment value that is unsurpassed.

### FEATURES INCLUDE:

1. Fully operational OTDR with functionalities that enable complete trace analysis and automatically displays an event table that simplifies the operator's test results.
2. **Power Meter** input providing a reading showing dBm power with zero reset capability.
3. **Visual Fault Source** that is most commonly used to identify near light loss or patch cord locations at the panel.
4. **Reporting Software** capability to provide Pass/Fail certification reports.
5. **Endface Inspection Probe (Optional)** USB inspection probe.

6.



**Link Checker** with a quick and easy push of a button a technician reads a display of critical measurements including fiber link length and attenuation. Get results in 5 seconds. *This feature is only available on SM ints only.*

7.



**Gigabit Analyzer** identify the fiber type and plug in. The unit measures length, dB loss, back reflection and compares to the fiber manufacturer's standards to determine if bandwidth requirements pass. Does not generate or evaluate an actual signal.

PART #	DESCRIPTION	PRICE
TB1315	SM (1310/1550) OTDR with PM and VFL	\$3,995.00
TB8513	MM (850/1300) OTDR with PM and VFL	3,995.00
TBQUAD	SM/MM (850/1300/1310/1550) OTDR with PM and VFL	5,895.00
F1DI1000	FIS digital USB endface inspection probe kit (tips included)	875.00

### THUNDERBOLT OTDR KITS

Basic kits come with ThunderBolt unit, FIS Bulkhead Ferrule Cleaner and FIS Launch Reels. Deluxe Kits come with basic kit contents plus the FIS USB Inspection Probe (F1DI1000).

PART #	DESCRIPTION	PRICE
TB1315BASKITSCU	Basic Kit:SM OTDR, one-click cleaner, two 150m launch reels SC/UPC-SC/UPC	\$4,195.00
TB1315DLXKITSCA	Deluxe Kit:SM OTDR, one-click cleaner, two 150m launch reels SC/UPC-SC/APC, USB inspection probe	4,995.00
TBQUADDLXKITCUST	Deluxe Kit: SM/MM OTDR, one-click cleaner, two SM 150m launch reels SC/UPC-SC/UPC, two 100m OM3 launch reels SC/PC-ST/PC, USB inspection probe	6,995.00

\* Many more launch reel configurations available, please call your FIS sales representative for more options.



# FIRECAT OTDR

The FIS Firecat OTDR provides an industry leading value with its low cost and easy functionality. This unit is perfect for both inexperienced and experienced technicians alike with its simple on screen 'soft key menus'. By providing the essentials for fiber optic troubleshooting, this OTDR is the perfect tool for basic link troubleshooting and is affordable enough for every truck, office or tool kit.

**FEATURES:**

- Dynamic Range - 23dB
- Lowest Cost OTDR in the Industry
- Easy Operation with 'Soft Key Menus'
- Small, Lightweight and Rugged
- Interchangeable Adapters
- Event Table and Auto-Test Modes
- USB Data Transfer
- Backlight Keypad and Screen for Easy Use in Dim Lighting Conditions
- Available in a Ruggedized Version for harsh conditions



Ruggedized Version

**NOW AVAILABLE WITH APC OPTION**



FIRECAT-1310

Each Unit Includes: 110v AC adapter, Certification Software, Data Transfer Cable, SC Interchangeable Adapter, Soft Carry Case, and Instruction Manual.

When purchasing unit for 220v application, 220v adapter must be purchased separately.

PART #	DESCRIPTION	PRICE
FIRECAT-850	Single Wavelength – Multimode 850nm	\$1,795.00
FIRECAT-1300	Single Wavelength – Multimode 1300nm	1,795.00
FIRECAT-1310	Single Wavelength – Singlemode 1310nm	1,795.00
FIRECAT-1550	Single Wavelength – Singlemode 1550nm	1,795.00
FIRECAT-8513	Dual Wavelength - Multimode 850/1300	2,400.00
FIRECAT-1315	Dual Wavelength – Singlemode 1310/1550	2,400.00
FIRECAT-QUAD	Quad Wavelength – MM/SM 850/1300/1310/1550	4,000.00

**NOTE: ADD "R" TO THE END OF THE PART NUMBER FOR RUGGEDIZED VERSION**  
 Add Additional \$100.00 to price (Example: FIRECAT – 850 – R = Single wavelength – Multimode 850 – Ruggedized)

**ACCESSORIES**

PART #	DESCRIPTION	PRICE
FIRECAT-AC110	AC Adapter 110v	\$35.00
FIRECAT-AC220	AC Adapter 220v	35.00
F1-OVXHRDCASE	Hard Carry Case	125.00
FIRECAT-USB	USB Flash Drive with Software	19.95
FIRECAT-CABLE	Data Transfer Cable	6.95
F1-FIRECAT-ST	ST Adapter	10.00
F1-FIRECAT-FC	FC Adapter	10.00
F1-FIRECAT-SC	SC Adapter	10.00



**THE MAXTESTER OTDR SERIES**

The MAX-700B/C Series is the first tablet-inspired OTDR line that is handy, lightweight and rugged enough for any outside plant environment. With a 7-inch, outdoor-enhanced touchscreen—the most efficient handheld display in the industry—it delivers an unprecedented user experience. Its intuitive Windows-like GUI ensures a fast learning curve. Plus, its new and improved OTDR 2 environment offers icon-based functions, instant boot-up, automatic macrobend finders as well as improved auto and real-time modes.

**FEATURES**

- Handy, lightweight, powerful, tablet-inspired design
- 7-inch, outdoor-enhanced touchscreen - Biggest in the handheld industry
- 12-hour autonomy
- Dead zones: EDZ 0.5 m, ADZ 2.5 m
- Dynamic range: 39/38/39 dB
- Rugged design built for outside plant
- iOLM-ready: intelligent and dynamic application that turns complex OTDR trace analysis into a one-touch task



**MAX-715B OTDR**

Optimized for the P2P testing and troubleshooting of FTx architectures, and ideal for testing short fibers (e.g., inside a CO, FTx drop cable or FTTA/DAS installations) (30 dB).

PART #	DESCRIPTION	PRICE
TK-MAX-715B-M1-XX	MAX-715B, Last Mile SM OTDR 1310/1550nm, 30/28 dB (9/125µm)	\$5,265.00
TK-MAX-715B-M2-XX	MAX-715B, Last Mile SM OTDR Port 1: 1310/1550nm, 30/28 dB (9/125µm) Port 2: Filtered 1625nm, 28 dB (9/125µm)	7,595.00
TK-MAX-715B-M3-XX	MAX-715B, Last Mile SM OTDR 1310/1550/ 1625nm, 30/28/28 dB (9/125µm)	7,285.00
PM2X-XX	Power Meter ONLY (GeX detector) With FOA-XX: Connector Adapter	745.00
VPM2X-XX	VFL + Power Meter - Visual Fault Locator (650nm) With 2.5mm Universal Adapter - Power Meter (GeX detector) With FOA-XX: Connector Adapter	990.00
RF	Built-in Wi-Fi and Bluetooth Capability	250.00

**MAX-720C OTDR**

Efficient testing of closely spaced events, such as patchords and patch panels in COs, and optimized for the P2P testing of any access network (36 dB).

PART #	DESCRIPTION	PRICE
MAX-720C-SM1-XX	MAX-720C, Access SM OTDR 1310/1550 nm, 36/35 dB (9/125 µm)	\$5,995.00
MAX-720C-SM2-XX	MAX-720C, SM OTDR Module Port 1: 1310/1550 nm, 36/35 dB (9/125 µm) Port 2: Filtered 1625 nm, 35 dB (9/125 µm) for live fiber testing	8,440.00
PM2X-XX	Power Meter ONLY (GeX detector) With FOA-XX: Connector Adapter	745.00
VPM2X-XX	VFL + Power Meter - Visual Fault Locator (650nm) With 2.5mm Universal Adapter - Power Meter (GeX detector) With FOA-XX: Connector Adapter	990.00
RF	Built-in Wi-Fi and Bluetooth Capability	250.00

**MAX-730C OTDR**

Fully featured, entry-level, dedicated OTDR with tablet-inspired design, suitable for P2P access network and metro link testing. Optimized to test through optical splitters, for seamless end-to-end FTTH characterization and troubleshooting. Filtered 1625nm port for live fiber testing available.

PART #	DESCRIPTION	PRICE
MAX-730C-SM1-XX	MAX-730C, FTTx/PON SM OTDR 1310/1550 nm, 39/38 dB (9/125 µm)	\$8,005.00
MAX-730C-SM2-XX	MAX-730C, FTTx/PON SM OTDR Port 1 : 1310/1550 nm, 39/38 dB (9/125 µm) Port 2 : Filtered 1625 nm, 39 dB (9/125 µm)	10,445.00
MAX-730C-SM3-XX	MAX-730C, FTTx/PON SM OTDR 1310/1550/1625 nm, 39/38/39 dB (9/125 µm)	10,125.00
PM2X-XX	Power Meter ONLY (GeX detector) With FOA-XX: Connector Adapter	745.00
VPM2X-XX	VFL + Power Meter - Visual Fault Locator (650nm) With 2.5mm Universal Adapter - Power Meter (GeX detector) With FOA-XX: Connector Adapter	990.00
RF	Built-in Wi-Fi and Bluetooth Capability	250.00

Models	MAX-715B	MAX-720C	MAX-730C
<b>Configurations</b>	1310/1550 nm 1310/1550 nm and 1625 live*	1310/1550 nm	1310/1550 nm 1310/1550 nm and 1625 live*
<b>Dynamic range at 1310/1550/1625</b>	30/28/28 dB	36/35/35 dB	39/38/38 dB
<b>ADZ/EDZ</b>	1m / 4 m	SM 0.7m/3m	0.5m/2.5m
<b>PON</b>	N/A	N/A	Up to 1 x 128

\* SEE PAGE 65 FOR VIDEO INSPECTION PRICES

**EXFO OPTICAL WAVE EXPERT**

An industry-first device that combines channel power validation with tunable DWDM OTDR capabilities on a single port. The rugged and compact MaxTester platform provides the most efficient and practical form factor for field use.

**FEATURES**

- Integrated DWDM channel checker and OTDR on a single port (patent-pending)
- Intelligent channel power level measurements
- Compact and portable form factor
- iOLM-ready: one-touch multiple acquisitions, with clear MUX/DEMUX characterization
- C-BAND ITU-T G.692 DWDM grid channels (12-62)
- Bar graph and table view on wide touchscreen display
- In-channel and testing of active networks
- Intuitive graphical user interface (GUI) and workflow

PART #	DESCRIPTION	PRICE
MAX-740C-DWOC-iO-iADV-EA-EUI-91-VPM2x-FOA-54B-RF	iOLM advanced, OTDR, VFL, Power Meter, Wifi, Bluetooth	\$23,880.00
MAX-740C-DWOC-OTDR-EA-EUI-91-VPM2x-FOA-54B-RF	OTDR, VFL, Power Meter, Wifi, Bluetooth	21,235.00
MAX-740C-DWOC-iOLM-00-EA-EUI-91-VPM2x-FOA-54B-RF	iOLM, OTDR, VFL, Power Meter, Wifi, Bluetooth	21,235.00
MAX-740C-DWOC-OTDR-EA-EUI-91-00-RF	OTDR, Wifi, Bluetooth	20,245.00

PLEASE CALL YOUR FIS SALES REPRESENTATIVE FOR OTHER AVAILABLE CONFIGURATIONS



EXFO OPTICAL WAVE EXPERT



### CONNECTORMAX MPO LINK TEST SOLUTION

The only solution that allows validation of MPO-12 and MPO-24 links with one automated step. This solution brings together the ConnectorMax Multifiber Source with the ConnectorMax Fiber Inspection Probe to validate the polarity type, continuity and connector cleanliness of MPO links. Results are loaded in the ConnectorMax Analysis Software, an app for mobile devices providing clear pass/fail status and reporting functions, making it easy for technicians to perform and view the results of all three of these tests on the spot.

#### KEY FEATURES AND BENEFITS

- Fully automated, quick test process
- Single solution to test MPO 12 and MPO 24 fiber cables
- Same unit supports both multimode and singlemode (need adapted jumpers)
- Cable stowing system supports APC, UPC, male (pinned) and female (unpinned) connectors
- Customizable pass/fail thresholds
- Automatic PDF reporting
- Combines the three essential tests needed to validate MPO links: polarity type, continuity and connector cleanliness.



ConnectorMax MPO Link Test Solution

**CALL FOR CUSTOMIZED PRICING**  
FOR MPO12 AND MPO24 CONFIGURATIONS

### Build Your Own ConnectorMax MPO Full Solution

Example: TK-MFS - XX - XX - FIP-435B - XX - MPO - XX

#### Source model

MFS-12 = Covering MPO 12

MFS-24 = Covering MPO 12 and MPO 24

#### Test Jumper

##### For EXFO model MFS-12

##### MPO 12 testing

TJ-B92M-12-92F-1.8m = Singlemode, output connector: APC female (unpinned)

TJ-B92M-12-92M-1.8m = Singlemode, output connector: APC male (pinned)

TJ-C92M-12-94F-1.8m = Multimode, output connector: UPC female (unpinned)

TJ-C92M-12-94M-1.8m = Multimode, output connector: UPC male (pinned)

##### For EXFO model MFS-24

##### MPO 24 testing

TJ-B92M-24-92F-1.8m = Singlemode, output connector: APC female (unpinned)

TJ-B92M-24-92M-1.8m = Singlemode, output connector: APC male (pinned)

TJ-C92M-24-94F-1.8m = Multimode, output connector: UPC female (unpinned)

TJ-C92M-24-94M-1.8m = Multimode, output connector: UPC male (pinned)

#### Y test jumpers

##### MPO 12 testing, one side female (unpinned) and one side male (pinned)

TJ-B92M-24-Y92F92M = Singlemode

TJ-C92M-24-Y94F94M = Multimode

#### CONNECTORMAX MPO

##### PART # DESCRIPTION

MFS-12 ConnectorMax Multifiber Source ( For MPO 12 Polarity and Contuinity testing)

MFS-24 ConnectorMax Multifiber Source ( For MPO 12 & 24 Polarity and Contuinity testing)

##### PRICE

\$4,120.00

6,180.00

#### Automated multifiber tips for the ConnectorMax Fiber Inspection Probe

UPC for MPO UPC connectors

FIPT-400-NZ-MPO (MPO UPC nozzle)

FIPT-400-MPO-BLK (MPO bulkhead adapter)

APC for MPO APC connectors

FIPT-400-NZ-MPO-APC (MPO APC nozzle)

FIPT-MPO-BLK (MPO bulkhead adapter)

K for MPO UPC and APC connectors

FIPT-400-NZ-MPO (MPO UPC nozzle)

FIPT-400-NZ-MPO-APC (MPO APC nozzle)

FIPT-MPO-BLK (MPO bulkhead adapter)

#### Single fiber tips for the ConnectorMax Fiber Inspection Probe

UPC = FIPT-400-FC-SC (FC-SC bulkhead tip)

FIPT-400-U25M (Universal patchcord tip, 2.5 mm ferrule)

APC = FIPT-400-SC-APC (SC APC tip for bulkhead adapter)

FIPT-400-U25MA (Universal patchcord tip, 2.5 mm ferrules)

### CONTACT FIS FOR CUSTOM CONFIGURATION PRICING AND/OR TO ARRANGE A DEMONSTRATION.

#### EXFO ACCESSORIES

PART #	DESCRIPTION	PRICE
iOLM	OTDR software and the intelligent Optical Link Mapper base software	\$2,115.00
FOA-32	ST Adapter for Power Meter	82.00
FOA-54	SC Adapter for Power Meter	82.00
FOA-22	FC Adapter for Power Meter	82.00
FOA-98	LC Adapter for Power Meter	170.00
FOA-U12	Universal 1.25mm Adapter for Power Meter	180.00
FOA-U25	Universal 2.5mm Adapter for Power Meter	180.00
EUI-89	FC Source Adapter	115.00
EUI-90	ST Source Adapter Compatible with UPC Connector Interface ONLY	115.00
EUI-91	SC Source Adapter	115.00
PMA-22	FC Connector adapter for EPM-50 power meter	25.00
PMA-32	ST Connector adapter for EPM-50 power meter	25.00
PMA-54	SC Connector adapter for EPM-50 power meter	25.00



EUI-91



FOA-54

\*Call for other adapter styles or APC configurations





FTB-1 v2 iOLM

# EXPERTISE REACHING OUT

## EXFO FTB-1v2 SINGLE- OR DUAL-CARRIER OTDR PLATFORM

The FTB-1 version 2 is a light-weight compact test platform allowing field technicians to carry out dedicated optical test applications simply and efficiently, thanks to its ultra-powerful processing and highly intuitive interface. Loaded with utilities, it provides all the tools required to maximize field testing. Now available for single- or dual-carrier configurations to slot FTBx test modules, the built-in intelligence of the FTB-1 V2 empowers frontline technicians to take field-testing efficiency to the next level.

### FEATURES

- 8-inch color multi-touch widescreen
- Two USB 2.0 ports and one USB 3.0 port
- Ethernet port (10/100/1000 Base-T)
- Headset/microphone port
- MicroSD card slot for extended storage space
- Optional built-in Wi-Fi and Bluetooth
- Optional plug-and-play power meter and VFL
- Remote access to your unit (via VNC or Remote Desktop)

## Build Your Own FTB-1 v2

TK-1-700 - XX - XX - XX - XX - XX - XX - XX - XX - XX

### Model

TK-1v2-700C Mainframe - (\$1,730 with module)  
(Specify Single or Dual Carrier Version (SC or DC))

### Display

S1 = TFT Active Screen (Standard)  
S2 = Outdoor Enhanced Screen (\$320)

### Memory

64G = 64 GB internal memory (flash)

### Wi-Fi/Bluetooth Option

RF = With RF Capability - Wi-Fi and Bluetooth (\$250)

### Power Meter

00 = Without power meter(PM)/VFL  
VPM2X = VFL platform; PM; GeX detector (\$990)  
VPM2X-CWDM = VFL platform; PM; GeX detector; CWDM wavelengths calibrated from 1270 nm to 1610 nm (\$1,425)

### Connector Adapter - Included

FOA-22 = FC/PC, FC/SPC, FC/UPC, FC/APC  
FOA-32 = ST: ST/PC, ST/SPC, SC/UPC, SC/APC  
FOA-54 = SC: SC/PC, SC/SPC, SC/UPC, SC/APC

### iOLM Software Option

00 = iOLM Standard  
iADV = iOLM Advanced  
iLOOP = iOLM loopback mode  
iCERT = iOLM tier-2 certification

### Digital Inspection Probe

FP410B-XX = Inspection Probe 200x/400x, Manual Focus, No Auto Analysis (\$1,440)  
FP420B-XX = Inspection Probe 200x/400x, Manual Focus, Auto Center, Auto Analysis (\$2,195)  
FP425B = Wireless Inspection Probe 200x/400x, Auto Center, Auto Analysis (\$3,155)  
FP430B-XX = Inspection Probe 200x/400x, Auto Focus, Auto Center, Auto Analysis (\$2,670)  
FP435B = Wireless Inspection Probe 200x/400x, Auto Focus, Auto Center, Auto Analysis (\$3,630)  
*XX- APC or UPC must be specified*

### OTDR Adapters XX - (Place EA Before the Adapter for APC Polish or EI for UPC Polish) - Included in Module Price

XX-EUI-89 = FC Adapter  
XX-EUI-90 = ST Adapter  
XX-EUI-91 = SC Adapter

### OTDR Module(s)

FTBx-720C-SM1-XX = SM 1310/1550nm, 36/35dB (\$5,615)  
FTBx-730C-SM1-XX = SM 1310/1550nm, 39/38dB (\$7,140)  
FTBx-720C-Q1-QUAD-XX = MM/SM 850/1300/1310/1550nm, 27/29/36/35dB (\$10,375)  
FTBx-720C-SM2-XX = Port 1: 1310/1550, 36/35dB  
Port 2: Filtered 1625nm, 34dB  
\* for live fiber testing (\$10,480)  
FTBx-730C-SM2-XX = Port 1: 1310/1550, 39/38dB  
Port 2: Filtered 1625nm, 34dB  
\* for live fiber testing with in-line power meter (\$12,185)

With the new dual-carrier configuration, you can add a 10Gb, 100Gb or OLTS module to your OTDR - Contact a FIS sales associate for more details.



**EXFO FTB-2 MODULAR OTR**

The FTB-2 is the most compact solution on the market for multirate, multi-technology, multiservice testing, delivering all the power of a high-end platform in a conveniently sized, go-anywhere field-testing tool.

**FEATURES**

- Connect anywhere: USB, mobile, Wi-Fi, VPN and Bluetooth
- Loaded with utilities: All the tools required to maximize field testing, and any third-party application
- Like a PC: Available with a dual- or quad-core processor and Windows-based operating system
- EXFO Connect-compatible: Automated asset management—data goes through the cloud and into a dynamic database



FTB-2 with iOLM



**EXFO FTB-2 (POPULAR CONFIGURATIONS)**

PART #	DESCRIPTION	PRICE
TK2XS1RFFTBX720CSM1EIEUI91	1310/1550nm, 36/34 dB, Wi-Fi/Bluetooth, Dual Module, SC/UPC	\$9,565.00
TK2XS1RFFTBX730CSM3EIEUI91	1310/1550/1625nm, 39/37/37 dB, Wi-Fi, Bluetooth, Tri-Wave SM, SC/UPC	15,470.00
TK2XS1RFFTBX720CQ1QUADEIEUI91	850/1300/1310/1550, 27/26/36/34 dB, Wi-Fi, Bluetooth, Quad Module, SC/UPC	14,325.00
TK2XS1RFVP2FOA54BFTBX720C-Q1QUADEIEUI91	850/1300/1310/1550nm, 27/26/36/34 dB MM/SM, PM, VFL, SC/UPC	15,315.00

**Software Option**

- FR2-PL = FastReporter 2 Software Fiber characterization package
- FR2-PL-LB = FastReporter 2 Software Fiber characterization package and iOLM Loopback mode

**Build Your Own FTB-2**

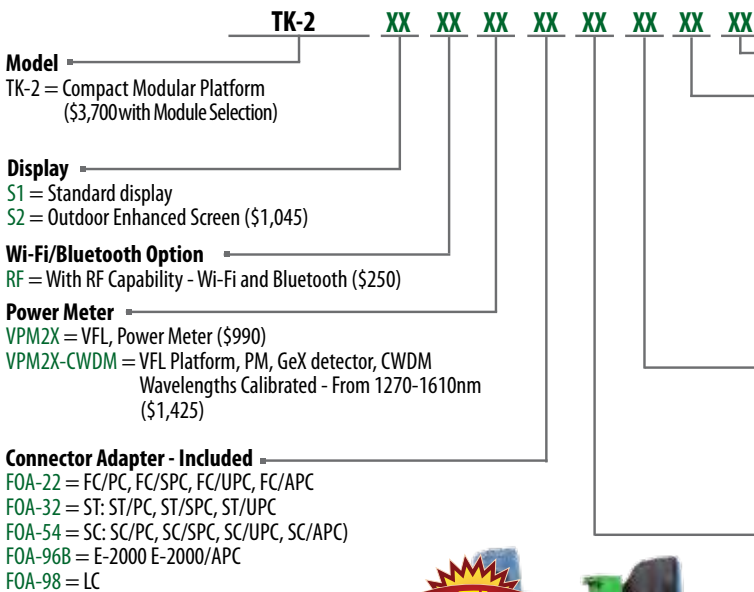

**Digital Inspection Probe**

- FP410B-XX = Inspection Probe 200x/400x, Manual Focus, No Auto Analysis (\$1,440)
- FP420B-XX = Inspection Probe 200x/400x, Manual Focus, Auto Center, Auto Analysis (\$2,195)
- FP425B-XX = Wireless Inspection Probe 200x/400x, Auto Center, Auto Analysis (\$3,155)
- FP430B-XX = Inspection Probe 200x/400x, Auto Focus, Auto Center, Auto Analysis (\$2,670)
- FP435B-XX = Wireless Inspection Probe 200x/400x, Auto Focus, Auto Center, Auto Analysis (\$3,630)

XX- APC or UPC must be specified

**OTDR Adapters**

- XX - (Place EA Before the Adapter for APC Polish or EU for UPC Polish) - Included in Module Price
- XX-EUI-89 = FC Adapter
- XX-EUI-90 = ST Adapter
- XX-EUI-91 = SC Adapter



**EXFO OPTICAL EXPLORER**

Verify optical links in seconds and automatically explore further when potential issues are suspected. Accelerate fiber rollouts, simplify activation procedures and improve robustness of repairs for better QoS and MTR.

**FEATURES**

- Displays fiber length, loss and optical return loss (ORL) in under 3 seconds, with single-ended process- Low cost of ownership
- On-the-spot detection and location of common causes of failures using EXFO's patent-pending Fault Explorer
- Built-in power checker and light source

PART #	DESCRIPTION	PRICE
OX1188	EXFO Optical Explorer USB-A to USB-C Cable w/Soft Carry Case, 1310/1550nm	\$2,690.00
OX1PRO188	EXFO Optical Explorer PRO w/USB-A to USB-C Cable & USB AC Adapter, 1310/1550nm	3,290.00
OX1PROM88	EXFO OX1 PRO model Optical Explorer SC/APC (1650 Live)	4,590.00

PLEASE CALL YOUR FIS SALES REPRESENTATIVE FOR OTHER AVAILABLE CONFIGURATIONS

Standard	FTTx	DWDM/CWDM
FTBX720CSM1XX = SM OTDR Module, 1310/1550 nm, 36/35 dB (9/125 μm) (\$5,615)	FTBX730CSM1XX = Quad 850/1300/1310/1550nm, 27/26/36/34dB (\$7,140)	FTBX740CCW10XX = CWDM SM OTDR Module module with 10 wavelengths 1430/1450/1470/1490/1510/1530/1550/1570/1590/1610 nm (\$13,003)
FTBX720CQ1QUADXX = QUAD OTDR Module (\$10,375)	FTBX735CSM1XX = SM OTDR Module, 1310/1550 nm, 42/41 dB (9/125 μm) (\$7,810)	FTBX740CCW18M8WXX = SM CWDM OTDR module with 8 activated wavelengths 1470/1490/1510/1530/1550/1570/1590/1610 nm (\$15,500)
Port 1: 850/1300 nm, 27/29 dB (50/125 & 62.5/125 μm)	FTBX750CSM1 = SM OTDR Module, 1310/1550 nm, 46/45 dB (9/125 μm)(\$11,805)	FTBX740CCW18M10WXX = SM CWDM OTDR module with 10 activated wavelengths 1430/1450/1470/1490/1510/1530/1550/1570/1590/1610 nm (\$18,000)
Port 2: 1310/1550 nm 36/35 dB (9/125 μm)	FTBX730CSM3XX = SM OTDR Module, 1310/1550/1625 nm, 39/38/39dB (9/125 μm) (\$11,520)	FTBX740CCW18M18WXX = SM CWDM OTDR module with all 18 activated wavelengths 1270/1290/1310/1330/1350/1370/1390/1410/1430/1450/1470/1490/1510/1530/1550/1570/1590/1610 nm (\$22,000)
	FTBX735CSM4XX = SM OTDR Module, 1310/1490/1550 nm, 42/41/41 dB (9/125 μm)(\$12,010)	FTBX740CCW18M18WXX = SM CWDM OTDR module with all 18 activated wavelengths 1270/1290/1310/1330/1350/1370/1390/1410/1430/1450/1470/1490/1510/1530/1550/1570/1590/1610 nm (\$22,000)
		FTBX740CDWCXX = SM Tunable DWDM OTDR Module C-band 1528/1564 nm (ITU 17-62), 100/50 GHz, 40 dB (9/125 μm)(\$22,000)

Intelligent Optical Link Mapper Base Software  
Choose iOLM or traditional trace software option - no charge  
Choose both iOLM and OTDR Trace software package - \$1,995



T-BERD MTS 4000 V2

# VIavi - WDM OTDRs T-BERD/MTS-4000 V2 OPTICAL TEST PLATFORM

MODULAR TEST PLATFORM DESIGNED FOR THE INSTALLATION, TURN-UP AND MAINTENANCE OF FIBER OPTIC NETWORKS

The VIavi T-BERD®/MTS-4000 V2 is the optical test platform engineers, technicians, installers and contractors can rely on, providing:

- An easy-to-use solution with intuitive icon-based graphical user interface (GUI) and multi-touch screen requiring minimal training
- A compact platform with field-replaceable modules covering multiple optical test functions (OTDRs, optical power & loss testing, Optical Spectrum Analyzer (OSA), etc. . . ) that enable complete optical network qualification.
- Optimum workflow and operation within the platform or through the cloud with VIavi StrataSync and SmartAccess Anywhere

## FEATURES

- Dual-modular handheld platform
- Large 9-inch high visibility touchscreen with permanent function keys
- Essential tools integrated and supported in the platform (visual fault locator, optical power meter, optical microscope and talkset)
- Flexible connectivity; Ethernet, WiFi, Bluetooth
- Smart Access Anywhere (SAA) for remote control & field tech support
- StrataSync enabled — centralized cloud based asset, configuration, test data and workflow management



CWDM-OTDR-Module

COSA Module with SFP

### VIavi T-BERD 4000 CWDM PACKAGES

PART #	DESCRIPTION	PRICE
TB4T-CWDM-P1	TB4T-CWDM-P1, T-BERD 4000 CWDM PACKAGE W/ C-OSA AND CWDM OTDR 1471-1611NM	\$22,310.00
TB4T-CWDM-P2	TB4T-CWDM-P2, T-BERD 4000 CWDM PACKAGE 2 W/ C-OSA CWDM OTDR AND P5000I	24,710.00

### VIavi T-BERD 4000 MPO OTDR PACKAGES

PART #	DESCRIPTION	PRICE
TB4-OTDRMPO-P1	TB4-OTDRMPO-P1, MPO OTDR kit TB4K -WiFi-PM-CableSLM SAA- 1310/1550 MA2 -APC- MPO	\$13,300.00
TB4-OTDRMPO-P2	TB4-OTDRMPO-P2, MPO OTDR kit TB4K -WiFi PM CableSLM SAA- 1310/1550/1625 MA2 -APC- MPO	14,700.00

### VIavi T-BERD 4000 DWDM PACKAGES

PART #	DESCRIPTION	PRICE
TB4-DWDM-P2	TB4-DWDM-P2, T-BERD 4000 WITH DWDM OTDR AND DWDM OCC PACKAGE	\$25,000.00
TB4K-DOTDR-AP0	TB4K-DOTDR-AP0, DWDM OTDR kit TB4000 / PMVFL / DWDMC / Cable-SLM / SAA / WiFi	15,500.00
TB4K-DOTDR-AP2	TB4K-DOTDR-AP2, DWDM/CWDM OTDR kit TB4000T / DWDMC / CWDM10U / Cable-SLM / SAA / WiFi	22,000.00





# VIAMI T-BERD/MTS-2000 OPTICAL TEST PLATFORM

HANDS-FREE TEST SET FOR THE INSTALLATION, TURN-UP AND MAINTENANCE OF FIBER OPTIC NETWORKS.



T-BERD MTS 2000

### VIAMI T-BERD 2000 PON OTDR PACKAGE

PART #	DESCRIPTION	PRICE
TB2T-PON-TK2	TB2T-PON-TK2, T-BERD2000 INSTALL AND REPAIR PON TEST KIT 1310/1550/1650NM	\$7,100.00

### VIAMI T-BERD 2000 WDM PACKAGES

PART #	DESCRIPTION	PRICE
TB2K-COSA-P1	TB2K-COSA-P1, T-BERD 2000 package with C-OSA module and 2xSFP slots	\$6,450.00
TB2-CWDM-P1	TB2-CWDM-P1, T-BERD 2000 WITH 1431-1611NM CWDM OTDR	9,200.00
TB2-DWDMOCC-P1	TB2-DWDMOCC-P1;T-BERD 2000 DWDM Channel Checker Package	8,000.00



OTDR Module with Filtered Port

### VIAMI T-BERD 2000 FTTH OTDR PACKAGES

PART #	DESCRIPTION	PRICE
TB2-OTDR-2WLA-SLM	TB2-OTDR-2WLA-SLM, T-Berd 2000 Short Range 1310/1550nm OTDR with LS, PM and SLM	\$3,880.00
TB2-OTDR-TK3	TB2-OTDR-TK3, T-BERD 2000 FTTA/FTTH CONTRACTOR OTDR TEST KIT	7,850.00
TB2-QUAD-TK2	TB2-QUAD-TK2, T-BERD 2000 QUAD FTTA/ENTERPRISE OTDR TEST KIT	8,500.00
TB2-FCOMP2-MA	T-BERD 2000 package 1310/1550nm FiberComplete w Metro Access OTDR 37/35 dB	8,549.00

### VIAMI T-BERD PLATFORM MODULES

PART #	DESCRIPTION	PRICE
2301/12	2301/12, COSA-4055 APC CWDM OSA Module with SFP Bay - SC optical adapter mounted FC enclosed	\$5,200.00
2331/12	2331/12, OCC-4056C APC, DWDM Analyzer with SFP Bay	6,741.00

### VIAMI CHANNEL CHECKERS

PART #	DESCRIPTION	PRICE
2277/44	2277/44, OCC-56C, DWDM Optical Channel Checker, C-Band; APC, SC mounted FC enclosed	\$5,800.00
2277/43	2277/43, OCC-55 Smart Optical Channel Checker CWDM APC SC mounted FC enclosed	4,600.00
2277/40	2277/40, OCC-55 Optical Channel Checker CWDM PC SC mounted FC enclosed	6,634.00



OCC-56C Channel Checker

### ADAPTERS AND ACCESSORIES

PART #	DESCRIPTION	PRICE
2256/90.05	2256/90.05, Connector Cleaning Sticks 2.5mm 5 Pieces	\$9.00
2014/00.09	2014/00.09, FC Type NTT.D3	106.00
2014/00.21	2014/00.21, Adapter 21: ST Type	93.45
2014/00.24	2014/00.24, Adapter 24: SC-PC SC-APC	106.00
2014/00.28	2014/00.28, Adapter 28: UPP for LC MU D 1.25mm	93.45
2014/00.29	2014/00.29, Adapter 29: LC F-3000 -PC -APC	106.00
2014/00.31	2014/00.31, UPP for DIN FC SC ST and MST D 2.5mm	100.80
2150/00.32	2150/00.32, Universal Optical Adapter: ST-Type	166.00
2150/00.50	2150/00.50, Universal Optical Adapter: DIN 47256-Type	166.00
2150/00.51	2150/00.51, Universal Optical Adapter: FC-PC FC-APC -Type	166.00
2150/00.58	2150/00.58, Universal Optical Adapter: SC-PC APC-Type	166.00
2237/90.04	2237/90.04, Universal Battery Charger AA/AAA-Accu NiCD/NiMH	123.00
2255/90.10	2255/90.10, FI-10 11 Adapter for 2.00mm Connector Types	113.00
2302/90.01	2302/90.01, SNT-505 Universal AC Power Adapter Micro USB Connector	\$40.00

CALL YOUR FIS SALES REPRESENTATIVE  
TO LEARN MORE ABOUT VIAMI'S FAMILY  
OF PRODUCTS





**SMARTOTDR™ HANDHELD OTDR FIBER TESTER**

Affordable, easy-to-use handheld testing for techs at any level. The lightweight and compact SmartOTDR solution performs all essential fiber tests for metro and access networks with:

**OTDR measurements**

- Fiber inspection with automated end-face analysis
- Optical loss testing (optical light source and optical power meter)
- Visual fault location

**Key Benefits**

- Simplifies OTDR analysis with Smart Link Mapper (SLM) option
- Automates testing with objective, pass/fail results

With a tailored interface for different skill levels, it speeds and optimizes field testing for any technician.

**KEY FEATURES**

- Single-/dual-/tri-wavelength versions with 1310, 1550, and in-service 1625 nm wavelengths
- Light, compact, hands-free design includes 5" high-visibility outdoor touchscreen
- Integrated CW light source
- PON optimized to test through a 1x128 splitter
- 3G/4G connectivity via USB, Bluetooth/ WiFi
- 3-year warranty
- All-day battery life

PART #	DESCRIPTION	PRICE
SMARTOTDR126A-P0	SMARTOTDR126A-P0;SmartOTDR 1310/1550nm with SLM	\$3,500.00
SMARTOTDR126A-P1	SMARTOTDR126A-P1;SmartOTDR 1310/1550 nm with PM VFL WiFi and SLM	4,650.00
SMARTOTDR136FB-P1	SMARTOTDR136FB-P1;SmartOTDR 1310/1550nm and Filtered 1625nm with PM VFL WiFi AND FTTH-SLM	9,600.00

**SMARTCLASS™ FIBER OLTS - 85P (INSPECTION AND TEST)**

The Viavi OLTS-85/85P handhelds are the industry's fastest and easiest solutions for tier 1 fiber certification. These latest additions to our popular SmartClass Fiber family let technicians measure length, measure optical loss (two fibers, two wavelengths), check polarity, inspect fiber end faces and generate certification reports.

**FEATURES**

- Complete Tier 1 fiber testing to TIA/ISO/IEC standards
- Dedicated MM, SM and Quad versions
- Fiber end-face inspection with automated pass/fail analysis on both local and remote devices
- Integrated saving of both local and remote results on the local device
- Encircled Flux Compliant
- Instant on from sleep mode
- Onboard storage for all test results.
- Easily-generated fiber certification reports
- 3.5" color touch screen
- Exports results via USB or directly to PC via FiberChekPROTM reporting software
- All-day battery life



PART #	DESCRIPTION	PRICE
2326/35	OLTS-85P Tier-1 Quad Optical Loss Kit with Patch Cord Microscope *	\$13,150.00
2325/35	OLTS-85 Tier-1 Quad Optical Loss Kit *	10,995.00
2325/34	OLTS-85 Tier-1 MM Optical Loss Kit *	10,995.00
2325/31	OLTS-85 Tier-1 SM Optical Loss Kit *	8,895.00
2325/11	OLTS-85 Tier-1 Loss Test Set SM **	4,378.00
2325/15	OLTS-85 Tier-1 Loss Test Set Quad **	5,923.00
2326/15	OLTS-85P Tier-1 Loss Test Set Quad SC mounted **	6,541.00

\* Kits (include local and remote test sets, carry case, and test reference cords)

\*\* Individual Test Sets (include local test set, battery, and charger)

**VIavi CERTIFIER40G CABLE CERTIFIER**

The industry standard in enterprise certification for both copper and fiber network certification. The Viavi Certifier40G equips technicians with all the capabilities they need to certify both copper and fiber networks quickly, completely, and correctly for all current and future cabling standards for the new enterprise.

The Certifier40G is not only the most advanced solution available, it is also the fastest and most complete. Whether certifying copper or fiber, users will get the job done right and on time... the first time!

**FEATURES**

- The industry's fastest CAT6A solution can certify each cable within 9 seconds
- Tier 1 certification of multimode, single-mode, and multimode MPO fiber in less than 6 seconds
- Automate pass/fail end-face analysis for all fiber types
- Gain complete test visibility at both local and remote ends
- Pre-configured with all leading manufacturer's cabling specifications
- Obtain comprehensive results for the latest TIA-568 and ISO 11801 requirements
- View test set up and results data and edit labels at both local and remote ends
- Low-cost copper only option with the Certifier10G, available

PART #	DESCRIPTION	PRICE
NGC-4500-FANA	Certifier 40G Copper	\$8,800.00
NGC-4500-CuMMEFNA	Certifier 40G Copper, Multimode (EF)	15,495.00
NGC-4500-CuQEFNA	Certifier40G copper, single-mode, multimode (EF)	21,495.00





## OLP-82/82P SERIES INTEGRATED FIBER INSPECTION AND TESTING

The OLP-82 and OLP-82P (with integrated patch cord microscope) combine fiber inspection and optical power measurement (OPM) into one convenient solution. As part of the SmartClass Fiber family from VIAVI Solutions, these handheld test tools feature a 3.5" color touch screen that allows users to inspect fiber end-faces with automated pass/fail analysis and with either a P5000i probe microscope (connected via USB) or the integrated patch cord microscope (OLP-82P) and also measure optical power at multiple calibrated wavelengths from 780 to 1625nm.

PART #	DESCRIPTION	PRICE
FIT-82P01-PRO	Fiber Optic Inspection and Test Kit 200/400x FBP Probe	\$2,700.00



FIT-82P01-PRO

## P5000I FIBER MICROSCOPE

Automated Fiber Inspection & Analysis Probe provides PASS/FAIL capability to PC, laptops, mobile devices and Viavi test solutions. The P5000i makes it fast and easy to certify that every connection in your network is clear and optimized. This intelligent fiber microscope removes the guesswork from fiber inspection and provides reliable and objective PASS/FAIL analysis of the fibers that connect customers to your network and to the best user experience possible.

PART #	DESCRIPTION	PRICE
FBP-SD101	Inspection Kit Digital FBP-P5000i, FiberChekPro Software, FBPT Tips SC, LC, U25M, U12M, carrying case	\$1,600.00
FIT-SD103	Digital Inspection and Test Kit Includes FBP-P5000i Digital Probe Microscope, inspection tips (SC, LC, Univ. 2.5 male, Univ. 1.25 male), MP-60 USB Optical Power Meter with Universal 2.5mm	2,100.00
SW-FCM-A1	Activation key for P5000i Android device compatibility	260.00



FBP-SD101

## FIBERCHEK PROBE MICROSCOPE

The FiberChek probe builds on Viavi's industry leading expertise in fiber inspection to deliver a single "all-in-one" handheld solution that every fiber technician can rely on for all of today's fiber inspection needs in a fully autonomous, handheld device. With built-in capabilities for image viewing, auto-focus, Pass/Fail analysis, storing/recalling results, the FiberChek probe completely automates inspection workflow to ensure fast and accurate performance. Whether used as on its own or connected (WiFi, Bluetooth, USB) to other devices, the FiberChek probe is the essential fiber tool for every technician.

PART #	DESCRIPTION	PRICE
FIT-FC-KIT1	FIT-FC-KIT1;Kit FiberChek Autofocus WiFi Microscope Case	\$3,300.00
FIT-FC-KIT2	FIT-FC-KIT2;Kit FiberChek Autofocus WiFi Microscope Tips for LC/PC and SC/PC Case	3,400.00
FIT-FC-KIT3	FIT-FC-KIT3;Kit FiberChek Autofocus WiFi Microscope Tips for LC/PC SC/PC and SC/APC Case	3,500.00



FIT-FC

## MINI VISUAL FAULT LOCATOR

Whether installing or troubleshooting, the Visual Fault Locator (VFL) is an essential tool that quickly and easily locates problem areas in fiber cables. By pinpointing the exact location of fiber damage, technicians can diagnose, troubleshoot, and fix the problem efficiently. The VFL is also used for conducting continuity tests and performing fiber identification.

PART #	DESCRIPTION	PRICE
FFL-050	Visual Fault Locator Mini 2.5mm (Pocket Sized)	\$175.00



FFL-050

## VIAVI ADAPTER TIPS

PART #	DESCRIPTION	PRICE
FBPT-LC-L	Tip LC Bulkhead Long-Reach for FBP	\$344.00
FBPT-MTP-L	Tip MTP Bulkhead Long-Reach for FBP	792.00
FBPT-FC-APC	Tip FC-APC Bulkhead for FBP	175.00
FBPT-SC	Tip SC Bulkhead for FBP (A)	58.00
FBPT-SC-APC	Tip SC-APC Bulkhead for FBP (B)	115.00
FBPT-U12M	Tip Univ. 1.25mm Patch Cord for FBP	81.00
FBPT-U25M	Tip Univ. 2.5mm Patch Cord for FBP	81.00
FBPT-U25MA	Tip Univ. 2.5mm Patch Cord APC Polish for FBP	92.00
FBPT-FC	Tip FC Bulkhead for FBP	81.00
FBPT-LC-APC	Tip LC/APC Bulkhead for FBP	520.00
FBPT-MTPA-L	Tip MTP-APC Bulkhead Long Reach for FBP	1,147.00
FBPT-LC	Tip LC Bulkhead for FBP	81.00
FBPT-U12MA-SF	Tip Univ. 1.25mm Patch Cord APC Polish Slip FIT for FBP	120.00
FBPT-ST	Tip ST Bulkhead for FBP	81.00

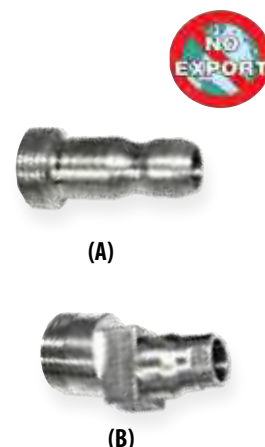

(A)

(B)



**ANRITSU MT1000A NETWORK MASTER™ SERIES**

The compact, battery-powered and easy-to-use Anritsu MT1000A provides everything needed to install and maintain communication networks in a rugged, field portable package. This lightweight instrument simplifies the daunting task of collecting and interpreting data with an easy-to-use GUI and clear summaries allowing users of any skill level to operate the instrument to its full potential.

The MT1000A is Dual-port, multi-function tester that can be configured with an array of transport testing functions (Ethernet, T1/T3, OC3/12/48), OLTS & OTDR modules to ensure you have the tools you need today plus the expandability for future technologies – all of which are field upgradeable.

**FEATURES**

- Large 9" full color touchscreen
- WLAN/Bluetooth/LAN connectivity
- Easy-to-use GUI to simplify the task of collecting and interpreting data
- Fast booting, virus prohibitive Linux operating system
- Full featured single mode /multimode OTDR with integrated loss test set and VFL
- Fiber Visualizer simplifies operation and results with icon-based summary
- Multiple remote control options
- Optical connector inspection – IEC61300-3-35 based PASS/FAIL to ensure quality
- Customizable PDF and XML report generation
- Wide range of OTDR, CPRI and Ethernet/SONET modules available



**FIS PRODUCT OFFER**  
**AUTO FOCUS PROBE**



**FEATURES**

The G0382A comes with the following standard accessories.

- Soft Bag
- Seven Connector Tips
  - 1.25mm PC Male      2.5mm PC Female(FC)
  - 2.5mm PC Male      2.5mm PC Female(SC)
  - 2.5mm APC Male      2.5mm APC Female(SC)
  - 1.25mm PC Female(LC)
- Quick Reference Guide



IEC 61300-3-35 Connector Inspection



Fiber Visualizer Summary



Traditional OTDR graph

PART #	DESCRIPTION	PRICE
MT1000A	Network Master™ Pro	\$3,727.00
MU100010A	10G Multirate Module	4,305.00
MU100010A-012	Ethernet 10G Dual Channel	8,650.00
MU100020A-020	Standard Dynamic Range (1310/1550 nm: 39/37.5 dB)	4,605.00
MU100021A-021	Enhanced Dynamic Range(1310/1550/850/1300 nm: 42/41/29/28 dB)	9,875.00
B0691B	Hard case for MT1000A	1,057.00
G0382A	Auto focus 400x Video Inspection Probe with tips	3,366.00
G0310A	Spare LiION battery for MT1000A	357.00
J0617B	Replacement FC Adapter	102.00
J0618D	Replacement ST Adapter	102.00
J0619B	Replacement SC Adapter	102.00

Contact FIS for additional options and modules available.

**ANRITSU SITE MASTER™ - S361E/S362E**

The Site Master S361E is a compact, handheld cable and antenna analyzer that provides coverage from 2 MHz to 6 GHz. The Site Master S362E includes an integrated spectrum analyzer that provides coverage from 9 kHz to 6 GHz. With its multi-functional capabilities, it eliminates the need to carry and learn multiple instruments. **Each Unit Includes:** Soft carrying case, AC/DC power supply, automotive power adapter 12V/60W, USB 2.0 A/Mini B cable, Li-Ion rechargeable battery, screen protector, stylus.

PART #	DESCRIPTION	PRICE
S361E	Site Master, 2 MHz to 6 GHz cable & antenna analyzer	\$8,710.00
S362E	Site Master, 2 MHz to 6 GHz cable & antenna analyzer, 9 kHz to 6 GHz spectrum analyzer	15,920.00
S361E-0010	Option 10, Bias Tee (requires Option 21)	670.00
S361E-0019	Option 19, High-Accuracy Power Meter (requires USB Power Sensor, sold separately)	590.00
S361E-0021	Option 21, 2-port Transmission Measurement	1,490.00
S361E-0031	Option 31, GPS Receiver (requires GPS antenna, sold separately)	480.00



**Touch Screen**



S361E / S362E

# FIS IS THE NATION'S LARGEST ANRITSU STOCKING DISTRIBUTOR

## ANRITSU ACCESS MASTER™ MT9085 SERIES



### FEATURES

- 8-inch TFT 16:9 wide touch screen display for use indoors and outdoors
- Longer battery operation time: Up to 12 hours
- Wider operating temperature range: -10 to 50°C
- Quickly change between trace and Fiber Visualizer summary
- Wi-Fi/Bluetooth connectivity
- Rotary knob and new short-cut function keys simplify and minimize operations and time to complete a test
- Fiber Visualizer software to simplify PASS/FAIL analysis and PDF reports directly from the OTDR



MT9085A2

The ACCESS Master MT9085x is a handheld complete Fiber Optic Cable tester for performing all optical pulse tests, optical loss/power measurements and optical fiber end-face inspections. Ideal for FTTx, PON, Metro WDM. The MT9085 now features an 8-inch TFT 16:9 wide touch screen display for use indoors and outdoors while providing a rotary knob and new short-cut function keys simplify and minimize operations and time to complete a test.

**Each Unit Includes:** Includes 8 inch wide Touchscreen Display, Protector Option, Softcase & Connector. Deluxe kits also include PM/LS, and VFL. Specify the adapter when ordering.



### MT9085A

PART #	DESCRIPTION	PRICE
MT9085A-053SM-BSC	Single Mode 1310/1550nm 39/37.5dB Basic Kit	\$7,841.00
MT9085A-063QM-BSC	Quad SM/MM 850/1300/1310/1550nm 29/28/39/37.5dB Basic Kit	12,031.00
MT9085A-053SM-DLX	Single Mode 1310/1550nm 39/37.5dB Deluxe Kit	9,151.00
MT9085A-063QM-DLX	Quad SM/MM 850/1300/1310/1550nm 29/28/39/37.5dB Deluxe Kit	13,341.00

### MT9085B

MT9085B-053SM-BSC	Single Mode 1310/1550nm 42/41dB Basic Kit	\$8,888.00
MT9085B-063QM-BSC	Quad SM/MM 850/1300/1310/1550nm 29/28/42/41dB Basic Kit	13,079.00
MT9085B-053SM-DLX	Single Mode 1310/1550nm 42/41dB Deluxe Kit	10,198.00
MT9085B-063QM-DLX	Quad SM/MM 850/1300/1310/1550nm 29/28/42/41dB Deluxe Kit	14,389.00

### MT9085C

MT9085C-053SM-BSC	Single Mode 1310/1550nm 46/46dB Basic Kit	\$11,507.00
MT9085C-053SM-DLX	Single Mode 1310/1550nm 46/46dB Deluxe Kit	12,817.00

### ADAPTERS

PART #	DESCRIPTION	PRICE
J0617B	Anritsu Replacement FC Adapter for MT9083/85	\$102.00
J0618D	Anritsu Replacement ST Adapter for MT9083/ 85	102.00
J0619B	Anritsu Replacement SC Adapter for MT9083/ 85	102.00
J1534A	SC/UPC - LC/UPC SM Adapter for MT9083/ 85	128.00

### ACCESSORIES

PART #	DESCRIPTION	PRICE
MT9083A-002	Visual Fault Locator (VFL) Option	\$578.00
MT9083A-007	SM/MM Optical Power Meter (UPC/APC, +6 to -67 dBm)	788.00
B0582A	Soft Carry Case for MT9083/85	193.00
B0583A	Hard Transit Case for MT9083/85 (suitcase style)	354.00
J1295	Cigarette Lighter Power Cord	53.00
G0306B	Video inspection probe with USB connector (incl. FC/ST/LC/SC/2.5mm/1.25mm/APC tips)	1,607.00

### LMR MASTER™ S412E

The LMR Master combines a high-performance spectrum analyzer, vector network analyzer (VNA), internal power meter, and a vector signal generator to create the ideal handheld instrument for field testing of land, mobile or radio systems up to 1.6 GHz. It allows field analysis and coverage mapping of LMR standards including: Analog FM, P25 (FDMA Phase 1 and TDMA Phase 2), TETRA, DMR (MotoTRBO™), NXDN™, dPMR, and PTC. Supports FirstNet LTE for public safety. **Each Unit Includes:** Soft carrying case, AC/DC power supply, automotive power adapter 12V/60W, USB A-mini cable, Li-Ion rechargeable battery, screen protector, stylus.

PART #	DESCRIPTION	PRICE
S412E	LMR Master S412E, 500 kHz to 1600 MHz LMR modulation analyzer and signal generator, VNA, spectrum analyzer	\$14,370.00
S412E-0006	Option 6, 6 GHz Coverage on Spectrum Analyzer	4,120.00
S412E-0016	Option 16, 6 GHz Coverage on Vector Network Analyzer	4,120.00
S412E-0019	Option 19, High Accuracy Power Meter (Requires USB Power Sensor, sold separately)	590.00
S412E-0025	Option 25, Interference Analyzer (Option 31 is recommended)	1,860.00
S412E-0031	Option 31, GPS Built-in Receiver (Requires GPS Antenna P/N 2000-1528-R, sold separately)	480.00
S412E-0431	Option 431, Coverage Mapping (Requires Option 31)	2,575.00

\*More options available, contact representative for complete list.



S412E



FS200

## AFL SINGLEMODE FLEXSCAN® FS200 OTDRS

Pocket-sized, performance-packed, user friendly FlexScan FS200 OTDRs enable both novice and expert technicians to quickly and reliably troubleshoot optical networks or fully characterize newly installed or repaired networks. Using FlexScan's innovative SmartAuto mode, multiple OTDR scans quickly and accurately detect, locate, identify and measure network components and faults. After applying industry-standard or user-set pass/fail criteria, the characterized network is displayed using FLEXSCAN's intuitive, icon-based LinkMap® view.

FLEXSCAN automates test setup, shortens test time and simplifies results interpretation, improving efficiency and reducing the cost of testing. Acquired results may be stored internally or externally. Internally stored results are easily accessed via USB, Bluetooth or WiFi.

With optional connector inspection, integrated source, power meter and VFL, FLEXSCAN offers an all-in one solution, ensuring technicians have everything they need to locate and resolve optical network issues. Uploaded results may be viewed and reports may be generated using the included Windows-compatible TRM® 3.0 Test Results Manager software.

### NEW FEATURES

- Fast! Flexpress mode completes dual-wavelength tests in <5 seconds – 10 x faster than conventional OTDRs! For multi-fiber testing, Flexpress mode automatically controls 12-fiber MPO Switch to further reduce multi-fiber test time.
- FlexScan FS200 now has built in MPO Switch control: MPO Kit: Includes selected FlexScan and accessories, MFS-12-SM Single-mode Multi-Fiber Switch, USB cable and 30 m fiber to connect FlexScan to Switch, plus 30 m MPO Launch Cable to connect Switch to MPO-terminated multi-fiber network

### FS200-50 KITS (1550 NM OTDR, OLS, OPM, VFL) / FS200-100 KITS (1310/1550 NM OTDR, OLS, OPM, VFL)

PART #	DESCRIPTION	PRICE
FS200-50-BAS-P1-W1	Basic Kit; TRM 3.0 Basic and carry case (1550nm OTDR, OLS, OPM, VFL)	\$2,995.00
FS200-50-PLUS-P1-W1	Plus Kit; Adds 150 m fiber ring and One-Click® cleaner	3,195.00
FS200-50-PRO-P1-W1	PRO Kit; Adds FOCIS Flex, 150 m fiber ring and One-Click cleaner	4,925.00
FS200-100-BAS-P1-W1	Basic Kit; TRM 3.0 Basic and carry case (1310/1550nm OTDR, OLS, OPM, VFL)	4,295.00
FS200-100-PLUS-P1-W1	Plus Kit; Adds 150 m fiber ring and One-Click cleaner	4,495.00
FS200-100-PRO-P1-W1	PRO Kit; Adds FOCIS Flex, 150 m fiber ring and One-Click cleaner	6,225.00
FS200-100-BIPM-P1-W1	Complete Kit; Adds OFI-BIPM, FOCIS Flex, 150 m fiber ring and One-Click cleaner	8,195.00

### FS200-300 KITS (1310/1550 OTDR, OLS/OPM, VFL) / FS200-304 KITS (1310/1550/1650 NM PON OTDR, OLS/OPM, VFL)

FS200-300/304 Kits are available with a variety of options. All kits include carry case, USB cable and TRM 3.0 Test Results Management software (Basic or Advanced, depending on kit). Kits can also include Fiber Rings, OLS/OPM, OFI-BI/BIPM, FOCIS Flex connector inspection probe and tips.

Please contact your FIS Sales Associate for kit part numbers and pricing.

PART #	DESCRIPTION	PRICE
FS200-300-BAS-P1-W1	FS200-300 Basic Kit, 1310/1550 OTDR, OLS/OPM, VFL, BT/WiFi, TRM 3.0 Basic	\$5,195.00
FS200-300-PLUS-P1-W1	Adds 150 m SMF fiber ring, One-click cleaner and TRM 3.0 Advanced to BASIC Kit	5,395.00
FS200-300-PRO-P1-W1	Adds FOCIS Flex and two adapter tips to PLUS Kit	7,125.00
FS200-300-BIPM-P1-W1	Adds OFI-BIPM to PRO Kit	9,095.00
FS200-300-MPO-P1-W1	Basic Kit plus MPO Switch, 150 m SMF fiber ring, 30 m 12-fiber MPO fiber ring, 2.5 mm and MPO One-click cleaners and TRM 3.0 Advanced	10,795.00
FS200-304-BAS-P1-W1	FS300-304 Basic Kit, 1310/1550/1650 PON OTDR, OLS/OPM, VFL, BT/WiFi, TRM 3.0 Basic	6,995.00
FS200-304-PLUS-P1-W1	Adds 150 m SMF fiber ring, One-click cleaner and TRM 3.0 Advanced to BASIC Kit	7,195.00
FS200-304-PRO-P1-W1	Adds FOCIS Flex and two adapter tips to PLUS Kit	8,925.00
FS200-304-BIPM-P1-W1	Adds OFI-BIPM to PRO Kit	10,895.00
FS200-304-MPO-P1-W1	Basic Kit plus MPO Switch, 150 m SMF fiber ring, 30 m 12-fiber MPO fiber ring, 2.5 mm and MPO One-click cleaners and TRM 3.0 Advanced	12,595.00

### ACCESSORIES

PART #	DESCRIPTION	PRICE
2900-50-0002MR	FC adapter, OTDR/OLS port	\$60.00
2900-50-0003MR	SC adapter, OTDR/OLS port	60.00
2900-50-0004MR	ST adapter, OTDR/OLS port	60.00
2900-50-0006MR	LC adapter, OTDR/OLS port	94.00
2900-52-0001MR	FC adapter, OPM port	56.00
2900-52-0002MR	SC adapter, OPM port	56.00
2900-52-0003MR	ST adapter, OPM port	56.00
2900-52-0004MR	LC adapter, OPM port	67.00
2900-52-0005MR	2.5 mm adapter, OPM port	56.00
2900-52-0006MR	1.25 mm adapter, OPM port	56.00
2900-53-0001MR	2.5 mm adapter, VFL port	56.00
2900-53-0002MR	1.25 mm adapter, VFL port	56.00
8800-00-0072PR	Dust cap for UCI outputs	5.00
1400-01-0045	Soft carry case	50.00



## FLEXSCAN® FS300 QUAD OTDR WITH SMARTAUTO® & LINKMAP®



**Performance-packed:** With SmartAuto multi-pulse acquisition, 37 dB dynamic range and best-in-class dead zones, FlexScan Quad OTDRs test multimode and single-mode networks – including FTTH PONs and POLANs up to 1:64 split ratio – while still detecting and measuring events <2 meters apart.

**User-friendly:** FlexScan OTDRs enable both expert and novice technicians to quickly, reliably and accurately detect, locate, identify and measure optical network components and faults. After applying industry-standard or user-set pass/fail criteria, the network is displayed using FlexScan's intuitive, icon-based LinkMap view. Results may be printed to PDF and stored internally or externally. FlexScan automates test setup, shortens test time and simplifies results interpretation, improving test efficiency and cost.

**Pocket-sized:** FlexScan OTDRs truly fit in your pocket, yet still deliver all-day battery operation plus a large, bright, indoor/outdoor, 5-inch 800x480 touchscreen display. With large touch controls, you'll never need a stylus.

**All-in-one test capability:** With optional connector inspection, integrated optical light source, power meter and VFL, FlexScan provides an all-in one solution, ensuring technicians have everything they need to locate and resolve optical network issues. Uploaded results may be viewed and professional reports may be generated using the included Windows-compatible TRM® 3.0 Test Results Manager software.

**Available in Convenient, Cost-saving Installation and Troubleshooting Kits:** Bundle FlexScan with choice of launch cable, FOCIS Flex connector inspection probe and tips, and/or AFL's universal optical fiber identifier (OFI).



### FEATURES

- Test MMF and SMF, point-to-point and PON
- SmartAuto detects closely spaced events without sacrificing range
- LinkMap icons clearly identify event type & pass/fail status
- Print-to-PDF plus internal & external data storage
- Best-in-class 20 m PON dead zone
- Integrated Source, Power Meter, Visual Fault Locator
- Bluetooth & Wi-Fi communications
- Tether-free connector inspection with FOCIS Flex/Duel
- Rugged, lightweight, handheld for field use

### APPLICATIONS

- OTDR and Insertion Loss test & reporting
- Fast, accurate P2P & PON verification & troubleshooting
- Locate faults exceeding industry or user pass/fail thresholds
- Visually pinpoint location of macro-bends or breaks

### FS300 KITS (850/1300 MM; 1310/1550 SM OTDR, WIFI, BLUETOOTH)

PART #	DESCRIPTION	PRICE
FS300-325-BAS-P0-W1	Basic kit with soft case, TRM 3.0 Basic, USB cable	\$7,495.00
FS300-325-PLUS-P0-W1	PLUS kit adds 150 m SMF & MMF fiber rings, One-Click cleaner, TRM 3.0 Advanced	7,930.00
FS300-325-PRO-P0-W1	PRO kit adds FOCIS Flex, 2 adapter tips, 150 m SMF & MMF fiber rings, One-Click cleaner, TRM 3.0 Advanced	9,660.00

### FS300 KITS (850/1300 MM; 1310/1550 SM OTDR, OLS/OPM, WIFI, BLUETOOTH)

FS300-325-BAS-P1-W1	Basic kit with soft case, TRM 3.0 Basic, USB cable	7,995.00
FS300-325-PLUS-P1-W1	PLUS kit adds 150 m SMF & MMF fiber rings, One-Click cleaner, TRM 3.0 Advanced	8,430.00
FS300-325-PRO-P1-W1	PRO kit adds FOCIS Flex, 2 adapter tips, 150 m SMF & MMF fiber rings, One-Click cleaner, TRM 3.0 Advanced	10,160.00
FS300-325-BI-P1-W1	BI Complete kit adds OFI-BI fiber identifier, FOCIS Flex, 2 adapter tips, 150 m SMF & MMF fiber rings, One-Click cleaner, TRM 3.0 Advanced	11,830.00
FS300-325-BIPM-P1-W1	BIPM Complete kit adds OFI-BIPM fiber identifier with power meter, FOCIS Flex, 2 adapter tips, 150 m SMF & MMF fiber rings, One-Click cleaner, TRM 3.0 Advanced	12,130.00

### AFL FOCIS LIGHTNING FIBER OPTIC CONNECTOR INSPECTION SYSTEM

FOCIS Lightning is a multi-fiber connector inspection probe with integrated screen, designed specifically for the inspection of multi-fiber connectors and bulkheads such MPO and MTP®. FOCIS Lightning performs industry standard and user-defined end-face cleanliness analysis at a rate of about 1 second per fiber. Lightning stores connector-level and individual fiber images, analysis, overlays, and zone tables locally and provides both Wi-Fi and Bluetooth wireless links. The AFL FOCIS app (iOS and Android) provides a comprehensive and user-friendly feature set as well as connectivity with AFL's cloud-based aeRos® workflow automation platform.

PART #	DESCRIPTION	PRICE
FOCIS-LTNG-N	FOCIS Lightning, Wireless, No Tips	\$5,495.00
FOCIS-LTNG-U	FOCIS Lightning, Wireless, UPC MPO tip	5,695.00
FOCIS-LTNG-A	FOCIS Lightning, Wireless, Angled MPO Tip	5,695.00
FOCIS-LTNG-UA	FOCIS Lightning, Wireless, UPC and Angled MPO Tips	5,895.00
FOCIS-LTNG-NW-N	FOCIS Lightning, No Wireless, No Tips	5,495.00
FOCIS-LTNG-NW-U	FOCIS Lightning, No Wireless, UPC MPO tip	5,695.00
FOCIS-LTNG-NW-A	FOCIS Lightning, No Wireless, MPO Angled Tip	5,695.00
FOCIS-LTNG-NW-UA	FOCIS Lightning, Wireless, UPC and Angled MPO Tips	5,895.00



FOCIS LIGHTNING



## MULTIFIBER™ PRO OPTICAL POWER METER AND TEST KITS

Introducing the MultiFiber™ Pro Optical Power Meter and Fiber Test Kits. MultiFiber Pro is the only fiber tester that tests MPO fiber trunks without the use of fan-out cords, eliminates the complexity of polarity issues and makes cassette testing in the field much easier.

### FEATURES

- Automatic scanning and testing of all fibers in MPO connectors
- Ensures correct end-to-end connectivity of MPO connectors with built-in polarity verification
- On-board MPO connector so no fan-out cords are required when testing fiber trunks
- Easy to interpret test results with a simple user interface that displays all 12 fibers

PART #	DESCRIPTION	PRICE
MFTK1200	MPO Testing Base Kit includes: MultiFiber Pro Power Meter, 850 Light Source, Test Cords, MPO adapters and carrying case.	\$11,575.00



## OPTIFIBER® PRO SERIES

Fluke Networks' OptiFiber® Pro Series OTDRs make novices and experts faster. Automated trace analysis and setup supports applications including data centers, PON and outside plant. Advanced features include Manual Expert mode, pinch and zoom for in-depth trace analysis and SmartLoop for bi-directional testing. Supports Versiv copper and fiber loss certification modules.

### FEATURES

- Effectively test data center fiber with the least set-up and trace time
- Reduce network downtime by quickly and precisely identifying faults on singlemode or multimode fiber
- Accelerate fiber certification with trace times as short as two seconds in Quick Test mode

PART #	DESCRIPTION	PRICE
OF2-100-M	OptiFiber Pro Multimode OTDR kit.	\$10,545.00
OF2-100-MI	OptiFiber Pro Multimode OTDR kit with inspection kit	13,145.00
OF2-100-Q	OptiFiber Pro Quad OTDR kit	15,995.00
OF2-100-S	OptiFiber Pro Singlemode OTDR kit	11,725.00
OF2-200-SI	OF2 HDR OTDR w/Inspection Kit & Wi-Fi (1310, 1550 nm)	14,745.00
OF2-200-SI1490	OF2 HDR OTDR w/Inspection Kit & Wi-Fi (1310, 1490, 1550 nm)	18,245.00
OF2-200-SI1625	OF2 HDR OTDR w/Inspection Kit & Wi-Fi (1310, 1550, 1625 nm)	19,395.00



DSX2-8000

## DSX CABLEANALYZER

The DSX CableAnalyzer Series from Fluke Networks is the testing platform for today - and tomorrow. This revolutionary new future-proof platform significantly reduces total time to certify by improving every aspect of the testing process. The AC Wiremap feature validates twisted-pair cabling for Power over Ethernet services in accordance with TIA/EIA standards, even if a midspan power supply is used.

### FEATURES

- Unmatched speed for Cat 5e, 6, 6a, 8, Class Fa, I/II and all current standards.
- Enables testing and certification of twisted pair cabling for up to 40 Gigabit Ethernet deployments
- Intertek Verified to TIA Level 2G – the most stringent accuracy requirement

PART #	DESCRIPTION	PRICE
DSX2-8000	A complete copper certification kit for cabling contractors testing Cat 8 and below channel and permanent links.	\$12,995.00
DSX2-8000MI	2GHZ DSX Cableanalyzer V2, w/ Wi-Fi	20,600.00
DSX2-8000PRO	2GHZ DSX Multimode OLTS INSPC V2, w/ Wi-Fi	65,495.00
DSX2-8000QI	2GHZ DSX QUAD OLTS INSPC V2, w/ Wi-Fi	27,150.00
DSX2-8000QOI	2GHZ DSX QUAD OTDR OLTS INSPC V2, w/ Wi-Fi	42,150.00



FI-7000

## FI-7000 FIBERINSPECTOR™ PRO

The FI-7000 FiberInspector Pro contains: Versiv Mainframe, USB Fiber Inspection Video Probe with 4 tips in a box (LC, FC/SC bulkhead, 1.25 and 2.5mm universal), Blank Module to protect the mainframe's rear connector, AC Charger, Shoulder Strap, USB Interface Cable, Versiv Open Source Software CD, Getting Started Guide, Soft Carrying Case.

### FEATURES

- Automated Pass/Fail certification of fiber optic connector end-faces
- Graphical indication of problem areas due to contamination, pits, chips, and scratches
- Certify to industry standards - IEC 61300-3-35
- Eliminate human subjectivity from fiber optic connector end-face measurements
- Save fiber optic connector end-face views during certification process

PART #	DESCRIPTION	PRICE
FI2-7000	FiberInspector Pro	\$3,995.00



IDEAL NETWORKS



IDEAL Networks specializes in user-friendly solutions which help technicians across the globe to install and test networks, data cable, Ethernet, CCTV installations, PROFINET, PoE and more.

A varied choice of innovative and intuitive handheld testers ensure that jobs are both productive and profitable, with Proof of Performance integral to design.

**IDEAL NETWORKS LANTECK IV AND FIBERTEK IV**

The LanTEK IV is a new Cable Certification System that brings a new standard to the industry, making the job faster, easier and more profitable. FiberTEK IV adapters are used with LanTEK IV for fast and simple Tier 1 certification of high bandwidth single-mode and multimode fiber optic cabling including support for encircled flux testing.

PART #	DESCRIPTION	PRICE
R163000	LanTEK IV-500MHz Cable Certifier. TIA Category 6A/ ISO Class EA	\$9,195.00
R163001	LanTEK IV-3000MHz Cable Certifier. TIA Category 8/ ISO Class I/II	11,095.00
R164008	FiberTEK IV-MM LED Kit. Two multimode FiberTEK IV modules	5,195.00
R164009	FiberTEK IV-SM Laser Kit. Two single-mode FiberTEK IV modules	6,075.00
R164010	FiberTEK IV-MM LED & SM Laser Kit. Two multimode FiberTEK IV modules and two single-mode FiberTEK IV modules	10,450.00



LanTek IV and FiberTek IV

**IDEAL NETWORKS SIGNALTEK NT**

If you install, maintain or troubleshoot data cabling and Ethernet networks, SignalTEK NT allows you to prove the performance up to Gigabit Ethernet transmission rates with helpful copper and fiber, network and PoE functions. Use the free IDEAL AnyWARE app to view and send data cable/network test reports to colleagues and clients anywhere.

PART #	DESCRIPTION	PRICE
R156005	SignalTEK NT – Network Transmission Tester	\$2,481.00



SignalTek NT

**IDEAL NETWORKS SECURITEST IP**

SecuriTEST IP is an installation and troubleshooting tester for digital/IP, HD coax and analog CCTV camera systems. With a single tester that can power, configure and document, SecuriTEST IP increases productivity from start to finish. Supply power to cameras via PoE/PoE+ (Power over Ethernet) or standard 12V DC power using its internal Li-Ion battery, eliminating the need for external power adapters and injectors.

PART #	DESCRIPTION	PRICE
R171000	SecuriTEST IP Digital/Analog/HD Coax CCTV Tester	\$750.00



SecuriTEST IP

**IDEAL NETWORKS VDV II SERIES**

The VDV II Series are easy to use cable testers that check the integrity of copper cables commonly found in residential, commercial or industrial voice, data or video installations, including telephone wiring, data network and video/security cabling.

PART #	DESCRIPTION	PRICE
R158000	VDV II – Voice, Data and Video Cable Verifier	\$133.00
R158002	VDV II Plus – Voice, Data and Video Cable Verifier	234.00
R158003	VDV II Pro – Voice, Data and Video Cable Verifier	382.00



VDV II Series

**IDEAL NETWORKS PoE PRO**

The new PoE Pro eliminates guesswork when installing, maintaining and troubleshooting networks where PoE is deployed. Displays pass/fail PoE per industry standard, class and available power.

PART #	DESCRIPTION	PRICE
R158004	PoE Pro – Data Cable and Power over Ethernet Verifier	\$595.00



PoE Pro

**IDEAL NETWORKS VFF5**

The Visual Fault Finder is a visible laser light source used to check continuity, locate breaks, poor mechanical splices and damaged connectors in fiber optic cabling.

PART #	DESCRIPTION	PRICE
VFF5	VFF5 - Visual Fault Locator	\$298.00



VFF5





## ANRITSU OTDR BARE FIBER PIGTAIL KIT

Save time by testing optical fibers without connectorizing. Easy-to-use, only a single drop of index matching oil is required. Strip, clean and cleave the fiber then insert into the unit until the end face meets the permanently mounted fiber. Specs: Choice of ST, SC or FC style connectors, Insertion Loss 0.6dB, Typical # of insertions: 2000.

**Kit Includes:** FiberConnect, Manual, Index Matching Oil, Maintenance Kit, Cleaning Brush, Magnetic Stand, Carry Case and Spare Pigtail.

PART #	DESCRIPTION	PRICE
FIBERCONNECT1-USC	FiberConnect Kit with SC/UPC pigtail	\$699.00
FIBERCONNECT1-UST	FiberConnect Kit with ST/UPC pigtail	699.00
FIBERCONNECT1-UFC	FiberConnect Kit with FC/UPC pigtail	699.00



## PREMIER BARE FIBER ADAPTER

Use this adapter for launching an OTDR or test set into an unconnectorized optical fiber for loss or length verification. Adapter can be cleaned easily if fiber breaks off during use. Specs: SC/UPC connector style plug-in, Typical insertion loss 1.0dB.

**Kit Includes:** Bare Fiber Adapter, Zipper Case, 122mtr SM Fiber Launch Reel with SC/UPC connectors, Cleaning Wire Kit and Instructions.

PART #	DESCRIPTION	PRICE
202073	Bare Fiber Adapter Launch Reel Kit	\$135.00



## DIVOT BARE FIBER TESTING DEVICE

The Divot™ is a faster system that uses index matching gel in disposable cartridges to allow for low loss connections and is much more forgiving of the quality of the cleaved fiber end. Each cartridge typically yields 500 insertions - 2 cartridges are included with the kit. Replacement cartridges can be purchased in packs of 3 or 12.

PART #	DESCRIPTION	PRICE
DVT-SMB3	Divot™ Bare Fiber Testing Device - SC 9µm Singlemode, 62.5µm and 50µm Multimode	\$395.00
DVT-RC3	Divot™ Replacement OCC Cartridge 3 pk	65.00
DVT-RC12	Divot™ Replacement OCC Cartridge 12 pk	250.00



F1-85UNIV

F1-81UNIV

## FIS UNIVERSAL TESTING SLEEVE

Designed specifically for testing applications, the FIS Universal Testing Sleeve reduces labor time while testing fiber optic patch cables with standard for 2.5mm ferrules. Adapters for ST or FC reference cord are available.

PART #	DESCRIPTION	PRICE
F1-81UNIV	FIS ST to 2.5mm Universal Test Adapter	\$15.95
F1-85UNIV	FIS FC to 2.5mm Universal Test Adapter	15.95

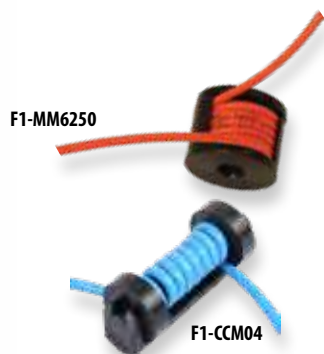

F1-MM6250

F1-CCM04

## FIS MULTIMODE MANDRELS

The use of mandrels in multimode insertion loss testing helps to ensure the proper launch condition into the fiber under test. By wrapping the fiber around the correct size mandrel, high order modes are stripped out and low order modes are spread out to achieve the desired launch conditions for testing. Each includes the mandrel and clip for holding the cable firmly in place during testing. Accepts jacket diameters from 1.6mm to 3.0mm and for use with both OM1, OM2 cable.

PART #	DESCRIPTION	PRICE
F1-MM6250	62.5/125µm and 50/125µm Mandrel Kit	\$29.00
F1-CCM04	4mm ClearCurve Mandrel (1.6 -2.0mm jacket recommended)	29.00

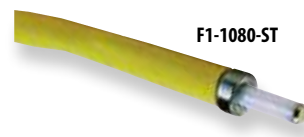

F1-1080-ST

## FIS GOLD TIPPED PIGTAIL

FIS gold tipped pigtailed are available for applications requiring a reference back reflection. Available in ST, FC, and SC style connectors. For singlemode applications the reflective quality of the gold provides high back reflection characteristics at 1310nm and 1550nm.

PART #	DESCRIPTION	PRICE
F1-1080-ST	1 Meter ST/UPC Pigtail with Gold Tipped Ferrule	\$45.00
F1-1080-FC	1 Meter FC/UPC Pigtail with Gold Tipped Ferrule	45.00
F1-1080-SC	1 Meter SC/UPC Pigtail with Gold Tipped Ferrule	45.00
F1-1080-SCAPC	1 Meter SC/APC Pigtail with Gold Tipped Ferrule	50.00
F1-1080-FCAPC	1 Meter FC/APC Pigtail with Gold Tipped Ferrule	50.00

## BUILD YOUR CUSTOM PULSE OR TEST BOX

Use this chart to build the launch box you need to your exact specifications.

Custom Ribbon MTP/MPO Launch Boxes

BOX PURPOSE	STYLE	FIBER #1 (CORE/CLAD)	FIBER LENGTH (IN METERS)	FIBER #2 (CORE/CLAD)	FIBER LENGTH (IN METERS)	INTERFACE	CONNECTOR FIBER 1 / FIBER 2
PS	7	3	2000	0	0	P	YU/YA
PS= Pulse suppressor TB= Test Box Test box includes 1 or more events, must specify distance between events	1= #1 4= #4 7= #7 9=#9 10=#10	1= 50/125µm - OM2 2= 62.5/125µm - OM1 3= 9/125µm - OS2 4= Other 8= BI 10G 50/125µm - OM3 9= ClearCurve® SM ZBL 10= BI 10G 50/125µm - OM4 12= 50µm10Gig - OM5		0= none 1= 50/125µm - OM2 2= 62.5/125µm - OM1 3= 9/125µm - OS2 4= Other 8= BI 10G 50/125µm - OM3 9= ClearCurve® SM ZBL 10= BI 10G 50/125µm - OM4 12= 50µm10Gig - OM5		(except boxes 1 and 8) P= Pigtailed R= Ruggedized Pigtailed (Microduct)	7U= FC/UPC 7A= FC/APC 8 = ST/PC LU= LC/UPC LA= LC/APC MU= MU/UPC YU= SC/UPC YA= SC/APC O= Other MT= MTP w/pins

**Part # Example:**  
**PS-7-3-2000-0-0-P-YU/YA**

Translates to: Pulse Suppressor (Style 7) in a 8"x6"x4" box with 2000 meters of 9/125µm fiber with (1) SC/UPC and (1) SC/APC Pigtail Interface



**STYLE #1**  
Dimensions: 5" Diameter  
Fiber Capacity: 160 mtrs  
(Pulse suppressor only)

**STYLE #9-Launch Pod**  
Dimensions: 5.5" x 4" x 2.5"  
Fiber Capacity: 300 mtr  
(Pulse suppressor only)

**STYLE #10-Launch Pod Plus**  
Dimensions: 6" x 4.5" x 2.5"  
Fiber Capacity: 1000 mtr  
(Pulse suppressor only)

**STYLE #7**  
Dimensions: 8" x 6" x 4"  
Fiber Capacity: 2200 mtr  
Test Box: 1 Event - 750 mtr, 2 Events - 600 mtr, 3 Events - 400 mtr

**STYLE #4**  
Dimensions: 14.2" x 11.4" x 6.5"  
Fiber Capacity: 5,000 mtrs  
Test Box:  
1 Event - 5,000 mtrs,  
2 Events - 4,500 mtrs,  
3 Events - 4,000 mtrs

**ARMORED LAUNCH CABLE**  
Dimensions: 4.5" Round Disk  
Fiber Capacity: 1000m

### FIS LAUNCH BOX PART NUMBER/PRICE EXAMPLES

PART #	DESCRIPTION	PRICE
PS-1-3-100-0-0-P-YU-YU	Launch Disc, Style #1, 100m Singlemode, SMF28 Ultra, 1.5m Pigtailed, SC/UPC Connectors Both Ends	\$120.00
PS-1-2-100-0-0-P-8U-YU	Launch Disc, Style #1, 100m Multimode OM1, Infinicor300, 1.5m Pigtailed, ST/UPC - SC/UPC	148.00
PS-10-3-1000-0-0-R-YU-YU	Launch Box, Style #10, 1000m Singlemode, SMF28 Ultra, 1m Armored Leads, SC/UPC - SC/UPC	225.00
PS-10-3-500-0-0-R-YU-YU	Launch Box, Style #10, 500m Singlemode, SMF28 Ultra, 1.5m Pigtailed, SC/UPC - SC/UPC	195.00
PS-9-3-150-0-0-R-YU-YU	Launch Box, Style #9, 150m Singlemode, SMF28 Ultra, 1m Armored Leads, SC/UPC - SC/UPC	165.00
PS-9-8-100-0-0-R-YU-YU	Launch Box, Style #9, 100m Multimode OM3 ClearCurve, 1m Armored Leads, SC/UPC - SC/UPC	160.00
PS-A-500-YUYU	Armored Launch Box, 500m, Singlemode, 9/125, SC/UPC - SC/UPC	495.00
PS-A-500-YULU	Armored Launch Box, 500m, Singlemode, 9/125, SC/UPC - LC/UPC	595.00

For Test Box\*When ordering Test Boxes, please specify type and location of up to 3 events. Each additional event cost \$30.00. Call for Pricing of Test Box.

### FIS RETRACTABLE LAUNCH CABLE

PART #	DESCRIPTION	PRICE
F1-FLS9LULU-1000	FIS Fiber Launch Cable SM 9/125, LC/UPC-LC/UPC 1000 meters (Not Pictured)	\$585.00
F1-FLS9YUYA-1000	FIS Fiber Launch Cable SM 9/125, SC/UPC- SC/APC 1000 meters (Not Pictured)	585.00
F1-FLS9YUYU-1000	FIS Fiber Launch Cable SM 9/125, SC/UPC-SC/UPC 1000 meters (Not Pictured)	585.00



### DID YOU KNOW... Utilizing Two Launch Cables (Pulse Suppressors) Allow Accurate Measurements

Using two (2) Pulse Suppressors, sometimes referred to as a launch and receive cable, allows a more accurate measurement of the cable link under test. It allows the pulse to settle down prior to the first connector on the cable link and lets the technician determine its insertion loss and back reflection (ORL). A receive cable placed on the far connector at the end of the cable is used to determine its insertion loss and back reflection (ORL).

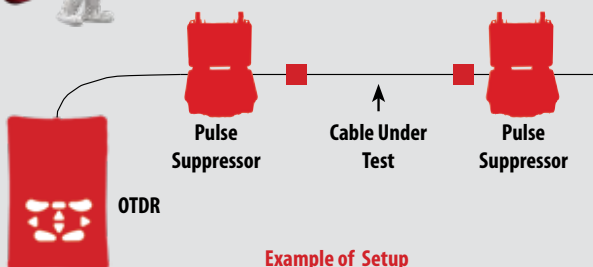

Example of Setup

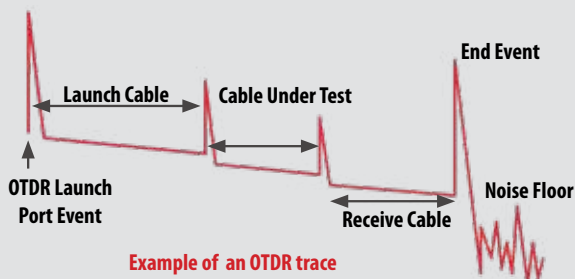

Example of an OTDR trace

## DID YOU KNOW... FIBER IDENTIFIERS



A Fiber Identifier allows you to see if a fiber is active without having to disconnect it from the network. They accomplish this by clamping onto a fiber mid-span and inducing a small macro bend. The Fiber Identifier can detect the small amount of light leaking through the macro bend to determine activity. Most units can also determine the direction of the traffic over the fiber link. Fiber Identifiers can also detect and identify specific modulated frequencies.

Fiber Identifiers are typically designed to work with 250µm coated, 900µm buffer, 2mm jacket and 3mm jacketed fibers. Ribbon Fiber versions are also available. Several higher end models are also capable of measuring the strength of the optical signal traveling down the fiber and displaying it on the unit.

## TYPICAL APPLICATION

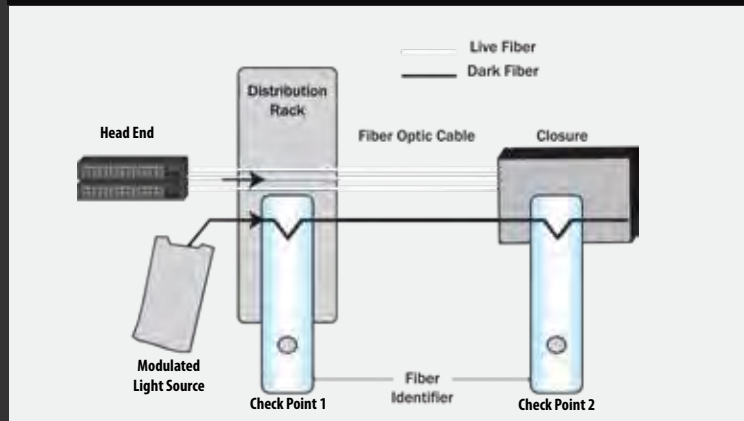

### EXFO LIVE FIBER IDENTIFIER AND TONE GENERATOR

The EXFO Fiber Finder can identify traffic, direction and tone detection on both active and dark fibers. With less than 1dB of induced loss, a live fiber can quickly be located and the power measured while minimizing network access time and the possibility for errors. The TG-300 is a non-intrusive, non-disruptive tone generator. Because of the low 0.2dB typical loss, they can be used on live fibers. The Fiber Finder and Toner work on all wavelengths and fiber types. One headpiece works on 900µm, 1.6mm and 3mm jackets and tones of 270Hz, 1kHz and 2kHz. The TK-FF kit includes both the Fiber Finder and Toner along with a case, AC adapter and 4 AA batteries per unit.

PART #	DESCRIPTION	PRICE
LFD-300B	Live Fiber Identifier	\$3,085.00
TG-300B	EXFO Fiber Tone Generator	3,705.00
TK-FF	Fiber Identifier Kit – LFD-300 plus TG-300	6,175.00



### FITEL FIBER IDENTIFIER

When you are doing maintenance on a network that can't be shut down for testing, reach for the Fitel Fiber Identifier. This device places a macro bend in the fiber that enables you to identify transmission direction, fiber path and relative core power on live optical fibers. A universal fiber optic adapter head accepts coated, ribbon or jacketed fiber optic cables. LED display and audible tone indicator.

**Each Unit Includes:** Battery, Strap and Manual

PART #	DESCRIPTION	PRICE
F1-IDH	Fitel Lightfinder ID-H Fiber Identifier with Universal Head	\$1,320.00



### VIAVI FI-60 LIVE FIBER IDENTIFIER

Live Fiber Identifier easily identifies the optical signal without having to disconnect the fiber or disrupt network traffic. Also converts to an Optical Power Meter (OPM).

The Viavi FI-60 LFI enables users to easily detect the optical signal without disconnecting fiber or disrupting network traffic. The FI-60 LFI also includes the unique Viavi SafeChek™ system, which ensures safe and repeatable engagement with most fiber types without the hassle of changing out costly dies. The FI-60 also converts to an Optical Power Meter (OPM), providing twice the value for your investment and reducing the number of tools carried on the job.

### FEATURES

- Avoid network downtime and damage with repeatable SafeChek™ easy-pull trigger system.
- Get the job done faster with a single LFI head that is compatible with multiple cable diameters (250µm to 3mm jacketed fibers).
- Have twice the tool at half the price! The FI-60 LFI easily converts to a full-function OPM that stores, recalls, and exports results to a PC via USB.

**Each Unit Includes:** Live Fiber Identifier with removable LFI attachment, 2.5 mm and 1.25mm OPM connector interfaces; USB cable; software; carrying case.

PART #	DESCRIPTION	PRICE
FI-60	Live Fiber Identifier with removable LFI attachment, 2.5 mm and 1.25mm OPM connector interfaces; USB cable; software; carrying case	\$846.00



**WILCOM FIBER IDENTIFIER**

Wilcom's Optical Fiber Identifiers are rugged metal units with the best sensitivity detection on the market today. They operate by inducing a macrobend on the fiber, and can be used for singlemode and multimode applications. Certain Wilcom models allow Relative Core Power measurements to be displayed. The unit can also detect the presence of 2kHz, 1kHz or 270Hz modulated tones. The optical head accepts a 3mm, 250µm /Ribbon or 900µm fibers.

**Each Unit Includes:** 9V Alkaline Battery, Carry Case and Interchangeable Heads for 3mm, 900µm, 250µm Fibers.

PART #	DESCRIPTION	PRICE
F6121A	Fiber Identifier	\$1,280.00
F6222	Fiber Identifier with Core Power and Digital Display	1,600.00
F6222C	CATV Fiber Identifier	1,590.00
F6121R	Ribbon Fiber Identifier	1,862.00
044-197731	3mm Adapter Head	65.00
044-1996501	2mm Adapter Head	65.00
044-20715011	1.6mm Adapter Head	65.00



**AFL OFI-BI AND OFI-BIPM SERIES OPTICAL FIBER IDENTIFIERS**

AFL's OFI-BI and OFI-BIPM are easy to use tools that determine if a fiber is live, the transmission direction and the relative core power on standard and bend-insensitive single-mode fibers. Its positive stop plunger mechanism provides the right pressure to ensure proper detection while keeping loss to a minimum. The design ensures traffic will not be interrupted and fibers will not be damaged.

The OFI-BI fiber identifier eliminates the need to access the optical fiber at a connection or splice point eliminating the possibility of interrupting service to a valued customer. The -BIPM model provides an integrated optical power meter for verification of power levels during installation or troubleshooting activities. The universal head of these OFIs eliminates the need to change adapter heads for jacketed, coated or ribbon fibers, making them extremely easy to use in the field. The touchscreen features provide simple to follow setup and clear to read results. OFI-BI and OFI-BIPM Optical Fiber Identifiers are warranted against defective material and workmanship for a period of one year from the date of delivery to the end user.

**FEATURES**

- World class signal detection sensitivity
- Trigger lock, positive stop for optimum detection
- Integrated optical power meter option (-BIPM model only)
- 2.4" color touchscreen with backlight

**APPLICATIONS**

- Maintenance of fiber optic networks
- Troubleshooting network issues
- Identification of live fibers or trace fibers
- Power level verification (-BIPM model only)

**Each Unit Includes:** 9V Alkaline Battery, Carry Case and Interchangeable Heads for 3mm, 900µm, 250µm Fibers.

PART #	DESCRIPTION	PRICE
OFI-BI	BI Optical Fiber Identifier	\$1,995.00
OFI-BIPM	BI Optical Fiber Identifier with integrated Optical Power Meter. The kit includes one 2.5 mm Universal Power Meter Port Adapter, BIPM-00-25.	2,295.00



**OPTIONAL OFI-BIPM ADAPTERS (ORDERED SEPARATELY)**

PART #	DESCRIPTION	PRICE
BIPM-00-25	OFI-BIPM 2.5 mm Universal Power Meter Port Adapter	\$165.00
BIPM-00-SC	OFI-BIPM SC Power Meter Port Adapter	165.00
BIPM-00-FC	OFI-BIPM FC Power Meter Port Adapter	165.00
BIPM-00-ST	OFI-BIPM ST Power Meter Port Adapter	165.00
BIPM-00-LC	OFI-BIPM LC Power Meter Port Adapter	165.00

**AFL OPTICAL FIBER IDENTIFIER**

The AFL OFI 200D Optical Fiber Identifier is a low-cost, high-tech approach to non-invasive fiber optic signal detection. Using a low-insertion loss, macrobend-detection technique, it discriminates signals without disrupting service or overstressing fiber. By simply clamping an Optical Fiber Identifier onto a gently bent fiber, the unit will indicate if there is [No Signal], [Tone], or [Traffic] and identify signal direction. This is all done with no head swapping or adjustments for different types of fiber, 250µm, 900µm, 3mm jacketed cable and ribbon fiber.

PART #	DESCRIPTION	PRICE
OFI200D	Optical Fiber Identifier	\$1,150.00
OFI400	Optical Fiber Identifier for use with 250µm, 900µm, Ribbon, 2mm and 3mm Jacketed Optical Fibers	1,395.00





Custom Configurations Always Available! Please Call Today!



F1-1315LR



F1-8513HR



9050-0000



RUGGEDIZED LIGHT SOURCE

RUGGEDIZED POWER METER

## FIS POWER METER AND LIGHT SOURCE KIT

Purchase either our hand held or ruggedized series power meter and light source together and receive a convenient carry case with reference cords and mating sleeves. Operating manuals and batteries included. Multimode sources standard with ST style interface, Singlemode sources standard with FC style interface. Power meters supplied with universal 2.5mm and 1.25mm adapter caps.

PART #	DESCRIPTION	PRICE
F1-813LR	Hand Held PM (0.01dB Resolution) 850/1300nm Dual LED LS (ST Interface)	\$725.00
F1-1315LR	Hand Held PM (0.01dB Resolution) 1310/1550nm Dual Laser LS (FC Interface)	850.00
F1-1835LR	Hand Held PM (0.01 Res), 850/1300nm and 1310/1550nm Light Sources (FC/SM, ST/MM Interface)	1,175.00
F1-1835LRVFL	Hand Held PM (0.01 Res), 850/1300nm and 1310/1550nm Light Sources and VFL	1,275.00
F1-1345LR	Hand Held PM (0.01 Res) 1310nm, 1490nm, 1550nm Laser Light Source (FC Interface)	1,375.00
F1-LRDLXCASE	Hard Case for 3 units (empty)	130.00

## FIS POWER METER

A power meter is the essential tool for measuring optical power within a fiber optic link. The FIS Power Meter is a solid performer, with 0.01dB resolution. Standard FIS units test from +5dBm to -65dBm, and FIS CATV units test from +23dBm to -45dBm.

**Each Unit Includes:** Operating Manual, 9V Battery, 2.5mm and 1.25mm Adapters, and Carry Case.

Available AC Adapter

PART #	DESCRIPTION	PRICE
F1-8513HR	Hand Held Power Meter with 0.01dB Resolution	\$299.00
F1-8513HRCATV	CATV Hand Held Power Meter with 0.01dB Resolution	339.00
F1-8513HR-4	0.01dB Resolution Power Meter with 1310/1490/1550nm	399.00
F1-8513HRCATV-4	CATV 0.01dB Resolution Power Meter with 1310/1490/1550nm	419.00
F1-8513UM	2.5mm Universal Adapter (ST, FC, SC) (Polymer)	\$39.00
F1-8513SC	SC Adapter	49.00
F1-8513ST	ST Adapter	49.00
F1-8513FC	FC Adapter	49.00
F1-8513LCMUM	1.25mm Universal Adapter (Polymer)	39.00
F1-9103U	Universal 110/220v AC Power Supply Adapter	30.00

## FIS LIGHT SOURCE

The FIS Light Source is the perfect match for the FIS Power Meter. Singlemode units are equipped with lasers having a typical output power of -1.0dBm. Multimode units have LED's with a minimum output of -17dBm.

**Each Unit Includes:** Operating Manual, 9V Battery and Carry Case.

PART #	DESCRIPTION	PRICE
9052-0000	Dual 850/1300nm LED Light Source with ST Adapter	\$375.00
9055-0000	Dual 1310/1550nm Laser Source with FC Adapter	325.00
9056-0000	1490/1550nm Laser Light Source with FC Adapter	575.00
9058-0000	Dual 1300nm LED/1310nm Laser Source (ST and FC)	375.00
9056-1625	Dual 1490/1625 Laser Source	875.00
F1-9103U	Universal 110/220v AC Power Supply Adapter	30.00

## FIS RUGGEDIZED POWER METER AND LIGHT SOURCE

FIS Ruggedized loss test sets are designed to withstand outdoor field environments where traditional handheld units are not appropriate. Units are available for both multimode and singlemode applications and run on re-chargeable NiCd batteries. Please specify ST or FC adapter style when ordering any FIS Ruggedized Test Equipment. The Power Meter has an easy to read LCD display and germanium detector incorporating three wavelength (850nm, 1300nm, 1550nm) measurement capability. The Light Source is a dual wavelength source with a continuous wave or 2KHz modulation. The 850nm and 1300nm light source is for multimode applications. The 1310nm and 1550nm Light Source is for singlemode applications.

PART #	DESCRIPTION	PRICE
9086-0000	Ruggedized Light Source 850/1300nm with ST Adapters	\$675.00
9087-0000	Ruggedized Light Source 1310/1550nm with FC Adapters	1,345.00
9088-0000	Ruggedized Light Source 1490/1550nm with FC Adapters	1,595.00
F1-813RG	Ruggedized PM (0.01 Res) 850/1300nm LED Light Source (ST Interface)	1,250.00
F1-1315RG	Ruggedized PM (0.01 Res) 1310/1550nm Laser Light Source (FC Interface)	1,895.00
9080-0000	Ruggedized Power Meter with 2.5mm and 1.25mm Universal Adapter	600.00

**FIS E-SERIES POWER METER AND LIGHT SOURCE KIT**

The new FIS E-Series Power Meter and Light Sources are also available in kits. These kits come in either Singlemode, Multimode or Quad versions and with carrying case and all reference cords needed for testing any connection type you encounter.

PART #	DESCRIPTION	PRICE
F1-8513KIT	Multimode Kit (Power Meter with 0.01dB Resolution and Multimode Light Source, Dual 850/1300nm)	\$510.00
F1-1315KIT	Singlemode Kit (Power Meter with 0.01dB Resolution and Singlemode Light Source, Dual 1310/1550nm)	550.00
F1-ESQUADKIT	SM/MM Kit (Power Meter, MM Light Source 850/1300nm/ SM Light Source 1310nm/1550nm)	750.00

\* Add a DS to the end of the part number if you want the Power Meter with Data Storage version. **Call for pricing.**

**FIS E-SERIES POWER METER AND LIGHT SOURCE**

The FIS E-Series Power Meter and Light Source provide an industry leading value for handheld test gear. With a new design for ease of use, LED backlight and referencing, technicians will have no problem testing and trouble shooting fiber optic links.

**FEATURES**

- Light Sources (minimum output -7dBm)
- Continuous Wave (CW) or 2kHz Modulation
- Auto Shut Off and Low Battery Indicator
- 60-Hour Typical Battery Life for Light Source
- 200-Hour Typical Battery Life for Power Meter
- Absolute Power Reference Display

**Each Unit Includes:** Operating Manual, 9V Battery and Carry Case.

PART #	DESCRIPTION	PRICE
F1-8513PM	Power Meter with 0.01dB Resolution	\$185.00
F1-8513PMVF	Power Meter with VFL	249.00
F1-8513PMDATA	Power Meter with Data Storage (1,000 Files)	295.00
F1-8513PMCATV	CATV Power Meter with 0.01dB Resolution	185.00
F1-8513LS	Multimode Light Source, Dual 850/1300nm	249.00
F1-1315LS	Singlemode Light Source, Dual 1310/1550nm	295.00
F1-QUADLS	FIS SM/MM Source, 850/1300/1310/1550	495.00
F1-FR15A	FIS Fiber Ranger (Fault Finder) - APC with VFL	695.00
F1-FR15U	FIS Fiber Ranger (Fault Finder) - UPC with VFL	695.00
F11314LSU	E-Series Triwave Source 1310/1490/1550 (UPC)	525.00
F11314LSA	E-Series Triwave Source 1310/1490/1550 (APC)	525.00
F11316LSU	E-Series Triwave Source 1310/1550/1625 (UPC)	695.00
F11316LSA	E-Series Triwave Source 1310/1550/1625 (APC)	695.00

**FIS E-SERIES PON POWER METER**

Intended for Fiber to the Home applications, it is able to simultaneously test and provide power readings on the signals of voice, data and video. An ideal tool for construction and installation technicians. Features interchangeable adapters, calibrated for 1310/1490/1550nm wavelengths. Our next generation PON Power Meter will also satisfy testing PON systems at 1270nm and 1577nm wavelengths.

**FEATURES**

- Interchangeable adapters (FC & SC)
- Calibrated for 1310/1490/1550nm wavelengths
- Reporting with Data Storage
- User Defined Pass/Fail Thresholds
- XGPON Power Meter calibrated for 1310/1490/1550nm & 1270/1577nm wavelengths

PART #	DESCRIPTION	PRICE
F1-1345PONA	FIS PON Power Meter APC	\$695.00
XGPON	FIS Next Generation Power Meter 1270/1577nm (APC)	1,195.00

**FIS FIBER OPTIC TALK SET**

The FIS Fiber Optic Talk Set units are designed for transmitting voice in both directions on a single fiber using two different wavelengths. Works with SM or MM fiber. Units include adjustments for power and sensitivity. The built in VOX (sensitivity) circuit is meant to conserve battery power when the operator is not speaking. In addition the unit also comes with a rechargeable 9V 540mAh battery and a charging port for in-unit charging. The Talk Set comes standard with SC or FC adapter ports. The loss budget for Multimode is 15dB; Singlemode is 20dB. Finally, each Talk Set comes equipped with a stereo headset with boom microphone, providing comfort for long-term use and high performance.

**Talk Set includes:** (2) Units, (2) Headphones with Microphone, (2) 9V Batteries

PART #	DESCRIPTION	PRICE
F1-9062TKS	FIS Singlemode/Multimode Talk Set (pair) w/ FC and SC Adapters	\$995.00 (pair)







## EXFO MAXTESTER 940/945 TELCO OLTS

The first tablet-inspired multifunction optical loss test set (OLTS) measuring insertion loss (IL), optical return loss (ORL) and fiber length at two wavelengths in 5 seconds via fully automated bidirectional FasTes™ analysis.

**Each Unit Includes:** AC Charger, Rechargeable lithium-polymer, Case and Shoulder Strap.

PART #	DESCRIPTION	PRICE
MAX-945-SM1-XX	OLTS, IL, Length & ORL Measurement, SM 1310/1550nm, InGaAs detector, connectors to be specified	\$5,635.00
MAX-945-SM1-RF-VFL-XX	OLTS, IL, Length & ORL Measurement, SM 1310/1550nm, InGaAs detector, Wi-Fi/Bluetooth, VFL, connectors to be specified	6,290.00
MAX-945-SM3-XX	OLTS, IL, Length & ORL Measurement, SM 1310/1550/1625nm, InGaAs detector, connectors to be specified	7,375.00
MAX-945-SM3-RF-VFL-XX	OLTS, IL, Length & ORL Measurement, SM 1310/1550/1625nm, InGaAs detector, Wi-Fi/Bluetooth, VFL connectors to be specified	8,030.00
MAX-945-SM4-XX	OLTS, IL, Length & ORL Measurement, SM 1310/1490/1550nm, InGaAs detector, connectors to be specified	6,905.00
MAX-945-SM4-RF-VFL-XX	OLTS, IL, Length & ORL Measurement, SM 1310/1490/1550nm, InGaAs detector, Wi-Fi/Bluetooth, VFL, connectors to be specified	7,560.00
MAX-945-iCERT-Q1-QUAD-XX	OLTS, IL, Length Measurement, ORL on SM port, Simplex cable test (on SM port) and Duplex cable test, Tier-1 Certification per international standards, EF compliant 50/125µm, Port 1 MM 850/1300nm, Port2 SM 1310/1550nm, InGaAs detector, connectors to be specified	7,340.00
MAX-945-iCERT-Q1-QUAD-RF-VFL-XX	OLTS, IL, Length Measurement, ORL on SM port, Simplex cable test (on SM port) and Duplex cable test, Tier-1 Certification per international standards, EF compliant 50/125µm, Port 1 MM 850/1300nm, Port2 SM 1310/1550nm, InGaAs detector, Wi-Fi/Bluetooth, VFL, connectors to be specified	7,995.00

Call For Configurator Connector Options (VFL or Video Probe).

## EXFO OPTICAL POWER EXPERT

State-of-the-art power meter with Bluetooth connectivity, a wide touchscreen and best-in-class optical performances in a pocket-sized form factor. Turns on instantly for use on the go and available in two configurations: PX1 and PX1-PRO. The PX1 includes 11 calibrated wavelengths. The PX1-PRO has an integrated visual fault locator, auto-wavelength recognition and switching, has 45 calibrated wavelengths and comes in a soft pouch. Both the PX1 and PX1-PRO are available with either standard InGaAs detector (10 to -70 dBm) or high-power InGaAs detector (26 to -50 dBm).

### FEATURES

- Connect to smart app via Bluetooth: data reporting from the field, cloud storage, workflow management
- User-friendly: Compact, color touchscreen and intuitive interface
- Robust and rugged: IP54 design for dust and water protection
- Time-saving features: no offset nulling, lightning-fast boot-up
- Data storage
- Error-free, automated wavelength recognition and switching (on PRO)
- 3-year warranty and calibration interval
- Visual fault locator (on PRO)

PART #	DESCRIPTION	PRICE
PX1-S-XX	InGaAs detector, 11 Calibrated Wavelengths	\$640.00
PX1-H-XX	High-power InGaAs detector, 11 Calibrated Wavelengths	695.00
PX1-PRO-S-XX	InGaAs detector, VFL, 45 Calibrated Wavelengths organized in wavelength bundles, Wavelength edition (1nm steps), Auto wavelength recognition & switching, Soft pouch carry case	895.00
PX1-PRO-H-XX	High-power InGaAs detector, VFL, 45 Calibrated Wavelengths organized in wavelength bundles, Wavelength edition (1nm steps), Auto wavelength recognition & switching, Soft pouch carry case	945.00



EXFO OPTICAL POWER EXPERT



AFL iB1 base OTR Module

## AFL ROGUE® OLTS AND CERTIFICATION KITS

ROGUE OLTS test sets use state-of-the-art technology to produce the most accurate results in the shortest amount of time. Modules contain bi-directional test ports as well as an optical power meter port and visual fault locator. All Multimode ports are Encircled Flux compliant as required by ANSI/TIA and ISO/IEC. ROGUE users can easily turn the OLTS solution into a full Tier 1 certifier simply by adding our TURBO Certification app (via Google Play).

PART #	DESCRIPTION	PRICE
RGK-CERT01	ROGUE Quad Certification Kit with cB1 Compact Base	\$8,500.00
RGK-CERT02	ROGUE Dual Engine SM + MM Certification Kit with cB1 Compact Base	17,500.00
RGK-CERT03	ROGUE Dual Engine SM Certification Kit with cB1 Compact Base	9,900.00
RGK-CERT04	ROGUE Dual Engine MM Certification Kit with cB1 Compact Base	8,250.00
RGK-CERT01B1	ROGUE Quad Certification Kit with iB1 Intelligent Base	9,950.00
RGK-CERT02B1	ROGUE Dual Engine SM + MM Certification Kit with iB1 Intelligent Base	18,900.00
RGK-CERT03B1	ROGUE Dual Engine SM Certification Kit with iB1 Intelligent Base	11,350.00
RGK-CERT04B1	ROGUE Dual Engine MM Certification Kit with iB1 Intelligent Base	\$9,700.00
RGK-CERT01-PRO	ROGUE Quad Certification Pro Kit with cB1 Compact Base, FOCIS Flex and cleaning	16,900.00
RGK-CERT01B1-PRO	ROGUE Quad Certification Kit with iB1 Intelligent Base, FOCIS Flex and cleaning	17,900.00
RGK-OLTS03	ROGUE Dual Engine SM OLTS Kit with cB1 Compact Base	4,280.00
RGK-OLTS03B1	ROGUE Dual Engine SM OLTS Kit with iB1 Intelligent Base	5,050.00
RG-1100-M01-D	Rogue Dual Engine Turbo OLTS Module 850/1300	2,600.00
RG-1100-Q01	Rogue Quad Turbo OLTS Module 850/1300/1310/1550	2,800.00
RG-1100-S01-D	Rogue Dual Engine Turbo OLTS Module 1310/1150	2,950.00

## EXFO FIBERBASIX 50 SERIES POWER METER/LIGHT SOURCE

The EPM-50 Power Meter allows power measurements up to 26 dBm with battery life of over 300 hours. It comes with a specific high power configuration for CATV and Telco markets. The ELS-50 Light Source offers the power stability and reliability necessary to perform loss measurement in Telco, CATV and FTTH applications using dual and triple wavelengths. Additional kits available.

**Each Unit Includes:** Soft pouch, PMA-22 FC connector adapter, LSA-89 FC connector adapter, quick reference sticker in five languages, Certificate of Calibration, Certificate of Compliance, and three AA batteries. **Other Adapters Available on pg 45.**

PART #	DESCRIPTION	PRICE
ELS5012CRBLSA89	Dual MM 850/1300nm LS with Rubber Boot, FC Adapter	\$630.00
ELS5023BLRBLSA89	Dual SM 1310/1550nm LS with Rubber Boot, FC Adapter	1,490.00
EPM53RBPMA22	Power Meter with InGaAs Detector, Rubber Boot, FC Adapter	375.00
EPM53XRBPMA22	Power Meter with High Power In GaAs Detector, FC adapter	415.00



FIBERBASIX 50 SERIES

## MPC-103 OPTICAL POWER CHECKER

This micro optical power checker brings optical testing capability to your Android or iOS smart device. The MPC-100 is an innovative optical power checker enabling smart device connectivity via Bluetooth. Paired with the FIP-425B or FIP-435B Wi-Fi inspection probes, this easy-to-use power checker lets you take full advantage of smart device connectivity. You can manage all your results in one place and lower the cost of ownership by utilizing your smart device to its full potential.

PART #	DESCRIPTION	PRICE
MPC-103	Bluetooth Micro Power Checker, InGaAs detector, 850,980,1300,1310,1490,1550,1625nm, Range: -60 to 10 dBm	\$455.00
MPC-103X	Bluetooth Micro Power Checker High Power InGaAs detector, 850,980,1300,1310,1490,1550,1625nm Range: -45 to 23 dBm	505.00



MPC-103

## EXFO FOT-300/600 OPTICAL LOSS TEST SET (OLTS)

The FOT-300 OLTS has both a built-in power meter and light source for bi-directional testing without technicians needing to exchange equipment.

The FOT-600 features a pass/fail LED indicator and lets technician set their own thresholds of absolute or relative loss measurements. When utilizing auto-switching mode, the light source automatically toggles between available wavelengths. The unit recognizes the wavelength in use and switches to proper calibration parameter. The FOT-600 has both built in power meter and light source for bi-directional testing.

### FEATURES FOT-300

- Auto-Wavelength Recognition
- Distance Referencing
- No offset Nulling
- FTTx Ready units available with 1490nm
- Factory Warranty – 3 years

### FEATURES FOT-600

- 40 calibrated wavelengths, including all CWDM wavelengths
- Memory capacity of 1000 data items
- Built-in reporting software with data transfer to a PC via USB connection
- No offset Nulling
- Built-in Visual Fault Locator
- Factory Warranty – 3 years

PART #	DESCRIPTION	PRICE
FOT-302-12D-YY	FOT-300 OLTS Power Meter, Dual 850/1300nm LED(62.5/125µm)	\$1,590.00
FOT-302X-23BL-YY	FOT-300 OLTS High Power Ge Power Meter, Dual 1310/1550nm Laser	2,225.00
FOT-302X-235BL-YY	FOT-300 OLTS High Power Ge Power Meter, Tri 1310/1490/1550nm	3,185.00
FOT-602X-23BL-YY-VFL	FOT-602 OLTS High Power Ge Power Meter, Dual 1310/1550nm Laser , VFL	2,600.00

X- indicate power meter adapter (FOA-54=SC, FOA-98=LC, FOA-22=FC, FOA-32=ST)  
YY- indicate source adapter (EUI-91=SC/UPC, EUI-89=FC/UPC, EUI-90=ST/UPC)



FOT-300

FOT-600

## EXFO PON POWER METER

The PPM-350D power meter is the first PON-aware™ power meter to automatically detect and test next-gen and legacy PON technologies: GPON, EPON, 10G-EPON, XG(S)-PON, NG-PON2 and RF overlay. Pass/Fail indicators for easy assessment of power values. The most easy-to-use instrument of its kind: simply connect the fiber and read the results.

**Includes:** Quick Reference Guide, USB Cable, Software, User Guide on CD, Wrist Strap, and Protective Cover for Optical Ports.

PART #	DESCRIPTION	PRICE
PPM-350D-SR-EA-EUI-91	PPM-350D Next-Gen PON Power Meter, SC/APC Connector Interface	\$2,470.00
PPM-350D-DR-VFL-EA-EUI-91	PPM-350D Next-Gen PON Power Meter, with VFL, SC/APC Connector Interface	4,170.00
PPM-350C - PPM-352C-XX	PON Power Meter, 2 Ports, Extended range - BPON, EPON, GPON   FTTH mode: 1310/1490/1550 nm	1,745.00
PPM-350C-VFL - PPM-352C-VFL-XX	PON Power Meter, 2 Ports, Extended range - BPON, EPON, GPON   FTTH mode: 1310/1490/1550 nm, Visual Fault Locator	2,115.00



EXFO PON POWER METER

## AFL SMLP5-5 SM/MM LOSS TEST KIT

An essential tool for certifying Singlemode and Multimode fiber networks to industry standards. Included TRM™ PC Reporting Software is a powerful tool for analyzing test results, applying industry standards, and generation of comprehensive certification reports using supplied industry accepted templates.

AFL SMLP5-5 test kit is ideally suited for testing Singlemode and/or Multimode fiber optic networks and cables. The OPM5-2D and OLS4 offer long battery life from common AA alkaline batteries with external AC adapter available as an option. The SMLP5-5 test kit is fully N.I.S.T. traceable.

**Includes:** (1) OLS4 Optical Light Source, (1) OPM5-2D Optical Power Meter, AA Batteries, Protective Rubber Boots, Adapter Cap, USB Cable, Windows® Compatible Software User's Guide, 50µm and 62.5µm Mandrels, and Carry Case.

PART #	DESCRIPTION	PRICE
SMLP55FC	AFL Quad Optical Loss Test Kit with FC Adapters	\$2,695.00
SMLP55LC	AFL Quad Optical Loss Test Kit with LC Adapters	2,695.00
SMLP55SC	AFL Quad Optical Loss Test Kit with SC Adapters	2,695.00
SMLP55ST	AFL Quad Optical Loss Test Kit with ST Adapters	2,695.00



SMLP-5





F1-CI1100



F1-DI2000



monitor sizes may vary

F1-VM400LCD



F1-MS200U



F1-VS400U



F1-VSF25

**FIS FIBER OPTIC INSPECTION MICROSCOPE**

**MONITOR MODULE**

- 3.5" TFT-LCD Screen with adjustable brightness and contrast
- 9.6V battery pack and AC power supply (4hr Life)
- Includes charger adapters for US, EU, UK and Australian standard

**FEATURES**

- Fast, easy focus with one hand operation
- Inspect patchcords (male) and in-adapter connectors (female)
- Comprehensive line of tips for both PC and APC type connectors

**HANDHELD VIDEO INSPECTION PROBE**

- 400x Magnification
- Resolution – 0.5µm detectable
- Manual focus adjustment

PART #	DESCRIPTION	PRICE
F1-DI1000	FIS Digital USB Inspection Probe Kit	\$875.00
F1-DI2000	FIS Digital USB Inspection Probe Kit with Auto Focus	975.00
F1-CI1100	FIS Digital USB Inspection Probe and Monitor Kit	1,195.00

**FIS PROBE ADAPTER TIPS \*Call For More Tip Options**

PART #	DESCRIPTION	PRICE
F1-PT2U25APCM	Universal 2.5mm probe tip for APC male connectors	\$75.00
F1-PT2FSAPCF	Tip for SC and FC APC female connectors	75.00
PT2SCPCFL	Long Extended tip for SC PC female connectors	260.00
PT2LCPCFL	Long Extended tip for LC PC female connectors	260.00
PT2MTPAPCEXT	Extended tip for MTP/APC 12-Fiber connectors	375.00

**FIS VIDEO MICROSCOPE**

The FIS Video Microscope is a natural choice for fast-paced production environments, where ease of use and fast, accurate inspections are a necessity. The microscope offers a high-resolution look at the end face of most standard connectors, with a choice of either 200x or 400x magnifications. The optics and internal components are designed to be rugged and reliable, with no user-serviceable parts.

**Each Package comes with:** (1) Video Microscope, (1) 10" LCD monitor (monitor sizes may vary), (1) 6" Video Cable, (1) 2.5mm Universal Adapter only

PART #	DESCRIPTION	PRICE
F1-VM200LCD	200x Video System (110v)	\$695.00
F1-VM400LCD	400x Video System (110v)	695.00
F1-VM200PLCD	200x Video System (220v)	795.00
F1-VM400PLCD	400x Video System (220v)	795.00
F1-VM200USB	200x, USB (No LCD Monitor included)	470.00
F1-VM400USB	400x, USB (No LCD Monitor included)	470.00

**FIS UNIVERSAL 100x MICROSCOPE**

The FIS Universal Microscope is provided with a 2.5mm universal faceplate. Insert the ferrule into the microscope and inspect the end face with ease. This complete 100x microscope is perfect for multimode connectors and is easy to use.

PART #	DESCRIPTION	PRICE
F1-VSF25	LED Fiber Inspection Scope with Universal 2.5mm UPC/APC Adapter for SC/ST/FC	\$65.00
F1-VSF125	LED Fiber Inspection Scope with Universal 1.25mm UPC/APC Adapter for LC/MU	70.00

**FIS 200x MINI FIBER MICROSCOPE**

Utilize this compact scope to inspect connector ferrule end faces for dirt, debris or oils that may interfere with signal transmission. Scope has both Oblique and Coaxial white LED lighting.

**Includes:** Microscope, (3) 1.5v LR44 Button Batteries, 2.5mm adapter, 1.25mm adapter

PART #	DESCRIPTION	PRICE
F1-MS200U	Compact 200x Microscope	\$115.00

**FIS 200x AND 400x MICROSCOPE**

These low cost, high quality microscopes are available in 200x or 400x magnification, and utilize white LED light to provide coaxial illumination of connector end faces. Three AAA batteries provide more than 40 hours of use before battery replacement is required. Provided with a universal 1.25mm and a 2.5mm adapter, with other connector styles available. Dimensions: 8.76" L x 2.16" H

PART #	DESCRIPTION	PRICE
F1-VS200U	200x Microscope with 1.25mm and 2.5mm Universal Adapter	\$110.00
F1-VS400U	400x Microscope with a 1.25mm and 2.5mm Universal Adapter	115.00

**MICROSCOPE ACCESSORIES**

Adapters are for use with the FIS Video Microscope VM Series and F1-VS200/400U Series.

PART #	DESCRIPTION	PRICE
F1-VS12U	Universal 1.25mm Adapter	\$60.00
F1-VS25	Universal 2.5mm Adapter	60.00
F1-VSAPC25	Universal 2.5mm APC Adapter	60.00
F1-VSLC	LC Simplex Adapter	60.00
F1-VSSMA	SMA Adapter	60.00





**AFL FOCUS FLEX FIBER OPTIC CONNECTOR INSPECTION SYSTEM**

FOCIS Flex is an ultra-compact Fiber Optic Connector Inspection System Scope utilizing the latest liquid lens technology for fast auto-focus, centering and PASS/FAIL analysis. Results can be stored locally or easily shared via USB, Wi-Fi and Bluetooth®.

PART #	DESCRIPTION	PRICE
FOCIS-FLX-P4XN	FOCIS FLEX, Wireless, No Tips	\$1,895.00
FOCIS-FLX-P4XU	FOCIS FLEX, Wireless, UPC Tips	\$1,995.00
FOCIS-FLX-P4XA	FOCIS FLEX, Wireless, Angled Tips	\$2,095.00
FOCIS-FLX-P4XUA	FOCIS FLEX, Wireless, UPC and Angled Tips	\$2,195.00
FOCIS-FLX-NW-P4XN	FOCIS FLEX, No Wireless, No Tips	\$1,895.00
FOCIS-FLX-NW-P4XU	FOCIS FLEX, No Wireless, UPC Tips	\$1,995.00
FOCIS-FLX-NW-P4XA	FOCIS FLEX, No Wireless, Angled Tips	\$2,095.00

**AFL FOCUS DUEL FIBER OPTIC CONNECTOR INSPECTION SYSTEM**

FOCIS Duel is a self-contained twin-ported Bluetooth connected fiber optic connector inspection probe with integrated screen. The first port (right hand side Port 1) is fully featured, identical to AFL's FOCIS Flex. The second port (left hand side Port 2) has fast and convenient female style LC "click-in" adapters (as well as SC and FC tip adapters), auto-focus and 2X zoom capabilities. The FOCIS Duel can perform IEC, IPC, AT&T and user defined end-face cleanliness analysis and store Port 1 images and reports locally. The AFL FOCIS App (iOS and Android) provides a comprehensive and user-friendly feature set as well as connectivity with AFL's cloud-based aeRos® workflow automation platform.

**Each FOCIS Duel Kit includes:** FOCIS Duel probe with wrist strap and dust cap, AC charger with country-specific plug, USB cable, quick reference guide, and soft carry case with strap.

PART #	DESCRIPTION	PRICE
FOCIS-DUEL-A	FOCIS Duel Kit, with 2 user-selected APC tips and One-Click®	\$2,695.00
FOCIS-DUEL-N	FOCIS Duel Kit, with No tips or One-Click	2,495.00
FOCIS-DUEL-U	FOCIS Duel Kit, with 2 user-selected UPC tips and One-Click	2,595.00
FOCIS-DUEL-UA	FOCIS Duel Kit, with 2 user-selected UPC a APC tips and One-Clicks	2,795.00

**FIBER INSPECTION PROBES (FIP-410B/420B/425B/435B) AND TIPS**

An intelligent and automated inspection tool. The 420B features automatic, fiber image-centering function to reduce test time. The Probe has on-board connector end face analysis via ConnectorMax2. Includes a Pass/Fail indicator for immediate diagnosis of connector cleanliness. The FIP-430B is 100% automated and the first of its kind. The probe will auto detect, center, focus, analyze and report findings of connector end face.

PART #	DESCRIPTION	PRICE
FIP-410B-XX	USB Digital Video Inspection Probe with Triple Magnification (probe only)	\$1,645.00
FIP-420B-XX	USB Digital Video Inspection Probe with Automated Pass/Fail analysis, Auto Centering and Triple Magnification (probe only)	2,435.00
FIP-425B-XX	Wireless Digital Video Inspection Probe, Automated Pass/Fail Analysis, Triple Magnification and Auto-centering	3,390.00
FIP-430B-XX	USB Digital Video Inspection Probe with Auto Focus, Auto Capture, Auto Detect, Automated Pass/Fail analysis, Auto Centering and Triple Magnification (probe only)	2,970.00
FIP-435B-XX	Wireless Digital Video Inspection Probe, Automated Focus, Automated Pass/Fail Analysis, Triple Magnification and Auto-centering	3,915.00
FIPT-400-U12M	Universal patch cable tip 1.25mm ferrules	82.00
FIPT-400-U25M	Universal patch cable tip 2.5mm ferrules	82.00
FIPT-400-U25MA	Universal patch cable tip 2.5mm APC ferrules	140.00
FIPT-400-U12MA	Universal patch cable tip 1.25mm APC ferrules	140.00
FIPT-400-FC-SC	FC and SC tip for bulkhead adapter	82.00
FIPT-400-FC-APC	FC/APC tip for bulkhead adapter	140.00
FIPT-400-SC-APC	SC/APC tip for bulkhead adapter	170.00
FIPT-400-LC	LC tip for bulkhead adapter	82.00
FIPT-400-LC-APC	LC/APC tip for bulkhead adapter	170.00

**MAX-FIP AND OPTIONS**

New Rugged tablet inspired design with latest innovations in automated connector and fiber certification. Features a bright 7-inch touchscreen display. Power meter and VFL options. Available automatic fiber image centering to reduce test time. Choose from (3) probe options.

PART #	DESCRIPTION	PRICE
TK-MAX-FIP-410B	Handheld Display with Digital Inspection Probe, Manual Center/Focus	\$2,330.00
TK-MAX-FIP-420B	Handheld Display with Digital Inspection Probe, Auto Center, Auto Pass/Fail Analysis Software	3,048.00
TK-MAX-FIP-430B	Handheld Display with Digital Inspection Probe, Auto Center, Auto Focus, Auto Pass/Fail Analysis Software	3,550.00
P2X-XX	Built in Power Meter	745.00
VP2X-XX	Built in Power Meter and VFL	990.00
GP-2177	Utility Glove for MAX-FIP	88.00
GP-2179	Glove harness	31.00



FOCIS FLEX

FOCIS DUEL



MAX-FIP





A



D

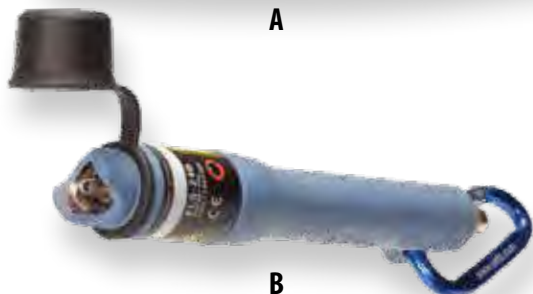

B



E



C



F



Fault Locators are a special class of light sources that emit a high intensity visible Red Laser into a patch cable or cable. This light can be used to both check the continuity of a fiber and identify the fiber's far end, or it can be used to visually identify the location of a fiber break. Most Fault Locators come optimized for singlemode fiber use; however they work equally as well with multimode fiber.

	A	B	C	D	E	F
<b>Manufacturer</b>						
<b>Part Number</b>	FFL-050	FLS-241-UNIV	VISIFALT	F6230A	HILITE	VFF5
<b>Type</b>	Pocket	Pocket	Pocket	Pocket	Pocket	Pocket
<b>Operating Wavelength</b>	650nm	635nm	650nm	650nm	650nm	650nm
<b>Distance</b>	7km   5km	5km	4km   3km	8km	4km	5km   5km
<b>Fiber Type</b>	SM/MM	SM/MM	SM/MM	SM/MM	SM/MM	SM/MM
<b>Battery Life/Type</b>	30hrs (2AA)	50hrs(2AAA)	80hrs(2AA)	N/A(1AA)	4hrs(1AAA)	80hrs (2AA)
<b>Optical Interface</b>	2.5mm Universal	2.5mm Universal	2.5mm Universal	2.5mm Universal	2.5mm Universal	2.5mm Universal
<b>Dimension</b>	4.5" x 1.4" x 0.8"	6.875" x 1"	6.2" x 2.0" x 1.3"	6.2" x 0.63" x 2.36"	2.8" x 1.4" x 0.6"	8.7" x 1.25"
<b>Special Feature</b>	Ruggedized Housing	Weather Proof	Long Battery Life	Low Battery Indicator	Small Key Chain Size	Rugged Aluminum Housing
<b>Price</b>	<b>\$195.00</b>	<b>\$395.00</b>	<b>\$398.00</b>	<b>\$169.95</b>	<b>\$180.00</b>	<b>\$298.00</b>



**FIS DUAL SOURCE VISUAL FAULT LOCATOR**

Fiber Instrument Sales introduces its Dual Source Visual Fault Locator made for duplex LC connectors. Because LC connectors are commonly clipped together this product eliminates the common mistake that is made of crossing Tx and Rx patchcords to active equipment. This unit allows the user to toggle between the "A" and "B" sources to ensure that everything is properly connected.

**Each Unit Includes:** Carrying pouch, 9V Battery, User Manual, One Year Warranty

**FEATURES**

- Dual visual fault locator for duplex LC cables
- 9 volt battery included
- Small handheld design
- Easy to identify the fault's location
- Easy verification of duplex cable polarity
- Quick identification of continuity of installation
- Low battery indicator light
- "A" and "B" source indicator lights
- Ergonomically friendly handheld soft case
- Plug and Play LC mating sleeve allows for secure connection
- Can activate single or both sources simultaneously, one modulates while one is constant



F1-DXVFL

PART #	DESCRIPTION	PRICE
F1DXVFL	FIS Dual Source Visual Fault Locator	\$295.00



F1-9000



F1-9000VFL

**FIS POCKET FAULT LOCATORS**

PART #	DESCRIPTION	PRICE
F1-9000	Pocket Fault Locator with 2.5 Universal Adapter (SM and MM), Rugged Aluminum Housing, 30hr Battery Life, 650nm, Blue	\$79.95
F1-9000VFL	Pocket Fault Locator with 2.5 Universal Adapter (SM and MM), Standard Aluminum Housing, 50hr Battery Life, 650nm, Black	69.95

**VFL ACCESSORIES**

PART #	DESCRIPTION	PRICE
F1-90125	1.25mm Adapter (Compatible with PFLs using Universal 2.5mm Adapters)	\$30.00

**FIS VISUAL FAULT LOCATOR**

The FIS Visual Fault Locator is an essential tool for troubleshooting a fiber optic system. A 1mW packaged laser sends a 650nm visible red light down the length of the fiber. The escaping light allows easy identification of breaks or severe macro bends. Internal optics are used to optimize the unit's performance for either singlemode or multimode applications. Fiber end identification and continuity testing for long distances are also natural applications.

**Each Unit Includes:** Manual, (1) 9v Batteries, and Carry Case.

PART #	DESCRIPTION	PRICE
OF-1000-UF	Visual Fault Locator with 2.5mm Universal Adapter (MM and SM)	\$295.00
OF-1000U-LC	Visual Fault Locator with LC Adapter (MM and SM)	295.00
OF-1000U-FCA	Visual Fault Locator with FC/APC Adapter (SM)	395.00
OF-1000U-SCA	Visual Fault Locator with SC/APC Adapter (SM)	395.00



OF-1000-UF

**FIS CONTINUITY TESTER**

A Continuity Tester enables you to easily verify light throughput as the LED transmits red light down the fiber, providing visual identification at the fiber's far end. Operates with two "AA" size batteries (provided).

**Recommended for Multimode Use Only. Each Unit Includes:** Tester and (2) AA Batteries.

PART #	DESCRIPTION	PRICE
F1-5000U	Fiber Continuity Tester 2.5mm Universal (ST, FC and SC)	\$29.95
F1-5000	Fiber Continuity Tester (ST)	29.95
F1-5000SMA	Fiber Continuity Tester (SMA)	39.95
F1-5000FC	Fiber Continuity Tester (FC)	29.95
F1-5000SC	Fiber Continuity Tester (SC)	29.95
F1-5000LC	Fiber Continuity Tester (LC)	29.95



F1-5000 SC





F1-850MPO



Ruggedized Version



MPOACCESSORYKITSM



F1EFRC-OM3

# FIS MPO TEST SET

This 12 Fiber MPO/MTP Test Set will provide the technician with link attenuation readings over all 12 fibers of the MPO/MTP ferrule in 10 seconds. MPO/MTP connectors are growing in popularity so the ability to measure efficiently, quickly and accurately the correct location of each fiber and its attenuation can assist technicians for certification. The test set will recognize A, B or C polarity wiring configurations used in the industry. Includes MPO/MTP to MPO/MTP reference cables, and reporting software.

\*MPO/MTP to LC Breakout cable available upon request

## FEATURES

- Singlemode or Multimode
- 12 Position Light Source and Power Meter
- Pass/Fail Reporting
- dBm/dB check criteria
- Select A, B or C Polarity
- USB Data Transfer
- Two Reference Cords with MTP Pro Connectors



F1-1310MPO

PART #	DESCRIPTION	PRICE
F1-850MPO	FIS MPO 12 Fiber Test System (850nm Source)	\$6,995.00
F1-1310MPO	FIS MPO 12 Fiber Test System (1310nm Source)	6,995.00
F1-1550MPO	FIS MPO 12 Fiber Test System (1550nm Source)	6,995.00

\* Call for pricing on individual Power Meter and/or Light Source units.  
 \* For ruggedized version add "R" to the end of the part number - Adds \$100.00 to price.

## FIS MPO ACCESSORY KITS

PART #	DESCRIPTION	PRICE
MPOACCESSORYKITMM	MPO Accessory Kit for Multimode OM3 MPO Accessory Kit includes: IBC MTP/MPO Cleaner, US Conec MTP gender change tool and mating sleeves & MM OM3 Reference Cord	\$495.00
MPOACCESSORYKITSM	MPO Accessory Kit includes: IBC MTP/MPO Cleaner, US Conec MTP gender change tool and mating sleeves & SM Reference Cord	495.00

## FIS MPO ENCIRCLED FLUX REFERENCE CORD

Ever increasing network speeds and tighter loss budgets make qualifying multimode fiber links a formidable challenge. Part of the challenge can stem from test instruments. In some scenarios different test instruments can produce different measurement results on the same network due to variations in launch conditions between test sources. Encircled Flux (EF) standards, TIA-526-14-B and IEC 61280-4-1 Ed. 2.0, define a method of controlling multimode launch conditions for optical test sources. More consistent test source launch conditions equate to more accurate and repeatable measurements. This is the goal driving the migration to encircled flux standards.

PART #	DESCRIPTION	PRICE
F1EFRC-OM3	OM3 Encircled Flux Reference Cord	\$299.95

**CHECK OUT THE MPO CLEANING SUPPLIES ON PAGES 116 & 117**

# SPLICING



Standard kit package with FIS CA6 Splicer, FC6 precision cleaver, one extended life battery, and electrodes



Quantity Pricing Available

## FEATURES

- Fast Splice Time – 6 Seconds in Singlemode Quick Mode
- 5" High Resolution Touch Screen
- 300 Splice and Heat Cycle per Battery
- Perfect for use with Splice-On Connectors

### FIS CA6 CORE ALIGNMENT SPLICER

Featuring a brand-new 5" touch screen and user interface, FIS' new CA6 core alignment fusion splicer is the latest enhancement to its fusion splicer offering. With the contractor in mind, the FIS CA6 is compact, lightweight, and faster than ever: with a 6 second splice time in SM Quick Mode and 15 second heat shrink time. Fully compatible with FIS Cheetah and Armordillo Splice on Connectors, this is the perfect fusion splicer for both premise and long-haul applications.

PART #	DESCRIPTION	PRICE
F1-CA6	CA6 Core Alignment Fusion Splicer kit w/ FC-6RS cleaver, Cheetah SOC Holder, Spare Electrodes, Sheath Clamps	\$7,495.00

### CA6 ACCESSORIES

PART #	DESCRIPTION	PRICE
FHS-025	250um Removable Fiber Holder (Pair)	\$300.00
FHS-09	900um Removable Fiber Holder (Pair)	300.00
ER-10	CA6 Electrodes	100.00
BU-16	CA6 Li-ion Battery	367.00

### FIS AC5 SOC HANDHELD FUSION SPLICER KIT

The FIS AC5 Active Clad Fusion Splice kit is an affordable and effective kit for doing fiber to fiber splicing as well as for FIS' line of Cheetah and Armordillo Splice on Connectors. With industry leading splice time of 6 seconds per splice, the kit also comes with our 900um SOC holder and 3.0mm cordage holder, standard crimp tool for the 3.0mm Armordillo solution, and our FIS external SOC oven for your large form SOC terminations. A solution for all of your splicing needs, the FIS AC5 Termination Kit will exceed your expectations, and more importantly, stay under your budget.

### FEATURES

- Active V-Groove Alignment
- 5" Touch Screen Monitor
- Long-life battery (200 splices/ shrinks per charge)
- Fully ruggedized for shock resistance
- Optimized kit for SOC and fiber to fiber applications

PART #	DESCRIPTION	PRICE
F1-SOCAC5	AC5 Splice-On Connector Termination Kit (Fusion Splicer, Cleaver, Universal SOC Oven, 900um SOC Holder, 3mm Cordage Holder, and Crimp Tool)	\$2,995.00



F1SOCAC5



**CONTACT FIS  
TO FIT YOUR  
LEGACY  
SPLICER TODAY!**



**900µm CHEETAH SOC™ ACCESSORIES**

PART #	DESCRIPTION	PRICE
F1SOCMTLCA6	FIS Metal SOC Holder for FIS CA6 Splicer	\$100.00
F1-SOCMTLA	FIS Metal SOC Holder for the AFL Splicers	100.00
F1-SOCMTLF	FIS Metal SOC Holder for the OFS Fitel Splicers	100.00
F1SOCSLAF2	FIS Metal SOC Holder for the OFS Fitel Splicers (NINJA and S179)	100.00
F1-SOCMTLS	FIS Metal SOC Holder for the Sumitomo Splicers	100.00
F1-FTLSHELF	FIS Utility/SOC Oven Shelf for Fitel Splicers	49.95
F1-AFL7SHELF	FIS Utility/SOC Oven Shelf for AFL Splicers	49.95
F1-UNIVSOVEN	Cheetah and Armordillo Splice-On Connector Sleeve Oven	395.00

**3/2mm ARMORDILLO SOC™ ACCESSORIES**

PART #	DESCRIPTION	PRICE
F1-UNIVSOVEN	Cheetah and Armordillo Splice-On Connector Sleeve Oven	\$395.00
F1-SOC30FISHDRCA6	FIS 3.0mm SOC Cordage Holder for FIS (CA6) Splicer	99.95
F1-SOC30FTLHLDR	FIS 3.0mm SOC Cordage Holder for Fitel Splicers	99.95
F1-SOC30AFLHLDR	FIS 3.0mm SOC Cordage Holder for AFL Splicers	99.95
F1-SOC30SHLDR	FIS 3.0mm SOC Cordage Holder for Sumitomo Splicers	99.95
F1-SOC30CRIMPTOOL	FIS Crimp Tool (Die and Handle) for the 3.0/2.0mm SOC	98.95
F1-SOC30STRIPCHART	3.0/2.0mm SOC Strip Chart	5.95
F1-SOC30FISHDRCA616	FIS 1.6mm SOC Cordage Holder for FIS (CA6) Splicer	99.95
F1-SOC30FTLHLDR16	FIS 1.6mm SOC Cordage Holder for Fitel Splicers	99.95
F1-SOC30AFLHLDR16	FIS 1.6mm SOC Cordage Holder for AFL Splicers	99.95
F1-SOC30SHLDR16	FIS 1.6mm SOC Cordage Holder for Sumitomo Splicers	99.95



F1-SOCMTL-FIS



F1-SOC-30FISHDR



View the Cheetah SOC™ video



F1-UNIVSOVEN

**FIS CHEETAH & ARMORDILLO SOC COMPATIBILITY CHART**

Manufacturer	Splicer Model	SOC Holder	2.0mm/3.0mm Cordage Holder	Cleaver * For Cordage Holder Only
FIS	CA6	F1SOCMTLCA6	F1SOC30FISHDRCA6	LYNX CT50 / CT08 S326A FC6 / FC8
	AC5	F1SOCMTLAC5	F1SOC30AC4HLDRAC5	
AFL/Fujikura	31S	F1SOCMTLA	F1SOC30AFLHLDR	CT50 CT08
	41S			
	19S			
	62S+			
	70S+			
Furukawa/Fitel	S153	F1SOCMTLF	F1SOC30FTLHLDR	S326A
	S179	F1SOCSLAF2		
	NINJA			
Sumitomo	Q102-CA	F1SOCMTLS	F1SOC30SHLDR	FC6RSC FC8R
	TYPE 56			
	QH201E			

Call a FIS Sales Representative for a complete list of compatible tools.

**FOR MORE  
INFORMATION  
SEE PAGES  
166 & 167**

**BECOME CERTIFIED ON OUR  
SPlice-ON CONNECTOR TODAY!**

**fis UNIVERSITY**  
PREMIER FIBER OPTIC EDUCATION



**Cheetah**  
Splice-On Connector



## TERMINATIONS IN LESS THAN 3 MINUTES

Visit us on our website to view the instructional video on the Cheetah SOC

**Cheetah**  
Splice-On Connector

### FIS CHEETAH SOC™

The FIS Cheetah SOC™ is the quickest pre-polished factory terminated pigtail to prepare, splice and install. The Cheetah SOC™ 27mm splice protection sleeve is encapsulated and protected by the strain relief boot eliminating the need for splice trays, chips and extra cabinets. When used with the required universal holder the SOC can be used with a variety of fusion splicers.

**Each 900µm Cheetah SOC™ Includes:** Connector, Cleave Protector, Extended Dust Cap, 900µm Boot, and Fusion Splice Sleeve.

PART #	DESCRIPTION	10pk PRICE	100pk PRICE
F1-LCAPC-SOC-X	LC/APC Singlemode, Green 900µm Boot	\$79.50	\$795.00
F1-LCUPC-SOC-X	LC/UPC Singlemode, White 900µm Boot	69.50	695.00
F1-LC62-SOC-X	LC/PC 62.5µm Multimode (OM1), Beige 900µm Boot	59.50	595.00
F1-LC50-SOC-X	LC/PC 50µm Multimode (OM2), Black 900µm Boot	59.50	595.00
F1-LCOM3-SOC-X	LC/PC 50µm Multimode (OM3), Aqua 900µm Boot	59.50	595.00
F1-LCOM4-SOC-M-X	LC/PC 50µm Multimode (OM4), Magenta 900µm Boot (Magenta Housing)	69.50	695.00
F1-LCOM4-SOCAQ-X	LC/PC 50µm Multimode (OM4), Aqua 900µm Boot (Aqua Housing)	69.50	695.00
F1-SCAPC-SOC-X	SC/APC Singlemode, Green 900µm Boot	79.50	795.00
F1-SCUPC-SOC-X	SC/UPC Singlemode, White 900µm Boot	69.50	695.00
F1-SC62-SOC-X	SC/PC 62.5µm Multimode (OM1), Beige 900µm Boot	59.50	595.00
F1-SC50-SOC-X	SC/PC 50µm Multimode (OM2), Black 900µm Boot	59.50	595.00
F1-SCOM3-SOC-X	SC/PC 50µm Multimode (OM3), Aqua 900µm Boot	59.50	595.00
F1-SCOM4-SOC-X	SC/PC 50µm Multimode (OM4), Magenta 900µm Boot	69.50	695.00
F1-STUPC-SOC-X	ST/UPC Singlemode, White 900µm Boot	69.50	695.00
F1-ST62-SOC-X	ST/PC 62.5µm Multimode (OM1), Beige 900µm Boot	59.50	595.00
F1-ST50-SOC-X	ST/PC 50µm Multimode (OM2), Black 900µm Boot	59.50	595.00
F1-STOM3-SOC-X	ST/PC 50µm Multimode (OM3), Aqua 900µm Boot	59.50	595.00
F1-FCAPC-SOC-X	FC/APC Singlemode, Green 900µm Boot	79.50	795.00
F1-FCUPC-SOC-X	FC/UPC Singlemode, White 900µm Boot	69.50	695.00
F1-FC62-SOC-X	FC/PC 62.5µm Multimode (OM1), Beige 900µm Boot	59.50	595.00
F1-FC50-SOC-X	FC/PC 50µm Multimode (OM2), Black 900µm Boot	59.50	595.00
F1-FCOM3-SOC-X	FC/PC 50µm Multimode (OM3), Aqua 900µm Boot	59.50	595.00

\*When ordering SOC are available in 10pks and 100pks. Replace 'X' w/ '-10' for 10 pack or '-100' for 100 pack

### 3mm / 2mm FIS ARMORDILLO™ SOC

Using a factory-terminated and pre-polished connector, the Armordillo Splice-On Connector (SOC) provides a connection that meets or exceeds industry standards for loss and back reflection. The Splice-On Connector is provided with a factory-cleaved 900um fiber stub to ensure ease of use and optimal performance.

The unique 3mm and 2mm boot allows the entire splice to be concealed and protected. The addition of an extended brass crimp ring provides extra protection to the splice and utilizes the Kevlar for maximized pull strength. The Armordillo is designed to work with FIS, Fitel, AFL and Sumitomo splicers and cleavers (cordage fiber holders required). The Universal SOC Oven can shrink the inner tube in 45 seconds.

- Splice-On solution for 3mm, 2mm and 1.6mm applications
- Splice protection encapsulated and protected by the extended brass crimp ring and strain relief boot
- Same ease of use as the 900um SOC

**Each Armordillo SOC Includes:** Connector, Cleave Protector, Extended Dust Cap, 3mm and 2mm Boot, Extended Brass Crimp Ring, and Protection Sleeve

PART #	DESCRIPTION	10pk PRICE	100pk PRICE
F1-LCAPC-SOC-A-X	LC/APC Singlemode, Green 3.0/2.0mm Boot	\$97.50	\$975.00
F1-LCUPC-SOC-A-X	LC/UPC Singlemode, White 3.0/2.0mm Boot	87.50	875.00
F1-LC62-SOC-A-X	LC/PC 62.5µm Multimode (OM1), Beige 3.0/2.0mm Boot	77.50	775.00
F1-LC50-SOC-A-X	LC/PC 50µm Multimode (OM2), Black 3.0/2.0mm Boot	77.50	775.00
F1-LCOM3-SOC-A-X	LC/PC 50µm Multimode (OM3), Aqua 3.0/2.0mm Boot	77.50	775.00
F1-LCOM4M-SOC-A-X	LC/PC 50µm Multimode (OM4), Magenta 3.0/2.0mm Boot (Magenta Housing)	87.50	875.00
F1-LCOM4A-SOC-A-X	LC/PC 50µm Multimode (OM4), Aqua 3.0/2.0mm Boot (Aqua Housing)	87.50	875.00
F1-SCAPC-SOC-A-X	SC/APC Singlemode, Green 3.0/2.0mm Boot	97.50	975.00
F1-SCUPC-SOC-A-X	SC/UPC Singlemode, White 3.0/2.0mm Boot	87.50	875.00
F1-SC62-SOC-A-X	SC/PC 62.5µm Multimode (OM1), Beige 3.0/2.0mm Boot	77.50	775.00
F1-SCOM3-SOC-A-X	SC/PC 50µm Multimode (OM3), Aqua 3.0/2.0mm Boot	77.50	775.00
F1-SCOM4M-SOC-A-X	SC/PC 50µm Multimode (OM4), Magenta 3.0/2.0mm Boot (Magenta Housing)	87.50	875.00
F1-STUPC-SOC-A-X	ST/UPC Singlemode, White 3.0/2.0mm Boot	87.50	875.00
F1-ST62-SOC-A-X	ST/PC 62.5µm Multimode (OM1), Beige 3.0/2.0mm Boot	77.50	775.00
F1-ST50-SOC-A-X	ST/PC 50µm Multimode (OM2), Black 3.0/2.0mm Boot	77.50	775.00
F1-STOM3-SOC-A-X	ST/PC 50µm Multimode (OM3), Aqua 3.0/2.0mm Boot	77.50	775.00

\*When ordering replace the "X" to specify 10= 10packs, 100= 100packs.



F1-LCOM3-SOC

**FREE FIS CA6 Fusion Splicer with Purchase of 2,500 Connectors in any combination!!**

Limited time offer

**FREE FIS AC5 SOC Splicer Kit with Purchase of 1,250 SOC Connectors**

Limited time offer



FIS Armordillo SOC™



**90S**  
Fusion Splicer

**FEATURES**

- Cleaver tracking and upkeep with wireless communication
- Automated wind protector, sheath clamps and splice operation
- Fiber type identification
- Loose and tight buffer with same sheath clamp
- Lithium-ion battery with 300 splices/shrinks per charge
- 5 mm cleave length for small package needs
- Multi-function transit case with integrated workstation

**AFL 90S SPLICER**

The 90S is the latest core alignment splicer from Fujikura. It's designed to give you high quality splices and to stay in the field. The 90S kit solves problems seen in the field today, from splicing poor quality legacy fiber to automated equipment maintenance and upkeep. The 90S can be utilized in any field splicing application seen today: bend-insensitive fibers in drop cables, long-haul terrestrial and submarine LEAF fibers, loose buffer fiber, splice on connectors, and the list goes on. The speed and accuracy of the 90S even make it suitable for certain production and specialty environments, where high output, tight packaging, and low loss requirements are needed. Regardless your use-case, the 90S is designed to keep you going with an extended battery life from 200 to 300 splice and heat cycles, and by alleviating the need for traditional operation tasks such as; frequent arc calibrations, cleaver blade rotations, cleaver usage tracking, and manual splicing operations with its multiple automated and ease-of-use features. A multi-purpose sheath clamp, redesigned work tray, cooling tray, and optional cable clamp make the 90S kit more versatile than any of its predecessors in adapting to varying work conditions and environments.

**90S Fusion Splicer Kit includes:** 90S Fusion Splicer, CT50 Cleaver, ADC-20 AC Adapter, ACC-14 AC Cord, BTR-15 Battery, ELCT2-16B Spare Electrodes (pair), Sheath Clamps, SP-03 Fiber Holder Set Plates, USB-01 Cable, Alcohol Dispenser, Splicer Carrying Strap, Quick Reference Guide, Work Tray J-Plate, SS03 single fiber stripper and CC39 Transit Case with Carrying Strap

PART #	DESCRIPTION	PRICE
S017521	90S Fusion Splicer Kit with Bluetooth	\$10,400.00
S017519	90S Fusion Splicer (machine only)	9,325.00
S017000	90S Fusion Splicer (machine only) without Bluetooth	9,100.00

**Call Your FIS Sales Representative For More Information**

**AFL 41S SPLICER**

The Fujikura 41S is a fully ruggedized, two camera, active cladding alignment fusion splicer. Core sensing loss estimation technology provides the most accurate assessment of splice loss available in any active cladding alignment splicer in the world. Enabled by Warm Splice Imaging (WSI), the 41S can determine the accuracy of core alignment by evaluation of the splice during the heating process. This technology delivers splice loss estimates with a greater level of accuracy as those based on only cladding alignment. State-of-the-art cleaver management via Bluetooth® connection with the CT50 Cleaver tracks usage and enables automated blade rotation as needed. The dual-camera, active V-groove alignment system provides consistent splicing performance in the most challenging conditions. A 6-second splice time and 25-second shrink time offers unmatched speed and productivity, while an easy-to-use touchscreen monitor provides simple and intuitive menu navigation. Interchangeable sheath clamps or fiber holders provide versatility for user preference, and compatibility with fusion installable connectors. The extended-life battery is rated for up to 200 splice and heat cycles. Long-life electrodes, lasting 5,000 splices, help minimize downtime for replacement and stabilization. The large 5" monitor provides a crystal clear image, even in the brightest sunlight. Software updates are accomplished via the internet allowing users to quickly update their software as new splice programs become available.

**41S Fusion Splicer Kit includes:** Fujikura 41S Fusion Splicer, S31A Sheath clamps (installed), SP-31 Set Plates, ADC-19A AC Adapter, BTR-11 Battery Pack (installed), ACC-09 Power Cord, ELCT2-16B Spare Electrodes (pair), Operation Manual on CD, Quick Reference Guide, SS-03 Single Fiber Stripper and CC-36 Transit Case

PART #	DESCRIPTION	PRICE
S017090	AFL Fujikura 41S Fusion Splicer Kit (Splicer Only)	\$3,295.00
S017091	AFL Fujikura 41S Fusion Splicer Kit w/CT50	3,995.00



**41S**  
Fusion Splicer

**FEATURES**

- Warm Splice Imaging (WSI) loss estimation technology
- Bluetooth enabled cleaver management
- Two-camera active v-groove alignment
- 5" touchscreen monitor
- Fully ruggedized for shock, moisture and dust resistance
- Extended-life electrodes, 5,000 splices, exchangeable w/o tools
- Long-life battery (200 splices/shrinks per charge)
- Perfect for use with Splice-On Connectors

**WSI = Warm Splice Image WHAT IS IT ?**

The hot fiber glows during the arc. The core glows more brightly than the cladding due to core dopants. Low resolution optical system can "see" the core (without focus motors). Therefore, loss estimation can be based on core observation. This enables more accurate loss estimation





**AFL 90R SPLICER**

The Fujikura 90R is the mass fusion splicer workhorse of the splicing world. As data demand continues to rise, the solution to handle the increased traffic is to increase fiber counts. As a result, fiber counts being utilized in enterprise data centers, campus, and metro networks have grown enough to make single fiber splicing too costly and timely. High density cabling made possible by SWR and others like it are spurring ribbon splicing activity in places that have traditionally used loose fiber. The 90R is the answer to these changes in splicing demand. With automated splice start, tube heater, wind protector, cleave tracking, and blade rotations for up to two cleavers at a time, this splicer frees up a lot of operator time for other fiber preparation steps. New to the 90R, you can keep your splicer in the field longer with field replaceable V-grooves. When V-grooves can no longer be cleaned after extended use, or are accidentally damaged, you can resume splicing in minutes by installing the spare set included with your 90R kit.

**90R Includes:** 90R Fusion Splicer, BTR-15 Battery, CT50 Cleave Kit, RS03 Stripper Kit, SS03 Single Fiber Stripper, ADC-20 AC Adapter, ACC-14 AC Cord, ELCT2-16B Spare Electrodes (pair) with spare V-Grooves (VG12-01), FH-70-12 Fiber Holder, USB Cable, Alcohol Dispenser, Screwdriver, Splicer Carrying Strap, Quick Reference Guide, Video Instruction Manual and CC-39 Transit Case with Carrying Strap

PART #	DESCRIPTION	PRICE
S017511	90R Fusion Splicer Kit with Bluetooth (with cleaver & thermal stripper)	\$15,225.00
S017540	90R Fusion Splicer without Bluetooth (with cleaver & thermal stripper)	13,225.00
S017509	90R Fusion Splicer (machine only)	13,225.00

**ACCESSORIES**

PART #	DESCRIPTION	PRICE
S017114	FH-70-2 2 Fiber Holder	\$240.50
S017115	FH-70-4 4 Fiber Holder	240.50
S017116	FH-70-6 6 Fiber Holder	240.50
S017117	FH-70-8 8 Fiber Holder	240.50
S017118	FH-70-10 10 Fiber Holder	240.50
S017119	FH-70-12 12 Fiber Holder	240.50
S017111	FH-70-250 (250 µm coated single fiber)	272.60
S017113	FH-70-900 (900 µm jacketed single fiber)	272.60
S015181	FH-60-LT900	419.35
S008720	FAA-03A Ribbon Forming Adhesive (4 oz. bottle)	50.30
S008622	FAA-03A Ribbon Forming Adhesive (0.5 liter bottle)	178.00
S014012	FST-12 Fiber Separation Tool	1,146.08
S010212	FAT-04 Fiber Arrangement Tool	503.00
S017119	AFL FH-70-12 Fiber Holder SWR (Pair)	273.00

**AFL 31S SPLICER**

The Fujikura 31S is a fully ruggedized, active cladding alignment fusion splicer. The two camera, active cladding alignment system provides consistent splicing performance in the most challenging conditions. A 6-second splice time and 25-second shrink time offers unmatched speed and productivity, while an easy-to-use touchscreen monitor provides simple and intuitive menu navigation. Interchangeable sheath clamps or fiber holders provide versatility for user preference, and compatibility with fusion-installable connectors. The extended-life battery is rated for up to 200 splice and heat cycles. Long-life electrodes, lasting 5,000 splices, help minimize downtime for replacement and stabilization. The large 5" monitor provides a crystal clear image, even in the brightest sunlight. Software updates are accomplished via the internet allowing users to quickly update their software as new splice programs become available.

**Fujikura 31S Fusion Splicer Kit includes:** Fujikura 31S Fusion Splicer, S31A Sheath clamps (installed), SP-31 Set Plates, ADC-19A AC Adapter, BTR-11 Battery Pack (installed), FH-70-250 Fiber Holders, FH-70-900 Fiber Holders, ACC-09 Power Cord, ELCT2-16B Spare Electrodes (pair), Operation Manual on CD, Quick Reference Guide, SS-03 Single Fiber Stripper and CC-35 Transit Case

PART #	DESCRIPTION	PRICE
S017081	AFL Fujikura 31S Fusion Splicer Kit (Splicer Only)	\$2,980.00
S017109	AFL Fujikura 31S Fusion Splicer Kit w/CT08 Cleave	3,595.00



**90R Fusion Splicer**

**FEATURES**

- Cleave tracking and upkeep with wireless communication
- Automated wind protector, tube heater and splice operation
- User replaceable v-grooves
- Single to 12 fiber splicing in one machine
- 200 µm and 250 µm SpiderWeb Ribbon® universal fiber holders
- Multi-function transit case with integrated workstation



**31S Fusion Splicer**

**FEATURES**

- Two-camera active v-groove alignment
- 5" touch screen monitor
- Interchangeable sheath clamps and fiber holders
- Fully ruggedized for shock, moisture and dust resistance
- Extended-life electrodes, 5,000 splices, exchangeable without tools
- Long-life battery (200 splices/shrinks per charge)
- Perfect for use with Splice-On Connectors





**Splice-On Connector Compatible**

**19S Fusion Splicer**

**FEATURES**

- Automated and programmable wind protector
- Li-Ion battery with 180 splice/heat cycles per charge
- 5 mm cleave length for splice-on connector
- Sheath clamp or fiber holder operation
- **Perfect for use with Splice-On Connectors**



**AFL Fiber Holders**



**AFL Portable Tripod Workstation**



**AFL V-Groove Cleaning Kit**

**AFL 19S+ SPLICER**

The 19S+ is a low cost, fixed v-groove single fiber splicer with similar features found on the FSM-70S . A user programmable, automated wind protector expedites the splicing process by automatically closing to initiate the splice process, and opening upon splice completion . A new automated “clamshell design” tube heater applies heat to both sides of the splice protection sleeve resulting in a faster shrink time. An innovative transit case doubles as a built-in or mobile workstation and makes splicing easier than ever before.

**19S+ Fusion Splicer Kit includes:** 19S+ Fusion Splicer, CT50 Cleaver, ADC-18 AC Adapter, ACC-14 AC Cord, ELCT2-20A Spare Electrodes (pair), S70A Sheath Clamp, USB Cable, Alcohol Dispenser, Screwdriver, Splicer Carrying Strap, Quick Reference Guide, Video Instruction Manual, and CC30 Transit Case with Carrying Strap

PART #	DESCRIPTION	PRICE
S015679	19S+ Fusion Splicer Kit (Splicer Only)	\$3,295.00
S015680	19S+ Fusion Splicer Kit with CT-50 Cleaver	3,995.00
S015681	19S+ Fusion Splicer Kit with CT-50 Cleaver, BTR-09 Battery, and DCC-18 Charge Cord	4,225.00

**AFL SPLICER ACCESSORIES**

PART #	DESCRIPTION	PRICE
S013532	AFL Electrodes for 17S/18S/19S/50S/R/60S/R/70S/R/90S/R (pair)	\$75.00
S017111	AFL FH-70-250 Fiber Holder(Pair)	272.50
S017113	FH-70-900 (900 μm jacketed fiber)	272.50
S017095	FH-70-160 (160 μm coated fiber)	272.50
S015181	FH-60-LT900 (Loose buffer 900 μm fiber)	419.35
S015275	FH-60-LT900 (each)	419.35
S014397	AFL Splicer V-Groove Cleaning Kit	142.00
S017528	DCC-21 Power Cord (connects AC Adapter to power source via alligator clips)	92.50
S017527	DCC-20 Power Cord (connects AC Adapter to cigarette lighter socket)	92.50
S017526	DCA-03 DC Adapter (Connect AC Adaptor without battery)	185.00
S014773	Portable Tripod Workstation	495.00
S010532	ASW-02 Splicing Workstation	1,057.25
S017522	JP-10 J-Plate (Cooling tray attaches to splicer)	148.00
S014012	FST-12 Fiber Separation Tool	1,146.08
S010212	FAT-04 Fiber Arrangement Tool	503.00
S017119	AFL FH-70-12 Fiber Holder SWR (Pair)	273.00
S017513	ADC-20 AC Adapter	335.00
S014536	ACC-14 AC Power Cord	21.00
S017512	BTR-15 Battery	305.25
F150CMTLA	FIS Metal SOC Holder for the AFL 62S,31S, 41S, 70S, 19S	100.00
F150C30AFLHLDR	FIS 3mm Cordage Holder for AFL	100.00
F150C30AFLHLDRP	FIS 3mm Cordage Holder for AFL removable platform 31S/41S	100.00
S014696	FH-FC-20 (900 μm within 2.0 mm sheathing) (each)	73.00
S014695	FH-FC-30 (900 μm within 3.0 mm sheathing) (pair)	73.00
S014697	FH-FC-900 (900 μm cable) (each)	73.00
S014705	CLAMP-FC-2000 (pair)	15.75
S014704	CLAMP-FC-3000 (pair)	15.75
S015915	AFL FP-60 Protection Sleeve (60mm)	20.00
S015916	AFL FP-40 Protection Sleeve (40mm)	20.00
S017010	AD-50 Adapter Plate	53.00
S015862	AFL S70D Sheath Clamp (Loose tube)	138.00
S016853	AFL S21B Sheath Clamp (Loose tube)	138.00
S012996	One Year Extended Warranty (splicer specific)	Please call for pricing
S013000	Two Year Extended Warranty (splicer specific)	Please call for pricing

## 3mm and 2mm FUSEConnect® Versions Available

### AFL FUSEConnect®

FUSEConnect® utilizes a fusion splicer to terminate a connector in the field, addressing return loss concerns present in analog optical networks. This advanced process yields true APC performance of >65dB return loss in an SC/APC configuration. Designed to work with an industry standard 10mm cleave length and splicers utilizing a fiber holder system, FuseConnect is compatible not only with Fujikura's fusion splicers, but also with most other industry available, fiber holder-based fusion splicing platforms.



PART #	DESCRIPTION	PRICE - 6pack
FUSE-SC3SMA-6	SM, SC/APC, 3mm boot, Green (package of 6)	\$82.95
FUSE-SC3SMU-6	SM, SC/UPC, 3mm boot, Blue (package of 6)	81.95
FUSE-SC3M62-6	MM, 62.5µm, SC, 3mm boot, Beige (package of 6)	80.95
FUSE-SC3M50L-6	MM, 50µm, 10GIG, SC, 3mm boot, Aqua (package of 6)	90.00
FUSE-LC2SMA-6	SM, LC/APC, 2mm boot, Green (package of 6)	86.95
FUSE-LC2SMU-6	SM, LC/UPC, 2mm boot, Blue (package of 6)	86.50
FUSE-LC2M62-6	MM, 62.5µm, LC, 2mm boot, Beige (package of 6)	85.55
FUSE-LC2M50L-6	MM, 50µm, 10GIG, LC, 2mm boot, Aqua (package of 6)	91.75
FUSEMPO-SMA-3-M-6	Single-mode (OS1), MPO Male (pins) for 3.0mm round boot (package of 6) <b>NEW</b>	656.25
FUSEMPO-SMA-3-F-6	Single-mode (OS1) MPO Female (No Pins) for 3.0mm round boot (package of 6) <b>NEW</b>	620.00
FUSEMPO-MMSL-3-M-6	Multimode 50 µm 10Gig (OM3/4) MPO, Male (pins) for 3.0mm round boot (package of 6) <b>NEW</b>	800.00
FUSEMPO-MMSL-3-F-6	Multimode 50 µm 10Gig (OM3/4) MPO, Female (no pins) for 3.0mm round boot (package of 6) <b>NEW</b>	722.20
FUSEMPO-TL-KT	FUSEConnect MPO Tool Kit	524.60
FUSE-RB-TL	FUSEConnect Ribbonize Tool	45.00
FUSE-ST-KT	FUSEConnect Stripping Tool (3.0 mm, 2.8 mm, 2.0 mm, and 1.6 mm)	304.00
FUSE-AS-KT	FUSEConnect MPO Assembly Tool	19.00
FUSE-TL-KT	FuseConnect Toolkit	840.00

NOTE: Use AFL Splicers with Fiber Holders for FUSEConnect® and Installation kit is recommended for best performance

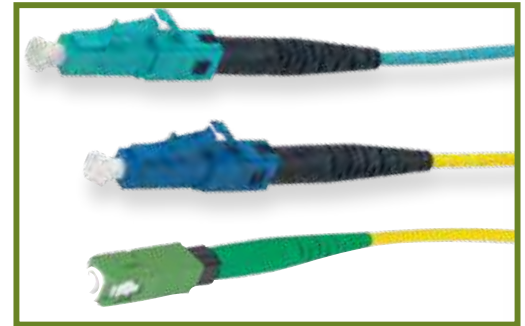

## 3mm and 2mm LYNX2-PLUS Versions Available

### SUMITOMO LYNX2-PLUS

Sumitomo Electric Lightwave continues its tradition of innovation and customer focused, market driven product advancements with the release of the Lynx2-PLUS. Maintaining all of the quality standards of the Lynx2, the Lynx2-PLUS incorporates an enhanced installation procedure and smaller overall completed connector design. Compatible with all SC, LC, FC and ST style fiber optic connectors, Lynx2- PLUS offers revolutionary Real-Time, On-Site flexibility for quick MACs, repairs, and restorations for minimal downtime, while eliminating crimping tools, gels, splice trays, and the inventory of varying length pre-terminated jumpers — providing the industry's most cost effective, reliable, and advanced choice in fiber termination.

PART #	DESCRIPTION	PRICE
LYNX2-LCUPCSM-250900	Lynx Splice-On Connector, LCUPC SMF 250um & 900um	\$10.88
LYNX2-LCPCMS10G-250900	Lynx Splice-On Connector, LCPC MMF-50um 10GIG, 250um & 900um	12.46
LYNX2-LCAPCSM-250900	Lynx Splice-On Connector, LCAPC SMF 250um & 900um	11.86
LYNX2-SCUPCSM-250900	Lynx Splice-On Connector, SCUPC SMF 250um & 900um	10.75
LYNX2-SCAPCSM-250900	Lynx Splice-On Connector, SCAPC SMF 250um & 900um	12.46
LYNX2-SCPCMS10G-250900	Lynx Splice-On Connector, SCPC MMF-50um 10GIG, 250um & 900um	10.75
LYNX2-SCPCM6-250900	Lynx Splice-On Connector, SCPC MMF-62.5um, 250um & 900um	10.75
LYNX2-STUPCSM-250900	Lynx Splice-On Connector, STUPC SMF 250um & 900um	12.44
LYNX2-STPCMS10G-250900	Lynx Splice-On Connector, STPC MMF-50um 10GIG, 250um & 900um	12.44
LYNX2-STPCM6-250900	Lynx Splice-On Connector, STPC MMF-62.5um, 250um & 900um	12.44
LYNX2-SOCTK-400	LYNX SOC Installation Kit with Connectorizer	1,935.00
LYNX2-TKU-MPO-RCATK	Tool Kit for terminating Lynx2 MPO Round Cord Connectors	1,765.00
FA-03	Fiber Arrangement Tool for Lynx2 MPO	795.00
FAC-24	Consumables for Fiber Arrangement Tool	22.50
FAC-24-003-A	Adhesive for Fiber Arrangement Tool (Included in FAC-24)	8.50
LYNX2-MPO12F-MM03-RBN	LYNX2 MPO 12ct. Female, MMF OM3, Ribbon	70.64
LYNX2-MPO12F-MM03-RC3.0	LYNX2 MPO 12ct. Female, MMF OM3, Round Cord 3.0	72.85
LYNX2-MPO12F-SMSL-RBN	LYNX2 MPO 12ct. Female, SMF Standard Loss, Ribbon	70.64
LYNX2-MPO12F-SMSL-RC3.0	LYNX2 MPO 12ct. Female, SMF Standard Loss, Round Cord 3.0	72.85
LYNX2-MPO12M-MM03-RBC	LYNX2 MPO 12ct. Male, MMF OM3, Oval Jacket	79.47
LYNX2-MPO12M-MM03-RBN	LYNX2 MPO 12ct. Male, MMF OM3, Ribbon	77.26
LYNX2-MPO12M-SMSL-RBN	LYNX2 MPO 12ct. Male, SMF Standard Loss, Ribbon	75.06
LYNX2-MPO12M-SMSL-RC3.0	LYNX2 MPO 12ct. Male, SMF Standard Loss, Round Cord 3.0	77.26



Please Call Your Sales Representative For More Connector Styles

Splice-On Connector Compatible



TYPEQ102CA

## SUMITOMO TYPE Q102-CA QUANTUM FUSION SPLICER KIT

The Quantum Type-Q102-CA™ is Sumitomo Electric Lightwave's next generation of the industry leading Quantum core alignment fusion splicers, redesigned from the ground up to redefine the industry standard in optical fiber core alignment fusion technology. Maintaining all of the qualities and industry first features of the Quantum Type-Q101-CA, the TYPE-Q102-CA continues to raise the bar in performance by still being the fastest splicer with blazing fast 5 second splice and 9 second sleeve heating times. These new speeds, coupled with the splicer's patent protected dual independent ovens, makes it the fastest in the industry by far. The built-in dual heater system, with its unprecedented speed, improves splicing efficiency by over 80% for perfectly streamlined, consecutive, and cost effective splices.

PART #	DESCRIPTION	PRICE
TYPEQ102CAKIT6RSCFH	<b>Type Q102CA Quantum Fusion Splicer Kit includes:</b> Precision Cleaver w/ Rotating Blade, 250µm/900µm/Loose Buffer Fiber Holders Fiber Stripper, One pack of Fiber Protection Sleeves, Shipping Case & One Set of Spare Electrodes, AC Interface/Battery Charger w/Power Cord Battery unit	\$11,227.00
TYPEQ102CAKIT8R	<b>TYPE Q102-CA Quantum Fusion Splicer Kit includes:</b> Precision Cleaver w/ Auto Rotating Blade, Fiber Stripper, One Pack of Fiber Protection Sleeves, Shipping Case, one set of Spare Electrodes, AC Interface/Battery Charger with Power Cord, Battery Unit	10,733.00
TYPEQ102CAKIT6RSC	<b>TYPE Q102-CA Quantum Fusion Splicer Kit includes:</b> Precision Cleaver w/ Auto Rotating Blade, Fiber Stripper, One Pack of Fiber Protection Sleeves, Shipping Case, one set of Spare Electrodes, AC Interface/Battery Charger with Power Cord, Battery Unit	10,733.00
TYPEQ102CAKIT8RFH	<b>Type Q102CA Quantum Fusion Splicer Kit includes:</b> Precision Cleaver w/Auto Rotating Blade, 250µm/900µm/Loose Buffer Fiber Holders. Fiber Stripper, One Pack of Fiber Protection Sleeves, Shipping Case, One Set of Spare Electrodes, AC Interface/Battery Charger w/Power Cord Battery Unit	11,206.00

NEW



TYPE-56

## SUMITOMO TYPE 56 FUSION SPLICE KIT W/ AUTO PRECISION CLEAVER

PART #	DESCRIPTION	PRICE
TYPE56CAKIT6RSC	<b>TYPE-56 Fusion Splicer Kit includes:</b> FC-6-RS-C Auto Rotating Cleaver, Fiber Stripper (JR-M03), One Pack of Fiber Protection Sleeves, Shipping Case, one set of Spare Electrodes (ER-10), AC Interface/Battery Charger with Power Cord, Battery Unit (BU-101)	\$6,967.19
TYPE56CAKIT8R	<b>TYPE-56 Fusion Splicer Kit includes:</b> FC-8R Auto Rotating Cleaver, Fiber Stripper (JR-M03), One Pack of Fiber Protection Sleeves, Shipping Case, one set of Spare Electrodes (ER-10), AC Interface/Battery Charger with Power Cord, Battery Unit (BU-101)	6,967.19



QH201E-VS

## SUMITOMO TYPE QH201E-VS QUANTUM HANDHELD FUSION SPLICER KIT

PART #	DESCRIPTION	PRICE
TYPEQH201EVSKIT8RH	<b>TYPE QH201e-VS Quantum Fusion Splice Kit includes:</b> 250um and 900um Fiber Holders, Precision Cleaver (FC-8R), Fiber Stripper (JR-M03), One Pack of Fiber Protection Sleeves, Hard Shipping Case, set of Spare Electrodes (ER-11), AC Interface/Battery Charger with Power Cord, Battery Unit (BU-12L), Cleaning Kit (FUS-CLN-KIT)	\$3,798.00

## SUMITOMO ACCESSORIES

PART #	DESCRIPTION	PRICE
ER10	Sumitomo Electrodes for Sumitomo Splicer (pair)	\$100.00
ER11	Sumitomo Electrode for QH201e Splicer (pair)	100.00
FHS09	Sumitomo Fiber Holders for 900um Single Fiber (Pair)	300.00
FHS025	Sumitomo Fiber Holder for 250um Single Fiber (Pair)	300.00
FHS025LB5L	Sumitomo Fiber Holder for 900um LT Fiber. Left side	250.00



F1FOSK

## FIS Introductory Fiber Optic Splice Kit

This kit provides the ability to perform emergency repairs on communication fiber. Kit instructions provide step by step practice exercises and actual final protected splices required for field repair. All contents may be purchased separately.

PART #	DESCRIPTION	PRICE
F1FOSK	Introductory Fiber Optic Splice Kit	\$149.00

- Kit Contents**
- (1) Visual Fault Locator
  - (1) Fiber Cleaver
  - (1) Cable Strippers
  - (6) Mechanical Splices
  - (2) Splice Protection Kit
  - (25') Simplex Cable
  - (1) Quick Curing Adhesive
  - (6) Alcohol Wipes
  - (1) Instructions
  - (1) Soft Case



**SUMITOMO TYPE Q102M12 QUANTUM COMPACT MASS FUSION SPlicER KIT**

Sumitomo Electric Lightwave announces its newest addition to the industry-leading Quantum® Fusion Splicer portfolio. Sumitomo Electric's new Type-Q102-M12 is accompanied with new features and benefits capable of deploying next generation hyperscale networks.

Consistent and quality low-loss splicing, the compatibility with Lynx Custom-Fit® 2 Splice-On Connectors, and Sumitomo Electric's patented dual independent ovens make this fusion splicer a preferred choice for extensive and diverse optical fiber networks. The new ribbon fiber splicer is capable of handling 250um and 200um ecosystems and is accompanied by SEL's 24/7 fusion splicer technical support and a three-year warranty

**FEATURES**

- Dual independent ovens for increased productivity
- Reduce your work time. Splicing: 11s Heating: 35s
- Active Auto Clamping Alignment System, or ACAS optimizes splice loss 0.05dB
- Touch optimized user interface and high resolution display

PART #	DESCRIPTION	PRICE
TYPE-Q102-M12-KIT-6RM1	<b>TYPE Q102-M12 Quantum Compact Mass Fusion Splicer Kit with Dual Built-in Heat Shrink Ovens, includes:</b> Mass Fiber Cleaver (FC-6RM- C), Heated Fiber Stripper (JR-6+), Splice Protection Sleeves (FPS-6 type), pair of 12-Fiber Holders(FHM-12), pair of 250um single fiber holders (FHS-025)	\$14,809.00
TYPE-Q102-M12-KIT-8RM1	<b>TYPE Q102-M12 Quantum Compact Mass Fusion Splicer Kit with Dual Built-in Heat Shrink Ovens, includes:</b> Mass Fiber Cleaver (FC-8R), Heated Fiber Stripper (JR-6+), Splice Protection Sleeves (FPS-6 type), pair of 12-Fiber Holders (FHM-12), pair of 250um single fiber holders (FHS-025)	14,999.55



Q102M12

**FITEL S179A SPlicER**

The powerful FITEL S179 Hand-Held, Core Alignment Fusion Splicer delivers fast and reliable optical fiber splicing even under harsh environmental conditions. Offering a wide range of capabilities, this fusion splicing machine opens the door to an entirely new range of applications.

Designed with end users and rugged field use in mind, the FITEL S179 Fusion Splicer delivers rapid splicing and heating for consistent results, splice after splice. Suitable for use with ultra-bend insensitive and large effective area fibers, this fusion splicing machine is an excellent choice for a variety of deployments including data centers, Metro and FTtx. A broad range of new features that enhance communication, ease of use, portability and field durability combine to make the S179 Fusion Splicer one of the most powerful and user friendly fusion splicing machines available today.

**FEATURES**

- Fast and consistent fiber splicing for exceptional performance
- NEW design features enhance ease of use, maintenance, speed and shock resistance
- Large capacity, internal battery charging system allows 200 splicing cycles (splicing/heating) in one charge
- Wide splicing chamber for easy fiber loading
- Lower profile, lighter weight design enhances portability
- Powerful, high-propulsion motor (8N) for stable splicing
- Perfect for use with Splice-On Connectors

**S179 Extended Kit Includes:** (S179A-EX-900 ) S179A Main Body, 250µm and 900µm Fiber Holders, AC Adapter for S179A, Spare Electrodes, Hard Carrying Case, Cleaning Brush, Electrode Cleaning Disc, Fiber Stripper, Two Batteries, Cleaning Fluid, Fiber Wipes and User Manual.

PART #	DESCRIPTION	PRICE
S179A-EX-10	Extended Kit with 10mm Clamps	\$9,300.00
S179A-EX-900	Extended Kit with 250µm and 900µm Fiber Holders	9,480.00
F1-SOCLAF2	Cheetah Splice-On Connector Holder	100.00



S179A Fusion Splicer

# FITEL®



**S124M12  
Fusion Splicer**



## FITEL S124M12

OFS/Fitel S124 Mass Ribbon splicer is the newest addition to the Fitel splicer offering. With the contractor in mind, additional lighting, larger splicer platform, and 1.96 Newton motor strength to move even the heaviest of cables. Fitel offers removable holders which allows the splicing of 1-12 fibers with ease, with the options of both 250um and 200um pitch V-grooves

### FEATURES

- High speed operation of 15 seconds fusion splicing and 17 seconds heat reinforcement
- Fiber Curl Removal Function
- Easy exchange of different diameter fiber and different pitch V grooves
- Easy operation with touch panel and GUI mounting
- Easy maintenance with removable V-groove
- Wireless communication function using Wi-Fi

**S124M12 Standard Kit Includes:** S124M12 Main Body (including battery, Hard Carrying Case, Spare Electrodes, AC Adapter, AC Cord, Electrode Sharpener, Cleaning Brush, User Manual, S712A-12e - 12 Fiber Holder and Thermal Ribbon Stripper.

PART #	DESCRIPTION	PRICE
S124M12	S124M12 Standard Kit	\$13,780.00
S712S-250	Fiber holder (0.25mm coating fiber) 1 pair	320.00
S712S-900	Fiber holder (0.90mm coating fiber) 1 pair	320.00
S712A-002	Fiber holder (2 fiber ribbon) 1 pair	369.00
S712A-04e	Fiber holder (4 fiber ribbon) 1 pair	369.00
S712A-006	Fiber holder (6 fiber ribbon) 1 pair	369.00
S712A-08e	Fiber holder (8 fiber ribbon) 1 pair	369.00
S712A-12e	Fiber holder (12 fiber ribbon) 1 pair	369.00



**NJ001  
Fusion Splicer**



## FITEL NINJA SPLICER

The FITEL NINJA NJ001 Hand-Held Single Fiber Fusion Splicer is applicable for all METRO, LAN and FTTx fibers including ultra bend-insensitive fibers. With its low-profile, compact, ruggedized body, the NJ001 offers reliable splicing under severe environmental conditions. The large battery capacity makes it possible to perform 100 cycles of splicing and heating. Combining portability, power flexibility and field ruggedness, the NJ001 delivers fast and consistent splicing with outstanding mobility and maximum ease of use.

### FEATURES

- 3 LED Lamps
- Ruggedized design
- Internal battery charging
- Easy maintenance
- PC interface software
- Auto-start function
- 100 cycles (Splicing and Heating)

**NJ001 Standard Kit Includes:** NJ001 Main Body (including battery, Hard Carrying Case, Spare Electrodes, AC Adapter, AC Cord, Electrode Sharpener, Cleaning Brush, User Manual, Cheetah SOC Holder and Quick Reference Guide (the packaged quick reference guide depends on the holder type)

PART #	DESCRIPTION	PRICE
NJ001-3-EX-10-V1	Extended Kit with 10mm Clamps	\$3,930.00
NJ001-3-EX-900-V1	Extended Kit with 250um and 900um Fiber Holders	3,990.00
NJ001-3-V1	Standard Kit with Splicer-No Holders	3,200.00
F1-SOCSLAF2	Cheetah Splice-On Connector Holder	100.00

Splice-On  
Connector  
Compatible

# FIS

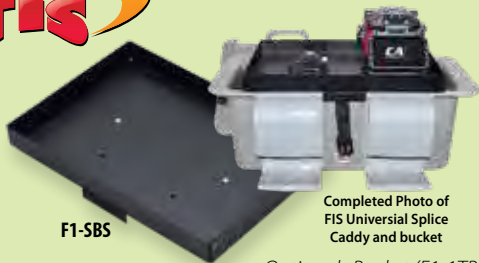

F1-SBS

Completed Photo of  
FIS Universal Splice  
Caddy and bucket

Optional: Bucket (F1-1TBSC)

## FIS UNIVERSAL SPLICE CADDY

The FIS Universal Splice Caddy is designed to securely fasten any fusion splicer and cleaver for aerial splice jobs. The Universal Splice Caddy easily attaches to FIS' Tool Bucket(F1-1TBSC) which provides technicians with a stable workstation for easy cable transition to both the cleaver and splicer. **Compatible with the FIS, FITEL, AFL and Sumitomo fusion splicers and cleavers.** **Kit Contents:** (1) FIS Universal Splice Caddy (F1-SBS), (2) Plugs included to cover open screw holes, (2) 16mmL Thumb Screw, (1) 8mmL Thumb Screw, (1) Accessory tray (For fiber optic cleaning solution and tools)

PART #	DESCRIPTION	PRICE
F1-SBS	Aerial Fusion Splicer Workstation (Fits up to 3" Bucket Lip)	\$79.00
F1-1TBSC	Workstation Bucket	160.00

## FIS BUCKET BUDDY

Technicians are faced with the challenge of securing the splicer or test equipment in a manner that facilitates a safe and easy fiber optic splice. The Bucket Buddy is unique in that its shape allows it to easily slide over the "lip" of the bucket on basically any aerial bucket truck. It will remain in place, attached securely to the bucket itself, to provide technicians a workstation attached to the bucket where they can perform fiber splices, tests, or terminate drops.

PART #	DESCRIPTION	PRICE
F1-AERIALBB	Aerial Fusion Splicer Workstation (Fits up to 3" Bucket Lip)	\$375.00

F1-AERIALBB





**FITEL EZ!FUSE**

OFSS's new Splice On Connector termination system allows for easy termination and flexibility in the field. This new "splice-on" connector (SOC) eliminates the need for field polishing and significantly improves the quality of the termination and installation time required. The connector is easily assembled by using a process that requires minimal skill or training. These connectors are optimal for use in FTTx applications. Both UPC and APC polish are available for single-mode fiber. EZ!Fuse Splice On Connector is compatible with the Fitel Fusion Splicer models Ninja, S179 and S178.

**2mm/3mm (only available in 10-packs)**

PART #	DESCRIPTION	PRICE
FSOC-SC09-SM-U	SC/UPC SM SOC 900um (10 pack)	84.00 / 10pk.
FSOC-SC23-SM-U	SC/UPC SM SOC 2.0mm/3.0mm (10 pack)	96.00 / 10pk.
FSOC-SC09-SM-A	SC/APC SM SOC 900um (10 pack)	84.00 / 10pk.
FSOC-SC23-SM-A	SC/APC SM SOC 2.0mm/3.0mm (10 pack)	96.00 / 10pk.
FSOC-SC09-M3-P	SC/PC OM3 MM SOC 900um (10 pack)	84.00 / 10pk.
FSOC-SC23-M3-P	SC/PC OM3 MM SOC 2.0mm/3.0mm (10 pack)	96.00 / 10pk.
FSOC-SC09-M1-P	SC/PC OM1 MM SOC 900um (10 pack)	84.00 / 10pk.
FSOC-SC23-M1-P	SC/PC OM1 MM SOC 2.0mm/3.0mm (10 pack)	96.00 / 10pk.
FSOC-LC09-SM-U	LC/UPC SM SOC 900um (10 pack)	92.40 / 10pk.
FSOC-LC20-SM-U	LC/UPC SM SOC 2.0mm (10 pack)	105.60 / 10pk.
FSOC-LC09-SM-A	LC/APC SM SOC 900um (10 pack)	92.40 / 10pk.
FSOC-LC20-SM-A	LC/APC SM SOC 2.0mm (10 pack)	105.60 / 10pk.
FSOC-LC09-M3-P	LC/PC OM3 MM SOC 900um (10 pack)	92.40 / 10pk.
FSOC-LC20-M3-P	LC/PC OM3 MM SOC 2.0mm (10 pack)	105.60 / 10pk.
FSOC-LC09-M1-P	LC/PC OM1 MM SOC 900um (10 pack)	92.40 / 10pk.
FSOC-LC20-M1-P	LC/PC OM1 MM SOC 2.0mm (10 pack)	105.60 / 10pk.

**FEATURES**

- Simple, Fast, and Consistent Field Termination
- Applicable for Interconnection Needing High Reliability
- Complies with Telcordia GR-326-CORE



FITEL's connector termination system allows for unsurpassed performance and flexibility in the field. The new "splice-on" connector (SOC) eliminates the need for field polishing and significantly improves the quality of the termination. FITEL's factory polished ferrules with pre-cleaved fiber stubs are spliced onto the field fiber utilizing FITEL's proprietary ferrule holder and fusion splicer. The connector is easily assembled by using a process that requires minimal skill or training. These connectors are optimal for use in data center applications and allow for easy field repair of pre-terminated splitters, fan outs, and drop terminals.

**900µm**

PART #	DESCRIPTION	PRICE
FIT-LC50SOC	MM LC/UPC 900µm (50/125) OM2	\$35.70/ 6pk.
FIT-LC62SOC	MM LC/UPC 900µm (62.5/125) OM1	35.70/ 6pk.
FIT-LCAPCSOC	SM LC/APC 900µm	47.70/ 6pk.
FIT-LCOM3SOC	MM LC/UPC 900µm (50/125) (OM3, Laser Optimized)	35.70/ 6pk.
FIT-LCUPCSOC	SM LC/UPC 900µm	41.70/ 6pk.
FIT-SC50SOC	MM SC/UPC 900µm (50/125) OM2	35.70/ 6pk.
FIT-SC62SOC	MM SC/UPC 900µm (62.5/125) OM1	35.70/ 6pk.
FIT-SCAPCSOC	SM SC/APC 900µm	47.70/ 6pk.
FIT-SCOM3SOC	MM SC/UPC 900µm (50/125) (OM3, Laser Optimized)	35.70/ 6pk.
FIT-SCUPCSOC	SM SC/UPC 900µm	41.70/ 6pk.

**U-TECK**

**Fiber Optic Splicing Workstation**

The U-TECK Fiber Optic Splicing Workstation was designed for, and dedicated to, today's professional fiber splicer.

The NEW Workstation offers twice the work space area compared to standard use tables, yet is light-weight and easy to store! The table top even has a molded recess area to keep items from falling. Also molded into the outside frame of the table are several recess areas that can be used to securely hold alcohol, wipes and fiber splicing sleeves.

**U-TECK WORKSTATION**

PART #	DESCRIPTION	PRICE
F1-55701	Workstation w/ cable management bracket (includes floor stand and two stand-off props with adjustable webbing)	\$410.00
F1-55706	Workstation w/ cable management bracket and floor stand only	198.00

**U-TECK WORKSTATION ACCESSORIES**

PART #	DESCRIPTION	PRICE
F1-55715	Aerial Strand Cables	\$84.75
F1-55615	LED Light and Magnifier	97.50
F1-55710	Mesh Bag	55.95
F1-55725	Splice Tray Holder	67.95
F1-55720	Tablet Holder	105.00
F1-55730	Cable Management Bracket	10.00
F1-55711	Wall Stand-offs	208.00



AERIAL STRAND CABLES



LED LIGHT AND MAGNIFIER



MESH BAG



SPLICETRAY HOLDER



TABLET HOLDER



CABLE MANAGEMENT BRACKET



WALL STAND OFFS





F1-LYNX



F1-LYNX2000



F1-LYNX3000



## FIS LYNX™ PRECISION CLEAVER

The LYNX provides clean, accurate cleaves required for fusion splicing. LYNX is also ideal for preparing fiber for quick-term style connectors such as Bobtails, UNICAMS and other pre-polished connectors. LYNX features a cleave angle of 90 degrees +/- 0.5 degrees. Its 16-position blade provides approximately 48,000 cleaves. LYNX cleaves single fibers (250-900µm). The LYNX Precision Cleaver can be used alone or mounted to an optional Work Tray that includes a goose neck LED.

PART #	DESCRIPTION	PRICE
F1-LYNX	LYNX Precision Cleaver - 3 Step Precision Cleaver	\$595.00
F1-LYNX2000	LYNX One-Step Deluxe Lynx Cleaver	625.00
F1-LYNX3000	LYNX One-Step Premium cleaver with Auto-Rotating blade	775.00
F1-LYNXBLADE	LYNX Replacement Blade	95.00



CT-08

## AFL CLEAVERS

The CT-50 Cleaver sets the standard for portability, reliability and ease of use. Available for either single fiber or ribbon splicing (up to 12 fiber ribbons) applications. The rugged, yet scaled-down design of the CT-08 cleaver offers cleave quality approaching that of the more expensive high precision cleavers but at a more economical price. The 16-position blade in each cleaver offers long life and performs cleaving in one single step.

PART #	DESCRIPTION	PRICE
S017030	CT-50 Cleaver	\$1,090.00
S017004	CT-08 Cleaver	610.00
S017013	Replacement Blade for CT-08 Cleaver	92.50
S017076	Replacement Blade for CT-50 Cleaver	92.50
S017010	AD-50 Adapter Plate	53.00



S326A

## FITEL PRECISION CLEAVER

The Fitel S326A precision cleaver solves the dilemma of stray fibers with a unique disposal system incorporated into the design. The automatic cleave function provides constant cleaving pressure and improves cleave quality. The cutting blade locks into place after scoring, preventing double scoring. Also can be used to cleave ribbon fiber.

PART #	DESCRIPTION	PRICE
S326A	S326A Cleaver	\$697.00
S326X24	Replacement Blade	130.00
S712CSGC9R	Cordage Holder for 3mm	375.00



FC-8R

## SUMITOMO PRECISION CLEAVERS

PART #	DESCRIPTION	PRICE
FC6RSC	Sumitomo Precision Optical Fiber Cleaver for single fiber cleaving with auto rotating/adjusting cleaver blade & fiber catcher	\$1,195.00
FC6RMC	Sumitomo Precision Optical Fiber Cleaver for single & mass fiber cleaving w/auto rotating/adjusting cleaver blade & fiber catcher	1,350.00
FC8R	Sumitomo Precision Optical Fiber Cleaver for single & mass fiber cleaving w/auto rotating/adjusting cleaver blade & fiber catcher	1,350.00
FCP7RBL	Sumitomo Replacement Blade for FC8R/7R/6R Auto-Rotating Models	195.00
FCPBL	Sumitomo Replacement Blade for FC6S/FCP Style Cleavers	155.00

**FIELD CLEAVERS**

This field or "beaver" cleaver is suitable for use with quick-term connectors and optimal for mechanical splicing. Each cleaver provides a guide for variable cleave lengths from 5-20mm. The blades will perform over 6,000 cleaves before replacement is necessary. The score and snap function is easy to use and preferred by many installers. **Note: No Export Available for F1-0010 and CL008.**

PART #	DESCRIPTION	PRICE
F1-6000	FIS Cleaver	\$139.00
F1-0010	FITEL Cleaver	198.00
S315X02	Replacement Leaf Spring <b>Suitable for both cleavers</b>	66.00
F1-60CBL	FIS Replacement Blade (Carbide) <b>Suitable for both cleavers</b>	35.00
F1-60DBL	FIS Replacement Blade (Diamond)	60.00
CL008	FITEL Replacement Blade (Carbide) <b>Suitable for both cleavers</b>	60.00



**AFL THERMAL STRIPPERS**

The RS01, RS02, RS03 and RS03-80 Thermal Strippers provide superior stripping performance for both single and multi-fiber stripping. The fast heating time of 3 seconds speeds productivity. The ergonomic design, combined with the low level of force needed for stripping, makes the RS series comfortable and easy to use for high fiber count applications. The strippers are also capable of stripping 200 µm coated fibers and ribbons. An audible beep and illuminated LED signal indicate that the proper heating temperature has been reached. A temperature selection switch permits easy field optimization for different fibers or operating conditions. These strippers accept all Fujikura field and factory style fiber holders. Bluetooth® capabilities on the RS02 and RS03 models provide a convenient way to program the stripper for user preferences via an Android or iOS smartphone app. The RS03 model includes a powerful Lithium-Ion battery that delivers enough power for 600 stripping cycles. The RS03-80 is offered for stripping 80 µm cladding fiber applications.

PART #	DESCRIPTION	PRICE
S016815	RS01 Thermal Stripper, Strips 200um to 400um coatings	\$647.50
S016816	RS02 Thermal Stripper, Strips 200um to 400um coatings, Bluetooth Capable	647.50
S016817	RS03 Thermal Stripper, Strips 200um to 400um coatings, Bluetooth Capable, Rechargeable Lithium-Ion Battery	1,750.00
S016842	RS03-80 Thermal Stripper, Strips 150um to 250um coatings, Bluetooth Capable, Rechargeable Lithium-Ion Battery, For use on 80um clad fibers	1,958.00
S016820	ADC-09A AC Adapter for RS Series strippers	92.50
S014390	ACC-09 Power Cord	18.00
S016832	BTR-12 Battery	111.00



**FIS FIBER OPTIC THERMAL STRIPPER**

The FIS family of fiber optic thermal strippers provide exceptional value and they are easy to use. Controlled heat is applied to the coated fibers to soften the acrylate coating, making it easier to strip the optical fibers.

PART #	DESCRIPTION	PRICE
TSAB-40	Thermal Stripper Adjustable Blade	\$2,530.00
TSFB-125	Thermal Stripper Fixed Blade	2,325.00
TSPE-125	Platform, Ericsson	188.95
TSPF-125	Platform, FITEL	188.95

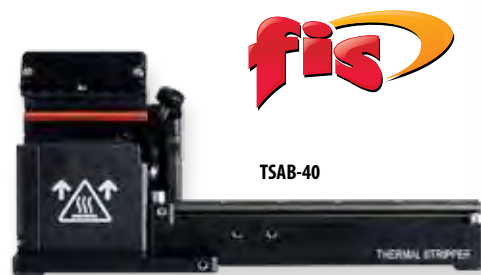

**FITEL HOT JACKET RIBBON STRIPPER**

The Fitel Hot Ribbon Stripper applies controlled heat to fibers/ribbons during stripping to reduce stripping force required and prevent fiber damage. Heats up in 13 sec. Includes Batteries, AC/DC Adapter. Fiber Holders not included.

PART #	DESCRIPTION	PRICE
S218-R	Fitel Hot Ribbon Stripper (fiber holders not included)	\$1,360.00
S218X-03	Single Fiber Adapter (For Use without Holders)	195.00



**STAY COMPLIANT WITH INDUSTRY STANDARDS BY TAKING ADVANTAGE OF OUR FULL SERVICE CALIBRATION LAB.**



**All Verifications come with the following Service Features**

- NIST traceable calibration
- Verification of conformance with the manufacturer's specification
- Ensure correct operation and performance
- All calibration and/or verification services include a NIST traceable calibration certificate

**FOR MORE INFORMATION SEE PAGE 9**



**Visit us on our website at [www.fiberinstrumentsales.com/calibration/](http://www.fiberinstrumentsales.com/calibration/)**

# SPlicing | MECHANICAL SPLICES

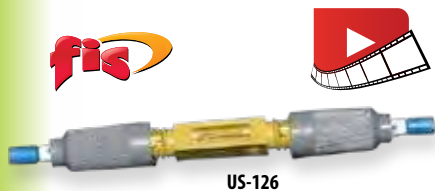

## FIS ULTRASPLICE

The ULTRASplice® is a high performance, easy to install reusable mechanical splice. It accepts fiber buffer sizes from 250µm-900µm. The average loss is .2dB with a fiber retention of over 2 lbs. Cleave, insert the fibers and secure by twisting a locking nut. US-126 is IBM #33G8228. Meets and exceeds Telcordia specifications.

PART #	DESCRIPTION	PRICE
US-126	Singlemode / Multimode Universal ULTRASplice®	\$7.95



## FIS LOCK JAW

With a self-gripping clamshell design this unique splice allows users to achieve a superior pull strength of 1.5 lbs by simply using super glue. Its design allows use in several splice trays, accepts 125µm clad Singlemode or Multimode with a typical loss of .2dB. Also available in the FIS Mechanical Splice Kit.

PART #	DESCRIPTION	PRICE
F1-MC125	Splice for 125µm Clad Fiber, SM or MM	\$2.95
F1-MC125SK	Splice Kit - (6) splices, cleaver, adhesive, cleaner and strip tool	139.00

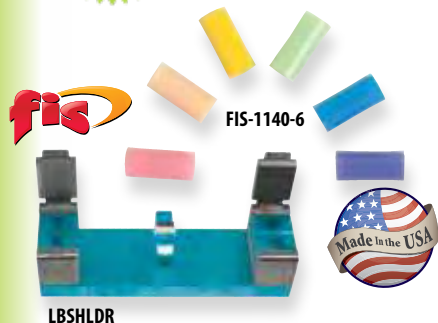

## ELASTOMERIC LAB SPLICE

The improved FIS Elastomeric Lab Splice is ideal for making temporary fiber connections and can be reused hundreds of times. To use the splice for instrument testing, simply insert a cleaved pigtail from OTDR or Power Meter and the cleaved unconnectorized fiber to be tested. Excellent for both Multimode and Singlemode fiber, the splice accepts fiber cladding diameters of 125µm to 140µm. The Lab Splices are supplied in blister packs of 6 (containing one of each color: pink, peach, yellow, green, blue and purple) or 12 (containing 2 of each color.)

PART #	DESCRIPTION	PRICE
FIS-1140-6	Pack of 6	\$9.95
FIS-1140-12	Pack of 12	16.95
LBSHLDR	Holder	200.00

CORNING



## CORNING FIBRLOK II

The Fibrlok has an insertion loss <.2dB with a fiber retention of >7.75 lbs. Known for low reflection characteristics of -35dB. Using V groove technology, it requires no epoxy. Uses Fibrlok assembly tool 2501. Splice completed in 30 seconds after preparing fiber ends. Thermal stability of -40°C to 80°C. Now Fibrloks fit 250-900µm buffer sizes. **Note: 2539 does not require 2501 tool for assembly.**

PART #	DESCRIPTION	PRICE
2529	FIBRLOK II (250µm or 900µm)	\$8.25
2501	Assembly Tool (For use with 2529)	70.00
2539	Splice and Holder with Built-in Actuator (250µm or 900µm)	12.95

CORNING



## CAMSPlice

This easy to install one size fits all mechanical splice features "Cam" locking mechanism, which requires no adhesive. The CamSplice incorporates a unique alignment method that self centers fibers, providing accurate alignment. Splice losses of less than 0.5dB are consistently achievable. Fits 250/250µm, 250/900µm and 900/900µm.

PART #	DESCRIPTION	PRICE
95-000-04	Camsplice	\$21.95
2104040-01	Assembly Fixture	275.00



## MECHANICAL SPLICE PROTECTION HOUSING

Available from FIS is a metallic protection sleeve that slips over mechanical splices for rugged protection. Install the tube and supplied shrink tubes onto the cable before installation and apply a heat source to fix housing into position. Accepts 95-000-04, US126, 2529, F1-MC125 splices offered above.

PART #	DESCRIPTION	PRICE
F1-1002M	Protection Housing	\$4.35





**ULTRASLEEVE® PROTECTION SLEEVE**

Simply load the fused fiber and close the sleeve. No heat shrink curing, crimping or gluing. Ultrasleeve® features an acrylic foam tape, which seals the sleeve and protects from damage. The Ultrasleeve® splice protector can be closed by hand and is installed after the splice is completed.



PART #	DESCRIPTION	PRICE
F1-FS60	60mm Splice Protection Sleeve	1.95

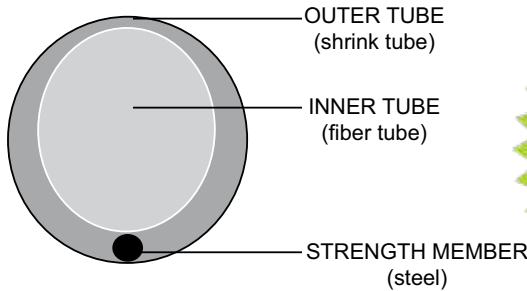

**FUSION SPLICE PROTECTION SLEEVES**

**STANDARD SLEEVE – (3.0mm AFTER SHRINK)**

This sleeve design represents the industry's most reliable, highest quality sleeve at an economical price. Standard lengths include 60mm and 40mm. Sleeves come standard with a clear outer tube for viewing the color of the fiber itself.

PART #	DESCRIPTION	1-9	10+
F1-1002C-50	60mm, 50 pk (Clear)	\$10.50	\$9.45
F1-100240C-50	40mm, 50 pk (Clear)	10.50	9.45
F1-1002RC-50	60mm, 50 pk (Red)	10.50	9.45

**SLIM SLEEVE – (2.5mm AFTER SHRINK)**

These clear protection sleeves use reduced diameter components for a smaller finished product. The smaller diameter allows users to fit more splices into existing splice trays.

PART #	DESCRIPTION	1-9	10+
F1-S25C-50	60mm, 50 pk (Clear)	\$10.50	\$9.45
F1-S2540C-50	40mm, 50 pk (Clear)	10.50	9.45

**TAPERED SLEEVE – (3.0mm AFTER SHRINK)**

This sleeve offers tapered ends designed to keep the metal strength member in proper position while in use. Available in 60mm and 40mm lengths.

PART #	DESCRIPTION	1-9	10+
F1-1002T-50	60mm, 50 pk (Clear)	\$10.50	\$9.45
F1-100240T-50	40mm, 50 pk (Clear)	10.50	9.45

**MICRO SLEEVE (1.5mm After Shrink) & MINI SLEEVE (2.0mm After Shrink)**

Designed to fit in smaller areas for splice storage are the Mini and Micro Protection Sleeves. Micro Sleeves will only accommodate 250µm coated fibers. Mini Sleeves will accommodate 900µm or 250µm coated fibers.

PART #	DESCRIPTION	1-9	10+
MCRO140CFD-50	Micro 40mm, 50 pk (Clear)	\$10.50	\$9.45
MCRO125CFD-50	Micro 25mm, 50 pk (Clear)	10.50	9.45
MINI140CDS-50	Mini 40mm, 50 pk (Clear)	\$10.50	\$9.45
MINI125CDS-50	Mini 25mm, 50 pk (Clear)	10.50	9.45

**RIBBON SPLICE PROTECTION SLEEVE**

FIS offers two ribbon sleeve styles: Dual Strength Member and Single Strength Member. The Dual Strength Member design eliminates any undue stress on the ribbon, creating a perfectly flat exit for the ribbon. Available with a ceramic strength member.

PART #	DESCRIPTION	1-9	10+
F1-10112DP-50	Dual Member 40mm, 50pk (Clear)	\$20.00	\$18.00
F1-10112CP-50	Single Member 40mm, 50pk (Clear)	20.00	18.00

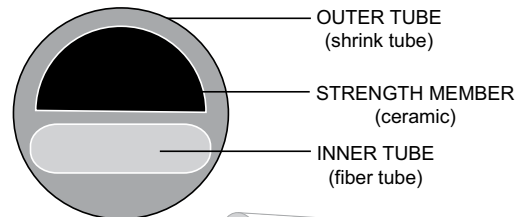

**DIELECTRIC SPLICE PROTECTION SLEEVE – (3.0mm After Shrink)**

Our Dielectric sleeves are manufactured with a non-metallic strength member for the ultimate in corrosion and electrical resistance.

PART #	DESCRIPTION	1-9	10+
F1-DE60-50	60mm, Clear	\$14.50	\$13.00
F1-DE40-50	40mm, Clear	14.50	13.00

**SPLICE SLEEVE SPATULA**

The splice sleeve spatula is the perfect tool to aid in removing stubborn splice sleeves from splice protection chips. This tool provides adequate leverage and a wide flat surface to gently loosen any splice protection sleeve, without damage.

PART #	DESCRIPTION	PRICING
10033301	FIS Splice Sleeve Spatula	\$8.95

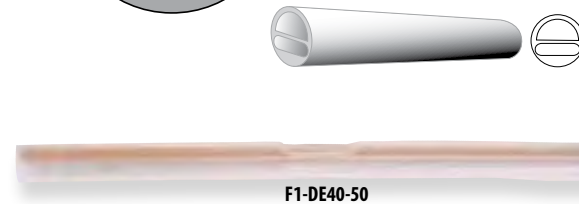

# CABLE



## RE-SPOOLING SERVICE

We cut and spool fiber or cable to your specified lengths



POF-KIT

## CABLE BUYING GUIDELINES

1. We strive to cut the cable that you order to the exact length that you request. This is not always possible, so following industry standard practice regarding cable, for shipping and billing purposes, we will not ship less than the amount that you order, but we may ship and bill up to 10% more than the length you specify when placing your order. (Allowable cable length for shipping and billing purposes is -0/+10%).
2. Cable cut/spool fees may apply on custom lengths. Please contact your FIS Sales Representative for pricing.
3. Cut charges do not apply when cable reels that are in stock are offered and accepted.
4. Minimum order quantities on non-stock cable will be required.
5. OS2 SM, OM3 MM, and OM4 MM Bare Ribbon Fiber is offered in stock spool lengths of 153 meters, 305 meters, 610m, 915m, 1,525m, and 2,000 meters. We have the ability to custom cut lengths up to, but not exceeding 100 meters. If you require a custom cut length greater than 100 meters, a \$25.00 cut fee and 2-3 week lead time will apply. The cut fee covers up to 4 cuts, an additional fee will apply to 5 or more custom cuts.

## THREE-PIECE SPOOL

The three-piece spool features plastic flanges bolted to a kraft barrel, creating a durable, dimensionally true and splinter-free reel. Flange diameter is 18" while the barrel diameter is 8.25", making it perfect for bulk cable or long assemblies.

PART #	DESCRIPTION	PRICE
F1-12SPOOL	Three Piece Spool - 1.75 Arbor Hole - 12"x9"x6"	\$11.95
F1-14SPOOL	Three Piece Spool - 1.75 Arbor Hole - 14"x9"x6"	13.95
F1-18SPOOL	Three Piece Spool - 1.75 Arbor Hole - 18"x15.5"x7.75"	15.95

## TLC PLASTIC FIBER OPTIC CABLE AND ACCESSORIES

TLC plastic optical fiber cables are designed for data transmission applications. The standard product is a 2.2mm jacket over 1.0mm step index PMMA plastic fiber. Standard colors are red and black, other colors are available upon request.

PART #	DESCRIPTION	DIA.	PRICE
P96TB01TRBL22	980/1000µm Core Simplex Plastic Fiber (Black)	2.2mm	75¢ /Mtr.
P96TD02TRBL44	980/1000µm Core Duplex Plastic Fiber (Black)	2.2/4.5mm	1.45¢ /Mtr.
POF-KIT	Plastic Fiber Optic Tool Kit		\$120.00
POF-HKN	Hot Knife for Cutting Plastic Fiber of all Diameters		17.95
F1-0065	ST Connector 1mm Stainless Alloy Ferrule for Plastic Fiber		3.75



## DID YOU KNOW... 10 GIG, CLEARCURVE® & BEYOND

What is OM1, OM2, OM3 and OM4 MULTIMODE CABLE?

Fiber-to-the-Home and Desk (FTTx) applications have resulted in the creation of several new grades of multimode fiber. The use of Gigabit and 10 Gig fibers can help future proof your network. Bend insensitive fibers, like Corning® ClearCurve can be bent down to very small diameters without affecting the optical signal. FTTx applications use Bend Insensitive fiber because of its ease and flexibility of installation.

TLC's Gigabit Cables are designed with ClearCurve optical fibers, engineered for laser-based local area network protocols such as Gigabit Ethernet. Thanks to Corning's latest innovation, the new SMF-28® Ultra optical fiber was the first in the market to combine the benefit of industry-leading attenuation and improved macrobend performance in one fiber. TLC will also customize materials and constructions to meet your individual requirements.

FIBER TYPE	STANDARD DESIGNATION	JACKET COLOR (typical)	MAXIMUM ATTENUATION (dB/km)			TRANSMISSION DISTANCE FOR (in meters)				MINIMAL MODAL BANDWIDTH (MHz/km)			
			850nm	953nm	1300nm	1 Gb/s	10 Gb/s	40 Gb/s	100 Gb/s	OVERFILLED LAUNCH (OFL) 850nm	OVERFILLED LAUNCH (OFL) 1300nm	OVERFILLED LAUNCH (EMB) 850nm	OVERFILLED LAUNCH (EMB) 953nm
62.5/125	OM1	Orange	2.9	-	0.6	275	33	-	-	200	300	-	-
50/125	OM2	Orange	2.3	-	0.6	550	150	-	-	700	500	950	-
50/125	OM3	Aqua	2.3	-	0.6	550	300	100	70	1500	500	2000	-
50/125	OM4	Aqua	2.3	-	0.6	550	550	150	100	3500	500	4700	-
50/125	OM5 (WB)	Lime Green	2.3	1.7	0.6	550	550	150	100	3500	500	4700	2470

Corning® ClearCurve® optical fiber

ClearCurve® fibers are fully compliant with ITU-T G.652.D and G.657 standards. These fibers are designed to meet a wide array of applications including both inside and outside plant installations. Network designers, operators, and installers choose ClearCurve fibers for their superior bending performance, backward compatibility with the G.652.D standard and their ability to minimize bend-loss throughout any installation. Use the chart, right, to aid in selecting the right ClearCurve fiber for your application.

Corning Product	Application	ITU-T	Radius	Corning Spec
ClearCurve® ZBL optical fiber or ClearCurve® single-mode optical fibers	• Virtually no bend-loss in most indoor applications • Very low loss in extreme (5mm) bend environments • Enables smaller components and flexible yet reliable networks	Exceeds G.657. A3/B3	5mm	<0.10 dB/turn
			7.5mm	
SMF-28® Ultra Optical Fiber	• Improved performance vs. standard singlemode fiber • Fully backward compatible with the installed base of legacy single-mode fibers. • Enables a broader range of cable design options and deployment flexibility	Exceeds G.657.A1	10mm	<0.50 dB/turn

**CORNING® BARE FIBER (245µm)**

For high-data-rate, long haul terrestrial, regional and metropolitan ring networks or local access and premise applications. Corning® offers fibers that are designed for greater capacity and flexibility. **Respooling capabilities are available. There is a repooling charge of 5¢ per meter for lengths over 2,000 meters. Any length under 2,000 meters will incur a minimum spooling charge of \$10.00.**

PART #	DESCRIPTION	PRICE
SMF-28e+®	Corning® SMF-28e+® fiber OS2 with NexCor Technology 9/125µm (G.652)	8¢ /Mtr.
SMF-28® Ultra	Corning® SMF-28® Ultra Optical Fiber (G.657.A1)	8¢ /Mtr.
SMFLF	Corning® LEAF® fiber Non-Zero Dispersion 9/125µm (G.655)	11¢ /Mtr.
ClearCurve®ZBL	Corning® ClearCurve® SM ZBL (G.657A/B)	15¢ /Mtr.
InfiniCor® 300	Corning® InfiniCor® 300 fiber® OM1 fiber 62.5/125µm	13¢ /Mtr.
ClearCurve®OM2	Corning® ClearCurve® OM2 fiber 50/125µm	13¢ /Mtr.
ClearCurve®OM3	Corning® ClearCurve® OM3 fiber 50/125µm	20¢ /Mtr.
ClearCurve®OM4	Corning® ClearCurve® OM4 fiber 50/125µm	30¢ /Mtr.

**CORNING® SPECIALTY PM PHOTONIC FIBERS**

Corning® Specialty PM Photonic Fibers, designed with the best polarization maintaining properties in the world today, offer low attenuation and excellent birefringence for next generation network systems. The fibers are available in a wide range of standard operating wavelengths up to 1550nm, including 1400-1490nm optimized for Raman applications.

PART #	DESCRIPTION	PRICE
PM15-U25	Puremode™ PM 1550 with 250µm Dual Acrylate Coating (100KPSI)	\$8.75 /Mtr.
PM15-U40	Puremode™ PM 1550 with 400µm Dual Acrylate Coating (100KPSI)	8.75 /Mtr.
PM98-U25H	Puremode™ PM 980 with 250µm Dual Acrylate Coating (200KPSI)	8.75 /Mtr.

**CORNING® SPECIALTY HI PHOTONIC FIBERS**

Corning® Specialty HI Photonic Fibers offer world class durability and reliability. When used as component pigtailed, this fiber allows for efficient fiber coupling within photonic products.

PART #	MAXIMUM ATTENUATION	CUTOFF WAVELENGTH	MODE-FIELD DIA.	PRICE
HI980-6	≤ 2.5dB/km @ 980nm	930 ± 50nm	4.2µm @ 980nm	\$2.50 /Mtr.
HI1060-6-H	2.1dB/km @ 980nm 1.5dB/km @ 1060nm	920 ± 50nm	5.9 ± 0.5µm @ 980nm 6.2 ± 0.5µm @ 1060nm 9.9 ± 0.5µm @ 1550nm	2.75 /Mtr.

**TLC FLAT RIBBON - OS2 / OM1 / OM2 / OM3 / OM4**

PART #	DESCRIPTION	PRICE
S09-RB012-CZ	12 Fiber Singlemode 9/125µm Bare 245µm - OS2	\$1.10 /Mtr.
M62-RB012-C	12 Fiber Multimode 62.5/125µm Bare 245µm - OM1	2.15 /Mtr.
M50-RB12-CG	12 Fiber Multimode 50/125µm ClearCurve® Bare 245µm - OM3	2.85 /Mtr.
M50-RB12-C4	12 Fiber Multimode 50/125µm ClearCurve® Bare 245µm - OM4	4.35 /Mtr.

**TLC FLAT RIBBON CABLE - OS2 / OM1 / OM2 / OM3 / OM4**

PART #	DESCRIPTION	PRICE
S09-RB12-CZNR	12 Fiber Singlemode 9/125µm Riser Jacket Yellow - OS2	\$1.15 /Mtr.
S09-RB12-CZNPY	12 Fiber Singlemode 9/125µm Plenum Jacket Yellow - OS2	1.30 /Mtr.
M62-RB12-C3NPO	12 Fiber Multimode 62.5/125µm Plenum Jacket Orange - OM1	2.75 /Mtr.
M50-RB12-C2NPO	12 Fiber Multimode 50/125µm Plenum Jacket Orange - OM2	2.35 /Mtr.
M50-RB12-CGNRA	12 Fiber Multimode 50/125µm Corning® ClearCurve® OM3 Riser Jacket Aqua	3.25 /Mtr.
M50-RB12-CGNPA	12 Fiber Multimode 50/125µm Corning® ClearCurve® OM3 Plenum Jacket Aqua	3.50 /Mtr.
M50-RB12-C4NPA	12 Fiber Multimode 50/125µm Corning® ClearCurve® OM4 Plenum Jacket Aqua	4.65 /Mtr.

**900µm TIGHT BUFFER SINGLEMODE AND MULTIMODE CABLE**

PART #	DESCRIPTION	PRICE	PART #	DESCRIPTION	PRICE
S09-TB01-CZNPW	White SM 9/125µm	18¢ /Mtr.	M62-TB01-C3NPW	White MM 62/125µm	23¢ /Mtr.
S09-TB01-CZNP	Aqua SM 9/125µm	18¢ /Mtr.	M62-TB01-C3NPO	Orange MM 62/125µm	23¢ /Mtr.
S09-TB01-CZNPY	Yellow SM 9/125µm	18¢ /Mtr.	M50-TB01-C2NPO	Orange MM 50/125µm	35¢ /Mtr.
M50-TB01-CGNPA	ClearCurve® MM OM3 Aqua	35¢ /Mtr.	M50-TB01-C4NPA	ClearCurve® MM OM4 Aqua	50¢ /Mtr.

**FIBERCORE LTD. POLARIZATION MAINTAINING FIBER**

Fibercore's HB series polarization maintaining fiber (80 and 125 micron) with the characteristic "bow tie" stress applying parts gives you the very best in performance and handling.

PART #	DESCRIPTION	OPERATING WAVELENGTH	PRICE
HB1250P	Polyimide Coated PM Fiber (145µm coating) 6.6/125µm	1300nm	\$17.75 /Mtr.
HB1250T	PM Fiber for Telecom Applications (400µm coating) 9/125µm	1310nm	12.50 /Mtr.

**FIBERCORE LTD. SPECIALTY SINGLEMODE FIBER**

Fibercore Ltd's Specialty Singlemode Optical Fibers (80 and 125 micron) have been proven to perform in a wide range of challenging applications for wavelengths from 450nm to 1500nm.

PART #	DESCRIPTION	OPERATING WAVELENGTH	PRICE
SM600	Singlemode Fiber 4.3/125µm (245µm coating)	633/688nm	\$2.95 /Mtr.
SM800	Singlemode Fiber 4.2/80µm (175µm coating)	830nm	2.50 /Mtr.

**TLC LARGE CORE FIBER CABLE**

PART #	DESCRIPTION	PRICE
M10-SX01-LNRG	100/140µm 3.0mm Simplex (MM) Green	\$2.45 /Mtr.
M20-SX01-LNRB	200/230µm 3.0mm Simplex (MM) Blue	1.35 /Mtr.
M10-DX02-LNRG	100/140µm 3.0mm Duplex (MM) Green	4.15 /Mtr.
M20-DX02-LNRB	200/230µm 3.0mm Duplex (MM) Blue	2.20 /Mtr.

CORNING

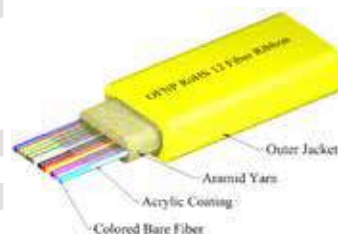
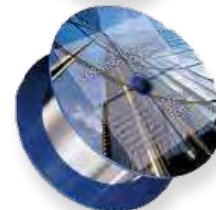
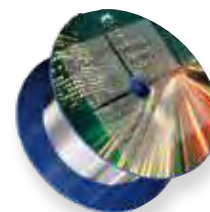



# CABLE | SIMPLEX / DUPLEX - SINGLEMODE

FIS supplies the industry's broadest array of Fiber Optic Cable and Tubing for all Access and Premises Network Applications. These include Standard and Customized Simplex, Duplex, Tight Buffer, Distribution, Loose Tube Indoor/Outdoor and Ribbon Cable, as well as furcation tubing to fit various fanout applications.



Corning's new SMF-28® Ultra optical fiber is the first in the market to combine the benefit of industry-leading attenuation and improved macrobend performance in one fiber. This premium single-mode fiber is designed for long-haul, metro, access, and fiber-to-the-home (FTTH) applications, and is fully backward compatible with the installed base of legacy single-mode fibers.

## Corning® SMF-28® Ultra Fiber

**Compatibility Matters.**

- MFD equivalence and 100% compatibility to G.652.D fiber allows for seamless integration into existing networks

**Bend Matters.**

The same improved bend performance of Corning® ClearCurve® XB fiber:

- 33% better bend than G.657. A 1 standard
- Capacity robustness: NGPON, WDM PON

**Simplicity Matters.**

- One fiber everywhere to minimize inventory management complexity

**Loss Matters.**

The same industry leading low-loss of Corning® SMF-28e+® LL fiber:

- Capacity robustness: 100G, 400G, Next Gen PON
- Low-cost capacity: less equipment, longer reach
- Enhanced Fixed-Mobile broadband coverage
- Repair resilience



Four huge benefits.  
One amazing fiber.  
Ultra has arrived.

CORNING

## 9/125µm - OS2 SINGLEMODE Corning® SMF-28® Ultra fiber

### SIMPLEX CABLE

PART #	DESCRIPTION	BUFFER SIZE	MFG	PRICE
<b>3.0mm</b>				
S09-SX01-CZNRV	Riser Yellow	900µm	TLC	18¢ /Mtr.
S09-SX01-CZNR	Riser Red	900µm	TLC	18¢ /Mtr.
S09-SX01-CZNPY	Plenum Yellow	900µm	TLC	20¢ /Mtr.
1E31-311-31	Riser Yellow	900µm	CCS	40¢ /Mtr.
<b>2.0mm</b>				
S09-SX01-CZNRV20	Riser Yellow	900µm	TLC	18¢ /Mtr.
S09-SX01-CZNPY20	Plenum Yellow	900µm	TLC	20¢ /Mtr.
S09-SX01-CZNRB20	Riser Blue	900µm	TLC	20¢ /Mtr.
<b>1.6mm</b>				
S09-SX01-CZNRV16	Riser Yellow	650µm	TLC	18¢ /Mtr.
S09-SX01-CZNPY16	Plenum Yellow	650µm	TLC	20¢ /Mtr.

### DUPLEX CABLE

PART #	DESCRIPTION	BUFFER SIZE	MFG	PRICE
<b>3.0mm</b>				
S09-DX02-CZNRV	Riser Yellow	900µm	TLC	28¢ /Mtr.
S09-DX02-CZNR	Riser Red	900µm	TLC	28¢ /Mtr.
S09-DX02-CZNPY	Plenum Yellow	900µm	TLC	35¢ /Mtr.
2E51-311-31	Riser Yellow	900µm	CCS	65¢ /Mtr.
<b>2.0mm</b>				
S09-DX02-CZNRV20	Riser Yellow	900µm	TLC	28¢ /Mtr.
S09-DX02-CZNPY20	Plenum Yellow	900µm	TLC	35¢ /Mtr.
S09-DX02-CZNRB20	Riser Blue	900µm	TLC	28¢ /Mtr.
<b>1.6mm</b>				
S09-DX02-CZNRV16	Riser Yellow	650µm	TLC	28¢ /Mtr.
S09-DX02-CZNPY16	Plenum Yellow	650µm	TLC	35¢ /Mtr.

## 9/125µm - SINGLEMODE ULTRA LOW BEND OPTIMIZED Corning® ClearCurve® ZBL fiber (5mm Radius) G657.B3

### SIMPLEX CABLE

PART #	DESCRIPTION	BUFFER SIZE	MFG	PRICE
<b>3.0mm</b>				
S09-SX01-CCNRV	Riser Yellow	900µm	TLC	35¢ /Mtr.
<b>1.6mm</b>				
S09-SX01-CCNRV16	Riser Yellow	650µm	TLC	35¢ /Mtr.

### DUPLEX CABLE

PART #	DESCRIPTION	BUFFER SIZE	MFG	PRICE
<b>3.0mm</b>				
S09-DX02-CCNRV	Riser Yellow	900µm	TLC	65¢ /Mtr.
<b>1.6mm</b>				
S09-DX02-CCNRV16	Riser Yellow	650µm	TLC	65¢ /Mtr.

## 62.5/125µm - OM1 MULTIMODE Corning® ClearCurve® OM1 fiber

### SIMPLEX CABLE

3.0mm PART #	DESCRIPTION	BUFFER SIZE	MFG	PRICE
M62-SX01-C3NRO	Riser Orange	900µm	TLC	25¢ /Mtr.
M62-SX01-C3NPO	Plenum Orange	900µm	TLC	29¢ /Mtr.
1K31-311-41	Riser Orange	900µm	CCS	70¢ /Mtr.
2.0mm				
M62-SX01-C3NRO20	Riser Orange	900µm	TLC	25¢ /Mtr.
M62-SX01-C3NPO20	Plenum Orange	900µm	TLC	29¢ /Mtr.
1.6mm				
M62-SX01-C3NRO16	Riser Orange	650µm	TLC	25¢ /Mtr.
M62-SX01-C3NPO16	Plenum Orange	650µm	TLC	29¢ /Mtr.

### DUPLEX CABLE

3.0mm PART #	DESCRIPTION	BUFFER SIZE	MFG	PRICE
M62-DX02-C3NRO	Riser Orange	900µm	TLC	45¢ /Mtr.
M62-DX02-C3NPO	Plenum Orange	900µm	TLC	55¢ /Mtr.
2K51-311-41	Riser Orange	900µm	CCS	\$1.10 /Mtr.
2.0mm				
M62-DX02-C3NRO20	Riser Orange	900µm	TLC	45¢ /Mtr.
M62-DX02-C3NPO20	Plenum Orange	900µm	TLC	55¢ /Mtr.
1.6mm				
M62-DX02-C3NRO16	Riser Orange	650µm	TLC	45¢ /Mtr.
M62-DX02-C3NPO16	Plenum Orange	650µm	TLC	55¢ /Mtr.

## 50/125µm - OM2 MULTIMODE Corning® ClearCurve® OM2 fiber

### SIMPLEX CABLE

3.0mm PART #	DESCRIPTION	BUFFER SIZE	MFG	PRICE
M50-SX01-C2NRO	Riser Orange	900µm	TLC	23¢ /Mtr.
M50-SX01-C2NPO	Plenum Orange	900µm	TLC	25¢ /Mtr.
001T31-311-3124	Plenum Orange	900µm	CCS	60¢ /Mtr.
2.0mm				
M50-SX01-C2NRO20	Riser Orange	900µm	TLC	23¢ /Mtr.
M50-SX01-C2NPO20	Plenum Orange	900µm	TLC	25¢ /Mtr.
1.6mm				
M50-SX01-C2NRO16	Riser Orange	650µm	TLC	23¢ /Mtr.
M50-SX01-C2NPO16	Plenum Orange	650µm	TLC	25¢ /Mtr.

### DUPLEX CABLE

3.0mm PART #	DESCRIPTION	BUFFER SIZE	MFG	PRICE
M50-DX02-C2NRO	Riser Orange	900µm	TLC	45¢ /Mtr.
M50-DX02-C2NPO	Plenum Orange	900µm	TLC	53¢ /Mtr.
002T51-311-3124	Plenum Orange	900µm	CCS	78¢ /Mtr.
2.0mm				
M50-DX02-C2NRO20	Riser Orange	900µm	TLC	45¢ /Mtr.
M50-DX02-C2NPO20	Plenum Orange	900µm	TLC	53¢ /Mtr.
1.6mm				
M50-DX02-C2NRO16	Riser Orange	650µm	TLC	45¢ /Mtr.
M50-DX02-C2NPO16	Plenum Orange	650µm	TLC	53¢ /Mtr.

## 50/125µm - OM3 MULTIMODE-10 Gig Corning® ClearCurve® OM3 fiber

### SIMPLEX CABLE

3.0mm PART #	DESCRIPTION	BUFFER SIZE	MFG	PRICE
M50-SX01-CGNRA	Riser Aqua	900µm	TLC	28¢ /Mtr.
M50-SX01-CGNPA	Plenum Aqua	900µm	TLC	35¢ /Mtr.
2.0mm				
M50-SX01-CGNRA20	Riser Aqua	900µm	TLC	28¢ /Mtr.
M50-SX01-CGNPA20	Plenum Aqua	900µm	TLC	35¢ /Mtr.
1.6mm				
M50-SX01-CGNRA16	Riser Aqua	650µm	TLC	28¢ /Mtr.
M50-SX01-CGNPA16	Plenum Aqua	650µm	TLC	35¢ /Mtr.

### DUPLEX CABLE

3.0mm PART #	DESCRIPTION	BUFFER SIZE	MFG	PRICE
M50-DX02-CGNRA	Riser Aqua	900µm	TLC	50¢ /Mtr.
M50-DX02-CGNPA	Plenum Aqua	900µm	TLC	55¢ /Mtr.
2.0mm				
M50-DX02-CGNRA20	Riser Aqua	900µm	TLC	50¢ /Mtr.
M50-DX02-CGNPA20	Plenum Aqua	900µm	TLC	55¢ /Mtr.
1.6mm				
M50-DX02-CGNRA16	Riser Aqua	650µm	TLC	50¢ /Mtr.
M50-DX02-CGNPA16	Plenum Aqua	650µm	TLC	55¢ /Mtr.

## 50/125µm - OM4 MULTIMODE-10 Gig Corning® ClearCurve® OM4 fiber

### SIMPLEX CABLE

3.0mm PART #	DESCRIPTION	BUFFER SIZE	MFG	PRICE
M50-SX01-C4NRA	Riser Aqua	900µm	TLC	47¢ /Mtr.
M50-SX01-C4NPA	Plenum Aqua	900µm	TLC	49¢ /Mtr.
M50-SX01-C4NRM	Riser Magenta	900µm	TLC	47¢ /Mtr.
M50-SX01-C4NPM	Plenum Magenta	900µm	TLC	59¢ /Mtr.
2.0mm				
M50-SX01-C4NRA20	Riser Aqua	900µm	TLC	43¢ /Mtr.
M50-SX01-C4NPA20	Plenum Aqua	900µm	TLC	46¢ /Mtr.
M50-SX01-C4NRM20	Riser Magenta	900µm	TLC	43¢ /Mtr.
M50-SX01-C4NPM20	Plenum Magenta	900µm	TLC	46¢ /Mtr.
1.6mm				
M50-SX01-C4NRA16	Riser Aqua	650µm	TLC	43¢ /Mtr.
M50-SX01-C4NPA16	Plenum Aqua	650µm	TLC	46¢ /Mtr.
M50-SX01-C4NRM16	Riser Magenta	650µm	TLC	43¢ /Mtr.
M50-SX01-C4NPM16	Plenum Magenta	650µm	TLC	46¢ /Mtr.

### DUPLEX CABLE

3.0mm PART #	DESCRIPTION	BUFFER SIZE	MFG	PRICE
M50-DX02-C4NRA	Riser Aqua	900µm	TLC	65¢ /Mtr.
M50-DX02-C4NPA	Plenum Aqua	900µm	TLC	75¢ /Mtr.
M50-DX02-C4NRM	Riser Magenta	900µm	TLC	65¢ /Mtr.
M50-DX02-C4NPM	Plenum Magenta	900µm	TLC	75¢ /Mtr.
2.0mm				
M50-DX02-C4NRA20	Riser Aqua	900µm	TLC	65¢ /Mtr.
M50-DX02-C4NPA20	Plenum Aqua	900µm	TLC	75¢ /Mtr.
M50-DX02-C4NRM20	Riser Magenta	900µm	TLC	65¢ /Mtr.
M50-DX02-C4NPM20	Plenum Magenta	900µm	TLC	75¢ /Mtr.
1.6mm				
M50-DX02-C4NRA16	Riser Aqua	650µm	TLC	65¢ /Mtr.
M50-DX02-C4NPA16	Plenum Aqua	650µm	TLC	75¢ /Mtr.
M50-DX02-C4NRM16	Riser Magenta	650µm	TLC	65¢ /Mtr.
M50-DX02-C4NPM16	Plenum Magenta	650µm	TLC	75¢ /Mtr.

## 50/125µm - OM5 MULTIMODE-40/100 Gig Corning® ClearCurve® OM5 fiber

### SIMPLEX CABLE

2.0mm PART #	DESCRIPTION	BUFFER SIZE	MFG	PRICE
M50-SX01-C5NRA20	Riser Lime Green	900µm	TLC	55¢ /Mtr.
M50-SX01-C5NPA20	Plenum Lime Green	900µm	TLC	65¢ /Mtr.
1.6mm				
M50-SX01-C5NRA16	Riser Lime Green	900µm	TLC	55¢ /Mtr.
M50-SX01-C5NPA16	Plenum Lime Green	900µm	TLC	65¢ /Mtr.

### DUPLEX CABLE

2.0mm PART #	DESCRIPTION	BUFFER SIZE	MFG	PRICE
M50-DX02-C5NRA20	Riser Lime Green	900µm	TLC	\$1.05 /Mtr.
M50-DX02-C5NPA20	Plenum Lime Green	900µm	TLC	\$1.05 /Mtr.
1.6mm				
M50-DX02-C5NRA16	Riser Lime Green	900µm	TLC	\$1.05 /Mtr.
M50-DX02-C5NPA16	Plenum Lime Green	900µm	TLC	\$1.05 /Mtr.



**DISTRIBUTION CABLE**

TLC Distribution Cables are designed for general indoor use. Available in all fiber types, a thick durable jacket offers excellent strength and protection during installations and restorations. The 900µm color coded tight buffers allow for easy identification and termination. Cables are available in OFNR and OFNP rated constructions and also a LSZH jacket.

FIBER COUNT	CABLE OD	FIBER COUNT	CABLE OD
2	4.4mm	48	15.4mm
4	4.4mm	72	20mm
6	4.8mm	96	22.9mm
12	5.8mm	144	25.1mm
24	7.8mm		

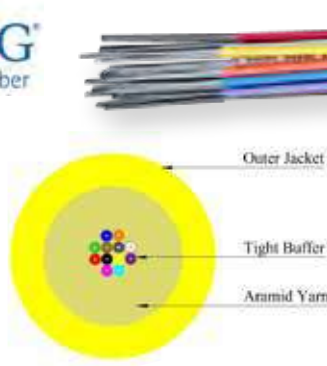
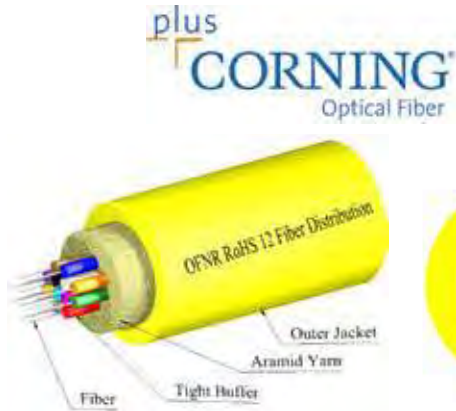

**See Page 90 for TLC Aluminum Interlocking Armored Distribution Cable**

**9/125µm - OS2 SINGLEMODE**

**Corning® SMF-28® Ultra fiber**

PART #	FIBER COUNT	DESCRIPTION	MFG	PRICE	PART #	FIBER COUNT	DESCRIPTION	MFG	PRICE
S09-DI06-CZNR48	6	Riser Yellow	TLC	60¢ /Mtr.	S09-DI48-CZNR48	48	Riser Yellow	TLC	\$3.50 /Mtr.
S09-DI12-CZNR58	12	Riser Yellow	TLC	\$1.10/Mtr.	S09-DI48-CZNPY48	48	Plenum Yellow	TLC	5.55/Mtr.
S09-DI12-CZNPY58	12	Plenum Yellow	TLC	1.20 /Mtr.	S09-DI72-CZNR48	72	Riser Yellow	TLC	5.50 /Mtr.
S09-DI24-CZNR78	24	Riser Yellow	TLC	1.80 /Mtr.	S09DI96CZNR48	96	Riser Yellow	TLC	7.00 /Mtr.
S09-DI24-CZNPY78	24	Plenum Yellow	TLC	2.35 /Mtr.	S09DI144CZNR48	144	Riser Yellow	TLC	9.25 /Mtr.

**62.5/125µm OM1 MULTIMODE**

**InfiniCor® 300 fiber**

PART #	FIBER COUNT	DESCRIPTION	MFG	PRICE	PART #	FIBER COUNT	DESCRIPTION	MFG	PRICE
M62-DI04-C3NR044	4	Riser Orange	TLC	\$1.05 /Mtr.	M62-DI12-C3NR058	12	Riser Orange	TLC	\$2.35 /Mtr.
M62-DI04-C3NP044	4	Plenum Orange	TLC	1.15 /Mtr.	M62-DI12-C3NP058	12	Plenum Orange	TLC	2.50 /Mtr.
M62-DI06-C3NR048	6	Riser Orange	TLC	1.25 /Mtr.	M62-DI24-C3NR078	24	Riser Orange	TLC	4.75 /Mtr.
M62-DI06-C3NP048	6	Plenum Orange	TLC	1.30 /Mtr.	M62-DI24-C3NP078	24	Plenum Orange	TLC	5.95 /Mtr.

**50/125µm - OM3 MULTIMODE - 10 Gig**

**Corning® ClearCurve® OM3 fiber**

PART #	FIBER COUNT	DESCRIPTION	MFG	PRICE	PART #	FIBER COUNT	DESCRIPTION	MFG	PRICE
M50-DI02-CGNRA44	2	Riser Aqua	TLC	55¢ /Mtr.	M50-DI24-CGNRA78	24	Riser Aqua	TLC	\$4.50 /Mtr.
M50-DI02-CGNPA44	2	Plenum Aqua	TLC	65¢ /Mtr.	M50-DI24-CGNPA78	24	Plenum Aqua	TLC	4.65 /Mtr.
M50-DI04-CGNRA44	4	Riser Aqua	TLC	90¢ /Mtr.	M50-DI48-CGNRA-A	48	Riser Aqua	TLC	10.25 /Mtr.
M50-DI04-CGNPA44	4	Plenum Aqua	TLC	\$1.00 /Mtr.	M50-DI48-CGNPA-A	48	Plenum Aqua	TLC	10.50 /Mtr.
M50-DI06-CGNRA48	6	Riser Aqua	TLC	1.30 /Mtr.	M50-DI72-CGNRA-A	72	Riser Aqua	TLC	13.00 /Mtr.
M50-DI06-CGNPA48	6	Plenum Aqua	TLC	1.65 /Mtr.	M50-DI72-CGNPA-A	72	Plenum Aqua	TLC	16.50 /Mtr.
M50-DI12-CGNRA58	12	Riser Aqua	TLC	2.75 /Mtr.	M50-DI96-CGNRA-A	96	Riser Aqua	TLC	16.50 /Mtr.
M50-DI12-CGNPA58	12	Plenum Aqua	TLC	3.00 /Mtr.	M50-DI144-CGNRA-A	144	Riser Aqua	TLC	23.65 /Mtr.

**50/125µm - OM4 MULTIMODE - 10 Gig**

**Corning® ClearCurve® OM4 fiber**

PART #	FIBER COUNT	DESCRIPTION	MFG	PRICE	PART #	FIBER COUNT	DESCRIPTION	MFG	PRICE
M50-DI6-C4NRA48	6	Riser Aqua	TLC	\$1.50/Mtr.	M50DI48C4NRA-A	48	Riser Aqua	TLC	12.55 /Mtr.
M50-DI6-C4NPA48	6	Plenum Aqua	TLC	1.80/Mtr.	M50DI48C4NPA-A	48	Plenum	TLC	15.30 /Mtr.
M50-DI12-C4NRA58	12	Riser Aqua	TLC	\$2.85/Mtr.	M50DI72C4NRA-A	72	Riser Aqua	TLC	19.95 /Mtr.
M50-DI12-C4NPA58	12	Plenum Aqua	TLC	3.20/Mtr.	M50DI72C4NPA-A	72	Plenum	TLC	22.80 /Mtr.



**50/125µm - OM5 MULTIMODE - 100 Gig**

**Corning® ClearCurve® OM5 fiber**

PART #	FIBER COUNT	DESCRIPTION	MFG	PRICE	PART #	FIBER COUNT	DESCRIPTION	MFG	PRICE
M50-DI12-C5NPLG-58	12	Plenum Aqua	TLC	\$6.25/Mtr.	M50-DI24-C5NPLG-78	24	Plenum Lime Green	TLC	12.35 /Mtr.





## TLC MICRO-DISTRIBUTION INDOOR CABLE

FIS is proud to offer the TLC line of Micro-Distribution Cables for the Data Center market. These cables are offered in Riser, Plenum or LSZH. They are available in OS2 Singlemode, OM1 62.5µm Multimode, OM2 50µm Multimode OM3 50µm Multimode, OM4 50µm Multimode. Numbered sub units available with either 6 or 12 fibers per tube. Micro Distribution cables with 3mm subunits available.

### 9/125µm - OS2 SINGLEMODE

Corning® SMF-28® Ultra fiber

PART #	FIBER COUNT	DESCRIPTION	PRICE
S09-MD12-CZNPY20	12	Plenum Yellow	70¢ /Mtr.
*S09-MD24-CZNPY20-Y	24	Plenum Yellow	\$2.25 / Mtr.
*S09-MD48-CZNPY20-Y	48	Plenum Yellow	3.25 / Mtr.
*S09-MD72-CZNPY20-Y	72	Plenum Yellow	4.25 / Mtr.
*S09-MD96-CZNPY20-Y	96	Plenum Yellow	5.40 / Mtr.
*S09-MD144-CZNPY20-Y	144	Plenum Yellow	8.55 / Mtr.

\*Indicates all buffers are colored Yellow

### 50/125µm - OM3 MULTIMODE

Corning® ClearCurve® OM3 fiber

PART #	FIBER COUNT	DESCRIPTION	PRICE
M50-MD12-CGNPA20	12	Plenum Aqua	\$1.95 / Mtr.
*M50-MD24-CGNPA20-A	24	Plenum Aqua	5.25 / Mtr.
*M50-MD48-CGNPA20-A	48	Plenum Aqua	9.00 / Mtr.
*M50-MD72-CGNPA20-A	72	Plenum Aqua	13.25 / Mtr.
*M50-MD96-CGNPA20-A	96	Plenum Aqua	14.60 / Mtr.
*M50-MD144-CGNPA20-A	144	Plenum Aqua	23.00 / Mtr.

### 50/125µm - OM4 MULTIMODE

Corning® ClearCurve® OM4 fiber

PART #	FIBER COUNT	DESCRIPTION	PRICE
M50-MD12-C4NPA20	12	Aqua Plenum	2.95 / Mtr.
*M50-MD24-C4NPA20-A	24	Aqua Plenum	6.95 / Mtr.
*M50-MD48-C4NPA20-A	48	Aqua Plenum	12.55 / Mtr.
*M50-MD72-C4NPA20-A	72	Aqua Plenum	16.40 / Mtr.
*M50-MD96-C4NPA20-A	96	Aqua Plenum	21.20 / Mtr.
*M50-MD144-C4NPA20-A	144	Aqua Plenum	35.00 / Mtr.

\*Indicates all buffers are colored Aqua

### 50/125µm - OM5 MULTIMODE

Corning® ClearCurve® OM5 fiber

PART #	FIBER COUNT	DESCRIPTION	PRICE
M50-MD12-C5NPLG-20	12	Plenum Lime Green	\$5.98 / Mtr.
M50-MD24-C5NPLG-20	24	Plenum Lime Green	12.35 / Mtr.



See Page 90 for TLC Aluminum Interlocking Armored Distribution Cable

Micro Distribution Cable

MICRO DISTRIBUTION CABLE DIAMETER CHART			
FIBER COUNT	CABLE OD	FIBER COUNT	CABLE OD
2	2mm	48	6.6mm
4	2mm	72	8mm
6	2mm	96	9.3mm
12	2mm	144	10.6mm
24	6.3mm		

INDOOR OUTDOOR CABLE DIAMETER CHART			
FIBER COUNT	CABLE OD	FIBER COUNT	CABLE OD
2	4.4mm	48	15.4mm
4	4.4mm	72	20mm
6	4.8mm	96	22.9mm
12	5.8mm	144	25.1mm
24	7.8mm		

## INDOOR/OUTDOOR CABLE

FIS offers indoor/outdoor cable in a distribution construction in both Riser and Plenum. These cables are flexible, easy to handle and simple to install. Since they do not use gel, the connectors can be terminated directly onto the 900µm fiber without breakout kits. This provides an easy and overall less expensive installation. **Note: When used in a burial application this cable must be placed in a conduit or innerduct and is not recommended for lashing applications.**

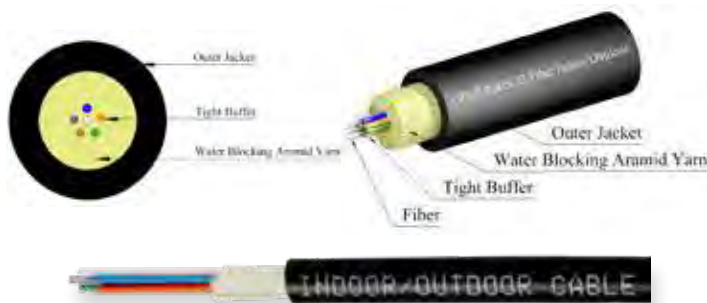

Indoor / Outdoor Cable

PART #	FIBER COUNT	DESCRIPTION	PRICE
<b>MULTIMODE 62.5/125µm InfiniCor® 300 fiber</b>			
M62-I006-C3NRBL48	6	Riser MM 62.5/125µm - OM1	1.45 /Mtr.
M62-I012-C3NRBL58	12	Riser MM 62.5/125µm - OM1	2.80 /Mtr.
M62-I024-C3NRBL78	24	Riser MM 62.5/125µm - OM1	5.50 /Mtr.
M62-I006-C3NPBL44	2	Plenum MM 62.5/125µm - OM1	80¢ /Mtr.
M62-I004-C3NPBL44	4	Plenum MM 62.5/125µm - OM1	\$1.30 /Mtr.
M62-I006-C3NPBL48	6	Plenum MM 62.5/125µm - OM1	1.60 /Mtr.
M62-I012-C3NPBL58	12	Plenum MM 62.5/125µm - OM1	3.00 /Mtr.
M62-I024-C3NPBL78	24	Plenum MM 62.5/125µm - OM1	5.95 /Mtr.

PART #	FIBER COUNT	DESCRIPTION	PRICE
<b>SINGLEMODE 9/125µm Corning® SMF-28® Ultra fiber</b>			
S09-I006-CZNRBL48	6	Riser SM 9/125µm - OS2	80¢ /Mtr.
S09-I012-CZNRBL58	12	Riser SM 9/125µm - OS2	\$1.60 /Mtr.
S09-I024-CZNRBL78	24	Riser SM 9/125µm - OS2	3.65 /Mtr.
S09-I006-CZNPBL48	6	Plenum SM 9/125µm - OS2	90¢ /Mtr.
S09-I012-CZNPBL58	12	Plenum SM 9/125µm - OS2	1.75 /Mtr.

<b>MULTIMODE 50/125µm Corning® ClearCurve® OM3 fiber</b>			
M50-I002-CGNRBL44	2	Riser 50/125 10 Gig MM - OM3	70¢ /Mtr.
M50-I004-CGNRBL44	4	Riser 50/125 10 Gig MM - OM3	\$1.15 /Mtr.
M50-I006-CGNRBL48	6	Riser 50/125 10 Gig MM - OM3	1.60 /Mtr.
M50-I012-CGNRBL58	12	Riser 50/125 10 Gig MM - OM3	2.75 /Mtr.
M50-I024-CGNRBL78	24	Riser 50/125 10 Gig MM - OM3	4.50 /Mtr.
M50-I006-CGNPBL48	6	Plenum 50/125 10 Gig MM - OM3	1.80 /Mtr.
M50-I012-CGNPBL58	12	Plenum 50/125 10 Gig MM - OM3	3.00 /Mtr.
M50-I024-CGNPBL78	24	Plenum 50/125 10 Gig MM - OM3	4.95 /Mtr.

<b>MULTIMODE 50/125µm Corning® ClearCurve® OM4 fiber</b>			
M50-I006-C4NRBL48	6	Riser 50/125 10 Gig MM - OM4	\$1.80 /Mtr.
M50-I006-C4NPBL48	6	Plenum 50/125 10 Gig MM - OM4	2.25 /Mtr.
M50-I012-C4NRBL58	12	Riser 50/125 10 Gig MM - OM4	3.30 /Mtr.
M50-I012-C4NPBL58	12	Plenum 50/125 10 Gig MM - OM4	3.75 /Mtr.
M50-I024-C4NRBL78	24	Riser 50/125 10 Gig MM - OM4	3.75 /Mtr.
M50-I024-C4NPBL78	24	Plenum 50/125 10 Gig MM - OM4	3.75 /Mtr.



**NEW**  
Smaller  
Diameter

plus  
**CORNING**  
Optical Fiber



Refer to page 23 for the  
AIA Grounding Kit



**BELDEN**



**BELDEN**



## TLC ALUMINUM INTERLOCKING ARMORED DISTRIBUTION CABLE

TLC Tight Buffered Aluminum Interlocking Armored cable consists of PVC outer jacket, PVC inner jacket with 2 to 48 tight buffered fibers surrounded by aramid yarn acting as a strength member. The core is protected by a spirally wrapped aluminum strip that offers easy installation and high crush resistance. These cables are available in OFCP rated constructions.

PART #	FIBER COUNT	DESCRIPTION	CABLE DIA.	PRICE
S09-DI06-CZNPY48-AIA2	6	SM Plenum 9/125µm - Yellow - OS2	13mm	\$2.85 /Mtr.
S09-DI12-CZNPY58-AIA2	12	SM Plenum 9/125µm - Yellow - OS2	14.7mm	3.25 /Mtr.
S09-DI24-CZNPY78-AIA2	24	SM Plenum 9/125µm - Yellow - OS2	16.2mm	6.55 /Mtr.
S09-DI48-CZNPY48-AIA	48	SM Plenum 9/125µm - Yellow - OS2	23.50mm	13.75 /Mtr.
M62-DI06-C3NPO48-AIA2	6	MM Plenum 62.5/125µm - Orange - OM1	13mm	3.50 /Mtr.
M62-DI12-C3NPO58-AIA2	12	MM Plenum 62.5/125µm - Orange - OM1	14.7mm	4.25 /Mtr.
M50-DI06-CGNPA48-AIA2	6	MM Plenum 50/125µm Aqua - OM3	13mm	3.60 /Mtr.
M50-DI12-CGNPA58-AIA2	12	MM Plenum 50/125µm Aqua - OM3	14.7mm	4.95 /Mtr.
M50-DI24-CGNPA78-AIA2	24	MM Plenum 50/125µm Aqua - OM3	16.2mm	8.50 /Mtr.
M50-DI06-C4NPA48-AIA2	6	MM Plenum 50/125µm Aqua - OM4	13mm	3.75 /Mtr.
M50-DI12-C4NPA58-AIA2	12	MM Plenum 50/125µm Aqua - OM4	14.7mm	6.35 /Mtr.
M50-DI24-C4NPA78-AIA2	24	MM Plenum 50/125µm Aqua - OM4	16.2mm	8.65 /Mtr.

## INTERLOCKING INDOOR/OUTDOOR ARMORED CABLE

PART #	FIBER COUNT	DESCRIPTION	CABLE DIA.	PRICE
S09-IO06-CZNPBL48-AIA2	6	SM Plenum 9/125µm Armored - OS2	13.0mm	\$2.98 / Mtr.
S09-IO12-CZNPBL58-AIA2	12	SM Plenum 9/125µm Armored - OS2	14.7mm	3.15 / Mtr.
S09-IO12-CZNRBL78-AIA2	12	SM Riser 9/125µm Armored - OS2	14.7mm	3.70 / Mtr.
M62-IO06-C3NPBL48-AIA2	6	MM Plenum 62.5/125µm Armored - OM1	13.0mm	3.45 / Mtr.
M62-IO12-C3NPBL58-AIA2	12	MM Plenum 62.5/125µm Armored - OM1	14.7mm	4.35 / Mtr.
M50-IO06-CGNPBL48-AIA2	6	MM Plenum 50/125µm 10 Gig Armored - OM3	13.0mm	3.95 / Mtr.
M50-IO12-CGNPBL58-AIA2	12	MM Plenum 50/125µm 10 Gig Armored - OM3	14.7mm	4.95 / Mtr.
M50-IO24-CGNPBL78-AIA2	24	MM Plenum 50/125µm 10 Gig Armored - OM3	16.2mm	6.95 / Mtr.

## ARMORED MICRO DISTRIBUTION CABLE

PART #	FIBER COUNT	DESCRIPTION	CABLE DIA.	PRICE
S09-MD12-CZNPY-AIA2	12	SM Plenum Yellow Armored - OS2	14.7mm	\$1.95 / Mtr.
M50-MD12-CGNPA-AIA2	12	MM Plenum Aqua Armored - OM3	14.7mm	4.35 / Mtr.
M50-MD24-CGNPAATW-AIA2	24	MM Plenum Aqua Armored - OM3	16.2mm	7.95 / Mtr.
M50-MD48-CGNPA4TA-AIA	48	MM Plenum Aqua Armored - OM3	17.45mm	11.25 / Mtr.
M50-MD12-C4NPA-AIA2	12	MM Plenum Aqua Armored - OM4	14.7mm	4.95 / Mtr.
M50-MD24-C4NPA2TA-AIA2	24	MM Plenum Aqua Armored - OM4	16.2mm	9.50 / Mtr.
M50-MD48-C4NPA4TA-AIA2	48	MM Plenum Aqua Armored - OM4	17.45mm	12.25 / Mtr.

## BELDEN ARMORED CENTRAL LOOSE TUBE OSP CABLE

Belden Armored Central Tube OSP cable offers rodent protection and direct burial for outdoor applications. Cable features: surrounded by gel for moisture resistance, corrugated steel tape and a polyethylene jacket for weather and UV protection.

PART #	FIBER COUNT	DESCRIPTION	CABLE DIA.	PRICE
FSSC00660	6	SM 9/125µm - OS2	13.5mm	\$1.65 /Mtr.
FSSC01260	12	SM 9/125µm - OS2	13.5mm	1.85 /Mtr.
FS1C00660	6	MM 62.5/125µm - OM1	13.5mm	2.35 /Mtr.
FS1C01260	12	MM 62.5/125µm - OM1	13.5mm	3.00 /Mtr.
FS3C00660	6	MM 50/125µm - OM3	13.5mm	2.95 /Mtr.
FS3C01260	12	MM 50/125µm - OM3	13.5mm	5.25 /Mtr.

## BELDEN CENTRAL LOOSE TUBE OSP CABLE

Belden Central Loose Tube OSP cable features the long-term, field-proven reliability of conventional polyethylene outdoor unitized construction surrounded by gel for moisture resistance. Recommended applications include building interconnections and data trunk, long haul networking and applications requiring good ozone, moisture and weather resistance. Other fiber counts and types available.

PART #	FIBER COUNT	DESCRIPTION	CABLE DIA.	PRICE
FSSC006N0	6	SM 9/125µm - OS2	8.26mm	\$1.05 /Mtr.
FSSC012N0	12	SM 9/125µm - OS2	8.26mm	1.25 /Mtr.
FS1C006N0	6	MM 62.5/125µm - OM1	8.26mm	1.70 /Mtr.
FS1C012N0	12	MM 62.5/125µm - OM1	8.26mm	2.50 /Mtr.
FS3C006N0	6	MM 50/125µm - OM3	8.26mm	2.50 /Mtr.
FS3C012N0	12	MM 50/125µm - OM3	9.65mm	4.20 /Mtr.

## AERIAL CABLE/SELF-SUPPORTING

Aerial cable provides ease of installation and reduces time and cost. Figure 8 cable can easily be separated between the fiber and the messenger. Temperature range -55°C to +85°C. Additional configurations available.

PART #	FIBER COUNT	DESCRIPTION	CABLE DIA.	PRICE
ARO4TB	4	MM 62.5/125µm - OM1	5.0mm	\$4.70 /Mtr.
ARO6TB	6	MM 62.5/125µm - OM1	6.0mm	4.95 /Mtr.

## FIS FLAT STRANDED SINGLE TUBE DROP CABLE

FIS is happy to offer flat Stranded Single Tube drop cable for Fiber to the Premise applications. This durable design incorporates two dielectric rigid rods for optimal tensile strength and crush protection.

PART #	FIBER COUNT	DESCRIPTION	PRICE
S09FD02CZEBLG	2	SM SMF28 Ultra Gel Flat Drop Cable PE Black	45¢ /Mtr.
S09FD02CZEBL-TLC	2	SM SMF28 Ultra Dry Flat Drop Cable PE Black	45¢ /Mtr.
S09FD06CZEBL-TLC	6	SM SMF28 Ultra Dry Flat Drop Cable PE Black	65¢ /Mtr.
S09FD12CZEBL-TLC	12	SM SMF28 Ultra Dry Flat Drop Cable PE Black	75¢ /Mtr.
S09FD02CZEBLG24G <b>NEW</b>	2	SM SMF28 Ultra Dry Flat Drop Cable PE Black - Tone Wire	50¢ /Mtr.



## CORNING® CABLE SYSTEMS DROP CABLES

SST-Drop™ Cables offer the ease of installation of standard ALTOS® cable in an easy-access stranded single-tube (SST) design. Intended for FTTH networks, bridging the space between distribution network and subscriber premise.

PART #	FIBER COUNT	DESCRIPTION	PRICE
001-EB4-14101A20	1	SM 9/125µm SST Drop™ Cable - OS2	50¢ /Mtr.
002-EB4-14101A20	2	SM 9/125µm SST Drop™ Cable - OS2	55¢ /Mtr.
004-EB4-14101A20	4	SM 9/125µm SST Drop™ Cable - OS2	65¢ /Mtr.
012-EB4-14101A20	12	SM 9/125µm SST Drop™ Cable - OS2	\$1.00 /Mtr.

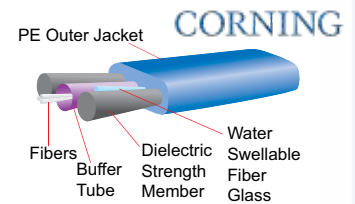

## COMMSCOPE OSP DROP CABLE

FIS carries CommScope armored outside plant cable. The cable is for buried, underground and aerial applications. It uses Arid-Core® water blocking technology that helps to protect fibers from moisture and reduces termination effort. The medium density polyethylene jacket is rugged, durable and easy to strip. This is the same cable used to construct FIS Node Cables.

PART #	FIBER COUNT	DESCRIPTION	CABLE DIA.	PRICE
0006DA8WF06NS/BP	6	Central LT Armored SM with Ripcord - OS2	8.1mm	\$1.10/mtr
0012DA8WF12NS/BP	12	Central LT Armored SM with Ripcord - OS2	8.1mm	1.25/mtr

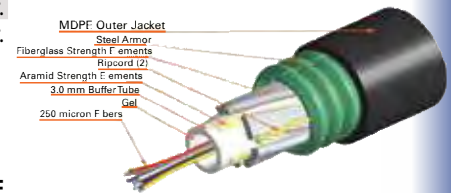

## TLC GEL FREE INDOOR/OUTDOOR CABLE

This cable has no gel fill to complicate the connectorization process. Instead, water swellable yarn replaces the gel. Each tube contains colored bare fibers, making your installation simple and fast. Available in 2 to 144 fibers. Fiber counts 2-12 are in one subunit and larger fiber counts are in separate subunits in multiples of 12. Jackets are available in Riser and Plenum. The FIS Fan Out Kits are a perfect match with this cable.

PART #	FIBER COUNT	DESCRIPTION	PRICE
S09-DL06-CZNRBL25	6	SM 9/125µm Riser PVC Black - OS2	70¢ /Mtr.
S09-DL12-CZNRBL25	12	SM 9/125µm Riser PVC Black - OS2	90¢ /Mtr.
S09-DL24-CZNRBL25	24	SM 9/125µm Riser PVC Black - OS2	\$1.85 /Mtr.
S09-DL48-CZNRBL25	48	SM 9/125µm Riser PVC Black - OS2	2.30 /Mtr.
S09-DL72-CZNRBL25	72	SM 9/125µm Riser PVC Black - OS2	3.55 /Mtr.
M62-DL-06-C3NRBL25	6	MM 62.5µm Riser PVC Black - OM1	1.35 /Mtr.
M62-DL-12-C3NRBL25	12	MM 62.5µm Riser PVC Black - OM1	2.10 /Mtr.
M50-DL06-CGNRBL25	6	MM 50/125µm Riser PVC Black - OM3	1.65 /Mtr.
M50-DL12-CGNRBL25	12	MM 50/125µm Riser PVC Black - OM3	2.45 /Mtr.
M50-DL12-C4NRBL25	12	MM 50/125µm Riser PVC Black - OM4	3.35 /Mtr.
M50-DL24-C4NPBL25	24	MM 50/125µm Plenum PVC Black - OM4	7.25 /Mtr.
M50-DL48-C4NPBL25	48	MM 50/125µm Plenum PVC Black - OM4	11.95 /Mtr.



## FIS BLUE TACTICAL CABLE

FIS Blue fiber optic tactical cable consists of a rugged, flexible polyurethane outer jacket and either two or four 900µm tight-buffered fibers surrounded by aramid yarn and an aramid ripcord. The jacket is pressure extruded over the strength member which allows the pulling device to be attached directly to the cable's outer jacket. This will transfer the pulling force directly to the strength members with no slippage.

PART #	FIBER COUNT	DESCRIPTION	PRICE
FB-SM6-TACCABLE	6	SM 9/125µm Tactical Cable - OS2	\$1.65 /Mtr.
FB-SM-TACCABLE-12	12	SM 9/125µm Tactical Cable - OS2	2.85 /Mtr.
FB-MM-TACCABLE-6	6	MM 62.5/125µm Tactical Cable - OM1	3.54 /Mtr.
FB-MM-TACCABLE-12	12	MM 62.5/125µm Tactical Cable - OM1	6.30 /Mtr.
FB-50-TACCABLE-6	6	MM 50/125µm Tactical Cable - OM3	3.94 /Mtr.
FB-50-TACCABLE-12	12	MM 50/125µm Tactical Cable - OM3	7.00 /Mtr.



## AFL MINI-SPAN® ADSS CABLE

AFL Mini-Span® All-Dielectric Self-Supporting (ADSS) cable is designed for outside plant aerial and duct applications in local and campus network loop architectures. A separate messenger support wire hanging system is not required, greatly reducing installation time and improving upfront and maintenance labor costs. Mini-Span® single-mode and laser-optimized multimode fibers are available. (Minimum order quantities may be required)

PART #	FIBER COUNT	DESCRIPTION	PRICE
AE0129C520AA4	12	SM Mini-Span® 424 - OS2	\$1.80 /Mtr.
AE0249C520AA4	24	SM Mini-Span® 424 - OS2	2.20 /Mtr.
AE0489C520AA4	48	SM Mini-Span® 424 - OS2	3.25 /Mtr.
AE0729C820EA7	72	SM Mini-Span® 535 - OS2	5.25 /Mtr.
AE0126C520AA4	12	62.5/125µm MM Mini-Span® 424 - OM1	3.70 /Mtr.





# CABLE | FURCATION TUBE

The TLC 2mm, 3mm, 3.8mm, and 4.8mm furcation tubing consists of an inner tube surrounded by aramid yarn and an overall PVC jacket. 12 standard colors are available. Inner tubes are available in specific sizes to accept either bare or buffered fibers. TLC's 900 micron furcation tubing is a single tube designed specifically for the protection and termination of 250µm bare fiber. 12 standard colors in Hytrel® as well as clear PVC are available.

## 900µm FURCATION TUBE

PART #	DESCRIPTION	PRICE
F00-FR900R-CLEAR	Clear (PVC) (Accepts 250µm Bare Fiber)	50¢ /Mtr.
F00-FR900-HN	Opaque (Accepts 250µm Bare Fiber)	50¢ /Mtr.
F00-FR900-HW	White (Accepts 250µm Bare Fiber)	50¢ /Mtr.
F00-FR900-HY	Yellow (Accepts 250µm Bare Fiber)	50¢ /Mtr.
F00-FR900-HO	Orange (Accepts 250µm Bare Fiber)	50¢ /Mtr.
F00-FR900-HA	Aqua (Accepts 250µm Bare Fiber)	50¢ /Mtr.

## 2.0mm FURCATION TUBE

Our 2.0mm furcation tubing has an inner tube surrounded by aramid fibers. The inner tube accepts 250µm bare fiber and 900µm tight buffered (1.5mm OD inner tube for 900µm) fiber. Other colors available.

PART #	DESCRIPTION	PRICE
F00-FR2NUO-900	Orange (Accepts 250µm Bare Fiber)	50¢ /Mtr.
F00-FR2NUY-900	Yellow (Accepts 250µm Bare Fiber)	50¢ /Mtr.
F00-FR2NUA-900	Aqua (Accepts 250µm Bare Fiber)	50¢ /Mtr.
F00-FR2-NUO	Orange (Accepts 900µm Tight Buffer)	50¢ /Mtr.
F00-FR2-NUY	Yellow (Accepts 900µm Tight Buffer)	50¢ /Mtr.
F00-FR2-NUR	Red (Accepts 900µm Tight Buffer)	50¢ /Mtr.
F00-FR2-NUB	Blue (Accepts 900µm Tight Buffer)	50¢ /Mtr.
F00-FR2-NUG	Green (Accepts 900µm Tight Buffer)	50¢ /Mtr.
F00-FR2-NUA	Aqua (Accepts 900µm Tight Buffer)	50¢ /Mtr.

## 3.0mm FURCATION TUBE

Our 3.0mm furcation tube that accepts 900µm has an inner tube with a Pull String. The 900µm inner hollow tube, the same tube found in FIS Universal Breakout Kits, may now be purchased separately. Includes aramid yarn strength member. Other colors available. (PS) Indicates Pull String.

PART #	DESCRIPTION	PRICE
F00-FR3NUO-900	Orange (Accepts 250µm Bare Fiber)	50¢ /Mtr.
F00-FR3NUY-900	Yellow (Accepts 250µm Bare Fiber)	50¢ /Mtr.
F00-FR3NUA-900	Aqua (Accepts 250µm Bare Fiber)	50¢ /Mtr.
F00-FR3-NUO (PS)	Orange (Accepts 900µm Tight Buffer)	50¢ /Mtr.
F00-FR3-NUY (PS)	Yellow (Accepts 900µm Tight Buffer)	50¢ /Mtr.
F00-FR3-NUR (PS)	Red (Accepts 900µm Tight Buffer)	50¢ /Mtr.
F00-FR3-NUB (PS)	Blue (Accepts 900µm Tight Buffer)	50¢ /Mtr.
F00-FR3-NUG (PS)	Green (Accepts 900µm Tight Buffer)	50¢ /Mtr.
F00-FR3-NUA (PS)	Aqua (Accepts 900µm Tight Buffer)	50¢ /Mtr.

## DUPLEX FURCATION TUBE

TLC 2.0mm and 3.0mm duplex furcation tubing consists of an inner tube surrounded by aramid fibers, and a PVC jacket sized for the industry standard connectors. The duplex design allows for professional termination of connector pairs. (PS) Indicates Pull String.

### 2.0mm

PART #	DESCRIPTION	PRICE
F00-FDX2-NUO	Orange (Accepts 250µm Bare Fiber)	75¢ /Mtr.
F00-FDX2-NUY	Yellow (Accepts 250µm Bare Fiber)	75¢ /Mtr.
F00-FDX2-NUA	Aqua (Accepts 250µm Bare Fiber)	75¢ /Mtr.

### 3.0mm

F00-FDX3-NUO (PS)	Orange (Accepts 900µm Tight Buffer)	75¢ /Mtr.
F00-FDX3-NUY (PS)	Yellow (Accepts 900µm Tight Buffer)	75¢ /Mtr.
F00-FDX3-NUG (PS)	Green (Accepts 900µm Tight Buffer)	75¢ /Mtr.
F00-FDX3-NUA (PS)	Aqua (Accepts 900µm Tight Buffer)	75¢ /Mtr.

## RIBBON FURCATION TUBE

FIS offers ribbon furcation tubing for protection of bare ribbon fibers. Standard size fits fiber counts of 4, 6, 8 and 12 fibers. There is no inner tube or strength member.

PART #	DESCRIPTION	PRICE
F00-FRRB-NRO	Orange	75¢ /Mtr.
F00-FRRB-NRY	Yellow	75¢ /Mtr.
F00-FRRB-NRA	Aqua	75¢ /Mtr.



## FEATURES

- Accepts either bare fiber or tight buffer
- Provides durable protection when breaking out cables
- Newly engineered inner tube protects against crushing and kinking
- Designed for all connector types
- 12 standard colors
- Also available with pull string for 2mm and 3mm furcation tubing

## APPLICATIONS

- Building up or breaking out of cables for termination
- Protection of bare fiber or tight buffer
- Color coded for easy identification



Spiral Wrap

## SPIRAL WRAP

PART #	DESCRIPTION	PRICE
HT316N	Nylon Spiral Cut Tubing 3/16"	\$1.49/mtr



F1-9795-3

## ROSIN BAG

FIS technicians utilize rosin bags to ease the application of furcation tubing and help remove flooding gels while stripping. The rosin bags are used to dry wet surfaces making furcation quicker and easier.

PART #	DESCRIPTION	PRICE
F1-9795-3	Rosin Bags 3/pack	\$7.95

**FIS COLOR CODED BUFFER TUBE/RIBBON FAN-OUT KITS**

FIS Fan-Out Kits are designed for a simple and easy breakout from standard Buffer Tubes or Ribbon Cables. The kits are pre-configured for 4, 6 and 12 fiber applications with 25" and 36" lengths of 900µm Hytel tubing in the appropriate industry-standard color code. FIS Fan-Out Kits have a unique snap-together design that offers the ability to unsnap the unit for reentry if necessary. Each kit comes with the adapters that accommodate round cable configurations, such as Buffer Tubes, and Ribbon Cables. This cost-saving feature allows you to cover your application possibilities with just one style.

PART #	DESCRIPTION	PRICE
F1-BF0425M	4 Fiber (25" Tubing) Accepts 250µm	\$9.75
F1-BF0625M	6 Fiber (25" Tubing) Accepts 250µm	10.50
F1-BF1225M	12 Fiber (25" Tubing) Accepts 250µm	11.75
F1-BF0436M	4 Fiber (36" Tubing) Accepts 250µm	10.50
F1-BF0636M	6 Fiber (36" Tubing) Accepts 250µm	11.75
F1-BF1236M	12 Fiber (36" Tubing) Accepts 250µm	12.75

**FIS COLOR CODED BREAKOUT KITS (Custom Colors Available.)**

The FIS 2mm and 3mm Breakout Kits are designed for the quick and simple termination of distribution cables. Color coded tubing eliminates the need for marking individual fiber ends, as your cable will be color coded to TIA/EIA standards.

PART #	DESCRIPTION	PRICE
F1-BOK0640-20M	2mm, 6 Fiber (40" Tubing) Accepts 900µm	\$27.00
F1-BOK1240-20M	2mm, 12 Fiber (40" Tubing) Accepts 900µm	31.50
F1-BOK0640MA	2mm, 6 Fiber (40" Tubing) Accepts 900µm - Aqua (numbered instead of color coded)	27.00
F1-BOK1240MA	2mm, 12 Fiber (40" Tubing) Accepts 900µm - Aqua (numbered instead of color coded)	31.50
F1-BOK0640M	3mm, 6 Fiber (40" Tubing) Accepts 900µm	27.00
F1-BOK1240M	3mm, 12 Fiber (40" Tubing) Accepts 900µm	31.50
F1-BOK0640M250	3mm, 6 Fiber Colored Coded, Accepts 250µm	27.00
F1-BOK1240M250	3mm 12 Fiber Colored Coded, Accepts 250µm	31.50

**FIS COLOR CODED BUFFER TUBE/RIBBON FAN-OUT KITS (24 Fiber)**

FIS Fan-Out Kits are designed for a simple and easy breakout from standard Buffer Tubes or Ribbon Cables. The kits are pre-configured for 24 fiber applications with 25" and 36" lengths of 900µm Hytel tubing in the appropriate industry standard color code. (4 Fiber, 6 Fiber and 12 Fiber Kits are also available) FIS Fan-Out Kits have a unique snap together design that offers the ability to unsnap the unit for re-entry if necessary. Each kit comes with the adapters that accommodate round cable configurations, such as Buffer Tubes, and Ribbon Cables. This cost saving feature allows you to cover your application possibilities with just one style breakout kit.

PART #	DESCRIPTION	PRICE
F1-BF2425M	24 Fiber (25" Tubing) Accepts 250µm	\$17.95
F1-BF2436M	24 Fiber (36" Tubing) Accepts 250µm	20.00

**CCS BUFFER TUBE FAN-OUT KITS**

Ideal for indoor or outdoor crossconnects, these kits provide the most compact, easy-to install fan-out solution. The compact design requires no additional hardware. The 900µm fan-out assembly is color coded to match the fiber color scheme and is available in 6- or 12-fiber units in lengths of 25, 36 or 47 inches.

PART #	DESCRIPTION	PRICE
FAN-BT25-06	6 Fiber (25" Tubing)	\$15.00
FAN-BT36-06	6 Fiber (36" Tubing)	15.00
FAN-BT25-12	12 Fiber (25" Tubing)	16.30
FAN-BT36-12	12 Fiber (36" Tubing)	16.30

**CCS SPIDER FAN-OUT KITS**

Corning® Cable Systems' Spider Fan-Out Kits are designed for both factory and field terminations of distribution or loose tube cables from 4 to 24 fibers. The fan-out tubing provides three layers of protection consisting of a Teflon inner tube, a dielectric strength member and an outer protective PVC jacket.

PART #	DESCRIPTION	PRICE
SFK-P06-250M	6 Fiber accepts 250µm (Orange)	\$40.00
SFK-P12-250M	12 Fiber accepts 250µm (Orange)	55.00
SFK-P24-250M	24 Fiber accepts 250µm (Orange)	96.25
SFK-P06-250S	6 Fiber accepts 250µm (Yellow)	40.00
SFK-P12-250S	12 Fiber accepts 250µm (Yellow)	55.00
SFK-P24-250S	24 Fiber accepts 250µm (Yellow)	96.25
SFK-P06-900M	6 Fiber accepts 900µm (Orange)	40.00
SFK-P06-900S	6 Fiber accepts 900µm (Yellow)	40.00

**RIBBON FAN-OUT KITS**

Corning® Cable Systems' Ribbon Fan-Out Kits are specifically designed for the termination of 12-fiber ribbon. Kits feature a 900µm fan-out assembly that is color-coded to match the industry-standard color code.

PART #	DESCRIPTION	PRICE
RIB-FAN-1225	12 Ribbon Fiber (25" Tubing)	\$17.95
RIB-FAN-1236	12 Ribbon Fiber Fan-Out kit (36" Tubing)	19.95

**FIS LOOSE BUFFER SPLICE CLIP**

The Loose Buffer Splice Clip is a simple and easy way to get consistent splices when trying to fusion splice loose buffer fiber. This small clip prevents the fiber from pistoning while attempting a fusion slice.

PART #	DESCRIPTION	PRICE
SPLICECLIP	FIS Loose Buffer Splice Clip (Package of 8)	\$11.35



# AIR BLOWN FIBER

Reduce cable installation cost when installing within a building or ditch-witching for outdoor requirements by installing microduct and jetting fiber to your destination. Contact your FIS Sales Representative with your microduct and fiber requirements.



## FIBER BLOWING MACHINES

PART #	DESCRIPTION	PRICE
MBM-910	Whisper Fiber Blowing Machine (Vari speed drill)	\$5,200.00
MBM-010	Breeze Fiber Blowing Machine (110/220 VAC)	\$11,950.00
89300	Airstream Fiber Blowing Machine (110/220 VAC)	\$14,600.00

\*Additional accessories required to match cable and tube sizes

The equipment will require an air compressor. The air supply floats the fiber reducing friction allowing the equipment to push the fiber through the duct. The maximum distance can be up to 3,200 feet with a compressor rated at 220psi/cfm.

**Microduct and Tube Cutting Tools, Connectors, and Enclosures are available. Call us for specs and pricing.**

## CABLE CHOICES

Singlemode and Multimode fiber from FIS, TLC and other manufacturers are constantly being evaluated for use in blown fiber applications.

Contact your FIS Sales Representative for all current cable choices.

## MICRODUCT 12/10

(Inner Tube size: 12 mm OD/10 ID mm)

### Indoor Applications

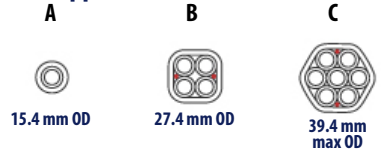

### Outdoor Applications



**Other configurations are available.**

CALL YOUR FIS REPRESENTATIVE FOR MORE OPTIONS AND DETAILS!

## MICRODUCT

STYLE	PART #	PRICE
A	KIA12101	CALL FOR \$\$
B	KIA12104	CALL FOR \$\$
C	KIA12107	CALL FOR \$\$
D	KDI12101	CALL FOR \$\$
E	KDI12104	CALL FOR \$\$
F	KDI12107	CALL FOR \$\$

There are many configurations and accessories available.

\*Minimum order quantities apply\*

## INNERDUCT

Fiber Instrument Sales distributes an Innerduct product line consisting of corrugated HDPE, riser rated PVC and plenum rated PVDF Innerduct in a variety of colors and sizes. A full line of fittings and accessories that complement the product line are available as well. The plenum and riser product lines are both UL 2024 listed and are among the most flexible flame-rated Innerduct products on the market. The HDPE outside plant products offer high tensile strength while being impervious to abrasion, scouring and root penetration. **Innerduct available in 250 and 500 foot coils.**

### HDPE CORRUGATED INNERDUCT - OUTDOOR RATED

PART #	DESCRIPTION	OUT. DIA.	IN. DIA.	PRICE
F1-14383P250	Single-Wall Orange with 900 lb. Pull Tape -250ft	1.35"	1.049"	\$125.00/Coil
F1-14383P500	Single-Wall Orange with 900 lb. Pull Tape -500ft	1.35"	1.049"	250.00/Coil
F1-14383SP250	Split HDPE Orange -250ft	1.35"	1.049"	150.00/Coil
F1-14383SP500	Split HDPE Orange -500ft	1.35"	1.049"	295.00/Coil

### INDOOR RATED INNERDUCT

PART #	DESCRIPTION	OUT. DIA.	IN. DIA.	PRICE
F1-14363P250	Riser Rated Orange with 900 lb. Pull Tape -250ft	1.35"	1.049"	\$187.50/Coil
F1-14363P500	Riser Rated Orange with 900 lb. Pull Tape -500ft	1.35"	1.049"	375.00/Coil
F1-11437P250	Plenum Rated Orange with 900 lb. Pull Tape -250ft	1.35"	1.049"	565.00/Coil
F1-11437P500	Plenum Rated Orange with 900 lb. Pull Tape -500ft	1.35"	1.049"	1,125.00/Coil

## INNERDUCT CUTTERS

PART #	DESCRIPTION	PRICE
F1-SL200	Innerduct Cutters - Will Cut Diameters 1/2" to 1.5"	87.25



OVERSIZED SHIPPING FEE MAY APPLY

IN STOCK



Innerduct Cutters



# CONNECTIVITY

## THE 2 MINUTE CONNECTION

## SATISFACTION GUARANTEED

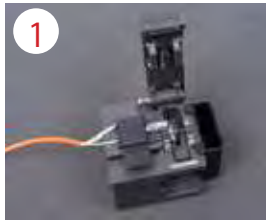

CLEAVE



LOAD IN HOLDER



LOAD FIBER

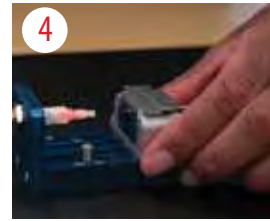

SLIDE FIBER INTO CONNECTOR and MAKE CONNECTION



EPOXY FIBER INTO PLACE

### FIS BOBTAIL™ NO-POLISH CONNECTOR (No Fiber Polishing Required)

FIS Bobtail Connectors provide a pre-polished, quick termination style connector for an industry leading value. Bobtail's are ideal for many applications including, but not limited to, local area networks, restoration work, testing applications, and laboratory settings. The open epoxy canal allows application of Crazy Glue, Super Glue or any Cyanoacrylate adhesives. As always, your satisfaction is guaranteed or return the connectors to FIS for a complete refund.

PART #	DESCRIPTION	BOOT SIZE	PRICE
F1-0066-BT	Bobtail ST Pre-polished Connector - 62.5µm (OM1)	900µm	\$4.95
F1-006650-BT	Bobtail ST Pre-polished Connector - 50µm (OM2)	900µm	4.95
F1-0069-BT	Bobtail ST Pre-polished Connector - Singlemode	900µm	5.95
F1-5066-BT	Bobtail LC Pre-polished Connector - 62.5µm (OM1)	900µm	5.95
F1-506650-BT	Bobtail LC Pre-polished Connector - 50µm (OM2)	900µm	5.95
F1-5069-BT	Bobtail LC Pre-polished Connector - Singlemode	900µm	6.95
F1-3066-BT	Bobtail SC Pre-polished Connector - 62.5µm (OM1)	900µm	4.95
F1-306650-BT	Bobtail SC Pre-polished Connector - 50µm (OM2)	900µm	4.95
F1-3069-BT	Bobtail SC Pre-polished Connector - Singlemode	900µm	5.95

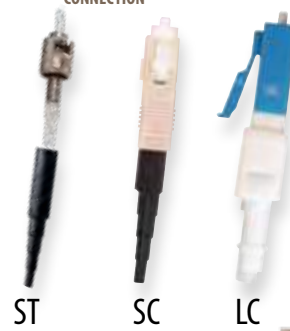

Improved Performance  
Request a Free Connector Sample!

### FIS BOBTAIL™ PULL FORCE (LBS.) VS . COMPETITION

	Connector A (leading competitor)	Connector B (leading competitor)	Bobtail™ Connector
Test #1	.6*	1.7	1.7
Test #2	.5*	1.8	1.3
Test #3	.4	1.8	1.2
Test #4	.5	2.1	1.9
Test #5	1.0*	1.3	2.1
Test #6	.8	1.6	2.3
	.6 lbs. average	1.71 lbs. average	1.75 lbs. average

\* Connector broke off fiber

**CAUTION:**  
FIS discourages the use of the Bobtail or any mechanical splice style connector in 10 G network systems.

**SEE ONLINE VIDEO:**  
[www.fiberinstrumentsales.com/information/fis-tv-videos/bobtail-connector](http://www.fiberinstrumentsales.com/information/fis-tv-videos/bobtail-connector)

### FIS UNIVERSAL SLIDING BOBTAIL HOLDER

The FIS assembly tool is now designed with a precision machined sled to aid in the insertion of the prepared field fiber. This feature virtually eliminates fiber stub breakage and minimizes insertion loss. Includes adapter plates for SC, LC, and ST Bobtail Connectors.

PART #	DESCRIPTION	PRICE
F1-00SUNBTH	FIS Universal Sliding Bobtail Holder	\$150.00

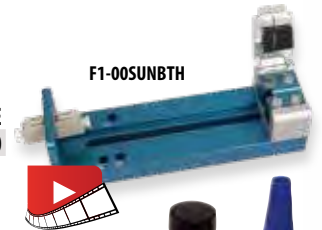

### CYANOACRYLATE ADHESIVE FOR BOBTAIL CONNECTORS

This quick set cyanoacrylate adhesive is provided for terminating FIS Bobtail connectors. An accelerant provides even faster cure time, less than 60 seconds.

PART #	DESCRIPTION	PRICE
F1BTXY	Two Part Epoxy for Bobtail Connector	\$32.95



### FIS FTX QUICK TERMINATION CONNECTOR

The new quick termination fiber optic SC/APC and SC/APC connector is available in two variations to install onto Singlemode 3mm jacketed or 900um fiber. Intended for Fiber to "x" applications such as home, antenna or Multi-Dwelling residences, it meets Telcordia GR-326 Core test standards. As with all field terminated mechanical connectors utilizing a precision cleaver is necessary for best performance.

PART #	DESCRIPTION	PRICE
F1SCAFTX3	SC/APC Quick termination mechanical splice connector, 3mm cable strain relief boot	\$4.95
F1SCAFTX9	SC/APC Quick termination mechanical splice connector, 900um fiber strain relief boot	4.95
F1SCUFTX3	SC/UPC Quick termination mechanical splice connector, 3mm fiber strain relief boot	4.95
F1SCUFTX9	SC/UPC Quick termination mechanical splice connector, 900um fiber strain relief boot	4.95
F1FTXKIT	FIS FTX Field Termination Kit (Tri-hole Stripper, Kevlar Cutter, Lynx Cleaver, Shard Container, Wipes)	CALL



CORNING



25 PACKS AVAILABLE

**UNICAM® PRETIUM™ PRE-POLISHED CONNECTOR AND TOOL KIT (No Fiber Polishing Required)**

The UniCam® Pretium™ Tool Kit can quickly install a UniCam Connector in about 45 seconds. From the cleaver, with its integrated fiber scrap bin and dual-clamp precision hold, to the installation tool with its immediate go/no-go feedback signal, the UniCam® Pretium™ Tool Kit was thoughtfully designed with the needs of network installers in mind.

DESCRIPTION	PART #
Trash Container	2104498-01
Scissors	100294-01
Black Permanent Marker	2104499-01
Fiber Optic Cleaning Fluid	*
Fiber Wipes	*
Pretium Cleaver	FBC-007
Pretium UniCam Installation Tool	TL-UCP
Cable Jacket Stripping Tool	3206001-01
Dual-Hole Stripping Tool	2104502-01
1.25 mm Ferrule Adapter	VFL-A125
UniCam Crimp Tool	3201007-01
Lanyards (2)	02-002853-001
Cleaning Stick - Size 2.5 mm	*
2.5 mm Ferrule Adapter (with Installation Tool)	VFL-250

PART#	DESCRIPTION	PRICE
TKT-UNICAM-PFC	Pretium™ Tool Kit	\$1,669.00

*Note: UniCam Pretium connectors can be terminated using the original TKT-UNICAM kit, however, Pretium performance is not guaranteed.*

**CONNECTORS AND ACCESSORIES**

PART #	STYLE	TYPE	FERRULE	TYPICAL LOSS	PRICE	PART #	STYLE	TYPE	FERRULE	TYPICAL LOSS	PRICE
95-000-50	ST	MM, 62.5/125µm	Composite	.3dB	\$10.75	95-050-41	SC	MM, 50/125µm	Zirconia	.3dB	\$14.80
95-050-51	ST	MM, 50/125µm	Zirconia	.3dB	14.75	95-050-41X	SC	MM, OM3 10G	Zirconia	.3dB	15.25
95-000-51	ST	MM, 62.5/125µm	Zirconia	.3dB	14.25	95-000-99	LC	MM, 62.5/125µm	Zirconia	.3dB	14.75
95-200-51	ST	SM, 8.3/125µm	Zirconia	.4dB	16.25	95-050-99	LC	MM, 50/125µm	Zirconia	.3dB	14.75
95-000-41	SC	MM, 62.5/125µm	Zirconia	.3dB	13.95	95-200-99	LC	SM, 8.3/125µm	Zirconia	.3dB	17.95
95-200-41	SC	SM, 8.3/125µm	Zirconia	.4dB	16.50	95-050-99X	LC	MM, OM3 10G	Zirconia	.3dB	14.80
95-000-40	SC	MM, 62.5/125µm	Composite	.3dB	10.75	TL-UC-01		Universal UniCam Installation Tool			475.00

CORNING

6366



**CORNING HOT MELT**

CORNING Hot Melts continue to be a popular choice among installers in the field. The Hot Melt connectors utilize an advanced adhesive technology eliminating the application of epoxy. The connectors provide quick termination in 2 minutes or less and are re-heatable to allow for fiber repositioning. **Fiber polishing required with Hot Melt Connectors.**



F1-9110



**AFL FASTConnect® FIELD-INSTALLABLE**

**(No Fiber Polishing Required)**

The FASTConnect Tool Kit provides all necessary installation tools required for fiber preparation of 250/900µm, 2mm and 3mm cordage for AFL's prepolished FASTConnect. The Kit carrying case contains all industry standard termination tools, installation instructions, as well as adequate storage for carrying extra FAST connectors for on-site convenience.

**KIT CONTENTS**

QTY	DESCRIPTION	PART #
1	CT-30A Universal Cleaver	S014080
1	FASTConnect SC Assembly Tool	CS007780
1	FASTConnect LC Assembly Tool	CS007779
1	3mm Cable Clamp	S014704
1	2mm Cable Clamp	S014705
1	250/900µm Cable Clamp	CS004442
1	Fiber Preparation Fluid	FRF1-00-0900
1	Installation Instructions	CS007701
1	Strip Length Template	CS001203
1	Assembly Video	CS001204
1	Carrying Case	CS001202

**NEW  
6 PACKS**



PART #	DESCRIPTION	PRICE
CS001201	FASTConnect Tool Kit	\$1,645.00

**FASTConnect**

PART #	DESCRIPTION	PRICE - 6 pack
FAST-SC-MM50-6	FASTConnect-SC 50/125µm MM 900µm Boot	\$56.35
FAST-SC-MM50L-6	FASTConnect-SC OM3 10G, 900µm Boot	59.40
FAST-SC-MM62.5-6	FASTConnect-SC 62.5/125µm MM 900µm Boot	56.40
FAST-SC-SM-6	FASTConnect-SC SM 900µm Boot	72.80
FAST-ST-MM62.5-6	FASTConnect-ST 62.5/125µm 900µm Boot	58.80
FAST-ST-SM-6	FASTConnect-ST SM 900µm Boot	72.80
FAST-LC-MM62.5-6	FASTConnect-LC 62.5/125µm 900µm Boot	62.40
FAST-LC-MM50-6	FASTConnect-LC 50/125µm 900µm Boot	62.40
FAST-LC-MM50L-6	FASTConnect-LC OM3 10G 900µm Boot	68.00
FAST-LC-SM-6	FASTConnect-LC SM 900µm Boot	80.00



**HOT MELT ACCESSORIES**

PART #	DESCRIPTION	PRICE
F1-9110	FIS 6 Port Hot Melt Oven 110V	325.00
F1-9110220	FIS 6 Port Hot Melt Oven 220V	495.00
F1-9130	FIS 12 Port Hot Melt Oven 110V	375.00
6192A	2µm 5" Polish Film 50 Pack	20.25
6192B	2µm 4" Polish Film for 6850A Polisher (with hole) 50 per Pack	15.50
6192-AA	Singlemode Final Polish Film for Hot Melts	50¢

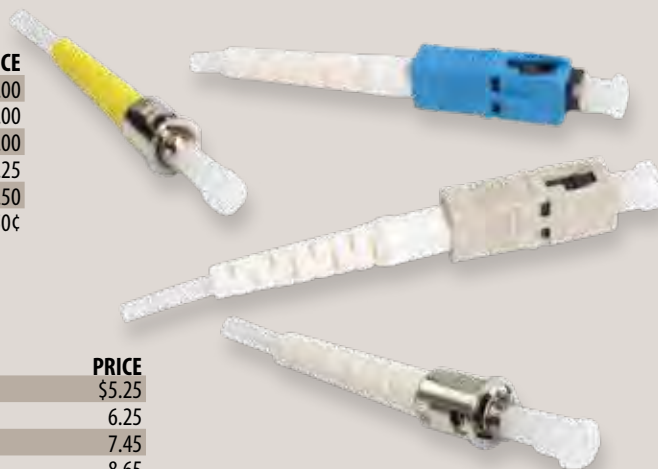

**CORNING HOT MELT CONNECTORS (Fiber Polishing Required)**

PART #	STYLE	FIBER SIZE	TYPICAL LOSS	TYPE	PRICE
6100	ST	125µm	.2dB	Multimode	\$5.25
8100YS	ST	126µm	.2dB	Singlemode	6.25
6200	FC	125µm	.2dB	Multimode	7.45
8200W	FC	126µm	.2dB	Singlemode	8.65
6300W	SC	125µm	.2dB	Multimode	5.50
8300	SC	126µm	.2dB	Singlemode	6.50





F1-5066AQ



F1-6068AQ

CORNING



95-100-LCSP



106024-5500

LC CONNECTORS

The LC connector licensed by Lucent Technologies provides a pull-proof design and small size perfect for high-density applications. Available in simplex or duplex versions. The LC connector is provided with a 1.25mm zirconia ferrule. The LC also incorporates a unique latching mechanism providing stability in system rack mounts.

PART #	TYPE	BOOT SIZE	FERRULE SIZE	FERRULE	PRICE
<b>FIS</b>					
F1-5066	Simplex-MM	3mm	128µm	Zirconia	\$2.30
F1-5066AAQ	Simplex-MM OM3/OM4 - Aqua	3mm	126µm	Zirconia	2.50
F1-506616AAQ	Simplex-MM OM3/OM4 - Aqua	1.6-2mm	128µm	Zirconia	2.50
F1-506616	Simplex-MM	1.6-2mm	128µm	Zirconia	2.30
F1-506616M	Simplex-MM OM4 - Magenta	1.6-2mm	128µm	Zirconia	2.75
F1-5066900	Simplex-MM	900µm	128µm	Zirconia	2.30
F1-5069	Simplex-SM	3mm	126µm	Zirconia	2.75
F1-506916	Simplex-SM	1.6-2mm	126µm	Zirconia	2.75
F1-5069900	Simplex-SM	900µm	126µm	Zirconia	2.75
F1-5069APC	Simplex APC	3mm	126µm	Zirconia	5.35
F1-5069900APC	Simplex APC	900µm	126µm	Zirconia	5.35
F1-6066	Duplex-MM	3mm	128µm	Zirconia	4.75
F1-606616	Duplex-MM	1.6-2mm	128µm	Zirconia	4.75
F1-606616M	Duplex-MM OM3 - Magenta	1.6-2mm	128µm	Zirconia	5.00
F1-6066AQ	Duplex-MM OM3/OM4 - Aqua	3mm	128µm	Zirconia	5.00
F1-606616AQ	Duplex-MM OM3/OM4 - Aqua	1.6-2mm	128µm	Zirconia	5.00
F1-6069	Duplex-SM	3mm	126µm	Zirconia	5.75
F1-606916	Duplex-SM	1.6-2mm	126µm	Zirconia	5.75
F1-6069900	Duplex-SM	900µm	126µm	Zirconia	5.75
F1-5066AR	Anaerobic-MM	3mm	128µm	Zirconia	3.50
F1-6067	Duplex Mini LC-SM - Blue *	1.6mm	126µm	Zirconia	5.75
F1-6068AQ	Duplex Mini LC-MM OM3/OM4 - Aqua *	1.6mm	127µm	Zirconia	4.75
F1-6068	Duplex Mini LC-MM - Beige *	1.6mm	127µm	Zirconia	4.75

\*The Mini LC Connector is designed with a narrow ferrule pitch (5.25mm) to work with the Mini SFP (mSFP) transceiver.

CCS

95-100-LCSP	Simplex-MM	3.0mm	125.5µm	Zirconia	\$5.25
95-100-LCSP2	Simplex-MM	2.0mm	125.5µm	Zirconia	5.25
TRIGGER-BP-D	LC Clips(each) - Simplex to duplex converters				30¢

MOLEX

106024-3500	Simplex-MM	900µm	128µm	Zirconia	\$6.85
106024-5500	Simplex-SM	900µm	126µm	Zirconia	9.60
106024-3259	Simplex-MM	3mm	127µm	Zirconia	6.50
106024-5259	Simplex-SM	3mm	126µm	Zirconia	7.25

BUY FIS IN BULK AND SAVE

FIS BULK EPOXY STYLE CONNECTORS

FIS multimode and singlemode ST, SC, LC and FC connectors utilize high quality zirconia ferrules. Bulk packaged in lots of 100 pieces, these connectors offer the best value in performance and cost savings. Provided with 3mm or 900µm boots.

PART #	DESCRIPTION	PRICE
F1-0066-100	FIS MM ST Connector with 3mm boots - (100 pk.)	\$150.00
F1-0069-100	FIS SM ST Connector with 3mm boots - (100 pk.)	170.00
F1-5066-100	FIS MM LC Connector with 3mm boots - (100 pk.)	200.00
F1-5069-100	FIS SM LC Connector with 3mm boots - (100 pk.)	265.00
F1-2073-100	FIS MM FC Connector with 3mm boots - (100 pk.)	298.00
F1-2070-100	FIS SM FC Connector with 3mm boots - (100 pk.)	330.00
F1-3066-100	FIS MM SC Connector with 3mm boots - (100 pk.)	210.00
F1-3069-100	FIS SM SC Connector with 3mm boots - (100 pk.)	230.00
F1-3066AQ-100	FIS MM 10 Gig SC Connector with 3mm boots - (100 pk.)	230.00
F1-5066AQ-100	FIS MM 10 Gig LC Connector with 3mm boots - (100 pk.)	265.00



Connectors Available In 900µm Versions

F1-5069-100

## MTP® CONNECTORS

US Conec manufactures durable MTP® brand connectors that provide quick connection for up to 72 optical fibers. Precision alignment is achieved with patented guide pins combined with the tightly controlled guide pin holes on US Conec's MT ferrules. Removable housings allow for quick change of gender, ferrule cleaning, interferometry or connector re-polishing.



PART #	DESCRIPTION	CABLE TYPE	PRICE
MTP-12MM	MTP Connector 12 Fiber Multimode OM1 Male Beige Housing	Ribbon/Oval	\$15.75
MTP-12MF	MTP Connector 12 Fiber Multimode OM1 Female Beige Housing	Ribbon/Oval	15.75
MTP-12SM	MTP Connector 12 Fiber Singlemode APC Male <b>Green Housing</b>	Ribbon/Oval	21.95
MTP-12SF	MTP Connector 12 Fiber Singlemode APC Female <b>Green Housing</b>	Ribbon/Oval	21.50
MTP-12MMRD	MTP Connector 12 Fiber Multimode Male OM3/4 <b>Aqua Housing</b>	3.0mm/Round	16.95
MTP-12MFRD	MTP Connector 12 Fiber Multimode Female OM3/4 <b>Aqua Housing</b>	3.0mm/Round	16.95
MTP-12MFRD2	MTP Connector 12 Fiber Multimode Female OM3/4 <b>Aqua Housing</b>	2.0mm/Round	15.95
MTP-12MMRD2	MTP Connector 12 Fiber Multimode Male OM3/4 <b>Aqua Housing</b>	2.0mm/Round	16.95
MTP-12MMRD2M	MTP Connector 12 Fiber Multimode Male OM4 <b>Magenta Housing</b>	2.0mm/Round	17.95
MTP-12SMRD	MTP Connector 12 Fiber Singlemode APC Male <b>Green Housing</b>	3.0mm/Round	21.50
MTP-12SFRD	MTP Connector 12 Fiber Singlemode APC Female <b>Green Housing</b>	3.0mm/Round	21.50
MTP-12MMBRD	MTP Connector 12 Fiber Multimode OM1 Male Beige Housing	3.0mm/Round	15.75
MTP-12MFRD	MTP Connector 12 Fiber Multimode OM1 Female Beige Housing	3.0mm/Round	15.75
MTP-12SMFE0V	MTP Elite Connector 12 Fiber Singlemode APC Female <b>Mustard Housing</b>	Ribbon/Oval	38.95
MTP-12SMME0V	MTP Elite Connector 12 Fiber Singlemode APC Male <b>Mustard Housing</b>	Ribbon/Oval	38.95
MTP-12MMME0V	MTP Elite Connector 12 Fiber Multimode OM3/4 Male <b>Aqua Housing</b>	Ribbon/Oval	25.75
MTP-24MFE0V	MTP Elite Connector 24 Fiber Multimode OM3/4 Female <b>Aqua Housing</b>	Ribbon/Oval	38.95
MTP-24MME0V	MTP Elite Connector 24 Fiber Multimode OM3/4 Male <b>Aqua Housing</b>	Ribbon/Oval	38.95
MTP-24SM0V	MTP Connector 24 Fiber Singlemode APC Male <b>Green Housing</b>	Ribbon/Oval	42.95
MTP-24SF0V	MTP Connector 24 Fiber Singlemode APC Female <b>Green Housing</b>	Ribbon/Oval	42.95

NOTE: Singlemode MTP Connectors are angled at 8° to improve performance (indicated by green housing)



MTP12MM



MTP12MMME0V



MTP12MMRD2M

SPECIFICATIONS				
	MM MT Elite® Multimode MT Ferrule	Standard Multimode MT Ferrule	SM MT Elite® Singlemode MT Ferrule	Standard Singlemode MT Ferrule
Insertion Loss	0.1dB Typical (All Fibers) 0.35dB Maximum (Single Fiber) <sup>2,3</sup>	0.20dB Typical (All Fibers) 0.60dB Maximum (Single Fiber) <sup>2,3</sup>	0.10dB Typical (All Fibers) 0.35dB Maximum (Single Fiber) <sup>1</sup>	0.25dB Typical (All Fibers) 0.75dB Maximum (Single Fiber) <sup>1</sup>
Optical Return Loss	>20dB	>20dB	>60dB (8° Angle Polish)	>60dB (8° Angle Polish)



## MTP PRO Available Now Call Us Today!

The MTP® PRO connector offers quick and effective polarity and pin reconfiguration in the field while ensuring product integrity and performance

PART #	DESCRIPTION	PRICE
18814	MTP Pro Field Tool	\$154.00
18841	MTP Pro Pin Exchanger, SM Elite, Female (No Pins), Yellow holder, 10 pack	18.50
18843	MTP Pro Pin Exchanger, SM Elite, Male (With Pins), Yellow holder, 10 pack	75.50
18256	MTP Pro Pin Exchanger, MM, Female (No Pins), Aqua holder, 10 pack	18.50
18842	MTP Pro Pin Exchanger, MM, Male (With Pins), Aqua holder, 10 pack	35.50

## MTP® ADAPTERS

PART #	DESCRIPTION	COLOR	PRICE
MTP-ADPT	MTP Adapter, Full Flange, Key Up to Key Down (Type A or C), Standard Footprint	Black	\$5.95
MTP-9299	MTP Adapter, Screw Mount 30 Degree Angle, Key Up to Key Down (Type A or C)	Black	13.95
MTP-RFADPT	MTP Adapter, Reduced Flange, Key Up to Key Down (Type A or C), Standard Footprint	Black	5.65
12219	MTP Adapter, Full Flange, Key Up to Key Down (Type A or C), SC Footprint	Aqua	7.50
5306	MTP Adapter, Full Flange, 1 Dust Cap, Key Up to Key Up (Type B)	Gray	5.70
12196	MTP Adapter, Full Flange, 2 Dust Cap, Key Up to Key Up (Type B)	Gray	6.50
12228	MTP Adapter SC Footprint Reduced Flange, Key Up to Key Down (Type A or C), SC Footprint	Green	6.00



MTP-ADPT



MTP-RFADPT



12228



12219



F1-0066

CORNING



6105

CORNING



95-250-06SP



106010-0000

ST CONNECTORS

The ST connector utilizes a bayonet twist-lock connection with 2.5mm ferrule; the ST connector features reliable and durable field installation. The design of the ST connector enables installers to crimp the back of the body directly onto the cable jacket and Kevlar®. This eliminates cable pull-away, ensuring a strong termination. Upon request, FIS ST connectors can be supplied without FIS markings. Stainless alloy ferrules can be custom drilled.

PART #	TYPE	BOOT SIZE	FERRULE SIZE	FERRULE	PRICE
<b>FIS</b>					
F1-0066	Multimode	3mm	127µm	Zirconia	\$1.60
F1-006620	Multimode	2mm	127µm	Zirconia	1.60
F1-0066900BLK	Multimode	900µm	127µm	Zirconia	1.60
F1-0067	Multimode	3mm	140µm	Zirconia	3.50
F1-0069	Singlemode	3mm	126µm	Zirconia	2.30
F1-006920	Singlemode	2mm	126µm	Zirconia	2.30
F1-0069900	Singlemode	900µm	126µm	Zirconia	2.30
F1-0061	Multimode	3mm	127µm	Stainless Alloy	2.95
F1-006120	Multimode	2mm	127µm	Stainless Alloy	2.95
F1-0063	Multimode	3mm	140µm	Stainless Alloy	3.75
F1-0064	Multimode	3mm	230µm	Stainless Alloy	3.75
F1-0065	Plastic Fiber	3mm	1000µm	Stainless Alloy	3.75
F1-1066AR	Multimode (Anaerobic)	3mm	125µm	Zirconia	2.75
F1-0066AQ	Multimode 10 Gig	3mm	127µm	Zirconia	2.30
F1-0066AQ20	Multimode 10 Gig	2mm	127µm	Zirconia	2.30
F1-0066AQ900	Multimode 10 Gig	900µm	127µm	Zirconia	2.30

CORNING

6105	Multimode	3mm	125µm	Zirconia	\$2.10
8106	Singlemode	3mm	126µm	Zirconia	2.85

CCS

95-100-44SP	Multimode	3mm	125.5µm	Zirconia	\$5.10
95-100-44SP2	Multimode	2mm	125.5µm	Zirconia	5.10
95-250-06SP	Singlemode	3mm	125.5µm	Composite	9.55

MOLEX

106010-0000	MM Long Boot with Plastic Housing	3mm	125µm	Zirconia	\$2.80
-------------	-----------------------------------	-----	-------	----------	--------

CORNING



6202

FC CONNECTORS

PART #	TYPE	BOOT SIZE	FERRULE SIZE	FERRULE	PRICE
<b>CORNING</b>					
6202	Multimode with Plastic Housing	3mm	125µm	Zirconia	\$4.25
8206FCAPC	Singlemode with Plastic Housing APC	3mm	126µm	Zirconia	5.95

CCS

95-100-10SP	Multimode	3mm	125µm	Zirconia	\$5.10
95-100-10SP2	Multimode	2mm	125.5µm	Zirconia	5.10

SEIKOH GIKEN

SAP8311260A300G	Singlemode	3mm	126µm	Zirconia	\$3.20
SNP8871261B3K2G	Singlemode APC	3mm	126µm	Zirconia	5.95

MOLEX

106053-5000	Singlemode	3mm	126µm	Zirconia	9.95
106055-5000	Singlemode - Narrow Key APC	3mm	126µm	Zirconia	12.30
106055-5500	Singlemode - Narrow Key APC	900µm	126µm	Zirconia	13.50

106053-3000





## SC CONNECTORS

The SC connector is a non-optical disconnect connector with a 2.5mm pre-radiused zirconia ferrule. Available in simplex and duplex styles, this connector features a push-pull connection design for quick patching of cables into rack or wall mounts. Utilize the reusable duplex holding clip to create duplex connections.

PART #	TYPE	BOOT SIZE	FERRULE SIZE	FERRULE	PRICE
<b>FIS</b>					
F1-3066	Multimode	3mm	127µm	Zirconia	\$2.30
F1-306620	Multimode	2mm	127µm	Zirconia	2.30
F1-3066900	Multimode	900µm	127µm	Zirconia	2.30
F1-3061	Multimode	3mm	127µm	Stainless Alloy	2.95
F1-3069	Singlemode	3mm	126µm	Zirconia	2.95
F1-306920	Singlemode	2mm	126µm	Zirconia	2.95
F1-3069900	Singlemode	900µm	126µm	Zirconia	2.95
F1-3069APC	Singlemode APC	3mm	126µm	Zirconia	5.50
F1-3069900APC	Singlemode APC	900µm	126µm	Zirconia	5.50
F1-3069APC20	Singlemode APC	2mm	126µm	Zirconia	5.50
F1-3066AR	Multimode (Anaerobic)	3mm	125µm	Zirconia	3.25
F1-CLBK	Duplex Clip (Black for Multimode)				0.50
F1-CLBL	Duplex Clip (Blue for Singlemode)				0.50
F1-3066AQ	Multimode 10 Gig	3.0mm	127µm	Zirconia	2.95
F1-3066AQ20	Multimode 10 Gig	1.6/ 2.0mm	127µm	Zirconia	2.95
F1-3066AQ900	Multimode 10 Gig	900µm	127µm	Zirconia	2.95
<b>CORNING</b>					
6306	Multimode	3mm	125µm	Zirconia	\$3.15
8306	Singlemode	3mm	126µm	Zirconia	3.60
8306SCAPC	Singlemode APC	3mm	126µm	Zirconia	5.45
8306SCAPC900	Singlemode APC	900µm	126µm	Zirconia	5.75
<b>CCS</b>					
95-100-48SP	Multimode	3mm	125.5µm	Zirconia	\$5.10
95-100-48SP2	Multimode	2mm	125.5µm	Zirconia	5.10
95-101-41SP	Multimode (Anaerobic)	3mm	125µm	Zirconia	5.65
<b>SEIKOH GIKEN</b>					
SSCPE3C1261A300G	Singlemode	3mm	126µm	Zirconia	\$3.25
SSCPNE871251B300G	Singlemode APC	3mm	125µm	Zirconia	5.95
<b>MOLEX</b>					
106063-0060	Multimode	3mm	125µm	Zirconia	\$5.00
106063-5000	Singlemode	3mm	126µm	Zirconia	7.25
106063-5500	Singlemode	900µm	126µm	Zirconia	7.25
106065-5000	Singlemode APC	3mm	126µm	Zirconia	14.25
106065-5500	Singlemode APC	900µm	126µm	Zirconia	17.00



F1-3066



8306



SSCPE3C1261A300G



106063-0060

## FIS FC CONNECTORS

FC connectors are specifically designed for telecommunication applications and provide non-optical disconnect performance. Designed with a threaded coupling for durable connections. The ferrule is PC finished to a pre-radius, which ensures low back reflection. Stainless alloy ferrules can be custom drilled to your specifications. All FIS FC connectors use narrow key (2.0mm).

PART #	TYPE	BOOT SIZE	FERRULE SIZE	FERRULE	PRICE
<b>FIS</b>					
F1-2073	Multimode	3mm	127µm	Zirconia	\$3.75
F-1207320	Multimode	2mm	127µm	Zirconia	3.75
F1-2073900	Multimode	900µm	127µm	Zirconia	3.75
F1-2777	Multimode	3mm	140µm	Zirconia	4.45
F1-2771	Multimode	3mm	128µm	Stainless Alloy	4.45
F1-2772	Multimode	3mm	140µm	Stainless Alloy	4.45
F1-2774	Multimode	3mm	230µm	Stainless Alloy	4.45
F1-2070	Singlemode	3mm	126µm	Zirconia	4.25
F1-207020	Singlemode	2mm	126µm	Zirconia	4.25
F1-2070900	Singlemode	900µm	126µm	Zirconia	4.25
F1-2070APC	Singlemode APC	3mm	126µm	Zirconia	5.50
F1-2070APC20	Singlemode APC	2mm	126µm	Zirconia	5.50
F1-2070900APC	Singlemode APC	900µm	126µm	Zirconia	5.50
F1-2073AQ	Multimode 10 Gig	3mm	127µm	Zirconia	4.25
F1-2073AQ900	Multimode 10 Gig	900µm	127µm	Zirconia	4.25



F1-2073

QUANTITY DISCOUNTS AVAILABLE

1. Choose your style
2. Choose your color

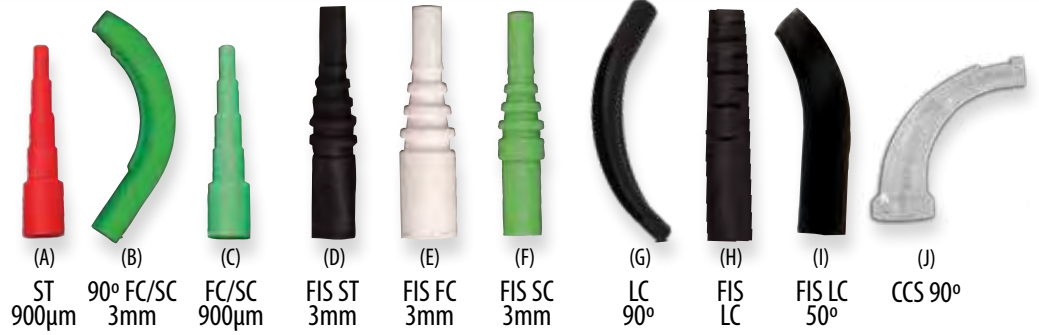
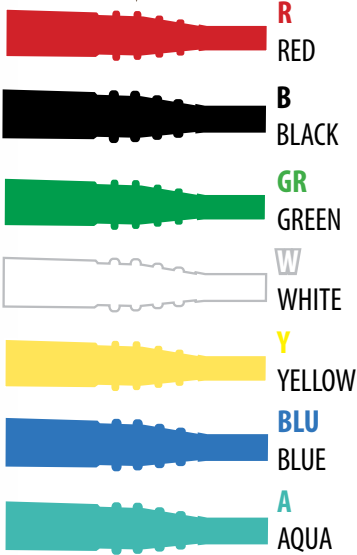

## STRAIN RELIEF BOOTS

Designed to be utilized on .128, .151, and .190 crimp sleeves. FIS boots are available in Red (R), Black (B), Green (GR), Blue (BLU), Aqua (A), White (W), and Yellow (Y). Replace X with abbreviation of color in parenthesis.

PART #	DESCRIPTION (See Strain Relief Boot style chart above)	ID	Length	Crimp Size	PRICE
667342900-25-X	FIS ST 900µm Boot (A) (25 pk.)	0.15	1.13"	0.128	\$6.25
CONN90-25-X	FIS SC and FC 3mm 90° Boot (B) (25 pk.)	0.20	1.40"	0.190	13.75
CONN107900-25-X	FIS SC and FC 900µm Boot (C) (25 pk.)	0.17	1.13"	0.179	6.25
667342-BC-25-X	FIS ST 3mm Boot (D) (25 pk.)	0.15	1.47"	0.128	6.25
6673422-BC-25-X	FIS ST 2mm Boot (25 pk.)	0.15	1.47"	0.128	6.25
CONN107BC-25-X	FIS FC 3mm Boot (E) (25 pk.)	0.20	1.25"	0.190	6.25
CONN1072-BC-25-X	FIS FC 2mm Boot (25 pk.)	0.20	1.25"	0.190	6.25
CONN205-25-X	FIS SC 3mm Boot (F) (25 pk.)	0.20	1.47"	0.190	6.25
F1-LC 90-BLK-25	FIS LC 90° 2mm Boot Black (G) (25 pk.)	0.137	1.44"	0.128	6.25
LCBOOTBL25	FIS LC 3mm Boot Black (H) (25 pk.)	0.137	1.10"	0.128	6.25
F1-LC45BL25	FIS LC 50° 2mm Boot Black (I) (25 pk.)	0.137	1.0"	0.128	6.25
F1-LC90M2590	FIS LC 90° 2mm Boot White (not shown) (25 pk.)	0.137	1.40"	0.128	6.25
F1-LC90GR25	FIS LC 90° 2mm Boot Green (not shown) (25 pk.)	0.137	1.40"	0.128	6.25
CONN205-XX-M20	FIS SC 2mm Boot (not shown) (25pk.)	0.20	1.47"	0.190	6.25
9540002BP	CCS Clip 90° for ST/SC/FC 3mm Boots (J)				1.80
9540004BPC	CCS Clip 90° for 2mm Boots				65¢

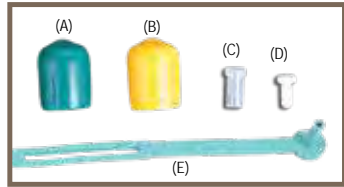

## FERRULE PROTECTION CAPS

FIS protection caps are designed to provide protection against various elements that could damage either the ferrule or fiber. The universal clear protection caps fit ST, FC and SC style 2.5mm ferrules.

PART #	DESCRIPTION	PRICE
CPCYGR-B	Green Dust Cap Covers FC Housing (A) (100 pk.)	\$25.00
CPCY-B	Yellow Dust Cap Covers FC Housing (B) (100 pk.)	25.00
CAPB-B	Universal Clear Cap for 2.5mm Ferrules (C) (100 pk.)	25.00
F1-0125	Universal Dust Cap for 1.25mm Ferrules (D) (100 pk.)	25.00
F1-0125SA-100	Universal Dust Cap for 1.25mm Ferrules with jacket strap Aqua (E) (100 pk.)	25.00
F1-0125SBK-100	Universal Dust Cap for 1.25mm Ferrules with jacket strap Black (100 pk.)	25.00
F1-90010M	Universal Dust Cap for 2.5mm Ferrules with jacket strap (100 pk.)	25.00

## MATING SLEEVE ADAPTER CAPS

The dust caps for adapters are easy to misplace and now FIS makes them just as easy to replace. Available in multiple colors, see chart above. Replace XX with the color desired: BL=Black, BU=Blue, GR=Green, BE=Beige AQ=Aqua.

PART #	DESCRIPTION	PRICE
F1-ADCAP-100-BU	SC Mating Sleeve Adapter Dust Cap, Blue - 100 pk.	A \$19.00
F1-ADCAP-100-CL	SC Mating Sleeve Adapter Cap, Clear - 100pk	19.00
F1-ADCAP-SC	SC Mating Sleeve Click-in Style Adapter Cap, Black - 100pk.	B 35.00
F1-ADCAP-LC	LC Mating Sleeve Round Head Adapter Cap, White - 100pk.	C 35.00
F1-ADCAP-LCS-XX	LC Mating Sleeve Square Head with Laser Warning Sticker - 100pk	D 47.95
F1-ADCAP-FCS-XX	FC Mating Sleeve Round Head with Laser Warning Sticker - 100pk	47.95
F1-ADCAP-ST5-XX	ST Mating Sleeve Round Head with Laser Warning Sticker - 100pk	E 47.95
931-CAP-W	LC Uniboot Dust Cap White - 100pk	F 35.00

## SPIRAL BOOT

The Spiral Cut Boot is designed for the times when you forget to put the boot on your cable before you terminated a connector. The unique spiral cut allows you to wrap the boot around the cable and then slide it up behind the connector. No need to cut off a good connector because of a forgotten boot. Boot is straight when relaxed.

PART #	DESCRIPTION	PRICE
SPIRALBOOT25	Spiral Cut 3mm Boot 25-Pack	\$12.95



**LASER SAFETY CAPS FOR MATING SLEEVES WITH METAL TILE**

FIS has created a solution to the problem of laser light emitted from fiber optic bulkhead adapters. Our new Laser Safety Caps come with a warning symbol on each to visually alert people to potentially harmful exposure to laser light and cap has a built-in metal tile to stop laser light up to +18dBm. They are available for SC, LC, ST and FC styles. Replace X with the color desired: BL=Black, BU=Blue, GR=Green, BE=Beige AQ=Aqua.

PART #	DESCRIPTION	PRICE
F1-BLSCST-X25	ST Bulkhead Laser Safety Cap - (25 pk.) (A)	\$19.95
F1-BLSCSC-X25	SC Bulkhead Laser Safety Cap - (25 pk.) (B)	19.95
F1-BLSCFC-X25	FC Bulkhead Laser Safety Cap - (25 pk.) (C)	19.95
F1-BLSCLC-X25	LC Bulkhead Laser Safety Cap - (25 pk.) (D)	19.95

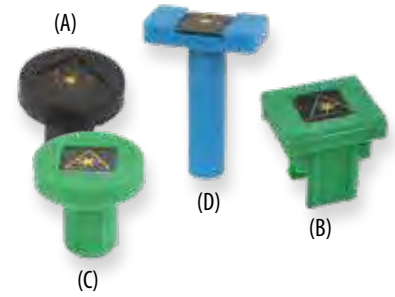

**METAL CAP AND CHAINS**

PART #	DESCRIPTION	PRICE
F1-9229-LC	Cap and Chain for LC Mating Sleeves	\$2.00
F1-9229-SC	Cap and Chain for SC Mating Sleeves	2.00
F1-9229-ST	Cap and Chain for ST Mating Sleeves	2.00
F1-9229-CH	Cap and Chain for FC Mating Sleeves	1.50



**MALE – FEMALE ADAPTERS**

Note: When purchasing these adapters be aware of the fiber type indicated and match to your application.

PART #	DESCRIPTION	HOUSING	SLEEVE	PRICE
F1-W1FSCA-SCU*	SC/APC Female to SC/UPC Male (Singlemode)	Metal	Zirconia	\$9.95
F1-W1FSCU-SCA*	SC/UPC Female to SC/APC Male (Singlemode)	Metal	Zirconia	9.95

\* Traditionally UPC and APC connectors have been incompatible to mate together due to the air-gap created between the two mating ferrules. This air-gap creates both undesirable high attenuation and high reflection in your network. The FIS M/F UPC-APC adapters allow UPC and APC fiber optic links to be mated together, adding flexibility to your network, while creating less than 1.0dB of Insertion Loss and -50dB of Return Loss.

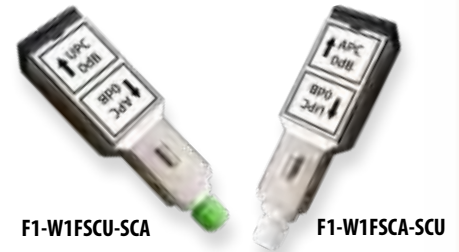

**BUFFERED FIBER ADAPTERS**

A Buffered Fiber Adapter enables you to make a quick, temporary connection to a cleaved buffered fiber without the need to connectorize. ST, FC, SC and SMA style adapters available. **Not recommended for use with test equipment.**

PART #	DESCRIPTION	PRICE
F1-8194	ST Buffered Fiber Adapter (For Use 900µm buffer)	\$39.95
F1-8294	FC Buffered Fiber Adapter (For Use 900µm buffer)	39.95
F1-8494	SC Buffered Fiber Adapter (For Use 900µm buffer)	39.95
F1-8394	SMA-905 Buffered Fiber Adapter (For Use 900µm buffer)	50.00



**FIS FIBER OPTIC ADAPTER KIT**

The FIS fiber optic adapter kit provides installers with all the popular mating sleeves to test or plug in fiber optic cables. **Perfect for Installers.**

PART #	DESCRIPTION	PRICE
F1-ADPTKIT	FIS Adapter Kit (includes 24 adapters)	\$79.00

**KIT CONTENTS (CONTAINS TWO OF EACH):**

LC-LC, LC/APC-LC/APC, SC-SC, SC/APC-SC/APC, ST-ST, FC-FC, FC/APC-FC/APC, FC/APC-SC/APC, SC-FC, FC-ST, SC-ST, MU-MU







**F1-8705-CSTSCS**  
ST (male) - SC (female) (Singlemode)  
Metal Housing  
Zirconia Sleeve  
\$25.00



**F1-8705-CSCFCS**  
SC (male) - FC (female) (Singlemode)  
Polymer Housing  
Zirconia Sleeve  
\$25.00



**F1-8705-CSTFCS**  
ST (male) - FC (female) (Singlemode)  
Metal Housing  
Zirconia Sleeve  
\$25.00



**F1-8705-SCSCS**  
SC (male) - SC (female) (Singlemode)  
Polymer Housing  
Zirconia Sleeve  
\$25.00



**F1-8705-CSCST**  
SC (male) - ST (female) (62.5/125µm)  
Polymer Housing  
Zirconia Sleeve  
\$20.00



**F1-8705-STST**  
ST (male) - ST (female) (62.5/125µm)  
Metal Housing  
Zirconia Sleeve  
\$20.00



**F1-8705-SMA**  
SMA(male) - ST (female)  
(62.5/125µm)  
Polymer Housing  
Zirconia Sleeve  
\$20.00



**F1-LCSCMF**  
LC (male) - SC (female) (Singlemode)  
Polymer Housing  
Zirconia Sleeve  
\$28.95



**F1-SCLCMF**  
SC (male) - LC (female) (Singlemode)  
Polymer Housing  
Zirconia Sleeve  
\$28.95



**F1-FCLCMF**  
FC (male) - LC (female) (Singlemode)  
Metal Housing  
Zirconia Sleeve  
\$35.00



**F1-8705-CSCSTS**  
SC (male) - ST (female) (Singlemode)  
Polymer Housing  
Zirconia Sleeve  
\$25.00

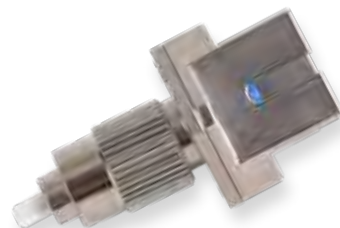

**F1-8705-CFCCS**  
FC (male) - SC (female) (Singlemode)  
Metal Housing  
Zirconia Sleeve  
\$28.95

\*50µm and 62.5µm available!



**F1-4732**  
SMA905 (female) - ST (female) (SM/MM)  
Metal Housing  
Zirconia Sleeve  
\$25.00



**F1-29202**  
ST (female) - FC (female) (SM/MM)  
Metal Housing  
Zirconia Sleeve  
\$25.00



**F1-19202**  
SC (female) - ST (female) (SM/MM)  
Metal Housing  
Zirconia Sleeve  
\$29.95



**F1-34202**  
SC (female) - FC (female) (SM/MM)  
Metal Housing  
Zirconia Sleeve  
\$3.75



**F1-2821CC**  
FC/APC (female) - SC/APC (female) (Square Flange)  
Metal Housing  
Zirconia Sleeve  
\$4.75



**F1-2822CC**  
FC/APC (female) - SC/APC (female) (Rectangular Flange)  
Metal Housing  
Zirconia Sleeve  
\$4.75



**F1-SCLFF**  
SC (female) - LC (female)  
Polymer Housing  
Zirconia Sleeve  
\$23.95



**F1-SCMUFF**  
SC (female) - MU (female)  
Polymer Housing  
Zirconia Sleeve  
\$35.00



**106172-0000**  
FC (female) - ST (female) (SM/MM)  
Metal Housing  
Zirconia Sleeve  
\$8.95



**F1-LCMUFF**  
LC (female) - MU (female) (SM/MM)  
Polymer Housing  
Zirconia Sleeve  
\$23.95

**Don't See What You Are Looking  
For Call Us Today!**

**1-800-5000-FIS(347)**

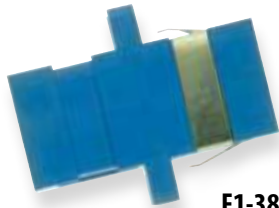

**F1-3810BC**  
Singlemode - Blue  
SC - Style 3  
Polymer Housing  
Zirconia Sleeve  
\$2.00



**F1-8601**  
Duplex Singlemode - Blue  
SC - Style 3  
Polymer Housing  
Zirconia Sleeve  
\$3.50



**F1-8601NF**  
Duplex Singlemode - Blue (No Flange)  
SC - Style 5  
Polymer Housing  
Zirconia Sleeve  
\$2.25



**F1-4800T**  
Singlemode APC - Green  
SC - Style 3  
Polymer Housing  
Zirconia Sleeve  
\$2.00



**F1-4800NFT**  
Singlemode APC - Green (No Flange)  
SC - Style 5  
Polymer Housing  
Zirconia Sleeve  
\$1.25

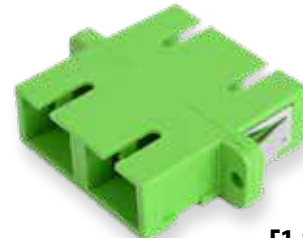

**F1-8701**  
Duplex Singlemode APC - Green  
SC - Style 3  
Polymer Housing  
Zirconia Sleeve  
\$3.75

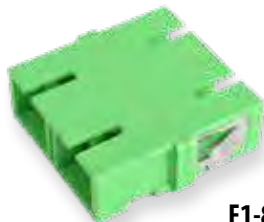

**F1-8701NF**  
Duplex Singlemode APC - Green (No Flange)  
SC - Style 5  
Polymer Housing  
Zirconia Sleeve  
\$1.25



**F1-8650**  
Duplex Multimode - 10 Gig - Aqua  
SC - Style 3  
Polymer Housing  
Zirconia Sleeve  
\$2.75



**F1-8350NF**  
Multimode - 10 Gig - Aqua (No Flange)  
SC - Style 5  
Polymer Housing  
Zirconia Sleeve  
\$1.00



**F1-8600ET**  
Duplex Multimode - Beige (No Flange)  
SC - Style 5  
Polymer Housing  
Phos. Bronze Sleeve  
\$2.75

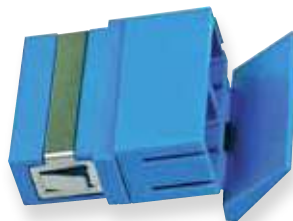

**F1-SCRD**  
Duplex Singlemode - Blue (No Flange)  
SC - Style 5 with Shutter  
Polymer Housing  
Zirconia Sleeve  
\$5.25



**F1-8620**  
Duplex Multimode - Black  
SC - Style 3  
Polymer Housing  
Phos. Bronze Sleeve  
\$2.75

**Call Your FIS Sales Representative  
for availability of other adapters!**





**F18005NF**  
Singlemode –Blue (No Flange)  
LC - Style 5  
Polymer Housing  
Zirconia Sleeve  
\$1.75



**F1-8035**  
Duplex Singlemode-Blue  
LC - Style 3  
SC Footprint  
Polymer Housing  
Zirconia Sleeve  
\$3.75



**F1-8050NF**  
Duplex Multimode – 10  
Gig Aqua (No Flange)  
LC - Style 5  
SC Footprint  
Polymer Housing  
Zirconia Sleeve  
\$2.75



**F1-8010NF**  
Duplex Singlemode – Blue  
(No Flange), Square  
LC - Style 5  
Polymer Housing  
Zirconia Sleeve  
\$2.95



**F1-LCAD02R**  
Duplex Singlemode – Blue  
LC - Style 3 with Shutter  
SC Footprint  
Polymer Housing  
Zirconia Sleeve  
\$5.35



**F1-8008**  
Singlemode - APC - Green  
LC APC - Style 1  
Polymer Housing  
Zirconia Sleeve  
\$2.00



**F1-8018**  
Duplex singlemode APC - Green  
LC APC  
Style 3 - SC Footprint  
Polymer Housing  
Zirconia Sleeve  
\$4.25



**F1-8015NF**  
Duplex Singlemode APC –  
Green (No Flange)  
LC APC - Style 5  
SC Footprint  
Polymer Housing  
Zirconia Sleeve  
\$3.25



**F1-8000A**  
Multimode-Beige (No Flange)  
LC - Style 1  
Polymer Housing  
Phos. Bronze Sleeve  
\$1.50



**F1-8030**  
Duplex Multimode-Beige  
LC - Style 3  
SC Footprint  
Polymer Housing  
Phos. Bronze Sleeve  
\$2.95



**F1-8020CNF**  
Duplex Multimode-Beige (No Flange)  
(No Flange), Square  
LC - Style 5  
Polymer Housing  
Zirconia Sleeve  
\$2.25



**F1-8050**  
Duplex MM -10 Gig - Aqua  
LC - Style 3  
SC Footprint  
Polymer Housing  
Phos. Bronze Sleeve  
\$3.00



**F1-8045NF**  
Quad Singlemode-Blue (No Flange)  
LC - Style 5  
Polymer Housing  
Zirconia Sleeve  
\$4.10



**F1-8040**  
Quad Multimode-Beige  
LC - Style 3  
SC Duplex Footprint  
Polymer Housing  
Phos. Bronze Sleeve  
\$5.00

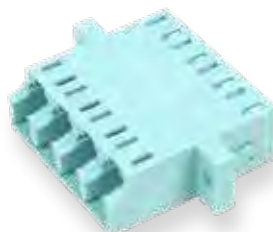

**F1-8041**  
Quad Multimode -10 Gig - Aqua  
LC - Style 3  
SC Duplex Footprint  
Polymer Housing  
Phos. Bronze Sleeve  
\$5.00

**Call Your FIS Sales Representative for availability of other adapters!**

Please refer to "style" Columns when making your selection.

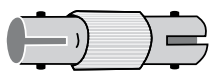

Floating Style 1



Threaded Style 2

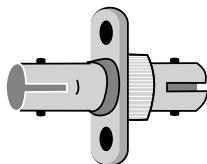

Flanged Style 3

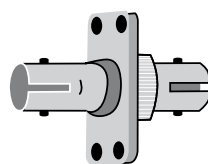

Rectangular Flanged Style 4

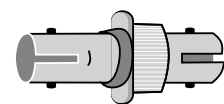

No Flanged Style 5



F1-8102SS



8119



6113



106110-1000



F1-8501S



F1-8520



8211APC



106152-0100



F1-890M



106102-0000



F1-5910S



F1-5915

## ST ADAPTERS

PART #	TYPE	STYLE	HOUSING	SLEEVE	PRICE
F1-8102SS	Multimode	2	Metal	Phos. Bronze	85¢
F1-8200A	Singlemode	2	Metal	Zirconia	\$1.30

## CORNING

6112	Multimode	2	Metal	Phos. Bronze	\$2.95
8119	Singlemode	2	Metal	Zirconia	2.75
6113	Duplex Multimode	2	Metal	Phos. Bronze	4.25
8113	Duplex Singlemode	2	Metal	Zirconia	3.95

## MOLEX

106113-0000	Multimode - Black	2	Polymer	Polymer	\$2.00
106110-1000	Singlemode	2	Metal	Zirconia	4.50
106110-0000	SM / MM - Black	2	Polymer	Zirconia	3.50

## MT-RJ ADAPTERS

PART #	TYPE	STYLE	HOUSING	PRICE
F1-890M	SM / MM	SC Footprint	Polymer	\$1.65
106102-0000	SM / MM	3	Polymer	3.25

## FC ADAPTERS

PART #	TYPE	STYLE	HOUSING	SLEEVE	PRICE
F1-8501SZ	Multimode	4	Metal	Zirconia	\$2.50
F1-8510	Multimode	2	Metal	Phos. Bronze	2.50
F1-8520	SM / MM	2	Metal	Zirconia	3.35
F1-8521S	Singlemode - APC	4	Metal	Zirconia	3.75
F1-8525	Singlemode - APC	2	Metal	Zirconia	3.75

## CORNING

8211	Singlemode	2	Metal	Zirconia	\$4.25
8211APC	Singlemode - APC	2	Metal	Zirconia	4.75

## MOLEX

106152-0100	SM / MM	4	Metal	Zirconia	\$7.45
106152-1000	SM / MM	2	Metal	Zirconia	5.75
106152-3000	Singlemode - APC	2	Metal	Zirconia	5.75

## MU ADAPTERS

PART #	TYPE	HOUSING	SLEEVE	PRICE
F1-5910S	Singlemode	Simplex - Polymer	Zirconia	\$5.00
F1-5915	Singlemode	Duplex - Polymer	Zirconia	6.70

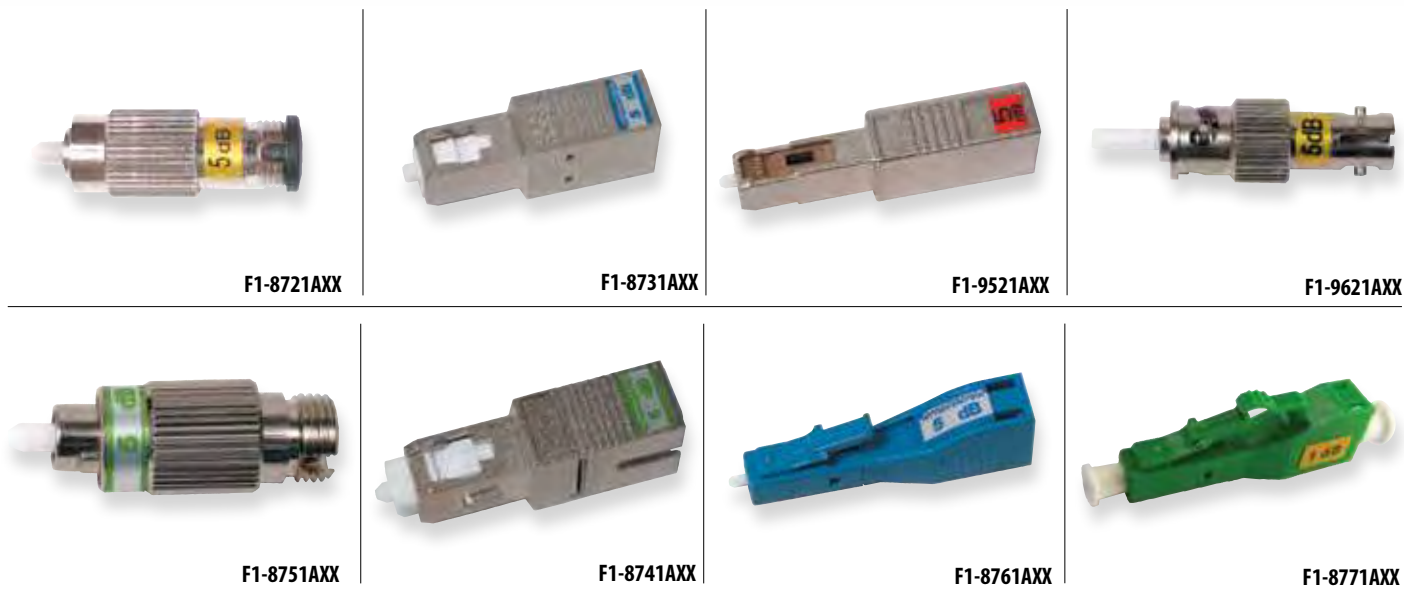

## MALE-TO-FEMALE ATTENUATORS

FIS male-to-female attenuators contain doped fiber suitable for both 1310nm and 1550nm operation. Fixed attenuation values are available in 1dB increments from 1 to 20dB. FIS stocks standard 5, 10, 15, 20dB attenuation levels in most styles.

TO SPECIFY ATTENUATION LEVEL REPLACE "XX" with desired attenuation level ex. 01=1dB, 02=2dB, 03=3dB, 04=4dB, etc. (Attenuators up to 20dB in stock.)

PART #	DESCRIPTION	PRICE
F1-8721AXX	FC/UPC Male to Female Attenuator	\$10.25
F1-8751AXX	FC/APC Male to Female Attenuator	11.95
F1-8731AXX	SC/UPC Male to Female Attenuator	10.25
F1-8741AXX	SC/APC Male to Female Attenuator	11.95
F1-9621AXX	ST/UPC Male to Female Attenuator	10.25
F1-8761AXX	LC/UPC Male to Female Attenuator	12.95
F1-8771AXX	LC/APC Male to Female Attenuator	13.95
F1-9521AXX	MU/UPC Male to Female Attenuator	13.95

## FIS BULKHEAD FEMALE-TO-FEMALE ATTENUATORS

FIS Bulkhead Attenuators utilize a wavelength sensitive neutral density filter to achieve attenuation. Available in 5, 10, 15 and 20dB values. Select from 1310nm or 1550nm options.

### ST ATTENUATOR 1310nm

PART #	DESCRIPTION	PRICE
F1-81215SC	FIS 5dB ST Attenuator for 1310nm	\$10.95
F1-8122510C	FIS 10dB ST Attenuator for 1310nm	10.95
F1-8123515C	FIS 15dB ST Attenuator for 1310nm	10.95
F1-8124520C	FIS 20dB ST Attenuator for 1310nm	10.95



### ST ATTENUATOR 1550nm

PART #	DESCRIPTION	PRICE
F1-81255	FIS 5dB ST Attenuator for 1550nm	\$10.95
F1-81265	FIS 10dB ST Attenuator for 1550nm	10.95
F1-81275	FIS 15dB ST Attenuator for 1550nm	10.95
F1-81285	FIS 20dB ST Attenuator for 1550nm	10.95

### SC ATTENUATOR 1310nm

PART #	DESCRIPTION	PRICE
F1-83215	FIS 5dB SC Attenuator for 1310nm	\$10.95
F1-83225	FIS 10dB SC Attenuator for 1310nm	10.95
F1-83235	FIS 15dB SC Attenuator for 1310nm	10.95
F1-83245	FIS 20dB SC Attenuator for 1310nm	10.95



### SC ATTENUATOR 1550nm

PART #	DESCRIPTION	PRICE
F1-83255	FIS 5dB SC Attenuator for 1550nm	\$10.95
F1-83265	FIS 10dB SC Attenuator for 1550nm	10.95
F1-83275	FIS 15dB SC Attenuator for 1550nm	10.95
F1-83285	FIS 20dB SC Attenuator for 1550nm	10.95

## FIS BULK ADAPTERS

FIS multimode and singlemode ST, SC, LC and FC adapters bulk packaged in lots of 100 pieces. These adapters offer the best value in performance and cost savings.

PART #	DESCRIPTION	PRICE
F1-81025S-100	FIS MM ST - (100 pk.)	\$85.00
F1-8200C-100	FIS SM ST - (100 pk.)	117.00
F1-8020NF-100	FIS MM LC Duplex - (100 pk.)	247.50
F1-8010NF-100	FIS SM LC Duplex - (100 pk.)	405.00
F1-8520-100	FIS SM FC Style 2 - (100 pk.)	300.00
F1-3800BC-100	FIS MM SC Beige - (100 pk.)	90.00
F1-3810BC-100	FIS SM SC Blue - (100 pk.)	157.00
F1-4800BC-100	FIS SM SC/APC Green - (100 pk.)	200.00
F1-8600ET-100	FIS MM SC Duplex - (100 pk.)	250.00



Other part numbers available upon request

F1-3800BC-100



FOR USE WITH 3mm  
JACKETED CABLE



F1-0045

FOR USE WITH 3mm  
JACKETED CABLE



F1-10015



F1-0031-40C



F1-2250



## FIS CLIP-ON VARIABLE ATTENUATOR

The Clip-On Variable Attenuator is a completely passive device, which works by physical attenuation of a 3mm jacketed singlemode cable. May be used with smaller jacket sizes however, attenuation performance may vary. It can be attached at any point in a cable, providing attenuation levels from 0 to >47dB at 1550nm (0 to >21dB at 1310nm) and low back reflection. Good for hundreds of uses, and leaves no lasting effects on the cable. Dimensions: Length = 1 1/2", Diameter = 3/4"

PART #	DESCRIPTION	PRICE
F1-0045	Clip-On Variable Attenuator	\$49.00

## FIS 3-STEP ATTENUATORS

The FIS 3-Step Attenuator is a completely passive device and achieves attenuation by exceeding the recommended bend radius specifications of the fiber cable, including ClearCurve fiber, without introducing back-reflections. This unit is designed for 3mm jacket types and a wavelength of 1310nm, but can also be used with various jacket sizes and wavelengths with varying attenuation levels. Use any combination of the three loops to achieve desired attenuation levels.

PART #	DESCRIPTION	PRICE
F1-10007	3-Step Attenuator 2-7dB (1310nm Singlemode)	\$29.95
F1-10015	3-Step Attenuator 5-15dB (1310nm Singlemode)	29.95
F1-10020	3-Step Attenuator 5-20dB (1310nm Singlemode)	29.95

## FIS IN-LINE FIXED ATTENUATORS

The FIS In-Line Fixed Attenuator is built to meet your low reflection attenuation requirements. Each cord is custom built to accommodate up to 10 meters of cable and the connector styles of your choice. The 5dB and 10dB versions hold a +/- .5dB tolerance with the 15dB and 20dB holding a 1dB tolerance. Please specify operating wavelength. The in-line attenuator provides negligible back reflection and is therefore recommended for use with UPC or APC style patch cable.

PART #	DESCRIPTION	PRICE
F1-ATS + 5dB or 10dB	In-line Attenuator	patch cable price + \$39.00
F1-ATS + 15dB or 20dB	In-line Attenuator	patch cable price + 49.00

## VARIABLE ATTENUATORS

This Variable Attenuator uses collimator lens technology enabling the user to change attenuation through the twist of a top-mounted screw. Use this variable attenuator to simulate the loss in a fiber system or testing your system's dynamic range. A power meter and light source can be used to determine the fixed attenuation value your system requires. The attenuator has a 0.8dB typical insertion loss and is available in a 2 meter length and may be connectorized. A low back reflection style is prepared with ultra PC connectors maintaining the internal low back reflection characteristics. Attenuation range: 0.8dB to 60dB.

PART #	DESCRIPTION	PRICE
F1-0031-40C	SM Attenuator 8-9µm Core (2 Meter Unconnectorized) Return Loss <-40dB	\$170.00
F1-1033-35C	MM Attenuator 62.5µm Core (2 Meter Unconnectorized) Return Loss <-35dB	170.00
F1-0031-LBR	SM Low Back Reflection Attenuator with FC/UPC Connector Return Loss <-50dB	235.00

## AIR-GAP VARIABLE ATTENUATORS

The Air-Gap Variable Attenuator has a ceramic alignment sleeve that provides a low insertion loss of .15dB and can be used on both multimode and singlemode applications. Included tool provides ability to increase attenuation to desired "level". Device may replace mating sleeve at the patchpanel, enabling variable attenuation levels to be introduced to the system. Attenuation range is 0dB to 20dB.

PART #	DESCRIPTION	PRICE
F1-2250	Air-Gap Variable ST Attenuator	\$60.00
F1-2251	Air-Gap Variable FC Attenuator	60.00

### TYPICAL ATTENUATION LEVELS (Installed At Light Source)

COLOR	850nm (dB)	1300nm (dB)
Red	2.5	7.4
Blue	3.6	9.1
Green	4.8	10.2
Gold	5.5	11.3
Silver	6	11.7

## FIS ST, SMA OR FDDI FIXED ATTENUATORS

The washer style attenuator is placed at the light source, spacing the mated connectors to cause attenuation. The attenuators of various thicknesses are not assigned specific dB values, several factors will dictate actual loss.

PART #	DESCRIPTION	PRICE
A450-FIS	ST Attenuators (Qty. 5) 1 Each Color	\$10.00 set
A40D-FIS	SMA Attenuators (Qty. 5) 1 Each Color	10.00 set
A450-FDDI	FDDI Attenuators (Qty. 10) 2 Each Color	20.00 set
A450-20	ST Attenuators (Qty. 10), State Color	17.95
A40D-20	SMA Attenuators (Qty. 10), State Color	17.95



# CUSTOM DRILLING SERVICES FROM FIS



High tolerance custom stainless alloy ferrules may be ordered to meet your special requirements.

## FIS PREMIUM FERRULES

FIS offers a wide range of high precision stainless alloy ferrules for ST, SC, and FC connectors. Our high precision ferrules are used in a wide range of specialized applications, including telecommunications, laser delivery, medical, military, laboratory, and industrial applications.

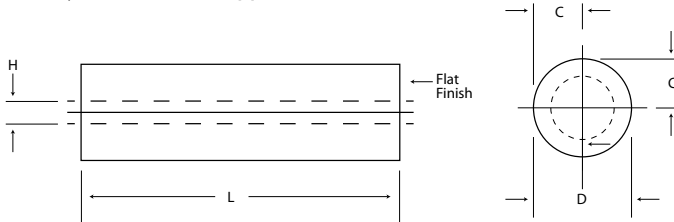

TYPE	MIN QTY	HOLE TOL "H"	CONCENTRICITY "C"	LENGTH "L"	DIAMETER "D"
Standard	25	-10µm / +50µm	± 50µm	10.5mm 12.7mm	2.5mm
Premium	25	-4µm / +10µm	± 25µm	Variable	Variable

FIS offers a fast turnaround on custom micro drilling services. FIS can accommodate almost any fiber size for special applications. We are capable of drilling FC and SC style stainless alloy connectors that range from 250µm to 1550µm. ST and SMA style stainless alloy connectors can be drilled up to 1550µm. However we cannot drill to odd sizes or pure stainless steel ferrules.

For **standard** drilled FIS stainless alloy connectors add \$1.80 to the list price of the connector drilled up to 900µm and \$2.25 to the connector drilled from 900µm or larger.

For **premium** drilled connectors add \$5.00 to the price of the connector.

If a drill bit not listed is required add a \$50 drill charge fee and allow an additional two weeks.

## STANDARD / PREMIUM DRILL SIZES

250µm	450µm	650µm	920µm
260µm	460µm	660µm	930µm
270µm	470µm	670µm	970µm
280µm	480µm	680µm	1000µm
300µm	490µm	710µm	1010µm
310µm	500µm	730µm	1040µm
330µm	510µm	750µm	1080µm
340µm	520µm	770µm	1100µm
350µm	530µm	800µm	1200µm
360µm	540µm	810µm	1300µm
380µm	550µm	830µm	1370µm
400µm	570µm	840µm	1500µm
410µm	600µm	860µm	1550µm
420µm	610µm	880µm	Drill Sizes
430µm	630µm	900µm	
440µm	640µm	910µm	

**\*Note: For Non-Standard Drill Sizes add \$50**

**\* 2 week lead time on Non-Standard Ferrules**



## FERRULES

FIS offers a variety of 2.5mm Zirconia and Stainless Alloy ferrules for multimode and singlemode applications. Zirconia ferrules have a standard PC radius. Stainless Alloy ferrules are suitable for many laboratory or other specialty applications. Custom lengths and diameters available.

NOT AVAILABLE INDIVIDUALLY

### PREMIUM DRILLED FERRULES

PART #	DESCRIPTION	LENGTH	PRICE
F1-PR240-25	240µm Premium Stainless Alloy Ferrule (25 pk.)	12.7mm	\$125.00
F1-PR250-25	250µm Premium Stainless Alloy Ferrule (25 pk.)	12.7mm	125.00
F1-PR140-25	140µm Premium Stainless Alloy Ferrule (25 pk.)	12.7mm	125.00

### FERRULES

PART #	DESCRIPTION	LENGTH	PRICE
F1-TSMM127-25	127µm Zirconia Ferrule (Multimode) (25 pk.)	10.5mm	\$15.75
F1-SM126-25	126µm Zirconia Ferrule (Singlemode) (25 pk.)	10.5mm	17.50
F1-140K-25	140µm Zirconia Ferrule (Multimode) (25 pk.)	10.5mm	39.95
F1-0061F-25	127µm Standard Stainless Alloy Ferrule (25 pk.)	12.7mm	45.00
F1-0063F-25	140µm Standard Stainless Alloy Ferrule (25 pk.)	12.7mm	45.00
F1-0064F-25	230µm Standard Stainless Alloy Ferrule (25 pk.)	12.7mm	45.00

## ALIGNMENT SPLIT SLEEVES

Split sleeves are designed to align 2.5mm ferrules with precision. The Phosphorous Bronze version provides the precision you require on multimode fiber applications. The split sleeves have an outside diameter of 3.2mm and a length of 11.4mm.

NOT AVAILABLE INDIVIDUALLY

PART #	DESCRIPTION	PRICE
F1-8300SSC-25	Zirconia Split Sleeve (25 pk.)	\$20.00
F1-8300SS-25	Phosphorous Bronze Split Sleeve (25 pk.)	7.50



# CONSUMABLES



F1-1007S

### CANNED AIR

Before removing a fiber optic connector for inspection or cleaning, make sure the area around the connector is free from dust. The FIS Micro Duster includes an extension nozzle to provide a powerful blast of air to remove particles from areas that are otherwise inaccessible. Competitively priced. **Shipping restrictions and fees may apply.**

PART #	DESCRIPTION	PRICE
F1-1007S	FIS Canned Air (10oz.)	\$6.50



F1-8328C



F1-8327

F1-8326

### FIBER OPTIC DISPOSAL UNIT

A handy and safe solution for disposing of cleaved fiber ends. Perfect for on-site installers. Choose from three sizes to accommodate any tool kit and splice/connector station. The large unit has a snap on hinge cover, while the standard and mini containers have traditional slide tops for easy opening and closing.

PART #	DESCRIPTION	PRICE
F1-8328C	Large Fiber Optic Disposal Unit with Snap Top (3 1/2"W x 5 1/2" H)	\$5.95
F1-8327	Standard Fiber Optic Disposal Unit with Slide Top (1 7/8"W x 4 3/8" H)	3.95
F1-8326	Mini Fiber Optic Disposal Unit with Slide Top (1 5/8"W x 1 1/2" H)	2.95



F1-007PL



F1-007P

### FIS DISPENSING BOTTLE

PART #	DESCRIPTION	PRICE
F1-007PL	8 oz. Automatic Alcohol Dispensing Bottle (Plastic)	\$6.75
F1-007P	8 oz. Automatic Alcohol Dispensing Bottle (Amber Glass)	6.75



F1-8265

### PIANO WIRE

A smart way to save a connector when a fiber breaks inside a ferrule during connectorization. Also an excellent tool to remove broken fiber from bare fiber adapters. Sticky colored tabs provided to hold wire.

PART #	DESCRIPTION	PRICE
F1-8265	FIS Piano Wire (8 wires /10 dots)	\$4.95



9006

### OPTICAL COUPLANT LIQUID

To reduce optical loss within fiber optic mechanical splices and connectors, apply optical couplant at the interface of the two mated fibers. This minimizes loss by reducing the difference in the index of refraction between the mated fibers. Available as liquid.

PART #	DESCRIPTION	PRICE
9006	Liquid Matching Couplant (.2 oz., Syringe)	\$14.50



F1-0001V

### MATCHING GEL (OPTICAL COUPLANT)

To reduce optical loss within fiber optic mechanical splices and connectors, apply optical couplant at the interface of the two mated fibers. This minimizes loss by reducing the difference in the index of refraction between the mated fibers.

PART #	DESCRIPTION	PRICE
F1-0001V	FIS Matching Gel (.4oz)	\$25.00



QBE



PQBE

### CHEMTRONICS QBE® SERIES

PART #	DESCRIPTION	PRICE
QBE	QBE® Lint Free Cleaning Wipes SC,ST,FC, 200 Perforated Wipes 2.75" x 3"	\$40.00
PQBE	Pocket QBE® Lint Free Cleaning Wipes SC,ST,FC, 200 Perforated Wipes 1.375" x 3"	43.00
QBE-R	QBE® Lint Free Cleaning Wipes SC/APC and MTP Recessed 200 Wipes 2.75" x 3"	40.95



WCS800



WCS100

### STICKLERS CLEANING WIPES AND BOX

Perfectly packaged for factories making jumpers and patch cords, this tool is designed for high-speed, high-volume production. Featuring a high-modulus fabric that will not lint, tear, or shred and allows for 3,200+ cleanings per roll for the large box and 400+ cleanings per roll for the small box.

PART #	DESCRIPTION	PRICE
WCS800	Sticklers Large Cleaning Box	\$31.95
WCS100	Sticklers Small Cleaning Box	15.95
WFW	CleanWipes™	\$8.50



WFW



## FIS FIBER OPTIC WIPES

The FIS low lint tissues can be used dry or with cleaning solvents to clean ferrule endfaces or prepare fibers for termination and/or splicing.

PART #	DESCRIPTION	PRICE
F1-6705	Low Lint Wipes (280 wipes per box)	\$1.95
F1-6705C	Case of (60 Boxes)	115.00

F1-6705



## KIMWIPES

Kim Wipes are the standard for use alone or with alcohol or solvents. Kim Wipes provide superior cleaning of fiber optic connector ferrules without risk of scratching. 280 wipes per box.

PART #	DESCRIPTION	PRICE 1-11	PRICE 12+
34-155	Individual box (4.4" x 8.4")	\$2.30	\$2.20
34-155C	Case (60 per case)	132.00	130.00
34-256C	Large Sheet Kim Wipes - 15 Boxes per case (14.7" x 16.6")	180.00	169.95

34-155



## FIS FIBER OPTIC 4"x4" NON-WOVEN WIPES

Non-Woven cloth wipes can be used alone or with alcohol or solvents. Provides superior cleaning of fiber optic connector ferrules without risk of scratching or lint residue.

PART #	DESCRIPTION	PRICE
F1-6702	Non-Woven Dry Wipes, 100 per pack, 4" x 4"	\$3.25
F1-6704	Non-Woven Dry Wipes, 1,200 per pack, 4" x 4"	25.00

F1-6702



## ISOPROPYL ALCOHOL PRODUCTS

This 99% ACS reagent grade isopropyl is used in cleaning fiber or connector end faces for better transmission performance. Also offered are pre-filled foam swabs and 4 oz. dispensing bottles available in glass or plastic. **Ground shipping only. Hazmat fees may apply.**

PART #	DESCRIPTION	PRICE
F1-0068	1 Case of (6) 4 oz. Canned Alcohol	\$31.95
F1-0007SP	4 oz. Alcohol Bottle with Spray Top	6.50
F1-0007	1 Case of (6) 4 oz. Alcohol Squeeze Bottles	12.75
F1-000728	Bottled Alcohol (28 oz.)	6.95
F1-1007GA	1 Case Alcohol (4 gallons per case)	106.75



HAZMAT FEES  
MAY APPLY  
GALLON ONLY



F1-0068

F1-0007

F1-000728

## FIBER OPTIC CLEANING SOLUTION

This fast-acting cleaner can be used with dry fiber wipes or tissues to remove dirt and soils from optical fibers prior to termination and splicing or to clean the end of connector ferrules.

PART #	DESCRIPTION	PRICE
F1-6706	Fiber Optic Cleaning Solution - <b>Air Ship Available</b>	\$14.95
F1-6706AQ	Water-based Fiber Optic Cleaner	9.75

Air Ship  
Available

F1-6706



## FIBER OPTIC SPLICE AND CONNECTOR CLEANER

Ideal for cleaning ferrules in connector bulkheads as well as individual fiber optic connectors. This fast-drying, optical-grade cleaning fluid can be used with wipes or cleaning sticks for wet/dry cleaning without chemical residue. Three-way dispenser enables you to select spray mode, dampening mode or wetting mode. Travel safe, non-flammable, non-regulated, and non-hazardous. No hazmat fees!

PART #	DESCRIPTION	PRICE
POC03M	Sticklers Splice and Connector Cleaner (3oz.)	\$15.00
FPF	MicroCare Optical Fiber Prep Cleaner (3oz.)	16.50
FCC2	Microcare Opical Fiber Connector Cleaner (3oz.)	16.95

Air Ship  
Available



FCC2

FPF

POC03M

## ITW CHEMTRONICS CLEANING SOLUTIONS

PART #	DESCRIPTION	PRICE
F1-ES810	Electro-Wash® 5 oz. Aerosol Can (PX) (Ground shipping required)	\$10.95
F1-ES110	Electro-Wash® 1 Gallon Bottle (PX) (Ground shipping required) (Not Pictured)	73.95
F1-ES1210	Electro-Wash® 12.5 oz. Aerosol Can (PX) (Ground shipping required) (Not Pictured)	20.25
F1-ES1607	Electro-Wash® 12 oz. Aerosol Can (NXO) (Ground shipping required) (Not Pictured)	60.95
F1-ES107	Electro-Wash® 1 Gallon Bottle (NXO) (Ground shipping required) (Not Pictured)	806.95
F1-MXCP	Electro-Wash® MX Cleaning Pen	9.35

F1-ES1607



F1-MXCP





F1-1004

## PRE-MOISTENED ALCOHOL WIPES

Fast evaporating alcohol pre-moistened wipes can be used on optical fiber to remove dirt, dust and oils. Contains: Isopropanol.

PART #	DESCRIPTION	PRICE
F1-1004	FIS Pre-Moistened Alcohol Wipes (50 pk.)	\$9.95



## POLYWATER ANHYDROUS ALCOHOL

Type FO™ is great for cleaning glass fiber or connector end faces for better light transmission performance. Type FO™ quickly removes dust, oils, and contaminants, while leaving no residue. The anhydrous alcohol in FO™ has essentially no water content. The towels are durable and non-linting. The package limits vapor exposure and eliminates spill hazards. **Hazmat fees may apply.**

PART #	DESCRIPTION	PRICE
FO-1	Type FO™ Alcohol Prep Wipe (50 pk.)	\$31.95
FO-16	Type FO™ 16-oz Alcohol Fiber Cleaner - <b>Hazmat fees may apply.</b>	11.95



F1-1010

## PRE-MOISTENED DEGREASER WIPES (ICKY-PIC CLEANER)

FIS Icky-Clean wipes can be used with outside plant, optical or copper cables. Utilize to remove Icky-Pic or gels from cables prior to splicing or termination. Great to clean up tools as well.

PART #	DESCRIPTION	PRICE
F1-1010	FIS Pre-Moistened Degreaser Wipes (12 pk.)	\$10.50
F1-1010-100	FIS Pre-Moistened Degreaser Wipes (100 pk.)	80.00



F1-TC1

## POLYWATER SQUEEKYKLEEN™ (ICKY-PIC CLEANER)

SqueekyKleen™ cleans and fans fiber in two wipes without alcohol. SqueekyKleen™ is less harsh on hands, reduces chemical odors and vapor concentrations to a minimum in splice trailers and vaults. Unique formulation and specially designed high-performance towelettes work to remove pic from the entire surface of loose-tube or ribbon fibers, leaving no residue. Safe on acrylate and Mylar®.

PART #	DESCRIPTION	PRICE
F1-TC1	Telcom Cleaner-Saturated Wipe (12 pk.)	\$16.95



F1-1091T

## POLYWATER HYDRASOL® SOLVENTS (ICKY-PIC CLEANER)

HydraSol® is a water-based solvent cleaner that is amazingly effective at dissolving and removing cable filling greases (Icky Pic). This economical product easily rinses off hands and tools. Our tear-resistant, presoaked towelette comes in an easy-open foil pack and is especially effective for smaller cleaning jobs and fiber optic splicing.

PART #	DESCRIPTION	PRICE
F1-1091T	HydraSol® Pre-moistened Tissues (12 pk.)	\$15.95
F1-1091GP	HydraSol® 1 Gallon Jug	55.95



F1-CP421

## ITW CHEMTRONICS DE-GREASER WIPES

PART #	DESCRIPTION	PRICE
F1-CP421	Electro-Wash® Wipes (MX) (25 individual wipes per box)	\$42.95



F1-1003

CP400

## ITW CHEMTRONICS OPTIC PREP WIPES

PART #	DESCRIPTION	PRICE
F1-1003	Optic Prep Tissue Pack Box (50pk)	\$23.95
CP400	Pre-Saturated Cleaning Wipe - Lint Free	26.75



S1P100P

## ITW CHEMTRONICS OPTIC PREP WIPES

PART #	DESCRIPTION	PRICE
S1P100P	Pre-Saturated Wipes (Ground shipping required) - <b>Hazmat Fees May Apply.</b>	\$29.95



## PT TECH D'GEL SOLVENTS

D'Gel Cable and Tool Cleaner is a full strength solvent specifically developed for removing cable gels, blocking compounds, licky Pic, and C-cement. It also removes grease, tar, oil, wax, resin and gum from copper and fiber optic cable. It works equally well on painted surfaces and machine equipment. D'Gel does not contain TCE, HCFC's or methylene chloride.

PART #	DESCRIPTION	PRICE
F1-1011	12 Pack Box of Premoistened Tissues	\$30.00
F1-1091G	1 Gallon Jug	69.95
F1-1091S	32 oz. Spray Bottle	20.00



FC451

F1-1091S

## FIBER-CLEAN® TOWELETTES

Remove licky Pic and water blocking compounds with Fiber-Clean® Towelettes. Each pre-moistened tissue enables installers to clean and prepare optical fibers for connectorization and splicing. There are 45 tissues in each Fiber-Clean® "pop-up" Dispenser. **Ground shipping required.**

PART #	DESCRIPTION	PRICE
FC451	Fiber-Clean® Towelettes	\$21.95



TC-128

TC-35LF

TC-35LR

## POLYWATER SQUEEKYKLEEN™

No follow-up with alcohol required to get fibers squeaky clean and separated when prepping for splicing. SqueakyKleen™ is less harsh on hands and reduces chemical odors and vapor concentrations to a minimum in splice trailers and vaults. SqueakyKleen™ helps keep splice equipment clean of contamination for better fiber alignment and splice quality. Safe on acrylate and Mylar®.

PART #	DESCRIPTION	PRICE
TC-16LF	Telcom Cleaner with Flip Top (6 oz.)	\$12.35
TC-35LF	Telcom Cleaner with Flip Top (1 qt)	15.30
TC-128	Telcom Cleaner (1 gallon)	48.50
TC-35LR	Telcom Cleaner with Sprayer	15.95



12890

05930

## KIMBERLY CLARK WYPALL TOWELS

For wiping small parts or reaching tight spaces, you can't beat WYPALL™ Detail Wipers. Unlike rags and shop towels, this small format wipe is specifically designed for detail work. Plus it delivers the durability, absorbency and convenience you need for those small but important tasks.

PART #	DESCRIPTION	PRICE
05930	WypAll Towels - X80	\$12.95
12890	WypAll Towels - X90 - Highest Performing	17.65



91371

## KIMBERLY CLARK WATERLESS CLEANING WIPES

Heavy duty hand cleaning wipes. Pre-moistened wipes with a heavy-duty waterless cleanser. Gets hands clean in the same place they got dirty.

PART #	DESCRIPTION	PRICE
58310	Dispenser with 50 Ct Cleaning Wipes	\$9.65
91371	Dispenser 75 Ct Waterless Cleaning Wipes	10.50
91367	75 Ct Refill for 91371 Bucket Dispenser	10.35



HTC-D72

## POLYWATER GRIME-AWAY™

Grime-Away™ wipes are heavy-duty towelettes pre-moistened with a multi-purpose cleaning solution. Grime-Away™ moisturizes and softens hands while cleaning tools and surfaces. Grime-Away™ towels feature a textured side to quickly remove greases, dirt, and grime. They also feature a soft side to be gentler on skin.

PART #	DESCRIPTION	PRICE
HTC-D72	Polywater Grime-Away	\$12.95

## HAND CLEANER TOWELS

When working with optical fiber, it is good practice to keep hands clean to ensure they are free of contaminants. However, soap and water are not always available on the jobsite. SCRUBS pre-moistened towels provide the answer, removing even hard to clean industrial soils and grease without water. Pleasant citrus fragrance and gentle on skin.

PART #	DESCRIPTION	PRICE
42272	Hand Cleaner Towels	\$16.50



42272





F1-6712

## FIS FIBER SWIPE500

This unique handheld connector ferrule end face cleaner removes dust, dirt and contaminants prior to mating a fiber optic connection. The fiber optic cleaner fits well in the technician's hand with a convenient trigger that automatically opens the top cleaning window to expose a single microfiber cleaning slot. Simply swipe the ferrule end-face with light pressure against the microfiber with the directional arrow and then release the trigger.

PART #	DESCRIPTION	PRICE
F1-6712	FIS Fiber Swipe500	\$39.95
F1-6713	Replacement Reel (20 ft)	15.00



F1-7020C

## FIS CONNECTOR CLEANER

Choose the FIS Hand Held Connector Cleaner as an alternative to alcohol or solvent and wipes. The cartridge offers lint-free, clean room grade cleaning media which effectively removes dirt, dust, oil, grease and debris from connector endfaces. A new resilient rubber pad beneath the cleaning surface prevents scratching, and a sliding cover protects the cleaning media from contamination when not in use. Reel refills available.

PART #	DESCRIPTION	PRICE
F1-7020C	FIS Connector Cleaner Universal (400 cleans)	\$10.95
F1-7021C	FIS Cleaning Media Replacement Reel (20 ft.)	4.95



F1-7111

## FIS CONNECTOR CLEANER WITHOUT RETRACTABLE COVER

PART #	DESCRIPTION	PRICE
F1-7111	FIS Connector Cleaner Universal (400 cleans)	\$15.95
F1-7112	Replacement Reel for F17111 (10ft.)	4.95



F1-6270S

## CLETOP CLEANING PRODUCTS

PART #	DESCRIPTION	PRICE
F1-6270	Cletop Connector Cleaner - SC, FC, ST, E2000 (Replacement Blue Tape F1-6271)	\$100.00
F1-6270MTRJ	Cletop MTRJ Male Cassette with White Tape (Replacement White Tape F1-6277)	100.00
F1-6270MT	Cletop MTP/MPO Male Cassette with White Tape (Replacement White Tape F1-6277)	115.00
F1-6210MF	Cletop MTRJ/MTP Female Cassette with White Tape (LC, MU also) (Replacement White Tape F1-6277)	100.00
F1-6270S	Cletop-S Connector Cleaner (A) - SC, FC, ST, E2000 (F1-0700)	90.00
F1-6270SMT	Cletop-S Connector Cleaner for LC, MU, Female MTP and MT-RJ (White Tape F1-0701)	90.00
F1-6271	Cletop Woven Film Replacement Reel Blue Tape	28.95
F1-6277	Cletop Woven Film Replacement Reel White Tape	28.95
F1-0700	Cletop-S Tape Cartridge Blue Tape (B)	28.95
F1-0701	Cletop-S Tape Cartridge White Tape	28.95



F1-6270

### Note:

The Blue Tape is the original color tape. It was used on connectors with 2.5mm diameter ferrules such as the FC, ST, and SC. With the introduction of the smaller 1.25mm diameter ferrules such as used in the LC connector and multifiber connectors such as the MPX, there was some concern the smaller geometry connectors might "snag" on the somewhat looser weave of the Blue Tape. Therefore, a smoother White Tape was developed. Over time, with very few exceptions, the looser weave of the Blue Tape turned out to not be a problem for the smaller geometry ferrules. Currently, the selection of Blue or White Tape is primarily user preference.



F1-0700

## OPTIPOP CLEANING PRODUCTS

PART #	DESCRIPTION	PRICE
FCRC	Optipop Fiber Optic Connector Cleaner (25 ft.)	\$70.00
FCRR	Optipop Cassette Refill	25.00
FCRCMTP	Optipop MTP/MPO Male Fiber Optic Connector Cleaner	70.00
FCRCMTRJ	Optipop MTRJ Male Fiber Optic Connector Cleaner	70.00
F1-6367	Card Cleaner (Includes 10 sheets)	30.00
F1-6368	Card Cleaner Refill (10 Sheets)	17.95



FCRC



SCKPTMPOGSC-05

## SENKO MPOPLUS®

The SENKO MPOPLUS® Effective for removing oil, dust, and dirt particulates that can have a negative impact on fiber optic performance. Cleans entire MPO Endface including PIN area. Easy to use with a push-pull function.

PART #	DESCRIPTION	PRICE
SCK-PT-MPO-GSC-05	MPO Smart Cleaner GEL Stick (pack of 5)	\$12.00
SCK-PT-MPO-01	MPO Smart Cleaner GEL Pad	\$5.00



SCKPTMP001

**FIS BULKHEAD FERRULE CLEANER**

PART #	DESCRIPTION	PRICE
F1-6717	Refillable Bulkhead Fiber Optic Cleaner for 2.5mm Ferrules and Alignment Sleeves, SC, ST, FC and E2000, UPC & APC	\$69.00
F1-6718	Refillable Bulkhead Fiber Optic Cleaner for 1.25mm Ferrules and Alignment Sleeves, LC, and MU, UPC & APC	69.00
F1-6717R	Refill for FIS Fiber Optic Cleaner F16717 for SC, ST, FC & E2000	56.00
F1-6718R	Refill for FIS Fiber Optic Cleaner F16718 for LC & MU	56.00
F1-6715	FIS 2.5mm Bulkhead Ferrule Cleaner (audible "click" with rotating head)	57.50
F1-6716	FIS 1.25mm Bulkhead Ferrule Cleaner (audible "click" with rotating head)	57.50
F1-6725	Connect-O Clean Ferrule Cleaner for 2.5mm connectors (SC,ST,FC)	39.95
F1-67125	Connect-O Clean Ferrule Cleaner for 1.25mm connectors (LC/MU)	39.95



F1-6718



F1-6715



F1-6716



F1-6725



F1-67125

**IBC™ BRAND CLEANING TOOLS SERIES**

The US Conec IBC™ Brand Cleaners are mechanical cleaning tools designed to clean connectors residing in an adapter or faceplate and unmated connectors. The IBC™ Brand Cleaning tools use a novel dry cleaning strand to gently sweep and lift away dust and residues from the connector end face.

**FEATURES**

- Audible "click" to alert the operator when tool is fully engaged
- Over 525+ engagements per unit
- Dry cleaning strand eliminates the need for solvents to be effective
- Impact resistant to survive drops over 1.5M

PART #	DESCRIPTION	PRICE
9392	IBC™ Cleaner SC (SC,ST, FC and E2000)	\$60.75
9393	IBC™ Cleaner LC (LC, MU) - pictured	60.75
12910	IBC™ Cleaner H-125 (1.25mm Harsh Environment Connectors)	72.00
12926	IBC™ M20 Cleaner SMTPE 304M (2mm Harsh Environment Connectors)	72.00
13310	IBC™ Cleaner M250 for TFOCA II® (2.5mm Connector Systems) - pictured	72.00
13964	IBC™ Mini-Clean 2.5mm (SC, ST, FC, E2000 - with key chain) - pictured	65.00
13965	IBC™ Mini-Clean 1.25mm (LC, MU - with keychain)	65.00
14303	IBC™ Brand Cleaner LC Duplex - pictured	87.50



9393



13310



13964



14303

**MTP/MPO IBC™ BRAND CLEANER**

The MTP IBC™ (In Bulkhead Cleaner) is the first dry cloth cleaner specifically designed to clean the MTP/MPO while inside of an adapter, face-plate, or bulkhead. The unique design enables cleaning of either male (with pins) or female (without pins) MT ferrules. EASY PUSH STYLE WITH AUDIBLE CLICK.

PART #	DESCRIPTION	PRICE
7104	MTP/MPO Bulkhead Cleaner	\$75.00



7104

**AFL ONE-CLICK® CLEANER**

The One-Click Cleaner is an easy-to-use option for cleaning connectors in adapters. Simply insert the One-Click Cleaner into an adapter and push until an audible "click" is heard. The One-Click Cleaner uses the mechanical push action to advance an optical grade cleaning tape while the cleaning tip is rotated to ensure the fiber end-face is effectively, but gently, cleaned. The One-Click Cleaner is a must-have for field technicians. Small enough to fit in a shirt pocket and a great addition to cleaning kits.

PART #	DESCRIPTION	PRICE
85003MZ	One-Click® Cleaner MPO/MTP	\$60.00
85001MZ	One-Click® Cleaner SC, ST, FC 2.5mm ferrules	60.75
85002MZ	One-Click® Cleaner LC/MU 1.25mm ferrules	60.75
8500-05-0007MZ	One-Click Ultra Cleaner 2.5 (enlarged cleaning) SC, ST, FC (500+ cleans)	69.00
8500-05-0008MZ	One-Click Cleaner D-LC, Duplex LC (2 x 500+ cleans)	82.50



85003MZ



85001MZ



85002MZ

**FERRULE MATE™**

Wouldn't it be great if you could limit your connector cleaning supplies to one versatile tool? You can, with Ferrule Mate™. The device cleans recessed fiber optic adapters as well as individual connectors. With the push of a button, the tool forwards and rotates the cleaning cloth. Cloth provides approximately 350 swipes, with a cost as low as 18 cents per cleaning. Use the SFM-250 for SC, FC, and ST. Use the SFM-125 for MU and LC.

PART #	DESCRIPTION	PRICE
SFM-250	Ferrule Mate™ 2.5mm Ferrules	\$62.50
SFM-125	Ferrule Mate™ 1.25mm Ferrules	62.50



SFM-250



SFM-125



F1-51005

## FIS ADHESIVE TIP DEBRIS REMOVAL SWAB

This swab has an adhesive tip for gathering fiber shards within work area or cleaver mechanism.

PART #	DESCRIPTION	PRICE
F1-51005	Debris Removal Swab - with Adhesive (5 pack)	\$3.50
F1-5100100	Debris Removal Swab - with Adhesive (100 pack)	40.00



F1-25184

## FIS WRAPPED SWABS - 2.5mm and 1.25mm

INTENDED FOR FERRULE END-FACE OR ALIGNMENT SLEEVE CLEANING

PART #	DESCRIPTION	PRICE
F1-25184	2.5mm Wrapped Swabs (5pk)	\$3.50
F1-25183	2.5mm Wrapped Swabs (100pk)	45.00
F1-25123	1.25mm Wrapped Swabs (5pk)	3.50
F1-25123B	1.25mm Wrapped Swabs (100 pk)	45.00



F1-25123

## FIS MINI-FOAM TIP SWABS - 2.5mm

INTENDED FOR FERRULE END-FACE OR ALIGNMENT SLEEVE CLEANING

PART #	DESCRIPTION	PRICE
F1-0005	2.5mm Mini Foam Swabs (50 pk)	\$12.65



F1-0005

## FIS MTP CONNECTOR END-FACE CLEANING SWAB

INTENDED FOR FERRULE END-FACE OR ALIGNMENT SLEEVE CLEANING

PART #	DESCRIPTION	PRICE
F1-25LCMTPB	MTP Chamois Swab (25 per tube)	\$19.25



F1-25LCMTPB

## FIS FUSION SPLICER V-GROOVE CLEANING SWAB

PART #	DESCRIPTION	PRICE
F1-38542F	V-Groove Cleaning Swab (50 per tube)	\$16.95



F1-38542F

## FIS FUSION SPLICER LENS CLEANING SWAB

PART #	DESCRIPTION	PRICE
F1-51125F	Fusion Splice Lens Cleaning Swab (15 per tube)	\$17.00



F1-51125F

## CONNECTOR CLEANING STICKS

MicroCare cleaning sticks use a fibrous sintered polymer tip that is molded, not hand wound. These cleaning sticks deliver fast and consistent cleaning, even inside alignment sleeves. Compatible with a wide variety of solvents in today's optical market. 50 sticks per clamshell.

PART #	DESCRIPTION	PRICE
MCC-S25	2.5mm Clamshell (50 pk)	\$29.75
MCC-S12	1.25mm Clamshell (50 pk)	29.75
MCC-VS	Combo Pack (20) 2.5, (10) 1.25mm and (20) Military Termini	29.75



MCC-VS

## CLETOP CLEANING SWABS

INTENDED FOR FERRULE END-FACE OR ALIGNMENT SLEEVE CLEANING

PART #	DESCRIPTION	PRICE
F1-0401	Cletop Stick 1.25mm (5 pk)	\$5.95
F1-0400	Cletop Stick 2.5mm (5 pk)	5.95
F1-0402	Cletop Stick 2.0mm MIL-AERO Application (5 pk)	5.95
F1-0403	Cletop 2 Sided Stick (2.0mm and 2.5) (5 pk)	11.25

MCC-S25

MCC-S12

F1-0401

## OPTIPOP CLEANING SWABS

INTENDED FOR FERRULE END-FACE OR ALIGNMENT SLEEVE CLEANING

PART #	DESCRIPTION	PRICE
F1-636510P	Optipop Stick Cleaner 1.25mm (10 pk)	\$7.00
F1-636610P	Optipop Stick Cleaner 2.5mm (10 pk)	7.00



F1-SWB110PK

## FIS ALCOHOL CLEANING COTTON SWABS

PART #	DESCRIPTION	PRICE
F1-SWB110PK	Contact Clean Pack (Single Sided Swabs 1 -dry and 1-wet (10 pk)	\$20.00

F1-0006

DRY

WET

## FIS GENERAL PURPOSE COTTON SWABS

PART #	DESCRIPTION	PRICE
F1-0006	General Purpose Cotton Swabs, 1 Bag (100 pk)	\$3.95





F1-0053CKV



F1-6714MPO



F1-0053FSMINI



F1-0053CKM



**FIS CLEANING KITS**

PART #	DESCRIPTION	PRICE
F1-6714	Fiber Optic Cleaning Station, Standard Kit (Wall Mountable) (Not pictured)	\$195.00
F1-6714MPO	Fiber Optic Cleaning Station, Standard Kit with MPO/MTP cleaning tool (Wall Mountable)	265.00
F1-0053FSMINI	FIS Mini Fiber Optic Cleaning Kit	69.95
F1-0053CKM	Fiber Optic Cleaning Kit with 200X Microscope	175.00
F1-0053CKV	Fiber Optic Cleaning Kit in Fabric Carry Case	167.00

**ITW Chemtronics Combination Cleaning Process™ Specialized Cleaning for Every Application**



CFK1000



CFK1010



FK03

**FIBER OPTIC CLEANING KITS**

PART #	DESCRIPTION	PRICE
CFK1003	ITW Chemtronics Fiber Optic Cleaning Kit (Not pictured)	\$140.00
CFK1000	ITW Chemtronics FTTH Fiber Optic Cleaning Kit	144.00
CFK1010	ITW Chemtronics Installation/Maintenance Fiber Optic Cleaning Kit	115.85
FK03	Sticklers Fiber Optic Cleaning Kit	98.00
FK05	Sticklers Military-Ready Cleaning Kit (Not Pictured)	98.00



**5G CLEANING KITS - RRH Cables**

New applications in the field with the implementation of high density radio heads for 5G deployment will require an increase in the use of hardened fiber optic connectors. Manufacturers of different radio heads have adopted certain hardened connector interfaces between their equipment and outdoor distribution enclosures. Technicians will find themselves confronted with new style connectors that may require deeper cleaning of the housing threads, inner body, O-rings and connector ferrule end face.

The unique 5G Cleaning Kits are targeted to provide a wider selection of popular cleaning tools and solvents to address new crevices in hardened connectors that are soiled from outdoor environments. It is important to clean these connectors prior to mating for maximum performance and minimum attenuation.

**KIT CONTENTS & INTENDED USE**

- Pressurized Canned Air and Alcohol – Clean and dry to remove any creviced debris or water.
- Connector End face Cleaning solution – Fast evaporating solvent intended for fiber optic end face.
- Connector Endface Cleaner – Auto Advancing 2.5mm and 1.25mm end face connector cleaning.
- Cleaning swabs – (3) different style swabs for cleaning internal body components and threads.
- Dry Wipes- Woven Cleaning wipes that won't tear while using for outer or inner body cleaning.
- Moistened Towelettes- Outer connector body and cable cleaning.
- (Optional) MPO Endface Cleaner – Auto Advancing cleaner for MTP or MPO end face cleaning.



**FIS 5G RRH CABLE CLEANING KITS**

PART #	DESCRIPTION	PRICE
F15GC	5G Hardened Connector Cleaning Kit (includes Auto Advance Cleaner for SC/LC connectors)	\$268.00
F15GCM	5G Hardened Connector Cleaning Kit w/ MPO Auto Advancing Cleaner	\$362.25



# Buy FIS in Bulk and Save!!

### FIS EPOXY FOR CONNECTORIZATION

Each pre-measured two-part packet contains the proper ratio for connectorization. Every packet includes specific directions for use with fiber optic connectors.

PART #	STYLE	2 GRAM PRICE	4 GRAM PRICE
H05-100-RX	Quick Cure - Single Pack	\$2.95	<b>Air Ship Available</b> \$3.95
T60-065-BX	Blue Dye - Single Pack	2.95	<b>Air Ship Available</b> 3.95
T120-023-CX	Room Cure - Single Pack	2.95	<b>Air Ship Available</b> 3.95 <b>No Air Ship.</b>
H15-080-RX	Heat Cure - Single Pack	2.95	<b>Air Ship Available</b> 3.95 <b>Air Ship Available</b>
H05-100-RX-50	Quick Cure - 50 Pack	135.00	<b>Air Ship Available</b> 177.75 <b>Air Ship Available</b>
T60-065-BX-50	Blue Dye - 50 Pack	135.00	<b>Air Ship Available</b> 177.75 <b>Air Ship Available</b>
T120-023-CX-50	Room Cure - 50 Pack	135.00	<b>Air Ship Available</b> 177.75 <b>No Air Ship.</b>
H15-080-RX-50	Heat Cure - 50 Pack	135.00	<b>Air Ship Available</b> 177.75 <b>Air Ship Available</b>

Replace "X" with "2" for 2 Gram Package or "4" for 4 Gram Package.



353ND

### EPO-TEK EPOXY

The two-part EPO-TEK Epoxy is a favorite of many fiber optic users. The epoxy remains liquid until heat is applied. The application of heat provides a quick cure, turning the epoxy to a reddish-brown color. The EPO-TEK Epoxy will not react like other epoxies to coating applied to the larger core/clad diameter of specialty fibers.

PART #	DESCRIPTION	PRICE
353ND	EPO-TEK Epoxy (8 oz. Kit)	\$58.95



BAF113SC

### TRA-CON EPOXY

PART #	DESCRIPTION	PRICE
BAF253	Quick Cure, 2.5 gram	\$8.35
BAF113SC	Blue Dye, 2.5 gram	7.95
BAF120	Room Cure, 2.5 gram	8.50
BAF112	Blue Dye, 2.5 gram	8.15
501202-1	Epoxy Mixer (Roller)	6.95

**Air Ship Available**

### ANAEROBIC ADHESIVE

This two-part system self cures in minutes with no heat required. The retaining compound is injected into the connector with a syringe needle. Dip or spray the fiber with primer and connectorize as usual. Sets in 30 seconds, fully cured in minutes. Domestic ground shipment only.

PART #	DESCRIPTION	PRICE
680	Anaerobic Adhesive Hardener, 10 milliliter	\$12.25
7649	Primer, 1.75 ounce	15.00
F1-ANAEROBICKIT	Kit (Anaerobic Adhesive, Primer and Syringe Tip)	55.00



F1-ANAEROBICKIT

F1-608

F1-707010

### HYSOL EPOXY

Contained in two separate tubes or packets, the Hysol Epoxy can be heat or time cured. Hysol Epoxy is excellent for general connector use. A quick dry, 4 gram, mini packet is available for individual connector repair.

PART #	DESCRIPTION	PRICE
F1-707010	Hysol Epoxy (3.4 oz.) (10 sets in each case)	\$123.95
F1-608	Mini Packet (4gm) Fast Cure Epoxy	2.75



WO-1057

### ULTRAVIOLET (UV) ADHESIVE

PART #	DESCRIPTION	PRICE
WO-1057	UV Adhesive (1 oz. bottle)	\$41.50



## FIS MPO/MTP CURING OVEN

Maximize productivity with the FIS MPO/MTP Cure Oven. Designed to cure up to 24 MPO/MTP ferrules at one time. The MPO/MTP Oven's temperature control is adjustable between 50° and 150°C to work with the cure schedules of all the popular brands of epoxies. The FIS MPO/MTP Cure Oven also features a built in timer for convenience. Like the rest of our family of connector cure ovens, the MPO/MTP Cure Oven is designed to be simple, durable and easy to use.

PART #	DESCRIPTION	PRICE
F19778	FIS MTP Curing Oven	\$1,395.00



## FIS CONNECTOR HEAT OVEN

To prevent epoxy "out gassing" that can cause fiber fractures and other connector problems, it is important that a connector curing oven provide reliable operation. The FIS Connector Oven is preferred by many installers because it is simple, dependable, and easy-to-use.

PART #	DESCRIPTION	PRICE
F1-9772	24 Port Heat Oven (FC/ST/D4/SMA/SC) 4011-0000 Included	\$245.00
F1-977220	24 Port Heat Oven (220 V) (FC/ST/D4/SMA/SC)4011-0000 Included	245.00
9091	MU/LC Holding Block	80.00
9090	Universal Holding Block (side A - ST, FC, SMA, D4, side B - Biconic, SC)	80.00
9092	MTRJ/MTP Ferrule Holding Block	80.00
4011-0000	24 Port Block (FC,ST,D4,SMA,SC)	80.00
F1-OVSTND	Curing Stand	26.95
8032-0000	Thermometer	15.35



F1-9772



OPTIONAL CURING STAND SHOWN

9091  
MU/LC



9090  
Universal



Side A



Side B

9092  
MTRJ/MTP



## OVEN PROTECTION SLEEVES

Use to prevent breakage of protruding fiber during connector heat oven curing process. These oven protection sleeves are reusable.

PART #	DESCRIPTION	PRICE
80879000M	Oven Protection Sleeve, 2.5mm Ferrules (Each)	40¢
867730011	Molex Oven Protection Sleeve, 1.25mm Ferrules (Each)	\$2.25



80879000M

## FIS HOT MELT AND DUAL PURPOSE HEAT OVENS

Sometimes, you may use epoxy-style connectors. Other times, you may prefer hot-melt connectors. This Dual Purpose Oven lets you use both! This unit includes an 8-port epoxy heater block, with temperature settings up to 100°C, and a 6-port hot melt block factory set at 245°C, which accepts 3M hot melt connectors. Each block has its own switch.

PART #	DESCRIPTION	PRICE
F1-9110	FIS 6 Port Hot Melt Oven (110v) (pictured)	\$335.00
F1-9110220	FIS 6 Port Hot Melt Oven (220v) (not pictured)	750.00
F1-9130	FIS 12 Port Hot Melt Oven (not pictured)	560.00
F1-9150	FIS 14 Port Dual Purpose Hot Melt / Epoxy Oven (not pictured)	695.00
F1-5225	FIS ST/SC/FC Universal Connector Holder (not pictured)	34.00



F1-9110

## EPOXY APPLICATION SYRINGE

When assembling multiple fiber optic connectors, these Epoxy Syringes enable you to work quickly and efficiently. The included dispensers (needles) enable you to easily inject epoxy into connectors. Economically priced, they can be replaced the moment the epoxy is no longer easily workable. A larger diameter 1.1mm applicator needle is also available, F1-4012, which can be used with the 501473-3IR empty syringe.

PART #	DESCRIPTION	PRICE
501473-3IRC5	Empty Syringe with .9mm Needle (5 pk.)	\$1.25
501473-3IRC25	Empty Syringe with .9mm Needle (25 pk.)	6.25
501473-3IRC100	Empty Syringe with .9mm Needle (100 pk.)	25.00
F1-4012	1.1mm Applicator Needle for 3M Connectors (25 pk.)	41.25



F1-4012  
1.1mm Needle



Syringe



.9mm Needle





**For Quality Assurance 3M™ Polish Film Is Sold Only In Factory Packs of 25 or 50**  
**Call for other grades, sizes and pressure sensitive adhesive (PSA) backed products.**

### 3M™ DIAMOND LAPPING FILMS

Premium diamond abrasive film to cut and polish hard ceramic ferrules and glass cores at the same level, at a consistent rate.

### 3M™ POLISHING FILM - MT

- Eliminates slurries and messy cleanup
- High first-pass yield minimizes rework
- Precisely graded particles are coated on a high-strength backing

### 3M™ LAPPING FILMS

- Micron graded materials on uniform polyester backing
- Provides consistent, repeatable finishes in sequence
- Use on ceramic, stainless steel, plastic and composite ferrules
- Innovative, cost-effective method to finish fiber optic connectors

### 3M™ FINAL POLISH DISCS

For final polishing fiber optic connectors, this film meets industry standards for back reflection.

- Eliminates slurries and messy cleanup
- High first-pass yield minimizes rework
- Meets Telcordia Standards GR-326

### 3M™ LAPPING FILM 5" DISCS

PART #	MATERIAL	GRIT	PACK SIZE	DISC PRICE
DLF5XN.5661X	Diamond	.5µm	25	\$4.50
DLF5XN01661X	Diamond	1µm	25	4.50
DLF5XN03661X	Diamond	3µm	25	4.50
DLF5XN06661X	Diamond	6µm	25	4.50
DLF5XN15661X	Diamond	15µm	25	4.95
A05XN.05263X	Aluminum Oxide	.05µm	50	.60¢
A05XN.3263X	Aluminum Oxide	.3µm	50	.60¢
A05XN03263X	Aluminum Oxide	3µm	50	.60¢
SC5XN15461X	Silicon Carbide	15µm	50	.60¢
HDF5XN0.5662XW	Diamond H	.5µm	25	5.00
HDF5XN01662XW	Diamond H	1µm	25	6.20
HDF5XN1.5662XW	Diamond H	1.5µm	25	6.20
HDF5XN03662XW	Diamond H	3µm	25	5.00
HDF5XN06662XW	Diamond H	6µm	25	6.25
863X5NH	5" Final Polish		50	2.95
865X5NH	5" Final Polish		50	2.95

### 3M™ POLISHING FILM - MT 5" DISCS

PART #	MATERIAL	GRIT	PACK SIZE	DISC PRICE
FCO-0.55XN598PSA	Cerium Oxide Flock Film PSA	0.5µm	50	\$2.50
FAO-0.55XN298PSA	Aluminum Oxide Flock Film PSA	0.5µm	50	3.25
FAO-015XN298PSA	Aluminum Oxide Flock Film PSA	1µm	50	3.00
FSC-035XN498PSA	Silicon Carbide Flock Film PSA	3µm	50	3.50
SC155XN468PSA	Silicon Carbide Lapping Film PSA	15µm	50	.85¢
SC035XN468PSA	Silicon Carbide Lapping Film PSA	3µm	50	.85¢
SC305XN468PSA	Silicon Carbide Lapping Film PSA	30µm	50	.85¢

### 3M™ LAPPING FILM 4" DISCS

PART #	MATERIAL	GRIT	PACK SIZE	DISC PRICE
DLF4XN.5661X	Diamond	.5µm	50	\$4.50
DLF4XN01661X	Diamond	1µm	50	5.00
DLF4XN03661X	Diamond	3µm	50	4.50
DLF4XN06661X	Diamond	6µm	50	4.50
DLF4XN15661X	Diamond	15µm	50	5.00
A04XN.05263X	Aluminum Oxide	.05µm	50	.60¢
A04XN.3263X	Aluminum Oxide	.3µm	50	.45¢
A04XN03263X	Aluminum Oxide	3µm	50	.45¢
SC4XN15461X	Silicon Carbide	15µm	50	.45¢
HDF4XN0.5662XW	Diamond H	.5µm	50	5.95
HDF4XN01662XW	Diamond H	1µm	50	5.95
HDF4XN1.5662XW	Diamond H	1.5µm	50	5.95
HDF4XN03662XW	Diamond H	3µm	50	5.95
HDF4XN06662XW	Diamond H	6µm	50	5.95
863X4NH	4" Final Polish		50	1.95
865X4NH	4" Final Polish		50	2.95

### 3M™ LAPPING FILM 9" X 13" SHEETS

PART #	MATERIAL	GRIT	PACK SIZE	SHEET PRICE
A09X130.3261X	Aluminum Oxide	.3µm	50	\$2.25
A09X1301262X	Aluminum Oxide	1µm	50	1.00
A09X1302262X	Aluminum Oxide	2µm	50	1.00
A09X1303261X	Aluminum Oxide	3µm	50	1.00
A09X1312261X	Aluminum Oxide	12µm	50	.90¢
A09X1309261X	Aluminum Oxide	9µm	50	.90¢
SC9X1305461X	Silicon Carbide	5µm	25	1.00
SC9X1315461X	Silicon Carbide	15µm	50	2.25
SC9X1330461X	Silicon Carbide	30µm	50	2.00

### 3M™ LAPPING FILM 9" X 6.5" SHEETS

PART #	MATERIAL	GRIT	PACK SIZE	SHEET PRICE
A09X60.3261X	Aluminum Oxide	.3µm	50	\$1.40
A09X601262X	Aluminum Oxide	1µm	50	1.40
A09X602262X	Aluminum Oxide	2µm	50	1.40
A09X603261X	Aluminum Oxide	3µm	50	1.40
A09X609261X	Aluminum Oxide	9µm	50	1.40
SC9X605461X	Silicon Carbide	5µm	50	1.40
SC9X615461X	Silicon Carbide	15µm	50	1.40
SC9X630461X	Silicon Carbide	30µm	50	1.40

### 3M™ LAPPING FILM 6" X 6" SHEETS

PART #	MATERIAL	GRIT	PACK SIZE	SHEET PRICE
DLF6X6.5661X	Diamond	.5µm	25	\$5.95
DLF6X601661X	Diamond	1µm	25	5.95
DLF6X603661X	Diamond	3µm	25	5.95
DLF6X606661X	Diamond	6µm	25	5.95
A06X6.05263X	Aluminum Oxide	.05µm	50	.90¢
A06X603263X	Aluminum Oxide	3µm	50	1.25
A06X605261X	Aluminum Oxide	5µm	50	.75¢
A06X612264M	Aluminum Oxide	12µm	50	.60¢
863X6X6NH	Final Polish		50	3.85

### 3M™ DIAMOND LAPPING FILM 3" X 6" SHEETS

PART #	GRIT	PACK SIZE	SHEET PRICE
DLF3X601661X	1µm	25	\$4.95
DLF3X603661X	3µm	25	4.95



Attention Cable Assembly Houses  
 FIS Proudly Introduces our  
 Cable Assembly Partnership Program (CAP)

FIS has joined with Manufacturers to offer preferred pricing and services under our Cable Assembly Partnership (CAP) Program. Cable Assembly Companies that qualify as CAP members will receive:

- Incredible pricing on cable, polish film, epoxy and connectors
- No quantity buys required
- Based on regular use of FIS and 3M products
- Limited memberships available
- Expanding product lines

Steps	3M™ 5" Disc Value	Mineral	Micron Size / Color
#1 De-Nub and Epoxy Removal	461X	Silicon Carbide	15µm / Gray
#2 Refine (Level Connector)	661X	Diamond	1µm / Lav 3µm / PNK 6µm / BRW
	662XW	Diamond	1µm / Lav 3µm / PNK 6µm / BRW
#3 Polish (Finish)	863XW	Silicon Dioxide	Final Polish/Translucent
	865X	Silica	Final Polish / White

Let Us Quote A 3 Step Solution!

With 20 years of cable assembly experience, FIS can show you how to achieve maximum value using specific 3M™ Lapping Films. The following are our current recommendations. The films highlighted above provide exceptional value in terms of pricing and performance.

FIS POLISH FILM-SOLD IN PACKS OF 25 SHEETS

When choosing polish film, you want to achieve two things; a high-quality end face finish, and maximum value for your money. FIS Polish Films provide both! Carefully graded abrasives are bonded with quality adhesives, enabling you to polish more connectors per sheet.

LARGE SHEETS 9" X 13"

PART #	MATERIAL	GRIT	COLOR	PRICE
F1-0109-03	Aluminum Oxide	.3µm	White	\$23.00
F1-0109-1	Aluminum Oxide	1µm	Lt. Green	19.50
F1-0109-3	Aluminum Oxide	3µm	Pink	19.50
F1-0109-5	Silicon Carbide	5µm	Black	19.50
F1-0109-9	Aluminum Oxide	9µm	Lt. Blue	19.50
F1-0109-12	Aluminum Oxide	12µm	Dark Yellow	19.50
F1-0109-15	Silicon Carbide	15µm	Dark Grey	19.50
F1-0109-5-1-03	3 in 1 Film	(5, 1, .3µm)		19.50

STANDARD SHEETS 9" X 6.5"

PART #	MATERIAL	GRIT	COLOR	PRICE
F1-0102-03	Aluminum Oxide	.3µm	White	\$11.75
F1-0102-1	Aluminum Oxide	1µm	Lt. Green	10.75
F1-0102-3	Aluminum Oxide	3µm	Pink	11.50
F1-0102-5	Silicon Carbide	5µm	Black	10.75
F1-0102-9	Aluminum Oxide	9µm	Lt. Blue	10.75
F1-0102-12	Aluminum Oxide	12µm	Dark Yellow	10.75
F1-0102-15	Silicon Carbide	15µm	Dark Grey	10.75

FIS DIAMOND POLISH FILM SHEETS (Sold in packs of 10.)

PART #	DESCRIPTION	GRIT	COLOR	PACK SIZE	PRICE
F1-010715-10	3" x 6" Sheet	1µm	Violet	10	\$45.00
F1-010735-10	3" x 6" Sheet	3µm	Pink	10	45.00
F1-010730S-10	3" x 6" Sheet	30µm	Green	10	55.00

FIS MACHINE POLISHING DISCS (Sold in packs of 10 and 25 discs.)

PART #	SIZE	TYPE	GRIT	COLOR	PACK SIZE	PRICE
F1-010705D-25	4" diameter	Aluminum Oxide	.05µm	Yellow	25	\$17.95
F1-01071DD-10	4" diameter	Diamond	1µm	Violet	10	35.00
F1-01073DD-10	4" diameter	Diamond	3µm	Pink	10	35.00
F1-01076DD-10	4" diameter	Diamond	6µm	Grey	10	35.00
F1-010730DD-10	4" diameter	Diamond	30µm	Green	10	35.00

F1-010805D-25	5" diameter	Aluminum Oxide	.05µm	Yellow	25	\$10.95
F1-01081DD-10	5" diameter	Diamond	1µm	Violet	10	50.00
F1-01083DD-10	5" diameter	Diamond	3µm	Pink	10	50.00
F1-01086DD-10	5" diameter	Diamond	6µm	Brown	10	50.00
F1-010830DD-10	5" diameter	Diamond	30µm	Green	10	50.00





SFP-560A



## SFP-560A RUGGEDIZED POLISH MACHINE

Seikoh Giken's SFP-560A provides high volume assemblers with an ultra ruggedized polisher for 24/7/365 operation. Mechanical durability, low operational costs and reduced maintenance requirements offer near zero downtime for maximum return on investment.

PART #	DESCRIPTION	PRICE
SFP-560A	SFP-560A Ruggedized Polish Machine	\$21,950.00

## SFP-550C MASS PRODUCTION POLISHING MACHINE

This high-performance polish machine offers superior quality and maximum throughput at a very affordable price. Utilizing a patented, high speed rotation and revolution method, this polisher prepares connectors which exceed Telcordia GR-326 requirements for end face geometry. Standard capacity 18 connectors, up to 48 LC/MU.

### FEATURES

- Compatible with all existing SFP series I.P.C. Holders
- Increased turntable speed
- Exceeds all requirements for GR-326 End-Face Geometry requirement

### STANDARD PACKAGE - SFP550C

DESCRIPTION	PART #	QTY
Main Body	SFP-550C	1
Cable Holder	FP-CH	1
Operating Manual	FP-IM12	1
Process Manual	FP-MM12	1
Maintenance Manual	FP-PM12	1
2A Fuse	FP-F2A	1
Hexagon Wrench	FP-TS	1



SFP-550C



PART #	DESCRIPTION	PRICE
SFP-550C	SFP-550C Polisher with standard package	\$9,700.00
SFP-550E3	SFP-550E3 Polisher with standard package	13,995.00
PH55-FP-20	FC/PC Polish Fixture (20 position)	4,025.00
PH55-FP8RC-18-1	FC/APC Polish Fixture (18 position)	4,800.00
PH55-CP-20	SC/PC Polish Fixture (20 position)	4,025.00
PH55-CP8C-18	SC/APC Polish Fixture (18 position)	4,800.00
PH55-SP-20	ST/PC Polish Fixture (20 position)	4,025.00
PH55-PL-24	LC Polish Fixture (24 position)	4,200.00
PH55-MT-24S1	MT/PC Fixture, 24 Position (1mm Protrusion Type)	6,700.00

### ACCESSORIES FOR SFP-550C

PART #	DESCRIPTION	QTY.	PRICE
GASD	30µm Silicon Carbide Adhesive Removal Film	500	\$264.00
DR5D-9U	9µm Diamond Rough Polish Film	20	88.00
DG5D-5U	5µm Diamond Rough Polish Film	20	88.00
DH5D-3U	3µm Diamond Middle Polish Film	20	88.00
DISD-1.5U	1.5µm Diamond Middle Polish Film	20	88.00
SF5D	1µm Alum. Oxide Final Polish Film	500	390.00
XF5D	0.5µm Silica Final Polish Film	100	210.00



PH55-MT24S1

## SFP-70D2 POLISHING MACHINE

The Seikoh Giken SFP-70D2 polishing machine polishes 2 ferrules at a time. It is best suited for lab use and re-polishing solution at mass production line. Its portability and light weight make this machine great for field polishing and re-polishing.

### FEATURES

- High performance polishing for a variety of applications
- Ergonomic, simple design for ease of use
- Uses SG patented Independent Pressure Control
- Short cycle times (2 min. typical for reworks)



SFP-70D2



PART #	DESCRIPTION	PRICE
SFP-70D2	Programmable Polisher with standard accessories	\$3,500.00
PH072-FP-2	FC/PC Polish Fixture (2 position)	500.00
PH072-FP8RC-2	FC/APC Polish Fixture (Conical Narrow Key)	1,000.00
PH072-CP-2	SC/PC Polish Fixture (2 position)	500.00
PH072-CP8C-2	SC/APC Polish Fixture (Conical 2 position)	1,000.00
PH072-SP-2	ST/PC Polish Fixture	500.00
PH072-PL-2	LC/PC Polish Fixture	500.00

### ACCESSORIES FOR SFP-70D2

PART #	DESCRIPTION	QTY.	PRICE
GA07	Height Adjustment Polishing Film	200	\$81.00
DR07-9U	9µm Diamond Rough Polishing Film	20	100.00
DH07-3U	3µm Diamond Medium Polishing Film	20	100.00
XF07	Final Polishing Film	100	200.00





**HAND POLISHING DISCS**

The metal fiber optic polishing discs are especially durable and are machined to close tolerances. They are designed to hold your fiber optic endface at exactly the correct angle to the polishing film during the polishing process.

PART #	DESCRIPTION	PRICE
F1-6925UN	ST/SC/FC Universal 2.5mm Polish Disc (C)	\$45.00
F1-6925ST	ST Polish Disc (D)	45.00
F1-6977ST	ST 4 Position Polish Disc (A)	125.00
F1-6928SC	SC Polish Disc (E)	45.00
F1-6928APC	SC/APC Polish Disc (B)	75.00
F1-6925FC	FC/PC Polish Disc	45.00
F1-6925FCAPC	FC/APC Polish Disc	75.00
F1-6930UN	MU/LC Polish Disc (F)	45.00
F1-6900APC	LC/APC Polish Disc	75.00
F1-6925SMA	SMA Polish Disc	45.00
F1-6926	D4 Polish Disc	85.00
F1-6927	Biconic Polish Disc (may not work with all brands)	150.00

**ULTRA PRECISION POLISHING PADS**

Ultra Pads are color coded for easy recognition by the machine operators. 4" and 5" discs are .079" thick and 6" x 6" squares are 0.250" thick.

PART #	DESCRIPTION	PRICE
F1-70D4	4" Circular Rubber Pad 70 Durometer (purple)	\$20.00
F1-90D4	4" Circular Rubber Pad 90 Durometer (black)	20.00
F1-70D5	5" Circular Rubber Pad 70 Durometer (purple)	20.00
F1-90D5	5" Circular Rubber Pad 90 Durometer (black)	20.00
F1-70DX6	6" x 6" Square Rubber Pad 70 Durometer (purple)	20.00
F1-90DX6	6" x 6" Square Rubber Pad 90 Durometer (black)	20.00



**POLISH PLATES, PADS AND MATS**

The polishing of fiber optic connectors calls for both a hard flat surface and a cushioned pad. The 9" x 13" or 6" x 9" polish plate is available in safety glass and mounted on four rubber feet for support. When polishing PC style pre-radius connectors, use the soft polish pad on the glass plate. Placing the lapping film over the pad assures the removal of epoxy and proper polish of fiber without destroying the pre-radius of the ferrule.

PART #	DESCRIPTION	PRICE
F1-9111	FIS Polish Glass Plate (9" x 13") (A)	\$17.95
F1-9111A	FIS Polish Glass Plate (6" x 9") (B)	16.95
PP-575	5.75" Square Polishing Pad, 1/16" Thick 70 Durometer (C)	6.95
F1-0024	Large Black Work Mat (22" x 14") (D)	7.50
PPG-575	5.75" Square Polishing Pad with 1/4" Acrylic Plate (not pictured)	17.95

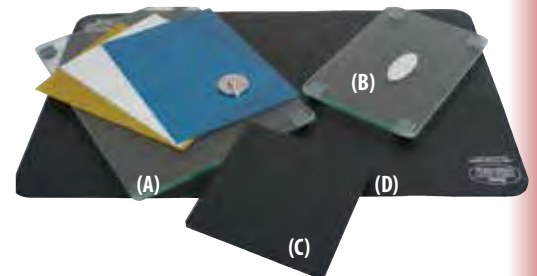

**DID YOU KNOW...**

**What is meant by the term "Air Polish"?**

After curing an epoxy connector and removing from oven the exposed fiber tip is typically scribed and picked off, then disposed in shards container. The remaining small tip of fiber then left protruding out the end of the ferrule is removed by an "Air Polish". Refer to manufacturer termination instructions but often a 5um silicon carbide film is utilized and by holding the connector in one hand and the film in the opposite hand technician can "Air Polish." Gently brush the dull looking side of the film with exposed fiber tip in a "figure 8" motion until the fiber tip is almost flush with the ferrule endface. Often you will also remove some of the epoxy bead but be sure to stop prior to removing the entire epoxy bead as the following polish steps to not use an aggressive grit size to remove scratches below ferrule tip.

# TOOLS

## DURABLE, CONVENIENT, AND FULLY CUSTOMIZABLE



FIS is the leader in the fiber optic industry and offers the best value on Tool Kits. Every year FIS expands upon its Tool Kit line and upgrades several tools to show our commitment to providing quality kits. The Universal Connectorization Epoxy Tool Kit provides a technician with materials to prep and connectorize standard fiber optic connectors such as ST, SC, and FC. For technicians searching for the ultimate Tool Kit, review our Universal Multimode Test Set Kit and Fusion Splicing Kits.



**Greenlee Tools available in Tool Kits. Look For Green Part Numbers.**

### CUSTOMIZE ANY TOOL KIT

You have the option to customize any of the FIS Tool Kits. You can add or swap items from the FIS kits. Please contact an FIS Sales Representative for pricing.

#### TEST EQUIPMENT OPTIONS

- FIS Pocket Fault Locator
- FIS Power Meters
- FIS Light Sources
- FIS Talk Sets
- FIS Mini-OTDR
- FIS Pulse Suppressors and Test Boxes

#### ATTENUATOR OPTIONS

- FIS Male-Female attenuators in 1-20dB for FC, FC/APC, SC, SC/APC, ST, LC, and MU
- FIS variable attenuators

#### KEVLAR CUTTER OPTIONS

- F1KS1 - Miller Scissors
- F100201 - FIS Economy Scissors
- F16430 - Clauss Kevlar Cutters
- F19809 - Miller Kevlar Cutter

#### PATCH CABLE OPTIONS

- FIS Singlemode simplex and duplex patch cables
- FIS Multimode simplex and duplex patch cables
- FIS Specialty patch cables: MTP, MT-RJ, E2000, MU, ESCON, FDDI or Polarization Maintaining, and patch cables

#### FIBER OPTIC STRIPPER OPTIONS

- F1-1301T - FIS Precision Fiber Stripper
- W01224 - Miller Stripper
- PA1171 - Paladin Fiber Optic Stripper

#### MICROSCOPE OPTIONS

- F1MS200U - FIS 200x Compact Microscope
- F1VS400F2.5 - FIS 400x Handheld Microscope
- F1VSF25 - FIS 100x Handheld Universal Scope



F1-0053HARD



F1-0053BSC

#### CUSTOM KIT CASE OPTIONS

PART #	DESCRIPTION	DIMENSIONS and WEIGHT	PRICE
F1-0053HARD	FIS Standard Tool Case, <b>Empty*</b>	20" x 8" x 15", 10 lbs	\$125.00
F1-0053BSC	FIS Mini Soft Case, <b>Empty*</b>	16" x 11" x 5", 4 lbs	125.00
F1-1600	FIS Educational Kit Case with foam and pallet, <b>Empty*</b>	21.43" x 16.5" x 17.87", 17.54 lbs	398.00
F1-0053SFN	FIS Standard Die Cut Foam Bottom Insert For F1-0053HARD		40.00
F1-0053PPN	FIS Pick N' Pluck Bottom Foam Insert		55.00
F1-0053STPN	FIS Standard Leather Pallet		45.00

\* Must order bottom insert and top pallet from choices above.



**Basic Fiber Optic Kit  
F1-0053**

**Supplied Greenlee Tools:**

- Jacket Stripper 26-16AWG (1917) - Replaces (F1-0016)
- 6" Side Cut Pliers (0251-06M) - Replaces (200038)
- 6" Needle Nose Pliers (0351-06M) - Replaces (100021)
- Utility Knife (0652-11) - Replaces (F1-0023BLK)

**FIS BASIC FIBER OPTIC TOOL KIT**

- PVC Electrical Tape (F1-0008)
- 2 oz. Cleaning Solvent (F1-6706)
- Trihole Fiber Stripper (F1-1301T)
- FIS Connector Cleaner (F1-7020C)
- Kevlar Scissors (F1-KS1)
- Jacket Stripper (F1-0016)
- Buffer Tube Stripper (F1-0017)
- Round Cable Slitter (MK02)
- 6" Side Cutting Pliers (200038)
- (50) Foam Swabs (F1-0005)
- Utility Knife (F1-0023BLK)
- Tweezers (F1-0019)
- Needle Nose Pliers (100021)
- Piano Wire (F1-8265K)
- Fiber Optic Wipes (F1-6705)
- 4 Bit Screwdriver (F1-0027)
- Black Marker (F1-9104)
- Safety Glasses (F1-S13390C)
- (5) Degreaser Wipes (F1-1010)
- Black Work Mat (F1-0024)
- Fiber Disposal Unit (F1-18329)
- Ruler (RMC-6)
- Fabric Tape Measure (F1-8273)
- 1/2" Nut Driver (1UG30G)
- Rugged Carry Case (F10053HARD)
- 1Mtr 3mm Furcation (F00FR3NUO)
- 1Mtr 900µm Furcation (F00FR900HW)
- Splice Sleeve and Shrink Tube Kit (P50KIT)
- Duct Tape (7788A202)



PART #	DESCRIPTION	PRICE
F1-0053	Basic Tool Kit (Pictured)	\$425.00
F1-0053C	Replacement Consumables	45.95
F1-0053P	Basic Tool Kit with PVFL (F1-9000)	510.00
F1-0053SB	Basic Tool Kit with Soft Case	430.00
F1-0053-G	Basic Tool Kit with Greenlee Tools (8 Tools See Below)	575.00
F1-0053P-G	Basic Tool Kit with PVFL (F1-9000) and Greenlee Tools ( See Below)	620.00

- 6 in 1 Screwdriver (0153-42C) - Replaces (F1-0027)
- 24' / 7.5 Meter Tape Measure (0155-7MA) - Replaces (F1-8273)
- 1/2" Nut Driver (0253-17C) - Replaces (1UG30G)
- 7/16" Nut Driver (0253-16C) - Addition

**CONNECTORIZATION EPOXY TOOL KIT (LC, MU)**

Includes all items in FIS Basic Tool Kit (F1-0053) plus:

- Glass Polish Plate (F1-9111)
- Carbide Scribe (F1-9773)
- LC/MU Crimp Tool (F1-8825)
- Rubber Polish Pad (PP-575)
- FIS Universal Microscope (F1-MS200U)
- (5) FIS 4gr. Blue Dye Epoxy (T60-065-B4)
- LC/MU Universal Polish Puck (F1-6930UN)
- (5) Syringes (5014733IRCS)
- (5) 0.5µm Diamond Polish Film Sheet (DLF6X6.5661X)
- (5) 1.5µm Diamond Polish Film Sheet (DLF6X61.5661X)
- Instructions for FIS Connectors LC (F217)

PART #	DESCRIPTION	PRICE
F1-0053LM	Universal 1.25mm Epoxy Connectorization Tool Kit (LC/MU)	\$775.00

**CONNECTORIZATION EPOXY TOOL KIT (SC, FC, ST)**

Includes all items in FIS Basic Tool Kit (F1-0053) plus:

- Carbide Scribe (F1-9773)
- FIS Universal Crimp Tool (F1-3227)
- Rubber Polish Pad (PP-575)
- Glass Polish Plate (F1-9111)
- (5) Syringes (5014733IRCS)
- Universal Polish Puck (F1-6925UN)
- (5) 0.3µm Polish Film Sheet (F1-0102-03S)
- (5) 1µm Polish Film Sheet (F1-0102-1S)
- (5) 5µm Polish Film Sheet (F1-0102-5S)
- Instructions for FIS Connectors ST, FC and SC (F217)
- (5) FIS 4gr. Blue Dye Epoxy (T60-065-B4)
- FIS Universal Microscope (F1-MS200U)

PART #	DESCRIPTION	PRICE
F1-0053U	Universal 2.5mm Epoxy Connectorization Tool Kit (SC, FC, ST)	\$650.00
F1-0053UO	Universal Epoxy Connectorization Tool Kit with 24-Port Heat Oven, 110 VAC	850.00
F1-0053UO220	Universal Epoxy Connectorization Tool Kit with 24-Port Heat Oven, 220 VAC	850.00
F1-0053U-G	Universal Epoxy Tool Kit with Greenlee Tools (8 Tools) -see above for list of Greenlee tools	765.00
F1-0053D	Replacement Consumables	90.00

**FIS MINI BASIC FIBER OPTIC TOOL KIT**

- Mini Soft Case (F1-0053BSC)
- PVC Electrical Tape (F1-0008)
- Tri-Hole Fiber Stripper (F1-1301T)
- FIS Connector Cleaner (F1-7020-C)
- Kevlar Scissors (F1-KS1)
- Buffer Tube Stripper (F1-0017)
- Round Cable Slitter (MK02)
- 6" Side Cutting Pliers (200038)
- (50) Foam Swabs (F1-0005)
- Fiber Optic Wipes (F1-6702)
- Utility Knife (F1-0023BLK)
- Tweezers (F1-0019)
- Needle Nose Pliers (100021)
- 4 Bit Screwdriver (F1-0027)
- Black Marker (F1-9104)
- Ruler (RMC-6)
- Fabric Tape Measure (F1-8273)
- 2 oz. Cleaning Solvent (F1-6706)
- Piano Wire (F1-8265)
- (5) Fusion Splice Sleeve 60mm (F1-1002C)

PART #	DESCRIPTION	PRICE
F1-0053MSB	Mini Basic Fiber Optic Tool Kit	\$325.00

**FIS FUSION SPLICING TOOL KIT**

Includes all items in FIS Basic Tool Kit (F1-0053) plus:

- Cable Cutters (F1-727)
- Flashlight (F1-412955)
- Spatula (10033301)
- (12) Degreaser Wipes (F1-1010)
- 50 Pack Protection Sleeves 60mm (F1-S25C)
- Optional Lynx Cleaver (F1-LYNX)
- Optional Pocket Fault Locator (F1-9000)

PART #	DESCRIPTION	PRICE
F1-0053FS	Fusion Splicing Tool Kit	\$500.00
F1-0053FS-C	with Lynx Cleaver (F1-LYNX) (Pictured)	1,050.00
F1-0053FS-VFL	with PFL (F1-9000)	575.00
F1-0053FS-C-VFL	with PFL and Cleaver	1,150.00
F1-0053FS-G	with Greenlee Tools	645.00



FIS Backpack Tool Kit  
F1-0053PACK



Now with  
E-Series  
PM & LS



FIS Universal MM Test Set Tool Kit  
F1-0053TS-MME



Hot Melt Tool Kit  
F1-0053HM



**FIS BACKPACK TOOL KIT**

All the great products you became accustomed to in the FIS Tool Kit now in a smaller, lightweight, and durable backpack. (Special custom kits are available)

PART #	DESCRIPTION	PRICE
F1-0053PACK	FIS Backpack Basic Fiber Optic Tool Kit	\$250.00
F1-0053PACKFS	FIS Backpack Fusion Splicing Tool Kit	325.00
F1-0053PACKFSC	FIS Backpack Splicing Tool Kit with Lynx Precision Cleaver	925.00
F1-0053PACKFSCVFL	FIS Backpack Splicing Tool Kit with PFL and Lynx Cleaver	1,025.00
F1-0053PACKFVFL	FIS Backpack Splicing Tool Kit with Pocket Fault Locator	425.00
F1-0053PACKVFL	FIS Backpack Basic Fiber Optic Tool Kit with Greenlee Tools	295.00
F1-0053PACKLM	FIS Backpack Universal 1.25mm Epoxy Tool Kit (LC/MU)	650.00
F1-0053PACKU	FIS Backpack Universal SC, FC, ST Epoxy Tool Kit	500.00

**FIS UNIVERSAL SM TEST SET TOOL KIT**

Includes all items in FIS Universal Epoxy Tool Kit (F1-0053U) plus:

- FIS E-Series Power Meter with Adapter (F1-8513PM)
- FIS E-Series SM 1310/1550nm Light Source (F1-1315LS)
- (2) Simplex 3mm SM Ultra SC/UPC-SC/UPC 2 Mtr (S9UYUS2FISCU)
- (2) Simplex 3mm SM Ultra ST/UPC-SC/UPC 2 Mtr (S98UYUS2FISCU)
- (2) Simplex 3mm SM Ultra FC/UPC-SC/UPC 2 Mtr (S97UYUS2FISCU)
- (2) FIS Simplex 1.6mm SM Ultra LC/UPC-SC/UPC 2 Mtr (Y9LUYUS2FISCU)
- Visual Fault Locator (F1-9000)
- (1) LC SM Simplex Adapter Blue No Flange (F18005NF)
- (1) SC SM/MM Adapter Zirconia Sleeve Blue w/ Flange (F13810BC)
- (1) 3M ST SM Adapter Threaded (8119)
- (1) Singlemode FC Adapter (F18520)

PART #	DESCRIPTION	PRICE
F10053TSSME	FIS Universal SM Test Set Tool Kit w/Series E PM & LS	\$2,195.00

**FIS UNIVERSAL MM TEST SET TOOL KIT**

Includes all items in FIS Universal Epoxy Tool Kit (F1-0053U) plus:

- FIS E-Series Power Meter with Adapter (F1-8513PM)
- FIS E-Series MM 850/1300nm Light Source (F1-1315LS)
- (2) FIS Simplex MM 62.5 SC-SC 2 Mtr Patchcord (S2YYM2FISC)
- (2) Simplex MM 62.5um ST/UPC-SC/UPC 2 Mtr Patchcord (S28YM2FISC)
- (2) Simplex MM 62.5 SC-LC 2 Mtr patchcord (Y2YLM2FISC)
- (2) Simplex SC-ST MM 50um OM3 Aqua 2 Mtr Patchcord (Y8Y8M2FISC)
- (2) Simplex SC-SC MM 50um OM3 Aqua 2 Mtr Patchcord (Y8YM2FISC)
- (2) Simplex LC/PC-SC/PC MM 50um OM3 Aqua 2 Mtr Patchcord (Y8LYM2FISC)
- (1) SC Simplex MM Adapter PB Zirconia Beige No Flange (F13800CNF)
- (1) LC MM Simplex Adapter Beige - No Flange (F18000A)
- (1) ST MM Adapter Bronze Sleeve (F18102SS)
- (1) 4mm Mandrel for Bend-Insensitive MM Fiber for 1.6/2mm cable (F1CCM04)
- (1) MM Mandrel Kit (50um and 62.5um) (F1MM6250)
- (1) Pocket Fault Locator (F1-9000)

PART #	DESCRIPTION	PRICE
F10053TSMME	FIS Universal MM Test Set Tool Kit w/Series E PM & LS	\$2,195.00

**FIS HOT MELT TOOL KIT**

Includes all items in FIS Basic Tool Kit (F1-0053) plus:

- FIS 6 Port Hot Melt Oven (F1-9110)
- (4pk) 3M Universal Holding Clips (6365HH)
- Universal Polish Disc (F1-6925UN)
- Carbide Scribe (F1-9773)
- FIS Universal Microscope (F1-MS200U)
- (2) Soft Polish Pad (F1-90D5)
- Glass Polish Plate (F1-9111)
- FIS Universal Crimp Tool (F1-3227)
- (50pk) 3M 2µm Film (6192A)
- (5) 3M .05µm SM Polish Disc (6192AA)

PART #	DESCRIPTION	PRICE
F1-0053HM	Hot Melt Tool Kit (110v Oven)	\$1,300.00
F1-0033HM	Hot Melt Tool Kit (220v Oven)	1,625.00

**FIS ANAEROBIC TOOL KIT (SC and LC) (NOT PICTURED)**

Includes all items in FIS Basic Tool Kit (F1-0053) plus:

- Anaerobic Adhesive Hardener (680)
- Anaerobic Primer (7649)
- (10) Syringe Tips (5014733IRC5)
- Carbide Scribe (F1-9773)
- Universal Crimp Tool (F1-3227)
- LC/MU Crimp Die (F1-8825LM)
- Rubber Polish Pad (PP-575)
- (5) 1µm Polish Film Sheet (F1-0102-1S)
- (5) 5µm Polish Film Sheet (F1-0102-5S)
- (5) 0.3µm Polish Film Sheet (F1-0102-03S)
- (5) 1.5µm Diamond Film Sheet (DLF6X6.5661X)
- (5) 0.5µm Diamond Film Sheet (DLF6X6.5661X)
- Glass Polish Plate (F1-9111)
- 2.5mm Universal Polish Puck (F1-6925UN)
- LC Universal Polish Puck (F1-6930UN)
- FIS Universal Microscope (F1-MS200U)

PART #	DESCRIPTION	PRICE
F1-0053AH	FIS Anaerobic Tool Kit	\$875.00

**FIS FIBRLOK™ SPLICE INSTALLATION KIT (NOT PICTURED)**

Includes all items in FIS Basic Tool Kit (F1-0053) plus:

- FIS Cleaver (F1-6000)
- (5) 3M Fibrlok Splices (2529)
- 3M Fibrlok Assembly Tool (2501)
- FIS Index Matching Gel (F1-0001K)

PART #	DESCRIPTION	PRICE
F1-0053FI	3M Fibrlok™ Splice Installation Kit	\$660.00
F1-0053FISM	3M Fibrlok™ Kit with Singlemode Cleaver (F1-LYNNX)	1,260.00

**DATA CENTER CLEANING STATION**

The FIS Fiber Optic Cleaning Station is a unique new product that provides immediate access to cleaning supplies for technicians. These cleaning kits are wall mountable similar to First Aid kits found throughout many facilities. Open the top cover and find cleaning notes for technicians not familiar with fiber optics. Kits include cleaning instruments for both 2.5mm and 1.25mm ferrules on patch cables and through adapters in the back plane of enclosures. Optional MPO/MTP cleaning tool can be added to kit as well. Special edition and custom kits are available. Standard kit contents: (100) 4"x4" Clean Dry Wipes, 2 oz. Cleaning Solution, Auto-Advance Connector Cleaner, 2.5mm and 1.25mm back plane ferrule cleaning tools. Optional kits with MPO/MTP cleaning tool or choice of IBC™ Cleaners/AFL One Click Cleaners.

PART #	DESCRIPTION	PRICE
F1-6714	Fiber Optic Cleaning Station, Standard Kit	\$195.00
F1-6714MPO	Fiber Optic Cleaning Station, Standard Kit with MPO/MTP cleaning tool	265.00
F1-6714IBC	Fiber Optic Cleaning Station, Special Edition Kit with IBC™ cleaning tools for 2.5/1.25mm adapters	215.00
F1-6714IBCMPO	Fiber Optic Cleaning Station, Special Edition Kit with IBC™ cleaning tools for 2.5/1.25mm adapters and MPO/MTP cleaner	275.00
F1-6714AFL	Fiber Optic Cleaning Station, Special Edition Kit with AFL cleaning tools for 2.5/1.25mm adapters	225.00
F1-6714AFLMPO	Fiber Optic Cleaning Station, Special Edition Kit with AFL cleaning tools for 2.5/1.25mm adapters and AFL MPO/MTP cleaner	295.00



**FIS FIBER OPTIC CLEANING KIT**

- Canned Air (10oz) (F1-1007S)
- Fiber Optic Wipes (F1-6702)
- 2.5mm Foam Swabs (5pk) (F1-25184)
- 1.25mm Wrapped Swabs (5pk) (F1-25123)
- Alcohol Wipes (50pk) (F1-1004)
- FIS Connector Cleaner (F1-7020-C)
- 4 oz. Bottle of Alcohol (F1-0007SP)

PART #	DESCRIPTION	PRICE
F1-0053CK	Fiber Optic Cleaning Kit	\$75.00
F1-0053CKM	With 200X Microscope (Pictured)	175.00
F1-0053CKC	Replacement Consumables	39.95



**FIS MINI CLEANING KIT**

The FIS Mini Cleaning Kit provides all of the essential cleaning supplies needed for fiber splicing. Kit includes: (1) FIS Connector Cleaner, (1 pack of 50) 2.5mm Mini Foam Swabs, Cleaning Pen, (1 pack of 100) 4" x 4" Woven Dry Wipes, (1 pack of 100) 4" x 6" Alcohol Towelettes, (1 pack of 12) FIS Icky Clean, Carry Case

PART #	DESCRIPTION	PRICE
F1-0053FSMINI	FIS Mini Fiber Optic Cleaning Kit	\$69.95



**DID YOU KNOW...  
ABOUT CLEANING WITH ENDFACE PICTURES  
AND IEC STANDARD?**

Connector cleanliness is one of the most important issues facing a fiber technician. A dirty or damaged connector is the single most common reason for network cable failure. Dust particles as small as 5µm can embed themselves into the end faces of connectors creating chips and pits. Damage to a connector end face can result in high attenuation and high Optical Return Loss (ORL) preventing network to operate as intended.

IEC 61300-3-35 is the industry standard pass/fail criteria developed for connector end face polishes. Many of the microscopes sold today incorporate the ability to test to this IEC standard and many OTDR certifications now require this test to be included with the certifying scans. This standard can also be modified for a tighter or wider test specification. Each end face is separated into 4 zones (A, B, C, D) that each have their own pass/fail criteria. Even if a technician does not have access to newer equipment with built in analysis, a handheld microscope can offer assistance in verifying the end face is clean and free of any large debris. See figure at right for the location of each zone and pass/fail for IEC 61300-3-35.

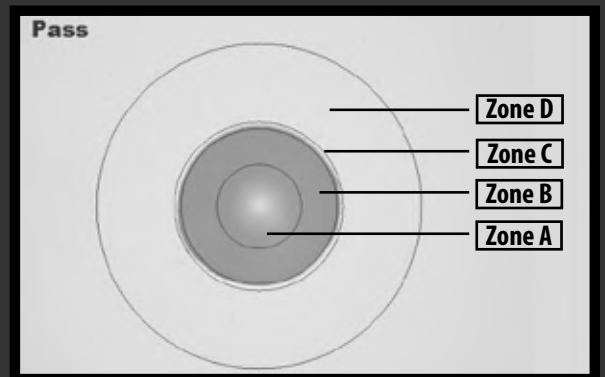

Zones	Scratches	Defects
<b>Zone A:</b> Core Zone	None	None
<b>Zone B:</b> Cladding Zone	No limit ≤ 3µm None > 3µm	No limit < 2µm 5 from 2 - 5µm None ≥ 5µm
<b>Zone C:</b> Adhesive Zone	No Limit	No Limit
<b>Zone D:</b> Contact Zone	No Limit	None ≥ 10µm



F1-1301T

## FIS PRECISION FIBER OPTIC STRIPPERS

FIS Precision Fiber Optic Strippers remove the 3mm jacket, 900µm tight buffer and 250µm buffer coating. Precision blades produce consistent clean strips. Tool length: 6.25 inches

PART #	DESCRIPTION	PRICE
F1-1301T	250µm, 900µm and 3mm Fiber Optic Stripper Three Hole	\$26.95



WO-1224

WO-1224D

WO1224T

## MILLER FIBER OPTIC STRIPPERS

The Miller Stripper is an exceptional tool recommended for stripping 250µm coated fiber and 900µm buffer tube. The Miller Stripper has a .0055" (0.14mm) laser drilled hole, soft plastic-cushioned handle grip, and super accurate hardened stripping jaws, ensuring smooth clean stripping action.

PART #	DESCRIPTION	PRICE
WO-1224	Miller Stripper (Strips 250µm) (Miller PN F0103-S-250)	\$39.50
WO-1224D	Dual Hole Stripper (Strips 250µm or 900µm) (Miller PN F0103-D-250)	66.75
WO-1224T	Tri Hole Stripper (Strips 250µm, 900µm, 3mm Jacket) (Miller PN F0103-T-250-J)	70.00



46107

81300

The Miller CFS-2 Fiber Stripper has "Super Comfort" grips. Ergonomically enhanced handles for extra comfort and ease of use. Factory set and locked calibration screw puck provides for better and more precise strips every time. Replacement for Clauss.

PART #	DESCRIPTION	PRICE
46107	Miller CFS-2 Stripper (Strips 250µm or 3mm)	\$21.95
81300	Miller CFS-3 Tri-Hole Stripper (Strips 250µm, 900µm, 3mm Jacket)	29.95



JIC-200

## JONARD 200µm FIBER OPTIC STRIPPER

Jonard fiber optic stripper removes the 200µm-125µm buffer coating.

PART #	DESCRIPTION	PRICE
JIC-200	200µm Fiber Optic Stripper	\$29.95



PA1171

## PALADIN GRIP-STRIPPER

The multi-function fiber optic stripper from Tempo has five settings for stripping fiber optic cable. Strips outer jacket from 2.0-2.4mm cable, 2.8-3.0mm cable and 2.0-3.0mm loose tube buffer tubes. Strips 900µm buffer from loose buffer without removing acrylate coating. Strips buffer and acrylate from 900/125µm and 250/125µm fiber. Factory set and calibrated.

PART #	DESCRIPTION	PRICE
PA1171	ProGrip 5-in-1 Fiber Optic Stripper	\$46.95



45-352

## MINILITE-STRIP™

The MiniLite-Strip™ is small and features a V-notch to remove buffer and coating from 125µm fiber. An additional larger V-notch removes a wide range of outer cable jackets.

PART #	DESCRIPTION	PRICE
45-352	MiniLite-Strip	\$54.95



## MICRO-STRIP TOOL KIT

When working with optical fiber, you don't want your work to be compromised by accidentally damaging a fiber. The Fiber Optic Micro-Strip Tool Kit provides an easy and efficient way to strip fiber optic cable without nicking or damaging the optical fiber. Strips fiber buffers up to 900µm, and jackets up to 3.5 mm. Kit includes interchangeable/replaceable blades and tube guides.

PART #	DESCRIPTION	PRICE
MS-FOK1	Kit (10 blades for fiber range of 125µm to 900µm)	\$140.00
MS-1FS	Blade Holder	14.75
MS-1RB06S	Replacement Blade-Violet (Strips to 125µm)	35.00
MS-1RB12S	Replacement Blade-White (Strips to 250µm)	35.00
MS-1RB21S	Replacement Blade-Royal Blue (Strips to 500µm)	35.00



F1-9999

## THERMAL FIBER OPTIC STRIPPER

The "Soft-Strip" Thermal Stripping Tool contains a heating element that softens and strips 900µm coatings. The thermal stripper permits precise stripping of these tough coatings with less than 1 lb. of peak pulling force for a single optical fiber. Excellent for use on fiber optic couplers and other delicate components. Uses two "AA" batteries, not included.

PART #	DESCRIPTION	PRICE
F1-9999	Thermal Fiber Stripper	\$150.00



**BUFFER TUBE RINGER/SLITTER**

Buffer Tube Ringer/Stripper with adjustable blades can be set for any depth to help assure nick-free jacket entry. Use for simplex fiber and a variety of fiber optic cables up to 1/8 inch diameter. Loose tube fiber demands a precision tool capable of cutting different buffer tube diameters without nicking the enclosed fiber. Available is the blue buffer tube stripper for cable from 1/8 inch to 7/32 inch.

PART #	DESCRIPTION	PRICE
F1-0017	Grey Buffer Tube Stripper (For Fiber/Coax Applications)	\$21.95
F1-0021	Blue Buffer Tube Stripper (For Fiber/Coax Applications)	19.95
F1-0018	Replacement Blades (1 Set of 4 Blades)	9.95

**BIG BLUE CABLE RINGER**

Strips round cable .250-.563 inches (6.4mm to 14.3mm) diameter. Adjustable blade, 1 or 2 step stripping, plus jacket slitting. .560 inch (14.22mm) blade spacing, rounded edge slitting blade included.

PART #	DESCRIPTION	PRICE
45164	Multicable Coax/Fiber Ringer Tool	\$53.25
L9226	Replacement Blade Set	12.95

**MILLER FTS SERIES FIBER TUBE SCORERS**

Precise, one-step buffer tube scorer. Fixed, hardened carbon steel blade requires no adjustments. FTS body comprised of strong & resilient acetal polymer.

PART #	DESCRIPTION	PRICE
80990	FTS-005 (red), Tube size upto 2mm, wall thickness 0.13 to 0.25mm	\$18.95
80980	FTS (yellow), Tube size upto 1.6 to 6mm, wall thickness 0.25 to 0.50mm	18.95
80985	FTS-035 (blue), Tube size upto 1.6 to 6mm, wall thickness 1.0 to 1.3mm	18.95

**MILLER ROUND CABLE SLITTERS**

The Miller Round Cable Slitters are manually operated cutting devices designed for fast, safe and precise jacket removal of PE, PVC and rubber jacket. The F1-114 is designed to strip cables from 4.5mm to 29mm Diameter. The F1-158 is designed to strip cables from 19mm to 40mm Diameter.

PART #	DESCRIPTION	PRICE
F1-114	Round Cable Slitter (4.5mm to 29mm diameter)	\$50.00
F1-158	Round Cable Slitter (19mm to 40mm diameter) (not pictured)	75.00
F1-231	1 Replacement Blade	14.25

The Round Cable Slitter removes outer jackets and insulations from 4.5mm to 28.5mm O.D. Stripping action is both circumferential, then longitudinal for removal of insulation section at the end or mid-span of wires. Adjustable depth up to 3mm. Weight: 4.2oz, Dimensions: 135 x 40 x 15mm.

PART #	DESCRIPTION	PRICE
MK02	Round Cable Slitter	\$35.95
39391	Spherical Cutting Replacement Blades	25.99

**TEMPO COMMUNICATIONS UNIVERSAL SLITTER**

Slit/Strip/Remove 0.18" (4.5mm) - 0.984" (25mm) diameter 500-1200-MCM power/telecom round cables rubber/PVC/nylon insulation. For mid-point taps. Cable support arm, stainless steel blade.

PART #	DESCRIPTION	PRICE
PA1822	Tempo Communications Universal Slitter	\$35.95

**OPTICAL FIBER SHEATH STRIPPER AND RING TOOL**

Used for stripping and butting tight buffer optical fiber cables. Use one blade to butt PVC sheathing and use the second blade to strip the sheathing. Adjustable for .018" or .031" thick plastic, rubber or fabric insulation.

PART #	DESCRIPTION	PRICE
JIC-4366	Optical Fiber Sheath Stripper	\$50.00

**ARMORED CABLE SLITTER AND CUTTER**

This tool slits outer polyethylene jacket and armor in one operation. Performs longitudinal slitting and circumferential (ringing) for end stripping. Blade rotates 90° by activating blade lever, allowing easy mid-span preparation (ringing and splitting) – Replacement blades available. Adjusts from 8-28.6mm OD.

PART #	DESCRIPTION	PRICE
F1-ACS	Armored Cable Slitter (8mm - 28.6mm cable OD's)	\$129.95
F1-ACS2	ACS-2 for smaller OD's (4mm - 10mm cable OD's)	156.95
F1-CB251K	Replacement Blade for F1-ACS and F1-ACS2	45.00
PST014	2-in-1 Cutter with Ratchet Handle	35.00



F1-0017



45164



80985

80980

80990



F1-114



MK02

\*Not for use with armored cable



PA1822



JIC-4366



F1-ACS



F1-ACS2



PST014



**KEVLAR® CUTTERS**

When cutting Kevlar®, you need a cutting tool with very durable blades. You also want the tool to cut cleanly, and to fit comfortably in your hand. FIS offers four Kevlar® cutters that fit the bill. The Kevlar® cutter, F1-KS1, features serrated blades and high leverage cutting, utilizing long cushioned handles. The Miller Kevlar® cutter, F1-9809, also features serrated blades and cushion handles.

PART #	DESCRIPTION	PRICE
F1-00201	Economy Kevlar® Cutters (Metal Blade)	\$5.95
F1-KS1	Miller Scissors (Carbon Molybdenum and Vanadium Steel Blade)	15.00
F1-6430	Kevlar- Cutters (Carbon Steel Blade)	26.95
F1-9809	Miller Kevlar® Cutters (Steel Blade) (Not Pictured)	31.95
KC699	Kevlar Scissor (Miller PN 46175)	14.95

**MILLER SCISSORS/SPLICER KIT**

Ergonomic snip for linemen and installers. One blade features ergonomically shaped, cushioned palm rest and the other blade has the traditional ring bow.

PART	DESCRIPTION	PRICE
925CS-ERGO	Ergonomic Scissor/Splicer Snips	\$19.95
925CS	Traditional Serrated Scissor	15.95
925CS-KIT	Splicer's Kit	35.95

**T-STYLE JACKET STRIPPER**

The dual "V" notch blade allows the quick removal of outer jacket. Plier nose, along with cushion grips and spring release are additional features making this stripper comparable to the Ideal T-Type® Stripper.

PART #	DESCRIPTION	PRICE
F1-0016	T-Style Stripper, 16-26 AWG	\$8.95
1917SS	Greenlee Stripper, 16-26 AWG	13.95

**US CONEC RIBBON STRIPPER**

The US Conec Optical Cable Jacket Removal Tool eliminates the need for sharp tools such as Exacto® knives or razor blades for cable jacket removal. The tool is designed for quick, reliable, economical removal of PVC jacket from ribbon interconnect cable, 3mm round cable and 2 fiber zipcord.

PART #	DESCRIPTION	PRICE
F1-2009	US Conec Ribbon Stripper	\$30.00

**US CONEC DISPOSABLE RIBBONIZERS**

The disposable ribbonizing tool utilizes a quick cure cyanoacrylate adhesive to provide a low-cost, robust ribbonization option. This solution is ideal for applications requiring excessive handling and multi-row termination applications.

PART #	DESCRIPTION	PRICE
14316	US Conec Disposable Ribbonizer, 12F, White, 10+ uses	\$0.85
14682	Disposable Ribbonizer, 8F, Purple, 10+ uses	0.85
16764	Disposable Ribbonizer, 4F, Gray, 10+ uses	0.85

**CORNING RIBBON SPLITTING TOOL**

The tool closes around the ribbon fibers, as the ribbon settles into the proper slot. With actuator depressed, the tool slides along a length of the ribbon, separating the length of ribbon that is needed into smaller ribbon counts. The tool has slots to separate the ribbon into the following smaller ribbon counts: 2/2, 2/4, 2/6, 4/4, 2/10, 4/8, 6/6, and 12/12.

PART #	DESCRIPTION	PRICE
RST-000	Corning Ribbon Splitting Tool	\$1,295.00

**AFL FAT-04 FIBER ARRANGEMENT TOOL RIBBONIZER**

The FAT-04 features an easy-to-use fiber arrangement method utilizing linear travel. The FAT-04 includes a spare paste applicator to allow ribbon making to continue even if one of the paste applicators needs cleaning.

PART #	DESCRIPTION	PRICE
S010212	AFL FAT-04 Fiber Arrangement Tool Ribbonizer	\$503.00
S008622	FAA-03A ribbon-forming adhesive (0.5 liter bottle)	157.00
S008720	FAA-03A ribbon-forming adhesive (4 oz. dispensing bottle)	44.00

**FITEL DE-RIBBONIZER**

The S220A uses two finely positioned blades to shave the matrix off the top and bottom of ribbon fiber while leaving the individual fiber jackets untouched. After the matrix is removed, the fibers separate out easily by hand. For use with 300 and 400µm ribbons of 2 to 12 strands. Blade life is 1,000 separations.

PART #	DESCRIPTION	PRICE
S220A	Fitel De-Ribbonizer	\$735.00

**RIBBON STRIPPING KIT**

This unique thermal stripping kit includes the patented "Soft-Strip" thermal stripping system and contains components for stripping from 4 to 12-fiber ribbon of various constructions: 'Bonded', 'Encapsulated' or 'Ribbonized' types. AC adapter sold separately.

PART #	DESCRIPTION	PRICE
MS-SK-1	Ribbon Stripping Kit	\$500.00
MS-T3	120 Volt AC Adapter for Thermal Stripper	40.95



**CORNING CABLE SYSTEMS MID-SPAN ACCESS TOOL**

Cutting a buffer tube mid-span without damaging the optical fibers inside can be a challenge - unless you have this specialized tool. Simply attach the tool and pull it along the buffer tube to slit the tube safely.

PART #	DESCRIPTION	PRICE
OFT-000	For 2.4mm - 3.0mm Tubes CCS Mid-Access Tool	\$280.00
OFT-001	Replacement Blade for OFT-000	22.95
UAT-3000	For 4.5mm - 22.0mm Tubes Enhanced Universal Access Tool	965.00
UAT3-BLADES	Replacement Blade for UAT-3000	95.00

CORNING



**MILLER MID-SPAN ACCESS TOOL**

The Miller Mid-Span Access Tool (MSAT-5) is used to quickly and easily access fibers in 1.9mm to 3mm buffer tubes in a mid-span location without damage to fiber. No blade adjustment is necessary.

PART #	DESCRIPTION	PRICE
MSAT-5	Mid-Span Access Tool	\$85.00
80935	Replacement Blade (5pk)	16.95



**MILLER MID SPAN ACCESS TOOL**

The new MSAT™ 16, an exciting new solution designed to easily access fibers in buffer tubes ranging from 1 to 3 mm diameters in mid-span applications.

PART #	DESCRIPTION	PRICE
MSAT16	Mid-Span Access Tool	\$120.00
MB017500	MSAT 16 Replacement Blade Kit	44.25



**MILLER MID-SPAN ACCESS TOOL**

Tool can access fibers in 2.0mm, 2.5mm, and 3.0mm buffer tubes. Buffer tube size gauges are located on the tool body for ease of selecting proper tube slitting channel.

PART #	DESCRIPTION	PRICE
80785	Mid Span Tool	\$295.00
80794	Replacement Blade (1 set)	39.25



**MID SPAN DROP CABLE SLITTER**

The MS-26 Mid Span Slitter is designed to open fiber jackets and loose buffer tubes to provide easy fiber access. The MS-26 is designed to work on cables or buffer tubes ranging in size from 2.9mm to 6.8mm in diameter. It's sleek ergonomic design allows you to open a jacket or buffer tube without damaging the fiber.

PART #	DESCRIPTION	PRICE
MS-6	Mid Span Drop Cable Slitter, 1.2mm to 3.3mm	\$56.75
MSB1533	Replacement Blades for MS-6	31.25
MS-26	Large Mid Span Drop Cable Slitter, 2.9mm to 6.8mm	79.60
MSB-2968	Replacement Blades for MS-26	34.85
MS-326	Micro Duct Fiber Cable Slit And Ring Tool	91.75
MSB-5010	Replacement Blade Set For MS-326	41.00
MS-426	Mid Span Slit & Ring Tool (5.8mm-12mm)	126.35
MS-426RB	Replacement Blade Set For MS-426	58.35



**AFL WRAPPING TUBE CABLE (WTC) CABLE ENTRY TOOL**

This tool is designed to help efficiently open Wrapping Tube Cable in both end prep and mid sheath entry. The blade angle and tool shape help prevent the blade from cutting too deep.

PART #	DESCRIPTION	PRICE
CS014530	WTC Cable Entry Tool	\$160.00
CS014966	Replacement Blade for WTC Entry Tool	56.95



**MILLER FLAT DROP CABLE SLITTER**

Unique articulating hinge allows accurate end and mid-span stripping without disassembling the tool -- simply close the tool over the cable and pull to slit the jacket. Ergonomic design with convenient opening tabs fits comfortably in hand and requires minimal effort to use. Comes with two installed reversible blades plus two additional replacement blades stowed conveniently in tool.

PART #	DESCRIPTION	PRICE
MB04-7000	Flat Drop Slitter With 2 Installed Blades And 2 Spare Blades	\$36.95
MB04-7500	Replacement Blade Kit with 2 Reversible Blades	8.95



**DROP CABLE SLITTER**

The FOD-2000 Fiber Optic Drop Cable Slitter is a patent pending tool that simplifies the slitting of drop cable jackets at the end of the cable or mid-span. The FOD-2000 puts a slit on both sides of the jacket allowing easy access to the fiber or strength member.

PART #	DESCRIPTION	PRICE
FOD-2000	Drop Cable Slitter	\$39.50
FOD-RB25	Replacement Blade for the FOD-2000 (Pack of 25)	41.60

**DRAKA BUFFER TUBE ACCESS TOOL**

This tool is designed for mid-span entry to fibers in a multiple of buffer tube sizes. The tool "shaves" only the tube wall to access the fibers providing safe, and reliable access. The tool kit includes interchangeable inserts supporting 2.5mm, 2.7mm and 3.0mm buffer tubes. **Includes:** Tool, Carry Case, Inserts, Spare Blade and Spare Head Screw

PART #	DESCRIPTION	PRICE
20021562	Buffer Tube Access Tool	\$946.70







**FIS DELUXE DIAMOND SCRIBE**

Housed in a deluxe metal casing, The Deluxe Diamond Scribe offers a retractable 60° cone point.

PART #	DESCRIPTION	PRICE 1-5	PRICE 6+
WO-1223	FIS Deluxe Diamond Scribe	\$17.95	\$15.95



**FIS ECONOMY DIAMOND SCRIBE**

This Economy Scribe has a 60° cone point and is housed in a rugged white plastic housing.

PART #	DESCRIPTION	PRICE 1-5	PRICE 6+
FO-90-C	FIS Economy Diamond Scribe	\$7.00	\$6.50



**FIS SAPPHIRE SCRIBE**

For a wider cutting surface, this scribe offers a 90° wedge. Housed in a deluxe metal casing.

PART #	DESCRIPTION	PRICE
FO-90-S	FIS Sapphire Scribe	\$19.95



**FIS 90° WEDGE DIAMOND SCRIBE**

Provides a wider cutting surface. The 90° Wedge Diamond Scribe is packaged in a rugged blue plastic housing.

PART #	DESCRIPTION	PRICE
FO-90-W	FIS 90° Wedge Diamond Scribe	\$35.00



**FIS CARBIDE SCRIBE**

This Carbide Scribe offers a wide cutting surface in a plastic pen-like housing.

PART #	DESCRIPTION	PRICE
F1-9773	FIS Carbide Scribe	\$19.95



**IDEAL SCRIBE TOOLS**

All three Ideal Scribes offer 30° beveled DualScribe™ reversible blades doubling the tools' useful life. Non-slip grips offer precise control during scribing. Clear safety caps protect blades when not in use.

PART #	DESCRIPTION	PRICE
45358	Sapphire Blade DualScribe™ (blue handle)	\$35.00
45357	Ruby Blade DualScribe™ (red handle)	35.00
45359	Carbide Blade DualScribe™ (black handle)	47.00



**FIS FIBER OPTIC CRIMP TOOLS**

Fiber optic connectors call for precision crimping which must meet non-optical disconnect requirements and increased pull strength demands. The FIS Crimp Tool is designed to successfully assemble a variety of connector styles for maximum optical performance and mechanical strength. The FIS Crimp Tool, part number F1-3227, contains 4 crimp sizes: .128, .137, .151 and .190 inches.

PART #	DESCRIPTION	PRICE
F1-3227	FIS Crimp Tool (Die and Handle) ST/FC/SC	\$65.00
F1-8825	FIS MU/LC Crimp Tool and Die (.120 round, .128 round)	75.00
F1-1302	FIS Crimp Tool Handle	35.00
PA-2043	MU/LC Crimp Tool and Die (.151 round, .178 round, .213 round)	29.95



**FIS CRIMP TOOL DIES**

PART #	DESCRIPTION	PRICE
F1-8825LM	FIS MU/LC Crimp Die (.120 Round, .128 Hex)	\$35.00
F1-3227M	FIS Crimp Tool Die (.128, .137, .151, .190)	35.00
PA-2051	Triple Hex Die (.068, .128, .178)	35.00



**ADDITIONAL CRIMP TOOLS**

PART#	CONN. MFG	CONNECTOR TYPE	PRICE
F1-3227	FIS	SC/ST/FC	\$65.00
6365CT	3M	FC/SC	150.00
320103101	CCS	ST/FC/SC	195.00

**3M LIGHTED SAFETY GLASSES**

Light Vision protective eyewear is industrial safety eyewear designed with integral hands-free lighting. Now, individuals can see and work in low light or dark environments with ultra-bright, adjustable LEDs on temples. Lights swivel for directional convenience, and long-lasting batteries provide up to 50 hours of continuous use. There are 2 styles to choose from: standard wrap-around and over-the-glasses.

PART #	DESCRIPTION	PRICE
11476-00000	3M Light Vision 2 LED Safety Glasses, Wrap Around Style	\$15.00
11489-00000	3M Light Vision LED Safety Glasses, Over-The-Glasses Style	15.00



**MAGNIFYING GLASSES**

Protect your eyes and see fiber with ease with the dual purpose Magna-Focuser. These glasses magnify objects 2.5 times, providing a critical visual advantage which still allows user both hands free. Perfect for individuals who find it difficult to work with small parts.

PART #	DESCRIPTION	PRICE
F1-1105	Magna-Focuser	\$19.95



**FIS EYE LOUPE SET**

Set includes 2X, 3X, 5X, 7X and 10X magnifications, these eye loupes allow users to make preliminary inspection of connector mating surfaces for dirt and scratches. The five piece set is made of durable lightweight plastic which makes it an excellent value.

PART #	DESCRIPTION	PRICE
98722	Eye Loupe Set	\$5.95



**RATCHETING CABLE CUTTERS**

The Ratcheting Cutter is great for aluminum armor, not intended for ACSR. Cuts up to 35mm diameter.

PART #	DESCRIPTION	PRICE
F1-900759	Greenlee Fully Ratcheting Cable Cutter	\$265.00

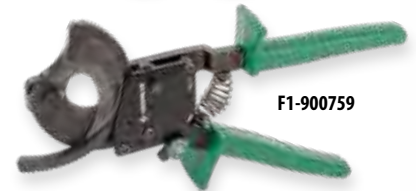

**HIGH LEVERAGE CABLE CUTTERS**

This is a utility cable cutter for up to 70mm cable. This manual tool is great for standard power, coaxial, and non-armored cables.

PART #	DESCRIPTION	PRICE
F1-727	Greenlee Cable Cutters	\$35.00



**SIDE CUTTING PLIERS**

The 6" side cutting pliers feature 1" cutting head for flush cutting, dual color cushioned handles and are manufactured of hardened steel.

PART #	DESCRIPTION	PRICE
0251-06D	Greenlee 6" Side Cutting Pliers	\$25.00



**LINEMAN'S B SIDE CUT PLIERS**

These pliers are high leverage for cutting bolts, nails, and many gauges of wire including high-strength wire. Cutting edges cut clean and remain sharp.

PART #	DESCRIPTION	PRICE
0151-08D	Greenlee 8" High Leverage Side Cutting Pliers	\$35.00



**UTILITY KNIVES**

PART #	DESCRIPTION	PRICE
0652-11	Utility Knife - Molded for secure, comfortable grip, retractable 3-position blade for safety and convenience, pop-up holder for blade storage	\$10.65
9952-11	Replacement Blades (5pk)	4.35
0652-23	Folding Utility Knife - High finish stainless steel handle with molded features for added comfort in rugged environments, 10 extra blades	20.50



**6" LONG NOSE SIDE CUTTING PLIERS**

- Forged from chrome vanadium steel for greater durability and strength
- Cuts both solid and stranded copper wire
- Serrated jaws and laser-hardened cutting edges
- Through-hardened steel for longer life
- Rugged riveted construction for smooth precise action

PART #	DESCRIPTION	PRICE
0351-06M	6" Long Nose Side Cutting Pliers	\$21.95





F1-IRD5-36



F1-IRD5-35



F1-SF1

808060



FOC-100



PA1900



0253-01C



F1-0911DH

F1-0912



FITMINIGUN



F1-5527

## FIS LASER SAFETY GLASSES

These high quality safety glasses employ superior laser safety lens technology. Laser protective dyes are molded into the plastic and will not scratch off, photobleach or degrade over time. The lenses protect from light wavelengths in the range of 800-1790nm. Glasses come with a protective carry case, lanyard and cleaning cloth. There are 2 styles to choose from: standard wrap-around and over-the-glasses. These are proudly made in the USA.

PART #	DESCRIPTION	PRICE
F1-IRD5-36	FIS Laser Safety Glasses, Over-The-Glasses Style, Adjustable Frames	\$120.00
F1-IRD5-35	FIS Laser Safety Glasses, Wrap-Around Style, Adjustable Frames	120.00

## INSERTION/EXTRACTION TOOLS

The Fiber Optic Connector Insertion/Extraction Tools are capable of reaching into very tight spaces to perform tasks. It has been designed to work with virtually all rectangular or square cross-section connectors.

PART #	DESCRIPTION	PRICE
F1-SF1	Extraction Tool	\$60.00
808060	Miller Extraction Tool	41.95

## FOCUS™ REMOVAL TOOL

The Focus™ removal tool from Cable Prep® inserts and removes SC and LC fiber optic connectors without disturbing adjacent connectors, even when working in densely populated panels.

PART #	DESCRIPTION	PRICE
FOC-100	Focus Removal Tool	\$58.95

## CAN WRENCH

- Strips PVC insulation, outer jacket of AWG22/4 and 24/4 telephone cable, insulation of AWG 22 (.34 mm2) and AWG 24 (.20 mm2) wire
- Durable shock-resistant design
- 3/8" (9.5 mm) and 7/16" (11 mm) hex sockets for accessing panels

PART #	DESCRIPTION	PRICE
PA1900	Can Wrench	\$16.95

## 7pc. NUT DRIVER / SCREW DRIVER SETS

The sets have rugged hollow shafts and heavy duty construction for longer life. Handles and shafts marked for easy identification of nut driver size.

**Nut Driver Set Contains:** 3/16", 1/4", 5/16", 11/32", 3/8", 7/16", and 1/2" Nut Drivers with 3" Shank

**Screw Driver Set Contains:** 3/16"x4", 3/16"x6" and 1/4"x4" Cabinet Tips, 1/4"x4" and 5/16"x6" Keystone Tip, #1x3" and #2x4" Phillips Tip

PART #	DESCRIPTION	PRICE
0253-01C	7pc. Nut Driver Set	\$50.00
0153-02C	7pc. Screw Driver Set	52.95

## HEAT GUN

The FIS Heat Gun is designed to shrink splice protection sleeves or breakout kit shrink tube. The heat gun provides a variable temperature range adjustment, allowing the user to apply the required heat.

PART #	DESCRIPTION	PRICE
F1-0911DH	FIS Digital Heat Gun 110V	\$42.95
F1-0912	FIS Heat Gun 220V	205.00

## SHRINK TUBE KIT

A complete, compact kit that includes a lightweight, portable heat gun and a variety of multicolored heat shrinkable tubing in six-inch cut pieces. Used for splicing, identification, cable repair.

PART #	DESCRIPTION	PRICE
FITMINIGUN	Portable Heat Gun Kit with variety pack (110V Only)	\$120.00
FIT221	Variety Pack Refill (60 - 6" cut pieces)	49.95

## COLORED SHRINK TUBES

The 13mm and 26mm are quality shrink tubes that contain adhesive inside of the tubes.

PART #	DESCRIPTION	PRICE
F1-5527-GN	Green Shrink Tube (3/16")	39¢ /ft
F1-5527-RD	Red Shrink Tube (3/16")	39¢ /ft
F1-5527-BL	Black Shrink Tube (3/16")	39¢ /ft
F1-5527-YE	Yellow Shrink Tube (3/16")	39¢ /ft
F1-5527-13A	13mm Black Adhesive Shrink Tube	80¢ /ft
F1-5527-26A	26mm Black Adhesive Shrink Tube	\$1.75 /ft



**CABLE PULLING LUBRICANT**

Polywater CGL Lubricant is a high performance gel lubricant for fiber optic, copper or coaxial cable pulls. It clings to cable for long distance horizontal pulls. The lubricant is compatible with PE and LSZH communication cable jackets. UL listed.

PART #	DESCRIPTION	PRICE
CGL-35	1 Quart Squeeze Bottle Polywater Lubricant CGL	\$9.95



CGL-35



FTTX-35LR

**POLYWATER FTTX LUBRICANT**

High Performance concentrated silicone lubricant that is fast drying to eliminate the "insertion loss" effect on data cables. Sprays easily in a stream to reduce mess during installation. Dries fast at the receiving side for quick splice or termination. Effective for fabric woven innerduct applications

PART #	DESCRIPTION	PRICE
CGL-640	5 Gallon Bucket Polywater Lubricant CGL	\$91.90
CGL-128	1 Gallon Bucket Polywater Lubricant CGL	24.30
FTTX-35LR	1 quart Spray Bottle Polywater Lubricant FTTx	25.00



TracerTape™

**TRACERTAPE™**

TracerTape™ is a functional product that is used for locating, pulling and measuring your duct and fiber. The TracerTape incorporates a solid corrosion resistant copper conductor which provides easy detection. Also available in 5,000 ft. reels. Call for double wire tracer tape.

PART #	DESCRIPTION	TENSILE/LBS.	PRICE
WPT1250	3,000 ft. Single Wire Reel	1,250 lbs.	\$260.00

**GREENLEE PULLING LINES**

- Strong, lightweight nylon
- Center feed for fast payout without tangling
- Mildew-resistant, can be pulled into the run with the wire to provide a means to add wires later.

PART #	DESCRIPTION	PRICE
595	2,150' Center Feed Fish Line	\$41.95
430	6,500' Poly Line	70.65
430-500	500' Poly Line	15.00



430-500



430

**DURAWHEEL**

The DuraWheel is ideal when you need to measure distances that are beyond the length of measuring tapes. Designed for rugged commercial use, the DW-PRO comes with a case, pistol grip brake and counter controls.

PART #	DESCRIPTION	PRICE
DW-PRO	DuraWheel Pro (12.5" wheel diameter) (feet)	159.00



DW-PRO

**GREENLEE FISH POLES**

Greenlee has the most innovative fishing systems designed to perform on the jobsite. Whether you're going a few short feet or through many walls and bends, having Greenlee's Fish Pole products on the jobsite will make the job easier for any commercial, industrial or utility application. These lightweight, durable poles are designed for both pushing and pulling cables and allow for use in cramped spaces.

PART #	DESCRIPTION	PRICE
540-15	3/16" Glo Stix 15' Kit	\$55.00
11427	3/16" x 5' Glo Stix Replacement 15 ft Section	25.00
11426	Whisk Nose Tip	15.95
10497	Hook Nose Tip	10.95
10498	Bullet Nose Tip	9.95
FP12	12 Foot Fish Pole	75.95
FP18	18 Foot Fish Pole	111.25



11426



10497



10498

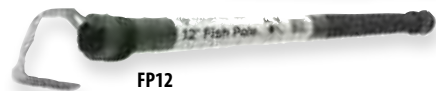

FP12

**CABLE CASTER**

This hand held device enables installers to fire a dart with pull rope up to 50 ft. Monofilament line attached to the dart is projected out from a take-up reel on the Cable Caster. Pull strings or ropes can be attached to the monofilament line and reeled back to the installer.

PART #	DESCRIPTION	PRICE
F1-9112	Cable Caster Installation Tool	\$67.00
F1-6259	Cable Caster Darts (4 Pack)	8.50



F1-9112

**FIS CABLE DISPENSER**

Cable Dispenser locks into an open position on padded, anti-skid legs that can not collapse. A removable, 5/8" solid spindle, capable of holding over 200 lbs., allows for simple installation of cable reels up to 25" in diameter and 16" in width.

PART #	DESCRIPTION	PRICE
F1-6111	Cable Dispenser	\$155.00



F1-6111



## FIS FIBER OPTIC TIE WRAPS

It's easy for installers to over-cinch thin zip ties, resulting in macrobends that attenuate fiber optic cables. With copper cables, the weight of cables pressing against thin ties can damage or deform them enough to create crosstalk issues. To solve these problems, FIS created the Universal Cable Strap with Foam Padding. FIS Fiber Optic Tie Wraps are 1" wide and 12" long, and they are available in your choice of colors. Substitute "X" with color of your choice: AQ = Aqua, BK = Black, BL = Blue, GR = Green, OR = Orange, and YE = Yellow.

PART #	DESCRIPTION	PRICE
FOTW-X-6	Tie Wrap with Foam Padding (Pack of 6)	\$7.75
FOTW-X-50	Tie Wrap with Foam Padding (Pack of 50)	65.00
FOTW-X-100	Tie Wrap with Foam Padding (Pack of 100)	125.00

## FIS BASIC TIE WRAPS

FIS has created the Universal Cable Strap, the widest, reusable cable tie that is designed for communications cable. FIS Basic Tie Wraps are 1" wide and 12" long, and they are available in your choice of colors. Substitute "X" with color of your choice: AQ = Aqua, BK = Black, BL = Blue, GR = Green, OR = Orange, and YE = Yellow.

PART #	DESCRIPTION	PRICE
BTW-X-6	Basic Tie Wrap (Pack of 6)	\$4.75
BTW-X-50	Basic Tie Wrap (Pack of 50)	35.00
BTW-X-100	Basic Tie Wrap (Pack of 100)	65.00

## VELCRO® Brand ONE-WRAP®

Bring your fiber optic cable installation to a new level with color match VELCRO® Brand ONE-WRAP® straps. Colors match fiber cable for enhanced cable type identification and installation appearance. VELCRO® Brand ONE-WRAP® straps are a safe alternative to other cable ties and will not pinch, damage or introduce unwanted insertion loss into the fiber network and are designed to bring your fiber network install from ordinary to extraordinary.

PART #	DESCRIPTION	PRICE
126886	VELCRO® Brand ONE-WRAP® 3/4" x 25 Yard Roll Yellow	\$23.95
126937	VELCRO® Brand ONE-WRAP® 3/4" x 25 Yard Roll Aqua	23.95
126927	VELCRO® Brand ONE-WRAP® 3/4" x 25 Yard Roll Erika Violet	23.95
176067	VELCRO® Brand ONE-WRAP® 3/4" x 25 Yard Roll Orange	23.95
151504	VELCRO® Brand ONE-WRAP® 3/4" x 25 Yard Roll Cranberry (Fire Retardant/UL Listed)	31.75
151494	VELCRO® Brand ONE-WRAP® 3/4" x 25 Yard Roll Black (Fire Retardant/UL Listed)	31.75

## VELCRO® Brand ROLL

This VELCRO® Brand Roll dispenses just like a tape roll and can be cut to the desired length. The center core of the roll has a male/female Velcro patch attached, which enables the roll to be affixed to any ladder or steel surface for convenient dispensing.

PART #	DESCRIPTION	PRICE
F1-VROLL	75' Velcro® Brand Roll 3/4" Black with Center Core	\$25.95

## HOOK AND LOOP FASTENER TIE WRAP

Protect your Fiber Optic and Category cable from over cinching with tie wraps. These low-cost wraps are reusable and are available in red and black. Now provided with cutout for screw mount support.

PART #	DESCRIPTION	PRICE
CT733	Red Tie Wrap 1" x 8" (75 pk)	\$28.95
CT255	Black Tie Wrap 1" x 8" (75 pk)	26.95
CT-3105	Black Tie Wrap 3/4" x 5" (25 pk)	9.95
CT-3108	Black Tie Wrap 1" x 8" (25 pk)	9.95
CT-3012	Black Tie Wrap 1" x 12" (25 pk)	12.00

## CONNECTOR AND CABLE CLAMPS

The ability to secure a connector or cable to a desired location is possible with this adhesive backed clamp. Re-enterable and adjustable up to 5/8".

PART #	DESCRIPTION	PRICE
F1-6209	Connector and Cable Clamps	.40¢
F1-13187	Cable Holder (package of 10)	6.95

## EXPANDABLE FIBER BRACKET

Designed to hold up to six 3.0mm fiber optic cables, this bracket provides expansion capabilities to fiber optic systems. Made from flame retardant nylon, cables snap into grooves without damaging the fiber.

PART #	DESCRIPTION	PRICE
F1-9124	Expandable Fiber Bracket (Package of 10)	\$2.75

## TIE WRAPS

Available from FIS are two sizes of tie wraps. The 4" long by 1/8" wide wrap is excellent for securing simplex or duplex cable. The 7" long by 3/16" wide wrap is designed to handle wrap diameters up to 1-1/4".

PART #	DESCRIPTION	PRICE
T185	4" Tie Wraps (100 pk)	\$2.25
T505	7" Tie Wraps (100 pk)	3.25

## CABLE CLAMPS

Use the Cable Clamp to organize copper or fiber cords and bulk cable. These clamps are available in 2 sizes: small (holding up to 1" in diameter), and large (up to 3").

PART #	DESCRIPTION	PRICE
CCS-0601	Small Cable Clamp (color red)	.85¢
CCS-0201	Large Cable Clamp (color blue)	1.60



**DYMO RHINO™ INDUSTRIAL 5200 HARD CASE KIT**

Rugged, versatile, and packed with time-saving features, the Rhino™ 5200 meets key ANSI and TIA/EIA 606-A labeling standards – and labels up to 77% faster than the competition. Proprietary Rhino “Hot Key” to automatically size, space and format text for perfect patch panel labels – then press another to print matching cable flags or face plate tabs, without retyping. Print module and fixed-length labels, horizontal and vertical wire wraps, terminal and 110 blocks and much more. Print Code 39 and Code 128 barcodes. Access 100+ industry symbols, fractions, and punctuation marks with a few quick keystrokes. Add the optional quick-charging lithium-ion battery for uninterrupted productivity.

**Kit Contents:** Rhino Industrial 5200 Label Maker, 3/4” White IND Vinyl Label Cartridge, 3/8” White IND Vinyl Label Cartridge, User Manual CD-ROM, Quick Reference Guide, AC Adapter, Carry Case, Rechargeable Lithium-ion Battery.

PART #	DESCRIPTION	PRICE
1756589	RHINO 5200 Hard Case Kit	\$ 294.50

**DYMO RHINO™ ACCESSORIES**

PART #	DESCRIPTION	PRICE
DY18443	RHINO 3/8” White Vinyl Label Cartridge	\$20.50
DY18444	RHINO 1/2” White Vinyl Label Cartridge	20.75
DY18488	1/2” Flex Nylon - Black/White Label Cartridge	24.30

**CABLE MARKER TAPE DISPENSER**

A dispenser holding 10 rolls of tape, numbered 0-9, gives you the ability to tag patch cables in your fiber optic system for easy identification. The 0-9 rolls of tape may be purchased under a separate part number. **Replace “X” with desired number 0-9 for replacements.**

PART #	DESCRIPTION	PRICE
STD09X	ScotchCode Wire Marker Dispenser with Tape STD-0-9	\$40.95
SDR09	Numerical marker, numbers 0 through 9	18.50
SDRX	Replacement Reel, individual numbers 0-9 (Replace “X” w/ individual number)	1.85



1756589



STD09



**DID YOU KNOW... LABELING STANDARDIZATION**

ANSI/TIA-606-B is a voluntary standard that establishes the labeling and record keeping standards for telecommunications and network systems in industrial, residential, and healthcare facilities. It identifies what needs to be labeled and provides a recommended identification scheme that is harmonized with the ISO/IEC TR14763-2-1 international identification scheme.

**The labeling principles that underlie 606-B include the following:**

- Labeling must be logical and consistent, across all locations, matching the project drawings.
- The labeling scheme must identify the associated physical locations (building, room, cabinet, rack, port, etc.)
- Labeling must be easily read, durable, and capable of surviving for the life of the component that was labeled.
- The labeling system, and the identifiers used, must be agreed upon by all stakeholders .
- Labeling should be pervasive; cables and connecting hardware should be labeled, but so should conduits and firestops, grounding and bonding locations, racks, cabinets, ports, and telecommunications spaces.

These principles are then translated into specific requirements.

**Requirements For Labels**

- All labels must use a permanent identifier that can be easily traced — that is, a useful numbering scheme. This scheme must be logical in its organization, using alphanumeric characters for ease of reference.
- Each cable and each pathway must be labeled on each end, and each label should identify the termination points of both ends of the cable.
- All labels must meet requirements for legibility, defacement, and adhesion, specified in UL969.
- Labels for station connections may appear on the face plate.
- All jack, connector, and block hardware may be labeled on either the outlet or panel.
- All labels must match up with the permanent record.



Custom Prints Available



F1-Alum



F1-Flex



F1-Dome

## SIGNS/POSTS

Baked enamel aluminum sign with clear protective coat forms extra UV and fade resistance. Fiberglass flexible marker post, 6ft, orange, with 2.875" x 13" vinyl/teldar label applied. No anchors are included. Dome marker post, 6ft, orange cap printed with black graphics.

PART #	DESCRIPTION	PRICE
F1-Alum	Aluminum Sign, 9" x 12", black on orange	\$19.95
F1-Flex	Flexible Line Marker Post, 3" x 6', orange	33.95
F1-Dome	Domed Marker Post, 3" x 6', orange cap, white pipe	28.95

Custom Prints Available



## SOILMARKERS

Clearly identify vulnerable underground assets with durable ground-level markers. Made of long-lasting and damage-resistant plastic, soil markers are perfect for urban, high-traffic, or other locations where posts and signs can't be used. These rugged markers can be walked on, driven over, or mowed over. 7" disk with 13" stake included.

PART #	DESCRIPTION	PRICE
SOILMARKER	7" disk with 13" Stake	\$11.75
SOILMARKERSS	7" disk with 13" Stainless Steel Stake	33.50

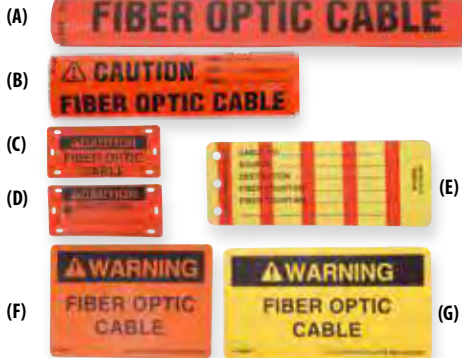

## WARNING LABELS

Warning labels are available from FIS in a variety of sizes and colors with many standard logos offered. Selection includes Wrap Around, Tie On, Sticky Back and Write-On. Call for Custom Labels.

PART #	DESCRIPTION	PRICE
F1-0099-SF	8" Long Wrap Around (Black on Orange) (A)	\$1.25
F1-0094F	4" Long Wrap Around (Black on Orange) (B)	1.50
F1-0100SF	3-7/8" x 1-3/4" Tie On (Black on Orange-20pk) (C)	13.00
F1-0100SL	3-7/8" x 1-3/4" Tie On with self laminating flap (20-pk) (D)	13.60
F1-0095	Write-On Cover All Tag (Black on Yellow-25pk) (E)	23.50
F1-0099F	2-3/4" x 4" Sticky Back (Black on Orange) (F)	50¢
F1-0096F	3-1/4" x 1-3/4" Sticky Back (Black on Yellow) (G)	50¢
F1-0092	2-3/4" x 5" Sticky Back (Black on Yellow) (Same Text as F and G)	60¢
F1-3801	Outdoor Durable Permanent Black Marker (Not Pictured)	1.25

Custom Sizes and Prints Available

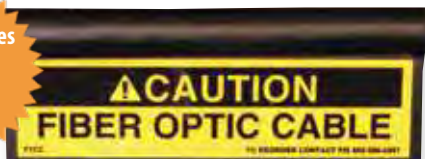

F1-CC

## CABLE CLIPPER LABELS

Extruded outdoor-durable black PVC cable marker clips over cable. Fits cable diameters 0.5" to 1.0". Additional size available for 0.25" diameter. Secured to cable with urethane adhesive strip. Labels available in a variety of colors to include your company name, logo, and emergency phone numbers. Background is brightly colored with Arial font black letters. Outdoor durable, minimum 10 years. Easy to read from ground, text height approximately 0.75" to 1". Standard size clipper is 6" length.

PART #	DESCRIPTION	PRICE
F1-CC	Clips with Reflective Laminated Label Applied. 6" Length. (generic print)	\$4.95

551165



## BURIED CABLE MARKER TAPES

Protect and locate buried fiber optic cable by placing buried marker tape above cable. Tape is 3" wide continuous strip labeled "Caution, Fiber Optic Line Buried Below." Available in detectable and non-detectable varieties.

PART #	DESCRIPTION	PRICE
551165	3" x 1000' Non-Detectable Terra Tape	\$10.65
F1-6508	3" x 1000' Detectable Tape (metallic material)	22.95



F1-RKIT

## REFLECTIVE NUMBER AND LETTER KITS

Reflective Number and Letter Kits are an excellent solution for marking and labeling your field assets. These letters are highly reflective, you can easily see them in all weather and at all times of day. Laminated for extra protection against UV rays, abrasion and chemicals, these durable 3M Scotchlite™ reflective labels are available in convenient kits that contain 25 each A-Z, 25 each 0-9, 25 each dash and blank and a handy storage case. Stock color is Black character on orange reflective background. Other colors are available.

PART #	DESCRIPTION	PRICE
F1-RKIT	Reflective Labeling Kit	\$155.00



**FIBER OPTIC SPLICE TRAILER**

Visit [www.fiberinstrumentsales.com](http://www.fiberinstrumentsales.com) For More Details

The Splice Trailer protects the splicing operation from weather and debris, while providing the technician with convenience and comfort in the field. The trailer features a 6'6" interior height with insulated walls and ceilings. The entrance door is located at the rear of the trailer to provide maximum workspace in the interior. Two fiber optic cable doors (one in the back and one on the curb side) enable technicians to work on outdoor lines in an inside environment. Features: New linoleum floor, rear step, heat and air conditioning units, 25 aluminum cabinets to store items, electric brakes, fluorescent lighting, a generator with an inside fuel gauge for added convenience and a full length roadside countertop. The ADJ front pintle hitch easily connects to the pulling vehicle, and more. Call your sales associate for additional specifications. FIS will arrange transportation to anywhere in the world. Delivery not included in price. **Outside Dimensions (16'10" L x 9' 1" W x 9' 7" H) (Length includes hitch)**

PART #	DESCRIPTION	PRICE
F1-9798NN	Fiber Optic Splice Trailer	\$28,900.00

**FIS PORTABLE TABLE**

These tables are perfect for splicing and terminating fiber optic cable. Tables weigh approximately 15-25lbs. The Work Table Kit is sold separately and includes a lamp (110VAC), magnifier, and universal clamp. Carrying Case sold separately.

PART #	DESCRIPTION	PRICE
F1-CT36	Work Table (22"x28")	\$355.00
F1-CT53	Work Table (22"x44")	525.00
F1-CT70	Work Table (22"x58")	515.00
FIS-AK	Work Table Kit (see description above)	370.00
CL400	Carrying Case	84.00



F1-CT36

**FIS SPLICE TENTS**

Splice tents for outside field applications are made of tough urethane coated polyester fabric. FIS offers the standard splice tents and the new Space Saver splice tents. Space Savers have approximately 25% shorter folded length for storage and can be set over a cable or pipe.

PART #	DESCRIPTION	PRICE
F1-97976GF	FIS Tent (6'L x 6'W x 6' 8"H) with floor	\$830.00
F1-97978GF	FIS Tent (8'L x 8'W x 7' 8"H) with floor	1,135.00
F1-97976GS	FIS Space Saver Tent (6'L x 6'W x 6' 8"H) without floor	640.00
F1-97978GS	FIS Space Saver Tent (8'L x 8'W x 7' 8"H) without floor	895.00
F1-979710GS	FIS Space Saver Tent (10'L x 8'W x 8' 4"H) without floor	1,150.00



F1-97976GF



**TEMPO COMMUNICATIONS TRACKER II CABLE LOCATOR**

With its inductive signal application, the Tracker II can be used on active or dead systems. Now you can trace the path and determine the depth of wires and metallic pipes without having to deactivate the systems. High frequency transmitter provides range up to 4000 feet (1219 m) and depths to 7 ft. (2 m). The transmitter offers three methods of connection: direct, inductive coupler, or inductive antenna.

PART #	DESCRIPTION	PRICE
501	Cable Locator TRACKER II	\$810.00



501

**TEMPO MARKER-MATE**

Marker-Mate™ Electronic Marker Locator is designed to locate all brands of buried, electronic markers, including the patented Tempo Omni Marker™, and Uni Marker™. This locator sets an industry standard with the capability of detecting all seven application-based electronic marker types simultaneously (power, water, sanitary, telephone, gas, cable TV, non-potable water.) Marker disks available.

PART #	DESCRIPTION	PRICE
EML100	Marker Mate	\$955.00



Marker Disks Available

EML100

# Long distance security, made simple.



## FIBER FENCE Security System

The FIS FIBER FENCE Security System is designed to detect intrusions over long distances using fiber optic cable. It's simple to install, and with built-in automatic calibration, no adjustment is required.

The system consists of the FIBER FENCE Zone Control Unit, sensing fiber, Mouse Trips and Proximity Sensors. Sensors are passive which allows the unit to be used in a wide range of environments including no-spark zones.

*You can protect 10 acres for less than \$1,000, and a square mile for less than \$1,500.*

**FREE information & instructional material upon request!**

**FIBER FENCE**  
SECURITY SYSTEM™

Phone: 800-500-0347 ext 2151 « Email: [fiberfence@fiberinstrumentsales.com](mailto:fiberfence@fiberinstrumentsales.com) « [www.fiber-fence.com](http://www.fiber-fence.com)

### APPLICATIONS



MANHOLE  
COVERS



MINING  
OPERATIONS



NO SPARK  
ENVIRONMENTS

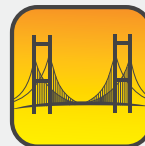

PIPELINES, RAILS,  
BRIDGES



CHEMICAL  
PLANTS



## FIBER FENCE Security System

The FIBER FENCE Security System operates on the principle of light attenuation. This system will detect perimeter or contained area intrusion, manhole, gate and valve positions and many industrial, facility and utility based applications – particularly in no-spark environments.

Call 800-500-0347 ext 2151 to talk to the Fiber Fence Product Line Manager.

# FIBER FENCE SECURITY SYSTEM™

### ZONE CONTROL UNIT

The heart of the FIBER FENCE Security System is the Zone Control Unit. The Control Unit sends light to one or more FIBER FENCE Mouse Trip or Opti-Mag sensors. The Zone Control Unit utilizes 9v DC power and may be rack mounted in a remote location. The Zone Control Unit is available in the 23dB range 1310nm single mode fiber coupled laser version. The power supply is included with each unit when purchased.

PART #	DESCRIPTION	PRICE
OMS-CML	Zone Control Unit L (10 mile range)	\$495.00
OMS-PWRS	Zone Control Unit 9V Power Supply (Will support up to 4 units plus)	74.95
OMS-RMS	Zone Control Unit Rack Mount System (4 Module Rack)	95.00
OMS-SPK	FIBER FENCE Splice Kit	149.00



OMS-CML

### OPTI-MAG SENSOR - THE "COVER COP"

FIBER FENCE Opti-Mag Sensors are sealed and contain a powerful internal magnet and spring mechanism that allow light transmission through the fiber only when it is positioned in the specified proximity to the selected target (i.e. door, manhole cover) or the optional sensing plate. When the target is moved away from the sensor, attenuation is created thus triggering the Zone Control Unit. When the target is returned to its position, light transmission is restored. Each Opti-Mag Proximity Sensor is rated for approximately 10,000 cycles.

PART #	DESCRIPTION	PRICE
OMS-PRX	FIBER FENCE Opti-Mag Proximity Sensor	\$105.00



OMS-PRX

### FIBER FENCE MOUSE TRIP™ SENSOR

The FIBER FENCE Mouse Trip sensors are designed to be mounted to the fence line perimeter and are tripped when the fence is disturbed. Mouse Trip Sensors do not require splicing. Triggered sensors must be reset at tripped location. Applications include perimeter fencing and area containment.

PART #	DESCRIPTION	PRICE
OMS-MT	FIBER FENCE Mouse Trip Sensor	\$69.00



OMS-MMT

### ZONE MAPPING SOFTWARE

The Zone Mapping Software allows the user to input a map and identify the perimeter with multiple zones. Each zone is protected by a Zone Control Unit. In addition to the features built into the Control Unit the signal can be monitored by the Mapping Software to identify an alarm and pinpoint the zone on the map. The software can also send text or e-mail messages for alarms and resets if the computer has internet access.

PART #	DESCRIPTION	PRICE
OMS-ZMAP	Zone Mapping Software	\$350.00



OMS-MT



OMS-ZMAP

### FIBER CABLE

The 900µm specially jacketed fiber is required for the Mouse Trip sensors and for Opti-Mag sensors. Cables can be customized to include connectors, Loop-Back modules to return to the Control Unit, and cut to length upon request. A separate quote will be provided.

PART #	DESCRIPTION	PRICE
OMS-SMPX	Simplex Bend Sensitive FIBER FENCE Singlemode Fiber	.45 per mt
OMS-DPX	Duplex Bend Sensitive FIBER FENCE Singlemode Fiber	.65 per mt
OMS-CNG	Corner Guard	\$7.50

Note: When possible, additional technical assistance for your specific application may be available. Installers are solely responsible for the actual installation of the system.

### TYPICAL OPTI-MAG NETWORK CONFIGURATIONS

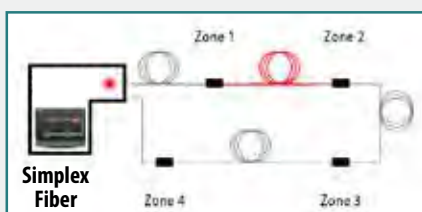

Zone Mapping (zone location identified)

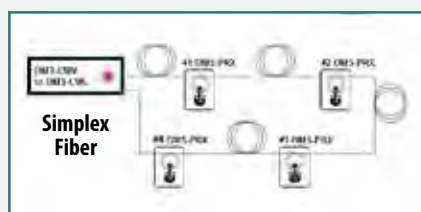

Multiple Opti-Mag Sensors in Series (trip location not identified)

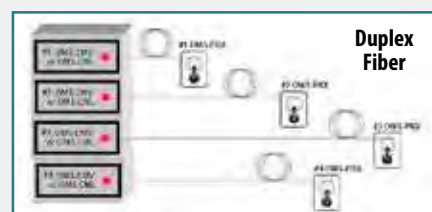

Shows four "Home Run" Alarm Modules (Racked using OMS-RMS)



# ZEUS FIBER MANAGEMENT CENTER

36"(h) x 27"(w) x 14"(d)

Environmentally sealed front door, Padlock style security latches and wind stop

Four cable entry ports with liquid tight sealing grommets and internal strain relief brackets

Built-in cable management brackets

Pad Mount Skirt features Front and Rear removable panels



24.71"(h) x 27"(w) x 14"(d)

**NEW**

## Zeus Mini Fiber Management Center Pole, Pad, or Wall Mounted - up to 144 SC/APC ports - Half the size

All modules built with individual swing-out panels to allow for easy rear access.

MOUNT TYPE	FIBER (INPUT)	STYLE	CONNECTOR	FEEDER LENGTH (ft)	FEEDER CABLE TYPE	NUMBER OF PORTS	DISTRIBUTION CABLE TYPE	DISTRIBUTION CABLE LENGTH	CONNECTOR	NUMBER OF DISTRIBUTION CABLES
A	24	0	3	50	LTD	144	LTD	100	3	1
A = Pad B = Pole C = Wall D = Mini Pole E = Mini Pad	24 48 72 96	I = Connectorized (No Trays) O = No Feeder (With Trays)	2 = SC UPC 3 = SC APC 4 = LC UPC 5 = LC APC	50 100 150 200	R = Ribbon LTD = Loose Tube LTA = Loose Tube Armor	144 288 432 576	R = Ribbon LTD = Loose Tube LTA = Loose Tube Armor	50 100 150 200	2 = SC UPC 3 = SC APC 4 = LC UPC 5 = LC APC	1 2 3 4

### Part # Example: ZA-24 -I-3-100-LTD-144-LTD-100-3-2

Translates to: Zeus Fiber Management Center - 24 Fiber Input SC/APC - 100FT Feeder - (2) 144 Distribution SC/APC 100' Distribution - Fully Loaded - Accommodates (12) LGX Splitter Modules **Price: \$4,200**

## ZEUS Fiber Management Center Accommodates up to 12 LGX Splitter Modules.

(Also in LC Connector Configurations)

### SPLITTER MODULES, LGX FOOTPRINT

PART #	DESCRIPTION	PRICE
Z104LGXSCA2	1x4 LGX Module w/ 2 Meter SC/APC leads	\$125.00
Z108LGXSCA2	1x8 LGX Module w/ 2 Meter SC/APC leads	187.50
Z116LGXSCA2	1x16 LGX Module w/ 2 Meter SC/APC leads	250.00
Z132LGXSCA2	1x32 LGX Module w/ 2 Meter SC/APC leads	375.00



Z132LGXSCA2



# Drive Your Business Forward with Zeus!

Now Available Consulting and Design Services

## FTTX FIBER OPTIC INTERCONNECT ENCLOSURES

Zeus FTTx Fiber Interconnects are a fully customizable solution for your next Fiber To The "x" project. You choose the connector style and whether to include pigtailed or not. Speak to your FIS Sales Rep for options and pricing for loaded enclosures.

PART #	DESCRIPTION	DIMENSIONS (HxWxD)	PRICE
Z1602FTTX	Fiber Optic Interconnect Enclosure for FTTx, No Adapters installed, includes ground post, hex security screw and allows for 3 meters of fiber slack	8.42" x 7.92" x 2.5"	\$25.00
Z176SFTTX	Fiber Optic Interconnect Enclosure for FTTx, No Adapters installed, includes ground post, hex security screw, splice holder and fiber slack routing spool for storage.	10" x 8.42" x 2.96"	35.00
Z1NG10FTTX	Fiber Optic Interconnect Enclosure for FTTx, No Adapters installed, includes ground post, hex security screw, splice holder and fiber slack storage.	11.91" x 8.31" x 3.35"	46.75



**NEW**

Z176SFTTX

For adapters and pigtailed contact your FIS Sales Representative.

## MDU SIMPLEX DROP FIBER

Zeus presents: MDU Drop Fiber: The FIS MDU Drop fiber is composed of 1 fiber Corning ClearCurve® ZBL Indoor / Outdoor Riser cable, terminated with (1) SC/APC Green Connector, and spooled on a 7 inch spool. Available in either white or black cable jacket.

PART #	DESCRIPTION	PRICE
Z1MDUSMDFYAYA31	MDU White Drop Cable SC/APC - SC/APC 31 meters(100ft) on small hand reel	\$27.00
Z1MDUSMDFYAYA61	MDU White Drop Cable SC/APC - SC/APC 61 meters(200ft) on small hand reel	\$37.00
Z1MDUSMDFYAYA92	MDU White Drop Cable SC/APC - SC/APC 92 meters(300ft) on small hand reel	\$47.00
Z1MDUSMDFYAYA153	MDU White Drop Cable SC/APC - SC/APC 153 meters(500ft) on small hand reel	\$67.00



CUSTOM LENGTHS AND PIGTAILS AVAILABLE

## FIS FLAT STRANDED SINGLE TUBE DROP CABLE

FIS is happy to offer flat Stranded Single Tube drop cable for Fiber to the Premise applications. This durable design incorporates two dielectric rigid rods for optimal tensile strength and crush protection.

PART #	FIBER COUNT	DESCRIPTION	PRICE
S09FD02CZEBLG	2	SM SMF28 Ultra Gel Flat Drop Cable PE Black	45¢ /Mtr.
S09FD02CZEBL-TLC	2	SM SMF28 Ultra Dry Flat Drop Cable PE Black	45¢ /Mtr.
S09FD06CZEBL-TLC	6	SM SMF28 Ultra Dry Flat Drop Cable PE Black	65¢ /Mtr.
S09FD12CZEBL-TLC	12	SM SMF28 Ultra Dry Flat Drop Cable PE Black	75¢ /Mtr.
S09FD02CZEBLG24G <b>NEW</b>	2	SM SMF28 Ultra Dry Flat Drop Cable PE Black - Tone Wire	50¢ /Mtr.



**NEW**

## FIS FTTX TEST KIT

The FTTx Kit provides a cost effective selection of test sets (PON Power Meter and FIS' Fiber Ranger) and optical cleaning supplies to ensure that each termination meets specifications.

PART #	DESCRIPTION	PRICE
F1-PPMFRKIT	PON Meter, Fiber Ranger, Fiber Test Leads, Connect-O-Clean ferrule push cleaner (includes 2.5mm and 1.25mm versions), 2 oz. of Fiber Optic cleaning solution (water based), Dry wipes (100), Ferrule cleaning sticks (2.5mm & 1.25mm versions), 2 - SC/APC female adapters, 2 meter SC/APC-SC/APC standard patch cord, 2 meter SC/APC ruggedized weatherproof connector patch cord	\$1,295.00



**NEW**

## FIS H-IP CONNECTOR ASSEMBLIES

FIS now offers an Outdoor Rated H-IP Connector that is fully compatible with Optitap® Solutions. Please call for Custom Assembly prices.



**NEW**



# ENCLOSURES



### Coyote<sup>®</sup> LCC

- Closure specifically designed for Round or Flat Drop Cable
- Max Splice Capacity - 24 single fusion / 72 ribbon fibers
- In-Line or Butt application
- Compact Size: 17" x 7" x 2.5"
- Easy re-entry and re-usable
- Designed for direct buried, below grade, pole/wall mount or aerial applications



### Coyote<sup>®</sup> DTC

- Closure specifically designed for Round or Flat Drop Cable
- Includes four cable ports and grommets for drop cable
- Max Splice Capacity - 16 single fusion / (3) 12 ribbon fibers
- In-Line or Butt application
- Compact Size: 9.1" x 7.6" x 1.7"
- Re-enterable and Re-usable
- Designed for direct buried, below grade, pole/wall mount or aerial applications



### Coyote<sup>®</sup> In-Line Runt

- In-Line or Butt application
- Max Splice Capacity - 80 single fusion / 288 ribbon fibers
- Capacity for two LITE-GRIP short trays
- Compact Size: 10" x 3.5" x 17.5"
- Re-enterable and Re-usable - No special tools needed
- Simple-to-use grommet sealing system with four grommet ports

#### INCLUDED COMPONENTS

PART #	DESCRIPTION	SPLICE TRAYS	GROMMETS	PRICE
COYDTC-001	COYOTE <sup>®</sup> DTC	(2) single fiber and 1 Ribbon LiteGrip Splice Blocks	(4) Round/Flate Drop	\$35.60
COYLCCF-001	LCC for Single Fusion Splices	(3) single fiber LiteGrip Splice Blocks	(1) 7-hole, (1) 12-hole	44.00
COYLCCF-002	LCC for Single Fusion Splices with Strength member Bobbin Kit	(3) single fiber LiteGrip Splice Blocks	(1) 7-hole, (1) 12-hole	47.50
COYLCCF-004	LCC for Single Fusion Splices	(3) single fiber LiteGrip Splice Blocks	(2) 7-hole	44.95
COYLCCF-005	LCC for Single Fusion Splices	(3) single fiber LiteGrip Splice Blocks	(2) 2-hole	44.95
COYLCCF-006	LCC for Single Fusion Splices	(3) single fiber LiteGrip Splice Blocks	(2) 4-hole	44.95

This family of enclosures offers a wide variety of applications from aerial to direct burial installations. Coyote Classic Enclosure styles utilize the Tape and C-Cement sealing technology which experienced installers of copper and fiber optics are familiar. With splice count options from 24-288 splices, the Coyote Classic line offers another set of options for a complete PLP offering.

#### PREFORMED LINE PRODUCTS – RUNT AND PUP CLOSURES

(Splice Trays NOT Included)

PART #	DESCRIPTION	PRICE
8006671	Runt Closure (8.5" x 3" x 14.75"), holds 2 splice trays, up to 24 single fiber splices	\$131.00
8006794	Expanded Runt (8.5" x 4.25" x 14.75") holds 4 splice trays, up to 48 single fiber splices	174.50
8006916	Runt with Cross Connect (Adapter Panels Sold Separately - call FIS for part numbers)	285.45
8006621	PUP Closure (6" x 17") Unitube Version, holds up to 4 splice trays/48 single fiber splices	194.00
8006622	PUP Closure (6" x 17") Buffer Tube Version, holds up to 4 splice trays/48 single fiber splices	194.00
8006951	In-Line Runt Closure (10" x 3.5" x 17.5") holds 2 splice trays, up to 24 single fiber splices, includes (4) 2-Hole	131.00



Runt 8006671



- Size: 17" x 10" x 4" (432 x 254 x 102 mm)
- Max Splice Capacity: 48
- Max Adapter Capacity: 16
- Grommet Quantity: Splice Chamber - 4, Drop Chamber - 8
- Application: Aerial
- Adapter Types Supported: SCAPC, SCUPC, LCAPC, LCUPC
- Flexible grommet sealing system supports a

- wide range of flat or round cable profiles
- Factory installed sealing materials
- Reenterable and reuseable
- Dual cover design allows independent access to each closure chamber
- Designed to GR-771 generic requirements for fiber splice closures

- Constructed with flame retardant UV stabilized material



CALL FOR MORE INFORMATION



- Size: 10.8" x 7.8" x 3.2" (274 x 198 x 82 mm)
- Max Splice Capacity: 24
- Flexible grommet sealing system supports a wide range of flat or round cable profiles
- Factory installed sealing materials
- Reenterable and reuseable

- Designed to GR-771 Generic Requirements for Fiber Splice Closures
- Constructed with flame retardant UV stabilized material

- Applications:
  - DTC4 and DTC6 - IP-68 rated
  - Aerial, below grade, direct buried, pole mount or interior applications

## PREFORMED LINE PRODUCTS – COYOTE DOME CLOSURES

PART #	DESCRIPTION	INCLUDED COMPONENTS GROMMETS	PRICE
8006877	Dome (6.5" x 22") 4-section endplate, holds 3 Lite-Grip or 6 low profile long splice trays	8003701	\$296.00
8006944	Dome (6.5" x 17") 4-section endplate, holds 3 Lite-Grip or 6 low profile short splice trays	8003701	185.00
80061055	Dome (9.5" x 28") 7-section endplate, holds 7 Lite-Grip or 13 low profile long splice trays, with Buffer Tube Organizer	8003692 8003693	400.00
800013691	Dome (9.5" x 19") 7-section endplate, holds 6 Lite-Grip or 12 low profile short splice trays	8003692 8003693	337.35



## PREFORMED LINE PRODUCTS – COYOTE CLOSURES

(Splice Trays NOT Included)

PART #	DESCRIPTION	PRICE
8006560	Coyote (6.5" x 22") with buffer tube storage, 6-port endplate, up to 4 trays/144 fibers	\$315.25
8006540	Coyote (6.5 x 22") for Unitube cable, 6-port endplate, up to 4 trays/144 fibers	310.50
8006561	Coyote (8.5" x 22") with buffer tube storage, 6-port endplate, up to 8 trays/288 fibers	569.00

Grommet Cable Entry for COYOTE Dome Closures



## PREFORMED LINE PRODUCTS – COYOTE ONE CLOSURE

(Splice Trays NOT Included)

PART #	DESCRIPTION	INCLUDED COMPONENTS GROMMETS	PRICE
COY1-001	Coyote One Closure, 16" x 10" x 5.7", 3-section endplate, holds 2 Lite-Grip or 5 low profile short splice trays	8003663 8003676	\$159.00

## PREFORMED LINE PRODUCTS – COYOTE GROUND LEVEL CLOSURES

PART #	DESCRIPTION	PRICE
COYGLC-F1B-000	COYOTE GLC Universal Kit with Base (Buffer Tube/Ribbon - up to 2 trays)	345.75
COYGLC-F2B-000	COYOTE GLC High Capacity Kit with Base (Buffer Tube/Ribbon - up to 6 trays)	345.75
COYGLC-F3B-000	COYOTE GLC Cross Connect Kit with Base (Unloaded)	366.25

PLP Ground Level Closure



### Grommets for New Breed of COYOTE Closures

PRICE	8003701	8003691	8003692	8003693	8003694	8003663	8003664	8003665	8003676	8003677	8003796
1-9 \$11.25 Each 10+ \$10.50 Each											
Hole Range (in)	.42-.60 in. .60-.85 in	.42-.60 in.	.60-.85 in	.85-1.0 in	1.0-1.25 in.	.42-.60 in.	.30-.43 in.	.125-.25 in. and Flat Drop	.42-.60 in. .125-.25 in. and Flat Drop	.125-.25 in. and Flat Drop	.125-.25 in. Flat Drop Only

## PREFORMED LINE PRODUCTS – SPLICE TRAYS

PART #	DESCRIPTION	PRICE
LGSTS16	Lite Grip Splice Tray Kit, Short Tray, includes 2 splice blocks to support up to 16 Single Fusion Splices	\$19.80
LGSTS40	Lite Grip Splice Tray Kit, Long Tray, includes 5 splice blocks to support up to 40 Single Fusion Splices	26.25
80806033	12-count splice tray for Runt, PUP and Coyote Dome Closures	23.25
80807701	12-count Low Profile Short Tray with Splice Block	23.25
8001127	36-count Low Profile Long Tray with Splice Block	42.15
80805110	36-count long splice tray for Coyote Closure (8006560/8006540/8006561/8006541)	36.25
80805514	36-count splice tray for Coyote Dome (8006878/8006877)	42.25
80809958	24-count short tray	22.50
80808945	Lite Grip Tray 40 count	23.25



## PREFORMED LINE PRODUCTS – OSP ACCESSORIES

PART #	DESCRIPTION	PRICE
8003832	Aerial Mounting Bracket for LCC	\$7.50
8004035	Aerial hanger bracket for Dome Closure	23.75
8003325	Adjustable aerial hanger bracket for PUP and Coyote Closures	25.50
8003467	Aerial hanger bracket for Runt Closure	25.50
8003571	Universal Mounting Bracket for Runt Closure	22.75
80805105	Three section endplate, 6 cable ports for Coyote(3) @ 3/4" (3) @ 7/8"	83.00
80805739	Three section endplate, 4 cable ports for Coyote(2) @ 1" (2) @ 1.25"	91.30
80805260	Blank endplate for Coyote Closure	35.45
80802567	LOCK-TAPE sealant 12ft roll	5.45
80802377	C-cement, 4oz can (Domestic ground shipment only)	5.75
8003663	2-entry grommet for .42-.60" port for Corning SST Cable	10.75
8003609	3-entry grommet for 7/8" port for Corning SST Cable	11.20
8003610	4-entry grommet for 1" port for Corning SST Cable	11.20



COMMSCOPE FOSC 450 FIBER OPTIC GEL CLOSURE



- Available in three sizes 8", 10" or 11.5" diameter
- Splice trays are hinged for direct access to any splice without disturbing other trays
- Can be used in aerial and burial conditions
- Single-Ended design butt closure with gel sealing technology - no heat shrink
- Gel seal automatically adjusts to cable size and shape without tools
- **Splice trays not included**

Closure	A4	B6	D6
Dimensions (inch) (Including Clamp)	8.5"	10"	12"
Length	19"	21"	30"

Splice Capacity	A4	B6	D6
Number of Trays	4	6	8
Single Fiber	96	144	768
Ribbon (12F)	144	288	1152
Cable Ports	4 Ports	6 Ports	6 Ports

A4: 2 small ports, each for cables .3-.9 inch diameter., 2 large ports for cable .4-1.1 inch diameter  
 B6 - D6: 6 ports, each for cable .35-1.0 inch diameter

PART #	DESCRIPTION	PRICE
FOSC450A42NT0A1V	COMMSCOPE "A" Closure, 4 round ports, holds up to 96 splices (8"W x 19"L)	\$185.00
FOSC450B66NT0B3V	COMMSCOPE "B" Closure, 6 round ports, holds up to 144 splices (10"W x 24"L)	285.00
FOSC450D66NT0D3V	COMMSCOPE "D" Closure, 6 round ports, holds up to 768 splices (11.5"W x 30"L)	445.00

CHANNELL GREEN HORNET - Easily Re-Enterable – No Special Tools Required



Key Features

- High drop density
- Environmentally sealed/air and water tight
- Impact resistant, solvent resistant, UV resistant
- Simple, easy to use design
- Splice trays are hinged, stackable and removable
- Tray design accommodates single and mass fusion splices as well as mechanical splices
- Each tray holds 24 single stacked fusion splices or 48 double stacked
- Pole or wall mount, underground vault, or aerial



G9L20S2F1B0G1A00

CHANNELL GREEN HORNET G6 ENCLOSURE

PART #	DESCRIPTION	PRICE
G6L18S2F1B0G1A00	Channell Green Hornet G6 Enclosure, Accommodates up to 96 Fibers, 6" diameter, 18" dome Includes (1) 24 Fiber Splice Tray, (1) Main Oval Port Grommet, Air Valve for Flash Testing and Ground Lug. Holds up to (4) 24 Fiber Splice Trays, 96 Fiber single stack.	\$325.00

CHANNELL GREEN HORNET G9 ENCLOSURE

PART #	DESCRIPTION	PRICE
G9L20S2F1B0G1A00	Channell Green Hornet G9 Enclosure, Accommodates up to 144 Fibers, 9" diameter, 20" dome Includes (1) 24 Fiber Splice Tray, (1) Main Oval Port Grommet, Air Valve for Flash Testing and Ground Lug. Holds up to (6) 24 Fiber Splice Trays, 144 Fiber single stack.	\$354.00



GR03106407-1

GR06116101-34-1

GREEN HORNET ENCLOSURE ACCESSORIES

PART #	DESCRIPTION	PRICE
CAS00567	24 Fiber Splice Tray and Cover	\$28.50
BR01292	Wall/Pole Mounting Bracket	15.60
BR01587	Aerial Mounting Bracket	42.60
GR03106407-1	Main Oval Port Grommet, G5 and G6	24.20
GR03106161-1	Branch Port Grommet, G5 and G6	9.90
GR16000672-1	Branch Port Grommet, G9	17.70
GR03106101-1250-1	Slotted Grommet, G6 and G9	3.24
GR06116101-45-1	Distribution/Drop Cable Grommet, G5, G6 and G9, .250"-.312"	2.80

(Other distribution/drop cable grommets available ask your sales representative.)





FOSC-ACC-A-24



FOSC-ACC-B-24



FOSC-ACC-D-72

## COMMSCOPE ACCESSORIES

Commscope splice trays are manufactured for specific style closures. Be sure to match the type of closure to correct splice tray. Trays range from 12 count to 72 count single fiber splices.

PART #	DESCRIPTION	PRICE	PART #	DESCRIPTION	PRICE
FOSC-ACC-A-12	Splice tray for "A" closure 12 Count (box of 2)	\$27.00	FOSC-ACC-D-72	Splice Tray for "D" Closure, 72 Count Capacity (box of 2)	\$70.00
FOSC-ACC-A-24	Splice Tray for "A" Closure 24 Count (box of 2)	32.50	FOSC-ACC-CABLESEAL1NT	Cable Sealing Kit for 1 round port cable	22.95
FOSC-ACC-B-12	Splice Tray for "B" Closure 12 Count (box of 2)	32.50	FOSC-ACCDBASKETTALL	Fiber Basket Holder	29.25
FOSC-ACC-B-24	Splice Tray for "B" Closure 24 Count (box of 2)	37.90	SMOUV-112001	60mm Splice Sleeve (100pk)	28.00
FOSC-ACC-D-36	Splice Tray for "D" Closure 36 Count (box of 2)	63.00	SMOUV-112002	45mm Splice Sleeve (100pk)	28.00

PART #	DESCRIPTION	PRICE
FOSC-ACC-AERIALCLAMPS	(2) Hanger Brackets and Clamps, (2) Snaplock Clamps, (2) Lashing Straps for FOSC450 Closures	\$35.00
FOSC-ACC-WALLPOLEMOUNT	FOSC450 Closure Wall/Pole Mount Hardware	36.00
FOSC-ACC-LASHINGSTRAPS	(2) Metallic Lashing Straps, (2) Nylon Lashing Straps and (4) Cable Spacers for FOSC450 Closures	18.00

## COMMSCOPE FOSC 500AA SLIM IN-LINE CLOSURE



FOSC 500AA

- 2 cable ports are provided at each side of the closure
- Butt or inline splice closure with gel sealing technology
- Holds up to 24 single fiber splices
- Compatible with most existing cable constructions (loose tube, central core)
- Splice tray included

PART #	DESCRIPTION	PRICE
FOSC500AAL24LTGV	Closure, Holds 24 Single Fiber Splices, for Loose Tube Cable with 24ct Splice Tray Included	\$160.00

## FIBER TAP® SERIES

Multilink's forward thinking Fiber Tap® system has revolutionized the Fiber to the Home (FTTH) implementation process. This system simplifies design, installation, and maintenance of plant for your cutting edge FTTH system. The Fiber Tap® system utilizes the ability to connectorize, splice, split, and distribute in one system. Connectorization can be furnished on most cable styles. This allows for numerous construction types to be accommodated from aerial, duct, or direct burial installations. Cable midspan / splicing access allows for large or long cable sizes to be utilized. With the capacity to facilitate passive splitting in our Multi-taps, you are able to do OSP splitting as a plug and play solution.

PART #	DESCRIPTION	PRICE
F1-020-306-10	4 Scout™ bulkhead adapters, 1 Flat Drop feeder port	\$119.88
F1-020-307-10	8 Scout™ bulkhead adapters, 1 Flat Drop feeder port	159.74
F1-020-308-10	12 Scout™ bulkhead adapters, 1 Flat Drop feeder port	234.93

## OPTIMA S

The Optima-S optical cross connect terminal offers the fastest hook up and disconnect of any drop cable field connection. The Optima-S utilizes computer aided engineering for optimal use in the Outside Plant and FTTX networks. It utilizes a specially designed, precision, cost effective, drop system with standard bulkhead adapters.

PART #	DESCRIPTION	PRICE
F1-020-349-10	4 Port Termination w/ Splicing Capabilities	\$171.69
F1-020-349-20	8 Port Termination w/ Splicing Capabilities	178.28
F1-020-349-30	12 Port Termination w/ Splicing Capabilities	183.32

## OPTIMA™C4

This cost effective option offers a simple four fiber drop port enclosure that can be ground, pole, pedestal, or strand mounted.

PART #	DESCRIPTION	PRICE
F1-020-347-00	4 Fiber drop ports and 1 input feeder port	\$81.97



F1-020-307-10



F1-020-349-10



F1-020-347-00



CORNING



2178XSBEGET



2178 Series

**CORNING 2178 SERIES CLOSURES** (SPlice TRAYS NOT INCLUDED)

3M™ Fiber Optic Splice Closure 2178 is engineered to meet common needs and field conditions, with different sizes to accommodate varying splice counts. 2178 Closures are made of a tough chemical-resistant material and have a gasket seal, making them ideal for a wide variety of applications. All 2178 closures are designed to be easy to install, easy to use and easy to re-enter.

- Full range of sizes - Fits your specific application
- No special tools required (standard torque wrench) - Easy installation and re-entry
- Constructed of a highly chemical-resistant material - Can be deployed in most applications: buried, underground and aerial
- Gasket seals - Reusable for easy re-entry

PART #	DESCRIPTION	PRICE
2178-XSBEGOT	Compact Splice Case (14.5"L x 10"W x 4.6"H), 3 cable ports, butt splice only, use 2532 splice tray	\$145.00
2178-S	Small Splice Case (21.9"L x 8.5"W x 4.7"H), up to 96 splices, use 2522/2523 splice trays	240.00
2178-LS	Standard Splice Case (21.9"L x 8.5"W x 8"H), up to 192 splices, use 2522/2523/2524FT trays	285.00
2178-LL	Large Splice Case (21.9"L x 8.5"W x 11.3"H), up to 312 splices, use 2522/2523/2524FT trays	320.00

**CORNING FIBER OPTIC SPLICE TRAYS AND OSP ACCESSORIES**

PART #	DESCRIPTION	PRICE
2532	Splice tray for 2178XSB, stackable/entry-exit both ends, up to 24 single fusion splices	\$18.75
2524-FT	Fusion splice organizer tray, holds 24 single fusion splices (splice inserts included)	41.95
2522	Fiber splice organizer tray – small (holds 2 chips/24 fiber) (11.5"L x 4"W x .75"H)	23.95
2523	Fiber splice organizer tray – large (holds 4 chips/48 fiber) (15"L x 4"W x .75"H)	27.95
2521F	Single fusion splice inserts (2 pack) –Fit 2522,2523,2527 trays (12 splices per insert)	18.00
2181-LS	Cable addition kit for 2178LS/LL cases, allows for 3 additional trays/4 cable ports.	105.00
2183-HAB	Gasket for 2178LS series splice cases	49.75
2527	Fiber Splice Organizer Tray – 24 single fusion	29.50
4414	CORNING Cable Cleaning Kit	33.50
4460-DFO	CORNING Scotchlok Shield Bond Connector Assembly	4.95

**AFL LG-500 AERIAL FIBER OPTIC CLOSURE**

This aerial weather tight fiber optic splice closure is for small to medium counts up to 72 fiber (or 288 ribbon fiber). Splice trays are available for single, mass or mechanical splicing. **Splice Trays Not Included**



- Four individual, self-sizing grommetted cable ports
- Tongue-in-groove cover seal system
- Holds (3) single fiber trays, holds (2) mass fiber trays
- Accommodates cables sizes 0.77" - 0.3"
- Weight 6.4 lbs, Dimensions 24" x 8.25" x 4"



LG-500

PART #	DESCRIPTION	PRICE
FC000026	LG-500 Aerial Compact Splice Closure with standard aerial hangers (no splice trays included)	\$110.00
911289-00-02	Universal splice tray (1) 24 fiber single fiber chip/(1) dual ribbon splices and VHB tape for mechanical splices	17.55

**AFL LG-250 AND LG-350 SEALED FIBER OPTIC CLOSURE**

This sealed dome closure is for medium count fiber splicing up to 96 fibers (288 ribbon) in a butt configuration. Can be utilized for aerial or underground applications where a sealed closure is required. Requires no tools for re-entry. **Splice Trays Not Included**

- Supports loose tube, central tube, dielectric and armored cable constructions
- 5 Cable ports and fully kitted with all parts to install five cables
- Holds (4) single fiber trays, (2) Ribbon fiber trays or (3) Mechanical splice trays
- Accommodates cables sizes 0.77" - 0.3"
- Weight: 11.5 lbs, Dimensions 19" x 8.75"



LG-250

PART #	DESCRIPTION	PRICE
FC000002-PS	LG-250 Dome Closure with 5 cable kits for sealing and retention. (No splice trays, hanger brackets)	\$200.00
FC000009-PS	Dome Enclosure 288 Single or 864 Mass Fusion Capable 5 Cable Kits for Sealing & Retention	265.00
911289-00-02	Universal splice tray (1) 24 fiber single fiber chip/(1) dual ribbon splices and VHB tape for mechanical splices	17.55
FC000655	3-port flat drop grommet for standard size drops for LG 150/250	15.00
911676-00-02	LL-4896 Universal Splice Tray—Stores (96) single fusion splices or (24) mass fusion splices (288 F). Maximum of 5 trays in the LG-350	37.78
FC000726	LG-350 Single Grommet Kit (Min. 0.40" - Max. 1.00")—For use in LG-350/AC/SD on Express Port side	26.62
FC000337	LG-350 Dual Grommet Kit (Min. 0.26" - Max. 0.44")—For use in LG-350/AC/SD on Express Port side	31.41
FC000421	LG-350 Quad Grommet Kit (Min. 0.26" - Max. 0.38")—For use in LG-350/AC/SD on Express Port side	23.19
FC000727	LG-350 Single Grommet Kit (Min. 0.26" - Max. 0.80")—For use in LG-350/AC/SD on Drop Port side	24.43
FC000422	LG-350 Drop 4 Flat Drop Grommet Kit—For use with standard flat drop cable and round cable up to 0.25" O.D.	15.82



### FIS QUICK FUSION SPLICE RESTORATION KIT

Ideal for restoring service to customers quickly during service outages. One side of the fiber is pre-prepped into the splice case to speed up restoration of service. The kit includes 1000' of 48 Fiber Dry Loose Tube Cable with Corning Bend Insensitive SMF28 Ultra Fiber, Spooled onto a Re-deployable Reel on wheels, 75' of the cable is spooled onto the inside flange. Also includes 2 Commscope FOSC-450A Splice Enclosures with (2) 24 Fiber Splice Trays each. Dimensions are 31.5" h x 31.5" w x 16" d. Optional Outdoor Cover available – Call your FIS Sales Rep for pricing.

- Portable
- Reusable
- Available
- Prepped
- Faster
- Affordable

PART #	DESCRIPTION	PRICE
F1-QSRK	Quick Fusion Splice Restoration Kit	\$2,142.00



### FIS INLINE HINGED ENCLOSURE

This hinged closure is designed to manage fiber splices with ease of maintenance for installers. Its versatility and durability allow direct buried, underground and aerial applications. It offers a simple re-entry system with a boltless mechanism that does not require an electric hand tool. Four splice trays included.

PART #	DESCRIPTION	PRICE
F1-ZOFC-B1	FIS Inline Enclosure up to 96 Fiber and 6 Cable Entry Ports	\$99.00



### FIS FIBER OPTIC SPLICE CLOSURE

This FIS Outside Plant Direct Burial Closure offers the perfect choice for low fiber count distribution applications involving butt and inline installations. The compact size and rugged design allow the closure to be deployed in below grade, aerial and buried installations. Dimensions: 21" L x 8" W x 4" H Weight: 9lbs.

- 4 Entry Ports
- Accepts cables from 10mm - 22mm diameter
- Can be configured for butt or in-line applications
- Integrated splice trays included
- Permanent waterproof sealing requires no re-entry kit
- IP rating:66 (Equal to NEMA 4 and 4X)
- Direct Burial or Aerial applications

PART #	DESCRIPTION	PRICE
F1-OSPDBC24	FIS Fiber Optic Splice Closure - 24 Fiber	\$99.95
F1-OSPDBC48	FIS Fiber Optic Splice Closure - 48 Fiber	119.95
F1-OSPTRAY	Splice Tray 12 but expandable to 24 Fiber For F1-OSPDBC-XX Closures	9.95



F1-OSPDBC48



F1-OSPDBC24

### FIS FIBER DISTRIBUTION ENCLOSURE (Strand Mount Only)

The fiber distribution closure provides protection at the fiber splice point and distribution of optical signals. It can also be used to connect individual subscribers in various applications. The closure is specially designed to accommodate 16 fiber drop cable and includes SC/APC adapters. It has 6 main entry ports on each end. The outer case is constructed of chemical resistant material. The trays are able to accommodate splitters and/or up to 24 individual fiber fusion splices.

PART #	DESCRIPTION	PRICE
F1-DTESCA-24612	Aerial Strand Mount only - 1-16 SC/APC Drop Adapters (1) 24ct Splice Tray (1) 12CT Pigtail (1) 6CT Pigtail - SC/APC Ends - All Grommets included for 12-144 Fiber Cable Diameters.	\$245.00



F1-DTESCA-24612

### FIS FLEXIBLE CABLE SPLICE PROTECTOR

The FIS Flexible Cable Splice Protector is an ideal solution for protecting fiber optic splices in challenging field conditions. This rugged, easy-to-install splice protector accommodates up to 12 splices with mini or micro protection sleeves, protecting them from moisture, vibration, shock and other adverse environmental conditions.

- Use for singlemode or multimode fibers
- Accommodates 25-60mm long splice sleeves
- 5" Minimum bend radius (Flexible center portion only)
- Dimensions: 13.75" (L) x 1.35" (W)

PART #	DESCRIPTION	PRICE
F1-FLEXSPLC	FIS Flexible Cable Splice Protector	\$65.00



F1-FLEXSPLC





To order the following components please have specific information regarding Application, Cable Construction/Part Number and Span/ Loading details. Without this specific information FIS is not able to accurately quote any ADSS products. Please call for pricing.



**FIBERLIGN LITE TENSION DEAD-ENDS**

The FIBERLIGN Lite Tension Dead-end is a dielectric dead-end designed to terminate short-span, low-tension ADSS fiber optic cables in low-voltage environments. The product effectively transfers the low axial load on the cable at the end of the dead-end legs to allow uniform radial compression near the dead-end loop. **This component must be ordered specifically based on cable Outside Diameter and span length. Part number will vary depending on cable O.D.**



**FIBERLIGN LITE SUPPORT (FLS)**

The FIBERLIGN Lite Support (FLS) system is designed to gently, but firmly, support All-Dielectric Self-Supporting (ADSS) cable. It is intended for tangent support installations on lines that feature relatively low voltages, very short spans and low mechanical loads. For most applications, the maximum line angle recommended is 20 degrees. **This component must be ordered specifically based on cable Outside Diameter and span length. Part number will vary depending on cable O.D.**



**FIBERLIGN DIELECTRIC SUPPORT (FDS)**

The FIBERLIGN Dielectric Support (FDS) system is designed to gently, but firmly, support All-Dielectric Self-Supporting (ADSS) cable. It is intended for tangent support installations on lines that feature relatively low voltages, short spans and modest mechanical loads. **This component must be ordered specifically based on cable Outside Diameter and span length. Part number will vary depending on cable O.D.**



**FIBERLIGN ALUMINUM SUPPORT (FAS)**

The FIBERLIGN Aluminum Support (FAS) is designed to gently, but firmly support All-Dielectric Self-Supporting (ADSS) cable. The FAS features the following: integrated bolt or band mount design, hinged keeper and base, single-bolt clamping, and stackability for multi-cable installations. For higher voltages (where track-resistant ADSS cables are required), longer spans and/or higher loads, use either the FIBERLIGN Aluminum Suspension with rods or the FIBERLIGN Dielectric Suspension. Maximum line angle typical is 20 degrees or less. **This component must be ordered specifically based on cable Outside Diameter and span length. Part number will vary depending on cable O.D.**

**FIBERLIGN ALUMINUM SUSPENSION (FASN)**

The FIBERLIGN Aluminum Suspension (FASN) is designed to gently, but firmly support All-Dielectric Self-Supporting (ADSS) cable. The FASN features the following: Short-to-Medium Span Option, Low-to-High Voltage Environment acceptance. **This component must be ordered specifically based on cable Outside Diameter and span length. Part number will vary depending on cable O.D.**



**PLP ADSS SPLICE CLOSURES**

PART #	DESCRIPTION	PRICE
8006944	6.5" x 17" Dome Enclosure for Central tube with Buffer tubes 48 splices	\$185.00
8006877	6.5" x 22" Dome Enclosure for Central tube with Buffer tubes 144 splices	296.00
80061055	9.5" x 28" Dome Enclosure for Central tube without Buffer tubes 48 splices	400.00

**TRAYS AND ACCESSORIES**

80806033	Standard splice tray for 8006944 12 splice count	\$23.00
80810086	Standard splice tray for 8006877 and 80061055 36 splice count	27.00

**PLP OPGW SPLICE CLOSURES**

PART #	DESCRIPTION	PRICE
800012143	6.5" x 17" Dome Enclosure for Central tube with Buffer tubes - 48 splices	Call For Pricing
800012145	6.5" x 22" Dome Enclosure for Central tube with Buffer tubes - 144 splices	Call For Pricing
800012147	6.5" x 17" Dome Enclosure for Central tube with out Buffer tubes - 48 splices	Call For Pricing
800012149	6.5" x 22" Dome Enclosure for Central tube with out Buffer tubes - 144 splices	Call For Pricing

**TRAYS AND ACCESSORIES**

8003754	OPGW Strain Relief Bracket Kit	Call For Pricing
800012162	Coyote Defender for 6.5" x 17" and 6.5" x 22" Domes	\$561.00
8003569	Double Arm Storage for Coyote Defender for 6.5" x 17" and 6.5" x 22" Domes	152.00

**PLP SNOW SHOES – FIBERLIGN IN-SPAN STORAGE**

Preformed Line Products’ aerial cable attachment hardware solutions use innovative Cable Capture Tabs to efficiently manage cable slack making them simpler, easier and quicker to install with fewer cable ties. This saves time and money and makes adjustments for slack loop length easy. The unique CLAS system can be used with either ADSS or lashed applications and simply folds over the cable and straps in place without needing any mounting hardware. CLAS units include cable ties. Abrasion protection guides are standard with the CLAS system and optional for the other styles. Optional block style Uni-Group cable guides are also available for all styles. Please contact FIS for these options.

PART #	DESCRIPTION	PRICE
FIS-12A	12" ADSS Mount Snow Shoe (one pair)	\$42.50
FIS-12M	12" Strand Mount Snow Shoe (one pair)	41.75
FIS-16A	16" ADSS Mount Snow Shoe (one pair)	44.50
FIS-16M	16" Strand Mount Snow Shoe (one pair)	44.50
710012375A	20" CLAS Universal Snow Shoe System (one pair)	84.00



**FIBERLIGN DROP CABLE STORAGE BRACKETS**

Stores slack cables in aerial, pole mount, vault and wall entrance installations. Stores flat drop cable and round drop cable up to 0.40" OD. 8" diameter size, All Dielectric, UV Resistant, Safe for Long Term Use. Stackable, Provides multi-level slack management.

PART #	DESCRIPTION	PRICE
FDC8	Fiberlign Drop Cable 8" Single Storage Bracket, Vault/Wall Service Entrance	\$19.00
FDC8M	Fiberlign Drop Cable 8" Single Storage Bracket, Aerial Lashed Messenger Systems	22.25
FDC8A	Fiberlign Drop Cable 8" Single Storage Bracket, Aerial ADSS Systems	22.39
FDC8P	Fiberlign Drop Cable 8" Single Storage Bracket, Wood Pole	21.50
7400029	Messenger Hanger Bracket	3.89
7400028	ADSS Hanger Bracket	5.00
7400030	FDC8 Stacking Kit with Spacers	5.00



**AFL FIBER STORAGE UNITS**

AFL Fiber Storage Units (FSU) are used to conveniently and safely store an extra length of cable along the support strand for later use. Sold as pairs (kit contains 2 FSUs and 2 sets of hanger brackets). FSUs are constructed from dielectric polypropylene with UV inhibitor or aluminum with baked acrylic enamel finish. All basic hardware for attachment to the support strand is provided. Galvanized strand clamping devices accommodate 1/4" to 7/16" strand. Contact an FIS sales representative for additional sizes not listed.

PART #	DESCRIPTION	PRICE
FA000004	FOSP-12-TMK Dielectric pair 12" with Horizontal Bracket	\$45.00
FA000002	FOSP-17-TMK Dielectric pair 17" with Horizontal Bracket	50.00
911110 -00	FSU- Aluminum pair 18" with Horizontal Bracket	66.50
911109 -00	FSU- Aluminum pair 16" with Horizontal Bracket	62.75
911108 -00	FSU- Aluminum pair 12" with Horizontal Bracket	57.00



**FIBER OPTIC SNO SHOES**

The plastic Sno Shoe is used to store additional lengths of fiber along the strand for later use. Sno Shoe is a durable and cost effective tool for storing fiber optic cable in the air. Adjustable Sno Shoes can be used aerially with standard tap brackets or the optional ADSS brackets. It can be mounted directly to the pole, or even in a manhole – anywhere you would want to store all of the slack at one location. Sno Shoes sold per pair.

PART #	DESCRIPTION	PRICE
2110-SSPTB	10" Plastic Sno Shoe with Strand Mount Only Hardware (one pair)	\$48.75
2116-SSPTB	16" Plastic Sno Shoe with Strand Mount Only Hardware (one pair)	48.75
2116-SAPTB	16" Plastic Adjustable Sno Shoe with Pole Mount Only Hardware (one pair)	75.00
2424-SAPTB	24" Plastic Adjustable Sno Shoe with Pole Mount Only Hardware (one pair)	141.75
2116-SSPSS	16" Plastic Sno Shoe with ADSS Hardware (one pair)	58.85





ZEUS-13X5-85

### IN-HOME FIBER INTERCONNECT WALL PLATE

- Junction box mounting platform
- Fiber slack storage spool with up to 5 feet of 3mm fiber slack storage
- Can be configured for fiber connection accessible from outside or protected inside the cover
- Snap on cover with security screw
- Vertical or horizontal distribution
- Angled or straight exit

PART #	DESCRIPTION	PRICE
ZEUS-13X5-85	Single gang fiber wall plate with two covers, fiber adapter and splice holder inside with fiber storage	\$13.95



F1-530

F1-502H



### LEVITON FIBER OPTIC NETWORK INTERFACE DEVICE (NID)

The rugged and secure NID provides protection from the elements and is offered in three variations. Constructed of a thermoplastic composite each NID safeguards fiber terminations, is wall mountable and designed with ease of maintenance for installers. Accommodates one 12-fiber splice tray. Specify connector/adaptor styles of SC/APC or SC/UPC for terminations.

See page 14 for adapter panels

PART #	DESCRIPTION	DIMENSIONS (HxWxD)	PRICE
F1-530S	NID houses 12 splices and/or 2 SC/UPC Adapters includes tray and adapters	10.22" x 5.64" x 2.73"	\$110.00
F1-502-H	NID houses 12 splices and/or (1) FD series adapter panel (not incl.)	8.54" x 10" x 2.88"	68.50
T5PLS9CV	12 Count Splice Tray with (2) Six Position Heat Shrink Splice Holders		35.00



DM000614

### AFL OptiNID® 500 OPTICAL DEMARCATION CLOSURE

The OptiNID (OPN) 500 is an optical demarcation closure designed for use in either indoor or outdoor environments. Smaller to suit FTTH demarcation applications and versatile to suit Category cable or coax connections, the closure is capable of housing up to six bulkhead adapters in one LGX® 118 compatible adapter plate.

- Weather-resistant thermoplastic alloy
- 1/2" or 3/4" NPT conduit fitting, compression cable fittings or grommeted entry ports

PART #	DESCRIPTION	PRICE
DM000614	1/2" NPT, Plug, Grommet, LGX 118 Black, 1 x SC/APC Adapter	\$40.00



F10SPSLACK61818

### NEMA RATED CABLE SLACK ENCLOSURES

The NEMA 4 rated outdoor fiber cable slack management enclosure contains four half cable management spools, pad lockable and 100% waterproof. This enclosure is pole and wall mountable (mounting bracket is included).

PART #	DESCRIPTION	PRICE
F10SPSLACK81212	NEMA 4 outdoor cable slack enclosure 12"x12"x8"	\$179.10
F10SPSLACK61818	NEMA 4 outdoor cable slack enclosure 18"x18"x6"	275.64
F10SPSLACK82424	NEMA 4 outdoor cable slack enclosure 24"x24"x8"	375.00

### DID YOU KNOW... IP VS. NEMA RATING?

There are two classifications for the degree of protection that an outside enclosure provides from solid objects and liquids in order to operate the enclosed electrical or optical equipment. The IP rating system set forth by the IEC is the rating system most prevalently recognized in Europe. In the United States, the National Electrical Manufacturers Association developed the NEMA rating for classifying an enclosure's level of protection from those environmental elements. While these test are different, you can use charts for finding equivalent ratings, at right are popular equivalents that are frequently asked.



4	Intended for indoor or outdoor use primarily to provide a degree of protection against windblown dust and rain, splashing water, hose-directed water, and damage from external ice formation.	NEMA 4 meets or exceeds IP56
4X	Intended for indoor or outdoor use primarily to provide a degree of protection against corrosion, windblown dust and rain, splashing water, hose-directed water, and damage from ice formation.	NEMA 4X meets or exceeds IP56
6	Intended for indoor or outdoor use primarily to provide a degree of protection against hose-directed water, the entry of water during occasional temporary submersion at a limited depth, and damage from external ice formation.	NEMA 6 meets or exceeds IP67

See FIS website for full listing



# FIS OUTDOOR POLYCARBONATE FIBER ENCLOSURES

## FTTX FIBER OPTIC INTERCONNECT ENCLOSURES

PART #	DESCRIPTION	(HxWxD)	PRICE
Z1602FTTX	Fiber Optic Interconnect Enclosure for FTTx, No Adapters installed, includes ground post, hex security screw and allows for 3 meters of fiber slack	8.42" x 7.92" x 2.5"	\$25.00
Z176SFTTX	Fiber Optic Interconnect Enclosure for FTTx, No Adapters installed, includes ground post, hex security screw, splice holder and fiber slack routing spool for storage.	10" x 8.42" x 2.96"	35.00
Z1NG10FTTX	Fiber Optic Interconnect Enclosure for FTTx, No Adapters installed, includes ground post, hex security screw, splice holder and fiber slack storage.	11.91" x 8.31" x 3.35"	46.75



Inquire with Sales about pre loaded enclosure for quicker installation.

## FIS FIBER OPTIC NID TERMINATION BOX

FIS Wall Mount Fiber Optic NID Terminal Box is designed to provide protection for fiber optic connectors and splices in indoor or outdoor environments (IP65 Rated). The enclosure has a built in, swing-out mini splice tray plus a bulkhead panel with SC cutout ports. 2 or 3 Cable access ports with built in weather-tight grommets allow for easy cable installation. **Adapters not included.**

PART #	DESCRIPTION	(HxWxD)	PRICE
F1-62DW-2	FIS NID Termination Box (For 2 Simplex SC or 2 Duplex LC Connections) 2 Entry Ports	8.2" x 6" x 2"	\$39.95
F1-62DW-3	FIS NID Termination Box (For 6 Duplex SC or 6 LC Quad Connections) 3 Entry Ports	10.2" x 7" x 2"	49.95

See SC and LC adapters for enclosures located on pages 106 and 107



## FIS 400 SERIES ENCLOSURE

The 400 series termination box is IP65 rated and made with polycarbonate for UV-Resistance. Accommodates (12) SC simplex adapters or duplex LC adapters for up to 24 fibers. Splices can be stored behind adapter panel and cable management is located on back of enclosure. (3) ports provided on bottom with gasketed ports. **Adapters not included.**

PART #	DESCRIPTION	(HxWxD)	WEIGHT	PRICE
F1-400	OSP Enclosure, up to 24 fibers (LC) w splicing/cable management	7.8" x 7.8" x 1.9"	1.1lbs(.52kg)	\$40.95
F1-400SCAPC6	MDU box loaded with 6 fiber SC/APC Pigtail	7.8" x 7.8" x 1.9"	NA	80.00
F1-4001X4SCAPC	MDU box loaded with 1x4 PLC splitter SC/APC Pigtail	7.8" x 7.8" x 1.9"	NA	114.50
F1-4001X8SCAPC	MDU box loaded with 1x8 PLC splitter SC/APC Pigtail	7.8" x 7.8" x 1.9"	NA	125.00

See SC and LC adapters for enclosures located on pages 106 and 107

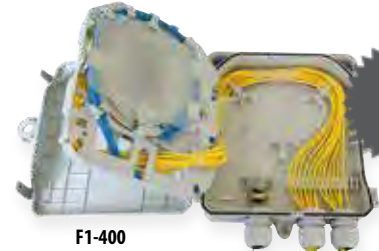

SHOWN LOADED

\*Adapters Sold Separately  
\*All splice trays included in each enclosure

## FIS 700 SERIES ENCLOSURE

The 700 series is manufactured for outside environments with IP54 rating and special gasketing. Has (2) cable ports on each side and up to 5 drop cable ports in center. Made of UV-resistant polycarbonate. 24 simplex SC cutouts in panel, accept SC Simplex, MTP/MPO as well as LC Duplex adapters for capacity of 24 or 48(LC) fibers. Fusion splice tray included. **Adapters not included.**

PART #	DESCRIPTION	(HxWxD)	WEIGHT	PRICE
F1-700	OSP Enclosure, up to 48 fibers (LC) w splicing/cable management	10.7" x 9.25" x 3.3"	1.7lbs (.78kg)	\$59.95
F1-7001X2SCAPC	MDU box loaded with 1x2 PLC splitter SC/APC Pigtail	10.7" x 9.25" x 3.3"	NA	95.00
F1-7001X4SCAPC	MDU box loaded with 1x4 PLC splitter SC/APC Pigtail	10.7" x 9.25" x 3.3"	NA	105.00
F1-7001X8SCAPC	MDU box loaded with 1x8 PLC splitter SC/APC Pigtail	10.7" x 9.25" x 3.3"	NA	114.00
F1-7001X16SCAPC	MDU box loaded with 1x16 PLC splitter SC/APC Pigtail	10.7" x 9.25" x 3.3"	NA	140.00

See SC and LC adapters for enclosures located on pages 106 and 107

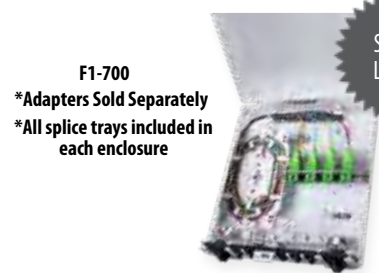

SHOWN LOADED

\*Adapters Sold Separately  
\*All splice trays included in each enclosure

## FIS 800 SERIES ENCLOSURE

The 800 series has 16 outlet ports for drop cables and 2 inlet ports. Made of UV-resistant polycarbonate. IP54 protected with special gasketing. Easy side latching system with lockable door. (16) simplex SC cutouts on panel accommodating (16) SC or MTP/MPO adapters or (32) LC connectors using duplex mating adapters. Also install PLC splitters inside enclosure for PONs. **Adapters not included.**

PART #	DESCRIPTION	(HxWxD)	WEIGHT	PRICE
F1-800	OSP Enclosure, up to 32 fibers (LC) w splicing/cable management	14.7" x 9.3" x 3.9"	2.4lbs(1.1kg)	\$61.95
F1-8001X8SCAPC	MDU box loaded with 1x8 PLC splitter SC/APC Pigtail	14.7" x 9.3" x 3.9"	NA	99.00
F1-8001X16SCAPC	MDU box loaded with 1x16 PLC splitter SC/APC Pigtail	14.7" x 9.3" x 3.9"	NA	165.00

See SC and LC adapters for enclosures located on pages 106 and 107



SHOWN LOADED

\*Adapters Sold Separately  
\*All splice trays included in each enclosure

## FIS 600 SERIES ENCLOSURE

The 600 series is designed for harsh environments with IP65 rating and gasket seal on the door. The polycarbonate is UV resistant. Comes with standard interconnect panel with duplex SC cutouts. Install SC duplex, MPO/MTP, or LC quad mating sleeves/adapters to accept up to 48 or 96 fibers. Splice Trays are included and mounted on the back wall behind the hinged adapter panels. Some cable management accessories included as well as grounding screw. **Adapters not included.**

PART #	DESCRIPTION	(HxWxD)	WEIGHT	PRICE
F1-600	OSP Enclosure, up to 96 fibers (LC) w splicing/cable management	16.5" x 13.4" x 5.1"	2.8lbs(1.3kg)	\$95.00
F1-6001X16SCAPC	MDU box loaded with 1x16 PLC splitter SC/APC Pigtail	16.5" x 13.4" x 5.1"	NA	143.00
F1-6001X32SCAPC	MDU box loaded with 1x32 PLC splitter SC/APC Pigtail	16.5" x 13.4" x 5.1"	NA	168.00

See SC and LC adapters for enclosures located on pages 106 and 107



SHOWN LOADED

\*Adapters Sold Separately  
\*All splice trays included in each enclosure

# COPPER



## CAT 6 AND CAT 5e PATCH CABLES

### FEATURES:

- Meet or Exceed Performance Standards
- 4-pair Stranded Unshielded, 24 AWG Conductor Cables
- Non-Plenum (CMR) Rated
- Pre-terminated with 8 Position RJ 45 Plug
- Available in a Variety of Lengths and Colors
- Universal Wiring ANSI/TIA T568A/T568B Standards

#### CATEGORY 5e STRANDED UNSHIELDED PATCH CABLE WITH SNAGLESS BOOT

FIS PART #	LENGTH	PRICE
CT-6080-03-XX	3ft	\$1.00
CT-6080-05-XX	5ft	1.25
CT-6080-07-XX	7ft	1.50
CT-6080-10-XX	10ft	2.15
CT-6080-15-XX	15ft	3.00
CT-6080-25-XX	25ft	4.75

(Note: When ordering the above Cat 5e cords, replace XX with color: BK=Black, BU=Blue, GN=Green, GY=Gray, OR=Orange, RD=Red, WH=White, YE=Yellow)

#### CATEGORY 6 STRANDED, UNSHIELDED PATCH CABLE WITH SNAGLESS BOOT

FIS PART #	LENGTH	PRICE
CT-6081-03-XX	3ft	\$1.75
CT-6081-05-XX	5ft	2.00
CT-6081-07-XX	7ft	2.40
CT-6081-10-XX	10ft	2.75
CT-6081-15-XX	15ft	3.50
CT-6081-25-XX	25ft	5.75

(Note: When ordering the above Cat 6 cords, replace XX with color: BK=Black, BU=Blue, GN=Green, GY=Gray, OR=Orange, RD=Red, WH=White, YE=Yellow)



#### CATEGORY 6 BULK 4 PAIR CABLE

HITACHI PART #	DESCRIPTION	PRICE
30024-8-XX-2	CAT6 UTP Riser Cable (CMR)	CALL
30237-8-XX-2	CAT6 UTP Plenum Cable (CMP)	CALL



#### CATEGORY 6 BULK 4 PAIR CABLE

PART #	DESCRIPTION	PRICE
6A234UTPRM3-X	CAT 6 23awg Riser Cable - 250MHz	CALL
6B234UTPM3-X	CAT 6 23awg Plenum Cable - 250MHz	CALL
6B234UTPENHM3-X	CAT 6 23awg Plenum Cable - 550MHz	CALL

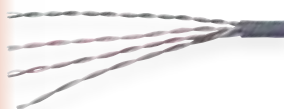

#### CATEGORY 5e BULK 4 PAIR CABLE

HITACHI PART #	DESCRIPTION	PRICE
38696-8-XX-2	CAT 5e UTP Riser Cable (CMR)	CALL
39419-8-XX-2	CAT 5e UTP Plenum Cable (CMP)	CALL



#### CATEGORY 5e BULK 4 PAIR CABLE

PART #	DESCRIPTION	PRICE
5AE244UTPRM2-X	CAT 5e Riser Cable - 100MHz	CALL
5BE244UTPM2-X	CAT 5e Plenum Cable - 350MHz	CALL
5BE244UTP350M2-X	CAT 5e Plenum Cable - 350MHz	CALL

(Note: When ordering, replace XX with BK = Black, BL = Blue, BR = Brown, GA = Gray, GR = Green, RD = Red, WH = White, and YE = Yellow.)

**One Week Lead Time**

### CUSTOM COPPER ASSEMBLIES:

Custom Cat 3, 5e, 6 and 6A Patch Cords can be made with or without snagless boots. Available in Black, Blue, Green, Pink, Purple, Red, White, and other colors. Each patch cord is tested and verified to ensure performance per TIA standards.

- Any Length
- Any Wiring Configuration
- Any Color
- Booted or Non-Booted
- Labeling Available
- You Provide the Spec
- Cross-over also Available

Other Copper assemblies are available.

**Call for more information!**

**DSX CABLEANALYZER**

The DSX CableAnalyzer Series from Fluke Networks is the testing platform for today - and tomorrow. This revolutionary new future-proof platform significantly reduces total time to certify by improving every aspect of the testing process. The AC Wiremap feature validates twisted-pair cabling for Power over Ethernet services in accordance with TIA/EIA standards, even if a Midspan power supply is used.

**FEATURES**

- Unmatched speed for Cat 5e, 6, 6a, 8, Class Fa, I/II and all current standards.
- Enables testing and certification of twisted pair cabling for up to 40 Gigabit Ethernet deployments
- Intertek Verified to ANSI/TIA-1152 Level 2AG – the most stringent accuracy requirement

PART #	DESCRIPTION	PRICE
DSX2-8000	A complete copper certification kit for cabling contractors testing Cat 8 and below channel and permanent links.	\$12,995.00
DSX2-8000MI	2GHZ DSX Cableanalyzer V2, w/ Wi-Fi	20,600.00
DSX2-8000-PRO	2GHZ DSX Multimode OLTS INSPC V2, w/ Wi-Fi	65,495.00
DSX2-8000QI	2GHZ DSX QUAD OLTS INSPC V2, w/ Wi-Fi	27,150.00
DSX2-8000QOI	2GHZ DSX QUAD OTDR OLTS INSPC V2, w/ Wi-Fi	42,150.00



DSX2-8000



33-100



**MOLEX SLT3**

**FEATURES**

- Verifies 1, 2, 3, and 4 pair UTP channels
- Unique 3-in-1 design
- Built-in Modular Jacks for USOC, EIA 568A and 568B
- Tests Open and Short Circuits

PART #	DESCRIPTION	PRICE
33-100	SLT3 UTP Single Line Tester	\$86.95

**GREENLEE COPPER TESTING KITS**

When it comes to wire identification, there's no better tool to have than the 701K Classic Tone and Probe Kit, from the world's largest manufacturer of tone and probe kits! This popular tone and probe kit is used by technicians everywhere to identify single conductors or cables within a bundle at a cross-connect point, or at remote ends.

Designed for more accurate wire identification, the 801K virtually eliminates power-related noise from their tone and probe operation. Our finest wire identification kit, the 801K Premium Tone and Probe Kit, offers all the features professionals are looking for.

**Tone and Probe Kit Includes:** 77HP High Power Tone Generator and the 200EP Inductive Amplifier in a Rugged, Woven Polyester Carrying Case.

PART #	DESCRIPTION	PRICE
701KG	Professional Tone & Probe Tracing Kit (Pictured)	\$125.00
801K	Premium Tone and Probe Kit	205.00



701KG

**NETCAT STRUCTURED WIRING TESTER AND TROUBLESHOOTER**

The NETcat® Pro is a digital tool for fast, accurate checking of cables, wiring and network service. Operated using a backlit touch screen display, the Pro not only tests wiring continuity and proper pair allocation, but measures the length of cables and determines if network service is available.

**FEATURES**

- Verifies the Integrity of Both Twisted Pair and Coaxial Telecom Cable
- Test Wiring Continuity and Check for the Correct Allocation of Wire Pairs
- Fast, Accurate Checking of Cables, Wiring, and Network Service
- Measures the Length of Cables and Determines if Network Service is Available

PART #	DESCRIPTION	PRICE
NC-100	NETcat Micro Digital Voice and Video Wiring Tester	\$110.00
NC-500	NETcat Pro Digital VDV Wiring Troubleshooter	327.95

NC-500



**GREENLEE CABLESCOUT® AND TELSCOUT® COPPER TDR**

**FEATURES**

- Copper TDR Designed for CATV Applications
- Ideal Choice for Digital Broadband Coax (TV220)
- Designed for Telephone Twisted Pair Applications (TS90) + (TS100)
- All Units Include Test Leads or Cables, Carry Case and Rechargeable Batteries

PART #	DESCRIPTION	PRICE
TV90	CableScout® TV90, 6 and 12ns pulse widths	\$1,900.25
TV220	CableScout® TV220, dual trace, 1, 5 and 25ns pulse widths, trace storage/download	4,203.50
TS90US	TelScout® TS90, 5 to 2500ns pulse widths	2,050.95
TS100-01-US	TelScout® TS100, 5 to 3000ns pulse widths, trace storage/download	4,827.95



TV220



**SIGNAMAX**



SKFL-3

DKFL-12

**SIGNAMAX KEYSTONE FACEPLATES AND SURFACE MOUNT BOXES**

PART #	DESCRIPTION	PRICE
SKFL-1	1 port Single Gang Keystone Faceplate with Labeling Windows	90¢
SKFL-2	2 port Single Gang Keystone Faceplate with Labeling Windows	90¢
SKFL-3	3 port Single Gang Keystone Faceplate with Labeling Windows	90¢
SKFL-4	4 port Single Gang Keystone Faceplate with Labeling Windows	90¢
SKFL-6	6 port Single Gang Keystone Faceplate with Labeling Windows	90¢
SKFLA-2	2 port Angled Single Gang Keystone Faceplate with Labeling Windows	95¢
SKFLA-4	4 port Angled Single Gang Keystone Faceplate with Labeling Windows	95¢
DKFL-6	6 port Double Gang Keystone Faceplate with Labeling Windows	\$1.50
DKFL-12	12 port Double Gang Keystone Faceplate with Labeling Windows	1.50
DKFLA-8	8 port Angled Double Gang Keystone Faceplate with Labeling Windows	1.50
SMB1-SG	Single Gang Surface Mount Faceplate Box	1.97
SMB1-DG	Double Gang Surface Mount Faceplate Box	3.25
SMKL-1	1 port Surface Mount Multimedia Box	1.05
SMKL-2	2 port Surface Mount Multimedia Box	1.40
SMKL-4	4 port Surface Mount Multimedia Box	1.95

[Note: The standard color for all the above is light ivory. For other colors add the following to the p/n -BK (Black), -GY (Gray), -WH (White)] (Faceplates also available without labeling window option.)  
[Note: Stainless Steel Wall Plates also available]

**SIGNAMAX**



KJ4MT-8600

KJ458MT

KJ458-C6C

CMK-SC

**SIGNAMAX KEYSTONE JACKS AND FIBER CONNECTOR MODULES**

**FEATURES:**

- Keystone jacks exceed all performance requirements as defined in TIA/EIA568-B
- Terminated with T10 tooling or 4 Pair MT Series Tool
- Ability to mount either color-coded icon tabs or dust covers

PART #	DESCRIPTION	PRICE
KJMT-8600	4 Pair Termination Tool for MT Series	\$26.55
KJ458MT-C6AC*	Cat 6A 10G MT Series Keystone Jack 568A/B Light Ivory	4.96
KJ458MT-C6AC	Cat6A 10G Screened Keystone Jack 568A/B	6.82
KJ458MT-C6C	Cat6+ MT Series Keystone Jack 568A/B Light Ivory	3.60
KJ458MT-C5E*	Cat5E+ MT Series Keystone Jack 568A/B Light Ivory	2.20
KJ126MT-C3**	Cat3 Voice Grade MT Series Keystone Jack Light Ivory	1.85
CMK-BL**	Blank Keystone Module	20¢
CMK-F***	F-Type Keystone Connector Module	\$1.15
CMK-BNC***	BNC Keystone Connector Module	2.05
CMK-110SVHS**	SVGH to 110 Connector Module	2.20
CMK-ST**	ST MM/SM Fiber Connector Module	2.75
CMK-SC**	SC MM/SM Fiber Connector Module	2.98
CMK-LC**	LC MM/SM Fiber Connector Module	8.55

\*(Note: When ordering, other than Light Ivory color, add the following to the p/n: -BK (Black), -BU (Blue), -GN (Green), -GR (Gray), -OR (Orange), -RD (Red), -WH (White), -YE (Yellow))

**UNSHIELDED RJ-45 MODULAR PLUGS**

**FEATURES:**

- Used for field termination of patch cords and applications
- Designed for 24 AWG stranded or solid cable
- Strain relief boots sold separately



RJ-45 Plug

PART #	DESCRIPTION	PRICE
KRJ45/5-100	RJ-45 for 24AWG Stranded Cable - 100 Pack	\$18.60
KRJ45/5SLD-100	RJ-45 for 24AWG Solid Cable - 100 Pack	29.95

**SIGNAMAX PATCH PANELS**

PART #	DESCRIPTION	PRICE
24458-C6A	Cat 6A 10Gig 1U, 19" Rack Mountable	\$155.00
48458-C6A	Cat 6A 10Gig 2U, 19" Rack Mountable	298.00
12458MD-C6C	Cat 6+ 12 port 1U, 19" Rack Mountable	67.00
24458MD-C6C	Cat 6+ 24 port 1U, 19" Rack Mountable	106.65
48458MD-C6C	Cat 6+ 48 port 2U, 19" Rack Mountable	186.00
24458MD-C5E	Cat 5e+ 24 port 1U, 19" Rack Mountable	65.10
48458MD-C5E	Cat 5e+ 48 port 2U, 19" Rack Mountable	119.00
12458M-C5E	Cat 5e + 12 port Mini Wall Mount	44.00
12458M-C6C	Cat6+12 Port Mini Wall Mount	62.00
24UHDMMPP	24 Port Unloaded Patchpanel Accepts Keystone Jacks, 19" Rack Mountable	31.00
48UHDMMPP	48 Port Unloaded Patchpanel Accepts Keystone Jacks, 19" Rack Mountable	43.40

[Note: Screened/Shielded Patch Pannels for Cat 5e, 6 and 6A also available.]



12458M-C5E

24458MD-C6C

48458MD-C5E

# NETWORK EQUIPMENT

## FIS SFP MODULES

A small form-factor pluggable (SFP) is a compact, hot-pluggable (swappable) network interface module used for both telecommunication and data communications applications. SFPs originated from the original larger GBIC (1 Gig speeds) modules. The form factor and electrical interface are specified by a multi-source agreement (MSA) that was jointly developed and supported by many network component vendors. Several vendors rejected the MSA agreement and developed their own Standard. FIS provides SFP modules for 100 Mbps(SFP) , 1 Gbps(SFP) , 10 Gbps(SFP+), 40 Gbps (QSFP+) and 100 Gbps(QSFP28) Ethernet switches in MSA format along with Cisco, Alcatel-Lucent, Dell, Juniper and a many other non-MSA formats. Medias available include Singlemode and Multimode fiber as well as UTP copper.

PART #	DESCRIPTION	PRICE
F1SFPM132KFEMS	SFP 100MB Fast Ethernet 1310nm Multimode, 2 km range, MSA Standard Compatible	\$29.00
F1SFPM855501GMS	SFP 1 Gigabit Ethernet 850nm Multimode, 550 m range, MSA Standard Compatible	18.00
F1SFPS1310K1GMS	SFP 1 Gigabit Ethernet 1310nm Singlemode, 10 km range, MSA Standard Compatible	20.00
F1SFPS1320K1GMS	SFP 1 Gigabit Ethernet 1310nm Singlemode, 20 km range, MSA Standard Compatible	25.00
F1SFPS1540K1GMS	SFP 1 Gigabit Ethernet 1550nm Singlemode, 40 km range, MSA Standard Compatible	28.00
F1SFPS1580K1GMS	SFP 1 Gigabit Ethernet 1550nm Singlemode, 80 km range, MSA Standard Compatible	69.00
F1SFPM85300M10GMS	SFP 10 Gigabit Ethernet 850nm Multimode, 300 m range, MSA Standard Compatible	27.00
F1SFPS1310K10GMS	SFP 10 Gigabit Ethernet 1310nm Singlemode, 10 km range, MSA Standard Compatible	47.00
F1SFPS1320K10GMS	SFP 10 Gigabit Ethernet 1310nm Singlemode, 20 km range, MSA Standard Compatible	55.00

## FIS WDM SFP MODULES

When limited by available fibers FIS carries Singlemode fiber WDM SFP modules. These SFPs transmit and receive over the same fiber using Wavelength Division Multiplexing (WDM) fiber optic technology. These SFPs utilize two different light sources (LASER) to achieve full duplex transmission over a single fiber minimizing fiber usage.

PART #	DESCRIPTION	PRICE
F1SFPB15310K1GMS	SFP 1 Gigabit Ethernet 1310-TX/1550-RX WDM Singlemode, 10 km range, MSA Standard Compatible	\$40.00
F1SFPB13510K1GMS	SFP 1 Gigabit Ethernet 1550-TX/1310-RX WDM Singlemode, 10 km range, MSA Standard Compatible	40.00
F1SFPB13520K1GMSA	SFP 1 Gigabit Ethernet 1310-TX/1550-RX WDM Singlemode, 20 km range, MSA Standard Compatible	47.00
F1SFPB15320K1GMSA	SFP 1 Gigabit Ethernet 1550-TX/1310-RX WDM Singlemode, 20 km range, MSA Standard Compatible	47.00

## INTEGRA OPTICS SMART CODER PLUS

The Smart Coder+ is the perfect device to maintain, test and recode your SFPs, SFP+s and QSFP+s. This device can recode any FIS SFP to over 50 OEM platforms to fit the device required. The testing option of the Smart Coder+ allows the end user to conduct diagnostic monitoring on both FIS and Non-FIS brand Transceivers. Testing includes transmit power, receive power, temperature, performance and more.

PART #	DESCRIPTION	PRICE
SMARTCODER+	SMART CODER PLUS enables you to easily reconfigure pluggable transceivers	\$2,500.00



## BUILD YOUR OWN CUSTOM SFP

### FIBER INSTRUMENT SALES SFP MODULES DESIGNED SPECIFICALLY FOR YOUR NETWORK

The FIS SFP fiber modules are custom built to order, to fit your network's specifications. Use the chart below to create your custom part number. When ready contact a FIS sales representative for ordering information.

ITEM NUMBER INITIALIZER	WAVELENGTH	RANGE	ETHERNET BIT RATE	COMPATIBILITY
F1-SFP	M85	550	1G	MS
	M85 = Multimode 850 M13 = Multimode 1300 S13 = Singlemode 1310 S15 = Singlemode 1550 B135 = Single Fiber 1310/1550 TX/RX B153 = Single Fiber 1550/1310 TX/RX  <b>Note:</b> Contact your FIS Sales Representative for information on CWDM and DWDM SFPs	300m = 300m (SX) 550m = 550m (SX) 2k = 2km (SX) 10k = 10km (LX) 40k = 40km (EX) 80k = 80km (ZX) 120k = 120km (EZ)	FE = 100 MBit (Fast Ethernet) 1G = 1 Gigabit 10G = 10 Gigabit 40G = 40 Gigabit	MS = MSA CP = OEM Compatible  <b>Note:</b> FIS SFPs can be programmed for compatibility with OEM equipment offered by manufacturers including: Alcatel-Lucent, Allied Telesis, Arris, Avaya, Cisco, Dell, Enterasys, Extreme, HP, Hirschmann, Huawei, IBM, Intel, Juniper, Moxa, Netgear, Nokia Siemens, Nortel, AND many more. Contact your FIS Representative with the manufacturer's SFP model number to cross reference.

**EXAMPLE : F1-SFP-M85-550-1G-MS**  
**FIS LIST PRICE: \$60.00**

## QSFP+ AOC (ACTIVE OPTICAL CABLE) 40 GIG

A QSFP+ (Quad Small Form-factor Pluggable) active optical cable (AOC) is the combination of a passive fiber optic cable and the active QSFP+s required to achieve 40 Gig network speeds. When purchasing this cable you have both the active and passive components needed to complete a 40 Gbps Ethernet circuit. The passive fiber optic portion of the AOC is a Singlemode or Multimode MPO to MPO connector cable (you chose the length) with 12 fibers (lanes). The reason for 12 fibers instead of the traditional 2 (one transmit, one receive) is due to the fact that the fiber equipment (QSFP+) only has the ability to transmit at a maximum speed of 10 Gbps per lane, due to this speed limitation it is required to use a minimum of 8 fibers to achieve the 40 Gbps required. The active components of the AOC are the 2 QSFP+ modules that are attached to ends of the passive fiber cable. The QSFP+ uses 8 total fibers, 4 fibers (4 x 10 Gbps = 40 Gbps) in each direction for a total of 8. AOCs are hot-pluggable (swappable) which makes using it a convenient and fast installation. Use the part number table to configure your AOC cable's length, fiber and cable type. All AOCs come with pull tabs for each SFP removal. Contact your FIS representative for pricing.



PART #	DESCRIPTION	PRICE
F4M-AOC-QSFP-F-1-1	High Speed (40 Gig) Quad SFP+ (QSFP+) Fiber Optic Assembly 1 meter, MM, OM3	\$145.00
	Each additional meter	2.15ea

## QSFP+ AOC (Active Optical Cable)

## ORDER CODES



**F4M-AOC - QSFP - F - S - S**



Note:

- 1) Various cable lengths available for all types
- 2) Long lengths available
- 3) Latch/tab available on Top or Bottom position

CODE	TYPE	CABLE LENGTH		CABLE TYPE	
F4M-AOC	QSFP-F (Fiber) QSFP+ Assembly	5	5m	1	Standard OM3
		10	10m	S	Specify
		..	..		
		50	50m		
		100	100m		
		S	Specify		

## QSFP+ COPPER CABLE 40 GIG

A high speed QSFP+ (Quad Small Form-factor Pluggable) cable is the combination of a twinax copper cable and the active QSFP+s required to achieve 40 Gig network speeds. The copper portion of the cable is a single twinax to twinax connection. The copper cable can range from 30 to 24 AWG; due to power requirements it is recommended that cables over 3 meters utilize 24 AWG. The active components of this cable are the 2 QSFP+ modules that are attached to ends of the twinax cable. All of these cables are hot-pluggable (swappable). Use the part number table to configure your cable's length, AWG (American Wire Gauge) and cable jacket type (PVC, or Non-Halogen). All AOCs come with pull tabs for each SFP removal. Contact your FIS representative for pricing.



PART #	DESCRIPTION	PRICE
F4M-QSFP-C-.5-30-1	High Speed (40 Gig) Quad SFP+(QSFP+) Copper Cable 30AWG PVC Jacket, half meter	\$38.00
	Each additional half meter	1.40ea
F4M-QSFP-C-3.5-24-1	High Speed (40 Gig) Quad SFP+(QSFP+) Copper Cable 24AWG PVC Jacket, 3.5 meters	\$87.00
	Each additional half meter	2.60ea

## High Speed QSFP+ Copper Cable

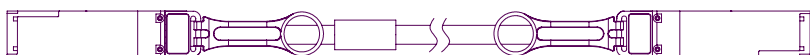

**F4M - QSFP-C - S - 28 - 1**

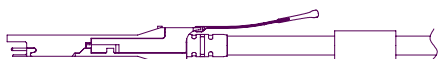

Note:

- 1) Copper type maximum length recommended at 15 meters
- 2) Various cable lengths available for all types
- 3) Latch/tab available on Top or Bottom position

CODE	TYPE	CABLE LENGTH		AWG	CABLE JACKET
F4M-	QSFP-C	5	5m	30	30AWG 1 PVC
	QSFP-CA	10	10m	28	28AWG 2 Non-Halogen
		15	15m	26	26AWG 3 Other
		S	Specify	24	24AWG



## SFP+ COPPER/COPPER ACTIVE CABLE 10 GIG

A high speed SFP+ (Small Form-factor Pluggable) cable is the combination of a twinax copper cable and the active SPF+s required to achieve 10 Gig network speeds. The copper portion of the cable is a single twinax to twinax connection. The copper cable can range from 30 to 24 AWG; due to power requirements it is recommended that cables over 3 meters utilize 24 AWG. The active components of this cable are the 2 SFP+ modules that are attached to ends of the twinax cable. All of these cables are hot-pluggable (swappable). Use the part number table to configure your cable's length, AWG (American Wire Gauge) and cable jacket type (PVC, or Non-Halogen). All AOCs come with pull tabs for each SFP removal. Contact your FIS representative for pricing.



PART #	DESCRIPTION	PRICE
F4M-SFPP-C-.5-30-1	10 Gig SFP+ Copper Cable 30AWG PVC Jacket, half meter	\$15.00
	Each additional half meter	1.25ea

## High Speed SFP+Copper Cable



F4M - SFPP - C - 5 - 28 - 1



CODE	TYPE	CABLE LENGTH	AWG	CABLE JACKET	
F4M-	SFPP-C	SFP+/Copper	1 1m	30 30AWG	1 PVC
	SFPP-CA	SFP+/Copper Active	5 5m	28 28AWG	2 Non-Halogen
			10 10m	26 26AWG	3 Other
			S Specify	24 24AWG	

Note:

- 1) Copper type maximum length recommended at 15 meters
- 2) Various cable lengths available for all types
- 3) Latch/tab available on Top or Bottom position

## QSFP+ TO 4X SFP+ BREAKOUT CABLE ASSEMBLIES 40 GIG - 10GIG

A high speed SFP+ (Small Form-factor Pluggable) cable is the combination of a twinax copper cable and the active SPF+s required to achieve 10 Gig network speeds. The copper portion of the cable is a single twinax to twinax connection. The copper cable can range from 30 to 24 AWG; due to power requirements it is recommended that cables over 3 meters utilize 24 AWG. The active components of this cable are the 2 SFP+ modules that are attached to ends of the twinax cable. All of these cables are hot-pluggable (swappable). Use the part number table to configure your cable's length, AWG (American Wire Gauge) and cable jacket type (PVC, or Non-Halogen). All AOCs come with pull tabs for each SFP removal. Contact your FIS representative for pricing.



PART #	DESCRIPTION	PRICE
F4M-QSSFP-C-1-30-1	QSFP+ to 4x SFP+ Breakout cable assemblies 30AWG, 1 meter, 40 Gig - 10Gig	\$79.00
	Each additional meter	1.40ea
F4M-QSSFP-C-4-24-1	QSFP+ to 4x SFP+ Breakout cable assemblies 24AWG, 4 meters, 40 Gig - 10Gig	\$94.00
	Each additional meter	13.50ea

## QSFP+ to 4x SFP+ Breakout Cable Assemblies

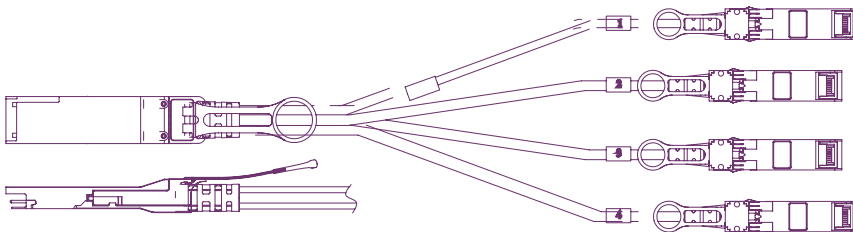

F4M - QSSFP - C - 1 - 28 - 2

CODE	TYPE	CABLE LENGTH	AWG	CABLE JACKET	
F4M-	QSSFP-C	QSFP+ to 4XSFP	1 1m	30 30AWG	1 PVC
			5 5m	28 28AWG	2 Non-Halogen
			10 10m	26 26AWG	3 Other
			S Specify	24 24AWG	

Note:

- 1) Various cable lengths available for all types
- 2) Latch/tab available on Top or Bottom position



# FIS MEDIA CONVERTERS AND SWITCHES

FIS offers a full line of quality Ethernet network active equipment, including fixed and SFP port multiport media converters and switch gear, as well as a comprehensive line of SFPs to match your specific network requirements.



F1-SFP0101G

### FIS MEDIA CONVERTERS 10/100 BASE

These Ethernet Media Converters meet IEEE Standards and are 10/100Base-TX and 100Base-FX with MDI/MDI-X auto negotiation. Full set of LED Indicators and 10/100Mbps and full/half duplex automatically configured in twisted pair port. The Multimode converters have a range of 2km and the Singlemode converters have a range of 20km.

PART #	DESCRIPTION	PRICE
F1-OEC3251-202	10/100 Base-T/TX to 100 Base-FX Media Converter, MM/FC 2km	70.00
F1-DU-100-13-20-ST	10/100 Base-T/TX to 100 Base-FX Media Converter, SM/SC 20km	50.00
F1-DU-100-13-20-FC	10/100 Base-T/TX to 100 Base-FX Media Converter, SM/ST 20km	50.00
F1-DU-100-13-2-FC	10/100 Base-T/TX to 100 Base-FX Media Converter, SM/FC 20km	50.00



F1-DU10001320SC

### FIS MEDIA CONVERTERS 10/100/1000 BASE

The FIS 10/100/1000 Base media converters are designed to convert 1000BASE-SX fiber to 1000Base-T copper media or vice versa. These Ethernet Media Converters meet IEEE Standards and have MDI/MDI-X auto negotiation.

See SFP modules on page 161

PART #	DESCRIPTION	PRICE
F1-DU-1000-13-2-ST	10/100/1000 Base-T/TX to 1000 Base-FX Media Converter, MM/ST 220m (62.5) / 550m (50)	\$75.00
F1-DU-1000-13-2-SC	10/100/1000 Base-T/TX to 1000 Base-FX Media Converter, MM/SC 220m (62.5) / 550m (50)	75.00
F1-DU-1000-13-20-ST	10/100/1000 Base-T/TX to 1000 Base-FX Media Converter, SM/ST 20km	75.00
F1-DU-1000-13-20-SC	10/100/1000 Base-T/TX to 1000 Base-FX Media Converter, SM/SC 20km	75.00
F1-SFP0101G	10/100/1000 Base-T/TX to 1000 Base-FX Media Converter, SFP Port	60.00
F1-SFP01P02	Media Converter (2) x 1.25 Gigabit SFP to (1) 2.5 Gigabit SFP	195.00



F1-DU4001320

### FIS SWITCHES 10/100 BASE

These FIS Switches are an inexpensive way to connect remote LAN devices using an existing fiber backbone. FIS has multiple options available for both Multimode and Singlemode. See SFP modules on page 161

PART #	DESCRIPTION	PRICE
F1-DU4001320	10/100 Switch, Multimode, SC, 4UTP	\$60.00
F1-SFP0107F	10/100M Switch, SFP Slot, 7UTP	60.00
F1-SFP0116F	10/100M Switch, SFP Slot, 16UTP	150.00



F1-SFP0801G

### FIS SWITCHES 10/100/1000 BASE

These FIS 10/100/1000 base switches are built with multiple SFP ports to support a wide range of network requirements. This powerful feature enables the switch to be extremely versatile at a low cost to the installer.

See SFP modules on page 161

PART #	DESCRIPTION	PRICE
F1-SFP0202G	10/100/1000 Media Converter, 2 SFP Slots, 2UTP	\$75.00
F1-SFP0204G	10/100/1000 Media Converter, 2 SFP Slots, 4UTP	120.00
F1-SFP0801G	10/100/1000 Media Converter, 8 SFP Slots, 1UTP	165.00

### FIS PoE SWITCHES

The FIS PoE Switch provides power and data from a single point, using power over Ethernet over a single CAT5e cable. The eight RJ45 network ports plus one fiber port can be used for any 10/100 Mbps link and four of these ports can supply industry-standard IEEE 802.3af power.

PART #	DESCRIPTION	PRICE
F1-PSE1009F	8 Port 10/100Mbps 802.3af PoE + 1-Port Fiber 10/100Mbps Desktop Switch	\$165.00
F1-PSE1009F-35-20	8 Port 10/100Mbps 802.3af PoE + 1-Port Fiber 10/100Mbps, Fiber is 1310nmT/1550nmR, 20Km	175.00



F1-SWMM1

### FIS THREE-PORT MINI SWITCHES

FIS mini-switches provide a simple and inexpensive way to add additional computers to a network. The 3-Port Mini Switch has (2) 100Mbps fiber ports and (1) 10/100Mbps twisted pair copper port.

PART #	DESCRIPTION	PRICE
F1-SWMM1	3-Port Mini Switch with (2) 100Base-FX MM/SC and One 10/100Base-T/TX Port	\$77.95
F1-SWSM1	3-Port Mini Switch with (2) 100Base-FX SM/SC and One 10/100Base-T/TX Port	95.00



FIS 8-Port Mini Switches

### FIS EIGHT-PORT DESKTOP SWITCHES

This 8-Port Switch is an inexpensive way to connect remote LAN devices using existing fiber backbone. FIS has 8-Port Desktop Switches with one fiber port in each. The 8-port switch has (1)100 Base-FX and (7) 10/100 Base-T/TX ports. Multimode units support up to 2km and Singlemode up to 20km. External power supply included.

PART #	DESCRIPTION	PRICE
F1-JC08A-MS	8-Port Switch with 1 MM/SC Fiber Port and (7) 10/100 Twisted Pair Ports	\$80.00
F1-JC08A-MT	8-Port Switch with 1 MM/ST Fiber Port and (7) 10/100 Twisted Pair Ports	80.00
F1-JC08A-S2	8-Port Switch with 1 SM/SC Fiber Port and (7) 10/100 Twisted Pair Ports	80.00

## SIGNAMAX MEDIA CONVERTERS

Signamax Connectivity Systems Switching Media Converters provide intelligent solutions for long distance connections between legacy copper networks and new fiber based installations. Extended distance Singlemode, as well as Gigabit versions are also available. Use the same converters for either wall or chassis mount. **Lifetime warranty.**

PART #	DESCRIPTION	DISTANCE	PRICE
065-1100	10/100 Base-T/TX to 100 Base-FX, MM/ST (with link fault signaling)	2km	\$95.00
065-1110	10/100 Base-T/TX to 100 Base-FX, MM/SC (with link fault signaling)	2km	95.00
065-1120	10/100 Base-T/TX to 100 Base-FX, SM/SC (with link fault signaling)	15km	235.00
065-1120ED	10/100 Base-T/TX to 100 Base-FX, SM/SC (with link fault signaling)	40km	390.00
065-1174	10/100 Base-T/TX to 100 Base FX MM/LC (with link fault signaling)	2km	160.00
065-1132	100 Base-FX, SM/SC to 100 Base-FX MM/SC	15km SM / 2km MM	432.00
065-1050ASC	10/100 Base-T/TX to 100 Base-FX, PoE/ PoE+ (PSE) SC/MM	2km	123.50
065-1196SFPDR*	10/100/1000 Base-T/TX to 1000/100 Base-SFP Converter	SFP	235.00
065-1196A	10/100/1000 Base-T/TX to 1000 Base-SX, MM/SC Switching	220m (62.5) / 550m (50)	310.00
065-1196AED	10/100/1000 Base-T/TX to 1000 Base-SX, MM/SC Switching	2km	713.00
065-1196ALX	10/100/1000 Base-T/TX to 1000 Base-LX, SM/SC Switching	10km	545.00
065-1195	1000 Base-TX to 1000 Base-SX MM/SC Gigabit Converter	220m (62.5) / 550m (50)	315.00
065-1194	1000 Base-LX SM/SC to 1000 Base-SX MM/SC Gigabit Converter	10km SM / 220m (62.5) / 550m (50)	868.00
065-1194ED	1000 Base-SX MM/SC to 1000 Base-LX SM/SC Extended Distance	20km	990.00
065-1197	1000 Base-T to 1000 Base-LX SM/SC (with link fault signaling)	10km	570.00
065-1050GSFP*	10/100/1000 Base-T/TX to 1000 Base-SFP, (PSE), PoE/PoE+	SFP	360.75
065-1200SC10	12-Channel Media Converter 10/100 Base-TX to 100 Base-FX MM/SC	2km	1,600.00
065-1200SC20	12-Channel Media Converter 10/100 Base-TX to 100 Base-FX SM/SC	15km	3,900.00
065-1200SC95	12-Channel Media Converter 1000 Base-TX to 1000 Base-SX MM/SC	220m(62.5) / 550m (50)	3,600.00

\*(Note: Fiber Types and Distances SFP dependent and SFP Insert Modules Sold Separately)

# SIGNAMAX



065-1110



SC10070

## SIGNAMAX GIGABIT UNMANAGED ETHERNET SWITCHES

PART #	DESCRIPTION	PRICE
SC10100	8 Port 10/100/1000 Base T/TX (RJ45) Unmanaged Compact Switch	38.00
SC10070	16 Port 10/100/1000 Base T/TX (RJ45) with 2 - 1000/GbE SFP Ports Unmanaged Switch	162.00
SC10040	24 Port 10/100/1000 Base T/TX (RJ45) with 2 - 1000/GbE SFP Ports Unmanaged Switch	199.00
SC30010	48 Port 10/100/1000 Base T/TX (RJ45) with 4 - 1000/GbE SFP Ports Unmanaged Switch	620.00



SC30060

## SIGNAMAX GIGABIT MANAGED ETHERNET SWITCHES

PART #	DESCRIPTION	PRICE
SC30060	8 Port 10/100/1000 Base T/TX (RJ45) with 2 - 1000/GbE SFP Ports Managed Switch	174.00
SC30040	24 Port 10/100/1000 Base T/TX (RJ45) with 4 - 1000/GbE SFP Ports Managed Switch	372.00



SC10060

## SIGNAMAX UNMANAGED POWER OVER ETHERNET (PoE+) SWITCHES

PART #	DESCRIPTION	PRICE
SC10110	4 Port 10/100/1000 Base T/TX (RJ45) PoE+ 2 - 10/100/1000 Base T/TX (RJ45) Unmanaged Switch	106.00
SC10090	8 Port 10/100 Base T/TX (RJ45) PoE+ 1 - 10/100 Base T/TX (RJ45) Unmanaged Switch	155.00
SC10080	8 Port 10/100/1000 Base T/TX (RJ45) PoE+ 2 - 1000/GbE SFP Ports Unmanaged Switch	248.00
SC10060	16 Port 10/100 Base T/TX (RJ45) PoE+ 2 - 1000/GbE SFP Ports Unmanaged Switch	310.00
SC10050	16 Port 10/100/1000 Base T/TX (RJ45) PoE+ 2 - 1000/GbE SFP Ports Unmanaged Switch	372.00
SC10020	24 Port 10/100 Base T/TX (RJ45) PoE+ 2 - 1000/GbE SFP Ports Unmanaged Switch	422.00
SC10010	24 Port 10/100/1000 Base T/TX (RJ45) PoE+ 2 - 1000/GbE SFP Ports Unmanaged Switch	496.00



## SIGNAMAX



SC30030

### SIGNAMAX MANAGED POWER OVER ETHERNET (PoE+) SWITCHES

This new stackable managed power over ethernet (PoE) switch provides the capability to remotely power wireless access points, VoIP telephones, powered device media converters and other devices that meet the IEEE 802.1af PoE standard.

PART #	DESCRIPTION	PRICE
SC30050	8 Port 10/100/1000 Base T/TX (RJ45) PoE+ 2 - 1000/GbE SFP Ports Managed Switch	372.00
SC30030	24 Port 10/100/1000 Base T/TX (RJ45) PoE+ 4 - 1000/GbE SFP Ports Managed Switch	558.00
SC30020	24 Port 10/100/1000 Base T/TX (RJ45) PoE+ 4 - 1000/GbE SFP Ports Full Power Managed Switch	744.00



SC10120

### SIGNAMAX FIBER ETHERNET ACCESS SWITCHES

Signamax's fiber Ethernet switches accommodate growing networks that require fiber connectivity. With 8 or 24 SFP ports these switches can be configured with multiple media types (UTP, Multimode and Singlemode fiber) for Gigabit and Fast Ethernet networks.

PART #	DESCRIPTION	PRICE
065-7310SFP	8 Port 100 Base SFP (RJ45) with 1-10/100/1000 Base T/TX Dual Media Port PoE+ 1 - 1000/GbE SFP Ports Unmanaged Switch	248.00
SC10120	8 Port 1000/GbE SFP Ports with 2-10/100/1000 Base T/TX Dual Media Port Unmanaged Switch	273.00
065-7890FSFPDP	24 Port 100/1000 SFP Ports with 4-10/100/1000 Base T/TX Ports with 4 - Dual Media Ports supporting 10/100/1000 Base T/TX Ports plus 4 - 1000 Base / 10 GbE SFP+	1,984.00



SI30040

### SIGNAMAX MANAGED INDUSTRIAL SWITCHES

These Hardened Managed Switches are designed to operate in rugged environments with extreme temperature conditions -40° F to 167° F (-40° C to 75° C).

PART #	DESCRIPTION	PRICE
SI30050	8 Port 10/100/1000 Base T/TX (RJ45) 2 - 1000/GbE SFP Ports Industrial Managed Switch	682.00
SI30040	8 Port 10/100/1000 Base T/TX (RJ45) PoE+ 2 - 1000/GbE SFP Ports Industrial Managed Switch	868.00
SI30030	16 Port 10/100/1000 Base T/TX (RJ45) 4 - 1000/GbE SFP Ports Industrial Managed Switch	1,240.00
SI30020	16 Port 10/100/1000 Base T/TX (RJ45) PoE+ 2 - 1000/GbE SFP Ports Industrial Managed Switch	1,488.00
SI30010	8 Port 10/100/1000 Base T/TX (RJ45) 8 - 100/1000/GbE SFP Ports 4 - 1000/GbE SFP Ports Industrial Managed Switch	1,364.00



MI10060

### SIGNAMAX DIN-RAIL INDUSTRIAL HARDENED MEDIA CONVERTERS

Signamax Din-Rail Industrial Hardened Media Converters have been developed to operate in harsh industrial environments that require ruggedized equipment that can operate in severe temperature extremes. These media converters are an affordable solution for outdoor environments, transportation roadside systems, shop floors, and other harsh environments where consistent operation at temperature extremes of -40°F to 167°F (-40°C to 75°C) are necessary.

(Meets NEMA TS1 Environmental Requirements for Traffic Control Equipment)

PART #	DESCRIPTION	PRICE
MI10060	2 Port 10/100 T/TX (RJ45) to 100Base FX SM/SC Industrial Media Converter	248.00
MI10050	2 Port 10/100 T/TX (RJ45) to 100Base FX MM/SC Industrial Media Converter	186.00
MI10040	2 Port 10/100 T/TX (RJ45) PoE+ to 100Base FX SM/SC Industrial Media Converter	372.00
MI10030	2 Port 10/100 T/TX (RJ45) PoE+ to 100Base FX MM/SC Industrial Media Converter	248.00
MI10020	2 Port 10/100/1000 T/TX (RJ45) to 2 - 1000/GbE SFP Ports Industrial Media Converter	248.00
MI10010	2 Port 10/100/1000 T/TX (RJ45) PoE+ to 2 - 1000/GbE SFP Ports Industrial Media Converter	310.00
065-1800GSPZ	10/100/1000Base T/TX to 1000Base SFP Industrial Media Converter PoE+ PSE	496.00
065-1800Z	10/100Base T/TX to 100Base FX Industrial Media Converter PoE+ ST/MM 2km Span	700.60
065-1810Z	10/100Base T/TX to 100Base FX Industrial Media Converter PoE+ SC/MM 3km Span	700.60
065-18200Z	10/100Base T/TX to 100Base FX Industrial Media Converter PoE + SC/SM 20km Span	756.40

[Note: 48 Volt, 75, 120, 240 Watt and 24 Volt, 30,60,75,120 Watt Din Rail Mt. Power supplies available.]



SI10020

### SIGNAMAX UNMANAGED HARDENED INDUSTRIAL SWITCHES

Signamax's Hardened Industrial DIN-Rail Mount Switches have been developed to operate in harsh industrial environments that require ruggedized equipment that can operate in severe temperature extremes. These switches are an affordable solution for outdoor environments, transportation roadside systems, shop floors, and other harsh environments where consistent operation at temperature extremes of -40°F to 167°F (-40°C to 75°C) is necessary. (Meets NEMA TS1 and TS2 Environmental Requirements for Traffic Control Equipment)

PART #	DESCRIPTION	PRICE
SI10050	4 Port 10/100Base T/TX (RJ45) PoE+ and 4 Port 10/100Base T/TX (RJ45) Industrial Switch	137.00
SI10040	4 Port 10/100/1000Base T/TX (RJ45) and 2 - 1000/GbE SFP Ports Industrial Switch	224.00
SI10030	4 Port 10/100/1000Base T/TX (RJ45) PoE+ and 2 - 1000/GbE SFP Ports Industrial Switch	310.00
SI10020	8 Port 10/100/1000Base T/TX (RJ45) and 2 - 1000/GbE SFP Ports Industrial Switch	312.00
SI10010	8 Port 10/100/1000Base T/TX (RJ45) PoE+ and 2 - 1000/GbE SFP Ports Industrial Switch	496.00
065-7407GPOEP	4 Port 10/100/1000Base T/TX (RJ45) PoE+ with 2 - 100/1000X SFP Ports	558.00
065-7410GPOEP	8 Port 10/100/1000Base T/TX (RJ45) PoE+ with 2 - 100/1000X SFP Ports	688.66

[Note: 48 Volt, 75,120,240 Watt and 24 Volt, 30,60,75,120 Watt Din Rail Mt Power Supplies Available. Other 4, 6, 8 Managed 10/100 and 10/100/1000 Industrial Din Rail Mt. Switches available with and without PoE ports available.]

## FIS FIBER OPTIC VIDEO TRANSMITTERS AND RECEIVERS

- Electronic-to-photonic signal conversion
- NTSC/PAL signal
- Low-profile stand-alone devices
- No field adjustments required
- Transparent to cameras and monitoring equipment



Fiber Optic Transmitter

Fiber optic video transmitters and receivers include the ability to convert video signals from coaxial cameras so that they can be transmitted over fiber optic cable. These low-profile stand-a-lone devices can be placed anywhere needed. They require no field adjustments during installation or additional maintenance thereafter. These devices are designed to be transparent to cameras and monitoring equipment regardless of the manufacturer. The receiver includes an indicator light that provides quick verification of system status.

### FIS FIBER OPTIC VIDEO TRANSMITTERS

PART #	DESCRIPTION	FIBER MODE	MAX. DISTANCE	PRICE
S-850TX	Standalone Fiber Optic Video Transmitter	MM 850nm	4 Km	\$95.00
S-1300TX	Standalone Fiber Optic Video Transmitter	MM 1300nm	8 Km	165.00
S-1310TX	Standalone Fiber Optic Video Transmitter	SM 1310nm	20 Km	220.00

### FIS FIBER OPTIC VIDEO RECEIVERS

PART #	DESCRIPTION	FIBER MODE	PRICE
S-850RX	Standalone Fiber Optic Video Receiver	MM 850nm	\$125.00
S-1300RX	Standalone Fiber Optic Video Receiver	SM/MM 1300nm	195.00

All include power supply



Fiber Optic Receiver

### SILENT ALARM TRANSMITTERS AND RECEIVERS

Our single channel 850nm converter is designed to provide a high performance, low cost solution for the transmission of Normally Open/Normally Closed contacts (NO/NC) over a single MM fiber. Alarm installers can now take a dry contact closure and wire it to our Fiber Optic transmitter and when the contact alarms it will convert that signal to light and send it to a receiver. This system allows for longer runs using pure light which can't be defeated by jumping.

PART #	DESCRIPTION	PRICE
S-850SATX	Silent Alarm TX with power supply	\$125.00
S-850SARX	Silent Alarm RX with power supply	125.00



## FIS INSTRUCTIONAL VIDEOS



*Our library of instructional videos is always growing! Check back often to see what's new!*



Access FIS instructional videos at [www.fiberinstrumentsales.com](http://www.fiberinstrumentsales.com)



# **fis** UNIVERSITY

PREMIER FIBER OPTIC EDUCATION

## **About FIS University**

*Founded in 1985 by Fiber Instrument Sales, the nation's leading supplier and manufacturer of fiber optic components, FIS University's instructors have trained more than 20,000+ professionals world-wide in both basic and advanced techniques related to connectorization, test and fiber optic splicing.*



### **Fiber Optics I and II – Two Days**

Classroom sessions provide hands-on instruction with theory, giving students the knowledge needed in today's fiber optic applications. In two consecutive days, students will gain experience with the essential tools used by network installers and technicians.

Classes cover fiber optic splicing, termination methods, network testing and more. Fiber Optics I and II is great for beginners as well as seasoned professionals who want to sharpen their skills.

*View full curriculum and register online at [www.fisuniversity.com](http://www.fisuniversity.com)*



### **Online Fiber Optic Training Course**

This is a perfect way to learn fiber optics at your own pace. This series is based on the extremely popular fiber classes that we have been conducting around the world since 1996. The course can be taken on your computer, right at home or at work. The program is broken down into 20 individual learning chapters devoted to all fiber optic related topics. At the end of each video is a ten question review quiz that reinforces the topics of that session. Each topic will give you an in depth understanding of fiber optics. These videos offer a straight to the point learning experience. From fiber optic history right through to splice on connector termination, these videos are a quick way to pick up the valuable knowledge that you need to have an understanding of the fiber optic industry and its applications. When the course is completed, the student will take a test and upon passing will receive a certificate of completion from FIS.



### **Custom and Corporate**

*Are you looking for fiber optic training uniquely geared for your organization?*

FIS University has developed and delivered thousands of customized courses, DVDs, videos, and other training materials for organizations around the world, each geared specifically to the skill levels and subject matters unique to your organization.

We can train you on your own equipment, or we can bring the entire program to you... including equipment and supplies.

*Learn more at [www.fisuniversity.com](http://www.fisuniversity.com)*





Register online at: [www.fisuniversity.com](http://www.fisuniversity.com)

# Training Sessions Are Held Across The Nation!

## 2020 Training Schedule Fiber Optics I & II

February 25-26 Albany, NY

March 9-10 Atlanta, GA  
March 11-12 Charlotte, NC  
March 24-25 Baltimore, MD

April 14-15 New Orleans, LA  
April 21-22 Pittsburgh, PA

May 11-12 Chicago, IL  
May 13-14 Detroit, MI  
May 26-27 Atlantic City, NJ

June 8-10 Brightside  
June 16-17 Nashville, TN  
June 22-24 Brightside

July 13-15 Brightside  
July 21-22 Denver, CO  
July 27-29 Brightside

August 10-12 Brightside  
August 24-26 Brightside

September 14-16 Brightside  
September 21-23 Brightside  
September 29-30 Albuquerque, NM

October 5-7 Brightside  
October 20-21 Cleveland, OH

November 2-3 Los Angeles, CA  
November 4-5 San Diego, CA  
November 17-18 Washington, DC

December 7-8 Boston, MA  
December 9-10 New York, NY

\*These are tentative dates for the 2020 year and are subject to change. Visit us on the web at [www.fisuniversity.com](http://www.fisuniversity.com) for an up to date schedule.



To learn more about FISU's Training Programs, visit [www.fisuniversity.com](http://www.fisuniversity.com), call 1-800-5000-FIS (347), or email [training@fissales.com](mailto:training@fissales.com)

### Further questions?

Contact Training Coordinator Grace Edel at 315-737-2169 or email [gedel@fissales.com](mailto:gedel@fissales.com)

BICSI recognizes FIS University's Fiber Optic I and II courses for BICSI Continuing Education Credits (CECs)



### FIBER OPTIC TEXTBOOK

PART #	DESCRIPTION	PRICE
F1-9791	FIS Lab Manual 4th Edition	\$19.95

### FIBER OPTIC TRAINING POSTERS

PART #	DESCRIPTION	PRICE
F1-TRANP01	Fiber Optic Connector Chart (24" x 36")	\$20.00
F1-TRANP02	Fiber Optic Cable Guide (24" x 36")	20.00
F1-TRANP03	Optical PM and LS Testing (24" x 36")	20.00

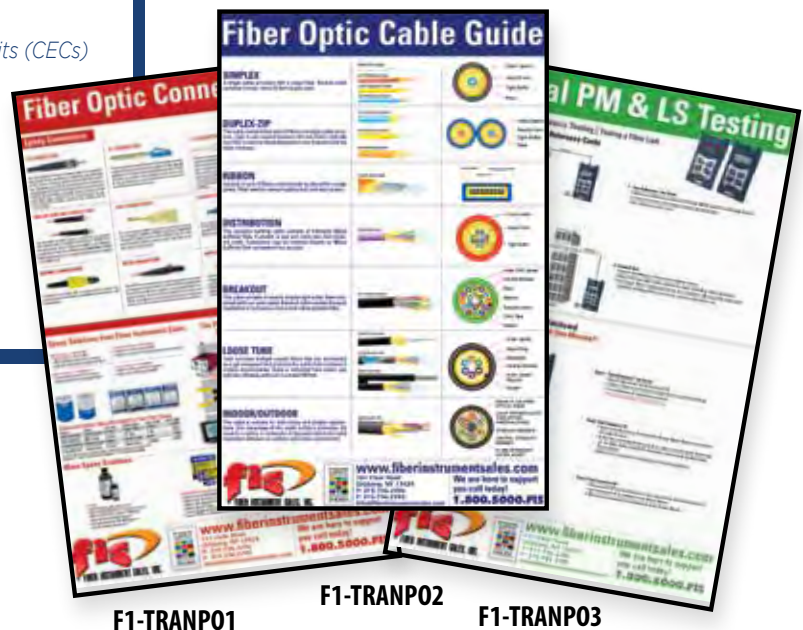

For more information about the tools used in class, recommended books and dvd's for a better understanding of fiber optics go to the website: [www.fisuniversity.com](http://www.fisuniversity.com)

# INDEX

Active Equipment .....	159-164	Connectors & Mating Sleeves .....	95-101, 104-108	Shrink Tubes, Colored .....	136
Adapters, Fiber Optic .....	104-108	Connectors, Bobtail Quick Term .....	95	Signs, Warning .....	140
Adapter Kit, Fiber Optic .....	103	Connectors, FC .....	100, 101	Simplex Cable .....	86, 87
Adapter Plates .....	14-16	Connectors, Fiber Optic .....	95-101	Singlemode Patch Cables .....	26, 27
Adapters, Buffered Fiber .....	103	Connectors, Fusion Splice-On .....	70, 71, 75, 79	SMPT Cable Assemblies .....	36
Adapters, FC Hybrid .....	104, 105	Connectors, Hot Melt .....	96, 97	SMPT Cleaning Kit .....	38
Adapters, Hybrid .....	104, 105	Connectors, LC .....	98	SMPT Ferrule Cleaning Gun .....	37
Adapters, LC Hybrid .....	104, 105	Connectors, MTP .....	99	SMPT Rack Mount Panels .....	39
Adapters, ST Hybrid .....	104, 105	Connectors, MT-RJ .....	99	SMPT Test Set .....	39
Adhesive, Anaerobic .....	120	Connectors, Quick Termination .....	95-97	Sno Shoes, Fiber Optic .....	153
Adhesive, Bobtail .....	95	Connectors, SC .....	101	Specialty Cable .....	85
Adhesives, UV .....	120	Connectors, ST .....	100	Spectrum Analyzer, Optical .....	44, 45, 49
Aerial Cable, Self-Supporting .....	90	Connectors, Terminator .....	34	Spectrum Analyzer, Wireless .....	50, 51
Air Blown Cable .....	94	Consumables .....	112-125	Splice Bridges .....	22
Air, Canned .....	112	Continuity Tester .....	67	Splice Closures, Outdoor .....	145-151, 154, 155
Alcohol Isopropyl .....	113	Copper .....	156-158	Splice on Connectors .....	70, 71, 75, 79
Anaerobic Adhesive .....	120	Copper Cable .....	156	Splice Holding Chips .....	22
Antenna Analyzer .....	50, 51	Copper Cable Assemblies .....	156	Splice Tents .....	141
Aqua Patch Cables, 10 Gig .....	28	Copper Cabling Patch Panels .....	158	Splice Sleeves .....	83
Armored Cable .....	90-91	Copper Connectors, Jacks & Inserts .....	158	Splice Trailer .....	141
Assemblies .....	26-35	Copper Faceplates & Outlets .....	158	Splice Trays .....	15, 22
Attenuators, Bulkhead .....	109	Copper Test Equipment .....	54, 55, 157	Splicers, Fusion .....	69, 72-74, 76-78
Attenuators, Fiber Optic .....	109, 110	Couplers / Splitters .....	21, 35	Splices, Lab .....	82
Backbone Trunk Cable Assemblies .....	30, 31	Coupler Modules .....	21, 35	Splices Mechanical .....	82
Bare Fiber .....	85	Crimp Tools, Fiber Optic .....	134	Splitters, Planar Lightwave .....	35
Bare Fiber Pigtail Kit .....	56	Custom Broadcast Cable Assemblies .....	36	ST Connectors .....	100
Bend Optimized Cable .....	86-91	Custom Cable Assemblies .....	30-33, 36	ST Hybrid Adapters .....	104, 105
Bobtail Adhesive .....	95	Custom Coupler Modules .....	21, 35	ST Mating Sleeves .....	108
Bobtail Installation Kit .....	95	Custom Drilling Service .....	111	Stripping Tools, Cable .....	81, 130, 132
Bobtail Quick Term Connectors .....	95	Custom Fiber Optic Enclosures .....	18-21	Swabs, Fiber Optic .....	118
Boots, Connector .....	102	Custom SFP Modules .....	161	Switch Modules, Ethernet .....	162, 163
Break-Out Kits .....	93	Custom STP Modules .....	57	Switches, Ethernet .....	162, 163
Broadcast Cable Reels .....	39	Custom Mode Conditioning Patch Cables .....	34	Switches, Ethernet Desktop .....	162, 163
Buffered Fiber Adapters .....	103	Custom Patch Panels .....	111	Switches, Mini, Ethernet .....	162
Bulk Connectors & Adapters .....	98, 109	Custom Splitters & CWDM Pre-Terminated Systems .....	21	Syringe, Epoxy .....	121
Bulkhead / Adapter Cleaners .....	117	Custom MTP Backbone Assemblies .....	30, 31	Table, Portable .....	79, 141
Buried Cable Marker Tapes .....	140	Custom Patch Cables .....	32, 33	Tactical/Broadcast Fiber Optic Cable .....	37, 91
Cable .....	86-91	Custom Rack Mounts .....	18-21	Tactical/Broadcast Products .....	36-39
Cable Aerial, Self-Supporting .....	90, 91	Data Center Cabling .....	89	Talk Sets, Fiber Optic .....	61
Cable, Air Blown .....	94	Disposal Unit, Fiber Optic .....	112	Terminator Connectors .....	34
Cable, Armored .....	90-91	Distribution Cable .....	88, 90	Test Boxes .....	57
Cable Assemblies .....	26-34	Drilling Service, Custom .....	111	Test Equipment, Fiber Optic .....	40-68
Cable Assemblies, Broadcast, Custom .....	36	Drop Cables .....	91	Test Equipment, Copper .....	54, 55, 157
Cable Assemblies, Copper .....	156	Duplex Cable .....	86, 87	Test Equipment Rentals .....	8
Cable Assemblies, Custom .....	30-33	E2000 Patch Cables / Mating Sleeves .....	34	Test Equipment, Ruggedized .....	41, 61
Cable Assemblies, SMPT .....	36	Elastomeric Lab Splice .....	82	Test Set, Optical Loss .....	60-63
Cable Assemblies, TFOCA II .....	36	Enclosures, Outdoor .....	145-151, 154, 155	Test Set Rentals .....	8
Cable, Bend Optimized .....	86-91	Enclosures, Rack & Wall Mount .....	10-15, 24	Test Set, SMPT .....	39
Cable Caster .....	137	Epoxy .....	120	TFOCA II Cable Assemblies .....	36
Cable Clamps .....	138	Epoxy Application Syringe .....	121	Tie Wraps .....	138
Cable, Copper .....	156	Epoxy Connectors .....	98-101	Tight Buffer Cable .....	85
Cable, Custom Fiber Optic .....	84	Ethernet Active Devices .....	162-164	Tools .....	126-141
Cable Cutting / Slitting Tools .....	131-133	Ethernet Desktop Switches .....	162, 163	Tool Kits, Fiber Optic .....	126-129
Cable Dispenser .....	39, 137	Ethernet Fiber Modules .....	162, 163	Tools, Cable Preparation .....	130-133, 135
Cable, Distribution .....	88, 90	Ethernet Mini Switches .....	162	Tools, Copper Cabling .....	158
Cable, Drop .....	91	Ethernet Switches .....	162, 163	Tracetape .....	137
Cable, Duplex .....	86, 87	Eye Loupe Set .....	135	Trailer, Splice .....	141
Cable, Fiber Optic .....	87-91	Fan-Out Kits .....	93	Training & Education .....	166, 167
Cable, Fiber, Tactical/Broadcast .....	37, 91	Fault Locator .....	67	Transceivers, Fiber Optic .....	165
Cable, Gigabit .....	86-90	FC Connectors .....	100, 101	Trunk Cable Assemblies, Backbone .....	30, 31
Cable, Large Core Fiber Optic .....	85	FC Hybrid Adapters .....	104, 105	UV Adhesives .....	120
Cable, Loose Tube .....	90	FC Mating Sleeves .....	104, 105, 108	Velcro Roll .....	138
Cable Management .....	23, 25	Ferrule Protection Caps .....	102	Video Microscopes .....	49, 64-65
Cable Management Racks .....	25	Ferrules, Connector .....	85	Video Transmitters & Receivers .....	165
Cable, Micro-Distribution .....	89	Fiber, Bare .....	85	Visual Fault Locator .....	66
Cable Preparation Tools .....	130-133, 135	Fiber Fence Security .....	142, 143	Wave Division Multiplexers .....	21, 35
Cable Pull Tape / String .....	137	Fiber Identifier .....	58, 59	WDM's .....	21, 35
Cable Pulling Lubricant .....	137	Fiber Inspection Probes .....	49, 64-66	Wireless Test Equipment .....	50, 51
Cable Reels, Broadcast .....	39	Fiber Modules, Ethernet .....	162, 163	Work Tables/Platforms .....	79, 141
Cable, Ribbon .....	85	Fiber Optic Adapter Kit .....	103		
Cable, Simplex .....	86, 87	Fiber Optic Attenuators .....	109, 110		
Cable Spools .....	84, 137	Fiber Optic Cable .....	86-91		
Cable Stripping Tools .....	81, 130, 132	Fiber Optic Cleaning Solutions .....	113, 115		
Cable Ties .....	138	Fiber Optic Cleaning Wipes .....	112-115		
Cable, Tight Buffer .....	85	Fiber Optic Connectors .....	95-101		
Calibration Services .....	9	Fiber Optic Disposal Unit .....	112		
Canned Air .....	112	Fiber Optic Patch Cables .....	26-34		
Cap & Chain, Metal .....	103	Fiber Optic Sensors .....	142, 143		
Cat 5e, 6, 6A Products .....	156-158	Fiber Optic Swabs .....	118		
Cleaning Kits .....	119, 129	Fiber Optic Talk Sets .....	61		
Cleaning Pen, Fiber Optic .....	113	Fiber Optic Tool Kits .....	126-129		
Cleaning Solutions, Fiber Optic .....	113, 115	Fiber, Specialty .....	85		
Cleaning Wipes, Fiber Optic .....	112-115	Fish Tape/Poles .....	137		
Cleavers, Fiber Optic .....	80, 81	Flush Mount Patch Frame .....	10		
Closures, Outdoor, Splice .....	145-151, 154, 155	Furcation Tubes .....	92		
Compact Node Cables .....	34	Fusion Splice-On Connectors .....	70, 71, 75, 79		
Connectors, Fiber Optic .....	95-101	Fusion Splicer Rentals .....	8		
Connector Boots .....	102	Fusion Splitters .....	69, 72-74, 76-78		
Connector Cleaner Cartridges .....	116, 117	Glasses, Safety and Magnifying .....	135		
Connector Epoxy .....	120	Hand Tools .....	130-136		
Connector Ferrules .....	111	Heat Gun .....	136		
Connector Heat Ovens .....	121	Heat Ovens, Connector .....	121		
Connector Removal Tools .....	136	Heater Protection Sleeve .....	121		
Connectors & Adapters Bulk .....	98, 109	Hermaphroditic 4 Channel Connectors .....	36		
Hot Melt Connectors .....	96, 97				
Hybrid Adapters .....	104, 105				
Identifier, Fiber .....	58, 59				
Infrared Detection Card .....	56				
Innerduct and Accessories .....	94				
Inspection Microscopes .....	64				
Inspection Probes .....	49, 64-66				
Interconnects, Rack .....	10, 11, 14, 15				
Kim Wipes .....	113				
Kits, Installation .....	126-128				
Kits/Connector Restoration .....	95				
Labels .....	139, 140				
Laser Safety Caps .....	103				
Launch Boxes .....	57				
LC Connectors .....	98				
LC Hybrid Adapters .....	104, 105				
LC Mating Sleeves .....	107				
Locators, Underground .....	141				
Loopback Modules .....	34				
Loose Tube Cable .....	90				
Magnifying and Safety Glasses .....	135				
Mandrels .....	56				
Marker Tapes, Buried Cable .....	140				
Matching Gel .....	112				
Mating Sleeves, FC .....	108				
Mating Sleeves, LC .....	107				
Mating Sleeves, SC .....	106				
Mating Sleeves, ST .....	108				
Mechanical Splice Protection Sleeves .....	82				
Mechanical Splices .....	82				
Media Converters .....	162-164				
Micro-Distribution Cable .....	89				
Microscopes, Inspection .....	64-66				
Microscopes, Video .....	64-66				
Mini OTDR's .....	41-44, 51-53				
Mode Conditioning Patch Cables .....	34				
MTP Backbone Assemblies, Custom .....	30-31				
MTP Cassettes .....	19, 20				
MTP Connectors .....	99				
MT-RJ Connectors/Mating Sleeves .....	99, 108				
MU Connectors/Mating Sleeves .....	108				
Multimode Patch Cables .....	28, 29				
NIDs, Fiber Optic .....	154, 155				
Node Cables, Compact .....	34				
Optical Couplant .....	112				
Optical Loss Test Equipment .....	60-63				
Optical Spectrum Analyzer .....	44, 45, 49				
OTDR Test Boxes .....	57				
OTDR Rentals .....	8				
OTDR's .....	40-48, 50-54				
Outside Plant .....	144-155				
Oven Protection Sleeves .....	121				
Patch Panels, Copper Cabling .....	158				
Patch Panels, Fiber Optic .....	10-12, 14, 15				
Patch Cables, Fiber Optic .....	26-34				
Patch Cables, 10 Gig OM3 & OM4 Aqua .....	28				
Patch Cables, Custom .....	30-33				
Patch Cables, Fiber Optic .....	26-34				
Patch Cables, Mode Conditioning .....	34				
Patch Cables, Multimode .....	28, 29				
Patch Cables, Polarization Maintaining .....	34				
Patch Cables, Singlemode .....	26, 27				
Piano Wire .....	112				
Pigtail, Gold Tipped .....	56				
Pigtail Kit, Bare Fiber .....	56				
Pigtail Snap Packs .....	17				
Pigtails for Splicing .....	17				
Pigtails, Distribution Style .....	17				
Planar Lightwave Splitters .....	35				
Plastic Fiber Optic Cable .....	84				
Plates, Adapter .....	14-17				
Pocket Fault Locator .....	67				
Polarization Maintaining Patch Cables .....	34				
Polish Films .....	122-123				
Polish Machines .....	124				
Polish Plates, Pads & Mats .....	125				
Polishing Discs .....	125				
Power Meter & Light Source .....	60-63				
Power Meter/Light Source Rentals .....	8				
Precision Cleavers .....	80				
Pre-loaded Distribution Interconnects .....	18, 19, 21				
Probe, Inspection .....	62, 64-66				
Protection Sleeve Heater .....	70				
Pulse Boxes, Test .....	57				
Quick Termination Connectors .....	95-97				
Rack & Wall Mount Enclosures .....	10-15				
Rack Mounts, Custom .....	18-21				
Racks, Cable Management .....	23, 25				
Rentals .....	8				
Ribbon Cable .....	85				
SC Adapter Caps .....	102, 103				
SC Connectors .....	101				
SC Mating Sleeves .....	104-106				
Scribe Tools .....	134				
Sensors, Fiber Optic .....	142, 143				
Service Cables .....	34				
Service Vacuum .....	23				
SFP-Small Form Pluggable .....	161				

## TRAINING

Fiber Optic Lab Manual .....	167
Fiber Optic Training Posters .....	167
Textbooks .....	167
Training Programs .....	166
Training Schedule .....	167

# FIS SATISFACTION GUARANTEED POLICY

If you are not 100% satisfied with your order, call toll-free to arrange for an exchange or return of goods. Any stock items contained in this catalog may be returned upon your prompt inspection of received goods.

Any discrepancies with an order must be reported to FIS within 24 hours of receipt. Returned Merchandise Authorization (RMA) numbers must be requested within 3 days of receipt of your product and returned to FIS head office within 7 days from receipt of goods. All product returned must be marked with an FIS RMA number and be new and in unopened, full shipping unit quantities. Credit cannot be issued without an FIS authorized RMA. Custom made and uncataloged items will not be accepted for return. FIS reserves the right to charge a re-stocking fee.

**Order Information:** Minimum Order: \$50.00. Terms: 30 days net. FOB: Oriskany, New York. Amex, Discover, Mastercard and Visa accepted. In all cases freight will be charged for all product shipped. Overdue accounts are subject to a 2% monthly finance charge. In case of price deviations, notification will be made prior to processing of your order. Photographs may not accurately portray present product. Specification sheets available on most catalog items. Quantity discounts available on all items upon request. First time orders for new accounts cannot be processed unless accompanied by a completed credit application. Please allow 3 working days for your application to be processed. TERMS: Net 30 days from date of invoice unless otherwise stated.

**IMPORTANT NOTICE:** Prices subject to change without notice. All statements, technical information and recommendations related to the Seller's products are based on information believed to be reliable, but the accuracy or completeness thereof is not guaranteed. Before utilizing the product, the user should determine the suitability of the product for its intended use. The user assumes all risks and liability whatsoever in connection with such use. Any statements of recommendations of the Seller which are not contained in the Seller's current publication shall have no force or effect unless contained in an agreement(s) signed by an authorized officer of Seller.

## TERMS AND CONDITIONS

### Warranty Overview

Fiber Instrument Sales Inc, hereafter referred to as FIS, warrants that a product will be free from defects in materials and workmanship and conforms to FIS Specifications. The warranty period for a product is a specified, fixed period commencing on the customer's date of purchase. A valid proof of purchase may be required. If the customer does not have a valid proof of purchase, the warranty period will be measured from the date of sale indicated within FIS records. If, during the warranty period, the product is not in good working order, FIS may, at its option, repair or replace it at no additional charge, except as is set forth below.

The warranty period for products sold and manufactured by FIS is as follows:

- All products, excluding test and fiber splicing equipment: 30 Days
- FIS manufactured test and fiber splicing equipment: 1 year
- Distributed test and fiber splicing equipment: Original manufacturer's warranty applies

### Items Not Covered by Warranty

FIS does not warrant uninterrupted or error-free operation of product or equipment. Unless specified otherwise, FIS references the original equipment manufacturer's warranty and its subsequent requirements on non-Fiber Instrument Sales Inc. products. Any technical or other support provided for a product under warranty, such as assistance via telephone with "how-to" questions and those regarding use, setup and installation, will be provided WITHOUT WARRANTIES OF ANY KIND.

### Extent of Warranty

The warranty does not cover the repair or exchange of a product resulting from misuse, accident, modification, unsuitable physical or operating environment, improper maintenance by the customer, or failure caused by a product for which FIS is not responsible. The warranty may be voided by removal or alteration of product, parts, security or identification labels.

THESE WARRANTIES ARE THE CUSTOMER'S EXCLUSIVE WARRANTIES AND REPLACE ALL OTHER WARRANTIES OR CONDITIONS, EXPRESS OR IMPLIED, INCLUDING, BUT NOT LIMITED TO, THE IMPLIED WARRANTIES OR CONDITIONS OF MERCHANTABILITY AND FITNESS FOR A PARTICULAR PURPOSE. THESE WARRANTIES GIVE THE CUSTOMER SPECIFIC LEGAL RIGHTS AND YOU MAY ALSO HAVE OTHER RIGHTS WHICH VARY FROM JURISDICTION TO JURISDICTION. SOME JURISDICTIONS DO NOT ALLOW THE EXCLUSION OR LIMITATION OF EXPRESS OR IMPLIED WARRANTIES, SO THE ABOVE EXCLUSION OR LIMITATION MAY NOT APPLY TO THE CUSTOMER. IN THAT EVENT, SUCH WARRANTIES ARE LIMITED IN DURATION TO THE WARRANTY PERIOD. NO WARRANTIES APPLY AFTER THAT PERIOD.

### Warranty Service

Warranty service may be obtained from FIS by returning a Return Material Authorization Form (RMA), during the warranty period for the FIS-manufactured product, to FIS's Quality Assurance Manager. The customer may be required to present proof of purchase or other similar proof of warranty entitlement. The customer may be responsible for any associated transportation charges, duties and insurance. The product, once arriving at FIS, will be evaluated to determine cause of failure, with warranty action determined from evaluation.



Fiber Instrument Sales, Inc.  
161 Clear Road  
Oriskany, NY 13424

Standard  
U.S. Postage  
**PAID**  
Fiber Instrument  
Sales, Inc.



Download the  
catalog onto  
your smartphone



## ASSOCIATIONS:



Society of Cable  
Telecommunications  
Engineers



## PARTNERS:

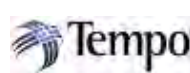

161 Clear Road, Oriskany, NY 13424  
Outside the US: 1-315-736-2206

Fax: (315) 736-2285  
Email: info@fiberinstrumentsales.com