

Cruise Summary Report – MEDWAVES survey

MEDiterranean out flow WAter and Vulnerable Ecosystems (MEDWAVES)

21st September - 26th October 2016

Research Vessel Sarmiento de Gamboa
(UTM-CSIC)



Covadonga Orejas, Anna Addamo, Marta Álvarez, Alberto Aparicio, Daniel Alcoverro, Sophie Arnaud-Haond, Meri Bilan, Joana Boavida, Verónica Cañzos, Rubén Calderón, Peregrino Cambeiro, Mónica Castaño, Alan Fox, Marina Gallardo, Andrea Gori, Cristina Gutiérrez, Lea-Anne Henry, Miriam Hermida, Juan Antonio Jiménez, José Luis López-Jurado, Pablo Lozano, Ángel Mateo-Ramírez, Guillem Mateu, José Luis Matoso, Carlos Méndez, Ana Morillas, Juancho Movilla, Alejandro Olariaga, Manuel Paredes, Víctor Pelayo, Safo Piñeiro, Maria Rakka, Teodoro Ramírez, Manuela Ramos, Jesus Reis, Jesús Rivera, Alberto Romero, José Luis Rueda, Toni Salvador, Íris Sampaio, Héctor Sánchez, Rocío Santiago, Alberto Serrano, Gerald Taranto, Javier Urrea, Pedro Vélez-Belchí, Nuria Viladrich, Martha Zein

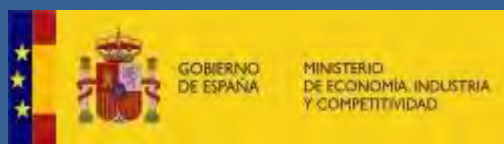



Cruise Summary Report - MEDWAVES survey
MEDiterranean out flow WAter and Vulnerable EcosystemS
(MEDWAVES)

21st September - 26th October 2016

Research Vessel Sarmiento de Gamboa (UTM-CSIC)

Chief Scientist: Covadonga Orejas Saco del Valle (Instituto Español de Oceanografía)

Recommended citation: Covadonga Orejas, Anna Addamo, Marta Álvarez, Alberto Aparicio, Daniel Alcoverro, Sophie Arnaud-Haond, Meri Bilan, Joana Boavida, Verónica Caínzos, Rubén Calderón, Peregrino Cambeiro, Mónica Castaño, Alan Fox, Marina Gallardo, Andrea Gori, Cristina Gutiérrez, Lea-Anne Henry, Miriam Hermida, Juan Antonio Jiménez, José Luis López-Jurado, Pablo Lozano, Ángel Mateo-Ramírez, Guillem Mateu, José Luis Matoso, Carlos Méndez, Ana Morillas, Juancho Movilla, Alejandro Olariaga, Manuel Paredes, Víctor Pelayo, Safo Piñeiro, Maria Rakka, Teodoro Ramírez, Manuela Ramos, Jesus Reis, Jesús Rivera, Alberto Romero, José Luis Rueda, Toni Salvador, Íris Sampaio, Héctor Sánchez, Rocío Santiago, Alberto Serrano, Gerald Taranto, Javier Urra, Pedro Vélez-Belchí, Nuria Viladrich, Martha Zein (2017) Cruise Summary Report - MEDWAVES survey. (MEDiterranean out flow WAter and Vulnerable EcosystemS), 21st September 26th October 2016. doi:10.5281/zenodo.556516



This project has received funding from the European Union's Horizon 2020 research and innovation programme under grant agreement No 678760 (ATLAS). This output reflects only the author's view and the European Union cannot be held responsible for any use that may be made of the information contained therein.

Contents

1. Executive summary.....	9
2. Introduction	11
3. Aims.....	12
4. Research Vessel Sarmiento de Gamboa	13
5. Mobile equipment on board for MEDWAVES: gears and instruments	14
6. Participants	16
6.1 Researchers and technicians.....	16
6.2 Sarmiento de Gamboa crew members	17
6.3 Scientists responsible for each type of data generated within MEDWAVES	18
7. Cruise itinerary	20
8. Narrative.....	21
9. MEDWAVES research and technical teams.....	28
9.1 Physical oceanography.....	31
9.1.1 <i>Personnel involved</i>	31
9.1.2 <i>Introduction. Aims</i>	31
9.1.3 <i>Sampling methodology</i>	32
9.1.4 <i>Instrumentation details</i>	34
9.1.5 <i>Problems encountered</i>	35
9.1.6 <i>Processing methodology</i>	35
9.1.7 <i>Calibration information</i>	36
9.1.8 <i>Preliminary results</i>	37
9.2 Biogeochemical characterization of water masses over oceanic seamounts	60
9.2.1 <i>Personnel involved</i>	60
9.2.2 <i>Introduction. Aims</i>	60
9.2.3 <i>Sampling and processing methodology (water sampling and analyses)</i>	61
9.2.4 <i>Instrumentation details</i>	73
9.2.5 <i>Problems encountered</i>	73
9.2.6 <i>Calibration information</i>	73
9.2.7 <i>Preliminary results</i>	74
9.3 Geomorphology and Habitat mapping	79
9.3.1 <i>Personnel involved</i>	79
9.3.2 <i>Introduction. Aims</i>	79
9.3.3 <i>Sampling methodology. Swath Bathymetry. ROV survey support</i>	81
9.3.4 <i>Instrument details and calibration information</i>	82

9.3.5	<i>Problems encountered</i>	82
9.3.6	<i>Preliminary results. Postprocessing</i>	82
9.4	Benthic ecology. Benthic biodiversity team.....	93
9.4.1	<i>Personnel involved</i>	93
9.4.2	<i>Introduction. Aims</i>	94
9.4.3	<i>Sampling methodology. Postprocessing. Instrument details</i>	96
9.4.4	<i>Problems encountered</i>	101
9.4.5	<i>Preliminary results</i>	102
9.5	Benthic ecology. Biogeochemical composition of the sedimentary organic matter ..	105
9.5.1	<i>Personnel involved</i>	105
9.5.2	<i>Introduction. Aims</i>	105
9.5.3	<i>Sampling methodology. Postprocessing</i>	108
9.5.4	<i>Instrumentation details and calibration information</i>	108
9.5.5	<i>Problems encountered</i>	108
9.5.6	<i>Preliminary results</i>	108
9.6	Benthic ecology. Foraminiferan fauna.....	111
9.6.1	<i>Personnel involved</i>	111
9.6.2	<i>Introduction. Aims</i>	112
9.6.3	<i>Sampling methodology. Postprocessing</i>	113
9.6.4	<i>Instrumentation details and calibration information</i>	115
9.6.5	<i>Problems encountered</i>	115
9.6.6	<i>Preliminary results</i>	115
9.7	Benthic ecology. Benthic annotation team (ROV / OFOP live annotations), collection of specimens for taxonomical purposes.....	117
9.7.1	<i>Personnel involved</i>	117
9.7.2	<i>Introduction. Aims</i>	118
9.7.3	<i>Sampling methodology. Postprocessing. ROV video recording and OFOP live video annotation</i>	119
9.7.4	<i>Instrumentation details and calibration information</i>	120
9.7.5	<i>Problems encountered</i>	120
9.7.6	<i>Preliminary results</i>	120
9.8	Benthic ecology. ROV video transects.....	140
9.8.1	<i>Personnel involved</i>	140
9.8.2	<i>Introduction. Aims</i>	141
9.8.3	<i>Sampling methodology. Processing methodology</i>	141
9.8.4	<i>Instrumentation details and calibration information</i>	142
9.8.5	<i>Problems encountered</i>	142
9.8.6	<i>Preliminary results. Brief description of all ROV dives conducted during MEDWAVES.</i> ..	142

9.9	Zooplankton sampling test with a new sampler prototype for the Liropus ROV	172
9.9.1	<i>Personnel involved</i>	172
9.9.2	<i>Introduction. Aims</i>	173
9.9.3	<i>Instrumentation details. Construction and adaptation to the Liropus ROV</i>	173
9.9.4	<i>Problems encountered</i>	178
9.9.5	<i>Operation on board</i>	178
9.10	Evolutionary ecology. Sampling for eDNA (WP3) and connectivity (WP4)	180
9.10.1	<i>Personnel involved</i>	180
9.10.2	<i>Introduction. Aims</i>	180
9.10.3	<i>Sampling methodology</i>	183
9.10.4	<i>Instruments detail and calibration</i>	191
9.10.5	<i>Problems encountered</i>	191
9.10.6	<i>Preliminary results</i>	191
9.11	Ecophysiology of cold-water corals and coral maintenance in aquaria	192
9.11.1	<i>Personnel involved</i>	192
9.11.2	<i>Introduction. Aims</i>	192
9.11.3	<i>Sampling Methodology. Aquaria set-up</i>	194
9.11.4	<i>Preliminary results.</i>	195
9.12	Outreach activities	204
9.12.1	<i>Personnel involved</i>	204
9.12.2	<i>MEDWAVES facebook page</i>	204
9.12.3	<i>MEDWAVES Blog</i>	205
9.12.4	<i>Ways Of the Waves (WOW). Artistic outreach project</i>	206
9.12.5	<i>Press releases, radio interviews and EURONEWS program</i>	207
9.13	Acknowledgements	209

List of Appendixes to this cruise report

Appendix I Work program of the research teams (page 3-22 of the appendix)

Appendix II General Station list MEDWAVES (page 25-35 of the appendix)

Appendix III Overview Meteorological conditions during MEDWAVES (page 39-50 of the appendix)

Appendix IV Biogeochemical oceanography General List (page 53-78 of the appendix)

Appendix V.1, V.2 Biogeochemical oceanography. pH and Carbonates data. (page 81-94 and 97-100 of the appendix)

Appendix VI MB lines (page 105-113 of the appendix)

Appendix VII Benthic samples descriptive plates (page 117-167 of the appendix)

Appendix VIII List ROV stations (page 171 of the appendix)

Appendix IX OFOP user guide (page 175-195 of the appendix)

Appendix X List of ROV samples collected during MEDWAVES (page 199-203 of the appendix)

Appendix XI List of hydroids collected during MEDWAVES (page 207 of the appendix)

Appendix XII MEDWAVES photocatalog samples on deck and UW ROV images (page 211-260 of the appendix)

Appendix XIII ACSM technical report (only available in Spanish) (page 263-279 of the appendix)

Appendix XIV Standardised ATLAS sampling protocols for DNA (page 283-297 of the appendix)

Appendix XV Technical report UTM (only available in Spanish) (page 301-364 of the appendix)

1. Executive summary

The MEDWAVES (MEDiterranean out flow WAter and Vulnerable EcosystemS) cruise targeted areas under the potential influence of the MOW within the Mediterranean and Atlantic realms. These include seamounts where Cold-water corals (CWCs) have been reported but that are still poorly known, and which may act as essential “stepping stones” connecting fauna of seamounts in the Mediterranean with those of the continental shelf of Portugal, the Azores and the Mid-Atlantic Ridge. During MEDWAVES sampling has been conducted in two of the case studies of ATLAS: **Case study 7** (Gulf of Cádiz-Strait of Gibraltar-Alboran Sea) and **Case study 8** (Azores).

The initially targeted areas in the Atlantic were: the Gazul Mud volcano, in the Gulf of Cádiz (GoC) area, included in the case study 7, and the Atlantic seamounts Ormonde (Portuguese shelf) and Formigas (by Azores), both part of the case study 8. In the Mediterranean the targeted areas were The Guadiaro submarine canyon and the Seco de los Olivos (also known as Chella Bank) seamount. Unfortunately it was not possible to sample in Guadiaro due to time constraints originated by adverse meteorological conditions which obligate us to reduce the time at sea focusing only in 4 of the 5 initially planned areas.

MEDWAVES was structured in two legs; the first leg took place from the 21st September (departure from Cádiz harbour in Spain) to the 13th October 2016 (arrival in Ponta Delgada, São Miguel, Azores, Portugal took place the 8th of October due to the meteorological conditions that obligated to conclude the first leg earlier as planned). during the Leg 1 sampling was carried out in Gazul, Ormonde and Formigas. The second leg started the 14th October (departure from Ponta Delgada) and finished the 26th October (arrival in Málaga harbour, Spain). MEDWAVES had a total of 30 effective sampling days, being 6 days not operative due to the adverse meteorological conditions experienced during the first leg which forced us to stay in Ponta Delgada from the 08th to the 13th October.

During MEDWAVES the daily routine followed a similar scheme, depending of course on the weather and sea conditions. The main activity during the day, starting early in the morning (around 08:00 AM, once the night activities were finished), was the ROV deployment. Generally a single ROV dive of around 8 hours was performed, however in several occasions two dives were carried out in the same day (see General station list, Appendix II). After the ROV (and sometimes between two dives) the Box Corer and/or Van Veen Grab and/or Multicore was deployed. After these activities,

during the night CTD-Rosette deployments and MB was conducted. Accordingly to this schema the scientific personnel worked in the day or in the night watch.

A total of 215 sampling stations have been covered in MEDWAVES, using the following sampling gears: Multibeam echosounder, CTD-Rosette, LADCP, Box Corer, Van Veen Grab, Multicorer and a Remotely Operated Vehicle (ROV). Table 1 summarised the number of sampling stations conducted with each gear in each sampling zone. Additionally MB surveys have been conducted during the transits between areas.

Table 1: number of stations sampled with each utilised gear and in each research area

	MB	CTD-Rosetter	Irradiance profiler	Box-Corer	Van Veen Grab	Multicorer	ROV
Gazul Mud Volcano	3	24	0	4	0	1	3
Ormonde Seamount	6	27	0	1	6	2	6
Formigas Seamount	12	42	4	0	23	4	10
Seco de los Olivos	0	21	0	0	15	3	7
	21	114	4	5	44	10	26

2. Introduction

The Strait of Gibraltar (SG) and the surrounding areas, Gulf of Cádiz (GoC) in the Atlantic, and Alboran sea (AS) in the Mediterranean, are key areas to understand the distribution and connectivity of marine communities (Patarnello et al. 2007), as the SG and the encounter of water masses at the Almeria Oran front represent an oceanographic transition area, connecting the Atlantic Ocean and the Mediterranean Sea (Lacombe & Richez 1982).

The Mediterranean water flows out from Gibraltar (MOW), extends towards the East of the Atlantic, building a warm and salty water mass which propagates in North West direction from Portugal originating the “Mediterranean Water” (MW) in the Atlantic. This warm and salty water mass becomes characteristic of the North Atlantic in mid waters (around 1100 m) (Candela 2001). The occurrence of CWC communities in the NE Atlantic has been related to the pathway of the MOW, whereby this current system would have an historical influence on the migration of coral larvae and (re)colonization of the Atlantic in the post-glacial era (De Mol et al. 2005, Henry et al. 2014).

The MEDWAVES (MEDiterranean out flow Water and Vulnerable EcosystemS) cruise target areas under the potential influence of the MOW within the Mediterranean and Atlantic realms. These include seamounts where CWC have been reported but that are still poorly known, and which may act as essential “stepping stones” connecting fauna of seamounts in the Mediterranean with those of the continental shelf of Portugal, the Azores and the Mid-Atlantic Ridge. During MEDWAVES sampling will be conducted through two of the case studies of ATLAS: **Case study 7** (Gulf of Cádiz-Strait of Gibraltar-Alboran Sea) and **Case study 8** (Azores).

References

- Candela J (2001) Mediterranean water and global circulation. *International Geophysics*. 77:419-XLVIII
- De Mol B, Henriot J-P, Canals M (2005) Development of coral banks in Porcupine Seabight: do they have Mediterranean ancestors? *Cold-Water Corals and Ecosystems*: Springer; p. 515-33
- Henry LA, Vad J, Findlay HS, Murillo J, Milligan R, Roberts JM. (2014) Environmental variability and biodiversity of megabenthos on the Hebrides Terrace Seamount (Northeast Atlantic). *Scientific reports* 4: 5589
- Lacombe H, Richez C (1982) The regime of the Strait of Gibraltar. Elsevier Oceanography Series. 34: 13-73

Patarnello T, Volckaert FAMJ, Castilho R (2007) Pillars of Hercules: is the Atlantic–Mediterranean transition a phylogeographical break? *Molecular Ecology* 16: 4426–4444

3. Aims

The main goals of the cruise were:

(1) to characterize physically and biogeochemically the MOW Path and understand its interaction with the general Atlantic Meridional Overturning Circulation (AMOC) stream, from the Alboran Sea to the Azores, through the Gulf of Cádiz, and the Ormonde Seamount (see map), exploring the relationship between the oceanographic settings of these target areas and the ecosystems therein (**ATLAS WP1 and WP3**) and

(2) to characterize communities associated with the transition area, and sample for population genetic analysis aiming at understanding the way the populations located in the target areas contribute or have contributed to connectivity between the Mediterranean Sea and the Atlantic Ocean (**ATLAS WP3 and WP4**). Results gathered during the cruise will also contribute later to feed other ATLAS WPs.

The activities conducted to achieve these aims are included in the section 9 of this cruise report where the activities of the different groups are presented. Previous to the cruise all participants delivered a plan of activities to develop. This document is attached as Appendix I.

4. Research Vessel Sarmiento de Gamboa

Operator: Unidad de Tecnología Marina (UTM, CSIC)

Country: Spain

Website: <http://www.utm.csic.es/sarmiento.asp>

Vessel Type: Multipurpose Research Vessel

Vessel Class: Global

Scientist berths: 26

Length: 70.5m



Figure 1: The research vessel Sarmiento de Gamboa in Cádiz harbour just before MEDWAVES started. (Photograph: Ángel Mateo-Ramírez).

Features:

The Sarmiento de Gamboa (Fig. 1) is a multidisciplinary research vessel, equipped for oceanography, geology, geophysics, hydrography, and fisheries research. The vessel has several science laboratories on board (250 m²) including a wet lab and a CTD Hangar (55 m²), as well as different freezing storage (50 m²) is a "quiet" vessel in terms of radiated noise to water. The vessel can operate deep sea ROVs, AUV, piston corer and large multichannel seismic (6,000 m) in addition to fixed scientific equipment on board.

Onboard scientific equipment:

The ship is equipped with an acoustic "gondola" with Multibeam (shallow and deep waters), single beam (hydrographical) and parametric echosounder transducers installed on the lower surface, which provides very high resolution seafloor mapping

and penetration into sub bottom surface respectively. This "gondola" is an "airplane-like" structure mounted on the hull. This structure is separated from the hull avoiding the bubbles produced by the bow of the ship that could affect the acoustic transducers installed on the lower surface. The ship also has two drop keels installed in the middle part of the ship. They can be lowered 3 meters below the keel to separate the transducers installed from the hull, avoiding the acoustic noise produced by water flux and from hull itself.

The complete list of equipment is as follows: Simrad EA600 (12 / 200 kHz).

Hydrography single beam echosounder. Installed on gondola. Simrad EK-60 (18 / 38 / 120/ 200 kHz.) Biologic echosounder. Installed on drop keel. Atlas DS (15 kHz). Deep water Multibeam echosounder. Installed on gondola. Atlas MD (50 kHz). Medium / shallow water multibeam echosounder. Installed on gondola. Atlas P35 (18 kHz).

Parametric Subbottom Profiler. Installed on gondola. RDI 75/150 kHz. ADCP Installed on gondola. IXSEA Posidonia. Acoustic Underwater Ultra Short Baseline (USBL) positioning. Installed on gondola. Scanmar net sensors (Trawl eye / Depth / Catch / Tension / Speed / Distance-Depth) with shipborne transducers installed on drop keel.

CTD, LHPR, SeaSoar from near the surface to depths down to 500 meters while moving at speeds up to 12 knots.

Deck equipment: Cranes and Winches CTD 8000 m. Coax Ø 11 mm Plankton sampling 6000 m / Ø 6 mm Coring 8000 m / Ø 16 mm Elect. Nets 7000 m / Coax Ø 14 mm 2 x mobile 20 ton trawling Multipurpose Cranes Aft A- frame Main crane (12Tons) Starboard A-Frame 2 x Aux. Cranes CTD Telescopic Crane.

5. Mobile equipment on board for MEDWAVES: gears and instruments

Sampling equipment and analysers on board (items underlined have been supplied by the researchers, the rest of the equipment belong to the vessel and is available on board). Scientist responsables of each gear/instrument have also been included.

- 2 CTD- Rosette. (SBE 911 with TC redundant sensors (3 pairs)+ with rosette (24 bottles, 12 litre each) and LADCP of 300 kHz with two heads, one of them master and the other slave, equipped with a nephelometer (Responsible Researchers (RR): P. Vélez-Belchí, J.L. López Jurado, S. Piñeiro, J.A. Jiménez)
- SBE21 with Turner fluorometer, temperature, conductivity and fluorescence (RR: P. Vélez-Belchí, J.L. López Jurado, S. Piñeiro, J.A. Jiménez)
- QSP-2300 radiance sensor (RR: P. Vélez-Belchí)
- ADCP and EK-60 (RR: P. Vélez-Belchí, J.L. López Jurado, S. Piñeiro, J.A. Jiménez)
- Multibeam echosounder (RR: J. Rivera / M. Hermida)
- ROV "Liropus" Super Mohawk (RR: C. Orejas / J. Rivera / M. Hermida)

- Box Corer 30 x 20 cm (RR: J.L. Rueda / J. Urra)
- Two different Van Veen dredges (36 x 30 cm) supplied by the Oceanographic Centres of Baleares and Málaga of the Spanish Institute of Oceanography (RR: J.L. Rueda / J. Urra)
- Multicorer (RR: S. Arnaud-Haond / J. Boavida)
- Side Scan Sonar DT 1 (RR: J. Rivera / M. Hermida)

Equipment and instruments for on board observations and analyses (items underlined have been supplied by the researchers, the rest of the equipment belong to the vessel and is available on board). Scientists responsables of each gear/instrument have also been included.

- Two stereomicroscopes (Nikon SMZ 645, Nikon SMZ 1500), cold lights, photcamera adaptable to the stereomicroscope (Nikon DS-FI1) (RR: J.L. Rueda)
- Spectrophotometer Perkin Elmer Lambda 850UV-VIS (RR: R. Santiago / A. Aparicio)
- Portasal (RR: R. Santiago / A. Aparicio)
- Three Metro titrando 808 (RR: R. Santiago / A. Aparicio)
- Vacuum pump (RR: C. Orejas)
- Chillers, pumps, filters, aquaria for maintenance of living organisms on board (RR: C. Orejas)
- Filtration equipment (RR: C. Orejas)
- Milli Q (Technicians UTM)
- Freezers -80°C y -20°C (Technicians UTM)
- Thermo baths (4 units) (RR: R. Santiago / A. Aparicio)
- Oven (RR: S. Arnaud-Haond)
- Refrigerated Microcentrifuge (RR: S. Arnaud-Haond)
- Vortex (RR: S. Arnaud-Haond)
- Sieves of different sizes and large container for sieving (RR: J.L. Rueda)

In the Appendix XV to this report the technical report from UTM has also been added (available only in Spanish).

Note: All gears used on board were operated and deployed by the technicians from the UTM (Unidad de Tecnología Marina, CSIC) and the crew.

6. Participants

In the following tables the information regarding the participants (researchers and technicians as well as crew) and the scientist responsible for each data set are displayed. Figures 1 and 2 correspond respectively to the participants in Leg 1 and Leg 2 of MEDWAVES.

6.1 Researchers and technicians

	Expertise	Name	email	1st leg (21.09- 13.10)	2nd leg (14.10- 26.10)	Institution
1	Physical Oceanography	López-Jurado, JL	lopez.jurado@ba.ieo.es	X		IEO/COB
2	Physical Oceanography	Vélez-Belchí, P	pedro.velez@oceanografia.es	X		IEO/COC
3	Physical Oceanography	Piñeiro, S	safopineiro@ba.ieo.es		X	IEO/COB
4	Physical Oceanography	Jiménez, JA	juan.jimenez@ba.ieo.es		X	IEO/COB
5	Physical Oceanography	Reis, J	Jesus.reis@oom.arditi.pt	X		ARDITI
6	Physical Oceanography	Fox, A	a.fox@hw.ac.uk		X	HW University
7	Biogeochemical Oceanography	Pelayo, V	vpelayo89@hotmail.com	X	X	IEO/COC
8	Biogeochemical Oceanography	Aparicio, A	alberto.aparicio@ba.ieo.es		X	IEO/COB
9	Biogeochemical Oceanography	Santiago, R	rocio.santiago@ba.ieo.es	X		IEO/COB
10	Biogeochemical Oceanography	Cainzos, V	veronica.cainzos@ba.ieo.es	X	X	IEO/COC
11	Benthos biol. & ecol. / PI	Orejas, C	cova.orejas@ba.ieo.es	X	X	IEO/COC
12	Benthos biol. & ecol.	Rueda, JL	jose.rueda@ma.ieo.es		X	IEO/COMA
13	Benthos biol. & ecol.	Gallardo, M	mgallardo@ma.ieo.es		X	IEO/COMA
14	Benthos biol. & ecol.	Mateo-Ramírez, Á	a.mateoramirez@gmail.com	X		UMA
15	Benthos biol. & ecol.	Urra, J	javier.urrarecuero@gmail.com	X		UMA
16	Benthos biol. & ecol.	Sampaio, Í	irisfs@gmail.com	X		IMAR-U Azores /Seckenberg am Meer
17	Benthos biol. & ecol.	Henry, LA	L.Henry@hw.ac.uk	X		Edinburgh Uni.
18	Benthos biol. & ecol.	Ramos, M	manuramo@gmail.com		X	IMAR-U Azores
19	Benthos biol. & ecol.	Rakka, M	marianinha.rk@gmail.com	X		IMAR-U

						Azores
20	Benthos biol. & ecol.	Movilla, J	jmovilla@icm.csic.es	X	X	ICM-CSIC
21	Benthos biol. & ecol.	Viladrich, N	viladrich.nuria@gmail.com		X	ICM-CSIC
22	Benthos biol. & ecol.	Gutiérrez, C	cgz.1991@gmail.com		X	A. Finisterrae
23	Benthos biol. & ecol.	Taranto, G	gh.taranto@gmail.com		X	IMAR-U Azores
24	Benthos biol. & ecol.	Bilan, M	meribilan@gmail.com	X		IMAR-U Azores
25	Evolutionary ecology	Arnaud-Haond, S	s-arnaud@univ-montp2.fr	X		IFREMER
26	Evolutionary ecology	Boavida, J	joanarboavida@gmail.com		X	IFREMER
27	Evolutionary ecology	Addamo, AM	am.addamo@gmail.com		X	MNCN- CSIC Madrid
28	Geomorphology	Rivera, J	jesus.rivera@md.ieo.es	X		IEO/Madrid
29	Geomorphology	Hermida, M	miriam.hermida@gmail.com	X	X	U Alcalá Henares
30	UTM Responsible (acoustic, CTD)	Paredes, M	mparedes@utm.csic.es	X	X	UTM (CSIC)
31	UTM (mechanic, Box corer, Van Veen, MUC)	Cambeiro, P	pirri@utm.csic.es	X	X	UTM (CSIC)
32	UTM (acoustic)	Sánchez, H	hsanchez@utm.csic.es	X	X	UTM (CSIC)
33	UTM (electronics, CTD)	Salvador, T	asalvador@utm.csic.es	X	X	UTM (CSIC)
34	UTM (laboratories)	Alcoverro, D	daniel@utm.csic.es	X	X	UTM (CSIC)
35	UTM (Computer, IT)	Serrano, JA	serrano@utm.csic.es	X	X	UTM (CSIC)
36	ROV operator 1 (ACSM)	Méndez, C	barbanzano@hotmail.com	X	X	ACSM
37	ROV operator 2 (ACSM)	Romero, A	alberto.alroga@hotmail.com	X	X	ACSM
38	ROV operator 3 (ACSM)	Calderón, R	rubencalderon91@hotmail.com	X	X	ACSM

6.2 Sarmiento de Gamboa crew members

	Name	Role
1	Campos Ramos, María Ángeles	Master
2	Rovira Gols, Arnau	1st Officer
3	Hérmendez Bernal, Juan Carlos	2nd Officer
4	Palacio Díaz, Mario	Chief engineer
5	Rico Lázaro, Pablo Antonio	Engine officer
6	García Varela, Juan Francisco	Bosun
7	Moledo García, Antonio	Deck crew
8	García Julián, Alberto	Deck crew
9	Barreiro Pereira, Óscar	Deck crew
10	García Giraldez, Manuel Ángel	Deck crew

11	Méndez Vaqueiro, Alejandro	Oiler
12	Campos Pereira, Gabriel	Oiler
13	Castiñeira Rivas, Eduardo	Oiler
14	Cousillas Varela, José Manuel	1st Chef
15	Castro Fonseca, Salvador	2nd Chef
16	Alonso Martínez, Estefanía	Bridge student
17	Ananyeva Ananyeva, Ilona	Bridge student
18	Delgado Espinoza, Fidel Ryan	Bridge student
19	Santos Alonso, José	Engine student

6.3 Scientists responsables for each type of data generated within MEDWAVES

	Expertise	Name	email	Institution
1	Physical Oceanography	Vélez-Belchí, P	pedro.velez@oceanografia.es	IEO/COB
2	Biogeochemical Oceanography	Álvarez, M	marta.alvarez@co.ieo.es	IEO/COC
3	Multibeam data	Rivera, J	jesus.rivera@md.ieo.es	IEO /Madrid
4	Benthic ecology Van Veen grab and Boxcorer samples	Rueda, JL	jose.rueda@ma.ieo.es	IEO/COMA
5	Benthic biology taxonomy octocorals, scleractinians, black corals ROV samples Ormonde and Formigas	Sampaio, Í	irisfs@gmail.com	IMAR-U Azores
6	Benthic biology taxonomy ROV samples Gazul, Seco de los Olivos	Rueda, JL	jose.rueda@ma.ieo.es	IEO/COMA
7	Benthic biology taxonomy hydroid ROV samples	Henry, LA	L.Henry@hw.ac.uk	Edinburgh Uni.
8	Benthic ecology OFOP data	Bilan, M Taranto, G	meribilan@gmail.com gh.taranto@gmail.com	IMAR-U Azores
9	Benthic ecology ROV transects quantitative processing	Orejas, C	cova.orejas@ba.ieo.es	IEO/COB
10	Ecophysiology	Viladrich, N	viladrich.nuria@gmail.com	ICM-CSIC
11	Molecular biology data	Arnaud-Haond, S	s-arnaud@univ-montp2.fr	IFREMER
12	Foraminiferan fauna	Mateu, G	guillem.mateu@uib.es	UIB
13	Biogeochemical analysis sediment	Ramírez, T	teodoro.ramirez@ma.ieo.es	IEO/COMA



Figure 1: Participants of MEDWSVES LEG 1 in Ponta Delgada harbour.



Figure 2: Participants of MEDWSVES LEG 2 at sea on the way to Málaga harbour.

7. Cruise itinerary

The originally planned itinerary from MEDWAVES included 5 research areas: Gazul Mud volcano, Ormonde Seamount, Formigas Seamount, Guadiaro submarine canyon and Seco de los Olivos Seamount. The weather conditions (see Executive summary and Narrative, chapter 8) force us to remove one of the areas from our sampling schema, the Guadiaro submarine canyon. The figure 1 a, b show the followed itinerary in the first (a) and second (b) leg respectively.

MEDWAVES first leg started the afternoon (17:30 local time) of the 21st September of 2016 in Cádiz harbour. During the first leg three of the five targeted areas were visited (details can be read in chapter 8), finishing the 8th of October (arriving in the harbour at 20:00, local time) in São Miguel. The adverse weather conditions in the area forced us to remain in the harbour until the 14th of October, date when the second leg of MEDWAVES started leaving the harbour at 14:30 (local time). During this second leg three of the five targeted areas have been explored (details can be read in chapter 8), finishing the MEDWAVES cruise the 26th of October 2016 in Málaga harbour arriving at 08:30 local time. The general station list is included in Appendix II

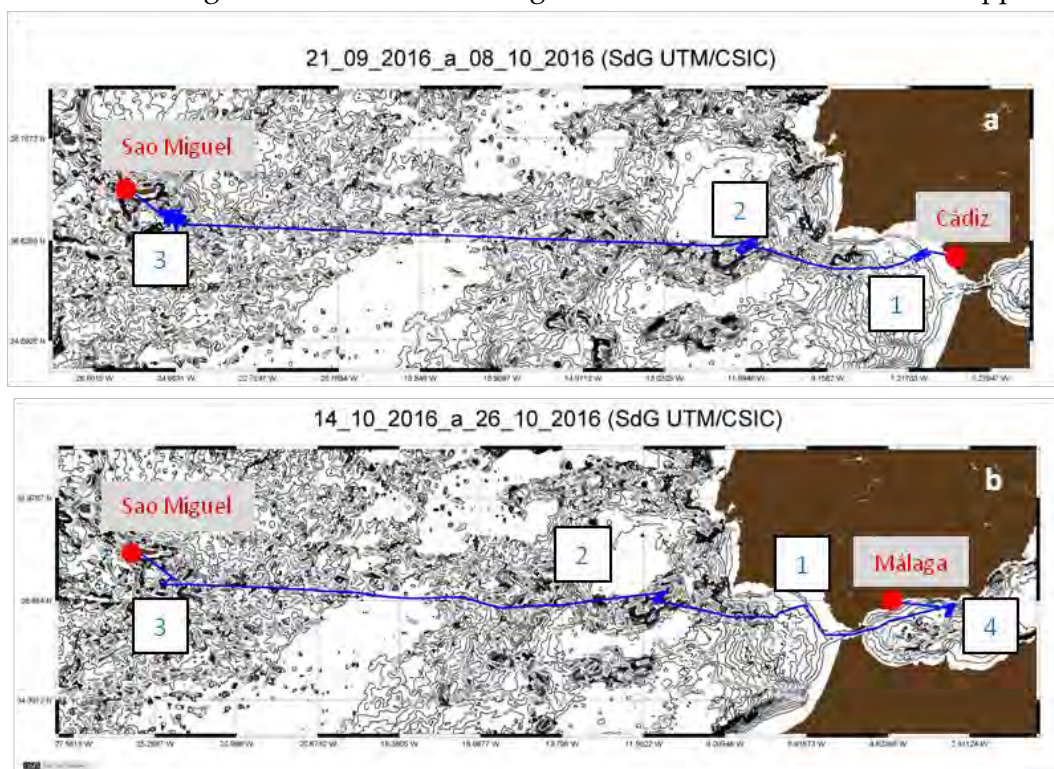

Figure 1: MEDWAVES itinerary. a) first leg, starting in Cádiz (Spain) and finishing in São Miguel (Azores); numbers correspond to the research areas 1: Gazul mud volcano, 2: Ormonde seamount, 3: Formigas seamount. b) second leg, starting in São Miguel and finishing in Málaga (Spain); numbers correspond to the research areas 3: Formigas seamount, 2: Ormonde seamount, 1: Gazul mud volcano, 4: Seco de los Olivos.

8. Narrative

21-24 September 2016. From Cádiz to Gazul

The first participants of MEDWAVES arrived to the vessel the 19th of September 2016 in order to prepare some of the gears and equipment to be used at sea. The 20th the ROV *Liropus* arrived from a previous cruise, to be installed on board the Sarmiento de Gamboa (SdG), as well as the technical personnel from ACSM, in charge of the vehicle. The 20th September was fully dedicated to the mounting of the ROV on board. A test of the vehicle was conducted in the Cádiz harbour in order to check all ROV components and functions. During the 20th all MEDWAVES participants arrived on board as it was planned during the organisation of the cruise. During the morning of the 21st September the safety instructions and information on life on board have been offer from the SdG crew to the participants, and last shopping took place before set sailing from Cádiz harbour. At 17:30 (local time) in the afternoon of the 21st of September our vessel (SdG) and home for the coming weeks leave the harbour, under perfect weather conditions, the SdG head to our first targeted area, the Gazul mud volcano, ca. 33 nautical miles (nm) away from Cádiz. The weather was good and this allows everyone to get familiar with a gentle ship movement and with the feeling of “to be at sea”. The MEDWAVES program was quite tight and there was not time to lose: arriving at Gazul, at 20:47 pm the MEDWAVES sampling program started. Sampling time on board was recorded as UTC (+ 2 hour local time in the area) and in this narrative this is the time code that will be used (as well as in the station lists, see Appendix II). The first deployment took place at 22:47 starting the CTD grid planned for Gazul. Seven successful CTD deployments, allowed the physical and chemical oceanography team to be busy and to gather the first data and water samples to work with. After the “CTD-night program”, the 22nd of September the whole morning was employed to conduct the necessary ROV test in the water and also check the connection between the ROV and the survey position, this is a very important task when working with the Liropus ROV, as the survey team is the one “connecting” the bridge of the RV SdG and the ROV team. After a successful test (Dive #0) the ROV started the first dive (Dive #1), finishing at around 16:00. The rest of the afternoon of the 22nd September was devoted to box coring and sampling with the Van Veen Grab. It was important to have all teams working and all gears tested, and during these first two days at sea all gears were deployed and all teams count on material to work with. For the MEDWAVES cruise a general routine was planned, trying to have regular watches for everyone during the whole cruise. Of course depending on weather conditions and also on technical problems, it was not always possible to keep the wished regularity but the activity plan was working quite well in most cases. The working day started always at around 07:00 with a briefing with the master, the chief, as well as the scientist and technician team leaders in order to briefly talk about the

weather conditions, the planned activities and to comment any potential aspects to be considered during the day. After this, the ROV deployment starts and it normally lasts until ca 17:30-18:30 (local time), time to deploy Box Corer (BC), the Van Veen Grab (VV) or the Multicorer (MUC). At around 22:00 the CTD-rosette started to be deployed, lasting this activity until 06:00-06:30 in the morning. In some cases, when it was necessary due to the lack of MB data from some areas, Multibeam (MB) survey was also carried out during the night.

The 23th of September was the first day where the whole sampling routine took place, 4 CTD-rosette casts took place at the beginning of the day, and later, after the briefing, the ROV was deployed in Gazul, at around 470 meters depth. The dive (Dive#2) lasted ca. 9 hours and after the dive one BC and 2 MUC deployments took place. At 18:20 the oceanography team started the CTD deployments finishing at 02:30 of the 24th September. The 23.09 at 07:46 the master of SdG received an announcement from the Spanish military authorities, communicating that the SdG should leave the area as soon as possible as at 07:30 of the 24th September military manoeuvres launching missiles (the announcement arrived around 20 hours in advance of the start of the manoeuvres). This forced us to leave the area and at 03:00 in the morning, heading the SdG to the second targeted area: Ormonde. We shortly considered the possibility to remain close to the area and continue the planned work in Gazul, but because the manoeuvres were planned for several days, we decided to move to the next target area. We planned four full days' work in Gazul, but these circumstances obliged us to reduce the time to just two days. However, thanks to the good weather conditions, the CTD station-grid was already completed (21 stations) and all teams gathered samples and data in the area.

24-26 September 2016. From Gazul to Ormonde

During the transit from GoC to Ormonde (ca. 205 nm) MB survey has been conducted. The arrival in Ormonde was at around 21:30 starting with the planned CTD grid in the area. The first CTD was deployed at 3,190 meters. Everyone was really excited about this first deep CTD and about detecting the Mediterranean Outflow Water (MOW) during the CTD deployment, what indeed was the case. The large working depths allowed completing 4 CTDs during this first night. After the briefing during which it was announced that the weather will be rough in the afternoon, the 25th a first ROV dive (Dive#3) took place in the area starting at around 07:30. An astonishing, fantastic dive by 2,000 meter depth discovered to our eyes wonderful creatures, from stalked sponges to black corals and gorgonians. The dive lasted until ca. 16:30 when the weather was already rough and it was not possible to continue the dive as we had wind speeds of 20 knots and 1,5m waves. One BC and one MUC deployment took place, also at ca. 2,000 meters depth. At 23:17 the oceanography team started the CTD grid, that night 7 CTD stations have been sampled, the weather avoided to keep going with the CTD casts and at ca. 06:30 the

sampling activities with the CTD concluded. The weather conditions got worst (30 knots wind and 2.5 to 3 meters waves) and it was possible only to conduct MB survey, hence from 07:30 to 20:30 of the 26th of September a MB survey was conducted in Ormonde what allow to complete the existing MB coverage of the area. As the weather forecast for the coming days was not favourable we decided to leave the area (hoping to have time enough to come back during the second leg) and head to our next research target: the Formigas seamount. Hence the 26th of September, at around 23:30 the transit to Formigas commenced and MB acquisition took place during the transit to Formigas. The weather was very rough when we leave Ormonde: winds of 27 knots and 3 meters waves.

26 September-8 October 2016. From Ormonde to Formigas

The transit to Formigas (ca 658 nm) lasted until the 29th at around 12:00 where the first ROV dive (Dive#4) in the SE part of Formigas seamount (1,500 m depth) took place. The dive was conducted without important problems, but the HD video camera failed in several occasions. At around 18:00 after the ROV dive, MB lines were conducted as the area was not completely mapped and good MB resolution was necessary to plan the following ROV dives. At around 23:00 the CTD grid was started, with a first CTD by 1,260 meters depth and the deepest one of the day at around 1,700 meters depth. A total of 5 CTD stations were completed finishing at 06:00 in the morning of the 30th of September. At 08:50 a second ROV dive (Dive #5) was conducted in the area, the dive started in the same position as the previous dive finished (SE side of the seamount, by 1,350 m depth) the dive was aborted due to technical problems as the propellers did not worked (the needed checking of the ROV elements were done and defected cards were replace, details on the technical aspects / problems regarding the ROV can be found in Appendix XIII). From 15:00 to 20:00 VV sampling (4) and one MUC have been deployed. The CTD sampling started at around 22:00, accomplishing five stations until around 05:30. The 1st of October, at around 08:45 an ROV dive (SE side) started at ca 1,200m depth, lasting until 16:30 (Dive#6). During the remaining time in the afternoon 2 VV grabs were deployed as well as one MUC, these tasks finished at around 19:00. After this around three hours transit was necessary to reach the next CTD targeted station. At 22:00 the first CTD was deployed; a total of 5 CTD stations were conducted, finishing at 03:30 due to rough weather (wind of 25 to 27 knots and waves of 2 meters). The 2nd of October the rough weather during the morning (also wind of 25 to 27 knots and waves of 2 meters) did not allow to perform any ROV dive, nevertheless the weather was again good enough to accomplish 4 irradiance profiles by Formigas which were requested by the colleagues from IMAR. At around 13:00 the weather allows to deploy the ROV, hence a dive in the SE flank was conducted (Dive#7), starting at a depth of 1,000m. After the dive 3 VV grabs (2 of them were valid) started at 18:00, finishing at 19:30. The sampling with the CTD started at ca. 21:00. Seven stations have been sampled

finishing at 07:30. After the usual briefing, the 3rd October a further ROV dive took place in the area (SE side) starting at 900 m depth (Dive#8) and finishing at around 11:30, continuing the work on board deploying VV. A total of 3 VV have been sampled. After this sampling event we head to the NW side of the seamount where at 14:00 a MB survey was conducted in order to gather the needed information on the area to plan the following ROV dives. The MB survey lasted until ca. 21:00. At 21:30 the CTD sampling started and a total of 6 CTD stations have been accomplished. The 4th of October at around 09:00 in the morning the first ROV dive in the NW side of Formigas was conducted (Dive#9), until around 16:00 in the afternoon. At 17:30 VV sampling started, three VV were successfully collected as well as a MUC. Until 21:30. At 23:00 the sampling of the CTD stations started and 5 CTD were collected, finishing at 06:00 in the morning. The 5th of October at ca. 09:00 a second ROV dive in the NW side of Formigas was carried out (Dive#10), starting at ca. 1,300 m depth. After 2,5 hours the dives was aborted due to technical problems as the backboard propellers fail. After recovering the ROV on deck, three VV grabs and a MUC have been sampled, finishing at 21:45. At around 23:00 the CTD sampling grid was continued and 4 CTD stations were completed at 05:00. Due to the rough weather conditions (winds of 26 knots and 2.5 meter waves), the 6th it was not possible to conduct any ROV dives, hence at ca. 09:00 a further MB survey was performed in order to characterize the geomorphology of the area. The survey finished at 21:30, and before the CTD sampling started a single VV grab was collected in the area. Two CTD stations were accomplished, both of them were deep (ca. 1,400m). The 7th of October the weather conditions were suitable for the ROV operations and at 09:00 another ROV dive (Dive #11) was conducted from 09:00 to around 13:00 and aborted due to technical problems. These problems were quickly resolved so that at 14:00 it was possible to carry on a further dive from 14:00 to 18:00 (Dive #12). At around 22:00 VV sampling started and 4 samples have been collected, finishing at ca. 01:30. Immediately after finishing with the VV sampling, the CTD team started with their sampling protocol (at ca. 02:00). A single CTD (yo-yo) was conducted until 07:00 in the morning. After the daily briefing, the 8th of October at ca. 09:00 an ROV dive was carried out (Dive#13), finishing (due to bad weather conditions at 12:30). The weather forecast for the coming days was very bad (cyclonic weather), this force us to sail before planned to Ponta Delgada in São Miguel (Azores) where we remain for six full days, finishing during that time the first leg of MEDWAVES. We arrive to São Miguel harbour at 20:00 local time.

08-14 October 2016. São Miguel

The bad weather conditions forced us to remain in the Island of São Miguel from the 8th to the 14th October. Hence the sampling events of the first leg finished the 8th of October 2016. During the days at the harbour the coral maintenance tasks continued as well as the work with some of the samples and data collected during the cruise

which could be processed on board. This was the case of the CTD data, some of the water sample analyses and the MB data. The 10th of February during the morning all the participant working teams presented the work conducted during the first leg of MEDWAVES as well as the preliminary results. The figure 1 presents some snapshots, as an example of the meteorological conditions of those days, the weather conditions of the 11th and 12th of October.

14-21 October 2016. From São Miguel to Ormonde

The 14th October at 15:00 the SdG left São Miguel, heading to Formigas with the aim to conduct some oceanographic surveys during the night as well as the remaining Irradiance profiles during the morning of the 15th October. Unfortunately the bad weather conditions (winds of 35 knots and 3 to 4 meters waves) did not allow to conduct the planned irradiance profiles and some MB lines were conducted in the area, to complete the MB survey, however the weather again forced to stop any sampling activities and considering the weather forecast for the area, which indicate high speed winds and high waves (winds of 35 knots and 3 to 4 meters waves), we decided to move to Ormonde, area which was poorly sampled during the first leg. During the transit the weather conditions remain rough with similar wind speeds and wave height as mentioned before.

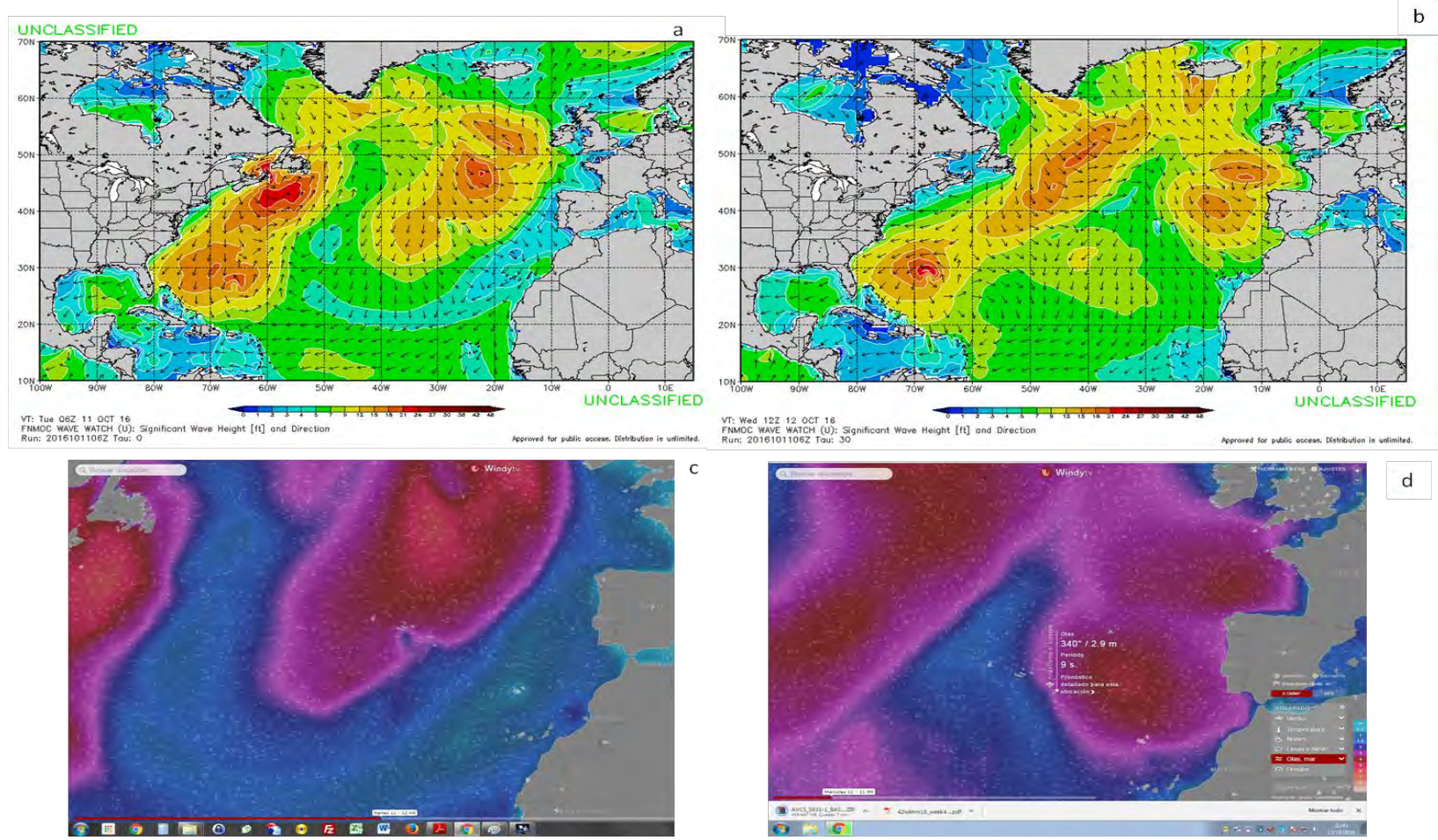

Figure 1: weather conditions the 11th and 12th October 2016 in the area of Azores. a) 7 to 12 meters wave indicated by the light green and orange-yellowish colours, b) 7 to 9 meters wave indicated by the light green and yellowish colours, c) 2 to 3 meters waves in the research area at 19:13 of the 12th of October, indicated by the purple and deep blue colours, d) at 22:43 of the same day the wave height even increased.

The 18th of October we reach Ormonde, starting the sampling program at around 12:30 with an ROV dive in the SE side of the seamount (Dive#14), at 1,500 m depth. The weather and sea conditions were optimal, but technical problems (the telemetry fail due to a problem with the optical fibre) obligated to stop the dive. At around 16:00 sampling with VV grab started and two successful sampling events took place. At ca. 23:00 in the night the oceanography team started with the CTD sampling covering four CTD stations. At 06:30 of the 19th October an ROV dive (Dive#15) took place in the same place with the dive from the previous day finished, however the strong currents forced to cancel the dive. At 12:00 a second trial with the ROV took place (Dive#16), this time without any problems, so that the dive last until 17:00 in the afternoon. After the successful dive, two VV grabs were collected and at 22:00 the CTD sampling continues. A total of 6 CTD stations were sampled. The 20th of October two ROV dive took place starting at 07:00 in the morning (Dive#17, Dive#18), and finishing at ca 18:00 in the evening. Two VV sampling events took place before the oceanography team started the sampling at ca. 20:30. Seven CTD stations were conducted, completing the CTD sampling planned for the area. That was the last activity conducted in Ormonde, and the 21st October at 06:00 the SdG headed to Gazul in the Gulf of Cádiz. The 22nd we arrive to Gazul where a CTD has been deployed to perform a sound profile in order to conduct some MB lines in order to have the MB bathymetry from the mud volcano. At 03:15 the MB survey finished and the SgG headed to Seco de los Olivos, the last research area of MEDWAVES which is located in the Alboran Sea.

22-26 October 2016. Seco de los Olivos-Málaga harbour

At 22:30 in the night we reach the last sampling zone included in MEDWAVES: the seamount of Seco de los Olivos, also known as Chella Bank.

As usual we started our “night sampling program” with the grid of CTDs, accomplishing 6 stations. After finishing with the oceanography sampling, at 07:00 an ROV dive started (Dive#19), but once again technical problems forced to stop the dive and continue with other sampling. Three VV grabs and one MUC have been successfully sampled and after this the ROV was again ready to be deployed (Dive#20). At 12:30 the ROV dive started and was followed by a second one (Dive#21). The ROV survey finished at 18:30 and it was followed by two VV grab sampling. At 21:00 was again the turn of the oceanography team which continued with the planned grid of stations, conducting a total of seven stations. The 24th, at 07:00 in the morning a further ROV dive took place (Dive#22) finishing at 10:15. From 11:00 to 12:00 three VV sampling events occurred and at 12:30 a further ROV deployment took place (Dive#23), lasting until 15:45. After this four VV grabs were collected and a MUC. At 20:30 the CTD sampling started and 8 CTD stations were completed. The 25th of October was the last sampling day of MEDWAVES. At 6:45 the

ROV was deployed and two dives took place this day (Dive#24, Dive#25), finishing at 15:45. After the ROV three VV and one MUC was sampled, finishing the sampling activities of MEDWAVES at 18:15 of the 25th of October. At this time the vessel headed to Málaga harbor where the vessel arrived at ca. 08:00 in the morning. General stations list and a summary of the meteorological conditions during the cruise are included respectively in Appendix II and III.

9. MEDWAVES research and technical teams

In the following paragraphs the research and technical teams of MEDWAVES are presented, affiliations and email contact can be found in the participants list (chapter 6 of this report).

Physical Oceanography team

Leg 1

Pedro Vélez-Belchí, Jose Luis López Jurado, Jesús Reis

Leg 2

Juan Antonio Jiménez, Safo Piñeiro, Alan Fox

Personnel at home

Rosa Balbín, Rui Caldeira

Biogeochemical Oceanography team

Leg 1

Rocío Santiago, Verónica Caínzos, Victor Pelayo

Leg 2

Alberto Aparicio, Verónica Caínzos, Victor Pelayo

Personnel at home

Marta Álvarez, Mónica Castaño

Geomorphology

Leg 1

Jesús Rivera, Miriam Hermida, Juancho Movilla

Leg 2

Miriam Hermida, Juancho Movilla

Personnel at home

Fernando Tempera

Benthic biodiversity team (Van Veen Grab & Box Corer)

Leg 1

Javier Urra, Ángel Mateo-Ramírez, Íris Sampaio

Leg 2

Jose Luis Rueda, Marina Gallardo

Personnel at home

Marina Carreiro-Silva, Telmo Morato

Biogeochemical composition of sedimentary organic matter

Leg 1

Sophie Arnaud-Haond

Leg 2

Joana Boavida, Anna Maria Addamo

Personnel at home

Teodoro Ramírez

Foraminiferan Fauna

Leg 1

Javier Urra, Ángel Mateo-Ramírez

Leg 2

Jose Luis Rueda, Marina Gallardo

Personnel at home

Guillem Mateu

Benthic annotation team (OFOP/ROV biodiversity)

Leg 1

Lea-Anne Henry, Meri Bilan, Maria Rakka, Íris Sampaio

Leg 2

Manuela Ramos, Gerald Taranto, Cristina Gutiérrez

Personnel at home

Marina Carreiro-Silva, Telmo Morato

ROV transects

Leg 1 & Leg 2

Covadonga Orejas, Juancho Movilla

Personnel at home

Andrea Gori, Marina Carreiro-Silva, Telmo Morato, Olga Reñones

Plankton sampling

Leg 1 & Leg 2

Covadonga Orejas, Juancho Movilla, Alberto Romero

Personnel at home

Alejandro Olariaga

Evolutionary Ecology

Leg 1

Sophie Arnaud-Haond, Juancho Movilla, Maria Rakka

Leg 2

Joana Boavida, Anna Addamo, Juancho Movilla

Ecophysiology**Leg 1**

Juancho Movilla, Maria Rakka, Covadonga Orejas

Leg 2

Juancho Movilla, Nuria Viladrich, Cristina Gutiérrez, Covadonga Orejas

Personnel at home

Andrea Gori

Out reach**Leg 1 & Leg 2**

Covadonga Orejas, MEDWAVES scientific party

Personnel at home

Ana Morillas, Pablo Lozano, Marta Zhein (Producciones Orgánicas), Jose Luis Matoso (La ventana invisible), Katherine Simpson (ATLAS coordination), Claudia Junge (AquaTT)

UTM and ACSM teams and SdG crew are all included in the corresponding tables of chapter 6.

9.1 Physical oceanography

P. Vélez-Belchí¹, J.L. López-Jurado², J. Reis³, J.A. Jiménez², S. Piñeiro², A. Fox⁴

1. Centro Oceanográfico de Canarias, Instituto Español de Oceanografía, Tenerife, Spain
2. Centro Oceanográfico de Baleares, Instituto Español de Oceanografía, Palma, Spain
3. Observatório Oceânico de Madeira, ARDITI, Madeira, Portugal
4. University of Edinburgh, Edinburgh, United Kingdom

9.1.1 Personnel involved

MEDWAVES-ATLAS Cruise LEG 1 -Cádiz – Ponta Delgada (21/09 – 13/10/2016)

Name	Institution	Role and responsibilities
P. Vélez-Belchí	Researcher (IEO), pedro.velez@oceanografia.es	Hydrographic and dynamic characterization (CTD, LADCP)
J.L. López-Jurado	Researcher (IEO) lopez.jurado@ba.ieo.es	Hydrographic and dynamic characterization (CTD)
J. Reis	Investigador (OOM), Jesus.reis@oom.arditi.pt	Hydrographic and dynamic characterization (CTD, VADCP)

MEDWAVES-ATLAS Cruise LEG 2 Ponta Delgada – Málaga (14/10 – 26/10/2016)

Name	Institution	Role and responsibilities
J.A. Jiménez	Researcher (IEO) Juan.Jimenez@ba.ieo.es	Hydrographic and dynamic characterization (CTD, ADCP)
S. Piñeiro	Phd fellow (IEO) Safo.Pineiro@ba.ieo.es	Hydrographic and dynamic characterization (CTD, ADCP)
A. Fox	Research Fellow (HWU) A.Fox@hw.ac.uk	Hydrographic and dynamic characterization (CTD, ADCP)

9.1.2 Introduction. Aims

Oceanic seamounts are underwater mountains, that rising from the ocean floor have a relatively flat summit that remains below the sea surface, or slightly over the surface. The perturbation that seamounts create in oceanic flow have and associated dynamics that, under idealized circumstances, known as Taylor columns, have the potential to isolate the oceanic circulation over the summit from the ocean circulation in the open waters. Additionally, under these idealized circumstances, upwelling phonemes that enrich the ecosystem, occurs over the seamount summit. Through the Strait of Gibraltar, waters of Mediterranean origin spill in to the Atlantic Ocean, advecting the properties and organism characteristic of the Mediterranean Sea. Our research

activities during the MEDWAVES-ATLAS cruise (MAC) were focus on the oceanic circulation associated with the seamounts found in the path of the Mediterranean Waters in the Atlantic Ocean, in order to determine the oceanic circulation on these seamounts and if they show the idealized behaviour known as Taylor columns.

Aims

The objective of the physical oceanography contribution during the MAC was to determine if the vertical water mass distribution, and specifically the Mediterranean Outflow Waters (MOW) affect the vertical distributing of Cold Waters Corals on the slope of the Seamounts; therefore, contributing to the ATLAS task 3.1 *Improve the understanding of biodiversity and biogeography in the deep North Atlantic*. Additionally, the results will permit also to understands if the seamounts in the in the path of the Mediterranean Waters into the north Atlantic may behave as nursery areas to organism characteristic of the Mediterranean Sea; contributing to the ATLAS task 1.3 *Quantify ocean transport pathways and connectivity of water masses at basin and regional management scales*. Thus, the specific objectives of the physical oceanography contribution during the MAC were:

- 1) To characterize the hydrographic conditions and the structure of the impinging oceanic flow over the Formigas, Ormonde and Seco de los Olivos seamount, and in the Gazul mud volcano.
- 2) To determine the structure of the oceanic circulation over the summits of the Formigas, Ormonde and Seco de los Olivos seamount, and in the Gazul mud volcano.
- 3) To determine the role of the Mediterranean Water in the circulation, over, and around the Formigas, Ormonde and Seco de los Olivos seamount, and in the Gazul mud volcano.

9.1.3 Sampling methodology

To achieve the planned specific objectives, in each one of the sub regions (Fig. 1 and Table 1), a set of hydrographic stations were carried out to determinate the hydrographic conditions, the geostrophic circulation and to identify the water masses in the area. The number of stations, and its distribution was designed as the minimum to determine the geostrophic circulation for each one of the regions sampled.

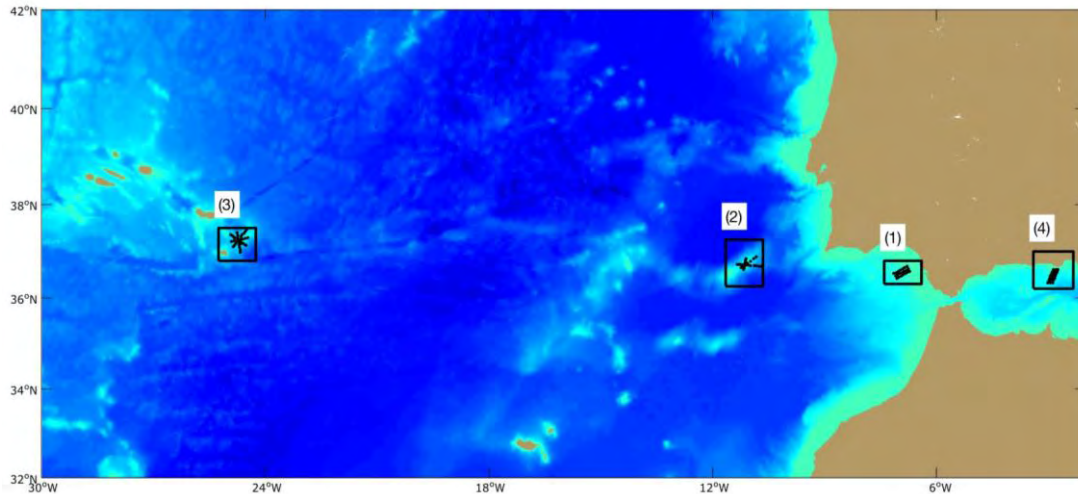

Figure 1: Stations distribution for the four regions studied during the MEDWAVES-ATLAS cruise: (1) Gazul mud volcano, (2) Ormonde seamount, (3) Formigas seamount and (4) Seco de los Olivos seamount

Table 1: Number of stations sampled in each area of study. See Appendix II for a list of all the stations, including position and date

Region	Stations sampled
1 Gazul mud volcano	21 stations, numbered from 101 to 121
2 Ormonde seamount	28 stations, numbered from 201 to 211 and from 206 to 234. Stations 232 to 235 were sampled twice 41 stations, numbered from 301 to 337, from 350 to 353 and 373
3 Formigas seamount	3 Yo-Yo stations, numbered from 370 to 372 3 CTD profiles were carried during daylight around the summing to measure Photosynthetically active radiation”
4 Seco de los olivos seamount	21 stations, numbered from 501 to 521

The water column was sampled from the surface to 5 metres to the bottom, by means of a CTD-Rosette (Fig. 2). Water samples were taken at different levels along the cast and at the bottom, to determine pH, alkalinity, dissolved oxygen and nutrient concentration (see chemical oceanography chapter), and to calibrate the conductivity sensors. Special attention was given to sampling the layer of Mediterranean Outflow water (maximum salinity and minimum oxygen). Additionally, in each of the stations, LADCP measurements were carried out to reference the geostrophic estimation of the circulation with a known reference level.

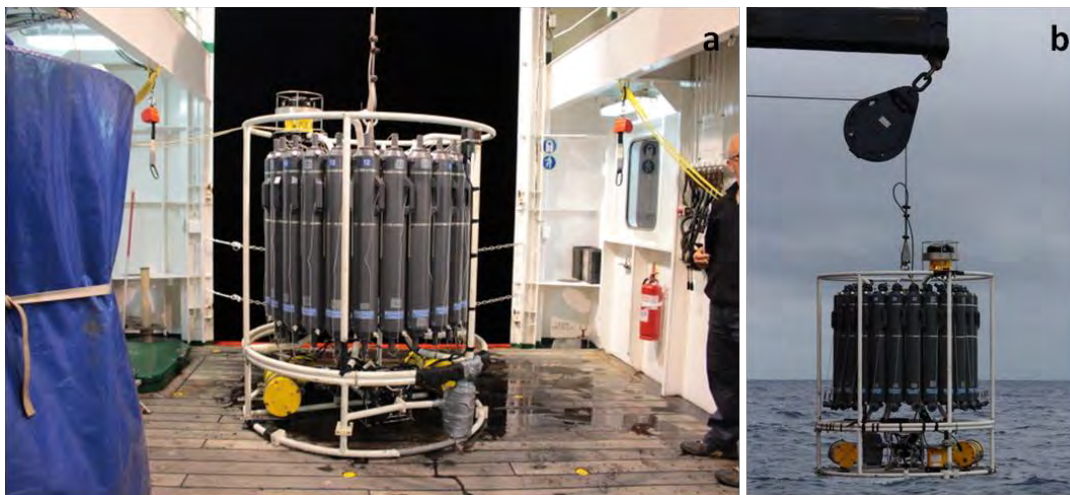

Figure 2: CTD-Rosette used on MEDWAVES. a) CTD-Rosette in the SdG Hangar, b) CTD-Rosette during deployment

9.1.4 Instrumentation details

CTD SBE911+

In each one of the hydrographic stations, a SBE9 s/n 0851 working at 24 Hz, coupled with a SBE11 (deck Unit) and a SBE32, with 24 bottles of 12 litres, was lowered at less than 55m/min. The following sensors were installed in the SBE9:

Table 2: Sensor installed in the SBE9 sued during MAC.

Sensor	Serial number	Calibration date
Temperature SBE	5363	18/04/2015
Conductivity SBE	3761	21/04/2015
Pressure	0851	16/04/2015
Temperature SBE	4721	17/04/2015
Conductivity SBE	3302	16/04/2015
Fluorometer Wet Labs. ECO-AFLU/FL	3594	18/06/2014
Turbidity Meter Wet Labs. ECO-NTU	3594	18/06/2014
Turbidity Meter Seapoint FTU	10249/11107	18/06/2014
Transmissometer Wet Labs. C-Star	1013DR	16/04/2010
Oxygen SBE43	1147	11/04/2015
Altimeter	40396	16/09/2015
Photosynthetically available radiation Bios. Chelsea	70338	12/06/2010

LADCP

A Dual RDI Workhorse 300 khz (slave and master) Lowered Acoustic Doppler Current Profiler was used in each station to measure ocean currents.

VADCP

A Dual RDI Ocean Surveyor 75 khz (Broadband and Narrowband) Vessel Acoustic Doppler Current Profiler was used between stations to measure ocean currents.

Other data

Underway temperature, salinity and fluorescence measurements were carried out with an SBE21 thermosalinograph.

Hydrographic data with a SBE37 (TC) was also collected in each ROV dive.

9.1.5 Problems encountered

Throughout Leg 1 all the equipment (CTDs, Carrousel, sensors, ADCPs) worked correctly. During Leg 2, on cast 75 (station 217) there were communication problems with the LADCP slave unit (top mounted). Several tests were performed to discard faulty cables. Finally, the unit was disconnected from the batteries to reset it. It was available again from cast 78 (station 220) onwards. On cast 101 (station 510), the turbidity meter Seapoint delivered a noisy signal and it was replaced by another one (same model) with serial number 11107.

9.1.6 Processing methodology

Hydrographic data were acquired with CTD SBE911+ using the acquisition software Seasave V7 of SEA BIRD. Seasave V7 acquires, converts, and displays real-time or archived raw data from Sea-Bird profiling CTDs and thermosalinographs. Seasave V7 is part of Seasoft V2 software suite of Sea Bird. The raw data was processed with a set of routines from the SBE Data processing package of SEA BIRD. This routine allowed us to transform the data to ascii format (*.cnv), correct for the cell thermal mass effect, the alignment between the conductivity and temperature sensors, and average in pressure bins. A first visualization of these data was obtained by mean software packed named Ocean Data View. Ocean Data View (ODV) is a software package for the interactive exploration, analysis and visualization of oceanographic and other geo-referenced profile, time-series, trajectory or sequence data. On a second step, MATLAB (matrix laboratory) multi-paradigm numerical computing environment and fourth-generation programming language, was used to analyse the data.

LADCP data was processed using the LDEO Software (Version IX.7). VADCP data was acquired with an RDI Ocean Surveyor 75 khz using the acquisition software

VmDas (Version 1.46.5) and the raw data was processed with CODAS software. After that, MATLAB was used to plot, and analyse the results.

9.1.7 Calibration information

Water samples were taken at different depths and stations to calibrate the Conductivity (salinity) sensors. The difference between the measurements of the SBE3 conductivity sensors from the SBE911+ and the *Guildline Portasal Salinometer 8410A* used on-board with the waters samples was within the accuracy of the conductive sensor (equivalent to 0.002 in salinity) and therefore no correction was applied.

The SBE911 was equipped with dual temperature and conductivity (salinity) sensors, which allowed monitoring the drift of the primary sensor. As indicated in figure 3, and coherent with the measurements take from the *Portasal Salinometer 8410A*, no-drift, beyond the accuracy of the sensors, between the primary and secondary sensors was detected. The difference between the conductivity sensors yield a difference in salinity between 0.001 and 0.0015 at the end of the cruise. For the temperature sensors, the difference was constant through the cruise at 0.0005°C.

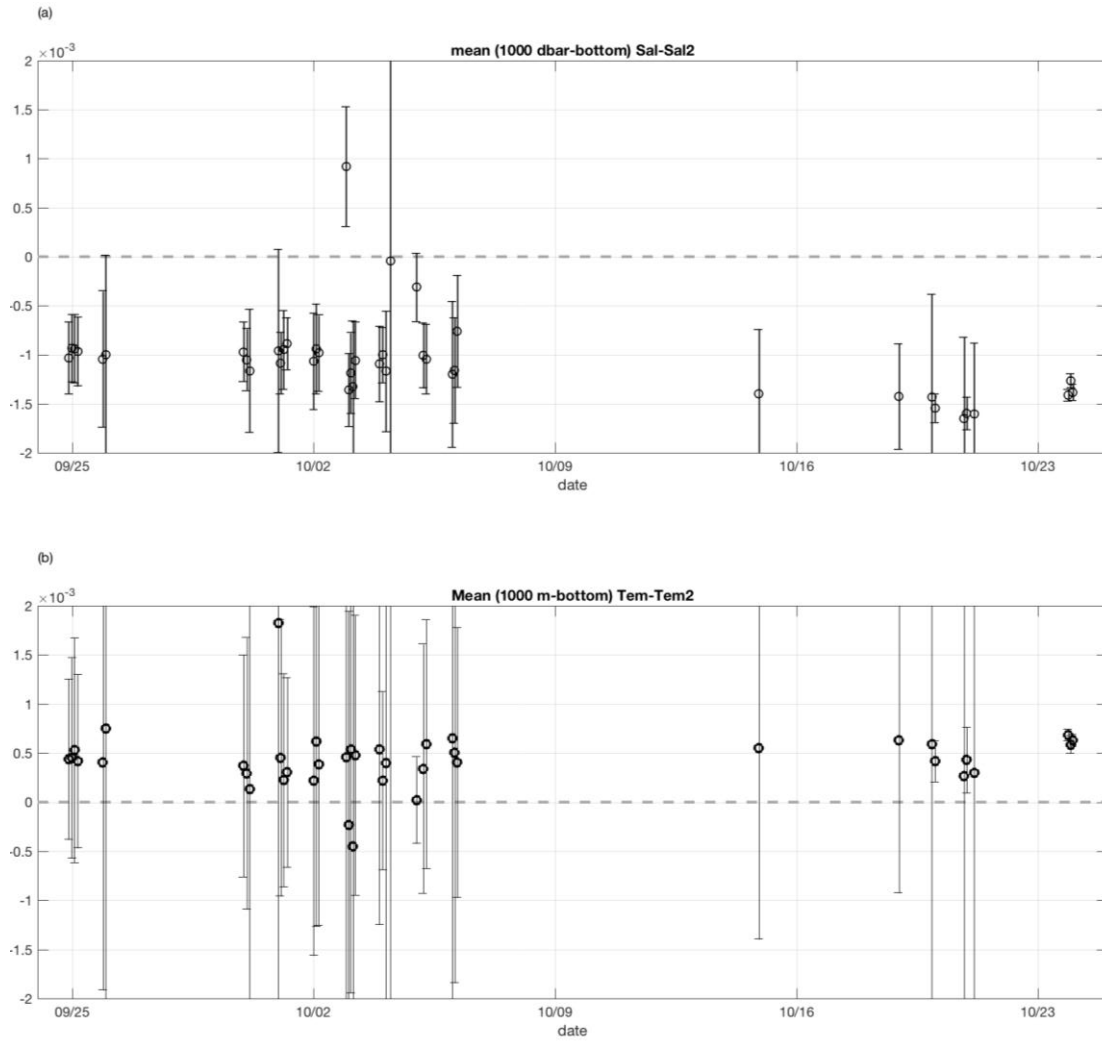

Figure 3: Time evolution, during the duration of the MAC, of the difference between the primary and secondary sensors for (a) salinity and (b) temperature.

9.1.8 Preliminary results

The θ/S Diagram for all the areas sampled (Fig. 4) shows the overall decrease in salinity that characterizes the propagation of the MOW into the Atlantic. From the 38.5 found in the Seco seamount to the relative maximum of 35.50 found in the Formigas sea mount. It is worth noticing that the relative maximum of salinity is at slightly similar γ^n (27.63 kg / m^3) in the Gazul mud volcano and at the Ormonde and Formigas seamounts.

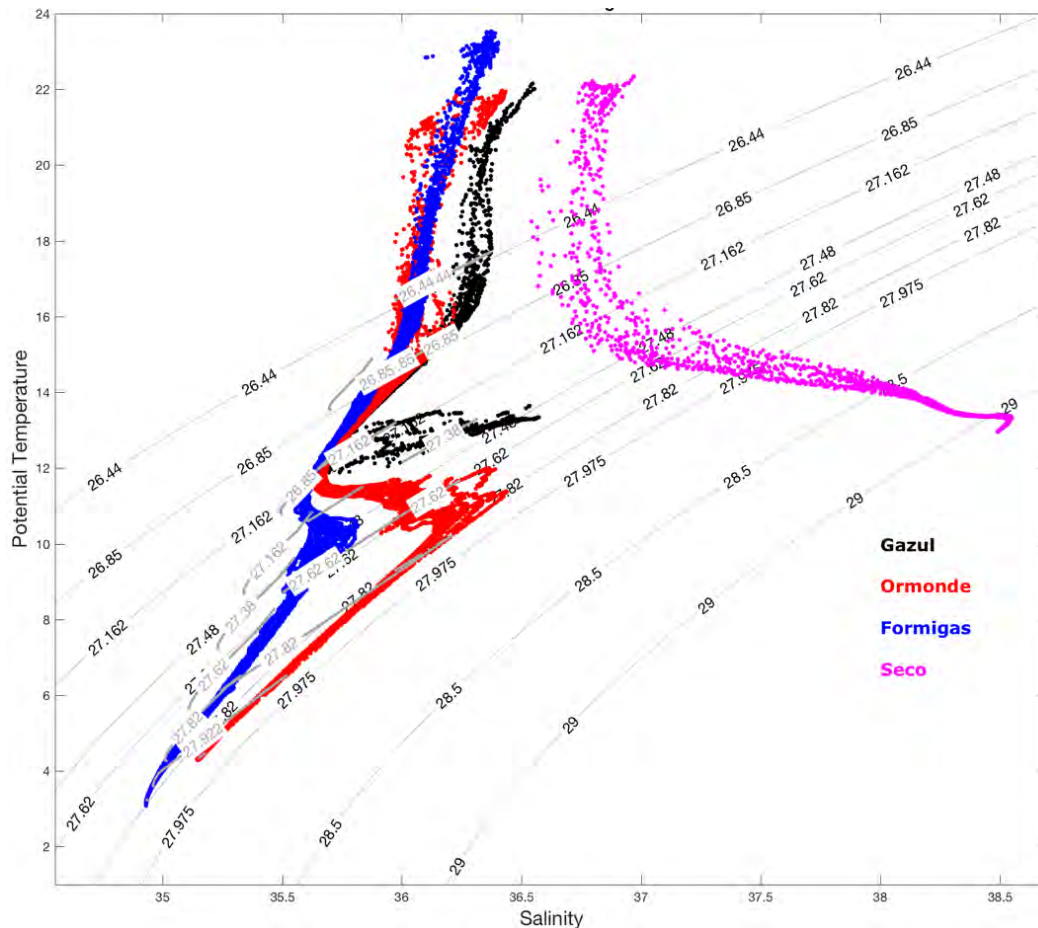

Figure 4: θ/S Diagram of all the stations sampled during MAC. The thin black lines correspond to the density isolines, while the thick grey lines correspond to the γ^n isolines.

9.1.8.1 *Gazul mud volcano*

The sampling design in the mud volcano of Gazul was composed of 3 hydrographic sections perpendicular to the slope, one over the volcano, one 5 nm north of it, and the last one 5 nm south of it (Fig. 5). The ocean circulation is characterized by a two-layer flow, with Atlantic waters on the upper layer and waters of Mediterranean influence near the bottom. The θ/S diagram (Fig. 6) shows these two different water masses, the colder and fresher North Atlantic Central Water (NACW), lighter than the $\gamma^n=27.1 \text{ kg/m}^3$ isopycnal and the relative warmer and saltier Mediterranean Outflow water (MOW), closer to the bottom. As can be observed in figure 7, the two water masses are separated by the isohaline of 35.75, at approximately 150 m above the bottom, and deeper than 350 m. The signal of the Mediterranean waters is also observed in the vertical distribution of temperature, with a relative maximum in temperature below the 350 m, and in the 150 m above the bottom. In the case of the temperature, the 12.5°C isotherm divide the waters from Atlantic and Mediterranean origin.

This two layer structure, with light NACW on top of heavier MOW, is also observed in the vertical distribution of horizontal velocities. As can be observed in figure 8, in

the upper layer, the LADCP velocities are predominantly eastward, while closer to the bottom and deeper than 300 m, the MOW is predominantly westward. The LADCP and the VMADCP (not shown) show a similar vertical distribution of horizontal velocities.

In the horizontal map of horizontal LADCP velocities (Fig. 9) this two layer structure is clearly observed. The upper eastward flow is due to the flow of Atlantic waters into the Strait of Gibraltar in the upper 300 m (Fig. 9a), while the westward flow of MOW from the Strait of Gibraltar is close to the bottom (Fig. 9b). Once the MOW exit the Strait of Gibraltar the flow follows the slope of the Gulf of Cádiz, as can be observed in the horizontal distribution of vertical averaged LADCP velocities for the deep layer (350-540 m). It is also interesting to note that the Gazul mud volcano, close to station 104 disrupts the flow at the upper and deeper level.

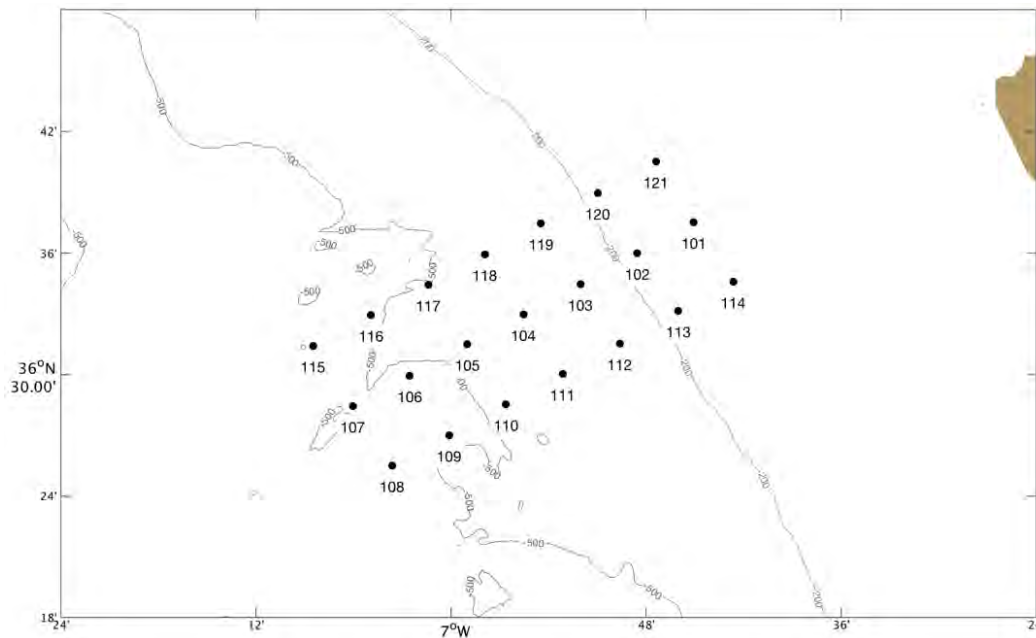

Figure 5: Stations distribution at the Gazul mud volcano.

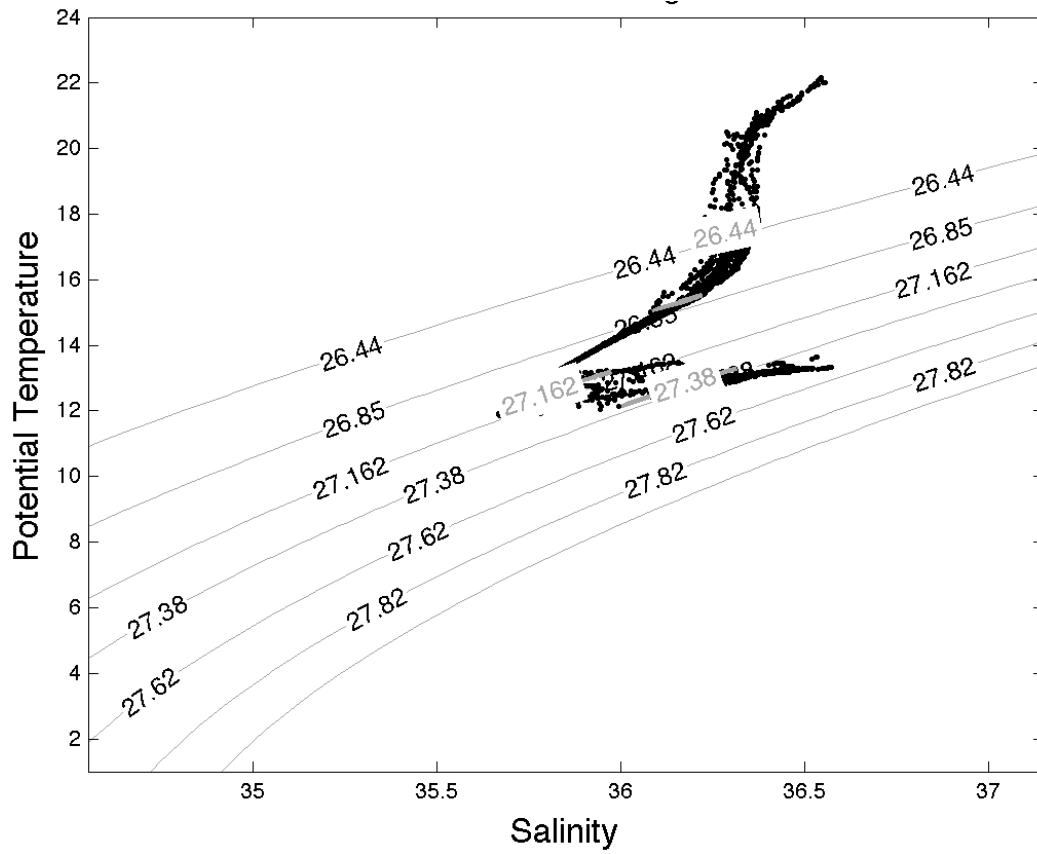

Figure 6: θ/S Diagram of all the stations sampled in the Gazul mud volcano. The thin black lines correspond to the in-situ density isolines, while the thick grey lines correspond to the γ^n isolines

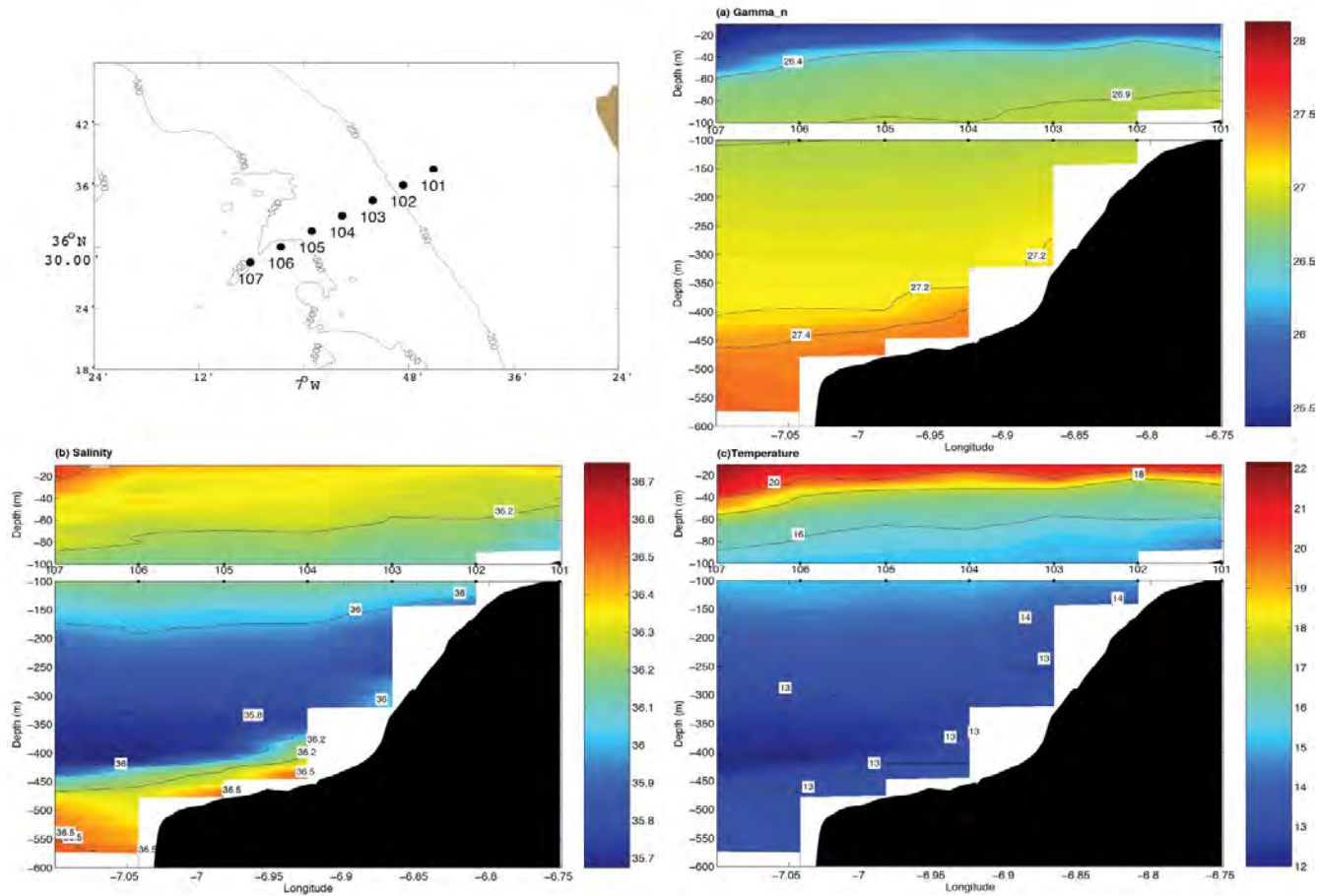

Figure 7: Southwest – northwest (stations 101 to 107) vertical section of (a) γ_n (kg/m³), (b) salinity and (c) temperature in the Gazul region. For each one of the vertical sections, the upper panel correspond to the top 100 metres, and the lower panel to the 100-600 m depth range. The numbers between both panels correspond to number of the stations.

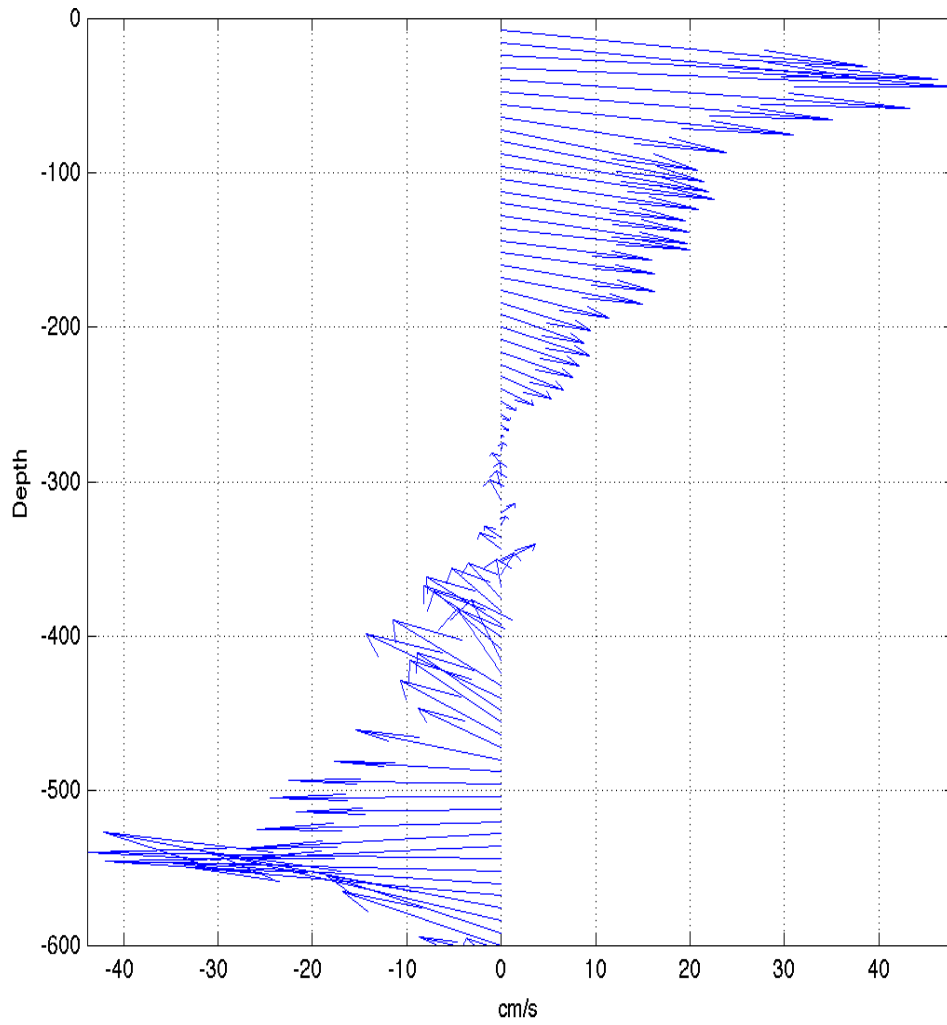
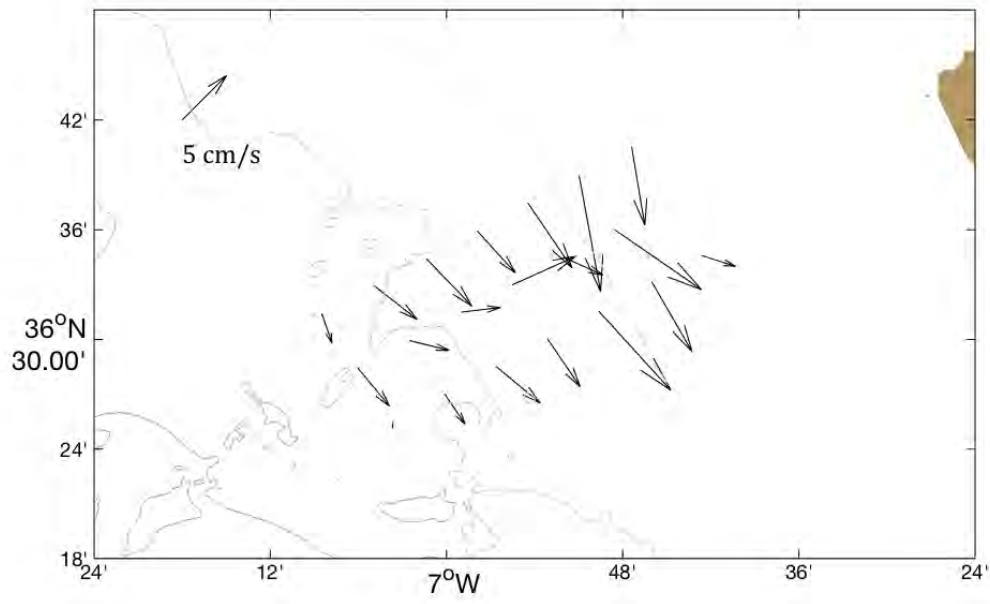

Figure 8: Horizontally averaged vertical profile of horizontal LADCP velocities. All the LADCP stations were used in the averaging.

a



b

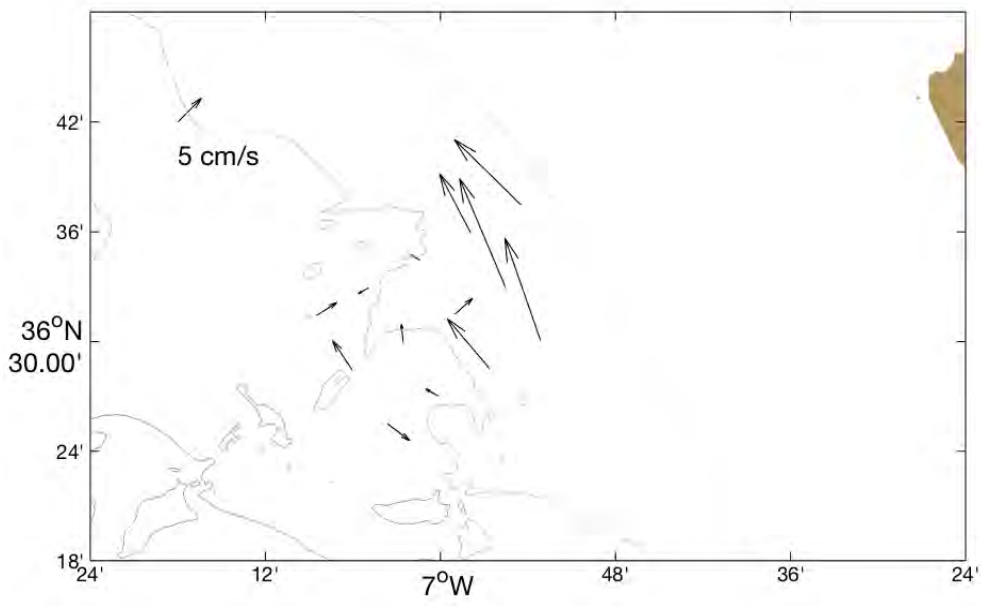

Figure 9: Horizontal distribution of vertical averaged LADCP velocities for the (a) upper layer (40-236 m) and the (b) deep layer (350-540m)

9.1.8.2. Ormonde

The Ormonde seamount was briefly visited on Leg 1, but due to the weather conditions the sampling was postponed to Leg 2. The sampling design in the Ormonde seamount was composed of 3 hydrographic sections perpendicular to the slope, and crossing the summit of the seamount (Fig. 10).

The Ormonde seamount shows the vertical distribution of waters masses characteristic of the subtropical Atlantic. The waters above the seasonal thermocline, $\gamma^n < 26.850 \text{ kg m}^{-3}$ are characterized on the θ/S diagram by scattered temperature and salinity values due to seasonal heating and evaporation (Fig. 11). Below the seasonal thermocline and through the permanent thermocline is the NACW, roughly delimited by $26.850 < \gamma^n < 27.200 \text{ kg m}^{-3}$. These waters are characterized in the θ/S diagram by an approximately straight line relationship between potential temperature ($11.67^\circ\text{C} < \theta < 13.45^\circ\text{C}$) and salinity ($35.65 < S < 35.83$). Due to the proximity of the Strait of Gibraltar, below the NACW there is a sharp increase in salinity that corresponds to the MOW. These waters, between $27.380 < \gamma^n < 27.820 \text{ kg m}^{-3}$, have a salinity up to 36.43.

The vertical distribution of temperature, salinity and γ^n (Fig. 12) shows this vertical distribution of waters masses. In the upper 50 m, there is a strong gradient in temperature, salinity and γ^n that corresponds to the seasonal thermocline. It is interesting to point out the higher salinity, at the seasonal thermocline, in the western side of Ormonde, due to proximity to the centre of the subtropical gyre, characterized by subduction, and therefore higher salinities. Between 200 and 400 m the salinity and the temperature decrease linearly, characteristic of the NACW. The Gorringe bank, where the Ormonde seamount is located, act as a barrier for the MOW flowing from the strait of Gibraltar. Deeper than 500 m, and with salinities higher than 35.7 the salinity increase linearly up to 36.43 at 900 m, the core of the MOW. Temperature decrease linearly with depth, and at the core of the MOW it has a value of 11°C . The distribution of MOW is non-uniform around the Ormonde Seamount, with an apparent piling of the MOW waters in the western side of the seamount, coherent with the main spreading pattern of the MOW from the strait of Gibraltar. The core of the MOW is at 1000 m. The waters with Mediterranean influence reach the 1400 m, as denoted by the 35.58 isohaline, and the $\gamma^n = 27.820 \text{ kg m}^{-3}$ isoline. It is interesting to note that the isohaline and the γ^n isoline that define the limits between the NACW and the MOW are very similar to those found at the Gazul mud volcano, due to the proximity of both places. The presence of the MOW has also a signature in the squared Brunt Väisälä frequency (Fig. 12), with a relative maximum around the core of the MOW, and therefore suggestion internal wave breaking in the slope of the seamount.

Regarding the dynamics in the seamount, the vertical distribution of density and temperature (Fig. 12) show the upward doming of the isopycnal, and isotherms, that characterize the cyclonic circulation on top of seamounts. However, the seamount is under the influence of the strong Azores current and the mesoscale activity associate to it. The vertical distribution of averaged horizontal velocity (Fig. 13) shows that the

predominant flow is eastward, with a slightly reduction at 1200 m due to the presence of the westward flowing MOW.

The horizontal distribution of horizontal velocities (Fig. 14) is coherent with this influence of the Azores currents, with east flow in the upper (40-540 m) and the (b) deep layer (560-1000 m) disrupted by the presence of the seamount and slightly anticyclonic veer in the upper layer.

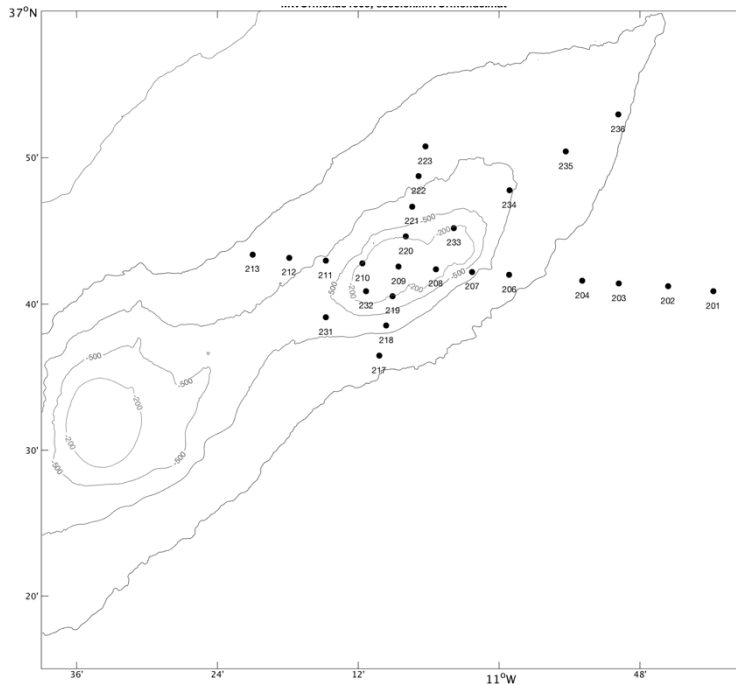

Figure 10: Station distribution at the Ormonde sea mount

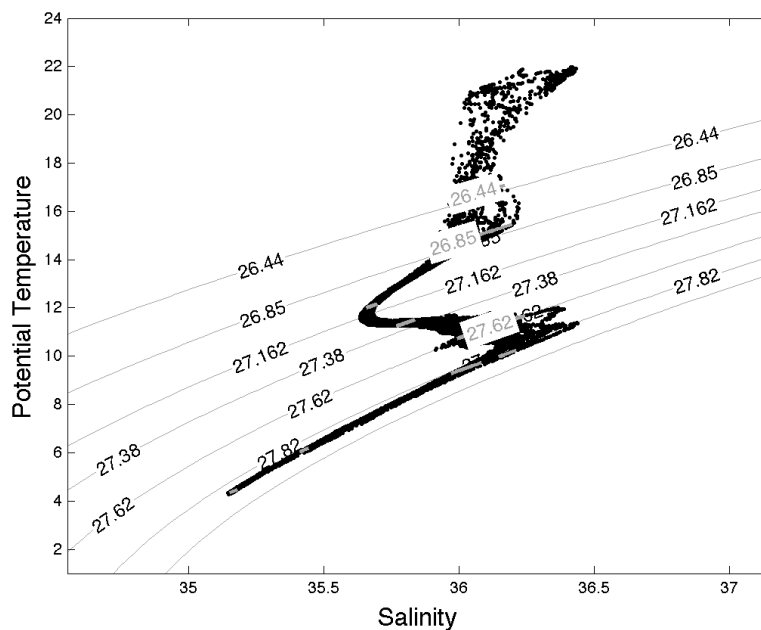

Figure 11: θ/S Diagram of all the stations sampled in the Ormonde seamount region. The thin black lines correspond to the density isolines, while the thick grey lines correspond to the γ^n isolines.

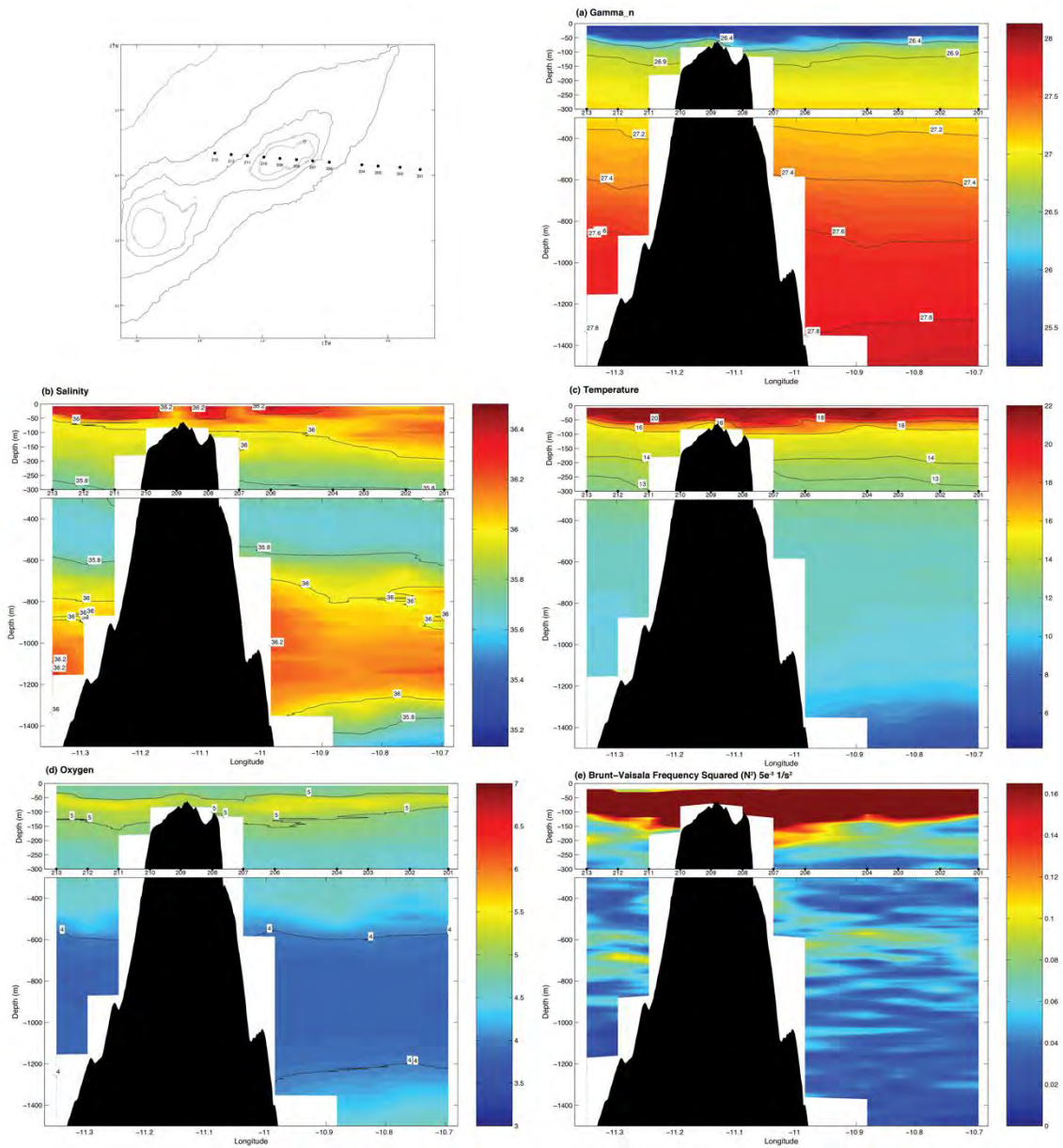

Figure 12: west – east (stations 201 to 213) vertical section of (a) density (γ_n in kg/m^3), (b) salinity, (c) temperature, (d) oxygen (ml/l) and (e) Brunt Väisälä frequency squared (N^2 , in $5e-3 \text{ 1/s}^2$) in the Ormonde seamount region. For each one of the vertical sections, the upper panel correspond to the top 300 metres, and the lower panel to the 300-1500 m depth range. The numbers between both panels correspond to number of the stations.

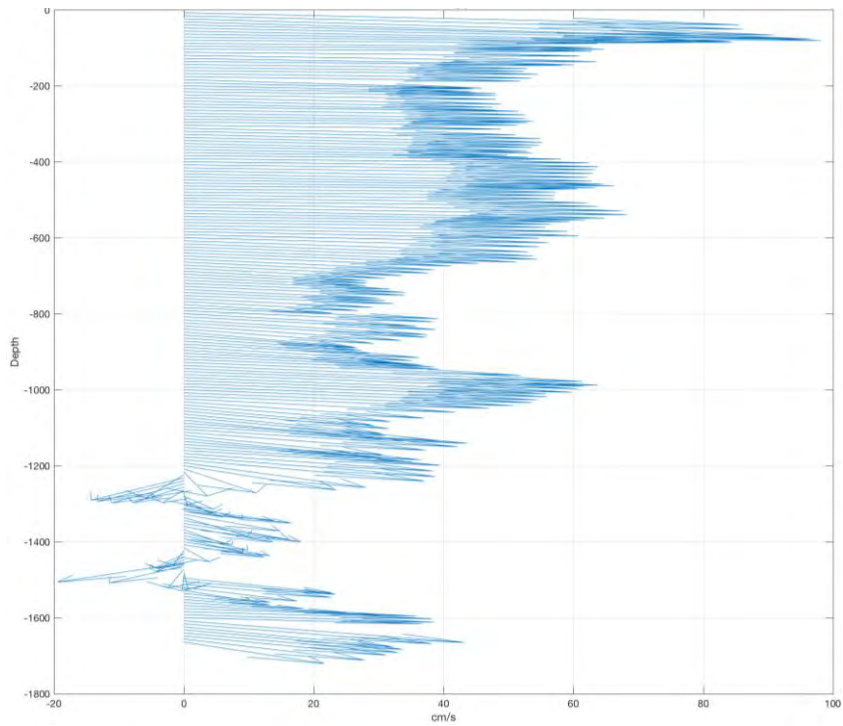

Figure 13: Horizontally averaged vertical profile of horizontal LADCP velocities. All the LADCP stations were used in the averaging.

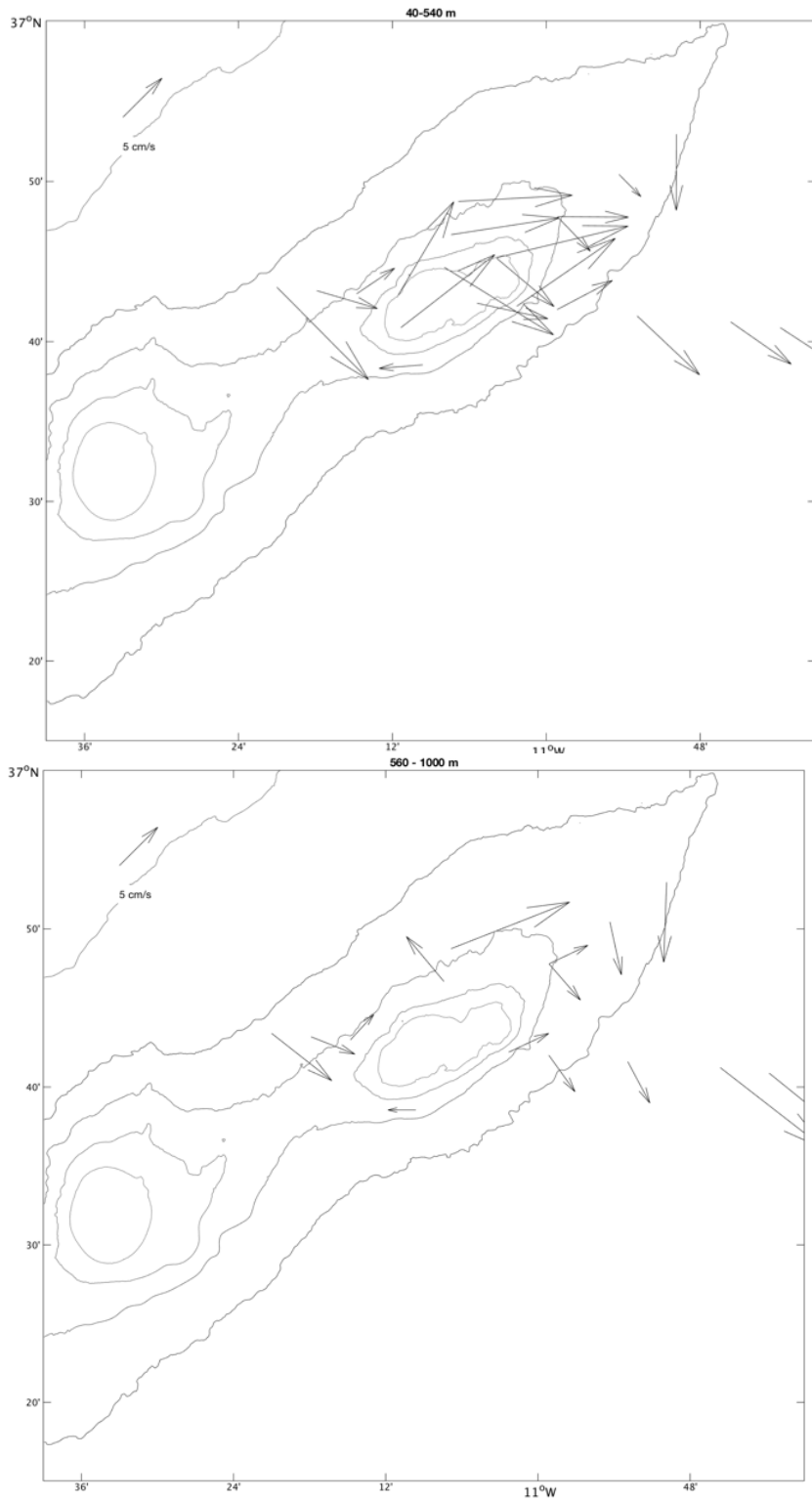

Figure 14: Horizontal distribution of vertical averaged LADCP velocities for the (a) upper layer (40-540 m) and the (b) deep layer (560-1000 m).

9.1.8.3 Formigas

The sampling design in the Formigas seamount was composed of 5 hydrographic sections perpendicular to the slope, and crossing the summit of the seamount (Fig. 15). The Formigas seamount shows the vertical distribution of waters masses characteristic of the central subtropical Atlantic. The waters above the seasonal thermocline (Fig. 16), $\gamma^n < 26.850 \text{ kg m}^{-3}$, are characterized on the θ/S diagram by relative low scattering in the temperature and salinity values, as opposed to other areas where the seasonal heating and evaporation produce large scattering. This is consequence of the proximity of the Formigas seamount to the centre of the subtropical gyre, characterized by subduction and therefore homogeneity at the surface levels. Below the seasonal thermocline and through the permanent thermocline is the NACW, roughly delimited by $26.850 < \gamma^n < 27.200 \text{ kg m}^{-3}$. These waters are characterized in the θ/S diagram by an approximately straight line relationship between potential temperature ($11.40^\circ\text{C} < \theta < 14.03^\circ\text{C}$) and salinity ($35.60 < S < 35.85$). Below the NACW there is a slight decrease in salinity that indicates the presence of diluted Antarctic Intermediate Waters (AAIW), due to the proximity of the seamount to the Middle Atlantic Ridge. Below the AAIW, there is an increase in salinity that correspond to the influence of the MOW, diluted since the Formigas sea mount is 900 nm from the Strait of Gibraltar. These diluted MOW, between $27.380 < \gamma^n < 27.720 \text{ kg m}^{-3}$, have a salinity up to 35.82. Below the MOW, the constant increase in salinity and temperature indicate the presence of upper North Atlantic Deep Waters (uNADW)

The vertical distributions of temperature, salinity and γ^n (Fig. 17) shows this vertical distribution of waters masses. In the upper 50 m, there is a relatively weak gradient in temperature, salinity and γ^n that corresponds to the seasonal thermocline. Between 200 and 400 m the salinity and the temperature decrease linearly, characteristic of the NACW. Deeper than 500 m, the salinity decrease slightly, mostly in the western side of the seamount, to reach a relative minimum of 35.56, characteristics of the AAIW, at 600 m. The presence of this diluted Antarctic AAIW is due to the proximity of the seamount to the Middle Atlantic Ridge, and coherently, since the Formigas bank block the eastern propagation of the AAIW, the presence of this waters is mostly observed in the western side of the seamount. Below the AAIW, there is a linear increase in salinity, to reach the maximum value of 36.70 at 1000 m, the core of the MOW. Temperature then decrease linearly with depth, and at the core of the MOW it has a value of 11°C . The waters with Mediterranean influence reach the 1400 m, as denoted by the 35.58 isohaline, and the $\gamma^n = 27.820 \text{ kg m}^{-3}$ isoline. The presence of the MOW has also a signature in the squared Brunt Väisälä frequency (Fig. 17), with a relative maximum around the core of the MOW, and therefore suggestion internal wave breaking in the slope of the seamount. Comparison of the oxygen signal from Formigas with that from Ormonde again shows the low-oxygen core of MOW, but as expected, weaker at Formigas.

Regarding the dynamics in the seamount, the vertical distribution of density and temperature (Fig. 17) show the upward doming of the isopycnal, and isotherms, that

characterize the cyclonic circulation on top of seamounts. The observed circulation over the Formigas seamount showed disruption of the flow at the level of the Mediterranean waters, with the incoming flow from the east surrounding anticyclone the western seamount and flowing between the two seamounts (Fig. 18, 19) At deepest levels, the ridge formed by both seamounts completely blocks the flow, which has to flow anticyclonally around the ridge. The Mediterranean waters present in the area are well mixed with the surrounding north Atlantic central waters, and possible with Antarctic intermediate waters, with maximum salinity close to 35.75. This maximum in salinity is slightly lower in the eastern side of the sea mountain as consequence of the mixing associated with the topography. This change in the properties of the Mediterranean waters across the seamount was also observed in the mean depth of the core of maximum of salinity which was shallower in the eastern side of the seamount. To further get insight into the possibility of breaking internal waves, several CTD Yo-Yo casts were carried out. During one night, at station 373, 8 casts, from surface to bed, were conducted over 6.5 hours. (Fig. 20). During this CTD Yo-Yo cast is observed an alternate deepening/shallowing of the isotherms and isohalines over the 6.5 hours, possibly associated with propagating internal waves.

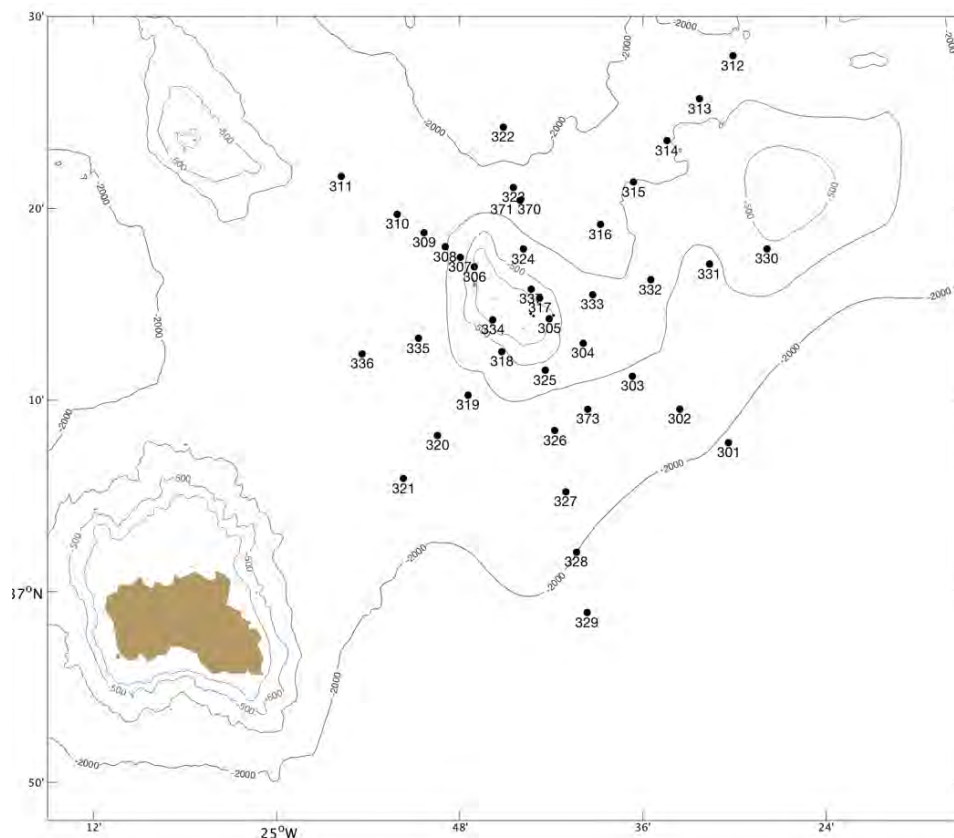

Figure 15: Stations distribution at the Formigas sea mount.

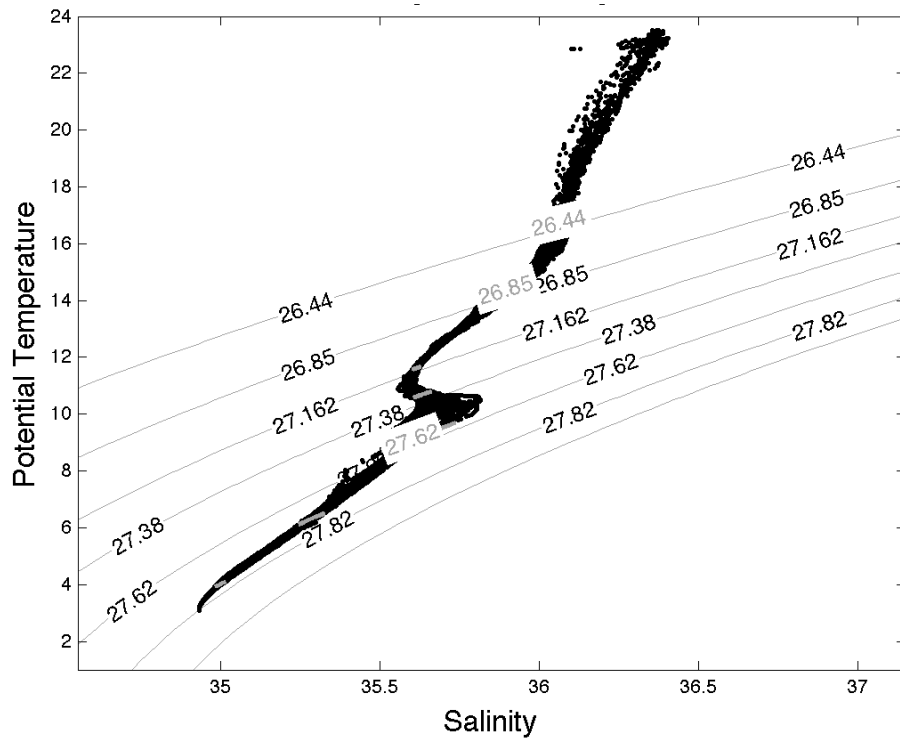

Figure 16: θ/S Diagram of all the stations sampled in the Formigas seamount region. The thin black lines correspond to the density isolines, while the thick grey lines correspond to the γ^n isolines.

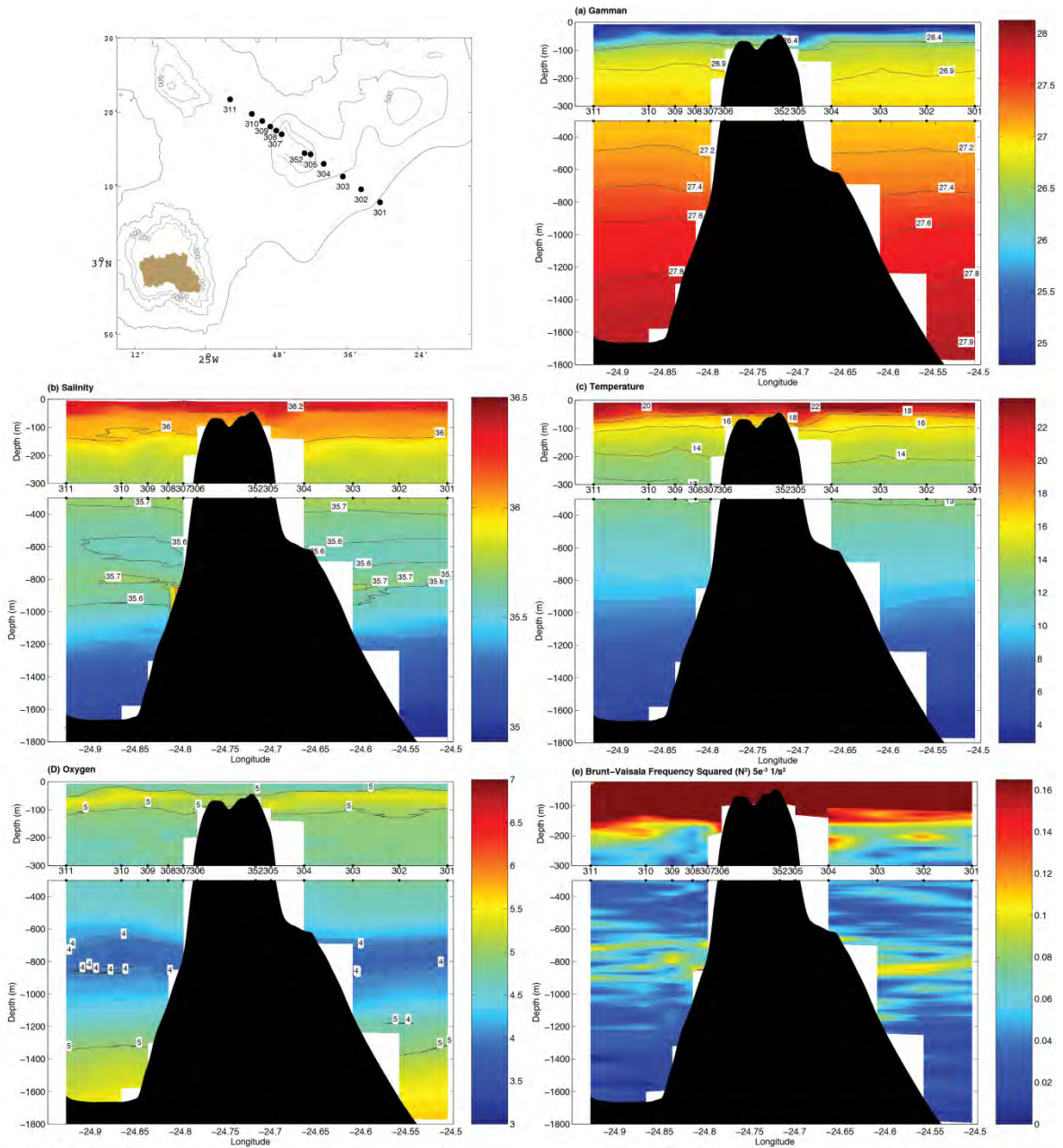

Figure 17: west – east (stations 201 to 213) vertical section of (a) density (γ^n in kg/m^3), (b) salinity, (c) temperature, (d) oxygen (ml/l) and (e) Brunt Väisälä frequency squared (N^2 , in $5e^{-3} 1/s^2$) in the Formigas seamount region. For each one of the vertical sections, the upper panel correspond to the top 300 metres, and the lower panel to the 300-1500 m depth range. The numbers between both panels correspond to number of the stations.

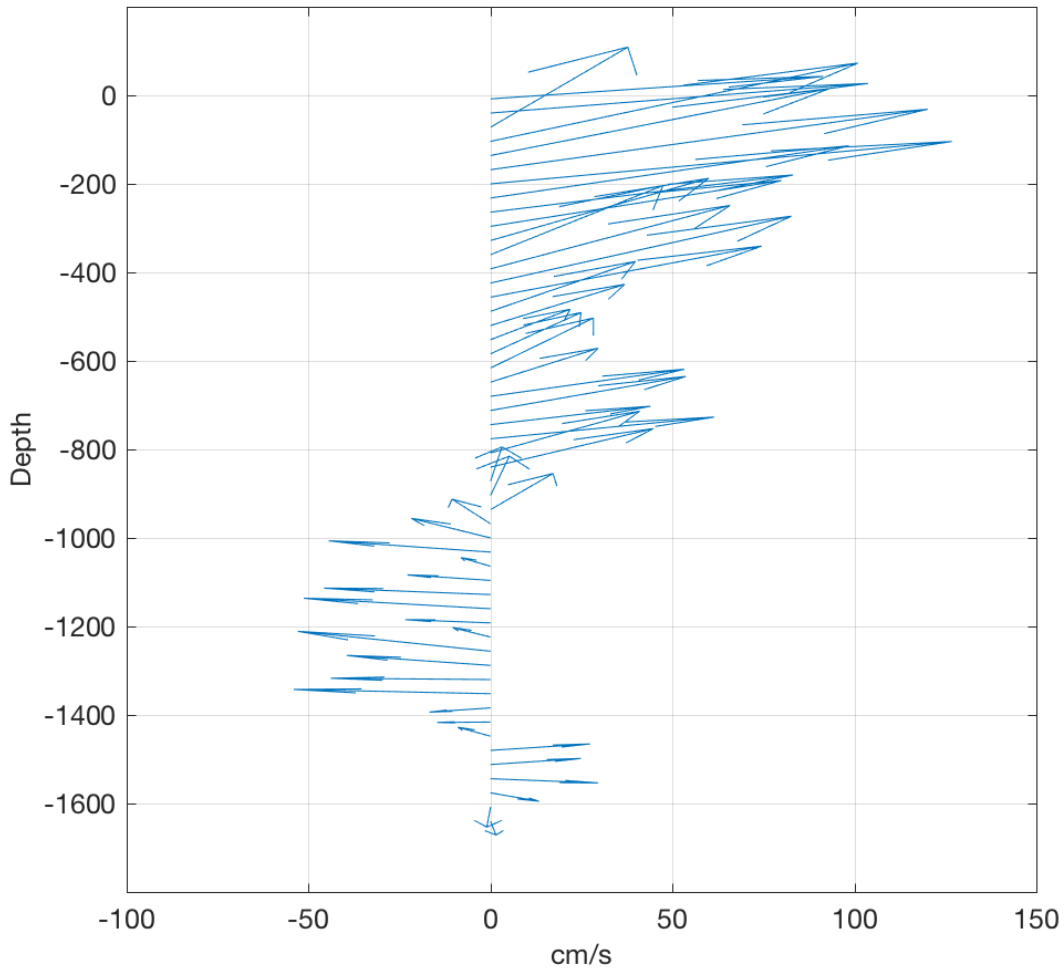

Figure 18: Horizontally averaged vertical profile of horizontal LADCP velocities. All the LADCP stations were used in the averaging.

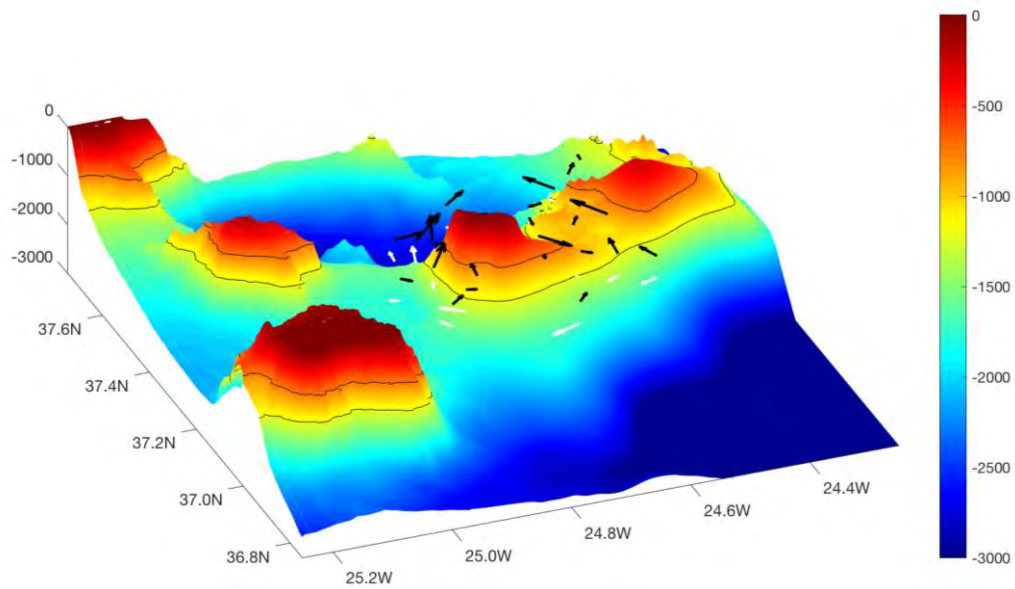

Figure 19: Horizontal distribution of LADCP velocities for the intermediate (750 m, black arrows) and upper deep waters (1200 m, white arrow).

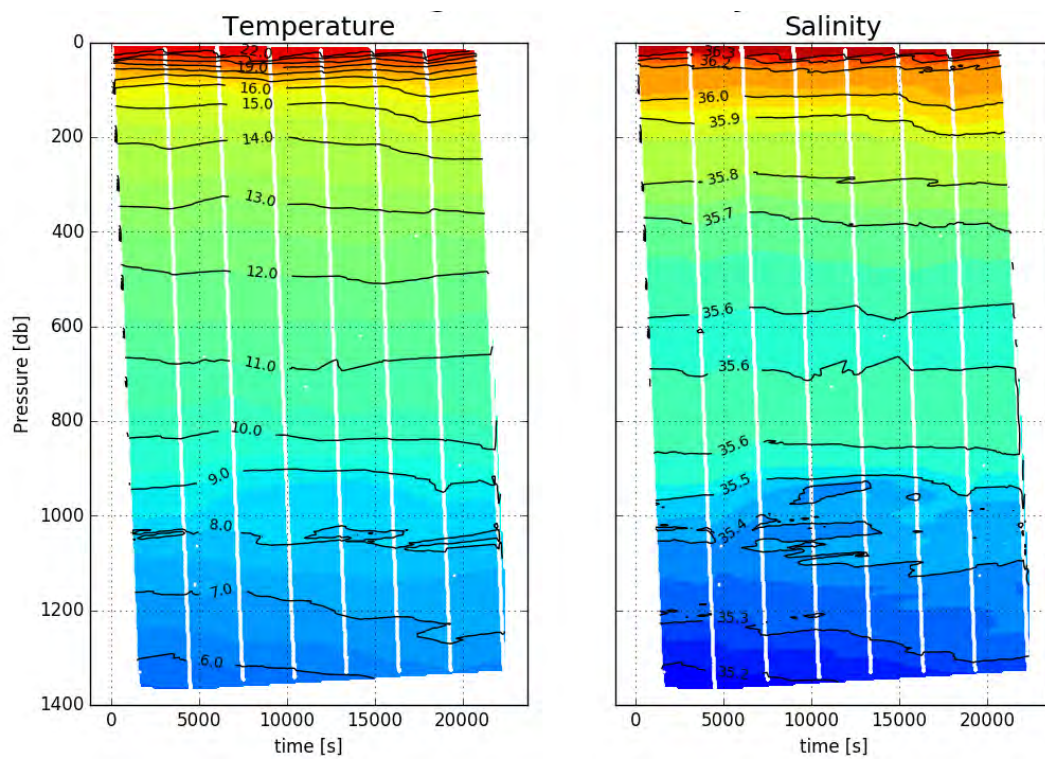

Figure 20: Time series of temperature and salinity at the CTD Yo-Yo station 373.

9.1.8.4 *Seco de los Olivos*

The full planned CTD survey was carried out at Seco de los Olivos, with 21 CTD casts over three nights (Fig. 21) distributed in three across-slope hydrographic sections over the bank.

The general structure of the water column is uniform, with Atlantic-origin warmer and fresher surface waters overlying cooler, saltier deeper waters, with a salinity maximum about 400-500 m depth corresponding to the core of the Levantine Intermediate Water (LIW), the main contributor to the characteristics of the MOW. Beneath the LIW, a smooth halocline/thermocline over the $\sigma_{\theta}=29.1$ kg/m³ isopycnal leads to the Western Mediterranean Deep Water (WMDW) (Fig. 22). The depleted oxygen levels associated with the LIW are the source of the low oxygen signal in MOW in the Atlantic (Fig. 23). The slightly differences in temperature and salinity across-slope suggest the presence of modified Atlantic Water (mAW) over the shelf (Fig. 23b, c).

The mean vertical velocity profile, computed over all the sampled stations, shows a uniform circulation pattern eastward, with decreasing velocities with depth (Fig. 24). This reinforces the idea of mAW flowing eastward in this region, probably due to the weaken of the Alboran gyre system during this part of the year that lets mAW to be found in the western Alboran Sea. Sloping isotherms and isohalines suggest also some circulation associated with the seamount (Fig. 23b, c). In the horizontal maps of horizontal LADCP velocities (Fig. 25) the interaction of the seamount in the circulation is clearly shown.

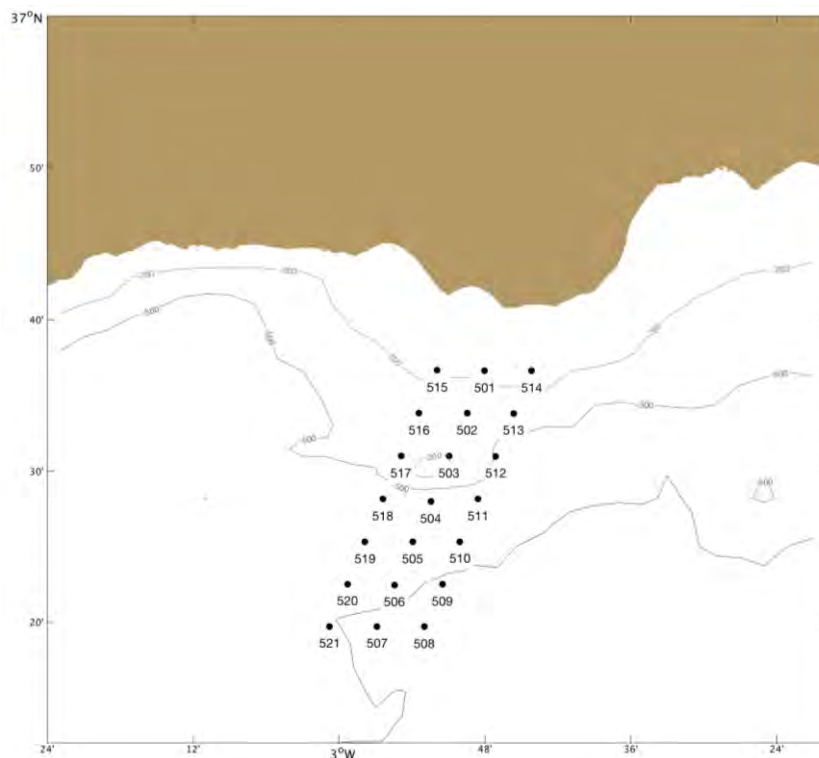

Figure 21: Station distribution at the Seco de los Olivos seamount

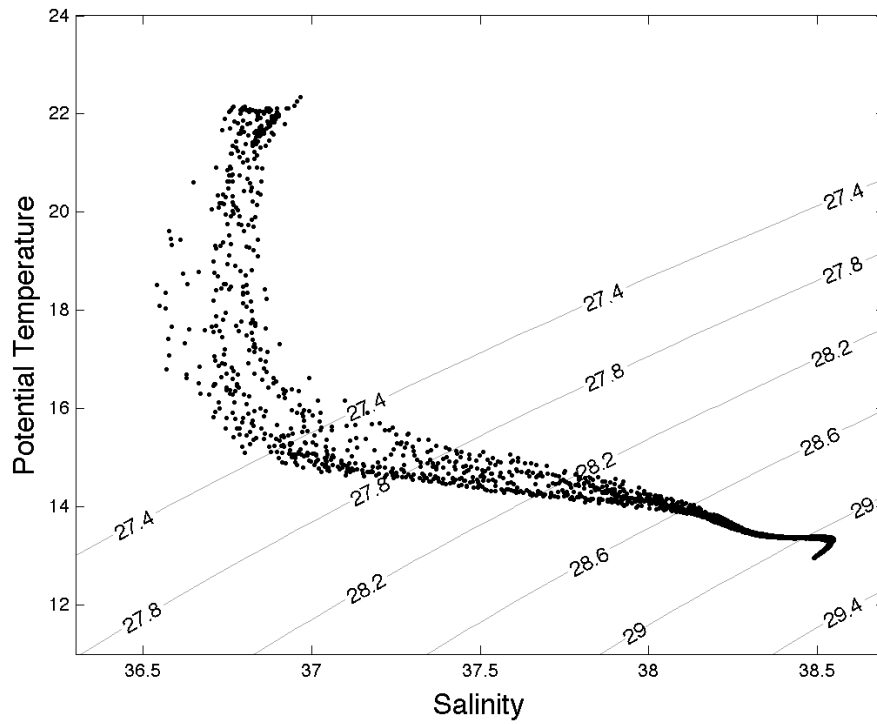

Figure 22: θ/S Diagram of all the stations sampled in the Seco de los Olivos seamount region. The thin black lines correspond to the density isolines.

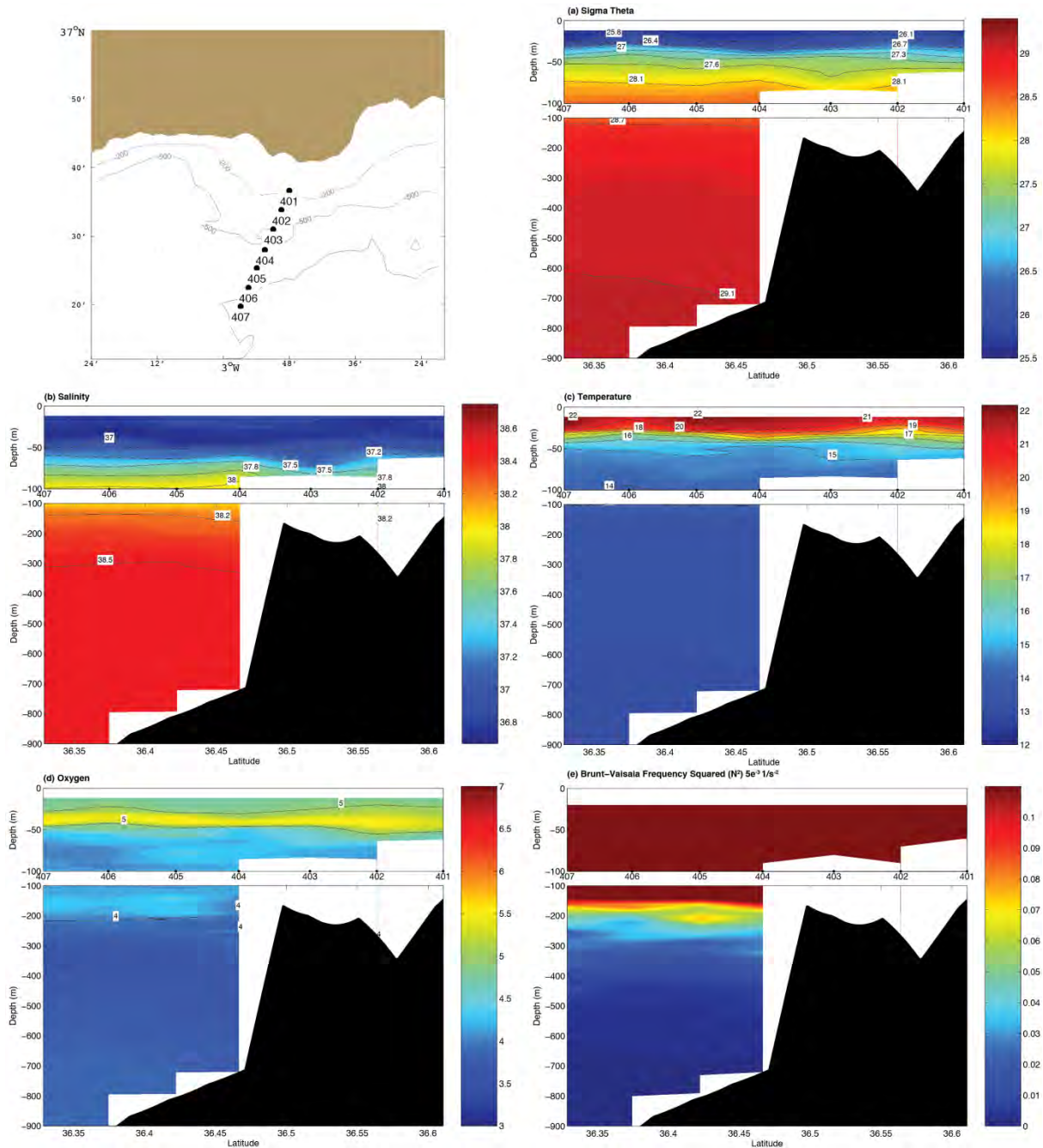

Figure 23: South – north (stations 401 to 407) vertical section of (a) σ_θ (kg/m^3), (b) salinity, (c) temperature, (d) oxygen (ml/l) and (e) Brunt Väisälä frequency squared (N^2 , in $5e^{-3} \text{ 1/s}^2$) in the Seco de los Olivos seamount region. For each one of the vertical sections, the upper panel correspond to the top 100 metres, and the lower panel to the 100-700 m depth range. The numbers between both panels correspond to number of the stations.

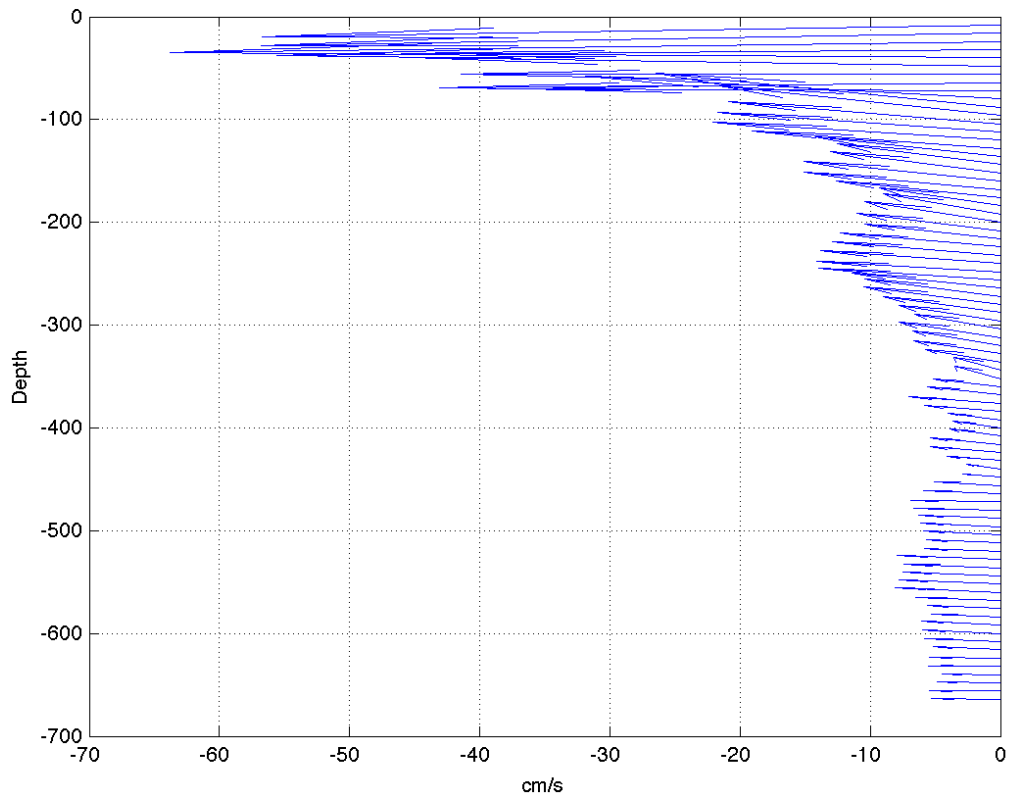
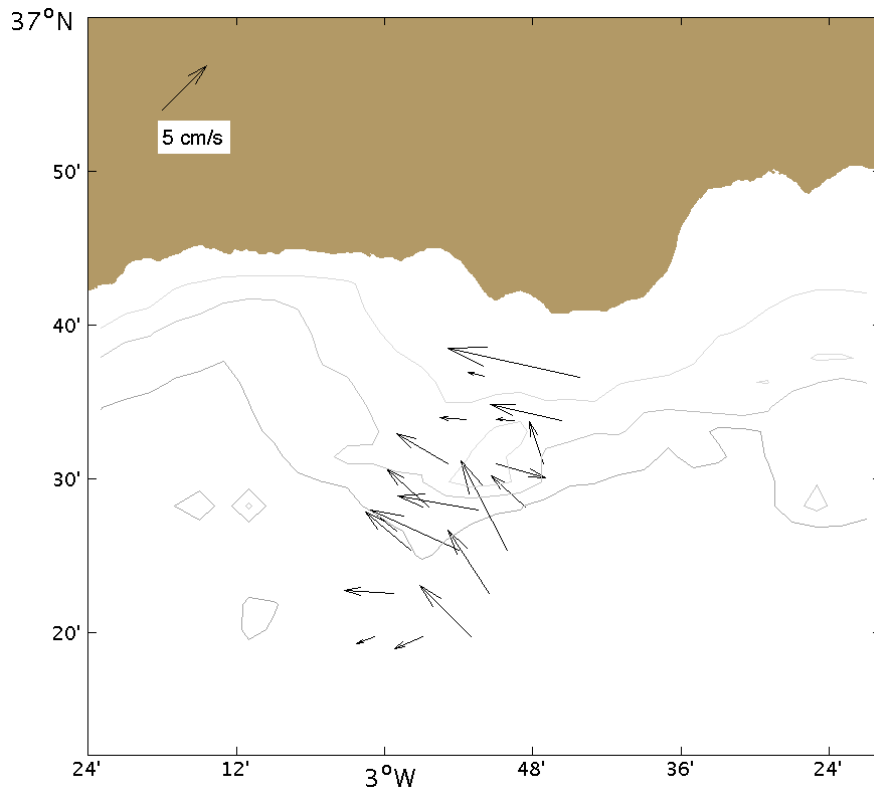

Figure 24: Horizontally averaged vertical profile of horizontal LADCP velocities. All the LADCP stations were used in the averaging.

a



b

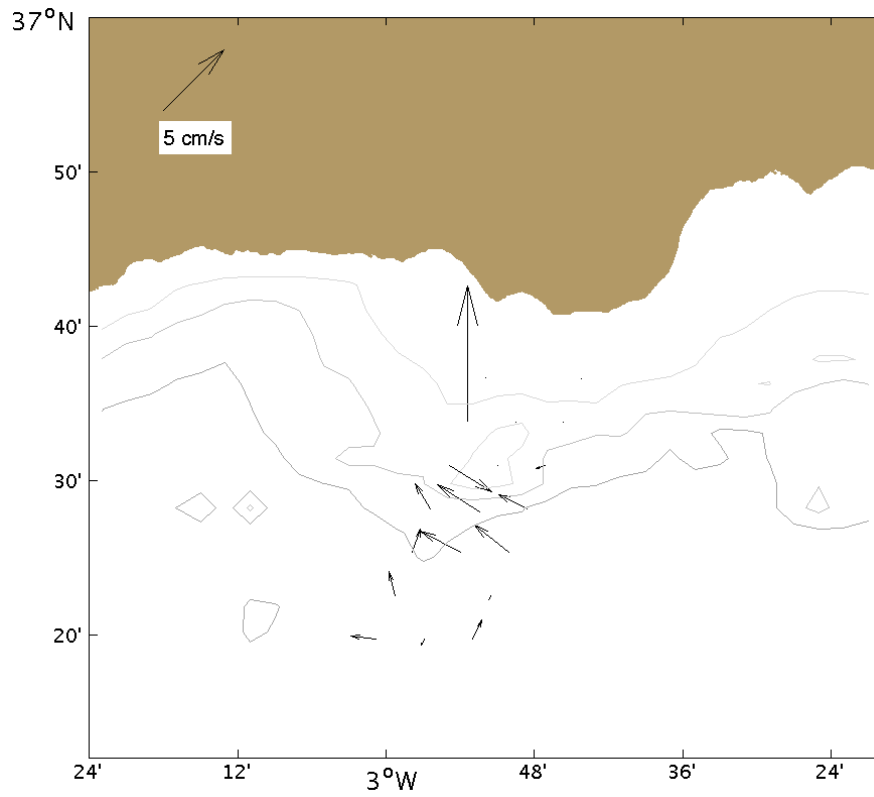

Figure 25: Horizontal distribution of vertical averaged LADCP velocities for the (a) upper layer (40-240 m) and the (b) deep layer (350-500 m).

9.2 Biogeochemical characterization of water masses over oceanic seamounts

Rocío Santiago¹, Alberto Aparicio¹, Marta Álvarez², Mónica Castaño², Verónica Caínzos¹, Victor Pelayo²

1. Instituto Español de Oceanografía, Centro Oceanográfico de Baleares, Palma, Spain
2. Instituto Español de Oceanografía, Centro Oceanográfico de A Coruña, Spain

9.2.1 Personnel involved

Scientific activities of the biogeochemical oceanography team during MEDWAVES-ATLAS Cruise LEG 1 Cádiz – Ponta Delgada (21/09 – 13/10/2016)

	Name	Institution	Role and responsibilities
1	R. Santiago	IEO - Baleares	Technical responsible
2	V. Caínzos	IEO - Baleares	Technicians
3	V. Pelayo	IEO - Baleares and A Coruña	Technicians

MEDWAVES-ATLAS Cruise LEG 2 Ponta Delgada – Málaga (14/10 – 26/10/2016)

	Name	Institution	Role and responsibilities
4	A. Aparicio	IEO - Baleares	Technical responsible
5	V. Caínzos	IEO - Baleares	Technicians
6	V. Pelayo	IEO - Baleares and A Coruña	Technicians

9.2.2 Introduction. Aims

The main objective of the work conducted by the biogeochemical oceanography team was to determine the biogeochemical role of the Mediterranean Water, over and around the Formigas, Ormonde and Seco de los Olivos seamounts, as well as the Gazul Mud volcano (ATLAS Task 1.3, potential contribution also to tasks 2.1 and 2.2).

Greater emphasis will be placed on fine scale biogeochemical characterization 500 meters above the bottom with emphasis on CO₂ variables to determine extant characteristics and any future threats / sensibility for benthic communities (ATLAS Tasks 1.3, 2.4 and potential contribution to task 2.2).

An Optimum Multi Parameter (OMP) analysis will be done to quantify the contribution of Mediterranean Water in the different seamounts in the Atlantic area. Within the Alborán Sea the contribution of recent and old Western Mediterranean Deep Water will be quantified (ATLAS Task 3.1).

9.2.3 Sampling and processing methodology (water sampling and analyses)

All information regarding the samples collected is included in Appendixes IV and V.

Sampled stations for chemical analyses are depicted in figures 1, 2, 3 and 4 and in Table 1.

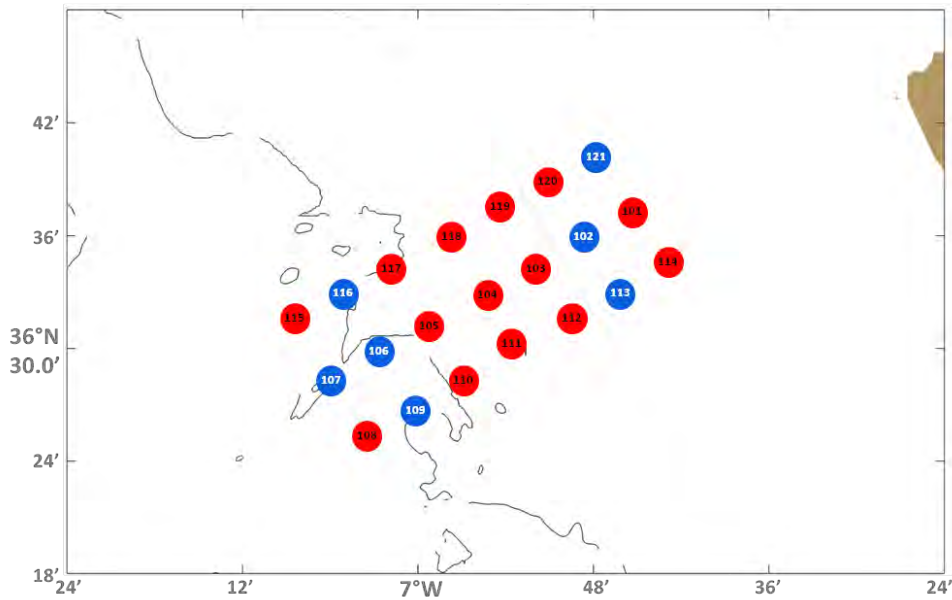

Figure 1: Map of sampling stations in Gazul Mud volcano. Red dots indicate stations where chemical sampling has been done and blue dots where only physical sampling has been conducted.

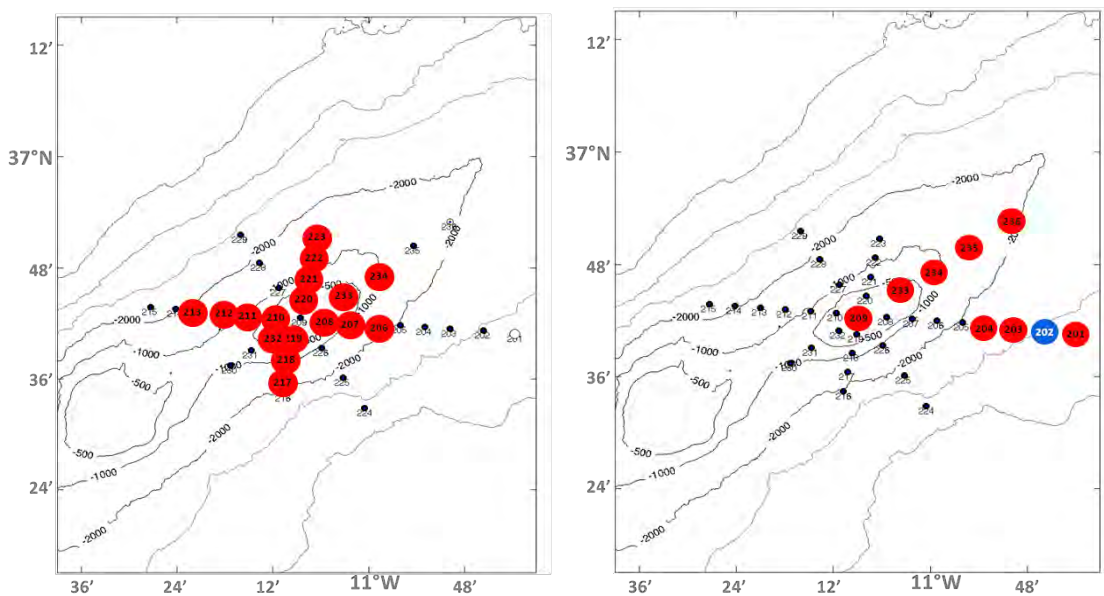

Figure 2: Map of sampling stations in Ormonde Seamount (a: sampling stations 1st leg, b: sampling stations 2nd leg). Red dots indicate stations where chemical sampling has been done and blue dots where only physical sampling has been conducted.

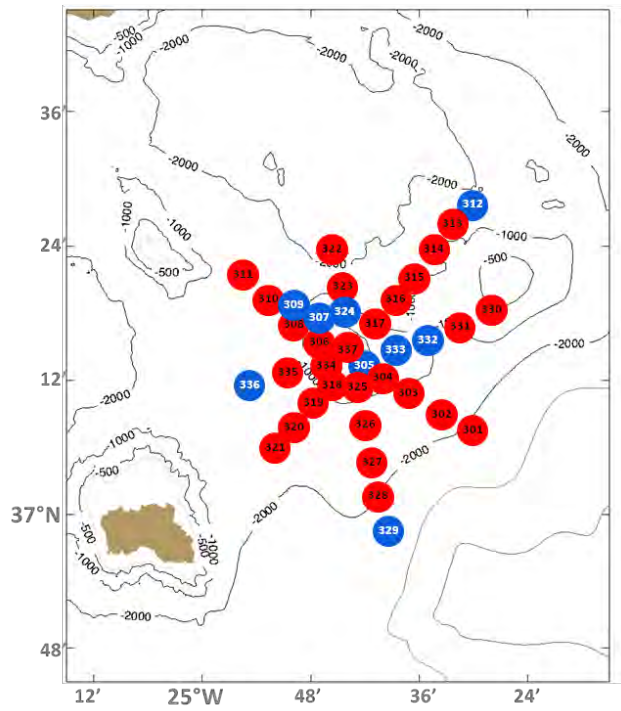

Figure 3: Map of sampling stations in Formigas Seamount. Red dots indicate stations where chemical sampling has been done and blue dots where only physical sampling has been conducted.

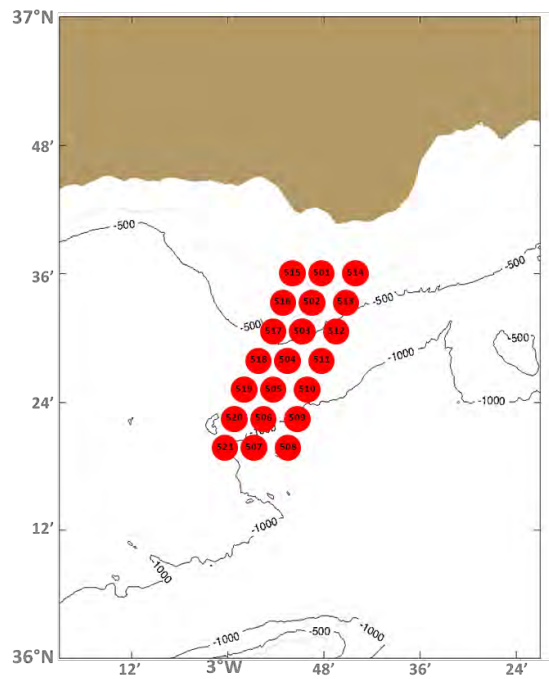

Figure 4: Maps of sampling stations in Seco de los Olivos seamount. Red dots indicate stations where chemical sampling has been performed.

Table 1: Summary of samples collected in each area of study. **Black numbers** correspond to samples collected during the first leg, **blue numbers** to samples collected during the second leg

		Gazul	Ormonde	Formigas	Seco de los Olivos
Number of stations		14	9 / 17	28 / 1	21
Samples already determined	Dissolved Oxygen	85	49 / 60	60	60
	pH	93	72 / 81	77	77
	Total Alkalinity	93	72 / 81	77	77
	Carbonates	7	10 / 64	35	35
Samples collected for further analyses	Nutrients	93	72 / 118	132	132
	Dissolved Inorganic Carbon		7	6	6
	Chlorophyll- <i>a</i>		3	3	3
	Turbidity		2	2	2

9.2.3.1 Dissolved Oxygen

Dissolved oxygen (DO) in seawater was measured at 48 stations. A total of 314 samples were collected and processed on board, covering different depths during the MEDWAVES cruise. DO was reported in $\mu\text{mol/kg}$ (see detailed information in Appendix V). DO was measured following the Winkler potentiometric method after Langdon (2010).

Sampling. Sample collection was performed by means of the Rosette, which was equipped with 24 Niskin bottles (12 litre). DO samples were collected first, once the Rosette was on board (Fig. 5). These samples were stored in pyrex "iodine titration" flasks with flared necks and ground glass stoppers, with a nominal volume of about 115 ml. The flasks were provided and calibrated by IEO – A Coruña. Each Niskin bottle was sampled using flexible silicone tubing placed at the bottom of the flasks, which was filled until overflowing. During the sampling the formation of bubbles was avoided. The temperature of seawater was measured with a digital thermometer while sampling. The pickling reagents were immediately added afterwards, 1 ml each. The recommendations given in Langdon (2010) were carefully followed in this particular step. After shaking, the fixed samples were stored in the dark until the analysis, which was usually done within a maximum of 24 hours.



Figure 5: member of the physical and biogeochemical oceanography teams sampling the CTD-Rosette during the first leg of MEDWAVES.

Titration. The reagents used during the cruise were:

Manganous chloride (3M), R1

Sodium iodide (4M) / sodium hydroxide (8M), R2

Sulfuric acid (5N), R3

Thiosulfate (0.03M nominal)

As standard solutions: potassium iodate (0.01N, provided by OSIL, UK).

Titration were performed within the sampling calibrated flasks using a 808 Titrande Metrohm potentiometric titrator with a platinum combined electrode. The Titrande was coupled with an exchangeable unit with a 5 ml burette.

The analytical determination of dissolved oxygen (DO) during the cruise has been carried out in sample batches. A total of 19 batches have been made and in each of them a reagent blank analysis has been performed, as well as an evaluation of the thiosulfate used. For each batch of DO the reagent blank and the thiosulfate molarity were determined. The table 2 and figure 6 show the evolution of both. Blanks give us the concentration of oxygen in the reagents we used. Thiosulfate is used as a titrant for the iodide ion released in the chemical process.

Table 2: Results of thiosulfate concentration and reagent blank in each batch of samples analyzed during the cruise.

Batch	Date	Thiosulfate Molarity 20°C	Thiosulfate CV*100	Reagent Blank ml	Reagent Blank STD*100	KIO ₃
1	22/09/2016	0.027584	0.04	0.008	0.20	IEO
2	23/09/2016	0.027584	0.35	0.012	0.83	OSIL
2	23/09/2016	0.027509	0.88	0.016	0.65	IEO
3	24/09/2016	0.027736	0.10	0.015	0.15	OSIL
4	25/09/2016	0.027732	0.18	0.019	0.27	OSIL
5	26/09/2016	0.027525	0.09	0.010	0.38	OSIL
6	30/09/2016	0.027364	0.16	0.019	0.61	OSIL
7	01/10/2016	0.027325	0.23	0.010	0.23	OSIL
8	02/10/2016	0.027352	0.04	0.017	0.21	OSIL
9	02/10/2016	0.027486	0.11	0.018	0.30	OSIL
10	04/10/2016	0.027452	0.08	0.016	0.33	OSIL
11	06/10/2016	0.027423	0.21	0.016	0.21	OSIL
12	06/10/2016	0.027208	0.09	0.008	0.18	OSIL
13	20/10/2016	0.027442	0.15	0.012	0.25	OSIL
17	24/10/2016	0.027267	0.04	0.027	0.05	OSIL
19	25/10/2016	0.027331	0.18	0.018	0.31	OSIL

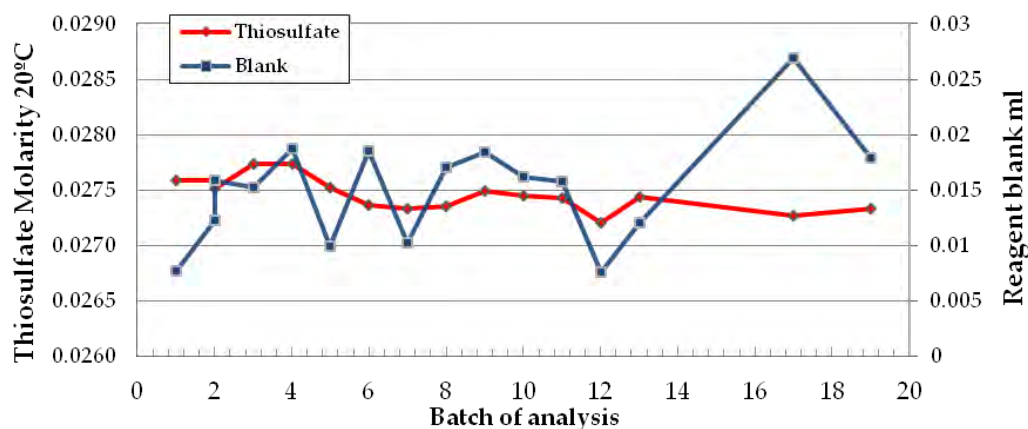

Figure 6: Graphic evolution of reagent blanks and thiosulfate molarity results throughout the cruise.

Note that on batch 2, both KIO₃ reference solutions IEO (home made) and OSIL were used to check the standardization of the thiosulfate solution. The agreement in the calculated molarity is very good.

The following graph (Fig. 7) compares the winkler measurements obtained with the CTD sensor and the one measured experimentally with the winkler method in order to detect bad values.

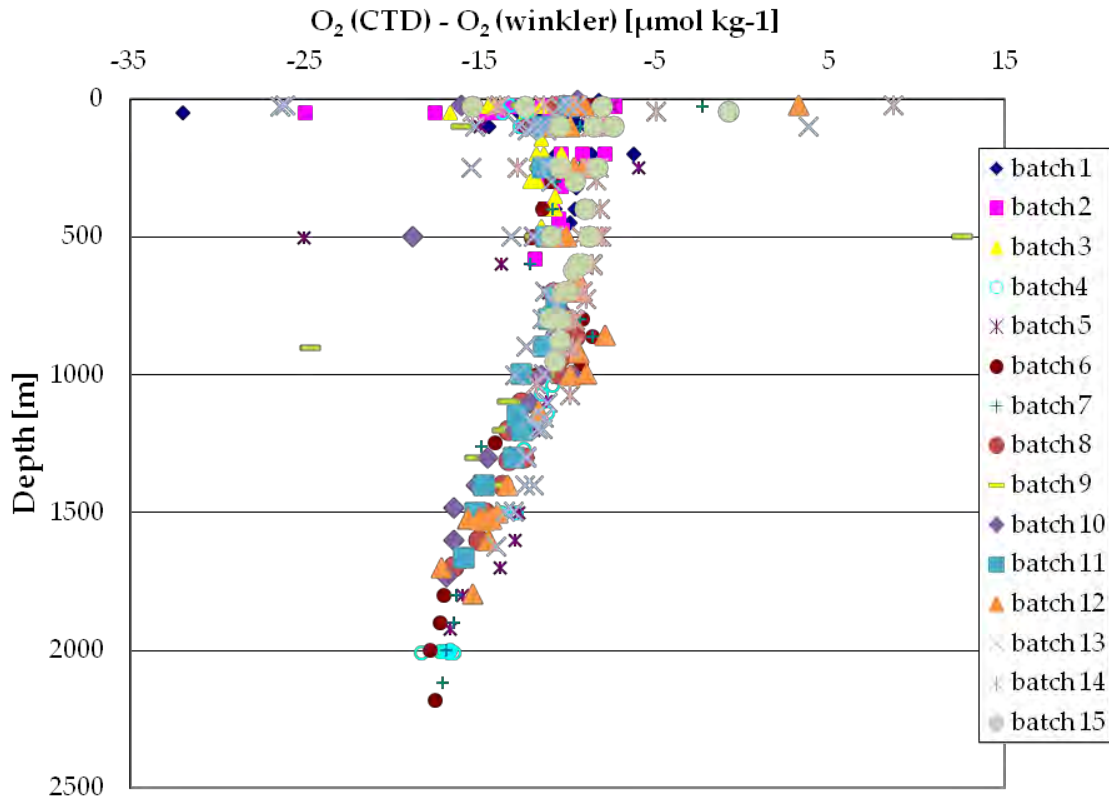

Figure 7: Difference between the values of dissolved oxygen obtained with the CTD less those calculated with titration against depth.

Reproducibility. In order to control the quality of our DO measurements, samples from different Niskin bottles fired at the same depth were obtained in stations 320 (pressure 1526 dbar, salinity 35.072, 249.96 ± 0.44 μmol/kg, 8 samples) and 202 (pressure 2006 dbar, salinity 35.151, 241.03 ± 0.47 μmol/kg, 6 samples) (Location of the stations is displayed in figures 1 - 4).

9.2.3.2 pH analysis

Spectrophotometric pH in seawater was measured following the methodology by Clayton & Byrne (1993) at selected stations and depths along the MEDWAVES cruise and reported at 25 °C and on the Total scale, hereinafter pH_{25T}. pH in seawater was measured at 75 stations within 400 depths during the MEDWAVES cruise (see detailed information in Appendix V).

Sampling. pH was sampled after dissolved oxygen. Samples were collected in cylindrical optical glass 10 cm pathlength cells, which were filled to overflowing and immediately stoppered. After sampling, the cells were immediately stabilised at 25 °C.

Analytical method. Seawater pH was measured using a double-wavelength spectrophotometric procedure (Byrne 1987). The indicator was a solution of m-cresol purple (Sigma Aldrich) prepared in seawater (2 mM). The indicator was kept in a blood bag out of contact with the air and light. All the absorbance measurements were obtained in the thermostatted (25 ± 0.2 °C) cell compartment placed in a Perkin Elmer double beam spectrophotometer. The temperature was controlled with a thermostatic bath.

After blanking with the sampled seawater without dye, 50 µl of the dye solution were added to each sample using an adjustable repeater pipette (Eppendorf Multipette plus). The absorbance was measured at three different fixed wavelengths (434, 578 and 730 nm).

pH_T, on the total hydrogen ion concentration scale, was calculated using the following formula (Clayton & Byrne 1993):

$$\text{pH}_T = 1245.69/T + 3.8275 + (2.11 \cdot 10^{-3}) \cdot (35-S) + \log((R-0.0069)/(2.222-R \cdot 0.133))$$

where R is the ratio of the absorbance (A) of the acidic and basic forms of the indicator corrected for baseline absorbance at 730 nm ($R = (578A-730A)/(434A-730A)$), T is temperature in Kelvin scale and S is salinity.

As the injection of the indicator into the seawater perturbs the sample pH slightly, the absorbance ratios measured in the seawater samples (R_m) should be corrected to the R values that would have been observed in an unperturbed analysis (R_{real}). In order to do this, we obtain the correction in the absorbance ratio of every sample as a function of the absorbance ratio measured (R_m). This linear function was calculated from second additions of the indicator over samples with a wide range of pH (Fig. 8). This function also corrects for deviations in the linear relationship between absorbance and the indicator concentration; i.e., deviations from the Beer Law in the spectrophotometer.

$$R_{\text{real}} = R_{\text{measured}} - (-0.0055 \pm 0.0015 \cdot R_{\text{measured}} + 0.0014 \pm 0.0022); \quad r^2 = 0.12, \quad n=92$$

All the pH measurements are referred to 25 °C and corrected for the addition of the indicator using the previous formula.

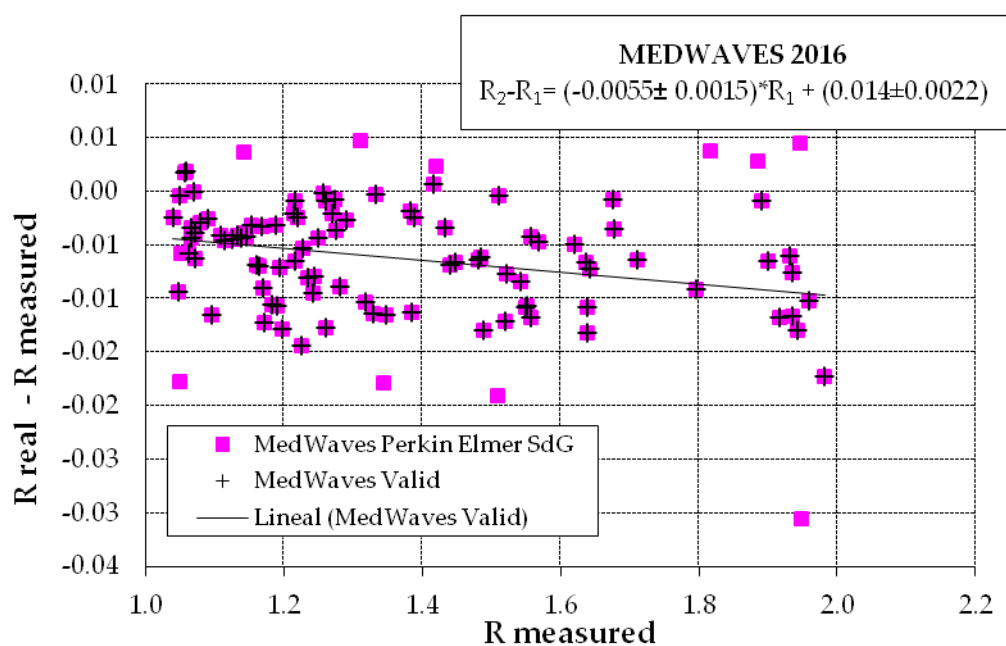

Figure 8: Results of the test performed as a second addition of the m-cresol color indicator used in the pH analysis. This allows us to correct the acidity caused by the addition of the colored indicator to the samples in the spectrophotometric method.

Accuracy. In order to check the precision of the pH measurements, samples of CO₂ Certified Reference Material (CRM, batch 155, distributed by A.G. Dickson from the Scripps Institution of Oceanography, SIO) were analysed during the cruise. Twelve samples from a CRM bottle (batch 155, certified chemical characteristics for salinity, 33.506; silicate, 2.9 μmol kg⁻¹; nitrate, 1.71 μmol kg⁻¹; nitrite, 0.00 μmol kg⁻¹; phosphate, 0.25 μmol kg⁻¹; total alkalinity, 2235.07±0.62 μmol kg⁻¹; and total inorganic carbon, 2042.75±0.70 μmol kg⁻¹) were drawn carefully to avoid bubbles and analysed for pH using the spectrophotometric method. The corresponding theoretical pH_{25T} value for this batch using the dissociation constants from Mehrbach et al. (1973) refitted by Dickson & Millero (1987) is 7.866. We found a measured value of 7.8472±0.0022 (N=9), so a difference with the calculated pH_{25T} of -0.0190. This mismatch will be assessed when studying the internal consistency of our CO₂ measurements after analysing stored DIC samples in the home laboratory.

Reproducibility. Regarding the reproducibility of our measurements, we analyzed several samples collected from the several Niskin bottles fired at the same depth (stations 202 (Ormonde) and 320 (Formigas)). Stations 320 (pressure 1526 dbar, salinity 35.072, pH 7.7095±0.0037, 6 samples) and 202 (pressure 2006 dbar, salinity 35.151, pH 7.7306±0.0027, 5 samples).

9.2.3.3 Total Alkalinity analysis

Total Alkalinity (TA) along the MEDWAVES cruise was analyzed following a double end point potentiometric technique by Pérez & Fraga (1987) further improved in Pérez et al. (2000). This technique is faster and comparable than the whole curve titration (Mintrop et al. 2000). 73 oceanographic stations within 400 samples were analyzed (see Figures 1 – 4). TA was measured at 75 stations within 400 depths during the MEDWAVES cruise (see detailed information in Appendix V).

Sampling. Seawater samples for TA were collected after pH samples, in 600 ml borosilicate bottles and stored in the laboratory until analysis, usually no later than 2 days. Samples were filled to overflowing and immediately stopped.

Analytical method. TA was measured using an automatic potentiometric titrator "Titrande 808 Metrohm", with a Metrohm Aquatrode Plus 6.0257.000 combination glass electrode and a Pt-1000 probe to check the temperature. The system is coupled with a 5 ml exchangeable unit. Potentiometric titrations were carried out with hydrochloric acid ([HCl] = 0.1N) to a final pH of 4.40 (Pérez & Fraga 1987). The electrodes were standardized using an ftatalate buffer of pH 4.42 made in CO₂ free seawater (Pérez et al. 2002). Concentrations are given in $\mu\text{mol kg}^{-1}$.

The 0.1N hydrochloric acid was prepared mixing 0.5 mol (18.231 g) of commercially HCl, supplied by Riedel-deHaën® (Fixanal 38285), with distilled water into a graduated 5 l beaker at controlled temperature conditions. The HCl normality is exactly referred to 20 °C. The variation of salinity after the titration is lower than 0.1 units, which is taken into account in the final TA calculation.

The analytical determination of TA during the cruise has been carried out in sample batches. A total of 19 batches have been made. Surface seawater was used as a "quasi-steady" seawater substandard. It consists in surface seawater taken from the non-toxic supply and stored in the dark into a large container (35 l) during 2 days before use. This substandard seawater was analysed at the beginning and at the end of each batch of analyses to control the drift in the analyses for each batch.

Also 3 or 4 replicates of CO₂ certified reference samples (CRM) has been analyzed at the beginning of each batch of analysis. Usually, each sample is analysed twice for alkalinity.

Accuracy. CRM analyses were performed in order to control the accuracy of our TA measurements. Accordingly, the final pH of every batch of analyses was corrected to obtain the closest mean TA on the CRM analyses to the certified value (see Fig. 9).

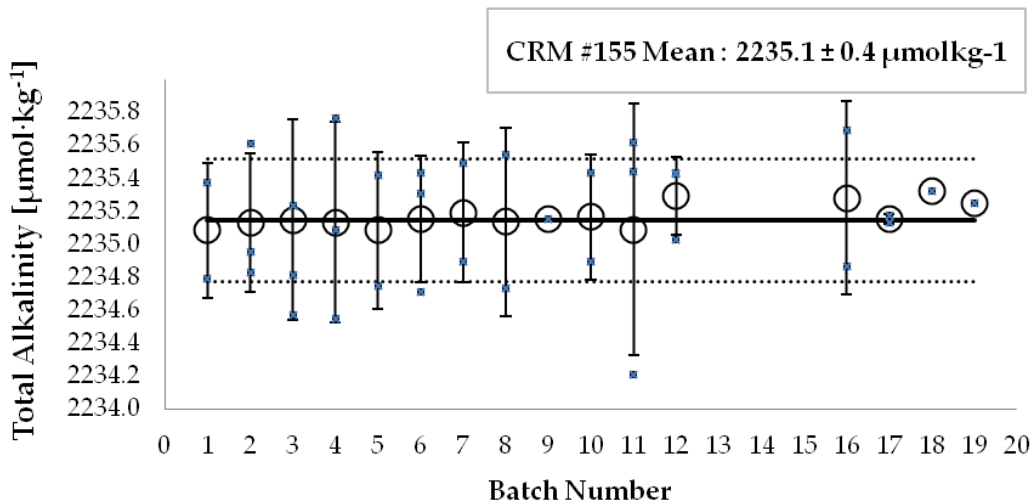

Figure 9: Analysis of CO₂ Certificated Reference Samples (CRM, batch 155, distributed by A.G. Dickson from the Scripps Institution of Oceanography, SIO, where certified total alkalinity is 2235.07±0.62 μmol kg⁻¹) in each batch of measurements during the cruise.

Table 3: Alkalinity analysis supplementary information for each batch of analysis: NHCl is the normality referred to 20 °C of the hydrochloric solution used; ΔpH is the pH correction applied to refer the TA determinations on the CRM to the corresponding nominal value. The mean value of the TA measurements on the CRM samples is also shown (Fitted TA±standard deviation (number of analysis)). The average of the difference (Av. Dif. and number of duplicates) in the duplicate's analyses is shown.

Batch	Date	Stations	N _{HCl}	ΔpH	Fitted TA	Av. Dif.
1	23/09/2016	101 103 104 105	0.10011361	-0.004	2235.08±0.41(2)	0.80
2	23/09/2016	108 110 111 112 114	0.10011361	0.004	2235.13±0.42(3)	0.86
3	24/09/2016	115 117 118 119 120	0.10011361	-0.006	2235.15±0.61(4)	0.87
4	25/09/2016	201 203 204	0.10011361	-0.006	2235.13±0.61(3)	0.72
5	27/09/2016	209 233 234 235 236	0.10011361	-0.012	2235.08±0.48(2)	0.76
6	30/09/2016	301 302 303 304	0.10011361	0.014	2235.15±0.39(3)	0.63
7	01/10/2016	325 326 327 328	0.10011361	0.010	2235.19±0.43(2)	1.16
8	02/10/2016	306 308 310	0.10011361	0.004	2235.14±0.57(2)	0.55
9	03/10/2016	313 314 315 316 317	0.10011361	0.006	2235.15±0(1)	0.79
10	04/10/2016	311 322 323 337	0.10011361	0.013	2235.17±0.38(2)	0.82
11	05/10/2016	330 331 334 335	0.10007145	0.016	2235.09±0.77(3)	1.12
12	07/10/2016	318 319 320 321	0.10007145	0.018	2235.29±0.23(3)	0.56
14	19/10/2016	217 218 219 220	0.10007145	-0.01	--	1.1
15	20/10/2016	208 212 213	0.10007145	-0.008	--	1.5
16	22/10/2016	206 222 223	0.10007145	-0.003	2235.28±0.58(2)	1.3
17	23/10/2016	502 503 504 506	0.10007145	-0.0025	2235.15±0.03(2)	1.7
18	24/10/2016	507 509 511	0.10007145	-0.003	2235.32±0(1)	0.6
19	25/10/2016	513 516 517 518 520	0.10007145	-0.007	2235.25±0(1)	1.1

After batch number 14 some technical problems were encountered, so the number of CRMs is reduced. The TA quality is guaranteed by means of an internal consistency analysis and using recent data in the area also as a further checking.

9.2.3.4 Carbonate ion concentration

The carbonate ion concentration (CO_3^{2-}) was determined spectrophotometrically following the recent method first proposed by Patsavas et al. (2015), after the works by Byrne and Yao (2008) and Easley et al. (2013). It was measured at 30 stations within 151 depths during the MEDWAVES cruise (see detailed information in Appendix V).

Sampling. Carbonate was sampled after pH. Samples were collected in cylindrical quartz 10 cm pathlength cells, which were filled to overflowing and immediately stoppered. After sampling the cells are immediately stabilised at 25 °C.

Analytical method. The concentration of CO_3^{2-} in seawater was measured using the method proposed by Patsavas et al. (2015). A solution of 0.022 M of the titrant $\text{Pb}(\text{ClO}_4)_2$ (Fisher Scientific, 99.99 % purity dissolved in distilled water) was added to the seawater sample, the complex PbCO_3 formed afterwards is detected spectrophotometrically in the UV spectra, using a Perkin Elmer double-wavelength spectrophotometer. All the absorbance measurements were obtained in the thermostatted (25 ± 0.2 °C) cell compartment of the spectrophotometer. The temperature was controlled with a thermostatic bath.

After blanking with the sampled seawater without dye, 20 μl of the dye solution were added to each sample using an adjustable repeater pipette (Eppendorf Multipette plus). The absorbance was measured at three different fixed wavelengths (234, 250 and 350 nm).

Each profile of ion carbonate measurements is inspected against depth. Below is a plot (Fig. 10) with all the determinations, note the high concentrations for waters on Seco de los Olivos corresponding to Mediterranean Sea waters.

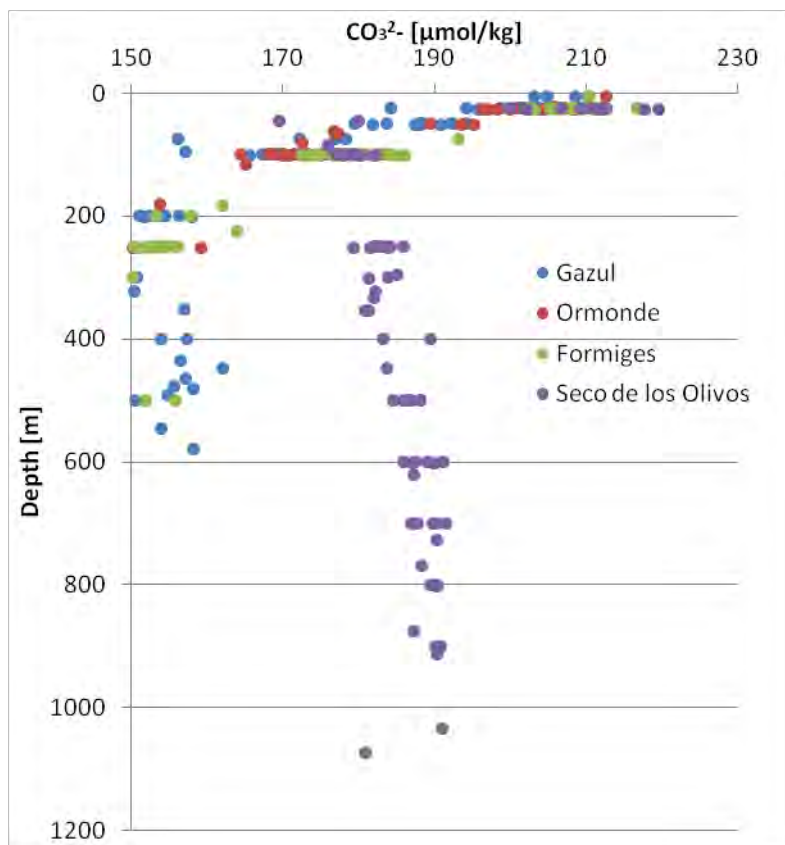

Figure 10: Concentration of the carbonate ion with the depth analyzed during the cruise in each study area.

Reproducibility. Regarding the reproducibility of our measurements, we analyzed several samples collected from the several Niskin bottles fired at the same depth (station 373, 12 samples at 500 m depth, CO_3^{2-} $130.392 \pm 0.798 \mu\text{mol/kg}$). (To locate the stations see figures 1 - 4).

9.2.3.5 Dissolved Inorganic Carbon

Samples for Dissolved Inorganic Carbon (DIC) were collected at three stations (301, 217 and 509) and stored to be analysed in IEO-A Coruña laboratory. Samples were stored in 500 ml borosilicate bottles, which are filled after the oxygen samples and immediately poisoned with 200 μl saturated HgCl_2 . A small headspace is allowed in the DIC bottle for the water to expand. The stoppers were greased with Apiezon L and sealed with a rubber band and collar. Samples will be stored in a dark and fresh place until analysis.

9.2.3.6 Dissolved Inorganic nutrients

Samples for Dissolved Inorganic Nutrients were obtained in each station and stored to be analyzed in IEO-Baleares laboratory using a 4-channel autoanalyzer (QuAAtro-39 Seal Analytical).

Sample were stored in 10 ml polypropilene tubes and immediately frozen at -20 °C.

9.2.3.7 Chlorophyll-a

Samples for Chlorophyll-*a* determination were taken in stations (315, 311, 331, 222, 221, 508) just to calibrate the fluorimeter sensor attached to the CTD and the deck fluorimeter connected to the continuous flow of subsurface water above the vessel.

A volume of 1 l of seawater was collected from different depths: 25 meters, Maximum Chlorophyll Depth, 100 meters (blank measurement) and seawater from continuous flow from the ship were filtered on board using Whatmann GF/F filters and immediately stored at -80 °C. Filters will be processed in IEO-Baleares by means of a TurnerDesigns Fluorimeter (Lorenzen & Jeffrey 1980). (To locate the stations see figures 1 - 4).

9.2.3.8 Turbidity

Three samples for Turbidity determination were taken in stations (217, 504 and 519) just to calibrate the turbidity sensor attached to the CTD.

A volume of 13.5 l of seawater were collected and filtered on board using Whatmann GF/F muffled and weighted filters and immediately stored at -20 °C.

9.2.4 Instrumentation details

DO has been measured using an 808 Metrohm potentiometric titrator (serial number 1808002011553) controlled by Tiamo 2.4 software. A platinum combined electrode (6.0451.100) has been used.

TA has been determinate by an 808 Metrohm potentiometric titrator (serial number 180802011566) with a Metrohm Aquatrode Plus electrode combined with a Pt-1000 probe to check the temperature (6.0257.000).

pH has been measured by a Perkin Elmer spectrophotometer, Lambda 850 model (serial number 850N6061301) controlled by UVwinlab L800/L900 software. A thermostatic bath from THERMO- Neslab RTE17 (serial number 106304007) has been used for temperature control.

9.2.5 Problems encountered

No problems have been detected with any equipment.

9.2.6 Calibration information

Details on calibration have been included in each section (see paragraphs above).

9.2.7 Preliminary results

The location maps of figure 11 showed a panoramic view of the research areas as well as the stations grid and the sections presented in figures 12 and 13 where an example of pH and TA analysis carried out on board is displayed.

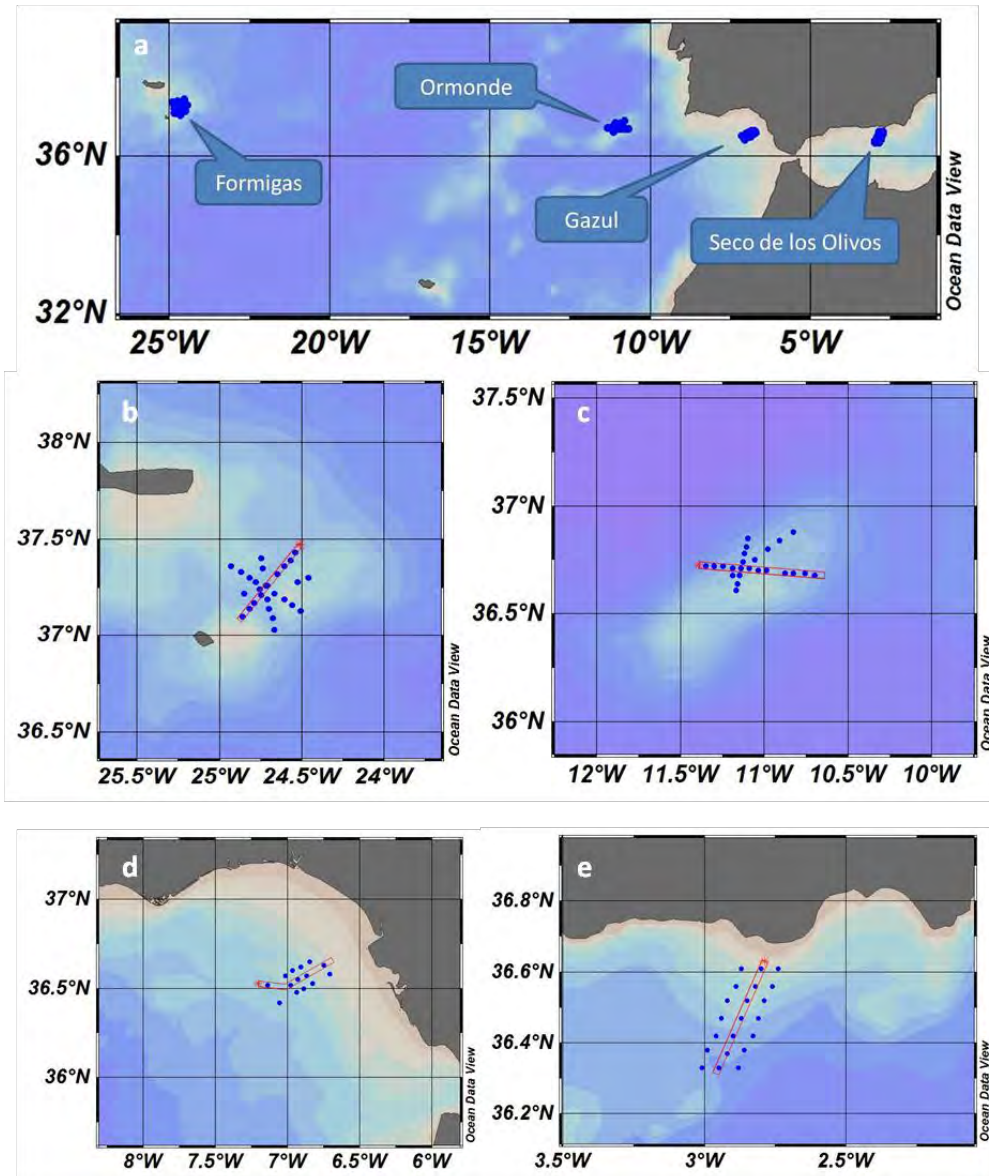

Figure 11: Location maps. a) General view of the sampling zones, b) Sampling stations in Formigas, c) Sampling stations in Ormonde, d) Sampling stations in Gazul, e) Sampling stations in Seco de los Olivos. Maps display the stations grid and the sections presented in figures 12 and 13.

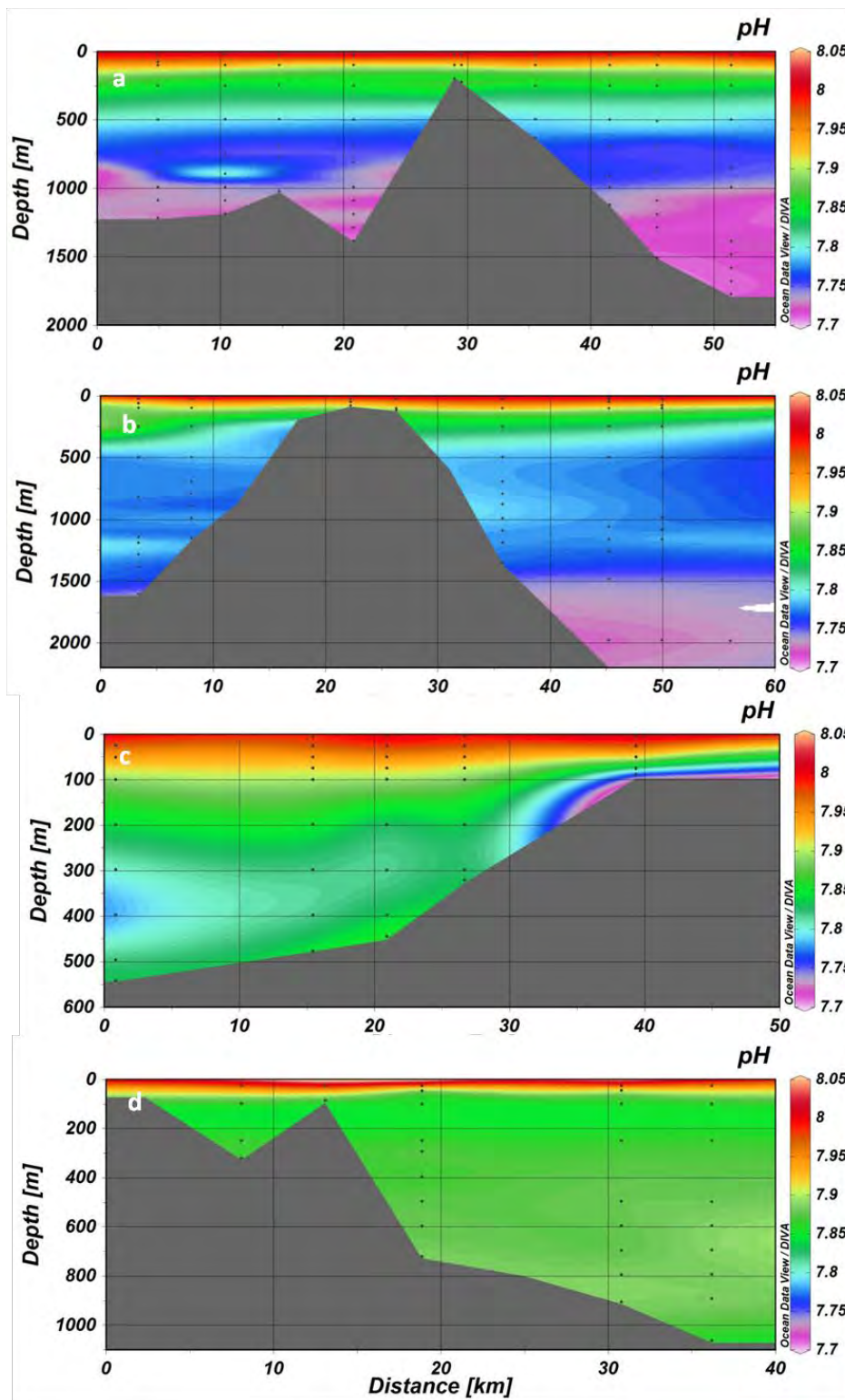

Figure 12: Examples of some pH sections for the 4 sampling areas. a) Northeast-Southwest section of Formigas, b) East-West section of Ormonde, c) Northeast-Southwest section of Gazul, d) North-South section of Seco de los Olivos.

In the four zones the highest pH values are given in surface (8.02), due to the removal of surface CO_2 by photosynthetic processes. The pH decreases progressively in the water column by processes of oxidation of the organic matter. The minimum values of pH

(7.70) are found in the deeper zones that are located in Formigas and Ormonde (Fig. 12). For total alkalinity (TA), a section of each zone is shown in figure 13.

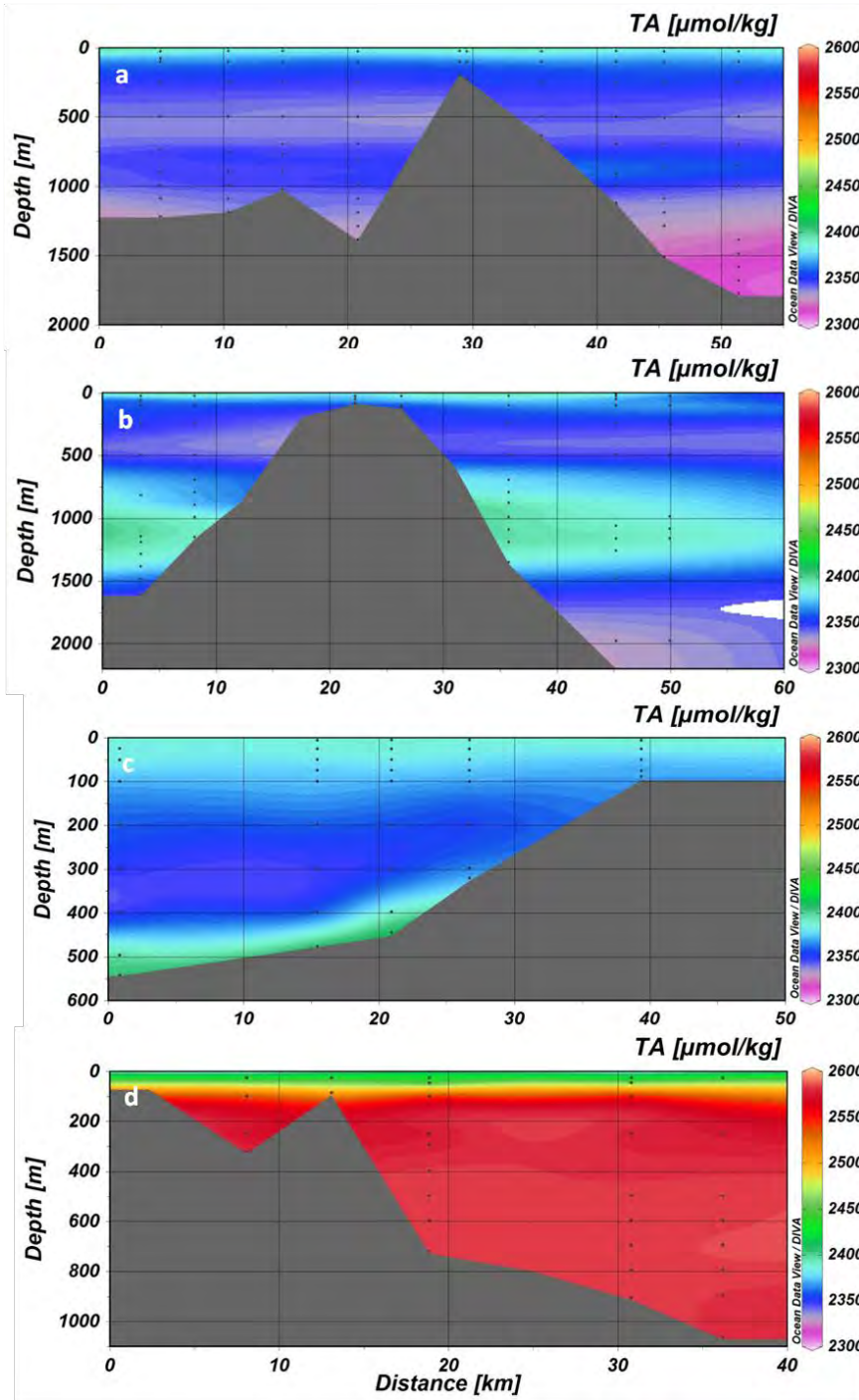

Figure 13: Examples of some TA ($\mu\text{mol kg}^{-1}$) sections for the 4 sampling areas. a) Northeast-Southwest section of Formigas, b) East-West section of Ormonde, c) Northeast-Southwest section of Gazul, d) North-South section of Seco de los Olivos.

The strong dependence of Total Alkalinity (TA) on salinity is well known. The highest values in Seco de los Olivos ($2,585.19 \mu\text{mol kg}^{-1}$) are noteworthy because it is located in the Mediterranean (with higher salinity), compared to the other three areas located in the Atlantic (lower salinity). In Seco de los Olivos the highest values are not in surface

(Fig. 13d), which can be due to the entrance of Atlantic water by the Strait of Gibraltar with lower salinity that remains in surface.

In Formigas (Fig. 13a) we see how the TA decreases with depth, but we can see a strip over 700 m with higher values (approximately $2,350 \mu\text{mol kg}^{-1}$), corresponding to the Mediterranean water plume. This signal is seen in the Ormonde zone (Fig. 13b) but at a deeper depth, about 1,000 – 1,200 m.

In Gazul (Fig. 13c) the TA decreases with depth although near the bottom it increases a little, this can be due to the depth of the Mediterranean water in this zone.

Finally, preliminary oxygen results can see in Figure 14. The maximum OD values have been found on the surface (around $250 \mu\text{mol kg}^{-1}$) due to photosynthesis processes and at the bottom of the Formigas zone due to the very cold atlantic waters in the area with great oxygen storage capacity. There is a minimum (around $160 \mu\text{mol kg}^{-1}$) between 500 and 1,000 m depth corresponding to the respiration of organic matter synthesized on the surface.

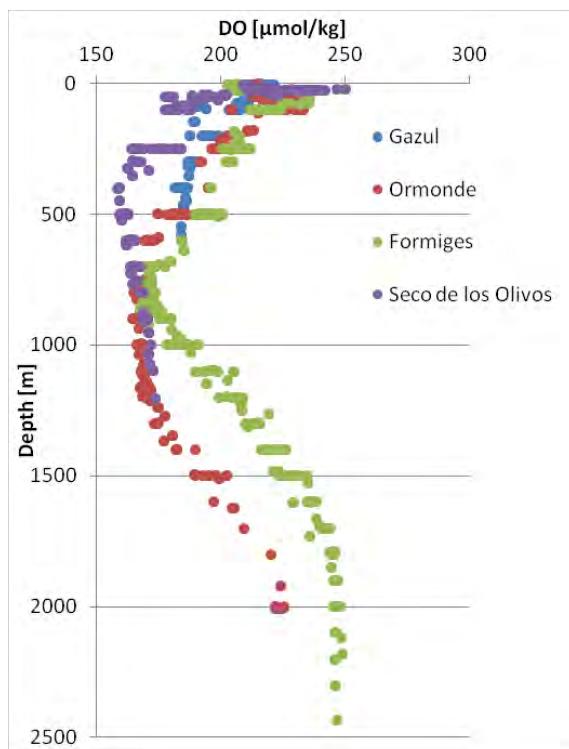

Figure 14: Values of dissolved oxygen ($\mu\text{mol/kg}$) in all research areas of MEDWAVES: Gazul in blue, Ormonde in red, Formigas in green and Seco de los Olivos in purple. The results covered the whole depth range of each area.

References

Byrne RH (1987) Standardization of standard buffers by visible spectrometry. Analytical Chemistry 59: 1479-1481

- Byrne RH, Yao W (2008) Procedures for measurement of carbonate ion concentrations in seawater by direct spectrophotometric observations of Pb(II) complexation. *Marine Chemistry* 112(1-2): 128–135, doi:10.1016/j.marchem.2008.07.009
- Clayton T, Byrne RH (1993) Spectrophotometric seawater pH measurements: total hydrogen ion concentration scale concentration scale calibration of m-cresol purple and at-sea results. *Deep-sea Research I* 40 (10): 2115-2129
- Dickson AG, Millero FJ (1987) A comparison of the equilibrium constants for the dissociation of carbonic acid in seawater media. *Deep-Sea Research* 34: 1733–1743
- Easley RA, Patsavas MC, Byrne RH, Liu X, Feely RA, Mathis JT (2013) Spectrophotometric measurement of calcium carbonate saturation states in seawater. *Environ Sci Technol* 47 (3): 1468–1477
- Langdon C (2010) Determination of dissolved oxygen in seawater by winkler titration using the amperometric technique. IOCCP Report N^o14, ICPO publication series N 134
- Lorenzen CJ, Jeffrey SW (1980) Determination of chlorophylls in seawater – report of intercalibration tests. UNESCO Tech. Pap. in Marine Science No. 35, 20 pp.
- Merzbach C, Culbertson CH, Hawley JE, Pytkowicz RM (1973) Measurement of the apparent dissociation constants of carbonic acid in seawater at atmospheric pressure. *Limnol Oceanogr* 18: 897–907
- Mintrop L, Fernández-Pérez F, González Dávila M, Körtzinger A, Santana Casiano JM (2000) Alkalinity determination by potentiometry- intercalibration using three different methods. *Ciencias Marinas* 26: 23-37
- Patsavas MC, Byrne RB, Yang B, Easley RA, Wanninkhof R, Liu X (2015) Procedures for direct spectrophotometric determination of carbonate ion concentrations: Measurements in US Gulf of Mexico and East Coast waters. *Marine Chemistry* 168: 80-85
- Pérez FF, Fraga F (1987) A precise and rapid analytical procedure for alkalinity determination. *Marine Chemistry* 21: 169-182
- Pérez FF, Ríos AF, Rellán T, Álvarez M (2000). Improvements in a fast potentiometric seawater alkalinity determination. *Ciencias Marinas* 26: 463-478

9.3 Geomorphology and Habitat mapping

Jesús Rivera¹, Miriam Hermida², Juancho Movilla³, Covadonga Orejas⁴

1. Instituto Español de Oceanografía, Servicios Centrales, Madrid, Spain
2. Universidad de Alcalá de Henares, Madrid, Spain
3. Instituto de Ciencias del Mar (CSIC), Barcelona, Spain

9.3.1 Personnel involved

MEDWAVES-ATLAS Cruise LEG 1

Cádiz – Ponta Delgada (21/09 – 13/10/2016)

	Name	Institution	Role and responsibilities
1	J. Rivera	IEO	Coordination of ROV Survey tasks & Swath bathymetry
2	M. Hermida	UAH	ROV Survey tasks & Swath bathymetry
3	J. Movilla	ICM-CSIC	ROV Survey tasks & Swath bathymetry
4	C. Orejas	IEO	Contribution ROV dives planning

MEDWAVES-ATLAS Cruise LEG 2

Ponta Delgada – Málaga (14/10 – 26/10/2016)

	Name	Institution	Role and responsibilities
1	M. Hermida	UAH	ROV Survey tasks & Swath bathymetry
2	J. Movilla	ICM-CSIC	ROV Survey tasks & Swath bathymetry
3	C. Orejas	IEO	Contribution ROV dives planning

9.3.2 Introduction. Aims

Geomorphology looks for evidences on the seabed trying to find the responsible mechanisms of the different forms present on the submarine landscape. Most of the geological processes taking place below and close to the seafloor leave an imprint on it. But not only the geological processes shape the bottom of the oceans, many other events of different nature (e.g. biological, physical, anthropic) model the submarine landscape as well. Moreover, the seascape influences back those processes in a loop that determine, for example bottom contour currents, the habitat suitability of the benthic fauna, or even the pelagic fauna by locally altering the water column hydrodynamics when seamounts interfere ocean currents producing turbulence, Taylor caps, and/or vertical fluxes. In

turn, upwellings lead to photic zone fertilization and microalgae blooms increasing nearby productivity (Bashmachnikov et al. 2013, Chapman & Haidvogel 1992). Geomorphology helps to understand the processes that are taking place now, but also, show the record of events from the past. On one hand this increase the range of the tool but on the other hand is crucial to determine the age of the shapes if we want to discriminate among processes. Geology, genetics, and isotopic analysis would help us to directly or indirectly determine the age of the forms.

Thanks to the proper location and interpretation of the bedforms and other morphological features present on the seabed, we are able to pinpoint the 'hot spots' in the study area and to guide the sampling in accordance. Therefore, geomorphology is actually a valuable tool for optimizing sampling effort, and in addition, the feedback of 'ground truthing' increases the power of the geomorphological analysis guiding us to the insights of the benthic environment.

Aims

The main aim of this activity is to collect swath data in order to accomplish MEDWAVES needs in two different areas:

- Assist ROV dives providing maps and their interpretation
- Gather data needed for habitat mapping, geological studies and provide a morphometric description of the seabed useful for setting the boundary conditions of MOW spreading and influence (Tasks included in WP3, WP6, WP7).

Multibeam echo sounders (MBES) are the most important tool for geomorphological studies in the marine environment. Thanks to this acoustic technique, we can build a Digital Elevation Model (DEM) of the seabed (Fig. 1). The DEM is the first step in the geomorphological description of the study area and the base map for the sampling activity. The primary task of the Geomorphology team in MEDWAVES cruise was the collection of MBES data (Gazul mud volcano, Ormond guyot and Formigas seamount). The Seco de los Olivos seamounts MBES is already available, hence no MBES acquisition took place during MEDWAVES. Swath bathymetry in conjunction with video footage, sediment sampling, and a close-up to the local hydrodynamics let to interpret the seascape in order to have a first impression of the benthic environment.

Based on that first quick geomorphological interpretation we can approach the geology and nature of the seabed in order to help in the ROV dive planning, suggesting dive locations in accordance to cruise objectives and providing geomorphometric parameters useful for ROV dives; as depth, slope, and the orientation of the geomorphological features. All this outputs are crucial to guide the ROV operations during the dives as Survey team, the other critical task of this group (Fig. 2).

After the cruise, the geomorphology group will be in charge of MBES data processing for a detail description of the submarine seascape needed for geological studies and habitat mapping among other future outcomes of the cruise.

9.3.3 Sampling methodology. Swath Bathymetry. ROV survey support

The used MBES was a Hydrosweep DS-3 model from ATLAS. Each beam width is 1° along track by 1° across track. Position records from GPS and vessel attitude is controlled by a POS MV unit from Applanix. Sound refraction is corrected by real time measurements of the sound velocity at the transducer depth in addition to sound velocity profiles of the water column gathered from different CTD casts taken before and after each survey.

Navisuite software package from EIVA was used for the management of the navigation planning lines and for the control of the swath coverage in real time. MBES settings and acquisition parameters were controlled by ATLAS software running under Linux OS. The topographic calibration of the sensors (DGPS antennas, transducers and Motion reference unit) was performed when the vessel was stranded for maintenance and the calibration offsets were set afterwards navigating calibration lines following the ATLAS calibration procedure. Vessel configuration file containing calibration offsets was used for TPE calculation and data processing using CUBE.

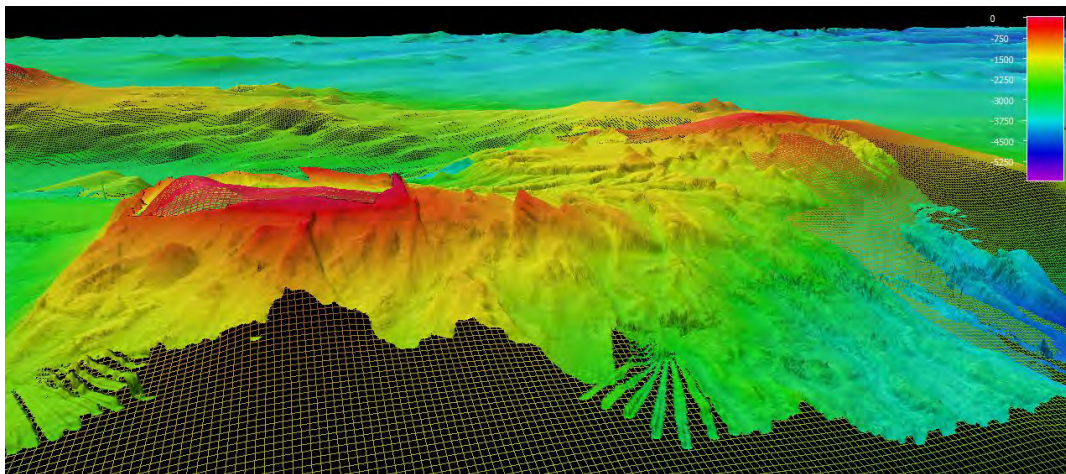

Figure 1: 3D view of submarine landscape around Formigas Bank. The mesh is the previous available bathymetry from EDMONET and the solid model show swath bathymetry from MEDWAVES cruise.

DEM from swath bathymetry was analyzed and inspected using GIS software (ArcGis 10.2) and advance 3D viewers (Fledermaus 7.6) in order to select the best locations for the ROV dives in accordance to main cruise objectives. Geomorphologic characteristics of the diving site were explained and discussed in the pre-dive briefing with the participation of the scientific chief, captain, chief engineer, chief technician and the team leader of the ROV pilots (see Narrative, chapter 8).

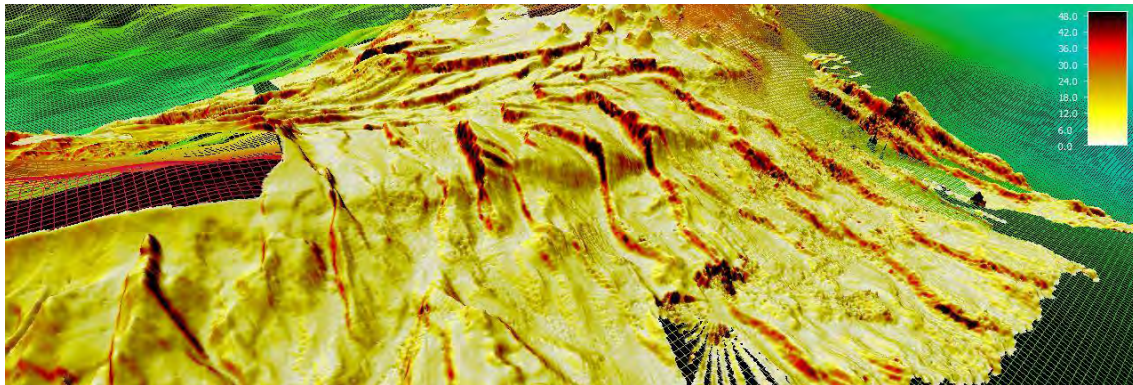

Figure 2: Typical coarse model used to support ROV operations. Yellow color represent gentle slopes and dark red the steepest areas. Formigas Bank from the south west.

During the dives, the survey team was in charge to guide the vessel and the ROV pilots through the planned path and advice about the possible risks and peculiarities of the seabed. Moreover, the survey team attended other tasks as video recording, acoustic tracking, telemetry recording and photographed the highlights of each dive using HD still camera of the ROV.

9.3.4 Instrument details and calibration information

These aspects have been included in the previous chapter (9.3.3)

9.3.5 Problems encountered

The problems experienced at the beginning of the cruise regarding ROV-Survey positioning system have been resolved and are detailed in Appendix XIII

9.3.6 Preliminary results. Postprocessing

The total surveyed area was 26,088 km². This extension comprises 22,740 km² surveyed in transit from one site to another and 3,348 km² surveyed in the study sites; Gazul, Ormonde and Formigas (Table 1).

Table 1: Summary of surveyed area specifying the extent of each site and the covered area during transits too

Site	Area (km ²)
Gazul	29,75
Omonde	1062,61
Formigas	2255,88
Formigas-Ormonde	19352,26
Gazul-Ormonde	3387,93

To achieve this coverage a total distance of 1,479 nm has been sailed in acquisition mode (Fig. 3).

The distance between navigation lines in the study sites was calculated in order to overlap the 25% of the across coverage on both sides, what means that 50% of the surveyed seabed was insonified twice.

A quick analysis of the gathered data evidence the complex geomorphology of the study sites. All of them are geological singular entities but their morphology is rather different from one to another. What those of them located in the Atlantic Ocean have in common (Formigas, Ormonde and Gazul), is their alignment to an outstanding tectonic lineation which extends from Mid Atlantic Ridge (MAR) to, at least, the strait of Gibraltar (Heezen et al., 1959). This tectonic feature is named East Azores Fracture Zone (EAFZ) and cross the abyssal plain in East-West direction at N 37° latitude; 40 km apart of Formigas Islets. EAFZ is the boundary between Eurasian (to the North) and African (to the South) tectonic plates in the northeastern Atlantic Ocean.

MEDWAVES cruise was narrowly related to the EAFZ as three of the four study sites are close to it. Furthermore most of the transits had been navigated following EAFZ direction crossing it several times.

Transits

Although the standard vessel cruising speed is too high for a proper survey, MBES was set to recording mode during transits whenever weather condition permitted it (Fig. 3). Thanks to this procedure more than twenty two thousand square kilometers were surveyed during transits (Table 1). This dataset show fragments of EAFZ and nearby area (Fig. 4).

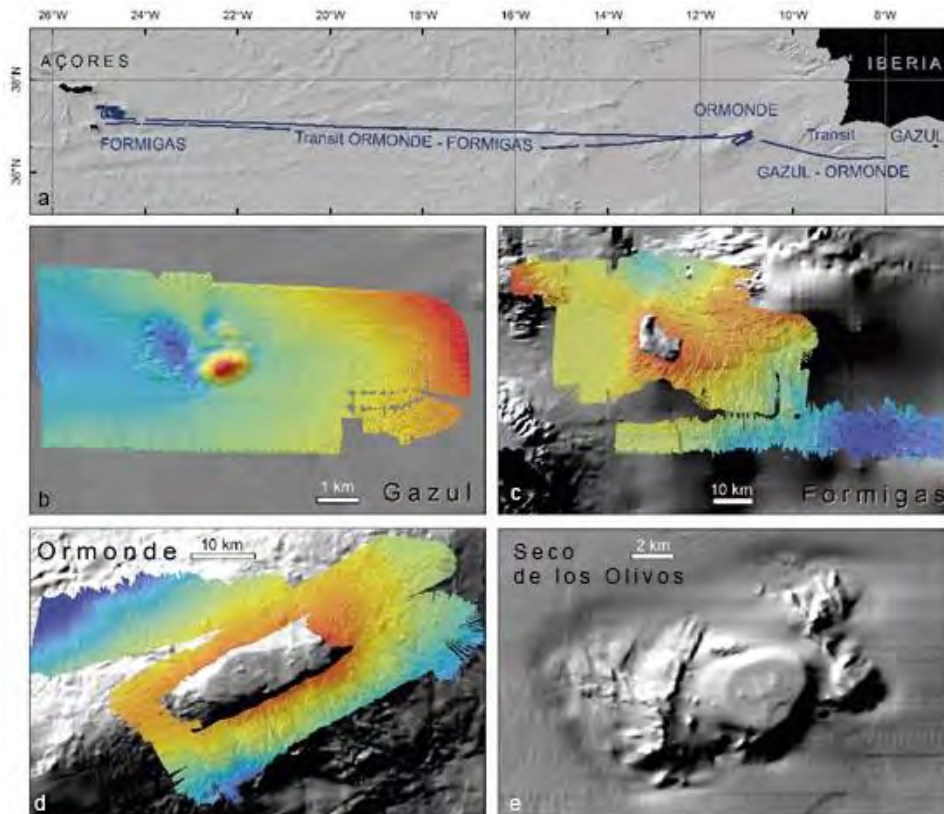

Figure 3: (a) Navigation lines in MBES acquisition mode. (b, c, d, e) MEDWAVES sites, colored seabed show the extent of the new swath bathymetry data. No swath bathymetry was recorded in the Seco de los Olivos aka Chella (e) as detailed bathymetric data was already available BY CAPESME project (“MA-4,” 2008).

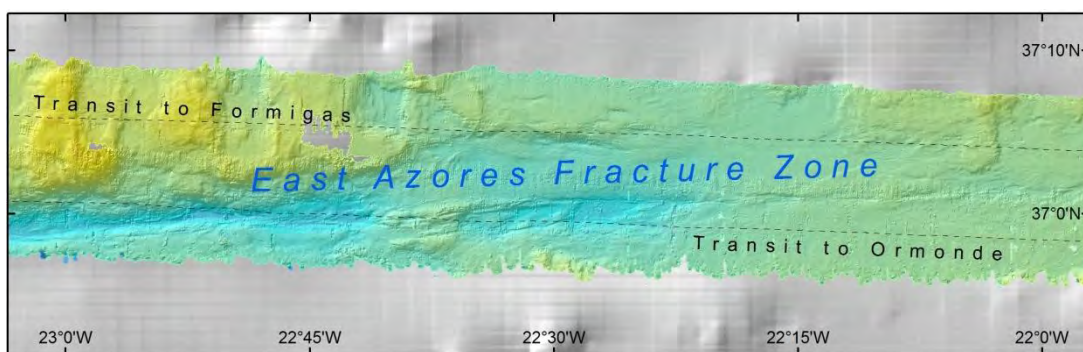

Figure 4: Swath bathymetry recorded during the transits between Ormonde and Formigas. The good weather conditions allowed collecting data in both ways overlapping both swaths. Black dashed lines represent vessel tracks.

Gazul

Gazul is a mud volcano located in the Gulf of Cádiz whose shape is sculpted by the Mediterranean Outflow Water (MOW). The intense bottom current has carved two depressions at both sides of the volcano cone downstream. Those depressions suggest

erosion due to the increase of the flow velocity at both sides of the apron facing the flow, whereas at the rear sector, a velocity waning enable sedimentation and models a peculiar saddle shape (Rueda et al. 2012, Palomino et al. 2016).

Two factors are responsible of the rough appearance of the DEM inside the depressions (Fig. 5). One is the more intense flow that rinses away sediment particles exposing hard substrata. The other one is the presence of methane chimneys formed by authigenic carbonates, as we could corroborate from ROV video records.

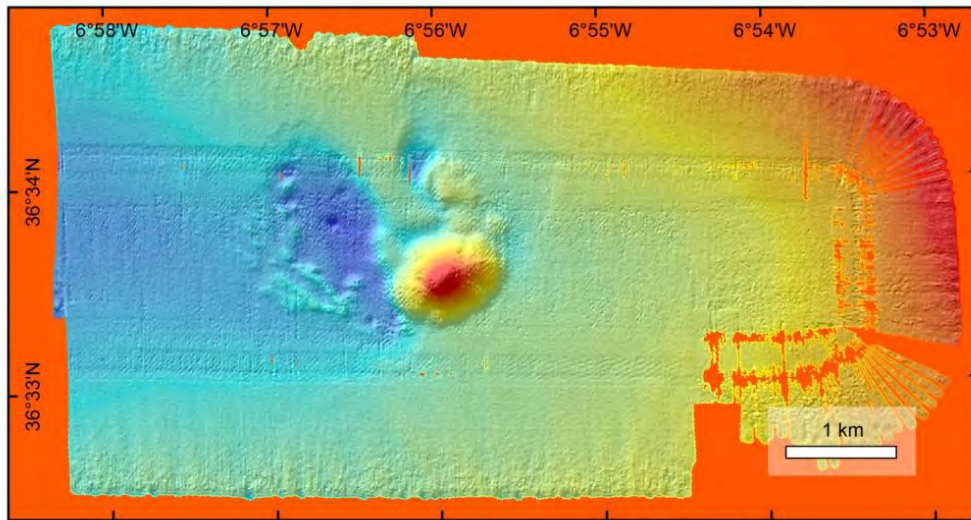

Figure 5: Swath bathymetry surveyed on Gazul.

Ormonde

This seamount is part of a volcanic ridge named Gorringer that rises from 5,000 m to less than 80m depth. Gorringer Ridge is located in the boundary between Eurasian and African tectonic plates following the EAFZ, that in this longitude (W 11°), has a locally northeast – southwest direction. Two summit plateaus are present in Gorringer Ridge the southwestern one is named Gettysburg and the North eastern one is named Ormonde (Hayward et al. 1999).

Swath bathymetry (Fig. 6) collected around Ormond Guyot show perceptible differences in the development of the drainage. The southeastern flank is steeper and presents gullies and incipient canyons, whereas northwestern flank doesn't show remarkable incise features. The southwestern end of Ormonde is the saddle between both guyots; Ormonde and Gettysburg. The maximum depth in this passage is 800 m. The north tip of the Ridge present a gentle slope spotted by few knolls that actually are volcanic cones as we could realize thanks to the ROV dives in this site study (Fig. 7).

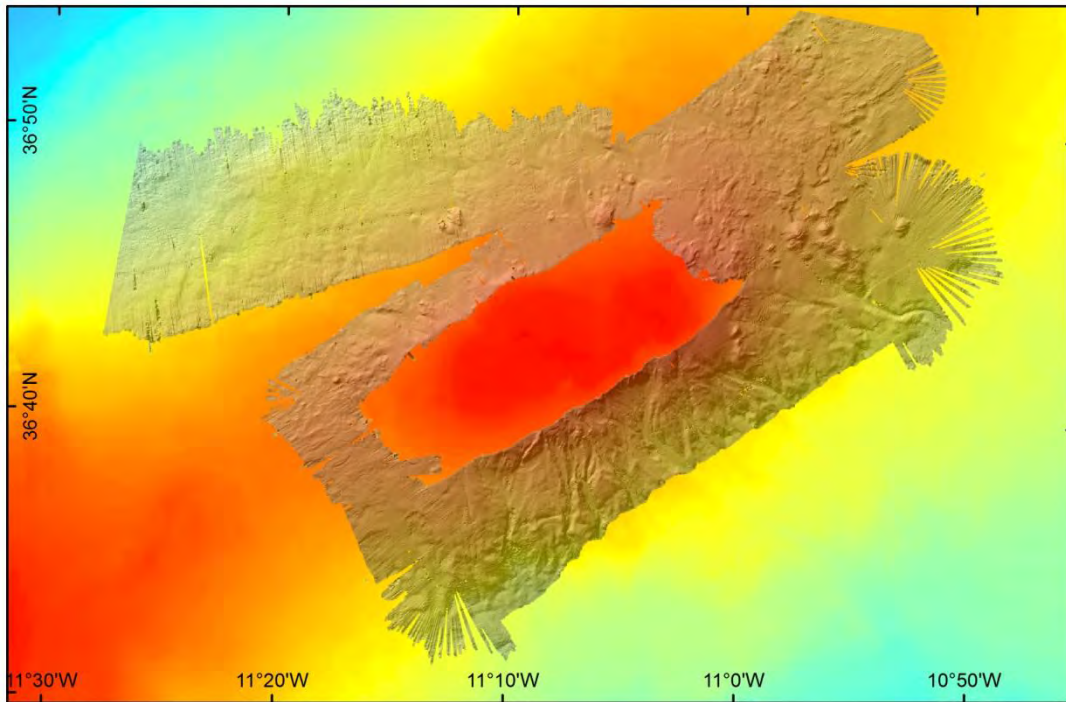

Figure 6: Swath bathymetry surveyed on Ormonde.

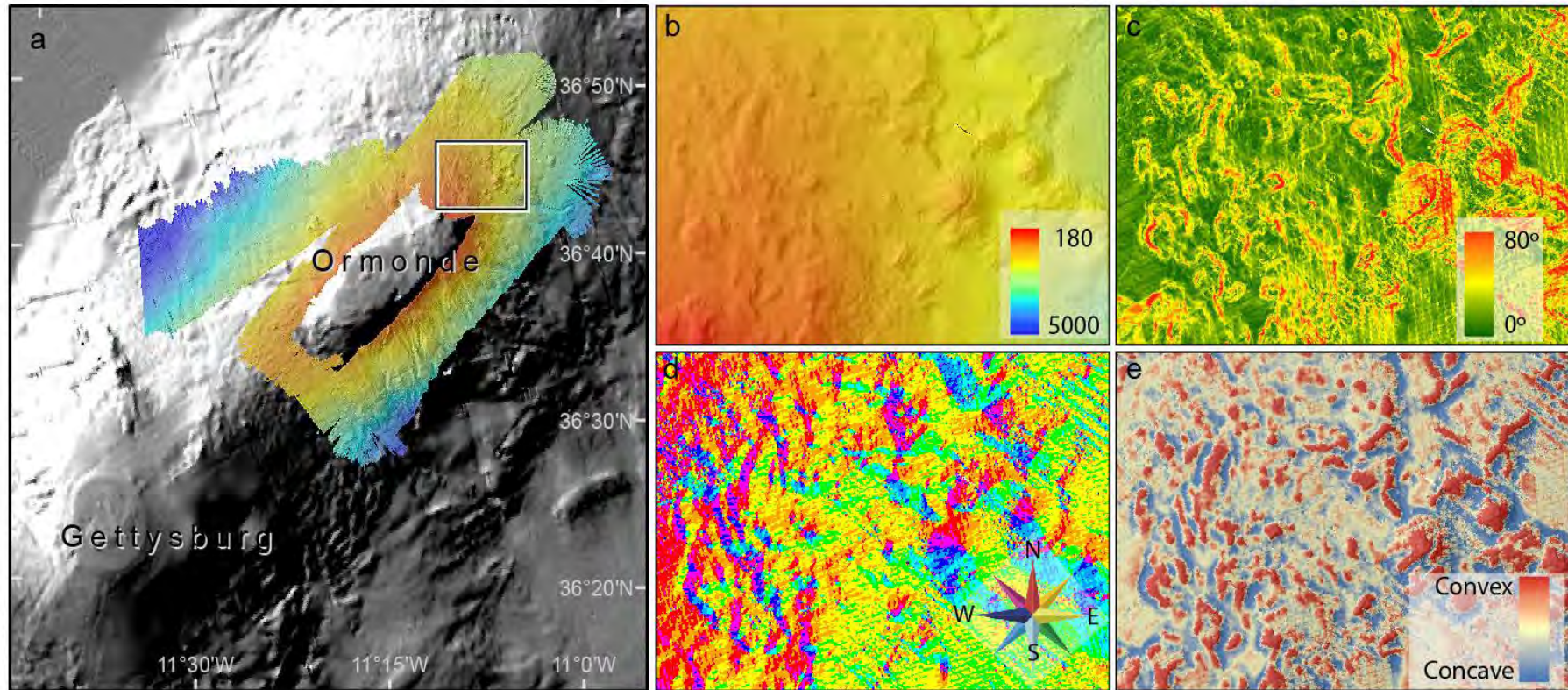

Figure 7: Approach to Ormonde morphology, a) Location Map MEDWAVES survey in bright colours. b) DEM. C) DTM showing slope value. d) DTM representing aspect; seabed orientation. e) DTM Showing relative seabed elevation; Benthic Position Index.

Formigas

Formigas has been the best surveyed zone. Ten ROV dives and more than two thousand square kilometers have been surveyed in this location (Fig. 8). Formigas Islets are part of a promontory named Formigas Bank (Abdel-Monem et al. 1975). This promontory is located next to the junction of EAFZ and Terceira Rift (Tempera et al. 2013). A rift belt that extends from MAR to EAFZ crossing through Graciosa, Terceira and São Miguel Islands (Machado 1959). Although EAFZ is formally a transform fault close to the MAR, is defined as a dextral strike-slip fault system at the eastern side of Sta. María island. On the contrary, Terceira Rift is dominated by tensional and/or transtensional forces depending on the authors (Madeira and Ribeiro 1990), (Fig. 9). DEM evidence this high tectonic activity in the area with two main fracture directions NNE to SWS (more perceptible in the eastern and southeastern sectors), and a WNW to ESE direction predominating in the Northern sector. On the western sector a 1,800 m depth flat abyssal plain extends. No remarkable morphological features are present at this side of the bank but a few incipient gullies on its flank. At the northeastern side of the surveyed area at least twenty knolls are spread on an area of 130 km². They probably are part of a volcanic field extending to the northeast beyond the limits of the DEM.

Seco de los Olivos

Seco de los Olivos aka Chella Bank is placed in a very active tectonic area. Its origin is related with a distensive regime resulting from two transpressive fault zones (Ballesteros et al. 2008). One is located to the north; Alpujaras fault zone, and the other one extends 90 km from land at north east side of the Bank to 1000 m depth to the south from Seco de los Olivos Bank; The Serrata Carboneras Fault Zone, a sinistral strike slip fault. Due to the flat top summit of the seamount we can infer it was emerged in the past. The rocky outcrops around and on top denote the volcanic nature of the edifice. Thank to hard substrata that represents the wide area of exposed rock sessile organisms are abundant including cold water coral colonies (Pardo et al. 2011, Lo Iacono et al. 2012).

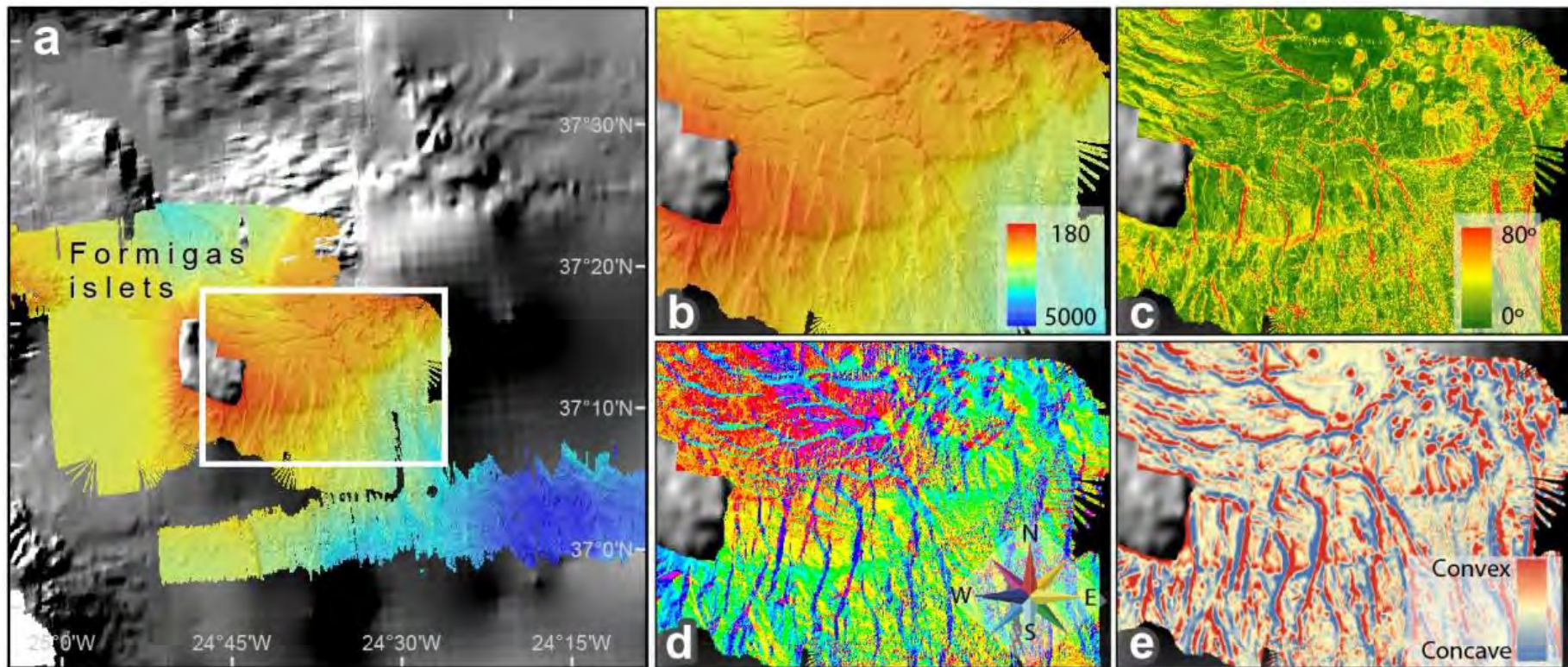

Figure 8: Approach to Formigas morphology. a) Location map showing the surveyed area in bright colors. b) DEM. c) DTM showing slope value. d) DTM representing aspect; seabed orientation. e) DTM showing relative seabed elevation; concave means that the surrounding area is higher and convex the opposite.

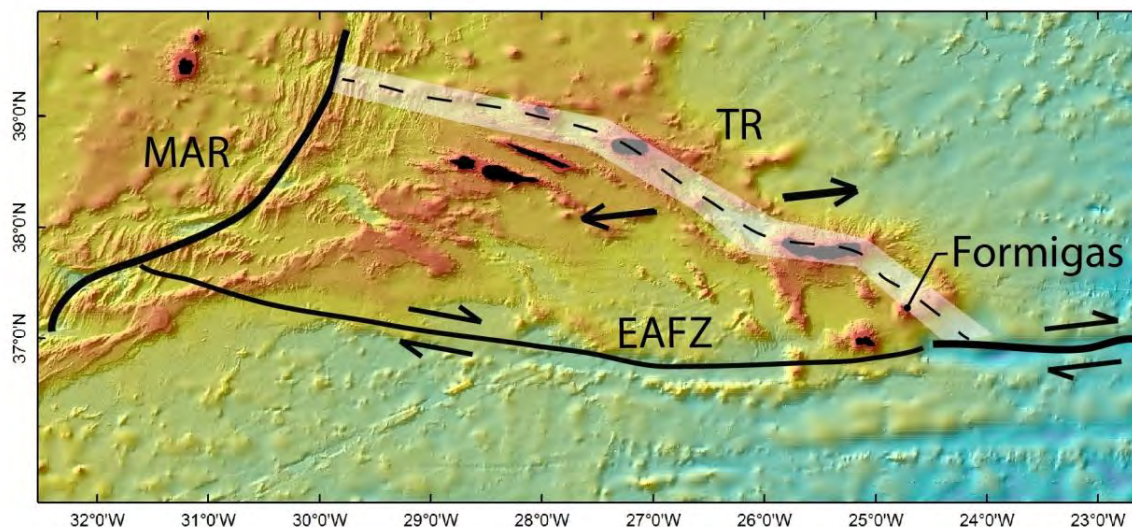

Figure 9: EDMONET bathymetry and geodynamic model schema from Madeira and Ribeiro (1990).

Postprocessing

A preliminary processing was carried out onboard for obtaining a coarse DEM needed for support sampling and ROV procedures (Fig. 3), but a further processing has to be done in order to obtain a sharp DEM for morphological and morphometric detailed analysis. The software used to process MBES data is Caris Hips&Sips 9.1 and the software that will be used to analyze morphology is ArcGIS 10.2, Federmaus 7.6, and other tools designed for morphological analysis like R scripts written for specific morphometric subjects.

After MBES data processing and morphological analysis we will obtain a number of Digital Terrain Models (DTM) which are the quantitative expression of certain morphometric parameters as slope, aspect, curvature, etc that will help us to interpret the shape of the seabed (Fig. 7).

These DTMs will also help us to map the different habitats identified on the video records and furthermore, they will let us perform predictive habitat suitability maps correlating geomorphology with biological facies. We expect that the combined analysis of all this information under a GIS environment lead us to the insights of the benthic ecology of the study sites and will help to respond the numerous questions in relation to CWC and MOW in the Atlantic Ocean.

Acknowledgements

We would like to thank Dr. Fernando Tempera and L.M. Fernández Salas their kind support providing us previous bathymetric data very helpful for planning our surveys. We will also like to thank to the crew and UTM technicians their assistance

and help during the cruise. We are especially grateful to the ACSM ROV pilot team for their very professional, collaborative and always positive contribution.

References

- Abdel-Monem AA, Fernandez LA, Boone GM (1975) K-Ar ages from the eastern Azores group (Santa Maria, São Miguel and the Formigas Islands). *Lithos* 8, 247–254. doi:10.1016/0024-4937(75)90008-0
- Ballesteros M, Rivera J, Muñoz A, Muñoz-Martín A, Acosta J, Carbó A, Uchupi E (2008) Alboran Basin, southern Spain—Part II: Neogene tectonic implications for the orogenic float model. *Mar. Pet. Geol.* 25, 75–101. doi:10.1016/j.marpetgeo.2007.05.004
- Bashmachnikov I, Loureiro CM, Martins A (2013) Topographically induced circulation patterns and mixing over Condor seamount. *Deep Sea Res. Part II Top. Stud. Oceanogr.* 98, 38–51. doi:10.1016/j.dsr2.2013.09.014
- Chapman DC, Haidvogel DB (1992) Formation of Taylor caps over a tall isolated seamount in a stratified ocean. *Geophys. Astrophys. Fluid Dyn.* 64, 31–65. doi:10.1080/03091929208228084
- Hayward N, Watts AB, Westbrook GK, Collier JS (1999) A seismic reflection and GLORIA study of compressional deformation in the Goringe Bank region, eastern North Atlantic. *Geophys. J. Int.* 138, 831–850. doi:10.1046/j.1365-246x.1999.00912.x
- Heezen BC, Tharp M, Ewing M (1959) The Floors of the Oceans I. The North Atlantic. *Geol. Soc. Am. Spec. Pap.* 65, 1–126. doi:10.1130/SPE65-p1
- Lo Iacono C, Gràcia E, Bartolomé R, Coiras E, Dañobeitia JJ, Acosta J (2012) Habitats of the Chella Bank, Eastern Alboran Sea (Western Mediterranean). doi:10.1016/B978-0-12-385140-6.00049-9
- Machado F (1959) Submarine pits of the azores plateau. *Bull. Volcanol.* 21, 109–116. doi:10.1007/BF02596510
- Madeira J, Ribeiro A (1990) Geodynamic models for the Azores triple junction: A contribution from tectonics. *Tectonophysics, Alpine Evolution of Iberia and its Continental Margins* 184, 405–415. doi:10.1016/0040-1951(90)90452-E
- Mar de Alborán (MA-4) Caladero de las 500 viviendas, 2008. *Cartas de Pesca del Mar de Alborán.*
- Palomino D, Vázquez JT, Somoza L, León R, López-González N, Medialdea T, Fernández-Salas LM, González FJ, Rengel JA (2016) Geomorphological features in the southern Canary Island Volcanic Province: The importance of volcanic processes and massive slope instabilities associated with seamounts. *Geomorphology* 255, 125–139. doi:10.1016/j.geomorph.2015.12.016

- Pardo E, Aguilar R, García S, de la Torriente A, Ubero J (2011) Documentación de arrecifes de corales de agua fría en el Mediterráneo occidental (Mar de Alborán). *Chron. Naturae* 1, 20–34.
- Rueda JL, Urra J, Gofas S, Lopez-Gonzalez N, Fernandez-Salas LM, Diaz-Del-Rio V (2012) New records of recently described chemosymbiotic bivalves for mud volcanoes within the European waters (Gulf of Cádiz). *Mediterr. Mar. Sci.* 13, 262–267. doi:10.12681/mms.307
- Tempera F, Hipólito A, Madeira J, Vieira S, Campos AS, Mitchell NC (2013) Condor seamount (Azores, NE Atlantic): A morpho-tectonic interpretation. *Deep Sea Res. Part II Top. Stud. Oceanogr.* 98, 7–23. doi:10.1016/j.dsr2.2013.09.016

9.4 Benthic ecology. Benthic biodiversity team

José Luis Rueda¹, Javier Urrea², Ángel Mateo-Ramírez², Marina Gallardo¹, Íris Sampaio³

1. Instituto Español de Oceanografía. Centro Oceanográfico de Málaga, Málaga, Spain

2. Universidad de Málaga, Málaga, Spain

3. Institute for Marine Research (IMAR), Azores, Portugal

9.4.1 Personnel involved

MEDWAVES-ATLAS Cruise LEG 1

Cádiz – Ponta Delgada (21/09 – 13/10/2016)

	Name	Institution	Role and responsibilities
1	Javier Urrea	Institution: Department of Animal Biology, University of Malaga, Spain Contact information: javier.urra.recuero@gmail.com	Field work: Collection, sieving and fixation of samples. Lab work: Separation of specimens with stereomicroscope; taxonomical identification of specimens; redaction of documents
2	Ángel Mateo-Ramírez	Institution: Department of Animal Biology, University of Malaga, Spain Contact information: a.mateoramirez@gmail.com	Field work: Collection, sieving and fixation of samples. Lab work: Separation of specimens with stereomicroscope; taxonomical identification of specimens; redaction of documents.
3	Íris Sampaio	Institution: MARE & DOP- Department of Oceanography and Fisheries, University of the Azores, Portugal; Senckenberg am Meer, Germany	Field work: Sieving and fixation of samples.

	Contact information: irisfs@gmail.com	
--	--	--

MEDWAVES-ATLAS Cruise LEG 2

Ponta Delgada – Málaga (14/10 – 26/10/2016)

	Name	Institution	Role and responsibilities
4	José Luis Rueda	Institution: Centro Oceanográfico de Málaga, Instituto Español de Oceanografía, Spain Contact information: jose.rueda@ma.ieo.es	Field work: Collection, sieving and fixation of samples. Lab work: Separation of specimens with stereomicroscope; taxonomical identification of specimens; redaction of documents.
5	Marina Gallardo	Institution: Centro Oceanográfico de Málaga, Instituto Español de Oceanografía, Spain Contact information: mgallardo@ma.ieo.es	Field work: Collection, sieving and fixation of samples. Lab work: Separation of specimens with stereomicroscope; taxonomical identification of specimens; redaction of documents.

9.4.2 Introduction. Aims

The Alboran Sea, Gulf of Cádiz as well as some areas within the NE Atlantic contains a wide diversity of habitats and species, including vulnerable and threatened ones, due to the complex hydrology, seafloor geomorphology and geographical location within different biogeographical regions (Hebbeln et al. 2009, de la Torre et al. 2014, Díaz del Río et al. 2014, Rueda et al. 2016). Nevertheless, knowledge on the spatial distribution of vulnerable marine ecosystems (VMEs) and on the composition and structure of their associated communities is still scarce and mainly available for specific areas and functional groups (e.g. megafauna). Information on small epifaunal and infaunal species is still needed on a large number of deep-sea VMEs and seafloor structures (e.g. seamounts, submarine canyons, etc.) in order to understand their role as biodiversity reservoirs (de la Torre et al. 2014, Díaz del Río et al. 2014). The study of this faunistic component of deep-sea communities is not important just for improving biodiversity estimates on these areas, but also for documenting the presence of rare species, and even of none previously described ones.

Our research activities during the MEDWAVES multidisciplinary expedition will focus on the study of habitats and associated biodiversity of different seafloor structures located in the bathyal zone of the Alboran Sea (Seco de los Olivos, also known as Chella Bank), Gulf of Cádiz (Gazul mud volcano [MV]), and Atlantic Iberian Margin-Azores (Formiges and Ormonde seamounts). These structures contain VMEs and are exposed to the influence of Mediterranean Water masses at different scales.

During the MEDWAVES expedition and after processing samples and underwater images, new data on micro, macro and megafauna will be obtained by our team, increasing the understanding and spatial resolution of these areas on different types of assemblages (megafauna to microfauna), and therefore improving the knowledge of different components of the communities of these VMEs.

Specific aims

- 1) To characterize the composition and structure of benthic communities, including macro and microfauna of both epifaunal and infaunal components in relation to sedimentological characteristics where these communities occur in different seafloor structures that are under a differential influence of Mediterranean Water Masses (ATLAS Task 3.1).
- 2) To study the relationships of benthic communities and key benthic species occurring in these seafloor structures with environmental (e.g. morphological, sedimentological and oceanographic variables) and anthropogenic variables (e.g. trawling activity), for improving our understanding of the spatial distribution within and among these seafloor structures (ATLAS Task 3.1).
- 3) To explore the distribution and biodiversity patterns of both habitats and key species occurring in MEDWAVES explored seafloor structures, following a bathymetric gradient, and different areas within the seafloor features, for detecting differences among areas influenced and not influenced by the MOW (ATLAS Task 3.1)
- 4) To analyze the feasibility of the MEDWAVES data for estimating indicators of Habitats (Descriptor 1-Biodiversity) of the Marine Strategy Framework Directive (ATLAS Task 3.3, 3.4).

9.4.3 Sampling methodology. Postprocessing. Instrument details

Faunistic samples have been collected during MEDWAVES by means of a Box-Corer (20 x 30 cm) and a Van Veen grab (opening of 36 cm by 30 cm that could potentially recollect sediments down to 19 cm below seafloor) (Fig. 1).

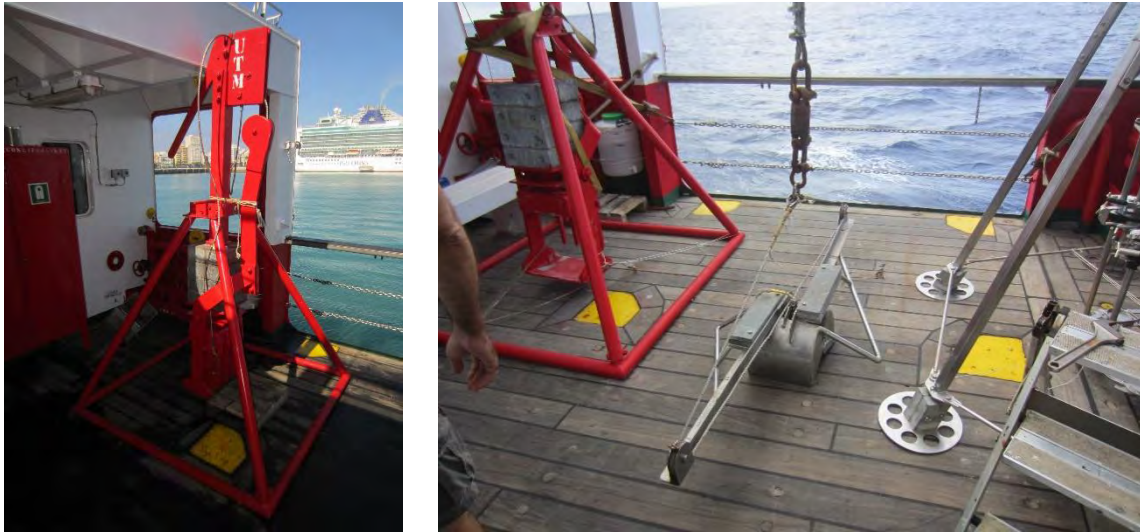

Figure 1: Box-corer (Left) and Van Veen grab (Right) used for the collection of sediment samples during MEDWAVES.

Samples collected with Box-Corer. A total of five sediment samples were collected with this sampling gear, four in Gazul MV and one in Ormonde seamount (Table 1). Sampling in other seafloor structures could not be done due to the presence of mixed bottoms or of potential smaller sampling area obtained with the box-corer (BC) in comparison to the Van Veen grab. The material collected was remained in the box-corer and on top of a large tray. The water was removed with a small hose placing the outflow on a 0.5mm sieve in order to avoid releasing small mobile benthic species, which were then added to the upper sediment layer subsample. General pictures of the surface material collected and detailed pictures of benthic species and substrates were taken with a label and a scale (Fig. 2).

Table 1: Summary of sediment and foraminifera (Foram) samples collected with Box-Corer during the MEDWAVES expedition. G= Gazul, O= Ormonde

Area	Sample code	MEDWAVES station	Date	Latitude	Longitude	Depth (m)	Notes	Foram Sample
G (MV)	BC01	10	22/09/2016	36°33.78	06°55.87	444	OK	Yes (only surficial)
G (MV)	BC02	11	22/09/2016	36°33.87	06°55.86	450	OK	Yes (only surficial)
G (MV)	BC03	12	22/09/2016	36°33.92	06°55.86	446	Qualitative	
G (MV)	BC04	21	23/09/2016	36°33.59	06°59.95	470	OK	Yes (only surficial)
O	BC05	37	25/09/2016	36°58.65	10°47.11	1919	OK	Yes (only surficial)

Before removing the BC metal frame, a PVC mini-corer (9 cm diameter) was placed vertically in the most stable part of the material collected. The sides of the PVC mini-corer were previously labeled with "TOP" in one side (this side was on the same side as the sediment surface) and "BOTTOM" at the opposite side. In case the sediment was very compact or it had a large amount of bioclasts and gravels, the top part of the mini-corer was hit carefully with a hammer on a wood block placed on top of the mini-corer (for not breaking the mini corer). In cases where it was not possible to penetrate the corer due to large amount of coral rubble, then sediment samples were collected in the different vertical sections (each 5cm) along the BC sample.



Figure 2: General view (*left*) and vertical profile (*right*) of the first sediment sample collected with the Box-corer (code: BC01) during Medwaves (Gazul MV).

The metallic box-corer frame was then lift up carefully avoiding slides of the sediment. Annotations of the height of the sediment sample were taken using a ruler, the sediment color was defined by using the Munsell color chart, and finally preliminary general information on the sediment composition (e.g. sand, muddy sand, mud breccia, etc.), bioclast characteristics (e.g. bivalve remains, cold-water coral remains, etc.), faunistic components (e.g. *Isidella elongata* on mud, etc.) or other components (e.g. presence of microplastics, etc.) was documented (Fig. 3). Then, a sediment sample from the sediment surface was collected using a 6 cc syringe for further analyses of foraminifera at the University of the Balearic Islands (UIB), placing them in a labeled hermetic plastic bag with the sample code, date and expedition.

Vertical sections (0-5, 5-10, 10-15 cm) were marked along the BC sample and every section was sieved on a 0.5mm sieve, sieved material was collected in a sample jar (double volume than the sample) to be fixed with ethanol 70%. The remaining deep levels (> 15 cm) of the BC sample were checked and remains of species that are representative of CWC habitats, ice-age periods or unknown species have been collected. The sample jar was gently shaken once fixed in ethanol 70%, labeled

outside and inside. Labels included the following information: "FAUNA", the sample code (e.g. BC10, VV07), the sediment layer (just for Box-Corer samples: 0-5cm, 5-10 cm, 10-15 cm, so it should be BC07/0-5cm), the date (e.g. 12/10/2016) and the expedition (MEDWAVES 0916). The identification of the fauna will be carried out at Centro Oceanográfico de Málaga from Instituto Español de Oceanografía (COM-IEO) in collaboration with specialists of different taxonomic groups from different institutions.



Figure 3: *Left*) Taking notes of a sediment sample collected with Box-corer in the Gazul mud volcano. *Right*) Sieving the 0-5 cm fraction of a sediment sample on a mesh size of 0.5 mm.

Once the sediment was removed for sieving, the PVC mini-corer was cut to final height using a PVC saw, remarking the TOP and BOTTOM sides in both parts of the corer and labeling the mini corer with the sample code (e.g. BC1, BC15), date (e.g. 23-09-2016) and sampling expedition (e.g. MEDWAVES0916) in both parts. The corer was enclosed with 2 yellow caps and cut in two halves using an electrical saw, making sure that, in one half, all labeling (top/bottom, sample code, date and expedition) was well detailed as this half was kept for future laboratory analyses. A nylon string was used to divide carefully the sediment column into two mini corer halves (Fig. 4). One half was used for preliminary corer description and sediment sample collection during the expedition, whereas the second half (containing all labeling) was wrapped in plastic foil and packed with some artificial foam inside for avoiding movement of the sediment sample to each of the two yellow caps at each side. Then it was placed into a labeled plastic bag and stored refrigerated at +4°C until arrival to the laboratory in IEO-COMA.



Figure 4: *Left)* Mini corer inserted in a BC sample. *Middle)* Cutting the mini corer in two halves using an electrical saw. *Right)* Resulting two halves of a mini core.

After describing the entire half of a mini corer in the datasheet form, 5 cm intervals were marked using the metric tape and the layers were cut by using spatulas. Two sediment samples of the upper 5 cm layer of sediment (one half of the section for each sample) were collected, one for grain size analyses and the other for organic matter content, in both cases using a 120 ml container. Sample processing was similar for the 5-10 cm and 10-15 cm layer. Samples were then labeled outside with a marker and inside with a greaseproof paper label using a pencil. The labels (outside and inside the samples) contained "SED GQ" for granulometric analysis samples and "SED OM" for geochemical analyses, the sample code (e.g. BC10), the sediment layer (0-5 cm, 5-10 cm, 10-15 cm, resulting in a code such as BC07/0-5 cm), the date (e.g. 12/10/2016) and the expedition (MEDWAVES0916). The samples for organic matter were placed in the freezer (-20 °C) until arriving at the laboratory of the COM-IEO. The samples for grain size analyses were dried in the stove at 50 °C.

Samples collected with Van Veen grabs: A total of 34 sediment samples were collected with the Van Veen grab in Formigas (16 samples, with 9 collected in the SE side and N side), Ormonde (6) and Seco de los Olivos (15). A total of 10 dredges were not valid from the 44 sampling operations performed (Table 2).

Table 2: Summary of sediment and foraminifera (Foram) samples collected with Van Veen grab (from the COB) during MEDWAVES. Formigas (FOR), Ormonde (ORM), Seco de los Olivos (SECO).

Sample code	Medwaves code	Zone	Date	Lat	Long	Depth (m)	Validity	Foram Sample
VV01	55	FOR	30/09/2016	37°09.09	24°37.70	1,535	OK	Yes
VV02	56	FOR	30/09/2016	37°09.09	24°37.70	1,536	OK	Yes
VV03	58	FOR	30/09/2016	37°10.73	24°37.95	1,172	OK	Yes
VV04	59	FOR	30/09/2016	37°10.73	24°37.96	1,173	OK	Yes
VV05	66	FOR	01/10/2016	37°11.44	24°37.63	1,122	Qualitative	No
VV06	67	FOR	01/10/2016	37°11.35	24°37.97	1,246	OK	Yes
VV07	79	FOR	02/10/2016	37°12.18	24°37.42	1,018	OK	Yes
VV08	80	FOR	02/10/2016	37°12.18	24°37.42	1,018	Not valid	NO
VV09	81	FOR	02/10/2016	37°12.18	24°37.42	1,018	Not valid	NO
VV10	90	FOR	03/10/2016	37°12.65	24°39.72	746	rock	NO
VV11	91	FOR	03/10/2016	37°12.65	24°39.72	746	Not valid	NO
VV12	92	FOR	03/10/2016	37°12.65	24°39.72	746	Qualitative	NO
VV13	104	FOR	04/10/2016	37°20.56	24°44.45	1,415	OK	Yes
VV14	105	FOR	04/10/2016	37°20.56	24°44.45	1,415	Not valid	NO
VV15	106	FOR	04/10/2016	37°20.56	24°44.45	1,415	OK	Yes
VV16	114	FOR	05/10/2016	37°20.40	24°45.35	1,324	Not valid	NO
VV17	115	FOR	05/10/2016	37°20.40	24°45.35	1,324	OK	Yes
VV18	116	FOR	05/10/2016	37°20.40	24°45.35	1,324	OK	Yes
VV19	123	FOR	06/10/2016	37°20.29	24°45.28	1,312	Not valid	NO
VV20	128	FOR	07/10/2016	37°19.59	24°44.72	1,043	OK	Yes
VV21	129	FOR	07/10/2016	37°16.60	24°44.70	1,048	Not valid	NO
VV22	130	FOR	07/10/2016	37°16.60	24°44.70	1,048	OK	Yes
VV23	131	FOR	07/10/2016	37°19.60	24°44.69	1,069	OK	Yes
VV24	139	ORM	18/10/2016	36°58.64	10°47.10	1,936	OK	Yes
VV25	140	ORM	18/10/2016	36°58.56	10°47.11	1,931	OK	Yes
VV26	147	ORM	19/10/2016	36°48.02	10°57.01	1,235	OK	Yes
VV27	148	ORM	19/10/2016	36°48.01	10°57.02	1,235	OK	Yes
VV28	157	ORM	20/10/2016	36°48.62	11°07.51	1,143	OK	Yes
VV29	158	ORM	20/10/2016	36°48.63	11°07.51	1,144	Not valid	NO
VV30	177	SECO	23/10/2016	36°28.85	2°53.67	729	Not valid	NO
VV31	178	SECO	23/10/2016	36°28.85	2°53.67	729	OK	Yes
VV32	180	SECO	23/10/2016	36°28.85	2°53.67	729	OK	Yes
VV33	183	SECO	23/10/2016	36°29.05	2°53.52	637	Not valid	NO
VV34	184	SECO	23/10/2016	36°29.05	2°53.52	637	OK	Yes
VV35	193	SECO	24/10/2016	36°22.55	2°49.16	320	OK	Yes
VV36	194	SECO	24/10/2016	36°22.55	2°49.16	321	OK	NO
VV37	195	SECO	24/10/2016	36°22.55	2°49.16	322	OK	Yes
VV38	197	SECO	24/10/2016	36°32.20	2°49.22	250	OK	Yes
VV39	198	SECO	24/10/2016	36°32.20	2°49.22	250	OK	NO
VV40	199	SECO	24/10/2016	36°32.20	2°49.22	250	OK	NO
VV41	200	SECO	24/10/2016	36°32.76	2°48.81	381	OK	Yes
VV42	212	SECO	25/10/2016	36°31.24	2°48.17	280	OK	Yes
VV43	213	SECO	25/10/2016	36°31.24	2°48.17	280	OK	Yes
VV44	214	SECO	25/10/2016	36°31.04	2°48.04	440	OK	Yes

The Van Veen grab was opened on a big tray and water was removed with a small hose by placing the outflow on a 0.5 mm sieve in order to avoid the releasing of small

mobile benthic species (e.g. amphipods). The material collected on the 0.5 mm sieve was added to the final sieved sample. General pictures of material collected and detailed pictures of benthic species and substrates were taken, placing a plastic label with sample code.

Notes about sediment characteristics (e.g. color, sediment composition, bioclast characteristics), as well as faunistic components or other elements (e.g. presence of microplastics, etc) were documented. Subsamples of sediment were collected for geochemical analyses (stored at -20 °C), grain size distribution analysis (stored dry) and foraminifera (stored dry as with BC samples). Then, each sample was sieved to 0.5 mm and stored in ethanol 70 % for species identification and quantification at IEO-COMA. Detailed pictures of some species were taken on board. The identification of the fauna will be carried out at IEO Málaga in collaboration with specialists of different taxonomic groups from different institutions.

Postprocessing

All samples, except those for foraminifer analyses, will be transported to the IEO-COMA for further processing. Faunistic samples will be sorted under the stereomicroscope and species will be identified to the lowest taxonomical level, sometimes using microscopy techniques and assistance from specialists on different taxonomic groups of different institutions. Sedimentological samples (including minicorers) will be processed at Laboratorio de sedimentología of IEO-COMA in collaboration with sedimentologists.

9.4.4 Problems encountered

There was no significant problem while working on board. Nevertheless the coordinates of the sampling stations were sometimes not updated in the screen located in the main lab, so we had to double check the position every time with the bridge or with other computers. The geomorphology of some seafloor structures (steep seamounts of volcanic origin), the limited sedimentary bottoms found at the base, the great depth (down to 2,000 m) and the duration of the sampling operation made difficult the collection of sediment samples in the Formigas seamount. At Seco de los Olivos, the patches with coral rubble displayed small coverage so sampling on this bottom type was very difficult with some samples targeted to this facies of the cold-water coral banks habitat that retrieved hemipelagic muds from adjacent bottoms.

Overall, 16 samples were collected in this area (three of them qualitative samples due to the low sedimentary volume collected) and had 7 invalid operations (the Van Veen grab was empty when returning to the boat or did not close once touching the seabed).

9.4.5 Preliminary results

Although the final and detailed processing of the sediment samples will be carried out at IEO-COMA, some remarks can be done from on board preliminary analyses. Further a card for each sediment sample collected with the BC and the VV grab has been prepared on board and all are included in the Appendix VII.

Samples collected at the Gazul mud volcano (MV) showed a strong stratification in the box-corer samples, with a top layer of muddy fine-medium sand (color code 7.5YR 7/4) and a lower layer of a highly cohesive mud breccia (GLEY2 5/10B) that is typical from MVs (Fig. 5). Samples collected at Ormonde and Formigas displayed a surficial hemipelagic fine sediment mainly composed by benthic and pelagic foraminiferans and pteropod gastropods (pelagic species with an internal shell) (Fig. 5), followed by a wide layer of muddy fine sand (2.5Y 6/4). These hemipelagic sediments are characteristic of offshore oceanic conditions which are typical of the environment where both Ormonde and Formigas seamounts are located. In the case of Ormonde, slightly harder carbonate deposits (2.5Y 8/2) were observed from 30-32 cm depth in a BC sample and centimetric-decimetric basaltic rocks colonized by small hydrozoans, bryozoans and sponges were collected with the Van Veen dredge. At Seco de los Olivos, the samples were mainly composed of hemipelagic muds (color code 10YR 5/2), but generally with a lower content on foraminifera and pteropods and a higher content of terrigenous muds probably due to its higher continental influence.

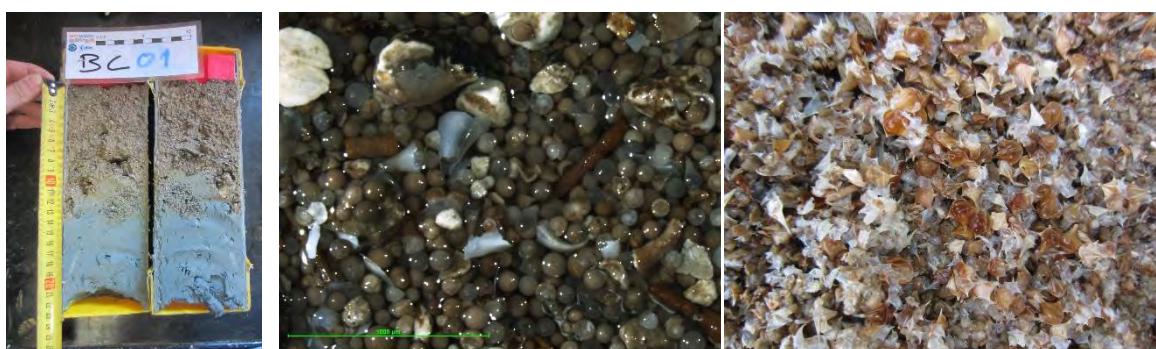

Figure 5: *Left)* Mini-corer collected from the sediment sample BC01 at Gazul MV displaying mud breccia (blue-grey colour) below a layer of muddy fine-medium sand (brown colour). *Middle)* Surficial hemipelagic sediment collected in Ormonde displaying large numbers of foraminifera (dominating *Orbulina universa*). *Right)* Shells of pteropods (mainly *Cavolinia* sp. and *Clio* sp.) after sieving a sediment sample collected in Formigas.

Overall molluscs, polychaetes, echinoderms and sessile invertebrates (e.g. bryozoans and small poriferans) were mainly collected in the 4 sampling areas, as well as a diverse thanatocenosis with the presence of different invertebrate groups (e.g.

molluscs, cnidarians, bryozoans). Sediment samples from Formigas highlighted for the presence of mollusc species that were associated with different organisms that are generally common in habitats conformed by cold-water coral and gorgonians such as anthozoan cnidarians (i.e. epitoniids), hydrozoans (i.e. ovulids), echinoderms (i.e. eulimids) as well as on other molluscs and polychaetes (i.e. pyramidellids) (Fig. 6). This would indicate the presence of a diverse benthic macrofauna in surrounding bottoms, which was confirmed by the observations made with the ROV. On the other hand, remains of CWC were collected in Gazul and Formigas, mainly of the reef-forming species *Lophelia pertusa* and *Madrepora oculata* (Fig. 7). Among the pteropods, four species were identified in both areas: *Cavolinia inflexa* (Lesueur, 1813), *Cuvierina columnella* (Rang, 1827), *Diacria trispinosa* (Lesueur, 1821), *Styliola subula* (Quoy & Gaimard, 1827). At Seco de los Olivos, several samples were collected on coral rubble with different degree of coverage and sedimentation, which contained a very rich fauna with porifera (*Terpio* sp., *Haliclona* sp.), bryozoa (*Reteporella* sp.), cnidaria (*Acanthogorgia* sp., Coralliomorpha, small zoantharia), brachiopods (*Terebratula* sp.), echinoderms (*Ophiothrix* sp., Crinoids), decapods (*Monadeus* sp.), annelids (*Eunice* sp., *Serpula* sp., *Vermiliopsis* sp.) and molluscs (*Coralliophyllia* sp., *Mitrella* sp., *Danilia* sp.). Some species associated with hemipelagic muddy bottoms were also detected among the muddy coral rubble (*Abra* sp., *Alpheus* sp.). The study of the coral rubble associated benthic community at this study area could provide important information on the description of new species and the role of this facies for the CWC habitat.

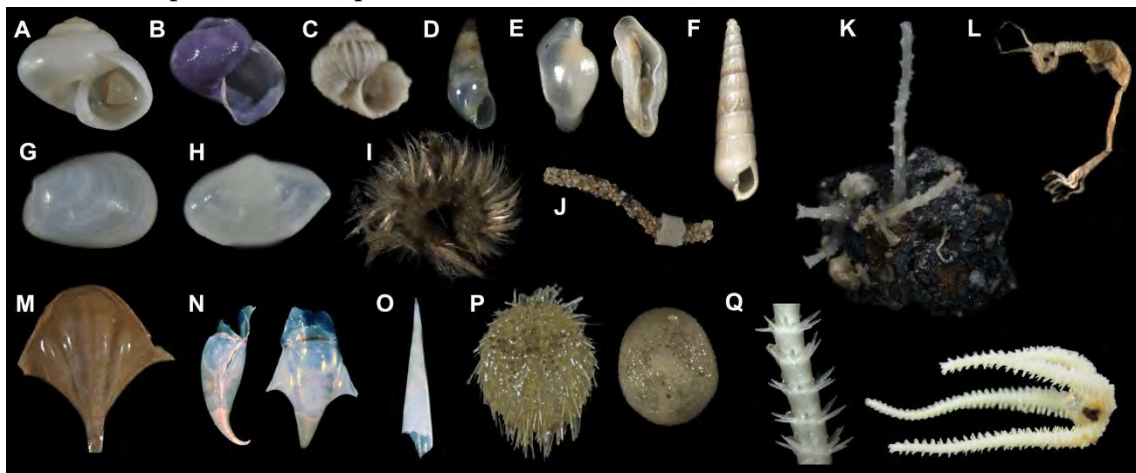

Figure 6: A small representation of live and dead species collected in Formigas. A) *Cirsonella* sp.; B) *Janthina exigua*; C) *Epitonium* sp.; D) *Vitreolina* sp.; E) *Pedicularia* sp.; F) *Eulimella* sp.; G) Mytilidae; H) *Yoldiella messanensis*; I) Aphroditidae; J) Polychaete tube; K) Bryozoan; L) Caprellid crustacean; M) *Diacria trispinosa*; N) *Cavolinia inflexa*; O) *Styliola subula*; P) Irregular echinoids; Q) Ophiurid echinoderm (Pictures taken on MEDWAVES).

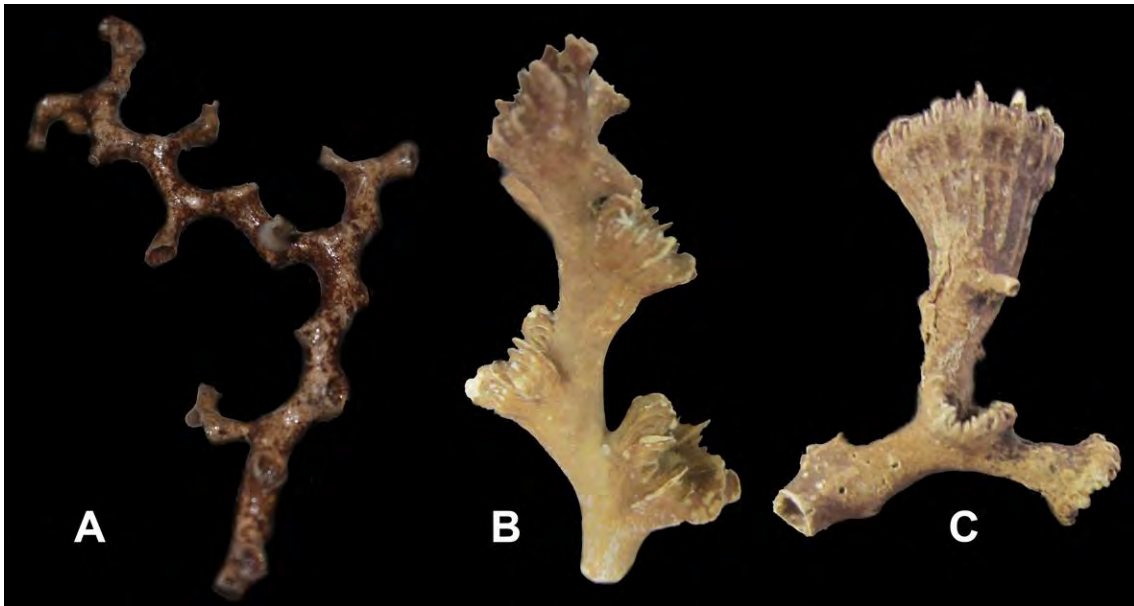

Figure 7: Remains of some CWC collected in Van Veen and BC samples: A) *Madrepora oculata*; B) *Lophelia pertusa*; C) *Desmophyllum* on a *L. pertusa* colony.

References

- de la Torriente A, Aguilar R, Serrano A, García S, Fernández-Salas LM, García Muñoz M, Punzón A, Arcos JM, Sagarminaga R (2014) Sur de Almería - Seco de los Olivivos. Proyecto LIFE+ INDEMARES. Fundación biodiversidad, Ministerio de Agricultura, Alimentación y Medio Ambiente
- Díaz del Río V, Bruque G, Fernández-Salas LM, Rueda JL, González E, López N, Palomino D, López FJ, Farias C, Sánchez R, Vázquez JT, Rittierott C, Fernández A, Marina P, Luque V, Oporto T, Sánchez O, García M, Urra J, Bárcenas P, Jiménez MP, Sagarminaga R, Arcos JM (2014) Volcanes de fango del golfo de Cádiz, Proyecto LIFE + INDEMARES. Fundación Biodiversidad, Ministerio de Agricultura, Alimentación y Medio Ambiente
- Hebbeln DC, Wienberg C, Beuck L, Freiwald A, Wintersteller P, cruise participants (2009) Report and preliminary results of RV Poseidon cruise POS 385 “cold-water corals of the Alboran Sea (Western Mediterranean Sea)”, Faro-Toulon, May-June 2009. Berichte, Fachbereich Geowissenschaften, Universität Bremen, No. 273.
- Rueda JL, González-García E, Krutzky C, López-Rodríguez FJ, Bruque G, López-González N, Palomino D, Sánchez RF, Vázquez JT, Fernández-Salas LM, Díaz-del-Río V (2016) From chemosynthesis-based communities to cold-water corals: vulnerable deep-sea habitats of the Gulf of Cádiz. *Mar Biodiv* 46:473–482

9.5 Benthic ecology. Biogeochemical composition of the sedimentary organic matter

Teodoro Ramírez¹, Sophie Arnaud-Haond², Joana Boavida², Anna Maria Addamo³

1. Instituto Español de Oceanografía, Centro Oceanográfico de Málaga, Málaga, Spain
2. L'Institut Français de Recherche pour l'Exploitation de la Mer, IFREMER, Montpellier, France
3. Museo Nacional de Ciencias Naturales (CSIC), Madrid, Spain

9.5.1 Personnel involved

Teodoro Ramírez was not on board. As the samples collected for the analyses he will perform proceed from the MUC, the MUC team was in charge of collecting and preserving the samples

MEDWAVES-ATLAS Cruise LEG 1

Cádiz – Ponta Delgada (21/09 – 13/10/2016)

	Name	Institution	Role and responsibilities
1	Sophie Arnaud-Haond	IFREMER, sarnaud@ifremer.fr	Sampling and sample preservation

MEDWAVES-ATLAS Cruise LEG 2

Ponta Delgada – Málaga (14/10 – 26/10/2016)

	Name	Institution	Role and responsibilities
1	Joana Boavida	IFREMER, joanarboavida@gmail.com	Sampling and sample preservation
2	Anna Maria Addamo	Museo Nacional de Ciencias Naturales (MNCN-CSIC), am.addamo@gmail.com	Sampling and sample preservation

9.5.2 Introduction. Aims

Primary production in the euphotic layer, the trophic interactions across the food webs and the ocean processes modulate the vertical flux of particles from the euphotic zone to the deep sea. A small fraction of this vertical flux of organic particle

(Graf 1989, Smith et al. 2008), reach eventually the seabed where different labile organic matter (OM) components provide a source of nutrients that fuel the biological activity in benthic ecosystems (Gooday & Turley 1990). The response of benthic communities to increased food availability may be rapid. Episodic pulses of food reaching the deep sea are extremely important in sustaining abyssal communities over long time periods. Thus, the vertical flux of particles to the deep sea and its composition plays a major role on the biogeochemical features of sediments and on the dynamics of benthic communities (Gooday & Turley 1990), the so called pelagic-benthic coupling. In the Alboran Sea and the Strait of Gibraltar the upwelling events of Mediterranean waters and the mixing between the Mediterranean Outflow Water (MOW) and the surface Atlantic waters, alongside other upwelling mechanisms linked to the hydrodynamic in this areas, lead to a frequent nutrient enrichment in the euphotic layer (Ramirez et al. 2005). These upwelling processes fuel primary production and lead to higher chlorophyll-a concentrations in comparison with other areas of the Western Mediterranean. Associated to the enhanced production, high vertical flux of particles has been observed in deep areas of this basin (Sánchez Vidal et al. 2005). Part of this flux can eventually reach the seabed providing a source of Carbon (C) and nutrients to communities inhabiting deep ecosystems. As observed in other deep sea areas (Thiel et al. 1989), these inputs of organic matter to the seabed should be reflected in the biogeochemical composition of sediments, as well as on the biogeochemical process in marine sediments and the biological and on the status of benthic communities. On the other hand, part of the vertical flux of particles in the Alboran Sea, the Strait of Gibraltar and the Gulf of Cádiz could eventually reach the MOW and would be transported westwards to the Atlantic Ocean (Marti et al. 2001, Freitas & Abrantes 2002), where Mediterranean waters flows at intermediate depths. The concentration of organic particles associated to the MOW in the NE Atlantic (Gulf of Cádiz) (Ambar et al. 2002) could be a source of C and nutrients for deep sea ecosystems. In its journey the particles advected by the MOW may travel further into the NE Atlantic and eventually settle down on the seabed, providing a source of OM available for benthic communities.

The biochemical composition of the sedimentary OM is therefore an important aspect to be considered in order to know the different potential sources of food for benthic consumers and to study the interconnections between the upper water column and the abundance, composition and diversity of benthic communities. The sum of proteins, carbohydrates, and lipids (the biopolimeric C) provides a proxy of the potential nutritional value of sedimentary organic matter (Neira et al. 2001), as the labile fraction of sedimentary OM is mainly composed of proteins, carbohydrates and lipids. Thus some authors have used the total protein and carbohydrate concentrations in coastal sediments for the classification of the trophic state of some coastal ecosystems (Dell'Anno et al. 2002, García Rodríguez et al. 2011). Although the

bulk of these fractions in the sedimentary OM does not represent the labile fraction of biopolymeric OM (Danovaro et al. 2001).

On the other hand phytodetritus is a major C source for benthic habitats and their export to the deep sea an impact on benthic communities and processes (Morata & Renaud 2008). Previous studies in different areas have found a close relationship between Chl-a in benthic ecosystems and Chl-a in the water column, which is indicative of a strong pelagic-benthic coupling. Some studies have found a close relationship between the chlorophyll in sediments and the oxygen consumption, which indicate the relevance of the composition of the OM reaching the sediment for benthic communities (Morata & Renaud 2008). Thus, Chl-a in sediments provides a proxy of recent inputs of phytodetritus, which represent a rich substrate for the growth of bacteria and protozoa (flagellates and foraminifers) and deposit feeders (Thiel et al. 1989, Gooday & Turley 1990). On the other hand, phaeopigments are indicative of the presence of faecal material from zooplankton and/or macrobenthic breakdown of phytodetritus containing chlorophyll-a (Cathalot et al. 2015).

The aim of this part of the work conducted on board MEDWAVES was to assess the quality of sedimentary OM, by analyzing the biogeochemical composition of surface sediments, and its potential role as nutritional source of carbon and nutrients to fuel benthic deep sea communities, as well as to assess the role of the influx of phytodetritus from the upper layers on the composition of the sedimentary OM, its connections with the processes in the water column and the effects on the status of the benthic ecosystems. The biogeochemical composition of the sedimentary OM and the presence of phytodetritus will be based on the analysis of Chl-a/phaeopigments, proteins, carbohydrates and lipids in surface sediments.

Moreover, the relationships between the biogeochemical composition of surface sediments and the physico-chemical and biological features of the overlaying water masses will allow to determine the degree of pelagic-benthic coupling in the different areas sampled in this survey, and therefore the connection between the composition of the sedimentary OM and the prevalent oceanographic conditions in the water column. Likewise, the relationship between the composition of the sedimentary OM and the benthic communities may be analyzed. Therefore, the biogeochemical composition of the sedimentary OM in surface sediments is expected to provide relevant information to explore further the influences of oceanographic conditions on target areas and the ecosystems therein. This activity is therefore linked to WP1, WP2 and WP3. In particular it is closely related to Task 2.2 (WP2) "Organic characterization and mineralization of organic matter" and it may provide information to contribute to task Task3.1 (WP3) "Improve the understanding of biodiversity and biogeography in the deep N Atlantic"

9.5 3 Sampling methodology. Postprocessing

This activity was not included originally in the activities foreseen in the ATLAS project, however, it was considered interesting as it will provide additional and complementary information to the other activities originally foreseen in the project. However, because the activity was introduced at a later stage, during the MEDWAVES survey priority was given to the sampling of sediments for the analysis and activities originally included in the ATLAS project. Therefore the subsampling for biogeochemical measurements was made whenever possible. Surface sediment samples were collected at MUC stations, whenever possible the subsamples were taken from the sediment homogenates left after the sampling for eDNA. Thus, the subsampling of sediments for these biogeochemical parameters was conducted once the first sediment horizon (0-1 cm) from the MUC cores was subsampled for eDNA. For each of the parameters (pigments, proteins, carbohydrates and lipids) 3 pseudoreplicates were taken (when possible) from the first horizon (0-1cm) of the 3 MUC cores sampled for eDNA. The samples were kept in small PE plastic bags, protected from light and store at -20°C until their analysis at the laboratory (IEO-COMA). Chlorophyll-a, protein, carbohydrates and lipid content in sediments will be analysed using the methods described by Dell'Anno et al. 2002.

Table 1: Stations where the Multicorer was sampled for biogeochemical analysis. Stations numbers correspond to the numbers included in the general station list (Appendix II)

Date	Area	Station number	Depth (m)
23.09.2016	Gazul Mud Volcano	22	470
01.10.2016	Formigas Seamount	68	1,245
05.10.2016	Formigas Seamount	117	1,325
23.10.2016	Seco de los Olivos	179	729
24.10.2016	Seco de los Olivos	201	381
25.10.2016	Seco de los Olivos	215	554

9.5 4 Instrumentation details and calibration information

Details are given in section 9.10 as well as in Appendix XV.

9.5 5 Problems encountered

None

9.5.6 Preliminary results

As the whole analyses will be performed in the home laboratory, there are no preliminary results to present.

References

- Ambar IN, Serra MJ, Brogueira G, Cabeçadas F, Abrantes P, Freitas C, Gonçalves Nicolás N (2002) Physical, chemical and sedimentological aspects of the Mediterranean outflow off Iberia, *Deep Sea Res.*, 49, Part II, 4163-4177
- Cathalot C, Rabouille C, Sauter E, Schewe I, T Soltwedel (2015) Benthic Oxygen Uptake in the Arctic Ocean Margins - A Case Study at the Deep-Sea Observatory HAUSGARTEN (Fram Strait). *PLOS ONE* | DOI:10.1371/journal.pone.0138339
- Danovaro R, Dell'Anno a, Fabiano M (2001) Bioavailability of organic matter in the sediments of the Porcupine Abyssal Plain, northeastern Atlantic. *Mar Ecol Prog Ser* 220: 25–32
- Dell'Anno A, Mei ML, Pusceddu A, Danovaro R (2002) Assessing the trophic state and eutrophication of coastal marine systems: a new approach based on the biochemical composition of sediment organic matter. *Mar Poll Bull* 44 (7), 611-622
- Freitas PS, Abrantes FF (2002) Suspended particulate matter in the Mediterranean water at the Gulf of Cádiz and off the southwest coast of the Iberian Peninsula. *Deep Sea Research Part II Topical Studies in Oceanography* 49(19):4245-4261
- Garcia-Rodriguez F, del Puerto L, Venturini N, Laura Pita A, Brugnoli E, Burone I P, Muniz P (2011) Diatoms, protein and carbohydrate sediment content as proxies for coastal eutrophication in Montevideo, Rio de la Plata Estuary, Uruguay. *Brazilian Journal of Oceanography*. 59, 4 <http://dx.doi.org/10.1590/S1679-87592011000400001>
- Gooday AL, Turley CM (1990) Responses by Benthic Organisms to Inputs of Organic Material to the Ocean Floor: A Review and Discussion. Volume 331, issue 1616 *Philosophical Transactions of the Royal Society*. DOI: 10.1098/rsta.1990.0060
- Graf G (1989) Benthic-pelagic coupling in a deep-sea benthic community. *Nature* 341, 437-439 (5 October 1989) | doi:10.1038/341437a0
- Marti S, Baynoa JM, Albaigés J (2001) A potential source of organic pollutants into the northeastern Atlantic: the outflow of the Mediterranean deep-lying waters through the Gibraltar Strait. *et al* 2001. *Environ Sci Technol*. 2001 Jul 1;35(13):2682-9
- Morata N, Renaud PE (2008) Sedimentary pigments in the western Barents Sea: a reflection of pelagic-benthic coupling? *Deep-Sea Research II* 55: 2381-2389. <http://dx.doi.org/10.1016/j.dsr2.2008.05.004>
- Neira C, Sellanes J, Levin LA, Arntz WE (2001) Meiofaunal distributions on the Peru margin: relationship to oxygen and organic matter availability. *Deep-Sea Research* 48: 2453–2472
- Ramírez T, Cortés D, Mercado JM *et al.* (2005) Seasonal dynamics of inorganic nutrients and phytoplankton biomass in the NW Alboran Sea. *Est Coast Shelf Sci* 65: 654–670
- Sanchez-Vidal A, Calafat A, Canals M, Frigola J, Fabres J (2005) Particle fluxes and organic carbon balance across the Eastern Alboran Sea (SW Mediterranean Sea). *Cont Shelf Res* 25; 609-625

- Smith KL, Ruhl HA, Kaufmann RS, Diego S (2008) Tracing abyssal food supply back to upper-ocean processes over a 17-year time series in the northeast Pacific. *Limnol Oceanogr* 53 (6): 2655–2667
- Thiel H, Pfannkuche O, Schriever G, Lochte K, Gooday AJ, Hemleben CH, Mantoura RFG, Turley CM, Patching JW, Riemann F (1989) Phytodetritus on the Deep-Sea Floor in a Central Oceanic Region of the Northeast Atlantic, *Biological Oceanography*, 6 (2): 203-239

9.6 Benthic ecology. Foraminiferan fauna

Guillem Mateu¹, Javier Urra², Ángel Mateo-Ramírez², José Luis Rueda³, Marina Gallardo³

1. Universitat de les Illes Balears, Palma, Spain
2. Universidad de Málaga, Málaga, Spain
3. Instituto Español de Oceanografía, Centro Oceanográfico de Málaga, Málaga, Spain

9.6.1 Personnel involved

Guillem Mateu was not on board. As the samples collected for the analyses he will perform proceed from the Box corer and Van Veen Grab, this was the team in charge of collecting and preserving the samples

MEDWAVES-ATLAS Cruise LEG 1

Cádiz – Ponta Delgada (21/09 – 13/10/2016)

	Name	Institution	Role and responsibilities
1	Javier Urra	Institution: Department of Animal Biology, University of Malaga, Spain Contact information: javier.urrea.recuero@gmail.com	Field work: Collection, sieving and fixation of samples. Lab work: Separation of specimens with stereomicroscope; taxonomical identification of specimens; redaction of documents
2	Ángel Mateo-Ramírez	Institution: Department of Animal Biology, University of Malaga, Spain Contact information: a.mateoramirez@gmail.com	Field work: Collection, sieving and fixation of samples. Lab work: Separation of specimens with stereomicroscope; taxonomical identification of specimens; redaction of documents.

MEDWAVES-ATLAS Cruise LEG 2

Ponta Delgada – Málaga (14/10 – 26/10/2016)

	Name	Institution	Role and responsibilities
4	José Luis Rueda	Institution: Centro Oceanográfico de Málaga, Instituto Español de Oceanografía, Spain Contact information: jose.rueda@ma.ieo.es	Field work: Collection, sieving and fixation of samples. Lab work: Separation of specimens with stereomicroscope; taxonomical identification of specimens; redaction of documents.
5	Marina Gallardo	Institution: Centro Oceanográfico de Málaga, Instituto Español de Oceanografía, Spain Contact information: mgallardo@ma.ieo.es	Field work: Collection, sieving and fixation of samples. Lab work: Separation of specimens with stereomicroscope; taxonomical identification of specimens; redaction of documents.

9.6.2 Introduction. Aims

Foraminifera are very abundant in all marine environments, have relatively short life cycles, and react quickly to environmental changes at global and local scales (Frontalini et al. 2009). Moreover, foraminiferal species (even genera) are highly adapted to well-defined ranges of environmental parameters, such as water temperature, depth, salinity, nutrition flux, wave regime, and pollution (Hallock et al. 2003, Morvan et al. 2004, Châtelet & Debenay 2010, Koukousioura et al. 2011, Hallock 2012). Furthermore, the tremendous taxonomic diversity of foraminiferal species gives them the potential for diverse biological responses to various chemical substances (Hallock et al. 2003). Therefore, these protozoans are very useful indicators to characterize a given environment in an integrated way (Pergent-Martini et al. 2005).

Foraminifers are among the more conspicuous components observed in the sediments from open marine areas. These protozoans can be clustered based on their type of wall structure. Most of them can be included within one of the subsequent groups:

- “agglutinate” that build their tests by agglutinating sediment particles from the environment,

- “porcellaneous” that secrete high-magnesium calcite microcrystals to construct their tests.
- “calcareous perforate” taxa with hyaline, low-magnesium calcite tests.

Agglutinated and porcellaneous forms include exclusively benthic taxa, whereas calcareous perforate tests occur in both benthic and planktic species.

Foraminiferal tests show a quite well defined array of chamber arrangements regardless of the type of wall. Thus, for benthic taxa there is a relationship between the test architecture, the type of substrate and the life-mode of species that are taxonomically distant, but dwell in similar environments (Langer 1993, Mancin 2001). Similarly, test shape, ornamentations and chamber arrangement in planktic taxa is related to their position within the water column (Bé 1977). Other factors such as temperature exert an important effect on the test determining pore-size and coiling-direction of many planktic species (Arnold & Parker 1999).

The analysis of the foraminiferal assemblage including both benthic and planktonic taxa will contribute to achieve some of the goals of the MEDWAVES cruise.

Foraminifers directly reflect the oceanographic conditions and the influence of the different water masses. Moreover, the composition of the assemblages may help to elucidate the connectivity between the Mediterranean and the Atlantic ecosystems. Indeed, regarding the particular work packages forming the ATLAS consortium, the study of the foraminiferal biocoenoses fits within the WP2 since this analysis requires understanding the ecosystem functions and distribution and how these are affected by climate. The characterization of the foraminiferal associations is also highly related with the WP3 as they will contribute to infer biodiversity in relationship with the oceanographic context.

9.6.3 Sampling methodology. Postprocessing

Table 1 shows the samples collected during MEDWAVES for foraminiferan studies. Sediment samples will be sieved (>63 microns) to wash the silt and mud. Subsequently, for the taxonomic analysis, up to 300 specimens will be picked and classified to species level. Statistical analysis will be performed on the resulting database to model the species distribution considering the oceanographic variables.

Table 1: Sediment samples collected for foraminiferan fauna analyses

Location	Station	Sample	Activity	Date	Depth	Preservation
Gazul MV	10	6 cc foraminifera and sediment	BC01	22/09/2016	444	Dry
Gazul MV	11	6 cc foraminifera and sediment	BC02	22/09/2016	450	Dry
Gazul MV	21	6 cc foraminifera and sediment	BC04	23/09/2016	470	Dry

Ormonde Seamount	37	6 cc foraminifera and sediment	BC05	25/09/2016	1919	Dry
Formigas Seamount	55	6 cc foraminifera and sediment	VV01	30/09/2016	1535	Dry
Formigas Seamount	56	6 cc foraminifera and sediment	VV02	30/09/2016	1536	Dry
Formigas Seamount	58	6 cc foraminifera and sediment	VV03	30/09/2016	1172	Dry
Formigas Seamount	59	6 cc foraminifera and sediment	VV04	30/09/2016	1173	Dry
Formigas Seamount	67	6 cc foraminifera and sediment	VV06	01/10/2016	1246	Dry
Formigas Seamount	79	6 cc foraminifera and sediment	VV07	02/10/2016	1018	Dry
Formigas Seamount	104	6 cc foraminifera and sediment	VV13	04/10/2016	1415	Dry
Formigas Seamount	106	6 cc foraminifera and sediment	VV15	04/10/2016	1415	Dry
Formigas Seamount	115	6 cc foraminifera and sediment	VV17	05/10/2016	1324	Dry
Formigas Seamount	116	6 cc foraminifera and sediment	VV18	05/10/2016	1324	Dry
Formigas Seamount	128	6 cc foraminifera and sediment	VV20	07/10/2016	1043	Dry
Formigas Seamount	130	6 cc foraminifera and sediment	VV22	07/10/2016	1048	Dry
Formigas Seamount	131	6 cc foraminifera and sediment	VV23	07/10/2016	1069	Dry
Ormonde Seamount	139	6 cc foraminifera and sediment	VV24	18/10/2016	1936	Dry
Ormonde Seamount	140	6 cc foraminifera and sediment	VV25	18/10/2016	1931	Dry
Ormonde Seamount	147	6 cc foraminifera and sediment	VV26	19/10/2016	1235	Dry
Ormonde Seamount	148	6 cc foraminifera and sediment	VV27	19/10/2016	1235	Dry
Ormonde Seamount	157	6 cc foraminifera and sediment	VV28	20/10/2016	1143	Dry
Seco de los Olivos SW	178	6 cc foraminifera and sediment	VV31	23/10/2016	729	Dry
Seco de los Olivos SW	180	6 cc foraminifera and sediment	VV32	23/10/2016	729	Dry
Seco de los Olivos SW	183	6 cc foraminifera and sediment	VV33	23/10/2016	637	Dry
Seco de los Olivos SW	184	6 cc foraminifera and sediment	VV34	23/10/2016	637	Dry
Seco de los Olivos SW	193	6 cc foraminifera and sediment	VV35	24/10/2016	320	Dry
Seco de los Olivos W	195	6 cc foraminifera and sediment	VV37	24/10/2016	322	Dry
Seco de los Olivos W	197	6 cc foraminifera and sediment	VV38	24/10/2016	250	Dry
Seco de los Olivos NE	199	6 cc foraminifera and sediment	VV40	24/10/2016	250	Dry
Seco de los Olivos NE	200	6 cc foraminifera and sediment	VV41	24/10/2016	381	Dry

Seco de los Olivos NE	212	6 cc foraminifera and sediment	VV42	25/10/2016	280	Dry
Seco de los Olivos NE	213	6 cc foraminifera and sediment	VV43	25/10/2016	280	Dry
Seco de los Olivos SE	214	6 cc foraminifera and sediment	VV44	25/10/2016	440	Dry

9.6 4 Instrumentation details and calibration information

Details are given in section 9.4 as well as in Appendix XV.

9.6 5 Problems encountered

None

9.6 6 Preliminary results

As the whole analyses will be performed in the home laboratory, there are no preliminary results to present.

References

- Arnold AJ, Parker WC (1999) Biogeography in Planktonic Foraminifera. Modern Foraminifera, (Editor: B. K. Sen Gupta). Dordrecht, The Netherlands, Kluwer Academic Publishers: 103-122
- Bé AHW (1977) An ecological, zoogeographic and taxonomic review of recent planktonic foraminifera. *Oceanic Micropaleontology*. A. T. S. Ramsay. London, Academic Press: 1-100
- Chatelet EA, Debenay JP (2010) The anthropogenic impact on the western French coasts as revealed by foraminifera: A review. *Revue de Micropal.*, v. 53 (3), p. 129-137
- Frontalini F, Buosi C, Da Pelo S, Coccioni R, Cherchi A, Bucci C (2009) Benthic foraminifera as bio-indicators of trace element pollution in the heavily contaminated Santa Gilla lagoon (Cagliari, Italy). *Mar. Poll. Bull.*, v. 58, p. 858–877
- Hallock P (2012) The FoRAM Index revisited: uses, challenges, and limitations, 12th International Coral Reef Symposium, Australia: Cairns Pergent-Martini et al., 2005).
- Hallock P, Lidz BH, Cockey-Burkhard EM, Donnelly KB (2003) Foraminifera as bioindicators in coral reef assessment and monitoring: The FORAM Index. *Environmental Monitoring and Assessment*, v. 81(1), p. 221-238
- Koukousioura O, Dimiza MD, Triantaphyllou MV, Hallock P (2011) Living benthic foraminifera as an environmental proxy in coastal ecosystems: A case study from

- the Aegean Sea (Greece, NE Mediterranean), *Journal of Marine Systems*, v. 88 (4), p. 489-501
- Langer MR (1993) Epiphytic foraminifera. *Mar Micropal*, v. 20, p. 235-265.
- Mancin N (2001) Agglutinated foraminifera from the Epiligurian succession (Middle Eocene/Lower Miocene, Northern Appenines, Italy): scanning electron microscopic characterization and paleoenvironmental implications, *Journal of Foraminiferal Research*, v. 31, p. 295-308.
- Morvan J, Le Cadre V, Jorissen F, Debenay J-P (2004) Foraminifera as potential bio-indicators of the "Erika" oil spill in the Bay of Bourgneuf: field and experimental studies. *Aquatic living resources* 17:317-322
- Pergent-Martini C, Leoni V, Pasqualini V, Ardizzone G, Balestri E, Bedini R, Belluscio A, Belsher T, Borg J, Boudouresque C (2005) Descriptors of *Posidonia oceanica* meadows: Use and application. *Ecological Indicators* 5:213-230

9.7 Benthic ecology. Benthic annotation team (ROV / OFOP live annotations), collection of specimens for taxonomical purposes

Lea-Anne Henry¹, Meri Bilan², Íris Sampaio², Maria Rakka², Manuela Ramos², Gerald Taranto², Cristina Gutiérrez³, Jesús Rivera⁴, Miriam Hermida⁵, Juancho Movilla⁶

1. University of Edinburgh, Edinburgh, United Kingdom
2. Institute of Marine Research (IMAR), Azores, Portugal
3. Aquarium Finisterrae, A Coruña, Spain
4. Instituto Español de Oceanografía, IEO, Madrid, Spain
5. Universidad de Alcalá de Henares, Madrid, Spain
6. Instituto de Ciencias del Mar (CSIC), Barcelona, Spain

9.7.1 Personnel involved

MEDWAVES-ATLAS Cruise LEG 1

Cádiz – Ponta Delgada (21/09 – 13/10/2016)

	Name	Institution	Role and responsibilities
1	Lea-Anne Henry	University of Edinburgh, UK	Video annotation with OFOP, taxonomical identification of octocorals and hydroids, report redaction.
2	Meri Bilan	IMAR-University of the Azores	Video annotation with OFOP, photography of specimens, report redaction.
3	Íris Sampaio	IMAR-University of the Azores; Senckenberg am Meer, Wilhemshaven	Video annotation, taxonomical identification of octocorals, collection and preservation of specimens and report redaction.
4	Maria Rakka	IMAR-University of the Azores	Video annotation, collection and preservation of specimens.
5	J. Rivera	IEO	Habitat mapping and coordination of ROV Survey tasks

6	M. Hermida	UAH	ROV Survey tasks
7	J. Movilla	ICM-CSIC	ROV Survey tasks

MEDWAVES-ATLAS Cruise LEG 2

Ponta Delgada – Málaga (14/10 – 26/10/2016)

	Name	Institution	Role and responsibilities
1	Gerald H. Taranto	IMAR-University of the Azores	Video annotation with OFOP, map design, report redaction.
2	Manuela Ramos	Lisbon University	Video annotation with OFOP, collection and preservation of specimens, report redaction.
3	Cristina Gutiérrez	Aquarium Finisterrae, A Coruña	Video annotation with OFOP, collection and preservation of specimens.
4	M. Hermida	UAH	Coordination ROV Survey tasks
5	J. Movilla	ICM-CSIC	Coordination ROV Survey tasks

9.7.2 Introduction. Aims

The export of Mediterranean Outflow Water (MOW) from the Mediterranean Sea basin is a critical component of the circulation, mixing, and transport processes in the Atlantic Ocean. The resulting outbound flow of energy and elements, and the formation of eddies, have implications for biological systems that are sustained by the food, particles, and physical/chemical conditions provided by MOW export. The extent to which MOW export drives large-scale biogeographic patterns is also not currently well depicted in policy tools to develop MPAs such as the IOC-UNESCO's GOODS (Global Open Oceans and Deep Seabed) classification scheme (Rice et al. 2011).

The MEDWAVES cruise, among others, aimed at characterizing the biodiversity and describing the megafaunal communities and habitat types of specific target areas of interest with the wider goal to study potential relationships between ecosystems and oceanographic conditions (ATLAS WP1, WP3) and locate possible key areas for the connectivity among populations in the Mediterranean Sea and Atlantic Ocean (ATLAS WP3, WP4). The thorough study of benthic communities was based primarily on the use of the ROV *Liropus* to conduct: i) video transects to characterise and describe quantitatively benthic communities and identify vulnerable marine

ecosystems (VMEs) or ecologically or biologically significant marine (EBSAs) areas; ii) targeted sampling for taxonomic identification and for genetic studies.

9.7.3 Sampling methodology. Postprocessing. ROV video recording and OFOP live video annotation

ROV videos represent a powerful tool to characterize deep-sea habitats and biotopes and quantitatively describe benthic communities *in situ* (e.g. Lee et al. 2015).

Vulnerable marine ecosystems (VMEs) and ecologically or biologically significant areas (EBSAs) identified through video analyses can inform management strategies and ultimately guide the formation of marine reserves. Moreover, videos collected through ROV footage help assess the extent of human impacts in deep basins (Pham et al. 2014). Finally, the coupled biological and environmental information obtained through ROV dives is crucial to construct and validate habitat suitability models which can then be used to predict the behaviour of deep-sea communities under different scenarios of climate change and human pressure.

During MEDWAVES, more than 115 hours of videos were recorded in 25 different ROV dives (see general Station list, Appendix II, detail of ROV stations in Appendix VIII). Real time annotation of all detectable benthic organisms was performed, including invertebrate and fish species or higher taxa. This activity aimed at facilitating the visualization of preliminary results and helping more detailed future video analysis.

OFOP (Ocean Floor Observation Protocol) v3.3.6 software was used to couple the logging of ocean floor observations with ROV positions and environmental parameters. During MEDWAVES it was used to annotate in real time the videos shot with the ROV. A detailed guide on the use of OFOP was prepared during the cruise (see Appendix IX). Its aim is to set the basis for a protocol to be used in other ATLAS expeditions.

Live annotation of all visible benthic and demersal organisms was performed, including invertebrate and fish species. However, special attention was given to habitat forming species, which may be indicators of VMEs or EBSAs. All occurrences of colonial scleractinian and aggregating octocorals were tracked as they were one of the main targets of the samples collected by ROV. Sponge aggregations were also annotated, but due to a lack of taxonomic expertise on board, these annotations remained at coarse taxonomical level. Deep-sea fishes, which can also indicate areas of particular importance for conservation, were also annotated at different taxonomic levels.

9.7.4 Instrumentation details and calibration information

Details on the ROV characteristics can be found in Appendix XIII

9.7.5 Problems encountered

It is important to have in mind the possible mistakes made with the annotations during the dives due to fast change in scenery (e.g. habitat, substrate, etc). Moreover, the different level of taxonomical expertise of the annotators and the lack of a well-defined and uniform annotation practice suggest a re-evaluation of at least a part of the video footage for more structured studies.

OFOP logs were slightly delayed when compared with the navigation files from the ROV. This results in some mismatch between ROV video and the position and depth OFOP records. Moreover, occasionally wrong depth records were registered in the OFOP files. Since the navigation logs are supposed to be more accurate than the OFOP ones, we suggest updating lat/lon and depth of the OFOP logs based on the navigation files. This can be done using an R script matching the time of the OFOP and navigation logs. Time constraints did not allowed the production of such a script during the cruise.

9.7.6 Preliminary results

9.7.6.1 Identification of VMEs

One of the main contributions of video analysis is the identification of vulnerable marine ecosystems (VMEs). The following maps (Figs. 1-4) show habitats identified during live OFOP annotation of ROV transects.

Overview of the faunal composition at the different study sites

In the following paragraphs a description obtained from the life OFOP annotations of some of the conducted ROV dives is presented. Further descriptions and underwater pictures of the ROV transects can be found in the section 9.8 of this report.

Gazul Mud Volcano

At Gazul it was possible to make two ROV dives between 300 and 450 m depth. During these two transects it was possible to observe coral garden habitats formed, among others, by the gorgonians *Callogorgia verticillata* and *Acanthogorgia spp.*, which dominated on mixed rocky substrata. Communities dominated by sponge aggregations were comprised of different species including *Phakellia cf. ventilabrum* and some hard texture sponges (e.g. *Petrosia sp.*). Some cold-water coral banks, mainly dominated by *Madrepora oculata* with some *Dendrophyllia cornigera*, were also detected. Moreover, aggregations of an unidentified actinarian species (probably *Actinauge*) inhabited soft bottoms with abundant bioclastic material, mainly composed of bivalve remains. The blackbelly rosefish *Helicolenus dactylopterus* and

some species of sharks such as the lesser-spotted catshark *Scyliorhinus canicula* were the most commonly observed fish.

Ormonde Seamount

At Ormonde Seamount, 6 dives were made covering a depth range from ca. 1,500 to ca. 600 m depth.

Rocky areas were dominated by the corals *Corallium tricolor* and *Pliobothrus* sp.. Encrusting sponges also characterized rocky habitats but agregations of *Hyalonema* sp. and several stipitate forms (cf. *Stylocordyla* sp.) were also observed. Massive aggregations of a white sponge (probably the astrophorid cf. *Pachastrella* sp. or the axinellid *Phakellia* sp.) with flabellate form were documented. A sample was taken for later taxonomic morphological work. Also, the bird's nest sponge *Pheronema carpenteri* was quite abundant. Several lithitids sponge species occurred in massive aggregations, covering the substrata, and encrusting rock and mixed rocky habitats. The eel fish *Synapobranchus kaupi* and macrourids were always around.

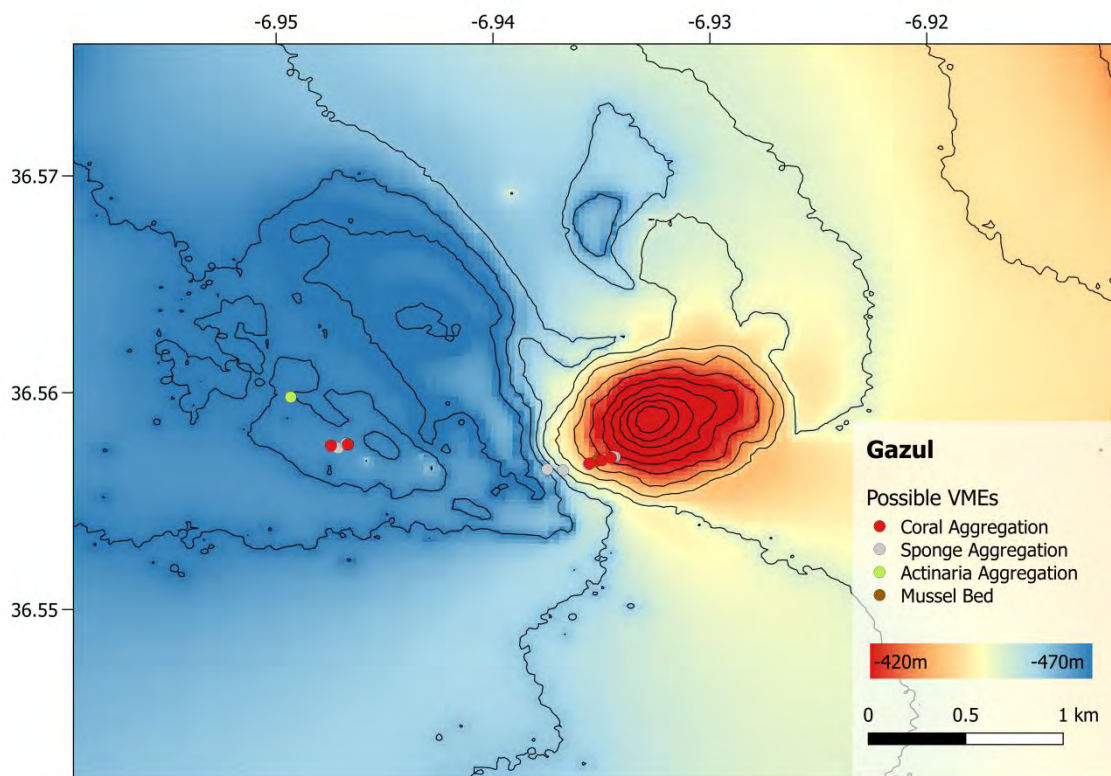

Figure 1: Possible VMEs in the Gazul Mud Volcano study area.

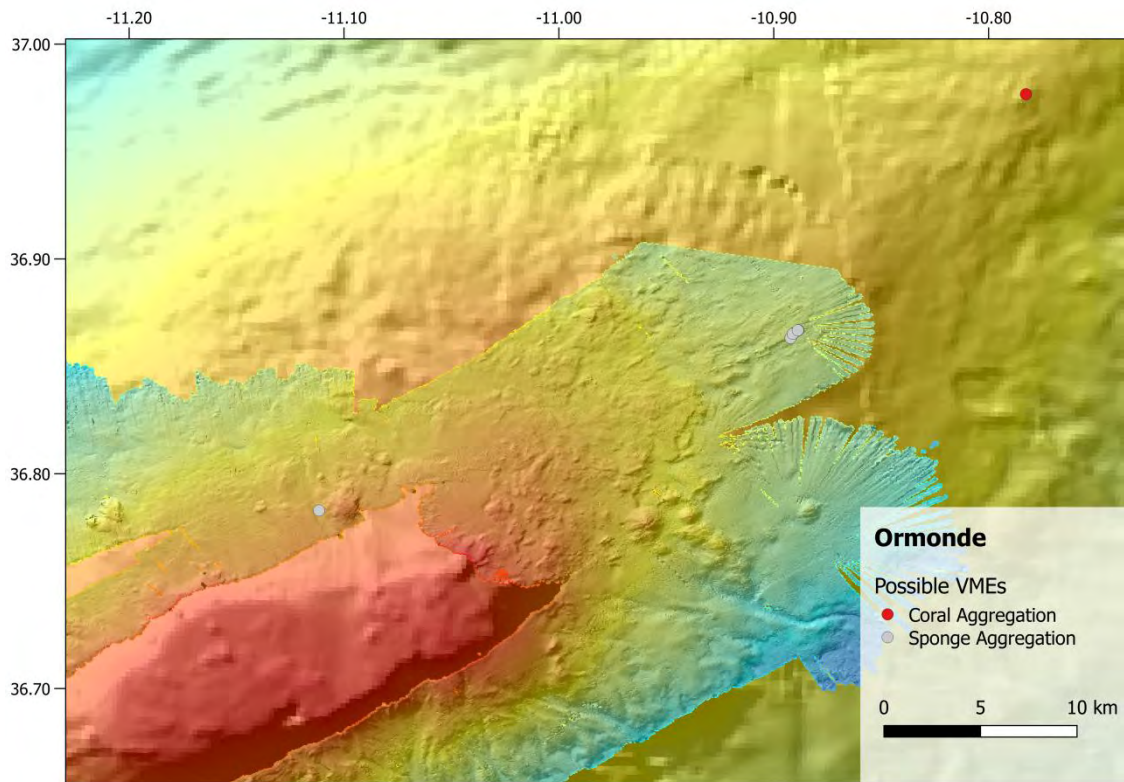

Figure 2: Possible VMEs in the Ormonde Seamount study area.

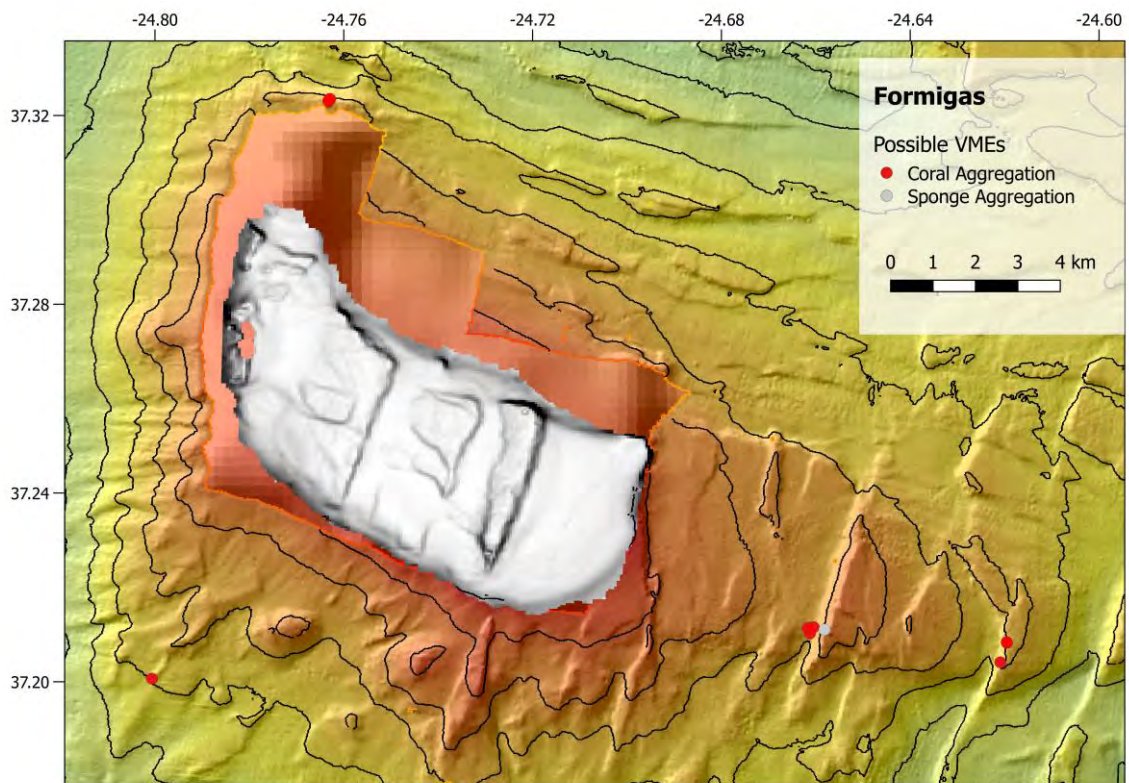

Figure 3: Possible VMEs in the Formigas Seamount study area.

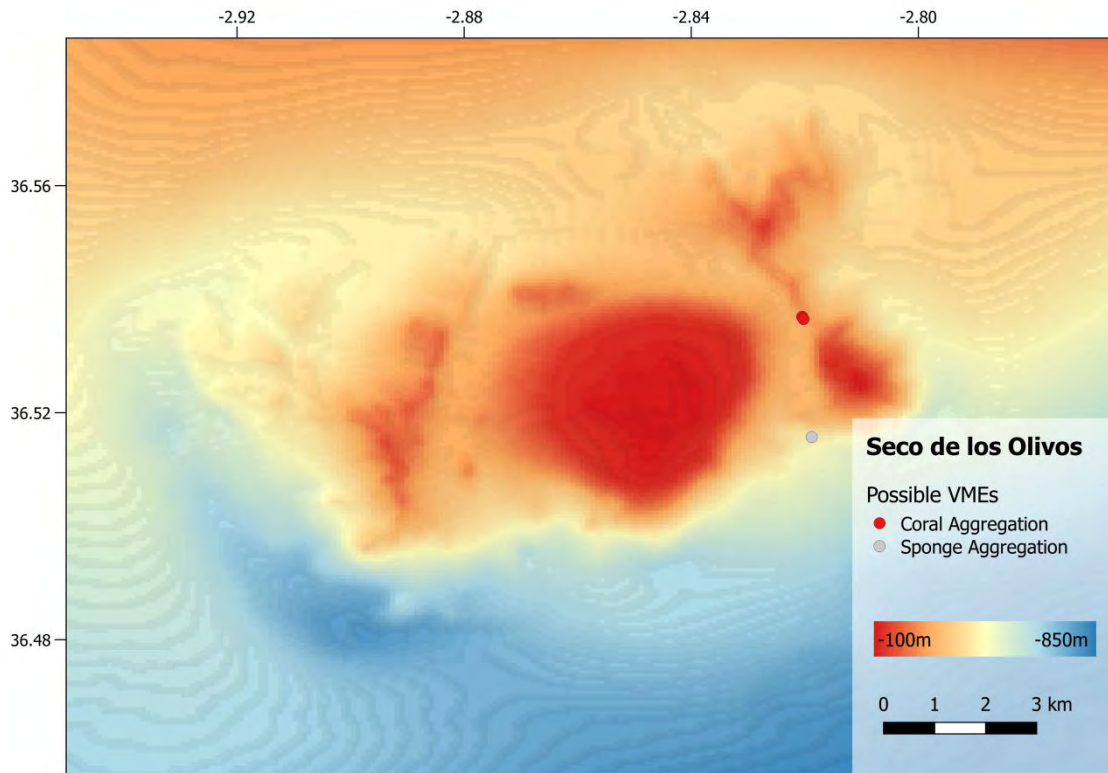

Figure 4: Possible VMEs in the Seco de los Olivos Seamount study area.

Formigas Seamount

Ten dives were carried out off Formigas covering a depth range from ca. 1,500 to ca. 500 m depth. Between 1,000-1,500m depth range (Dives 4, 5), the habitat composition at rocky outcrops was characterized by bamboo corals like *Acanella arbuscula*, chrysogorgiid corals *Chrysogorgia* sp. and *Iridogorgia* sp. and several plexaurids along with the black or antipatharian corals *Leiopathes* sp., *Bathypathes* sp. and *Stichopathes* sp. Mixed substrata varied between soft bottom to rock and coral rubble communities with high densities of hexactinellids (*Eupletella* sp., cf. *Rossella* sp., etc.). Several macrourid fish species, the orange roughy and oreo fish (*Neocyttus* sp.) were also registered at these depths.

Seco de los Olivos

A total of 7 ROV dives were conducted in the Alboran Sea region of the Mediterranean Sea at Seco de los Olivos, the depth range covered by the video transects was from ca. 800 to 270 m depth. The first ROV transect (Dive 19) was initiated on a mixed bottom of sand and rock, where several colonies of gorgonians and sponges were observed. On soft sediments, *Paranthispathes* sp. occurred very frequently. On mixed rock, *Acanthogorgia* sp. appeared in large gardens. Several scleractinian corals including solitary corals (either a *Dendrophyllia* sp. or possibly

Leptosammia sarmentosa) and a few living *Madrepora oculata* colonies were observed and sampled. An extensive habitat formed by coral rubble, composed of dead skeletons of *Madrepora oculata*, was observed at the base of the seamount. It was noticed that a heavy presence of fishing gear and trawls tracks was observed during the surveys. On soft bottoms *Kophobelemnion* sp., other pennatulaceans and ceriantharians were very frequent. Throughout the transect many invertebrates were observed: pagurid hermit crabs, the echinoderm *Brisingella* sp. and holothurians *Parastichopus* sp. Several fish records were also observed, including the macrourid *Nezumia* sp., bony fishes (*Helicolenus* sp., *Calyonimus* sp., *Capros aper*) and sharks *Galeus* sp.

Estimate of total data returns

A more detailed video analysis is planned as a part of several PhD projects, and there are a variety of interests from ATLAS partners to provide a better view of the species and habitats of interest in future. We hope that the OFOP annotations will be used as a guide to detect some specific areas of interest and thus reduce the time needed for the conclusion of the videos analysis. The expected date for the first results of the video analysis is by the end of 2018.

9.7.6.2 Ecologically or Biologically Significant Marine Areas (EBSAs)

The region between the Alboran Sea and the Azores is inhabited by species and habitats of global conservation interest such as CWC, sponges, hydrothermal vents. Mobile or highly migratory megafauna such as fish, marine mammals and seabirds are also resident or transient visitors to regional features such as seamounts. Networks of Marine Protected Areas in the region are cornerstones of achieving policy targets such as those enshrined by the Convention on Biological Diversity and OSPAR. However, recent expert synthesis in the region (e.g., Abecasis et al. 2015) identified several areas of research needs including the need to identify key areas prioritised by the CBD i.e., EBSAs, and to understand whether spatial management tools like MPAs can benefit certain life stages of mobile or migratory animals. Elasmobranchs (sharks, skates and rays) are in particular threatened by human pressures around the world, and in the MEDWAVES region many species suffer high rates of fisheries mortality as bycatch in longline fisheries. The seamounts of the MEDWAVES cruise could also be excellent opportunities to observe rare elasmobranch species or simply make new observations. MEDWAVES was not designed to sample fish fauna, however, ROV observations can still make valuable contributions to building the case for support to create an EBSA based on EBSA criteria such as rare species or important fish habitats.

The MEDWAVES cruise offered an excellent opportunity to continue building the case for an EBSA in the region between the Gulf of Cádiz and the Azores. Specifically, the team from the University of Edinburgh were seeking new data on the distribution and habitat use of elasmobranchs (sharks, skates, and rays) in the region. Research efforts during MEDWAVES were focussed primarily on mapping out elasmobranch egg-laying sites but also species identification for the sharks observed during the cruise. Furthermore, besides elasmobranchs, notable were relatively high densities of octopus pairings (the commercially important non-cirrate octopod *Eledone cirrhosa*, also known as the curled octopus) at Gazul Mud Volcano, and high densities of eels (*Synaphobranchus* sp.) at Formigas Bank, which are also summarised here to complement the EBSA evidence base.

Methods

Observations were made routinely during each ROV dive. OFOP recorders were annotating occurrences of any elasmobranch or evidence of egg-laying habitat (e.g., locations containing egg capsules deposited by oviparous sharks, skates or rays). Where possible, eggs were collected by the ROV manipulator arm when one of the OFOP annotators requested this from the ROV pilots. Species identifications will be confirmed upon review of the original dive video post-cruise. To summarise the observations, data are presented on shark occurrences and evidence of egg-laying sites (Fig. 5), along with further notes on the octopus pairings at Gazul and high densities of eels and possible parturition grounds at Formigas Bank.

Gazul

Elasmobranch egg-laying grounds

In total, 5 egg-laying sites were discovered on the Gazul Mud Volcano (see figure 5 above). These were interspersed with OFOP annotations of sharks being recorded during Dives 1 and 2, most of which appeared to be scyliorhinids (the catshark *Scyliorhinus canicula*). One egg-laying site occurred in association with cold-water coral habitat: a group of 3 egg cases were attached by long tendrils to a single yellow coral colony of the azooxanthellate colonial scleractinian coral *Dendrophyllia cornigera*. A sample of this coral was requested for genetic meta-barcoding and for live aquarium experiments. When the ROV collected the sample, an egg case remained attached to the coral allowing examination when the sample was recovered on deck (see figure 6 below).

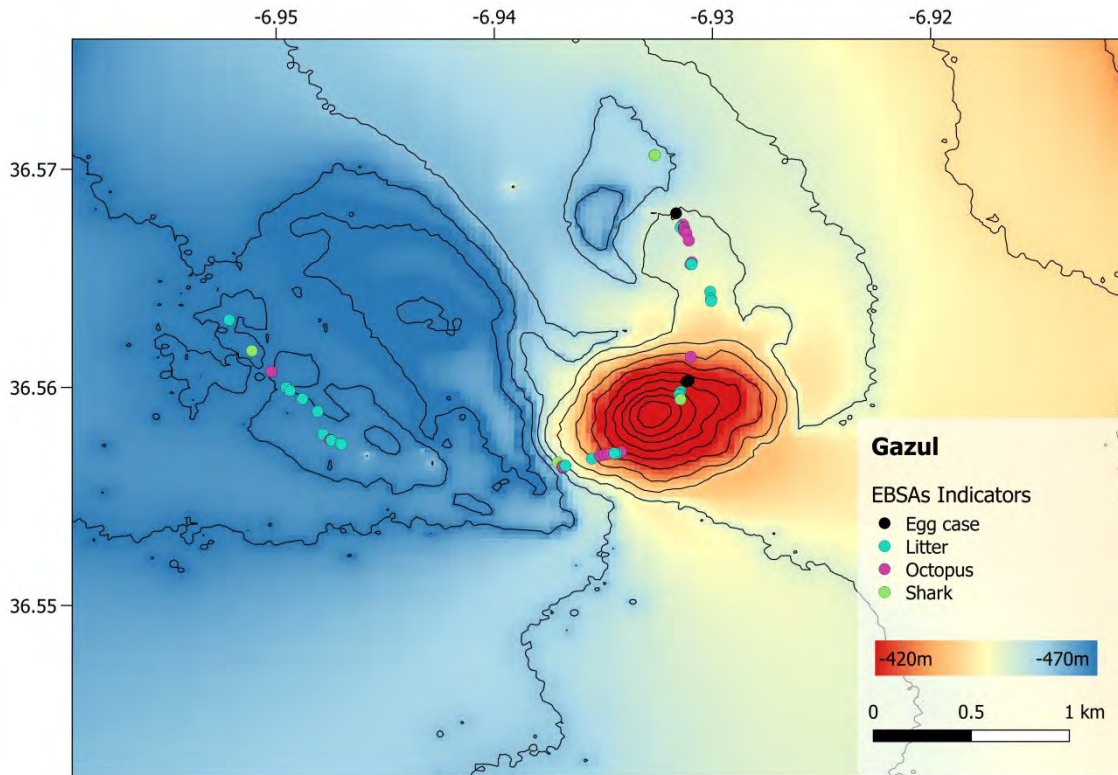

Figure 5: Observations of sharks, shark egg-laying ground, commercially important octopus species and litter on the seabed of the Gazul Mud Volcano that could be used to support evidence for an EBSA and evidence for negative human impacts.

In most aspects, inspection and comparison of this egg case to the published literature suggests it belonged to the lesser-spotted catshark *Scyliorhinus canicula*. It was noted, however, that it lacked the more typical longitudinal striations along the length of the egg case. A small sample of the yolk and sac were taken for meta-barcoding to confirm the species.



Figure 6: A tan coloured egg capsule belonging to the catshark *Scyliorhinus canicula*, attached by its tendrils to the habitat-forming stony coral *Dendrophyllia cornigera* at the Gazul Mud Volcano.

Octopus

In situ octopus sightings are rare during day-time ROV missions, many of these species remain hidden from view or shelter from the ROV. During the 2 dives at Gazul, octopus were recorded 16 different times (Fig. 5), with several octopus observed at once. Identification was not clear at the time, but the species conforms in all ways to the curles octopus, *Eledone cirrhosa*. Another non-cirrate octopod, *Octopus vulgaris*, is also known from the region and is a commercially important species.

Plans for post cruise analysis

Gazul

A small sample of the yolk and sac of one elasmobranch egg case from the Gazul Mud Volcano were taken for meta-barcoding to confirm the species back in the laboratory. All elasmobranchs from the mud volcano will be identified to species level with the help of teams from Edinburgh and the Azores through review of the ROV video footage from these 2 dives.

Species identification of the octopus was verified by reviewing ROV video footage in the video-processing suite at the University of Edinburgh, UK. The nature of these octopus pairings (and sometimes groupings) will be investigated in a bit more detail by mapping the habitat type where they occurred, their sizes, any notes on behaviours, overlaps with potential competitors and/or predators such as the catsharks, and evidence for hunting and feeding grounds including large stands of shelled-mollusc prey on the seabed. This work forms the basis of an undergraduate dissertation project in Edinburgh. Close collaborations have formed between the IEO team and the University of Edinburgh to combine multibeam echosounder data, a seabed terrain analysis and environmental settings with the octopus habitat use observations.

It is anticipated that analyses will be concluded by May 2017. All data will be made open-access (OpenAire, Zenodo) through the ATLAS Data Management Work package.

Formigas

Deep-sea sharks were observed swimming and resting on several occasions at Formigas Bank during the ROV dives 7, 11 and 13. Most remained hidden from a distance beyond the ROV camera range, so species verification will be difficult in most cases. However in a couple of instances species identification seems possible. Also observed at the surface of Formigas were two manta rays and white-sided letrado porpoise. At least 2 mantas were spotted, one of the swimming just below the surface and alongside the port and starboard aft section of the boat for at least 30 minutes. Lestado rode the ship's bow waves for about 20 minutes during a transit to São Miguel, then could not be spotted any longer.

Eels (*Synaphobranchus* spp.) were frequent on all dives on Formigas (see figure 7).



Figure 7: A possible *Synaphobranchus* sp. eel, which frequented the Formigas Seamount.

Eels ranged in size from very small (< 20 cm) to very large (> 100 cm) and were observed cannibalising injured eels and many exhibited signs of external scarring possibly from fending off intraspecific attacks or perhaps these were mating scars. It was suspected there were at least 2 species of *Synaphobranchus* spp., which appeared morphologically distinct. It was also notable that in one case, a large *Synaphobranchus* sp. swam by the ROV camera and appeared to be pregnant, which could suggest that Formigas is used as a parturition ground for this species to deliver.

Plans for analysis

All elasmobranchs from Formigas Bank will be identified to species level with the help of teams from Edinburgh and the Azores through review of the ROV video footage from these 3 dives. The same teams will strive to identify the eel species as well. It is hoped that with the help of the wider oceanography and multibeam teams from MEDWAVES, a more complete picture of deep-sea shark and eel habitat use on Formigas can be elucidated. This could be achieved by combining species occurrence data, habitat data, abundance and density data with seabed terrain analyses and the CTD profiling data to understand how geomorphology and chemical oceanography may influence populations and habitat use by these animals.

9.7.6.3 ROV sampling. Processing, preservation and taxonomic identification of samples

ROV sampling tried to address different purposes: population connectivity studies, physiologic experiments and taxonomic identification. The next paragraphs mainly refer to samples collected for taxonomic identification.

The ROV provided much of the specimens for collection and taxonomic purposes (ROV collected samples during MEDWAVES are included in the Appendix X). Every time a specimen was collected with the ROV (arm and sucker) it was written an event log (sample number). This event number (e.g. Sample 1 / Sample 2 ...) was written in the tray in order that another user of the database could find the exact specimen position (depth and lat/lon). Each organism was given an ID number. This number is a parent number of the event (SubSample 1.1, 1.2 / SubSample 2.1, 2.2 and so on). Once organisms were labelled and sorted, they were divided into 3 preservation chemicals (ethanol 96%, ethanol 70% and formol 10%) for genetics and histological/morphological work, depending on quantity and organism protocol. Some were also dried.

In order to generate more information about the specimens (live colour, etc.) a photograph of the whole organism with a scale bar and zoom (for details of polyps open, tentacles out, etc) was taken to comply with publication standards.

Coral and sponge sampling (IMAR)

Coral taxonomy was a main objective of the benthic sampling. We acquired 21 specimens of the bamboo coral *Acanella* sp., most of them from Formigas Seamount (18) but also some (3) from Ormonde Seamount. The full tables of specimens collected (leg 1 and leg 2) are included in Appendix X. There are several representatives of Plexauridae, *Narella* sp., *Acanthogorgia* sp., *Swiftia* sp., *Bebryce* sp., *Callogorgia* sp., *Candidella* sp., and also the black coral *Leiopathes* sp. for the different seamount sites (see examples on figure 8).

The presence of sponge aggregations was observed and sampled by the ROV. Massive sponges such as *Pheronema* sp., cf. *Polymastia* sp., cf. *Stelletta* sp. (see figures 9. A and B) were collected at Ormonde from deeper areas (below 1,100 m). Several undetermined sponges (e.g. hexactinellids) were also collected, and were found encrusting both rock and coral rubble substrata. A list of mostly coral and sponge samples obtained by the IMAR group are reported in Table 1.

Table 1: Number of collected samples (taxa) within MEDWAVES sampling sites: Formigas, Gazul, Ormonde and Seco de los Olivos (SdO).

TAXA	Formigas	Gazul	Ormonde	SdO	Total
<i>Acanella</i> sp.	18		3		21
<i>Acanthogorgia</i> sp.	1	1		1	3
Alcyonacea (small)	1				1
<i>Amphianthus</i> sp.			1		1
Antipatharian	1				1
<i>Bebryce mollis</i>		1			1
<i>Callogorgia</i> sp.		1		1	2
<i>Candidella</i> sp.	2		1		3
Cirripedia			1		1
<i>Corallium tricolor</i>			1		1
<i>Crypthelia</i> sp.	1				1
Demospongiae			1		1
Edwardsiidae				1	1
Eggs (?)			1		1
Hexactinellida			1		1
<i>Hyalonema</i> sp.			1		1
Isopoda			1		1
<i>Leiopathes</i> sp.	2				2
<i>Lophelia pertusa</i> (fragment)	1				1
<i>Madrepora oculata</i>	2				2
Mollusca	1				1
<i>Narella</i> sp.	4		1		5
Ophiuroid	4		1	1	6
<i>Pheronema carpenteri</i>	1				1
<i>Placogorgia</i> sp.			1		1
Plexauridae			2	1	3
Plexauridae (white)	2				2
Plexauridea (pink)	1				1
<i>cf. Polymastia</i> sp.			1		1
Porifera	1				1
Porifera (flabeliform)			1		1
Porifera			1		1
Porifera (encrusting rock)			1		1
<i>Solenosmilia variabilis</i>	1		1		2
Porifera	1				1
<i>cf. Stelletta</i> sp.			1		1
Stolonifera	1				1
<i>Swiftia</i> sp.	3				3
<i>Victogorgia</i> sp.		1			1
Zoantharia			1	1	2
Total	49	4	24	6	83

One of the most abundant, and probably habitat-structuring flabelliform sponge from the Ormonde seamount was collected at 1100 m depth (Fig. 9 C). At the same seamount, a specimen of *Hyalonema* sp. was collected at 1,153 m depth (Fig. 9 D).

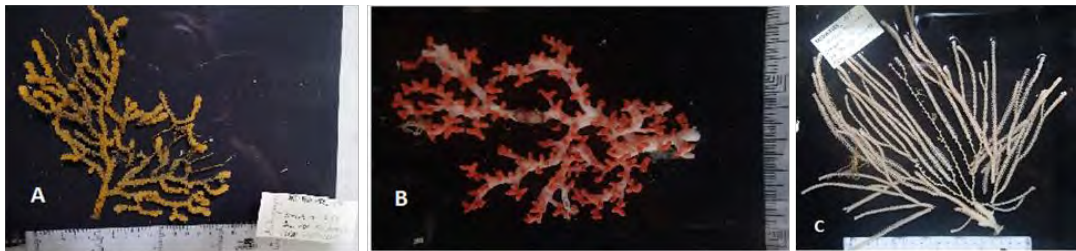

Figure 8: Corals specimens collected at Ormonde Seamount. A. *Acanthogorgia* sp.; B. *Corallium tricolor*; C. *Narella* cf. *bellissima*.



Figure 9: Porifera specimens collected at Ormonde Seamount.

Hydrozoan sampling (Edinburgh University)

Rationale

Previous work has demonstrated that the history of cold-water coral reef (CWR) ecosystems in European waters have depended tremendously on the export of MOW. After the last glacial-interglacial cycle for example, the export of MOW and coral larvae flowing along its pathway and along stepping-stones is directly linked to the

rapid re-establishment of depleted coral ecosystems as far north as the northern Norway (Henry et al. 2014).

Much of the fauna associated with CWRs is also expected to be connected to the Mediterranean fauna through the export of MOW, but this has not been comprehensively evaluated across many taxa. Hydroids (Cnidaria: Hydrozoa) are a ubiquitous aspect of this fauna, and it has been shown that they have strong Mediterranean affinities (Henry & Roberts 2007, 2008). MEDWAVES brought the opportunity to determine how connected hydroid communities were across geographically distant regions such as Formigas Bank off the Azores. The data collected during the MEDWAVES campaign will be used to understand the biogeography of the deepwater Azores fauna associated with these habitats, and will also contribute to a larger database on the North Atlantic hydroids from CWRs that will be used by ATLAS to ground-truth the new GOODS biogeographic classifications scheme for WP3.

Methods

Hydroids were sampled opportunistically at the Formigas Bank during routine MEDWAVES ROV surveys (Appendix XI). Samples were selected during the OFOP annotations. When a colony of hydroids looked easy to access for the ROV, Henry made a request for a sample to be obtained to the ROV pilots. If the ROV could be positioned safely to obtain the sample, a collection was made with the manipulator pincers of the *Liropus* (Fig. 10). Each benthic sample was noted during the OFOP annotation to enable the collection position along the dive transect to be identified. Henry also made a note of the substratum upon which the hydroid was attached. Hydroids were placed into the biobox of the *Liropus* and at the end of the dive, the ROV returned to the surface where all samples were placed into large trays and photographed by the Azores research group (Fig. 11). Henry removed the hydroids from the buckets once photos of each bucket were taken. Each hydroid was placed onto a section of medical gauze soaked in 95% ethanol, wrapped in the gauze, and placed into a sealed transparent bag. A label containing the MEDWAVES station#, ROV dive#, date and substratum was placed inside the bag, and this label was written on the outside of the bag.



Figure 10: Image displays a large feathery aglaopheniid hydroid on the crest of a precipice just behind the scleractinian coral colony *Madrepora oculata* on Formigas Seamount.

Hydroids were also collected opportunistically from other samples obtained by the ROV. This was done by examining all samples brought to the surface on the deck of the B/O *Sarmiento de Gamboa* while the samples were being photographed. Similarly, substratum was also noted.

The hydroids sampled from MEDWAVES occurred on a variety of hard substrata. Mostly these hydroids were epifaunal, living on corals (e.g. the stoloniferous alcyonacean *Telestula* sp., the antipatharian *Leiopathes* sp., the solitary scleractinian coral Caryophylliidae sp.). As well, hydroids were sampled from rock substrata, including the stylasterid hydrocoral *Crypthelia* sp. Notably, a large aglaopheniid hydroid specimen had fused to a branch of the scleractinian colonial coral *Solenosmilia variabilis*, both were sampled from the precipice of a small crest on Formigas Bank.

Plans for analysis

All samples of hydroids will be examined by Henry back at the laboratory at the University of Edinburgh, UK. Species will be identified to the lowest possible taxonomic level. The species and stations will be added to the large North Atlantic database on hydroids for biogeographic analyses. It is hoped that other MEDWAVES teams (oceanography and multibeam) can contribute to the analyses using their expertise and interpretations of water mass structure and seabed terrain.

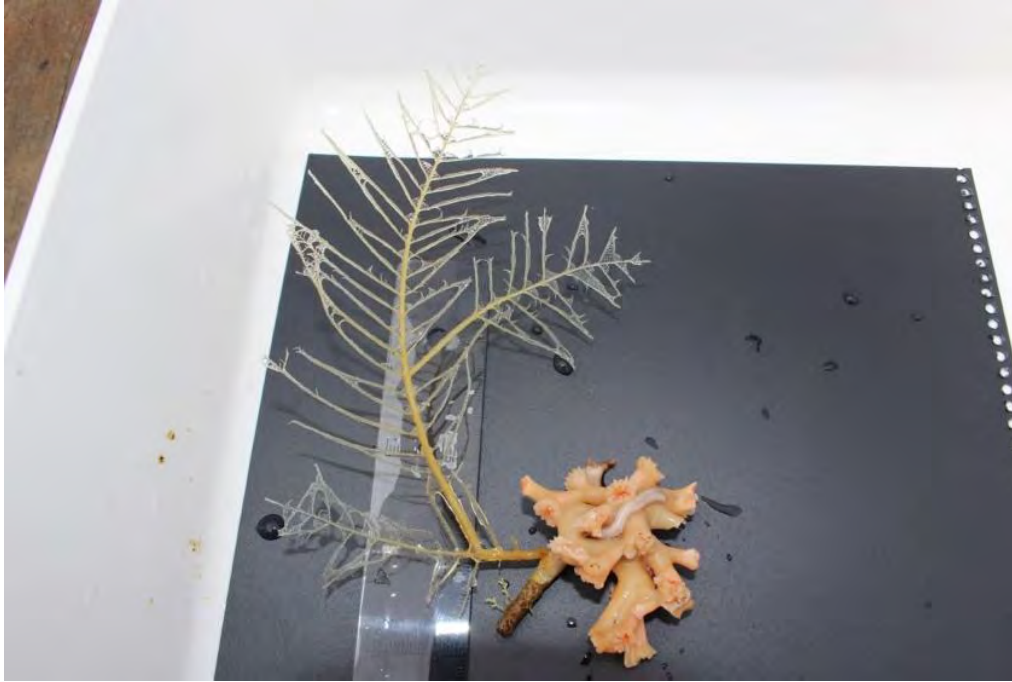

Figure 11: A large aglaopheniid fused to the pink colonial scleractinian *Solenosmilia variabilis* on Formigas.

Within Formigas Bank, there could, for example, be considerable differences between northern and southern dive transects over the bank due to e.g., substratum differences, or influence of MOW. Such analyses will include regression analyses of community analysis and k-means clustering. It is anticipated that analyses will be concluded by August 2017. All data will be made open-access (OpenAire, Zenodo) through the ATLAS Data Management Workpackage.

Octocoral sampling (IMAR)

Circulation patterns within the Atlantic Ocean have an influence on the species distribution, colonization and evolution in the deep sea (Van Dover et al. 2002). Cold-water octocorals (CWOs) rely on food provided by the currents and disperse through larvae travelling long distances. Mediterranean eddies, topographically guided currents, are formed within the Atlantic and may provide a pathway for CWOs between the Mediterranean Sea and the North Atlantic Ocean. While the Mediterranean Outflow Water (MOW) is known to have an influence on the dispersal of coral reefs (Freiwald 2002), its influence on the patterns of distribution of CWOs from the Mediterranean to the Central North Atlantic Ocean (Azores) is still unknown. Nonetheless, CWOs of the Central North Atlantic Ocean (Azores) present the highest zoogeographical affinity (34%) with the Lusitanian-Mediterranean region (Braga-Henriques et al. 2013). MEDWAVES followed the MOW and gathered data on

oceanography and CWOs videos, images and sampling. More than reporting important coral habitats and coral species inhabiting both Mediterranean Sea and North Atlantic Ocean, data collected during MEDWAVES will enable researchers to link the variables that influence their distribution and understand the zoogeographical patterns behind it. CWOs play an important role as structure of deep-sea ecosystems that are considered VMEs and EBSAs. Policy drivers will increase their accuracy by incorporating basic taxonomic and biology knowledge with oceanography in the study and conservation of CWOs of the North Atlantic Ocean and Mediterranean Sea.

Methods

ROV dives took place at Gazul Mud Volcano, the Ormonde peak of Gorringe Bank and Formigas Bank (NE Atlantic Ocean) during the first leg of MEDWAVES cruise. While video annotation using OFOP software took place, most coral taxa were identified to the genus or species level taking into account the expertise on taxonomy of the scientists onboard: Lea-Anne Henry, Íris Sampaio and Covadonga Orejas. Specific species of octocorals were selected for sampling considering its importance for the ATLAS project, specific goals of each study, and the possibility of sampling considering ROV or seabed bottom type constraints. Geographic and depth details of each sampling site were annotated in OFOP. Throughout sampling the corals were caught by one of the arms or the ROV “*Liropus*” Super Mohawk and placed together in the biobox. Colonies were sampled for taxonomy, genetics, biogeography (requested by Íris Sampaio) and connectivity studies (requested by Sophie Arnaud-Haond) or aquaria experiments (requested by Covadonga Orejas) (Fig. 12).

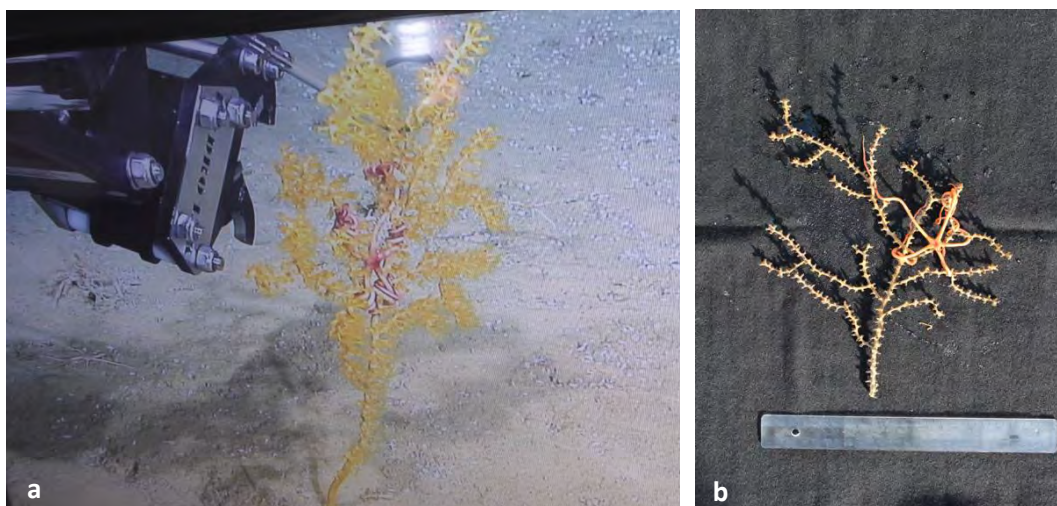

Figure 12: Sampling of Plexauridae and associated Ophiuroidae: a) underwater; b) after collection.

Also, samples of octocorals were collected opportunistically by Box Corer or Van Veen Grab by the Benthic team. Octocoral associated fauna or other invertebrate

macrofauna were also preserved by Íris Sampaio for the Biological Reference Collection of the Department of Oceanography and Fisheries, University of the Azores (COLETA). Samples were photographed, sub-sampled and preserved in ethanol 70% and 96% and formaldehyde 10% for morphological, genetic and reproduction studies. Labels of specimens and sub-samples contained taxa name, date, cruise name, ROV dive, Box Corer or Van Veen Grab number and preservation medium.

Preliminary Results and Plans for analysis

Cold-water octocorals (Octocorallia: Alcyonacea) were observed forming coral gardens in most of the ROV dives performed by the ROV *Liropus*. Gazul Mud Volcano was characterized by a coral garden of *Acanthogorgia* sp. and Ormonde peak of Gorringe Bank by a coral garden of *Acanella arbuscula* at almost 2,000m depth. At Formigas Bank, the same species formed extensive coral gardens on sandy or rocky substrata. Yet, the coral garden diversity at Formigas seemed to be dominated by octocorals of the family Primnoidae like *Candidella imbricata*, *Narella bellissima* and *Narella verluysi* and also some *Thouarella* species, which sometimes represent the structural species of extensive coral gardens and at other times only having scattered distributions (Fig. 13).

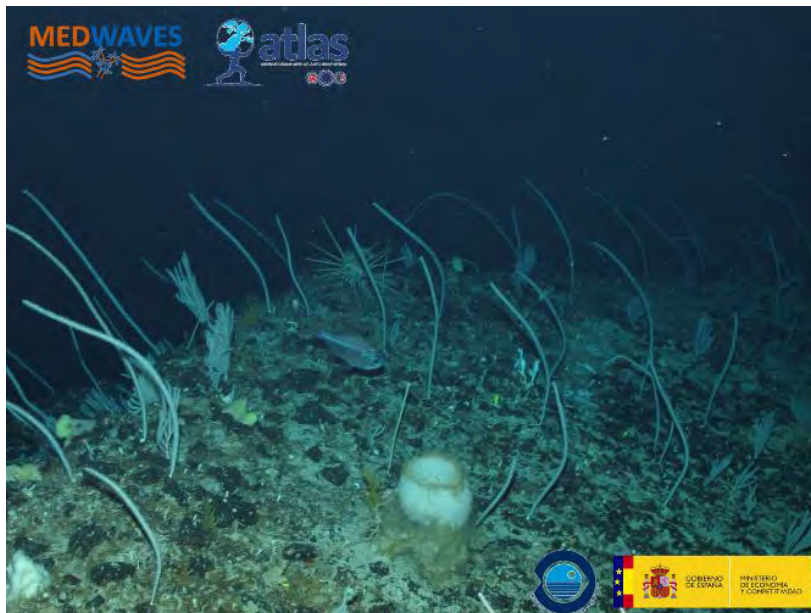

Figure 13: Coral garden composed by two species of the genus *Narella* at Formigas Bank.

A white species of Plexauridae, *Acanthogorgia armata*, *Chrysogorgia* sp., *Corallium tricolor* and *Chelidonisis aurantiaca* were also abundant and characteristic of biotopes within this bank. During the ROV dive, 6 families of octocorals together with black corals formed a diverse coral garden at Formigas, but the highlight of this dive was

the presence of the bamboo coral *Chelidonisis aurantiaca* (Fig. 14). This octocoral was previously reported for the occidental and central group of islands of the Azores by the historical literature of Prince Albert of Monaco I and Biaçores expeditions.



Figure 14: *Chelidonisis aurantiaca* from Gulf of Cádiz, RV *Pelagia* (Photo credit: MARUM, Prof. Dr. André Freiwald).

It is the first record for this group of islands and the first time it was observed *in situ* in the Azorean archipelago. Filmed during the RV *Pelagia* cruise in the Gulf of Cádiz and observed at MOW depths at Formigas during MEDWAVES, its occurrence off the Azores seems to indicate the influence of the MOW on the dispersion of this species within the North Atlantic Ocean.

Most sampling of octocorals with the ROV *Liropus* aimed to collect specimens of the family Plexauridae, one of the most represented families among octocorals, in order to study its diversity through an integrative approach of taxonomy, DNA barcoding and zoogeographic analysis (Íris Sampaio PhD project) (Fig. 15).

Their identification through ROV videos is extremely difficult or even impossible. Further electron microscopy and genetic work will reveal the identity of most plexaurid species collected in the future at IMAR- University of the Azores and Senckenberg am Meer by Íris Sampaio. Likewise, unknown observed species were also collected with the aim of identification or description of new species for science. A specimen looking like a gorgonian or a hydroid was sampled and later observed by microscopy. This specimen revealed to be an antipatharian of unknown identification because its branching pattern is uncommon on the genus of black corals described by Dennis Opresko in the USA. Further analysis needs to be done in order to confirm its identity or to describe it as new species.

A total of 45 taxa including octocorals and respective associated fauna were sampled during the first leg of MEDWAVES cruise (Appendix X). All the samples collected during this cruise will be deposited in the COLETA collection and database (DOP-UAç). Furthermore, a complete and valuable image catalogue of corals and other organisms observed during MEDWAVES has also been created to assist in future annotations of the ROV video (Appendix XII). During the ATLAS project, scientists will have priority to work with the samples and data collected during MEDWAVES, after which all specimens and datasets will be available for scientists that can request samples and collaborate in future biodiversity studies.

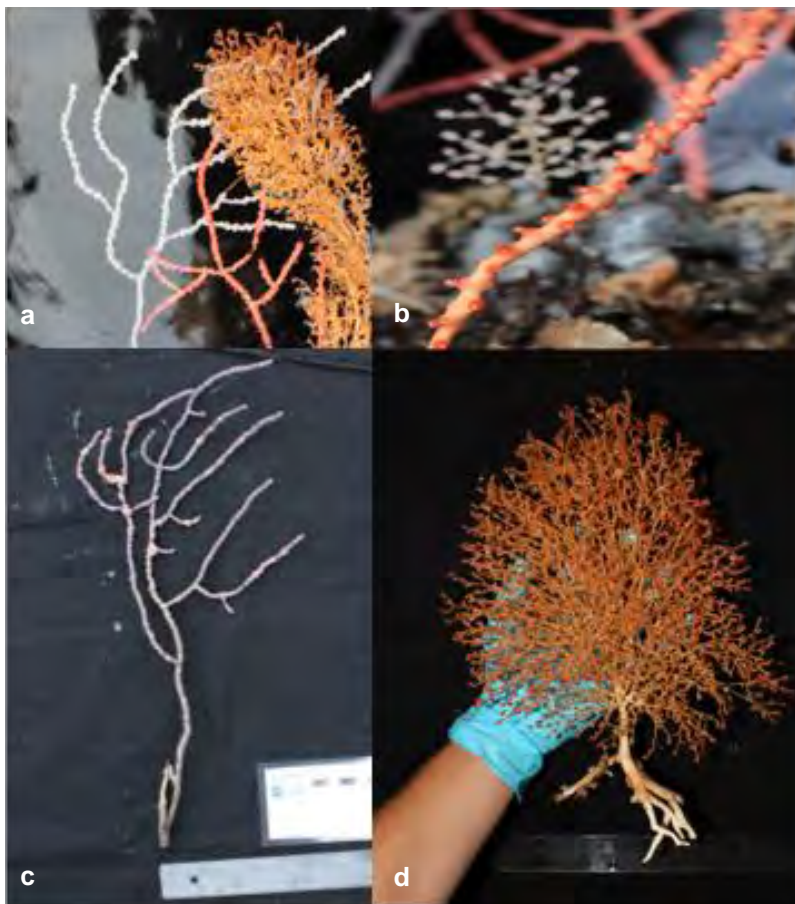

Figure 15: Samples of octocorals collected by the ROV *Liropus* during MEDWAVES cruise: a) Plexauridae, *Swiftia* sp. and *Acanella arbuscula*; b) detail of *Swiftia* sp. and *Chrysogorgia* sp. as background, c) Plexauridae; d) *Acanella arbuscula*.

References

- Abecasis et al. (2015) Marine conservation in the Azores: evaluating marine protected area development in a remote island context. *Frontiers in Marine Science* 2: 104.
Braga-Henriques A, Porteiro FM, Ribeiro PA, de Matos V, Sampaio Í, Ocaña O,

- Santos RS (2013) Diversity, distribution and spatial structure of the cold-water coral fauna of the Azores (NE Atlantic). *Biogeosciences* 10: 4009-4036.
doi:10.5194/bg-10-4009-2013.
- Freiwald A (2002) Reef-forming cold-water corals. *Ocean margin systems* pp. 365-385. Springer Berlin Heidelberg.
- Henry L-A, Roberts JM (2007) Biodiversity and ecological composition of macrobenthos on cold-water coral mounds and adjacent off-mound habitat in the bathyal Porcupine Seabight, NE Atlantic. *Deep-Sea Research Part I* 54: 654–672
- Henry L-A, Roberts JM (2008) First record of *Bedotella armata* (Cnidaria: Hydrozoa) from the Porcupine Seabight: do north-east Atlantic coral carbonate mound fauna have Mediterranean ancestors? *Marine Biodiversity Records* 1: e24
- Henry L-A, Frank N, Hebbeln D, Wienberg C, Robinson L, van de Flierdt T, Dahl M, Douarin M, Morrison CL, López Correa M, Rogers AD, Ruckelshausen M, Roberts JM (2014) Global ocean conveyor lowers extinction risk in the deep sea. *Deep Sea Research I* 88: 8-16
- Lee et al. (2015) Baseline seabed habitat and biotope mapping for proposed marine reserves. *PeerJ* 3:e1446.
- Pham et al., 2014. Marine litter distribution and density in European seas from the shelves to deep basins. *PlosONE* 9
- Rice J, Gjerde KM, Ardron J, Arico S, Cresswell I, Escobar E, Grant S, Vierros M (2011) Policy relevance of biogeographic classification for conservation and management of marine biodiversity beyond national jurisdiction, and the GOODS biogeographic classification. *Ocean Coastal Manage* 54:110-122
- Van Dover CL, German CR, Speer, KG, Parson LM, Vrijenhoek, RC (2002) Evolution and Biogeography of Deep-Sea Vent and Seep Invertebrates. *Science* 295, 1253.

9.8 Benthic ecology. ROV video transects

Covadonga Orejas¹, Juancho Movilla², Jesús Rivera³, Miriam Hermida⁴

1. Instituto Español de Oceanografía. Centro Oceanográfico de Baleares, Palma, Spain
2. Instituto de Ciencias del Mar (CSIC), Barcelona, Spain
3. Instituto Español de Oceanografía. Servicios centrales, Madrid, Spain
4. Universidad de Alcalá de Henares, Madrid, Spain

9.8.1 Personnel involved

MEDWAVES-ATLAS Cruise LEG 1

Cádiz – Ponta Delgada (21/09 – 13/10/2016)

	Name	Institution	Role and responsibilities
1	Covadonga Orejas	Instituto Español de Oceanografía. Centro Oceanográfico de Baleares	Dive planning, video annotations, sampling
2	Juancho Movilla	Instituto de CC del Mar (CSIC)	Video annotations, survey tasks
3	Jesús Rivera	Instituto Español de Oceanografía. Servicios Centrales	Habitat mapping, Dive planning, coordination survey tasks
4	Miriam Hermida	Universidad de Alcalá de Henares	Survey tasks

MEDWAVES-ATLAS Cruise LEG 2

Ponta Delgada – Málaga (14/10 – 26/10/2016)

	Name	Institution	Role and responsibilities
1	Covadonga Orejas	Instituto Español de Oceanografía. Centro Oceanográfico de Baleares	Dive planning, video annotations, sampling
2	Juancho Movilla	Instituto de CC del Mar (CSIC)	Video annotations, coordination survey tasks
3	Miriam Hermida	Universidad de Alcalá de Henares	Coordination survey tasks

9.8.2 Introduction. Aims

The use of underwater video transects to characterise and map megabenthic communities have been largely applied in different geographical regions (e.g. Huvenne et al. 2011, Savini et al. 2014) and the use of the video transects as quantitative sampling methods has largely increased in the last decades (e.g. Orejas et al. 2009, Gori et al. 2013, Purser et al. 2013, Grinyó et al. 2016). These advances allowed to obtain information from the video transects of, for instance, species density, size class structure or co-occurrence of species. Further the ROV transects are a useful tool to gather precise information on the substrate characteristics and the geomorphology of the area complementing and completing the data gathered with the swath bathymetry (see chapter 9.3 of this report).

The main goals we wanted to achieve conducting ROV transects in the targeted sampling areas of MEDWAVES where:

- (1) to characterised the geomorphologic settings of the target areas, from the Alboran Sea to the Azores, through the Gulf of Cádiz, and the Ormonde Seamount and the ecosystems therein and (ATLAS WP 1 and 3),
- (2) to characterize the megabenthic communities of the targeted areas (ATLAS WP 3), and
- (3) to develop indicators of vulnerability for benthic ecosystems (ATLAS WP 3). The overall aim is to compare the morphological expression of the reefs and colonies in every site surveyed, studying its relation with the environmental conditions in terms of habitat suitability and form response.

9.8.3 Sampling methodology. Processing methodology

During MEDWAVES the video transects were performed by means of the ROV Liropus in the four targeted areas we were able to explore. Transects were conducted in different locations of the target areas in order to characterize in a comprehensive way the benthic communities inhabiting areas with different geographical orientations and influence of water masses and currents (ATLAS Task 1.3).

Positioning of the ROV Liropus was achieved using the HYPACK software. The multibeam bathymetry data available and the new data acquired during the cruise were used to locate the transects, with the aim of surveying hard bottom areas as far as possible. Throughout the dives, a pair of parallel laser beams mounted 10 cm apart allowed to have a scale which will help to determine the wide of the transects to be analysed later in the home lab. The Liropus was equipped with: a Kongsber HDTW colour zoom video camera oe14-502, a colour zoom camera Kongsberg oe14-366/367, a LCC – 600 video monochrome video camera and a Kongsberg minicamera oe14-

376/377 and a Kongsberg low light underwater navigation camera oe13-124/125. The illumination was provided by a Sealite Spheres. A Kongsberg underwater photo still camera OE14-408 / 408E, was also mounted in the ROV, as well as Kongsberg flash OE11-442.

Currently the video material is being processed quantitatively in the home labs to gain information on biodiversity, as well as distribution patterns of targeted species, further the development of new indicators of vulnerability will be explored (ATLAS Tasks 3.1, 3.3).

9.8.4 Instrumentation details and calibration information

Details on the ROV can be found in the previous section as well as in the Appendix XIII.

9.8.5 Problems encountered

As mentioned in the narrative (chapter 8 of this report), several technical problems occurred during the operation of the ROV. Details on the problems occurred, the solutions applied on board and the potential sources of the problems can be found in the Appendix XIII which included a comprehensive report supplied by the ROV company (ACSM). The report is available only in Spanish.

9.8.6 Preliminary results. Brief description of all ROV dives conducted during MEDWAVES. Beside the information gathered by the "OFOP annotation team", during the ROV dives the person's responsible for the ROV dives annotate the main characteristics of the different ecosystems visited. In the following paragraphs a short qualitative, panoramic description, with the main aspects to highlight from each conducted ROV dive, will be presented and some images, representative for the transects have also been included to help the reader to have a more precise idea about the habitats visited and discovered during MEDWAVES. In the following plate (Fig. 0) the ROV transect track can be visualized in the 3D MB bathymetry. The stations where the ROV transects were conducted in included in the general station list (Appendix II).

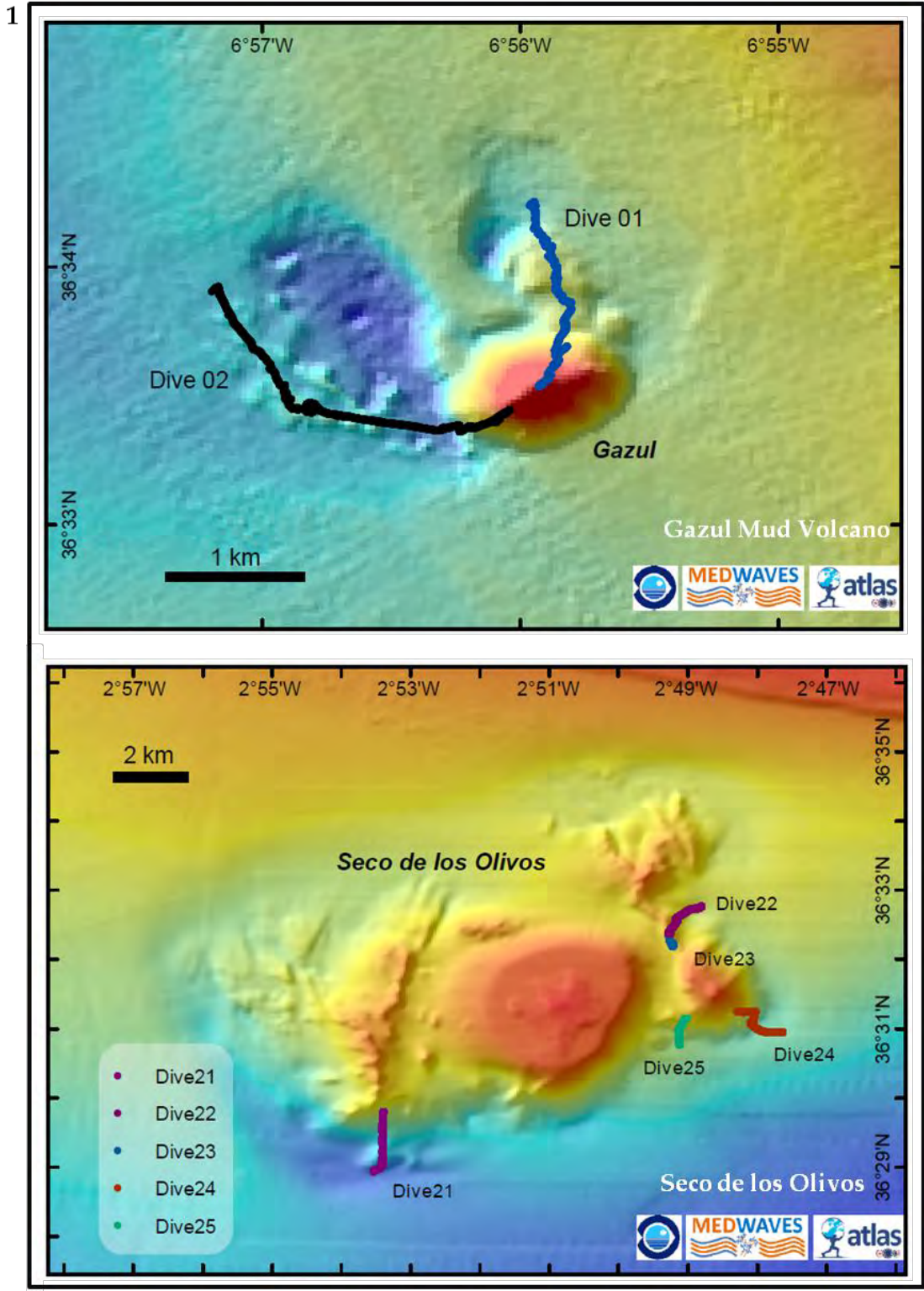

(Continue)

2

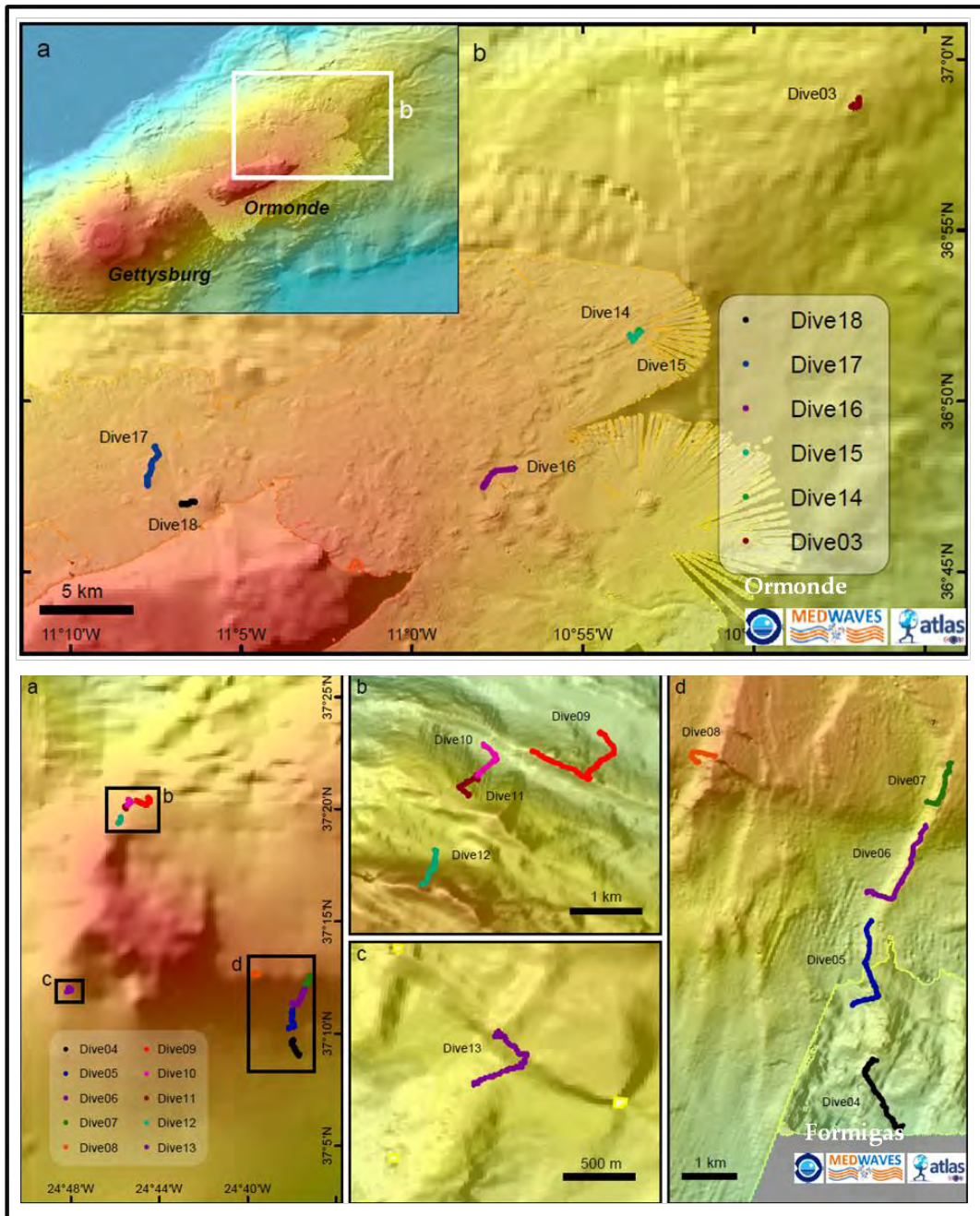

Figure 0: Panel 1 (page 136) show the ROV dives conducted in Gazul (above) and Seco de los Olivos (below); Panel 2 show the ROV dives conducted in Ormonde seamount (above) and Formigas seamount (below).

22.09.2016. St. 9. Gazul Mud Volcano. Dive#1

Depth range. 470-400 m

The deepest areas of the transect were characterised by sandy seafloor with biogenic remains. Bacterial mats and chimneys occurred. Among the benthic organisms, some *Flabellum* specimens were present. The substrate presented authigenic carbonates. At around 450 m depth hard substrate areas start to dominate and large sponge fields and gorgonian aggregations occurred (Fig. 1). During the transect also sharks were observed and different fish species have been also recorded. At around 440 m small colonies of *Lophelia pertusa* and *Madrepora oculata* occurred, presenting patchy distribution. Fishing lines and nets were also observed.



Figure 1: Some seascapes recorded in Gazul mudvolcano in Dive#1. From left to right, (1) sponge fields, (2) large *Callogorgia verticilata* specimen and (3) small colonies of *Lopheliapertusa* and *Madrepora oculata*.

23.09.2016. St. 20. Gazul Mud Volcano. Dive#2

Depth range. 475-400 m

The deepest areas of the transect were characterised by sedimentary substrate with marked ripples (Fig. 2). The dominant fauna were actinians (*Actinauge*-like) and specimens of the sea urchin *Cidaris* sp. At the same depths also boulders colonised by actinians occurred with presence of fish (e.g. *Helicolenus dactylopterus*). At 460 m isolated *Madrepora* colonies occurred but in a bit shallower areas (400-450 m) a mixed community of *Madrepora*, *Lophelia*, *Dendrophyllia*, as well as different gorgonians and sponges colonised the area.

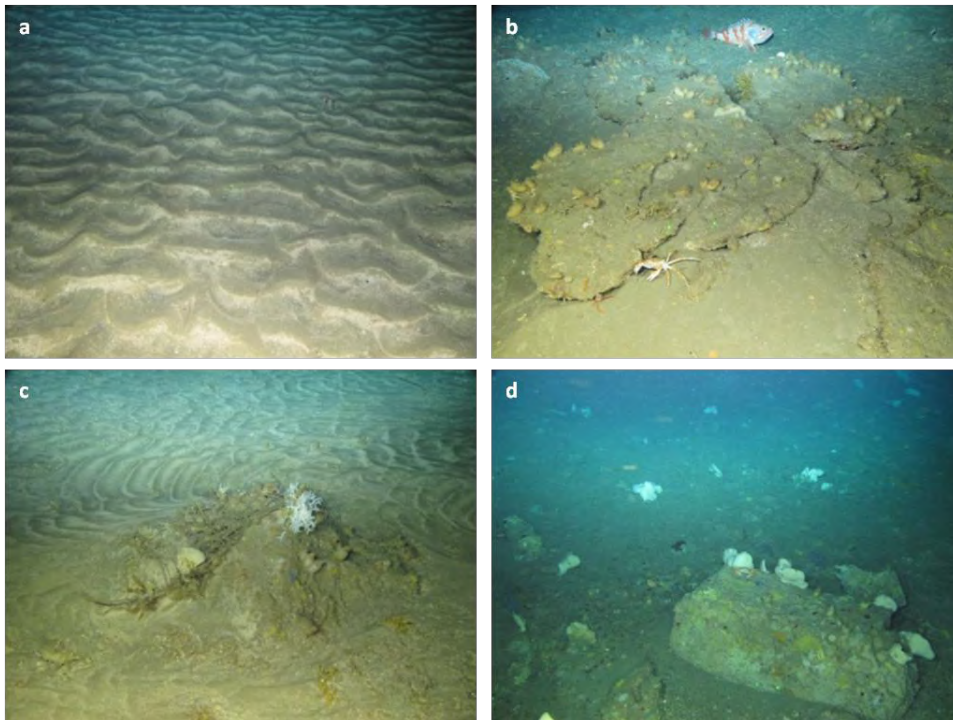

Figure 2: Four images representative of the Dive #2 in Gazul. a) Ripples in the soft sediment, actinians colonised the substrate but this is difficult to see in the image, b) Rocky substrate in the area with ascidians colonising the rock and some mobile fauna around (see *Helicolenus* specimen and a crab), c) An isolated *Madrepora* colony, d) sponge field.

25.09.2016. St. 36. Ormonde seamount. Dive#3

Depth range. 1,960-1,940 m

Due to the weather conditions (quite unstable and which at the end obligated to abort the dive, this Dive was not a “real” transect but an exploratory dive). At 1,900 meters depth the substrate was characterized by soft sediment with presence of a lot of pteropod shells in the sediment. The fauna observed was very spectacular, with low densities of specimens but astonishing diversity. Stalked sponge and bamboo corals (Fig. 3) occurred and a high diversity of gorgonian species (see chapter 9.5). At 1,940 meters some rocky substrate was documented with, high diversity of black corals and presence of stalked crinoids.

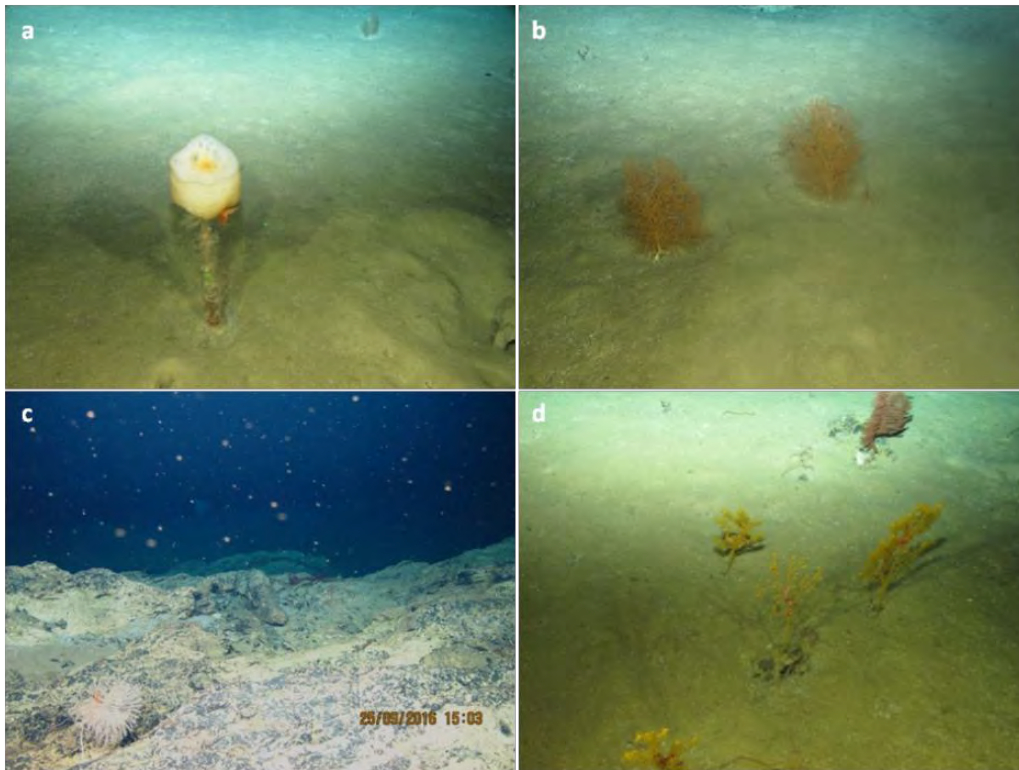

Figure 3: Four images representative of the Dive #3 in Ormonde (all of them from 1,960-1,940 meters depth). a) Stalked sponge at 1,960 meters depth, b) Specimens of *Acanella arbuscula*, one of the bamboo coral gorgonians which will accompanied us during almost the whole cruise, c) An isolated specimen of *Iridogorgia* sp. in the rocky substrate, d) several specimens of the gorgonian *Placogorgia* sp. with basket stars.

29.09.2016. St. 47. Formigas seamount South East side. Dive#4

Depth range.1,575-1,350 m

The first dive in Formigas seamount was conducted in the SE side of the mount. In the deepest part of the transect soft sediment (with marked ripples) dominate with presence of some actinians and of the typical seamount fish: the orange roughy. Rocky boulders occur colonized by gorgonians as well as incrusting sponges (Fig. 4).



Figure 4: The deepest locations of the Dive # 4 in Formigas. A) Soft sediment with ripples and a *Ceriantharia* specimen, b) isolated gorgonian and an orange roughy, c) despite the quality of the image, some rocky boulders can be observed, colonized by large gorgonians.

At around 1,500m depth the rocky substrate increases and dominates in front of the soft bottom areas, presenting also a marked slope. The rocky boulders appear profusely colonized by black corals (*Stichopathes*-like) and gorgonians (e.g. *Metallogorgia*-like) (Fig. 5a), in the sedimentary areas *Flabellum* specimens occur as well as colonies of *Acanella arbuscula*. It is also remarkable the presence also of *Solenosmillia* and solitary corals. At 1,380 a large colony of *Enallopsamia rostrata* was observed (Fig. 5d). The rocky boulders were also colonized by a diverse sponge fauna.

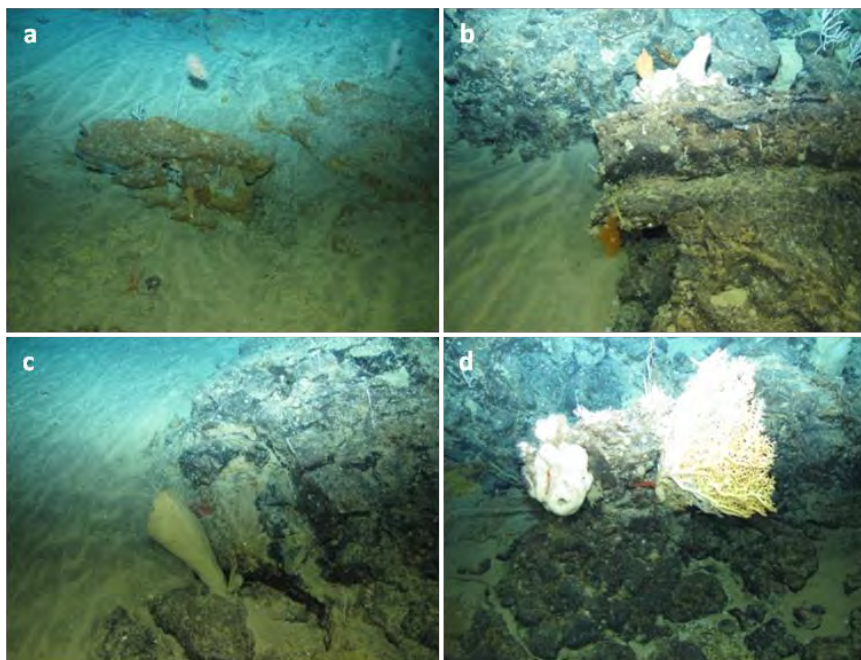

Figure 5: Some images from the depth range 1,500-1,300 meters depth of Dive # 4. a) specimen of *Metallogorgia*-like growing on rocky substrate, b, c) rocky substrate colonised by diverse megabenthic fauna, d) a large specimen of *Enallopsamia rostrata*.

30.09.2016. St. 54. Formigas Seamount South East side. Dive#5

Depth range. 1,360-1,160 m

In this transect, that started at 1,360 meters depth, the soft substrate areas were colonized mostly by *Flabellum* sp and seapens. However, this transect is characterized by steep rocky walls with only small spaces, like terraces, in between where soft substrates are present. The fauna of the rocky walls at ca. 1,350 m depths were dominated by gorgonians and stylasterids. Orange roughy specimens were also present. The figure 6 present some images of this spectacular seascape.



Figure 6: Panoramics of the Dive #5. a, b) Steep walls and two eels, c) some of the typical colonizers in the area: different gorgonian species.

In a bit shallower areas, from 1,250 m to 1,160m, variations in substrate were observed, with alternance of soft bottom areas with marked ripples and rocky plates. This was the first transect were we observed nest sponges (Fig. 7). The rocky areas were dominated by a high diversity of gorgonians.

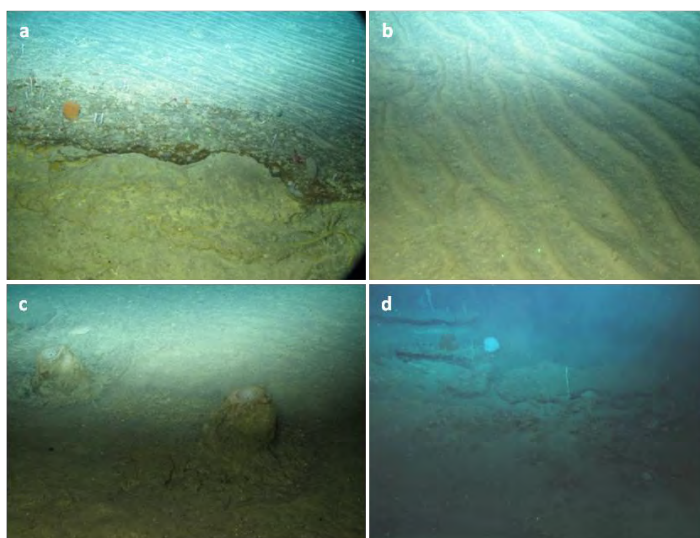

Figure 7: Panoramics of the shallower areas of Dive #5. a) Soft substrate and rocky plates, b) Soft substrate with marked ripples, c) Two specimens of nest sponges, d) Rocky outcrops colonized by high diversity of gorgonians.

01.10.2016. St. 65. Formigas seamount. South East side. Dive#6

Depth range. 1,256-918 m

This dive is a continuation of the previous transects covering the depth range between ca. 1,200 meters and 900 meters. A high variation of substrate was documented in very short distances. The areas with soft sediment display marked ripples. Several specimens of a shrimp (probably family Aristidae, the species could be *Aristaeopsis edwardsiana*), *A. arbuscula* and *Cidaris*-like occur. Where rocky boulders were present, *Madrepora* and *Solenosmillia* occur as well as black corals *Leiopathes*-like (Fig. 8).

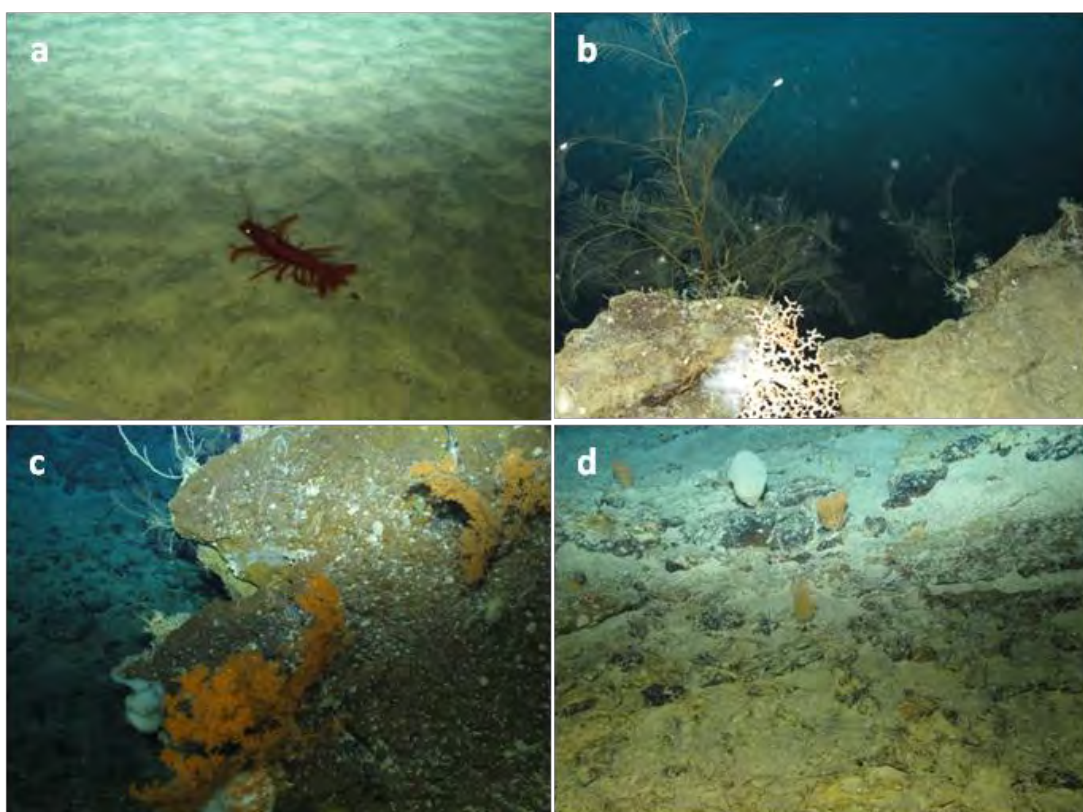

Figure 8: Some examples of the sea scapes of Dive #6. a) A specimen of a shrimp (probably family Aristidae), b) hydroids and *Madrepora oculata* on a rocky outcrop, c) Rocky boulders colonized by *Leiopathes* (black corals), gorgonians and sponges, d) Rocky plates with some *A. arbuscula* and sponges.

In the depth range between 1,150 and 918 meters, soft and hard substrate alternate; in the soft substrate lolly-pop sponges (*Stylocordila*-like) and Stylateridae colonised the sea floor. In the rocky substrate a high diversity of species occur: *Madrepora oculata*, *Lophelia pertusa*, black corals and *Desmophyllum*-like dense populations (Fig. 9).

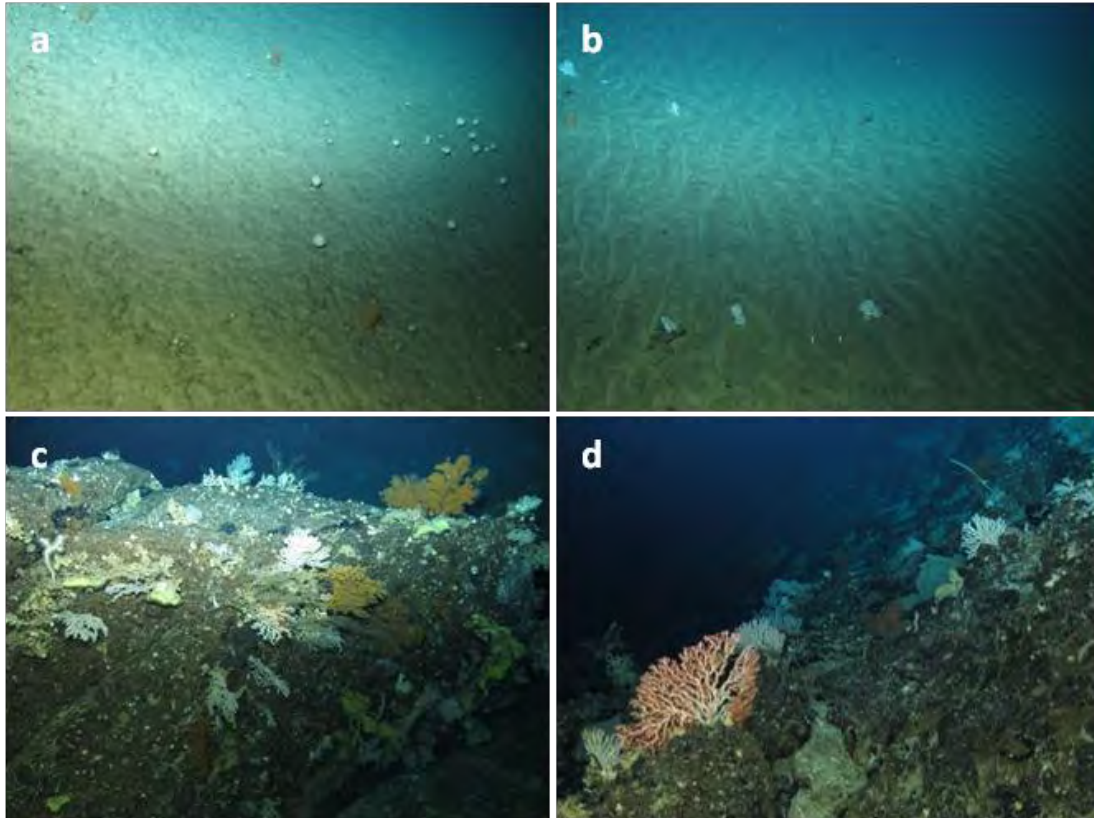

Figure 9: Some examples of the sea scapes of Dive #6. a) specimens on a lolly-pop sponge *Stylocordyla* sp., b) Stylasteridae, c) dense colonisation of gorgonians, scleractinians and black corals in the basalt rocky outcrops, d) basalt rock colonised by different cnidarians, among others the large pink specimen of the precious coral *Corallium tricolor*.

02.10.2016. St. 78. Formigas seamount. South East side. Dive#7

Depth range. 1,000-700 m

At 1,000 m depth the substrate was dominated by coral rubble and in a bit shallower areas (960 meters depth), a rocky area occur with presence of a dense high diverse community with dominance of gorgonians, nest sponges and *Acanella arbuscula*, as well as with abundant presence of mobile fauna, for instance crabs. Further some specimens of *Chaunax* (which is a subtropical species) were recorded (Fig. 10).

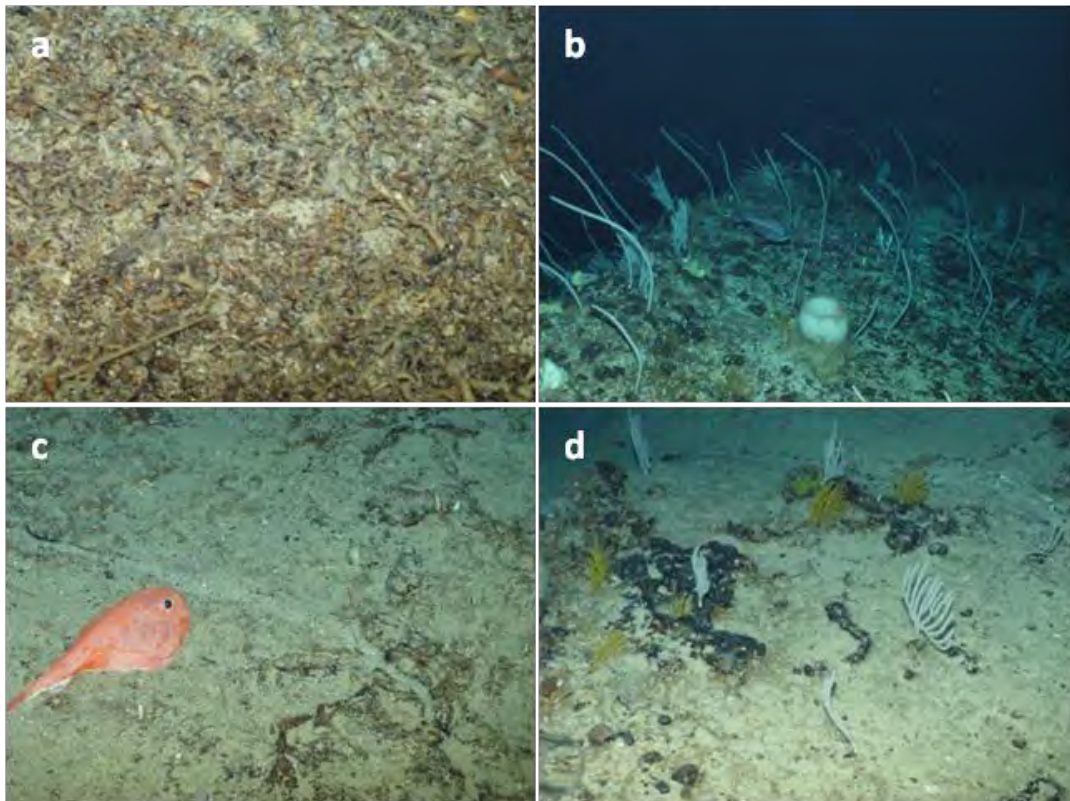

Figure 10: Dive #7 display a highly diverse orography and substrate types, a) coral rubble dominated by 1,000 meters depth, b) in the rocky substrate communities with different dominances occur, here flagelliform gorgonians dominated with presence of nest sponges, c) a specimen of *Chaunax*, a subtropical fish species, d) rocky substrate dominated by two gorgonian species *Narella bellissima* and *Acanthogorgia cf armata*.

03.10.2016. St. 89. Formigas seamount. South East side. Dive#8

Depth range. 740-500 m

This was the last dive conducted in the SE side of Formigas, covering the shallow depth range of 740 to 500 meters depth. Soft and rocky substrate alternate, being apparently the diversity of the megabenthic fauna much lower than in deeper areas. Long lines remains were visible here. Some areas were colonized by flageliform gorgonians, and the rocky substrates presented high diversity of encrusting sponges. The figure 11 display images from the deeper areas of the transect, whereas figure 12 display images from the communities occurring at 500 meters depth.



Figure 11: Some seascapes in the shallower areas (ca 740 meters) of the SE Formigas transect. a) Community dominated by flagelliform gorgonians, b) a large sponge Rosella-like in the soft substrate, c) Rocky boulder colonized by encrusting sponges and a Stylasteridae.

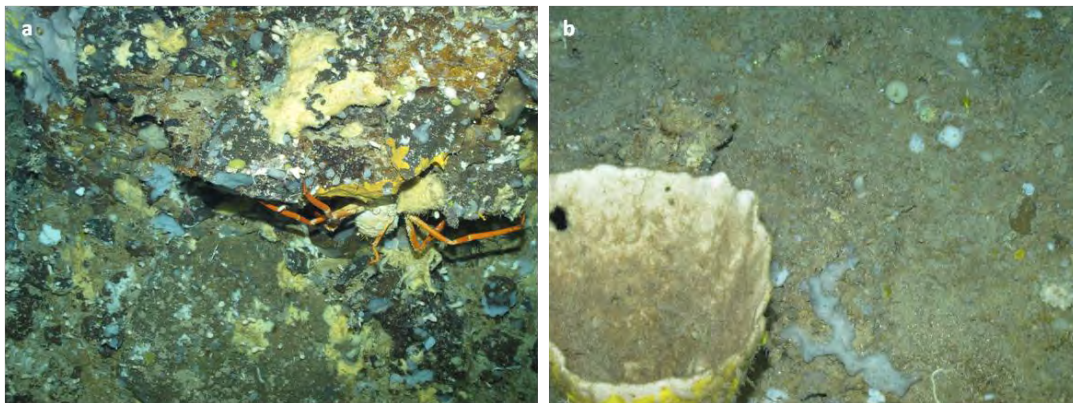

Figure 12: Some details of the seascapes in the shallowest areas (ca 500 meters) of the SE Formigas transect. a) rocky substrate colonized by high diversity of encrusting sponges, b) large glass sponge.

04.10.2016. St. 103 Formigas seamount. Noth West side. Dive#9

Depth range. 1,400-1,200 m

This was the first transect conducted in the NW side of Formigas. Soft substrate dominate in the deeper areas with patches of coral rubble and some rocky boulders. The megafauna was scarce, occurrence of eels was frequent (Fig. 13a). Also some actinians appear in the soft substrate areas but with low density as well as some sea cucumbers and shrimps. Fish presence was abundant. The rocky boulders were colonized by gorgonians which started to appear at around 1,350 m depth with marked slope. These rocky boulders were not much colonised (Fig. 13 b). *Acanella* displayed high densities at ca 1,250 m depth, at this depth the rocky substrate dominate, being the basaltic rocks colonized by *Leiopathes*-like black corals, by gorgonians, and by scleractinians. The presence of basaltic rock was always

associated with higher densities and diversity of species. This area displayed a high diversity in gorgonian fauna.

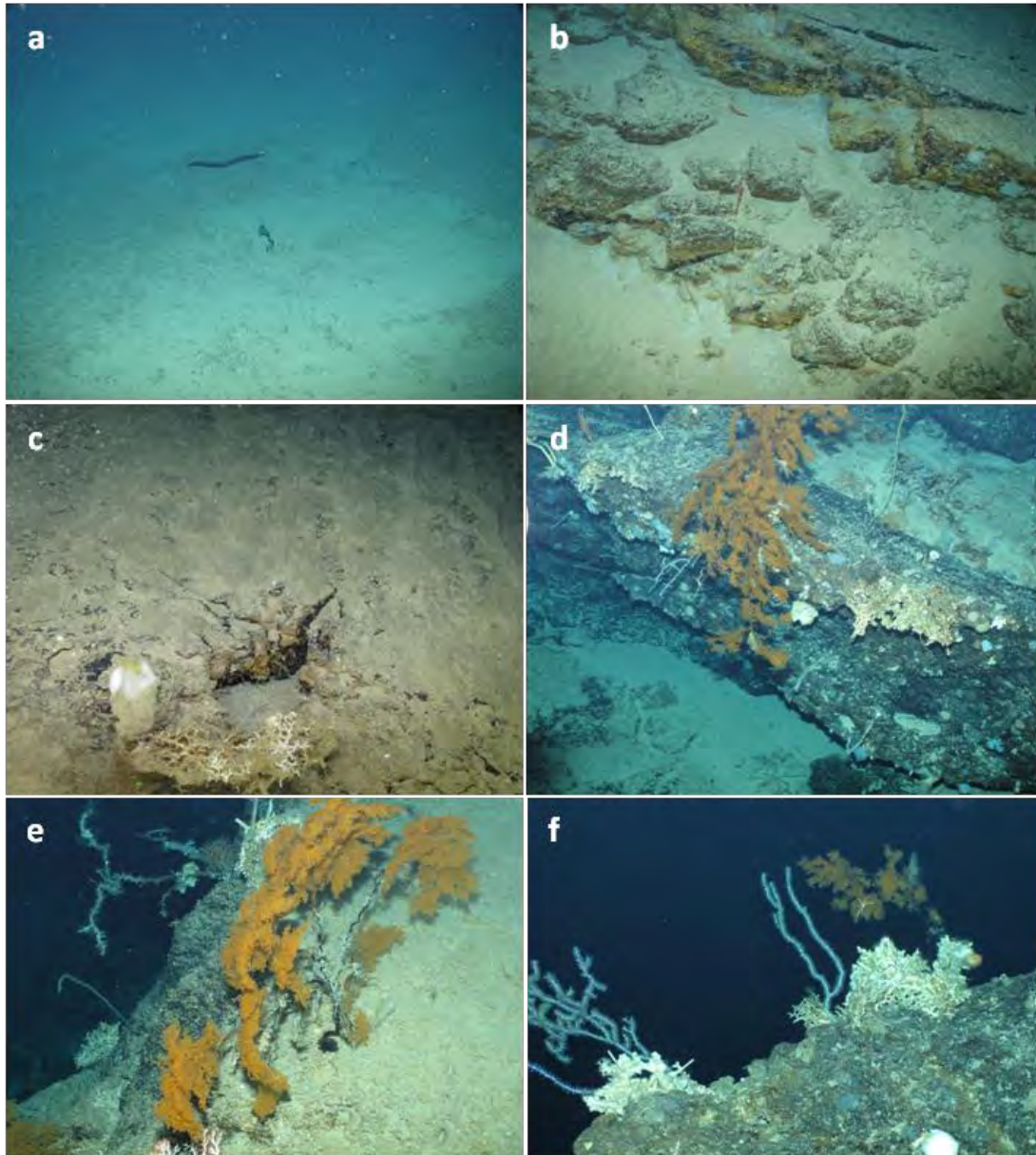

Figure 13: Panoramic of the different seascapes present in the Dive#9. a) Soft substrate in the deeper areas of the transect with eel occurrence, b) rocky boulders scarcely colonized by megabenthic fauna, c) an isolated colony of *Madrepora oculata*, d-f) basaltic substrate with marked slope highly colonized by black corals, gorgonians and scleractinians.

05.10.2016. St. 113. Formigas seamount North West side. Dive#10

Depth range. 1,325-1,060 m

This dive was characterized at the beginning by soft sandy sediment with pteropods shells. A field of nest sponges was documented as well as shrimps (probably *Aristidae*), sea cucumbers and fish. In general the mega fauna was not very abundant. Some small gorgonians were observed as well as some actinians and sea urchins. At around 1,270 meters depth rocky substrate with pronounced slope occurred but the colonization by megabenthos was also scarce (Fig. 14). In general, this NW side transect present much lower occurrence of megabenthos than the transect conducted in the NE side of the seamount.

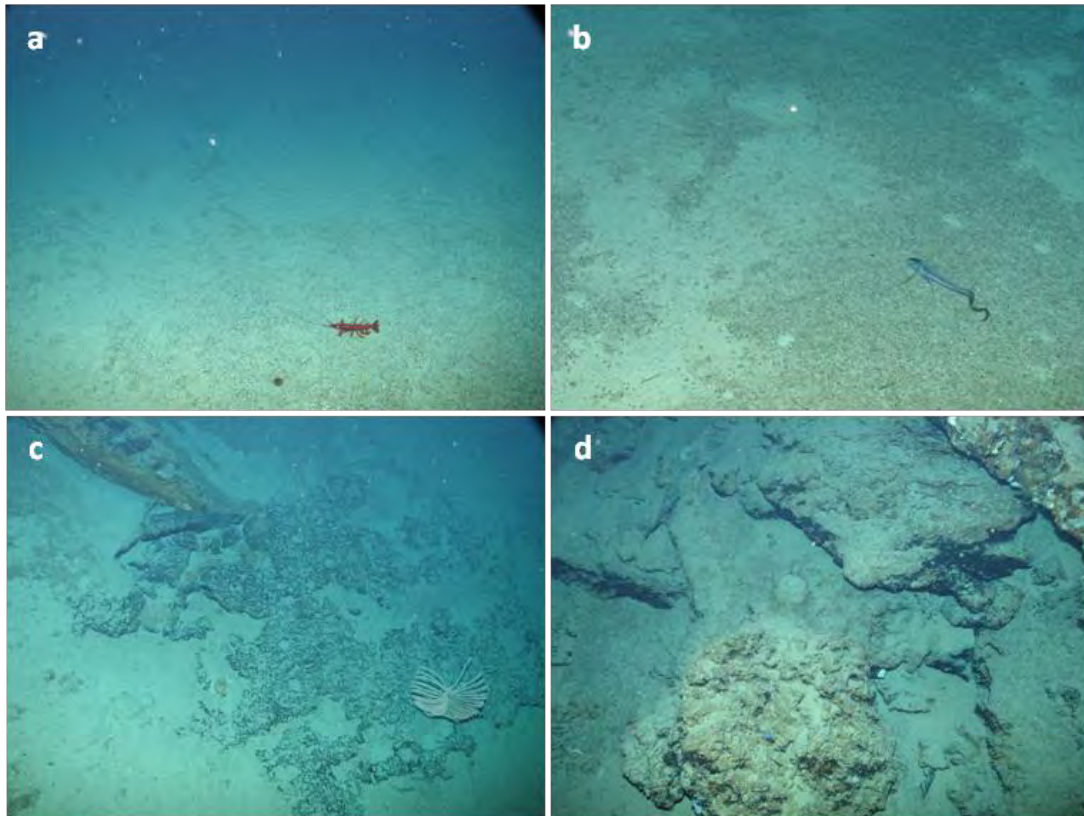

Figure 14: Dive # 10 was characterized by the dominant presence of soft substrate (a, b) with presence of mobile fauna but scarce colonization by megabenthic organisms. At around 1,270 meters depth rocky substrate occur but with scarce colonization of megabenthos, nevertheless a black coral can be observed in c) and a nest sponge in d).

07.10.2016. St. 126. Formigas seamount. North West side. Dive#11

Depth range. 1,080-1,030 m

Dive #11 covered a narrow depth range (1,080-1,030 m depth), rocky substrate dominate with some patches of sandy seafloor. *Acanella* occurred at high densities, but in general the benthic megafauna was scarce. Presence of some sponges, *Cidaris*-like were recorded. At around 1,040 meters the species diversity seemed to increase

and *Madrepora*, *Lophelia*, several hydroids and gorgonians species as well as *Leiopathes* occurred (Fig. 15). In the rocky promontories outcrops as well as on the top of the boulders the fauna was also not very abundant. In the vertical walls and outcrops the diversity was, however, high.

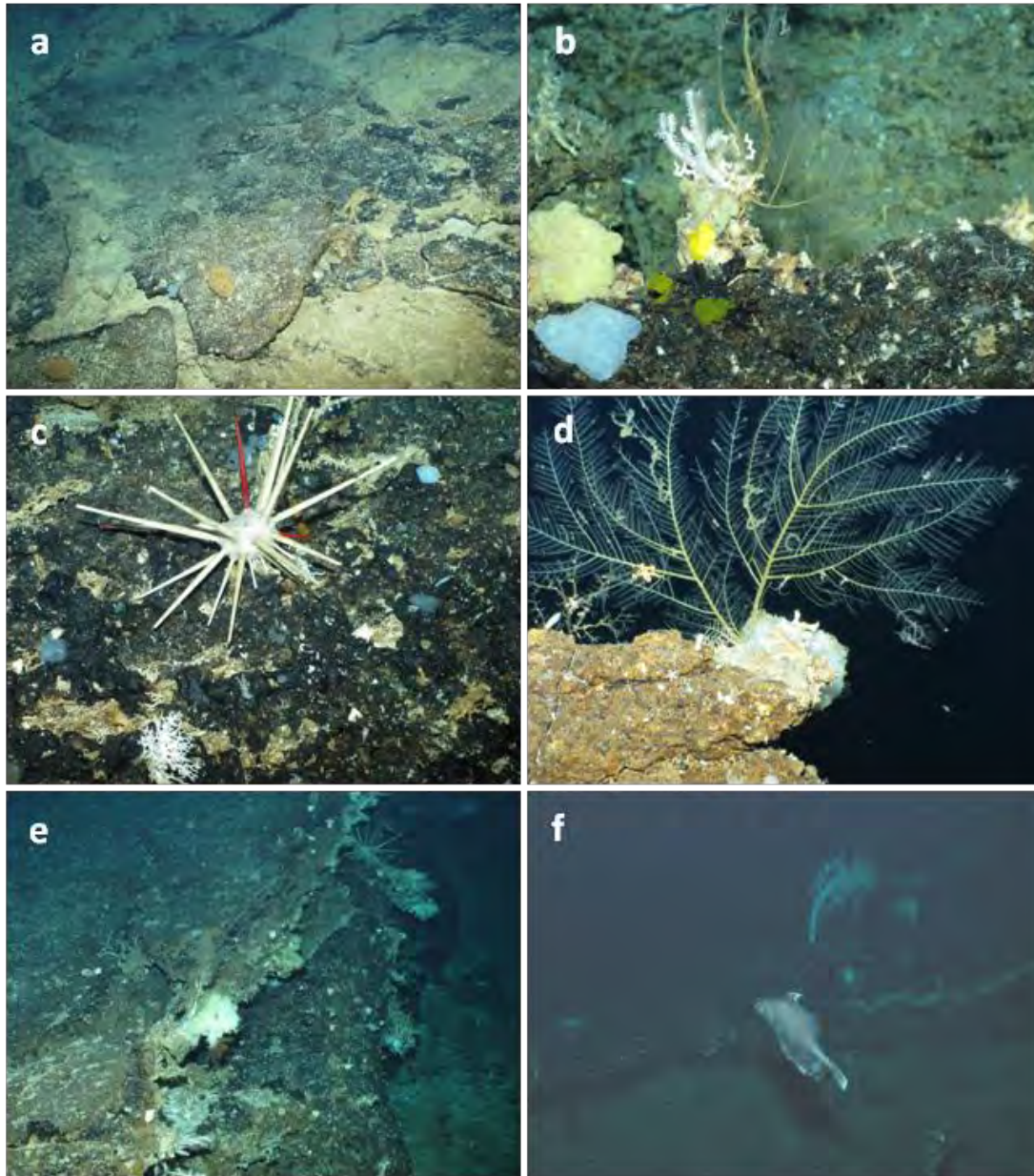

Figure 15: Dive # 11 was characterized by presence of rocky substrate but the density of megafauna was not very high. The images above are representative of the transect displaying the presence of *Acanella* (a), some colonies of *Madrepora* (b), *Cidaris*-like specimens (c), hydroids (d), rocky outcrops colonized by different megafauna species and (e) deep sea fish species to be determined.

07.10.2016. St. 127. Formigas seamount. North West side. Dive#12

Depth range. 1,030-670 m

At ca. 1,000 meters depth the substrate was dominated by coral rubble and large rocky boulders. Some shark specimens were observed (Fig. 16b) and in general fish were abundant through the transect. The Aristidae shrimp also occur frequently but the benthic megafauna was scarce in the deeper areas of the transect. At ca. 900 meters solitary corals were present as well as isolated colonies of *Madrepora* and *Lophelia*. In the rocky boulders black corals *Leiopathes*-like (at ca. 750 meters depth) colonized the substrate, together with scleractinians and with presence of *Cidaris*-like sea urchins (Fig. 16c-e). Between the large rocky boulders soft substrate patches occur (with large amounts of coral rubble and dead coral framework), being the soft substrate colonized by nest sponges (Fig. 16f). Large yellow gorgonians. Black corals at 750 meters.

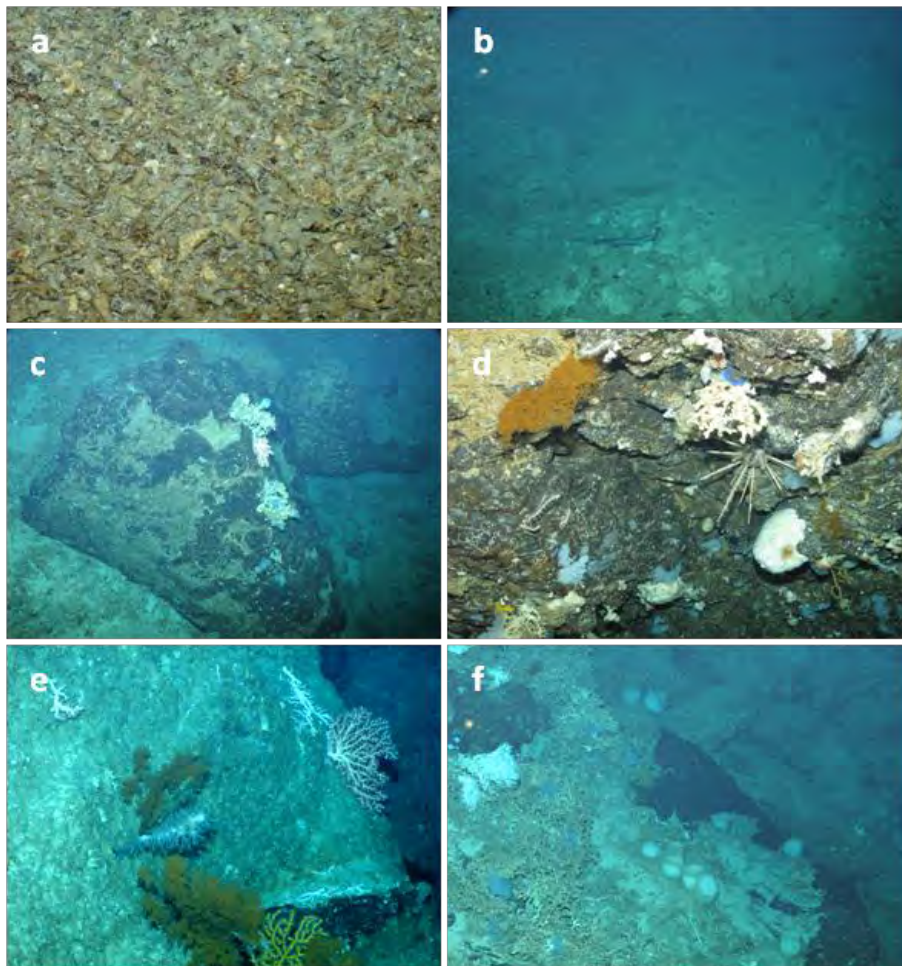

Figure 16: Dive # 12 was characterized by presence of coral rubble in the deeper areas, and rocky boulders with patches of soft substrate with coral rubble and dead coral frame work in shallower areas (around 700 meters depth). The images above are representative of the transect displaying the presence of coral rubble (a), deep-sea sharks (b), rocky boulders colonized by different cnidarians (c-e), and nest sponges

occupying the locations covered by soft substrate with abundant coral rubble and dead coral framework (f).

08.10.2016. St. 133. Formigas seamount. South side. Dive#13

Depth range. 1,040-920 m

The deepest areas of this transect were characterized by soft bottom with marked ripples, the ROV manipulator allowed to confirm the presence of hard substrate underneath the sand. The rocky boulders and vertical walls (Fig. 17 b-d) were colonized by gorgonians, sponges *Phakellia*-like as well as *Acanella* and sea cucumbers, *Acanella* display different densities through the transect. Among the mobile fauna, the Aristidae shrimp was also present as well as fishes. On the top of the large rocky terraces, flageliform gorgonians colonized the rocky substrate. In the areas where soft substrate were present it was also documented the presence of nest sponges. *Lophelia* and *Madrepora* colonized rocky areas at ca. 1,000 meters depth. In this transect some fishing nets were documents. At around 900 meters basaltic rocks occurred and they were, as previously observed in other locations colonized by a high diversity of gorgonians and scleractinians as well as Stylasteridae.

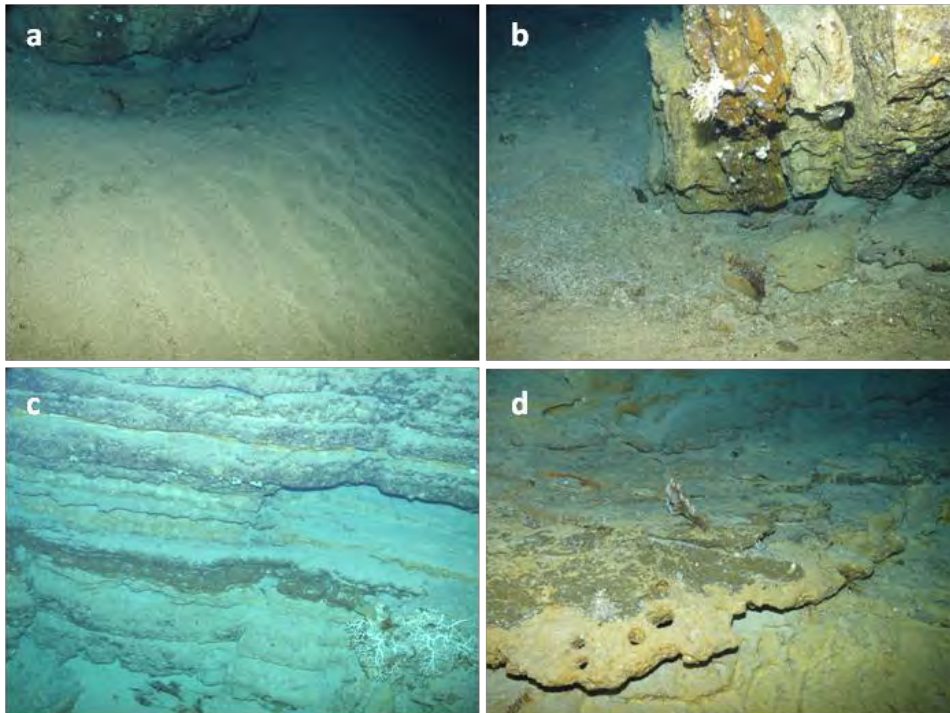

Figure 17: The deeper areas documented in the Dive # 13 were characterized by a) presence of soft substrate with marked ripples, the substrate was in general dominated by rocky areas including vertical walls (c), the hard substrate (especially the basaltic substrate) was colonized by a high diversity of gorgonians, scleractinians and stylasteridae.

18.10.2016. St. 138. Ormonde South East side. Dive#14

Depth range. 1,540-1,500 m

This dive was very short due to technical problems, the substrate was formed by patches of soft sediment and rocky boulders and a sponge field formed by large specimens was documented as it can be seen in the image below (Fig. 18).



Figure 18: patched soft-hard substrate at ca 1,500 meters depth in South East side of Ormonde seamount, large sponges colonized the rocky areas.

19.10.2016. St. 145. Ormonde. North East side. Dive#15

Depth range. 1,543-1,475 m

The first dive conducted in the NE side of Ormonde reveal a substrate dominated by coral rubble and basaltic rocks in the deeper areas. A diverse and coloured fauna was document in this transect with presence of solitary *Cariophyllia*-like cup corals, crinoids and sponge fields growing in the rocks (Fig. 19a-b). The sponges were all orientated in the same direction, pointing out to very directional currents in the area; specimens of *Corallium tricolor* were also observed (Fig. 19b). As in many other transects, *Acanella* occur being one of the most abundant species, specimens of *Narella bellissima* were also recorded but displaying not very dense population, colonizing the hard substrate zones, as well as *Corallium tricolor* or *Solenosmillia variabilis* (Fig. 19

b,c,e). The sponge communities inhabiting the area displayed a remarkable species diversity. Black corals *Stichopates*-like were also present in the areas as well as gorgonians *Viminella*-like. Also solitary cup-corals *Desmophyllum*-like were documented in the area.

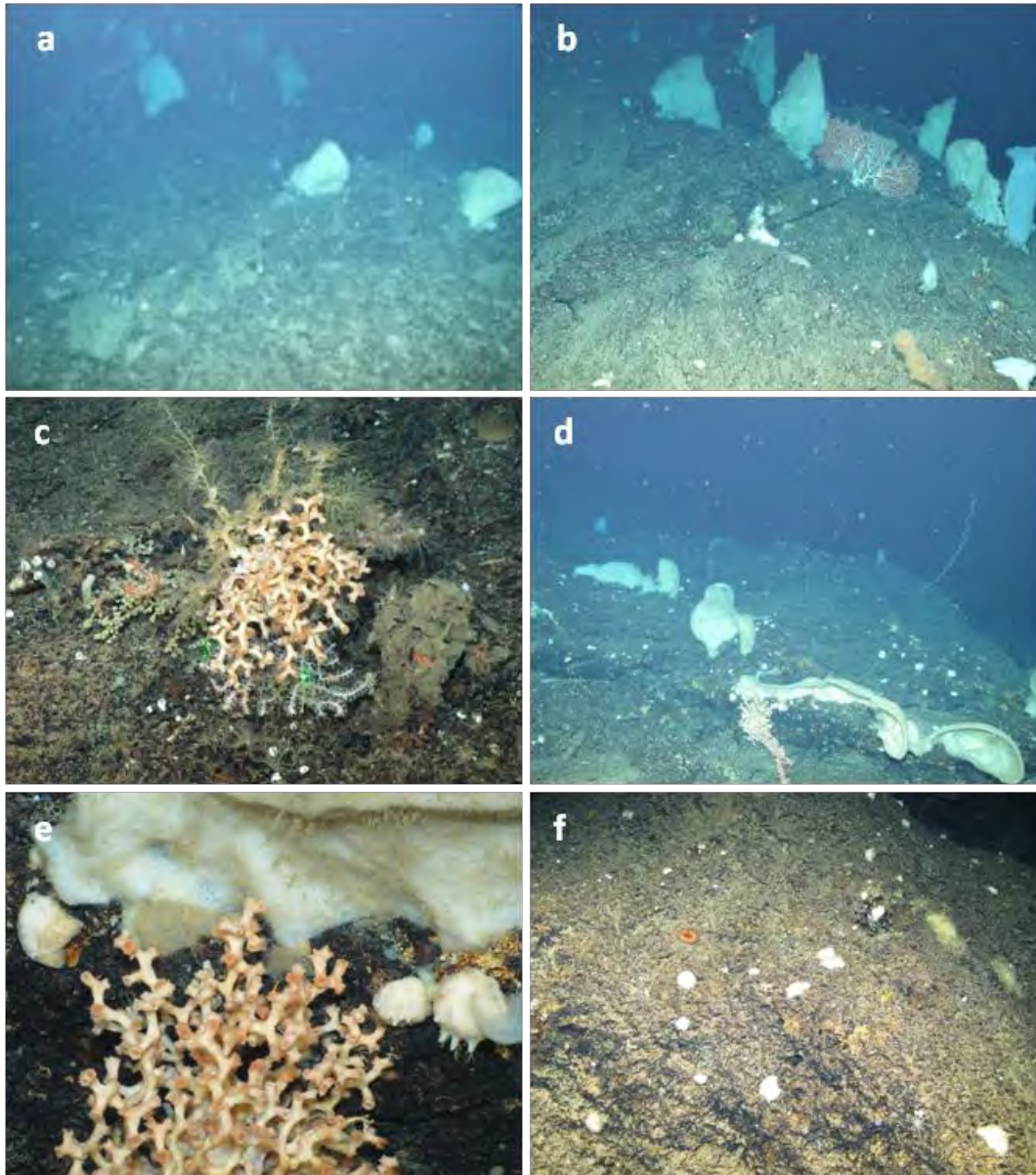

Figure 19: An overview of some of the communities dominating the hard substrate zones of the transect conducted during dive #15. a, b, c) sponge dominated communities, c,e) *Solenosmillia variabilis* growing in the rocky substrate, f) some *Desmophyllum*-like cup-corals (orange), growing in the rocky substrate together with some sponges (white).

19.10.2016. St. 146. Ormonde North East side. Dive#16

Depth range. 1,230-1,060 m

The seafloor of this area was characterized by a substrate dominated by pebbles and coral rubble (Fig. 20a). During the whole transect rocky boulders occurred colonized by large sponges growing in the outcrops (Fig. 20b). Also black corals occurred in the area (*Stichopathes*-like). Although the density of the sponges was not very high it was remarkable the large sizes of the specimens. At around 1,150 m the diversity of sponges was remarkable and the density was also higher. Some sharks were recorded and some *Cidaris*-like. Very few cnidarians occurred through the transect (Fig. 20 f).

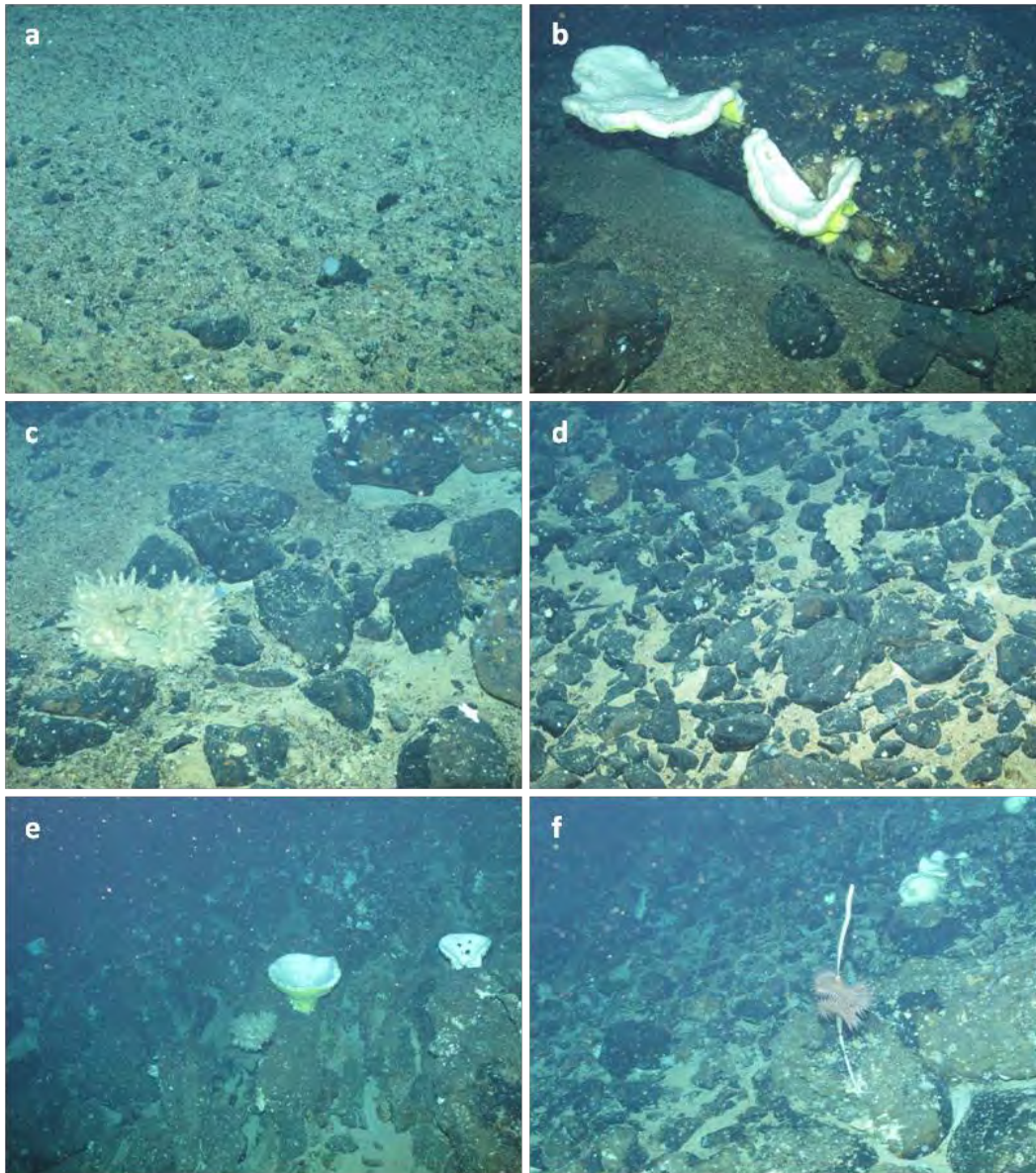

Figure 20: Overview of the transect conducted during the dive #16. Basaltic hard substrate dominated the transect as well as the colonisation of the substrate by large sponges (b-e), few cnidarians were observed in the area (f).

20.10.2016. St. 155. Ormonde seamount. North East side. Dive#17

Depth range. 1,155-945 m

This dive displayed areas with diverse substrates from soft to hard substrate with dominance of soft substrate in some regions and of rocky boulders in other zones. Presence of different communities with different dominances, from areas where gorgonians *Viminella*-like dominated to others where Lolly pop-sponges (Fig. 21b) or sea pens where the dominant taxa. In some areas of the transect the slope was remarkable with higher presence of basaltic rock, these areas where frequently dominated by *Viminella*-like gorgonians and some nest sponges (Fig. 21e). In other parts of the transect the basaltic rocks were colonized by large sponges. Through the transect it was remarkable the presence of fish, sharks, crabs and shrimps (Fig. 21a, c, g). In general the megabenthic fauna was not very abundant and not very diverse. At 1,000m the slope was still remarkable and Stylasteridae and nest sponges colonised the substrate. Large *Asconema* sponges were also recorded in the transect (Fig. 21f), as well as some gorgonians communities dominated by *Narella*-like specimen, with presence of *Swiftia*-like gorgonians and also solitary corals.

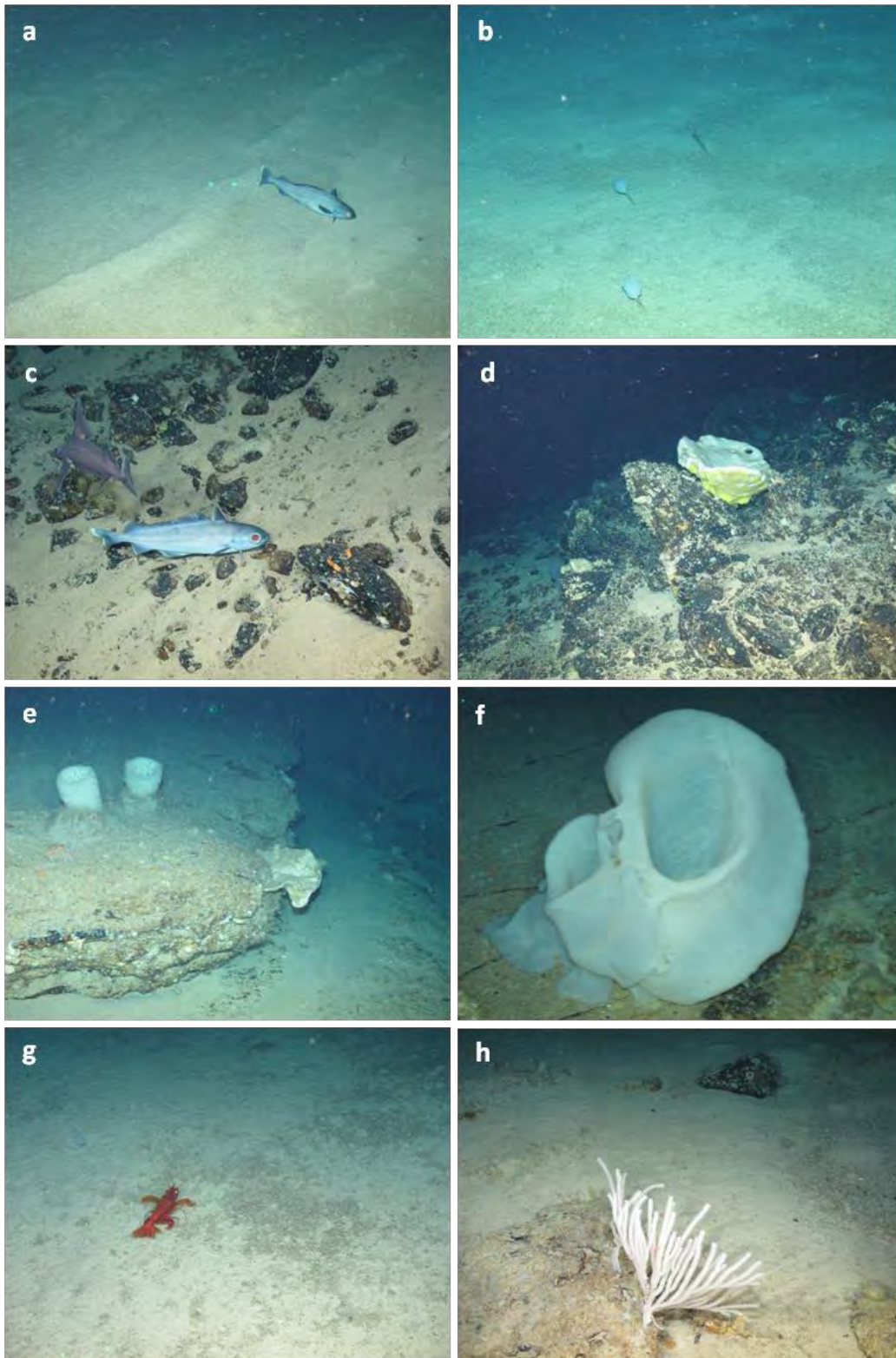

Figure 21: Some snapshots of Dive#17. Fish occurrence as well as of other mobile fauna was frequent through the transect (a,c,g), a field of lolly-pop sponges (b), some large sponges colonizing different zones (d,e,f), an specimen of a gorgonian in a rock. Image c displays a specimen which probably belong to the deep sea shark genus *Oxynotus*.

20.10.2016. St. 156. Ormonde North side. Dive#18

Depth range. 870-660 m

The last dive in Ormonde was conducted also in the north side of the mount. Rocky substrate was dominant in the area with specimens of *Cerianthus* colonizing the areas with soft substrates, also some areas were covered by coral rubble (Fig. 22d). The vertical rocky walls were highly colonized by sponges (Fig. 22a) and in these areas the presence of fish was remarkable. Deep sea-sharks were also document in the area.

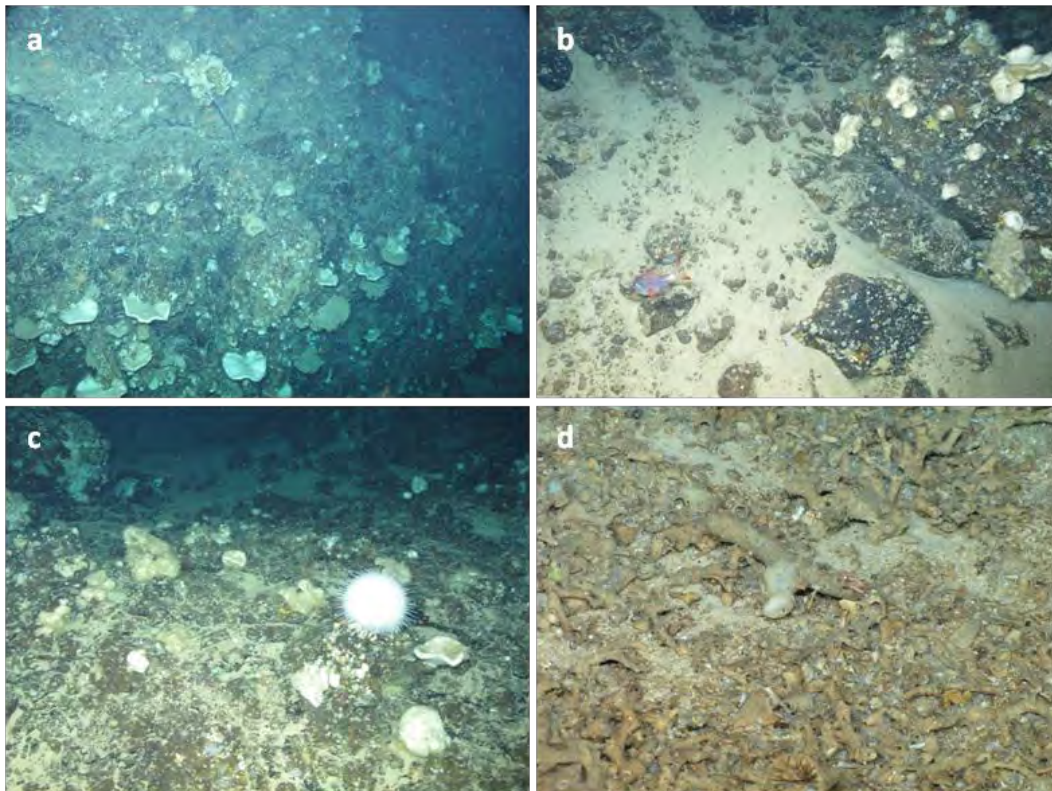

Figure 22: The last dive conducted in Ormonde was characterized by rocky boulders and plates colonized by sponges (b,c) and vertical walls also highly colonized by sponges (a), in the areas where soft substrate where present coral rubble was also documented (d).

23.10.2016. St. 176. Seco de los Olivos. South West side. Dive#19

Depth range. 790-700 m

The first ROV dive conducted in Seco de los Olivos was very short as there were some technical problems which obligate to abort the dive. The area was characterized by muddy soft substrate. Some mobile fauna was detected in the area: sea cucumbers,

crabs, also some sharks, but the visibility was in general quite bad. Also some sea urchins were observed as well as polychaetes *Aphrodita*-like. When rocky substrate were present *Cidaris*-like specimens were associated to this hard substrate. In the muddy areas bioturbation was clearly visible and specimens from Alcyonacea and seapens as well as *Cerianthus* were documented.

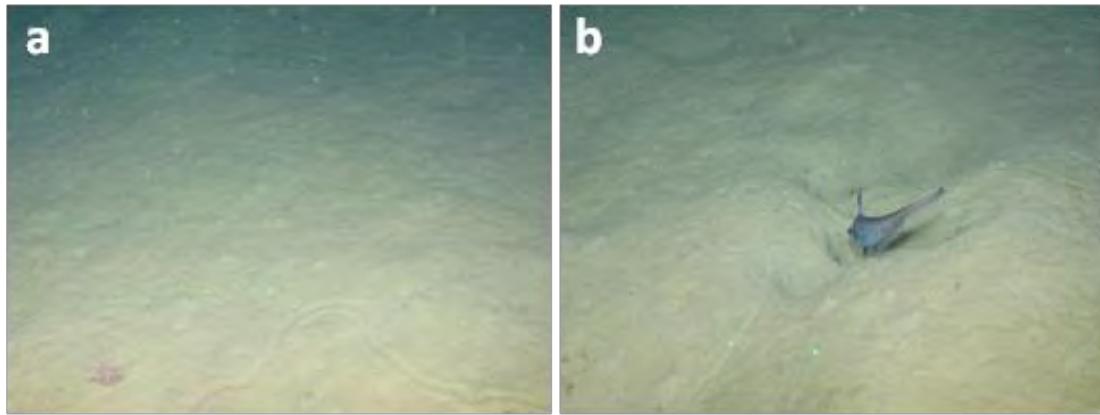

Figure 23: Substrate of the SW side of Seco de los Olivos, muddy soft sediment with bioturbation and a sea pen (a), Macrouridae specimen (b).

23.10.2016. St. 182. Seco de los Olivos. South West side. Dive#21

Depth range. 690-345 m

This dive start in a location close to the area were Dive#20 was aborted. The area display also soft substrate butwith large amounts of coral rubble and dead coral frame work at shallower depths (Fig. 24a,b). The coral rubble and coral frame work was colonized by many different organisms displaying a high biodiversity (Fig. 24c). It was especially astonishing the high density of a fish species belonging to the genus *Hoplostethus*, in the area, clearly associated to the presence of the coral rubble and dead framework (Fig. 24 d,e). In the soft bottom areas without coral rubble, sea pens and *Cerianthus* dominated. At around 628 m depth live *Lophelia pertusa* was documented. Large sponges (*Asconema setubalense*) were also recorded as well as the presence of sharks (Fig. 24f). In this area the footprint of the anthropogenic impact was present and clear with trawl marks in the seafloor, long line weights and also some glass bottles.

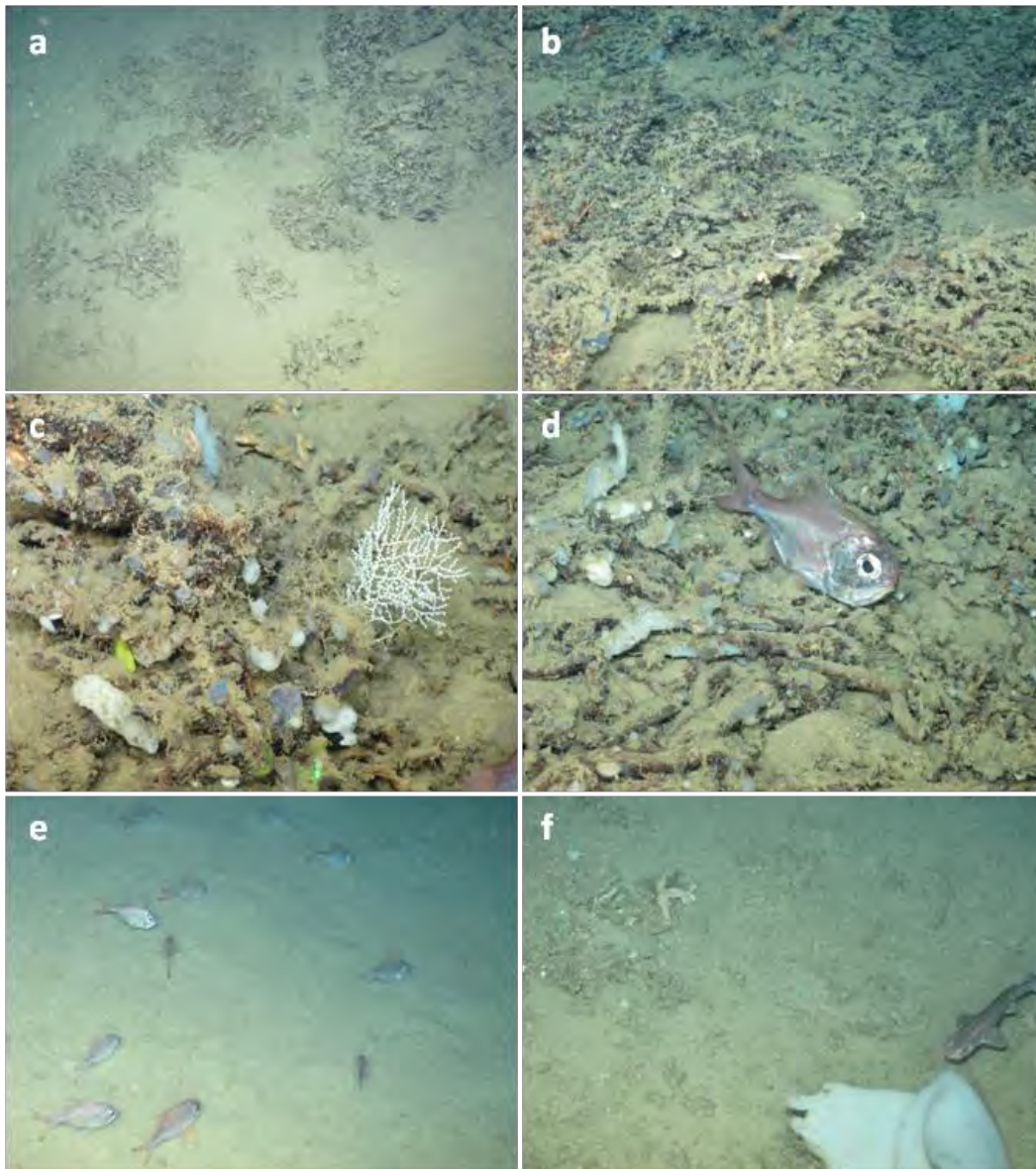

Figure 24: Southwest side of Seco de los Olivos by 690-345 meters depth. Coral rubble (a) and dead frame work (b) were abundant in the deeper zones of the transect, the coral rubble was highly colonized by diverse benthic fauna (c) and the fish *Hoplostethus mediterraneus* was very abundant and associated to the coral rubble and dead framework (d,e). In some areas the presence of large *Asconema setubalense* specimens was remarkable as well as the presence of sharks (f).

24.10.2016. St. 192. Seco de los Olivos. East side. Dive#22

Depth range. 385-256 m

This dive was characterized by the dominance of soft bottoms and some rocky substrate. *Cerianthus* was abundant in the soft substrate areas and it was remarkable the presence of abundant and diverse fish (Fig. 25a,b,c) including sharks. The areas

with hard substrate were colonized by sponges (Fig. 25d) and black corals (Fig. 25e) among others. Rests of long lines have also been documented in the area (Fig. 25 f).

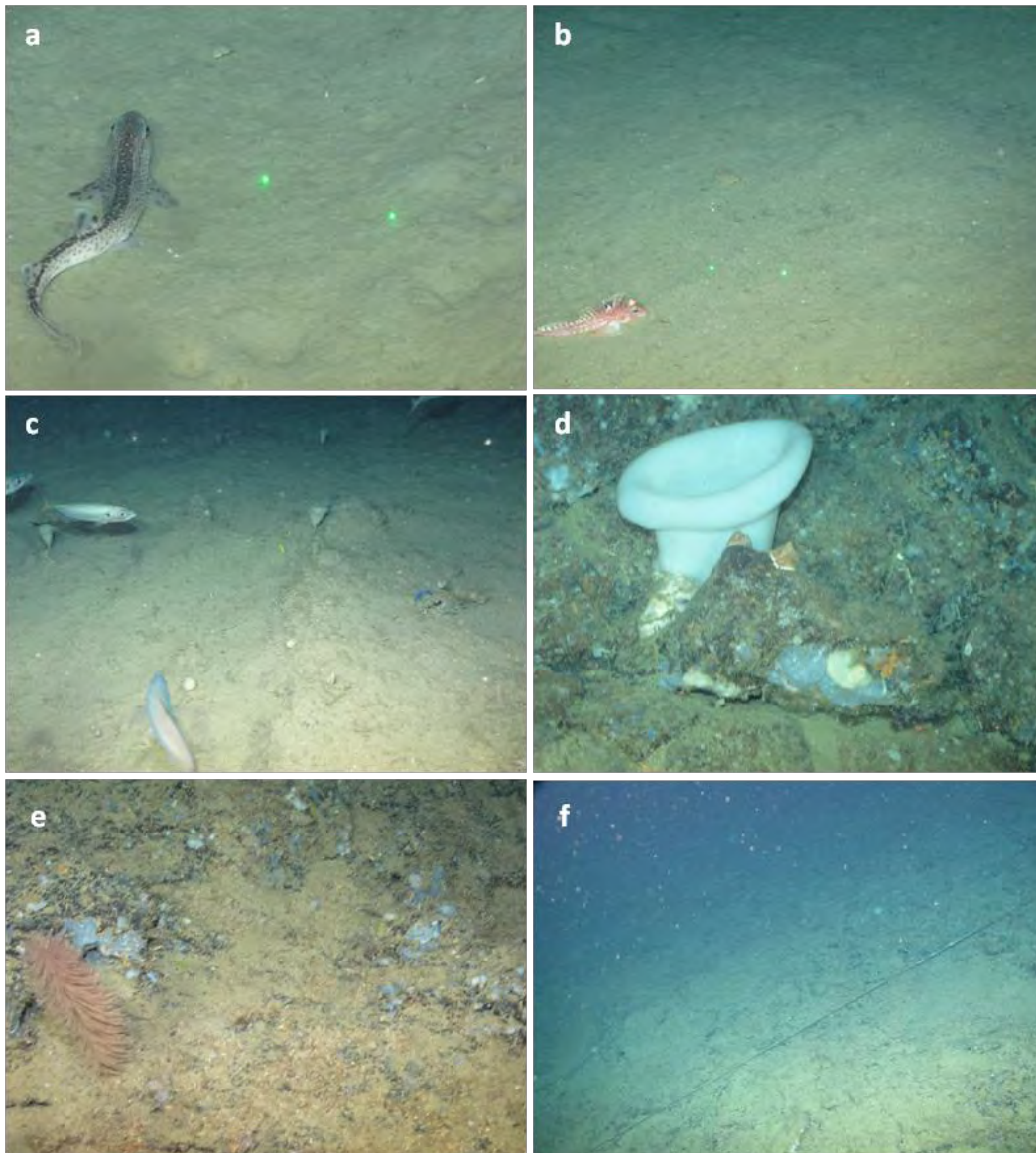

Figure 25: Diverse communities in the East side of Seco de los Olivos by 385-250 meters depth. Fish community diverse and abundant (a,b,c), rocky areas colonized by sponges (*Asconema setubalense*) and black corals (d,e), long lines remains in the seafloor.

24.10.2016. St. 196. Seco de los Olivos. East side. Dive#23

Depth range. 250-220 m

Area characterized by soft bottom with presence of coral rubble. High species diversity with some communities dominated by sponges (Fig. 26 e) and others by

gorgonians *Acanthogorgia*-like (Fig. 26 g,h) with presence of black corals. In several areas presence of *Dendrophyllia cornigera* small colonies (Fig. 26f). Presence of fish was also frequent throughout the transect (Fig. 26c,d).

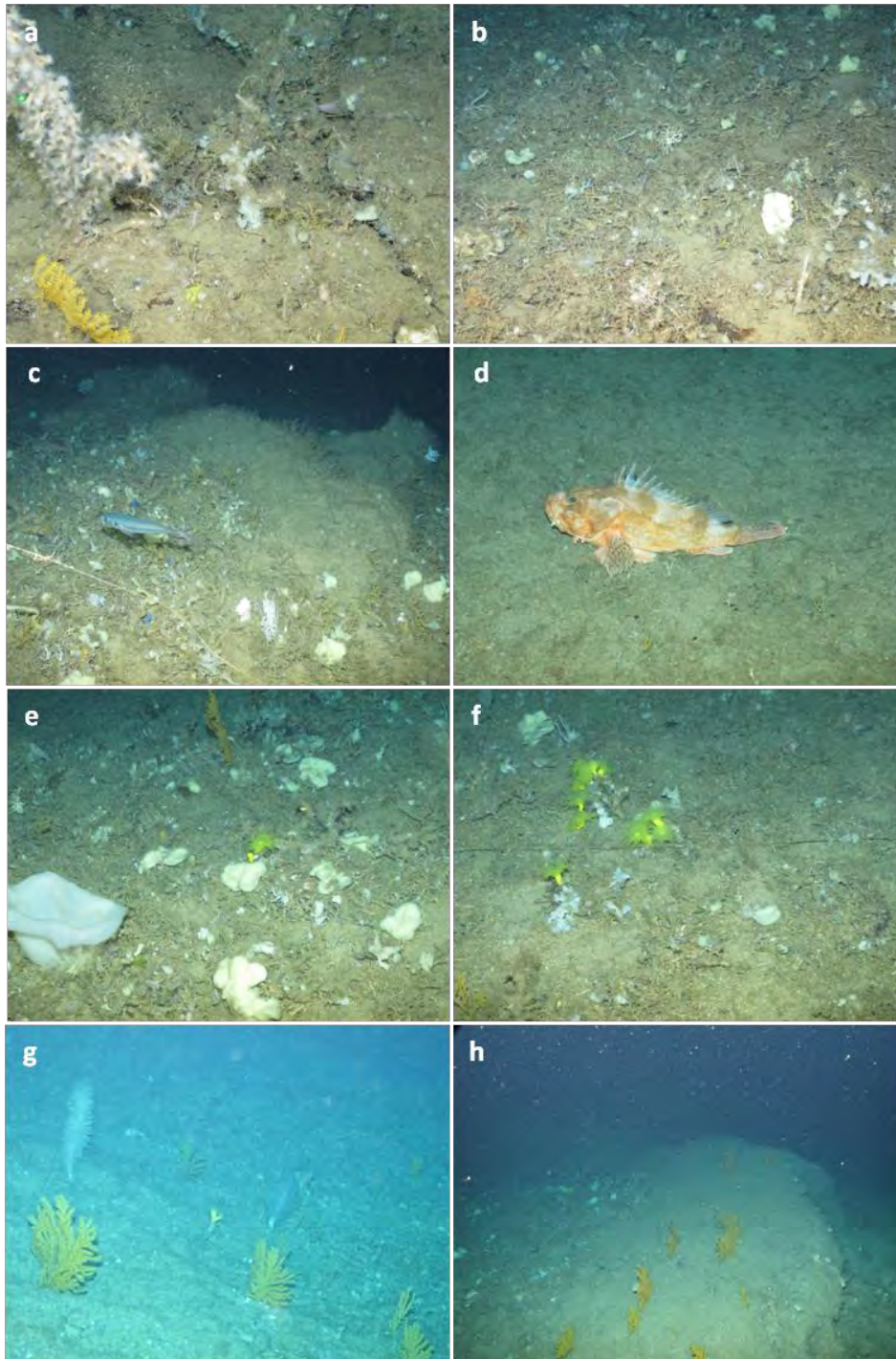

Figure 26: Communities documented in the E side of Seco de los Olivos at 250-220 meters depth. Substrate with coral rubble and occurrence of zoanthidea (a) and diverse sponge and cnidaria fauna, sponge fields (e), small *Dendrophyllia cornigera* colonies, communities dominated by *Acanthogorgia*-like gorgonians with presence of bottle brush black corals and *D. cornigera* (g,h).

25.10.2016. St. 210. Seco de los Olivos. South East side. Dive#24

Depth range. 560-280 m

Transect dominated by soft bottoms with coral rubble (Fig. 27b). In the soft bottom areas *Cerianthus*, sea cucumbers, alcyonacea and *Cidaris*-like dominated (Fig. 27d). Fish, including sharks were also frequent through the transect (Fig. 27a, b, e, f). Footprints of anthropogenic activity were also visible: remainings of long lines but also glass bottles (Fig. 27 c). In the areas were coral rubble were present also isolated small colonies of *Lophelia pertusa* were detected.

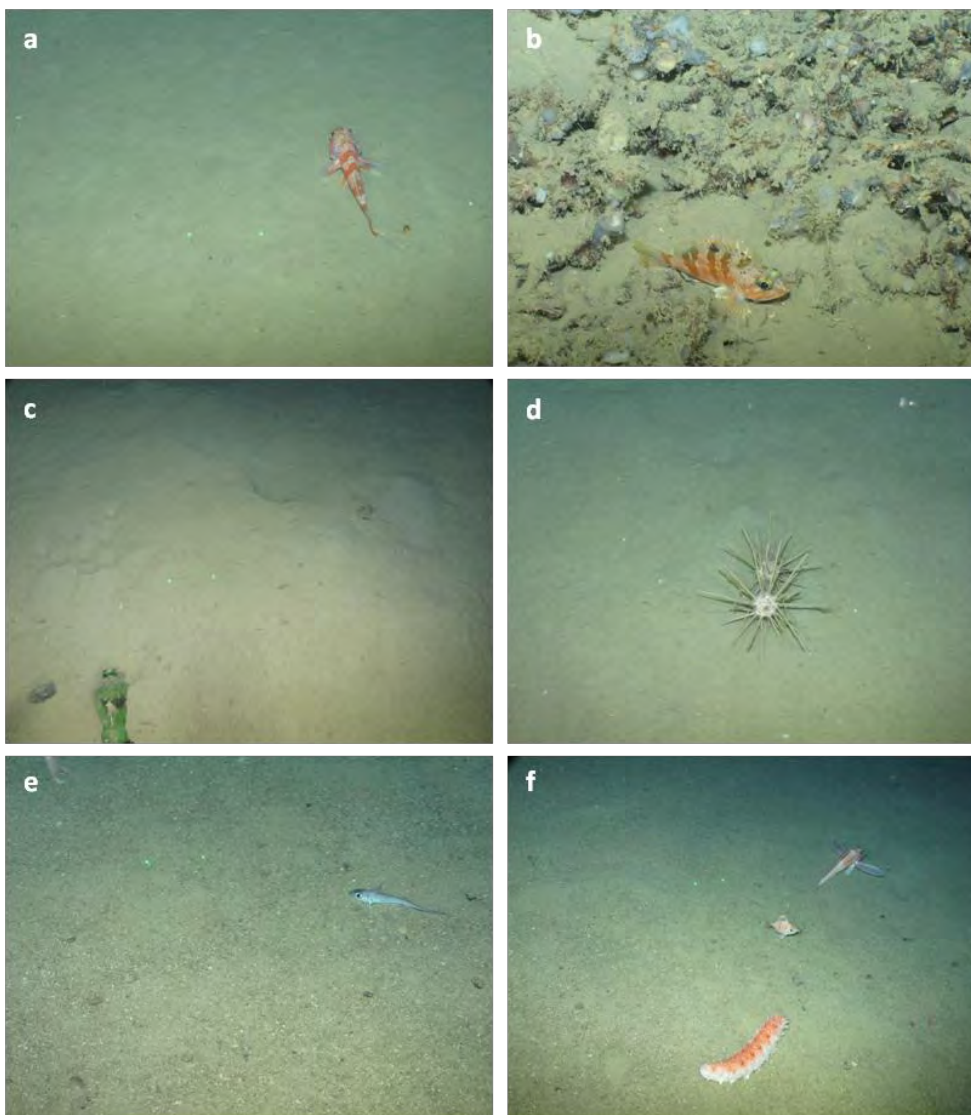

Figure 27: South east side of Seco de los Olivos at 560-280 meters depth. Soft substrate areas dominated, with presence of coral rubble in some zones (b). Mobile fauna was abundant and diverse through the transect (a, b, d, e, f), foot prints of anthropogenic activities have also been documented (c).

25.10.2016. St. 211. Seco de los Olivos. South East side. Dive#25

Depth range. 447-300 m

This area was characterized by rocky substrate covered by sediment. High density of shrimps and crinoids was detected associated to the rocks (Fig. 28a,b). The rocky areas were colonized by sponges (e.g. *Asconema setubalense*, Fig. 28 e) and cnidarians, including *Parazoanthus*, *Madepora*, *Lophelia*, *Dendrophyllia cornigera* and *Viminella*-like specimens. The occurrence of *Cidaris*-like was also detected as well as the presence in the soft substrate of the seapen *Kophobelemnon stelliferum*. Several areas of the transect were characterized by a marked slope and in several places remaining of long lines and nets were recorded.

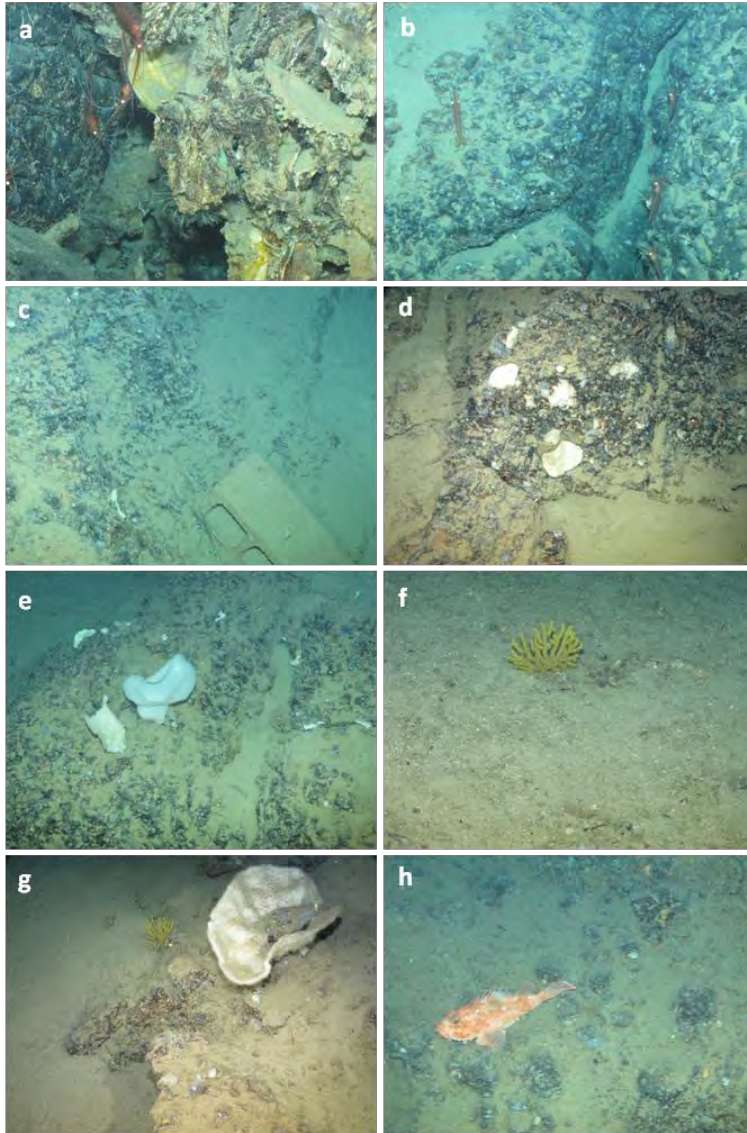

Figure 28: Communities in the SE side of Seco de los Olivos, rocky substrate with presence of shrimps and crinoids (a, b), dominance of sponges (d, e ,g) and cnidarians (f) and presence of fish (h), anthropogenic footprint (c).

Acknowledgements

Many thanks are due to the survey team: Jesús, Miriam and Juancho for their fantastic work on board. Thanks also to the ACSM-ROV team for their impeccable and professional work. Many thanks also to the UTM for their technical support. We are grateful to the master of the RV Sarmiento de Gamboa and the whole crew who make possible and very pleasant our work on board.

References

- Gori A, Orejas C, Madurell T, Bramanti L, Martins M, Quintanilla E, Marti-Puig P, Lo Iacono C, Puig P, Requena S, Greenacre M, Gili JM (2013) Bathymetrical distribution and size structure of cold-water coral populations in the Cap de Creus and Lacaze-Duthiers canyons (northwestern Mediterranean). *Biogeosciences* 10:2049-2060
- Grinyó J, Gori A, Ambroso S, Purroy A, Calatayud C, Dominguez-Carrió C, Coppari M, Lo Iacono C, López-González PJ, Gili J-M (2016) Diversity, distribution and population size structure of deep Mediterranean gorgonian assemblages (Menorca Channel, Western Mediterranean Sea). *Progress in Oceanography* 145:42-56
- Huvenne VAI, Tyler PA, Masson DG, Fisher EH, Hauton C, Huhnerbach V, Le Bas TP, Wolff GA (2011) A Picture on the Wall: Innovative Mapping Reveals Cold-Water Coral Refuge in Submarine Canyon. *Plos One* 6
- Orejas C, Gori A, Lo Iacono C, Puig P, Gili JM, Dale MRT (2009) Cold-water corals in the Cap de Creus canyon, northwestern Mediterranean: spatial distribution, density and anthropogenic impact. *Marine Ecology Progress Series* 397:37-51
- Purser A, Orejas C, Gori A, Unnithan V, Thomsen L (2013) Local variation in the distribution of benthic megafauna species associated with cold-water coral reefs on the Norwegian margin. *Cont Shelf Res* 54:37-51
- Savini A, Vertino A, Marchese F, Beuck L, Freiwald A (2014) Mapping Cold-Water Coral Habitats at Different Scales within the Northern Ionian Sea (Central Mediterranean): An Assessment of Coral Coverage and Associated Vulnerability. *PloS one* 9:e87108

9.9 Zooplankton sampling test with a new sampler prototype for the Liropus ROV

Juancho Movilla¹, Alejandro Olariaga², Covadonga Orejas³, Jesús Rivera⁴, Alberto Romero⁵, Rubén Calderón⁵, Carlos Méndez⁵

1. Instituto de Ciencias del Mar (CSIC), Barcelona, Spain
2. Can Busquets s/n, Llinar del Vallés, Spain
3. Instituto Español de Oceanografía, Centro Oceanográfico de Baleares, Palma, Spain
4. Instituto Español de Oceanografía, Servicios centrales, Madrid, Spain
5. ACSM, A Coruña, Spain

9.9.1 Personnel involved

A. Olariaga, who was the designer and constructor of the device, was not on board. The team involved in the operation of the device are included in the table below.

MEDWAVES-ATLAS Cruise LEG 1

Cádiz – Ponta Delgada (21/09 – 13/10/2016)

	Name	Institution	Role and responsibilities
1	J. Movilla	ICM-CSIC	Adaptation and fixing of the sampler to the ROV
2	A. Romero	ACSM	Adaptation and fixing of the sampler to the ROV
3	C. Méndez	ACSM	Operation of the sampler to the ROV
4	R. Calderón	ACSM	Operation of the sampler to the ROV
5	J. Rivera	IEO	Preparative work

			in ACSM base station. Operation survey
--	--	--	--

MEDWAVES-ATLAS Cruise LEG 2

Ponta Delgada – Málaga (14/10 – 26/10/2016)

	Name	Institution	Role and responsibilities
1	J. Movilla	ICM-CSIC	Adaptation and fixing of the sampler to the ROV
2	A. Romero	ACSM	Adaptation and fixing of the sampler to the ROV
3	C. Méndez	ACSM	Operation of the sampler to the ROV
4	R. Calderón	ACSM	Operation of the sampler to the ROV

9.9.2 Introduction. Aims

The zooplankton sampler was conceived as a small device connected to an electrical pump already installed in the ROV Liropus. This prototype should be able to collect several zooplankton samples in each ROV dive (three replicates) and to allow having quantitative data of the planktonic communities living around the targeted benthic communities (ATLAS Task 3.3).

9.9.3 Instrumentation details. Construction and adaptation to the Liropus ROV

Previous to MEDWAVES cruise, since the ROV Liropus was placed in Naron (Galicia, NW Spain) some visits were organized to that place in order to perform the prototype installation. During the first encounter, a first contact with the ROV Liropus and the company operating this device (ACSM) was made. Some technical aspects were decided in this meeting, as the location and size of the zooplankton sampler, the connection between the sampler and the electrical pump of the ROV, the suitable mesh size for filtering, the diameter of the suction tube and other aspects related with the

operation of the hydraulic arms. It was decided that the sampler should be located in replacement of a pump pre-filter already located in the port side of the ROV. The size of the sampler was set as 39 x 25 x 24 cm (high/width/depth) and it would be fixed to the ROV with stainless steel rods. The suction tube and the sample collectors will be made on acrylic of 32 and 40 mm diameter, respectively. Other aspects were discussed during this visit, as the step by step rotation gear for the sample collectors. An electrical or hydraulic trigger system was initially proposed by the zooplankton sampler constructor. However, the personal from ACSM considered this kind of mechanisms to be neither feasible, since all the hydraulic and electrical connections of the ROV will be used for other purposes during the MEDWAVES dives. Finally, it was decided that the sampler will have a mechanical trigger system activated with one of the ROV's hydraulic arm.

A second visit to the ACMS headquarter was arranged once the filtration system was ready. The main objective of this meeting was to install the prototype in the ROV in the same way that was previously planned. A test was done in-situ (out of the water) once the system was installed in the ROV. Several shots of the step by step rotation gear were successfully completed and everything worked as expected. The zooplankton sampler could not remain permanently installed since another ROV configuration was needed for a previous expedition to MEDWAVES. It was decided (together with the ROV personnel from ACSM) that the zooplankton sampler will be installed in Cádiz the day before the beginning of MEDWAVES. The figure 1 shows the zooplankton sampler prototype.

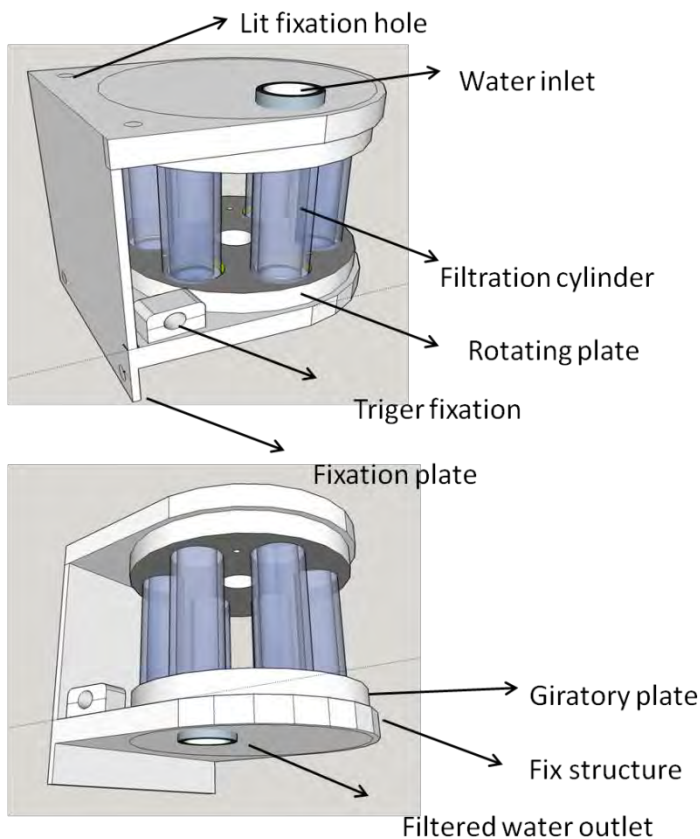

Figure 1: Design of the zooplankton sampler prototype to be installed in the ROV Liropus.

The suction tube is connected to one of the hydraulic arm of the ROV by stainless steel plates equipped with a support assembly made of PVC that can be regulated to different angles (22.5, 45, 68 and 90°) allowing all movements of the hydraulic arm (Figs. 2, 3 and 4). The 40 mm diameter suction tube is made on transparent acrylic and it is connected to the ROV pump with a 40 mm diameter flexible hose specially designed for suction. A perforated PVC plate with 5 mm hole is located in the upper side of the suction tube and acts as a pre-filter to avoid the entry of big sediment particles into the pump or the sample collectors.

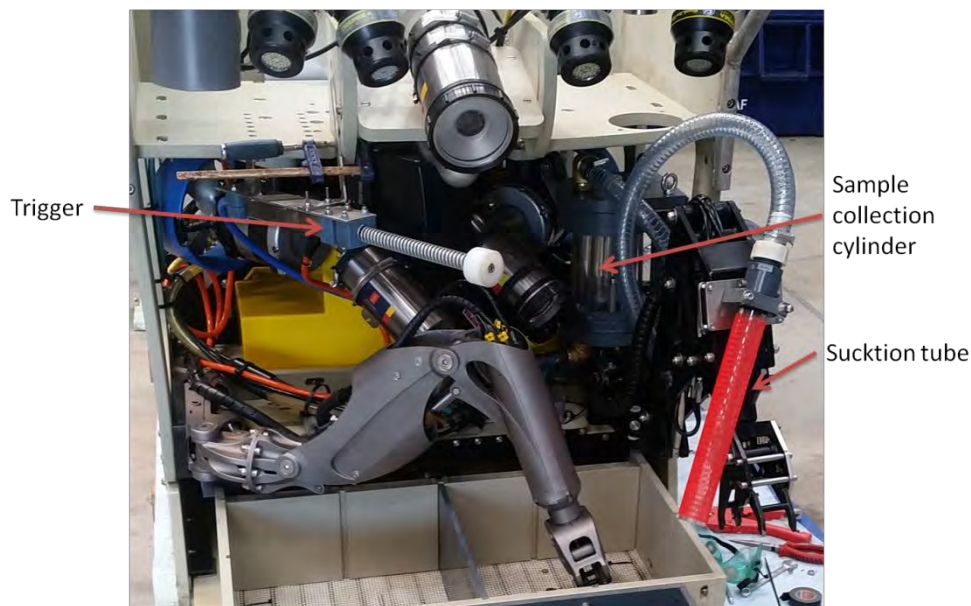

Figure 2: Zooplankton filtration system installed in the ROV Liropus in the ACSM headquarter.

Sea water inlet (with plankton)

Fix plate – Connection between the sampler and the ROV

Rotating part equipped with filtrating cylinders

Flexible stainless steel wire. Connect trigger with the rotation gear teeth

Step by Step rotation gear

Filtered water outlet

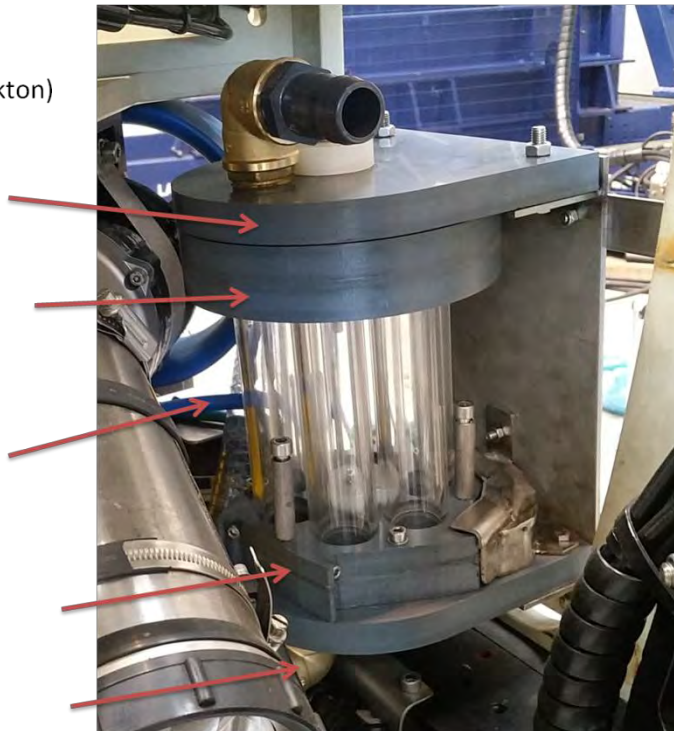

Figure 3: Details of the zooplankton filtration system installed in the ROV Liropus. The six acrylic collectors for the zooplankton samples are displayed.



Figure 4: Suction tube installed in one of the hydraulic arms of the ROV Liropus.

The figure 5 shows the step by step rotation gear. This mechanism contains 6 acrylic cylinders of 150 mm high. Three of these cylinders are empty and the other three have a 200-um mesh size. The empty ones allow the system to capture small fragments of corals or other organisms, while the cylinders equipped with the mesh are designed to filter the seawater to capture zooplankton. The step by step rotation gear is activated

by a stainless-steel wire connected to the mechanical trigger and alternate the different cylinders.



Figure 5: Step by step rotation gear and connection of the suction hose to the upper part of the sample collector.

The figure 6 shows the mechanical trigger that has a maximal stroke of 130 mm and allows turning the cylinder to the six positions, one for each acrylic sample collector.

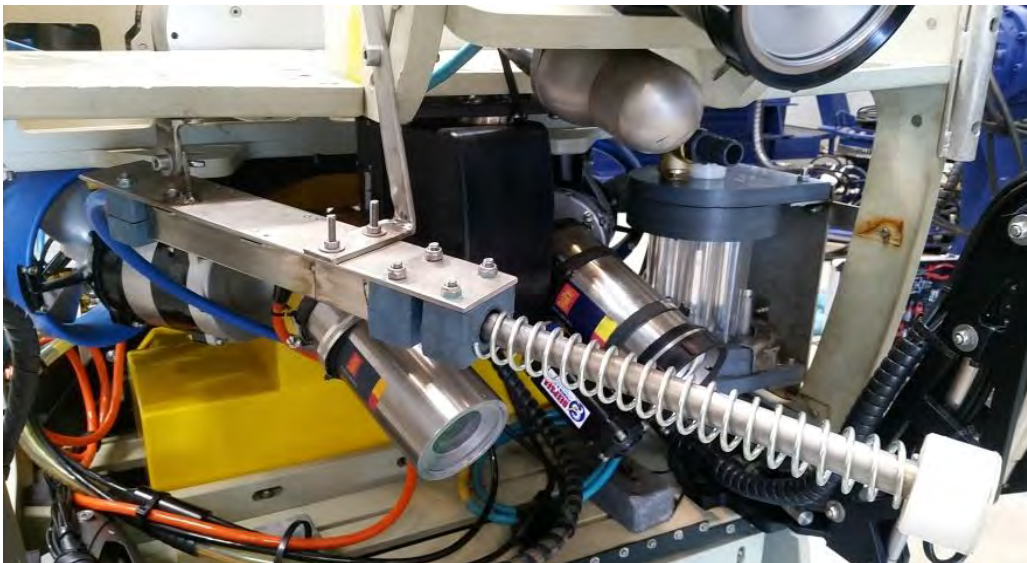

Figure 6: Mechanical trigger that allows turning the step by step rotatory gear to change the six sample collectors.

9.9.4 Problems encountered

When we arrived to the port of Cádiz to perform the installation of the filtering prototype, we realized that the ROV had a different configuration to the original one accorded in the first meeting in the ACSM headquarter. This was due to the requirements demanded during the last cruise in where the ROV was involved before the beginning of MEDWAVES cruise. The new illumination and photographic equipment placed in the bow of the ROV did not allow the fixation of the trigger of our filtration system in the agreed position. Finally, after several attempts with the ROV technicians, we decided to install the mechanical trigger in the starboard side of the ROV. It was the only available place to avoid interfere with the other installed equipment. The principal problem detected in this position was that the hydraulic arm had not enough strength to shoot the mechanical trigger. We did several modifications into the trigger and into the fixation angles and we finally found an acceptable position that allowed the hydraulic arm to work properly. However, we realized a round test on deck and we detected that when the hydraulic arm was not able to do the whole extending stroke of 130 mm in a continuous movement, the rotation gear could remain in a 'dead place', being then necessary to manually relocated the rotatory gear again into the correct position. We decided to do the first tests with this setting enabled and to perform on board the necessary modifications throughout the cruise.

9.9.5 Operation on board

Once on board and throughout the MEDWAVES cruise we detected some problems in the operation of the prototype. Due to the modifications done in the Port of Cádiz, the actuation of the mechanical trigger was not the most appropriate once the ROV was in water, and in several cases the hydraulic arm was unable to perform the complete movement of the rotatory gear. As we observed on port, this caused that the stainless-steel cable remained in a neutral position, being then necessary to operate the rotatory gear manually on deck once the ROV was recovered. We decided to make modifications on the initial design to optimize the operation of the filtering prototype, removing the mechanical drive and opting for a hydraulic trigger. To do this and thanks to the help of the ACSM team on board, we use one of the hydraulic piston of the second arm of the ROV to operate the steel cable that acts as a trigger. The use of this hydraulic piston, with a stroke less than the mechanical trigger (100 and 130 mm, respectively), meant also to modify the step by step rotatory gear that changes the sample collectors. The modifications carried out resulted in 100% success in all tests done and allowed us to perform the first sampling of zooplankton. However, once the system was working properly, we detected a second problem. After several attempts at different depths, with different concentration of zooplankton (seen

by the ROV camera) and different sampling times, we observed that the zooplankton capture was very low. This was probably due to the escape velocity of the zooplankton and to the diameter of the suction acrylic tube, designed at first as a multifunction tool, both for catching coral fragments (a function that was perfectly fulfilled throughout the campaign) and for sampling the zooplankton. It is for this reason that we consider interesting to continue testing the prototype in this line and to have on mind the possibility of a variable opening system for the suction tube according to the requirements in next dives with the ROV Liropus.

9.10 Evolutionary ecology. Sampling for eDNA (WP3) and connectivity (WP4)

Sophie Arnaud-Haond¹, Joana Boavida¹, Anna Maria Addamo², Maria Rakka³, Gerald Taranto³, Juancho Movilla⁴

1. L'Institut Français de Recherche pour l'Exploitation de la Mer, IFREMER, Montpellier, France
2. Museo Nacional de Ciencias Naturales (CSIC), Madrid, Spain
3. Institute for Marine Research (IMAR), Azores, Portugal
4. Instituto de Ciencias del Mar (CSIC), Barcelona, Spain

9.10.1 Personnel involved

MEDWAVES-ATLAS Cruise LEG 1

Cádiz – Ponta Delgada (21/09 – 13/10/2016)

	Name	Institution	Role and responsibilities
1	Sophie Arnaud-Haond	IFREMER, sarnaud@ifremer.fr	Coordination, sampling, redaction cruise report. Leader WP4 ATLAS
2	Maria Rakka	IMAR, marianinha.rk@gmail.com	Sampling, redaction of the cruise report
3	Juancho Movilla	ICM-CSIC, jmovilla@icm.csic.es	Sampling

MEDWAVES-ATLAS Cruise LEG 2

Ponta Delgada – Málaga (14/10 – 26/10/2016)

	Name	Institution	Role and responsibilities
1	Joana Boavida	IFREMER, joanarboavida@gmail.com	Sampling, redaction cruise report
2	Anna Maria Addamo	Museo Nacional de Ciencias Naturales (MNCN-CSIC), am.addamo@gmail.com	Sampling
3	Gerald Taranto	IMAR, gh.taranto@gmail.com	Sampling

9.10.2 Introduction. Aims

The current lack of knowledge on deep-sea ecosystems prevents our understanding of their role and functioning within the global ocean, and hampers their protection through efficient Policies and Conservation and Management measures (see Costello *et al.* 2010, Hughes *et al.* 2015, Miller *et al.* 2009). The MEDWAVES research cruise

covers two case studies of the EU project ATLAS (A Trans-Atlantic assessment and deep-water ecosystem-based spatial management plan for Europe): Case Study 7. Gulf of Cádiz/Strait of Gibraltar/Alborán Sea (Spain and Portugal) and Case Study 8. Azores (Portugal). The sampling performed on deep-sea ecosystems aims at feeding two work packages: WP3 on resilient biodiversity and WP4 on connectivity. WP3 aims at assessing biodiversity in different ecosystems in the Atlantic (e.g., seamounts), to unravel the extent, heterogeneity and distribution of benthic assemblages, and to understand the environmental drivers of such distribution. WP4 aims at unravelling the pattern of connectivity among populations of deep-sea species that characterize some of the major ecosystems (coral associated ecosystems or chemosynthetic ecosystems) studied in ATLAS. This is where the synergy with oceanographic models developed in WP1 takes place, as these models describe the Atlantic Meridional Overturning Circulation (AMOC) system and its interaction with the Mediterranean Outflow Water (MOW) - a central target of the case studies tackled by MEDWAVES. Once there is a sound understanding of the influence of these current systems on the distribution of biodiversity (WP3) and its connectivity (WP4), Atlas aims to forecast the biotic changes expected (in terms of biodiversity - WP3, and connectivity - WP4) in scenarios of a changed AMOC caused by global change.

DNA approaches developed in ATLAS integrate the following:

WP3: Test next-generation meta-barcode sequencing and environmental DNA (eDNA) technology tools as innovative standardised methods for integrated ecosystem approaches to assess biodiversity of deep-sea ecosystems.

WP4: Unravel the temporal and spatial dynamics of populations of species forming community assemblages revealed through previous projects as well as in the ATLAS case studies and characterized through WP3.

Aims

MEDWAVES Case Studies are focused on the interaction between the AMOC and MOW in terms of oceanography and biology (diversity distribution and connectivity). The specific aims of MEDWAVES relative to DNA sampling were:

WP3: To measure the effects of MOW export on the biodiversity of cold-water coral communities from the Gibraltar Strait where MOW penetrates deep into the Mid-Atlantic as part of the ATLAS Case Studies: Azores-Gulf of Cádiz-Alborán Sea.

WP4: To position the Azores on the connectivity map history of cold water coral populations (colonization) with the Western and Eastern Atlantic. This is a central

information that will allow uncovering the potential role of populations from the Azores in maintaining cross-Atlantic connectivity.

MEDWAVES objective was thus to gather samples of eDNA (e.g., seawater and sediment samples) and specimens of species targeted for population genetics and connectivity assessment from the Alboran Sea to the Azores to:

- * describe the deep-sea diversity of ecosystems harbouring coral and sponge-associated communities and diversity changes from the Mediterranean to the Mid-Atlantic;

- * verify if next generation DNA sequencing approaches can efficiently detect deep-sea Vulnerable Marine Ecosystem (VME) indicator species or pelagic marine animals visiting seamounts and therefore be used to identify important areas for conservation (Sinniger *et al.* 2016). As a preliminary approach, we collected water samples for eDNA analyses around known cold-water coral reefs and gardens and on several seamounts, and performed *in situ* census for detecting the presence of particular species. In addition we sampled the open ocean to compare and validate negative results. If eDNA can successfully help identifying deep-sea VME indicator species, we will expand our sampling efforts to many deep-sea areas and seamounts in the North Atlantic, and in other parts of the globe. Therefore, this new improved framework may represent an important tool to increase seamount knowledge and promote seamount conservation;

- * infer the connectivity of a set of target species broadly distributed through population genomics (e.g., scleractinians and associated species, octocorals).

This last point was particularly relevant in MEDWAVES as the cruise allowed targeting two strategic sites to understand past and present connectivity, and thus advance toward improved forecasts. First, the Gibraltar strait constitutes a transition zone for many shallow water species (Patarnello *et al.* 2007), likely a remnant of glacial ages. This transition zone can move between Gibraltar and Alboran Sea and deserves to be assessed to determine its existence and location for deep-sea species, relatively to the positioning of MOW. Second, the Azores may have had a specific role (in terms of connectivity) during the glacial age and, given their central position in the Atlantic, raise the question of their relationship with eastern and western populations (Matos *et al.* 2015). Also, MEDWAVES sampling will contribute towards uncovering the Azores potential past and present role as a source or stepping stone in meta-population systems distributed across the Atlantic and possibly connected with Mediterranean ones (Henry *et al.* 2014).

9.10.3 Sampling methodology

9.10.3.1 WP3: Instruments used to sample eDNA¹

Water samples were collected during the MEDWAVES cruise for feeding ATLAS WP3 objectives, namely to validate eDNA methods for monitoring and screening deep-sea biodiversity. UCD and IMAR focused on evaluating quantitative qPCR as a sensitive tool to detect and quantify biomass of keystone species. A standardized scheme was followed, comprising water collection at the bottom, mid-water, and upper-water depths, filtered with 47 mm diameter 0.47 µm pore size nylon filters, preserved in ethanol, and stored in a fridge (4 °C). IFREMER focused on evaluating the performance of next generation meta-barcoding for assessing deep-sea biodiversity. A standardized scheme was also followed, comprising water sampling at the bottom, the depth of Mediterranean Outflow Water (MOW) as determined by observation of CTD profiles, the depth of Antarctic apparent signature, the Chlorophyll maximum, and at 250 m depth. Water samples were filtered with 2 µ, 0.2 µ and 0.02 µ pore size filters and preserved at -80°C for meta-barcoding.

The CTD-rosette was used to collect water samples from different layers of the water column:

- qPCR detection of VMEs associated and exploited species (IMAR/UAC): 2 samples from Gazul, 7 from Ormonde, 4 from Formigas, 4 from Seco de los Olivos. Each of these samples comprised bottom, mid and surface water and they were spaced on and of seamount summits (Table 1);
- Community composition through meta-barcode (this goal was updated onboard, following the work of the IEO oceanographic team on the signature of water masses; IFREMER): 3 samples per site, 4 depths per sample in Formigas (bottom, at the approx. depths of the possible signatures of Antarctic water, and Mediterranean Outflow Waters, 250 m and at the Chlorophyll maximum (Chlor. max.), 4 depths per sample in Ormonde on return (signatures of the Atlantic, MOW, at 250 m depth and at the Chlor. max.) and in Seco de los Olivos (bottom, Atlantic water, i.e., surface, Mediterranean water at depths determined with the CTD data from the IEO team, and Chlor. max.). To assess the composition of plankton communities (micro, nano and picoplankton) associated to the different

¹ Protocols circulated among ATLAS partners and annexed (Appendix XIV) to this cruise report. As a note, intensive disinfection of tools was performed on board between each MUC slice and filter using a solution of 4% bleach, abundantly rinsed with Ethanol 96% and MilliQ water from the lab (as bleach degrades DNA it is important that no trace of bleach are left on the tools before sampling or filtering again).

water masses, 5 liters of water from each sample were filtered on-board through 47 mm diameter filter membranes of 2 microns followed by 0.2 microns. A sample of between 2 L and 200 mL of this filtered water was then filtered through 25 mm diameter membranes of 0.02 microns.

A Niskin bottle adapted on the ROV was used to sample water from the interface with the sediment:

- Contribution to community composition through meta-barcode: Niskins of 2 L (sometimes 1.5 L) filtered on-board through 2, 0.2 and 0.02 microns to contribute to local benthic community inventories.

A multicore (MUC) was deployed whenever it was possible, to obtain replicates of sediment samples to which different treatment/analyses can be applied:

- Three core of sediment for eDNA cut in a maximum of nine layers and preserved at -80°C to contribute to local benthic community inventories;
- Together with 3 cores with similar slicing for either Ethanol 96% or formalin preservation for morphological comparison of biodiversity assessment;
- During the cruise also three times the three extra cores were conditioned for microplastic detection (this is a potential contribution of MEDWAVES to an Ifremer project);
- Finally, in each of the 0-1 cm layer for eDNA analysis, 4 spoons of sediment were collected and preserved at -20°C for further biochemical analysis (as a contribution to the team of Teodoro Ramirez in Malaga, COM, see corresponding chapter 9.5).

The following tables (1 to 3) present the inventory of the samples collected using the different gears for WP3

Table 1: qPCR water samples collected and filtered during MEDWAVES (IMAR & UDC). b = bottom water, m = mid-water, s = surface water. Coordinates in WGS1984.

Area	Station	Depth (m)		Lat	Lon
Gazul	13	570	b	36.45	-7.002
	13	250	m	36.45	-7.002
	13	5	s	36.45	-7.002
		436	b		
	16			36.501	-6.886
	16	200	m	36.501	-6.886
	16	25	s	36.501	-6.886
Ormonde	39	1894	b	36.883	-10.906

	39	1100	m	36.883	-10.906
	39	5	s	36.883	-10.906
	41	925	b	36.797	-10.985
	41	500	m	36.13	-10.152
	41	5	s	36.13	-10.152
	43	80	b	36.71	-11.143
	43	50	m	36.71	-11.143
	43	5	s	36.71	-11.143
	150	1162	b	36.72	-11.298
	150	500	m	36.72	-11.298
	150	25	s	36.72	-11.298
	151	875	b	36.716	-11.246
	151	500	m	36.716	-11.246
	151	25	s	36.716	-11.246
	159	1344	b	36.846	-11.105
	159	700	m	36.846	-11.105
	159	25	s	36.846	-11.105
	164	1365	b	36.7	-10.986
	164	700	m	36.7	-10.986
	164	25	s	36.7	-10.986
Formigas	50	1776	b	37.159	-24.56
	50	1000	m	37.159	-24.56
	50	5	s	37.159	-24.56
	52	1460	b	37.216	-24.666
	52	1000	m	37.216	-24.666
	52	5	s	37.216	-24.666
	69	300	b	37.284	-24.787
	69	150	m	37.284	-24.787
	69	5	s	37.284	-24.787
	71	1311	b	37.3	-24.82
	71	700	m	37.3	-24.82
	71	25	s	37.3	-24.82
Seco de los Olivos	172	84	b	36.517	-2.849
	172	50	m	36.517	-2.849
	172	5	s	36.517	-2.849
	188	891	b	36.423	-2.835
	188	500	m	36.423	-2.835
	188	25	s	36.423	-2.835
	191	250	b	36.564	-2.76
	191	100	m	36.564	-2.76
	191	25	s	36.564	-2.76
	204	755	b	36.423	-2.963
	204	500	m	36.423	-2.963
	204	25	s	36.423	-2.963

Table 2: Water samples collected and filtered during MEDWAVES. Niskin refers to a Niskin bottle attached to the ROV; CTD refers to the CTD Rosette (see text for further

details). Ifremer and Imar&UCD indicate at which institute the corresponding samples will be analysed. St= station, btl= bottle.

Water	Ifremer Niskin	Sts.	Depth (m)	Imar & UCD	Ifremer	St.	Depth (m)
Gazul	1 btl			2 CTD 3 Depths	-		
Ormonde	5 btl	3, 16, 17, 18	696, 950, 1,084, 1,920	3 CTD 3 Depths	3 CTD 4 Depths	206/164, 213/149, 217/141	62, 100, 250, 300, 1,000, 1,155, 1,496, 1,623
Formigas	4 btl	4, 6, 7	250, 779, 1,160, 1,550	4 CTD 3 Depths	3 CTD 5 Depths	316/83, 330/108, 373/134	250, 720, 750, 800, 820, 900, 1,000, 1,147, 1,720, 1,400
Seco de los Olivos	3 btl	21, 25	346	4 CTD 3 Depths	3 CTD 4 Depths	506/175, 507/175, 521/202	25, 44, 47, 50, 250, 500, 942, 1,072

Table 3: Sediment samples collected and conditioned for metabarcode during MEDWAVES. Ifremer indicates at which institute the corresponding samples will be analysed. St= station.

Location	Ifremer	St. Nr	Depth (m)
Gazul	2 MUC (penetrated half depth) for eDNA	22, 23	470
Ormonde	1 MUC for eDNA and taxonomy	38	1920, 1925
Formigas	2 MUC for eDNA and taxonomy	68, 117	1245, 1325
Seco de los Olivos	3 MUC for eDNA and taxonomy	179, 201, 215	381, 554, 729

9.10.3.2 WP4: Collection of specimens

Specimens for the connectivity assessment were collected from ROV transects (Fig. 1), in all targeted research areas (Fig. 2), using most often the pince & Slurp gun, sometimes the “net grab”. They were stored in the drawer of the ROV and lifted with it back to the deck. For the first 4 dives pictures were taken on the deck to take advantage of the daylight, thus specimens may not be recommended for metabarcode of bacterial communities. After photographs for the first four ROV dives, and immediately after arrival on deck for all other dives, samples were taken with the

necessary care (i.e., stored at 4 °C thermo-regulated room for processing until fixation). Sampled specimens crossed the water column unprotected in the ROV drawer; nonetheless they might be of interest for microbiology.

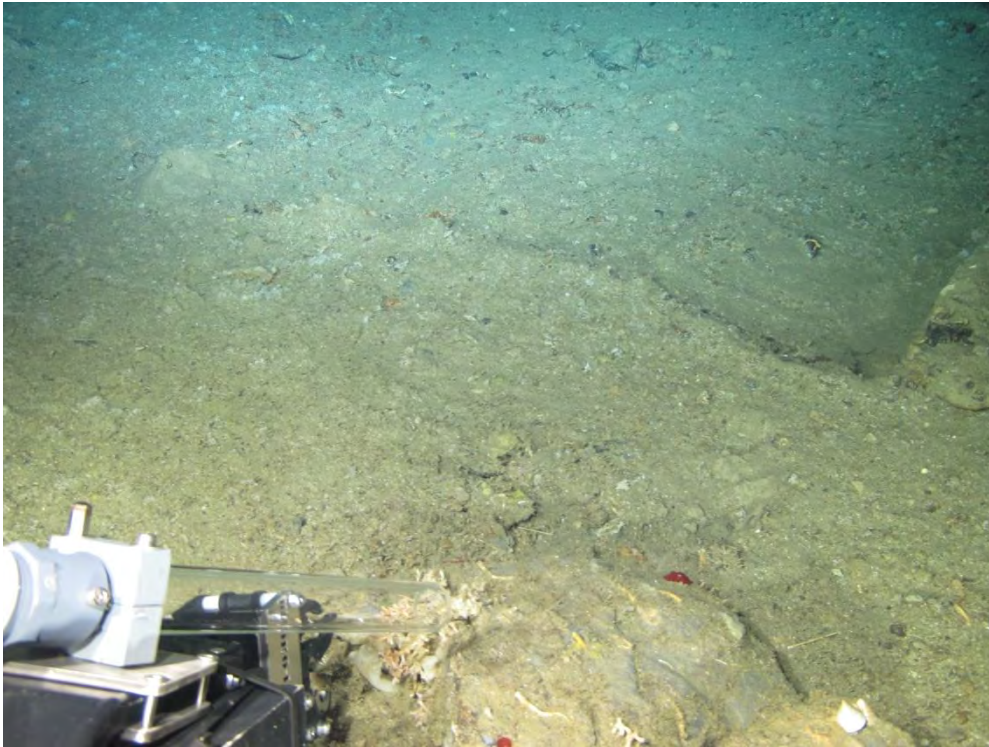

Figure 1: sampling of a *Lophelia pertusa* specimen with the slurp gun of the Liropus ROV.

Most specimens were kept in Ethanol 96% to avoid problems linked to incidental disruption of the cold chain during transport. Samples fixed in Ethanol were stored at -20 °C during the cruise. Some samples were however frozen directly at -80°C to allow future RNA analysis if necessary.

A total of 30 specimens is usually recommended per site in order to optimize chances to obtain significant results when a signal of difference exists, despite weak. It is however usually challenging to meet this magic number due to difficulties in sampling with ROV and the trade-off between the time imparted to observation and transect to that invested in grasping samples.

The following tables (4 and 5) present the inventory of the samples collected using the ROV for WP4.

Table 4: Target species for the WP4 to undergo population genomics analyses, with the number of specimens sampled per site (**top** - samples collected for DNA analyses; **bottom** - RNA analyses).

Target Species	Gazul	Ormonde	Formigas	Seco de los Olivos
<i>Dendrophyllia cornigera</i>	1	1		24
<i>Desmophyllum dianthus</i>		3		2
<i>Lophelia pertusa</i> ²	5	3	8	5
<i>Madrepora oculata</i>	6	5	9	15
<i>Leiopathes (glaberrima)</i>			3	
<i>Acanella arbuscula</i>	1	2	12	
<i>Acanthogorgia armata</i>			1	1
<i>Eunice norvegica</i>		1	3	2
<i>Pheronema carpenteri</i>			1	

Species (RNA)	Gazul	Ormonde	Formigas	Seco de los Olivos
<i>Dendrophyllia cornigera</i>	1			1
<i>Lophelia pertusa</i> ³	4		2	1
<i>Madrepora oculata</i>	3		1	
<i>Solenosmilia variabilis</i>		1		
<i>Callogorgia-like</i> *				
<i>Corallium tricolor</i>		1		
<i>Narella bellissima</i>		1		
<i>Zoantharia sp.1</i>		1		
<i>Eunice norvegica</i>			1	

*possibly *Narella* sp.

² *Lophelia pertusa* is currently under revision for the taxonomy Addamo AM, Vertino A, Stolarski J, *et al.* (2016) Merging scleractinian genera: the overwhelming genetic similarity between solitary *Desmophyllum* and colonial *Lophelia*. *BMC Evolutionary Biology* **16**, 1-17.

Table 5: Non-target species collected for WP4, with the number of specimens sampled per site.

Non-target Species	Gazul	Ormonde	Formigas	Seco de los Olivos
<i>Solenosmilia variabilis</i>		3		
<i>Crypthelia</i>			1	
<i>Candidella imbricata</i>		1		
<i>Callogorgia-like*</i>				2
<i>Chrysogorgia</i>			1	
<i>Corallium tricolor</i>		1		
<i>Narella bellissima</i>		1		
<i>Narella sp.1</i>			2	
<i>Narella sp.2</i>			1	
<i>Placogorgia</i>		1		
Plexauridae sp. 1			1	1
Plexauridae sp. 2		1		
Plexauridae sp. 3		1		
<i>Stichopathes sp.</i>			1	
Stolonifera			1	
<i>Swiftia sp.</i>			1	
<i>Victogorgia josephinae</i>	1			
Zoantharia sp.1		2		
Zoantharia sp.2		1		
Demospongiae N.ID		1		
Glass sponge			1	
<i>Hyalonema sp.</i>		1		
<i>Pheronema carpenteri</i>			1	
<i>Polymastia cf.</i>		3		
Porifera sp. (flabelliforme white sponge)		1		
<i>Stelletta cf.</i>		1		
Polychaete		1		
Ophiuroidea sp.1		1		
Ophiuroidea sp.2		1		
Ophiuroidea sp.3		1		
Crinoidea sp.1		1		4
Crinoidea sp.2		1		
Crinoidea sp.3			6	
Crinoidea sp.4			1	

*possibly *Narella sp.*

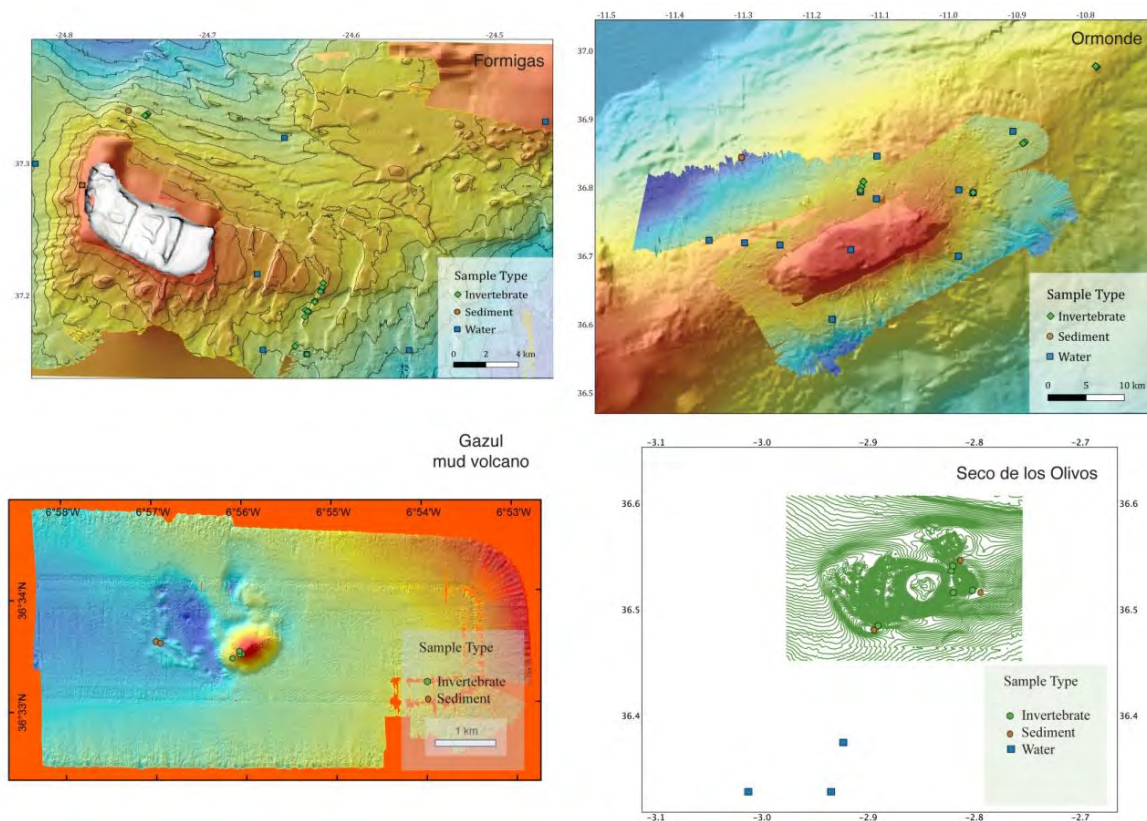

Figure 2: Sampling locations of water, sediment and invertebrate samples for WP3 and WP4.

Postprocessing

Data will be processed as detailed in Atlas GA:

- Metabarcoding will be performed on sediment and Niskin samples as planned during ATLAS for metazoan species. Samples will also be included in the ongoing Ifremer project “Pourquoi Pas les Abysses” for microbial characterization (microbial eukaryotes and prokaryotes, as well as the viral fraction). Additionally, the same protocol will be applied to the CTD water sampled during ATLAS to compare the communities’ composition with the signatures obtained through CTD by the oceanography team;
- qPCR will be performed on water samples by UCD on the basis of CTD water sampled at three or four depths and using specific primers for target species;
- Population genomics will be performed on target species for which a sufficient sampling will be available. Tests are ongoing as planned in ATLAS to perform genome scans on species retained.

9.10.4 Instruments detail and calibration

For instrumentation, calibration and processing see report (chapter 9.1) from the Oceanography team for CTD.

9.10.5 Problems encountered

None

9.10.6 Preliminary results

As all data analyses need to be performed in the lab, no preliminary results can be presented here.

Estimate of total data returns

Depending on the quality of DNA obtained and on the possible obstacles during processing, data production on the basis of those samples should be completed between the end of 2017 and mid 2018.

References

- Addamo AM, Vertino A, Stolarski J, *et al.* (2016) Merging scleractinian genera: the overwhelming genetic similarity between solitary *Desmophyllum* and colonial *Lophelia*. *BMC Evolutionary Biology* **16**, 1-17.
- Costello MJ, Coll M, Danovaro R, *et al.* (2010) A census of carine biodiversity knowledge, resources, and future challenges. *Plos One* **5**, -.
- Henry LA, Frank N, Hebbeln D, *et al.* (2014) Global ocean conveyor lowers extinction risk in the deep sea. *Deep-Sea Research Part I-Oceanographic Research Papers* **88**, 8-16.
- Hughes DJ, Shimmield TM, Black KD, Howe JA (2015) Ecological impacts of large-scale disposal of mining waste in the deep sea. *Sci Rep* **5**.
- Matos L, Mienis F, Wienberg C, *et al.* (2015) Interglacial occurrence of cold-water corals off Cape Lookout (NW Atlantic): First evidence of the Gulf Stream influence. *Deep-Sea Research Part I-Oceanographic Research Papers* **105**, 158-170.
- Miller K, Neil H, Tracey D (2009) Recent advances in deep-sea coral science and emerging links to conservation and management of deep-sea ecosystems. *Marine Ecology Progress Series* **397**, 1-5.
- Patarnello T, Volckaert FAMJ, Castilho R (2007) Pillars of Hercules: is the Atlantic-Mediterranean transition a phylogeographical break? *Molecular Ecology* **16**, 4426-4444.
- Sinniger F, Pawlowski J, Harii S, *et al.* (2016) Worldwide analysis of sedimentary DNA reveals major gaps in taxonomic knowledge of deep-sea benthos. *Frontiers in Marine Science* **3**.

9.11 Ecophysiology of cold-water corals and coral maintenance in aquaria

Juancho Movilla¹, Núria Viladrich¹, Maria Rakka², Cristina Gutiérrez³, Alberto Aparicio⁴, Covadonga Orejas⁴, Andrea Gori¹

1. Instituto de Ciencias del Mar (CSIC)
2. Institute of Marine Research (IMAR)
3. Aquarium Finisterrae
4. Instituto Español de Oceanografía (IEO), Centro Oceanográfico de Baleares, Palma, Spain

9.11.1 Personnel involved

MEDWAVES-ATLAS Cruise LEG 1

Cádiz – Ponta Delgada (21/09 – 13/10/2016)

	Name	Institution	Role and responsibilities
1	Juancho Movilla	ICM-CSIC jmovilla@icm.csic.es	Coordination, aquaria setting-up, redaction cruise report
2	Maria Rakka	IMAR marianinha.rk@gmail.com	Sampling, aquaria experiment, redaction cruise report

MEDWAVES-ATLAS Cruise LEG 2

Ponta Delgada – Málaga (14/10 – 26/10/2016)

	Name	Institution	Role and responsibilities
1	Núria Viladrich	ICM-CSIC viladrich.nuria@gmail.com	Aquaria experiment, redaction cruise report
2	Cristina Gutiérrez	Aquarium Finisterrae cgz.1991@gmail.com	Aquaria experiment, specimens sampling

9.11.2 Introduction. Aims

The occurrence, distribution and abundance of cold-water coral (CWC) species are strongly influenced by several abiotic factors such as seawater temperature, carbonate chemistry, oxygen concentration, type of substratum, food supply and hydrodynamism (e.g. Orejas et al. 2009, Roberts et al. 2009). One of the objectives in MEDWAVES is to evaluate the physiological response of CWC communities to

changes in these abiotic factors (WP2).

However, there are inherent difficulties for sampling in deep-sea areas and only in recent years has it been possible to apply the available technology for this purpose. In fact, during MEDWAVES cruise, the remotely operated vehicle (ROV) Liropus (IEO) had a main role characterizing the deep benthic communities, thanks to the visualization and video recording of the benthic communities inhabiting the seafloor. Furthermore, this ROV allowed a much targeted sampling methodology of different benthic organisms, which could be used for many different purposes like genetic, taxonomic, morphological analysis or experimental work.

Regarding this experimental work, our team was responsible for the assembly and maintenance of an aquaria system on board to keep alive the collected samples of CWC throughout the entire cruise (Table 1) and to perform four experimental ecophysiology studies with some of those organisms along the second leg. In the last decades considerable efforts have been done conducting studies focused on evaluating the physiological response in CWC simulating several scenarios in aquarium, including different temperature (e.g. Naumann et al. 2013, Gori et al. 2014, Brooke et al. 2015), oxygen concentration (e.g. Maier et al. 2013a, Gori et al. 2016), food availability (e.g. Purser et al. 2010, Orejas et al. 2016) or carbonate chemistry conditions (e.g. Carreiro-Silva et al. 2014, Maier et al. 2013b, Movilla et al. 2014a,b, Hennige et al. 2014). Although we are only beginning to understand the biological processes and the potential impacts of environmental pressures in CWC, this kind of experiments in aquarium conditions can be of great help to understand the physiological limits of the organisms and allow us to get insight in their capability to adapt to different environmental conditions.

Table 1: List of specimens collected during MEDWAVES cruise available for the ecophysiology aquaria experiment.

Location	Station #	Dive #	Date	Longitude (Deg.Dec.)	Latitude (Deg.Dec.)	Depth (m)	Species
Ormonde	20	2	23/9/16	36° 33,4206	6° 56,0794	420	<i>Dendrophyllia</i>
Ormonde	36	3	25/9/16	36° 58,6215	10° 47,0246	1955	<i>Acanella arbuscula</i>
				36° 58,6215	10° 47,0246	1955	<i>Acanella arbuscula</i>
				36° 58,6215	10° 47,0246	1955	<i>Acanella arbuscula</i>
Formigas	65	6	1/10/16	37° 11,3443	24° 37,9202	1255	<i>Madrepora</i>
				37° 11,7141	24° 37,526	1064	<i>Lophelia</i>
Formigas	103	9	4/10/16	37° 20,268	24° 44,5059	1282	<i>Madrepora</i>
				37° 20,1674	24° 44,5632	1188	<i>Lophelia & Madrepora</i>

				37° 20,1882	44° 61,8	1182	<i>Lophelia & Madrepora</i>
Formigas	126	11	7/10/16	37° 20,1108	24° 45,5209	1044	<i>Madrepora</i>
				37° 20,1094	24° 45,5262	1040	<i>Madrepora</i>
				37° 20,1073	24° 45,5255	1039	<i>Madrepora</i>
				37° 20,1071	24° 45,52	1039	<i>Madrepora</i>
Formigas	133	13	8/10/16	-	-	1034	<i>Madrepora</i>
				37° 11,9247	24° 47,9583	1034	<i>Lophelia</i>
				-	-	969	<i>Lophelia</i>
Ormonde	182	21	23/10/16	36° 29,5891	2° 53,406	446	<i>Lophelia</i>
				36° 29,5891	2° 53,406	436	<i>Lophelia</i>
				36° 29,777	2° 53,398	346	<i>Dendrophyllia</i>
Ormonde	192	22	24/10/16	36° 32,522	2° 49,172	317	<i>Madrepora</i>
				36° 32,47	2° 49,204	298	<i>Madrepora</i>
				36° 32,408	2° 49,257	260	<i>Madrepora</i>
Ormonde	196	23	24/10/16	36° 32,341	2° 49,269	244	<i>Dendrophyllia</i>
				36° 32,3047	2° 49,2609	243	<i>Dendrophyllia</i>
				36° 32,2944	2° 49,2629	240	<i>Dendrophyllia</i>
				36° 32,2836	2° 49,2651	239	<i>Madrepora</i>
				36° 32,258	2° 49,253	243	<i>Dendrophyllia</i>
				36° 32,2101	2° 49,2267	247	<i>Madrepora</i>
Ormonde	211	25	25/10/16	36° 30,944	2° 49,125	329	<i>Lophelia</i>
				36° 30,981	2° 49,1307	309	<i>Dendrophyllia</i>

Aims

The general aim of MEDWAVES regarding the ecophysiological studies on CWC was included in WP2; Task 2.4 (Ecophysiology under changing ocean scenarios): Aquarium experiments to measure the physiological responses of different types of benthic communities under predicted environmental changes including ocean acidification, temperature and food supply.

The specific goal of the 4 experiments (2 replicates per treatment) carried out on board along the second leg of the cruise was to assess how the same species of CWC (*Madrepora oculata* and *Lophelia pertusa* collected along the first leg) behave under the influence of two water bodies with different physico-chemical conditions, the Mediterranean (warmer, saltier and more alkaline) and the Atlantic water (lower temperature, salinity and alkalinity). For that purpose, three different physiological processes were analysed: respiration, NH₄ excretion and calcification after a 6-hour exposure to the different conditions.

9.11.3 Sampling Methodology. Aquaria set-up

The experimental set-up was installed inside a thermo-regulated room, ensuring

constant values (~12 °C) during the whole cruise. The aquaria set-up on-board comprised an acclimation 100 liters tank and two experimental 50 liters tanks. Each of these tanks were connected to chiller units (Hailea HC-150) to maintain controlled water temperature (12°C and 7°C for Mediterranean and Atlantic conditions, respectively) and a mechanic filtering system was used in the acclimation tank to retain small particles and impurities carried along by the sampled organisms. Water pumps (HYDOR Koralia pumps; 4.5 W; 1500 L h⁻¹) were used in every tank to ensure a proper water-flow in all the aquaria and two shake plate (Thermo Fisher Scientific) were installed in the experimental aquaria to keep the water moving inside the jars used for the experimental incubations.

Whenever weather conditions allowed it, Mediterranean and Atlantic water were collected with the CTD-rosette (Fig. 1), stored at the corresponding temperature and 2/3 of total volume of each tank was refreshed every day.



Figure 1. Seawater collection from the CTD-rosette for aquaria renewal.

9.11.4 Preliminary results.

9.11.4.1 Experimental work: metabolic activity and growth rates of two CWC under the influence of different water bodies (Mediterranean vs Atlantic) by N. Viladrich C. Gutiérrez and Alberto Aparicio

Lophelia pertusa and *Madrepora oculata* specimens were collected during the first leg of MEDWAVES cruise at around 1,000-1,250 m water depth (Table 1). Corals were

immediately transferred to the acclimation tank installed in the thermo-regulated room and maintained in seawater collected with the CTD-rosette at 12°C. Seven coral nubbins of each species (~5-6 polyps for *L. pertusa* and ~20 polyps for *M. oculata*) were prepared using the best-preserved branches from three different colonies, fixed with epoxy in methacrylate bases for better handling and maintained in the acclimation tank for 5 days to allow the recovery of the polyps after manipulation. After that, nubbins of both species were placed in two experimental tanks simulating Mediterranean and Atlantic temperature treatments (11° and 7°C, respectively), using for that the seawater sampled by the CTD-rosette at different depths. Coral nubbins were acclimated for another 3 days to the new temperature conditions before the beginning of the experiment.

At the beginning of the experimental phase, each coral nubbin was transferred to an incubation chamber (~300 ml volume; three replicates of each species per treatment) and placed over the shake plates in the experimental tanks. An extra incubation chamber without any specimen was used as a control. Each experimental chamber included a stirrer to keep the water in movement. Once filled with corresponding seawater from the CTD-rosette pre-filtered by 50 µm, every chamber was sealed with parafilm (ensuring no air-bubbles inside) to avoid any gas exchange (Fig. 2).

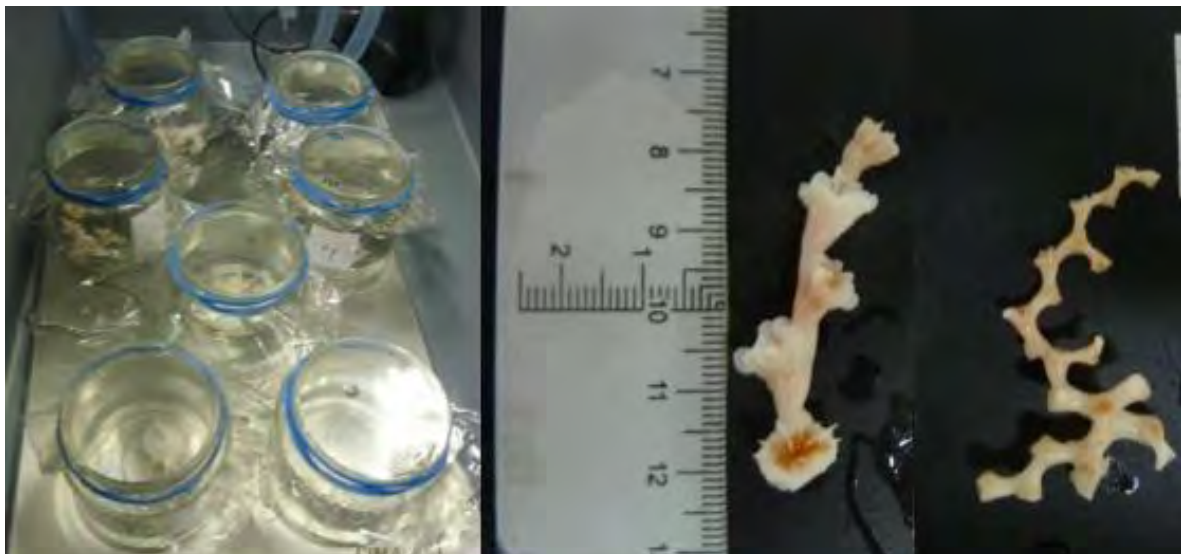

Figure 2: Incubation chambers used during the experiment (**left**) and coral nubbins of *L. pertusa* and *M. oculata* after the exposure time, being prepared for preserving at -80°C (**right**).

The incubation time of each experiment was 6 hours, in which status of colonies were observed and annotated every 30 minutes. At the beginning and at the end of the experiment, measurements of calcification and metabolic activity (respiration and ammonium excretion) were conducted. Water temperature was also monitored along the experiment in order to correct its influence in the ecophysiological measurements. The experimental design is shown in figure 3.

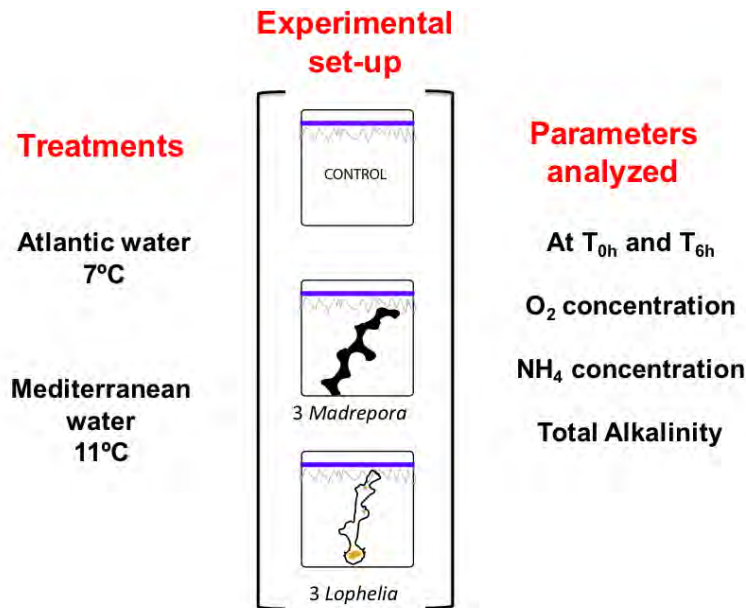

Figure 3: Experimental design used during the experiments on board.

Calcification rate of each specimen was analyzed by the alkalinity anomaly technique (Smith & Key 1975). Among current methods used to estimate net calcification rates of organisms and communities, this technique has been widely used for short-term incubations or *in situ* studies due to be a non-destructive and accurately measurement (Gazeau et al. 2015 and references there in). Due to the value of total alkalinity (A_T) is highly influenced by $[HCO_3^-]$ and $[CO_3^{2-}]$ (together with a multitude of other minor compounds) and that calcification process consumes 2 moles of HCO_3^- (therefore decreasing A_T by 2 moles per mole of $CaCO_3$ produced), it is possible to derive the net calcification rate of an organisms by measuring A_T before and after the incubation time. Determination of A_T was performed on board by potentiometric titration following the methodology described by Perez & Fraga 1987 and Perez et al. 2000 (For further details of the analytical method used see the chapter 9.2: Biogeochemical Oceanography Report).

Respiration rates were assessed by measuring oxygen concentration in the incubation chambers with an optode calibrated with seawater at 0 and 100% oxygen saturation values. Variation in oxygen concentration measured in the control chamber was subtracted from those measured in the experimental chambers, and respiration rate of each specimen was derived from the recorded depletion of dissolved oxygen over the incubation time. Oxygen consumption rates were converted to Carbon (C) equivalents (μmol) according to the equation:

$$C \text{ respired} = O_2 \text{ consumed} \cdot RQ,$$

where **RQ** is a coral-specific respiratory quotient equal to 0.8 mol C/mol O₂ (Muscatine et al. 1981, Anthony & Fabricius 2000, Naumann et al. 2011).

For determining excretion rates, 20 ml seawater samples (two replicates per each incubation chamber) were sterile pre-filtered by 0.2 µm and kept frozen (-80°C) until ammonium concentration was determined in the laboratory by means of spectrofluorometric techniques (Holmes et al. 1999, protocol B).

Results from calcification, respiration and ammonium excretion measurements will be normalized by the coral skeletal surface area (S) and the organic matter (OM) content to compare with previous studies. For that, all samples were photographed at the end of the experimental phase and kept frozen at -80°C for further OM composition analysis in the laboratory. The S of each coral polyp was determined by means of Advanced Geometry (Naumann et al. 2011) according to the equation:

$$S = \Pi \cdot (r + R) \cdot a + \Pi \cdot R^2,$$

where **r** and **R** represent the basal and apical radius of each polyp respectively, and **a** is the apothem measured with a caliper (Rodolfo-Metalpa et al. 2006). The proportion of OM of each nubbin will be determined from the reduction to ash during 4 h at 500°C in a muffle furnace (Relp 2H-M9). OM will be then calculated as the difference between dry and ash weight according to Slattery et al. (1995).

The analyses of results are still to be done as OM composition and ammonium analysis were done after the end of the cruise. Nevertheless, the differences observed between initial and final oxygen concentration as well as ammonium excretion, may indicate a successful detection of the respiration and excretion rates from colonies reared under different experimental conditions. Some of the preliminary results are display in figure 4 and Tables 2 and 3.

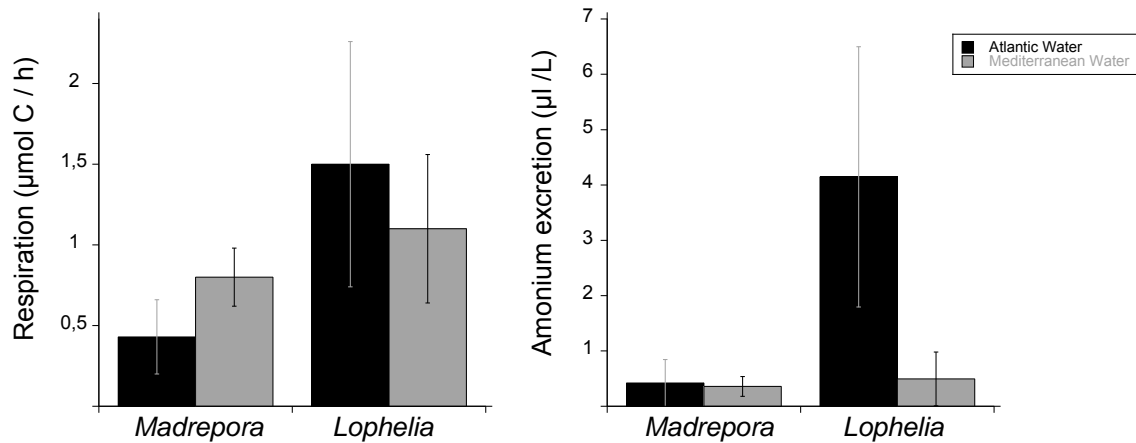

Figure 4: Respiration(left) and ammonium excretion rates (right) of *Madrepora oculata* and *Lophelia pertusa* nubbins incubated in individual beakers for 6 hours under Atlantic (black) and Mediterranean conditions (grey). Values are presented as mean ± standard deviation.

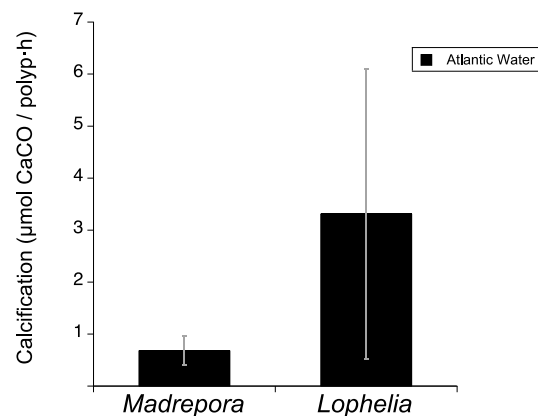

Figure 5: Preliminary alkalinity results on experimental set of Atlantic conditions in *Madrepora oculata* and *Lophelia pertusa* nubbins incubated during 6 hours.

Table 3: Percentage of open polyps observed during the experiments. Annotations were done every 30 minutes (minutes are display in brackets).

	<i>Madrepora oculata</i> % open polyps (minutes)	<i>Lophelia pertusa</i> % open polyps (minutes)
Atlantic conditions	27.3 (30'), 0 (60'), 18.2 (90'), 90.9 (120'), 90.9 (150'), 72.7 (180')	54.4 (30'), 0 (60'), 54.4 (90'), 18.2 (120'), 0 (150'), 63.6 (180')
Mediterranean conditions	18.2 (30'), 0 (60'), 54.5	81.8 (30'), 0 (60'), 63.6

(90'), 54.5 (120'), 0 (150'), (90'), 63.9 (120'), 90.9
63.6 (180') (150'), 90.9 (180')

9.11.4.2 Stress response of deep-coral species under aquarium conditions by M. Rakka and J. Movilla

Cnidarians, despite their structural simplicity, can survive hostile periods by going through complex processes such as the transformation of adult forms into resting forms or earlier developmental stages. Such states are usually characterized by inert metabolic and developmental functions which get reactivated under favorable conditions (Piraino et al. 2004). A number of stress responses have been reported for coral species, including polyp bail-out, the expulsion of polyps from colonies under stress which has been described as an escape response and possible dispersal mechanism under hostile environmental conditions (Sammarco 1982). Such strategies consist important biological traits which might significantly contribute to asexual reproduction and provide pathways for dispersal of coral populations under stress, with the latter being included in the key objectives for studies within the ATLAS project (WP4: Connected resources; Task 4.2: Predicted and realized dispersal: influence of history and life history traits in connectivity).

While the expulsion of polyps as a stress response has been described for scleractinians, there is virtually no information for its occurrence in octocoral species. The ROV diving activities during MEDWAVES and maintenance of octocoral colonies in aquaria conditions onboard allowed for the opportunistic observation of a stress response displayed by colonies of the species *Acanella arbuscula*.

Collection and maintenance of specimens

Specimens of *A. arbuscula* were collected on the 4th and 7th of October, during the ROV dives 8 (MEDWAVES Station 103) and 9 (MEDWAVES Station 127) respectively. Upon immersion specimens were transferred in buckets with water of low temperature (~4 °C). After collection of samples for genetic, reproductive and taxonomical studies, the remaining parts of the specimens were transferred in aquaria, either fixed on plastic bases by using epoxy, or secured among rocks to ensure upright position. The temperature of the aquaria was kept at 12 °C and specimens were feed daily.

Stress response

Immediately after collection, mucus residues were observed on all specimens while mucus production continued during the whole period of maintenance. Within 12

hours after positioning in aquaria, most specimens started expelling polyps, which were either solitary or created small aggregations on the bottom of the tank or on rocks (Fig. 5a). Polyp detachment began with the expulsion of sclerites and tissue off the lateral side of the polyps (Fig. 5b), creating an opening which allowed a gradual separation of polyp tissue from the skeleton. This procedure led to the release of oocytes which are normally found at the polyp base (Fig. 5a) and were subsequently encountered floating in various levels of the water column. We believe that this release was an inevitable result of polyp detachment that can be easily mistaken with spawning.

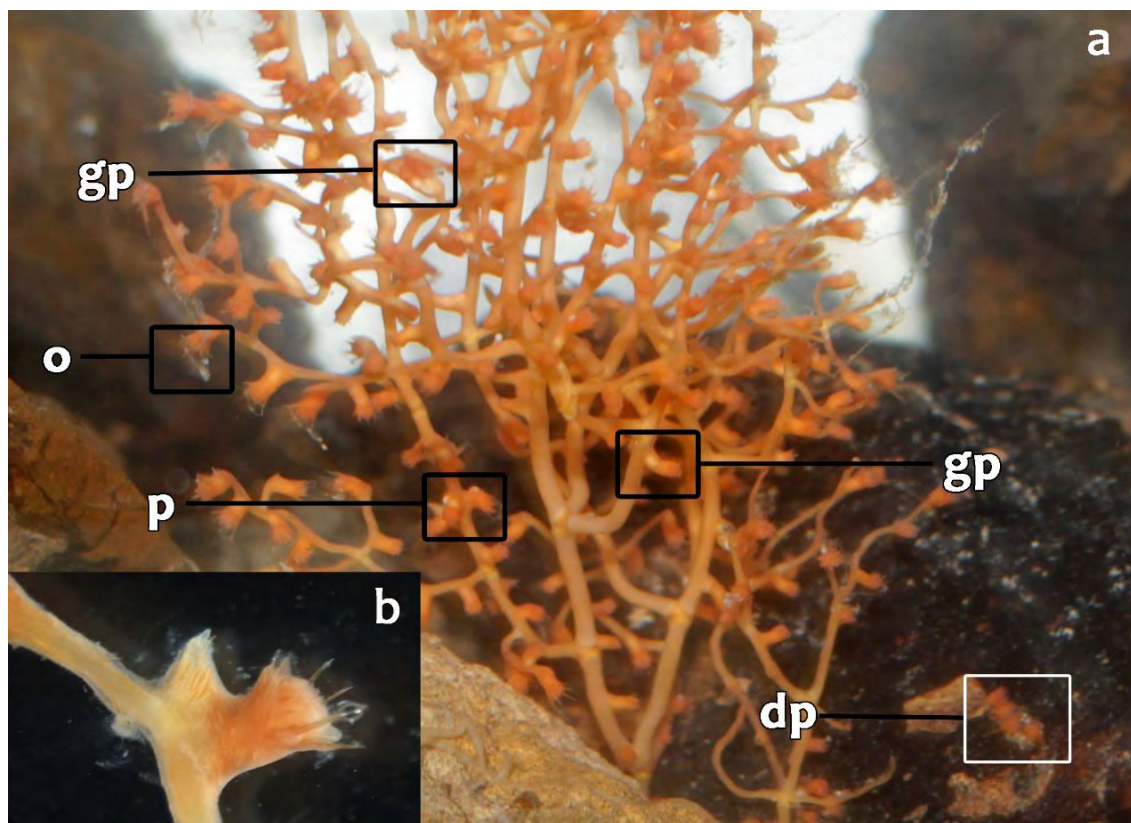

Figure 5: (a) Colony of *Acanella sp.* in the aquarium. gp: gravid polyps with visible oocytes at the base polyps; o: released oocyte entangled in mucus; p: polyps getting detached with oocytes getting released; dp: detached polyps creating aggregations (b) polyp during the detachment process.

References

Anthony KRN, Fabricius KE (2000) Shifting roles of heterotrophy and autotrophy in coral energy budgets at variable turbidity. *J Expl Mar Biol Ecol* 252:221-253

- Brooke S, Ross SW, Bane JM, Seim HE, Young CM (2013) Temperature tolerance of the deep-sea coral *Lophelia pertusa* from the southeastern United States. *Deep-Sea Research II* 92:240-248
- Carreiro-Silva M, Cerqueira T, Godinho A, Caetano M, Santos RS, Bettencourt R (2014) Molecular mechanisms underlying the physiological responses of the coldwater coral *Desmophyllum dianthus* to ocean acidification. *Coral Reefs* 33:465-476
- Gazeau F, Urbini L, Cox T, et al (2015) Comparison of the alkalinity and calcium anomaly techniques to estimate rates of net calcification. *Mar Ecol Prog Ser* 527:1-12
- Gori A, Reynaud S, Orejas C, Gili JM, Ferrier-Pagès C (2014) Physiological performance of the cold-water coral *Dendrophyllia cornigera* reveals its preference for temperate environments. *Coral Reefs* 33:665-674
- Gori A, Orejas C, Mienis F, Ferrier-Pagès C, Dullo C, Saturov D, Flöter S, Reynaud S, Wienberg C, Hebbeln D (2016) Physiological performance of the cold-water coral *Lophelia pertusa* under natural low oxygen conditions in the Angola margin (southeastern Atlantic Ocean). Poster communication. 6th International Symposium on Deep-Sea Corals 11-16.09.2016, Boston.
- Hennige S, Wicks L, Kamenos N, Bakker D, Findlay H, Dumousseaud C, Roberts J (2014) Short-term metabolic and growth responses of the cold-water coral *Lophelia pertusa* to ocean acidification. *Deep Sea Research Part II: Topical Studies in Oceanography* 99:27-35
- Holmes RM, Aminot A, Kérouel R, Hooker BA, Peterson BJ (1999) A simple and precise method for measuring ammonium in marine and freshwater ecosystems. *Can J Fish Aquat Sci* 56:1801-1808
- Maier C, Bils F, Weinbauer MG, Watremez P, Peck MA, Gattuso JP (2013a) Respiration of Mediterranean cold-water corals is not affected by ocean acidification as projected for the end of the century. *Biogeosciences* 10:7617-7640
- Maier C, Schubert A, Berzunza Sánchez MM, Weinbauer MG, Watremez P, Gattuso JP (2013b) End of the century pCO₂ levels do not impact calcification in Mediterranean cold-water corals. *PLoS ONE* 8: e62655 [doi:10.1371/journal.pone.0062655]
- Movilla J, Gori A, Calvo E, Orejas C, López-Sanz À, Domínguez-Carrió C, Grinyó J, Pelejero C (2014a) Resistance of two Mediterranean cold-water coral species to low-pH conditions. *Water* 6:59-67
- Movilla J, Orejas C, Calvo E, Gori A, López-Sanz À, Grinyó J, Domínguez-Carrió C, Pelejero C (2014b) Differential response of two Mediterranean cold-water coral species to ocean acidification. *Coral Reefs* 33:675-686
- Muscantine L, McCloskey LR, Marian RE (1981) Estimating the daily contribution of carbon from zooxanthellae to coral animal respiration. *Limnol Oceanogr* 26:601-611
- Naumann MS, Orejas C, Wild C, Ferrier-Pagès C (2011) First evidence for zooplankton feeding sustaining key physiological processes in a scleractinian cold-water coral. *J Exp Biol* 214:3570-3576

- Naumann MS, Orejas C, Ferrier-Pagès C (2013) High thermal tolerance of two Mediterranean cold-water coral species maintained in aquaria. *Coral Reefs* 32:749-754
- Orejas C, Gori A, Lo Iacono C, et al (2009) Cold-water corals in the Cap de Creus canyon, northwestern Mediterranean: spatial distribution, density and anthropogenic impact. *Mar Ecol Prog Ser* 397:37–51
- Orejas C, Gori A, Rad-Menéndez C, Last KS, Davies AJ, Beveridge CM, Roberts JM (2016) The effect of flow speed and food size on the capture efficiency and feeding behaviour of the cold-water coral *Lophelia pertusa*. *J Exp Mar Biol Ecol* 481:34-40
- Pérez FF, Fraga F (1987) A precise and rapid analytical procedure for alkalinity determination. *Mar Chem* 21:169-182
- Pérez FF, Rios AF, Rellán T, Alvarez M (2000) Improvements in a fast potentiometric seawater alkalinity determination. *Ciencias Marinas* 26:463- 478
- Piraino S, De Vito S, Schmich J, Bouillon J, Boero F (2004) Reverse development in Cnidaria. *CanJZool.* 82: 1748–1754
- Purser A, Larsson AI, Thomsen L, van Oevelen D (2010) The influence of flow velocity and food concentration on *Lophelia pertusa* (Scleractinia) zooplankton capture rates. *J Exp Mar Biol Ecol* 395:55–62
- Roberts JM, Wheeler A, Freiwald A, Cairns S (2009) *Cold-Water Corals: The Biology and Geology of Deep-Sea Coral Habitats*, 1st edn New York: Cambridge University Press [isbn: 9780521884853]
- Rodolfo-Metalpa R, Richard C, Allemand D, Ferrier-Pagès C (2006) Growth and photosynthesis of two Mediterranean corals, *Cladocora caespitosa* and *Oculina patagonica*, under normal and elevated temperatures. *J Exp Biol* 209:4546-4556
- Sammarco PW (1982) Polyp bail-out: An escape response to environmental stress and a new means of reproduction in corals. *Mar Ecol Prog Ser* 10: 57-65
- Slattery M, McClintock JB, Heine J (1995) Chemical defenses in Antarctic soft corals: evidence for antifouling compounds. *J Exp Mar Biol Ecol* 190:61–77
- Smith SV, Key GS (1975) Carbon dioxide and metabolism in marine environments. *Limnol Oceanogr* 20: 493–495

9.12 Outreach activities

Covadonga Orejas¹, Ana Morillas¹, Pablo Lozano², MEDWAVES scientific party, Martha Zein³, Jose Luis Matoso⁴

1. Instituto Español de Oceanografía, Centro Oceanográfico de Baleares, Palma, Spain
2. Instituto Español de Oceanografía, Servicios Centrales, Madrid, Spain
2. Producciones Orgánicas, Palma, Spain
3. La ventana invisible, Málaga, Spain

9.12.1 Personnel involved

All scientists' participants of MEDWAVES were involved in some of the outreach activities carried out previous and during the cruise.

In the coming paragraphs a brief description of the different activities carried out is included.

9.12.2 MEDWAVES facebook page

Some week before the cruise we open a facebook page for MEDWAVES (Fig. 1), as this is one of the current ways to disseminate effectively information to wide spectrum of profiles. In the facebook page pur main aim was to present in real time the activities carried out by the scientists and crew: manouvres, deplying of devices, sampling, sampling processing in the lab as well as the life on board. Also some underwater images and samples images where presented in the facebook page. One of the most important activities presented in the page was the announcemts of our blog (which was publishes every two-three days) as well as our artistic - dissemination project: Ways of the Waves (WoW).

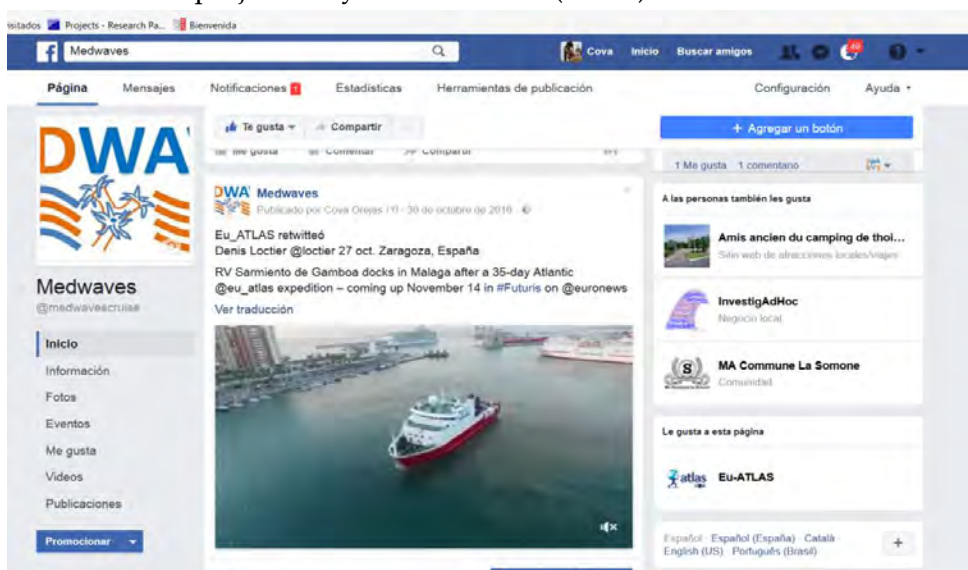

Figure 1: facebook page of MEDWAVES

9.12.3 MEDWAVES Blog

During MEDWAVES we also open a Blog (<https://medwavesblog.wordpress.com/>) (Fig. 2) in order to present the ATLAS project, the MEDWAVES cruise, the RV Sarmiento de Gamboa, the participants (Fig. 3) as well as a narrative of the cruise including scientific, technical and personal aspects of these 35 days at sea, also the artistic-dissemination project Ways of the Waves is included in the blog. Many member of the MEDWAVES scientific party were involved in the blog (Fig. 4).

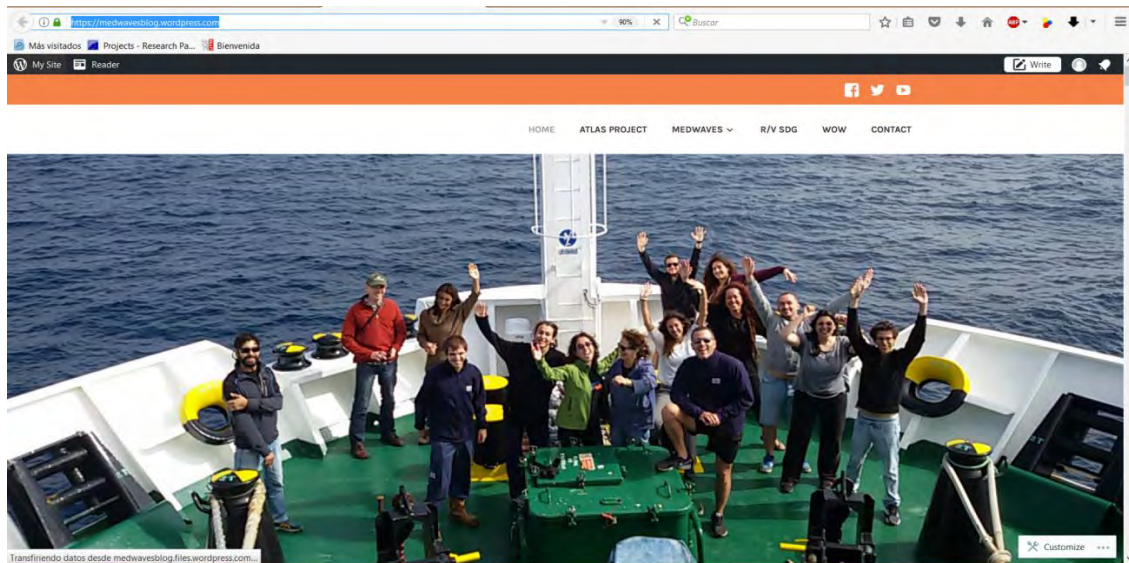

Figure 2: Home page of the MEDWAVES blog (<https://medwavesblog.wordpress.com/>)

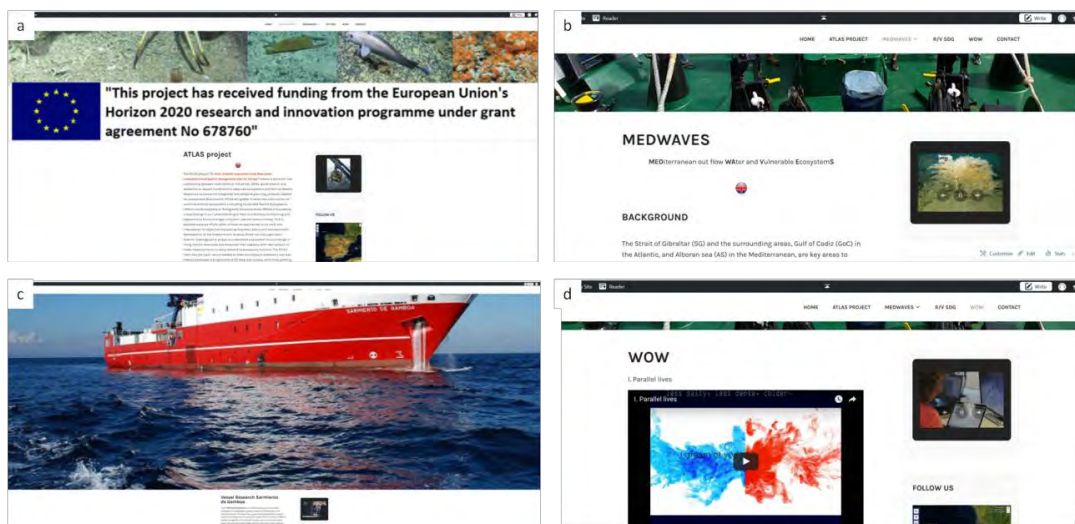

Figure 3: overview of some of the topics included in the MEDWAVES blog: a) ATLAS, b) MEDWAVES, c) The RV Sarmiento de Gamboa, d) the artistic dissemination project Ways of the Waves. All information is available in English and Spanish.

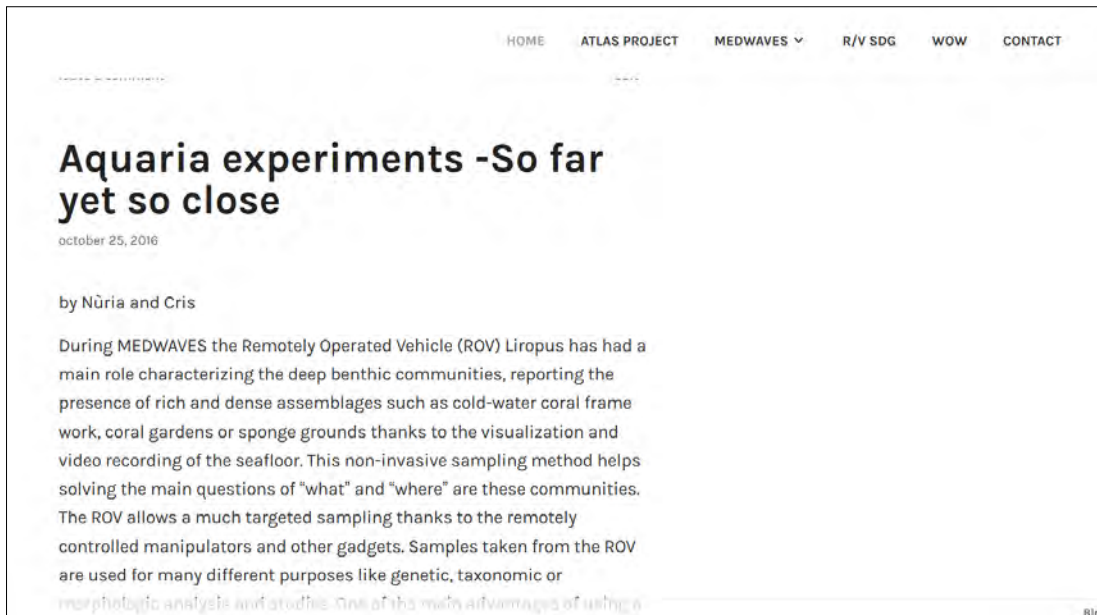
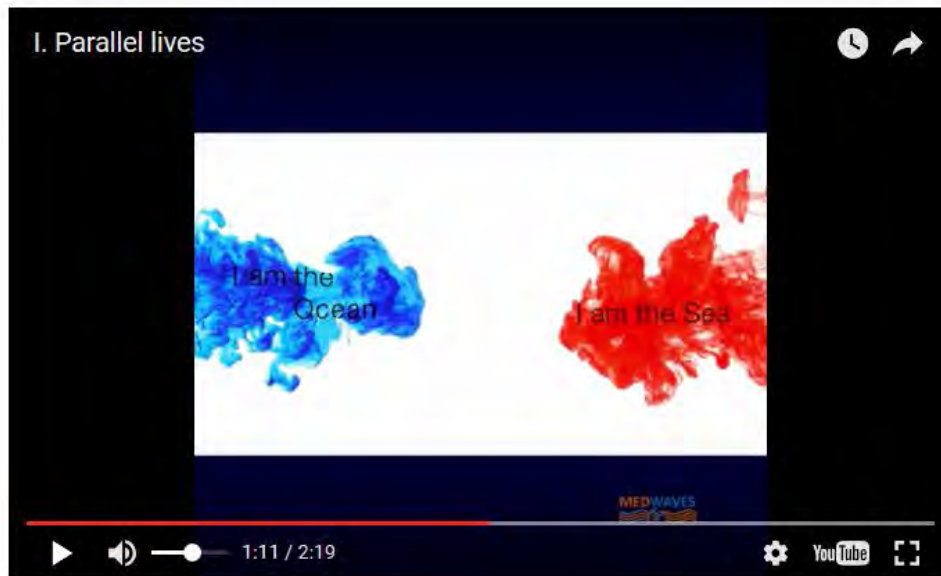

Figure 4: The last entry of the MEDWAVES blog

9.12.4 *Ways Of the Waves (WOW). Artistic outreach project*

We were very lucky counting with the collaboration of the artists Martha Zein (Producciones Orgánicas <http://www.produccionesorganicas.org/flash/>) y Jose Luis Matoso (La ventana invisible, <http://www.laventanainvisible.com/>) who create the project *Ways of the Waves (WoW)*. *WoW* intends to be an outreach project that combines research and scientific exploration with art. *WOW* produced seven short videos showing how the relationship between the Mediterranean and the Atlantic is both separated and linked by the worlds that the ocean and sea are part of. Creative imagery has been used to tell this narrative, as well as highlighting the research questions that were explored during MEDWAVES as a part of the European Commission funded research project ATLAS. The concept of *WoW* has been created and developed by Martha Zein (producciones orgánicas); filmmaking has been undertaken by Jose Luis Matoso (La ventana invisible), and Covadonga Orejas was in charge of the scientific coordination. After the *WoW* experience, we are confident that we will be able to continue developing this fusion that we have named **CONCIENCIARTE** (this is a play on words, as in Spanish “concienciarse” is “to become aware of something”, but by separating the syllables it also reads “With Science Art”). The figure 5 presents the beginning of the first video from *WoW*.



II. The date

Figure 5: Photogram of the first video of WoW, “The date”

9.12.5 Press releases, radio interviews and EURONEWS program

In Cádiz harbour the day MEDWAVES started, a presse conference took place on the bridge of the SdG. The following media were present there:

Television: Canal Sur, Onda Cádiz

Radio: Cadena SER Cádiz, COPE Cádiz

Newspapers: Diario de Cádiz, La Voz de Cádiz

Agencies: EFE, Europa Press

Further in Málaga, when we arrived to the harbour a team from EURONEWS (**Fig. 6**) were there together with Prof. Roberts (ATLAS coordinator). The reportage can be visualised under: <https://www.youtube.com/user/euronewsknowledge/videos>



Figure 6: The EURONEWS reportage published in our MEDWAVES facebook page.

Acknowledgements

Many thanks to Katherine Simpson (ATLAS coordination office) and Claudia Junge (AQuaTT) for helping disseminating MEDWAVES. Thanks are due to the EURONEWS team Denis Loctier and Thierry Winn for a great reportage on MEDWAVES.

9.13 Acknowledgements

Such a long and complex cruise has been possible thanks to many institutions and individuals. The research vessel Sarmiento de Gamboa (SdG) as well as the gears and technical support from the UTM (CSIC) have been financed by the Spanish Ministry of Economy, Industry and Competitiveness. We are indebted to the administration department from IEO as well as the logistic from UTM and the RV Sarmiento de Gamboa, without all of them this cruise would never have happened. Thanks also to José Ignacio Díaz (IEO) for the logistic coordination of the ROV adjustments for this cruise, mobilization, demobilisation and other activities around this device. Thanks to the MEDWAVES teams at home for helping before, during and after MEDWAVES.

Thanks are due to the Portuguese authorities (Região Autónoma dos Açores, Secretaria Regional do Mar, Ciência e Tecnologia and Ministério dos negócios Estrangeiros, Direção-geral de política externa, unidade de sobrevoos e escalas navais) who allow conducting our sampling program in Ormonde and Formigas. The Spanish Ministry for Agriculture, Fisheries, Environment and Food are also acknowledged for giving us the authorization to sample in the Natura 2000 zones of Gazul and Seco de los Olivos.

We would like to thank the master of the Research Vessel Sarmiento de Gamboa María Ángeles Campos and the whole crew for their support and for making our work and life on board very pleasant. Thanks are due also to the technicians as well as the personnel at home (Barcelona and Vigo) from the Unit of Marine Technology (UTM, CSIC) for their technical support in all our activities on board and also preparing the cruise. We are grateful to the ROV team (ACSM) for their fantastic work on board and their disponibility.

Many thanks to Pedro Madureira (EMEPC) for allowing us the use of the existing bathymetry of Formigas and Ormonde and to Luis Miguel Fernández (IEO) for allowing us to use the existing bathymetry of Gazul to plan the ROV dives in that area.

Many thanks to Telmo Morato, Marina Carreiro-Silva and Fernando Tempera for their support to the preparation of the cruise and their help when we were on board. Thanks also to Dierk Hebbeln, Claudia Wienberg and the whole Squid ROV team on board the RV METEOR (December-January 2016) for precious advice and assessment for the MEDWAVES organization.

Thanks to Autun Purser for the *Lophelia* drawings included in the MEDWAVES logo.

Thanks goes also to Miguel Hernández for last editing of this report.

The coordinator of the ATLAS project Prof. Dr. Murray Roberts as well as Dr. Katherine Simpson from the coordination office in Edinburgh have been from the beginning one of the main supports to MEDWAVES, we are grateful for infinite support and for the presence of Prof. Roberts in Málaga at our arrival after 35 days at sea.

The MEDWAVES cruise has been supported by the Spanish Ministry of Economy, Industry and Competitiveness.

The ATLAS project has received funding from the European Union's Horizon 2020 research and innovation programme under grant agreement No 678760 (ATLAS). This output reflects only the author's view and the European Union cannot be held responsible for any use that may be made of the information contained therein.

Cruise report MEDWAVES survey

21st September - 26th October 2016

MEDiterranean out flow WAter and
Vulnerable EcosystemS
(MEDWAVES)

Research Vessel Sarmiento de Gamboa
(UTM-CSIC)



Appendixes

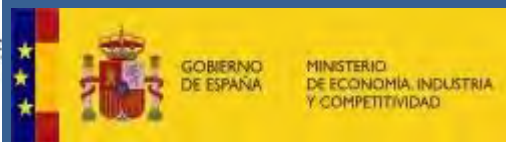

Appendixes I to XV



Appendix I Work program of the research teams

Physical and chemical oceanography team (IEO)

Team responsables: Pedro Vélez (IEO, Canary Islands), Jose Luis López-Jurado, Rosa Balbín (IEO, Balearic Islands), Marta Álvarez (IEO, Coruña)

Background

Oceanic seamounts are underwater mountains, that rising from the ocean floor have a relatively flat-summit that remains below of the sea surface. The perturbation that seamounts create in oceanic flow, has an associated dynamics that, under idealized circumstances, known as Taylor columns, have the potential to isolate the oceanic circulation over the summit from the ocean circulation in the open waters. Additionally under these idealized circumstances, upwelling phenomena, that enrich the ecosystem, occurs over the seamount summit.

Through the strait of Gibraltar, waters of Mediterranean origin (Mediterranean Outflow Water, MOW) spill in to the Atlantic Ocean, advecting properties and organism characteristics of the Mediterranean Sea.

Our research activities during the MEDWAVES-ATLAS cruise will focus on the oceanic circulation associated to seamounts found in the path of the Mediterranean Waters in the Atlantic Ocean, in order to determine the oceanic circulation on these seamounts and if they show the idealized behavior known as Taylor columns. The final objective will be to characterize the benthic communities inhabiting the targeted seafloor features (sea mountains and a submarine canyon) investigating the potential relation between the composition and characteristics of these communities and the physical and chemical characteristics of the water masses in the area.

Aims

- 1) To characterize the structure of the impinging oceanic flow over the Atlantic features: Formigas and Ormonde seamounts and Gazul Mud volcano, and the Mediterranean features: Guadiaro canyon and Seco de los Olivos (Chella Bank) seamount (**ATLAS Task 1.3**).
- 2) To determine the structure of the oceanic circulation over the summits of the Atlantic features: Formigas and Ormonde seamounts and Gazul Mud volcano, and the Mediterranean Seco de los Olivos (Chella Bank) seamount, as well as the Mediterranean canyon of Guadiaro (**ATLAS Task 1.3**).
- 3) To determine the role of the Mediterranean Water in the circulation and biogeochemistry, over, and around the Formigas and Ormonde seamounts and the Gazul Mud volcano (**ATLAS Task 1.3, potential contribution also to tasks 2.1 and 2.2**).
- 4) Fine scale biogeochemical characterization 400 meters above the bottom with emphasis on CO₂ variables to determine extant characteristics and any future threats / sensibility for benthic communities (**ATLAS Tasks 1.3, 2.4 and potential contribution to task 2.2**).



- 5) Optimum MultiParameter (OMP) analysis to quantify the contribution of Mediterranean Water formed at the Gulf of Cadiz in the different seamounts in the Atlantic area, within the Alboran Sea the contribution of recent and old Western Mediterranean Deep Water will be quantified (**ATLAS Task 3.1**).
- 6) Characterization of the penetration of solar radiation in the water column, which is a very important parameter to interpret sublittoral biological communities (like *Cystoseira* and deep kelp beds) on the Gorringe and Formigas Bank.

Work on board

To achieve the planned aims, in each of the seamounts, mud volcano and the submarine canyon, a set of hydrographic (CTD) stations will be carried out, in order to determinate the water masses in the area, and the geostrophic circulation. The number of stations, and the geographic distribution has been designed as a minimum to determine the geostrophic circulation, however, depending on the in situ bathymetrical observations, the design may be modified. Around 30 hydrographic stations will be sampled in each seamount, using a CTD Sea-Bird model 911+, including, at least, temperature, salinity, fluorescence, dissolved oxygen and pressure sensors. The water column will be sampled from the surface to the bottom, with a finer-scale biogeochemical sampling near the bottom closer to the communities.

Biogeochemical analysis will include: inorganic nutrient concentrations (instrument: SEAL QuAAtro 39; water samples will be frozen on board and subsequently analysed in the COB-IEO lab), Chla (water samples from surface to 100-150 meters depth, will be filtered on board using Whatmann GF/F filters, filters will be processed on board and analysed by means of a Turner Designs fluorometer), particulate organic carbon (water samples will be filtered on board using Whatmann GF/F filters, filters will be frozen for subsequent analyses back in the home lab), pH (water samples will be analysed on board by V spectrophotometry), Total Alkalinity (samples will be processed on board by potentiometric titration), carbonate ion concentration (samples analysed on board by means of UV spectrophotometry), dissolved inorganic carbon (samples conserved to be analysed at the IEO-A Coruña lab by coulometry), salinity (water samples will be analysed on board using the PORTASAL) and dissolved oxygen (samples will be measured by winkler titration and will be also used to calibrate the CTD oxygen sensors). Additionally, in each of the stations LADCP measurements will be carried out to reference the geostrophic estimation of the circulation to a known reference level.

To characterize the penetration of solar radiation in the water column, light attenuation profiles will be collected if time is available, using a QSP-2300 irradiance profiler and a surface BioSpherical QSR-2200 PAR Sensor on the seamount sampling locations established for CTD/fluorometer profiling. In order to investigate shoreward changes in light profiles, comparative sampling locations will also be established on the neighbouring island shelf of São Miguel. These stations, to be sampled either during the approach or departure from Ponta Delgada, should be representative of a gradient of seafloor depths, e.g.: 200m, 150m, 100m, 50m and possibly 25m.



During the transit, water surface data will be gathered (e.g. salinity, temperature and fluorescence) by means of a thermosalinograph (SBE21) and fluorometer installed on board.

Data from the meteorological station will be stored for subsequent use in data analyses and interpretation.

IEO Oceanography team anticipates close planning and integration with the following teams but welcomes others:

- Benthic ecology and habitat mapping teams (IEO & IMAR)
- Benthic group of geociencias marinas (IEO)
- Evolutionary ecology, biogeography and population genetics group (IFREMER)



Benthic ecology and habitat mapping team (IEO)

Team responsables: Covadonga Orejas (IEO, Balearic Islands), Jesús Rivera (IEO, Madrid)

Background

The Strait of Gibraltar (SG) and the surrounding areas, Gulf of Cadiz (GoC) in the Atlantic, and Alboran sea (AS) in the Mediterranean, are key areas to understand the distribution and connectivity of marine communities, as the SG and the encounter of water masses at the Almeria Oran front represent an oceanographic transition area, connecting the Atlantic Ocean and the Mediterranean Sea. The Mediterranean water flows out from Gibraltar (MOW), extends towards the East of the Atlantic, building a warm and salty water mass which propagates in North West direction from Portugal originating the “Mediterranean Water” (MW) in the Atlantic. This warm and salty water mass becomes characteristic of the North Atlantic in mid waters (around 1,100 m). The occurrence of cold-water coral (CWC) communities in the NE Atlantic has been related to the pathway of the MOW, whereby this current system would have an historical influence on the migration of coral larvae and (re)colonization of the Atlantic in the post-glacial era. The influence of MOW in the seabed shaping is evident as it is responsible of massive contouritic deposits along the Iberian continental slope and affects the flow regime of its canyons. The MEDWAVES cruise targets areas under the potential influence of the MOW within the Mediterranean and Atlantic realms, including two of the case studies of ATLAS (**case study 8** Azores, **case study 7** GoC-Gibraltar-Seco de los Olivos); These case studies include seamounts where CWC have been reported but that are still poorly known, and which may act as essential “stepping stones” connecting fauna of seamounts in the Mediterranean with those of oceanic islands such as Madeira, the Azores and the Mid- Atlantic Ridge.

Aims

Our main goals are (1) to explore the relationship between the oceanographic (see work program from the Oceanography group), and geomorphologic settings of the target areas (from the Alboran Sea to the Azores, through the Gulf of Cadiz, and the Ormonde Seamount (Gorringe complex) and the ecosystems therein and (**ATLAS WP 1 and 3**) (2) to characterize the megabenthic communities of the targeted areas, and sample for population genetic analysis aiming at understanding the way the populations located in the target areas contribute or have contributed to connectivity between the Mediterranean Sea and the Atlantic Ocean (**ATLAS WP 2, 3 and 4**), (3) to develop indicators of vulnerability for benthic ecosystems (**ATLAS WP 3**); In addition we will compare the morphological expression of the reefs and colonies in every site surveyed, studying its relation with the environmental conditions in terms of habitat suitability and form response.

Work on board

Video transects will be performed by means of the ROV Liropus in all the targeted areas. Transects will be conducted in different locations of the target areas in order to characterize in



a comprehensive way the benthic communities inhabiting areas with different geographical orientations and influence of water masses and currents (**ATLAS Task 1.3**). Video material will be quantitatively processed in the home labs to gain information on biodiversity, as well as distribution patterns of targeted species, further the development of new indicators of vulnerability will be explored (**ATLAS Tasks 3.1, 3.3**). Sampling of selected specimens will be also performed for experimental work in aquaria and for further lab analyses (e.g. taxonomic purposes, genetic analyses, stable isotopes etc.) (**ATLAS Tasks 2.3, 4.1, 4.2**). The ROV will be equipped with a plankton sampler which will allow having quantitative data in the planktonic communities living around the targeted benthic communities (**ATLAS Task 3.3**). In the areas explored with the ROV, MB lines will be also performed as well as SSS transects (if needed and if possible) in some selected locations for geomorphological description and characterization (**ATLAS Task 3.1, contributing also to WP6**). Moreover high frequency sonar imaging and video records will be used to describe the morphology of reefs and colonies as well as fine scale bedforms like mounds or ripples. Box corer and ROV sediment samples will be processed for granulometric analyses (see program from benthic group of Málaga) (**ATLAS Task 3.1**).

IEO Benthic ecology and habitat mapping team anticipates close planning and integration with all MEDWAVES teams, also further collaborations which can emerge before, during or after the cruise are welcome:

- IEO Physical and Chemical Oceanography team
- IMAR benthic ecology and habitat mapping team (IMAR)
The work planned by IEO benthic ecology and habitat mapping team & IMAR has been planned in close collaboration; we will work as a single team belonging to two different institutions
- Benthic group of Geociencias marinas (IEO)
- Evolutionary ecology, biogeography and population genetics group (IFREMER)
- Species biogeography and Ecologically or Biologically Sensitive Areas team (HWU)
- Foraminifera biodiversity (UIB)
- Biogeochemical composition of sediment (IEO Málaga)

Benthic ecology and habitat mapping team (IMAR)

Team responsables: Marina Carreiro, Telmo Morato (IMAR)

Background

The Azores is a volcanic archipelago located in the northeast Atlantic approximately 1,600km westwards of Portugal's mainland coast, lying above a tectonically active triple junction between the North American, Eurasian and African plates. Oceanography in the region is influenced by two eastward currents branching from the Gulf Stream, the North Atlantic Current in the north and the Azores Current to the south. Mediterranean water eddies (meddies) are also an important feature in the region, present as distinct lenses of warm and salty Mediterranean water at 800-1,200 m deep. In general, productivity is low, but localized upwelling associated with island slopes and seamounts can enhance local production. The



water current patterns result in a complex circulation, high salinity and temperature, and a low nutrient regime that typifies the Azores.

Biogeographic studies indicate that coral species in the Azores show mixed zoographic affinities with a greater affinity to the Lusitanian-Mediterranean biogeographic region and to a lesser extent to the western North Atlantic. Although the underlying reasons for the observed affinities are unknown, it is suggested that the pathway of the Mediterranean water from the Mediterranean into the Atlantic Ocean may help explain the CWC biodiversity/biogeography patterns in the Azores and North Atlantic. For example, the distribution of reef-building coral *Lophelia pertusa* in the NE Atlantic has been related to the pathway of the Mediterranean outflow seawater, whereby this current system would have had an historical influence on the migration of coral larvae and (re)colonization of the Atlantic in the post-glacial era. In this context, seamounts in the Azores may act as essential “stepping stones” connecting fauna in the Mediterranean with those in the North Atlantic. Data on water masses characterization, larval dispersal potential and population genetics collected during the MEDWAVES cruise will help to clarify the role of the Azores in the connectivity and biogeographic patterns between the different geographic areas. But more importantly, it will help predicting how shifts in the Atlantic water masses will affect the distribution of deep-sea biodiversity and ecosystem function.

Aims

Our main goals are (1) to collaborate with the IEO on the study of the relationship between the oceanographic (see work program from the IEO Oceanography group), the geomorphologic settings of the target areas (from the Alboran Sea to the Azores, through the Gulf of Cadiz, and the Ormonde Seamount (Gorringe complex) and the ecosystems therein (see work program from the IEO benthic ecology and habitat mapping team) and (2) to characterize the megabenthic communities of the targeted areas (see work programs from the IEO benthic ecology and habitat mapping team and the IEO Geociencias Marinas Málaga team); (3) collect cold-water coral specimens for (i) taxonomic identification (especially the *Octocorallia* group); (ii) for population genetic analysis aiming at understanding the way the populations located in the target areas contribute or have contributed to connectivity between the Mediterranean Sea and the Atlantic Ocean (focus on black coral *Leiopathes* sp) and (iii) life history traits and their influence on connectivity patterns among the different case study areas; (6) collected eDNA seawater samples from different areas within the Azores region (7) to develop indicators of vulnerability and GES for benthic ecosystems.

See details below on the relationship between the proposed IMAR aims, the different work packages of the ATLAS project and the expertise of the IMAR team members participating in the cruise.



Work on board

The IMAR team will collaborate with the benthic ecology and habitat mapping IEO team in the definition of the location and length of video transects to be performed with the ROV Liropus in all the targeted areas.

Transects will be conducted in different locations of the target areas in order to characterize in a comprehensive way the benthic communities inhabiting areas with different geographical orientations and influence of water masses and currents.

IMAR will also collaborate with IEO on the video analysis for the characterization of megabenthic communities (e.g. cold-water corals and sponges) and associated fish species. Sampling of selected specimens will be also performed for experimental work in aquaria and for further lab analyses (e.g. taxonomic purposes, genetic analyses, stable isotopes etc.).

The work proposed by the IMAR team within the MEDWAVES cruise, contributes to **tasks of the WP 2, 3 and 4 of the ATLAS project**. Specifically:

WP2 Functional Ecosystems

Task 2.3 Experimental physiology. Collaborate with the IEO on the collection and maintenance of coral specimens alive on board, which will be transported later to the aquaria facilities of IMAR. One of the IMAR team members, Maria Rakka, is a prospective PhD student of the ATLAS project working on the impacts of climate change stressors of cold-water coral physiology and will work towards this task.

WP3 Biodiversity and Biogeography

Task 3.1 Improve the understanding of biodiversity and biogeography in the deep N Atlantic

1) Collect and analyze new biodiversity data (especially within the group Octocorallia) using conventional taxonomy methods and barcoding. Another participant of IMAR in the MEDWAVES cruise, Iris Sampaio, is a PhD student within the ATLAS project, studying the biodiversity and biogeography of octocorals in the North Atlantic Ocean and Mediterranean Sea. Iris has an extensive experience on the participation on research cruises and on the processing, preservation and taxonomic identification of cold water corals and some sponges. In the cruise Iris can help with the processing and preservation of biological material.

2) Collect ROV imagery data for the characterization of new habitats/biotopes The IMAR team has several team members with experience in video analysis and characterization of habitats (Fernando Tempera), including one PhD student within the ATLAS project (Manuela Ramos), working on habitat characterization within the Azores Region. Therefore, our objective is to work in collaboration with the IEO team in this task. The team has also experience on fish identification (Telmo Morato, José Nuno Pereira), and could contribute towards this specific task in the video analysis.

Task 3.2 Validate eDNA methods for monitoring and screening deep-sea biodiversity Telmo Morato has collected eDNA seawater samples from different areas within the Azores region and would like to collect further samples to increase the spatial coverage of the study



(particular within the Azores case Study). Sample analyses are being made in collaboration with UCD and IFREMER, who are also partners of the ATLAS project.

Task 3.3 Conduct biodiversity assessments to measure GES in European Case Studies

Collaborate with the IEO in extracting data from ROV video analysis on evidence of anthropogenic impacts (fishing, litter) on the studied areas and evaluate GES for the Azores case study. The IMAR team member, Gerald Taranto, is a prospective PhD student working on the evaluation of GES in the Azores region.

WP4 Connected resources

Task 4.1 Multi-species genomics to identify sources and stepping stones The IMAR team can contribute to the collection and processing of targeted species within the ATLAS project. The IMAR has the specific task of conducting population genetics analysis of the black coral *Leiopathes* sp, as agreed with Sophie Arnaud (IFREMER).

Task 4.2 Predicted and realised dispersal: influence of history and life history traits on connectivity IMAR is interested in collecting specimens of the octocoral species *Callogorgia verticillata*, *Dentomuricea meteor* and *Paracalyptrophora josephinae* and black coral *Antipathella wollastoni*, whose reproductive traits are already being conducted in the Azores region (Maria Rakka), so that life history traits and their influence on connectivity patterns can be assessed in the different case study areas.

Equipment needed:

Pump and filtration ramp

Dissection microscope

Freezers for preserving samples at -20 and -80 C

IMAR Benthic ecology and habitat mapping team anticipates close planning and integration with the following teams but welcomes others:

- IEO Physical and Chemical Oceanography team (IEO)
- IEO benthic ecology and habitat mapping team (IEO)
- Benthic group of Geociencias marinas (IEO)
- Evolutionary ecology, biogeography and population genetics group (IFREMER)
- Species biogeography and Ecologically or Biologically Sensitive Areas team (HWU)

Benthic group of Geociencias marinas (IEO)

Team responsables: José L. Rueda and Marina Gallardo (IEO Málaga)

Background

The Gulf of Cádiz (GoC), Strait of Gibraltar (SG) and Alboran Sea (AS) contain a wide diversity of habitats and species due to the complex hydrology, seafloor geomorphology and geographical location, but knowledge on biodiversity, structure and spatial distribution of benthic communities and habitats is still needed for some areas. Our research activities during



the MEDWAVES-ATLAS cruise will focus on habitats and associated biodiversity of different seafloor structures located in circalittoral and bathyal zones of the Gulf of Cádiz (GoC), the Strait of Gibraltar (SG) and the Alborán Sea (AS), as well as in two Atlantic seamounts. The targeted features are: the Formiges and Ormonde seamounts, the Gazul mud volcano in the Gulf of Cádiz, the Guadiaro submarine canyon close the Strait of Gibraltar and the Seco de los Olivos (Chella Bank) seamount in the Alborán sea. Our research team has already some data and samples of some of these structures (Gazul, Guadiaro, Seco de los Olivos) gathered during previous cruises conducted in the framework of the projects INDEMARES and VIATAR; scientific drafts on geological and habitat/benthic aspects have been developed. Nevertheless during MEDWAVES new samples and data will be obtained, increasing our understanding and spatial resolution of these areas, and improving the knowledge of benthic biodiversity and habitat distribution at a wider scale under the influence of Mediterranean water masses (MWM).

Aims

- 1) To characterize the composition and structure (species abundances, abundance-sizes of habitat forming species) of habitats and benthic communities, including megafauna and microfauna of both epifaunal and infaunal components, in different seafloor structures (mud volcano, submarine canyon and seamounts) that are under the influence of MWM and the MOW in the Atlantic targeted features (**ATLAS Task 3.1**).
- 2) To study the relationships of habitats and key benthic species occurring in these seafloor structures with environmental (e.g. morphological, sedimentological and oceanographic variables) and anthropogenic variables (e.g. trawling activity), for improving our understanding of the spatial distribution within and among these seafloor structures (**ATLAS Task 3.1**).
- 3) To explore the distribution and biodiversity patterns of both habitats and key species occurring in MEDWAVES explored seafloor structures, following a bathymetric gradient, and exploring different zones of the seafloor features, to investigate the potential differences among locations influenced and not influenced by the MOW (**ATLAS Task 3.1**).
- 4) To analyze the feasibility of the data obtained after the MEDWAVES for estimating indicators of Habitats (Descriptor 1-Biodiversity) of the Marine Strategy Framework Directive (**ATLAS Task 3.3, 3.4**).

Work on board

For achieving these 4 aims we propose combining sediment sampling techniques, mainly targeting the infauna such as Box-Corer / Van Veen Grab, and underwater imagery techniques (ROV), targeting the epifauna, during MEDWAVES. For achieving aims 2 and 3, high resolution bathymetry and reflectivity, sediment (grain size distribution, geochemical parameters) and water masses data (near-bottom current speed, temperature, salinity, POC) obtained during



MEDWAVES are needed to perform different types of multivariate/GIS analyses that may explore the potential relationships between the benthic community and environmental and anthropogenic factors. For those components of the study we will be interested to collaborate with responsible researchers of those data. Trawling activity (VMS data) have been previously obtained in the framework of other research projects for some of the MEDWAVES targeted seafloor structures.

During MEDWAVES, sediment samples from Box-Corer / Van Veen grabs will be stored dry (grain size distribution) and, if possible at -20°C (geochemical analyses), for further analyses at the equipped Sedimentological Laboratory of the IEO Málaga. For sampling the sediment column, corers of 9 cm diameter will be used. Sediment data could be used for geological and habitat characterization, and for exploring relationships with the associated biota. Fauna from remaining sediment will be sieved to 0.5 mm following a vertical sampling procedure (at different sediment depths when possible) and stored in ethanol 70% / Formaldehyde 10% for species identification and quantification at the IEO Málaga. Pictures of some species will be taken, especially when taxonomical features of importance for their identification will be lost after fixation. Identification of fauna will be carried out in collaboration with specialists of different taxonomic groups from different institutions.

Underwater images obtained with ROV will be processed after MEDWAVES to obtain data on substrate characteristics and habitat types, as well as megafauna of the epibenthic component. Using image analysis and specific software for video processing, megafauna will be identified to the lowest taxonomical level and quantified / measured when needed for intra-transect characterization and further comparisons with other seafloor structures located in the target areas (Aim 3) as well as for achieving Aim 4. Identification of fauna will be carried out in collaboration with specialists of different taxonomic groups from different institutions. Comparison of MEDWAVES results with other seafloor structures (Aim 3) will be conducted thanks to available data obtained from previous sampling expeditions/projects carried out by Geociencias Marinas team in the GoC (TASYO, INDEMARES, ISUNEPKA, SUBVENT, CADHYS) as well as in the SG and AS (DEEPER, VIATAR, INDEMARES, MEDITS/IRIS-SES, MONTERA).

Benthic group of Geociencias Marinas (IEO) and UMA (University of Málaga) team anticipates close planning and integration with the following teams but welcomes others:

- Physical and Chemical Oceanography Team (IEO)
- Benthic Ecology and Habitat Mapping Team (IEO)
- Species biogeography and Ecologically or Biologically Sensitive Areas team (HWU) (for Hydroids identification)



Evolutionary ecology, biogeography and population genetics group (IFREMER)

Team responsible: Sophie Arnaud-Haond (IFREMER)

Background

The Ifremer team contribution to the ATLAS project is diverse, including experts in taxonomy, deep-sea ecology, habitat modelling and population genomics. Sophie Arnaud-Haond who will contribute to MEDWAVES cruise is an evolutionary ecologist mostly working on biogeography and population genetics. She had experience working on both coastal ecosystem (seagrass, mangroves, corals) and deep-sea ones, including (invertebrates associated to chemosynthetic ecosystems-shrimp and clams, mainly) and cold-water corals. She participated in HERMIONE and CoralFISH EU FP7 projects and is the leader of the ATLAS workpackage on connectivity (WP4).

Aims

Ifremer will contribute to the ATLAS project mainly in the **Work Packages 3 and 4**, as well as **6**. We are interested in the spatial distribution of biodiversity in relation with the ecosystem and environmental conditions, and in the spatial dynamics (connectivity) at different spatial and temporal scales. We will thus contribute to habitat mapping and to the characterization of deep-sea communities through metabarcode, and we are leading the work package on population genomics (**WP4**). Within ATLAS we thus aim at contributing to the acquisition of samples for the molecular inventories of biodiversity planned in **WP3** (eDNA metabarcode), and to the sampling of specimens for the connectivity workpackage (**WP4**) including scleractinians, associated polychaetes and if possibly fishes.

Ifremer will participate as contributor to the **WP1, 3, 4 and 6** of the project **ATLAS**. Thus, the contribution of IFREMER partner to the cruise will, beyond the contribution to common tasks usually shared during an oceanographic cruise, specifically focus on the aspects included in the paragraph below.

Work on board

Contributing to the WP3:

Sampling, conditioning and if possible processing of samples dedicated to eDNA analysis of biodiversity, i.e. sediment and water.

The sampling strategy will have to be define among partners as stated in the project “*for water filtration, sediment sieving and DNA extraction from multiple sources (e.g. seawater, sediment, plankton samples, VME indicator taxa, and commercially valuable fish species)*”. It will then be applied for the first time during the MEDWAVES cruise to collect water, sediment and plankton samples for eDNA analyses. In the meantime IFREMER is also engaging in comparative sampling in early 2016 (April) in the framework of an institutional project. Depending on the data available, the strategy will be refined among partners during the kick-off meeting in June. We anticipate the possible use, ideally, of multitube core sampling, sieving with a series of



mesh size following ISA recommendations (1000; 500; 200; 40; 20 μm), equipment to filter water (a serie of filters of 20, 2, and 0.2 μm , a minimum of 5 to 20 liter sample).

Equipment required: freezer -80°C and -20°C, sieving columns, water filtering equipment, multitube core or cores to subsample box core if multitube is not available, water sampling tools.

Environmental data: Within WP3 and WP4, the IFREMER team will also be interested in contributing to the acquisition and processing of environmental data (temperature salinity, nutriments, O₂, primary production...) for large scale modelling, in particular to investigate the interest of environmental descriptors and habitat characterization in relation to genetic analysis (i.e. seascape genomics).

Contribution to the WP4:

Sampling, conditioning and if possible processing of samples for the connectivity estimates.

Cold-water corals (*Acanella arbuscula*, *Antipathella wollastony*, *Callogorgia verticillata*, *Dendrophyllia cornigera*, *Desmophyllum dianthus*, *Leiopathes* spp., *Lophelia pertusa*, *Madrepora oculata*, *Paracalyptrophora josephinae*), sponges (*Geodia* spp. *Pheronema* spp.), key invertebrates (*Cidaris cidaris*, *Parastichopus tremulus*) and fish (*Bentosema glaciale*, *Corphaenoides* spp., *Dalatias licha*, *Helicolenus dactylopterus*, *Hoplostethus atlanticus*, *Protomyctophum arcticum*, *Maurolicus muelleri*, *Micromesistius poutassou*, *Notoscopelus kroeyeri*, *Polyprion americanus*, *Sebastes* sp.). The species planned to be analyzed at IFREMER are underlined, the other will be collected for partners. For the species to be analyzed for connectivity, a minimum of 30 samples is usually aimed at per sampling location, of course depending on what is feasible considering the geographical location and the logistic constraints of the dives

Equipment needed: -20°C, possibly -80°C, water or dry bath or oven up to 60°C, centrifuge for small (2ml) tubes, vortex/shaker

Evolutionary ecology, biogeography and population genetics group (IFREMER) team anticipates close planning and integration with the following teams but welcomes others:

- ROV (C. Orejas) for collecting the list of species here above
- Box corer (JL Rueda) for collecting the list of species here above and as a surrogate for multicore when not feasible (to be subsampled with tubes the size of cores to standardize the sampling)
- Van Veen (JL Rueda) for collecting the list of species here above
- SEAL QuAAtro 39; water samples from the bottom (the layer just above the sediment) to be filtered for subsequent metabarcode in WP3
- Multibeam echosounder (J. Rivera) to integrate seabed mapping with bio and phylogeography, and in places where needed to assess the nature of sediment to confirm the possibility to deploy the multicorer
- Physical and chemical oceanography team (IEO) to integrate oceanography into bio & phylogeography and to gather environmental data and data on sediment chemistry to



- feed WP3 workpackage of Atlas on the influence of environmental variables on species composition
- Benthic ecology and habitat mapping teams (IEO & IMAR) as planned in WP3 and 4 of Atlas

Species biogeography and Ecologically or Biologically Sensitive Areas team (Edinburgh University)

Team responsible: Lea-Anne Henry (Edinburgh University) (on 1st leg from Cádiz to San Miguel)

Background

The export of Mediterranean Outflow Water (MOW) from the Mediterranean Sea basin is a critical component of the circulation, mixing, and transport processes in the Atlantic Ocean. The resulting outbound flow of energy and elements, and the formation of eddies, have implications for biological systems that are sustained by the food, particles, and physical/chemical conditions provided by MOW export. The region between the Gulf of Cádiz and the Azores is inhabited by species and habitats of global conservation interest such as cold-water corals, sponges, hydrothermal vents. Mobile or highly migratory megafauna such as fish, marine mammals and seabirds are also resident or transient visitors to regional features such as seamounts. Networks of Marine Protected Areas in the region are cornerstones of achieving policy targets such as those enshrined by the CBD and OSPAR. However, recent expert synthesis in the region (e.g., Abecasis et al., 2015) identified several areas of research needs including the need to identify key areas prioritised by the CBD i.e., Ecologically or Biologically Sensitive Areas (EBSAs), and to understand whether spatial management tools like MPAs can benefit certain life stages of mobile or migratory animals. The extent to which MOW export drives large-scale biogeographic patterns is also not currently well depicted in policy tools to develop MPAs such as the IOC-UNESCO's GOODS (Global Open Oceans and Deep Seabed) classification scheme (Rice et al., 2011).

Aims

Our 2 main goals are linked with higher level ambitions of the ATLAS project and are cross-linked with goals of others participating on the MEDWAVES-ATLAS cruise. Specifically, HWU goals on the cruise are to:

- (1) identify and map areas with high densities of aggregating fish and other mobile megafauna during the cruise that could be used to strengthen the evidence base for regional EBSAs in the northeast Atlantic; this will include identifying features or habitats that could benefit from spatial management and no-take zones e.g., egg-laying or nursery sites for elasmobranchs, aggregations of marine mammals, etc.
- (2) understand effects of MOW transport on biogeography of regional and trans-Atlantic fauna [Henry will focus on hydroids (Cnidaria: Hydrozoa) but work with other teams on how MOW affects VME indicator taxa]



Work on board and links to ATLAS Workpackages and Deliverables

The HWU team (Henry) is responsible for the collection and analysis of new data on high density aggregations of mobile and sessile megafauna and important fish habitats that could contribute to EBSAs and new MPAs. She will also be responsible for collecting new samples of hydroids to assess their biodiversity and biogeography in relation to water mass structure and

seabed features, with a special emphasis on effects of MOW. Henry will ensure this hydroid work is integrated with work from other teams on biogeography of VME indicator taxa to improve GOODS. All new data will be directly relevant to ATLAS WP3 Biodiversity & Biogeography, and WP6 Maritime Spatial Planning. Methods for data collection and relevance to ATLAS Deliverables are described herein. It is anticipated that these new data will need to be closely integrated with other teams' outputs including seabed mapping and oceanographic profiling in order for fully comprehensive assessments of EBSAs and biogeography to be made.

Hydroid biogeography and effects of water mass structure

WP3 Biodiversity & Biogeography

Deliverable 3.1 – Biodiversity and biogeography in relation to water masses (ATLAS lead IEO)

Deliverable 3.2 – Refined GOODS using SDMs and HDMs (ATLAS lead HWU)

Deliverable 3.4 – Ocean-hydrographic controls on biodiversity and biogeography (ATLAS lead HWU)

Henry has 20 years of experience in the classical taxonomy of hydroids (Cnidaria: Hydrozoa). She has conducted a standardised synthesis of deep-sea hydroids collected from CWC reef ecosystems from around the N Atlantic but crucial data gaps in collection sites in the Gulf of Cádiz – Azores region prohibit a truly basin-scale synthesis. GOODS also lacks data from this region in structurally complex habitats. Thus, Henry aims to work with other groups such as IEO and IMAR to study effects of MOW export and water mass structure on these taxa to see if GOODS can be improved to reflect biogeographic boundaries.

Henry plans to work within the scope of the daily planned routines to collect new hydroid data. Each ROV dive, Van Veen grab and box core will be visually inspected by Henry for hydroid occurrence. Henry will remove hydroids from each sample type and preserve these in molecular-grade EtOH, and ensure the removed hydroids noted are noted by other teams working on biodiversity in order to keep track of the fate of all material. She would like to request access to stereomicroscope facilities including bench space during the cruise to identify as much material as possible to species-level.

HWU anticipates close planning and integration with the following teams but welcomes others:

- ROV (C. Orejas) for collecting hydroids
- Box corer (JL Rueda) for collecting hydroids
- Van Veen (JL Rueda) for collecting hydroids
- Multibeam echosounder (J. Rivera) to integrate seabed mapping with biogeography
- Physical and chemical oceanography team (IEO) to integrate oceanography into biogeography
- Benthic ecology and habitat mapping teams (IEO & IMAR)



Data to support EBSA development

WP3 Biodiversity & Biogeography

Deliverable 3.5 – Conservation management issues in ATLAS (ATLAS lead Ifremer)

WP6 Maritime Spatial Planning

Deliverable 6.1 – MSP goals and operational objectives (ATLAS lead NUIG, not on cruise)

Deliverable 6.2 – Ecosystem goods and services case study (ATLAS lead NUIG, not on cruise)

Henry has experience mapping important seabed habitats for deepwater elasmobranchs including the identification of egg-laying sites on cold-water coral reefs and seamounts (Henry et al., 2013, 2014). This habitat mapping integrates physicochemical data including multibeam and oceanographic data to provide a more comprehensive assessment of how these habitats provide areas for different fish species across their life stages.

On-board measurements of data to support EBSAs will include analysing ROV survey footage searching for features such as egg cases deposited by oviparous elasmobranchs, and observations of juvenile life stages. Van Veen grabs and box cores may also be useful, because spurious collections of egg cases can sometimes be obtained when sampling complex physical habitats used by some deepwater elasmobranchs to safely attach their cases to. Where collections of egg cases are possible, these will be transferred to molecular grade EtOH for storage and possible future genetic analyses.

HWU anticipates close planning and integration with the following teams but welcomes others:

- ROV (C. Orejas) for surveying seabed habitats searching for fish habitats
- Box corer (JL Rueda) in case of spurious collections of elasmobranch egg cases
- Van Veen (JL Rueda) in case of spurious collections of elasmobranch egg cases
- Multibeam echosounder (J. Rivera) to integrate seabed mapping with fish habitat
- Physical and chemical oceanography team (IEO) to integrate oceanography into fish habitat
- Benthic ecology and habitat mapping teams (IEO & IMAR)

Equipment needed:

Dissection microscope and bench space

References:

- Abecasis et al., 2015. Marine conservation in the Azores: evaluating marine protected area development in a remote island context. *Frontiers in Marine Science* 2: 104.
- Henry et al., 2014. Environmental variability and biodiversity of megabenthos on the Hebrides Terrace Seamount (Northeast Atlantic) *Nature Scientific Reports* 4: 5589.
- Henry et al., 2013. Cold-water coral reef habitats benefit recreationally valuable sharks. *Biological Conservation* 161: 67–70.



Rice et al., 2011. Policy relevance of biogeographic classification for conservation and management of marine biodiversity beyond national jurisdiction, and the GOODS biogeographic classification. *Ocean and Coastal Management* 54: 110-122.

Foraminifera biodiversity (UIB)

Team responsible: Guillem Mateu-Vicens (UIB)

Foraminifera are very abundant in all marine environments, have relatively short life cycles, and react quickly to environmental changes at global and local scales (Frontalini et al., 2009). Moreover, foraminiferal species (even genera) are highly adapted to well-defined ranges of environmental parameters, such as water temperature, depth, salinity, nutrition flux, wave regime, and pollution (Hallock et al., 2003; Morvan et al., 2004; Châtelet & Debenay, 2010; Koukousioura et al., 2011; Hallock, 2012). Furthermore, the tremendous taxonomic diversity of foraminiferal species gives them the potential for diverse biological responses to various chemical substances (Hallock et al., 2003). Therefore, these protozoans are very useful indicators to characterize a given environment in an integrated way (Pergent-Martini et al.,

2005). Foraminifers are among the more conspicuous components observed in the sediments from open marine areas. These protozoans can be clustered based on their type of wall structure. Most of them can be included within one of the subsequent groups:

- “agglutinate” that build their tests by agglutinating sediment particles from the environment,
- “porcellaneous” that secrete high-magnesium calcite microcrystals to construct their tests.
- “calcareous perforate” taxa with hyaline, low-magnesium calcite tests.

Agglutinated and porcellaneous forms include exclusively benthic taxa, whereas calcareous perforate tests occur in both benthic and planktic species.

Foraminiferal tests show a quite well defined array of chamber arrangements regardless of the type of wall. Thus, for benthic taxa there is a relationship between the test architecture, the type of substrate and the life-mode of species that are taxonomically distant, but dwell in similar environments (Langer 1993; Mancin 2001). Similarly, test shape, ornamentations and chamber arrangement in planktic taxa is related to their position within the water column (Bé 1977). Other factors such as temperature exert an important effect on the test determining pore-size and coiling-direction of many planktic species (Arnold and Parker 1999).

Sampling

Foraminiferal assemblages will be studied from box-core samples. Surface subsamples will be collected using one 6 cc syringe with the bottom removed.

1. Insert the barrel of the syringe into the surface sediment and, at the same time, carefully and slowly pull back on the plunger so that the sediment remains structured while the syringe barrel is pushed into the sediment.
2. Extrude the sediment until the base of the plunger is at 3 cc mark.
3. Transfer the sediment into a hermetic plastic bag.



UIB anticipates close planning and integration with the following teams but welcomes others:

- Box corer (JL Rueda)
- Van Veen (JL Rueda)
- Physical and chemical oceanography team (IEO)
- Benthic ecology and habitat mapping teams (IEO & IMAR)

Biogeochemical composition of the sedimentary organic matter (IEO-Málaga)

Team responsible: Teodoro Ramírez (IEO-Málaga)

Primary production in the euphotic layer, the trophic interactions across the food webs and the ocean processes modulate the vertical flux of particles from the euphotic zone to the deep sea. A small fraction of this vertical flux of organic particle (Graf 1989, Smith et al. 2008), reach eventually the seabed where different labile organic matter components provide a source of nutrients that fuel the biological activity in benthic ecosystems (Gooday & Turley 1990). The response of benthic communities to increased food availability may be rapid.

Episodic pulses of food reaching the deep sea are extremely important in sustaining abyssal communities over long time periods. Thus, the vertical flux of particles to the deep sea and its composition plays a major role on the biogeochemical features of sediments and on the dynamics of benthic communities (Gooday & Turley 1990), the so called pelagic benthic-pelagic coupling.

In the Alboran Sea and the Strait of Gibraltar the upwelling events of Mediterranean waters and the mixing between the MOW and the surface Atlantic waters, alongside other upwelling mechanisms linked to the hydrodynamic in this areas, lead to a frequent nutrient enrichment in the euphotic layer (Ramirez et al. 2005). These upwelling processes fuel primary production and lead to higher Chla concentrations in comparison with other areas from the Western Mediterranean. Associated to the enhanced production, high vertical flux of particles has been observed in deep areas of this basin (Sánchez Vidal et al. 2005). Part of this flux can eventually reach the seabed providing a source of C and nutrients to communities inhabiting deep ecosystems. As observed in other deep sea areas (Thiel, et al. 1989), these inputs of organic matter to the seabed should be reflected in the biogeochemical composition of sediments, as well as in the biogeochemical and biological and processes and the benthic communities.

On the other hand, part of the vertical flux of particles would reach the MOW and would be transported westwards into the Atlantic Ocean (Marti et al. 2001, Freitas & Abrantes 2002), where Mediterranean waters flows at intermediate depths. The concentration of organic particles associated to the MOW in the NE Atlantic (Ambar et al. 2002) could be a source of carbon and nutrients for deep sea ecosystems in the NE Atlantic. In its journey from the Alboran Sea to the NE Atlantic, organic particles advected by the MOW may sink further and eventually settle down on the seabed, which could have an effect on amount of organic matter available for benthic communities and on its nutritional value.

The biochemical composition of the sedimentary organic matter is therefore an important aspect to be considered in order in order to know the different potential sources of food for benthic consumers and to study the interconnections between the upper water column and the abundance, composition and diversity of benthic communities. The sum of proteins, carbohydrates, and lipids (the biopolimeric C) provides a proxy of the potential nutritional value of sedimentary organic matter (Neira et al. 2001), as the labile fraction of sedimentary organic matter is mainly composed of proteins, carbohydrates and lipids. Thus some authors have used the total protein and carbohydrate concentrations in costal sediments for the



classification of the trophic state of some coastal ecosystems (Dell'Anno et al. 2002; García Rodríguez et al. 2011). Although the bulk of these fractions in the sedimentary organic matter does not represent the labile fraction of biopolymeric organic matter (Danovaro et al. 2001).

On the other hand, phytodetritus is a major carbon source for benthic habitats and their export to the deep sea has an impact on benthic communities and processes (Morata & Renaud 2008). Previous studies in different areas have found a close relationship between Chl *a* in benthic ecosystems and Chl *a* in the water column, which is indicative of a strong pelagic-benthic coupling. Some studies have found a close relationship between the chlorophyll in sediments and the oxygen consumption, which indicates the relevance of the composition of the organic matter reaching the sediment for benthic communities (Morata & Renaud 2008). Thus, chlorophyll *a* in sediments provides a proxy of recent inputs of phytodetritus, which represent a rich substrate for the growth of bacteria and protozoa (flagellates and foraminifers) and deposit feeders (Thiel et al. 1989, Gooday & Turley 1990). On the other hand, phaeopigments are indicative of the presence of faecal material from zooplankton and/or macrobenthic breakdown of phytodetritus containing chlorophyll-*a*. (Cathalot et al. 2015).

Aim

To assess the quality of sedimentary organic matter, by analyzing the biogeochemical composition of surface sediments, and its potential role as a nutritional source of carbon and nutrients to fuel benthic deep sea communities, as well as to assess the role of the influx of phytodetritus from the upper layers on the composition of the sedimentary organic matter, its connections with the processes in the water column and the effects on the status of the benthic ecosystems. The biogeochemical composition of the sedimentary organic matter and the presence of phytodetritus will be based on the analysis of chlorophyll *a*/phaeopigments, proteins, carbohydrates and lipids in surface sediments.

Moreover, the relationships between the biogeochemical composition of surface sediments and the physico-chemical and biological features of the overlying water masses would allow to determine the degree of pelagic-benthic coupling in the different areas sampled in this survey. Likewise, the influence of the composition of the sedimentary organic matter on the abundance, diversity and status of benthic communities could be analyzed. Therefore, the biogeochemical composition of the sedimentary organic matter in surface sediments is expected to provide important information to explore the relationship between the oceanographic settings of the target areas and the ecosystems therein, contributing thus to Objective 1 of MEDWAVES (ATLAS WP1 and WP3).

Work on board

Surface sediment samples (0-1 cm) from the multicorer stations will be collected for the analysis of the biogeochemical features of surface sediments (pigments, proteins, carbohydrates and lipids) as described in the specific protocol elaborated for this purpose (for further details see the protocol). Briefly, at each MUC station, undisturbed surface sediment samples will be taken from the homogenates of the 3 MUC sediment cores used for eDNA. The sampling for these biogeochemical parameters will be conducted after the sampling for eDNA from the first horizon (0-1 cm) has been completely finalized (details need to be discussed with Dr. Sophie Arnaud). Thus, the subsampling for biogeochemical parameters will be done using the remaining sediment from the first sediment horizon (0-1 cm) after the sampling for eDNA. 3 pseudoreplicates for each of these parameters will be taken from the first horizon (0-1 cm) of the 3 MUC cores sampled for eDNA, when possible (following the indication of Dr. Sophie



Arnaud). Thus, from each core used for eDNA, 4 subsamples will be taken from the first horizon 0-1 cm (one sample for each biogeochemical parameter). If after completing the sampling there is still some sediment left from the homogenate of the first horizon from eDNA cores, then additional pseudoreplicates would be taken from each core. When possible take 3 additional extra samples from the first horizon of each eDNA core. The samples will be kept in plastic bags/vials, that have been previously labeled and store at -20°C in the freezer until their analysis at the laboratory (IEO Málaga).

Equipment needed: MUC; Push corer; freezer -20°C.

Close planning and integration is foreseen with the following groups, but others are welcome:

- IEO Physical and Chemical Oceanography team (IEO)
- IMAR benthic ecology and habitat mapping team (IMAR). The work planned by IEO benthic ecology and habitat mapping team & IMAR has been planned in close collaboration; we will work as a single team belonging to two different institutions.
- Benthic group of Geociencias marinas (IEO)
- Evolutionary ecology, biogeography and population genetics group (IFREMER)
- Species biogeography and Ecologically or Biologically Sensitive Areas team (HW)
- Foraminifera biodiversity (UIB)

References

- Ambar I, Serra N, Brogueira MJ, Cabeçadas G, Abrantes F, Freitas P, Gonçalves C, Nicolás N (2002) Physical, chemical and sedimentological aspects of the Mediterranean outflow off Iberia, *Deep Sea Res.*, 49, Part II, 4163-4177.
- Cathalot C, Rabouille C, Sauter E, Schewe I, Soltwedel T (2015) Benthic Oxygen Uptake in the Arctic Ocean Margins - A Case Study at the Deep-Sea Observatory HAUSGARTEN (Fram Strait). *PLOS ONE* | DOI:10.1371/journal.pone.0138339 October 14, 2015)
- Danovaro R, Dell'Anno A, Fabiano M (2001) Bioavailability of organic matter in the sediments of the Porcupine Abyssal Plain, northeastern Atlantic. *Mar Ecol Prog Ser* 220: 25–32,
- Freitas PS, Abrantes FF (2002) Suspended particulate matter in the Mediterranean water at the Gulf of Cadiz and off the southwest coast of the Iberian Peninsula. *Deep Sea Research Part II Topical Studies in Oceanography* 49(19):4245-4261
- Gooday, Turley CM (1990) Responses by Benthic Organisms to Inputs of Organic Material to the Ocean Floor: A Review and Discussion. Volume 331, issue 1616. *Philosophical Transactions of the Royal Society*. DOI: 10.1098/rsta.1990.0060
- Graf G (1989) Benthic-pelagic coupling in a deep-sea benthic community. *Nature* 341, 437-439 (5 October 1989) | doi:10.1038/341437a0;
- Thiel H, Pfannkuche O, Schriever G, Lochte K, Gooday AJ, Hemleben Ch, Mantoura RFG, Turley CM, Patching JW, Riemann F (1989) Phytodetritus on the Deep-Sea Floor in a Central Oceanic Region of the Northeast Atlantic, *Biological Oceanography*, 6:2, 203-239.
- Marti S, Baynoa JM, Albaigés J (2001) A potential source of organic pollutants into the northeastern Atlantic: the outflow of the Mediterranean deep-lying waters through the Gibraltar Strait. *et al* 2001. *Environ Sci Technol*. 2001 Jul 1;35(13):2682-9.



- Morata N, Renaud PE (2008). Sedimentary pigments in the western Barents Sea: a reflection of pelagic-benthic coupling? *Deep-Sea Research II* 55: 2381-2389.
- Neira C, Sellanes J, Levin LA, Arntz W (2001) Meiofaunal distributions on the Peru margin: relationship to oxygen and organic matter availability. *Deep-Sea Research* 48: 2453–2472
- Ramírez T, Cortés D, Mercado JM *et al.* (2005) Seasonal dynamics of inorganic nutrients and phytoplankton biomass in the NW Alboran Sea. *Est Coast Shelf Sci* 65: 654–670.
- Sanchez-Vidal A, Calafat A, Canals M, Frigola J, Fabres J (2005) Particle fluxes and organic carbon balance across the Eastern Alboran Sea (SW Mediterranean Sea). *Continental Shelf Research* 25, 609-625
- Smith KL, Ruhl HA, Kaufmann RS, Diego S (2008) Tracing abyssal food supply back to upper-ocean processes over a 17-year time series in the northeast Pacific. *Limnol. Oceanogr.* 53 (6): 2655–2667

Appendix II General Station List MEDWAVES

MEDWAVES 21.09.2016-26.10.2016

Gears: CTD; Box Corer=BC; Van Veen Grab=VV; Multicorer= MUC; Remotely Operated Vehicle=ROV; Side Scan Sonar=SSS; Multibeam=MB

Color codes:

Gazul	Ormonde	Formigas	Seco de los Olivos	Transits	Harbour / departure
-------	---------	----------	--------------------	----------	---------------------

Date	Site	St. Nr	Gear	Start St. UTC time (hh:mm)	End St. UTC time (hh:mm)	Lat Start	Lat Start	Long Start	Long Start	Lat End	Lat End	Long End	Long End	Depth (start-end) (m)	Comments
21.09.2016	Cádiz Harbour														Departure at 17:30 Local time
21.09.2016	Gazul	1	CTD	22:47	23:05	36	37.5200	6	45.0700					96	
22.09.2016	Gazul	2	CTD	0:05	0:20	36	36.0100	6	48.5500					150	No BTL
22.09.2016	Gazul	3	CTD	1:00	1:29	36	34.4900	6	52.0000					327	
22.09.2016	Gazul	4	CTD	2:21	2:57	36	32.9800	6	55.5500					451	
22.09.2016	Gazul	5	CTD	3:47	4:21	36	31.4900	6	59.0100					479	
22.09.2016	Gazul	6	CTD	5:08	5:38	36	29.9600	7	2.5600					669	No BTL
22.09.2016	Gazul	7	CTD	6:27	6:53	36	28.4500	7	6.0500					571	No BTL
22.09.2016	Gazul	8	ROV Dive#00	8:41	9:06	36	34.2470	6	55.9465						TRIMADO TMS*ROV O. TRIMADO ROV NOT OK, ROV ON DECK
22.09.2016	Gazul	9	ROV Dive#1	9:38	15:56	36	34.2419	6	55.9551	36	33.5300	6	55.9500	467-405	Pos and final time

															on deck	
22.09.2016	Gazul	10	BC-1	16:16		36	33.7800	6	55.8700						444	
22.09.2016	Gazul	11	BC-2	17:34		36	33.8700	6	55.8600						450	
22.09.2016	Gazul	12	BC-3	18:16		36	33.9200	6	55.8600						446	Lot of sediment was lost. Qualitative sample
22.09.2016	Gazul	13	CTD	20:44	21:12	36	25.5800	7	3.4700						577	NoBTL
22.09.2016	Gazul	14	CTD	22:06	22:36	36	27.0300	7	0.1400						491	CTD 109
22.09.2016	Gazul	15	CTD	23:16	23:42	36	28.5400	6	56.6400						475	CTD 110
23.09.2016	Gazul	16	CTD	0:40	1:01	36	30.0500	6	53.1400						437	CTD 111
23.09.2016	Gazul	17	CTD	1:51	2:07	36	31.5600	6	49.6400						320	CTD112
23.09.2016	Gazul	18	CTD	2:45	3:00	36	33.1500	6	46.0200						140	CTD113
23.09.2016	Gazul	19	CTD	3:37	3:50	36	34.5900	6	42.6300						100	CTD114
23.09.2016	Gazul	20	ROV Dive#2	7:31	16:10	36	33.9200	6	57.1900						472	
23.09.2016	Gazul	21	BC-4	16:34		36	33.5900	6	59.9500							
23.09.2016	Gazul	22	MUC	17:25	17:49	36	33.5900	6	56.9500						470	
23.09.2016	Gazul	23	CTD	18:20	18:45	36	33.6300	6	56.9900							
23.09.2016	Gazul	24	CTD	20:20	20:32	36	40.5400	6	47.4000						100	No BTL
23.09.2016	Gazul	25	CTD	21:10	21:25	36	38.9900	6	50.9500						149	
23.09.2016	Gazul	26	CTD	21:58	22:28	36	37.4800	6	54.4500						355	
23.09.2016	Gazul	27	CTD	23:09	23:35	36	35.9600	6	57.9500						465	
24.09.2016	Gazul	28	CTD	0:10	0:40	36	34.4500	7	1.4500						490	
24.09.2016	Gazul	29	CTD	1:22	1:52	36	32.9400	7	4.9400						542	
24.09.2016	Gazul	30	CTD	2:31		36	31.4300	7	8.4400						547	
24.09.2016	Gazul	31	MB	9:30		36	18.0600	7	58.5000	36	40.85	10	41.66			Line
24.09.2016	Ormonde	32	CTD	21:20	22:40	36	40.8800	10	41.7400						3190.9	CTD201
24.09.2016	Ormonde	33	CTD	23:32	0:50	36	41.2300	10	45.6500						3110	CTD202

25.09.2016	Ormonde	34	CTD	1:30	3:00	36	41.4200	10	49.8100					2590	CTD203
25.09.2016	Ormonde	35	CTD	3:45	5:00	36	41.6000	10	52.9100					2529	CTD204
25.09.2016	Ormonde	36	ROV Dive#3	7:41	16:25	36	58.6700	10	47.0700					1951	
25.09.2016	Ormonde	37	BC-05	16:52	18:30	36	58.6500	10	47.1100					1919	
25.09.2016	Ormonde	38	MUC	18:40	20:06	36	50.6500	10	78.1500					1925	
25.09.2016	Ormonde	39	MUC	21:03	22:27	36	52.9600	10	49.8400					1895	
25.09.2016	Ormonde	40	CTD	23:17	0:22	36	50.4200	10	54.3600					1498	
25.09.2016	Ormonde	41	CTD	1:06	1:52	36	47.8200	10	59.0900					932	
25.09.2016	Ormonde	42	CTD	2:46	3:00	36	45.2000	11	3.8600						CTD233
26.09.2016	Ormonde	43	CTD	3:56	4:21	36	42.5700	11	8.5700						CTD209
26.09.2016	Ormonde	44	CTD	4:57	5:20	36	40.8900	11	11.3200						CTD232
26.09.2016	Ormonde	45	CTD	5:44	6:20	36	39.0900	11	14.7500						CTD231
26.09.2016	Ormonde	46	MB	7:26	10:05	36	35.9800	11	12.9200	36	47.0000	10	53.7700	1522	L1
26.09.2016	Ormonde	46	MB	10:21	13:10	36	45.7600	10	52.4600	36	34.6400	11	11.7300	1719	L2
26.09.2016	Ormonde	46	MB	14:18	15:50	36	41.0800	11	18.1500	36	34.0200	11	12.2400	2150	L3
26.09.2016	Ormonde	46	MB	18:07	19:09	36	52.8200	10	57.0400	36	40.4600	11	19.1800	956	L4
26.09.2016	Ormonde	46	MB	19:22	20:16	36	45.6300	11	1.3100	36	48.9500	10	55.8500	506	L5
26.09.2016	Ormonde	46	MB	20:18	23:30	36	48.9500	10	55.8500	36	43.7300	11	43.3700	4600	L6 (cerrar sambic?)
27.09.2016	Ormonde-Formigas		MB transit	0:00	23:59	36	45.6500	11	43.5900	36	53.6000	16	52.5300	4300	Sampling interrupted due to militar maouvres in the area. MB transit from Ormonde to Formigas
28.09.2016	Ormonde-Formigas		MB transit	0:00	23:59	36	53.6000	16	52.5300	37	1.8700	21	20.9900	4180	MB transit from Ormonde to Formigas
29.09.2016	Ormonde-Formigas		MB transit	0:00	23:59	36	56.4900	18	39.2900	37	6.5800	23	59.4700	3730	MB transit from Ormonde to Formigas

29.09.2016	Formigas	47	ROV Dive#4	11:52	17:49	37	8.0130	24	8.1420					1544	
29.09.2016	Formigas	48	MB	18:01	18:15	37	9.9680	24	38.8000	37	10.6100	24	41.7600	1259	L1
29.09.2016	Formigas		MB	18:27	19:11	37	13.1800	24	42.1300	37	13.1200	24	30.7300	1410	L2
29.09.2016	Formigas		MB	19:19	21:59	37	14.7200	24	31.1300	37	14.5200	24	41.5600	1134	L3
29.09.2016	Formigas		MB	22:12	23:17	37	12.4700	24	41.3000	37	12.2400	24	35.0200	3685	L4
29.09.2016	Formigas	49	CTD	23:10	0:34	37	7.8000	24	30.4000					1261	CTD301
30.09.2016	Formigas	50	CTD	1:26	2:48	37	9.5300	24	33.5700					1777	CTD302
30.09.2016	Formigas	51	CTD	3:22	4:21	37	11.7600	24	36.0700					1243	CTD303
30.09.2016	Formigas	52	CTD	5:00	5:40	37	17.9800	24	39.4300						CTD309
30.09.2016	Formigas	53	CTD	6:10	6:29	37	14.2690	24	42.1400					148	CTD305
30.09.2016	Formigas	54	ROV Dive#5	8:50	14:08	37	10.2510	24	38.1100					1350	
30.09.2016	Formigas	55	VV01	14:58	16:04	37	9.0900	24	37.7000					1535	
30.09.2016	Formigas	56	VV02	16:20	17:10	37	9.0000	24	37.7000					1536	
30.09.2016	Formigas	57	MUC	17:25	18:25	37	9.8700	24	37.7000					1536	empty
30.09.2016	Formigas	58	VV03	19:08	19:54	37	10.7300	24	37.9500					1172	
30.09.2016	Formigas	59	VV04	20:04	20:48	37	10.7300	24	37.9600					1173	
30.09.2016	Formigas	60	CTD	21:55	23:00	37	11.5700	24	42.4000					664	MW-325
30.09.2016	Formigas	61	CTD	23:15	0:12	37	8.4140	24	41.7710					1250	MW-326
01.10.2016	Formigas	62	CTD	0:56	2:22	37	5.2400	24	41.0300					1840	MW-327
01.10.2016	Formigas	63	CTD	2:56	4:32	37	2.7200	24	40.6300					2150	MW-328
01.10.2016	Formigas	64	CTD	5:18	5:48	36	58.9000	24	39.6690					2458	MW-329
01.10.2016	Formigas	65	ROV Dive#6	8:45	16:19	37	11.3600	24	37.9700	37	11.5870	24	37.2413	1244-918	
01.10.2016	Formigas	66	VV05	16:52	17:38	37	11.4400	24	37.6300					1122	qualitative
01.10.2016	Formigas	67	VV06	17:56	18:45	37	11.3500	24	37.9700					1246	
01.10.2016	Formigas	68	MUC	18:50	20:00	37	11.3500	24	37.9800					1245	
01.10.2016	Formigas	69	CTD	22:02	22:22	37	17.0200	24	47.2400						MW-306
01.10.2016	Formigas	70	CTD	22:40	23:24	37	17.4400	24	48.0000					890	MW-307

03.10-2016	Formigas	93	MB	13:51	14:38	37	12.5900	24	39.4900	37	14.1197	24	48.5160		L1
03.10-2016	Formigas	94	MB	15:04	15:56	37	11.0800	24	48.4056	37	18.4059	24	49.6901		L2a
03.10-2016	Formigas	95	MB	17:50	19:17	37	21.4761	24	51.3638	37	10.0292	24	51.7994		L3
03.10-2016	Formigas	96	MB	19:41	20:50	37	10.6275	24	55.6899	37	20.1400	24	55.2904		L4
03.10-2016	Formigas	97	CTD	21:33	22:45	37	21.6830	24	55.7600					1725	MW-311
03.10-2016	Formigas	98	CTD	23:50	1:27	37	24.2550	24	45.1590					1410	MW-322
04.10-2016	Formigas	99	CTD	2:05	3:14	37	21.1020	24	44.4590					1495	MW-323
04.10-2016	Formigas	100	CTD	4:00	4:22	37	15.8050	24	43.3420					232	MW-337
04.10-2016	Formigas	101	CTD	5:12	6:00	37	16.3000	24	37.4700					1055	MW-332
04.10-2016	Formigas	102	CTD	6:51	7:27	37	17.8930	24	43.8330					784	MW-324
04.10-2016	Formigas	103	ROV Dive#9	8:59	15:52	37	20.5110	24	44.4500	37	20.3500	24	44.9700	1405-1209	
04.10-2016	Formigas	104	VV13	17:25	18:15	37	20.5600	24	44.4500	37	20.5600	24	44.4500	1415-1415	
04.10-2016	Formigas	105	VV14	18:20	19:16	37	20.5600	24	44.4500	37	20.5600	24	44.4500	1415-1415	null
04.10-2016	Formigas	106	VV15	19:20	20:15	37	20.5600	24	44.4500	37	20.5600	24	44.4500	1415-1415	
04.10-2016	Formigas	107	MUC	20:40	21:35	37	20.5600	24	44.4500					1415	empty
04.10-2016	Formigas	108	CTD	23:26	0:17	37	17.9000	24	27.8800					1150	MW-330
05.10-2016	Formigas	109	CTD	0:55	1:40	37	17.0800	24	31.6600					1060	MW-331
05.10-2016	Formigas	110	CTD	3:18	3:38	37	14.1970	24	45.8440					182	MW-334
05.10-2016	Formigas	111	CTD	4:19	5:35	37	13.1800	24	50.7100						MW-335
05.10-2016	Formigas	112	CTD	6:10	7:24	37	12.4310	24	54.3890						MW-326
05.10-2016	Formigas	113	ROV Dive#10	9:00	11:29	37	20.4000	24	45.3400	37	20.1700	24	45.3900	1323-1057	
05.10-2016	Formigas	114	VV16	17:40	18:31	37	20.4000	24	45.3500	37	20.4000	24	45.3500	1324-1325	null
05.10-2016	Formigas	115	VV17	18:34	19:29	37	20.4000	24	45.3500	37	20.4000	24	45.3500	1324-1324	
05.10-2016	Formigas	116	VV18	19:38	20:30	37	20.4000	24	45.3100	37	20.4000	24	45.3100	1325-1325	
05.10-2016	Formigas	117	MUC	20:45	21:45	37	20.4000	24	45.3100					1325	
05.10-2016	Formigas	118	CTD	23:12	23:46	37	12.5400	24	45.2400					642	MW-318
06.10-2016	Formigas	119	CTD	0:20	1:12	37	10.3400	24	47.3900					1130	MW-319

06.10-2016	Formigas	120	CTD	1:50	2:59	37	8.1860	24	49.4600					1515	MW-320
06.10-2016	Formigas	121	CTD	3:50	5:05	37	5.9300	24	51.7000					1795	MW-321
06.10-2016	Formigas	122	MB	9:52	11:50	37	22.3570	24	45.9720	37	22.6210	25	3.5160		L1
06.10-2016	Formigas		MB	12:11	15:10	37	24.9320	25	3.8140	37	24.5211	24	34.7753	1088	L2
06.10-2016	Formigas		MB	15:37	19:30	37	21.3896	24	34.8071	37	21.3900	24	47.9700	1552	L3
06.10-2016	Formigas		MB	19:53	21:30	37	14.9906	24	27.0930	37	16.8200	24	43.3400	610	L4
06.10-2016	Formigas	123	VV19	22:05	22:59	37	20.2900	24	45.2800	37	20.3000	24	45.2900	1312-1310	null
06.10-2016	Formigas	124	CTD	23:30	1:20	37	20.4320	24	44.0370					1435	MW-370
07.10-2016	Formigas	125	CTD	1:40	7:01	37	20.4320	24	44.0370					1435	MW-371
07.10-2016	Formigas	126	ROV Dive#11	8:52	13:15	37	20.1800	24	45.3900	37	20.0400	24	44.0000	1078-1005	
07.10-2016	Formigas	127	ROV Dive#12	14:11	18:22	37	19.6400	24	45.7000	37	19.3900	24	45.8200	1016-648	
07.10-2016	Formigas	128	VV20	22:17	23:00	37	19.5900	24	44.7200	37	16.6000	24	44.7200	1043-2048	
07.10-2016	Formigas	129	VV21	23:08	23:49	37	19.0000	24	44.7000	37	19.6000	24	44.7000	1049-1049	null
07.10-2016	Formigas	130	VV22	23:52	0:33	37	16.6000	24	44.7000	37	19.6000	24	44.7000	1048-1048	
08.10-2016	Formigas	131	VV23	0:40	1:20	37	19.6000	24	44.6900	37	19.6000	24	44.6900	1069-1069	
08.10-2016	Formigas	132	CTD	2:10	7:00	37	15.7900	24	49.6400					1498	MW-372
08.10-2016	Formigas	133	ROV Dive#13	8:55	12:33	37	11.8700	24	48.1100	37	12.0500	24	48.0200	1037-989	
08.10/14.10-2016															Ponta Delgada Harbour due to Bad weather conditions. Arrival in Ponta Delgada at 20:00 local time the 08/10/2016. Departure from Ponta Delgada at 15:00 Local time the 14/10/2016.
14.10-2016	Formigas	134	CTD	21:32	22:40	37	9.5500	24	39.6100					1349	
14.10-2016	Formigas	135	CTD yo-yo	23:34	6:20	37	9.5500	24	39.6100					1350	CTD yo-yo

15.10-2016	Formigas	136	MB	11:24	8:11	37	2.7000	24	50.4700	36	55.3000	20	51.3700	1998	L1 Formigas to Ormonde (transit). MB Survey cancelled due to bad weather
16.10.2017	Formigas-Ormonde														Transit Formigas-Ormonde
17.10-2016	Formigas-Ormonde	137	MB	14:25	8:00	36	31.2233	15	27.8392	36	48.2300	11	38.3100	3605	L2
18.10-2016	Ormonde	138	ROV Dive#14	12:43	15:45	36	52.0300	10	53.3700	36	52.0300	10	53.3600	1499-1500	Technical problems
18.10-2016	Ormonde	139	VV24	15:56	17:13	36	58.6400	10	47.1000	36	58.6400	10	53.1000	1936-1932	
18.10-2016	Ormonde	140	VV25	17:43	18:58	36	58.5600	10	47.1100	36	58.5600	10	47.1100	1931-1932	
18.10-2016	Ormonde	141	CTD	23:12	0:16	36	36.4883	11	10.2223	36	36.4878	11	10.2229	1489	LADCP connection failed
19.10-2016	Ormonde	142	CTD	1:35	2:17	36	38.5479	11	9.6227	36	38.5477	11	9.6226	909	LADCP master only
19.10-2016	Ormonde	143	CTD	3:07	3:20	36	40.5585	11	9.0736	36	40.5582	11	9.0734	226	
19.10-2016	Ormonde	144	CTD	4:19	4:34	36	44.6375	11	7.9421	36	44.6389	11	7.9431	248	LACDP working
19.10-2016	Ormonde	145	ROV Dive#15	6:26	11:21	36	52.0300	10	53.3700	36	51.9400	10	53.6400	1498-1476	It was aborted due to very strong currents
19.10-2016	Ormonde	146	ROV Dive#16	12:07	17:22	36	48.0100	10	57.0300	36	47.4500	10	57.9100	1232-1063	
19.10-2016	Ormonde	147	VV26	17:50	18:40	36	48.0200	10	57.0100	36	48.0100	10	57.0100	1235-1234	
19.10-2016	Ormonde	148	VV27	18:45	19:35	36	48.0100	10	57.0200	36	48.0100	10	57.0200	1235-1235	Ok low sediment volume
19.10-2016	Ormonde	149	CTD	22:09	23:13	36	43.3972	11	20.9999	36	43.3974	11	21.0008	1616	
20.10-2016	Ormonde	150	CTD	0:21	1:08	36	43.1792	11	17.8886	36	43.1791	11	17.8892	1167	
20.10-2016	Ormonde	151	CTD	1:52	2:28	36	42.9865	11	14.7837	36	42.9867	11	14.7850	875	
20.10-2016	Ormonde	152	CTD	3:04	3:17	36	42.7822	11	11.6313	36	42.7800	11	11.6300	193	
20.10-2016	Ormonde	153	CTD	4:18	4:29	36	42.3996	11	5.3987	36	42.3995	11	5.3989	127	
20.10-2016	Ormonde	154	CTD	5:02	5:28	36	42.9830	11	2.3321	36	42.2150	11	2.3320	592	
20.10-2016	Ormonde	155	ROV Dive#17	7:09	14:19	36	48.6600	11	7.5600	36	47.5400	11	7.7600	1146-945	

20.10-2016	Ormonde	156	ROV Dive#18	15:37	17:52	36	46.9800	11	6.7600	36	47.0400	11	6.3700	866-661	
20.10-2016	Ormonde	157	VV28	18:10	19:05	36	48.6200	11	7.5100	36	48.6300	11	7.5000	1143	
20.10-2016	Ormonde	158	VV29	19:12	19:57	36	48.6300	11	7.5000	36	48.6500	11	7.5100	1144	null (arrived open on deck)
20.10-2016	Ormonde	159	CTD	20:37	21:30	36	50.7737	11	6.2884	36	50.7739	11	6.2894	1342	
20.10-2016	Ormonde	160	CTD	22:26	23:12	36	48.7480	11	6.8523	36	48.7476	11	6.8526	1113	
20.10-2016	Ormonde	161	CTD	23:48	0:28	36	46.6778	11	7.4154	36	46.6775	11	7.4152	788	
21.10-2016	Ormonde	162	CTD	0:57	1:09	36	45.2464	11	3.8350	36	45.2453	11	3.8336	193	
21.10-2016	Ormonde	163	CTD	1:59	2:36	36	47.7974	10	59.1013	36	47.7995	10	59.0994	941	
21.10-2016	Ormonde	164	CTD	3:31	4:27	36	42.0081	10	59.1367	36	42.0085	10	59.1376	1367	
21.10-2016	Ormonde	165	CTD	5:48	5:57	36	40.8780	11	11.3350	36	40.8754	11	11.3316	111	
Transit to Gazul Mud Volcano															
22.10-2016	Gazul	166	CTD	1:13	1:35	36	34.0909	6	58.3832	36	34.0912	6	58.3827	482	
22.10-2016	Gazul	167	CTD	1:47	1:59	36	34.0916	6	58.3831	36	34.0907	6	58.3832	300	
22.10-2016	Gazul	168	MB	2:07	2:38	36	34.0748	6	58.2710	36	33.9414	6	53.8757	482-426	L1
22.10-2016	Gazul	169	MB	2:48	3:17	36	33.1109	6	53.8445	36	32.8157	6	56.8776	427-478	L2
Transit to Seco de los Olivos															
22.10-2016	Seco de los Olivos	170	CTD	22:45	22:54	36	36.6527	2	48.0240					73	
22.10-2016	Seco de los Olivos	171	CTD	23:31	23:51	36	33.8326	2	49.4767					329	
23.10-2016	Seco de los Olivos	172	CTD	0:34	0:40	36	31.0035	2	50.9611					96	
23.10-2016	Seco de los Olivos	173	CTD	1:20	1:52	36	27.9938	2	52.4656					728	
23.10-2016	Seco de los Olivos	174	CTD	2:41	3:15	36	25.3383	2	53.9446					801	
23.10-2016	Seco de los Olivos	175	CTD	3:49	4:28	36	22.4779	2	55.4592					914	
23.10-2016	Seco de los Olivos	176	ROV Dive#19	7:01	8:43	36	28.7200	2	53.7500	36	28.8900	2	53.6500	787-715	

23.10-2016	Seco de los Olivos	177	VV30	8:53	9:20	36	28.8500	2	53.6700	36	28.8500	2	53.6700	729-729	null
23.10-2016	Seco de los Olivos	178	VV31	9:31	10:00	36	28.8500	2	53.6700	36	28.8500	2	53.6700	729-729	
23.10-2016	Seco de los Olivos	179	MUC	-	10:52	-	-	-	-	36	28.8500	2	53.6700	729-729	
23.10-2016	Seco de los Olivos	180	VV32	10:58	11:43	36	28.8600	2	53.6800	36	28.8600	2	53.6800	729-729	
23.10-2016	Seco de los Olivos	181	ROV Dive#20	12:23	13:15	36	28.9500	2	53.5200	36	28.9300	2	53.5200	658-656	
23.10-2016	Seco de los Olivos	182	ROV Dive#21	13:54	18:28	36	28.9600	2	53.5200	36	29.7890	2	53.3860	658-325	
23.10-2016	Seco de los Olivos	183	VV33	18:48	19:17	36	29.0500	2	53.5200	36	29.0500	2	53.5200	637-658	null. Open
23.10-2016	Seco de los Olivos	184	VV34	19:18	19:47	36	29.0500	2	53.5200	36	29.0500	2	53.5200	636-655	
23.10-2016	Seco de los Olivos	185	CTD	21:04	21:51	36	19.7100	2	56.8800	36	19.7100	2	56.8900	1071	
23.10-2016	Seco de los Olivos	186	CTD	22:41	23:30	36	19.7200	2	53.0000	36	19.7200	2	52.9800	1198	
24.10-2016	Seco de los Olivos	187	CTD	0:20	1:30	36	22.5400	2	51.5000	36	22.5300	2	51.5000	1030	
24.10-2016	Seco de los Olivos	188	CTD	1:42	2:15	36	25.3600	2	50.1000	36	25.3400	2	50.0600	897	
24.10-2016	Seco de los Olivos	189	CTD	2:59	3:29	36	28.1800	2	48.6000	36	28.1700	2	48.5700	767	
24.10-2016	Seco de los Olivos	190	CTD	4:05	4:28	36	31.0000	2	47.1000	36	31.0000	2	47.1000	521	
24.10-2016	Seco de los Olivos	191	CTD	5:03	5:20	36	33.8200	2	45.6000	36	33.8200	2	45.6000	333	
24.10-2016	Seco de los Olivos	192	ROV Dive#22	6:41	10:14	36	32.7600	2	48.7800	36	32.2800	2	49.2400	385-256	
24.10-2016	Seco de los Olivos	193	VV35	10:58	11:17	36	22.5500	2	49.1600	36	22.5500	2	49.1600	320-318	
24.10-2016	Seco de los Olivos	194	VV36	11:18	11:34	36	22.5500	2	49.1600	36	32.5500	2	49.1600	321-321	
24.10-2016	Seco de los Olivos	195	VV37	11:37	11:56	36	32.5500	2	40.1600	36	32.5500	2	49.1600	321-322	
24.10-2016	Seco de los Olivos	196	ROV Dive#23	12:27	15:39	36	32.3800	2	49.2600	36	32.2200	2	49.1800	240-257	

24.10-2016	Seco de los Olivos	197	VV38	16:24	16:38	36	22.2000	2	49.2200	36	32.2000	2	49.2200	250-250	
24.10-2016	Seco de los Olivos	198	VV39	16:41	16:54	36	32.2000	2	49.2200	36	32.2000	2	49.2200	250-250	
24.10-2016	Seco de los Olivos	199	VV40	16:58	17:10	36	32.2000	2	49.2200	36	32.2000	2	49.2200	250-250	
24.10-2016	Seco de los Olivos	200	VV41	17:34	17:52	36	32.7600	2	48.8100	36	32.7600	2	48.8100	381-382	
24.10-2016	Seco de los Olivos	201	MUC	18:00	18:33	36	32.7600	2	48.8100	36	32.5500	2	48.9200	381-385	
24.10-2016	Seco de los Olivos	202	CTD	20:36	21:18	36	19.7237	3	0.7851	36	19.7235	3	0.7841	942	
24.10-2016	Seco de los Olivos	203	CTD	22:00	22:38	36	22.5410	2	59.3112	36	22.5400	2	59.3000	875	
24.10-2016	Seco de los Olivos	204	CTD	23:23	23:54	36	25.3600	2	57.8000	36	25.3300	2	57.8000	756	
25.10-2016	Seco de los Olivos	205	CTD	0:33	1:02	36	28.1800	2	56.4000	36	28.1700	2	56.3800	620	
25.10-2016	Seco de los Olivos	206	CTD	1:46	2:06	36	31.0000	2	54.9000	36	31.0000	2	54.9000	446	
25.10-2016	Seco de los Olivos	207	CTD	2:40	3:01	36	33.8200	2	53.4000	36	33.8200	2	53.4000	354	
25.10-2016	Seco de los Olivos	208	CTD	3:32	3:47	36	36.6400	2	25.0000	36	36.6800	2	51.9400	84	
25.10-2016	Seco de los Olivos	209	CTD	4:42	4:48	36	36.6400	2	44.2000	36	36.6800	2	44.1600	62	
25.10-2016	Seco de los Olivos	210	ROV Dive#24	6:47	10:49	36	30.9600	2	47.6200	36	31.2500	2	48.2500	553-234	
25.10-2016	Seco de los Olivos	211	ROV Dive#25	11:45	15:38	36	30.7700	2	49.0900	36	31.1500	2	49.0100	441-288	
25.10-2016	Seco de los Olivos	212	VV42	16:18	16:34	36	31.2400	2	48.1700	36	31.2400	2	48.1700	280-282	
25.10-2016	Seco de los Olivos	213	VV43	16:34	16:50	36	31.2400	2	48.1700	36	31.2400	2	48.1700	280-281	
25.10-2016	Seco de los Olivos	214	VV44	17:10	17:31	36	31.0400	2	48.0400	36	31.0300	2	48.0400	440-449	
25.10-2016	Seco de los Olivos	215	MUC	17:40	18:15	36	30.9400	2	47.6510					554	
26.10-2016	Málaga harbour														Arrival at 08:00 Local time

Appendix III. Overview meteorological conditions during MEDWAVES

Surface Wind (knots)
GFS 000 Hour Analysis Mon 26 Sep 2016 12 UTC

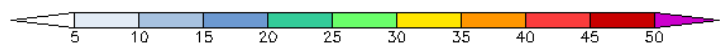
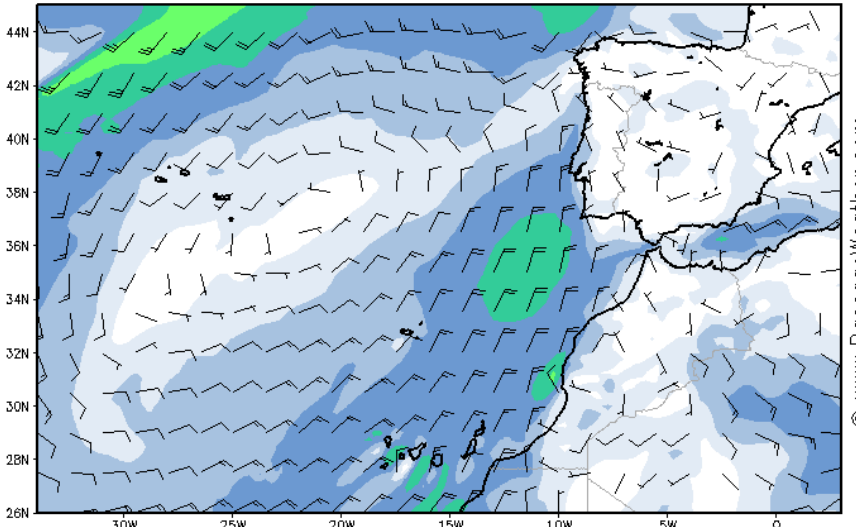

Surface Wind (knots)
GFS 024 Hour Forecast Tue 27 Sep 2016 12 UTC

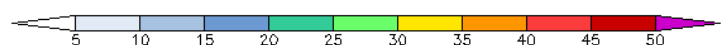
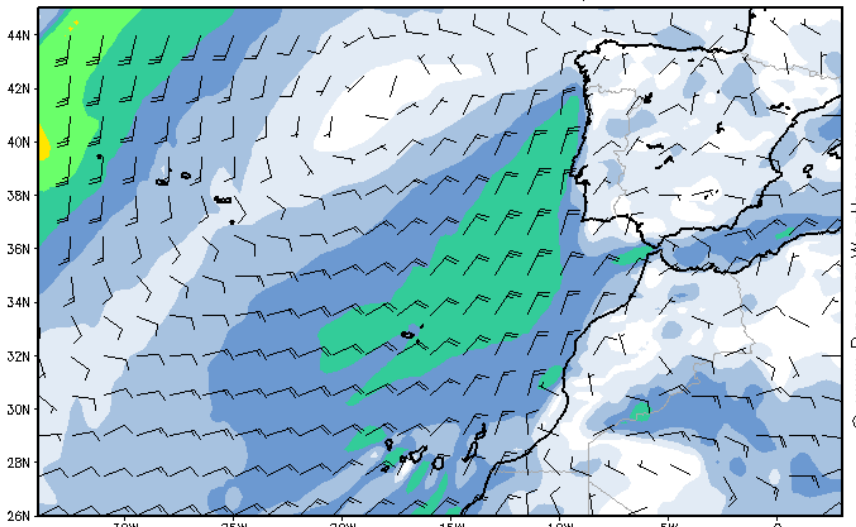

Wave Height (m) and Direction
WW3 000 Hour Analysis Mon 26 Sep 2016 12 UTC

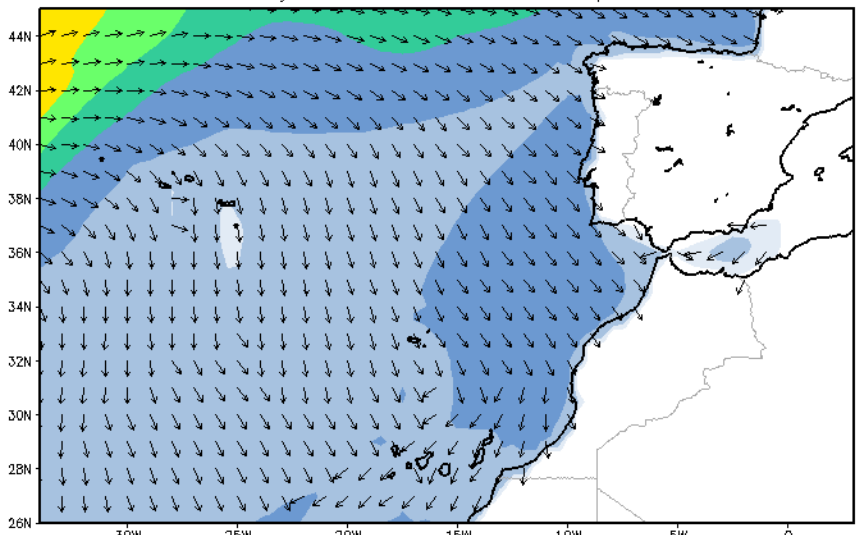

Wave Height (m) and Direction
WW3 024 Hour Forecast Tue 27 Sep 2016 12 UTC

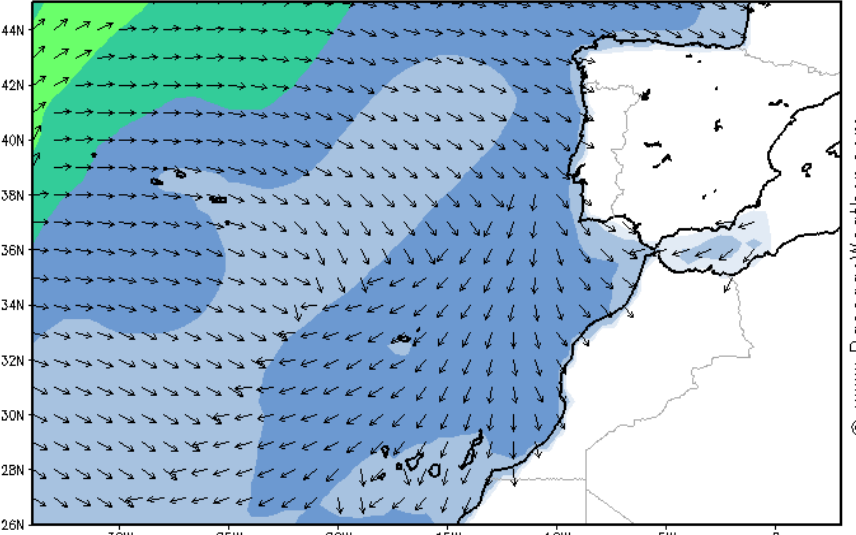

© www.PassageWeather.com

© www.PassageWeather.com

© www.PassageWeather.com

© www.PassageWeather.com

Surface Wind (knots)
GFS 048 Hour Forecast Wed 28 Sep 2016 12 UTC

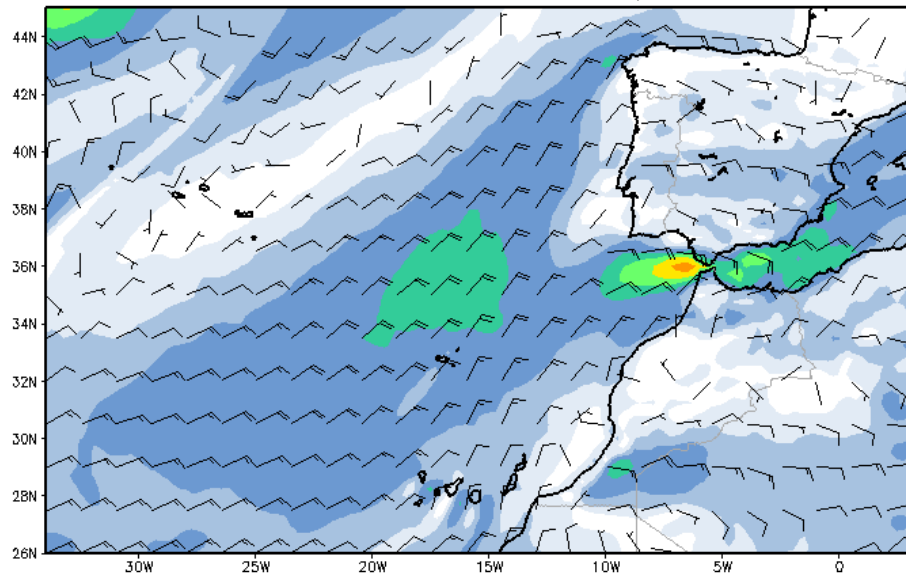

© www.PassageWeather.com

Surface Wind (knots)
GFS 072 Hour Forecast Thu 29 Sep 2016 12 UTC

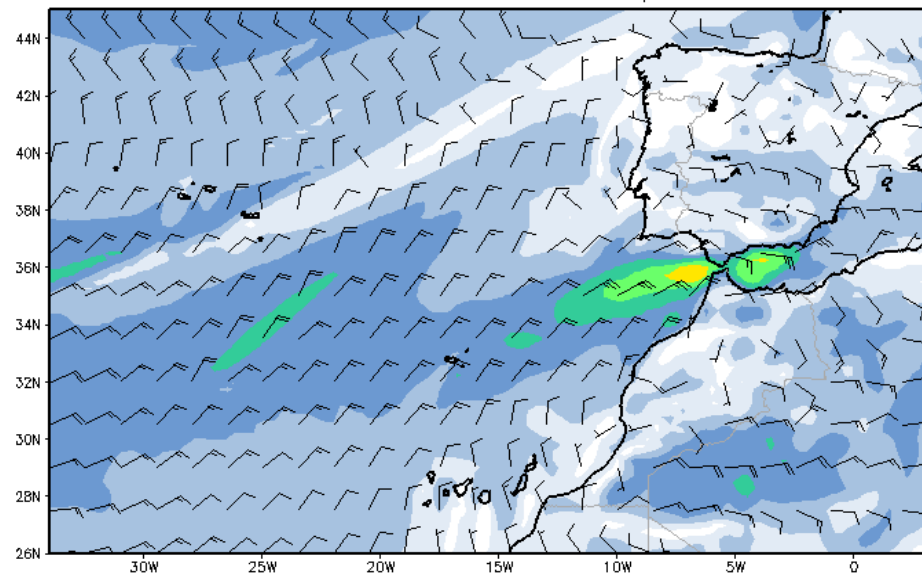

© www.PassageWeather.com

Wave Height (m) and Direction
WW3 048 Hour Forecast Wed 28 Sep 2016 12 UTC

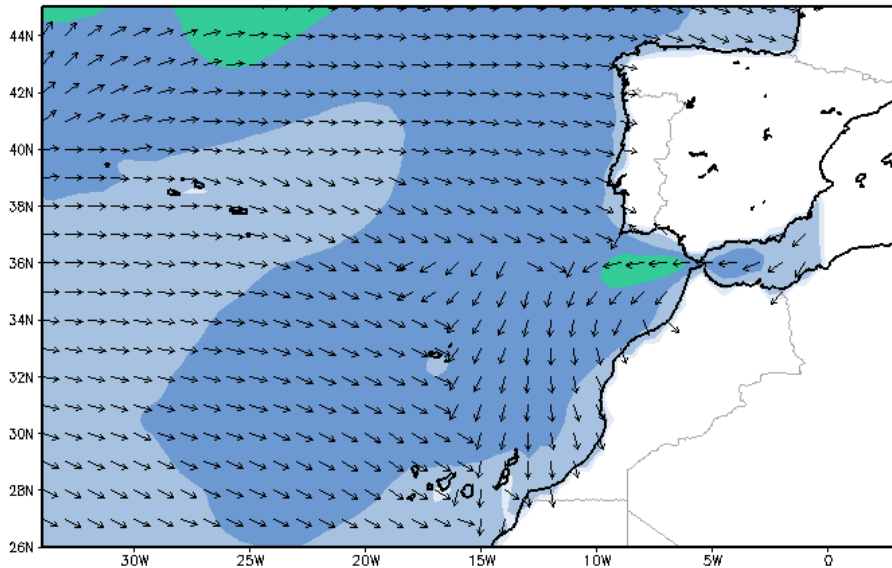

© www.PassageWeather.com

Wave Height (m) and Direction
WW3 072 Hour Forecast Thu 29 Sep 2016 12 UTC

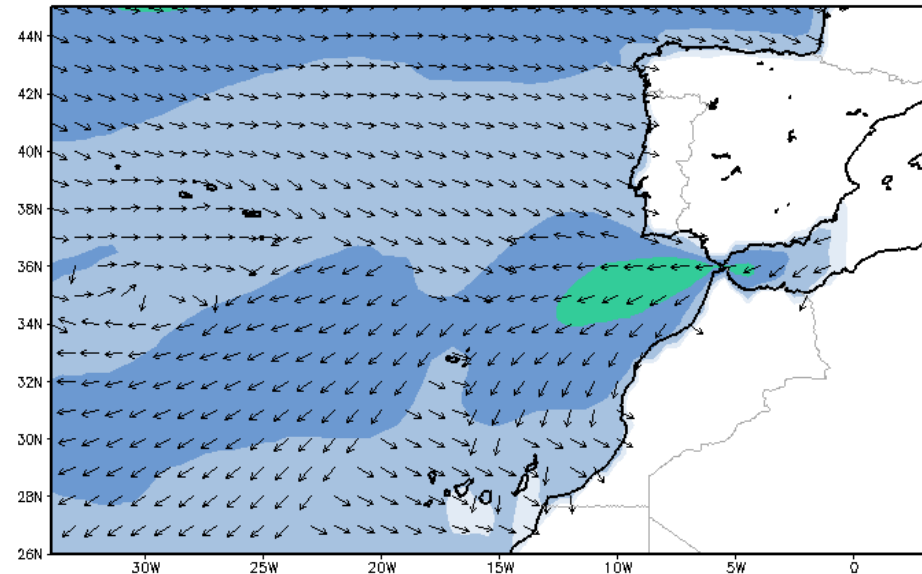

© www.PassageWeather.com

Surface Wind (knots)
GFS 096 Hour Forecast Fri 30 Sep 2016 12 UTC

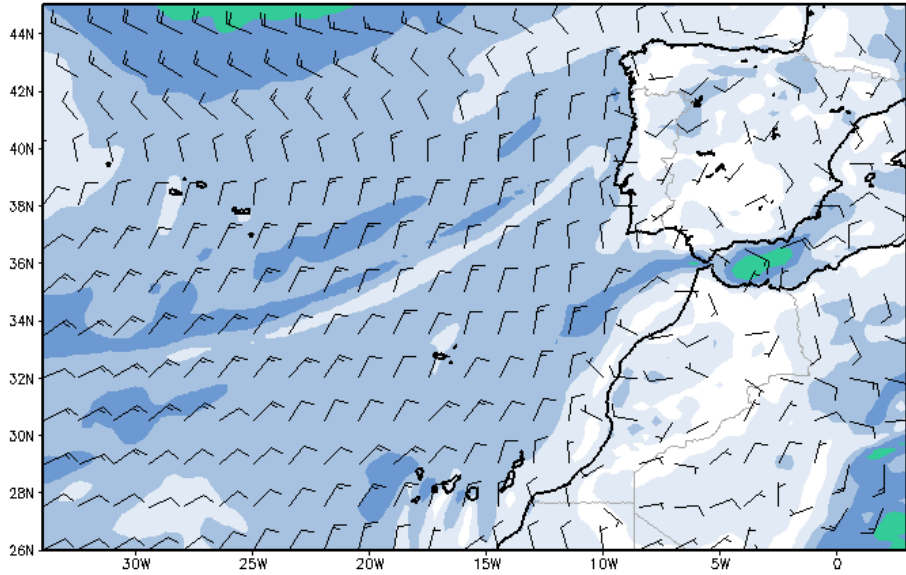

© www.PassageWeather.com

Surface Wind (knots)
GFS 120 Hour Forecast Sat 01 Oct 2016 12 UTC

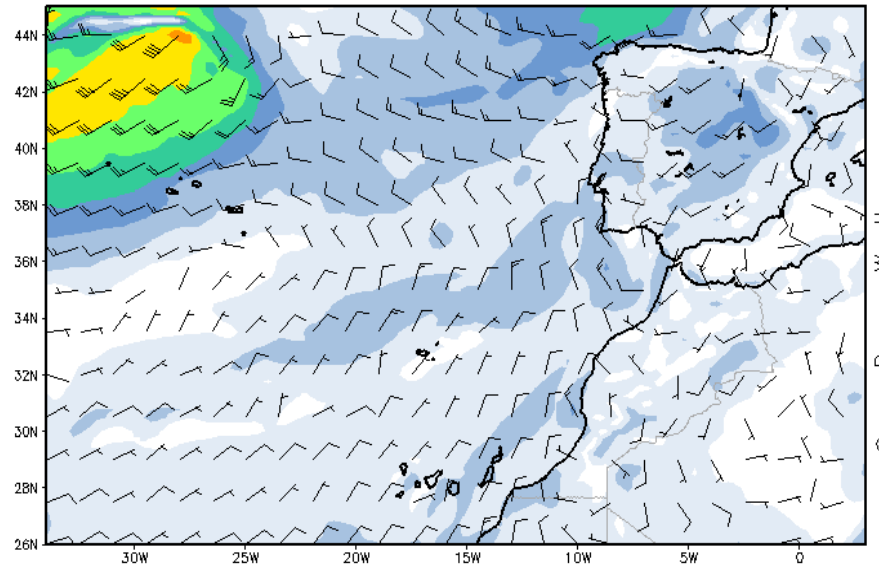

© www.PassageWeather.com

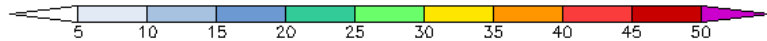

Wave Height (m) and Direction
WW3 096 Hour Forecast Fri 30 Sep 2016 12 UTC

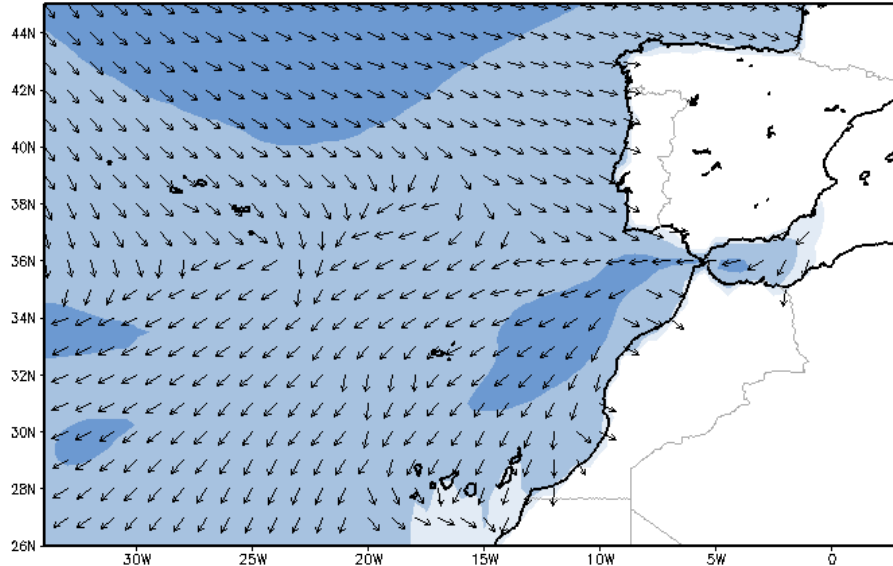

© www.PassageWeather.com

Wave Height (m) and Direction
WW3 120 Hour Forecast Sat 01 Oct 2016 12 UTC

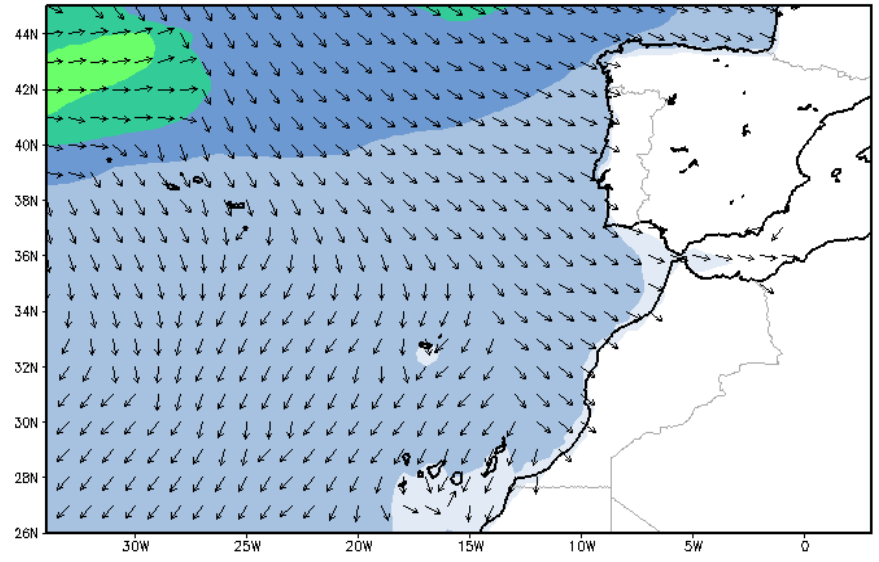

© www.PassageWeather.com



Surface Wind (knots)

GFS 144 Hour Forecast

Sun 02 Oct 2016

12 UTC

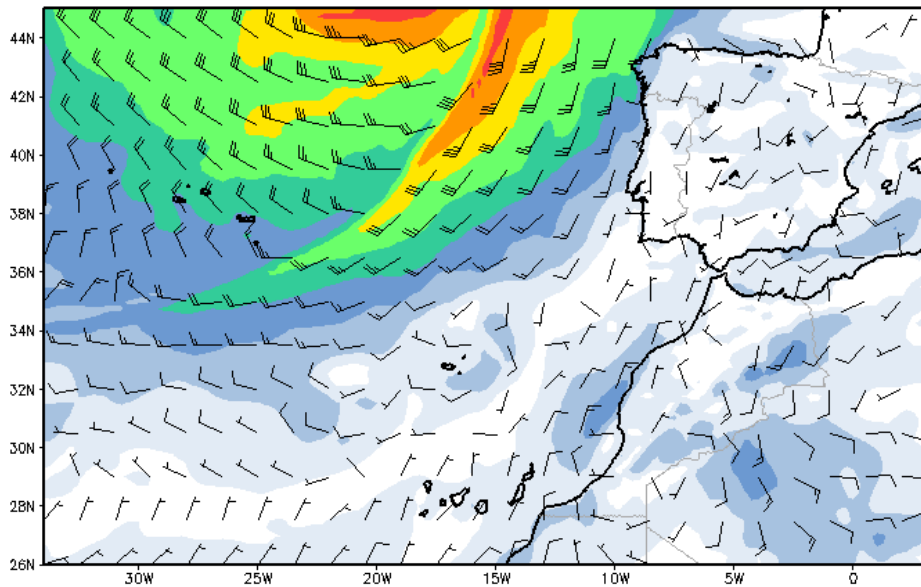

Surface Wind (knots)

GFS 168 Hour Forecast

Mon 03 Oct 2016

12 UTC

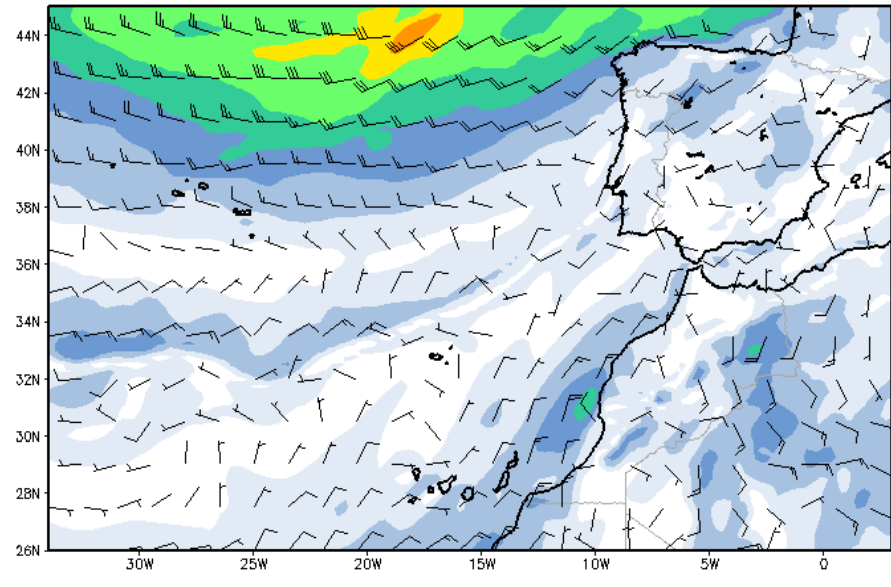

wave Height (m) and Direction

WW3 144 Hour Forecast

Sun 02 Oct 2016

12 UTC

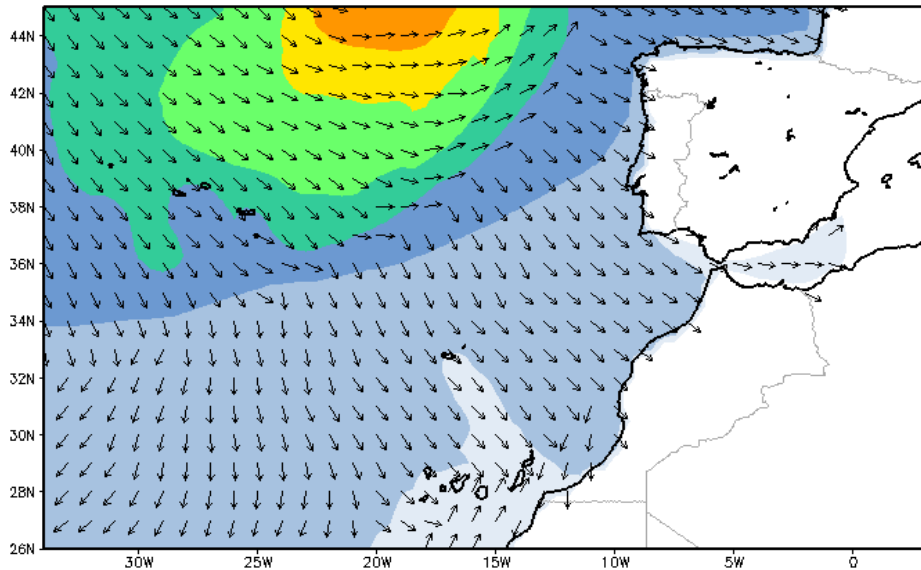

Wave Height (m) and Direction

WW3 168 Hour Forecast

Mon 03 Oct 2016

12 UTC

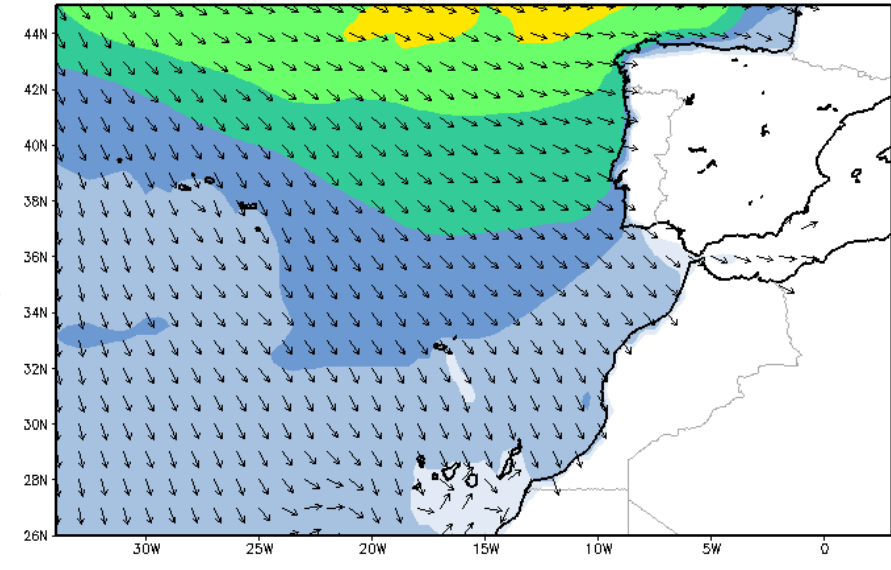

© www.PassageWeather.com

© www.PassageWeather.com

© www.PassageWeather.com

© www.PassageWeather.com

Surface Wind (knots)
GFS 156 Hour Forecast

Tue 04 Oct 2016 12 UTC

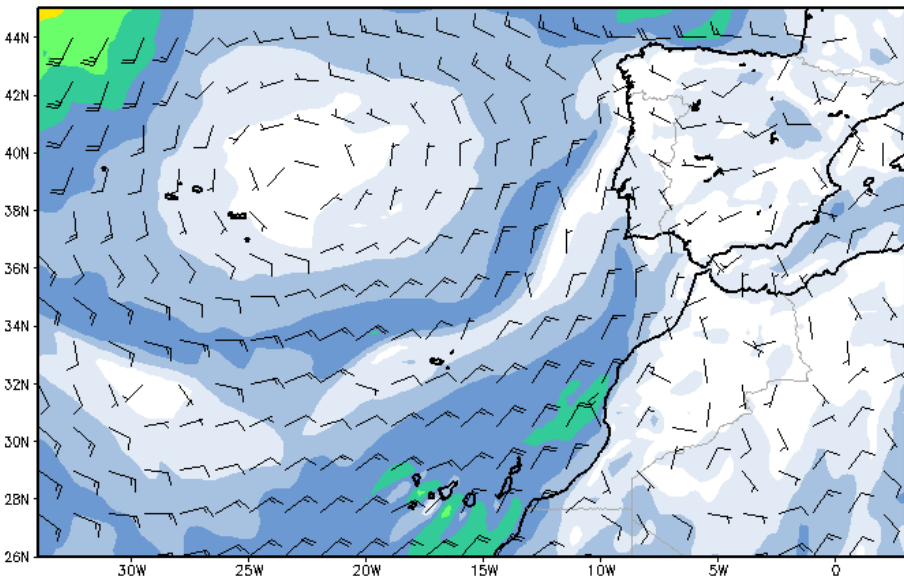

© www.PassageWeather.com

Surface Wind (knots)
GFS 180 Hour Forecast

Wed 05 Oct 2016 12 UTC

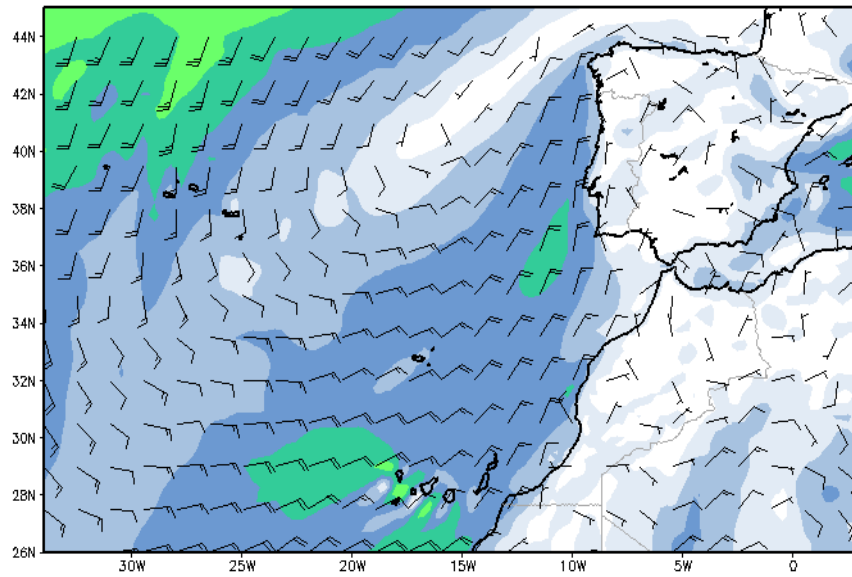

© www.PassageWeather.com

Wave Height (m) and Direction

WW3 156 Hour Forecast

Tue 04 Oct 2016 12 UTC

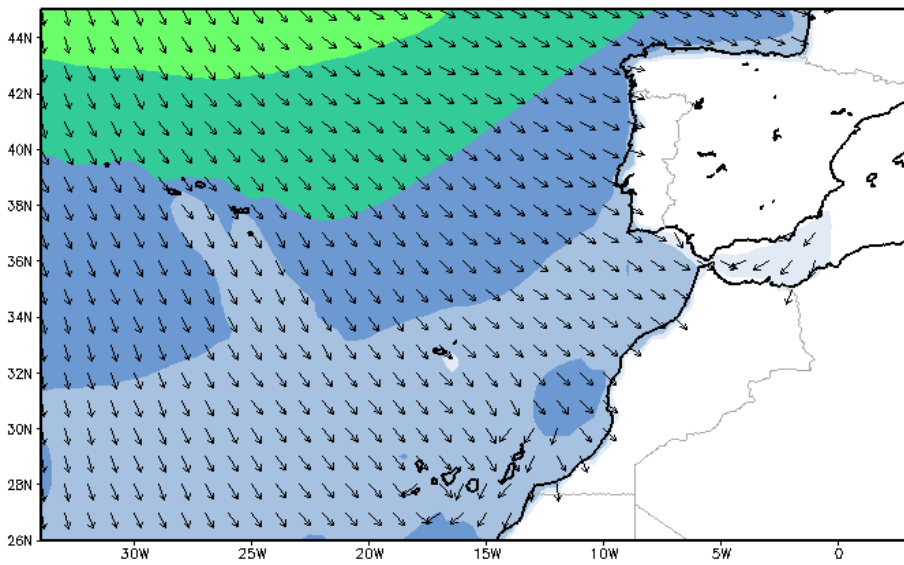

© www.PassageWeather.com

Wave Height (m) and Direction

WW3 180 Hour Forecast

Wed 05 Oct 2016 12 UTC

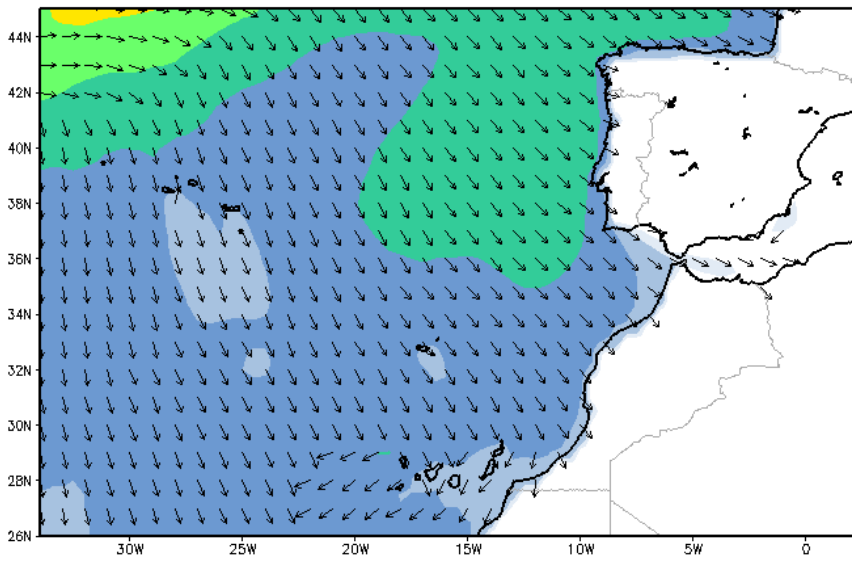

© www.PassageWeather.com

Surface Wind (knots)
GFS 024 Hour Forecast Thu 06 Oct 2016 12 UTC

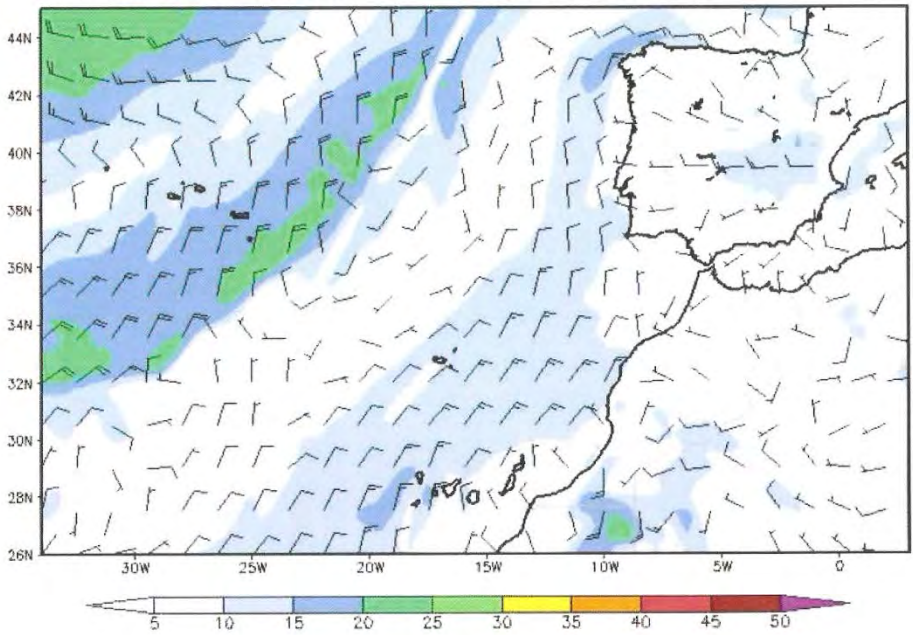

Surface Wind (knots)
GFS 012 Hour Forecast Mon 10 Oct 2016 12 UTC

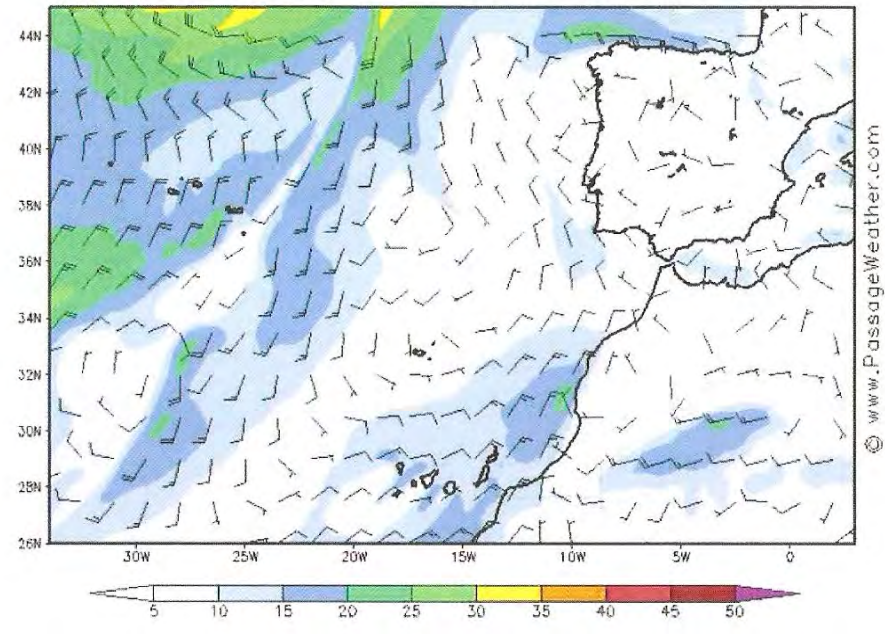

Wave Height (m) and Direction
WW3 024 Hour Forecast Thu 06 Oct 2016 12 UTC

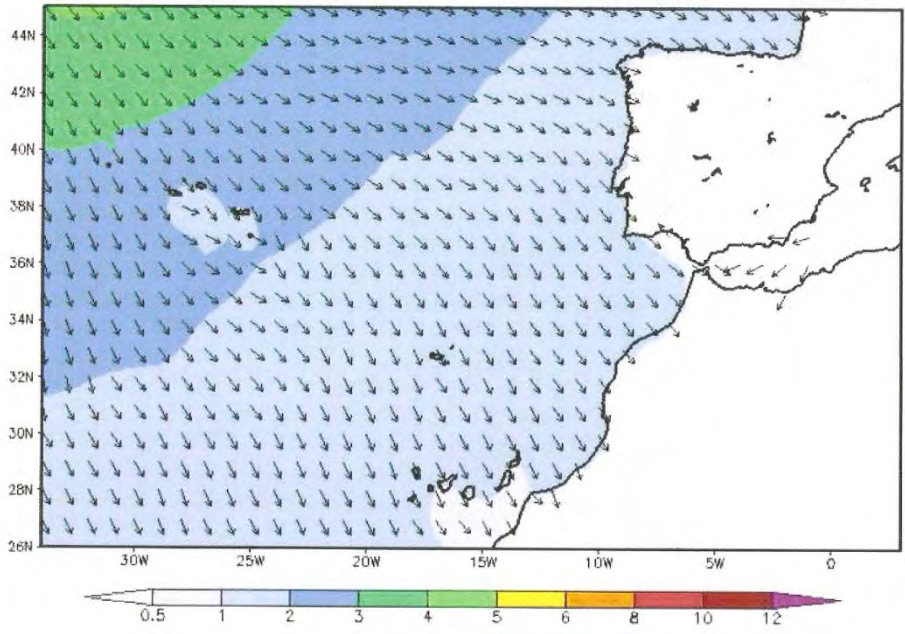

Wave Height (m) and Direction
WW3 012 Hour Forecast Mon 10 Oct 2016 12 UTC

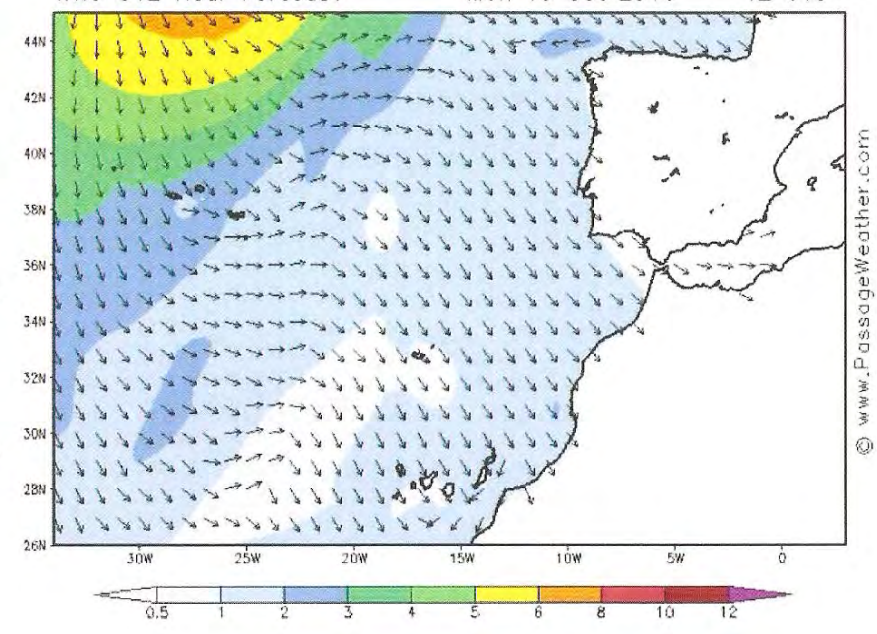

Surface Wind (knots)
GFS 036 Hour Forecast Tue 11 Oct 2016 12 UTC

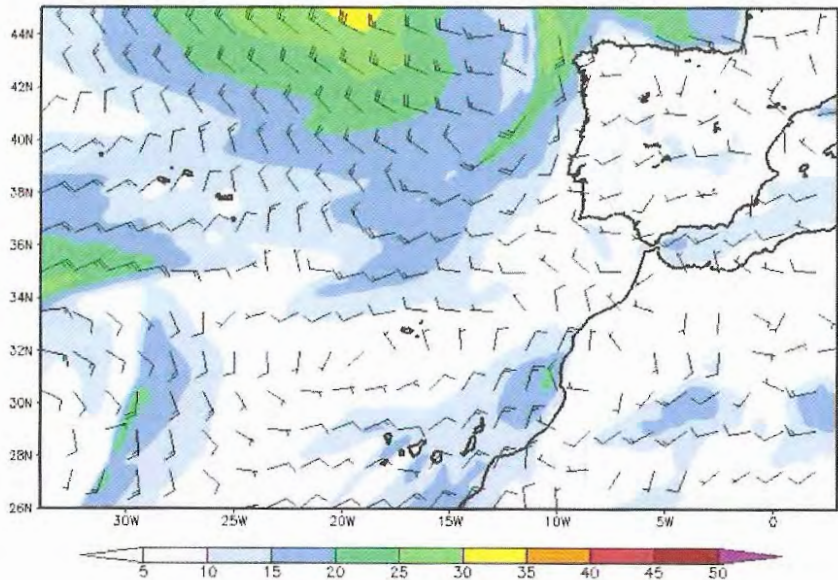

Surface Wind (knots)
GFS 009 Hour Forecast Wed 12 Oct 2016 15 UTC

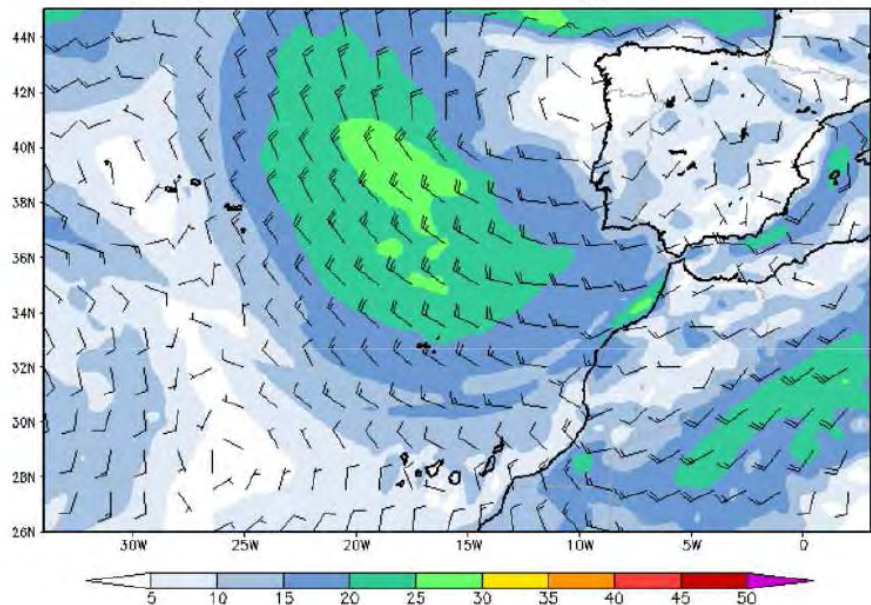

Wave Height (m) and Direction
WW3 036 Hour Forecast Tue 11 Oct 2016 12 UTC

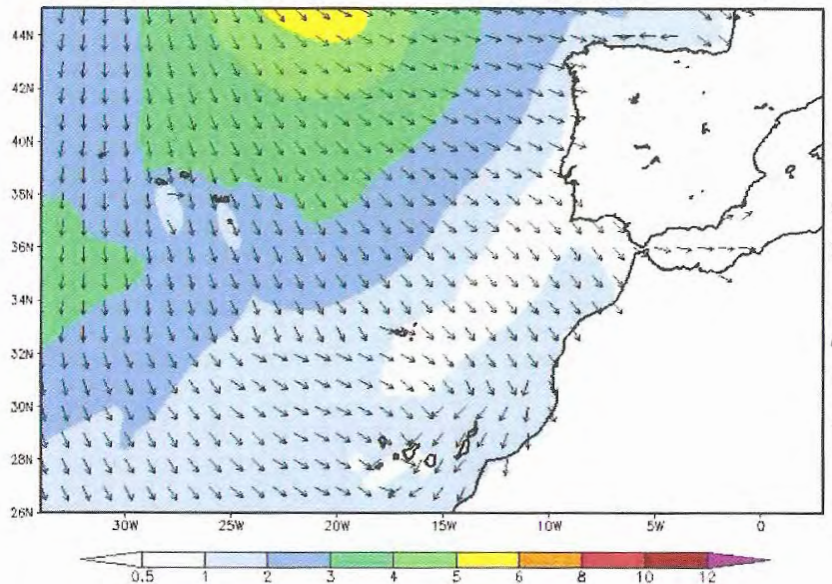

Wave Height (m) and Direction
WW3 009 Hour Forecast Wed 12 Oct 2016 15 UTC

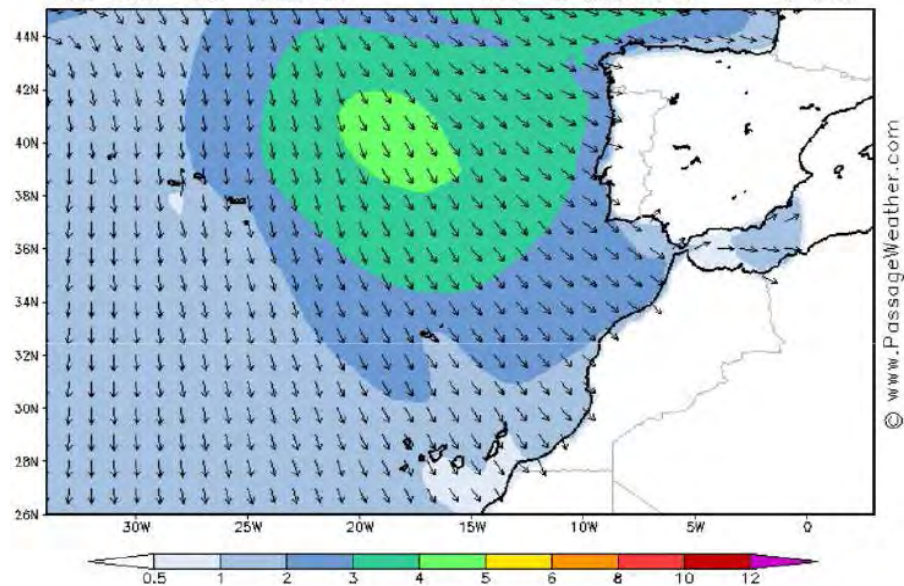

Surface Wind (knots)
GFS 030 Hour Forecast Thu 13 Oct 2016 12 UTC

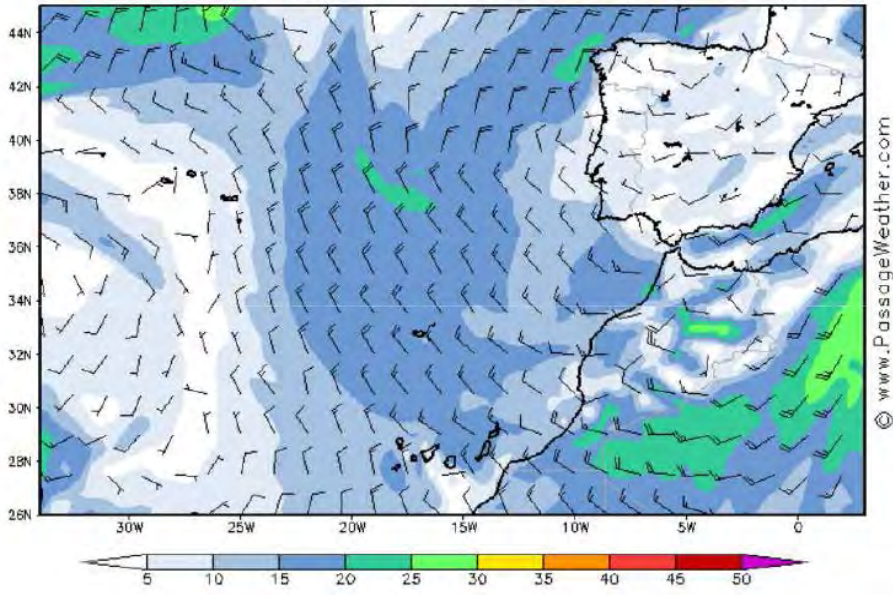

Surface Wind (knots)
GFS 054 Hour Forecast Fri 14 Oct 2016 12 UTC

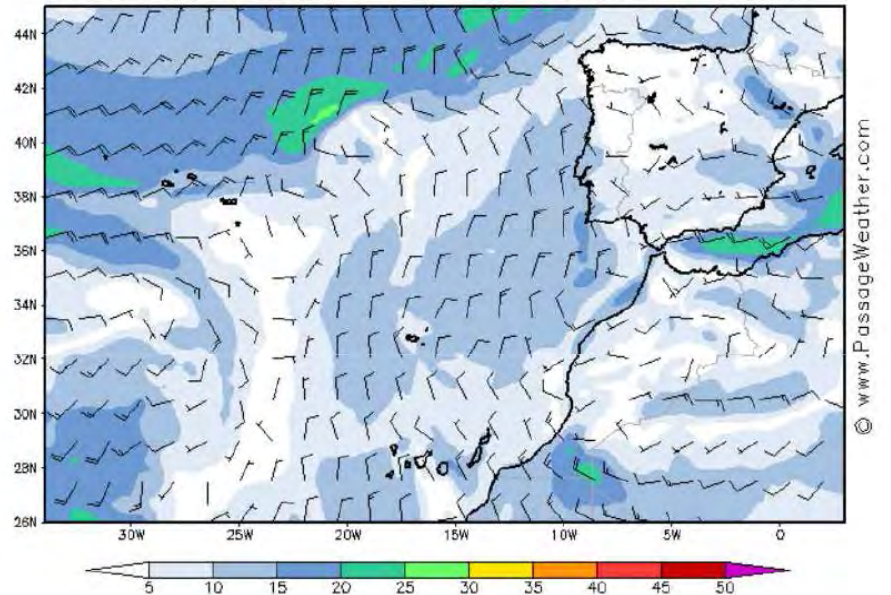

Wave Height (m) and Direction
WW3 030 Hour Forecast Thu 13 Oct 2016 12 UTC

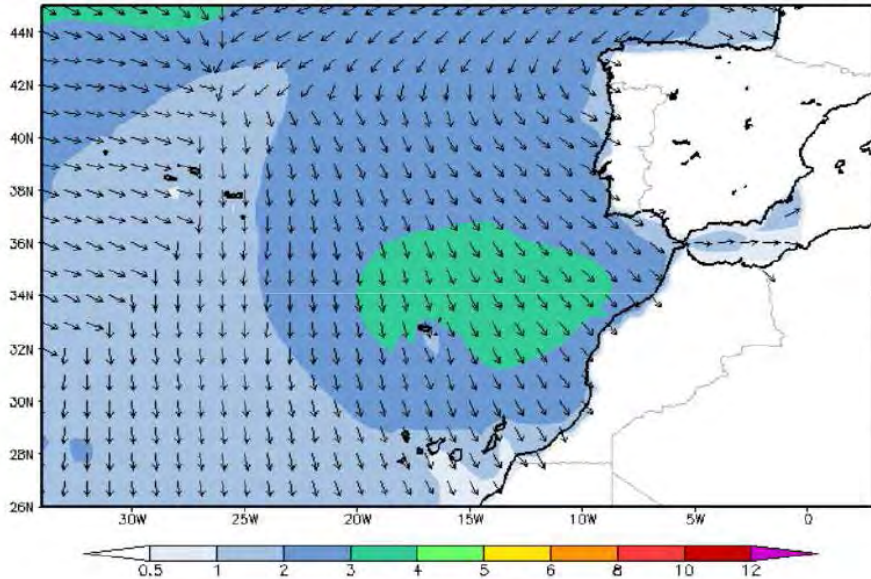

Wave Height (m) and Direction
WW3 054 Hour Forecast Fri 14 Oct 2016 12 UTC

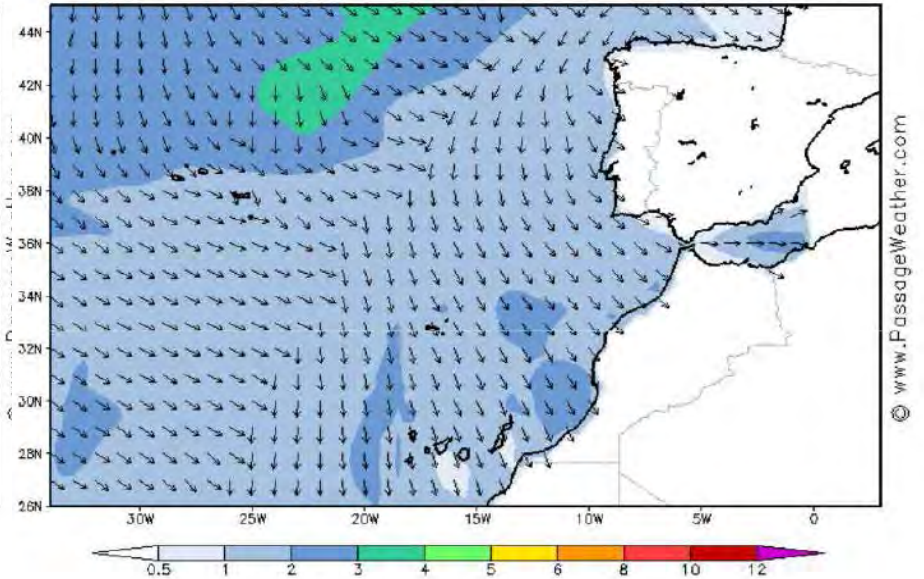

Surface Wind (knots)
GFS 024 Hour Forecast Mon 17 Oct 2016 12 UTC

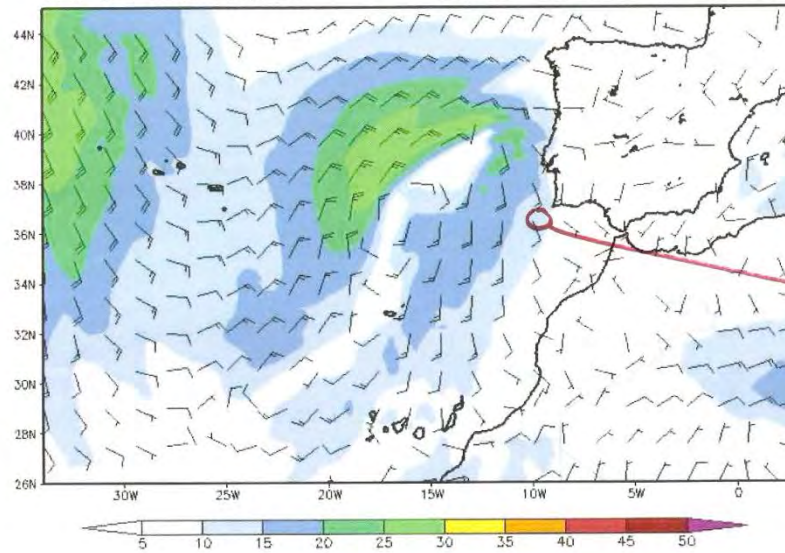

Wave Height (m) and Direction
WW3 024 Hour Forecast Mon 17 Oct 2016 12 UTC

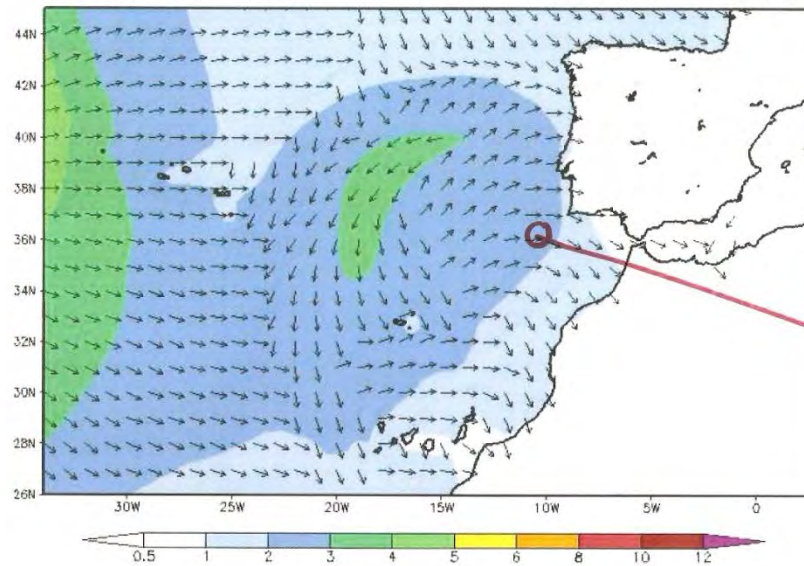

Surface Wind (knots)
GFS 033 Hour Forecast Tue 18 Oct 2016 09 UTC

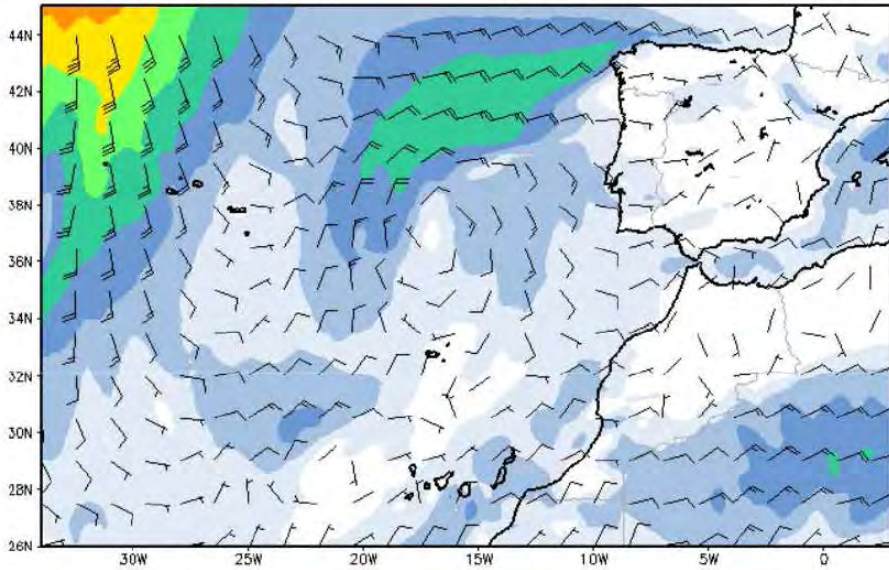

Surface Wind (knots)
GFS 027 Hour Forecast Wed 19 Oct 2016 09 UTC

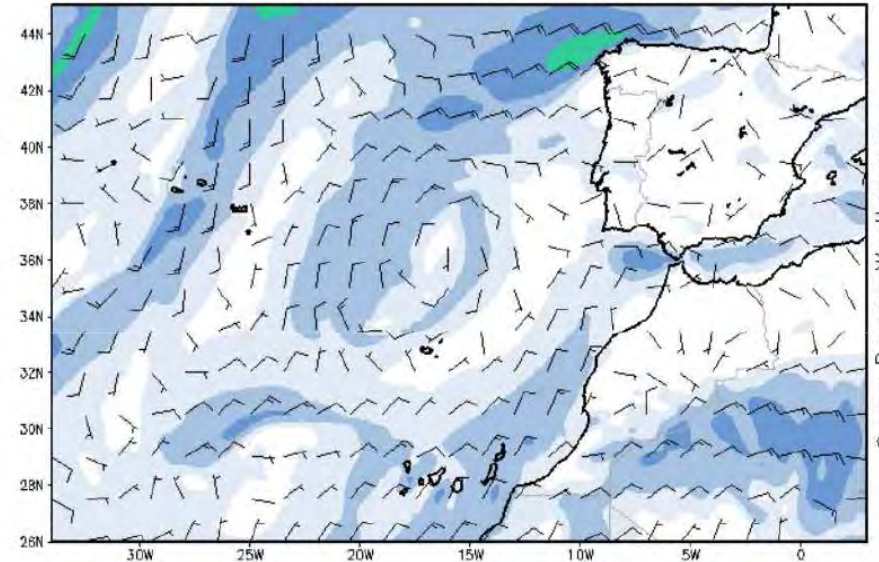

Wave Height (m) and Direction
WW3 033 Hour Forecast Tue 18 Oct 2016 09 UTC

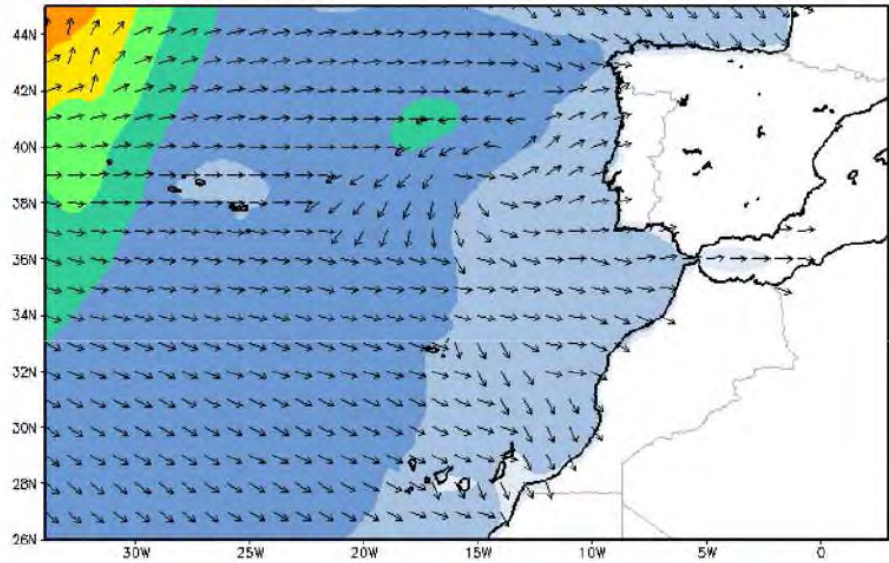

Wave Height (m) and Direction
WW3 036 Hour Forecast Wed 19 Oct 2016 12 UTC

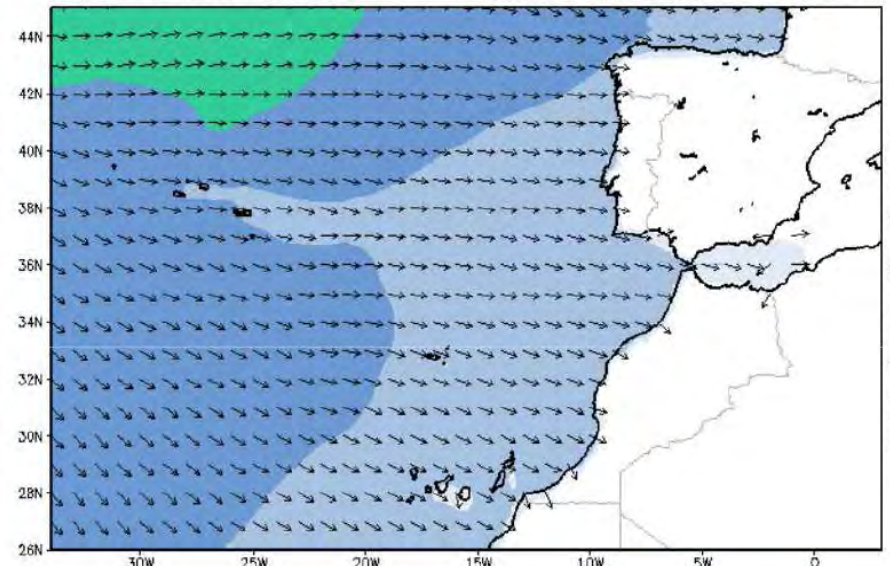

Surface Wind (knots)
GFS 024 Hour Forecast Thu 20 Oct 2016 12 UTC

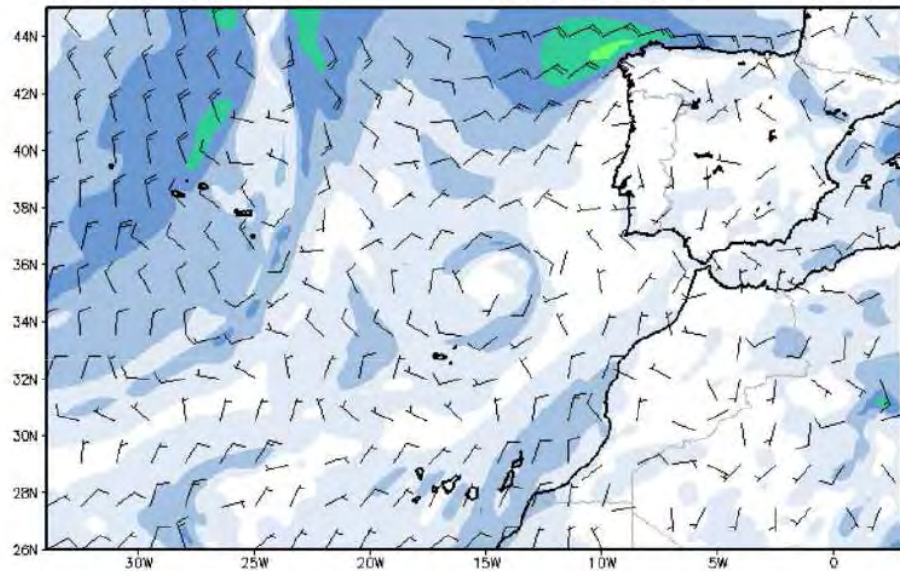

Surface Wind (knots)
GFS 012 Hour Forecast Fri 21 Oct 2016 12 UTC

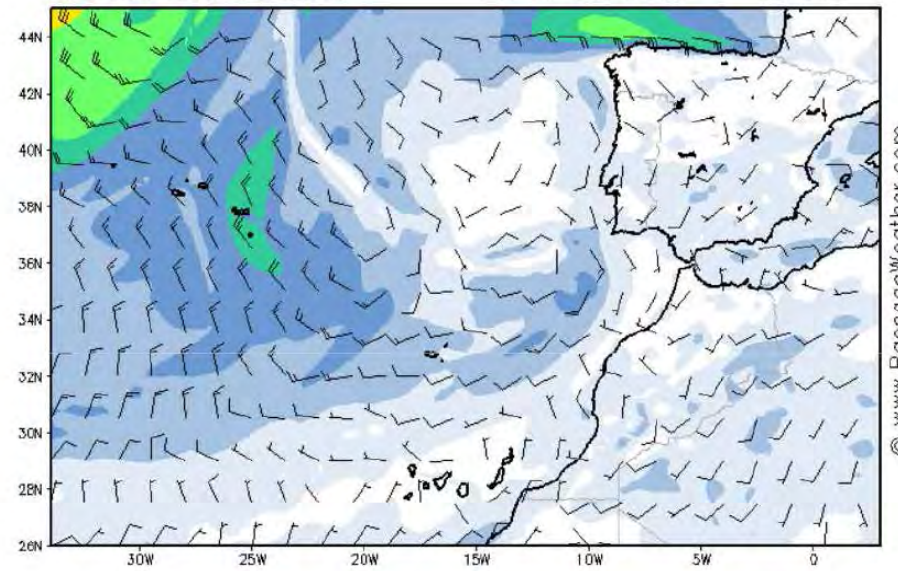

Wave Height (m) and Direction
WW3 024 Hour Forecast Thu 20 Oct 2016 12 UTC

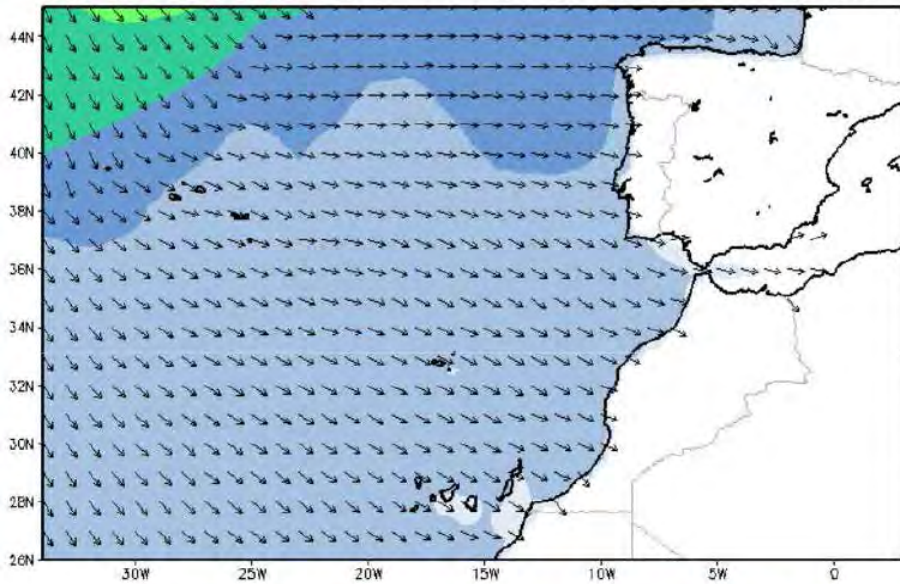

Wave Height (m) and Direction
WW3 012 Hour Forecast Fri 21 Oct 2016 12 UTC

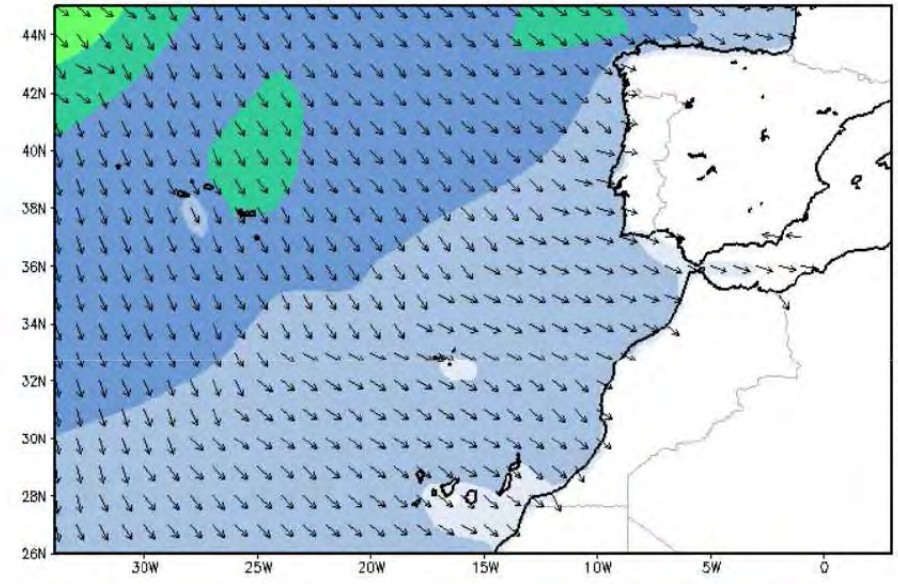

Surface Wind (knots)
GFS 036 Hour Forecast Sat 22 Oct 2016 12 UTC

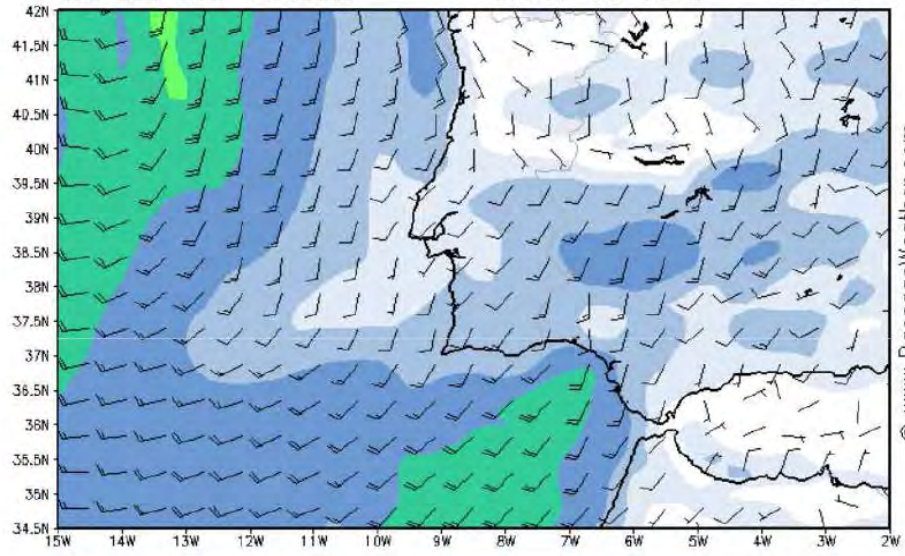

Surface Wind (knots)
GFS 030 Hour Forecast Mon 24 Oct 2016 12 UTC

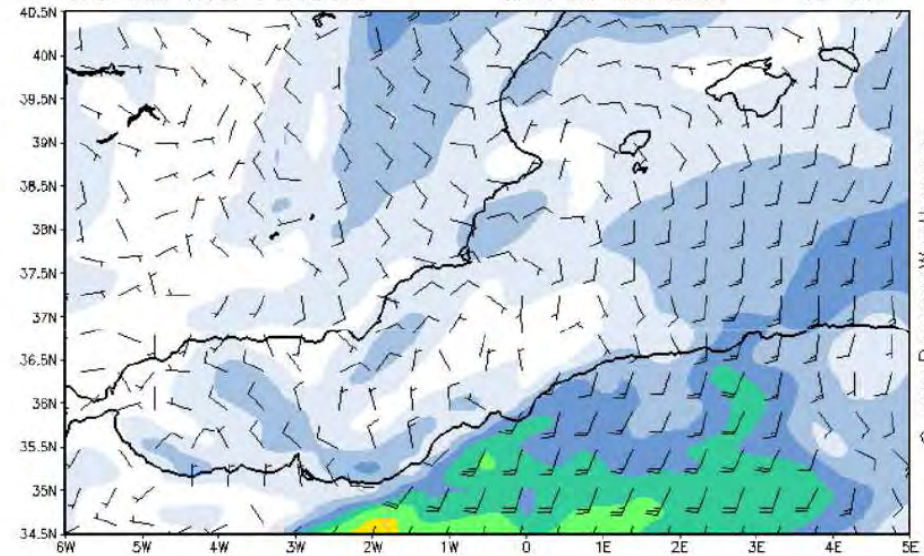

Wave Height (m) and Direction
WW3 036 Hour Forecast Sat 22 Oct 2016 12 UTC

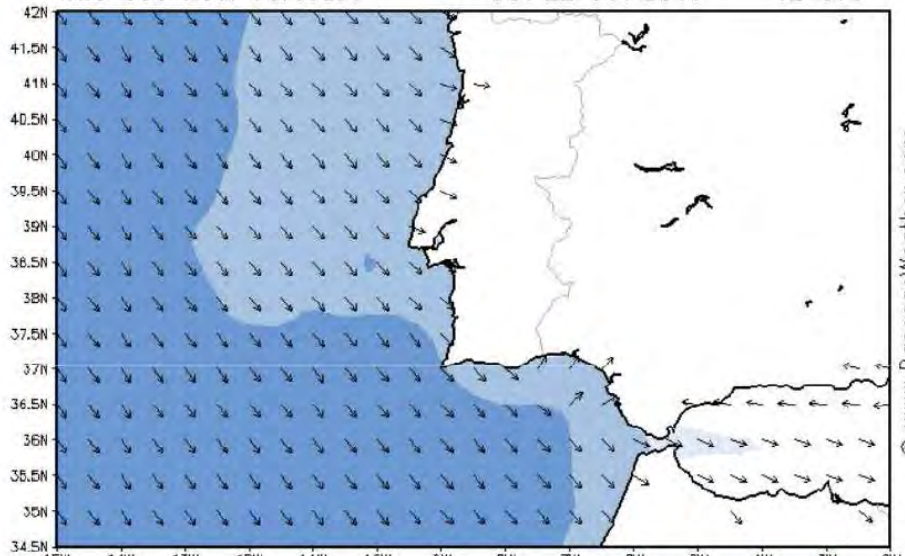

Wave Height (m) and Direction
WW3 036 Hour Forecast Mon 24 Oct 2016 12 UTC

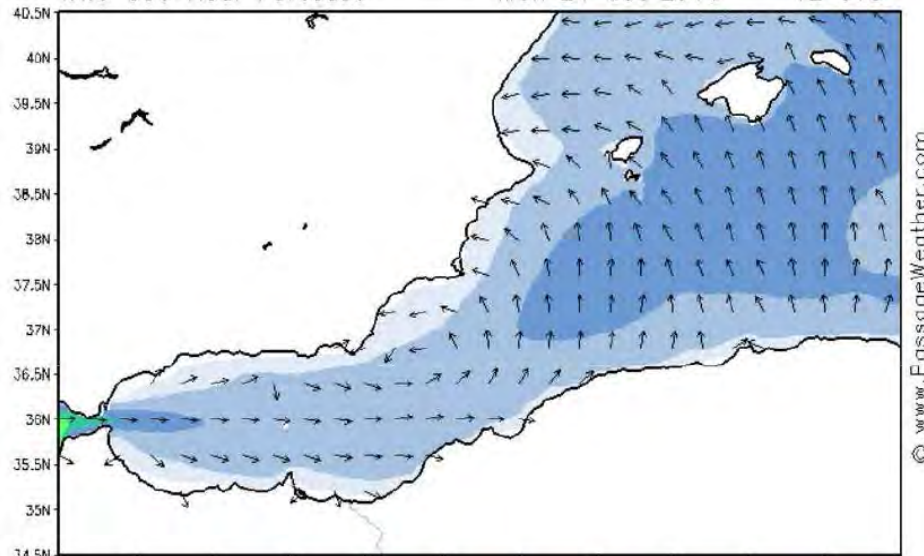

Appendix IV Biogeochemical Oceanography General List

						UTC	UTC												Vol filtered 1L	13,5 L
Leg	Station	Batch	Date	Lat	Long	CTD in water	CTD on board	Depth (max)	Niskin	Theor. depth	OD flask	T fixation OD	pH flow cell	TA flask	Nutrient tube	Salinity bottle	Carbonates flow cell	DIC bottle	chl filter	turbidity filter
1	101	1	21/09/2016	36° 37,53	6° 45,08	22:42	23:05	96	1	85	1	14.7	1	93	1					
1	101	1	21/09/2016	36° 37,53	6° 45,08	22:42	23:05	96	3	75	2	15	2	94	2					
1	101	1	21/09/2016	36° 37,53	6° 45,08	22:42	23:05	96	5	5	3	16	3	95	3					
1	101	1	21/09/2016	36° 37,53	6° 45,08	22:42	23:05	96	7	25	4	18	4	96	4					
1	101	1	21/09/2016	36° 37,53	6° 45,08	22:42	23:05	96	9	5	5	21	5	97	5					
1	103	1	22/09/2016	36° 34,49	6° 52,04	01:02	01:30	328	1	328	6	13.4	6	98	6					
1	103	1	22/09/2016	36° 34,49	6° 52,04	01:02	01:30	328	3	300	7	13.4	7	99	7					
1	103	1	22/09/2016	36° 34,49	6° 52,04	01:02	01:30	328	5	200	8	13.6	8	100	8					
1	103	1	22/09/2016	36° 34,49	6° 52,04	01:02	01:30	328	7	100	9	15.1	9	101	9					
1	103	1	22/09/2016	36° 34,49	6° 52,04	01:02	01:30	328	9	75	10	15.6	10	102	10					
1	103	1	22/09/2016	36° 34,49	6° 52,04	01:02	01:30	328	11	50	11	16.5	11	103	11					
1	103	1	22/09/2016	36° 34,49	6° 52,04	01:02	01:30	328	13	25	12	18.4	12	104	12					
1	103	1	22/09/2016	36° 34,49	6° 52,04	01:02	01:30	328	15	5	13	20.7	13	105	13					
1	104	1	22/09/2016	36° 32,98	6° 55,54	02:21	02:57	451	1	450	14	13.7	14	106	14					
1	104	1	22/09/2016	36° 32,98	6° 55,54	02:21	02:57	451	2	400	15	13.3	15	107	15					
1	104	1	22/09/2016	36° 32,98	6° 55,54	02:21	02:57	451	3	300	16	13.3	16	108	16					
1	104	1	22/09/2016	36° 32,98	6° 55,54	02:21	02:57	451	4	200	17	14.1	17	109	17					
1	104	1	22/09/2016	36° 32,98	6° 55,54	02:21	02:57	451	5	100	18	15.6	18	110	18					
1	104	1	22/09/2016	36° 32,98	6° 55,54	02:21	02:57	451	6	75	19	16	19	111	19					
1	104	1	22/09/2016	36° 32,98	6° 55,54	02:21	02:57	451	7	50	20	16.6	20	112	20					
1	104	1	22/09/2016	36° 32,98	6° 55,54	02:21	02:57	451	8	25	21	18.3	21	1	21					
1	104	1	22/09/2016	36° 32,98	6° 55,54	02:21	02:57	451	9	5	22	21	22	2	22					
1	105	1	22/09/2016	36° 31,50	6° 59,00	03:44	04:21	479	1	480	23	13.4	23	3	23					

1	105	1	22/09/2016	36º 31,50	6º 59,00	03:44	04:21	479	2	400	24	12.8	24	4	24					
1	105	1	22/09/2016	36º 31,50	6º 59,00	03:44	04:21	479	3	300	25	13.3	25	5	25					
1	105	1	22/09/2016	36º 31,50	6º 59,00	03:44	04:21	479	4	200	26	14	26	6	26					
1	105	1	22/09/2016	36º 31,50	6º 59,00	03:44	04:21	479	5	100	27	15.3	27	7	27					
1	105	1	22/09/2016	36º 31,50	6º 59,00	03:44	04:21	479	6	75	28	15.8	28	8	28					
1	105	1	22/09/2016	36º 31,50	6º 59,00	03:44	04:21	479	7	50	29	16.5	29	9	29					
1	105	1	22/09/2016	36º 31,50	6º 59,00	03:44	04:21	479	8	25	30	18	30	10	30					
1	105	1	22/09/2016	36º 31,50	6º 59,00	03:44	04:21	479	9	5	31	20.6	31	11	31					
1	108	2	22/09/2016	36º 25,51	7º 3,65	20:44	21:12	577	1	577	32	13.4	1	12	32					
1	108	2	22/09/2016	36º 25,51	7º 3,65	20:44	21:12	577	3	500	33	13	2	13	33					
1	108	2	22/09/2016	36º 25,51	7º 3,65	20:44	21:12	577	5	400	34	12.6	3	14	34					
1	108	2	22/09/2016	36º 25,51	7º 3,65	20:44	21:12	577	7	300	35	13.2	4	15	35					
1	108	2	22/09/2016	36º 25,51	7º 3,65	20:44	21:12	577	9	200	36	14.1	5	16	36					
1	108	2	22/09/2016	36º 25,51	7º 3,65	20:44	21:12	577	11	100	37	15.6	6	17	37					
1	108	2	22/09/2016	36º 25,51	7º 3,65	20:44	21:12	577	15	50	38	17	7	18	38					
1	108	2	22/09/2016	36º 25,51	7º 3,65	20:44	21:12	577	17	25	39	19.5	9	19	39					
1	110	2	23/09/2016	36º 28,50	6º 56,63	23:15	23:42	475	1	475	40	13.4	10	20	40					
1	110	2	23/09/2016	36º 28,50	6º 56,63	23:15	23:42	475	3	400	41	12.8	11	21	41					
1	110	2	23/09/2016	36º 28,50	6º 56,63	23:15	23:42	475	5	300	42	13.1	12	22	42					
1	110	2	23/09/2016	36º 28,50	6º 56,63	23:15	23:42	475	7	200	43	14.1	13	23	43					
1	110	2	23/09/2016	36º 28,50	6º 56,63	23:15	23:42	475	9	100	44	15.4	14	24	44					
1	110	2	23/09/2016	36º 28,50	6º 56,63	23:15	23:42	475	13	50	45	17	15	25	45					
1	110	2	23/09/2016	36º 28,50	6º 56,63	23:15	23:42	475	15	25	1	19.3	16	26	46					
1	111	2	23/09/2016	36º 30,05	6º 53,14	00:40	01:01	436	1	436	2	13.6	17	27	47					
1	111	2	23/09/2016	36º 30,05	6º 53,14	00:40	01:01	436	3	400	3	13.7	18	28	48					
1	111	2	23/09/2016	36º 30,05	6º 53,14	00:40	01:01	436	5	300	4	13	19	29	49					
1	111	2	23/09/2016	36º 30,05	6º 53,14	00:40	01:01	436	7	200	5	14	20	30	50					
1	111	2	23/09/2016	36º 30,05	6º 53,14	00:40	01:01	436	9	100	6	15.6	21	31	51					

1	111	2	23/09/2016	36º 30,05	6º 53,14	00:40	01:01	436	13	50	7	16.8	22	32	52					
1	111	2	23/09/2016	36º 30,05	6º 53,14	00:40	01:01	436	15	25	8	19	23	33	53					
1	112	2	23/09/2016	36º 31,56	6º 49,64	01:49	02:07	318	1	318	9	13.5	24	34	54					
1	112	2	23/09/2016	36º 31,56	6º 49,64	01:49	02:07	318	3	300	10	13.5	25	35	55					
1	112	2	23/09/2016	36º 31,56	6º 49,64	01:49	02:07	318	5	200	11	13.8	26	36	56					
1	112	2	23/09/2016	36º 31,56	6º 49,64	01:49	02:07	318	7	100	12	15.2	27	37	57					
1	112	2	23/09/2016	36º 31,56	6º 49,64	01:49	02:07	318	11	50	13	16.5	28	38	58					
1	112	2	23/09/2016	36º 31,56	6º 49,64	01:49	02:07	318	13	25	14	18.2	29	39	59					
1	114	2	23/09/2016	36º 34,61	6º 42,64	03:39	03:45	100	1	100	15	14.7	10	40	60					
1	114	2	23/09/2016	36º 34,61	6º 42,64	03:39	03:45	100	5	50	16	16.2	11	41	61					
1	114	2	23/09/2016	36º 34,61	6º 42,64	03:39	03:45	100	7	25	17	18	12	42	62					
1	120	3	23/09/2016	36º 38,97	6º 50,97	21:00	21:24	148.01	1	140	18	14.4	10	43	63					
1	120	3	23/09/2016	36º 38,97	6º 50,97	21:00	21:24	148.01	3	50	19	15.7	11	44	64					
1	120	3	23/09/2016	36º 38,97	6º 50,97	21:00	21:24	148.01	5	25	20	17	12	93	65					
1	119	3	23/09/2016	36º 37,47	6º 54,47	22:00	22:28	354	1	354	21	13.6	1	100	66					
1	119	3	23/09/2016	36º 37,47	6º 54,47	22:00	22:28	354	3	300	22	13.5	2	95	67					
1	119	3	23/09/2016	36º 37,47	6º 54,47	22:00	22:28	354	5	200	23	13.4	3	96	68					
1	119	3	23/09/2016	36º 37,47	6º 54,47	22:00	22:28	354	7	100	24	14.8	4	97	69					
1	119	3	23/09/2016	36º 37,47	6º 54,47	22:00	22:28	354	11	50	25	15.7	5	98	70					
1	119	3	23/09/2016	36º 37,47	6º 54,47	22:00	22:28	354	13	25	26	17	6	99	71					
1	118	3	23/09/2016	36º 35,96	6º 54,94	23:10	23:35	463	1	463	27	13.6	7	1	72		1			
1	118	3	23/09/2016	36º 35,96	6º 54,94	23:10	23:35	463	3	400	28	12.8	9	2	73		2			
1	118	3	23/09/2016	36º 35,96	6º 54,94	23:10	23:35	463	5	300	29	12.9	13	3	74		3			no hay carbonatos
1	118	3	23/09/2016	36º 35,96	6º 54,94	23:10	23:35	463	7	200	30	13.7	14	4	75		4			posible error en carbonatos
1	118	3	23/09/2016	36º 35,96	6º 54,94	23:10	23:35	463	9	100	31	15.1	15	5	76		5			
1	118	3	23/09/2016	36º 35,96	6º 54,94	23:10	23:35	463	13	50	32	16.1	16	6	77		6			
1	118	3	23/09/2016	36º 35,96	6º 54,94	23:10	23:35	463	15	25	33	17.4	17	7	78		7			
1	117	3	24/09/2016	36º 34,46	7º 01,41	00:10	00:40	491	1	491	34	13.2	18	8	79					

1	117	3	24/09/2016	36º 34,46	7º 01,41	00:10	00:40	491	3	400	35	12	19	9	80					
1	117	3	24/09/2016	36º 34,46	7º 01,41	00:10	00:40	491	5	300	36	13	20	10	81					
1	117	3	24/09/2016	36º 34,46	7º 01,41	00:10	00:40	491	7	200	1	14	21	11	82					
1	117	3	24/09/2016	36º 34,46	7º 01,41	00:10	00:40	491	9	100	2	15.4	22	12	83					
1	117	3	24/09/2016	36º 34,46	7º 01,41	00:10	00:40	491	13	50	3	16.6	23	13	84					
1	117	3	24/09/2016	36º 34,46	7º 01,41	00:10	00:40	491	15	25	4	17.8	24	101	85					
1	115	3	24/09/2016	36º 31,44	7º 8,49	01:21	01:52	544	1	544			1	16	86					
1	115	3	24/09/2016	36º 31,44	7º 8,49	01:21	01:52	544	3	500			2	17	87					
1	115	3	24/09/2016	36º 31,44	7º 8,49	01:21	01:52	544	5	400			3	18	88					
1	115	3	24/09/2016	36º 31,44	7º 8,49	01:21	01:52	544	7	300			4	19	89					
1	115	3	24/09/2016	36º 31,44	7º 8,49	01:21	01:52	544	9	200			5	20	90					
1	115	3	24/09/2016	36º 31,44	7º 8,49	01:21	01:52	544	11	100			6	21	91					
1	115	3	24/09/2016	36º 31,44	7º 8,49	01:21	01:52	544	15	50			7	22	92					
1	115	3	24/09/2016	36º 31,44	7º 8,49	01:21	01:52	544	17	25			9	23	93					
1	201	4	25/09/2016	36º 40,88	10º 41,77	21:15	22:40	3148	1	2000	1	5.8	1	103	94	1				
1	201	4	25/09/2016	36º 40,88	10º 41,77	21:15	22:40	3148	3	1500	2	8	2	104	95	2				
1	201	4	25/09/2016	36º 40,88	10º 41,77	21:15	22:40	3148	7	1137	3	11	3	105	96	3				
1	201	4	25/09/2016	36º 40,88	10º 41,77	21:15	22:40	3148	9	1037	4	11.1	4	106	97	4				MW
1	201	4	25/09/2016	36º 40,88	10º 41,77	21:15	22:40	3148	11	500	5	12	5	107	98	5				
1	201	4	25/09/2016	36º 40,88	10º 41,77	21:15	22:40	3148	13	250	6	13.4	6	108	99	6				
1	201	4	25/09/2016	36º 40,88	10º 41,77	21:15	22:40	3148	15	100	7	15.6	7	109	100	7				
1	201	4	25/09/2016	36º 40,88	10º 41,77	21:15	22:40	3148	19	50	8	17.6	9	110	101	8				
1	201	4	25/09/2016	36º 40,88	10º 41,77	21:15	22:40	3148	21	25	9	20	11	111	102	9				
1	202	4	25/09/2016	36º 41,23	10º 45,62	23:30	00:50	3110	1	2000	10	5.6	12							control reproducibilidad
1	202	4	25/09/2016	36º 41,23	10º 45,62	23:30	00:50	3110	3	2000	11	5.7	13							control reproducibilidad
1	202	4	25/09/2016	36º 41,23	10º 45,62	23:30	00:50	3110	4	2000	12	5.7	14							control reproducibilidad
1	202	4	25/09/2016	36º 41,23	10º 45,62	23:30	00:50	3110	5	2000	13	5.8	15							control reproducibilidad

1	202	4	25/09/2016	36º 41,23	10º 45,62	23:30	00:50	3110	6	2000	14	5.9	16							control reproducibilidad
1	202	4	25/09/2016	36º 41,23	10º 45,62	23:30	00:50	3110	7	2000	15	6	17							control reproducibilidad
1	202	4	25/09/2016	36º 41,23	10º 45,62	23:30	00:50	3110	8	2000			18							control reproducibilidad
1	203	4	25/09/2016	36º 41,42	10º 49,81	01:30	02:53	2760	1	2500			19	93	102	10				
1	203	4	25/09/2016	36º 41,42	10º 49,81	01:30	02:53	2760	3	1500			20	94	103	11				
1	203	4	25/09/2016	36º 41,42	10º 49,81	01:30	02:53	2760	5	1172			21	95	104	12				
1	203	4	25/09/2016	36º 41,42	10º 49,81	01:30	02:53	2760	7	1096			22	96	105	13				
1	203	4	25/09/2016	36º 41,42	10º 49,81	01:30	02:53	2760	9	996			23	97	106					
1	203	4	25/09/2016	36º 41,42	10º 49,81	01:30	02:53	2760	11	500			24	98	107					
1	203	4	25/09/2016	36º 41,42	10º 49,81	01:30	02:53	2760	13	250			25	99	108					
1	203	4	25/09/2016	36º 41,42	10º 49,81	01:30	02:53	2760	15	100			26	100	109					
1	203	4	25/09/2016	36º 41,42	10º 49,81	01:30	02:53	2760	17	75			27	101	110					
1	203	4	25/09/2016	36º 41,42	10º 49,81	01:30	02:53	2760	19	25			28	102	111					
1	204	4	25/09/2016	36º 41,61	10º 52,91	03:45	05:00	2530	1	2000	16	6	1	21	112					
1	204	4	25/09/2016	36º 41,61	10º 52,91	03:45	05:00	2530	3	1500	17	8.6	2	22	113					
1	204	4	25/09/2016	36º 41,61	10º 52,91	03:45	05:00	2530	5	1272	18	10.4	3	23	114					
1	204	4	25/09/2016	36º 41,61	10º 52,91	03:45	05:00	2530	7	1172	19	11	4	24	115					
1	204	4	25/09/2016	36º 41,61	10º 52,91	03:45	05:00	2530	9	1072	20	11.4	5	25	116					
1	204	4	25/09/2016	36º 41,61	10º 52,91	03:45	05:00	2530	11	500	21	12	6	26	117					
1	204	4	25/09/2016	36º 41,61	10º 52,91	03:45	05:00	2530	13	250	22	13.7	7	27	118					
1	204	4	25/09/2016	36º 41,61	10º 52,91	03:45	05:00	2530	15	100	23	15.5	9	28	119					
1	204	4	25/09/2016	36º 41,61	10º 52,91	03:45	05:00	2530	17	50	24	18.3	10	29	120					
1	204	4	25/09/2016	36º 41,61	10º 52,91	03:45	05:00	2530	19	25	25	21	11	30	121					
1	204	4	25/09/2016	36º 41,61	10º 52,91	03:45	05:00	2530	21	5	26	21.6	12	31	122					
1	236	5	26/09/2016	36º 52,95	10º 49,85	21:05	22:24	1894	1	1894	1	6	1	1	123					
1	236	5	26/09/2016	36º 52,95	10º 49,85	21:05	22:24	1894	3	1800	2	6.4	2	2	124					
1	236	5	26/09/2016	36º 52,95	10º 49,85	21:05	22:24	1894	4	1700	3	7	3	3	125					

1	236	5	26/09/2016	36º 52,95	10º 49,85	21:05	22:24	1894	5	1600	4	8	4	4	126					
1	236	5	26/09/2016	36º 52,95	10º 49,85	21:05	22:24	1894	6	1500	5	8.9	5	5	127					
1	236	5	26/09/2016	36º 52,95	10º 49,85	21:05	22:24	1894	7	1300	6	10.7	6	6	128					
1	236	5	26/09/2016	36º 52,95	10º 49,85	21:05	22:24	1894	8	1200	7	11.6	7	7	129					
1	236	5	26/09/2016	36º 52,95	10º 49,85	21:05	22:24	1894	9	1100	8	11.4	9	8	130					
1	236	5	26/09/2016	36º 52,95	10º 49,85	21:05	22:24	1894	10	500	9	11.9	10	9	131					
1	236	5	26/09/2016	36º 52,95	10º 49,85	21:05	22:24	1894	12	100	10	15.2	11	10	132					
1	236	5	26/09/2016	36º 52,95	10º 49,85	21:05	22:24	1894	18	25	11	20.7	13	11	133					
1	235	5	26/09/2016	36º 50,42	10º 54,36	23:21	00:19	1496	1	1496			14	12	134		1			
1	235	5	26/09/2016	36º 50,42	10º 54,36	23:21	00:19	1496	3	1400			15	13	135		2			
1	235	5	26/09/2016	36º 50,42	10º 54,36	23:21	00:19	1496	4	1300			16	14	136		3			
1	235	5	26/09/2016	36º 50,42	10º 54,36	23:21	00:19	1496	5	1215			17	15	137		4			
1	235	5	26/09/2016	36º 50,42	10º 54,36	23:21	00:19	1496	6	1115			18	16	138		5			
1	235	5	26/09/2016	36º 50,42	10º 54,36	23:21	00:19	1496	7	1015			19	17	139		6			
1	235	5	26/09/2016	36º 50,42	10º 54,36	23:21	00:19	1496	8	500			20	18	140		7			
1	235	5	26/09/2016	36º 50,42	10º 54,36	23:21	00:19	1496	9	250			21	19	141		8			
1	235	5	26/09/2016	36º 50,42	10º 54,36	23:21	00:19	1496	11	100			22	26	142		9			
1	235	5	26/09/2016	36º 50,42	10º 54,36	23:21	00:19	1496	16	25			23	103	143		10			
1	234	5	26/09/2016	36º 47,79	10º 59,12	01:03	01:52	934	1	934	12	11.2	24	33	144					
1	234	5	26/09/2016	36º 47,79	10º 59,12	01:03	01:52	934	3	800	13	11.3	25	34	145					
1	234	5	26/09/2016	36º 47,79	10º 59,12	01:03	01:52	934	5	700	14	11.8	26	35	146					
1	234	5	26/09/2016	36º 47,79	10º 59,12	01:03	01:52	934	7	600	15	11.8	27	36	147					
1	234	5	26/09/2016	36º 47,79	10º 59,12	01:03	01:52	934	9	500	16	12	28	37	148					
1	234	5	26/09/2016	36º 47,79	10º 59,12	01:03	01:52	934	11	250	17	13.3	29	38	149					
1	234	5	26/09/2016	36º 47,79	10º 59,12	01:03	01:52	934	13	100	18	15.4	30	39	150					
1	234	5	26/09/2016	36º 47,79	10º 59,12	01:03	01:52	934	15	25	19	21	31	40	151					
1	233	5	26/09/2016	36º 45,21	11º 3,87	02:44	03:00	187	1	187			1	41	152					
1	233	5	26/09/2016	36º 45,21	11º 3,87	02:44	03:00	187	3	100			2	42	153					

1	233	5	26/09/2016	36º 45,21	11º 3,87	02:44	03:00	187	7	25			3	43	154					
1	209	5	26/09/2016	36º 42,67	11º 8,57	03:56	04:15	89	1	89			17	44	155					
1	209	5	26/09/2016	36º 42,67	11º 8,57	03:56	04:15	89	3	50			18	21	156					
1	209	5	26/09/2016	36º 42,67	11º 8,57	03:56	04:15	89	5	25			19	22	157					
1	301	6	29/09/2016	37º 07,80	24º 30,39	23:10	00:04	2160	1	2153	1	4.9	1	1	158	14-15	1	1		
1	301	6	29/09/2016	37º 07,80	24º 30,39	23:10	00:04	2160	3	2000	2	5	2	2	159	16-17	2			
1	301	6	29/09/2016	37º 07,80	24º 30,39	23:10	00:04	2160	5	1900	3	5.1	3	3	160	18-19	3			
1	301	6	29/09/2016	37º 07,80	24º 30,39	23:10	00:04	2160	7	1800	4	5.4	4	4	161	20-21	4	2		
1	301	6	29/09/2016	37º 07,80	24º 30,39	23:10	00:04	2160	9	1700	5	5.7	5	5	162	22-23	5			
1	301	6	29/09/2016	37º 07,80	24º 30,39	23:10	00:04	2160	11	1500	6	6.4	6	6	163	24-25	6	3		
1	301	6	29/09/2016	37º 07,80	24º 30,39	23:10	00:04	2160	12	1300	7	7.5	7	7	164		7			
1	301	6	29/09/2016	37º 07,80	24º 30,39	23:10	00:04	2160	13	960	8	9.9	9	8	165		8	4		AAIW?
1	301	6	29/09/2016	37º 07,80	24º 30,39	23:10	00:04	2160	15	800	9	11	10	9	166		9	5		MW
1	301	6	29/09/2016	37º 07,80	24º 30,39	23:10	00:04	2160	16	500	10	12.4	11	10	167		10	6		
1	301	6	29/09/2016	37º 07,80	24º 30,39	23:10	00:04	2160	17	100	11	16.4	12	11	168		11			
1	301	6	29/09/2016	37º 07,80	24º 30,39	23:10	00:04	2160	18	25	12	23.2	13	12	169		12	7		
1	302	6	30/09/2016	37º 09,55	24º 34,00	01:26	02:48	1776	1	1776			14	13	170	26-27				
1	302	6	30/09/2016	37º 09,55	24º 34,00	01:26	02:48	1776	3	1700			15	15	171	28-29				
1	302	6	30/09/2016	37º 09,55	24º 34,00	01:26	02:48	1776	5	1600			16	16	172	30				
1	302	6	30/09/2016	37º 09,55	24º 34,00	01:26	02:48	1776	7	1500			17	17	173					
1	302	6	30/09/2016	37º 09,55	24º 34,00	01:26	02:48	1776	9	1400			18	18	174					
1	302	6	30/09/2016	37º 09,55	24º 34,00	01:26	02:48	1776	11	1000			19	19	175					
1	302	6	30/09/2016	37º 09,55	24º 34,00	01:26	02:48	1776	13	900			20	93	176					
1	302	6	30/09/2016	37º 09,55	24º 34,00	01:26	02:48	1776	15	820			21	94	177					
1	302	6	30/09/2016	37º 09,55	24º 34,00	01:26	02:48	1776	17	500			22	95	178					
1	302	6	30/09/2016	37º 09,55	24º 34,00	01:26	02:48	1776	19	100			23	97	179					
1	302	6	30/09/2016	37º 09,55	24º 34,00	01:26	02:48	1776	21	25			24	98	180					
1	303	6	30/09/2016	37º 11,76	24º 36,07	03:22	04:21	1246	1	1246	13	7.6	25	99	181					

1	303	6	30/09/2016	37º 11,76	24º 36,07	03:22	04:21	1246	3	1100	14	8.7	26	100	182					
1	303	6	30/09/2016	37º 11,76	24º 36,07	03:22	04:21	1246	5	1000	15	9.6	27	101	183					
1	303	6	30/09/2016	37º 11,76	24º 36,07	03:22	04:21	1246	7	862	16	10.7	28	102	184					
1	303	6	30/09/2016	37º 11,76	24º 36,07	03:22	04:21	1246	9	500	17	12.2	29	103	185					
1	303	6	30/09/2016	37º 11,76	24º 36,07	03:22	04:21	1246	11	100	18	16	30	104	186					
1	303	6	30/09/2016	37º 11,76	24º 36,07	03:22	04:21	1246	13	25	19	23	31	105	187					
1	304	6	30/09/2016	37º 12,98	24º 39,93	05:00	05:40	700	1	700	20	11	1	106	188					
1	304	6	30/09/2016	37º 12,98	24º 39,93	05:00	05:40	700	3	500	21	12	2	107	189					
1	304	6	30/09/2016	37º 12,98	24º 39,93	05:00	05:40	700	5	400	22	12.6	3	108	190					
1	304	6	30/09/2016	37º 12,98	24º 39,93	05:00	05:40	700	7	300	23	13.2	4	109	191					
1	304	6	30/09/2016	37º 12,98	24º 39,93	05:00	05:40	700	9	100	24	16.3	5	110	192					
1	304	6	30/09/2016	37º 12,98	24º 39,93	05:00	05:40	700	11	25	25	23	6	111	193					
1	325	7	30/09/2016	37º 11,58	24º 42,41	22:00	23:00	676	1	676	1	11.2	1	21	194					
1	325	7	30/09/2016	37º 11,58	24º 42,41	22:00	23:00	676	3	600	2	11.6	2	22	195					
1	325	7	30/09/2016	37º 11,58	24º 42,41	22:00	23:00	676	5	500	3	12	3	23	196					
1	325	7	30/09/2016	37º 11,58	24º 42,41	22:00	23:00	676	7	400	4	12.5	4	24	197					
1	325	7	30/09/2016	37º 11,58	24º 42,41	22:00	23:00	676	9	300	5	13.4	5	25	198					
1	325	7	30/09/2016	37º 11,58	24º 42,41	22:00	23:00	676	13	100	6	15.7	6	26	199					
1	325	7	30/09/2016	37º 11,58	24º 42,41	22:00	23:00	676	15	25	7	22.1	7	27	200					
1	326	7	01/10/2016	37º 8,41	24º 41,77	23:15	00:12	1236	1	1240	8	6.8	9	28	201					
1	326	7	01/10/2016	37º 8,41	24º 41,77	23:15	00:12	1236	3	1100	9	7.7	10	29	202					
1	326	7	01/10/2016	37º 8,41	24º 41,77	23:15	00:12	1236	5	1000	10	8.7	11	30	203					
1	326	7	01/10/2016	37º 8,41	24º 41,77	23:15	00:12	1236	7	900	11	10	12	31	204					
1	326	7	01/10/2016	37º 8,41	24º 41,77	23:15	00:12	1236	9	875	12	10.5	13	32	205					MW
1	326	7	01/10/2016	37º 8,41	24º 41,77	23:15	00:12	1236	11	800	13	10.9	14	33	206					
1	326	7	01/10/2016	37º 8,41	24º 41,77	23:15	00:12	1236	13	500	14	12.2	15	34	207					
1	326	7	01/10/2016	37º 8,41	24º 41,77	23:15	00:12	1236	15	250	15	13.6	16	35	208					
1	326	7	01/10/2016	37º 8,41	24º 41,77	23:15	00:12	1236	17	100	16	16	17	36	209					

1	326	7	01/10/2016	37º 8,41	24º 41,77	23:15	00:12	1236	19	25	17	22.1	18	37	210					
1	327	7	01/10/2016	37º 05,24	24º 41,03	00:56	02:22	1840	1	1840			19	38	211		1			
1	327	7	01/10/2016	37º 05,24	24º 41,03	00:56	02:22	1840	3	1700			20	39	212		2			
1	327	7	01/10/2016	37º 05,24	24º 41,03	00:56	02:22	1840	5	1600			21	40	213		3			
1	327	7	01/10/2016	37º 05,24	24º 41,03	00:56	02:22	1840	7	1500			22	41	214		4			
1	327	7	01/10/2016	37º 05,24	24º 41,03	00:56	02:22	1840	9	1400			23	42	215		5			
1	327	7	01/10/2016	37º 05,24	24º 41,03	00:56	02:22	1840	11	980			24	43	216		6			AAIW
1	327	7	01/10/2016	37º 05,24	24º 41,03	00:56	02:22	1840	13	880			25	44	217		7			MW
1	327	7	01/10/2016	37º 05,24	24º 41,03	00:56	02:22	1840	15	500			26	1	218		8			
1	327	7	01/10/2016	37º 05,24	24º 41,03	00:56	02:22	1840	17	250			27	2	219		9			
1	327	7	01/10/2016	37º 05,24	24º 41,03	00:56	02:22	1840	19	100			28	3	220		10			
1	327	7	01/10/2016	37º 05,24	24º 41,03	00:56	02:22	1840	21	25			29	4	221		11			
1	328	7	01/10/2016	37º 02,07	24º 40,37	02:56	04:32	2147	1	2140	18	5.3	1	5	222					
1	328	7	01/10/2016	37º 02,07	24º 40,37	02:56	04:32	2147	3	2000	19	5.2	2	6	223					
1	328	7	01/10/2016	37º 02,07	24º 40,37	02:56	04:32	2147	5	1900	20	5.4	3	7	224					
1	328	7	01/10/2016	37º 02,07	24º 40,37	02:56	04:32	2147	7	1800	21	5.6	4	8	225					
1	328	7	01/10/2016	37º 02,07	24º 40,37	02:56	04:32	2147	9	1700	22	5.7	5	9	226					
1	328	7	01/10/2016	37º 02,07	24º 40,37	02:56	04:32	2147	11	1500	23	6.2	6	10	227					
1	328	7	01/10/2016	37º 02,07	24º 40,37	02:56	04:32	2147	12	1300	24	7.3	7	11	228					
1	328	7	01/10/2016	37º 02,07	24º 40,37	02:56	04:32	2147	13	860	25	11	9	12	229					
1	328	7	01/10/2016	37º 02,07	24º 40,37	02:56	04:32	2147	15	700	26	11.4	10	13	230					
1	328	7	01/10/2016	37º 02,07	24º 40,37	02:56	04:32	2147	17	500	27	12.4	11	14	231					
1	328	7	01/10/2016	37º 02,07	24º 40,37	02:56	04:32	2147	19	250	28	13.8	12	15	232					
1	328	7	01/10/2016	37º 02,07	24º 40,37	02:56	04:32	2147	21	100	29	15.5	13	16	233					
1	328	7	01/10/2016	37º 02,07	24º 40,37	02:56	04:32	2147	23	25	30	21.4	14	17	234					
1	306	8	01/10/2016	37º 17,02	24º 47,24	22:02	22:24	187	1	187			1	94	235					
1	306	8	01/10/2016	37º 17,02	24º 47,24	22:02	22:24	187	3	100			2	95	236					
1	306	8	01/10/2016	37º 17,02	24º 47,24	22:02	22:24	187	5	25			3	96	237					

1	308	8	01/10/2016	37º 18,01	24º 48,98	23:50	00:49	1297	1	1290	1	7.2	4	97	238		1			
1	308	8	01/10/2016	37º 18,01	24º 48,98	23:50	00:49	1297	3	1200	2	7.6	5	98	239		2			
1	308	8	01/10/2016	37º 18,01	24º 48,98	23:50	00:49	1297	5	1100	3	8	6	99	240		3			
1	308	8	01/10/2016	37º 18,01	24º 48,98	23:50	00:49	1297	7	1000	4	9	7	100	241		4			
1	308	8	01/10/2016	37º 18,01	24º 48,98	23:50	00:49	1297	9	940	5	9.5	9	101	242		5			AAIW
1	308	8	01/10/2016	37º 18,01	24º 48,98	23:50	00:49	1297	11	860	6	10.6	10	102	243		6			MW
1	308	8	01/10/2016	37º 18,01	24º 48,98	23:50	00:49	1297	13	700	7	11.3	11	103	244		7			
1	308	8	01/10/2016	37º 18,01	24º 48,98	23:50	00:49	1297	15	500	8	12	12	104	245		8			
1	308	8	01/10/2016	37º 18,01	24º 48,98	23:50	00:49	1297	17	250	9	13.1	13	105	246		9			
1	308	8	01/10/2016	37º 18,01	24º 48,98	23:50	00:49	1297	19	100	10	15.8	14	106	247		10			
1	308	8	01/10/2016	37º 18,01	24º 48,98	23:50	00:49	1297	21	25	11	22.4	15	107	248		11			
1	310	8	02/10/2016	37º 19,70	24º 52,10	03:30	04:46	1690	1	1690	12	5.7	16	21	249					
1	310	8	02/10/2016	37º 19,70	24º 52,10	03:30	04:46	1690	3	1600	13	6	17	22	250					
1	310	8	02/10/2016	37º 19,70	24º 52,10	03:30	04:46	1690	5	1500	14	6.4	18	23	251					
1	310	8	02/10/2016	37º 19,70	24º 52,10	03:30	04:46	1690	7	1400	15	6.7	19	24	252					
1	310	8	02/10/2016	37º 19,70	24º 52,10	03:30	04:46	1690	9	1300	16	7.4	20	25	253					
1	310	8	02/10/2016	37º 19,70	24º 52,10	03:30	04:46	1690	11	850	17	10.4	21	26	254					
1	310	8	02/10/2016	37º 19,70	24º 52,10	03:30	04:46	1690	13	700	18	11.1	22	27	255					
1	310	8	02/10/2016	37º 19,70	24º 52,10	03:30	04:46	1690	15	500	19	12	23	28	256					
1	310	8	02/10/2016	37º 19,70	24º 52,10	03:30	04:46	1690	17	250	20	13.8	24	29	257					
1	310	8	02/10/2016	37º 19,70	24º 52,10	03:30	04:46	1690	19	100	21	16.2	25	30	258					
1	310	8	02/10/2016	37º 19,70	24º 52,10	03:30	04:46	1690	21	25	22	21	26	31	259					
1	317	9	02/10/2016	37º 19,70	24º 42,76	21:20	21:37	190	1	190			1	32	260					
1	317	9	02/10/2016	37º 19,70	24º 42,76	21:20	21:37	190	3	100			2	33	261					
1	317	9	02/10/2016	37º 19,70	24º 42,76	21:20	21:37	190	5	25			3	34	262					
1	316	9	02/10/2016	37º 19,16	24º 38,79	22:32	23:32	1390	1	1390	1	7	4	35	263		1			
1	316	9	02/10/2016	37º 19,16	24º 38,79	22:32	23:32	1390	3	1300	2	7	5	36	264		2			
1	316	9	02/10/2016	37º 19,16	24º 38,79	22:32	23:32	1390	5	1200	3	7.8	6	37	265		3			

1	316	9	02/10/2016	37º 19,16	24º 38,79	22:32	23:32	1390	7	1100	4	8.3	7	38	266		4			
1	316	9	02/10/2016	37º 19,16	24º 38,79	22:32	23:32	1390	9	1000	5	9.1	9	39	267		5			
1	316	9	02/10/2016	37º 19,16	24º 38,79	22:32	23:32	1390	11	820	6	10.6	10	40	268		6			MW
1	316	9	02/10/2016	37º 19,16	24º 38,79	22:32	23:32	1390	13	700	7	11.2	11	41	269		7			
1	316	9	02/10/2016	37º 19,16	24º 38,79	22:32	23:32	1390	15	500	8	12	12	42	270		8			
1	316	9	02/10/2016	37º 19,16	24º 38,79	22:32	23:32	1390	17	250	9	13.9	13	43	271		9			
1	316	9	02/10/2016	37º 19,16	24º 38,79	22:32	23:32	1390	19	100	10	16	14	44	272		10			
1	316	9	02/10/2016	37º 19,16	24º 38,79	22:32	23:32	1390	21	25	11	22.9	15	108	273		11			
1	315	9	03/10/2016	37º 21,37	24º 36,63	00:20	01:07	1030	1	1030			17	1	274					
1	315	9	03/10/2016	37º 21,37	24º 36,63	00:20	01:07	1030	3	900			18	2	275					AAIW
1	315	9	03/10/2016	37º 21,37	24º 36,63	00:20	01:07	1030	5	780			19	3	276					MW
1	315	9	03/10/2016	37º 21,37	24º 36,63	00:20	01:07	1030	7	700			20	4	277					
1	315	9	03/10/2016	37º 21,37	24º 36,63	00:20	01:07	1030	9	500			21	5	278				1	
1	315	9	03/10/2016	37º 21,37	24º 36,63	00:20	01:07	1030	11	250			22	6	279					
1	315	9	03/10/2016	37º 21,37	24º 36,63	00:20	01:07	1030	13	100			23	7	280					
1	315	9	03/10/2016	37º 21,37	24º 36,63	00:20	01:07	1030	15	74									2	DCM
1	315	9	03/10/2016	37º 21,37	24º 36,63	00:20	01:07	1030	17	25			24	8	281					
1	315	9	03/10/2016	37º 21,37	24º 36,63	00:20	01:07	1030	19	5									3	
1	315	9	03/10/2016	37º 21,37	24º 36,63	00:20	01:07	1030		continuous									4	
1	314	9	03/10/2016	37º 23,53	24º 34,45	01:43	02:32	1187	1	1187	12	7.9	1	10	282					
1	314	9	03/10/2016	37º 23,53	24º 34,45	01:43	02:32	1187	3	1100	13	8.3	2	11	283					
1	314	9	03/10/2016	37º 23,53	24º 34,45	01:43	02:32	1187	5	1000	14	9	3	12	284					
1	314	9	03/10/2016	37º 23,53	24º 34,45	01:43	02:32	1187	7	900	15	14.5	4	13	285					AAIW
1	314	9	03/10/2016	37º 23,53	24º 34,45	01:43	02:32	1187	9	760	16	11	5	14	286					MW
1	314	9	03/10/2016	37º 23,53	24º 34,45	01:43	02:32	1187	13	500	17	11.2	6	15	287					
1	314	9	03/10/2016	37º 23,53	24º 34,45	01:43	02:32	1187	15	250	18	13.7	7	16	288					
1	314	9	03/10/2016	37º 23,53	24º 34,45	01:43	02:32	1187	17	100	19	16.7	9	17	289					
1	314	9	03/10/2016	37º 23,53	24º 34,45	01:43	02:32	1187	21	25	20	22.4	10	18	290					

1	313	9	03/10/2016	37º 25,72	24º 32,30	03:20	04:10	1226	1	1200			11	19	291					
1	313	9	03/10/2016	37º 25,72	24º 32,30	03:20	04:10	1226	3	1100			12	20	292					
1	313	9	03/10/2016	37º 25,72	24º 32,30	03:20	04:10	1226	5	1000			13	93	293					
1	313	9	03/10/2016	37º 25,72	24º 32,30	03:20	04:10	1226	7	900			14	94	294					
1	313	9	03/10/2016	37º 25,72	24º 32,30	03:20	04:10	1226	11	740			15	95	295					
1	313	9	03/10/2016	37º 25,72	24º 32,30	03:20	04:10	1226	13	500			16	96	296					
1	313	9	03/10/2016	37º 25,72	24º 32,30	03:20	04:10	1226	15	250			17	97	297					
1	313	9	03/10/2016	37º 25,72	24º 32,30	03:20	04:10	1226	17	100			18	98	298					
1	313	9	03/10/2016	37º 25,72	24º 32,30	03:20	04:10	1226	19	50			19	99	299					
1	313	9	03/10/2016	37º 25,72	24º 32,30	03:20	04:10	1226	21	25			20	100	300					
1	311	10	03/10/2016	37º 21,68	24º 55,76	21:33	22:45	1724	1	1700	21	5.7	1	21	301					
1	311	10	03/10/2016	37º 21,68	24º 55,76	21:33	22:45	1724	3	1600	22	6	2	22	302					
1	311	10	03/10/2016	37º 21,68	24º 55,76	21:33	22:45	1724	5	1500	23	6.6	3	23	303					
1	311	10	03/10/2016	37º 21,68	24º 55,76	21:33	22:45	1724	7	1400	24	7	4	24	304					
1	311	10	03/10/2016	37º 21,68	24º 55,76	21:33	22:45	1724	9	1300	25	7.4	5	25	305					
1	311	10	03/10/2016	37º 21,68	24º 55,76	21:33	22:45	1724	11	1000	26	9.4	6	26	306					
1	311	10	03/10/2016	37º 21,68	24º 55,76	21:33	22:45	1724	13	770	27	11	7	27	307					
1	311	10	03/10/2016	37º 21,68	24º 55,76	21:33	22:45	1724	15	500	28	14.8	9	28	308				1	
1	311	10	03/10/2016	37º 21,68	24º 55,76	21:33	22:45	1724	17	250	29	13.6	10	29	309					
1	311	10	03/10/2016	37º 21,68	24º 55,76	21:33	22:45	1724	19	100	30	16.6	11	32	310					
1	311	10	03/10/2016	37º 21,68	24º 55,76	21:33	22:45	1724	20	80									2	
1	311	10	03/10/2016	37º 21,68	24º 55,76	21:33	22:45	1724	21	25	31	22.7	12	31	311					
1	311	10	03/10/2016	37º 21,68	24º 55,76	21:33	22:45	1724	23	5									3	
1	311	10	03/10/2016	37º 21,68	24º 55,76					continuous									4	
1	322	10	04/10/2016	37º 24,56	24º 45,16	23:50	01:27	2412	1	2400			13	33	312		1			
1	322	10	04/10/2016	37º 24,56	24º 45,16	23:50	01:27	2412	3	2300			14	34	313		2			
1	322	10	04/10/2016	37º 24,56	24º 45,16	23:50	01:27	2412	5	2200			15	35	314		3			
1	322	10	04/10/2016	37º 24,56	24º 45,16	23:50	01:27	2412	7	2100			16	36	315		4			

1	322	10	04/10/2016	37° 24,56	24° 45,16	23:50	01:27	2412	9	2000			17	37	316		5			carbonato 5 MAL
1	322	10	04/10/2016	37° 24,56	24° 45,16	23:50	01:27	2412	11	1500			18	38	317		6			
1	322	10	04/10/2016	37° 24,56	24° 45,16	23:50	01:27	2412	13	1000			19	39	318		7			
1	322	10	04/10/2016	37° 24,56	24° 45,16	23:50	01:27	2412	15	835			20	40	319		8			MW
1	322	10	04/10/2016	37° 24,56	24° 45,16	23:50	01:27	2412	17	500			21	41	320		9			
1	322	10	04/10/2016	37° 24,56	24° 45,16	23:50	01:27	2412	19	250			22	42	321		10			
1	322	10	04/10/2016	37° 24,56	24° 45,16	23:50	01:27	2412	21	100			23	43	322		11			
1	322	10	04/10/2016	37° 24,56	24° 45,16	23:50	01:27	2412	23	25			24	44	323		12			
1	323	10	04/10/2016	37° 21,10	24° 44,46	02:05	03:14	1495	1	1490	32	6.7	1	101	324					
1	323	10	04/10/2016	37° 21,10	24° 44,46	02:05	03:14	1495	3	1400	33	7	2	102	325					
1	323	10	04/10/2016	37° 21,10	24° 44,46	02:05	03:14	1495	5	1300	34	7.4	3	103	326					
1	323	10	04/10/2016	37° 21,10	24° 44,46	02:05	03:14	1495	8	1200	35	8	4	104	327					
1	323	10	04/10/2016	37° 21,10	24° 44,46	02:05	03:14	1495	9	1100	36	8.6	6	105	328					
1	323	10	04/10/2016	37° 21,10	24° 44,46	02:05	03:14	1495	11	1000	44	9.7	5	106	329					
1	323	10	04/10/2016	37° 21,10	24° 44,46	02:05	03:14	1495	13	850	38	10.4	7	107	330					
1	323	10	04/10/2016	37° 21,10	24° 44,46	02:05	03:14	1495	15	500	39	12.3	9	108	331					
1	323	10	04/10/2016	37° 21,10	24° 44,46	02:05	03:14	1495	17	250	40	13.7	10	109	332					
1	323	10	04/10/2016	37° 21,10	24° 44,46	02:05	03:14	1495	19	100	41	16	11	110	333					
1	323	10	04/10/2016	37° 21,10	24° 44,46	02:05	03:14	1495	21	25	42	21.9	12	111	334					
1	323	10	04/10/2016	37° 21,10	24° 44,46	02:05	03:14	1495	23	5	43	23	25	112	335					
1	337	10	04/10/2016	37° 15,81	24° 43,32	04:00	04:22	231	1	230			26	1	336					
1	337	10	04/10/2016	37° 15,81	24° 43,32	04:00	04:22	231	3	100			27	2	337					
1	337	10	04/10/2016	37° 15,81	24° 43,32	04:00	04:22	231	5	25			28	3	338					
1	330	11	04/10/2016	37° 17,90	24° 27,88	23:29	00:14	1145	1	1145	1	8.4	1	4	339					
1	330	11	04/10/2016	37° 17,90	24° 27,88	23:29	00:14	1145	3	1000	2	8.8	2	5	340					
1	330	11	04/10/2016	37° 17,90	24° 27,88	23:29	00:14	1145	5	900	3	9.7	3	6	341					
1	330	11	04/10/2016	37° 17,90	24° 27,88	23:29	00:14	1145	7	800	4	10.4	4	7	342					
1	330	11	04/10/2016	37° 17,90	24° 27,88	23:29	00:14	1145	9	720	5	11	5	8	343					

1	330	11	04/10/2016	37º 17,90	24º 27,88	23:29	00:14	1145	11	500	6	12	6	9	344					
1	330	11	04/10/2016	37º 17,90	24º 27,88	23:29	00:14	1145	13	250	7	13.7	7	10	345					
1	330	11	04/10/2016	37º 17,90	24º 27,88	23:29	00:14	1145	15	100	8	15.8	9	11	346					
1	330	11	04/10/2016	37º 17,90	24º 27,88	23:29	00:14	1145	17	25	9	22.6	10	12	347					
1	331	11	05/10/2016	37º 17,10	24º 31,66	00:58	01:36	997	1	997			11	15	348		1			
1	331	11	05/10/2016	37º 17,10	24º 31,66	00:58	01:36	997	3	870			12	16	349		2			
1	331	11	05/10/2016	37º 17,10	24º 31,66	00:58	01:36	997	5	760			13	17	350		3			
1	331	11	05/10/2016	37º 17,10	24º 31,66	00:58	01:36	997	7	500			14	18	351		4		1	
1	331	11	05/10/2016	37º 17,10	24º 31,66	00:58	01:36	997	9	250			15	19	352		5			
1	331	11	05/10/2016	37º 17,10	24º 31,66	00:58	01:36	997	11	100			16	20	353		6			
1	331	11	05/10/2016	37º 17,10	24º 31,66	00:58	01:36	997	13	56									2	DCM
1	331	11	05/10/2016	37º 17,10	24º 31,66	00:58	01:36	997	15	25			17	93	354		7			
1	331	11	05/10/2016	37º 17,10	24º 31,66	00:58	01:36	997	17	5									3	
1	331	11	05/10/2016	37º 17,10	24º 31,66					continuous									4	
1	334	11	05/10/2016	37º 14,20	24º 45,84	03:19	03:36	182	1	180			18	94	355					
1	334	11	05/10/2016	37º 14,20	24º 45,84	03:19	03:36	182	3	100			19	95	356					
1	334	11	05/10/2016	37º 14,20	24º 45,84	03:19	03:36	182	5	25			20	96	357					
1	335	11	05/10/2016	37º 13,22	24º 50,72	04:23	05:35	1669	1	1666	10	5.6	1	97	358					
1	335	11	05/10/2016	37º 13,22	24º 50,72	04:23	05:35	1689	3	1500	11	6.2	2	98	359					
1	335	11	05/10/2016	37º 13,22	24º 50,72	04:23	05:35	1689	5	1400	12	6.6	3	99	360					
1	335	11	05/10/2016	37º 13,22	24º 50,72	04:23	05:35	1689	7	1300	13	7.1	4	100	361					
1	335	11	05/10/2016	37º 13,22	24º 50,72	04:23	05:35	1689	9	1200	14	7.7	5	101	362					
1	335	11	05/10/2016	37º 13,22	24º 50,72	04:23	05:35	1689	11	850	15	10.8	6	102	363					
1	335	11	05/10/2016	37º 13,22	24º 50,72	04:23	05:35	1689	13	500	16	12	7	103	364					
1	335	11	05/10/2016	37º 13,22	24º 50,72	04:23	05:35	1689	15	250	17	14	9	104	365					
1	335	11	05/10/2016	37º 13,22	24º 50,72	04:23	05:35	1689	17	100	18	16.7	10	105	366					
1	335	11	05/10/2016	37º 13,22	24º 50,72	04:23	05:35	1689	19	25	19	22.7	11	21	367					
1	318	12	05/10/2016	37º 12,54	24º 45,24	23:12	23:46	640	1	640	20	11.6	1	22	368					

1	318	12	05/10/2016	37º 12,54	24º 45,24	23:12	23:46	640	3	500	21	12	2	23	369					
1	318	12	05/10/2016	37º 12,54	24º 45,24	23:12	23:46	640	5	250	22	13.4	3	24	370					
1	318	12	05/10/2016	37º 12,54	24º 45,24	23:12	23:46	640	7	100	23	16.7	4	25	371					
1	318	12	05/10/2016	37º 12,54	24º 45,24	23:12	23:46	640	9	25	24	22.4	5	26	372					
1	319	12	06/10/2016	37º 10,34	24º 47,39	00:20	01:12	1130	1	1130	25	7.6	6	27	373		1			
1	319	12	06/10/2016	37º 10,34	24º 47,39	00:20	01:12	1130	3	1000	26	9.2	7	28	374		2			
1	319	12	06/10/2016	37º 10,34	24º 47,39	00:20	01:12	1130	5	920	27	10.3	9	29	375		3			
1	319	12	06/10/2016	37º 10,34	24º 47,39	00:20	01:12	1130	7	700	28	11	10	31	376		4			
1	319	12	06/10/2016	37º 10,34	24º 47,39	00:20	01:12	1130	9	500	29	11.9	11	32	377		6			
1	319	12	06/10/2016	37º 10,34	24º 47,39	00:20	01:12	1130	11	250	30	14	12	33	378		7			
1	319	12	06/10/2016	37º 10,34	24º 47,39	00:20	01:12	1130	13	100	31	16	13	34	379		8			
1	319	12	06/10/2016	37º 10,34	24º 47,39	00:20	01:12	1130	15	25	32	21.4	14	35	380		9			
1	320	12	06/10/2016	37º 08,19	24º 49,46	01:50	02:59	1514	1	1514	35	5.7	15							control reproducibilidad
1	320	12	06/10/2016	37º 08,19	24º 49,46	01:50	02:59	1514	3	1514	34	5.8	16							control reproducibilidad
1	320	12	06/10/2016	37º 08,19	24º 49,46	01:50	02:59	1514	4	1514	33	6	17							control reproducibilidad
1	320	12	06/10/2016	37º 08,19	24º 49,46	01:50	02:59	1514	5	1514	36	6	18							control reproducibilidad
1	320	12	06/10/2016	37º 08,19	24º 49,46	01:50	02:59	1514	6	1514	37	6	19							control reproducibilidad
1	320	12	06/10/2016	37º 08,19	24º 49,46	01:50	02:59	1514	7	1514	38	6.2	20							control reproducibilidad
1	320	12	06/10/2016	37º 08,19	24º 49,46	01:50	02:59	1514	8	1514	39	6.2	21							control reproducibilidad
1	320	12	06/10/2016	37º 08,19	24º 49,46	01:50	02:59	1514	9	1514	40	6.2	22	36	381					control reproducibilidad
1	320	12	06/10/2016	37º 08,19	24º 49,46	01:50	02:59	1514	11	1300			23	37	382					
1	320	12	06/10/2016	37º 08,19	24º 49,46	01:50	02:59	1514	12	1200			24	38	383					
1	320	12	06/10/2016	37º 08,19	24º 49,46	01:50	02:59	1514	13	1100			25	39	384					
1	320	12	06/10/2016	37º 08,19	24º 49,46	01:50	02:59	1514	14	875			26	40	385					
1	320	12	06/10/2016	37º 08,19	24º 49,46	01:50	02:59	1514	16	700			27	41	386					

2	217	14	18/10/2016	36º 36,39	11º 09,99	22:16	00:20	1489	1	1496	1	8.8	1	1	403	3--4	1	8		
2	217	14	18/10/2016	36º 36,39	11º 09,99	22:16	00:20	1489	3	1400	2	9.6	2	2	404	5--6	2			
2	217	14	18/10/2016	36º 36,39	11º 09,99	22:16	00:20	1489	5	1300	3	10.6	3	3	405	7--8	3	9		
2	217	14	18/10/2016	36º 36,39	11º 09,99	22:16	00:20	1489	7	1200	4	11.4	4	4	406	9--10	4			
2	217	14	18/10/2016	36º 36,39	11º 09,99	22:16	00:20	1489	9	1100	5	11.7	5	5	407	11--12	6			
2	217	14	18/10/2016	36º 36,39	11º 09,99	22:16	00:20	1489	11	1000	6	12	6	6	408	13-14	7	10		
2	217	14	18/10/2016	36º 36,39	11º 09,99	22:16	00:20	1489	13	900	7	12	7	7	409	15-16	8			4
2	217	14	18/10/2016	36º 36,39	11º 09,99	22:16	00:20	1489	15	750	8	12	9	8	410	17-18	9	11		
2	217	14	18/10/2016	36º 36,39	11º 09,99	22:16	00:20	1489	17	500	9	11.9	10	9	411	19-20	10			
2	217	14	18/10/2016	36º 36,39	11º 09,99	22:16	00:20	1489	19	300	10	12.9	11	10	412	21-22	11	12		
2	217	14	18/10/2016	36º 36,39	11º 09,99	22:16	00:20	1489	21	100	11	15.9	12	11	413	23-24	12	13		1
2	217	14	18/10/2016	36º 36,39	11º 09,99	22:16	00:20	1489	23	25	12	21.2	13	12	414	25-26	13	14		
2	217	14	18/10/2016	36º 36,39	11º 09,99					continuous						1--2				
2	218	14	19/10/2016	36º 38,55	11º 9,62	01:38	02:17	912	1	912			14	13	415		14			
2	218	14	19/10/2016	36º 38,55	11º 9,62	01:38	02:17	912	3	800			15	15	416		15			
2	218	14	19/10/2016	36º 38,55	11º 9,62	01:38	02:17	912	5	700			16	16	417		16			
2	218	14	19/10/2016	36º 38,55	11º 9,62	01:38	02:17	912	7	600			17	17	418		17			
2	218	14	19/10/2016	36º 38,55	11º 9,62	01:38	02:17	912	9	500			18	18	419		18			
2	218	14	19/10/2016	36º 38,55	11º 9,62	01:38	02:17	912	11	250			19	19	420		19			
2	218	14	19/10/2016	36º 38,55	11º 9,62	01:38	02:17	912	13	100			20	20	421		20			
2	218	14	19/10/2016	36º 38,55	11º 9,62	01:38	02:17	912	15	25			21	21	422		21			
2	219	14	19/10/2016	36º 40,55	11º 9,07	03:07	03:20	215	1	215			1	22	423		22			
2	219	14	19/10/2016	36º 40,55	11º 9,07	03:07	03:20	215	3	100			2	23	424		23			
2	219	14	19/10/2016	36º 40,55	11º 9,07	03:07	03:20	215	9	25			3	24	425		24			
2	220	14	19/10/2016	36º 44,64	11º 7,94	04:19	04:34	245	1	245	13	13.1	6	26	426		1			
2	220	14	19/10/2016	36º 44,64	11º 7,94	04:19	04:34	245	7	100	14	15	7	27	427		2			
2	220	14	19/10/2016	36º 44,64	11º 7,94	04:19	04:34	245	8	100	20	15.4								
2	220	14	19/10/2016	36º 44,64	11º 7,94	04:19	04:34	245	10	22	15	21.2	9	28	428		3			

2	213	15	19/10/2016	36º 43,39	11º 20,98	22:05	23:13	1617	1	1623	16	7.2	14	93	429	27-28	1			
2	213	15	19/10/2016	36º 43,39	11º 20,98	22:05	23:13	1617	3	1500	17	8.2	15	94	430	29-30	2			
2	213	15	19/10/2016	36º 43,39	11º 20,98	22:05	23:13	1617	5	1400	18	9.5	16	95	431	31-32	3			
2	213	15	19/10/2016	36º 43,39	11º 20,98	22:05	23:13	1617	7	1300	19	10.3	17	96	432	33-34	4			
2	213	15	19/10/2016	36º 43,39	11º 20,98	22:05	23:13	1617	8	1200	21	11	18	97	433	35-36	6			
2	213	15	19/10/2016	36º 43,39	11º 20,98	22:05	23:13	1617	9	1155	22	11.2	19	98	434	37-38	7			
2	213	15	19/10/2016	36º 43,39	11º 20,98	22:05	23:13	1617	13	825	23	11.3	20	99	435	39-40	8			
2	213	15	19/10/2016	36º 43,39	11º 20,98	22:05	23:13	1617	15	500	24	11.7	21	100	436	41-42	9			
2	213	15	19/10/2016	36º 43,39	11º 20,98	22:05	23:13	1617	17	250	25	15	22	101	437	43-44	10			
2	213	15	19/10/2016	36º 43,39	11º 20,98	22:05	23:13	1617	19	100	26	14.7	23	102	438	45-46	11			
2	213	15	19/10/2016	36º 43,39	11º 20,98	22:05	23:13	1617	21	62	27	15.4	24	103	439	47-48	12			
2	213	15	19/10/2016	36º 43,39	11º 20,98	22:05	23:13	1617	23	25	28	19	25	104	440	49-50	13			
2	212	15	20/10/2016	36º 43,18	11º 17,89	00:21	01:08	1167	1	1162	29	11	1	29	441		14			
2	212	15	20/10/2016	36º 43,18	11º 17,89	00:21	01:08	1167	3	1000	30	11	2	31	442					
2	212	15	20/10/2016	36º 43,18	11º 17,89	00:21	01:08	1167	5	900	31	11	3	32	443					
2	212	15	20/10/2016	36º 43,18	11º 17,89	00:21	01:08	1167	7	800	32	11.2	4	33	444					
2	212	15	20/10/2016	36º 43,18	11º 17,89	00:21	01:08	1167	9	700	33	11.6	5	34	445					
2	212	15	20/10/2016	36º 43,18	11º 17,89	00:21	01:08	1167	11	500	34	11.8	6	35	446					
2	212	15	20/10/2016	36º 43,18	11º 17,89	00:21	01:08	1167	13	250	35	13.2	7	36	447					
2	212	15	20/10/2016	36º 43,18	11º 17,89	00:21	01:08	1167	15	100	36	15.2	9	37	448					
2	212	15	20/10/2016	36º 43,18	11º 17,89	00:21	01:08	1167	17	25	37	21.4	26	38	449					
2	211	15	20/10/2016	36º 42,99	11º 14,78	01:52	02:28	875	1	875					450					
2	211	15	20/10/2016	36º 42,99	11º 14,78	01:52	02:28	875	3	800					451					
2	211	15	20/10/2016	36º 42,99	11º 14,78	01:52	02:28	875	5	700					452					
2	211	15	20/10/2016	36º 42,99	11º 14,78	01:52	02:28	875	7	600					453					
2	211	15	20/10/2016	36º 42,99	11º 14,78	01:52	02:28	875	9	500					454					
2	211	15	20/10/2016	36º 42,99	11º 14,78	01:52	02:28	875	11	250					455					
2	211	15	20/10/2016	36º 42,99	11º 14,78	01:52	02:28	875	13	100					456					

2	211	15	20/10/2016	36º 42,99	11º 14,78	01:52	02:28	875	15	25					457				
2	210	15	20/10/2016	36º 42,78	11º 11,63	03:04	03:17	193	1	190					458				
2	210	15	20/10/2016	36º 42,78	11º 11,63	03:04	03:17	193	3	100					459				
2	210	15	20/10/2016	36º 42,78	11º 11,63	03:04	03:17	193	23	25					460				
2	208	15	20/10/2016	36º 42,40	11º 5,40	04:18	04:29	592	1	115	38	15	1	39	461				
2	208	15	20/10/2016	36º 42,40	11º 5,40	04:18	04:29	592	1	115	39	15.4							
2	208	15	20/10/2016	36º 42,40	11º 5,40	04:18	04:29	592	3	100	40	16	2	40	462				
2	208	15	20/10/2016	36º 42,40	11º 5,40	04:18	04:29	592	13	25	41	21.4	3	41	463				
2	207	15	20/10/2016	36º 42,98	11º 23,32	05:02	05:28	593	1	587					464				
2	207	15	20/10/2016	36º 42,98	11º 23,32	05:02	05:28	593	3	500					465				
2	207	15	20/10/2016	36º 42,98	11º 23,32	05:02	05:28	593	11	250					466				
2	207	15	20/10/2016	36º 42,98	11º 23,32	05:02	05:28	593	13	100					467				
2	207	15	20/10/2016	36º 42,98	11º 23,32	05:02	05:28	593	15	25					468				
2	207	15	20/10/2016	36º 42,98	11º 23,32					continuous						51-52			
2	223	16	20/10/2016	36º 50,78	11º 06,29	20:37	21:30	1344	1	1344	42	9.5	1	1	469		1		
2	223	16	20/10/2016	36º 50,78	11º 06,29	20:37	21:30	1344	3	1200	43	10.5	2	2	470		2		
2	223	16	20/10/2016	36º 50,78	11º 06,29	20:37	21:30	1344	5	1100	44	11	3	3	471		3		
2	223	16	20/10/2016	36º 50,78	11º 06,29	20:37	21:30	1344	7	1000	45	10.8	4	4	472		4		
2	223	16	20/10/2016	36º 50,78	11º 06,29	20:37	21:30	1344	9	900	46	11	5	5	473		6		
2	223	16	20/10/2016	36º 50,78	11º 06,29	20:37	21:30	1344	11	700	47	11.4	6	6	474		7		
2	223	16	20/10/2016	36º 50,78	11º 06,29	20:37	21:30	1344	13	500	48	11.6	7	22	475		8		
2	223	16	20/10/2016	36º 50,78	11º 06,29	20:37	21:30	1344	15	250	49	12.6	9	23	476		9		
2	223	16	20/10/2016	36º 50,78	11º 06,29	20:37	21:30	1344	17	100	50	14.9	10	24	477		10		
2	223	16	20/10/2016	36º 50,78	11º 06,29	20:37	21:30	1344	19	25	51	20.4	11	25	478		11		
2	222	16	20/10/2016	36º 48,75	11º 6,85	22:26	23:12	1114	1	1114			12	7	479		12		
2	222	16	20/10/2016	36º 48,75	11º 6,85	22:26	23:12	1114	3	1000			13	8	480				
2	222	16	20/10/2016	36º 48,75	11º 6,85	22:26	23:12	1114	5	900			14	9	481				
2	222	16	20/10/2016	36º 48,75	11º 6,85	22:26	23:12	1114	7	800			15	10	482				

2	222	16	20/10/2016	36º 48,75	11º 6,85	22:26	23:12	1114	9	700			16	11	483				
2	222	16	20/10/2016	36º 48,75	11º 6,85	22:26	23:12	1114	11	500			17	12	484				
2	222	16	20/10/2016	36º 48,75	11º 6,85	22:26	23:12	1114	13	250			18	26	485				
2	222	16	20/10/2016	36º 48,75	11º 6,85	22:26	23:12	1114	15	100			19	27	486				
2	222	16	20/10/2016	36º 48,75	11º 6,85	22:26	23:12	1114	17	67			20	28	487			4	
2	222	16	20/10/2016	36º 48,75	11º 6,85	22:26	23:12	1114	19	25			21	42	488				
2	222	16	20/10/2016	36º 48,75	11º 6,85					continuous								1	
2	221	16	21/10/2016	36º 46,68	11º 7,42	23:48	00:28	788	1	781					489				
2	221	16	21/10/2016	36º 46,68	11º 7,42	23:48	00:28	788	3	700					490				
2	221	16	21/10/2016	36º 46,68	11º 7,42	23:48	00:28	788	5	600					491				
2	221	16	21/10/2016	36º 46,68	11º 7,42	23:48	00:28	788	7	500					492				
2	221	16	21/10/2016	36º 46,68	11º 7,42	23:48	00:28	788	9	400					493				
2	221	16	21/10/2016	36º 46,68	11º 7,42	23:48	00:28	788	11	250					494				
2	221	16	21/10/2016	36º 46,68	11º 7,42	23:48	00:28	788	13	100					495				
2	221	16	21/10/2016	36º 46,68	11º 7,42	23:48	00:28	788	15	80					496			3	
2	221	16	21/10/2016	36º 46,68	11º 7,42	23:48	00:28	788	17	25					497				
2	233	16	21/10/2016	36º 45,25	11º 3,84	00:57	01:09	193	1	180					498				
2	233	16	21/10/2016	36º 45,25	11º 3,84	00:57	01:09	193	3	100					499				
2	233	16	21/10/2016	36º 45,25	11º 3,84	00:57	01:09	193	5	25					500				
2	233	16	21/10/2016	36º 45,25	11º 3,84					continuous						53-54			
2	234	16	21/10/2016	36º 47,80	10º 59,10	01:59	02:35	941	1	937					501				
2	234	16	21/10/2016	36º 47,80	10º 59,10	01:59	02:35	941	3	800					502				
2	234	16	21/10/2016	36º 47,80	10º 59,10	01:59	02:35	941	5	700					503				
2	234	16	21/10/2016	36º 47,80	10º 59,10	01:59	02:35	941	7	600					504				
2	234	16	21/10/2016	36º 47,80	10º 59,10	01:59	02:35	941	9	500					505				
2	234	16	21/10/2016	36º 47,80	10º 59,10	01:59	02:35	941	11	250					506				
2	234	16	21/10/2016	36º 47,80	10º 59,10	01:59	02:35	941	13	100					507				
2	234	16	21/10/2016	36º 47,80	10º 59,10	01:59	02:35	941	15	25					508				

2	206	16	21/10/2016	36º 42,01	10º 59,14		04:27	1373	1	1365	1	10	1	15	509					
2	206	16	21/10/2016	36º 42,01	10º 59,14		04:27	1373	3	1200	2	10.8	2	16	510					
2	206	16	21/10/2016	36º 42,01	10º 59,14		04:27	1373	5	1100	3	11	3	17	511					
2	206	16	21/10/2016	36º 42,01	10º 59,14		04:27	1373	7	1000	4	11.5	4	18	512		13			
2	206	16	21/10/2016	36º 42,01	10º 59,14		04:27	1373	9	885	5	11.7	5	19	513					
2	206	16	21/10/2016	36º 42,01	10º 59,14		04:27	1373	11	800	6	11.7	6	20	514					
2	206	16	21/10/2016	36º 42,01	10º 59,14		04:27	1373	13	700	7	11.8	7	21	515					
2	206	16	21/10/2016	36º 42,01	10º 59,14		04:27	1373	15	500	8	12.9	9	29	516					
2	206	16	21/10/2016	36º 42,01	10º 59,14		04:27	1373	17	250	9	13.8	10	31	517					
2	206	16	21/10/2016	36º 42,01	10º 59,14		04:27	1373	19	100	10	16.8	11	32	518					
2	206	16	21/10/2016	36º 42,01	10º 59,14		04:27	1373	23	25	11	21.5	12	43						
2	232	16	21/10/2016	36º 40,89	11º 11,33	05:48	05:57	111	2	110					519					
2	232	16	21/10/2016	36º 40,89	11º 11,33	05:48	05:57	111	16	25					520					
2	501	17	22/10/2016	36º 36,65	2º 48,03	22:46	22:54	73	1	63					521					
2	501	17	22/10/2016	36º 36,65	2º 48,03	22:46	22:54	73	3	25					522					
2	502	17	22/10/2016	36º 33,83	2º 49,48	23:35	23:51	329	1	320			1	1	523					
2	502	17	22/10/2016	36º 33,83	2º 49,48	23:35	23:51	329	2	320										
2	502	17	22/10/2016	36º 33,83	2º 49,48	23:35	23:51	329	5	250			2	2	524					
2	502	17	22/10/2016	36º 33,83	2º 49,48	23:35	23:51	329	7	100			3	3	525		1			
2	502	17	22/10/2016	36º 33,83	2º 49,48	23:35	23:51	329	9	25			4	4	526					
2	503	17	23/10/2016	36º 31,00	2º 50,96	00:34	00:40	96	1	96			5	5	527		2			
2	503	17	23/10/2016	36º 31,00	2º 50,96	00:34	00:40	96	5	25			6	6	528					
2	504	17	23/10/2016	36º 27,99	2º 52,47	01:20	01:52	729	1	726	1	13.2	7	7	529					
2	504	17	23/10/2016	36º 27,99	2º 52,47	01:20	01:52	729	3	600	2	13.3	9	8	530		3			
2	504	17	23/10/2016	36º 27,99	2º 52,47	01:20	01:52	729	5	500	3	13.4	10	9	531					
2	504	17	23/10/2016	36º 27,99	2º 52,47	01:20	01:52	729	7	400	4	13.4	11	10	532					
2	504	17	23/10/2016	36º 27,99	2º 52,47	01:20	01:52	729	9	300	5	13.4	12	20	533					
2	504	17	23/10/2016	36º 27,99	2º 52,47	01:20	01:52	729	11	250	7	13.5	13	13	534					

2	504	17	23/10/2016	36º 27,99	2º 52,47	01:20	01:52	729	13	100	6	14	14	15	535					
2	504	17	23/10/2016	36º 27,99	2º 52,47	01:20	01:52	729	15	46	8	15	15	17	536					5
2	504	17	23/10/2016	36º 27,99	2º 52,47	01:20	01:52	729	17	25	9	19.1	16	18	537					
2	505	17	23/10/2016	36º 25,34	2º 53,95	02:41	03:15	801	1	799					538					
2	505	17	23/10/2016	36º 25,34	2º 53,95	02:41	03:15	801	3	700					539					
2	505	17	23/10/2016	36º 25,34	2º 53,95	02:41	03:15	801	5	600					540					
2	505	17	23/10/2016	36º 25,34	2º 53,95	02:41	03:15	801	7	500					541					
2	505	17	23/10/2016	36º 25,34	2º 53,95	02:41	03:15	801	9	400					542					
2	505	17	23/10/2016	36º 25,34	2º 53,95	02:41	03:15	801	11	250					543					
2	505	17	23/10/2016	36º 25,34	2º 53,95	02:41	03:15	801	13	100					544					
2	505	17	23/10/2016	36º 25,34	2º 53,95	02:41	03:15	801	15	25					545					
2	506	17	23/10/2016	36º 22,48	2º 55,46	03:49	04:28	914	1	912	10	13.1	17	19	546		4			
2	506	17	23/10/2016	36º 22,48	2º 55,46	03:49	04:28	914	3	800	11	13.1	18	21	547		6			
2	506	17	23/10/2016	36º 22,48	2º 55,46	03:49	04:28	914	5	700	12	13.2	19	22	548		7			
2	506	17	23/10/2016	36º 22,48	2º 55,46	03:49	04:28	914	7	600	13	13.3	20	23	549		8			
2	506	17	23/10/2016	36º 22,48	2º 55,46	03:49	04:28	914	9	500	14	13.3	21	24	550		9			
2	506	17	23/10/2016	36º 22,48	2º 55,46	03:49	04:28	914	11	250	15	13.4	22	25	551		10			
2	506	17	23/10/2016	36º 22,48	2º 55,46	03:49	04:28	914	13	100	16	14	23	26	552		11			
2	506	17	23/10/2016	36º 22,48	2º 55,46	03:49	04:28	914	15	44	17	15.4	24	27	553		12			
2	506	17	23/10/2016	36º 22,48	2º 55,46	03:49	04:28	914	17	25	18	19.1	25	28	554		13			
2	507	18	23/10/2016	36º 19,72	2º 56,88	21:04	21:51	1071	1	1072	19	13	1	11	555		1			
2	507	18	23/10/2016	36º 19,72	2º 56,88	21:04	21:51	1071	3	900	20	13	2	12	556					
2	507	18	23/10/2016	36º 19,72	2º 56,88	21:04	21:51	1071	5	800	21	13.1	3	16	557					
2	507	18	23/10/2016	36º 19,72	2º 56,88	21:04	21:51	1071	7	700	22	13.2	4	31	558					
2	507	18	23/10/2016	36º 19,72	2º 56,88	21:04	21:51	1071	9	600	23	13.2	5	32	559					
2	507	18	23/10/2016	36º 19,72	2º 56,88	21:04	21:51	1071	11	500	24	13.3	6	43	560					
2	507	18	23/10/2016	36º 19,72	2º 56,88	21:04	21:51	1071	13	250	25	13.6	7	34	561					
2	507	18	23/10/2016	36º 19,72	2º 56,88	21:04	21:51	1071	15	100	26	14	9	35	562					

2	507	18	23/10/2016	36º 19,72	2º 56,88	21:04	21:51	1071	21	25	27	18	10	36	563					
2	508	18	23/10/2016	36º 19,72	2º 52,99	22:41	23:30	1198	1	1195					564	6				
2	508	18	23/10/2016	36º 19,72	2º 52,99	22:41	23:30	1198	3	1100					565	8			2	
2	508	18	23/10/2016	36º 19,72	2º 52,99	22:41	23:30	1198	5	1000					566	10				
2	508	18	23/10/2016	36º 19,72	2º 52,99	22:41	23:30	1198	7	900					567	12				
2	508	18	23/10/2016	36º 19,72	2º 52,99	22:41	23:30	1198	9	800					568	14				
2	508	18	23/10/2016	36º 19,72	2º 52,99	22:41	23:30	1198	11	700					569	16				
2	508	18	23/10/2016	36º 19,72	2º 52,99	22:41	23:30	1198	13	600					570	18				
2	508	18	23/10/2016	36º 19,72	2º 52,99	22:41	23:30	1198	15	500					571	20				
2	508	18	23/10/2016	36º 19,72	2º 52,99	22:41	23:30	1198	17	250					572	22				
2	508	18	23/10/2016	36º 19,72	2º 52,99	22:41	23:30	1198	19	100					573	24				
2	508	18	23/10/2016	36º 19,72	2º 52,99	22:41	23:30	1198	21	46					574	26			5	
2	508	18	23/10/2016	36º 19,72	2º 52,99	22:41	23:30	1198	23	25					575	28				
2	508	18	23/10/2016	36º 19,72	2º 52,99					continuous						30			6	
2	509	18	24/10/2016	36º 22,54	2º 51,50	00:20	01:30	1031	1	1030	28	13.1	11	29	576		2	15		
2	509	18	24/10/2016	36º 22,54	2º 51,50	00:20	01:30	1031	3	900	29	13.1	12	37	577		3	16		
2	509	18	24/10/2016	36º 22,54	2º 51,50	00:20	01:30	1031	5	800	30	13.1	13	38	578		4	17		
2	509	18	24/10/2016	36º 22,54	2º 51,50	00:20	01:30	1031	7	700	31	13.2	14	39	579		6	18		
2	509	18	24/10/2016	36º 22,54	2º 51,50	00:20	01:30	1031	9	600	32	13.3	15	41	580		7	19		
2	509	18	24/10/2016	36º 22,54	2º 51,50	00:20	01:30	1031	11	500	33	13.4	16	44	581		8	20		
2	509	18	24/10/2016	36º 22,54	2º 51,50	00:20	01:30	1031	13	250	39	13.6	17	33	582		9			
2	509	18	24/10/2016	36º 22,54	2º 51,50	00:20	01:30	1031	15	100	38	14.1	18	40	583		10			
2	509	18	24/10/2016	36º 22,54	2º 51,50	00:20	01:30	1031	17	25	37	18.1	19	1	584		11			
2	510	18	24/10/2016	36º 25,35	2º 50,06	01:42	02:15	897	1	891					585					
2	510	18	24/10/2016	36º 25,35	2º 50,06	01:42	02:15	897	3	800					586					
2	510	18	24/10/2016	36º 25,35	2º 50,06	01:42	02:15	897	5	700					587					
2	510	18	24/10/2016	36º 25,35	2º 50,06	01:42	02:15	897	7	600					588					
2	510	18	24/10/2016	36º 25,35	2º 50,06	01:42	02:15	897	9	500					589					

2	510	18	24/10/2016	36º 25,35	2º 50,06	01:42	02:15	897	11	250					590				
2	510	18	24/10/2016	36º 25,35	2º 50,06	01:42	02:15	897	13	100					591				
2	510	18	24/10/2016	36º 25,35	2º 50,06	01:42	02:15	897	15	43					592				
2	510	18	24/10/2016	36º 25,35	2º 50,06	01:42	02:15	897	17	25					593				
2	511	18	24/10/2016	36º 28,18	2º 48,60	02:59	03:29	767	1	767				20	2	594			
2	511	18	24/10/2016	36º 28,18	2º 48,60	02:59	03:29	767	3	700				21	3	596		13	
2	511	18	24/10/2016	36º 28,18	2º 48,60	02:59	03:29	767	5	600				22	4	597			
2	511	18	24/10/2016	36º 28,18	2º 48,60	02:59	03:29	767	7	500				23	21	598			
2	511	18	24/10/2016	36º 28,18	2º 48,60	02:59	03:29	767	9	250				24	22	599			
2	511	18	24/10/2016	36º 28,18	2º 48,60	02:59	03:29	767	11	100				25	42	600			
2	511	18	24/10/2016	36º 28,18	2º 48,60	02:59	03:29	767	13	25				26	5	601			
2	512	18	24/10/2016	36º 31,00	2º 47,10	04:05	04:28	521	1	520						602			
2	512	18	24/10/2016	36º 31,00	2º 47,10	04:05	04:28	521	3	250						603			
2	512	18	24/10/2016	36º 31,00	2º 47,10	04:05	04:28	521	5	100						604			
2	512	18	24/10/2016	36º 31,00	2º 47,10	04:05	04:28	521	7	25						605			
2	513	18	24/10/2016	36º 33,82	2º 45,60	05:03	05:20	333	1	333				1	93	606			
2	513	18	24/10/2016	36º 33,82	2º 45,60	05:03	05:20	333	3	250				2	94	607		18	
2	513	18	24/10/2016	36º 33,82	2º 45,60	05:03	05:20	333	5	100				3	95	608			
2	513	18	24/10/2016	36º 33,82	2º 45,60	05:03	05:20	333	7	25				4	96	609			
2	521	19	24/10/2016	36º 19,72	3º 0,78	20:36	21:18	952	1	950	1	13.1				610			
2	521	19	24/10/2016	36º 19,72	3º 0,78	20:36	21:18	952	5	800	2	13.1				611			
2	521	19	24/10/2016	36º 19,72	3º 0,78	20:36	21:18	952	7	700	3	13.1				612			
2	521	19	24/10/2016	36º 19,72	3º 0,78	20:36	21:18	952	9	600	4	13.3				613			
2	521	19	24/10/2016	36º 19,72	3º 0,78	20:36	21:18	952	11	500	5	13.4				614			
2	521	19	24/10/2016	36º 19,72	3º 0,78	20:36	21:18	952	13	250	6	13.6				615			
2	521	19	24/10/2016	36º 19,72	3º 0,78	20:36	21:18	952	15	100	7	14				616			
2	521	19	24/10/2016	36º 19,72	3º 0,78	20:36	21:18	952	17	47	8	15.7				617			
2	521	19	24/10/2016	36º 19,72	3º 0,78	20:36	21:18	952	19	25	9	19.5				618			

2	520	19	24/10/2016	36º 22,54	2º 59,30	22:00	22:38	876	1	875	10	13.1	1	97	619		1			
2	520	19	24/10/2016	36º 22,54	2º 59,30	22:00	22:38	876	3	800	11	13.1	2	98	627		2			
2	520	19	24/10/2016	36º 22,54	2º 59,30	22:00	22:38	876	5	700	12	13.2	3	99	621		3			
2	520	19	24/10/2016	36º 22,54	2º 59,30	22:00	22:38	876	7	600	13	13.3	4	100	622		4			
2	520	19	24/10/2016	36º 22,54	2º 59,30	22:00	22:38	876	9	500	14	13.3	5	102	623		6			
2	520	19	24/10/2016	36º 22,54	2º 59,30	22:00	22:38	876	11	250	15	13.4	6	103	624		7			
2	520	19	24/10/2016	36º 22,54	2º 59,30	22:00	22:38	876	13	100	16	14	7	104	625		8			
2	520	19	24/10/2016	36º 22,54	2º 59,30	22:00	22:38	876	15	25	17	20	9	105	626		9			
2	519	19	24/10/2016	36º 25,36	2º 57,85	23:23	23:54	756	1	755					628					7
2	519	19	24/10/2016	36º 25,36	2º 57,85	23:23	23:54	756	3	700					629					
2	519	19	24/10/2016	36º 25,36	2º 57,85	23:23	23:54	756	5	600					630					
2	519	19	24/10/2016	36º 25,36	2º 57,85	23:23	23:54	756	7	500					631					
2	519	19	24/10/2016	36º 25,36	2º 57,85	23:23	23:54	756	9	250					632					
2	519	19	24/10/2016	36º 25,36	2º 57,85	23:23	23:54	756	11	100					633					
2	519	19	24/10/2016	36º 25,36	2º 57,85	23:23	23:54	756	13	25					634					
2	518	19	25/10/2016	36º 28,18	2º 56,38	00:33	01:02	625	1	620	18	13.3	10	106	635					
2	518	19	25/10/2016	36º 28,18	2º 56,38	00:33	01:02	625	3	500	19	13.3	11	107	636		10			
2	518	19	25/10/2016	36º 28,18	2º 56,38	00:33	01:02	625	5	400	20	13.4	12	108	637					
2	518	19	25/10/2016	36º 28,18	2º 56,38	00:33	01:02	625	7	300	21	13.5	13	109	638					
2	518	19	25/10/2016	36º 28,18	2º 56,38	00:33	01:02	625	9	250	22	13.6	14	110	639					
2	518	19	25/10/2016	36º 28,18	2º 56,38	00:33	01:02	625	11	100	23	14.3	15	111	640					
2	518	19	25/10/2016	36º 28,18	2º 56,38	00:33	01:02	625	13	25	24	17.8	16	112	641					
2	517	19	25/10/2016	36º 31,00	2º 54,91	01:46	01:46	456	1	446			17	7	642					
2	517	19	25/10/2016	36º 31,00	2º 54,91	01:46	01:46	456	3	300			18	6	643		11			
2	517	19	25/10/2016	36º 31,00	2º 54,91	01:46	01:46	456	5	250			19	8	644					
2	517	19	25/10/2016	36º 31,00	2º 54,91	01:46	01:46	456	7	100			20	9	645					
2	517	19	25/10/2016	36º 31,00	2º 54,91	01:46	01:46	456	9	25			21	10	646					
2	516	19	25/10/2016	36º 33,85	2º 53,43	02:40	03:01	365	1	360			22	11	647					

2	516	19	25/10/2016	36º 33,85	2º 53,43	02:40	03:01	365	3	250			23	12	648		12			
2	516	19	25/10/2016	36º 33,85	2º 53,43	02:40	03:01	365	5	100			24	15	649					
2	516	19	25/10/2016	36º 33,85	2º 53,43	02:40	03:01	365	7	25			25	16	650					
2	515	19	25/10/2016	36º 36,64	2º 51,94	03:32	03:47	96	1	84					651					
2	515	19	25/10/2016	36º 36,64	2º 51,94	03:32	03:47	96	9	25					652					
2	514	19	25/10/2016	36º 36,64	2º 44,16	04:42	04:48	73	1	62					653					
2	514	19	25/10/2016	36º 36,64	2º 44,16	04:42	04:48	73	3	25					654					

Chemical Oceanography- pH. Appendix V.1

leg	Station	Batch	Date	T lab	Niskin	ph flow cell	T flow cell	DR	time incubation
1	101	1	22/09/2016	25	1	1	25.8		02:00
1	101	1	22/09/2016	25	3	2	25.9		
1	101	1	22/09/2016	25	5	3	26		
1	101	1	22/09/2016	25	7	4	25.9		
1	101	1	22/09/2016	25	9	5	26		
1	103	1	22/09/2016	25	1	6	25.7		04:15
1	103	1	22/09/2016	25	3	7	25.7		
1	103	1	22/09/2016	25	5	8	26		
1	103	1	22/09/2016	25	7	9	26		
1	103	1	22/09/2016	25	9	10	26.6		
1	103	1	22/09/2016	25	11	11	25.7		
1	103	1	22/09/2016	25	13	12	25.6		
1	103	1	22/09/2016	25	15	13	25.6		
1	104	1	22/09/2016	25	1	14	26	si	05:30
1	104	1	22/09/2016	25	2	15	26.2	si	
1	104	1	22/09/2016	25	3	16	25.8		
1	104	1	22/09/2016	25	4	17	26	si	
1	104	1	22/09/2016	25	5	18	25.7		
1	104	1	22/09/2016	25	6	19	26	si	
1	104	1	22/09/2016	25	7	20	25.6		
1	104	1	22/09/2016	25	8	21	25.6		
1	104	1	22/09/2016	25	9	22	25.8	si	
1	105	1	22/09/2016	25	1	23	25.7		07:00
1	105	1	22/09/2016	25	2	24	25.4		
1	105	1	22/09/2016	25	3	25	25.6		
1	105	1	22/09/2016	25	4	26	25.7		
1	105	1	22/09/2016	25	5	27	25.5		
1	105	1	22/09/2016	25	6	28	25.6		
1	105	1	22/09/2016	25	7	29	25.6		
1	105	1	22/09/2016	25	8	30	25.6		
1	105	1	22/09/2016	25	9	31	25.6		
1	108	2	23/09/2016	25	1	1	25.6		00:00
1	108	2	23/09/2016	25	3	2	26	si	
1	108	2	23/09/2016	25	5	3	25.6		
1	108	2	23/09/2016	25	7	4	25.7	si	
1	108	2	23/09/2016	25	9	5	25.7		
1	108	2	23/09/2016	25	11	6	26	si	
1	108	2	23/09/2016	25	15	7	25.3		
1	108	2	23/09/2016	25	17	9	25.8	si	
1	110	2	23/09/2016	25.5	1	10	25.6		02:10
1	110	2	23/09/2016	25.5	3	11	25.3		
1	110	2	23/09/2016	25.5	5	12	25.2		
1	110	2	23/09/2016	25.5	7	13	25.6		
1	110	2	23/09/2016	25.5	9	14	25.4		

1	110	2	23/09/2016	25.5	13	15	25.1		
1	110	2	23/09/2016	25.5	15	16	25.2		
1	111	2	23/09/2016	25.5	1	17	25.5		03:30
1	111	2	23/09/2016	25.5	3	18	25.3		
1	111	2	23/09/2016	25.5	5	19	25.3		
1	111	2	23/09/2016	25.5	7	20	25		
1	111	2	23/09/2016	25.5	9	21	25.4		
1	111	2	23/09/2016	25.5	13	22	25.5		
1	111	2	23/09/2016	25.5	15	23	25.4		
1	112	2	23/09/2016	25.5	1	24	25.4		04:35
1	112	2	23/09/2016	25.5	3	25	25.5		
1	112	2	23/09/2016	25.5	5	26	25.7		
1	112	2	23/09/2016	25.5	7	27	25.7		
1	112	2	23/09/2016	25.5	11	28	25.7		
1	112	2	23/09/2016	25.5	13	29	25.7		
1	114	2	23/09/2016	25.5	1	10	25.7		06:10
1	114	2	23/09/2016	25.5	5	11	25.5		
1	114	2	23/09/2016	25.5	7	12	25.5		
1	120	3	23/09/2016	25.5	1	10	25.7		23:45
1	120	3	23/09/2016	25.5	3	11	25		
1	120	3	23/09/2016	25.5	5	12	25.2		
1	119	3	23/09/2016	25.5	1	1	25.6	si	01:00
1	119	3	23/09/2016	25.5	3	2	25.2		
1	119	3	23/09/2016	25.5	5	3	25.8	si	
1	119	3	23/09/2016	25.5	7	4	25.4		
1	119	3	23/09/2016	25.5	11	5	25.7	si	
1	119	3	23/09/2016	25.5	13	6	25.4		
1	118	3	23/09/2016	25.5	1	7	25.5		02:18
1	118	3	23/09/2016	25.5	3	9	25.7		
1	118	3	23/09/2016	25.5	5	13	25.6		
1	118	3	23/09/2016	25.5	7	14	25.7		
1	118	3	23/09/2016	25.5	9	15	25.7		
1	118	3	23/09/2016	25.5	13	16	25.6		
1	118	3	23/09/2016	25.5	15	17	25.7		
1	117	3	24/09/2016	25.5	1	18	25.6		03:30
1	117	3	24/09/2016	25.5	3	19	25.7		
1	117	3	24/09/2016	25.5	5	20	25.4		
1	117	3	24/09/2016	25.5	7	21	25.6		
1	117	3	24/09/2016	25.5	9	22	25.4		
1	117	3	24/09/2016	25.5	13	23	25.6		
1	117	3	24/09/2016	25.5	15	24	25.7		
1	115	3	24/09/2016	25.5	1	1	25.7		05:30
1	115	3	24/09/2016	25.5	3	2	25.5		
1	115	3	24/09/2016	25.5	5	3	25.5		
1	115	3	24/09/2016	25.5	7	4	25.6		
1	115	3	24/09/2016	25.5	9	5	25.5		

1	115	3	24/09/2016	25.5	11	6	25.4		
1	115	3	24/09/2016	25.5	15	7	25.6		
1	115	3	24/09/2016	25.5	17	9	25.4		
1	201	4	25/09/2016	26	1	1	25.7		01:30
1	201	4	25/09/2016	26	3	2	25		
1	201	4	25/09/2016	26	7	3	25.5		
1	201	4	25/09/2016	26	9	4	25.2		
1	201	4	25/09/2016	26	11	5	25.5		
1	201	4	25/09/2016	26	13	6	25.6		
1	201	4	25/09/2016	26	15	7	25.4		
1	201	4	25/09/2016	26	19	9	25.6		
1	201	4	25/09/2016	26	11	11	25.5		
1	202	4	25/09/2016	26	1	12	25.7		03:15
1	202	4	25/09/2016	26	3	13	26		
1	202	4	25/09/2016	26	4	14	25.7		
1	202	4	25/09/2016	26	5	15	25.6		
1	202	4	25/09/2016	26	6	16	25.7		
1	202	4	25/09/2016	26	7	17	25.4		
1	202	4	25/09/2016	26	8	18	25.6		
1	203	4	25/09/2016	26	1	19	25.7	si	05:30
1	203	4	25/09/2016	26	3	20	25.7	si	
1	203	4	25/09/2016	26	5	21	26	si	
1	203	4	25/09/2016	26	7	22	25.7	si	
1	203	4	25/09/2016	26	9	23	25.7	si	
1	203	4	25/09/2016	26	11	24	25.9		
1	203	4	25/09/2016	26	13	25	25.6	si	
1	203	4	25/09/2016	26	15	26	25.7		
1	203	4	25/09/2016	26	17	27	25.7	si	
1	203	4	25/09/2016	26	19	28	25.7		
1	204	4	25/09/2016	26	1	1	25.4		07:45
1	204	4	25/09/2016	26	3	2	25.3		
1	204	4	25/09/2016	26	5	3	25.3		
1	204	4	25/09/2016	26	7	4	25.3		
1	204	4	25/09/2016	26	9	5	25.3		
1	204	4	25/09/2016	26	11	6	25.3		
1	204	4	25/09/2016	26	13	7	25.3		
1	204	4	25/09/2016	26	15	9	25.3		
1	204	4	25/09/2016	26	17	10	25.3		
1	204	4	25/09/2016	26	19	11	25.3		
1	204	4	25/09/2016	26	21	12	25.3		
1	236	5	26/09/2016	24	1	1	25.5	si	01:05
1	236	5	26/09/2016	24	3	2	25		
1	236	5	26/09/2016	24	4	3	25.4	si	
1	236	5	26/09/2016	24	5	4	25		
1	236	5	26/09/2016	24	6	5	25	si	
1	236	5	26/09/2016	24	7	6	25		

1	236	5	26/09/2016	24	8	7	25	si	
1	236	5	26/09/2016	24	9	9	25		
1	236	5	26/09/2016	24	10	10	25.4	si	
1	236	5	26/09/2016	24	12	11	25		
1	236	5	26/09/2016	24	18	13	25.4	si	
1	235	5	26/09/2016	25	1	14	25		02:48
1	235	5	26/09/2016	25	3	15	25.1		
1	235	5	26/09/2016	25	4	16	25.3		
1	235	5	26/09/2016	25	5	17	25.1		
1	235	5	26/09/2016	25	6	18	25		
1	235	5	26/09/2016	25	7	19	25.2		
1	235	5	26/09/2016	25	8	20	25.2		
1	235	5	26/09/2016	25	9	21	25		
1	235	5	26/09/2016	25	11	22	25.2		
1	235	5	26/09/2016	25	16	23	25.4		
1	234	5	26/09/2016	25	1	24	25.7		04:45
1	234	5	26/09/2016	25	3	25	25.6		
1	234	5	26/09/2016	25	5	26	25.6		
1	234	5	26/09/2016	25	7	27	25.4		
1	234	5	26/09/2016	25	9	28	25.4		
1	234	5	26/09/2016	25	11	29	25.3		
1	234	5	26/09/2016	25	13	30	25.4		
1	234	5	26/09/2016	25	15	31	25.3		
1	233	5	26/09/2016	25	1	1	25.6		05:10
1	233	5	26/09/2016	25	3	2	25.3		
1	233	5	26/09/2016	25	7	3	25.3		
1	209	5	26/09/2016	25	1	17	25.5		06:24
1	209	5	26/09/2016	25	3	18	25.2		
1	209	5	26/09/2016	25	5	19	25.4		
1	ctr_1	ctr_1	28/09/2016	25	1	1	25.7		12:15
1	ctr_1	ctr_1	28/09/2016	25	2	2	25.4		
1	ctr_1	ctr_1	28/09/2016	25	3	3	25.4		
1	ctr_1	ctr_1	28/09/2016	25	4	4	25.5		
1	ctr_1	ctr_1	28/09/2016	25	5	5	25.4		
1	ctr_1	ctr_1	28/09/2016	25	6	6	25.4		
1	ctr_1	ctr_1	28/09/2016	25	7	7	25.4		
1	ctr_1	ctr_1	28/09/2016	25	9	9	25.6		
1	ctr_1	ctr_1	28/09/2016	25	10	10	25.4		
1	ctr_1	ctr_1	28/09/2016	25	11	11	25.4		
1	ctr_1	ctr_1	28/09/2016	25	12	12	25.4		
1	ctr_1	ctr_1	28/09/2016	25	13	13	25.3		
1	301	6	29/09/2016	25	1	1	25.4		02:20
1	301	6	29/09/2016	25	3	2	25.2	si	
1	301	6	29/09/2016	25	5	3	25.6	si	
1	301	6	29/09/2016	25	7	4	26	si	
1	301	6	29/09/2016	25	9	5	26	si	

1	301	6	29/09/2016	25	11	6	26.1	si	
1	301	6	29/09/2016	25	12	7	25.7	si	
1	301	6	29/09/2016	25	13	9	25.7	si	
1	301	6	29/09/2016	25	15	10	25.7	si	
1	301	6	29/09/2016	25	16	11	25.6	si	
1	301	6	29/09/2016	25	17	12	25.9	si	
1	301	6	29/09/2016	25	18	13	25.6	si	
1	302	6	30/09/2016	25	1	14	25		
1	302	6	30/09/2016	25	3	15	25		
1	302	6	30/09/2016	25	5	16	25		
1	302	6	30/09/2016	25	7	17	25		
1	302	6	30/09/2016	25	9	18	25		
1	302	6	30/09/2016	25	11	19	24.7		
1	302	6	30/09/2016	25	13	20	25		
1	302	6	30/09/2016	25	15	21	25.3		
1	302	6	30/09/2016	25	17	22	25.3		
1	302	6	30/09/2016	25	19	23	25.3		
1	302	6	30/09/2016	25	21	24	25.3		
1	303	6	30/09/2016	25	1	25	25.4		
1	303	6	30/09/2016	25	3	26	25.4		
1	303	6	30/09/2016	25	5	27	25.6		
1	303	6	30/09/2016	25	7	28	25.6		
1	303	6	30/09/2016	25	9	29	25.6		
1	303	6	30/09/2016	25	11	30	25.4		
1	303	6	30/09/2016	25	13	31	25.4		
1	304	6	30/09/2016	25	1	1	25.4		
1	304	6	30/09/2016	25	3	2	25.4		
1	304	6	30/09/2016	25	5	3	25.4		
1	304	6	30/09/2016	25	7	4	25.3		
1	304	6	30/09/2016	25	9	5	25.4		
1	304	6	30/09/2016	25	11	6	25.4		
1	325	7	30/09/2016	24.5	1	1	25.5	si	23:54
1	325	7	30/09/2016	24.5	3	2	25		
1	325	7	30/09/2016	24.5	5	3	25.5	si	
1	325	7	30/09/2016	24.5	7	4	25.1	si	
1	325	7	30/09/2016	24.5	9	5	25.6	si	
1	325	7	30/09/2016	24.5	13	6	25.3	si	
1	325	7	30/09/2016	24.5	15	7	25.3	si	
1	326	7	01/10/2016	24.5	1	9	25		01:50
1	326	7	01/10/2016	24.5	3	10	25		
1	326	7	01/10/2016	24.5	5	11	25		
1	326	7	01/10/2016	24.5	7	12	25.1		
1	326	7	01/10/2016	24.5	9	13	25		
1	326	7	01/10/2016	24.5	11	14	25		
1	326	7	01/10/2016	24.5	13	15	25		
1	326	7	01/10/2016	24.5	15	16	25		

1	326	7	01/10/2016	24.5	17	17	25		
1	326	7	01/10/2016	24.5	19	18	25		
1	327	7	01/10/2016	24.5	1	19	25		03:45
1	327	7	01/10/2016	24.5	3	20	25		
1	327	7	01/10/2016	24.5	5	21	25		
1	327	7	01/10/2016	24.5	7	22	25		
1	327	7	01/10/2016	24.5	9	23	25.2		
1	327	7	01/10/2016	24.5	11	24	25		
1	327	7	01/10/2016	24.5	13	25	25		
1	327	7	01/10/2016	24.5	15	26	25		
1	327	7	01/10/2016	24.5	17	27	25		
1	327	7	01/10/2016	24.5	19	28	25.1		
1	327	7	01/10/2016	24.5	21	29	25		
1	328	7	01/10/2016	24.5	1	1	25		06:10
1	328	7	01/10/2016	24.5	3	2	25		
1	328	7	01/10/2016	24.5	5	3	25		
1	328	7	01/10/2016	24.5	7	4	25.1		
1	328	7	01/10/2016	24.5	9	5	25		
1	328	7	01/10/2016	24.5	11	6	25		
1	328	7	01/10/2016	24.5	12	7	25		
1	328	7	01/10/2016	24.5	13	9	25		
1	328	7	01/10/2016	24.5	15	10	25		
1	328	7	01/10/2016	24.5	17	11	25.3		
1	328	7	01/10/2016	24.5	19	12	25		
1	328	7	01/10/2016	24.5	21	13	25.3		
1	328	7	01/10/2016	24.5	23	14	25.2		
1	306	8	01/10/2016	26	1	1	26		00:00
1	306	8	01/10/2016	26	3	2	25.6		
1	306	8	01/10/2016	26	5	3	25.6		
1	308	8	01/10/2016	25	1	4	25.6		02:20
1	308	8	01/10/2016	25	3	5	25.4		
1	308	8	01/10/2016	25	5	6	25		
1	308	8	01/10/2016	25	7	7	25		
1	308	8	01/10/2016	25	9	9	25.2		
1	308	8	01/10/2016	25	11	10	25.4		
1	308	8	01/10/2016	25	13	11	25.2		
1	308	8	01/10/2016	25	15	12	25		
1	308	8	01/10/2016	24.5	17	13	25.2		
1	308	8	01/10/2016	24.5	19	14	25.3		
1	308	8	01/10/2016	24.5	21	15	25.3		
1	310	8	02/10/2016	24.5	1	16	25	si	05:15
1	310	8	02/10/2016	24.5	3	17	25		
1	310	8	02/10/2016	24.5	5	18	25	si	
1	310	8	02/10/2016	24.5	7	19	25		
1	310	8	02/10/2016	24.5	9	20	25.4	si	
1	310	8	02/10/2016	24.5	11	21	25		

1	310	8	02/10/2016	24.5	13	22	25	si	
1	310	8	02/10/2016	24.5	15	23	25		
1	310	8	02/10/2016	24.5	17	24	25	si	
1	310	8	02/10/2016	24.5	19	25	25		
1	310	8	02/10/2016	24.5	21	26	25.1	si	
1	317	9	03/10/2016	23	1	1	25		22:00
1	317	9	03/10/2016	23	3	2	24.9		
1	317	9	03/10/2016	23	5	3	25		
1	316	9	03/10/2016	23	1	4	24.7		00:05
1	316	9	03/10/2016	23	3	5	25		
1	316	9	03/10/2016	23	5	6	25		
1	316	9	03/10/2016	23	7	7	24.9		
1	316	9	03/10/2016	23	9	9	25		
1	316	9	03/10/2016	23	11	10	25		
1	316	9	03/10/2016	23	13	11	25		
1	316	9	03/10/2016	23	15	12	25		
1	316	9	03/10/2016	23	17	13	25		
1	316	9	03/10/2016	23	19	14	25		
1	316	9	03/10/2016	23	21	15	24.9		
1	315	9	03/10/2016	23	1	17	25	si	01:20
1	315	9	03/10/2016	23	3	18	24.9		
1	315	9	03/10/2016	23	5	19	25	si	
1	315	9	03/10/2016	23	7	20	24.9		
1	315	9	03/10/2016	23	9	21	24.9	si	
1	315	9	03/10/2016	23	11	22	24.9		
1	315	9	03/10/2016	23	13	23	25	si	
1	315	9	03/10/2016	23	17	24	24.9	si	
1	314	9	03/10/2016	25	1	1	25		03:15
1	314	9	03/10/2016	25	3	2	25		
1	314	9	03/10/2016	25	5	3	25		
1	314	9	03/10/2016	25	7	4	25		
1	314	9	03/10/2016	25	9	5	25.4		
1	314	9	03/10/2016	25	13	6	25.1		
1	314	9	03/10/2016	25	15	7	25		
1	314	9	03/10/2016	25	17	9	25		
1	314	9	03/10/2016	25	21	10	25		
1	313	9	03/10/2016	24	1	11	25		04:40
1	313	9	03/10/2016	24	3	12	24.9		
1	313	9	03/10/2016	24	5	13	24.8		
1	313	9	03/10/2016	24	7	14	25		
1	313	9	03/10/2016	24	11	15	25		
1	313	9	03/10/2016	24	13	16	25		
1	313	9	03/10/2016	24	15	17	25		
1	313	9	03/10/2016	24	17	18	25		
1	313	9	03/10/2016	24	19	19	25		
1	313	9	03/10/2016	24	21	20	25.1		

1	311	10	03/10/2016	23	1	1	24.9	si	11:10
1	311	10	03/10/2016	23	3	2	24.8		
1	311	10	03/10/2016	23	5	3	25	si	
1	311	10	03/10/2016	23	7	4	24.9		
1	311	10	03/10/2016	23	9	5	24.9	si	
1	311	10	03/10/2016	24	11	6	24.9		
1	311	10	03/10/2016	24	13	7	24.8	si	
1	311	10	03/10/2016	24	15	9	25		
1	311	10	03/10/2016	24	17	10	25	si	
1	311	10	03/10/2016	24	19	11	25		
1	311	10	03/10/2016	24	21	12	25	si	
1	322	10	04/10/2016	23	1	13	24.6		02:00
1	322	10	04/10/2016	23	3	14	24.9		
1	322	10	04/10/2016	23	5	15	24.7		
1	322	10	04/10/2016	23	7	16	24.9		
1	322	10	04/10/2016	23	9	17	24.8		
1	322	10	04/10/2016	24	11	18	25		
1	322	10	04/10/2016	24	13	19	24.7		
1	322	10	04/10/2016	24	15	20	25		
1	322	10	04/10/2016	24	17	21	25		
1	322	10	04/10/2016	24	19	22	24.9		
1	322	10	04/10/2016	24	21	23	25		
1	322	10	04/10/2016	24	23	24	25		
1	323	10	04/10/2016	24	1	1	25		04:00
1	323	10	04/10/2016	24	3	2	25		
1	323	10	04/10/2016	24	5	3	25		
1	323	10	04/10/2016	24	8	4	24.8		
1	323	10	04/10/2016	24	9	6	25		
1	323	10	04/10/2016	24	11	5	25		
1	323	10	04/10/2016	24	13	7	25		
1	323	10	04/10/2016	24	15	9	25		
1	323	10	04/10/2016	24	17	10	25		
1	323	10	04/10/2016	24	19	11	25		
1	323	10	04/10/2016	25	21	12	25.2		
1	323	10	04/10/2016	26	23	25	25.5		
1	337	10	04/10/2016	24	1	26	25		04:35
1	337	10	04/10/2016	24	3	27	24.8		
1	337	10	04/10/2016	24	5	28	24.9		
1	330	11	04/10/2016	26	1	1	25.2		23:45
1	330	11	04/10/2016	25	3	2	25.1		
1	330	11	04/10/2016	24	5	3	25		
1	330	11	04/10/2016	24	7	4	25		
1	330	11	04/10/2016	24	9	5	25		
1	330	11	04/10/2016	24	11	6	25		
1	330	11	04/10/2016	24	13	7	25.3		
1	330	11	04/10/2016	24	15	9	25		

1	330	11	04/10/2016	24	17	10	25		
1	331	11	05/10/2016	25	1	11	25.4	si	02:15
1	331	11	05/10/2016	25	3	12	25.3	si	
1	331	11	05/10/2016	25	5	13	25.3	si	
1	331	11	05/10/2016	25	7	14	25		
1	331	11	05/10/2016	25	9	15	25	si	
1	331	11	05/10/2016	25	11	16	25.2		
1	331	11	05/10/2016	25	15	17	25.3	si	
1	334	11	05/10/2016	24.5	1	18	25		03:50
1	334	11	05/10/2016	24.5	3	19	25.1		
1	334	11	05/10/2016	24.5	5	20	25		
1	335	11	05/10/2016	24.5	1	1	25		05:55
1	335	11	05/10/2016	24.5	3	2	25		
1	335	11	05/10/2016	24.5	5	3	25		
1	335	11	05/10/2016	24.5	7	4	25		
1	335	11	05/10/2016	24.5	9	5	25		
1	335	11	05/10/2016	24.5	11	6	25		
1	335	11	05/10/2016	24.5	13	7	25		
1	335	11	05/10/2016	24.5	15	9	25		
1	335	11	05/10/2016	24.5	17	10	25		
1	335	11	05/10/2016	24.5	19	11	25		
1	318	12	05/10/2016	24	1	1	25		00:00
1	318	12	05/10/2016	24	3	2	25		
1	318	12	05/10/2016	24	5	3	25		
1	318	12	05/10/2016	24	7	4	25.1		
1	318	12	05/10/2016	24	9	5	25		
1	319	12	06/10/2016	24	1	6	25		01:30
1	319	12	06/10/2016	24	3	7	25		
1	319	12	06/10/2016	24	5	9	25		
1	319	12	06/10/2016	24	7	10	25		
1	319	12	06/10/2016	24	9	11	25		
1	319	12	06/10/2016	24	11	12	25		
1	319	12	06/10/2016	24	13	13	25		
1	319	12	06/10/2016	24	15	14	25		
1	320	12	06/10/2016	24	1	15	25		04:45
1	320	12	06/10/2016	24	3	16	24.9		
1	320	12	06/10/2016	24	4	17	24.7		
1	320	12	06/10/2016	24	5	18	24.7		
1	320	12	06/10/2016	24	6	19	25.1		
1	320	12	06/10/2016	24	7	20	25		
1	320	12	06/10/2016	24	8	21	25		
1	320	12	06/10/2016	24	9	22	25		
1	320	12	06/10/2016	24	11	23	24.8	si	
1	320	12	06/10/2016	24	12	24	25	si	
1	320	12	06/10/2016	24	13	25	24.9	si	
1	320	12	06/10/2016	24	14	26	25	si	

1	320	12	06/10/2016	24	16	27	25	si	
1	320	12	06/10/2016	24	17	28	25	si	
1	320	12	06/10/2016	24	18	29	25.1	si	
1	320	12	06/10/2016	24	19	30	25.2	si	
1	320	12	06/10/2016	24	21	31	25.2	si	
1	321	12	06/10/2016	24	1	1	25		05:30
1	321	12	06/10/2016	24	3	2	25		
1	321	12	06/10/2016	24	5	3	25		
1	321	12	06/10/2016	24	7	4	25		
1	321	12	06/10/2016	24	9	5	25.1		
1	321	12	06/10/2016	24	11	6	25.1		
1	321	12	06/10/2016	24	13	7	25.3		
1	321	12	06/10/2016	24	15	9	25.4		
1	321	12	06/10/2016	24	17	10	25.3		
1	321	12	06/10/2016	24	19	11	25		
1	321	12	06/10/2016	24	21	12	25		
1	321	12	06/10/2016	24	23	13	25		
2	217	14	18/10/2016	22	1	1	24.7	si	00:50
2	217	14	18/10/2016	22	3	2	24.7		
2	217	14	18/10/2016	22	5	3	24.8	si	
2	217	14	18/10/2016	22	7	4	24.8		
2	217	14	18/10/2016	22	9	5	24.9	si	
2	217	14	18/10/2016	22	11	6	24.7		
2	217	14	18/10/2016	22	13	7	24.9	si	
2	217	14	18/10/2016	22	15	9	25		
2	217	14	18/10/2016	23	17	10	24.9	si	
2	217	14	18/10/2016	23	19	11	24.9		
2	217	14	18/10/2016	23	21	12	25	si	
2	217	14	18/10/2016	23	23	13	25		
2	218	14	19/10/2016	23	1	14	25		03:00
2	218	14	19/10/2016	23	3	15	24.9		
2	218	14	19/10/2016	23	5	16	25		
2	218	14	19/10/2016	23	7	17	24.8		
2	218	14	19/10/2016	23	9	18	24.9		
2	218	14	19/10/2016	23	11	19	25		
2	218	14	19/10/2016	23	13	20	24.8		
2	218	14	19/10/2016	23	15	21	24.7		
2	219	14	19/10/2016	23	1	1	25		03:45
2	219	14	19/10/2016	23	3	2	25		
2	219	14	19/10/2016	23	9	3	25		
2	220	14	19/10/2016	23	1	6	25		05:00
2	220	14	19/10/2016	23	7	7	25		
2	220	14	19/10/2016	23	10	9	25		
2	ctr_2	ctr_2	19/10/2016	26	1	1	25		23:15
2	ctr_2	ctr_2	19/10/2016	25	2	2	25		
2	ctr_2	ctr_2	19/10/2016	25	3	3	25		

2	ctr_2	ctr_2	19/10/2016	24	4	4	24.9		
2	ctr_2	ctr_2	19/10/2016	24	5	5	25		
2	ctr_2	ctr_2	19/10/2016	24	6	6	25		
2	ctr_2	ctr_2	19/10/2016	24	7	7	25		
2	ctr_2	ctr_2	19/10/2016	23	10	10	24.8		
2	ctr_2	ctr_2	19/10/2016	23	11	11	25		
2	ctr_2	ctr_2	19/10/2016	23	12	12	25		
2	ctr_2	ctr_2	19/10/2016	23	13	13	25		
2	213	15	20/10/2016	23	1	14	25		00:50
2	213	15	20/10/2016	23	3	15	25	si	
2	213	15	20/10/2016	23	5	16	25		
2	213	15	20/10/2016	23	7	17	25.1	si	
2	213	15	20/10/2016	23	8	18	25		
2	213	15	20/10/2016	23	9	19	25	si	
2	213	15	20/10/2016	23	13	20	24.8		
2	213	15	20/10/2016	23	15	21	25	si	
2	213	15	20/10/2016	23	17	22	24.7		
2	213	15	20/10/2016	23	19	23	24.5	si	
2	213	15	20/10/2016	23	21	24	25		
2	213	15	20/10/2016	23	23	25	25.1	si	
2	212	15	20/10/2016	24	1	1	25		02:45
2	212	15	20/10/2016	24	3	2	25		
2	212	15	20/10/2016	24	5	3	25		
2	212	15	20/10/2016	24	7	4	25		
2	212	15	20/10/2016	24	9	5	25		
2	212	15	20/10/2016	24	11	6	25.4		
2	212	15	20/10/2016	24	13	7	25		
2	212	15	20/10/2016	24	15	9	25.1		
2	212	15	20/10/2016	24	17	26	25		
2	208	15	20/10/2016	23	1	1	25		05:50
2	208	15	20/10/2016	23	3	2	25		
2	208	15	20/10/2016	23	13	3	25.3		
2	223	16	20/10/2016	26	1	1	25		23:10
2	223	16	20/10/2016	24	3	2	25		
2	223	16	20/10/2016	24	5	3	25		
2	223	16	20/10/2016	24	7	4	24.9		
2	223	16	20/10/2016	24	9	5	25		
2	223	16	20/10/2016	24	11	6	25		
2	223	16	20/10/2016	24	13	7	25		
2	223	16	20/10/2016	24	15	9	25.4		
2	223	16	20/10/2016	24	17	10	25.3		
2	223	16	20/10/2016	24	19	11	25		
2	222	16	20/10/2016	24	1	12	25	si	00:38
2	222	16	20/10/2016	24	3	13	25		
2	222	16	20/10/2016	24	5	14	25.1	si	
2	222	16	20/10/2016	24	7	15	25		

2	222	16	20/10/2016	24	9	16	25.2	si	
2	222	16	20/10/2016	24	11	17	25		
2	222	16	20/10/2016	24	13	18	25	si	
2	222	16	20/10/2016	24	15	19	25		
2	222	16	20/10/2016	24	17	20	25	si	
2	222	16	20/10/2016	24	19	21	25		03:29
2	206	16	21/10/2016	24	1	1	24.9		07:10
2	206	16	21/10/2016	24	3	2	25		
2	206	16	21/10/2016	24	5	3	24.9		
2	206	16	21/10/2016	24	7	4	24.7		
2	206	16	21/10/2016	23	9	5	24.8		
2	206	16	21/10/2016	23	11	6	24.9		
2	206	16	21/10/2016	23	13	7	24.9		
2	206	16	21/10/2016	23	15	9	25		
2	206	16	21/10/2016	23	17	10	25		
2	206	16	21/10/2016	23	19	11	25		
2	206	16	21/10/2016	23	23	12	25		
2	502	17	22/10/2016	25	1	1	25.3		02:10
2	502	17	22/10/2016	25	5	2	25		
2	502	17	22/10/2016	25	7	3	25.2		
2	502	17	22/10/2016	25	9	4	25		
2	503	17	23/10/2016	25	1	5	25		02:52
2	503	17	23/10/2016	25	5	6	25		
2	504	17	23/10/2016	25	1	7	25	si	04:30
2	504	17	23/10/2016	25	3	9	25		
2	504	17	23/10/2016	25	5	10	25	si	
2	504	17	23/10/2016	25	7	11	25		
2	504	17	23/10/2016	25	9	12	24.9	si	
2	504	17	23/10/2016	25	11	13	25		
2	504	17	23/10/2016	25	13	14	25	si	
2	504	17	23/10/2016	25	15	15	25		
2	504	17	23/10/2016	25	17	16	25	si	
2	506	17	23/10/2016	25	1	17	25.1		06:55
2	506	17	23/10/2016	25	3	18	25.2		
2	506	17	23/10/2016	25	5	19	25.2		
2	506	17	23/10/2016	25	7	20	25		
2	506	17	23/10/2016	25	9	21	25.1		
2	506	17	23/10/2016	25	11	22	25.3		
2	506	17	23/10/2016	25	13	23	25		
2	506	17	23/10/2016	25	15	24	24.9		
2	506	17	23/10/2016	25	17	25	25.1		
2	507	18	23/10/2016	24	1	1	24.9	si	00:20
2	507	18	23/10/2016	23	3	2	25		
2	507	18	23/10/2016	23	5	3	25	si	
2	507	18	23/10/2016	23	7	4	24.8		
2	507	18	23/10/2016	23	9	5	25.3	si	

2	507	18	23/10/2016	23	11	6	25		
2	507	18	23/10/2016	23	13	7	25	si	
2	507	18	23/10/2016	23	15	9	25.2		
2	507	18	23/10/2016	23	21	10	25.2	si	
2	509	18	24/10/2016	23	1	11	25		03:30
2	509	18	24/10/2016	23	3	12	25		
2	509	18	24/10/2016	23	5	13	24.9		
2	509	18	24/10/2016	23	7	14	25		
2	509	18	24/10/2016	23	9	15	25		
2	509	18	24/10/2016	23	11	16	25		
2	509	18	24/10/2016	23	13	17	25		
2	509	18	24/10/2016	23	15	18	25		
2	509	18	24/10/2016	23	17	19	25		
2	511	18	24/10/2016	25	1	20	25		05:50
2	511	18	24/10/2016	25	3	21	25		
2	511	18	24/10/2016	25	5	22	25		
2	511	18	24/10/2016	25	7	23	25		
2	511	18	24/10/2016	25	9	24	25		
2	511	18	24/10/2016	25	11	25	25		
2	511	18	24/10/2016	25	13	26	25		
2	513	18	24/10/2016	25	1	1	24.8		07:35
2	513	18	24/10/2016	25	3	2	24.7		
2	513	18	24/10/2016	25	5	3	25		
2	513	18	24/10/2016	25	7	4	24.7		
2	520	19	24/10/2016	25	1	1	25.6	si	01:00
2	520	19	24/10/2016	25	3	2	25.4	si	
2	520	19	24/10/2016	25	5	3	25.4		
2	520	19	24/10/2016	25	7	4	25	si	
2	520	19	24/10/2016	25	9	5	25.3		
2	520	19	24/10/2016	24	11	6	25	si	
2	520	19	24/10/2016	24	13	7	25		
2	520	19	24/10/2016	24	15	9	25.3	si	
2	518	19	24/10/2016	24	1	10	25		03:40
2	518	19	24/10/2016	24	3	11	25		
2	518	19	24/10/2016	24	5	12	25.3		
2	518	19	24/10/2016	23	7	13	25		
2	518	19	24/10/2016	23	9	14	25		
2	518	19	24/10/2016	23	11	15	25		
2	518	19	24/10/2016	23	13	16	25		
2	517	19	25/10/2016	23	1	17	25		04:20
2	517	19	25/10/2016	23	3	18	25		
2	517	19	25/10/2016	23	5	19	25		
2	517	19	25/10/2016	23	7	20	25		
2	517	19	25/10/2016	23	9	21	25		
2	516	19	25/10/2016	23	1	22	25		05:15
2	516	19	25/10/2016	23	3	23	25		

2	516	19	25/10/2016	23	5	24	25		
2	516	19	25/10/2016	23	7	25	25		

Chemical Oceanography- Carbonates. Appendix V.2

leg	Station	Batch	Date	T lab	Niskin	CO3 flow cell	T flow cell	time incubation
1	118	3	23/09/2016	25.5	1	1		02:18
1	118	3	23/09/2016	25.5	3	2		
1	118	3	23/09/2016	25.5	5	3		
1	118	3	23/09/2016	25.5	7	4		
1	118	3	23/09/2016	25.5	9	5		
1	118	3	23/09/2016	25.5	13	6		
1	118	3	23/09/2016	25.5	15	7		
1	235	5	26/09/2016	25	1	1		02:48
1	235	5	26/09/2016	25	3	2		
1	235	5	26/09/2016	25	4	3		
1	235	5	26/09/2016	25	5	4		
1	235	5	26/09/2016	25	6	5		
1	235	5	26/09/2016	25	7	6		
1	235	5	26/09/2016	25	8	7		
1	235	5	26/09/2016	25	9	8		
1	235	5	26/09/2016	25	11	9		
1	235	5	26/09/2016	25	16	10		
1	301	6	29/09/2016	25	1	1	25.6	02:20
1	301	6	29/09/2016	25	3	2	25.6	
1	301	6	29/09/2016	25	5	3	25.3	
1	301	6	29/09/2016	25	7	4	25.4	
1	301	6	29/09/2016	25	9	5	25	
1	301	6	29/09/2016	25	11	6	25.4	
1	301	6	29/09/2016	25	12	7	25	
1	301	6	29/09/2016	25	13	8	25	
1	301	6	29/09/2016	25	15	9	25	
1	301	6	29/09/2016	25	16	10	25	
1	301	6	29/09/2016	25	17	11	25	
1	301	6	29/09/2016	25	18	12	25	
1	327	7	01/10/2016	24.5	1	1		03:45
1	327	7	01/10/2016	24.5	3	2		
1	327	7	01/10/2016	24.5	5	3		
1	327	7	01/10/2016	24.5	7	4		
1	327	7	01/10/2016	24.5	9	5		
1	327	7	01/10/2016	24.5	11	6		
1	327	7	01/10/2016	24.5	13	7		
1	327	7	01/10/2016	24.5	15	8		
1	327	7	01/10/2016	24.5	17	9		
1	327	7	01/10/2016	24.5	19	10		
1	327	7	01/10/2016	24.5	21	11		
1	308	8	01/10/2016	25	1	1		02:20
1	308	8	01/10/2016	25	3	2		
1	308	8	01/10/2016	25	5	3		
1	308	8	01/10/2016	25	7	4		

1	308	8	01/10/2016	25	9	5		
1	308	8	01/10/2016	25	11	6		
1	308	8	01/10/2016	25	13	7		
1	308	8	01/10/2016	25	15	8		
1	308	8	01/10/2016	25	17	9		
1	308	8	01/10/2016	25	19	10		
1	308	8	01/10/2016	25	21	11		
1	316	9	03/10/2016	23	1	1		00:05
1	316	9	03/10/2016	23	3	2		
1	316	9	03/10/2016	23	5	3		
1	316	9	03/10/2016	23	7	4		
1	316	9	03/10/2016	23	9	5		
1	316	9	03/10/2016	23	11	6		
1	316	9	03/10/2016	23	13	7		
1	316	9	03/10/2016	23	15	8		
1	316	9	03/10/2016	23	17	9		
1	316	9	03/10/2016	23	19	10		
1	316	9	03/10/2016	23	21	11		
1	322	10	04/10/2016	24	1	1		02:00
1	322	10	04/10/2016	24	3	2		
1	322	10	04/10/2016	24	5	3		
1	322	10	04/10/2016	24	7	4		
1	322	10	04/10/2016	24	9	5		
1	322	10	04/10/2016	24	11	6		
1	322	10	04/10/2016	24	13	7		
1	322	10	04/10/2016	24	15	8		
1	322	10	04/10/2016	24	17	9		
1	322	10	04/10/2016	24	19	10		
1	322	10	04/10/2016	24	21	11		
1	322	10	04/10/2016	24	23	12		
1	331	11	05/10/2016	25	1	1		02:15
1	331	11	05/10/2016	25	3	2		
1	331	11	05/10/2016	25	5	3		
1	331	11	05/10/2016	25	7	4		
1	331	11	05/10/2016	25	9	5		
1	331	11	05/10/2016	25	11	6		
1	331	11	05/10/2016	25	15	7		
1	319	12	06/10/2016	24	1	1	25	04:45
1	319	12	06/10/2016	24	3	2	25	
1	319	12	06/10/2016	24	5	3	25	
1	319	12	06/10/2016	24	7	4	25	
1	319	12	06/10/2016	24	9	6	25	
1	319	12	06/10/2016	24	11	7	25	
1	319	12	06/10/2016	24	13	8	25	
1	319	12	06/10/2016	24	15	9	25	

	Station	Batch	Date	T lab	Niskin	CO3 flow cell	T flow cell	time incubation
2	373	13	14/10/2016	23	5	1	25	22:54
2	373	13	14/10/2016	23	5	2	24.7	
2	373	13	14/10/2016	23	5	3	24.8	
2	373	13	14/10/2016	23	5	4	24.9	
2	373	13	14/10/2016	23	5	6	25	
2	373	13	14/10/2016	23	5	7	24.9	
2	373	13	14/10/2016	23	6	8	24.8	
2	373	13	14/10/2016	23	7	9	25	
2	373	13	14/10/2016	23	8	10	24.9	
2	373	13	14/10/2016	23	9	11	24.9	
2	373	13	14/10/2016	23	10	12	25	
2	373	13	14/10/2016	23	11	13	25	
2	217	14	18/10/2016	24	1	1	25	00:50
2	217	14	18/10/2016	24	3	2	24.8	
2	217	14	18/10/2016	24	5	3	25	
2	217	14	18/10/2016	24	7	4	25	
2	217	14	18/10/2016	24	9	6	25	
2	217	14	18/10/2016	24	11	7	25	
2	217	14	18/10/2016	24	13	8	25	
2	217	14	18/10/2016	24	15	9	25	
2	217	14	18/10/2016	24	17	10	25	
2	217	14	18/10/2016	24	19	11	25	
2	217	14	18/10/2016	24	21	12	25	
2	217	14	18/10/2016	24	23	13	25	
2	218	14	19/10/2016	23	1	14	25	03:00
2	218	14	19/10/2016	23	3	15	24.9	
2	218	14	19/10/2016	23	5	16	24.9	
2	218	14	19/10/2016	23	7	17	25	
2	218	14	19/10/2016	23	9	18	25	
2	218	14	19/10/2016	23	11	19	25	
2	218	14	19/10/2016	23	13	20	25	
2	218	14	19/10/2016	23	15	21	25	
2	219	14	19/10/2016	23	1	22	25	03:45
2	219	14	19/10/2016	23	3	23	25	
2	219	14	19/10/2016	23	9	24	25	
2	220	14	19/10/2016	23	1	1	25.4	05:00
2	220	14	19/10/2016	23	7	2	25	
2	220	14	19/10/2016	23	10	3	25.4	
2	213	15	20/10/2016	24	1	1	25	00:50
2	213	15	20/10/2016	24	3	2	25	
2	213	15	20/10/2016	24	5	3	25	
2	213	15	20/10/2016	24	7	4	25	
2	213	15	20/10/2016	24	8	6	25	
2	213	15	20/10/2016	24	9	7	25	
2	213	15	20/10/2016	24	13	8	25	

2	213	15	20/10/2016	24	15	9	25	
2	213	15	20/10/2016	24	17	10	25	
2	213	15	20/10/2016	24	19	11	25	
2	213	15	20/10/2016	24	21	12	25	
2	213	15	20/10/2016	24	23	13	25	
2	212	15	20/10/2016	24	1	14	25	02:45
2	223	16	20/10/2016	24	1	1	25	
2	223	16	20/10/2016	24	3	2	24	
2	223	16	20/10/2016	24	5	3	25.3	
2	223	16	20/10/2016	24	7	4	25	
2	223	16	20/10/2016	24	9	6	25	
2	223	16	20/10/2016	24	11	7	25	
2	223	16	20/10/2016	24	13	8	25	
2	223	16	20/10/2016	24	15	9	25	
2	223	16	20/10/2016	24	17	10	25	
2	223	16	20/10/2016	24	19	11	25	
2	222	16	20/10/2016	24	1	12	25	
2	206	16	21/10/2016	24	7	13	25	
2	502	17	22/10/2016	25	7	1	25.2	02:10
2	503	17	23/10/2016	25	1	2	25	02:52
2	504	17	23/10/2016	25	3	3	25	04:30
2	506	17	23/10/2016	25	1	4	25.1	06:55
2	506	17	23/10/2016	25	3	6	25.2	
2	506	17	23/10/2016	25	5	7	25.2	
2	506	17	23/10/2016	25	7	8	25	
2	506	17	23/10/2016	25	9	9	25.1	
2	506	17	23/10/2016	25	11	10	25.3	
2	506	17	23/10/2016	25	13	11	25	
2	506	17	23/10/2016	25	15	12	24.9	
2	506	17	23/10/2016	25	17	13	25.1	
2	507	18	23/10/2016	24	1	1	25	00:20
2	509	18	24/10/2016	25	1	2	25	03:30
2	509	18	24/10/2016	25	3	3	25.3	
2	509	18	24/10/2016	25	5	4	25.2	
2	509	18	24/10/2016	25	7	6	25.5	
2	509	18	24/10/2016	25	9	7	25.4	
2	509	18	24/10/2016	25	11	8	25.5	
2	509	18	24/10/2016	25	13	9	25.3	
2	509	18	24/10/2016	25	15	10	25.4	
2	509	18	24/10/2016	25	17	11	25	
2	511	18	24/10/2016	25	3	13	25	05:50
2	513	18	24/10/2016	25	3	18	25	07:35
2	520	19	24/10/2016	24	1	1	25.1	01:00
2	520	19	24/10/2016	24	3	2	25	
2	520	19	24/10/2016	24	5	3	25	
2	520	19	24/10/2016	24	7	4	25	

2	520	19	24/10/2016	24	9	6	25	
2	520	19	24/10/2016	24	11	7	25	
2	520	19	24/10/2016	24	13	8	25	
2	520	19	24/10/2016	24	15	9	25	
2	518	19	24/10/2016	24	3	10	25	03:40
2	517	19	25/10/2016	24	3	11	25	04:20
2	516	19	25/10/2016	24	3	12	25	05:15

Appendix VI Multibeam lines

Site	Vessel / Echosounder	Julian day	Date	Line	Start time	End time	Total time	Heading °	Length (m)	Speed (m/s)	Distance (nm)	Speed (kn)
Ormonde	Sarmiento_Hydrosweep_DS	2016-268	24-Sep-16	160924073556	7:35:55	8:36:00	1:00	261	20220	5.61	10.9	10.9
Ormonde	Sarmiento_Hydrosweep_DS	2016-268	24-Sep-16	160924083556	8:35:56	8:51:01	0:15	249	5132	5.67	2.8	11.0
Ormonde	Sarmiento_Hydrosweep_DS	2016-268	24-Sep-16	160924085056	8:50:56	9:06:02	0:15	248	5283	5.83	2.9	11.3
Ormonde	Sarmiento_Hydrosweep_DS	2016-268	24-Sep-16	160924090558	9:05:58	9:21:04	0:15	253	5258	5.80	2.8	11.3
Ormonde	Sarmiento_Hydrosweep_DS	2016-268	24-Sep-16	160924092059	9:21:00	9:36:05	0:15	257	5221	5.77	2.8	11.2
Ormonde	Sarmiento_Hydrosweep_DS	2016-268	24-Sep-16	160924093601	9:36:01	9:51:07	0:15	257	5165	5.70	2.8	11.1
Ormonde	Sarmiento_Hydrosweep_DS	2016-268	24-Sep-16	160924095103	9:51:03	10:06:08	0:15	257	5108	5.64	2.8	11.0
Ormonde	Sarmiento_Hydrosweep_DS	2016-268	24-Sep-16	160924100604	10:06:04	10:21:10	0:15	258	5119	5.65	2.8	11.0
Ormonde	Sarmiento_Hydrosweep_DS	2016-268	24-Sep-16	160924102106	10:21:06	10:36:11	0:15	260	4812	5.32	2.6	10.3
Ormonde	Sarmiento_Hydrosweep_DS	2016-268	24-Sep-16	160924103607	10:36:07	10:40:26	0:04	325	264	1.02	0.1	2.0
Ormonde	Sarmiento_Hydrosweep_DS	2016-268	24-Sep-16	160924105604	10:56:03	11:11:08	0:15	260	4913	5.43	2.7	10.5
Ormonde	Sarmiento_Hydrosweep_DS	2016-268	24-Sep-16	160924111104	11:11:04	11:26:09	0:15	259	4825	5.33	2.6	10.4
Ormonde	Sarmiento_Hydrosweep_DS	2016-268	24-Sep-16	160924112606	11:26:05	11:41:12	0:15	259	4918	5.43	2.7	10.5
Ormonde	Sarmiento_Hydrosweep_DS	2016-268	24-Sep-16	160924114107	11:41:08	11:56:13	0:15	259	4985	5.51	2.7	10.7
Ormonde	Sarmiento_Hydrosweep_DS	2016-268	24-Sep-16	160924115609	11:56:09	12:11:15	0:15	258	4905	5.41	2.6	10.5
Ormonde	Sarmiento_Hydrosweep_DS	2016-268	24-Sep-16	160924121110	12:11:11	12:26:16	0:15	260	4689	5.18	2.5	10.1
Ormonde	Sarmiento_Hydrosweep_DS	2016-268	24-Sep-16	160924122612	12:26:12	12:41:18	0:15	264	4815	5.31	2.6	10.3
Ormonde	Sarmiento_Hydrosweep_DS	2016-268	24-Sep-16	160924124114	12:41:14	12:56:19	0:15	269	4951	5.47	2.7	10.6
Ormonde	Sarmiento_Hydrosweep_DS	2016-268	24-Sep-16	160924125615	12:56:15	13:11:21	0:15	272	4905	5.41	2.6	10.5
Ormonde	Sarmiento_Hydrosweep_DS	2016-268	24-Sep-16	160924131117	13:11:17	13:26:22	0:15	272	5005	5.53	2.7	10.7
Ormonde	Sarmiento_Hydrosweep_DS	2016-268	24-Sep-16	160924132618	13:26:18	13:41:24	0:15	271	5036	5.56	2.7	10.8
Ormonde	Sarmiento_Hydrosweep_DS	2016-268	24-Sep-16	160924134120	13:41:20	13:56:25	0:15	272	4921	5.44	2.7	10.6
Ormonde	Sarmiento_Hydrosweep_DS	2016-268	24-Sep-16	160924135621	13:56:21	14:11:27	0:15	271	4914	5.42	2.7	10.5
Ormonde	Sarmiento_Hydrosweep_DS	2016-268	24-Sep-16	160924141123	14:11:23	14:26:28	0:15	271	4868	5.38	2.6	10.5
Ormonde	Sarmiento_Hydrosweep_DS	2016-268	24-Sep-16	160924142624	14:26:24	14:41:30	0:15	272	4825	5.33	2.6	10.3
Ormonde	Sarmiento_Hydrosweep_DS	2016-268	24-Sep-16	160924144126	14:41:26	14:56:31	0:15	272	4776	5.28	2.6	10.3
Ormonde	Sarmiento_Hydrosweep_DS	2016-268	24-Sep-16	160924145628	14:56:27	15:11:34	0:15	272	4813	5.31	2.6	10.3
Ormonde	Sarmiento_Hydrosweep_DS	2016-268	24-Sep-16	160924151129	15:11:30	15:26:35	0:15	273	4738	5.24	2.6	10.2

Ormonde	Sarmiento_Hydrosweep_DS	2016-268	24-Sep-16	160924152631	15:26:31	15:41:37	0:15	277	4791	5.29	2.6	10.3
Ormonde	Sarmiento_Hydrosweep_DS	2016-268	24-Sep-16	160924154132	15:41:33	15:56:38	0:15	279	4819	5.32	2.6	10.3
Ormonde	Sarmiento_Hydrosweep_DS	2016-268	24-Sep-16	160924155634	15:56:34	16:11:40	0:15	279	4841	5.34	2.6	10.4
Ormonde	Sarmiento_Hydrosweep_DS	2016-268	24-Sep-16	160924161135	16:11:36	16:26:41	0:15	276	4808	5.31	2.6	10.3
Ormonde	Sarmiento_Hydrosweep_DS	2016-268	24-Sep-16	160924162637	16:26:37	16:41:43	0:15	276	4845	5.35	2.6	10.4
Ormonde	Sarmiento_Hydrosweep_DS	2016-268	24-Sep-16	160924164139	16:41:39	16:56:44	0:15	277	4851	5.36	2.6	10.4
Ormonde	Sarmiento_Hydrosweep_DS	2016-268	24-Sep-16	160924165640	16:56:40	17:11:45	0:15	279	4781	5.28	2.6	10.3
Ormonde	Sarmiento_Hydrosweep_DS	2016-268	24-Sep-16	160924171142	17:11:41	17:26:48	0:15	278	4669	5.15	2.5	10.0
Ormonde	Sarmiento_Hydrosweep_DS	2016-268	24-Sep-16	160924172643	17:26:44	17:41:49	0:15	277	4756	5.26	2.6	10.2
Ormonde	Sarmiento_Hydrosweep_DS	2016-268	24-Sep-16	160924174145	17:41:45	17:56:51	0:15	276	4758	5.25	2.6	10.2
Ormonde	Sarmiento_Hydrosweep_DS	2016-268	24-Sep-16	160924175646	17:56:47	18:11:52	0:15	277	4759	5.26	2.6	10.2
Ormonde	Sarmiento_Hydrosweep_DS	2016-268	24-Sep-16	160924181148	18:11:48	18:26:54	0:15	277	4893	5.40	2.6	10.5
Ormonde	Sarmiento_Hydrosweep_DS	2016-268	24-Sep-16	160924182650	18:26:50	18:41:55	0:15	276	4917	5.43	2.7	10.6
Ormonde	Sarmiento_Hydrosweep_DS	2016-268	24-Sep-16	160924184151	18:41:51	18:56:57	0:15	276	4880	5.39	2.6	10.5
Ormonde	Sarmiento_Hydrosweep_DS	2016-268	24-Sep-16	160924185653	18:56:53	19:11:58	0:15	279	4817	5.32	2.6	10.3
Ormonde	Sarmiento_Hydrosweep_DS	2016-268	24-Sep-16	160924191154	19:11:54	19:27:00	0:15	279	4773	5.27	2.6	10.2
Ormonde	Sarmiento_Hydrosweep_DS	2016-268	24-Sep-16	160924192656	19:26:56	19:42:01	0:15	278	4735	5.23	2.6	10.2
Ormonde	Sarmiento_Hydrosweep_DS	2016-268	24-Sep-16	160924194157	19:41:57	19:57:03	0:15	278	4803	5.30	2.6	10.3
Ormonde	Sarmiento_Hydrosweep_DS	2016-268	24-Sep-16	160924195659	19:56:59	20:12:04	0:15	279	4898	5.41	2.6	10.5
Ormonde	Sarmiento_Hydrosweep_DS	2016-268	24-Sep-16	160924201200	20:12:00	20:27:06	0:15	278	4898	5.41	2.6	10.5
Ormonde	Sarmiento_Hydrosweep_DS	2016-268	24-Sep-16	160924202702	20:27:02	20:42:07	0:15	276	4942	5.46	2.7	10.6
Ormonde	Sarmiento_Hydrosweep_DS	2016-268	24-Sep-16	160924204204	20:42:03	20:57:09	0:15	277	4901	5.41	2.6	10.5
Ormonde	Sarmiento_Hydrosweep_DS	2016-268	24-Sep-16	160924205705	20:57:05	21:05:51	0:08	279	1318	2.51	0.7	4.9
Ormonde	Sarmiento_Hydrosweep_DS	2016-270	26-Sep-16	160926070631	7:06:31	7:09:59	0:03	164	1160	5.58	0.6	10.8
Ormonde	Sarmiento_Hydrosweep_DS	2016-270	26-Sep-16	160926072624	7:26:24	7:41:30	0:15	45	3260	3.60	1.8	7.0
Ormonde	Sarmiento_Hydrosweep_DS	2016-270	26-Sep-16	160926074125	7:41:26	7:56:31	0:15	45	3333	3.68	1.8	7.2
Ormonde	Sarmiento_Hydrosweep_DS	2016-270	26-Sep-16	160926075627	7:56:27	8:11:33	0:15	44	3483	3.84	1.9	7.5
Ormonde	Sarmiento_Hydrosweep_DS	2016-270	26-Sep-16	160926081129	8:11:29	8:26:34	0:15	45	3499	3.87	1.9	7.5
Ormonde	Sarmiento_Hydrosweep_DS	2016-270	26-Sep-16	160926082630	8:26:30	8:41:36	0:15	45	3553	3.92	1.9	7.6
Ormonde	Sarmiento_Hydrosweep_DS	2016-270	26-Sep-16	160926084132	8:41:32	8:56:37	0:15	45	3289	3.63	1.8	7.1
Ormonde	Sarmiento_Hydrosweep_DS	2016-270	26-Sep-16	160926085633	8:56:33	9:11:39	0:15	44	3639	4.02	2.0	7.8
Ormonde	Sarmiento_Hydrosweep_DS	2016-270	26-Sep-16	160926091135	9:11:35	9:26:40	0:15	44	3569	3.94	1.9	7.7

Ormonde	Sarmiento_Hydrosweep_DS	2016-270	26-Sep-16	160926092637	9:26:36	9:41:42	0:15	46	3334	3.68	1.8	7.1
Ormonde	Sarmiento_Hydrosweep_DS	2016-270	26-Sep-16	160926094138	9:41:38	9:56:43	0:15	44	3341	3.69	1.8	7.2
Ormonde	Sarmiento_Hydrosweep_DS	2016-270	26-Sep-16	160926095640	9:56:39	10:05:49	0:09	45	1968	3.58	1.1	7.0
Ormonde	Sarmiento_Hydrosweep_DS	2016-270	26-Sep-16	160926100545	10:05:45	10:20:50	0:15	127	3729	4.12	2.0	8.0
Ormonde	Sarmiento_Hydrosweep_DS	2016-270	26-Sep-16	160926102046	10:20:46	10:21:13	0:05	217	108	4.01	0.1	7.8
Ormonde	Sarmiento_Hydrosweep_DS	2016-270	26-Sep-16	160926102109	10:21:09	10:36:15	0:15	224	3335	3.68	1.8	7.2
Ormonde	Sarmiento_Hydrosweep_DS	2016-270	26-Sep-16	160926103611	10:36:11	10:51:17	0:15	225	3325	3.67	1.8	7.1
Ormonde	Sarmiento_Hydrosweep_DS	2016-270	26-Sep-16	160926105112	10:51:13	11:06:18	0:15	225	3221	3.56	1.7	6.9
Ormonde	Sarmiento_Hydrosweep_DS	2016-270	26-Sep-16	160926110614	11:06:14	11:21:20	0:15	225	3243	3.58	1.8	7.0
Ormonde	Sarmiento_Hydrosweep_DS	2016-270	26-Sep-16	160926112115	11:21:16	11:36:21	0:15	224	3179	3.51	1.7	6.8
Ormonde	Sarmiento_Hydrosweep_DS	2016-270	26-Sep-16	160926113617	11:36:17	11:51:23	0:15	225	3170	3.50	1.7	6.8
Ormonde	Sarmiento_Hydrosweep_DS	2016-270	26-Sep-16	160926115119	11:51:19	12:06:24	0:15	225	3192	3.53	1.7	6.9
Ormonde	Sarmiento_Hydrosweep_DS	2016-270	26-Sep-16	160926120620	12:06:20	12:21:26	0:15	225	3233	3.57	1.7	6.9
Ormonde	Sarmiento_Hydrosweep_DS	2016-270	26-Sep-16	160926122122	12:21:22	12:36:27	0:15	225	3227	3.57	1.7	6.9
Ormonde	Sarmiento_Hydrosweep_DS	2016-270	26-Sep-16	160926123623	12:36:23	12:51:29	0:15	225	3249	3.59	1.8	7.0
Ormonde	Sarmiento_Hydrosweep_DS	2016-270	26-Sep-16	160926125125	12:51:25	13:06:30	0:15	225	3189	3.52	1.7	6.8
Ormonde	Sarmiento_Hydrosweep_DS	2016-270	26-Sep-16	160926130626	13:06:26	13:10:28	0:04	225	873	3.61	0.5	7.0
Ormonde	Sarmiento_Hydrosweep_DS	2016-270	26-Sep-16	160926131025	13:10:24	13:25:29	0:15	272	3243	3.58	1.8	7.0
Ormonde	Sarmiento_Hydrosweep_DS	2016-270	26-Sep-16	160926132526	13:25:25	13:40:31	0:15	309	4149	4.58	2.2	8.9
Ormonde	Sarmiento_Hydrosweep_DS	2016-270	26-Sep-16	160926134027	13:40:27	13:55:32	0:15	313	4176	4.61	2.3	9.0
Ormonde	Sarmiento_Hydrosweep_DS	2016-270	26-Sep-16	160926135529	13:55:28	14:10:35	0:15	312	4209	4.65	2.3	9.0
Ormonde	Sarmiento_Hydrosweep_DS	2016-270	26-Sep-16	160926141030	14:10:31	14:15:22	0:04	319	1302	4.47	0.7	8.7
Ormonde	Sarmiento_Hydrosweep_DS	2016-270	26-Sep-16	160926141518	14:15:18	14:30:23	0:15	45	3306	3.65	1.8	7.1
Ormonde	Sarmiento_Hydrosweep_DS	2016-270	26-Sep-16	160926143019	14:30:19	14:45:25	0:15	46	3244	3.58	1.8	7.0
Ormonde	Sarmiento_Hydrosweep_DS	2016-270	26-Sep-16	160926144520	14:45:21	15:00:26	0:15	46	3361	3.71	1.8	7.2
Ormonde	Sarmiento_Hydrosweep_DS	2016-270	26-Sep-16	160926150022	15:00:22	15:15:28	0:15	46	3201	3.53	1.7	6.9
Ormonde	Sarmiento_Hydrosweep_DS	2016-270	26-Sep-16	160926151524	15:15:24	15:30:29	0:15	45	3160	3.49	1.7	6.8
Ormonde	Sarmiento_Hydrosweep_DS	2016-270	26-Sep-16	160926153025	15:30:25	15:45:31	0:15	46	3133	3.46	1.7	6.7
Ormonde	Sarmiento_Hydrosweep_DS	2016-270	26-Sep-16	160926154527	15:45:27	16:00:32	0:15	46	3318	3.67	1.8	7.1
Ormonde	Sarmiento_Hydrosweep_DS	2016-270	26-Sep-16	160926160028	16:00:28	16:15:34	0:15	46	3203	3.53	1.7	6.9
Ormonde	Sarmiento_Hydrosweep_DS	2016-270	26-Sep-16	160926161530	16:15:30	16:16:13	0:07	43	151	3.52	0.1	6.8
Ormonde	Sarmiento_Hydrosweep_DS	2016-270	26-Sep-16	160926162340	16:23:40	17:23:45	1:00	46	12897	3.58	7.0	7.0

Ormonde	Sarmiento_Hydrosweep_DS	2016-270	26-Sep-16	160926172341	17:23:41	17:41:38	0:17	46	3677	3.42	2.0	6.6
Ormonde	Sarmiento_Hydrosweep_DS	2016-270	26-Sep-16	160926174134	17:41:34	17:56:35	0:15	135	4475	4.97	2.4	9.6
Ormonde	Sarmiento_Hydrosweep_DS	2016-270	26-Sep-16	160926175631	17:56:31	18:56:36	1:00	224	14558	4.04	7.9	7.8
Ormonde	Sarmiento_Hydrosweep_DS	2016-270	26-Sep-16	160926185631	18:56:31	19:09:03	0:12	221	3000	3.99	1.6	7.8
Ormonde	Sarmiento_Hydrosweep_DS	2016-270	26-Sep-16	160926190859	19:08:59	20:09:04	1:00	60	12395	3.44	6.7	6.7
Ormonde	Sarmiento_Hydrosweep_DS	2016-270	26-Sep-16	160926200900	20:09:00	20:16:33	0:07	40	1451	3.20	0.8	6.2
Ormonde	Sarmiento_Hydrosweep_DS	2016-270	26-Sep-16	160926201630	20:16:29	21:16:34	1:00	260	13381	3.71	7.2	7.2
Ormonde	Sarmiento_Hydrosweep_DS	2016-270	26-Sep-16	160926211630	21:16:30	21:25:25	0:08	258	2062	3.86	1.1	7.5
Ormonde	Sarmiento_Hydrosweep_DS	2016-270	26-Sep-16	160926212521	21:25:21	22:25:27	1:00	248	19081	5.29	10.3	10.3
Ormonde	Sarmiento_Hydrosweep_DS	2016-270	26-Sep-16	160926222522	22:25:23	23:25:27	1:00	250	20325	5.64	11.0	11.0
Ormonde	Sarmiento_Hydrosweep_DS	2016-270	26-Sep-16	160926232523	23:25:23	0:25:28	1:00	257	19360	5.37	10.4	10.4
Ormonde	Sarmiento_Hydrosweep_DS	2016-271	27-Sep-16	160927002525	0:25:24	1:25:30	1:00	262	19358	5.37	10.4	10.4
Ormonde	Sarmiento_Hydrosweep_DS	2016-271	27-Sep-16	160927012526	1:25:26	2:25:31	1:00	262	19452	5.40	10.5	10.5
Ormonde	Sarmiento_Hydrosweep_DS	2016-271	27-Sep-16	160927022527	2:25:27	3:25:32	1:00	266	19126	5.31	10.3	10.3
Ormonde	Sarmiento_Hydrosweep_DS	2016-271	27-Sep-16	160927032528	3:25:28	4:25:33	1:00	263	19119	5.30	10.3	10.3
Ormonde	Sarmiento_Hydrosweep_DS	2016-271	27-Sep-16	160927042529	4:25:28	5:25:34	1:00	264	20086	5.57	10.8	10.8
Ormonde	Sarmiento_Hydrosweep_DS	2016-271	27-Sep-16	160927052530	5:25:30	6:25:35	1:00	263	19691	5.46	10.6	10.6
Ormonde	Sarmiento_Hydrosweep_DS	2016-271	27-Sep-16	160927062531	6:25:31	7:25:36	1:00	266	19169	5.32	10.3	10.3
Ormonde	Sarmiento_Hydrosweep_DS	2016-271	27-Sep-16	160927072532	7:25:32	8:25:37	1:00	263	19353	5.37	10.4	10.4
Ormonde	Sarmiento_Hydrosweep_DS	2016-271	27-Sep-16	160927082533	8:25:33	9:25:38	1:00	264	19315	5.36	10.4	10.4
Ormonde	Sarmiento_Hydrosweep_DS	2016-271	27-Sep-16	160927092534	9:25:34	10:25:39	1:00	263	19099	5.30	10.3	10.3
Ormonde	Sarmiento_Hydrosweep_DS	2016-271	27-Sep-16	160927102535	10:25:35	11:25:40	1:00	263	19679	5.46	10.6	10.6
Ormonde	Sarmiento_Hydrosweep_DS	2016-271	27-Sep-16	160927112536	11:25:36	12:25:42	1:00	263	19427	5.39	10.5	10.5
Ormonde	Sarmiento_Hydrosweep_DS	2016-271	27-Sep-16	160927122537	12:25:38	13:25:42	1:00	264	19753	5.48	10.7	10.6
Ormonde	Sarmiento_Hydrosweep_DS	2016-271	27-Sep-16	160927132538	13:25:38	14:25:43	1:00	265	20207	5.60	10.9	10.9
Ormonde	Sarmiento_Hydrosweep_DS	2016-271	27-Sep-16	160927142539	14:25:39	15:25:44	1:00	266	20756	5.76	11.2	11.2
Ormonde	Sarmiento_Hydrosweep_DS	2016-271	27-Sep-16	160927152540	15:25:40	16:25:46	1:00	265	20200	5.60	10.9	10.9
Ormonde	Sarmiento_Hydrosweep_DS	2016-271	27-Sep-16	160927162542	16:25:42	17:25:46	1:00	266	20417	5.66	11.0	11.0
Ormonde	Sarmiento_Hydrosweep_DS	2016-271	27-Sep-16	160927172542	17:25:42	18:25:47	1:00	265	20040	5.56	10.8	10.8
Ormonde	Sarmiento_Hydrosweep_DS	2016-271	27-Sep-16	160927182544	18:25:43	19:25:49	1:00	265	19595	5.44	10.6	10.6
Ormonde	Sarmiento_Hydrosweep_DS	2016-271	27-Sep-16	160927192545	19:25:45	20:25:50	1:00	264	19705	5.47	10.6	10.6
Ormonde	Sarmiento_Hydrosweep_DS	2016-271	27-Sep-16	160927202546	20:25:46	21:25:51	1:00	264	19676	5.46	10.6	10.6

Ormonde	Sarmiento_Hydrosweep_DS	2016-271	27-Sep-16	160927212547	21:25:47	22:25:51	1:00	267	19686	5.46	10.6	10.6
Ormonde	Sarmiento_Hydrosweep_DS	2016-271	27-Sep-16	160927222548	22:25:47	23:25:53	1:00	268	19605	5.44	10.6	10.6
Ormonde	Sarmiento_Hydrosweep_DS	2016-271	27-Sep-16	160927232549	23:25:49	0:25:54	1:00	266	19524	5.42	10.5	10.5
Ormonde	Sarmiento_Hydrosweep_DS	2016-272	28-Sep-16	160928002550	0:25:50	1:25:55	1:00	266	19575	5.43	10.6	10.5
Ormonde	Sarmiento_Hydrosweep_DS	2016-272	28-Sep-16	160928012551	1:25:50	2:25:55	1:00	266	19500	5.41	10.5	10.5
Ormonde	Sarmiento_Hydrosweep_DS	2016-272	28-Sep-16	160928022552	2:25:51	3:25:57	1:00	266	19959	5.54	10.8	10.8
Ormonde	Sarmiento_Hydrosweep_DS	2016-272	28-Sep-16	160928032553	3:25:53	4:25:58	1:00	267	19648	5.45	10.6	10.6
Ormonde	Sarmiento_Hydrosweep_DS	2016-272	28-Sep-16	160928042554	4:25:54	5:25:59	1:00	267	19718	5.47	10.6	10.6
Ormonde	Sarmiento_Hydrosweep_DS	2016-272	28-Sep-16	160928052555	5:25:54	6:26:00	1:00	267	19431	5.39	10.5	10.5
Ormonde	Sarmiento_Hydrosweep_DS	2016-272	28-Sep-16	160928062556	6:25:56	7:26:01	1:00	266	18840	5.23	10.2	10.2
Ormonde	Sarmiento_Hydrosweep_DS	2016-272	28-Sep-16	160928072557	7:25:57	8:26:02	1:00	266	18787	5.21	10.1	10.1
Ormonde	Sarmiento_Hydrosweep_DS	2016-272	28-Sep-16	160928082558	8:25:58	9:26:03	1:00	266	19169	5.32	10.3	10.3
Ormonde	Sarmiento_Hydrosweep_DS	2016-272	28-Sep-16	160928092559	9:25:59	10:26:05	1:00	267	19387	5.38	10.5	10.4
Ormonde	Sarmiento_Hydrosweep_DS	2016-272	28-Sep-16	160928102601	10:26:01	11:26:05	1:00	267	19702	5.47	10.6	10.6
Ormonde	Sarmiento_Hydrosweep_DS	2016-272	28-Sep-16	160928112601	11:26:01	12:26:06	1:00	268	20022	5.55	10.8	10.8
Ormonde	Sarmiento_Hydrosweep_DS	2016-272	28-Sep-16	160928122602	12:26:02	13:26:07	1:00	268	20481	5.68	11.1	11.0
Ormonde	Sarmiento_Hydrosweep_DS	2016-272	28-Sep-16	160928132603	13:26:03	14:26:09	1:00	269	20751	5.76	11.2	11.2
Ormonde	Sarmiento_Hydrosweep_DS	2016-272	28-Sep-16	160928142604	14:26:04	15:26:09	1:00	269	20789	5.77	11.2	11.2
Ormonde	Sarmiento_Hydrosweep_DS	2016-272	28-Sep-16	160928152605	15:26:05	16:26:10	1:00	270	20374	5.65	11.0	11.0
Ormonde	Sarmiento_Hydrosweep_DS	2016-272	28-Sep-16	160928162606	16:26:06	17:26:12	1:00	270	20627	5.72	11.1	11.1
Ormonde	Sarmiento_Hydrosweep_DS	2016-272	28-Sep-16	160928172607	17:26:08	18:26:13	1:00	268	20058	5.56	10.8	10.8
Ormonde	Sarmiento_Hydrosweep_DS	2016-272	28-Sep-16	160928182608	18:26:08	19:26:13	1:00	269	20510	5.69	11.1	11.1
Ormonde	Sarmiento_Hydrosweep_DS	2016-272	28-Sep-16	160928192609	19:26:09	20:26:14	1:00	269	20340	5.64	11.0	11.0
Ormonde	Sarmiento_Hydrosweep_DS	2016-272	28-Sep-16	160928202610	20:26:10	21:26:16	1:00	269	20051	5.56	10.8	10.8
Ormonde	Sarmiento_Hydrosweep_DS	2016-272	28-Sep-16	160928212611	21:26:12	22:26:17	1:00	269	19563	5.43	10.6	10.5
Ormonde	Sarmiento_Hydrosweep_DS	2016-272	28-Sep-16	160928222612	22:26:12	23:26:17	1:00	269	19799	5.49	10.7	10.7
Ormonde	Sarmiento_Hydrosweep_DS	2016-272	28-Sep-16	160928232613	23:26:13	0:26:18	1:00	270	19849	5.51	10.7	10.7
Formigas	Sarmiento_Hydrosweep_DS	2016-273	29-Sep-16	160929092625	9:26:23	10:26:29	1:00	268	19082	5.29	10.3	10.3
Formigas	Sarmiento_Hydrosweep_DS	2016-273	29-Sep-16	160929102626	10:26:25	11:26:30	1:00	266	18341	5.09	9.9	9.9
Formigas	Sarmiento_Hydrosweep_DS	2016-273	29-Sep-16	160929112627	11:26:26	11:36:54	0:10	278	1423	2.27	0.8	4.4
Formigas	Sarmiento_Hydrosweep_DS	2016-273	29-Sep-16	160929180106	18:01:05	18:34:27	0:33	316	9823	4.91	5.3	9.5
Formigas	Sarmiento_Hydrosweep_DS	2016-273	29-Sep-16	160929183424	18:34:23	19:34:28	1:00	85	12979	3.60	7.0	7.0

Formigas	Sarmiento_Hydrosweep_DS	2016-273	29-Sep-16	160929193425	19:34:24	19:48:57	0:14	85	3131	3.59	1.7	7.0
Formigas	Sarmiento_Hydrosweep_DS	2016-273	29-Sep-16	160929194854	19:48:53	20:48:59	1:00	279	12560	3.48	6.8	6.8
Formigas	Sarmiento_Hydrosweep_DS	2016-273	29-Sep-16	160929204856	20:48:55	21:18:39	0:29	263	6091	3.41	3.3	6.6
Formigas	Sarmiento_Hydrosweep_DS	2016-273	29-Sep-16	160929211835	21:18:35	22:11:00	0:52	108	13206	4.20	7.1	8.2
Formigas	Sarmiento_Hydrosweep_DS	2016-273	29-Sep-16	160929221058	22:10:57	22:11:00	0:00	89	15	5.05	0.0	9.8
Ormonde	Sarmiento_Hydrosweep_DS	2016-273	29-Sep-16	160929002614	0:26:14	1:26:20	1:00	270	19104	5.30	10.3	10.3
Ormonde	Sarmiento_Hydrosweep_DS	2016-273	29-Sep-16	160929012616	1:26:16	2:26:21	1:00	269	19566	5.43	10.6	10.5
Ormonde	Sarmiento_Hydrosweep_DS	2016-273	29-Sep-16	160929022616	2:26:16	3:26:21	1:00	270	19450	5.39	10.5	10.5
Ormonde	Sarmiento_Hydrosweep_DS	2016-273	29-Sep-16	160929032618	3:26:17	4:26:23	1:00	270	19541	5.42	10.5	10.5
Ormonde	Sarmiento_Hydrosweep_DS	2016-273	29-Sep-16	160929042619	4:26:19	5:26:24	1:00	270	19417	5.39	10.5	10.5
Ormonde	Sarmiento_Hydrosweep_DS	2016-273	29-Sep-16	160929052620	5:26:20	6:26:25	1:00	270	19556	5.42	10.6	10.5
Ormonde	Sarmiento_Hydrosweep_DS	2016-273	29-Sep-16	160929062622	6:26:21	7:26:26	1:00	270	19330	5.36	10.4	10.4
Ormonde	Sarmiento_Hydrosweep_DS	2016-273	29-Sep-16	160929072623	7:26:22	8:26:28	1:00	271	19292	5.35	10.4	10.4
Formigas	Sarmiento_Hydrosweep_DS	2016-277	03-Oct-16	161003135116	13:51:15	14:32:59	0:41	284	10090	4.03	5.4	7.8
Formigas	Sarmiento_Hydrosweep_DS	2016-277	03-Oct-16	161003143255	14:32:55	14:38:05	0:05	194	1214	3.92	0.7	7.6
Formigas	Sarmiento_Hydrosweep_DS	2016-277	03-Oct-16	161003143801	14:38:01	14:59:18	0:21	176	5379	4.21	2.9	8.2
Formigas	Sarmiento_Hydrosweep_DS	2016-277	03-Oct-16	161003145913	14:59:14	15:04:24	0:05	68	1181	3.81	0.6	7.4
Formigas	Sarmiento_Hydrosweep_DS	2016-277	03-Oct-16	161003150420	15:04:20	15:56:40	0:52	356	12925	4.12	7.0	8.0
Formigas	Sarmiento_Hydrosweep_DS	2016-277	03-Oct-16	161003155636	15:56:36	16:07:19	0:10	356	2623	4.08	1.4	7.9
Formigas	Sarmiento_Hydrosweep_DS	2016-277	03-Oct-16	161003160715	16:07:15	16:25:09	0:17	355	4272	3.98	2.3	7.7
Formigas	Sarmiento_Hydrosweep_DS	2016-277	03-Oct-16	161003172937	17:29:37	17:29:39	0:00	155	1	0.32	0.0	0.6
Formigas	Sarmiento_Hydrosweep_DS	2016-277	03-Oct-16	161003173457	17:34:57	17:47:47	0:12	263	3991	5.18	2.2	10.1
Formigas	Sarmiento_Hydrosweep_DS	2016-277	03-Oct-16	161003174744	17:47:43	17:50:40	0:02	191	805	4.55	0.4	8.8
Formigas	Sarmiento_Hydrosweep_DS	2016-277	03-Oct-16	161003175036	17:50:36	18:50:42	1:00	176	14809	4.11	8.0	8.0
Formigas	Sarmiento_Hydrosweep_DS	2016-277	03-Oct-16	161003185037	18:50:38	19:17:38	0:27	176	6699	4.13	3.6	8.0
Formigas	Sarmiento_Hydrosweep_DS	2016-277	03-Oct-16	161003191734	19:17:34	19:20:34	0:03	233	877	4.87	0.5	9.5
Formigas	Sarmiento_Hydrosweep_DS	2016-277	03-Oct-16	161003192030	19:20:30	19:37:41	0:17	265	5479	5.31	3.0	10.3
Formigas	Sarmiento_Hydrosweep_DS	2016-277	03-Oct-16	161003193737	19:37:37	19:41:11	0:03	344	868	4.05	0.5	7.9
Formigas	Sarmiento_Hydrosweep_DS	2016-277	03-Oct-16	161003194107	19:41:07	20:41:12	1:00	356	14733	4.09	8.0	7.9
Formigas	Sarmiento_Hydrosweep_DS	2016-277	03-Oct-16	161003204108	20:41:08	21:08:54	0:27	356	6690	4.02	3.6	7.8
Formigas	Sarmiento_Hydrosweep_DS	2016-279	05-Oct-16	161005122556	12:25:56	12:26:44	0:00	185	208	4.33	0.1	8.4
Formigas	Sarmiento_Hydrosweep_DS	2016-279	05-Oct-16	161005122647	12:26:47	12:28:11	0:01	180	364	4.33	0.2	8.4

Formigas	Sarmiento_Hydrosweep_DS	2016-279	05-Oct-16	161005122807	12:28:07	13:03:31	0:35	175	8824	4.15	4.8	8.1
Formigas	Sarmiento_Hydrosweep_DS	2016-279	05-Oct-16	161005130327	13:03:27	13:12:50	0:09	175	2278	4.05	1.2	7.9
Formigas	Sarmiento_Hydrosweep_DS	2016-279	05-Oct-16	161005131247	13:12:46	13:56:33	0:43	93	10993	4.18	5.9	8.1
Formigas	Sarmiento_Hydrosweep_DS	2016-279	05-Oct-16	161005135629	13:56:29	14:56:34	1:00	89	14665	4.07	7.9	7.9
Formigas	Sarmiento_Hydrosweep_DS	2016-279	05-Oct-16	161005145630	14:56:30	15:07:41	0:11	88	2753	4.10	1.5	8.0
Formigas	Sarmiento_Hydrosweep_DS	2016-279	05-Oct-16	161005150737	15:07:37	15:42:42	0:35	4	10042	4.77	5.4	9.3
Formigas	Sarmiento_Hydrosweep_DS	2016-279	05-Oct-16	161005154238	15:42:38	16:38:22	0:55	279	13981	4.18	7.5	8.1
Formigas	Sarmiento_Hydrosweep_DS	2016-279	05-Oct-16	161005163818	16:38:18	17:17:31	0:39	275	11951	5.08	6.4	9.9
Formigas	Sarmiento_Hydrosweep_DS	2016-279	05-Oct-16	161005171728	17:17:28	17:17:31	0:00	275	15	5.06	0.0	9.8
Formigas	Sarmiento_Hydrosweep_DS	2016-280	06-Oct-16	161006095242	9:52:42	10:52:47	1:00	266	14343	3.98	7.7	7.7
Formigas	Sarmiento_Hydrosweep_DS	2016-280	06-Oct-16	161006105244	10:52:43	11:49:49	0:57	266	12861	3.75	6.9	7.3
Formigas	Sarmiento_Hydrosweep_DS	2016-280	06-Oct-16	161006114945	11:49:45	11:52:02	0:02	319	394	2.88	0.2	5.6
Formigas	Sarmiento_Hydrosweep_DS	2016-280	06-Oct-16	161006115159	11:51:58	12:09:24	0:17	353	3973	3.80	2.1	7.4
Formigas	Sarmiento_Hydrosweep_DS	2016-280	06-Oct-16	161006120920	12:09:20	12:09:31	0:00	9	37	3.41	0.0	6.6
Formigas	Sarmiento_Hydrosweep_DS	2016-280	06-Oct-16	161006120927	12:09:27	12:09:38	0:00	19	37	3.39	0.0	6.6
Formigas	Sarmiento_Hydrosweep_DS	2016-280	06-Oct-16	161006120934	12:09:34	12:11:25	0:01	65	387	3.49	0.2	6.8
Formigas	Sarmiento_Hydrosweep_DS	2016-280	06-Oct-16	161006121120	12:11:21	13:11:25	1:00	86	14446	4.01	7.8	7.8
Formigas	Sarmiento_Hydrosweep_DS	2016-280	06-Oct-16	161006131120	13:11:21	14:11:25	1:00	86	14738	4.09	8.0	7.9
Formigas	Sarmiento_Hydrosweep_DS	2016-280	06-Oct-16	161006141121	14:11:21	14:35:47	0:24	86	6020	4.11	3.2	8.0
Formigas	Sarmiento_Hydrosweep_DS	2016-280	06-Oct-16	161006143547	14:35:46	14:35:51	0:01	85	19	3.83	0.0	7.4
Formigas	Sarmiento_Hydrosweep_DS	2016-280	06-Oct-16	161006143548	14:35:47	14:54:15	0:18	86	4518	4.08	2.4	7.9
Formigas	Sarmiento_Hydrosweep_DS	2016-280	06-Oct-16	161006145411	14:54:11	15:10:50	0:16	87	4000	4.00	2.2	7.8
Formigas	Sarmiento_Hydrosweep_DS	2016-280	06-Oct-16	161006151047	15:10:46	15:19:43	0:08	155	2274	4.23	1.2	8.2
Formigas	Sarmiento_Hydrosweep_DS	2016-280	06-Oct-16	161006151941	15:19:40	15:19:47	0:01	173	31	4.49	0.0	8.7
Formigas	Sarmiento_Hydrosweep_DS	2016-280	06-Oct-16	161006151943	15:19:43	15:23:02	0:03	175	868	4.36	0.5	8.5
Formigas	Sarmiento_Hydrosweep_DS	2016-280	06-Oct-16	161006152258	15:22:58	15:23:48	0:08	174	220	4.39	0.1	8.5
Formigas	Sarmiento_Hydrosweep_DS	2016-280	06-Oct-16	161006152347	15:23:46	15:23:52	0:00	173	27	4.48	0.0	8.7
Formigas	Sarmiento_Hydrosweep_DS	2016-280	06-Oct-16	161006152349	15:23:48	15:33:20	0:09	176	2485	4.34	1.3	8.4
Formigas	Sarmiento_Hydrosweep_DS	2016-280	06-Oct-16	161006153317	15:33:16	15:37:11	0:03	239	974	4.15	0.5	8.1
Formigas	Sarmiento_Hydrosweep_DS	2016-280	06-Oct-16	161006153707	15:37:06	16:37:12	1:00	265	14108	3.91	7.6	7.6
Formigas	Sarmiento_Hydrosweep_DS	2016-280	06-Oct-16	161006163708	16:37:08	17:00:34	0:23	265	5570	3.96	3.0	7.7
Formigas	Sarmiento_Hydrosweep_DS	2016-280	06-Oct-16	161006170030	17:00:30	17:13:36	0:13	131	3338	4.25	1.8	8.3

Formigas	Sarmiento_Hydrosweep_DS	2016-280	06-Oct-16	161006171332	17:13:32	18:13:37	1:00	92	14261	3.96	7.7	7.7
Formigas	Sarmiento_Hydrosweep_DS	2016-280	06-Oct-16	161006181333	18:13:33	19:13:38	1:00	92	13939	3.87	7.5	7.5
Formigas	Sarmiento_Hydrosweep_DS	2016-280	06-Oct-16	161006191334	19:13:34	19:27:59	0:14	97	3408	3.94	1.8	7.7
Formigas	Sarmiento_Hydrosweep_DS	2016-280	06-Oct-16	161006192755	19:27:55	19:51:51	0:23	190	6766	4.71	3.7	9.2
Formigas	Sarmiento_Hydrosweep_DS	2016-280	06-Oct-16	161006195146	19:51:47	20:51:52	1:00	272	16955	4.70	9.1	9.1
Formigas	Sarmiento_Hydrosweep_DS	2016-280	06-Oct-16	161006205147	20:51:47	21:20:08	0:28	272	8307	4.88	4.5	9.5
Formigas	Sarmiento_Hydrosweep_DS	2016-289	15-Oct-16	161015112410	11:24:10	12:24:14	1:00	85	17614	4.89	9.5	9.5
Formigas	Sarmiento_Hydrosweep_DS	2016-289	15-Oct-16	161015122410	12:24:10	13:24:16	1:00	82	18412	5.11	9.9	9.9
Formigas	Sarmiento_Hydrosweep_DS	2016-289	15-Oct-16	161015132411	13:24:12	14:24:17	1:00	86	18036	5.00	9.7	9.7
Formigas	Sarmiento_Hydrosweep_DS	2016-289	15-Oct-16	161015142413	14:24:13	15:09:01	0:44	89	13394	4.98	7.2	9.7
Formigas	Sarmiento_Hydrosweep_DS	2016-289	15-Oct-16	161015152142	15:21:42	16:21:47	1:00	87	17723	4.92	9.6	9.6
Formigas	Sarmiento_Hydrosweep_DS	2016-289	15-Oct-16	161015162143	16:21:43	17:21:49	1:00	86	17843	4.95	9.6	9.6
Formigas	Sarmiento_Hydrosweep_DS	2016-289	15-Oct-16	161015172144	17:21:44	18:21:49	1:00	87	18148	5.03	9.8	9.8
Formigas	Sarmiento_Hydrosweep_DS	2016-289	15-Oct-16	161015182145	18:21:45	19:21:50	1:00	86	18224	5.05	9.8	9.8
Formigas	Sarmiento_Hydrosweep_DS	2016-289	15-Oct-16	161015192146	19:21:46	19:58:48	0:37	85	10969	4.94	5.9	9.6
Formigas	Sarmiento_Hydrosweep_DS	2016-289	15-Oct-16	161015201343	20:13:42	21:13:48	1:00	86	17922	4.97	9.7	9.7
Formigas	Sarmiento_Hydrosweep_DS	2016-289	15-Oct-16	161015211344	21:13:44	22:13:49	1:00	87	17796	4.94	9.6	9.6
Formigas	Sarmiento_Hydrosweep_DS	2016-289	15-Oct-16	161015221345	22:13:45	23:13:49	1:00	86	17322	4.81	9.3	9.3
Formigas	Sarmiento_Hydrosweep_DS	2016-289	15-Oct-16	161015231346	23:13:45	0:13:51	1:00	86	17143	4.76	9.3	9.2
Formigas	Sarmiento_Hydrosweep_DS	2016-290	16-Oct-16	161016001347	0:13:47	1:13:52	1:00	86	16651	4.62	9.0	9.0
Formigas	Sarmiento_Hydrosweep_DS	2016-290	16-Oct-16	161016011348	1:13:48	2:13:52	1:00	86	16234	4.50	8.8	8.8
Formigas	Sarmiento_Hydrosweep_DS	2016-290	16-Oct-16	161016021349	2:13:48	3:11:13	0:57	86	15213	4.42	8.2	8.6
Formigas	Sarmiento_Hydrosweep_DS	2016-290	16-Oct-16	161016032220	3:22:19	4:22:26	1:00	86	16058	4.45	8.7	8.7
Formigas	Sarmiento_Hydrosweep_DS	2016-290	16-Oct-16	161016042221	4:22:22	5:22:26	1:00	86	17016	4.72	9.2	9.2
Formigas	Sarmiento_Hydrosweep_DS	2016-290	16-Oct-16	161016052222	5:22:22	6:22:27	1:00	87	16792	4.66	9.1	9.0
Formigas	Sarmiento_Hydrosweep_DS	2016-290	16-Oct-16	161016062223	6:22:23	7:22:29	1:00	86	16896	4.69	9.1	9.1
Formigas	Sarmiento_Hydrosweep_DS	2016-290	16-Oct-16	161016072224	7:22:25	8:08:28	0:46	86	12406	4.49	6.7	8.7
Formigas	Sarmiento_Hydrosweep_DS	2016-291	17-Oct-16	161017142442	14:24:42	15:24:47	1:00	78	22621	6.27	12.2	12.2
Formigas	Sarmiento_Hydrosweep_DS	2016-291	17-Oct-16	161017152443	15:24:43	16:24:49	1:00	75	22894	6.35	12.4	12.3
Formigas	Sarmiento_Hydrosweep_DS	2016-291	17-Oct-16	161017162445	16:24:45	17:24:49	1:00	75	19051	5.29	10.3	10.3
Formigas	Sarmiento_Hydrosweep_DS	2016-291	17-Oct-16	161017172446	17:24:45	18:08:45	0:43	74	13854	5.25	7.5	10.2
Formigas	Sarmiento_Hydrosweep_DS	2016-291	17-Oct-16	161017184419	18:44:19	19:44:23	1:00	77	18804	5.22	10.1	10.1

Formigas	Sarmiento_Hydrosweep_DS	2016-291	17-Oct-16	161017194420	19:44:19	20:44:24	1:00	78	18453	5.12	10.0	9.9
Formigas	Sarmiento_Hydrosweep_DS	2016-291	17-Oct-16	161017204421	20:44:20	21:17:26	0:33	76	10660	5.37	5.8	10.4
Formigas	Sarmiento_Hydrosweep_DS	2016-291	17-Oct-16	161017211827	21:18:27	22:18:32	1:00	75	19077	5.29	10.3	10.3
Formigas	Sarmiento_Hydrosweep_DS	2016-291	17-Oct-16	161017221828	22:18:28	23:18:33	1:00	72	19340	5.36	10.4	10.4
Formigas	Sarmiento_Hydrosweep_DS	2016-291	17-Oct-16	161017231829	23:18:29	0:18:34	1:00	70	19130	5.31	10.3	10.3
Ormonde	Sarmiento_Hydrosweep_DS	2016-292	18-Oct-16	161018001830	0:18:29	1:18:35	1:00	74	18813	5.22	10.2	10.1
Ormonde	Sarmiento_Hydrosweep_DS	2016-292	18-Oct-16	161018011831	1:18:31	2:18:36	1:00	74	19032	5.28	10.3	10.3
Ormonde	Sarmiento_Hydrosweep_DS	2016-292	18-Oct-16	161018021832	2:18:32	3:18:37	1:00	75	18951	5.26	10.2	10.2
Ormonde	Sarmiento_Hydrosweep_DS	2016-292	18-Oct-16	161018031833	3:18:33	3:40:59	0:22	76	6943	5.16	3.7	10.0
Ormonde	Sarmiento_Hydrosweep_DS	2016-292	18-Oct-16	161018034640	3:46:40	4:46:46	1:00	75	18558	5.15	10.0	10.0
Ormonde	Sarmiento_Hydrosweep_DS	2016-292	18-Oct-16	161018044641	4:46:42	5:46:46	1:00	72	18931	5.25	10.2	10.2
Ormonde	Sarmiento_Hydrosweep_DS	2016-292	18-Oct-16	161018054642	5:46:42	6:46:47	1:00	74	19050	5.28	10.3	10.3
Ormonde	Sarmiento_Hydrosweep_DS	2016-292	18-Oct-16	161018064643	6:46:43	7:46:48	1:00	74	18662	5.18	10.1	10.1
Ormonde	Sarmiento_Hydrosweep_DS	2016-292	18-Oct-16	161018074644	7:46:44	8:42:28	0:55	74	18158	5.43	9.8	10.6
Gazul	Sarmiento_Hydrosweep_DS	2016-296	22-Oct-16	161022020643	2:06:43	2:37:56	0:31	80	7101	3.79	3.8	7.4
Gazul	Sarmiento_Hydrosweep_DS	2016-296	22-Oct-16	161022023752	2:37:52	2:47:29	0:09	174	2372	4.11	1.3	8.0
Gazul	Sarmiento_Hydrosweep_DS	2016-296	22-Oct-16	161022024725	2:47:25	3:17:29	0:30	260	6815	3.78	3.7	7.3

Appendix VII: Benthic samples descriptive plates.

Research Vessel: SARMIENTO DE GAMBOA			
Sampling technique: Box-corer			
Sample code:	BC01	Starting time:	16:16
Location:	GAZUL MUD VOLCANO	Finishing time:	16:45
Date:	22/09/2016	Sampling Station:	10

DREDGE ON BOTTOM	
LAT:	36°33.78 N
LON:	06°55.87 W
DEPTH (m)	444

DESCRIPTION

The box-corer collects about 10 liters of sediment. It is composed of muddy coarse sediment (0 [upper surface]-7 cm) with bryozoans and bivalve remains, and live specimens of the polychaetes *Hyalinoecia tubicola* and *Lanice conchilega*; and mud breccia (7-20 cm [lower surface]). The sediment color is brown (7.5YR 7/4) for the muddy coarse sediment and grey (GLE2 5/10B) for the mud breccia. The sample has been sub-sampled with a mini-corer for the analysis of organic matter (120ml), geochemistry (120ml) and foraminifera (6cc), whereas the other half of the mini corer was frozen for further analysis. The sample was divided in 5cm intervals, sieving onboard the intervals 0-5cm, 5-10cm and 10-15cm on a 0.5mm sieve. The >15cm interval was checked for organisms but not sieved.



Mini corer



Description:

0-12 cm: (7.5YR 4/3) Coarse sand with carbonated components

12-22 cm: (GLEY2 5/10B) Mud breccia

Research Vessel: SARMIENTO DE GAMBOA			
Sampling technique: Box-corer			
Sample code:	BC02	Starting time:	17:34
Location:	GAZUL MUD VOLCANO	Finishing time:	18:05
Date:	22/09/2016	Sampling Station:	11

DREDGE ON BOTTOM	
LAT:	36°33.87 N
LON:	06°55.86 W
DEPTH(m)	450

DESCRIPTION

The box-corer collects about 5 liters of sediment. It is composed of muddy fine sediment with some gravels (0 [upper surface]-5 cm) with brachiopod and bivalve remains, and live specimens of the bivalves *Astarte sulcata*, *Asperarca nodulosa* and *Cuspidaria cf. cuspidata*; and mud breccia (5-10-12 cm [lower surface]). The sediment color is brown (10YR 4/2) for the upper muddy coarse sediment and brown-grey (2.5Y4/2) for the mud breccia. The sample has been sub-sampled with a mini-corer for the analysis of organic matter (120ml), geochemistry (120ml) and foraminifera (6cc), whereas the other half of the mini corer was frozen for further analysis. The sample was divided in 5cm intervals, sieving onboard the intervals 0-5cm, 5-10/12cm on a 0.5mm sieve.



Mini corer



Description:

0-4 cm: (10YR 4/2) muddy fine sediment with some gravels

4-15 cm: (2.5Y 4/2) Mud breccia

Research Vessel: SARMIENTO DE GAMBOA			
Sampling technique: Box-corer			
Sample code:	BC03	Starting time:	18:16
Location:	GAZUL MUD VOLCANO	Finishing time:	18:46
Date:	22/09/2016	Sampling Station:	12

DREDGE ON BOTTOM	
LAT:	36°33.92 N
LON:	06°55.86 W
DEPTH (m)	446

DESCRIPTION
<p>This is just a qualitative sample. A rock seemed to obstruct the box-corer.</p> <p>The remaining sediment was composed of gravel and slab fragments as well as crusts, with bivalves (<i>Astarte sulcata</i>), bryozoans, <i>Caryophyllia</i> and <i>Madrepora oculata</i> remains. Digitate sponges and a juvenile specimen of <i>Acanthogorgia</i> sp. were observed on slab fragments and crusts.</p>

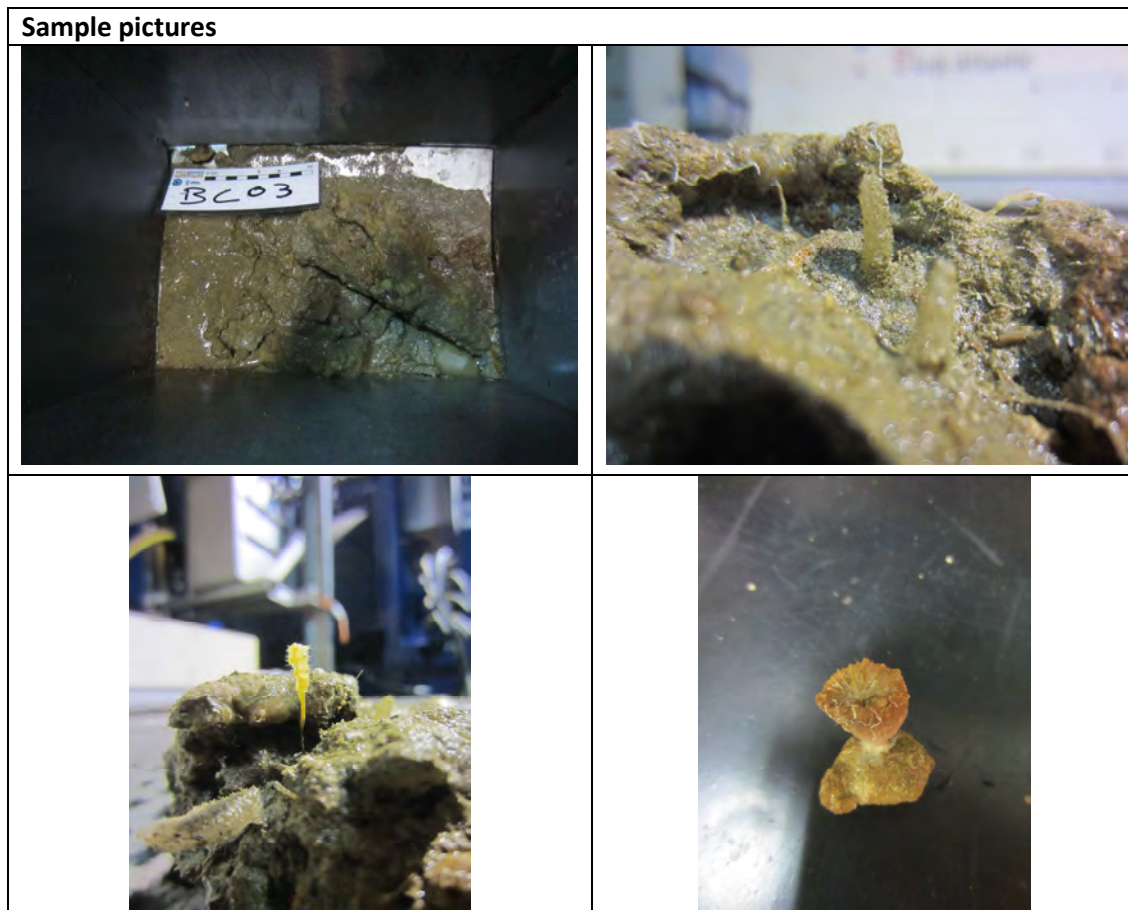

Research Vessel: SARMIENTO DE GAMBOA			
Sampling technique: Box-corer			
Sample code:	BC04	Starting time:	16:34
Location:	GAZUL MUD VOLCANO	Finishing time:	17:04
Date:	23/09/2016	Sampling Station:	21

DREDGE ON BOTTOM	
LAT:	36°33.59 N
LON:	06°59.95 W
DEPTH (m)	470

DESCRIPTION
The box-corer collects about 5 liters of sediment, which is composed of muddy coarse sediment with echinoid (<i>Cidaris</i> sp.), coral, bivalve (<i>Astarte</i>) and polychaete (e.g. <i>Ditrupa</i>) remains. The sediment color is brown (10YR 4/3) for the 0-5cm interval and grey-brown (Gley1 3/4) for the 5-10cm interval. The sample has been sub-sampled with a mini-corer for the analysis of organic matter (120ml), geochemistry (120ml) and foraminifera (6cc), whereas the other half of the mini corer was frozen for further analysis. The sample was divided in 5cm intervals, sieving onboard the 0-5cm and 5-10cm intervals on a 0.5mm sieve.

Sample pictures

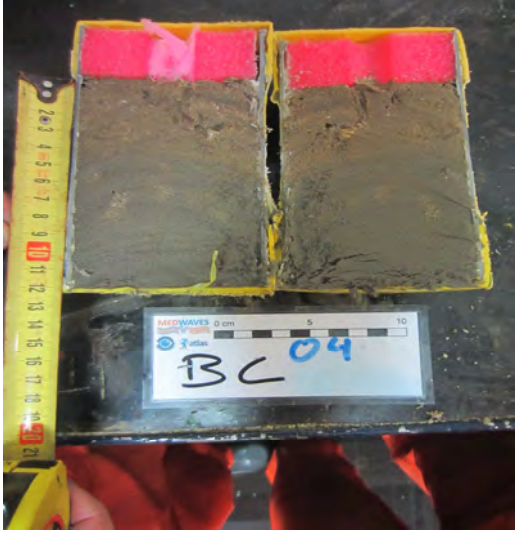

<p>Mini corer</p>	
	<p>Description:</p> <p>0-5 cm: (10YR 4/2) Muddy fine sediment with bivalve and coral remains.</p> <p>5-10 cm: (GLE1 3/10Y) Mud.</p>

Research Vessel: SARMIENTO DE GAMBOA			
Sampling technique: Box-corer			
Sample code:	BC05	Starting time:	16:52
Location:	ORMONDE SEAMOUNT	Finishing time:	18:30
Date:	25/09/2016	Sampling Station:	37

DREDGE ON BOTTOM	
LAT:	36°58.65 N
LON:	10°47.11 W
DEPTH(m)	1919

DESCRIPTION

The box-corer collects about 20 liters of sediment. It is composed of muddy fine sediment with hemipelagic mud (0 [upper surface]-5cm) containing pteropod shells (*Cavolinia*), sandy mud (5-32cm) with shell and coral remains, and carbonated deposits (32-36cm [lower surface]) with shell remains at the bottom. The sediment color is brown (2.5Y 6/4) for the first 32cm, and also brown (2.5Y 8/2) for the remaining 5cm. The sample has been sub-sampled with a mini-corer for the analysis of organic matter (120ml), geochemistry (120ml) and foraminifera (6cc), whereas the other half of the mini corer was frozen for further analysis. The sample was divided in 5cm intervals, sieving onboard the 0-5cm, 5-10cm and 10-15cm intervals on a 0.5mm sieve. The sediment below 15cm was checked for organisms but not sieved.



Sieved sample pictures

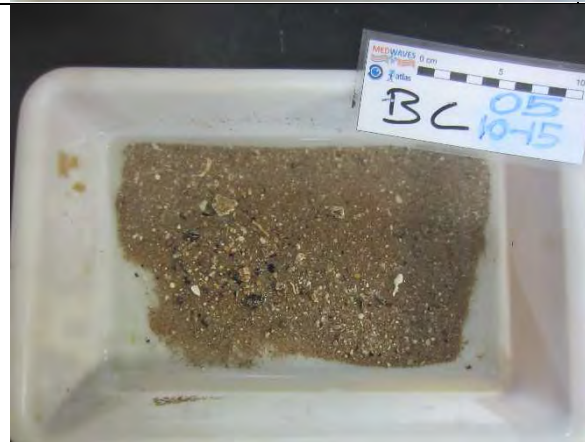

Mini corer



Description:

0-32 cm: (2.5Y 6/4) Muddy fine sediment
32-37 cm: (2.5Y 8/2) Carbonated deposits

Research Vessel: SARMIENTO DE GAMBOA			
Sampling technique: Van-Veen C.O. Baleares			
Sample code:	VV01	Starting time:	14:58
Location:	FORMIGAS SEAMOUNTS	Finishing time:	16:04
Date:	30/09/2016	Sampling Station:	55

DREDGE ON BOTTOM	
LAT:	37°9.09 N
LON:	24°37.70 W
DEPTH(m)	1535

DESCRIPTION

The Van Veen dredge collects about 4 liters of muddy fine and medium sand sediment and centimetric black basaltic and pumice stones. The sediment color is brown (2.5Y 5/3) and contains pteropod shells (*Cavolinia*), sea-urchin spines and some gastropod shells (*Nodulus*), as well as bryozoan remains and some live gastropods. The sediment has been sub-sampled for the analysis of organic matter (120ml), geochemistry (120ml) and foraminifera (6cc).

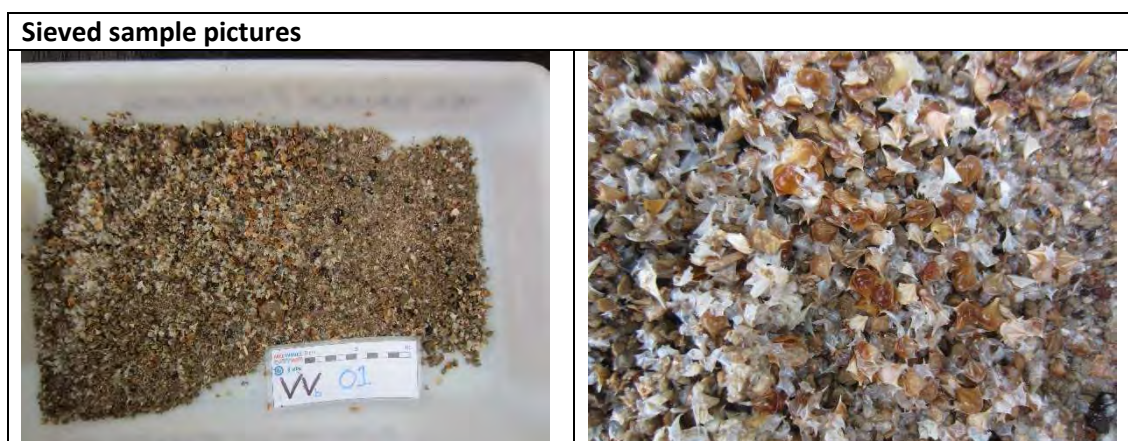

Research Vessel: SARMIENTO DE GAMBOA			
Sampling technique: Van-Veen C.O. Baleares			
Sample code:	VV02	Starting time:	16:20
Location:	FORMIGAS SEAMOUNTS	Finishing time:	17:20
Date:	30/09/2016	Sampling Station:	56

DREDGE ON BOTTOM	
LAT:	37°9.09 N
LON:	24°37.70 W
DEPTH(m)	1536

DESCRIPTION

The Van Veen dredge collects about 6 liters of muddy fine and medium sand with centimetric black basaltic and pumice stones. The sediment color is brown (2.5Y 5/3) and contains abundant pteropod shells (*Cavolinia*) and sea-urchin spines. The sediment has been sub-sampled for the analysis of organic matter (120ml), geochemistry (120ml) and foraminifera (6cc).

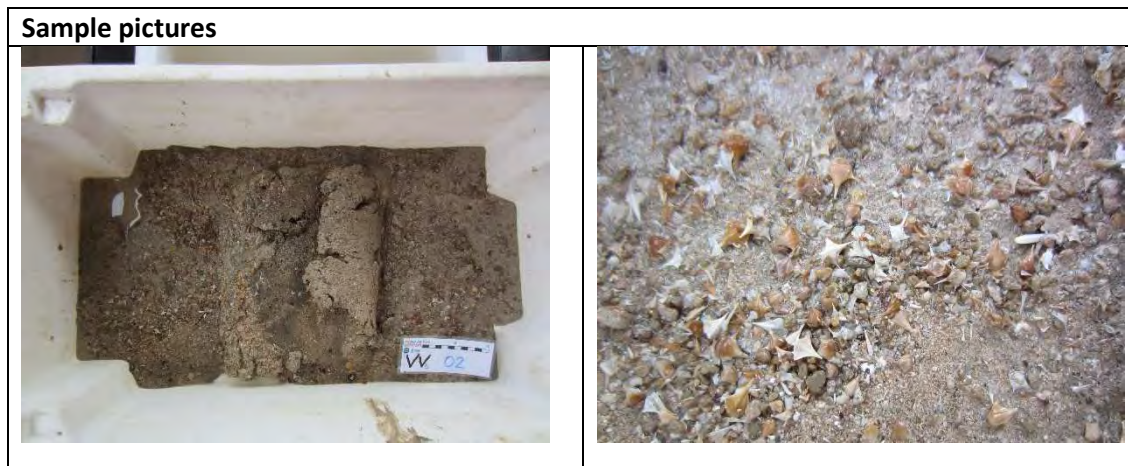

Research Vessel: SARMIENTO DE GAMBOA			
Sampling technique: Van-Veen Baleares			
Sample code:	VV03	Starting time:	19:08
Location:	FORMIGAS SEAMOUNTS	Finishing time:	19:54
Date:	30/09/2016	Sampling Station:	58

DREDGE ON BOTTOM	
LAT:	37°10.73 N
LON:	24°37.95 W
DEPTH(m)	1172

DESCRIPTION
The Van Veen dredge collects about 3 liters of muddy fine sand which is brown-grey (2.5Y 5/3) and contains pteropod shells (<i>Cavolinia</i>) and some polychaetes. The sediment has been sub-sampled for the analysis of organic matter (120ml), geochemistry (120ml) and foraminifera (6cc).

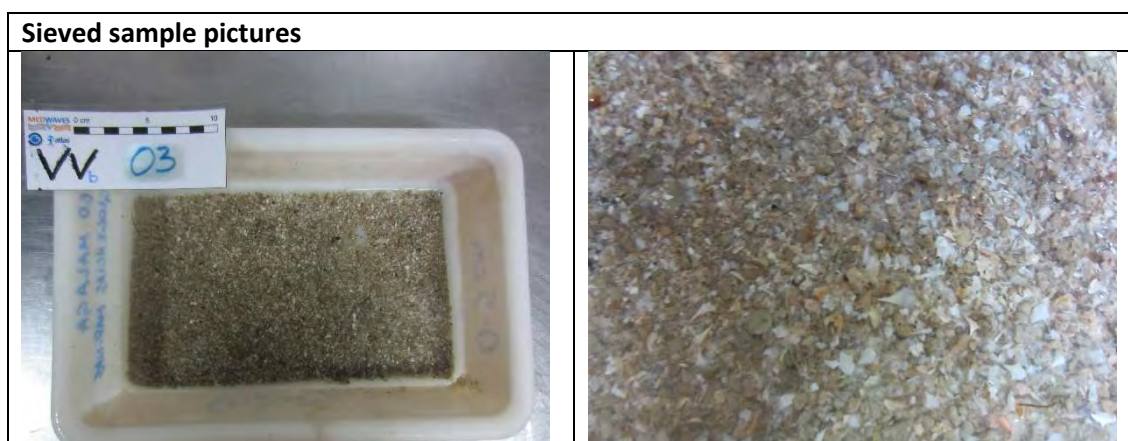
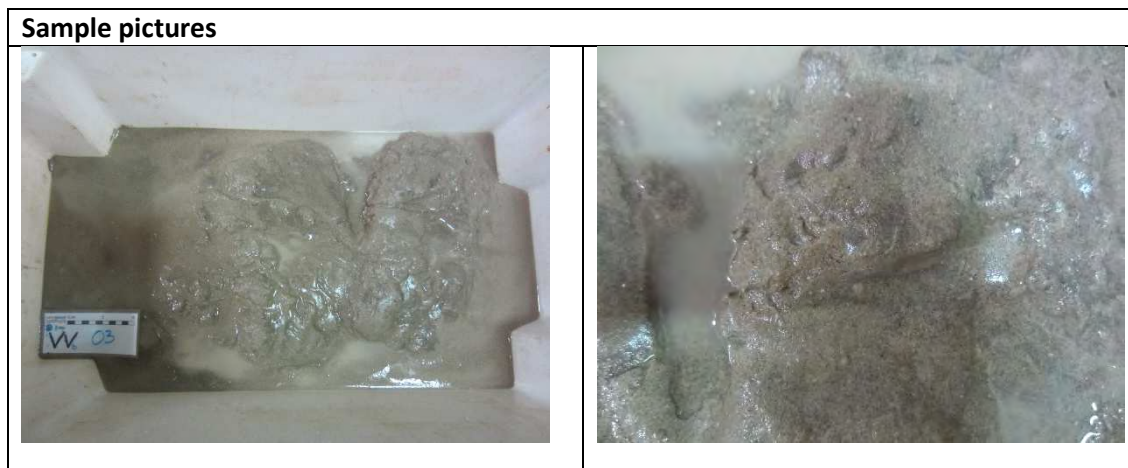

Research Vessel: SARMIENTO DE GAMBOA			
Sampling technique: Van-Veen C.O. Baleares			
Sample code:	VV04	Starting time:	20:05
Location:	FORMIGAS SEAMOUNTS	Finishing time:	20:48
Date:	30/09/2016	SamplingStation:	59

DREDGE ON BOTTOM	
LAT:	37°10.73 N
LON:	24°37.96 W
DEPTH(m)	1173

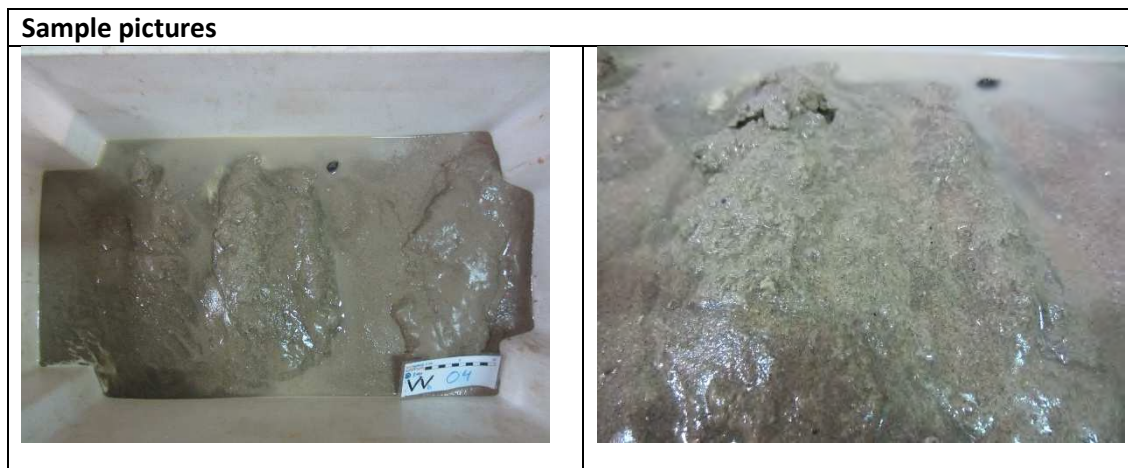

DESCRIPTION
 The Van Veen dredge collects about 3 liters of muddy fine sand with centimetric black basaltic stones. The sediment color is brown-grey (2.5Y 5/3) and contains pteropod shells (*Cavolinia*, *Diacria*, *Clio*). The sediment has been sub-sampled for the analysis of organic matter (120ml), geochemistry (120ml) and foraminifera (6cc).



Research Vessel: SARMIENTO DE GAMBOA			
Sampling technique: Van-Veen C.O. Baleares			
Sample code:	VV05	Starting time:	16:52
Location:	FORMIGAS SEAMOUNTS	Finishing time:	17:38
Date:	01/10/2016	Sampling Station:	66

DREDGE ON BOTTOM	
LAT:	37°11.44 N
LON:	24°37.63 W
DEPTH(m)	1122

DESCRIPTION
<p>This is a qualitative sample.</p> <p>The Van Veen dredge collects very few sediment, which is fine sand of brown color (2.5Y 4/3) and contains pteropod shells (<i>Cavolinia</i>), an echinoid plate, bryozoan remains and one ophiuroid. The sediment has not been sub-sampled for further analyses.</p>

Sample pictures	
	
	

Research Vessel: SARMIENTO DE GAMBOA			
Sampling technique: Van-Veen C.O. Baleares			
Sample code:	VV06	Starting time:	17:56
Location:	FORMIGAS SEAMOUNTS	Finishing time:	18:45
Date:	01/10/2016	Sampling Station:	67

DREDGE ON BOTTOM	
LAT:	37°11.35 N
LON:	24°37.97 W
DEPTH(m)	1246

DESCRIPTION
 The Van Veen dredge collects about 6 liters of muddy fine-medium sand that is brown (2.5Y 5/3) and contains pteropod shells (*Cavolinia*). The sediment has been sub-sampled for the analysis of organic matter (120ml), geochemistry (120ml) and foraminifera (6cc).

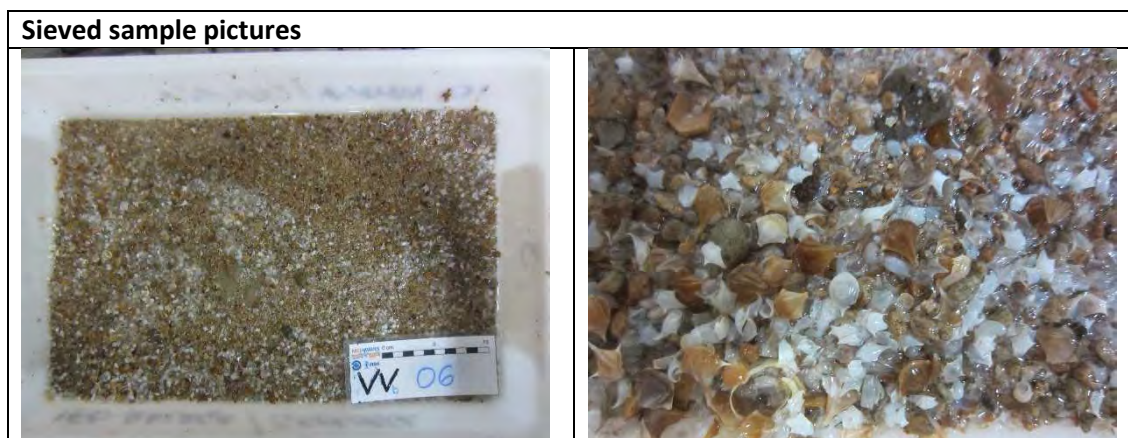
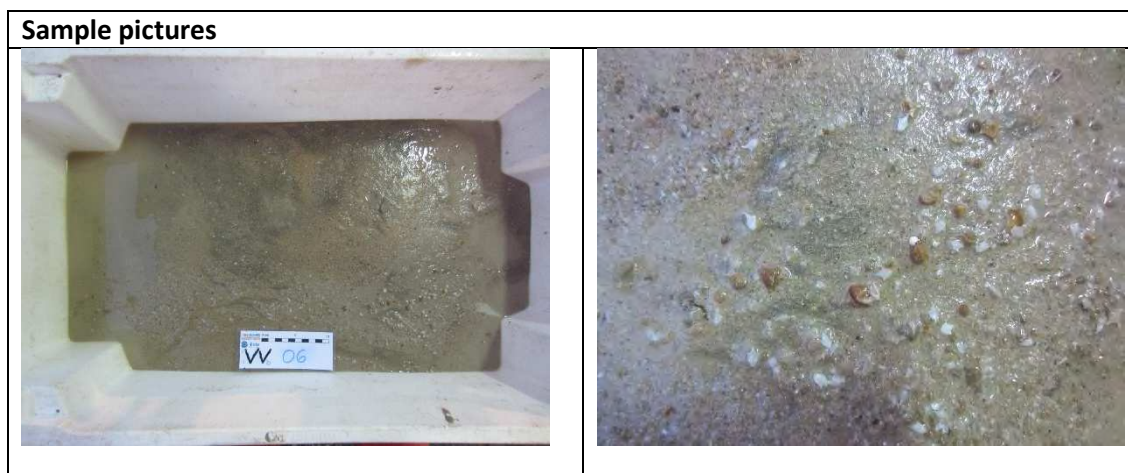

Research Vessel: SARMIENTO DE GAMBOA			
Sampling technique: Van-Veen Baleares			
Sample code:	VV07	Starting time:	18:02
Location:	FORMIGAS SEAMOUNTS	Finishing time:	19:02
Date:	02/10/2016	Sampling Station:	79

DREDGE ON BOTTOM	
LAT:	37°12.18 N
LON:	24°37.42 W
DEPTH (m)	1018

DESCRIPTION
The VV collects about 6 liters of muddy fine sand that is brown-grey(2.5Y 5/3). The sediment contains pteropod shells (<i>Cavolinia</i>), pelagic foraminifers, hydrocoral (<i>Crypterya</i>), cold-water coral (<i>Lophelia</i> , <i>Madrepora</i>) and balanid remains. Live animals include ophiuroids and polychaetes. The sediment has been sub-sampled for the analysis of organic matter (120ml), geochemistry (120ml) and foraminifera (6cc).

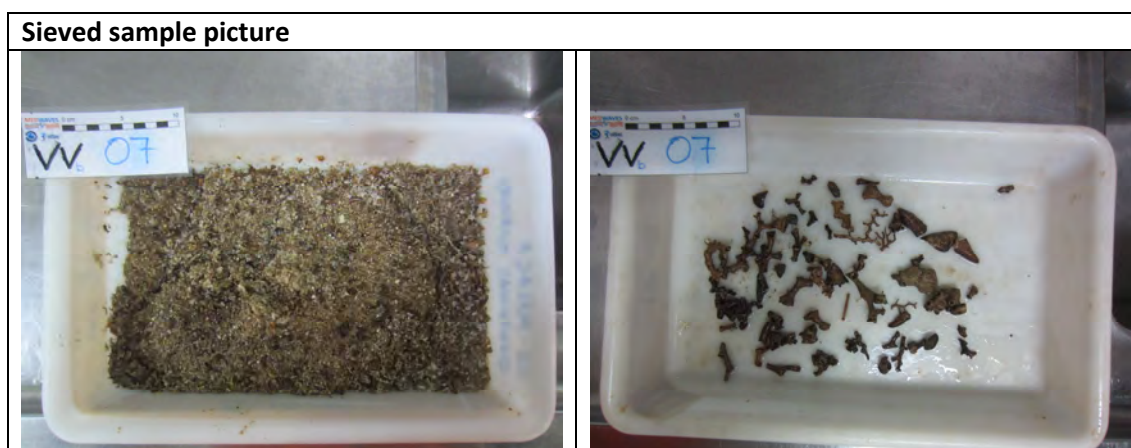
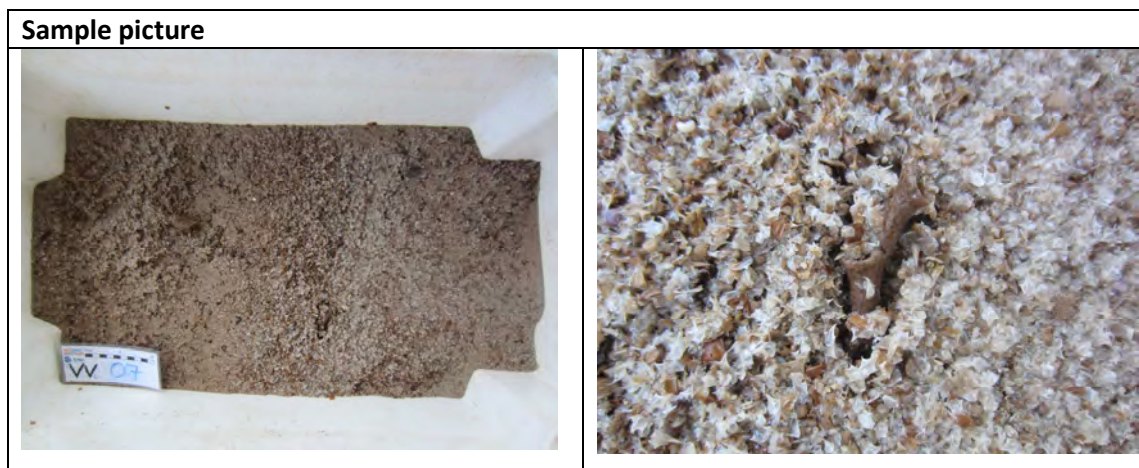

Research Vessel:: SARMIENTO DE GAMBOA			
Sampling technique: Van-Veen C.O. Baleares			
Sample code:	VV10	Starting time:	11:50
Location:	FORMIGAS SEAMOUNTS	Finishing time:	12:21
Date:	03/10/2016	Sampling Station:	90

DREDGE ON BOTTOM	
LAT:	37°12.65 N
LON:	24°39.72 W
DEPTH (m)	746

DESCRIPTION
<p><u>This is a qualitative sample</u></p> <p>The Van Veen collects a rock fragment (25x15 cm) made of coral rubble, shells and polychaete tube remains, as well as ca. 250 ml of medium sand of brown color (2.5Y 5/4). The sediment contains bryozoan remains. Live specimens include three octocorals (1 adult and 1 juvenile of <i>Narella</i> sp.; 1 <i>Swiftia</i> sp, the latter transferred to IMAR) and ophiuroids, all of them found on the rock fragment. No sub-samples for the analysis of organic matter, geochemistry or foraminifera were taken.</p>



Sieved sample pictures

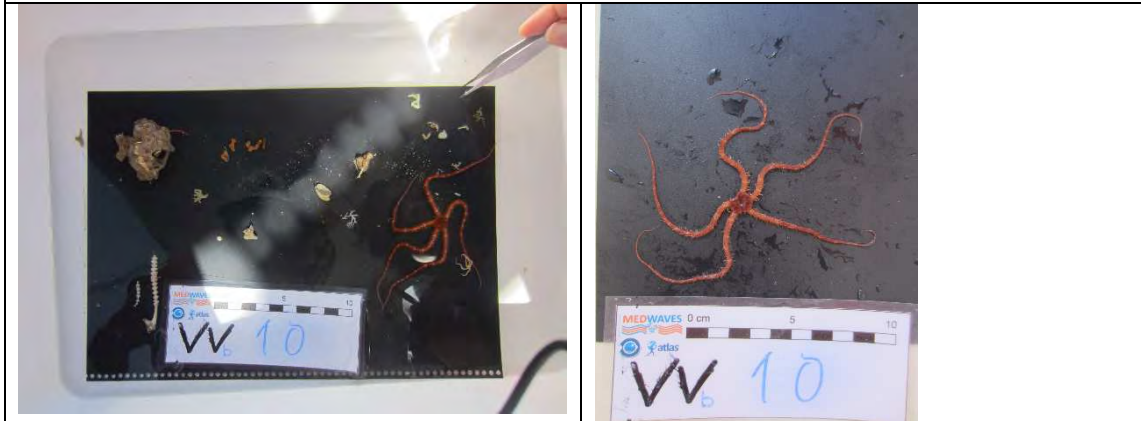

Research Vessel: SARMIENTO DE GAMBOA			
Sampling technique: Van-Veen C.O. Baleares			
Sample code:	VV12	Starting time:	12:59
Location:	FORMIGAS SEAMOUNTS	Finishing time:	13:29
Date:	03/10/2016	Sampling Station	92

DREDGE ON BOTTOM	
LAT:	37°12.65 N
LON:	24°39.72 W
DEPTH(m)	746

DESCRIPTION
<p>This is a qualitative sample</p> <p>The Van Veen dredge collects just a little amount of sediment. The sediment contains coral rubble. Live specimens include hydrozoans and ophiuroids. No sub-samples for the analysis of organic matter, geochemistry or foraminifera were taken.</p>

Sample pictures

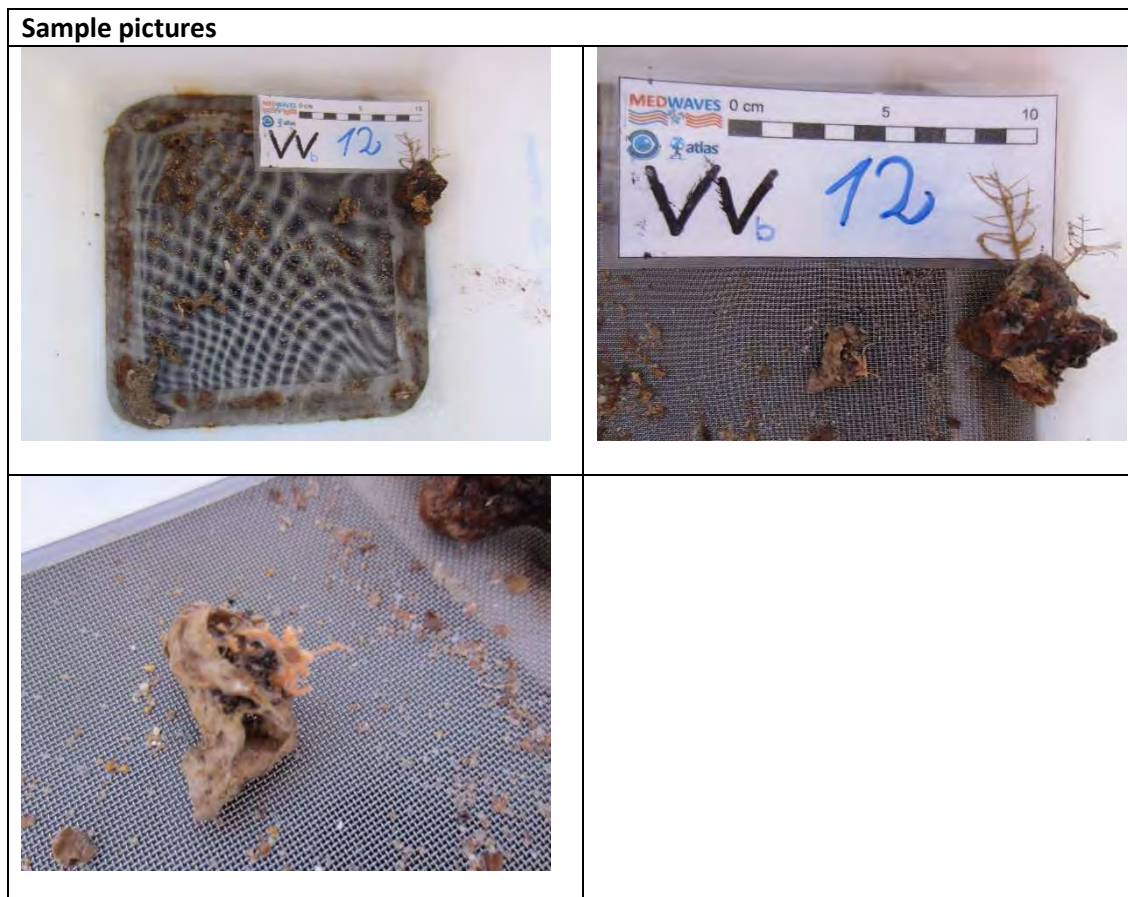

Research Vessel: SARMIENTO DE GAMBOA			
Sampling technique: Van-Veen C.O. Baleares			
Sample code:	VV13	Starting time	17:25
Location:	FORMIGAS SEAMOUNTS	Finishing time:	
Date:	04/10/2016	Sampling Station:	104

DREDGE ON BOTTOM	
LAT:	37°20.56 N
LON:	24°44.45 W
DEPTH(m)	1415

DESCRIPTION
 The Van Veen dredge collects about 6 liters of brown muddy-fine sand (2.5Y 6/3) that contains pteropod shells. The sediment has been sub-sampled for the analysis of organic matter (120ml), geochemistry (120ml) and foraminifera (6cc).

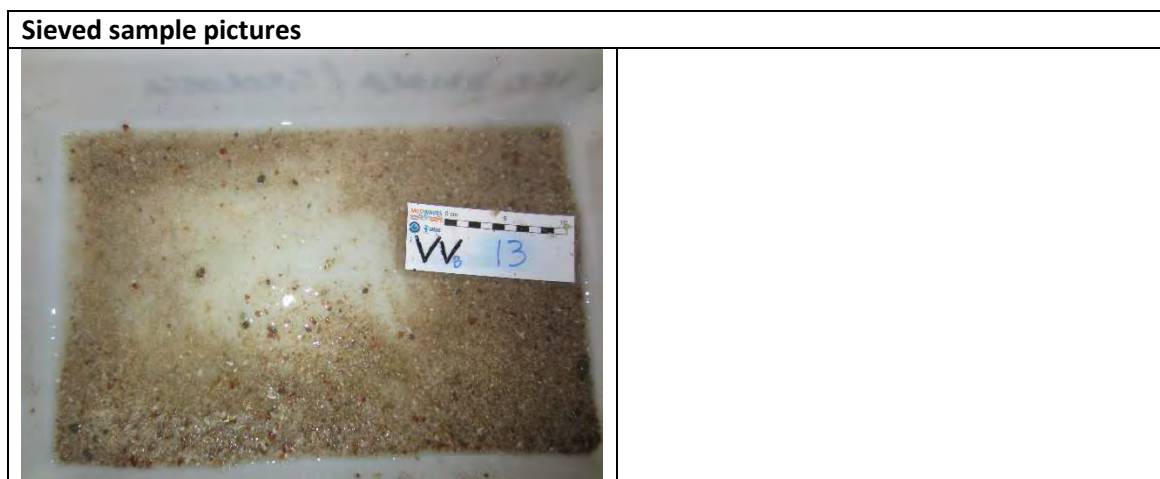
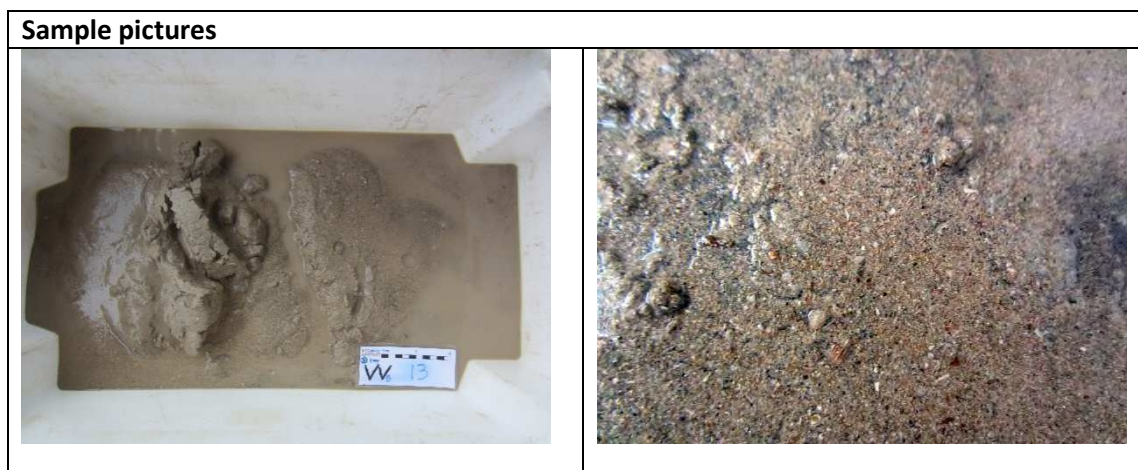

Research Vessel: SARMIENTO DE GAMBOA			
Sampling technique: Van-Veen C.O. Baleares			
Sample code:	VV15	Starting time:	19:20
Location:	FORMIGAS SEAMOUNTS	Finishing time:	
Date:	04/10/2016	Sampling Station:	104

DREDGE ON BOTTOM	
LAT:	37°20.56 N
LON:	24°44.45 W
DEPTH (m)	1415

DESCRIPTION
 The Van Veen dredge collects about 1 liter of muddy-fine sand that is brown (2.5Y 5/3) and contains a high amount of pteropod shells (*Cavolinia*). No sub-samples for the analysis of organic matter, geochemistry or foraminifera were taken.

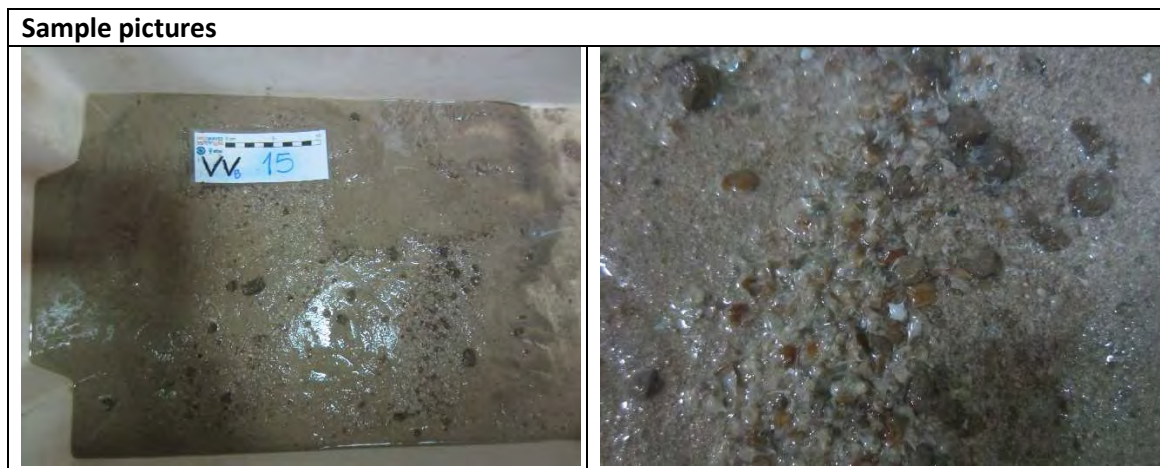

Research Vessel: SARMIENTO DE GAMBOA			
Sampling technique: Van-Veen C.O. Baleares			
Sample code:	VV17	Starting time:	18:34
Location:	FORMIGAS SEAMOUNTS	Finishing time:	19:29
Date:	05/10/2016	Sampling Station:	115

DREDGE ON BOTTOM	
LAT:	37°20.40 N
LON:	24°45.35 W
DEPTH(m)	1324

DESCRIPTION
The Van Veen dredge collects about 10 liters of muddy-fine sediment with a large amount of hemipelagic mud. The sediment color is brown (2.5Y 5/3) and contains abundant pteropod shells (<i>Cavolinia</i>). Live specimens include small sponges. The sediment has been sub-sampled for the analysis of organic matter (120ml), geochemistry (120ml) and foraminifera (6cc).



Sample pictures

Sample sieved pictures

Research Vessel: SARMIENTO DE GAMBOA			
Sampling technique: Van-Veen C.O. Baleares			
Sample code:	VV18	Starting time:	19:38
Location:	FORMIGAS SEAMOUNTS	Finishing time:	20:30
Date:	05/10/2016	Sampling Station:	116

DREDGE ON BOTTOM	
LAT:	37°20.40 N
LON:	24°45.31 W
DEPTH(m)	1325

DESCRIPTION
The Van Veen dredge collects about 5 liters of muddy fine sediment with a high amount of hemipelagic mud. The sediment color is brown (2.5Y 5/3) and contains pteropod shells (e.g. <i>Cavolinia</i>). The sediment has been sub-sampled for the analysis of organic matter (120ml), geochemistry (120ml) and foraminifera (6cc).

Sample pictures	
Sieved sample pictures	
	
	

Research Vessel: SARMIENTO DE GAMBOA			
Sampling technique: Van-Veen C.O. Baleares			
Samplecode:	VV20	Starting time	22:17
Location:	FORMIGAS SEAMOUNTS	Finishing time:	23:00
Date:	07/10/2016	Sampling Station:	128

DREDGE ON BOTTOM	
LAT:	37°19.59 N
LON:	24°44.72 W
DEPTH(m)	1043

DESCRIPTION
The Van Veen dredge collects about 6 liters of muddy fine sediment with a brown color (5Y 4/4) that contains pteropod shells (<i>Cavolinia</i>). The sediment has been sub-sampled for the analysis of organic matter (120ml), geochemistry (120ml) and foraminifera (6cc).

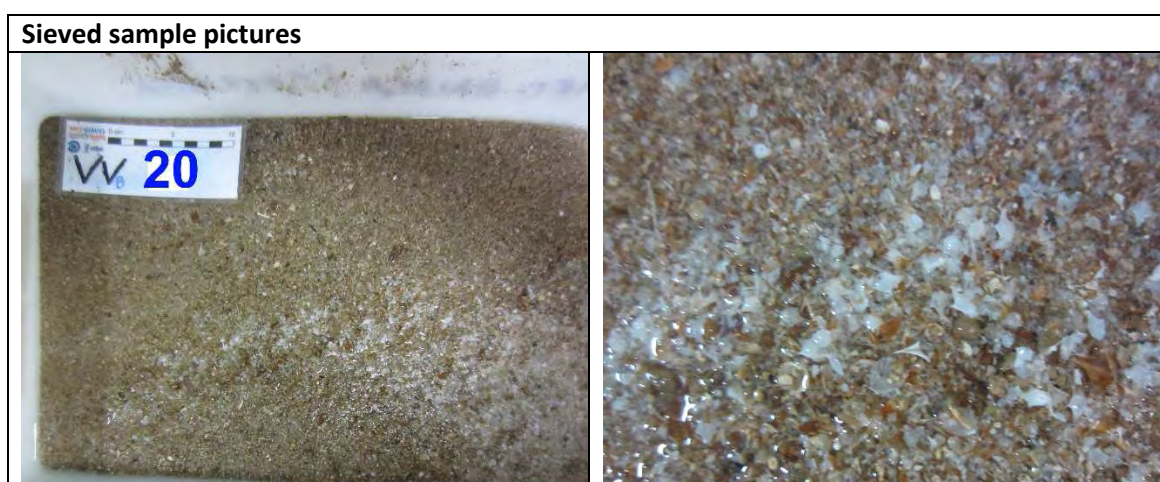

Research Vessel: SARMIENTO DE GAMBOA			
Sampling technique: Van-Veen C.O. Baleares			
Sample code:	VV22	Starting time	23:52
Location:	FORMIGAS SEAMOUNTS	Finishing time:	00:33
Date:	07/10/2016	Sampling Station:	130

DREDGE ON BOTTOM	
LAT:	37°16.60 N
LON:	24°44.70 W
DEPTH(m)	1048

DESCRIPTION
The Van Veen dredge collects about 8 liters of muddy-sand sediment. The color of the sediment is brown (2.5Y 4/3) and contains pteropod shells and a <i>Cidaris</i> spine. Live specimens include one button coral. The sediment has been sub-sampled for the analysis of organic matter (120ml), geochemistry (120ml) and foraminifera (6cc).

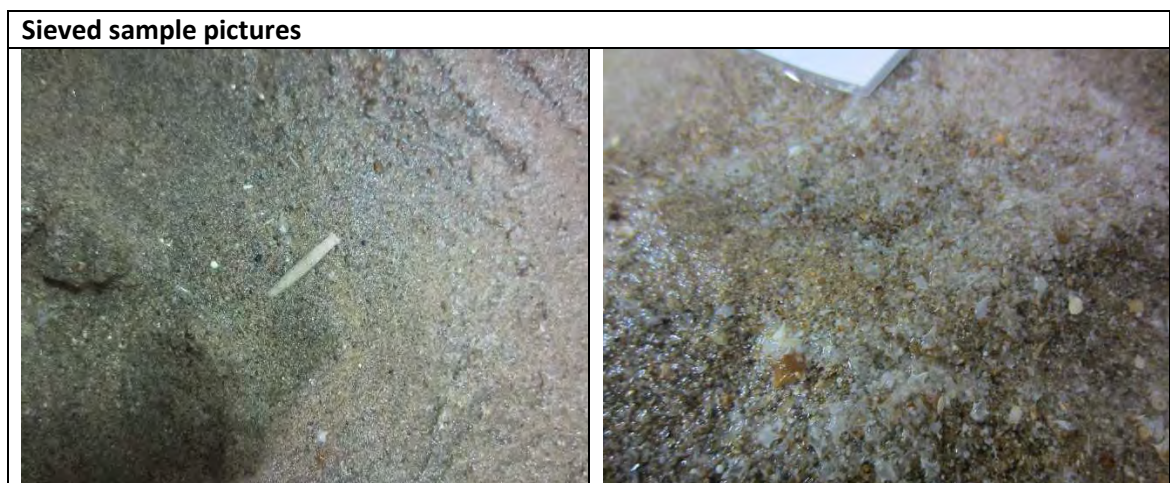

Research Vessel: SARMIENTO DE GAMBOA			
Sampling technique: Van-Veen C.O. Baleares			
Sample code:	VV23	Starting time:	00:40
Location:	FORMIGAS SEAMOUNTS	Finishing time	01:20
Date:	08/10/2016	Sampling Station:	131

DREDGE ON BOTTOM	
LAT:	37°19.60 N
LON:	24°44.69 W
DEPTH(m)	1069

DESCRIPTION
The Van Veen dredge collects about 10 liters of muddy fine sediment that is brown (2.5Y 4/3) and contains pteropod shells. Live specimens include one cirriped over a small stone. The sediment has been sub-sampled for the analysis of organic matter (120ml), geochemistry (120ml) and foraminifera (6cc).





Research Vessel: SARMIENTO DE GAMBOA			
Sampling technique: Van-Veen C.O. Baleares			
Sample code:	VVb 24	Starting time:	15:56
Location:	ORMONDE NE FLANK	Finishing time:	17:13
Date:	18/10/16	Sampling station:	139

DREDGE ON BOTTOM	
LAT:	36°58.64 N
LON:	10°47.10 W
DEPTH (m)	1936m

DESCRIPTION
 The Van Veen collects about 8 litres of sediment with abundant hemipelagic mud, containing pteropod shells (*Cavolinia*, *Diacria*), foraminifera, spicule of poriferans and remains of bivalves (*Malletia* sp). The sediment has been sub-sampled for the analysis of organic matter (120ml), geochemistry (120ml) y foraminifera (6cc). The sediment color is brown(2.5Y 6/3) and uniform .

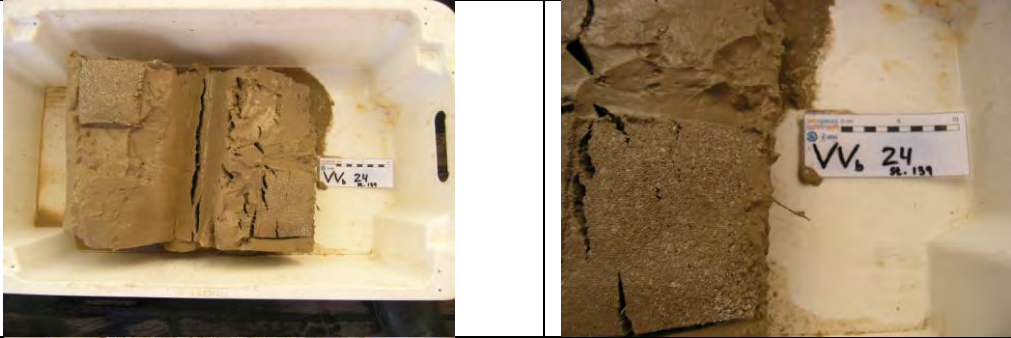
Sample pictures

Sieved sample pictures

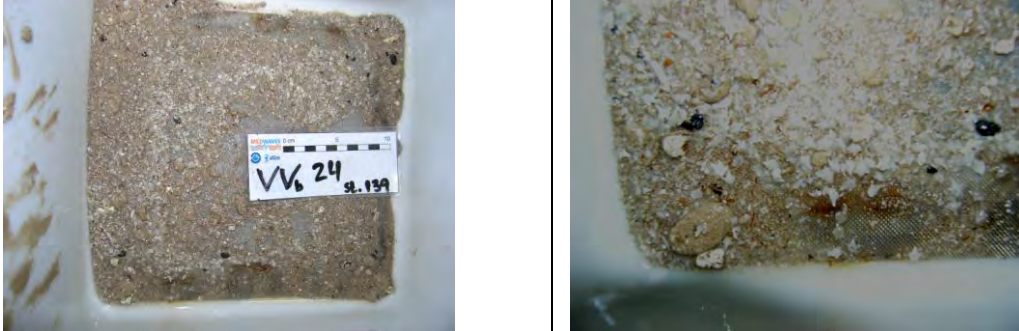

Research Vessel: SARMIENTO DE GAMBOA			
Sampling technique: Van-Veen C.O. Baleares			
Sample code:	VVb 25	Starting time:	17:43
Location:	ORMONDE NE FLANK	Finishing time:	18:58
Date:	18/10/16	Sampling Station:	140

DREDGE ON BOTTOM	
LAT:	36°58.56 N
LON:	10°47.11 W
DEPTH (m)	1931m

DESCRIPTION

The Van Veen dredge collects a significant sample about 8 liters with hemipelagic mud, with remains of pteropods shells. (*Cavolinia*, *Diacria*, *Clio*), Foraminifera, sea urchin spines and basal part of *Isidella elongata*. The sediment has been sub-sampled for the analysis of organic matter (120ml), geochemistry (120ml) y foraminifera (6cc). The sediment color is brown (2.5Y 6/3) uniform and very similar to VVb-25.

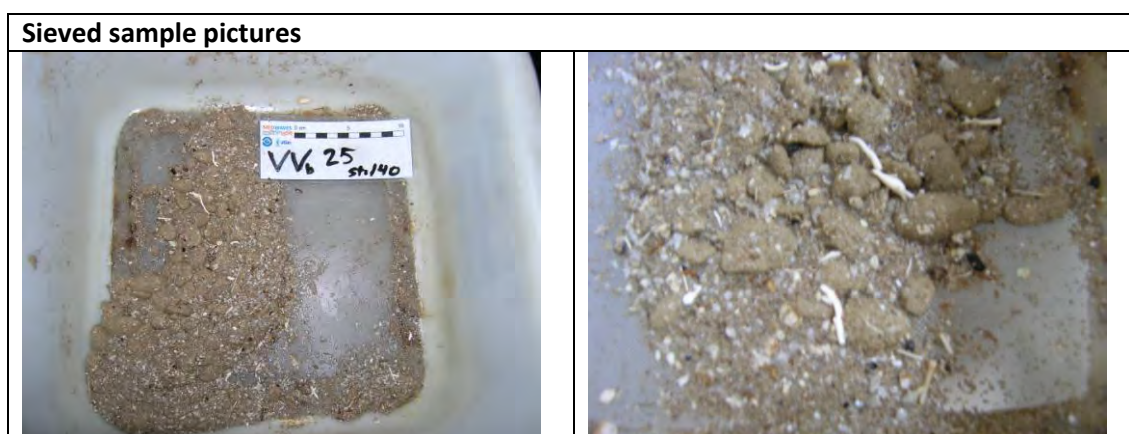
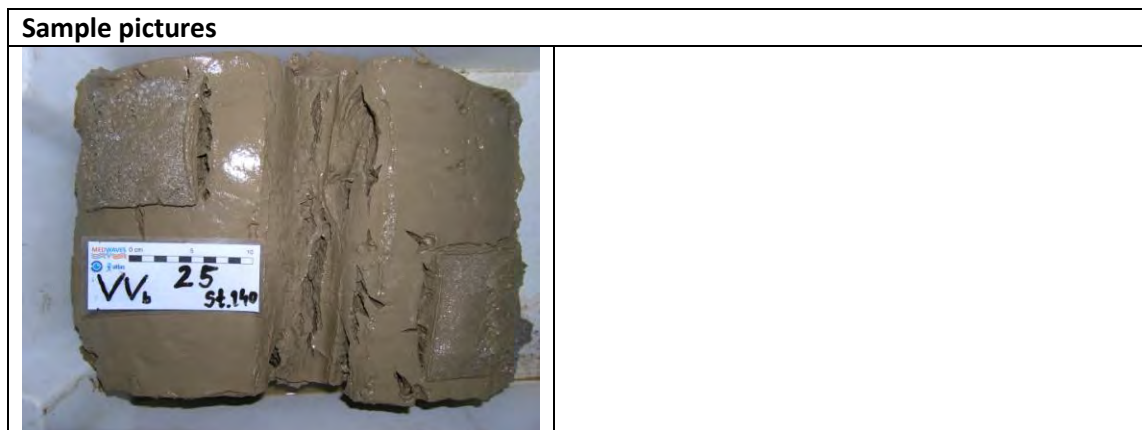

Research Vessel: SARMIENTO DE GAMBOA			
Sampling technique: Van-Veen C.O. Baleares			
Sample code:	VVb 26	Starting time:	17:50
Location:	ORMONDE NE FLANK	Finishing time:	18:40
Date:	19/10/16	Sampling Station:	147

DREDGE ON BOTTOM	
LAT:	36°48.02 N
LON:	10°57.01 W
DEPTH (m)	1235m

DESCRIPTION

The Van Veen dredge collects about 6 liters of coarse sand with hemipelagic mud and centimetric gravels. The sediment color is brown (2.5Y 7/3) and the gravels display varying colors between black and light brown. The sediment contains pteropod shells (*Cavolinia*, *Diacria*, *Clio*), benthic and pelagic foraminifers, cold-water coral and octocoral remains (*Solenosmilia*, *Acanella*) as well as brachiopods and bivalve molluscs (*Cuspidaria*, *Pseudamussium*). Among live specimens there are poriferans similar to *Polymastia*, bryozoans colonizing gravels, gastropods (*Amphissa*, *Clelandella*) and ophiuroids. The sediment has been sub-sampled for the analysis of organic matter (120ml), geochemistry (120ml) and foraminifera (6cc).

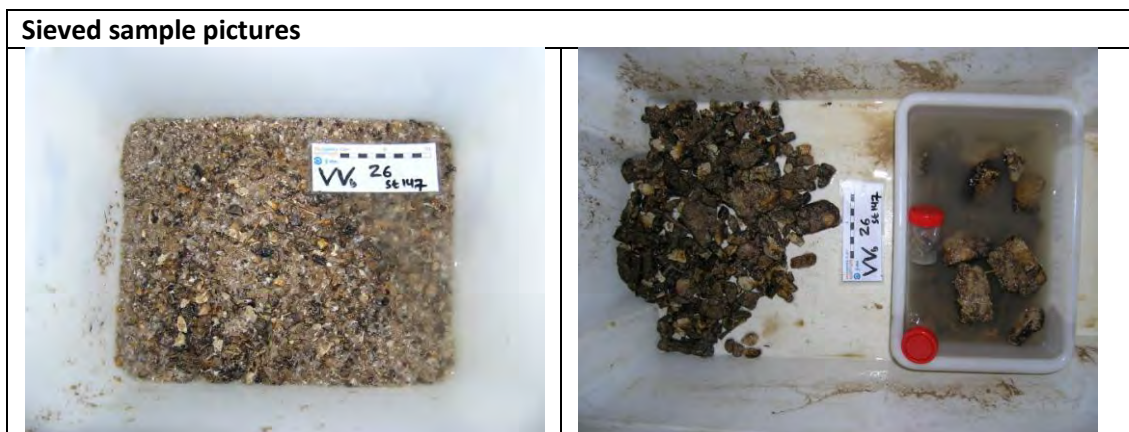
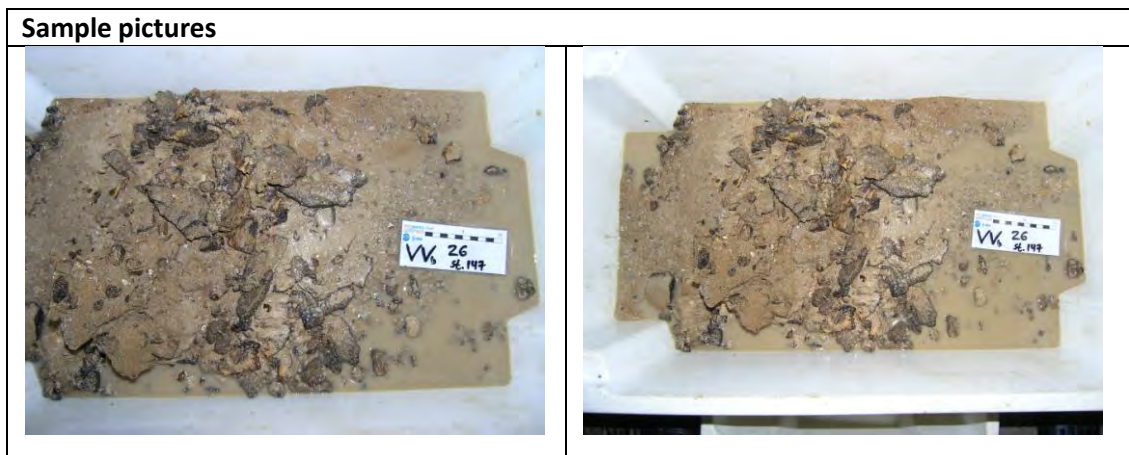

Research Vessel: SARMIENTO DE GAMBOA			
Sampling technique: Van-Veen C.O. Baleares			
Sample code:	VVb 27	Starting time:	18:45
Location:	ORMONDE NE FLANK	Finishing time:	19:35
Date:	19/10/16	Sampling Station:	148

DREDGE ON BOTTOM	
LAT:	36°48.01 N
LON:	10°57.01 W
DEPTH (m)	1235m

DESCRIPTION

The Van Veen dredge collects less sediment than in VVb26, around 4 liters, containing coarse sand with hemipelagic mud and centrimetric gravels, with remains of pteropods (*Cavolinia*, *Clio*, *Diacria*), cold-water corals (*Solenosmyllia*) and bryozoans, as well as a large amount of benthic and pelagic foraminifera. The sediment color is brown (2.5Y 7/3) and gravels display varying colors between black and light brown. Among the collected live fauna there are small poriferans, bryozoans and hydrozoans on gravels as well as molluscs (*Amphissa*, *Spirotropis*). The sediment has been sub-sampled for the analysis of organic matter (120ml), geochemistry (120ml) y foraminifera (6cc).

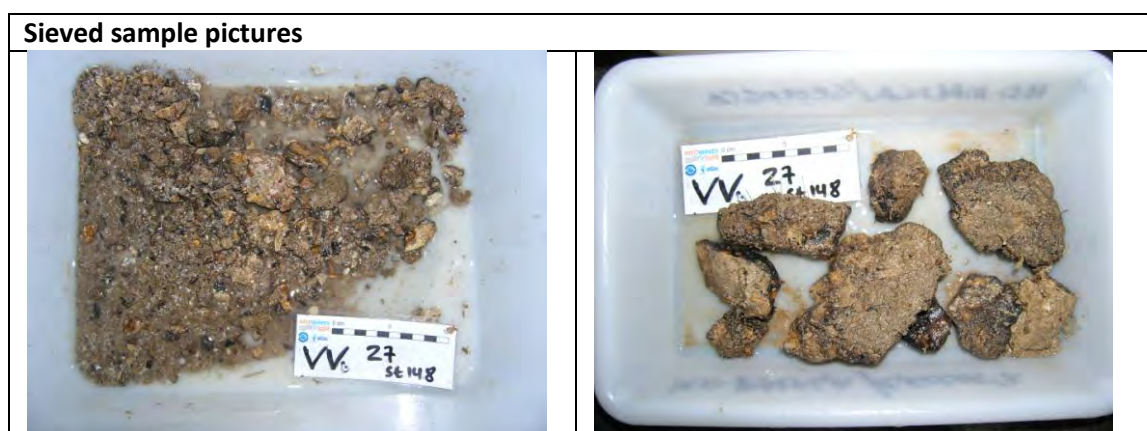

Research Vessel: SARMIENTO DE GAMBOA			
Sampling technique: Van-Veen C.O. Baleares			
Sample code:	VVb 28	Starting time:	18:10
Locations:	ORMONDE N FLANK	Finishing time:	19:05
Date:	20/10/16	Sampling Station:	157

DREDGE ON BOTTOM	
LAT:	36° 48.62 N
LON:	11° 7.51 W
DEPTH(m)	1143 m

DESCRIPTION
The Van Veen dredge collects a homogenous sample (about 8 liters of sediment), containing muddy sand with hemipelagic mud of light brown color (2.5Y 6/4), with abundant pteropod shells (<i>Cavolinia</i> , <i>Clio</i> , <i>Diacria</i>) and foraminifers (<i>Orbulina</i> , <i>Globorotalia</i>). Live specimens include small globular poriferans, polychaetes (<i>Capitellidae</i> , <i>Eunicidae</i>) and mollusc (<i>Dentalium</i> , <i>Yoldiella</i> , <i>Cuspidaria</i>). The sediment has been sub-sampled for the analysis of organic matter (120ml), geochemistry (120ml) and foraminifera (6cc).

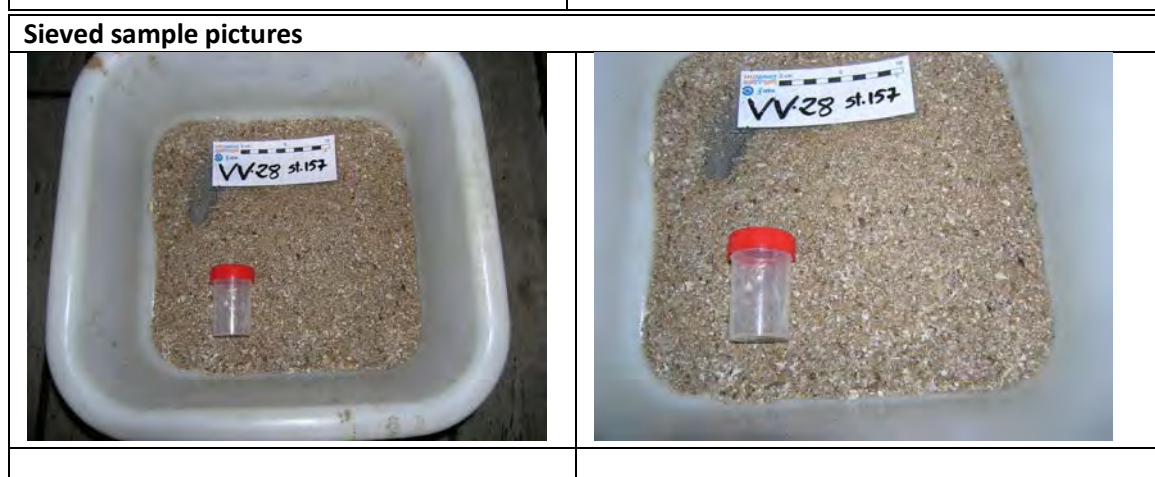

Research Vessel: SARMIENTO DE GAMBOA			
Sampling technique: Van-Veen C.O. Baleares			
Sample code:	VVb 31	Starting time:	09:30
Location:	SECO DE LOS OLIVOS SW	Finishing time:	10:00
Date:	23/10/16	Sampling Station:	178

DREDGE ON BOTTOM	
LAT:	36°28.85 N
LON:	2°53.67 W
DEPTH (m)	729m

DESCRIPTION
<p>The Van Veen dredge arrives full on board after collecting about 8 liters, mainly containing hemipelagic mud with some pteropod shells and foraminifers. The sediment is very homogeneous and its color is uniformly brown 10YR 5/2 in all sample.</p> <p>There is a presence of remains (<i>Aporrhais</i>, <i>Lunatia</i> and slag) and some live specimens (<i>Abra</i> sp., polychaetes, Amphipods and isopods). The sediment has been sub-sampled for the analysis of organic matter (120ml), geochemistry (120ml) and foraminifera (6cc).</p>

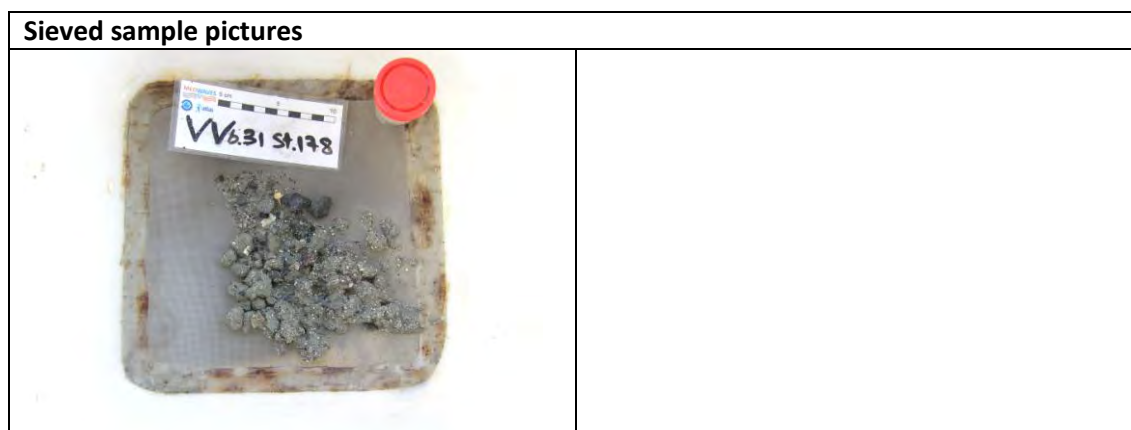



Research Vessel: SARMIENTO DE GAMBOA			
Sampling technique: Van-Veen C.O. Baleares			
Sample code:	VVb 32	Starting time:	10:58
Location:	SECO DE LOS OLIVOS SW	Finishing time:	11:43
Date:	23/10/16	Sampling Station:	180

DREDGE ON BOTTOM	
LAT:	36°28.86 N
LON:	2°53.68 W
DEPTH (m)	729m

DESCRIPTION
The Van Veen dredge is retrieved full of sediment (about 8 liters), predominantly hemipelagic mud with some pteropod shells (<i>Cavolinia</i>) and foraminifers. The sediment is homogeneous, with a uniform brown color 10YR 5/2 in all the sample. It contains remains of <i>Aporrhais</i> and <i>Calumbonella</i> , as well as some live fauna (mainly polychaetes and amphipods). It has been sub-sampled for analysis of organic matter (120ml), geochemistry (120ml) and foraminifera (6cc).

Sample pictures

Sieved sample pictures	
	

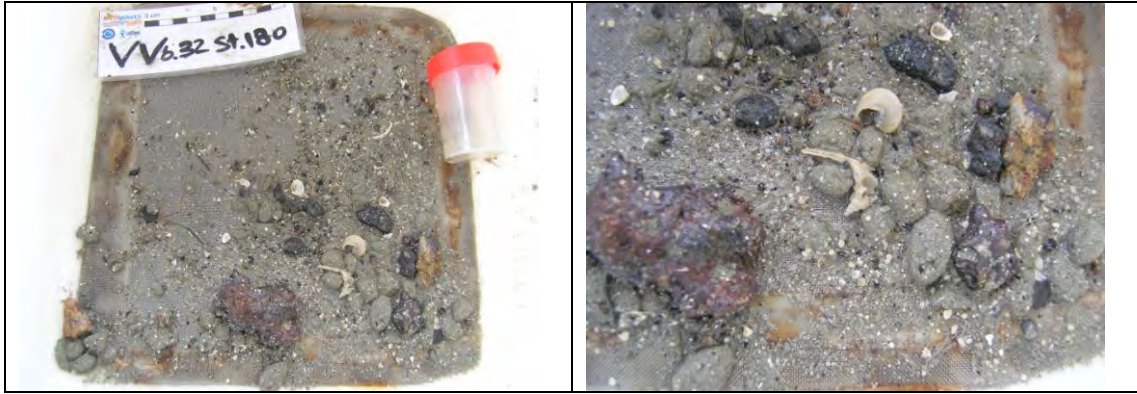

Research Vessel: SARMIENTO DE GAMBOA			
Sampling technique: Van-Veen C.O. Baleares			
Sample Code:	VVb 34	Starting time:	19:18
Locations:	SECO DE LOS OLIVOS SW	Finishing time:	19:47
Date:	23/10/16	Sampling Station:	184

DREDGE ON BOTTOM	
LAT:	36°29.05 N
LON:	2°53.52 W
DEPTH (m)	637m

DESCRIPTION
The Van Veen dredge collects about ±8 liters of sediment, containing hemipelagic mud with pteropod shells (<i>Cavolinia</i>) and foraminifers. The sediment color is uniformly brown (10YR 5/2) in all the sample. The sediment has been sub-sampled for the analysis of organic matter (120ml), geochemistry (120ml) and foraminifers (6cc).

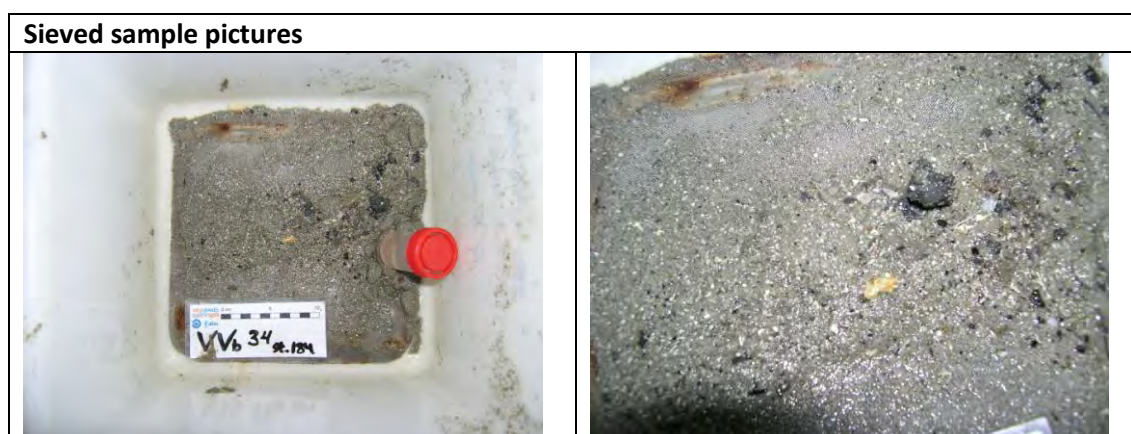

Research Vessel: SARMIENTO DE GAMBOA			
Sampling technique: Van-Veen C.O. Baleares			
Sample code:	VVb 35	Starting time:	10:58
Locations:	SECO DE LOS OLIVOS	Finishing time:	11:17
Date:	24/10/16	Sampling Station:	193

DREDGE ON BOTTOM	
LAT:	36°22.55 N
LON:	2°49.16 W
DEPTH(m)	320m

DESCRIPTION
The Van Veen collects ca. 3 liters of sandy mud with coral rubble (mainly containing <i>M. oculata</i>) and brachiopods (<i>Gryphus</i>). Live specimens such as poriferans and bryozoans were also observed in the sample. The sediment color is uniformly brown (10Y 4/4) in the whole sample. The sediment has been sub-sampled for the organic matter (120ml), geochemistry (120ml) y foraminifers (6cc).

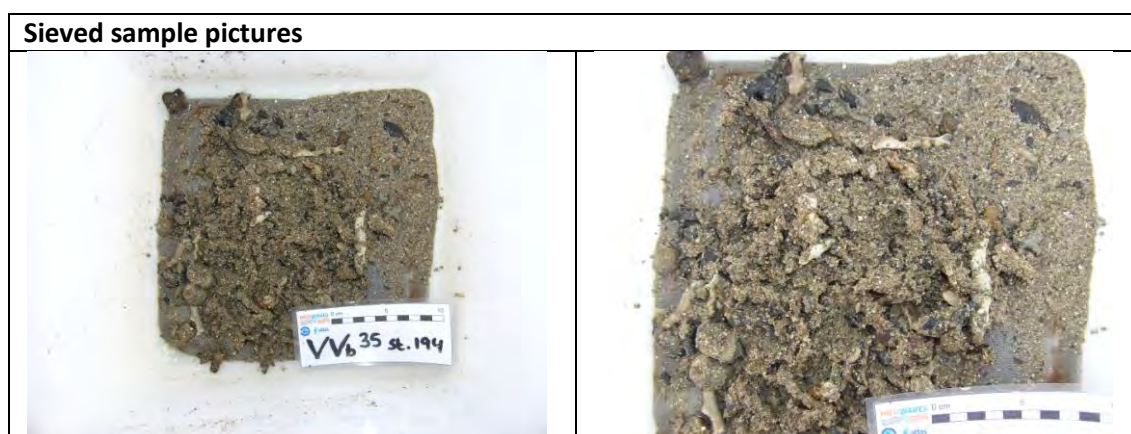

Research Vessel: SARMIENTO DE GAMBOA			
Sampling technique: Van-Veen C.O. Baleares			
Sample code:	VVb 36	Starting time:	11:18
Locations:	SECO DE LOS OLIVOS SE	Finishing time:	11:34
Date:	24/10/16	Sampling Station:	194

DREDGE ON BOTTOM	
LAT:	36°22.55 N
LON:	2°49.16 W
DEPTH (m)	321 m

DESCRIPTION
The Van Veen dredge collects ca. 4 liters of sediment, containing sand with bioclasts, coral rubble (mainly <i>Madrepora</i>) and rock fragments. No sub-sampling for the analysis of organic matter, geochemistry or foraminifera was done because the sample was very similar to the previous one (VVb-35). The sediment color is uniformly brown (10Y 4/4).

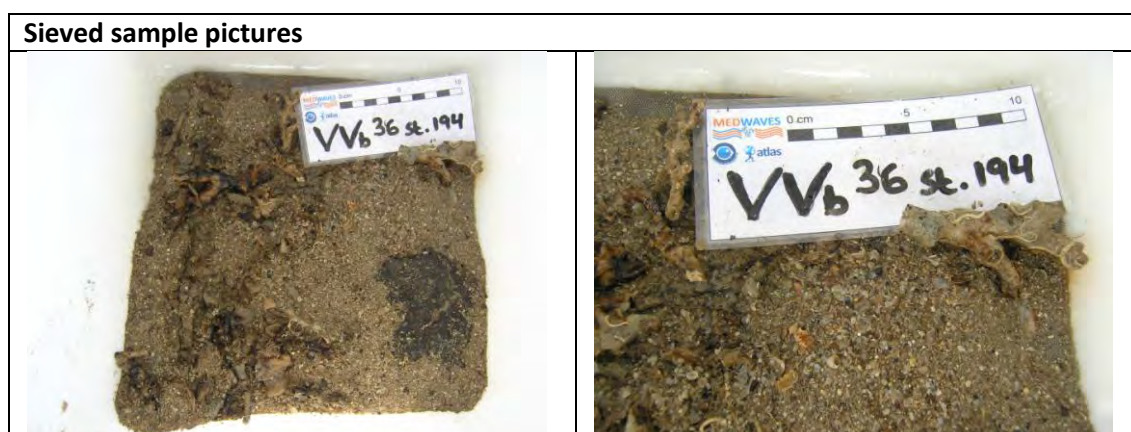
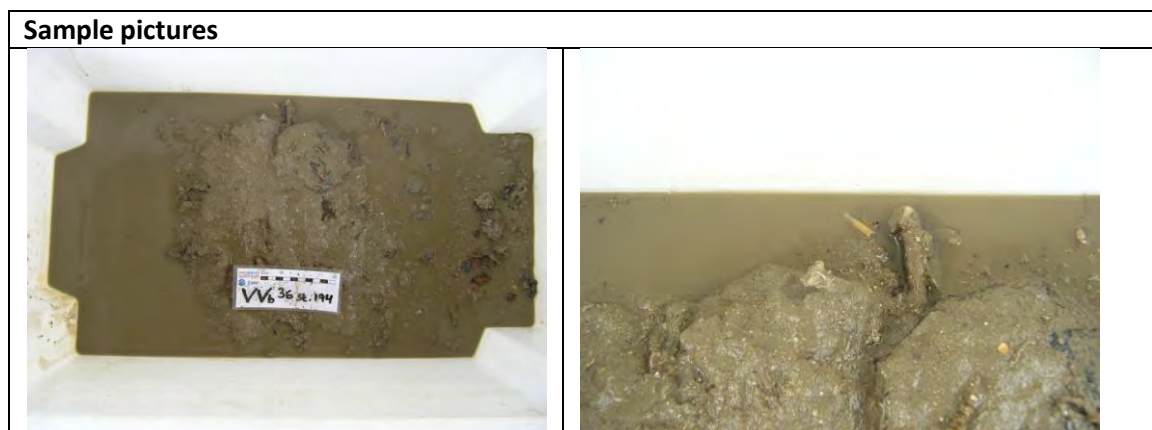

Resarch Vessel: SARMIENTO DE GAMBOA			
Sampling technique: Van-Veen C.O. Baleares			
Sample code:	VVb 37	Starting time:	11:37
Location:	SECO DE LOS OLIVOS W	Finishing time:	11:56
Date:	24/10/16	Sampling Station:	195

DREDGE ON BOTTOM	
LAT:	36°32.55 N
LON:	2°49.16 W
DEPTH (m)	321 m

DESCRIPTION
The VV dredge collects ca. 6 liters of hemipelagic sand that contains abundant coral remains (<i>Madrepora</i> , <i>Lophelia</i> , <i>Caryophyllia</i>) and live specimens of bryozoans, hydrozoans, polychaetes, bivalves (<i>Abra</i> , <i>Cuspidaria</i>) and gastropods (<i>Mitrella</i> , <i>Danilia</i>). The sediment is uniformly brown (2.5Y 6/3) in the entire sample. The sediment has been sub-sampled for the analysis of organic matter (120ml), geochemistry (120ml) and foraminifera (6cc).

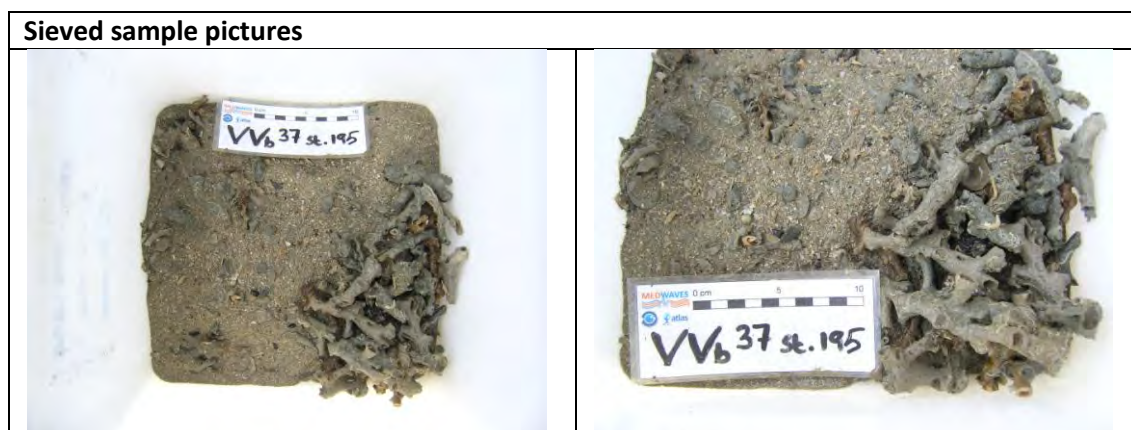
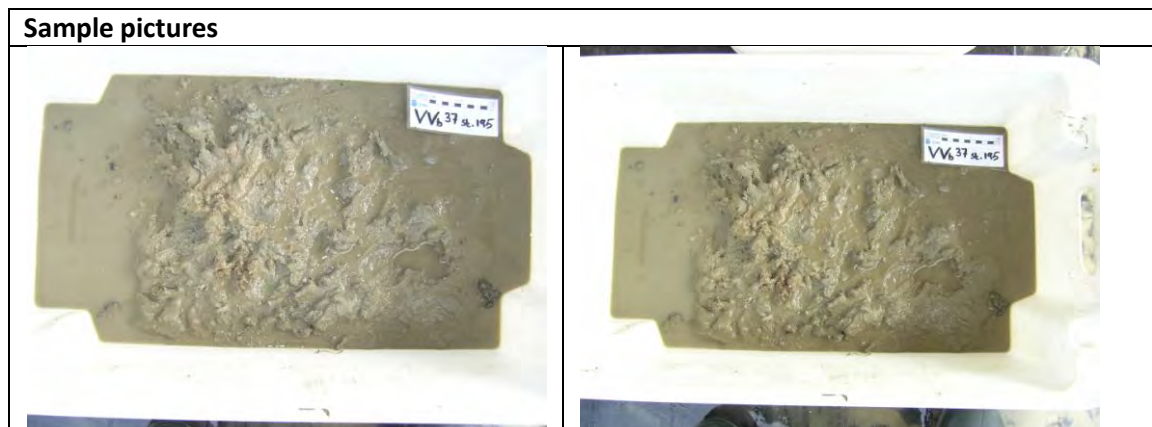

Research Vessel: SARMIENTO DE GAMBOA			
Sampling technique: Van-Veen C.O. Baleares			
Sample code:	VVb 38	Starting time:	16:24
Location:	SECO DE LOS OLIVOS NE	Finishing time:	16:38
Date:	24/10/16	Sampling Station:	197

DREDGE ON BOTTOM	
LAT:	36°22.20 N
LON:	2°49.22 W
DEPTH (m)	250m

DESCRIPTION
La Van Veen dredge collects ±8 litros of mud with fragmented coral rubble (<i>Madrepora</i>) and live specimens with contain (<i>Terpios</i> , <i>Haliclona</i> , <i>Ophiothrix</i> , <i>Crinoids</i> , <i>Reteporella</i> , <i>Eunice</i> , <i>Brachiopods</i> , <i>Coralliophyllia</i> and a big number specimens (about 50). Has been sub-sampled for the analysis of organic matter (120ml), geochemistry (120ml) and foraminifera (6cc). The sediment color si brown (10Y 4/2) and is uniform all sample.

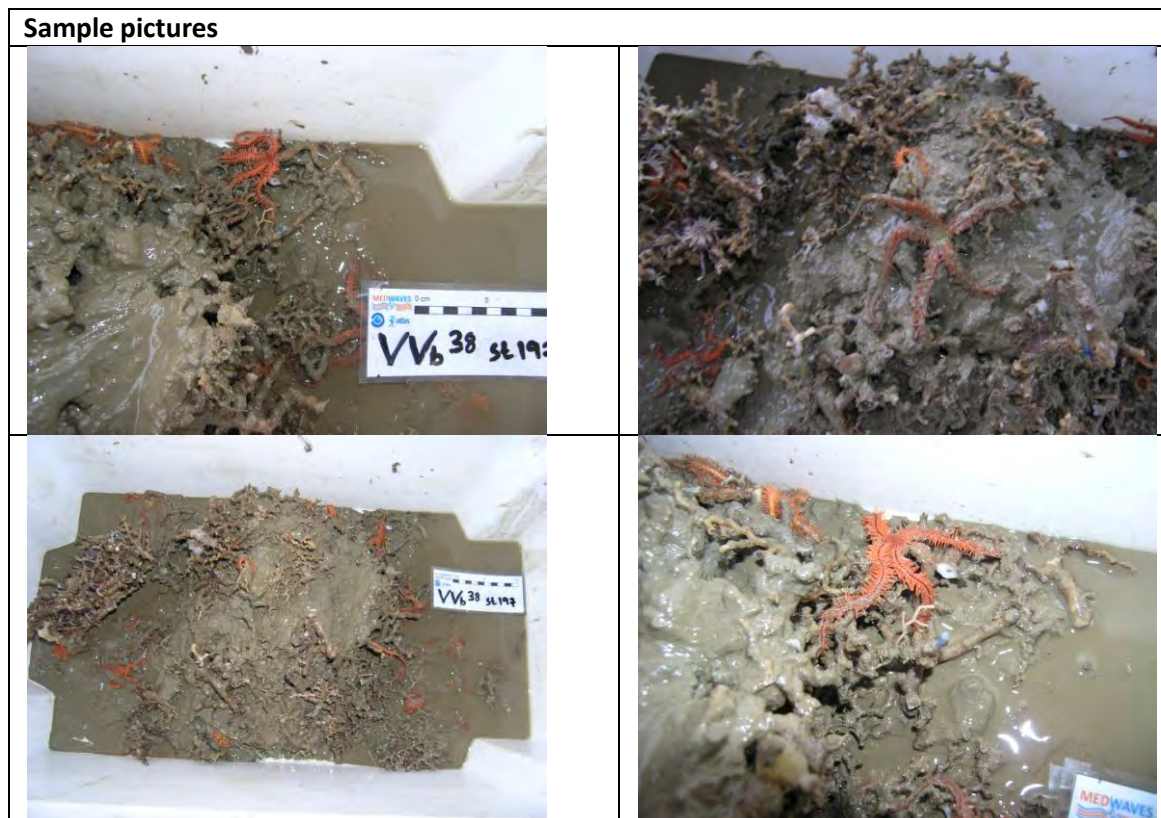

Sieved sample pictures



Research Vessel: SARMIENTO DE GAMBOA			
Sampling technique: Van-Veen C.O. Baleares			
Sample code:	VVb 39	Starting time:	16:41
Location:	SECO DE LOS OLIVOS NE	Finishing time:	16:54
Date:	24/10/16	Sampling Station:	198

DREDGE ON BOTTOM	
LAT:	36°32.20 N
LON:	2°49.22 W
DEPTH (m)	250m

DESCRIPTION
<p>The Van Veen dredge collects ca. 8 liters of sediment that contains mud and gravels with coral rubble (<i>Madrepora</i>) and live fauna that contains a specimen of the fish <i>Gaidropsaurus vizcayensis</i>, as well as solitary corals, mainly Caryophyllia (fixed in absolut Ethanol), ophiuroids (<i>Ophiothrix</i>), crinoids, Brachiopods, small sponges (<i>Terpios</i>, <i>Haliclona</i>) as well as small Zoantharians (fixed absolut Ethanol). Because this sample is very similar to the previous one (VVb-38), no sub-sampling for the analysis of organic matter (120ml), geochemistry (120ml) or foraminifers (6cc) was performed. The sediment is uniformly brown (10Y 4/2) through the sample.</p>

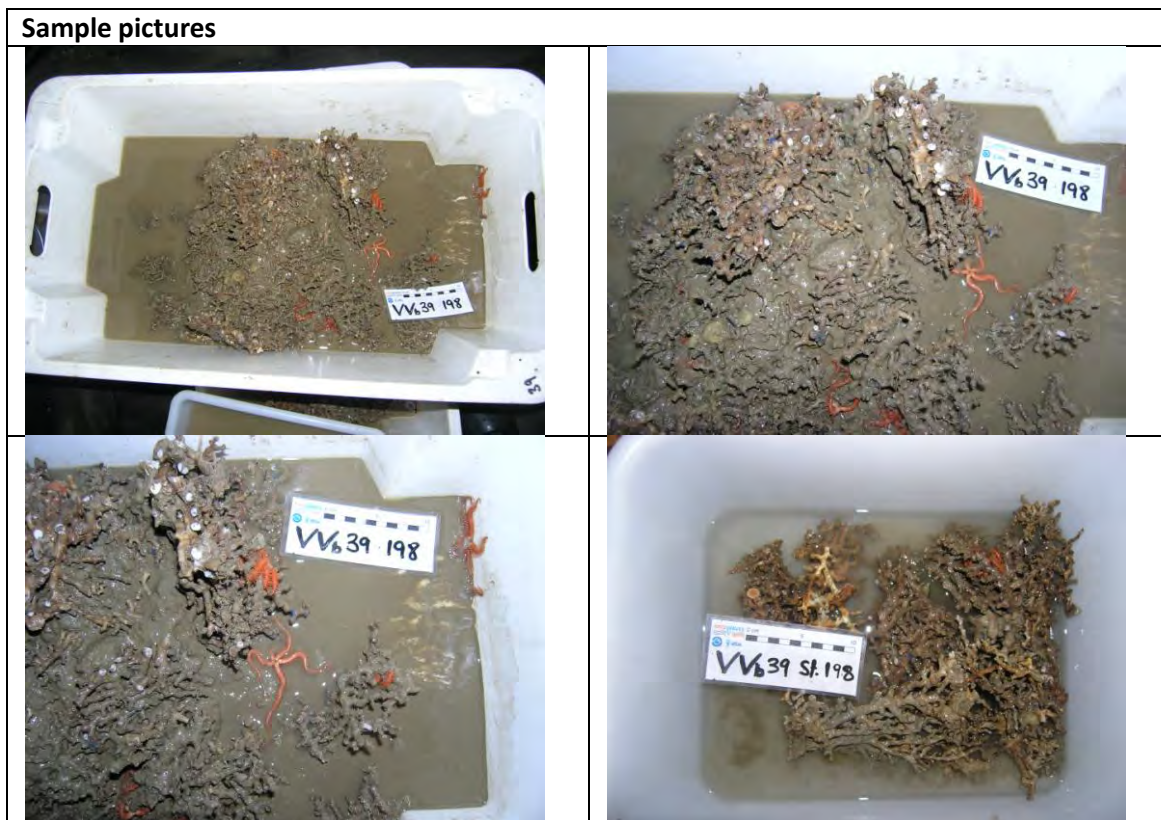

Sieved sample pictures



Research Vessel: SARMIENTO DE GAMBOA			
Sampling technique: Van-Veen C.O. Baleares			
Sample code:	VVb 40	Starting time:	16:58
Location:	SECO DE LOS OLIVOS NE	Finishing time:	17:10
Date:	24/10/16	Sampling Station:	199

DREDGE ON BOTTOM	
LAT:	36°32.20 N
LON:	2°49.22 W
DEPTH (m)	250m

DESCRIPTION
The Van Veen dredge collects a sample that contains ca. 8 liters of mud with abundant coral remains (mainly <i>Madrepora</i>) and a wide variety of live invertebrates (<i>Ophiothrix</i> , crinoids, <i>Coralliophila</i> , <i>Caryophyllia</i> , <i>Haliclona</i> , small zoantharians and brachiopods). The sediment is evenly brown (10Y 4/2) through the sample. The sediment has been sub-sampled for the analysis of organic matter (120ml), geochemistry (120ml) and foraminifers (6cc).

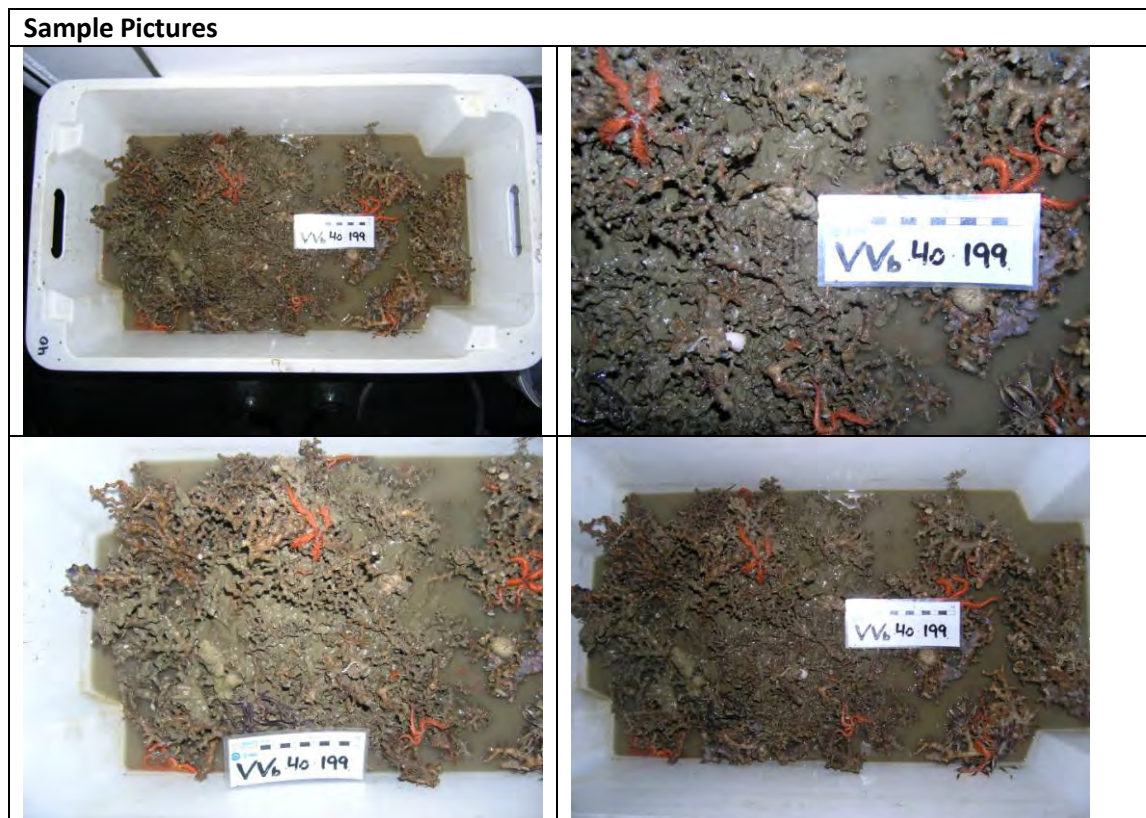

Sieved sample pictures

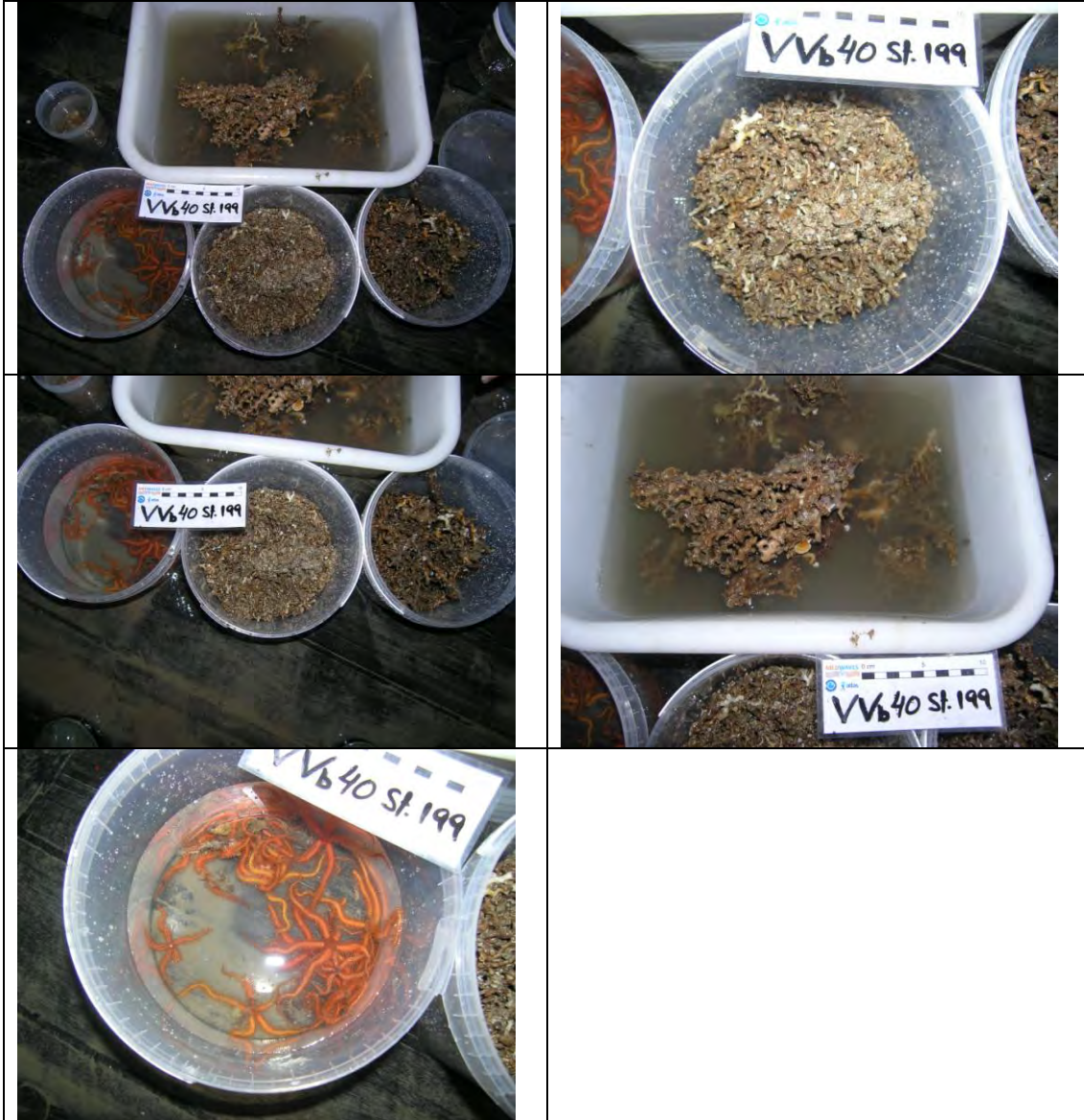

Research Vessel: SARMIENTO DE GAMBOA			
Sampling technique: Van-Veen C.O. Baleares			
Sample code:	VVb 41	Starting time:	17:34
Location:	SECO DE LOS OLIVOS NE	Finishing time:	17:52
Date:	24/10/16	Sampling Station:	200

DREDGE ON BOTTOM	
LAT:	36°32.76 N
LON:	2°48.81 W
DEPTH (m)	381m

DESCRIPTION
The Van Veen dredge collects ca. 8 liters of homogeneous hemipelagic mud with dead (<i>Abra</i> , <i>Calumbonella</i> and <i>Brissopsis</i>) and live fauna, being the latter mainly represented by polychaetes and bivalves(<i>Abra</i> sp.). The sediment is consistently brown (10Y 4/2) in the entire sample. Sub-sampling for the analysis of organic matter (120ml), geochemistry (120ml) and foraminifers (6cc) was carried out.

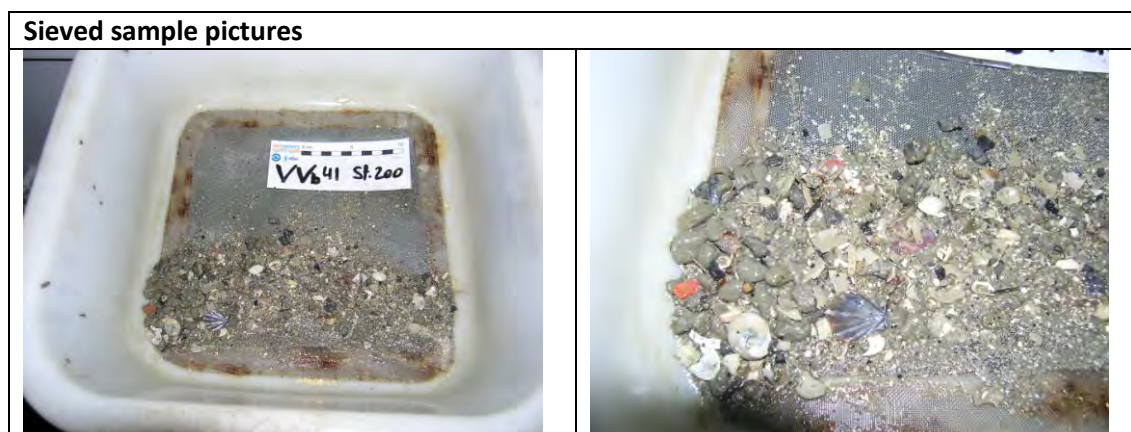

Resarch Vessel: SARMIENTO DE GAMBOA			
Sampling technique: Van-Veen C.O. Baleares			
Sample code:	VVb 42	Starting time:	16:18
Location:	SECO DE LOS OLIVOS SE	Finishing time:	16:34
Date:	25/10/16	Sampling Station:	212

DREDGE ON BOTTOM	
LAT:	36°31.24 N
LON:	2°48.17 W
DEPTH (m)	280m

DESCRIPTION

The Van Veen dredge collects ca. 8 liters of sediment containing coarse sand with bioclasts of *Pectinidae*, *Cuspidaria* and Bryozoa as well as live fauna represented by small hydrozoans, bivalves and polychaetes. The sediment is predominantly brown (2,5Y 4/2) in the whole sample. It has been sub-sampled for the analysis of organic matter (120ml), geochemistry (120ml) and foraminifers (6cc).

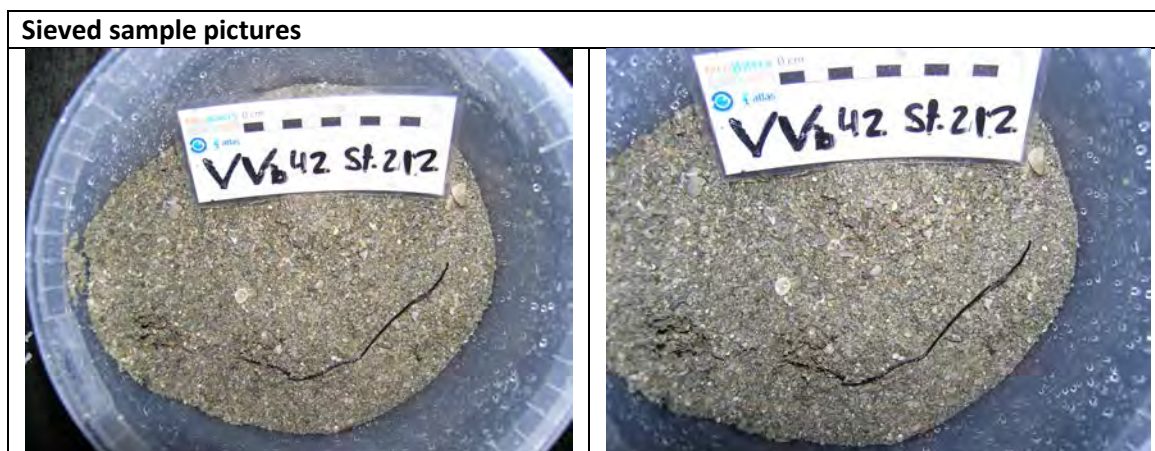

Research Vessel: SARMIENTO DE GAMBOA			
Sampling technique: Van-Veen C.O. Baleares			
Sample code:	VVb 43	Starting time:	16:34
Location:	SECO DE LOS OLIVOS SE	Finishing time:	16:50
Date:	25/10/16	Sampling Station:	213

DREDGE ON BOTTOM	
LAT:	36°31.24 N
LON:	2°48.17 W
DEPTH (m)	280m

DESCRIPTION
The Van Veen dredge collects a similar sample as the one of VVb-42 (ca. 8 liters of sediment), which is composed of coarse sand, mud and bioclasts of <i>Gryphus vitreus</i> , bryozoans and bivalves as well as live fauna containing polychaetes and bivalves. The sediment is uniformly brown (2,5Y 4/2) and it was sub-sampled for the analysis of organic matter (120ml), geochemistry (120ml) and foraminifers (6cc).

Sample pictures

Sieved sample pictures

Research Vessel: SARMIENTO DE GAMBOA			
Sampling technique: Van-Veen C.O. Baleares			
Sample code:	VVb 44	Starting time:	17:10
location:	SECO DE LOS OLIVOS SE	Finishing time:	17:31
Date:	25/10/16	Sampling Station:	214

DREDGE ON BOTTOM	
LAT:	36°31.04 N
LON:	2°48.04 W
DEPTH(m)	440m

DESCRIPTION

The Van Veen collects ca. 8 liters of hemipelagic mud with coral (*Madrepora*, *Desmophyllum*, *Lophelia*, *Caryophyllia*) and bivalve remains (*Astarte*) as well as live fauna represented by polychaetes and bivalves (*Astarte*). The sediment color is uniformly brown (7,5Y 4/2) in the entire sample. Sub-sampling for the analysis of organic matter (120ml), geochemistry (120ml) and foraminifers (6cc) was performed.



Appendix VIII: List of the 25 ROV dives conducted during MEDWAVES.

Date	Time		Dive	Lat		Lon		TOTAL TIME
22/09/2016	09:38:00	15:56:00	1	36	34.2419	6	55.9551	06:18:00
23/09/2016	07:31:00	16:10:00	2	36	33.92	6	57.19	08:39:00
25/09/2016	07:41:00	16:25:00	3	36	58.67	10	47.07	08:44:00
29/09/2016	11:52:00	17:49:00	4	37	8.013	24	8.142	05:57:00
30/09/2016	08:50:00	14:08:00	5	37	10.251	24	38.11	05:18:00
01/10/2016	08:45:00	16:19:00	6	37	11.36	24	37.97	07:34:00
02/10/2016	13:00:00	17:10:00	7	37	12.19	24	37.91	04:10:00
03/10/2016	09:08:00	11:30:00	8	37	12.62	24	39.69	02:22:00
04/10/2016	08:59:00	15:52:00	9	37	20.511	24	44.45	06:53:00
05/10/2016	09:00:00	11:29:00	10	37	20.4	24	45.34	02:29:00
07/10/2016	08:52:00	13:15:00	11	37	20.18	24	45.39	04:23:00
07/10/2016	14:11:00	18:22:00	12	37	19.64	24	45.7	04:11:00
08/10/2016	08:55:00	12:23:00	13	37	11.87	24	48.11	03:28:00
18/10/2016	12:43:00	15:45:00	14	36	52.03	10	53.37	03:02:00
19/10/2016	06:26:00	11:21:00	15	36	52.03	10	53.37	04:55:00
19/10/2016	12:07:00	17:22:00	16	36	48.01	10	57.03	05:15:00
20/10/2016	07:09:00	14:19:00	17	36	48.66	11	7.56	07:10:00
20/10/2016	15:37:00	17:52:00	18	36	46.98	11	6.76	02:15:00
23/10/2016	07:01:00	08:43:00	19	36	28.72	2	53.75	01:42:00
23/10/2016	12:23:00	13:15:00	20	36	28.95	2	53.52	00:52:00
23/10/2016	13:54:00	18:28:00	21	36	28.96	2	53.52	04:34:00
24/10/2016	06:41:00	10:14:00	22	36	32.76	2	48.78	03:33:00
24/10/2016	12:27:00	15:39:00	23	36	32.38	2	49.26	03:12:00
25/10/2016	06:47:00	10:49:00	24	36	30.96	2	47.62	04:02:00
25/10/2016	11:45:00	15:38:00	25	36	30.77	2	49.09	03:53:00

Appendix IX: OFOP users guide for MEDWAVES

This protocol is done within the ATLAS project in order to make live annotations easier to use among different people.

It is a work in progress so any contribution to the improvement is more than welcome.

Please if you have any questions, comments feel free to ask on meribilan@gmail.com

1.1. Download OFOP

You can download the software from <http://www.ofop-by-sams.eu/>

Follow the instructions and be aware that you include the latest version in the OFOP program files (Fig.1).

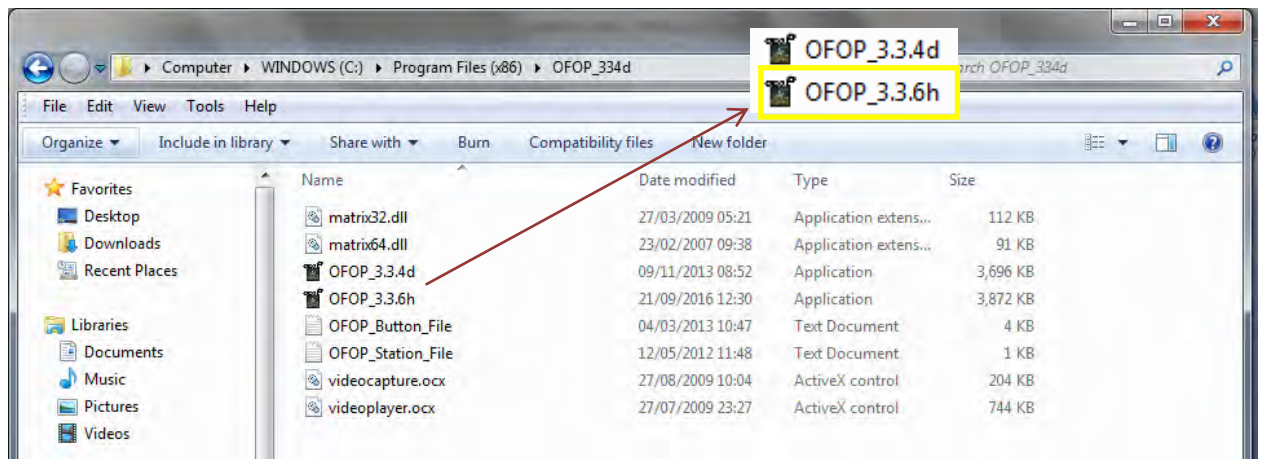

Figure 1. OFOP in program files with the latest version OFOP_3.3.6h

The download is the demo version. If you are able to have a key, this is great. In that case keep the pen drive with the key in the computer when using OFOP.

In case you cannot get the key, you can still use the software but every 15 min a pop-up will appear asking if you want to close the software. Occasional freezing of the software or similar issues may appear.

When downloaded, if you will use it frequently, you can make a shortcut on desktop. Be careful to make a shortcut of the latest version.

1.2. Live annotation

In my experience, the videos are recorded on one computer while the annotation in OFOP is done on another. How to set up OFOP and work in that kind of situation will be presented in this guide.

One important thing before opening OFOP is to synchronize the **time on your computer** with the **time that the video is recorded in** and **time that the navigation is recorded in** (Fig.2). UTC time is very useful in these cases, but nevertheless whatever time you chose to work on take notes and be sure that everyone involved in the ROV mission knows on what time are you all working in.

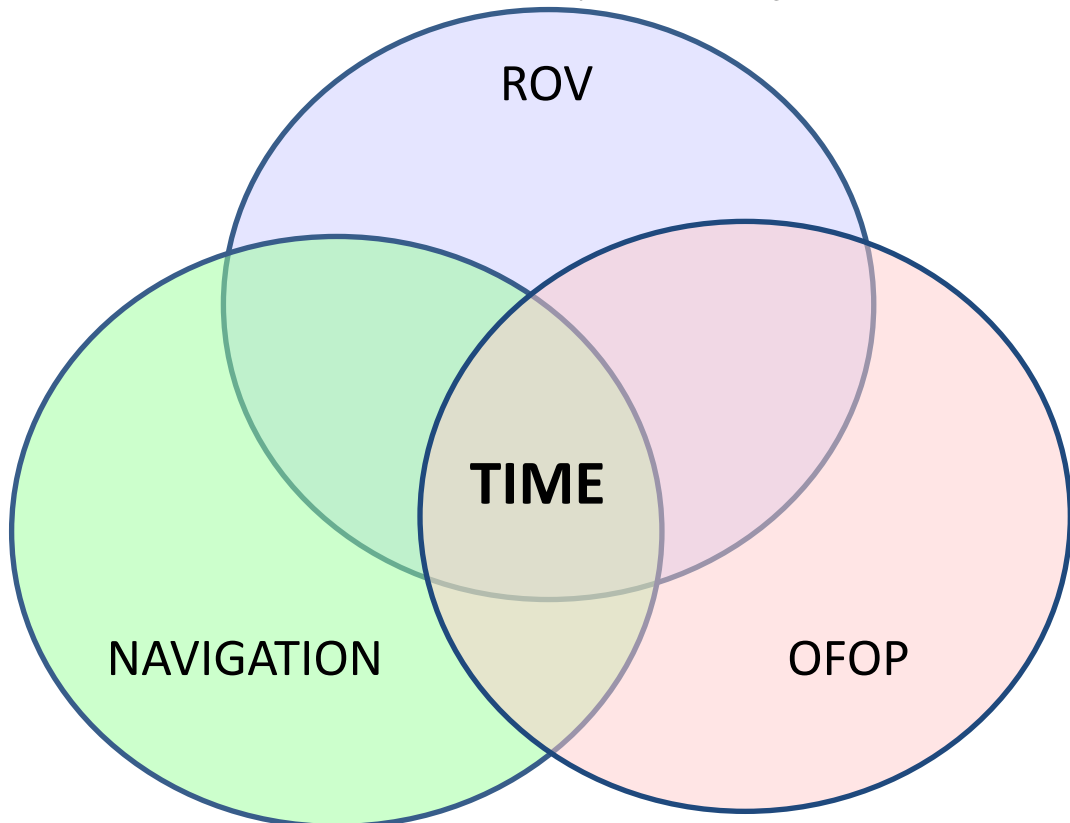

Figure 2. Scheme of different groups contributing to the ocean floor observation process. For it to succeed time has to be the same in all groups

Time can be change by clicking on "Change time and date settings" in the lower right corner of the taskbar where the date and time are displayed.

1. Open OFOP

The Map Tools window can be closed at the moment.

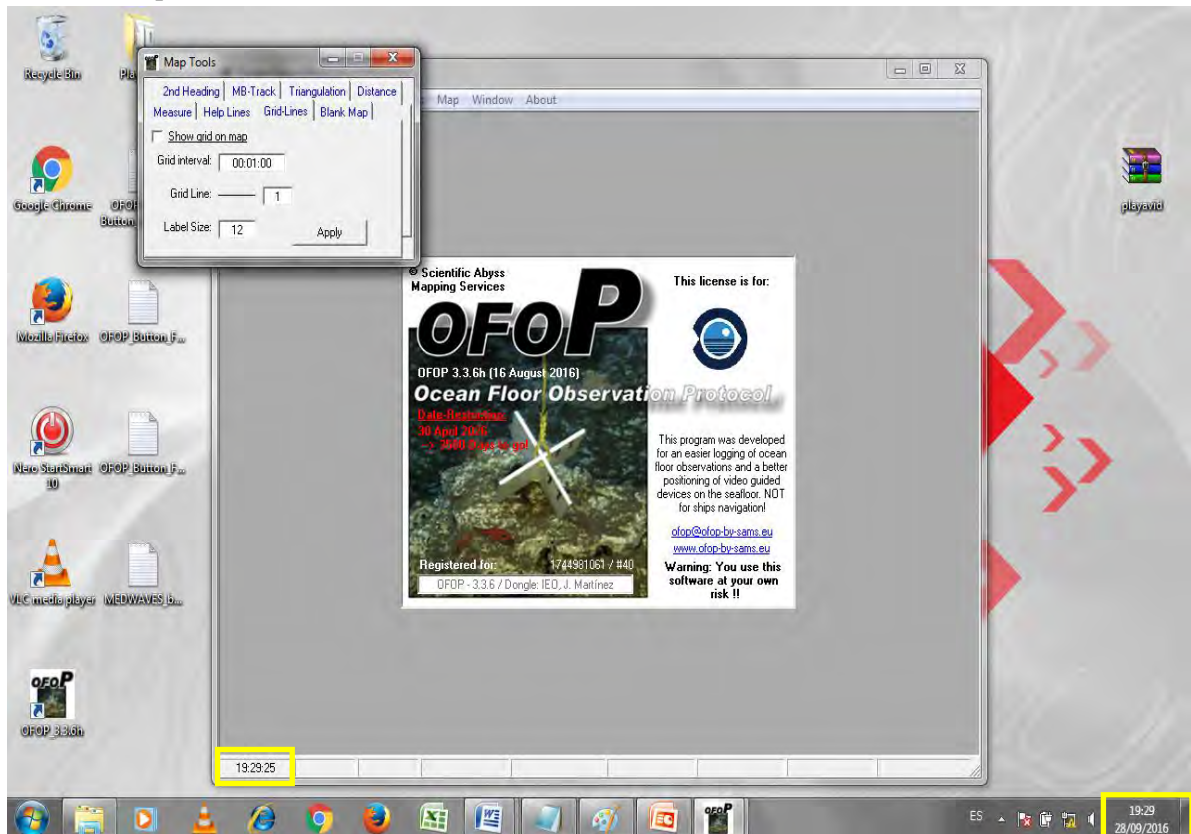

Figure 3. Open OFOP

OFOP connects to the computer time, as you can see in the lower left corner of the main OFOP window (yellow boxes in Fig. 3).

There is a possibility in Tools to connect time on the computer with the navigation (this will be presented a bit later), but if possible it is better to have the computer on agreed time and avoid misunderstandings. In any case, be sure to make a note so other people using the data afterwards know this kind of information.

2. GPS & Logging

After adjusting the time, we need to connect OFOP to the navigation systems of the ship and ROV. This is a very important step in the whole annotation process and you need to consult with either the ROV team or the scientists navigating the ROV

threw the planned transects. If in doubt best is to approach the chief scientist that will introduce you to the people involved.

First make sure that you are connected to the ships network via Ethernet cable (or other means depending on the ship)

Open OFOP/ GPS & Logging tab/ SHIP & SUB – Data Connection

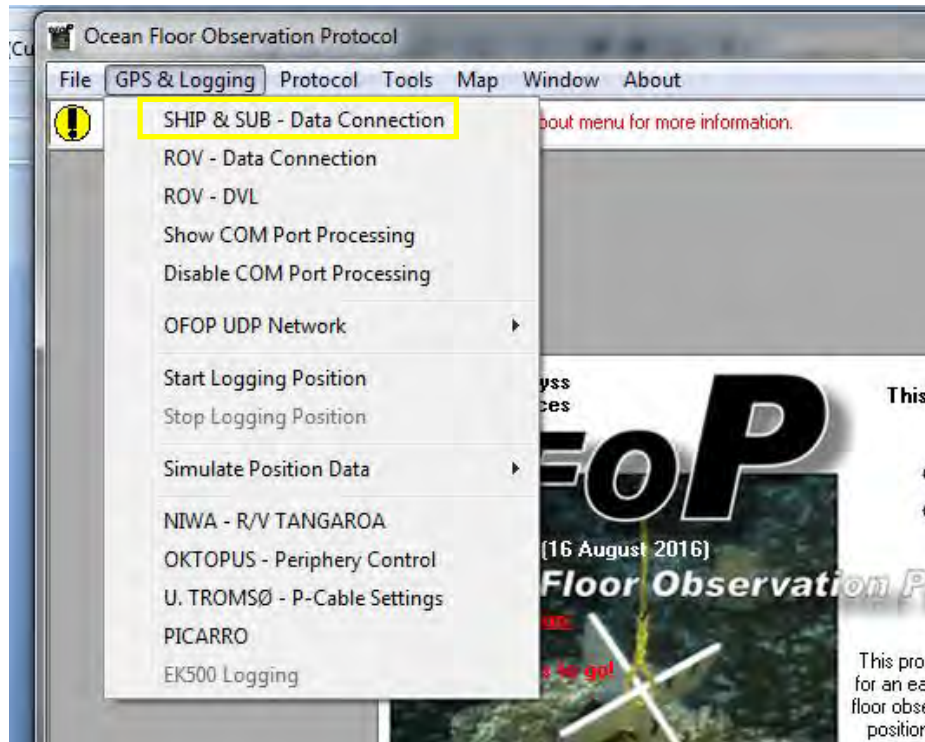

Figure 4. GPS & Logging tab

SHIP (1st Position)

During the MEDWAVES expedition we received the data from the Server (green box in Fig. 5) not from the COM port. For this reason in this protocol it is presented the details of “Read Data from Server on Port” kind of data connection.

In the red box in Fig. 5 you can see OFOPs IP address in the network.

You need to insert the correct IP address of the server and the port number (blue box in Fig.5). For this you need the help of someone in charge to give you the correct numbers.

Check the Read Data from Server on Port (pink arrow in Fig.5)

Make sure that all firewalls or antivirus software ARE TURNED OFF!

If everything is ok you should get something similar to what is shown in the yellow box in Fig.5.

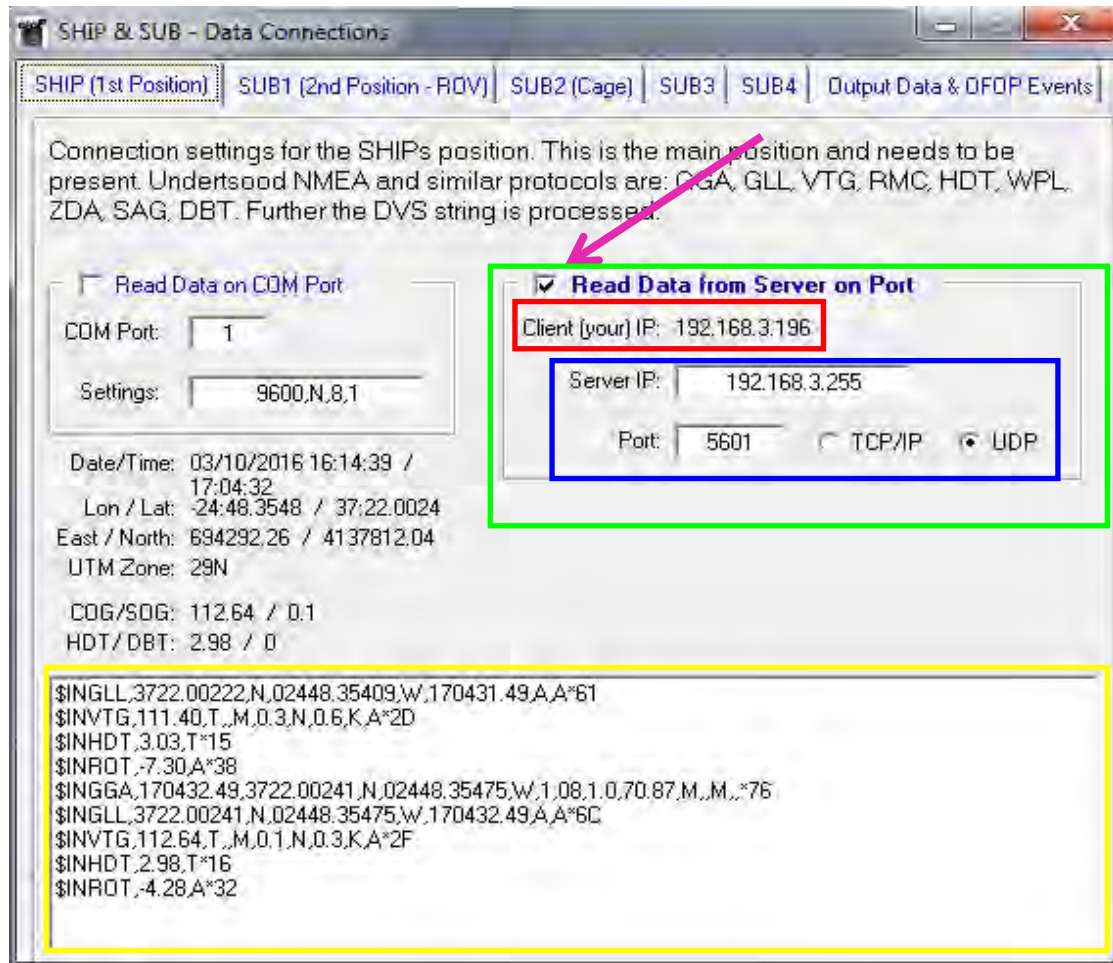

Figure 5. SHIP (1st Position) tab

SUB (2st Position - ROV)

In the red box in Fig. 6 you can see OFOPs IP address in the network.

You need to insert the correct IP address of the server and the port number (yellow box in Fig.6). For this you need the help of someone in charge to give you the correct numbers. Note that the server IP and port are different for the ship and sub (compare blue box in Fig. 5 and yellow box in Fig. 6).

In the Processed Protocol section (orange box in Fig. 6) in the dropdown menu you need to choose which type of protocol is processed so OFOP can read the data coming from the server in the correct way. In this case we used GGA, GLL, RMC.

Check the Show Position for SUB1 (ROV)

Check the Read Data from Server on Port (purple arrow in Fig.6)

Make sure that all firewalls or antivirus software ARE TURNED OFF!

If everything is ok you should get something similar to what is shown in the blue box in Fig.6.

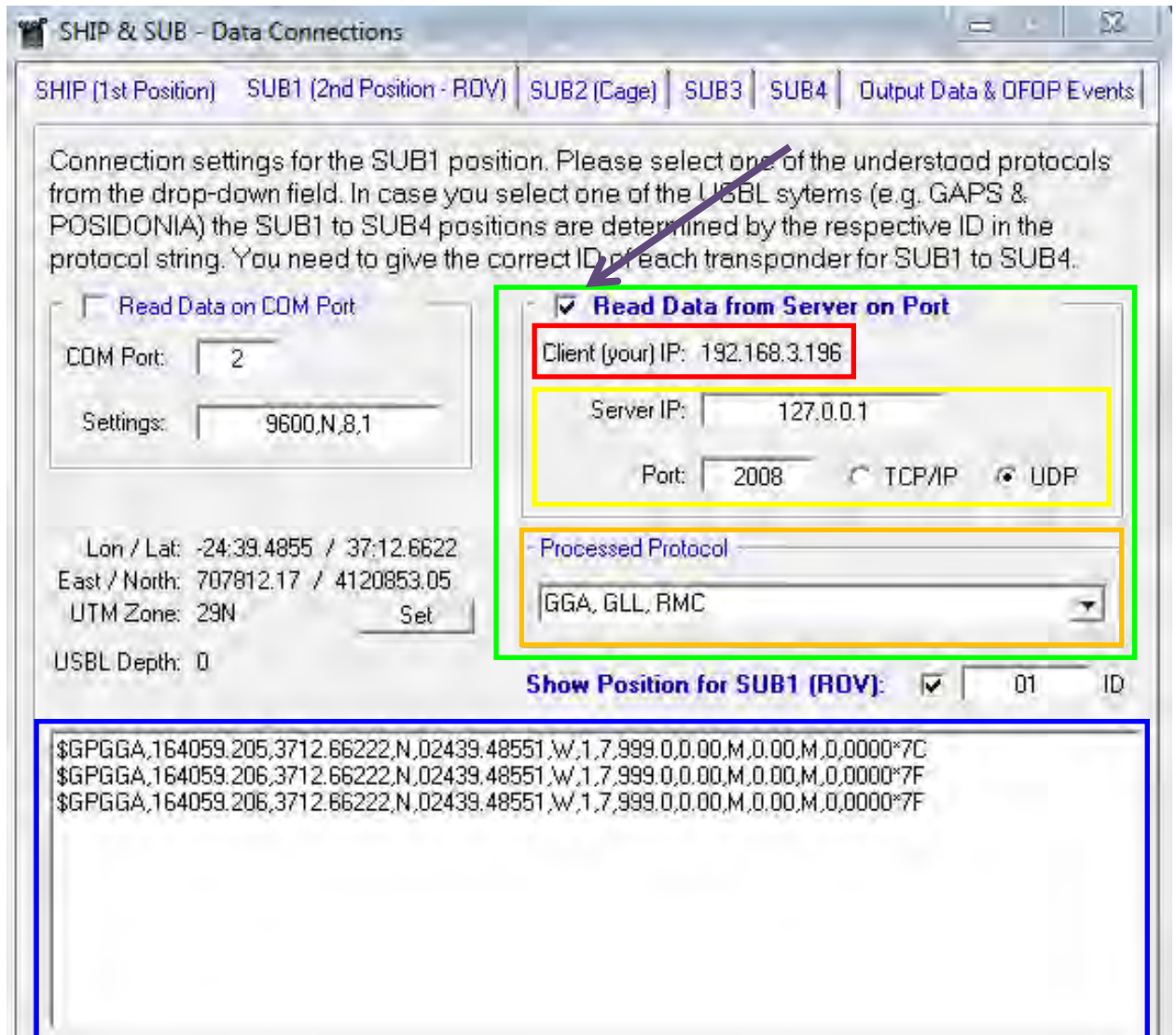

Figure 6. SUB (2nd Position - ROV) tab

If you want you can do a similar procedure for the SUB2 (Cage), but during the first leg of MEDWAVES we did not use it.

3. Button file

The "button" file is a .txt document that you import to OFOP in order to make annotations. You customize the buttons as you like depending on what you want to annotate. With the download of the software you get an example of the button file, as in Fig 7.

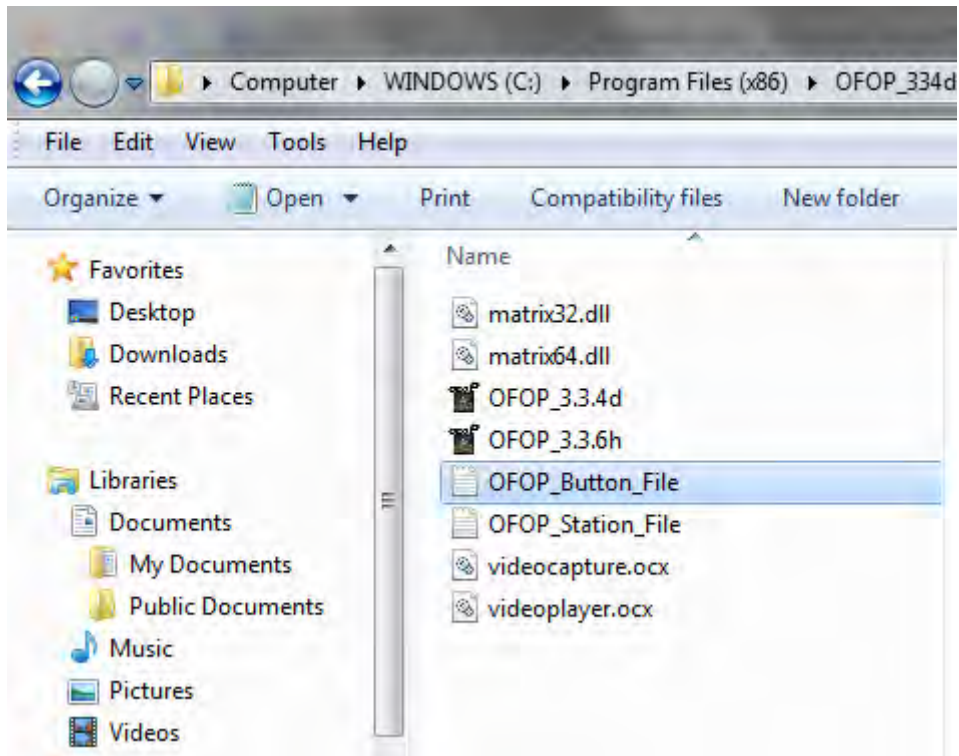

Figure 7. Location of the example button file

The header of the file has all the necessary information you need to follow to make it work. Be sure to have enough time to make a button file and save it as a .txt.

After customizing and saving your button file you need to load it in OFOP by Protocol/Seafloor Observation Window shown in Fig. 8.

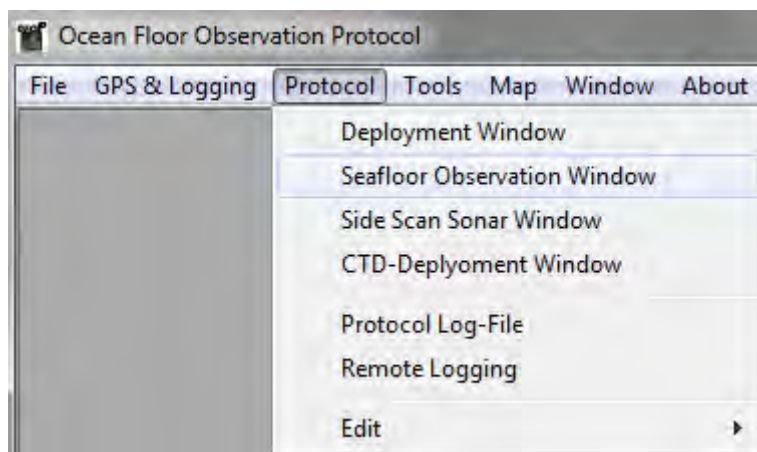

Figure 8. Seafloor observation window location

In Fig. 9 is the loaded button file. At any time during the annotations you can edit the button file (yellow arrow in Fig. 9), save it and load it again (blue arrow in Fig. 9). You can also write in the area that is highlighted with the green arrow in Fig.9.

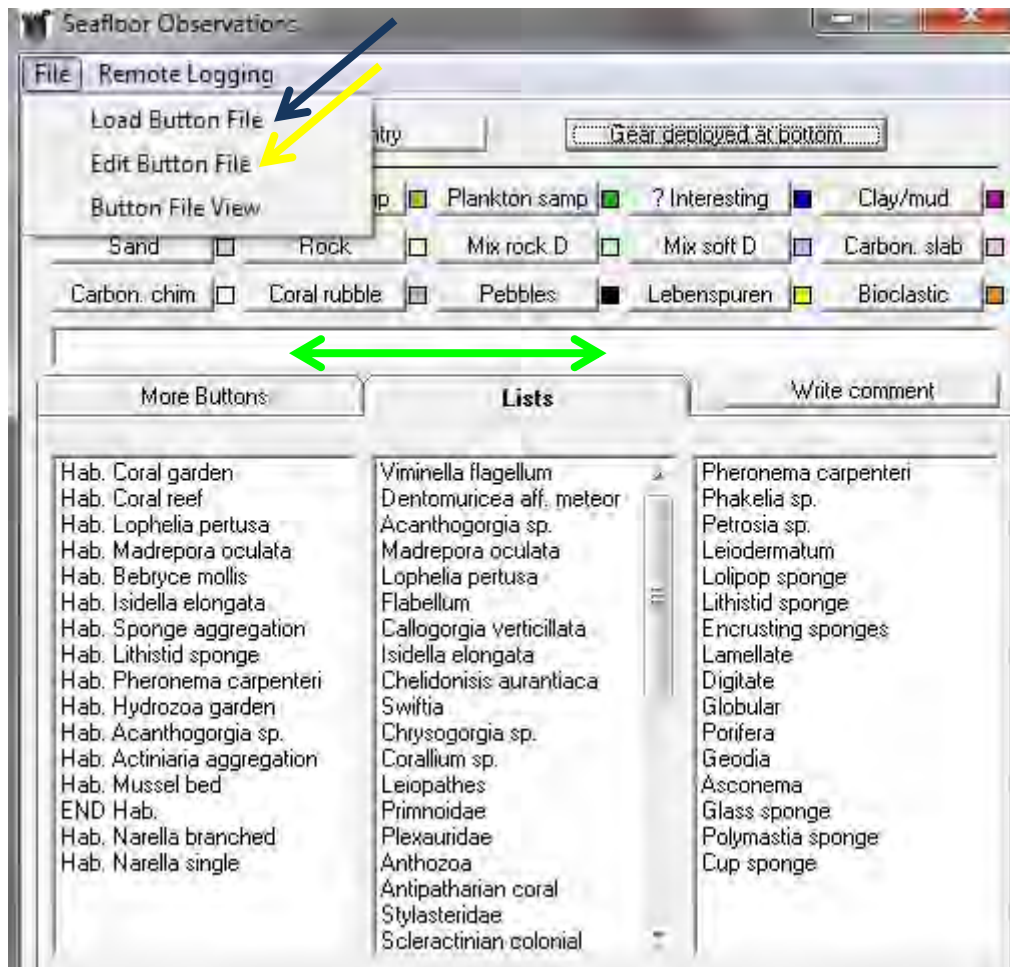

Figure 9. Loaded button file

4. New protocol

The navigation and the annotations are within a protocol. You create a new protocol by File/New protocol as shown in Fig. 10. Probably you will get a pop up window as in Fig 11, so make sure that all your previous work is saved.

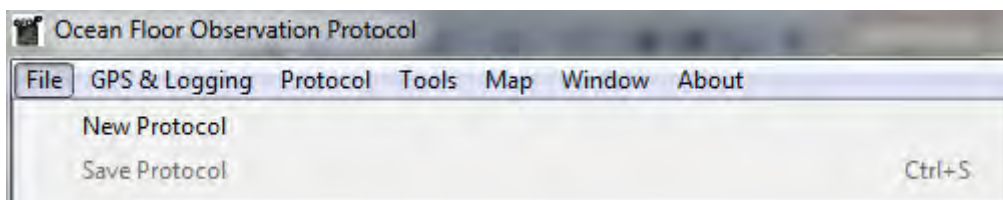

Figure 10. File tab

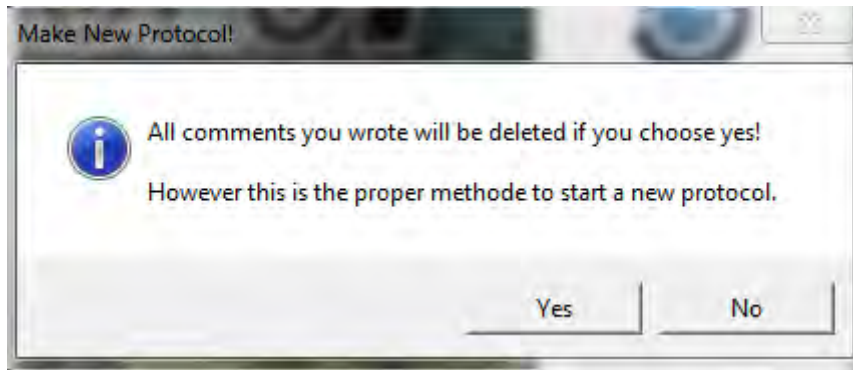

Figure 11. Make New Protocol!

After saving the new protocol open the folder you saved it in to check if all the files necessary are there. OFOP creates three different files: `_obser`, `_posi` and `_prot` (Fig.12). All these files have different combinations of data collected but the basics are:

- In the `_obser` files OFOP writes the annotations made by clicking on the buttons and lists in the button window.
- In the `_posi` file OFOP writes the coordinates in decimal degrees for the ship and the sub for each second of the dive. Here you can also find the depth of the ROV in meters (but check the values with the ROV team or navigation control)
- In the `_prot` file you can find all the annotations made with the button file, all the comments made during annotation, metadata and coordinates of the ship and ROV

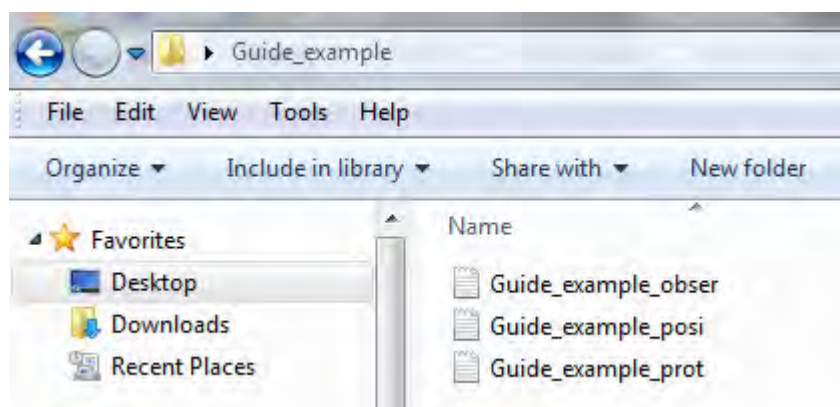

Figure 12. Files that make OFOP protocol

5. Map

It is useful to have the map of the area that is investigated. During the ROV dive, location of the ROV is immediately transferred to the map. You ask for the map to the ROV team, navigation control or chief scientist.

Go to File/Load Map Image (blue arrow in Fig. 13). This should be in a JPEG file. The image should have either a lat/long grid or two points on diagonally opposite sides with known coordinates.

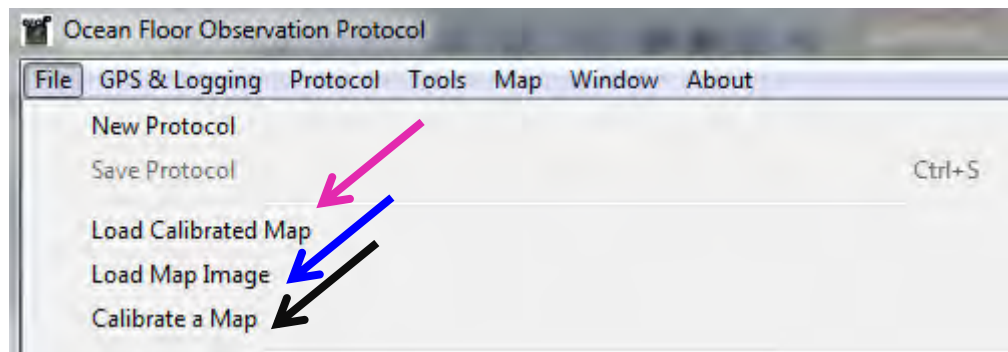

Figure 13. Map tabs

Once you have loaded the map image you need to calibrate it by clicking on Calibrate a Map (black arrow in Fig.13) which opens a new window Map Calibration (Fig.14).

Make sure that everything in the Projection section (blue box in Fig. 14) is correct.

You click on the 1st Coordinate section (yellow box in Fig.14). Then you click on first point on the map image and enter the first coordinates in the tabs named Latitude and Longitude. The coordinates have to be in degrees: minute.decimal. Be careful with North/South and East/West.

You repeat the same process for the second point on the map image (red box in Fig. 14).

After you finish click on Save calibration.

This will create a .map file.

Now you proceed to the Load Calibrated Map (pink arrow in Fig. 13) where you pick from the folder the .map file.

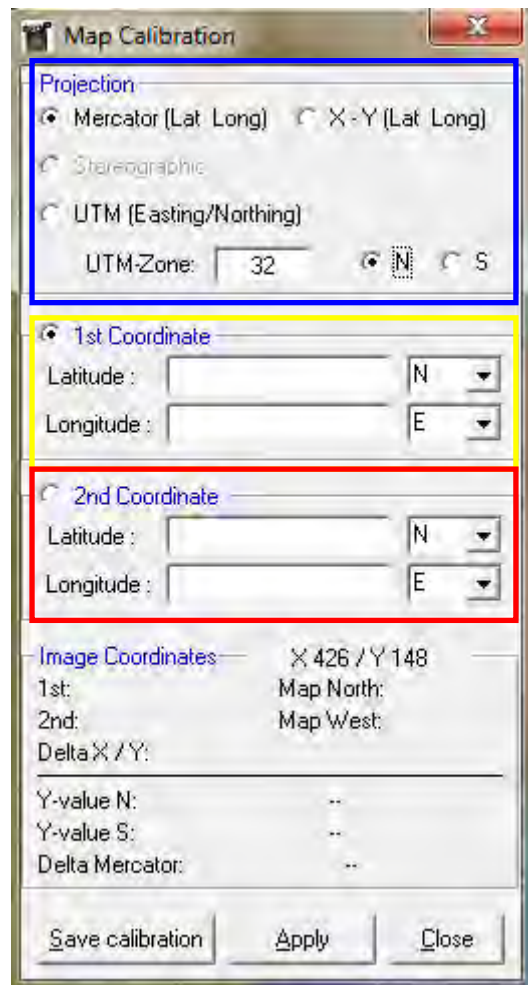

Figure 14. Map Calibration tab

In the Map/Information you can choose what kind of information you want to have on the map (Fig. 15).

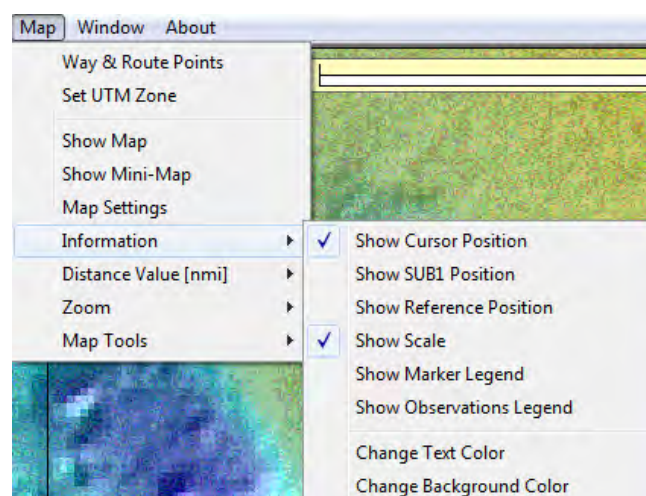

Figure 15. Map tab (part 1)

In Map/Map tools/Show you can choose what you want present on the map (Fig.16).

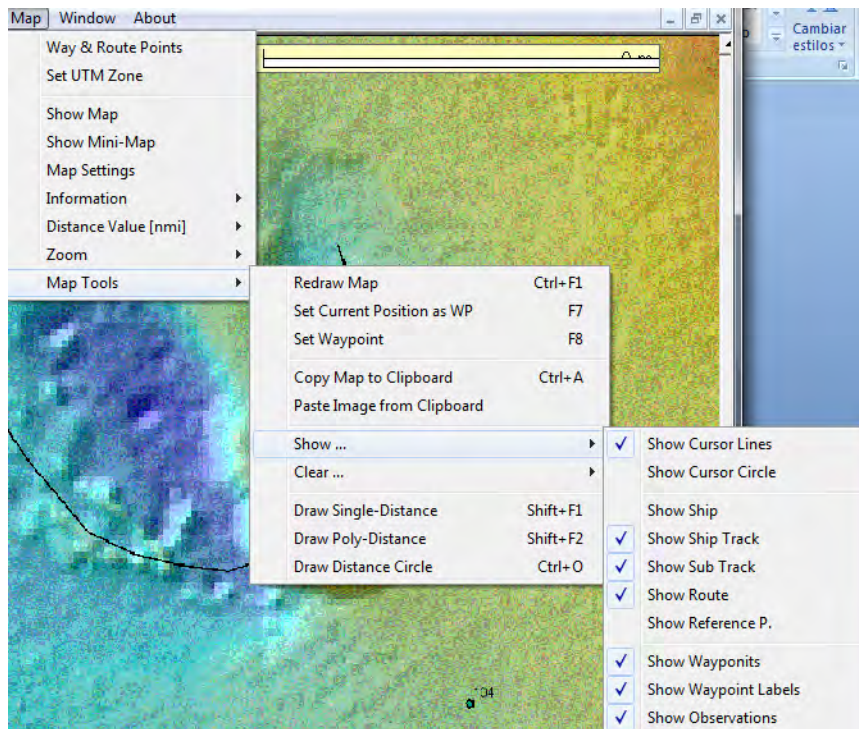

Figure 16. Map tab (part 2)

In Map/Map Settings you can change some of the properties of the objects presented in the map (black box in Fig. 17). Here you can also change what is presented in the `_prot` and `_posi` files (red box in Fig. 17).

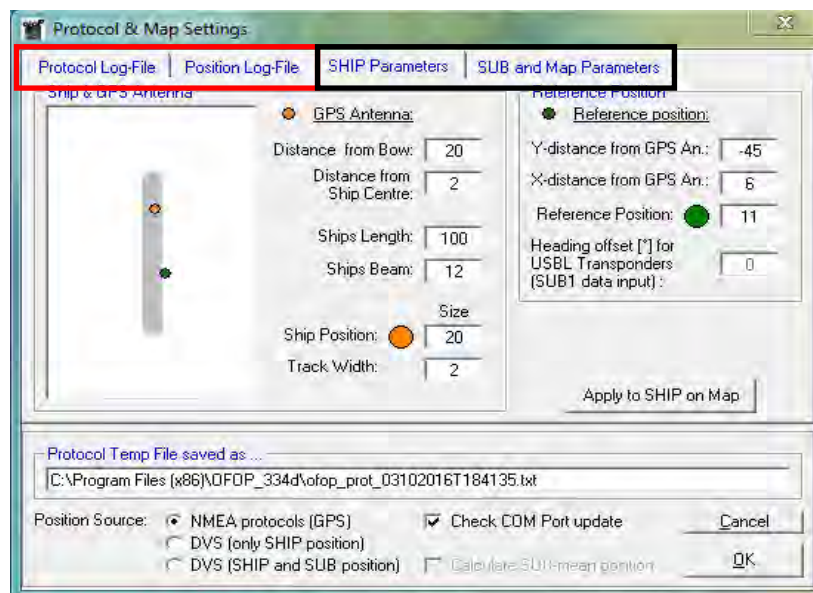

Figure 17. Protocol & Map Settings

6. Start Logging Position

The next steps should be done just before the start of the ROV, but it is necessary to have done all the steps described before!

Before the dive in GPS & Logging click on the Start Logging Position (red arrow in Fig. 18).

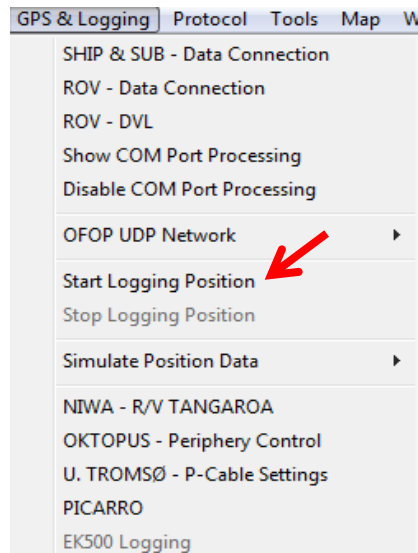

Figure 18. Start Logging Position

7. Deployment Window

Go to Protocol/Deployment Window which opens a pop-up like in the Fig.19. On the Deployment Basics (blue arrow in Fig.19) you enter the Cruise name and station number as well as any other useful information.

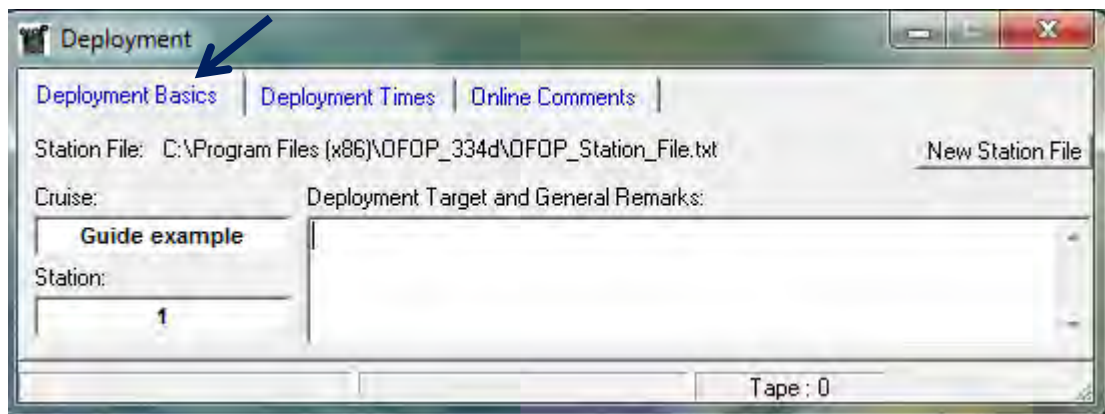

Figure 19. Deployment window

Switch to the Deployment Times tab in the Deployment Window.

Make sure you have the 4h tapes checked (yellow box in Fig. 20).

Click start recording (red box in Fig.20). The tape time should start like you can see in the green box in Fig. 21.

When the ROV enter the sea click on “In the water” and a pop-up will appear where you can add the depth (blue box in Fig. 21). You note when the ROV is at the bottom (and the depth), when is it off the bottom and when it is on the deck.

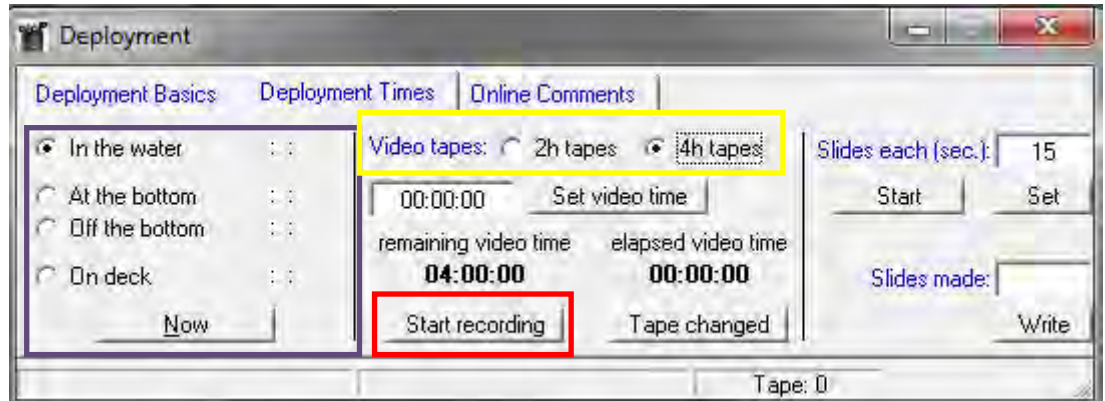

Figure 20. Deployment Window/Deployment times (part 1)

If the ROV dive is longer than 4 hours a pop-up window will appear 10 minutes before the tape runs out of space. You click on Tape changed and OFOP will continue to log (black box Fig.21).

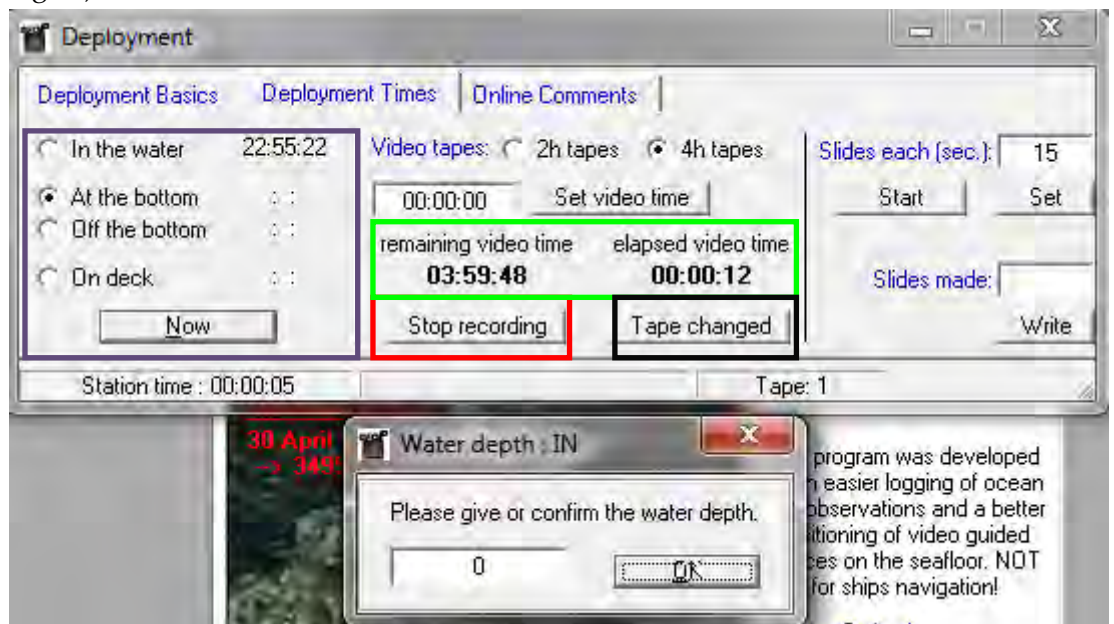

Figure 21. Deployment Window/Deployment times (part 2)

The tape change is for internal OFOP count. It doesn't change the time or the navigation, but it is necessary to do in order to keep the observations in the same file.

When the ROV is off the bottom you note by clicking on the Off the bottom like in the blue box in Fig. 21.

When the dive is finished you click on the On deck and it automatically stops recording, or you can terminate the recording by clicking on the Stop recording shown in the red box in Fig. 21.

A pop up window will appear asking to save the map it logged during the dive. You should click yes and it saves it in the same folder where are all the files from the dive.

Before closing the OFOP you should save the protocol with Ctrl+S or File/Save protocol.

1.3. Post processing

After the dive there is still some work to be done in order to make the files as user friendly as possible and check if some mistakes occurred.

1. Ask for the navigation files from the navigation team

The navigation team have their files that are created every dive. If you ask politely, they can give you the file after each dive. During the MEDWAVES, I recommend to continue with the same practice.

These files are collected in the ROV files folder.

I have created a vlookup excel file with in the Documents. This file is used to check if the navigation is ok and to find the depth from the ROV files. We have found that the depth that we get through OFOP does not match the one in the ROV files. Since we haven't figured out what is the exact issue, I have searched the depths for every dive in the corresponding ROV file.

If it is possible to detect the issue during the second leg, please note it in this document in order to avoid similar mistakes in the future.

2. Checking latitude

Open the vlookup file, spreadsheet latitude.

Open the ROV file in another excel file. This is dot and coma delimited, so be aware of this when opening.

Open the posi file in another excel file. This is tab delimited, so be aware of this when opening.

Proceed with copy/pasting as follows in Fig. 22:

	A	B	C	D	E	F	G	H	I	J	K	L
1	Hora	Latitud	Time	ROV find	SUB1_Lat	Degrees	Minutes with N	Minutes	Minutes/60	Degrees decimal	Difference	State
2	08:57:24	3720.368N	08:58:52	3720.368N	37.3394708	37	20.368N	20.368	0.33946667	37.33946667	1.0000001	Good
3	08:57:25	3720.368N	08:58:53	3720.368N	37.3394708	37	20.368N	20.368	0.33946667	37.33946667	1.0000001	Good

- A. Hora - copy Hora (time) from the ROV file
- B. Latitud - copy Latitude from the ROV file
- C. Time – copy Time from the posi file
- D. ROV find – finds the latitude from B if A and C match
- E. SUB1_Lat – copy SUB1_Lat from the posi file
- F. Degrees – finds the degrees from B
- G. Minutes with N – finds the minutes with N (for north) in B
- H. Minutes – removes the N from the minutes
- I. Minutes/60 – divides minutes from H with 60 in order to get a decimal format
- J. Degrees decimal – adds the degrees from F with minutes from I
- K. Difference – checks the difference between the E and J
- L. State – if the difference is less than 0.0001 the state is good, otherwise is bad

Figure 22. Vlookup/Latitude

Check if all the rows are filled. Sometimes you may find #N/A, and the problem is usually that the Vlookup formula cannot find the correct hour. In that case move the search borders of the formula to a smaller number. For example as shown in Fig 23. The search starts at C260 & A260, but it cannot find it, so you move the search to C200 & A200.

```
=BUSCARV(C260:C723,A260:B30705,2)
```

```
=BUSCARV(C200:C723,A200:B30705,2)
```

Figure 23. Change in Vlookup borders

If everything is ok, you can move on.

3. Checking longitude

Open the vlookup file, spreadsheet longitude.

Open the ROV file in another excel file. This is dot and coma delimited, so be aware of this when opening.

Open the posi file in another excel file. This is tab delimited, so be aware of this when opening.

Proceed with copy/pasting as follows in Fig. 24:

	A	B	C	D	E	F	G	H	I	J	K	L	M	N
1	Hora	Longitud	Time	ROV find	SUB1_Lon	Degrees	Minutes with W	Minutes	Minutes/60	Add the -	Degrees decimal	Minus degrees decimal	Difference	State
2	08:57:24	02444.9991W	08:58:52	02444.9991W	-24.74998533	24	44.9991W	44.9991	0.749985	-	24.749985	-24.749985	1.00000001	Good
3	08:57:25	02444.9991W	08:58:53	02444.9991W	-24.74998533	24	44.9991W	44.9991	0.749985	-	24.749985	-24.749985	1.00000001	Good

- A. Hora - copy Hora (time) from the ROV file
- B. Longitude - copy Longitude from the ROV file
- C. Time – copy Time from the posi file
- D. ROV find – finds the longitude from B if A and C match
- E. SUB1_Lon – copy SUB1_Lon from the posi file
- F. Degrees – finds the degrees from B
- G. Minutes with W – finds the minutes with W (for west) in B
- H. Minutes – removes the W from the minutes
- I. Minutes/60 – divides minutes from H with 60 in order to get a decimal format
- J. Add the - – adds a minus in front the degrees
- K. Degrees decimal – adds the degrees from F with minutes from I
- L. Minus degrees decimal – adds the minus in front of the degrees
- M. Difference – checks the difference between the E and L
- N. State – if the difference is less than 0.0001 the state is good, otherwise is bad

Figure 24. Vlookup/Longitude

Check if all the rows are filled. Sometimes you may find #N/A, and the problem is usually that the Vlookup formula cannot find the correct hour. In that case change the borders of the search in the formula as shown in Fig 23.

If everything is ok, you can move on.

4. Check depth

Open the vlookup file, spreadsheet latitude.

Open the ROV file in another excel file. This is dot and coma delimited, so be aware of this when opening.

Open the posi file in another excel file. This is tab delimited, so be aware of this when opening.

Proceed with copy/pasting as follows in Fig. 25:

	A	B	C	D
1	Hora	Prof_ROV_m	Time	Depth check
2	14:02:44	7.58	14:35:01	1009.634
3	14:02:45	7.58	14:35:23	1012.075

- A. Hora – Copy Hora (time) from the ROV file
- B. Prof_ROV_m – Copy depth from ROV file
- C. Copy Time from posi file
- D. Finds B if A and C are the same

Figure 25. Vlookup/Depth

Check if all the rows are filled. Sometimes you may find #N/A, and the problem is usually that the Vlookup formula cannot find the correct hour. In that case change the borders of the search in the formula as shown in Fig 23.

When you checked, copy the column D back to the posi file in the columns Water Depth and SUB_1_Depth. Save the file as originalname_with_depth_posi.

You repeat the same process for the _prot file. Save the file as originalname_with_depth_prot. I did this only for these two files because the _prot file contains the comments made during the dive, unlike the _obser file.

5. Processing & Observations

When plotting the _posi file you can see that there are outliers. In order to remove these outliers and eventual gaps in the navigation (sometimes the signal does not come every second but has gaps of couple of seconds), we can use this tool in OFOP.

Open Tools/Processing & Observations as in Fig. 26. You open a window Edith & Smooth track by clicking on the tab like the yellow box in Fig. 27.

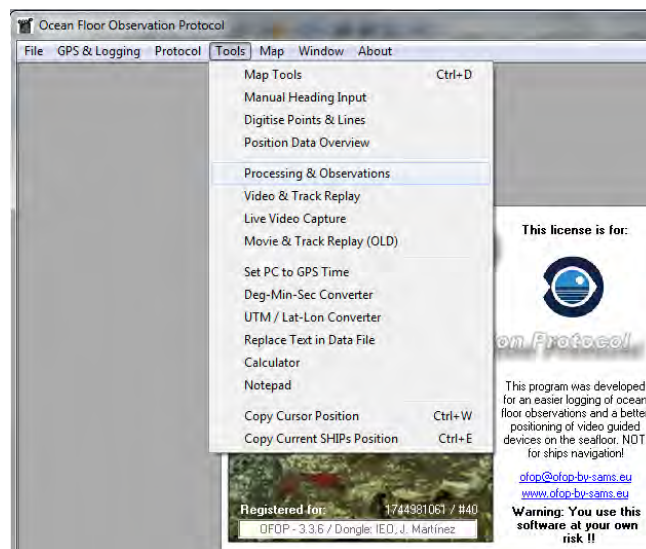

Figure 26. Processing & observations

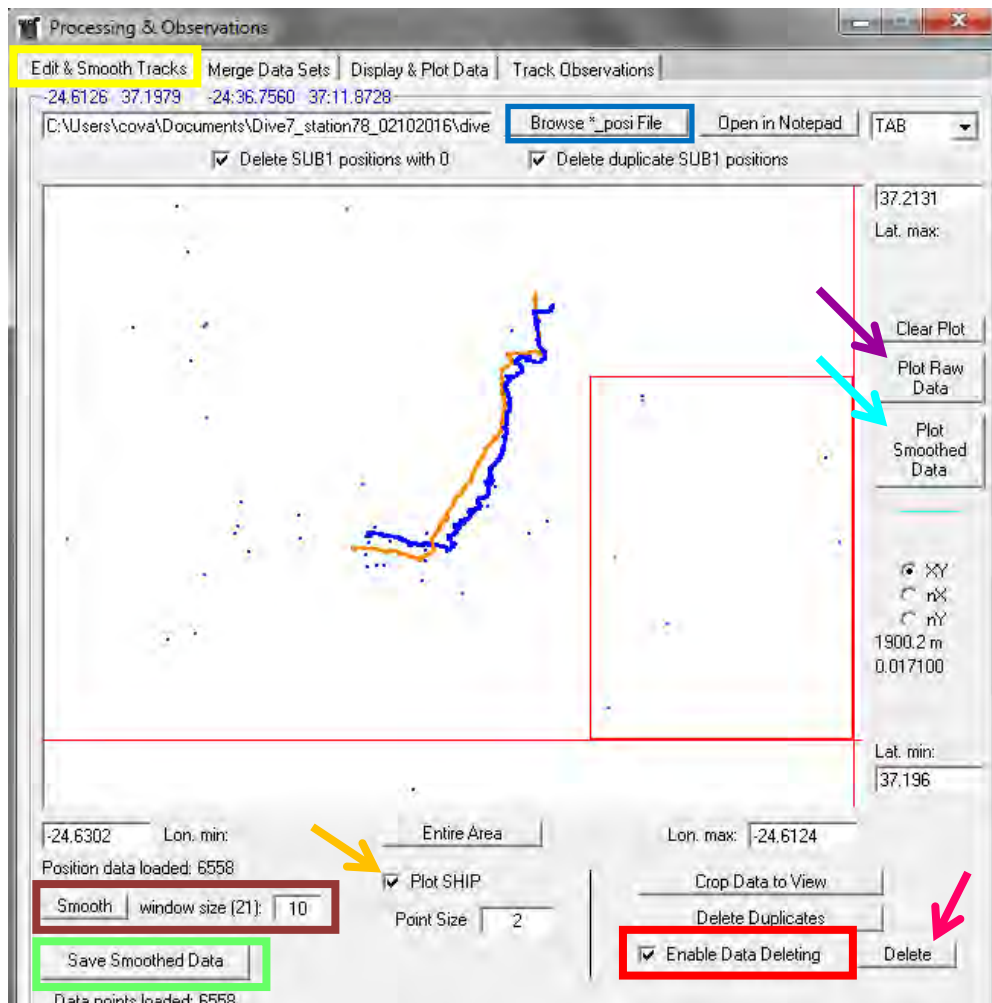

Figure 27. Processing & Observations/ Edit & Smooth track

In the Edit & Smooth track you load the with_depth_posi file by clicking on the Browse*_posi file like the blue box in Fig.27.

When it is loaded it will plot it like in Fig. 27 where the blue line and dots are the SUB1 (ROV) track and the orange track is the ship. You can remove the ship track by unchecking the Plot SHIP box showed with an orange arrow in Fig.27.

In order to remove the outliers you need to check the Enable Data Deleting shown as a red box in Fig. 27.

With the cursor you select the area where you think are the outliers.

Click Delete shown with a pink arrow in Fig. 27.

Click Plot Raw Data shown with a purple arrow in Fig.27.

You repeat this process for all the outliers.

In case you want to zoom in an area, you need to uncheck the Enable Data Deleting as shown with a red box in Fig.27. After data you select an area with the cursor and click on the Plot Raw Data as shown with a purple arrow in Fig. 27.

When you finished removing all the outliers you click on the Save Smoothed Data shown as a green box in Fig. 27.

You save the file in the folder as originalname_with_depth_CLEAN_posi

Now you click on the Smooth button shown in the brown box in Fig.27. With this OFOP checks for every point, 10 points behind and 10 points in front. In case there is a point missing from these 20 points it calculates where the point should be. That is why you have the 21. You can change this, but make sure you make a note if it and describe the rational.

Check how the smoothed line looks by clicking on the Plot Smoothed Data shown with a light blue arrow in Fig. 27. It will plot it on the graph in the same color. If you see some outliers, go back to the outliers cleaning section described before and repeat the smoothing again.

If you are content with the smoothing click on the Save Smoothed Data as shown in the green box in Fig.27.

Save the file as originalname_with_depth_CLEAN_SMOOTH_posi.

Now you click on the next tab in Processing & Observations window which is Merge Data Sets as shown in a purple box in Fig. 28.

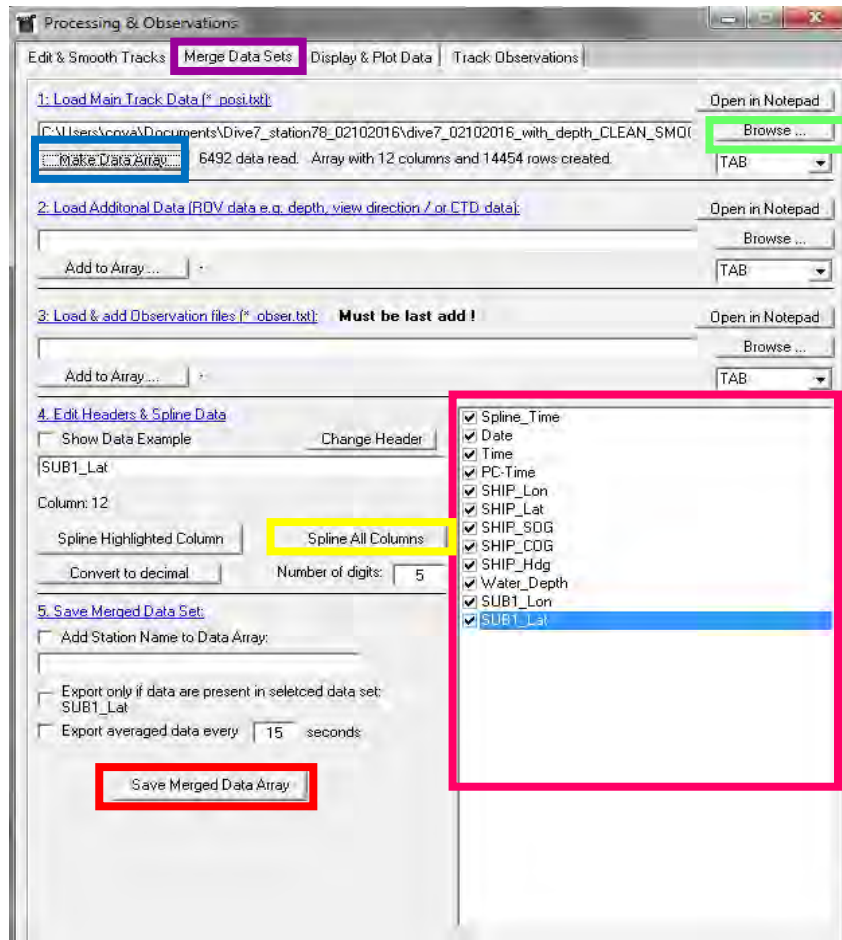

Figure 28. Processing & Observations / Merge Data Sets

To load the originalname_with_depth_CLEAN_SMOOTH_posi you click the Browse (green box in Fig. 28).

Click on the Merge Data Array (blue box in Fig. 28) that shows all the columns in the file to be made as shown in the pink box in Fig. 28.

Click on Spline All Columns as shown in the yellow box in Fig. 28.

Then click Save Merged Data Array as shown in the red box in Fig. 28.

Save the file in the folder as originalname_with_depth_CLEAN_SMOOTH_SPLINE_posi.

For the future analysis of the videos you will use this file.

Appendix X: List of ROV samples obtained by the IMAR-University of Azores team for the Benthic Ecology work during MEDWAVES.

Location	Station	Sample	Activity	Day	Lat	Lon	Depth	Preservation	Observations
Gazul	12	Bebryce mollis	BC	22/09/2016	36.56533333	-6.931	446	A70;A96;F10	
Gazul	12	Callogorgia verticillata	BC	22/09/2016	36.56533333	-6.931	446	F10	
Gazul	12	Acanthogorgia sp.	ROV2	23/09/2016	36.55698717	-6.9344985	420.3	A70;A96;F10	
Gazul	12	cf Victogorgia	ROV2	23/09/2016	36.55711183	-7	406.8	A70;A96;F10	
Ormonde	20	Placogorgia	ROV3	25/09/2016	36.9773863	-10.7818393	1956.57	A70;A96;F10	
Ormonde	20	Acanella arbuscula	ROV3	25/09/2016	36.976732	-10.7848875	1954.44	A70;A96;F10	
Ormonde	20	Acanella arbuscula	ROV3	25/09/2016	36.9777237	-10.7818393	1950.8	A70;A96;F10	
Ormonde	20	Acanella arbuscula	ROV3	25/09/2016	36.9777237	-10.7818393	1950.8	A70;A96;F10	
Formigas	47	Solenosmilia	ROV4	29/09/2016	37.1556777	-24.6308633	1499	A70;A96;F10	
Formigas	47	Plexauridae	ROV4	29/09/2016	37.1617947	-24.63193	1343	A70;A96;F10	
Formigas	47	Plexauridae	ROV4	29/09/2016	37.1618345	-24.631932	1343	A70;A96;F10	included in sample 3
Formigas	47	Swiftia sp.	ROV4	29/09/2016	37.1618345	-24.631932	1343	A70;A96;F10	included in sample 3
Formigas	47	Swiftia sp.	ROV4	29/09/2016	37.1618345	-24.631932	1343	A70;A96;F10	included in sample 3
Formigas	47	Acanella sp.	ROV4	29/09/2016	37.1618345	-24.631932	1343	A70;A96;F10	included in sample 3
Formigas	54	Pheronema carpenteri	ROV5	30/09/2016	37.1718043	-24.6317458	1259	A70;A96;F10	
Formigas	54	Ophiuridae	ROV5	30/09/2016	37.1718043	-24.6317458	1259	A70;A96;F10	
Formigas	65	Leiopathes sp.	ROV6	01/10/2016	37.1962363	-24.6253658	1033	A70;A96;F10	
Formigas	65	Stolonifera	ROV6	01/10/2016	37.1882943	-24.6303348	1161	A70;A96;F10	no sampling coordinates, ROV coordinates aprox.
Formigas	65	Crypthelia	ROV6	01/10/2016	37.1882943	-24.6303348	1161	A70;A96;F10	no sampling coordinates, ROV coordinates aprox.
Formigas	65	Lophelia fragment	ROV6	01/10/2016	37.1952338	-24.6254485	1063	A70;A96;F10	no sampling coordinates, ROV coordinates aprox.

Formigas	65	Unknown	ROV6	01/10/2016	37.1883618	-24.6303142	1161	A70;A96;F10	
Formigas	65	Ophiuridae	ROV6	01/10/2016	37.1882943	-24.6303348	1161	A70;A96;F10	no sampling coordinates, ROV coordinates aprox.
Formigas	65	Sponge	ROV6	01/10/2016	37.1882943	-24.6303348	1161	A70;A96;F10	no sampling coordinates, ROV coordinates aprox.
Formigas	65	Alcyonacea	ROV6	01/10/2016	37.1882943	-24.6303348	1161	A70;A96;F10	no sampling coordinates, ROV coordinates aprox.
Formigas	65	Madrepora	ROV6	01/10/2016	37.1891472	-24.6319745	1254	A70;A96;F10	no sampling coordinates, ROV coordinates aprox.
Formigas	78	Narella sp.	ROV7	02/10/2016	37.2031408	-24.6214172	787.453	A70;A96;F10	
Formigas	78	Narella sp.	ROV7	02/10/2016	37.2096822	-24.6194978	779.305	A70;A96;F10	
Formigas	78	Acanthogorgia sp.	ROV7	02/10/2016	37.2096763	-24.6195275	779.5	A96	
Formigas	92	Narella sp.	VV	03/10/2016	37.1265	-24.3972	746	A70	
Formigas	92	Narella sp.	VV	03/10/2016	37.1265	-24.3972	746	A70	
Formigas	92	Swiftia sp.	VV	03/10/2016	37.1265	-24.3972	746	A70	
Formigas	103	Acanella arbuscula	ROV9	04/10/2016	37.337252	-24.742081	1253	F10,A70	
Formigas	103	Acanella arbuscula	ROV9	04/10/2016	37.337283	-24.742137	1252	F10,A70	
Formigas	103	Acanella arbuscula	ROV9	04/10/2016	37.337294	-24.7421562	1251	F10,A70	
Formigas	103	Acanella arbuscula	ROV9	04/10/2016	37.337316	-24.7421613	1251	F10,A70	
Formigas	103	Antipatharia	ROV9	04/10/2016	37.3361503	-24.7427118	1187	F10,A70	
Formigas	103	Plexauridea	ROV9	04/10/2016	37.336096	-24.7427265	1187	F10,A70	
Formigas	103	Ophiuridae	ROV9	04/10/2016	37.336096	-24.7427265	1187	F10,A70	
Formigas	103	Mollusca	ROV9	04/10/2016	37.336096	-24.7427265	1187	F10,A70	
Formigas	127	Acanella arbuscula	ROV11	07/10/2016	37.3356078	-24.7579203	1094	F10,A96	
Formigas	127	Acanella arbuscula	ROV11	07/10/2016	37.3355897	-24.7579237	1093	F10,A96	
Formigas	127	Acanella arbuscula	ROV11	07/10/2016	37.33559	-24.7579235	1094	F10,A96	
Formigas	127	Acanella arbuscula	ROV11	07/10/2016	37.3355317	-24.7579113	1038	F10,A96	
Formigas	127	Acanella arbuscula	ROV11	07/10/2016	37.3355479	-24.7579315	1032	F10,A96	

Formigas	127	Acanella arbuscula	ROV11	07/10/2016	37.3349528	-24.7588025	1032	F10,A96	
Formigas	127	Acanella arbuscula	ROV11	07/10/2016	37.3349868	-24.7587955	1032	F10,A96	
Formigas	127	Leiopathes sp.	ROV11	07/10/2016	37.335082	-24.7588575	1034	F10,A96	
Formigas	127	Candidella sp.	ROV11	07/10/2016	37.33633333	-24.7565	1187	F10,A96	no sampling coordinates, ROV coordinates aprox.
Formigas	127	Candidella sp.	ROV11	07/10/2016	37.33633333	-24.7565	1044	A96	no sampling coordinates, ROV coordinates aprox.
Formigas	127	Madrepora	ROV11	07/10/2016	37.3351803	-24.5786975	1283	A96	
Formigas	127	Ophiuridae	ROV11	07/10/2016	37.3351803	-24.5786975	1283	F10	no sampling coordinates, ROV coordinates aprox.
Formigas	127	Porifera	ROV11	07/10/2016	37.3351803	-24.5786975	1283	F10	no sampling coordinates, ROV coordinates aprox.
Ormonde	145	Porifera Flabeliforme	ROV 15	19/10/2016	36.86683667	-10.8885	1540	E70;E96;F10;Dry	
Ormonde	145	Corallium tricolor	ROV 15	19/10/2016	36.86515333	-10.89115	1537	E70;E96;F10	
Ormonde	145	Amphianthus sp.	ROV 15	19/10/2016	36.86515333	-10.89115	1537	F10	association C. tricolor sample 1.2
Ormonde	145	Solenosmilia varibilis	ROV 15	19/10/2016	36.86510167	-10.89117167	1538	E96	
Ormonde	145	Candidella imbricata	ROV 15	19/10/2016	36.86510167	-10.89117167	1538	E70;E96;F10	
Ormonde	145	Plexauridae	ROV 15	19/10/2016	36.86510167	-10.89117167	1538	E70;E96;F10	
Ormonde	145	Ophiuroidea	ROV 15	19/10/2016	36.86510167	-10.89117167	1538	E70;E96;F10	association S. variabilis sample 2.1
Ormonde	145	Cirripedia	ROV 15	19/10/2016	36.86510167	-10.89117167	1538	E70	association Plexauridae sample 2.3
Ormonde	146	Stelletta cf.	ROV 16	19/10/2016	36.79296667	-10.96390167	1114	E70;E96	
Ormonde	146	Polymastia cf.	ROV 16	19/10/2016	36.79296667	-10.96390167	1114	E70;E96	

Ormonde	146	Demospongiae n.ID	ROV 16	19/10/2016	36.79296667	10.96390167	-	1114	E70;E96	association Polymastia sample 1.2
Ormonde	146	Hexactinellida	ROV 16	19/10/2016	36.79296667	10.96390167	-	1114	E70;E96	association Polymastia sample 1.2
Ormonde	146	Eggs (?)	ROV 16	19/10/2016	36.79296667	10.96390167	-	1114	E70	association Polymastia sample 1.2
Ormonde	146	Isopoda	ROV 16	19/10/2016	36.79296667	10.96390167	-	1114	E70	association Porifera sample 1
Ormonde	146	Porifera n.ID	ROV 16	19/10/2016	36.79296667	10.96390167	-	1114	E70;E96	digitiforme
Ormonde	155	Hyalonema sp.	ROV 17	20/10/2016	36.80911667	11.12435333	-	1153	E70	
Ormonde	155	Zoantharia	ROV 17	20/10/2016	36.80911667	11.12435333	-	1153	F10	
Ormonde	155	Rock_Porifera Incrustants	ROV 17	20/10/2016	36.80595833	11.12415833	-	1093	E70	
Ormonde	155	Plexauridae	ROV 17	20/10/2016	36.80196667	11.12716167	-	1026	E70;E96	Limopsis on rock
Ormonde	155	Narella bellissima	ROV 17	20/10/2016	36.796295	-11.1288	-	950	E70;E96;F10	E70_bag inside Jar
Ormonde	155	Zoanthid Epibionte	ROV 17	20/10/2016	36.796295	-11.1288	-	950	E70;E96;F10	E70_bag inside Jar
Ormonde	155	Crinoid	ROV 17	20/10/2016	36.796295	-11.1288	-	950	E70	E70_bag inside Jar
Ormonde	155	Swiftia	ROV 17	20/10/2016	36.79572	11.12887167	-	944	E70;E96;F10	E70_bag inside Jar
Seco Olivos	182	Callogorgia	ROV 21	23/10/2016	36.496	-2.89	-	356	E96	
Seco Olivos	182	Edwardsiidae	ROV 21	23/10/2016	36.4932	-2.8901	-	446	F10	
Seco Olivos	196	Zoanthids	ROV 23	24/10/2016	36.53682667	2.820431667	-	247	E70;E96;F10	Cf. Savaglia; E70 inside bag
Seco	196	Ophiuroid	ROV 23	24/10/2016	36.53682667	-	-	247	E70	

Olivos						2.820431667			
Seco Olivos	196	Acanthogorgia	ROV 23	24/10/2016	36.53696667	- 2.820466667	247	E70;E96;F10	E70 inside bag
Seco Olivos	196	Plexauridae	ROV 23	24/10/2016	36.53908333	-2.82115	244	E70;E96;F10	E70 inside bag

Appendix XI: List of hydroid samples obtained by ROV from Formigas Bank during Leg 1 of MEDWAVES.

Station#	ROV Dive#	Date	Depth (m)	Latitude (Dec.Deg.)	Longitude (Dec.Deg.)	Substratum
47	4	29.9.16	1343	37.1618345	-24.631932	Rock
65	6	1.10.16	1161	37.1883392	-24.6303435	solitary coral
65	6	1.10.16	1161	37.1883618	-24.6303142	Rock
65	6	1.10.16	1153	37.1880455	-24.6293027	<i>Crypthelia</i> sp. on rock
65	6	1.10.16	1034	37.1962267	-24.6253728	<i>Leiopathes</i> sp.
65	6	1.10.16	1254	37.1891435	-24.63201	fused to <i>Solenosmilia</i>
103	9	4.10.16	1188	37.336096	-24.7427265	purple plexaurid
103	9	4.10.16	1183	37.3364577	-24.7436048	<i>Lophelia</i>
103	9	4.10.16	1183	37.3364382	-24.7435967	solitary coral with <i>Lophelia</i>
103	9	4.10.16	1283	37.337859	-24.7417025	<i>Madrepora oculata</i>
103	9	4.10.16	1283	37.3378342	-24.7417262	<i>Madrepora oculata</i>
126	11	7.10.16	1044	37.3351755	-24.7586668	<i>Madrepora</i> & octocoral
126	11	7.10.16	1045	37.3351803	-24.7586975	sertulariid on <i>Madrepora</i>
126	11	7.10.16	1040	37.3351223	-24.7587443	<i>Lophelia</i>
133	13	8.10.16	1034	37.1986242	-24.7994812	sertulariid on <i>Lophelia</i>
133	13	8.10.16	968	37.2006583	-24.800734	Eudendriidae on <i>Lophelia</i>



MEDWAVES CRUISE 2016

RV Sarmiento de Gamboa

Coral catalogue

Photography onboard:

Íris Sampaio

Maria Rakka

Meri Bilan

ROV & survey control

Preparation:

Meri Bilan and Íris Sampaio

Species identification:

Íris Sampaio



Sample photographs

Class: Anthozoa
Order: Antipatharia
Family:
Species:



Sample photographs

Class: Anthozoa
Order: Antipatharia
Family:
Species:

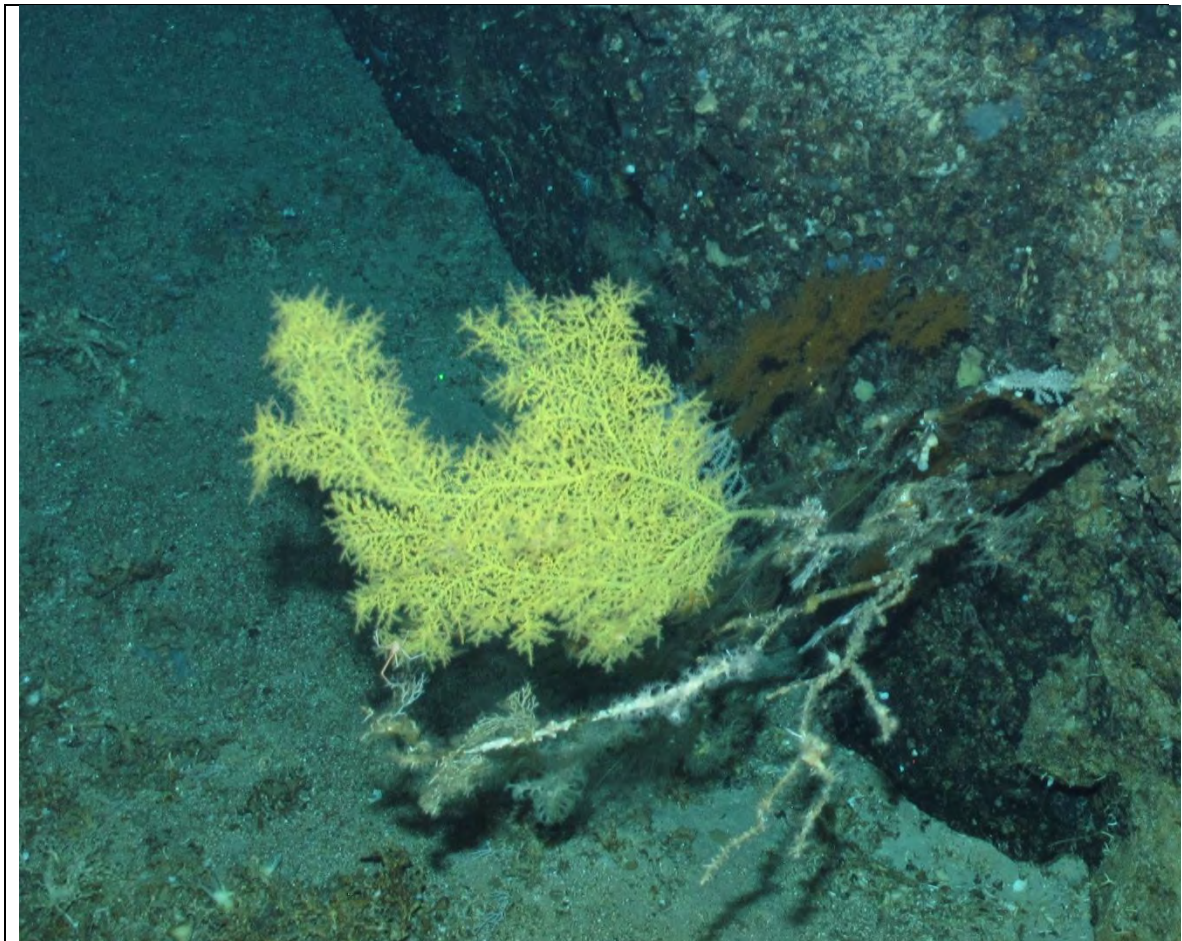

Underwater photographs

Class: Anthozoa
Order: Antipatharia
Family:
Species:

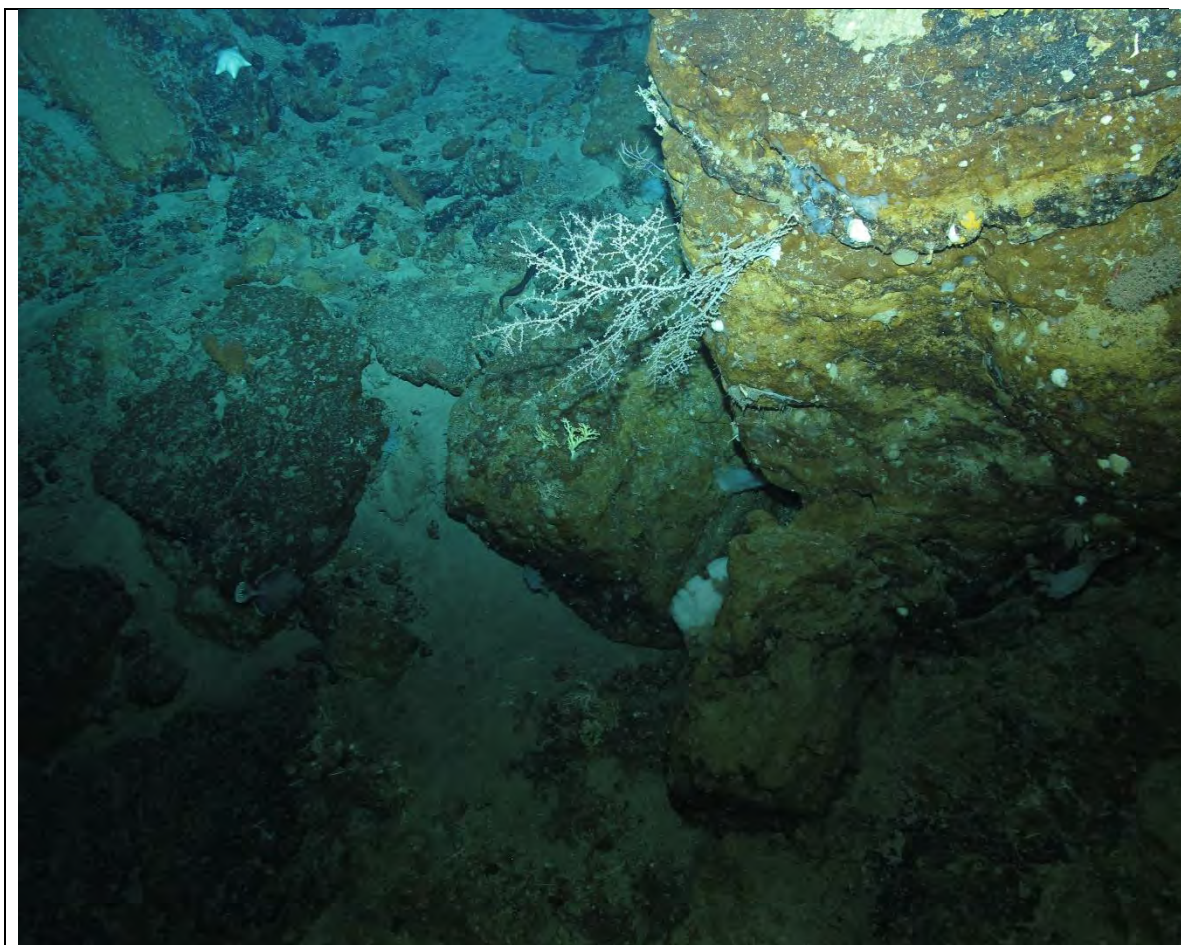

Underwater photographs

Class:
Order: Antipatharia
Family:
Species:



Sample photographs

Class: Anthozoa

Order: Antipatharia

Family: Leiopathidae

Species: *Leiopathes* cf. *glaberrima*



Underwater photographs

Class: Anthozoa
Order: Antipatharia
Family: Schizopathidae
Species:



Underwater photographs

Class: Anthozoa
Order: Antipatharia
Family: Schizopathidae
Species: *Bathypathes* sp.



Underwater photographs

Class: Anthozoa
Order: Scleractinia
Family: Caryophylliidae
Species:



Sample photographs

Class: Anthozoa
Order: Scleractinia
Family: Caryophylliidae
Species: *Caryophyllia* sp.



Underwater photographs

Class: Anthozoa
Order: Scleractinia
Family: Caryophylliidae
Species: *Desmophyllum dianthus*

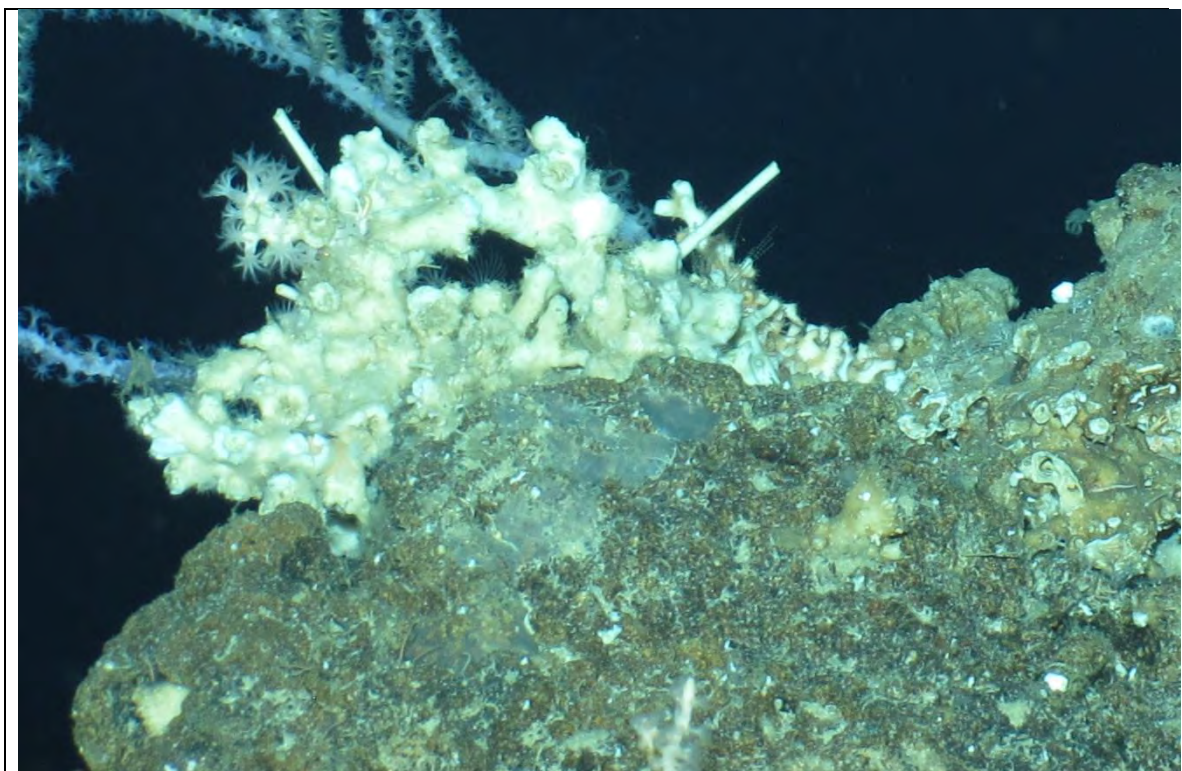

Underwater photographs

Class: Anthozoa
Order: Scleractinia
Family: Caryophylliidae
Species: *Lophelia pertusa*



Sample photographs

Class: Anthozoa
Order: Scleractinia
Family: Caryophylliidae
Species: *Solenosmilia variabilis*



Sample photographs

Class: Anthozoa

Order: Scleractinia

Family: Dendrophylliidae

Species: cf. *Dendrophyllia cornigera*



Underwater photographs

Class: Anthozoa
Order: Scleractinia
Family: Dendrophylliidae
Species: cf. *Leptopsammia* sp.



Sample photographs

Class: Anthozoa
Order: Scleractinia
Family: Oculinidae
Species: *Madrepora oculata*

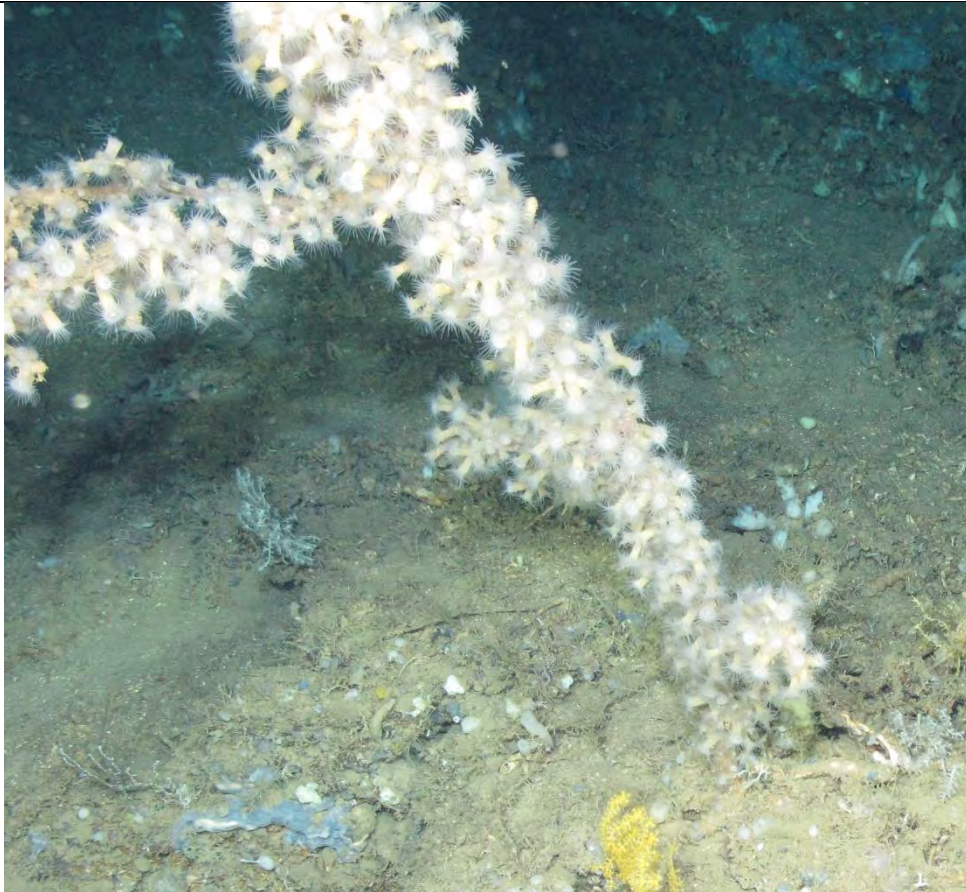

Underwater photographs

Class: Anthozoa
Order: Zoantharia
Family: Zoanthidae
Species:



Underwater photographs

Class: Anthozoa
Order: Zoantharia
Family: Zoanthidae
Species:

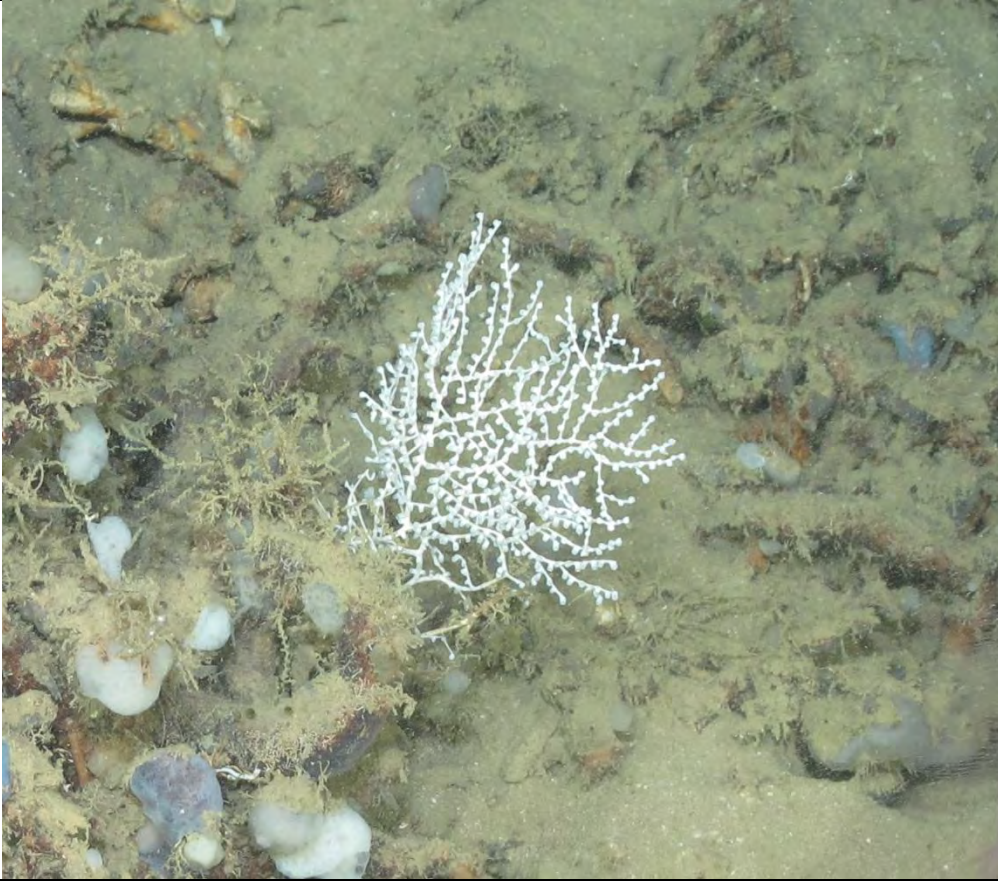

Underwater photographs

Class: Anthozoa
Order: Alcyonacea
Family:
Species:



Underwater photographs

Class: Anthozoa
Order: Alcyonacea
Family:
Species:



Underwater photographs

Class: Anthozoa

Order: Alcyonacea

Family: Acanthogorgiidae

Species: cf. *Acanthogorgia* sp.

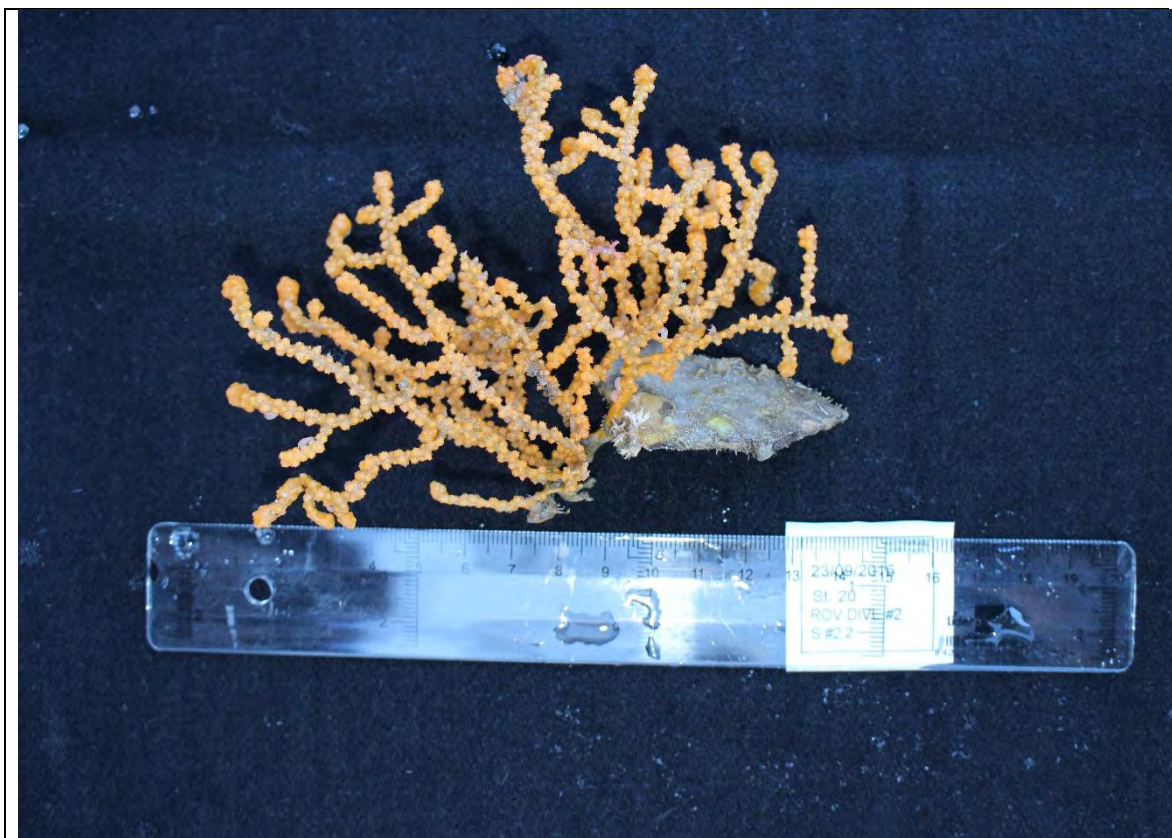

Sample photographs

Class: Anthozoa
Order: Alcyonacea
Family: Acanthogorgiidae
Species: *Acanthogorgia* cf. *armata*

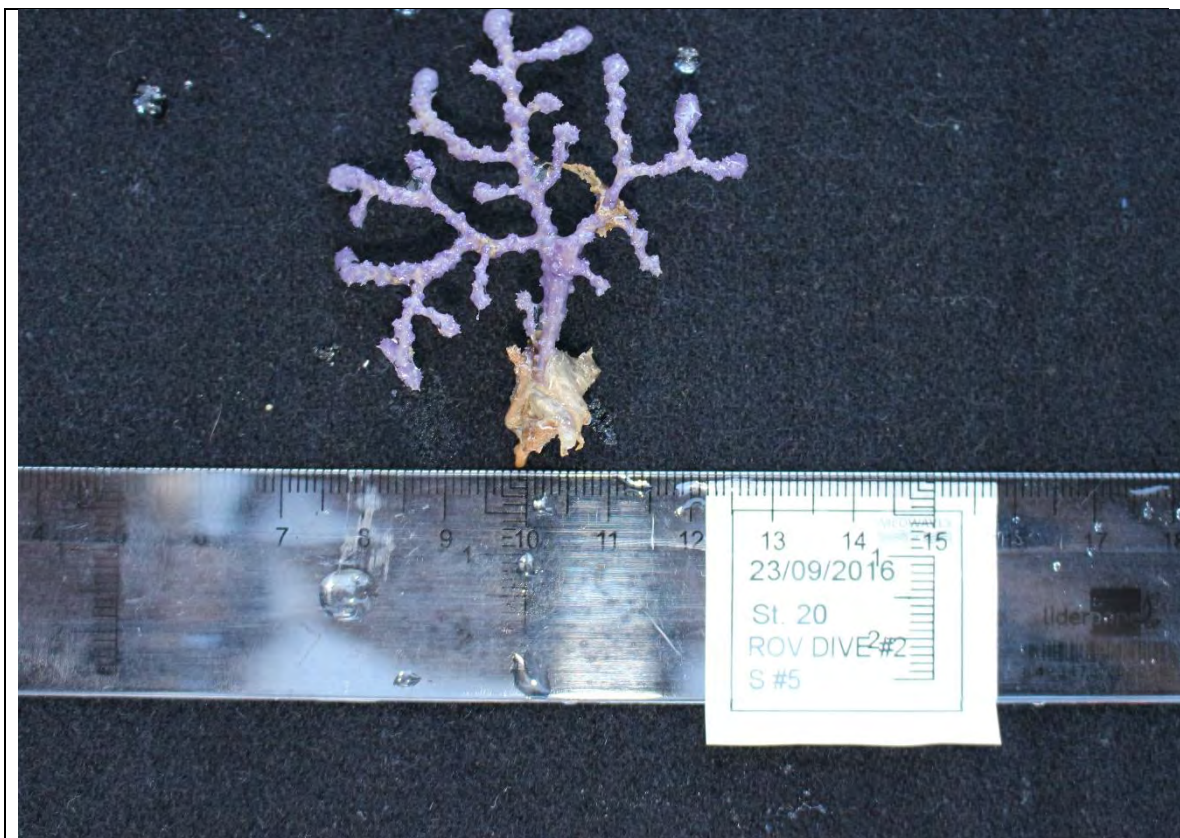

Sample photographs

Class: Anthozoa
Order: Alcyonacea
Family: Anthothelidae
Species: cf. *Victorgorgia josephinae*



Sample photographs

Class: Anthozoa
Order: Alcyonacea
Family: Chrysogorgiidae
Species:



Underwater photographs

Class: Anthozoa
Order: Alcyonacea
Family: Chrysogorgiidae
Species: *Chrysogorgia* sp.

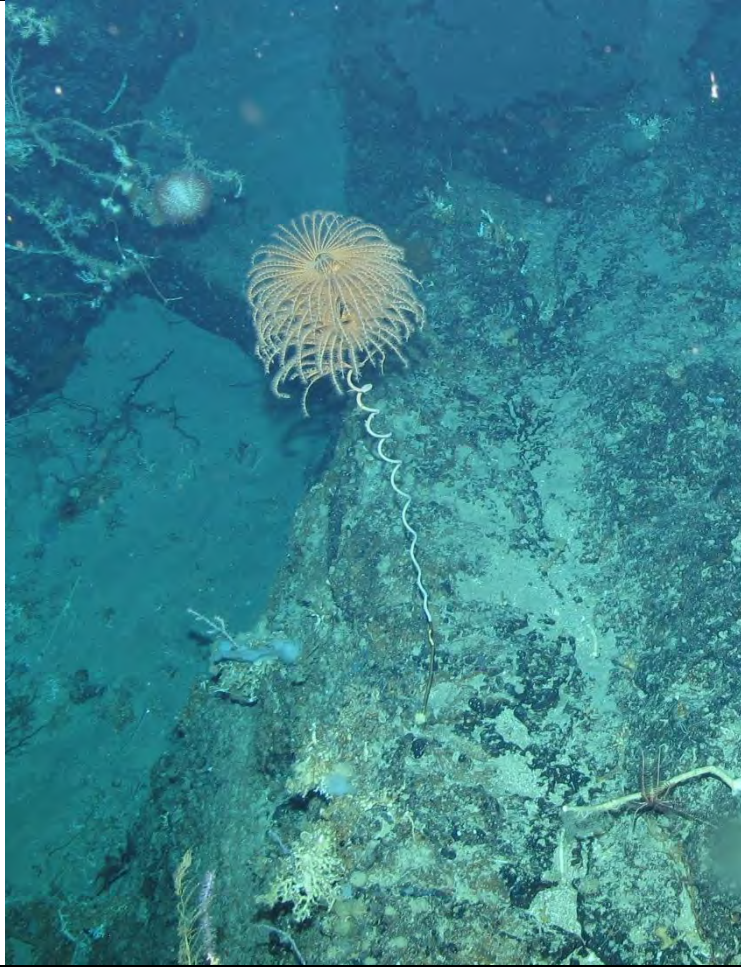

Underwater photographs

Class: Anthozoa
Order: Alcyonacea
Family: Chrysogorgiidae
Species: *Iridogorgia* sp.



Sample photographs

Class: Anthozoa
Order: Alcyonacea
Family: Clavulariidae
Species: cf. *Telestula* sp.

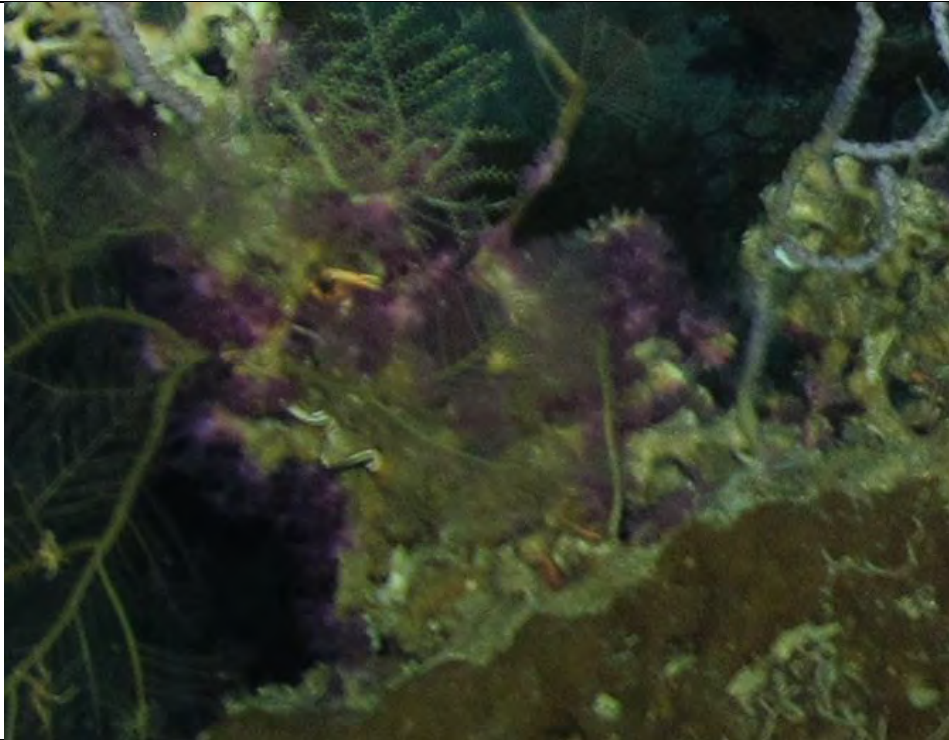

Underwater photographs

Class: Anthozoa

Order: Alcyonacea

Family: Clavulariidae

Species: cf. *Clavularia borealis*



Underwater photographs

Class: Anthozoa
Order: Alcyonacea
Family: Coralliidae
Species: cf. *Corallium niobe*



Underwater photographs

Class: Anthozoa
Order: Alcyonacea
Family: Coralliidae
Species: *Corallium tricolor*



Underwater photographs

Class: Anthozoa
Order: Alcyonacea
Family: Isididae
Species:



Sample photographs

Class: Anthozoa
Order: Alcyonacea
Family: Isididae
Species: *Acanella arbuscula*



Sample photographs

Class: Anthozoa
Order: Alcyonacea
Family: cf. Plexauridae
Species:



Underwater photographs

Class: Anthozoa
Order: Alcyonacea
Family: Plexauridae
Species:



Sample photographs

Class: Anthozoa
Order: Alcyonacea
Family: Plexauridae
Species: *Bebryce mollis*



Sample photographs

Class: Anthozoa
Order: Alcyonacea
Family: Plexauridae
Species: cf. *Paramuricea* sp.

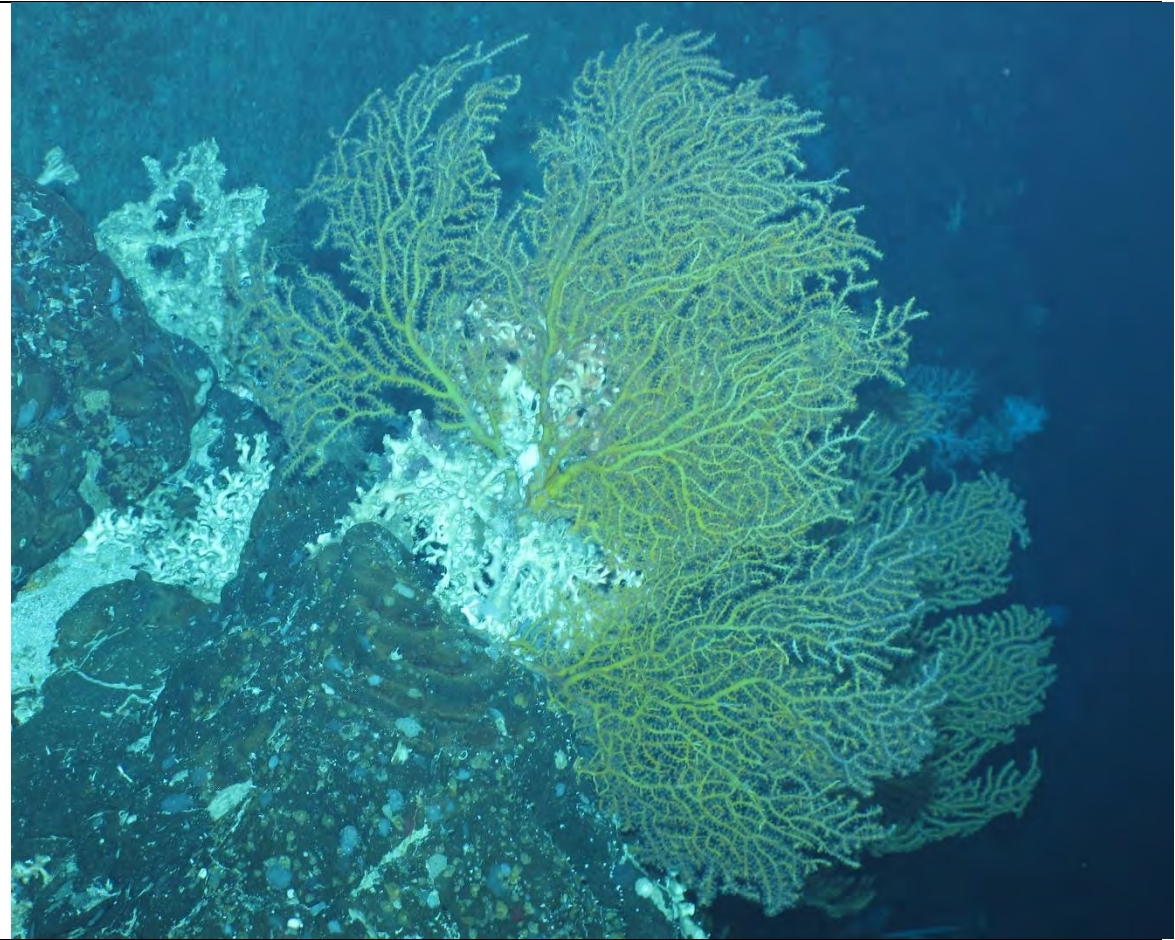

Underwater photographs

Class: Anthozoa
Order: Alcyonacea
Family: Plexauridae
Species: cf. *Paramuricea* sp.

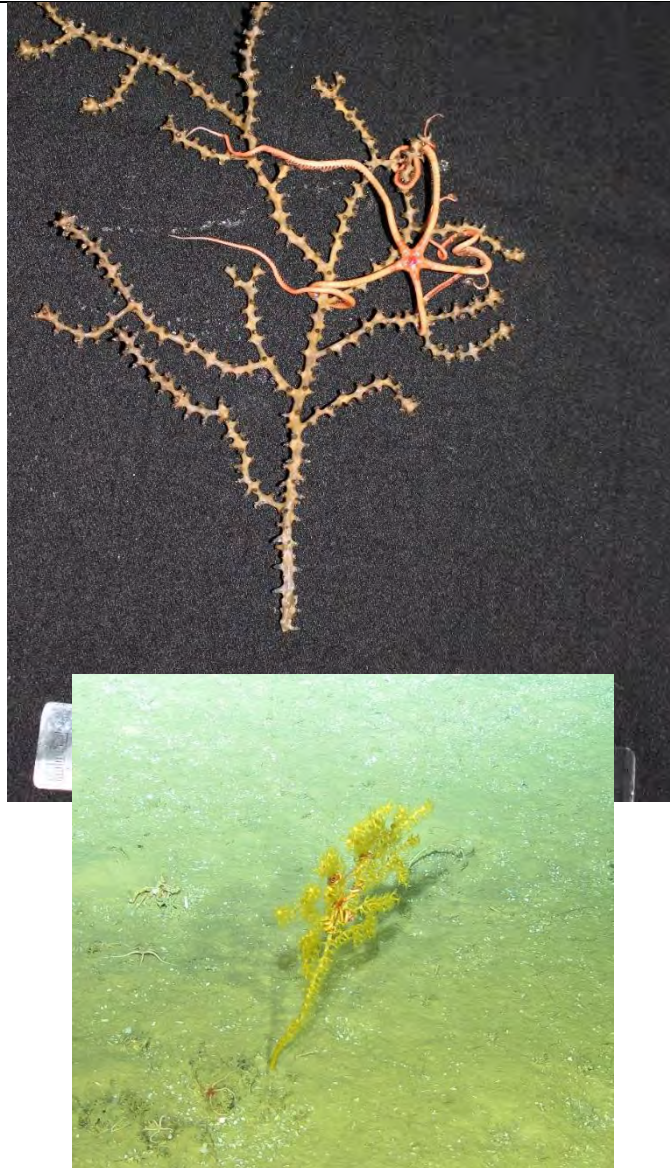

Underwater photographs
Sample photographs

Class: Anthozoa
Order: Alcyonacea
Family: Plexauridae
Species: *Placogorgia* sp.



Sample photographs

Class: Anthozoa
Order: Alcyonacea
Family: Plexauridae
Species: *Swiftia* sp.



Underwater photographs

Class: Anthozoa
Order: Alcyonacea
Family: Primnoidae
Species: *Callogorgia verticillata*

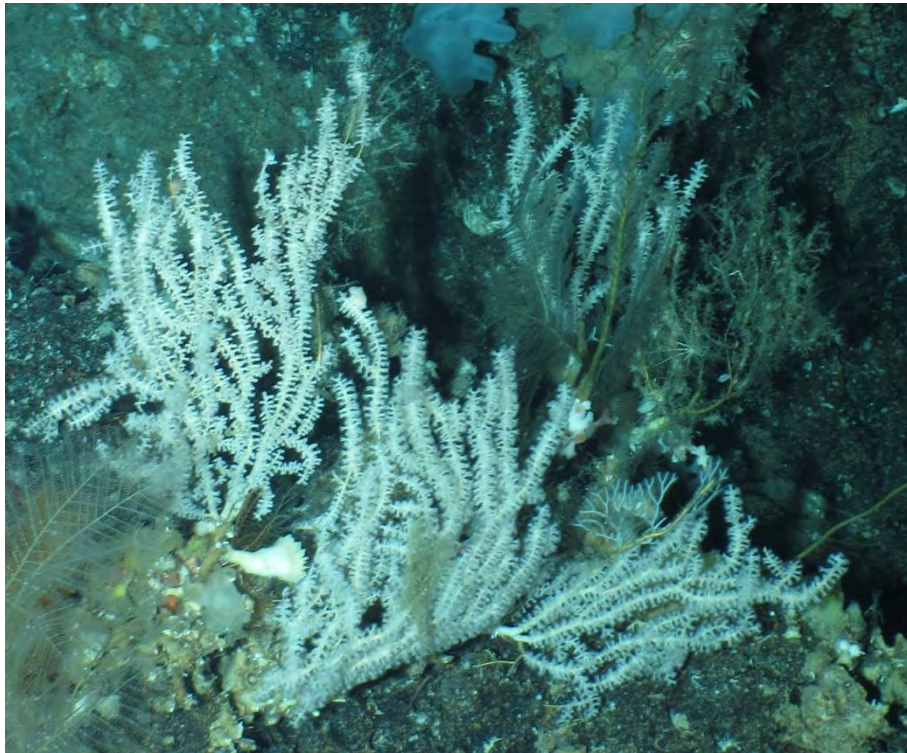

Underwater photographs

Class: Anthozoa

Order: Alcyonacea

Family: Primnoidae

Species: cf. *Candidella imbricata*



Underwater photographs

Class: Anthozoa
Order: Alcyonacea
Family: Primnoidae
Species: *Narella bellissima*

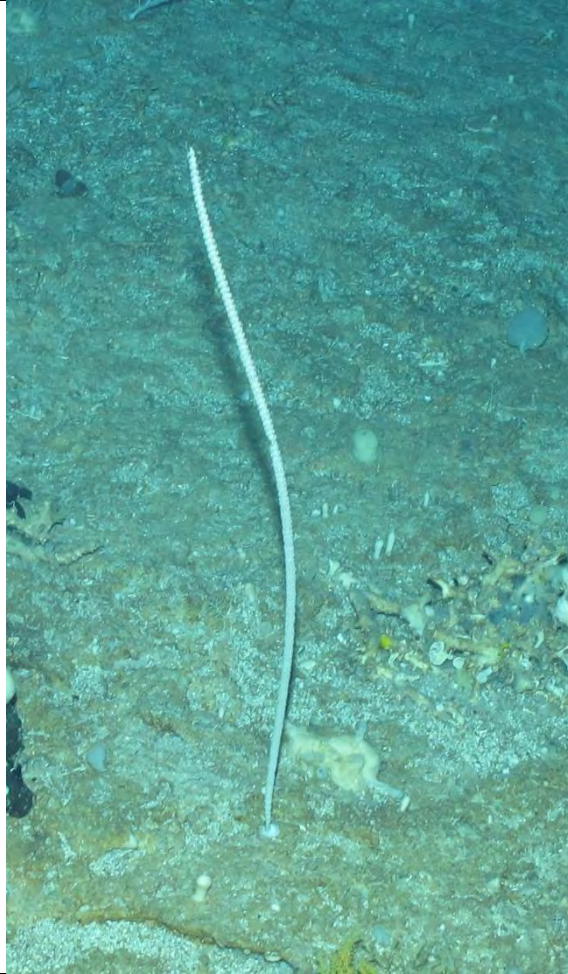

Underwater photographs

Class: Anthozoa
Order: Alcyonacea
Family: Primnoidae
Species: *Narella* cf. *verlyusi*



Underwater photographs

Class: Anthozoa
Order: Alcyonacea
Family: Primnoidae
Species: *Thouarella* sp.



Underwater photographs

Class: Anthozoa
Order: cf. Pennatulacea
Family:
Species:



Underwater photographs

Class: Hydrozoa

Order:

Family:

Species:

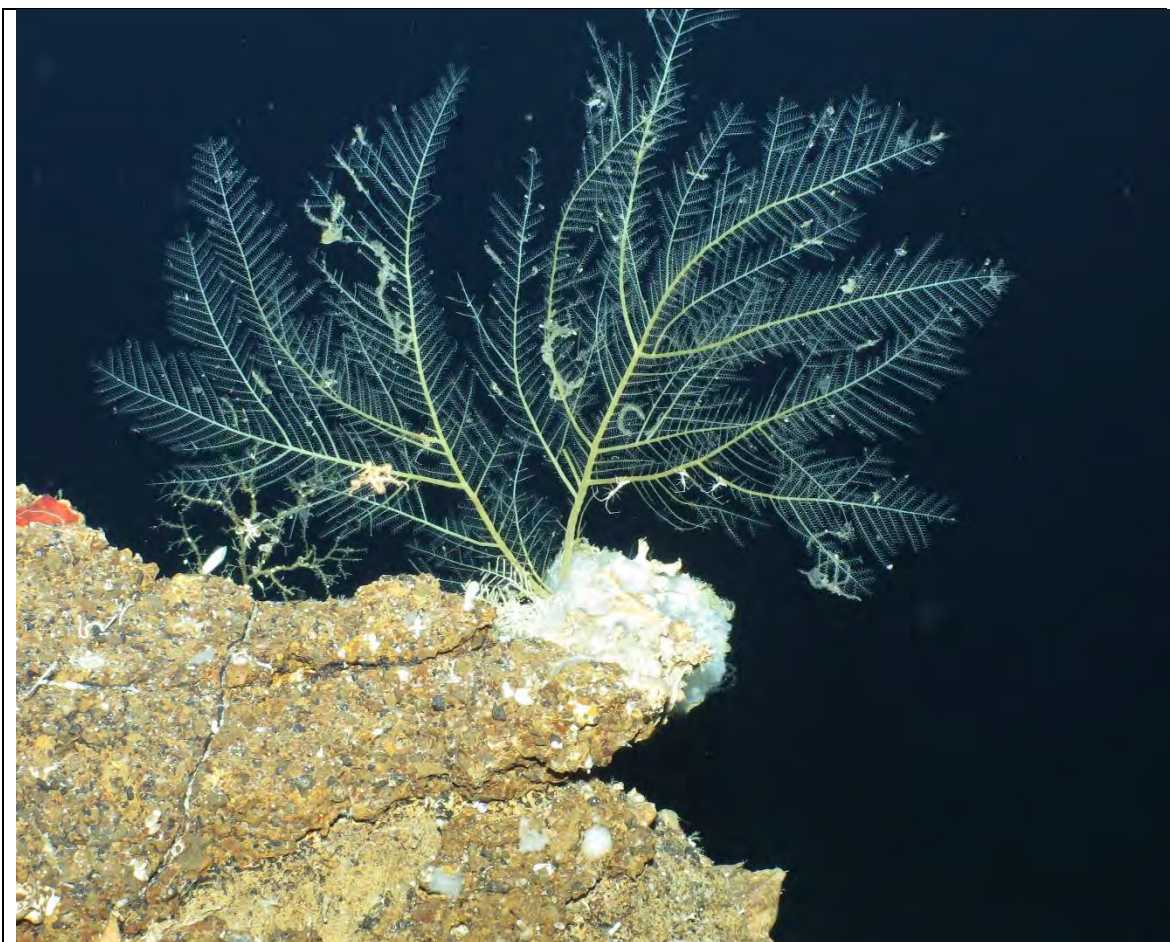

Underwater photographs

Class: Hydrozoa
Order: Leptothecata
Family: Aglaopheniidae
Species:



Sample photographs

Class: Hydrozoa
Order: Anthoathecata
Family: cf. Stylasteridae
Species:

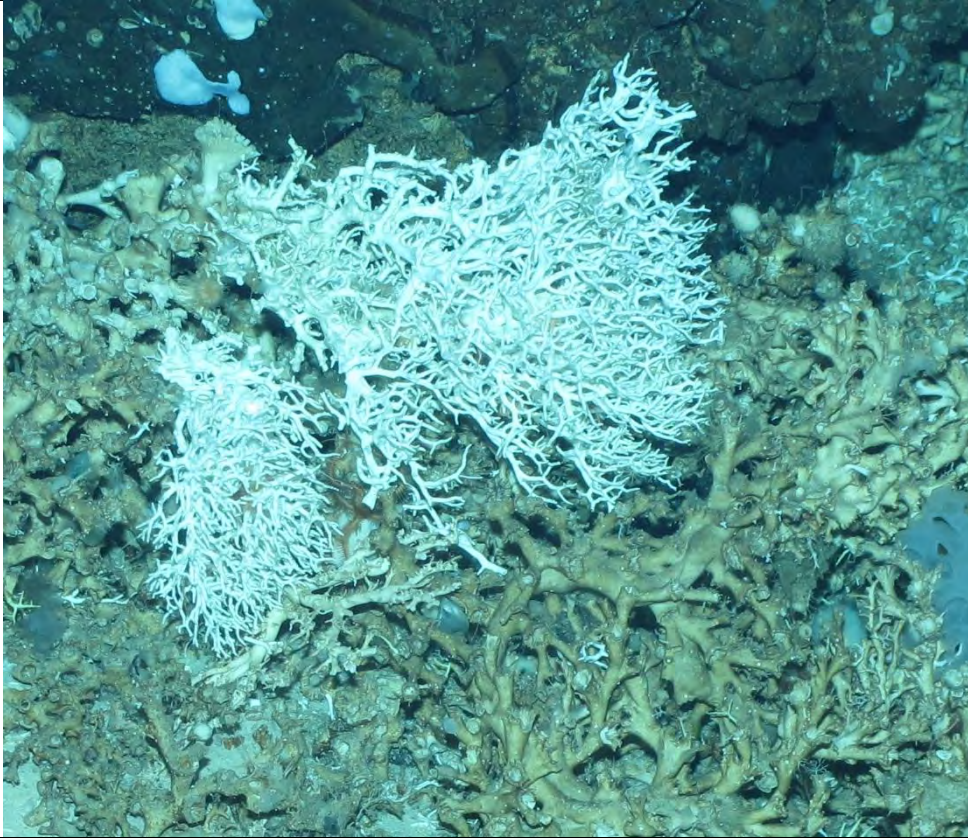

Underwater photographs

Class: Hydrozoa
Order: Anthoathecata
Family: cf. Stylasteridae
Species:



Sample photographs

Class: Hydrozoa
Order: Anthoathecata
Family: Stylasteridae
Species: *Crypthelia* sp.

Appendix XIII: ACSM technical report (only available in Spanish)

CLIENT / Cliente	IEO	DATE / Fecha	31/10/2016
VESSEL / Buque	B/O Sarmiento de Gamboa	LOCATION / Lugar	Málaga
PROJECT / Proyecto	ATLAS / MEDWAVES	SUBSEA SYSTEM Sistema Sumergible	Liropus 2000 (SM33)
REPORT DESCRIPTION Descripción del Informe	Informe Final de Campaña ATLAS / MEDWAVES		
PERFORMED BY: NAME & POSITION Realizado por: Nombre y Cargo	Carlos Méndez / Supervisor de ROV	SIGNED Firma	CMS

Informe final de la Campaña ATLAS / MEDWAVES, realizada a bordo del B/O Sarmiento de Gamboa con el sistema ROV Liropus 2000.

21/09/16

Se termina de configurar el puesto de Survey y se comprueban de nuevo todos los envíos y recepciones de datos. Todo funciona correctamente.

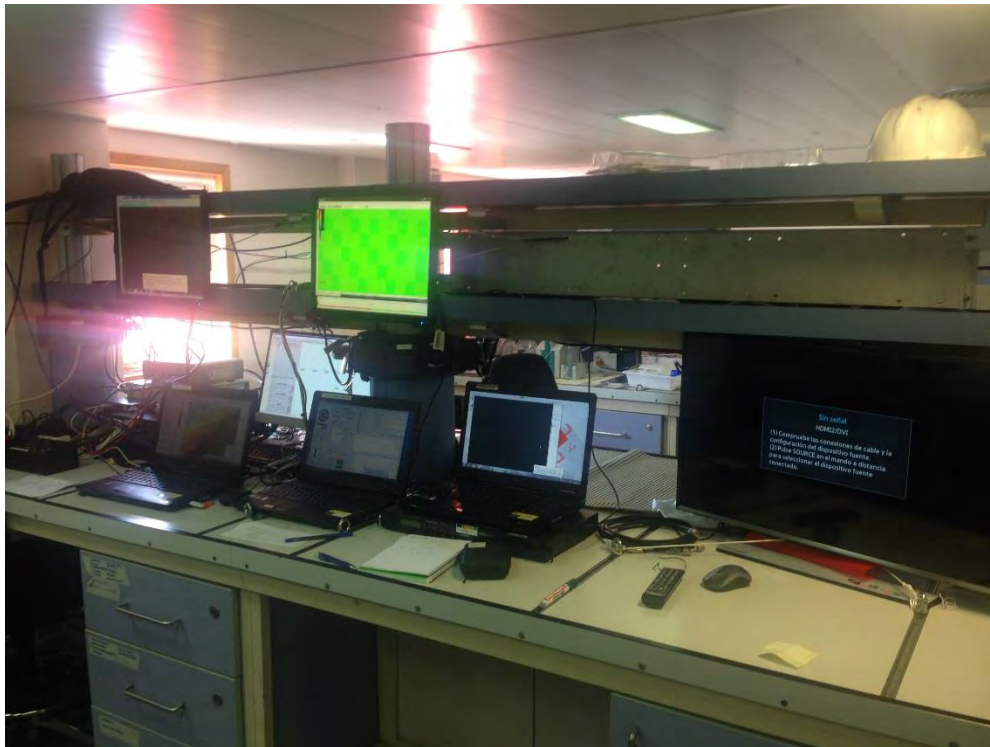

Se prepara el Vehículo con pesos y flotaciones extras debido a la instalación de equipo científico para realizar una prueba de flotabilidad (*Ballast test*) antes de realizar la primera inmersión de la campaña.

El barco zarpa del puerto de Cádiz a las 19:30UTC hacia la zona de trabajo.

**22/09/16**

En la zona de trabajo a las 8:30UTC se realiza la primera inmersión para comprobar flotabilidad (*Ballast test*), se comprueba el trimado del vehículo saliendo del TMS y que el ROV está funcionado bien al igual que los equipos científicos.

A las 9:08UTC se recupera a cubierta donde se le añade algo más de flotabilidad para compensar el balanceo (*roll*).

A las 9:35UTC comenzamos la maniobra de arriado para la primera inmersión (Dive#01). Durante toda la inmersión el funcionamiento es correcto y todos los sistemas trabajan correctamente excepto el posicionamiento de ROV y TMS en pantalla de navegación, después de unas comprobaciones verificamos que la navegación no es correcta ya que el posicionamiento acústico en el HIPAP no coincide con la realidad. Debido al tipo de fondo marino (arenoso) no se suspende y se continúa con la inmersión. En caso de fondos rocosos o volcánicos habría riesgo de pérdida del vehículo debido a que al no ubicar bien ROV y TMS el umbilical puede dañarse al ser tendido por el fondo marino. Se informa del problema al puesto de Survey y a la Jefa de Campaña.

Unos 30 minutos antes de la hora prevista de recuperación, el sistema da una alarma de bajo aislamiento en el suministro de 24VDC, se comprueba y no se detecta con el vehículo en el fondo de qué se trata. Al finalizar la inmersión (ROV en cubierta a las 15:59UTC), comienzan las comprobaciones. Tras constatar que

no hay signos de problemas externos, se procede a abrir POD de telemetría (estribor) y se detecta gran cantidad de agua. Algo de condensación sería normal pero en este caso se comprueba que ha habido una filtración.

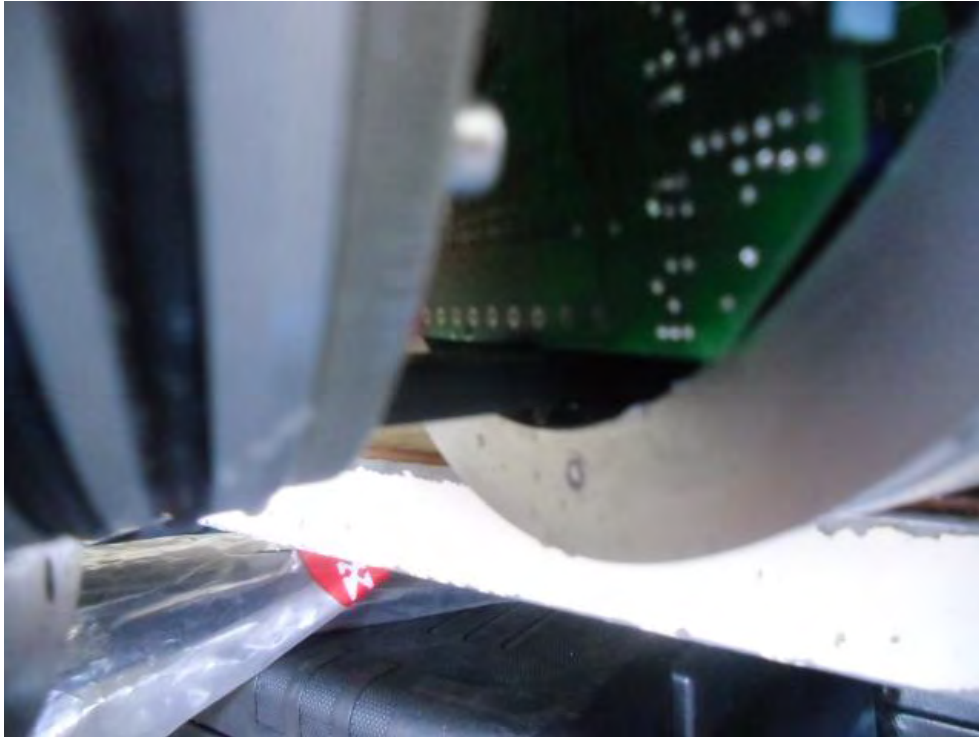

Después de realizar distintas pruebas, no se detecta el problema, ya que con el Test de Vacío del POD no se aprecia ninguna fuga. Se achaca, por tanto, el problema a la propia válvula del test de vacío. Se sustituye por un penetrador sellando así el POD. Se comprobará la estanqueidad en el agua en las siguientes inmersiones.



El resumen operacional del día es que se ha realizado el trabajo como estaba planeado y no ha habido ningún contratiempo para realizar el mismo.

23/09/16

A las 7:27UTC se procede a realizar una inmersión (Dive#02), que finaliza a las 16:11UTC con una duración de casi **9 horas** a 460 metros de profundidad. Durante la inmersión no se registró ninguna alarma ni avería.

Se procede a abrir POD electrónico de telemetría para comprobar si hay fallo de estanqueidad, todo parece estar correcto, lo habitual es un poco de condensación al abrir el POD debido a la temperatura que llega a cubierta después de una inmersión. Se harán más comprobaciones en las siguientes inmersiones para descartar que efectivamente se reparó la vía de agua.

24/09/16

No se espera realizar ninguna inmersión durante el día de hoy por estar realizando tránsito a una nueva área de trabajo.

Se le instalan al ROV balizas (*beacon*) de posición para el sistema de navegación Posidonia, equipo de los técnicos de UTM para comprobar la calibración de HIPAP / HYPACK durante la próxima inmersión.

Se colocan nuevos pesos y flotaciones para configurar una nueva flotación neutra del vehículo.

También se ajustan velocidades de manipuladores para tomar muestras a 2000metros de profundidad.

Se realiza chequeo *Pre-Dive* completo y todo funciona correctamente.

25/09/16

A las 7:38UTC se comienza maniobra para realizar la inmersión *Dive#03* en la que se alcanzan casi 2000m de profundidad. Todo el sistema estuvo trabajando correctamente durante la inmersión de casi 9 horas, la cual se estuvo dudando de realizar debido a las condiciones meteorológicas (vientos rondando los 20 nudos y olas de 1 a 1,5 metros).

Después de realizar la maniobra de arriado y ya en el fondo se decide salir de TMS debido a que se ve que es segura porque el TMS no oscilaba más de 1m (causado por el balance en superficie del barco).

El sistema de navegación Hypack ha sido calibrado para que se correspondiera con la posición de TMS y ROV. La proa del barco no cambió su posición durante la inmersión, lo que no dejó lugar a la comprobación de la navegación desde distintos rumbos del buque.

Al recuperar a cubierta se desmontan las balizas de la UTM y se revisa el arnés de conexión de la cámara HD, que dio algún que otro fallo sin demasiada importancia.

También se estiba correctamente umbilical armado que venía fuera de sitio desde la primera capa quedando todo corregido y bien colocado para las siguientes inmersiones.

26/09/16

Se repara arnés de Cámara HD en taller y se revisa fallo de lámpara estroboscópica que indica presencia de 3000v en el sistema al arrancar el vehículo; esta no funcionaba por fallo de relé en transformador de alta tensión.

Las condiciones meteorológicas son adversas y con mucho balance en el barco. Las condiciones no son adecuadas para realizar trabajos de mantenimiento por lo cual se suspenden los trabajos hasta que mejore el tiempo.

27/09/16

Continuamos tránsito a nueva zona de trabajo, las condiciones meteorológicas siguen siendo adversas para realizar tareas de mantenimiento en cubierta.

28/09/16

Continuamos tránsito a nueva zona de trabajo (Formigas).

Se repara y se instala la consola local eléctrica del LARS para hacer maniobras de arriado y recuperación.

Se perfecciona cajón de muestras para adaptar a las necesidades de los biólogos.

Se realizan planos de corrección en LARS para quedar constancia en sistema modificaciones realizadas.

Tampoco se esperan hacer inmersiones el día de hoy debido a que navegamos hacia la zona de trabajo de Formigas.

29/09/16

Al llegar a la zona de trabajo se realiza inmersión de 6 horas de duración (*Dive#04*).

En cubierta se revisa fallo intermitente de Cámara HD.

Se realiza nueva derivación de puertos serie para anotar dato de posición geográfica en *overlay* durante la grabación de cámara de piloto.

30/09/16

Se cambia tarjeta convertora de imagen de cámara HD dentro del POD del ROV para descartar posibles fallos de cámara.

En este día se realiza inmersión *Dive#05* que dura aproximadamente 6 horas y se recupera por fallo de hélices proa y popa estribor.

Se cambian tarjetas de dichas hélices y queda ROV operativo para realizar nuevas inmersiones.

La avería detectada es que fallan dos TRIACs de cada tarjeta y, a consecuencia de ello, se funden los fusibles de protección. Las tarjetas son reparadas sustituyendo los TRIACs y los fusibles, son comprobadas según procedimiento del manual.

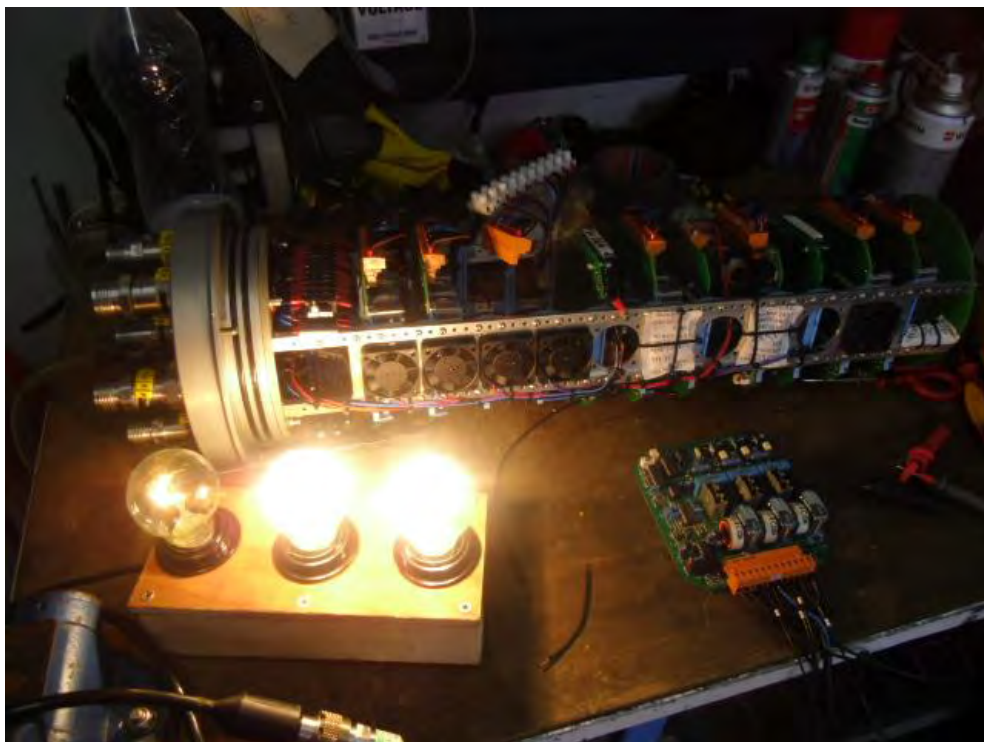
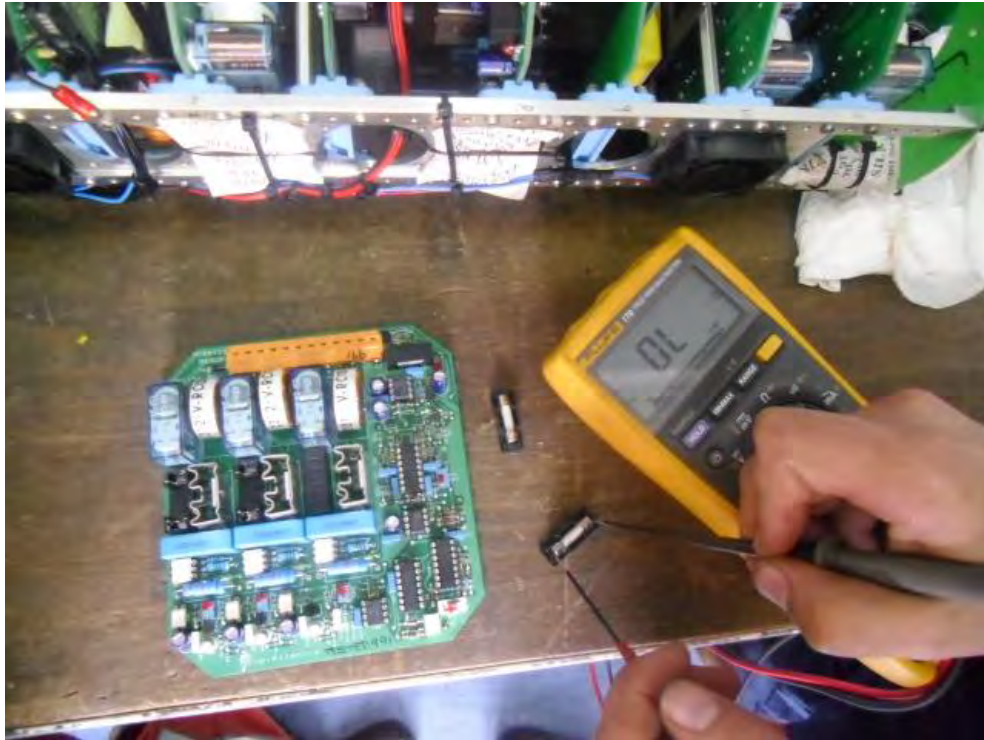

01/10/16

Se realiza una inmersión (*Dive#06*) de 7 horas y 44 minutos sin ningún problema a destacar en el sistema.

Al final del día se descargan videos y fotos para los científicos y se revisa el sistema quedando operativo y listo para las inmersiones futuras programadas.

02/10/16

Se hace inmersión a medio día debido al mal tiempo y a que la posición en DP del buque esta en límites operacionales.

La inmersión *Dive#07* se realiza con éxito con una duración de 4 horas y media.

Durante los chequeos *Post-Dive* se detecta que no funciona hélice proa estribor y se cambia. También se sustituye y repara la tarjeta de la hélice.

03/10/16

Se realiza la inmersión *Dive#08*, con una duración de 2h 22min. Se recupera por fin de transecto.

Con vehículo en cubierta, falla hélice de proa – estribor, la cual queda operativa después de cambiar y reparar la tarjeta de control correspondiente.

Se hace una inmersión de prueba en superficie de 30 min y vehículo queda operativo y probado para siguientes inmersiones.

04/10/16

Se realiza la inmersión *Dive#09*, que tiene una duración de casi 7h sin haber ningún tipo de percañe considerable.

Las hélices no fallan como venían haciendo después de realizar el chequeo *Post-Dive* en cubierta.

Se hacen como siempre todos los ajustes del sistema: nivel compensadores, etc., y se deja el sistema operativo para siguientes inmersiones finalizando así la jornada.

05/10/16

Después de inmersión de 2 horas y media (*Dive#10*) se recuperara vehículo por fallo operacional; es incontrolable. El motivo es el fallo de las dos hélices axiales de babor. Se recupera el vehículo a cubierta, se desmonta el POD, y se realizan las comprobaciones necesarias, tras lo cual el vehículo queda operativo después un cambio y reparación de tarjetas controladoras de hélices.

Debido a lo anormal del problema que se viene dando a lo largo de los últimos días se cancelan inmersiones para intentar localizar el fallo en el sistema.

Después de revisar todo el sistema desde superficie hasta el vehículo, no se localiza nada que pueda provocar estas averías por lo que se procede a realizar cambios en el sistema para descartar por eliminación posibles fallos.

Se cambia alimentación del sistema que está actualmente a 440VAC, quedando conectado a 400VAC en otro transformador; se realiza este cambio debido a que el LIROPUS hasta ahora no se había trabajado a esta tensión, por tanto se ajustan conexiones del primario de tensión (*tappings*) en el sistema en transformador.

Se sospecha también que el hecho de que las hélices estén succionando peces (congrios) puede estar provocando el bloqueo de las palas y causando estos problemas. Se fabrican e instalan a bordo unas protecciones de rejilla para evitar este problema:

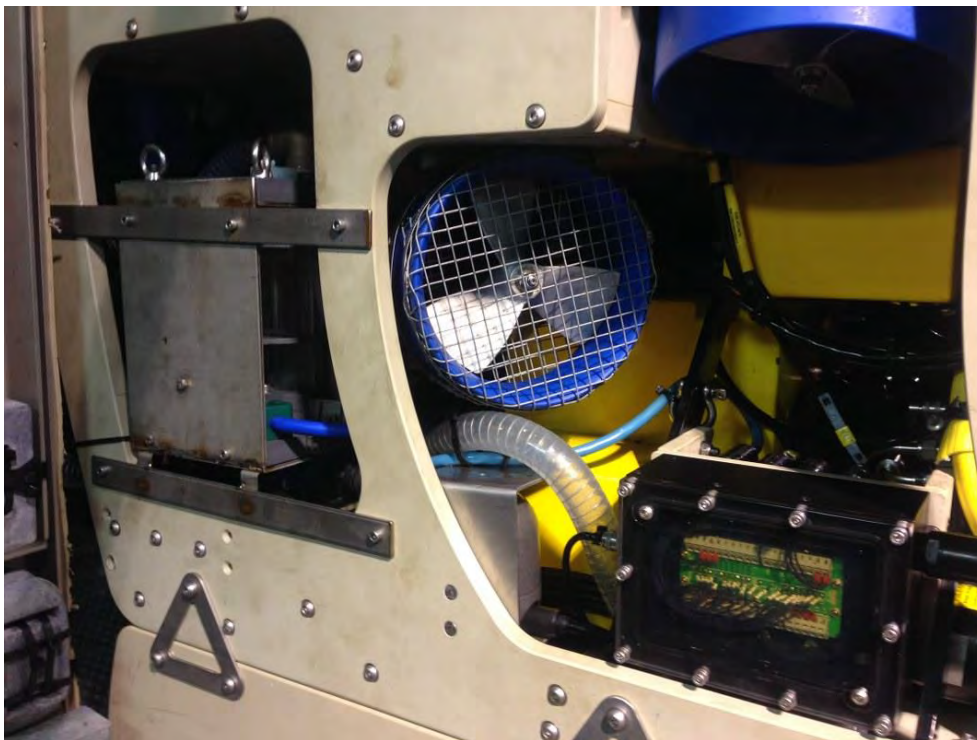

06/10/16

Debido a las condiciones meteorológicas no se esperan realizar inmersiones el día de hoy por lo que se aprovecha para revisar todo el sistema en busca de anomalías que causen el fallo en las hélices del ROV.

Después de comprobar conexiones en todo el sistema y de hacer diferentes pruebas no se llega a ninguna conclusión más de que el sistema funciona perfectamente y no hay nada que corregir.

07/10/16

Después de realizar las inmersiones Dive#11 y Dive#12, que ocupan casi toda la jornada con una duración de casi 9h, se realiza chequeo *Post-Dive*, quedando el sistema operativo y sin ningún problema o avería en las hélices para futuras inmersiones.

Hay que mencionar que el sistema, aparte de tenerlo que reiniciar estando sumergidos por fallo de PC/Software en una ocasión, fue fiable al 100%.

08/10/16

Se realiza la inmersión *Dive#13*, cuya duración se reduce a algo más de 3h y media, tras lo cual se cancela por condiciones meteorológicas, como se esperaba a lo largo del día.

Debido al mal tiempo el barco pone rumbo a tierra para pasar unos días al abrigo hasta que pase la borrasca.

Después de realizar un chequeo *Post-Dive* se detecta fallo de Hélice nuevamente, lo que provoca que se sigan realizando cambios en el sistema con el fin de descartar la posible avería que causa estos problemas en las tarjetas controladoras de las hélices. En esta ocasión, se decide hacer una nueva reterminación: se corta un trozo de *tether* de 6 metros que pudiera estar dañada y se realiza la reterminación eléctrica y de fibra óptica.

09/10/16

Estando atracados en Puerto de San Miguel (Azores), se realiza un test del ROV en superficie para probar hélices, durante la prueba falla otra tarjeta, que es posteriormente cambiada y reparada, y quedando en funcionamiento nuevamente.

10/10/16

Durante el día se sigue intentando descartar de dónde puede venir el posible fallo, y se descubre un importante hecho a tener en consideración dejando abierta una nueva vía de investigación.

En el barco **existe una conexión de ROV con alimentación hasta 150 Amperios a 400VAC limpia de armónicos**. Esta no había sido ofrecida por el departamento de máquinas para conectar el sistema debido a

estar **fuera de servicio**, por tanto todo apunta a que los problemas de las hélices del ROV pueden provenir de la alimentación suministrada por el barco.

11/10/16

Se realizan chequeos al sistema y se continúa analizando avería de las hélices. También se aprovecha para realizar diversas labores de mantenimiento.

Se espera estar varios días en puerto debido al mal tiempo.

12/11/10

Se incorpora en San Miguel el técnico de ACSM Bernardo Cornide, para auditar el sistema y colaborar en la detección del problema con las hélices del ROV.

Coincide a lo largo del día en que el sistema no presenta ningún problema y que todo está en orden después de realizar las inspecciones y pruebas necesarias. Trae también a bordo un osciloscopio, lo que nos permite estudiar la alimentación suministrada por el barco que durará los días restantes de la campaña.

13/10/16

Continúa la investigación para descubrir el origen de los problemas con las tarjetas de control de hélices. Asimismo, se reparan de manera provisional las unidades que han ido fallando durante la campaña.

Se empieza a monitorizar con el osciloscopio la onda de tensión generada a bordo. En puerto no se detectan problemas en la alimentación.

Se hace una prueba en agua (*wet test*) en puerto durante 1 hora y todo funciona correctamente quedando el ROV operativo para las siguientes inmersiones.

14/10/16

Se hace mantenimiento ordinario al sistema estando el barco en puerto.

Se prueban nuevas configuraciones también en puesto de Survey y mejoras para realizar los trabajos de la segunda parte de la campaña.

El técnico Bernardo Cornide abandona el barco y retorna a la base de ACSM.

15/10/16

Se sale a la mar y las condiciones climatológicas no son favorables. No se realizarán más inmersiones en Formigas. Comienza, por tanto, traslado a nueva zona de trabajo. Mientras el barco se encuentra en tránsito, el ROV queda en *stand-by* a la espera de órdenes.

16/10/16

El ROV continúa en *stand-by* a la espera de la mejora del tiempo.

Se aprovecha para realizar las tareas de mantenimiento posibles ante las condiciones meteorológicas.

17/10/16

Debido al estado de la mar no se puede trabajar en cubierta y simplemente nos limitamos estudiar los cambios de tensión y revisión de armónicos suministrados en la alimentación del sistema.

Se perfecciona Revolver de muestras también para futuras inmersiones.

18/10/16

Se llega a la nueva zona de trabajo a mediodía y se realiza la inmersión *Dive#14*, con una duración de 2h. La inmersión se aborta por un fallo de telemetría por interrupción de la comunicación por fibra óptica.

Se recupera a cubierta ROV en TMS sin telemetría y se comprueba que la fibra se ha partido a la altura del un conector ST en la caja de terminación del ROV.

Se retermina otra fibra óptica y se repara la avería, quedando comprobadas todas las comunicaciones entre ROV y Superficie.

19/10/16

Se realizan las inmersiones *Dive#15* y *Dive#16*, con una duración total de 10h, y se recupera el sistema al terminar los trabajos asignados sin haber fallado nada. Cabe destacar que el DP del barco casi no trabaja debido a que el estado de la mar está en calma total.

Comprobando el osciloscopio se aprecian armónicos pero en el día de hoy parecen no afectar al vehículo.

20/10/16

Al igual que el día anterior toda la jornada se realiza con ROV en el agua y sin ningún tipo de percance.

Se realizan las inmersiones *Dive#17* y *Dive#18*, con una duración combinada de 9 horas y media, y se continúa sin fallos en las tarjetas de las hélices.

El tiempo continúa siendo muy favorable.

21/10/16

El barco se encuentra en tránsito hacia una nueva zona de trabajo, por lo que no se prevé utilizar el ROV.

Se aprovecha para realizar diversas tareas de mantenimiento pendientes: se estiba correctamente todo el *tether* en el carrete del TMS, y se repara salida de video PAL desde el Control al puesto de Survey.

22/10/16

En este día no se esperan inmersiones debido a cambio de zona de trabajo por lo que se procede a realizar trabajos de mantenimiento ordinario y se continúa monitorizando y estudiando los problemas de suministro eléctrico al sistema.

Se detectan importantes variaciones de la tensión suministrada, así como el rizado de la onda sinusoidal. Se entregará un informe separado a este respecto.

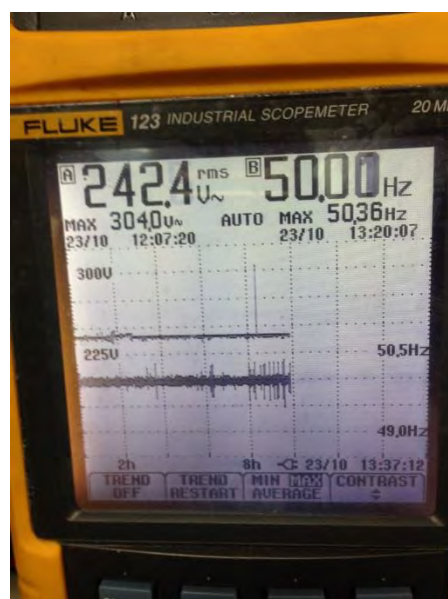

Al final del día, el barco llega a la nueva zona de trabajo (Seco de los Olivos)

23/10/16

Se consiguen hacer 7h de inmersión después de realizar 3 inmersiones (*Dive#19, Dive#20, Dive#21*), en las que los problemas han sido variados. Vuelven a producirse fallos de tarjetas de hélices y se finaliza transecto por haber presencia de redes y líneas de pesca en gran cantidad en la zona de trabajo.

Los problemas de suministro continúan y el equipo de ROV trata de reparar y poner vehículo operativo para realizar el mayor número de horas de inmersión posible sin poner en riesgo el vehículo.

24/10/16

En el día de hoy se consiguen hacer 7 horas de inmersión en dos inmersiones (*Dive#22, Dive#23*) con los problemas habituales, se siguen reparando tarjetas de hélices y sustituyendo por las que van fallando.

Aun así, se consigue realizar parte de los objetivos propuestos para las inmersiones.

25/10/16

En la jornada de este día se consiguen realizar 8 horas de inmersión (*Dive#24, Dive#25*), finalizando los transectos previstos, pero experimentando de nuevo averías en las hélices.

Con esto, se terminan las inmersiones previstas para la campaña MEDWAVES.

Se comienzan al final del día los trabajos de desmovilización nada más recuperar el vehículo del agua dejando el ROV operativo para realizar las grabaciones de prensa en puerto.

El barco se dirige a puerto de Málaga donde se continuarán las tareas de desmovilización.

26/10/16

Después de finalizar las grabaciones de prensa se continúa con la desconexión eléctrica del sistema y puesto de Survey.

Se espera dejar el sistema totalmente desconectado y recogido para agilizar la desmovilización en el puerto de Vigo.

27/10/16

Continúan los trabajos de desconexión y recogida de todos los elementos de cubierta.

Desembarcan en Málaga los 3 técnicos de ACSM.

Fin de la campaña

Carlos Méndez
Supervisor de ROV
ACSM Subsea Team

Appendix XIV: Standardised ATLAS sampling protocols for DNA

4. Contacts

Institute	Contact person	Samples
IFREMER	Sophie Arnaud-Haond sarnaud@ifremer.fr	Sediment cores, and water

5. Material

If you contact us before the cruise, we'd provide you with lists and material prepared and 'ready to use' for a quick and efficient sampling.

SAMPLING ADN IN SEDIMENT / WATER

A- Sediment : 3 cores from each sites.

Use disposable material, or clean each piece of material using “DNA away” before changing slice or core. Decontaminate tube cores before reusing them (DNA away or SDS followed by rinsing with filtered water)

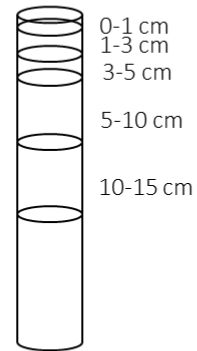

Step 1: cutting cores in depth layers

Code for samples:
Divenumber-
corenumber-
slicenumber (0-1,
1-3, 3-5...)



Step 2 : preserving in individual ziplock bags at -80°C with identifier written on the bag

B- Water samples

2 options

*with plankton net (if possible down to 5 μ)

*with Niskin bottles (5L), water filtered on 5 μ

Processed as follows:

* filtered on 20 μ m, 2 μ m, 0.2 μ m

* filters freezed in individual bags at -80°C

Code for samples:

**Divenumber-bottleornetnumber mesh
size (20, 2, 0.2**

Sampling Plankton using MultiNet/MOCNESS in ATLAS

Samples should be processed **as soon as possible** after their arrival on the deck, wearing **gloves** and using **cleaned material** as two important issues have to be taken care of:

1) DNA contamination is a very real problem (including human DNA)

-ensure that gloves are used whenever handling the samples to avoid contamination when the samples are manipulated

- to avoid contamination between tows, ensure MultiNet/MOCNESS sampling bottles are cleaned before use to avoid DNA degradation before they are fixed in ethanol or frozen

2) DNA and sample degradation can be very quick, thus ensure that samples are transferred to ethanol (EtOH) or formalin immediately on MultiNet/MOCNESS retrieval

1. Collection

For each sample, information on exact location (preferably GPS) and date, length and speed of tow, time and depth are needed.

- The basic question we want to answer with plankton tows is representation of different organisms at different depth at different times. Hence, a day and night sample in the epipelagic and mesopelagic might reveal what species are in each of the different regions at night or day. Similarly, a sample above features (hydrothermal vents, cold seeps, sponge gardens and coral reefs etc.) would help answering questions about larval dispersal and connectivity.
- It is difficult to state exactly how long a plankton tow should be, it is often dictated by the equipment used and equipment users often have a very good idea how to do the tow (this is also dependent on the amount of plankton in the water etc. However, 0.5 litres is regarded as a big sample.
- Make sure you shake the sample bottle from the MultiNet/MOCNESS well. Pour half the volume (well mixed) into a sterile bottle for DNA analyses and the remaining half of the volume in a bottle for morphological taxonomy.
- Make sure you shake the sample bottle from the MultiNet/MOCNESS well. Pour half the volume (well mixed) into a sterile bottle for DNA analyses and the remaining half of the volume in a bottle for morphological taxonomy.

2. Preservation & Storage

- For DNA Analysis samples need to be preserved soon as possible after collecting to avoid DNA degradation, contamination from other samples collected or with human DNA. Add EtOH (95-100%) in a ration 8:2 of EtOH to sample volume. Ensure the volume of sample and EtOH is recorded. Samples can then be stored at room temperature, but ensure they are not exposed to sunlight (or any UV light).
- For morphological taxonomy of zooplankton, use a 4% formaldehyde solution made from 1:9 ratio of 40% concentrated formaldehyde and seawater. After 12-16 hours gently pour off the formaldehyde solution thoroughly (most of the

samples will have precipitated in the bottle but not all, so be very careful or you will unknowingly be pouring off formaldehyde and sample) and transfer to 70% alcohol (final concentration). Alcohol is a good long-term preservative, but it does not fix animal protein histologically. Samples can then be stored in room temperature.

3. Recording data

We will provide you with bottles for storage of plankton samples, EtOH, formaldehyde and IMS (Alcohol). Bottles are labelled with numbers. All you will have to do is to put one plankton tow per bottle (i.e. do not mix them), and write down on the sampling sheet the coordinates for the start and end of tows, length of tow, depth of tows.

See excel sheet provided

Name of the cruise

Species name	Date	Depth	GPS coordinates	Dive number	Sample number (to be written on the tube)	Comments if necessary	Name of the contact who samples

4. Contacts

Institute	Contact person	Samples
	Jens Carlsson jens.carlsson@ucd.ie	
UCD	Nettán Carlsson nettán11@gmail.com	Plankton net

5. Material

If you contact us before the cruise, we will provide you with lists and material prepared and 'ready to use' for a quick and efficient sampling.



Sampling Corals & associated species for DNA analysis in ATLAS

Sampling corals can be quick, the only restriction is that it should be done as soon as possible after the submersible is back and the collection tray becomes accessible. This is for two reasons:

- to avoid contamination when the samples are manipulated
- to avoid DNA degradation before they are fixed in ethanol or frozen

For each area to be studied and replaced in an analysis to assess connectivity on a large scale, a set of 20 to 50 samples per species per site will be ideal. They can obviously be sampled at once or gathered during several days of collection, as long as information on exact location (preferably GPS) and date are provided.

1. Collection

- For DNA Analysis samples need to be fixed as soon as possible after collecting. Do not let specimens dry before wet fixation. Also collect specimens for genetic work as soon as possible to avoid contamination from other samples collected or with human DNA.
- Avoid as much as possible using your hands to collect branches for DNA preservation. Even if you wear gloves, use forceps and a scalpel to collect the branches for DNA preservation. Using a clean kimwipe, blot excess water from the tissue just before adding it to the preservative.
- Clean (with ethanol) or change the forceps and scalpel after every collection.

2. Preservation & Storage

Each tissue sample will be stored **separately** in individual containers (Eppendorf, falcon, else... just the volume has to be enough to encompass the sample but also the volume of preservative if needed –ethanol-, see here below) that should be labelled to track the sample with its metadata.

Corals	Large coral polyps may need to be semi-crushed with pliers before being placed in sample tubes.
Polychaetes	preserved whole if small. If large dissection of ~5mm of the body is required for preservation
Crustaceans	preserved whole if small or the legs / chela are removed from one side only for DNA preservation. The rest of the animal should be preserved for taxonomy
Parastichopus	require dissection to remove ~ 1 cm of a longitudinal muscle band from inside the body wall
Sea urchins (Cidaris)	require opening and the dark red muscle tissue and gonads are removed from inside the test wall
Ophiuroidea	either preserved whole or ~1cm of the arm is removed for DNA preservation
Others	May be preserved if possible in ethanol or formalin for taxonomy

Store the samples either in Ethanol, in liquid nitrogen, at -80°C, or at -20°C. Ethanol usually yields DNA of lower quality (though in general this is very sufficient for DNA analysis), but is safer than nitrogen or -80°C for which any incident during transportation may lead to the complete loss of samples.

- *Ethanol*: Samples can be kept in Ethanol 70-95%, the EtOH volume should exceed 5 to 10 times the volume of tissue that is fixed. Store at room temperature, avoid sun exposition or temperatures >30°C. When possible, it is optimal to change ethanol within 1 ours/ 24 hours of sampling
- *Freezing* : Samples frozen in liquid nitrogen work best for DNA work, as long as they can be kept frozen. Storing at -20 to -80 degrees Celsius.
- *RNA Later*. Samples to be stored in 5-10 times volume. Refrigerate for 24 hours and then pour of supernatant and freeze at -80°C. Alternatively freeze at -80°C with liquid inside. RNA Later is non-hazardous and can be transported by plane. RNA can be commercial or supplied from Ifremer or ADR's laboratory (home made).

Label each vial with a permanent marker, and, especially if ethanol preserved, please also add a piece of paper with the number written using a pencil as this resist all ethanol incident. Label the vial/tube & paper a digit number to each sample with letters to identify species and fill in a separate paper sheet listing samples, on which those numbers would be associated with the details needed as to location, species, etc...

3. Recording data

Tubes have to be labelled with numbers. All you'll have to do is to put one specimen per tube (ie don't mix them), and write down on the sampling sheet the dive code, site name and the species. Add EtOH if you choose to store them in EtOH.

The date of collection, detailed locality information (include GPS info when available), date, collector(s) name, species, individual sample identification number (length and weight when available) should be written on data sheets associated with their corresponding set of ethanol tubes.

See excel sheet provided

Name of the cruise

Species name	Date	Depth	GPS coordinates	Dive number	Sample number (to be written on the tube)	Comments if necessary	Name of the contact who samples

4. Target species & contacts

Institute	Contact person	Species
IFREMER	Sophie Arnaud-Haond sarnaud@ifremer.fr	<i>Madrepora oculata</i> , <i>Lophelia pertusa</i> , <i>Eunice norvegica</i> except Rockall Bank and Western UK (see UOx here below for those locations)
IMAR	Marina Parra Carreiro carreirosilvamarina@gmail.com	Black corals (<i>Leiopathes</i> sp, <i>Antipathella wollastony</i>), octocorals (<i>Viminella flagellum</i> , <i>Paracalyptrophora josephinae</i>).
IEO	Covadonga Oraja cova.orejas@ba.ieo.es	<i>Dendrophyllia cornigera</i> , <i>Desmophyllum dianthus</i>
UCD	Jens Carlsson jens.carlsson@ucd.ie	<i>Nephrops</i> sp.
Uox	Alex Rogers alex.rogers@zoo.ox.ac.uk	<i>Lophelia pertusa</i> & <i>Desmophyllum dianthus</i> (Rockall Bank and Western UK, <i>Acanella arbuscula</i> , <i>Cidaris cidaris</i> , <i>Parastichopus tremulus</i> ; also associates with Scleractinia, especially <i>Eunice norvegica</i> (Rockall Bank and Western UK), scale worms, spider crabs, squat lobsters and Ophiuroidea

5. Material

If you contact us before the cruise, we'd provide you with lists and material prepared and 'ready to use' for a quick and efficient sampling. We can also if needed provide you with tubes of 1.5 to 2 ml, 15ml or 50ml for biggest samples, and we can find a way for you to have EtOH if needed.

SAMPLING INVERTEBRATES FOR DNA

Sampling corals for DNA analyses

COLLECTION

Sample the specimens asap
Always use gloves!



- Do not use the hands to hold and cut the specimens!
- Hold coral with forceps, cut with pliers / scalpel, take the fragment with forceps
- Material need to be clean (use ethanol to clean)

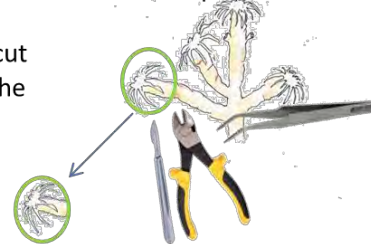

- Scleractinians: 1-2 polyps
- Gorgonians 2 cm

PRESERVATION AND STORAGE



High strength ethanol 90-96%

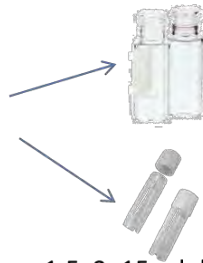

1,5, 2, 15 ml depending on sample size. Minimum 10:1 ratio ethanol : tissue. Tissue need to be covered by ethanol. One vial per specimen.

Or direct freezing



Store by +4°C

LABEL



Sample 1 Sp. A
Use a permanent marker a pencil written paper within the vial. Fill in a separate sheet list of samples. Numbers and letters would be associated to the details needed (e.g. Station, species, etc...)

Sampling Fish for DNA analysis in ATLAS

Sampling fish tissue can be quick, the only restriction is that it should be done as soon as possible after the submersible is back and the collection tray becomes accessible. This is for two reasons:

- to avoid contamination when the samples are manipulated
- to avoid DNA degradation before they are fixed in ethanol

For each area to be studied and replaced in an analysis to assess connectivity on a large scale, a set of 30 to 50 samples per species per site would be ideal. They can obviously be sampled at once or gathered during several days of collection, as long as information on exact location (preferably GPS) and date are provided.

- 1. Collection:** Cut a small piece of fin from the caudal, or muscle tissue, of the fish using clean scissors or a scalpel blade. Hands of the collector (preferably with gloves) and tools to cut should be cleaned of mucus and scales between handled samples (in order not to contaminate with the preceding one). Tissue size should be at a minimum 5 mm² (see footpage).
- 2. Preservation & Storage:**

Each tissue sample will be stored **separately** in individual containers (Eppendorf, falcon, else... just the volume has to be enough to encompass the sample but also the volume of preservative if needed –ethanol-, see here below) that should be labeled to track the sample with its metadata (see below).

- Place the fin clip into a small glass or plastic vial, and then preserve it either frozen (liquid nitrogen or -20 to -80) or
- Preserved in ethanol (vial filled to the top, a minimum 10:1 ratio of ethanol : preservative to tissue is needed; tissue should not be exposed to air in the vial, but totally immersed for DNA to be preserved). The ethanol (minimum 90%, up to 96% but avoid absolute) will preserve the tissue and the DNA at room temperature, so does not need to be refrigerated (however if possible to keep in a freezer, preservation is usually much better).

3. Recording data

Label each vial with a permanent marker, and, especially if ethanol preserved, please also add a piece of paper with the number written using a pencil as this resist all ethanol incident. Label the vial/tube & paper a digit number to each sample with letters to identify species and fill in a separate paper sheet listing samples, on which those numbers would be associated with the details needed as to location, species, etc...

The date of collection, detailed locality information (include GPS info when available), date, collector(s) name, species, individual sample identification number (length and weight when

available) should be written on data sheets associated with their corresponding set of ethanol tubes.

Approximate size of a sample if fin clip:



See excel sheet provided

Name of the cruise

Species name	Date	Depth	GPS coordinates	Dive number	Sample number (to be written on the tube and with a pencil on a paper within the vial)	Comments if necessary	Name of the contact who samples

4. Target species & contacts

Institute	Contact person	Species
IFREMER	Sophie Arnaud-Haond sarnaud@ifremer.fr	<i>Micromesistius poutassou</i> , <i>Lophius</i> sp., <i>Helicolenus dactylopterus</i> Fish species from Azores: <i>Polyprion americanus</i> , <i>Hoplostethus atlanticus</i> , one spp of deep-sea sharks (such as <i>Dalatias licha</i> depending on sampling opportunities).
UCD	Jens Carlsson jens.carlsson@ucd.ie	<i>Caprus aper</i> , <i>Nephros</i> sp.

SAMPLING FISH FOR DNA

Sampling fish for DNA analyses

COLLECTION

Always use gloves!



Cut a piece of the caudal fin or muscle tissue

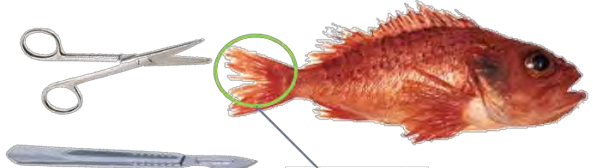

Scissors/scalpel need to be CLEAN (use ethanol to clean)

Minimum sample size: 5 mm²

PRESERVATION AND STORAGE



High strength ethanol 90-96%

Place tissue in small glass /plastic vial. Minimum 10:1 ratio ethanol : tissue. Tissue need to be covered by ethanol

Or direct freezing



Store by +4°C

LABEL



Vial or Eppendorf: 1 specimen per container

Use a permanent marker a pencil written paper within the vial Fill in a separate sheet list of samples. Numbers and letters would be associated to the details needed (e.g. Station, species, etc...)

Appendix XV: Technical report UTM (only available in Spanish)

059-SG 20161026 ó ATLAS-MEDWAVES

Informe Técnico

SEPTIEMBRE - OCTUBRE



Título: Informe técnico Campaña ATLAS-MEDWAVES.

Autores: Manuel PAREDES, Hector SANCHEZ, Antonio SALVADOR, Peregrino CAMBEIRO, José Alberto SERRANO

Departamentos: Acústica, Mecánica, Electrónica, ROV y Telemática.

Fecha: 29/11/16.

Páginas:50.

Localización: Golfo de Cádiz-Plataforma Portugal-Azores-Gibraltar-Alborán

Detalles campaña: Batimetría + ROV+CTDs+Muestreos (BOX CORER, VanVeen y MUC).

INDICE

Contenido

INDICE	2
0. FICHA TÉCNICA	4
1. CARACTERÍSTICAS DE CAMPAÑA	5
2. INSTRUMENTACIÓN ACÚSTICA	5
2.1 SONDA MULTHAZ AGUAS PROFUNDAS ATLAS HYDROSWEEP	5
2.1.1 Descripción	5
2.1.2.- Características técnicas.....	6
2.1.3.- Metodología.....	7
2.1.4.- Calibración	7
2.1.5.- Incidencias	8
2.2.- SONDA MONOHAZ SIMRAD EA-600.....	9
2.2.1.- Descripción.....	9
2.2.2.- Metodología.....	10
2.2.3.-Incidencias	10
2.3.- CORRENTÍMETRO DOPPLER 75 KHZ.....	11
2.3.1.- Descripción.....	11
2.3.2.- Metodología.....	12
2.3.3.- Modos de trabajo.....	4
2.3.4.-Incidencias	4
2.4.- APPLANIX POS MV	5
2.4.1.- Introducción.....	5
2.4.2.- Descripción del sistema.....	6
2.4.3.-CARACTERÍSTICAS TÉCNICAS	6
2.4.4.- Incidencias	7
2.5.- SISTEMA DE NAVEGACIÓN EIVA.....	8
2.5.1.- Descripción.....	8
2.5.2.- Incidencias	9
2.6 SISTEMA DE POSICIONAMIENTO SUBMARINO HIPAP 351P	10
2.6.1 Introduccion:	10

2.6.2.-Descipcion del Sistema.	11
2.6.3.- Instalacion en el Sarmiento de Gamboa.	12
2.6.4.- Incidencias:	13
3.-INSTRUMENTACION LABORATORIOS.....	14
3.1.-Equipos y laboratorios	14
3.2.-Necesidades y Material	19
4.-TELEMATICA	20
4.1.-ACTIVIDADES TIC.....	20
4.1.1 INTRODUCCIÓN.....	20
4.1.2 RESUMEN DE ACTIVIDADES	22
4.1.3 INCIDENCIAS	27
4.2.-SISTEMA DE COMUNICACIONES DE BANDA ANCHA EN EL SARMIENTO DE GAMBOA	30
4.2.1- Descripción del sistema.....	30
4.2.1.1- Introducción.....	30
4.2.1.2- El equipo del BO Sarmiento.....	31
4.2.2- Acceso a Internet.....	32
4.2.3- Acceso a la red de la UTM en el CMIMA	34
4.2.4- Telefonía	35
5.-ELECTRONICA	36

0. FICHA TÉCNICA

FICHA TÉCNICA			
ACRÓNIMO	ATLAS-MEDWAVES		
Título Proyecto	ATLAS		
CÓDIGO REN	ATLAS-GA-678760	CÓDIGO UTM	059 SG 20161026
JEFE CIENTÍFICO	Dra. Covadonga OREJAS	INSTITUCIÓN	IEO
INICIO	Cádiz (ESP) 21/Septiembre/2016	FINAL	Málaga (ESP) 26/Octubre/2016
BUQUE	Sarmiento de Gamboa		
Zona de trabajo	Golfo de Cádiz-Plataforma Portugal-Azores-Gibraltar-Alborán		
Responsable Técnico	Manuel Paredes	Organización	U.T.M.
Equipo Técnico	Manuel PAREDES y Héctor SANCHEZ (UTM Acústica) Peregrino CAMBEIRO, (UTM Mecánica) J.Alberto SERRANO (UTM Telemática) Antonio SALVADOR (UTM Electrónica) Daniel ALCOVERRO (UTM Laboratorios)		
Instrumentación utilizada	Sonda multihaz ATLAS [®] Hydrosweep DS, Sonda monohaz SIMRAD [®] EA-600, ADCP TELEDYNE [®] Ocean Surveyor 75kHz, USBL KONGSBERG [®] HiPAP351+. CTD SEABIRD [®] 9Plus, LADCP TELEDYNE [®] WorkHorse Monitor 300kHz Sistema de navegación EIVA [®] . Sistema de Posicionamiento POSMV APPLANIX [®] .		

1. CARACTERÍSTICAS DE CAMPAÑA

2. INSTRUMENTACIÓN ACÚSTICA

2.1 Sonda Multihaz Aguas Profundas ATLAS Hydrosweep

2.1.1 Descripción

La sonda multihaz Hydrosweep DS es una sonda multihaz de última generación, diseñada para realizar levantamientos batimétricos de fondos marinos hasta profundidades mayores de 11000 metros, cumpliendo las normativas IHO S44 para dichos levantamientos.

La Sonda multihaz Atlas Hydrosweep DS es un sistema completo que incluye desde los transductores hasta el procesado final de los datos y su impresión final.

El equipo está compuesto por los siguientes módulos:

- **Transductores:** Instalados en una barquilla situada a proa del buque, a 6 m. de profundidad.
- **Transceptores:** Es la electrónica de adquisición y tratamiento de los datos. La forman diferentes unidades:
- **AEU:** Unidad de electrónica analógica. Contiene la electrónica de potencia (electrónica de transmisión y bloques de capacitadores) y recepción (preamplificadores, digitalizadores).
- **DEU:** Unidad Digitalizadora. Incluye toda la unidad de tratamiento y filtrado de los datos adquiridos. También incluye las fuentes de alimentación de baja y alta tensión para el resto de unidades.
- **ICU:** Unidad de interconexión.
- **Ordenador de Control:** Gestiona la adquisición de los datos en diferentes formatos y controla la electrónica de adquisición.
- **Sensores auxiliares (posición, actitud, velocidad del sonido, etc):** Se conectan a unidades independientes de adquisición (DIP) que re-envían la información a la red para que esté disponible para todos los instrumentos (Atlas MD, Atlas PS).

La adquisición de los datos brutos se hace con el software propio de Atlas (Atlas Parastore y Atlas Hydromap Control), creando los ficheros (*.ASD). Se utiliza también un software externo, en este caso EIVA NaviScan, para adquirir los datos de la sonda (ficheros *.SBD) y representar por pantalla el Modelo Digital del Terreno, así como los datos de Side Scan.

Se ha realizado procesado a bordo de los datos. Los archivos *.sbd y los *.asd de la frecuencia PHS ambos con Caris Ships and Hips, versión 10.2..

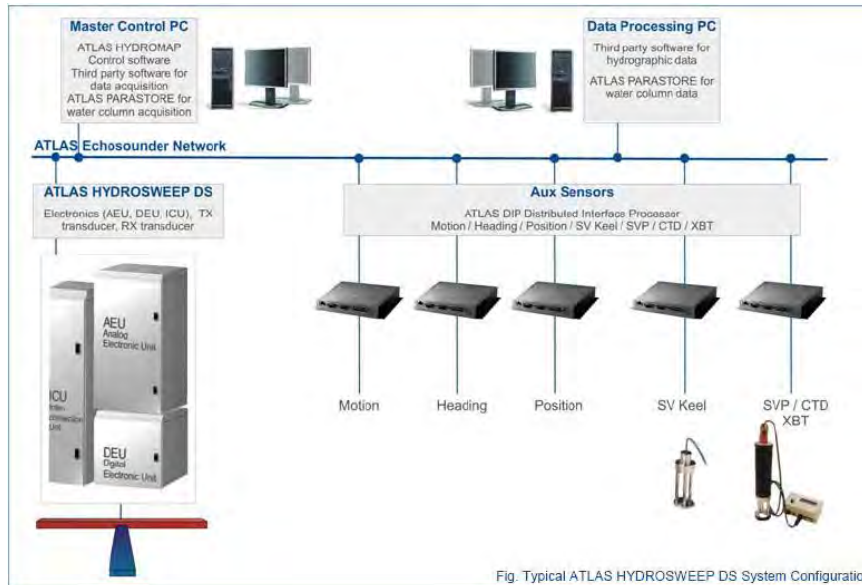

Esquema del sistema. Atlas DS

2.1.2.- Características técnicas

- Frecuencia de emisión: 14.5 a 16 kHz.
- Rango de operación: 10 a 11000 metros
- Max. Range Resolution: 6.1 cm
- Precisión: 0.5 m, 0.2% de la profundidad (2 sigma)
- Longitud de pulso: 0.17 a 25 ms
- Frecuencia de muestreo: <12.2 Khz.
- Máx. tasa de emisión: <10 Hz.
- Cobertura máxima: 6 veces la profundidad, 20 km máximo. En esta campaña hemos estado en 5 veces la profundidad.
- Nº de haces: 141 por hardware y 960 con High Order Beamforming.
- Apertura del haz: 1° x 1°.
- Espaciado de haces: Equi-angular, equidistante.
- Estabilización
 - Telegramas de profundidad: Cabeceo, balanceo.
 - Software NaviScan: Cabeceo, balanceo, guiñada, altura de ola.
- Interfaces:
 - Sensor de actitud Applanix POS-MV
 - Software de adquisición EIVA NaviScan
 - Sensor de velocidad del sonido superficial
 - Sistema de navegación EIVA.



Imagen del funcionamiento en pantalla de la Atlas Hydrosweep DS.

2.1.3.- Metodología

El software corrige las posiciones GPS y las lleva al transductor, por lo que no es necesario hacer ninguna corrección adicional. Se ha trabajado con las sondas sin sincronizar al no detectarse ninguna interferencia reseñable entre los equipos.

Se tienen en pantalla y en tiempo real los valores del sensor de velocidad de sonido superficial situado en el quilla retráctil de estribor. De tal modo que si el operador observa una variación de más de 5 m/s respecto al valor a 6 m de profundidad, que es la profundidad a la que se despliega dicha quilla durante el registro batimétrico, se hace o un perfil de velocidad del sonido o se lanza un XBT, esto último en el caso de que la sismica esté desplegada.

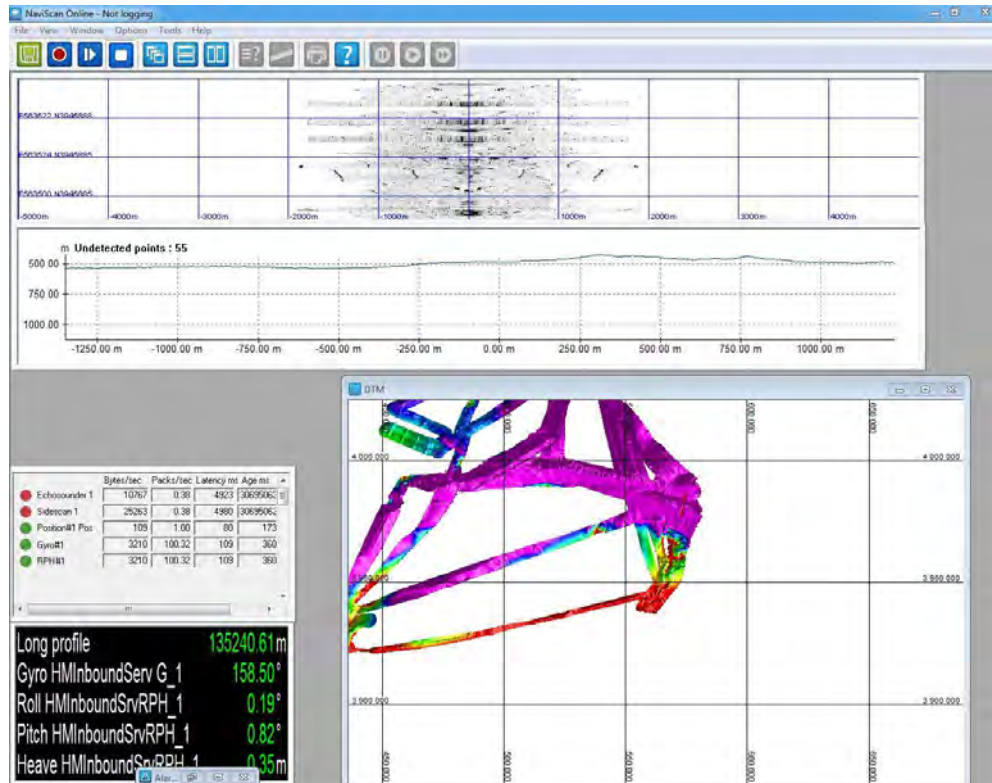
2.1.4.- Calibración

Introducción

Para que los datos de batimetría nos den unos resultados correctos se debe calibrar tanto la velocidad de desplazamiento del sonido en el agua como las variaciones en las coordenadas xyz del transductor respecto a su posición de equilibrio.

La calibración de la velocidad del sonido se hace midiendo las características de la columna de agua en cuanto a temperatura y conductividad.

Metodología

Echosounder Equipment: Atlas Hydrosweep DS

Sound Velocity Profiles: CTDs deployments

Projection parameters:

Projection	UTM
Hemisphere	North
UTM Zone	29 (Se usaron 4 zonas UTM diferentes).
Central Meridian	W3
Units	Meters

Geodetic Parameters

Datum	WGS84
Spheroid	WGS84

Los datos de batimetría se han procesado con **CARIS HIPS&SIPS 10.2**.

ANNEX 1: Vessel file values (CARIS)

- Transducer 1: X=0 Y=0 Z=0 P=-5 R=0 Y=0
- Transducer 2: X=0 Y=0 Z=0 P=0 R=0 Y=0
- Navigation: Latency=0.150s
- Heave: X=0 Y=0 Z=0, Apply? Yes
- Pitch: X=0 Y=0 Z=0, Apply? No
- Roll: X=0 Y=0 Z=0, Apply? No
- SVP1: X=0.140 Y=16.050 Z=6.620 P=4.788 R=0.038 A=0
- SVP2: X=-0.190 Y=11.990 Z=6.350 P=4.545 R= 0.077 A=0
- Waterline Height: Apply? No

2.1.5.- Incidencias

El equipo sufrió en varias ocasiones problemas de software en el pc de adquisición. Se tenía que reiniciar el equipo cada vez. Esto sucedía cada 6 u 8 horas.

Para calibrar la velocidad del sonido se usaron los perfiles del CTD obtenidos durante las noches.

2.2.- SONDA MONOHAZ SIMRAD EA-600

2.2.1.- Descripción

Sonda monohaz de doble frecuencia. Las frecuencias de trabajo son de 12 kHz en modo activo o pasivo activo, (PINGER) utilizado en combinación con el Pinger Benthos, y 200 kHz.

La sonda dispone de salidas serie, Ethernet y Centronics para impresora. Los datos se presentan en pantalla, a los que se añaden los datos de navegación y hora. Los datos de navegación, tiempo y actitud le llegan del POS-MV, mediante unas líneas serie cuya configuración es la siguiente

Telegrama	Puerto	Baudios	Bits Datos	Bits Stop	Paridad
Navegación y tiempo	COM3	9600	8	1	No
Actitud	COM2	19600	8	1	No

La profundidad se envía a través de la red Ethernet por el puerto UDP:2020 al sistema de adquisición de datos SADO.

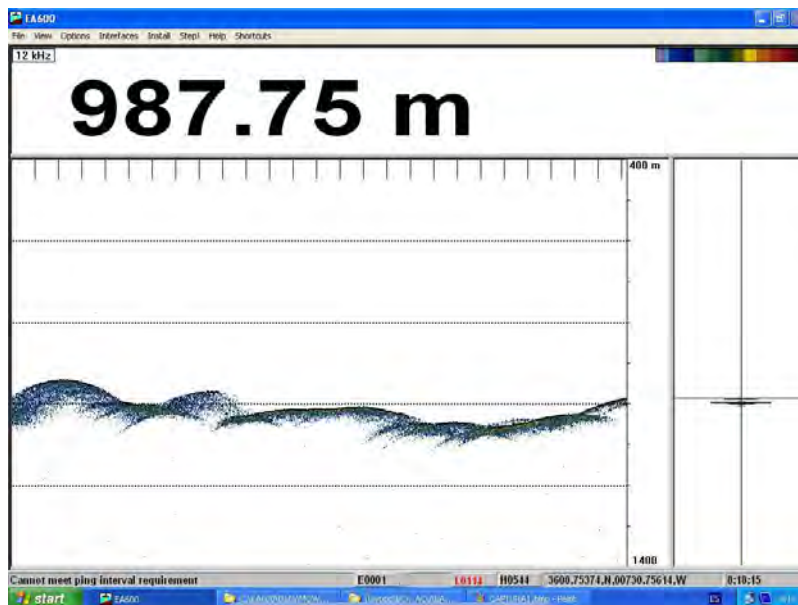

Pantalla principal EA 600

2.2.2.- Metodología

Esta sonda se utiliza para la navegación y para incorporar la profundidad en el telegrama de datos distribuido y la BBDD SADO. Paralelamente, ha sido de gran utilidad en los muestreos de dragas, box corer y multicorer dado que se detectaban estos equipos durante el descenso y ascenso, y se sabía cuándo se tocaba fondo.

2.2.3.-Incidencias

Ninguna incidencia reseñable.

2.3.- Correntímetro doppler 75 kHz

2.3.1.- Descripción

El ADCP (Acoustic Doppler Current Profiler) de 75 kHz se ha empleado en la campaña tanto para el usual registro de datos de dirección e intensidad de corriente.

El perfilador de corrientes por efecto Doppler es un equipo que nos da las componentes de la velocidad del agua en diferentes capas de la columna de agua. El transductor está instalado en la quilla retráctil de babor. El sistema consta de un transductor que emite ondas acústicas, una unidad electrónica que genera los pulsos y pre-procesa las ondas recibidas, y un PC que adquiere los datos y los procesa.

El ADCP utiliza el efecto Doppler transmitiendo sonido a una frecuencia fija y escuchando los ecos retornados por los reflectores en el agua. Estos reflectores son pequeñas partículas o plancton que reflejan el sonido hacia el ADCP. Estos reflectores flotan en el agua y se mueven a la misma velocidad que el agua. Cuando el sonido enviado por el ADCP llega a los reflectores, éste está desplazado a una mayor frecuencia debido al efecto Doppler, este desplazamiento frecuencial es proporcional a la velocidad relativa entre el ADCP y los reflectores. Parte de este sonido desplazado frecuencialmente es reflejado hacia el ADCP donde se recibe desplazado una segunda vez. La fórmula que relaciona la velocidad con la frecuencia es:

$$F_d = 2 F_s (V/C)$$

Donde:

F_d es el desplazamiento Doppler en frecuencia

F_s es la frecuencia del sonido cuando todo está en calma

V es la velocidad relativa (m/seg.)

C es la velocidad del sonido (m/seg.)

Para poder calcular los vectores tridimensionales de la corriente necesitamos tener tres haces de sonido apuntando en diferentes direcciones. El equipo instalado en el Sarmiento de Gamboa dispone de cuatro haces, un par produce una componente horizontal y una vertical, mientras el otro par de haces produce una segunda componente horizontal perpendicular así como una segunda componente vertical de la velocidad. De esta forma tenemos dos velocidades

horizontales y dos estimaciones de la velocidad vertical para las tres componentes del flujo. Con las dos estimaciones de la velocidad vertical podemos detectar errores debidos a la no homogeneidad del agua así como fallos en el equipo.

2.3.2.- Metodología

El ADCP OS75 se ha utilizado para obtener datos acerca de la intensidad y dirección de las corrientes marinas. La frecuencia de trabajo fue de 75 kHz, utilizándose la misma configuración durante toda la campaña.

Existen dos programas, el VmDas y el WINADCP. La adquisición se realiza desde el programa VmDas, el cual hay que configurar mediante una serie de parámetros. Estos parámetros los introducimos en el menú OPTIONS cargando alguno de los perfiles con extensión .INI

El software de adquisición de datos ha sido el Vm-Das 1.46.

El archivo de configuración que se han utilizado es el siguiente:

ARCHIVO MEDWAVES_NB-BB-75_BT.txt

Restore factory default settings in the ADCP

cr1

; set the data collection baud rate to 38400 bps,

; no parity, one stop bit, 8 data bits

; NOTE: VmDas sends baud rate change command after all other commands in

; this file, so that it is not made permanent by a CK command.

cb611

; Set for narrowband single-ping profile mode (NP), one hundred (NN) 16 meter bins (NS),

; 8 meter blanking distance (NF)

NP00001

NN100

NS0800

NF0800

; Set for broadband single-ping profile mode (WP), one hundred (WN) 4 meter bins (WS),

; 8 meter blanking distance (WF), 390 cm/s ambiguity vel (WV)

WP00001

WN125

WS0800

WF0800

WV390

; Enable single-ping bottom track (BP),

; Set maximum bottom search depth to 1200 meters (BX)

BP001

BX12000

; output velocity, correlation, echo intensity, percent good

WD111100000

;ND111100000

; One and a half seconds between bottom and water pings

TP000000

; Zero seconds between ensembles

; Since VmDas uses manual pinging, TE is ignored by the ADCP.

; You must set the time between ensemble in the VmDas Communication options

TE00000000

; Set to calculate speed-of-sound, no depth sensor, external synchro heading

; sensor, no pitch or roll being used, no salinity sensor, use internal transducer

; temperature sensor

EZ1020001

; Output beam data (rotations are done in software)

EX00000

; Set transducer misalignment (hundredths of degrees)

EA04513

; Set transducer depth (decimeters)

ED00080

; Set Salinity (ppt)

ES36

; save this setup to non-volatile memory in the ADCP

CK

El programa WINADCP sirve para visualizar los ficheros en tiempo real, es muy útil ya que se pueden mirar todos los datos de una forma rápida.



Imagen del Software VmDas de adquisición del ADCP de 75 KHz.

Las características de este ADCP son las siguientes:

Parámetro	Valor
Frecuencia	76800 Hz
Ping Rate	0.7 Hz
Bottom Track	950 m
Angulo de los haces	30°
Configuración del transductor	4 haces, Janus
Patrón de los haces	Convexo
Sensor de temperatura	Interno
Tipo de Transductor	Redondo 32x32
CPU Firmware	23.11
FPGA Version	XC

Las características del perfil de agua en modo Long Range son las siguientes:

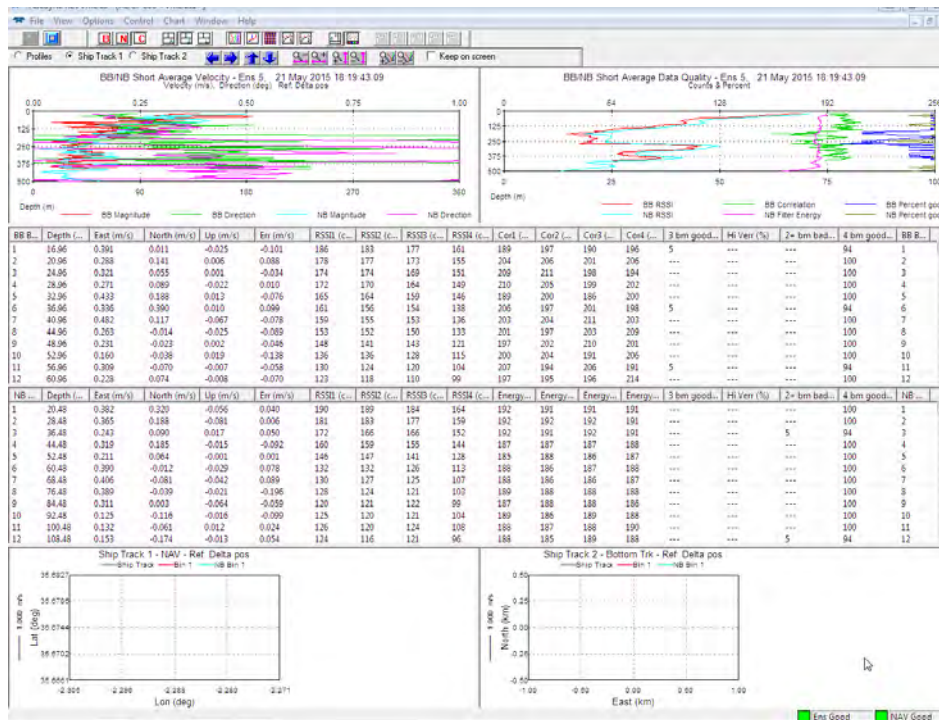
Longitud de la celda	Alcance máximo	Precisión (cm/s)
8	520-650	30
16	560-700	17

Las características del perfil de agua en modo Alta precisión son las siguientes:

Longitud de la celda	Alcance máximo	Precisión (cm/s)
8	310-430	12
16	350-450	9

2.3.3.- Modos de trabajo

El Ocean Surveyor puede trabajar en modo NARROW BAND, BROAD BAND y ambos combinados. Esto se especifica en el fichero de configuración .TXT del menú OPTIONS / PROGRAM OPTIONS / ADCP SETUP. Para trabajar en modo Broad Band se ha de especificar que el parámetro WP sea 1 o superior (por defecto es 1) de la misma forma para Narrow band ha de ser NP1 y para trabajar en ambos modos los dos han de estar a 1.

2.3.4.-Incidencias

El telegrama de actitud y posición le entra al equipo por la misma tarjeta multipuerto del pc de adquisición. La señal pareció que sufriera interferencias entre las dos. Se cambió una de las entradas de estos telegramas a otra tarjeta diferente del mismo pc y se solucionó el problema.

2.4.- Applanix POS MV

2.4.1.- Introducción

El POS-MV es el alma de los sensores de actitud del barco. Consta de dos antenas GPS, situadas en el sobrepunte, una unidad central y su pantalla, situadas en el rack de proa del laboratorio de Equipos Electrónicos Proa (Sondas) y la VRU situada en el local de gravimetría.

El equipo toma datos del GPS y de la VRU (Unidad de referencia vertical) que da información sobre la actitud del barco, cabeceo, balanceo, oleaje. Procesa los datos y genera telegramas NMEA heading, actitud y de posición, que se reparten por todo el barco a través de unas cajas con puertos serie también se reparten los telegramas vía Ethernet.

La posición que proporciona el POS-MV corresponde al centro de gravedad del Barco (MRU en el local de gravimetría).

2.4.2.- Descripción del sistema

Las antenas GPS proporcionan la información de Heading, velocidad, posición y tiempo, mientras que la VRU proporciona la información de actitud.

Para asegurar que las marcas de tiempo son correctas, el PPS del GPS se utiliza como tiempo de referencia tanto para la unidad central como la VRU.

La información de POS-MV está disponible en la pantalla y en 5 Leds situados en la unidad central. Los Leds indican el estado de la unidad.

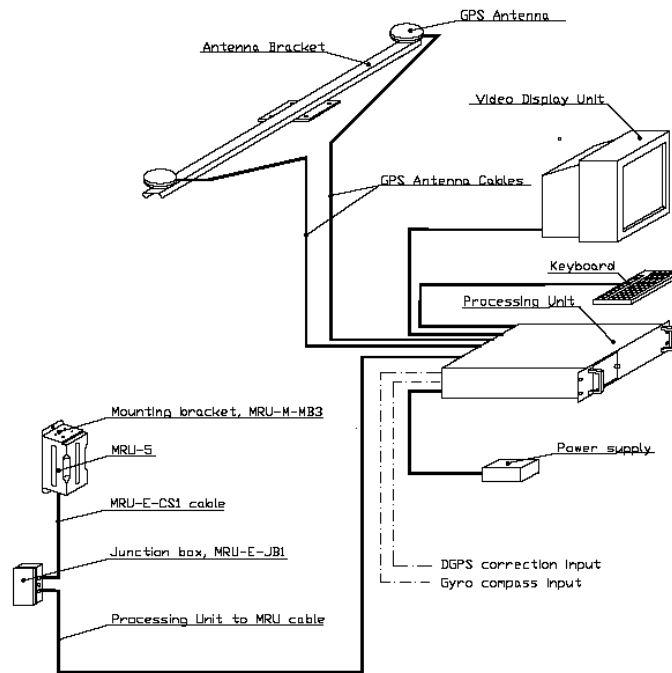

Esquema de la instalación del POS-MV.

2.4.3.-CARACTERÍSTICAS TÉCNICAS

- Precisión del cabeceo y balanceo: 0.02° RMS (1 sigma)
- Precisión de altura de ola: 5 cm o 5% (el que sea mayor)
- Precisión del rumbo: 0.01° (1 sigma)
- Precisión de la posición: 0,5 a 2 m (1 sigma) dependiendo de las correcciones
- Precisión de la velocidad : 0,03 m/s en horizontal



Imagen de la pantalla principal del POS-MV

2.4.4.- Incidencias

Ninguna incidencia.

2.5.- SISTEMA DE NAVEGACIÓN EIVA

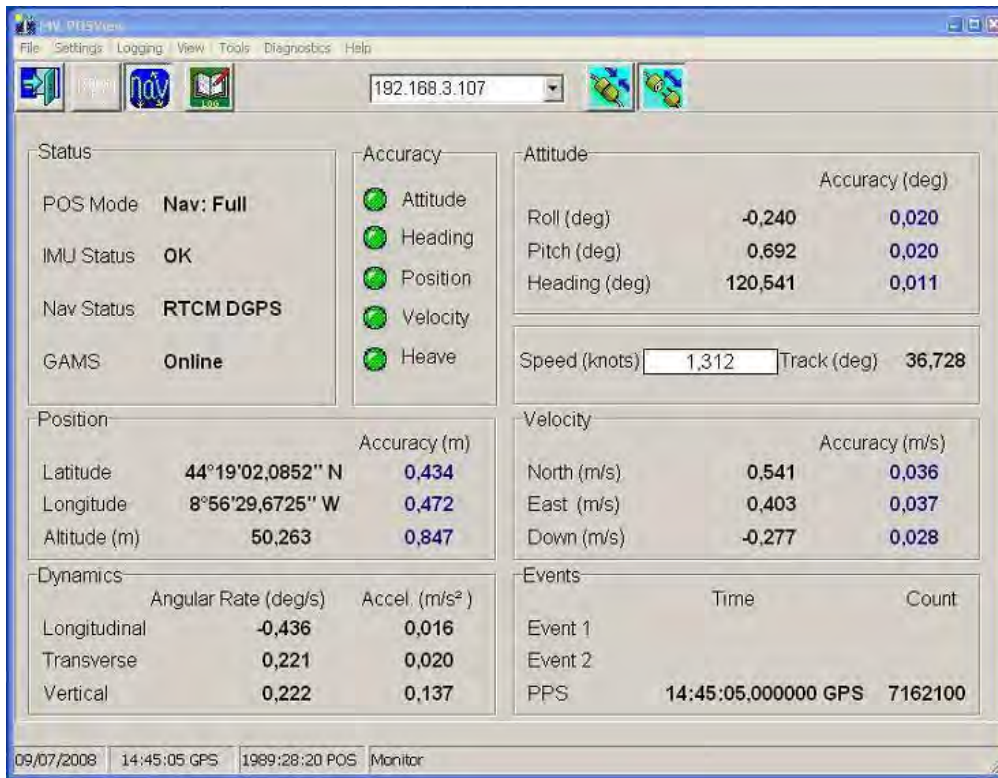
2.5.1.- Descripción

El sistema de navegación EIVA consta de un ordenador con S.O. Windows, los datos de los diferentes sensores le llegan vía Ethernet y serie. Con estos datos y un software específico, el programa genera una representación georreferenciada de la posición del barco y crea una serie de telegramas que alimentan a diferentes sistemas e instrumentos.



Imagen del navegador Eiva, concretamente el módulo Helmsman

Los sensores de entrada son los siguientes:

DATO	PUERTO	SENSOR	COMUNICACION
Posición	COM 4	GPS Ashtech	9600, 8, N, 1
Gyro	COM 3	POS-MV	4800, 8, N, 1
Motion	UDP/IP	POS-MV	Port:8602 Addr: 127.0.0.1
USBL	UDP/IP	Posidonia	Port:2500 Addr: 192.168.3.78

El programa recoge todos los datos de los sensores que le llegan por los diferentes puertos y los representa en pantalla, sobre un sistema geodésico elegido anteriormente.

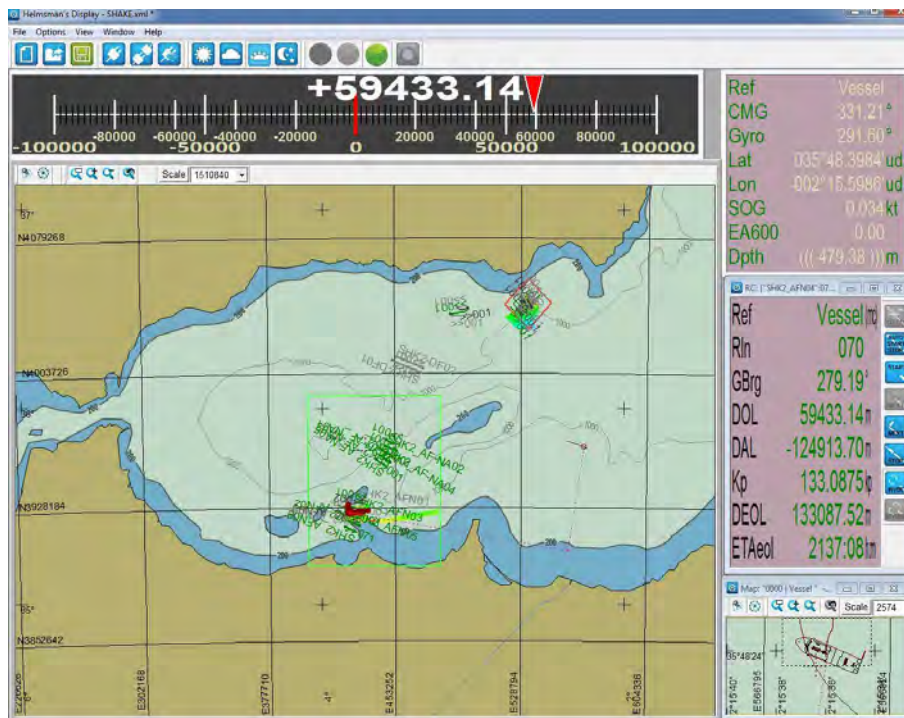
Para facilitar la navegación, en el puente hay un monitor repetidor del navegador. En esta campaña se instaló un Eiva “cliente”, a partir del Eiva de los equipos sísmicos. De este modo, los oficiales del puente tienen la facilidad de cargar y seleccionar líneas, ampliar o alejar la pantalla a su antojo, etc.

2.5.2.- Incidencias

Durante toda la campaña se trabajó con varias proyecciones, UTM 29, 30, 28, 27 y 26 N.

Dado que el pc del Survey del ROV no entendía el telegrama enviado desde el HIPAP (posicionamiento submarino), se envió un telegrama de posición desde el Eiva hacia este pc de survey. De este modo el Hypack sí que pudo interpretar bien la señal de posición del ROV y plotearla correctamente. Para mas detalles se adjunta el ANEXO1.

No hubo ninguna incidencia.

2.6 Sistema de Posicionamiento Submarino HiPAP 351P

2.6.1 Introducción:

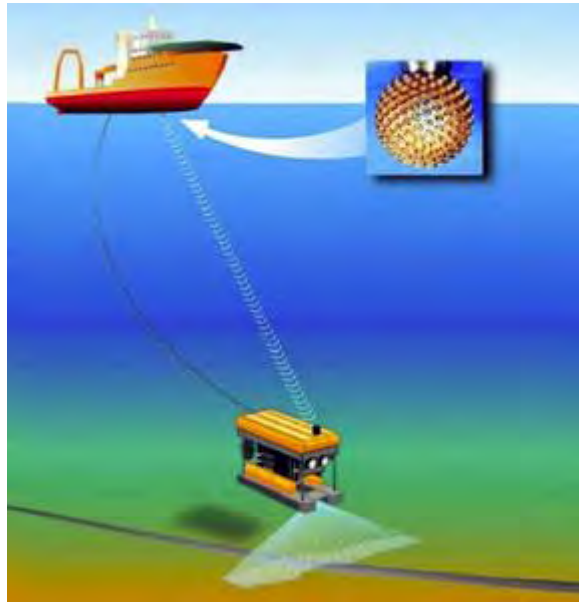

Esquema funcionamiento USBL

Un sistema de posicionamiento USBL (Ultra Short Base Line) es un método de posicionamiento acústico bajo el agua. Un sistema USBL completo consiste en un transceptor, que está montado en el la quilla de estribor del Sarmiento de Gamboa, y un transpondedor o respondedor en el fondo marino, un pez o en un ROV. Un ordenador, o "unidad de la parte superior", se utiliza para calcular una posición con rumbo y distancia medidos por el transceptor.

Un impulso acústico es transmitido por el transceptor y detectado por el transpondedor submarino, que responde con su propio impulso acústico. Este impulso de retorno es detectado por el transceptor de a bordo. El tiempo desde la transmisión del impulso acústico inicial hasta que se detecta la respuesta se mide mediante el sistema USBL.

Para calcular una posición submarina, el USBL calcula tanto un rango como un ángulo desde el transceptor a la baliza submarina. Los ángulos se miden por el transceptor, que contiene una matriz de transductores. La cabeza del transceptor contiene normalmente tres o más transductores separados por una línea de base de 10 cm o menos. Un método denominado "diferenciación de fase" dentro de esta matriz de transductores se utiliza para calcular el ángulo con respecto al transpondedor submarino.

2.6.2.-Descripción del Sistema.

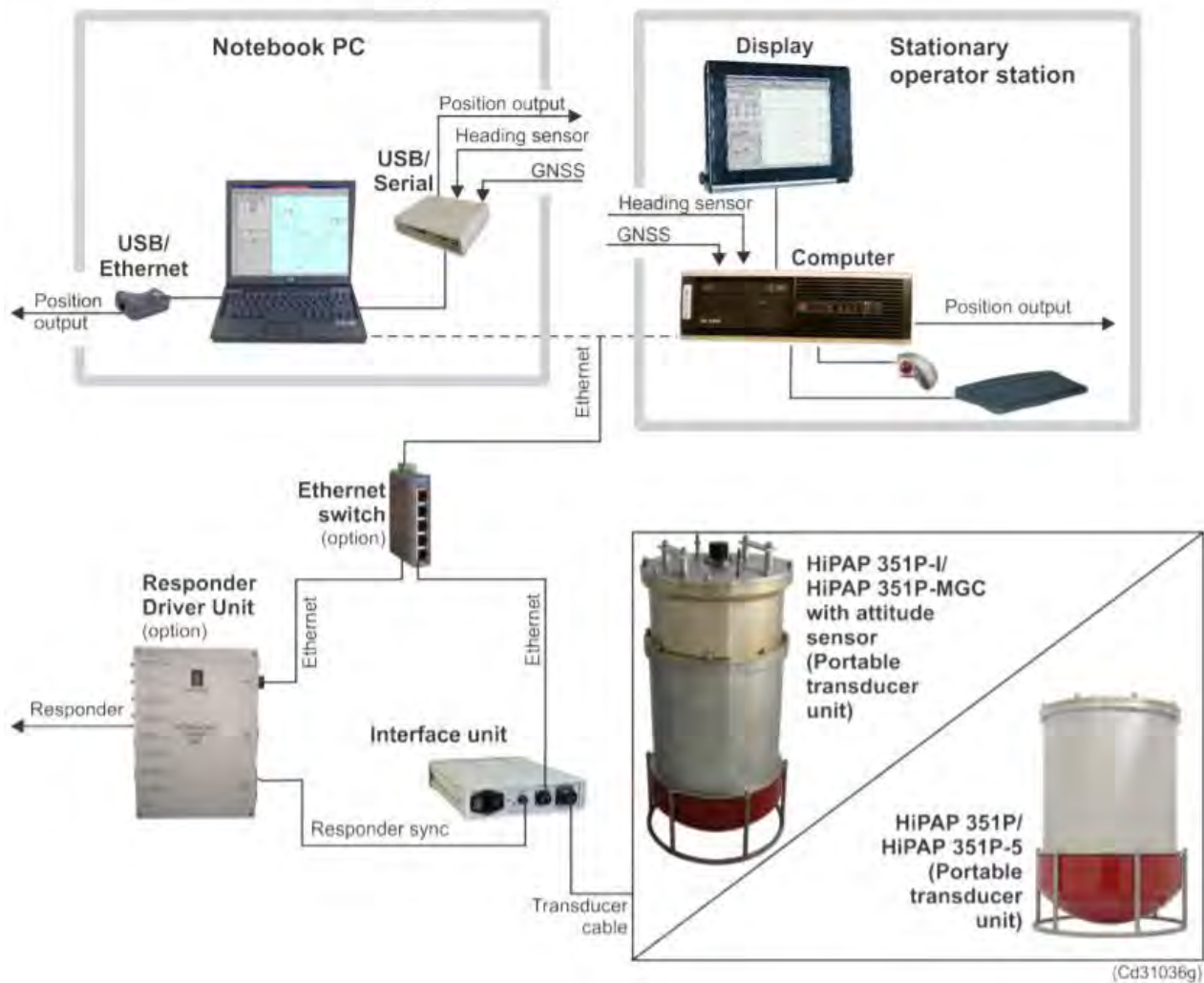

Información General:

- Rango de operación 1-4000 m
- Exactitud de la posición en % del rango 0.3%
- Usando transpondedores en modo Cymbal la exactitud puede incrementarse hasta un 30% en condiciones ruidosas. La exactitud en detección del rango usando Cymbal es de 0.01m

Datos de Actitud:

- Sensor inercial interno que nos da correcciones de Heading, Pitch y Roll, con una exactitud de 0.05°

Transductor

- Cobertura operativa $\pm 90^\circ$
- Cobertura de trabajo óptimo $\pm 80^\circ$
- Número de elementos 46
- Haz de recepción estrecho 15°

Frecuencias de trabajo

- Cymbal frequency band 22.0 - 29.6 kHz

2.6.3.- Instalacion en el Sarmiento de Gamboa.

La instalación del transductor se realizó en la quilla de estribor, utilizando una brida que se hizo en anteriores campañas donde se utilizó el ROV Liropus 2000 del IEO, esa brida pertenece al IEO y por tanto se devolvió al equipo de ACSM una vez finalizada la campaña.

El cable del transductor se pasó por la quilla usando las rejillas de ventilación del tronco de quillas para no desmontar los techos de la cubierta principal.

El equipo de control APOS, la interface unit y la unidad responder se instaló en el laboratorio principal.

Los datos de posición y rumbo del barco se tomaron de las cajas de Atlas en el laboratorio principal. A su vez se largó un cable de la responder unit al container de control de ROV para que el Beacon cNODE del ROV funcionase en modo RESPONDER.

La navegación del puesto de survey se realizaba con un equipo portátil con el software Hypack (propiedad del IEO). A este sistema le entraba por serie la posición que daba el USBL y por Ethernet la posición del barco.

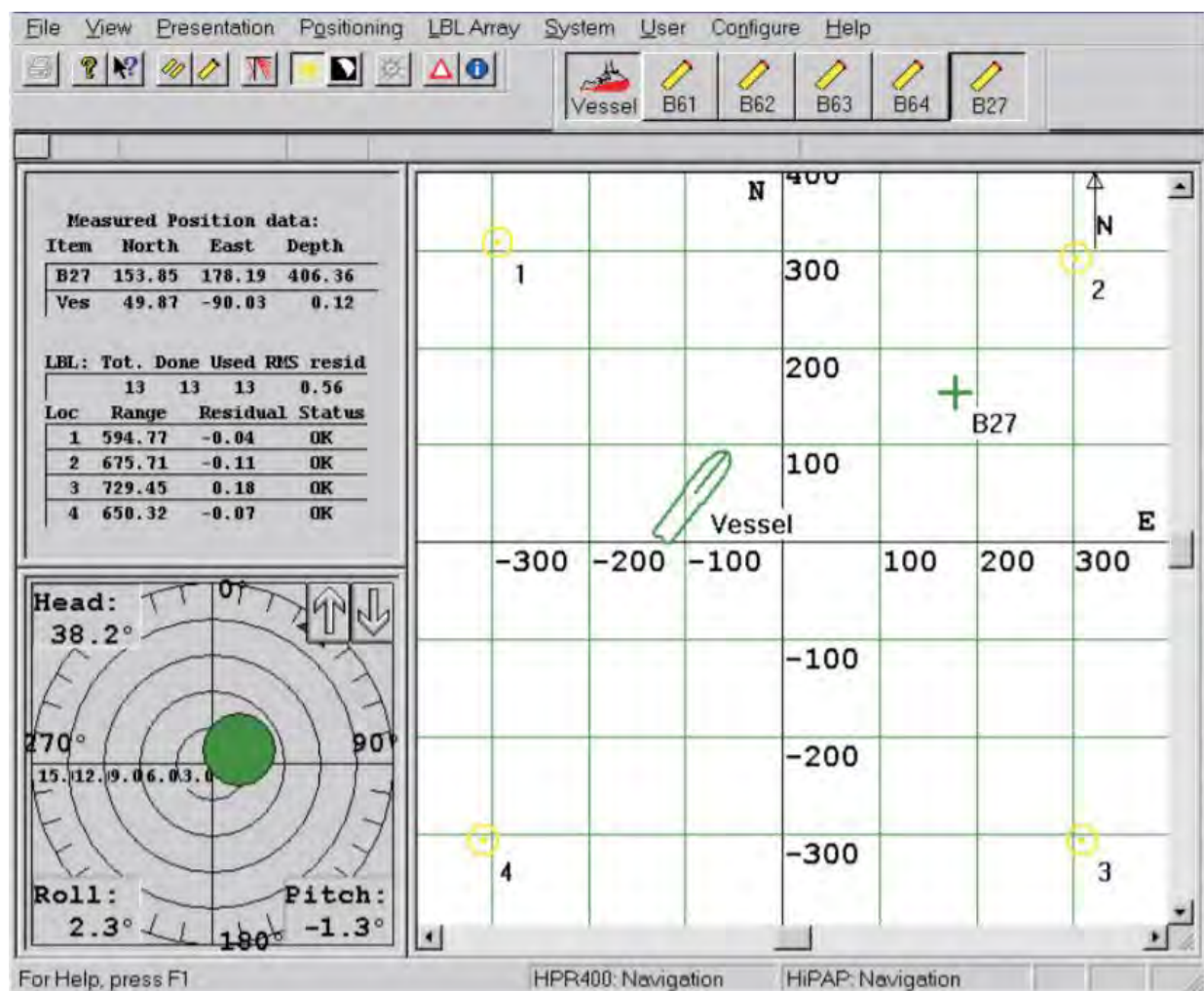

Pantalla APOS

2.6.4.- Incidencias:

El equipo de survey planteaba mal las posiciones tanto del TMS como del ROV, se decidió pasarle por Ethernet en formato GGA, las posiciones que planteaba el sistema EIVA al ver que este las planteaba correctamente. Una vez que se vio que con este formato las posiciones eran las correctas se comprobó que el HyPack estaba utilizando los driver del HPR400 en lugar del telegrama propio del HIPAP 350.

Una vez localizada la fuente de error se decidió utilizar este sistema, en las siguientes inmersiones.

Como recomendación en las siguientes campañas de ROV, será necesario actualizar el sistema de survey proporcionado por el IEO, o en su defecto comprobar con la persona encargada de la integración el perfecto funcionamiento de este, comprobando las librerías o drivers instalados en el equipo.

Se adjunta un anexo con un escrito firmado por los responsables de cada departamento involucrado.

3.-INSTRUMENTACION LABORATORIOS

3.1.-Equipos y laboratorios

En esta campaña se ha trabajado en todos los laboratorios, utilizándose el siguiente instrumental de la UTM por parte del equipo científico:

- Bomba de succión (EYELA)
- Baño de ultrasonidos mod. 5510 (BRANSON)
- Bomba de vacío (MILLIPORE)
- Baños termostáticos NESLAB RTE 17 (THERMO) (X1)
- Cabina de extracción de gases (FLOWTRONIC) (laboratorios principal y de química)
- Cámara fotográfica para microscopía DR-U2 (NIKON)
- Centrífuga ALLEGRA X 22 (BECKMAN COULTER)
- Equipo de control ambiental Comptrol 1002 (STULZ) –Lab. termostático-
- Equipos de purificación de agua MILLI-Q ADVANTAGE (MILLIPORE) (x2)
- Equipo de purificación de agua ELIX10 (MILLIPORE) (x2)
- Espectrofotómetro Lambda 850 UV-Vis (PERKINELMER)
- Estufa de desecación DIGITRONIC (JP SELECTA)
- Estufa de incubación INCUDIGIT (JP SELECTA)
- Fluorómetro continuo TURNER 10-AU (TURNER DESINGS)
- Incubadora Certomat-BS-T (SARTORIUS)
- Lupa binocular SMZ 1500 (NIKON) –con cámara conectada-
- Lupa estereoscópica SMZ 645 (NIKON)
- Microcentrífuga Microfuge 22R (BECKMAN COULTER)
- Microscopio directo de epifluorescencia ECLIPSE 80 i (NIKON)
- Neveras (x2)
- Salinómetro Portasal 8140A (GUILDLINE)
- Valoradores automáticos TITRANDO 808 (x2)
- Ultracongelador MDF 593 (SANYO)

Es importante comentar que el laboratorio termorregulado ha estado funcionando con un punto de consigna de 11°C, de manera que el equipo de control climático ha estado sometido a un uso muy exigente durante prácticamente 35 días.

Cabe destacar las siguientes incidencias y actuaciones en relación a los equipos responsabilidad del departamento:

Si bien durante la campaña toda la instrumentación ha funcionado sin fallos, los problemas que han ido surgiendo se han solucionado de manera a evitar, en lo posible, las interferencias en el desarrollo de las labores científicas realizadas a bordo.

Termosalinógrafo SBE 21 SEACAT + Fluorómetro continuo

Aunque el TS SBE 21 no es estrictamente un equipo del departamento LAB, también participamos en su puesta en marcha y vigilamos su correcto funcionamiento.

En esta ocasión, al poner en funcionamiento el equipo, aparecían símbolos extraños en el programa *Termosal* en lugar de aparecer los datos correctos.

El problema radicaba en que la velocidad de transmisión de los datos desde el equipo a la *interface* no era la correcta para este equipo concreto.

Una vez verificada en el manual la correcta velocidad de transmisión de datos se cambió y el equipo estuvo funcionando y transmitiendo datos sin problemas durante toda la campaña

Valoradores automáticos TITRANDO 808 (x2)

En los dos valoradores automáticos que se han estado utilizando en esta campaña aparecieron burbujas de aire, en contacto con el émbolo de teflón, en el interior de la bureta.

La primera actuación realizada fue apretar bien las conexiones de todos los tubos de la unidad intercambiable. Aun así, continuaron apareciendo burbujas con el uso del equipo.

Este hecho hace presuponer que las burbujas se generan a partir de la desgasificación del reactivo utilizado en la valoración por lo que, para evitar su aparición debido a una fuerza de succión demasiado elevada en el llenado de la bureta, se bajó la velocidad de su llenado en un 50%. A pesar de ello, posteriormente siguieron apareciendo burbujas.

Finalmente, al revisar de nuevo todo el equipo y accesorios, se observó que las tapas (ref. 6.2701.020) para los tubos de secado de vidrio transparente (ref. 6.1609.000) en ambos equipos no tenían ningún orificio a través del cual permitir el paso de aire a las botellas de reactivo. Así, al generar el émbolo la fuerza de succión necesaria para rellenar las buretas en las

unidades intercambiables y, al no permitir las tapas la entrada de aire al circuito a través del tubo de secado hasta la botella de reactivo, se provocaba la desgasificación de los reactivos con la consiguiente generación de burbujas pegadas al émbolo. La solución consistió en realizar algunos agujeros en las tapas para permitir el paso de aire y las burbujas no se volvieron a generar.

Cabe añadir que estos accesorios (botellas para los reactivos y tubos de secado con sus tapas) las traían los propios investigadores y las acoplaban a nuestros valoradores que, por otro lado, han funcionado sin problemas propios durante toda la campaña.

Cámara fotográfica para microscopía DR-U2 (NIKON)

El ordenador al cual se conecta la interface y dónde está instalado el programa de gestión de la cámara no se encendía y, al presionar el botón de arranque, hacía unos suaves pitidos.

Se desmontó y se dignificaron los cables del interior, haciendo especial atención a los provenientes del botón de arranque.

Aprovechando que se abrió el equipo se limpiaron los ventiladores y la rejilla de ventilación de la caja del ordenador.

Al montarlo de nuevo funcionó sin problemas todo el resto de la campaña.

Sería conveniente valorar la adquisición de un nuevo ordenador ya que este equipo, que tiene ya más de ocho años, se monta y desmonta muy a menudo puesto que se ubica en un laboratorio diferente prácticamente en cada campaña.

Cabina de extracción de gases (FLOWTRONIC) (laboratorio de química)

La puerta de guillotina de la cabina de gases se quedó cerrada y bloqueada en dos ocasiones.

Durante los primeros días del segundo leg de la campaña, los usuarios del laboratorio de química dispusieron mucho material en el interior de la cabina y cerraron la puerta de guillotina con una caja sobresaliendo por el frente. Esto provocó que los cables que mueven el sistema de puertas y el contrapeso que facilita su apertura quedaran distendidos y que uno de los cables se desenganchase de su anclaje del contrapeso.

De desmontó el panel lateral de estribor de la vitrina y se colocó de nuevo el anclaje del cable de la puerta a su contrapeso. En la segunda ocasión de fijaron los ganchos de los cables a las anillas del contrapeso para evitar posteriores problemas.

Estufa de desecación DIGITRONIC (JP SELECTA)

Al conectar de nuevo la estufa de desecación al inicio del segundo leg, ésta no se puso en funcionamiento y en el *display* aparecía el mensaje de error *rtf*. Este mensaje, según el manual, informa de que la sonda de temperatura Pt100 está rota.

Al contactar con el servicio técnico del fabricante del equipo nos indicaron que, a menudo, no es la sonda de temperatura lo que falla sino la placa de control del equipo. También nos informaron que se podía verificar el correcto funcionamiento de la sonda si, a temperatura ambiente, ésta tenía una resistencia de 110 ohm. Así, utilizando el esquema eléctrico del equipo, verificamos el estado de la sonda y observamos que estaba en perfecto estado.

Se aprovechó que estaba accesible la placa de control frontal para desmontarla y limpiar con cuidado todos los conectores. Se montó de nuevo y la estufa volvió a estar operativa todo el resto de la campaña.

Espectrofotómetro Lambda 850 UV-Vis (PERKINELMER)

Al poner en marcha el programa UVWinLab aparece el siguiente mensaje:

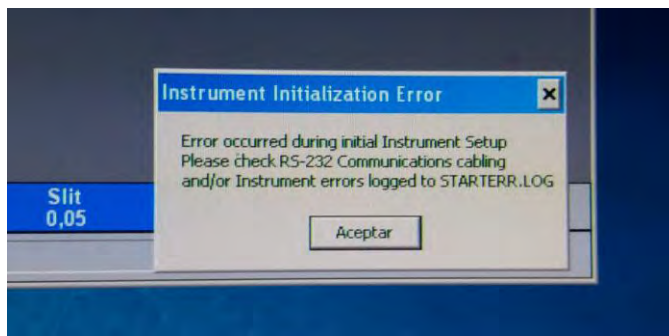

Generalmente ocurre por dos motivos:

- 1º.- Se inicia el software antes de que pasen dos o tres minutos desde la puesta en marcha del equipo. Esto se debe que no se ha dejado tiempo suficiente a que el equipo haya llevado a cabo todos sus protocolos de verificación iniciales o,
- 2º.- El equipo se ha puesto en marcha correctamente y se ha fundido una de las lámparas durante el periodo de tiempo en que se deja el equipo funcionando para que las lámparas se estabilicen. Posteriormente, al iniciar el programa de utilización del equipo aparece este error.

En este caso se fundió la lámpara de tungsteno. Se sustituyó y el equipo se continuó usando durante el resto de la campaña sin más inconvenientes.

Armario de seguridad para productos químicos del laboratorio principal

Se rompió la placa que se eleva al girar la llave en la cerradura y que permite abrir el armario.

Se desmontó la leva con placa metálica existente y cortamos otra de similares dimensiones, en acero inoxidable, que acoplamos al mecanismo existente.

Equipo de control ambiental Comptrol 1002 (STULZ) –Lab. termorregulado-

El equipo se paró completamente y en el *display* aparecía el mensaje FL01, lo que indica la existencia un problema en el flujo de aire en uno de los módulos de refrigeración.

Se solucionó abriendo el panel frontal del equipo y ajustando el potenciómetro que regula ese flujo de aire hasta que fue suficiente.

El equipo no volvió a presentar problemas durante el resto de la campaña.

Ultracongelador MDF 593 (SANYO) – nº serie: 60711453

La penúltima noche antes de terminar la campaña el ultracongelador subió a una temperatura de -60°C en lugar de los -80°C que tenía establecidos de punto de consigna.

El origen de esta temperatura anómala residió en que se incorporaron una gran cantidad de muestras al congelador y la tapa quedó mal cerrada, provocando la acumulación de escarcha en los bordes y el mal cierre de la tapa.

Para preservar la integridad de las muestras se conectó el otro ultracongelador y los investigadores traspasaron las muestras a él.

Posteriormente se paró, descongeló y limpió el ultracongelador inicial que quedó, de nuevo, totalmente funcional.

3.2.-Necesidades y Material

A partir del desarrollo de esta campaña se ha observado que es necesario adquirir el material detallado a continuación:

- 1.- Valorar la compra de un ordenador nuevo para la utilización con la cámara fotográfica para microscopía DR-U2 (NIKON)

4.-Telematica

4.1.-Actividades TIC

4.1.1 INTRODUCCIÓN

Durante la campaña se han utilizado los recursos de la red informática del buque para la adquisición y el almacenamiento de datos, la edición e impresión de documentos, el primer procesado de los datos y el servicio de correo electrónico.

El Sistema Informático del buque cuenta con los siguientes servidores:

- **TABLERO**:..... Servidor de Virtualización con el equipo: MERO.
- **MERO**:..... Sistema ZENTYAL Virtualizado en TABLERO para VPN, Firewall, DNS, NTOP.
- **PULPO**:..... Servidor de Virtualización con los equipos: DORADA y LENGUADO2
- **LENGUADO2**:..... Servidor Virtualizado con OpenCPN integra fuentes de: dgps, Gyro, Corredera, mru, posmv, ek
- **LENGUADO1**:..... Servidor con OpenCPN integra fuentes de: dgps, Gyro, Corredera, ais, mru, posmv, ek/ea
- **DORADA**:..... Sistema Virtualizado para la Intranet, RTP.
- **MERLUZA**:..... Futuro SistemaVirtualizado para el SADO.
- **SEPIA**:..... Sistema de Adquisición de Datos Oceanográficos (SADO) Principal.
- **DATOS**:..... NAS de Datos de Campaña.
- **TRABAJO**:..... NAS con ficheros del: Capitán, Cocina, Máquinas, Puente, Tripulación y la UTM.
- **BIGBROTHER**:..... Servidor de cámaras.
- **CÁMARAS**:..... Acceso a Cámaras y DataTurbine
- **NTP0**:..... Servidor de tiempo 1.
- **NTP1**:..... Servidor de tiempo 2.

- **ALDRISI:**..... SADO de Respaldo, DataTurbine, GIS, WebGUMPII y Web Eventos.
- **CONTROL-LEDS:**..... Servidor de control de los paneles led.
- **ROUTER-4G:**..... Servidor de salida a internet vía 3G.

Para acceder a Internet se dispone de 3 PCs de usuario en la Sala de Informática y Procesado. Se han conectado todos los portátiles a la red del barco usando el servicio DHCP que asigna direcciones a estos equipos de manera automática, salvo configuraciones manuales requeridas para el Jefe Científico.

Para la impresión se ha dispuesto de 8 impresoras y un plotter:

- **Color-Info:**..... HP LaserJet Pro 400 Color MFP m475dw, en la Sala de Informática.
- **Plotter:**..... HP DesignJet 500 Plus, sito en la Sala de Informática.
- **Color-Puente:**.... HP LaserJet Pro 400 Color MFP m475dw, en la oficina del puente.
- **Fax-Puente:**..... BROTHER MFC-490CW, en la oficina del puente.
- **Samsung:**..... Samsung Xpress SL-M2070/SEE, en la oficina del puente.
- **Puente:**..... OKI Microline 280 Elite, en el puente.
- **Multifunción:**.... HP OfficeJet J4680, en el camarote del Capitán.
- **B/N-Maquinas:**. HP LaserJet 1018 b/n, en la Sala de Máquinas.
- **1er Ofic.Puente:** HP-DeskJet 6940, en el camarote del 1er. Oficial Puente.

Los datos adquiridos por el Sistema de Adquisición de Datos Oceanográficos (S.A.D.O.), se almacenan en: [\\sado\](#)

Los Datos adquiridos por los instrumentos y los Metadatos generados se almacenan en: [\\datos\instrumentos\MEDWAVES\](#)

El espacio colaborativo común para informes, papers, etc de los científicos, está en: [\\datos\cientificos\ MEDWAVES](#)

Al final de la campaña de todos estos datos se realizan 2 copias, una que se entrega al Jefe Científico, y otra copia para la UTM, esta copia queda claramente etiquetada y bajo llave en

nuestros armarios de la sala de informática del Sarmiento a la espera de que se lleve a Barcelona.

Posteriormente y antes de comenzar la siguiente campaña, se borran TODOS los datos de campaña de:

`\\datos\instrumentos\` igualmente se borran todos los informes y ficheros de: `\\datos\cientificos\`

4.1.2 RESUMEN DE ACTIVIDADES

- Al inicio de campaña se mantiene una reunión con los científicos indicando las normas de funcionamiento de la red informática a bordo, incidiendo especialmente en el uso de la telefonía priorizando las llamadas entrantes a las salientes. También se les explica la puesta en marcha de un sistema de creación de Metadatos que acompañarán al informe de campaña y a las actividades y equipos desplegados en la misma y se les explica su funcionamiento, aleccionándoles para que ellos mismos se encarguen de ir introduciendo los mismos.
- Se cuelga en el mamparo de la sala de informática un resumen de los servicios que ofrece el Dpto.TIC así como la forma de actuar y marcación a realizar en las llamadas telefónicas.
- Se arranca el SADO al inicio de la campaña para que comience la adquisición y la integración de los datos de Navegación, etc.
- Se proporciona apoyo informático al resto de los departamentos de la UTM cuando este es requerido.
- Se configura la red e impresoras a los portátiles de los científicos que no lo pueden conseguir por sus propios medios
- Se vigila diariamente que la adquisición e integración de los datos del SADO se realiza correctamente.
- Se vigila periódicamente el estado de los servidores y la conexión y tráfico del enlace V-SAT.
- Se colabora en la puesta en marcha del ROV.
- Se configura el acceso a internet del portátil de la Jefa Científica.
- Se da acceso a internet a un portátil de los miembros del ROV para que dispongan de correo para comunicar incidencias y/o asuntos de trabajo.
- Se ayuda en la instalación/ajuste de un proyector para la rueda de prensa y de la TV para las reuniones iniciales de campaña.

- Limpieza de cámaras exteriores. Algunas de ellas habría que limpiarlas por dentro en puerto con tiempo pues acumulan suciedad. Igualmente habría que adquirir las cámaras que faltan tanto de exteriores como de pasillos para cumplir con el ISPS. Se prueba alguna cámara de pasillo que había en la sala de racks, pero estas no funcionan.
- Instalación/Configuración (moxa-dgps-cosmos) .122 para mandar la posición del buque a la web sin necesidad de tener ningún equipo propio o de terceros permanentemente conectado. Igualmente se instala detrás de la consola de babor del puente una BlackBox para poder disponer de varias salidas serie, una para este Moxa y otra para el Moxa-dgps.

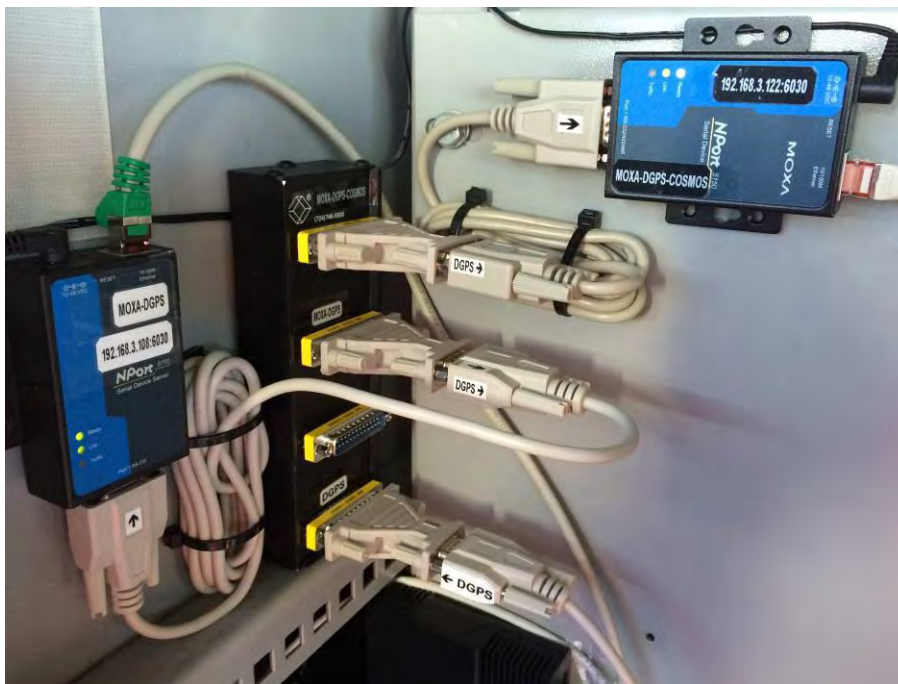

- Se cambian los permisos al usuario: '*ciencia*' en el NAS (DATOS), pues podían leer/escribir en la carpeta: Instrumentos, cuando solo deberían poder leer.
- Los cajones de plástico adquiridos para nuestro material son muy prácticos para tenerlo todo más ordenado, habría que comprar alguno más.
- Se cambia el idioma (a inglés) de un portátil de los científicos Con Windows 7 Pro en Castellano.
- Se suben a través de la VPN los Metadatos de las últimas campañas de ALIDRISI a ORTELIUS.
- A requerimiento de uno de los científicos a instalar en uno de los PCs de Usuario un software de procesado, se le indica que estos PCs no son para estos trabajos pues se acapararían para ello, dejando al resto de usuarios sin el servicio que ofrecen. Como solución, dado que era usuario de Mac, y el soft requerido era para Windows, se le enseña la aplicación VirtuaBox para su sistema, se le crea una Máquina Virtual (Windows10) totalmente funcional y en ella se instala el software que requería, pudiéndolo usar con normalidad a lo largo de la campaña.
- Se entregan los Metadatos generados en la campaña a la jefa científica, del resto de datos de adquisición se hace una copia que junto con estos metadatos se enviará a Barcelona para su almacenamiento.
- Se crean en 3 Pendrives Herramientas TIC de arranque y se juntan en un llavero. En uno de ellos hay Antivirus (AVG Rescue, ESET SysRescue, Avira, GData y Kaspersky Rescue), en otro SSOO (Ubuntu 16.04 LTS, Ubuntu Server 16.04, CentOS 7 y Linux Mint 18) y en el tercero: (GParted x32-x64, Clonezilla x32-x64, Hiren's Boot, System Rescue y OphCrack) para hacer uso de ellos como parte de nuestras herramientas básicas de trabajo. Quedan en los cajones organizadores de los armarios al lado de las unidades de CD/DVD externas.
- Se configuran e instalan los 4 Puntos de Acceso Wi-Fi adquiridos. Dichos puntos disponen del estándar IEEE 802.11ac funcionando en el rango de los 5 Ghz. Quedan algunos Puntos de acceso obsoletos que no rinden como los nuevos, por lo que habría que adquirir alguno más para dar una buena cobertura en todas las estancias por igual. El Plano de los A.P. del buque es el que se adjunta:



- Se ordenan los cables que había por el suelo y colgando de los PCs de Usuario pues los científicos al pisarlos y tocarlos con los pies los desenchufaban y apagaban el equipo.
- Se instalan en los restantes PCs de usuarios Hubs UBS 3.0 debajo de sus respectivas pantallas para que el usuario los tenga más a mano así como lectores multitarjeta en todos ellos.
- Igualmente se instalan los 2 Hubs USB 3.0 y lectores multitarjeta restantes en el PC del Capitán y en el PC del Puente.
- Se reconfigurara el puesto TIC del Sarmiento a la espera de que lleguen y se instalen en breve los nuevos equipos. Se añade una nueva pantalla y se usa la aplicación: **Synergy** para compartir el teclado y ratón con varios SSOO sin necesidad de usar KVMs, despejando la mesa de trabajo, teniendo con ello más información a disposición para nuestras tareas habituales.
- Se cambian las contraseñas de varios Moxas dado que el Dpto. de Acústica necesita acceder a ellos para gestionar su configuración. Los Moxas que gestionarían serían: **moxa-gyro** (.123), **moxa-dt1** (.95), **moxa-posicion1** (.88), **moxa-gravímetro** (.89), **moxa-posidonia1** (.91), **moxa-**

posidonia2 (.92), moxa.scanmar1 (.90), moxa-multi (.85) El resto de Moxas los gestionaría el Dpto. TIC, con lo que mantienen su password de acceso. Al instalar cualquier otro moxa se aconseja ponerle una contraseña para evitar que cualquier usuario de la red acceda a su configuración y lo desconfigure.

- Se crean varios esquemas con la configuración de los Moxas que se ven en la red a bordo del Sarmiento y se envían por correo al Dpto.TIC y al de Acústica para su disposición.

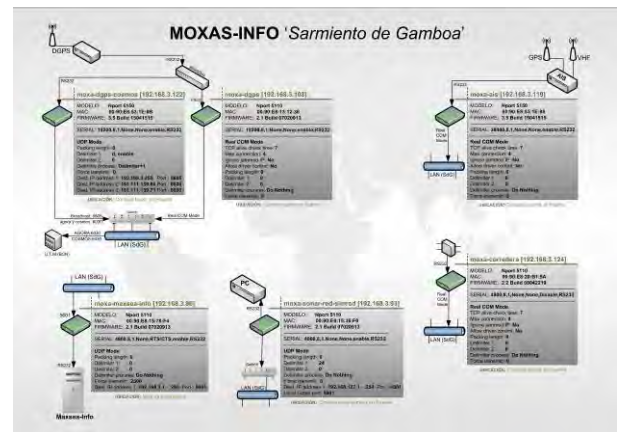
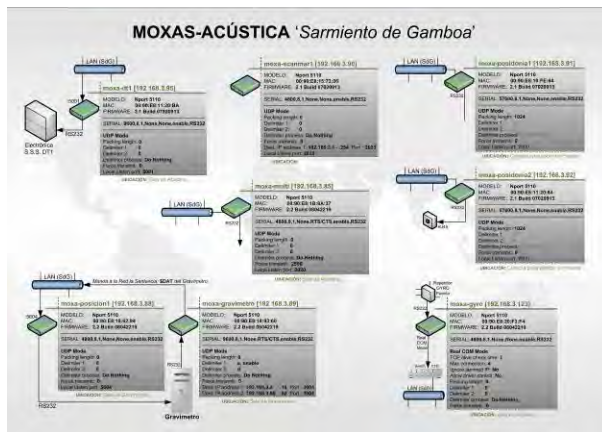

- Se actualiza el esquema de los servidores del sarmiento, al igual que el de los puntos Wi-Fi.
- La media del consumo telefónico durante los días de campaña es de: **5,0078** Euros/día

4.1.3 INCIDENCIAS

- Las pletinas VNC se congelan continuamente llevando a los científicos a tomar anotaciones erróneas de los datos que en ellas se reflejan. Para solventar que dicha anotación de datos sea veraz en el puesto que más usan, se instala un PC y se visualiza vía web el RTP que es el visualizador que más demandan en esta campaña. A pesar de que estas pletinas no están resultando muy óptimas para esta visualización de datos, ya se les indicó en la reunión previa que los datos del RTP, así como otros, los podían ver en la intranet sin problemas y en tiempo real en sus portátiles cuando así lo requiriesen. Se podrían sustituir estas pletinas por Rasperrys para solventar estos problemas, siendo éstos dispositivos de bajo coste y más flexibles por si se les quiere dar otros usos.
- Durante un par de días la impresora de la sala de informática tiene un comportamiento anómalo. A pesar de que aparece en la red, se queda bloqueada no pudiéndose hacer uso de ella. Al reiniciarla funciona con normalidad unos pocos minutos pero vuelve al mismo tipo de bloqueo. Buscando información por el código de error que muestra la impresora en la web de HP, se indica que se reemplace el controlador DC. La incidencia se resuelve cargando de nuevo su firmware, a partir de entonces vuelve a funcionar con normalidad.

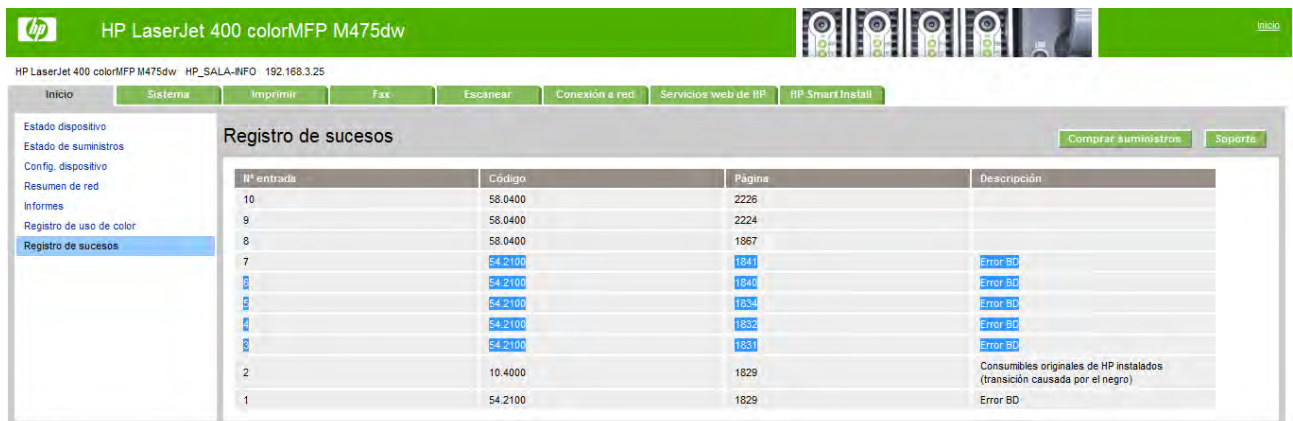

HP LaserJet 400 colorMFP M475dw HP_SALA-INFO 192.168.3.25

Inicio Sistema Imprimir Fax Escanear Conexión e red Servicios web de HP RP Smart Install

Estado dispositivo Estado de suministros Config. dispositivo Resumen de red Informes Registro de uso de color **Registro de sucesos**

Comprar suministros Soporte

Nº entrada	Código	Página	Descripción
10	58.0400	2226	
9	58.0400	2224	
8	58.0400	1867	
7	54.2100	1841	Error BD
6	54.2100	1840	Error BD
5	54.2100	1834	Error BD
4	54.2100	1832	Error BD
3	54.2100	1831	Error BD
2	10.4000	1829	Consumibles originales de HP instalados (transición causada por el negro)
1	54.2100	1829	Error BD

- El teléfono de la cabina del puente tiene un funcionamiento errático, al realizar pruebas de llamadas entrantes, en unas ocasiones establece la llamada y en otras no. Después de realizar todo tipo de comprobaciones (Teléfono, línea, cableado, conector,...) se observa que dicho teléfono al estar instalado sobre el mamparo en posición vertical, tiene cierta holgura entre el auricular y la base, por lo que dependiendo del balanceo del barco, esta holgura hace que el auricular no presione bien sobre la base y haga que este parezca descolgado y al intentar realizar la llamada esta no pueda establecerse. Para solventarlo de forma temporal se pone una pegatina en el auricular y se saca la base ligeramente por su parte inferior mediante el tornillo de sujeción, con ello se quita por completo la holgura entre auricular y base y a partir de esto todas las pruebas realizadas son positivas. Si se cambiará por cualquier motivo este teléfono por otro idéntico (prácticamente todos los que hay son iguales) se ha puesto una indicación en la cabina para recordar este detalle, pues estaba haciéndonos perder mucho tiempo buscando y solucionando la incidencia.
- El V-SAT tiene varios cortes a lo largo de la campaña, siendo estos más continuados cerca de las islas Azores, en esta zona se está fuera de la huella de varios satélites, quedando por tanto con menos opciones de comunicación, a pesar de ello y con la asistencia del NOC se resuelven todas las incidencia por cortes o problemas con el establecimiento de conexión. En una de estas incidencias más prolongadas es necesario subir al sobre-puente a reiniciar la antena a instancia del NOC.
- Se reinicia varias veces Alidrisi por problemas con el envío de telegramas al exterior y con el servidor de aplicaciones.
- Durante varios días los datos en el Sado de la meteo se adquieren con líneas a 0 intercaladas en el resto de datos, se reinicia Alidrisi y Sepia pero se sigue adquiriendo con la misma incidencia. El día de entrada en puerto en Isla San Miguel 08/10/16, sobre las 20:00 horas aproximadamente (según reflejan los ficheros de adquisición), desaparece la incidencia.
- Se ponen contraseñas de acceso (las de administración TIC) a la web de administración de las impresoras (Sala-Info y Puente) pues se observa a un científico accediendo a ella cuando no debería ser accesible esta interfaz por ningún usuario. Evitando con ello que se desconfiguren y queden inoperativas.
- El teléfono Inmarsat para llamar al NOC el lado del rack del V-SAT falla. No se consigue establecer llamadas en ninguna ocasión.

- El NTP-1 tiene alarmas desde que hace unos meses se actualizara.

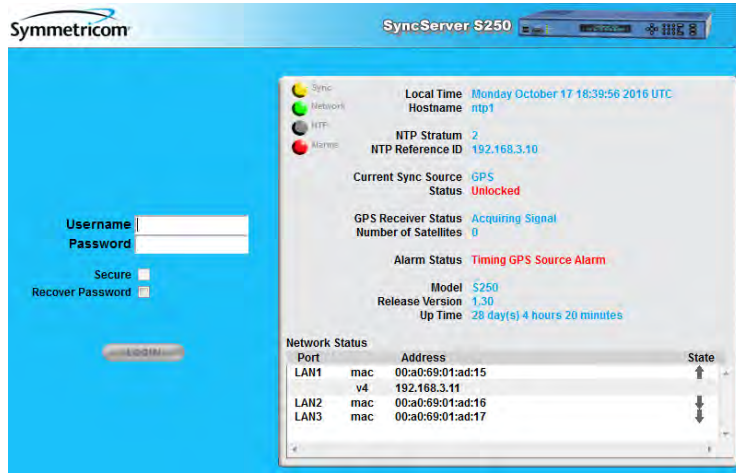

4.2.-Sistema de Comunicaciones de Banda Ancha en el Sarmiento de Gamboa.

4.2.1- Descripción del sistema.

4.2.1.1- Introducción.

Desde Abril de 2008, el BO Sarmiento de Gamboa cuenta con un enlace de datos de “banda ancha” vía satélite con capacidad de conexión a redes IP (Internet) y con cuatro líneas de voz de alta calidad (3 de voz y 1 de fax).

Dicho enlace se realiza a través de un terminal VSAT (Very Small Aperture Terminal) que permite enlazar con los satélites geoestacionarios de telecomunicaciones de la red Seamobile. Dichos satélites geoestacionarios poseen una órbita circular, en el plano ecuatorial a una altura de 35786 km, de periodo igual al de rotación de la tierra por lo que se les ve siempre en la misma posición. Su disposición orbital y la de las estaciones en tierra, que los enlazan con las redes de comunicaciones terrestres, proporcionan cobertura global en todo el planeta a excepción de las zonas polares (su cobertura eficaz está entre 70° N y 70° S).

El terminal del buque emplea la tecnología de banda C, en la que se emplean frecuencias 5,925 - 6,425 GHz para el enlace del satélite a tierra y 3,7 – 4,2 GHz para el sentido contrario.

La antena del terminal, de 2.4 m de diámetro, permite alcanzar tasas de transmisión de datos cercanas a los 5 Mbs (Megabits por segundo) en un escenario de cobertura global.

A diferencia de las conexiones vía satélite Inmarsat, utilizadas hasta ahora en el buque, el terminal de banda C proporciona mayor capacidad de transmisión de datos, no sólo porque nominalmente es capaz de transmitir datos a mayor velocidad si no porque dicha tasa está garantizada bajo contrato con un mínimo establecido. En las conexiones Inmarsat todos los buques situados en una misma zona deben “competir” por el enlace de satélite, mientras que para las conexiones VSAT se establecen canales de comunicación exclusivos.

Las comunicaciones VSAT se suelen contratar con una tarifa plana para periodos de uno a tres años, por lo que a pesar de su elevado coste es hoy en día el sistema más eficaz y económico para establecer conexiones de banda ancha permanentes a terminales remotos (buque).

En general las prestaciones de las comunicaciones satélites son inferiores a las conexiones de banda ancha terrestres (de las que disfrutamos en casa o en nuestros centros de trabajo). Las comunicaciones vía satélite, y en especial las instaladas en buques, tienen algunas características singulares que hay que tener en cuenta para valorar su potencial real.

En primer lugar está el retardo que introduce la transmisión de la señal al viajar tan grandes distancias. Con 36.000 km de altura orbital, la señal ha de recorrer como mínimo 72.000 km, lo cual supone un retardo de 250 milisegundos. En algunos casos estos retardos pueden suponer un serio inconveniente, degradando de forma apreciable el rendimiento de los enlaces si los protocolos de comunicaciones empleados no están preparados para asumirlos. A priori no podemos esperar que las aplicaciones de red que acostumbramos a usar en el entorno terrestre funcionen con la misma agilidad usando enlace satélite.

En segundo lugar está el movimiento natural del buque. Puesto que utilizamos satélites geoestacionarios nuestra antena debe estar en continuo movimiento para “enfocar” siempre al satélite que permanece aparentemente inmóvil, compensando todos los movimientos del buque y su continuo cambio de emplazamiento. Las condiciones de mala mar y/o un equilibrado defectuoso de la antena pueden disminuir mucho la calidad de las transmisiones y de la vida útil del sistema.

Finalmente las interferencias electromagnéticas de otros equipos electrónicos empleados en el buque (radares y equipos de radio de elevada potencia) y los obstáculos físicos interpuestos en la línea de visión de la antena al satélite (chimeneas, mástiles, etc.) también pueden reducir sensiblemente la calidad de las transmisiones o hacerlas inoperativas.

4.2.1.2- El equipo del BO Sarmiento.

El VSAT del BO Sarmiento es un equipo ensamblado por la empresa Seamobile (líder mundial en comunicaciones VSAT marinas) y la empresa española ERZIASAT (quien ha realizado la ingeniería de integración del sistema al buque). La antena, de la marca SeaTel, posee un ródomo de 4m de diámetro y un peso de 800Kg.

El conjunto ha sido dimensionado para poder establecer enlaces simétricos de hasta 5Mbps (el mismo ancho de banda de bajada que de subida al satélite) aunque el contrato de comunicaciones que se ha establecido sobre un ancho de banda garantizado de 256 Kbps con el doble en ráfaga. El coste de dicho enlace es de aproximadamente 60.000 € anuales.

La simetría del enlace es ideal para enviar datos en tiempo real de los parámetros de propósito general (posición, meteorología, características físicas/químicas del agua del mar) a los centros de investigación en tierra, permitiendo un seguimiento al segundo del transcurso de una campaña.

Dicha simetría también garantiza una calidad mínima para el establecimiento de llamadas de telefonía IP, videoconferencia o “video streaming” (siempre dentro de unos límites razonables en cuanto al tamaño del video enviado).

Aún con todas las ventajas y garantías de calidad del enlace, es necesario establecer una política de gestión para hacer un uso óptimo del mismo y para evitar al máximo situaciones que pongan en riesgo la seguridad de los sistemas informáticos y de adquisición de datos del buque.

Los escenarios de uso que se detallan a continuación son el fruto de la reflexión técnica sobre estos aspectos y no serán modificados a petición en el transcurso de una campaña.

4.2.2- Acceso a Internet.

La conexión de banda ancha permite el acceso permanente desde el buque a redes que trabajen con protocolos IP -Internet. Por motivos de seguridad y eficiencia dicho acceso se ha limitado a ciertos equipos, que disponen de un emplazamiento fijo, una configuración controlada y una funcionalidad que precisa dicha conexión.

El resto de ordenadores del buque solo accederán a Internet cuando el buque esté en un puerto nacional a través de la conexión de telefonía móvil 3G.

El uso y las limitaciones previstas para estos puestos con conexión IP es el siguiente:

- Conexión a servidores de los centros de investigación con el fin de recibir/enviar datos (protocolos scp, sftp,...) y consultar bases de datos (bibliográficas, meteorológicas, oceanográficas, geofísicas, etc).
- Navegación por sitios Web. Se excluye la descarga/subida de contenidos multimedia (videos, música, presentaciones) de sitios no relacionados con la actividad científico/técnica que se desarrolle en el buque. Expresamente se deshabilitan en el cortafuegos el acceso a sitios de intercambio de contenidos tipo P2P y sitios chat.

- Intranet del Buque:

Se ofrecen diversos servicios a través de la Intranet del buque, como son:

- Información general del Buque.
- Visualización de datos de Navegación, Estación meteorológica, Termosalinómetro.
- Graficas de adquisición en tiempo real (RDV).

- Herramienta de extracción de datos y generación de mapas de navegación en PDF, KMZ, KML.

Unidad de Tecnología Marina

BO SARMIENTO DE GAMBOA

SDG
DATOS TIEMPO REAL
RDV
MAXSEA
DATOS
METADATOS
ARCHIVOS



Bienvenid@s al B/O Sarmiento de Gamboa

El Buque Oceanográfico (B/O) Sarmiento de Gamboa es un buque de investigación multidisciplinar de ámbito global no polar. La instrumentación y los laboratorios con los que cuenta le permiten investigar los recursos y riesgos naturales, el cambio global, los recursos marinos, la circulación oceánica global y la biodiversidad marina. La investigación que en él se realiza está fundamentalmente dirigida y financiada por el Plan Nacional de I+D+i.

Cuenta además con las tecnologías más avanzadas en cuanto a sistemas de navegación (por ejemplo, el posicionamiento dinámico) y es el primer buque oceanográfico español que puede trabajar con ROV's (Remote Operated Vehicle) de altas profundidades y con AUV's (Autonomous Underwater Vehicle).

El B/O Sarmiento de Gamboa pertenece al Consejo Superior de Investigaciones Científicas y tiene su base en Vigo donde fue botado en 2006. La Unidad de Tecnología Marina del CSIC es la responsable de la gestión del buque así como del mantenimiento del equipamiento científico y aporta el personal técnico para la realización de las campañas oceanográficas.

EL BUQUE

[Bienvenida](#)

[Teléfonos Interiores \(SDG\)](#)

[Ficha General del Buque](#)

Nombre de Usuario

Contraseña

Recordarme

INICIAR SESIÓN

[¿Olvido su contraseña?](#)

[¿Olvido su nombre de usuario?](#)



- Puntos de Acceso Wi-Fi:

Existen diversos puntos de acceso Wí-Fi a la red del Buque, dichos accesos sirven durante las campañas tanto para la conexión a la red interna del buque, como para el servicio de Whatsapp. En puertos nacionales a través de dichos puntos de acceso también es posible la conexión a Internet a través de la red 3G. Los SSID de los A.P. son:

- puente
- tripulación-babor
- tripulación-estribor
- científicos-babor
- científicos-estribor
- laboratorio
- comedor
- salaTV
- reuniones

4.2.3- Acceso a la red de la UTM en el CMIMA

Otra de las características de la conexión del buque es que permite enlazar la red de área local de abordaje con los recursos de red que la UTM tiene en su centro de Barcelona (situado en el Centro Mediterráneo de Investigaciones Marinas y Ambientales) mediante lo que se denomina Red Privada Virtual o VPN.

Este enlace que se establece mediante protocolos de red seguros (IPSec) permite entre otras cosas lo siguiente:

- Realizar copias de seguridad de datos en los servidores de la UTM.
- Envío en tiempo real de datos. Monitorizar desde la sede de Barcelona los parámetros de propósito general de los sistemas de adquisición del buque. Acceso desde cualquier punto de Internet a la visualización en tiempo real de un conjunto escogido de dichos parámetros.
- Sincronizar las bases de datos de los sistemas de trabajo corporativo y difusión pública de la UTM con el segmento embarcado de dichos sistemas (página web, sistema de documentación, sistema de gestión de flotas, etc.)
- Acceso remoto a los sistemas informáticos del buque desde la sede de Barcelona. Lo que permite la tele-asistencia en caso de avería, problema o configuración de la mayoría de equipos embarcados críticos.

4.2.4- Telefonía

Adicionalmente a la conexión de datos, el sistema de banda ancha del buque proporciona tres líneas de voz analógicas y una de fax (ver Figura Anexo).

Estas líneas de telefonía están enlazadas con la centralita de extensiones telefónicas internas del buque distribuyéndose de la siguiente manera:

- Núm. 942 01 63 01 (voz). Extensión 128 localizada en el laboratorio de procesado / informática
- Núm. 942 01 63 03 (voz). Extensión 213 localizada en el camarote del capitán
- Núm. 942 01 63 02 (voz). Extensión 210 localizada en el camarote del jefe técnico
- Núm. 942 01 63 04 (voz/fax). Extensión 101 localizada en el local/oficina radio en puente

El número de teléfono oficial del buque será el **942 01 63 01**. Cuando se llame a este número sonará por primera vez en el laboratorio pero si a los cuatro tonos no se ha descolgado el aparato, sonará a la vez en las demás extensiones (puente, capitán, jefe técnico). El motivo de enlazar el número principal con el laboratorio es el de mantener libre lo máximo posible las extensiones del puente y la del capitán, pues se usan como medio de comunicación entre el puente y máquinas o las demás partes estratégicas del buque.

Se dispone además de un conjunto de 5 terminales de telefonía analógica/IP inalámbricos, enlazados con la extensión 128 (al número 942 01 63 01) mediante una centralita IP.

Con estos terminales podemos hacer lo siguiente:

- Establecer/Recibir llamadas IP (sin coste adicional) con la sede de la UTM en Barcelona
- Establecer/Recibir llamadas analógicas con cualquier teléfono de la red mundial de telefonía conmutada.
- Establecer/Recibir llamadas a una extensión interna del buque
- Establecen/Recibir llamadas entre cualquiera de los 5 terminales inalámbricos.

Los números de voz poseen la numeración de Santander, por lo que llamar al buque desde España tiene el coste de una llamada nacional. Las llamadas salientes realizadas desde el buque tienen un coste de 0.5 € minuto.

5.-ELECTRONICA



Centre Mediterrani d'Investigacions Marines i Ambientals, CMIMA
Passeig Marítim de la Barceloneta, 37- 49- 08003 Barcelona – España
Telf: +34 93 230 95 00
Fax: + 34 93 230 95 SS

E-mail ((MIMA): ugboele@gmail.com)

TÉCNICOS

Antonio Salvador Cuevas

FECHAS: 21/09/2016-26/10/2016

INFORME TÉCNICO

ATLAS

B/O Sarmiento de Gamboa

Fechas: 21/09/2016 – 26/10/2016

Centre Mediterrani d'Investigacions Marines i Ambientals, CMIMA
Passeig Marítim de la Barceloneta, 37- 49- 08003 Barcelona – España
Telf: +34 93 230 95 00
Fax: + 34 93 230 95 SS

E-mail ((MIMA): ugboele@gmail.com)

TÉCNICOS

Antonio Salvador Cuevas



FECHAS: 21/09/2016-26/10/2016

Título Informe Campaña ATLAS
Autor. Antonio Salvador Cuevas
Dpto. Equipos Desplegables
Fecha. 12/11/2016
Páginas. 11
Localización. Cadiz-Azores.



Centre Mediterrani d'Investigacions Marines i Ambientals, CMIMA
Passeig Marítim de la Barceloneta, 37- 49- 08003 Barcelona – España
Telf: +34 93 230 95 00
Fax: + 34 93 230 95 SS

E-mail ((MIMA): ugboele@gmail.com)

TÉCNICOS

Antonio Salvador Cuevas

FECHAS: 21/09/2016-26/10/2016

Cruise: ATLAS

OBJETIVOS:

Los objetivos de la compañía son caracterizar la conectividad entre el mar Mediterráneo y el océano Atlántico explorando y estudiando las características de las masas de agua, geomorfología y comunidades bentónicas en 5 zonas del océano Atlántico y el mar Mediterráneo.

Las zonas de trabajo son Ormonde, Gazul, Formigas, cañon de Guadairo y Seco de los Olivos.

La rutina de trabajo son trabajos con ROV, muestreos con dragas y multicorer durante el día, y muestreos con CTD durante la noche.

MUESTREO:

En esta campaña se realizaron los muestreos con CTD con LADCP durante la noche en los puntos indicados realizando transectos alrededor de la zona de trabajo según las indicaciones de los responsables de campaña.

También se realizaron towyo en tres ocasiones durante un periodo de unas 6h cada uno durante tres noches.

MANIOBRA:

La maniobra del CTD se realizó de la forma habitual por el hangar sin ninguna incidencia destacable durante toda la campaña.

INCIDENCIAS:

- Se tuvieron que sustituir bastantes juntas tóricas que sujetan la válvula de vaciado de las botellas.



Centre Mediterrani d'Investigacions Marines i Ambientals, CMIMA
Passeig Marítim de la Barceloneta, 37- 49- 08003 Barcelona – España
Telf: +34 93 230 95 00
Fax: + 34 93 230 95 SS

E-mail ((MIMA): ugboele@gmail.com)

TÉCNICOS

Antonio Salvador Cuevas

FECHAS: 21/09/2016-26/10/2016

- El LADCP comenzó funcionando correctamente pero poco a poco empezó a dar fallos primero en la descarga de los ficheros y finalmente en la conexión.
Se solucionó conectando los cabezales en dos ordenadores diferentes por lo que el problema sea debido a que los ordenadores empiezan a quedarse obsoletos y dan problemas de fiabilidad, velocidad y puertos saturados. Sería imprescindible pensar en adquirir equipos nuevos.
- Se sustituyó un turbidímetro que empezó a fallar, en seco funcionaba bien por lo que creo que era por un problema con el cable o la conexión.
- El fluoroturbidímetro daba una gráfica de turbidez que variaba con el tiempo y salía de forma no lineal, el valor de fluorometría lo daba correctamente.
- El PC del CTD2 no arranca a la primera, hay que revisarlo.

FICHA TÉCNICA

Equipos utilizados

CTD S/N 0851.

LADCP 16396

LADCP 16387

Centre Mediterrani d'Investigacions Marines i Ambientals, CMIMA
Passeig Marítim de la Barceloneta, 37- 49- 08003 Barcelona – España
Telf: +34 93 230 95 00
Fax: + 34 93 230 95 SS

E-mail ((MIMA): ugboele@gmail.com)

TÉCNICOS

Antonio Salvador Cuevas

FECHAS: 21/09/2016-26/10/2016

LISTADO DE SENSORES

Sensor de temperatura S/N 5363
Sensor de temperatura S/N 4721
Sensor de conductividad S/N 3761
Sensor de presión S/N 0851 Sensor
de conductividad S/N 3302
Fluorómetro y turbidímetro S/N 3594
Sensor de oxígeno S/N 1147
Turbidímetro S/N 10249
Altímetro S/N 40396
Sensor PAR S/N 70338

- `<TemperatureSensor SensorID="55" >`
 - `<SerialNumber>5363</SerialNumber>`
 - `<CalibrationDate>18-Apr-15</CalibrationDate>`
 - `<UseG_J>1</UseG_J>`
 - `<A>0.00000000e+000`
 - `0.00000000e+000`
 - `<C>0.00000000e+000</C>`
 - `<D>0.00000000e+000</D>`
 - `<F0_Old>0.000</F0_Old>`
 - `<G>4.41015116e-003</G>`
 - `<H>6.40949127e-004</H>`
 - `<I>2.25144199e-005</I>`
 - `<J>2.02985691e-006</J>`
 - `<F0>1000.000</F0>`
 - `<Slope>1.00000000</Slope>`
 - `<Offset>0.0000</Offset>`
- `<ConductivitySensor SensorID="3" >`
 - `<SerialNumber>3761</SerialNumber>`
 - `<CalibrationDate>21-Apr-15</CalibrationDate>`
 - `<CPcor>-9.57000000e-008</CPcor>`
 - `</Coefficients>`
 - `<Coefficients equation="1" >`
 - `<G>-9.86347208e+000</G>`
 - `<H>1.42405856e+000</H>`
 - `<I>-1.52522705e-003</I>`
 - `<J>1.94230689e-004</J>`
 - `<CPcor>-9.57000000e-008</CPcor>`
 - `<CTcor>3.2500e-006</CTcor>`
 - `<!-- WBOTC not applicable unless ConductivityType = 1. -->`
 - `<WBOTC>0.00000000e+000</WBOTC>`
 - `</Coefficients>`
 - `<Slope>1.00000000</Slope>`
 - `<Offset>0.00000</Offset>`



Centre Mediterrani d'Investigacions Marines i Ambientals, CMIMA
Passeig Marítim de la Barceloneta, 37- 49- 08003 Barcelona – España
Telf: +34 93 230 95 00
Fax: + 34 93 230 95 SS

E-mail ((MIMA): ugboele@gmail.com)

TÉCNICOS

Antonio Salvador Cuevas

FECHAS: 21/09/2016-26/10/2016

- <PressureSensor SensorID="45" >
 <SerialNumber>0851</SerialNumber>
 <CalibrationDate>16-Apr-15</CalibrationDate>
 <C1>-3.986651e+004</C1>
 <C2>-3.682873e-001</C2>
 <C3>1.204900e-002</C3>
 <D1>3.408700e-002</D1>
 <D2>0.000000e+000</D2>
 <T1>3.026991e+001</T1>
 <T2>-3.253242e-004</T2>
 <T3>3.921000e-006</T3>
 <T4>3.443790e-009</T4>
 <Slope>0.99998282</Slope>
 <Offset>0.26552</Offset>
 <T5>0.000000e+000</T5>
 <AD590M>1.288100e-002</AD590M>
 <AD590B>-8.605830e+000</AD590B>
- <TemperatureSensor SensorID="55" >
 <SerialNumber>4721</SerialNumber>
 <CalibrationDate>17-Apr-15</CalibrationDate>
 <UseG_J>1</UseG_J>
 <A>0.00000000e+000
 0.00000000e+000
 <C>0.00000000e+000</C>
 <D>0.00000000e+000</D>
 <F0_Old>0.000</F0_Old>
 <G>4.39024516e-003</G>
 <H>6.41953756e-004</H>
 <I>2.16222272e-005</I>
 <J>1.81363312e-006</J>
 <F0>1000.000</F0>
 <Slope>1.00000000</Slope>
 <Offset>0.0000</Offset>



Centre Mediterrani d'Investigacions Marines i Ambientals, CMIMA
Passeig Marítim de la Barceloneta, 37- 49- 08003 Barcelona – España
Telf: +34 93 230 95 00
Fax: + 34 93 230 95 SS

E-mail ((MIMA): ugboele@gmail.com)

TÉCNICOS
Antonio Salvador Cuevas

FECHAS: 21/09/2016-26/10/2016

- ```
<ConductivitySensor SensorID="3" >
 <SerialNumber>3302</SerialNumber>
 <CalibrationDate>16-Apr-15</CalibrationDate>
 <UseG_J>1</UseG_J>
 <!-- Cell const and series R are applicable only for wide
range sensors. -->
 <SeriesR>0.0000</SeriesR>
 <CellConst>2000.0000</CellConst>
 <ConductivityType>0</ConductivityType>
 <Coefficients equation="0" >
 <A>0.00000000e+000
 0.00000000e+000
 <C>0.00000000e+000</C>
 <D>0.00000000e+000</D>
 <M>0.0</M>
 <CPcor>-9.57000000e-008</CPcor>
 </Coefficients>
 <Coefficients equation="1" >
 <G>-1.03029370e+001</G>
 <H>1.52018446e+000</H>
 <I>4.67574556e-005</I>
 <J>7.49803020e-005</J>
 <CPcor>-9.57000000e-008</CPcor>
 <CTcor>3.2500e-006</CTcor>
 <!-- WBOTC not applicable unless ConductivityType =
1. -->
 <WBOTC>0.00000000e+000</WBOTC>
 </Coefficients>
 <Slope>1.00000000</Slope>
 <Offset>0.00000</Offset>
```



E-mail ((MIMA): [ugboele@gmail.com](mailto:ugboele@gmail.com))

#### TÉCNICOS

Antonio Salvador Cuevas

FECHAS: 21/09/2016-26/10/2016

```
<FluoroWetlabECO_AFL_FL_Sensor SensorID="20" >
 <SerialNumber>3594</SerialNumber>
 <CalibrationDate>18/06/2014</CalibrationDate>
 <ScaleFactor>6.00000000e+000</ScaleFactor>
 <!-- Dark output -->
 <Vblank>0.0640</Vblank>
</FluoroWetlabECO_AFL_FL_Sensor>
</Sensor>
<Sensor index="6" SensorID="67" >
 <TurbidityMeter SensorID="67" >
 <SerialNumber>3594</SerialNumber>
 <CalibrationDate>18/06/2014</CalibrationDate>
 <ScaleFactor>2.000000</ScaleFactor>
 <!-- Dark output -->
 <DarkVoltage>0.039000</DarkVoltage>
 </TurbidityMeter>
<OxygenSensor SensorID="38" >
 <SerialNumber>1147</SerialNumber>
 <CalibrationDate>11-Apr-15</CalibrationDate>
 <Use2007Equation>1</Use2007Equation>
 <CalibrationCoefficients equation="0" >
 <!-- Coefficients for Owens-Millard equation. -->
 <Boc>0.0000</Boc>
 <Soc>0.0000e+000</Soc>
 <offset>0.0000</offset>
 <Pcor>0.00e+000</Pcor>
 <Tcor>0.0000</Tcor>
 <Tau>0.0</Tau>
 </CalibrationCoefficients>
 <CalibrationCoefficients equation="1" >
 <!-- Coefficients for Sea-Bird equation - SBE calibration in 2007 and
later. -->
 <Soc>4.8250e-001</Soc>
 <offset>-0.5253</offset>
 <A>-3.8803e-003
 1.8509e-004
 <C>-2.5179e-006</C>
 <D0> 2.5826e+000</D0>
 <D1> 1.92634e-004</D1>
 <D2>-4.64803e-002</D2>
 <E> 3.6000e-002</E>
 <Tau20> 2.3300</Tau20>
 <H1>-3.3000e-002</H1>
 <H2> 5.0000e+003</H2>
 <H3> 1.4500e+003</H3>
```

**Centre Mediterrani d'Investigacions Marines i Ambientals, CMIMA**  
Passeig Marítim de la Barceloneta, 37- 49- 08003 Barcelona – España  
Telf: +34 93 230 95 00  
Fax: + 34 93 230 95 55

E-mail ((MIMA): [ugboele@gmail.com](mailto:ugboele@gmail.com))

**TÉCNICOS**  
Antonio Salvador Cuevas

FECHAS: 21/09/2016-26/10/2016

```
<OBS_SeapointTurbiditySensor SensorID="33" >
 <SerialNumber>10249</SerialNumber>
 <CalibrationDate></CalibrationDate>
 <!-- The following is an array index, not the actual gain setting. -->
 <GainSetting>3</GainSetting>
 <ScaleFactor>1.000</ScaleFactor>
</OBS_SeapointTurbiditySensor>
</Sensor>
<Sensor index="10" SensorID="71" >
 <WET_LabsCStar SensorID="71" >
 <SerialNumber>1013DR</SerialNumber>
 <CalibrationDate>16/04/10</CalibrationDate>
 <M>24.6455</M>
 -1.3801
 <PathLength>0.250</PathLength>
 </WET_LabsCStar>
</Sensor>
<Sensor index="11" SensorID="0" >
 <AltimeterSensor SensorID="0" >
 <SerialNumber>40396</SerialNumber>
 <CalibrationDate>16/09/2015</CalibrationDate>
 <ScaleFactor>15.000</ScaleFactor>
 <Offset>0.000</Offset>
 </AltimeterSensor>
</Sensor>
<Sensor index="12" SensorID="42" >
 <PAR_BiosphericalLicorChelseaSensor SensorID="42" >
 <SerialNumber>70338</SerialNumber>
 <CalibrationDate>12/06/10</CalibrationDate>
 <M>1.00000000</M>
 0.00000000
 <CalibrationConstant>17064846416.38229900</
CalibrationConstant>
 <Multiplier>1.00000000</Multiplier>
 <Offset>-0.05973070</Offset>
 </PAR_BiosphericalLicorChelseaSensor>
```



**Centre Mediterrani d'Investigacions Marines i Ambientals, CMIMA**  
Passeig Marítim de la Barceloneta, 37- 49- 08003 Barcelona – España  
Telf: +34 93 230 95 00  
Fax: + 34 93 230 95 SS

E-mail ((MIMA): [ugboele@gmail.com](mailto:ugboele@gmail.com))

**TÉCNICOS**

**Antonio Salvador Cuevas**

FECHAS: 21/09/2016-26/10/2016

```
<D>0.00000000e+000</D>
<M>0.0</M>
<CPcor>-9.57000000e-008</CPcor>
</Coefficients>
<Coefficients equation="1">
 <G>-1.01326713e+001</G>
 <H>1.43665640e+000</H></>-1.03371916e-004</I>
 <J>8.72526791e-005</J>
 <CPcor>-9.57000000e-008</CPcor>
 <CTcor>3.2500e-006</CTcor>
 <!-- WBOTC not applicable unless ConductivityType = 1. -->
 <WBOTC>0.00000000e+000</WBOTC>
</Coefficients>
<Slope>1.00000000</Slope>
<Offset>0.00000</Offset>
</ConductivitySensor>
```

**Centre Mediterrani d'Investigacions Marines i Ambientals, CMIMA**  
 Passeig Marítim de la Barceloneta, 37- 49- 08003 Barcelona – España  
 Telf: +34 93 230 95 00  
 Fax: + 34 93 230 95 55

E-mail ((MIMA): [ugboele@gmail.com](mailto:ugboele@gmail.com))

**TÉCNICOS**  
**Antonio Salvador Cuevas**

FECHAS: 21/09/2016-26/10/2016

**Overview of the MEDWAVES cruise**



**Leg 1 (23 days)**

- From Cádiz to zone 1 (Gazul Mud Volcano) → ~ 33nm → ~ 4h transit
- Zone 1 → 4 days
- From zone 1 to zone 2 (Ormonde) → 205 nm → ~ 20.5 h (~ 1 day transit)
- Zone 2 → 7 days
- From zone 2 to zone 3 (Formiges & Dollabaral) → ~ 658 nm → 66 h (~ 3 days transit)
- Zone 3 → 7 days
- From zone 3 to San Miguel Harbour → ~ 74 nm → 8 h

**Leg 2 (13 days)**

- From San Miguel harbor to zone 3 → ~ 74 nm → ~ 7.5h transit
- Zone 3 → 1 day
- From zone 3 to zone 4 (Guadiaro canyon) → ~ 930 nm → 93 h (~ 4 days transit)
- Zone 4 → 3 days
- From zone 4 to zone 5 (Seco de los Olivos/Chella Bank) → ~ 128 nm → ~ 13 h transit
- Zone 5 → 3 days
- From zone 5 to Málaga harbor → ~ 77 nm → ~ 8 h transit

# INFORME DEPARTAMENTO DE MECANICA CAMPAÑA "IDRISSI Y MEDWAVES"

B/O SARMIENTO DE GAMBOA

EQUIPAMIENTO MECANICO:

-VAN VEEN

-MULTICORER

-BOX CORER

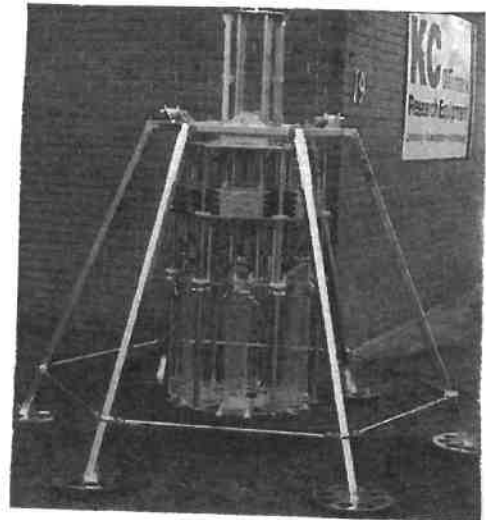
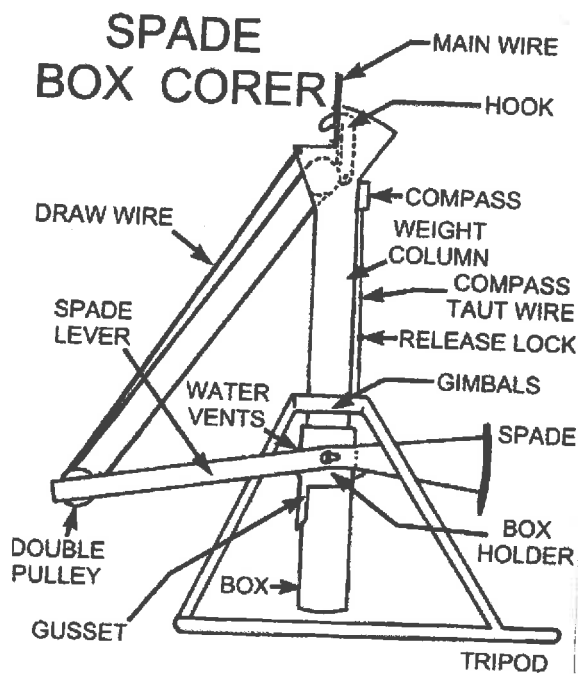

KC Multi-corer, 6 x  $\phi$ 100 mm  
Model 70 000

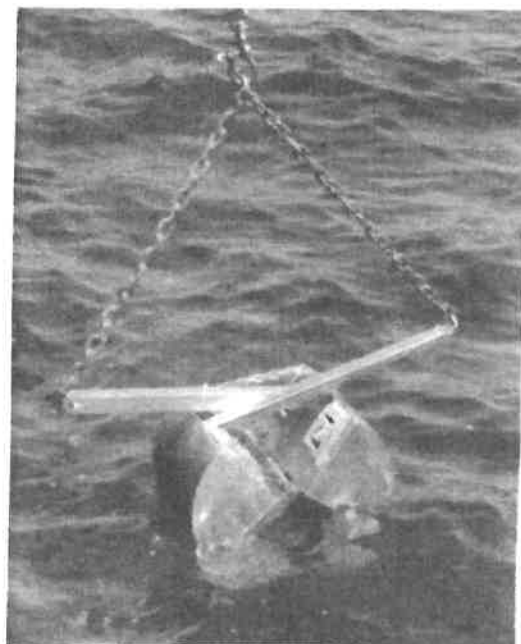



fecha	estación	hora	equipo	latitud	longitud	sonda
22/9	10	16:16	BOX CORER	36°33'78	06°55'87	444
22/9	11	17:35	BOX CORER	36°33'87	06°55'86	450
22/9	12	18:16	BOX CORER	36°33'92	0655'86	446
23/9	21	18:34	BOX CORER	36°33'59	06°59'95	471
23/9	22	17:25	MULTICORER	36°33'59	0656'95	470
23/9	23	18:20	MULTICORER	36°33'63	06°56'99	467
25/9	37	16.52	BOX CORER	36°58'65	1047'11	1921
25/9	38	20:06	MULTICORER	35°50'65	10°78'15	1920
30/9	55	15:04	VAN VEEN	37°09'05	24°37'42	1535
30/9	56	16:09	VAN VEEN	37°09'05	24°37'42	1534
30/9	57	17:25	MULTICORER	37°09'05	24°37'42	1535
30/9	58	19:05	VAN VEEN	37°10'44	24°37'57	1172
30/9	59	20:02	VAN VEEN	37°10'44	24°37'57	1172
1/10	66	16:54	VAN VEEN	37°11'26	24°37'38	1122
1/10	67	18:55	VAN VEEN	37°11'20	24°37'58	1248
1/10	68	19:03	MULTICORER	37°11'20	24°37'58	1245
2/10	79	18:05	VAN VEEN	37°12'10	24°37'15	1015
2/10	80	18:49	VAN VEEN	37°12'10	24°37'15	1015
2/10	81	19:30	VAN VEEN	37°12'10	24°37'15	1015
3/10	90	11:53	VAN VEEN	37°12'39	24°12'39	746
3/10	91	12:25	VAN VEEN	37°12'39	24°12'39	746
3/10	92	13:00	VAN VEEN	37°12'39	24°12'39	746
4/10	104	17:20	VAN VEEN	37°20'33	24°44'26	1415
4/10	105	18:08	VAN VEEN	37°20'33	24°44'26	1415
4/10	106	19:18	VAN VEEN	37°20'33	24°44'26	1415
4/10	107	20:30	MULTICORER	37°20'33	24°44'26	1415
5/10	114	17:43	VAN VEEN	37°20'24	24°45'21	1326
5/10	115	18:30	VAN VEEN	37°20'24	24°45'21	1416
5/10	116	19:38	VAN VEEN	37°20'23	24°45'18	1324
5/10	117	20.45	MULTICORER	37°20'23	24°45'18	1324
6/10	123	22:05	VAN VEEN	37°20'35	24°45'17	1240
7/10	128	22:17	VAN VEEN	37°19'35	24°44'22	1046
7/10	129	23:09	VAN VEEN	37°19'35	24°44'22	1048
7/10	130	23:52	VAN VEEN	37°19'35	24°44'22	1048
8/10	131	00.38	VAN VEEN	37°19'35	24°44'22	1936
18/10	139	15:56	VAN VEEN	36°58'38	10°47'05	1931
18/10	140	17:45	VAN VEEN	36°58'33	10°47'06	1235
19/10	147	17:53	VAN VENN	36°48'00	10°57'00	1233
19/10	148	18:45	VAN VEEN	36°48'00	10°57'01	1143
20/10	157	18:10	VAN VEEN	36°48'37	11°07'30	1145
20/10	158	19:12	VAN VEEN	36°48'37	11°07'30	729
23/10	177	08:54	VAN VEEN	36°28'51	2°53'40	729
23/10	178	09:31	VAN VEEN	36°29'51	2°53'40	729
23/10	179	10:23	VAN VEEN	36°28'51	2°53'40	729
23/10	180	10:58	VAN VEEN	36°28'51	2°53'40	729
23/10	183	18:50	VAN VEEN	36°29'02	2°53'31	654
23/10	184	19:18	VAN VEEN	36°29'02	2°53'31	654
24/10	193	10:58	VAN VEEN	36°32'32	2°49'09	314



24/10	194	11:20	VAN VEEN	36°32'32	2°49'09	324
24/10	195	11:37	VAN VEEN	36°32'32	2°49'09	325
24/10	197	16:25	VAN VEEN	36°32'11	2°49'13	249
24/10	198	16:42	VAN VEEN	36°32'11	2°49'13	249
24/10	199	16:58	VAN VEEN	36°32'11	2°49'13	381
24/10	200	17:35	VAN VEEN	36°32'45	2°45'48	381
24/10	201	18:04	MULTICORER	36°32'45	2°45'48	381
25/10	212	16:20	VAN VEEN	36°32'14	2°48'10	283
25/10	213	16:36	VAN VEEN	36°32'14	2°48'10	283
25/10	214	17:10	VAN VEEN	36°31'02	2°48'02	449
25/10	215	19:46	MULTICORER	36°30'56	2°47'38	554

## TRABAJOS REALIZADOS :

Se sanea la estructura de transporte del multicorer encontrándose bastante deteriorada con perforaciones en las barras .

Se cambio una guillotina porque estaba doblada. Y se endereza la parrilla inferior del multicorer.

Tanto el multicorer como el box corer y la van veen funcionaron adecuadamente toda la campaña







This project has received funding from the European Union's Horizon 2020 research and innovation programme under grant agreement No 678760 (ATLAS). This output reflects only the author's view and the European Union cannot be held responsible for any use that may be made of the information contained therein.