

SEP 30 1998

ENGINEERING DATA TRANSMITTAL

1. EDT 622967

Sta. 37 (20)

2. To: (Receiving Organization) Packaging Engineering	3. From: (Originating Organization) Packaging Engineering	4. Related EDT No.: NA
5. Proj./Prog./Dept./Div.: 03E00	6. Design Authority/ Design Agent/Cog. Engr.: W. A. McCormick	7. Purchase Order No.: NA
8. Originator Remarks: The attached safety analysis report for packaging (SARP) is being submitted for approval and release. This SARP consolidates, simplifies, updates, and replaces the following three SARPs: SD-RE-SAP-002, SD-RE-SAP-024, and SD-RE-SAP-033.		9. Equip./Component No.: NA
11. Receiver Remarks: 11A. Design Baseline Document? <input type="checkbox"/> Yes <input checked="" type="checkbox"/> No		10. System/Bldg./Facility: NA
		12. Major Assm. Dwg. No.: NA
		13. Permit/Permit Application No.: NA
		14. Required Response Date: NA

15. DATA TRANSMITTED					(F)	(G)	(H)	(I)
(A) Item No.	(B) Document/Drawing No.	(C) Sheet No.	(D) Rev. No.	(E) Title or Description of Data Transmitted	Approval Designator	Reason for Transmittal	Originator Disposition	Receiver Disposition
1	HNF-2209	NA	0	Safety Analysis Report for Packaging (Onsite) Steel Drum	SQ	1,2	1	

16. KEY

Approval Designator (F)	Reason for Transmittal (G)			Disposition (H) & (I)	
E, S, Q, D or N/A (see WHC-CM-3.5, Sec.12.7)	1. Approval	4. Review	2. Release	5. Post-Review	1. Approved
	3. Information	6. Dist. (Receipt Acknow. Required)			2. Approved w/comment
					3. Disapproved w/comment
					4. Reviewed no/comment
					5. Reviewed w/comment
					6. Receipt acknowledged

17. SIGNATURE/DISTRIBUTION
(See Approval Designator for required signatures)

(G) Reason	(H) Disp.	(J) Name	(K) Signature	(L) Date	(M) MSIN	(G) Reason	(H) Disp.	(J) Name	(K) Signature	(L) Date	(M) MSIN
		Design Authority				1	1	SRB Chairman DL McCall*	<i>[Signature]</i>	9/24/98	H1-11
		Design Agent				1	1	WMH JL Westcott*	<i>[Signature]</i>	9/24/98	T3-04
1	1	Cog. Eng. WA McCormick	<i>[Signature]</i>	9/24/98	H1-15						
1	1	Cog. Mgr. JG Field	<i>[Signature]</i>	9/24/98	H1-15						
1	1	QA MA McGhan*	<i>[Signature]</i>	9/25/98	H1-15						
1	1	Safety T Romano*	<i>[Signature]</i>	9/25/98	H1-15						
1	1	Ind. Rev. PC Ferrell*	<i>[Signature]</i>	9/25/98	H1-15						
1	1	Transp. Log. LL Cole	<i>[Signature]</i>	9/24/98	H1-14						

18. Signature of EDT Originator <i>[Signature]</i> 9/24/98	19. Authorized Representative Date for Receiving Organization	20. Signature of Design Authority/ Cognizant Manager <i>[Signature]</i> 9/24/98	21. DOE APPROVAL (if required) Ctrl. No. <input type="checkbox"/> Approved <input type="checkbox"/> Approved w/comments <input type="checkbox"/> Disapproved w/comments
---	---	--	--

Safety Analysis Report for Packaging (Onsite) Steel Drum

W. A. McCormick

Waste Management federal Services, Inc., Northwest Operations
Richland, WA 99352, for Fluor Daniel Hanford, Inc.
U.S. Department of Energy Contract DE-AC06-96RL13200

EDT/ECN: EDT 622967 UC: 513
Org Code: 03E00 Charge Code: B1272 Task Order: GS080003
Project: 772027 Crosswalk: 40-012-001
B&R Code: EX7002000 Total Pages: ~~300~~ *ja* 382

Key Words: Type B, 208 L (55-gal) drum, N-55 Overpack, TRU

Abstract: This Safety Analysis Report for Packaging (SARP) provides the analyses and evaluations necessary to demonstrate that the steel drum packaging system meets the transportation safety requirements of HNF-PRO-154, *Responsibilities and Procedures for all Hazardous Material Shipments*, for an onsite packaging containing Type B quantities of solid and liquid radioactive materials. The basic component of the steel drum packaging system is the 208 L (55-gal) steel drum.

TRADEMARK DISCLAIMER. Reference herein to any specific commercial product, process, or service by trade name, trademark, manufacturer, or otherwise, does not necessarily constitute or imply its endorsement, recommendation, or favoring by the United States Government or any agency thereof or its contractors or subcontractors.

Printed in the United States of America. To obtain copies of this document, contact: WHC/BCS Document Control Services, P.O. Box 1970, Mailstop H6-08, Richland WA 99352, Phone (509) 372-2420; Fax (509) 376-4989.

W. L. Bukland 9/29/98
Release Approval Date

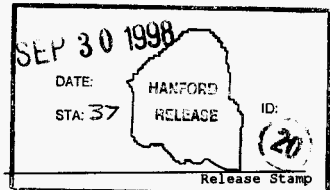

Approved for Public Release

RELEASE AUTHORIZATION

Document Number: HNF-2209, Revision 0

Document Title: Safety Analysis Report for
Packaging (Onsite) Steel Drum

This document, reviewed in accordance with DOE Order 1430.1D, "Scientific and Technical Information Management," and DOE G 1430.1D-1, "Guide to the Management of Scientific and Technical Information," does not contain classified or sensitive unclassified information and is:

APPROVED FOR PUBLIC RELEASE

V. L. Birkland

V. L. Birkland

9/29/98

Lockheed Martin Services, Inc.
Document Control/Information Clearance

Reviewed for Applied Technology, Business Sensitive, Classified, Copyrighted, Export Controlled, Patent, Personal/Private, Proprietary, Protected CRADA, Trademark, Unclassified Controlled Nuclear Information.

Trademark Disclaimer. Reference herein to any specific commercial product, process, or service by trade name, trademark, manufacturer, or otherwise, does not necessarily constitute or imply its endorsement, recommendation, or favoring by the United States Government or any agency thereof or its contractors or subcontractors. The views and opinions of authors expressed herein do not necessarily state or reflect those of the United States Government or any agency thereof. This report has been reproduced from the best available copy.

Printed in the United States of America.

Available to the U.S. Department of Energy and its contractors from the U.S. Department of Energy Office of Scientific and Technical Information, P.O. Box 62, Oak Ridge, TN 37831; Telephone: 423/676-8401.

Available to the public from the U.S. Department of Commerce National Technical Information Service, 5285 Port Royal Road, Springfield, VA 22161; Telephone: 703/487-4650.

LIST OF EFFECTIVE PAGES

Page	Revision	Comment
	0	EDT
	0	SD
	0	LOEP
iii-xii	0	TOC
A1-1 - A1-2	0	
A2-1 - A2-6	0	
A3-1 - A3-4	0	
A4-1 - A4-4	0	
A5-1 - A5-2	0	
A6-1 - A6-2	0	
A7-1 - A7-6	0	
A8-1 - A8-2	0	
A9-1 - A9-2	0	
B1-1 - B1-2	0	
B2-1 - B2-4	0	
B3-1 - B3-8	0	
B4-1 - B4-22	0	
B5-1 - B5-24	0	
B6-1 - B6-4	0	
B7-1 - B7-224	0	
B8-1 - B8-20	0	
B9-1 - B9-28	0	
B10-1 - B10-3	0	

CONTENTS

PART A: PACKAGE DESCRIPTION AND OPERATIONS

1.0 INTRODUCTION	A1-1
1.1 GENERAL INFORMATION	A1-1
1.2 SYSTEM DESCRIPTION	A1-1
1.3 REVIEW AND UPDATE CYCLE	A1-2
2.0 PACKAGING SYSTEM	A2-1
2.1 CONFIGURATION AND DIMENSIONS, MATERIALS OF CONSTRUCTION, AND WEIGHTS	A2-1
2.1.1 N-55 Overpack	A2-2
2.1.2 Packaging Configuration for Liquids	A2-2
2.2 CONTAINMENT BOUNDARY	A2-5
2.3 HEAT DISSIPATION	A2-5
2.4 SHIELDING	A2-5
2.5 LIFTING DEVICES	A2-5
2.6 TIEDOWN DEVICES	A2-5
3.0 PACKAGE CONTENTS	A3-1
3.1 GENERAL DESCRIPTION	A3-1
3.1.1 Fissile Material Content	A3-3
3.1.2 Physical and Chemical Composition	A3-3
3.2 GAS GENERATION RESTRICTION	A3-3
3.3 SIZE AND WEIGHT	A3-3
4.0 TRANSPORT SYSTEM	A4-1
4.1 TRANSPORTER	A4-1
4.2 TIEDOWN SYSTEM	A4-1
4.2.1 System Design and Requirements	A4-1
4.2.2 Attachments, Ratings, and Requirements	A4-3
4.3 SPECIAL TRANSFER REQUIREMENTS	A4-3
4.3.1 Routing and Access Control	A4-3
4.3.2 Radiological Limitations	A4-3
4.3.3 Mileage Limits	A4-4
4.3.4 Speed Limits	A4-4
4.3.5 Array Restrictions	A4-4
5.0 ACCEPTANCE OF PACKAGING FOR USE	A5-1
5.1 208 L (55-GAL) DRUMS	A5-1
5.1.1 Packaging for Continued Use	A5-1
5.2 RETRIEVAL DRUMS	A5-1
5.2.1 Documentation	A5-2
5.3 N-55 OVERPACK	A5-2
5.3.1 Inspection Prior to Use	A5-2
5.3.2 Documentation	A5-2
6.0 OPERATING REQUIREMENTS	A6-1
6.1 DRUMS	A6-1

CONTENTS (cont.)

6.2 N-55 OVERPACK	A6-1
6.2.1 Loading	A6-1
6.2.2 Unloading	A6-2
6.2.3 Additional Requirements for Retrieval Drums	A6-2
7.0 QUALITY ASSURANCE REQUIREMENTS	A7-1
7.1 INTRODUCTION	A7-1
7.2 GENERAL REQUIREMENTS	A7-1
7.3 ORGANIZATION	A7-1
7.4 QUALITY ASSURANCE ACTIVITIES	A7-1
7.5.1 THI	A7-2
7.5.2 QLS	A7-3
7.6 QUALITY REQUIREMENTS	A7-3
7.6.1 Design Control	A7-3
7.6.2 Procurement and Fabrication Control	A7-4
7.6.9 QA Records and Document Control	A7-4
7.7 SARP CONTROL SYSTEM	A7-5
8.0 MAINTENANCE	A8-1
8.1 GENERAL	A8-1
8.2 MAINTENANCE AND VERIFICATION SCHEDULES	A8-1
8.2.1 208 L (55-Gal) Drums	A8-1
8.2.2 N-55 Overpack	A8-1
8.3 RECORDS AND DOCUMENTATION	A8-1
9.0 REFERENCES	A9-1

PART B: PACKAGE EVALUATION

1.0 INTRODUCTION	B1-1
1.1 SAFETY EVALUATION METHODOLOGY	B1-1
1.2 EVALUATION SUMMARY AND CONCLUSIONS	B1-1
1.3 REFERENCES	B1-2
2.0 CONTENTS EVALUATION	B2-1
2.1 CHARACTERIZATION	B2-1
2.1.1 Fissile Material Content	B2-3
3.0 RADIOLOGICAL RISK EVALUATION	B3-1
3.1 INTRODUCTION	B3-1
3.1.1 Discussion and Results	B3-1
3.2 RISK ACCEPTANCE CRITERIA	B3-1
3.3 DOSE CONSEQUENCE ANALYSIS RESULTS	B3-2
3.4 PACKAGE FAILURE THRESHOLD ANALYSIS	B3-2
3.5 ACCIDENT FREQUENCY ASSESSMENT	B3-3
3.5.1 Approach	B3-3
3.5.2 Accident Release Frequency Analysis	B3-4
3.5.2 Joint Probabilities	B3-6

CONTENTS (cont.)

3.6	EVALUATION AND CONCLUSION	B3-7
3.7	REFERENCES	B3-7
4.0	CONTAINMENT EVALUATION	B4-1
4.1	INTRODUCTION	B4-1
4.2	CONTAINMENT SOURCE SPECIFICATION	B4-1
4.3	NORMAL TRANSFER CONDITIONS	B4-1
4.4	ACCIDENT CONDITIONS	B4-1
4.4.1	Introduction and Overview	B4-3
4.4.2	Dose Consequence Analysis Methodology	B4-3
4.5	REFERENCES	B4-12
4.6	APPENDIX: DOSE CONSEQUENCE INPUT FILES	B4-12
4.6.1	ISO-PC Input	B4-12
4.6.2	GENII Input	B4-18
5.0	SHIELDING EVALUATION	B5-1
5.1	INTRODUCTION	B5-1
5.2	DIRECT RADIATION SOURCE SPECIFICATION	B5-1
5.2.1	Gamma Source	B5-1
5.2.2	Beta Source	B5-1
5.2.3	Neutron Source	B5-3
5.3	SUMMARY OF SHIELDING PROPERTIES OF MATERIALS	B5-3
5.4	NORMAL TRANSFER CONDITIONS	B5-3
5.4.1	Conditions To Be Evaluated	B5-3
5.4.2	Acceptance Criteria	B5-3
5.4.3	Shielding Model	B5-3
5.4.4	Shielding Results	B5-5
5.5	ACCIDENT CONDITIONS	B5-5
5.6	SHIELDING EVALUATION AND CONCLUSIONS	B5-6
5.7	REFERENCES	B5-6
5.8	APPENDICES	B5-7
5.8.1	ORIGEN-S Input Files	B5-7
5.8.2	MCNP Input Files	B5-11
5.8.3	Neutron Dose Rate Calculation	B5-21
6.0	CRITICALITY EVALUATION	B6-1
6.1	INTRODUCTION	B6-1
6.1.1	Assumptions	B6-1
6.1.2	Results	B6-1
6.2	CRITICALITY SOURCE SPECIFICATION	B6-1
6.3	SUMMARY OF CRITICALITY PROPERTIES OF MATERIALS	B6-1
6.4	NORMAL TRANSFER CONDITIONS	B6-2
6.5	ACCIDENT CONDITIONS	B6-2
6.6	CRITICAL BENCHMARK EXPERIMENTS	B6-2
6.7	CRITICALITY EVALUATION AND CONCLUSIONS	B6-3
6.8	REFERENCES	B6-3
7.0	STRUCTURAL EVALUATION	B7-1
7.1	INTRODUCTION	B7-1
7.2	ENVELOPING STRUCTURAL EVALUATION OF PACKAGES	B7-1
7.2.1	Structural Design and Features	B7-1
7.2.2	Mechanical Properties of Materials	B7-2

CONTENTS (cont.)

7.2.3	Conditions To Be Evaluated	B7-3
7.2.4	Acceptance Criteria	B7-5
7.2.5	Chemical and Galvanic Reactions	B7-5
7.2.6	Size of Package and Cavity	B7-5
7.2.7	Weight and Center of Gravity	B7-6
7.2.8	Tamper-Indicating Feature	B7-6
7.2.9	Positive Closure	B7-6
7.2.10	Lifting and Tiedown Devices	B7-6
7.2.11	Brittle Fracture	B7-6
7.3	NORMAL TRANSFER CONDITIONS	B7-6
7.3.1	Structural Model	B7-6
7.3.2	Environmental Heat Loading	B7-13
7.3.3	Maximum Thermal and Pressure Stresses	B7-13
7.3.4	Vibration	B7-13
7.3.5	Water Spray	B7-13
7.3.6	Compression	B7-14
7.3.7	Free Drop	B7-14
7.3.8	Penetration	B7-22
7.3.9	Structural Evaluations and Conclusions	B7-22
7.4	ACCIDENT CONDITIONS	B7-22
7.4.1	Conditions To Be Evaluated	B7-23
7.4.2	Acceptance Criteria	B7-23
7.4.3	Structural Model	B7-23
7.4.4	Structural Evaluations and Conclusions	B7-24
7.5	EVALUATION OF THE RESPONSE OF AN ARRAY OF DRUMS TO AN ACCIDENT	B7-59
7.6	REFERENCES	B7-69
7.7	APPENDICES	B7-70
7.7.1	Input Files	B7-70
7.7.2	Engineering Safety Evaluations	B7-218
8.0	THERMAL EVALUATION	B8-1
8.1	INTRODUCTION	B8-1
8.2	ENVELOPING THERMAL EVALUATION OF PACKAGE	B8-1
8.2.1	Package Description	B8-1
8.2.3	Material Properties	B8-2
8.3	NORMAL TRANSFER CONDITIONS THERMAL EVALUATION	B8-3
8.3.1	Conditions To Be Evaluated	B8-3
8.3.2	Acceptance Criteria	B8-4
8.3.3	Thermal Evaluation and Conclusions	B8-4
8.4	REFERENCES	B8-4
8.5	APPENDICES	B8-6
8.5.1	Thermal With Solar (Liquid Content) Evaluation	B8-6
8.5.2	Thermal With Solar (Solid Content) Evaluation	B8-17
9.0	PRESSURE AND GAS GENERATION EVALUATION	B9-1
9.1	GAS GENERATION	B9-1
9.2	APPENDIX: HYDROGEN GAS GENERATION ANALYSIS	B9-2

CONTENTS (cont.)

10.0 PACKAGE TIEDOWN SYSTEM EVALUATION	B10-1
10.1 SYSTEM DESIGN AND REQUIREMENTS	B10-1
10.1.1 Standard Drums	B10-1
10.1.2 Retrieval Drums	B10-2
10.2 ATTACHMENTS, RATINGS, AND REQUIREMENTS	B10-3
10.3 REFERENCES	B10-3

LIST OF FIGURES

A2-1. Standard N-55 Overpack/208 L (55-Gal) Drum Configuration	A2-3
A4-1. Standard 208 L (55-Gal) Drum Array	A4-2
B3-1. Flow Chart for Small-Package Accidents	B3-5
B5-2. Photon Fluence-to-Dose Conversion Factors	B5-4
B5-3. Shielding Parameters for the Steel Drum	B5-4
B5-4. Gamma-Emitting Radionuclide Quantities in a Solid Waste Matrix	B5-5
B7-1. Typical Drum Dimensions.	B7-2
B7-2. General View of Finite Element Model for Impact Analysis.	B7-7
B7-3. Element Map of Drum Bottom Plate.	B7-8
B7-4. Element Map of Drum Wall.	B7-8
B7-5. Element Map of Drum Lid.	B7-9
B7-6. Element Map of Closing Ring.	B7-9
B7-7. Element Map of Closing Ring Details.	B7-9
B7-8. Element Map of Closing Ring Bolt.	B7-10
B7-9. General View of Payload.	B7-10
B7-10. Velocity History of the Drum with the 1.2 m (4-ft) Top-Corner Impact.	B7-15
B7-11. Displacement History of the Drum With the 1.2 m (4-ft) Top-Corner Impact.	B7-15
B7-12. Stress at EL 721 with the 1.2-m (4-ft) Top-Corner Impact.	B7-16
B7-13. Accumulated Plastic Strain at EL 721 With the 1.2 m (4-ft) Top-Corner Impact.	B7-16
B7-14. Strain Energy Density at EL 721 With the 1.2 m (4-ft) Top-Corner Impact.	B7-17
B7-15. 1.2 m (4-ft) Corner-Impact Displacement History.	B7-18
B7-16. 1.2 m (4-ft) Top-Corner-Impact Velocity History.	B7-18
B7-17. 1.2 m (4-ft) Top-Corner-Impact Acceleration History (Unfiltered).	B7-19
B7-18. 1.2 m (4-ft) Top-Corner-Impact Acceleration History (Filtered at 1000 Hz).	B7-19
B7-19. 1.2 m (4-ft) Top-Corner-Impact Stress Intensity at EL 461.	B7-20
B7-20. 1.2 m (4-ft) Top-Corner-Impact Accumulated Strain at EL 461.	B7-21
B7-21. 1.2 m (4-ft) Top-Corner-Impact Strain Energy Density at EL 461.	B7-21
B7-22. 1.2 m (4-ft) Top-Corner-Impact Deformation Plot.	B7-22
B7-23. General View of Finite Element Model for Dynamic Crush Analysis.	B7-24
B7-24. Velocity History of the Drum With the 48 km/h (30-mi/h) Bottom-End Impact.	B7-25
B7-25. Velocity History of the Drum With the 89 km/h (55-mi/h) Bottom-End Impact.	B7-25
B7-26. Typical Strain Energy History of the Drum With the 89 km/h (55-mi/h) Bottom-End Impact.	B7-26
B7-27. The Deformation of Drum and Concrete With the 89 km/h (55-mi/h) Bottom-End Impact.	B7-26
B7-28. The Deformation of Concrete With the 89 km/h (55-mi/h) Bottom-End Impact.	B7-27
B7-29. Velocity History of the Drum With the 48 km/h (30-mi/h) Side Impact.	B7-28
B7-30. Velocity History of the Drum With the 80 km/h (50-mi/h) Side Impact.	B7-28
B7-31. Typical Strain Energy History of the Drum With the 80 km/h (50-mi/h) Side Impact.	B7-30

LIST OF FIGURES (cont.)

B7-32. The Deformation of Drum and Concrete With the 80 km/h (50-mi/h) Side Impact.	B7-30
B7-33. The Deformation of Concrete With the 80 km/h (50-mi/h) Side Impact.	B7-31
B7-34. Velocity History of the Drum With the 48 km/h (30-mi/h) Top-Corner Impact.	B7-32
B7-35. Velocity History of the Drum With the 64 km/h (40-mi/h) Top-Corner Impact.	B7-32
B7-36. Typical Strain Energy History of the Drum With the 64 km/h (40-mi/h) Top-Corner Impact.	B7-34
B7-37. The Deformation of Drum and Concrete With the 48 km/h (30-mi/h) Top-Corner Impact.	B7-35
B7-38. The Deformation of Concrete With the 48 km/h (30-mi/h) Top-Corner Impact.	B7-35
B7-39. The Deformation of Drum With the 48 km/h (30-mi/h) Top-Corner Impact.	B7-36
B7-40. The Deformation of Drum With the 64 km/h (40-mi/h) Top-Corner Impact.	B7-36
B7-41. 48 km/h (30-mi/h) Top-Corner-Impact Displacement History.	B7-37
B7-42. 48 km/h (30-mi/h) Top-Corner-Impact Velocity History.	B7-38
B7-43. 48 km/h (30 mi/h) Top Corner Impact Acceleration History (Unfiltered).	B7-38
B7-44. 48 km/h (30 mi/h) Top Corner Impact Acceleration History (Filtered at 1000 Hz).	B7-39
B7-45. 48 km/h (30-mi/h) Top-Corner-Impact Strain Energy Density at EL 701.	B7-40
B7-46. 48 km/h (30 mi/h) Top Corner Impact Deformation Plot.	B7-40
B7-47. Velocity History of the Drum in the Dynamic Crush Analysis With 1,361 kg (3000-lb) Load and 48 km/h (30-mi/h) Impact Velocity.	B7-42
B7-48. Velocity History of the Drum in the Dynamic Crush Analysis With 2,268 kg (5,000-lb) Load and 40 km/h (25-mi/h) Impact Velocity.	B7-43
B7-49. The Deformation of Drum With the 1,361 kg (3000-lb), 48 km/h (30-mi/h) Dynamic Crush Case.	B7-43
B7-50. 48 km/h (30-mi/h), 726 kg- (1,600-lb-) Load, Dynamic Crush-Impact Displacement History.	B7-44
B7-51. 48 km/h (30-mi/h), 726 kg- (1,600-lb-) Load, Dynamic Crush-Impact Velocity History.	B7-45
B7-52. 48 km/h (30 mi/h), 726 kg- (1,600-lb-) Load, Dynamic Crush-Impact Acceleration History (Unfiltered).	B7-45
B7-53. 48 km/h (30-mi/h), 726 kg- (1,600-lb-) Load, Dynamic Crush-Impact Acceleration History (Filtered at 1,000 Hz).	B7-46
B7-54. 48 km/h (30 mi/h) 726 kg (1,600 lb) Load Dynamic Crush Impact Strain Energy Density at EL 701.	B7-47
B7-55. 48 km/h (30-mi/h), 726 kg- (1,600-lb-) Load, Dynamic Crush-Impact Deformation Plot.	B7-48
B7-56. Displacement History of Standard Drum Under Top-Corner Impact.	B7-50
B7-57. Velocity History of Standard Drum Under Top-Corner Impact.	B7-51
B7-58. Acceleration History of Standard Drum Under Top-Corner Impact.	B7-51
B7-59. Strain Energy Density at Drum Wall (EL 461) Standard Drum Top-Corner Impact.	B7-53
B7-60. Strain Energy Density at Drum Wall (EL 721) Standard Drum Top-Corner Impact.	B7-53
B7-61. Deformation Plot of the Standard Drum Under a Top-Corner Impact.	B7-54
B7-62. Displacement History of Retrieval Drum Under Top-Corner Impact.	B7-55
B7-63. Velocity History of Retrieval Drum Under Top-Corner Impact.	B7-55
B7-64. Acceleration History (Filtered at 1,000 Hz) of Retrieval Drum Under Top-Corner Impact.	B7-56
B7-65. Strain Energy Density at (EL 441) of the Retrieval Drum Wall Under Top-Corner Impact.	B7-57
B7-66. Strain Energy Density at (EL 721) of Retrieval Drum Closing Ring Under Top- Corner Impact.	B7-58
B7-67. Deformation Plot of Retrieval Drum Under Top-Corner Impact.	B7-58
B7-68. Preliminary Model.	B7-60

LIST OF FIGURES (cont.)

B7-69. General Model Treating Drums Involved in a Collision.	B7-61
B7-70. Model for the Drum Dynamic Crush Failure Threshold.	B7-62
B7-71. Deceleration and Total Absorbed Energy for Case 1: Three Drums of Equal Mass Traveling at 30 mi/h (13.4 m/s).	B7-64
B7-72. Cumulative Distribution Functions for the Total Absorbed Energy of the First Drum for 30, 35, and 40 mi/h, Respectively.	B7-66
B8-1. Typical Drum Dimensions.	B8-2

LIST OF TABLES

A2-1. Nominal Drum Dimensions	A2-1
A3-1. Payload 1 Limits (Nonfissile, Solid)	A3-1
A3-2. Payload 2 Limits (Fissile, Solid)	A3-2
A3-3. Payload 3 Limits (N-55 Overpack, Solid)	A3-2
A3-4. Payload 4 Limits (Liquid)	A3-2
A4-1. External Contamination Limits	A4-3
A7-1. Functional Responsibility Matrix	A7-2
A7-2. Design Quality Levels for TH-1	A7-3
A7-3. Retention and Location Matrix	A7-4
B2-1. Payload 1 Limits (Nonfissile, Solid)	B2-1
B2-2. Payload 2 Limits (Fissile, Solid)	B2-2
B2-3. Payload 3 Limits (N-55 Overpack, Solid)	B2-2
B2-4. Payload 4 Limits (Liquid)	B2-2
B3-1. Risk Acceptance Criteria Limits (Effective Dose Equivalent)	B3-2
B3-2. Failure Thresholds, Occurrence and Conditional Failure Probabilities of a Single Drum	B3-4
B4-1. Dose-Consequence-Based Isotope Limits for Payload 1	B4-2
B4-2. Dose-Consequence-Based Isotope Limits for Payload 2	B4-3
B4-3a. Evaluation of Payload 1 Dose Consequences.	B4-5
B4-3b. Evaluation of Payload 2 Dose Consequences.	B4-6
B4-4. β -Particle Effective Dose Equivalent Calculations	B4-8
B5-1. Photon Emission Rates (Photons/s) for 3.7×10^{10} Bq (1 Ci) of Selected Radionuclides	B5-2
B7-1. 208 L (55-gal) Drum Physical Properties	B7-3
B7-2. Solar Heat Loads	B7-4
B7-3. Steel Component Plastic Stress and Strain	B7-11
B7-4. Rebar Steel Plastic Stress and Strain	B7-12
B7-5. Acceleration Data of 1.2 m (4-ft) Top Corner Impact	B7-20
B7-6. Drum Strain Energy Density Results of 48 km/h (30-mi/h) Side Impact	B7-29
B7-7. Drum Strain Energy Density Results of 80 km/h (50-mi/h) Side Impact	B7-29
B7-8. Drum Strain Energy Density Results of 48 km/h (30-mi/h) Top-Corner Impact	B7-33
B7-9. Drum Strain Energy Density Results of 64 km/h (40-mi/h) Top-Corner Impact	B7-33
B7-10. Acceleration Data of 48 km/h (30-mi/h) Top-Corner Impact	B7-39
B7-11. Drum Strain Energy Density Results of 48 km/h (30 mi/h) Top-Corner Impact	B7-39
B7-12. Drum Strain Energy Density Results Dynamic Crush (1,361 kg/48 km/h [3000-lb/30-mi/h]) Impact	B7-41
B7-13. Drum Strain Energy Density Results Dynamic Crush (2,268 kg/40 km/h [5,000-lb/25-mi/h]) Impact	B7-42
B7-14. Acceleration Data of Dynamic Crush Impact	B7-46
B7-15. Drum Strain Energy Density Results of Dynamic Crush Impact	B7-47

LIST OF TABLES (cont.)

B7-16. Drum Strain Energy Density Results	B7-48
B7-17. Drum Acceleration for Impact Cases Load Acceleration for Dynamic Crush Cases ..	B7-49
B7-18. Acceleration Data of the Standard-Wall-Thickness Drum Under (10 ft) Top- Corner Impact	B7-52
B7-19. Strain Energy Density Results of the Standard-Wall-Thickness Drum Under (10 ft) Top-Corner Impact	B7-52
B7-20. Acceleration Data of the Retrieval Drum Under a Top-Corner Impact	B7-56
B7-21. Strain Energy Density Results of the Retrieval Drum Under 3.1 m (10-ft) Top- Corner Impact	B7-57
B7-22. Summary of Results From Dynamic Crush Failure Threshold Analysis and Finite Element Analysis	B7-62
B7-23. Spring Constant, k, Dissipative Constant, C, and Total Absorbed Energy Determined to Match the Results in Table B7-22	B7-63
B7-24. Uncertainty Distributions for Mass of a Drum, Spring Constant, k, and Dissipative Constant, C	B7-65
B8-1. Material Properties.	B8-3

LIST OF TERMS

ANSI	American National Standards Institute
ARF	airborne release fraction
ASME	American Society of Mechanical Engineers
ASTM	American Society for Testing and Materials
B&PVC	<i>Boiler and Pressure Vessel Code</i>
cm	centimeter
CoC	Certificate of Compliance
DOE	U.S. Department of Energy
DOT	U.S. Department of Transportation
DR	damage ratio
DRM	Documentation and Records Management
ft	foot
ft-lb	foot-pound
g/cm ³	grams per cubic centimeter
gal	gallon
Hz	hertz
in.	inch
in-lbf/in ³	inch-pound-force per cubic inch
ISS	Information and Scientific Systems
kg	kilogram
km/h	kilometers per hour
kPa	kilopascal
ksi	1000-lb per square inch
L	liter
lb	pound
lbf/in ²	pound-force per square inch
LPF	leak path factor
m	meter
MAR	material at risk
mCi	millicurie
mm	millimeter
mm/yr	millimeters per year
MPa	megapascal
mph	miles per hour
mSv/h	millisievert per hour
N•cm/cm ³	newton centimeters per cubic centimeter
N•m/m ³	newton meters per cubic meter
NRC	U.S. Nuclear Regulatory Commission
NTC	normal transfer conditions
psi	pounds per square inch
QL	Quality Level
RCRA	<i>Resource Conservation and Recovery Act of 1976</i>
RF	respirable fraction
SARP	safety analysis report for packaging
THI	Transportation Hazard Index
TRU	transuranic
W	watt
WMNW	Waste Management Federal Services, Inc., Northwest Operations

This page intentionally left blank.

SAFETY ANALYSIS REPORT FOR PACKAGING (ONSITE) STEEL DRUM

PART A: DESCRIPTION AND OPERATIONS

1.0 INTRODUCTION

1.1 GENERAL INFORMATION

On the Hanford Site, radioactive material is frequently packaged and transported in 208 L (55-gal) steel drums. This packaging system is suitable for storage and burial on the Hanford Site. Retrieval drums are not authorized for reuse.

The purpose of this document is to evaluate and authorize the onsite transportation of fissile, Type B quantities of solid and liquid radioactive materials in steel drums.

This document consolidates, simplifies, and updates three previous safety analysis reports for packaging (SARP) that addressed three different payloads. These documents are as follows:

- *Safety Analysis Report for Packaging (Onsite) Transport and Storage of TRU Contaminated Liquid Organics (SD-RE-SAP-002)*, approved by Rockwell Hanford Operations in 1982
- *Transuranic Radioactive Material in the 55-Gallon Drum, HCS-042-002, Safety Analysis Report for Packaging (Onsite) (SD-RE-SAP-033)*
- *Safety Analysis Report for Packaging (Onsite) Non-TRU, Non-Fissile Radioactive Material in the 55-Gallon Drum (SD-RE-SAP-024)*, approved by Rockwell Hanford Operations in 1983.

These documents will be canceled when this SARP is issued.

This SARP provides the analyses and evaluations necessary to demonstrate that the steel drum packaging system meets the transportation safety requirements of HNF-PRO-154, *Responsibilities and Procedures for all Hazardous Material Shipments*, for an onsite packaging.

1.2 SYSTEM DESCRIPTION

The basic component of the steel drum packaging system is a 208 L (55-gal) steel drum. This drum meets one of the following specifications:

- U.S. Department of Transportation (DOT)-17C or -17H drum, galvanized with gasket
- UN1A2 208 L (55-gal) drum, galvanized, or with an interior coating, with gasket.

There are four configurations of steel drum packaging authorized under this SARP as follows.

Solids

1. Drum. The drum configuration consists of a 208 L (55-gal) drum, locking ring, and lid. It is authorized to transport Payload 1 contents only (see Part A, Section 3.1).
2. Drum with liner, vented. This configuration consists of a 208 L (55-gal) drum with locking ring and lid, a NucFil¹ filter or equivalent, and a nominal 4-mil-thick (or equivalent) polyethylene liner bag that is sealed (horsetailed and taped). It is authorized to transport Payload 1 or 2 contents.
3. Drum in N-55 Overpack. This configuration consists of a 208 L (55 gal) drum with locking ring and lid in an N-55 Overpack. It is authorized to transport Payload 1, 2, or 3.

Liquids

4. Drum with liner and internal containers. This configuration is authorized for liquid contents (see Part A, Section 2.1.2).

The inner configuration consists of plastic bags or liners for solid contents and bottles with bags, liners, and absorbent for liquid contents.

1.3 REVIEW AND UPDATE CYCLE

This SARP is subject to periodic reviews and updates. The reviews shall be performed every 5 years to ensure that all SARP evaluations and other included information meet new or revised regulatory and/or company requirements. The first complete review and update of this onsite SARP will be approximately September 2003. Review shall be through the formal process per Part A, Section 7.5.

¹NucFil is a trademark of NFT Incorporated.

2.0 PACKAGING SYSTEM

2.1 CONFIGURATION AND DIMENSIONS, MATERIALS OF CONSTRUCTION, AND WEIGHTS

The steel drum packaging system consists of a right circular cylinder with a removable head and various inner configurations dependent on the payload.

Several types of drums, which are similar in manufacture, are authorized for use as follows:

- DOT Specification 17C drums per 49 CFR 178, "Specifications for Packagings," .115, "Steel, DOE-17C" (DOT 1990)*
- DOT Specification 17H drums per 49 CFR 178.118, "Steel, DOT-17H" (DOT 1990)*

*NOTE: Only applies to existing drums. New drums purchased must be UN1A2 drums.

- DOT Specification 7A, Type A per 49 CFR 178.350, "Specification 7A; General Packaging, Type A"; Part 173, "Shippers--General Requirements for Shipments and Packagings"; and Subpart L, "Non-bulk Performance-oriented Packaging Standards," and Subpart M, "Testing of Non-bulk Packagings and Packages," of Part 178. These are type A, UN1A2 drums.

The nominal dimensions for each drum are listed below in Table A2-1.

Table A2-1. Nominal Drum Dimensions.

	DOT-17C	DOT-17H	DOT-7A/ UN1A2
Wall thickness (gauge)	16	18 (top is 16)	16
Outside diameter	24 in.	24 in.	24 in.
Outside height	35 in.	35 in.	35 in.
Locking ring	12 gauge	12 gauge	12 gauge

DOT = U.S. Department of Transportation.

The DOT-17C drums are constructed of 16-gauge carbon steel with three rolled or swaged-in hoops. The DOT-17H drums are similarly constructed, utilizing 18-gauge carbon steel on the cylindrical portion and on the bottom end. Overall external dimensions of the 17C/17H drums are nominally 24 in. in diameter by 35 in. high. The drums are equipped with a removable head. The head is retained by a fully removable bolted type locking ring. The locking ring is 12-gauge (0.1046 in. nominal) with drop forged lugs and a 5/8-in. bolt and nut. The gasket used for closure is a rubber type material that is bonded to the removable head and meets the respective DOT specification for the drum type. The locking ring bolt is torqued to nominally 40 ft-lb when the drum is sealed.

The Type A-UN1A2 drums are similarly constructed to the DOT-17C and -17H drums and are deemed equivalent to DOT-17C and -17H drums. These drums are fabricated to WHC-S-0465,

Specification for Drums; UN1A2; Type A, Solid and Liquid Material, High Performance Coatings (WHC 1996a), and WHC-S-0466, *Specification for Drums; UN1A2; Type A; Solid Material, Painted* (WHC 1996b), which delineate the DOT-7A, Type A performance standards and the UN1A2 performance standards. Meeting the requirements from the drum specifications must be demonstrated by the manufacturer by testing and analysis before acceptance of the Type A-UN1A2 drums.

Retrieval drums are drums retrieved from noncompliant *Resource Conservation and Recovery Act of 1976* (RCRA) storage for the purpose of characterization, transfer, or other operations. However, as a result of the noncompliant RCRA storage environment, their condition may be degraded structurally from that of a drum that meets the specification requirements. Emptying of the drum to inspect the payload or verify its structural integrity is highly undesirable due to the personnel radiation exposure that could result. Such operations could damage an otherwise transportable drum and would delay the transfer of the waste to compliant storage. Minimum requirements are set forth in each section of Part A to allow for onsite transfer of such drums for the purpose of full characterization of the contents and the drum. *Retrieval drum transfers will be performed by exclusive-use vehicles and with restricted speeds. Interarea transfers will require security escorts.*

2.1.1 N-55 Overpack

For those drums that contain Payload 3 contents, an N-55 Type B Overpack, USA/9070/B(U) (NRC 1996), is used. This overpack may be used for those drums that exceed the normal drum payload restrictions and also fall within the payload limits provided for the N-55. See Table A3-3 for N-55 Overpack payload restrictions. Figure A2-1 shows a standard N-55 Overpack/208 L (55-gal) drum configuration.

2.1.2 Packaging Configuration for Liquids

2.1.2.1 Absorbent. The absorbent to be used is a nonbiodegradable polypropylene absorbent material or an approved universal-type polypropylene substitute material as listed in WHC-EP-0063 (WHC 1993). Existing, loaded packages that were packaged in accordance with SD-RE-SAP-002 can be shipped as payload type 4 provided the radioactive constituents do not exceed the allowables in Table A3-4.

Transuranic (TRU) liquid organics not meeting Waste Isolation Pilot Plant (WIPP) requirements shall not be absorbed; therefore, absorbent material shall not be used inside the bottle containing the liquid.

2.1.2.2 Inner Container for Liquids. For absorbed liquids, the inner container shall consist of a maximum size of 4 L (≈ 1 gal) polyethylene (poly) or polypropylene wide-mouth bottle with a screw cap.

Free (unabsorbed) liquids shall be packaged in a vented, 4 L (≈ 1 gal), glass and/or poly bottle.

Figure A2-1. Standard N-55 Overpack/208 L (55-Gal) Drum Configuration.

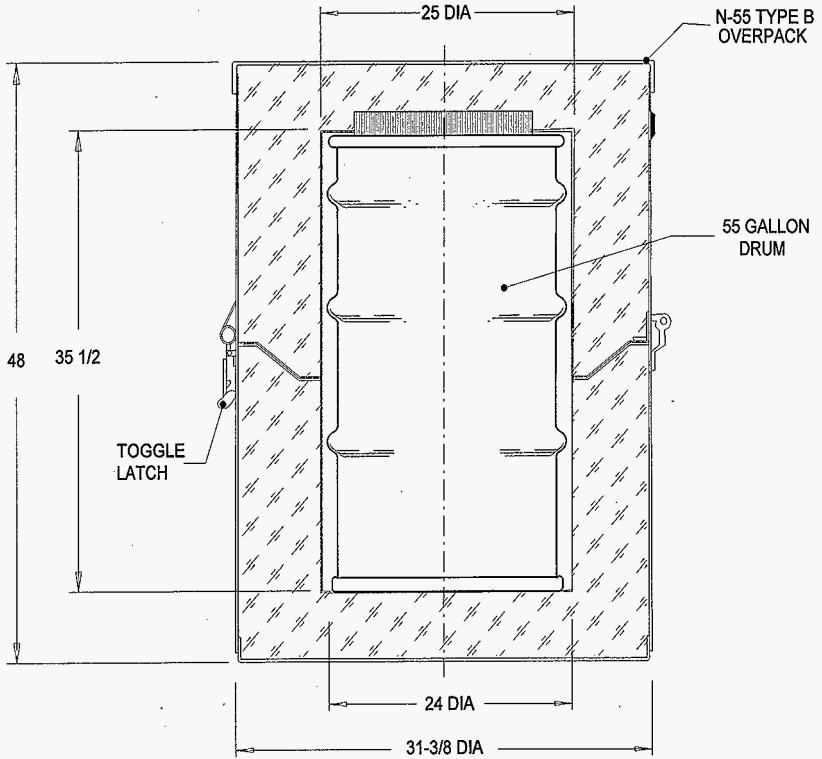

The poly bottle screw caps will be provided with a vent hole (No. 60 drill) to preclude pressurization of the bottles. The vent hole will be covered with a filter having greater than 99% retentivity.²

A second barrier of the inner containment is provided by placing the poly bottle inside a vented poly bag. The vent hole shall be covered by a filter,² and the bag will be closed either by heat sealing or by twisting the end and sealing with tape.

A 3/8-in.-by-19-in.-diameter plywood disk shall be used between the tiers of bottles as a tier support for the top bottles.

2.1.2.3 Outer Container. The outer container shall consist of a 208 L (55-gal) galvanized DOT-17C drum with a rigid 90-mil polyethylene liner or a Type A-UN1A2 interior-coated 208 L (55-gal) drum with the rigid 90-mil polyethylene liner. The polyethylene liner lid will be vented with a puncture hole greater than 1/16 in. in diameter and less than 1/2 in. in diameter. This hole will also be covered with a filter. A vent clip (H-2-28798), NucFil filtered vent, or equivalent shall be used for the release of built up gases or pressures within the drum.

2.1.2.3.1 Vent Clip Usage. A vent clip (H-2-28798) shall be placed over the rim of the 208 L (55-gal) drum unless a NucFil filter is used.

2.1.2.3.2 NucFil Filter Usage. One NucFil filter (flow rate \geq 5 L/min) vented lid will be placed on the drum. If a NucFil filter is installed, the filter must be torqued to 120 in-lb (\pm 25 in-lb).

The packaging consists of the absorbent, a two barrier inner containment, and a two barrier outer containment.

Evaluations of the DOT-17C and -17H drums were performed for the U.S. Department of Energy (DOE) by Mound Laboratory as part of the DOT-7A Type A Packaging Program and were documented in DOE/RL-96-57, *Test and Evaluation Document for DOT Specification 7A Type A Packaging*. The evaluations and testing concluded that both drum designs are acceptable as Type A Packagings in accordance with applicable parts of 49 CFR 178. A number of test units successfully passed normal-condition water spray, free drop, compression, and penetration tests. Based on these evaluations and the earlier testing, both drums are acceptable for use for larger quantities of material subject to the administrative controls discussed herein.

The Type A-UN1A2 drums, as stated in specifications WHC-S-0465 (WHC 1996a) and WHC-S-0466 (WHC 1996b), must meet the UN1A2 performance standards and the DOT-7A, Type A specification. Meeting these requirements must be demonstrated and documented by the manufacturer by testing or analysis before acceptance.

Retrieval drums may not meet the DOT Specification 17C, 17H, or Type A-UN1A2 requirements; however, the drums will be inspected to ensure that the containment boundary is intact and the wall thickness (by a series of ultrasonic thickness measurements) is not less than the minimum required dimension. See Part A, Section 6.0, for retrieval drum requirements.

²Hollingsworth and Vose Co. LB-521--glass fiber filter (or equivalent). These filters have greater than 99% retentivity based on standard DOP tests.

2.2 CONTAINMENT BOUNDARY

The containment boundary is provided by the 208 L (55-gal) drum body, lid, and gasket as well as a high-efficiency particulate air filter, if used.

2.3 HEAT DISSIPATION

Heat dissipation is by passive and conductive thermal radiation.

2.4 SHIELDING

Shielding is provided by the contents and the packaging. There is very little shielding material present.

2.5 LIFTING DEVICES

Connection to the drum for lifting shall be with a lifting attachment designed for lifting 208 L (55 gal) drums by the chime. The lifting attachment shall have a rated load in excess of 658 kg (1450 lb).

2.6 TIEDOWN DEVICES

There are no tiedown devices that are a structural part of the packaging system. Drums shall be secured to the truck as specified in Part A, Section 4.2.

This page intentionally left blank.

3.0 PACKAGE CONTENTS

3.1 GENERAL DESCRIPTION

The Steel Drum Packaging System is used to transport Type B quantities of liquid or solid radioactive material. Some packages may contain fissile material.

Authorized contents include contaminated glass, paper, plastic, rags, wood, metal, soil, and other solid materials. Organic and inorganic liquids, absorbed or free, are also authorized subject to the limits listed below.

The addition of shielding material inside the drum for the express purpose of reducing the external dose rate is strictly prohibited. This does not include waste material that may incidentally provide shielding by its presence in the waste matrix.

In practice, the allowable quantity of a particular isotope may be limited by the source term definition as listed in the tables of this section, by the dose rate limits, or by the gas generation constraints.

The source term has been divided into four categories:

Payload 1.	Nonfissile or fissile excepted
Payload 2.	Fissile
Payload 3.	High activity (up to 27,000 Ci)
Payload 4.	Liquid.

The material quantities allowed and restrictions are shown in Tables A3-1 through A3-4. The maximum activities are based on the maximum source term allowed based on the dose consequence analysis in Part B, Section 4.0, of this SARP. The thermal limits are based on the thermal evaluation in Part B, Section 8.0, of this SARP. Maximum weights are based on the structural evaluation in Part B, Section 7.0, of this SARP. Venting requirements are determined by payload type as described in Part B, Section 9.0, of this SARP. Drum array restrictions are based on the accident conditions evaluated in Part B, Section 7.0, and dose consequence evaluation in Part B, Section 4.0, of this SARP.

Table A3-1. Payload 1 Limits (Nonfissile, Solid).

Attribute	Maximum authorized
No. drums per shipment	One or array, maximum of four drums per row
Venting requirement	Optional See Part B, Section 9.0 Appendix, Fig. 2, for inorganic solids See Part B, Section 9.0 Appendix, Fig. 3, for organic solids
Watts/drum	12
Mass (kg)	658
Fissile isotopes per drum (g)	Fissile excepted
Total activity per single drum (Ci)*	25 A ₂ s
Total activity per drum in an array (Ci)*	6 A ₂ s

*A sum of the fractions of actual/limit must be less than 1.

Table A3-2. Payload 2 Limits (Fissile, Solid).

Attribute	Maximum authorized
No. drums per shipment	One or array, maximum of four drums per row
Venting requirement	Required See Part B, Section 9.0 Appendix, Fig. 2, for inorganic solids See Part B, Section 9.0 Appendix, Fig. 3, for organic solids
Watts/drum	12
Mass (kg)	658
Fissile isotopes per single drum (g)	100
Fissile isotopes per drum in an array (g)	45
Total activity per drum (Ci)*	2,500 A ₂ s
Total activity per drum in an array (Ci)*	600 A ₂ s

*A sum of the fractions of actual/limit must be less than 1.

Table A3-3. Payload 3 Limits (N-55 Overpack, Solid).

Attribute	Maximum authorized
No. drums per shipment	Two (one drum per N-55)
Venting requirement	Required See Part B, Section 9.0 Appendix, Fig. 2, for inorganic solids See Part B, Section 9.0 Appendix, Fig. 3, for organic solids
Watts/drum	5
Mass (kg)	249
Fissile isotopes per drum (g)	200
Fissile isotopes per shipment (g)	400
Total activity per single drum (Ci)*	27,000 Ci, less than 3,000 A ₂ s

*A sum of the fractions of actual/limit must be less than 1.

Table A3-4. Payload 4 Limits (Liquid).

Attribute	Maximum authorized
No. drums per shipment	One or array, maximum of four drums per row
Venting requirement	Required Reference Part B, Section 9.0, for specific guidance
Watts/drum	0.75
Mass (kg)	227
Volume	40 L total
Fissile isotopes per single drum (g)	100
Fissile isotopes per drum in an array (g)	45
Total activity per drum (Ci)*	2,500 A ₂ s
Total activity per drum in an array (Ci)*	600 A ₂ s

*A sum of the fractions of actual/limit must be less than 1.

These limits are based on dose consequence analyses (see Part B, Section 4.0), criticality control (Part B, Section 6.0), and thermal constraints (Part B, Section 8.0). The intent of these restrictions is to allow an unlimited number of shipments (see Part B, Section 3.0).

3.1.1 Fissile Material Content

The fissile material allowable contents are based on the dose consequence evaluation and the criticality analysis and are shown in Tables A3-1 to A3-4.

3.1.2 Physical and Chemical Composition

Typical payloads include contaminated plastic, cloth, metal, and other waste. Liquids, both free and absorbed, are authorized. However, mixing of both solid and liquid waste in a single drum is specifically prohibited.

It is the shipper's responsibility to comply with the requirements of 49 CFR 173.24, "General Requirements for Packagings and Packages," and to ensure the contents are not reactive or chemically incompatible with the packaging.

3.2 GAS GENERATION RESTRICTION

Gas generation is known to develop for many of the payload types authorized by this SARP. It is the shipper's responsibility to determine venting needs for each drum authorized by this SARP. Part B, Section 9.0, provides specific guidance for making this determination.

3.3 SIZE AND WEIGHT

The drums considered in this SARP are a standard 208 L (55-gal) UN1A2 drum, DOT-17C and -17H drums, and retrieval drums. The drums will nominally measure 89 cm (35 in.) in height and 61 cm (24 in.) in diameter. The maximum weight of a drum with solids is limited to 658 kg (1,450 lb) or 227 kg (500 lb) with a liquid payload. The maximum weight of a drum in the N-55 Overpack is 249 kg (550 lb).

This page intentionally left blank.

4.0 TRANSPORT SYSTEM

4.1 TRANSPORTER

4.2 TIEDOWN SYSTEM

4.2.1 System Design and Requirements

Since both standard 208 L (55-gal) and retrieval drums are transported onsite in various numbers, in arrangements dependent upon the conveyance, and on many types of conveyances, securement requirements to the conveyance shall meet the requirements of 49 CFR 393, "Parts and Accessories Necessary for Safe Operations," .100, "General Rules for Protection Against Shifting or Falling Cargo." Also, individual drums or batches of drums shall be secured to the conveyance per the requirements of 49 CFR 393.102, "Securement Systems," and blocked and braced against shifting in accordance with the requirements of 49 CFR 393.104, "Blocking and Bracing." In addition the following restrictions are imposed to meet the normal transfer conditions and risk assessment accident structural parameters of this SARP.

4.2.1.1 Standard Drums. Standard 208 L (55-gal) drums may shipped in an array as follows (see Figure A4-1). The total combined weight of the drums in the array may not exceed 2,268 kg (5,000 lb).

- The first row of drums in the array must be placed at the front end structure of the conveyance.
- Between each row of drums there must be a set of intermediate restraint beams which are secured to the conveyance.
- Each set of intermediate restraint beams must have an aggregate load limit of two times the total gross weight of the array. This is based on the AISC (1989) equivalency for a uniformly loaded beam.
- Drum rows at either the front or rear of the conveyance shall be blocked and braced from shifting in any direction by the walls of the conveyance, by intermediate restraint beams, by blocking and bracing of the drum array, or by any combination of the three. Blocking and bracing shall be accomplished by the following:
 - Wooden chock blocks nailed to the bed of a wooden deck conveyance
 - Chains, wire rope, or straps wrapped around the array of drums and secured to the conveyance
 - Carbon steel clips welded or bolted to the bed of a steel deck conveyance.
- Each array must be secured to the conveyance in accordance with 49 CFR 393.102.

Figure A4-1. Standard 208 L (55-Gal) Drum Array.

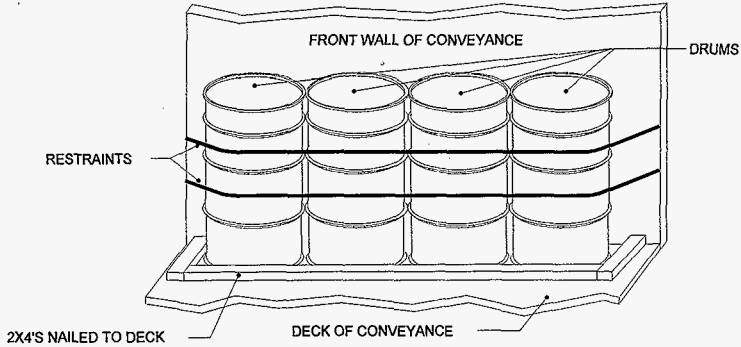

4.2.1.2 Retrieval Drums. Retrieval drums only may be shipped in one array form. Retrieval drum shipments are restricted to a maximum speed of 48 km/h (30 mph) with a maximum total gross weight of 726 kg (1,600 lb) in the array. This means that the total gross weight of all the drums in the array may not exceed 726 kg (1,600 lb).

Multiple arrays of retrieval drums may be transported on a conveyance provided the following requirements are met.

- The first row of drums on the array at the front must be placed at the front-end structure of the conveyance.
- Between each array of drums there must be a set of intermediate restraint beams that are secured to the conveyance.
- Each set of intermediate restraint beams must have an aggregate load limit of two times the total gross weight of the array. This is based on the AISC (1989) equivalency for a uniformly load beam.
- Drum arrays at either the front or rear of the conveyance shall be blocked and braced from shifting in any direction by the walls of the conveyance, by intermediate restraint beams, by blocking and bracing of the drum array, or by a combination of the three. Blocking and bracing shall be accomplished by the following:
 - Wooden chock blocks nailed to the bed of a wooden deck conveyance
 - Chains, wire rope, or straps wrapped around the array of drums and secured to the conveyance
 - Carbon steel clips or angles welded or bolted to the bed of a steel deck conveyance.

- Each array must be secured individually to the conveyance in accordance with 49 CFR 393.102.

Drum array shipments, shall be secured to the front end of the conveyance in accordance with 49 CFR 393.102 and, blocked and braced in accordance with 49 CFR 393.104 for the rearward and lateral directions.

4.2.2 Attachments, Ratings, and Requirements

Tiedown attachments to the conveyance and tiedown components must have the same rated working capacity or working load of the tiedown. Chains, straps, or wire rope used as chocking must have an aggregate working capacity or working load of one half the weight of the drum or drum array. Wooden chock blocks nailed to the deck or carbon steel clips or angles welded to the deck must have a load capacity of one half the weight of the drum or drum array.

4.3 SPECIAL TRANSFER REQUIREMENTS

4.3.1 Routing and Access Control

Shipments are authorized anywhere within the Hanford Site boundaries. Road closure is required for public access roads that are used for shipments that cover routes south of the Wye Barricade.

4.3.2 Radiological Limitations

For transportation purposes, the dose rate at the external surface of an individual steel drum packaging is limited to 100 mSv/h (1000 mrem/h). The dose rate in the occupied space of the transport vehicle shall not exceed 0.02 mSv/h (2 mrem/h) unless a radiologically trained driver is used, where the dose rate may not exceed 0.05 mSv/h (5 mrem/h). The dose rate measured at a vertical plane projected from the outer edge of the vehicle is limited to 2 mSv/h (200 mrem/h), and the dose rate at any point 2 m from this plane is limited to 0.1 mSv/h (10 mrem/h).

Surface contamination limits for transporting the drum are specified in Table A4-1.

Table A4-1. External Contamination Limits.

Contaminant	Maximum permissible limits		
	Bq/cm ²	μCi/cm ²	dpm/cm ²
Beta-gamma-emitting radionuclides; all radionuclides with half-lives less than ten days; natural uranium; natural thorium; uranium-235; uranium-238; thorium-232; thorium-228 and thorium-230 when contained in ores or physical concentrates	0.4	10 ⁻⁵	22
All other alpha-emitting radionuclides	0.04	10 ⁻⁶	2.2

4.3.3 Mileage Limits

There are no mileage limits.

4.3.4 Speed Limits

Retrieval drum shipments are restricted to a vehicle speed of 48 km/h (30 mph) or less.

Standard drum shipments are restricted to a vehicle speed of 48 km/h (30 mph) or 40 km/h (25 mph) depending on the array configuration (see Part B, Section 10.0).

4.3.5 Array Restrictions

Part B, Section 10.0, describes the weight restrictions applicable to arrays of drums. For purposes of definition, a row is considered an arrangement of drums in a line across the transport vehicle in the lateral direction (see Figure A4-1). A column is considered an arrangement of drums in the longitudinal direction on the transporter.

The weight restrictions identified in Part B, Section 10.0, apply to an arrangement of drums in any single column.

5.0 ACCEPTANCE OF PACKAGING FOR USE

5.1 208 L (55-GAL) DRUMS

The packaging shall meet the DOT Specification 7A, Type A design and test requirements identified by 49 CFR 178.350. Hanford specification WHC-S-0465 (WHC 1996a) or WHC-S-0466 (WHC 1996b) shall be used to procure new UN1A2 drums.

5.1.1 Packaging for Continued Use

The following applies to 208 L (55-gal) drums that have been transported and/or stored with radioactive materials.

5.1.1.1 Acceptance Requirements. Visual acceptance criteria shall be that there is no container material degradation that could affect the containment features of the packaging. The container shall be cleaned of nonfixed external contamination (Table A4-1).

Documentation shall be verified that the drum has met the acceptance requirements of Part A, Section 5.1, of this SARP. If verification is not possible, then the drum may not be used to transport payloads authorized by this SARP.

5.1.1.2 Inspection. For continued use with payloads authorized in this SARP, the drums shall have the following:

- The lid and gasket inspected to ensure no degradation has occurred
- The high-efficiency particulate air filter (if present) inspected or replaced
- A smear test performed on the external surfaces of the drum to ensure that contamination levels are within limits (Table A4-1)
- No physical degradation present. Dented drums or those with significant evidence of corrosion are not suitable for payloads authorized by this SARP. If the bottom of the drum is corroded, it shall not be used for transporting payloads identified in this SARP.

5.1.1.3 Documentation. All inspections shall be documented in procedures or inspection checklists and verified by Quality Control. This documentation shall be maintained for the life of the packaging or 5 years, whichever is longer.

5.2 RETRIEVAL DRUMS

Retrieval drums have been evaluated in this SARP and deemed suitable for transport of the authorized payloads provided all controls are met. Primarily it is important to note that the transporter speed be limited to 48 km/h (30 mph) and that the tiedown system meets the requirements of Part A, Section 4.0. Retrieval drums are not reusable.

The inspection requirements listed in Part A, Section 5.1.1.2, apply to the exterior of retrieval drums. Those drums that are suspected not to provide suitable integrity shall be packaged in the N-55 Overpack provided their contents fall within the limits prescribed for this packaging.

5.2.1 Documentation

All inspections shall be documented in procedures or inspection checklists and verified by Quality Control. This documentation shall be maintained for the life of the packaging or 5 years, whichever is longer.

5.3 N-55 OVERPACK

The N-55 Overpack shall be procured to meet the requirements of its Certificate of Compliance USA/9070/B(U) (NRC 1996). Documentation of this shall meet the requirements of 10 CFR 71, Subpart H.

5.3.1 Inspection Prior to Use

1. The lid, gasket, and closure clamps shall be inspected to ensure no degradation has occurred.
2. If contamination is suspected, a smear test shall be performed on the external surfaces of the N-55 Overpack to ensure that contamination levels are within limits (Table A4-1).
3. No physical degradation shall be present on all surfaces of the packaging.

5.3.2 Documentation

All inspections shall be documented in procedures or inspection checklists and verified by Quality Control. This documentation shall be maintained per the requirements of 10 CFR 71, Subpart H.

6.0 OPERATING REQUIREMENTS

The facility using the 208 L (55-gal) drums and/or N-55 Overpack is responsible for developing specific operating procedures for the loading, transport, and unloading of packages described and regulated by this SARP. The following provides general guidance for the development of plant operating procedures for packaging and transport of hazardous material in the 208 L (55-gal) drums and for use of the N-55 Overpack.

6.1 DRUMS

1. Select the proper individual drum configuration based on the payload descriptions in Part A, Section 3.0.
2. Verify that the payload does not exceed the radiological limits provided in Part A, Section 3.0, for the drum configuration selected.
3. Verify that the drum closure ring is properly configured and that the drum lock ring bolt is properly torqued per the manufacturer's recommendation.
4. Determine if venting is required for each drum (See Part B, Section 9.0, for guidance).
5. Survey the package to ensure contamination limits are not exceeded.
6. Ensure that each drum is properly marked and labeled and that shipping papers are complete.
7. Determine that the drum array configuration meets the limits imposed in Part A, Sections 3.0 and 4.0.
8. Verify that the tiedown system meets the requirements of Part A, Section 4.0.

6.2 N-55 OVERPACK

6.2.1 Loading

1. Unfasten the clamps that secure the lid to the body of the overpack.
2. Remove the overpack lid by attaching suitable hooks to the lifting lugs on the lid. Care should be taken during this operation so as not to damage the lid body interface seal while setting the lid down.
3. Inspect the inside of the base and lid to ensure there are no loose articles within the packaging. Inspect the N-55 gasket.
4. Place the 208 L (55-gal) drum into the base of the overpack.
5. Replace the lid and secure it to the body by fastening the clamps.
6. Survey the package to ensure contamination limits are not exceeded.

7. Inspect the package for proper labeling and marking.
8. Using suitable handling equipment, transfer the package to the transport vehicle.
9. Once the overpack(s) are placed on the transport vehicle, ensure that the tiedown system employed meets the requirements of Part A, Section 4.0.

6.2.2 Unloading

1. Move the unopened package to an appropriate area using suitable handling equipment.
2. Perform an external inspection of the unopened package. Record any significant or potentially significant observations.
3. Unfasten the clamps that secure the lid to the body of the overpack.
4. Remove the overpack lid by attaching suitable hooks to the lifting lugs on the lid. Care should be taken during this operation so as not to damage the lid body interface seal while setting the lid down.
5. Using suitable handling equipment, remove the 208 L (55-gal) drum.
6. Replace the lid on the N-55 base, secure the clamps, and place the N-55 in a safe location.

6.2.3 Additional Requirements for Retrieval Drums

Retrieval drums must be either shipped in covered conveyances or covered with waterproof material during transport.

7.0 QUALITY ASSURANCE REQUIREMENTS

7.1 INTRODUCTION

This section describes the quality assurance (QA) requirements for the design, procurement, fabrication, and maintenance of the onsite transportation of radioactive materials in the steel drum packaging systems described in this SARP. The requirements are taken from HNF-MP-599, *Project Hanford Quality Assurance Program Description*.

7.2 GENERAL REQUIREMENTS

These requirements apply to activities which could affect the safety basis or quality of the steel drum packaging systems and associated hardware. The overall Steel drum packaging systems assembly is described per HNF-PRO-154.

Specific components of the steel drum packaging systems are assigned quality categories based upon HNF-PRO-154, and are used to show that each individual component meets the requirements of the overall steel drum packaging systems safety classification.

7.3 ORGANIZATION

The organizational structure and the assignment of responsibility shall be such that quality is achieved and maintained by those who have been assigned responsibility for performing work. Quality achievement is to be verified by persons or organizations not directly responsible for performing the work.

Waste Management Federal Services, Inc., Northwest Operations (WMNW) Engineering and cognizant project managers are responsible for the quality of the work performed by their respective organizations and for performing the following activities:

- Follow current requirements of this SARP, HNF-MP-599, and applicable procedures.
- Provide instructions for implementing QA requirements.

The Vice President, Quality Assurance, is responsible for developing and administering the Fluor Daniel Hanford, Inc., QA program as stated in HNF-MP-599.

7.4 QUALITY ASSURANCE ACTIVITIES

Each cognizant engineer involved with design, procurement, fabrication, use, or maintenance of the steel drum packaging systems is responsible for ensuring that the assigned tasks are performed in accordance with controlling plans and procedures, which must, in turn, conform to the requirements of this section. QA requirements for tasks are determined and documented in the plans and procedures used by the involved organizations.

Requirements are imposed on organizations by direct reference in plans and procedures. Table A7-1, "Functional Responsibility Matrix," shows documentation review requirements. This matrix assigned responsibility for review and approval to the appropriate organization either designing or using the steel drum packaging systems.

Table A7-1. Functional Responsibility Matrix.

Document	Waste Management Federal Services, Inc., Northwest Operations	User
Steel drum packaging systems safety analysis report for packaging	P,R,A	R,A
Procurement documents	P,R,A	R,A
Operating procedures	R	P,R,A
Maintenance procedures	R	P,R,A

A = Approval.

P = Primary responsibility (organization responsible for developing the document).

R = Review.

7.5 TRANSPORTATION HAZARD INDEX (THI)/QUALITY LEVEL (QL) TABLE

7.5.1 THI

The THI is assigned to represent the relative safety significance of an onsite packaging system based on HNF-PRO-154. This indicator is assigned based on the hazard of the authorized contents of the packaging system. A THI of 1 represents the highest safety significance and greatest content hazard; a THI of 4 representing the least safety significance, or the least content hazard category. The drum is considered a THI-3. The N-55 is considered a THI-1 package.

THI-1: This represents the highest level of hazard from the contents. A packaging system assigned this level transports material that has the potential of causing a dose consequence, to an individual, in excess of 25 rem at the Hanford site boundary if fully released.

THI-2: This represents the second highest level of hazard from the contents. A packaging system assigned this level transports material that has the potential of causing a dose consequence, to an individual between 0.5 rem and 25 rem at the Hanford Site boundary, or greater than 5 rem within the site, if fully released.

THI-3: This represents the second lowest level of hazard from the contents. A packaging system assigned this level transports material that has the potential of causing a dose consequence, to an individual, of between 0.01 rem and 0.5 rem at the Hanford site boundary or between 0.2 rem and 5 rem within the site, if fully released.

THI-4: This represents the lowest level of hazard from the contents. A packaging system assigned this level transports material that has the potential of causing a dose consequence to an individual less than 0.01 rem at the Hanford Site boundary or less than 0.2 rem within the Site if fully released.

7.5.2 QLs

QLs, as defined below, are based upon HNF-PRO-154 and establish a graded approach for determining applicable QA requirements for the design, procurement, and fabrication of each steel drum packaging systems component.

QL-A: Critical impact on safety and associated functional requirements: items or components whose single failure or malfunction could directly result in an unacceptable condition of containment, shielding, or nuclear criticality control.

QL-B: Impact on safety and associated functional requirements: components whose failure or malfunction in conjunction with one other independent failure or malfunction could result in an unacceptable condition of containment, shielding, or nuclear criticality control.

QL-C: Minor impact on safety and associated functional requirements: components whose failure or malfunction would not reduce packaging effectiveness and would not result in an unacceptable condition of containment, shielding, or nuclear criticality control, regardless of other single failures.

7.6 QUALITY REQUIREMENTS

7.6.1 Design Control

QLs for design control of steel drum packaging systems components are shown in Table A7-2. Classification of components into these quality categories is per HNF-PRO-154 and ensures that critical parameters of a given component are reviewed in a manner consistent with their importance. The design and analysis shall correspond to the QA requirements of the assigned quality level.

Table A7-2. Design Quality Levels for TH1-1.

Component	Quality Level
Closure bolts	A-3
Closure ring	A-3
Drum lid gasket	A-3
NucFil* filter on drum lid	A-3
Drum lid	A-3
Drum body	A-3
Liner	B-3
Vent clip	A-3
N-55 Overpack	A-1

*NucFil is a trademark of NFT Incorporated.

The drum components are purchased through the Container Management Program using WHC-S-0465 (WHC 1996a) or WHC-S-0466 (WHC 1996b). The N-55 Overpack is already designed. Any design changes would require revision to this SARP.

7.6.2 Procurement and Fabrication Control

Procurement of drums is performed using WHC-S-0465 (WHC 1996a) or WHC-S-0466 (WHC 1996b). They are general services items. *The N-55 Overpack shall be procured to meet the requirements of its certificate of compliance.*

7.6.9 QA Records and Document Control

Records that furnish documentary evidence of quality shall be specified, prepared, and maintained per HNF-PRO-224, *Document Control*.

The cognizant engineer is responsible for ensuring accessibility to the latest issue of all such documents. *Use or maintenance of the steel drum packaging systems shall not start until all required documents are readily available.*

All records associated with hazardous material packaging and transportation shall be retained for the life of the packaging (see Table A7-3).

Table A7-3. Retention and Location Matrix.

Document	Retention Period	Location
Packaging design criteria/safety analysis report for package	Lifetime	DRM
Maintenance Procedures	Lifetime	User facility
Inspection plans/procedures	Lifetime	User facility
Operating procedures	Lifetime	User facility
Quality Assurance/Quality Control inspection reports	Lifetime	Quality Assurance/ISS
Nonconformance reports	Lifetime	Quality Assurance/ISS
Steel drum packaging systems specification and drawings	Lifetime	WMNW/ISS
Purchase orders	Lifetime	Procurement/ISS

DRM = Documentation and Records Management.

ISS = Information and Scientific Systems.

WMNW = Waste Management Federal Services, Inc., Northwest Operations.

7.7 SARP CONTROL SYSTEM

This SARP shall be copy controlled in accordance with HNF-PRO-225, *Distributing Copy-Controlled Unclassified Documents*, to ensure that only up-to-date approved versions are used. Any changes made to this SARP will be by engineering change notices, which are distributed to users through the Copy Control System and incorporated into the SARP.

Any review comment records produced during the initial release or subsequent changes will be on file with WMNW Engineering Business Unit.

This page intentionally left blank.

8.0 MAINTENANCE

8.1 GENERAL

Maintenance of the 208 L (55-gal) drums and the N-55 Overpack shall be per the manufacturer's recommendations or instructions. Wherever possible, empty and new drums shall be stored indoors or under protective cover to eliminate or minimize the effects of the sun, wind, snow, rain, or other environmental conditions that could cause environmental degradation. The N-55 shall be stored under protective cover when not in use.

8.2 MAINTENANCE AND VERIFICATION SCHEDULES

8.2.1 208 L (55-Gal) Drums

These inspections are required (1) if the drums have been in storage longer than 5 years or (2) prior to shipment. If operations require, the inspections may be performed periodically during storage. Note that these inspections are **required** for both new drums and retrieval drums prior to transport.

8.2.1.1 Visual Container Inspections. Surveillance of the 208 L (55-gal) drums includes a visual inspection for any package degradation. The following are examples of visual inspections.

1. Determine drum external contaminations, and document.
2. Determine drum external dose rates, and document.
3. Visually inspect drum markings for degradation.
4. Visually inspect drum surfaces (interior and exterior) for paint chipping, discoloration, or other surface defects. If found, correct defect by repair if necessary, and repaint the affected area.

NOTE: Retrieval drums do not require interior inspection. If degradation is apparent, then the drum walls must be ultrasonically tested.

5. Inspect the bottom of the drum for corrosion. Significant signs of corrosion warrant extreme caution when handling the drum. Overpacking may be necessary.
6. Inspect the drum closure ring and bolt assembly for signs of deterioration. Replace if necessary.

8.2.2 N-55 Overpack

N-55 Overpacks shall be inspected and maintained per the manufacturer's recommendations and verified per 10 CFR 71, Subpart H.

8.3 RECORDS AND DOCUMENTATION

Visual inspection of drums shall be documented, including Quality Control verification, and maintained for the life of the drum or 5 years, whichever is longer.

This page intentionally left blank.

9.0 REFERENCES

- 10 CFR 71, "Packaging and Transportation of Radioactive Material," *Code of Federal Regulations*, as amended.
- 49 CFR 173, "Shippers -- General Requirements for Shipments and Packagings," *Code of Federal Regulations*, as amended.
- 49 CFR 178, "Specifications for Packagings and Shippings," *Code of Federal Regulations*, as amended.
- 49 CFR 393, "Parts and Accessories Necessary for Safe Operations," *Code of Federal Regulations*, as amended.
- HNF-MP-599, *Project Hanford Quality Assurance Program Description*, Fluor Daniel Hanford, Inc., Richland, Washington.
- HNF-PRO-154, *Responsibilities and Procedures for all Hazardous Material Shipments*, Fluor Daniel Hanford, Inc., Richland, Washington.
- HNF-PRO-224, *Document Control*, Fluor Daniel Hanford, Inc., Richland, Washington.
- HNF-PRO-225, *Distributing Copy-Controlled Unclassified Documents*, Fluor Daniel Hanford, Inc., Richland, Washington.
- AISC, 1989, *Manual of Steel Construction*, Ninth Edition, American Institute of Steel Construction, Chicago, Illinois.
- DOE/RL-96-57, *Test and Evaluation Document for DOT Specification 7A Type A Packaging*, Volume 1 (1998, Rev. 0-B) and Volume 2 (1997, Draft A), U.S. Department of Energy, Richland Operations Office, Richland, Washington.
- DOT, 1990, "Specifications for Packagings," *Code of Federal Regulations*, 49 CFR 178, U.S. Department of Transportation, Washington, D.C.
- NRC, 1996, *Certificate of Compliance for Radioactive Materials Packages*, USA/9070/B(U), U.S. Nuclear Regulatory Commission, Washington, D.C.
- Resource conservation and Recovery Act of 1976*, 42 USC 6901 et seq.
- WHC, 1996a, *Specification for Drums; UN1A2; Type A, Solid and Liquid Material, High Performance Coatings*, WHC-S-0465, Rev. 0, Westinghouse Hanford Company, Richland, Washington.
- WHC, 1996b, *Specification for Drums; UN1A2; Type A; Solid Material, Painted*, WHC-S-0466, Rev. 0, Westinghouse Hanford Company, Richland, Washington.
- WHC, 1993, *Hanford Site Solid Waste Acceptance Criteria*, WHC-EP-0063, Rev. 4, Westinghouse Hanford Company, Richland, Washington.

This page intentionally left blank.

PART B: PACKAGE EVALUATION**1.0 INTRODUCTION****1.1 SAFETY EVALUATION METHODOLOGY**

The 208 L (55-gal) drum packaging system includes four configurations, each having different performance characteristics. Three of the configurations involve the drum as the containment boundary and the exterior surface of the package. For these configurations, the normal transfer conditions (NTC) are based on Site conditions and the Type A performance capability of each drum. In the case of the N-55 Overpack configuration, the performance capability of the N-55 Overpack system is shown to meet the Type B requirements as evidenced by its Certificate of Compliance (CoC) USA/9070/B(U) (NRC 1996).

The three drum configurations are each evaluated in terms of their performance in Site accident conditions. Failure thresholds are determined for the basic drum and are used to determine the predicted annual accident release frequency. This is performed for a single drum and for an array of drums. Separately, each drum configuration is evaluated in terms of its release potential to determine maximum dose consequences for an accident at the failure threshold. The form of the contents is considered. The N-55 Overpack system is shown to meet the hypothetical accident conditions by virtue of its CoC (NRC 1996).

Shielding calculations are performed to determine key radionuclides, but are variable due to the nature of the contents. Measurement by the shipper will verify the limits are met.

Criticality is evaluated based on minimum critical mass arguments.

The controlling document for these evaluations is HNF-PRO-154, *Responsibilities and Procedures for all Hazardous Material Shipments*, which requires that the 208 L (55-gal) drums meet the onsite transportation safety criteria. The evaluations and analyses presented in Part B of this safety analysis report for packaging (SARP) were developed to meet the intent of HNF-PRO-154.

1.2 EVALUATION SUMMARY AND CONCLUSIONS

Source: Source terms are limited to those described in Part B, Section 2.0. Liquids are not allowed in the N-55 Overpack.

Containment: It is shown in Part B, Section 7.0, that the 208 L (55-gal) drum meets the performance requirements for NTC. Venting is required for certain configurations due to gas generation (Part B, Section 9.0) to maintain retention of the radioactive contents.

It is shown in Part B, Section 3.0, that single drums and arrays of drums meet the onsite transportation safety acceptance criteria for accident dose consequences when transported as required in Part A.

Shielding: Shielding performance is reviewed in Part B, Section 5.0, and acceptance criteria are given in Part A. Measurement will verify that the limits are met.

Criticality: Criticality safety (Part B, Section 6.0) is shown using minimum critical mass arguments. Because of the variable nature of the contents and the accident performance of the drums, array restrictions on fissile material are imposed in Part A.

It is concluded, with the above considerations, that the 208 L (55-gal) drums authorized by this SARP comply with the requirements of the HNF-PRO-154 when loaded with the contents identified. In addition, it is concluded that drums with contents exceeding the normal limits provided by this SARP may be shipped in an N-55 Type B Overpack provided the drums meet the N-55 Overpack use restrictions provided in Part A, Section 3.0, of this SARP.

1.3 REFERENCES

HNF-PRO-154, *Responsibilities and Procedures for all Hazardous Material Shipments*, Flour Daniel Hanford, Inc., Richland, Washington.

NRC, 1996, *Certificate of Compliance for Radioactive Materials Packages, USA/9070/B(U)*, U.S. Nuclear Regulatory Commission, Washington, D.C.

2.0 CONTENTS EVALUATION

2.1 CHARACTERIZATION

The Steel Drum Packaging System is used to transport Type B quantities of liquid or solid radioactive material. Some packages may contain fissile material.

Authorized contents include contaminated glass, paper, plastic, rags, wood, metal, soil, and other solid materials. Organic and inorganic liquids, absorbed or free, are also authorized subject to the limits listed below.

The addition of shielding material inside the drum to reduce the external dose rates is strictly prohibited.

In practice, the allowable quantity of a particular isotope may be limited by the source term definition as listed in the tables of this section, by the dose rate limits, or by the gas generation constraints.

The source term has been divided into four categories:

- Payload 1. Nonfissile or fissile excepted
- Payload 2. Fissile
- Payload 3. High activity
- Payload 4. Liquid.

The material quantities allowed and restrictions are shown in Tables B2-1 through B2-4. The maximum activities are based on the maximum source term allowed based on the dose consequence analysis in Part B, Section 4.0, of this SARP. The thermal limits are based on the thermal evaluation in Part B, Section 8.0, of this SARP. Maximum weights are based on the structural evaluation in Part B, Section 7.0, of this SARP. Venting requirements are determined by payload type as described in Part B, Section 9.0, of this SARP. Drum array restrictions are based on the accident conditions evaluated in Part B, Section 7.0, and dose consequence evaluation in Part B, Section 4.0, of this SARP.

Table B2-1. Payload 1 Limits (Nonfissile, Solid).

Attribute	Maximum authorized
No. drums per shipment	One or array, maximum of four drums per row
Venting requirement	Optional See Part B, Section 9.0 Appendix, Fig. 2, for inorganic solids See Part B, Section 9.0 Appendix, Fig. 3, for organic solids
Watts/drum	12
Mass (kg)	658
Fissile isotopes per drum (g)	Fissile excepted
Total activity per single drum (Ci)*	25 A ₂ s
Total activity per drum in an array (Ci)*	6 A ₂ s

*A sum of the fractions of actual/limit must be less than 1.

Table B2-2. Payload 2 Limits (Fissile, Solid).

Attribute	Maximum authorized
No. drums per shipment	One or array, maximum of four drums per row
Venting requirement	Required See Part B, Section 9.0 Appendix, Fig. 2, for inorganic solids See Part B, Section 9.0 Appendix, Fig. 3, for organic solids
Watts/drum	12
Mass (kg)	658
Fissile isotopes per single drum (g)	100
Fissile isotopes per drum in an array (g)	45
Total activity per drum (Ci)*	2,500 A ₂ s
Total activity per drum in an array (Ci)*	600 A ₂ s

*A sum of the fractions of actual/limit must be less than 1.

Table B2-3. Payload 3 Limits (N-55 Overpack, Solid).

Attribute	Maximum authorized
No. drums per shipment	Two (one drum per N-55)
Venting requirement	Required See Part B, Section 9.0 Appendix, Fig. 2, for inorganic solids See Part B, Section 9.0 Appendix, Fig. 3, for organic solids
Watts/drum	5
Mass (kg)	249
Fissile isotopes per drum (g)	200
Fissile isotopes per shipment (g)	400
Total activity per single drum (Ci)*	27,000 Ci, less than 3,000 A ₂ s

*A sum of the fractions of actual/limit must be less than 1.

Table B2-4. Payload 4 Limits (Liquid).

Attribute	Maximum authorized
No. drums per shipment	One or array, maximum of four drums per row
Venting requirement	Required Reference Part B, Section 9.0, for specific guidance
Watts/drum	0.75
Mass (kg)	227
Volume	40 L total
Fissile isotopes per single drum (g)	100
Fissile isotopes per drum in an array (g)	45
Total activity per drum (Ci)*	2,500 A ₂ s
Total activity per drum in an array (Ci)*	600 A ₂ s

*A sum of the fractions of actual/limit must be less than 1.

These limits are based on dose consequence analyses (see Part B, Section 4.0), criticality control (Part B, Section 6.0), and thermal constraints (Part B, Section 8.0). The intent of these restrictions is to allow an unlimited number of shipments (see Part B, Section 3.0).

2.1.1 Fissile Material Content

The fissile material allowable contents are based on the dose consequence evaluation and the criticality analysis and are shown in Tables B2-1 to B2-4.

This page intentionally left blank.

3.0 RADIOLOGICAL RISK EVALUATION

3.1 INTRODUCTION

The steel drum package is used to ship Type B quantities of radioactive material throughout the Hanford Site. Authorized contents include fissile quantities. Radiological risks are evaluated to determine compliance with onsite transportation safety requirements per HNF-PRO-154.

There are two configurations of interest: drums shipped as packages and drums shipped inside N-55 overpacks. Drums shipped inside N-55 overpacks form a system that meets the performance requirements of the transportation regulations. Thus, that configuration meets the risk acceptance criteria. The other configuration is evaluated as follows.

The assumptions for the radiological risk evaluation are the following:

- Highway mode
- Closed roads when traveling south of the Wye Barricade
- The drums withstand NTC.

For accident environments, the drums must meet onsite transportation safety requirements as outlined in HNF-PRO-154 and Mercado (1994). The requisite safety is determined by a radiological risk evaluation that uses dose consequences, risk acceptance criteria, failure threshold values, and Hanford Site accident frequencies. For the evaluation, accidents are categorized as impact, crush, puncture, and fire. Risk acceptance criteria are outlined in Section 3.2. The dose consequence analyses results are discussed in Section 3.3. Failure thresholds are given in Section 3.4. The analysis of accident release frequencies for associated failure thresholds is given in Section 3.5. The conclusion is provided in Section 3.6.

3.1.1 Discussion and Results

There are three drum internal configurations: (1) drum; (2) drum with liner, vented; and (3) drum with liner, vented, and internal containers. These drums may be transported either singly or in an array. The dose consequence analysis performed in Section 4.0 does differentiate among the three configurations in terms of release potential. However, the failure thresholds and associated annual accident frequencies are based on drum performance singly and in an array.

The maximum authorized contents have been selected based on maintaining the drum as a Transportation Hazard Index (THI)-3 system. This has been done because of the general service nature of the drum and the associated components and because of the high-use rate of drums. Annual mileage associated with drum use will not be tracked. Since drums are frequently transported in large arrays (e.g., 20 drums), the predicted dose consequences from accidents involving an array were also evaluated. The dose consequence results from Section 4.0 are presented in Section 3.3. The annual accident release frequencies for a single drum and for an array are developed in Section 3.5. It is shown in Section 3.6 that the dose consequence acceptance criteria are met when the shipments are performed as required in Part A.

3.2 RISK ACCEPTANCE CRITERIA

Graded dose limitations for probable, credible, and incredible accident frequencies ensure safety in radioactive material packaging and transportation (Mercado 1994). The dose limitations

to the offsite and onsite individual for probable, credible, and incredible accident frequencies are presented in Table B3-1.

Table B3-1. Risk Acceptance Criteria Limits (Effective Dose Equivalent).

Description	Annual frequency	Onsite dose limit Sv (rem)	Offsite dose limit Sv (rem)
Incredible	$<10^{-7}$	None	None
Incredible	10^{-7} to $<10^{-6}$	None	0.25 (25)
Credible	10^{-6} to 10^{-3}	0.05 (5)	0.005 (0.5)
Probable	10^{-3} to 1	0.002 (0.2)	0.0001 (0.01)

3.3 DOSE CONSEQUENCE ANALYSIS RESULTS

The single drum configuration requiring no internal lining was evaluated based on 100% of the contents being available for release. The drum configurations involving liners and/or inner containers were considered to have partial releases based on the form of the contents and the inherent barriers to release. In both cases, the maximum allowable source terms were selected such that the maximum dose to the onsite individual is less than 0.05 Sv (5 rem) and that the offsite dose is less than 0.005 Sv (0.5 rem).

Since drums are frequently shipped in arrays, the performance of drums in an accident involving an array was evaluated in Part B, Section 7.0. It was found that, with high confidence, only the front row of an array is predicted to fail at the impact failure threshold. In Part A, the number of drums in a row is restricted to four drums. Consequently, the maximum source term per drum in an array is limited to one-fourth the maximum source term allowed in a single drum.

3.4 PACKAGE FAILURE THRESHOLD ANALYSIS

The failure thresholds of the steel drum have been determined for impact, puncture, crush, and fire as follows:

- *Impact:* 48 km/h (30 mph) velocity change on to a typical Hanford Site surface (see Part B, Section 7.4)
- *Puncture:* v/r ratio of 40 sec^{-1} (v/r = velocity for small package puncture failure divided by the radius of the puncturing probe) (see Part B, Section 7.4)
- *Crush:* Assume fails static crush
- *Fire:* Assume fails any fire.

There is an additional failure consideration for drums transported in an array. It is shown in Section 7.5 that the front row of drums may reach their failure threshold due to dynamic crush caused by the rows behind them. This, in essence, changes the failure threshold for impact to include the following:

- *Impact:* 40 km/h (25-mph) velocity change due to dynamic crush of drums with a maximum of 2,268 kg (5,000 lb) (726 kg [1,600 lb] for retrieval drums) of weight behind the first row.

Since the overall accident frequency is so low, it will be conservatively assumed, for simplicity, that the impact failure threshold is 40 km/h (25 mph) for either case. Note that drums are small packages, and we would normally include dynamic crush with static crush following Dennis et al. (1978). In this case, a specified tiedown system is used, which restricts the packages' movement, whereas Dennis et al. (1978) assumes the packages are free to move.

The impact failure threshold is reported to be 48 km/h (30 mph) for a single drum in Part B, Section 7.0. Partial drum failure is shown to begin at 27.8 km/h (17.3 mph). Use of the 40 km/h (25-mph) failure threshold defining a relatively complete loss of drum containment is conservative. Any partial release would still be below the dose consequence acceptance criteria.

3.5 ACCIDENT FREQUENCY ASSESSMENT

3.5.1 Approach

The accident release frequency assessment is based on the assumption that all failure modes from the different forces described as impact, puncture, crush, and fire result in the same level of consequence. The union of the package conditional release probabilities from different scenarios with similar consequences is multiplied by the frequency of truck accidents to arrive at a total accident release frequency.

The frequency (F) of a truck accident is the product of the annual number of trips, the number of miles per trip, and the accident rate per mile.

$$F = \frac{\text{number of trips}}{\text{year}} \times \frac{\text{miles}}{\text{trip}} \times \frac{\text{accidents}}{\text{mile}}$$

Hanford Site truck accidents have been compiled in a report using Site-specific data (Green et al. 1996), which gives the accident rate for trucks as 2.0×10^{-7} accidents per mile. For a shipment of radioactive materials north of the Wye Barricade that is carried out by trained truck drivers during daylight hours in good road conditions, a total reduction factor of 40 can be applied to lower the rate to 5×10^{-9} (H&R 1995) accidents per mile. Appendix B of *Recommended Onsite Transportation Risk Management Methodology* (H&R 1995) summarizes statistics from the U.S. Department of Transportation (DOT) and the studies conducted by Sandia National Laboratory on accident responses of small and large packages. The report recommends reducing truck accident rates by 10 for "safe" truck drivers, a factor of 2 for travel north of the Wye Barricade and another factor of 2 for shipment of radioactive material. Travel south of the Wye Barricade will occur only on closed roads, which may reduce accidents by another factor of 20. However, this closed-road reduction factor is ignored. The reduction factors are based on the following logic.

- **Safe truck drivers:** Hanford Site truck drivers have special training. Drivers must complete several driver's education courses, have a valid commercial driver's license with hazardous endorsement, complete specific training for highway route controlled quantities of radioactive material, and complete radiation worker and hazardous materials training. References show that drivers that participate in special safety programs reduce single-vehicle accident rates by up to a factor of 100. The H&R report (H&R 1995) recommends using an overall accident reduction factor of 10.

- Travel north of the Wye Barricade: The general population is excluded north of the Wye Barricade. The roads are straight and generally flat. These conditions eliminate conditions caused by after-work activities, such as alcohol consumption and travel during limited visibility. Statistics show that the difference between travel during day and night leads to an accident reduction of 2.67. Therefore, although the steel drum is not limited to shipment during daylight hours, a conservative factor of 2 reduction is recommended for travel north of the Wye Barricade because there is a constraint on traveling during adverse weather conditions, which may affect visibility, and because no alcohol consumption is permitted on the Hanford Site.
- Travel south of the Wye Barricade: Travel will occur south of the Wye Barricade on closed roads. Road closure reduces rear-end collision by a factor of 10, and multiple-vehicle accidents are reduced by another factor of 20. However, only a reduction factor of 2 is applied in this analysis in order to be consistent with the approach to the portion of the shipment north of the Wye Barricade.
- Radioactive material: An additional factor of 2 is recommended based on the higher level of training required for drivers of vehicles carrying radioactive material and the higher level of caution that would be expected from drivers of cargos consisting of radioactive material. Conditional release probabilities for fire, crush, impact, and puncture are determined for highway from a Sandia National Laboratory study for accidents involving small packages (Clarke et al. 1976) and from a Hanford Site risk management study (H&R 1995). The conditional release probabilities are presented in the flow chart in Figure B3-1.

3.5.2 Accident Release Frequency Analysis

An accident sequence analysis is developed for each failure type (impact, puncture, crush, and fire) and presented in the event tree shown in Figure B3-1. Information for the conditional probability of occurrence and conditional probabilities of failure was taken from Clarke et al. (1976) and H&R (1995). Mechanical failure conditional probabilities are further subdivided into those affected by fire. The conditional probabilities are summed for comparison to the risk criteria. A summary of the conditional probabilities and summation are shown in Table B3-2.

Table B3-2. Failure Thresholds, Occurrence and Conditional Failure Probabilities of a Single Drum.

Force type	Failure threshold	Conditional probability of occurrence	Conditional probability of failure
Impact failure	40 km/h (25 mph)	0.8935	0.08
Crush failure	>> 7,260 kg (16,000 lb)	0.8935 x 0.05	1
Puncture failure	40 sec ⁻¹	0.8935 x 0.224	0.039
Fire failure	Fails any fire	0.00467 + 0.8935 x 0.00193 = 0.00639	1
Total conditional release probability			0.126

Figure B3-1. Flow Chart for Small-Package Accidents.

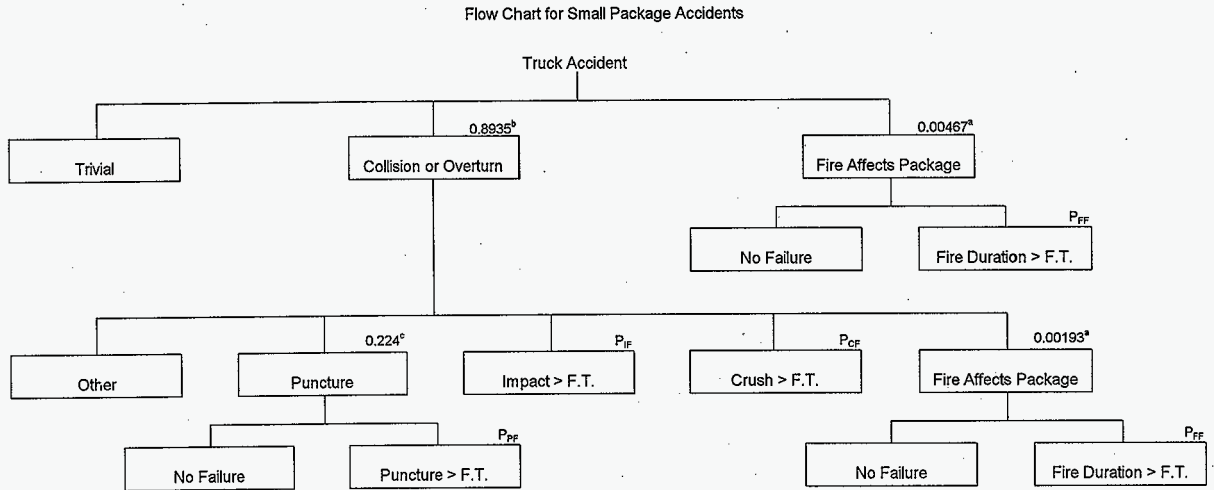

F.T. = Failure Threshold
 P_{CF} = Probability of Crush Failure
 P_{FF} = Probability of Fire Failure
 P_{IF} = Probability of Impact Failure
 P_{PF} = Probability of Puncture Failure

- a) Clarke, 91
- b) Clarke, 13
- c) Clarke, 89

The impact failure threshold was determined to be a 40 km/h (25-mph) change in velocity caused by dynamic crush (see Part B, Section 7.0). The annual probability of occurrence of a collision or overturn event is $0.8935 \times F$, and the conditional probability of impact failure is 0.08.

Puncture probabilities are determined by the v/r ratio, which is the puncture failure threshold velocity divided by the radius of the probe. The probability of occurrence of collision or overturn is 0.8935. This is multiplied by the probability of a puncture accident (0.224) and by the conditional failure probability for the 40 sec^{-1} failure threshold, which is 0.039.

The drums are assumed to fail in any static crush or fire event.

Note that partial drum failure begins occurring at 27 km/h (17 mph). The conditional probability of impact failure at this threshold is 0.13. It is shown in Section 3.5.2 that the annual accident release frequency is well within the TH1-3 dose consequence acceptance criteria range.

Fire failure has a conditional release probability of 0.0064. This event is shown in Section 3.6 to have an annual release frequency of below 10^6 .

3.5.2 Joint Probabilities

The joint probability is calculated by taking the union of events (McCormick 1981). The equation represents the sum of the probabilities of independent events while the subtracted terms eliminate double counting arising from the overlap caused by the intersection of the events. The general equation is given as:

$$P(A_1 + A_2 + \dots + A_N) = \sum_{n=1}^N P(A_n) - \sum_{n=1}^{N-1} \sum_{m=n+1}^N P(A_n A_m) + \dots + (-1)^{N-1} P(A_1 A_2 \dots A_N).$$

where

$P(f|a)$ = the probability of fire given that an accident has occurred

$P(fc|a)$ = the probability of fire and crush given that an accident has occurred

and

$P(FTE f|f)$ = the probability that the failure threshold is exceeded by fire given that a fire has occurred

then the above equation can be expanded and written as:

$$P = P(f|a) P(FTE f|f) + P(c|a) P(FTE c|c) + P(l|a) P(FTE l|l) + P(p|a) P(FTE p|p) - P(fc|a) P(FTE f|f) P(FTE c|c) - P(fi|a) P(FTE f|f) P(FTE l|l) - \dots$$

Thus, the values from the flow chart in Figure B3-1 and the conditional probabilities from Table B3-2 yield a total conditional release probability of 0.126.

3.6 EVALUATION AND CONCLUSION

Table B3-2 shows the conditional release probabilities calculated for each scenario and sums them to give a total conditional release probability. The summed probability is then multiplied by F, the frequency, to arrive at an annual accident release frequency. With a total conditional release probability of 0.126 and the reduced accident frequency of $5 \times 10^{-9}/\text{mi}$, the accident release frequency is $6.3 \times 10^{-10}/\text{mi}$. It is highly unlikely that there would be more than 16,093 km (10,000 mi) of shipments in any year; thus, an annual accident release frequency of 6.3×10^{-6} is bounding.

The dose consequence values determined in Section 4.0 that are related to the total conditional release probability are based on impact-related release. Fire release was also reviewed. From Section 3.5.1 fire has a conditional probability of release of 0.0064 with an accident frequency of $5 \times 10^{-9}/\text{mi}$; this results in a fire release frequency of $3 \times 10^{-11}/\text{mi}$. Assuming 16,093 km (10,000 mi) per year, the annual fire release frequency is 3×10^{-7} . It is shown in Section 4.0 that releases due to fire meet the acceptance criteria for this frequency.

Since the dose consequences are below the acceptance criteria when shipments are conducted in accordance with the requirements of this SARP, the shipment of the steel drums meets the onsite transportation safety requirements without mileage restriction.

3.7 REFERENCES

- HNF-PRO-154, *Responsibilities and Procedures for All Hazardous Material Shipments*, Fluor Daniel Hanford, Inc., Richland, Washington.
- Clarke, R. K., J. T. Foley, W. F. Hartman, and D. W. Lawson, 1976, *Severities of Transportation Accidents Volume III--Motor Carriers*, SLA-74-0001, Sandia Laboratories, Albuquerque, New Mexico.
- Green, J. R., B. D. Flanagan, and H. Harris, 1996, *Hanford Site Truck Accident Rate, 1990-1995*, WHC-SD-TP-RPT-021, Rev. 0, Westinghouse Hanford Company, Richland, Washington.
- H&R, 1995, *Recommended Onsite Transportation Risk Management Methodology*, 522-1, H&R Technical Associates, Inc., Oak Ridge, Tennessee.
- Mercado, J. E., 1994, *Report on Equivalent Safety for Transportation and Packaging of Radioactive Materials*, WHC-SD-TP-RPT-001, Rev. 0, Westinghouse Hanford Company, Richland, Washington.
- McCormick, N. J., 1981, *Reliability and Risk Analysis: Methods and Nuclear Power Applications*, Academic Press, San Diego, California.



CHECKLIST FOR CHECKING OF ANALYSIS/CALCULATIONS

Document Number/Revision: _____

Document Title: Steel Drum SARP, Section 3 Rad Risk Evaluation

Yes No N/A

- | | | | |
|-------------------------------------|--------------------------|-------------------------------------|--|
| <input checked="" type="checkbox"/> | <input type="checkbox"/> | <input type="checkbox"/> | Problem completely defined. |
| <input checked="" type="checkbox"/> | <input type="checkbox"/> | <input type="checkbox"/> | Appropriate analytical method used. |
| <input checked="" type="checkbox"/> | <input type="checkbox"/> | <input type="checkbox"/> | Necessary assumptions are appropriate and explicitly stated. |
| <input type="checkbox"/> | <input type="checkbox"/> | <input checked="" type="checkbox"/> | Computer codes and data files documented. |
| <input checked="" type="checkbox"/> | <input type="checkbox"/> | <input type="checkbox"/> | Data used in calculations explicitly stated in document. |
| <input checked="" type="checkbox"/> | <input type="checkbox"/> | <input type="checkbox"/> | Sources of non-standard formula/data are referenced and the correctness of the reference verified. |
| <input checked="" type="checkbox"/> | <input type="checkbox"/> | <input type="checkbox"/> | Data checked for consistency with original source information as applicable. |
| <input checked="" type="checkbox"/> | <input type="checkbox"/> | <input type="checkbox"/> | Mathematical derivations checked including dimensional consistency of results. |
| <input checked="" type="checkbox"/> | <input type="checkbox"/> | <input type="checkbox"/> | Models appropriate and used within range of validity or use outside range of established validity justified. |
| <input checked="" type="checkbox"/> | <input type="checkbox"/> | <input type="checkbox"/> | Hand calculations checked for errors. |
| <input type="checkbox"/> | <input type="checkbox"/> | <input checked="" type="checkbox"/> | Code run streams correct and consistent with analysis documentation. |
| <input type="checkbox"/> | <input type="checkbox"/> | <input checked="" type="checkbox"/> | Code output consistent with input and with results reported in analysis documentation. |
| <input type="checkbox"/> | <input type="checkbox"/> | <input checked="" type="checkbox"/> | Acceptability limits on analytical results applicable and supported. Limits checked against sources. |
| <input checked="" type="checkbox"/> | <input type="checkbox"/> | <input type="checkbox"/> | Safety Margins consistent with good engineering practices. |
| <input checked="" type="checkbox"/> | <input type="checkbox"/> | <input type="checkbox"/> | Conclusions consistent with analytical results and applicable limits. |
| <input checked="" type="checkbox"/> | <input type="checkbox"/> | <input type="checkbox"/> | Results and conclusions address all points required in the problem statement. |

I have checked the analysis/calculation and it is complete and accurate to the best of my knowledge.

Engineer/Checker

Brian Peters

Date 9/16/98

NOTE: Any hand calculations, notes or summaries generated as part of this check should be signed, dated, and attached to this checklist. Material should be labeled and recorded so that it is intelligible to a technically qualified third party.

4.0 CONTAINMENT EVALUATION

4.1 INTRODUCTION

The 208 L (55-gal) drum provides one containment barrier for all four payload types. The containment boundary consists of the 208 L (55-gal) drum, lid, and bolting ring and in some cases a NucFil¹ filter. The drum provides contents retention during NTC. For unvented drums, internal pressure is negligible due to a lack of gas generation and low internal heat loading. Drums vented by NucFil filter are equalized with the outside atmosphere.

Containment performance of the drum in an accident is evaluated based on predicted failure thresholds and dose consequences. The entire package is considered in the release evaluation.

For Payload 3, the drum is transported in an N-55 Overpack. The N-55 Overpack is a Type B Package that has been tested to the NRC regulation to meet normal and hypothetical accident conditions. This configuration meets the containment requirements and is not evaluated further in this section.

4.2 CONTAINMENT SOURCE SPECIFICATION

The authorized contents are described in Part B, Section 2.0. Typical Payload 1 and 2 contents include contaminated glass, paper, plastic, rags, metal, and other solid material. Payload 4 contents include liquids.

There are three drum internal configurations of interest. The basic configuration depends only on the drum for containment and does not require venting. This configuration provides the least accident release protection and is restricted to Payload 1 contents. The second configuration involves the basic drum, NucFil filter, and drum liner. This configuration is authorized for Payload 2 contents, which may be gas generating and fissile. Because of the internal drum configuration, the allowable contents are higher. The third configuration provides for certain liquid contents, defined as Payload 4. The configuration involves the basic drum, NucFil filter, and inner containers.

Payload 1 and 2 releases are evaluated to determine the maximum allowable source terms in Section 4.4. Payload 4 contents are well bounded by the Payload 2 evaluation and are not evaluated further.

4.3 NORMAL TRANSFER CONDITIONS

The performance of a 208 L (55-gal) drum alone and in an array is evaluated under NTC in Section 7.0. The specific conditions are defined in Section 7.2.3.1. The drums are shown to retain the contents under NTC.

4.4 ACCIDENT CONDITIONS

This section evaluates the accident dose consequences for Payloads 1, 2, and 4. Payload 3 of Part B, Section 2.1, is not specifically evaluated because the overpacked drum meets the performance requirements for a certified packaging. The N-55 system is acceptable as a THI-1 package.

¹NucFil is a trademark of NFT Incorporated.

Tables B4-1 and B4-2 list the individual dose-consequence-based isotope limits that result in a THI-3 for the payload types. The activities are derived as shown in Tables B4-3a and b. These contents are THI-3. The criteria for THI-3, as stated in HNF-PRO-154 is as follows:

“THI-3: This represents the second lowest level of hazard from the contents. A packaging system assigned this level transports material that has the potential of causing a dose consequence to an individual between 0.01 rem and 0.5 rem at the Hanford Site boundary, or between 0.2 rem and 5 rem within the site, if fully released.”

Table B4-1. Dose-Consequence-Based Isotope Limits for Payload 1.

Isotope	Activity (Ci)	A ₂ Value	Number of A ₂ s	Isotope	Activity (Ci)	A ₂ Value	Number of A ₂ s
⁶⁰ Co	4.5 E+01	10.8	4.2	²³³ Pa	3.8 E+02	24.3	15.6
⁹⁰ Sr	3.4 E+02	2.7	126	²³⁴ Pa	5.4 E+01	0.5	108
⁹⁰ Y	3.6 E+02	---	---	²³⁷ Np	0.11	5.4 x 10 ⁻³	20.4
⁹³ Zr	2.2 E+02	5.4	40.7	²³⁸ Np	2.0 E+02	5.4 x 10 ⁻⁴	Large
^{93m} Nb	2.3 E+03	162	14.7	²³⁸ Pu	1.8 E-01	5.4 x 10 ⁻³	33.3
¹³⁷ Cs	1.6 E+02	13.5	11.9	²³⁹ Pu	1.7 E-01	5.4 x 10 ⁻³	31.5
^{137m} Ba	with ¹³⁷ Cs	---	---	²⁴⁰ Pu	1.7 E-01	5.4 x 10 ⁻³	31.5
¹⁴⁴ Ce	1.8 E+02	5.41	33.3	²⁴¹ Pu	8.3 E+00	0.27	30.7
^{144m} Pr	---	---	---	²⁴² Pu	1.7 E-01	5.4 x 10 ⁻³	31.5
¹⁴⁴ Pr	3.4 E+02	0.5	680	²⁴¹ Am	1.5 E-01	5.4 x 10 ⁻³	27.7
¹⁵² Eu	7.5 E+01	24.3	3.1	²⁴² Cm	4.1 E+00	0.27	15.2
¹⁵⁴ Eu	6.6 E+01	13.5	4.9	²³⁸ U	5.2 E-01	2.7 x 10 ⁻³	193
²²⁸ Ra	5.1 E+03	0.54	Large	²³⁴ U	5.2 E-01	2.7 x 10 ⁻²	19.3
²²⁶ Ac	5.7 E+03	0.27	Large	²³⁵ U	5.6 E-01	Unlimited	0
²²⁹ Th	8.9 E+02	8 x 10 ⁻⁴	Large	²³⁶ U	5.6 E-01	2.7 x 10 ⁻²	20.7
²³¹ Th	3.8 E+03	24.3	156	²³⁷ U	5.8 E+02	5.4 x 10 ⁻⁴	Large
²³⁴ Th	8.7 E+03	5.41	1608	²³⁸ U	6.0 E-01	Unlimited	0

The activities presented in Table B4-1 represent the maximum values per isotope to reach the THI-3 dose consequence limits. As shown in Part B, Section 5.0, the predominant gamma-emitting isotopes, such as ⁶⁰Co, will be restricted to well below the reported activities by the dose rate limits given in Part A. Otherwise, the contents will be restricted to 25 A₂s.

Table B4-2. Dose-Consequence-Based Isotope Limits for Payload 2.

Isotope	Activity (Ci)	A ₂ Value	Number of A ₂ s	Isotope	Activity (Ci)	A ₂ Value	Number of A ₂ s
⁶⁰ Co	5.2 E+01	10.8	4.8	²³³ Pa	3.8 E+02	24.3	15.6
⁹⁰ Sr	1.6 E+04	2.7	5930	²³⁴ Pa	5.4 E+01	0.5	108
⁹⁰ Y	3.8 E+02	---	---	²³⁷ Np	1.1 E+01	5.4 X 10 ⁻³	2040
⁹² Zr	2.2 E+04	5.4	4070	²³⁸ Np	2.0 E+02	5.4 X 10 ⁻⁴	Large
^{93m} Nb	1.9 E+05	162	1170	²³⁸ Pu	1.8 E+01	5.4 X 10 ⁻³	3330
¹³⁷ Cs	1.7 E+02	13.5	12.6	²³⁹ Pu	1.7 E+01	5.4 X 10 ⁻³	3150
^{137m} Ba	with ¹³⁷ Cs	---	---	²⁴⁰ Pu	1.7 E+01	5.4 X 10 ⁻³	3150
¹⁴⁴ Ce	3.4 E+03	5.41	628	²⁴¹ Pu	8.3 E+02	0.27	3070
^{144m} Pr	---	---	---	²⁴² Pu	1.7 E+01	5.4 X 10 ⁻³	3150
¹⁴⁴ Pr	3.4 E+02	0.5	680	²⁴¹ Am	1.5 E+01	5.4 X 10 ⁻³	2780
¹⁵² Eu	9.6 E+01	24.3	4.0	²⁴² Cm	4.1 E+02	0.27	1520
¹⁵⁴ Eu	8.9 E+01	13.5	6.6	²³³ U	5.2 E+01	2.7 X 10 ⁻³	Large
²²⁵ Ra	5.1 E+03	0.54	9440	²³⁴ U	5.2 E+01	2.7 X 10 ⁻²	1930
²²⁵ Ac	5.7 E+03	0.27	Large	²³⁵ U	5.1 E+01	Unlimited	0
²²⁸ Th	8.9 E+02	8 x 10 ⁻⁴	Large	²³⁶ U	5.6 E+01	2.7 X 10 ⁻²	2070
²³¹ Th	3.8 E+03	24.3	156	²³⁷ U	5.8 E+02	5.4 X 10 ⁻⁴	Large
²³⁴ Th	8.7 E+03	5.41	1610	²³⁸ U	6.0 E+01	Unlimited	0

The activities presented in Table B4-2 represent the maximum values per isotope to reach the THL-3 dose consequence limits. As shown in Part B, Section 5.0, the predominant gamma-emitting isotopes, such as ⁶⁰Co, will be restricted to well below the reported activities by the dose rate limits given in Part A. Otherwise, the contents will be restricted to 25 A₂s.

4.4.1 Introduction and Overview

The following sections discuss the general methodology used to perform the dose consequence calculations, the source term used, and the various exposure pathways considered.

4.4.2 Dose Consequence Analysis Methodology

IAEA (1990) defines a standardized approach for evaluating transportation packaging requirements, called the Q-system. The Q-system methods have been incorporated into a Westinghouse Hanford Company document *Report on Equivalent Safety for Transportation and Packaging of Radioactive Materials* (Mercado 1994). This SARP demonstrates that onsite shipments meet onsite transportation safety requirements per HNF-PRO-154.

In the Q-system, the following five exposure pathways are considered: (1) external exposure to photons, (2) external exposure to β-particles, (3) inhalation, (4) skin contamination and ingestion, and (5) submersion in a cloud of gaseous isotopes. In special cases such as α-particle or neutron emitters, other exposure routes are considered. In some cases, a pathway will be judged

to be small with respect to the others, and consideration will be minimal. Modifications to the IAEA scenarios are incorporated to more closely describe the particular conditions of the shipment. Detailed calculations for the postulated accident are performed whenever possible. However, in some cases, IAEA's (1990) worst-case rules-of-thumb are used.

The Q-system was developed as an all-encompassing generalized methodology using only the isotope as the defining variable. In this report, the specifics of the package are considered. Some of the dose pathways may be considered incredible (frequency $< 10^{-6}/\text{yr}$), and although these pathways are covered in IAEA (1990), they are disregarded in the analysis.

In this IAEA system, the Q-values that are calculated are the radionuclide activities corresponding to each exposure route that causes the individual to receive the effective dose equivalent limit. The minimum Q-values define the A_2 values for the shipped materials. In the case of nondispersible materials (limited by the A_1 values), only the first two Q-values (based on exposure to external photon and external beta particles) are used. Note that for all radiation except neutrons, protons, and heavier charged particles (including α particles), 1 Gray (Gy) = 1 Sievert (Sv), and 1 rad = 1 rem.

There are two receptors of interest in the Q-system. They are the Hanford Site worker and the public receptor. The Hanford Site worker is assumed to be located 3 m from the package. The public receptor is assumed to be located at the point of public access incurring the greatest dose, determined to be via inhalation on the Columbia River adjacent to the 300 Area. A comparison of the THI-3 dose limits and the parameters used in calculating the onsite and offsite inhalation doses shows that the onsite limits are reached by the worker before the offsite limits are reached by the public receptor. As a result, limiting the onsite worker's exposure to onsite limits will keep the public receptor's exposure below offsite limits. Thus, only the dominating case of the onsite worker is considered herein.

4.4.2.1 Source Term. The activity limits for the drums were derived by calculating the dose consequence that would meet the THI-3 limits. Rather than setting radionuclide-specific limits, limits are set for three categories of radionuclides based on historical waste streams generated onsite. Limits on specific radionuclides are not imposed because of the large number of radionuclides that are transported onsite. If other limits, such as thermal, are more restrictive, then those nuclides are flagged for individual restriction.

As stated in the previous section, the dose to an onsite worker is predicted to dominate the dose consequences for a THI-3, and so the appropriate dose consequence pathways for detailed calculations are inhalation, external beta radiation, and external gamma radiation. The computer program GENII version 1.485 (Napier et al. 1988) is used to obtain the inhalation dose normalized per curie to an onsite worker for radionuclides commonly found onsite. The THI-3 dose limit of 5 rem was then divided by the normalized rem per curie inhalation dose to obtain the activity required for a 5-rem onsite inhalation dose. The activities required for 5 rem by the external beta and external gamma pathways are similarly obtained; details are given in the sections for the respective pathways below. To obtain the activity required to give a 5-rem onsite dose from the simultaneous exposure to these three pathways, the 5-rem limit is divided by the sum of the normalized doses per curie. This activity was then compared to the activities calculated from limits other than dose consequence.

Inhalation dominates the dose consequence exposure pathways, and the dose is dependent on the choice of the airborne release fraction and respirable fraction (DOE 1994). These fractions are a function of the accident scenario and drum contents. Because 95% of the drum payloads are expected to transport surface-contaminated trash (e.g., paper, rags, cardboard, and plastic), the release scenario is based on the estimated fraction available for release. A discussion of release fractions is given in Section 4.4.2.4, "Inhalation and Ingestion Dose."

Table B4-3a. Evaluation of Payload 1 Dose Consequences.

Nuclide	INHALATION			BETA		PHOTON		COMPOSITE	
	Inhalation dose per Ci at 100 m (rem)	Inhalation dose per Ci at 3 m, xARF-RF (rem)		Whole Body beta dose per Ci (rem)	Activity for 5 rem - beta only (Ci)	Photon dose per Ci (rem)	Activity for 5 rem, gamma only (Ci)	inhalation, beta, & gamma	
		Activity for 5 rem (Ci)	Activity for 5 rem (Ci)					Activity for 5 rem (Ci)	Mass for 5 rem (g)
CO 60	4.9E+00	1.5E-02	3.4E+02			9.7E-02	5.2E+01	4.5E+01	4.0E-02
SR 90	4.9E+00	1.5E-02	3.4E+02	1.5E-04	3.3E+04	1.5E-05	3.3E+05	3.4E+02	2.5E+00
Y 90	2.1E-01	6.3E-04	7.9E+03	1.3E-02	3.9E+02	3.2E-04	1.6E+04	3.6E+02	6.6E-04
ZR 93	7.6E+00	2.3E-02	2.2E+02			3.1E-08	1.6E+08	2.2E+02	8.5E+04
NB 93M	7.2E-01	2.2E-03	2.3E+03			5.0E-06	9.9E+05	2.3E+03	9.7E+00
CS 137	7.3E-01	2.2E-03	2.3E+03	3.8E-04	1.3E+04	2.9E-02	1.7E+02	1.6E+02	1.8E+00
BA 137M	<i>included with Cs 137</i>					<i>included with Cs 137</i>		<i>included with Cs 137</i>	
CE 144	8.9E+00	2.7E-02	1.9E+02			1.2E-03	4.2E+03	1.8E+02	5.6E-02
PR 144M	0	0							
PR 144	0	0		1.3E-02	3.9E+02	1.7E-03	2.9E+03	3.4E+02	4.6E-06
EU 152	5.0E+00	1.5E-02	3.3E+02	4.2E-04	1.2E+04	5.2E-02	9.7E+01	7.5E+01	4.3E-01
EU 154	6.6E+00	2.0E-02	2.5E+02	1.2E-03	4.1E+03	5.4E-02	9.2E+01	6.6E+01	2.4E-01
RA 225	0	0				9.8E-04	5.1E+03	5.1E+03	1.3E-01
AC 225	0	0				8.8E-04	5.7E+03	5.7E+03	9.8E-02
TH 229	0	0				5.6E-03	8.9E+02	8.9E+02	4.2E+03
TH 231	0	0				1.3E-03	3.8E+03	3.8E+03	7.2E-03
TH 234	0	0				5.8E-04	8.7E+03	8.7E+03	3.8E-01
PA 233	0	0				1.3E-02	3.8E+02	3.8E+02	1.8E-02
PA 234	0	0		1.1E-03	4.5E+03	9.1E-02	5.5E+01	5.4E+01	2.7E-05
NP 237	1.5E+04	4.5E+01	1.1E-01			1.8E-03	2.7E+03	1.1E-01	1.6E+02
NP 238	0	0		1.9E-03	2.6E+03	2.3E-02	2.2E+02	2.0E+02	7.7E-04
PU 238	9.4E+03	2.8E+01	1.8E-01			4.6E-05	1.1E+05	1.8E-01	1.0E-02
PU 239	1.0E+04	3.0E+01	1.7E-01			1.1E-05	4.5E+05	1.7E-01	2.7E+00
PU 240	1.0E+04	3.0E+01	1.7E-01			2.1E-06	2.4E+06	1.7E-01	7.3E-01
PU 241	2.0E+02	6.0E-01	8.3E+00			8.2E-08	6.1E+07	8.3E+00	8.1E-02
PU 242	9.7E+03	2.9E+01	1.7E-01			3.7E-05	1.3E+05	1.7E-01	4.4E+01
AM 241	1.1E+04	3.3E+01	1.5E-01			1.7E-03	2.9E+03	1.5E-01	4.4E-02
CM 242	4.1E+02	1.2E+00	4.1E+00			3.1E-05	1.6E+05	4.1E+00	1.2E-03
U 233	3.2E+03	9.6E+00	5.2E-01			1.9E-05	2.7E+05	5.2E-01	5.4E+01
U 234	3.2E+03	9.6E+00	5.2E-01			2.6E-05	1.9E+05	5.2E-01	8.4E+01
U 235	3.0E+03	9.0E+00	5.6E-01			8.9E-03	5.6E+02	5.6E-01	2.6E+05
U 236	3.0E+03	9.0E+00	5.6E-01			5.4E-06	9.2E+05	5.6E-01	8.6E+03
U 237	0	0				8.7E-03	5.8E+02	5.8E+02	7.1E-03
U 238	2.8E+03	8.4E+00	6.0E-01			2.0E-05	2.6E+05	6.0E-01	1.8E+06

$$\chi / Q = 7.32E-02 \text{ s/m}^3$$

$$\text{ARF} \times \text{RF} = 1.00E-04$$

Table B4-3b. Evaluation of Payload 2 Dose Consequences.

Nuclide	INHALATION			BETA		PHOTON		COMPOSITE	
	Inhalation dose per Ci at 100 m (rem)			Whole Body beta dose per Ci (rem)	Activity for 5 rem - beta only (Ci)	Photon dose per Ci (rem)	Activity for 5 rem - gamma only (Ci)	inhalation, beta, & gamma	
	Inhalation dose per Ci at 100 m (rem)	Inhalation dose per Ci at 3 m, x ARF-RF (rem)	Activity for 5 rem (Ci)					Activity for 5 rem (Ci)	Mass for 5 rem (g)
CO 60	4.9E+00	1.5E-04	3.4E+04			9.7E-02	5.2E+01	5.2E+01	4.6E-02
SR 90	4.9E+00	1.5E-04	3.4E+04	1.5E-04	3.3E+04	1.5E-05	3.3E+05	1.6E+04	1.2E+02
Y 90	2.1E-01	6.3E-06	7.9E+05	1.3E-02	3.9E+02	3.2E-04	1.6E+04	3.8E+02	7.0E-04
ZR 93	7.6E+00	2.3E-04	2.2E+04			3.1E-08	1.6E+08	2.2E+04	8.5E+06
NB 93M	7.2E-01	2.2E-05	2.3E+05			5.0E-06	9.9E+05	1.9E+05	7.8E+02
CS 137	7.3E-01	2.2E-05	2.3E+05	3.8E-04	1.3E+04	2.9E-02	1.7E+02	1.7E+02	1.9E+00
BA 137M	<i>included with Cs 137</i>					<i>included with Cs 137</i>		<i>included with Cs 137</i>	
CE 144	8.9E+00	2.7E-04	1.9E+04			1.2E-03	4.2E+03	3.4E+03	1.1E+00
PR 144M	0	0							
PR 144	0	0		1.3E-02	3.9E+02	1.7E-03	2.9E+03	3.4E+02	4.6E-06
EU 152	5.0E+00	1.5E-04	3.3E+04	4.2E-04	1.2E+04	5.2E-02	9.7E+01	9.6E+01	5.5E-01
EU 154	6.6E+00	2.0E-04	2.5E+04	1.2E-03	4.1E+03	5.4E-02	9.2E+01	8.9E+01	3.3E-01
RA 225	0	0				9.8E-04	5.1E+03	5.1E+03	1.3E-01
AC 225	0	0				8.8E-04	5.7E+03	5.7E+03	9.8E-02
TH 229	0	0				5.6E-03	8.9E+02	8.9E+02	4.2E+03
TH 231	0	0				1.3E-03	3.8E+03	3.8E+03	7.2E-03
TH 234	0	0				5.8E-04	8.7E+03	8.7E+03	3.8E-01
PA 233	0	0				1.3E-02	3.8E+02	3.8E+02	1.8E-02
PA 234	0	0		1.1E-03	4.5E+03	9.1E-02	5.5E+01	5.4E+01	2.7E-05
NP 237	1.5E+04	4.5E-01	1.1E+01			1.8E-03	2.7E+03	1.1E+01	1.6E+04
NP 238	0	0		1.9E-03	2.6E+03	2.3E-02	2.2E+02	2.0E+02	7.7E-04
PU 238	9.4E+03	2.8E-01	1.8E+01			4.8E-05	1.1E+05	1.8E+01	1.0E+00
PU 239	1.0E+04	3.0E-01	1.7E+01			1.1E-05	4.5E+05	1.7E+01	2.7E+02
PU 240	1.0E+04	3.0E-01	1.7E+01			2.1E-06	2.4E+06	1.7E+01	7.3E+01
PU 241	2.0E+02	6.0E-03	8.3E+02			8.2E-08	6.1E+07	8.3E+02	8.1E+00
PU 242	9.7E+03	2.9E-01	1.7E+01			3.7E-05	1.3E+05	1.7E+01	4.4E+03
AM 241	1.1E+04	3.3E-01	1.5E+01			1.7E-03	2.9E+03	1.5E+01	4.4E+00
CM 242	4.1E+02	1.2E-02	4.1E+02			3.1E-05	1.6E+05	4.1E+02	1.2E-01
U 233	3.2E+03	9.6E-02	5.2E+01			1.9E-05	2.7E+05	5.2E+01	5.4E+03
U 234	3.2E+03	9.6E-02	5.2E+01			2.6E-05	1.9E+05	5.2E+01	8.4E+03
U 235	3.0E+03	9.0E-02	5.6E+01			8.9E-03	5.6E+02	5.1E+01	2.3E+07
U 236	3.0E+03	9.0E-02	5.6E+01			5.4E-06	9.2E+05	5.6E+01	8.6E+05
U 237	0	0				8.7E-03	5.8E+02	5.8E+02	7.1E-03
U 238	2.8E+03	8.4E-02	6.0E+01			2.0E-05	2.6E+05	6.0E+01	1.8E+08

$\chi / Q = 7.32E-02 \text{ s/m}^3$
 $ARF \times RF = 1.00E-06$

Note that the release assumptions are developed separately for Payload 1 and Payload 2 contents. Payload 1 contents are those authorized to be transported in an unvented drum that provides the only barrier to release. Payload 2 contents are transported in a vented drum with internal release barriers, such as bags and liners.

4.4.2.2 External Dose Due to Photon Exposure. The external dose due to photons is considered in the scenario that assumes a person is exposed to a damaged transport package following an accident, in which the shielding of the package is assumed to be completely lost. This analysis is done assuming a person remains 3 m from the source for a period of 15 minutes. The 3 m distance and 15-minute exposure period differ from the IAEA scenario where the worker is assumed to remain 1 m from the source for a period of 30 minutes. The greater distance and shorter exposure period are justified because the Hanford Site emergency response occurs in less than 15 minutes, and site workers will remain at a much greater distance than 1 m from a damaged package consistent with their radiological worker training. Also, drivers are generally at least 3 m from the radiological source contained in the package.

The external dose due to photon exposure is calculated using the computer program ISO-PC (Rittman 1995). This code calculates the dose rate due to photons from gamma sources plus the bremsstrahlung radiation produced by the deceleration of β -particles. The fluence-to-dose conversion factors used are for the anterior-to-posterior orientation. For solid materials, the waste matrix is considered to be polyethylene with a density of 0.5 g/cm³ (compacted trash). This assumption represents the minimum self-shielding of organic and inorganic wastes. The isotope of interest is assumed to be uniformly distributed throughout the waste matrix. The ISO-PC input files for each isotope are shown in Part B, Section 4.4.4.1. The photon dose consequences are included in Table B4-2a,b.

4.4.2.3 External Dose Due to β -Particles. Because of the limited range of β -particles relative to that of photons, a shielding factor is used by the IAEA to account for residual shielding from such material as package debris. Except for this factor, no effort is made to account for either self-shielding or shielding from an accurate model of the damaged package in this calculation. Shielding and dose rate factors are graphed in IAEA (1990) as a function of the maximum energy of the β -particle. The IAEA β dose rate calculation methods are based on an individual located 1 m from the unshielded source.

This analysis assumes an individual remains at a distance of 3 m from the source for a 15-minute exposure period. A factor is applied to the dose rates calculated using the IAEA method to account for the difference between the 1 m distance assumed in developing the shielding factors and the 3 m distance in this analysis. This factor is conservatively taken to be 0.333 [(1 m)/(3 m)], since the dose rate falls off somewhere between $1/r$ and $1/r^2$, where r is the distance from the source. This also conservatively ignores any attenuation of the beta particles over the 3 m distance.

Table B4-4 provides the dose calculations for β -particle emitters likely to be transported in the drum. The 15-minute effective dose equivalent is the whole-body dose per curie at 3 m from the source to the skin, using a tissue weighting factor of 0.01 (ICRP 1991). The β dose consequences are included in Table B4-3a,b.

4.4.2.4 Inhalation and Ingestion Dose. The dose due to inhalation and submersion in a plume of radioactive material made airborne is considered in the scenario in which the drum is exposed to a stress that causes radionuclides to be resuspended or volatilized. This stress is assumed to be due to impact or a fire, which causes a fraction of the material to be suspended in air as an aerosol and available for transport. Of this amount, a fraction is of the appropriate size to be inhaled into the human respiratory system. Worst-case meteorological conditions transport the plume downwind, where the 50-year dose equivalent commitment to a receptor is calculated.

Table B4-4. β -Particle Effective Dose Equivalent Calculations.

Isotope	Branching Ratio	E_{\max} (MeV)	Dose rate factor ^a	Shielding factor ^b	Total Dose rate ^c (rem/h-Ci)	15-minute Effective Dose Equivalent (rem/Ci)
⁹⁰ Sr	1.00000	0.546	1.8E-4	100	6.00E-2	1.50E-4
⁹⁰ Y	0.99989	2.2839	3.1E-4	2	5.17E0	1.29E-2
¹³⁷ Cs	0.94600	0.51155	1.8E-4	100	5.68E-2	3.74E-4
	0.05400	1.17320	3.1E-4	6	9.30E-2	
¹⁴⁴ Pr	0.01170	2.2995	3.1E-4	2	6.04E-2	1.28E-2
	0.97740	2.996	3.1E-4	2	5.05E0	
¹⁵² Eu	0.00890	1.0638	3.1E-4	6	1.53E-2	4.0E-2
	0.08440	1.4749	3.1E-4	6	1.45E-1	
¹⁵⁴ Eu	0.36500	0.5694	1.8E-4	100	2.19E-2	1.17E-3
	0.17400	0.83918	1.8E-4	20	5.22E-2	
	0.11400	1.8439	3.1E-4	3	3.93E-1	
²³⁴ Pa	0.24000	0.68869	1.8E-4	100	1.44E-2	1.05E-3
	0.16000	0.71069	1.8E-4	20	4.80E-2	
	0.03800	0.71124	1.8E-4	20	1.14E-2	
	0.07700	0.81039	1.8E-4	20	2.31E-2	
	0.10000	1.183	3.1E-4	6	1.72E-1	
	0.06200	1.2378	3.1E-4	6	1.07E-1	
	0.01700	1.2444	3.1E-4	6	2.93E-2	
	0.00800	1.2592	3.1E-4	6	1.38E-2	
²³⁸ Np	0.45000	1.2478	3.1E-4	6	7.75E-1	1.94E-3

^aDose rate factor in units of Gy/h or Sv/h for a 1 mCi source from IAEA (1990).

^bShielding factor from IAEA (1990).

^cNote that a factor of 0.3333 is applied to the dose rates to account for a receptor distance of 3 m for this analysis, versus the 1 m distance assumed in the development of the dose rate factors from IAEA (1990). Only β decay paths leading to dose rates greater than 10 mrem/h-Ci are shown.

IAEA, 1990, *Explanatory Material for the IAEA Regulations for the Safe Transport of Radioactive Material*, Safety Series No. 7, Second Edition (As Amended 1990), International Atomic Energy Agency, Vienna, Austria.

The integrated normalized air concentration (χ/Q') is used to characterize the dilution of the airborne contaminants during atmospheric transport and dispersion and is a function of the atmospheric conditions and distance to the receptor. Values for 16 sectors that represent the compass points (i.e., S, SSW, SW, etc.) at the onsite (100 m) location for the 100, 200, 300, and 400 Areas are generated using the computer program GXQ version 4.0 (Hey 1994a, 1994b). These values are exceeded in their respective sector only 0.5 % of the time. The maximum value of all sectors is chosen as the value of χ/Q' used in the analysis. The maximum value is 7.32 E-2 s/m^3 ; this value corresponds to a receptor located 100 m from the release point in the 100 Area.

Unit activities of the nuclides most likely to be transported in the drum and the appropriate value of χ/Q' are used in GENII. GENII calculates for each nuclide the 50-year effective dose-equivalent commitment; i.e., the dose to an individual that will accumulate during the 50 years following the intake of radioisotopes from an acute release considering the quality factor of the radiation and the sensitivity of the organ. To convert the onsite dose given by GENII at 100 m to a corresponding dose at 3 m, a factor of 30 is applied in accordance with IAEA (1990). The inhalation dose consequences are included in Table B4-2a,b. The input files from GENII are included in Part B, Section 4.4.4.2. These calculations used the Worst Case solubility class library, which is the most conservative library. The GENII libraries used were as follows:

GENII Default Parameter Values (28-Mar-90 RAP)
 Radionuclide Library - Times < 100 years (23-July-93 PDR)
 External Dose Factors for GENII in person Sv/yr-per Bq/n (8-May-90)
 Worst Case Solubilities, Yearly Dose Increments (23-July-93 PDR).

A formula for the airborne source term to be used in the calculation of the inhalation dose is taken from DOE (1994), given by

$$\text{airborne source term} = \text{MAR} \cdot \text{DR} \cdot \text{ARF} \cdot \text{RF} \cdot \text{LPF}$$

where

MAR = material at risk,
 DR = damage ratio,
 ARF = airborne release fraction,
 RF = respirable fraction, and
 LPF = leakpath factor.

Payload 2

MAR is the amount of each radionuclide (Ci or g) available to be acted on by a given physical stress. Because an impact would affect the entire inventory of the drum, MAR is 100%.

DR is the fraction of the MAR actually affected by accident-generated conditions. A postulated impact scenario will not result in the entire drum contents being ejected and strewn about. The structural analysis (Part B, Section 7.0) for the worst-case corner drop indicates that the drum lid will be significantly deformed; however, it remains in such a condition that it will prevent the drum contents from being completely released. The impact is of short duration and will therefore affect only a fraction of the waste material near the top of the drum. It is assumed for this analysis that the DR is 0.1; i.e., 10% of the contents are involved in the release.

ARF is the fraction of radioactive material suspended in air as an aerosol and thus available for transport due to physical stresses from a specific accident. RF is the fraction of the radioactive airborne particles that can be transported through air and inhaled into the human respiratory system, commonly assumed to include particles 10 mm aerodynamic equivalent diameter and less.

The aerodynamic equivalent diameter is the diameter of a sphere of density 1 g/cm^3 that exhibits the same terminal velocity as the particle in question. Median and bounding values of ARF and RF are found in DOE (1994) for several materials for various damage scenarios. These data are based on common industrial accidents likely to be encountered in nonreactor nuclear facilities. While the experimental conditions used in the determination of the data may not exactly match the event conditions, values are taken from the scenario that most closely matches the event.

Because 95% of the drum payloads are expected to transport surface-contaminated waste (e.g., paper, rags, cardboard, and plastic) and the reasonable accident scenario is some type of impact, ARF and RF are given as $1\text{E-}3$ and 0.1 , respectively (DOE 1994). These values are derived considering both the free-fall of powder and the free-fall of surface-contaminated waste.

LPF is the fraction of the radionuclides in the aerosol transported through some confinement. Here, the confinement includes the contents (rags, paper, etc.), liners, and the steel drum. As mentioned above, the drum lid remains in such a condition that it will prevent the drum contents from being completely released after the postulated impact accident event. The release of radioactive material to the environment will occur through a breach or tear in the top of the drum liner that was caused by the impact event. The surface area of the material loaded in the drum is much greater than the exposed surface area for release. Therefore, the contamination on the internal surfaces has to pass through a tortuous path before it is released to the environment, which greatly reduces the amount of radioactive material that becomes airborne. The LPF is assumed to be 0.1 for this analysis, which accounts for the filtration effect of the contents themselves and the way the contents are packed.

Substituting these values of MAR, DR, ARF, RF, and LPF into the equation for the airborne source term yields $1.0 \times 0.1 \times 10^{-3} \times 10^{-1} \times 10^{-1} = 1 \times 10^{-6}$ times the source activities in Table B4-3b. The resulting source term is used to obtain the inhalation dose consequences in Table B4-3b.

A bounding ARF x RF value of 5×10^{-4} (DOE 1994) for packaged mixed waste under thermal stress conditions is applicable to drums containing mixed radioactive waste for an accident scenario involving a fire. A value of 1 for the DR and LPF is appropriate for a fire scenario where it is assumed that the entire drum is engulfed in flames. The ARF x RF x DR x LPF for the fire scenario is 500 times that for the nonfire scenario, which results in the inhalation dose consequences being 500 times greater than those for the nonfire scenario. However, the risk evaluation indicates that the frequency of an accident involving a fire is so low ($< 10^{-6}$) that there are no specific limits on the allowable dose for the onsite worker, and the allowable dose to the public is 25 rem. Therefore, the nonfire scenario dose consequence results are more restrictive than those for the fire scenario for this analysis.

Payload 1

The MAR, ARF, and RF values remain the same for Payload 1: 1.0 , 10^{-3} , and 0.1 , respectively. However, DR and LPF are assumed to be 1.0 and 1.0 , respectively, since the Payload 1 drum configuration cannot be assumed to inhibit the release of the radioactive material. The resulting source term is used to obtain the inhalation dose consequences in Table B4-3a.

Payload 4

The packaging configuration for liquids consists of absorbent material surrounding the inner containment, which consists of 4 L poly bottles with screw caps. A second barrier of the inner containment is provided by placing the poly bottle inside a vented poly bag, which is closed either by heat sealing or by twisting the end and sealing with tape. The outer container consists of the drum with a 90-mil rigid polyethylene liner.

The postulated accident impact event may result in the failure of one or all of the poly bottles contained in the drum and the breaching of the vented poly bag, thus releasing the liquid contents inside the drum. Because the absorbent pads are placed above and below the poly bottles, very little free liquid would be available for release through the opening in the drum caused by deformation of the drum lid, which is the only pathway to the environment. Note that it is very likely that the 90-mil rigid polyethylene liner would maintain its integrity following the postulated impact event, thus preventing any release of liquid to the environment.

However, for this evaluation, it is assumed that one percent (i.e., 0.01) of the total liquid contained in the bottles is available as free liquid near the opening in the drum. The value of one percent accounts for the DR and LPF for the packaging configuration (i.e., absorbent, poly bottles, vented poly bag, 90-mil polyethylene liner, and drum) for the liquids.

A bounding ARF x RF value of 1×10^{-4} is given in DOE (1994) for a free-fall spill of aqueous solutions with a density of approximately 1 g/cm^3 for a 3 m fall distance. A bounding ARF x RF value of 2×10^{-5} is given for a free-fall spill of solutions with a density of $> 1.2 \text{ g/cm}^3$ for a 3 m fall distance. This results in combined values of 1×10^{-6} and 2×10^{-7} for the ARF x RF x DR x LPF for 1 g/cm^3 and $> 1.2 \text{ g/cm}^3$ liquids, respectively. These values are bounded by the 1×10^{-6} airborne fraction for Payload 2; therefore, the Payload 2 dose consequence results bound those for Payload 4.

4.4.2.5 Dose Due to β -Particle Emitter Skin Contamination. The dose due to β -particle skin contamination is considered in the scenario that 1% of the package contents are spread over an area of 1 m^2 around the package, and handling of debris results in contamination of the hands to 10% of this level. The receptor then ingests all of the contamination from 10 cm^2 of skin over a 24-hour period.

This pathway is normally not considered for onsite workers because they are trained in the appropriate response to protect themselves from experiencing unnecessary radiation exposure, including preventing skin contamination and ingestion.

4.4.2.6 Submersion Dose Due to Gaseous Vapor. The dose due to submersion in a cloud of gaseous isotopes that are not taken into the body is considered in the scenario of a rapid release of 100% of the package contents into a confined structure. These isotopes are the noble gases that are not incorporated into the body and whose daughter products are either a stable nuclide or another noble gas isotope. In the few cases where this condition is not fulfilled, dosimetric routes other than submersion in a radioactive cloud are considered.

Because of the absence of noble gases, this pathway is not applicable.

4.4.2.7 Special Considerations. Because of the presence of uranium and TRU, neutrons may be produced in the drum via spontaneous fission and (α, n) reactions with light elements. Per Part B, Section 5.2.3, the surface dose rate due to neutrons was determined to be 5.23 E-3 mSv/h (0.523 mrem/h). Neglecting attenuation from the drum surface to 3 m, the corresponding dose over 15 minutes is 1.31 E-3 mSv (0.131 mrem), which is less than 0.003% of the THI-3 dose limit of 5 rem. Therefore, the neutron dose is insignificant relative to the gamma dose rate and is not explicitly calculated in this evaluation.

4.5 REFERENCES

- HNF-PRO-154, *Responsibilities and Procedures for All Hazardous Material Shipments*, Fluor Daniel Hanford, Inc., Richland, Washington.
- DOE, 1994, *Airborne Release Fractions/Rates and Respirable Fractions for Nonreactor Nuclear Facilities*, DOE-HDBK-3010-94, U.S. Department of Energy, Washington, D.C.
- Hey, B. E., 1994a, *GXQ Program User's Guide*, WHC-SD-GN-SWD-3002, Rev. 1, Westinghouse Hanford Company, Richland, Washington.
- Hey, B. E., 1994b, *GXQ Program Verification and Validation*, WHC-SD-GN-SWD-3032, Rev. 1, Westinghouse Hanford Company, Richland, Washington.
- IAEA, 1990, *Explanatory Material for the IAEA Regulations for the Safe Transport of Radioactive Material*, Safety Series No. 7, Second Edition (As Amended 1990), International Atomic Energy Agency, Vienna, Austria.
- ICRP, 1991, *International Commission on Radiological Protection, Annals of the ICRP*, Publication 60, 1991, International Commission on Radiological Protection, New York, New York.
- Mercado, J. E., 1994, *Report on Equivalent Safety for Transportation and Packaging of Radioactive Materials*, WHC-SD-TP-RPT-001, Rev. 0, Westinghouse Hanford Company, Richland, Washington.
- Napier, B. A., et al., 1988, *GENII - The Hanford Environmental Radiation Dosimetry Software System*, PNL-6584, Vol. 1, UC-600, Pacific Northwest Laboratory, Richland, Washington.
- Rittman, P. D., 1995, *ISO-PC Version 1.98 - User's Guide*, WHC-SD-WM-UM-030, Rev. 0, Westinghouse Hanford Company, Richland, Washington.

4.6 APPENDIX: DOSE CONSEQUENCE INPUT FILES

4.6.1 ISO-PC Input

```

0          2 Steel Drum Dose Consequence Analysis
3 m from bare waste
&Input Next=1, OPTION=0, ISpec=3, DUNIT=1, ICONC=0, SFACT=1.0,
  IGeom=7, T(1)=27.7114,1.e3, X=327.7114, Y=41.6815, SLTH=83.363,
  NShld=1, JBuf=1, NTheta=30, NPsi=20
WEIGHT(102)=1.00E+00 &
  H          4 0.07
1 C          6 0.43
End.
&Input Next=6 &

```

```

0          2 Steel Drum Dose Consequence Analysis
3 m from bare waste
&Input Next=1, OPTION=0, ISpec=3, DUNIT=1, ICONC=0, SFACT=1.0,
  IGeom=7, T(1)=27.7114,1.e3, X=327.7114, Y=41.6815, SLTH=83.363,
  NShld=1, JBuf=1, NTheta=30, NPsi=20
WEIGHT(103)=1.00E+00 &
  H          4 0.07
1 C          6 0.43
End.
&Input Next=6 &

```

```

0      2 Steel Drum Dose Consequence Analysis
3 m from bare waste
&Input Next=1, OPTION=0, ISpec=3, DUNIT=1, ICONC=0, SFACT=1.0,
IGeom=7, T(1)=27.7114,1.e3, X=327.7114, Y=41.6815, SLTH=83.363,
NShld=1, JBuf=1, NTheta=30, NPsi=20
WEIGHT(82)=1.00E+00 &
H      4 0.07
1 C    6 0.43
End.
&Input Next=6 &

```

```

0      2 Steel Drum Dose Consequence Analysis
3 m from bare waste
&Input Next=1, OPTION=0, ISpec=3, DUNIT=1, ICONC=0, SFACT=1.0,
IGeom=7, T(1)=27.7114,1.e3, X=327.7114, Y=41.6815, SLTH=83.363,
NShld=1, JBuf=1, NTheta=30, NPsi=20
WEIGHT(472)=1.00E+00 &
H      4 0.07
1 C    6 0.43
End.
&Input Next=6 &

```

```

0      2 Steel Drum Dose Consequence Analysis
3 m from bare waste
&Input Next=1, OPTION=0, ISpec=3, DUNIT=1, ICONC=0, SFACT=1.0,
IGeom=7, T(1)=27.7114,1.e3, X=327.7114, Y=41.6815, SLTH=83.363,
NShld=1, JBuf=1, NTheta=30, NPsi=20
WEIGHT(415)=1.00E+00 &
H      4 0.07
1 C    6 0.43
End.
&Input Next=6 &

```

```

0      2 Steel Drum Dose Consequence Analysis
3 m from bare waste
&Input Next=1, OPTION=0, ISpec=3, DUNIT=1, ICONC=0, SFACT=1.0,
IGeom=7, T(1)=27.7114,1.e3, X=327.7114, Y=41.6815, SLTH=83.363,
NShld=1, JBuf=1, NTheta=30, NPsi=20
WEIGHT(408)=1.00E+00 &
H      4 0.07
1 C    6 0.43
End.
&Input Next=6 &

```

```

0      2 Steel Drum Dose Consequence Analysis
3 m from bare waste
&Input Next=1, OPTION=0, ISpec=3, DUNIT=1, ICONC=0, SFACT=1.0,
IGeom=7, T(1)=27.7114,1.e3, X=327.7114, Y=41.6815, SLTH=83.363,
NShld=1, JBuf=1, NTheta=30, NPsi=20
WEIGHT(377)=1.00E+00 &
H      4 0.07
1 C    6 0.43
End.
&Input Next=6 &

```

```

0      2 Steel Drum Dose Consequence Analysis
3 m from bare waste
&Input Next=1, OPTION=0, ISpec=3, DUNIT=1, ICONC=0, SFACT=1.0,
IGeom=7, T(1)=27.7114,1.e3, X=327.7114, Y=41.6815, SLTH=83.363,
NShld=1, JBuf=1, NTheta=30, NPsi=20
WEIGHT(376)=1.00E+00 &
H      4 0.07
1 C    6 0.43
End.
&Input Next=6 &

```

```

0      2 Steel Drum Dose Consequence Analysis
3 m from bare waste

```

```

&Input Next=1, OPTION=0, ISpec=3, DUNIT=1, ICONC=0, SFACT=1.0,
IGeom=7, T(1)=27.7114,1.e3, X=327.7114, Y=41.6815, SLTH=83.363,
NShld=1, JBuf=1, NTheta=30, NPsi=20
WEIGHT(336)=1.00E+00 &
  H      4 0.07
1 C      6 0.43
End.
&Input Next=6 &

```

```

0          2 Steel Drum Dose Consequence Analysis
3 m from bare waste
&Input Next=1, OPTION=0, ISpec=3, DUNIT=1, ICONC=0, SFACT=1.0,
IGeom=7, T(1)=27.7114,1.e3, X=327.7114, Y=41.6815, SLTH=83.363,
NShld=1, JBuf=1, NTheta=30, NPsi=20
WEIGHT(335)=1.00E+00 &
  H      4 0.07
1 C      6 0.43
End.
&Input Next=6 &

```

```

0          2 Steel Drum Dose Consequence Analysis
3 m from bare waste
&Input Next=1, OPTION=0, ISpec=3, DUNIT=1, ICONC=0, SFACT=1.0,
IGeom=7, T(1)=27.7114,1.e3, X=327.7114, Y=41.6815, SLTH=83.363,
NShld=1, JBuf=1, NTheta=30, NPsi=20
WEIGHT(84)=1.00E+00 &
  H      4 0.07
1 C      6 0.43
End.
&Input Next=6 &

```

```

0          2 Steel Drum Dose Consequence Analysis
3 m from bare waste
&Input Next=1, OPTION=0, ISpec=3, DUNIT=1, ICONC=0, SFACT=1.0,
IGeom=7, T(1)=27.7114,1.e3, X=327.7114, Y=41.6815, SLTH=83.363,
NShld=1, JBuf=1, NTheta=30, NPsi=20
WEIGHT(398)=1.00E+00 &
  H      4 0.07
1 C      6 0.43
End.
&Input Next=6 &

```

```

0          2 Steel Drum Dose Consequence Analysis
3 m from bare waste
&Input Next=1, OPTION=0, ISpec=3, DUNIT=1, ICONC=0, SFACT=1.0,
IGeom=7, T(1)=27.7114,1.e3, X=327.7114, Y=41.6815, SLTH=83.363,
NShld=1, JBuf=1, NTheta=30, NPsi=20
WEIGHT(526)=1.00E+00 &
  H      4 0.07
1 C      6 0.43
End.
&Input Next=6 &

```

```

0          2 Steel Drum Dose Consequence Analysis
3 m from bare waste
&Input Next=1, OPTION=0, ISpec=3, DUNIT=1, ICONC=0, SFACT=1.0,
IGeom=7, T(1)=27.7114,1.e3, X=327.7114, Y=41.6815, SLTH=83.363,
NShld=1, JBuf=1, NTheta=30, NPsi=20
WEIGHT(520)=1.00E+00 &
  H      4 0.07
1 C      6 0.43
End.
&Input Next=6 &

```

```

0          2 Steel Drum Dose Consequence Analysis
3 m from bare waste
&Input Next=1, OPTION=0, ISpec=3, DUNIT=1, ICONC=0, SFACT=1.0,

```

```

IGeom=7, T(1)=27.7114,1.e3, X=327.7114, Y=41.6815, SLTH=83.363,
NShld=1, JBuf=1, NTheta=30, NPsi=20
WEIGHT(519)=1.00E+00 &
H      4 0.07
1 C    6 0.43
End.
&Input Next=6 &

```

```

0          2 Steel Drum Dose Consequence Analysis
3 m from bare waste
&Input Next=1, OPTION=0, ISpec=3, DUNIT=1, ICONC=0, SFACT=1.0,
IGeom=7, T(1)=27.7114,1.e3, X=327.7114, Y=41.6815, SLTH=83.363,
NShld=1, JBuf=1, NTheta=30, NPsi=20
WEIGHT(517)=1.00E+00 &
H      4 0.07
1 C    6 0.43
End.
&Input Next=6 &

```

```

0          2 Steel Drum Dose Consequence Analysis
3 m from bare waste
&Input Next=1, OPTION=0, ISpec=3, DUNIT=1, ICONC=0, SFACT=1.0,
IGeom=7, T(1)=27.7114,1.e3, X=327.7114, Y=41.6815, SLTH=83.363,
NShld=1, JBuf=1, NTheta=30, NPsi=20
WEIGHT(516)=1.00E+00 &
H      4 0.07
1 C    6 0.43
End.
&Input Next=6 &

```

```

0          2 Steel Drum Dose Consequence Analysis
3 m from bare waste
&Input Next=1, OPTION=0, ISpec=3, DUNIT=1, ICONC=0, SFACT=1.0,
IGeom=7, T(1)=27.7114,1.e3, X=327.7114, Y=41.6815, SLTH=83.363,
NShld=1, JBuf=1, NTheta=30, NPsi=20
WEIGHT(515)=1.00E+00 &
H      4 0.07
1 C    6 0.43
End.
&Input Next=6 &

```

```

0          2 Steel Drum Dose Consequence Analysis
3 m from bare waste
&Input Next=1, OPTION=0, ISpec=3, DUNIT=1, ICONC=0, SFACT=1.0,
IGeom=7, T(1)=27.7114,1.e3, X=327.7114, Y=41.6815, SLTH=83.363,
NShld=1, JBuf=1, NTheta=30, NPsi=20
WEIGHT(504)=1.00E+00 &
H      4 0.07
1 C    6 0.43
End.
&Input Next=6 &

```

```

0          2 Steel Drum Dose Consequence Analysis
3 m from bare waste
&Input Next=1, OPTION=0, ISpec=3, DUNIT=1, ICONC=0, SFACT=1.0,
IGeom=7, T(1)=27.7114,1.e3, X=327.7114, Y=41.6815, SLTH=83.363,
NShld=1, JBuf=1, NTheta=30, NPsi=20
WEIGHT(502)=1.00E+00 &
H      4 0.07
1 C    6 0.43
End.
&Input Next=6 &

```

```

0          2 Steel Drum Dose Consequence Analysis
3 m from bare waste
&Input Next=1, OPTION=0, ISpec=3, DUNIT=1, ICONC=0, SFACT=1.0,
IGeom=7, T(1)=27.7114,1.e3, X=327.7114, Y=41.6815, SLTH=83.363,
NShld=1, JBuf=1, NTheta=30, NPsi=20

```

```

WEIGHT(497)=1.00E+00 &
  H      4 0.07
1 C     6 0.43
End.
&Input Next=6 &

```

```

0          2 Steel Drum Dose Consequence Analysis
3 m from bare waste
&Input Next=1, OPTION=0, ISpec=3, DUNIT=1, ICONC=0, SFACT=1.0,
  IGeom=7, T(1)=27.7114,1.e3, X=327.7114, Y=41.6815, SLTH=83.363,
  NSHld=1, JBuf=1, NTheta=30, NPsi=20
WEIGHT(496)=1.00E+00 &
  H      4 0.07
1 C     6 0.43
End.
&Input Next=6 &

```

```

0          2 Steel Drum Dose Consequence Analysis
3 m from bare waste
&Input Next=1, OPTION=0, ISpec=3, DUNIT=1, ICONC=0, SFACT=1.0,
  IGeom=7, T(1)=27.7114,1.e3, X=327.7114, Y=41.6815, SLTH=83.363,
  NSHld=1, JBuf=1, NTheta=30, NPsi=20
WEIGHT(495)=1.00E+00 &
  H      4 0.07
1 C     6 0.43
End.
&Input Next=6 &

```

```

0          2 Steel Drum Dose Consequence Analysis
3 m from bare waste
&Input Next=1, OPTION=0, ISpec=3, DUNIT=1, ICONC=0, SFACT=1.0,
  IGeom=7, T(1)=27.7114,1.e3, X=327.7114, Y=41.6815, SLTH=83.363,
  NSHld=1, JBuf=1, NTheta=30, NPsi=20
WEIGHT(494)=1.00E+00 &
  H      4 0.07
1 C     6 0.43
End.
&Input Next=6 &

```

```

0          2 Steel Drum Dose Consequence Analysis
3 m from bare waste
&Input Next=1, OPTION=0, ISpec=3, DUNIT=1, ICONC=0, SFACT=1.0,
  IGeom=7, T(1)=27.7114,1.e3, X=327.7114, Y=41.6815, SLTH=83.363,
  NSHld=1, JBuf=1, NTheta=30, NPsi=20
WEIGHT(493)=1.00E+00 &
  H      4 0.07
1 C     6 0.43
End.
&Input Next=6 &

```

```

0          2 Steel Drum Dose Consequence Analysis
3 m from bare waste
&Input Next=1, OPTION=0, ISpec=3, DUNIT=1, ICONC=0, SFACT=1.0,
  IGeom=7, T(1)=27.7114,1.e3, X=327.7114, Y=41.6815, SLTH=83.363,
  NSHld=1, JBuf=1, NTheta=30, NPsi=20
WEIGHT(492)=1.00E+00 &
  H      4 0.07
1 C     6 0.43
End.
&Input Next=6 &

```

```

0          2 Steel Drum Dose Consequence Analysis
3 m from bare waste
&Input Next=1, OPTION=0, ISpec=3, DUNIT=1, ICONC=0, SFACT=1.0,
  IGeom=7, T(1)=27.7114,1.e3, X=327.7114, Y=41.6815, SLTH=83.363,
  NSHld=1, JBuf=1, NTheta=30, NPsi=20
WEIGHT(491)=1.00E+00 &
  H      4 0.07

```

1 C 6 0.43

End.

&Input Next=6 &

0 2 Steel Drum Dose Consequence Analysis

3 m from bare waste

&Input Next=1, OPTION=0, ISpec=3, DUNIT=1, ICONC=0, SFACT=1.0,
 IGeom=7, T(1)=27.7114,1.e3, X=327.7114, Y=41.6815, SLTH=83.363,
 NShld=1, JBuf=1, NTheta=30, NPsi=20

WEIGHT(490)=1.00E+00 &

H 4 0.07

1 C 6 0.43

End.

&Input Next=6 &

0 2 Steel Drum Dose Consequence Analysis

3 m from bare waste

&Input Next=1, OPTION=0, ISpec=3, DUNIT=1, ICONC=0, SFACT=1.0,
 IGeom=7, T(1)=27.7114,1.e3, X=327.7114, Y=41.6815, SLTH=83.363,
 NShld=1, JBuf=1, NTheta=30, NPsi=20

WEIGHT(476)=1.00E+00 &

H 4 0.07

1 C 6 0.43

End.

&Input Next=6 &

0 2 Steel Drum Dose Consequence Analysis

3 m from bare waste

&Input Next=1, OPTION=0, ISpec=3, DUNIT=1, ICONC=0, SFACT=1.0,
 IGeom=7, T(1)=27.7114,1.e3, X=327.7114, Y=41.6815, SLTH=83.363,
 NShld=1, JBuf=1, NTheta=30, NPsi=20

WEIGHT(450)=1.00E+00 &

H 4 0.07

1 C 6 0.43

End.

&Input Next=6 &

0 2 Steel Drum Dose Consequence Analysis

3 m from bare waste

&Input Next=1, OPTION=0, ISpec=3, DUNIT=1, ICONC=0, SFACT=1.0,
 IGeom=7, T(1)=27.7114,1.e3, X=327.7114, Y=41.6815, SLTH=83.363,
 NShld=1, JBuf=1, NTheta=30, NPsi=20

WEIGHT(441)=1.00E+00 &

H 4 0.07

1 C 6 0.43

End.

&Input Next=6 &

0 2 Steel Drum Dose Consequence Analysis

3 m from bare waste

&Input Next=1, OPTION=0, ISpec=3, DUNIT=1, ICONC=0, SFACT=1.0,
 IGeom=7, T(1)=27.7114,1.e3, X=327.7114, Y=41.6815, SLTH=83.363,
 NShld=1, JBuf=1, NTheta=30, NPsi=20

WEIGHT(412)=1.00E+00 &

H 4 0.07

1 C 6 0.43

End.

&Input Next=6 &

0 2 Steel Drum Dose Consequence Analysis

3 m from bare waste

&Input Next=1, OPTION=0, ISpec=3, DUNIT=1, ICONC=0, SFACT=1.0,
 IGeom=7, T(1)=27.7114,1.e3, X=327.7114, Y=41.6815, SLTH=83.363,
 NShld=1, JBuf=1, NTheta=30, NPsi=20

WEIGHT(530)=1.00E+00 &

H 4 0.07

1 C 6 0.43

End.

&Input Next=6 &

4.6.2 GENII Input

Program GENII Input File ##### 8 Jul 88 ###
 Title: drum sarp - option 1 (100 area-onsite-worst case)
 \GENII\drum3.in Created on 01-22-1990 at 07:30

OPTIONS----- Default -----
 F Near-field scenario? (Far-field) NEAR-FIELD: narrowly-focused
 F Population dose? (Individual) release, single site
 T Acute release? (Chronic) FAR-FIELD: wide-scale release,
 Maximum Individual data set used multiple sites
 Complete Section Complete
 TRANSPORT OPTIONS===== EXPOSURE PATHWAY OPTIONS=====
 T Air Transport 1 F Finite plume, external 5
 F Surface Water Transport 2 T Infinite plume, external 5
 F Biotic Transport (near-field) 3,4 F Ground, external 5
 F Waste Form Degradation (near) 3,4 F Recreation, external 5
 T Inhalation uptake 5,6
 REPORT OPTIONS-----
 T Report AEDE only F Drinking water ingestion 7,8
 F Report by radionuclide F Aquatic foods ingestion 7,8
 F Report by exposure pathway F Terrestrial foods ingestion 7,9
 F Debug report on screen F Animal product ingestion 7,10
 F Inadvertent soil ingestion

INVENTORY #####

4 Inventory input activity units: (1-pCi 2-uCi 3-mCi 4-Ci 5-Bq)
 0 Surface soil source units (1- m2 2- m3 3- kg)
 Equilibrium question goes here

Use when	Release Terms			Basic Concentrations			
	transport selected	near-field scenario, optionally					
Release	Surface	Buried	Surface	Deep	Ground	Surface	
Radio-	Air	Water	Waste	Air	Soil	Soil	Water
nuclide	/yr	/yr	/m3	/m3	/unit	/m3	/L
							Water
							/L

SR90 1.0
 Y 90 1.0
 CO60 1.0
 CS137 1.0
 EU154 1.0
 EU152 1.0
 AM241 1.0
 NB93M 1.0
 CM242 1.0
 U 234 1.0
 U 235 1.0
 U 236 1.0
 NP237 1.0
 PU240 1.0
 PU239 1.0
 PU238 1.0
 PU241 1.0
 PU242 1.0
 CE144 1.0
 ZR93 1.0
 U 238 1.0
 U 233 1.0

Use when	Derived Concentrations			
	measured values are known			
Release	Terres.	Animal	Drink	Aquatic
Radio-	Plant	Product	Water	Food
nuclide	/kg	/kg	/L	/kg

TIME #####

1 Intake ends after (yr)
 50 Dose calc. ends after (yr)
 1 Release ends after (yr)
 0 No. of years of air deposition prior to the intake period
 0 No. of years of irrigation water deposition prior to the intake period

FAR-FIELD SCENARIOS (IF POPULATION DOSE) #####

0 Definition option: 1-Use population grid in file POP.IN
 0 2-Use total entered on this line

NEAR-FIELD SCENARIOS #####

Prior to the beginning of the intake period: (yr)
 0 When was the inventory disposed? (Package degradation starts)
 0 When was LOIC? (Biotic transport starts)
 0 Fraction of roots in upper soil (top 15 cm)
 0 Fraction of roots in deep soil
 0 Manual redistribution: deep soil/surface soil dilution factor
 0 Source area for external dose modification factor (m2)

TRANSPORT #####

====ATR TRANSPORT====SECTION 1====
 0-Calculate PM | 0 Release type (0-3)
 1 Option: 1-Use chi/Q or PM value | F Stack release (T/F)
 2-Select MI dist & dir | 0 Stack height (m)
 3-Specify MI dist & dir | 0 Stack flow (m3/sec)
 7.32e-2 Chi/Q or PM value | 0 Stack radius (m)
 7 MI sector index (1=5) | 0 Effluent temp. (C)
 100. MI distance from release point (m) | 0 Building x-section (m2)
 T Use jf data, (T/F) else chi/Q grid | 0 Building height (m)

====SURFACE WATER TRANSPORT====SECTION 2====

0 Mixing ratio model: 0-use value, 1-river, 2-lake
 0 Mixing ratio, dimensionless
 0 Average river flow rate for: MIXFLG=0 (m3/s), MIXFLG=1,2 (m/s),
 0 Transit time to irrigation withdrawal location (hr)
 0 If mixing ratio model > 0:
 0 Rate of effluent discharge to receiving water body (m3/s)
 0 Longshore distance from release point to usage location (m)
 0 Offshore distance to the water intake (m)
 0 Average water depth in surface water body (m)
 0 Average river width (m), MIXFLG=1 only
 0 Depth of effluent discharge point to surface water (m), lake only

====WASTE FORM AVAILABILITY====SECTION 3====

0 Waste form/package half life, (yr)
 0 Waste thickness, (m)
 0 Depth of soil overburden, m

====BIOTIC TRANSPORT OF BURIED SOURCE====SECTION 4====

T Consider during inventory decay/buildup period (T/F)?
 T Consider during intake period (T/F)? | 1-Arid non agricultural
 0 Pre-Intake site condition..... | 2-Humid non agricultural
 | 3-Agricultural

EXPOSURE #####

====EXTERNAL EXPOSURE====SECTION 5====

Exposure time: | Residential irrigation:
 0 Plume (hr) | T Consider: (T/F)
 0 Soil contamination (hr) | 0 Source: 1-ground water
 0 Swimming (hr) | 2-surface water
 0 Boating (hr) | 0 Application rate (in/yr)
 0 Shoreline activities (hr) | 0 Duration (mo/yr)
 0 Shoreline type: {1-river, 2-lake, 3-ocean, 4-tidal basin)
 0 Transit time for release to reach aquatic recreation (hr)
 1.0 Average fraction of time submersed in acute cloud (hr/person hr)

8766.0 ===INHALATION=====SECTION 6=====
 0 Hours of exposure to contamination per year
 0 0-No resus- 1-Use Mass Loading 2-Use Anspaugh model
 0 pension Mass loading factor (g/m3) Top soil available (cm)

===INGESTION POPULATION=====SECTION 7=====
 0 Atmospheric production definition (select option):
 0 0-Use food-weighted chi/Q, (food-sec/m3), enter value on this line
 1-Use population-weighted chi/Q
 2-Use uniform production
 3-Use chi/Q and production grids (PRODUCTION will be overridden)
 0 Population ingesting aquatic foods, 0 defaults to total (person)
 0 Population ingesting drinking water, 0 defaults to total (person)
 F Consider dose from food exported out of region (default=F)

Note below: S* or Source: 0-none, 1-ground water, 2-surface water
 3-Derived concentration entered above

=== AQUATIC FOODS / DRINKING WATER INGESTION=====SECTION 8=====
 F Salt water? (default is fresh)

USE ?	FOOD T/F TYPE	TRAN- SIT hr	PROD- UCTION kg/yr	-CONSUMPTION- HOLDUP da	RATE kg/yr		DRINKING WATER
F	FISH	0.00	0.0E+00	0.00	0.0	0	Source (see above)
F	MOLLUS	0.00	0.0E+00	0.00	0.0	T	Treatment? T/F
F	CRUSTA	0.00	0.0E+00	0.00	0.0	0	Holdup/transit(da)
F	PLANTS	0.00	0.0E+00	0.00	0.0	0	Consumption (L/yr)

===TERRESTRIAL FOOD INGESTION=====SECTION 9=====

USE ?	FOOD T/F TYPE	GROW TIME da	--IRRIGATION-- S RATE * in/yr	TIME mo/yr	YIELD kg/m2	PROD- UCTION kg/yr	--CONSUMPTION-- HOLDUP da	RATE kg/yr
F	LEAF V	0.00	0	0.0	0.0	0.0E+00	0.0	0.0
F	ROOT V	0.00	0	0.0	0.0	0.0E+00	0.0	0.0
F	FRUIT	0.00	0	0.0	0.0	0.0E+00	0.0	0.0
F	GRAIN	0.00	0	0.0	0.0	0.0E+00	0.0	0.0

===ANIMAL PRODUCTION CONSUMPTION=====SECTION 10=====

USE ?	FOOD T/F TYPE	---HUMAN--- CONSUMPTION RATE kg/yr	TOTAL HOLDUP da	PROD- UCTION kg/yr	DRINK WATER CONTAM FRACT.	DIET FRACT.	GROW TIME da	---STORED FEED--- S RATE * in/yr	--IRRIGATION-- TIME mo/yr	YIELD kg/m3	STOR- AGE da
F	BEEF	0.0	0.0	0.00	0.00	0.00	0.0	0.0	0.00	0.00	0.0
F	POULTR	0.0	0.0	0.00	0.00	0.00	0.0	0.0	0.00	0.00	0.0
F	MILK	0.0	0.0	0.00	0.00	0.00	0.0	0.0	0.00	0.00	0.0
F	EGG	0.0	0.0	0.00	0.00	0.00	0.0	0.0	0.00	0.00	0.0
	BEEF						0.00	0.0	0.0	0.00	0.0
	MILK						0.00	0.0	0.0	0.00	0.0

#####



CHECKLIST FOR CHECKING OF ANALYSIS/CALCULATIONS

Document Number/Revision: HNF-2209Document Title: Safety Analysis Report for Packaging (Onsite) Steel DrumScope of Review: Dose Consequence Evaluation (Section 4.4), Shielding Evaluation (Section 5), Criticality Evaluation (Section 6)

Yes	No	N/A	
<input checked="" type="checkbox"/>	<input type="checkbox"/>	<input type="checkbox"/>	Problem completely defined.
<input checked="" type="checkbox"/>	<input type="checkbox"/>	<input type="checkbox"/>	Appropriate analytical method used.
<input checked="" type="checkbox"/>	<input type="checkbox"/>	<input type="checkbox"/>	Necessary assumptions are appropriate and explicitly stated.
<input checked="" type="checkbox"/>	<input type="checkbox"/>	<input type="checkbox"/>	Computer codes and data files documented.
<input checked="" type="checkbox"/>	<input type="checkbox"/>	<input type="checkbox"/>	Data used in calculations explicitly stated in document.
<input type="checkbox"/>	<input type="checkbox"/>	<input checked="" type="checkbox"/>	Sources of non-standard formula/data are referenced and the correctness of the reference verified.
<input checked="" type="checkbox"/>	<input type="checkbox"/>	<input type="checkbox"/>	Data checked for consistency with original source information as applicable.
<input checked="" type="checkbox"/>	<input type="checkbox"/>	<input type="checkbox"/>	Mathematical derivations checked including dimensional consistency of results.
<input checked="" type="checkbox"/>	<input type="checkbox"/>	<input type="checkbox"/>	Models appropriate and used within range of validity or use outside range of established validity justified.
<input checked="" type="checkbox"/>	<input type="checkbox"/>	<input type="checkbox"/>	Hand calculations checked for errors.
<input checked="" type="checkbox"/>	<input type="checkbox"/>	<input type="checkbox"/>	Code run streams correct and consistent with analysis documentation.
<input checked="" type="checkbox"/>	<input type="checkbox"/>	<input type="checkbox"/>	Code output consistent with input and with results reported in analysis documentation.
<input checked="" type="checkbox"/>	<input type="checkbox"/>	<input type="checkbox"/>	Acceptability limits on analytical results applicable and supported. Limits checked against sources.
<input checked="" type="checkbox"/>	<input type="checkbox"/>	<input type="checkbox"/>	Safety Margins consistent with good engineering practices.
<input checked="" type="checkbox"/>	<input type="checkbox"/>	<input type="checkbox"/>	Conclusions consistent with analytical results and applicable limits.
<input checked="" type="checkbox"/>	<input type="checkbox"/>	<input type="checkbox"/>	Results and conclusions address all points required in the problem statement.

I have checked the analysis/calculation and it is complete and accurate to the best of my knowledge.

Engineer/Checker A. V. Savino

Date 9/22/98

This page intentionally left blank.

5.0 SHIELDING EVALUATION

5.1 INTRODUCTION

This shielding evaluation supports the use of steel 208 L (55-gal) drums to ship a variety of solid or liquid radioactive materials on the Hanford Site. Solid materials may include absorbed organic or inorganic liquids, glass, paper, wood, or metal. Liquid materials may include a number of different configurations in volumes up to 40 L, provided the drum has sufficient absorbent material for twice the liquid volume. The radioactive constituents may include a wide variety of radionuclides, but the contents may be limited by the drum external dose rates. Due to the variability of the payload, this shielding evaluation will estimate the maximum quantity of certain nuclides that may be transported in a single drum based on a surface dose rate limit of 10 mSv/h (1,000 mrem/h).

Because this evaluation will only consider the selected nuclides individually in a single configuration and since the payloads will vary significantly during operations, the shipper must ensure that the dose rate limits for transportation are met at the time of shipment. Radiation dose rate limits are 10 mSv/h (1,000 mrem/h) on the drum surface, 2 mSv/h (200 mrem/h) at the vehicle edge, and 0.1 mSv/h (10 mrem/h) at 2 m (7 ft) from the edge of the vehicle. There is an additional limit of 0.05 mSv/h (5 mrem/h) at the driver location provided the driver is a qualified Hanford Site radiological worker; otherwise, the limit is 0.02 mSv/h (2 mrem/h). The allowable contents will not be restricted based on the predicted shielding-based maximum activities. They are provided as guidance.

5.2 DIRECT RADIATION SOURCE SPECIFICATION

The isotopes selected for evaluation are ^{60}Co , ^{90}Sr , ^{137}Cs , ^{152}Eu , ^{154}Eu , and ^{239}Pu . These isotopes, except for ^{239}Pu , were individually evaluated to determine the maximum quantity of material that could be evenly distributed in a drum with a surface dose rate of 10 mSv/h (1,000 mrem/h). Because the amount of fissile material is limited, the neutron dose was evaluated for 200 g of ^{239}Pu only.

5.2.1 Gamma Source

The ORIGEN-S (Bowman 1997, WMNW 1998b) computer code was used to calculate the gamma-ray source for 3.7×10^{10} Bq (1.0 Ci) of the radionuclides ^{60}Co , ^{90}Sr , ^{137}Cs , ^{152}Eu , and ^{154}Eu . The gamma source term for ^{239}Pu was not determined since it is limited to 200 g of total material. Table B5-1 lists the ORIGEN-S photon emission rates for each energy group for each nuclide. The cases used the photon library for bremsstrahlung in water and the input files for each isotope are attached in Part B, Section 5.8.1.

5.2.2 Beta Source

The beta source inside the drum leads to an insignificant dose rate outside the drum because of the shielding provided by the drum wall. The bremsstrahlung radiation produced by the deceleration of the beta particles in the source is accounted for in the photon emission rates calculated using the ORIGEN-S (Bowman 1997, WMNW 1998b) computer code.

Table B5-1. Photon Emission Rates (Photons/s) for
3.7 x 10¹⁰ Bq (1 Ci) of Selected Radionuclides.

Energy	⁶⁰ Co	⁹⁰ Sr	¹³⁷ Cs	¹⁵² Eu	¹⁵⁴ Eu
1.50 E-02	5.92 E+07	9.03 E+08	1.18 E+08	1.77 E+07	1.70 E+08
2.50 E-02	2.54 E+07	4.48 E+08	5.44 E+07	8.54 E+06	8.12 E+07
3.75 E-02	1.74 E+07	3.57 E+08	2.31 E+09	2.67 E+10	8.64 E+09
5.25 E-02	1.08 E+07	2.70 E+08	2.76 E+07	2.41 E+09	1.82 E+09
6.50 E-02	4.45 E+06	1.29 E+08	1.23 E+07	2.25 E+06	2.07 E+07
7.25 E-02	1.77 E+06	5.56 E+07	5.11 E+06	9.56 E+05	8.77 E+06
8.75 E-02	5.40 E+06	2.23 E+08	1.81 E+07	3.67 E+06	3.43 E+07
1.25 E-01	3.43 E+06	2.32 E+08	1.53 E+07	1.02 E+10	1.48 E+10
1.75 E-01	8.84 E+05	1.63 E+08	7.46 E+06	1.03 E+07	1.18 E+08
2.50 E-01	2.26 E+05	1.31 E+08	4.22 E+06	2.99 E+09	2.46 E+09
3.50 E-01	2.83 E+06	1.01 E+08	1.64 E+06	1.01 E+10	1.20 E+08
4.25 E-01	1.09 E+04	3.13 E+07	2.86 E+05	2.03 E+09	2.54 E+08
4.80 E-01	1.02 E+04	3.13 E+07	2.25 E+05	2.42 E+08	1.23 E+08
5.11 E-01	0.00 E+00	0.00 E+00	0.00 E+00	2.74 E+07	1.45 E+07
5.56 E-01	4.18 E+03	1.42 E+07	7.91 E+04	4.59 E+08	2.38 E+09
6.50 E-01	6.00 E+03	2.15 E+07	3.20 E+10	6.50 E+08	9.33 E+08
7.50 E-01	3.49 E+03	1.45 E+07	4.58 E+04	5.10 E+09	8.76 E+09
9.00 E-01	2.58 E+06	1.67 E+07	2.35 E+04	7.84 E+09	1.08 E+10
1.10 E+00	3.94 E+10	8.18 E+06	1.44 E+03	9.41 E+09	4.98 E+09
1.27 E+00	1.95 E+10	3.33 E+06	8.88 E-02	1.22 E+09	1.35 E+10
1.39 E+00	1.78 E+10	1.33 E+06	0.00 E+00	7.81 E+09	2.24 E+07
1.47 E+00	2.94 E-02	4.43 E+05	0.00 E+00	1.79 E+08	2.47 E+08
1.54 E+00	2.82 E-02	4.24 E+05	0.00 E+00	9.45 E+07	2.34 E+07
1.62 E+00	0.00 E+00	5.46 E+05	0.00 E+00	7.11 E+06	6.11 E+08
1.73 E+00	0.00 E+00	4.21 E+05	0.00 E+00	3.67 E+06	1.55 E+06
1.90 E+00	0.00 E+00	2.27 E+05	0.00 E+00	1.88 E-08	5.08 E+05
2.08 E+00	0.00 E+00	4.49 E+04	0.00 E+00	0.00 E+00	0.00 E+00
2.25 E+00	3.90 E+05	0.00 E+00	0.00 E+00	8.66 E-19	0.00 E+00
2.43 E+00	6.88 E+02	2.71 E+02	0.00 E+00	0.00 E+00	0.00 E+00
2.75 E+00	6.06 E+02	0.00 E+00	0.00 E+00	4.35 E-19	0.00 E+00
3.25 E+00	0.00 E+00	0.00 E+00	0.00 E+00	2.18 E-19	0.00 E+00
3.75 E+00	0.00 E+00	0.00 E+00	0.00 E+00	1.09 E-19	0.00 E+00
4.25 E+00	0.00 E+00	0.00 E+00	0.00 E+00	5.48 E-20	0.00 E+00
4.75 E+00	0.00 E+00	0.00 E+00	0.00 E+00	2.75 E-20	0.00 E+00
5.25 E+00	0.00 E+00	0.00 E+00	0.00 E+00	1.38 E-20	0.00 E+00
5.75 E+00	0.00 E+00	0.00 E+00	0.00 E+00	6.92 E-21	0.00 E+00
6.25 E+00	0.00 E+00	0.00 E+00	0.00 E+00	3.47 E-21	0.00 E+00
6.75 E+00	0.00 E+00	0.00 E+00	0.00 E+00	1.74 E-21	0.00 E+00
7.25 E+00	0.00 E+00	0.00 E+00	0.00 E+00	8.73 E-22	0.00 E+00
7.75 E+00	0.00 E+00	0.00 E+00	0.00 E+00	4.38 E-22	0.00 E+00
9.00 E+00	0.00 E+00	0.00 E+00	0.00 E+00	3.95 E-22	0.00 E+00
1.10 E+01	0.00 E+00	0.00 E+00	0.00 E+00	1.30 E-23	0.00 E+00
1.30 E+01	0.00 E+00	0.00 E+00	0.00 E+00	0.00 E+00	0.00 E+00
1.70 E+01	0.00 E+00	0.00 E+00	0.00 E+00	0.00 E+00	0.00 E+00
Total	7.68 E+10	3.16 E+09	3.45 E+10	8.75 E+10	7.10 E+10

5.2.3 Neutron Source

The total neutron source for 200 g of ^{239}Pu (0.46 TBq [12.4 Ci]) from spontaneous fission and alpha-n reactions was calculated to be 8.44×10^3 neutrons/s using the ORIGEN-S (Bowman 1997, WMNW 1998b) computer code. Note that the neutron source term was calculated assuming that the source material was in oxide form. The neutron dose rate was estimated using the methods described in *Estimation of Neutron Dose Rates from Nuclides Waste Packages* (Nelson 1996) and was found to be insignificant compared to the gamma dose rate for each nuclide evaluated, 5.23×10^{-3} mSv/h (5.23×10^{-1} mrem/h). However, note that strong neutron emitters, for example Cf, or Es could produce very high neutron dose rates. The ORIGEN-S input file and neutron source term are attached in Part B, Section 5.8.2.6, and the neutron dose rate estimate is shown in Part B, Section 5.8.3.

5.3 SUMMARY OF SHIELDING PROPERTIES OF MATERIALS

The shielding attenuation properties for the bulk materials used in this analysis were obtained from the Monte Carlo N-Particle (MCNP) computer code data library (RSICC 1997, WMNW 1998a). A description of the configuration and densities of the shielding materials used in the calculational models is given in Part B, Section 5.4.3.

5.4 NORMAL TRANSFER CONDITIONS

5.4.1 Conditions To Be Evaluated

Dose rates will be evaluated at the drum surface only (side and top) assuming a uniformly distributed payload. Each isotope listed in Part B, Section 5.2, above, will be evaluated individually.

5.4.2 Acceptance Criteria

Dose rate limits for normal shipments are 10 mSv/h (1,000 mrem/h) on the drum surface. Due to the variability of the payloads and loading configurations, the dose rate limits must be checked by the shipper as stated in Part B, Section 5.1, above.

5.4.3 Shielding Model

The MCNP computer code (RSICC 1997, WMNW 1998a) was used for the gamma-ray dose rate calculations. MCNP is a three-dimensional Monte Carlo computer code and uses Evaluated Nuclear Data Files (ENDF/B) for cross sections (BNL 1991). The ENDF/B system is maintained by the National Nuclear Data Center at Brookhaven National Laboratory under contract from the U.S. Department of Energy. The quality assurance documentation of MCNP for use within WMNW is given in WMNW (1998a). Bremsstrahlung photons are accounted for in the dose rate calculations. Fluence-to-dose conversion factors were conservatively based on an anterior-to-posterior irradiation pattern (ANSI/ANS 1991) and are listed in Table B5-2.

Table B5-2. Photon Fluence-to-Dose Conversion Factors.

Energy (MeV)	Flux-to-dose rate (mrem/h)/(photon/cm ² /s)	Energy (MeV)	Flux-to-dose rate (mrem/h)/(photon/cm ² /s)
1.00 E-02	2.232 E-05	5.00 E-01	9.144 E-04
1.50 E-02	5.625 E-05	6.00 E-01	1.076 E-03
2.00 E-02	8.568 E-05	8.00 E-01	1.379 E-03
3.00 E-02	1.184 E-04	1.00 E+00	1.656 E-03
4.00 E-02	1.314 E-04	1.50 E+00	2.246 E-03
5.00 E-02	1.382 E-04	2.00 E+00	2.758 E-03
6.00 E-02	1.440 E-04	3.00 E+00	3.672 E-03
8.00 E-02	1.624 E-04	4.00 E+00	4.500 E-03
1.00 E-01	1.919 E-04	5.00 E+00	5.292 E-03
1.50 E-01	2.797 E-04	6.00 E+00	6.012 E-03
2.00 E-01	3.708 E-04	8.00 E+00	7.488 E-03
3.00 E-01	5.616 E-04	1.00 E+01	8.892 E-03
4.00 E-01	7.416 E-04	1.20 E+01	1.040 E-02

Source: ANSI/ANS, 1991, *Neutron and Gamma-ray Fluence-to-dose Factors*, ANSI/ANS-6.1.1-1991, American National Standards Institute/American Nuclear Society, New York, New York.

The radial and axial shielding parameters used are shown in Table B5-3. The model used is a standard UN1A2 steel drum with a 90 mil plastic liner. The drum and liner are shown in DOE/RL-96-57, *Test and Evaluation Document for DOT Specification 7A Type A Packaging*. For solid materials, the waste matrix was considered to be polyethylene with a density of 0.5 g/cm³ (compacted trash).

Table B5-3. Shielding Parameters for the Steel Drum.

Zone (material)	Zone outer radius or height		Zone thickness		Zone material density
	cm	in.	cm	in.	g/cm ³
Radial parameters, drum filled with solid materials					
Source (polyethylene)	27.711	10.91	27.711	10.91	0.5
Liner (polyethylene)	27.940	11	0.229	0.09	0.9
Air gap	28.258	11.125	0.318	0.125	0.00129
Wall (16 ga steel)	28.410	11.185	0.152	0.060	7.86
Axial parameters, drum filled with solid materials, measured from the outside bottom of the drum to the top					
Wall (16 ga steel)	0.152	0.060	0.152	0.060	7.86
Liner (polyethylene)	0.381	0.15	0.229	0.09	0.9
Source (polyethylene)	83.744	32.97	83.363	32.82	0.5
Liner (polyethylene)	83.972	33.06	0.229	0.09	0.9
Air gap	84.607	33.31	0.635	0.25	0.00129
Wall (16 ga steel)	84.759	33.370	0.152	0.060	7.86

5.4.4 Shielding Results

The MCNP computer code was used to iteratively to determine the amount of each radionuclide that may be transported in the drum. The configuration utilized the parameters shown in Table B5-3 and assumed the isotope of interest was uniformly distributed in the waste matrix. Starting with 3.7×10^{10} Bq (1 Ci) of each isotope, the total photon production rate was iterated in MCNP until an emission rate was determined that would produce a dose rate on the side surface of the drum of 10 mSv/h (1,000 mrem/h). As expected, the photon emission rate is directly proportional to the amount of the radionuclide present, which results in the loading shown in Table B5-4. Note that the limit for fissile material in the drum is established at 200 g, and the ^{239}Pu entry reflects this limit without any evaluation of the small gamma activity for Pu. The MCNP input files for each isotope are shown in Part B, Sections 5.8.2.1. through 5.8.2.5.

Table B5-4. Gamma-Emitting Radionuclide Quantities in a Solid Waste Matrix.

Isotope	Quantity	
	TBq	Ci
^{60}Co	4.48 E-03	1.21 E-01
^{90}Sr	1.71 E+00	4.61 E+01
^{137}Cs	1.90 E-02	5.13 E-01
^{152}Eu	1.02 E-02	2.76 E-01
^{154}Eu	8.79 E-03	2.37 E-01
^{239}Pu	Limited to 200 g of fissile material	

5.5 ACCIDENT CONDITIONS

5.5.1 Conditions To Be Evaluated

The drum and the payload offer no substantial shielding. Therefore, the dose rate directly from the payload alone, assuming a complete release of the payload, will be evaluated for all the isotopes considered above.

5.5.2 Acceptance Criteria

The external dose rate limit for accident conditions is 10 mSv/h (1,000 mrem/h) at 1 m (3 ft) from a drum.

5.5.3 Shielding Model

The same shielding model used for normal conditions above will be used for accidents except that the materials, other than the payload, will be replaced with air. The MCNP input for ^{60}Co is attached in part B, Section 5.8.2.6. The inputs for the other radionuclides were derived from this by using the photon emission rates shown in Table B5-1 with the allowed source term from Table B5-4 for each isotope.

5.5.4 Shielding Results

For the conditions evaluated, the dose rate at 1 m from the unshielded payload is varies from a low of 0.63 mSv/h (63 mrem/h) for ^{60}Co to a high of 0.97 mSv/h (97 mrem/h) for ^{90}Sr . This is well below the limit of 10 mSv/h (1,000 mrem/h). Note that higher activities may be transported based on direct measurement. The shipper is not authorized to use internal shielding that could result in an unacceptable accident dose rate. It is assumed any extra internal self-shielding would continue to function in an accident due to the nature of the contents.

5.6 SHIELDING EVALUATION AND CONCLUSIONS

The radionuclide limits shown in Table B5-4 are based on the amount of material that would produce a dose rate on the surface of the drum of approximately 10 mSv/h (1,000 mrem/h), except for ^{239}Pu , which is limited to no more than 200 g. The accident condition dose rate is met assuming a complete release of the payload, a conservative assumption, for all nuclides evaluated. The consequences of an accident are discussed in Part B, Section 4.0. Note that the results are only valid for the conditions evaluated. Because the material which may be shipped in the drum is not limited to the isotopes shown and configuration shown, the shipper must ensure that all transportation dose rate limits are met at the time of shipment.

5.7 REFERENCES

- ANSI/ANS, 1991, *Neutron and Gamma-ray Fluence-to-dose Factors*, ANSI/ANS-6.1.1-1991, American National Standards Institute/American Nuclear Society, New York, New York.
- BNL, 1991, *ENDF/B-VI Summary Documentation*, BNL-NCS-17541, 4th edition, Brookhaven National Laboratory, Upton, New York.
- Bowman, S. M., 1997, RSICC Computer Code Collection, SCALE 4.3, Radiation Shielding Information Center, Oak Ridge National Laboratory, Oak Ridge Tennessee.
- DOE/RL-96-57, *Test and Evaluation Document for DOT Specification 7A Type A Packaging*, Volume 1 (1998, Rev. 0-B) and Volume 2 (1997, Draft A), U.S. Department of Energy, Richland Operations Office, Richland, Washington.
- Nelson, J. V., 1996, *Estimation of Neutron Dose Rates from Nuclear Waste Packages*, (internal memo 8M730-JVN-96-007 to J. R. Green, March 8), Westinghouse Hanford Company, Richland, Washington.
- RSICC, 1997, *MCNP4B-Monte Carlo N-Particle Transport Code System*, CCC-660, Radiation Safety Information Computational Center, Oak Ridge, Tennessee.
- WMNW, 1998a, *WMNW Computer Program Verification for MCNP Version 4B*, EBU-SQA-002, Revision 0-A, Waste Management Federal Services, Inc., Northwest Operations, Richland, Washington.
- WMNW, 1998b, *WMNW Computer Program Verification for SCALE 4.3*, EBU-SQA-001, Revision 0-A, Waste Management Federal Services, Inc., Northwest Operations, Richland, Washington.

5.8 APPENDICES

5.8.1 ORIGEN-S Input Files

5.8.1.1 ⁶⁰Co.

```

#ORIGENS
0$$ A11 71 E T
DECAY CASE
3$$ 21 1 1 0 A16 4 A33 44 E T
35$$ 0 T
56$$ A2 1 A6 1 A10 0 A13 1 A15 3 E
57** 0 E T
CO 60 DECAT
CI
60** .01
61** F.00001
65$$
'GRAM-ATOMS GRAMS CURIES WATTS-ALL WATTS-GAMMA
3Z 3Z 0 0 1 3Z 3Z 6Z
3Z 3Z 0 0 1 3Z 3Z 6Z
3Z 3Z 0 0 1 3Z 3Z 6Z
81$$ 2 0 24 1 E
82$$ 2
83** 2.E+7 1.4E+7 1.2E+7 1.E+7 8.E+6
7.5E+6 7.E+6 6.5E+6 6.E+6 5.5E+6
5.E+6 4.5E+6 4.E+6 3.5E+6 3.E+6
2.5E+6 2.349999E+6 2.149999E+6 2.E+6 1.799999E+6
1.659999E+6 1.569999E+6 1.5E+6 1.439999E+6 1.329999E+6
1.199999E+6 1.E+6 7.999999E+5 6.999999E+5 5.999999E+5
5.119999E+5 5.099999E+5 4.499999E+5 3.999999E+5 2.999999E+5
1.999999E+5 1.499999E+5 9.999994E+4 7.499994E+4 6.999994E+4
6.E+4 4.5E+4 3.E+4 2.E+4 9.999996E+3
73$$ 270600
74** 1.0E00
75$$ 1 T
CO 60 DECAT TIMESTEP 1
56$$ 0 0 A10 1 E T
56$$ FO T
END

```

5.8.1.2 ⁹⁰Sr/⁹⁰Y.

```

#ORIGENS
0$$ A11 71 E T
DECAY CASE
3$$ 21 1 1 0 A16 4 A33 44 E T
35$$ 0 T
56$$ A2 1 A6 1 A10 0 A13 2 A15 3 E
57** 0 E T
SR90
CI
60** .01
61** F.00001
65$$
'GRAM-ATOMS GRAMS CURIES WATTS-ALL WATTS-GAMMA
21Z
21Z
3Z 3Z 0 0 1 3Z 3Z 6Z
81$$ 2 0 24 1 E
82$$ 2
83** 2.E+7 1.4E+7 1.2E+7 1.E+7 8.E+6
7.5E+6 7.E+6 6.5E+6 6.E+6 5.5E+6
5.E+6 4.5E+6 4.E+6 3.5E+6 3.E+6
2.5E+6 2.349999E+6 2.149999E+6 2.E+6 1.799999E+6

```

```

1.659999E+6 1.569999E+6 1.5E+6 1.439999E+6 1.329999E+6
1.199999E+6 1.E+6 7.999999E+5 6.999999E+5 5.999999E+5
5.119999E+5 5.099999E+5 4.499999E+5 3.999999E+5 2.999999E+5
1.999999E+5 1.499999E+5 9.999994E+4 7.499994E+4 6.999994E+4
6.E+4 4.5E+4 3.E+4 2.E+4 9.999996E+3
73$$ 380900 390900
74** 1.00E00 1.00E00
75$$ 3 3 T
SR90 TIMESTEP 1
56$$ 0 0 A10 1 E T
56$$ FO T
END

```

5.8.1.3 ¹³⁷Cs/^{137m}Ba.

```

#ORIGENS
O$$ A11 71 E T
DECAY CASE
3$$ 21 1 1 0 A16 4 A33 44 E T
35$$ 0 T
56$$ A2 1 A6 1 A10 0 A13 2 A15 3 E
57** 0 E T
CS137
CI
60** .01
61** F0.00001
65$$
'GRAM-ATOMS GRAMS CURIES WATTS-ALL WATTS-GAMMA
21Z
21Z
3Z 3Z 0 0 1 3Z 3Z 6Z
81$$ 2 0 24 1 E
82$$ 2
83** 2.E+7 1.4E+7 1.2E+7 1.E+7 8.E+6
7.5E+6 7.E+6 6.5E+6 6.E+6 5.5E+6
5.E+6 4.5E+6 4.E+6 3.5E+6 3.E+6
2.5E+6 2.349999E+6 2.149999E+6 2.E+6 1.799999E+6
1.659999E+6 1.569999E+6 1.5E+6 1.439999E+6 1.329999E+6
1.199999E+6 1.E+6 7.999999E+5 6.999999E+5 5.999999E+5
5.119999E+5 5.099999E+5 4.499999E+5 3.999999E+5 2.999999E+5
1.999999E+5 1.499999E+5 9.999994E+4 7.499994E+4 6.999994E+4
6.E+4 4.5E+4 3.E+4 2.E+4 9.999996E+3
73$$ 551370 561371
74** 1.0 0.946
75$$ 3 3 T
CS137 TIMESTEP 1
56$$ 0 0 A10 1 E T
56$$ FO T
END

```

5.8.1.4 ¹⁵²Eu.

```

#ORIGENS
O$$ A11 71 E T
DECAY CASE
3$$ 21 1 1 0 A16 4 A33 44 E T
35$$ 0 T
56$$ A2 1 A6 1 A10 0 A13 1 A15 3 E
57** 0 E T
EU152
CI
60** .01
61** F0.00001
65$$
'GRAM-ATOMS GRAMS CURIES WATTS-ALL WATTS-GAMMA
21Z
21Z

```

```

      3Z      3Z      0 0 1      3Z      3Z      6Z
81$$ 2 0 24 1 E
82$$ 2
83** 2.E+7      1.4E+7      1.2E+7      1.E+7      8.E+6
 7.5E+6      7.E+6      6.5E+6      6.E+6      5.5E+6
 5.E+6      4.5E+6      4.E+6      3.5E+6      3.E+6
 2.5E+6      2.349999E+6      2.149999E+6      2.E+6      1.799999E+6
 1.659999E+6      1.569999E+6      1.5E+6      1.439999E+6      1.329999E+6
 1.199999E+6      1.E+6      7.999999E+5      6.999999E+5      5.999999E+5
 5.119999E+5      5.099999E+5      4.499999E+5      3.999999E+5      2.999999E+5
 1.999999E+5      1.499999E+5      9.999994E+4      7.499994E+4      6.999994E+4
 6.E+4      4.5E+4      3.E+4      2.E+4      9.999996E+3
73$$ 631520
74** 1.00E00
75$$ 3 T
EUI52 TIMESTEP 1
56$$ 0 0 A10 1 E T
56$$ FO T
END

```

5.8.1.5 ¹⁵⁴Eu.

```

#ORIGENS
0$$ A11 71 E T
DECAY CASE
3$$ 21 1 1 0 A16 4 A33 44 E T
35$$ 0 T
56$$ A2 1 A6 1 A10 0 A13 1 A15 3 E
57** 0 E T
EUI54
CI
60** .01
61** FO.00001
65$$
'GRAM-ATOMS GRAMS CURIES WATTS-ALL WATTS-GAMMA
 21Z
 21Z
      3Z      3Z      0 0 1      3Z      3Z      6Z
81$$ 2 0 24 1 E
82$$ 2
83** 2.E+7      1.4E+7      1.2E+7      1.E+7      8.E+6
 7.5E+6      7.E+6      6.5E+6      6.E+6      5.5E+6
 5.E+6      4.5E+6      4.E+6      3.5E+6      3.E+6
 2.5E+6      2.349999E+6      2.149999E+6      2.E+6      1.799999E+6
 1.659999E+6      1.569999E+6      1.5E+6      1.439999E+6      1.329999E+6
 1.199999E+6      1.E+6      7.999999E+5      6.999999E+5      5.999999E+5
 5.119999E+5      5.099999E+5      4.499999E+5      3.999999E+5      2.999999E+5
 1.999999E+5      1.499999E+5      9.999994E+4      7.499994E+4      6.999994E+4
 6.E+4      4.5E+4      3.E+4      2.E+4      9.999996E+3
73$$ 631540
74** 1.00E00
75$$ 3 T
EUI54 TIMESTEP 1
56$$ 0 0 A10 1 E T
56$$ FO T
END

```

5.8.1.6 200 g of ²³⁹Pu (Neutron Production Rate).

```

#ORIGENS
0$$ A11 71 E T
DECAY CASE
3$$ 21 1 1 238 A16 4 A33 44 E T
35$$ 0 T
56$$ A2 2 A6 1 A10 0 A13 1 A14 5 A15 3 E
57** 0 E T
FU239

```



```

74** 12.4
75$$ 2 T
PU239 TIMESTEP 2
56$$ 0 0 A10 2 E T
56$$ F0 T
END

```

5.8.2 MCNP Input Files

5.8.2.1 ⁶⁰Co.

Determine Amount of Co 60 to Produce Dose on a Drum surface of 1,000 mrem/h

```

c
c First define the source cells
c mat# mat den surfaces
c
1 1 -0.5 -1 2 -3 $ source
2 2 -0.9 -4 5 -6 #1 $ liner
3 3 -0.00129 -7 5 -8 #1 #2 $ air
4 4 -7.86 -9 10 -11 #1 #2 #3 $ drum
5 3 -0.00129 9 -12 13 -14 #1 #2 #3 #4 $ Cell detector
6 5 -0.00129 -15 #1 #2 #3.#4 #5 $ air around drum
7 0 15 $ void - outside universe

```

```

c
c Radial surfaces
c
1 cz 27.7114 $ source
4 cz 27.9400 $ liner
7 cz 28.2575 $ air gap
9 cz 28.4099 $ drum
12 cz 30.4099 $ cell detector boundary

```

```

c
c Axial surfaces
c
2 pz 0.381 $ Bottom of source
3 pz 83.744 $ Top of source
5 pz 0.152 $ Bottom of liner, bottom of air cylinder
6 pz 83.973 $ Top of liner
8 pz 84.608 $ Top of air gap
10 pz 0.0 $ Bottom of drum
11 pz 84.76 $ Top of drum
13 pz 41.38 $ Bottom of cell detector
14 pz 43.38 $ Top of cell detector
15 sz 42.38 200 $ air

```

```

mode p $photon
c *****
c SOURCE
c *****
sdef cel=1 wgt= 9.285E+09 erg=d1 pos= 0 0 0
rad= d2 ext= d3 axs= 0 0 1
scl Source distribution from ORIGENS
# sil sp1 sb1
l d d
1.50E-02 5.92E+07 1.0
2.50E-02 2.54E+07 1.0
3.75E-02 1.74E+07 1.0
5.25E-02 1.08E+07 1.0
6.50E-02 4.45E+06 1.0
7.25E-02 1.77E+06 1.0
8.75E-02 5.40E+06 1.0
1.25E-01 3.43E+06 1.0
1.75E-01 8.84E+05 1.0
2.50E-01 2.26E+05 1.0
3.50E-01 2.83E+06 1.0

```

```

4.25E-01  1.09E+04  1.0
4.80E-01  1.02E+04  1.0
5.56E-01  4.18E+03  1.0
6.50E-01  6.00E+03  1.0
7.50E-01  3.49E+03  1.0
9.00E-01  2.58E+06  1.0
1.10E+00  3.94E+10  1.0
1.27E+00  1.95E+10  1.0
1.39E+00  1.78E+10  1.0
1.47E+00  2.94E-02  1.0
1.54E+00  2.82E-02  1.0
2.25E+00  3.90E+05  1.0
2.43E+00  6.88E+02  1.0
2.75E+00  6.06E+02  1.0
c Total from ORIGENS for 1 Ci = 7.68E+10, 0.121 Ci= 9.285E+09 photons/s
sc2 Source radius
si2 0 27.7114
sc3 Source length
si3 0.381 83.744
c
c ansi/ans-6.1.1-1991 fluence-to-dose, photons (mrem/hr/ (p/cm**2/s)
c.
de0 log .01 .015 .02 .03 .04 .05
      .06 .08 .10 .15 .20 .30
      .40 .50 .60 .80 1.0 1.5
      2.0 3.0 4.0 5.0 6.0 8.0
      10. 12.
df0 log 2.232e-5 5.652e-5 8.568e-5 1.184e-4 1.314e-4 1.382e-4
      1.440e-4 1.624e-4 1.919e-4 2.797e-4 3.708e-4 5.616e-4
      7.416e-4 9.144e-4 1.076e-3 1.379e-3 1.656e-3 2.246e-3
      2.758e-3 3.672e-3 4.500e-3 5.292e-3 6.012e-3 7.488e-3
      8.892e-3 1.040e-2
c
c Material Definitions
c
m1 1000.01p -0.07 $ plastic - hydrogen
    6000.01p -0.43 $ plastic - carbon
m2 1000.01p -0.14 $ plastic - hydrogen
    6000.01p -0.86 $ plastic - carbon
m3 7000.01p -0.765 $ air - Nitrogen
    8000.01p -0.235 $ air - Oxygen
m4 26000.01p -0.6797 $ SS 304
    24000.01p -0.200
    28000.01p -0.100
    25000.01p -0.020
    6000.01p -0.0003
m5 7000.01p -0.765 $ air - Nitrogen
    8000.01p -0.235 $ air - Oxygen
c
print
phys:p j 0 0 $ Brems on & Coherent Scattering On
fc4 cell detector on surface
f4:p 5
fc5 point detector on surface
f5:p 29.4099 0 42.38 0
imp:p
c
c Cell Importances
c
c Cell 1 2 3 4 5 6 7
      1 1 1 1 1 0
nps 400000 $history

```

5.8.2.2 ⁹⁰Sr/⁹⁰Y.

```

Determine Amount of Sr 90/Y 90 to Produce Dose on a Drum surface of 1,000 mrem/h
c
c First define the source cells

```



```

c mat# mat den surfaces
c
1 1 -0.5 -1 2 -3 $ source
2 2 -0.9 -4 5 -6 #1 $ liner
3 3 -0.00129 -7 5 -8 #1 #2 $ air
4 4 -7.86 -9 10 -11 #1 #2 #3 $ drum
5 5 -0.00129 9 -12 13 -14 #1 #2 #3 #4 $ Cell detector
6 5 -0.00129 -15 #1 #2 #3 #4 #5 $ air around drum
7 0 15 $ void - outside universe

```

```

c
c Radial surfaces
c
1 cz 27.7114 $ source
4 cz 27.9400 $ liner
7 cz 28.2575 $ air gap
9 cz 28.4099 $ drum
12 cz 30.4099 $ cell detector boundary

```

```

c
c Axial surfaces
c
2 pz 0.381 $ Bottom of source
3 pz 83.744 $ Top of source
5 pz 0.152 $ Bottom of liner, bottom of air cylinder
6 pz 83.973 $ Top of liner
8 pz 84.608 $ Top of air gap
10 pz 0.0 $ Bottom of drum
11 pz 84.76 $ Top of drum
13 pz 41.38 $ Bottom of cell detector
14 pz 43.38 $ Top of cell detector
15 sz 42.38 200 $ air

```

```

mode p $photon
c *****
c SOURCE
c *****

```

```

sdef cel=1 wgt= 1.457e+11 erg=d1 pos=0 0 42.38 $
sc1 Source distribution from ORIGENS

```

#	sil	spl	sbl
	l	d	d
1.50E-02	9.03E+08	1.0	
2.50E-02	4.48E+08	1.0	
3.75E-02	3.57E+08	1.0	
5.25E-02	2.70E+08	1.0	
6.50E-02	1.29E+08	1.0	
7.25E-02	5.56E+07	1.0	
8.75E-02	2.23E+08	1.0	
1.25E-01	2.32E+08	1.0	
1.75E-01	1.63E+08	1.0	
2.50E-01	1.31E+08	1.0	
3.50E-01	1.01E+08	1.0	
4.25E-01	3.13E+07	1.0	
4.80E-01	3.13E+07	1.0	
5.56E-01	1.42E+07	1.0	
6.50E-01	2.15E+07	1.0	
7.50E-01	1.45E+07	1.0	
9.00E-01	1.67E+07	1.0	
1.10E+00	8.18E+06	1.0	
1.27E+00	3.33E+06	1.0	
1.39E+00	1.33E+06	1.0	
1.47E+00	4.43E+05	1.0	
1.54E+00	4.24E+05	1.0	
1.62E+00	5.46E+05	1.0	
1.73E+00	4.21E+05	1.0	
1.90E+00	2.27E+05	1.0	
2.08E+00	4.49E+04	1.0	
2.43E+00	2.71E+02	1.0	

```

c Total from ORIGENS for 1 Ci = 3.16E+09, 46.12 Ci = 1.457e+11

```

```

c
c      ansi/ans-6.1.1-1991 fluence-to-dose, photons (mrem/hr/ (p/cm**2/s)
c
de0   log   .01 .015 .02 .03 .04 .05
        .06 .08 .10 .15 .20 .30
        .40 .50 .60 .80 1.0 1.5
        2.0 3.0 4.0 5.0 6.0 8.0
        10. 12.
df0   log   2.232e-5 5.652e-5 8.568e-5 1.184e-4 1.314e-4 1.382e-4
        1.440e-4 1.624e-4 1.919e-4 2.797e-4 3.708e-4 5.616e-4
        7.416e-4 9.144e-4 1.076e-3 1.379e-3 1.656e-3 2.246e-3
        2.758e-3 3.672e-3 4.500e-3 5.292e-3 6.012e-3 7.488e-3
        8.892e-3 1.040e-2

```

```

c
c      Material Definitions
c

```

```

m1   1000.01p -0.07      $ plastic - hydrogen
      6000.01p -0.43      $ plastic - carbon
m2   1000.01p -0.14      $ plastic - hydrogen
      6000.01p -0.86      $ plastic - carbon
m3   7000.01p -0.765     $ air - Nitrogen
      8000.01p -0.235     $ air - Oxygen
m4   26000.01p -0.6797   $ SS 304
      24000.01p -0.200
      28000.01p -0.100
      25000.01p -0.020
      6000.01p  -0.0003
m5   7000.01p -0.765     $ air - Nitrogen
      8000.01p -0.235     $ air - Oxygen

```

```

c
print
phys:p j 0 0      $ Brems on & Coherent Scattering On
fc4  cell detector on surface
f4:p 5
fc5  point detector on surface
f5:p 29.4099 0 42.38 0
imp:p
c
c      Cell Importances
c
c      Cell  1 2 3 4 5 6 7
          1 1 1 1 1 1 0
nps    200000 $history

```

5.8.2.3 ¹³⁷Cs/^{137m}Ba.

Determine Amount of Cs137/Ba137m to Surface Dose of 1,000 mrem/h on Drum

```

c
c      First define the source cells
c      mat# mat den surfaces
c
1     1 -0.5 -1 2 -3      $ source
2     2 -0.9 -4 5 -6 #1  $ liner
3     3 -0.00129 -7 5 -8 #1 #2 $ air
4     4 -7.86 -9 10 -11 #1 #2 #3 $ drum
5     5 -0.00129 9 -12 13 -14 #1 #2 #3 #4 $ Cell detector
6     6 -0.00129 -15 #1 #2 #3 #4 #5 $ air around drum
7     7 0 15 $ void - outside universe

```

```

c
c      Radial surfaces
c
1     cz 27.7114 $ source
4     cz 27.9400 $ liner
7     cz 28.2575 $ air gap
9     cz 28.4099 $ drum
12    cz 30.4099 $ cell detector boundary
c

```

```

c   Axial surfaces
c
2   pz 0.381    $ Bottom of source
3   pz 83.744  $ Top of source
5   pz 0.152    $ Bottom of liner, bottom of air cylinder
6   pz 83.973  $ Top of liner
8   pz 84.608  $ Top of air gap
10  pz 0.0      $ Bottom of drum
11  pz 84.76   $ Top of drum
13  pz 41.38   $ Bottom of cell detector
14  pz 43.38   $ Top of cell detector
15  sz 42.38 200 $ air

mode p                               $photon
c *****
c                               SOURCE
c *****
sdef   cel=1  wgt= 1.77E+10  erg=d1  pos= 0 0 0
       rad = d2  ext= d3  axs= 0 0 1
sc1    Source distribution from ORIGENS
#      sil      spl      sbl
       1        d        d
1.50E-02  1.18E+08  1.0
2.50E-02  5.44E+07  1.0
3.75E-02  2.31E+09  1.0
5.25E-02  2.76E+07  1.0
6.50E-02  1.23E+07  1.0
7.25E-02  5.11E+06  1.0
8.75E-02  1.81E+07  1.0
1.25E-01  1.53E+07  1.0
1.75E-01  7.46E+06  1.0
2.50E-01  4.22E+06  1.0
3.50E-01  1.64E+06  1.0
4.25E-01  2.86E+05  1.0
4.80E-01  2.25E+05  1.0
5.56E-01  7.91E+04  1.0
6.50E-01  3.20E+10  1.0
7.50E-01  4.58E+04  1.0
9.00E-01  2.35E+04  1.0
1.10E+00  1.44E+03  1.0
1.27E+00  8.88E-02  1.0
c   Total from ORIGENS for 1 Ci = 3.45E+10, 0.513 Ci= 1.77E+10 photons/s
sc2   Source radius
si2   0 27.7114
sc3   Source length
si3   0.381 83.744
c
c   ansi/ans-6.1.1-1991 fluence-to-dose,photons (mrem/hr)/(p/cm**2/s)
c
de0   log .01 .015 .02 .03 .04 .05
       .06 .08 .10 .15 .20 .30
       .40 .50 .60 .80 1.0 1.5
       2.0 3.0 4.0 5.0 6.0 8.0
       10. 12.
df0   log 2.232e-5 5.652e-5 8.568e-5 1.184e-4 1.314e-4 1.382e-4
       1.440e-4 1.624e-4 1.919e-4 2.797e-4 3.708e-4 5.616e-4
       7.416e-4 9.144e-4 1.076e-3 1.379e-3 1.656e-3 2.246e-3
       2.758e-3 3.672e-3 4.500e-3 5.292e-3 6.012e-3 7.488e-3
       8.892e-3 1.040e-2
c
c   Material Definitions
c
m1    1000.01p -0.07    $ plastic - hydrogen
       6000.01p -0.43    $ plastic - carbon
m2    1000.01p -0.14    $ plastic - hydrogen
       6000.01p -0.86    $ plastic - carbon
m3    7000.01p -0.765   $ air - Nitrogen
       8000.01p -0.235   $ air - Oxygen

```

```

m4 26000.01p -0.6797 $ SS 304
    24000.01p -0.200
    28000.01p -0.100
    25000.01p -0.020
    6000.01p -0.0003
m5 7000.01p -0.765 $ air - Nitrogen
    8000.01p -0.235 $ air - Oxygen
c
print
phys:p j 0 0 $ Brems on & Coherent Scattering On
fc4 cell detector on surface
f4:p 5
fc5 point detector on surface
f5:p 29.4099 0 42.38 0
imp:p
c
c Cell Importances
c
c Cell 1 2 3 4 5 6 7
      1 1 1 1 1 1 0
nps 600000 $history
    
```

5.8.2.4 ¹⁵²Eu.

Determine Amount of Eu 152 to Produce Dose on a Drum surface of 1,000 mrem/h

```

c
c First define the source cells
c mat# mat den surfaces
c
1 1 -0.5 -1 2 -3 $ source
2 2 -0.9 -4 5 -6 #1 $ liner
3 3 -0.00129 -7 5 -8 #1 #2 $ air
4 4 -7.86 -9 10 -11 #1 #2 #3 $ drum
5 3 -0.00129 9 -12 13 -14 #1 #2 #3 #4 $ Cell detector
6 5 -0.00129 -15 #1 #2 #3 #4 #5 $ air around drum
7 0 15 $ void - outside universe
    
```

```

c
c Radial surfaces
c
1 cz 27.7114 $ source
4 cz 27.9400 $ liner
7 cz 28.2575 $ air gap
9 cz 28.4099 $ drum
12 cz 30.4099 $ cell detector boundary
    
```

```

c
c Axial surfaces
c
2 pz 0.381 $ Bottom of source
3 pz 83.744 $ Top of source
5 pz 0.152 $ Bottom of liner, bottom of air cylinder
6 pz 83.973 $ Top of liner
8 pz 84.608 $ Top of air gap
10 pz 0.0 $ Bottom of drum
11 pz 84.76 $ Top of drum
13 pz 41.38 $ Bottom of cell detector
14 pz 43.38 $ Top of cell detector
15 sz 42.38 200 $ air
    
```

```

mode p $photon
c *****
c SOURCE
c *****
sdef cel=1 wgt= 2.418E+10 erg=d1 pos= 0 0 0
      rad= d2 ext= d3 axs= 0 0 1
scl Source distribution from ORIGENS
# sil spl sbl
  1 d d
    
```

1.50E-02	1.77E+07	1.0
2.50E-02	8.54E+06	1.0
3.75E-02	2.67E+10	1.0
5.25E-02	2.41E+09	1.0
6.50E-02	2.25E+06	1.0
7.25E-02	9.56E+05	1.0
8.75E-02	3.67E+06	1.0
1.25E-01	1.02E+10	1.0
1.75E-01	1.03E+07	1.0
2.50E-01	2.99E+09	1.0
3.50E-01	1.01E+10	1.0
4.25E-01	2.03E+09	1.0
4.80E-01	2.42E+08	1.0
5.11E-01	2.74E+07	1.0
5.56E-01	4.59E+08	1.0
6.50E-01	6.50E+08	1.0
7.50E-01	5.10E+09	1.0
9.00E-01	7.84E+09	1.0
1.10E+00	9.41E+09	1.0
1.27E+00	1.22E+09	1.0
1.39E+00	7.81E+09	1.0
1.47E+00	1.79E+08	1.0
1.54E+00	9.45E+07	1.0
1.62E+00	7.11E+06	1.0
1.73E+00	3.67E+06	1.0
1.90E+00	1.88E-08	1.0
2.25E+00	8.66E-19	1.0
2.75E+00	4.35E-19	1.0
3.25E+00	2.18E-19	1.0
3.75E+00	1.09E-19	1.0
4.25E+00	5.48E-20	1.0
4.75E+00	2.75E-20	1.0
5.25E+00	1.38E-20	1.0
5.75E+00	6.92E-21	1.0
6.25E+00	3.47E-21	1.0
6.75E+00	1.74E-21	1.0
7.25E+00	8.73E-22	1.0
7.75E+00	4.38E-22	1.0
9.00E+00	3.95E-22	1.0
1.10E+01	1.30E-23	1.0

c Total from ORIGENS for 1 Ci = 8.7526E+10, 0.276.Ci= 2.418E+10 photons/s

sc2 Source radius

si2 0 27.7114

sc3 Source length

si3 0.381 83.744

c

ansi/ans-6.1.1-1991 fluence-to-dose,photons(mrem/hr)/(p/cm**2/s)

c

de0 log .01 .015 .02 .03 .04 .05
 .06 .08 .10 .15 .20 .30
 .40 .50 .60 .80 1.0 1.5
 2.0 3.0 4.0 5.0 6.0 8.0
 10. 12.

df0 log 2.232e-5 5.652e-5 8.568e-5 1.184e-4 1.314e-4 1.382e-4
 1.440e-4 1.624e-4 1.919e-4 2.797e-4 3.708e-4 5.616e-4
 7.416e-4 9.144e-4 1.076e-3 1.379e-3 1.656e-3 2.246e-3
 2.758e-3 3.672e-3 4.500e-3 5.292e-3 6.012e-3 7.488e-3
 8.892e-3 1.040e-2

c

Material Definitions

m1	1000.01p	-0.07	\$ plastic - hydrogen
	6000.01p	-0.43	\$ plastic - carbon
m2	1000.01p	-0.14	\$ plastic - hydrogen
	6000.01p	-0.86	\$ plastic - carbon
m3	7000.01p	-0.765	\$ air - Nitrogen
	8000.01p	-0.235	\$ air - Oxygen
m4	26000.01p	-0.6797	\$ SS 304

```

24000.01p -0.200
28000.01p -0.100
25000.01p -0.020
6000.01p -0.0003
m5 7000.01p -0.765 $ air - Nitrogen
8000.01p -0.235 $ air - Oxygen
c
print
phys:p j 0 0 $ Brems on & Coherent Scattering On
fc4 cell detector on surface
f4:p 5
fc5 point detector on surface
f5:p 29.4099 0 42.38 0
imp:p
c
c Cell Importances
c
c Cell 1 2 3 4 5 6 7
1 1 1 1 1 1 0
nps 200000 $history

```

5.8.2.5 ¹⁵⁴Eu.

Determine Amount of Eu 154 to Produce Dose on a Drum surface of 1,000 mrem/h

```

c
c First define the source cells
c mat# mat den surfaces
c
1 1 -0.5 -1 2 -3 $ source
2 2 -0.9 -4 5 -6 #1 $ liner
3 3 -0.00129 -7 5 -8 #1 #2 $ air
4 4 -7.86 -9 10 -11 #1 #2 #3 $ drum
5 5 -0.00129 9 -12 13 -14 #1 #2 #3 #4 $ Cell detector
6 6 -0.00129 -15 #1 #2 #3 #4 #5 $ air around drum
7 7 0 15 $ void - outside universe

```

```

c
c Radial surfaces
c
1 cz 27.7114 $ source
4 cz 27.9400 $ liner
7 cz 28.2575 $ air gap
9 cz 28.4099 $ drum
12 cz 30.4099 $ cell detector boundary

```

```

c
c Axial surfaces
c
2 pz 0.381 $ Bottom of source
3 pz 83.744 $ Top of source
5 pz 0.152 $ Bottom of liner, bottom of air cylinder
6 pz 83.973 $ Top of liner
8 pz 84.608 $ Top of air gap
10 pz 0.0 $ Bottom of drum
11 pz 84.76 $ Top of drum
13 pz 41.38 $ Bottom of cell detector
14 pz 43.38 $ Top of cell detector
15 sz 42.38 200 $ air

```

```

mode p $photon
c *****
c SOURCE
c *****
sdef cel=1 wgt= 1.683E+10 erg=d1 pos= 0 0 0
rad = d2 ext= d3 axs= 0 0 1
scl Source distribution from ORIGENS
# sil spl sb1
1 d d
1.50E-02 1.70E+08 1.0

```

```

2.50E-02  8.12E+07  1.0
3.75E-02  8.64E+09  1.0
5.25E-02  1.82E+09  1.0
6.50E-02  2.07E+07  1.0
7.25E-02  8.77E+06  1.0
8.75E-02  3.43E+07  1.0
1.25E-01  1.48E+10  1.0
1.75E-01  1.18E+08  1.0
2.50E-01  2.46E+09  1.0
3.50E-01  1.20E+08  1.0
4.25E-01  2.54E+08  1.0
4.80E-01  1.23E+08  1.0
5.11E-01  1.45E+07  1.0
5.56E-01  2.38E+09  1.0
6.50E-01  9.33E+08  1.0
7.50E-01  8.76E+09  1.0
9.00E-01  1.08E+10  1.0
1.10E+00  4.98E+09  1.0
1.27E+00  1.35E+10  1.0
1.39E+00  2.24E+07  1.0
1.47E+00  2.47E+08  1.0
1.54E+00  2.34E+07  1.0
1.62E+00  6.11E+08  1.0
1.73E+00  1.55E+06  1.0
1.90E+00  5.08E+05  1.0
c Total from ORIGENS for 1 Ci = 7.10E+10, 0.237 Ci = 1.683E+10 photons/
sc2 Source radius
si2 0 27.7114
sc3 Source length
si3 0.381 83.744
c
c ansi/ans-6.1.1-1991 fluence-to-dose,photons(mrem/hr)/(p/cm**2/s)
c
de0 log .01 .015 .02 .03 .04 .05
      .06 .08 .10 .15 .20 .30
      .40 .50 .60 .80 1.0 1.5
      2.0 3.0 4.0 5.0 6.0 8.0
      10. 12.
df0 log 2.232e-5 5.652e-5 8.568e-5 1.184e-4 1.314e-4 1.382e-4
      1.440e-4 1.624e-4 1.919e-4 2.797e-4 3.708e-4 5.616e-4
      7.416e-4 9.144e-4 1.076e-3 1.379e-3 1.656e-3 2.246e-3
      2.758e-3 3.672e-3 4.500e-3 5.292e-3 6.012e-3 7.488e-3
      8.892e-3 1.040e-2
c
c Material Definitions
c
m1 1000.01p -0.07 $ plastic - hydrogen
   6000.01p -0.43 $ plastic - carbon
m2 1000.01p -0.14 $ plastic - hydrogen
   6000.01p -0.86 $ plastic - carbon
m3 7000.01p -0.765 $ air - Nitrogen
   8000.01p -0.235 $ air - Oxygen
m4 26000.01p -0.6797 $ SS 304
   24000.01p -0.200
   28000.01p -0.100
   25000.01p -0.020
   6000.01p -0.0003
m5 7000.01p -0.765 $ air - Nitrogen
   8000.01p -0.235 $ air - Oxygen
c
print
phys:p j 0 0 $ Brems on & Coherent Scattering On
fc4 cell detector on surface
f4:p 5
fc5 point detector on surface
f5:p 29.4099 0 42.38 0
imp:p
c

```

```

c Cell Importances
c
c Cell 1 2 3 4 5 6 7
      1 1 1 1 1 1 0
nps 200000 $history
    
```

5.8.2.6 Accident for a ⁶⁰Co Payload.

Determine dose rate from Co 60 under accident conditions.

```

c
c First define the source cells. Replace all materials
c with air, except the source.
c mat# mat den surfaces
c
1 1 -0.5 -1 2 -3 $ source
2 3 -0.00129 -4 5 -6 #1 $ liner
3 3 -0.00129 -7 5 -8 #1 #2 $ air
4 3 -0.00129 -9 10 -11 #1 #2 #3 $ drum
5 3 -0.00129 9 -12 13 -14 #1 #2 #3 #4 $ Cell detector
6 3 -0.00129 -15 #1 #2 #3 #4 #5 $ air around drum
7 0 15 $ void - outside universe
    
```

```

c
c Radial surfaces
c
1 cz 27.7114 $ source
4 cz 27.9400 $ liner
7 cz 28.2575 $ air gap
9 cz 28.4099 $ drum
12 cz 30.4099 $ cell detector boundary
    
```

```

c
c Axial surfaces
c
2 pz 0.381 $ Bottom of source
3 pz 83.744 $ Top of source
5 pz 0.152 $ Bottom of liner, bottom of air cylinder
6 pz 83.973 $ Top of liner
8 pz 84.608 $ Top of air gap
10 pz 0.0 $ Bottom of drum
11 pz 84.76 $ Top of drum
13 pz 41.38 $ Bottom of cell detector
14 pz 43.38 $ Top of cell detector
15 sz 42.38 200 $ air
    
```

```

mode p $photon
c *****
c SOURCE
c *****
sdef cel=1 wgt= 9.285E+09 erg= dl pos= 0 0 0
      rad = d2 ext= d3 axs= 0 0 1
scl Source distribution from ORIGENS
# sil spl sbl
  1 d d
1.50E-02 5.92E+07 1.0
2.50E-02 2.54E+07 1.0
3.75E-02 1.74E+07 1.0
5.25E-02 1.08E+07 1.0
6.50E-02 4.45E+06 1.0
7.25E-02 1.77E+06 1.0
8.75E-02 5.40E+06 1.0
1.25E-01 3.43E+06 1.0
1.75E-01 8.84E+05 1.0
2.50E-01 2.26E+05 1.0
3.50E-01 2.83E+06 1.0
4.25E-01 1.09E+04 1.0
4.80E-01 1.02E+04 1.0
5.56E-01 4.18E+03 1.0
6.50E-01 6.00E+03 1.0
    
```



```

7.50E-01  3.49E+03  1.0
9.00E-01  2.58E+06  1.0
1.10E+00  3.94E+10  1.0
1.27E+00  1.95E+10  1.0
1.39E+00  1.78E+10  1.0
1.47E+00  2.94E-02  1.0
1.54E+00  2.82E-02  1.0
2.25E+00  3.90E+05  1.0
2.43E+00  6.88E+02  1.0
2.75E+00  6.06E+02  1.0
c Total from ORIGENS for 1 Ci = 7.68E+10, 0.121 Ci= 9.285E+09 photons/s
sc2 Source radius
si2 0 27.7114
sc3 Source length
si3 0.381 83.744
c
c ansi/ans-6.1.1-1991 fluence-to-dose,photons(mrem/hr/(p/cm**2/s)
c
de0 log .01 .015 .02 .03 .04 .05
      .06 .08 .10 .15 .20 .30
      .40 .50 .60 .80 1.0 1.5
      2.0 3.0 4.0 5.0 6.0 8.0
      10. 12.
df0 log 2.232e-5 5.652e-5 8.568e-5 1.184e-4 1.314e-4 1.382e-4
      1.440e-4 1.624e-4 1.919e-4 2.797e-4 3.708e-4 5.616e-4
      7.416e-4 9.144e-4 1.076e-3 1.379e-3 1.656e-3 2.246e-3
      2.758e-3 3.672e-3 4.500e-3 5.292e-3 6.012e-3 7.488e-3
      8.892e-3 1.040e-2
c
c Material Definitions
c
m1 1000.01p -0.07 $ plastic - hydrogen
    6000.01p -0.43 $ plastic - carbon
m2 1000.01p -0.14 $ plastic - hydrogen
    6000.01p -0.86 $ plastic - carbon
m3 7000.01p -0.765 $ air - Nitrogen
    8000.01p -0.235 $ air - Oxygen
m4 26000.01p -0.6797 $ SS 304
    24000.01p -0.200
    28000.01p -0.100
    25000.01p -0.020
    6000.01p -0.0003
c
c
print
phys:p j 0 0 $ Brems on & Coherent Scattering On
fc4 cell detector on surface
f4:p 5
fc5 point detector at 1 m from surface
f5:p 128.4099 0 42.38 0
imp:p
c
c Cell Importances
c
c Cell 1 2 3 4 5 6 7
      1 1 1 1 1 1 0
nps 200000 $history

```

5.8.3 Neutron Dose Rate Calculation

In the method described in *Neutron Dose Rates from Nuclear Waste Packages* (Nelson 1996), the total neutron source term $S(T)$, which accounts for neutron multiplication, is determined by adding the spontaneous fission source term ($S(SF)$) and the α,n source term ($S(\alpha,n)$) and dividing by 1 minus the k_{eff} .

$$S(S_T) = \frac{(S(SF) + S(\alpha, n))}{(1 - k_{eff})}$$

S(SF) and S(α, n) are determined either from Nelson (1996) or ORIGEN. In this case, ORIGEN-S (Bowman 1997, WMNW 1998b) was used as shown in Part B, Section 5.8.2, to determine (SF) and S(α, n). After S(S_T) is determined, it is used to determine the dose rate in the equation;

$$D(r) = \frac{0.01 \cdot S(T)}{r^2}$$

where r is the distance from the source and D(r) is the dose in mrem/h as a function of r.

Since the neutron source for ²³⁹Pu dominates the neutron source for fissile materials, as shown in Part B, Section 5.8.1.6, only ²³⁹Pu (0.46 TBq [12.4 Ci]) is used for the neutron dose estimate. Using S(SF) and S(α, n) from ORIGEN and conservatively assuming a k_{eff} of 0.8, S(S_T) is determined to be,

$$S(S_T) = \frac{4.52 + 8.44 \times 10^3}{(1 - 0.8)} = 4.22 \times 10^4 \text{ n/s.}$$

Assuming r to be 28.41 cm (11.2 in) (the distance from the center of the drum to the surface as measured radially), the total neutron dose rate is estimated to be,

$$D(r) = \frac{0.01 \cdot 4.22 \times 10^4}{28.41^2} = 5.23 \times 10^{-1} \text{ mrem/h}$$



CHECKLIST FOR CHECKING OF ANALYSIS/CALCULATIONS

Document Number/Revision: HNF-2209

Document Title: Safety Analysis Report for Packaging (Onsite) Steel Drum

Scope of Review: Dose Consequence Evaluation (Section 4.4), Shielding Evaluation (Section 5), Criticality Evaluation (Section 6)

Yes	No	N/A	
<input checked="" type="checkbox"/>	<input type="checkbox"/>	<input type="checkbox"/>	Problem completely defined.
<input checked="" type="checkbox"/>	<input type="checkbox"/>	<input type="checkbox"/>	Appropriate analytical method used.
<input checked="" type="checkbox"/>	<input type="checkbox"/>	<input type="checkbox"/>	Necessary assumptions are appropriate and explicitly stated.
<input checked="" type="checkbox"/>	<input type="checkbox"/>	<input type="checkbox"/>	Computer codes and data files documented.
<input checked="" type="checkbox"/>	<input type="checkbox"/>	<input type="checkbox"/>	Data used in calculations explicitly stated in document.
<input type="checkbox"/>	<input type="checkbox"/>	<input checked="" type="checkbox"/>	Sources of non-standard formula/data are referenced and the correctness of the reference verified.
<input checked="" type="checkbox"/>	<input type="checkbox"/>	<input type="checkbox"/>	Data checked for consistency with original source information as applicable.
<input checked="" type="checkbox"/>	<input type="checkbox"/>	<input type="checkbox"/>	Mathematical derivations checked including dimensional consistency of results.
<input checked="" type="checkbox"/>	<input type="checkbox"/>	<input type="checkbox"/>	Models appropriate and used within range of validity or use outside range of established validity justified.
<input checked="" type="checkbox"/>	<input type="checkbox"/>	<input type="checkbox"/>	Hand calculations checked for errors.
<input checked="" type="checkbox"/>	<input type="checkbox"/>	<input type="checkbox"/>	Code run streams correct and consistent with analysis documentation.
<input checked="" type="checkbox"/>	<input type="checkbox"/>	<input type="checkbox"/>	Code output consistent with input and with results reported in analysis documentation.
<input checked="" type="checkbox"/>	<input type="checkbox"/>	<input type="checkbox"/>	Acceptability limits on analytical results applicable and supported. Limits checked against sources.
<input checked="" type="checkbox"/>	<input type="checkbox"/>	<input type="checkbox"/>	Safety Margins consistent with good engineering practices.
<input checked="" type="checkbox"/>	<input type="checkbox"/>	<input type="checkbox"/>	Conclusions consistent with analytical results and applicable limits.
<input checked="" type="checkbox"/>	<input type="checkbox"/>	<input type="checkbox"/>	Results and conclusions address all points required in the problem statement.

I have checked the analysis/calculation and it is complete and accurate to the best of my knowledge.

Engineer/Checker A. V. Savino *Anthony Savino* Date 9/22/98

This page intentionally left blank.

6.0 CRITICALITY EVALUATION

6.1 INTRODUCTION

This criticality evaluation supports the shipment of 208 L (55-gal) drums with a variety of contents. The drums are transported singly, in large arrays (e.g., 20 drums), or in an N-55 Overpack. The contents are generally contaminated items that are destined for disposition or storage.

The Payload 1 drum configuration is restricted to fissile-excepted contents and requires no further criticality evaluation. Payloads 2, 3, and 4 may contain fissile material in various forms and may be transported in large arrays.

6.1.1 Assumptions

The following assumptions were used in this evaluation.

- The isotope distribution of the fissile material is not defined, so ^{239}Pu shall be assumed because it is the most reactive with respect to criticality of the five fissile isotopes considered for transportation (^{233}U , ^{235}U , ^{238}Pu , ^{239}Pu , and ^{241}Pu [49 CFR 173.403]).
- The fissile material or matrix material form is not defined, so it shall be assumed to be ^{239}Pu in a homogeneous polyethylene moderator. This is shown to be the worst documented situation as shown in Part B, Section 6.3.
- An array of drums is restricted to rows of four drums, and the credible accident is assumed to involve release of material from four drums.

6.1.2 Results

This criticality evaluation supports the shipment of single 208 L (55-gal) drums on the Hanford Site with a *maximum* of 100 g of fissile material in solid form or liquid form per drum. Array shipments are limited to no more than 45 g of fissile material per drum if any single package contains fissile material. Shipments of drums in N-55 Overpacks are limited to 200 g of fissile material per drum. An array is restricted to a single layer containing rows of four drums with no limit on the total number of rows of drums.

6.2 CRITICALITY SOURCE SPECIFICATION

The isotopes ^{233}U , ^{235}U , ^{238}Pu , ^{239}Pu , and ^{241}Pu (49 CFR 173.403) are the considered fissile materials with respect to transportation. Since the specific distribution of the fissile isotopes is not defined for the drum, the fissile material is assumed to be ^{239}Pu as it has the most significant effect on criticality for the conditions evaluated.

6.3 SUMMARY OF CRITICALITY PROPERTIES OF MATERIALS

Because no specific matrix material or hydrogen-to-fissile-nuclei (H/X) ratio is defined, the configuration is considered to be a sphere of ^{239}Pu in a polyethylene matrix $(\text{CH}_2)_n$. This is demonstrated to be the worst configuration for criticality as shown in *A Survey of Criticality*

Parameters for ²³⁹Pu in Organic Material (ANS 1977) and Packaging, Storage, and Disposal of Solid Waste (55-Gallon Drums, Unrestricted H/Pu Only) (Friar 1989).

The criticality properties of the materials considered, ²³⁹Pu in polyethylene, are specified in Friar (1989) and ANS (1977). Although Friar (1989) does not include soil as a matrix material, 200 g of ²³⁹Pu is below a minimum critical mass as shown in ANS (1977) and in water as shown in *Criticality Handbook* (Carter 1969). In addition, diatomaceous earth, a somewhat similar composition to soil, is shown to have a negative effect on criticality when mixed with weapons-grade Pu as shown in *Safety Analysis Report for Packaging (Onsite) Transuranic Performance Demonstration Program Sample Packaging* (McCoy 1997). Therefore, soil is an acceptable matrix material in the drum.

6.4 NORMAL TRANSFER CONDITIONS

It is shown in Friar (1989) that an infinite array of drums in the xy plane stacked five high will remain subcritical with 200 g of ²³⁹Pu in each drum. It is shown in Part B, Section 7.0, that the drum contents and array configuration are retained during NTC. Therefore, the 200 g limit would apply.

However, the drum contents are limited by dose consequence requirements and by the accident criticality acceptance criteria. In addition, because specific calculations have not been performed to verify the criticality transport index, double contingency must be assumed. Drums transported alone would then be required to meet a 100 g limit based on NTC. The drums transported in the N-55 Overpack would still be authorized for up to 200 g based on the N-55 Overpack Certificate of Compliance.

6.5 ACCIDENT CONDITIONS

The failure threshold evaluation in Part B, Section 7.0, combined with the risk evaluation in Part B, Section 3.0, show that drums transported in arrays perform well in accidents. The actual failure leading to release of material is shown to be just credible (5×10^{-6}). However, only the front row of the drum array is found to release material.

Since the isotopic distribution of the fissile material or the H/X ratio is not defined, the worst case is assumed (²³⁹Pu in polyethylene). The amount of fissile material in the shipment available for release must remain subcritical under the worst conditions. Therefore, the amount of fissile material available for release must not exceed 370 g (ANS 1977).

Again considering double contingency, the amount available for release will be restricted to 185 g. Since four drums are assumed to fail, drums in an array will be restricted to a maximum of 45 g of fissile material.

6.6 CRITICAL BENCHMARK EXPERIMENTS

The value for k_{eff} was not determined for the payload since the ²³⁹Pu is shown to be below the most conservative minimum critical mass. Therefore, no benchmarking is necessary.

6.7 CRITICALITY EVALUATION AND CONCLUSIONS

Based on double-contingency criticality control, the following fissile material limits are required:

- For payload 2 or 4 contents, shipped exclusive use as a single drum: 100 g fissile material
- For payload 2 or 4 contents, shipped exclusive use in a single horizontal array with no more than four drums in a row: 45 g fissile material maximum per drum
- For Payload 3 contents (N-55 Overpack): 200 g fissile material per drum, up to two packages on a single conveyance.

This criticality evaluation establishes that the steel drums meet the requirements for criticality safety per HNF-PRO-334, *Criticality Safety General Requirements*; HNF-PRO-537, *Criticality Safety Control of Fissionable Material*; and HNF-PRO-545, *Fissionable Material Packaging and Transportation*.

6.8 REFERENCES

- 49 CFR 173, "Shippers--General Requirements for Shipments and Packagings," *Code of Federal Regulations*, as amended.
- ANS, 1977, "A Survey of Criticality Parameters for ²³⁹Pu in Organic Media," *Transactions of the American Nuclear Society*, Volume 77, P 419, American Nuclear Society, La Grange Park, Illinois.
- Carter, R. D., et al., 1969, *Criticality Handbook*, ARH-600, Vol. II, Atlantic Richfield Hanford Company, Richland, Washington.
- Friar, D. E., 1989, *Packaging, Storage, and Disposal of Solid Waste (55-Gallon Drums, Unrestricted H/Pu Only)*, WHC-SD-SQA-CSA-20121, Rev. 0, Westinghouse Hanford Company, Richland, Washington.
- HNF-PRO-334, *Criticality Safety General Requirements*, Fluor Daniel Hanford, Inc., Richland, Washington.
- HNF-PRO-537, *Criticality Safety Control of Fissionable Material*, Fluor Daniel Hanford, Inc., Richland, Washington.
- HNF-PRO-545, *Fissionable Material Packaging and Transportation*, Fluor Daniel Hanford, Inc., Richland, Washington.
- McCoy, J. C., 1997, *Safety Analysis Report for Packaging (Onsite) Transuranic Performance Demonstration Program Sample Packaging*, HNF-SD-TP-SARP-026, Rev. 0, Waste Management Federal Services, Inc., Northwest Operations, Richland, Washington.



CHECKLIST FOR CHECKING OF ANALYSIS/CALCULATIONS

Document Number/Revision: HNF-2209

Document Title: Safety Analysis Report for Packaging (Onsite) Steel Drum

Scope of Review: Dose Consequence Evaluation (Section 4.4), Shielding Evaluation (Section 5),
Criticality Evaluation (Section 6)

Yes	No	N/A	
<input checked="" type="checkbox"/>	<input type="checkbox"/>	<input type="checkbox"/>	Problem completely defined.
<input checked="" type="checkbox"/>	<input type="checkbox"/>	<input type="checkbox"/>	Appropriate analytical method used.
<input checked="" type="checkbox"/>	<input type="checkbox"/>	<input type="checkbox"/>	Necessary assumptions are appropriate and explicitly stated.
<input checked="" type="checkbox"/>	<input type="checkbox"/>	<input type="checkbox"/>	Computer codes and data files documented.
<input checked="" type="checkbox"/>	<input type="checkbox"/>	<input type="checkbox"/>	Data used in calculations explicitly stated in document.
<input type="checkbox"/>	<input type="checkbox"/>	<input checked="" type="checkbox"/>	Sources of non-standard formula/data are referenced and the correctness of the reference verified.
<input checked="" type="checkbox"/>	<input type="checkbox"/>	<input type="checkbox"/>	Data checked for consistency with original source information as applicable.
<input checked="" type="checkbox"/>	<input type="checkbox"/>	<input type="checkbox"/>	Mathematical derivations checked including dimensional consistency of results.
<input checked="" type="checkbox"/>	<input type="checkbox"/>	<input type="checkbox"/>	Models appropriate and used within range of validity or use outside range of established validity justified.
<input checked="" type="checkbox"/>	<input type="checkbox"/>	<input type="checkbox"/>	Hand calculations checked for errors.
<input checked="" type="checkbox"/>	<input type="checkbox"/>	<input type="checkbox"/>	Code run streams correct and consistent with analysis documentation.
<input checked="" type="checkbox"/>	<input type="checkbox"/>	<input type="checkbox"/>	Code output consistent with input and with results reported in analysis documentation.
<input checked="" type="checkbox"/>	<input type="checkbox"/>	<input type="checkbox"/>	Acceptability limits on analytical results applicable and supported. Limits checked against sources.
<input checked="" type="checkbox"/>	<input type="checkbox"/>	<input type="checkbox"/>	Safety Margins consistent with good engineering practices.
<input checked="" type="checkbox"/>	<input type="checkbox"/>	<input type="checkbox"/>	Conclusions consistent with analytical results and applicable limits.
<input checked="" type="checkbox"/>	<input type="checkbox"/>	<input type="checkbox"/>	Results and conclusions address all points required in the problem statement.

I have checked the analysis/calculation and it is complete and accurate to the best of my knowledge.

Engineer/Checker A. V. Savino *Anthony Savino* Date 9/22/98

7.0 STRUCTURAL EVALUATION

7.1 INTRODUCTION

Within the boundaries of the Hanford Site, two types of drums are used. The most common are the standard 208 L (55-gal) drum packages, which are used to transport and store TRU and non-TRU wastes in both liquid and solid form. Less common are the retrieval drums. These drums are retrieved from noncompliant *Resource Conservation and Recovery Act of 1976* (RCRA) storage for characterization, transfer, or other operations.

Depending on content, the standard 208 L (55-gal) drums meet one of three drum specifications and have one-to-four containment barriers. As a function of the contents, the gross weight of the drums may reach up to a maximum of 658 kg (1,450 lb). Also, some of the drums are equipped with inner liners and/or filters and vent clips. The objective of this evaluation is to envelope the variations in drum specification, gross weight, and number of containment boundaries to demonstrate the structural integrity of the standard 208 L (55-gal) drum packages under normal transfer conditions (NTC). This evaluation also provides enveloping impact velocity change and dynamic crush failure threshold data of the drums for probabilistic risk assessments of accident conditions.

In the cases of retrieval drums, they are assumed to not meet any of the specification requirements for the standard 208 L (55-gal) drum. These drums are assumed to have a wall thickness of 0.76 mm (0.030 in.). However, in this case the maximum weight of the drum is limited to 181 kg (400 lb).

Drums with a high-activity content as specified in Part A of this SARP shall be shipped in NuPac Model N-55 Overpack System (NuPac 1987). This system has been demonstrated and certified by the U.S. Nuclear Regulatory Commission to provide overpacked drums with fire and impact resistance per 10 CFR 71 for payload weights up to 229 kg (550 lb). Consequently, the structural performance of this system is not evaluated in this section.

7.2 ENVELOPING STRUCTURAL EVALUATION OF PACKAGES

7.2.1 Structural Design and Features

The 208 L (55-gal) drum configurations approved for onsite transport are the DOT Specification 17C, 17H, and Type A-UN1A2. These drums are metal containers in the shape of a right circular cylinder constructed of carbon steel with three swaged or rolled hoops. All three drum types are similar in construction and have a usable interior height of 85.1 cm (33.25 in.) and an inside diameter of 57.2 cm (22.5 in.). The drums are equipped with removable gasketed heads, which are retained during transport by a bolted locking ring. The locking ring is constructed of 12-gauge carbon steel with drop forged lugs. The ring is locked together by a bolted assembly consisting of a $\frac{1}{2}$ -in.-diameter bolt and hex nut. Typical drum dimensions are shown in Figure B7-1. The drums are sealed with an elastomeric gasket that is bonded to the underside of the removable head.

DOT-17C drums are constructed entirely of 16-gauge carbon steel. The DOT-17H drum body and bottom head are constructed of 18-gauge carbon steel. For the DOT-17H, the removable head is constructed of 16-gauge carbon steel. Both drums have the bottom head double seamed to the body with a nonhardening seaming compound. The side seams are welded. The top head is 2.22 cm ($\frac{7}{16}$ in.) deep and fully removable with a convex head. The top head fits over a rolled false wire at the open end and is secured to the body by the locking ring.

Figure B7-1. Typical Drum Dimensions.

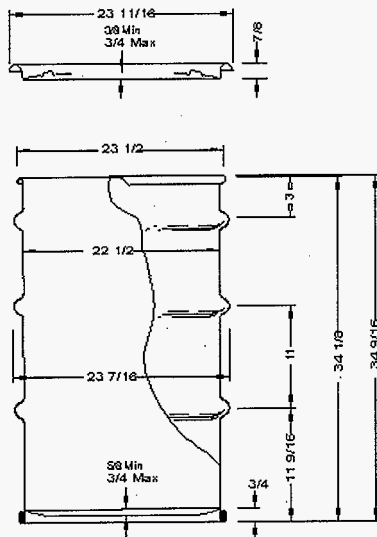

The Type A-UN1A2 drums are similar in construction to the DOT-17C and -17H drums. These drums are manufactured to WHC-S-0465, *Specification for Drums; UN1A2; Type A, Solid and Liquid Material, High Performance Coatings* (WHC 1996a), and WHC-S-0466, *Specification for Drums; UN1A2; Type A; Solid Material, Painted* (WHC 1996b), which define the DOT-7A, Type A performance standards and the UN1A2 performance standards. Conformance with these performance standards is demonstrated by the manufacturer.

This structural evaluation envelopes the variations among the drums by constituting a hypothetical drum using the worst-case characteristics and parameters of each. This worst-case drum is assumed to be constructed of the thinnest and weakest drum materials. The drum is assumed to be loaded with the heaviest payload, and only the drum is assumed to provide containment of the contents.

The retrieval drums are assumed to have the same outer dimensions of a standard 208 L (55-gal) drum. However, the wall thickness of the lid, bottom, and drum walls are assumed to be only 0.76 mm (0.030 in.) thick.

7.2.2 Mechanical Properties of Materials

DOT-17C, -17H, and Type A-UN1A2 retrieval drum body, lid, and locking ring can be manufactured from various grades of steel. In this evaluation, the drum body, lid, and locking ring are assumed to be manufactured to American Society for Testing and Materials (ASTM) A36 specifications for carbon steel structural members. This is a relatively common steel with mechanical properties that envelope the various steels from which the drum components can be

fabricated. The locking ring fastening bolt is assumed to be manufactured to ASTM A307, Grade C, specifications for carbon steel bolts. Bolts provided under this specification envelope possible fastening bolts supplied with the locking ring. The mechanical properties of both the drum components and bolt material are shown in Table B7-1.

Table B7-1. 208 L (55-gal) Drum Physical Properties.

Component	Specification grade/type	Temperature °F	Yield strength	Ultimate strength	s_m ksi	s_{me} ksi	Elastic modulus 10^6 psi
Body and lid	ASTM A 36	100	36	58	14.5	16	29.5
		200	34.2 ^a	56.8 ^a	14.5	16	28.8
		300	32.8 ^a	56.3 ^a	14.5	16	28.3
Locking ring bolt	ASTM A 307 Grade C	100	36	58	14.5 ^b	16	29.5
		200	34.2 ^a	56.8 ^a	14.5 ^b	16	28.8
		300	32.8 ^a	56.3 ^a	14.5 ^b	16	28.3

NOTE: Unless otherwise designated, all values are from ASME (1995a).

^aValues derived from DOD (1994).

^bValues assumed as same for values listed in ASME (1995a) for SA-36.

ASME, 1995a, *Boiler and Pressure Vessel Code, Section II, Part D, American Society of Mechanical Engineers*, New York, New York.

DOD, 1994, *Military Handbook--Metallic Materials and Elements for Aerospace Vehicle Structures*, MIL-HDBK-5G,

U.S. Department of Defense, Washington, D.C.

ASME = American Society of Mechanical Engineers.

ASTM = American Society for Testing and Materials.

The drum gaskets are manufactured from various synthetic elastomeric rubbers. All of these synthetic rubbers have an operating range equal to or greater than -40 °C (-40 °F) to 70 °C (158 °F) with a Shore durometer range from 40 to 100. For this evaluation the gasket material is assumed to be nitrile or Buna N rubber. This is a common gasketing material, which envelopes the material properties of the various rubbers commonly used as drum gaskets. Buna N rubber has an operating service temperature range of -54 °C (-65 °F) to 135 °C (275 °F) with a Shore durometer range of 20 to 90 (Parker 1991). This rubber has a helium permeability of 19.3×10^{-8} cc cm/cm² sec. bar at 50 °C (122 °F) (Parker 1991).

7.2.3 Conditions To Be Evaluated

7.2.3.1 NTC Performance Test Requirements.

7.2.3.1.1 General Standards for All Packages.

- The smallest overall package dimension shall not be less than 10.0 cm (4.0 in.).
- The outside of package shall have a tamper-indicating device.
- Each package shall have a positive closure device.
- The package shall be constructed of materials that have no significant chemical galvanic or other reactions between the package and components.

- The package accessible surfaces in still air at 46 °C (115 °F) and in the shade shall not exceed 85 °C (185 °F).
- Packages that must be vented for safety reasons, such as hydrogen generation, and that do not require leak-tight containment of the contents from dose requirements may be continuously vented during shipment. The venting must be through nationally recognized high-efficiency particulate air filter systems and shall be impervious to or protected from migration of liquids.

7.2.3.1.2 Hot and Cold Conditions.

Heat. Package and payload performance shall be evaluated for extreme ambient temperature of 46 °C (115 °F) in still air, with decay heat and solar insolation for a 12-hour day based on the information in Table B7-2.

Table B7-2. Solar Heat Loads.

Form and location of surface	Insulation for 12 hours per day
Flat surface transported horizontally Base Other surfaces	None 647 cal/cm ² (2,386 Btu/ft ²)
Flat surface not transported horizontally Each surface	162 cal/cm ² (597 Btu/ft ²)
Curved surfaces	324 cal/cm ² (1,194 Btu/ft ²)

Cold. Package and payload performance shall be evaluated for extreme ambient temperature of -33 °C (-27 °F) in still air and in the shade.

7.2.3.1.3 Reduced and Increased External Pressure.

Reduced External Pressure. External pressure shall be 95.21 kPa absolute (13.81 psia).

Increased External Pressure. External pressure shall be 102.38 kPa absolute (14.85 psia).

7.2.3.1.4 Vibration. Package fatigue performance shall be evaluated for vibration normally incident to transport using response parameters given in American National Standards Institute (ANSI) N14.23, *Draft American National Standard Design Basis for Resistance to Shock and Vibration of Radioactive Material Packages Greater Than One Ton in Truck Transport* (ANSI 1992).

7.2.3.1.5 Water Spray. Drum performance shall be evaluated for a simulated rainfall of 1.5 cm (0.6 in.) per hour for at least 1 hour.

7.2.3.1.6 Free Drop. Drum performance shall be evaluated for a free drop of 1.2 m (4 ft). The defined drop surface shall be a concrete slab 20.3 cm (8.0 in.) thick, two-way reinforced with number 7 rebar on 30.5 cm (12.0-in.) centers.

7.2.3.1.7 Compression. Drum performance shall be evaluated for a compression load of 5 times the weight of the drum applied uniformly on the top and bottom of a drum or 12.75 kPa (1.85 psi) applied over the horizontal projected area of the drum.

7.2.3.1.8 Penetration. Drum performance shall be evaluated for a vertical steel cylinder with a hemispherical end 3.2 cm in diameter and 6 kg of mass, dropping from a height of 1 m onto the drum. The cylinder is assumed to strike the drum's exposed surface in the region most vulnerable to puncture. The long axis of the cylinder is assumed to be perpendicular to the package surface.

7.2.3.1.9 Lifting and Tiedown. Drum lifting device performance shall be evaluated to DOE/RL-92-36, *Hanford Site Hoisting and Rigging Manual*, requirements. For tiedown attachments attached to the drum, performance shall be evaluated either for (1) failure of the attachment before damage of the drum or (2) attachment meets the 10, 2, and 5 requirement of 10 CFR 71.45 (b).

7.2.3.1.10 Brittle Fracture. As a minimum, all metallic materials susceptible to brittle fracture shall be evaluated per *Boiler and Pressure Vessel Code* (BPVC), Section VIII, Division 1 (ASME 1995c), criteria for listed materials for an ambient temperature of -33 °C (-27 °F). For unlisted materials, linear elastic fracture mechanics shall be used to determine the minimum nil ductility temperature. Plastic and rubber materials shall be evaluated to the manufacturer's recommended service limits.

7.2.4 Acceptance Criteria

NTC performance acceptance criteria are based on BPVC, Section III, Subsection NE (ASME 1995b). For load evaluations the worst-case temperature, pressure, and drop loads; temperature, pressure, and vibration loads; temperature, pressure, and compression loads; temperature, pressure, and lifting loads; and temperature, pressure, and tiedown stress intensities shall be combined. The combined stress intensities shall be evaluated against the requirements defined for Service Level A. The combined stress intensities from temperature, pressure, and drop shall be evaluated against the requirements defined for Service Level C. As an alternative the drum shall be shown to retain the contents when subjected to the loads from the above NTC performance tests.

7.2.5 Chemical and Galvanic Reactions

The standard 208 L (55-gal) drums are either painted on the outside and equipped with an inner polyethylene liner or painted on both inside and outside surfaces. This inhibits both chemical and galvanic corrosive reactions of the carbon steel drum material. Consequently, standard 208 L (55-gal) drums' corrosive chemical and galvanic reactions will be inhibited during NTC and will not affect the structural integrity of the drum.

In the case of retrieval drums, any prior protective coating is assumed to have worn off, and corrosion of the drum walls and lids has occurred. This is accounted for in the structural evaluations by assuming the wall thickness of both the drum walls and lids has been thinned to 0.76 mm (0.030 in.). The estimate is conservatively based on a corrosion rate of roughly 0.38 mm/yr (1.5 mil/yr) for 20 years. The structural evaluations from the various NTC loading scenarios show that retrieval drums will maintain structural integrity after being subjected to corrosive attacks, which reduce the wall and lid thickness.

7.2.6 Size of Package and Cavity

As a minimum the exterior and interior dimensions of all the drums conform to ANSI/ASC MH2-1985, *American National Standard for Materials Handling (Containers)--Steel Drums and Pails* (ANSI 1985). The 208 L (55-gal) drums manufactured to this standard meet the component

configuration and material thickness requirements for DOT-17C and -17H drums. The retrieval drums are assumed have a reduced wall and lid thickness of 0.76 mm (0.030 in.).

7.2.7 Weight and Center of Gravity

The maximum permissible gross weight of a standard 208 L (55-gal) drum is 658 kg (1,450 lb), and for a retrieval drum the maximum permissible gross weight is 181 kg (400 lb). In both cases, the center of gravity of a fully loaded package is at the geometric center of the drum.

7.2.8 Tamper-Indicating Feature

Tamper indication shall be provided by wire/lead disc seals fixed to the drum lid or closure ring.

7.2.9 Positive Closure

All the drums are fitted with bolted locking rings, which prevent inadvertent opening.

7.2.10 Lifting and Tiedown Devices

No integral lifting or tiedown devices are provided on the drum. Drums are to be lifted by ancillary equipment specifically designed for drum handling and meeting the requirements of DOE/RL-92-36. Tiedown devices and methods are described in Part B, Section 10.0, of this document.

7.2.11 Brittle Fracture

Based on the thickness of drum materials, brittle fracture of the material is not an issue. This is demonstrated by meeting the material toughness testing requirements specified in BPVC, Section III, Division 3 (ASME 1997). Ferrous materials with a nominal section thickness of less than 0.48 cm (3/16 in.) and bolts under a nominal diameter of 2.54 cm (1.0 in.) are not required to be fracture toughness tested. The maximum material thickness of the drums is 12 gauge, and the nominal diameter of the locking ring bolt is $\frac{5}{8}$ in., both of which are less than the specified nominal thicknesses.

7.3 NORMAL TRANSFER CONDITIONS

7.3.1 Structural Model

7.3.1.1 Computer Program Description. The ABAQUS is a general-purpose finite-element analysis program that can be used for elastic, plastic, and other inelastic analysis of structural members. It offers a full spectrum of elements from simple elements to continuum elements, more sophisticated rock/soil elements, and hypo- and hyperplastic elements. They can be used in one-, two-, and three-dimensional analysis. The ABAQUS provides two subsets of analysis scheme; one is ABAQUS/Standard, and the other is ABAQUS/Explicit (HKS 1995). The latter is used in this impact evaluation.

The ABAQUS' explicit dynamic finite-element program, ABAQUS/Explicit, is fully vectorized for use on high-end computers. In order to achieve faster computations, some limitations of intrinsic element characteristics have been incorporated, such as a smaller subset of elements (compared to ABAQUS/Standard) to be allowed in ABAQUS/Explicit (HKS 1995) and the use of diagonal mass matrix.

An important feature of ABAQUS/Explicit (HKS 1995) is its ability in solving a contact problem as in simulation of cask impacts. The contact surface definition and the contact pair of surfaces are easy to use and effectively simulate impacts when defined properly.

7.3.1.2 Description of Model. Taking advantage of model symmetry, a half-section (180°) model is developed for this analysis. The drum assembly with its payload remains in its upright position, but the concrete/soil target is rotated and positioned for various impact orientations.

The model uses ABAQUS three-dimensional shell element S4R for the drum body, drum lid, closing ring, and payload and ABAQUS three-dimensional tension truss T3D2 for the closing ring bolt. The concrete and soil are modeled with ABAQUS eight-node solid element C3D8R. The size of the concrete pad is 3.1 m (10.0 ft) square by 20.32 cm (8.0 in.) thick (modeled half section). The rebar steel is smeared into the concrete layers with ABAQUS *REBAR command. The size of the soil model is the same as the concrete, but with 127 cm (50.0-in.) thickness. The model is shown in Figure B7-2 for the general view of the bottom-end impact. The element maps of drum bottom plate, wall, and lid are shown in Figures B7-3 through B7-5. The closing ring is shown in Figures B7-6 and B7-7, which show the details around the closing ring. The bolt is shown in Figure B7-8. The payload is shown in Figure B7-9.

Figure B7-2. General View of Finite Element Model for Impact Analysis.

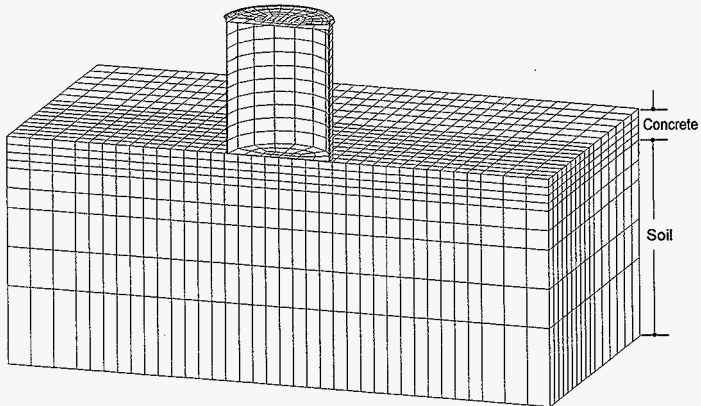

Figure B7-3. Element Map of Drum Bottom Plate.

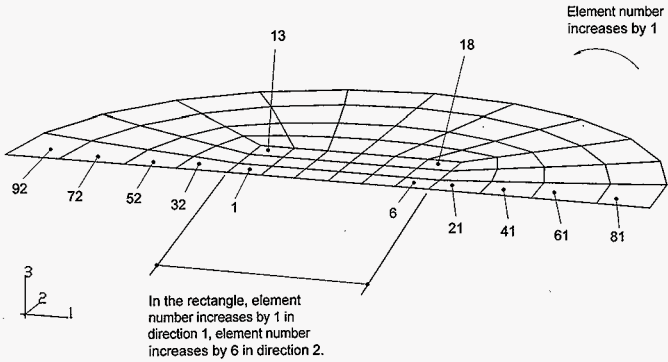

Figure B7-4. Element Map of Drum Wall.

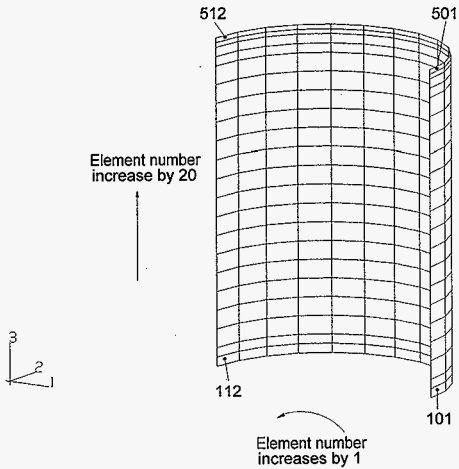

Figure B7-5. Element Map of Drum Lid.

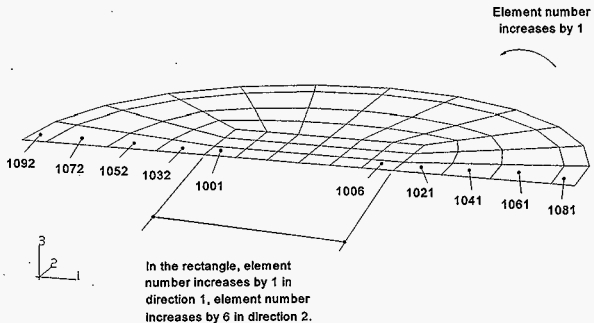

Figure B7-6. Element Map of Closing Ring.

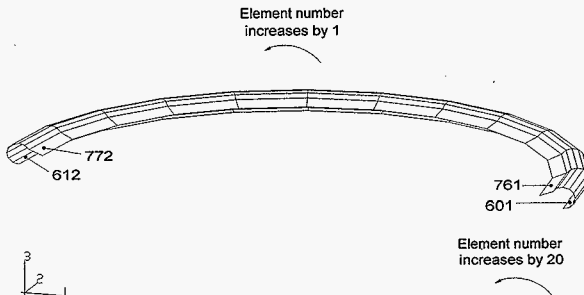

Figure B7-7. Element Map of Closing Ring Details.

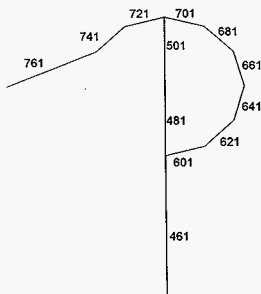

Figure B7-8. Element Map of Closing Ring Bolt.

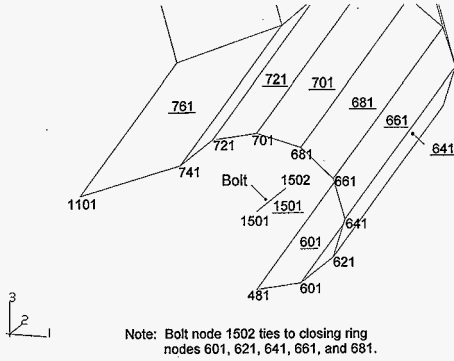
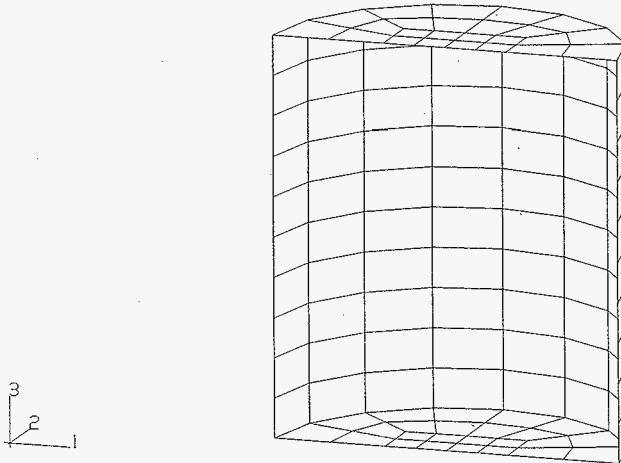

Figure B7-9. General View of Payload.



7.3.1.3 Material Model.

7.3.1.3.1 55-Gal Drum Assembly. The drum assembly consists of a drum body, a lid, a closing ring, and a ½-in.-diameter bolt and nut combination. The drum is manufactured from carbon steel, and in this analysis the structural steel is assumed as ASTM A36 for the drum body, lid, and closing ring. The bolt and nut material is assumed to be manufactured from steel equivalent to A36 steel, ASTM A307, Grade C. The mechanical properties of these steels are as follows: the modulus of elasticity is 2×10^5 MPa (29×10^6 psi); the Poisson’s ratio is 0.3; the yield strength is 248 MPa (36,000 psi); the ultimate tensile strength is 414 MPa (60,000 psi); and the minimum elongation is 0.23. Density of the steel is 8 g/cm^3 (0.29 lb/in^3). The material rupture toughness with a 0.9 reduction factor is established as $6,853 \text{ N}\cdot\text{m/m}^3$ ($9,940 \text{ in}\cdot\text{lb/in}^3$).

The steel is assumed to gradually soften after reaching its maximum strength. Failure of the material follows ABAQUS *FAILURE description. The material starts to fail at 25% strain and to rupture at 30% strain, which considers a 30% increase due to dynamic loading.

The plasticity portion of the stress-strain curve is shown in Table B7-3.

Table B7-3. Steel Component Plastic Stress and Strain.

Stress (lbf/in ²)	Plastic strain
36000	0
60000	0.23
30000	0.24
10000	0.25
5000	0.26
1000	0.27

7.3.1.3.2 Payload. The payload is used to increase the drum package total weight to 658 kg (1,450 lb). A shell with the same thickness as the drum is used to model the payload. The payload is assumed to be the same material as the drum, but its density is adjusted. The payload is assumed to be elastic throughout the analysis run.

7.3.1.3.3 Reinforced Concrete. The reinforced concrete is assumed to have a compressive strength of 27.6 MPa (4,000 psi) and is 20.3 cm (8.0 in.) thick with No. 7 reinforcing steels in two orthogonal directions. The steel bars are embedded 5.1 cm (2.0 in.) below the surface on both faces. The spacing between steel bars is 30.5 cm (12.0 in.) center to center.

The modulus of elasticity of concrete is assumed as 24.8 MPa (3.6×10^6 psi) with a Poisson’s ratio of 0.15. The concrete density is assumed as 2.08 g/cm^3 (130 lb/in^3). The ABAQUS Drucker-Prager model used to simulate the concrete yield surface and the plasticity is defined as follows.

*DRUCKER PRAGER
 35.1,1.0,35.1
 *DRUCKER PRAGER HARDENING
 2250.,0.0
 3900.,0.0013

3000.,0.0024
 2400.,0.0034
 1790.,0.0044
 1180.,0.0054
 800.,0.006
 100.,0.0061

The rebar steel material properties are as follows: the modulus of elasticity is 2×10^5 MPa (29.5×10^6 psi), and the Poisson's ratio is 0.3. The rebar steel density is assumed as 7.85 g/cm^3 (490 lb/ft^3). The plasticity portion of the stress-strain relationship is shown in Table B7-4.

Table B7-4. Rebar Steel Plastic Stress and Strain.

Stress (lbf/in ²)	Plastic strain
71170	0
71626	0.004985
83130	0.017098
96460	0.036202
104728	0.055113
109080	0.073795

7.3.1.3.4 Soil. The soil is assumed to have a modulus of elasticity of 39.3 MPa (5,700 psi) and a Poisson's ratio of 0.35. The soil density is assumed to be 1.76 Mg/m^3 (110 lb/in^3). The ABAQUS Drucker-Prager model used to simulate the soil yield surface and plasticity is as follows.

```
*DRUCKER PRAGER
35.2,0.82,35.2
*DRUCKER PRAGER HARDENING
2.0,0.0
6.54,0.0055
8.64,0.0156
9.96,0.0259
10.68,0.0362
10.98,0.0467
11.1,0.0573
11.04,0.068
10.8,0.0788
10.44,0.0897
9.9,0.1
9.0,0.112
```

7.3.1.4 Data Post-Processing and Result Reporting. The filtered stress and cumulative strain results are reported after the structural response has stabilized. Based on the recommendations of International Atomic Energy Agency Safety Series No. 7, *Explanatory Material for the IAEA Regulations for the Safe Transport of Radioactive Material* (IAEA 1990), the data is filtered at 1,000 Hz by using a six-pole sine-Butterworth filter in the ABAQUS post processor. The rationale for this is that the cumulative strains, which occur after the structural response has stabilized, are the real measure of structural damage. Also, because the structure cannot respond to the initial high-frequency peak stress wave values, the BPVC stress intensities are developed after the

structural response has stabilized. Consequently, results of stress intensities and cumulative logarithmic strains are examined after stabilization of the response. In some cases, due to relaxation of a highly stressed region, the redistribution of the load results in regions of high stress with lower strain values. In such cases, the highest stressed element at the end of the analysis is also reported for BPVC comparisons.

7.3.2 Environmental Heat Loading

In the case of a worst-case liquid content, as shown in the thermal evaluation (Part B, Section 8.0), the exterior steady-state temperature of the drums is 62 °C (144 °F). This temperature is based upon a conservative heat source of 0.75 W with solar insolation. For the case of the worst-case solid content, the exterior steady-state temperature of the drum is 63 °C (145 °F) based on a 12-W heat source under solar insolation. These temperatures are well within the range of allowable material properties specified for the drum materials of construction.

7.3.3 Maximum Thermal and Pressure Stresses

Under NTC, the drums are not subjected to any significant thermal stresses. The interior wall and exterior wall temperatures are essentially the same due to the relative thin wall of the drums. Also, since the drums are vented and not sealed, increased pressure due to internal or external heating is not a concern.

In the event the standard 208 L (55-gal) drums are required to be sealed, 17C and 17H drums will by definition (49 CFR 178.115 and 178.118) withstand pressures in excess of 1.5 times the standard atmospheric pressure. The UN1A2 drums are required to withstand pressures defined as "Not less than the total gauge pressure measured in the packaging (i.e., the vapor pressure of the filling material and the partial pressure of the air or other inert gas minus 100 kPa [15 psi] at 55 °C [131 °F], multiplied by a safety factor of 1.5)."

7.3.4 Vibration

As shown in Part B, Section 7.6, the lid, locking ring, and bolt will sustain the NTC vibrational loads specified in ANSI (1992). The estimated number of cycles for a drum is based on a transport distance of 16 km (10 mi) at an average speed of 56 km/h (35 mi/h) with an average vibrational frequency of 5 Hz. Based on these parameters the drum is subjected to 5,200 cycles. At this relatively low number of cycles and low cyclic stresses, fatigue on the drum or any lid components is not a concern. Also, as shown in Part B, Section 7.6, because of the low cyclic loading, the locking ring bolt has a sufficient preload to prevent loosening of the nut.

7.3.5 Water Spray

Water spray testing of the DOT-17C and -17H standard 208 L (55-gal) drums performed by Mound Laboratory show no leakage or other effects that would affect the performance of the drums. UN1A2 drums are required to demonstrate the ability to meet the Type A requirements. In the case of the retrieval drums, these drums cannot be demonstrated to meet the requirements due to deterioration of the seals. Consequently, retrieval drums must be shipped in covered conveyances or covered with waterproof material during transport.

7.3.6 Compression

Compression testing has been performed on DOT-17C and -17H drum test units as documented in WHC-SD-RE-TI-111, *Reference Attachments for the Safety Analysis Report for Packaging (SARP) for Transuranic Radioactive Material Transport in the 55-Gallon Drum HCS-042--002* (RHO 1994), and MLM-3245, DOE/DP/0053-H1, *DOE Evaluation Document for DOT 17A Type A Packaging* (DOE 1987). These tests demonstrated acceptable performance of the DOT-17C and -17H drums. Compression testing of UN1A2 drums is required by the DOT-7A, Type A specification and must be demonstrated by the manufacturer by either testing or analysis before acceptance.

In the case of the retrieval drums, it is demonstrated in Part B, Section 7.6, that the thin-walled retrieval drums meet the performance requirements for compression specified in Part B, Sections 7.2.3 and 7.2.4.

7.3.7 Free Drop

7.3.7.1 Standard 208 L (55-Gal) Drums. To demonstrate acceptable performance of the drums for a free drop, a numerical simulation of a test was performed with a 1.2 m (4.0-ft) drop with the center of gravity over the top corner on the specified concrete/soil surface. The case of center of gravity over the top corner is chosen because it results in the most damage to the drum. The initial impact velocity for a 1.2 m (4.0-ft) drop is 17.61 km/h (10.94 mi/h).

The results of the numerical simulation show that at the node midway between the top and bottom of the drum, the average acceleration of impact is 36gs. The time and velocity at the rebound are determined at the maximum displacement of the drum. The velocity history is shown in Figure B7-10, and the displacement history is shown in Figure B7-11.

The maximum stress and accumulated plastic strain occur at Element 721, on the closing ring. The stress is 355 MPa (51,490 psi), and the accumulated plastic strain is 13.37%. The maximum stress is within the ASME (1995b) Service Level C limit for general membrane and bending stress of 364 MPa (52.8 ksi), which is 1.5 times the yield strength of the material at maximum temperature. Also at this element, the strain energy density is the highest among all locations at 3,962 N•cm/cm³ (5,747 in-lbf/in³). This strain energy density is below the allowable material rupture toughness of 6,853 N•cm/cm³ (9,940 in-lbf/in³). The stress, the accumulated plastic strain, and the strain energy density curves at EL 721 are shown in Figures B7-12 through B7-14, respectively.

Figure B7-10. Velocity History of the Drum with the 1.2 m (4-ft) Top-Corner Impact.

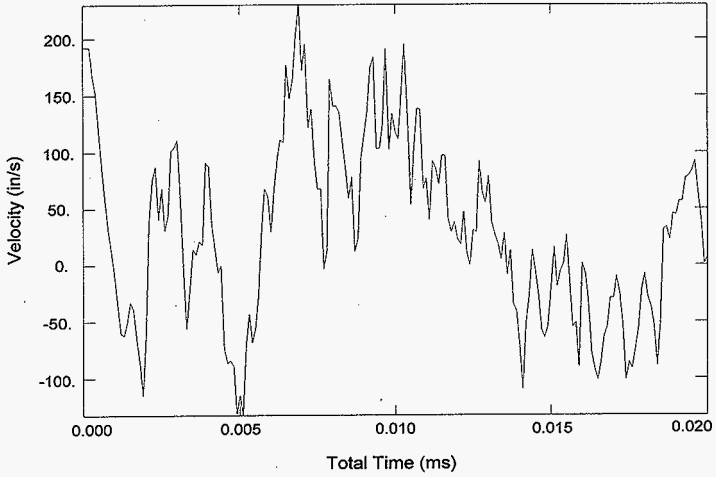

Figure B7-11. Displacement History of the Drum With the 1.2 m (4-ft) Top-Corner Impact.

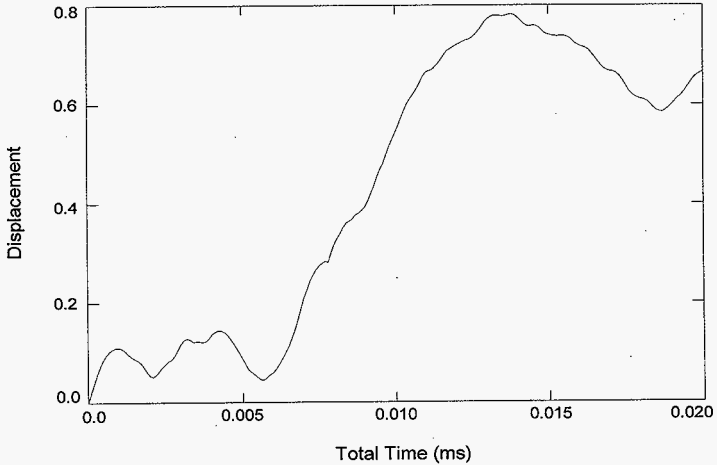

Figure B7-12. Stress at EL 721 with the 1.2-m (4-ft) Top-Corner Impact.

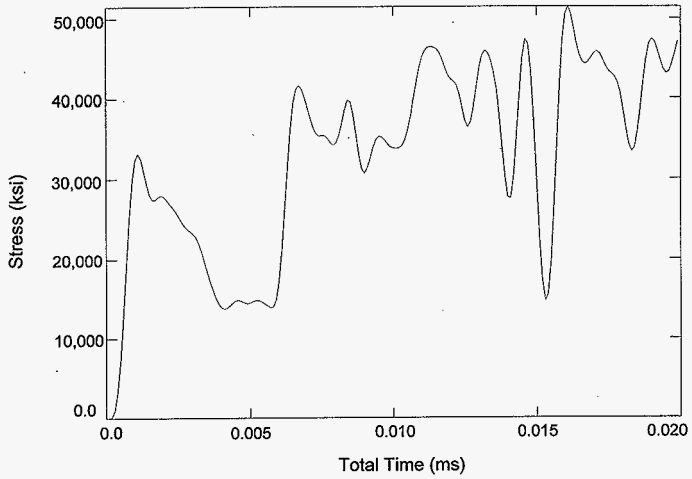

Figure B7-13. Accumulated Plastic Strain at EL 721 With the 1.2 m (4-ft) Top-Corner Impact.

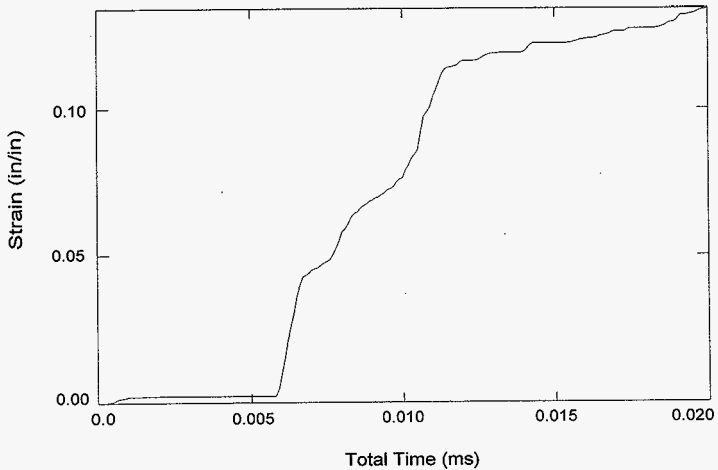
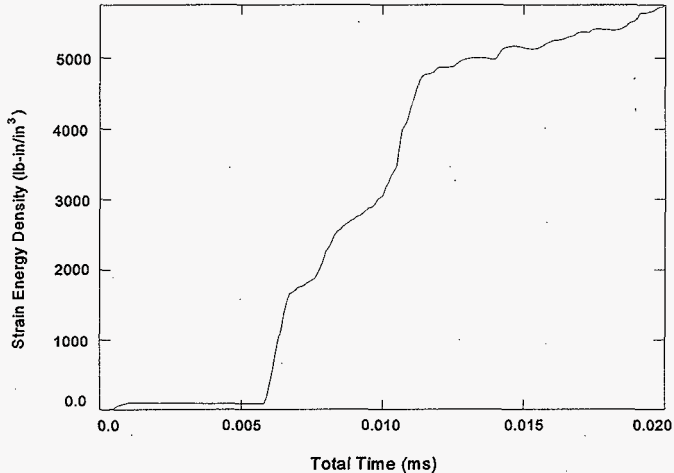

Figure B7-14. Strain Energy Density at EL 721 With the 1.2 m (4-ft) Top-Corner Impact.



7.3.7.2 Retrieval Drums. As with the standard 208 L (55-gal) drum, a computer simulation was performed of the impact resulting from a 1.2 m (4.0-ft) drop onto the specified concrete/soil surface. An impact orientation with the center of gravity over the top corner is chosen because this results in the most damage to the drum. As with the standard 208 L (55-gal) drums, the initial impact velocity is 17.61 km/h (10.94 mi/h).

The computer model developed for the standard 208 L (55-gal) drum is for the simulation with minor changes. The wall thickness of the drum components is reduced to 0.076 cm (0.030 in.), and the payload is reduced to 181 kg (400 lb). Results of displacement, velocity, and acceleration are determined. The strain energy and stress intensity at critical locations are compared with the material rupture toughness and ASME (1995b) Service Level C limits to assess the drum's performance.

Results of the computer simulation show the average acceleration is 45.3gs at the node midway between the top and bottom of the drum. The rebound time is chosen when displacement of drum is at its maximum. The displacement history is shown in Figure B7-15, and the velocity history is shown in Figure B7-16. The acceleration history is processed from the reaction forces and is shown in Figure B7-17 with no filtration and in Figure B7-18 filtered at 1000 Hz. The peak acceleration with 1000 Hz filtration is approximately 85.3gs. Acceleration data is summarized in Table B7-5.

Figure B7-15. 1.2 m (4-ft) Corner-Impact Displacement History.

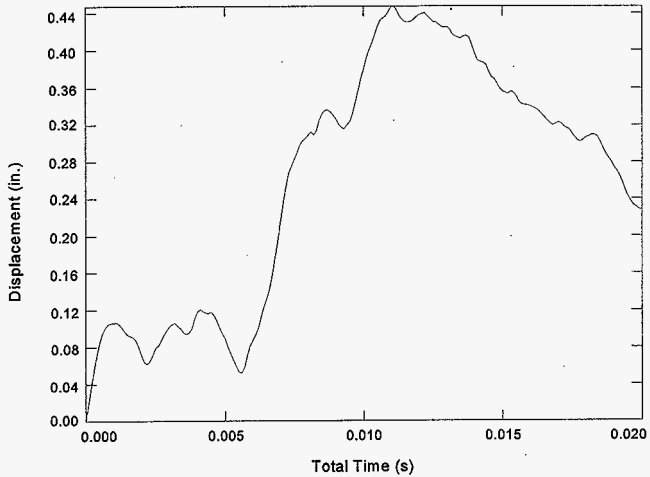

Figure B7-16. 1.2 m (4-ft) Top-Corner-Impact Velocity History.

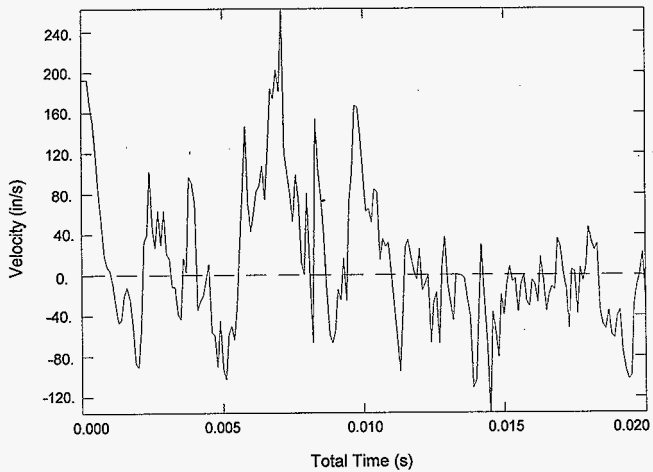

Figure B7-17. 1.2 m (4-ft) Top-Corner-Impact Acceleration History (Unfiltered).

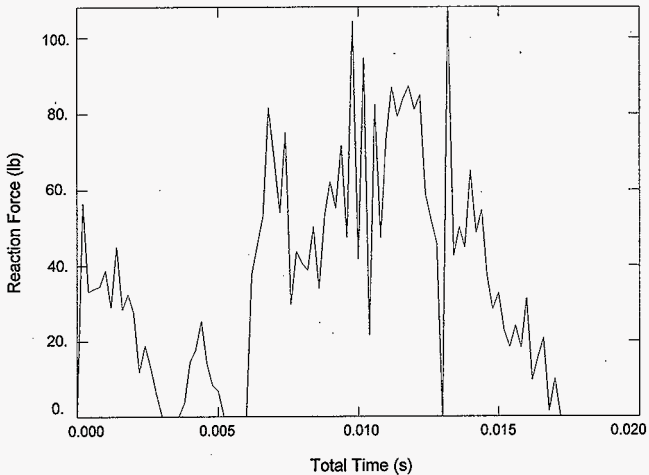

Figure B7-18. 1.2 m (4-ft) Top-Corner-Impact Acceleration History (Filtered at 1000 Hz).

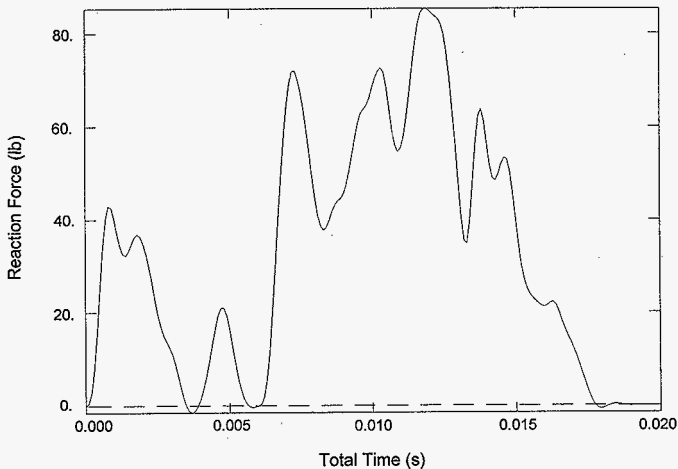

Table B7-5. Acceleration Data of 1.2 m (4-ft) Top Corner Impact.

Case	Average impact-period acceleration (g)	Peak acceleration (g)	Impact period (ms)
1.2 m (4 ft) top corner impact	45.3	85.3	11

The maximum stress and accumulated plastic strain occur at Element 461, which is on the drum wall. The stress is 381 MPa (55,220 psi) and the accumulated strain is 9%. At this element, is the maximum strain energy density at 2,523 N•cm/cm³ (3,660 in-lbf/in³). The strain energy density value is below the material rupture toughness of 6,853 N•cm/cm³ (9,940 in-lbf/in³). In this case, the stress exceeds the ASME (1995b) Service Level C limit at maximum temperature. However the strain energy density is well below the material rupture toughness. Consequently, the drum will be severely deformed but no breach of the material retention boundary will occur. This damage condition satisfies the performance requirements as defined above. The stress intensity, the accumulated strain, and the strain energy density curves at EL 461 are shown in Figures B7-19 through B7-21, respectively. A plot of the deformed drum is shown in Figure B7-22.

Figure B7-19. 1.2 m (4-ft) Top-Corner-Impact Stress Intensity at EL 461.

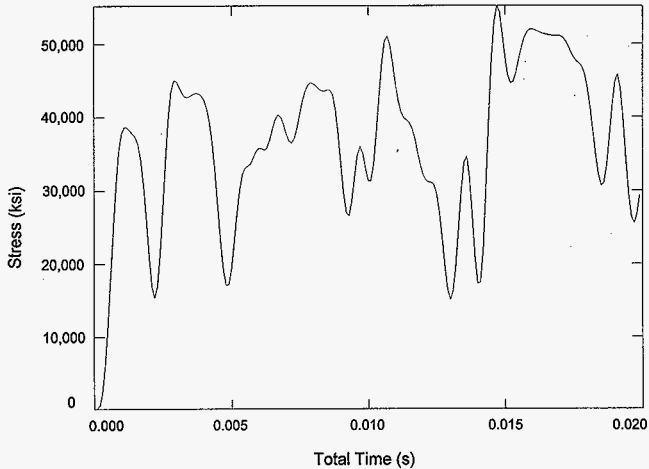

Figure B7-20. 1.2 m (4-ft) Top-Corner-Impact Accumulated Strain at EL 461.

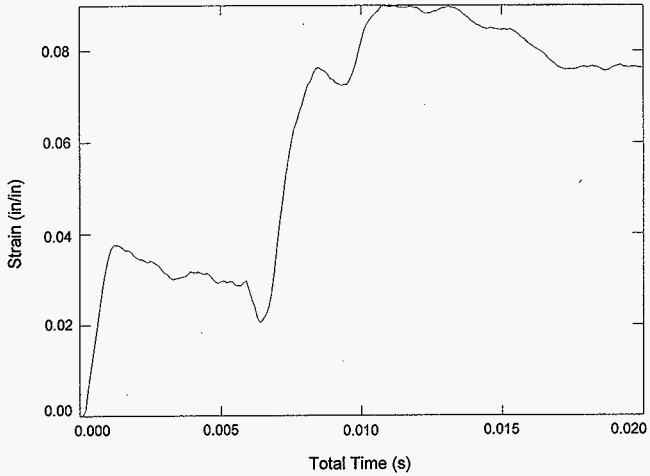

Figure B7-21. 1.2 m (4-ft) Top-Corner-Impact Strain Energy Density at EL 461.

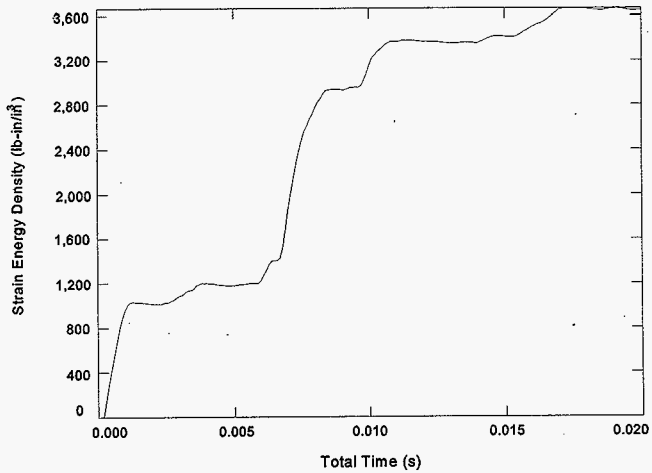
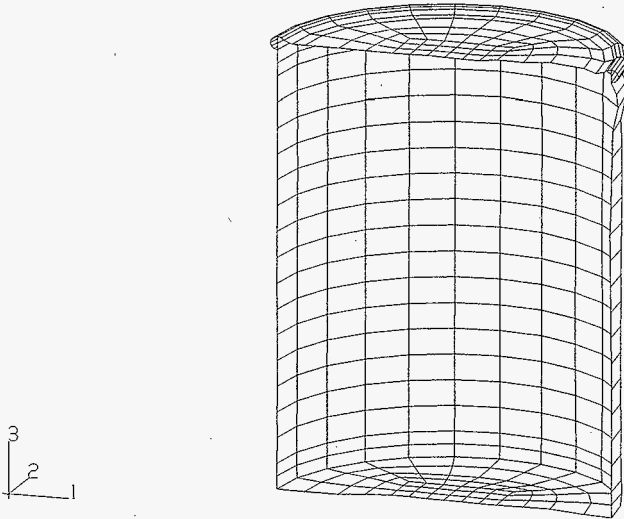

Figure B7-22. 1.2 m (4-ft) Top-Corner-Impact Deformation Plot.



7.3.8 Penetration

Penetration tests of DOT-17C and -17H drums, documented in WHC-SD-RE-TI-111 (RHO 1994) and MLM-3245 (DOE 1987), demonstrate that these drums meet the penetration test performance requirements. Testing of UN1A2 drums are required by the DOT-7A, Type A specification and must be demonstrated to meet the requirements by the manufacturer.

In the case of the retrieval drums, it is demonstrated in Part B, Section 7.6, that the thin-walled retrieval drums meet the performance requirements for penetration tests specified in Part B, Section 7.2.3.

7.3.9 Structural Evaluations and Conclusions

Based on the structural NTC criteria established in this section and performance evaluations of both the standard 208 L (55-gal) and retrieval drums presented above, it is concluded that both meet NTC.

7.4 ACCIDENT CONDITIONS

Standard 208 L (55-gal) drums and retrieval drums transported under the requirements set forth by this SARP are risk-based shipments. Consequently, accident conditions evaluated herein are in support of the risk analysis section of this SARP.

7.4.1 Conditions To Be Evaluated

In support of the risk analysis, the failure threshold for impact velocity change, dynamic crush (for small packages), and puncture thickness are to be determined. No other loadings are superimposed on the drum for these evaluations.

7.4.2 Acceptance Criteria

For impact velocity change and dynamic crush, the failure threshold of the package is defined as the velocity and force parameters, respectively, at which the package will breach sufficiently to spill the entire contents. The failure of the drum is established as the total strain energy (density) of a section that exceeds the material rupture toughness (allowable strain energy density) with a safety margin of 10%. This material rupture toughness is a measure of its ability to absorb energy when stressed in the plastic range as described in the following equation.

$$U_r = \left(\frac{\sigma_u + \sigma_y}{2} \times \epsilon \right) \times \text{margin}$$

$$\text{margin} = 0.9$$

This is also the material's energy-absorbing capacity for resisting fracture under a dynamic load.

7.4.3 Structural Model

The structural model and modeling used for determination of the impact velocity change failure thresholds are the same as described in Part B, Section 7.3.1, for the 1.2 m (4-ft) free drop.

For the dynamic crush failure threshold determination, the drums are modeled the same as for the impact velocity change failure threshold determination. In this numerical simulation the drums are assumed to be arranged in some specific pattern inside the transporter: the drums are not stacked, and each drum stands on the bed of the conveyance with bottom end down. The drums are arranged in rows and columns, either in line or staggered. They may be grouped into several sections to limit the number of drums in each section, with intermediate restraining beams placed between sections. During a front-end accident, the drums in the first row are pinched laterally between the front wall of the transporter and the rear drums, thereby subjecting the drum to high dynamic forces. This numerical simulation is intended to determine the failure threshold of the 208 L (55-gal) drum under this dynamic crush condition. The dynamic crush numerical simulation is conservatively modeled as the drum placed against a stationary hard unyielding plate and being loaded by a second hard unyielding plate with a designated weight and initial velocity to simulate the total weight of all drums behind the first drum. The stationary hard unyielding plate is used to simulate the front end of the conveyance. The half-section model is shown in Figure B7-23.

Figure B7-23. General View of Finite Element Model for Dynamic Crush Analysis.

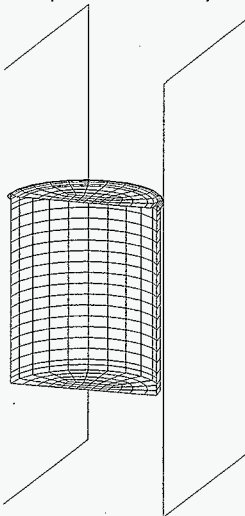

7.4.4 Structural Evaluations and Conclusions

7.4.4.1 Standard 208 L (55-gal) Drum Impact Velocity Change Failure Threshold.

7.4.4.1.1 Bottom End Impact. A 48 km/h (30-mi/h) impact and a 89 km/h (55-mi/h) impact at the bottom end of the drum with the concrete/soil target are evaluated. Using the velocity data of a node at the middle elevation of the drum, the average acceleration of the drum is approximately 467*gs* for the 48 km/h (30-mi/h) impact and 710*gs* for the 89 km/h (55-mi/h) impact. The velocity histories are shown in Figures B7-24 and B7-25 for the 48 km/h (30-mi/h) and the 89 km/h (55-mi/h) impacts, respectively.

In this case, the most severely strained location occurs at the bottom of the drum wall. The strain energy density for the 48 km/h (30-mi/h) impact is negligible in comparison with the material rupture toughness. Even with the 89 km/h (55-mi/h) impact, the highest strain energy density is only 2,987 N•cm/cm³ (4,332 in-lb/in³) at Element 101 in the bottom region of the drum wall. The strain energy density history at this element is shown in Figure B7-26. The allowable strain energy density of A36 or A307 steel is 6,853 N•cm/cm³ (9,940 in-lb/in³). Consequently, no catastrophic failure, such as rupture, is expected for this case.

The deformation of the drum and concrete for the 89 km/h (55-mi/h) bottom-end-impact case is shown in Figure B7-27. The deformation of the concrete alone is shown in Figure B7-28.

Figure B7-24. Velocity History of the Drum With the 48 km/h (30-mi/h) Bottom-End Impact.

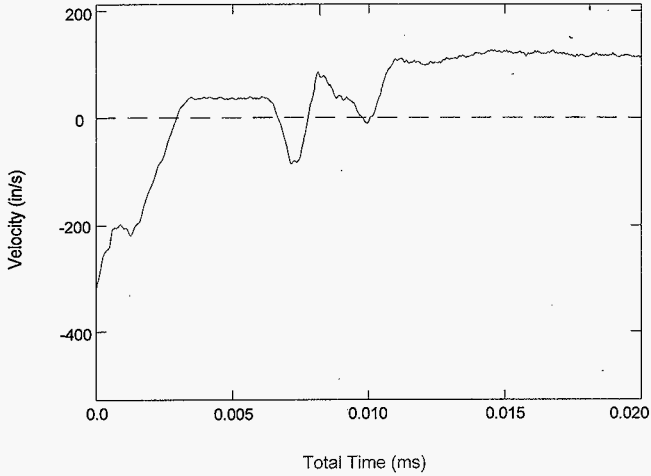

Figure B7-25. Velocity History of the Drum With the 89 km/h (55-mi/h) Bottom-End Impact.

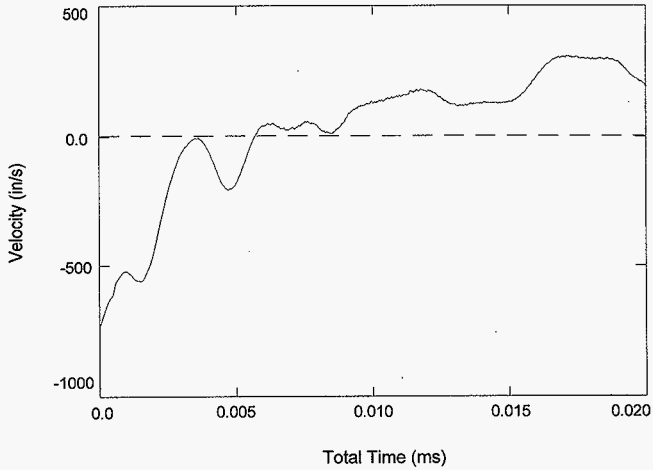

Figure B7-26. Typical Strain Energy History of the Drum With the 89 km/h (55-mi/h) Bottom-End Impact.

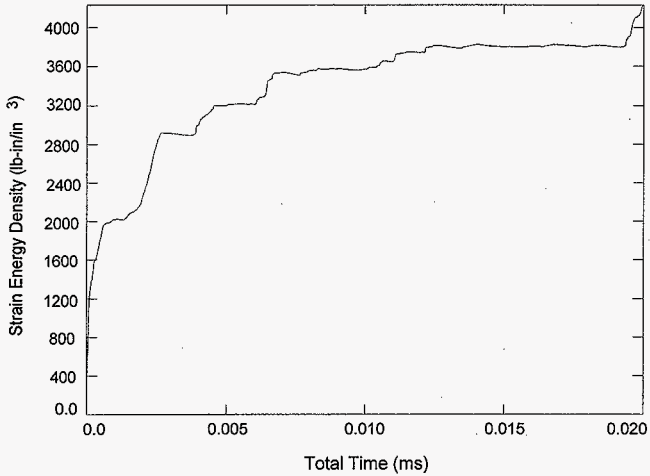

Figure B7-27. The Deformation of Drum and Concrete With the 89 km/h (55-mi/h) Bottom-End Impact.

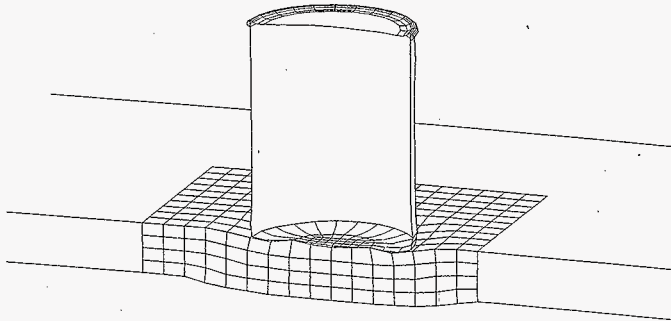
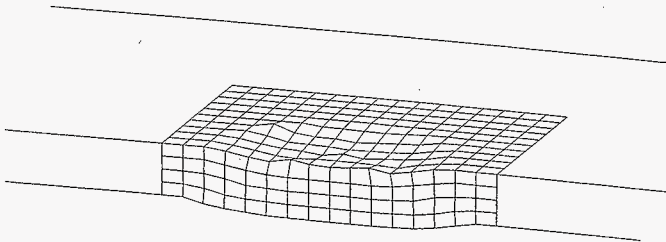

Figure B7-28. The Deformation of Concrete With the 89 km/h (55-mi/h) Bottom-End Impact.



7.4.4.1.2 Side Impact. Two side-impact cases are analyzed, a 48 km/h (30-mi/h) impact and a 80 km/h (50-mi/h) impact onto the concrete/soil target. The average acceleration obtained at a node midway between the top and bottom of the drum shows 242gs for the 48 km/h (30-mi/h) impact and 308gs for the 80 km/h (50-mi/h) impact. The velocity histories are shown in Figures B7-29 and B7-30 for the 48 km/h (30-mi/h) and 80 km/h (50-mi/h) impacts, respectively.

Even though the strain energy density resulting from the side impact is substantially higher than that of the bottom-end impact, the magnitude is still within the range that complete rupture of a drum section can be excluded. Some of the elements show a strain energy density exceeding the material rupture toughness, but these are localized and isolated. The results are tabulated in Tables B7-6 and B7-7 for the 48 km/h (30-mi/h) and 80 km/h (50-mi/h) impacts, respectively. A typical strain energy history at EL 463 (top region of drum wall) for the 80 km/h (50-mi/h) impact is shown in Figure B7-31.

The deformation of the drum and concrete for the 80 km/h (50-mi/h) side impact is shown in Figure B7-32. The deformation of the concrete is shown in Figure B7-33.

Figure B7-29. Velocity History of the Drum With the 48 km/h (30-mi/h) Side Impact.

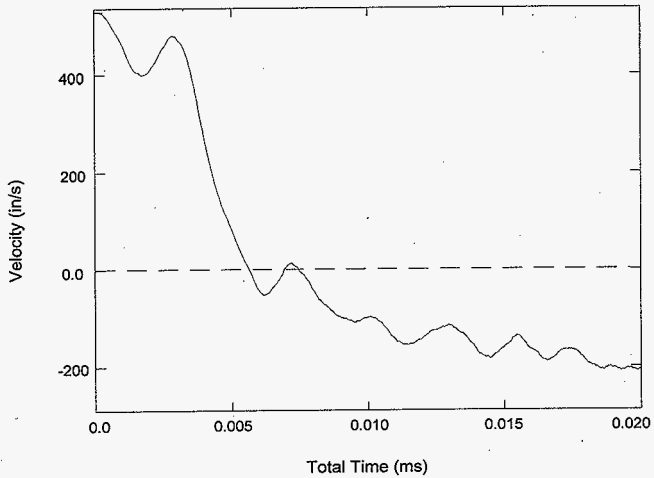

Figure B7-30. Velocity History of the Drum With the 80 km/h (50-mi/h) Side Impact.

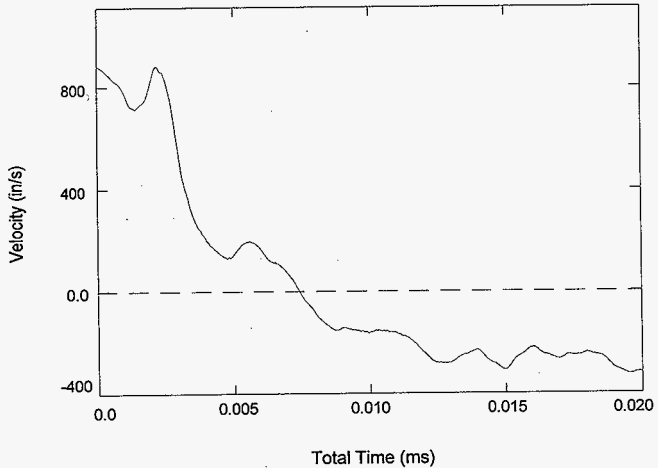

Table B7-6. Drum Strain Energy Density Results of
48 km/h (30-mi/h) Side Impact.

Element	Maximum strain energy density N•cm/cm ³ (in-lb/in ³)	Location
82	5221 (7572)	Edge of drum bottom plate
101	3764 (5460)	Bottom region of drum wall
441	4789 (6946)	Top region of drum wall
661	6792 (9851)	Closing ring
1081	3587 (5202)	Edge of drum lid

Table B7-7. Drum Strain Energy Density Results of
80 km/h (50-mi/h) Side Impact.

Element	Maximum strain energy density N•cm/cm ³ (in-lb/in ³)	Location
82	7184 (10420)	Edge of drum bottom plate
101	4990 (7237)	Bottom region of drum wall
441	7881 (11430)	Top region of drum wall
463	8149 (11820)	Top region of drum wall
661	6271 (9096)	Closing ring
1081	4743 (6880)	Edge of drum lid

Figure B7-31. Typical Strain Energy History of the Drum With the 80 km/h (50-mi/h) Side Impact.

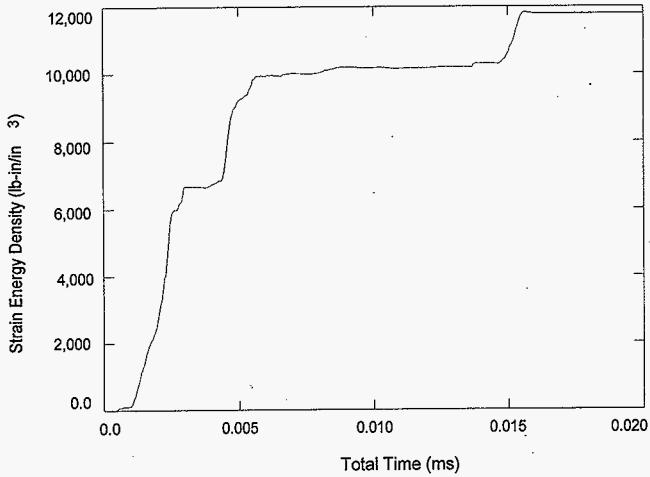

Figure B7-32. The Deformation of Drum and Concrete With the 80 km/h (50-mi/h) Side Impact.

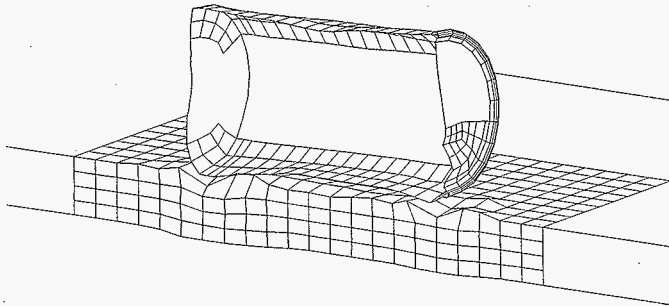
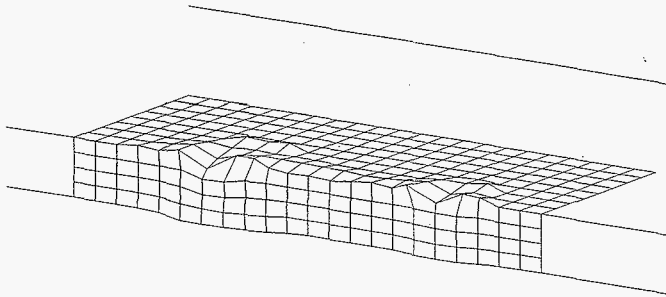

Figure B7-33. The Deformation of Concrete With the 80 km/h (50-mi/h) Side Impact.



7.4.4.1.3 Top-Corner Impact. The top-corner-impact analysis simulates the worst impact condition; i.e., center of gravity over the corner. Two top-corner-impact cases are analyzed, a 48 km/h (30 mi/h) and a 64 km/h (40 mi/h). Because of model numerical instability, the payload was modified for a 64 km/h (40-mi/h) impact from a flexible shell to a more conservative rigid shell. The average acceleration obtained at a node midway between the top and bottom of the drum shows 133gs for the 48 km/h (30-mi/h) impact and 151gs for the 64 km/h (40-mi/h) impact. The velocity histories are shown in Figures B7-34 and B7-35 for the 48 km/h (30-mi/h) and 64 km/h (40-mi/h) impacts, respectively.

The most severely damaged locations in this case are the top region of the drum, including the drum wall, closing ring, drum lid, and bolt, all of which are near the impact point. The strain energy density results are tabulated in Tables B7-8 and B7-9 for the 48 km/h (30-mi/h) and 64 km/h (40-mi/h) velocities, respectively, for these locations. In the case of the 48 km/h (30-mi/h) impact, only localized failure occurs at or near the point of impact on the closure ring and at the top of the drum. For the 64 km/h (40-mi/h) impact velocity, the whole section exceeds the allowable strain energy density. A typical strain energy density curve at EL 721 in the 64 km/h (40-mi/h) impact is shown in Figure B7-36.

Figure B7-34. Velocity History of the Drum With the 48 km/h (30-mi/h) Top-Corner Impact.

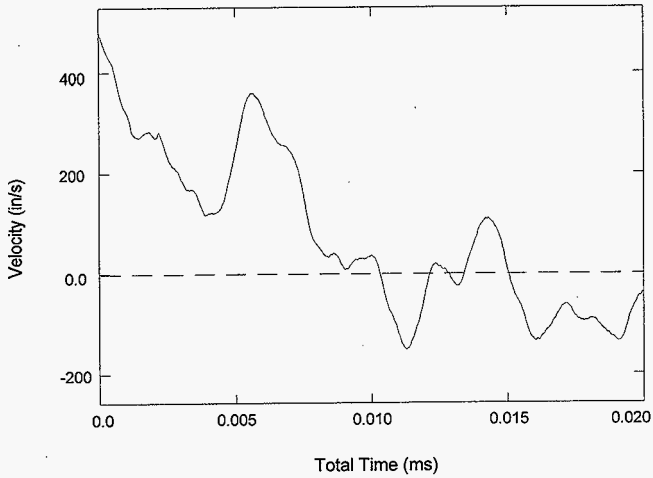

Figure B7-35. Velocity History of the Drum With the 64 km/h (40-mi/h) Top-Corner Impact.

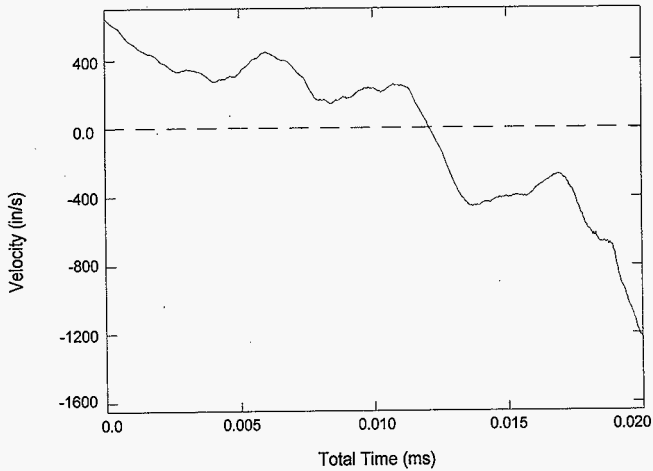

Table B7-8. Drum Strain Energy Density Results
of 48 km/h (30-mi/h) Top-Corner Impact.

Element	Maximum strain energy density N•cm/cm ³ (in-lb/in ³)	Location
461	8067 (11700)	Top region of drum wall
701	7977 (11570)	Closing ring
721	8094 (11740)	Closing ring
722	8005 (11610)	Closing ring

Table B7-9. Drum Strain Energy Density Results
of 64 km/h (40-mi/h) Top-Corner Impact.

Element	Maximum strain energy density N•cm/cm ³ (in-lb/in ³)	Location
421	8149 (11820)	Top region of drum wall
441-446	> 8115 (> 11770)	*Whole section ruptured
461-466	> 7619 (> 11050)	*Whole section ruptured
481-486	> 7646 (> 11090)	*Whole section ruptured
501-506	> 8047 (> 10710)	*Whole section ruptured
601-603	> 6922 (> 10040)	Closing ring
621	6991 (10140)	Closing ring
661	7274 (10550)	Closing ring
701-702	> 8129 (> 11790)	Closing ring
721-723	> 7336 (> 10640)	Closing ring
741	7619 (11050)	Closing ring
761	15354 (22270)	Closing ring
1060-1066	> 8101 (> 11750)	Edge of drum lid *Whole section ruptured
1081-1086	> 8074 (> 11710)	*Whole section ruptured

Figure B7-36. Typical Strain Energy History of the Drum
With the 64 km/h (40-mi/h) Top-Corner Impact.

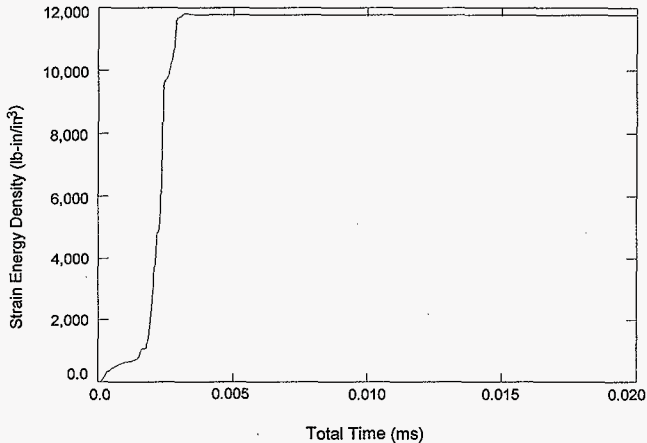

As shown in Table B7-9 for the 64 km/h (40-mi/h) impact case, numerous locations, including a whole section of the drum, have ruptured, such as the top of the drum wall, the closing ring, and the drum lid. However, in the 48 km/h (30-mi/h) impact case only localized rupture occurs, which does not result in complete loss of contents.

The deformation of the drum and concrete for the 48 km/h (30-mi/h) top-corner impact is shown in Figure B7-37. The deformation of the concrete for the 48 km/h (30-mi/h) impact is shown in Figure B7-38. The deformation of the drum with the 48 km/h (30-mi/h) impact at the end of a 20 ms run is shown in Figure B7-39. For the 64 km/h (40-mi/h) impact, the deformation of the drum with the drum lid removed is shown in Figure B7-40 just before the complete rupture occurs.

Figure B7-37. The Deformation of Drum and Concrete With the 48 km/h (30-mi/h) Top-Corner Impact.

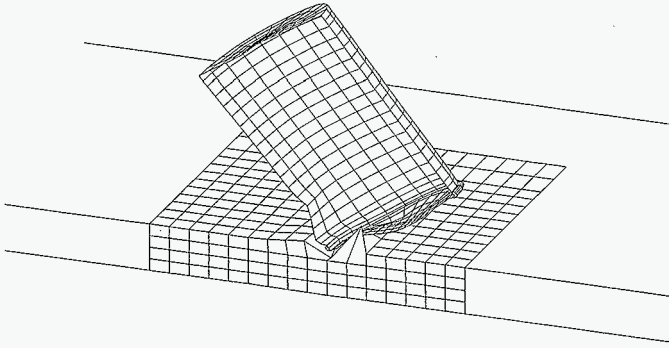

Figure B7-38. The Deformation of Concrete With the 48 km/h (30-mi/h) Top-Corner Impact.

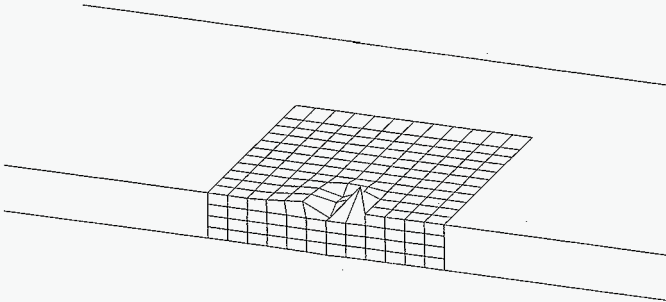

Figure B7-39. The Deformation of Drum With the 48 km/h (30-mi/h) Top-Corner Impact.

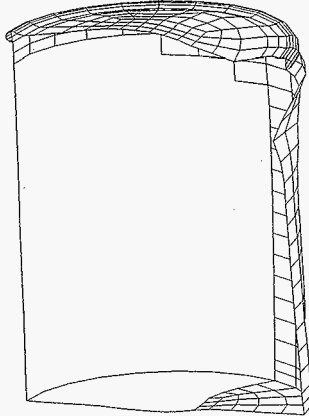
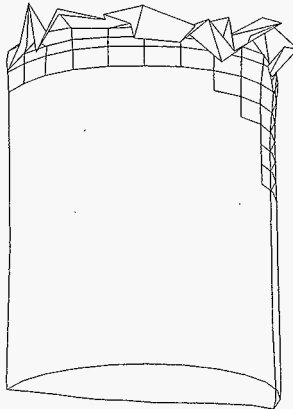

Figure B7-40. The Deformation of Drum With the 64 km/h (40-mi/h) Top-Corner Impact.



7.4.4.2 Retrieval Drum Impact Velocity Change Failure Threshold. In the case of the retrieval drums, the only orientation evaluated is with the center of gravity over the top-corner impact. This has been demonstrated in the previous evaluations as the impact orientation that causes the most damage to the drum.

The average acceleration at a node midway between the top and bottom of the drum shows the drum to have 193.6gs for this case. The rebound time was chosen when the displacement of the drum was at the maximum. The displacement history is shown in Figure B7-41, and the velocity history is shown in Figure B7-42. The acceleration history is processed from the reaction forces and is shown in Figure B7-43 when unfiltered and in Figure B7-44 when filtered at 1000 Hz. The peak acceleration with 1000 Hz filtration is approximately 488gs. Pertinent acceleration data are summarized in Table B7-10.

Several locations have a strain energy density that exceeds the allowable material rupture toughness. These locations are localized around the closing ring and are tabulated in Table B7-11. These locations are at or near the impact corner and restricted in a localized region. A typical strain density plot at EL 701 is shown in Figure B7-45. Consequently, no catastrophic rupture failure of the drum will occur. A plot of the deformed drum for this 48 km/h (30-mi/h) impact with the center of gravity over the top corner is shown in Figure B7-46.

Figure B7-41. 48 km/h (30-mi/h) Top-Corner-Impact Displacement History.

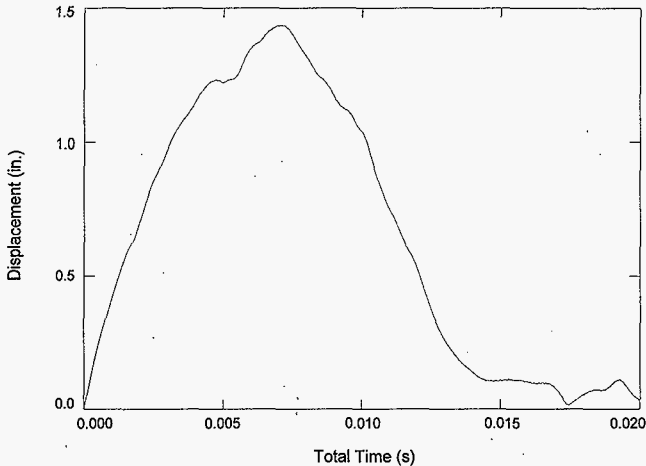

Figure B7-42. 48 km/h (30-mi/h) Top-Corner-Impact Velocity History.

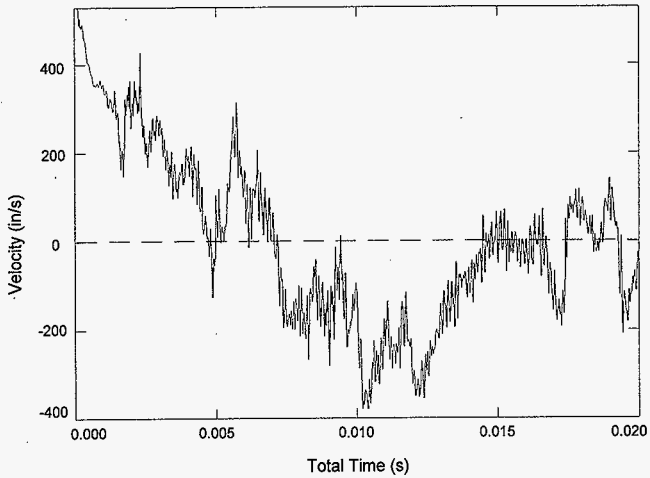

Figure B7-43. 48 km/h (30 mi/h) Top Corner Impact Acceleration History (Unfiltered).

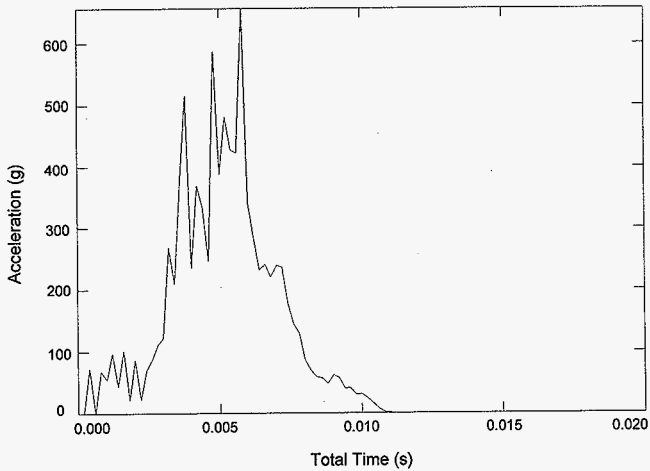

Figure B7-44. 48 km/h (30 mi/h) Top Corner Impact Acceleration History (Filtered at 1000 Hz).

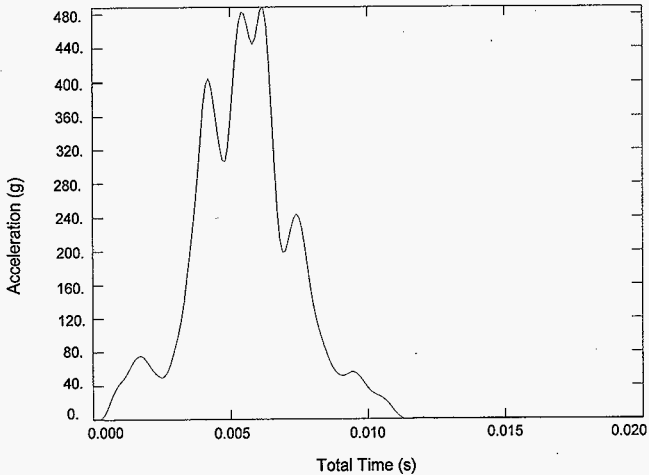

Table B7-10. Acceleration Data of 48 km/h (30-mi/h) Top-Corner Impact.

Case	Average impact-period acceleration (g)	Peak acceleration (g)	Impact period (ms)
48 km/h (30 mi/h) top corner impact	193.6	488	7.06

Table B7-11. Drum Strain Energy Density Results of 48 km/h (30 mi/h) Top-Corner Impact.

Element	Maximum Strain Energy Density N*cm/cm ³ (in-lb/in ³)	Location
701	7632 (11070)	Closing ring
721	7239 (10500)	Closing ring

Figure B7-45. 48 km/h (30-mi/h) Top-Corner-Impact Strain Energy Density at EL 701.

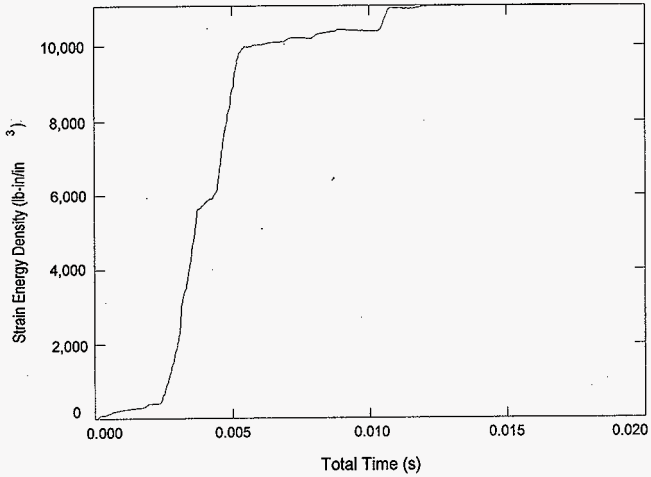
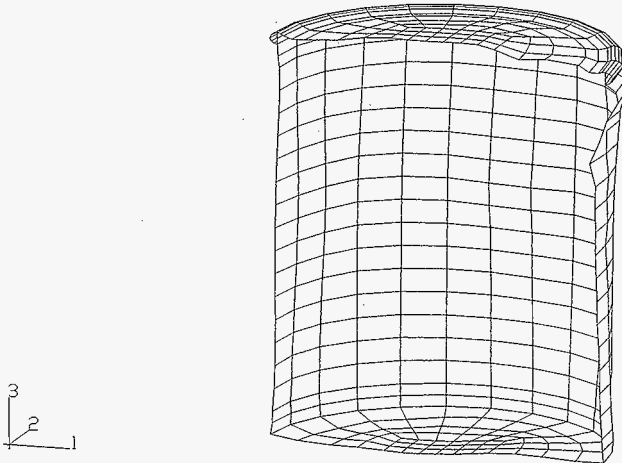

Figure B7-46. 48 km/h (30 mi/h) Top Corner Impact Deformation Plot.



7.4.4.3 Standard 208 L (55-gal) Drum Dynamic Crush Failure Threshold. After several iterations, two cases have been defined that establish the parameters where the standard 208 L (55-gal) drum catastrophically fails. The first is for a 1,361 kg (3,000-lb) load with a 48 km/h (30-mi/h) initial velocity impacting a stationary drum. The second case is a 2,268 kg (5000-lb) load with a 40 km/h (25-mi/h) initial velocity impacting a stationary drum. In the second case there is 15% more kinetic energy imposed onto the stationary drum. These two cases also bound the various drum arrangements and tiedown methods in or on a conveyance.

The 1,361 kg/48 km/h (3000-lb/30-mi/h) case shows that the drum ruptures in the bottom region. The strain energy density at the bottom region of the drum wall is up to the material rupture toughness in most places. There are 12 elements used around the half section in the drum wall, and 9 out of 12 elements exceed the material rupture toughness. The remaining three elements are at least 80% of the material rupture toughness. Table B7-12 shows the elements where strain energy density exceeds the rupture toughness. In this case the average deceleration factor on the drum is approximately 76gs. The velocity history is shown in Figure B7-47.

Table B7-12. Drum Strain Energy Density Results Dynamic Crush (1,361 kg/48 km/h [3000-lb/30-mi/h]) Impact.

Element	Maximum strain energy density N*cm/cm ³ (in-lb/in ³)	Location
16	7253 (10520)	Drum bottom plate
81-82	8136 (11800)	Edge of drum bottom plate
91	8129 (11790)	Edge of drum bottom plate
101-104	8129 (11790)	Bottom region of drum wall
106	7274 (10550)	Bottom region of drum wall
108	8129 (11790)	Bottom region of drum wall
110-112	8129 (11790)	Bottom region of drum wall
121-125	8129 (11790)	Bottom region of drum wall
128	8129 (11790)	Bottom region of drum wall
130	7088 (10280)	Bottom region of drum wall
441-443	8129 (11790)	Top region of drum wall
451-452	8129 (11790)	Top region of drum wall

The 2,268 kg/40 km/h (5000-lb/25-mi/h) case shows that the drum ruptures at the bottom of the wall joining the bottom plate. The strain energy density in this region, taken as a whole cross-section, exceeds the material rupture toughness. Table B7-13 shows the elements where strain energy density exceeds the rupture toughness. The average deceleration factor on the drum is approximately 53gs. The velocity history is shown in Figure B7-48.

The deformation of the drum in the 1,361 kg/48 km/h (3,000-lb/30-mi/h) dynamic crush case is shown in Figure B7-49. As can be seen, the sides of the drum wall have been flattened by the load and the target.

Figure B7-47. Velocity History of the Drum in the Dynamic Crush Analysis With 1,361 kg (3000-lb) Load and 48 km/h (30-mi/h) Impact Velocity.

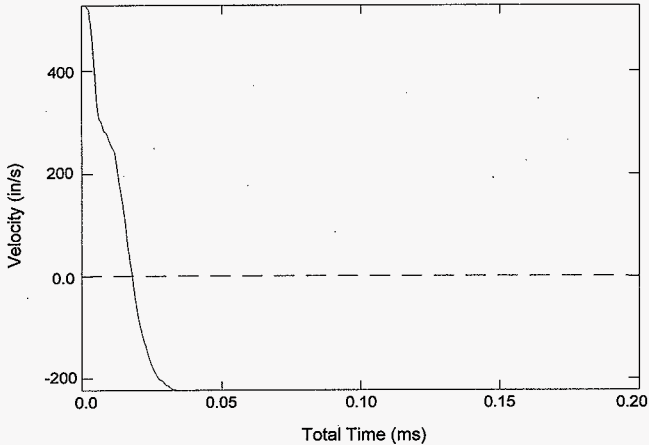

Table B7-13. Drum Strain Energy Density Results Dynamic Crush (2,268 kg/40 km/h [5,000-lb/25-mi/h]) Impact.

Element	Maximum strain energy density N*cm/cm ³ (in-lb/in ³)	Location
6	6929 (10050)	Drum bottom plate
62	7598 (11020)	Drum bottom plate
72	8129 (11790)	Drum bottom plate
82-83	8129 (11790)	Edge of drum bottom plate
91	8163 (11840)	Edge of drum bottom plate
101-112	6957 (>10090)	Bottom region of drum wall *Whole section ruptured
121-125	8129 (11790)	Bottom region of drum wall
129-132	6929 (>10050)	Bottom region of drum wall
441-443	8129 (11790)	Top region of drum wall
450-452	8129 (11790)	Top region of drum wall
461	7095 (10290)	Top region of drum wall
472	7267 (10540)	Top region of drum wall
1002-1003	6970 (>10110)	Drum Lid
1011	8129 (11790)	Drum Lid
1017-1018	7398 (>10730)	Drum Lid
1082	8129 (11790)	Edge of drum lid

Figure B7-48. Velocity History of the Drum in the Dynamic Crush Analysis With 2,268 kg (5,000-lb) Load and 40 km/h (25-mi/h) Impact Velocity.

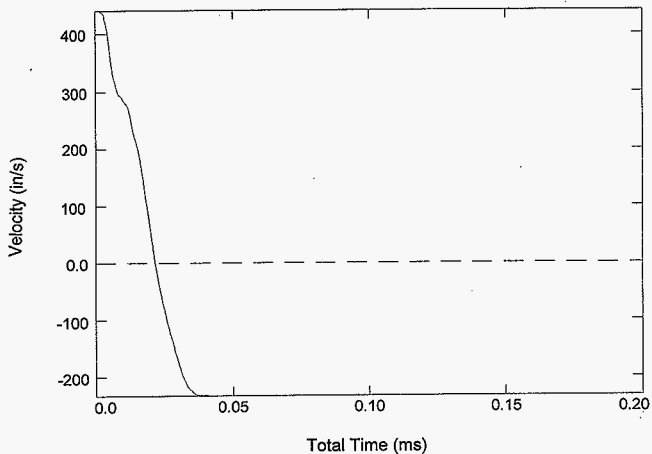
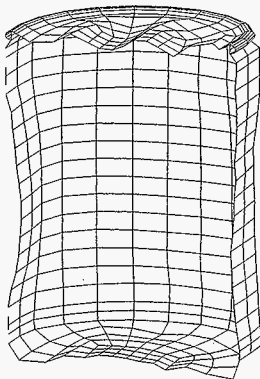

Figure B7-49. The Deformation of Drum With the 1,361 kg (3000-lb), 48 km/h (30-mi/h) Dynamic Crush Case.



Based on these numerical simulations, the dynamic crush failure thresholds establish two limiting arrangements for drums on or in a conveyance. At an allowable speed of 48 km/h (30 mi/h), the total gross weight of the drums, including the first drum, that can be placed directly behind the first drum against any of the conveyance walls cannot be greater than 1,361 kg (3,000 lb). As alternative, with an allowable speed of 40 km/h (25 mi/h), the total gross weight of the drums, including the first drum, that can be placed directly behind the first drum against any of the conveyance walls cannot be greater than 2,268 kg (5,000 lb).

7.4.4.4 Retrieval Drum Dynamic Crush Failure Threshold. In this case a 726 kg (1,600-lb) load with a 48 km/h (30-mi/h) speed is numerically simulated to be crushing into the side of the retrieval drum, which is against a stationary wall. For conservatism, the load is assumed as a rigid plate, and the stationary wall opposite the drum is also a rigid plate. The displacement history of the load is shown in Figure B7-50, and the velocity history is shown in Figure B7-51. Based on the above data, the average acceleration factor on the drum is approximately 87.3gs. The acceleration history of the load is shown in Figure B7-52 when unfiltered and in Figure B7-53 when filtered at 1000 Hz. The peak acceleration with 1000 Hz filtration is approximately 168.5gs. Pertinent acceleration data are summarized in Table B7-14.

Figure B7-50. 48 km/h (30-mi/h), 726 kg- (1,600-lb-) Load, Dynamic Crush-Impact Displacement History.

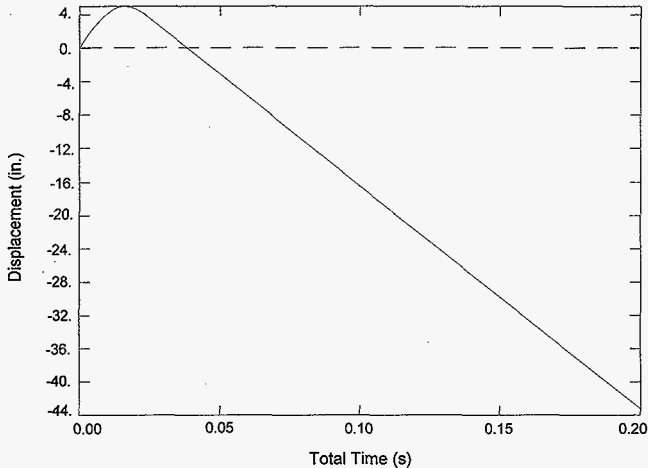

Figure B7-51. 48 km/h (30-mi/h), 726 kg- (1,600-lb-) Load,
Dynamic Crush-Impact Velocity History.

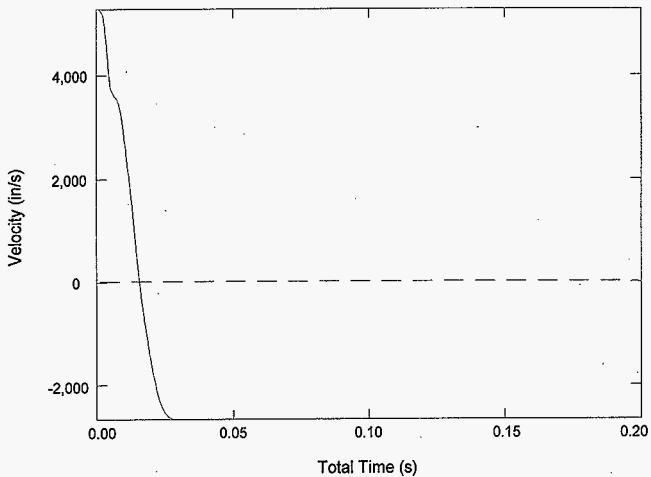

Figure B7-52. 48 km/h (30 mi/h), 726 kg- (1,600-lb-) Load,
Dynamic Crush-Impact Acceleration History (Unfiltered).

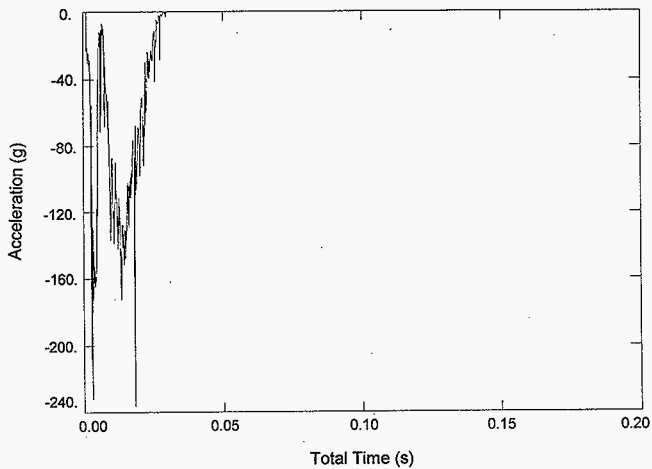

Figure B7-53. 48 km/h (30-mi/h), 726 kg- (1,600-lb-) Load, Dynamic Crush-Impact Acceleration History (Filtered at 1,000 Hz).

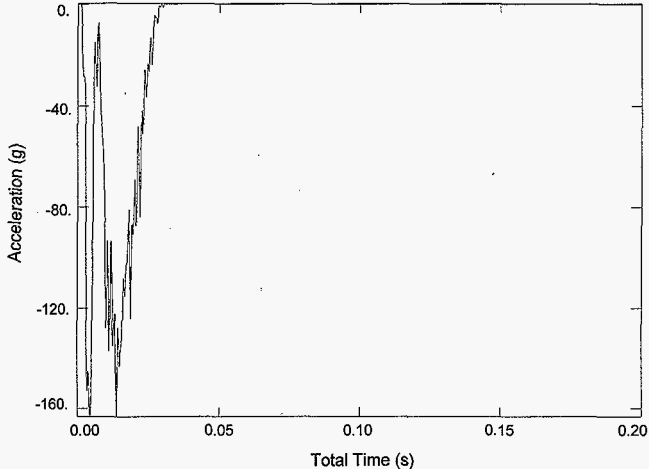

Table B7-14. Acceleration Data of Dynamic Crush Impact.

Case	Average impact-period acceleration (g)	Peak acceleration (g)	Impact period (ms)
Dynamic crush impact (48 km/h/726 kg [30 mi/h/1,600 lb])	87.3	163.3	15.65

Several locations have a strain energy density that exceeds the allowable material rupture toughness. They are tabulated in Table B7-15. Critical locations are at the bottom plate, the lower wall region, and the top wall region. However, these critical regions are restricted to small localized areas; catastrophic failure is not predicted to occur. A typical strain density plot at EL 441 is shown in Figure B7-54. A plot of the deformed drum for this 48 km/h (30-mi/h) dynamic crush impact is shown in Figure B7-55.

Table B7-15. Drum Strain Energy Density Results of Dynamic Crush Impact.

Element	Maximum strain energy density N•cm/cm ³ (in-lb/in ³)	Location
81	8129 (11790)	Edge of drum bottom plate
82	7005 (10160)	Edge of drum bottom plate
91	8136 (11800)	Edge of drum bottom plate
101	8129 (11790)	Bottom region of drum wall
123	7481 (10850)	Bottom region of drum wall
441	8136 (11800)	Top region of drum wall
442	7232 (10490)	Top region of drum wall
452	8136 (11800)	Top region of drum wall

Figure B7-54. 48 km/h (30 mi/h) 726 kg (1,600 lb) Load Dynamic Crush Impact Strain Energy Density at EL 701.

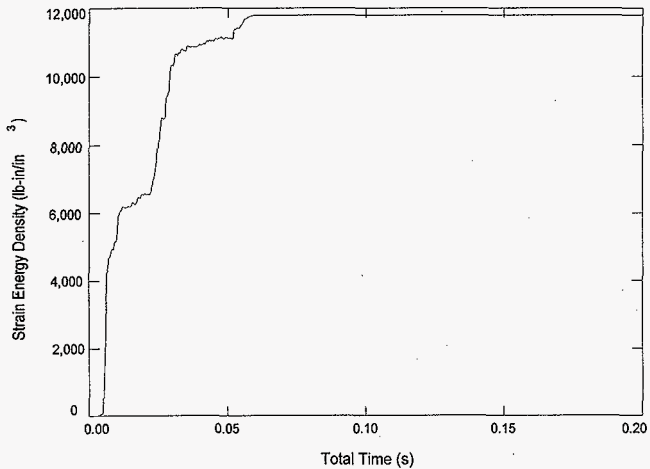
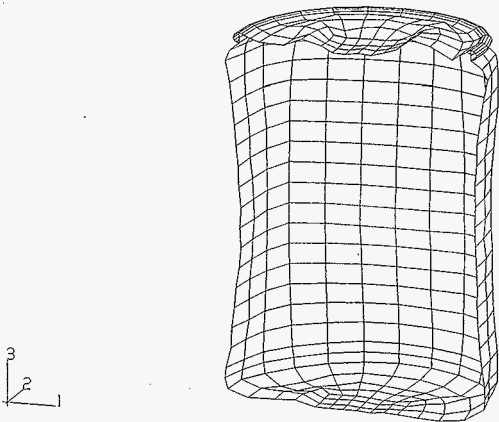

Figure B7-55. 48 km/h (30-mi/h), 726 kg- (1,600-lb-) Load, Dynamic Crush-Impact Deformation Plot.



Based on these numerical simulations, the dynamic crush failure thresholds establish two limiting arrangements for drums on or in a conveyance. At an allowable speed of 48 km/h (30 mi/h), the total gross weight of the drums, including the first drum, that can be placed directly behind the first drum against any of the conveyance walls cannot be greater than 726 kg (1,600 lb).

7.4.4.5 Summary and Conclusions. For quick reference all critical locations of the standard 208 L (55-gal) drum with high strain energies are shown in Table B7-16. The average acceleration results are shown in Table B7-17.

Table B7-16. Drum Strain Energy Density Results.

Case		Maximum strain energy density N*cm/cm ³ (in-lb/in ³)	Critical locations	Rupture
Bottom end impact	48 km/h (30 mi/h)	Negligible		No
	89 km/h (55 mi/h)	2987 (4332)	Bottom region of drum wall	No
Side impact	48 km/h (30 mi/h)	6792 (9851)	Closing ring	No
	80 km/h (50 mi/h)	8149 (11820)	Top region of drum wall	No
Top corner impact	48 km/h (30 mi/h)	8094 (11740)	Closing ring and top region of drum wall	No
	64 km/h (40 mi/h)	8129 (11790)	Closing ring, drum lid, and top region of drum wall	Yes
Dynamic crush (side)	1,361 kg/48 km/h (3000 lb/30 mi/h)	8129 (11790)	Drum bottom plate, bottom and top region of drum wall	No
	2,268 kg/40 km/h (5000 lb/25 mi/h)	8129 (11790)	Drum bottom plate, bottom and top region of drum wall, and drum lid	Yes

Table B7-17. Drum Acceleration for Impact Cases
Load Acceleration for Dynamic Crush Cases.

Case		Average acceleration (g)
Bottom end impact	48 km/h (30 mi/h)	467
	89 km/h (55 mi/h)	710
Side impact	48 km/h (30 mi/h)	242
	80 km/h (50 mi/h)	308
Corner impact	48 km/h (30 mi/h)	133
	64 km/h (40 mi/h)	151
Dynamic crush (side)	1,361 kg/48 km/h (3000 lb/30mi/h)	76
	2,268 kg/40 km/h (5000 lb/25 mi/h)	53

The above data show that catastrophic impact velocity-change failure of the a worst-case standard 208 L (55-gal) drum begins to occur at 64 km/h (40 mi/h); consequently, the maximum failure threshold velocity is defined as 64 km/h (40 mi/h). This is based on the impact orientation that causes the most damage. For dynamic crush there are two allowable conditions at which catastrophic failure of the drums initiates. At an allowable speed of 48 km/h (30 mi/h), the total gross weight of the drum arrangement against a conveyance wall with intermediate supports cannot be greater than 1,361 kg (3,000 lb). For an allowable speed of 40 km/h (25 mi/h), the total gross weight of the drum arrangement against a conveyance wall with intermediate supports cannot be greater than 2,268 kg (5,000 lb).

In the case of the retrieval drums, the impact velocity failure threshold of the drum is 48 km/h (30 mi/h) with only localized failure. Under dynamic crush for an allowable speed of 48 km/h (30 mi/h), the total gross weight of the drums, including the first, placed against the wall of the conveyance is 726 kg (1,600 lb).

Results of this evaluation show that the impact velocity change threshold at which a standard drum loaded to 658 kg (1450 lb) will begin to lose its ability to contain the material is 28 km/h (17.3 mi/h). This is shown by one element of the drum exceeding 90% of the material toughness. This impacting velocity change threshold is determined as the impact velocity at which the strain energy density exceeds 90% of the material toughness at any location on the drum. Exceeding the material toughness at a location by the criteria established, signifies that the drum has been breached at that location. In the case of the retrieval drum with the lower payload weight, the strain energy densities of all elements of the drum are well below 90% of the material toughness at an impacting velocity of 28 km/h (17.3 mi/h). However, due to the uncertainty in retrieval drum condition, an impacting velocity of 28 km/h (17.3 mi/h) is established as the upper bound at which containment failure would be initiated.

7.4.4.6 Standard and Retrieval Drum Containment Loss Impact Velocity Failure Threshold. The above ABAQUS/Explicit (HKS 1995) impact velocity failure threshold numerical simulations determine the impact velocity at which the drums sustain catastrophic rupture and complete loss of contents. In this ABAQUS/Explicit impact numerical simulation, the impact velocity threshold at which the drum containment performance fails is determined. As with the failure threshold numerical simulations, the containment loss threshold evaluation evaluates both the standard 208 L (55 gal) and thin-walled retrieval drums. The previous numerical simulations show that the top-corner impact is the worst-case impact and results in the lowest velocity thresholds. Subsequently, this numerical simulation only simulates the top-corner impacts of both types of drums onto the concrete/soil target. The previously developed standard drum model and the thin-walled retrieval drum model are used with only minor changes to initial impact velocity. After the numerical simulation, results of the displacement, velocity, and acceleration were evaluated. The strain energy density of critical location was compared with the material rupture toughness to assess the drum performance. From the numerical simulations, it has been determined that drum containment failure begins to occur at an initial impact velocity of approximately 28 km/h (17.3 mi/h) for both the standard and retrieval drums. This initial impact velocity equates to an equivalent drop height of 3.1 m (10 ft). The commonality of this failure point is due to the lighter weight of the retrieval drums that offsets the reduction in wall thickness. This is also shown in the previous numerical simulations. The results of the final numerical simulation are summarized below.

7.4.4.6.1 (10 ft) Top-Corner Impact of the Standard Wall Thickness Drum. The displacement and velocity at a node midway between the geometric center of the drum are evaluated. The displacement history is shown in Figure B7-56, and the velocity history is shown in Figure B7-57. The rebound time of the drum was assumed to be at maximum drum displacement. The average acceleration is calculated from the initial impacting velocity and the time to rebound. The acceleration history is developed from the reaction forces of the target and converted to the acceleration by dividing the total reaction force by the weight of the packaging. The peak acceleration was determined to be approximately 158*gs* at 1,000 Hz filtration. Figure B7-58 shows the filtered acceleration history, and the acceleration data are summarized in Table B7-18.

Figure B7-56. Displacement History of Standard Drum Under Top-Corner Impact.

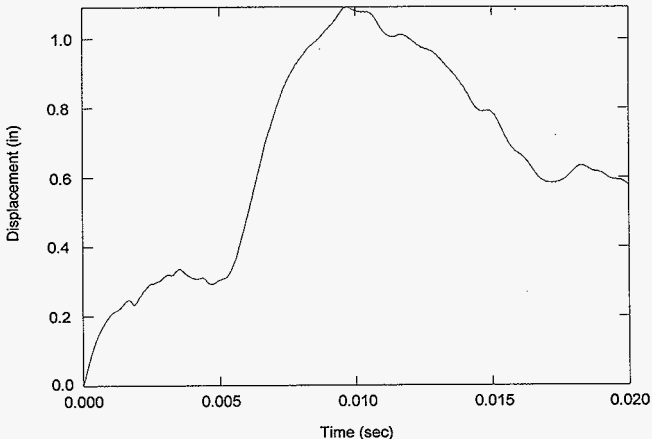

Figure B7-57. Velocity History of Standard Drum Under Top-Corner Impact.

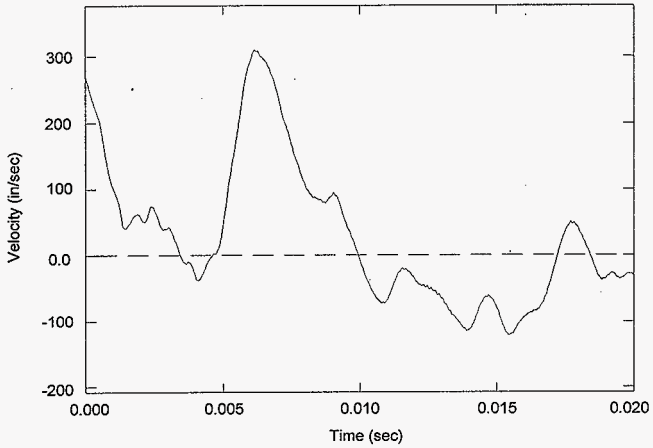

Figure B7-58. Acceleration History of Standard Drum Under Top-Corner Impact.

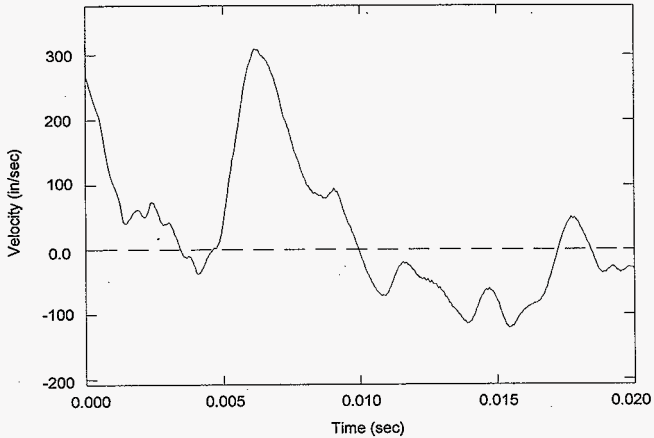

Table B7-18. Acceleration Data of the Standard-Wall-Thickness Drum Under (10 ft) Top-Corner Impact.

Case	Average impact-period acceleration (g)	Peak acceleration (g)	Impact period (ms)
Standard drum	81.3	158.1	9.69

Table B7-19 shows the highest strain energy densities of the drum. Table B7-19 shows the drum wall data are below the allowable rupture toughness of 6853 N-cm/cm³ (9,940 in-lb/in³). Only one element on the drum closing ring has a higher strain energy density than the allowable rupture toughness of the material. The location of this high-strain energy density is at the impact point. At this location the ring deformation is restricted in a localized region. A typical strain density plot of the drum wall (EL 461) is shown in Figure B7-59, and a typical strain density plot of the drum closing ring (EL 721) is shown in Figure B7-60. A plot of the deformed drum for this 3.1 m (10-ft) top-corner impact is shown in Figure B7-61.

Table B7-19. Strain Energy Density Results of the Standard-Wall-Thickness Drum Under (10 ft) Top-Corner Impact.

Element	Maximum strain energy density N•cm/cm ³ (in-lb/in ³)	Location
421	1751 (2539)	Drum wall
422	2021 (2931)	Drum wall
441	3784 (5489)	Drum wall
442	4073 (5908)	Drum wall
461	4568 (6626)	Drum wall
462	4554 (6605)	Drum wall
701	6819 (9890)	Closing ring
702	4441 (6441)	Closing ring
721	7956 (11540)	Closing ring
722	6032 (8749)	Closing ring
741	1917 (2780)	Closing ring
742	4710 (6831)	Closing ring

Figure B7-59. Strain Energy Density at Drum Wall (EL 461)
Standard Drum Top-Corner Impact.

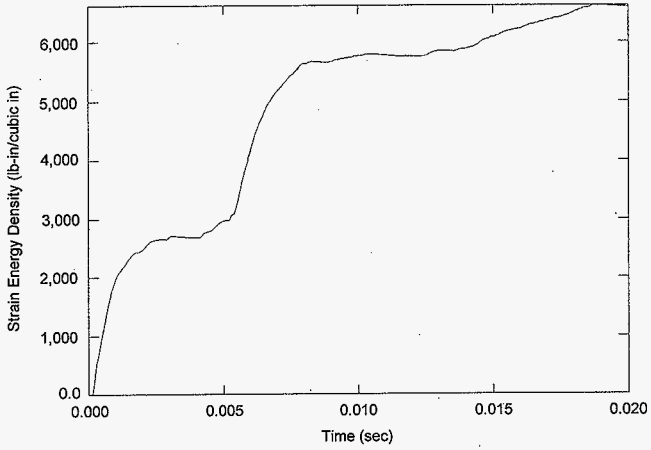

Figure B7-60. Strain Energy Density at Drum Wall (EL 721)
Standard Drum Top-Corner Impact.

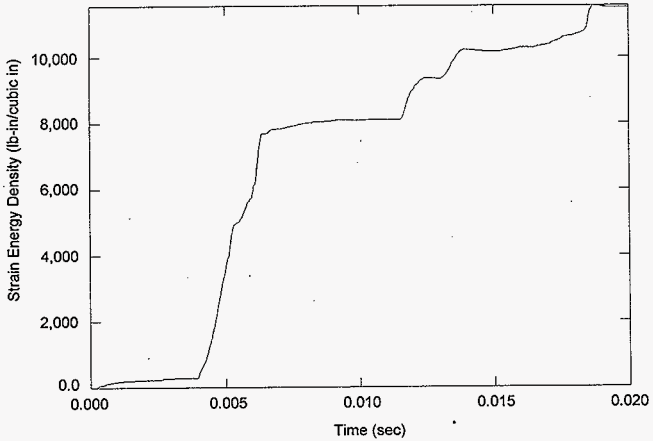
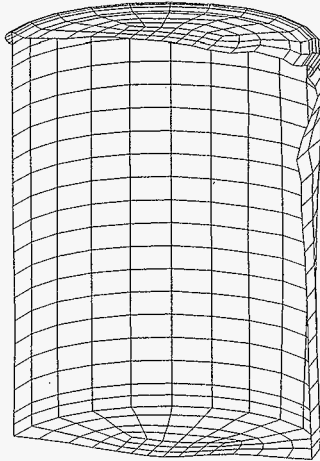

Figure B7-61. Deformation Plot of the Standard Drum Under a Top-Corner Impact.



7.4.4.6.2 (10 ft) Top-Corner Impact of Retrieval Drum. The displacement and velocity at a node at the geometric center of the drum are evaluated. The displacement history is shown in Figure B7-62, and the velocity history is shown in Figure B7-63. The rebound time of the drum is assumed to be at maximum drum displacement. The average acceleration is calculated from the initial impacting velocity and the rebound time. As with the standard drum, the acceleration history is developed from the reaction forces on the target and is shown in Figure B7-64 when filtered at 1,000 Hz. The peak acceleration filtered at 1,000 Hz is approximately 208*g*. Pertinent acceleration data are summarized in Table B7-20.

Figure B7-62. Displacement History of Retrieval Drum Under Top-Corner Impact.

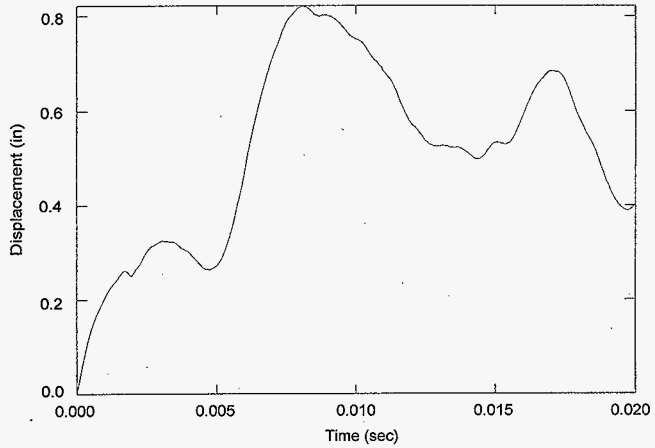

Figure B7-63. Velocity History of Retrieval Drum Under Top-Corner Impact.

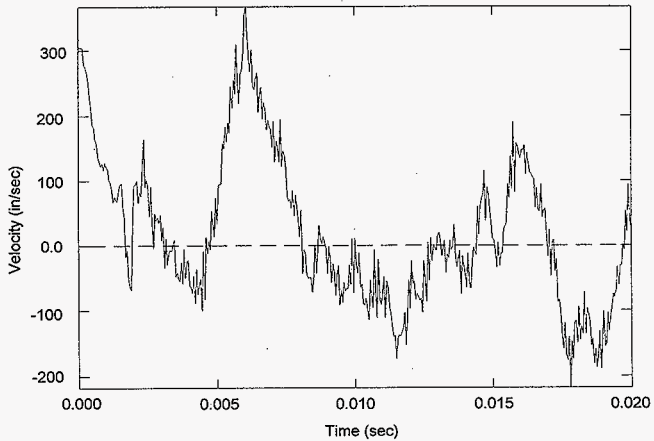

Figure B7-64. Acceleration History (Filtered at 1,000 Hz) of Retrieval Drum Under Top-Corner Impact.

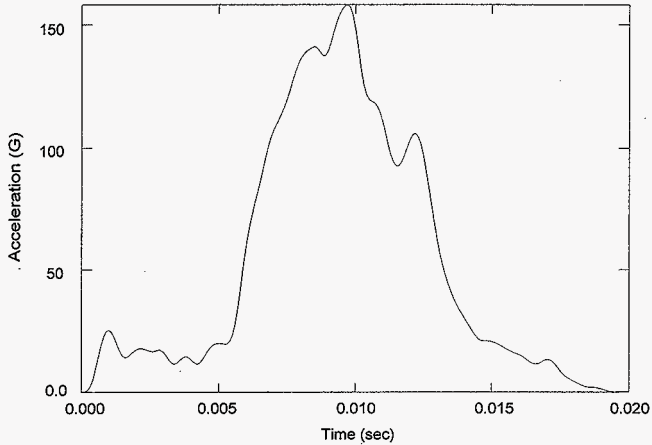

Table B7-20. Acceleration Data of the Retrieval Drum Under a Top-Corner Impact.

Case	Average impact-period acceleration (g)	Peak acceleration (g)	Impact period (ms)
Retrieval drum	97.3	208.4	8.1

The strain energy densities of the drum wall and the closing ring are all less than the allowable rupture toughness in this case. The strain energy density data are summarized in Table B7-21. A typical strain energy density plot of the drum wall (EL 441) is shown in Figure B7-65, and a typical strain energy density plot of the drum closing ring (EL 721) is shown in Figure B7-66. A plot of the deformed drum for this 3.1 m (10-ft) top-corner impact is shown in Figure B7-67.

Table B7-21. Strain Energy Density Results of the Retrieval Drum Under 3.1 m (10-ft) Top-Corner Impact.

Element	Maximum strain energy density N•cm/cm ³ (in-lb/in ³)	Location
421	1615 (2343)	Drum wall
422	1654 (2399)	Drum wall
441	3622 (5254)	Drum wall
442	3264 (4734)	Drum wall
461	3507 (5087)	Drum wall
462	3457 (5014)	Drum wall
701	2156 (3127)	Closing ring
702	689 (1000)	Closing ring
721	3025 (4387)	Closing ring
722	1601 (2322)	Closing ring
741	1240 (1798)	Closing ring
742	856 (1241)	Closing ring

Figure B7-65. Strain Energy Density at (EL 441) of the Retrieval Drum Wall Under Top-Corner Impact.

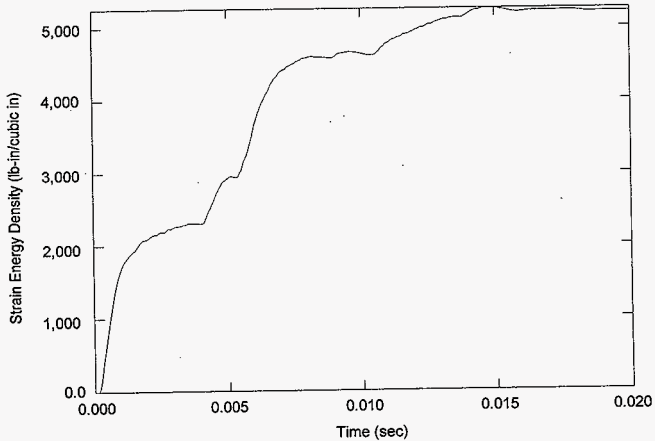

Figure B7-66. Strain Energy Density at (EL 721) of Retrieval Drum Closing Ring Under Top-Corner Impact.

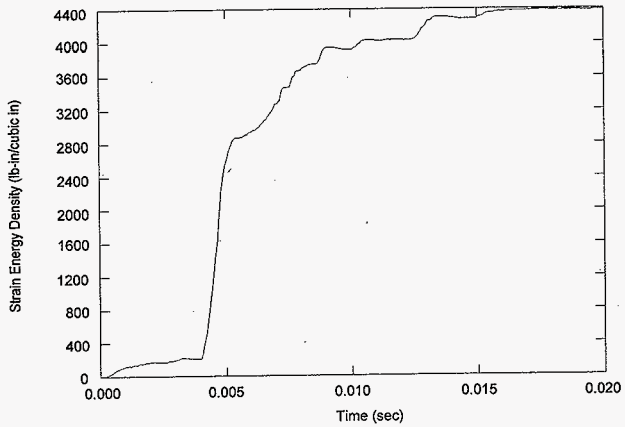
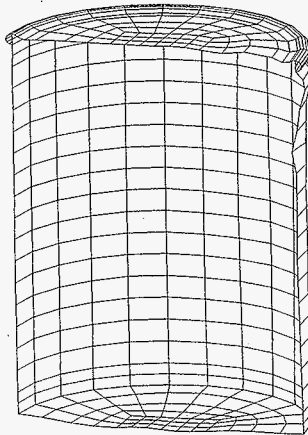

Figure B7-67. Deformation Plot of Retrieval Drum Under Top-Corner Impact.



7.5 EVALUATION OF THE RESPONSE OF AN ARRAY OF DRUMS TO AN ACCIDENT

The purpose of this section is to evaluate the response of an array of drums loaded in a conveyance vehicle to a transportation accident. Specifically, the objective of the analysis is to determine the number of drums in an array that may be damaged as a result of the accident as a function of the conveyance vehicle initial velocity. The analysis uses the information developed in Part B, Section 7.4.4.3, "Drum Dynamic Crush Failure Threshold," as a starting point to consider the response of an array of drums to an accident situation and to validate the model that is developed. The model assumes that an array of drums is being transported on a truck moving with an initial velocity \vec{V}_O . Therefore, each drum in the array has an initial momentum $\vec{P}_i = m\vec{V}_O$.

There are three situations that can be considered. First, the conveyance vehicle impacts an object in a head-on collision. Second, the conveyance vehicle is impacted by an object from behind (i.e., a rear-end collision), and, third, the conveyance vehicle is impacted by an object striking at an angle from the side (i.e., a side collision). The relative velocity of the conveyance vehicle, with initial velocity \vec{V}_O , and another object, with initial velocity \vec{V}_T , is given by;

$$\vec{V}_R = \vec{V}_O - \vec{V}_T$$

The following discussion demonstrates that the relative velocity is largest for a head-on collision; hence, the momentum transfer will be largest for a head-on collision. Also, the largest change in momentum comes from the conveyance vehicle striking a stationary, unyielding surface. Consequently, the analysis focuses on a head-on collision of the conveyance vehicle with a stationary, unyielding surface. Other collision situations will be less devastating, and, hence, the analysis will be conservative.

For a head-on collision where the two bodies are traveling in opposite directions, the relative velocity is given by;

$$\text{Head-On Collision: } V_R = V_O + V_T$$

For a rear-end collision where the second body strikes the first body from behind, the relative velocity is given by;

$$\text{Rear-End Collision: } V_R = V_T - V_O$$

and for a side collision the relative velocity is given by;

$$\text{Side Collision: } V_R = V_O - V_T \cos \theta$$

where the velocity of the second body is at an angle θ relative to the velocity of the conveyance vehicle. As θ changes from zero, to 90° , to 180° , the relative velocity changes from that for a rear-end collision, to a side collision at right angles, to a head-on collision.

If the object which the conveyance vehicle strikes is stationary, but of large mass (approaching infinite), the momentum transfer will be the largest. Hence, as noted above, the analysis will consider a head-on collision of the conveyance vehicle with a stationary, unyielding surface. A preliminary model is depicted in Figure B7-68 for which the equations of motion can be solved in closed form. This preliminary model is used to set the framework for a more extensive model to be discussed later.

Figure B7-68. Preliminary Model.

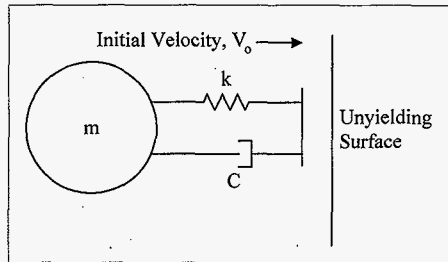

The equation of motion for the preliminary model identified in Figure B7-68, is;

$$m \frac{d^2x}{dt^2} = -kx - C \frac{dx}{dt} ,$$

where k represents the constant of the elastic portion of the model (equivalent to a spring) and C represents the constant of the inelastic portion of the model, which is represented by an energy-absorbing device.

The closed form solutions of the above equation are;

$$x(t) = C_1 e^{-(\alpha-\beta)t} + C_2 e^{-(\alpha+\beta)t} , \text{ and}$$

$$v(t) = C_1(-(\alpha-\beta))e^{-(\alpha-\beta)t} + C_2(\alpha+\beta)e^{-(\alpha+\beta)t} .$$

where

$$\alpha \equiv \frac{C}{2m} \quad \text{and} \quad \beta \equiv \sqrt{\left(\frac{C}{2m}\right)^2 - k} ,$$

and the root of the characteristic equation are ;

$$\lambda_{1,2} = -\frac{C}{2m} \pm \sqrt{\left(\frac{C}{2m}\right)^2 - k} = \alpha \pm \beta .$$

From the initial conditions of the model [$x(0) = 0$ and $v(0) = V_0$], the constants C_1 and C_2 are determined as $C_1 = -C_2$ and $C_1 = V_0/2\beta$. Therefore, the closed form solutions to the preliminary model are;

$$x(t) = \frac{V_0}{2\beta} [e^{-(\alpha-\beta)t} - e^{-(\alpha+\beta)t}] ,$$

$$v(t) = \frac{V_0}{2\beta} [-(\alpha-\beta)e^{-(\alpha-\beta)t} + (\alpha+\beta)e^{-(\alpha+\beta)t}] , \text{ and}$$

$$a(t) = -\frac{k}{m}x(t) - \frac{C}{m}v(t)$$

The above equations represent a damped system, and the value for the displacement, velocity, and acceleration can be evaluated as functions of time. The values of the velocity and acceleration decrease exponentially, approaching zero as t approaches infinity. The time dependence of the above equations as functions of time were used to gauge the solutions of a more general model.

Using the preliminary model in Figure B7-68 as a guide, a more general model was developed that represents several objects moving together with an initial system velocity that strike a stationary, unyielding surface. The more general model is provided in Figure B7-69. In the general model, the elastic springs in series sum as reciprocals (i.e., they behave like electrical capacitors and store energy), while the inelastic components in series sum (i.e., they behave like electrical resistors and dissipate energy).

Figure B7-69. General Model Treating Drums Involved in a Collision.

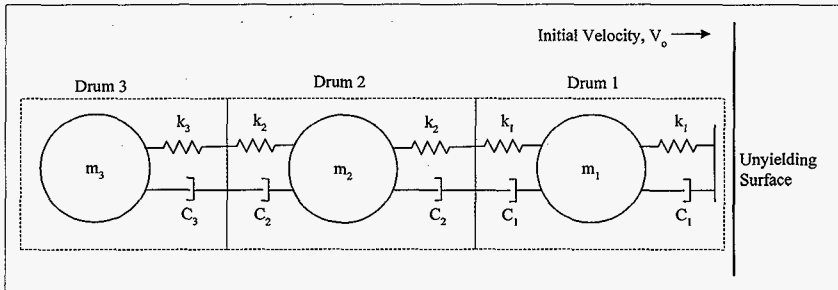

The coupled, second-order differential equations that represent the equations of motion for each drum in Figure B7-69 can be written explicitly in terms of the total forces acting on each drum. The coupled, second-order differential equations are solved as difference equations using Euler's method. In order to check the solutions of the finite element model, a similar model was developed using the MathCad computer program, which contains a solver for second-order differential equations. The results of the two solutions were compared and were in good agreement, indicating that the solutions for the finite element model were correct.

The next step was to identify the appropriate constants k and C that are to be used for the drums in the finite element model. This was accomplished by modifying the general model to match the analysis that was completed in Part B, Section 7.4.4.3, for the drum dynamic crush failure threshold. The finite element model for the drum dynamic crush failure threshold is presented in Figure 7.3-3, which represents the configuration applicable to the failure threshold of drums under a dynamic crush condition (see Figure B7-23). The finite element model represents a drum at rest against a stationary, unyielding surface that is loaded, or impacted, by a second mass with a designated weight and initial velocity. In the analysis in Part B, Section 7.4.4.3, the second

mass was assumed to be a hard, unyielding plate with a designated weight and initial velocity to simulate the total weight of all drums behind the first drum.

Figure B7-70. Model for the Drum Dynamic Crush Failure Threshold.

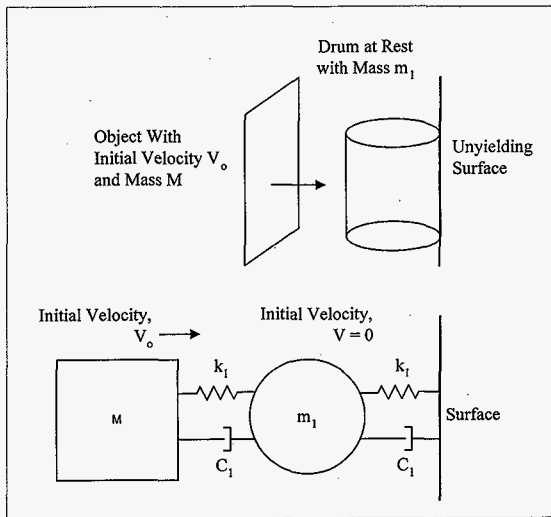

The results of the drum dynamic crush failure threshold analysis (Part B, Section 7.4.4.3) are presented in Table B7-22 along with the results that were obtained from the finite element model shown in Figure B7-70. The values for the spring constants, k , and dissipative constants, C , were varied until the results for the finite element analysis were in agreement with the dynamic crush failure threshold analysis. The values for the spring constants, k , and the dissipative constants, C , determined by matching the analysis are presented in Table B7-23. The average for these values (given in Table B7-23) are used for the corresponding spring constants, k , and dissipative constants, C , for drums in the remaining analysis.

Table B7-22. Summary of Results From Dynamic Crush Failure Threshold Analysis and Finite Element Analysis.

Case	Analysis	Average acceleration (g)	Peak acceleration (g)	Impact period (m/sec)
25 mph (11.18 m/sec) 5000 lb (2226 kg)	Original	52.8	111.6	21.55
	Finite element	51	110	21.7
30 mph (13.41 m/sec) 3000 lb (1361 kg)	Original	76	252	18
	Finite element	75	255	18.1

Table B7-23. Spring Constant, k, Dissipative Constant, C, and Total Absorbed Energy Determined to Match the Results in Table B7-22.

		C (kg/sec)	k (kg/sec ²)	Total absorbed energy (nt-m)
Case 1	25 mph (11.18 m/sec) 5000 lb (2226 kg)	2.5×10^5	1.8×10^7	131,000
Case 2	30 mph (13.41 m/sec) 3000 lb (1361 kg)	2.2×10^5	1.2×10^7	116,000
Average		2.35×10^5	1.5×10^7	123,000

The total energy absorbed by the drum of mass m_1 that was being crushed by the load of mass M was determined for the two cases. The results for the total absorbed energy is also given in Table B7-23. This total absorbed energy is in the form of a potential energy associated with the elastic deformation of the drum plus the energy associated with inelastic deformation of the drum. Note that the plastic stress and strain relations for the drum (see Table B7-3, Section 7.3.1.3) and the modulus of elasticity of the drum suggest that the majority of the energy is in the dissipative term associated with inelastic deformation. For the results presented in Table B7-23 for the total absorbed energy, about 1% is in the form of elastic deformation, and nearly 99% of the total absorbed energy is in the form of inelastic deformation. These results further support the relative relationship between the values for k and C given in Table B7-23.

The first analysis considered three drums of equal mass moving with an initial velocity of 13.4 m/s (30 mi/h) using the model identified in Figure B7-69. The spring constants, k, and dissipative constants, C, used in the analysis are the average values given in Table B7-23. The deceleration and total absorbed energy for the three masses are shown in Figure B7-71. Note that the first drum (Mass 1) has a much larger deceleration after striking the unyielding surface than the second (Mass 2) or third (Mass 3) drum. The second and third drum (Mass 2 and 3) are tightly coupled such that they move with nearly the same velocity and the same acceleration. The kinetic energy of the second and third drum is transformed into dissipative energy in the first drum, and because of the large deceleration of the first drum, the first drum absorbs much more energy than the second or third drum as seen in Figure B7-71. The results in Figure B7-71 suggest that the first drum may be damaged (an absorbed energy larger than 116,000 to 130,000 nt-m), but the second and third drums most likely would not be damaged.

Figure B7-71. Deceleration and Total Absorbed Energy for Case 1:
Three Drums of Equal Mass Traveling at 30 mi/h (13.4 m/s).

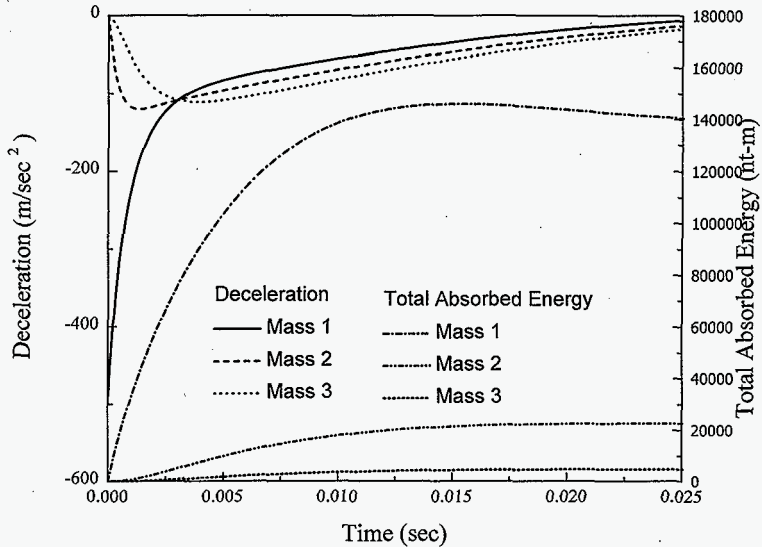

The above results are point-value results using the values of k and C presented in Table B7-23 and three drums with a maximum weight of 658 kg (1450 lb). Even though the average standard 208 L (55-gal) drum has a maximum weight of 658 kg, the actual weight of a drum loaded with waste would be between 800 and 900 lb (363 to 408 kg) and many may not weigh more than an empty drum. The uncertainty associated with the mass that may be loaded in either of the three drums was represented by a triangular probability density function with the appropriate parameters given in Table B7-24. Also, the uncertainty in the spring constant, k , and the dissipative constant, C , was represented by a triangular probability density function with the values defining the distributions given in Table B7-24. For this analysis a triangular probability density function was an adequate representation of the uncertainty. Other probability density functions (e.g., a normal distribution, or lognormal distribution) could have been used, but would have provided similar results.

Table B7-24. Uncertainty Distributions for Mass of a Drum, Spring Constant, k, and Dissipative Constant, C.

	Minimum	Most likely	Maximum
Mass (kg)	20	386	658
Mass (lb)	45	850	1450
k (kg/sec ²)	3.0×10^6	1.5×10^7	3.0×10^7
C (kg/sec)	5.0×10^4	2.35×10^5	5.0×10^5

Three cases were evaluated using uncertainty analysis where the mass, k, and C for each of three drums in the model of Figure B7-69 was represented by an uncertainty probability density function. The three cases were for an initial system velocity of 30, 35 and 40 mi/h, respectively (13.4, 15.6, and 17.9 m/s). The model was analyzed using Monte Carlo convolution techniques to randomly vary each of the above variables. The results for the total absorbed energy for each drum were represented by a cumulative distribution function. The cumulative distribution function provides the probability of not exceeding a specified value. The results of these three cases are presented in Figure B7-72. Note that only the total absorbed energy for the first drum is presented in Figure B7-72. The cumulative distribution functions for the second and third drums were significantly below the cumulative distribution function for the first drum as identified by the data in Figure B7-71.

For an initial system velocity of 30 mi/h (13.4 m/s), there is greater than a 95% confidence that none of the drums will exceed the failure criteria of between 116,000 and 130,000 nt-m. For an initial system velocity of 35 mi/h (15.6 m/s), there is 70 to 80% confidence that only the first drum will fail the criteria and that the other drums behind the first drum will not fail the criteria. For an initial system velocity of 40 mi/h (17.9 m/s), there is only a 30 to 40% confidence that the first drum will fail the criteria. However, at this initial system velocity the other drums behind the first drum do not fail the criteria. As noted earlier, this is because the second and third drums are tightly coupled and transfer all of their momentum to the first drum as seen in the much larger deceleration of the first drum in Figure B7-71.

Figure B7-72. Cumulative Distribution Functions for the Total Absorbed Energy of the First Drum for 30, 35, and 40 mi/h, Respectively.

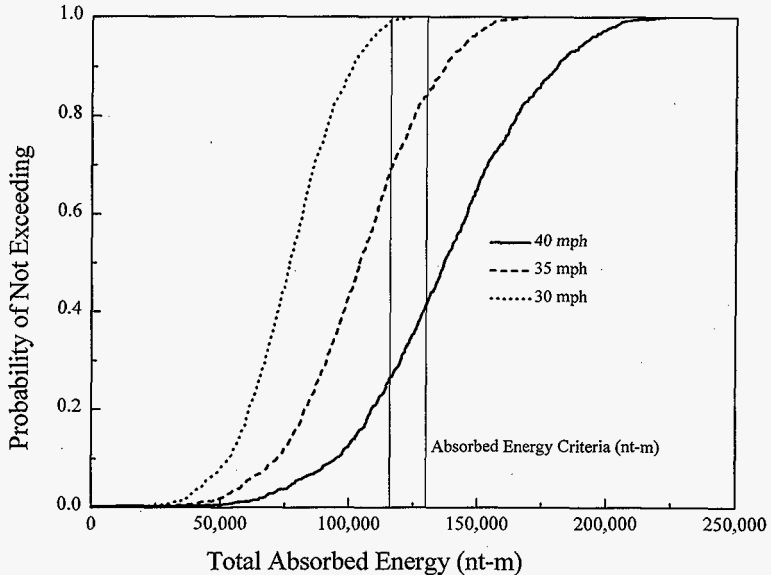

If other drums were included in the model, the results would be similar in that each drum would be tightly coupled to the one in front of it, and the group would transfer all of its momentum to fail the first drum and then to fail the second drum. Thus, for more drums in the array, the likelihood of the second drum failing the criteria would increase. However, for the results presented in Figure B7-72, the second and third drums were significantly below the failure criteria such that it would take many more drums before the second drum would exceed the failure criteria.

The coupling of drums to either side of a row of drums in the direction of the initial system velocity has been neglected in the above analysis. This coupling would be small since the momentum transfer from drum to drum is largest in the direction of the initial system velocity. Any perpendicular coupling of drums (i.e., perpendicular to the initial motion of the system) would initially be zero and would tend to absorb energy. Thus, any perpendicular coupling of drums would tend to reduce the total absorbed energy in each drum.

The results presented in Figure B7-72 are very conservative for the following reasons. First, in a front-end collision the conveyance vehicle would absorb a sufficient amount of energy that would not be transferred to the first drum. The large mass of the conveyance vehicle and the energy that the conveyance vehicle would absorb were not included in the analysis. Second, the analysis considered a collision of the system with a stationary, unyielding surface. No surface is truly unyielding, specifically another approaching vehicle or the wall of a building. Third, the

dynamic crush failure threshold analysis in Part B, Section 7.4.4.3, was completed for a drum that had a maximum weight of 658 kg. The results in Part B, Section 7.4.4.3, would have been substantially different if a drum with a lighter mass had been used. Consequently, as noted, the results presented in Figure B7-72 are very conservative.

One can conclude, therefore, that there is a greater-than-95% confidence that for an initial system velocity of 30 mi/h (13.4 m/s), or less, none of the drums on a conveyance vehicle would fail in an accident collision. For an initial system velocity of 35 mi/h (15.6 m/s), there is greater than an 80% confidence that in an accident collision only the first drum in a series of drums would fail and that the other drums behind the first drum would not fail.



CHECKLIST FOR CHECKING OF ANALYSIS/CALCULATIONS

Document Number/Revision: _____

Document Title: Evaluation of the Response of an Array of Drums to An Accident

Yes	No	N/A	
<input checked="" type="checkbox"/>	<input type="checkbox"/>	<input type="checkbox"/>	Problem completely defined.
<input checked="" type="checkbox"/>	<input type="checkbox"/>	<input type="checkbox"/>	Appropriate analytical method used.
<input checked="" type="checkbox"/>	<input type="checkbox"/>	<input type="checkbox"/>	Necessary assumptions are appropriate and explicitly stated.
<input checked="" type="checkbox"/>	<input type="checkbox"/>	<input type="checkbox"/>	Computer codes and data files documented.
<input checked="" type="checkbox"/>	<input type="checkbox"/>	<input type="checkbox"/>	Data used in calculations explicitly stated in document.
<input type="checkbox"/>	<input type="checkbox"/>	<input checked="" type="checkbox"/>	Sources of non-standard formula/data are referenced and the correctness of the reference verified.
<input type="checkbox"/>	<input type="checkbox"/>	<input checked="" type="checkbox"/>	Data checked for consistency with original source information as applicable.
<input checked="" type="checkbox"/>	<input type="checkbox"/>	<input type="checkbox"/>	Mathematical derivations checked including dimensional consistency of results.
<input checked="" type="checkbox"/>	<input type="checkbox"/>	<input type="checkbox"/>	Models appropriate and used within range of validity or use outside range of established validity justified.
<input type="checkbox"/>	<input type="checkbox"/>	<input checked="" type="checkbox"/>	Hand calculations checked for errors.
<input checked="" type="checkbox"/>	<input type="checkbox"/>	<input type="checkbox"/>	Code run streams correct and consistent with analysis documentation.
<input checked="" type="checkbox"/>	<input type="checkbox"/>	<input type="checkbox"/>	Code output consistent with input and with results reported in analysis documentation.
<input checked="" type="checkbox"/>	<input type="checkbox"/>	<input type="checkbox"/>	Acceptability limits on analytical results applicable and supported. Limits checked against sources.
<input type="checkbox"/>	<input type="checkbox"/>	<input checked="" type="checkbox"/>	Safety Margins consistent with good engineering practices.
<input checked="" type="checkbox"/>	<input type="checkbox"/>	<input type="checkbox"/>	Conclusions consistent with analytical results and applicable limits.
<input checked="" type="checkbox"/>	<input type="checkbox"/>	<input type="checkbox"/>	Results and conclusions address all points required in the problem statement.

I have checked the analysis/calculation and it is complete and accurate to the best of my knowledge.

Engineer/Checker: [Signature] / Jewish M. Muleskin Date 9/15/98

NOTE: Any hand calculations, notes or summaries generated as part of this check should be signed, dated, and attached to this checklist. Material should be labeled and recorded so that it is intelligible to a technically qualified third party.

7.6 REFERENCES

- 10 CFR 71, "Packaging and Transportation of Radioactive Material," *Code of Federal Regulations*, as amended.
- 49 CFR 178, "Specifications for Packagings," *Code of Federal Regulations*, as amended.
- ANSI, 1997, *Materials Handling (Containers)--Steel Drums and Pails*, ANSI MH2, American National Standards Institute, New York, New York.
- ANSI, 1992, *Draft American National Standard Design Basis for Resistance to Shock and Vibration of Radioactive Material Packages Greater than One Ton in Truck Transport*, ANSI N14.23, American National Standard Institute, New York, New York.
- ANSI, 1985, *American National Standard for Materials Handling (Containers)--Steel Drums and Pails*, ANSI/ASC MH2-1985, American National Standards Institute, New York, New York.
- ASME, 1997, *Boiler and Pressure Vessel Code*, Section III, Division 3, American Society of Mechanical Engineers, New York, New York.
- ASME, 1995a, *Boiler and Pressure Vessel Code*, Section II, Part D, American Society of Mechanical Engineers, New York, New York.
- ASME, 1995b, *Boiler and Pressure Vessel Code*, Section III, Subsection NE, American Society of Mechanical Engineers, New York, New York.
- ASME, 1995c, *Boiler and Pressure Vessel Code*, Section VIII, Division 1, American Society of Mechanical Engineers, New York, New York.
- DOD, 1994, *Military Handbook--Metallic Materials and Elements for Aerospace Vehicle Structures*, MIL-HDBK-5G, U.S. Department of Defense, Washington, D.C.
- DOE, 1987, *DOE Evaluation Document for DOT 17A Type A Packaging*, MLM-3245, DOE/DP/O053-H1, U.S. Department of Energy, Washington, D.C.
- DOE/RL-92-36, *Hanford Site Hoisting and Rigging Manual*, U.S. Department of Energy, Richland Operations Office, Richland, Washington.
- HKS, 1995, *ABAQUS/Explicit User's Manual, Version 5.5*, Hibbit, Karlsson, & Sorensen, Inc., Pawtucket, Rhode Island.
- IAEA, 1990, *Explanatory Material for the IAEA Regulations for the Safe Transport of Radioactive Material*, IAEA Safety Series No. 7, 1985 Edition as amended in 1990, International Atomic Energy Agency, Vienna, Austria.
- NuPac, 1987, *Application for NRC Certificate of Compliance Authorizing Shipment of Nuclear Materials in NuPac Model N-55 Packaging*, Nuclear Packaging, Incorporated, Federal Way, Washington.
- Parker, 1991, *Parker O-Ring Handbook*, ORD-5700, Parker Seals Group, Lexington, Kentucky.
- RHO, 1994, *Reference Attachments for the Safety Analysis Report for Packaging (SARP) for Transuranic Radioactive Material Transport in the 55-Gallon Drum HCS-042--002*, WHC-SD-RE-T-111, Rockwell Hanford Operations, Richland, Washington.

WHC, 1996a, *Specification for Drums; UN1A2; Type A, Solid and Liquid Material, High Performance Coatings*, WHC-S-0465, Rev. 0, Westinghouse Hanford Company, Richland, Washington.

WHC, 1996b, *Specification for Drums; UN1A2; Type A; Solid Material, Painted*, WHC-S-0466, Rev. 0, Westinghouse Hanford Company, Richland, Washington.

7.7 APPENDICES

7.7.1 Input Files

7.7.1.1 DOT-17H 55-Gal Drum 30-MPH Side Drop.

```

*HEADING
DOT-17H 55 GALLON DRUM, 30 MPH SIDE DROP, FILE=DSD30M
*RESTART, WRITE, NUMBER INTERVAL=10
*****
**      DRUM
*****
**
** GENERATE THE NODES OF DRUM BOTTOM PLATE
**
*NODE, SYSTEM=R
*NODE
1, -3.6, 0.0, 0.0
7, 3.6, 0.0, 0.0
22, -3.6, 3.6, 0.0
28, 3.6, 3.6, 0.0
*NGEN, NSET=LINEA
1, 7, 1
*NGEN, NSET=LINEB
22, 28, 1
*NFILL, NSET=DMB1
LINEA, LINEB, 3, 7
*NODE, NSET=DMB2
41, 5.4417, 0.0, 0.0
42, 5.3380, 1.5872, 0.0
43, 5.0342, 3.1208, 0.0
44, 4.5508, 4.5508, 0.0
45, 3.1208, 5.0342, 0.0
46, 1.5872, 5.3380, 0.0
47, 0.0, 5.4417, 0.0
48, -1.5872, 5.3380, 0.0
49, -3.1208, 5.0342, 0.0
50, -4.5508, 4.5508, 0.0
51, -5.0342, 3.1208, 0.0
52, -5.3380, 1.5872, 0.0
53, -5.4417, 0.0, 0.0
61, 7.2833, 0.0, 0.0
62, 7.0760, 1.9745, 0.0
63, 6.4683, 3.8417, 0.0
64, 5.5016, 5.5016, 0.0
65, 3.8417, 6.4683, 0.0
66, 1.9745, 7.0760, 0.0
67, 0.0, 7.2833, 0.0
68, -1.9745, 7.0760, 0.0
69, -3.8417, 6.4683, 0.0
70, -5.5016, 5.5016, 0.0
71, -6.4683, 3.8417, 0.0
72, -7.0760, 1.9745, 0.0
73, -7.2833, 0.0, 0.0
81, 9.6000, 0.0, 0.0
82, 9.2729, 2.4847, 0.0
83, 8.3138, 4.8000, 0.0
84, 6.7882, 6.7882, 0.0
85, 4.8000, 8.3138, 0.0
86, 2.4847, 9.2729, 0.0
87, 0.0, 9.6000, 0.0
88, -2.4847, 9.2729, 0.0

```

```

89, -4.8000, 8.3138, 0.0
90, -6.7882, 6.7882, 0.0
91, -8.3138, 4.8000, 0.0
92, -9.2729, 2.4847, 0.0
93, -9.6000, 0.0, 0.0
*NODE, NSET = DMB3
101, 11.5000, 0.0, 0.0
102, 11.1081, 2.9764, 0.0
103, 9.9593, 5.7500, 0.0
104, 8.1317, 8.1317, 0.0
105, 5.7500, 9.9593, 0.0
106, 2.9764, 11.1081, 0.0
107, 0.0, 11.5000, 0.0
108, -2.9764, 11.1081, 0.0
109, -5.7500, 9.9593, 0.0
110, -8.1317, 8.1317, 0.0
111, -9.9593, 5.7500, 0.0
112, -11.1081, 2.9764, 0.0
113, -11.5000, 0.0, 0.0
*NSSET, NSET = DMB
DMB1, DMB2, DMB3
**
** GENERATE THE ELEMENTS OF DRUM BOTTOM PLATE
**
**
*ELEMENT, TYPE = S4R
1, 1, 2, 9, 8
*ELGEN, ELSET = DMBA
1, 6, 1, 1, 3, 7, 6
*ELEMENT, TYPE = S4R, ELSET = DMBB
21, 7, 41, 42, 14
22, 14, 42, 43, 21
23, 21, 43, 44, 28
24, 28, 44, 45, 27
25, 27, 45, 46, 26
26, 26, 46, 47, 25
27, 25, 47, 48, 24
28, 24, 48, 49, 23
29, 23, 49, 50, 22
30, 22, 50, 51, 15
31, 15, 51, 52, 8
32, 8, 52, 53, 1
41, 41, 61, 62, 42
*ELGEN, ELSET = DMBB
41, 12, 1, 1, 3, 20, 20
*ELSET, ELSET = DMB
DMBA, DMBB
*SHELL SECTION, ELSET = DMB, MATERIAL = ST
0,0478
**
** GENERATE THE DRUM CYLINDRICAL WALL
**
**
** NODES
**
**
*NCOPY, SHIFT, CHANGE NU = 40, OLD SET = DMB3, NEW SET = L1
0.0, 0.0, 2.0
0.0, 0.0, 0.0, 0.0, 0.0, 1.0, 0.0
*NCOPY, SHIFT, CHANGE NU = 300, OLD SET = L1, NEW SET = L2
0.0, 0.0, 30.0
0.0, 0.0, 0.0, 0.0, 0.0, 1.0, 0.0
*NCOPY, SHIFT, CHANGE NU = 40, OLD SET = L2, NEW SET = L3
0.0, 0.0, 2.0
0.0, 0.0, 0.0, 0.0, 0.0, 0.0, 1.0, 0.0
*NFILL, NSET = DMW1
DMW3, L1, 2, 20
*NFILL, NSET = DMW2
L1, L2, 15, 20
*NFILL, NSET = DMW3
L2, L3, 2, 20
*NODE, NSET = DMW4
501, 11.5000, 0.0, 34.5
701, 11.5000, 0.0, 35.0
*NCOPY, SHIFT, MULTIPLE = 12, CHANGE NU = + 1, OLD SET = DMW4, NEW SET = DMW4
0.0, 0.0, 0.0
0.0, 0.0, 0.0, 0.0, 0.0, 1.0, +15.00
*NSSET, NSET = DMW
DMW1, DMW2, DMW3, DMW4
**
** ELEMENTS

```

```

**
*ELEMENT, TYPE=S4R, ELSET=DMW1
101, 101, 121, 122, 102
*ELGEN, ELSET=DMW1
101, 12, 1, 1, 2, 20, 20
*ELEMENT, TYPE=S4R, ELSET=DMW2
141, 141, 161, 162, 142
*ELGEN, ELSET=DMW2
141, 12, 1, 1, 15, 20, 20
*ELEMENT, TYPE=S4R, ELSET=DMW3
441, 441, 461, 462, 442
*ELGEN, ELSET=DMW3
441, 12, 1, 1, 2, 20, 20
*ELEMENT, TYPE=S4R, ELSET=DMW4
481, 481, 501, 502, 482
501, 501, 701, 702, 502
*ELGEN, ELSET=DMW4
481, 12, 1, 1
501, 12, 1, 1
*ELSET, ELSET=DMW
DMW1, DMW2, DMW3, DMW4
*SHELL SECTION, ELSET=DMW, MATERIAL=ST
0.0478
**
** GENERATE THE NODES OF DRUM LID
**
*NCOPY,SHIFT,CHANGE NU=1000,OLD SET=DMB,NEW SET=DML
0.0, 0.0, 34.50
0.0, 0.0, 0.0, 0.0, 0.0, 1.0, 0.0
** MODIFY NODES
**
*NODE, NSET=DML
1101, 10.5000, 0.0, 34.50
1102, 10.1422, 2.7176, 34.50
1103, 9.0933, 5.2500, 34.50
1104, 7.4248, 7.4248, 34.50
1105, 5.2500, 9.0933, 34.50
1106, 2.7176, 10.1422, 34.50
1107, 0.0, 10.5000, 34.50
1108, -2.7176, 10.1422, 34.50
1109, -5.2500, 9.0933, 34.50
1110, -7.4248, 7.4248, 34.50
1111, -9.0933, 5.2500, 34.50
1112, -10.1422, 2.7176, 34.50
1113, -10.5000, 0.0, 34.50
**
** GENERATE THE DRUM LID
**
*ELEMENT, TYPE=S4R
1001, 1001, 1002, 1009, 1008
*ELGEN, ELSET=DMLA
1001, 6, 1, 1, 3, 7, 6
*ELEMENT, TYPE=S4R, ELSET=DMLB
1021, 1007, 1041, 1042, 1014
1022, 1014, 1042, 1043, 1021
1023, 1021, 1043, 1044, 1028
1024, 1028, 1044, 1045, 1027
1025, 1027, 1045, 1046, 1026
1026, 1026, 1046, 1047, 1025
1027, 1025, 1047, 1048, 1024
1028, 1024, 1048, 1049, 1023
1029, 1023, 1049, 1050, 1022
1030, 1022, 1050, 1051, 1015
1031, 1015, 1051, 1052, 1008
1032, 1008, 1052, 1053, 1001
*ELEMENT, TYPE=S4R
1041, 1041, 1061, 1062, 1042
*ELGEN, ELSET=DMLC
1041, 12, 1, 1, 2, 20, 20
*ELEMENT, TYPE=S4R
1081, 1081, 1101, 1102, 1082
*ELGEN, ELSET=DMLD
1081, 12, 1, 1
*ELSET, ELSET=DML
DMLA, DMLB, DMLC, DMLD
*SHELL SECTION, ELSET=DML, MATERIAL=ST
0.0478
**
** NSET, NSET=DM
DMB, DMW, DML

```



```

*ELSET, ELSET = DM
DM8, DMW, DML
*****
** CLOSING RING, DRUM LID, AND DRUM ASSEMBLY
*****
*NODE, NSET = RING
601, 11.7500, 0.0, 34.0670
621, 11.9330, 0.0, 34.2500
641, 12.0000, 0.0, 34.5000
661, 11.9330, 0.0, 34.7500
681, 11.7500, 0.0, 34.9330
701, 11.5000, 0.0, 35.0000
721, 11.2500, 0.0, 34.9330
741, 11.0670, 0.0, 34.7500
*NCOPY,SHIFT,MULTIPLE=12,CHANGE NU = +1,OLD SET = RING,NEW SET = RING
0.0, 0.0, 0.0
0.0, 0.0, 0.0, 0.0, 0.0, 1.0, +15.00
*ELEMENT, TYPE = S4R
601, 481, 482, 602, 601
621, 601, 602, 622, 621
721, 701, 702, 722, 721
761, 741, 742, 1102, 1101
*ELGEN, ELSET = RING1
601, 12, 1, 1
621, 12, 1, 1, 5, 20, 20
*ELGEN, ELSET = RING2
721, 12, 1, 1, 2, 20, 20
761, 12, 1, 1
*ELSET, ELSET = RING
RING1, RING2
*SHELL SECTION, ELSET = RING1, MATERIAL = ST
0.50
*SHELL SECTION, ELSET = RING2, MATERIAL = ST
0.35
*****
** CLOSING RING BOLT
*****
*NODE, NSET = BOLT
1501, 11.500, 0.0, 34.500
1502, 11.500, 0.5, 34.500
*ELEMENT, TYPE = T3D2, ELSET = BOLT
1501, 1501, 1502
*SOLID SECTION, ELSET = BOLT, MATERIAL = BOLT
0.226
*MPC
TIE,601,1502
TIE,621,1502
TIE,641,1502
TIE,661,1502
TIE,681,1502
*EQUATION
2
1501,1,1.0,1502,1,-1.0
*EQUATION
2
1501,3,1.0,1502,3,-1.0
*****
** PAYLOAD
*****
*NODE, SYSTEM = R
*NODE
2001, -4.0, 0.0, 0.024
2005, 4.0, 0.0, 0.024
2011, -4.0, 4.0, 0.024
2015, 4.0, 4.0, 0.024
*NGEN, NSET = LINEC
2001, 2005, 1
*NGEN, NSET = LINED
2011, 2015, 1
*NFRILL, NSET = PAYB1
LINEC, LINED, 2, 5
*NODE, NSET = PAYB2
2021, 7.625, 0.0, 0.024
2022, 7.1968, 3.1526, 0.024
2023, 5.9775, 5.9775, 0.024
2024, 3.1526, 7.1968, 0.024
2025, 0.0, 7.625, 0.024
2026, -3.1526, 7.1968, 0.024

```

```

2027, -5.9775, 5.9775, 0.024
2028, -7.1968, 3.1526, 0.024
2029, -7.825, 0.0, 0.024
*NODE, NSET = PAYB3
2031, 11.25, 0.0, 0.024
2032, 10.394, 4.3052, 0.024
2033, 7.9550, 7.9550, 0.024
2034, 4.3052, 10.394, 0.024
2035, 0.0, 11.25, 0.024
2036, -4.3052, 10.394, 0.024
2037, -7.9550, 7.9550, 0.024
2038, -10.394, 4.3052, 0.024
2039, -11.25, 0.0, 0.024
*NSET, NSET = PAYB
PAYB1, PAYB2, PAYB3
*ELEMENT, TYPE = S4R
2001, 2001, 2002, 2007, 2006
*ELGEN, ELSET = PAYB1
2001, 4, 1, 1, 2, 5, 5
*ELEMENT, TYPE = S4R, ELSET = PAYB2
2011, 2005, 2021, 2022, 2010
2012, 2010, 2022, 2023, 2015
2013, 2015, 2023, 2024, 2014
2014, 2014, 2024, 2025, 2013
2015, 2013, 2025, 2026, 2012
2016, 2012, 2026, 2027, 2011
2017, 2011, 2027, 2028, 2006
2018, 2006, 2028, 2029, 2001
*ELEMENT, TYPE = S4R
2021, 2021, 2031, 2032, 2022
*ELGEN, ELSET = PAYB2
2021, 8, 1, 1
*ELSET, ELSET = PAYB
PAYB1, PAYB2
*SHELL SECTION, ELSET = PAYB, MATERIAL = PAYLD
0.0478
*****
*NCOPY, SHIFT, CHANGE NU = 100, OLD SET = PAYB3, NEW SET = PAYW1
0.0, 0.0, 33.25
0.0, 0.0, 0.0, 0.0, 0.0, 1.0, 0.0
*NFILL, NSET = PAYW
PAYB3, PAYW1, 10, 10
*ELEMENT, TYPE = S4R
2031, 2031, 2041, 2042, 2032
*ELGEN, ELSET = PAYW
2031, 8, 1, 1, 10, 10, 10
*SHELL SECTION, ELSET = PAYW, MATERIAL = PAYLD
0.0478
*****
*NCOPY, SHIFT, CHANGE NU = 200, OLD SET = PAYB, NEW SET = PAYT
0.0, 0.0, 33.25
0.0, 0.0, 0.0, 0.0, 0.0, 1.0, 0.0
*ELEMENT, TYPE = S4R
2201, 2201, 2202, 2207, 2206
*ELGEN, ELSET = PAYT1
2201, 4, 1, 1, 2, 5, 5
*ELEMENT, TYPE = S4R, ELSET = PAYT2
2211, 2205, 2221, 2222, 2210
2212, 2210, 2222, 2223, 2215
2213, 2215, 2223, 2224, 2214
2214, 2214, 2224, 2225, 2213
2215, 2213, 2225, 2226, 2212
2216, 2212, 2226, 2227, 2211
2217, 2211, 2227, 2228, 2206
2218, 2206, 2228, 2229, 2201
*ELEMENT, TYPE = S4R
2221, 2221, 2131, 2132, 2222
*ELGEN, ELSET = PAYT2
2221, 8, 1, 1
*ELSET, ELSET = PAYT
PAYT1, PAYT2
*ELSET, ELSET = PAY
PAYB, PAYW, PAYT
*NSET, NSET = PAY
PAYB, PAYW, PAYT
*SHELL SECTION, ELSET = PAYT, MATERIAL = PAYLD
0.0478
*****

```

```

** GENERATE THE ELEMENTS OF CONCRETE PAD
** 10' X 10' RECTANGULAR HALF SECTION (NO INF)
**
**
*NODE, SYSTEM = R
*NODE, NSET = C1
160001, -60.0, 0.0, -8.0
*NODE, NSET = C2
160004, -45.0, 0.0, -8.0
*NODE, NSET = C3
160034, 45.0, 0.0, -8.0
*NODE, NSET = C4
160037, 60.0, 0.0, -8.0
*NFILL, NSET = LINE1
C1, C2, 3
C2, C3, 30
C3, C4, 3
*NCOPY, SHIFT, CHANGE NU = 500, OLD SET = LINE1, NEW SET = LINE2
0.0, 30.0, 0.0
0.0, 0.0, 0.0, 0.0, 0.0, 1.0, 0.0
*NCOPY, SHIFT, CHANGE NU = 300, OLD SET = LINE2, NEW SET = LINE3
0.0, 30.0, 0.0
0.0, 0.0, 0.0, 0.0, 0.0, 1.0, 0.0
*NFILL, NSET = CONC1
LINE1, LINE2, 10, 50
LINE2, LINE3, 6, 50
*NCOPY, SHIFT, CHANGE NU = 2000, OLD SET = CONC1, NEW SET = CONC2
0.0, 0.0, 2.0
0.0, 0.0, 0.0, 0.0, 0.0, 1.0, 0.0
*NCOPY, SHIFT, CHANGE NU = 2000, OLD SET = CONC2, NEW SET = CONC3
0.0, 0.0, 2.0
0.0, 0.0, 0.0, 0.0, 0.0, 1.0, 0.0
*NCOPY, SHIFT, CHANGE NU = 2000, OLD SET = CONC3, NEW SET = CONC4
0.0, 0.0, 2.0
0.0, 0.0, 0.0, 0.0, 0.0, 1.0, 0.0
*NCOPY, SHIFT, CHANGE NU = 2000, OLD SET = CONC4, NEW SET = CONC5
0.0, 0.0, 2.0
0.0, 0.0, 0.0, 0.0, 0.0, 1.0, 0.0
*NSET, NSET = CONC0
CONC1, CONC2, CONC3, CONC4, CONC5,
**
** GENERATE THE SOIL NODES
**
*NCOPY, SHIFT, CHANGE NU = 20000, OLD SET = CONC1, NEW SET = SOIL1
0.0, 0.0, -50.0
0.0, 0.0, 0.0, 0.0, 0.0, 1.0, 0.0
*NCOPY, SHIFT, CHANGE NU = 2000, OLD SET = SOIL1, NEW SET = SOIL2
0.0, 0.0, +20.0
0.0, 0.0, 0.0, 0.0, 0.0, 1.0, 0.0
*NCOPY, SHIFT, CHANGE NU = 2000, OLD SET = SOIL2, NEW SET = SOIL3
0.0, 0.0, +10.0
0.0, 0.0, 0.0, 0.0, 0.0, 1.0, 0.0
*NCOPY, SHIFT, CHANGE NU = 2000, OLD SET = SOIL3, NEW SET = SOIL4
0.0, 0.0, +10.0
0.0, 0.0, 0.0, 0.0, 0.0, 1.0, 0.0
*NCOPY, SHIFT, CHANGE NU = 2000, OLD SET = SOIL4, NEW SET = SOIL5
0.0, 0.0, +5.0
0.0, 0.0, 0.0, 0.0, 0.0, 1.0, 0.0
*NSET, NSET = SOIL0
SOIL1, SOIL2, SOIL3, SOIL4, SOIL5
**
** GENERATE THE INCLINED IMPACT SURFACES
**
*NCOPY, SHIFT, CHANGE NU = -100000, OLD SET = CONC0, NEW SET = CONC
12.250, 0., 17.5
12.250, 0., 17.5, 12.250, 1., 17.5, -90.0
*NCOPY, SHIFT, CHANGE NU = -100000, OLD SET = SOIL0, NEW SET = SOIL
12.250, 0., 17.5
12.250, 0., 17.5, 12.250, 1., 17.5, -90.0
**
** CONCRETE PAD ELEMENT
**
*ELEMENT, TYPE = C3D8R
60001, 60001, 60002, 60052, 60051, 62001, 62002, 62052, 62051
*ELGEN, ELSET = CONC1
60001, 36, 1, 1, 16, 50, 50
*ELCOPY, OLD SET = CONC1, NEW SET = CONC2, ELEMENT SH = 2000, SHIFT NO = 2000
*ELCOPY, OLD SET = CONC2, NEW SET = CONC3, ELEMENT SH = 2000, SHIFT NO = 2000
*ELCOPY, OLD SET = CONC3, NEW SET = CONC4, ELEMENT SH = 2000, SHIFT NO = 2000

```

```

*ELSET, ELSET=CONC
CONC1, CONC2, CONC3, CONC4,
*SOLID SECTION, ELSET=CONC, MATERIAL=CONCRETE
**
** GENERATE REBARS
**
*REBAR,ELEM=CONTINUUM,MAT=REBAR,GEOM=ISOPARAMETRIC,NAME=LX
CONC1,0.60,12.0,0.0,1.0,4,2
*REBAR,ELEM=CONTINUUM,MAT=REBAR,GEOM=ISOPARAMETRIC,NAME=LY
CONC1,0.60,12.0,0.90,1.0,4,2
*REBAR,ELEM=CONTINUUM,MAT=REBAR,GEOM=ISOPARAMETRIC,NAME=UX
CONC4,0.60,12.0,0.0,0.0,4,2
*REBAR,ELEM=CONTINUUM,MAT=REBAR,GEOM=ISOPARAMETRIC,NAME=UY
CONC4,0.60,12.0,0.90,0.0,4,2
**
** GENERATE THE SOIL
**
*ELCOPY,OLD SET=CONC1,NEW SET=SOIL1,ELEMENT SH=20000,SHIFT NO=20000
*ELCOPY,OLD SET=SOIL1,NEW SET=SOIL2,ELEMENT SH=2000,SHIFT NO=2000
*ELCOPY,OLD SET=SOIL2,NEW SET=SOIL3,ELEMENT SH=2000,SHIFT NO=2000
*ELCOPY,OLD SET=SOIL3,NEW SET=SOIL4,ELEMENT SH=2000,SHIFT NO=2000
*ELEMENT, TYPE=C3D8, ELSET=SOIL5
*ELEMENT, TYPE=C3D8R
88001, 88001, 88002, 88052, 88051, 60001, 60002, 60052, 60051
*ELGEN, ELSET=SOIL5
88001, 36, 1, 1, 16, 50, 50
*ELSET, ELSET=SOIL
SOIL1, SOIL2, SOIL3, SOIL4, SOIL5
*SOLID SECTION, ELSET=SOIL, MATERIAL=SOIL
*****
** ASTM A36
**
*MATERIAL, NAME=ST
*ELASTIC
29.0E6, 0.3
*PLASTIC
36000., 0.
60000., 0.23
*DENSITY
7.5052E-4
**
** CLOSING RING BOLT MATERIAL
** ASTM A307, GR. C
**
*MATERIAL, NAME=BOLT
*ELASTIC
29.0E6, 0.3
*PLASTIC
36000.0, 0.0
60000.0, 0.23
*DENSITY
7.5052E-4
*MATERIAL, NAME=PAYLD
*ELASTIC
29.0E6, 0.3
*DENSITY
0.02437
*material,name=concrete
** 4000 PSI CONCRETE
*density
1.95E-04
*elastic
3.6E+06,0.15
*drucker prager
35,1,1,0,35,1
*drucker prager hardening
2250.,0.0
3900.,0.0013
3000.,0.0024
2400.,0.0034
1790.,0.0044
1180.,0.0054
800.,0.006
100.,0.0061
*material,name=soil
*density
1.647E-04

```

```

*elastic
5700.,0.35
*drucker prager
35.2,0.82,35.2
*drucker prager hardening
2,0,0
6.54,0.0055
8.64,0.0156
9.96,0.0259
10.68,0.0362
10.98,0.0467
11.1,0.0573
11.04,0.068
10.8,0.0788
10.44,0.0897
9.9,0.1
9.0,0.112
**
** REBAR STEEL
**
*MATERIAL, NAME=REBAR
*DENSITY
7.34E-4
*ELASTIC
29.5E6, 0.30
*PLASTIC
71170., 0.0
71626., 0.004985
83130., 0.017098
96460., 0.036202
104728., 0.055113
109080., 0.073795
***FAILURE
**0.30, 0.03
**
** ELEMENT SET DEFINITIONS
**
*ELSET,ELSET= ALLEL
DMB, DMW, DML
RING, BOLT
PAY,
**
** NODE SET DEFINITIONS
**
*NSET,NSET=ALLND
DMB, DMW, DML
RING, BOLT
PAY,
*NSET,NSET=YSYMM,GENERATE
60001,60037,1
62001,62037,1
64001,64037,1
68001,68037,1
68001,68037,1
80001,80037,1
82001,82037,1
84001,84037,1
86001,86037,1
88001,88037,1
*NSET,NSET=YSYMM,GENERATE
1, 7, 1
41, 53, 12
61, 73, 12
81, 93, 12
101, 501, 20
113, 513, 20
613, 693, 20
701, 741, 20
713, 753, 20
1001, 1007, 1
1041, 1053, 12
1061, 1073, 12
1081, 1093, 12
1101, 1113, 12
1501, 1501, 1
2001, 2005, 1
2021, 2029, 8
2031, 2131, 10

```

```

2039, 2139, 10
2201, 2205, 1
2221, 2229, 8
*NSET,NSET=SOILBT,GENERATE
80001,80837,1
*NSET,NSET=CONC5,GENERATE
68001,68837,1
*BOUNDARY
YSYMM,YSYMM
SOILBT,1,3
*****
*INITIAL CONDITIONS,TYPE=VELOCITY
ALLND,1,528.0
*STEP
*DYNAMIC,EXPLICIT
,20.0E-03
**
** DEFINE THE CONTACT SURFACES BETWEEN
** THE DRUM BOTTOM AND TARGET
**
*SURFACE DEFINITION,NAME=CONC4T
CONC4,S2
*SURFACE DEFINITION,NAME=DMOUT,NO THICK
DMB,SNEG
DMW1,SNEG
DMW2,SNEG
DMW3,SNEG
RING,SPOS
DML,SPOS
*CONTACT PAIR
CONC4T,DMOUT
**
** DEFINE THE CONTACT SURFACES BETWEEN
** THE DRUM INSIDE AND PAYLOAD OUTSIDE
**
*SURFACE DEFINITION,NAME=DMINS,NO THICK
DMB,SPOS
DMW1,SPOS
DMW2,SPOS
DMW3,SPOS
DMW4,SPOS
RING2,SNEG
DML,SNEG
*SURFACE DEFINITION,NAME=PAYOUT,NO THICK
PAYB,SNEG
PAYW,SNEG
PAYT,SPOS
*CONTACT PAIR
DMINS,PAYOUT
*****
*NSET,NSET=DMDIS,GENERATE
4,4,1
1004,1004,1
101,113,3
301,313,3
541,553,3
*ELSET,ELSET=DMBST,GENERATE
61,66,1
81,86,1
*ELSET,ELSET=DMBST
DMBA,
*ELSET,ELSET=DMWST,GENERATE
101,106,1
121,126,1
141,421,20
142,422,20
143,423,20
441,446,1
461,466,1
481,486,1
501,506,1
*ELSET,ELSET=DMLST,GENERATE
1061,1066,1
1081,1086,1
*ELSET,ELSET=DMLST
DMLA,
*ELSET,ELSET=RINGST,GENERATE
601,606,1

```

```
621,626,1
641,646,1
661,666,1
681,686,1
701,706,1
721,726,1
741,746,1
761,766,1
*ELSET,ELSET=BOLTST,GENERATE
1501,1501,1
*****
*HISTORY OUTPUT, TIME=5.E-5
*NODE HISTORY, NSET=DMDIS
U, V, A
*EL HISTORY, ELSET=DMBST
MISES,
PEEQ,
SENER,
PENER,
*EL HISTORY, ELSET=DMWST
MISES,
PEEQ,
SENER,
PENER,
*EL HISTORY, ELSET=DMLST
MISES,
PEEQ,
SENER,
PENER,
*EL HISTORY, ELSET=RINGST
MISES,
PEEQ,
SENER,
PENER,
*EL HISTORY, ELSET=BOLTST
MISES,
PEEQ,
SENER,
PENER,
*FILE OUTPUT, NUMBER INTERVAL=100
*NODE FILE
RF,
*MONITOR,NODE=307,DOF=1
*END STEP
-
```



CHECKLIST FOR CHECKING OF ANALYSIS/CALCULATIONS

Document Number/Revision: HNF-2209/Rev. 0

Document Title: DOT-17H 55 Gallon Drum 30 MPH Side Drop

Yes	No	N/A	
<input checked="" type="checkbox"/>	<input type="checkbox"/>	<input type="checkbox"/>	Problem completely defined.
<input checked="" type="checkbox"/>	<input type="checkbox"/>	<input type="checkbox"/>	Appropriate analytical method used.
<input checked="" type="checkbox"/>	<input type="checkbox"/>	<input type="checkbox"/>	Necessary assumptions are appropriate and explicitly stated.
<input checked="" type="checkbox"/>	<input type="checkbox"/>	<input type="checkbox"/>	Computer codes and data files documented.
<input checked="" type="checkbox"/>	<input type="checkbox"/>	<input type="checkbox"/>	Data used in calculations explicitly stated in document.
<input type="checkbox"/>	<input type="checkbox"/>	<input checked="" type="checkbox"/>	Sources of non-standard formula/data are referenced and the correctness of the reference verified.
<input checked="" type="checkbox"/>	<input type="checkbox"/>	<input type="checkbox"/>	Data checked for consistency with original source information as applicable.
<input type="checkbox"/>	<input type="checkbox"/>	<input checked="" type="checkbox"/>	Mathematical derivations checked including dimensional consistency of results.
<input checked="" type="checkbox"/>	<input type="checkbox"/>	<input type="checkbox"/>	Models appropriate and used within range of validity or use outside range of established validity justified.
<input type="checkbox"/>	<input type="checkbox"/>	<input checked="" type="checkbox"/>	Hand calculations checked for errors.
<input checked="" type="checkbox"/>	<input type="checkbox"/>	<input type="checkbox"/>	Code run streams correct and consistent with analysis documentation.
<input checked="" type="checkbox"/>	<input type="checkbox"/>	<input type="checkbox"/>	Code output consistent with input and with results reported in analysis documentation.
<input checked="" type="checkbox"/>	<input type="checkbox"/>	<input type="checkbox"/>	Acceptability limits on analytical results applicable and supported. Limits checked against sources.
<input checked="" type="checkbox"/>	<input type="checkbox"/>	<input type="checkbox"/>	Safety Margins consistent with good engineering practices.
<input checked="" type="checkbox"/>	<input type="checkbox"/>	<input type="checkbox"/>	Conclusions consistent with analytical results and applicable limits.
<input checked="" type="checkbox"/>	<input type="checkbox"/>	<input type="checkbox"/>	Results and conclusions address all points required in the problem statement.

I have checked the analysis/calculation and it is complete and accurate to the best of my knowledge.

Engineer/Checker Scott Shiraga

Date 09/01/98

NOTE: Any hand calculations, notes or summaries generated as part of this check should be signed, dated, and attached to this checklist. Material should be labeled and recorded so that it is intelligible to a technically qualified third party.

7.7.1.2 DOT-17H 55-Gal Drum 50-MPH Side Drop.

```

*HEADING
DOT-17H 55 GALLON DRUM, 50 MPH SIDE DROP, FILE=DSD50N
*RESTART, WRITE, NUMBER INTERVAL=10
*****
**      DRUM
*****
**
** GENERATE THE NODES OF DRUM BOTTOM PLATE
**
*NODE, SYSTEM=R
*NODE
1, -3.6, 0.0, 0.0
7, -3.6, 0.0, 0.0
22, -3.6, 3.6, 0.0
28, 3.6, 3.6, 0.0
*NGEN, NSET=LINEA
1, 7, 1
*NGEN, NSET=LINEB
22, 28, 1
*NFILL, NSET=DMB1
LINEA, LINEB, 3, 7
*NODE, NSET=DMB2
41, 5.4417, 0.0, 0.0
42, 5.3380, 1.5872, 0.0
43, 5.0342, 3.1208, 0.0
44, 4.5508, 4.5508, 0.0
45, 3.1208, 5.0342, 0.0
46, 1.5872, 5.3380, 0.0
47, 0.0, 5.4417, 0.0
48, -1.5872, 5.3380, 0.0
49, -3.1208, 5.0342, 0.0
50, -4.5508, 4.5508, 0.0
51, -5.0342, 3.1208, 0.0
52, -5.3380, 1.5872, 0.0
53, -5.4417, 0.0, 0.0
61, 7.2833, 0.0, 0.0
62, 7.0760, 1.9745, 0.0
63, 6.4683, 3.8417, 0.0
64, 5.5016, 5.5016, 0.0
65, 3.8417, 6.4683, 0.0
66, 1.9745, 7.0760, 0.0
67, 0.0, 7.2833, 0.0
68, -1.9745, 7.0760, 0.0
69, -3.8417, 6.4683, 0.0
70, -5.5016, 5.5016, 0.0
71, -6.4683, 3.8417, 0.0
72, -7.0760, 1.9745, 0.0
73, -7.2833, 0.0, 0.0
81, 9.6000, 0.0, 0.0
82, 9.2729, 2.4847, 0.0
83, 8.3138, 4.8000, 0.0
84, 6.7882, 6.7882, 0.0
85, 4.8000, 8.3138, 0.0
86, 2.4847, 9.2729, 0.0
87, 0.0, 9.6000, 0.0
88, -2.4847, 9.2729, 0.0
89, -4.8000, 8.3138, 0.0
90, -6.7882, 6.7882, 0.0
91, -8.3138, 4.8000, 0.0
92, -9.2729, 2.4847, 0.0
93, -9.6000, 0.0, 0.0
*NODE, NSET=DMB3
101, 11.5000, 0.0, 0.0
102, 11.1081, 2.9764, 0.0
103, 9.9593, 5.7500, 0.0
104, 8.1317, 8.1317, 0.0
105, 5.7500, 9.9593, 0.0
106, 2.9764, 11.1081, 0.0
107, 0.0, 11.5000, 0.0
108, -2.9764, 11.1081, 0.0
109, -5.7500, 9.9593, 0.0
110, -8.1317, 8.1317, 0.0
111, -9.9593, 5.7500, 0.0
112, -11.1081, 2.9764, 0.0
113, -11.5000, 0.0, 0.0

```

```

*NSET, NSET = DMB
DMB1, DMB2, DMB3
**
** GENERATE THE ELEMENTS OF DRUM BOTTOM PLATE
**
*ELEMENT, TYPE = S4R
1, 1, 2, 9, 8
*ELGEN, ELSET = DMBA
1, 6, 1, 1, 3, 7, 6
*ELEMENT, TYPE = S4R, ELSET = DMBB
21, 7, 41, 42, 14
22, 14, 42, 43, 21
23, 21, 43, 44, 28
24, 28, 44, 45, 27
25, 27, 45, 46, 26
26, 26, 46, 47, 25
27, 25, 47, 48, 24
28, 24, 48, 49, 23
29, 23, 49, 50, 22
30, 22, 50, 51, 15
31, 15, 51, 52, 8
32, 8, 52, 53, 1
41, 41, 61, 62, 42
*ELGEN, ELSET = DMBB
41, 12, 1, 1, 3, 20, 20
*ELSET, ELSET = DMB
DMBA, DMBB
*SHELL SECTION, ELSET = DMB, MATERIAL = ST
0.0478
**
** GENERATE THE DRUM CYLINDRICAL WALL
**
** NODES
**
*NCOPY, SHIFT, CHANGE NU = 40, OLD SET = DMB3, NEW SET = L1
0.0, 0.0, 2.0
0.0, 0.0, 0.0, 0.0, 0.0, 1.0, 0.0
*NCOPY, SHIFT, CHANGE NU = 300, OLD SET = L1, NEW SET = L2
0.0, 0.0, 30.0
0.0, 0.0, 0.0, 0.0, 0.0, 1.0, 0.0
*NCOPY, SHIFT, CHANGE NU = 40, OLD SET = L2, NEW SET = L3
0.0, 0.0, 2.0
0.0, 0.0, 0.0, 0.0, 0.0, 1.0, 0.0
*NFill, NSET = DMW1
DMB3, L1, 2, 20
*NFill, NSET = DMW2
L1, L2, 15, 20
*NFill, NSET = DMW3
L2, L3, 2, 20
*NODE, NSET = DMW4
501, 11, 5000, 0.0, 34.5
701, 11, 5000, 0.0, 35.0
*NCOPY, SHIFT, MULTIPLE = 12, CHANGE NU = + 1, OLD SET = DMW4, NEW SET = DMW4
0.0, 0.0, 0.0
0.0, 0.0, 0.0, 0.0, 0.0, 1.0, + 15.00
*NSET, NSET = DMW
DMW1, DMW2, DMW3, DMW4
**
** ELEMENTS
**
*ELEMENT, TYPE = S4R, ELSET = DMW1
101, 101, 121, 122, 102
*ELGEN, ELSET = DMW1
101, 12, 1, 1, 2, 20, 20
*ELEMENT, TYPE = S4R, ELSET = DMW2
141, 141, 161, 162, 142
*ELGEN, ELSET = DMW2
141, 12, 1, 1, 15, 20, 20
*ELEMENT, TYPE = S4R, ELSET = DMW3
441, 441, 461, 462, 442
*ELGEN, ELSET = DMW3
441, 12, 1, 1, 2, 20, 20
*ELEMENT, TYPE = S4R, ELSET = DMW4
481, 481, 501, 502, 482
501, 501, 701, 702, 502
*ELGEN, ELSET = DMW4
481, 12, 1, 1
501, 12, 1, 1

```

```

*ELSET, ELSET = DMW
DMW1, DMW2, DMW3, DMW4
*SHELL SECTION, ELSET = DMW, MATERIAL = ST
0.0478
**
** GENERATE THE NODES OF DRUM LID
**
*NCOPY,SHIFT,CHANGE NU = 1000,OLD SET = DMB,NEW SET = DML
0.0, 0.0, 34.50
0.0, 0.0, 0.0, 0.0, 0.0, 1.0, 0.0
** MODIFY NODES
*NODE, NSET = DML
1101, 10.5000, 0.0, 34.50
1102, 10.1422, 2.7176, 34.50
1103, 9.0933, 5.2500, 34.50
1104, 7.4246, 7.4246, 34.50
1105, 5.2500, 9.0933, 34.50
1106, 2.7176, 10.1422, 34.50
1107, 0.0, 10.5000, 34.50
1108, -2.7176, 10.1422, 34.50
1109, -5.2500, 9.0933, 34.50
1110, -7.4246, 7.4246, 34.50
1111, -9.0933, 5.2500, 34.50
1112, -10.1422, 2.7176, 34.50
1113, -10.5000, 0.0, 34.50
**
** GENERATE THE DRUM LID
**
*ELEMENT, TYPE = S4R
1001, 1001, 1002, 1009, 1008
*ELGEN, ELSET = DMLA
1001, 6, 1, 1, 3, 7, 6
*ELEMENT, TYPE = S4R, ELSET = DMLB
1021, 1007, 1041, 1042, 1014
1022, 1014, 1042, 1043, 1021
1023, 1021, 1043, 1044, 1028
1024, 1028, 1044, 1045, 1027
1025, 1027, 1045, 1046, 1026
1026, 1026, 1046, 1047, 1025
1027, 1025, 1047, 1048, 1024
1028, 1024, 1048, 1049, 1023
1029, 1023, 1049, 1050, 1022
1030, 1022, 1050, 1051, 1015
1031, 1015, 1051, 1052, 1008
1032, 1008, 1052, 1053, 1001
*ELEMENT, TYPE = S4R
1041, 1041, 1061, 1062, 1042
*ELGEN, ELSET = DMLC
1041, 12, 1, 1, 2, 20, 20
*ELEMENT, TYPE = S4R
1081, 1081, 1101, 1102, 1082
*ELGEN, ELSET = DMLD
1081, 12, 1, 1
*ELSET, ELSET = DML
DMLA, DMLB, DMLC, DMLD
*SHELL SECTION, ELSET = DML, MATERIAL = ST
0.0478
*NSET, NSET = DM
DMB, DMW, DML
*ELSET, ELSET = DM
DMB, DMW, DML
*****
** CLOSING RING, DRUM LID, AND DRUM ASSEMBLY
*****
*NODE, NSET = RING
601, 11.7500, 0.0, 34.0670
621, 11.9330, 0.0, 34.2500
641, 12.0000, 0.0, 34.5000
661, 11.9330, 0.0, 34.7500
681, 11.7500, 0.0, 34.9330
701, 11.5000, 0.0, 35.0000
721, 11.2500, 0.0, 34.9330
741, 11.0670, 0.0, 34.7500
*NCOPY,SHIFT,MULTIPLE = 12,CHANGE NU = + 1,OLD SET = RING,NEW SET = RING
0.0, 0.0, 0.0
0.0, 0.0, 0.0, 0.0, 0.0, 1.0, + 15.00
*ELEMENT, TYPE = S4R
601, 481, 482, 602, 601

```

```

621, 601, 602, 622, 621
721, 701, 702, 722, 721
761, 741, 742, 1102, 1101
*ELGEN, ELSET=RING1
601, 12, 1, 1
621, 12, 1, 1, 5, 20, 20
*ELGEN, ELSET=RING2
721, 12, 1, 1, 2, 20, 20
761, 12, 1, 1
*ELSET, ELSET=RING
RING1, RING2
*SHELL SECTION, ELSET=RING1, MATERIAL=ST
0.50
*SHELL SECTION, ELSET=RING2, MATERIAL=ST
0.35
*****
** CLOSING RING BOLT
*****
*NODE, NSET=BOLT
1501, 11.500, 0.0, 34.500
1502, 11.500, 0.5, 34.500
*ELEMENT, TYPE=T3D2, ELSET=BOLT
1501, 1501, 1502
*SOLID SECTION, ELSET=BOLT, MATERIAL=BOLT
0.228
*MPC
TIE,601,1502
TIE,621,1502
TIE,641,1502
TIE,661,1502
TIE,681,1502
*EQUATION
2
1501,1,1,0,1502,1,-1.0
*EQUATION
2
1501,3,1,0,1502,3,-1.0
*****
** PAYLOAD
*****
*NODE, SYSTEM=R
*NODE
2001, -4.0, 0.0, 0.024
2005, 4.0, 0.0, 0.024
2011, -4.0, 4.0, 0.024
2015, 4.0, 4.0, 0.024
*NGEN, NSET=LINEC
2001, 2005, 1
*NGEN, NSET=LINED
2011, 2015, 1
*NFILL, NSET=PAYB1
LINEC, LINED, 2, 5
*NODE, NSET=PAYB2
2021, 7.625, 0.0, 0.024
2022, 7.1968, 3.1526, 0.024
2023, 5.9775, 5.9775, 0.024
2024, 3.1526, 7.1968, 0.024
2025, 0.0, 7.625, 0.024
2026, -3.1526, 7.1968, 0.024
2027, -5.9775, 5.9775, 0.024
2028, -7.1968, 3.1526, 0.024
2029, -7.625, 0.0, 0.024
*NODE, NSET=PAYB3
2031, 11.25, 0.0, 0.024
2032, 10.394, 4.3052, 0.024
2033, 7.9550, 7.9550, 0.024
2034, 4.3052, 10.394, 0.024
2035, 0.0, 11.25, 0.024
2036, -4.3052, 10.394, 0.024
2037, -7.9550, 7.9550, 0.024
2038, -10.394, 4.3052, 0.024
2039, -11.25, 0.0, 0.024
*NSET, NSET=PAYB
PAYB1, PAYB2, PAYB3
*ELEMENT, TYPE=S4R
2001, 2001, 2002, 2007, 2006
*ELGEN, ELSET=PAYB1
2001, 4, 1, 1, 2, 5, 5

```

```

*ELEMENT, TYPE=S4R, ELSET=PAYB2
2011, 2005, 2021, 2022, 2010
2012, 2010, 2022, 2023, 2015
2013, 2015, 2023, 2024, 2014
2014, 2014, 2024, 2025, 2013
2015, 2013, 2025, 2026, 2012
2016, 2012, 2026, 2027, 2011
2017, 2011, 2027, 2028, 2006
2018, 2006, 2028, 2029, 2001
*ELEMENT, TYPE=S4R
2021, 2021, 2031, 2032, 2022
*ELGEN, ELSET=PAYB2
2021, 8, 1, 1
*ELSET, ELSET=PAYB
PAYB1, PAYB2
*SHELL SECTION, ELSET=PAYB, MATERIAL=PAYLD
0.0478
*****
*NCOPY,SHIFT,CHANGE NU = 100,OLD SET=PAYB3,NEW SET=PAYW1
0.0, 0.0, 33.25
0.0, 0.0, 0.0, 0.0, 0.0, 1.0, 0.0
*NFILL, NSET=PAYW
PAYB3, PAYW1, 10, 10
*ELEMENT, TYPE=S4R
2031, 2031, 2041, 2042, 2032
*ELGEN, ELSET=PAYW
2031, 8, 1, 1, 10, 10, 10
*SHELL SECTION, ELSET=PAYW, MATERIAL=PAYLD
0.0478
*****
*NCOPY,SHIFT,CHANGE NU = 200,OLD SET=PAYB,NEW SET=PAYT
0.0, 0.0, 33.25
0.0, 0.0, 0.0, 0.0, 0.0, 1.0, 0.0
*ELEMENT, TYPE=S4R
2201, 2201, 2202, 2207, 2206
*ELGEN, ELSET=PAYT1
2201, 4, 1, 1, 2, 5, 5
*ELEMENT, TYPE=S4R, ELSET=PAYT2
2211, 2205, 2221, 2222, 2210
2212, 2210, 2222, 2223, 2215
2213, 2215, 2223, 2224, 2214
2214, 2214, 2224, 2225, 2213
2215, 2213, 2225, 2226, 2212
2216, 2212, 2226, 2227, 2211
2217, 2211, 2227, 2228, 2206
2218, 2206, 2228, 2229, 2201
*ELEMENT, TYPE=S4R
2221, 2221, 2131, 2132, 2222
*ELGEN, ELSET=PAYT2
2221, 8, 1, 1
*ELSET, ELSET=PAYT
PAYT1, PAYT2
*ELSET, ELSET=PAY
PAYB, PAYW, PAYT
*NSET, NSET=PAY
PAYB, PAYW, PAYT
*SHELL SECTION, ELSET=PAYT, MATERIAL=PAYLD
0.0478
*****
** GENERATE THE ELEMENTS OF CONCRETE PAD
** 10' X 10' RECTANGULAR HALF SECTION (NO INF)
**
*NODE, SYSTEM=R
*NODE, NSET=C1
160001, -60.0, 0.0, -8.0
*NODE, NSET=C2
160004, -45.0, 0.0, -8.0
*NODE, NSET=C3
160034, 45.0, 0.0, -8.0
*NODE, NSET=C4
160037, 60.0, 0.0, -8.0
*NFILL, NSET=LINE1
C1, C2, 3
C2, C3, 30
C3, C4, 3
*NCOPY,SHIFT,CHANGE NU = 500,OLD SET=LINE1,NEW SET=LINE2
0.0, 30.0, 0.0
0.0, 0.0, 0.0, 0.0, 0.0, 1.0, 0.0

```

```

*NCOPY,SHIFT,CHANGE NU = 300,OLD SET = LINE2,NEW SET = LINE3
0.0, 30.0, 0.0
0.0, 0.0, 0.0, 0.0, 0.0, 1.0, 0.0, 0.0
*NFILL, NSET = CONC1
LINE1, LINE2, 10, 50
LINE2, LINE3, 5, 50
*NCOPY,SHIFT,CHANGE NU = 2000,OLD SET = CONC1,NEW SET = CONC2
0.0, 0.0, 2.0
0.0, 0.0, 0.0, 0.0, 0.0, 1.0, 0.0
*NCOPY,SHIFT,CHANGE NU = 2000,OLD SET = CONC2,NEW SET = CONC3
0.0, 0.0, 2.0
0.0, 0.0, 0.0, 0.0, 0.0, 1.0, 0.0
*NCOPY,SHIFT,CHANGE NU = 2000,OLD SET = CONC3,NEW SET = CONC4
0.0, 0.0, 2.0
0.0, 0.0, 0.0, 0.0, 0.0, 1.0, 0.0
*NCOPY,SHIFT,CHANGE NU = 2000,OLD SET = CONC4,NEW SET = CONC5
0.0, 0.0, 2.0
0.0, 0.0, 0.0, 0.0, 0.0, 1.0, 0.0
*NSET,NSET = CONCO
CONC1, CONC2, CONC3, CONC4, CONC5,
**
** GENERATE THE SOIL NODES
**
*NCOPY, SHIFT, CHANGE NU = 20000, OLD SET = CONC1, NEW SET = SOIL1
0.0, 0.0, -50.0
0.0, 0.0, 0.0, 0.0, 0.0, 1.0, 0.0
*NCOPY, SHIFT, CHANGE NU = 2000, OLD SET = SOIL1, NEW SET = SOIL2
0.0, 0.0, +20.0
0.0, 0.0, 0.0, 0.0, 0.0, 1.0, 0.0
*NCOPY, SHIFT, CHANGE NU = 2000, OLD SET = SOIL2, NEW SET = SOIL3
0.0, 0.0, +10.0
0.0, 0.0, 0.0, 0.0, 0.0, 1.0, 0.0
*NCOPY, SHIFT, CHANGE NU = 2000, OLD SET = SOIL3, NEW SET = SOIL4
0.0, 0.0, +10.0
0.0, 0.0, 0.0, 0.0, 0.0, 1.0, 0.0
*NCOPY, SHIFT, CHANGE NU = 2000, OLD SET = SOIL4, NEW SET = SOIL5
0.0, 0.0, +5.0
0.0, 0.0, 0.0, 0.0, 0.0, 1.0, 0.0
*NSET,NSET = SOILO
SOIL1, SOIL2, SOIL3, SOIL4, SOIL5
**
** GENERATE THE INCLINED IMPACT SURFACES
**
*NCOPY,SHIFT,CHANGE NU = -100000,OLD SET = CONCO,NEW SET = CONC
12.250, 0., 17.5
12.250, 0., 17.5, 12.250, 1., 17.5, -90.0
*NCOPY,SHIFT, CHANGE NU = -100000, OLD SET = SOILO, NEW SET = SOIL
12.250, 0., 17.5
12.250, 0., 17.5, 12.250, 1., 17.5, -90.0
**
** CONCRETE PAD ELEMENT
**
*ELEMENT, TYPE = C3D8R
60001, 60001, 60002, 60052, 60051, 62001, 62002, 62052, 62051
*ELGEN, ELSET = CONC1
60001, 36, 1, 1, 16, 50, 50
*ELCOPY,OLD SET = CONC1,NEW SET = CONC2,ELEMENT SH = 2000,SHIFT NO = 2000
*ELCOPY,OLD SET = CONC2,NEW SET = CONC3,ELEMENT SH = 2000,SHIFT NO = 2000
*ELCOPY,OLD SET = CONC3,NEW SET = CONC4,ELEMENT SH = 2000,SHIFT NO = 2000
*ELSET, ELSET = CONC
CONC1, CONC2, CONC3, CONC4,
*SOLID SECTION, ELSET = CONC, MATERIAL = CONCRETE
**
** GENERATE REBARS
**
*REBAR,ELEM = CONTINUUM,MAT = REBAR,GEOM = ISOPARAMETRIC,NAME = LX
CONC1,0.60,12.0,0.0,1.0,4,2
*REBAR,ELEM = CONTINUUM,MAT = REBAR,GEOM = ISOPARAMETRIC,NAME = LY
CONC1,0.60,12.0,90.,1.0,4,2
*REBAR,ELEM = CONTINUUM,MAT = REBAR,GEOM = ISOPARAMETRIC,NAME = UX
CONC4,0.60,12.0,0.0,0.0,4,2
*REBAR,ELEM = CONTINUUM,MAT = REBAR,GEOM = ISOPARAMETRIC,NAME = UY
CONC4,0.60,12.0,90.,0.0,4,2
**
** GENERATE THE SOIL
**
*ELCOPY,OLD SET = CONC1,NEW SET = SOIL1,ELEMENT SH = 20000,SHIFT NO = 20000
*ELCOPY,OLD SET = SOIL1,NEW SET = SOIL2,ELEMENT SH = 2000,SHIFT NO = 2000

```

```

*ELCOPY,OLD SET =SOIL2,NEW SET =SOIL3,ELEMENT SH = 2000,SHIFT NO = 2000
*ELCOPY,OLD SET =SOIL3,NEW SET =SOIL4,ELEMENT SH = 2000,SHIFT NO = 2000
*ELEMENT, TYPE = C3D6, ELSET = SOIL5
*ELEMENT, TYPE = C3D8R
88001, 88001, 88002, 88052, 88051, 60001, 60002, 60052, 60051
*ELGEN, ELSET = SOIL5
88001, 36, 1, 1, 16, 50, 50
*ELSET, ELSET = SOIL
SOIL1, SOIL2, SOIL3, SOIL4, SOIL5
*SOLID SECTION, ELSET = SOIL, MATERIAL = SOIL
*****
**
** ASTM A36
**
*MATERIAL, NAME = ST
*ELASTIC
29.0E6, 0.3
*PLASTIC
36000., 0.
60000., 0.23
30000., 0.24
10000., 0.25
5000., 0.26
1000., 0.27
*DENSITY
7.5052E-4
*FAILURE
0.30, 0.25
**
** CLOSING RING BOLT MATERIAL
** ASTM A307, GR. C
**
*MATERIAL, NAME = BOLT
*ELASTIC
29.0E6, 0.3
*PLASTIC
36000., 0.
60000., 0.23
30000., 0.24
10000., 0.25
5000., 0.26
1000., 0.27
*DENSITY
7.5052E-4
*FAILURE
0.30, 0.25
*MATERIAL, NAME = PAYLD
*ELASTIC
29.0E6, 0.3
*DENSITY
0.02437
*material,name = concrete
** 4000 PSI CONCRETE
*density
1.95E-04
*elastic
3.6E+06,0.15
*drucker prager
35.1,1.0,35.1
*drucker prager hardening
2250.,0.0
3900.,0.0013
3000.,0.0024
2400.,0.0034
1790.,0.0044
1180.,0.0054
800.,0.006
100.,0.0061
*material,name = soil
*density
1.647E-04
*elastic
5700.,0.35
*drucker prager
35.2,0.82,35.2
*drucker prager hardening
2.0,0.0
6.54,0.0055

```

```

8.64,0.0156
9.96,0.0259
10.88,0.0362
10.98,0.0467
11.1,0.0573
11.04,0.0668
10.8,0.0788
10.44,0.0897
9.9,0.1
9.0,0.112
**
** REBAR STEEL
**
*MATERIAL, NAME=REBAR
*DENSITY
7.34E-4
*ELASTIC
29.5E6, 0.30
*PLASTIC
71170., 0.0
71626., 0.004965
83130., 0.017098
96460., 0.036202
104728., 0.055113
109080., 0.073795
***FAILURE
**0.30, 0.03
**
** ELEMENT SET DEFINITIONS
**
*ELSET,ELSET=ALLEL
DMB, DMW, DML
RING, BOLT
PAY,
**
** NODE SET DEFINITIONS
**
*NSET,NSET=ALLND
DMB, DMW, DML
RING, BOLT
PAY,
*NSET,NSET=YSYMM,GENERATE
60001,60037,1
62001,62037,1
64001,64037,1
66001,66037,1
68001,68037,1
80001,80037,1
82001,82037,1
84001,84037,1
86001,86037,1
88001,88037,1
*NSET,NSET=YSYMM,GENERATE
1, 7, 1
41, 53, 12
61, 73, 12
81, 93, 12
101, 501, 20
113, 513, 20
613, 693, 20
701, 741, 20
713, 753, 20
13001, 1007, 1
1041, 1053, 12
1061, 1073, 12
1081, 1093, 12
1101, 1113, 12
1501, 1501, 1
2001, 2005, 1
2021, 2029, 8
2031, 2131, 10
2039, 2139, 10
2201, 2205, 1
2221, 2229, 8
*NSET,NSET=SOILBT,GENERATE
80001,80837,1
*NSET,NSET=CONC5,GENERATE
68001,68837,1

```



```

*BOUNDARY
YSYMM,YSYMM
SOILBT,1,3
*****
*INITIAL CONDITIONS,TYPE=VELOCITY
ALLND,1,880.0
*STEP
*DYNAMIC,EXPLICIT
,20.0E-03
**
** DEFINE THE CONTACT SURFACES BETWEEN
** THE DRUM BOTTOM AND TARGET
**
*SURFACE DEFINITION,NAME=CONC4T
CONC4,S2
*SURFACE DEFINITION,NAME=CONC3T
CONC3,S2
*SURFACE DEFINITION,NAME=CONC2T
CONC2,S2
*SURFACE DEFINITION,NAME=CONC1T
CONC1,S2
*SURFACE DEFINITION,NAME=DMOUT,NO THICK
DMB,SNEG
DMW1,SNEG
DMW2,SNEG
DMW3,SNEG
RING,SPOS
DML,SPOS
*CONTACT PAIR
CONC4T,DMOUT
CONC3T,DMOUT
CONC2T,DMOUT
CONC1T,DMOUT
**
** DEFINE THE CONTACT SURFACES BETWEEN
** THE DRUM INSIDE AND PAYLOAD OUTSIDE
**
*SURFACE DEFINITION,NAME=DMINS,NO THICK
DMB,SPOS
DMW1,SPOS
DMW2,SPOS
DMW3,SPOS
DMW4,SPOS
RING2,SNEG
DML,SNEG
*SURFACE DEFINITION,NAME=PAYOUT,NO THICK
PAYB,SNEG
PAYW,SNEG
PAYT,SPOS
*CONTACT PAIR
DMINS,PAYOUT
*****
*NSET,NSET=DMDIS,GENERATE
4,4,1
1004,1004,1
101,113,3
301,313,3
541,553,3
*ELSET,ELSET=DMBST,GENERATE
61,66,1
81,86,1
*ELSET,ELSET=DMBST
DMBA,
*ELSET,ELSET=DMWST,GENERATE
101,106,1
121,126,1
141,421,20
142,422,20
143,423,20
441,446,1
461,466,1
481,486,1
501,506,1
*ELSET,ELSET=DMLST,GENERATE
1061,1066,1
1081,1086,1
*ELSET,ELSET=DMLST
DMLA,

```

```
*ELSET,ELSET = RINGST,GENERATE
601,606,1
621,626,1
641,646,1
661,666,1
681,686,1
701,706,1
721,726,1
741,746,1
761,766,1
*ELSET,ELSET = BOLTST,GENERATE
1501,1501,1
*****
*HISTORY OUTPUT, TIME=0.5E-5
*NODE HISTORY, NSET = DMDIS
U, V, A
*EL HISTORY, ELSET = DMBST
MISES,
PEEQ,
SENER,
PENER,
*EL HISTORY, ELSET = DMWST
MISES,
PEEQ,
SENER,
PENER,
*EL HISTORY, ELSET = DMLST
MISES,
PEEQ,
SENER,
PENER,
*EL HISTORY, ELSET = RINGST
MISES,
PEEQ,
SENER,
PENER,
*EL HISTORY, ELSET = BOLTST
MISES,
PEEQ,
SENER,
PENER,
*FILE OUTPUT, NUMBER INTERVAL = 100
*NODE FILE
RF,
*MONITOR,NODE=307,DOF=1
*END STEP
-
```



CHECKLIST FOR CHECKING OF ANALYSIS/CALCULATIONS

Document Number/Revision: HNF-2209/Rev. 0

Document Title: DOT-17H 55 Gallon Drum 50 MPH Side Drop

Yes	No	N/A	
<input checked="" type="checkbox"/>	<input type="checkbox"/>	<input type="checkbox"/>	Problem completely defined.
<input checked="" type="checkbox"/>	<input type="checkbox"/>	<input type="checkbox"/>	Appropriate analytical method used.
<input checked="" type="checkbox"/>	<input type="checkbox"/>	<input type="checkbox"/>	Necessary assumptions are appropriate and explicitly stated.
<input checked="" type="checkbox"/>	<input type="checkbox"/>	<input type="checkbox"/>	Computer codes and data files documented.
<input checked="" type="checkbox"/>	<input type="checkbox"/>	<input type="checkbox"/>	Data used in calculations explicitly stated in document.
<input type="checkbox"/>	<input type="checkbox"/>	<input checked="" type="checkbox"/>	Sources of non-standard formula/data are referenced and the correctness of the reference verified.
<input checked="" type="checkbox"/>	<input type="checkbox"/>	<input type="checkbox"/>	Data checked for consistency with original source information as applicable.
<input type="checkbox"/>	<input type="checkbox"/>	<input checked="" type="checkbox"/>	Mathematical derivations checked including dimensional consistency of results.
<input checked="" type="checkbox"/>	<input type="checkbox"/>	<input type="checkbox"/>	Models appropriate and used within range of validity or use outside range of established validity justified.
<input type="checkbox"/>	<input type="checkbox"/>	<input checked="" type="checkbox"/>	Hand calculations checked for errors.
<input checked="" type="checkbox"/>	<input type="checkbox"/>	<input type="checkbox"/>	Code run streams correct and consistent with analysis documentation.
<input checked="" type="checkbox"/>	<input type="checkbox"/>	<input type="checkbox"/>	Code output consistent with input and with results reported in analysis documentation.
<input checked="" type="checkbox"/>	<input type="checkbox"/>	<input type="checkbox"/>	Acceptability limits on analytical results applicable and supported. Limits checked against sources.
<input checked="" type="checkbox"/>	<input type="checkbox"/>	<input type="checkbox"/>	Safety Margins consistent with good engineering practices.
<input checked="" type="checkbox"/>	<input type="checkbox"/>	<input type="checkbox"/>	Conclusions consistent with analytical results and applicable limits.
<input checked="" type="checkbox"/>	<input type="checkbox"/>	<input type="checkbox"/>	Results and conclusions address all points required in the problem statement.

I have checked the analysis/calculation and it is complete and accurate to the best of my knowledge.

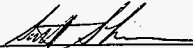
Engineer/Checker Scott Shiraga  Date 09/01/98

NOTE: Any hand calculations, notes or summaries generated as part of this check should be signed, dated, and attached to this checklist. Material should be labeled and recorded so that it is intelligible to a technically qualified third party.

7.7.1.3 DOT-17H 55-Gal Drum 4-Ft Top-Corner Drop.

```

*HEADING
DOT-17H 55 GALLON DRUM, 4-FT TOP CORNER DROP, FILE=DTC04N
VELOCITY = 192.6 IPS/10.94 MPH
*RESTART, WRITE, NUMBER INTERVAL=10
*****
** DRUM
*****
**
** GENERATE THE NODES OF DRUM BOTTOM PLATE
**
*NODE, SYSTEM=R
*NODE
1, -3.6, 0.0, 0.0
7, 3.6, 0.0, 0.0
22, -3.6, 3.6, 0.0
28, 3.6, 3.6, 0.0
*NGEN, NSET=LINEA
1, 7, 1
*NGEN, NSET=LINEB
22, 28, 1
*NFILL, NSET=DMB1
LINEA, LINEB, 3, 7
*NODE, NSET=DMB2
41, 5.4417, 0.0, 0.0
42, 5.3380, 1.5872, 0.0
43, 5.0342, 3.1208, 0.0
44, 4.5508, 4.5508, 0.0
45, 3.1208, 5.0342, 0.0
46, 1.5872, 5.3380, 0.0
47, 0.0, 5.4417, 0.0
48, -1.5872, 5.3380, 0.0
49, -3.1208, 5.0342, 0.0
50, -4.5508, 4.5508, 0.0
51, -5.0342, 3.1208, 0.0
52, -5.3380, 1.5872, 0.0
53, -5.4417, 0.0, 0.0
61, 7.2833, 0.0, 0.0
62, 7.0760, 1.9745, 0.0
63, 6.4683, 3.8417, 0.0
64, 5.5016, 5.5016, 0.0
65, 3.8417, 6.4683, 0.0
66, 1.9745, 7.0760, 0.0
67, 0.0, 7.2833, 0.0
68, -1.9745, 7.0760, 0.0
69, -3.8417, 6.4683, 0.0
70, -5.5016, 5.5016, 0.0
71, -6.4683, 3.8417, 0.0
72, -7.0760, 1.9745, 0.0
73, -7.2833, 0.0, 0.0
81, 9.6000, 0.0, 0.0
82, 9.2729, 2.4847, 0.0
83, 8.3138, 4.8000, 0.0
84, 6.7882, 6.7882, 0.0
85, 4.8000, 8.3138, 0.0
86, 2.4847, 9.2729, 0.0
87, 0.0, 9.6000, 0.0
88, -2.4847, 9.2729, 0.0
89, -4.8000, 8.3138, 0.0
90, -6.7882, 6.7882, 0.0
91, -8.3138, 4.8000, 0.0
92, -9.2729, 2.4847, 0.0
93, -9.6000, 0.0, 0.0
*NODE, NSET=DMB3
101, 11.5000, 0.0, 0.0
102, 11.1081, 2.9764, 0.0
103, 9.9593, 5.7500, 0.0
104, 8.1317, 8.1317, 0.0
105, 5.7500, 9.9593, 0.0
106, 2.9764, 11.1081, 0.0
107, 0.0, 11.5000, 0.0
108, -2.9764, 11.1081, 0.0
109, -5.7500, 9.9593, 0.0
110, -8.1317, 8.1317, 0.0
111, -9.9593, 5.7500, 0.0
112, -11.1081, 2.9764, 0.0

```

```

113, -11.5000, 0.0, 0.0
*NSSET, NSET = DMB
DMB1, DMB2, DMB3
**
** GENERATE THE ELEMENTS OF DRUM BOTTOM PLATE
**
*ELEMENT, TYPE = S4R
1, 1, 2, 9, 8
*ELGEN, ELSET = DMBA
1, 6, 1, 1, 3, 7, 6
*ELEMENT, TYPE = S4R, ELSET = DMBB
21, 7, 41, 42, 14
22, 14, 42, 43, 21
23, 21, 43, 44, 28
24, 28, 44, 45, 27
25, 27, 45, 46, 26
26, 26, 46, 47, 25
27, 25, 47, 48, 24
28, 24, 48, 49, 23
29, 23, 49, 50, 22
30, 22, 50, 51, 15
31, 15, 51, 52, 8
32, 8, 52, 53, 1
41, 41, 61, 62, 42
*ELGEN, ELSET = DMBB
41, 12, 1, 1, 3, 20, 20
*ELSET, ELSET = DMB
DMBA, DMBB
*SHELL SECTION, ELSET = DMB, MATERIAL = ST
0.0478
**
** GENERATE THE DRUM CYLINDRICAL WALL
**
** NODES
**
**
**NCOPY, SHIFT, CHANGE NU = 40, OLD SET = DMB3, NEW SET = L1
0.0, 0.0, 2.0
0.0, 0.0, 0.0, 0.0, 0.0, 1.0, 0.0
*NCOPY, SHIFT, CHANGE NU = 300, OLD SET = L1, NEW SET = L2
0.0, 0.0, 30.0
0.0, 0.0, 0.0, 0.0, 0.0, 1.0, 0.0
*NCOPY, SHIFT, CHANGE NU = 40, OLD SET = L2, NEW SET = L3
0.0, 0.0, 2.0
0.0, 0.0, 0.0, 0.0, 0.0, 1.0, 0.0
*NFILL, NSET = DMW1
DMB3, L1, 2, 20
*NFILL, NSET = DMW2
L1, L2, 15, 20
*NFILL, NSET = DMW3
L2, L3, 2, 20
*NODE, NSET = DMW4
501, 11.5000, 0.0, 34.5
701, 11.5000, 0.0, 35.0
*NCOPY, SHIFT, MULTIPLE = 12, CHANGE NU = +1, OLD SET = DMW4, NEW SET = DMW4
0.0, 0.0, 0.0
0.0, 0.0, 0.0, 0.0, 0.0, 1.0, +15.00
*NSSET, NSET = DMW
DMW1, DMW2, DMW3, DMW4
**
** ELEMENTS
**
*ELEMENT, TYPE = S4R, ELSET = DMW1
101, 101, 121, 122, 102
*ELGEN, ELSET = DMW1
101, 12, 1, 1, 2, 20, 20
*ELEMENT, TYPE = S4R, ELSET = DMW2
141, 141, 161, 162, 142
*ELGEN, ELSET = DMW2
141, 12, 1, 1, 15, 20, 20
*ELEMENT, TYPE = S4R, ELSET = DMW3
441, 441, 461, 462, 442
*ELGEN, ELSET = DMW3
441, 12, 1, 1, 2, 20, 20
*ELEMENT, TYPE = S4R, ELSET = DMW4
481, 481, 501, 502, 482
501, 501, 701, 702, 502
*ELGEN, ELSET = DMW4
481, 12, 1, 1

```

```

501, 12, 1, 1
*ELSET, ELSET = DMW
DMW1, DMW2, DMW3, DMW4
*SHELL SECTION, ELSET = DMW, MATERIAL = ST
0.0478
**
** GENERATE THE NODES OF DRUM LID
**
*NCOPY, SHIFT, CHANGE NU = 1000, OLD SET = DMB, NEW SET = DML
0.0, 0.0, 34.50
0.0, 0.0, 0.0, 0.0, 0.0, 1.0, 0.0
** MODIFY NODES
*NODE, NSET = DML
1101, 10.5000, 0.0, 34.50
1102, 10.1422, 2.7176, 34.50
1103, 9.0933, 5.2500, 34.50
1104, 7.4246, 7.4246, 34.50
1105, 5.2500, 9.0933, 34.50
1106, 2.7176, 10.1422, 34.50
1107, 0.0, 10.5000, 34.50
1108, -2.7176, 10.1422, 34.50
1109, -5.2500, 9.0933, 34.50
1110, -7.4246, 7.4246, 34.50
1111, -9.0933, 5.2500, 34.50
1112, -10.1422, 2.7176, 34.50
1113, -10.5000, 0.0, 34.50
**
** GENERATE THE DRUM LID
**
*ELEMENT, TYPE = S4R
1001, 1001, 1002, 1009, 1008
*ELGEN, ELSET = DMLA
1001, 6, 1, 1, 3, 7, 6
*ELEMENT, TYPE = S4R, ELSET = DMLB
1021, 1007, 1041, 1042, 1014
1022, 1014, 1042, 1043, 1021
1023, 1021, 1043, 1044, 1028
1024, 1028, 1044, 1045, 1027
1025, 1027, 1045, 1046, 1026
1026, 1026, 1046, 1047, 1025
1027, 1025, 1047, 1048, 1024
1028, 1024, 1048, 1049, 1023
1029, 1023, 1049, 1050, 1022
1030, 1022, 1050, 1051, 1015
1031, 1015, 1051, 1052, 1008
1032, 1008, 1052, 1053, 1001
*ELEMENT, TYPE = S4R
1041, 1041, 1061, 1062, 1042
*ELGEN, ELSET = DMLC
1041, 12, 1, 1, 2, 20, 20
*ELEMENT, TYPE = S4R
1081, 1081, 1101, 1102, 1082
*ELGEN, ELSET = DMLD
1081, 12, 1, 1
*ELSET, ELSET = DML
DMLA, DMLB, DMLC, DMLD
*SHELL SECTION, ELSET = DML, MATERIAL = ST
0.0478
*NSET, NSET = DM
DMB, DMW, DML
*ELSET, ELSET = DM
DMB, DMW, DML
*****
** CLOSING RING, DRUM LID, AND DRUM ASSEMBLY
*****
*NODE, NSET = RING
601, 11.7500, 0.0, 34.0670
621, 11.9330, 0.0, 34.2500
641, 12.0000, 0.0, 34.5000
661, 11.9330, 0.0, 34.7500
681, 11.7500, 0.0, 34.9330
701, 11.5000, 0.0, 35.0000
721, 11.2500, 0.0, 34.9330
741, 11.0670, 0.0, 34.7500
*NCOPY, SHIFT, MULTIPLE = 12, CHANGE NU = +1, OLD SET = RING, NEW SET = RING
0.0, 0.0, 0.0
0.0, 0.0, 0.0, 0.0, 1.0, +15.00
*ELEMENT, TYPE = S4R

```

```

601, 481, 482, 602, 601
621, 601, 602, 622, 621
721, 701, 702, 722, 721
761, 741, 742, 1102, 1101
*ELGEN, ELSET = RING1
601, 12, 1, 1
621, 12, 1, 1, 5, 20, 20
*ELGEN, ELSET = RING2
721, 12, 1, 1, 2, 20, 20
761, 12, 1, 1
*ELSET, ELSET = RING
RING1, RING2
*SHELL SECTION, ELSET = RING1, MATERIAL = ST
0.50
*SHELL SECTION, ELSET = RING2, MATERIAL = ST
0.35
*****
** CLOSING RING BOLT
*****
*NODE, NSET = BOLT
1501, 11.500, 0.0, 34.500
1502, 11.500, 0.5, 34.500
*ELEMENT, TYPE = T3D2, ELSET = BOLT
1501, 1501, 1502
*SOLID SECTION, ELSET = BOLT, MATERIAL = BOLT
0.228
*MPC
TIE,601,1502
TIE,621,1502
TIE,641,1502
TIE,661,1502
TIE,681,1502
*EQUATION
2
1501,1,1,0,1502,1,-1.0
*EQUATION
2
1501,3,1,0,1502,3,-1.0
*****
** PAYLOAD
*****
*NODE, SYSTEM = R
*NODE
2001, -4.0, 0.0, 0.024
2005, 4.0, 0.0, 0.024
2011, -4.0, 4.0, 0.024
2015, 4.0, 4.0, 0.024
*NGEN, NSET = LINEC
2001, 2005, 1
*NGEN, NSET = LINED
2011, 2015, 1
*NFILL, NSET = PAYB1
LINEC, LINED, 2, 5
*NODE, NSET = PAYB2
2021, 7.625, 0.0, 0.024
2022, 7.1968, 3.1526, 0.024
2023, 5.9775, 5.9775, 0.024
2024, 3.1526, 7.1968, 0.024
2025, 0.0, 7.625, 0.024
2026, -3.1526, 7.1968, 0.024
2027, -5.9775, 5.9775, 0.024
2028, -7.1968, 3.1526, 0.024
2029, -7.625, 0.0, 0.024
*NODE, NSET = PAYB3
2031, 11.25, 0.0, 0.024
2032, 10.394, 4.3052, 0.024
2033, 7.9550, 7.9550, 0.024
2034, 4.3052, 10.394, 0.024
2035, 0.0, 11.25, 0.024
2036, -4.3052, 10.394, 0.024
2037, -7.9550, 7.9550, 0.024
2038, -10.394, 4.3052, 0.024
2039, -11.25, 0.0, 0.024
*NSET, NSET = PAYB
PAYB1, PAYB2, PAYB3
*ELEMENT, TYPE = S4R
2001, 2001, 2002, 2007, 2006
*ELGEN, ELSET = PAYB1

```

```

2001, 4, 1, 1, 2, 5, 5
*ELEMENT, TYPE=S4R, ELSET=PAYB2
2011, 2005, 2021, 2022, 2010
2012, 2010, 2022, 2023, 2015
2013, 2015, 2023, 2024, 2014
2014, 2014, 2024, 2025, 2013
2015, 2013, 2025, 2026, 2012
2016, 2012, 2026, 2027, 2011
2017, 2011, 2027, 2028, 2006
2018, 2006, 2028, 2029, 2001
*ELEMENT, TYPE=S4R
2021, 2021, 2031, 2032, 2022
*ELGEN, ELSET=PAYB2
2021, 8, 1, 1
*ELSET, ELSET=PAYB
PAYB1, PAYB2
*SHELL SECTION, ELSET=PAYB, MATERIAL=PAYLD
0.0478
*****
**NCPY,SHIFT,CHANGE NU=100,OLD SET=PAYB3,NEW SET=PAYW1
0.0, 0.0, 33.25
0.0, 0.0, 0.0, 0.0, 0.0, 1.0, 0.0
*NFILL, NSET=PAYW
PAYB3, PAYW1, 10, 10
*ELEMENT, TYPE=S4R
2031, 2031, 2041, 2042, 2032
*ELGEN, ELSET=PAYW
2031, 8, 1, 1, 10, 10, 10
*SHELL SECTION, ELSET=PAYW, MATERIAL=PAYLD
0.0478
*****
**NCPY,SHIFT,CHANGE NU=200,OLD SET=PAYB,NEW SET=PAYT
0.0, 0.0, 33.25
0.0, 0.0, 0.0, 0.0, 0.0, 1.0, 0.0
*ELEMENT, TYPE=S4R
2201, 2201, 2202, 2207, 2206
*ELGEN, ELSET=PAYT1
2201, 4, 1, 1, 2, 5, 5
*ELEMENT, TYPE=S4R, ELSET=PAYT2
2211, 2205, 2221, 2222, 2210
2212, 2210, 2222, 2223, 2215
2213, 2215, 2223, 2224, 2214
2214, 2214, 2224, 2225, 2213
2215, 2213, 2225, 2226, 2212
2216, 2212, 2226, 2227, 2211
2217, 2211, 2227, 2228, 2206
2218, 2206, 2228, 2229, 2201
*ELEMENT, TYPE=S4R
2221, 2221, 2131, 2132, 2222
*ELGEN, ELSET=PAYT2
2221, 8, 1, 1
*ELSET, ELSET=PAYT
PAYT1, PAYT2
*ELSET, ELSET=PAY
PAYB, PAYW, PAYT
*NSET, NSET=PAY
PAYB, PAYW, PAYT
*SHELL SECTION, ELSET=PAYT, MATERIAL=PAYLD
0.0478
*****
** GENERATE THE ELEMENTS OF CONCRETE PAD
** 10' X 10' RECTANGULAR HALF SECTION (NO INF)
**
*NODE, SYSTEM=R
*NODE, NSET=C1
160001, -60.0, 0.0, -8.0
*NODE, NSET=C2
160004, -45.0, 0.0, -8.0
*NODE, NSET=C3
160034, 45.0, 0.0, -8.0
*NODE, NSET=C4
160037, 60.0, 0.0, -8.0
*NFILL, NSET=LINE1
C1, C2, 3
C2, C3, 30
C3, C4, 3
*NCOPY,SHIFT,CHANGE NU=500,OLD SET=LINE1,NEW SET=LINE2
0.0, 30.0, 0.0

```



```

0.0, 0.0, 0.0, 0.0, 0.0, 1.0, 0.0
*NCOPY,SHIFT,CHANGE NU = 300,OLD SET = LINE2,NEW SET = LINE3
0.0, 30.0, 0.0
0.0, 0.0, 0.0, 0.0, 0.0, 1.0, 0.0
*NIFILL, NSET = CONC1
LINE1, LINE2, 10, 50
LINE2, LINE3, 6, 50
*NCOPY,SHIFT,CHANGE NU = 2000,OLD SET = CONC1,NEW SET = CONC2
0.0, 0.0, 2.0
0.0, 0.0, 0.0, 0.0, 0.0, 1.0, 0.0
*NCOPY,SHIFT,CHANGE NU = 2000,OLD SET = CONC2,NEW SET = CONC3
0.0, 0.0, 2.0
0.0, 0.0, 0.0, 0.0, 0.0, 1.0, 0.0
*NCOPY,SHIFT,CHANGE NU = 2000,OLD SET = CONC3,NEW SET = CONC4
0.0, 0.0, 2.0
0.0, 0.0, 0.0, 0.0, 0.0, 1.0, 0.0
*NCOPY,SHIFT,CHANGE NU = 2000,OLD SET = CONC4,NEW SET = CONC5
0.0, 0.0, 2.0
0.0, 0.0, 0.0, 0.0, 0.0, 1.0, 0.0
*NSET,NSET = CONCO
CONC1, CONC2, CONC3, CONC4, CONC5,
**
** GENERATE THE SOIL NODES
**
*NCOPY, SHIFT, CHANGE NU = 20000, OLD SET = CONC1, NEW SET = SOIL1
0.0, 0.0, -50.0
0.0, 0.0, 0.0, 0.0, 0.0, 1.0, 0.0
*NCOPY, SHIFT, CHANGE NU = 2000, OLD SET = SOIL1, NEW SET = SOIL2
0.0, 0.0, +20.0
0.0, 0.0, 0.0, 0.0, 0.0, 1.0, 0.0
*NCOPY, SHIFT, CHANGE NU = 2000, OLD SET = SOIL2, NEW SET = SOIL3
0.0, 0.0, +10.0
0.0, 0.0, 0.0, 0.0, 0.0, 1.0, 0.0
*NCOPY, SHIFT, CHANGE NU = 2000, OLD SET = SOIL3, NEW SET = SOIL4
0.0, 0.0, +10.0
0.0, 0.0, 0.0, 0.0, 0.0, 1.0, 0.0
*NCOPY, SHIFT, CHANGE NU = 2000, OLD SET = SOIL4, NEW SET = SOIL5
0.0, 0.0, +5.0
0.0, 0.0, 0.0, 0.0, 0.0, 1.0, 0.0
*NSET,NSET = SOILO
SOIL1, SOIL2, SOIL3, SOIL4, SOIL5
**
** GENERATE THE INCLINED IMPACT SURFACES
**
*NCOPY,SHIFT,CHANGE NU = -100000,OLD SET = CONCO,NEW SET = CONC
12.000, 0., 34.8
12.000, 0., 34.8, 12.000, 1., 34.8, -146.31
*NCOPY,SHIFT, CHANGE NU = -100000, OLD SET = SOILO, NEW SET = SOIL
12.000, 0., 34.8
12.000, 0., 34.8, 12.000, 1., 34.8, -146.31
**
** CONCRETE PAD ELEMENT
**
*ELEMENT, TYPE = C3D8R
60001, 60001, 60002, 60052, 60051, 62001, 62002, 62052, 62051
*ELGEN, ELSET = CONC1
60001, 38, 1, 1, 16, 50, 50
*ELCOPY,OLD SET = CONC1,NEW SET = CONC2,ELEMENT SH = 2000,SHIFT NO = 2000
*ELCOPY,OLD SET = CONC2,NEW SET = CONC3,ELEMENT SH = 2000,SHIFT NO = 2000
*ELCOPY,OLD SET = CONC3,NEW SET = CONC4,ELEMENT SH = 2000,SHIFT NO = 2000
*ELSET, ELSET = CONC
CONC1, CONC2, CONC3, CONC4,
*SOLID SECTION, ELSET = CONC, MATERIAL = CONCRETE
**
** GENERATE REBARS
**
*REBAR,ELEM = CONTINUUM,MAT = REBAR,GEOM = ISOPARAMETRIC,NAME = LX
CONC1,0.60,12.0,0.0,1.0,4,2
*REBAR,ELEM = CONTINUUM,MAT = REBAR,GEOM = ISOPARAMETRIC,NAME = LY
CONC1,0.60,12.0,90.,1.0,4,2
*REBAR,ELEM = CONTINUUM,MAT = REBAR,GEOM = ISOPARAMETRIC,NAME = UX
CONC4,0.60,12.0,0.0,0.0,4,2
*REBAR,ELEM = CONTINUUM,MAT = REBAR,GEOM = ISOPARAMETRIC,NAME = UY
CONC4,0.60,12.0,90.,0.0,4,2
**
** GENERATE THE SOIL
**
*ELCOPY,OLD SET = CONC1,NEW SET = SOIL1,ELEMENT SH = 20000,SHIFT NO = 20000

```

```

*ELCOPY,OLD SET =SOIL1,NEW SET =SOIL2,ELEMENT SH =2000,SHIFT NO = 2000
*ELCOPY,OLD SET =SOIL2,NEW SET =SOIL3,ELEMENT SH =2000,SHIFT NO = 2000
*ELCOPY,OLD SET =SOIL3,NEW SET =SOIL4,ELEMENT SH =2000,SHIFT NO = 2000
*ELEMENT, TYPE =C3D6, ELSET =SOIL5
*ELEMENT, TYPE =C3D8R
88001, 88001, 88002, 88052, 88051, 80001, 60002, 60052, 60051
*ELGEN, ELSET =SOIL5
88001, 36, 1, 1, 16, 50, 50
*ELSET, ELSET =SOIL
SOIL1, SOIL2, SOIL3, SOIL4, SOIL5
*SOLID SECTION, ELSET =SOIL, MATERIAL =SOIL
*****
**
** ASTM A36
**
**
*MATERIAL, NAME =ST
*ELASTIC
29.0E6, 0.3
*PLASTIC
36000., 0.
60000., 0.23
30000., 0.24
10000., 0.25
5000., 0.26
1000., 0.27
*DENSITY
7.5052E-4
*FAILURE
0.30, 0.25
**
** CLOSING RING BOLT MATERIAL
** ASTM A307, GR. C
**
**
*MATERIAL, NAME =BOLT
*ELASTIC
29.0E6, 0.3
*PLASTIC
36000.0, 0.0
60000.0, 0.23
30000., 0.24
10000., 0.25
5000., 0.26
1000., 0.27
*DENSITY
7.5052E-4
*FAILURE
0.30, 0.25
*MATERIAL, NAME =PAYLD
*ELASTIC
29.0E6, 0.3
*DENSITY
0.02437
*material,name = concrete
** 4000 PSI CONCRETE
*density
1.95E-04
*elastic
3.6E+06,0.15
*drucker prager
35.1,1.0,35.1
*drucker prager hardening
2250.,0.0
3900.,0.0013
3000.,0.0024
2400.,0.0034
1790.,0.0044
1180.,0.0054
800.,0.006
100.,0.0061
*material,name =soil
*density
1.647E-04
*elastic
5700.,0.35
*drucker prager
35.2,0.82,35.2
*drucker prager hardening
2.0,0.0

```

```

6.54,0.0055
8.64,0.0156
9.96,0.0259
10.68,0.0362
10.98,0.0467
11.1,0.0573
11.04,0.068
10.8,0.0788
10.44,0.0897
9.9,0.1
9.0,0.112
**
** REBAR STEEL
**
*MATERIAL, NAME=REBAR
*DENSITY
7.34E-4
*ELASTIC
29.5E6, 0.30
*PLASTIC
71170., 0.0
71626., 0.004985
83130., 0.017098
96460., 0.036202
104728., 0.055113
109080., 0.073795
** *FAILURE
** *0.30, 0.03
**
** ELEMENT SET DEFINITIONS
**
*ELSET,ELSET=ALLEL
DMB, DMW, DML
RING, BOLT
PAY,
**
** NODE SET DEFINITIONS
**
*NSET,NSET=ALLND
DMB, DMW, DML
RING, BOLT
PAY,
*NSET,NSET=YSYMM,GENERATE
60001,60037,1
62001,62037,1
64001,64037,1
66001,66037,1
68001,68037,1
80001,80037,1
82001,82037,1
84001,84037,1
86001,86037,1
88001,88037,1
*NSET,NSET=YSYMM,GENERATE
1, 7, 1
41, 53, 12
61, 73, 12
81, 93, 12
101, 501, 20
113, 513, 20
613, 693, 20
701, 741, 20
713, 753, 20
1001, 1007, 1
1041, 1053, 12
1061, 1073, 12
1081, 1093, 12
1101, 1113, 12
1501, 1501, 1
2001, 2005, 1
2021, 2029, 8
2031, 2131, 10
2039, 2139, 10
2201, 2205, 1
2221, 2229, 8
*NSET,NSET=SOILBT,GENERATE
80001,80837,1
*NSET,NSET=CONCS,GENERATE

```

```

68001,68837,1
*BOUNDARY
YSYMM,YSYMM
SOILBT,1,3
*****
*INITIAL CONDITIONS,TYPE=VELOCITY
ALLND,1,106.84
ALLND,3,180.25
*STEP
*DYNAMIC,EXPLICIT
,20.0E-03
**
** DEFINE THE CONTACT SURFACES BETWEEN
** THE DRUM BOTTOM AND TARGET
**
*SURFACE DEFINITION,NAME=CONC4T
CONC4,S2
*SURFACE DEFINITION,NAME=DMOUT,NO THICK
DMB,SNEG
DMW1,SNEG
DMW2,SNEG
DMW3,SNEG
RING,SPOS
DML,SPOS
*CONTACT PAIR
CONC4T,DMOUT
**
** DEFINE THE CONTACT SURFACES BETWEEN
** THE DRUM INSIDE AND PAYLOAD OUTSIDE
**
*SURFACE DEFINITION,NAME=DMINS,NO THICK
DMB,SPOS
DMW1,SPOS
DMW2,SPOS
DMW3,SPOS
DMW4,SPOS
RING2,SNEG
DML,SNEG
*SURFACE DEFINITION,NAME=PAYOUT,NO THICK
PAYB,SNEG
PAYW,SNEG
PAYT,SPOS
*CONTACT PAIR
DMINS,PAYOUT
*****
*NSET,NSET=DMDIS,GENERATE
4,4,1
1004,1004,1
661,661,1
101,113,3
301,313,3
541,553,3
*ELSET,ELSET=DMBST,GENERATE
61,66,1
81,86,1
*ELSET,ELSET=DMBST
DMBA
*ELSET,ELSET=DMWST,GENERATE
101,106,1
121,126,1
141,421,20
142,422,20
143,423,20
441,446,1
461,466,1
481,486,1
501,506,1
*ELSET,ELSET=DMLST,GENERATE
1061,1066,1
1081,1086,1
*ELSET,ELSET=DMLST
DMLA
*ELSET,ELSET=RINGST,GENERATE
601,606,1
621,626,1
641,646,1
661,666,1
681,686,1

```

```
701,706,1
721,726,1
741,746,1
761,766,1
*ELSET,ELSET = BOLTST,GENERATE
1501,1501,1
*****
*HISTORY OUTPUT, TIME = 1.0E-4
*NODE HISTORY, NSET = DMDIS
U, V, A
*EL HISTORY, ELSET = DMBST
MISES,
PEEQ,
SENER,
PENER,
*EL HISTORY, ELSET = DMWST
MISES,
PEEQ,
SENER,
PENER,
*EL HISTORY, ELSET = DMLST
MISES,
PEEQ,
SENER,
PENER,
*EL HISTORY, ELSET = RINGST
MISES,
PEEQ,
SENER,
PENER,
*EL HISTORY, ELSET = BOLTST
MISES,
PEEQ,
SENER,
PENER,
*FILE OUTPUT, NUMBER INTERVAL = 100
*NODE FILE
RF,
*MONITOR,NODE=307,DOF=3
*END STEP
-
```



CHECKLIST FOR CHECKING OF ANALYSIS/CALCULATIONS

Document Number/Revision: HNF-2209/Rev. 0

Document Title: DOT-17H 55 Gallon Drum 4-ft Top Corner Drop

Yes	No	N/A	
<input checked="" type="checkbox"/>	<input type="checkbox"/>	<input type="checkbox"/>	Problem completely defined.
<input checked="" type="checkbox"/>	<input type="checkbox"/>	<input type="checkbox"/>	Appropriate analytical method used.
<input checked="" type="checkbox"/>	<input type="checkbox"/>	<input type="checkbox"/>	Necessary assumptions are appropriate and explicitly stated.
<input checked="" type="checkbox"/>	<input type="checkbox"/>	<input type="checkbox"/>	Computer codes and data files documented.
<input checked="" type="checkbox"/>	<input type="checkbox"/>	<input type="checkbox"/>	Data used in calculations explicitly stated in document.
<input type="checkbox"/>	<input type="checkbox"/>	<input checked="" type="checkbox"/>	Sources of non-standard formula/data are referenced and the correctness of the reference verified.
<input checked="" type="checkbox"/>	<input type="checkbox"/>	<input type="checkbox"/>	Data checked for consistency with original source information as applicable.
<input type="checkbox"/>	<input type="checkbox"/>	<input checked="" type="checkbox"/>	Mathematical derivations checked including dimensional consistency of results.
<input checked="" type="checkbox"/>	<input type="checkbox"/>	<input type="checkbox"/>	Models appropriate and used within range of validity or use outside range of established validity justified.
<input type="checkbox"/>	<input type="checkbox"/>	<input checked="" type="checkbox"/>	Hand calculations checked for errors.
<input checked="" type="checkbox"/>	<input type="checkbox"/>	<input type="checkbox"/>	Code run streams correct and consistent with analysis documentation.
<input checked="" type="checkbox"/>	<input type="checkbox"/>	<input type="checkbox"/>	Code output consistent with input and with results reported in analysis documentation.
<input checked="" type="checkbox"/>	<input type="checkbox"/>	<input type="checkbox"/>	Acceptability limits on analytical results applicable and supported. Limits checked against sources.
<input checked="" type="checkbox"/>	<input type="checkbox"/>	<input type="checkbox"/>	Safety Margins consistent with good engineering practices.
<input checked="" type="checkbox"/>	<input type="checkbox"/>	<input type="checkbox"/>	Conclusions consistent with analytical results and applicable limits.
<input checked="" type="checkbox"/>	<input type="checkbox"/>	<input type="checkbox"/>	Results and conclusions address all points required in the problem statement.

I have checked the analysis/calculation and it is complete and accurate to the best of my knowledge.

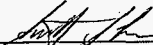
Engineer/Checker Scott Shiraga  Date 09/01/98

NOTE: Any hand calculations, notes or summaries generated as part of this check should be signed, dated, and attached to this checklist. Material should be labeled and recorded so that it is intelligible to a technically qualified third party.

7.7.1.4 55-Gal Drum/30-Mil Wall Thickness 4-Ft Top-Corner Drop.

```

*HEADING
FILE=DTCOAX 3/18/98
55 GALLON DRUM/30 MIL THICKNESS, 4-FT TOP CORNER DROP
VELOCITY = 192.6 IPS/10.94 MPH/4-FT DROP
*RESTART, WRITE, NUMBER INTERVAL = 10
*****
**   DRUM
*****
**
**   GENERATE THE NODES OF DRUM BOTTOM PLATE
**
*NODE, SYSTEM=R
*NODE
1, -3.6, 0.0, 0.0
7, 3.6, 0.0, 0.0
22, -3.6, 3.6, 0.0
28, 3.6, 3.6, 0.0
*NGEN, NSET=LINEA
1, 7, 1
*NGEN, NSET=LINEB
22, 28, 1
*NFILL, NSET=DMB1
LINEA, LINEB, 3, 7
*NODE, NSET=DMB2
41, 5.4417, 0.0, 0.0
42, 5.3380, 1.5872, 0.0
43, 5.0342, 3.1208, 0.0
44, 4.5508, 4.5508, 0.0
45, 3.1208, 5.0342, 0.0
46, 1.5872, 5.3380, 0.0
47, 0.0, 5.4417, 0.0
48, -1.5872, 5.3380, 0.0
49, -3.1208, 5.0342, 0.0
50, -4.5508, 4.5508, 0.0
51, -5.0342, 3.1208, 0.0
52, -5.3380, 1.5872, 0.0
53, -5.4417, 0.0, 0.0
61, 7.2833, 0.0, 0.0
62, 7.0760, 1.9745, 0.0
63, 6.4683, 3.8417, 0.0
64, 5.5016, 5.5016, 0.0
65, 3.8417, 6.4683, 0.0
66, 1.9745, 7.0760, 0.0
67, 0.0, 7.2833, 0.0
68, -1.9745, 7.0760, 0.0
69, -3.8417, 6.4683, 0.0
70, -5.5016, 5.5016, 0.0
71, -6.4683, 3.8417, 0.0
72, -7.0760, 1.9745, 0.0
73, -7.2833, 0.0, 0.0
81, 9.6000, 0.0, 0.0
82, 9.2729, 2.4847, 0.0
83, 8.3138, 4.8000, 0.0
84, 6.7882, 6.7882, 0.0
85, 4.8000, 8.3138, 0.0
86, 2.4847, 9.2729, 0.0
87, 0.0, 9.6000, 0.0
88, -2.4847, 9.2729, 0.0
89, -4.8000, 8.3138, 0.0
90, -6.7882, 6.7882, 0.0
91, -8.3138, 4.8000, 0.0
92, -9.2729, 2.4847, 0.0
93, -9.6000, 0.0, 0.0
*NODE, NSET=DMB3
101, 11.5000, 0.0, 0.0
102, 11.1081, 2.9764, 0.0
103, 9.9593, 5.7500, 0.0
104, 8.1317, 8.1317, 0.0
105, 5.7500, 9.9593, 0.0
106, 2.9764, 11.1081, 0.0
107, 0.0, 11.5000, 0.0
108, -2.9764, 11.1081, 0.0
109, -5.7500, 9.9593, 0.0
110, -8.1317, 8.1317, 0.0
111, -9.9593, 5.7500, 0.0

```

```

112, -11.1081, 2.9764, 0.0
113, -11.5000, 0.0, 0.0
*NSET, NSET = DMB
DMB1, DMB2, DMB3
**
** GENERATE THE ELEMENTS OF DRUM BOTTOM PLATE
**
*ELEMENT, TYPE = S4R
1, 1, 2, 9, 8
*ELGEN, ELSET = DMBA
1, 6, 1, 1, 3, 7, 6
*ELEMENT, TYPE = S4R, ELSET = DMBB
21, 7, 41, 42, 14
22, 14, 42, 43, 21
23, 21, 43, 44, 28
24, 28, 44, 45, 27
25, 27, 45, 46, 26
26, 26, 46, 47, 25
27, 25, 47, 48, 24
28, 24, 48, 49, 23
29, 23, 49, 50, 22
30, 22, 50, 51, 15
31, 15, 51, 52, 8
32, 8, 52, 53, 1
41, 41, 61, 62, 42
*ELGEN, ELSET = DMBB
41, 12, 1, 1, 3, 20, 20
*ELSET, ELSET = DMB
DMBA, DMBB
*SHELL SECTION, ELSET = DMB, MATERIAL = ST
0.030
**
** GENERATE THE DRUM CYLINDRICAL WALL
**
** NODES
**
*NCOPY, SHIFT, CHANGE NU = 40, OLD SET = DMB3, NEW SET = L1
0.0, 0.0, 2.0
0.0, 0.0, 0.0, 0.0, 0.0, 1.0, 0.0
*NCOPY, SHIFT, CHANGE NU = 300, OLD SET = L1, NEW SET = L2
0.0, 0.0, 30.0
0.0, 0.0, 0.0, 0.0, 0.0, 1.0, 0.0
*NCOPY, SHIFT, CHANGE NU = 40, OLD SET = L2, NEW SET = L3
0.0, 0.0, 2.0
0.0, 0.0, 0.0, 0.0, 0.0, 1.0, 0.0
*NFILL, NSET = DMW1
DMB3, L1, 2, 20
*NFILL, NSET = DMW2
L1, L2, 15, 20
*NFILL, NSET = DMW3
L2, L3, 2, 20
*NODE, NSET = DMW4
501, 11.5000, 0.0, 34.5
701, 11.5000, 0.0, 35.0
*NCOPY, SHIFT, MULTIPLE = 12, CHANGE NU = +1, OLD SET = DMW4, NEW SET = DMW4
0.0, 0.0, 0.0
0.0, 0.0, 0.0, 0.0, 0.0, 1.0, +15.00
*NSET, NSET = DMW
DMW1, DMW2, DMW3, DMW4
**
** ELEMENTS
**
*ELEMENT, TYPE = S4R, ELSET = DMW1
101, 101, 121, 122, 102
*ELGEN, ELSET = DMW1
101, 12, 1, 1, 2, 20, 20
*ELEMENT, TYPE = S4R, ELSET = DMW2
141, 141, 161, 162, 142
*ELGEN, ELSET = DMW2
141, 12, 1, 1, 15, 20, 20
*ELEMENT, TYPE = S4R, ELSET = DMW3
441, 441, 461, 462, 442
*ELGEN, ELSET = DMW3
441, 12, 1, 1, 2, 20, 20
*ELEMENT, TYPE = S4R, ELSET = DMW4
481, 481, 501, 502, 482
501, 501, 701, 702, 502
*ELGEN, ELSET = DMW4

```



```

481, 12, 1, 1
501, 12, 1, 1
*ELSET, ELSET=DMW
DMW1, DMW2, DMW3, DMW4
*SHELL SECTION, ELSET=DMW, MATERIAL=ST
0.030
**
** GENERATE THE NODES OF DRUM LID
**
*NCOPY,SHIFT,CHANGE NU = 1000,OLD SET=DMB,NEW SET=DML
0.0, 0.0, 34.50
0.0, 0.0, 0.0, 0.0, 0.0, 1.0, 0.0
** MODIFY NODES
*NODE, NSET=DML
1101, 10.5000, 0.0, 34.50
1102, 10.1422, 2.7176, 34.50
1103, 9.0933, 5.2500, 34.50
1104, 7.4246, 7.4246, 34.50
1105, 5.2500, 9.0933, 34.50
1106, 2.7176, 10.1422, 34.50
1107, 0.0, 10.5000, 34.50
1108, -2.7176, 10.1422, 34.50
1109, -5.2500, 9.0933, 34.50
1110, -7.4246, 7.4246, 34.50
1111, -9.0933, 5.2500, 34.50
1112, -10.1422, 2.7176, 34.50
1113, -10.5000, 0.0, 34.50
**
** GENERATE THE DRUM LID
**
*ELEMENT, TYPE=S4R
1001, 1001, 1002, 1009, 1008
*ELGEN, ELSET=DMLA
1001, 6, 1, 1, 3, 7, 6
*ELEMENT, TYPE=S4R, ELSET=DMLB
1021, 1007, 1041, 1042, 1014
1022, 1014, 1042, 1043, 1021
1023, 1021, 1043, 1044, 1028
1024, 1028, 1044, 1045, 1027
1025, 1027, 1045, 1046, 1026
1026, 1026, 1046, 1047, 1025
1027, 1025, 1047, 1048, 1024
1028, 1024, 1048, 1049, 1023
1029, 1023, 1049, 1050, 1022
1030, 1022, 1050, 1051, 1015
1031, 1015, 1051, 1052, 1008
1032, 1008, 1052, 1053, 1001
*ELEMENT, TYPE=S4R
1041, 1041, 1061, 1062, 1042
*ELGEN, ELSET=DMLC
1041, 12, 1, 1, 2, 20, 20
*ELEMENT, TYPE=S4R
1081, 1081, 1101, 1102, 1082
*ELGEN, ELSET=DMLD
1081, 12, 1, 1
*ELSET, ELSET=DML
DMLA, DMLB, DMLC, DMLD
*SHELL SECTION, ELSET=DML, MATERIAL=ST
0.030
*NSET, NSET=DM
DMB, DMW, DML
*ELSET, ELSET=DM
DMB, DMW, DML
*****
** CLOSING RING, DRUM LID, AND DRUM ASSEMBLY
*****
*NODE, NSET=RING
601, 11.7500, 0.0, 34.0670
621, 11.9330, 0.0, 34.2500
641, 12.0000, 0.0, 34.5000
661, 11.9330, 0.0, 34.7500
681, 11.7500, 0.0, 34.9330
701, 11.5000, 0.0, 35.0000
721, 11.2500, 0.0, 34.9330
741, 11.0670, 0.0, 34.7500
*NCOPY,SHIFT,MULTIPLE=12,CHANGE NU = +1,OLD SET=RING,NEW SET=RING
0.0, 0.0, 0.0
0.0, 0.0, 0.0, 0.0, 0.0, 1.0, +15.00

```

```

*ELEMENT, TYPE=S4R
601, 481, 482, 602, 601
621, 601, 602, 622, 621
721, 701, 702, 722, 721
761, 741, 742, 1102, 1101
*ELGEN, ELSET=RING1
601, 12, 1, 1
621, 12, 1, 1, 5, 20, 20
*ELGEN, ELSET=RING2
721, 12, 1, 1, 2, 20, 20
761, 12, 1, 1
*ELSET, ELSET=RING
RING1, RING2
*SHELL SECTION, ELSET=RING1, MATERIAL=ST
0.50
*SHELL SECTION, ELSET=RING2, MATERIAL=ST
0.35
*****
** CLOSING RING BOLT
*****
*NODE, NSET=BOLT
1501, 11.500, 0.0, 34.500
1502, 11.500, 0.5, 34.500
*ELEMENT, TYPE=T3D2, ELSET=BOLT
1501, 1501, 1502
*SOLID SECTION, ELSET=BOLT, MATERIAL=BOLT
0.226
*MPC
TIE,601,1502
TIE,621,1502
TIE,641,1502
TIE,661,1502
TIE,681,1502
*EQUATION
2
1501,1,1.0,1502,1,-1.0
*EQUATION
2
1501,3,1.0,1502,3,-1.0
*****
** PAYLOAD
*****
*NODE, SYSTEM=R
*NODE
2001, -4.0, 0.0, 0.024
2005, 4.0, 0.0, 0.024
2011, -4.0, 4.0, 0.024
2015, 4.0, 4.0, 0.024
*NGEN, NSET=LINEC
2001, 2005, 1
*NGEN, NSET=LINED
2011, 2015, 1
*LNILL, NSET=PAYB1
LINEC, LINED, 2, 5
*NODE, NSET=PAYB2
2021, 7.625, 0.0, 0.024
2022, 7.1968, 3.1526, 0.024
2023, 5.9775, 5.9775, 0.024
2024, 3.1526, 7.1968, 0.024
2025, 0.0, 7.625, 0.024
2026, -3.1526, 7.1968, 0.024
2027, -5.9775, 5.9775, 0.024
2028, -7.1968, 3.1526, 0.024
2029, -7.625, 0.0, 0.024
*NODE, NSET=PAYB3
2031, 11.25, 0.0, 0.024
2032, 10.394, 4.3052, 0.024
2033, 7.9550, 7.9550, 0.024
2034, 4.3052, 10.394, 0.024
2035, 0.0, 11.25, 0.024
2036, -4.3052, 10.394, 0.024
2037, -7.9550, 7.9550, 0.024
2038, -10.394, 4.3052, 0.024
2039, -11.25, 0.0, 0.024
*NSET, NSET=PAYB
PAYB1, PAYB2, PAYB3
*ELEMENT, TYPE=S4R
2001, 2001, 2002, 2007, 2006

```

```

*ELGEN, ELSET = PAYB1
2001, 4, 1, 1, 2, 5, 5
*ELEMENT, TYPE = S4R, ELSET = PAYB2
2011, 2005, 2021, 2022, 2010
2012, 2010, 2022, 2023, 2015
2013, 2015, 2023, 2024, 2014
2014, 2014, 2024, 2025, 2013
2015, 2013, 2025, 2026, 2012
2016, 2012, 2026, 2027, 2011
2017, 2011, 2027, 2028, 2006
2018, 2006, 2028, 2029, 2001
*ELEMENT, TYPE = S4R
2021, 2021, 2031, 2032, 2022
*ELGEN, ELSET = PAYB2
2021, 8, 1, 1
*ELSET, ELSET = PAYB
PAYB1, PAYB2
*SHELL SECTION, ELSET = PAYB, MATERIAL = PAYLD
0.030
*****
*NCOPY, SHIFT, CHANGE NU = 100, OLD SET = PAYB3, NEW SET = PAYW1
0.0, 0.0, 33.25
0.0, 0.0, 0.0, 0.0, 0.0, 1.0, 0.0
*NFILL, NSET = PAYW
PAYB3, PAYW1, 10, 10
*ELEMENT, TYPE = S4R
2031, 2031, 2041, 2042, 2032
*ELGEN, ELSET = PAYW
2031, 8, 1, 1, 10, 10, 10
*SHELL SECTION, ELSET = PAYW, MATERIAL = PAYLD
0.030
*****
*NCOPY, SHIFT, CHANGE NU = 200, OLD SET = PAYB, NEW SET = PAYT
0.0, 0.0, 33.25
0.0, 0.0, 0.0, 0.0, 0.0, 1.0, 0.0
*ELEMENT, TYPE = S4R
2201, 2201, 2202, 2207, 2206
*ELGEN, ELSET = PAYT1
2201, 4, 1, 1, 2, 5, 5
*ELEMENT, TYPE = S4R, ELSET = PAYT2
2211, 2205, 2221, 2222, 2210
2212, 2210, 2222, 2223, 2215
2213, 2215, 2223, 2224, 2214
2214, 2214, 2224, 2225, 2213
2215, 2213, 2225, 2226, 2212
2216, 2212, 2226, 2227, 2211
2217, 2211, 2227, 2228, 2206
2218, 2206, 2228, 2229, 2201
*ELEMENT, TYPE = S4R
2221, 2221, 2131, 2132, 2222
*ELGEN, ELSET = PAYT2
2221, 8, 1, 1
*ELSET, ELSET = PAYT
PAYT1, PAYT2
*ELSET, ELSET = PAY
PAYB, PAYW, PAYT
*NSET, NSET = PAY
PAYB, PAYW, PAYT
*SHELL SECTION, ELSET = PAYT, MATERIAL = PAYLD
0.030
*****
** GENERATE THE ELEMENTS OF CONCRETE PAD
** 10' X 10' RECTANGULAR HALF SECTION (NO INF)
**
*NODE, SYSTEM = R
*NODE, NSET = C1
160001, -60.0, 0.0, -8.0
*NODE, NSET = C2
160004, -45.0, 0.0, -8.0
*NODE, NSET = C3
160034, 45.0, 0.0, -8.0
*NODE, NSET = C4
160037, 60.0, 0.0, -8.0
*NFILL, NSET = LINE1
C1, C2, 3
C2, C3, 30
C3, C4, 3
*NCOPY, SHIFT, CHANGE NU = 500, OLD SET = LINE1, NEW SET = LINE2

```

```

0.0, 30.0, 0.0
0.0, 0.0, 0.0, 0.0, 0.0, 1.0, 0.0
*NCOPY,SHIFT,CHANGE NU = 300,OLD SET = LINE2,NEW SET = LINE3
0.0, 30.0, 0.0
0.0, 0.0, 0.0, 0.0, 0.0, 1.0, 0.0
*NFILL, NSET = CONC1
LINE1, LINE2, 10, 50
LINE2, LINE3, 6, 50
*NCOPY,SHIFT,CHANGE NU = 2000,OLD SET = CONC1,NEW SET = CONC2
0.0, 0.0, 2.0
0.0, 0.0, 0.0, 0.0, 0.0, 1.0, 0.0
*NCOPY,SHIFT,CHANGE NU = 2000,OLD SET = CONC2,NEW SET = CONC3
0.0, 0.0, 2.0
0.0, 0.0, 0.0, 0.0, 0.0, 1.0, 0.0
*NCOPY,SHIFT,CHANGE NU = 2000,OLD SET = CONC3,NEW SET = CONC4
0.0, 0.0, 2.0
0.0, 0.0, 0.0, 0.0, 0.0, 1.0, 0.0
*NCOPY,SHIFT,CHANGE NU = 2000,OLD SET = CONC4,NEW SET = CONC5
0.0, 0.0, 2.0
0.0, 0.0, 0.0, 0.0, 0.0, 1.0, 0.0
*NSET,NSET = CONCO
CONC1, CONC2, CONC3, CONC4, CONC5,
**
** GENERATE THE SOIL NODES
**
*NCOPY, SHIFT, CHANGE NU = 20000, OLD SET = CONC1, NEW SET = SOIL1
0.0, 0.0, -50.0
0.0, 0.0, 0.0, 0.0, 0.0, 1.0, 0.0
*NCOPY, SHIFT, CHANGE NU = 2000, OLD SET = SOIL1, NEW SET = SOIL2
0.0, 0.0, +20.0
0.0, 0.0, 0.0, 0.0, 0.0, 1.0, 0.0
*NCOPY, SHIFT, CHANGE NU = 2000, OLD SET = SOIL2, NEW SET = SOIL3
0.0, 0.0, +10.0
0.0, 0.0, 0.0, 0.0, 0.0, 1.0, 0.0
*NCOPY, SHIFT, CHANGE NU = 2000, OLD SET = SOIL3, NEW SET = SOIL4
0.0, 0.0, +10.0
0.0, 0.0, 0.0, 0.0, 0.0, 1.0, 0.0
*NCOPY, SHIFT, CHANGE NU = 2000, OLD SET = SOIL4, NEW SET = SOIL5
0.0, 0.0, +5.0
0.0, 0.0, 0.0, 0.0, 0.0, 1.0, 0.0
*NSET,NSET = SOILO
SOIL1, SOIL2, SOIL3, SOIL4, SOIL5
**
** GENERATE THE INCLINED IMPACT SURFACES
**
*NCOPY,SHIFT,CHANGE NU=-100000,OLD SET = CONCO,NEW SET = CONC
12.000, 0., 34.8
12.000, 0., 34.8, 12.000, 1., 34.8, -146.31
*NCOPY,SHIFT, CHANGE NU = -100000, OLD SET = SOILO, NEW SET = SOIL
12.000, 0., 34.8
12.000, 0., 34.8, 12.000, 1., 34.8, -146.31
**
** CONCRETE PAD ELEMENT
**
*ELEMENT, TYPE = C3D8R
60001, 60001, 60002, 60052, 60051, 62001, 62002, 62052, 62051
*ELGEN, ELSET = CONC1
60001, 36, 1, 1, 16, 50, 50
*ELCOPY,OLD SET = CONC1,NEW SET = CONC2,ELEMENT SH = 2000,SHIFT NO = 2000
*ELCOPY,OLD SET = CONC2,NEW SET = CONC3,ELEMENT SH = 2000,SHIFT NO = 2000
*ELCOPY,OLD SET = CONC3,NEW SET = CONC4,ELEMENT SH = 2000,SHIFT NO = 2000
*ELSET, ELSET = CONC
CONC1, CONC2, CONC3, CONC4,
*SOLID SECTION, ELSET = CONC, MATERIAL = CONCRETE
**
** GENERATE REBARS
**
*REBAR,ELEM = CONTINUUM,MAT = REBAR,GEOM = ISOPARAMETRIC,NAME = LX
CONC1,0.60,12.0,0.0,1.0,4,2
*REBAR,ELEM = CONTINUUM,MAT = REBAR,GEOM = ISOPARAMETRIC,NAME = LY
CONC1,0.60,12.0,90.,1.0,4,2
*REBAR,ELEM = CONTINUUM,MAT = REBAR,GEOM = ISOPARAMETRIC,NAME = UX
CONC4,0.60,12.0,0.0,0.0,4,2
*REBAR,ELEM = CONTINUUM,MAT = REBAR,GEOM = ISOPARAMETRIC,NAME = UY
CONC4,0.60,12.0,90.,0.0,4,2
**
** GENERATE THE SOIL

```

```

*ELCOPY,OLD SET = CONC1,NEW SET = SOIL1,ELEMENT SH = 20000,SHIFT NO = 20000
*ELCOPY,OLD SET = SOIL1,NEW SET = SOIL2,ELEMENT SH = 2000,SHIFT NO = 2000
*ELCOPY,OLD SET = SOIL2,NEW SET = SOIL3,ELEMENT SH = 2000,SHIFT NO = 2000
*ELCOPY,OLD SET = SOIL3,NEW SET = SOIL4,ELEMENT SH = 2000,SHIFT NO = 2000
*ELEMENT, TYPE = C3D6, ELSET = SOILS
*ELEMENT, TYPE = C3D8R
88001, 88001, 88002, 88052, 88051, 60001, 60002, 60052, 60051
*ELGEN, ELSET = SOIL5
88001, 38, 1, 1, 16, 50, 50
*ELSET, ELSET = SOIL
SOIL1, SOIL2, SOIL3, SOIL4, SOIL5
*SOLID SECTION, ELSET = SOIL, MATERIAL = SOIL
*****
**
** ASTM A36
**
*MATERIAL, NAME = ST
*DENSITY
7.5052E-4
*ELASTIC
29.0E6, 0.3
*PLASTIC
36000., 0.
60000., 0.23
30000., 0.24
10000., 0.25
5000., 0.26
1000., 0.27
*FAILURE
0.30, 0.25
**
** CLOSING RING BOLT MATERIAL
** ASTM A307, GR. C
**
*MATERIAL, NAME = BOLT
*DENSITY
7.5052E-4
*ELASTIC
29.0E6, 0.3
*PLASTIC
36000.0, 0.0
60000.0, 0.23
30000., 0.24
10000., 0.25
5000., 0.26
1000., 0.27
*FAILURE
0.30, 0.25
*MATERIAL, NAME = PAYLD
*DENSITY
0.01110
*ELASTIC
29.0E6, 0.3
*material,name = concrete
** 4000 PSI CONCRETE
*density
1.95E-04
*elastic
3.6E+06,0.15
*drucker prager
35.1,1.0,35.1
** drucker prager hardening
2250.,0.0
3800.,0.0013
3000.,0.0024
2400.,0.0034
1790.,0.0044
1180.,0.0054
800.,0.006
100.,0.0061
*material,name = soil
*density
1.647E-04
*elastic
5700.,0.35
*drucker prager
35.2,0.82,35.2
*drucker prager hardening

```

```

2,0,0,0
6.54,0.0055
8.64,0.0156
9.96,0.0259
10.68,0.0362
10.98,0.0467
11.1,0.0573
11.04,0.068
10.8,0.0788
10.44,0.0897
9.9,0.1
9.0,0.112
**
** REBAR STEEL
**
*MATERIAL, NAME=REBAR
*DENSITY
7.34E-4
*ELASTIC
29.5E6, 0.30
*PLASTIC
71170., 0.0
71626., 0.004985
83130., 0.017098
96460., 0.036202
104728., 0.055113
109080., 0.073795
***FAILURE
**0.30, 0.03
**
** ELEMENT SET DEFINITIONS
**
*ELSET,ELSET=ALLEL
DMB, DMW, DML
RING, BOLT
PAY,
**
** NODE SET DEFINITIONS
**
*NSET,NSET=ALLND
DMB, DMW, DML
RING, BOLT
PAY,
*NSET,NSET=YSYMM,GENERATE
60001,60037,1
62001,62037,1
64001,64037,1
66001,66037,1
68001,68037,1
80001,80037,1
82001,82037,1
84001,84037,1
86001,86037,1
88001,88037,1
*NSET,NSET=YSYMM,GENERATE
1, 7, 1
41, 53, 12
61, 73, 12
81, 93, 12
101, 501, 20
113, 513, 20
613, 693, 20
701, 741, 20
713, 753, 20
1001, 1007, 1
1041, 1053, 12
1061, 1073, 12
1081, 1093, 12
1101, 1113, 12
1501, 1501, 1
2001, 2005, 1
2021, 2029, 8
2031, 2131, 10
2039, 2139, 10
2201, 2205, 1
2221, 2229, 8
*NSET,NSET=SOILBT,GENERATE
80001,80837,1

```

```

*NSSET,NSET = CONC5,GENERATE
68001,68837,1
*BOUNDARY
YSYMM,YSYMM
SOILBT,1,3
*****
*INITIAL CONDITIONS,TYPE = VELOCITY
ALLND,1,106.84
ALLND,3,160.25
*STEP
*DYNAMIC,EXPLICIT
,20.0E-03
**
** DEFINE THE CONTACT SURFACES BETWEEN
** THE DRUM BOTTOM AND TARGET
**
*SURFACE DEFINITION,NAME = CONC4T
CONC4,S2
*SURFACE DEFINITION,NAME = DMOUT,NO THICK
DMB,SNEG
DMW1,SNEG
DMW2,SNEG
DMW3,SNEG
RING,SPOS
DML,SPOS
*CONTACT PAIR
CONC4T,DMOUT
**
** DEFINE THE CONTACT SURFACES BETWEEN
** THE DRUM INSIDE AND PAYLOAD OUTSIDE
**
*SURFACE DEFINITION,NAME = DMINS,NO THICK
DMB,SPOS
DMW1,SPOS
DMW2,SPOS
DMW3,SPOS
DMW4,SPOS
RING2,SNEG
DML,SNEG
*SURFACE DEFINITION,NAME = PAYOUT,NO THICK
PAYB,SNEG
PAYW,SNEG
PAYT,SPOS
*CONTACT PAIR
DMINS,PAYOUT
*****
*NSSET,NSET = DMDIS,GENERATE
4,4,1
1004,1004,1
661,661,1
101,113,3
301,313,3
541,553,3
*ELSET,ELSET = DMBST,GENERATE
61,66,1
81,86,1
*ELSET,ELSET = DMBST
DMBA,
*ELSET,ELSET = DMWST,GENERATE
101,106,1
121,126,1
141,421,20
142,422,20
143,423,20
441,446,1
461,466,1
481,486,1
501,506,1
*ELSET,ELSET = DMLST,GENERATE
1061,1066,1
1081,1086,1
*ELSET,ELSET = DMLST
DMLA,
*ELSET,ELSET = RINGST,GENERATE
601,606,1
621,626,1
641,646,1
661,666,1

```

681,686,1
701,706,1
721,726,1
741,746,1
761,766,1
*ELSET,ELSET=BOLTST,GENERATE
1501,1501,1

*HISTORY OUTPUT, TIME=1.0E-4
*NODE HISTORY, NSET=DMDIS
U, V, A
*EL HISTORY, ELSET=DMBST
SP,
LEP,
SENER,
PENER,
*EL HISTORY, ELSET=DMWST
SP,
LEP,
SENER,
PENER,
*EL HISTORY, ELSET=DMLST
SP,
LEP,
SENER,
PENER,
*EL HISTORY, ELSET=RINGST
SP,
LEP,
SENER,
PENER,
*EL HISTORY, ELSET=BOLTST
SP,
LEP,
SENER,
PENER,
*FILE OUTPUT, NUMBER INTERVAL=100
*NODE FILE
RF,
*MONITOR,NODE=307,DOF=3
*END STEP
-



CHECKLIST FOR CHECKING OF ANALYSIS/CALCULATIONS

Document Number/Revision: HNF-2209/Rev. 0

Document Title: 55 Gallon Drum/30-mil Wall Thickness 4-ft Top Corner Drop

Yes	No	N/A	
<input checked="" type="checkbox"/>	<input type="checkbox"/>	<input type="checkbox"/>	Problem completely defined.
<input checked="" type="checkbox"/>	<input type="checkbox"/>	<input type="checkbox"/>	Appropriate analytical method used.
<input checked="" type="checkbox"/>	<input type="checkbox"/>	<input type="checkbox"/>	Necessary assumptions are appropriate and explicitly stated.
<input checked="" type="checkbox"/>	<input type="checkbox"/>	<input type="checkbox"/>	Computer codes and data files documented.
<input checked="" type="checkbox"/>	<input type="checkbox"/>	<input type="checkbox"/>	Data used in calculations explicitly stated in document.
<input type="checkbox"/>	<input type="checkbox"/>	<input checked="" type="checkbox"/>	Sources of non-standard formula/data are referenced and the correctness of the reference verified.
<input checked="" type="checkbox"/>	<input type="checkbox"/>	<input type="checkbox"/>	Data checked for consistency with original source information as applicable.
<input type="checkbox"/>	<input type="checkbox"/>	<input checked="" type="checkbox"/>	Mathematical derivations checked including dimensional consistency of results.
<input checked="" type="checkbox"/>	<input type="checkbox"/>	<input type="checkbox"/>	Models appropriate and used within range of validity or use outside range of established validity justified.
<input type="checkbox"/>	<input type="checkbox"/>	<input checked="" type="checkbox"/>	Hand calculations checked for errors.
<input checked="" type="checkbox"/>	<input type="checkbox"/>	<input type="checkbox"/>	Code run streams correct and consistent with analysis documentation.
<input checked="" type="checkbox"/>	<input type="checkbox"/>	<input type="checkbox"/>	Code output consistent with input and with results reported in analysis documentation.
<input checked="" type="checkbox"/>	<input type="checkbox"/>	<input type="checkbox"/>	Acceptability limits on analytical results applicable and supported. Limits checked against sources.
<input checked="" type="checkbox"/>	<input type="checkbox"/>	<input type="checkbox"/>	Safety Margins consistent with good engineering practices.
<input checked="" type="checkbox"/>	<input type="checkbox"/>	<input type="checkbox"/>	Conclusions consistent with analytical results and applicable limits.
<input checked="" type="checkbox"/>	<input type="checkbox"/>	<input type="checkbox"/>	Results and conclusions address all points required in the problem statement.

I have checked the analysis/calculation and it is complete and accurate to the best of my knowledge.

Engineer/Checker Scott Shiraga

Date 09/01/98

NOTE: Any hand calculations, notes or summaries generated as part of this check should be signed, dated, and attached to this checklist. Material should be labeled and recorded so that it is intelligible to a technically qualified third party.

7.7.1.5 DOT-17H 55-Gal Drum 10-Ft Top-Corner Drop.

```

*HEADING
DOT-17H 55 GALLON DRUM, 10-FT TOP CORNER DROP
FILE=DTCTION 8/13/98
**RESTART, WRITE, NUMBER INTERVAL = 10
*****
** DRUM
*****
**
** GENERATE THE NODES OF DRUM BOTTOM PLATE
**
*NODE, SYSTEM=R
*NODE
1, -3.6, 0.0, 0.0
7, 3.6, 0.0, 0.0
22, -3.6, 3.6, 0.0
28, 3.6, 3.6, 0.0
*NGEN, NSET=LINEA
1, 7, 1
*NGEN, NSET=LINEB
22, 28, 1
*NFILL, NSET=DMB1
LINEA, LINEB, 3, 7
*NODE, NSET=DMB2
41, 5.4417, 0.0, 0.0
42, 5.3380, 1.5872, 0.0
43, 5.0342, 3.1208, 0.0
44, 4.5508, 4.5508, 0.0
45, 3.1208, 5.0342, 0.0
46, 1.5872, 5.3380, 0.0
47, 0.0, 5.4417, 0.0
48, -1.5872, 5.3380, 0.0
49, -3.1208, 5.0342, 0.0
50, -4.5508, 4.5508, 0.0
51, -5.0342, 3.1208, 0.0
52, -5.3380, 1.5872, 0.0
53, -5.4417, 0.0, 0.0
61, 7.2833, 0.0, 0.0
62, 7.0760, 1.9745, 0.0
63, 6.4683, 3.8417, 0.0
64, 5.5016, 5.5016, 0.0
65, 3.8417, 6.4683, 0.0
66, 1.9745, 7.0760, 0.0
67, 0.0, 7.2833, 0.0
68, -1.9745, 7.0760, 0.0
69, -3.8417, 6.4683, 0.0
70, -5.5016, 5.5016, 0.0
71, -6.4683, 3.8417, 0.0
72, -7.0760, 1.9745, 0.0
73, -7.2833, 0.0, 0.0
81, 9.6000, 0.0, 0.0
82, 9.2729, 2.4847, 0.0
83, 8.3138, 4.8000, 0.0
84, 6.7882, 6.7882, 0.0
85, 4.8000, 8.3138, 0.0
86, 2.4847, 9.2729, 0.0
87, 0.0, 9.6000, 0.0
88, -2.4847, 9.2729, 0.0
89, -4.8000, 8.3138, 0.0
90, -6.7882, 6.7882, 0.0
91, -8.3138, 4.8000, 0.0
92, -9.2729, 2.4847, 0.0
93, -9.6000, 0.0, 0.0
*NODE, NSET=DMB3
101, 11.5000, 0.0, 0.0
102, 11.1081, 2.9764, 0.0
103, 9.9593, 5.7500, 0.0
104, 8.1317, 8.1317, 0.0
105, 5.7500, 9.9593, 0.0
106, 2.9764, 11.1081, 0.0
107, 0.0, 11.5000, 0.0
108, -2.9764, 11.1081, 0.0
109, -5.7500, 9.9593, 0.0
110, -8.1317, 8.1317, 0.0
111, -9.9593, 5.7500, 0.0
112, -11.1081, 2.9764, 0.0

```

```

113, -11.5000, 0.0, 0.0
*NSET, NSET = DMB
DMB1, DMB2, DMB3
**
** GENERATE THE ELEMENTS OF DRUM BOTTOM PLATE
**
*ELEMENT, TYPE = S4R
1, 1, 2, 9, 8
*ELGEN, ELSET = DMBA
1, 6, 1, 1, 3, 7, 6
*ELEMENT, TYPE = S4R, ELSET = DMBB
21, 7, 41, 42, 14
22, 14, 42, 43, 21
23, 21, 43, 44, 28
24, 28, 44, 45, 27
25, 27, 45, 46, 26
26, 26, 46, 47, 25
27, 25, 47, 48, 24
28, 24, 48, 49, 23
29, 23, 49, 50, 22
30, 22, 50, 51, 15
31, 15, 51, 52, 8
32, 8, 52, 53, 1
41, 41, 61, 62, 42
*ELGEN, ELSET = DMBB
41, 12, 1, 1, 3, 20, 20
*ELSET, ELSET = DMB
DMBA, DMBB
*SHELL SECTION, ELSET = DMB, MATERIAL = ST
0.0478
**
** GENERATE THE DRUM CYLINDRICAL WALL
**
** NODES
**
**
*NCOPY, SHIFT, CHANGE NU = 40, OLD SET = DMB3, NEW SET = L1
0.0, 0.0, 2.0
0.0, 0.0, 0.0, 0.0, 0.0, 1.0, 0.0
*NCOPY, SHIFT, CHANGE NU = 300, OLD SET = L1, NEW SET = L2
0.0, 0.0, 30.0
0.0, 0.0, 0.0, 0.0, 0.0, 1.0, 0.0
*NCOPY, SHIFT, CHANGE NU = 40, OLD SET = L2, NEW SET = L3
0.0, 0.0, 2.0
0.0, 0.0, 0.0, 0.0, 0.0, 1.0, 0.0
*NFILL, NSET = DMW1
DMB3, L1, 2, 20
*NFILL, NSET = DMW2
L1, L2, 15, 20
*NFILL, NSET = DMW3
L2, L3, 2, 20
*NODE, NSET = DMW4
501, 11.5000, 0.0, 34.5
701, 11.5000, 0.0, 35.0
*NCOPY, SHIFT, MULTIPLE = 12, CHANGE NU = +1, OLD SET = DMW4, NEW SET = DMW4
0.0, 0.0, 0.0
0.0, 0.0, 0.0, 0.0, 0.0, 1.0, +15.00
*NSET, NSET = DMW
DMW1, DMW2, DMW3, DMW4
**
** ELEMENTS
**
**
*ELEMENT, TYPE = S4R, ELSET = DMW1
101, 101, 121, 122, 102
*ELGEN, ELSET = DMW1
101, 12, 1, 1, 2, 20, 20
*ELEMENT, TYPE = S4R, ELSET = DMW2
141, 141, 161, 162, 142
*ELGEN, ELSET = DMW2
141, 12, 1, 1, 15, 20, 20
*ELEMENT, TYPE = S4R, ELSET = DMW3
441, 441, 461, 462, 442
*ELGEN, ELSET = DMW3
441, 12, 1, 1, 2, 20, 20
*ELEMENT, TYPE = S4R, ELSET = DMW4
481, 481, 501, 502, 482
501, 501, 701, 702, 502
*ELGEN, ELSET = DMW4
481, 12, 1, 1

```

```

501, 12, 1, 1
*ELSET, ELSET = DMW
DMW1, DMW2, DMW3, DMW4
*SHELL SECTION, ELSET = DMW, MATERIAL = ST
0.0478
**
** GENERATE THE NODES OF DRUM LID
**
**NCPY,SHIFT,CHANGE NU = 1000,OLD SET = DMB,NEW SET = DML
0.0, 0.0, 34.50
0.0, 0.0, 0.0, 0.0, 0.0, 0.0, 1.0, 0.0
** MODIFY NODES
**NODE, NSET = DML
1101, 10.5000, 0.0, 34.50
1102, 10.1422, 2.7176, 34.50
1103, 9.0933, 5.2500, 34.50
1104, 7.4246, 7.4246, 34.50
1105, 5.2500, 9.0933, 34.50
1106, 2.7176, 10.1422, 34.50
1107, 0.0, 10.5000, 34.50
1108, -2.7176, 10.1422, 34.50
1109, -5.2500, 9.0933, 34.50
1110, -7.4246, 7.4246, 34.50
1111, -9.0933, 5.2500, 34.50
1112, -10.1422, 2.7176, 34.50
1113, -10.5000, 0.0, 34.50
**
** GENERATE THE DRUM LID
**
**ELEMENT, TYPE = S4R
1001, 1001, 1002, 1009, 1008
**ELGEN, ELSET = DMLA
1001, 6, 1, 1, 3, 7, 6
**ELEMENT, TYPE = S4R, ELSET = DMLB
1021, 1007, 1041, 1042, 1014
1022, 1014, 1042, 1043, 1021
1023, 1021, 1043, 1044, 1028
1024, 1028, 1044, 1045, 1027
1025, 1027, 1045, 1046, 1028
1026, 1026, 1046, 1047, 1025
1027, 1025, 1047, 1048, 1024
1028, 1024, 1048, 1049, 1023
1029, 1023, 1049, 1050, 1022
1030, 1022, 1050, 1051, 1015
1031, 1015, 1051, 1052, 1008
1032, 1008, 1052, 1053, 1001
**ELEMENT, TYPE = S4R
1041, 1041, 1061, 1062, 1042
**ELGEN, ELSET = DMLC
1041, 12, 1, 1, 2, 20, 20
**ELEMENT, TYPE = S4R
1081, 1081, 1101, 1102, 1082
**ELGEN, ELSET = DMLD
1081, 12, 1, 1
**ELSET, ELSET = DML
DMLA, DMLB, DMLC, DMLD
*SHELL SECTION, ELSET = DML, MATERIAL = ST
0.0478
**NSET, NSET = DM
DMB, DMW, DML
**ELSET, ELSET = DM
DMB, DMW, DML
*****
** CLOSING RING, DRUM LID, AND DRUM ASSEMBLY
*****
**NODE, NSET = RING
601, 11.7500, 0.0, 34.0670
621, 11.9330, 0.0, 34.2500
641, 12.0000, 0.0, 34.5000
661, 11.9330, 0.0, 34.7500
681, 11.7500, 0.0, 34.9330
701, 11.5000, 0.0, 35.0000
721, 11.2500, 0.0, 34.9330
741, 11.0670, 0.0, 34.7500
**NCPY,SHIFT,MULTIPLE = 12,CHANGE NU = + 1,OLD SET = RING,NEW SET = RING
0.0, 0.0, 0.0
0.0, 0.0, 0.0, 0.0, 0.0, 1.0, + 15.00
**ELEMENT, TYPE = S4R

```

```

601, 481, 482, 602, 601
621, 601, 602, 622, 621
721, 701, 702, 722, 721
761, 741, 742, 1102, 1101
*ELGEN, ELSET=RING1
601, 12, 1, 1
621, 12, 1, 1, 5, 20, 20
*ELGEN, ELSET=RING2
721, 12, 1, 1, 2, 20, 20
761, 12, 1, 1
*ELSET, ELSET=RING
RING1, RING2
*SHELL SECTION, ELSET=RING1, MATERIAL=ST
0.50
*SHELL SECTION, ELSET=RING2, MATERIAL=ST
0.35
*****
**          CLOSING RING BOLT
*****
*NODE, NSET=BOLT
1501, 11.500, 0.0, 34.500
1502, 11.500, 0.5, 34.500
*ELEMENT, TYPE=T3D2, ELSET=BOLT
1501, 1501, 1502
*SOLID SECTION, ELSET=BOLT, MATERIAL=BOLT
0.226
*MPC
TIE,601,1502
TIE,621,1502
TIE,641,1502
TIE,661,1502
TIE,681,1502
*EQUATION
2
1501,1,1,0,1502,1,-1,0
*EQUATION
2
1501,3,1,0,1502,3,-1,0
*****
**          PAYLOAD
*****
*NODE, SYSTEM=R
*NODE
2001, -4.0, 0.0, 0.024
2005, 4.0, 0.0, 0.024
2011, -4.0, 4.0, 0.024
2015, 4.0, 4.0, 0.024
*NGEN, NSET=LINEC
2001, 2005, 1
*NGEN, NSET=LINED
2011, 2015, 1
*NFill, NSET=PAYB1
LINEC, LINED, 2, 5
*NODE, NSET=PAYB2
2021, 7.625, 0.0, 0.024
2022, 7.1968, 3.1526, 0.024
2023, 5.9775, 5.9775, 0.024
2024, 3.1526, 7.1968, 0.024
2025, 0.0, 7.625, 0.024
2026, -3.1526, 7.1968, 0.024
2027, -5.9775, 5.9775, 0.024
2028, -7.1968, 3.1526, 0.024
2029, -7.625, 0.0, 0.024
*NODE, NSET=PAYB3
2031, 11.25, 0.0, 0.024
2032, 10.394, 4.3052, 0.024
2033, 7.9550, 7.9550, 0.024
2034, 4.3052, 10.394, 0.024
2035, 0.0, 11.25, 0.024
2036, -4.3052, 10.394, 0.024
2037, -7.9550, 7.9550, 0.024
2038, -10.394, 4.3052, 0.024
2039, -11.25, 0.0, 0.024
*NSET, NSET=PAYB
PAYB1, PAYB2, PAYB3
*ELEMENT, TYPE=S4R
2001, 2001, 2002, 2007, 2006
*ELGEN, ELSET=PAYB1

```

```

2001, 4, 1, 1, 2, 5, 5
*ELEMENT, TYPE=S4R, ELSET=PAYB2
2011, 2005, 2021, 2022, 2010
2012, 2010, 2022, 2023, 2015
2013, 2015, 2023, 2024, 2014
2014, 2014, 2024, 2025, 2013
2015, 2013, 2025, 2026, 2012
2016, 2012, 2026, 2027, 2011
2017, 2011, 2027, 2028, 2006
2018, 2006, 2028, 2029, 2001
*ELEMENT, TYPE=S4R
2021, 2021, 2031, 2032, 2022
*ELGEN, ELSET=PAYB2
2021, 8, 1, 1
*ELSET, ELSET=PAYB
PAYB1, PAYB2
*SHELL SECTION, ELSET=PAYB, MATERIAL=PAYLD
0.0478
*****
*NCOPY,SHIFT,CHANGE NU=100,OLD SET=PAYB3,NEW SET=PAYW1
0.0, 0.0, 33.25
0.0, 0.0, 0.0, 0.0, 0.0, 1.0, 0.0
*NFILL, NSET=PAYW
PAYB3, PAYW1, 10, 10
*ELEMENT, TYPE=S4R
2031, 2031, 2041, 2042, 2032
*ELGEN, ELSET=PAYW
2031, 8, 1, 1, 10, 10, 10
*SHELL SECTION, ELSET=PAYW, MATERIAL=PAYLD
0.0478
*****
*NCOPY,SHIFT,CHANGE NU=200,OLD SET=PAYB,NEW SET=PAYT
0.0, 0.0, 33.25
0.0, 0.0, 0.0, 0.0, 0.0, 1.0, 0.0
*ELEMENT, TYPE=S4R
2201, 2201, 2202, 2207, 2206
*ELGEN, ELSET=PAYT1
2201, 4, 1, 1, 2, 5, 5
*ELEMENT, TYPE=S4R, ELSET=PAYT2
2211, 2205, 2221, 2222, 2210
2212, 2210, 2222, 2223, 2215
2213, 2215, 2223, 2224, 2214
2214, 2214, 2224, 2225, 2213
2215, 2213, 2225, 2226, 2212
2216, 2212, 2226, 2227, 2211
2217, 2211, 2227, 2228, 2206
2218, 2206, 2228, 2229, 2201
*ELEMENT, TYPE=S4R
2221, 2221, 2131, 2132, 2222
*ELGEN, ELSET=PAYT2
2221, 8, 1, 1
*ELSET, ELSET=PAYT
PAYT1, PAYT2
*ELSET, ELSET=PAY
PAYB, PAYW, PAYT
*NSET, NSET=PAY
PAYB, PAYW, PAYT
*SHELL SECTION, ELSET=PAYT, MATERIAL=PAYLD
0.0478
*****
** GENERATE THE ELEMENTS OF CONCRETE PAD
** 10' X 10' RECTANGULAR HALF SECTION (NO INF)
**
*NODE, SYSTEM=R
*NODE, NSET=C1
160001, -60.0, 0.0, -8.0
*NODE, NSET=C2
160004, -45.0, 0.0, -8.0
*NODE, NSET=C3
160034, 45.0, 0.0, -8.0
*NODE, NSET=C4
160037, 60.0, 0.0, -8.0
*NFILL, NSET=LINE1
C1, C2, 3
C2, C3, 30
C3, C4, 3
*NCOPY,SHIFT,CHANGE NU=500,OLD SET=LINE1,NEW SET=LINE2
0.0, 30.0, 0.0

```

```

0.0, 0.0, 0.0, 0.0, 0.0, 1.0, 0.0
*NCOPY,SHIFT,CHANGE NU = 300,OLD SET = LINE2,NEW SET = LINE3
0.0, 30.0, 0.0
0.0, 0.0, 0.0, 0.0, 0.0, 1.0, 0.0
*NFILL, NSET = CONC1
LINE1, LINE2, 10, 50
LINE2, LINE3, 6, 50
*NCOPY,SHIFT,CHANGE NU = 2000,OLD SET = CONC1,NEW SET = CONC2
0.0, 0.0, 2.0
0.0, 0.0, 0.0, 0.0, 0.0, 1.0, 0.0
*NCOPY,SHIFT,CHANGE NU = 2000,OLD SET = CONC2,NEW SET = CONC3
0.0, 0.0, 2.0
0.0, 0.0, 0.0, 0.0, 0.0, 1.0, 0.0
*NCOPY,SHIFT,CHANGE NU = 2000,OLD SET = CONC3,NEW SET = CONC4
0.0, 0.0, 2.0
0.0, 0.0, 0.0, 0.0, 0.0, 1.0, 0.0
*NCOPY,SHIFT,CHANGE NU = 2000,OLD SET = CONC4,NEW SET = CONC5
0.0, 0.0, 2.0
0.0, 0.0, 0.0, 0.0, 0.0, 1.0, 0.0
*NSET,NSET = CONCO
CONC1, CONC2, CONC3, CONC4, CONC5,
**
** GENERATE THE SOIL NODES
**
*NCOPY, SHIFT, CHANGE NU = 20000, OLD SET = CONC1, NEW SET = SOIL1
0.0, 0.0, -50.0
0.0, 0.0, 0.0, 0.0, 0.0, 1.0, 0.0
*NCOPY, SHIFT, CHANGE NU = 2000, OLD SET = SOIL1, NEW SET = SOIL2
0.0, 0.0, +20.0
0.0, 0.0, 0.0, 0.0, 0.0, 1.0, 0.0
*NCOPY, SHIFT, CHANGE NU = 2000, OLD SET = SOIL2, NEW SET = SOIL3
0.0, 0.0, +10.0
0.0, 0.0, 0.0, 0.0, 0.0, 1.0, 0.0
*NCOPY, SHIFT, CHANGE NU = 2000, OLD SET = SOIL3, NEW SET = SOIL4
0.0, 0.0, +10.0
0.0, 0.0, 0.0, 0.0, 0.0, 1.0, 0.0
*NCOPY, SHIFT, CHANGE NU = 2000, OLD SET = SOIL4, NEW SET = SOIL5
0.0, 0.0, +5.0
0.0, 0.0, 0.0, 0.0, 0.0, 1.0, 0.0
*NSET,NSET = SOILO
SOIL1, SOIL2, SOIL3, SOIL4, SOIL5
**
** GENERATE THE INCLINED IMPACT SURFACES
**
*NCOPY,SHIFT,CHANGE NU = -100000,OLD SET = CONCO,NEW SET = CONC
12.000, 0., 34.8
12.000, 0., 34.8, 12.000, 1., 34.8, -146.31
*NCOPY,SHIFT, CHANGE NU = -100000, OLD SET = SOILO, NEW SET = SOIL
12.000, 0., 34.8
12.000, 0., 34.8, 12.000, 1., 34.8, -146.31
**
** CONCRETE PAD ELEMENT
**
*ELEMENT, TYPE = C3D8R
60001, 60001, 60002, 60052, 60051, 62001, 62002, 62052, 62051
*ELGEN, ELSET = CONC1
60001, 36, 1, 1, 16, 50, 50
*ELCOPY,OLD SET = CONC1,NEW SET = CONC2,ELEMENT SH = 2000,SHIFT NO = 2000
*ELCOPY,OLD SET = CONC2,NEW SET = CONC3,ELEMENT SH = 2000,SHIFT NO = 2000
*ELCOPY,OLD SET = CONC3,NEW SET = CONC4,ELEMENT SH = 2000,SHIFT NO = 2000
*ELSET, ELSET = CONC
CONC1, CONC2, CONC3, CONC4.
*SOLID SECTION, ELSET = CONC, MATERIAL = CONCRETE
**
** GENERATE REBARS
**
*REBAR,ELEM = CONTINUUM,MAT = REBAR,GEOM = ISOPARAMETRIC,NAME = LX
CONC1,0.60,12.0,0.0,1.0,4,2
*REBAR,ELEM = CONTINUUM,MAT = REBAR,GEOM = ISOPARAMETRIC,NAME = LY
CONC1,0.60,12.0,90.,1.0,4,2
*REBAR,ELEM = CONTINUUM,MAT = REBAR,GEOM = ISOPARAMETRIC,NAME = UX
CONC4,0.60,12.0,0.0,0.0,4,2
*REBAR,ELEM = CONTINUUM,MAT = REBAR,GEOM = ISOPARAMETRIC,NAME = UY
CONC4,0.60,12.0,90.,0.0,4,2
**
** GENERATE THE SOIL
**
*ELCOPY,OLD SET = CONC1,NEW SET = SOIL1,ELEMENT SH = 20000,SHIFT NO = 20000

```

```

*ELCOPY,OLD SET = SOIL1,NEW SET = SOIL2,ELEMENT SH = 2000,SHIFT NO = 2000
*ELCOPY,OLD SET = SOIL2,NEW SET = SOIL3,ELEMENT SH = 2000,SHIFT NO = 2000
*ELCOPY,OLD SET = SOIL3,NEW SET = SOIL4,ELEMENT SH = 2000,SHIFT NO = 2000
*ELEMENT, TYPE = C3D8, ELSET = SOIL5
*ELEMENT, TYPE = C3D8R
88001, 88001, 88002, 88052, 88051, 60001, 60002, 60052, 60051
*ELGEN, ELSET = SOIL5
88001, 36, 1, 1, 16, 50, 50
*ELSET, ELSET = SOIL
SOIL1, SOIL2, SOIL3, SOIL4, SOIL5
*SOLID SECTION, ELSET = SOIL, MATERIAL = SOIL
*****
**
** ASTM A36
**
*MATERIAL, NAME = ST
*DENSITY
7.5052E-4
*ELASTIC
29.0E6, 0.3
*PLASTIC
36000., 0.
60000., 0.23
30000., 0.24
10000., 0.25
5000., 0.26
1000., 0.27
*FAILURE
0.30, 0.25
**
** CLOSING RING BOLT MATERIAL
** ASTM A307, GR. C
**
*MATERIAL, NAME = BOLT
*DENSITY
7.5052E-4
*ELASTIC
29.0E6, 0.3
*PLASTIC
36000.0, 0.0
60000.0, 0.23
*FAILURE
0.23, 0.22
*MATERIAL, NAME = PAYLD
*DENSITY
0.02437
*ELASTIC
29.0E6, 0.3
*material,name = concrete
** 4000 PSI CONCRETE
*density
1.95E-04
*elastic
3.6E+06,0.15
*drucker prager
35.1,1.0,35.1
*drucker prager hardening
2250.,0.0
3900.,0.0013
3000.,0.0024
2400.,0.0034
1790.,0.0044
1180.,0.0054
500.,0.006
100.,0.0061
*material,name = soil
*density
1.647E-04
*elastic
5700.,0.35
*drucker prager
35.2,0.82,35.2
*drucker prager hardening
2.0,0.0
6.54,0.0055
8.54,0.0159
9.96,0.0259
10.68,0.0362

```



```

10.98,0.0467
11.1,0.0573
11.04,0.068
10.8,0.0788
10.44,0.0897
9.9,0.1
9.0,0.112
**
** REBAR STEEL
**
*MATERIAL, NAME=REBAR
*DENSITY
7.34E-4
*ELASTIC
29.5E6, 0.30
*PLASTIC
71170., 0.0
71826., 0.004985
83130., 0.017098
96460., 0.036202
104728., 0.055113
109080., 0.073795
**
** ELEMENT SET DEFINITIONS
**
*ELSET,ELSET = ALLEL
DMB, DMW, DML
RING, BOLT
PAY,
**
** NODE SET DEFINITIONS
**
*NSET,NSET = ALLND
DMB, DMW, DML
RING, BOLT
PAY,
*NSET,NSET = YSYMM,GENERATE
60001,60037,1
62001,62037,1
64001,64037,1
66001,66037,1
68001,68037,1
80001,80037,1
82001,82037,1
84001,84037,1
86001,86037,1
88001,88037,1
*NSET,NSET = YSYMM,GENERATE
1, 7, 1
41, 53, 12
61, 73, 12
81, 93, 12
101, 501, 20
113, 513, 20
613, 693, 20
701, 741, 20
713, 753, 20
1001, 1007, 1
1041, 1053, 12
1061, 1073, 12
1081, 1093, 12
1101, 1113, 12
1501, 1501, 1
2001, 2005, 1
2021, 2029, 8
2031, 2131, 10
2039, 2139, 10
2201, 2205, 1
2221, 2229, 8
*NSET,NSET = SOILBT,GENERATE
80001,80837,1
*NSET,NSET = CONC5,GENERATE
68001,68837,1
*BOUNDARY
YSYMM,YSYMM
SOILBT,1,3
*****
*INITIAL CONDITIONS,TYPE=VELOCITY

```

```

ALLND,1,168.92
ALLND,3,253.38
*STEP
*DYNAMIC,EXPLICIT
,20.0E-03
**
** DEFINE THE CONTACT SURFACES BETWEEN
** THE DRUM BOTTOM AND TARGET
**
*SURFACE DEFINITION,NAME=CONC4T
CONC4,S2
*SURFACE DEFINITION,NAME=DMOUT,NO THICK
DMB,SNEG
DMW1,SNEG
DMW2,SNEG
DMW3,SNEG
RING,SPOS
DML,SPOS
*CONTACT PAIR
CONC4T,DMOUT
**
** DEFINE THE CONTACT SURFACES BETWEEN
** THE DRUM INSIDE AND PAYLOAD OUTSIDE
**
*SURFACE DEFINITION,NAME=DMINS,NO THICK
DMB,SPOS
DMW1,SPOS
DMW2,SPOS
DMW3,SPOS
DMW4,SPOS
RING2,SNEG
DML,SNEG
*SURFACE DEFINITION,NAME=PAYOUT,NO THICK
PAYB,SNEG
PAYW,SNEG
PAYT,SPOS
*CONTACT PAIR
DMINS,PAYOUT
*****
*NSET,NSET=DMDIS,GENERATE
4,4,1
1004,1004,1
*681,681,1
101,113,3
301,313,3
541,553,3
*NSET,NSET=DMRF
DMB,
DMW1,
DMW2,
DMW3,
RING,
DML,
*ELSET,ELSET=DMBST,GENERATE
61,66,1
81,86,1
*ELSET,ELSET=DMBST
DMBA,
*ELSET,ELSET=DMWST,GENERATE
101,106,1
121,126,1
141,421,20
142,422,20
143,423,20
441,446,1
481,486,1
481,486,1
501,506,1
*ELSET,ELSET=DMLST,GENERATE
1061,1066,1
1081,1086,1
*ELSET,ELSET=DMLST
DMLA,
*ELSET,ELSET=RINGST,GENERATE
601,606,1
621,626,1
641,646,1
661,666,1

```

681,686,1
701,706,1
721,726,1
741,746,1
761,766,1
*ELSET,ELSET = BOLTST,GENERATE
1501,1501,1

*HISTORY OUTPUT, TIME = 5.E-5
*NODE HISTORY, NSET = DMDIS
U, V, A
*NODE HISTORY, NSET = DMRF
RF,
*NODE HISTORY, NSET = CONC5
RF,
*EL HISTORY, ELSET = DMBST
SP,
LEP,
SENER,
PENER,
*EL HISTORY, ELSET = DMWST
SP,
LEP,
SENER,
PENER,
*EL HISTORY, ELSET = DMLST
SP,
LEP,
SENER,
PENER,
*EL HISTORY, ELSET = RINGST
SP,
LEP,
SENER,
PENER,
*EL HISTORY, ELSET = BOLTST
SP,
LEP,
SENER,
PENER,
*FILE OUTPUT, NUMBER INTERVAL = 100
*ENERGY HISTORY
ALLKE,
*MONITOR,NODE = 307,DOF = 3
*END STEP
-



CHECKLIST FOR CHECKING OF ANALYSIS/CALCULATIONS

Document Number/Revision: HNF-2209/Rev. 0

Document Title: DOT-17H 55 Gallon Drum 10-ft Top Corner Drop

Yes	No	N/A	
<input checked="" type="checkbox"/>	<input type="checkbox"/>	<input type="checkbox"/>	Problem completely defined.
<input checked="" type="checkbox"/>	<input type="checkbox"/>	<input type="checkbox"/>	Appropriate analytical method used.
<input checked="" type="checkbox"/>	<input type="checkbox"/>	<input type="checkbox"/>	Necessary assumptions are appropriate and explicitly stated.
<input checked="" type="checkbox"/>	<input type="checkbox"/>	<input type="checkbox"/>	Computer codes and data files documented.
<input checked="" type="checkbox"/>	<input type="checkbox"/>	<input type="checkbox"/>	Data used in calculations explicitly stated in document.
<input type="checkbox"/>	<input type="checkbox"/>	<input checked="" type="checkbox"/>	Sources of non-standard formula/data are referenced and the correctness of the reference verified.
<input checked="" type="checkbox"/>	<input type="checkbox"/>	<input type="checkbox"/>	Data checked for consistency with original source information as applicable.
<input type="checkbox"/>	<input type="checkbox"/>	<input checked="" type="checkbox"/>	Mathematical derivations checked including dimensional consistency of results.
<input checked="" type="checkbox"/>	<input type="checkbox"/>	<input type="checkbox"/>	Models appropriate and used within range of validity or use outside range of established validity justified.
<input type="checkbox"/>	<input type="checkbox"/>	<input checked="" type="checkbox"/>	Hand calculations checked for errors.
<input checked="" type="checkbox"/>	<input type="checkbox"/>	<input type="checkbox"/>	Code run streams correct and consistent with analysis documentation.
<input checked="" type="checkbox"/>	<input type="checkbox"/>	<input type="checkbox"/>	Code output consistent with input and with results reported in analysis documentation.
<input checked="" type="checkbox"/>	<input type="checkbox"/>	<input type="checkbox"/>	Acceptability limits on analytical results applicable and supported. Limits checked against sources.
<input checked="" type="checkbox"/>	<input type="checkbox"/>	<input type="checkbox"/>	Safety Margins consistent with good engineering practices.
<input checked="" type="checkbox"/>	<input type="checkbox"/>	<input type="checkbox"/>	Conclusions consistent with analytical results and applicable limits.
<input checked="" type="checkbox"/>	<input type="checkbox"/>	<input type="checkbox"/>	Results and conclusions address all points required in the problem statement.

I have checked the analysis/calculation and it is complete and accurate to the best of my knowledge.

Engineer/Checker Scott Shiraga

Date 09/01/98

NOTE: Any hand calculations, notes or summaries generated as part of this check should be signed, dated, and attached to this checklist. Material should be labeled and recorded so that it is intelligible to a technically qualified third party.

7.7.1.6 DOT-17H 55-Gal Drum 30-MPH Top-Corner Drop.

*HEADING

DOT-17H 55 GALLON DRUM, 30 MPH TOP CORNER DROP, FILE=DTC30M

*RESTART, WRITE, NUMBER INTERVAL=10

** DRUM

**

** GENERATE THE NODES OF DRUM BOTTOM PLATE

**

*NODE, SYSTEM=R

*NODE

1, -3.6, 0.0, 0.0

7, 3.6, 0.0, 0.0

22, -3.6, 3.6, 0.0

28, 3.6, 3.6, 0.0

*NGEN, NSET=LINEA

1, 7, 1

*NGEN, NSET=LINEB

22, 28, 1

*NFILL, NSET=DMB1

LINEA, LINEB, 3, 7

*NODE, NSET=DMB2

41, 5.4417, 0.0, 0.0

42, 5.3380, 1.5872, 0.0

43, 5.0342, 3.1208, 0.0

44, 4.5508, 4.5508, 0.0

45, 3.1208, 5.0342, 0.0

46, 1.5872, 5.3380, 0.0

47, 0.0, 5.4417, 0.0

48, -1.5872, 5.3380, 0.0

49, -3.1208, 5.0342, 0.0

50, -4.5508, 4.5508, 0.0

51, -5.0342, 3.1208, 0.0

52, -5.3380, 1.5872, 0.0

53, -5.4417, 0.0, 0.0

61, 7.2833, 0.0, 0.0

62, 7.0760, 1.9745, 0.0

63, 6.4683, 3.8417, 0.0

64, 5.5016, 5.5016, 0.0

65, 3.8417, 6.4683, 0.0

66, 1.9745, 7.0760, 0.0

67, 0.0, 7.2833, 0.0

68, -1.9745, 7.0760, 0.0

69, -3.8417, 6.4683, 0.0

70, -5.5016, 5.5016, 0.0

71, -6.4683, 3.8417, 0.0

72, -7.0760, 1.9745, 0.0

73, -7.2833, 0.0, 0.0

81, 9.6000, 0.0, 0.0

82, 9.2729, 2.4847, 0.0

83, 8.3138, 4.8000, 0.0

84, 6.7882, 6.7882, 0.0

85, 4.8000, 8.3138, 0.0

86, 2.4847, 9.2729, 0.0

87, 0.0, 9.6000, 0.0

88, -2.4847, 9.2729, 0.0

89, -4.8000, 8.3138, 0.0

90, -6.7882, 6.7882, 0.0

91, -8.3138, 4.8000, 0.0

92, -9.2729, 2.4847, 0.0

93, -9.6000, 0.0, 0.0

*NODE, NSET=DMB3

101, 11.5000, 0.0, 0.0

102, 11.1081, 2.9764, 0.0

103, 9.9593, 5.7500, 0.0

104, 8.1317, 8.1317, 0.0

105, 5.7500, 9.9593, 0.0

106, 2.9764, 11.1081, 0.0

107, 0.0, 11.5000, 0.0

108, -2.9764, 11.1081, 0.0

109, -5.7500, 9.9593, 0.0

110, -8.1317, 8.1317, 0.0

111, -9.9593, 5.7500, 0.0

112, -11.1081, 2.9764, 0.0

113, -11.5000, 0.0, 0.0

```

*NSSET, NSET = DMB
DMB1, DMB2, DMB3
**
** GENERATE THE ELEMENTS OF DRUM BOTTOM PLATE
**
*ELEMENT, TYPE = S4R
1, 1, 2, 9, 8
*ELGEN, ELSET = DMBA
1, 6, 1, 1, 3, 7, 8
*ELEMENT, TYPE = S4R, ELSET = DMBB
21, 7, 41, 42, 14
22, 14, 42, 43, 21
23, 21, 43, 44, 28
24, 28, 44, 45, 27
25, 27, 45, 46, 26
26, 26, 46, 47, 25
27, 25, 47, 48, 24
28, 24, 48, 49, 23
29, 23, 49, 50, 22
30, 22, 50, 51, 15
31, 15, 51, 52, 8
32, 8, 52, 53, 1
41, 41, 61, 62, 42
*ELGEN, ELSET = DMBB
41, 12, 1, 1, 3, 20, 20
*ELSET, ELSET = DMB
DMBA, DMBB
*SHELL SECTION, ELSET = DMB, MATERIAL = ST
0,0478
**
** GENERATE THE DRUM CYLINDRICAL WALL
**
** NODES
**
*NCOPY,SHIFT,CHANGE NU=40,OLD SET = DMB3,NEW SET = L1
0,0, 0,0, 2,0
0,0, 0,0, 0,0, 0,0, 0,0, 1,0, 0,0
*NCOPY,SHIFT,CHANGE NU = 300,OLD SET = L1,NEW SET = L2
0,0, 0,0, 30,0
0,0, 0,0, 0,0, 0,0, 0,0, 1,0, 0,0
*NCOPY,SHIFT,CHANGE NU=40,OLD SET = L2,NEW SET = L3
0,0, 0,0, 2,0
0,0, 0,0, 0,0, 0,0, 0,0, 1,0, 0,0
*NFILL, NSET = DMW1
DMB3, L1, 2, 20
*NFILL, NSET = DMW2
L1, L2, 15, 20
*NFILL, NSET = DMW3
L2, L3, 2, 20
*NODE, NSET = DMW4
501, 11,5000, 0,0, 34.5
701, 11,5000, 0,0, 35.0
*NCOPY,SHIFT,MULTIPLE = 12,CHANGE NU = + 1,OLD SET = DMW4,NEW SET = DMW4
0,0, 0,0, 0,0
0,0, 0,0, 0,0, 0,0, 0,0, 1,0, +15.00
*NSSET, NSET = DMW
DMW1, DMW2, DMW3, DMW4
**
** ELEMENTS
**
*ELEMENT, TYPE = S4R, ELSET = DMW1
101, 101, 121, 122, 102
*ELGEN, ELSET = DMW1
101, 12, 1, 1, 2, 20, 20
*ELEMENT, TYPE = S4R, ELSET = DMW2
141, 141, 161, 162, 142
*ELGEN, ELSET = DMW2
141, 12, 1, 1, 15, 20, 20
*ELEMENT, TYPE = S4R, ELSET = DMW3
441, 441, 461, 462, 442
*ELGEN, ELSET = DMW3
441, 12, 1, 1, 2, 20, 20
*ELEMENT, TYPE = S4R, ELSET = DMW4
481, 481, 501, 502, 482
501, 501, 701, 702, 502
*ELGEN, ELSET = DMW4
481, 12, 1, 1
501, 12, 1, 1

```

```

*ELSET, ELSET = DMW
DMW1, DMW2, DMW3, DMW4
*SHELL SECTION, ELSET = DMW, MATERIAL = ST
0.0478
**
** GENERATE THE NODES OF DRUM LID
**
**NCPY,SHIFT,CHANGE NU = 1000,OLD SET = DMB,NEW SET = DML
0.0, 0.0, 34.50
0.0, 0.0, 0.0, 0.0, 0.0, 1.0, 0.0
** MODIFY NODES
*NODE, NSET = DML
1101, 10.5000, 0.0, 34.50
1102, 10.1422, 2.7176, 34.50
1103, 9.0933, 5.2500, 34.50
1104, 7.4246, 7.4246, 34.50
1105, 5.2500, 9.0933, 34.50
1106, 2.7176, 10.1422, 34.50
1107, 0.0, 10.5000, 34.50
1108, -2.7176, 10.1422, 34.50
1109, -5.2500, 9.0933, 34.50
1110, -7.4246, 7.4246, 34.50
1111, -9.0933, 5.2500, 34.50
1112, -10.1422, 2.7176, 34.50
1113, -10.5000, 0.0, 34.50
**
** GENERATE THE DRUM LID
**
*ELEMENT, TYPE = S4R
1001, 1001, 1002, 1009, 1008
*ELGEN, ELSET = DMLA
1001, 6, 1, 1, 3, 7, 6
*ELEMENT, TYPE = S4R, ELSET = DMLB
1021, 1007, 1041, 1042, 1014
1022, 1014, 1042, 1043, 1021
1023, 1021, 1043, 1044, 1028
1024, 1028, 1044, 1045, 1027
1025, 1027, 1045, 1046, 1025
1026, 1026, 1046, 1047, 1025
1027, 1025, 1047, 1048, 1024
1028, 1024, 1048, 1049, 1023
1029, 1023, 1049, 1050, 1022
1030, 1022, 1050, 1051, 1015
1031, 1015, 1051, 1052, 1008
1032, 1008, 1052, 1053, 1001
*ELEMENT, TYPE = S4R
1041, 1041, 1061, 1062, 1042
*ELGEN, ELSET = DMLC
1041, 12, 1, 1, 2, 20, 20
*ELEMENT, TYPE = S4R
1081, 1081, 1101, 1102, 1082
*ELGEN, ELSET = DMLD
1081, 12, 1, 1
*ELSET, ELSET = DML
DMLA, DMLB, DMLC, DMLD
*SHELL SECTION, ELSET = DML, MATERIAL = ST
0.0478
*NSET, NSET = DM
DMB, DMW, DML
*ELSET, ELSET = DM
DMB, DMW, DML
*****
** CLOSING RING, DRUM LID, AND DRUM ASSEMBLY
*****
*NODE, NSET = RING
601, 11.7500, 0.0, 34.0670
621, 11.9330, 0.0, 34.2500
641, 12.0000, 0.0, 34.5000
661, 11.9330, 0.0, 34.7500
681, 11.7500, 0.0, 34.9330
701, 11.5000, 0.0, 35.0000
721, 11.2500, 0.0, 34.9330
741, 11.0670, 0.0, 34.7500
**NCPY,SHIFT,MULTIPLE = 12,CHANGE NU = +1,OLD SET = RING,NEW SET = RING
0.0, 0.0, 0.0
0.0, 0.0, 0.0, 0.0, 0.0, 1.0, +15.00
*ELEMENT, TYPE = S4R
601, 481, 482, 602, 601

```

```

621, 601, 602, 622, 621
721, 701, 702, 722, 721
761, 741, 742, 1102, 1101
*ELGEN, ELSET=RING1
601, 12, 1, 1
621, 12, 1, 1, 5, 20, 20
*ELGEN, ELSET=RING2
721, 12, 1, 1, 2, 20, 20
761, 12, 1, 1
*ELSET, ELSET=RING
RING1, RING2
*SHELL SECTION, ELSET=RING1, MATERIAL=ST
0.50
*SHELL SECTION, ELSET=RING2, MATERIAL=ST
0.35
*****
** CLOSING RING BOLT
*****
*NODE, NSET=BOLT
1501, 11.500, 0.0, 34.500
1502, 11.500, 0.5, 34.500
*ELEMENT, TYPE=T3D2, ELSET=BOLT
1501, 1501, 1502
*SOLID SECTION, ELSET=BOLT, MATERIAL=BOLT
0.226
*MPC
TIE,601,1502
TIE,621,1502
TIE,641,1502
TIE,661,1502
TIE,681,1502
*EQUATION
2
1501,1,1,0,1502,1,-1.0
*EQUATION
2
1501,3,1,0,1502,3,-1.0
*****
** PAYLOAD
*****
*NODE, SYSTEM=R
*NODE
2001, -4.0, 0.0, 0.024
2005, 4.0, 0.0, 0.024
2011, -4.0, 4.0, 0.024
2015, 4.0, 4.0, 0.024
*NGEN, NSET=LINEC
2001, 2005, 1
*NGEN, NSET=LINED
2011, 2015, 1
*NFILL, NSET=PAYB1
LINEC, LINED, 2, 5
*NODE, NSET=PAYB2
2021, 7.625, 0.0, 0.024
2022, 7.1968, 3.1526, 0.024
2023, 5.9775, 5.9775, 0.024
2024, 3.1526, 7.1968, 0.024
2025, 0.0, 7.625, 0.024
2026, -3.1526, 7.1968, 0.024
2027, -5.9775, 5.9775, 0.024
2028, -7.1968, 3.1526, 0.024
2029, -7.625, 0.0, 0.024
*NODE, NSET=PAYB3
2031, 11.25, 0.0, 0.024
2032, 10.394, 4.3052, 0.024
2033, 7.9550, 7.9550, 0.024
2034, 4.3052, 10.394, 0.024
2035, 0.0, 11.25, 0.024
2036, -4.3052, 10.394, 0.024
2037, -7.9550, 7.9550, 0.024
2038, -10.394, 4.3052, 0.024
2039, -11.25, 0.0, 0.024
*NSET, NSET=PAYB
PAYB1, PAYB2, PAYB3
*ELEMENT, TYPE=54R
2001, 2001, 2002, 2007, 2006
*ELGEN, ELSET=PAYB1
2001, 4, 1, 1, 2, 5, 5

```



```

*ELEMENT, TYPE=S4R, ELSET=PAYB2
2011, 2005, 2021, 2022, 2010
2012, 2010, 2022, 2023, 2015
2013, 2015, 2023, 2024, 2014
2014, 2014, 2024, 2025, 2013
2015, 2013, 2025, 2026, 2012
2016, 2012, 2026, 2027, 2011
2017, 2011, 2027, 2028, 2006
2018, 2006, 2028, 2029, 2001
*ELEMENT, TYPE=S4R
2021, 2021, 2031, 2032, 2022
*ELGEN, ELSET=PAYB2
2021, 8, 1, 1
*ELSET, ELSET=PAYB
PAYB1, PAYB2
*SHELL SECTION, ELSET=PAYB, MATERIAL=PAYLD
0.0478
*****
*NCOPY,SHIFT,CHANGE NU=100,OLD SET=PAYB3,NEW SET=PAYW1
0.0, 0.0, 33.25
0.0, 0.0, 0.0, 0.0, 0.0, 1.0, 0.0
*NFILL, NSET=PAYW
PAYB3, PAYW1, 10, 10
*ELEMENT, TYPE=S4R
2031, 2031, 2041, 2042, 2032
*ELGEN, ELSET=PAYW
2031, 8, 1, 1, 10, 10, 10
*SHELL SECTION, ELSET=PAYW, MATERIAL=PAYLD
0.0478
*****
*NCOPY,SHIFT,CHANGE NU=200,OLD SET=PAYB,NEW SET=PAYT
0.0, 0.0, 33.25
0.0, 0.0, 0.0, 0.0, 0.0, 1.0, 0.0
*ELEMENT, TYPE=S4R
2201, 2201, 2202, 2207, 2206
*ELGEN, ELSET=PAYT1
2201, 4, 1, 1, 2, 5, 5
*ELEMENT, TYPE=S4R, ELSET=PAYT2
2211, 2205, 2221, 2222, 2210
2212, 2210, 2222, 2223, 2215
2213, 2215, 2223, 2224, 2214
2214, 2214, 2224, 2225, 2213
2215, 2213, 2225, 2226, 2212
2216, 2212, 2226, 2227, 2211
2217, 2211, 2227, 2228, 2206
2218, 2206, 2228, 2229, 2201
*ELEMENT, TYPE=S4R
2221, 2221, 2131, 2132, 2222
*ELGEN, ELSET=PAYT2
2221, 8, 1, 1
*ELSET, ELSET=PAYT
PAYT1, PAYT2
*ELSET, ELSET=PAY
PAYB, PAYW, PAYT
*NSET, NSET=PAY
PAYB, PAYW, PAYT
*SHELL SECTION, ELSET=PAYT, MATERIAL=PAYLD
0.0478
*****
** GENERATE THE ELEMENTS OF CONCRETE PAD
** 10' X 10' RECTANGULAR HALF SECTION (NO INF)
**
*NODE, SYSTEM=R
*NODE, NSET=C1
160001, -60.0, 0.0, -8.0
*NODE, NSET=C2
160004, -45.0, 0.0, -8.0
*NODE, NSET=C3
160034, 45.0, 0.0, -8.0
*NODE, NSET=C4
160037, 60.0, 0.0, -8.0
*NFILL, NSET=LINE1
C1, C2, 3
C2, C3, 30
C3, C4, 3
*NCOPY,SHIFT,CHANGE NU=500,OLD SET=LINE1,NEW SET=LINE2
0.0, 30.0, 0.0
0.0, 0.0, 0.0, 0.0, 0.0, 1.0, 0.0

```

```

*NCOPY,SHIFT,CHANGE NU = 300,OLD SET = LINE2,NEW SET = LINE3
0.0, 30.0, 0.0
0.0, 0.0, 0.0, 0.0, 0.0, 1.0, 0.0
**FILL, NSET = CONC1
LINE1, LINE2, 10, 50
LINE2, LINE3, 6, 60
*NCOPY,SHIFT,CHANGE NU = 2000,OLD SET = CONC1,NEW SET = CONC2
0.0, 0.0, 2.0
0.0, 0.0, 0.0, 0.0, 0.0, 1.0, 0.0
*NCOPY,SHIFT,CHANGE NU = 2000,OLD SET = CONC2,NEW SET = CONC3
0.0, 0.0, 2.0
0.0, 0.0, 0.0, 0.0, 0.0, 1.0, 0.0
*NCOPY,SHIFT,CHANGE NU = 2000,OLD SET = CONC3,NEW SET = CONC4
0.0, 0.0, 2.0
0.0, 0.0, 0.0, 0.0, 0.0, 1.0, 0.0
*NCOPY,SHIFT,CHANGE NU = 2000,OLD SET = CONC4,NEW SET = CONC5
0.0, 0.0, 2.0
0.0, 0.0, 0.0, 0.0, 0.0, 1.0, 0.0
**NSET,NSET = CONC0
CONC1, CONC2, CONC3, CONC4, CONC5,
**
** GENERATE THE SOIL NODES
**
*NCOPY, SHIFT, CHANGE NU = 20000, OLD SET = CONC1, NEW SET = SOIL1
0.0, 0.0, -50.0
0.0, 0.0, 0.0, 0.0, 0.0, 1.0, 0.0
*NCOPY, SHIFT, CHANGE NU = 2000, OLD SET = SOIL1, NEW SET = SOIL2
0.0, 0.0, +20.0
0.0, 0.0, 0.0, 0.0, 0.0, 1.0, 0.0
*NCOPY, SHIFT, CHANGE NU = 2000, OLD SET = SOIL2, NEW SET = SOIL3
0.0, 0.0, +10.0
0.0, 0.0, 0.0, 0.0, 0.0, 1.0, 0.0
*NCOPY, SHIFT, CHANGE NU = 2000, OLD SET = SOIL3, NEW SET = SOIL4
0.0, 0.0, +10.0
0.0, 0.0, 0.0, 0.0, 0.0, 1.0, 0.0
*NCOPY, SHIFT, CHANGE NU = 2000, OLD SET = SOIL4, NEW SET = SOIL5
0.0, 0.0, +5.0
0.0, 0.0, 0.0, 0.0, 0.0, 1.0, 0.0
**NSET,NSET = SOILO
SOIL1, SOIL2, SOIL3, SOIL4, SOIL5
**
** GENERATE THE INCLINED IMPACT SURFACES
**
*NCOPY,SHIFT,CHANGE NU = -100000,OLD SET = CONC0,NEW SET = CONC
12.000, 0., 34.8
12.000, 0., 34.8, 12.000, 1., 34.8, -146.31
*NCOPY,SHIFT, CHANGE NU = -100000, OLD SET = SOILO, NEW SET = SOIL
12.000, 0., 34.8
12.000, 0., 34.8, 12.000, 1., 34.8, -146.31
**
** CONCRETE PAD ELEMENT
**
*ELEMENT, TYPE = C3D8R
60001, 60001, 60002, 60052, 60051, 62001, 62002, 62052, 62051
*ELGEN, ELSET = CONC1
60001, 36, 1, 1, 16, 50, 50
*ELCOPY,OLD SET = CONC1,NEW SET = CONC2,ELEMENT SH = 2000,SHIFT NO = 2000
*ELCOPY,OLD SET = CONC2,NEW SET = CONC3,ELEMENT SH = 2000,SHIFT NO = 2000
*ELCOPY,OLD SET = CONC3,NEW SET = CONC4,ELEMENT SH = 2000,SHIFT NO = 2000
*ELSET, ELSET = CONC
CONC1, CONC2, CONC3, CONC4,
*SOLID SECTION, ELSET = CONC, MATERIAL = CONCRETE
**
** GENERATE REBARS
**
*REBAR,ELEM = CONTINUUM,MAT = REBAR,GEOM = ISOPARAMETRIC,NAME = LX
CONC1,0.60,12.0,0.0,1.0,4,2
*REBAR,ELEM = CONTINUUM,MAT = REBAR,GEOM = ISOPARAMETRIC,NAME = LY
CONC1,0.60,12.0,90.,1.0,4,2
*REBAR,ELEM = CONTINUUM,MAT = REBAR,GEOM = ISOPARAMETRIC,NAME = UX
CONC4,0.60,12.0,0.0,0.0,4,2
*REBAR,ELEM = CONTINUUM,MAT = REBAR,GEOM = ISOPARAMETRIC,NAME = UY
CONC4,0.60,12.0,90.,0.0,4,2
**
** GENERATE THE SOIL
**
*ELCOPY,OLD SET = CONC1,NEW SET = SOIL1,ELEMENT SH = 20000,SHIFT NO = 20000
*ELCOPY,OLD SET = SOIL1,NEW SET = SOIL2,ELEMENT SH = 2000,SHIFT NO = 2000

```

```

*ELCOPY,OLD SET=SOIL2,NEW SET=SOIL3,ELEMENT SH=2000,SHIFT NO=2000
*ELCOPY,OLD SET=SOIL3,NEW SET=SOIL4,ELEMENT SH=2000,SHIFT NO=2000
*ELEMENT, TYPE=C3D6, ELSET=SOIL5
*ELEMENT, TYPE=C3D8R
88001, 88001, 88002, 88052, 88051, 60001, 60002, 60052, 60051
*ELGEN, ELSET=SOIL5
88001, 36, 1, 1, 16, 50, 50
*ELSET, ELSET=SOIL
SOIL1, SOIL2, SOIL3, SOIL4, SOIL5
*SOLID SECTION, ELSET=SOIL, MATERIAL=SOIL
*****
**
**  ASTM A36
**
*MATERIAL, NAME=ST
*ELASTIC
29.0E6, 0.3
*PLASTIC
36000., 0.
60000., 0.23
30000., 0.24
10000., 0.25
5000., 0.26
1000., 0.27
*DENSITY
7.5052E-4
*FAILURE
0.30, 0.25
**
**  CLOSING RING BOLT MATERIAL
**  ASTM A307, GR. C
**
*MATERIAL, NAME=BOLT
*ELASTIC
29.0E6, 0.3
*PLASTIC
36000.0, 0.0
60000.0, 0.23
*DENSITY
7.5052E-4
*MATERIAL, NAME=PAYLD
*ELASTIC
29.0E6, 0.3
*DENSITY
0.02437
*material,name=concrete
** 4000 PSI CONCRETE
*density
1.95E-04
*elastic
3.6E+06,0.15
*drucker prager
35.1,1.0,35.1
*drucker prager hardening
2250.,0.0
3900.,0.0013
3000.,0.0024
2400.,0.0034
1790.,0.0044
1180.,0.0054
800.,0.006
100.,0.0061
*material,name=soil
*density
1.647E-04
*elastic
5700.,0.35
*drucker prager
35.2,0.82,35.2
*drucker prager hardening
2.0,0.0
6.54,0.0055
8.64,0.0156
9.96,0.0259
10.68,0.0362
10.98,0.0467
11.1,0.0573
11.04,0.068

```

10.8,0.0788
10.44,0.0887
9.9,0.1
9.0,0.112
**
** REBAR STEEL
**
*MATERIAL, NAME = REBAR
*DENSITY
7.34E-4
*ELASTIC
29.5E6, 0.30
*PLASTIC
71170., 0.0
71626., 0.004985
83130., 0.017098
96460., 0.036202
104728., 0.055113
109080., 0.073795
***FAILURE
**0.30, 0.03
**
** ELEMENT SET DEFINITIONS
**
*ELSET, ELSET = ALLEL
DMB, DMW, DML
RING, BOLT
PAY,
**
** NODE SET DEFINITIONS
**
*NSET, NSET = ALLND
DMB, DMW, DML
RING, BOLT
PAY,
*NSET, NSET = YSYMM, GENERATE
6001, 80037, 1
6201, 82037, 1
6401, 84037, 1
6601, 86037, 1
6801, 88037, 1
8001, 80037, 1
8201, 82037, 1
8401, 84037, 1
8601, 86037, 1
8801, 88037, 1
*NSET, NSET = YSYMM, GENERATE
1, 7, 1
41, 53, 12
61, 73, 12
81, 93, 12
101, 501, 20
113, 513, 20
613, 693, 20
701, 741, 20
713, 753, 20
1001, 1007, 1
1041, 1053, 12
1061, 1073, 12
1081, 1093, 12
1101, 1113, 12
1501, 1501, 1
2001, 2005, 1
2021, 2029, 8
2031, 2131, 10
2039, 2139, 10
2201, 2205, 1
2221, 2229, 8
*NSET, NSET = SOILBT, GENERATE
80001, 80837, 1
*NSET, NSET = CONC5, GENERATE
68001, 68837, 1
*BOUNDARY
YSYMM, YSYMM
SOILBT, 1, 3

*INITIAL CONDITIONS, TYPE = VELOCITY
ALLND, 1, 292.88

```

ALLND,3,439.32
*STEP
*DYNAMIC,EXPLICIT
,20.0E-03
**
** DEFINE THE CONTACT SURFACES BETWEEN
** THE DRUM BOTTOM AND TARGET
**
*SURFACE DEFINITION,NAME=CONC4T
CONC4,S2
*SURFACE DEFINITION,NAME=DMOUT,NO THICK
DMB,SNEG
DMW1,SNEG
DMW2,SNEG
DMW3,SNEG
RING,SPOS
DML,SPOS
*CONTACT PAIR
CONC4T,DMOUT
**
** DEFINE THE CONTACT SURFACES BETWEEN
** THE DRUM INSIDE AND PAYLOAD OUTSIDE
**
*SURFACE DEFINITION,NAME=DMINS,NO THICK
DMB,SPOS
DMW1,SPOS
DMW2,SPOS
DMW3,SPOS
DMW4,SPOS
RING2,SNEG
DML,SNEG
*SURFACE DEFINITION,NAME=PAYOUT,NO THICK
PAYB,SNEG
PAYW,SNEG
PAYT,SPOS
*CONTACT PAIR
DMINS,PAYOUT
*****
*NSET,NSET=DMDIS,GENERATE
4,4,1
1004,1004,1
661,661,1
101,113,3
301,313,3
541,553,3
*ELSET,ELSET=DMBST,GENERATE
61,66,1
81,86,1
*ELSET,ELSET=DMBST
DMBA,
*ELSET,ELSET=DMWST,GENERATE
101,106,1
121,126,1
141,421,20
142,422,20
143,423,20
441,446,1
461,466,1
481,486,1
501,506,1
*ELSET,ELSET=DMLST,GENERATE
1061,1066,1
1081,1086,1
*ELSET,ELSET=DMLST
DMLA,
*ELSET,ELSET=RINGST,GENERATE
601,606,1
621,626,1
641,646,1
661,666,1
681,686,1
701,706,1
721,726,1
741,746,1
761,766,1
*ELSET,ELSET=BOLTST,GENERATE
1501,1501,1
*****

```

*HISTORY OUTPUT, TIME=5.E-5
*NODE HISTORY, NSET=DMDIS
U, V, A
*EL HISTORY, ELSET = DMBST
MISES,
PEEQ,
SENER,
PENER,
*EL HISTORY, ELSET = DMWST
MISES,
PEEQ,
SENER,
PENER,
*EL HISTORY, ELSET = DMLST
MISES,
PEEQ,
SENER,
PENER,
*EL HISTORY, ELSET = RINGST
MISES,
PEEQ,
SENER,
PENER,
*EL HISTORY, ELSET = BOLTST
MISES,
PEEQ,
SENER,
PENER,
*FILE OUTPUT, NUMBER INTERVAL = 100
*NODE FILE
RF,
*MONITOR,NODE=307,DOF=3
*END STEP
-



CHECKLIST FOR CHECKING OF ANALYSIS/CALCULATIONS

Document Number/Revision: HNF-2209/Rev. 0

Document Title: DOT-17H 55 Gallon Drum 30 MPH Top Corner Drop

Yes	No	N/A	
<input checked="" type="checkbox"/>	<input type="checkbox"/>	<input type="checkbox"/>	Problem completely defined.
<input checked="" type="checkbox"/>	<input type="checkbox"/>	<input type="checkbox"/>	Appropriate analytical method used.
<input checked="" type="checkbox"/>	<input type="checkbox"/>	<input type="checkbox"/>	Necessary assumptions are appropriate and explicitly stated.
<input checked="" type="checkbox"/>	<input type="checkbox"/>	<input type="checkbox"/>	Computer codes and data files documented.
<input checked="" type="checkbox"/>	<input type="checkbox"/>	<input type="checkbox"/>	Data used in calculations explicitly stated in document.
<input type="checkbox"/>	<input type="checkbox"/>	<input checked="" type="checkbox"/>	Sources of non-standard formula/data are referenced and the correctness of the reference verified.
<input checked="" type="checkbox"/>	<input type="checkbox"/>	<input type="checkbox"/>	Data checked for consistency with original source information as applicable.
<input type="checkbox"/>	<input type="checkbox"/>	<input checked="" type="checkbox"/>	Mathematical derivations checked including dimensional consistency of results.
<input checked="" type="checkbox"/>	<input type="checkbox"/>	<input type="checkbox"/>	Models appropriate and used within range of validity or use outside range of established validity justified.
<input type="checkbox"/>	<input type="checkbox"/>	<input checked="" type="checkbox"/>	Hand calculations checked for errors.
<input checked="" type="checkbox"/>	<input type="checkbox"/>	<input type="checkbox"/>	Code run streams correct and consistent with analysis documentation.
<input checked="" type="checkbox"/>	<input type="checkbox"/>	<input type="checkbox"/>	Code output consistent with input and with results reported in analysis documentation.
<input checked="" type="checkbox"/>	<input type="checkbox"/>	<input type="checkbox"/>	Acceptability limits on analytical results applicable and supported. Limits checked against sources.
<input checked="" type="checkbox"/>	<input type="checkbox"/>	<input type="checkbox"/>	Safety Margins consistent with good engineering practices.
<input checked="" type="checkbox"/>	<input type="checkbox"/>	<input type="checkbox"/>	Conclusions consistent with analytical results and applicable limits.
<input checked="" type="checkbox"/>	<input type="checkbox"/>	<input type="checkbox"/>	Results and conclusions address all points required in the problem statement.

I have checked the analysis/calculation and it is complete and accurate to the best of my knowledge.

Engineer/Checker Scott Shiraga  Date 09/01/98

NOTE: Any hand calculations, notes or summaries generated as part of this check should be signed, dated, and attached to this checklist. Material should be labeled and recorded so that it is intelligible to a technically qualified third party.

7.7.1.7 55-Gal Drum/30-Mil Wall Thickness 30-Ft Top-Corner Drop.

```

*HEADING
FILE=DTC30X 3/18/98
55 GALLON DRUM/30 MIL THICKNESS, 30 MPH (30-FT) TOP CORNER DROP
*RESTART, WRITE, NUMBER INTERVAL=10
*****
** DRUM
*****
**
** GENERATE THE NODES OF DRUM BOTTOM PLATE
**
*NODE, SYSTEM=R
*NODE
1, -3.6, 0.0, 0.0
7, 3.6, 0.0, 0.0
22, -3.6, 3.6, 0.0
28, 3.6, 3.6, 0.0
*NGEN, NSET=LINEA
1, 7, 1
*NGEN, NSET=LINEB
22, 28, 1
*NFILL, NSET=DMB1
LINEA, LINEB, 3, 7
*NODE, NSET=DMB2
41, 5.4417, 0.0, 0.0
42, 5.3380, 1.5872, 0.0
43, 5.0342, 3.1208, 0.0
44, 4.5508, 4.5508, 0.0
45, 3.1208, 5.0342, 0.0
46, 1.5872, 5.3380, 0.0
47, 0.0, 5.4417, 0.0
48, -1.5872, 5.3380, 0.0
49, -3.1208, 5.0342, 0.0
50, -4.5508, 4.5508, 0.0
51, -5.0342, 3.1208, 0.0
52, -5.3380, 1.5872, 0.0
53, -5.4417, 0.0, 0.0
61, 7.2833, 0.0, 0.0
62, 7.0760, 1.9745, 0.0
63, 6.4683, 3.8417, 0.0
64, 5.5016, 5.5016, 0.0
65, 3.8417, 6.4683, 0.0
66, 1.9745, 7.0760, 0.0
67, 0.0, 7.2833, 0.0
68, -1.9745, 7.0760, 0.0
69, -3.8417, 6.4683, 0.0
70, -5.5016, 5.5016, 0.0
71, -6.4683, 3.8417, 0.0
72, -7.0760, 1.9745, 0.0
73, -7.2833, 0.0, 0.0
81, 9.6000, 0.0, 0.0
82, 9.2729, 2.4847, 0.0
83, 8.3138, 4.8000, 0.0
84, 6.7882, 6.7882, 0.0
85, 4.8000, 8.3138, 0.0
86, 2.4847, 9.2729, 0.0
87, 0.0, 9.6000, 0.0
88, -2.4847, 9.2729, 0.0
89, -4.8000, 8.3138, 0.0
90, -6.7882, 6.7882, 0.0
91, -8.3138, 4.8000, 0.0
92, -9.2729, 2.4847, 0.0
93, -9.6000, 0.0, 0.0
*NODE, NSET=DMB3
101, 11.5000, 0.0, 0.0
102, 11.1081, 2.9764, 0.0
103, 9.9593, 5.7500, 0.0
104, 8.1317, 8.1317, 0.0
105, 5.7500, 9.9593, 0.0
106, 2.9764, 11.1081, 0.0
107, 0.0, 11.5000, 0.0
108, -2.9764, 11.1081, 0.0
109, -5.7500, 9.9593, 0.0
110, -8.1317, 8.1317, 0.0
111, -9.9593, 5.7500, 0.0
112, -11.1081, 2.9764, 0.0

```



```

113, -11.5000, 0.0, 0.0
*NSET, NSET = DMB
DMB1, DMB2, DMB3
**
** GENERATE THE ELEMENTS OF DRUM BOTTOM PLATE
**
*ELEMENT, TYPE = S4R
1, 1, 2, 9, 8
*ELGEN, ELSET = DMBA
1, 6, 1, 1, 3, 7, 6
*ELEMENT, TYPE = S4R, ELSET = DMBB
21, 7, 41, 42, 14
22, 14, 42, 43, 21
23, 21, 43, 44, 28
24, 28, 44, 45, 27
25, 27, 45, 46, 26
26, 26, 46, 47, 25
27, 25, 47, 48, 24
28, 24, 48, 49, 23
29, 23, 49, 50, 22
30, 22, 50, 51, 15
31, 15, 51, 52, 8
32, 8, 52, 53, 1
41, 41, 61, 62, 42
*ELGEN, ELSET = DMBB
41, 12, 1, 1, 3, 20, 20
*ELSET, ELSET = DMB
DMBA, DMBB
*SHELL SECTION, ELSET = DMB, MATERIAL = ST
0.030
**
** GENERATE THE DRUM CYLINDRICAL WALL
**
** NODES
**
**
*NCOPY, SHIFT, CHANGE NU = 40, OLD SET = DMB3, NEW SET = L1
0.0, 0.0, 2.0
0.0, 0.0, 0.0, 0.0, 0.0, 1.0, 0.0
*NCOPY, SHIFT, CHANGE NU = 300, OLD SET = L1, NEW SET = L2
0.0, 0.0, 30.0
0.0, 0.0, 0.0, 0.0, 0.0, 1.0, 0.0
*NCOPY, SHIFT, CHANGE NU = 40, OLD SET = L2, NEW SET = L3
0.0, 0.0, 2.0
0.0, 0.0, 0.0, 0.0, 0.0, 1.0, 0.0
*NFILL, NSET = DMW1
DMB3, L1, 2, 20
*NFILL, NSET = DMW2
L1, L2, 15, 20
*NFILL, NSET = DMW3
L2, L3, 2, 20
*NODE, NSET = DMW4
501, 11.5000, 0.0, 34.5
701, 11.5000, 0.0, 35.0
*NCOPY, SHIFT, MULTIPLE = 12, CHANGE NU = +1, OLD SET = DMW4, NEW SET = DMW4
0.0, 0.0, 0.0
0.0, 0.0, 0.0, 0.0, 0.0, 1.0, +15.00
*NSET, NSET = DMW
DMW1, DMW2, DMW3, DMW4
**
** ELEMENTS
**
*ELEMENT, TYPE = S4R, ELSET = DMW1
101, 101, 121, 122, 102
*ELGEN, ELSET = DMW1
101, 12, 1, 1, 2, 20, 20
*ELEMENT, TYPE = S4R, ELSET = DMW2
141, 141, 161, 162, 142
*ELGEN, ELSET = DMW2
141, 12, 1, 1, 15, 20, 20
*ELEMENT, TYPE = S4R, ELSET = DMW3
441, 441, 461, 462, 442
*ELGEN, ELSET = DMW3
441, 12, 1, 1, 2, 20, 20
*ELEMENT, TYPE = S4R, ELSET = DMW4
481, 481, 501, 502, 482
501, 501, 701, 702, 502
*ELGEN, ELSET = DMW4
481, 12, 1, 1

```

```

501, 12, 1, 1
*ELSET, ELSET = DMW
DMW1, DMW2, DMW3, DMW4
*SHELL SECTION, ELSET = DMW, MATERIAL = ST
0.030
**
** GENERATE THE NODES OF DRUM LID
**
*NCOPY, SHIFT, CHANGE NU = 1000, OLD SET = DMB, NEW SET = DML
0.0, 0.0, 34.50
0.0, 0.0, 0.0, 0.0, 0.0, 1.0, 0.0
** MODIFY NODES
*NODE, NSET = DML
1101, 10.5000, 0.0, 34.50
1102, 10.1422, 2.7176, 34.50
1103, 9.0933, 5.2500, 34.50
1104, 7.4246, 7.4246, 34.50
1105, 5.2500, 9.0933, 34.50
1106, 2.7176, 10.1422, 34.50
1107, 0.0, 10.5000, 34.50
1108, -2.7176, 10.1422, 34.50
1109, -5.2500, 9.0933, 34.50
1110, -7.4246, 7.4246, 34.50
1111, -9.0933, 5.2500, 34.50
1112, -10.1422, 2.7176, 34.50
1113, -10.5000, 0.0, 34.50
**
** GENERATE THE DRUM LID
**
*ELEMENT, TYPE = S4R
1001, 1001, 1002, 1009, 1008
*ELGEN, ELSET = DMLA
1001, 6, 1, 1, 3, 7, 6
*ELEMENT, TYPE = S4R, ELSET = DMLB
1021, 1007, 1041, 1042, 1014
1022, 1014, 1042, 1043, 1021
1023, 1021, 1043, 1044, 1028
1024, 1028, 1044, 1045, 1027
1025, 1027, 1045, 1046, 1026
1026, 1026, 1046, 1047, 1025
1027, 1025, 1047, 1048, 1024
1028, 1024, 1048, 1049, 1023
1029, 1023, 1049, 1050, 1022
1030, 1022, 1050, 1051, 1015
1031, 1015, 1051, 1052, 1008
1032, 1008, 1052, 1053, 1001
*ELEMENT, TYPE = S4R
1041, 1041, 1061, 1062, 1042
*ELGEN, ELSET = DMLC
1041, 12, 1, 1, 2, 20, 20
*ELEMENT, TYPE = S4R
1081, 1081, 1101, 1102, 1082
*ELGEN, ELSET = DMLD
1081, 12, 1, 1
*ELSET, ELSET = DML
DMLA, DMLB, DMLC, DMLD
*SHELL SECTION, ELSET = DML, MATERIAL = ST
0.030
*NSET, NSET = DM
DMB, DMW, DML
*ELSET, ELSET = DM
DMB, DMW, DML
*****
** CLOSING RING, DRUM LID, AND DRUM ASSEMBLY
*****
*NODE, NSET = RING
601, 11.7500, 0.0, 34.0670
621, 11.9330, 0.0, 34.2500
641, 12.0000, 0.0, 34.5000
661, 11.9330, 0.0, 34.7500
681, 11.7500, 0.0, 34.9330
701, 11.5000, 0.0, 35.0000
721, 11.2500, 0.0, 34.9330
741, 11.0670, 0.0, 34.7500
*NCOPY, SHIFT, MULTIPLE = 12, CHANGE NU = + 1, OLD SET = RING, NEW SET = RING
0.0, 0.0, 0.0
0.0, 0.0, 0.0, 0.0, 1.0, + 15.00
*ELEMENT, TYPE = S4R

```

```

601, 481, 482, 602, 601
621, 601, 602, 622, 621
721, 701, 702, 722, 721
761, 741, 742, 1102, 1101
*ELGEN, ELSET=RING1
601, 12, 1, 1
621, 12, 1, 1, 5, 20, 20
*ELGEN, ELSET=RING2
721, 12, 1, 1, 2, 20, 20
761, 12, 1, 1
*ELSET, ELSET=RING
RING1, RING2
*SHELL SECTION, ELSET=RING1, MATERIAL=ST
0.50
*SHELL SECTION, ELSET=RING2, MATERIAL=ST
0.35
*****
** CLOSING RING BOLT
*****
*NODE, NSET=BOLT
1501, 11.500, 0.0, 34.500
1502, 11.500, 0.5, 34.600
*ELEMENT, TYPE=T3D2, ELSET=BOLT
1501, 1501, 1502
*SOLID SECTION, ELSET=BOLT, MATERIAL=BOLT
0.226
*MPC
TIE,601,1502
TIE,621,1502
TIE,641,1502
TIE,661,1502
TIE,681,1502
*EQUATION
2
1501,1,1,0,1502,1,-1.0
*EQUATION
2
1501,3,1,0,1502,3,-1.0
*****
** PAYLOAD
*****
*NODE, SYSTEM=R
*NODE
2001, -4.0, 0.0, 0.024
2005, 4.0, 0.0, 0.024
2011, -4.0, 4.0, 0.024
2015, 4.0, 4.0, 0.024
*NGEN, NSET=LINEC
2001, 2005, 1
*NGEN, NSET=LINED
2011, 2015, 1
*NFILL, NSET=PAYB1
LINEC, LINED, 2, 5
*NODE, NSET=PAYB2
2021, 7.625, 0.0, 0.024
2022, 7.1968, 3.1526, 0.024
2023, 5.9775, 5.9775, 0.024
2024, 3.1526, 7.1968, 0.024
2025, 0.0, 7.625, 0.024
2026, -3.1526, 7.1968, 0.024
2027, -5.9775, 5.9775, 0.024
2028, -7.1968, 3.1526, 0.024
2029, -7.625, 0.0, 0.024
*NODE, NSET=PAYB3
2031, 11.25, 0.0, 0.024
2032, 10.394, 4.3052, 0.024
2033, 7.9550, 7.9550, 0.024
2034, 4.3052, 10.394, 0.024
2035, 0.0, 11.25, 0.024
2036, -4.3052, 10.394, 0.024
2037, -7.9550, 7.9550, 0.024
2038, -10.394, 4.3052, 0.024
2039, -11.25, 0.0, 0.024
*NSSET, NSET=PAYB
PAYB1, PAYB2, PAYB3
*ELEMENT, TYPE=S4R
2001, 2001, 2002, 2007, 2006
*ELGEN, ELSET=PAYB1

```

```

2001, 4, 1, 1, 2, 5, 5
*ELEMENT, TYPE=S4R, ELSET=PAYB2
2011, 2005, 2021, 2022, 2010
2012, 2010, 2022, 2023, 2015
2013, 2015, 2023, 2024, 2014
2014, 2014, 2024, 2025, 2013
2015, 2013, 2025, 2026, 2012
2016, 2012, 2026, 2027, 2011
2017, 2011, 2027, 2028, 2006
2018, 2006, 2028, 2029, 2001
*ELEMENT, TYPE=S4R
2021, 2021, 2031, 2032, 2022
*ELGEN, ELSET=PAYB2
2021, 8, 1, 1
*ELSET, ELSET=PAYB
PAYB1, PAYB2
*SHELL SECTION, ELSET=PAYB, MATERIAL=PAYLD
0.030
*****
*NCOPY,SHIFT,CHANGE NU=100,OLD SET=PAYB3,NEW SET=PAYW1
0.0, 0.0, 33.25
0.0, 0.0, 0.0, 0.0, 0.0, 1.0, 0.0
*NFILL, NSET=PAYW
*PAYB3, PAYW1, 10, 10
*ELEMENT, TYPE=S4R
2031, 2031, 2041, 2042, 2032
*ELGEN, ELSET=PAYW
2031, 8, 1, 1, 10, 10, 10
*SHELL SECTION, ELSET=PAYW, MATERIAL=PAYLD
0.030
*****
*NCOPY,SHIFT,CHANGE NU=200,OLD SET=PAYB,NEW SET=PAYT
0.0, 0.0, 33.25
0.0, 0.0, 0.0, 0.0, 0.0, 1.0, 0.0
*ELEMENT, TYPE=S4R
2201, 2201, 2202, 2207, 2206
*ELGEN, ELSET=PAYT1
2201, 4, 1, 1, 2, 5, 5
*ELEMENT, TYPE=S4R, ELSET=PAYT2
2211, 2205, 2221, 2222, 2210
2212, 2210, 2222, 2223, 2215
2213, 2215, 2223, 2224, 2214
2214, 2214, 2224, 2225, 2213
2215, 2213, 2225, 2226, 2212
2216, 2212, 2226, 2227, 2211
2217, 2211, 2227, 2228, 2206
2218, 2206, 2228, 2229, 2201
*ELEMENT, TYPE=S4R
2221, 2221, 2131, 2132, 2222
*ELGEN, ELSET=PAYT2
2221, 8, 1, 1
*ELSET, ELSET=PAYT
PAYT1, PAYT2
*ELSET, ELSET=PAY
PAYB, PAYW, PAYT
*NSET, NSET=PAY
PAYB, PAYW, PAYT
*SHELL SECTION, ELSET=PAYT, MATERIAL=PAYLD
0.030
*****
** GENERATE THE ELEMENTS OF CONCRETE PAD
** 10' X 10' RECTANGULAR HALF SECTION (NO INF)
**
*NODE, SYSTEM=R
*NODE, NSET=C1
160001, -60.0, 0.0, -8.0
*NODE, NSET=C2
160004, -45.0, 0.0, -8.0
*NODE, NSET=C3
160034, 45.0, 0.0, -8.0
*NODE, NSET=C4
160037, 60.0, 0.0, -8.0
*NFILL, NSET=LINE1
C1, C2, 3
C2, C3, 30
C3, C4, 3
*NCOPY,SHIFT,CHANGE NU=500,OLD SET=LINE1,NEW SET=LINE2
0.0, 30.0, 0.0

```

```

0.0, 0.0, 0.0, 0.0, 0.0, 1.0, 0.0
*NCOPY,SHIFT,CHANGE NU = 300,OLD SET = LINE2,NEW SET = LINE3
0.0, 30.0, 0.0
0.0, 0.0, 0.0, 0.0, 0.0, 1.0, 0.0
*NFILL, NSET = CONC1
LINE1, LINE2, 10, 50
LINE2, LINE3, 6, 50
*NCOPY,SHIFT,CHANGE NU = 2000,OLD SET = CONC1,NEW SET = CONC2
0.0, 0.0, 2.0
0.0, 0.0, 0.0, 0.0, 0.0, 1.0, 0.0
*NCOPY,SHIFT,CHANGE NU = 2000,OLD SET = CONC2,NEW SET = CONC3
0.0, 0.0, 2.0
0.0, 0.0, 0.0, 0.0, 0.0, 1.0, 0.0
*NCOPY,SHIFT,CHANGE NU = 2000,OLD SET = CONC3,NEW SET = CONC4
0.0, 0.0, 2.0
0.0, 0.0, 0.0, 0.0, 0.0, 1.0, 0.0
*NCOPY,SHIFT,CHANGE NU = 2000,OLD SET = CONC4,NEW SET = CONC5
0.0, 0.0, 2.0
0.0, 0.0, 0.0, 0.0, 0.0, 1.0, 0.0
*NSET,NSET = CONCO
CONC1, CONC2, CONC3, CONC4, CONC5,
**
** GENERATE THE SOIL NODES
**
*NCOPY, SHIFT, CHANGE NU = 20000, OLD SET = CONC1, NEW SET = SOIL1
0.0, 0.0, -50.0
0.0, 0.0, 0.0, 0.0, 0.0, 1.0, 0.0
*NCOPY, SHIFT, CHANGE NU = 2000, OLD SET = SOIL1, NEW SET = SOIL2
0.0, 0.0, +20.0
0.0, 0.0, 0.0, 0.0, 0.0, 1.0, 0.0
*NCOPY, SHIFT, CHANGE NU = 2000, OLD SET = SOIL2, NEW SET = SOIL3
0.0, 0.0, +10.0
0.0, 0.0, 0.0, 0.0, 0.0, 1.0, 0.0
*NCOPY, SHIFT, CHANGE NU = 2000, OLD SET = SOIL3, NEW SET = SOIL4
0.0, 0.0, +10.0
0.0, 0.0, 0.0, 0.0, 0.0, 1.0, 0.0
*NCOPY, SHIFT, CHANGE NU = 2000, OLD SET = SOIL4, NEW SET = SOIL5
0.0, 0.0, +5.0
0.0, 0.0, 0.0, 0.0, 0.0, 1.0, 0.0
*NSET,NSET = SOILO
SOIL1, SOIL2, SOIL3, SOIL4, SOIL5
**
** GENERATE THE INCLINED IMPACT SURFACES
**
*NCOPY,SHIFT,CHANGE NU = -100000,OLD SET = CONCO,NEW SET = CONC
12.000, 0., 34.8
12.000, 0., 34.8, 12.000, 1., 34.8, -146.31
*NCOPY,SHIFT, CHANGE NU = -100000, OLD SET = SOILO, NEW SET = SOIL
12.000, 0., 34.8
12.000, 0., 34.8, 12.000, 1., 34.8, -146.31
**
** CONCRETE PAD ELEMENT
**
*ELEMENT, TYPE = C3D8R
60001, 60001, 60002, 60052, 60051, 62001, 62002, 62052, 62051
*ELGEN, ELSET = CONC1
60001, 36, 1, 1, 16, 50, 50
*ELCOPY,OLD SET = CONC1,NEW SET = CONC2,ELEMENT SH = 2000,SHIFT NO = 2000
*ELCOPY,OLD SET = CONC2,NEW SET = CONC3,ELEMENT SH = 2000,SHIFT NO = 2000
*ELCOPY,OLD SET = CONC3,NEW SET = CONC4,ELEMENT SH = 2000,SHIFT NO = 2000
*ELSET, ELSET = CONC
CONC1, CONC2, CONC3, CONC4,
*SOLID SECTION, ELSET = CONC, MATERIAL = CONCRETE
**
** GENERATE REBARS
**
*REBAR,ELEM = CONTINUUM,MAT = REBAR,GEOM = ISOPARAMETRIC,NAME = LX
CONC1,0.60,12.0,0.0,1.0,4,2
*REBAR,ELEM = CONTINUUM,MAT = REBAR,GEOM = ISOPARAMETRIC,NAME = LY
CONC1,0.60,12.0,90.,1.0,4,2
*REBAR,ELEM = CONTINUUM,MAT = REBAR,GEOM = ISOPARAMETRIC,NAME = UX
CONC4,0.60,12.0,0.0,0.0,4,2
*REBAR,ELEM = CONTINUUM,MAT = REBAR,GEOM = ISOPARAMETRIC,NAME = UY
CONC4,0.60,12.0,90.,0.0,4,2
**
** GENERATE THE SOIL
**
*ELCOPY,OLD SET = CONC1,NEW SET = SOIL1,ELEMENT SH = 20000,SHIFT NO = 20000

```

```

*ELCOPY,OLD SET = SOIL1,NEW SET = SOIL2,ELEMENT SH = 2000,SHIFT NO = 2000
*ELCOPY,OLD SET = SOIL2,NEW SET = SOIL3,ELEMENT SH = 2000,SHIFT NO = 2000
*ELCOPY,OLD SET = SOIL3,NEW SET = SOIL4,ELEMENT SH = 2000,SHIFT NO = 2000
*ELEMENT, TYPE = C3D8, ELSET = SOIL5
*ELEMENT, TYPE = C3D8R
88001, 88001, 88002, 88052, 88051, 60001, 60002, 60052, 60051
*ELGEN, ELSET = SOIL5
88001, 36, 1, 1, 16, 50, 50
*ELSET, ELSET = SOIL
SOIL1, SOIL2, SOIL3, SOIL4, SOIL5
*SOLID SECTION, ELSET = SOIL, MATERIAL = SOIL
*****
**
** ASTM A36
**
*MATERIAL, NAME = ST
*DENSITY
7.5052E-4
*ELASTIC
29.0E6, 0.3
*PLASTIC
36000., 0.
60000., 0.23
30000., 0.24
10000., 0.25
5000., 0.26
1000., 0.27
*FAILURE
0.30, 0.25
**
** CLOSING RING BOLT MATERIAL
** ASTM A307, GR. C
**
*MATERIAL, NAME = BOLT
*DENSITY
7.5052E-4
*ELASTIC
29.0E6, 0.3
*PLASTIC
36000.0, 0.0
60000.0, 0.23
*MATERIAL, NAME = PAYLD
*DENSITY
0.01110
*ELASTIC
29.0E6, 0.3
*material,name = concrete
** 4000 PSI CONCRETE
*density
1.95E-04
*elastic
3.6E+06,0.15
*drucker prager
35.1,1.0,35.1
*drucker prager hardening
2250.,0.0
3900.,0.0013
3000.,0.0024
2400.,0.0034
1790.,0.0044
1180.,0.0054
800.,0.006
100.,0.0061
*material,name = soil
*density
1.847E-04
*elastic
5700.,0.35
*drucker prager
35.2,0.82,35.2
*drucker prager hardening
2.0,0.0
6.54,0.0055
8.64,0.0156
9.96,0.0259
10.88,0.0362
10.98,0.0467
11.1,0.0573

```

```

11.04,0.068
10.8,0.0788
10.44,0.0897
9.9,0.1
9.0,0.112
**
** REBAR STEEL
**
**MATERIAL, NAME=REBAR
**DENSITY
7.34E-4
**ELASTIC
29.5E6, 0.30
**PLASTIC
71170., 0.0
71626., 0.004985
83130., 0.017098
96460., 0.036202
104728., 0.055113
109080., 0.073795
***FAILURE
**0.30, 0.03
**
** ELEMENT SET DEFINITIONS
**
**ELSET,ELSET=ALLEL
DMB, DMW, DML
RING, BOLT
PAY,
**
** NODE SET DEFINITIONS
**
**NSET,NSET=ALLND
DMB, DMW, DML
RING, BOLT
PAY,
**NSET,NSET=YSYMM,GENERATE
60001,80037,1
62001,82037,1
64001,84037,1
66001,86037,1
68001,88037,1
80001,80037,1
82001,82037,1
84001,84037,1
86001,86037,1
88001,88037,1
**NSET,NSET=YSYMM,GENERATE
1, 7, 1
41, 53, 12
61, 73, 12
81, 93, 12
101, 501, 20
113, 513, 20
613, 693, 20
701, 741, 20
713, 753, 20
1001, 1007, 1
1041, 1053, 12
1061, 1073, 12
1081, 1093, 12
1101, 1113, 12
1501, 1501, 1
2001, 2005, 1
2021, 2029, 8
2031, 2131, 10
2039, 2139, 10
2201, 2205, 1
2221, 2229, 8
**NSET,NSET=SOILBT,GENERATE
80001,80837,1
**NSET,NSET=CONC5,GENERATE
68001,68837,1
**BOUNDARY
YSYMM,YSYMM
SOILBT,1,3
*****
**INITIAL CONDITIONS,TYPE=VELOCITY

```

```

ALLND,1,292.88
ALLND,3,439.32
*STEP
*DYNAMIC,EXPLICIT
,20.0E-03
**
** DEFINE THE CONTACT SURFACES BETWEEN
** THE DRUM BOTTOM AND TARGET
**
*SURFACE DEFINITION,NAME = CONC4T
CONC4,S2
*SURFACE DEFINITION,NAME = DMOUT,NO THICK
DMB,SNEG
DMW1,SNEG
DMW2,SNEG
DMW3,SNEG
RING,SPOS
DML,SPOS
*CONTACT PAIR
CONC4T,DMOUT
**
** DEFINE THE CONTACT SURFACES BETWEEN
** THE DRUM INSIDE AND PAYLOAD OUTSIDE
**
*SURFACE DEFINITION,NAME = DMINS,NO THICK
DMB,SPOS
DMW1,SPOS
DMW2,SPOS
DMW3,SPOS
DMW4,SPOS
RING2,SNEG
DML,SNEG
*SURFACE DEFINITION,NAME = PAYOUT,NO THICK
PAYB,SNEG
PAYW,SNEG
PAYT,SPOS
*CONTACT PAIR
DMINS,PAYOUT
*****
*NSET,NSET = DMDIS,GENERATE
4,4,1
1004,1004,1
661,661,1
101,113,3
301,313,3
541,553,3
*ELSET,ELSET = DMBST,GENERATE
61,66,1
81,86,1
*ELSET,ELSET = DMBST
DMBA,
*ELSET,ELSET = DMWST,GENERATE
101,106,1
121,126,1
141,421,20
142,422,20
143,423,20
441,446,1
461,466,1
481,486,1
501,506,1
*ELSET,ELSET = DMLST,GENERATE
1061,1066,1
1081,1086,1
*ELSET,ELSET = DMLST
DMLA,
*ELSET,ELSET = RINGST,GENERATE
601,606,1
621,626,1
641,646,1
661,666,1
681,686,1
701,706,1
721,726,1
741,746,1
761,766,1
*ELSET,ELSET = BOLTST,GENERATE
1501,1501,1

```



```
*****  
*HISTORY OUTPUT, TIME=1,E-4  
*NODE HISTORY, NSET=DMDIS  
U, V, A  
*EL HISTORY, ELSET=DMBST  
SP,  
LEP,  
SENER,  
PENER,  
*EL HISTORY, ELSET=DMWST  
SP,  
LEP,  
SENER,  
PENER,  
*EL HISTORY, ELSET=DMLST  
SP,  
LEP,  
SENER,  
PENER,  
*EL HISTORY, ELSET=RINGST  
SP,  
LEP,  
SENER,  
PENER,  
*EL HISTORY, ELSET=BOLTST  
SP,  
LEP,  
SENER,  
PENER,  
*FILE OUTPUT, NUMBER INTERVAL=100  
*NODE FILE  
RF,  
*MONITOR,NODE=307,DOF=3  
*END STEP  
-
```



CHECKLIST FOR CHECKING OF ANALYSIS/CALCULATIONS

Document Number/Revision: HNF-2209/Rev. 0

Document Title: 55 Gallon Drum/30-mil Wall Thickness 30-ft Top Corner Drop

Yes	No	N/A	
<input checked="" type="checkbox"/>	<input type="checkbox"/>	<input type="checkbox"/>	Problem completely defined.
<input checked="" type="checkbox"/>	<input type="checkbox"/>	<input type="checkbox"/>	Appropriate analytical method used.
<input checked="" type="checkbox"/>	<input type="checkbox"/>	<input type="checkbox"/>	Necessary assumptions are appropriate and explicitly stated.
<input checked="" type="checkbox"/>	<input type="checkbox"/>	<input type="checkbox"/>	Computer codes and data files documented.
<input checked="" type="checkbox"/>	<input type="checkbox"/>	<input type="checkbox"/>	Data used in calculations explicitly stated in document.
<input type="checkbox"/>	<input type="checkbox"/>	<input checked="" type="checkbox"/>	Sources of non-standard formula/data are referenced and the correctness of the reference verified.
<input checked="" type="checkbox"/>	<input type="checkbox"/>	<input type="checkbox"/>	Data checked for consistency with original source information as applicable.
<input type="checkbox"/>	<input type="checkbox"/>	<input checked="" type="checkbox"/>	Mathematical derivations checked including dimensional consistency of results.
<input checked="" type="checkbox"/>	<input type="checkbox"/>	<input type="checkbox"/>	Models appropriate and used within range of validity or use outside range of established validity justified.
<input type="checkbox"/>	<input type="checkbox"/>	<input checked="" type="checkbox"/>	Hand calculations checked for errors.
<input checked="" type="checkbox"/>	<input type="checkbox"/>	<input type="checkbox"/>	Code run streams correct and consistent with analysis documentation.
<input checked="" type="checkbox"/>	<input type="checkbox"/>	<input type="checkbox"/>	Code output consistent with input and with results reported in analysis documentation.
<input checked="" type="checkbox"/>	<input type="checkbox"/>	<input type="checkbox"/>	Acceptability limits on analytical results applicable and supported. Limits checked against sources.
<input checked="" type="checkbox"/>	<input type="checkbox"/>	<input type="checkbox"/>	Safety Margins consistent with good engineering practices.
<input checked="" type="checkbox"/>	<input type="checkbox"/>	<input type="checkbox"/>	Conclusions consistent with analytical results and applicable limits.
<input checked="" type="checkbox"/>	<input type="checkbox"/>	<input type="checkbox"/>	Results and conclusions address all points required in the problem statement.

I have checked the analysis/calculation and it is complete and accurate to the best of my knowledge.

Engineer/Checker Scott Shiraga

Date 09/01/98

NOTE: Any hand calculations, notes or summaries generated as part of this check should be signed, dated, and attached to this checklist. Material should be labeled and recorded so that it is intelligible to a technically qualified third party.

7.7.1.8 DOT-17H 55-Gal Drum 40-MPH Top-Corner Drop.

```

*HEADING
DOT-17H 55 GALLON DRUM, 40 MPH TOP CORNER DROP, FILE=DTC400
*RESTART, WRITE, NUMBER INTERVAL=10
*****
** DRUM
*****
**
** GENERATE THE NODES OF DRUM BOTTOM PLATE
**
*NODE, SYSTEM=R
*NODE
1, -3.6, 0.0, 0.0
7, 3.6, 0.0, 0.0
22, -3.6, 3.6, 0.0
28, 3.6, 3.6, 0.0
*NGEN, NSET=LINEA
1, 7, 1
*NGEN, NSET=LINEB
22, 28, 1
*NFill, NSET=DMB1
LINEA, LINEB, 3, 7
*NODE, NSET=DMB2
41, 5.4417, 0.0, 0.0
42, 5.3380, 1.5872, 0.0
43, 5.0342, 3.1208, 0.0
44, 4.5508, 4.5508, 0.0
45, 3.1208, 5.0342, 0.0
46, 1.5872, 5.3380, 0.0
47, 0.0, 5.4417, 0.0
48, -1.5872, 5.3380, 0.0
49, -3.1208, 5.0342, 0.0
50, -4.5508, 4.5508, 0.0
51, -5.0342, 3.1208, 0.0
52, -5.3380, 1.5872, 0.0
53, -5.4417, 0.0, 0.0
61, 7.2833, 0.0, 0.0
62, 7.0760, 1.9745, 0.0
63, 6.4683, 3.8417, 0.0
64, 5.5016, 5.5016, 0.0
65, 3.8417, 6.4683, 0.0
66, 1.9745, 7.0760, 0.0
67, 0.0, 7.2833, 0.0
68, -1.9745, 7.0760, 0.0
69, -3.8417, 6.4683, 0.0
70, -5.5016, 5.5016, 0.0
71, -6.4683, 3.8417, 0.0
72, -7.0760, 1.9745, 0.0
73, -7.2833, 0.0, 0.0
81, 9.6000, 0.0, 0.0
82, 9.2729, 2.4847, 0.0
83, 8.3138, 4.8000, 0.0
84, 6.7882, 6.7882, 0.0
85, 4.8000, 8.3138, 0.0
86, 2.4847, 9.2729, 0.0
87, 0.0, 9.6000, 0.0
88, -2.4847, 9.2729, 0.0
89, -4.8000, 8.3138, 0.0
90, -6.7882, 6.7882, 0.0
91, -8.3138, 4.8000, 0.0
92, -9.2729, 2.4847, 0.0
93, -9.6000, 0.0, 0.0
*NODE, NSET=DMB3
101, 11.5000, 0.0, 0.0
102, 11.1081, 2.9764, 0.0
103, 9.9593, 5.7500, 0.0
104, 8.1317, 8.1317, 0.0
105, 5.7500, 9.9593, 0.0
106, 2.9764, 11.1081, 0.0
107, 0.0, 11.5000, 0.0
108, -2.9764, 11.1081, 0.0
109, -5.7500, 9.9593, 0.0
110, -8.1317, 8.1317, 0.0
111, -9.9593, 5.7500, 0.0
112, -11.1081, 2.9764, 0.0
113, -11.5000, 0.0, 0.0

```

```

* NSET, NSET = DMB
DMB1, DMB2, DMB3
**
** GENERATE THE ELEMENTS OF DRUM BOTTOM PLATE
**
* ELEMENT, TYPE = S4R
1, 1, 2, 9, 8
* ELGEN, ELSET = DMBA
1, 8, 1, 1, 3, 7, 6
* ELEMENT, TYPE = S4R, ELSET = DMBB
21, 7, 41, 42, 14
22, 14, 42, 43, 21
23, 21, 43, 44, 28
24, 28, 44, 45, 27
25, 27, 45, 46, 26
26, 26, 46, 47, 25
27, 25, 47, 48, 24
28, 24, 48, 49, 23
29, 23, 49, 50, 22
30, 22, 50, 51, 15
31, 15, 51, 52, 8
32, 8, 52, 53, 1
41, 41, 61, 62, 42
* ELGEN, ELSET = DMBB
41, 12, 1, 1, 3, 20, 20
* ELSET, ELSET = DMB
DMBA, DMBB
* SHELL SECTION, ELSET = DMB, MATERIAL = ST
0.0478
**
** GENERATE THE DRUM CYLINDRICAL WALL
**
** NODES
**
* NCOPY, SHIFT, CHANGE NU = 40, OLD SET = DMB3, NEW SET = L1
0.0, 0.0, 2.0
0.0, 0.0, 0.0, 0.0, 0.0, 1.0, 0.0
* NCOPY, SHIFT, CHANGE NU = 300, OLD SET = L1, NEW SET = L2
0.0, 0.0, 30.0
0.0, 0.0, 0.0, 0.0, 0.0, 1.0, 0.0
* NCOPY, SHIFT, CHANGE NU = 40, OLD SET = L2, NEW SET = L3
0.0, 0.0, 2.0
0.0, 0.0, 0.0, 0.0, 0.0, 1.0, 0.0
* NFILL, NSET = DMW1
DMB3, L1, 2, 20
* NFILL, NSET = DMW2
L1, L2, 15, 20
* NFILL, NSET = DMW3
L2, L3, 2, 20
* NODE, NSET = DMW4
501, 11, 5000, 0.0, 34.5
701, 11, 5000, 0.0, 35.0
* NCOPY, SHIFT, MULTIPLE = 12, CHANGE NU = +1, OLD SET = DMW4, NEW SET = DMW4
0.0, 0.0, 0.0
0.0, 0.0, 0.0, 0.0, 0.0, 1.0, +15.00
* NSET, NSET = DMW
DMW1, DMW2, DMW3, DMW4
**
** ELEMENTS
**
* ELEMENT, TYPE = S4R, ELSET = DMW1
101, 101, 121, 122, 102
* ELGEN, ELSET = DMW1
101, 12, 1, 1, 2, 20, 20
* ELEMENT, TYPE = S4R, ELSET = DMW2
141, 141, 161, 162, 142
* ELGEN, ELSET = DMW2
141, 12, 1, 1, 15, 20, 20
* ELEMENT, TYPE = S4R, ELSET = DMW3
441, 441, 461, 462, 442
* ELGEN, ELSET = DMW3
441, 12, 1, 1, 2, 20, 20
* ELEMENT, TYPE = S4R, ELSET = DMW4
481, 481, 501, 502, 482
501, 501, 701, 702, 502
* ELGEN, ELSET = DMW4
481, 12, 1, 1
501, 12, 1, 1

```

```

*ELSET, ELSET =DMW
DMW1, DMW2, DMW3, DMW4
*SHELL SECTION, ELSET =DMW, MATERIAL =ST
0.0478
**
** GENERATE THE NODES OF DRUM LID
**
**NCPY,SHIFT,CHANGE NU = 1000,OLD SET =DMB,NEW SET =DML
0.0, 0.0, 34.50
0.0, 0.0, 0.0, 0.0, 0.0, 1.0, 0.0
** MODIFY NODES
*NODE, NSET =DML
1101, 10.5000, 0.0, 34.50
1102, 10.1422, 2.7176, 34.50
1103, 9.0933, 5.2500, 34.50
1104, 7.4246, 7.4246, 34.50
1105, 5.2500, 9.0933, 34.50
1106, 2.7176, 10.1422, 34.50
1107, 0.0, 10.5000, 34.50
1108, -2.7176, 10.1422, 34.50
1109, -5.2500, 9.0933, 34.50
1110, -7.4246, 7.4246, 34.50
1111, -9.0933, 5.2500, 34.50
1112, -10.1422, 2.7176, 34.50
1113, -10.5000, 0.0, 34.50
**
** GENERATE THE DRUM LID
**
*ELEMENT, TYPE =S4R
1001, 1001, 1002, 1009, 1008
*ELGEN, ELSET =DMLA
1001, 6, 1, 1, 3, 7, 6
*ELEMENT, TYPE =S4R, ELSET =DMLB
1021, 1007, 1041, 1042, 1014
1022, 1014, 1042, 1043, 1021
1023, 1021, 1043, 1044, 1028
1024, 1028, 1044, 1045, 1027
1025, 1027, 1045, 1046, 1026
1026, 1026, 1046, 1047, 1025
1027, 1025, 1047, 1048, 1024
1028, 1024, 1048, 1049, 1023
1029, 1023, 1049, 1050, 1022
1030, 1022, 1050, 1051, 1015
1031, 1015, 1051, 1052, 1008
1032, 1008, 1052, 1053, 1001
*ELEMENT, TYPE =S4R
1041, 1041, 1061, 1062, 1042
*ELGEN, ELSET =DMLC
1041, 12, 1, 1, 2, 20, 20
*ELEMENT, TYPE =S4R
1081, 1081, 1101, 1102, 1082
*ELGEN, ELSET =DMLD
1081, 12, 1, 1
*ELSET, ELSET =DML
DMLA, DMLB, DMLC, DMLD
*SHELL SECTION, ELSET =DML, MATERIAL =ST
0.0478
*NSET, NSET =DM
DMB, DMW, DML
*ELSET, ELSET =DM
DMB, DMW, DML
*****
** CLOSING RING, DRUM LID, AND DRUM ASSEMBLY
*****
*NODE, NSET =RING
601, 11.7500, 0.0, 34.0670
621, 11.9330, 0.0, 34.2500
641, 12.0000, 0.0, 34.5000
661, 11.9330, 0.0, 34.7500
681, 11.7500, 0.0, 34.9330
701, 11.5000, 0.0, 35.0000
721, 11.2500, 0.0, 34.9330
741, 11.0670, 0.0, 34.7500
*NCPY,SHIFT,MULTIPLE =12,CHANGE NU = +1,OLD SET =RING,NEW SET =RING
0.0, 0.0, 0.0
0.0, 0.0, 0.0, 0.0, 0.0, 1.0, +15.00
*ELEMENT, TYPE =S4R
601, 481, 482, 602, 601

```

```

621, 601, 602, 622, 621
721, 701, 702, 722, 721
761, 741, 742, 1102, 1101
*ELGEN, ELSET=RING1
601, 12, 1, 1
621, 12, 1, 1, 5, 20, 20
*ELGEN, ELSET=RING2
721, 12, 1, 1, 2, 20, 20
761, 12, 1, 1
*ELSET, ELSET=RING
RING1, RING2
*SHELL SECTION, ELSET=RING1, MATERIAL=ST
0.50
*SHELL SECTION, ELSET=RING2, MATERIAL=ST
0.35
*****
** CLOSING RING BOLT
*****
*NODE, NSET=BOLT
1501, 11.500, 0.0, 34.500
1502, 11.500, 0.5, 34.500
*ELEMENT, TYPE=TRD2, ELSET=BOLT
1501, 1501, 1502
*SOLID SECTION, ELSET=BOLT, MATERIAL=BOLT
0.226
*MPC
TIE,601,1502
TIE,621,1502
TIE,641,1502
TIE,661,1502
TIE,681,1502
*EQUATION
2
1501,1,1,0,1502,1,-1.0
*EQUATION
2
1501,3,1,0,1502,3,-1.0
*****
** PAYLOAD
*****
*NODE, SYSTEM=R
*NODE
2001, -4.0, 0.0, 0.024
2005, 4.0, 0.0, 0.024
2011, -4.0, 4.0, 0.024
2015, 4.0, 4.0, 0.024
*NGEN, NSET=LINEC
2001, 2005, 1
*NGEN, NSET=LINED
2011, 2015, 1
*NFILL, NSET=PAYB1
LINEC, LINED, 2, 5
*NODE, NSET=PAYB2
2021, 7.625, 0.0, 0.024
2022, 7.1968, 3.1526, 0.024
2023, 5.9775, 5.9775, 0.024
2024, 3.1526, 7.1968, 0.024
2025, 0.0, 7.625, 0.024
2026, -3.1526, 7.1968, 0.024
2027, -5.9775, 5.9775, 0.024
2028, -7.1968, 3.1526, 0.024
2029, -7.625, 0.0, 0.024
*NODE, NSET=PAYB3
2031, 11.25, 0.0, 0.024
2032, 10.394, 4.3052, 0.024
2033, 7.9550, 7.9550, 0.024
2034, 4.3052, 10.394, 0.024
2035, 0.0, 11.25, 0.024
2036, -4.3052, 10.394, 0.024
2037, -7.9550, 7.9550, 0.024
2038, -10.394, 4.3052, 0.024
2039, -11.25, 0.0, 0.024
*NSET, NSET=PAYB
PAYB1, PAYB2, PAYB3
*ELEMENT, TYPE=R3D4
2001, 2001, 2002, 2007, 2006
*ELGEN, ELSET=PAYB1
2001, 4, 1, 1, 2, 5, 5

```

```

*ELEMENT, TYPE=R3D4, ELSET=PAYB2
2011, 2005, 2021, 2022, 2010
2012, 2010, 2022, 2023, 2015
2013, 2015, 2023, 2024, 2014
2014, 2014, 2024, 2025, 2013
2015, 2013, 2025, 2026, 2012
2016, 2012, 2026, 2027, 2011
2017, 2011, 2027, 2028, 2006
2018, 2006, 2028, 2029, 2001
*ELEMENT, TYPE=R3D4
2021, 2021, 2031, 2032, 2022
*ELGEN, ELSET=PAYB2
2021, 8, 1, 1
*ELSET, ELSET=PAYB
PAYB1, PAYB2
***SHELL SECTION, ELSET=PAYB, MATERIAL=PAYLD
**0.0478
*****
*NCOPY, SHIFT, CHANGE NU = 100, OLD SET=PAYB3, NEW SET=PAYW1
0.0, 0.0, 33.25
0.0, 0.0, 0.0, 0.0, 0.0, 1.0, 0.0
*NFILL, NSET=PAYW
PAYB3, PAYW1, 10, 10
*ELEMENT, TYPE=R3D4
2031, 2031, 2041, 2042, 2032
*ELGEN, ELSET=PAYW
2031, 8, 1, 1, 10, 10, 10
***SHELL SECTION, ELSET=PAYW, MATERIAL=PAYLD
**0.0478
*****
*NCOPY, SHIFT, CHANGE NU = 200, OLD SET=PAYB, NEW SET=PAYT
0.0, 0.0, 33.25
0.0, 0.0, 0.0, 0.0, 0.0, 1.0, 0.0
*ELEMENT, TYPE=R3D4
2201, 2201, 2202, 2207, 2206
*ELGEN, ELSET=PAYT1
2201, 4, 1, 1, 2, 5, 5
*ELEMENT, TYPE=R3D4, ELSET=PAYT2
2211, 2205, 2221, 2222, 2210
2212, 2210, 2222, 2223, 2215
2213, 2215, 2223, 2224, 2214
2214, 2214, 2224, 2225, 2213
2215, 2213, 2225, 2226, 2212
2216, 2212, 2226, 2227, 2211
2217, 2211, 2227, 2228, 2206
2218, 2206, 2228, 2229, 2201
*ELEMENT, TYPE=R3D4
2221, 2221, 2131, 2132, 2222
*ELGEN, ELSET=PAYT2
2221, 8, 1, 1
*ELSET, ELSET=PAYT
PAYT1, PAYT2
*ELSET, ELSET=PAY
PAYB, PAYW, PAYT
*NSET, NSET=PAY
PAYB, PAYW, PAYT
***SHELL SECTION, ELSET=PAYT, MATERIAL=PAYLD
**0.0478
* RIGID BODY, ELSET=PAY, REF NODE=2000
*ELEMENT, TYPE=MASS, ELSET=MASS
2000, 2000
*MASS, ELSET=MASS
1.8159
*****
** GENERATE THE ELEMENTS OF CONCRETE PAD
** 10' X 10' RECTANGULAR HALF SECTION (NO INF)
**
*NODE, SYSTEM=R
*NODE, NSET=C1
160001, -60.0, 0.0, -8.0
*NODE, NSET=C2
160004, -45.0, 0.0, -8.0
*NODE, NSET=C3
160034, 45.0, 0.0, -8.0
*NODE, NSET=C4
160037, 60.0, 0.0, -8.0
*NFILL, NSET=LINE1
C1, C2, 3

```

```

C2, C3, 30
C3, C4, 3
*NCOPY,SHIFT,CHANGE NU = 500,OLD SET = LINE1,NEW SET = LINE2
0.0, 30.0, 0.0
0.0, 0.0, 0.0, 0.0, 0.0, 1.0, 0.0
*NCOPY,SHIFT,CHANGE NU = 300,OLD SET = LINE2,NEW SET = LINE3
0.0, 30.0, 0.0
0.0, 0.0, 0.0, 0.0, 0.0, 1.0, 0.0
*NFILL, NSET = CONC1
LINE1, LINE2, 10, 50
LINE2, LINE3, 6, 50
*NCOPY,SHIFT,CHANGE NU = 2000,OLD SET = CONC1,NEW SET = CONC2
0.0, 0.0, 2.0
0.0, 0.0, 0.0, 0.0, 0.0, 1.0, 0.0
*NCOPY,SHIFT,CHANGE NU = 2000,OLD SET = CONC2,NEW SET = CONC3
0.0, 0.0, 2.0
0.0, 0.0, 0.0, 0.0, 0.0, 1.0, 0.0
*NCOPY,SHIFT,CHANGE NU = 2000,OLD SET = CONC3,NEW SET = CONC4
0.0, 0.0, 2.0
0.0, 0.0, 0.0, 0.0, 0.0, 1.0, 0.0
*NCOPY,SHIFT,CHANGE NU = 2000,OLD SET = CONC4,NEW SET = CONC5
0.0, 0.0, 2.0
0.0, 0.0, 0.0, 0.0, 0.0, 1.0, 0.0
*NSET,NSET = CONC0
CONC1, CONC2, CONC3, CONC4, CONC5,
**
** GENERATE THE SOIL NODES
**
*NCOPY,SHIFT,CHANGE NU = 20000, OLD SET = CONC1, NEW SET = SOIL1
0.0, 0.0, -50.0
0.0, 0.0, 0.0, 0.0, 0.0, 1.0, 0.0
*NCOPY,SHIFT,CHANGE NU = 2000, OLD SET = SOIL1, NEW SET = SOIL2
0.0, 0.0, +20.0
0.0, 0.0, 0.0, 0.0, 0.0, 1.0, 0.0
*NCOPY,SHIFT,CHANGE NU = 2000, OLD SET = SOIL2, NEW SET = SOIL3
0.0, 0.0, +10.0
0.0, 0.0, 0.0, 0.0, 0.0, 1.0, 0.0
*NCOPY,SHIFT,CHANGE NU = 2000, OLD SET = SOIL3, NEW SET = SOIL4
0.0, 0.0, +10.0
0.0, 0.0, 0.0, 0.0, 0.0, 1.0, 0.0
*NCOPY,SHIFT,CHANGE NU = 2000, OLD SET = SOIL4, NEW SET = SOIL5
0.0, 0.0, +5.0
0.0, 0.0, 0.0, 0.0, 0.0, 1.0, 0.0
*NSET,NSET = SOIL0
SOIL1, SOIL2, SOIL3, SOIL4, SOIL5
**
** GENERATE THE INCLINED IMPACT SURFACES
**
*NCOPY,SHIFT,CHANGE NU = -100000,OLD SET = CONC0,NEW SET = CONC
12.000, 0., 34.8
12.000, 0., 34.8, 12.000, 1., 34.8, -146.31
*NCOPY,SHIFT,CHANGE NU = -100000, OLD SET = SOIL0, NEW SET = SOIL
12.000, 0., 34.8
12.000, 0., 34.8, 12.000, 1., 34.8, -146.31
**
** CONCRETE PAD ELEMENT
**
*ELEMENT,TYPE = C3D8R
60001, 60001, 60002, 60052, 60051, 62001, 62002, 62052, 62051
*ELGEN,ELSET = CONC1
60001, 36, 1, 1, 16, 50, 50
*ELCOPY,OLD SET = CONC1,NEW SET = CONC2,ELEMENT SH = 2000,SHIFT NO = 2000
*ELCOPY,OLD SET = CONC2,NEW SET = CONC3,ELEMENT SH = 2000,SHIFT NO = 2000
*ELCOPY,OLD SET = CONC3,NEW SET = CONC4,ELEMENT SH = 2000,SHIFT NO = 2000
*ELSET,ELSET = CONC
CONC1, CONC2, CONC3, CONC4.
*SOLID SECTION,ELSET = CONC, MATERIAL = CONCRETE
**
** GENERATE REBARS
**
*REBAR,ELEM = CONTINUUM,MAT = REBAR,GEOM = ISOPARAMETRIC,NAME = LX
CONC1,0.60,12.0,0.0,1.0,4,2
*REBAR,ELEM = CONTINUUM,MAT = REBAR,GEOM = ISOPARAMETRIC,NAME = LY
CONC1,0.60,12.0,90.,1.0,4,2
*REBAR,ELEM = CONTINUUM,MAT = REBAR,GEOM = ISOPARAMETRIC,NAME = UX
CONC4,0.60,12.0,0.0,0.0,4,2
*REBAR,ELEM = CONTINUUM,MAT = REBAR,GEOM = ISOPARAMETRIC,NAME = UY
CONC4,0.60,12.0,90.,0.0,4,2

```



```

**
** GENERATE THE SOIL
**
*ELCOPY,OLD SET = CONC1,NEW SET = SOIL1,ELEMENT SH = 20000,SHIFT NO = 20000
*ELCOPY,OLD SET = SOIL1,NEW SET = SOIL2,ELEMENT SH = 2000,SHIFT NO = 2000
*ELCOPY,OLD SET = SOIL2,NEW SET = SOIL3,ELEMENT SH = 2000,SHIFT NO = 2000
*ELCOPY,OLD SET = SOIL3,NEW SET = SOIL4,ELEMENT SH = 2000,SHIFT NO = 2000
*ELEMENT, TYPE = C3D6, ELSET = SOIL5
*ELEMENT, TYPE = C3D8R
88001, 88001, 88002, 88052, 88051, 60001, 60002, 60052, 60051
*ELGEN, ELSET = SOIL5
88001, 36, 1, 1, 16, 50, 50
*ELSET, ELSET = SOIL
SOIL1, SOIL2, SOIL3, SOIL4, SOIL5
*SOLID SECTION, ELSET = SOIL, MATERIAL = SOIL
*****
**
** ASTM A36
**
*MATERIAL, NAME = ST
*ELASTIC
29.0E6, 0.3
*PLASTIC
36000., 0.
60000., 0.23
30000., 0.24
10000., 0.25
5000., 0.26
1000., 0.27
*DENSITY
7.5052E-4
*FAILURE
0.30, 0.25
**
** CLOSING RING BOLT MATERIAL
** ASTM A307, GR. C
**
*MATERIAL, NAME = BOLT
*ELASTIC
29.0E6, 0.3
*PLASTIC
36000.0, 0.0
60000.0, 0.23
30000., 0.24
10000., 0.25
5000., 0.26
1000., 0.27
*DENSITY
7.5052E-4
*FAILURE
0.30, 0.25
*material,name = concrete
** 4000 PSI CONCRETE
*density
1.95E-04
*elastic
3.6E+06,0.15
*drucker prager
35.1,1,0,35.1
*drucker prager hardening
2250.,0.0
3900.,0.0013
3000.,0.0024
2400.,0.0034
1790.,0.0044
1180.,0.0054
800.,0.006
100.,0.0061
*material,name = soil
*density
1.647E-04
*elastic
5700.,0.35
*drucker prager
35.2,0.82,35.2
*drucker prager hardening
2,0,0.0
6.54,0.0055

```

```

8.64,0.0156
9.96,0.0259
10.68,0.0362
10.98,0.0467
11.1,0.0573
11.04,0.068
10.8,0.0788
10.44,0.0897
9.9,0.1
9.0,0.112
**
** REBAR STEEL
**
*MATERIAL, NAME=REBAR
*DENSITY
7.34E-4
*ELASTIC
29.5E6, 0.30
*PLASTIC
71170., 0.0
71626., 0.004985
83130., 0.017098
98480., 0.038202
104728., 0.055113
109080., 0.073795
***FAILURE
**0.30, 0.03
**
** ELEMENT SET DEFINITIONS
**
*ELSET,ELSET=ALLEL
DME, DMW, DML
RING, BOLT
PAY,
**
** NODE SET DEFINITIONS
**
*NSET,NSET=ALLND
DME, DMW, DML
RING, BOLT
PAY,
*NSET,NSET=YSYMM,GENERATE
60001,60037,1
62001,62037,1
64001,64037,1
68001,68037,1
68001,68037,1
80001,80037,1
82001,82037,1
84001,84037,1
86001,86037,1
88001,88037,1
*NSET,NSET=YSYMM,GENERATE
1, 7, 1
41, 53, 12
61, 73, 12
81, 93, 12
101, 501, 20
113, 513, 20
613, 693, 20
701, 741, 20
713, 753, 20
1001, 1007, 1
1041, 1053, 12
1061, 1073, 12
1081, 1093, 12
1101, 1113, 12
1501, 1501, 1
2000, 2000, 1
2001, 2005, 1
2021, 2029, 8
2031, 2131, 10
2039, 2139, 10
2201, 2205, 1
2221, 2229, 8
*NSET,NSET=SOILBT,GENERATE
80001,80837,1
*NSET,NSET=CONCS,GENERATE

```

```

68001,68837,1
*BOUNDARY
YSYMM,YSYMM
SOILBT,1,3
*****
*INITIAL CONDITIONS,TYPE=VELOCITY
ALLND,1,390.51
ALLND,3,585.76
2000,1,390.51
2000,3,585.76
*STEP
*DYNAMIC,EXPLICIT
,20.0E-03
**
** DEFINE THE CONTACT SURFACES BETWEEN
** THE DRUM BOTTOM AND TARGET
**
*SURFACE DEFINITION,NAME=CONC4T
CONC4,S2
*SURFACE DEFINITION,NAME=DMOUT,NO THICK
DMB,SNEG
DMW1,SNEG
DMW2,SNEG
DMW3,SNEG
RING,SPOS
DML,SPOS
*CONTACT PAIR
CONC4T,DMOUT
**
** DEFINE THE CONTACT SURFACES BETWEEN
** THE DRUM INSIDE AND PAYLOAD OUTSIDE
**
*SURFACE DEFINITION,NAME=DMINS,NO THICK
DMB,SPOS
DMW1,SPOS
DMW2,SPOS
DMW3,SPOS
DMW4,SPOS
RING2,SNEG
DML,SNEG
*SURFACE DEFINITION,NAME=PAYOUT,NO THICK
PAYB,SNEG
PAYW,SNEG
PAYT,SPOS
*CONTACT PAIR
DMINS,PAYOUT
*****
*NSET,NSET=DMDIS,GENERATE
4,4,1
1004,1004,1
681,681,1
101,113,3
301,313,3
541,553,3
*ELSET,ELSET=DMBST,GENERATE
61,66,1
81,86,1
*ELSET,ELSET=DMBST
DMBA,
*ELSET,ELSET=DMWST,GENERATE
101,105,1
121,126,1
141,421,20
142,422,20
143,423,20
441,446,1
461,466,1
481,486,1
501,506,1
*ELSET,ELSET=DMLST,GENERATE
1061,1066,1
1081,1086,1
*ELSET,ELSET=DMLST
DMLA,
*ELSET,ELSET=RINGST,GENERATE
601,606,1
621,626,1
641,646,1

```

661,666,1
681,686,1
701,706,1
721,726,1
741,746,1
761,766,1
*ELSET,ELSET=BOLTST,GENERATE
1501,1501,1

*HISTORY OUTPUT, TIME=5.E-5
*NODE HISTORY, NSET=DMDIS
U, V, A
*EL HISTORY, ELSET=DMBST
MISES,
PEEQ,
SENER,
PENER,
*EL HISTORY, ELSET=DMWST
MISES,
PEEQ,
SENER,
PENER,
*EL HISTORY, ELSET=DMLST
MISES,
PEEQ,
SENER,
PENER,
*EL HISTORY, ELSET=RINGST
MISES,
PEEQ,
SENER,
PENER,
*EL HISTORY, ELSET=BOLTST
MISES,
PEEQ,
SENER,
PENER,
*FILE OUTPUT, NUMBER INTERVAL=100
*NODE FILE
RF
*MONITOR,NODE=307,DOF=3
*END STEP
..



CHECKLIST FOR CHECKING OF ANALYSIS/CALCULATIONS

Document Number/Revision: HNF-2209/Rev. 0

Document Title: DOT-17H 55 Gallon Drum 40 MPH Top Corner Drop

Yes	No	N/A	
<input checked="" type="checkbox"/>	<input type="checkbox"/>	<input type="checkbox"/>	Problem completely defined.
<input checked="" type="checkbox"/>	<input type="checkbox"/>	<input type="checkbox"/>	Appropriate analytical method used.
<input checked="" type="checkbox"/>	<input type="checkbox"/>	<input type="checkbox"/>	Necessary assumptions are appropriate and explicitly stated.
<input checked="" type="checkbox"/>	<input type="checkbox"/>	<input type="checkbox"/>	Computer codes and data files documented.
<input checked="" type="checkbox"/>	<input type="checkbox"/>	<input type="checkbox"/>	Data used in calculations explicitly stated in document.
<input type="checkbox"/>	<input type="checkbox"/>	<input checked="" type="checkbox"/>	Sources of non-standard formula/data are referenced and the correctness of the reference verified.
<input checked="" type="checkbox"/>	<input type="checkbox"/>	<input type="checkbox"/>	Data checked for consistency with original source information as applicable.
<input type="checkbox"/>	<input type="checkbox"/>	<input checked="" type="checkbox"/>	Mathematical derivations checked including dimensional consistency of results.
<input checked="" type="checkbox"/>	<input type="checkbox"/>	<input type="checkbox"/>	Models appropriate and used within range of validity or use outside range of established validity justified.
<input type="checkbox"/>	<input type="checkbox"/>	<input checked="" type="checkbox"/>	Hand calculations checked for errors.
<input checked="" type="checkbox"/>	<input type="checkbox"/>	<input type="checkbox"/>	Code run streams correct and consistent with analysis documentation.
<input checked="" type="checkbox"/>	<input type="checkbox"/>	<input type="checkbox"/>	Code output consistent with input and with results reported in analysis documentation.
<input checked="" type="checkbox"/>	<input type="checkbox"/>	<input type="checkbox"/>	Acceptability limits on analytical results applicable and supported. Limits checked against sources.
<input checked="" type="checkbox"/>	<input type="checkbox"/>	<input type="checkbox"/>	Safety Margins consistent with good engineering practices.
<input checked="" type="checkbox"/>	<input type="checkbox"/>	<input type="checkbox"/>	Conclusions consistent with analytical results and applicable limits.
<input checked="" type="checkbox"/>	<input type="checkbox"/>	<input type="checkbox"/>	Results and conclusions address all points required in the problem statement.

I have checked the analysis/calculation and it is complete and accurate to the best of my knowledge.

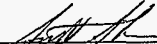
Engineer/Checker Scott Shiraga  Date 09/01/98

NOTE: Any hand calculations, notes or summaries generated as part of this check should be signed, dated, and attached to this checklist. Material should be labeled and recorded so that it is intelligible to a technically qualified third party.

7.7.1.9 55-Gal Drum/30-Mil Wall Thickness 30-MPH/1600-Lb Dynamic Crush.

```

*HEADING
FILE=DY30X 3/18/98
55 GALLON DRUM/30 MIL THICKNESS, 30 MPH DYNAMIC CRUSH (SIDE)
RIGID TARGET
1600 POUNDS RIGID LOAD
**RESTART, WRITE, NUMBER INTERVAL = 10
*****
** DRUM
*****
**
** GENERATE THE NODES OF DRUM BOTTOM PLATE
**
*NODE, SYSTEM=R
*NODE
1, -3.6, 0.0, 0.0
7, 3.6, 0.0, 0.0
22, -3.6, 3.6, 0.0
28, 3.6, 3.6, 0.0
*NGEN, NSET=LINEA
1, 7, 1
*NGEN, NSET=LINEB
22, 28, 1
*NFill, NSET=DMB1
LINEA, LINEB, 3, 7
*NODE, NSET=DMB2
41, 5.4417, 0.0, 0.0
42, 5.3380, 1.5872, 0.0
43, 5.0342, 3.1208, 0.0
44, 4.5508, 4.5508, 0.0
45, 3.1208, 5.0342, 0.0
46, 1.5872, 5.3380, 0.0
47, 0.0, 5.4417, 0.0
48, -1.5872, 5.3380, 0.0
49, -3.1208, 5.0342, 0.0
50, -4.5508, 4.5508, 0.0
51, -5.0342, 3.1208, 0.0
52, -5.3380, 1.5872, 0.0
53, -5.4417, 0.0, 0.0
61, 7.2833, 0.0, 0.0
62, 7.0760, 1.9745, 0.0
63, 6.4683, 3.8417, 0.0
64, 5.5016, 5.5016, 0.0
65, 3.8417, 6.4683, 0.0
66, 1.9745, 7.0760, 0.0
67, 0.0, 7.2833, 0.0
68, -1.9745, 7.0760, 0.0
69, -3.8417, 6.4683, 0.0
70, -5.5016, 5.5016, 0.0
71, -6.4683, 3.8417, 0.0
72, -7.0760, 1.9745, 0.0
73, -7.2833, 0.0, 0.0
81, 9.6000, 0.0, 0.0
82, 9.2729, 2.4847, 0.0
83, 8.3138, 4.8000, 0.0
84, 6.7882, 6.7882, 0.0
85, 4.8000, 8.3138, 0.0
86, 2.4847, 9.2729, 0.0
87, 0.0, 9.6000, 0.0
88, -2.4847, 9.2729, 0.0
89, -4.8000, 8.3138, 0.0
90, -6.7882, 6.7882, 0.0
91, -8.3138, 4.8000, 0.0
92, -9.2729, 2.4847, 0.0
93, -9.6000, 0.0, 0.0
*NODE, NSET=DMB3
101, 11.5000, 0.0, 0.0
102, 11.1081, 2.9764, 0.0
103, 9.9593, 5.7500, 0.0
104, 8.1317, 8.1317, 0.0
105, 5.7500, 9.9593, 0.0
106, 2.9764, 11.1081, 0.0
107, 0.0, 11.5000, 0.0
108, -2.9764, 11.1081, 0.0
109, -5.7500, 9.9593, 0.0
110, -8.1317, 8.1317, 0.0

```

```

111, -9.9593, 5.7500, 0.0
112, -11.1081, 2.9764, 0.0
113, -11.5000, 0.0, 0.0
*NSET, NSET = DMB
DMB1, DMB2, DMB3
**
** GENERATE THE ELEMENTS OF DRUM BOTTOM PLATE
**
*ELEMENT, TYPE = S4R
1, 1, 2, 9, 8
*ELGEN, ELSET = DMBA
1, 6, 1, 1, 3, 7, 8
*ELEMENT, TYPE = S4R, ELSET = DMBB
21, 7, 41, 42, 14
22, 14, 42, 43, 21
23, 21, 43, 44, 28
24, 28, 44, 45, 27
25, 27, 45, 46, 26
26, 26, 46, 47, 25
27, 25, 47, 48, 24
28, 24, 48, 49, 23
29, 23, 49, 50, 22
30, 22, 50, 51, 15
31, 15, 51, 52, 8
32, 8, 52, 53, 1
41, 41, 61, 62, 42
*ELGEN, ELSET = DMBB
41, 12, 1, 1, 3, 20, 20
*ELSET, ELSET = DMB
DMBA, DMBB
*SHELL SECTION, ELSET = DMB, MATERIAL = ST
0.030
**
** GENERATE THE DRUM CYLINDRICAL WALL
**
** NODES
**
*NCOPY,SHIFT,CHANGE NU = 40,OLD SET = DMB3,NEW SET = L1
0.0, 0.0, 2.0
0.0, 0.0, 0.0, 0.0, 0.0, 1.0, 0.0
*NCOPY,SHIFT,CHANGE NU = 300,OLD SET = L1,NEW SET = L2
0.0, 0.0, 30.0
0.0, 0.0, 0.0, 0.0, 0.0, 1.0, 0.0
*NCOPY,SHIFT,CHANGE NU = 40,OLD SET = L2,NEW SET = L3
0.0, 0.0, 2.0
0.0, 0.0, 0.0, 0.0, 0.0, 1.0, 0.0
*NFILL, NSET = DMW1
DMB3, L1, 2, 20
*NFILL, NSET = DMW2
L1, L2, 15, 20
*NFILL, NSET = DMW3
L2, L3, 2, 20
*NODE, NSET = DMW4
501, 11.5000, 0.0, 34.5
701, 11.5000, 0.0, 35.0
*NCOPY,SHIFT,MULTIPLE = 12,CHANGE NU = +1,OLD SET = DMW4,NEW SET = DMW4
0.0, 0.0, 0.0
0.0, 0.0, 0.0, 0.0, 0.0, 1.0, +15.00
*NSET, NSET = DMW
DMW1, DMW2, DMW3, DMW4
**
** ELEMENTS
**
*ELEMENT, TYPE = S4R, ELSET = DMW1
101, 101, 121, 122, 102
*ELGEN, ELSET = DMW1
101, 12, 1, 1, 2, 20, 20
*ELEMENT, TYPE = S4R, ELSET = DMW2
141, 141, 161, 162, 142
*ELGEN, ELSET = DMW2
141, 12, 1, 1, 15, 20, 20
*ELEMENT, TYPE = S4R, ELSET = DMW3
441, 441, 461, 462, 442
*ELGEN, ELSET = DMW3
441, 12, 1, 1, 2, 20, 20
*ELEMENT, TYPE = S4R, ELSET = DMW4
481, 481, 501, 502, 482
501, 501, 701, 702, 502

```

```

*ELGEN, ELSET = DMW4
481, 12, 1, 1
501, 12, 1, 1
*ELSET, ELSET = DMW
DMW1, DMW2, DMW3, DMW4
*SHELL SECTION, ELSET = DMW, MATERIAL = ST
0.030
**
** GENERATE THE NODES OF DRUM LID
**
*NCOPY,SHIFT,CHANGE NU = 1000,OLD SET = DMB,NEW SET = DML
0.0, 0.0, 34.50
0.0, 0.0, 0.0, 0.0, 0.0, 1.0, 0.0
** MODIFY NODES
*NODE, NSET = DML
1101, 10.5000, 0.0, 34.50
1102, 10.1422, 2.7176, 34.50
1103, 9.0933, 5.2500, 34.50
1104, 7.4246, 7.4246, 34.50
1105, 5.2500, 9.0933, 34.50
1108, 2.7176, 10.1422, 34.50
1107, 0.0, 10.5000, 34.50
1108, -2.7176, 10.1422, 34.50
1109, -5.2500, 9.0933, 34.50
1110, -7.4246, 7.4246, 34.50
1111, -9.0933, 5.2500, 34.50
1112, -10.1422, 2.7176, 34.50
1113, -10.5000, 0.0, 34.50
**
** GENERATE THE DRUM LID
**
*ELEMENT, TYPE = S4R
1001, 1001, 1002, 1009, 1008
*ELGEN, ELSET = DMLA
1001, 6, 1, 1, 3, 7, 6
*ELEMENT, TYPE = S4R, ELSET = DMLB
1021, 1007, 1041, 1042, 1014
1022, 1014, 1042, 1043, 1021
1023, 1021, 1043, 1044, 1028
1024, 1028, 1044, 1045, 1027
1025, 1027, 1045, 1046, 1026
1026, 1026, 1046, 1047, 1025
1027, 1025, 1047, 1048, 1024
1028, 1024, 1048, 1049, 1023
1029, 1023, 1049, 1050, 1022
1030, 1022, 1050, 1051, 1015
1031, 1015, 1051, 1052, 1008
1032, 1008, 1052, 1053, 1001
*ELEMENT, TYPE = S4R
1041, 1041, 1061, 1062, 1042
*ELGEN, ELSET = DMLC
1041, 12, 1, 1, 2, 20, 20
*ELEMENT, TYPE = S4R
1081, 1081, 1101, 1102, 1082
*ELGEN, ELSET = DMLD
1081, 12, 1, 1
*ELSET, ELSET = DML
DMLA, DMLB, DMLC, DMLD
*SHELL SECTION, ELSET = DML, MATERIAL = ST
0.030
*NSET, NSET = DM
DMB, DMW, DML
*ELSET, ELSET = DM
DMB, DMW, DML
*****
** CLOSING RING, DRUM LID, AND DRUM ASSEMBLY
*****
*NODE, NSET = RING
601, 11.7500, 0.0, 34.0670
621, 11.9330, 0.0, 34.2500
641, 12.0000, 0.0, 34.5000
661, 11.9330, 0.0, 34.7500
681, 11.7500, 0.0, 34.9330
701, 11.5000, 0.0, 35.0000
721, 11.2500, 0.0, 34.9330
741, 11.0670, 0.0, 34.7500
*NCOPY,SHIFT,MULTIPLE = 12,CHANGE NU = + 1,OLD SET = RING,NEW SET = RING
0.0, 0.0, 0.0

```



```

0.0, 0.0, 0.0, 0.0, 0.0, 1.0, +15.00
*ELEMENT, TYPE=S4R
601, 481, 482, 602, 601
621, 601, 602, 622, 621
721, 701, 702, 722, 721
761, 741, 742, 1102, 1101
*ELGEN, ELSET=RING1
601, 12, 1, 1
621, 12, 1, 1, 5, 20, 20
*ELGEN, ELSET=RING2
721, 12, 1, 1, 2, 20, 20
761, 12, 1, 1
*ELSET, ELSET=RING
RING1, RING2
*SHELL SECTION, ELSET=RING1, MATERIAL=ST
0.50
*SHELL SECTION, ELSET=RING2, MATERIAL=ST
0.35
*****
** CLOSING RING BOLT
*****
*NODE, NSET=BOLT
1501, 11.500, 0.0, 34.500
1502, 11.500, 0.5, 34.500
*ELEMENT, TYPE=T3D2, ELSET=BOLT
1501, 1501, 1502
*SOLID SECTION, ELSET=BOLT, MATERIAL=BOLT
0.226
*MPC
TIE,601,1502
TIE,621,1502
TIE,641,1502
TIE,661,1502
TIE,681,1502
*EQUATION
2
1501,1,1,0,1502,1,-1.0
*EQUATION
2
1501,3,1,0,1502,3,-1.0
*****
** PAYLOAD
*****
*NODE, SYSTEM=R
*NODE
2001, -4.0, 0.0, 0.024
2005, 4.0, 0.0, 0.024
2011, -4.0, 4.0, 0.024
2016, 4.0, 4.0, 0.024
*NGEN, NSET=LINEC
2001, 2005, 1
*NGEN, NSET=LINED
2011, 2015, 1
*NFill, NSET=PAYB1
LINEC, LINED, 2, 5
*NODE, NSET=PAYB2
2021, 7.625, 0.0, 0.024
2022, 7.1968, 3.1526, 0.024
2023, 5.9775, 5.9775, 0.024
2024, 3.1526, 7.1968, 0.024
2025, 0.0, 7.625, 0.024
2026, -3.1526, 7.1968, 0.024
2027, -5.9775, 5.9775, 0.024
2028, -7.1968, 3.1526, 0.024
2029, -7.625, 0.0, 0.024
*NODE, NSET=PAYB3
2031, 11.25, 0.0, 0.024
2032, 10.394, 4.3052, 0.024
2033, 7.9550, 7.9550, 0.024
2034, 4.3052, 10.394, 0.024
2035, 0.0, 11.25, 0.024
2036, -4.3052, 10.394, 0.024
2037, -7.9550, 7.9550, 0.024
2038, -10.394, 4.3052, 0.024
2039, -11.25, 0.0, 0.024
*NSET, NSET=PAYB
PAYB1, PAYB2, PAYB3
*ELEMENT, TYPE=S4R

```

```

2001, 2001, 2002, 2007, 2006
*ELGEN, ELSET=PAYB1
2001, 4, 1, 1, 2, 5, 5
*ELEMENT, TYPE=S4R, ELSET=PAYB2
2011, 2005, 2021, 2022, 2010
2012, 2010, 2022, 2023, 2015
2013, 2015, 2023, 2024, 2014
2014, 2014, 2024, 2025, 2013
2015, 2013, 2025, 2026, 2012
2016, 2012, 2026, 2027, 2011
2017, 2011, 2027, 2028, 2006
2018, 2006, 2028, 2029, 2001
*ELEMENT, TYPE=S4R
2021, 2021, 2031, 2032, 2022
*ELGEN, ELSET=PAYB2
2021, 8, 1, 1
*ELSET, ELSET=PAYB
PAYB1, PAYB2
*SHELL SECTION, ELSET=PAYB, MATERIAL=PAYLD
0.030
*****
**NOCOPY,SHIFT,CHANGE NU=100,OLD SET=PAYB3,NEW SET=PAYW1
0.0, 0.0, 33.25
0.0, 0.0, 0.0, 0.0, 0.0, 1.0, 0.0
*NFRILL, NSET=PAYW
PAYB3, PAYW1, 10, 10
*ELEMENT, TYPE=S4R
2031, 2031, 2041, 2042, 2032
*ELGEN, ELSET=PAYW
2031, 8, 1, 1, 10, 10, 10
*SHELL SECTION, ELSET=PAYW, MATERIAL=PAYLD
0.030
*****
**NOCOPY,SHIFT,CHANGE NU=200,OLD SET=PAYB,NEW SET=PAYT
0.0, 0.0, 33.25
0.0, 0.0, 0.0, 0.0, 0.0, 1.0, 0.0
*ELEMENT, TYPE=S4R
2201, 2201, 2202, 2207, 2206
*ELGEN, ELSET=PAYT1
2201, 4, 1, 1, 2, 5, 5
*ELEMENT, TYPE=S4R, ELSET=PAYT2
2211, 2205, 2221, 2222, 2210
2212, 2210, 2222, 2223, 2215
2213, 2215, 2223, 2224, 2214
2214, 2214, 2224, 2225, 2213
2215, 2213, 2225, 2226, 2212
2216, 2212, 2226, 2227, 2211
2217, 2211, 2227, 2228, 2206
2218, 2206, 2228, 2229, 2201
*ELEMENT, TYPE=S4R
2221, 2221, 2131, 2132, 2222
*ELGEN, ELSET=PAYT2
2221, 8, 1, 1
*ELSET, ELSET=PAYT
PAYT1, PAYT2
*ELSET, ELSET=PAY
PAYB, PAYW, PAYT
*NSET, NSET=PAY
PAYB, PAYW, PAYT
*SHELL SECTION, ELSET=PAYT, MATERIAL=PAYLD
0.030
*****
** RIGID TARGET
*****
**NODE, NSET=TARGETO
115000, 0.0, 0.0, -0.025
115001, -40.0, -0.001, -0.025
115002, 40.0, -0.001, -0.025
115003, 40.0, 40.0, -0.025
115004, -40.0, 40.0, -0.025
*****
** RIGID CRUSH LOAD
*****
**NODE, NSET=LOADO
120000, 0.0, 0.0, -0.025
120001, -40.0, -0.001, -0.025
120002, 40.0, -0.001, -0.025
120003, 40.0, 40.0, -0.025

```

```

120004, -40.0, 40.0, -0.025
**
** GENERATE THE INCLINED IMPACT SURFACES
**
**NOCOPY,SHIFT,CHANGE NU =-100000,OLD SET = TARGET0,NEW SET = TARGET
12.565, 0., 17.5
12.565, 0., 17.5, 12.565, 1., 17.5, -90.0
**NOCOPY,SHIFT,CHANGE NU =-100000,OLD SET = LOAD0,NEW SET = LOAD
-12.565, 0., 17.5
-12.565, 0., 17.5, -12.565, 1., 17.5, +90.0
*****
** RIGID TARGET
*****
**ELEMENT,TYPE=R3D4,ELSET = TARGET
15000,15001,15002,15003,15004
**RIGID BODY, ELSET = TARGET, REF NODE = 15000
*****
** RIGID CRUSH LOAD
*****
**ELEMENT,TYPE = R3D4,ELSET = LOAD
20000,20001,20002,20003,20004
**RIGID BODY, ELSET = LOAD, REF NODE = 20000
**ELEMENT,TYPE = MASS,ELSET = MASS
20001,20000
**MASS,ELSET = MASS
2.070
**
** ASTM A36
**
**MATERIAL, NAME = ST
**DENSITY
7.5052E-4
**ELASTIC
29.0E6, 0.3
**PLASTIC
36000., 0.
60000., 0.23
30000., 0.24
10000., 0.25
5000., 0.26
1000., 0.27
**FAILURE
0.30, 0.25
**
** CLOSING RING BOLT MATERIAL
** ASTM A307, GR. C
**
**MATERIAL, NAME = BOLT
**DENSITY
7.5052E-4
**ELASTIC
29.0E6, 0.3
**PLASTIC
36000., 0.
60000., 0.23
30000., 0.24
10000., 0.25
5000., 0.26
1000., 0.27
**FAILURE
0.30, 0.25
**MATERIAL, NAME = PAYLD
**DENSITY
0.01110
**ELASTIC
29.0E6, 0.3
**
** ELEMENT SET DEFINITIONS
**
**ELSET,ELSET = ALLEL
DMB, DMW, DML
RING, BOLT
PAY,
**
** NODE SET DEFINITIONS
**
**NSET,NSET = ALLND
DMB, DMW, DML

```

```

RING, BOLT
PAY,
*NSET,NSET=YSYMM,GENERATE
15001,15002,1
20001,20002,1
*NSET,NSET=YSYMM,GENERATE
1, 7, 1
41, 53, 12
61, 73, 12
81, 93, 12
101, 501, 20
113, 513, 20
613, 693, 20
701, 741, 20
713, 753, 20
1001, 1007, 1
1041, 1053, 12
1061, 1073, 12
1081, 1093, 12
1101, 1113, 12
1501, 1501, 1
2001, 2005, 1
2021, 2029, 8
2031, 2131, 10
2039, 2139, 10
2201, 2205, 1
2221, 2229, 8
*BOUNDARY
YSYMM,YSYMM
15000,1,6
*****
*INITIAL CONDITIONS,TYPE=VELOCITY
20000,1,528.0
*STEP
*DYNAMIC,EXPLICIT
,200.0E-03
**
** DEFINE THE CONTACT SURFACES BETWEEN
** THE DRUM OUTSIDE AND TARGET
**
*SURFACE DEFINITION,NAME=TGTOP,NO THICK
TARGET,SPOS
*SURFACE DEFINITION,NAME=DMOUT,NO THICK
DMB,SNEG
DMW1,SNEG
DMW2,SNEG
DMW3,SNEG
RING,SPOS
DML,SPOS
*CONTACT PAIR
TGTOP,DMOUT
**
** DEFINE THE CONTACT SURFACES BETWEEN
** THE LOAD AND DRUM OUTSIDE
**
*SURFACE DEFINITION,NAME=LOADBT,NO THICK
LOAD,SPOS
*CONTACT PAIR
LOADBT,DMOUT
**
** DEFINE THE CONTACT SURFACES BETWEEN
** THE DRUM INSIDE AND PAYLOAD OUTSIDE
**
*SURFACE DEFINITION,NAME=DMINS,NO THICK
DMB,SPOS
DMW1,SPOS
DMW2,SPOS
DMW3,SPOS
DMW4,SPOS
RING2,SNEG
DML,SNEG
*SURFACE DEFINITION,NAME=PAYOUT,NO THICK
PAYB,SNEG
PAYW,SNEG
PAYT,SPOS
*CONTACT PAIR
DMINS,PAYOUT
*****

```

```

*NSSET,NSSET = DMDIS,GENERATE
4,4,1
1004,1004,1
101,113,3
301,313,3
541,553,3
20000,20000,1
*ELSET,ELSET = DMBST,GENERATE
1,18,1
61,72,1
81,92,1
*ELSET,ELSET = DMWST,GENERATE
101,112,1
121,132,1
141,152,1
161,172,1
441,452,1
461,472,1
481,492,1
501,512,1
*ELSET,ELSET = DMLST,GENERATE
1001,1018,1
1061,1072,1
1081,1092,1
*ELSET,ELSET = BOLTST,GENERATE
1501,1501,1
.....
*HISTORY OUTPUT, TIME=1.0E-4
*NODE HISTORY, NSSET=DMDIS
U, V, A
*EL HISTORY, ELSET=DMBST
SENER,
PENER,
*EL HISTORY, ELSET=DMWST
SENER,
PENER,
*EL HISTORY, ELSET=DMLST
SENER,
PENER,
*EL HISTORY, ELSET=BOLTST
SENER,
PENER,
*FILE OUTPUT, NUMBER INTERVAL=400
*NODE FILE
RF,
*MONITOR,NODE=307,DOF=1
*END STEP
-

```



CHECKLIST FOR CHECKING OF ANALYSIS/CALCULATIONS

Document Number/Revision: HNF-2209/Rev. 0

Document Title: 55 Gallon Drum/30-mil Wall Thickness 30 MPH/1600 Pounds Dynamic Crush

Yes	No	N/A	
<input checked="" type="checkbox"/>	<input type="checkbox"/>	<input type="checkbox"/>	Problem completely defined.
<input checked="" type="checkbox"/>	<input type="checkbox"/>	<input type="checkbox"/>	Appropriate analytical method used.
<input checked="" type="checkbox"/>	<input type="checkbox"/>	<input type="checkbox"/>	Necessary assumptions are appropriate and explicitly stated.
<input checked="" type="checkbox"/>	<input type="checkbox"/>	<input type="checkbox"/>	Computer codes and data files documented.
<input checked="" type="checkbox"/>	<input type="checkbox"/>	<input type="checkbox"/>	Data used in calculations explicitly stated in document.
<input type="checkbox"/>	<input type="checkbox"/>	<input checked="" type="checkbox"/>	Sources of non-standard formula/data are referenced and the correctness of the reference verified.
<input checked="" type="checkbox"/>	<input type="checkbox"/>	<input type="checkbox"/>	Data checked for consistency with original source information as applicable.
<input type="checkbox"/>	<input type="checkbox"/>	<input checked="" type="checkbox"/>	Mathematical derivations checked including dimensional consistency of results.
<input checked="" type="checkbox"/>	<input type="checkbox"/>	<input type="checkbox"/>	Models appropriate and used within range of validity or use outside range of established validity justified.
<input type="checkbox"/>	<input type="checkbox"/>	<input checked="" type="checkbox"/>	Hand calculations checked for errors.
<input checked="" type="checkbox"/>	<input type="checkbox"/>	<input type="checkbox"/>	Code run streams correct and consistent with analysis documentation.
<input checked="" type="checkbox"/>	<input type="checkbox"/>	<input type="checkbox"/>	Code output consistent with input and with results reported in analysis documentation.
<input checked="" type="checkbox"/>	<input type="checkbox"/>	<input type="checkbox"/>	Acceptability limits on analytical results applicable and supported. Limits checked against sources.
<input checked="" type="checkbox"/>	<input type="checkbox"/>	<input type="checkbox"/>	Safety Margins consistent with good engineering practices.
<input checked="" type="checkbox"/>	<input type="checkbox"/>	<input type="checkbox"/>	Conclusions consistent with analytical results and applicable limits.
<input checked="" type="checkbox"/>	<input type="checkbox"/>	<input type="checkbox"/>	Results and conclusions address all points required in the problem statement.

I have checked the analysis/calculation and it is complete and accurate to the best of my knowledge.

Engineer/Checker Scott Shiraga  Date 09/01/98

NOTE: Any hand calculations, notes or summaries generated as part of this check should be signed, dated, and attached to this checklist. Material should be labeled and recorded so that it is intelligible to a technically qualified third party.

7.7.1.10 DOT-17H 55-Gal Drum 30-MPH/3,000-Lb Dynamic Crush.

*HEADING

DOT-17H 55 GALLON DRUM, 30 MPH DYNAMIC CRUSH (SIDE), FILE=DY3K30P

RIGID TARGET

3000 POUNDS RIGID LOAD

*RESTART, WRITE, NUMBER INTERVAL=10

** DRUM

**

** GENERATE THE NODES OF DRUM BOTTOM PLATE

**

*NODE, SYSTEM=R

*NODE

1, -3.6, 0.0, 0.0

7, 3.6, 0.0, 0.0

22, -3.6, 3.6, 0.0

28, 3.6, 3.6, 0.0

*NGEN, NSET=LINEA

1, 7, 1

*NGEN, NSET=LINEB

22, 28, 1

*NFILL, NSET=DMB1

LINEA, LINEB, 3, 7

*NODE, NSET=DMB2

41, 5.4417, 0.0, 0.0

42, 5.3380, 1.5872, 0.0

43, 5.0342, 3.1208, 0.0

44, 4.5508, 4.5508, 0.0

45, 3.1208, 5.0342, 0.0

46, 1.5872, 5.3380, 0.0

47, 0.0, 5.4417, 0.0

48, -1.5872, 5.3380, 0.0

49, -3.1208, 5.0342, 0.0

50, -4.5508, 4.5508, 0.0

51, -5.0342, 3.1208, 0.0

52, -5.3380, 1.5872, 0.0

53, -5.4417, 0.0, 0.0

61, 7.2833, 0.0, 0.0

62, 7.0760, 1.9745, 0.0

63, 6.4683, 3.8417, 0.0

64, 5.5016, 5.5016, 0.0

65, 3.8417, 6.4683, 0.0

66, 1.9745, 7.0760, 0.0

67, 0.0, 7.2833, 0.0

68, -1.9745, 7.0760, 0.0

69, -3.8417, 6.4683, 0.0

70, -5.5016, 5.5016, 0.0

71, -6.4683, 3.8417, 0.0

72, -7.0760, 1.9745, 0.0

73, -7.2833, 0.0, 0.0

81, 9.6000, 0.0, 0.0

82, 9.2729, 2.4847, 0.0

83, 8.3138, 4.8000, 0.0

84, 6.7882, 6.7882, 0.0

85, 4.8000, 8.3138, 0.0

86, 2.4847, 9.2729, 0.0

87, 0.0, 9.6000, 0.0

88, -2.4847, 9.2729, 0.0

89, -4.8000, 8.3138, 0.0

90, -6.7882, 6.7882, 0.0

91, -8.3138, 4.8000, 0.0

92, -9.2729, 2.4847, 0.0

93, -9.6000, 0.0, 0.0

*NODE, NSET=DMB3

101, 11.5000, 0.0, 0.0

102, 11.1081, 2.9764, 0.0

103, 9.9593, 5.7500, 0.0

104, 8.1317, 8.1317, 0.0

105, 5.7500, 9.9593, 0.0

106, 2.9764, 11.1081, 0.0

107, 0.0, 11.5000, 0.0

108, -2.9764, 11.1081, 0.0

109, -5.7500, 9.9593, 0.0

110, -8.1317, 8.1317, 0.0

111, -9.9593, 5.7500, 0.0

```

112, -11.1081, 2.9764, 0.0
113, -11.5000, 0.0, 0.0
*NSEI, NSET = DMB
DMB1, DMB2, DMB3
**
** GENERATE THE ELEMENTS OF DRUM BOTTOM PLATE
**
*ELEMENT, TYPE = S4R
1, 1, 2, 9, 8
*ELGEN, ELSET = DMBA
1, 6, 1, 1, 3, 7, 6
*ELEMENT, TYPE = S4R, ELSET = DMBB
21, 7, 41, 42, 14
22, 14, 42, 43, 21
23, 21, 43, 44, 28
24, 28, 44, 45, 27
25, 27, 45, 46, 26
26, 26, 46, 47, 25
27, 25, 47, 48, 24
28, 24, 48, 49, 23
29, 23, 49, 50, 22
30, 22, 50, 51, 15
31, 15, 51, 52, 8
32, 8, 52, 53, 1
41, 41, 61, 62, 42
*ELGEN, ELSET = DMBB
41, 12, 1, 1, 3, 20, 20
*ELSET, ELSET = DMB
DMBA, DMBB
*SHELL SECTION, ELSET = DMB, MATERIAL = ST
0.0478
**
** GENERATE THE DRUM CYLINDRICAL WALL
**
** NODES
**
*NCOPY, SHIFT, CHANGE NU = 40, OLD SET = DMB3, NEW SET = L1
0.0, 0.0, 2.0
0.0, 0.0, 0.0, 0.0, 0.0, 1.0, 0.0
*NCOPY, SHIFT, CHANGE NU = 300, OLD SET = L1, NEW SET = L2
0.0, 0.0, 30.0
0.0, 0.0, 0.0, 0.0, 0.0, 1.0, 0.0
*NCOPY, SHIFT, CHANGE NU = 40, OLD SET = L2, NEW SET = L3
0.0, 0.0, 2.0
0.0, 0.0, 0.0, 0.0, 0.0, 1.0, 0.0
*NFILL, NSET = DMW1
DMB3, L1, 2, 20
*NFILL, NSET = DMW2
L1, L2, 15, 20
*NFILL, NSET = DMW3
L2, L3, 2, 20
*NODE, NSET = DMW4
501, 11.5000, 0.0, 34.5
701, 11.5000, 0.0, 35.0
*NCOPY, SHIFT, MULTIPLE = 12, CHANGE NU = +1, OLD SET = DMW4, NEW SET = DMW4
0.0, 0.0, 0.0
0.0, 0.0, 0.0, 0.0, 0.0, 1.0, +15.00
*NSET, NSET = DMW
DMW1, DMW2, DMW3, DMW4
**
** ELEMENTS
**
*ELEMENT, TYPE = S4R, ELSET = DMW1
101, 101, 121, 122, 102
*ELGEN, ELSET = DMW1
101, 12, 1, 1, 2, 20, 20
*ELEMENT, TYPE = S4R, ELSET = DMW2
141, 141, 161, 162, 142
*ELGEN, ELSET = DMW2
141, 12, 1, 1, 15, 20, 20
*ELEMENT, TYPE = S4R, ELSET = DMW3
441, 441, 461, 462, 442
*ELGEN, ELSET = DMW3
441, 12, 1, 1, 2, 20, 20
*ELEMENT, TYPE = S4R, ELSET = DMW4
481, 481, 501, 502, 482
501, 501, 701, 702, 502
*ELGEN, ELSET = DMW4

```



```

481, 12, 1, 1
501, 12, 1, 1
*ELSET, ELSET = DMW
DMW1, DMW2, DMW3, DMW4
*SHELL SECTION, ELSET = DMW, MATERIAL = ST
0.0478
**
** GENERATE THE NODES OF DRUM LID
**
*NCOPY, SHIFT, CHANGE NU = 1000, OLD SET = DMB, NEW SET = DML
0.0, 0.0, 34.50
0.0, 0.0, 0.0, 0.0, 0.0, 1.0, 0.0
** MODIFY NODES
*NODE, NSET = DML
1101, 10.5000, 0.0, 34.50
1102, 10.1422, 2.7176, 34.50
1103, 9.0933, 5.2500, 34.50
1104, 7.4246, 7.4246, 34.50
1105, 5.2500, 9.0933, 34.50
1106, 2.7176, 10.1422, 34.50
1107, 0.0, 10.5000, 34.50
1108, -2.7176, 10.1422, 34.50
1109, -5.2500, 9.0933, 34.50
1110, -7.4246, 7.4246, 34.50
1111, -9.0933, 5.2500, 34.50
1112, -10.1422, 2.7176, 34.50
1113, -10.5000, 0.0, 34.50
**
** GENERATE THE DRUM LID
**
*ELEMENT, TYPE = S4R
1001, 1001, 1002, 1009, 1008
*ELGEN, ELSET = DMLA
1001, 6, 1, 1, 3, 7, 6
*ELEMENT, TYPE = S4R, ELSET = DMLB
1021, 1007, 1041, 1042, 1014
1022, 1014, 1042, 1043, 1021
1023, 1021, 1043, 1044, 1028
1024, 1028, 1044, 1045, 1027
1025, 1027, 1045, 1046, 1026
1026, 1026, 1046, 1047, 1025
1027, 1025, 1047, 1048, 1024
1028, 1024, 1048, 1049, 1023
1029, 1023, 1049, 1050, 1022
1030, 1022, 1050, 1051, 1015
1031, 1015, 1051, 1052, 1008
1032, 1008, 1052, 1053, 1001
*ELEMENT, TYPE = S4R
1041, 1041, 1061, 1062, 1042
*ELGEN, ELSET = DMLC
1041, 12, 1, 1, 2, 20, 20
*ELEMENT, TYPE = S4R
1081, 1081, 1101, 1102, 1082
*ELGEN, ELSET = DMLD
1081, 12, 1, 1
*ELSET, ELSET = DML
DMLA, DMLB, DMLC, DMLD
*SHELL SECTION, ELSET = DML, MATERIAL = ST
0.0478
**
*NSET, NSET = DM
DMB, DMW, DML
*ELSET, ELSET = DM
DMB, DMW, DML
*****
** CLOSING RING, DRUM LID, AND DRUM ASSEMBLY
*****
**
*NODE, NSET = RING
601, 11.7500, 0.0, 34.0670
621, 11.9330, 0.0, 34.2500
641, 12.0000, 0.0, 34.5000
661, 11.9330, 0.0, 34.7500
681, 11.7500, 0.0, 34.9330
701, 11.5000, 0.0, 35.0000
721, 11.2500, 0.0, 34.9330
741, 11.0670, 0.0, 34.7500
*NCOPY, SHIFT, MULTIPLE = 12, CHANGE NU = + 1, OLD SET = RING, NEW SET = RING
0.0, 0.0, 0.0
0.0, 0.0, 0.0, 0.0, 0.0, 1.0, +15.00

```

```

*ELEMENT, TYPE=S4R
601, 481, 482, 602, 601
621, 601, 602, 622, 621
721, 701, 702, 722, 721
761, 741, 742, 1102, 1101
*ELGEN, ELSET=RING1
601, 12, 1, 1
621, 12, 1, 1, 5, 20, 20
*ELGEN, ELSET=RING2
721, 12, 1, 1, 2, 20, 20
761, 12, 1, 1
*ELSET, ELSET=RING
RING1, RING2
*SHELL SECTION, ELSET=RING1, MATERIAL=ST
0.50
*SHELL SECTION, ELSET=RING2, MATERIAL=ST
0.35
*****
** CLOSING RING BOLT
*****
*NODE, NSET=BOLT
1501, 11.500, 0.0, 34.500
1502, 11.500, 0.5, 34.500
*ELEMENT, TYPE=T3D2, ELSET=BOLT
1501, 1501, 1502
*SOLID SECTION, ELSET=BOLT, MATERIAL=BOLT
0.226
*MPC
TIE,601,1502
TIE,621,1502
TIE,641,1502
TIE,661,1502
TIE,681,1502
*EQUATION
2
1501,1,1,0,1502,1,-1,0
*EQUATION
2
1501,3,1,0,1502,3,-1,0
*****
** PAYLOAD
*****
*NODE, SYSTEM=R
*NODE
2001, -4.0, 0.0, 0.024
2005, 4.0, 0.0, 0.024
2011, -4.0, 4.0, 0.024
2015, 4.0, 4.0, 0.024
*NGEN, NSET=LINEC
2001, 2005, 1
*NGEN, NSET=LINED
2011, 2015, 1
*NFILL, NSET=PAYB1
LINEC, LINED, 2, 5
*NODE, NSET=PAYB2
2021, 7.625, 0.0, 0.024
2022, 7.1968, 3.1526, 0.024
2023, 5.9775, 5.9775, 0.024
2024, 3.1526, 7.1968, 0.024
2025, 0.0, 7.625, 0.024
2026, -3.1526, 7.1968, 0.024
2027, -5.9775, 5.9775, 0.024
2028, -7.1968, 3.1526, 0.024
2029, -7.625, 0.0, 0.024
*NODE, NSET=PAYB3
2031, 11.25, 0.0, 0.024
2032, 10.394, 4.3052, 0.024
2033, 7.9550, 7.9550, 0.024
2034, 4.3052, 10.394, 0.024
2035, 0.0, 11.25, 0.024
2036, -4.3052, 10.394, 0.024
2037, -7.9550, 7.9550, 0.024
2038, -10.394, 4.3052, 0.024
2039, -11.25, 0.0, 0.024
*NSSET, NSET=PAYB
PAYB1, PAYB2, PAYB3
*ELEMENT, TYPE=S4R
2001, 2001, 2002, 2007, 2006

```

```

*ELGEN, ELSET =PAYB1
2001, 4, 1, 1, 2, 5, 5
*ELEMENT, TYPE=S4R, ELSET =PAYB2
2011, 2005, 2021, 2022, 2010
2012, 2010, 2022, 2023, 2015
2013, 2015, 2023, 2024, 2014
2014, 2014, 2024, 2025, 2013
2015, 2013, 2025, 2026, 2012
2016, 2012, 2026, 2027, 2011
2017, 2011, 2027, 2028, 2006
2018, 2006, 2028, 2029, 2001
*ELEMENT, TYPE=S4R
2021, 2021, 2031, 2032, 2022
*ELGEN, ELSET =PAYB2
2021, 8, 1, 1
*ELSET, ELSET =PAYB
PAYB1, PAYB2
*SHELL SECTION, ELSET =PAYB, MATERIAL =PAYLD
0.0478
*****
*NCOPY,SHIFT,CHANGE NU = 100,OLD SET =PAYB3,NEW SET =PAYW1
0.0, 0.0, 33.25
0.0, 0.0, 0.0, 0.0, 0.0, 1.0, 0.0
*NFILL, NSET =PAYW
PAYB3, PAYW1, 10, 10
*ELEMENT, TYPE=S4R
2031, 2031, 2041, 2042, 2032
*ELGEN, ELSET =PAYW
2031, 8, 1, 1, 10, 10, 10
*SHELL SECTION, ELSET =PAYW, MATERIAL =PAYLD
0.0478
*****
*NCOPY,SHIFT,CHANGE NU = 200,OLD SET =PAYB,NEW SET =PAYT
0.0, 0.0, 33.25
0.0, 0.0, 0.0, 0.0, 0.0, 1.0, 0.0
*ELEMENT, TYPE=S4R
2201, 2201, 2202, 2207, 2206
*ELGEN, ELSET =PAYT1
2201, 4, 1, 1, 2, 5, 5
*ELEMENT, TYPE=S4R, ELSET =PAYT2
2211, 2205, 2221, 2222, 2210
2212, 2210, 2222, 2223, 2215
2213, 2215, 2223, 2224, 2214
2214, 2214, 2224, 2225, 2213
2215, 2213, 2225, 2226, 2212
2216, 2212, 2226, 2227, 2211
2217, 2211, 2227, 2228, 2206
2218, 2206, 2228, 2229, 2201
*ELEMENT, TYPE=S4R
2221, 2221, 2131, 2132, 2222
*ELGEN, ELSET =PAYT2
2221, 8, 1, 1
*ELSET, ELSET =PAYT
PAYT1, PAYT2
*ELSET, ELSET =PAY
PAYB, PAYW, PAYT
*NSET, NSET =PAY
PAYB, PAYW, PAYT
*SHELL SECTION, ELSET =PAYT, MATERIAL =PAYLD
0.0478
*****
** RIGID TARGET
*****
*NODE, NSET =TARGETO
115000, 0.0, 0.0, -0.025
115001, -40.0, -0.001, -0.025
115002, 40.0, -0.001, -0.025
115003, 40.0, 40.0, -0.025
115004, -40.0, 40.0, -0.025
*****
** RIGID CRUSH LOAD
*****
*NODE, NSET =LOADO
120000, 0.0, 0.0, -0.025
120001, -40.0, -0.001, -0.025
120002, 40.0, -0.001, -0.025
120003, 40.0, 40.0, -0.025
120004, -40.0, 40.0, -0.025

```

```

**
** GENERATE THE INCLINED IMPACT SURFACES
**
**NCOPIY,SHIFT,CHANGE NU=-100000,OLD SET = TARGET0,NEW SET = TARGET
12.565, 0., 17.5
12.565, 0., 17.5, 12.565, 1., 17.5, -90.0
**NCOPIY,SHIFT,CHANGE NU=-100000,OLD SET = LOAD0,NEW SET = LOAD
-12.565, 0., 17.5
-12.565, 0., 17.5, -12.565, 1., 17.5, +90.0
*****
** RIGID TARGET
*****
**ELEMENT,TYPE = R3D4,ELSET = TARGET
15000,15001,15002,15003,15004
**RIGID BODY, ELSET = TARGET, REF NODE = 15000
*****
** RIGID CRUSH LOAD
*****
**ELEMENT,TYPE = R3D4,ELSET = LOAD
20000,20001,20002,20003,20004
**RIGID BODY, ELSET = LOAD, REF NODE = 20000
**ELEMENT,TYPE = MASS,ELSET = MASS
20001,20000
**MASS,ELSET = MASS
3.882
**
** ASTM A36
**
**MATERIAL, NAME = ST
**ELASTIC
29.0E6, 0.3
**PLASTIC
36000., 0.
60000., 0.23
30000., 0.24
10000., 0.25
5000., 0.26
1000., 0.27
**DENSITY
7.5052E-4
**FAILURE
0.30, 0.25
**
** CLOSING RING BOLT MATERIAL
** ASTM A307, GR. C
**
**MATERIAL, NAME = BOLT
**ELASTIC
29.0E6, 0.3
**PLASTIC
36000., 0.
60000., 0.23
30000., 0.24
10000., 0.25
5000., 0.26
1000., 0.27
**DENSITY
7.5052E-4
**FAILURE
0.30, 0.25
**MATERIAL, NAME = PAYLD
**ELASTIC
29.0E6, 0.3
**DENSITY
0.02437
**
** ELEMENT SET DEFINITIONS
**
**ELSET,ELSET = ALLEL
DMB, DMW, DML
RING, BOLT
PAY,
**
** NODE SET DEFINITIONS
**
**NSET,NSET = ALLND
DMB, DMW, DML
RING, BOLT

```

```

PAY,
*NSET,NSET=YSYMM,GENERATE
15001,15002,1
20001,20002,1
*NSET,NSET=YSYMM,GENERATE
1, 7, 1
41, 53, 12
61, 73, 12
81, 93, 12
101, 501, 20
113, 513, 20
613, 693, 20
701, 741, 20
713, 753, 20
1001, 1007, 1
1041, 1053, 12
1061, 1073, 12
1081, 1093, 12
1101, 1113, 12
1501, 1501, 1
2001, 2005, 1
2021, 2029, 8
2031, 2131, 10
2039, 2139, 10
2201, 2205, 1
2221, 2229, 8
*BOUNDARY
YSYMM,YSYMM
15000,1,6
*****
*INITIAL CONDITIONS,TYPE=VELOCITY
20000,1,528.0
*STEP
*DYNAMIC,EXPLICIT
,200.0E-03
**
** DEFINE THE CONTACT SURFACES BETWEEN
** THE DRUM OUTSIDE AND TARGET
**
*SURFACE DEFINITION,NAME= TGTOP,NO THICK
TARGET,SPOS
*SURFACE DEFINITION,NAME= DMOUT,NO THICK
DMB,SNEG
DMW1,SNEG
DMW2,SNEG
DMW3,SNEG
RING,SPOS
DML,SPOS
*CONTACT PAIR
TGTOP,DMOUT
**
** DEFINE THE CONTACT SURFACES BETWEEN
** THE LOAD AND DRUM OUTSIDE
**
*SURFACE DEFINITION,NAME= LOADBT,NO THICK
LOAD,SPOS
*CONTACT PAIR
LOADBT,DMOUT
**
** DEFINE THE CONTACT SURFACES BETWEEN
** THE DRUM INSIDE AND PAYLOAD OUTSIDE
**
*SURFACE DEFINITION,NAME= DMINS,NO THICK
DMB,SPOS
DMW1,SPOS
DMW2,SPOS
DMW3,SPOS
DMW4,SPOS
RING2,SNEG
DML,SNEG
*SURFACE DEFINITION,NAME= PAYOUT,NO THICK
PAYB,SNEG
PAYW,SNEG
PAYT,SPOS
*CONTACT PAIR
DMINS,PAYOUT
*****
*NSET,NSET= DMDIS,GENERATE

```

```

4,4,1
1004,1004,1
101,113,3
301,313,3
541,553,3
20000,20000,1
*ELSET,ELSET = DMBST,GENERATE
1,18,1
61,72,1
81,92,1
*ELSET,ELSET = DMWST,GENERATE
101,112,1
121,132,1
141,152,1
161,172,1
441,452,1
461,472,1
481,492,1
501,512,1
*ELSET,ELSET = DMLST,GENERATE
1001,1018,1
1061,1072,1
1081,1092,1
*ELSET,ELSET = BOLTST,GENERATE
1501,1501,1
*****
*HISTORY OUTPUT, TIME = 1.0E-4
*NODE HISTORY, NSET = DMDIS
U, V, A
*EL HISTORY, ELSET = DMBST
SENER,
PENER,
*EL HISTORY, ELSET = DMWST
SENER,
PENER,
*EL HISTORY, ELSET = DMLST
SENER,
PENER,
*EL HISTORY, ELSET = BOLTST
SENER,
PENER,
*FILE OUTPUT, NUMBER INTERVAL = 400
*NODE FILE
RF,
*MONITOR,NODE = 307,DOF = 1
*END STEP
-

```



CHECKLIST FOR CHECKING OF ANALYSIS/CALCULATIONS

Document Number/Revision: HNF-2209/Rev. 0

Document Title: DOT-17H 55 Gallon Drum 30 MPH/3000 Pounds Dynamic Crush

Yes	No	N/A	
<input checked="" type="checkbox"/>	<input type="checkbox"/>	<input type="checkbox"/>	Problem completely defined.
<input checked="" type="checkbox"/>	<input type="checkbox"/>	<input type="checkbox"/>	Appropriate analytical method used.
<input checked="" type="checkbox"/>	<input type="checkbox"/>	<input type="checkbox"/>	Necessary assumptions are appropriate and explicitly stated.
<input checked="" type="checkbox"/>	<input type="checkbox"/>	<input type="checkbox"/>	Computer codes and data files documented.
<input checked="" type="checkbox"/>	<input type="checkbox"/>	<input type="checkbox"/>	Data used in calculations explicitly stated in document.
<input type="checkbox"/>	<input type="checkbox"/>	<input checked="" type="checkbox"/>	Sources of non-standard formula/data are referenced and the correctness of the reference verified.
<input checked="" type="checkbox"/>	<input type="checkbox"/>	<input type="checkbox"/>	Data checked for consistency with original source information as applicable.
<input type="checkbox"/>	<input type="checkbox"/>	<input checked="" type="checkbox"/>	Mathematical derivations checked including dimensional consistency of results.
<input checked="" type="checkbox"/>	<input type="checkbox"/>	<input type="checkbox"/>	Models appropriate and used within range of validity or use outside range of established validity justified.
<input type="checkbox"/>	<input type="checkbox"/>	<input checked="" type="checkbox"/>	Hand calculations checked for errors.
<input checked="" type="checkbox"/>	<input type="checkbox"/>	<input type="checkbox"/>	Code run streams correct and consistent with analysis documentation.
<input checked="" type="checkbox"/>	<input type="checkbox"/>	<input type="checkbox"/>	Code output consistent with input and with results reported in analysis documentation.
<input checked="" type="checkbox"/>	<input type="checkbox"/>	<input type="checkbox"/>	Acceptability limits on analytical results applicable and supported. Limits checked against sources.
<input checked="" type="checkbox"/>	<input type="checkbox"/>	<input type="checkbox"/>	Safety Margins consistent with good engineering practices.
<input checked="" type="checkbox"/>	<input type="checkbox"/>	<input type="checkbox"/>	Conclusions consistent with analytical results and applicable limits.
<input checked="" type="checkbox"/>	<input type="checkbox"/>	<input type="checkbox"/>	Results and conclusions address all points required in the problem statement.

I have checked the analysis/calculation and it is complete and accurate to the best of my knowledge.

Engineer/Checker Scott Shiraga  Date 09/01/98

NOTE: Any hand calculations, notes or summaries generated as part of this check should be signed, dated, and attached to this checklist. Material should be labeled and recorded so that it is intelligible to a technically qualified third party.

7.7.1.11 DOT-17H 55-Gal Drum 25-MPH/5,000-Lb Dynamic Crush.

*HEADING

DOT-17H 55 GALLON DRUM, 25 MPH DYNAMIC CRUSH (SIDE), FILE=DY5K25P

RIGID TARGET

5000 POUNDS RIGID LOAD

*RESTART, WRITE, NUMBER INTERVAL=10

** DRUM

** GENERATE THE NODES OF DRUM BOTTOM PLATE

**

*NODE, SYSTEM=R

*NODE

1, -3.6, 0.0, 0.0

7, 3.6, 0.0, 0.0

22, -3.6, 3.6, 0.0

28, 3.6, 3.6, 0.0

*NGEN, NSET=LINEA

1, 7, 1

*NGEN, NSET=LINEB

22, 28, 1

*NFILL, NSET=DMB1

LINEA, LINEB, 3, 7

*NODE, NSET=DMB2

41, 5.4417, 0.0, 0.0

42, 5.3380, 1.5872, 0.0

43, 5.0342, 3.1208, 0.0

44, 4.5508, 4.5508, 0.0

45, 3.1208, 5.0342, 0.0

46, 1.5872, 5.3380, 0.0

47, 0.0, 5.4417, 0.0

48, -1.5872, 5.3380, 0.0

49, -3.1208, 5.0342, 0.0

50, -4.5508, 4.5508, 0.0

51, -5.0342, 3.1208, 0.0

52, -5.3380, 1.5872, 0.0

53, -5.4417, 0.0, 0.0

61, 7.2833, 0.0, 0.0

62, 7.0760, 1.9745, 0.0

63, 6.4683, 3.8417, 0.0

64, 5.5016, 5.5016, 0.0

65, 3.8417, 6.4683, 0.0

66, 1.9745, 7.0760, 0.0

67, 0.0, 7.2833, 0.0

68, -1.9745, 7.0760, 0.0

69, -3.8417, 6.4683, 0.0

70, -5.5016, 5.5016, 0.0

71, -6.4683, 3.8417, 0.0

72, -7.0760, 1.9745, 0.0

73, -7.2833, 0.0, 0.0

81, 9.6000, 0.0, 0.0

82, 9.2729, 2.4847, 0.0

83, 8.3138, 4.8000, 0.0

84, 6.7882, 6.7882, 0.0

85, 4.8000, 8.3138, 0.0

86, 2.4847, 9.2729, 0.0

87, 0.0, 9.6000, 0.0

88, -2.4847, 9.2729, 0.0

89, -4.8000, 8.3138, 0.0

90, -6.7882, 6.7882, 0.0

91, -8.3138, 4.8000, 0.0

92, -9.2729, 2.4847, 0.0

93, -9.6000, 0.0, 0.0

*NODE, NSET=DMB3

101, 11.5000, 0.0, 0.0

102, 11.1081, 2.9764, 0.0

103, 9.9593, 5.7500, 0.0

104, 8.1317, 8.1317, 0.0

105, 5.7500, 9.9593, 0.0

106, 2.9764, 11.1081, 0.0

107, 0.0, 11.5000, 0.0

108, -2.9764, 11.1081, 0.0

109, -5.7500, 9.9593, 0.0

110, -8.1317, 8.1317, 0.0

111, -9.9593, 5.7500, 0.0

```

112, -11.1081, 2.9764, 0.0
113, -11.5000, 0.0, 0.0
* NSET, NSET = DMB
DMB1, DMB2, DMB3
**
** GENERATE THE ELEMENTS OF DRUM BOTTOM PLATE
**
* ELEMENT, TYPE = S4R
1, 1, 2, 9, 8
* ELGEN, ELSET = DMBA
1, 6, 1, 1, 3, 7, 6
* ELEMENT, TYPE = S4R, ELSET = DMBB
21, 7, 41, 42, 14
22, 14, 42, 43, 21
23, 21, 43, 44, 28
24, 28, 44, 45, 27
25, 27, 45, 46, 26
26, 26, 46, 47, 25
27, 25, 47, 48, 24
28, 24, 48, 49, 23
29, 23, 49, 50, 22
30, 22, 50, 51, 15
31, 15, 51, 52, 8
32, 8, 52, 53, 1
41, 41, 61, 62, 42
* ELGEN, ELSET = DMBB
41, 12, 1, 1, 3, 20, 20
* ELSET, ELSET = DMB
DMBA, DMBB
* SHELL SECTION, ELSET = DMB, MATERIAL = ST
0.0478
**
** GENERATE THE DRUM CYLINDRICAL WALL
**
** NODES
**
* NCOPY, SHIFT, CHANGE NU = 40, OLD SET = DMB3, NEW SET = L1
0.0, 0.0, 2.0
0.0, 0.0, 0.0, 0.0, 0.0, 1.0, 0.0
* NCOPY, SHIFT, CHANGE NU = 300, OLD SET = L1, NEW SET = L2
0.0, 0.0, 30.0
0.0, 0.0, 0.0, 0.0, 0.0, 1.0, 0.0
* NCOPY, SHIFT, CHANGE NU = 40, OLD SET = L2, NEW SET = L3
0.0, 0.0, 2.0
0.0, 0.0, 0.0, 0.0, 0.0, 1.0, 0.0
* NFILL, NSET = DMW1
DMB3, L1, 2, 20
* NFILL, NSET = DMW2
L1, L2, 15, 20
* NFILL, NSET = DMW3
L2, L3, 2, 20
* NODE, NSET = DMW4
501, 11.5000, 0.0, 34.5
701, 11.5000, 0.0, 35.0
* NCOPY, SHIFT, MULTIPLE = 12, CHANGE NU = +1, OLD SET = DMW4, NEW SET = DMW4
0.0, 0.0, 0.0
0.0, 0.0, 0.0, 0.0, 0.0, 1.0, +15.00
* NSET, NSET = DMW
DMW1, DMW2, DMW3, DMW4
**
** ELEMENTS
**
* ELEMENT, TYPE = S4R, ELSET = DMW1
101, 101, 121, 122, 102
* ELGEN, ELSET = DMW1
101, 12, 1, 1, 2, 20, 20
* ELEMENT, TYPE = S4R, ELSET = DMW2
141, 141, 161, 162, 142
* ELGEN, ELSET = DMW2
141, 12, 1, 1, 15, 20, 20
* ELEMENT, TYPE = S4R, ELSET = DMW3
441, 441, 461, 462, 442
* ELGEN, ELSET = DMW3
441, 12, 1, 1, 2, 20, 20
* ELEMENT, TYPE = S4R, ELSET = DMW4
481, 481, 501, 502, 482
501, 501, 701, 702, 502
* ELGEN, ELSET = DMW4

```

```

481, 12, 1, 1
501, 12, 1, 1
*ELSET, ELSET = DMW
DMW1, DMW2, DMW3, DMW4
*SHELL SECTION, ELSET = DMW, MATERIAL = ST
0.0478
**
** GENERATE THE NODES OF DRUM LID
**
*NCOPY, SHIFT, CHANGE NU = 1000, OLD SET = DMB, NEW SET = DML
0.0, 0.0, 34.50
0.0, 0.0, 0.0, 0.0, 0.0, 1.0, 0.0
** MODIFY NODES
*NODE, NSET = DML
1101, 10.5000, 0.0, 34.50
1102, 10.1422, 2.7176, 34.50
1103, 9.0933, 5.2500, 34.50
1104, 7.4246, 7.4246, 34.50
1105, 5.2500, 9.0933, 34.50
1106, 2.7176, 10.1422, 34.50
1107, 0.0, 10.5000, 34.50
1108, -2.7176, 10.1422, 34.50
1109, -5.2500, 9.0933, 34.50
1110, -7.4246, 7.4246, 34.50
1111, -9.0933, 5.2500, 34.50
1112, -10.1422, 2.7176, 34.50
1113, -10.5000, 0.0, 34.50
**
** GENERATE THE DRUM LID
**
*ELEMENT, TYPE = S4R
1001, 1001, 1002, 1009, 1008
*ELGEN, ELSET = DMLA
1001, 6, 1, 1, 3, 7, 6
*ELEMENT, TYPE = S4R, ELSET = DMLB
1021, 1007, 1041, 1042, 1014
1022, 1014, 1042, 1043, 1021
1023, 1021, 1043, 1044, 1028
1024, 1028, 1044, 1045, 1027
1025, 1027, 1045, 1046, 1026
1026, 1026, 1046, 1047, 1025
1027, 1025, 1047, 1048, 1024
1028, 1024, 1048, 1049, 1023
1029, 1023, 1049, 1050, 1022
1030, 1022, 1050, 1051, 1015
1031, 1015, 1051, 1052, 1008
1032, 1008, 1052, 1053, 1001
*ELEMENT, TYPE = S4R
1041, 1041, 1061, 1062, 1042
*ELGEN, ELSET = DMLC
1041, 12, 1, 1, 2, 20, 20
*ELEMENT, TYPE = S4R
1081, 1081, 1101, 1102, 1082
*ELGEN, ELSET = DMLD
1081, 12, 1, 1
*ELSET, ELSET = DML
DMLA, DMLB, DMLC, DMLD
*SHELL SECTION, ELSET = DML, MATERIAL = ST
0.0478
**NSET, NSET = DM
DMB, DMW, DML
*ELSET, ELSET = DM
DMB, DMW, DML
*****
** CLOSING RING, DRUM LID, AND DRUM ASSEMBLY
*****
*NODE, NSET = RING
601, 11.7500, 0.0, 34.0670
621, 11.9330, 0.0, 34.2500
641, 12.0000, 0.0, 34.5000
661, 11.9330, 0.0, 34.7500
681, 11.7500, 0.0, 34.9330
701, 11.5000, 0.0, 35.0000
721, 11.2500, 0.0, 34.9330
741, 11.0670, 0.0, 34.7500
*NCOPY, SHIFT, MULTIPLE = 12, CHANGE NU = +1, OLD SET = RING, NEW SET = RING
0.0, 0.0, 0.0
0.0, 0.0, 0.0, 0.0, 0.0, 1.0, +15.00

```

```

*ELEMENT, TYPE=S4R
601, 481, 482, 602, 601
621, 601, 602, 622, 621
721, 701, 702, 722, 721
761, 741, 742, 1102, 1101
*ELGEN, ELSET=RING1
601, 12, 1, 1
621, 12, 1, 1, 5, 20, 20
*ELGEN, ELSET=RING2
721, 12, 1, 1, 2, 20, 20
761, 12, 1, 1
*ELSET, ELSET=RING
RING1, RING2
*SHELL SECTION, ELSET=RING1, MATERIAL=ST
0.50
*SHELL SECTION, ELSET=RING2, MATERIAL=ST
0.35
*****
** CLOSING RING BOLT
*****
*NODE, NSET=BOLT
1501, 11.500, 0.0, 34.500
1502, 11.500, 0.5, 34.500
*ELEMENT, TYPE=T3D2, ELSET=BOLT
1501, 1501, 1502
*SOLID SECTION, ELSET=BOLT, MATERIAL=BOLT
0.226
*MFC
TIE,601,1502
TIE,621,1502
TIE,641,1502
TIE,661,1502
TIE,681,1502
*EQUATION
2
1501,1,1,0,1502,1,-1.0
*EQUATION
2
1501,3,1,0,1502,3,-1.0
*****
** PAYLOAD
*****
*NODE, SYSTEM=R
*NODE
2001, -4.0, 0.0, 0.024
2005, 4.0, 0.0, 0.024
2011, -4.0, 4.0, 0.024
2015, 4.0, 4.0, 0.024
*NGEN, NSET=LINEC
2001, 2005, 1
*NGEN, NSET=LINED
2011, 2015, 1
*NFILL, NSET=PAYB1
LINEC, LINED, 2, 5
*NODE, NSET=PAYB2
2021, 7.625, 0.0, 0.024
2022, 7.1968, 3.1526, 0.024
2023, 5.9775, 5.9775, 0.024
2024, 3.1526, 7.1968, 0.024
2025, 0.0, 7.625, 0.024
2026, -3.1526, 7.1968, 0.024
2027, -5.9775, 5.9775, 0.024
2028, -7.1968, 3.1526, 0.024
2029, -7.625, 0.0, 0.024
*NODE, NSET=PAYB3
2031, 11.25, 0.0, 0.024
2032, 10.394, 4.3052, 0.024
2033, 7.9550, 7.9550, 0.024
2034, 4.3052, 10.394, 0.024
2035, 0.0, 11.25, 0.024
2036, -4.3052, 10.394, 0.024
2037, -7.9550, 7.9550, 0.024
2038, -10.394, 4.3052, 0.024
2039, -11.25, 0.0, 0.024
*NSET, NSET=PAYB
PAYB1, PAYB2, PAYB3
*ELEMENT, TYPE=S4R
2001, 2001, 2002, 2007, 2006

```

```

*ELGEN, ELSET = PAYB1
2001, 4, 1, 1, 2, 5, 5
*ELEMENT, TYPE = S4R, ELSET = PAYB2
2011, 2005, 2021, 2022, 2010
2012, 2010, 2022, 2023, 2015
2013, 2015, 2023, 2024, 2014
2014, 2014, 2024, 2025, 2013
2015, 2013, 2025, 2026, 2012
2016, 2012, 2026, 2027, 2011
2017, 2011, 2027, 2028, 2008
2018, 2006, 2028, 2029, 2001
*ELEMENT, TYPE = S4R
2021, 2021, 2031, 2032, 2022
*ELGEN, ELSET = PAYB2
2021, 8, 1, 1
*ELSET, ELSET = PAYB
PAYB1, PAYB2
*SHELL SECTION, ELSET = PAYB, MATERIAL = PAYLD
0.0478
*****
*NCOPY,SHIFT,CHANGE NU = 100,OLD SET = PAYB3,NEW SET = PAYW1
0.0, 0.0, 33.25
0.0, 0.0, 0.0, 0.0, 0.0, 1.0, 0.0
*NFILL, NSET = PAYW
PAYB3, PAYW1, 10, 10
*ELEMENT, TYPE = S4R
2031, 2031, 2041, 2042, 2032
*ELGEN, ELSET = PAYW
2031, 8, 1, 1, 10, 10, 10
*SHELL SECTION, ELSET = PAYW, MATERIAL = PAYLD
0.0478
*****
*NCOPY,SHIFT,CHANGE NU = 200,OLD SET = PAYB,NEW SET = PAYT
0.0, 0.0, 33.25
0.0, 0.0, 0.0, 0.0, 0.0, 1.0, 0.0
*ELEMENT, TYPE = S4R
2201, 2201, 2202, 2207, 2206
*ELGEN, ELSET = PAYT1
2201, 4, 1, 1, 2, 5, 5
*ELEMENT, TYPE = S4R, ELSET = PAYT2
2211, 2205, 2221, 2222, 2210
2212, 2210, 2222, 2223, 2215
2213, 2215, 2223, 2224, 2214
2214, 2214, 2224, 2225, 2213
2215, 2213, 2225, 2226, 2212
2216, 2212, 2226, 2227, 2211
2217, 2211, 2227, 2228, 2206
2218, 2206, 2228, 2229, 2201
*ELEMENT, TYPE = S4R
2221, 2221, 2131, 2132, 2222
*ELGEN, ELSET = PAYT2
2221, 8, 1, 1
*ELSET, ELSET = PAYT
PAYT1, PAYT2
*ELSET, ELSET = PAY
PAYB, PAYW, PAYT
*NSET, NSET = PAY
PAYB, PAYW, PAYT
*SHELL SECTION, ELSET = PAYT, MATERIAL = PAYLD
0.0478
*****
** RIGID TARGET
*****
*NODE, NSET = TARGET0
115000, 0.0, 0.0, -0.025
115001, -40.0, -0.001, -0.025
115002, 40.0, -0.001, -0.025
115003, 40.0, 40.0, -0.025
115004, -40.0, 40.0, -0.025
*****
** RIGID CRUSH LOAD
*****
*NODE, NSET = LOAD0
120000, 0.0, 0.0, -0.025
120001, -40.0, -0.001, -0.025
120002, 40.0, -0.001, -0.025
120003, 40.0, 40.0, -0.025
120004, -40.0, 40.0, -0.025

```

```

**
** GENERATE THE INCLINED IMPACT SURFACES
**
*NCOPY,SHIFT,CHANGE NU=-100000,OLD SET=TARGET0,NEW SET=TARGET
12.565, 0., 17.5
12.565, 0., 17.5, 12.565, 1., 17.5, -90.0
*NCOPY,SHIFT,CHANGE NU=-100000,OLD SET=LOAD0,NEW SET=LOAD
-12.565, 0., 17.5
-12.565, 0., 17.5, -12.565, 1., 17.5, +90.0
*****
** RIGID TARGET
*****
*ELEMENT,TYPE=R3D4,ELSET=TARGET
15000,15001,15002,15003,15004
*RIGID BODY, ELSET=TARGET, REF NODE=15000
*****
** RIGID CRUSH LOAD
*****
*ELEMENT,TYPE=R3D4,ELSET=LOAD
20000,20001,20002,20003,20004
*RIGID BODY, ELSET=LOAD, REF NODE=20000
*ELEMENT,TYPE=MASS,ELSET=MASS
20001,20000
*MASS,ELSET=MASS
6.470
**
** ASTM A36
**
*MATERIAL, NAME=ST
*ELASTIC
29.0E6, 0.3
*PLASTIC
36000., 0.
60000., 0.23
30000., 0.24
10000., 0.25
5000., 0.26
1000., 0.27
*DENSITY
7.5052E-4
*FAILURE
0.30, 0.25
**
** CLOSING RING BOLT MATERIAL
** ASTM A307, GR. C
**
*MATERIAL, NAME=BOLT
*ELASTIC
29.0E6, 0.3
*PLASTIC
36000., 0.
60000., 0.23
30000., 0.24
10000., 0.25
5000., 0.26
1000., 0.27
*DENSITY
7.5052E-4
*FAILURE
0.30, 0.25
*MATERIAL, NAME=PAYLD
*ELASTIC
29.0E6, 0.3
*DENSITY
0.02437
**
** ELEMENT SET DEFINITIONS
**
*ELSET,ELSET=ALLEL
DMB, DMW, DML
RING, BOLT
PAY,
**
** NODE SET DEFINITIONS
**
*NSET,NSET=ALLND
DMB, DMW, DML
RING, BOLT

```

```

PAY,
*NSET,NSET=YSYMM,GENERATE
15001,15002,1
20001,20002,1
*NSET,NSET=YSYMM,GENERATE
1, 7, 1
41, 53, 12
61, 73, 12
81, 93, 12
101, 501, 20
113, 513, 20
613, 693, 20
701, 741, 20
713, 753, 20
1001, 1007, 1
1041, 1053, 12
1061, 1073, 12
1081, 1093, 12
1101, 1113, 12
1501, 1501, 1
2001, 2005, 1
2021, 2029, 8
2031, 2131, 10
2039, 2139, 10
2201, 2205, 1
2221, 2229, 8
*BOUNDARY
YSYMM,YSYMM
15000,1,6
*****
*INITIAL CONDITIONS,TYPE=VELOCITY
20000,1,440.0
*STEP
*DYNAMIC,EXPLICIT
,200.0E-03
**
** DEFINE THE CONTACT SURFACES BETWEEN
** THE DRUM OUTSIDE AND TARGET
**
*SURFACE DEFINITION,NAME= TGTOP,NO THICK
TARGET,SPOS
*SURFACE DEFINITION,NAME= DMOUT,NO THICK
DMB,SNEG
DMW1,SNEG
DMW2,SNEG
DMW3,SNEG
RING,SPOS
DML,SPOS
*CONTACT PAIR
TGTOP,DMOUT
**
** DEFINE THE CONTACT SURFACES BETWEEN
** THE LOAD AND DRUM OUTSIDE
**
*SURFACE DEFINITION,NAME= LOADBT,NO THICK
LOAD,SPOS
*CONTACT PAIR
LOADBT,DMOUT
**
** DEFINE THE CONTACT SURFACES BETWEEN
** THE DRUM INSIDE AND PAYLOAD OUTSIDE
**
*SURFACE DEFINITION,NAME= DMINS,NO THICK
DMB,SPOS
DMW1,SPOS
DMW2,SPOS
DMW3,SPOS
DMW4,SPOS
RING2,SNEG
DML,SNEG
*SURFACE DEFINITION,NAME= PAYOUT,NO THICK
PAYB,SNEG
PAYW,SNEG
PAYT,SPOS
*CONTACT PAIR
DMINS,PAYOUT
*****
*NSET,NSET=DMDIS,GENERATE

```

```

4,4,1
1004,1004,1
101,113,3
301,313,3
541,553,3
20000,20000,1
*ELSET,ELSET = DMBST,GENERATE
1,18,1
61,72,1
81,92,1
*ELSET,ELSET = DMWST,GENERATE
101,112,1
121,132,1
141,182,1
161,172,1
441,452,1
461,472,1
481,492,1
501,512,1
*ELSET,ELSET = DMLST,GENERATE
1001,1018,1
1061,1072,1
1081,1092,1
*ELSET,ELSET = BOLTST,GENERATE
1501,1501,1
*****
*HISTORY OUTPUT, TIME = 1.0E-4
*NODE HISTORY, NSET = DMDIS
U, V, A
*EL HISTORY, ELSET = DMBST
SENER,
PENER,
*EL HISTORY, ELSET = DMWST
SENER,
PENER,
*EL HISTORY, ELSET = DMLST
SENER,
PENER,
*EL HISTORY, ELSET = BOLTST
SENER,
PENER,
*FILE OUTPUT, NUMBER INTERVAL = 400
*NODE FILE
RF,
*MONITOR,NODE = 307,DOF = 1
*END STEP
-

```



CHECKLIST FOR CHECKING OF ANALYSIS/CALCULATIONS

Document Number/Revision: HNF-2209/Rev. 0Document Title: DOT-17H 55 Gallon Drum 25 MPH/5000-Lb Dynamic Crush

Yes	No	N/A	
<input checked="" type="checkbox"/>	<input type="checkbox"/>	<input type="checkbox"/>	Problem completely defined.
<input checked="" type="checkbox"/>	<input type="checkbox"/>	<input type="checkbox"/>	Appropriate analytical method used.
<input checked="" type="checkbox"/>	<input type="checkbox"/>	<input type="checkbox"/>	Necessary assumptions are appropriate and explicitly stated.
<input checked="" type="checkbox"/>	<input type="checkbox"/>	<input type="checkbox"/>	Computer codes and data files documented.
<input checked="" type="checkbox"/>	<input type="checkbox"/>	<input type="checkbox"/>	Data used in calculations explicitly stated in document.
<input type="checkbox"/>	<input type="checkbox"/>	<input checked="" type="checkbox"/>	Sources of non-standard formula/data are referenced and the correctness of the reference verified.
<input checked="" type="checkbox"/>	<input type="checkbox"/>	<input type="checkbox"/>	Data checked for consistency with original source information as applicable.
<input type="checkbox"/>	<input type="checkbox"/>	<input checked="" type="checkbox"/>	Mathematical derivations checked including dimensional consistency of results.
<input checked="" type="checkbox"/>	<input type="checkbox"/>	<input type="checkbox"/>	Models appropriate and used within range of validity or use outside range of established validity justified.
<input type="checkbox"/>	<input type="checkbox"/>	<input checked="" type="checkbox"/>	Hand calculations checked for errors.
<input checked="" type="checkbox"/>	<input type="checkbox"/>	<input type="checkbox"/>	Code run streams correct and consistent with analysis documentation.
<input checked="" type="checkbox"/>	<input type="checkbox"/>	<input type="checkbox"/>	Code output consistent with input and with results reported in analysis documentation.
<input checked="" type="checkbox"/>	<input type="checkbox"/>	<input type="checkbox"/>	Acceptability limits on analytical results applicable and supported. Limits checked against sources.
<input checked="" type="checkbox"/>	<input type="checkbox"/>	<input type="checkbox"/>	Safety Margins consistent with good engineering practices.
<input checked="" type="checkbox"/>	<input type="checkbox"/>	<input type="checkbox"/>	Conclusions consistent with analytical results and applicable limits.
<input checked="" type="checkbox"/>	<input type="checkbox"/>	<input type="checkbox"/>	Results and conclusions address all points required in the problem statement.

I have checked the analysis/calculation and it is complete and accurate to the best of my knowledge.

Engineer/Checker Scott ShiragaDate 09/01/98

NOTE: Any hand calculations, notes or summaries generated as part of this check should be signed, dated, and attached to this checklist. Material should be labeled and recorded so that it is intelligible to a technically qualified third party.

7.7.1.12 55-Gal Drum/30-Mil Wall Thickness 10-ft Top-Corner Drop.

```

*HEADING
FILE=TTC10X 8/17/98
55 GALLON DRUM/30 MIL THICKNESS, 10-FT TOP CORNER DROP
**RESTART, WRITE, NUMBER INTERVAL=10
*****
** DRUM
*****
**
** GENERATE THE NODES OF DRUM BOTTOM PLATE
**
*NODE, SYSTEM=R
*NODE
1, -3.6, 0.0, 0.0
7, 3.6, 0.0, 0.0
22, -3.6, 3.6, 0.0
28, 3.6, 3.6, 0.0
*NGEN, NSET=LINEA
1, 7, 1
*NGEN, NSET=LINEB
22, 28, 1
*NFILL, NSET=DMB1
LINEA, LINEB, 3, 7
*NODE, NSET=DMB2
41, 5.4417, 0.0, 0.0
42, 5.3380, 1.5872, 0.0
43, 5.0342, 3.1208, 0.0
44, 4.5508, 4.5508, 0.0
45, 3.1208, 5.0342, 0.0
46, 1.5872, 5.3380, 0.0
47, 0.0, 5.4417, 0.0
48, -1.5872, 5.3380, 0.0
49, -3.1208, 5.0342, 0.0
50, -4.5508, 4.5508, 0.0
51, -5.0342, 3.1208, 0.0
52, -5.3380, 1.5872, 0.0
53, -5.4417, 0.0, 0.0
61, 7.2833, 0.0, 0.0
62, 7.0760, 1.9745, 0.0
63, 6.4683, 3.8417, 0.0
64, 5.5016, 5.5016, 0.0
65, 3.8417, 6.4683, 0.0
66, 1.9745, 7.0760, 0.0
67, 0.0, 7.2833, 0.0
68, -1.9745, 7.0760, 0.0
69, -3.8417, 6.4683, 0.0
70, -5.5016, 5.5016, 0.0
71, -6.4683, 3.8417, 0.0
72, -7.0760, 1.9745, 0.0
73, -7.2833, 0.0, 0.0
81, 9.6000, 0.0, 0.0
82, 9.2729, 2.4847, 0.0
83, 8.3138, 4.8000, 0.0
84, 6.7882, 6.7882, 0.0
85, 4.8000, 8.3138, 0.0
86, 2.4847, 9.2729, 0.0
87, 0.0, 9.6000, 0.0
88, -2.4847, 9.2729, 0.0
89, -4.8000, 8.3138, 0.0
90, -6.7882, 6.7882, 0.0
91, -8.3138, 4.8000, 0.0
92, -9.2729, 2.4847, 0.0
93, -9.6000, 0.0, 0.0
*NODE, NSET=DMB3
101, 11.5000, 0.0, 0.0
102, 11.1081, 2.9764, 0.0
103, 9.9593, 5.7500, 0.0
104, 8.1317, 8.1317, 0.0
105, 5.7500, 9.9593, 0.0
106, 2.9764, 11.1081, 0.0
107, 0.0, 11.5000, 0.0
108, -2.9764, 11.1081, 0.0
109, -5.7500, 9.9593, 0.0
110, -8.1317, 8.1317, 0.0
111, -9.9593, 5.7500, 0.0
112, -11.1081, 2.9764, 0.0

```

```

113, -11.5000, 0.0, 0.0
* NSET, NSET = DMB
DMB1, DMB2, DMB3
**
** GENERATE THE ELEMENTS OF DRUM BOTTOM PLATE
**
* ELEMENT, TYPE = S4R
1, 1, 2, 9, 8
* ELGEN, ELSET = DMBA
1, 6, 1, 1, 3, 7, 6
* ELEMENT, TYPE = S4R, ELSET = DMBB
21, 7, 41, 42, 14
22, 14, 42, 43, 21
23, 21, 43, 44, 28
24, 28, 44, 45, 27
25, 27, 45, 46, 26
26, 26, 46, 47, 25
27, 25, 47, 48, 24
28, 24, 48, 49, 23
29, 23, 49, 50, 22
30, 22, 50, 51, 15
31, 15, 51, 52, 8
32, 8, 52, 53, 1
41, 41, 61, 62, 42
* ELGEN, ELSET = DMBB
41, 12, 1, 1, 3, 20, 20
* ELSET, ELSET = DMB
DMBA, DMBB
* SHELL SECTION, ELSET = DMB, MATERIAL = ST
0.030
**
** GENERATE THE DRUM CYLINDRICAL WALL
**
** NODES
**
* NCOPY, SHIFT, CHANGE NU = 40, OLD SET = DMB3, NEW SET = L1
0.0, 0.0, 2.0
0.0, 0.0, 0.0, 0.0, 0.0, 1.0, 0.0
* NCOPY, SHIFT, CHANGE NU = 300, OLD SET = L1, NEW SET = L2
0.0, 0.0, 30.0
0.0, 0.0, 0.0, 0.0, 0.0, 1.0, 0.0
* NCOPY, SHIFT, CHANGE NU = 40, OLD SET = L2, NEW SET = L3
0.0, 0.0, 2.0
0.0, 0.0, 0.0, 0.0, 0.0, 1.0, 0.0
* NFILL, NSET = DMW1
DMB3, L1, 2, 20
* NFILL, NSET = DMW2
L1, L2, 15, 20
* NFILL, NSET = DMW3
L2, L3, 2, 20
* NODE, NSET = DMW4
501, 11.5000, 0.0, 34.5
701, 11.5000, 0.0, 35.0
* NCOPY, SHIFT, MULTIPLE = 12, CHANGE NU = + 1, OLD SET = DMW4, NEW SET = DMW4
0.0, 0.0, 0.0
0.0, 0.0, 0.0, 0.0, 0.0, 1.0, + 15.00
* NSET, NSET = DMW
DMW1, DMW2, DMW3, DMW4
**
** ELEMENTS
**
* ELEMENT, TYPE = S4R, ELSET = DMW1
101, 101, 121, 122, 102
* ELGEN, ELSET = DMW1
101, 12, 1, 1, 2, 20, 20
* ELEMENT, TYPE = S4R, ELSET = DMW2
141, 141, 161, 162, 142
* ELGEN, ELSET = DMW2
141, 12, 1, 1, 15, 20, 20
* ELEMENT, TYPE = S4R, ELSET = DMW3
441, 441, 461, 462, 442
* ELGEN, ELSET = DMW3
441, 12, 1, 1, 2, 20, 20
* ELEMENT, TYPE = S4R, ELSET = DMW4
481, 481, 501, 502, 482
501, 501, 701, 702, 502
* ELGEN, ELSET = DMW4
481, 12, 1, 1

```

```

501, 12, 1, 1
*ELSET, ELSET = DMW
DMW1, DMW2, DMW3, DMW4
*SHELL SECTION, ELSET = DMW, MATERIAL = ST
0.030
**
** GENERATE THE NODES OF DRUM LID
**
*NCOPY, SHIFT, CHANGE NU = 1000, OLD SET = DMB, NEW SET = DML
0.0, 0.0, 34.50
0.0, 0.0, 0.0, 0.0, 0.0, 1.0, 0.0
** MODIFY NODES
*NODE, NSET = DML
1101, 10.5000, 0.0, 34.50
1102, 10.1422, 2.7176, 34.50
1103, 9.0933, 5.2500, 34.50
1104, 7.4246, 7.4246, 34.50
1105, 5.2500, 9.0933, 34.50
1106, 2.7176, 10.1422, 34.50
1107, 0.0, 10.5000, 34.50
1108, -2.7176, 10.1422, 34.50
1109, -5.2500, 9.0933, 34.50
1110, -7.4246, 7.4246, 34.50
1111, -9.0933, 5.2500, 34.50
1112, -10.1422, 2.7176, 34.50
1113, -10.5000, 0.0, 34.50
**
** GENERATE THE DRUM LID
**
*ELEMENT, TYPE = S4R
1001, 1001, 1002, 1009, 1008
*ELGEN, ELSET = DMLA
1001, 6, 1, 1, 3, 7, 6
*ELEMENT, TYPE = S4R, ELSET = DMLB
1021, 1007, 1041, 1042, 1014
1022, 1014, 1042, 1043, 1021
1023, 1021, 1043, 1044, 1028
1024, 1028, 1044, 1045, 1027
1025, 1027, 1045, 1046, 1026
1026, 1026, 1046, 1047, 1025
1027, 1025, 1047, 1048, 1024
1028, 1024, 1048, 1049, 1023
1029, 1023, 1049, 1050, 1022
1030, 1022, 1050, 1051, 1015
1031, 1015, 1051, 1052, 1008
1032, 1008, 1052, 1053, 1001
*ELEMENT, TYPE = S4R
1041, 1041, 1061, 1062, 1042
*ELGEN, ELSET = DMLC
1041, 12, 1, 1, 2, 20, 20
*ELEMENT, TYPE = S4R
1081, 1081, 1101, 1102, 1082
*ELGEN, ELSET = DMLD
1081, 12, 1, 1
*ELSET, ELSET = DML
DMLA, DMLB, DMLC, DMLD
*SHELL SECTION, ELSET = DML, MATERIAL = ST
0.030
*NSET, NSET = DM
DMB, DMW, DML
*ELSET, ELSET = DM
DMB, DMW, DML
*****
** CLOSING RING, DRUM LID, AND DRUM ASSEMBLY
*****
*NODE, NSET = RING
601, 11.7500, 0.0, 34.0670
621, 11.9330, 0.0, 34.2500
641, 12.0000, 0.0, 34.5000
661, 11.9330, 0.0, 34.7500
681, 11.7500, 0.0, 34.9330
701, 11.5000, 0.0, 35.0000
721, 11.2500, 0.0, 34.9330
741, 11.0670, 0.0, 34.7500
*NCOPY, SHIFT, MULTIPLE = 12, CHANGE NU = + 1, OLD SET = RING, NEW SET = RING
0.0, 0.0, 0.0
0.0, 0.0, 0.0, 0.0, 0.0, 1.0, + 15.00
*ELEMENT, TYPE = S4R

```

```

601, 481, 482, 602, 601
621, 601, 602, 622, 621
721, 701, 702, 722, 721
761, 741, 742, 1102, 1101
*ELGEN, ELSET=RING1
601, 12, 1, 1
621, 12, 1, 1, 5, 20, 20
*ELGEN, ELSET=RING2
721, 12, 1, 1, 2, 20, 20
761, 12, 1, 1
*ELSET, ELSET=RING
RING1, RING2
*SHELL SECTION, ELSET=RING1, MATERIAL=ST
0.50
*SHELL SECTION, ELSET=RING2, MATERIAL=ST
0.35
*****
** CLOSING RING BOLT
*****
*NODE, NSET=BOLT
1501, 11.500, 0.0, 34.500
1502, 11.500, 0.5, 34.500
*ELEMENT, TYPE=T3D2, ELSET=BOLT
1501, 1501, 1502
*SOLID SECTION, ELSET=BOLT, MATERIAL=BOLT
0.226
*MPC
TIE,601,1502
TIE,621,1502
TIE,641,1502
TIE,661,1502
TIE,681,1502
*EQUATION
2
1501,1,1,0,1502,1,-1.0
*EQUATION
2
1501,3,1,0,1502,3,-1.0
*****
** PAYLOAD
*****
*NODE, SYSTEM=R
*NODE
2001, -4.0, 0.0, 0.024
2005, 4.0, 0.0, 0.024
2011, -4.0, 4.0, 0.024
2015, 4.0, 4.0, 0.024
*NGEN, NSET=LINEC
2001, 2005, 1
*NGEN, NSET=LINED
2011, 2015, 1
*NFILL, NSET=PAYB1
LINEC, LINED, 2, 5
*NODE, NSET=PAYB2
2021, 7.625, 0.0, 0.024
2022, 7.1968, 3.1526, 0.024
2023, 5.9775, 5.9775, 0.024
2024, 3.1526, 7.1968, 0.024
2025, 0.0, 7.625, 0.024
2026, -3.1526, 7.1968, 0.024
2027, -5.9775, 5.9775, 0.024
2028, -7.1968, 3.1526, 0.024
2029, -7.625, 0.0, 0.024
*NODE, NSET=PAYB3
2031, 11.25, 0.0, 0.024
2032, 10.394, 4.3052, 0.024
2033, 7.9550, 7.9550, 0.024
2034, 4.3052, 10.394, 0.024
2035, 0.0, 11.25, 0.024
2036, -4.3052, 10.394, 0.024
2037, -7.9550, 7.9550, 0.024
2038, -10.394, 4.3052, 0.024
2039, -11.25, 0.0, 0.024
*NSET, NSET=PAYB
PAYB1, PAYB2, PAYB3
*ELEMENT, TYPE=S4R
2001, 2001, 2002, 2007, 2006
*ELGEN, ELSET=PAYB1

```

```

2001, 4, 1, 1, 2, 5, 5
*ELEMENT, TYPE=S4R, ELSET=PAYB2
2011, 2005, 2021, 2022, 2010
2012, 2010, 2022, 2023, 2015
2013, 2015, 2023, 2024, 2014
2014, 2014, 2024, 2025, 2013
2015, 2013, 2025, 2026, 2012
2016, 2012, 2026, 2027, 2011
2017, 2011, 2027, 2028, 2006
2018, 2006, 2028, 2029, 2001
*ELEMENT, TYPE=S4R
2021, 2021, 2031, 2032, 2022
*ELGEN, ELSET=PAYB2
2021, 8, 1, 1
*ELSET, ELSET=PAYB
PAYB1, PAYB2
*SHELL SECTION, ELSET=PAYB, MATERIAL=PAYLD
0.030
*****
*NCOPY,SHIFT,CHANGE NU=100,OLD SET=PAYB3,NEW SET=PAYW1
0.0, 0.0, 33.25
0.0, 0.0, 0.0, 0.0, 1.0, 0.0
*NFILL, NSET=PAYW
PAYB3, PAYW1, 10, 10
*ELEMENT, TYPE=S4R
2031, 2031, 2041, 2042, 2032
*ELGEN, ELSET=PAYW
2031, 8, 1, 1, 10, 10, 10
*SHELL SECTION, ELSET=PAYW, MATERIAL=PAYLD
0.030
*****
*NCOPY,SHIFT,CHANGE NU=200,OLD SET=PAYB,NEW SET=PAYT
0.0, 0.0, 33.25
0.0, 0.0, 0.0, 0.0, 1.0, 0.0
*ELEMENT, TYPE=S4R
2201, 2201, 2202, 2207, 2206
*ELGEN, ELSET=PAYT1
2201, 4, 1, 1, 2, 5, 5
*ELEMENT, TYPE=S4R, ELSET=PAYT2
2211, 2205, 2221, 2222, 2210
2212, 2210, 2222, 2223, 2215
2213, 2215, 2223, 2224, 2214
2214, 2214, 2224, 2225, 2213
2215, 2213, 2225, 2226, 2212
2216, 2212, 2226, 2227, 2211
2217, 2211, 2227, 2228, 2206
2218, 2206, 2228, 2229, 2201
*ELEMENT, TYPE=S4R
2221, 2221, 2131, 2132, 2222
*ELGEN, ELSET=PAYT2
2221, 8, 1, 1
*ELSET, ELSET=PAYT
PAYT1, PAYT2
*ELSET, ELSET=PAY
PAYB, PAYW, PAYT
*NSET, NSET=PAY
PAYB, PAYW, PAYT
*SHELL SECTION, ELSET=PAYT, MATERIAL=PAYLD
0.030
*****
** GENERATE THE ELEMENTS OF CONCRETE PAD
** 10' X 10' RECTANGULAR HALF SECTION (NO INF)
**
*NODE, SYSTEM=R
*NODE, NSET=C1
160001, -60.0, 0.0, -8.0
*NODE, NSET=C2
160004, -45.0, 0.0, -8.0
*NODE, NSET=C3
160034, 45.0, 0.0, -8.0
*NODE, NSET=C4
160037, 60.0, 0.0, -8.0
*NFILL, NSET=LINE1
C1, C2, 3
C2, C3, 30
C3, C4, 3
*NCOPY,SHIFT,CHANGE NU=500,OLD SET=LINE1,NEW SET=LINE2
0.0, 30.0, 0.0

```

```

0.0, 0.0, 0.0, 0.0, 0.0, 1.0, 0.0
*NCOPY,SHIFT,CHANGE NU = 300,OLD SET = LINE2,NEW SET = LINE3
0.0, 30.0, 0.0
0.0, 0.0, 0.0, 0.0, 0.0, 1.0, 0.0
*NIFILL, NSET = CONC1
LINE1, LINE2, 10, 50
LINE2, LINES, 6, 50
*NCOPY,SHIFT,CHANGE NU = 2000,OLD SET = CONC1,NEW SET = CONC2
0.0, 0.0, 2.0
0.0, 0.0, 0.0, 0.0, 0.0, 1.0, 0.0
*NCOPY,SHIFT,CHANGE NU = 2000,OLD SET = CONC2,NEW SET = CONC3
0.0, 0.0, 2.0
0.0, 0.0, 0.0, 0.0, 0.0, 1.0, 0.0
*NCOPY,SHIFT,CHANGE NU = 2000,OLD SET = CONC3,NEW SET = CONC4
0.0, 0.0, 2.0
0.0, 0.0, 0.0, 0.0, 0.0, 1.0, 0.0
*NCOPY,SHIFT,CHANGE NU = 2000,OLD SET = CONC4,NEW SET = CONC5
0.0, 0.0, 2.0
0.0, 0.0, 0.0, 0.0, 0.0, 1.0, 0.0
*NCOPY,SHIFT,CHANGE NU = 2000,OLD SET = CONC4,NEW SET = CONC5
0.0, 0.0, 2.0
0.0, 0.0, 0.0, 0.0, 0.0, 1.0, 0.0
*NSET,NSET = CONC0
CONC1, CONC2, CONC3, CONC4, CONC5,
**
** GENERATE THE SOIL NODES
**
*NCOPY, SHIFT, CHANGE NU = 20000, OLD SET = CONC1, NEW SET = SOIL1
0.0, 0.0, -50.0
0.0, 0.0, 0.0, 0.0, 0.0, 1.0, 0.0
*NCOPY, SHIFT, CHANGE NU = 2000, OLD SET = SOIL1, NEW SET = SOIL2
0.0, 0.0, +20.0
0.0, 0.0, 0.0, 0.0, 0.0, 1.0, 0.0
*NCOPY, SHIFT, CHANGE NU = 2000, OLD SET = SOIL2, NEW SET = SOIL3
0.0, 0.0, +10.0
0.0, 0.0, 0.0, 0.0, 0.0, 1.0, 0.0
*NCOPY, SHIFT, CHANGE NU = 2000, OLD SET = SOIL3, NEW SET = SOIL4
0.0, 0.0, +10.0
0.0, 0.0, 0.0, 0.0, 0.0, 1.0, 0.0
*NCOPY, SHIFT, CHANGE NU = 2000, OLD SET = SOIL4, NEW SET = SOIL5
0.0, 0.0, +5.0
0.0, 0.0, 0.0, 0.0, 0.0, 1.0, 0.0
*NSET,NSET = SOIL0
SOIL1, SOIL2, SOIL3, SOIL4, SOIL5
**
** GENERATE THE INCLINED IMPACT SURFACES
**
*NCOPY,SHIFT,CHANGE NU = -100000,OLD SET = CONC0,NEW SET = CONC
12.000, 0., 34.8
12.000, 0., 34.8, 12.000, 1., 34.8, -146.31
*NCOPY,SHIFT, CHANGE NU = -100000, OLD SET = SOIL0, NEW SET = SOIL
12.000, 0., 34.8
12.000, 0., 34.8, 12.000, 1., 34.8, -146.31
**
** CONCRETE PAD ELEMENT
**
*ELEMENT, TYPE = C3D8R
60001, 60001, 60002, 60052, 60051, 62001, 62002, 62052, 62051
*ELGEN, ELSET = CONC1
60001, 36, 1, 1, 16, 50, 50
*ELCOPY,OLD SET = CONC1,NEW SET = CONC2,ELEMENT SH = 2000,SHIFT NO = 2000
*ELCOPY,OLD SET = CONC2,NEW SET = CONC3,ELEMENT SH = 2000,SHIFT NO = 2000
*ELCOPY,OLD SET = CONC3,NEW SET = CONC4,ELEMENT SH = 2000,SHIFT NO = 2000
*ELSET, ELSET = CONC
CONC1, CONC2, CONC3, CONC4,
*SOLID SECTION, ELSET = CONC, MATERIAL = CONCRETE
**
** GENERATE REBARS
**
*REBAR,ELEM = CONTINUUM,MAT = REBAR,GEOM = ISOPARAMETRIC,NAME = LX
CONC1,0.60,12.0,0.0,1.0,4,2
*REBAR,ELEM = CONTINUUM,MAT = REBAR,GEOM = ISOPARAMETRIC,NAME = LY
CONC1,0.60,12.0,90.,1.0,4,2
*REBAR,ELEM = CONTINUUM,MAT = REBAR,GEOM = ISOPARAMETRIC,NAME = UX
CONC4,0.60,12.0,0.0,0.0,4,2
*REBAR,ELEM = CONTINUUM,MAT = REBAR,GEOM = ISOPARAMETRIC,NAME = UY
CONC4,0.60,12.0,90.,0.0,4,2
**
** GENERATE THE SOIL
**
*ELCOPY,OLD SET = CONC1,NEW SET = SOIL1,ELEMENT SH = 2000,SHIFT NO = 20000

```

```

*ELCOPY,OLD SET =SOIL1,NEW SET =SOIL2,ELEMENT SH =2000,SHIFT NO = 2000
*ELCOPY,OLD SET =SOIL2,NEW SET =SOIL3,ELEMENT SH =2000,SHIFT NO = 2000
*ELCOPY,OLD SET =SOIL3,NEW SET =SOIL4,ELEMENT SH =2000,SHIFT NO = 2000
*ELEMENT, TYPE =C3D6, ELSET =SOIL5
*ELEMENT, TYPE =C3D8R
88001, 88001, 88002, 88052, 88051, 60001, 60002, 60052, 60051
*ELGEN, ELSET =SOIL5
88001, 36, 1, 1, 16, 50, 50
*ELSET, ELSET =SOIL
SOIL1, SOIL2, SOIL3, SOIL4, SOIL5
*SOLID SECTION, ELSET =SOIL, MATERIAL =SOIL
*****
**
** ASTM A36
**
*MATERIAL, NAME =ST
*DENSITY
7.5052E-4
*ELASTIC
29.0E6, 0.3
*PLASTIC
36000., 0
60000., 0.23
30000., 0.24
10000., 0.25
5000., 0.26
1000., 0.27
*FAILURE
0.30, 0.25
**
** CLOSING RING BOLT MATERIAL
** ASTM A307, GR. C
**
*MATERIAL, NAME =BOLT
*DENSITY
7.5052E-4
*ELASTIC
29.0E6, 0.3
*PLASTIC
36000.0, 0.0
60000.0, 0.23
*FAILURE
0.23, 0.22
*MATERIAL, NAME =PAYLD
*DENSITY
0.01110
*ELASTIC
29.0E6, 0.3
*material, name =concrete
** 4000 PSI CONCRETE
*density
1.95E-04
*elastic
3.6E+06,0.15
*drucker prager
35.1,1.0,35.1
*drucker prager hardening
2250.,0.0
3900.,0.0013
3000.,0.0024
2400.,0.0034
1790.,0.0044
1180.,0.0054
800.,0.006
100.,0.0061
*material, name =soil
*density
1.647E-04
*elastic
5700.,0.35
*drucker prager
35.2,0.82,35.2
*drucker prager hardening
2.0,0.0
6.54,0.0055
8.64,0.0156
9.96,0.0259
10.68,0.0362

```

```

10.98,0.0467
11.1,0.0573
11.04,0.068
10.8,0.0788
10.44,0.0897
9.9,0.1
9.0,0.112
**
** REBAR STEEL
**
*MATERIAL, NAME=REBAR
*DENSITY
7.34E-4
*ELASTIC
29.5E6, 0.30
*PLASTIC
71170., 0.0
71626., 0.004985
83130., 0.017098
96460., 0.036202
104728., 0.055113
109080., 0.073795
**
** ELEMENT SET DEFINITIONS
**
*ELSET,ELSET = ALLEL
DMB, DMW, DML
RING, BOLT
PAY,
**
** NODE SET DEFINITIONS
**
*NSET,NSET = ALLND
DMB, DMW, DML
RING, BOLT
PAY,
*NSET,NSET = YSYMM,GENERATE
60001,60037,1
62001,62037,1
64001,64037,1
66001,66037,1
68001,68037,1
80001,80037,1
82001,82037,1
84001,84037,1
86001,86037,1
88001,88037,1
*NSET,NSET = YSYMM,GENERATE
1, 7, 1
41, 53, 12
61, 73, 12
81, 93, 12
101, 501, 20
113, 513, 20
613, 693, 20
701, 741, 20
713, 753, 20
1001, 1007, 1
1041, 1053, 12
1061, 1073, 12
1081, 1093, 12
1101, 1113, 12
1501, 1501, 1
2001, 2005, 1
2021, 2029, 8
2031, 2131, 10
2039, 2139, 10
2201, 2205, 1
2221, 2229, 8
*NSET,NSET = SOILBT,GENERATE
80001,80837,1
*NSET,NSET = CONC5,GENERATE
68001,68837,1
*BOUNDARY
YSYMM,YSYMM
SOILBT,1,3
*****
*INITIAL CONDITIONS,TYPE=VELOCITY

```



```

ALLND,1,168.92
ALLND,3,253.38
*STEP
*DYNAMIC,EXPLICIT
,20.0E-03
**
** DEFINE THE CONTACT SURFACES BETWEEN
** THE DRUM BOTTOM AND TARGET
**
*SURFACE DEFINITION,NAME=CONC4T
CONC4,S2
*SURFACE DEFINITION,NAME=DMOUT,NO THICK
DMB,SNEG
DMW1,SNEG
DMW2,SNEG
DMW3,SNEG
RING,SPOS
DML,SPOS
*CONTACT PAIR
CONC4T,DMOUT
**
** DEFINE THE CONTACT SURFACES BETWEEN
** THE DRUM INSIDE AND PAYLOAD OUTSIDE
**
*SURFACE DEFINITION,NAME=DMINS,NO THICK
DMB,SPOS
DMW1,SPOS
DMW2,SPOS
DMW3,SPOS
DMW4,SPOS
RING2,SNEG
DML,SNEG
*SURFACE DEFINITION,NAME=PAYOUT,NO THICK
PAYB,SNEG
PAYW,SNEG
PAYT,SPOS
*CONTACT PAIR
DMINS,PAYOUT
*****
*NSET,NSET=DMDIS,GENERATE
4,4,1
1004,1004,1
681,681,1
101,113,3
301,313,3
541,553,3
*NSET,NSET=DMRF
DMB,
DMW1,
DMW2,
DMW3,
RING,
DML,
*ELSET,ELSET=DMBST,GENERATE
61,66,1
81,86,1
*ELSET,ELSET=DMBST
DMBA,
*ELSET,ELSET=DMWST,GENERATE
101,106,1
121,126,1
141,421,20
142,422,20
143,423,20
441,446,1
481,466,1
481,486,1
501,506,1
*ELSET,ELSET=DMLST,GENERATE
1061,1066,1
1081,1086,1
*ELSET,ELSET=DMLST
DMLA,
*ELSET,ELSET=RINGST,GENERATE
601,606,1
621,626,1
641,646,1
661,666,1

```

681,686,1
701,706,1
721,726,1
741,746,1
761,766,1
*ELSET,ELSET = BOLTST,GENERATE
1501,1501,1

*HISTORY OUTPUT, TIME = 5.E-5
*NODE HISTORY, NSET = DMDIS
U, V, A
*NODE HISTORY, NSET = DMRF
RF,
*NODE HISTORY, NSET = CONC5
RF,
*EL HISTORY, ELSET = DMBST
SP,
LEP,
SENER,
PENER,
*EL HISTORY, ELSET = DMWST
SP,
LEP,
SENER,
PENER,
*EL HISTORY, ELSET = DMLST
SP,
LEP,
SENER,
PENER,
*EL HISTORY, ELSET = RINGST
SP,
LEP,
SENER,
PENER,
*EL HISTORY, ELSET = BOLTST
SP,
LEP,
SENER,
PENER,
*FILE OUTPUT, NUMBER INTERVAL = 100
*ENERGY HISTORY
ALLKE,
*MONITOR,NODE = 307,DOF = 3
*END STEP
-



CHECKLIST FOR CHECKING OF ANALYSIS/CALCULATIONS

Document Number/Revision: HNF-2209/Rev. 0

Document Title: 55 Gallon Drum/30-Mil Wall Thickness 10-ft Top Corner Drop

Yes	No	N/A	
<input checked="" type="checkbox"/>	<input type="checkbox"/>	<input type="checkbox"/>	Problem completely defined.
<input checked="" type="checkbox"/>	<input type="checkbox"/>	<input type="checkbox"/>	Appropriate analytical method used.
<input checked="" type="checkbox"/>	<input type="checkbox"/>	<input type="checkbox"/>	Necessary assumptions are appropriate and explicitly stated.
<input checked="" type="checkbox"/>	<input type="checkbox"/>	<input type="checkbox"/>	Computer codes and data files documented.
<input checked="" type="checkbox"/>	<input type="checkbox"/>	<input type="checkbox"/>	Data used in calculations explicitly stated in document.
<input type="checkbox"/>	<input type="checkbox"/>	<input checked="" type="checkbox"/>	Sources of non-standard formula/data are referenced and the correctness of the reference verified.
<input checked="" type="checkbox"/>	<input type="checkbox"/>	<input type="checkbox"/>	Data checked for consistency with original source information as applicable.
<input type="checkbox"/>	<input type="checkbox"/>	<input checked="" type="checkbox"/>	Mathematical derivations checked including dimensional consistency of results.
<input checked="" type="checkbox"/>	<input type="checkbox"/>	<input type="checkbox"/>	Models appropriate and used within range of validity or use outside range of established validity justified.
<input type="checkbox"/>	<input type="checkbox"/>	<input checked="" type="checkbox"/>	Hand calculations checked for errors.
<input checked="" type="checkbox"/>	<input type="checkbox"/>	<input type="checkbox"/>	Code run streams correct and consistent with analysis documentation.
<input checked="" type="checkbox"/>	<input type="checkbox"/>	<input type="checkbox"/>	Code output consistent with input and with results reported in analysis documentation.
<input checked="" type="checkbox"/>	<input type="checkbox"/>	<input type="checkbox"/>	Acceptability limits on analytical results applicable and supported. Limits checked against sources.
<input checked="" type="checkbox"/>	<input type="checkbox"/>	<input type="checkbox"/>	Safety Margins consistent with good engineering practices.
<input checked="" type="checkbox"/>	<input type="checkbox"/>	<input type="checkbox"/>	Conclusions consistent with analytical results and applicable limits.
<input checked="" type="checkbox"/>	<input type="checkbox"/>	<input type="checkbox"/>	Results and conclusions address all points required in the problem statement.

I have checked the analysis/calculation and it is complete and accurate to the best of my knowledge.

Engineer/Checker Scott Shiraga

Date 09/01/98

NOTE: Any hand calculations, notes or summaries generated as part of this check should be signed, dated, and attached to this checklist. Material should be labeled and recorded so that it is intelligible to a technically qualified third party.

7.7.1.13 DOT-17H 55-Gal Drum 30-MPH Bottom-End Drop.

*HEADING

DOT-17H 55 GALLON DRUM, 30 MPH BOTTOM END DROP, FILE=DBE30M

*RESTART, WRITE, NUMBER INTERVAL=10

** DRUM

**

** GENERATE THE NODES OF DRUM BOTTOM PLATE

**

*NODE, SYSTEM=R

*NODE

1, -3.6, 0.0, 0.0

7, 3.6, 0.0, 0.0

22, -3.6, 3.6, 0.0

28, 3.6, 3.6, 0.0

*NGEN, NSET=LINEA

1, 7, 1

*NGEN, NSET=LINEB

22, 28, 1

*NFILL, NSET=DMB1

LINEA, LINEB, 3, 7

*NODE, NSET=DMB2

41, 5.4417, 0.0, 0.0

42, 5.3380, -1.5872, 0.0

43, 5.0342, 3.1208, 0.0

44, 4.5508, 4.5508, 0.0

45, 3.1208, 5.0342, 0.0

46, 1.5872, 5.3380, 0.0

47, 0.0, 5.4417, 0.0

48, -1.5872, 5.3380, 0.0

49, -3.1208, 5.0342, 0.0

50, -4.5508, 4.5508, 0.0

51, -5.0342, 3.1208, 0.0

52, -5.3380, 1.5872, 0.0

53, -5.4417, 0.0, 0.0

61, 7.2833, 0.0, 0.0

62, 7.0760, 1.9745, 0.0

63, 6.4683, 3.8417, 0.0

64, 5.5016, 5.5016, 0.0

65, 3.8417, 6.4683, 0.0

66, 1.9745, 7.0760, 0.0

67, 0.0, 7.2833, 0.0

68, -1.9745, 7.0760, 0.0

69, -3.8417, 6.4683, 0.0

70, -5.5016, 5.5016, 0.0

71, -6.4683, 3.8417, 0.0

72, -7.0760, 1.9745, 0.0

73, -7.2833, 0.0, 0.0

81, 9.6000, 0.0, 0.0

82, 9.2729, 2.4847, 0.0

83, 8.3138, 4.8000, 0.0

84, 6.7882, 6.7882, 0.0

85, 4.8000, 8.3138, 0.0

86, 2.4847, 9.2729, 0.0

87, 0.0, 9.6000, 0.0

88, -2.4847, 9.2729, 0.0

89, -4.8000, 8.3138, 0.0

90, -6.7882, 6.7882, 0.0

91, -8.3138, 4.8000, 0.0

92, -9.2729, 2.4847, 0.0

93, -9.6000, 0.0, 0.0

*NODE, NSET=DMB3

101, 11.5000, 0.0, 0.0

102, 11.1081, 2.9764, 0.0

103, 9.9593, 5.7500, 0.0

104, 8.1317, 8.1317, 0.0

105, 5.7500, 9.9593, 0.0

106, 2.9764, 11.1081, 0.0

107, 0.0, 11.5000, 0.0

108, -2.9764, 11.1081, 0.0

109, -5.7500, 9.9593, 0.0

110, -8.1317, 8.1317, 0.0

111, -9.9593, 5.7500, 0.0

112, -11.1081, 2.9764, 0.0

113, -11.5000, 0.0, 0.0

```

*NSSET, NSET = DMB
DMB1, DMB2, DMB3
**
** GENERATE THE ELEMENTS OF DRUM BOTTOM PLATE
**
*ELEMENT, TYPE = S4R
1, 1, 2, 9, 8
*ELGEN, ELSET = DMBA
1, 6, 1, 1, 3, 7, 6
*ELEMENT, TYPE = S4R, ELSET = DMBB
21, 7, 41, 42, 14
22, 14, 42, 43, 21
23, 21, 43, 44, 28
24, 28, 44, 45, 27
25, 27, 45, 46, 28
26, 26, 46, 47, 25
27, 25, 47, 48, 24
28, 24, 48, 49, 23
29, 23, 49, 50, 22
30, 22, 50, 51, 15
31, 15, 51, 52, 8
32, 8, 52, 53, 1
41, 41, 61, 62, 42
*ELGEN, ELSET = DMBB
41, 12, 1, 1, 3, 20, 20
*ELSET, ELSET = DMB
DMBA, DMBB
*SHELL SECTION, ELSET = DMB, MATERIAL = ST
0.0478
**
** GENERATE THE DRUM CYLINDRICAL WALL
**
** NODES
**
*NCOPY,SHIFT,CHANGE NU = 40,OLD SET = DMB3,NEW SET = L1
0.0, 0.0, 2.0
0.0, 0.0, 0.0, 0.0, 0.0, 1.0, 0.0
*NCOPY,SHIFT,CHANGE NU = 300,OLD SET = L1,NEW SET = L2
0.0, 0.0, 30.0
0.0, 0.0, 0.0, 0.0, 0.0, 1.0, 0.0
*NCOPY,SHIFT,CHANGE NU = 40,OLD SET = L2,NEW SET = L3
0.0, 0.0, 2.0
0.0, 0.0, 0.0, 0.0, 0.0, 1.0, 0.0
*NFILL, NSET = DMW1
DMB3, L1, 2, 20
*NFILL, NSET = DMW2
L1, L2, 15, 20
*NFILL, NSET = DMW3
L2, L3, 2, 20
*NODE, NSET = DMW4
501, 11.5000, 0.0, 34.5
701, 11.5000, 0.0, 35.0
*NCOPY,SHIFT,MULTIPLE = 12,CHANGE NU = + 1,OLD SET = DMW4,NEW SET = DMW4
0.0, 0.0, 0.0
0.0, 0.0, 0.0, 0.0, 0.0, 1.0, +15.00
*NSSET, NSET = DMW
DMW1, DMW2, DMW3, DMW4
**
** ELEMENTS
**
*ELEMENT, TYPE = S4R, ELSET = DMW1
101, 101, 121, 122, 102
*ELGEN, ELSET = DMW1
101, 12, 1, 1, 2, 20, 20
*ELEMENT, TYPE = S4R, ELSET = DMW2
141, 141, 161, 162, 142
*ELGEN, ELSET = DMW2
141, 12, 1, 1, 15, 20, 20
*ELEMENT, TYPE = S4R, ELSET = DMW3
441, 441, 461, 462, 442
*ELGEN, ELSET = DMW3
441, 12, 1, 1, 2, 20, 20
*ELEMENT, TYPE = S4R, ELSET = DMW4
481, 481, 501, 502, 482
501, 501, 701, 702, 502
*ELGEN, ELSET = DMW4
481, 12, 1, 1
501, 12, 1, 1

```

```

*ELSET, ELSET = DMW
DMW1, DMW2, DMW3, DMW4
*SHELL SECTION, ELSET = DMW, MATERIAL = ST
0.0478
**
** GENERATE THE NODES OF DRUM LID
**
*NCOPY, SHIFT, CHANGE NU = 1000, OLD SET = DMB, NEW SET = DML
0.0, 0.0, 34.50
0.0, 0.0, 0.0, 0.0, 0.0, 1.0, 0.0
** MODIFY NODES
*NODE, NSET = DML
1101, 10.5000, 0.0, 34.50
1102, 10.1422, 2.7176, 34.50
1103, 9.0933, 5.2500, 34.50
1104, 7.4246, 7.4246, 34.50
1105, 5.2500, 9.0933, 34.50
1106, 2.7176, 10.1422, 34.50
1107, 0.0, 10.5000, 34.50
1108, -2.7176, 10.1422, 34.50
1109, -5.2500, 9.0933, 34.50
1110, -7.4246, 7.4246, 34.50
1111, -9.0933, 5.2500, 34.50
1112, -10.1422, 2.7176, 34.50
1113, -10.5000, 0.0, 34.50
**
** GENERATE THE DRUM LID
**
*ELEMENT, TYPE = S4R
1001, 1001, 1002, 1009, 1008
*ELGEN, ELSET = DMLA
1001, 6, 1, 1, 3, 7, 6
*ELEMENT, TYPE = S4R, ELSET = DMLB
1021, 1007, 1041, 1042, 1014
1022, 1014, 1042, 1043, 1021
1023, 1021, 1043, 1044, 1028
1024, 1028, 1044, 1045, 1027
1025, 1027, 1045, 1046, 1026
1026, 1026, 1046, 1047, 1025
1027, 1025, 1047, 1048, 1024
1028, 1024, 1048, 1049, 1023
1029, 1023, 1049, 1050, 1022
1030, 1022, 1050, 1051, 1015
1031, 1015, 1051, 1052, 1008
1032, 1008, 1052, 1053, 1001
*ELEMENT, TYPE = S4R
1041, 1041, 1081, 1062, 1042
*ELGEN, ELSET = DMLC
1041, 12, 1, 1, 2, 20, 20
*ELEMENT, TYPE = S4R
1081, 1081, 1101, 1102, 1082
*ELGEN, ELSET = DMLD
1081, 12, 1, 1
*ELSET, ELSET = DML
DMLA, DMLB, DMLC, DMLD
*SHELL SECTION, ELSET = DML, MATERIAL = ST
0.0478
**
** NSET, NSET = DM
DMB, DMW, DML
*ELSET, ELSET = DM
DMB, DMW, DML
*****
** CLOSING RING, DRUM LID, AND DRUM ASSEMBLY
*****
*NODE, NSET = RING
601, 11.7500, 0.0, 34.0670
621, 11.9330, 0.0, 34.2500
641, 12.0000, 0.0, 34.5000
661, 11.9330, 0.0, 34.7500
681, 11.7500, 0.0, 34.9330
701, 11.5000, 0.0, 35.0000
721, 11.2500, 0.0, 34.9330
741, 11.0670, 0.0, 34.7500
*NCOPY, SHIFT, MULTIPLE = 12, CHANGE NU = + 1, OLD SET = RING, NEW SET = RING
0.0, 0.0, 0.0
0.0, 0.0, 0.0, 0.0, 0.0, 1.0, + 15.00
*ELEMENT, TYPE = S4R
601, 481, 482, 602, 601

```

```

621, 601, 602, 622, 621
721, 701, 702, 722, 721
761, 741, 742, 1102, 1101
*ELGEN, ELSET = RING1
601, 12, 1, 1
621, 12, 1, 1, 5, 20, 20
*ELGEN, ELSET = RING2
721, 12, 1, 1, 2, 20, 20
761, 12, 1, 1
*ELSET, ELSET = RING
RING1, RING2
*SHELL SECTION, ELSET = RING1, MATERIAL = ST
0.50
*SHELL SECTION, ELSET = RING2, MATERIAL = ST
0.35
*****
** CLOSING RING BOLT
*****
*NODE, NSET = BOLT
1501, 11.500, 0.0, 34.500
1502, 11.500, 0.5, 34.500
*ELEMENT, TYPE = T3D2, ELSET = BOLT
1501, 1501, 1502
*SOLID SECTION, ELSET = BOLT, MATERIAL = BOLT
0.226
*MPC
TIE,601,1502
TIE,621,1502
TIE,641,1502
TIE,661,1502
TIE,681,1502
*EQUATION
2
1501,1,1,0,1502,1,-1.0
*EQUATION
2
1501,3,1,0,1502,3,-1.0
*****
** PAYLOAD
*****
*NODE, SYSTEM = R
*NODE
2001, -4.0, 0.0, 0.024
2005, 4.0, 0.0, 0.024
2011, -4.0, 4.0, 0.024
2015, 4.0, 4.0, 0.024
*NGEN, NSET = LINEC
2001, 2005, 1
*NGEN, NSET = LINED
2011, 2015, 1
*NFRLL, NSET = PAYB1
LINEC, LINED, 2, 5
*NODE, NSET = PAYB2
2021, 7.625, 0.0, 0.024
2022, 7.1968, 3.1526, 0.024
2023, 5.9775, 5.9775, 0.024
2024, 3.1526, 7.1968, 0.024
2025, 0.0, 7.625, 0.024
2026, -3.1526, 7.1968, 0.024
2027, -5.9775, 5.9775, 0.024
2028, -7.1968, 3.1526, 0.024
2029, -7.625, 0.0, 0.024
*NODE, NSET = PAYB3
2031, 11.25, 0.0, 0.024
2032, 10.394, 4.3052, 0.024
2033, 7.9550, 7.9550, 0.024
2034, 4.3052, 10.394, 0.024
2035, 0.0, 11.25, 0.024
2036, -4.3052, 10.394, 0.024
2037, -7.9550, 7.9550, 0.024
2038, -10.394, 4.3052, 0.024
2039, -11.25, 0.0, 0.024
*NSET, NSET = PAYB
PAYB1, PAYB2, PAYB3
*ELEMENT, TYPE = S4R
2001, 2001, 2002, 2007, 2006
*ELGEN, ELSET = PAYB1
2001, 4, 1, 1, 2, 5, 5

```

```

*ELEMENT, TYPE=S4R, ELSET=PAYB2
2011, 2005, 2021, 2022, 2010
2012, 2010, 2022, 2023, 2015
2013, 2015, 2023, 2024, 2014
2014, 2014, 2024, 2025, 2013
2015, 2013, 2025, 2026, 2012
2016, 2012, 2026, 2027, 2011
2017, 2011, 2027, 2028, 2006
2018, 2006, 2028, 2029, 2001
*ELEMENT, TYPE=S4R
2021, 2021, 2031, 2032, 2022
*ELGEN, ELSET=PAYB2
2021, 8, 1, 1
*ELSET, ELSET=PAYB
PAYB1, PAYB2
*SHELL SECTION, ELSET=PAYB, MATERIAL=PAYLD
0.0478
*****
*NCOPY,SHIFT,CHANGE NU=100,OLD SET=PAYB3,NEW SET=PAYW1
0.0, 0.0, 33.25
0.0, 0.0, 0.0, 0.0, 0.0, 1.0, 0.0
*NFILL, NSET=PAYW
PAYB3, PAYW1, 10, 10
*ELEMENT, TYPE=S4R
2031, 2031, 2041, 2042, 2032
*ELGEN, ELSET=PAYW
2031, 8, 1, 1, 10, 10, 10
*SHELL SECTION, ELSET=PAYW, MATERIAL=PAYLD
0.0478
*****
*NCOPY,SHIFT,CHANGE NU=200,OLD SET=PAYB,NEW SET=PAYT
0.0, 0.0, 33.25
0.0, 0.0, 0.0, 0.0, 0.0, 1.0, 0.0
*ELEMENT, TYPE=S4R
2201, 2201, 2202, 2207, 2206
*ELGEN, ELSET=PAYT1
2201, 4, 1, 1, 2, 5, 5
*ELEMENT, TYPE=S4R, ELSET=PAYT2
2211, 2205, 2221, 2222, 2210
2212, 2210, 2222, 2223, 2215
2213, 2215, 2223, 2224, 2214
2214, 2214, 2224, 2225, 2213
2215, 2213, 2225, 2226, 2212
2216, 2212, 2226, 2227, 2211
2217, 2211, 2227, 2228, 2206
2218, 2206, 2228, 2229, 2201
*ELEMENT, TYPE=S4R
2221, 2221, 2131, 2132, 2222
*ELGEN, ELSET=PAYT2
2221, 8, 1, 1
*ELSET, ELSET=PAYT
PAYT1, PAYT2
*ELSET, ELSET=PAY
PAYB, PAYW, PAYT
*NSET, NSET=PAY
PAYB, PAYW, PAYT
*SHELL SECTION, ELSET=PAYT, MATERIAL=PAYLD
0.0478
*****
** GENERATE THE ELEMENTS OF CONCRETE PAD
** 10' X 10' RECTANGULAR HALF SECTION (NO INF)
**
*NODE, SYSTEM=R
*NODE, NSET=C1
60001, -60.0, 0.0, -8.0
*NODE, NSET=C2
60004, -45.0, 0.0, -8.0
*NODE, NSET=C3
60034, 45.0, 0.0, -8.0
*NODE, NSET=C4
60037, 60.0, 0.0, -8.0
*NFILL, NSET=LINE1
C1, C2, 3
C2, C3, 30
C3, C4, 3
*NCOPY,SHIFT,CHANGE NU=500,OLD SET=LINE1,NEW SET=LINE2
0.0, 30.0, 0.0
0.0, 0.0, 0.0, 0.0, 0.0, 1.0, 0.0

```



```

*NCOPY,SHIFT,CHANGE NU=300,OLD SET=LINE2,NEW SET=LINE3
0.0, 30.0, 0.0
0.0, 0.0, 0.0, 0.0, 1.0, 0.0
*NPLL, NSET = CONC1
LINE1, LINE2, 10, 50
LINE2, LINE3, 6, 50
*NCOPY,SHIFT,CHANGE NU=2000,OLD SET=CONC1,NEW SET=CONC2
0.0, 0.0, 2.0
0.0, 0.0, 0.0, 0.0, 1.0, 0.0
*NCOPY,SHIFT,CHANGE NU=2000,OLD SET=CONC2,NEW SET=CONC3
0.0, 0.0, 2.0
0.0, 0.0, 0.0, 0.0, 1.0, 0.0
*NCOPY,SHIFT,CHANGE NU=2000,OLD SET=CONC3,NEW SET=CONC4
0.0, 0.0, 2.0
0.0, 0.0, 0.0, 0.0, 1.0, 0.0
*NCOPY,SHIFT,CHANGE NU=2000,OLD SET=CONC4,NEW SET=CONC5
0.0, 0.0, 2.0
0.0, 0.0, 0.0, 0.0, 1.0, 0.0
*NSET,NSET=CONCO
CONC1, CONC2, CONC3, CONC4, CONC5,
**
** GENERATE THE SOIL NODES
**
*NCOPY, SHIFT, CHANGE NU=20000, OLD SET=CONC1, NEW SET=SOIL1
0.0, 0.0, -50.0
0.0, 0.0, 0.0, 0.0, 1.0, 0.0
*NCOPY, SHIFT, CHANGE NU=2000, OLD SET=SOIL1, NEW SET=SOIL2
0.0, 0.0, +20.0
0.0, 0.0, 0.0, 0.0, 1.0, 0.0
*NCOPY, SHIFT, CHANGE NU=2000, OLD SET=SOIL2, NEW SET=SOIL3
0.0, 0.0, +10.0
0.0, 0.0, 0.0, 0.0, 1.0, 0.0
*NCOPY, SHIFT, CHANGE NU=2000, OLD SET=SOIL3, NEW SET=SOIL4
0.0, 0.0, +10.0
0.0, 0.0, 0.0, 0.0, 1.0, 0.0
*NCOPY, SHIFT, CHANGE NU=2000, OLD SET=SOIL4, NEW SET=SOIL5
0.0, 0.0, +5.0
0.0, 0.0, 0.0, 0.0, 1.0, 0.0
*NSET,NSET=SOILO
SOIL1, SOIL2, SOIL3, SOIL4, SOIL5
**
** CONCRETE PAD ELEMENT
**
*ELEMENT, TYPE=C3D8R
60001, 60001, 60002, 60052, 60051, 62001, 62002, 62052, 62051
*ELGEN, ELSET=CONC1
60001, 36, 1, 1, 16, 50, 50
*ELCOPY,OLD SET=CONC1,NEW SET=CONC2,ELEMENT SH=2000,SHIFT NO=2000
*ELCOPY,OLD SET=CONC2,NEW SET=CONC3,ELEMENT SH=2000,SHIFT NO=2000
*ELCOPY,OLD SET=CONC3,NEW SET=CONC4,ELEMENT SH=2000,SHIFT NO=2000
*ELSET, ELSET=CONC
CONC1, CONC2, CONC3, CONC4,
*SOLID SECTION, ELSET=CONC, MATERIAL=CONCRETE
**
** GENERATE REBARS
**
*REBAR,ELEM=CONTINUUM,MAT=REBAR,GEOM=ISOPARAMETRIC,NAME= LX
CONC1,0.60,12.0,0.0,1.0,0.4,2
*REBAR,ELEM=CONTINUUM,MAT=REBAR,GEOM=ISOPARAMETRIC,NAME= LY
CONC1,0.60,12.0,0.90,,1.0,4,2
*REBAR,ELEM=CONTINUUM,MAT=REBAR,GEOM=ISOPARAMETRIC,NAME= UX
CONC4,0.60,12.0,0.0,0.0,4,2
*REBAR,ELEM=CONTINUUM,MAT=REBAR,GEOM=ISOPARAMETRIC,NAME= UY
CONC4,0.60,12.0,0.90,,0.0,4,2
**
** GENERATE THE SOIL
**
*ELCOPY,OLD SET=CONC1,NEW SET=SOIL1,ELEMENT SH=20000,SHIFT NO=20000
*ELCOPY,OLD SET=SOIL1,NEW SET=SOIL2,ELEMENT SH=2000,SHIFT NO=2000
*ELCOPY,OLD SET=SOIL2,NEW SET=SOIL3,ELEMENT SH=2000,SHIFT NO=2000
*ELCOPY,OLD SET=SOIL3,NEW SET=SOIL4,ELEMENT SH=2000,SHIFT NO=2000
*ELEMENT, TYPE=C3D6, ELSET=SOILS
*ELEMENT, TYPE=C3D8R
88001, 88001, 88002, 88052, 88051, 60001, 60002, 60052, 60051
*ELGEN, ELSET=SOIL5
88001, 36, 1, 1, 16, 50, 50
*ELSET, ELSET=SOIL
SOIL1, SOIL2, SOIL3, SOIL4, SOIL5

```

```

*SOLID SECTION, ELSET=SOIL, MATERIAL=SOIL
*****
**
** ASTM A36
**
*MATERIAL, NAME=ST
*ELASTIC
29.0E6, 0.3
*PLASTIC
36000., 0.
60000., 0.23
*DENSITY
7.5052E-4
**
** CLOSING RING BOLT MATERIAL
** ASTM A307, GR. C
**
*MATERIAL, NAME=BOLT
*ELASTIC
29.0E6, 0.3
*PLASTIC
36000.0, 0.0
60000.0, 0.23
*DENSITY
7.5052E-4
*MATERIAL, NAME=PAYLD
*ELASTIC
29.0E6, 0.3
*DENSITY
0.02437
*material,name = concrete
** 4000 PSI CONCRETE
*density
1.95E-04
*elastic
3.6E+06,0.15
*drucker prager
35.1,1.0,35.1
*drucker prager hardening
2250.,0.0
3900.,0.0013
3000.,0.0024
2400.,0.0034
1790.,0.0044
1180.,0.0054
800.,0.006
100.,0.0061
*material,name = soil
*density
1.647E-04
*elastic
5700.,0.35
*drucker prager
35.2,0.82,35.2
*drucker prager hardening
2.0,0.0
6.54,0.0055
8.64,0.0156
9.96,0.0259
10.86,0.0362
10.98,0.0467
11.1,0.0573
11.04,0.068
10.8,0.0788
10.44,0.0897
9.9,0.1
9.0,0.112
**
** REBAR STEEL
**
*MATERIAL, NAME=REBAR
*DENSITY
7.34E-4
*ELASTIC
29.5E6, 0.30
*PLASTIC
71170., 0.0
71626., 0.004985

```

```

83130., 0.017098
96460., 0.036202
104728., 0.055113
109080., 0.073795
***FAILURE
**0.30, 0.03
**
** ELEMENT SET DEFINITIONS
**
*ELSET,ELSET=ALLEL
DMB, DMW, DML
RING, BOLT
PAY,
**
** NODE SET DEFINITIONS
**
*NSET,NSET=ALLND
DMB, DMW, DML
RING, BOLT
PAY,
*NSET,NSET=YSYMM,GENERATE
60001,60037,1
62001,62037,1
64001,64037,1
66001,66037,1
68001,68037,1
80001,80037,1
82001,82037,1
84001,84037,1
86001,86037,1
88001,88037,1
*NSET,NSET=YSYMM,GENERATE
1, 7, 1
41, 53, 12
61, 73, 12
81, 93, 12
101, 501, 20
113, 513, 20
613, 693, 20
701, 741, 20
713, 753, 20
1001, 1007, 1
1041, 1053, 12
1061, 1073, 12
1081, 1093, 12
1101, 1113, 12
1501, 1501, 1
2001, 2005, 1
2021, 2029, 8
2031, 2131, 10
2039, 2139, 10
2201, 2205, 1
2221, 2229, 8
*BOUNDARY
YSYMM,YSYMM
SOIL1,1,3
*****
*INITIAL CONDITIONS,TYPE=VELOCITY
ALLND,3,-528.0
*STEP
*DYNAMIC,EXPLICIT
,20.0E-03
**
** DEFINE THE CONTACT SURFACES BETWEEN
** THE DRUM BOTTOM AND TARGET
**
*SURFACE DEFINITION,NAME=CONC4T
CONC4,S2
*SURFACE DEFINITION,NAME=DMBOT,NO THICK
DMB,SNEG
*CONTACT PAIR
CONC4T,DMBOT
**
** DEFINE THE CONTACT SURFACES BETWEEN
** THE DRUM INSIDE AND PAYLOAD OUTSIDE
**
*SURFACE DEFINITION,NAME=DMINS,NO THICK
DMB,SPOS

```

DMW1,SPOS
 DMW2,SPOS
 DMW3,SPOS
 DMW4,SPOS
 DML,SNEG
 RING2,SNEG
 *SURFACE DEFINITION,NAME=PAYOUT,NO THICK
 PAYB,SNEG
 PAYW,SNEG
 PAYT,SPOS
 *CONTACT PAIR
 DMINS,PAYOUT

 *NSET,NSET=DMDIS,GENERATE
 4,4,1
 1004,1004,1
 101,113,3
 301,313,3
 541,553,3
 *ELSET,ELSET=DMBST,GENERATE
 61,66,1
 81,86,1
 *ELSET,ELSET=DMBST
 DMBA,
 *ELSET,ELSET=DMWST,GENERATE
 101,106,1
 121,126,1
 141,421,20
 142,422,20
 143,423,20
 441,446,1
 461,466,1
 481,486,1
 501,506,1
 *ELSET,ELSET=DMLST,GENERATE
 1061,1066,1
 1081,1086,1
 *ELSET,ELSET=DMLST
 DMLA,
 *ELSET,ELSET=RINGST,GENERATE
 601,606,1
 621,626,1
 641,646,1
 661,666,1
 681,686,1
 701,706,1
 721,726,1
 741,746,1
 761,766,1
 *ELSET,ELSET=BOLTST,GENERATE
 1501,1501,1

 *HISTORY OUTPUT. TIME=5.E-5
 *NODE HISTORY, NSET=DMDIS
 U, V, A
 *EL HISTORY, ELSET=DMBST
 MISES,
 PEEQ,
 SENER,
 PENER,
 *EL HISTORY, ELSET=DMWST
 MISES,
 PEEQ,
 SENER,
 PENER,
 *EL HISTORY, ELSET=DMLST
 MISES,
 PEEQ,
 SENER,
 PENER,
 *EL HISTORY, ELSET=RINGST
 MISES,
 PEEQ,
 SENER,
 PENER,
 *EL HISTORY, ELSET=BOLTST
 MISES,
 PEEQ,

SENER,
PENER,
*FILE OUTPUT, NUMBER INTERVAL = 100
*NODE FILE
RF,
*MONITOR,NODE=301,DOF=3
*END STEP



CHECKLIST FOR CHECKING OF ANALYSIS/CALCULATIONS

Document Number/Revision: HNH-2209/Rev. 0

Document Title: DOT-17H 55 Gallon Drum 30 MPH Bottom End Drop

Yes	No	N/A	
<input checked="" type="checkbox"/>	<input type="checkbox"/>	<input type="checkbox"/>	Problem completely defined.
<input checked="" type="checkbox"/>	<input type="checkbox"/>	<input type="checkbox"/>	Appropriate analytical method used.
<input checked="" type="checkbox"/>	<input type="checkbox"/>	<input type="checkbox"/>	Necessary assumptions are appropriate and explicitly stated.
<input checked="" type="checkbox"/>	<input type="checkbox"/>	<input type="checkbox"/>	Computer codes and data files documented.
<input checked="" type="checkbox"/>	<input type="checkbox"/>	<input type="checkbox"/>	Data used in calculations explicitly stated in document.
<input type="checkbox"/>	<input type="checkbox"/>	<input checked="" type="checkbox"/>	Sources of non-standard formula/data are referenced and the correctness of the reference verified.
<input checked="" type="checkbox"/>	<input type="checkbox"/>	<input type="checkbox"/>	Data checked for consistency with original source information as applicable.
<input type="checkbox"/>	<input type="checkbox"/>	<input checked="" type="checkbox"/>	Mathematical derivations checked including dimensional consistency of results.
<input checked="" type="checkbox"/>	<input type="checkbox"/>	<input type="checkbox"/>	Models appropriate and used within range of validity or use outside range of established validity justified.
<input type="checkbox"/>	<input type="checkbox"/>	<input checked="" type="checkbox"/>	Hand calculations checked for errors.
<input checked="" type="checkbox"/>	<input type="checkbox"/>	<input type="checkbox"/>	Code run streams correct and consistent with analysis documentation.
<input checked="" type="checkbox"/>	<input type="checkbox"/>	<input type="checkbox"/>	Code output consistent with input and with results reported in analysis documentation.
<input checked="" type="checkbox"/>	<input type="checkbox"/>	<input type="checkbox"/>	Acceptability limits on analytical results applicable and supported. Limits checked against sources.
<input checked="" type="checkbox"/>	<input type="checkbox"/>	<input type="checkbox"/>	Safety Margins consistent with good engineering practices.
<input checked="" type="checkbox"/>	<input type="checkbox"/>	<input type="checkbox"/>	Conclusions consistent with analytical results and applicable limits.
<input checked="" type="checkbox"/>	<input type="checkbox"/>	<input type="checkbox"/>	Results and conclusions address all points required in the problem statement.

I have checked the analysis/calculation and it is complete and accurate to the best of my knowledge.

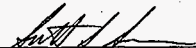
Engineer/Checker Scott Shiraga  Date 09/01/98

NOTE: Any hand calculations, notes or summaries generated as part of this check should be signed, dated, and attached to this checklist. Material should be labeled and recorded so that it is intelligible to a technically qualified third party.

7.7.1.14 DOT-17H 55-Gal Drum 55-MPH Bottom-End Drop.

*HEADING

DOT-17H 55 GALLON DRUM, 55 MPH BOTTOM END DROP, FILE=DBE55N

*RESTART, WRITE, NUMBER INTERVAL=10

** DRUM

**

** GENERATE THE NODES OF DRUM BOTTOM PLATE

**

*NODE, SYSTEM=R

*NODE

1, -3.6, 0.0, 0.0

7, 3.6, 0.0, 0.0

22, -3.6, 3.6, 0.0

28, 3.6, 3.6, 0.0

*NGEN, NSET=LINEA

1, 7, 1

*NGEN, NSET=LINEB

22, 28, 1

*NFILL, NSET=DMB1

LINEA, LINEB, 3, 7

*NODE, NSET=DMB2

41, 5.4417, 0.0, 0.0

42, 5.3380, 1.5872, 0.0

43, 5.0342, 3.1208, 0.0

44, 4.5508, 4.5508, 0.0

45, 3.1208, 5.0342, 0.0

46, 1.5872, 5.3380, 0.0

47, 0.0, 5.4417, 0.0

48, -1.5872, 5.3380, 0.0

49, -3.1208, 5.0342, 0.0

50, -4.5508, 4.5508, 0.0

51, -5.0342, 3.1208, 0.0

52, -5.3380, 1.5872, 0.0

53, -5.4417, 0.0, 0.0

61, 7.2833, 0.0, 0.0

62, 7.0760, 1.9745, 0.0

63, 6.4683, 3.8417, 0.0

64, 5.5016, 5.5016, 0.0

65, 3.8417, 6.4683, 0.0

66, 1.9745, 7.0760, 0.0

67, 0.0, 7.2833, 0.0

68, -1.9745, 7.0760, 0.0

69, -3.8417, 6.4683, 0.0

70, -5.5016, 5.5016, 0.0

71, -6.4683, 3.8417, 0.0

72, -7.0760, 1.9745, 0.0

73, -7.2833, 0.0, 0.0

81, 9.6000, 0.0, 0.0

82, 9.2729, 2.4847, 0.0

83, 8.3138, 4.8000, 0.0

84, 6.7882, 6.7882, 0.0

85, 4.8000, 8.3138, 0.0

86, 2.4847, 9.2729, 0.0

87, 0.0, 9.6000, 0.0

88, -2.4847, 9.2729, 0.0

89, -4.8000, 8.3138, 0.0

90, -6.7882, 6.7882, 0.0

91, -8.3138, 4.8000, 0.0

92, -9.2729, 2.4847, 0.0

93, -9.6000, 0.0, 0.0

*NODE, NSET=DMB3

101, 11.5000, 0.0, 0.0

102, 11.1081, 2.9764, 0.0

103, 9.9593, 5.7500, 0.0

104, 8.1317, 8.1317, 0.0

105, 5.7500, 9.9593, 0.0

106, 2.9764, 11.1081, 0.0

107, 0.0, 11.5000, 0.0

108, -2.9764, 11.1081, 0.0

109, -5.7500, 9.9593, 0.0

110, -8.1317, 8.1317, 0.0

111, -9.9593, 5.7500, 0.0

112, -11.1081, 2.9764, 0.0

113, -11.5000, 0.0, 0.0

```

* NSET, NSET = DMB
DMB1, DMB2, DMB3
**
** GENERATE THE ELEMENTS OF DRUM BOTTOM PLATE
**
* ELEMENT, TYPE = S4R
1, 1, 2, 9, 8
* ELGEN, ELSET = DMBA
1, 6, 1, 1, 3, 7, 6
* ELEMENT, TYPE = S4R, ELSET = DMBB
21, 7, 41, 42, 14
22, 14, 42, 43, 21
23, 21, 43, 44, 28
24, 28, 44, 45, 27
25, 27, 45, 46, 26
26, 26, 46, 47, 25
27, 25, 47, 48, 24
28, 24, 48, 49, 23
29, 23, 49, 50, 22
30, 22, 50, 51, 15
31, 15, 51, 52, 8
32, 8, 52, 53, 1
41, 41, 61, 62, 42
* ELGEN, ELSET = DMBB
41, 12, 1, 1, 3, 20, 20
* ELSET, ELSET = DMB
DMBA, DMBB
* SHELL SECTION, ELSET = DMB, MATERIAL = ST
0.0478
**
** GENERATE THE DRUM CYLINDRICAL WALL
**
** NODES
**
* NCOPY, SHIFT, CHANGE NU = 40, OLD SET = DMB3, NEW SET = L1
0.0, 0.0, 2.0
0.0, 0.0, 0.0, 0.0, 0.0, 1.0, 0.0
* NCOPY, SHIFT, CHANGE NU = 300, OLD SET = L1, NEW SET = L2
0.0, 0.0, 30.0
0.0, 0.0, 0.0, 0.0, 0.0, 1.0, 0.0
* NCOPY, SHIFT, CHANGE NU = 40, OLD SET = L2, NEW SET = L3
0.0, 0.0, 2.0
0.0, 0.0, 0.0, 0.0, 0.0, 1.0, 0.0
* NFILL, NSET = DMW1
DMB3, L1, 2, 20
* NFILL, NSET = DMW2
L1, L2, 15, 20
* NFILL, NSET = DMW3
L2, L3, 2, 20
* NODE, NSET = DMW4
501, 11.5000, 0.0, 34.5
701, 11.5000, 0.0, 35.0
* NCOPY, SHIFT, MULTIPLE = 12, CHANGE NU = +1, OLD SET = DMW4, NEW SET = DMW4
0.0, 0.0, 0.0
0.0, 0.0, 0.0, 0.0, 0.0, 1.0, +15.00
* NSET, NSET = DMW
DMW1, DMW2, DMW3, DMW4
**
** ELEMENTS
**
* ELEMENT, TYPE = S4R, ELSET = DMW1
101, 101, 121, 122, 102
* ELGEN, ELSET = DMW1
101, 12, 1, 1, 2, 20, 20
* ELEMENT, TYPE = S4R, ELSET = DMW2
141, 141, 161, 162, 142
* ELGEN, ELSET = DMW2
141, 12, 1, 1, 15, 20, 20
* ELEMENT, TYPE = S4R, ELSET = DMW3
441, 441, 461, 462, 442
* ELGEN, ELSET = DMW3
441, 12, 1, 1, 2, 20, 20
* ELEMENT, TYPE = S4R, ELSET = DMW4
481, 481, 501, 502, 482
501, 501, 701, 702, 502
* ELGEN, ELSET = DMW4
481, 12, 1, 1
501, 12, 1, 1

```



```

*ELSET, ELSET = DMW
DMW1, DMW2, DMW3, DMW4
*SHELL SECTION, ELSET = DMW, MATERIAL = ST
0.0478
**
** GENERATE THE NODES OF DRUM LID
**
*NCOPY,SHIFT,CHANGE NU = 1000,OLD SET = DMB,NEW SET = DML
0.0, 0.0, 34.50
0.0, 0.0, 0.0, 0.0, 0.0, 1.0, 0.0
** MODIFY NODES
*NODE, NSET = DML
1101, 10.5000, 0.0, 34.50
1102, 10.1422, 2.7176, 34.50
1103, 9.0933, 5.2500, 34.50
1104, 7.4246, 7.4246, 34.50
1105, 5.2500, 9.0933, 34.50
1106, 2.7176, 10.1422, 34.50
1107, 0.0, 10.5000, 34.50
1108, -2.7176, 10.1422, 34.50
1109, -5.2500, 9.0933, 34.50
1110, -7.4246, 7.4246, 34.50
1111, -9.0933, 5.2500, 34.50
1112, -10.1422, 2.7176, 34.50
1113, -10.5000, 0.0, 34.50
**
** GENERATE THE DRUM LID
**
*ELEMENT, TYPE = S4R
1001, 1001, 1002, 1009, 1008
*ELGEN, ELSET = DMLA
1001, 6, 1, 1, 3, 7, 8
*ELEMENT, TYPE = S4R, ELSET = DMLB
1021, 1007, 1041, 1042, 1014
1022, 1014, 1042, 1043, 1021
1023, 1021, 1043, 1044, 1028
1024, 1028, 1044, 1045, 1027
1025, 1027, 1045, 1046, 1026
1026, 1026, 1046, 1047, 1025
1027, 1025, 1047, 1048, 1024
1028, 1024, 1048, 1049, 1023
1029, 1023, 1049, 1050, 1022
1030, 1022, 1050, 1051, 1015
1031, 1015, 1051, 1052, 1008
1032, 1008, 1052, 1053, 1001
*ELEMENT, TYPE = S4R
1041, 1041, 1061, 1062, 1042
*ELGEN, ELSET = DMLC
1041, 12, 1, 1, 2, 20, 20
*ELEMENT, TYPE = S4R
1081, 1081, 1101, 1102, 1082
*ELGEN, ELSET = DMLD
1081, 12, 1, 1
*ELSET, ELSET = DML
DMLA, DMLB, DMLC, DMLD
*SHELL SECTION, ELSET = DML, MATERIAL = ST
0.0478
*NSET, NSET = DM
DMB, DMW, DML
*ELSET, ELSET = DM
DMB, DMW, DML
*****
** CLOSING RING, DRUM LID, AND DRUM ASSEMBLY
*****
*NODE, NSET = RING
601, 11.7500, 0.0, 34.0670
621, 11.9330, 0.0, 34.2500
641, 12.0000, 0.0, 34.5000
661, 11.9330, 0.0, 34.7500
681, 11.7500, 0.0, 34.9330
701, 11.5000, 0.0, 35.0000
721, 11.2500, 0.0, 34.9330
741, 11.0670, 0.0, 34.7500
*NCOPY,SHIFT,MULTIPLE = 12,CHANGE NU = + 1,OLD SET = RING,NEW SET = RING
0.0, 0.0, 0.0
0.0, 0.0, 0.0, 0.0, 0.0, 1.0, + 15.00
*ELEMENT, TYPE = S4R
601, 481, 482, 602, 601

```

```

621, 601, 602, 622, 621
721, 701, 702, 722, 721
761, 741, 742, 1102, 1101
*ELGEN, ELSET=RING1
601, 12, 1, 1
621, 12, 1, 1, 5, 20, 20
*ELGEN, ELSET=RING2
721, 12, 1, 1, 2, 20, 20
761, 12, 1, 1
*ELSET, ELSET=RING
RING1, RING2
*SHELL SECTION, ELSET=RING1, MATERIAL=ST
0.50
*SHELL SECTION, ELSET=RING2, MATERIAL=ST
0.35
*****
** CLOSING RING BOLT
*****
*NODE, NSET=BOLT
1501, 11.500, 0.0, 34.500
1502, 11.500, 0.5, 34.500
*ELEMENT, TYPE=T3D2, ELSET=BOLT
1501, 1501, 1502
*SOLID SECTION, ELSET=BOLT, MATERIAL=BOLT
0.226
*MPC
TIE,601,1502
TIE,621,1502
TIE,641,1502
TIE,661,1502
TIE,681,1502
*EQUATION
2
1501,1,1,0,1502,1,-1.0
*EQUATION
2
1501,3,1,0,1502,3,-1.0
*****
** PAYLOAD
*****
*NODE, SYSTEM=R
*NODE
2001, -4.0, 0.0, 0.024
2005, 4.0, 0.0, 0.024
2011, -4.0, 4.0, 0.024
2015, 4.0, 4.0, 0.024
*NGEN, NSET=LINEC
2001, 2005, 1
*NGEN, NSET=LINED
2011, 2015, 1
*NFILL, NSET=PAYB1
LINEC, LINED, 2, 5
*NODE, NSET=PAYB2
2021, 7.625, 0.0, 0.024
2022, 7.1968, 3.1526, 0.024
2023, 5.9775, 5.9775, 0.024
2024, 3.1526, 7.1968, 0.024
2025, 0.0, 7.625, 0.024
2026, -3.1526, 7.1968, 0.024
2027, -5.9775, 5.9775, 0.024
2028, -7.1968, 3.1526, 0.024
2029, -7.625, 0.0, 0.024
*NODE, NSET=PAYB3
2031, 11.25, 0.0, 0.024
2032, 10.394, 4.3052, 0.024
2033, 7.9550, 7.9550, 0.024
2034, 4.3052, 10.394, 0.024
2035, 0.0, 11.25, 0.024
2036, -4.3052, 10.394, 0.024
2037, -7.9550, 7.9550, 0.024
2038, -10.394, 4.3052, 0.024
2039, -11.25, 0.0, 0.024
*NSET, NSET=PAYB
PAYB1, PAYB2, PAYB3
*ELEMENT, TYPE=S4R
2001, 2001, 2002, 2007, 2006
*ELGEN, ELSET=PAYB1
2001, 4, 1, 1, 2, 5, 5

```

```

*ELEMENT, TYPE=S4R, ELSET=PAYB2
2011, 2005, 2021, 2022, 2010
2012, 2010, 2022, 2023, 2015
2013, 2015, 2023, 2024, 2014
2014, 2014, 2024, 2025, 2013
2015, 2013, 2025, 2026, 2012
2016, 2012, 2026, 2027, 2011
2017, 2011, 2027, 2028, 2006
2018, 2006, 2028, 2029, 2001
*ELEMENT, TYPE=S4R
2021, 2021, 2031, 2032, 2022
*ELGEN, ELSET=PAYB2
2021, 8, 1, 1
*ELSET, ELSET=PAYB
PAYB1, PAYB2
*SHELL SECTION, ELSET=PAYB, MATERIAL=PAYLD
0.0478
*****
*NCOPY,SHIFT,CHANGE NU=100,OLD SET=PAYB3,NEW SET=PAYW1
0.0, 0.0, 33.25
0.0, 0.0, 0.0, 0.0, 0.0, 1.0, 0.0
*NFill, NSET=PAYW
PAYB3, PAYW1, 10, 10
*ELEMENT, TYPE=S4R
2031, 2031, 2041, 2042, 2032
*ELGEN, ELSET=PAYW
2031, 8, 1, 1, 10, 10, 10
*SHELL SECTION, ELSET=PAYW, MATERIAL=PAYLD
0.0478
*****
*NCOPY,SHIFT,CHANGE NU=200,OLD SET=PAYB,NEW SET=PAYT
0.0, 0.0, 33.25
0.0, 0.0, 0.0, 0.0, 0.0, 1.0, 0.0
*ELEMENT, TYPE=S4R
2201, 2201, 2202, 2207, 2206
*ELGEN, ELSET=PAYT1
2201, 4, 1, 1, 2, 5, 5
*ELEMENT, TYPE=S4R, ELSET=PAYT2
2211, 2205, 2221, 2222, 2210
2212, 2210, 2222, 2223, 2215
2213, 2215, 2223, 2224, 2214
2214, 2214, 2224, 2225, 2213
2215, 2213, 2225, 2226, 2212
2216, 2212, 2226, 2227, 2211
2217, 2211, 2227, 2228, 2206
2218, 2206, 2228, 2229, 2201
*ELEMENT, TYPE=S4R
2221, 2221, 2131, 2132, 2222
*ELGEN, ELSET=PAYT2
2221, 8, 1, 1
*ELSET, ELSET=PAYT
PAYT1, PAYT2
*ELSET, ELSET=PAY
PAYB, PAYW, PAYT
*NSET, NSET=PAY
PAYB, PAYW, PAYT
*SHELL SECTION, ELSET=PAYT, MATERIAL=PAYLD
0.0478
*****
** GENERATE THE ELEMENTS OF CONCRETE PAD
** 10' X 10' RECTANGULAR HALF SECTION (NO INF)
**
*NODE, SYSTEM=R
*NODE, NSET=C1
60001, -60.0, 0.0, -8.0
*NODE, NSET=C2
60004, -45.0, 0.0, -8.0
*NODE, NSET=C3
60034, 45.0, 0.0, -8.0
*NODE, NSET=C4
60037, 60.0, 0.0, -8.0
*NFill, NSET=LINE1
C1, C2, 3
C2, C3, 30
C3, C4, 3
*NCOPY,SHIFT,CHANGE NU=500,OLD SET=LINE1,NEW SET=LINE2
0.0, 30.0, 0.0
0.0, 0.0, 0.0, 0.0, 0.0, 1.0, 0.0

```

```

*NCOPY,SHIFT,CHANGE NU = 300,OLD SET = LINE2,NEW SET = LINE3
0.0, 30.0, 0.0
0.0, 0.0, 0.0, 0.0, 0.0, 1.0, 0.0
*NFILL, NSET = CONC1
LINE1, LINE2, 10, 50
LINE2, LINE3, 6, 50
*NCOPY,SHIFT,CHANGE NU = 2000,OLD SET = CONC1,NEW SET = CONC2
0.0, 0.0, 2.0
0.0, 0.0, 0.0, 0.0, 0.0, 1.0, 0.0
*NCOPY,SHIFT,CHANGE NU = 2000,OLD SET = CONC2,NEW SET = CONC3
0.0, 0.0, 2.0
0.0, 0.0, 0.0, 0.0, 0.0, 1.0, 0.0
*NCOPY,SHIFT,CHANGE NU = 2000,OLD SET = CONC3,NEW SET = CONC4
0.0, 0.0, 2.0
0.0, 0.0, 0.0, 0.0, 0.0, 1.0, 0.0
*NCOPY,SHIFT,CHANGE NU = 2000,OLD SET = CONC4,NEW SET = CONC5
0.0, 0.0, 2.0
0.0, 0.0, 0.0, 0.0, 0.0, 1.0, 0.0
*NSET,NSET = CONC0
CONC1, CONC2, CONC3, CONC4, CONC5,
**
** GENERATE THE SOIL NODES
**
*NCOPY, SHIFT, CHANGE NU = 20000, OLD SET = CONC1, NEW SET = SOIL1
0.0, 0.0, -50.0
0.0, 0.0, 0.0, 0.0, 0.0, 1.0, 0.0
*NCOPY, SHIFT, CHANGE NU = 2000, OLD SET = SOIL1, NEW SET = SOIL2
0.0, 0.0, +20.0
0.0, 0.0, 0.0, 0.0, 0.0, 1.0, 0.0
*NCOPY, SHIFT, CHANGE NU = 2000, OLD SET = SOIL2, NEW SET = SOIL3
0.0, 0.0, +10.0
0.0, 0.0, 0.0, 0.0, 0.0, 1.0, 0.0
*NCOPY, SHIFT, CHANGE NU = 2000, OLD SET = SOIL3, NEW SET = SOIL4
0.0, 0.0, +10.0
0.0, 0.0, 0.0, 0.0, 0.0, 1.0, 0.0
*NCOPY, SHIFT, CHANGE NU = 2000, OLD SET = SOIL4, NEW SET = SOIL5
0.0, 0.0, +5.0
0.0, 0.0, 0.0, 0.0, 0.0, 1.0, 0.0
*NSET,NSET = SOIL0
SOIL1, SOIL2, SOIL3, SOIL4, SOIL5
**
** CONCRETE PAD ELEMENT
**
*ELEMENT, TYPE = C3D8R
60001, 60001, 60002, 60052, 60051, 62001, 62002, 62052, 62051
*ELGEN, ELSET = CONC1
60001, 36, 1, 1, 16, 50, 50
*ELCOPY,OLD SET = CONC1,NEW SET = CONC2,ELEMENT SH = 2000,SHIFT NO = 2000
*ELCOPY,OLD SET = CONC2,NEW SET = CONC3,ELEMENT SH = 2000,SHIFT NO = 2000
*ELCOPY,OLD SET = CONC3,NEW SET = CONC4,ELEMENT SH = 2000,SHIFT NO = 2000
*ELSET, ELSET = CONC
CONC1, CONC2, CONC3, CONC4
*SOLID SECTION, ELSET = CONC, MATERIAL = CONCRETE
**
** GENERATE REBARS
**
*REBAR,ELEM = CONTINUUM,MAT = REBAR,GEOM = ISOPARAMETRIC,NAME = LX
CONC1,0.60,12.0,0.0,1.0,4,2
*REBAR,ELEM = CONTINUUM,MAT = REBAR,GEOM = ISOPARAMETRIC,NAME = LY
CONC1,0.60,12.0,90.,1.0,4,2
*REBAR,ELEM = CONTINUUM,MAT = REBAR,GEOM = ISOPARAMETRIC,NAME = UX
CONC4,0.60,12.0,0.0,0.0,4,2
*REBAR,ELEM = CONTINUUM,MAT = REBAR,GEOM = ISOPARAMETRIC,NAME = UY
CONC4,0.60,12.0,90.,0.0,4,2
**
** GENERATE THE SOIL
**
*ELCOPY,OLD SET = CONC1,NEW SET = SOIL1,ELEMENT SH = 20000,SHIFT NO = 20000
*ELCOPY,OLD SET = SOIL1,NEW SET = SOIL2,ELEMENT SH = 2000,SHIFT NO = 2000
*ELCOPY,OLD SET = SOIL2,NEW SET = SOIL3,ELEMENT SH = 2000,SHIFT NO = 2000
*ELCOPY,OLD SET = SOIL3,NEW SET = SOIL4,ELEMENT SH = 2000,SHIFT NO = 2000
*ELEMENT, TYPE = C3D6, ELSET = SOIL5
*ELEMENT, TYPE = C3D8R
88001, 88001, 88002, 88052, 88051, 60001, 60002, 60052, 60051
*ELGEN, ELSET = SOIL5
88001, 36, 1, 1, 16, 50, 50
*ELSET, ELSET = SOIL
SOIL1, SOIL2, SOIL3, SOIL4, SOIL5

```

```

*SOLID SECTION, ELSET=SOIL, MATERIAL=SOIL
*****
**
** ASTM A36
**
*MATERIAL, NAME=ST
*ELASTIC
29.0E6, 0.3
*PLASTIC
36000., 0.
60000., 0.23
30000., 0.24
10000., 0.25
5000., 0.26
1000., 0.27
*DENSITY
7.5052E-4
*FAILURE
0.30, 0.25
**
** CLOSING RING BOLT MATERIAL
** ASTM A307, GR. C
**
*MATERIAL, NAME=BOLT
*ELASTIC
29.0E6, 0.3
*PLASTIC
36000., 0.
60000., 0.23
30000., 0.24
10000., 0.25
5000., 0.26
1000., 0.27
*DENSITY
7.5052E-4
*FAILURE
0.30, 0.25
*MATERIAL, NAME=PAYLD
*ELASTIC
29.0E6, 0.3
*DENSITY
0.02437
*material,name = concrete
** 4000 PSI CONCRETE
*density
1.95E-04
*elastic
3.6E+06,0.15
*drucker prager
35.1,1.0,35.1
*drucker prager hardening
2250.,0.0
3900.,0.0013
3000.,0.0024
2400.,0.0034
1790.,0.0044
1180.,0.0054
800.,0.006
100.,0.0061
*material,name = soil
*density
1.647E-04
*elastic
5700.,0.35
*drucker prager
35.2,0.82,35.2
*drucker prager hardening
2.0,0.0
6.54,0.0055
8.64,0.0156
9.96,0.0259
10.68,0.0362
10.98,0.0467
11.1,0.0573
11.04,0.068
10.8,0.0788
10.44,0.0897
9.9,0.1

```

```

9.0,0.112
**
** REBAR STEEL
**
*MATERIAL, NAME=REBAR
*DENSITY
7.34E-4
*ELASTIC
29.5E6, 0.30
*PLASTIC
71170., 0.0
71626., 0.004985
83130., 0.017098
96460., 0.036202
104728., 0.055113
109080., 0.073795
**FAILURE
**0.30, 0.03
**
** ELEMENT SET DEFINITIONS
**
*ELSET,ELSET=ALLEL
DMB, DMW, DML
RING, BOLT
PAY,
**
** NODE SET DEFINITIONS
**
*NSET,NSET=ALLND
DMB, DMW, DML
RING, BOLT
PAY,
*NSET,NSET=YSYMM,GENERATE
60001,60037,1
62001,62037,1
64001,64037,1
66001,66037,1
68001,68037,1
80001,80037,1
82001,82037,1
84001,84037,1
86001,86037,1
88001,88037,1
*NSET,NSET=YSYMM,GENERATE
1, 7, 1
41, 53, 12
61, 73, 12
81, 93, 12
101, 501, 20
113, 513, 20
613, 693, 20
701, 741, 20
713, 753, 20
1001, 1007, 1
1041, 1053, 12
1061, 1073, 12
1081, 1093, 12
1101, 1113, 12
1501, 1501, 1
2001, 2005, 1
2021, 2029, 8
2031, 2131, 10
2039, 2139, 10
2201, 2205, 1
2221, 2229, 8
*BOUNDARY
YSYMM,YSYMM
SOIL1,1.3
*****
*INITIAL CONDITIONS,TYPE=VELOCITY
ALLND,3,-968.0
*STEP
*DYNAMIC,EXPLICIT
,20.0E-03
**
** DEFINE THE CONTACT SURFACES BETWEEN
** THE DRUM BOTTOM AND TARGET
**

```

```

*SURFACE DEFINITION,NAME=CONC4T
CONC4,S2
*SURFACE DEFINITION,NAME=DMBOT,NO THICK
DMB,SNEG
*CONTACT PAIR
CONC4T,DMBOT .
**
** DEFINE THE CONTACT SURFACES BETWEEN
** THE DRUM INSIDE AND PAYLOAD OUTSIDE
**
*SURFACE DEFINITION,NAME=DMINS,NO THICK
DMB,SPOS
DMW1,SPOS
DMW2,SPOS
DMW3,SPOS
DMW4,SPOS
DML,SNEG
RING2,SNEG
*SURFACE DEFINITION,NAME=PAYOUT,NO THICK
PAYB,SNEG
PAYW,SNEG
PAYT,SPOS
*CONTACT PAIR
DMINS,PAYOUT
*****
*NSET,NSET=DMDIS,GENERATE
4,4,1
1004,1004,1
101,113,3
301,313,3
541,553,3
*ELSET,ELSET=DMBST,GENERATE
61,66,1
81,86,1
*ELSET,ELSET=DMBST
DMBA,
*ELSET,ELSET=DMWST,GENERATE
101,106,1
121,126,1
141,421,20
142,422,20
143,423,20
441,446,1
461,466,1
481,486,1
501,506,1
*ELSET,ELSET=DMLST,GENERATE
1061,1066,1
1081,1086,1
*ELSET,ELSET=DMLST
DMLA,
*ELSET,ELSET=RINGST,GENERATE
601,606,1
621,626,1
641,646,1
661,666,1
681,686,1
701,706,1
721,726,1
741,746,1
761,766,1
*ELSET,ELSET=BOLTST,GENERATE
1501,1501,1
*****
*HISTORY OUTPUT, TIME=0.5E-5
*NODE HISTORY, NSET=DMDIS
U, V, A
*EL HISTORY, ELSET=DMBST
MISES,
PEEQ,
SENER,
PENER,
*EL HISTORY, ELSET=DMWST
MISES,
PEEQ,
SENER,
PENER,
*EL HISTORY, ELSET=DMLST

```

```
MISES,  
PEEQ,  
SENER,  
PENER,  
*EL HISTORY, ELSET = RINGST  
MISES,  
PEEQ,  
SENER,  
PENER,  
*EL HISTORY, ELSET = BOLTST  
MISES,  
PEEQ,  
SENER,  
PENER,  
*FILE OUTPUT, NUMBER INTERVAL = 100  
*NODE FILE  
RF,  
*MONITOR,NODE = 301,DOF = 3  
*END STEP  
--
```



CHECKLIST FOR CHECKING OF ANALYSIS/CALCULATIONS

Document Number/Revision: HNF-2209/Rev. 0

Document Title: DOT-17H 55 Gallon Drum 55 MPH Bottom End Drop

Yes	No	N/A	
<input checked="" type="checkbox"/>	<input type="checkbox"/>	<input type="checkbox"/>	Problem completely defined.
<input checked="" type="checkbox"/>	<input type="checkbox"/>	<input type="checkbox"/>	Appropriate analytical method used.
<input checked="" type="checkbox"/>	<input type="checkbox"/>	<input type="checkbox"/>	Necessary assumptions are appropriate and explicitly stated.
<input checked="" type="checkbox"/>	<input type="checkbox"/>	<input type="checkbox"/>	Computer codes and data files documented.
<input checked="" type="checkbox"/>	<input type="checkbox"/>	<input type="checkbox"/>	Data used in calculations explicitly stated in document.
<input type="checkbox"/>	<input type="checkbox"/>	<input checked="" type="checkbox"/>	Sources of non-standard formula/data are referenced and the correctness of the reference verified.
<input checked="" type="checkbox"/>	<input type="checkbox"/>	<input type="checkbox"/>	Data checked for consistency with original source information as applicable.
<input type="checkbox"/>	<input type="checkbox"/>	<input checked="" type="checkbox"/>	Mathematical derivations checked including dimensional consistency of results.
<input checked="" type="checkbox"/>	<input type="checkbox"/>	<input type="checkbox"/>	Models appropriate and used within range of validity or use outside range of established validity justified.
<input type="checkbox"/>	<input type="checkbox"/>	<input checked="" type="checkbox"/>	Hand calculations checked for errors.
<input checked="" type="checkbox"/>	<input type="checkbox"/>	<input type="checkbox"/>	Code run streams correct and consistent with analysis documentation.
<input checked="" type="checkbox"/>	<input type="checkbox"/>	<input type="checkbox"/>	Code output consistent with input and with results reported in analysis documentation.
<input checked="" type="checkbox"/>	<input type="checkbox"/>	<input type="checkbox"/>	Acceptability limits on analytical results applicable and supported. Limits checked against sources.
<input checked="" type="checkbox"/>	<input type="checkbox"/>	<input type="checkbox"/>	Safety Margins consistent with good engineering practices.
<input checked="" type="checkbox"/>	<input type="checkbox"/>	<input type="checkbox"/>	Conclusions consistent with analytical results and applicable limits.
<input checked="" type="checkbox"/>	<input type="checkbox"/>	<input type="checkbox"/>	Results and conclusions address all points required in the problem statement.

I have checked the analysis/calculation and it is complete and accurate to the best of my knowledge.

Engineer/Checker Scott Shiraga

Date 09/01/98

NOTE: Any hand calculations, notes or summaries generated as part of this check should be signed, dated, and attached to this checklist. Material should be labeled and recorded so that it is intelligible to a technically qualified third party.

7.7.2 Engineering Safety Evaluations

7.7.2.1 55-Gal Drum Vibration Evaluation.



ENGINEERING SAFETY EVALUATION

Subject: 55 Gallon Drum Vibration Evaluation	Page 1 of 5
Preparer: S. S. Shiraga <i>[Signature]</i>	Date 9/15/98
Checker: S. N. Huang <i>[Signature]</i>	Date 9/17/98
Section Chief: R. J. Smith <i>[Signature]</i>	Date 9/17/98

1.0 OBJECTIVE

The objective of this evaluation is to assess the vibrational performance of 55 gallon drums during normal transport.

2.0 REFERENCES

ANSI, *Draft American National Standard Design Basis for Resistance to Shock and Vibration of Radioactive Material Packages Greater than One Ton in Truck Transport*, ANSI N14.23, American National Standard Institute, New York, New York, 1980.

3.0 ASSUMPTIONS, RESULTS, AND CONCLUSIONS

The basic assumption of this evaluation is all drum shipments are one-way, and the drums are not subjected to high cyclic transportation loading. For conservatism it is also assumed that the drums are subjected to vertical shock loading specified in ANSI N14.23 due to the relatively light weight of the packages. The loading on the closure ring joint is idealized as the transverse loads from the entire weight of the drums loading, increase by 2 for shock loads, against the closure ring. This vertical loading is idealized as producing a pseudo-pressure on the closure ring which results in a load tending to separate the closure ring and thereby producing a load on the closure bolt joint.

Result of this evaluation shows that based on an assumed distance of 10 miles, at an average speed of 35 mph, at the highest probable frequency of 5 Hz, the number of cycles on the drums is very low at approximately 5,200 cycles. The evaluation also shows that the natural frequency of the drum lid is significantly higher than the highest probable frequency. Consequently, no load amplification will occur on a continuous basis. Evaluation of the closure ring joint shows that a 2g continuous shock loading there is not sufficient force applied to the bolt to result in loosening during transport. This is demonstrated by a large margin of the forcing tending to loosen the bolt versus the force applied by a tightening torque of 40 ft-lb on the bolt.



ENGINEERING SAFETY EVALUATION

Subject: 55 Gallon Drum Vibration Evaluation Page 2 of 5
 Preparer: S. S. Shiraga Date 9/15/98
 Checker: S. N. Huang Date 9/17/98
 Section Chief: R. J. Smith Date 9/17/98

4.0 EVALUATION

Drum Vibrational Analysis:

On this package as specified in ANSI N14.23 consider only vertical vibration. However since this is a light package assume the shock load of 2gs in the vertical direction is the normal loading.

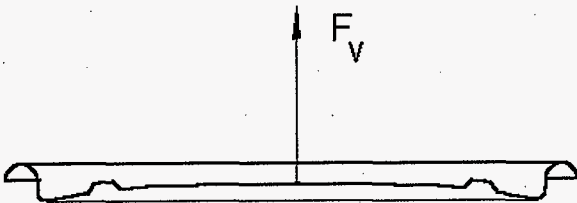

Determine first three resonance frequencies of drum lid and compare with transport vibration:

Elastic modulus: $E_s = 29.6 \cdot 10^6 \text{ psi}$ Poisson's Ratio: $\nu = 0.3$ Material density: $\rho_s = 0.28 \frac{\text{lb}}{\text{in}^3}$

Diameter of lid: $d_{\text{lid}} = 23.5 \text{ in}$ Radius of lid: $r_{\text{lid}} = \frac{d_{\text{lid}}}{2}$

Idealize drum lid as a circular plate and determine natural frequencies:

Lid thickness: $t_{\text{lid}} = 0.0478 \text{ in}$ Stiffness of plate: $D_p = \frac{E_s \cdot t_{\text{lid}}^3}{12(1-\nu^2)}$

First frequency: $\omega_1 = \frac{10.21}{2\pi \cdot r_{\text{lid}}^2} \sqrt{\frac{D_p \cdot g}{\rho_s \cdot t_{\text{lid}}}}$ $\omega_1 = 34 \cdot \text{Hz}$

Second frequency: $\omega_2 = \frac{39.77}{2\pi \cdot r_{\text{lid}}^2} \sqrt{\frac{D_p \cdot g}{\rho_s \cdot t_{\text{lid}}}}$ $\omega_2 = 134 \cdot \text{Hz}$



ENGINEERING SAFETY EVALUATION

Subject: 55 Gallon Drum Vibration Evaluation Page 3 of 5
 Preparer: S. S. Shiraga Date 9/15/98
 Checker: S. N. Huang Date 9/17/98
 Section Chief: R. J. Smith Date 9/17/98

$$\text{Third frequency: } \omega_3 := \frac{88.9}{2\pi \cdot r_{lid}^2} \sqrt{\frac{D p' g}{\rho_s t_{lid}}} \quad \omega_3 = 299 \cdot \text{Hz}$$

Since normal transport vibration is 5 to 7 Hz, 99.9 % of the time, no load amplification occurs.

Determine number of cycles for a typical transport.

Projected travel distance: $\text{dist} := 10\text{-mi}$ Projected average speed of conveyance: $v := 35\text{-mph}$

Nominal frequency of transport: $f := 5\text{-Hz}$ Number of loading cycles: $n_{\text{cyc}} = \frac{\text{dist}}{v} \cdot f = 5143$

This is an extremely low number of cycles, combined with low load amplitude and relative displacement, fatigue is not a problem.

Determine loading on closure ring bolts:

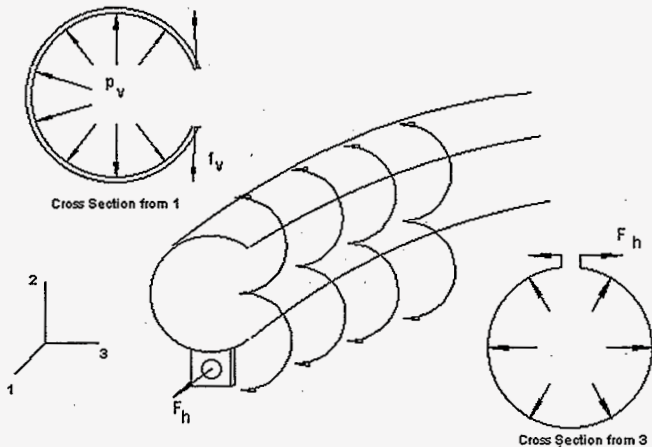



ENGINEERING SAFETY EVALUATION

Subject: 55 Gallon Drum Vibration Evaluation Page 4 of 5
 Preparer: S. S. Shiraga Date 9/15/98
 Checker: S. N. Huang Date 9/17/98
 Section Chief: R. J. Smith Date 9/17/98

Idealize as a ring loaded by vertical force tending to open closure ring and forcing apart the bolted joint. Insert a pseudo-pressure to act as driver for force acting to spring apart the bolted joint.

Radius of lid: $R_d := \frac{d_{lid}}{2}$ Thickness of closure ring: $t_d := 0.0533 \text{ in}$

Radius of closure ring: $r_{ring} := 0.3125 \text{ in}$ Weight of package: $w_d := 1450 \text{ lbf}$

Inertial loading from shock: $n_i := 2$ Force springing closure ring: $F_v := 2 \cdot w_d$

Force per unit length of circumference: $f_v := \frac{F_v}{\pi \cdot d_{lid}}$ $f_v = 39.28 \frac{\text{lbf}}{\text{in}}$

Unit length: $\text{unit} := 1 \text{ in}$

Pseudo-pressure on ring: $p_v := \frac{f_v \cdot \text{unit}}{2 \cdot r_{ring} \cdot t_d}$ $p_v = 1179 \text{ psi}$

Resulting horizontal load on bolt due to vibration tending to loosen bolt: $F_h := p_v \cdot (2 \cdot R_d \cdot t_d)$ $F_h = 1477 \text{ lb}$

Determine holding force on bolt:

The block on the figure represents an element of the nut bearing against the ramp formed by the unwrapped and flattened thread. Since the system is in equilibrium, all forces, with due regard to direction and sign will balance one another. In other words all the forces acting parallel to the ramp will sum up to zero and the sum of all forces acting normal to the ramp will equal zero.

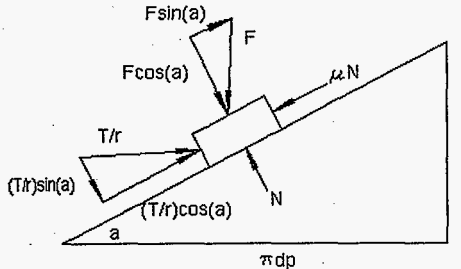



ENGINEERING SAFETY EVALUATION

Subject: 55 Gallon Drum Vibration Evaluation Page 5 of 5
 Preparer: S. S. Shiraga Date 9/15/98
 Checker: S. N. Huang Date 9/17/98
 Section Chief: R. J. Smith Date 9/17/98

Derive equation for applied force on joint:

$$\Sigma F=0 \quad \frac{T}{r} \cdot \cos(a) - \mu N - F \sin(a) = 0 \quad \text{and} \quad \Sigma N=0 \quad N - F \cos(a) - \frac{T}{r} \sin(a) = 0$$

The term $(T/r)\sin(a)$ is very small subsequently ignore.

Combine the two and solve for F:
$$F = \frac{T}{r \left(\mu \frac{\cos(a)}{\cos(a)} + \frac{\sin(a)}{\cos(a)} \right)}$$

This is the force applied to the bolt from the preload. Also r in this case is the diametral pitch:

Closure bolt is 3/8-16 UNC.

Diametral pitch: $dp = 0.330$ in Helix angle: $a = 3.5$ deg

Coefficient of thread friction: $\mu = 0.15$ Preload torque: $T_{tight} = 40$ ft-lbf

Clamping force from preload: $F_{tight} = \frac{T_{tight}}{dp \cdot (\mu + \tan(a))}$ $F_{tight} = 6888$ lbf

Since F_{tight} significantly higher than F_h or force tending to loosen joint, bolt will not loosen.

7.7.2.2 Drum Normal Transfer Conditions Penetration Test Evaluation.



ENGINEERING SAFETY EVALUATION

Subject: <u>Drum NTC Penetration Test Evaluation</u>	Page <u>1</u> of <u>2</u>
Preparer: <u>S. S. Shiraga</u>	Date <u>9/16/98</u>
Checker: <u>S. N. Huang</u>	Date <u>9/17/98</u>
Section Chief: <u>R. J. Smith</u>	Date <u>9/17/98</u>

1.0 OBJECTIVE

The objective of this evaluation is to determine the minimum thickness of material to prevent perforation of either a retrieval or standard drum.

2.0 REFERENCES

Bangash, M.Y.H., 1993, *Impact and Explosion Analysis and Design*, CRC Press, Boca Raton, Florida.

3.0 ASSUMPTIONS, RESULTS, AND CONCLUSIONS

In this analysis it is assumed the drum material is a mild to medium steel with a Brinell hardness of less than 350. For this steel the Kar steel target formula is used to determine the minimum thickness of steel to prevent perforation by a 13 lb rod having a spherical nose of 1.25 in diameter falling from a height of 1 m. Use of the Kar empirical formula shows that the minimum thickness of steel to prevent perforation is 0.008 in. The minimum thickness of a retrieval drum is 0.030 in and a standard drum is 0.0428 in. Consequently, penetration under DOT test conditions can be precluded.



ENGINEERING SAFETY EVALUATION

Subject: Drum NTC Penetration Test Evaluation Page 2 of 2
 Preparer: S. S. Shiraga Date 9/16/98
 Checker: S. N. Huang Date 9/17/98
 Section Chief: R. J. Smith Date 9/17/98

4.0 EVALUATION

Determine Minimum Drum Thickness to Prevent Penetration:

Using Kar steel target formula for mid to medium hard homogeneous steel, determine penetration thickness to prevent perforation of steel (Bangash, 1993, page 385):

Assumed Brinell Hardness of steel: BHN := 150 Diameter of impact rod: d := 1.25 in

Mass of rod: m := 13-lb Modulus of target: E := 30 · 10³-ksi

Velocity of rod for a 1m drop: v := 14.53 $\frac{\text{ft}}{\text{sec}}$

Radius of nose to diameter of rod: n := $\frac{1}{2}$

Nose shape factor assume n=1/2: N := 0.72 + 0.25 $\left(\frac{1}{2} - 0.25\right)^{0.5}$

Penetrability coefficient: K_p := $\frac{0.632 \text{BHN} + 94.88}{275}$

Minimum thickness to prevent perforation:

$$t_p := \frac{E}{29000 \text{ksi}} \cdot (0.72 + N) \cdot K_p \cdot \left[\frac{m \text{ (ft)}}{g \cdot (\text{lb} \cdot \text{sec}^2)} \cdot \left[\frac{v}{\left(\frac{\text{ft}}{\text{sec}}\right)} \right]^2 \right]^{0.667} \cdot (1067) \cdot 2 \cdot \left(\frac{d}{\text{in}}\right) \quad t_p = 0.008 \text{in}$$

By this empirical method, an 8 mil thick sheet will prevent perforation of mid to medium steel.

8.0 THERMAL EVALUATION

8.1 INTRODUCTION

Within the boundaries of the Hanford Site, two types of drums are used. The most common are the standard 208 L (55-gal) drum packages used to transport and store TRU and non-TRU wastes in both liquid and solid form. Less common are the retrieval drums. These drums are retrieved from noncompliant RCRA storage for characterization, transfer, or other operations.

Depending on content, the standard 208 L (55-gal) drums meet one of three drum specifications and have one-to-four containment barriers. As a function of the contents, the heat load in the drums may vary up to a maximum of 12 W for solid payloads and 0.75 W for liquid payloads. The objective of this evaluation is to envelope the variations in drum specification, gross weight, form of content, heat load, and number of containment boundaries to demonstrate the thermal performance of the standard 208 L (55-gal) drum packages under NTC. This evaluation does not provide any evaluation of accident conditions, since in the risk assessment of these packages they are assumed to fail hypothetical thermal accidents.

In the cases of retrieval drums, they are assumed to only meet the dimensional requirements of the standard 208 L (55-gal) drum specification. These drums are assumed to have a wall thickness of 0.76 mm (0.030 in). From a thermal evaluation standpoint these drums are assumed to have the same characteristics and properties of the standard 208 L (55-gal) drum.

Drums with a high-activity content as specified in Part A of this SARP shall be shipped in NuPac Model N-55 Overpack System (NuPac 1987). This system has been demonstrated and certified by the U.S. Nuclear Regulatory Commission to provide overpacked drums with fire and impact resistance per 10 CFR 71 for contents with a heat load of up to 5 W. Consequently, the thermal performance of this system is not evaluated in this section.

8.2 ENVELOPING THERMAL EVALUATION OF PACKAGE

8.2.1 Package Description

The 208 L (55-gal) drum configurations approved for onsite transport are the DOT Specification 17C, 17H, and Type A-UN1A2. These drums are metal containers in the shape of a right circular cylinder constructed of carbon steel with three swaged or rolled hoops. All three drum types are similar in construction and have a usable interior height of 85.1 cm (33 1/4 in.) and an inside diameter of 57.2 cm (22 1/2 in.). The drums are equipped with removable gasketed heads, which are retained during transport by a bolted locking ring. The locking ring is constructed of 12-gauge carbon steel with drop forged lugs. The ring is locked together by a bolted assembly consisting of a 5/8-in.-diameter bolt and hex nut. Typical drum dimensions are shown in Figure B8-1. The drums are sealed with an elastomeric gasket that is bonded to the underside of the removable head.

DOT-17C drums are constructed entirely of 16-gauge carbon steel. The DOT-17H drum body and bottom head are constructed of 18-gauge carbon steel. For the DOT-17H, the removable head is constructed of 16-gauge carbon steel. Both drums have the bottom head double seamed to the body with a nonhardening seaming compound. The side seams are welded. The top head is 2.22 cm (7/8 in.) deep and fully removable with a convex head. The top head fits over a rolled false wire at the open end and secured to the body by the locking ring.

Figure B8-1. Typical Drum Dimensions.

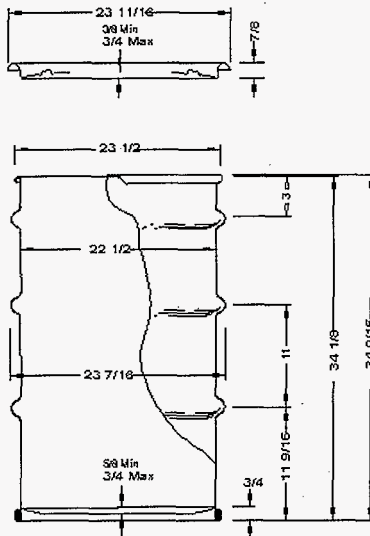

The Type A-UN1A2 drums are similar in construction to the DOT-17C and -17H drums. These drums are manufactured to specifications WHC-S-0465 and WHC-S-0466, which define the DOT-7A, Type A performance standards and the UN performance standards. Conformance with these performance standards is demonstrated by the manufacturer.

The retrieval drums are assumed to have the same outer dimensions of a standard 208 L (55-gal) drum. However the wall thickness of the lid, bottom, and drum walls are assumed to be only 0.76 mm (0.030 in.) thick.

As an enveloping case for liquid drum contents, the assumed internal heat load is 0.75 W. To envelope solid drum contents, the assumed internal heat load is 12 W. In the case of the liquid drum contents, the liquid is assumed to be contained in a polyethylene bottle, which is packed in the center of a polyethylene inner liner with absorbent material, all within the drum. For solid drum contents, the solids are assumed to be distributed in the total volume of the drum. The polyethylene liner is assumed to have a wall thickness of (0.090 in.) with an outer diameter of (22 in.). Assumed enveloping dimensions of the polyethylene bottle are an outer diameter of (6 in.) with a wall thickness of (3/16 in.).

8.2.3 Material Properties

The drum, locking ring, and closure bolts for all drums are assumed to be manufactured from ASTM A-36 carbon steel. The drum gaskets are manufactured from various synthetic elastomeric rubbers. All of these synthetic rubbers have a operating range equal to or greater than

-40 °C to 70 °C with a Shore A durometer range from 40 to 100. For this evaluation the gasket material is assumed to be Nitrile (Buna N) rubber. This is a common gasketing material, which envelopes the material properties of the various rubbers commonly used as drum gaskets. Buna N rubber has an operating service temperature range of -54 °C to 135 °C with a Shore durometer range of 20 to 90 (Parker 1991).

To envelope the thermal properties of internal components for liquid drum contents, the inner liner is assumed to be manufactured from medium density polyethylene and having a thickness of (0.090 in.). The absorbent packing material between the polyethylene bottle and inner is conservatively assumed to have the same insulating properties as loose asbestos. The polyethylene bottle is assumed to have the same insulating properties as the inner liner with a thickness of (3/16 in). The thermal conductivity of the materials used in this evaluation are provided in Table B8-1.

Table B8-1. Material Properties.

Materials	Temperature °F	Thermal conductivity watt/m-°C (BTU/s-in-°F)
Carbon steel	70	55.39 (0.000741)
	400	48.81 (0.000653)
Polyethylene	0	0.41 (0.000005544)
	203	0.41 (0.000005544)
Absorbent	32	0.154 (0.00000205)*
	212	0.161 (0.00000215)*
Air	100	0.027 (0.000000356)
	200	0.030 (0.000000403)

Unless otherwise noted, all properties are from WHC-SD-TP-RPT-005 (Irwin 1996).

*Properties assumed for loose asbestos from Element of Heat Transfer (Bayazitoglu and Ozisik 1988).

Irwin, J. J., 1996, *Thermal Analysis Methods for Safety Analysis Reports for Packaging*, WHC-SD-TP-RPT-005, Rev. 0, Westinghouse Hanford Company, Richland, Washington.

Bayazitoglu, Y., and M. Ozisik, 1988, *Elements of Heat Transfer*, McGraw-Hill Book Company, New York, New York.

The material emissivities used in the evaluation are obtained from WHC-SD-TP-RPT-005 (Irwin 1996). The emissivity of painted carbon steel used to determine solar heat loading is 0.9. For determination of radiative heat transfer of the gap between the carbon steel drum and the polyethylene liner, the effective emissivity factor for carbon steel to fiberglass of 0.82 is assumed.

8.3 NORMAL TRANSFER CONDITIONS THERMAL EVALUATION

8.3.1 Conditions To Be Evaluated

Thermal performance of the package is assessed for Hanford Site NTC in this section. The package is evaluated for the worst-case Hanford Site thermal loading condition of still air ambient temperature of 46 °C (115 °F) (Fadeff 1992) with decay heat sources with and without solar insolation. For enveloping the liquid and solid contents of the drum, the effects of the following two heat sources are evaluated:

1. A 4 L polyethylene drum filled with 1.7 L of material, packed in an absorbent material in a polyethylene inner liner, generating a worst-case heat load of 0.75 W.
2. A uniformly distributed solid, generating a worst-case heat load of 12 W.

8.3.2 Acceptance Criteria

The criteria for acceptable performance of the package is that the accessible surface of the package in still air at 46 °C (115 °F) and in the shade is not to exceed 82 °C (185 °F). This is based on this package being transported as an exclusive-use shipment. Also the temperature of liquid contents under solar insolation are not to reach the boiling point of water for normal operating conditions. As input to the NTC structural evaluation, the temperatures of critical components at maximum ambient temperature, maximum content heat source, and under full solar insolation are provided. Drum gasket temperatures are not to exceed the exterior temperature of the manufacturer's recommended operating service temperatures.

8.3.3 Thermal Evaluation and Conclusions

In Appendix 8.5, because of the variability of the type and form of the contents, two cases are evaluated to envelope the contents. The first enveloping case assumes a liquid content with a 0.75-W heat source and packaged as described above. In this evaluation the temperatures of the contents and outer surface of the drum are determined both under solar insolation and in the shade. To envelope the solid contents, the second case considers the worse-case 12-W heat source as uniformly distributed inside the drum with and without solar insolation. In all cases where solar insolation is applied, the sun is assumed to shine on the drum for 12 hours at the worst solar angle. The maximum ambient temperature is assumed as 46 °C (115 °F).

Results of this evaluation in all cases show the exterior temperatures of the drum under solar insolation are below 93 °C (200 °F) for the limiting temperatures in the structural evaluation. Also, assuming the maximum exterior temperature of the drum is the temperature of the gasket, the evaluation demonstrates that the temperatures do not exceed the manufacturer's recommended operating temperatures for gasket materials. In all cases the results also show the drum meets the NTC exterior surface temperature requirement of 82 °C (185 °F) in the shade for exclusive-use shipments. As a worst case, evaluation results show the liquid contents of a drum under the defined parameters does not reach 100 °C (212 °F), which is the boiling point of water.

8.4 REFERENCES

- 10 CFR 71, "Packaging and Transportation of Radioactive Materials," *Code of Federal Regulations*, as amended.
- Bayazitoglu, Y., and M. Ozisik, 1988, *Elements of Heat Transfer*, McGraw-Hill Book Company, New York, New York.
- Fadeff, J. G., 1992, *Environmental Conditions for On-site Hazardous Materials Packages*, WHC-SD-TP-RPT-004, Rev. 0, Westinghouse Hanford Company, Richland, Washington.
- Irwin, J. J., 1996, *Thermal Analysis Methods for Safety Analysis Reports for Packaging*, WHC-SD-TP-RPT-005, Rev. 0, Westinghouse Hanford Company, Richland, Washington.

NuPac, 1987, *Application for NRC Certificate of Compliance Authorizing Shipment of Nuclear Materials in NuPac Model N-55 Packaging*, Nuclear Packaging, Incorporated, Federal Way, Washington.

Parker, 1991, *Parker O-Ring Handbook*, ORD 5700, Park Seals Group, Lexington, Kentucky.

Resource Conservation and Recovery Act of 1976, as amended, 42 USC 6901 et seq.

8.5 APPENDICES

8.5.1 Thermal With Solar (Liquid Content) Evaluation



ENGINEERING SAFETY EVALUATION

Subject: <u>NTC 55-Gallon Drum Thermal w/ Solar (Liquid Content)</u>	Page <u>1</u> of <u>11</u>
Preparer: <u>S S Shiraga</u>	Date <u>4/23/98</u>
Checker: <u>P C Ferrell</u>	Date <u>9/15/98</u>
Section Chief: <u>R. J. Smith</u>	Date <u>9/15/98</u>

1.0 OBJECTIVE

The objective of this evaluation is to determine the NTC exterior surface temperature of a 55 Gallon drum with a liquid content. Also, for this evaluation the maximum internal temperature of the contents is determined.

2.0 REFERENCES

Irwin, J. J., 1995, WHC-SD-TP-RPT-005, Rev. 1, *Thermal Analysis Methods for Safety Analysis Reports for Packaging*, Westinghouse Hanford Company, Richland, Wash.

Fadeff, J. G., 1992, WHC-SD-TP-RPT-004, Rev. 0, *Environmental Conditions for On-site Hazardous Material Packages*, Westinghouse Hanford Company, Richland, Wash.

Bayazitoglu, Y. & Ozisik, M., 1988, *Elements of Heat Transfer*, McGraw-Hill Book Company, New York, New York.

ORNL, 1970, *Cask Designer's Guide*, ORNL-NISC-68, Oak Ridge National Laboratory, Oak Ridge, Tennessee.

Mathcad Plus 5, 1994, *User's Guide*, Math Soft Inc., Cambridge, Massachusetts.

3.0 ASSUMPTIONS, RESULTS, AND CONCLUSIONS

In this evaluation, it is conservatively assumed that the sun shines on the drum for 12 hrs at the worst solar angle. It is also assumed that the drum is suspended in the air, so as to conservatively negate conduction exterior to the package. The drum dimensions of a 17-H drum are assumed. As a worst case the contents is assumed as a single 4 liter polyethylene bottle filled with 1.7 liters of liquid generating a heat load of 0.75 watts. The bottle is assumed to be centered and packed tightly with absorbent material in a drum with a 90-mil polyethylene liner. The absorbent material is assumed to have the thermal conductivity of loose asbestos.



ENGINEERING SAFETY EVALUATION

Subject: <u>NTC 55-Gallon Drum Thermal w/ Solar (Liquid Content)</u>	Page <u>2</u> of <u>11</u>
Preparer: <u>S S Shiraga</u>	Date <u>4/23/98</u>
Checker: <u>P C Ferrell</u>	Date <u>9/15/98</u>
Section Chief: <u>R. J. Smith</u>	Date <u>9/15/98</u>

Results of the evaluation show that under worst case solar insolation the exposed external surface temperature of the drum is 62 °C (144 °F). In the shade the external temperature of exposed tank surfaces is 46 °C (115 °F). Based on this evaluation, it is demonstrated that the exposed external surface temperature of the tank is below the temperature required for normal non-exclusive use transport of the 55-Gallon steel drum.

The liquid contents temperature is determined by a conservative and simplified one-dimensional evaluation, based on the internal heat load from the contents and the maximum drum exterior surface temperature. Results of this evaluation with the above assumptions show the temperature of the contents is 72 °C (161 °F).



ENGINEERING SAFETY EVALUATION

Subject: NTC 55-Gallon Drum Thermal w/ Solar (Liquid Content) Page 3 of 11
 Preparer: S S Shiraga Date 4/23/98
 Checker: P C Ferrell Date 9/15/98
 Section Chief: R. J. Smith Date 9/15/98

4.0 EVALUATION

NTC Thermal Evaluation of 55 Gallon Drum with Liquid Contents with Solar Loading:

Determine temperature of outer surface with solar insolation. Assume sun shines on top and half the side of the cylinder. For conservatism, assume the drum is suspended in the air. Assume drum is a 17H drum.

Evaluate as steady state heat transfer for the drum idealized as a right circular cylinder:

Free convection coefficients from Irwin, 1995.

Free convection coefficient for a vertical cylinder:

$$k_{vc} := 0.29 \frac{\text{BTU}}{\text{hr} \cdot \text{ft}^2}$$

Free convection coefficient for a horizontal surface with hot surface facing up:

$$k_{hs} := 0.27 \frac{\text{BTU}}{\text{hr} \cdot \text{ft}^2}$$

Free convection coefficient for a horizontal surface with cold surface facing up:

$$k_{cs} := 0.12 \frac{\text{BTU}}{\text{hr} \cdot \text{ft}^2}$$

Height of vertical plane: $h_{vp} := \left(34 + \frac{9}{16}\right) \cdot \text{in}$

Inside diameter of drum: $d_{\text{drum}} := 22.5 \text{ in}$

Drum wall thickness: $t_{\text{wd}} := 0.0428 \text{ in}$

Outside diameter of drum, ignore hoops: $d_{\text{od}} := d_{\text{drum}} + 2 \cdot t_{\text{wd}} \quad d_{\text{od}} = 22.59 \text{ in}$

Outside diameter of drum lid: $d_{\text{lid}} := \left(23 + \frac{11}{16}\right) \cdot \text{in}$

Vertical surface area of cylinder: $A_c := \pi \cdot d_{\text{od}} \cdot h_{vp}$ Surface area of ends: $A_{\text{end}} := \frac{\pi \cdot d_{\text{lid}}^2}{4}$

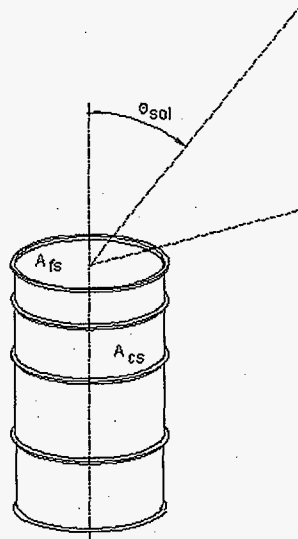



ENGINEERING SAFETY EVALUATION

Subject: NTC 55-Gallon Drum Thermal w/ Solar (Liquid Content) Page 4 of 11
 Preparer: S S Shiraga Date 4/23/98
 Checker: P C Ferrell Date 9/15/98
 Section Chief: R. J. Smith Date 9/15/98

Total surface area of drum: $A_{tot} := A_c + 2 \cdot A_{end}$

Combined convection constant: $hd := \left[\frac{k_{vc} \cdot A_c}{\left(\frac{h_{vp}}{ft}\right)^4} + \frac{k_{hs} \cdot A_{end}}{\left(\frac{d_{lid}}{ft}\right)^4} + \frac{k_{cs} \cdot A_{end}}{\left(\frac{d_{lid}}{ft}\right)^4} \right] \cdot R^4$

Radiant heating constant:

Stefan-Boltzman's natural constant: $\sigma_{sb} := 0.1714 \cdot 10^{-8} \cdot \frac{BTU}{hr \cdot ft^2 \cdot R^4}$

Emissivity of painted carbon steel (Irwin, pg 29): $\epsilon_s := 0.9$

$$K_1 := \sigma_{sb} \cdot \epsilon_s \cdot A_{tot} \quad K_1 = 3.57 \cdot 10^{-8} \cdot \frac{BTU}{hr \cdot R^4}$$

Determination of solar loading from Cask Designers Guide (ORNL, 1970):

Assume solar angle of declination relative to vertical for maximum loading: $\theta_{sol} := 30\text{-deg}$

Solar heat loading for various surfaces, hourly average loading based on a 12 hr period:

Solar heat loading is from Fadeff, 1992, page 8 & 9.

Flat horizontal surfaces: $q_{fsh} := 2386 \cdot \frac{BTU}{ft^2}$ Curved surfaces: $q_{fsc} := 1193 \cdot \frac{BTU}{ft^2}$

Solar heat loading for hourly averaged loading based on a 12 hr period: $t_{hr} := 12\text{hr}$

Flat horizontal surfaces: $Q_{fsh} := \frac{q_{fsh}}{t_{hr}}$ $Q_{fsh} = 627 \cdot \frac{watt}{m^2}$

Curved surfaces: $Q_{fsc} := \frac{q_{fsc}}{t_{hr}}$ $Q_{fsc} = 314 \cdot \frac{watt}{m^2}$

Conservative internal heat load: $q_{int} := 0.75\text{-watt}$

Assumed solar absorptivity: $\alpha_{sol} := 0.9$



ENGINEERING SAFETY EVALUATION

Subject: NTC 55-Gallon Drum Thermal w/ Solar (Liquid Content) Page 5 of 11
 Preparer: S S Shiraga Date 4/23/98
 Checker: P C Ferrell Date 9/15/98
 Section Chief: R. J. Smith Date 9/15/98

$$\text{Solar heat load: } q_{\text{sol}} := a_{\text{sol}} \left(Q_{\text{fsh}} \cdot A_{\text{end}} \cdot \cos(\theta_{\text{sol}}) + Q_{\text{fsc}} \cdot \frac{A_c}{2} \cdot \sin(\theta_{\text{sol}}) \right) \quad q_{\text{sol}} = 251 \cdot \text{watt}$$

$$\text{Total heat load: } q_{\text{tot}} := q_{\text{sol}} + q_{\text{int}} \quad q_{\text{tot}} = 858 \cdot \frac{\text{BTU}}{\text{hr}}$$

Outside ambient temperature is 115 °F and in Rankine: $T_o := (115 + 459.7) \cdot \text{R}$

Using conservation of energy: $q_{\text{in}} - q_{\text{out}} = 0$

Then by substitution: $q_{\text{tot}} - q_{\text{rad}} - q_{\text{con}} = 0$ or

$$q_{\text{tot}} - K_1 \cdot (T_f^4 - T_o^4) - \text{hd} \cdot (T_f - T_o)^{\frac{1}{4}} = 0$$

Solve for T_f which the temperature at the surface using MathCad roots of equation solution:

$$T_{f1} := \text{root} \left[q_{\text{tot}} - K_1 \cdot (T_f^4 - T_o^4) - \text{hd} \cdot (T_f - T_o)^{\frac{1}{4}}, T_f \right]$$

External surface temperature in sun: $T_{f1} = 603 \cdot \text{R}$

Temperature in °F: $T_{ff} := \frac{T_{f1} - 459.7 \cdot \text{R}}{\text{R}} \quad T_{ff} = 144$

Temperature in Shade:

Total shaded heat load: $q_{\text{stot}} := q_{\text{int}}$

Solve for T_f which the temperature at the surface using MathCad roots of equation solution:

$$T_{f2} := \text{root} \left[q_{\text{stot}} - K_1 \cdot (T_f^4 - T_o^4) - \text{hd} \cdot (T_f - T_o)^{\frac{1}{4}}, T_f \right]$$

External surface temperature in shade: $T_{f2} = 575 \cdot \text{R}$



ENGINEERING SAFETY EVALUATION

Subject: NTC 55-Gallon Drum Thermal w/ Solar (Liquid Content) Page 6 of 11
 Preparer: S S Shiraga Date 4/23/98
 Checker: P C Ferrell Date 9/15/98
 Section Chief: R. J. Smith Date 9/15/98

Temperature in °F: $T_{ff2} := \left| \frac{T_{\infty} - 459.7R}{R} \right|$ $T_{ff2} = 115$

With a simplified one dimensional idealization determine temperature of inner shell with solar insolation:

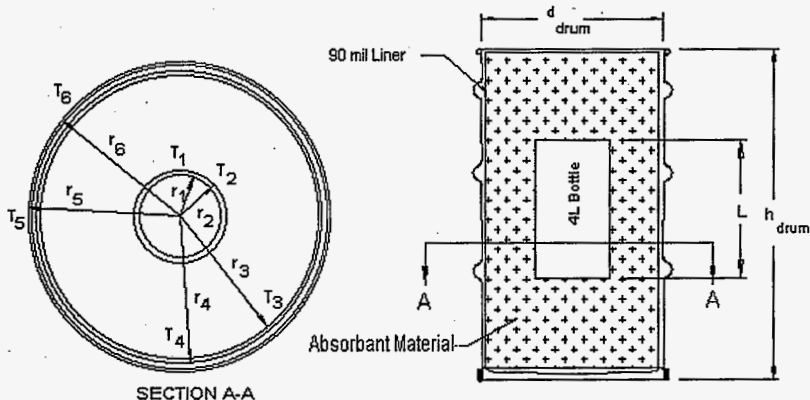

Material properties:

Unpainted Carbon steel:

Thermal conductivity at 400 °F, Irwin; pg A-10: $k_{cs} := 0.000653 \frac{BTU}{sec \cdot in}$

Poly Liner and container, assume medium density polyethylene:

Thermal conductivity at 200 °F, Irwin; pg A-15: $k_{pl} := 0.000005544 \frac{BTU}{sec \cdot in}$



ENGINEERING SAFETY EVALUATION

Subject: NTC 55-Gallon Drum Thermal w/ Solar (Liquid Content) Page 7 of 11
 Preparer: S S Shiraga Date 4/23/98
 Checker: P C Ferrell Date 9/15/98
 Section Chief: R. J. Smith Date 9/15/98

Assume absorbent material is as loose asbestos, Bayazitoglu; pg 423:

Thermal conductivity at 100 °F: $k_{am} := 0.161 \frac{\text{watt}}{\text{m}}$ Conversion factor to English: $\text{conv} := 0.5779 \frac{\text{BTU}}{\text{hr-ft}}$

Thermal conductivity in English units: $k_{amc} := \frac{k_{am}}{\left(\frac{\text{watt}}{\text{m}}\right) \cdot \text{conv}}$ $k_{amc} = 2.15 \cdot 10^{-6} \frac{\text{BTU}}{\text{sec-in}}$

Geometric properties:

17 H drum:

Outside radius: $r_6 := \frac{d_{od}}{2}$ Inside radius: $r_5 := \frac{d_{drum}}{2}$

Assumed payload poly bottle:

Outside diameter: $od_{bottle} := 6\text{-in}$ Assumed thickness of bottle: $t_{bottle} := \frac{3}{16}\text{-in}$

Outside radius: $r_2 := \frac{od_{bottle}}{2}$ Inside radius: $r_1 := r_2 - t_{bottle}$

Assumed poly liner

Outside diameter: $od_{liner} := 22\text{-in}$ Assumed thickness of liner: $t_{liner} := 0.090\text{in}$

Outside radius: $r_4 := \frac{od_{liner}}{2}$ Inside radius: $r_3 := r_4 - t_{liner}$

Determine length of heat source:

Assume above diameter of poly bottle, determine length of heat source based on restricted volume in SARP, SD-RE-SAP-002 of: $vol := 1.7\text{ liter}$

Length of heat source: $L := \frac{vol}{\pi \cdot r_1^2}$ $L = 4.17 \cdot \text{in}$ Length of liner: $l_{liner} := 33\text{-in}$

Temperature at inside steel drum (T_5) using the following equation: $q_{int} = \frac{T_5 - T_6}{R_{drum}}$

Exterior surface temperature of steel drum in °F: $T_6 := T_{ff}$ $T_6 = 144$



ENGINEERING SAFETY EVALUATION

Subject: NTC 55-Gallon Drum Thermal w/ Solar (Liquid Content) Page 8 of 11
 Preparer: S S Shiraga Date 4/23/98
 Checker: P C Ferrell Date 9/15/98
 Section Chief: R. J. Smith Date 9/15/98

Thermal resistance of drum by conduction: $R_{\text{drum}} := \frac{\ln\left(\frac{r_6}{r_5}\right)}{2 \cdot \pi \cdot k_{cs} \cdot L}$

Inside temperature of steel drum in °F: $T_5 := T_6 + q_{\text{int}} \cdot R_{\text{drum}}$ $T_5 = 144$

Temperature at exterior of poly liner, across gap between liner and drum:

Gap between liner and drum: $\delta_{\text{gap}} := r_5 - r_4$ $\delta_{\text{gap}} = 0.25 \cdot \text{in}$

Thermal resistance across gap by convection, assuming air in gap:

Prandtl number of air at 200°F, Irwin; pg B-17: $Pr := 0.72$

Grashof number parameter at 200°F, Irwin; B-17: $Grp := \frac{0.85 \cdot 10^6}{\text{ft}^3}$

Grashof number at 100°F: $Gr_g = Grp \cdot (T_4 - T_5) \cdot \delta_{\text{gap}}^3$ Rayleigh number of gap: $Ra_g = Gr_g \cdot Pr$

Rayleigh number of cylinder: $Ra_{cy} = \frac{\ln\left(\frac{r_5}{r_4}\right) \cdot Ra_g^{\frac{1}{4}}}{\delta_{\text{gap}}^{\frac{3}{4}} \cdot \left[(2 \cdot r_4)^{\frac{3}{5}} + (2 \cdot r_5)^{\frac{3}{5}} \right]^{\frac{5}{4}}} = \frac{\ln\left(\frac{r_5}{r_4}\right) \cdot \left[Grp \cdot (T_4 - T_5) \cdot \delta_{\text{gap}} \cdot Pr \right]^{\frac{1}{4}}}{\delta_{\text{gap}}^{\frac{3}{4}} \cdot \left[(2 \cdot r_4)^{\frac{3}{5}} + (2 \cdot r_5)^{\frac{3}{5}} \right]^{\frac{5}{4}}}$

Conductivity of air at 200 °F: $k_{\text{air}} := 0.0174 \frac{\text{BTU}}{\text{hr} \cdot \text{ft}}$



ENGINEERING SAFETY EVALUATION

Subject: NTC 55-Gallon Drum Thermal w/ Solar (Liquid Content) Page 9 of 11
 Preparer: S S Shiraga Date 4/23/98
 Checker: P C Ferrell Date 9/15/98
 Section Chief: R. J. Smith Date 9/15/98

Equation for effective gas conductivity, Irwin; pg 27:

$$k_{ea} = 0.386 \left(\frac{Pr}{0.861 + Pr} \right)^{\frac{1}{4}} \cdot Ra_{cy}^{\frac{1}{4}} \cdot k_{air} = 0.386 \left(\frac{Pr}{0.861 + Pr} \right)^{\frac{1}{4}} \cdot \left[\frac{\ln \left(\frac{r_5}{r_4} \right) \cdot \left[Gr_p (T_4 - T_5) \cdot \delta_{gap}^3 \cdot Pr \right]^{\frac{1}{4}}}{\delta_{gap}^{\frac{3}{4}} \cdot \left[(2 \cdot r_4)^{\frac{3}{5}} + (2 \cdot r_5)^{\frac{3}{5}} \right]^{\frac{1}{4}}} \right]^{\frac{1}{4}} \cdot k_{ai}$$

Thermal resistance of gap convection:

$$R_{gapc} = \frac{\ln \left(\frac{r_5}{r_4} \right)}{2 \cdot \pi \cdot k_{ea} \cdot l_{liner}} = \frac{\ln \left(\frac{r_5}{r_4} \right)}{2 \cdot \pi \cdot \left[0.386 \left(\frac{Pr}{0.861 + Pr} \right)^{\frac{1}{4}} \cdot \left[\frac{\ln \left(\frac{r_5}{r_4} \right) \cdot \left[Gr_p (T_4 - T_5) \cdot \delta_{gap}^3 \cdot Pr \right]^{\frac{1}{4}}}{\delta_{gap}^{\frac{3}{4}} \cdot \left[(2 \cdot r_4)^{\frac{3}{5}} + (2 \cdot r_5)^{\frac{3}{5}} \right]^{\frac{1}{4}}} \right]^{\frac{1}{4}} \cdot k_{air} \right] \cdot l_{liner}}$$

Thermal radiation resistance across gap:

Emissivity factor for narrow gaps, assume carbon steel to fiberglass, Irwin; pg 29: $\Phi_{45} = 0.82$

Thermal radiation resistance across gap:

$$R_{gapr} = \frac{1}{\sigma_{sb} \cdot \Phi_{45} \left[\left[(T_4 + 459.7) \cdot R \right]^4 - \left[(T_5 + 459.7) \cdot R \right]^4 \right] \cdot (2 \cdot \pi \cdot r_4 \cdot l_{liner})}$$



ENGINEERING SAFETY EVALUATION

Subject: NTC 55-Gallon Drum Thermal w/ Solar (Liquid Content) Page 10 of 11
 Preparer: S S Shiraga Date 4/23/98
 Checker: P C Ferrell Date 9/15/98
 Section Chief: R. J. Smith Date 9/15/98

Total resistance across gap:

$$R_{\text{gapt}} = \frac{\ln\left(\frac{r_5}{r_4}\right)}{2\pi \cdot \left[\frac{0.386 \left(\frac{\text{Pr}}{0.861 + \text{Pr}}\right)^{\frac{1}{4}} \cdot \ln\left(\frac{r_5}{r_4}\right) \cdot \left[\text{GrPr} (T_4 - T_5) \cdot \delta_{\text{gap}} \cdot \text{Pr} \right]^{\frac{1}{4}}}{\delta_{\text{gap}}^{\frac{3}{4}} \cdot \left[(2r_4)^{\frac{-3}{5}} + (2r_5)^{\frac{-3}{5}} \right]^{\frac{5}{4}}} \right] \cdot k_{\text{air}} \cdot \text{liner}} + \frac{\sigma_{\text{sb}} \cdot \Phi \cdot 45 \left[(T_4 + 459.7) \cdot R \right]^4 - \left[(T_5 + 459.7) \cdot R \right]^4}{2\pi \cdot r_4^2 \cdot \text{iner}}$$

Temperature at outside of liner (T_4) using the following equation: $q_{\text{int}} = \frac{T_4 - T_5}{R_{\text{gapt}}}$

By substitution:

$$q_{\text{int}} = \frac{2\pi \cdot \text{liner} \cdot (T_4 - T_5)}{\ln\left(\frac{r_5}{r_4}\right)} + \frac{0.386 \left(\frac{\text{Pr}}{0.861 + \text{Pr}}\right)^{\frac{1}{4}} \cdot \ln\left(\frac{r_5}{r_4}\right) \cdot \left[\text{GrPr} (T_4 - T_5) \cdot \delta_{\text{gap}} \cdot \text{Pr} \right]^{\frac{1}{4}}}{\delta_{\text{gap}}^{\frac{3}{4}} \cdot \left[(2r_4)^{\frac{-3}{5}} + (2r_5)^{\frac{-3}{5}} \right]^{\frac{5}{4}}} \cdot k_{\text{air}} + \frac{\sigma_{\text{sb}} \cdot \Phi \cdot 45 \left[(T_4 + 459.7) \cdot R \right]^4 - \left[(T_5 + 459.7) \cdot R \right]^4}{r_4}$$



ENGINEERING SAFETY EVALUATION

Subject: NTC 55-Gallon Drum Thermal w/ Solar (Liquid Content) Page 11 of 11
 Preparer: S S Shiraga Date 4/23/98
 Checker: P C Ferrell Date 9/15/98
 Section Chief: R. J. Smith Date 9/15/98

Use MathCad find routine to solve above equation for temperature T_4 : $T_{4f} := \text{Find}(T_4)$ $T_{4f} = 145$

Determine inside temperature of poly bottle:

Thermal resistance of liner by conduction: $R_{\text{liner}} := \frac{\ln\left(\frac{r_4}{r_3}\right)}{2\pi \cdot k_{pl} \cdot L}$ $R_{\text{liner}} = 0.02 \frac{\text{hr}}{\text{BTU}}$

Thermal resistance of absorbent material by conduction: $R_{\text{abs}} := \frac{\ln\left(\frac{r_3}{r_2}\right)}{2\pi \cdot k_{amc} \cdot L}$ $R_{\text{abs}} = 6.35 \frac{\text{hr}}{\text{BTU}}$

Thermal resistance of poly bottle by conduction: $R_{\text{bottle}} := \frac{\ln\left(\frac{r_2}{r_1}\right)}{2\pi \cdot k_{pl} \cdot L}$ $R_{\text{bottle}} = 0.12 \frac{\text{hr}}{\text{BTU}}$

Temperature at inside surface of poly bottle °F: $T_1 := T_{4f} + q_{\text{int}}(R_{\text{liner}} + R_{\text{abs}} + R_{\text{bottle}})$ $T_1 = 161$

8.5.2 Thermal With Solar (Solid Content) Evaluation



ENGINEERING SAFETY EVALUATION

Subject: <u>NTC 55-Gallon Drum Thermal w/ Solar (Solid Content)</u>	Page <u>1</u> of <u>4</u>
Preparer: <u>S. S. Shiraga</u>	Date <u>4/15/98</u>
Checker: <u>P. C. Ferrell</u>	Date <u>9/15/98</u>
Section Chief: <u>R. J. Smith</u>	Date <u>9/15/98</u>

1.0 OBJECTIVE

The objective of this evaluation is to determine the NTC exterior surface temperature of a 55-Gallon drum with a solid content.

2.0 REFERENCES

Irwin, J. J., 1995, WHC-SD-TP-RPT-005, Rev. 1, *Thermal Analysis Methods for Safety Analysis Reports for Packaging*, Westinghouse Hanford Company, Richland, Wash.

Fadoff, J. G., 1992, WHC-SD-TP-RPT-004, Rev. 0, *Environmental Conditions for On-site Hazardous Material Packages*, Westinghouse Hanford Company, Richland, Wash.

ORNL, 1970, *Cask Designer's Guide*, ORNL-NISC-68, Oak Ridge National Laboratory, Oak Ridge, Tennessee.

Mathcad Plus 5, 1994, *User's Guide*, Math Soft Inc., Cambridge, Massachusetts.

3.0 ASSUMPTIONS, RESULTS, AND CONCLUSIONS

In this evaluation, it is conservatively assumed that the sun shines on the drum for 12 hrs at the worst solar angle. It is also assumed that the drum is suspended in the air, so as to conservatively negate conduction exterior to the package. The drum dimensions of a 17-H drum are assumed. The worst case heat source is assumed as solids uniformly distributed in the drum generating a total heat load of 12 watts.

Results of the evaluation show that under worst case solar insolation the exposed external surface temperature of the drum is 63 °C (145 °F). In the shade the external temperature of exposed drum surfaces is 47 °C (116 °F). Based on this evaluation, it is demonstrated that the exposed external surface temperature of the drum is below the temperature required for normal non-exclusive use transport of the 55-Gallon steel drum.



ENGINEERING SAFETY EVALUATION

Subject: NTC 55-Gallon Drum Thermal w/ Solar (Solid Content)	Page 2 of 4
Preparer: S. S. Shiraga	Date 4/15/98
Checker: P. C. Ferrell	Date 9/15/98
Section Chief: R. J. Smith	Date 9/15/98

4.0 EVALUATION

NTC Thermal Evaluation of 55 Gallon Drum with the Worst Case Heat Load (Solid Contents):

Determine temperature of outer surface with solar insolation. Assume sun shines on top and half the side of the cylinder. For conservatism, assume the drum is suspended in the air. Assume drum is a 17H drum.

Evaluate as steady state heat transfer for the drum idealized as a right circular cylinder:

Free convection coefficients from Irwin, 1995.

Free convection coefficient for a vertical cylinder:

$$k_{vc} := 0.29 \frac{\text{BTU}}{\text{hr-ft}^2}$$

Free convection coefficient for a horizontal surface with hot surface facing up:

$$k_{hs} := 0.27 \frac{\text{BTU}}{\text{hr-ft}^2}$$

Free convection coefficient for a horizontal surface with cold surface facing up:

$$k_{cs} := 0.12 \frac{\text{BTU}}{\text{hr-ft}^2}$$

Height of vertical plane: $h_{vp} := \left(34 + \frac{9}{16}\right)$ in

Inside diameter of drum: $d_{\text{drum}} := 22.5$ in

Drum wall thickness: $t_{wd} := 0.0428$ in

Outside diameter of drum, ignore hoops: $d_{od} := d_{\text{drum}} + 2 \cdot t_{wd}$ $d_{od} = 22.59$ in

Outside diameter of drum lid: $d_{lid} := \left(23 + \frac{11}{16}\right)$ in

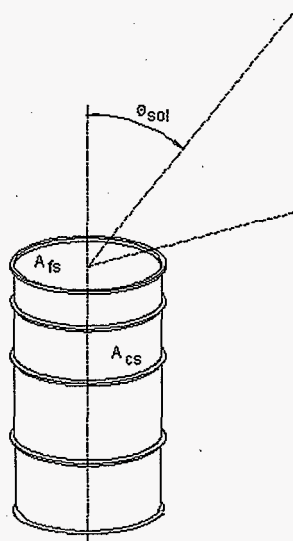



ENGINEERING SAFETY EVALUATION

Subject: NTC 55-Gallon Drum Thermal w/ Solar (Solid Content) Page 3 of 4
 Preparer: S. S. Shiraga Date 4/15/98
 Checker: P. C. Ferrell Date 9/15/98
 Section Chief: R. J. Smith Date 9/15/98

Vertical surface area of cylinder: $A_c := \pi \cdot d_{od} \cdot h_{vp}$ Surface area of ends: $A_{end} := \frac{\pi \cdot d_{lid}^2}{4}$

Total surface area of drum: $A_{tot} := A_c + 2 \cdot A_{end}$

Combined convection constant: $hd := \left[\frac{k_{vc} \cdot A_c}{\left(\frac{h_{vp}}{ft}\right)^{-\frac{1}{4}}} + \frac{k_{hs} \cdot A_{end}}{\left(\frac{d_{lid}}{ft}\right)^{-\frac{1}{4}}} + \frac{k_{cs} \cdot A_{end}}{\left(\frac{d_{lid}}{ft}\right)^{-\frac{1}{4}}} \right] \cdot R^{-\frac{1}{4}}$

Radiant heating constant:

Stefan-Boltzman's natural constant: $\sigma_{sb} := 0.171410^8 \cdot \frac{BTU}{hr \cdot ft^2 \cdot R^4}$

Emissivity of painted carbon steel (Irwin, pg 29): $\epsilon_s := 0.9$

$$K_1 := \sigma_{sb} \cdot \epsilon_s \cdot A_{tot} \quad K_1 = 3.57 \cdot 10^{-3} \cdot \frac{BTU}{hr \cdot R^4}$$

Determination of solar loading from Cask Designers Guide (ORNL, 1970):

Assume solar angle of declination relative to vertical for maximum loading: $\theta_{sol} := 30\text{-deg}$

Solar heat loading for various surfaces, hourly average loading based on a 12 hr period:

Solar heat loading is from Fadeff, 1992, page 8 & 9.

Flat horizontal surfaces: $q_{fsh} := 2386 \cdot \frac{BTU}{ft^2}$ Curved surfaces: $q_{fsc} := 1193 \cdot \frac{BTU}{ft^2}$

Solar heat loading for hourly averaged loading based on a 12 hr period: $t_{hr} := 12\text{-hr}$

Flat horizontal surfaces: $Q_{fsh} := \frac{q_{fsh}}{t_{hr}}$ $Q_{fsh} = 627 \cdot \frac{watt}{m^2}$

Curved surfaces: $Q_{fsc} := \frac{q_{fsc}}{t_{hr}}$ $Q_{fsc} = 314 \cdot \frac{watt}{m^2}$

Conservative internal heat load: $q_{int} := 12\text{-watt}$



ENGINEERING SAFETY EVALUATION

Subject: NTC 55-Gallon Drum Thermal w/ Solar (Solid Content) Page 4 of 4
 Preparer: S. S. Shiraga Date 4/15/98
 Checker: P. C. Ferrell Date 9/15/98
 Section Chief: R. J. Smith Date 9/15/98

Assumed solar absorptivity: $\alpha_{sol} := 0.9$

$$\text{Solar heat load: } q_{sol} := \alpha_{sol} \left(Q_{fsh} \cdot A_{end} \cdot \cos(\theta_{sol}) + Q_{fsc} \cdot \frac{A_c}{2} \cdot \sin(\theta_{sol}) \right) \quad q_{sol} = 251 \text{ watt}$$

$$\text{Total heat load: } q_{tot} := q_{sol} + q_{int} \quad q_{tot} = 896 \frac{\text{BTU}}{\text{hr}}$$

Outside ambient temperature is 115 °F and in Rankine: $T_o := (115 + 459.7) \cdot R$

Using conservation of energy: $q_{in} - q_{out} = 0$

$$\text{Then by substitution: } q_{tot} - q_{rad} - q_{con} = 0 \quad \text{or}$$

$$q_{tot} - K_1 \cdot (T_f^4 - T_o^4) - hd \cdot (T_f - T_o) = 0$$

Solve for T_f which the temperature at the surface using MathCad roots of equation solution:

$$T_{f1} := \text{root} \left[q_{tot} - K_1 \cdot (T_f^4 - T_o^4) - hd \cdot (T_f - T_o), T_f \right]$$

External surface temperature in sun: $T_{f1} = 605 \cdot R$

$$\text{Temperature in } ^\circ\text{F: } T_{ff} := \frac{T_{f1} - 459.7R}{R} \quad T_{ff} = 145$$

Temperature in Shade:

Total shaded heat load: $q_{stot} := q_{int}$

Solve for T_f which the temperature at the surface using MathCad roots of equation solution:

$$T_{f2} := \text{root} \left[q_{stot} - K_1 \cdot (T_f^4 - T_o^4) - hd \cdot (T_f - T_o), T_f \right]$$

External surface temperature in shade: $T_{f2} = 576 \cdot R$

$$\text{Temperature in } ^\circ\text{F: } T_{ff2} := \frac{T_{f2} - 459.7R}{R} \quad T_{ff2} = 116$$

9.0 PRESSURE AND GAS GENERATION EVALUATION

Radioactive waste transported in the 208 L (55-gal) drums may generate flammable gases from both radiolysis and chemical reactions. Gas generation within the drums is calculated to determine both pressure rise and the amount of time to reach the lower flammability limit.

9.1 GAS GENERATION

The gas generation evaluation is presented in the appendix of this section. The evaluation describes the process and methodology for determining the radiolytic and chemical hydrogen generation rate. A maximum seal time (shipping window) is determined based on the generation rate and void space in the drums. The void volume is the amount of free air space that exists in the container. The graphical and tabulated results presented in Section 5.0 of Appendix 9.2 to this section provide the user with guidance for venting requirements of individual drums. Figures 1 through 5 of Appendix 9.2 show venting requirements by waste type, decay heat, and weight.

Gas-generating contents will normally be shipped in drums that are vented through a vent clip or NucFil filter. For sealed drums, Appendix 9.2 provides guidance to the shipper on seal time. Table 5 of Appendix 9.2 shows seal times for a normal source term. Figures 1 through 5 of Appendix 9.2 should be used for actual payloads. Venting is required for drum payloads with data points that are determined to be above the lines in the figures.

9.2 APPENDIX: HYDROGEN GAS GENERATION ANALYSIS



ENGINEERING SAFETY EVALUATION

Subject:	<u>Steel Drum Packaging System Hydrogen Gas Generation Analysis</u>	Page <u>1</u> of <u>27</u>
Preparer:	<u>J.G. McFadden</u>	Date <u>9/10/98</u>
Checker:	<u>H.E. Adkins, Jr</u>	Date <u>9/10/98</u>
Section Chief:	<u>J.G. McFadden</u>	Date <u>9/10/98</u>

1.0 OBJECTIVE

The radiolytic production of hydrogen gas generated by waste materials may cause safety concerns in storage and transportation situations. The objective of this engineering evaluation is to determine criteria which function to identify 55 gallon drums with radioactive waste which do not pose a safety concern from the standpoint of radiolytic hydrogen gas generation. Drums identified with the subject criteria, therefore, may be safely shipped or stored without a safety issue resulting from radiolytic hydrogen gas production. Alternately, the criteria can be used to screen drums and identify those which may need further study or which require continuous venting to ensure safety.

Furthermore, the identifying criteria must be or relate to commonly available parameter associated with radioactive waste in 55 gallon steel drums which typically would not require further testing or measurements. To that end, five commonly stored and transported waste types are chosen and upper limit decay heats as a function of gross drum mass are identified to represent the delineating criteria.

2.0 REFERENCES

- Connolly, M.J. and S.T. Kosiewicz, 1997. "TRU Waste Transportation - The Flammable Gas Generation Problem," *Journal of the Franklin Institute*, Vol. 334A.
- McFadden, J.G., Hillesland, K.E. and J.G. Field, 1998. *Radcalc for Windows Version 2.01*. HNF-2549, Rev. 0, Richland, Washington.
- Spinks, J.W.T. and R.J. Woods, 1990. *Introduction to Radiation Chemistry*, 3rd Edition, Wiley Interscience, New York, New York.
- Westinghouse Electric Corporation, 1997. *Safety Analysis Report for the TRUPACT-II Shipping Package*, Rev. 16, Carlsbad, New Mexico.



ENGINEERING SAFETY EVALUATION

Subject: <u>Steel Drum Packaging System Hydrogen Gas Generation Analysis</u>	Page <u>2</u> of <u>27</u>
Preparer: <u>J.G. Mcadden</u>	Date <u>9/10/98</u>
Checker: <u>H.E. Adkins, Jr</u>	Date <u>9/10/98</u>
Section Chief: <u>J.G. McFadden</u>	Date <u>9/10/98</u>

Experimental Data presented and discussed in Meeting Between J. Schierloh of Rocky Flats SSOc Wet/Combustible SubProgram and J.G. McFadden and W.S. Edwards of Transportation and Packaging, Waste Management, Northwest Operations, May 1998.

Experimental Data presented and discussed in Meeting Attended by J.G. concerning The Matrix Depletion Project, Albuquerque NM, August 1998.

NRC, 1984, Clarification of Conditions for Waste Shipments Subject to Hydrogen Gas Generation, SSINS No. 6835, Information Notice 84-72, September 10, U.S. Nuclear Regulatory Commission, Washington, D.C.

3.0 ASSUMPTIONS, RESULTS, AND CONCLUSIONS

Current research on G values indicates that the production of hydrogen in waste containers is much less than indicated in previous reports. However, until more research is completed and $G(H_2)$ values are quantified, bounding $G(H_2)$ values must be used. As research becomes available, this report could be updated and the criteria changed to reflect new data. Also, because the G values used are based on alpha emitters, the presence of ^{241}Am does not greatly affect the results. If the new G values show a marked decrease for gamma radiation, a future effort may revise the tables presented herein.

Input parameters and assumptions are addressed at some length in Section 4. Radcalc for Windows, Version 2.01 was used to evaluate the selected cases. Presented in Table 5 of Section 5.1 of this evaluation are results stemming from the two worst-case source terms evaluated with alternate waste masses. Indicated in this table are the times (in days) required to generate 5% Hydrogen gas (by volume) associated with the particular waste loading scenarios. Nuclear Regulatory Commission (NRC) IEE Notice I-84 requires that the allowable shipping window for a package be half the time required to reach 5% hydrogen gas by volume. In this evaluation the shipping window is defined as 60 days. As indicated in Table 5 of Section 5.1 of this evaluation, a majority of the waste type to waste mass configurations require venting. In fact, all of the waste type to waste mass configurations involving waste type III, IV, and V require venting. This is due to the fact that the 5% Hydrogen gas (by volume) limit is exceeded before 120 days. Also indicated, is that the Case 1 source term presents the worst-case or bounding loading scenario.

Conservatively using the bounding constituents from the bounding Case 1 source term exclusively (^{90}Sr and ^{90}Y) and Radcalc for Windows, Version 2.01, further evaluations were conducted for cases targeted to produce 5% hydrogen in 120 days. Resulting cases were



ENGINEERING SAFETY EVALUATION

Subject: <u>Steel Drum Packaging System Hydrogen Gas Generation Analysis</u>	Page <u>3</u> of <u>27</u>
Preparer: <u>J.G. Mcadden</u>	Date <u>9/10/98</u>
Checker: <u>H.E. Adkins, Jr</u>	Date <u>9/10/98</u>
Section Chief: <u>J.G. McFadden</u>	Date <u>9/10/98</u>

tabulated and are shown in Figure 1 through Figure 5 of Section 5.2. The results are given in the form of decay heat per drum versus waste mass. Five waste types were considered and evaluated.

Figure 1 through Figure 5, in Section 5.2, represent a conservative means to identify drums which need further hydrogen gas generation study or venting before transportation or storage. Figure 1 shows waste type I which is solidified inorganic liquids represented by soil or inorganic absorbents such as kitty litter that has absorbed contaminated inorganic liquids. Figure 2 represents waste type II. Waste type II is solid inorganics that include contaminated metal or glass debris or solidified inorganic sludge which is bagged in LDPE plastic bags or 90 mil HDPE liners. Figure 3 shows waste type III. Waste type III is solid organic debris consisting of contaminated gloves, plastics, polyethylene, rubber, cotton and miscellaneous organic materials. Waste type IV, shown in Figure 4, is absorbed organic liquids consisting of solidified organics such as contaminated oils or aqueous solutions which have been absorbed with polyacrylate or polypropylene absorbent. Finally, waste type V, represented by Figure 5, is contaminated organic liquids such as oil and water. Interpretation of these five figures is as follows.

Within each of the five figures presented in Section 5.2, a safe shipping window is delineated by the area under the curve. Each curve represents a worst-case source term threshold in which 5% Hydrogen is generated at 120 days, thus allowing a 60 day shipping window. This threshold is a direct function of decay heat and waste mass intended for loading. Subsequently, the quantity of waste should be selected such that the intersection with its corresponding decay heat is under the curve. Any wastes resulting in a point above the curve require venting or further analyses or measurement before shipping.

This study includes many conservatisms. G values, waste types and densities, drum void volume, and source terms were all chosen to represent bounding values. If a drum exceeds the criteria indicated as being safe within the figures and table above, further evaluation may show that no hazard exists. The figures and table provided herein are meant to represent a screening tools and to provide a method for eliminating drums which could not possibly pose a safety concern from the radiolytic production of hydrogen.

4.0 EVALUATION

The criteria developed in this evaluation represents a conservative limit which can be used to screen 55 gallon drums for the radiolytic production of hydrogen gas. The limit is expressed in terms of decay heat per drum as a function of drum waste mass. Drums which contain radionuclides which generate decay heat below the criteria pose no safety concern for shipment or storage due to the radiolytic production of hydrogen gas.



ENGINEERING SAFETY EVALUATION

Subject: <u>Steel Drum Packaging System Hydrogen Gas Generation Analysis</u>	Page <u>4</u> of <u>27</u>
Preparer: <u>J.G. Mcadden</u>	Date <u>9/10/98</u>
Checker: <u>H.E. Adkins, Jr</u>	Date <u>9/10/98</u>
Section Chief: <u>J.G. McFadden</u>	Date <u>9/10/98</u>

Assumptions were made in the representation of the waste types and the choice of their corresponding G values to maximize hydrogen gas generation. Likewise, source parameters were chosen to optimize hydrogen gas production and drum void space was minimized. Therefore, this study results in established criteria which are conservative. In cases where drums are determined to exceed the limit, further study may reveal that the radiolytic hydrogen gas generation may not be a concern.

Radcalc for Windows 2.01 (McFadden et al. 1998) was used to model the radiolytic production of hydrogen gas. The code has been verified and validated. The methodology used in Radcalc for Windows is called the G value approach and has been accepted by the NRC as a calculational technique for the quantification of the radiolytic generation of hydrogen gas. Cases were run until a 5% hydrogen gas concentration was present along with other cases that were run for a period of 120 days. The cases consisted of five different waste types. Descriptions of the five types are presented below. Examples of files containing input and its accompanying output are found in the Section 6.2 "Example Radcalc Cases".

4.1 Waste Types

The waste types were chosen to represent approximately 90% of the waste stream commonly shipped and stored on the Hanford Site. The five waste types were defined to be roughly equivalent to the waste types used in conjunction with the TRUPACT-II (Westinghouse Electric Corp. 1997) and data yielded by the Matrix Depletion Project (August 1998). Assumptions in the compositions of the waste types were made on the basis of process and waste knowledge and were supplied by Solid Waste at the Hanford Site.

I Solidified inorganic liquids - Solidified inorganic liquids are represented by soil or inorganic absorbent such as kitty litter which has absorbed contaminated inorganic liquids. An upper bound of 25 weight percent water is assumed with a density of 1 g/cm³. The soil or kitty litter has a density of 2.2 g/cm³.

II Solid inorganics - Solid inorganics include contaminated metal or glass debris or solidified inorganic sludge which is bagged in LDPE plastic bags or 90 mil HDPE liners. HDPE liners have higher G values and thus yield higher quantities of hydrogen gas and were therefore chosen to be representative of the polyethylene which may be present. The drum is assumed to consist of 1 weight percent HDPE with a density of 0.93 g/cm³. The remainder of the waste is assumed to consist of metal debris with a density of 7.8 g/cm³. No liquids or absorbed liquids are allowed in the waste category.



ENGINEERING SAFETY EVALUATION

Subject: <u>Steel Drum Packaging System Hydrogen Gas Generation Analysis</u>	Page <u>5</u> of <u>27</u>
Preparer: <u>J.G. Mcadden</u>	Date <u>9/10/98</u>
Checker: <u>H.E. Adkins, Jr</u>	Date <u>9/10/98</u>
Section Chief: <u>J.G. McFadden</u>	Date <u>9/10/98</u>

III Solid organic debris - Solid organic debris consists of contaminated gloves, plastics, polyethylene, rubber, cotton and miscellaneous organic materials. HDPE has the highest density of this waste type with a density of 0.93 g/cc.

IV Absorbed organic liquids - Absorbed organic liquids consist of solidified organics such as contaminated oils or aqueous solutions which have been absorbed with polyacrylate or polypropylene absorbent. Polyacrylate has a very low G value, however the G value for polypropylene is high. Therefore polypropylene was used to bound this waste category type and the oil was modeled as machine oil. The densities used are 0.51 g/cm³ and 0.93 g/cm³ respectively.

V Organic liquids - Organic liquids consisting mostly of liquids such as oil and water which are contaminated as well. This waste category is assumed to have a density of 1.0 g/cc.

4.2 G Values

G(H₂) values are in units of moles of hydrogen gas produced per 100 eV energy absorbed in the media. The amount of gas produced in a media is calculated by multiplying the G value for the radiation type times the energy absorbed in the media. G(H₂) values, therefore, are a measure of the hydrogen gas produced in a matrix. G values are dependent upon the material type of the waste, the radiation decay type (gamma, alpha, or beta) and energy, the radiation absorbed dose, the length of time the material has been subjected to the radiation, the physical state of the material (pressure and temperature), and to some extent on the other gases present in the waste which may cause back-reactions and lower the total quantity of hydrogen produced.

G value research has been conducted in a wide variety of laboratory conditions and show marked variations. Care needs to be exercised in using G values cited in literature. Earlier research has been found to be unreliable and is generally discounted. The TRUPACT-II SARP (Westinghouse Electric Corp 1997) gathers together a wide range of references and discusses them at length. An additional reference is Spinks and Woods (1990) *Radiation Chemistry*. In addition, research conducted on G values as part of the Matrix Depletion Program has yielded a number of G values by drums containing a variety of waste types. Table 1 gives the G values from the cited references for the waste category types and the input values used for the Radcalc for Windows cases.

Waste type I contains soils or kitty litter and absorbed moisture (water). Most inorganics and metals without the addition of moisture do not generate hydrogen. Water has been well



ENGINEERING SAFETY EVALUATION

Subject: <u>Steel Drum Packaging System Hydrogen Gas Generation Analysis</u>	Page <u>6</u> of <u>27</u>
Preparer: <u>J.G. Mcadden</u>	Date <u>9/10/98</u>
Checker: <u>H.E. Adkins, Jr</u>	Date <u>9/10/98</u>
Section Chief: <u>J.G. McFadden</u>	Date <u>9/10/98</u>

studied and the $G(H_2)$ values shown in Table 1 are typical (Spinks and Woods 1990). Research has been performed on soil samples with an average organic content of 7 weight percent and with moisture contents ranging from 0.2 to 25.5 weight percent. The alpha $G(\text{gas})$ value for these studies was determined to be 1.6 with a production of 23% H_2 . This yields a $G(H_2)$ value of 0.37. Studies conducted with heat source plutonium in soils at the Mound Site with an average of 5 weight percent water yielded $G(H_2)$ values of 0.15 (Westinghouse Electric Corp. 1997). Water absorbed in a medium appears to disassociate at a slower rate than free standing water justifying the use of lower G values. A $G(H_2)$ value of 0.37 is therefore chosen to represent an upper bound for solid inorganics containing up to 25 weight percent absorbed liquid.

Waste type II contains metal debris or solid inorganic sludges contained in polyethylene liners or bags. The metal debris does not generate hydrogen, however the HDPE liners or LDPE bags have relatively high $G(H_2)$ values. The TRUPACT-II SARP (Westinghouse Electric Corp. 1997) discusses the generation of hydrogen in the presence and absence of oxygen for both LDPE and HDPE. It cites several studies performed on HDPE and gives $G(H_2)$ values in the range of 1.6 - 2.4 for alpha and gamma $G(H_2)$ values from 3.1 - 4.0. It concludes that an upper bound $G(H_2)$ value for HDPE in the presence of oxygen is 3.5 for all radiation types. Experimental research, however, at both Rocky Flats and Los Alamos National Laboratory (LANL) on drums with HDPE liners containing inorganic solids have consistently yielded $G(H_2)$ values that are much lower than the $G(H_2)$ values for HDPE alone. The TRUPACT-II SARP cites a Rocky Flats experimentally derived $G(H_2)$ value of 0.3 for materials of this type packaged in HDPE lined drums. Connolly and Kosiewicz (1997) also verify that the lower G values have been found in recent hydrogen gas generation studies for materials of this type. The Matrix Depletion Project represents the most recent research at LANL that reaffirms the lower $G(H_2)$ value. The experimental data yielded at LANL supports a $G(H_2)$ value of 0.27. The $G(H_2)$ value of 0.27 is, therefore, used in this evaluation.

Waste type III contains a mixture of gloves, kimwipes, cotton material, LDPE and HDPE. $G(H_2)$ values for cellulosic materials ranges from 0.4 to 1.2. The HDPE bounding $G(H_2)$ value is 3.5. However, research has shown that this $G(H_2)$ value is overly conservative. LANL produced $G(H_2)$ values of 0.1 to 0.4 for rags, plastics, and gloves contaminated with plutonium and stored in drums lined with HDPE. The Rocky Flats experimental data produced a $G(H_2)$ value of 0.84 for Type III waste (Refer to Section 6.1). This value represents the 95% confidence level for the data collected at Rocky Flats.



ENGINEERING SAFETY EVALUATION

Subject: Steel Drum Packaging System Hydrogen Gas Generation Analysis Page 7 of 27
 Preparer: J.G. Mcadden Date 9/10/98
 Checker: H.E. Adkins, Jr Date 9/10/98
 Section Chief: J.G. McFadden Date 9/10/98

Table 1 - G (H₂) Values As A Function Of Waste Type

Type	Material	G (H ₂) Value			Reference
		Alpha	Beta	Gamma	
I	Solidified inorganic liquids				
	Soil with water	0.15 - 0.37			TRUPACT-II SARP
	Water	1.6	0.53	0.45	Spinks and Woods, 1990
	Radcalc Input	0.37	0.37	0.37	
II	Solid inorganics				
	Metal debris	0	0	0	Spinks and Woods, 1990
	HDPE	3.5			TRUPACT-II SARP
	LDPE	0 - 2.2			TRUPACT-II SARP
	Rocky Flats Experimental Data	0.3			TRUPACT-II SARP
	LANL (Polyethylene)	0.27			Matrix Depletion Project
	Radcalc Input	0.27	0.27	0.27	
III	Solid organic debris				
	HDPE	3.5			TRUPACT-II SARP
	Cellulose	0.4 - 1.2			TRUPACT-II SARP
	Rocky Flats Experimental Data	0.84			Schierloh, 1998
	LANL (Polyethylene)	0.27			Matrix Depletion Project
	LANL (Dry Cellulosics)	0.29			Matrix Depletion Project
	Radcalc Input	0.84	0.84	0.84	
IV	Absorbed organic liquids				
	Mineral oil			2.7	TRUPACT-II SARP
	Machine oil	2.8			TRUPACT-II SARP
	Polyacrylate	0.46			TRUPACT-II SARP
	Polypropylene	3.3			TRUPACT-II SARP
	LANL	0.48			Matrix Depletion Project
	Radcalc input	1.64	1.64	1.64	
V	Organic liquids				
	Machine oil	2.8	2.3	2.3	TRUPACT-II SARP
	Radcalc input	2.8	2.3	2.3	

Waste type IV contains oil and polypropylene or polyacrylate absorbent. Oil is bounded by a G(H₂) value of 2.8 (Westinghouse Electric Corp. 1997). Polyacrylates have low G values of 0.46, however polypropylene is bounded by a value of 3.3 (Westinghouse Electric Corp. 1989). The



ENGINEERING SAFETY EVALUATION

Subject: <u>Steel Drum Packaging System Hydrogen Gas Generation Analysis</u>	Page <u>8</u> of <u>27</u>
Preparer: <u>J.G. Mcadden</u>	Date <u>9/10/98</u>
Checker: <u>H.E. Adkins, Jr</u>	Date <u>9/10/98</u>
Section Chief: <u>J.G. McFadden</u>	Date <u>9/10/98</u>

Matrix Depletion Project data reports $G(H_2)$ values for polypropylene of 0.48. This value is a more reasonable value since polyacrylates have slightly lower G values. Therefore an average $G(H_2)$ of 1.64 comprised of that reported for Oil ($G(H_2)=2.8$) and the later reporting for polypropylene ($G(H_2)=0.48$) will be used in this report.

Waste type V contains mostly liquids such as oil etc., which is modeled in the Radcalc cases as machine oil. Machine oil is bounded by a $G(H_2)$ value of 2.8 for alpha, and 2.3 for beta and gamma $G(H_2)$ (Westinghouse Electric Corp. 1997). Therefore a $G(H_2)$ value 2.8 will be utilized.

Unfortunately, even though research has shown that in many instances gamma G values are approximately 4 times less than alpha G values most of the values reported in the referenced literature are for bounding values which do not discriminate between decay type. Therefore, even though gamma and beta G values may be as much as four times less than the reported alpha G values, the bounding values are utilized. Additionally, current research on G values is indicating that the production of hydrogen in waste containers is much less than would be indicated by using the $G(H_2)$ values given in Table 1. However, until such research is completed and $G(H_2)$ values are quantified, bounding $G(H_2)$ values must be used. As research becomes available this study could be updated and the criteria changed to reflect new data.

4.3 Container Data

The radioactive waste is contained in 55 gallon drums which have a nominal internal volume of 217,000 cm^3 . Calculations are performed for the five waste types for drums containing waste masses of 25 kg, 75 kg, and the mass associated with 90% of the drum internal volume unless limited by capacity (i.e. Type II). The nominal void space within the container is calculated using the waste material type, weight percent and associated density. Table 2 gives the physical parameters used in the evaluation.

4.4 Source Term

The source term used for the gas generation criteria study was chosen to represent 90% of the waste received by Solid Waste for disposal at the Hanford Site. Beta decay is represented by $^{90}Sr/^{90}Y$ and gamma decay by ^{137}Cs and its daughter product ^{137m}Ba . Drums categorized as containing TRU waste must be vented, therefore, the majority of alpha emitters will be present in sealed drums at less than 100 nCi/g. ^{241}Am was chosen to represent alpha emitters.



ENGINEERING SAFETY EVALUATION

Subject: <u>Steel Drum Packaging System Hydrogen Gas Generation Analysis</u>	Page <u>9</u> of <u>27</u>
Preparer: <u>J.G. Mcadden</u>	Date <u>9/10/98</u>
Checker: <u>H.E. Adkins, Jr</u>	Date <u>9/10/98</u>
Section Chief: <u>J.G. McFadden</u>	Date <u>9/10/98</u>

Table 2 - Physical Parameters Of The Drum And Waste

Barrel and Waste Configurations				
	Waste Weight	Density	Waste Volume	Package void volume
Type I	25 kg	1.9 g/cc	13158 cc	203842 cc
	75 kg	1.9 g/cc	39474 cc	177526 cc
	371 kg	1.9 g/cc	195300 cc	21700 cc (10%)
Type II	25 kg	7.72 g/cc	3240 cc	213762 cc
	75 kg	7.72 g/cc	9715 cc	207285 cc
	<i>(limited by maximum capacity)</i> 634 kg	7.72 g/cc	82124 cc	134876 cc
Type III	25 kg	0.93 g/cc	26882 cc	190118 cc
	75 kg	0.93 g/cc	136354 cc	80646 cc
	182 kg	0.93 g/cc	195300 cc	21700 cc (10%)
Type IV	25 kg	0.72 g/cc	34724 cc	182278 cc
	75 kg	0.72 g/cc	112833 cc	104167 cc
	141 kg	0.72 g/cc	195300 cc	21700 cc (10%)
Type V	25 kg	1.0 g/cc	25000 cc	192000 cc
	75 kg	1.0 g/cc	75000 cc	142000 cc
	195 kg	1.0 g/cc	195300 cc	21700 cc (10%)

Care was taken in the source term selection process. Hanford site source term documentation relating to fission products and waste streams from N reactor and Single Pass reactor fuel, the K Basins, and Tank Waste Remediation System (TWRS) were reviewed. In all cases ^{90}Sr and ^{137}Cs represented the greatest quantities of beta and gamma emitters. Strontium and its daughter product yttrium are by far the most common of the beta emitters in Hanford Site waste. Gamma emitters of concern included ^{154}Eu as well as $^{137}\text{Cs}/^{137\text{m}}\text{Ba}$. However, unless the waste is specifically treated to remove ^{137}Cs and $^{137\text{m}}\text{Ba}$, the europium will be two or three orders of magnitude less than the cesium/barium. The same is true for other gamma emitters of concern. Therefore, gamma emitters were represented by ^{137}Cs and its daughter product $^{137\text{m}}\text{Ba}$.

Cases were run comparing plutonium isotopes and ^{241}Am . Americium produced higher quantities of hydrogen gas for equal masses of plutonium. Therefore, ^{241}Am was chosen to represent alpha emitters.



ENGINEERING SAFETY EVALUATION

Subject: Steel Drum Packaging System Hydrogen Gas Generation Analysis Page 10 of 27
 Preparer: J.G. Mcadden Date 9/10/98
 Checker: H.E. Adkins, Jr Date 9/10/98
 Section Chief: J.G. McFadden Date 9/10/98

Since Hanford Site waste typically involves uranium isotopes of either ²³³U, ²³⁵U, or ²³⁸U, a sensitivity study was conducted to determine which of these isotopes represented (in conjunction with the beta & alpha or gamma & alpha source terms discussed above) the highest Hydrogen generation potential. Presented in Table 3 are the results of this comparison. As shown, considering the uranium quantity to be solely comprised of ²³³U would pose the highest degree of conservatism.

The beta and gamma emitters selected above were then grouped with ²⁴¹Am and ²³³U to form two separate case source terms. These case source terms reflect the SARP limits and are indexed as "Case 1" and "Case 2" are defined as presented in Table 4. The Cs/Ba ratio is 1 : 0.946 and the Sr/Yt ratio is 1 : 1. The 0.1 ci of ²⁴¹Am stays the same throughout both cases along with the 0.5 ci of ²³³U. Uranium was picked because it represents a worst case alpha emitter.

Bounding or conservative variations of the source terms discussed are applied in the study and determination of shipping windows as discussed in the Section 3.0 of this analysis.

Table 3 - Uranium Isotope Comparison

Comparison conducted to 5% Hydrogen	
Isotope	Time To Reach 5% H ₂
²³³ U	47.0 days
²³⁵ U	47.01 days
²³⁸ U	47.03 day

Table 4 - Case Source Terms

Case 1 Source Term		Case 2 Source Term	
Constituent	Content	Constituent	Content
⁹⁰ Sr	180 ci	¹³⁷ Cs	180 ci
⁹⁰ Y	180 ci	^{137m} Ba	170.28 ci
²⁴¹ Am	0.1 ci	²⁴¹ Am	0.1 ci
²³³ U	0.5 ci	²³³ U	0.5 ci



ENGINEERING SAFETY EVALUATION

Subject: Steel Drum Packaging System Hydrogen Gas Generation Analysis Page 11 of 27
 Preparer: J.G. Mcadden
 Checker: H.E. Adkins, Jr *HEA* Date 9/10/98
 Section Chief: J.G. McFadden *JGM* Date 9/10/98

5.0 GRAPHICAL AND TABLIZED RESULTS

5.1 Exemplary Loading Cases

Table 5- Exemplary Loading Cases

Duration To Reach 5% Hydrogen Gas As A Function of Loading				
	25 kg of waste	75 kg of waste	10% void volume	Weight Limit for Solids 634 kg
Case 1 Source Term				
Solidified inorganic liquids (Type I)	110 days*	96 days*	11.7 days*	
Solid inorganics (Type II)	159 days	154 days	--	100 days*
Solid organic debris (Type III)	45.3 days*	32.4 days*	5.2 days*	
Absorbed organic liquids (Type IV)	22.2 days*	13.7 days*	2.6 days*	
Organic liquids (Type V)	16.6 days*	12.3 days*	1.9 days*	
Case 2 Source Term				
Solidified inorganic liquids (Type I)	190 days	165 days	20.1 days*	
Solid inorganics (Type II)	308 days	298 days	--	193 days
Solid organic debris (Type III)	93 days*	67 days*	10.6 days*	
Absorbed organic liquids (Type IV)	49.1 days*	30.4 days*	5.8 days*	
Organic liquids (Type V)	33.3 days*	24.6 days*	3.81 days*	

* Venting Required



ENGINEERING SAFETY EVALUATION

Subject: <u>Steel Drum Packaging System Hydrogen Gas Generation Analysis</u>	Page <u>12</u> of <u>27</u>
Preparer: <u>J.G. Mcadden</u>	Date <u>9/10/98</u>
Checker: <u>H.E. Adkins, Jr</u>	Date <u>9/10/98</u>
Section Chief: <u>J.G. McFadden</u>	Date <u>9/10/98</u>

5.2 120 Day Reference As A Function Of Waste Type

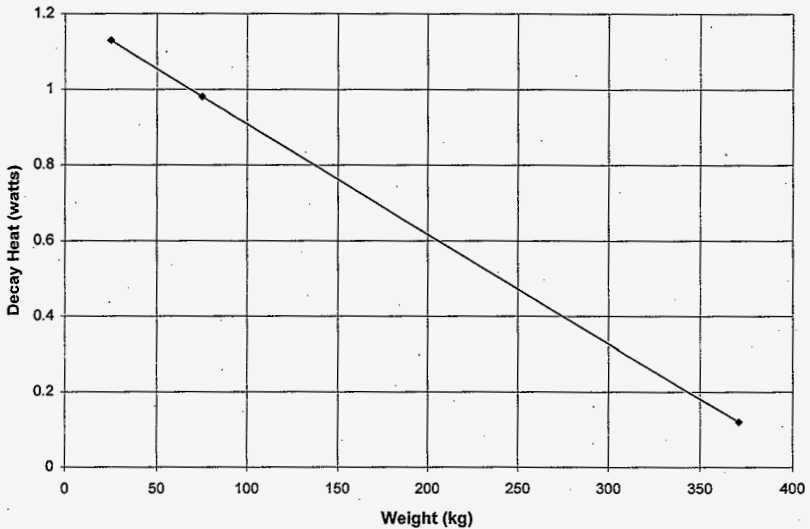

Figure 1- Waste Type I: Solidified Inorganic Liquids For Bounding Source Term



ENGINEERING SAFETY EVALUATION

Subject: Steel Drum Packaging System Hydrogen Gas Generation Analysis Page 13 of 27
Preparer: J.G. Mcadden *JGM* Date 9/10/98
Checker: H.E. Adkins, Jr *HEA* Date 9/10/98
Section Chief: J.G. McFadden *JGM* Date 9/10/98

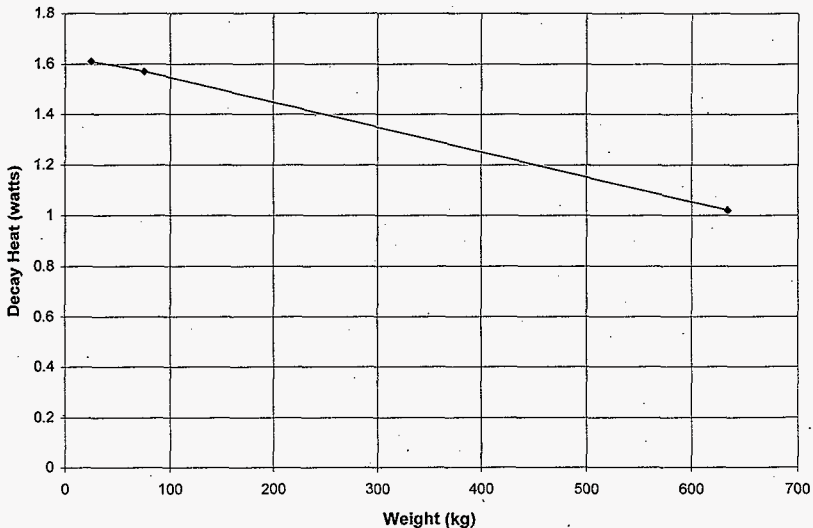

Figure 2- Waste Type II: Solid Inorganics For Bounding Source Term



ENGINEERING SAFETY EVALUATION

Subject: <u>Steel Drum Packaging System Hydrogen Gas Generation Analysis</u>	Page <u>14</u> of <u>27</u>
Preparer: <u>J.G. Mcadden</u>	Date <u>9/10/98</u>
Checker: <u>H.E. Adkins, Jr</u>	Date <u>9/10/98</u>
Section Chief: <u>J.G. McFadden</u>	Date <u>9/10/98</u>

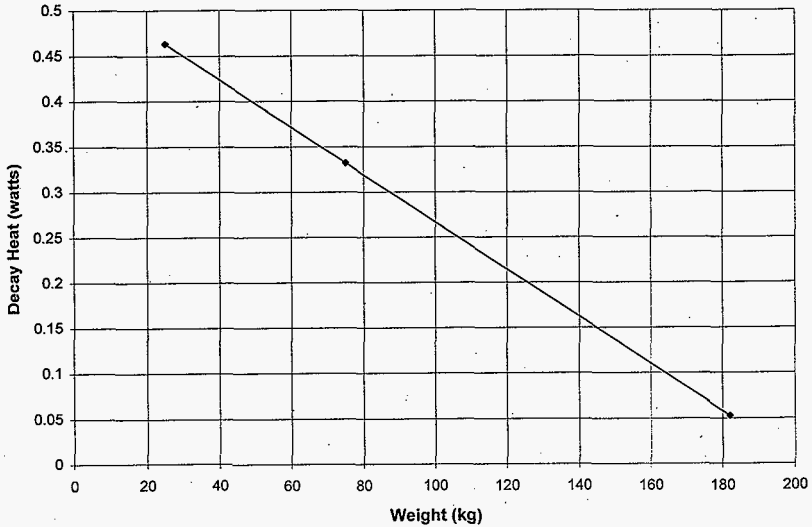

Figure 3- Waste Type III: Solid Organic Debris For Bounding Source Term



ENGINEERING SAFETY EVALUATION

Subject: <u>Steel Drum Packaging System Hydrogen Gas Generation Analysis</u>	Page <u>15</u> of <u>27</u>
Preparer: <u>J.G. Mcadden</u>	Date <u>9/10/98</u>
Checker: <u>H.E. Adkins, Jr</u>	Date <u>9/10/98</u>
Section Chief: <u>J.G. McFadden</u>	Date <u>9/10/98</u>

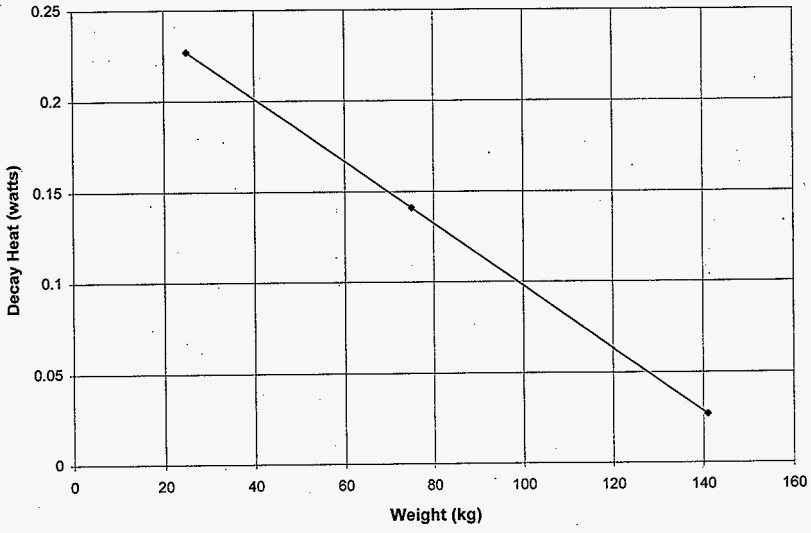

Figure 4- Waste Type IV: Absorbed Organic Liquids For Bounding Source Term



ENGINEERING SAFETY EVALUATION

Subject: Steel Drum Packaging System Hydrogen Gas Generation Analysis Page 16 of 27
 Preparer: J.G. Mcadden Date 9/10/98
 Checker: H.E. Adkins, Jr Date 9/10/98
 Section Chief: J.G. McFadden Date 9/10/98

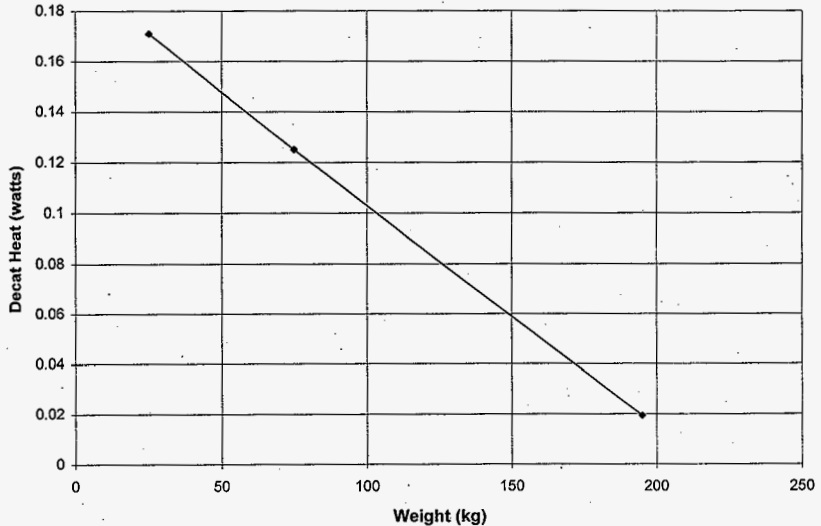

Figure 5- Waste Type V: Organic Liquids For Bounding Source Term



ENGINEERING SAFETY EVALUATION

Subject: Steel Drum Packaging System Hydrogen Gas Generation Analysis Page 17 of 27
 Preparer: J.G. Mcadden *JGM* Date 9/10/98
 Checker: H.E. Adkins, Jr *H.E.A.* Date 9/10/98
 Section Chief: J.G. McFadden *JGM* Date 9/10/98

6.0 APPENDIX

6.1 Support Data

From the data gathered by J. Schierloh of Rocky Flats SSOC Wet/Combustible SubProgram (Presented in Table 6.1) the 95% percent confidence level for the $G_{\text{effective}}$ molecules/100eV for solid organic materials (category Type III waste) was calculated to be 0.84 (Shown in Table 6.2). The data was analyzed by Microsoft excel in the descriptive statistics toolpak.

Table 6.1 – Experimental Values

$G_{\text{effective}}$ Molecules/100eV		
0.393	-0.025	0.38
0.61	0.374	0.158
0.487	0.171	0.223
-0.008	0.356	0.216
1.114	0.625	0.045
0.304	0.446	0.009
0.116	0.329	0.176
0.385	0.54	0.108
0.661	0.191	0.035
0.428	0.56	0.101
0.181	0.421	0.042
0.487	0.166	0.122
0.435	0.368	0.2695
0.453	0.217	0.26
0.025	0.419	-0.025
0.157	0.35	0.028
0.151	0.188	0.403
0.672	0.841	
0.129	0.363	
0.489	0.849	
0.033	0.956	
0.147	0.578	
0.387	0.61	
0.422	0.393	
-0.509	0.307	

Table 6.2 – Experimental Value Statistics

Statistics	
Mean	0.32
Standard Error	0.032
Median	0.33
Mode	0.39
Standard Deviation	0.26
Sample Variance	0.068
Kurtosis	1.66
Skewness	0.29
Range	1.62
Minimum	-0.5
Maximum	1.11
Sum	21.31
Count	66
Confidence Level(95.0%)	0.064
Mean + 2 sigma	0.84



ENGINEERING SAFETY EVALUATION

Subject: Steel Drum Packaging System Hydrogen Gas Generation Analysis Page 18 of 27
 Preparer: J.G. Mcadden Date 9/10/98
 Checker: H.E. Adkins, Jr Date 9/10/98
 Section Chief: J.G. McFadden Date 9/10/98

6.2 Example Radcalc Cases

6.2.1 Waste Type I, Case 1 Source Term, 25Kg Waste Mass

Radcalc for Windows 2.01

Date: 08-05-98 14:59

Performed By: John Knepp

Checked By: Janet McFadden

File: CASE1.RAD

===== Input Information =====

Source from input:

Radionuclide:	Curies:	
Sr-90	1.80E+002	
Y-90	1.80E+002	(Daughter)
U-233	5.00E-001	
Am-241	1.00E-001	

Total Activity: 3.61E+002

Total Activity Minus Daughters: 1.81E+002

Waste Form: Normal
 Physical Form: Solid
 Container Type: 55 Gallon Drum

Package Void Volume: 2.04E+005 cc
 Waste Volume: 1.32E+004 cc
 Waste Mass: 2.50E+004 g
 Waste True Density: 1.90 g/cc

Date to begin source decay: 12:00 Aug. 3, 1998
 Date container sealed: 12:00 Aug. 3, 1998
 Days to decay source before seal time: 0.00 days
 Calculate number of days sealed until 5.00% hydrogen is reached.

Entered G Values:

G Alpha	G Beta	G Gamma
0.37	0.37	0.37

Comments:

===== Calculated Results =====

HYDROGEN:

The sealed package will contain 5.00 % hydrogen in 110.38 days.
 This corresponds to date: 21:00 Nov. 21, 1998
 H2 Volume: 1.07E+004 cc
 H2 Generation Rate: 4.05 cc/hour

DECAY HEAT AND PRESSURE:

Heat Generated at seal time: 1.22 Watts
 Partial Pressure (H2): 5.33 kPa
 Total Pressure (H2 and Air): 107. kPa



ENGINEERING SAFETY EVALUATION

Subject: Steel Drum Packaging System Hydrogen Gas Generation Analysis Page 19 of 27
 Preparer: J.G. Mcadden Date 9/10/98
 Checker: H.E. Adkins, Jr Date 9/10/98
 Section Chief: J.G. McFadden Date 9/10/98

6.2.2 Waste Type I, Case 2 Source Term, 25Kg Waste Mass

Radcalc for Windows 2.01

Date: 08-05-98 10:38
 Performed By: John Knepp
 Checked By: Janet McFadden

File: CASE2.RAD

=====
 Input Information =====

Source from input:

Radionuclide:	Curies:	
Cs-137	1.80E+002	
Ba-137m	1.70E+002	(Daughter)
U-233	5.00E-001	
Am-241	1.00E-001	

Total Activity: 3.51E+002
 Total Activity Minus Daughters: 1.81E+002

Waste Form: Normal
 Physical Form: Solid
 Container Type: 55 Gallon Drum

Package Void Volume: 2.04E+005 cc
 Waste Volume: 1.32E+004 cc
 Waste Mass: 2.50E+004 g
 Waste True Density: 1.90 g/cc

Date to begin source decay: 12:00 Aug. 3, 1998
 Date container sealed: 12:00 Aug. 3, 1998
 Days to decay source before seal time: 0.00 days
 Calculate number of days sealed until 5.00% hydrogen is reached.

Entered G Values:
 G Alpha G Beta G Gamma
 0.37 0.37 0.37

Comments:

=====
 Calculated Results =====

HYDROGEN:
 The sealed package will contain 5.00 % hydrogen in 189.84 days.
 This corresponds to date: 8:00 Feb. 9, 1999
 H2 Volume: 1.07E+004 cc
 H2 Generation Rate: 2.35 cc/hour

DECAY HEAT AND PRESSURE:
 Heat Generated at seal time: 0.887 Watts
 Partial Pressure (H2): 5.33 kPa
 Total Pressure (H2 and Air): 107. kPa



ENGINEERING SAFETY EVALUATION

Subject: Steel Drum Packaging System Hydrogen Gas Generation Analysis Page 20 of 27
 Preparer: J.G. Mcadden Date 9/10/98
 Checker: H.E. Adkins, Jr Date 9/10/98
 Section Chief: J.G. McFadden Date 9/10/98

6.2.3 Waste Type II, Case 1 Source Term, 25Kg. Waste Mass

Radcalc for Windows 2.01

Date: 08-05-98 10:41
 Performed By: John Knepp
 Checked By: Janet McFadden

File: CASE1.RAD

===== Input Information =====

Source from input:

Radionuclide:	Curies:	
Sr-90	1.80E+002	
Y-90	1.80E+002	(Daughter)
U-233	5.00E-001	
Am-241	1.00E-001	

Total Activity: 3.61E+002
 Total Activity Minus Daughters: 1.81E+002

Waste Form: Normal
 Physical Form: Solid
 Container Type: 55 Gallon Drum

Package Void Volume: 2.14E+005 cc
 Waste Volume: 3.24E+003 cc
 Waste Mass: 2.50E+004 g
 Waste True Density: 7.72 g/cc

Date to begin source decay: 12:00 Aug. 3, 1998
 Date container sealed: 12:00 Aug. 3, 1998
 Days to decay source before seal time: 0.00 days
 Calculate number of days sealed until 5.00% hydrogen is reached.

Entered G Values:
 G Alpha G Beta G Gamma
 0.27 0.27 0.27

Comments:

===== Calculated Results =====

HYDROGEN:
 The sealed package will contain 5.00 % hydrogen in 158.87 days.
 This corresponds to date: 9:00 Jan. 9, 1999
 H2 Volume: 1.13E+004 cc
 H2 Generation Rate: 2.95 cc/hour

DECAY HEAT AND PRESSURE:
 Heat Generated at seal time: 1.22 Watts
 Partial Pressure (H2): 5.33 kPa
 Total Pressure (H2 and Air): 107. kPa



ENGINEERING SAFETY EVALUATION

Subject: Steel Drum Packaging System Hydrogen Gas Generation Analysis Page 21 of 27
 Preparer: J.G. Mcadden *JGM* Date 9/10/98
 Checker: H.E. Adkins, Jr *HEA* Date 9/10/98
 Section Chief: J.G. McFadden *JGM* Date 9/10/98

6.2.4 Waste Type II, Case 2 Source Term, 25Kg Waste Mass

Radcalc for Windows 2.01

Date: 08-05-98 10:42

Performed By: John Knepp

Checked By: Janet McFadden

File: CASE2.RAD

===== Input Information =====

Source from input:

Radionuclide:	Curies:	
Cs-137	1.80E+002	
Ba-137m	1.70E+002	(Daughter)
U-233	5.00E-001	
Am-241	1.00E-001	

Total Activity: 3.51E+002

Total Activity Minus Daughters: 1.81E+002

Waste Form: Normal
 Physical Form: Solid
 Container Type: 55 Gallon Drum

Package Void Volume: 2.14E+005 cc
 Waste Volume: 3.24E+003 cc
 Waste Mass: 2.50E+004 g
 Waste True Density: 7.72 g/cc

Date to begin source decay: 12:00 Aug. 3, 1998
 Date container sealed: 12:00 Aug. 3, 1998
 Days to decay source before seal time: 0.00 days
 Calculate number of days sealed until 5.00% hydrogen is reached.

Entered G Values:

G Alpha	G Beta	G Gamma
0.27	0.27	0.27

Comments:

===== Calculated Results =====

HYDROGEN:

The sealed package will contain 5.00 % hydrogen in 307.63 days.

This corresponds to date: 3:00 Jun. 7, 1999

H2 Volume: 1.13E+004 cc

H2 Generation Rate: 1.52 cc/hour

DECAY HEAT AND PRESSURE:

Heat Generated at seal time: 0.887 Watts

Partial Pressure (H2): 5.33 kPa

Total Pressure (H2 and Air): 107. kPa



ENGINEERING SAFETY EVALUATION

Subject: Steel Drum Packaging System Hydrogen Gas Generation Analysis Page 22 of 27
 Preparer: J.G. Mcadden Date 9/10/98
 Checker: H.E. Adkins, Jr Date 9/10/98
 Section Chief: J.G. McFadden Date 9/10/98

6.2.5 Waste Type III, Case 1 Source Term, 25Kg Waste Mass

Radcalc for Windows 2.01 Date: 09-08-98 08:29
 Performed By: John Knepp
 Checked By: Janet McFadden

File: CASE1.RAD

=====
 Input Information
 =====

Source from input:

Radionuclide:	Curies:	
Sr-90	1.80E+002	
Y-90	1.80E+002	(Daughter)
U-233	5.00E-001	
Am-241	1.00E-001	

Total Activity: 3.61E+002
 Total Activity Minus Daughters: 1.81E+002

Waste Form: Normal
 Physical Form: Solid
 Container Type: 55 Gallon Drum

Package Void Volume: 1.90E+005 cc
 Waste Volume: 2.69E+004 cc
 Waste Mass: 2.50E+004 g
 Waste True Density: 0.930 g/cc

Date to begin source decay: 12:00 Aug. 3, 1998
 Date container sealed: 12:00 Aug. 3, 1998
 Days to decay source before seal time: 0.00 days
 Calculate number of days sealed until 5.00% hydrogen is reached.

Entered G Values:
 G Alpha G Beta G Gamma
 0.84 0.84 0.84

Comments:

=====
 Calculated Results
 =====

HYDROGEN:

The sealed package will contain 5.00 % hydrogen in 45.25 days.
 This corresponds to date: 18:00 Sep. 17, 1998
 H2 Volume: 1.00E+004 cc
 H2 Generation Rate: 9.21 cc/hour

DECAY HEAT AND PRESSURE:

Heat Generated at seal time: 1.22 Watts
 Partial Pressure (H2): 5.33 kPa
 Total Pressure (H2 and Air): 107. kPa



ENGINEERING SAFETY EVALUATION

Subject: Steel Drum Packaging System Hydrogen Gas Generation Analysis Page 23 of 27
 Preparer: J.G. Mcadden *JGM* Date 9/10/98
 Checker: H.E. Adkins, Jr *HEA* Date 9/10/98
 Section Chief: J.G. McFadden *JGM* Date 9/10/98

6.2.6 Waste Type III, Case 2 Source Term, 25Kg Waste Mass

Radcalc for Windows 2.01

Date: 09-08-98 08:29

Performed By: John Knepp

Checked By: Janet McFadden

File: CASE2.RAD

===== Input Information =====

Source from input:

Radionuclide:	Curies:	
Cs-137	1.80E+002	
Ba-137m	1.70E+002	(Daughter)
U-233	5.00E-001	
Am-241	1.00E-001	

Total Activity: 3.51E+002

Total Activity Minus Daughters: 1.81E+002

Waste Form: Normal
 Physical Form: Solid
 Container Type: 55 Gallon Drum

Package Void Volume: 1.90E+005 cc
 Waste Volume: 2.69E+004 cc
 Waste Mass: 2.50E+004 g
 Waste True Density: 0.930 g/cc

Date to begin source decay: 12:00 Aug. 3, 1998
 Date container sealed: 12:00 Aug. 3, 1998
 Days to decay source before seal time: 0.00 days
 Calculate number of days sealed until 5.00% hydrogen is reached.

Entered G Values:

G Alpha	G Beta	G Gamma
0.84	0.84	0.84

Comments:

===== Calculated Results =====

HYDROGEN:

The sealed package will contain 5.00 % hydrogen in 92.80 days.
 This corresponds to date: 7:00 Nov. 4, 1998
 H2 Volume: 1.00E+004 cc
 H2 Generation Rate: 4.49 cc/hour

DECAY HEAT AND PRESSURE:

Heat Generated at seal time: 0.887 Watts
 Partial Pressure (H2): 5.33 kPa
 Total Pressure (H2 and Air): 107. kPa



ENGINEERING SAFETY EVALUATION

Subject: Steel Drum Packaging System Hydrogen Gas Generation Analysis Page 24 of 27
 Preparer: J.G. Mcadden Date 9/10/98
 Checker: H.E. Adkins, Jr Date 9/10/98
 Section Chief: J.G. McFadden Date 9/10/98

6.2.7 Waste Type IV, Case 1 Source Term, 25Kg Waste Mass

Radcalc for Windows 2.01 Date: 09-08-98 09:03
 Performed By: John Knepp
 Checked By: Janet McFadden

File: CASE1.RAD

===== Input Information =====

Source from input:
 Radionuclide: Curies:
 Sr-90 1.80E+002
 Y-90 1.80E+002 (Daughter)
 U-233 5.00E-001
 Am-241 1.00E-001

Total Activity: 3.61E+002
 Total Activity Minus Daughters: 1.81E+002

Waste Form: Normal
 Physical Form: Solid
 Container Type: 55 Gallon Drum

Package Void Volume: 1.82E+005 cc
 Waste Volume: 3.47E+004 cc
 Waste Mass: 2.50E+004 g
 Waste True Density: 0.720 g/cc

Date to begin source decay: 12:00 Aug. 3, 1998
 Date container sealed: 12:00 Aug. 3, 1998
 Days to decay source before seal time: 0.00 days
 Calculate number of days sealed until 5.00% hydrogen is reached.

Entered G Values:
 G Alpha G Beta G Gamma
 1.64 1.64 1.64

Comments:

===== Calculated Results =====

HYDROGEN:
 The sealed package will contain 5.00 % hydrogen in 22.20 days.
 This corresponds to date: 17:00 Aug. 25, 1998
 H2 Volume: 9.59E+003 cc
 H2 Generation Rate: 18.0 cc/hour

DECAY HEAT AND PRESSURE:
 Heat Generated at seal time: 1.22 Watts
 Partial Pressure (H2): 5.33 kPa
 Total Pressure (H2 and Air): 107. kPa



ENGINEERING SAFETY EVALUATION

Subject: Steel Drum Packaging System Hydrogen Gas Generation Analysis Page 25 of 27
 Preparer: J.G. Mcadden Date 9/10/98
 Checker: H.E. Adkins, Jr Date 9/10/98
 Section Chief: J.G. McFadden Date 9/10/98

6.2.8 Waste Type IV, Case 2 Source Term, 25Kg Waste Mass

Radcalc for Windows 2.01

Date: 09-08-98 09:03
 Performed By: John Knepp
 Checked By: Janet McFadden

File: CASE2.RAD

===== Input Information =====

Source from input:

Radionuclide:	Curies:	
Cs-137	1.80E+002	
Ba-137m	1.70E+002	(Daughter)
U-233	5.00E-001	
Am-241	1.00E-001	

Total Activity: 3.51E+002
 Total Activity Minus Daughters: 1.81E+002

Waste Form: Normal
 Physical Form: Liquid
 Container Type: 55 Gallon Drum

Package Void Volume: 1.82E+005 cc
 Waste Volume: 3.47E+004 cc
 Waste Mass: 2.50E+004 g
 Waste True Density: 0.720 g/cc

Date to begin source decay: 12:00 Aug. 3, 1998
 Date container sealed: 12:00 Aug. 3, 1998
 Days to decay source before seal time: 0.00 days
 Calculate number of days sealed until 5.00% hydrogen is reached.

Entered G Values:
 G Alpha G Beta G Gamma
 1.64 1.64 1.64

Comments:

===== Calculated Results =====

HYDROGEN:
 The sealed package will contain 5.00 % hydrogen in 49.10 days.

This corresponds to date: 14:00 Sep. 21, 1998
 H2 Volume: 9.59E+003 cc
 H2 Generation Rate: 8.14 cc/hour

DECAY HEAT AND PRESSURE:
 Heat Generated at seal time: 0.887 Watts
 Partial Pressure (H2): 5.33 kPa
 Total Pressure (H2 and Air): 107. kPa



ENGINEERING SAFETY EVALUATION

Subject: Steel Drum Packaging System Hydrogen Gas Generation Analysis Page 26 of 27
 Preparer: J.G. Mcadden Date 9/10/98
 Checker: H.E. Adkins, Jr Date 9/10/98
 Section Chief: J.G. McFadden Date 9/10/98

6.2.9 Waste Type V, Case 1 Source Term, 25Kg Waste Mass

Radcalc for Windows 2.01

Date: 08-05-98 11:02
 Performed By: John Knepp
 Checked By: Janet McFadden

File: CASE1.RAD

=====
 Input Information
 =====

Source from input:

Radionuclide:	Curies:	
Sr-90	1.80E+002	
Y-90	1.80E+002	(Daughter)
U-233	5.00E-001	
Am-241	1.00E-001	

Total Activity: 3.61E+002
 Total Activity Minus Daughters: 1.81E+002

Waste Form: Normal
 Physical Form: Liquid
 Container Type: 55 Gallon Drum

Package Void Volume: 1.92E+005 cc
 Waste Volume: 2.50E+004 cc
 Waste Mass: 2.50E+004 g
 Waste True Density: 1.00 g/cc

Date to begin source decay: 12:00 Aug. 3, 1998
 Date container sealed: 12:00 Aug. 3, 1998
 Days to decay source before seal time: 0.00 days
 Calculate number of days sealed until 5.00% hydrogen is reached.

Entered G Values:
 G Alpha G Beta G Gamma
 2.8 2.3 2.3

Comments:

=====
 Calculated Results
 =====

HYDROGEN:

The sealed package will contain 5.00 % hydrogen in 16.62 days.
 This corresponds to date: 3:00 Aug. 20, 1998
 H2 Volume: 1.01E+004 cc
 H2 Generation Rate: 25.3 cc/hour

DECAY HEAT AND PRESSURE:

Heat Generated at seal time: 1.22 Watts
 Partial Pressure (H2): 5.33 kPa
 Total Pressure (H2 and Air): 107. kPa



ENGINEERING SAFETY EVALUATION

Subject: Steel Drum Packaging System Hydrogen Gas Generation Analysis Page 27 of 27
 Preparer: J.G. Mcadden Date 9/10/98
 Checker: H.E. Adkins, Jr Date 9/10/98
 Section Chief: J.G. McFadden Date 9/10/98

6.2.10 Waste Type V, Case 2 Source Term, 25Kg Waste Mass

Radcalc for Windows 2.01 Date: 08-05-98 11:03
 Performed By: John Knepp
 Checked By: Janet McFadden

File: CASE2.RAD

=====
 ===== Input Information =====

Source from input:

Radionuclide:	Curies:	
Cs-137	1.80E+002	
Ba-137m	1.70E+002	(Daughter)
U-233	5.00E-001	
Am-241	1.00E-001	

Total Activity: 3.51E+002
 Total Activity Minus Daughters: 1.81E+002

Waste Form: Normal
 Physical Form: Liquid
 Container Type: 55 Gallon Drum

Package Void Volume: 1.92E+005 cc
 Waste Volume: 2.50E+004 cc
 Waste Mass: 2.50E+004 g
 Waste True Density: 1.00 g/cc

Date to begin source decay: 12:00 Aug. 3, 1998
 Date container sealed: 12:00 Aug. 3, 1998
 Days to decay source before seal time: 0.00 days
 Calculate number of days sealed until 5.00% hydrogen is reached.

Entered G Values:
 G Alpha G Beta G Gamma
 2.8 2.3 2.3

Comments:

=====
 ===== Calculated Results =====

HYDROGEN:
 The sealed package will contain 5.00 % hydrogen in 33.26 days.
 This corresponds to date: 18:00 Sep. 5, 1998
 H2 Volume: 1.01E+004 cc
 H2 Generation Rate: 12.7 cc/hour

DECAY HEAT AND PRESSURE:
 Heat Generated at seal time: 0.887 Watts
 Partial Pressure (H2): 5.33 kPa
 Total Pressure (H2 and Air): 107. kPa

10.0 PACKAGE TIEDOWN SYSTEM EVALUATION

10.1 SYSTEM DESIGN AND REQUIREMENTS

Since both standard 208 L (55-gal) and retrieval drums are transported onsite in various numbers, in arrangements dependent upon the conveyance, and on many types of conveyances, securement requirements to the conveyance shall meet the requirements of 49 CFR 393.100 "General Rules for Protection Against Shifting or Falling Cargo." Also, individual drums or batches of drums shall be secured to the conveyance per the requirements of 49 CFR 393.102, "Securement Systems," and blocked and braced against shifting in accordance with the requirements of 49 CFR 393.104, "Blocking and Bracing." In addition the following restrictions are imposed to meet the NTC and risk assessment accident structural parameters of this SARP.

High-activity-content drums packaged in NuPac Model N-55 Overpack Systems shall be secured to the front end of the conveyance in accordance with 49 CFR 393.102. In addition the overpack shall be blocked and braced in accordance with 49 CFR 393.104 for the rearward and lateral directions by either wooden blocks nailed to the deck or chocking chains secured to the conveyance.

10.1.1 Standard Drums

Standard 208 L (55-gal) drums may shipped in two array forms as follows, which are dependent upon the allowable speed as shown in Part B, Section 7.4.

1. Drum shipments with an allowable speed of 48 km/h (30 mph) may be shipped in an array with a total gross weight of 1,361 kg (3,000 lb). The total gross weight of all the drums in the array may not exceed 1,361 kg (3,000 lb).
2. As an alternative, with an allowable speed of 40 km/h (25 mph), an array with a total gross weight of 2,268 kg (5,000 lb) may be transported.

In both cases, either array of drums may be transported on a conveyance provided the following requirements are met.

- The first row of drums on the array at the front must be placed at the front end structure of the conveyance.
- Between each set of drums there must be a set of intermediate restraint beams that are secured to the conveyance.
- Each set of intermediate restraint beams must have an aggregate load limit of 2 times the total gross weight of the array. This is based on the AISC (1989) equivalency for a uniformly loaded beam.
- The drum at either the front or rear of the conveyance shall be blocked and braced from shifting in any direction by the walls of the conveyance, intermediate restraint beams, blocking and bracing of the drum array, or any combination of the three. Blocking and bracing shall be accomplished by the following:
 - Wooden chock blocks nailed to the bed of a wooden deck conveyance

- Chains, wire rope, or straps wrapped around the array of drums and secured to the conveyance
- Carbon steel clips welded or bolted to the bed of a steel deck conveyance.
- The array must be secured to the conveyance in accordance with 49 CFR 393.102.

Single drum or single drum-array shipments shall be secured to the front end of the conveyance in accordance with 49 CFR 393.102 and blocked and braced in accordance with 49 CFR 393.104 for the rearward and lateral directions.

10.1.2 Retrieval Drums

Retrieval drums only may be shipped in one array form. Retrieval drum shipments are restricted to a maximum speed of 48 km/h (30 mph) with a maximum total gross weight of 726 kg (1,600 lb) in the array. This means the total gross weight of all the drums in the array may not exceed 726 kg (1,600 lb).

An array of retrieval drums may be transported on a conveyance provided the following requirements are met.

- The first row of drums on the array at the front must be placed at the front end structure of the conveyance.
- Between each set of drums, there must be a set of intermediate restraint beams that are secured to the conveyance.
- Each set of intermediate restraint beams must have an aggregate load limit of 2 times the total gross weight of the array. This based on the AISC (1989) equivalency for a uniformly loaded beam.
- Drums at either the front or rear of the conveyance shall be blocked and braced from shifting in any direction by the walls of the conveyance, intermediate restraint beams, blocking and bracing of the drum array, or a combination of the three. Blocking and bracing shall be accomplished by the following:
 - Wooden chock blocks nailed to the bed of a wooden deck conveyance
 - Chains, wire rope, or straps wrapped around the array of drums and secured to the conveyance
 - Carbon steel clips or angles welded or bolted to the bed of a steel deck conveyance.
- The array must be secured individually to the conveyance in accordance with 49 CFR 393.102.

Single drum or single drum-array shipments shall be secured to the front end of the conveyance in accordance with 49 CFR 393.102 and blocked and braced in accordance with 49 CFR 393.104 for the rearward and lateral directions.

10.2 ATTACHMENTS, RATINGS, AND REQUIREMENTS

Tiedown attachments to the conveyance and tiedown components must have the same rated working capacity or working load of the tiedown. Chains, straps, or wire rope used as chocking must have an aggregate working capacity or working load of $\frac{1}{2}$ the weight of the drum or drum array. Wooden chock blocks nailed to the deck or carbon steel clips or angles welded to the deck must have a load capacity of $\frac{1}{2}$ the weight of the drum or drum array.

10.3 REFERENCES

49 CFR 393, "Parts and Accessories Necessary for Safe Operations," *Code of Federal Regulations*, as amended.

AISC, 1989, *Manual of Steel Construction*, Ninth Edition, American Institute of Steel Construction, Chicago, Illinois.

DISTRIBUTION SHEET

To	From	Page 1 of 1
Distribution	Packaging Engineering	Date 09/30/98
Project Title/Work Order		EDT No. 622967
Safety Analysis Report for Packaging (Onsite) Steel Drum (HNF-2209)		ECN No. NA

Name	MSIN	Text With All Attach.	Text Only	Attach./ Appendix Only	EDT/ECN Only
M. D. Aichele	T4-04	X			
D. F. Baker	T5-56	X			
E. G. Backlund	T5-54	X			
M. W. Benecke	L6-26	X			
E. P. Bonadie	T5-55	X			
D. W. Claussen	S7-55	X			
R. L. Clawson	H1-14	X			
N. R. Dahl	N2-57	X			
D. C. Derosa	T3-28	X			
J. G. Field	H1-15	X			
L. M. Hay	H1-15	X			
P. K. Huff	S3-25	X			
J. H. Kelley	T4-15	X			
M. L. Martin	P8-34	X			
A. K. McDowell	T3-05	X			
M. A. McGhan	H1-15	X			
D. R. Pyzel	S6-30	X			
D. E. Rasmussen	L1-04	X			
Y. M. Shehadeh	T3-04	X			
S. K. Shirley	T6-20	X			
D. M. Southwick	S3-30	X			
M. R. Turner	H1-15	X			
Central Files	B1-07	X			
DOE/RL Reading Room	H2-53	X			
Hanford Technical Library	P8-55	X			