

379
N816
No. 3982

**BIODIVERSITY OF CADDISFLIES (TRICHOPTERA) OF THE
INTERIOR HIGHLANDS OF NORTH AMERICA**

VOLUME I

DISSERTATION

Presented to the Graduate Council of the
University of North Texas in Partial
Fulfillment of the Requirements

For the Degree of

DOCTOR OF PHILOSOPHY

By

Stephen R. Moulton II, B.S., M.S.

Denton, Texas

August, 1994

379
N816
No. 3982

**BIODIVERSITY OF CADDISFLIES (TRICHOPTERA) OF THE
INTERIOR HIGHLANDS OF NORTH AMERICA**

VOLUME I

DISSERTATION

Presented to the Graduate Council of the
University of North Texas in Partial
Fulfillment of the Requirements

For the Degree of

DOCTOR OF PHILOSOPHY

By

Stephen R. Moulton II, B.S., M.S.

Denton, Texas

August, 1994

Moulton, Stephen R., II, **Biodiversity of Caddisflies (Trichoptera) in the Interior Highlands of North America**. Doctor of Philosophy (Biology), August, 1994, 602 pp., 6 tables, 616 figures, bibliography, 279 titles.

Caddisflies (Trichoptera) were collected from over 500 different locations throughout the Interior Highlands (Ozark, Ouachita, Arbuckle, and Wichita Mountains) between March 1990 and March 1994. I systematically sampled representative lotic and lentic habitats in 131 natural watersheds that comprise the 17 different physiographic subregions of this area. From my examination of approximately 60,000 specimens, surveys of regional museum collections, and review of literature records, I document 229 species distributed in 16 families and 58 genera. Included in this total are 27 endemic species and 15 new regional records. Descriptions are provided for a species new to science (*Cheumatopsyche robisoni*), four larvae (*Helicopsyche limnella*, *H. piroa*, *Marilia* species A, *Polycentropus crassicornis*) and a female (*Helicopsyche piroa*). *Hydropsyche reiseni* Denning, previously known only from the Arbuckle Mountains, is reduced in synonymy with *H. arinale* Ross. Further, I provide illustrated family, generic, and selected species-level keys that reflect this regional biodiversity.

Associations are tabulated for each species with the 17 physiographic subregions, stream order, six stream widths and substrate types, four flow permanence types, and three vegetation categories. This information, coupled

with summarized adult flight periods, will enhance the predictive capabilities of regional biologists to ascertain which caddisfly species may be present in certain aquatic habitats. A detrended correspondence analysis (DCA) of species present in the 131 natural watersheds revealed three biologically meaningful faunal regions. Clustered watersheds did not correspond well to known subregional differences based on geologic or vegetational characteristics. However, Spearman Rank Correlation of DCA Axis 1 scores revealed significant ($\alpha = 0.05$) associations with latitude, geology, and the presence of high-volume springs. The Interior Highlands caddisfly fauna is most closely allied with those of the southern (74 %) and eastern (72%) United States. Distributions of regional species appear best explained by events of the Pleistocene Glaciations, as well as specific life-history parameters such as voltinism, diapausing life stages, and trophic guild.

ACKNOWLEDGMENTS

This research was supported by grants from the National Science Foundation (DEB-9200895 and DEB-9347758), and the Entomological and Faculty Research Funds of UNT. I thank with great sincerity the advice and guidance of my major professor Dr. K. W. Stewart, and other members of my doctoral committee Drs. B. J. Armitage, T. L. Beitinge, G. A. Schuster, and E. G. Zimmerman. I am indebted to many individuals who assisted me in various ways during the course of this research: J. C. Abbott, Dr. B. J. Armitage, D. Baumgardner, Dr. D. E. Bowles, Dr. R. E. DeWalt, Dr. O. S. Flint, Jr., Dr. M. Floyd, Dr. S. Hamilton, Dr. G. L. Harp, Dr. S. C. Harris, D. C. Hilburn, Dr. R. W. Holzenthal, Dr. J. Kennedy, K. Manuel, Dr. M. L. Mathis, Dr. J. C. Morse, E. K. Moulton, K. A. Moulton, S. R. Moulton III, V. Nations, Dr. B. C. Poulton, Dr. H. W. Robison, Dr. G. A. Schuster, L. Trial, Dr. C. Vaughn, Dr. D. Webb, and Dr. G. B. Wiggins.

TABLE OF CONTENTS

VOLUME I

	Page
LIST OF TABLES	vi
LIST OF FIGURES	vii
CHAPTER	
1. INTRODUCTION	1
2. MATERIALS AND METHODS	12
3. RESULTS	20
4. FAMILY BRACHYCENTRIDAE	42
5. FAMILY GLOSSOSOMATIDAE	52
6. FAMILY HELICOPSYCHIDAE	64
7. FAMILY HYDROPSYCHIDAE	72
8. FAMILY HYDROPTILIDAE	121
9. FAMILY LEPIDOSTOMATIDAE	211
10. FAMILY LEPTOCERIDAE	219
11. FAMILY LIMNEPHILIDAE	277
12. FAMILY MOLANNIDAE	299

VOLUME II

13. FAMILY ODONTOCERIDAE	306
14. FAMILY PHILOPOTAMIDAE	310
15. FAMILY PHRYGANEIDAE	323
16. FAMILY POLYCENTROPODIDAE	333
17. FAMILY PSYCHOMYIIDAE	362
18. FAMILY RHYACOPHILIDAE	369
19. FAMILY UENOIDAE	380
20. BIOGEOGRAPHY OF INTERIOR HIGHLAND TRICHOPTERA	386
BIBLIOGRAPHY	398
TABLES	421
FIGURES	447

LIST OF TABLES

Table No.	Page No.
1.	Number of caddisfly species from states occupying the Interior Highland region and those peripheral to it 421
2.	List of the 131 natural watershed subdivisions of the Interior Highlands shown in Fig. 16 (modified from Poulton and Stewart 1991) 422
3.	Trichoptera species richness, number of endemic species, and percent of total (N) for each of the 17 physiographic subregions depicted in Fig. 2 423
4.	Number and percent similarity of Interior Highland caddisfly species (N=229) shared with other regions (after Poulton and Stewart 1991) in North America including Mexico and the neotropics 424
5.	Interior Highlands Trichoptera summary table, including total number of collection records (N), and associations with different physiographic subregions, stream orders, stream widths, flow permanence types, substrate types, and vegetation types. A (?) denotes unknown information. 425
6.	Seasonal presence of Interior Highland caddisfly adults. Dotted lines represent larval collections only 435

LIST OF FIGURES

Figure No.		Page No.
1.	Physiographic regions of the Eastern United States (after Ross 1965)	447
2.	Natural physiographic subregions of the Interior Highlands (modified from Poulton and Stewart 1991)	449
3.	Mean monthly water temperatures of Interior Highland streams, 1990 - 1992	451
4.	Janes Creek, in the Central Plateau subregion, Randolph Co., Arkansas. Note the dense growths of waterwillow, a common rooted aquatic macrophyte in the Interior Highlands	453
5.	A small spring creek with dense growths of watercress	453
6.	The Boston Mountains in northern Arkansas	453
7.	Pittman Creek, a "losing stream" in the Caddo River headwaters, Montgomery Co., Arkansas	453
8.	Big Spring, a high-volume spring on the Current River near Van Buren, Carter Co., Missouri	453
9.	Big Spring, a small spring seep near the town of Big Spring, Stone Co., Arkansas	453
10.	Honey Creek, an Arbuckle Mountain stream at Turner Falls, Murray Co., Oklahoma	455
11.	Typical intermittent stream in the Ozark Mountains during the summer	455
12.	North Sylamore Creek, a pristine fourth-order stream in the Ozark National Forest, Stone Co., Arkansas	455
13.	Gunner Pool at North Sylamore Creek, Stone Co., Arkansas	455

14.	Confluence of the Ouachita and Little Missouri Rivers in the Gulf Coastal Plain subregion, Ouachita Co., Arkansas	455
15.	Clear-cut forest in the Ouachita Mountains, Arkansas	455
16.	Natural watershed subdivisions of the Interior Highlands (modified from Poulton and Stewart 1991)	457
17.	Regional counties of Arkansas, Illinois, Missouri, and Oklahoma, and states peripheral to the Interior Highlands	459
18.	Distribution of species richness among the 16 caddisfly families present in the Interior Highlands	461
19.	Detrended correspondence analysis clusters of faunistically similar watersheds of the Interior Highlands based on presence or absence of regional caddisfly species	463
20.	Larval head of <i>Glyphopsyche missouri</i> , dorsal	465
21.	Larval thoracic nota and abdominal segment I of <i>Glyphopsyche missouri</i> , dorsal	465
22.	Larval head and prothorax, lateral view	465
23.	Components of the larval leg	465
24.	Prothoracic leg of larval Polycentropodidae	467
25.	Prothoracic leg of larval Psychomyiidae	467
26.	Characters of larval abdominal segments I - IV in lateral view	467
27.	A branched, larval abdominal gill	467
28.	Lateral view of head capsule of larval Lepidostomatidae	467
29.	Pro- and mesonotum of larval Uenoidae	467

30.	Larval case of <i>Helicopsyche borealis</i> (Helicopsychidae)	469
32.	Larval case of <i>Orthotrichia</i> sp (Hydroptilidae)	469
33.	Larval case of <i>Oxyethira</i> sp (Hydroptilidae)	469
31.	Larval case of <i>Agapetus illini</i> (Glossosomatidae)	469
34.	Larval case of <i>Triaenodes</i> sp (Leptoceridae)	469
35.	Larval case of <i>Nectopsyche diarina</i> (Leptoceridae)	469
36.	Larval case of <i>Molanna ulmerina</i> (Molannidae)	469
37.	Larval case of <i>Pycnopsyche lepida</i> Group (Limnephilidae)	469
38.	Larval case of <i>Lepidostoma ozarkense</i> (Lepidostomatidae)	469
39.	Lateral view of <i>Rhyacophila kiamichi</i> male (Rhyacophilidae), wings omitted	471
40.	Head and thorax of <i>Rhyacophila kiamichi</i> (dorsal)	471
41.	Fore- (top) and hindwing (bottom) venation of <i>Rhyacophila kiamichi</i> male	471
42.	Mesonotum of <i>Dibusa angata</i> (Hydroptilidae)	473
43.	Mesonotum of <i>Hydropsyche bidens</i> (Hydropsychidae)	473
44.	Mesonotum of <i>Polycentropus crassicornis</i> (Polycentropodidae) . . .	473
45.	Mesonotum of <i>Ceraclea cancellata</i> (Leptoceridae)	473
46.	Mesonotum of <i>Micrasema ozarkana</i> (Brachycentridae)	473
47.	Adult head of <i>Chimarra obscura</i> (Philopotamidae)(dorsal)	473
48.	Adult head of <i>Helicopsyche limnella</i> (Helicopsychidae)(dorsal)	473

49.	Adult head (dorsal), pro- and mesonotum of <i>Marilia flexuosa</i> (Odontoceridae)	473
50.	Maxillary palp of <i>Chimarra obscura</i> (Philopotamidae)	473
51.	Maxillary palp of <i>Rhyacophila kiamichi</i> (Rhyacophilidae)	473
52.	Maxillary palp of <i>Hydropsyche bidens</i> (Hydropsychidae)	473
53.	Maxillary palp of <i>Molanna ulmerina</i> (Molannidae)	473
54.	Hindwing of <i>Neophylax fuscus</i> (Uenoidae)	473
55.	Larval head of <i>Brachycentrus numerosus</i> , dorsal	475
56.	Larval head of <i>B. lateralis</i> , dorsal	475
57.	Metathoracic leg of <i>B. numerosus</i>	475
58.	Metathoracic leg of <i>B. lateralis</i>	475
59.	Larval head of <i>Micrasema rusticum</i> , dorsal	475
60.	Larval head of <i>M. ozarkana</i> , dorsal	475
61.	Forewing of <i>Micrasema</i> sp	477
62.	Forewing of <i>Brachycentrus</i> sp	477
63.	Male genitalia of <i>B. numerosus</i> , lateral	477
64.	Apex of tergum X of <i>B. numerosus</i> , dorsal	477
65.	Male genitalia of <i>B. lateralis</i> , lateral	477
66.	Apex of tergum X of <i>B. lateralis</i> , dorsal	477
67.	Male genitalia of <i>M. ozarkana</i> , lateral	477

68.	Apex of tergum X of <i>M. ozarkana</i> , dorsal	477
69.	Male genitalia of <i>M. rusticum</i> , lateral	477
70.	Apex of tergum X <i>M. rusticum</i> , dorsal	477
71.	Male genitalia of <i>M. wataga</i> , lateral	477
72.	Apex of tergum X of <i>M. wataga</i> , dorsal	477
73.	Larval mesonotum of <i>Agapetus</i> sp	479
74.	Larval mesonotum of <i>Protophila</i> sp	479
75.	Adult head of <i>Agapetus</i> sp., dorsal	479
76.	Adult head of <i>Glossosoma intermedium</i> , dorsal	479
77.	Male genitalia of <i>A. artesus</i> , lateral	479
78.	Inferior appendage of <i>A. artesus</i> , ventral	479
79.	Male genitalia of <i>A. medicus</i> , lateral	479
80.	Inferior appendage of <i>A. medicus</i> , ventral	479
81.	Male genitalia of <i>A. illini</i> , lateral	479
82.	Male genitalia of <i>G. intermedium</i> , lateral	479
83.	Sternite VIII of <i>P. tenebrosa</i> , ventral	481
84.	Sternite VIII of <i>P. maculata</i> , ventral	481
85.	Male genitalia of <i>P. tenebrosa</i> , lateral	481
86.	Male genitalia of <i>P. maculata</i> , lateral	481
87.	Male genitalia of <i>P. lega</i> , lateral	481

88.	Male genitalia of <i>P.</i> species A, lateral	481
89.	Male genitalia of <i>Helicopsyche borealis</i> , lateral	483
90.	Female genitalia of <i>H. borealis</i> , ventral	483
91.	Male genitalia of <i>H. limnella</i> , lateral	483
92.	Female genitalia of <i>H. limnella</i> , ventral	483
93.	Female sternite VI of <i>H. limnella</i>	483
94.	Larval head of <i>H. limnella</i> , dorsal	483
95.	Male genitalia of <i>H. piroa</i> , lateral	483
96.	Female sternite VI of <i>H. piroa</i>	483
97.	Larval head of <i>H. piroa</i> , dorsal	483
98.	Larval prosternum of <i>Hydropsyche</i> spp	485
99.	Larval prosternum of <i>Cheumatopsyche</i> spp	485
100.	Larval mandible of <i>Cheumatopsyche</i> sp., dorsal	485
101.	Dorsal abdominal setae of some <i>Hydropsyche</i> spp	485
102.	Larval mandible of <i>Potamyia flava</i> , dorsal	485
103.	Larval head of <i>P. flava</i> , ventral	485
104.	Larval abdominal sternites VIII and IX of <i>P. flava</i>	485
105.	Larval abdominal sternites VIII and IX of <i>Cheumatopsyche</i> sp	485
106.	Larval abdominal sternite VIII of <i>Smicridea fasciatella</i>	485
107.	Larval head of <i>Diplectrona modesta</i> , dorsal	487

108.	Larval head of <i>D. metaqui</i> , dorsal	487
109.	Larval head of <i>D. modesta</i> , ventral	487
110.	Larval head of <i>Macrostemum carolina</i> , dorsal	487
111.	Larval head of <i>Homoplectra doringa</i> , dorsal	487
112.	Larval foreleg of <i>M. carolina</i> , dorsal	487
113.	Forewing of <i>M. carolina</i>	489
114.	Forewing of <i>S. fasciatella</i>	489
115.	Hindwing of <i>D. modesta</i>	489
116.	Adult abdominal sternites IV - VI of <i>D. modesta</i>	489
117.	Hindwing of <i>H. doringa</i>	489
118.	Adult abdominal sternite V of <i>H. doringa</i>	489
119.	Fore- (top) and hindwing (bottom) of <i>C. robisoni</i> NEW SPECIES . . .	489
120.	Fore- (top) and hindwing (bottom) of <i>P. flava</i>	489
121.	Postero-apical margin of forewing of <i>Hydropsyche</i> sp	489
122.	Postero-apical margin of forewing of <i>Ceratopsyche</i> sp	489
123.	Adult head of <i>D. modesta</i> , dorsal	491
124.	Adult head of <i>D. metaqui</i> , dorsal	491
125.	Adult head of <i>H. betteni</i> , dorsal	491
126.	Adult head of <i>H. doringa</i> , dorsal	491
127.	Larval head of <i>Ceratopsyche morosa</i> , dorsal	491

128.	Larval head of <i>C. piatrix</i> , dorsal (redrawn from Schuster and Etnier 1978)	491
129.	Larval head of <i>C. slossonae</i> , dorsal	491
130.	Male genitalia of <i>C. piatrix</i> , lateral	493
131.	Phallus of <i>C. piatrix</i> , lateral	493
132.	Male genitalia of <i>C. slossonae</i> , lateral	493
133.	Phallus of <i>C. slossonae</i> , lateral	493
134.	Phallus of <i>C. cheilonis</i> , lateral	493
135.	Male genitalia of <i>C. bronta</i> , lateral	493
136.	Phallus of <i>C. bronta</i> , lateral	493
137.	Male genitalia of <i>C. morosa</i> , lateral	493
138.	Phallus of <i>C. morosa</i> , east-central form, lateral	493
139.	Phallus of <i>C. morosa</i> , west-central form, lateral	493
140.	Male genitalia of <i>Cheumatopsyche sordida</i> , lateral	495
141.	Male tergum X of <i>C. sordida</i> , caudal	495
142.	Male genitalia of <i>C. minuscula</i> , lateral	495
143.	Male tergum X of <i>C. minuscula</i> , caudal	495
144.	Male genitalia of <i>C. comis</i> , lateral	495
145.	Male tergum X of <i>C. comis</i> , caudal	495
146.	Male genitalia of <i>C. harwoodi enigma</i> , lateral	495

147.	Male tergum X of <i>C. harwoodi enigma</i> , caudal	495
148.	Male genitalia of <i>C. rossi</i> , holotype, lateral	495
149.	Male tergum X of <i>C. rossi</i> , holotype, caudal	495
150.	Male genitalia of <i>C. robisoni</i> NEW SPECIES, lateral	495
151.	Male inferior appendage of <i>C. robisoni</i> NEW SPECIES, caudal	495
152.	Male tergum X of <i>C. robisoni</i> NEW SPECIES, caudal	495
153.	Male genitalia of <i>C. speciosa</i> , lateral	497
154.	Male tergum X of <i>C. speciosa</i> , caudal	497
155.	Male genitalia of <i>C. pettiti</i> , lateral	497
156.	Male tergum X of <i>C. pettiti</i> , caudal	497
157.	Male genitalia of <i>C. pasella</i> , lateral	497
158.	Male tergum X of <i>C. pasella</i> , caudal	497
159.	Male genitalia of <i>C. lasia</i> , lateral	497
160.	Male tergum X of <i>C. lasia</i> , caudal	497
161.	Male genitalia of <i>C. campyla</i> , lateral	497
162.	Male tergum X of <i>C. campyla</i> , caudal	497
163.	Male genitalia of <i>C. burksi</i> , lateral	497
164.	Male tergum X of <i>C. burksi</i> , caudal	497
165.	Male genitalia of <i>C. gracilis</i> , lateral	499
166.	Male tergum X of <i>C. gracilis</i> , caudal	499

167.	Male genitalia of <i>C. halima</i> , lateral	499
168.	Male tergum X of <i>C. halima</i> , caudal	499
169.	Male genitalia of <i>C. aphantia</i> , lateral	499
170.	Male tergum X of <i>C. aphantia</i> , caudal	499
171.	Male genitalia of <i>C. oxa</i> , lateral	499
172.	Male tergum X of <i>C. oxa</i> , caudal	499
173.	Male inferior appendage of <i>C. oxa</i> , caudal	499
174.	Larval head of <i>Hydropsyche orris</i> , dorsal	501
175.	Larval head of <i>H. orris</i> , lateral	501
176.	Larval head of <i>H. bidens</i> , dorsal	501
177.	Larval head of <i>H. scalaris</i> , dorsal	501
178.	Left side of abdominal sternite IX and anal proleg of <i>H. scalaris</i> , ventral	501
179.	Larval head of <i>H. betteni</i> , lateral	501
180.	Larval head of <i>H. simulans</i> , dorsal	501
181.	Male genitalia of <i>H. arinale</i> , lateral	503
182.	Phallus of <i>H. arinale</i> , ventral	503
183.	Phallus of <i>H. arinale</i> , lateral	503
184.	Male genitalia of <i>H. rossi</i> , lateral	503
185.	Phallus of <i>H. rossi</i> , ventral	503

186.	Phallus of <i>H. rossi</i> , lateral	503
187.	Male genitalia of <i>H. simulans</i> , lateral	503
188.	Phallus of <i>H. simulans</i> , lateral	503
189.	Male genitalia of <i>H. orris</i> , lateral	503
190.	Phallus of <i>H. orris</i> , ventral	503
191.	Male genitalia of <i>H. scalaris</i> , lateral	503
192.	Phallus of <i>H. scalaris</i> , ventral	503
193.	Phallus of <i>H. scalaris</i> , lateral	503
194.	Phallus of <i>H. bidens</i> , lateral	503
195.	Phallus of <i>H. bidens</i> , ventral	503
196.	Phallus of <i>H. alvata</i> , ventral	503
197.	Phallus of <i>H. betteni</i> , lateral	503
198.	Male genitalia of <i>Macrostemum carolina</i> , lateral	505
199.	Male tergum X of <i>M. carolina</i> , dorsal	505
200.	Male genitalia of <i>H. doringa</i> , lateral	505
201.	Male genitalia of <i>D. modesta</i> , lateral	505
202.	Male genitalia of <i>S. fasciatella</i> , lateral	505
203.	Male genitalia of <i>P. flava</i> , lateral	505
204.	Larval habitus of <i>L. pictipes</i> , dorsal	507
205.	Larval legs of <i>Oxyethira</i> sp., dorsal	507

206.	Posterior end of larval abdomen of <i>Hydroptila</i> sp., dorsal	507
207.	Larval prothoracic leg of <i>Dibusa angata</i> , dorsal	507
208.	Larval mesonotum of <i>Hydroptila</i> sp., lateral	507
209.	Larval mesonotum of <i>Ochrotrichia</i> sp., lateral	507
210.	Larval head of <i>Mayatrichia</i> sp., dorsal	507
211.	Dorsal abdominal seta of larval <i>D. angata</i>	507
212.	Larval habitus of <i>Ithytrichia clavata</i> , lateral	507
213.	Male genitalia of <i>D. angata</i> , lateral	509
214.	Phallus of <i>I. clavata</i> (redrawn from Ross 1944)	509
215.	Male genitalia of <i>I. clavata</i> , ventral (redrawn from Ross 1944)	509
216.	Male genitalia of <i>I. mazon</i> , ventral (redrawn from Ross 1944)	509
217.	Male genitalia of <i>M. ayama</i> , lateral (redrawn from Ross 1944)	509
218.	Male genitalia of <i>L. pictipes</i> , lateral (redrawn from Flint 1972)	509
219.	Male genitalia of <i>M. ponta</i> , lateral (redrawn from Ross 1944)	509
220.	Male genitalia of <i>H. virgata</i> , lateral (redrawn from Ross 1944)	511
221.	Male abdominal sternite VII process of <i>H. virgata</i> , lateral (redrawn from Ross 1944)	511
222.	Phallus of <i>H. virgata</i> (redrawn from Ross 1944)	511
223.	Phallus of <i>H. hamata</i> (redrawn from Ross 1944)	511
224.	Male abdominal sternite VII process of <i>H. hamata</i> , lateral (redrawn from Ross 1944)	511

225.	Male genitalia of <i>H. artesa</i> , lateral (redrawn from Mathis and Bowles 1990)	511
226.	Male tergum X of <i>H. artesa</i> , dorsal (redrawn from Mathis and Bowles 1990)	511
227.	Phallus of <i>H. artesa</i> (redrawn from Mathis and Bowles 1990)	511
228.	Male tergum X of <i>H. oneili</i> , dorsal (redrawn from Harris 1985)	511
229.	Phallus of <i>H. remita</i>	511
230.	Male tergum X of <i>H. sandersoni</i> , dorsal (redrawn from Mathis and Bowles 1990)	511
231.	Male genitalia of <i>H. sandersoni</i> , lateral (redrawn from Mathis and Bowles 1990)	511
232.	Phallus of <i>H. sandersoni</i> (redrawn from Mathis and Bowles 1990)	511
233.	Male tergum X of <i>H. amoena</i> , dorsal (redrawn from Harris 1985)	511
234.	Male genitalia of <i>H. spatulata</i> , lateral (redrawn from Ross 1944)	513
235.	Apex of phallus of <i>H. spatulata</i> (redrawn from Ross 1944)	513
236.	Male genitalia of <i>H. armata</i> , lateral (redrawn from Ross 1944)	513
237.	Apex of phallus of <i>H. armata</i> , lateral (redrawn from Ross 1944)	513
238.	Male genitalia of <i>H. vala</i> , lateral (redrawn from Ross 1944)	513
239.	Male genitalia of <i>H. grandiosa</i> , lateral (redrawn from Ross 1944)	513
240.	Male genitalia of <i>H. delineata</i> , ventral (redrawn from Ross 1944)	513
241.	Male genitalia of <i>H. waubesiana</i> , ventral (redrawn from Ross 1944)	513
242.	Phallus of <i>H. quinola</i> (redrawn from Ross 1947)	515

243.	Male genitalia of <i>H. quinola</i> , ventral (redrawn from Ross 1947)	515
244.	Male genitalia of <i>H. broweri</i> , ventral (redrawn from Blickle 1963) . . .	515
245.	Phallus of <i>H. broweri</i> (redrawn from Blickle 1963)	515
246.	Phallus of <i>H. scolops</i> (redrawn from Ross 1944)	515
247.	Male genitalia of <i>H. scolops</i> (redrawn from Ross 1944)	515
248.	Inferior appendages of <i>H. bernerii</i> , ventral (redrawn from Ross 1941b)	515
249.	Phallus of <i>H. bernerii</i> (redrawn from Ross 1941b)	515
250.	Phallus of <i>H. strepha</i> (redrawn from Ross 1941b)	515
251.	Inferior appendages of <i>H. strepha</i> , ventral (redrawn from Ross 1941b)	515
252.	Male genitalia of <i>H. melia</i> , lateral (redrawn from Ross 1938a)	517
253.	Male tergum X of <i>H. melia</i> , dorsal (redrawn from Ross 1938a)	517
254.	Phallus of <i>H. melia</i> (redrawn from Ross 1938a)	517
255.	Male genitalia of <i>H. tusculum</i> , lateral (redrawn from Ross 1947) . . .	517
256.	Male genitalia of <i>H. tusculum</i> , ventral (redrawn from Ross 1947) . . .	517
257.	Male genitalia of <i>H. albicornis</i> , lateral (redrawn from Ross 1944) . . .	517
258.	Inferior appendages of <i>H. albicornis</i> , ventral (redrawn from Ross 1944)	517
259.	Phallus of <i>H. albicornis</i> (redrawn from Ross 1944)	517
260.	Inferior appendages of <i>H. angusta</i> , ventral (redrawn from Ross 1944)	517

261.	Phallus of <i>H. angusta</i> (redrawn from Ross 1944)	517
262.	Male genitalia of <i>H. consimilis</i> , ventral (redrawn from Ross 1944) . .	519
263.	Phallus of <i>H. consimilis</i> (redrawn from Ross 1944)	519
264.	Male tergum X of <i>H. protera</i> , dorsal (redrawn from Ross 1938a) . . .	519
265.	Phallus of <i>H. protera</i> (redrawn from Ross 1938a)	519
266.	Male tergum X of <i>H. perdita</i> , dorsal (redrawn from Ross 1944)	519
267.	Inferior appendages of <i>H. perdita</i> , ventral, (redrawn from Ross 1944)	519
268.	Phallus of <i>H. perdita</i> , (redrawn from Ross 1944)	519
269.	Male genitalia of <i>H. ajax</i> , lateral, (redrawn from Ross 1944)	519
270.	Phallus of <i>H. ajax</i> , (redrawn from Ross 1944)	519
271.	Inferior appendages of <i>H. ajax</i> , ventral, (redrawn from Ross 1944) . .	519
272.	Inferior appendages of <i>H. icona</i> , ventral, (redrawn from Ross 1944)	519
273.	Male genitalia of <i>Neotrichia kitae</i> , lateral, (redrawn from Ross 1944)	521
274.	Male genitalia of <i>N. kitae</i> , ventral, (redrawn from Ross 1944)	521
275.	Male genitalia of <i>N. collata</i> , ventral, (redrawn from Ross 1944)	521
276.	Phallus of <i>N. collata</i> , (redrawn from Ross 1944)	521
277.	Phallus of <i>N. riegeli</i> , (redrawn from Ross 1944)	521
278.	Male genitalia of <i>N. riegeli</i> , ventral, (redrawn from Ross 1944)	521

279.	Male genitalia of <i>N. okopa</i> , ventral, (redrawn from Ross 1944)	521
280.	Phallus of <i>N. arkansasensis</i> , (redrawn from Mathis and Bowles 1990)	521
281.	Male genitalia of <i>N. arkansasensis</i> , ventral, (redrawn from Mathis and Bowles 1990)	521
282.	Male genitalia of <i>N. minutisimella</i> , lateral, (redrawn from Ross 1944)	523
283.	Inferior appendages of <i>N. minutisimella</i> , ventral, (redrawn from Ross 1944)	523
284.	Male genitalia of <i>N. vibrans</i> , ventral, (redrawn from Ross 1944)	523
285.	Phallus of <i>N. vibrans</i> , (redrawn from Ross 1944)	523
286.	Phallus of <i>N. edalis</i> , (redrawn from Ross 1944)	523
287.	Male genitalia of <i>N. edalis</i> , ventral, (redrawn from Ross 1944)	523
288.	Male genitalia of <i>Ochrotrichia (Metrichia) nigritta</i> , lateral	525
289.	Phallus of <i>O. (M.) nigritta</i>	525
290.	Male genitalia of <i>O. xena</i> , dorsal	525
291.	Male genitalia of <i>O. unio</i> , dorsal	525
292.	Male tergum X of <i>O. weddleae</i> , dorsal	525
293.	Male genitalia of <i>O. weddleae</i> , lateral	525
294.	Male genitalia of <i>O. robisoni</i> , lateral, (redrawn from Frazier and Harris 1991)	525
295.	Male tergum X of <i>O. robisoni</i> , dorsal, (redrawn from Frazier and Harris 1991)	525

296.	Male tergum X of <i>O. contorta</i> , dorsal, (redrawn from Frazier and Harris 1991)	525
297.	Male tergum X of <i>O. anisca</i> , dorsal, (redrawn from Frazier and Harris 1991)	525
298.	Male tergum X of <i>O. shawnee</i> , dorsal, (redrawn from Frazier and Harris 1991)	525
299.	Male tergum X of <i>O. tarsalis</i> , dorsal, (redrawn from Frazier and Harris 1991)	525
300.	Male tergum X of <i>O. stylata</i> , dorsal, (redrawn from Ross 1938a) . . .	525
301.	Male genitalia of <i>O. riesi</i> , dorsal, (redrawn from Ross 1944)	527
302.	Inferior appendages of <i>O. riesi</i> , ventral, (redrawn from Ross 1944) .	527
303.	Male genitalia of <i>O. spinosa</i> , dorsal, (redrawn from Ross 1944) . . .	527
304.	Inferior appendages of <i>O. spinosa</i> , ventral, (redrawn from Ross 1944)	527
305.	Male genitalia of <i>O. eliaga</i> , dorsal, (redrawn from Ross 1944)	527
306.	Inferior appendages of <i>O. eliaga</i> , ventral, (redrawn from Ross 1944)	527
307.	Male genitalia of <i>O. arva</i> , dorsal, (redrawn from Ross 1944)	527
308.	Inferior appendages of <i>O. arva</i> , ventral, (redrawn from Ross 1944) .	527
309.	Male genitalia of <i>Oxyethira azteca</i> , ventral, (redrawn from Kelley 1982)	529
310.	Male genitalia of <i>O. azteca</i> , lateral, (redrawn from Kelley 1982)	529
311.	Male genitalia of <i>O. janella</i> , ventral, (redrawn from Kelley 1982) . . .	529

312.	Male genitalia of <i>O. janella</i> , lateral, (redrawn from Kelley 1982)	529
313.	Male genitalia of <i>O. pallida</i> , lateral, (redrawn from Kelley 1982)	529
314.	Phallus of <i>O. pallida</i> , (redrawn from Kelley 1982)	529
315.	Male genitalia of <i>O. novasota</i> , lateral, (redrawn from Kelley 1982) . .	531
316.	Phallus of <i>O. novasota</i> , (redrawn from Kelley 1982)	531
317.	Male genitalia of <i>O. rivicola</i> , lateral, (redrawn from Kelley 1982) . . .	531
318.	Phallus of <i>O. rivicola</i> , (redrawn from Kelley 1982)	531
319.	Male genitalia of <i>O. coercens</i> , lateral, (redrawn from Kelley 1982) . .	531
320.	Phallus of <i>O. coercens</i> , (redrawn from Kelley 1982)	531
321.	Male genitalia of <i>O. aculea</i> , lateral, (redrawn from Kelley 1982)	531
322.	Phallus of <i>O. aculea</i> , (redrawn from Kelley 1982)	531
323.	Male genitalia of <i>O. glasa</i> , lateral, (redrawn from Kelley 1982)	533
324.	Phallus of <i>O. glasa</i> , (redrawn from Kelley 1982)	533
325.	Male genitalia of <i>O. zeronia</i> , lateral, (redrawn from Kelley 1982) . . .	533
326.	Phallus of <i>O. zeronia</i> , (redrawn from Kelley 1982)	533
327.	Male genitalia of <i>O. forcipata</i> , lateral, (redrawn from Kelley 1982) . .	533
328.	Phallus of <i>O. forcipata</i> , (redrawn from Kelley 1982)	533
329.	Male genitalia of <i>O. dualis</i> , lateral, (redrawn from Kelley 1982)	533
330.	Phallus of <i>O. dualis</i> , (redrawn from Kelley 1982)	533
331.	Male genitalia of <i>Orthotrichia cristata</i> , ventral,	535

332.	Male genitalia of <i>O. aegerfasciella</i> , ventral, (redrawn from Ross 1944)	535
333.	Male genitalia of <i>O. instabilis</i> , ventral	535
334.	Male genitalia of <i>Paucicalcaria ozarkensis</i> , lateral, (redrawn from Mathis and Bowles 1989)	535
335.	Male genitalia of <i>Stactobiella palmata</i> , ventral	535
336.	Bracteole of <i>S. palmata</i> , lateral	535
337.	Male genitalia of <i>S. delira</i> , ventral	535
338.	Male genitalia of <i>Lepidostoma libum</i> , lateral	537
339.	Male genitalia of <i>L. lescheni</i> , lateral, (redrawn from Bowles <i>et al.</i> 1994)	537
340.	Head of adult male <i>L. lescheni</i> , lateral, (redrawn from Bowles <i>et al.</i> 1994)	537
341.	Head of adult male <i>L. griseum</i> , lateral	537
342.	Male genitalia of <i>L. griseum</i> , lateral	537
343.	Male genitalia of <i>L. carrolli</i> , lateral	537
344.	Male genitalia of <i>L. ozarkense</i> , lateral	537
345.	Male genitalia of <i>L. togatum</i> , lateral	537
346.	Larval mesothoracic leg of <i>Leptocerus americanus</i> , posterior	539
347.	Larval metathoracic leg of <i>Nectopsyche diarina</i> , posterior	539
348.	Larval metathoracic leg of <i>Mystacides sepulchralis</i> , posterior	539
349.	Larval head of <i>Oecetis</i> sp., dorsal	539

350.	Larval head of <i>N. diarina</i> , dorsal	539
351.	Anal region of larval <i>Setodes oxapius</i> , ventrocaudal	539
352.	Larval head of <i>M. sepulchralis</i> , ventral	539
353.	Larval head of <i>N. diarina</i> , ventral	539
354.	Forewing of male <i>Triaenodes dipsius</i>	541
355.	Forewing of male <i>O. inconspicua</i>	541
356.	Forewing of male <i>Ceraclea maccalmonti</i>	541
357.	Head of male <i>C. maccalmonti</i> , dorsal	541
358.	Head of male <i>M. sepulchralis</i> , dorsal	541
359.	Mesopleuron of <i>C. maccalmonti</i>	541
360.	Mesopleuron of <i>N. exquisita</i>	541
361.	Larval head, pro- and mesonotum of <i>C. transversa</i> , (redrawn from Resh 1976a)	543
362.	Anal proleg of <i>C. punctata</i> , lateral, (redrawn from Resh 1976a)	543
363.	Larval mesonotum of <i>C. cancellata</i> , (redrawn from Resh 1976a)	543
364.	Larval mesonotum of <i>C. maculata</i> , (redrawn from Resh 1976a)	543
365.	Larval case of <i>C. maccalmonti</i> (from Moulton and Stewart 1992)	543
366.	Larval head, pro- and mesonotum of <i>C. maccalmonti</i> , (modified from Moulton and Stewart 1992)	543
367.	Larval mesonotum of <i>C. ancyllus</i> , (redrawn from Resh 1976a)	543
368.	Larval mesonotum of <i>C. flava</i> , (redrawn from Resh 1976a)	543

369.	Larval case of <i>C. flava</i>	543
370.	Male genitalia of <i>C. flava</i> , lateral	545
371.	Inferior appendages of <i>C. flava</i> , ventral	545
372.	Inferior appendages of <i>C. ancylus</i> , ventral	545
373.	Male genitalia of <i>C. ancylus</i> , lateral	545
374.	Male genitalia of <i>C. maccalmonti</i> , lateral	545
375.	Inferior appendage of <i>C. maccalmonti</i> , caudal	545
376.	Male genitalia of <i>C. nepha</i> , lateral	545
377.	Male genitalia of <i>C. protonepha</i> , lateral	545
378.	Phallus of <i>C. protonepha</i> , lateral	545
379.	Male genitalia of <i>C. tarsipunctata</i> , lateral	545
380.	Phallus of <i>C. tarsipunctata</i> , lateral	545
381.	Male genitalia of <i>C. transversus</i> , lateral	545
382.	Inferior appendage of <i>C. transversus</i> , caudal	547
383.	Male tergum X of <i>C. transversus</i> , dorsal	547
384.	Male genitalia of <i>C. resurgens</i> , lateral	547
385.	Inferior appendage of <i>C. resurgens</i> , caudal	547
386.	Male genitalia of <i>C. punctata</i> , lateral	547
387.	Male genitalia of <i>C. maculata</i> , lateral	547
388.	Male genitalia of <i>C. cancellata</i> , lateral	547

389.	Male genitalia of <i>C. ophioderus</i> , lateral	547
390.	Male genitalia of <i>Nectopsyche candida</i> , lateral	549
391.	Male sternite IX processes of <i>N. candida</i> , ventral	549
392.	Male genitalia of <i>N. exquisita</i> , lateral	549
393.	Forewing of <i>N. exquisita</i>	549
394.	Male genitalia of <i>N. pavidata</i> , lateral	549
395.	Male genitalia of <i>N. diarina</i> , lateral	549
396.	Male genitalia of <i>N. spiloma</i> , lateral	549
397.	Male head of <i>N. diarina</i> , ventral	549
398.	Male head of <i>N. spiloma</i> , ventral	549
399.	Male genitalia of <i>Oecetis ouachita</i> , lateral	551
400.	Male genitalia of <i>O. ozarkensis</i> , lateral	551
401.	Male genitalia of <i>O. eddlestoni</i> , lateral	551
402.	Male genitalia of <i>O. persimilis</i> , lateral	551
403.	Phallus of <i>O. persimilis</i> , lateral	551
404.	Male genitalia of <i>O. osteni</i> , lateral	551
405.	Male genitalia of <i>O. cinerascens</i> , lateral	551
406.	Inferior appendages of <i>O. cinerascens</i> , ventral	551
407.	Male genitalia of <i>O. avara</i> , lateral	551
408.	Male genitalia of <i>O. inconspicua</i> , lateral	553

409.	Phallus of <i>O. inconspicua</i> , lateral	553
410.	Inferior appendages of <i>O. inconspicua</i> , ventral	553
411.	Male genitalia of <i>O. ditissa</i> , lateral	553
412.	Phallus of <i>O. ditissa</i> , lateral	553
413.	Inferior appendages of <i>O. ditissa</i> , ventral	553
414.	Male genitalia of <i>O. nocturna</i> , lateral	553
415.	Inferior appendages of <i>O. nocturna</i> , ventral	553
416.	Male genitalia of <i>Leptocerus americanus</i> , lateral	555
417.	Male genitalia of <i>Mystacides sepulchralis</i> , lateral	555
418.	Male sternite IX of <i>M. sepulchralis</i>	555
419.	Male genitalia of <i>Setodes oxapius</i> , lateral	555
420.	Male genitalia of <i>S. oxapius</i> , variant, lateral	555
421.	Male genitalia of <i>Triaenodes smithi</i> , lateral, (redrawn from Ross 1959)	555
422.	Male genitalia of <i>T. ignitus</i> , lateral	557
423.	Male genitalia of <i>T. injustus</i> , lateral	557
424.	Male tergum X of <i>T. injustus</i>	557
425.	Male genitalia of <i>T. tridentatus</i> , lateral	557
426.	Male genitalia of <i>T. abus</i> , lateral	557
427.	Male genitalia of <i>T. nox</i> , lateral	557

428.	Male genitalia of <i>T. ochraceus</i> , lateral	557
429.	Male genitalia of <i>T. pernus</i> , lateral	557
430.	Male genitalia of <i>T. melacus</i> , lateral	559
431.	Male genitalia of <i>T. flavescens</i> , lateral	559
432.	Male tergum X of <i>T. flavescens</i>	559
433.	Male genitalia of <i>T. dipsius</i> , lateral	559
434.	Male genitalia of <i>T. tardus</i> , lateral	559
435.	Male tergum X of <i>T. tardus</i>	559
436.	Male genitalia of <i>T. cumberlandensis</i> , lateral	559
437.	Male tergum X of <i>T. cumberlandensis</i>	559
438.	Male genitalia of <i>T. marginatus</i> , lateral	559
439.	Male tergum X of <i>T. marginatus</i>	559
440.	Forewing of male <i>Platycentropus radiatus</i>	561
441.	Forewing of male <i>Frenesia missa</i>	561
442.	Forewing of male <i>Glyphopsyche missouri</i>	561
443.	Forewing of male <i>Ironoquia punctatissima</i>	561
444.	Forewing of male <i>Pseudostenophylax uniformis</i>	561
445.	Forewing of male <i>Limnephilus submonilifer</i>	561
446.	Forewing of male <i>P. guttifer</i>	561
447.	Forewing of male <i>P. rossi</i>	561

448.	Forewing of male <i>P. lepida</i>	561
449.	Forewing of male <i>P. indiana</i>	561
450.	Forewing of male <i>P. subfasciata</i>	561
451.	Male genitalia of <i>P. radiatus</i> , lateral	563
452.	Phallus of <i>P. radiatus</i> , lateral	563
453.	Male genitalia of <i>F. missa</i> , lateral	563
454.	Phallus of <i>F. missa</i> , lateral	563
455.	Male genitalia of <i>G. missouri</i> , lateral	563
456.	Phallus of <i>G. missouri</i> , lateral	563
457.	Male genitalia of <i>I. punctatissima</i> , lateral	565
458.	Male genitalia of <i>I. kaskaskia</i> , lateral	565
459.	Male genitalia of <i>P. uniformis</i> , lateral	565
460.	Phallus of <i>P. uniformis</i> , lateral	565
461.	Male genitalia of <i>L. submonilifer</i> , lateral	565
462.	Phallus of <i>L. submonilifer</i> , lateral	565
463.	Male genitalia of <i>P. guttifer</i> , lateral	567
464.	Inferior appendage of <i>P. guttifer</i> , caudal	567
465.	Tergum VIII of male <i>P. rossi</i> , lateral	567
466.	Inferior appendage of <i>P. rossi</i> , caudal	567
467.	Inferior appendage of <i>P. scabripennis</i> , caudal	567

468.	Tergum VIII of male <i>P. lepida</i> , dorsal	567
469.	Inferior appendage of <i>P. lepida</i> , caudal	567
470.	Phallus of <i>P. lepida</i> , lateral	567
471.	Phallus of <i>P. indiana</i> , lateral	567
472.	Phallus of <i>P. subfasciata</i> , lateral	567
473.	Inferior appendage of <i>P. subfasciata</i> , caudal	567
474.	Male genitalia of <i>P. subfasciata</i> , lateral	567
475.	Larval head of <i>Molanna ulmerina</i> , dorsal	569
476.	Larval prothoracic leg of <i>M. ulmerina</i>	569
477.	Larval head of <i>M. uniophila</i> , dorsal	569
478.	Larval prothoracic leg of <i>M. blenda</i>	569
479.	Male genitalia of <i>M. uniophila</i> , lateral	569
480.	Male genitalia of <i>M. blenda</i> , lateral	569
481.	Male genitalia of <i>M. ulmerina</i> , lateral	569
482.	Subgenital plate of female <i>M. blenda</i> , ventral	569
483.	Subgenital plate of female <i>M. uniophila</i> , ventral	569
484.	Hindwing of <i>M. ulmerina</i> , dorsal	569
485.	Male genitalia of <i>Marilia flexuosa</i> , lateral	571
486.	Phallus of <i>M. flexuosa</i> , lateral	571
487.	Forewing of male <i>M. flexuosa</i> , dorsal	571

488.	Larval head of <i>M. flexuosa</i> , dorsal	571
489.	Larval head of <i>M. sp. A</i> , dorsal	571
490.	Larval head of <i>M. sp. A</i> , ventral	571
491.	Larval thorax of <i>M. sp. A</i> , dorsal	571
492.	Larval case of <i>M. sp. A</i>	571
493.	Larval head of <i>Chimarra sp.</i> , dorsal	573
494.	Larval head of <i>Wormaldia sp.</i> , dorsal	573
495.	Hindwing of <i>Chimarra sp</i>	573
496.	Hindwing of <i>Wormaldia sp</i>	573
497.	Male genitalia of <i>C. obscura</i> , lateral	573
498.	Male genitalia of <i>C. feria</i> , lateral	573
499.	Inferior appendage of <i>C. feria</i> , caudal	573
500.	Male genitalia of <i>C. aterrima</i> , lateral	573
501.	Inferior appendage of <i>C. aterrima</i> , caudal	573
502.	Male genitalia of <i>C. parasocia</i> , lateral	575
503.	Dorsal phallic rod of <i>C. parasocia</i> , lateral	575
504.	Male genitalia of <i>C. socia</i> , lateral	575
505.	Dorsal phallic rod of <i>C. socia</i> , lateral	575
506.	Male genitalia of <i>C. moseleyi</i> , lateral	575
507.	Phallus of <i>C. moseleyi</i> , dorsal	575

508.	Male genitalia of <i>W. moesta</i> , lateral	575
509.	Male genitalia of <i>W. strota</i> , lateral	575
510.	Male tergum X of <i>W. strota</i> , dorsal	575
511.	Male genitalia of <i>W. shawnee</i> , lateral	575
512.	Male tergum X of <i>W. shawnee</i> , dorsal	575
513.	Male genitalia of <i>Agrypnia vestita</i> , lateral	577
514.	Phallus of <i>A. vestita</i> , lateral	577
515.	Male genitalia of <i>Phryganea sayi</i> , lateral	577
516.	Phallus of <i>P. sayi</i> , lateral	577
517.	Male genitalia of <i>Ptilostomis ocellifera</i> , lateral	577
518.	Phallus of <i>P. ocellifera</i> , lateral	577
519.	Male genitalia of <i>P. postica</i> , lateral	577
520.	Phallus of <i>P. postica</i> , lateral	577
521.	Anteroapical margin of female forewing of <i>P. postica</i>	579
522.	Anteroapical margin of female forewing of <i>A. vestita</i>	579
523.	Vaginal apparatus of <i>P. ocellifera</i> , lateral	579
524.	Vaginal apparatus of <i>P. postica</i> , lateral	579
525.	Female genitalia of <i>P. sayi</i> , ventral	579
526.	Female genitalia of <i>A. vestita</i> , ventral	579
527.	Larval head of <i>Neureclipsis crepuscularis</i> , dorsal	581

528.	Larval anal proleg of <i>N. crepuscularis</i> , lateral	581
529.	Larval anal claw of <i>Nyctiophylax</i> sp., lateral	581
530.	Larval anal proleg of <i>Cyrnellus fraternus</i> , dorsal	581
531.	Larval anal proleg of <i>Polycentropus</i> sp., dorsal	581
532.	Larval anal proleg of <i>Polycentropus</i> sp., lateral	581
533.	Larval anal proleg of <i>P. crassicornis</i> , lateral	581
534.	Larval head and pronotum of <i>P. crassicornis</i> , dorsal	581
535.	Forewing of male <i>Phylocentropus placidus</i>	583
536.	Male genitalia of <i>P. placidus</i> , lateral	583
537.	Inferior appendage of <i>P. placidus</i> , caudal	583
538.	Fore- and hindwing of <i>P. centralis</i>	583
539.	Hindwing of <i>P. harpi</i>	583
540.	Hindwing of <i>N. crepuscularis</i>	583
541.	Maxillary palpus of <i>C. fraternus</i> , lateral	583
542.	Maxillary palpus of <i>N. affinis</i> , lateral	583
543.	Male genitalia of <i>P. nascotius</i> , lateral, (redrawn from Ross 1941) . . .	583
544.	Male genitalia of <i>Cernotina calcea</i> , lateral	585
545.	Male genitalia of <i>C. spicata</i> , lateral	585
546.	Male genitalia of <i>C. oklahoma</i> , lateral	585
547.	Male genitalia of <i>C. fraternus</i> , lateral	585

548.	Inferior appendage of <i>C. fraternus</i> , caudal	585
549.	Male genitalia of <i>N. crepuscularis</i> , lateral	585
550.	Male genitalia of <i>N. serratus</i> , lateral	585
551.	Posteroapical margin of tergum X of male <i>N. serratus</i> , lateral	585
552.	Male genitalia of <i>N. affinis</i> , lateral	585
553.	Inferior appendage of <i>N. affinis</i> , caudal	585
554.	Male genitalia of <i>N. moestus</i> , lateral, (redrawn from Morse 1972)	585
555.	Inferior appendage of <i>N. moestus</i> , caudal, (redrawn from Morse 1972)	585
556.	Dorsobasal process of inferior appendage of <i>P. centralis</i> , caudal	587
557.	Dorsobasal process of inferior appendage of <i>P. stephani</i> , caudal	587
558.	Male genitalia of <i>P. chelatus</i> , lateral	587
559.	Phallus of <i>P. chelatus</i> , lateral	587
560.	Male genitalia of <i>P. stephani</i> , lateral, paratype	587
561.	Phallus of <i>P. stephani</i> , lateral, paratype	587
562.	Male genitalia of <i>P. confusus</i> , lateral	587
563.	Phallus of <i>P. confusus</i> , lateral	587
564.	Male genitalia of <i>P. centralis</i> , lateral	587
565.	Phallus of <i>P. centralis</i> , lateral	587
566.	Male genitalia of <i>P. crassicornis</i> , lateral	587

567.	Male genitalia of <i>P. cinereus</i> , lateral	587
568.	Phallus of <i>P. cinereus</i> , dorsal	587
569.	Phallus of <i>P. harpi</i> , dorsal, paratype	587
570.	Male genitalia of <i>P. harpi</i> , lateral, paratype	587
571.	Larval habitus of <i>Paduniella nearctica</i> , dorsal	589
572.	Larval head of <i>Psychomyia flavida</i> , dorsal	589
573.	Adult maxillary palpus of male <i>P. nearctica</i> , lateral	589
574.	Hindwing of <i>P. flavida</i>	589
575.	Hindwing of <i>Lype diversa</i>	589
576.	Male genitalia of <i>P. flavida</i> , lateral	589
577.	Male tergum X of <i>P. flavida</i> , caudal	589
578.	Male genitalia of <i>L. diversa</i> , lateral	589
579.	Male genitalia of <i>P. nearctica</i> , lateral	589
580.	Larval head of <i>Rhyacophila glaberimma</i> , dorsal	591
581.	Larval maxillary palpus of <i>R. glaberimma</i>	591
582.	Larval head of <i>R. lobifera</i> , dorsal	591
583.	Larval anal claw of <i>R. lobifera</i> , lateral	591
584.	Larval head of <i>R. banksi</i> , dorsal	591
585.	Larval anal claw of <i>R. banksi</i> , lateral	591
586.	Larval head of <i>R. fenestra</i> , dorsal	591

587.	Larval maxillary palpus of <i>R. fenestra</i>	591
588.	Larval head of <i>R. kiamichi</i> , dorsal	591
589.	Male genitalia of <i>R. glaberimma</i> , lateral	593
590.	Phallus of <i>R. glaberimma</i> , lateral	593
591.	Male genitalia of <i>R. lobifera</i> , lateral	593
592.	Phallus of <i>R. lobifera</i> , lateral	593
593.	Male genitalia of <i>R. banksi</i> , lateral	593
594.	Male genitalia of <i>R. kiamichi</i> , lateral	593
595.	Phallus of <i>R. kiamichi</i> , lateral	593
596.	Male genitalia of <i>R. fenestra</i> , lateral	593
597.	Phallus of <i>R. fenestra</i> , lateral	593
598.	Male genitalia of <i>R. ledra</i> , lateral	595
599.	Phallus of <i>R. ledra</i> , lateral	595
600.	Female sternite VIII of <i>R. lobifera</i>	595
601.	Female sternite VIII of <i>R. glaberimma</i>	595
602.	Female sternite VIII of <i>R. banksi</i>	595
603.	Female tergite VIII of <i>R. fenestra</i>	595
604.	Female tergite VIII of <i>R. kiamichi</i>	595
605.	Male genitalia of <i>Neophylax concinnus</i> , lateral	597
606.	Female genitalia of <i>N. concinnus</i> , ventral	597

607.	Larval head of <i>N. concinnus</i> , lateral	597
608.	Larval head of <i>N. concinnus</i> , dorsal	597
609.	Male genitalia of <i>N. fuscus</i> , lateral	597
610.	Female genitalia of <i>N. fuscus</i> , ventral	597
611.	Larval head of <i>N. fuscus</i> , dorsal	597
612.	Distributions of five endemic Annulipalpia species. <i>Agapetus artesus</i> (solid circle), <i>Agapetus medicus</i> (solid square), <i>Protoptila</i> species A (solid triangle), <i>Rhyacophila kiamichi</i> (open circle), <i>Wormaldia strotta</i> (open square)	599
613.	Distributions of five endemic Annulipalpia species. <i>Ceratopsyche piatrix</i> (solid circle), <i>Cheumatopsyche robisoni</i> (solid square), <i>Cheumatopsyche rossi</i> (solid triangle), <i>Polycentropus stephani</i> (open circle), <i>Paduniella nearctica</i> (open square)	599
614.	Distributions of seven endemic Annulipalpia. <i>Hydroptila artesa</i> (solid circle), <i>Neotrichia arkansasensis</i> (solid square), <i>Neotrichia kitae</i> (solid triangle), <i>Ochrotrichia contorta</i> (open circle), <i>Ochrotrichia robisoni</i> (open square), <i>Ochrotrichia weddleae</i> (open triangle), <i>Paucicalcaria ozarkensis</i> (asterisk)	599
615.	Distributions of six endemic Integripalpia species. <i>Ceraclea maccalmonti</i> (solid circle), <i>Helicopsyche limnella</i> (solid square), <i>Marilia</i> sp. A (solid triangle), <i>Oecetis ouachita</i> (open circle), <i>Oecetis ozarkana</i> (open square), <i>Setodes oxapius</i> (open triangle)	601
616.	Distributions of four endemic Integripalpia species. <i>Glyphopsyche missouri</i> (asterisk), <i>Lepidostoma lescheni</i> (solid circle), <i>Lepidostoma ozarkense</i> (solid square), <i>Micrasema ozarkana</i> (solid triangle)	601

CHAPTER 1

INTRODUCTION

Caddisflies (Trichoptera) are a small group of holometabolus aquatic insects known from every major biogeographic faunal region except Antarctica. Their World diversity has been variously estimated between 7,000 and 50,000 species (Schmid 1984, Wiggins 1990). Morse (1993) listed 1653 species, representing 164 genera in 24 families for North America (including Greenland and Mexico).

Larval caddisflies have exploited a wide range of permanent and temporary aquatic habitats, largely accommodated by their utilization of silk. Families other than Rhyacophilidae, are perhaps best known for their intricate retreats and portable cases, constructed of various combinations of silk, mineral and organic materials. Caddisflies play a major role as secondary producers in the cycling of nutrients in aquatic ecosystems (Rhame and Stewart 1976, Wiggins and Mackay 1978, Benke and Wallace 1980, Ross and Wallace 1983) and as dietary components of insectivorous fishes and other animals (Wiggins 1977, Robison and Buchanan 1988). Additionally, they are generally intolerant of adverse anthropogenic activities, and are therefore

considered to be excellent biological indicators of water quality (Ross 1967, Wiggins 1977, Hilsenhoff 1987, Jones *et al.* 1987). All life stages of caddisflies, except eggs, are recreationally important, since fly fishermen imitate them in artificial fly tying, and study their behavior to enhance their fishing presentation techniques (LaFontaine 1981, McCafferty 1981). These attributes combine to make caddisflies one of the most important aquatic insect orders in terms of their value to biodiversity and contribution to ecosystem integrity.

Despite this great importance, caddisflies are still relatively poorly known even in North America. There is a current emphasis on inventorying the rich caddisfly fauna and other aquatic faunas of Costa Rica and other tropical areas. The importance of such inventories in establishing a baseline of biodiversity and biogeographic and ecological affinities and associations against which the continued degradation of species and ecosystem diversity can be measured, are well documented (Wilson 1988, 1989, National Research Council Report 1980, International Congress of Entomology Resolution 1984, Office of Technological Assessment Task Force on Technologies to Maintain Biological Diversity 1988, Knutson 1989). Protection of aquatic diversity, including that of the riparian zone, is also an important problem in temperate regions. The risk to aquatic invertebrate biodiversity in temperate regions is great and continuing, yet has received little effective attention (Franklin 1988). Assessment and protection of biodiversity in temperate, as well as in tropical

systems such as those of major mountain regions of North America has been indicated as a priority of the highest order (Franklin 1988).

Distributional studies of caddisflies in North America have usually focused on political entities such as counties, states, and provinces; the fauna of major biogeographic regions such as mountain systems or physiographic provinces are known only to the extent that piece meal biogeographic or taxonomic studies can be meshed together. The last comprehensive faunal studies of Trichoptera in North America were those of Betten (1934), Ross (1944, 1956), and Denning (1956). Unzicker *et al.* (1982) presented an excellent review of the larval taxonomy and ecology of caddisflies in North and South Carolina. Family level taxonomy for larvae, pupae, and adults was recently updated by Wiggins (1984). This, and the comprehensive generic level treatments of larvae by Wiggins (1977) and Morse and Holzenthal (1984) have paved the way for more effective and comprehensive biogeographic treatment in North America. Ross (1944) and Schmid (1980) have remained the most useful generic references for identification of caddisfly pupae and adults.

Past Regional Trichoptera Studies

Despite the availability of published species checklists for the states occupying the Interior Highlands, including those peripherally (Table 1), little comprehensive attention has been given to the regional Trichoptera fauna. Regional checklists have been helpful additions to the knowledge of caddisfly distributions, but generally have not (except Hamilton *et al.* 1983) been related

to physiographic subregions, or watershed characteristics such as stream order/width, flow permanence, substrate type, and vegetation type.

Unzicker *et al.* (1970) published the first preliminary list of Arkansas caddisflies, documenting 105 species. Records from that study were concentrated in the northwestern corner of Arkansas in the vicinity of Fayetteville. The next serious attempt to survey the state occurred during the mid 1970's, when Henry W. Robison began making extensive light trap collections throughout Arkansas as part of a collaborative effort with J. Unzicker, S. Harris, and B. Armitage. This effort was subsequently abandoned upon publication of a checklist by Bowles and Mathis (1989) that documented 153 species for the mountainous areas of Arkansas. J. Howland and J. Unzicker began a survey of the Missouri caddisflies *circa* 1975 (Guenter A. Schuster, pers. comm.) and later drafted a manuscript which documented 104 species. This manuscript was never published, and their material has the care of G. Schuster at Eastern Kentucky University (Richmond, KY). During the late 1980's M. Mathis and D. Bowles began compiling records for Missouri (Mathis and Bowles 1992) and Oklahoma (Bowles and Mathis 1992) in conjunction with their Arkansas work. These lists were useful compilations from previous literature, survey of some museum collections and sampling in these states. They were not comprehensive treatments of the fauna based on designed sampling as in this present study, and did not include some prior species discoveries, name changes and revisions.

Poulton and Stewart (1991) completed a comprehensive monographic treatment of the Plecoptera of the Ozark-Ouachita Mountain region. Their work established a framework for this and future regional companion studies. Herein I present 1) a comprehensive listing of regional caddisfly biodiversity, based on previous studies, additional museum survey and extensive sampling by myself and several colleagues, 2) illustrated keys to the larvae and adults of families and genera of the region, and species of all adults and larvae of selected groups that we were able to rear, 3) an examination of species affinities with key environmental and physiographic variables, and 4) an examination of biogeographic relationships of the Interior Highlands fauna to that of other intra-continental regions.

Description of the Study Area

I recognize Allen's definition of the Interior Highlands as the area including the Ozark, Ouachita, Arbuckle and Wichita Mountains (Fig. 1)(Allen 1990). These mountainous areas cover approximately 400,000 km² of land in portions of Arkansas, Illinois, Missouri, and Oklahoma. Pfeleiger (1975), Rafferty (1980, 1982), Robison and Buchanan (1988) and Stroud and Hanson (1981) have variously subdivided this region based on distinct topographical, geological, vegetational, and climatic zones. For comparative purposes, I follow the 15 subdivisions recognized by Poulton and Stewart (1991) and add two additional subregions (Fig. 2). These subregions are: 1) Ouachita Mountains, 2) Boston Mountains, 3) Springfield Plateau, 4) White River Hills, 5)

Central Plateau, 6) Osage-Gasconade Hills, 7) Curtois Hills, 8) St. Francois Mountains, 9) Missouri River Border, 10) Mississippi River Uplands, 11) Illinois Ozarks, 12) Crowley's Ridge, 13) Mississippi River bottomland, 14) Gulf Coastal Plain, 15) Arkansas River Valley, 16) Arbuckle Mountains, and the 17) Wichita Mountains.

Elevations range from 182 m in the Mississippi River alluvial plain, to 860 m in the Ozark Mountains (Poulton and Stewart 1991). Mean air temperatures range from 2°C in January to 29°C in August (Petersen 1992). Mean annual precipitation ranges from 91 - 127 cm/yr, most of which occurs during the spring and fall (Poulton and Stewart 1991). Mean pH of regional streams ranges from 6.7 in the Ouachita Mountains and Gulf Coastal Plain to 7.8 in the Ozark Mountains. Mean water temperatures of streams not influenced by springs ranged from 5 to 28°C (Poulton and Stewart 1991, this study Fig. 3). Water temperatures of spring-fed streams exhibited a "winter warm - summer cool" thermal regime (Fig. 3).

Major vegetation types in the Ozark-Ouachita Mountains include loblolly and shortleaf pines (*Pinus* spp.), upland oaks (*Quercus* spp.) and hickories (*Carya* spp.), bottomland gum (*Nyssa* sp.) and cypress (*Taxodium* sp.), and prairie regions. Vegetation in the Arbuckle and Wichita Mountains are characterized by post and blackjack oaks (*Quercus stellata* and *Quercus marilandica*, respectively) and juniper (*Juniperus* sp.). Aquatic macrophytes in most regional streams were dominated by water willow (*Justicia*

americana)(Fig. 4). Large springs and streams with nearby spring input characteristically had dense growths of watercress (*Nasturtium* sp.)(Fig. 5).

The Interior Highlands were formed during periods of slow uplifting near the beginning of the Pleistocene glaciation (Udvardy 1969). They are geologically most similar to the Appalachian Mountains despite being separated by several hundred miles of coastal plain and alluvial areas (Thornbury 1965). Although the Ozark and Ouachita Mountains are tectonically unique from each other, there is considerable biological evidence to suggest that the two regions were once connected (Ross 1965, Mayden 1985). Mayden (1985) suggests that the event responsible for their separation was the evolution of the Arkansas River and its associated lowlands. Thornbury (1965) provided an excellent account of the geological history of the Interior Highlands. The brief synopsis provided below was adapted from his work.

The Ozark Mountains (Fig. 6) largely consist of low plateaus, although a few well dissected areas in the Boston Mountains subregion may exceed 610 m in elevation. Dominant geological formations in the Ozarks include limestones and dolomites except in the St. Francois and Boston Mountains subregions, where varieties of igneous rock and sandstone/shales occur, respectively. Chert is abundant and widespread throughout the Ozarks and may be responsible for obscuring a large number of sinkholes. Chert is so abundant and loosely packed in some streams that it permits substantial amounts of sub-surface flow. In these instances, termed "losing streams" (Fig.

7), there is no surface flow. Surface flow in these streams often reappears in the form of springs. The karst topography has accommodated the formation of a large number of high-volume springs in this area. These springs, most of which are located in Missouri, produce from 23 million to 954 million L of water per day. Although fairly constant in average daily flows during dry periods, many of these springs experience rapid fluctuations following surface runoff from storm events. Big Spring near Van Buren, Carter Co., Missouri, is the largest of the regional high-volume springs (Fig. 8). Its source has been traced with dye from losing streams up to 88 km away (Poulton and Stewart 1991).

The Ouachita Mountains consist of a series of strongly folded and faulted formations that results in marked east-west ranges extending through Arkansas and Oklahoma. Sedimentary rock types such as sandstone and shale, predominate except for igneous formations that appear scattered in areas between Hot Springs and Little Rock, Arkansas. Magazine Mountain in Logan Co., Arkansas, is the highest point in the Interior Highlands with an elevation of 860 m. Generally, elevations are highest and the topography is more pronounced in areas of the western Ouachita Mountains near the Arkansas/Oklahoma border. Although high-volume springs are noticeably absent in the Ouachita Mountains, small springs (Fig. 9) and seeps are common.

The Arbuckle Mountains lie in a small area of southcentral Oklahoma just north of the Red River and west of the Ouachita Mountains. The Arbuckles

may be more appropriately termed an "uplifted" area as elevations do not exceed 396 m. The dominant geological formations are comprised of granites and travertine limestone. The travertine geology is so apparent that several streams exhibit a turquoise blue color and any instream substrate (mineral or organic) is virtually encrusted with precipitating calcium carbonate. Small to medium sized springs are common in this area. The most notable attraction is the 25 m waterfall on Honey Creek in Turner Falls Park near Davis, Murray Co., Oklahoma (Fig. 10). This site is the type locality for several regional caddisfly species described by H. H. Ross during the 1930's and 40's.

Last in the series of mountainous areas that form the Interior Highlands are the Wichita Mountains. They are situated in southcentral Oklahoma, approximately 100 km west of the Arbuckle Mountains. Mount Scott is the highest point in the Wichitas at an elevation of 751 m. The geology is dominated by a variety of granite and sedimentary rocks.

Many of the regional headwater streams (orders 1-3) are completely dry or become intermittent during the summer months (Fig. 11). Poulton and Stewart (1991) noted that a few of the larger streams in the Ouachita Mountains were sluggish and sometimes intermittent. Several regional streams influenced by significant spring inputs were more thermally uniform compared to the extreme seasonal fluctuations observed in streams not fed by springs (Figs. 12, 13). Major navigable and regulated rivers in the region include the Mississippi, Arkansas, White, Ouachita (Fig. 14), and Red Rivers. According to

Benke (1990), the only regional rivers over 200 km in length that do not have any major physical alterations (e.g. dams) include the Blue (Oklahoma), Buffalo (Arkansas), Saline (Arkansas), Current (Arkansas and Missouri) and Gasconade (Missouri) Rivers. The Missouri Chapter of The Nature Conservancy first introduced the concept of a "National River" (Palmer 1986). In 1964, the Current River and its main tributary the Jacks Fork River, became the first national river system. Later in 1972, the Buffalo River became the second of only four national rivers to date (Benke 1990). According to Benke (1990), the National Rivers Inventory is currently monitoring 3368 km and 935 km of streams in the Ozark and Ouachita Mountains, respectively.

Despite the public praise for aesthetic, recreational, and economical rewards of streams, there is little awareness of the potential loss of their unique ecological characteristics and biological diversity (Benke 1990). The Interior Highlands are adversely impacted by a number of anthropogenic practices or accidents. The major problems include crude oil spills (Crunkilton and Duchrow 1990), mining (Duchrow 1983), clearcutting of timber (Fig. 15)(Matlock and Maughan 1988, Patterson 1990), and agricultural practices that include crop, livestock, and poultry farming. The Ozark and Ouachita Mountains are home to the largest concentration of poultry-producing operations in the world. This industry disposes more than a million tons of chicken manure per year (Anonymous 1994). I visited several streams in northwestern Arkansas and southwestern Missouri that were severely impacted

by organic enrichment as a result of waste runoff from nearby poultry farms. The Interior Highlands continue to be a popular tourist attraction and offer a diverse array of outdoor recreational activities. However, their national beauty has fallen victim to a proliferation of vacation and retirement communities (Anonymous 1994) and entertainment meccas. One such mecca, Branson, Missouri, received approximately 5.6 million visitors in 1993 (Branson Chamber of Commerce, pers. communication). Clearly, watersheds bordering these urban areas are affected by habitat destruction and polluted effluents from point and non-point sources.

CHAPTER 2

METHODS AND MATERIALS

Collecting Trips

Collections from over 500 different locations were made from representative lentic and lotic habitats in the 17 natural physiographic subregions (Fig. 2) and variable sized streams within the 131 natural watersheds (Fig. 16, Table 2). Access to most of these sites were determined from the detailed county maps prepared by the Arkansas, Missouri, and Oklahoma Departments of Transportation. A summary of counties is presented in Fig. 17.

Particular attention was paid to unique habitats such as waterfalls, spring seeps, bogs, and temporary pools (vernal and autumnal). Wiggins (1973) and Wiggins *et al.* (1980) have shown that several species of caddisflies have evolved specific mechanisms (e.g. egg diapause, non-aquatic oviposition, and gelatinous egg masses) for surviving in temporary habitats. Locations that had a high diversity and/or had been designated as caddisfly type localities were revisited seasonally.

Known seasonal emergence patterns were used to locate and obtain rare or infrequently collected species. Extensive collecting trips of approximately one week duration each were made monthly, except during the winter, from March 1990 through November 1992. These were designed to provide good seasonal and subregional/stream coverage. Additional limited collecting was conducted until March 1994. Turbidity, stream order, stream width, vegetation, flow permanence, drainage identification and subregion were recorded for each collection at every site. Water and air temperature, and pH were recorded for representative aquatic habitats in each watershed.

Immature stages were collected with dipnets, sieves or hand-picking from various substrates. Sieving sandy depositional areas proved to be an efficient method of collecting genera such as *Molanna* and *Setodes*. Hand-picking was particularly valuable in locating pupal cases which were adhered to substrates. Adults were collected using a variety of active and passive methods. Aerial and sweep nets were used along instream and riparian vegetation. Bridges, fences, emergent rocks and other potential adult resting sites were searched during the day with an aspirator. On a few occasions, 6 m malaise traps (Debby Focks Co., Gainesville, Florida) equipped with two alcohol collecting heads, were stretched across small streams to capture flying adults. Portable ultra-violet (UV) light traps were used to make mass

collections of adult material. On any one night of collecting, as many as ten traps were set out over a 100 to 175 km distance, transacting a number of watersheds. The light source for each trap consisted of a portable, commercially-available, emergency light outfitted with either a long or short wavelength, 8 watt UV bulb (Sylvania™ F6T5 UV). The UV lights were situated over white enamel trays containing 80% isopropanol and operated for one to two hours just after dusk. This combination effectively attracts many adult caddis, and entraps them in the alcohol (Brian Armitage, pers. communication). During the spring and fall, when overnight air temperatures ranged from 7 to 15°C, traps were operated through the night to permit a longer attractance period. At the end of each sampling period, traps were dumped into 1 L sample bottles and topped off with fresh isopropanol. The use of isopropanol in the field was more cost effective for the large number of samples taken on a given trip. This material was sorted and transferred into 70% ethanol. Periodically adults of the leptocerid genus *Nectopsyche* were coaxed from a white sheet into a cyanide killing jar and pinned in the field. This reduced the amount of distortion to diagnostic wing hair patterns, that usually results with alcohol preservation.

Rearing Studies

Mature larvae and pupae to be reared were transported alive to the laboratory in portable styrofoam, "six-pack", rearing chambers (Szczytko and Stewart 1979) containing stream water and the appropriate natural substrate

and food. During the summer months, these rearing chambers were transported in a larger ice chest packed with ice to help minimize thermal stress. Larvae were transferred to a conditioned Frigid Units Living Stream™ in the laboratory, maintained at the appropriate seasonal photoperiod and water temperature. Reared adults were collected along with their pupal and larval exuviae. The "metamorphotype method" (Milne 1938) was used to associate the larva, pupa, and adult of each species.

Caddisfly Determinations

Species determinations were based primarily on males, although some records came from identifiable females or larvae. Adults were prepared for determination by clearing the genitalia in a gently boiling 10% potassium hydroxide solution for two to five minutes or by soaking them overnight at room temperature. Specimens were cleared in different ways depending on their relative size. Smaller species such as Hydroptilidae were cleared whole; the entire abdomen or the last three or four abdominal segments were removed and cleared, respectively, for medium sized (e.g. hydropsychids) and large (e.g. limnephilids, phryganeids) species. In some cases, optimum presentation of the cleared male or female genitalia for viewing or drawing was obtained by blowing out the degraded viscera with the following alcohol-injection procedure: a 70% ethanol solution was gently injected into the abdominal cavity with a 0.5 cc insulin syringe from the cut-end or base, while holding the cut-end cuticle around the needle with forceps to control the fluid

pressure. Fluid pressure exerted in the haemocoel dislodged the viscera and expanded membranous structures in some cases. This procedure was performed while viewing the specimen under an appropriate magnification. Prepared specimens were placed in a watch glass or on a slide containing glycerin and examined. Determinations were made using a Wild™ 50x dissecting scope equipped with 10 or 20x oculars or a Nikon™ compound microscope. The major taxonomic references and keys used included Armitage (1983, 1991), Armitage and Hamilton (1990), Morse (1975), Morse and Holzenthal (1984), Ross (1938a,b, 1941, 1944, 1947, 1956), Scheffer and Wiggins (1986), Schmid (1980), Schuster and Etnier (1978), Weaver (1988), and Wiggins (1977, 1984).

Preparation of Illustrations

A *camera lucida* attachment to both microscopes mentioned above was used to make each initial, rough penciled drawing. These were enlarged to a suitable plate size by making a xerox copy; the final drawing was an ink tracing of the enlarged, rough version using a series of Pigma Pens (005, 01, 03, 05). Bilateral structures such as dorsal views of head capsules, were illustrated using the same technique, except that only the right half was drawn initially and the left half added by tracing on a light table. Most illustrations were prepared from our own regional collections or those in other institutions. Those of rare species we did not collect, and many of the adult Hydroptilidae were redrawn from the original, published illustrations while comparing them

with either type specimens or non-regional voucher specimens. Proper acknowledgment for these illustrations are provided in the figure captions.

Voucher Collections

Synoptic voucher specimens have been deposited at the following institutions: Arkansas State University Museum of Zoology (ASUMZ), Clemson University Arthropod Collection, Eastern Kentucky University, Illinois Natural History Survey (INHS), National Museum of Natural History (NMNH), Ohio Biological Survey/Ohio State University, Southern Arkansas University and the University of North Texas. Single records or rare species are deposited at the NMNH and other duplicate material is deposited in the personal collection of the senior author. Type material examined during this study are deposited in the California Academy of Sciences (CAS), NMNH, or INHS.

Data and Analysis

Field and laboratory data were managed using the relational data base system of Alpha Four™. Six variables were selected *a priori* to have a predictive value on caddisfly distributions and were recorded for each of the 131 watersheds similar to that done by Matthews and Robison (1988) for fish distributions in Arkansas. These variables included:

1. Longitude: Determined to the nearest whole degree.
2. Latitude: Determined to the nearest whole degree.
3. Physiographic Subregion: Determined by assigning the watershed to one of the 17 subregions depicted in Fig. 2. If a watershed occupied

- more than one subregion, it was assigned to the subregion having the greatest portion of the watershed.
4. **Geology:** The dominant formation for each watershed was determined from 1:500,000 geologic maps of Arkansas, Illinois, Missouri, and Oklahoma, and based on the following scale: 1 = alluvium; 2 = shale; 3 = sandstone; 4 = chert; 5 = limestone; 6 = dolomite. Mixtures of neighboring formations in the same watershed were scored as intermediates.
 5. **High-volume Springs:** Major springs in a watershed were scored as: 1 = present; 2 = absent.
 6. **Vegetation:** The major vegetation type common to each watershed was scored based on the following scale: 1 = upland pine; 2 = upland hardwood; 3 = bottomland hardwood.

Detrended Correspondence Analysis (DCA), a multivariate ordination procedure, was performed using MVSP (Multivariate Statistical Package, Kovach 1993) on a multidimensional data matrix of species presence (coded 1) or absence (coded 0) in the 131 watersheds. DCA, or more commonly known in older literature as detrended reciprocal averaging, is an indirect gradient analysis that reduces complex patterns inherent in large data sets to a low-dimensional ordination space (Garono and Kooser 1992, Palmer 1993). In distributional studies such as this one, DCA has several benefits over Principle Components Analysis (PCA). First, DCA performs both Q-type (species) and

R-type (watersheds) ordinations simultaneously (Garono and MacLean 1988, Garono and Kooser 1992). Second, DCA does not produce the "arch" that is commonly observed in other ordination techniques including PCA and Correspondence Analysis (Kovach 1993). According to Palmer (1993), this arch is a spurious second axis that is a curvilinear function of the first axis. Third, DCA works well with abundance or presence/absence data, whereas PCA is better suited for data on a continuous scale (Kovach 1993). The primary objective of DCA is to ordinate communities along environmental gradients, if such gradients exist (Hill and Gauch 1980, Gauch 1982, Chang and Gauch 1986). Since obvious gradients do exist in the Interior Highlands, it was appropriate in this study to use DCA to further clarify caddisfly distributions (Matthews and Robison 1988).

To compliment the DCA ordinations, we examined the association of DCA axis scores with the six, *a priori* selected environmental variable listed above. A Spearman Rank Correlation was performed on these data using the Statistical Analysis System (SAS).

CHAPTER 3

RESULTS

Trichoptera Biodiversity

A total of 4500 records were documented from my examination of an approximately 60,000 specimens. These records, including valid literature records and verified museum material revealed 229 species of caddisflies, distributed among 16 families and 58 genera, in the Interior Highlands region of Eastern North America. Three families, Hydroptilidae (71 spp.), Leptoceridae (43 spp.), and Hydropsychidae (34 spp.), accounted for 65% of the total species richness (Fig. 18). Only seven genera (*Hydroptila* 26 spp., *Cheumatopsyche* 16 spp., *Ochrotrichia* 14 spp., *Triaenodes* 13 spp., *Ceraclea* 12 spp., *Oxyethira* 11 spp., and *Oecetis* 10 spp.) had 10 or more species, and accounted for 45% of the total number of species. Higher classification in the checklist below follows that presented by Weaver and Morse (1986) and Wiggins (1977). Twenty-seven species (bold face type) are considered endemic to the region. A (?) denotes records that are tentatively included here.

INTERIOR HIGHLAND TRICHOPTERA CHECKLIST

- Suborder Annulipalpia
 - Infraorder Spicipalpia
 - Superfamily Rhyacophiloidea
 - Family Rhyacophilidae
 - Subfamily Rhyacophilinae
 - Genus *Rhyacophila* Pictet 1834
 - Rhyacophila banksi* Ross¹
 - Rhyacophila fenestra* Ross
 - Rhyacophila glaberimma* Ulmer
 - Rhyacophila kiamichi* Ross**
 - Rhyacophila ledra* Ross
 - Rhyacophila lobifera* Betten
- Superfamily Hydroptiloidea
 - Family Glossosomatidae
 - Subfamily Agapetinae
 - Genus *Agapetus* Curtis 1834
 - Agapetus artesus* Ross**
 - Agapetus illini* Ross
 - Agapetus medicus* Ross**
 - Subfamily Glossosomatinae
 - Genus *Glossosoma* Curtis 1834
 - Glossosoma intermedium* (Klapálek)
 - Subfamily Protoptilinae
 - Genus *Protoptila* Banks 1904
 - Protoptila lega* Ross
 - Protoptila maculata* (Hagen)
 - Protoptila tenebrosa* (Walker)
 - Protoptila species A***
- Family Hydroptilidae
 - Subfamily Hydroptilinae
 - Genus *Dibusa* Ross 1939
 - Dibusa angata* Ross
 - Genus *Hydroptila* Dalman 1819
 - Hydroptila ajax* Ross
 - Hydroptila albicornis* Hagen
 - Hydroptila amoena* Ross
 - Hydroptila angusta* Ross
 - Hydroptila armata* Ross
 - Hydroptila artesa* Mathis and Bowles**
 - Hydroptila bernerii* Ross
 - Hydroptila broweri* Blickle
 - Hydroptila consimilis* Morton

Hydroptila delineata Morton
Hydroptila grandiosa Ross
Hydroptila hamata Morton
Hydroptila icona Mosely
Hydroptila melia Ross
Hydroptila oneili Harris¹
Hydroptila perdita Morton
Hydroptila protera Ross
Hydroptila quinola Ross
Hydroptila remita Blickle and Morse¹
Hydroptila sandersoni Mathis and Bowles
Hydroptila spatulata Morton
Hydroptila strepha Ross
Hydroptila tusculum Ross
Hydroptila vala Ross
Hydroptila virgata Ross
Hydroptila waubesiana Betten
 Genus *Ochrotrichia* Mosely 1934
Ochrotrichia anisca (Ross)
Ochrotrichia arva (Ross)
***Ochrotrichia contorta* (Ross)**
Ochrotrichia eliaga Ross
Ochrotrichia nigritta (Banks)
Ochrotrichia riesi Ross
***Ochrotrichia robisoni* Frazler and Harris**
Ochrotrichia shawnee (Ross)
Ochrotrichia spinosa (Ross)
Ochrotrichia stylata (Ross)
Ochrotrichia tarsalis (Hagen)
Ochrotrichia unio (Ross)
***Ochrotrichia weddleae* Ross**
Ochrotrichia xena (Ross)
 Genus *Oxyethira* Eaton 1873
Oxyethira aculea Ross
Oxyethira azteca (Mosely)
Oxyethira coercens Morton
Oxyethira dualis Morton
Oxyethira forcipata Mosely
Oxyethira glasa Ross
Oxyethira janella Denning¹
Oxyethira novasota Ross
Oxyethira pallida (Banks)
Oxyethira rivicola Blickle and Morse
Oxyethira zeronia Ross

- Genus *Paucicalcaria* Mathis and Bowles 1989
***Paucicalcaria ozarkensis* Mathis and Bowles**
- Genus *Stactobiella* Martynov 1925
Stactobiella delira (Ross)
Stactobiella palmata (Ross)
- Subfamily Leucotrichinae
 Genus *Leucotrichia* Mosely 1934
Leucotrichia pictipes (Banks)
- Subfamily Orthotrichinae
 Genus *Ithytrichia* Eaton 1873
Ithytrichia clavata Morton
Ithytrichia mazon Ross
- Genus *Orthotrichia* Eaton 1873
Orthotrichia aegerfasciella (Chambers)
Orthotrichia cristata Morton
Orthotrichia instabilis Denning
- Incertae Sedis*
 Genus *Mayatrichia* Mosely 1937
Mayatrichia ayama (Mosely)
Mayatrichia ponta Ross
- Genus *Neotrichia* Morton 1905
***Neotrichia arkansasensis* Mathis and Bowles**
Neotrichia collata Morton
Neotrichia edalis Ross
***Neotrichia kitae* Ross**
Neotrichia minutisimella (Chambers)
Neotrichia okopa Ross
Neotrichia riegeli Ross
Neotrichia vibrans Ross
- Infraorder Curvipalpia
 Superfamily Philopotamoidea
 Family Philopotamidae
 Subfamily Chimarrinae
 Genus *Chimarra* Stephens 1829
Chimarra aterrima Hagen
Chimarra feria Ross
 ?*Chimarra moselyi* Denning
Chimarra obscura (Walker)
Chimarra parasocia Lago and Harris
Chimarra socia Hagen
- Subfamily Philopotaminae
 Genus *Wormaldia* McLachlan 1865
Wormaldia moesta (Banks)
Wormaldia shawnee (Ross)

***Wormaldia strota* (Ross)**

Superfamily Hydropsychoidea

Family Polycentropodidae

Subfamily Dipseudopsinae

Genus *Phylocentropus* Banks 1907*Phylocentropus placidus* (Banks)

Subfamily Polycentropodinae

Genus *Cernotina* Ross 1938*Cernotina calcea* Ross*Cernotina oklahoma* Ross*Cernotina spicata* RossGenus *Cyrnellus* Banks 1913*Cyrnellus fraternus* (Banks)Genus *Neureclipsis* McLachlan 1864*Neureclipsis crepuscularis* (Walker)Genus *Nyctiophylax* Brauer 1865*Nyctiophylax affinis* (Banks)*Nyctiophylax moestus* Banks*Nyctiophylax serratus* Lago and Harris¹Genus *Polycentropus* Curtis 1835*Polycentropus centralis* Banks*Polycentropus chelatus* Ross and Yamamoto*Polycentropus cinereus* Hagen*Polycentropus confusus* Hagen*Polycentropus crassicornis* Walker*Polycentropus harpi* Moulton and Stewart?*Polycentropus nascotius* Ross***Polycentropus stephani* Bowles, Mathis, and Hamilton**

Family Psychomyiidae

Subfamily Paduniellinae

Genus *Paduniella* Ulmer 1913***Paduniella nearctica* Flint**

Subfamily Psychomyiinae

Genus *Lype* McLachlan 1879*Lype diversa* (Banks)Genus *Psychomyia* Pictet 1834*Psychomyia flavida* Hagen

Family Hydropsychidae

Subfamily Diplectroninae

Genus *Diplectrona* Westwood 1840*Diplectrona modesta* Banks*Diplectrona metaqui* RossGenus *Homoplectra* Ross 1938*Homoplectra doringa* (Milne)

Subfamily Hydropsychinae

Genus *Ceratopsyche* Ross and Unzicker 1977*Ceratopsyche bronta* (Ross)*Ceratopsyche morosa* (Hagen)***Ceratopsyche piatrix* (Ross)***Ceratopsyche slossonae* (Banks)Genus *Cheumatopsyche* Wallengren 1891*Cheumatopsyche aphantia* Ross*Cheumatopsyche burksi* Ross*Cheumatopsyche campyla* Ross*Cheumatopsyche comis* Edwards and Arnold¹*Cheumatopsyche gracilis* (Banks)*Cheumatopsyche halima* Denning*Cheumatopsyche harwoodi enigma* Ross, Morse and Gordon*Cheumatopsyche lasia* Ross*Cheumatopsyche minuscula* (Banks)*Cheumatopsyche oxa* Ross*Cheumatopsyche pasella* Ross*Cheumatopsyche pettiti* (Banks)***Cheumatopsyche* sp. A NEW SPECIES*****Cheumatopsyche rossi* Gordon***Cheumatopsyche sordida* (Hagen)*Cheumatopsyche speciosa* (Banks)Genus *Hydropsyche* Pictet 1834*Hydropsyche alvata* Ross*Hydropsyche arinale* Ross*Hydropsyche betteni* Ross*Hydropsyche bidens* Ross*Hydropsyche orris* Ross*Hydropsyche rossi* Flint, Voshell, and Parker*Hydropsyche scalaris* Hagen*Hydropsyche simulans* RossGenus *Potamyia* Banks 1900*Potamyia flava* (Hagen)Genus *Smicridea* McLachlan 1871*Smicridea fasciatella* McLachlan

Subfamily Macronematinae

Genus *Macrostemum* Kolenati 1859*Macrostemum carolina* (Banks)

Suborder Integripalpia

Infraorder Plenitentoria

Superfamily Limnephiloidea

Family Brachycentridae

Genus *Brachycentrus* Curtis 1834

- Brachycentrus lateralis* (Say)
Brachycentrus numerosus (Say)
 Genus *Micrasema* McLachlan 1876
 ***Micrasema ozarkana* Ross and Unzicker**
 Micrasema rusticum (Hagen)
 Micrasema wataga Ross
 Family Lepidostomatidae
 Genus *Lepidostoma* Rambur 1842
 Lepidostoma carrolli Flint¹
 Lepidostoma griseum (Banks)¹
 ***Lepidostoma lescheni* Bowles, Mathis and Weaver**
 Lepidostoma libum Ross
 ***Lepidostoma ozarkense* Flint and Harp**
 Lepidostoma togatum (Hagen)
 Family Limnephilidae
 Subfamily Dicosmoecinae
 Genus *Ironoquia* Banks 1916
 Ironoquia kaskaskia (Ross)
 Ironoquia punctatissima (Walker)
 Subfamily Pseudostenophylacinae
 Genus *Pseudostenophylax* Martynov 1909
 Pseudostenophylax uniformis (Betten)
 Subfamily Limnephilinae
 Genus *Frenesia* Betten and Mosely 1940
 Frenesia missa (Milne)
 Genus *Glyphopsyche* Banks 1904
 ***Glyphopsyche missouri* Ross**
 Genus *Limnephilus* Leach 1815
 ?*Limnephilus submonilifer* Walker
 Genus *Platycentropus* Ulmer 1905
 Platycentropus radiatus (Say)¹
 Genus *Pycnopsyche* Banks 1905
 Pycnopsyche guttifer (Walker)
 Pycnopsyche indiana (Ross)¹
 Pycnopsyche lepida (Hagen)
 Pycnopsyche rossi Betten
 Pycnopsyche subfasciata (Say)
 Family Uenoidae
 Subfamily Neophylacinae
 Genus *Neophylax* McLachlan 1871
 Neophylax concinnus McLachlan
 Neophylax fuscus Banks
 Superfamily Phryganeioidea
 Family Phryganeidae

Subfamily Phryganeinae

Genus *Agrypnia* Curtis 1835*Agrypnia vestita* (Walker)Genus *Phryganea* Linnaeus 1758*Phryganea sayi* MilneGenus *Ptilostomis* Kolenati 1859*Ptilostomis ocellifera* (Walker)*Ptilostomis postica* (Walker)

Infraorder Brevitentoria

Superfamily Leptoceroidea

Family Leptoceridae

Subfamily Leptocerinae

Genus *Ceraclea* Stephens 1829*Ceraclea ancylus* (Vorhies)*Ceraclea cancellata* (Betten)*Ceraclea flava* (Banks)*Ceraclea maculata* (Banks)***Ceraclea maccalmonti* Moulton and Stewart***Ceraclea nepha* (Ross)*Ceraclea ophioderus* Ross¹*Ceraclea protonepha* Morse and Ross*Ceraclea punctata* (Banks)? *Ceraclea resurgens* (Walker)*Ceraclea tarsipunctata* (Vorhies)*Ceraclea transversa* (Hagen)Genus *Leptocerus* Leach 1815*Leptocerus americanus* (Banks)Genus *Mystacides* Berthold 1827*Mystacides sepulchralis* (Walker)Genus *Nectopsyche* Müller*Nectopsyche candida* (Hagen)*Nectopsyche diarina* (Ross)*Nectopsyche exquisita* (Walker)*Nectopsyche pavidata* (Hagen)*Nectopsyche spiloma* (Ross)Genus *Oecetis* McLachlan 1877*Oecetis avara* (Banks)*Oecetis cinerascens* (Hagen)*Oecetis ditissa* Ross*Oecetis eddlestoni* Ross*Oecetis inconspicua* (Walker)*Oecetis nocturna* Ross*Oecetis osteni* Milne¹***Oecetis ouachita* Moulton and Stewart**

Oecetis ozarkensis Moulton and Stewart*Oecetis persimilis* (Banks)Genus *Setodes* Rambur 1842***Setodes oxapius* (Ross)**Genus *Triaenodes* McLachlan 1865*Triaenodes abus* Milne*Triaenodes cumberlandensis* Etnier and Way¹*Triaenodes dipsius* Ross*Triaenodes flavescens* Banks*Triaenodes ignitus* (Walker)*Triaenodes injustus* (Hagen)*Triaenodes marginatus* Sibley*Triaenodes melacus* Ross*Triaenodes nox* Ross*Triaenodes ochraceus* Betten and Mosely¹*Triaenodes pernus* Ross*Triaenodes smithi* Ross*Triaenodes tardus* Milne*Triaenodes tridonta* Ross

Family Molannidae

Genus *Molanna* Curtis 1834*Molanna blenda* Sibley*Molanna ulmerina* Navas*Molanna uniophila* Vorhies

Family Odontoceridae

Subfamily Odontocerinae

Genus *Marilia* Müller 1878*Marilia flexuosa* Ulmer***Marilia species A***

Superfamily Sericostomatoidea

Family Helicopsychoidea

Genus *Helicopsyche* Von Siebold 1856*Helicopsyche borealis* (Hagen)***Helicopsyche limnella* Ross***Helicopsyche piroa* Ross¹¹ Species being reported for the first time in the Interior Highlands.

Several species that have been reported in previous regional state checklists and other distributional summaries, are not included in this regional checklist for a variety of reasons, including 1) misidentifications

(*Cheumatopsyche mollala* Denning, *Chimarra angustipennis* Banks, *Hydropsyche incommoda* Hagen, *Macrostemum zebratum* (Hagen), *Oecetis scala* Milne, *Pycnopsyche scabripennis* Rambur), 2) previously or newly designated synonyms (*Ceratopsyche bifida* (Banks), *Hydropsyche reiseni* Denning, *Molanna musetta* Betten), 3) extralimital species unlikely to occur in the region (*Brachycentrus occidentalis* Banks, *Ceraclea diluta* (Hagen), *Limnephilus taloga* Ross, *Ochrotrichia potomus* Denning, *Polycentropus flavus* Banks), or 4) lack of good historical information and material to substantiate regional presence (*Palaeagapetus celsus* Ross, *Polycentropus* species A). Commentary concerning a few of these records, especially those that represent misidentifications or synonyms, is provided in their respective generic section.

Fifteen species are reported here for the first time from the Interior Highlands. These and other new distributional discoveries have expanded the regional state checklists for Arkansas, Missouri, and Oklahoma to 176, 155, and 141, respectively. Specific state records are treated in the species accounts. The greatest overall caddisfly biodiversity (153 spp.) was found in the Ouachita Mountains subregion (Table 3). Three of the 13 endemic species found in this subregion (*Cheumatopsyche robisoni*, *Ochrotrichia robisoni*, and *Ochrotrichia weddleae*) are restricted to it. Ozark subregions (except the Illinois Ozarks) contained 23 endemic species, of which 15 were confined to this area. The Springfield and Central Plateaus, had greater than 50% of the total regional biodiversity (Table 3). No endemic species were found in the

Illinois Ozarks subregion. Crowley's Ridge, the Arkansas River Valley, Wichita Mountains and the Mississippi River border (upland) subregion had fewer than 25 species. The low species richness in these areas can be explained in part by my decreased emphasis in sampling them. The greatest degree of faunal similarity between the Interior Highlands and other intra-continental regions was observed for the southern (74%) and eastern (72%) United States (Table 4). Only 24% similarity was observed for the western states and provinces. Mexico and other neotropical areas shared 26 species with the Interior Highlands (Table 4).

Detrended Correspondence Analysis & Correlation

DCA of the 131 natural watersheds produced two axes of ecological interest. According to Matthews and Robison (1988), DCA seeks the maximum resolution in the first one or two axes. Therefore, it is uncommon for additional axes to be of any ecological interest. In general, Axis 1 consisted of watersheds in the Ouachita Mountains, Gulf Coastal Plain, Mississippi River basin, and Illinois Ozarks clustering to the left, while Ozark watersheds clustered to the right. Axis 2 appears related to latitude, with watersheds at higher latitudes having higher scores and those in lower latitudes having lower scores. Axes 1 and 2 had eigenvalues of 0.206 and 0.152, respectively. Axis 1 scores ranged from 0 to 384, indicating 3.84 standard deviations along this axis. According to Hill (1979), a difference of 4 SD indicates nearly a complete change in species present in any two samples; a difference of approximately 1

SD between two samples indicates a 50% change in species composition. Three biologically meaningful faunal regions (Fig. 19) based on Axis 1 gaps of 13 units were identified. Even though the Ozark Mountain subregions were clearly distinguished, the analysis failed to distinguish watersheds in the Illinois Ozarks, Mississippi River areas, the Gulf Coastal Plain, and a majority of the Ouachita Mountains subregion. A possible explanation for this may be the high vagility of most caddisfly species (Ross 1965, Garono and MacLean 1988). Inter-watershed dispersals by adults may tend to "homogenize" clearly defined physiographic regions that are based on geological and vegetational characteristics. Interestingly, the analysis identified a cluster of watersheds (Nos. 13, 49, 61, 130) in the Ouachita and Arbuckle Mountains faunistically related to the Ozark Mountains cluster (Fig. 19). Species common to these areas include *Hydroptila spatulata*, *Lepidostoma togatum*, *Molanna blenda*, *Ochrotrichia spinosa*, and *Triaenodes marginatus*. Poulton and Stewart (1991, Fig. 5) observed an almost identical result in their cluster analysis of the regional stonefly fauna. They suggested that their disjunct cluster of watersheds (Nos. 14, 17, 39, 48, 49, 61) resulted from the presence of small, headwater springs or their physiographic position as ecotones. The four cluster solution of Poulton and Stewart (1991) identified a distinct faunal element in the Ouachita Mountains, but did not distinguish between the Gulf Coastal Plain, Mississippi River basin and Illinois Ozarks. Although most stoneflies are capable of dispersal flights, some species are brachypterus (i.e.

underdeveloped wings) and are not capable of great inter-watershed dispersals.

Several studies have employed DCA in the ordination of various faunas along clearly defined environmental gradients (Culp and Davies 1980, Leland *et al.* 1986, Garono and MacLean 1988, Matthews and Robison 1988, Ward *et al.* 1990, Williams 1991). Matthews and Robison (1988) defined five fish faunal regions in 101 Arkansas watersheds. Their two axis solution consisted of a separation between upland and lowland streams on the first axis, and large streams and small streams on the second axis. However, the vagility of fishes is much less than that of winged caddisflies, and as a result, the regionalization of clearly defined fish faunas becomes more apparent.

Spearman Rank Correlation of DCA axis 1 scores of the watersheds (N=131) and six environmental parameters revealed significant associations with latitude ($R=0.587$, $p=0.0001$), geology ($R=0.5950$, $p=0.0001$), and high-volume springs ($R=-0.202$, $p=0.039$). Longitude, physiographic subregion, and vegetation type were not significantly associated. Garono and MacLean (1988) observed a significant association between DCA axis scores and latitude for caddisfly bog communities in Ohio.

Environmental Affinities and Emergence

Species affinities with the 17 physiographic subregions and other categorical data such as stream order, stream width, flow permanence, substrate type, and major vegetation type are provided in Table 5. This

information should prove valuable for stream ecologists in predicting which caddisfly species might be expected in certain types of aquatic systems. I was unable to provide information for some species because accurate data on habitat conditions were not discernable from some literature records or it was not provided with contributed material by other workers. Physiographic subregion most accurately predicted the presence of endemic species, including those characteristic of conditions in a particular area; this same relationship was observed for regional stoneflies (Poulton and Stewart 1991). For example, several species, such as *Ceratopsyche piatrix*, *Glossosoma intermedium*, *Hydroptila artesa*, and *Micrasema ozarkana*, were typically collected in the Central Plateau and Curtois Hills subregions due to their geology and large number of cold, high-volume springs (category 4, Table 5). Stream order (1-6+), width, substrate, and vegetation type, are related to stream size and energy input. Headwater streams (orders 1-3) were generally characterized by widths less than 10m, substrates consisting of gravel, cobbles, or boulders, and upland vegetation. A majority of these streams and vernal pools dried up or became intermittent during the summer. As a result, some of the species inhabiting these temporary lotic habitats exhibited life cycle attributes that allowed them to survive during dry periods. Two common attributes included either a spring emergence with subsequent oviposition of drought-resistant eggs (e.g. *Agapetus illini* and *Wormaldia moesta*), or a pre-

pupal, summer diapause followed by a fall emergence (e.g. *Neophylax* spp. and *Pycnopsyche* spp.).

Caddisfly emergence occurred year round with the greatest species diversity being present during the spring and fall (Table 6). This is apparently related to rainfall, since the diversity of caddisflies and other insects decreases as dry conditions prevail (Allen 1990). Exceptions to this include collections from larger, more permanent streams and springs (Allen 1990). Unlike the synchronous emergences and comparatively shorter presence periods of four months or less observed for regional stoneflies (Poulton and Stewart 1991), collection records indicate that 30% of the species are present for at least six months. Many of these species, especially the hydropterygids, have overlapping, asynchronous emergences. Thirty-four percent of the species were present for two months or less. Winter emergence of adults was generally limited to spring habitats that were thermally stable in creating "winter warm, summer cool" conditions. Regional populations of *Helicopsyche borealis* that inhabited spring streams were multivoltine while those in non-spring streams were univoltine (Vaughn 1985a). Extended periods of warm weather during the winter months could also trigger an early emergence of some species.

Taxonomy of Interior Highlands Trichoptera

The following keys were constructed to include the verified and probable Interior Highlands caddisfly fauna. The larval and adult keys to families were

modified from those of Wiggins (1977, 1984). Single genera or species representing a particular family are keyed immediately. For ease in accessing information, families and taxa within families are organized alphabetically. Illustrated keys are provided for the males of all species. Species keys are presented for females and larvae of a few genera. Included in them, are the description of a new species (*Cheumatopsyche robisoni*), 4 new larval descriptions (*Marilia* sp. A, *Helicopsyche limnella*, *H. piroa* and *Polycentropus crassicornis*), and a new female description (*H. piroa*).

Individual species accounts consist of the following information: 1) reference to figures, 2) a brief synonymy that only includes designated synonyms and misspellings from other regional works, 3) the type locality, 4) a summary of regional watersheds, and in the case of endemic or infrequently collected species, complete collection data of available records, 5) a Nearctic distributional summary of states and/or provinces, including countries outside of the Nearctic realm, and 6) a brief discussion of the relationships with congeners and environmental affinities in the region, and pertinent biological information. Frequently used larval characters are shown in Figs. 20 - 23, 26; those for adults are shown in Figs. 39 - 41.

KEYS TO THE FAMILIES OF INTERIOR HIGHLANDS TRICHOPTERA

larvae

1. Larvae with a portable case of sand grains, coiled and resembling a

- snail shell (Fig. 30); anal claw comb-like
- **Helicopsychidae: *Helicopsyche* Von Siebold (p. 64)**
- Larvae free-living or construct a fixed retreat or portable case of various designs (Figs. 32 - 38), but never like a snail shell 2
2. All thoracic nota entirely covered by large, plate-like sclerites (Fig. 204) 3
- Metanotum and sometimes mesonotum entirely membranous or with very small sclerites not covering a large portion of the notum (Figs. 21, 571) 4
3. Ventrolateral surfaces of abdomen with branched finger-like gills (Fig. 27); larvae construct a fixed silk retreat incorporating various materials **Hydropsychidae (p. 72)**
- Ventrolateral surfaces of abdomen without gills (Fig. 212); terminal instar larvae construct a portable or fixed purse cases of various materials (Figs. 32, 33) **Hydroptilidae (p. 121)**
4. Antennae very long and prominent, 6 times as long as wide (Figs. 349, 350) and/or mesonotal sclerites light except for a pair of dark curved bars (Figs. 361, 366) **Leptoceridae (p. 219)**
- Antennae shorter, not more than 3 times as long as wide, or inconspicuous (Figs. 20, 21, 28); mesonotum never with a pair of dark curved bars 5
5. Mesonotum largely membranous or with 2 - 3 sclerites not covering

- more than one-half of the notum (Figs. 73, 74), if present, sclerites may be light-colored and difficult to see) 6
- Mesonotum largely covered by conspicuous sclerites that are pigmented and variously divided (Figs. 21, 29, 491) 11
6. Dorsum of abdominal segment IX with a sclerite 7
- Dorsum of abdominal segment IX membranous 9
7. Prosternal horn present (as in Fig. 22); mature larvae large up to 45 mm in length; case long, tubular, and constructed of plant materials
- **Phryganeidae (p. 323)**
- Prosternal horn absent; mature larvae smaller, less than 20 mm; free-living or construct a portable tortoise-like case of small pebbles 8
8. Anal proleg and claw well developed and free from abdomen (Fig. 583); free-living **Rhyacophilidae: *Rhyacophila* Pictet (p. 369)**
- Anal proleg and claw reduced and broadly joined to abdomen; larvae construct a tortoise-like case (Fig. 31) **Glossosomatidae (p. 52)**
9. Labrum membranous, and T-shaped (Fig. 493), sometimes retracted in preserved material **Philopotamidae (p. 310)**
- Labrum sclerotized, not T-shaped or retractable (Fig. 534, 571) 10
10. Trochantin of prothoracic leg with apex acute (Fig. 24)
- **Polycentropodidae (p. 333)**
- Trochantin of prothoracic leg with apex hatchet-shaped (Fig. 25)
- **Psychomyiidae (p. 362)**

11. Abdominal segment I without dorsal and lateral membranous humps; larvae construct straight tubular or four-sided cases various materials
 **Brachycentridae (p. 42)**
 Abdominal segment I with lateral humps, with or without a median dorsal hump (Fig. 26); humps may be depressed in preserved material 12
12. Metatarsal claw modified into a setose stub; larvae construct a flat sand-grain case with a dorsal and lateral flanges (Fig. 36)
 **Molannidae: *Molanna* Curtis (p. 229)**
 Metatarsal claw not different in structure from other claws 13
13. Antennae situated very closely to the anterior margin of the head capsule (Figs. 488, 489) **Odontoceridae: *Marilia* Müller (p. 306)**
 Antennae located at the anterior margin of the eye (Fig. 28) or midway between eye and anterior margin of head capsule (Figs. 20, 22) 14
14. Antennae situated next to the anterior margin of the eye (Fig. 28); hump on abdominal segment I absent; case tubular or four-sided (Fig. 38) of a variety of materials **Lepidostomatidae: *Lepidostoma* Rambur (p. 211)**
 Antennae situated approximately halfway between the eye and anterior margin of the head capsule (Figs. 20, 22) 15
15. Anteromesal corner of each mesonotal sclerite notched, combined they form a distinct median notch (Fig. 29); larval case constructed from small pebbles **Uenoidae: *Neophylax* McLachlan (p. 380)**
 Anteromesal corner of each mesonotal sclerite entire, combined they

form a straight margin (Fig. 21); cases variable in size and structure, and composition (Fig. 37) **Limnephilidae (p. 277)**

adults

1. Small, usually less than 5 mm; no mesoscutal warts; mesoscutellum forming an angulate ridge posteriorly (Fig. 42) . . . **Hydroptilidae (p. 121)**
 Usually greater than 5 mm; mesoscutum with (Fig. 44) or without warts (Fig. 43); mesoscutellum usually rounded, never forming an angulate ridge 2
2. Ocelli present (Figs. 47, 75, 76) 3
 Ocelli absent (Figs. 48, 49) 8
3. Maxillary palp with 5 segments, the apical segment 5 flexible and at least twice as long as segment 4 (Fig. 50) **Philopotamidae (p. 310)**
 Maxillary palp with 3,4 or 5 segments, the apical segment similar in structure and length as the preceding ones 4
4. Maxillary palp with 5 segments, segment 2 rounded and same length as segment 1 (Fig. 51) 5
 Maxillary palp with 3,4 or 5 segments, segment 2 slender and longer than 1 6
5. Protibiae each with a preapical spur
 **Rhyacophilidae: *Rhyacophila* Pictet (p. 369)**
 Protibiae without preapical spurs **Glossosomatidae (p. 52)**

6. Middle tibiae each with 2 preapical spurs **Phryganeidae (p. 323)**
 Middle tibia with 1 or no preapical spurs 7
7. Hindwings each with 2, dark, stout basocostal setae at least three times longer than hooked setae on costal margin (Fig. 54); forewing length 10 mm **Uenoidae: *Neophylax* McLachlan (p. 380)**
 Hindwings with stout setae as above, or if basocostal setae present, then numerous and silky; forewing length 12 - 20 mm (except *Glyphopsyche missouri*, 10 mm) **Limnephilidae (p. 277)**
8. Maxillary palp with 5 or 6 segments (Fig. 52, 573) 9
 Maxillary palp with fewer than 5 segments 12
9. Apical segment of maxillary palp long and flexible with numerous cross-striae (Fig. 52) 10
 Apical segment of maxillary palp similar in structure to preceding segments or some segments with prominent hair brushes (Fig. 53) . . 12
10. Mesoscutum without setal warts or setae (Fig. 43)
 **Hydropsychidae (p. 72)**
 Mesoscutum with a pair of small, round setal warts (Fig. 44) 11
11. Protibiae each with a preapical spur, or if absent (as in *Cernotina*), length of basal tarsal segment less than twice the length of the longer apical spur **Polycentropodidae (p. 333)**
 Protibiae without preapical spurs; length of basal tarsal segment twice the length of the longer spur **Psychomyiidae (p. 362)**

12. Mesoscutal setae diffuse over most of the length of the scutum (Fig. 45) 3
 Mesoscutal setae confined to a pair of small discrete warts (Fig. 46, 49) 4
13. Antennae 2-3 times length of body; middle tibiae with out preapical
 spurs **Leptoceridae (p. 219)**
 Antennae 1.5 times or shorter than body; middle tibiae with 2 preapical
 spurs **Molannidae: *Molanna* Curtis (p. 299)**
14. Dorsum of head with posterior warts very large (Fig. 48); antennae never
 longer than forewing
 **Helicopsychidae: *Helicopsyche* Von Siebold (p. 64)**
 Dorsum of head with warts smaller than above; or antennae 1.5 times
 longer than forewing 15
15. Mesoscutellum with a single, large wart that covers most of the
 scutellum (Fig. 49) **Odontoceridae: *Marilia* Müller (p. 306)**
 Mesoscutellum with a pair of small warts that may be touching along the
 midline 16
16. Tibial spurs 2-2-2 or 2-3-3 **Brachycentridae (p. 42)**
 Tibial spurs 2-4-4 . **Lepidostomatidae: *Lepidostoma* Rambur (p. 211)**

CHAPTER 4

FAMILY BRACHYCENTRIDAE

This is a small family in North America with approximately 33 species (Morse 1993). The two largest genera, *Brachycentrus* and *Micrasema*, both occur in the Interior Highlands but are relatively uncommon. This is likely the result of the specificity of larvae for large river and spring habitats, and seasonality of some species. Larvae have a largely sclerotized mesonotum and lack dorsal and lateral humps on abdominal segment I. They construct cases that are either round or four-sided in cross section. The four-sided cases of *Brachycentrus* differ from those of some *Lepidostoma* larvae by having more rectangular pieces incorporated, and are stronger. Adults range from 6 to 10 mm in forewing length and are generally dark brown. Tibial spur count is either 2-2-2 or 2-3-3, which will readily separate them from the lepidostomatids that have a 2-4-4 count. Keys presented here were modified from those of Ross and Unzicker (1965), Chapin (1978), and Flint (1984).

KEYS TO THE GENERA OF BRACHYCENTRIDAE

larvae

1. Ventral margins of meso- and metathoracic legs with a row of short, spine-like setae (Figs. 57, 58); case four-sided and made of organic materials ***Brachycentrus* Curtis**
- Ventral margins of meso- and metathoracic legs without a row of short, spine-like setae; case round and made of organic or mineral materials ***Micrasema* McLachlan**

adults

1. Forewings with R_1 angled at stigmal region (Fig. 62); spurs 2-3-3 ***Brachycentrus* Curtis**
- Forewings with R_1 not angled at stigmal region (Fig. 61); spurs 2-2-2 ***Micrasema* McLachlan**

Genus *Brachycentrus* Curtis

The genus *Brachycentrus* is represented in North America by 13 species (Morse 1993). Two species are recorded for the Interior Highlands; their accounts are based largely on larval material collected from large rivers. Flint (1984) reviewed the systematics of this genus in North America. He speculated that adult collection records are rare possibly due the observation that most species emerge for short periods (a week or so) early in the year before most collectors are out. Emergence is fairly synchronous and usually occurs in swarms. Adults are generally crepuscular and do not come to lights.

Larvae construct a four-sided case of narrow, rectangular strips of organic material (Wiggins 1977). Larvae filter feed by attaching the anterior end of the case to the substrate with silk and extend their legs openly in a "filtering pose" (Flint 1984).

KEYS TO THE SPECIES OF *Brachycentrus*

larvae

1. Meso- and metathoracic tibiae with one large basomesal seta (Fig. 58); frontoclypeus with a pale V-shaped mark (Fig.56) ***B. lateralis* (Say)**
- Meso- and metathoracic tibiae with 3 - 5 enlarged basomesal setae in a row (Fig. 57); anterolateral margins of frontoclypeus with pale bars not forming a contiguous V-shaped mark (Fig. 55) ***B. numerosus* (Say)**

adults

1. Tergum X deeply notched with each arm bearing a single, stout seta apically (Figs. 65, 66) ***B. lateralis* (Say)**
- Tergum X with shallow notch and no stout setae (Figs. 63, 64)
 ***B. numerosus* (Say)**

***Brachycentrus lateralis* (Say)**

Figs. 56, 58, 65, 66

Phryganea lateralis Say 1823:161.

Sphinctogaster lutescens Provancher 1877:262.

Type Locality.- Momence, Illinois.

Regional Distribution.- Watersheds 47, 107. ARKANSAS: Randolph Co., Eleven Point River, Dalton, 22-X-1978, R. Mauer, 3 larvae; MISSOURI: Phelps Co., Gasconade River, Jerome Access, 29-III-1990, B.C. Poulton, 1 ♂.

Nearctic Distribution.- US: AR, IL, IN, KY, MD, ME, MI, MO, NC, NH, NY, PA, SC, TN, VA, VT, WI, WV; CANADA: ON, PQ.

Discussion.- Reported here for the first time in the region. My records are based on a single male collected from the Gasconade R. in Phelps Co., Missouri and three larvae from the Eleven Point R. in Randolph Co., Arkansas. Larvae are distinguished by having a prominent V- shaped pale area on the frontoclypeus (Fig. 56). Males have tergum X deeply bifurcated with a single, stout seta at the apex of each lobe (Figs. 65, 66). This species inhabits large rivers (Table 5). Emergence occurs in early spring (Table 6).

***Brachycentrus numerosus* (Say)**

Figs. 55, 57, 63, 64

Phryganea numerosus Say 1823:160.

Type Locality.- Momence, Illinois.

Regional Distribution.- Watersheds 24, 47, 67, 104. ARKANSAS: Craighead Co., St. Francis River, 17-X-1987, B.C. Cochran, 1 larva; Randolph Co., Eleven Point River, Dalton, 22-X-1978, R. Mauer, 5 larvae; same but 18-

VIII-1984, S.R. Moulton, 1 larva.

Nearctic Distribution.- US: AL, AR, CT, DE, FL, IL, IN, KS, KY, LA, MA, MD, ME, MI, MN, MO, MS, NC, NH, NJ, PA, SC, TN, VA, WI, WV; CANADA: MB, ON, PQ

Discussion.- Reported here for the first time for Arkansas. I did not collect this species but had the opportunity to examine a good series of larval material in the ASUMZ collection. Flint (1984) examined larval material collected from the lower Black River drainage near Williamsville, Missouri. The male I have illustrated (Fig. 63, 64) was reared from Big Cow Creek in Jasper Co., Texas. Larvae were found in large numbers in this spring-fed, sandy-bottomed, creek on blades of submerged grass. Larvae are readily distinguished from those of *B. lateralis* by having a darker head capsule with prominent pale areas on the anterolateral corners of the frontoclypeus and the parietal region (Fig. 55). The male tergum X has a shallow, apical concavity and lacks stout setae (Figs. 63, 64). Ross (1944) reported that it has a univoltine life cycle in Illinois with adult emergence taking place in late April and early May. My records indicate a March-April emergence in Texas (Table 6).

Genus *Micrasema* McLachlan

Eighteen species of *Micrasema* are known from North America (Morse 1993). Three of these occur in the Interior Highlands and all belong to the

monophyletic *M. rusticum* Group. Members of this group are distinguished from all other *Micrasema* species groups by lacking any subdivision of the inferior appendages (Chapin 1978). Larvae construct cylindrical cases of a variety of materials (Wiggins 1977). Chapin (1978) reviewed the North American systematics of this genus.

KEYS TO THE SPECIES OF *Micrasema*

larvae

1. Head pale with distinct dark brown muscle scars (Fig. 59); case made of sand, may have bits of organic debris attached ***M. rusticum* (Hagen)**
 Head either dark brown or with indistinct brown muscle scars; case made entirely of algae 2
2. Head dark brown (Fig. 60); known only from large Ozark springs
 ***M. ozarkana* Ross & Unzicker**
 Head irregularly mottled; known from large rivers ***M. wataga* Ross**

males

1. Dorsobasal lobes of tergum X very long and narrow (Fig. 71)
 ***M. wataga* Ross**
 Dorsobasal lobes of tergum X very short and broad (Fig. 67) 2
2. Apex of tergum X with a broad, shallow emargination (Fig. 68)
 ***M. ozarkana* Ross & Unzicker**

Apex of tergum X with a narrow, deep incision (Fig. 70)

. *M. rusticum* (Hagen)

***Micrasema ozarkana* Ross & Unzicker**

Figs. 46, 60, 67, 68

Micrasema ozarkana Ross & Unzicker 1965:254.

Type Locality.- Missouri, Greer Spring.

Regional Distribution.- Watersheds 47, 53, 100, 116, 125. ARKANSAS:
Fulton Co., Mammoth Spring, US Hwy 63, Mammoth Springs (town), 25-V-
1990, S.R. Moulton, many ♂♂♀♀; same but 23-IX-1992, many ♂♂♀♀;
MISSOURI: Dallas Co., Bennett Spring, Bennett Spring State Park, 7-VI-1991,
S.R. Moulton, many ♂♂♀♀; Shannon Co., Jacks Fork River, MO Hwy 106, W
Eminence, 24-IX-1992, S.R. Moulton, 1 ♂.

Nearctic Distribution.- US: AR, MO.

Discussion.- Males differ from those of *M. rusticum* in having the apical lobes of tergum X divergent, separated by a shallow concavity (Fig. 68). Larvae differ in having the head uniformly dark brown (Fig. 60). The larval case is dark and made entirely of silk. It is one of the dominant caddisfly species of the high volume springs in the Interior Highland region (Table 5). Chapin (1978) suggested that *M. ozarkana* is probably semivoltine as is indicative of other *Micrasema* species. However, since I observed adults to emerge year

round (Table 6), a multivoltine lifecycle seems more plausible. Nothing is known about its life history.

***Micrasema rusticum* (Hagen)**

Figs. 59, 69, 70

Dasytoma rusticum Hagen 1868:272.

Micrasema falcatum Banks 1914:265.

Type Locality.- Saskatchewan.

Regional Distribution.- Watersheds 17, 44, 47, 74, 77, 80, 123.

ARKANSAS: Franklin Co., Indian Creek, 6 mi E Cass, 19-V-1983, H.W. Robison and D. Koym, 1 ♂; Montgomery Co., Little Missouri River, Falls Rec. Area, 14-III-1992, S.R. Moulton, 4 larvae; Polk Co., Cossatot River, 3 mi S Shady, 15-III-1992, R.J. Currie, 2 larvae; Pope Co., Big Piney Creek, Long Pool Rec. Area, 25 mi N Russellville, 24-IV-1992, H.W. Robison, 1 ♀.

Nearctic Distribution.- US: AL, AR, GA, IL, IN, KY, MA, ME, MI, MN, MO, NC, NH, OH, OK, SC, TN, VA, VT, WI; CANADA: MB, NS, ON, PQ, SK.

Discussion.- Bowles and Mathis (1989) noted that this species had a scattered, locally abundant distribution in the mountainous portions of Arkansas. Males resemble those of *M. ozarkana* but are distinguished by the more parallel lobes of tergum X and deeper incision (Fig. 70). Larvae are readily identified by the lighter head capsule and scattered dark muscle scars (Fig. 59). The larval case incorporates sand grains. It was most often

collected from small headwater streams having a cobble substrate (Table 5). Chapin (1978) reported that larvae inhabit small cold streams, typically in mats of *Fontinalis* where they graze on moss, leaves and detritus. Emergence occurs from mid- to late spring (Table 6).

***Micrasema wataga* Ross**

Figs. 71, 72

Micrasema wataga Ross 1938a:178.

Type Locality.- Elkmont, Tennessee.

Regional Distribution.- Watershed 25. ARKANSAS: Benton Co., War Eagle Cr., War Eagle, T19N R28W S34 SE (Unzicker *et al.* 1970).

Nearctic Distribution.- US: AL, AR, CT, FL, GA, IL, KY, LA, MA, MD, ME, MI, MN, MS, NC, NH, NY, OH, OK, SC, TN, VA, VT, WI; CANADA: MB, NB, NF, NS, ON, PQ, SK.

Discussion.- Unzicker *et al.* (1970) provided the only record of its presence to date in the Interior Highlands (see above). I could not locate Unzickers' material to confirm this record. However, the distinctive nature of the male genitalia lends credence to the probability that it was not confused with the other regional species. Males are easily separated from the other two regional species by the very long, slender, dorsobasal lobes of tergum X (Fig. 71). Larvae have a yellow to red-brown head with irregular brown markings giving it a mottled appearance (Chapin 1978). Literature records indicate an

April-May emergence. Chapin (1978) indicated that it was usually associated with mats of *Podostemum* in large streams and rivers. He also noted that it "undoubtedly occurs in every state east of the Great Plains".

CHAPTER 5

FAMILY GLOSSOSOMATIDAE

This family is represented in North America by approximately 122 species distributed among seven genera (Morse 1993). Three genera and eight species are recorded here for the Interior Highlands. Members of this family are commonly referred to as saddle or tortoise case-makers (Fig. 31). This is due to the unique case-building behavior of the larvae, whereby they completely conceal themselves beneath a portable dome housing of pebbles, resulting in some protection from predation. Anterior and posterior openings created by a ventro-mesal strap of pebbles across the case, permits only the head, thorax, and anal prolegs to reach the substrate. This strap is removed and the perimeter of the case attached to a stable substrate prior to pupation (Wiggins 1977). They are usually found grazing on algae and diatoms from large cobbles. The case design does not permit expansion as larvae grow; instead they construct a new case with each new instar (Wiggins 1977). Larvae may even abandon their cases under stressful conditions (Anderson and Bourne 1974). Like the Rhyacophilidae, glossosomatids spin a parchment-like cocoon prior to pupation.

KEYS TO THE GENERA OF GLOSSOSOMATIDAE

larvae

1. Mesonotum without sclerites . . . *Glossosoma intermedium* (Klapálek)
- Mesonotum with 2 or 3 sclerites (Note: these may be light and hard to see (Figs. 73, 74) 2
2. Mesonotum with 2 sclerites (Fig. 73) *Agapetus Curtis*
- Mesonotum with 3 sclerites (Fig. 74) *Protoptila Banks*

adults

1. Tibial spurs 0-4-4 *Protoptila Banks*
- Tibial spurs 2-4-4 2
2. Dorsum of head with both pairs of warts connected by transverse epicranial suture (Fig. 75) *Agapetus Curtis*
- Dorsum of head with neither pair of warts connected by sutures (Fig. 76) *Glossosoma intermedium* Klapálek

Genus *Agapetus* Curtis

Morse (1993) recorded 31 species from North America. Three species are represented in the Interior Highlands, two of which are endemic. Larvae differ from the other regional genera in having two mesonotal sclerites. Reared and field associated larvae were studied and no characters were found to separate the three species. Larvae of each species possessed brown heads

with a pair of pale spots in the tentorial region of the frontoclypeus. At best, larvae can be tentatively separated on distributional information. *Agapetus* adults differ from those of *Glossosoma* by the presence of transverse epicranial sutures, and from *Protoptila* by their 2-4-4 tibial spur count.

KEY TO THE MALES OF *Agapetus*

1. Apex of X acute in lateral view (Fig. 77) ***A. artesus* Ross**
 Apex of X truncate in lateral view 2
2. Apex of X irregularly serrate; inferior appendages shorter than X, tapered (Fig. 81) ***A. illini* Ross**
 Apex of X not serrate, with 1 or 2 teeth on apicodorsal margin; inferior appendages as long as X, their apices truncated (Fig. 79)
 ***A. medicus* Ross**

***Agapetus artesus* Ross**

Figs. 77, 78

Agapetus artesus Ross 1938a:106.

Type Locality.- Missouri, Greer Spring.

Regional Distribution.- Watersheds 47, 124, 125. MISSOURI: Phelps Co., Meremec Spring, off MO Hwy 8, E St. James, 19-VIII-1990, S.R. Moulton, 2 ♂♂, 1 ♀; same but 28-IX-1991, 30 ♂♂, 4 ♀♀.

Nearctic Distribution.- US: MO.

Discussion.- This species is one of the two regional endemic *Agapetus* species. Males are distinguished from the other two regional species by the acutely tapered apex of tergum X in lateral view (Fig. 77). It is known only from a few of the high-volume springs in Missouri (Table 5). At Meremec Spring, Missouri, large numbers of adults were found on blades of riparian grasses. Although detailed aspects of its life history have not been studied, collection data suggests that it is at least bivoltine. Adults were collected from July through January (Table 6). It is presently listed as a "category 2" species by the United States Fish and Wildlife Service.

***Agapetus illini* Ross**

Fig. 81

Agapetus illini Ross 1938a:106.

Type Locality.- Illinois, Herod.

Regional Distribution.- Watersheds 1, 4, 8, 9, 10, 23, 34, 35, 42, 43, 44, 47, 52, 53, 54, 55, 56, 60, 69, 72, 74, 77, 80, 81, 87, 88, 91, 94, 95, 96, 100, 104, 105, 106, 110, 115, 116, 118, 119, 121, 122, 124, 128.

Nearctic Distribution.- US: AR, IL, IN, KS, KY, MO, OK, TN.

Discussion.- Males are distinguished by the dark, irregularly serrate apex of tergum X (Fig. 81). It is one of the earliest and most common caddisflies to emerge in the Interior Highlands in the spring (Table 6) and inhabits a wide range of stream types including many of the small headwater

streams that dry up in the summer (Table 5). Bowles and Allen (1992) studied its life history from a third order reach of the Mulberry River, Johnson Co., Arkansas. Their results confirm that this species exhibits a univoltine-fast, life cycle; larvae were collected only from October through May; pupae and adults were found in May. They suggested that this type of cycle may provide a mechanism for reaching maximum larval densities during periods of optimal food availability. It is likely that an egg diapause allows this species to avoid summer temperature extremes (up to 35°C) and stream intermittence.

***Agapetus medicus* Ross**

Figs. 79, 80

Agapetus medicus Ross 1938a:107.

Type Locality.- Arkansas, McFadden Springs.

Regional Distribution.- Watersheds 14, 17, 49, 56. ARKANSAS: Montgomery Co., Caddo River, AR Hwy 8, 4.5 mi W Black Springs, 15-III-1992, S.R. Moulton, 1 ♂; Smith Creek, AR Hwy 8, 0.5 mi NW Caddo Gap, 19-V-1982, H.W. Robison, 75 ♂♂; Little Missouri River, Albert Pike Rec. Area, N Langley, 15-IV-1982, H.W. Robison, 7 ♂♂; Polk Co., Big Fork Creek, AR Hwy 8 16 mi W Norman, 14-III-1990, S.R. Moulton, 7 ♂♂, 5 ♀♀ (reared); Board Camp Creek, AR Hwy 8, 1 mi W Board Camp, 21-V-1982; 12 ♂♂; Mine Creek, 2 mi E Shady, 16 May 1981, H.W. Robison, 12 ♂♂.

Nearctic Distribution.- US: AR.

Discussion.- Males differ from those of *A. illini* by the unserrated apex of tergum X and the truncated apex of each inferior appendage (Fig. 79). Like *A. artesus*, this species is endemic to the Interior Highlands. It is known to occur only in the small headwater streams of the Ouachita Mountain physiographic subregion (Table 5). Adults were collected only during May and June (Table 6). Although its life history is unknown, it probably has a univoltine life cycle, much like that of *A. illini*. I have successfully reared and associated larvae in the laboratory.

Genus *Glossosoma* Curtis

Twenty-two species have been recorded for North America (Morse 1993). The greatest diversity occurs in the western montane regions. *Glossosoma intermedium* is the only species known to occur in the Interior Highlands. Larvae differ from other genera in lacking sclerites on the mesonotum. Their larval habitat is generally restricted to swift, cold streams and springs. Unlike other regional genera, *Glossosoma* larvae construct their cases of uniform pebble size (Wiggins 1977, Fig. 4.4 B). Adults are generally dark brown.

***Glossosoma intermedium* (Klapálek)**

Figs. 76, 82

Mystrophora intermedia Klapálek 1892:19.

Type Locality.- Europe.

Regional Distribution.- Watersheds 38, 68, 93, 100, 124, 125.

MISSOURI: Carter Co., Big Spring, off MO Hwy 103, 2 mi S Van Buren, 14-III-1991, S.R. Moulton and J.C. Abbott, 1 ♂ mmt; Dent Co., Montauk Spring, Montauk State Park, off MO Hwy 119, 15-III-1991, S.R. Moulton and J.C. Abbott, 1 ♂; same but, 24-IX-1992, S.R. Moulton, 1 ♂; Phelps Co., Meremec Spring, off MO Hwy 8, E St. James, 19-VIII-1990, S.R. Moulton, 4 larvae; Shannon Co., Alley Spring, MO Hwy 106, W Eminence, 24-IX-1992, S.R. Moulton, many ♂♂♀♀; Round Spring, MO Hwy 19, N Eminence, 24-IX-1992, 5 ♂♂.

Nearctic Distribution.- US: IL, IN, KY, ME, MI, MN, MO, MT, OH, PA, TN, VT, WI; CANADA: AB, BC, MB, NF, ON, PQ, YT.

Discussion.- Wiggins and Parker (1984) placed *G. intermedium* in a group of species characterized as "amphi-Beringian" as it is widespread in both the Nearctic and Palearctic regions. In North America, its distribution is northern-transcontinental. In Missouri, this species is known only from some of the high-volume springs (Table 5). My collection dates are from the late summer and fall (Table 6). It is easily distinguished from other regional glossosomatids by its larger size and distinctive male genitalia (Fig. 82). Ross (1944) described and illustrated the larva.

Genus *Protophila* Banks

Morse (1993) documented 39 species from North America. He previously reported distributional information for 13 species in the United States and Canada (Morse 1988). Four species are known from the Interior Highlands. Larvae generally inhabit warmer streams than other glossosomatid genera (Wiggins 1977). However, Ross (1956) noted that they are often abundant in large, cool rivers. *Protophila* are the smallest members of the family and they are often "rough sorted" with the Hydroptilidae. Characters have not been found to separate the larvae. Larval cases are similar to those of *Agapetus* in that they may incorporate a larger stone laterally (Wiggins 1977, Fig. 4.1 B, C). *Protophila* adults differ from those of *Agapetus* and *Glossosoma* by their 0-4-4 tibial spur count. Adults of the regional *Protophila* species are similar in general appearance, and all have a pale streak that runs transversely across the middle of the forewings. Males are readily separated by modifications of the eighth sternite and male genitalia; females are not easily separated unless collected in copula with males. Ross (1944) keyed some females but was unable to reliably separate those of *P. lega* and *P. maculata*. Life histories are unknown for any regional *Protophila* species.

KEY TO THE MALES OF *Protophila*

1. Sternite VIII produced posterad, apex with a shallow concavity (Fig. 83)
 *P. tenebrosa* (Walker)

- Sternum VIII produced posterad, apex deeply bifurcate (Fig. 84) 2
2. Lateral phallic styles straight or slightly sinuate (Fig. 87) . . . ***P. lega* Ross**
 Lateral phallic styles with apex angled or corkscrew-like 3
3. Phallic styles short, apex angled (Fig. 86) ***P. maculata* (Hagen)**
 Phallic styles long, apical one-half corkscrew-like (Fig. 88) ***P. sp. A***

***Protophila lega* Ross**

Fig. 87

Protophila lega Ross 1941b:48.

Type Locality.- Illinois, Oakwood.

Regional Distribution.- Watersheds 38, 39, 41, 47, 49, 53, 60, 62, 100, 107, 115, 122.

Nearctic Distribution.- US: AL, AR, IL, MO, MS, OH, OK, WI; CANADA: NB, ON.

Discussion.- Males are readily distinguished from the other regional species by the straight, slightly sinuate lateral phallic styles (Fig. 87). Often collected with *P. maculata* from medium to large streams and rivers (Table 5). Adults were collected from April through September (Table 6).

***Protophila maculata* (Hagen)**

Figs. 84, 86

Beraea ? *maculata* Hagen 1861:296.

Protophila lloydi Mosely 1934b:151.

Protophila expositionis Nimmo 1966:690.

Type Locality.- Canada.

Regional Distribution.- Watersheds 4, 23, 47, 56, 97, 103, 107, 109, 118, 122, 123, 124.

Nearctic Distribution.- US: AL, AR, DC, IL, IN, KY, MA, MD, ME, MN, MO, NH, NY, OH, OK, PA, TN, TX, VA, WI, WV; CANADA: MB, ON, PQ.

Discussion.- Males are most similar to *P. sp. A*, but differ in the shorter phallic styles (Fig. 86). Ross (1944) described and illustrated the larva. He indicated that it was probably multivoltine in Illinois. Commonly collected from mid-sized streams to large rivers (Table 5); often collected with *P. lega*. Adults were present from May to September (Table 6).

***Protophila tenebrosa* (Walker)**

Figs. 83, 85

Hydroptila tenebrosa Walker 1852:134.

Type Locality.- Ontario.

Regional Distribution.- Watersheds 38, 47, 68, 95, 100, 116, 117, 122. MISSOURI: Dallas Co., Bennett Spring, Bennett Spring State Park, 7-VI-1991, S.R. Moulton, 1 ♂; Douglas Co., Bryant Creek, spring off MO Hwy 5, W Bryant, 25-IX-1992, S.R. Moulton, 1 ♂; Laclede Co., Osage Fork Creek, MO Hwy 5, N jct. Rte V, 8-VI-1991, S.R. Moulton, 4 ♂♂; Oregon Co., Eleven Point River, MO

Hwy 142, Calm (town), 24-IX-1992, S.R. Moulton, 1 ♂; Shannon Co., Alley Spring and Jacks Fork River, MO Hwy 106, W Eminence, 24-IX-1992, S.R. Moulton, many ♂♂.

Nearctic Distribution.- US: AR, ID, MI, MN, MO, MT, NY, WI, WY;
CANADA: AB, BC, ON.

Discussion.- Males are readily distinguished from the other regional species by the shallow, apical concavity of sternite VIII (Fig. 83). Collected from a wide range of stream types (Table 5). Adults were collected during June, July, and September (Table 6).

***Protoptila* sp. A**

Fig. 88

Protoptila sp. nr. *maculata*: Mathis and Bowles (1992).

Regional Distribution.- Watersheds 68, 100, 124; MISSOURI: Shannon Co., Round Spring, MO Hwy 19, N Eminence, 24-IX-1992, S.R. Moulton, 1 ♂.

Discussion.- This species is currently being described by M. L. Mathis. Male genitalia appears to be intermediate of *P. maculata* and *P. palina* Ross. It is distinguished from the former by having the phallic styles much longer and corkscrew-like; it differs from the latter in that the phallic styles are more sharply twisted and the apico-ventral margin of the phallus is not produced (Fig. 88). Collection records indicate that it is probably endemic to the colder, spring-fed reaches of the Current River in Missouri (Table 5). Mathis and

Bowles (1992) reported the first records of it from Big Spring and the Jacks Fork River near Van Buren and Eminence, Missouri, respectively.

CHAPTER 6

FAMILY HELICOPSYCHIDAE

The Helicopsychidae are best known for their larval cases of sand grains that resemble a snail shell (Fig. 30). Morse (1993) listed 18 species in two genera for North America. *Helicopsyche* is the only genus occurring in the United States where six species are known (Hamilton & Holzenthal 1984, Morse et al. 1989).

Genus *Helicopsyche* Von Siebold

Three species are known from the region, one of which is endemic to the Ozark and Ouachita Mountains. Larvae are common in most small to medium sized streams. Vorhies (1909) reported larvae from wave swept rocky shorelines of lakes and to depths of 8 to 10 feet in Wisconsin. Pupae can usually be found in large aggregations on the undersides of medium sized cobbles. Adults are among the first caddisflies to emerge in the spring. They may be present year round around large springs. Mature larvae were easily reared in the laboratory.

KEYS TO THE SPECIES OF *Helicopsyche*

larvae

1. Dorsum of head capsule light yellow (Fig. 94) ***H. limnella* Ross**
 Dorsum of head capsule dark brown 2
2. Tentorial pits represented by a pair of large pale spots (Fig. 97)
 ***H. piroa* Ross**
 Tentorial pits not represented by large pale spots . ***H. borealis* (Hagen)**

adults

1. Maxillary palpi 2 segmented (males) 2
 Maxillary palpi 5 segmented (females) 4
2. Inferior appendage with posteroapical margin acutely produced (Fig. 91)
 ***H. limnella* Ross**
 Inferior appendage with posteroapical margin rounded 3
3. Inferior appendage boomerang-shaped (Fig. 95) ***H. piroa* Ross**
 Inferior appendage in lateral view broad with dorsal margin convex (Fig.
 89) ***H. borealis* (Hagen)**
4. Sixth sternite with a mesal spur-like process (Figs. 93, 96) 5
 Sixth sternite without such a spur-like process; lateral margins of
 spermathecal sclerite noticeably concave in middle (Fig. 90)
 ***H. borealis* (Hagen)**

5. Mesal process on sixth sternite minute, not reaching the posterior margin of the sternite (Fig. 93) ***H. limnella* Ross**
- Mesal process on sixth sternite large, reaching to the posterior margin of the sternite (Fig. 96) ***H. piroa* Ross**

***Helicopsyche borealis* (Hagen)**

Figs. 89, 90

Notidobia borealis Hagen 1861:266.

Helicopsyche glabra Hagen 1864:

Helicopsyche californica Banks 1899:210.

Helicopsyche annulicornis Banks 1904b:212.

Type Locality.- Washington.

Regional Distribution.- Watersheds 4, 23, 28, 38, 41, 47, 49, 52, 53, 55, 56, 61, 66, 67, 68, 69, 72, 74, 77, 81, 85, 87, 91, 93, 95, 96, 97, 99, 100, 102, 103, 105, 106, 107, 108, 109, 110, 115, 116, 117, 118, 121, 122, 124, 125, 128, 129, 130, 131.

Nearctic Distribution.- US: AL, AR, AZ, CA, CO, CT, DE, FL, GA, ID, IL, IN, KS, KY, MA, MD, ME, MI, MN, MO, MS, MT, NC, ND, NH, NJ, NM, NY, OH, OK, OR, PA, SC, SD, TN, TX, UT, VA, WA, WI, WV, WY; CANADA: AB, MB, NB, NF, NS, NT, ON, PQ, SK; MEXICO; CENTRAL AMERICA.

Discussion.- This species was originally described by Lea (1834) as a snail (Wiggins 1977). It is the most common and widely distributed member of

the genus in North America. It is known from 49 of the 131 watersheds in the region and is associated with a wide range of stream types (Table 5). Adults may be present all year (Table 6), especially near springs. Mature larvae are usually recognizable in the field by their dark head capsules and absence of distinct tentorial pale spots. Males are readily distinguished from the other regional *Helicopsyche* by the broad, dorsally convex margin of the inferior appendages (Fig. 89). Females lack a mesal process of sternite VI. Vaughn (1985a,b, 1986, 1987) reported detailed life history aspects of *H. borealis* in two Oklahoma streams. She observed that a population inhabiting a thermally fluctuating Ozark stream (9 - 25°C) was univoltine, with larval densities peaking in the spring and adults present only during the summer. Another population in a thermally constant Arbuckle Mountain stream (17°C) was multivoltine. Laboratory rearings of *H. borealis* at 19 to 21°C took 63 to 84 days to go from egg to pupa (Vaughn 1985a). Larval densities are apparently greatest where there are high concentrations of algal chlorophyll a, with no preference exhibited between diatoms, green filamentous, or blue-green filamentous algae when given a choice (Vaughn 1986). Vaughn (1987) demonstrated that the larval instars orient differently to current by occupying different positions on rock surfaces.

***Helicopsyche limnella* Ross**

Figs. 48, 91, 92, 93, 94

Helicopsyche limnella Ross 1938a:179.

Type Locality.- Arkansas, McFadden Springs.

Regional Distribution.- Watersheds 1, 9, 17, 23, 31, 35, 44, 46, 48, 49, 54, 56, 57, 65, 74, 77, 96.

Nearctic Distribution.- US: AR, MO, OK.

The larva is described for the first time below.

Larva (Fig. 94): head capsule width 0.7 mm; dorsum yellow and appearing grainy at 500X, two distinct carinae, each passing from the anterolateral corners of the frontoclypeus through the eye and ending posterad; venter mostly pale with a cluster of yellow muscle scars posterolaterad; occiput with a small pale area; mandibles and head setae black; notal sclerites and legs yellow to light brown; case typical for genus.

Although Ross (1938) first described the female, I have redescribed here to provide additional characters to distinguish it from females of the other regional species.

Female (Figs. 92, 93): length of forewing 5.5 mm; maxillary palpi 5 segmented; color and general structure similar to male; honeycomb-like reticulations surrounding a single seta present on sternites IV and V; short, acute, mesal process present on sternite VI, not reaching posterior margin of sternite; apex of tergum X tapering to a rounded point; spermathecal sclerite in ventral view with lateral margins nearly straight, converging slightly anterad.

Discussion.- This species is endemic to the Ozark and Ouachita

Mountains (Table 5). I have collected it from a wide range of stream types during most of the year (Table 6). It is likely the sister species of *H. paralimnella* Hamilton (in Morse *et al.* 1989) which is known only from South Carolina. Morse *et al.* (1989) provided a diagnosis for the males of these two species and an illustration of the female of *H. paralimnella*. The female may be distinguished from *H. paralimnella* by the following: 1) mesal process present on sternite VI, 2) reticulations present on sternites IV and V (present on III - V in *H. paralimnella*) and 3) 5-segmented maxillary palpi (4-segmented in *H. paralimnella*). *Helicopsyche limnella* females are readily distinguished from those of *H. borealis* by the presence of the mesal process on sternite VII and concave lateral margins of the spermathecal sclerite (Figs. 92, 93). Males differ by the pointed posteroapical margin of each inferior appendage (Fig. 91). Larvae are distinguished by the lighter head capsule (Fig. 94). Bowles and Allen (1992) reported its life cycle as bivoltine with overlapping generations in the Mulberry River, Johnson Co., Arkansas.

***Helicopsyche piroa* Ross**

Figs. 95, 96, 97

Helicopsyche piroa Ross 1944:289.

Type Locality.- San Antonio River, San Antonio, Texas.

Regional Distribution.- Watersheds 43, 46, 48, 60, 79, 103, 129.

ARKANSAS: Saline Co., South Fork Saline River, N Nance, 15-VIII-1980, H.W.

Robison & S. Winters, 1♂; Sevier/Howard Cos., Saline River @ AR Hwy 24, 5 mi E Lockesburg, 26-VI-1982, 10♂♂; OKLAHOMA: Murray Co., Travertine Creek, Chickasaw National Rec. Area, Sulphur, 30-VIII-1992, S.R. Moulton, 1 ♂.

Nearctic Distribution.- US: AR, KS, LA, OK, TX; MEXICO.

The larva and female are described for the first time below.

Larva (Fig. 97): head capsule width 0.5 - 0.6 mm; dorsum of head dark brown except for a single pale area at each tentorial pit, scattered light brown muscle scars present; venter of head largely pale with clusters of light brown, elongated muscle scars posterolaterad; eyes encircled by a pale area; head setae yellow; mandibles black; pronotum dark brown; meso- and metanotal sclerites light to dark brown; legs yellow; case typical for genus.

Female (Fig. 96): color, form, and genitalia similar to *H. limnella*; long, acute, mesal process present on sternite VI, its apex reaching to posterior margin of sternite.

Discussion.- Males are readily distinguished from the other regional species by the boomerang-shaped inferior appendage (Fig. 95). The female and larval descriptions above were from material collected in Louisiana and loaned to us by S. W. Hamilton. Females differ in having the mesal process of sternite VI prominent and reaching the posterior margin of the sternite (Fig. 96). Larvae are distinctive in having a darker head capsule with a large pale spot on each tentorial pit (Fig. 97). Its presence in the Interior Highlands is apparently confined to the Arbuckle and Ouachita Mountains (Table 5). Bowles and

Mathis (1992) provided an additional Ouachita Mountain record from the Glover River, McCurtain Co., Oklahoma. The life history of this species has not been studied.

CHAPTER 7

FAMILY HYDROPSYCHIDAE

This is one of the largest families represented in the region with 37 species distributed among eight genera. Hydropsychids are often taxonomically diverse and can dominate the secondary production for entire benthic communities. This is especially true below impoundments where seston loads are often high. Larvae construct a fixed retreat of organic and inorganic debris tied together with silk, and opening to a silken filtering net. Mesh sizes of the nets vary among genera and species, leading to an efficient means of partitioning particle size of food resources (Cudney and Wallace 1980). Generally, taxa in the upper and middle reaches of streams and rivers have nets with coarser meshes to filter CPOM, while those in lower reaches will have correspondingly finer meshes to filter FPOM. Larvae exhibit a wide range of tolerances to environmental perturbations. They are morphologically distinct in possessing sclerotized plates on all three thoracic nota, and having highly branched ventral abdominal gills. Mature larvae and pupae can be easily reared under laboratory conditions, and metamorphotypes (Milne 1938) provide an invaluable means of associating the adults. Adults are readily collected

throughout the day by a variety of methods. They do not possess ocelli or mesoscutellar warts, and have the fifth maxillary palp segment long, flexible, and grooved with numerous cross striae. Adult wing coloration ranges from uniformly dark brown to yellow, or mottled.

KEYS TO THE GENERA OF HYDROPSYCHIDAE

larvae

1. Posterior ventral apotome at least one-half as long as median ecdysial suture adjoining the genae (Fig. 109) 2
 - Posterior ventral apotome much less than one-half as long as median ecdysial suture (Fig. 103) 3
2. Anterior margin of frontoclypeus asymmetrical in dorsal view, the left side with a notch, head straw colored (Fig. 111)
 - ***Homoplectra doringa* (Milne)**
 - Anterior margin of frontoclypeus in dorsal view, entire, slightly convex (Fig. 107), or if concave in middle, then left mandible with a prominent thumb-like process (Fig. 108) ***Diplectrona* Westwood**
3. Tibiae and tarsi of forelegs with a dense brush of setae, fore trochantin never forked (Fig. 112); dorsum of head flattened with a high, sharp carina (Fig. 110) ***Macrostemum carolina* (Banks)**
 - Forelegs without a dense brush of setae; head without a high, sharp carina; fore trochantin sometimes forked 4

4. Venter of VIII with a single median, setigerous sclerite (Fig. 106)
 ***Smicridea fasciatella* MacLachlan**
 Venter of VIII with a pair of setigerous sclerites (Figs. 104, 105) 5
5. Prosternum with a pair of large sclerites posterior to prosternal plate
 (often concealed in intersegmental fold) (Fig. 98) 6
 Prosternum with a pair of minute sclerites, each located posterolaterally
 to the prosternal plate (Fig. 99) 7
6. Abdominal terga I - III at least with minute spines in addition to
 appressed setae and scale setae (Fig. 101) ***Hydropsyche* Pictet**
 Abdominal terga without minute spines and scale setae, and appressed
 present ***Ceratopsyche* Ross and Unzicker**
7. Sclerites on abdominal sternum IX with posterior margins entire (Fig.
 104); lateral margin of each mandible with a flange (Fig. 102)
 ***Potamyia flava* (Hagen)**
 Sclerites on abdominal sternum IX notched (Fig. 105); lateral margin of
 mandibles without a flange (Fig. 100) . . . ***Cheumatopsyche* Wallengren**

adults

1. Forewings with a distinct pattern of pale-yellow and dark brown areas
 (Fig. 113); male genitalia as in Fig. 198
 ***Macrostemum carolina* (Banks)**
 Forewings unicolored or variously patterned other than above; male

- genitalia not as in Fig. 198 2
2. Forewings with R_4 and R_5 very close together at base (Fig. 114); male genitalia as in Fig. 202 ***Smicridea fasclatella* MacLachlan**
- Forewings with R_4 and R_5 diverge quickly at base (Fig. 115) 3
3. Abdominal sternite V with a pair of external glands, either long and filamentous (Fig. 116) or short and finger-like (Fig. 118); eye usually situated far forward on head (Figs. 123, 125) 4
- Abdominal sternite V with external glands barely apparent or, if short and finger-like, then eyes not situated far-forward on head (Fig. 124), and fore- and hindwings dissimilar in shape (Figs. 119, 120) 5
4. Ventrolateral glands of abdominal segment V long and filamentous (Fig. 116) ***Diplectrona* Westwood**
- Ventrolateral glands of abdominal segment V short and finger-like, may be partially concealed in intersegmental groove (Fig. 118); male genitalia as in Fig. 200 ***Homoplectra doringa* (Milne)**
5. Hindwing with R_{2+3} unbranched; stems of M and Cu diverging from base (Fig. 119); anterior end of male phallobase bulbous (Fig. 140)
- ***Cheumatopsyche* Wallengren**
- Hindwing with R_{2+3} branched; stems of M and Cu parallel throughout length (Fig. 120); anterior end of male phallobase not bulbous 6
6. Forewing with m-cu and intercubital crossveins meeting (Fig. 119); general appearance straw-colored, antennae much longer than

- forewings ***Potamyia flava* (Hagen)**
- Forewings with m-cu and intercubital crossveins widely separated;
 general appearance brown with some pale mottling; antennae not longer
 than forewing 7
7. Forewings with Cu₂ and A meeting at or before wing margin (Fig. 121);
 males with phallotremal sclerites enclosed in a mesal cavity (Fig. 182)
 ***Hydropsyche* Pictet**
- Forewings with Cu₂ and A ending separately (but very close) on wing
 margin (Fig. 122); males with phallotremal sclerites exposed, situated
 dorsally (Fig. 131) ***Ceratopsyche* Ross and Unzicker**

Genus *Ceratopsyche* Ross and Unzicker

Morse (1993) listed 26 species from North America. The genus is represented in the Interior Highlands by five species. Their generic placement has been the focus of considerable debate (Ross and Unzicker 1977, Schuster 1984, Scheffer et al. 1986). Species are currently considered in the literature under *Hydropsyche* (*Ceratopsyche*), *Ceratopsyche*, or less commonly *Symphitopsyche*. Schuster (1984) provided convincing arguments that incorporated aspects of larval, pupal and adult morphology, as well as ecological information to support generic status of *Ceratopsyche*. Schuster and Etnier (1978) and Scheffer and Wiggins (1986) reviewed the larval taxonomy. Separation of *C. bronta*, *C. cheilonis* Ross, and *C. morosa* using

the chaetotaxy characters presented by Scheffer and Wiggins (1986) can be tenuous. Some populations of these species in the Ozarks may show some overlap in these setal characteristics (P. Scheffer, pers. communication).

KEYS TO THE SPECIES OF *Ceratopsyche*

larvae

1. Dorsum of head capsule with a checkerboard head capsule pattern (Fig. 127) ***C. bronta* (Ross), *C. morosa* (Hagen)**
 Dorsum of head patterned other than checkerboard 2
2. Dorsum of head dark with a single, large, median pale spot, or less commonly with a second spot anterior or posterior to it (Fig. 129)
 ***C. slossonae* (Banks)**
 Frontoclypeus with a central pale spot surrounded by a dark marking as in Fig. 128 ***C. piatrix* Ross**

adults

1. Apicolateral membranes of phallus long and projecting anteriorly; dorsolateral membranes and sclerites (= spines *sensu* Ross 1944) poorly developed (Fig. 131) ***C. piatrix* (Ross)**
 Apicolateral membranes short or absent; dorsolateral membranes and sclerites well developed and variable 2
2. Phallobase strongly arched in middle; dorsolateral sclerite small, curving

- dorsad (Fig. 133) ***C. slossonae* (Banks)**
 Phallobase not strongly arched; dorsolateral sclerite more prominent and
 projecting ventrally, or if small then not curving dorsally 3
3. Dorsolateral sclerites long and hanging well below ventral margin of
 phallobase (Figs. 134, 136) 4
 Dorsolateral sclerites short, not hanging below ventral margin of
 phallobase (Figs. 138, 139) 5
4. Dorsolateral sclerites robust, apico- and apicolateral spines few,
 inconspicuous (Fig. 136) ***C. bronta* (Ross)**
 Dorsolateral sclerites slender, apico- and apicolateral spines numerous
 and conspicuous (Fig. 134) ***C. cheilonis* (Ross)**
5. Dorsolateral sclerite prominent, lanceolate (Fig. 138)
 ***C. morosa* (Hagen) (east-central)**
 Dorsolateral sclerite minute, triangular (Fig. 139)
 ***C. morosa* (Hagen) (west-central)**

***Ceratopsyche bronta* (Ross)**

Figs. 134, 135

Hydropsyche bronta Ross 1938a:149.

Type Locality.- Michigan, Bronson, along Prairie River.

Regional Distribution.- Watersheds 4, 28, 38, 47, 52, 66, 81, 85, 92, 95,
 96, 100, 102, 103, 116, 117, 118, 121, 122.

Nearctic Distribution.- US: AR, CO, CT, DE, IL, IN, KY, MA, MD, ME, MI, MN, MO, MT, NC, ND, NH, NY, OH, OK, PA, SC, TN, VA, VT, WI, WV, WY; CANADA: AB, MB, NB, NS, ON, PQ, SK.

Discussion.- Males most closely resemble those of *C. cheilonis* (Fig. 133), but are distinguished by the more robust dorsolateral phallic sclerites and fewer apical spines. They differ from *C. morosa* males by the shorter apicolateral lobes of tergum X and the longer dorsolateral phallic sclerites, which hang well below the ventral margin of the phallus (Figs. 135, 136). This species ranges throughout the eastern United States and transcontinentally across the southern portions of Canada. The Ozark populations represent a disjunct unit (Scheffer and Wiggins 1986). Larvae of the eastern populations typically have a striped head capsule while the Ozark populations show a checkerboard design. Scheffer and Wiggins (1986) noted that this species usually occurs in cool, headwater streams (Table 5), and is tolerant of some organic enrichment. Adults were present from March to September (Table 6).

***Ceratopsyche morosa* (Hagen)**

Figs. 127, 137, 138, 139

Hydropsyche morosa Hagen 1861:287.

Hydropsyche chlorotica Hagen 1861:290.

Hydropsyche bifida Banks 1905:15.

Type Locality.- Canada, St. Lawrence River.

Regional Distribution.- Watersheds (east-central form) 28, 38, 41, 52, 67, 68, 85, 93, 100, 103, 107, 109, 116, 122, 124; (west-central form) 128, 129.

Nearctic Distribution.- US: AR, CO, CT, DC, DE, GA, IA, ID, IL, IN, KS, KY, MA, ME, MI, MN, MO, MT, NC, ND, NH, NJ, NY, OH, OK, PA, SC, TN, UT, VA, VT, WA, WI, WV, WY; CANADA: AB, BC, MB, NB, NS, ON, PQ, SK.

Discussion.- Scheffer and Wiggins (1986) recognized *C. bifida* (Banks) as a "west-central" variant of the typical "east-central" form of *C. morosa*, based on intermediate forms from northern transcontinental areas. I have not observed intermediate forms in the Interior Highlands. Males of the "west-central" form differ from those of the "east-central" form in the more reduced dorsolateral phallic sclerite (Figs. 139). The examination of numerous males in my collections indicates that the former predominates in the Ozark and Ouachita Mountains, while the latter is found only in the spring-fed streams of the Arbuckle Mountains (Table 5). Moulton *et al.* (1993) reported a mean critical thermal maximum (CTM) of 34.2°C for a population of this species from the Castor River in Missouri, acclimated to 19°C. Adults were present in my study from May to September (Table 6).

***Ceratopsyche piatrix* (Ross)**

Figs. 128, 130, 131

Hydropsyche piatrix Ross 1938a:148.

Type Locality.- Missouri, Greer Springs.

Regional Distribution.- Watersheds 47, 53, 68, 100, 104, 124.

ARKANSAS: Fulton Co., Mammoth Springs, US Hwy 63, Mammoth Springs (town), 25-V-1990, S.R. Moulton, 6 ♂♂; same but, 23-IX-1992, 12 ♂♂;

MISSOURI: Dent Co., Montauk Spring, Montauk State Park, 24-IX-1992, S.R. Moulton, many ♂♂; Shannon Co., Alley Spring and Jacks Fork River, MO Hwy 106, W Eminence, 24-IX-1992, S.R. Moulton, many ♂♂; Round Spring, MO Hwy 19, N Eminence, 24-IX-1992, S.R. Moulton, many ♂♂.

Nearctic Distribution.- US: AR, MO.

Discussion.- Males differ greatly from other regional species by the prominent apico-lateral membranes and the poorly developed dorsolateral sclerites of the phallus (Fig. 131). It is restricted to high-volume springs in Arkansas and Missouri (Table 5). Larvae were never collected, but adult collection records indicate that this species is probably multivoltine. The larval head illustrated herein (Fig. 128) was redrawn from Schuster and Etnier (1978). Adults were collected during March to October (Table 6) using sweep nets or UV light traps. This species has been placed on a watch list of threatened or endangered insects in Missouri (Wilson 1984, Anonymous 1992). Harris and Carlson (1977) reported 2 females in a small stream in North Dakota; this record is suspect since it is only based on females.

***Ceratopsyche slossonae* (Banks)**

Figs. 129, 132, 133

Hydropsyche slossonae Banks 1905:14.

Type Locality.- New Hampshire, Franconia.

Regional Distribution.- Watersheds 23, 28, 93, 95. ARKANSAS: Stone Co., Blanchard Springs above Mirror Lake, 24-V-1990, S.R. Moulton, 2 ♂♂, 5 ♀♀; MISSOURI: Barry Co., Roaring River State Park, Rte. F, 17-VIII-1990, S.R. Moulton, 1 ♂, 16 ♀♀; same but Roaring River at low water bridge (T21N R26W SEC6), 9 ♂♂, 5 ♀♀; Douglas Co., Bryant Creek, at spring off MO Hwy 5, W Bryant, 25-IX-1992, S.R. Moulton, 8 ♂♂, several larvae.

Nearctic Distribution.- US: AR, CO, CT, DE, IL, IN, KY, MA, ME, MI, MN, MO, MT, NC, ND, NH, NJ, NY, OH, PA, SC, TN, VA, VT, WI, WV, WY; CANADA: AB, BC, LB, MB, NB, NF, NS, NT, ON, PQ, SK.

Discussion.- Males are differentiated from other regional species by the configuration of tergum X (Fig. 132) and the reduced dorsolateral phallic sclerites (Fig. 133). The larval head capsule is dark dorsally, with a prominent pale spot centrally in the frontoclypeus; sometimes there were smaller pale areas coalesced anterad (Fig. 129). It was primarily collected from small, spring-fed streams and a few of the regional high-volume springs (Table 5). Scheffer and Wiggins (1986) reported that it inhabits cool, unpolluted streams. Mackay (1986) reported a univoltine life cycle for a population inhabiting an impounded, Minnesota trout stream. Adults were collected from March to September (Table 6).

Genus *Cheumatopsyche* Wallengren

Forty-three species are presently recorded from North America (Morse 1993). I am reporting 15 species from the Interior Highlands, including a species previously unknown to science. Herein I describe that new species. This genus is one of the most commonly encountered caddisfly groups in the region. Larvae are found in a variety of stream types with different water qualities, and therefore have been well represented in regional museum collections and water quality studies. Despite this, their species-level taxonomy has remained problematic. Some progress using setational characters has been made, but this is extremely preliminary since only about one-fourth of the species have associated larvae (Scheffer and Wiggins 1987). Adults are also common in collections that have utilized a variety of sampling methods. It was not uncommon in this study to encounter as many as six congeners and several thousand individuals from a single UV light trap sample. The adult taxonomy and phylogeny of *Cheumatopsyche* was last reviewed by Gordon (1974). Many species have multivoltine life cycles with adults present for nine or ten months out of the year. Bowles and Mathis (1991) reported an annual secondary production estimate of 1.24 g/m² ash free dry weight for an assemblage of at least four species in a third-order reach of the Mulberry River, Johnson Co., Arkansas. Studies of *C. campyla* and *C. lasia* in the Brazos River in nearby Texas (Malas 1983, and my unpublished work) suggest that

production is probably much higher than this in modified sections of warmer rivers of the Interior Highlands.

KEY TO THE MALES OF *Cheumatopsyche*

1. Distal segment of each inferior appendage forming a tapered, acute process (Fig. 146) 4
 - Distal article of each inferior appendage not forming a tapered, acute process (Fig. 140) 2
2. Long, apically rounded, median process projecting from beneath tergum X (Fig. 142); X in caudal view forming a high arch with dark, apicodorsal tooth-like projections; lobes of X weakly developed (Fig. 143)
 - ***C. minuscula* (Banks)**
 - Above median process absent or concealed beneath tergum X; caudal lobes of X well developed 3
3. Inferior appendage slender (Fig. 140); apicomesal margin of lobes of X angled upward (Fig. 141); widely distributed ***C. sordida* (Hagen)**
 - Inferior appendages stout (Fig. 144); apicomesal margin of lobes of X angled downward (Fig. 145); known only from a spring stream in southcentral Oklahoma ***C. comis* Edwards and Arnold**
4. Lobes of X held away from rest of tergum and forming a gap (Fig. 146) 5
 - Lobes of X held against tergum (Figs. 153, 161), or if gap is present then lobes are long and acute (Fig. 157) 8

5. Lobes of X truncate apically in caudal view (Fig. 147); inferior appendages long and slender (Fig. 146)
- ***C. harwoodi enigma* Ross, Morse and Gordon**
- Lobes of X rounded (Fig. 149); inferior appendages stouter 6
6. Lobes of X narrow basally, broadest in middle and then tapering quickly to a rounded point (Fig. 152) ***C. robisoni* NEW SPECIES**
- Lobes of X with apices broadly rounded (Fig. 149) 7
7. Lobes of X projecting well above level of tergum (Fig. 148, 149)
- ***C. rossi* Gordon**
- Lobes of X level with or projecting slightly above tergum (Fig. 155, 156)
- ***C. pettiti* (Banks)**
8. Lobes of X reflexed anteriorly (Figs. 153, 159) 9
- Lobes of X not reflexed (Fig. 157) 10
9. Tergum X with a prominent dorsolateral ridge anterior to the apical lobes; apical segment of inferior appendages slightly hooked (Fig. 153)
- ***C. speciosa* (Banks)**
- Tergum X with a weak dorsolateral ridge; apical segment of inferior appendages not hooked (Fig. 159) ***C. lasia* Ross**
10. Lobes of X slender with apices acute (Figs. 158, 162, 164) 11
- Lobes of X oblong or widened apically (Figs. 170, 172) 13
11. Lobes of X held away from tergum and directed postero-dorsally well above tergum (Fig. 157, 158) ***C. pasella* Ross**

- Lobes of X against tergum (Fig. 161) 12
12. Apical two-thirds of lobes of X with outer margins convex (Figs. 164) . . .
 **C. burksi Ross**
- Apical one-half of lobes of X with outer margins concave (Fig. 162)
 **C. campyla Ross**
13. Lobes of X oblong, uniformly wide (Figs. 170, 172) 14
- Lobes of X widened apically (Figs. 166, 168) 15
14. Inferior appendages with a definite shoulder where the basal and apical
 segments join, distal article much shorter than one-half the length of
 basal article (Fig. 169) **C. aphantia Ross**
- Inferior appendages without a definite shoulder, distal article one-half the
 length of basal article (Figs. 171, 173) **C. oxa Ross**
15. Tergum X sharply angled downward; lobes of X projecting above tergum
 (Fig. 167, 168) **C. halima Denning**
- Tergum X nearly horizontal; lobes of X scarcely projecting above tergum
 (Fig. 165, 166) **C. gracilis (Banks)**

Cheumatopsyche aphantia Ross

Figs. 169, 170

Cheumatopsyche aphantia Ross 1938a:151.

Type Locality.- Illinois, Oakwood.

Regional Distribution.- Watersheds 9, 17, 28, 31, 35, 39, 44, 48, 49, 53, 56, 74, 77, 85, 91, 96, 107.

Nearctic Distribution.- US: AR, IL, IN, KS, KY, MI, MN, MO, ND, NH, NY, OH, OK, PA, TN, TX, VT, WI; CANADA: NB, PQ.

Discussion.- Males are distinguished by the short, robust inferior appendages which have a prominent shoulder at the junction of the apical segment (Fig. 169). It was collected from a variety of stream types in eight of the 17 physiographic subregions (Table 5). Adults were present from March to October (Table 6).

***Cheumatopsyche burksi* Ross**

Figs. 163, 164

Cheumatopsyche burksi Ross 1941b:83.

Type Locality.- Illinois, Havana.

Regional Distribution.- Watersheds 6, 24, 31, 35, 58, 67, 69, 70, 77, 80.
 ARKANSAS: Arkansas Co., India Bayou, AR Hwy 1, White River National Wildlife Refuge, 4-IX-1990, S. Chordas, 28 ♂♂; Craighead Co., gravel pit 1 mi E AR Hwy 1, Mt. Pisgoh Cemetery, 13-VIII-1991, S.R. Moulton and J.C. Abbott, 1 ♂; Polk Co., Cross Creek, 5 mi W Grannis, 25-VI-1982, H.W. Robison, 1 ♂;
 OKLAHOMA: Pushmataha Co., Kiamichi River, 13-VI-1991, R. Tucker, 2 ♂♂.

Nearctic Distribution.- US: AL, AR, CT, FL, IL, IN, KY, LA, MS, NY, OK, TN, VA, VT.

Discussion.- Males are distinguished by the blade-like lobes of tergum X (Fig. 164). These lobes are held close to IX, are convex on the outer margins, and taper to a point. It is most commonly found in medium to large bottomland streams in the Mississippi Alluvial Plain, Gulf Coastal Plain, and Crowley's Ridge physiographic subregions (Table 5). Adults were present during the late spring and summer (Table 6).

***Cheumatopsyche campyla* Ross**

Figs. 161, 162

Cheumatopsyche campyla Ross 1938a:152.

Type Locality.- Illinois, Mokenca.

Regional Distribution.- Watersheds 1, 4, 19, 20, 23, 24, 27, 28, 32, 35, 39, 48, 49, 52, 55, 56, 58, 62, 67, 68, 70, 77, 80, 81, 84, 85, 89, 102, 105, 106, 107, 108, 116, 117, 122, 126, 129, 130.

Nearctic Distribution.- US: AL, AR, AZ, CA, CO, CT, DE, GA, IA, ID, IL, IN, KS, KY, MA, ME, MI, MN, MO, MS, MT, ND, NE, NH, NJ, NM, NY, OH, OK, OR, PA, TN, TX, UT, VA, VT, WA, WI, WV, WY; CANADA: AB, BC, LB, MB, NF, NS, ON, PQ, SK.

Discussion.- Males may be confused with those of *C. pasella*; they differ in having the tergum X lobes broadest in middle then tapering apically to rounded points (Fig. 162). These lobes are shorter and held closer to IX than *C. pasella*. I also examined a variant male that had the area of tergum X

immediately anterad of the lobes strongly arched dorsad (see discussion for *C. lasia*). This was one of the most commonly collected caddisfly species in the region, being associated with nearly all levels of the environmental parameters I examined (Table 5). Even though I have not found this species along the Mississippi River border, Arkansas River Valley, and Wichita Mountains subregions, additional collecting in those areas should produce records of this ubiquitous of this species. Adults were present throughout the year except in winter (Table 6).

***Cheumatopsyche comis* Edwards and Arnold**

Figs. 144, 145

Cheumatopsyche comis Edwards and Arnold 1961:409.

Type Locality.- Texas, Hays Co., San Marcos River.

Regional Distribution.- Watershed 59. OKLAHOMA: Love Co., unnamed spring, near Thackerville, 19-IV-1991, S.R. Moulton, 1 ♂.

Nearctic Distribution.- US: OK, NM, TX.

Distribution.- Males are somewhat similar to the regionally common *C. sordida*. However, the *C. comis* inferior appendages are stouter (Fig. 144) and the apicomesal margin of the tergum X lobes are angled downward (Fig. 145). This species was previously known only from spring-fed streams and rivers in the Edwards Plateau region of central Texas. The record reported here represents a northern range extension of about 250 miles. This is not

surprising, since several caddisfly species in the Arbuckle Mountains subregion exhibit similar disjunct distributional patterns. The south-central Oklahoma spring where I collected this male is located within the coastal plain Red River watershed, but it mimics several springs and spring-fed streams of the nearby Arbuckle Mountains.

***Cheumatopsyche gracilis* (Banks)**

Figs. 165, 166

Hydropsyche gracilis Banks 1899:216.

Type Locality.- Colorado, Fort Collins.

Regional Distribution.- Watersheds 4, 23, 49, 56, 100, 103, 107, 124.

Nearctic Distribution.- US: AL, AR, CO, CT, KS, MA, ME, MI, MN, MO, NC, ND, NJ, NY, OH, OK, PA, SC, TN, UT, VA, VT, WI, WV, WY; CANADA: AB, BC, LB, MB, NF, ON, PQ.

Discussion.- This species was first reported from Arkansas by Unzicker *et al.* (1970). Males are similar in some respects to those of *C. halima* and *C. harwoodi*, but may be distinguished from them by the shape and position of the tergum X lobes and longer, robust size of each inferior appendage (Fig. 165). It was infrequently collected from permanent, or spring-fed headwater streams (Table 5) from May to October (Table 6).

***Cheumatopsyche halima* Denning**

Figs. 167, 168

Cheumatopsyche halima Denning 1948:400.

Type locality.- Massachusetts, Amherst.

Regional Distribution.- ARKANSAS: Benton Co., July (Gordon 1974).

Nearctic Distribution.- US: AR, MA, ME, OH, PA, SC, VA, VA, WV;

CANADA: NB, PQ.

Discussion.- Males are similar to those of *C. aphanta*, except for their more slender inferior appendages (Fig. 167) and more angular configuration of tergum X lobes (Fig. 168). The regional presence of this species is based entirely on the county record provided by Gordon (1974). From that information I was unable to determine its watershed and other physiographic affinities. Bowles and Mathis (1989) reported it from Crystal Springs Rec. Area in Montgomery Co., Arkansas. However, I compared their material to the holotype male of *C. halima* (CAS type No. 16150) and found it be that of my new species *C. robisoni*.

Cheumatopsyche harwoodi enigma

Ross, Morse and Gordon

Figs. 146, 147

Cheumatopsyche harwoodi Denning 1949:41.

Cheumatopsyche harwoodi enigma Ross, Morse, and Gordon 1971:301.

Type Locality.- Georgia, Union Co., Wolf Creek.

Regional Distribution.- Watersheds 23, 85, 121. ARKANSAS: Stone Co., Sylamore Creek, Gunner Pool Rec. Area, July, 3 ♂♂ (Bowles and Mathis 1989); MISSOURI: Reynolds Co., West Fork Black River, MO Hwy 21, 0.5 km N Centerville, 27-IX-1991, S.R. Moulton, 1 ♂; Taney Co., Beaver Creek, 1 mi N Bradleyville, low water bridge off Hwy 125, August (Mathis And Bowles 1992).

Nearctic Distribution.- US: AR, GA, MO, NC, SC, VA

Discussion.- Males are readily identified by the broad, truncate tergum X lobes and long, slender inferior appendages (Figs. 146, 147). It was infrequently collected from medium sized, permanent streams (Table 5). Adults were present during the mid- to late summer (Table 6).

***Cheumatopsyche lasia* Ross**

Figs. 159, 160

Cheumatopsyche lasia Ross 1938a:154.

Type Locality.- Oklahoma, Davis, along Washita River.

Regional Distribution.- Watersheds 48, 104, 128, 129.

Nearctic Distribution.- US: AZ, IA, IL, IN, KS, MN, MO, MT, ND, NE, NM, OK, PA, TX, WY; CANADA: AB, SK; MEXICO.

Discussion.- The type locality is near the Turner Falls area in the Arbuckle Mountains subregion. Bowles and Mathis (1992) provided additional Oklahoma locality records which are centered in that subregion. Males are

similar to *C. speciosa* in having the apical lobe of tergum X reflexed, but differ in the flared bases of these lobes (Fig. 160). Ross (1944) reported it from Missouri. Bowles and Mathis (1989) reported a single male collected at Bard Springs, a small, headwater stream in Polk Co., Arkansas. I examined this male and found it to be a variant of *C. campyla* (see discussion). As a result I am tentatively removing it from the Arkansas state list until definitive specimens are located. Ross (1944) noted an association of this species with large, silt laden rivers. This observation certainly holds true for the Washita River at Davis, which transports enormous quantities of red clay and is always turbid. Rhame and Stewart (1976) provided a thorough account of its life history in the Brazos River, Texas. Their data suggests a bivoltine or trivoltine life cycle. Adults were present during the spring and summer (Table 6).

***Cheumatopsyche minuscula* (Banks)**

Figs. 142, 143

Hydropsyche minuscula Banks 1907a:130.

Cheumatopsyche montrealinsis Nimmo 1966:689.

Type Locality.- Maryland, Plummer's Island.

Regional Distribution.- Watersheds 4, 9, 17, 23, 35, 39, 44, 48, 49, 52, 56, 60, 66, 73, 74, 77, 80, 96, 100, 103, 104, 115, 116, 117, 118, 121, 122, 123.

Nearctic Distribution.- US: AL, AR, CT, DC, GA, KS, KY, MA, MD, ME,

MN, MO, NC, ND, NH, NY, OH, OK, PA, SC, TN, VA, VT, WI, WV; CANADA:
MB, ON, PQ.

Discussion.- Of the regional species, this one most resembles *C. sordida*. Males are distinguished by the sharp apices of the tergum X lobes (Fig. 143) and the elongated, finger-like process that projects posterad beneath X (Fig. 142). It was collected from a wide range of permanent streams having a gravel-cobble substrate (Table 5). Adults were present most of the year except during winter (Table 6).

***Cheumatopsyche oxa* Ross**

Figs. 171, 172, 173

Cheumatopsyche oxa Ross 1938b:155.

Type Locality.- Indiana, Columbia City.

Regional Distribution.- Watersheds 4, 17, 23, 28, 31, 38, 39, 44, 46, 49, 52, 53, 56, 67, 68, 69, 74, 77, 81, 93, 95, 100, 102, 105, 106, 116, 117, 121, 122.

Nearctic Distribution.- US: AL, AR, CT, GA, IL, IN, KS, KY, ME, MI, MN, MO, MT, NC, NH, NY, OH, OK, PA, SC, SD, TN, VA, VT, WI, WV, WY; CANADA: AB, BC, MB, ON, PQ, SK.

Discussion.- Males are most similar to *C. aphanta*, but differ in the more sinuate lateral margins of the tergum X lobes (Fig. 172), and the longer distal article of each inferior appendage (Fig. 173). A commonly collected species

from small headwater and medium sized streams (Table 5) during March to October (Table 6).

***Cheumatopsyche pasella* Ross**

Figs. 157, 158

Cheumatopsyche pasella Ross 1941b:84.

Type Locality.- Kentucky, Pinewood.

Regional Distribution.- Watersheds 24, 39, 49, 55, 61, 62, 63, 68, 70.

Nearctic Distribution.- US: AL, AR, CT, DE, FL, GA, IL, IN, KY, LA, MA, MD, ME, MS, MT, NC, ND, NH, NJ, OH, OK, OR, PA, RI, SC, TN, VA, VT, WA, WI, WV; CANADA: ON, PQ.

Discussion.- Males are most similar to those of *C. campyla* except that the lobes of tergum X are narrower and longer, and project well above, and slightly posterad, the rest of the tergum (Fig. 157). Less common than *C. campyla*, this species was most often collected from lowland streams surrounding the mountainous areas (Table 5). Adults were present in UV light traps during March to September (Table 6). Cudney and Wallace (1980) reported a bivoltine life cycle for a population in the Savannah River, Georgia.

***Cheumatopsyche pettiti* (Banks)**

Figs. 155, 156

Hydropsyche pettiti Banks 1908b:265.

surprising, since several caddisfly species in the Arbuckle Mountains subregion exhibit similar disjunct distributional patterns. The south-central Oklahoma spring where I collected this male is located within the coastal plain Red River watershed, but it mimics several springs and spring-fed streams of the nearby Arbuckle Mountains.

***Cheumatopsyche gracilis* (Banks)**

Figs. 165, 166

Hydropsyche gracilis Banks 1899:216.

Type Locality.- Colorado, Fort Collins.

Regional Distribution.- Watersheds 4, 23, 49, 56, 100, 103, 107, 124.

Nearctic Distribution.- US: AL, AR, CO, CT, KS, MA, ME, MI, MN, MO, NC, ND, NJ, NY, OH, OK, PA, SC, TN, UT, VA, VT, WI, WV, WY; CANADA: AB, BC, LB, MB, NF, ON, PQ.

Discussion.- This species was first reported from Arkansas by Unzicker *et al.* (1970). Males are similar in some respects to those of *C. halima* and *C. harwoodi*, but may be distinguished from them by the shape and position of the tergum X lobes and longer, robust size of each inferior appendage (Fig. 165). It was infrequently collected from permanent, or spring-fed headwater streams (Table 5) from May to October (Table 6).

Cheumatopsyche analis Banks 1903b:243 (sensu Ross 1944).

Type Locality.- Michigan, Agricultural College.

Regional Distribution.- Watersheds 1, 4, 6, 9, 10, 13, 17, 20, 23, 27, 28, 31, 35, 39, 43, 44, 46, 47, 48, 49, 52, 53, 55, 56, 57, 58, 60, 61, 62, 66, 67, 69, 70, 74, 77, 80, 81, 88, 89, 105, 106, 109, 115, 116, 117, 118, 119, 121, 122, 124, 125, 126, 128, 129.

Nearctic Distribution.- US: AL, AR, CO, CT, DE, FL, GA, HI, ID, IL, IN, KS, KY, LA, MA, MD, ME, MI, MN, MO, MS, MT, NC, ND, NH, NJ, NY, OH, OK, OR, PA, SC, SD, TN, TX, UT, VA, VT, WA, WI, WV, WY; CANADA: AB, BC, MB, NF, NS, ON, PE, PQ, SK

Discussion.- This was the most frequently collected species of *Cheumatopsyche* in the region (Table 5). Males are distinguished primarily by the less robust lobes of tergum X, which project little, if any, above the tergum (Fig. 156). Adults were collected nearly year round (Table 6) using a variety of active and passive collecting methods. Mackay (1986) reported a univoltine life cycle for a population from a cold, spring stream in Minnesota. She noted that it was at least bivoltine in Ontario streams where water temperatures reached 30°C during the summer.

***Cheumatopsyche robisoni* Moulton and Stewart**

NEW SPECIES

Figs. 119, 150, 151, 152

Description.- MALE: Length of forewing 5.0 - 7.0 mm; wings light brown in alcohol. Head and thorax brown; legs and antennae straw-colored. Abdominal segment IX annular with dorsal lobes having long setae. Tergum X shelf-like in lateral view; superior appendages (= cercus of Gordon 1974) setose, longer than wide in lateral view, semicircular in caudal view; apex divided into a pair of setose lobes, each lobe in caudal view narrowest basally, broadest in middle, tapering to a rounded apex, dorsal one-half projecting above tergum, separated from rest of tergum by a width less than width of lobe. Inferior appendages slender in lateral view, basal article projecting to dorsum of X or slightly below; apical article arising from posterior side of basal article, forming a distinct shoulder, apex slightly recurved anterad, in caudal view slender and sinuate. Phallobase bulbous, phallosome somewhat elongate.

Diagnosis.- Based on the configuration of the tergum X lobes and the gap separating them from the rest of the tergum, *C. robisoni* appears most closely related to members of the monophyletic *C. rossi* Group of the *C. gracilis* Complex (Gordon 1974). The *C. rossi* Group includes *C. logani* Gordon and Smith, *C. pettiti*, *C. rossi*, and *C. smithi* Gordon. It appears most closely related to the nominate species of this group. I compared *C. robisoni* to the holotype male of *C. rossi* and found it to differ substantially in the narrower gap separating the tergum X lobes from the rest of the tergum, the

tapered, wedge-shaped appearance of these lobes in caudal view (circular in *C. rossi*), and the longer phallosome (shorter in *C. rossi*).

Type Material.- HOLOTYPE ♂: ARKANSAS: Montgomery Co., Strawn Spring, 0.5 mi E Caddo Gap, 12-IX-1980, H.W. Robison; PARATYPES: Garland Co., Cooper Creek, AR Hwy 171, 23-VIII-1990, H.W. Robison, 10 ♂♂; Montgomery Co., same data as holotype, 8 ♂♂; unnamed tributary of South Fork Caddo River, 5 mi NE Fancy Hill, 28-VII-1989, H.W. Robison, 3 ♂♂; South Fork Caddo River, 0.5 mi W Fancy Hill, H.W. Robison, 3 ♂♂; Crystal Springs Rec. Area, 15-VI-1987, D.E. Bowles, 10 ♂♂; Polk Co., Ouachita River, 5.5 mi E jct. AR Hwy 272 and US Hwy 270, 10-VI-1990, H.W. Robison, 1 ♂; unnamed tributary to Big Fork Creek, AR Hwy 8, 8-VI-1989, H.W. Robison, 1 ♂; spring on Rich Mountain, W Pioneer Cemetery, Queen Wilhelmina State Park, 14-V-1991, H.W. Robison, 1 ♂; 6.4 mi W Mena, 27-VI-1990, H.W. Robison, 26 ♂♂.

Etymology.- I take great pleasure in naming this species in honor of Dr. Henry W. Robison for his avid caddisfly collecting in the region and unending encouragement and support for this research.

Regional Distribution.- Watersheds 49, 56, 57, 74.

Discussion.- This species appears to be endemic to small, spring-fed streams in the Ouachita Mountain physiographic subregion (Table 5). Adults were often abundant in UV light trap samples. The larva is unknown. Bowles and Mathis (1989) reported this species as *C. halima*; their material is included above as paratypes.

***Cheumatopsyche rossi* Gordon**

Figs. 148, 149

Cheumatopsyche rossi Gordon 1974:129.

Type Locality.- Arkansas, Fulton Co., Mammoth Springs.

Regional Distribution.- Watersheds 47, 80, 100. ARKANSAS: see type locality, 6-VI-1937, H.H. Ross, holotype ♂; MISSOURI: Shannon Co., Alley Spring, MO Hwy 106, W Eminence, 24-IX-1992, S.R. Moulton, 4 ♂♂.

Nearctic Distribution.- US: AR, KS, MO, OK.

Discussion.- Males are distinguished from the closely related species in the *C. rossi* Group (see diagnosis for *C. robisoni*) in having the lobes of tergum X broader, sub-circular, and projecting well above the tergum (Fig. 149). It is known only from the high-volume springs and associated riverways of the Central Plateau and Curtois Hills physiographic subregions (Table 5). Bowles and Mathis (1992) reported it from Latimer Co., Oklahoma. However, their record may actually be *C. robisoni*. Bowles and Mathis (1989) and Allen (1990) reported additional county records from the Boston Mountains and Arkansas River Valley. Adults were present during April to October (Table 6).

***Cheumatopsyche sordida* (Hagen)**

Figs. 140, 141

Hydropsyche sordida Hagen 1861:290.

Type Locality.- Canada, St. Lawrence River.

Regional Distribution.- Watersheds 4, 38, 68, 81, 85, 87, 100, 102, 103, 107, 109, 116, 120, 122, 124.

Nearctic Distribution.- US: AL, AR, DC, GA, IL, IN, KY, LA, MD, ME, MI, MN, MO, MS, NC, NH, NJ, NY, OK, PA, SC, TN, TX, VA, WI, WV; CANADA: MB, NB, PN, PQ.

Discussion.- Males resemble those of *C. comis*, except that the inferior appendages are long and slender (Fig. 140), and the apicomeral margin of the tergum X lobes are angled upward (Fig. 141). Recorded from a variety of stream types in most of the subregions that comprise the Ozark Mountains (Table 5). I did not collect it in the Ouachita Mountains. Adults have been collected from April to October (Table 6).

***Cheumatopsyche speciosa* (Banks)**

Figs. 153, 154

Hydropsyche speciosa Banks 1904b:214.

Type Locality.- Maryland, Plummer's Island.

Regional Distribution.- Watersheds 28, 54, 67, 69, 87, 104.

ARKANSAS: Cleburne Co., Little Red River, 12-VII-1984, H.W. Robison, 1 ♂; Independence Co., Curia Creek 4 mi NE Charlotte, 19-VII-1986, H.W. Robison, 1 ♂; Piney Creek, 5 mi NE Pleasant Plains, 31-V-1986, H.W. Robison, 1 ♂.

Nearctic Distribution.- US: AR, CO, CT, DE, IL, IN, KY, MD, MN, MO, MT, NC, ND, NY, OH, OK, PA, TN, VA, WI; CANADA: AB, LB, MB, ON, PQ, SK.

Discussion.- Males have the tergum X lobes strongly reflexed anterad, with the upper portion of each lobe directed dorsad like a setose thumb-like process; the remainder of the lobe forms a sharp ridge (Fig. 153). Adults were infrequently collected in the region (Table 5) during March - October (Table 6).

Genus *Diplectrona* Westwood

Two of the six North American species (Morse 1993) are represented in the Interior Highlands. Larvae were collected from aquatic mosses and leaf packs in headwater streams (Wiggins (1977)). Larvae are distinguished from other hydroptychid genera by having the posterior ventral apotome, one-half as long as the median ecdysial suture (Fig. 109), and the pronotum lacking a transverse sulcus on its posterior two-thirds. Adults possess a pair of long, filamentous glands on abdominal sternite V (Fig. 116).

KEYS TO THE SPECIES OF *Diplectrona*

larvae

1. Left mandible in dorsal view, with a thumb-like process, anterior margin of frontoclypeus with a wide notch (Fig. 108) ***D. metaqui* Ross**
- Left mandible in dorsal view, without a thumb-like process, similar in structure to right mandible, anterior margin of frontoclypeus slightly convex (Fig. 107) ***D. modesta* Banks**

adults

1. Eyes large and extending to posterior margin of head (Fig. 123)
 ***D. modesta* Banks**
- Eyes smaller and situated far forward on head (Figs. 124)
 ***D. metaqui* Ross**

***Diplectrona metaqui* Ross**

Figs. 108, 124

Diplectrona metaqui Ross 1970:229.

Type Locality.- Illinois, Johnson Co., Cache Creek, 5 mi N Bloomfield.

Regional Distribution.- Watersheds 89, 94, 122. ILLINOIS: see type locality, 5-V-1965, Dysart and Stannard, holotype ♂; MISSOURI: Pulaski Co., unnamed spring, Roam Farm near Swedeborg, S Road T-740, 30-I-1987, M. L. Mathis, 1 larva.

Nearctic Distribution.- US: CT, GA, IL, IN, KY, MO, NC, OH, TN, VA.

Discussion.- Larvae of this species were first reported by Ross (1944) as "Hydropsychid Genus A". It was originally thought to be generically distinct based on the asymmetrical, anterior frontoclypeal margin, and the large, dorsal, thumb-like process of the left mandible. After positive association with mature metamorphotypes and adults, it was decided that it belonged in *Diplectrona* (Ross 1970). I examined the ♂ holotype in the INHS and confirm Ross' (1970) evaluation that the genitalia are indistinguishable from those of *D. modesta*.

Adults are best separated from the latter by the comparatively smaller mid-dorsal setal warts and compound eyes. This species is known in the region from its type locality in the Illinois Ozarks and a second location in the Missouri Ozarks (Mathis and Bowles 1992)(Table 5). The larval head illustration (Fig. 108) is from the Missouri specimen. My illustration of the adult male head (Fig. 124) was drawn from the holotype.

***Diplectrona modesta* Banks**

Figs. 107, 109, 115, 116, 122, 201

Diplectrona modesta Banks 1908b:266.

Type Locality.- Massachusetts, Riverside.

Regional Distribution.- Watersheds 9, 14, 17, 23, 36, 44, 49, 55, 56, 57, 72, 74, 77, 80, 89, 122.

Nearctic Distribution.- US: AL, AR, CT, DE, FL, GA, IL, IN, KS, KY, MA, ME, MI, MO, MS, NC, NH, NY, OH, OK, PA, SC, SD, TN, VA, VT, WI, WV;
CANADA: NF, ON, PQ.

Discussion.- This is the most common and widely distributed of the two regional species. It was collected from first and second order spring-fed streams, some of which become intermittent during the summer (Table 5). Haefner and Wallace (1981) reported a univoltine life cycle for this species in an Appalachian Mountain stream. Adults were present from April to September (Fig. 6). Its regional life history has never been studied.

Genus *Homoplectra* Ross

Eleven species are known from North America (Weaver 1985, Morse 1993). Of these, only *H. doringa* is recorded from the region. Previously, this species and another Appalachian species (*H. monticola* (Flint)) had been treated under *Aphropsyche* Ross. Weaver (1985) reevaluated these genera and noted that the only feature separating them was their Nearctic distribution. The inadequacy of this distinction and the concomitant similarity of morphological characters led to the reduction of *Aphropsyche* as a junior synonym (Weaver 1985).

***Homoplectra doringa* (Milne)**

Figs. 111, 117, 118, 125, 200

Diplectrona doringa Milne 1936:68.

Aphropsyche aprilis Ross 1941:79.

Type Locality.- New Hampshire, Glen House.

Regional Distribution.- Watersheds 10, 69. ARKANSAS: Independence Co., unnamed tributary to Salado Creek, 5.6 km N Pleasant Plains, US Hwy 167, 18-IV-1987, P.A. Harp, 1 ♀; Logan Co., dripping springs, Magazine Mountain, 20-IV-1987, D.E. Bowles, 6 ♂♂, 2 ♀♀; Gutter Rock Creek, Magazine Mountain, 13-14-III-1992, S.R. Moulton, 4 larvae (1 ♀ reared 16-VI-1992); Newton Co., unnamed tributary of West Fork Shop Creek, 2 mi S Parthenon, 19-II-1994, B.C. Poulton and H.W. Robison, 2 larvae.

Nearctic Distribution.- *Homoplectra doringa*-US: AL, AR, IN, KY, MA, NC, NH, TN, VA.

Discussion.- Bowles and Mathis (1989) reported that it was commonly collected at spring-runs, but had a scattered distribution. The majority of the material I collected and examined came from first-order, spring-fed tributaries of Gutter Rock Creek on Magazine Mountain that are dry during the summer and fall (Table 5). Mature larvae and adults were collected only during the spring (Table 6). Although its regional life history is unknown, collection data suggests that it probably exhibits a univoltine-fast life cycle. I was able to successfully rear this species in the laboratory (see above). The larva was illustrated and keyed by Wiggins (1977) as *Aphropsyche* ? sp.; the male was illustrated by Ross (1944) as *A. aprilis*.

Genus *Hydropsyche* Pictet

Morse (1993) listed 49 species for North America. Eight of these are recorded from the Interior Highlands. This genus was one of the most commonly collected in the region. Larvae, pupae and adults were readily taken from a wide range of stream habitats. Adults were collected in the greatest numbers with UV light traps. *Hydropsyche* larvae are distinguished from those of *Ceratopsyche* in possessing minute spines covering the abdominal terga. Adults are distinguished from those of the latter in having the A and Cu₂ forewing veins meet at or before the wing margin (Fig. 121), and by

their respective differences in genitalia. Regional life histories are unknown, but Rhame and Stewart (1976) reported a multivoltine life cycle for *H. simulans* in a nearby Texas modified river. Schuster and Etnier (1978) provided detailed descriptions, diagnoses and illustrated keys in their review of the eastern United States species. The larval key below was modified from their work. The larva of *H. alvata* is unknown. Previously, adults were identified using either Ross (1944) or Nimmo (1987).

KEYS TO THE SPECIES OF *Hydropsyche*

larvae

1. Anterior margin of frontoclypeus with two large upturned teeth (Figs. 174, 175) 2
 Anterior margin of frontoclypeus without large upturned teeth (Fig. 177) 3
2. Frontoclypeus with a prominent V-shaped pale mark (Fig. 174)
 ***H. orris* Ross**
 Frontoclypeus with two large anterolateral pale spots (Fig. 176)
 ***H. bidens* Ross**
3. Heavily sclerotized, stout, reddish setae on ventral surface of anal prolegs (Fig. 178) ***H. scalaris* Hagen**
 Heavily sclerotized, stout, reddish setae absent from ventral surface of anal prolegs 4
4. Posterior corner of frontoclypeus with an elevated mound or tubercle,

- best seen in lateral view of head (Fig. 179) ***H. betteni* Ross**
- Posterior corner of frontoclypeus level with rest of posterior one-half of
sclerite 5
5. Scale setae (Fig. 101) very abundant on all abdominal segments, may
be fewer on segments I and II; dorsum of head with a pair of large pale
spots (Fig. 180) ***H. rossi* Flint, Voshell, and Parker; *H. simulans* Ross**
- Scale setae sparse on at least abdominal segments I - IV; dorsum of
head without a pair of large pale spots as above ***H. arinale* Ross**

males

1. Phallobase recurved posteroventrally forming a semicircle in lateral view
(Fig. 197) ***H. betteni* Ross**
- Phallobase not recurved (Fig. 183); apex of phallus expanded laterally
and with a ventromesal opening (182) 2
2. Phallus in ventral view with swelling anterad of apex (Fig. 182)
. ***H. arinale* Ross**
- Shaft of phallus not bulging anterad of apex (Fig. 185) 3
3. Phallus with lateral flanges narrow, appearing as thin curved lines, cavity
in ventral view widely opened (Fig. 185)
. ***H. rossi* Flint, Voshell, and Parker**
- Lateral flanges more developed; mesal cavity variable; opening of apex
variable but not widely opened (Figs. 190, 195, 196) 4

4. Phallus with endothelial processes produced well beyond mesal cavity
(Fig. 192) ***H. scalaris* Hagen**
Endothelial processes slightly produced (Fig. 190) 5
5. Phallus very robust (Fig. 188) ***H. simulans* Ross**
Phallus less robust (Fig. 193) 6
6. Inner margins of lateral flanges nearly parallel (Fig. 190); endothelial
processes directed obliquely in lateral view ***H. orris* Ross**
Inner margins of lateral flanges emarginate apically (Fig. 195) or
divergent (Fig. 196) 7
7. Inner margins of lateral flanges emarginate apically (Fig. 195);
endothelial processes straight in lateral view (Fig 194) ***H. bidens* Ross**
Inner margins of lateral flanges strongly divergent in middle (Fig. 196) . .
. ***H. alvata* Denning**

***Hydropsyche alvata* Denning**

Fig. 196

Hydropsyche alvata Denning 1949:40.

Type Locality.- Mississippi, Jackson.

Regional Distribution.- Watersheds 25, 36, 53, 67, 68, 80, 107.

ARKANSAS: Randolph Co., Current River, AR Hwy 62, 1 VI-1986, H.W.

Robison, 4 ♂♂; MISSOURI: Osage Co., Gasconade River, Pointers Creek

Access, off Rte. RA, 15-VI-1990, B.C. Poulton, 3 ♂♂.

Nearctic Distribution.- US: AL, AR, FL, GA, IL, IN, LA, MI, MO, MS, VA, OK.

Discussion.- Represented in the region from a few scattered localities. Males share a number of genitalic similarities with *H. bidens* and *H. orris*, but are distinguished from them by the strongly divergent mid-inner margins of the phallic lateral flanges (best viewed ventrally, Fig. 196). Adults were present during the late spring and summer (Table 6).

***Hydropsyche arinale* Ross**

Figs. 181, 182, 183

Hydropsyche arinale Ross 1938a:143.

Hydropsyche reiseni Denning 1975:322. **NEW SYNONYM.**

Type Locality.- Illinois, Oregon (town).

Regional Distribution.- Watersheds 4, 9, 17, 27, 31, 41, 43, 44, 46, 48, 49, 55, 56, 60, 61, 77, 80, 91, 115, 128.

Nearctic Distribution.- US: AR, IL, IN, KS, MO, OK, WI; CANADA: ON.

Discussion.- Denning (1975) described *H. reiseni* from Turner Falls Park in the Arbuckle Mountains physiographic subregion. Bowles and Mathis (1992) reported it again in their Oklahoma checklist, but never attempted to relocate or investigate its identity (D.E. Bowles, pers. communication). Since it had apparently never been recollected since the type series, it was recently considered for category 2 status under the Endangered Species Act of 1975

(Caryn Vaughn, pers. communication). My collections of *H. arinale* from other Arbuckle Mountain streams and the inability to relocate *H. reiseni* from the type locality prompted an examination of the type series. I examined the holotype ♂ (CAS type No. 16193) and 16 ♂♂ paratypes of *H. reiseni* and found them to agree well with Ross' description of *H. arinale*. Further, they matched perfectly with *H. arinale* collected from locations throughout the region. Consequently, I feel that it is appropriate to designate *H. reiseni* as a junior synonym.

Hydropsyche arinale was collected from medium to large streams and rivers throughout the region (Table 5). Males are distinguished by the preapical swelling of the phallobase and the configuration of the ventral, phallic opening (Fig. 182). I observed small groups of 6 - 10 males swarming above emergent instream vegetation during the late summer. This may represent some kind of "encounter site"/pheromone release behavior in attracting females. When disturbed, these swarms would disperse temporarily only to reappear minutes later. Adults were present during April to October (Table 6). Ross (1944) noted that its distribution followed closely the western boundary of the oak-hickory forest.

***Hydropsyche betteni* Ross**

Figs. 179, 197

Hydropsyche betteni Ross 1938a:146.

Type Locality.- Illinois, Richmond.

Regional Distribution.- Watersheds 4, 9, 17, 23, 28, 39, 44, 49, 53, 56, 57, 67, 69, 74, 80, 81, 88, 103, 116, 118, 122, 125.

Nearctic Distribution.- US: AL, AR, CT, DE, FL, GA, IA, IL, IN, KS, KY, LA, MA, ME, MI, MN, MO, MS, NC, ND, NH, NY, OH, OK, PA, SC, TN, VA, VT, WI, WV; CANADA: MB, NF, NS, ON, PE, PQ, SK.

Discussion.- This is a commonly collected species in the region. Larvae are distinguished by the bump or tubercle on the posterior corner of the frontoclypeus (Fig. 179). Males are best identified by the blunt, tubular apex of the phallus and the recurved phallobase (Fig. 197). I collected it from headwater and mid-sized streams throughout much of the region (Table 5). Schuster and Etnier (1978) and Schmude and Hilsenhoff commented that it was one of the most tolerant caddisfly species of organic pollution. I often encountered large numbers of larvae in streams draining large scale agricultural areas or domestic sewage treatment facilities. Larval retreats were particularly abundant on concrete raceways associated with low water bridges. Mackay (1979) reported both univoltine and bivoltine populations in southern Ontario.

***Hydropsyche bidens* Ross**

Figs. 43, 52, 176, 194, 195

Hydropsyche bidens Ross 1938a:142.

Type Locality.- Illinois, Apple River Canyon State Park.

Regional Distribution.- Watersheds 4, 24, 39, 62, 89, 104, 105, 106, 126.

Nearctic Distribution.- US: AR, CO, GA, IA, IL, IN, KS, MI, MN, MO, MT, ND, OH, OK, TX, WI; CANADA: MB, PQ.

Discussion.- The larval head illustrated herein was redrawn from Schuster and Etnier (1978). Larvae are similar to those of *H. orris*, but differ in only having a pair of large pale areas on the frontoclypeus (Fig. 176). Males are most similar to *H. orris*, but are distinguished by the emarginate inner margins of the phallic lateral flanges (Fig. 195) and the straight endothecal process which is best view laterally (Fig. 194). It is primarily collected from large rivers, especially those in the Mississippi Alluvial subregion (Table 5). Adults were abundant in UV light trap collections made during April to October (Table 6).

***Hydropsyche orris* Ross**

Figs. 174, 175, 188, 189

Hydropsyche cornuta Ross 1938a:141 (preoccupied).

Hydropsyche orris Ross 1938d:121.

Type Locality.- Illinois, Hamilton.

Regional Distribution.- Watersheds 4, 6, 9, 24, 39, 43, 44, 48, 56, 68, 70, 74, 77, 80, 89, 94, 100, 105, 106, 126, 128, 129.

Nearctic Distribution.- US: AL, AR, FL, GA, IA, IL, IN, KS, KY, LA, MI, MN, MO, MS, NC, NY, OH, OK, SD, TN, TX, WI, WV.

Discussion.- The larval illustrations were redrawn from Schuster and Etnier (1978). Larvae differ from those of *H. bidens* by the V-shaped pale band on the dorsum of the head (Fig. 174). Males are closest to *H. bidens*, but differ in the nearly parallel inner margins of the lateral phallic margins (Fig. 189) and the obliquely directed endothecal processes. Larvae have a pair of upturned knobs on the anterior margin of the frontoclypeus; the dorsum of the head capsule usually has a distinct V-shaped pale band. It was collected from a variety of stream types, especially large rivers (Table 5). Schuster and Etnier (1978) noted that it tolerated high siltation and could reach tremendous densities in places where there is a high concentration of suspended solids. Beckett (1982) reported a bivoltine life cycle for a population in the Ohio River near Cincinnati. Fremling (1960) studied its life history. Adults were present from April to September (Table 6).

***Hydropsyche rossi* Flint, Voshell, and Parker**

Figs. 184, 185, 186

Hydropsyche rossi Flint, Voshell, and Parker 1979:854.

Type Locality.- Mississippi, Forest Co., Hattiesburg.

Regional Distribution.- Watersheds 4, 24, 48, 67, 69, 70, 77, 80, 81, 105.

Nearctic Distribution.- US: AL, AR, FL, GA, IL, IN, KY, LA, MO, MS, NC, NY, OK, SC, TN, TX, VA.

Discussion.- Males differ from the other regional species in having the lateral phallic flanges very narrow and creating a widely opened apico-ventral cavity (Fig. 185). This is the species long thought to be *H. incommoda*, as reported by Unzicker et al. (1970) and Bowles and Mathis (1989). This confusion is probably explained by the misidentification of *H. rossi* as *H. incommoda* by Ross (1944). Flint et al. (1979) concluded that the true *H. incommoda* probably does not occur west of the Appalachian Mts. I have collected many males of *H. rossi* and find them to match perfectly with the description given by Flint et al. (1979). This species was most often encountered in bottomland areas of the Gulf Coastal Plain and Mississippi Alluvial subregions (Table 5). Adults were only collected in UV light traps during April to October (Table 6).

***Hydropsyche scalaris* Hagen**

Figs. 177, 178, 191, 192, 193

Hydropsyche scalaris Hagen 1861:286.

Type Locality.- Canada, St. Lawrence River.

Regional Distribution.- Watersheds 4, 17, 23, 39, 49, 63, 92, 100, 102, 107, 109, 120, 121, 122, 128, 129.

Nearctic Distribution.- US: AL, AR, DC, DE, GA, IL, IN, KS, MD, ME, MN, MO, NC, NJ, NY, OH, OK, PA, TN, TX, VA, VT, WI, WV, WY; CANADA: MB, PQ.

Discussion.- Males are differentiated on the basis of the endothelial processes produced well beyond the mesal cavity (Fig. 192). Larvae are distinguished from the other regional species by the presence of stout, reddish, spine-like setae on the ventral surface of each anal proleg (Fig. 178). Flint *et al.* (1979) noted that distributional records prior to Ross (1944) are suspect due to widespread misidentifications. Little is known about the life history of this widely distributed hydropsyche. Mackay (1979) reported a univoltine life cycle for a population in a southern Ontario stream. Schuster and Etnier (1978) characterized its habitat as "warm-water, smallmouth bass type streams". I collected it from a wide range of stream sizes throughout the region (Table 5). Adults were present during April to September (Table 6).

***Hydropsyche simulans* Ross**

Figs. 180, 186, 187

Hydropsyche simulans Ross 1938a:139.

Type Locality.- Illinois, Mount Carmel, Wabash River.

Regional Distribution.- Watersheds 4, 39, 62, 63, 67, 68, 77, 89, 100, 104, 107, 118, 122, 128, 129.

Nearctic Distribution.- US: AL, AR, CO, IA, IL, IN, KS, KY, MA, MI, MN, MO, MS, MT, ND, OH, OK, TN, TX, WI, WV, WY; CANADA: MB, NE, ON.

Discussion.- Males are distinguished by the more robust phallus (Fig. 188). It was collected from a wide range of stream types throughout the region (Table 5). Larvae have a pair of pale areas located centrally on the frontoclypeus (Fig. 180). Adults were present during most of the year except winter (Table 6). This species is common and widely distributed over the eastern and central United States (Schuster and Etnier 1978). Rhame and Stewart (1976) and Malas (1984) studied its life history and secondary production, respectively, in the Brazos River, Texas. Their results suggest at least a bivoltine life cycle for this species. Moulton *et al.* (1993) studied its critical thermal maxima in the laboratory. They reported a range in sublethal temperature tolerances of 34 to 38°C which followed an increase in acclimation temperature.

Genus *Macrostemum* Kolenati

This genus is comprised of three species that are primarily distributed throughout eastern North America. Only *M. carolina* is known from the region. Mathis and Bowles (1992) reported *M. zebratum* (Hagen) from Big Spring, Carter Co., Missouri. I examined the single male at the INHS (Lot No. 1964-1) that this record was presumably based on, compared it to other material of both species, and found it to be *M. carolina*. *Macrostemum zebratum*, despite

having virtually identical male genitalia to those of *M. carolina*, can be distinguished by having comparatively smaller eyes and larger overall size (15 - 18 mm).

Larvae of this genus are easily identified in the field by the high carina that encircles the frontoclypeus of the head capsule (Fig. 110). This feature creates a flat, slanted appearance in lateral view. They typically inhabit large rivers and as a result, have extremely fine-mesh, filtering nets which allows them to utilize FPOM as a food resource (Wiggins 1977). Adults are generally dark with long antennae; their most striking feature are the ornately-patterned forewings (Fig. 113).

***Macrostemum carolina* (Banks)**

Figs. 110, 112, 113, 198, 199

Macronema carolina Banks 1909:342.

Type Locality.- South Carolina, Southern Pines.

Regional Distribution.- Watersheds 24, 38, 48, 60, 63, 77, 80, 100.

ARKANSAS: Arkansas Co., India Bayou, AR Hwy 1, White River National

Wildlife Refuge, 4-IX-1990, S. Chordas, 1 ♀; same but Lake Gut, 29-IX-1990, 1

♂; Bradley Co., Saline River, AR Hwy 172, 2-VII-1981, E.J. Bacon, 3 ♀♀;

Craighead Co., St. Francis River, AR Hwy 18, Lake City, 12-VIII-1991, S.R.

Moulton, 1 ♀; Sevier/Howard Cos., Saline River, AR Hwy 24, 5 mi E

Lockesburg, 26-VI-1982, H.W. Robison and D. Koym, 3 ♂♂, 3 ♀♀; OKLAHOMA:

Pushmataha Co., Kiamichi River, old US Hwy 271, 2.3 mi E Tuskahoma, 13-VI-1991, R. Tucker, 17 ♂♂, 3 ♀♀.

Nearctic Distribution.- US: AL, AR, DE, FL, GA, IL, IN, LA, MD, MO, MS, NC, NJ, NY, OK, PA, SC, TN, VA.

Discussion.- Larvae were never collected in this study. My larval figures (Figs. 110, 112) were prepared from a Maryland specimen. It was collected from bottomland river systems of the Gulf Coastal Plain and Mississippi Alluvial subregions (Table 5). Adults were present in UV light trap samples from April to September (Table 6). Cudney and Wallace (1980) reported a univoltine life cycle in the Savannah River, Georgia.

Genus *Potamyia* Banks

A single species, *P. flava*, is known from North America (Morse 1993). Wiggins (1977) illustrated the larval habitus. Larvae are separated from other hydroptychid genera by the lateral mandibular flange (Fig. 102) and the unnotched posterior margin of the sclerites on abdominal sternite IX (Fig. 104). Adults may be identified in the field by their straw-colored appearance and long antennae.

***Potamyia flava* (Hagen)**

Figs. 102, 104, 119, 203

Macronema flavum Hagen 1861:285.

Hydropsyche kansensis Banks 1905b:15.

Type Locality.- Missouri, St. Louis.

Regional Distribution.- Watersheds 4, 9, 10, 24, 28, 38, 39, 44, 48, 56, 60, 62, 67, 68, 69, 70, 74, 77, 80, 81, 85, 89, 100, 103, 105, 106, 107, 122, 124, 126, 129.

Nearctic Distribution.- US: AL, AR, DE, FL, GA, IA, IL, IN, KS, KY, LA, MD, MI, MN, MO, MS, MT, NC, ND, NY, OH, OK, PA, SC, SD, TN, TX, VA, WI, WV; CANADA: MB, ON, PQ.

Discussion.- This species is generally regarded as a large river species.

Fremling (1960) reported the greatest abundance of larval retreats on silt free cobbles. I collected it from a variety of stream types in every physiographic subregion except the Wichita Mountains (Table 5). I have also collected adults in UV light traps situated around small ponds in areas where the nearest stream was several miles away. Adults were present from April to October (Table 6).

Genus *Smicridea* MacLachlan

Morse (1993) reported 23 species from North America. Members of this genus are primarily neotropical in origin (Flint 1974). Only *S. fasciatella* has been reported from the Arbuckle Mountain subregion. Larvae differ from other regional genera by the single median sclerite on abdominal segment VIII (Fig.

106). Adults have forewing veins R_4 and R_5 running very close together at their base (Fig. 114).

***Smicridea fasciatella* McLachlan**

Figs. 106, 114, 202

Smicridea fasciatella MacLachlan 1871:136

Hydropsyche divisa (Banks) 1903a:244.

Polycentropus dispar (Banks) 1905:16

Type Locality.- Texas.

Regional Distribution.- Watershed 128. OKLAHOMA: Johnston Co., Pennington Creek, Reagan (Flint 1974).

Nearctic Distribution.- US: AZ, CO, NM, OK, TX; MEXICO.

Discussion.- I did not encounter this species in my collections from the Arbuckle Mountains. Its presence in this area is based on material examined by Ross (1944), Flint (1974) and Wiggins (1977). Wiggins (1977) illustrated the larval habitus from a specimen collected in Johnston Co., Oklahoma. The male illustrated herein was drawn from a specimen collected at the Brazos River in north-central Texas. Adult collection dates include April, June and October (Bowles and Mathis 1992).

CHAPTER 8

FAMILY HYDROPTILIDAE

Members of this family are commonly referred to as the "microcaddisflies". Most species are 2 to 4 mm in forewing length, although some such as *Dibusa angata*, are around 5 mm. They inhabit most types of lotic and lentic habitats. Larvae exhibit a special type of complete metamorphosis termed "hypermetamorphosis" (Nielsen 1948), involving a dual lifestyle; the first four larval instars are free-living while the terminal (usually fifth) instar constructs a fixed or portable "purse" case of silk, algae, and/or sand grains. Adults are readily distinguished from other caddisflies by their densely hirsute wings and shelf-like posterior margin of the mesoscutellum. They are collected using a variety of methods, but the greatest numbers and diversity are usually obtained with some type of UV light trap. The secretive, diurnal habits of adults often preclude them from being collected by the more active methods of aspirating and sweeping. I was successful in aspirating some species while they scurried between crevices on concrete bridges and their supports. Marshall (1979) revised the world genera, and Blickle (1979) provided the most recent taxonomic review of the North American species,

north of Mexico. The larval key below was modified from Wiggins (1977). The larva of *Paucicalcaria ozarkensis* is unknown.

KEYS TO THE GENERA AND SPECIES OF HYDROPTILIDAE

larvae

1. Middorsal ecdysial suture absent on meso- and metanotum; abdominal segments V and VI, in dorsal view, much wider than other segments (Fig. 204); case consisting of a single silken valve with a small circular opening at each end ***Leucotrichia pictipes* (Banks)**
Middorsal ecdysial suture present on all thoracic nota; abdominal segments V and VI not markedly wider than others; case constructed of a variety of materials but consisting of 2 flattened valves or cylindrical 2
2. Metathoracic tarsi stout, each about as long as its claw; if metathoracic tarsi slender and slightly longer than their claws, then prothoracic tibiae each with a well developed posteroventral lobe (Fig. 205) 3
Metathoracic tarsi slender, at least twice as long as their claw; if metathoracic tarsi only slightly longer than their claw, then prothoracic tibiae without a posteroventral lobe 7
3. Tarsal claws stout and angled at base, each with a stout basal process (Fig. 207) 4
Tarsal claws slender, curved gently and with a thin basal process (Fig.

- 205) 5
4. Dorsal abdominal setae stout, each with a basal sclerite (Fig. 211)
 ***Dibusa angata* Ross**
 Dorsal abdominal setae slender and without basal sclerites
 ***Stactobiella* Martynov**
5. Meso- and metathoracic legs 2 to 3 times longer than prothoracic legs
 (Fig. 205); case flask-shaped and constructed of silk (Fig. 33)
 ***Oxyethira* Eaton**
 Meso- and metathoracic legs less than twice as long as prothoracic legs;
 case variable 6
6. Apex of abdomen with 3 opaque, filamentous gills, 1 middorsally, and 1
 each laterally (Fig. 206); anteroventral corner of metanotum setose and
 forming a right angle (Fig. 208) ***Hydroptila* Dalman**
 Apex of abdomen without filamentous gills; anteroventral corner of
 metanotum forming a lobe, without setae (Fig. 209) ***Ochrotrichia* Mosely**
7. Head noticeably narrowed anterad (Fig. 210); anal prolegs elongate and
 cylindrical 8
 Head not markedly narrowed anterad; anal prolegs shorter and broadly
 joined to abdomen 9
8. Abdomen with intersegmental grooves prominent, lateral hair fringe
 present; case cylindrical, made of sand grains ***Neotrichia* Morton**
 Abdomen with intersegmental grooves indistinct, lateral hair fringe

absent; case cylindrical, made of silk, may be encrusted with CaCO_3 . . .

..... ***Mayatrichia* Mosely**

9. Most abdominal segment with well developed, dorsal and ventral lobes
(Fig. 212) ***Ithytrichia* Eaton**

Abdominal segments without dorsal and ventral lobes; case made of silk
with 5 longitudinal ridges (Fig. 32) ***Orthotrichia* Eaton**

adults

1. Spurs 1-3-4 9

Protibia without spurs 2

2. Spurs 0-1-2; ocelli absent; male genitalia as in Fig. 334
..... ***Paucicalcaria ozarkensis* Mathis and Bowles**

Spurs 0-2-3, 0-2-4, or 0-3-4; ocelli present or absent 3

3. Spurs 0-2-3; ocelli present ***Neotrichia* Morton**

Spurs 0-2-4 or 0-3-4; ocelli present or absent 4

4. Spurs 0-2-4 5

Spurs 0-3-4 6

5. Ocelli present ***Mayatrichia* Mosely**

Ocelli absent ***Hydroptila* Dalman**

6. Ocelli present 7

Ocelli absent ***Orthotrichia* Eaton**

7. Mesoscutellum with a transverse fracture line

- ***Ochrotrichia (Ochrotrichia)* Mosely**
- Transverse fracture line absent 8
8. Posterodorsal margin of mesoscutellum touching posterior margin at
middle ***Oxyethira* Eaton**
- Posterodorsal margin of mesoscutellum separated from posterior margin
by a narrow strip ***Ithytrichia* Eaton**
9. Ocelli present 10
- Ocelli absent; male genitalia as in Fig. 213 ***Dibusa angata* Ross**
10. Metascutellum rectangular, as wide as scutum . ***Stactobiella* Martynov**
- Metascutellum pentagonal or triangular, narrower than scutum 11
11. Metascutellum pentagonal; male genitalia as in Fig. 218
..... ***Leucotrichia pictipes* (Banks)**
- Metascutellum triangular; male genitalia as in Figs. 288, 289
..... ***Ochrotrichia (Metrichia) nigritta* (Banks)**

Genus *Dibusa* Ross

This monotypic genus has an uncertain relationship within the Hydroptilidae (Marshall 1979). The type species, *D. angata*, is restricted to the eastern United States. Its presence in the Ouachita Mts. probably represents its western most distributional limit. Additional discussion is provided below.

***Dibusa angata* Ross**

Figs. 42, 207, 211, 213

Dibusa angata Ross 1939a:67.*Dibusia angata* Ross: misspelling (Unzicker *et al.* 1970:172).**Type Locality.**- North Carolina, Dillsboro.**Regional Distribution.**- Watersheds 9, 17, 55, 74, 77. ARKANSAS:

Montgomery Co., Little Missouri River at Falls Rec. Area, 14-III-1992, S.R.

Moulton, 9 ♂♂♀♀ mmt; Pope Co., Big Piney Creek, Long Pool Rec. Area, 25

mi N Russellville, 24-IV-1992, H.W. Robison, 3 ♂♂; Searcy Co., Buffalo River,

Woolum Access, 17-III-1992, R.W. Killam, many ♂♂; OKLAHOMA: Pushmataha

Co., Patterson Creek OK Hwy 2, 2 mi N Moyers, 27-IV-1991, S.R. Moulton and

J. Kennedy, 1 ♂; Johns Creek, Kiamichi Wilderness Area, 10 mi N jct. OK Hwy

2, 17-V-1993, D.E. Baumgardner, 4 ♂♂.

Nearctic Distribution.- US: AL, AR, GA, IN, KY, MA, ME, NC, NH, OK, PA, SC, TN, VA, VT, WV; CANADA: ON.**Discussion.**- This species is among the largest of regional hydroptilids with an adult forewing length of about 5 mm. Adults are readily distinguished by the presence of an apical spur on each protibia, the absence of ocelli, and the deep, bifurcation of each inferior appendage (Fig. 213). Resh and Houp (1986) studied its life history in a Kentucky stream and found that it exhibited a univoltine life cycle. *Dibusa angata* is dependent on the red alga, *Lemanea australis*, on which it feeds and constructs a purse case. This is the only

known specific insect-plant relationship in Trichoptera (Resh and Houp 1986). It was collected from small to medium-sized permanent streams (Table 5) during the spring (Table 6).

Genus *Hydroptila* Dalman

This is the most diverse of the hydroptilid genera, with approximately 110 species recorded from North America (Morse 1993); it is represented in the Interior Highlands by 26 species. Larvae are most often found in association with filamentous green algae, which is used as a food resource and in case construction by the terminal instar (Wiggins 1977, Marshall 1979). Some larval cases may also have sand grains incorporated into them. Larvae feed by piercing algal cells and sucking out their contents. Marshall (1979) indicated that life cycles vary among species and locations, with both univoltine and bivoltine patterns observed. Larvae cannot be reliably identified to species. Ross (1944) provided diagnoses for a few of the species treated herein. However, his separations were based on head and pronotal color patterns that tend to be highly variable (Marshall 1979, Moulton pers. observation). As a result, positive associations can only be made through examination of mature, male metamorphotypes. Immature stages were most successfully collected by inspecting hand-picked cobbles containing dense periphyton. Adults were often collected in tremendous numbers using UV light traps. The diversity of

congeners in these samples often approached or exceeded 10 species. Males were redrawn from their respective original illustrations or those of Ross (1944).

KEY TO THE MALES OF *Hydroptila*

1. Sternite VII with an elongated mesal process (Fig. 225) 2
 Sternite VII with at most, a short, spur-like, mesal process (Fig. 239) 11
2. Sternite VIII with a rounded, apico-mesal process (Fig. 220)
 ***H. virgata* Ross**
 Sternite VIII without an apico-mesal process 3
3. Inferior appendages beak-like and curving ventrad to a point, shorter
 than tergum X (Fig. 231) 4
 Inferior appendages elongate, as long as tergum X (Fig. 234) 9
4. Apical one-half of phallus divided into 2 processes, one straight, the
 other with tip bent 90° (Fig. 223); apex of mesal process of VII blade-like
 (Fig. 224) ***H. hamata* Morton**
 Both phallic processes straight or curved, tips never bent 90°; apex of
 mesal process of VII tubular (Fig. 225) 5
5. Phallic processes straight, their apices close together (Fig. 227) 6
 Phallic processes entwined about each other, their apices greatly
 separated (Fig. 229) ***H. remita* Blickle and Morse**
6. Phallus shorter, less than one-third the length of the abdomen, apex of
 longest process flared (Fig. 227) ***H. artesa* Mathis and Bowles**

- Phallus longer, greater than one-third the length of the abdomen, its apex not flared (Fig. 232) 7
7. Tergum X narrow, apex convex, not emarginate (Fig. 230)
 ***H. sandersoni* Mathis and Bowles**
- Apex of tergum X emarginate (Figs. 228, 233) 8
8. Apex of tergum X with a deep, median incision (Fig. 233)
 ***H. amoena* Ross**
- Apex of tergum X with a shallow, median notch (Fig. 228)
 ***H. oneili* Harris**
9. Apex of phallus terminating in a rounded lobe preceded by a preapical spur directed laterad (Fig. 235) ***H. spatulata* Morton**
- Apex of phallus not terminating in a rounded lobe but with an apical spur directed laterad 10
10. Inferior appendages each terminating in an upturned tooth (Fig. 236)
 ***H. armata* Ross**
- Inferior appendages not terminating in a tooth directed dorsad (Fig. 238)
 ***H. vala* Ross**
11. Tergum X divided apically into two processes, either short, thorn-like and curved laterad (Fig. 241), or slender and curved ventrad (Fig. 239, 240) 12
- Tergum X entire, or if divided, then processes not as above 14
12. Apex of tergum X divided into two short, thorn-like processes curved laterad (Fig. 241) ***H. waubesiana* Betten**

- Tergum X divided into two, long processes curving ventrad 13
13. Processes of X strongly curved ventrad around a pair of slender sinuate rods (not the inferior appendages), 4 - 6 dark, stout spines present on posterior margin of VIII (Fig. 239); common ***H. grandiosa* Ross**
- Processes of X gently curving postero-ventrad under the knobbed apices of the inferior appendages, dark stout spines absent from posterior margin of VIII (Fig. 240); rare ***H. delineata* Morton**
14. Phallus with a spiral process near middle, variously developed (Figs. 249, 254, 263) 16
- Phallus without a spiral process (Fig. 242) 15
15. Phallus short and straight, much less than one-half length of abdomen (Fig. 242); inferior appendages long and slender, tapering apically in ventral view (Fig. 243) ***H. quinola* Ross**
- Phallus long, greater than one-half length of abdomen, apical article bent obliquely (Fig. 245); inferior appendages stouter, widening towards apex, each with a apicolateral point (Fig. 244) ***H. broweri* Blickle**
16. Phallic spiral small, indistinct (Fig. 249) 17
- Phallic spiral stout, well developed (Fig. 265) 21
17. Base of phallus flared, wider than rest of phallus, spiral process not encircling shaft (Fig. 246); inferior appendages sub-rectangular, apico-lateral corner of each terminating in a sclerotized point (Fig. 247)
- ***H. scolops* Ross**

- Base of phallus not much wider, if any, than rest of phallus, spiral process slender, encircling shaft (Fig. 249) 18
18. Apical article of phallus sickle-like (Figs. 249, 250) 19
- Apical article of phallus straight (Fig. 254) 20
19. Inferior appendages in ventral view hooked apically, terminating in a sclerotized point directed laterad (Fig. 248) ***H. berneri* Ross**
- Inferior appendages in ventral view straight, not hooked apically, without sclerotized points (Fig. 251) ***H. strepha* Ross**
20. Tergum X V-shaped, lateral processes blade-like, tapering gradually to apex (Fig. 253); inferior appendages with a ventro-mesal point in middle (Fig. 252); known only from Arbuckle Mt. subregion ***H. melia* Ross**
- Tergum X trifold apically, mesal portion membranous, truncated, lateral processes tapering abruptly near apex, forming sclerotized needle-like tips (Fig. 256); inferior appendages without a mid-ventral sclerotized point (Figs. 255, 256) ***H. tusculum* Ross**
21. Inferior appendages in ventral view finger-like, lateral margin of each with a prominent, sclerotized point in middle (Figs. 257, 258); distal article of phallus uniformly tubular, with a small lip and bent slightly from main shaft (Fig. 259) ***H. albicornis* Ross**
- Inferior appendages in ventral view blade-like (Fig. 260), or if finger-like, then each terminating in sclerotized points (Figs. 267, 272); phallus not as above 22

22. Inferior appendages in ventral view finger-like, baso-lateral portion
shoulder-like (Figs. 271, 272) 26
- Inferior appendages in ventral view blade-like, without a prominent baso-
lateral shoulder (Fig. 260) 23
23. Apex of phallus stout, terminating in a prominent angled or curved
process (Figs. 263, 265, 268) 24
- Apex of phallus slender, terminating in a small preapical curved process,
neck region below spiral process annulated (Fig. 261); inferior
appendages in ventral view tapering to a point, slightly curved laterad
(Fig. 260) ***H. angusta* Ross**
24. Apical portion of phallus with preapical process set perpendicular to
shaft (Fig. 263); apex of inferior appendages in ventral view broadly
rounded with sclerotized points situated mesad and preapico-laterad
(Fig. 262) ***H. consimilis* Morton**
- Apical portion of phallus blade-like and curved around central shaft (Fig.
265, 268) 25
25. Tergum X broadly rounded on posterior margin, largely membranous
except for a lightly sclerotized, mesal strip (Fig. 266); widely distributed
throughout region ***H. perdita* Morton**
- Sclerotized portion of tergum X V-shaped, apices of lateral processes
angled laterad in dorsal view, mesal portion membranous (Fig. 264);
known only from the Arbuckle Mt. subregion ***H. protera* Ross**

26. Inferior appendages in ventral view with length of main arm from shoulder to apex much longer than distance from base to shoulder (Fig. 271); widely distributed throughout region ***H. ajax* Ross**
- Inferior appendages in ventral view with length of main arm from shoulder to apex subequal to distance from base to shoulder (Fig. 272); known only from Arbuckle Mt. subregion ***H. icona* Mosely**

***Hydroptila ajax* Ross**

Figs. 269, 270, 271

Hydroptila ajax Ross 1938a:127.

Type Locality.- Illinois, Oakwood, Salt Fork River.

Regional Distribution.- Watersheds 88, 115, 116, 118, 122, 128, 129.

Nearctic Distribution.- US: CO, IA, ID, IL, IN, KS, KY, MN, MO, MT, NY, OH, OK, OR, TX, UT, VA, WA, WI, WV, WY; CANADA: MB; MEXICO.

Discussion.- Males differ from those of *H. icona* in the longer, more slender inferior appendages (Fig. 271). It is also more widely distributed throughout the region and North America. My records indicate a wide preference for permanent and spring-fed streams (Table 5). Adults were present during May to August (Table 6). Ross (1944) noted that the larvae usually had pale yellow heads and thoracic nota.

***Hydroptila albicornis* Hagen**

Figs. 257, 258, 259

Hydroptila albicornis Hagen 1861:275.**Type Locality.-** Canada, St. Lawrence River.**Regional Distribution.-** Watersheds 38, 41, 47, 53, 66, 68, 95, 100, 102, 107, 122, 124.**Nearctic Distribution.-** US: AR, IL, IN, ME, MN, MO, NY, OH, OK, TN, WI; CANADA: MB, ON, PQ.**Discussion.-** Males are quite distinctive from the other regional species. Their inferior appendages are finger-like, each with a dark lateral point in middle (Figs. 257, 258), and the phallus has the apical one-third, tubular and angled obliquely from the main shaft (Fig. 259). The extreme apex of this tubular portion is produced into a small lip. It was infrequently collected from a wide range of permanent streams and high-volume springs (Table 5). Adults were present from April to October (Table 6). Ross (1944) illustrated the larval head and pronotum.***Hydroptila amoena* Ross**

Fig. 233

Hydroptila amoena Ross 1938a:124.**Type Locality.-** Illinois, Herod.**Regional Distribution.-** Watersheds 23, 38, 48, 60, 81, 106, 121, 129.

ARKANSAS: Stone Co., North Sylamore Creek at Gunner Pool Rec. Area, 24-X-1991, S.R. Moulton, 1 ♂; same data but at Barkshed Rec. Area; MISSOURI: Douglas Co., Beaver Creek at MO Hwy 14, approximately 7 km NW Ava, 8-VI-1991, S.R. Moulton, 1 ♂; OKLAHOMA: Sequoyah Co., Cato Creek, W OK Hwy 82, Buzzards Roost Nature Trail, 5-VI-1991, S.R. Moulton, 1 ♂.

Nearctic Distribution.- US: AL, AR, IL, IN, KY, MN, MO, NH, OH, OK, TN, VA, WI; CANADA: PQ.

Discussion.- This species is most closely related to *H. oneilli* and *H. sandersoni* (Mathis and Bowles 1990). Males are distinguished from them by the deeply incised apex of tergum X, in dorsal view (Fig. 233). Early regional records of *H. amoena* (e.g. Unzicker *et al.* 1970) may have been mistaken for either of these recently described species, using the keys of Ross (1944) or Blickle (1979). In addition to the above regional records, Ross (1938a) designated a series of paratypes from Honey Creek at Turner Falls Park, Oklahoma. The ♀ allotype is from Broken Bow, Oklahoma (Ross 1944), presumably in the Little River watershed. It is reported here for the first time from Missouri. My collection data (Table 5) and Ross (1944) confirm an affinity for small, spring-fed headwater streams. Adults emerged from April to September (Table 6).

***Hydroptila angusta* Ross**

Figs. 260, 261

Hydroptila angusta Ross 1938a:130.

Type Locality.- Illinois, Muncie, Stoney Creek.

Regional Distribution.- Watersheds 4, 20, 81, 84, 88, 96, 107, 115, 118, 119, 122, 128, 129.

Nearctic Distribution.- US: AL, AR, CO, IL, IN, KS, KY, MO, MS, NC, NM, OH, OK, SC, TX; CANADA: MB; MEXICO.

Discussion.- Males are distinguished from *H. consimilis* by the small pre-apical process of the phallus (Fig. 261) and more blade-like inferior appendages, in ventral view (Fig. 260). It was first reported from Arkansas by Frazer et al. (1991) in Clear Creek, Crawford County. It has been collected from permanent headwater streams to large rivers (Table 5). Adult records are from the late spring to late summer (Table 6). Ross (1944) noted that the larval head and thoracic nota varied from yellow to dark brown, without any pattern.

***Hydroptila armata* Ross**

Figs. 236, 237

Hydroptila armata Ross 1938a:123.

Type Locality.- Indiana, Winamac.

Regional Distribution.- Watersheds 1, 13, 23, 26, 38, 42, 43, 47, 49, 55, 62, 68, 77, 80, 81, 87, 95, 100, 102, 107, 108, 112, 115, 116, 117, 118, 122, 123, 128, 129.

Nearctic Distribution.- US: AL, AR, IL, IN, KS, KY, MI, MN, MO, MS,

NH, NY, OH, OK, SC, TN, TX, VA, WI, WV; CANADA: MB, PQ.

Discussion.- Males superficially resemble those of *H. spatulata* and *H. vala* in having a pair of recurved processes arise beneath tergum X. It differs from them in the upturned apex of each inferior appendage and the slender, lateral processes of X, which taper to a pointed apex in lateral view (Fig. 236). It was a very commonly collected species during the early spring through to the fall (Table 6). It was collected from a wide range of stream sizes and substrate types (Table 5).

***Hydroptila artesa* Mathis and Bowles**

Figs. 225, 226, 227

Hydroptila artesa Mathis and Bowles 1990:87.

Hydroptila species B (nr. *paramoena*): Bowles and Mathis (1989:239)

Type Locality.- Missouri, Shannon Co., Alley Spring, 5 mi W. Eminence, Hwy 106.

Regional Distribution.- Watersheds 38, 47, 53, 68, 95, 100, 124.

ARKANSAS: Fulton Co., Mammoth Spring, US Hwy 63, 23-X-1992, S.R.

Moulton, 3 ♂♂; MISSOURI: Douglas Co., Bryant Creek off MO Hwy 5, W of Bryant (town), 25-IX-1992, S.R. Moulton, 1 ♂; same as type locality but, 24-IX-1992, S.R. Moulton, many ♂♂; Round Spring, at MO Hwy 19, N Eminence, 24-IX-1992, S.R. Moulton, many ♂♂.

Nearctic Distribution.- US: AR, MO.

Discussion.- Males of this Ozark Mountains endemic are readily distinguished from *H. amoena*, *H. oneilli*, and *H. sandersoni* by the shorter phallus, which is less than one-third the length of the abdomen. Also the apex of tergum X, in dorsal view, is flared and slightly concave on its posterior margin (Fig. 226) and the apex of the longer phallic process is flared (Fig. 227). Mathis and Bowles (1990) described and illustrated the female. They designated many paratypes from several localities in the high-volume spring systems of the Current, Eleven Point, and North Fork White Rivers. This species is known only from streams having substantial spring input in the White River Hills, Central Plateau, and Curtois Hills physiographic subregions (Table 5). Adults were common in UV light trap collections made during the summer and fall (Table 6).

***Hydroptila bernerii* Ross**

Figs. 248, 249

Hydroptila bernerii Ross 1941b:67.

Type Locality.- Florida, Alachua Co., Santa Fe River.

Regional Distribution.- Watersheds 49, 57. ARKANSAS: Montgomery Co., Strawn Spring, E Caddo Gap, 12-IX-1980, H.W. Robison, 1♂.

Nearctic Distribution.- US: AL, AR, FL, LA, MN, NC, SC, WI; CANADA: PQ.

Discussion.- Males are distinctive among the regional species in having the inferior appendages hooked laterad at their apices (Fig. 248), and by the sickle-shaped apical portion of the phallus (Fig. 249). Bowles and Mathis (1989) provided the first Arkansas record from Camp Clear Fork in Garland County; they listed it as rare. I only encountered it in one other nearby location in the Caddo River watershed (Table 5). Adults were collected with UV lights during June and September (Table 6).

***Hydroptila broweri* Blickle**

Figs. 244, 245

Hydroptila broweri Blickle 1963:18.

Type Locality.- Maine, Allagash.

Regional Distribution.- Watersheds 26, 38, 55, 68, 85, 96, 100.

ARKANSAS: Searcy Co., Buffalo River, at US Hwy 65 (Tyler Point), 10-X-1991, P. Yeager, 4 ♂♂; MISSOURI: Douglas Co., Indian Creek, at MO Hwy 76, 25-IX-1992, S.R. Moulton, 1 ♂; Shannon Co., Round Spring, at MO Hwy 19, N Eminence, 24-IX-1992, S.R. Moulton, 8 ♂♂; Jacks Fork River, MO Hwy 106, 8 km W Eminence, 24-IX-1992, 1 ♂.

Nearctic Distribution.- US: AR, ME, MO, NH.

Discussion.- Males of this species and *H. quinola* are the only regional species that lack a spiral process on the phallus. It is primarily distinguished from the latter in having the phallus greater than one-half the length of the

abdomen with the apical one-third angled obliquely (Fig. 245). This species has a very disjunct distribution, consisting of a population centered in the Interior Highlands and another some 1200 miles to the northeast in New England. This is despite substantial collecting as indicated by relatively thorough checklists in the intervening states. Frazer *et al.* (1991) and Mathis and Bowles (1992) first reported *H. broweri* from Arkansas and Missouri, respectively. It was collected from small to large spring-fed streams (Table 5), during the spring, late summer, and fall (Table 6).

***Hydroptila consimilis* Morton**

Figs. 262, 263

Hydroptila consimilis Morton 1905:65.

Type Locality.- New York, Ithaca.

Regional Distribution.- Watersheds 23, 28, 47, 66, 68, 81, 93, 95, 100, 107, 116, 121, 122, 124, 128, 129.

Nearctic Distribution.- US: AL, AR, AZ, CO, CT, DE, ID, IL, IN, KS, KY, ME, MI, MN, MO, MT, NH, NM, NY, OH, OK, OR, PA, TN, TX, UT, VA, VT, WA, WI, WY; CANADA: AB, BC, MB, NB, ON, PQ.

Discussion.- males of this common species differ from those of *H. protera* in having a stout, pre-apical process held perpendicular to the phallus (Fig. 263). Bowles and Mathis (1989) reported it as "uncommon; collected from small streams". My regional records indicate that it is widely distributed,

that it also occurs in large numbers throughout most of the year (Table 6). It was collected from small to medium-sized permanent and spring-fed streams having a variety of substrate types (Table 5). Ross (1944) illustrated the larval head and pronotum, describing them as being "mostly black" except for pale bands along the anterior margins of the thoracic nota.

***Hydroptila delineata* Morton**

Fig. 240

Hydroptila delineata Morton 1905:66.

Type Locality.- New York, Ithaca.

Regional Distribution.- Watersheds 14, 49. ARKANSAS: Howard Co., Bakers Creek, AR Hwy 4, 28-VI-1989, S. Speight, 1 ♂.

Nearctic Distribution.- US: AL, AR, IN, KY, MN, NC, NH, NY, OH, SC, TN, VA, WV; CANADA: NS, PQ.

Discussion.- Males of this species have the divided apices of tergum X curving ventrad around the apices of the inferior appendages (Fig. 240).

Bowles and Mathis (1989) first reported it in the region from the Caddo River, 3 mi NE Amity in Montgomery Co., Arkansas. Their record and mine above represent the only known regional records. These few localities represent medium to large streams in the transitional area between the Ouachita and Gulf Coastal Plain physiographic subregions (Table 5). Adults were collected in June and August (Table 6).

***Hydroptila grandiosa* Ross**

Fig. 239

Hydroptila grandiosa Ross 1938a:126.**Type Locality.-** Illinois, Oakwood, Salt Fork River.**Regional Distribution.-** Watersheds 1, 4, 13, 17, 27, 31, 38, 39, 48, 49, 54, 56, 58, 60, 61, 62, 68, 74, 77, 80, 81, 84, 85, 96, 100, 107, 115, 116, 118, 122, 124, 129.**Nearctic Distribution.-** US: AL, AR, IL, IN, KS, KY, MN, MO, MS, OH, OK, TX, VA, WI, WV; CANADA: MB.**Discussion.-** Males of *H. grandiosa* have the divided lateral processes of tergum X strongly curving ventrad around a pair of sinuate, elongated rods that arise beneath the tergum (Fig. 239). These rods may initially be mistaken for the inferior appendages, which are small and inconspicuous. Collection data indicate a wide preference of stream types (Table 5). Adults were collected during the spring through to the fall (Table 6). Ross (1944) illustrated the larval head and pronotum.***Hydroptila hamata* Morton**

Figs. 223, 224

Hydroptila hamata Morton 1905:67.**Type Locality.-** New York, Ithaca.

Regional Distribution.- Watersheds 1, 13, 23, 27, 31, 34, 35, 38, 39, 42, 43, 45, 46, 48, 49, 55, 56, 58, 60, 61, 62, 66, 74, 77, 80, 81, 85, 95, 96, 97, 100, 102, 106, 107, 115, 116, 118, 121, 122, 124, 128, 129.

Nearctic Distribution.- US: AL, AR, AZ, CA, CO, CT, FL, GA, ID, IL, IN, KY, LA, ME, MI, MN, MO, MS, MT, NC, NH, NM, NY, OH, OK, OR, PA, SC, TN, TX, UT, VA, VT, WA, WI, WV, WY; CANADA: MB, ON, PQ; MEXICO.

Discussion.- This was the most common and abundant of the regional species which possess an elongated mesal process on sternum VII. Males are distinguished by the apex of the phallus bent at a right angle, and by the presence of a third, small, spur-like process near the middle (Fig. 223). It was collected from a variety of stream types (Table 5). Adults were present for most of the year except in the winter (Table 6). The larval head and pronotum, and adult habitus were illustrated in Ross (1944). He was the first to document its abundance in the Ozarks.

***Hydroptila icona* Mosely**

Fig. 272

Hydroptila icona Mosely 1937:161.

Type Locality.- Mexico.

Regional Distribution.- Watershed 128, see Discussion.

Nearctic Distribution.- US: AZ, CA, CO, NM, OK, TX; MEXICO; HONDURAS.

Discussion.- Males differ from the closely related *H. ajax* by the shorter inferior appendages (Fig. 272). It is restricted to the southwestern U.S. and Central America. All known Interior Highlands collections of this species, including those of Ross (1944) and Bowles and Mathis (1992) are from Pennington Creek, near the town of Mill Creek, Johnston Co., Oklahoma. At this site the creek is approximately third-order, spring-fed, and has a cobble substrate (Table 5). Cloud and Stewart (1974) reported on its drift ecology in the Brazos River, Palo Pinto Co., Texas. They observed seasonal peaks in drift density during April and October, four to five hours after sunset.

***Hydroptila melia* Ross**

Figs. 252, 253, 254

Hydroptila melia Ross 1938a:128.

Type Locality.- Oklahoma, Murray Co., Turner Falls Park, Honey Creek.

Regional Distribution.- Watershed 129. OKLAHOMA: see type locality, 2-VI-1937, H.H. Ross, holotype ♂, 36 ♂♂ paratypes.

Nearctic Distribution.- US: OK, TX.

Discussion.- Males are distinctive in having tergum X deeply divided into prominent blade-like, lateral processes that taper apically to a sharp point (Fig. 253). This species is known in the region only from the type series (Ross 1938a). Despite making numerous collections at this location, I never encountered it. Illustrations of the male, redrawn here from Ross (1938),

compare well with specimens I collected recently from the Edwards Plateau region of central Texas. The holotype is deposited in the INHS.

***Hydroptila oneill* Harris**

Fig. 228

Hydroptila oneilli Harris 1985:618.

Type Locality.- Alabama, Bibb Co., spring at Schutlz Creek Church, 2.5 mi SW of West Blocton.

Regional Distribution.- Watershed 49. ARKANSAS: Montgomery Co., Strawn Spring, E Caddo Gap, 12-IX-1980, H.W. Robison, 1 ♂.

Nearctic Distribution.- US: AL, AR, GA.

Discussion.- Males are most similar to those of *H. amoena*, but differ in the shallow apical emargination of tergum X (Fig. 228). It is recorded here for the first time from Arkansas, and therefore must be considered rare in the region. However, closer examination of past collections may reveal additional records previously determined as *H. amoena*. It was collected from a first-order, spring-fed stream in the Caddo River watershed of the Ouachita Mountain physiographic subregion (Table 5).

***Hydroptila perdita* Morton**

Figs. 266, 267, 268

Hydroptila perdita Morton 1905:67.

Type Locality.- New York, Ithaca.

Regional Distribution.- Watersheds 1, 4, 13, 23, 38, 39, 42, 49, 55, 80,

81, 85, 93, 95, 96, 97, 100, 102, 103, 107, 108, 112, 115, 116, 117, 118, 120,
122, 124.

Nearctic Distribution.- US: AL, AR, DE, IL, IN, KS, KY, MD, MI, MN,
MO, NH, NY, OH, OK, PA, WI, WV; CANADA: MB, ON, PQ.

Discussion.- Males are readily distinguished by the broadly rounded posterior margin of tergum X which is largely membranous except for a lightly sclerotized, mesal strip (Fig. 266). It was commonly encountered in UV light trap samples from a variety of stream types (Table 5) during March to October (Table 6).

***Hydroptila protera* Ross**

Figs. 264, 265

Hydroptila protera Ross 1938:131.

Type Locality.- Oklahoma, Murray Co., Turner Falls Park, Honey Creek.

Regional Distribution.- Watershed 129. OKLAHOMA: see type locality,
2-VI-1937, H.H. Ross, holotype ♂, 8 ♂♂ paratypes.

Nearctic Distribution.- US: OK, TX.

Discussion.- Males are generally similar to those of *H. consimilis* and *H. perdita*, but they can be distinguished from those species by the angled,

apico-lateral apices of tergum X (Fig. 264) and the twisted, blade-like apical process of the phallus (Fig. 265). Like *H. melia*, this species is known only in the region from the type series (Ross 1938a). This series is deposited in the INHS. My recent collections from Turner Falls did not produce additional specimens. Illustrations of the male, redrawn here from Ross (1938), compare well with specimens I recently collected in the Edwards Plateau region of Texas. The holotype is deposited in the INHS.

***Hydroptila quinola* Ross**

Figs. 242, 243

Hydroptila quinola Ross 1947:147.

Type Locality.- Ontario, Algonquin Park, Costello Lake.

Regional Distribution.- Watersheds 9, 39, 46, 49, 56, 61, 62, 74.

ARKANSAS: Hempstead Co., Eleys Lake, AR Hwy 24, E Nashville, 11-VI-1985, N. Eley, 1 ♂; Johnson Co., Mackay East Spring, 7 mi N Clarksville, 12-VII-1993, G. Leeds, 1 ♂; Nevada Co., Wilson Creek, 5 mi N Prescott, 15-VI-1983, D. Koym, 9 ♂♂; Ouachita Co., Little Missouri River, at Red Hill, 24-VI-1988, E.J. Bacon, 1 ♂; Pedron Lake (oxbow of Ouachita River), SE Camden, 3-VI-1980, H.W. Robison, 3 ♂♂; Polk Co., 4.2 mi W Mena, 27-VII-1990, H.W. Robison, 1 ♂; unnamed spring, S lodge at Queen Wilhelmina State Park, Rich Mountain, 14-V-1991, H.W. Robison, 1 ♂; Saline Co., Dog Creek, AR Hwy 298, 30-V-1992, H.W. Robison, 1 ♂.

Nearctic Distribution.- US: AL, AR, CT, FL, GA, ME, MN, MS, NC, NH, SC, VA; CANADA: ON, PQ.

Discussion.- Males are identified by the absence of a mid-phallic, spiral process, and the shorter needle-like phallus (Fig. 242). Bowles and Mathis (1989) listed this species as rare, reporting it from one location each in the Upper Saline River and Caddo River watersheds. My collection records indicate a wider occurrence; I have found it in small to medium sized streams and lakes in the Boston Mountains, Gulf Coastal Plain, and Ouachita Mountain physiographic subregions (Table 5). Adult collection dates range from May to August (Table 6).

***Hydroptila remita* Blickie and Morse**

Fig. 229

Hydroptila remita Blickie and Morse 1954:124.

Type Locality.- New Hampshire, Durham.

Regional Distribution.- Watersheds 13, 39, 56, 58. ARKANSAS: Clark Co., Terre Noir Creek, at AR Hwy 26, 8 mi E Antoine, 21-VI-1992, S.R. Moulton, 2 ♂♂; Montgomery Co., Brushy Creek, at US Hwy 270, 5 mi NW Whitetown, 23-X-1991, S.R. Moulton, 9 ♂♂; Pike Co., Little Missouri River, below narrows dam, 15-VII-1992, J.S. Rader, 1 ♂.

Nearctic Distribution.- US: AL, AR, FL, LA, ME, MS, NC, NH, NJ, PA, SC, TN

Discussion.- Reported here for the first time from Arkansas and the Interior Highlands. General structure of the male genitalia is similar to *H. amoena* and its allies, except that the phallic processes are entwined such that the apices of each are widely separated (Fig. 229). Adults were collected in medium to large sized streams of the Ouachita and Gulf Coastal Plain physiographic subregions (Table 5).

***Hydroptila sandersoni* Mathis and Bowles**

Figs. 230, 231, 232

Hydroptila sandersoni Mathis and Bowles 1990:88.

Hydroptila species A (nr. *amoena*): Bowles and Mathis (1989:239).

Type Locality.- Arkansas, Stone Co., Sylamore Creek, Gunner Pool Recreation Area.

Regional Distribution.- Watersheds 13, 23, 28, 38, 44, 46, 49, 56, 77, 80, 96, 100, 116. ARKANSAS: Montgomery Co., Brushy Creek, at US Hwy 270, 5 mi NW Whitetown, 23-X-1991, S.R. Moulton, 1 ♂; Pike Co., Rock Creek, at AR Hwy 8, 1 mi S US Hwy 270, 29-VII-1989, H.W. Robison, 1 ♂. Polk Co., Ouachita River, at US Hwy 71, Acorn, 24-X-1991, S.R. Moulton, 1 ♂; MISSOURI: Christian Co., Swan Creek, at Rte. DD, W Keltner, 8-VI-1991, S.R. Moulton, 3 ♂♂; Dallas Co., Bennett Spring, at Bennett Spring State Park, 7-VI-1991, S.R. Moulton, 1 ♂; Douglas Co., Indian Creek, at MO Hwy 76, 25-IX-1992, S.R. Moulton, many ♂♂; Shannon Co., Jacks Fork River, at MO Hwy 106,

W Eminence, 24-IX-1992, S.R. Moulton, 1 ♂; OKLAHOMA: Pushmataha Co., Crumb Creek, at OK Hwy 2, S Stanley, 27-IV-1991, S.R. Moulton and J. Kennedy, 3 ♂♂.

Nearctic Distribution.- US: AL, AR, KY, MO, OK.

Discussion.- Males are distinguished from those of *H. amoena* and *H. oneilli* by the convex posterior margin of tergum X (Fig. 230) and the more slender inferior appendages (Fig. 231). This species had previously been considered a regional endemic, but recent collections from Alabama and Kentucky have extended its known range into those states (Floyd 1992, Harris *et al.* 1991). In addition to the distributional information of the type series, my records considerably extend the distribution of this species beyond the type locality in Arkansas (Mathis and Bowles 1992), and into Missouri. It was collected from a wide variety of stream types (Table 5) during April to November (Table 6).

***Hydroptila scolops* Ross**

Figs. 246, 247

Hydroptila scolops Ross 1938a:128.

Type Locality.- Illinois, Shawneetown, along Ohio River.

Regional Distribution.- Watershed 106. ILLINOIS: see type locality, 11-V-1935, C. O. Mohr, holotype ♂.

Nearctic Distribution.- US: IL.

Discussion.- Males are distinguished by the flared phallobase (Fig. 246) and the subrectangular inferior appendages in ventral view (Fig. 247). The apico-lateral corners of each inferior appendage terminate in a sclerotized point. I examined the ♂ holotype in the INHS collection and included the species because of the close proximity of its type locality to the Illinois Ozark subregion and the possibility that it may eventually be found in the mountainous portions of the region.

***Hydroptila spatulata* Morton**

Figs. 234, 235

Hydroptila spatulata Morton 1905:66.

Type Locality.- New York, Ithaca.

Regional Distribution.- Watersheds 38, 49, 60, 95, 100, 107, 122, 124.

ARKANSAS: Montgomery Co., Jones Creek, at AR Hwy 8, Caddo Gap, 12-IX-1980, H.W. Robison, 2 ♂♂; MISSOURI: Douglas Co., Bryant Creek, at MO Hwy 76, W jct. Rte. C, 25-IX-1992, S.R. Moulton, 1 ♂; Gasconade Co., Gasconade River, at Hwy 89, Rollins Ferry Access, 27-IX-1990, B.C. Poulton, 8 ♂♂.

Nearctic Distribution.- US: AL, AR, DE, IL, IN, KY, MD, MI, MN, MO, NH, NY, OH, OK, PA, TN, VA, WI; CANADA: MB, PQ.

Discussion.- Males are readily distinguished by the rounded lobe-like apex of the phallus, which is preceded by a stout, triangular spur (Fig. 235). Despite its uncommon occurrence in the region, this species appears to be

associated with larger river systems (Table 5). Bowles and Mathis (1989) reported a single male from the lower Caddo River near Amity, Arkansas. The material noted above from Jones Creek, a first order creek, probably came from the Caddo River which is a few hundred meters away. Adults emerged from April to September, with the majority of records coming from the late summer (Table 6). Ross (1944) illustrated the larval head and pronotum and described them as "tawny yellow, ... with a scattering of small dark spots".

***Hydroptila strepha* Ross**

Figs. 250, 251

Hydroptila strepha Ross 1941b:68.

Type Locality.- Pennsylvania, Athens, Susquehanna River.

Regional Distribution.- Watersheds 23, 38, 68, 85, 100. ARKANSAS: Stone Co., North Sylamore Creek, at Barkshed Rec. Area, 24-X-1991, S.R. Moulton, 3 ♂♂; same but Gunner Pool Rec. Area, 22-VII-1987, M.L. Mathis, 1 ♂; MISSOURI: Reynolds Co., West Fork Black River, at MO Hwy 21, N Centerville, 27-IX-1991, S.R. Moulton, 1 ♂; Shannon Co., Jacks Fork River, at MO Hwy 106, 8 km W Eminence, 24-IX-1992, S.R. Moulton, 1 ♂; Round Spring, at MO Hwy 19, N Eminence, 24-IX-1992, S.R. Moulton, 2 ♂♂.

Nearctic Distribution.- US: AR, ME, MN, MO, MS, NC, NH, OH, SC, WI.

Discussion.- Until recently, the regional status of this species was uncertain. Bowles and Mathis (1989) and Mathis and Bowles (1992) reported it

as *H. nr. strepha* from Arkansas and Missouri, respectively. Some of this uncertainty may have stemmed from its close similarity with *H. bernerii*. Males of *H. strepha* may be differentiated from those of *H. bernerii* by the straighter, more slender inferior appendages (in ventral view, Fig. 251) and by the stouter phallus (Fig. 250). Further confusion may have resulted from the written description by Ross (1941b). In it, he states that "beneath the tenth tergite arises a pair of very slender filaments". I could never really see these "filaments" in this position except that, upon closer examination, I discovered that he was probably referring to the thickened lateral margins of the subgenital plate. Further in Ross' description, he made reference to an "apical thickening" of this plate. Collections were made from small to medium sized, spring-fed, stream and rivers in the Ozark Mountains (Table 5). Adults were collected during the summer and fall (Table 6).

***Hydroptila tusculum* Ross**

Figs. 255, 256

Hydroptila tusculum Ross 1947:148.

Type Locality.- Tennessee, Green Co., Tusculum College.

Regional Distribution.- Watershed 100. MISSOURI: Shannon Co., Alley Spring, 16-VIII-1987, Mathis and Tedder, 1 ♂.

Nearctic Distribution.- US: AL, LA, MO, MS, TN.

Discussion.- The first and only record of this species in the region was given by Mathis and Bowles (1992). Males are unique in having the apico-lateral portions of tergum X tapered abruptly in lateral view; the mesal lobe of tergum X in dorsal view is truncate (Fig. 256). The inferior appendages in ventral aspect, are widest basally, taper to narrow, pointed apices, and lack mid-ventral sclerotized points. The occurrence of this species at Alley Spring suggests that it may occur in other high-volume springs of the upper Current and Eleven Point Rivers (Table 5), but my collection effort in most of those springs failed to turn up additional records.

***Hydroptila vala* Ross**

Fig. 238

Hydroptila vala Ross 1938a:123.

Type Locality.- Illinois, Herod.

Regional Distribution.- Watersheds 9, 10, 44, 72, 80, 106. ARKANSAS: Franklin Co., Fane Creek, AR Hwy 23, at Cass, 19-V-1983, H.W. Robison and D. Koym, 32 ♂♂; Izard Co., East Twin Creek, at AR Hwy 9, Brandenburg, 25-V-1990, S.R. Moulton, 4 ♂♂; Johnson Co., Gee Creek, 1.3 mi from Haw Creek Rec. Area, 22-V-1981, B. Armitage, 5 ♂♂; ILLINOIS: Pope Co., Big Grand Pierre Creek, IL Hwy 34, Herod, 25-V-1992, S.R. Moulton, 2 ♂♂.

Nearctic Distribution.- US: AL, AR, IL, IN, KY, OH, OK, TN; CANADA: MB.

Discussion.- Males are most similar to those of *H. armata*. They are distinguished from that species by the arched dorsal margin of the inferior appendages, in lateral view, and the absence of an apical tooth directed dorsad (Fig. 238). Bowles and Mathis (1989) first reported this species from two locations in Arkansas; they considered it rare. My records indicate an association with spring-fed, headwater streams (Table 5). Despite its absence in my collections from Missouri and those of Mathis and Bowles (1992), it should occur in similar habitats in that state. Collection dates from this study and those from other parts of its known range, indicate that it is probably univoltine, with adults emerging in the late spring (Table 6).

***Hydroptila virgata* Ross**

Figs. 220, 221, 222

Hydroptila virgata Ross 1938a:125.

Type Locality.- Illinois, Herod.

Regional Distribution.- Watersheds 6, 34, 35, 44, 49, 56, 74, 77, 80, 81, 104, 106, 108, 110, 118, 121, 124.

Nearctic Distribution.- US: AL, AR, DE, IL, KY, MN, MO, NH, OH, OK, TN, WI; CANADA: MB, PQ.

Discussion.- Males are quite distinctive among the regional species in having a heavily sclerotized, rudder-like, apico-mesal process on sternite VIII (Fig. 220), the apex of its phallus is twisted (Fig. 222). Ross (1944) noted its

restriction in Illinois to the small, swift streams of the Illinois Ozarks. I encountered it throughout much of the region in spring-fed, headwater streams (Table 5). Although some researchers have reported adult collections from the summer and fall (Bowles and Mathis 1989, Mathis and Bowles 1992), my records and those of Ross (1944) also indicate a primary spring emergence during April to June (Table 6).

***Hydroptila waubesiana* Betten**

Fig. 241

Hydroptila waubesiana Betten 1934:160.

Hydroptila wausbesiana: misspelling, Bowles and Mathis (1992:32).

Type Locality.- Wisconsin, Waubesa Lake.

Regional Distribution.- Watersheds 1, 6, 13, 27, 39, 49, 59, 60, 62, 63, 68, 70, 77, 80, 81, 90, 116, 118, 122, 128.

Nearctic Distribution.- US: AL, AR, CO, DE, FL, GA, IA, IL, IN, KS, KY, LA, MB, MD, MI, MN, MO, MS, MT, NC, ND, NJ, NY, OH, OK, PA, SC, TX, VA, WI; CANADA: MB, ON, PQ, SK.

Discussion.- Males are readily identified by the heavily sclerotized, thorn-like, apical processes of tergum X (Fig. 241). Ross (1944) noted extreme color variation in the larva. He provided illustrations of the larval habitus, and light and dark forms of the larval head and pronotum. Bowles and Mathis (1989) reported this species as "rare" in Arkansas, but I found it to be very

common and widely distributed. This is a good example of the value of designed collecting in the different watersheds of a region. Collections were made from a wide range of stream types and lakes (Table 5). Adults were present from March to October (Table 6).

Genus *Ithytrichia* Eaton

This genus is represented in the United States and Mexico by three species (Harris and Contreras-Ramos 1989). Two of these, *I. clavata* and *I. mazon*, occur in the Interior Highlands.

Terminal instar larvae are morphologically unique among the other hydroptilid genera in having irregular dorsal and ventral lobes on most of the laterally compressed abdominal segments (Fig. 212). The larval case, made entirely of silk, is transparent and flat. The anterior end tapers to a small circular opening through which the head and thorax project; the posterior end is broadly rounded and open (Wiggins 1977). Larvae are usually found on smooth rock surfaces in swift riffles, and are classified as scrapers (Wiggins 1977). Their diet largely consists of diatoms. Nielsen (1948) studied the life cycle of *I. lamellaris* in Denmark and found that it had a univoltine pattern with larvae overwintering as fifth instars. In my collecting from the region and Texas, I have only found mature larvae during the winter months and early spring. Specific separation of the larvae and females of *Ithytrichia* species is not possible since this stage and sex are unknown for *I. mazon*. Adults are

separated from those of *Oxyethira* by the narrow strip that separates the postero-dorsal and posterior margins of the mesoscutellum. Males were infrequently collected in UV light trap collections.

KEY TO THE MALES OF *Ithytrichia*

1. Each inferior appendage in ventral view tapering past middle to a rounded point (Fig. 215) ***I. clavata* Morton**
- Each inferior appendage in ventral view of uniform width to truncated apex (Fig. 216) ***I. mazon* Ross**

***Ithytrichia clavata* Morton**

Figs. 212, 214, 215

Ithytrichia clavata Morton 1905:67.

Type Locality.- New York, Ithaca.

Regional Distribution.- Watersheds 53, 73, 100, 107, 122, 124.

ARKANSAS: Randolph Co., Jane's Creek, at AR Hwy 90, S Ravenden Springs, III-1985, S.R. Moulton, 1 larva; MISSOURI: Gasconade Co., Gasconade River, Held's Island Access, 28-VIII-1990, B.C. Poulton, 3 ♂♂; Maries Co., Gasconade River, Island Ford Resort, at Hwy 42, 7-VIII-1990, B.C. Poulton, 1 ♂; same but Paydown Access, SW Belle, 15-VII-1990, B.C. Poulton, 1 ♂; Osage Co., Gasconade River, Hwy 89 at Dallas Ferry Access, 27-IX-1990, B.C. Poulton, 2 ♂♂.

Nearctic Distribution.- US: AR, CA, IL, KS, ME, MN, MO, MT, NH, NY, OH, OK, PA, TX, UT, VA, WI, WY; CANADA: BC, MB, ON, PQ.

Discussion.- Males are distinguished from those of *I. mazon* by the tapered inferior appendages in ventral view (Fig. 215). *Ithytrichia clavata* is more widely distributed than the latter and, as a result, most of the known larval records are presumed to be it. Although Mathis and Bowles (1992) and Bowles and Mathis (1992) reported it from other localities in Missouri and Oklahoma, respectively, I only collected it from the Gasconade River in Missouri and a tributary of the Spring River in northeastern Arkansas. The latter record is the first for that state. *Ithytrichia clavata* was reported from the Brazos River, Texas by Cloud and Stewart (1974) and Moulton *et al.* (1993); Cloud and Stewart (1974) reported fifth instars to drift mostly at night. Nothing is known about the life history of this interesting microcaddisfly. I collected adults in the Interior Highlands from June to September (Table 6).

***Ithytrichia mazon* Ross**

Fig. 216

Ithytrichia mazon Ross 1944:124.

Type Locality.- Illinois, Mazon, Mazon Creek.

Regional Distribution.- Watershed 90. ARKANSAS: Logan Co., Sixmile Creek, (T7N R27W SEC3 SE1/4), 23-V-1986, H.W. Robison, 1 ♂.

Nearctic Distribution.- US: AR, IL, KY.

Discussion.- Males are distinguished from those of *I. clavata* by the nearly uniform width of the inferior appendages in ventral view (Fig. 216). The larva and female are unknown. The above location in Arkansas is the only record of this species in the region (Frazer *et al.* 1990). It is an approximately third order stream (Table 5), which flows north into the Arkansas River just north of Magazine Mountain. I examined the male holotype in the INHS. Ross (1944) characterized the type locality as "a small stream laden with pollution".

Genus *Leucotrichia* Mosely

Six species are recorded from North America (Morse 1993). They are distributed throughout the southwestern United States and Mexico. Only *L. pictipes* is reported from the region (Wilson 1984, L. Trial pers. communication). Like *Ithytrichia*, terminal instar larvae of this genus exhibit an interesting morphological modification of some abdominal segments. This modification is a pronounced lateral expansion of segments V and VI (Fig. 204). The free-living, early instars have been mistaken for the entirely free-living larvae of *Alisotrichia* Flint (S.C. Harris pers. communication). Terminal instar *Leucotrichia* construct a flattened, oval valve of silk. This valve is cemented along its periphery to a stable substrate and has a small circular opening on the anterior and posterior ends. Mature larvae are thus restricted to grazing periphyton near each end of the case (Wiggins 1977). My collections of *Leucotrichia* larvae from Arizona, Maryland and Texas, have

always come from swift, cool streams. Their numbers were usually quite high and their cases were butted against and on top of each other. Wiggins (1977) noted that most larvae over winter as fifth instars and emerge during the spring and summer. Adults are readily identified by their 1-3-4 tibial spur formula, the presence of ocelli, and a pentagonal metascutellum. Flint (1970) provided the most recent comprehensive taxonomic review of this genus.

***Leucotrichia pictipes* (Banks)**

Figs. 204, 218

Orthotrichia pictipes Banks 1911:359.

Type Locality.- New York, Johnstown, Hales Creek and Connecticut, Poquonock.

Regional Distribution.- Watershed 99. MISSOURI: Dent Co., Crooked Creek, upstream from gravel road crossing (T34N R2W SEC4 NW1/4 NE1/4), 28-V-1979, L. Trial, 9 larvae; same but 13-VII-1979, 4 larvae; same but 22-VIII-1979, 34 larvae; same but; 12-IX-1979, 97 larvae, same but 10-X-1979, 145 larvae.

Nearctic Distribution.- US: AL, AZ, CA, CO, CT, DE, ID, IL, KS, MA, MN, MO, MT, NC, NM, NV, NY, NY, OR, TN, UT, VA, VT, WI, WV, WY.

Discussion.- Generic characters will suffice to identify this species since the other congeners are confined to the southwestern United States and Mexico. Males have the inferior appendages fused to form a median spatulate

structure from which two, stout, preapical spines arise dorsad (Fig. 218). My illustration was redrawn from Flint (1970) and my larval habitus was drawn from a specimen collected in Maryland. Ross (1944), Flint (1970), and Wiggins (1977) described and illustrated the larva and/or adults. Wilson (1984) included this species in a listing of rare and endangered species of Missouri; its present status remains undetermined (Anonymous 1992). Mathis and Bowles (1992) included it in their Missouri checklist. In correspondence with Linden Trail (Missouri Dept. Conservation), I obtained specific collection data associated with the Wilson (1984) literature record. These collections were from a site on Crooked Creek, characterized by a bedrock substrate with scattered rubble pockets, and covered by varying amounts of algae and diatoms.

Genus *Mayatrichia* Mosely

This genus is comprised of five species in North America (Morse 1993). Two species, *M. ayama* and *M. ponta*, occur in the southwestern areas of the Interior Highlands. Larvae are generally similar to those of *Neotrichia* except that the abdomen lacks lateral hair fringes and the intersegmental grooves are indistinct. They inhabit rapid sections of streams and rivers. The larval case, made entirely of silk, is tubular, slightly curved, and tapered posterad (Wiggins 1977). I have a series of *M. ponta* larvae collected from Honey Creek inside Turner Falls Park, that have the case encrusted with calcium carbonate.

Wiggins (1977) speculated that the narrowed anterior head region may be related to some specialized feeding or case-building behavior. Adults differ from those of *Neotrichia* by the presence of a fourth metatibial spur. Nothing has been reported about the life histories of *Mayatrichia* species.

KEY TO THE SPECIES OF *Mayatrichia*

larvae

1. Case with numerous longitudinal or transverse ridges ***M. ayama* Mosely**
 Case smooth except for a pair of ventro-lateral ridges . ***M. ponta* Ross**

males

1. Postero-lateral margins of IX produced into a blade-like process curved ventrad (Fig. 217) ***M. ayama* Mosely**
 Postero-lateral margin of IX produced into a mitten-like process, the ventral lobe thumb-like (Fig. 219) ***M. ponta* Ross**

***Mayatrichia ayama* Mosely**

Fig. 217

Mayatrichia ayama Mosely 1937:182.

Type Locality.- Mexico.

Regional Distribution.- Watersheds 17, 31, 58, 128, 129. ARKANSAS:
 Clark Co., Terre Noir Creek, AR Hwy 26, 8 mi E Antoine, 21-VI-1992, S.R.

Moulton, 1 ♂; Montgomery Co., Little Missouri River, Albert Pike Rec. Area, 21-III-1981, E.J. Bacon, 4 ♂♂; Polk Co., Cross Creek, 5 mi W Grannis, 25-VI-1982, H.W. Robison, 4 ♂♂.

Nearctic Distribution.- US: AL, AR, CO, FL, GA, IA, IL, IN, KS, KY, ME, MI, MN, MO, MS, MT, NC, NH, NY, OH, OK, PA, SC, TN, TX, UT, VA, VT, WI; CANADA: AB, MB, NB, NT, ON, PQ, SK; MEXICO; HONDURAS; COSTA RICA.

Discussion.- Males are distinguished from those of *M. ponta* by the blade-like, posterolateral extension of IX (Fig. 217). The Arkansas records listed above are the first for that state. Ross (1944) recorded it from Missouri, but Mathis and Bowles (1992) were uncertain of its distributional status in that state. I have collected it infrequently from small and medium sized streams in the Ouachita Mountain, Gulf Coastal Plain, and Arbuckle Mountain physiographic subregions (Table 5). Adults were present during the spring and summer (Table 6). Ross (1944) described and illustrated the free-living early instar larva and the terminal case-building larva.

***Mayatrichia ponta* Ross**

Fig. 219

Mayatrichia ponta Ross 1944:278.

Type Locality.- Oklahoma, Murray Co., Turner Falls Park, Honey Creek.

Regional Distribution.- Watersheds 128, 129. OKLAHOMA: Murray Co.,

type locality, 22-II-1992, D.E. Baumgardner, 15 ♂♂; Travertine Creek, Chickasaw National Rec. Area, Sulphur, 29-30-VIII-1992, S.R. Moulton, 6 ♂♂.

Nearctic Distribution.- US: OK, WY.

Discussion.- Males are distinguished from the previous species by the mitten-like, posterolateral extension of IX (Fig. 219). Ross (1944) noted that the apex of the phallus terminated in a slender, filiform style. This species is known only in the region from small streams (Table 5) near its type locality in the Arbuckle Mountain physiographic subregion. Adults were present in February, May, June, and August (Table 6). Wiggins (1977) illustrated the larva and case.

Genus *Neotrichia* Morton

Approximately 32 species have been recorded from North America (Morse 1993). Most of the generic diversity appears to be centered in the Neotropical region (Ross 1944, Marshall 1979). Eight species are known from the Interior Highlands. Larvae most resemble those of *Mayatrichia*, except that the anterior portion of the head is less attenuate, and the abdomen has distinct intersegmental grooves and lateral hair fringes. Larvae inhabit riffles in streams and construct small tubular cases of sand grains (Wiggins 1977 Fig. 7.8F, Marshall 1979). *Neotrichia* species are among the smallest caddisflies with adults measuring 2 mm or less. Adults are distinguished by their 0-2-3 tibial spur count and the presence of ocelli. Nothing has been reported on the life

histories of the regional species. My illustrations of male genitalia were redrawn from Ross (1944); the male of *N. arkansasensis* was redrawn from Mathis and Bowles (1990). The species key below was modified from Ross (1944).

KEY TO THE MALES OF *Neotrichia*

1. Abdominal segment IX deeply emarginate laterally to produce dorsal and ventral finger-like processes (Fig. 273, 274) ***N. kitae* Ross**
 Lateral portion of IX not so divided 2
2. Phallus armed with a pair of stout, sclerotized hooks (Figs. 276, 277) . 3
 Phallus without stout, sclerotized hooks (Fig. 280, 285) 4
3. Phallic hooks equal in size and situated at apex of phallus (Fig. 276);
 inferior appendages much longer than wide (Fig. 275) ***N. collata* Morton**
 Phallic hooks unequal in size, arising in different positions in apical one-half of phallus (Fig. 277); inferior appendages as long as wide (Fig. 278)
 ***N. riegeli* Ross**
4. Apex of phallus tubular and distinct from rest of phallus by a constriction encircled with a sclerotized coil (Fig. 280); inferior appendages heavily sclerotized, black (Figs. 279, 281 left sides) 5
 Apex of phallus variable but not tubular and not completely encircled by a coil (Figs. 285, 286); inferior appendages not heavily sclerotized . . . 6

5. Inferior appendages each in ventral view with a prominent mesal point
(Fig. 279) ***N. okopa* Ross**
Inferior appendages without a prominent mesal point (Fig. 281)
..... ***N. arkansasensis* Mathis and Bowles**
6. Inferior appendages fused, in ventral view they form a rectangular plate
that tapers apically to an upturned lip (Figs. 282, 283)
..... ***N. minutisimella* (Chambers)**
Inferior appendages not fused (Figs. 284, 287) 7
7. Tergum X divided apically into diverging, pointed, sclerotized processes
(Fig. 284) ***N. vibrans* Ross**
Tergum X membranous, not divided apically into sclerotized points (Fig.
287) ***N. edalis* Ross**

***Neotrichia arkansasensis* Mathis and Bowles**

Figs. 280, 281

Neotrichia arkansasensis Mathis and Bowles 1990:90.

Neotrichia species A (nr. *sonora*): Bowles and Mathis (1989:239).

Type Locality.- Arkansas, Madison Co., Kings River, 5 mi S Kingston.

Regional Distribution.- Watersheds 9, 42, 44, 53, 65, 74, 96, 121.

ARKANSAS: Johnson Co., O-Deer Spring, 1 mi E Oark, 29-VI-1993, G. Leeds,

1 ♂; Polk Co., 4.2 mi W Mena, 27-VII-1990, H.W. Robison, 1 ♂; MISSOURI:

Christian Co., Swan Creek, Rte. DD, 1 mi W Keltner, 8-VI-1991, S.R. Moulton,

15 ♂♂; Douglas Co., Beaver Creek, MO Hwy 14, 4 mi NW Ava, 8-VI-1991, S.R. Moulton, many ♂♂.

Nearctic Distribution.- US: AR, MO.

Discussion.- Males resemble those of *N. okopa* but are distinguished by lacking a prominent mesal point on each inferior appendage (Fig. 281). This is one of two regionally endemic *Neotrichia* (Mathis and Bowles 1992). My Missouri records listed above, are the first for that state. Adults were collected from small to medium-sized, permanent streams (Table 5) during the spring and summer (Table 6).

***Neotrichia collata* Morton**

Figs. 274, 275

Neotrichia collata Morton 1905:72.

Type Locality.- New York, Ithaca.

Regional Distribution.- Watershed 94. ILLINOIS: Eddyville, Lusk Creek, 19-20-VI-1940, Mohr and Riegel.

Nearctic Distribution.- US: AL, IL, KY, ME, NY, SC, UT, VT.

Discussion.- This species is known in the region only from the record listed above. I examined this material, which is deposited in the INHS. Males are distinct from the other regional species by the presence of a pair of similarly sized, blade-like processes situated at the phallus apex (Fig. 276).

***Neotrichia edalis* Ross**

Figs. 286, 287

Neotrichia edalis Ross 1941b:62.**Type Locality.-** Oklahoma, Reagan, Pennington Creek.**Regional Distribution.-** Watershed 128. OKLAHOMA: see type locality, 1-VI-1937, H. H. Ross, holotype ♂, allotype ♀.**Nearctic Distribution.-** US: IL, MO, OK, TX.**Discussion.-** I did not collect this species during my study, but did reaffirm its presence in the Arbuckle Mountains by examining the holotype ♂ deposited in the INHS; it is intact and nearly transparent. Males are distinguished by the configuration of the inferior appendages (Fig. 287) and the truncated, spatulate phallic apex; there is a preapical, thumb-like process (Fig. 286).***Neotrichia kitae* Ross**

Figs. 273, 274

Neotrichia kitae Ross 1941b:60.**Type Locality.-** Missouri, Hollister.**Regional Distribution.-** Watershed 32. MISSOURI: see type locality, 14-VIII-1938, Mrs. Vitae Kitae, holotype ♂.**Nearctic Distribution.-** US: MO.

Discussion.- Males of this enigmatic, rare species, are unique in having tergum X divided laterally into two processes; the upper process narrow and finger-like, the lower one blade-like (Fig. 273). The regional presence of this species in the region is based solely on material (683 specimens) collected from Hollister, Missouri (Ross 1944). This town is located between Table Rock and Bull Shoals Reservoirs, just south of Branson, Missouri. This area receives a heavy amount of tourism (5.6 million visitors in 1993, Branson Chamber of Commerce) and as a result, "urbanization" and degraded water quality have possibly decimated the local populations. Efforts by us and M. L. Mathis (pers. communication) to relocate it near this location were unsuccessful. I examined the holotype, which is deposited in the INHS.

***Neotrichia minutisimella* (Chambers)**

Figs. 282, 283

Cyllene minutisimella Chambers 1873:125.

Type Locality.- Kentucky.

Regional Distribution.- Watersheds 38, 100, 104, 124. ARKANSAS: Crawford Co., Hurricane Creek, 3 mi W White Rock Mountain; Washington Co., Fayetteville; MISSOURI: Carter Co., Current River, Big Spring National Park, 7 mi S Van Buren, Hwy 103; Ozark Co., North Fork White River, Patrick Bridge Access, H Hwy, 8 mi NW Caufield; Shannon Co., Jack's Fork River, Hwy 106, 5 mi W Eminence; Wayne Co., Williamsville.

Nearctic Distribution.- US: AL, AR, FL, GA, IL, IN, KS, KY, LA, MO, MS, NC, OK, SC, TX; CANADA: MB.

Discussion.- This tiny caddisfly was originally described by Chambers (1873) as a lepidopteran. According to Ross (1944) it is the smallest (1.5 - 2.0 mm) caddisfly known in North America. Although I did not collect it, Unzicker *et al.* (1970), and Mathis and Bowles (1992) provided the localities listed above for Arkansas and Missouri, respectively. Ross (1944) documented it from Oklahoma, but gave no specific locality information. Males are differentiated by the fused, plate-like inferior appendages in ventral view (Fig. 283); in lateral view, the apex of this structure is produced into an upturned lip (Fig. 282). Adult collection dates are from June to August (Table 6).

***Neotrichia okopa* Ross**

Fig. 279

Neotrichia okopa Ross 1939b:629.

Type Locality.- Pennsylvania, Athens, Susquehanna River.

Regional Distribution.- Watersheds 4, 42, 44, 94, 96, 128. ARKANSAS: Johnson Co., Dripping Vat Hollow Spring, 1 mi E Catalpa, 29-VI-1993, G. Leeds, 1 ♂; Searcy Co., Little Red River, U.S. Hwy 65, 2 mi SE Leslie, 14-VI-1984, H.W. Robison, 2 ♂♂; MISSOURI: Christian Co., Swan Creek, at Rte DD, 1 mi W Keltner, 8-VI-1991, S.R. Moulton, 1 ♂.

Nearctic Distribution.- US: AL, AR, CA, CO, FL, IL, IN, KS, KY, ME, MN, MO, NH, NY, OH, OK, OR, PA, TX, WI; CANADA: MB, ON, PQ.

Discussion.- Males closely resemble those of *N. arkansasensis* but differ in the presence of a mesal sclerotized point midway on each inferior appendage (Fig. 279). Frazer *et al.* (1991) first reported this species from the Middle Fork Little Red River in Searcy Co., Arkansas. The Missouri records listed above are the first for that state. Ross (1944) commented that it was particularly abundant in Lusk Creek in the Illinois Ozarks subregion. Collection records indicate a preference for permanent or spring-fed, headwater streams (Table 5). Adults were collected during the summer (Table 6).

***Neotrichia riegeli* Ross**

Figs. 277, 278

Neotrichia riegeli Ross 1941b:61.

Type Locality.- Illinois, Eddyville, Lusk Creek.

Regional Distribution.- Watersheds 74, 77, 94. ARKANSAS: Polk Co., East Fork Powell Creek, Ewing Farm, 7 mi W Mena, 6-VII-1991, B. Ewing, 1 ♂; base of Mena District Rifle Range, 1 mi NW Mena, 11-VI-1991, B. Ewing, 1 ♂; OKLAHOMA: Pushmataha Co., unnamed creek, 2.5 mi E Albion, 17-VII-1993, D.E. Baumgardner, 1 ♂.

Nearctic Distribution.- US: AR, IL, KY, OK.

Discussion.- Males have small, quadrate inferior appendages (Fig. 278) and two blade-like phallic processes, that are dissimilar in shape and do not arise together (Fig. 277). Originally described from the Illinois Ozarks subregion, it is now known for the first time from Arkansas and Oklahoma. The eastern Oklahoma records probably represent its western-most distribution in the eastern deciduous forest biome. Adults were collected in June and July (Table 6) from small head water streams (Table 5). Ross (1944) associated the larva and adults.

***Neotrichia vibrans* Ross**

Figs. 284, 285

Neotrichia vibrans Ross 1938a:119.

Noetrichia vibrans Ross: misspelling, Unzicker *et al.* (1970:172).

Type Locality.- Illinois, Oakwood, Middle Fork River.

Regional Distribution.- Watersheds 4, 28, 38, 48, 68, 81, 100, 104, 107, 122. ARKANSAS: Fulton Co., Forty Islands Creek, NW Hardy, 23-IX-1993, S.R. Moulton, 4 ♂♂; Randolph Co., Current River, AR Hwy 62, 1-VI-1986, H.W. Robison, 1 ♂; Sevier/Howard Cos., Saline River, 5 mi E Lockesburg, 26-VI-1982, H.W. Robison and D. Koym, 1 ♂; MISSOURI: Maries Co., Gasconade River, US Hwy 63 at Morelands Resort, 10-IX-1990, B.C. Poulton, 1 ♂; Shannon Co., Round Spring, MO Hwy 19, N Eminence, 24-IX-1992, S.R. Moulton, 1 ♂;

OKLAHOMA: Cherokee Co., Town Branch Creek, OK Hwy 82, Tahlequah, 5-VI-1991, S.R. Moulton, 5 ♂♂.

Nearctic Distribution.- US: AL, AR, FL, GA, IL, KS, KY, ME, MN, MO, MS, NH, OH, OK, SC, TN, VA, WI, WV; MEXICO.

Discussion.- Males are readily identified by the diverging sclerotized apices of tergum X (Fig. 284) and the lobate phallic apex which bears two stiff setae (Fig. 285). Ross (1944) designated the female allotype from Hollister, Missouri. He noted that *N. vibrans* has a preference for small clear streams in Illinois. My records also include collections from large rivers (Table 5). Adults were collected during the summer and fall (Table 6).

Genus *Ochrotrichia* Mosely

Approximately 73 species are known from North America (Morse 1993), of which 10 are reported from the Interior Highlands. Species in this genus are recognized in the literature under two subgenera, *O. (Metrichia)* and *O. (Ochrotrichia)*. Uncertainty as to the taxonomic status of *Metrichia* has received much attention. Ross (1938c) erected the genus *Metrichia* for *Orthotrichia nigrutta* Banks which differed considerably from the accepted definition of *Orthotrichia* Eaton. Flint (1968) reduced *Metrichia* to subgeneric status under the common and widely distributed genus *Ochrotrichia* Mosely based on the similarity of adult morphology and general larval appearance. Despite the similarities he observed, many researchers still recognize *Metrichia*

as valid due to differences in the tibial spur count, eversible glands on male abdominal segment VI, and the distinctive nature of the adult genitalia (Blickle and Denning 1977, S.C. Harris, pers. communication). I follow Flints' definition of *Metrichia* as a subgenus, pending resolution of the problem. Species of *O. (Metrichia)* are primarily southwestern Nearctic and Neotropical in distribution.

Larvae occur in a wide variety of lotic habitats including temporary streams (Ross 1944, Wiggins 1977). Their morphology and case design are most similar to larvae of *Hydroptila*. Larvae may be distinguished from the latter by the absence of terminal abdominal gills and the presence of a lobate process on the anteroventral corners of the metanotal sclerites (Fig. 209). Some larvae that inhabit madicolous habitats (i.e. thin sheet of water flowing over a rock surface) may construct a case which is carried more in a tortoise shell fashion (Marshall 1979, Wiggins 1977). These cases have a flat ventral valve which is covered by a dome-like dorsal valve (see Wiggins 1977, Fig. 7.9 B, C). My illustrations of male *O. (Ochrotrichia)* species, except *O. (O.) unio*, *O. (O.) xena*, and *O. (O.) weddleae*, were redrawn from Ross (1944) or Frazier and Harris (1991). My key to males was modified from these references.

KEY TO THE MALES OF *Ochrotrichia*

1. Spurs 1-3-4; male abdominal segment VI with a pair of bifurcated, lobate glands situated dorsally, genitalia as in Figs. 288, 289
 ***O. (Metrichia) nigritta (Banks)***

- Spurs 0-3-4; abdominal segment VI without any such glands
- **O. (Ochrotrichia) spp.** 2
2. Tergum X simple, either triangular (Fig. 290), finger-like (Fig. 291), or
with apex resembling a fish hook barb (Fig. 292) 3
- Tergum X complex, consisting of several sclerotized processes of
varying orientation (Figs. 295 - 300, 301, 305) 5
3. Apex of tergum X, in dorsal view, resembling a fish hook barb (Fig. 292);
inferior appendages as wide as long with a posterior notch (Figs. 293) .
. **O. weddleae Ross**
- Tergum X triangular or finger-like; inferior appendages much longer than
wide (Figs. 290, 291) 4
4. Tergum X with apex acute, dorsal surface with small sclerotized spur;
inferior appendages each with an apico- and preapicomesal patch of
stout spines (Fig. 290) **O. xena (Ross)**
- Tergum X finger-like, dorsal surface without spur; inferior appendages
with only a apicomesal patch of stout setae (Fig. 291) . **O. unio (Ross)**
5. Apical portion of tergum X in dorsal view, with a spiral, lateral spur-like
projection present at base of process B (Figs, 295 - 298) 6
- Apical portion of tergum X without a spiral (Figs. 299, 300, 303) 9
6. Process D broad basally; process F bulbous at base (Fig. 296) 7
- Process D slender; process F uniform in width for much of its length
(Fig. 295) **O. robisoni Frazier and Harris**

7. Outer margin of process E with denticles (Figs. 297, 298) 8
 Outer margin of process E without denticles (Fig. 296)
 ***O. contorta* (Ross)**
8. Process C broad apically and curved sharply to right, apicomesal margin
 of process E concave (Fig. 297) ***O. anisca* (Ross)**
 Process C slender, uniform width, slightly curved to right, apicomesal
 margin of process E not concave (Fig. 298) ***O. shawnee* (Ross)**
9. Ventral margin of inferior appendages in lateral view, nearly straight, not
 sinuate 10
 Ventral margin of inferior appendages in lateral view, angular or sinuate
 (Figs. 301, 303, 305, 307) 11
10. Process D bent sharply mesad (Fig. 299) ***O. tarsalis* (Hagen)**
 Process D straight (Fig. 300) ***O. stylata* (Ross)**
11. Inferior appendages in ventral view, each with a row of 4 stout spines on
 a mesal shoulder (Fig. 302) ***O. riesi* Ross**
 Inferior appendages in ventral view, with spines on mesal shoulders
 asymmetrically arranged (Figs. 304, 306, 308) 12
12. Inferior appendages in lateral view, strongly sigmoidal, their ventral
 margins prominently angled in middle (Fig. 303) . . . ***O. spinosa* (Ross)**
 Inferior appendages at most weakly sigmoidal and not angled in middle
 (Figs. 305, 307) 13
13. Inferior appendages in ventral view, each with 4 to 6 apicomesal, peg-

- like spines (Fig. 306) ***O. eliaga* (Ross)**
 Inferior appendages in ventral view, with only 1 or 2 apicomesal, peg-like
 spines (Fig. 308) ***O. arva* (Ross)**

***Ochrotrichia (Ochrotrichia) anisca* (Ross)**

Fig. 297

Polytrichia anisca Ross 1941b:58.

Type Locality.- Illinois, Wolf Lake.

Regional Distribution.- Watersheds 4, 9, 14, 23, 34, 35, 39, 42, 44, 45, 49, 54, 56, 66, 68, 74, 77, 80, 81, 87, 89, 96, 97, 107, 115, 116, 118, 121, 122, 123.

Nearctic Distribution.- US: AR, IL, KS, KY, MO, OK, TX.

Discussion.- This is the most common and widely distributed of the regional *Ochrotrichia* species. Males are distinguished by the curved process C being distally widened (Fig. 297). Collection data suggest a wide preference for temporary and permanent stream types (Table 5). Ross (1944) noted that it inhabited several temporary streams in the Illinois Ozark subregion. The larva and female were described by Ross (1944). Adults were collected during the spring and early summer (Table 6).

***Ochrotrichia (Ochrotrichia) arva* (Ross)**

Figs. 307, 308

Polytrichia arva Ross 1941b:58.

Type Locality.- Tennessee, Martin Springs.

Regional Distribution.- Watersheds 38, 44. MISSOURI: Ozark Co., Althea Spring, 8 mi NW Caufield, H Hwy, 8-VIII-1988, Mathis and Tedder, 8 ♂♂.

Nearctic Distribution.- US: AL, AR, MI, MO, OH, TN, VA.

Discussion.- males closely resemble those of *O. eliaga*, but differ in having only one apicomesal spine on each inferior appendage (Fig. 308). Ross (1944) noted the possibility of a second spine in this position; however, I did not observe this in regional material. Mathis and Bowles (1992) provided the first and only records of this species in the region. Their collections came from a spring-fed stretch of the North Fork White River (Table 5) during August (Table 6).

***Ochrotrichia (Ochrotrichia) contorta* (Ross)**

Fig. 296

Polytrichia contorta Ross 1941b:60.

Type Locality.- Missouri, Greer Spring.

Regional Distribution.- Watershed 47. MISSOURI: see type locality, 28-III-1937, T.H. Frison, ♂ holotype.

Nearctic Distribution.- US: MO.

Discussion.- This rare species is endemic to the region and known only from the original collection by Ross (1941). I examined the male holotype in

the INHS. Males are distinguished by the absence of minute denticles on the lateral margin of process E and the tapered, acute apex of process C (Fig. 296). The type locality is a major high-volume spring in the region.

***Ochrotrichia (Ochrotrichia) eliaga* (Ross)**

Figs. 305, 306

Polytrichia eliaga Ross 1941b:57.

Ochrotrichia eliga (Ross): misspelling, Frazer *et al.* (1991:445).

Type Locality.- Tennessee, Jasper.

Regional Distribution.- Watersheds 4, 23, 53, 55, 66, 89, 95, 96, 116, 118, 121, 122. ARKANSAS: Randolph Co., Janes Creek, AR Hwy 90, 1 mi S Ravenden Springs, 14-III-1991, S.R. Moulton and J.C. Abbott, 1 ♂; Stone Co., Gunner Pool at North Sylamore Creek, 24-V-1990, S.R. Moulton, 1 ♂; Marcella Spring, at AR Hwy 14, 1.5 mi N Marcella, 13-III-1991, S.R. Moulton and J.C. Abbott, 32 ♂♂, 13 ♀♀ (reared); same but Big Spring, at Big Spring (town), 14 ♂♂, 5 ♀♀; MISSOURI: Christian Co., Swan Creek, Rte. DD, 1 mi W Keltner, 8-VI-1991, S.R. Moulton, 2 ♂♂; Dade Co., Sons Creek, US Hwy 160, 1 mi E Lockwood, 21-V-1992, S.R. Moulton and D.E. Baumgardner, 6 ♂♂; Douglas Co., Beaver Creek, MO Hwy 14, 4 mi NW Ava, 8-VI-1991, S.R. Moulton, 11 ♂♂; Laclede Co., Bennett Spring, Bennett Spring State Park, 7-VI-1991, S.R. Moulton 2 ♂♂; McDonald Co., Bentonville Hollow Branch, at spring off MO Hwy 90, 2 mi S Powell, 6-VI-1991, S.R. Moulton, 8 ♂♂.

Nearctic Distribution.- US: AL, AR, IL, IN, MO, OH, OK, TN.

Discussion.- Males differ from those of *O. arva* by the presence of four black spines on the apicomesal margin of each inferior appendage (Fig. 306). Frazer *et al.* (1991) and Mathis and Bowles (1992) provided the first records of this species from Arkansas and Missouri, respectively. Ross (1944) described the larva and female. I collected this species during the late spring and early summer (Table 6) from spring-fed headwater and medium sized streams (Table 5). Some larvae were successfully reared in the laboratory. I examined the male holotype in the INHS.

Ochrotrichia (Metrichia) nigrutta (Banks)

Figs. 288, 289

Orthotrichia nigrutta Banks 1907b:163.

Metrichia volada Blickle and Denning 1977:295.

Type Locality.- Texas, Austin.

Regional Distribution.- Watersheds 128, 129. OKLAHOMA: Johnston Co., unnamed spring seep, approximately 7 mi SW Mill Creek (town), 25-IV-1992, S.R. Moulton, many ♂♂, ♀♀; Murray Co., Travertine Creek (Buffalo and Antelope Springs), Chickasaw National Rec. Area, Sulphur, 28-IV-1991, S.R. Moulton and J. Kennedy, 66 ♂♂, 22 ♀♀; Pontatoc Co., Byrds Mill Spring, 1 mi W Fittstown, 25-IV-1992, S.R. Moulton, 4 ♂♂.

Nearctic Distribution.- US: AZ, OK, TX; MEXICO; EL SALVADOR.

Discussion.- This jet black microcaddisfly was only collected from the Arbuckle Mountains subregion. It is apparently restricted to small and medium-sized spring habitats (Table 5). Males were usually aspirated from blades of riparian grass near the springs. The larva was described by Edwards and Arnold (1961). It constructs a purse case of silk and algal filaments that is atypical of the sand grain, purse cases of *O. (Ochrotrichia) spp.* The presence of bilobed, dorsal abdominal glands, the 1-3-4 tibial spur count, and structuring of the male genitalia (Figs. 288, 289) will readily distinguish this species from other regional *Ochrotrichia*. Adults were collected throughout most of the year (Table 6).

***Ochrotrichia (Ochrotrichia) riesi* Ross**

Figs. 301, 302

Ochrotrichia riesi Ross 1944:132.

Type Locality.- Illinois, Utica, Split Rock Brook.

Regional Distribution.- Watersheds 9, 55, 68, 122. ARKANSAS:

Johnson Co., Gilliam Bog, 2 mi S Ozone, 12-VII-1993, G. Leeds, 1 ♂; same but McKay East Spring, 7 mi N Clarksville, 2 mi S Ozone, 2 ♂♂; New Perspective North Spring, 0.5 mi N Long Creek, 7 mi N Clarksville, 29-VI-1993, G. Leeds, 5 ♂♂; Newton Co., falls on Clear Creek, at Lost Valley Rec Area, 18-X-1990, S.R. Moulton, 1 ♂ mmt, 87 larvae; MISSOURI: Shannon Co., Round Spring, MO Hwy 19, N Eminence, 24-IX-1992, S.R. Moulton, 1 ♂.

Nearctic Distribution.- US: AL, AR, IL, IN, MO, TN.

Discussion.- Males are very distinctive among the regional species in having a row of four stout, basomesal spines on each inferior appendage (in ventral view, Figs. 301, 302). Mathis and Bowles (1992) first reported it from region; my Arkansas records listed above are the first ones for that state. It has been collected from small headwater streams and waterfalls (Table 5). Adults were present during the summer and fall (Table 6). My collection of larvae from Newton Co., Arkansas was made from the torrential face of a waterfall. They were best collected in this habitat by placing a fine mesh, hand aquarium net against the rock and then gently hand rubbing the area above. The larval cases were of the tortoise-shell variety. Ross (1944) described the larva and female.

***Ochrotrichia (Ochrotrichia) robisoni* Frazier and Harris**

Figs. 294, 295

Ochrotrichia robisoni Frazier and Harris 1991:364.

Type Locality.- Arkansas, Perry Co., Bear Creek at AR 7 2 mi S Hollis.

Regional Distribution.- Watersheds 18, 44, 74, 77. ARKANSAS: Franklin Co., Fane Creek, AR Hwy 23, Cass, 19-V-1983, H.W Robison and D. Koym, 1 ♂; Perry Co., see type locality, 11-VI-1983, H.W. Robison, 1 ♂; Polk Co., base of Mena District Rifle Range, 10 mi NW Mena, 11-VI-1991, B. Ewing,

1 ♂; OKLAHOMA: Pushmataha Co., Kiamichi River, 3 mi E Albion, 11-V-1991, R. Tucker, 2 ♂♂.

Nearctic Distribution.- US: AR, OK.

Discussion.- This recently described regional endemic is most closely related to *O. contorta*. It differs from that species by the narrower base of process F, the slenderer process C, and the angled apex of process E (Fig. 295). Frazer and Harris (1991) included this species in their cladistic review of the *O. shawnee* species group. My collections are from small to medium sized temporary or permanent streams (Table 5). The Oklahoma record is the first for that state. Adults were present during May and June (Table 6).

***Ochrotrichia (Ochrotrichia) shawnee* (Ross)**

Fig. 298

Polytrichia shawnee Ross 1938a:120.

Type Locality.- Illinois, Herod.

Regional Distribution.- Watershed 106. ILLINOIS: see type locality, 29-V-1935, Ross and Mohr, holotype ♂, 11 ♂♂, 6 ♀♀ paratypes.

Nearctic Distribution.- US: AL, IL, KY, NY, TN.

Discussion.- Males are distinguished from the other regional species by the slender, slightly sinuate process C (Fig. 298). It is known in the Interior Highlands only from its type locality in the Illinois Ozarks physiographic

subregion. I am uncertain of the specific habitat features since Ross (1938a) did not provide any stream locality.

***Ochrotrichia (Ochrotrichia) spinosa* (Ross)**

Figs. 303, 304

Polytrichia spinosa Ross 1938a:121.

Type Locality.- Oklahoma, Murray Co., Turner Falls Park, Honey Creek.

Regional Distribution.- Watersheds 23, 38, 48, 49, 56, 68, 81, 87, 110, 124, 129.

Nearctic Distribution.- US: AR, IL, KY, MN, MO, OH, OK, PA, WI;
CANADA: MB, NT.

Discussion.- Males are readily distinguished by the sigmoidal shape of the inferior appendages in lateral view (Fig. 303), and by the widely separated, stout spines on the ventromesal surface of the left inferior appendage (Fig. 304). Bowles and Mathis (1989) listed it as "rare", based on two records in Arkansas. My records indicate that it is locally abundant in small, spring-fed streams throughout the region (Table 5). Adults were collected during May, June, and September (Table 6). I examined the holotype ♂ in the INHS.

***Ochrotrichia (Ochrotrichia) stylata* (Ross)**

Fig. 300

Polytrichia stylata Ross 1938a:120.

Type Locality.- Wyoming, Farson, along Little Sandy Creek.

Regional Distribution.- Watersheds 128, 129.

Nearctic Distribution.- US: AZ, CA, CO, ID, MN, MT, ND, OK, OR, SD, UT, WA, WY; CANADA: BC; MEXICO; GUATEMALA.

Discussion.- Males are most closely related to *O. tarsalis*, except that process D of tergum X is straight (Fig. 300). It is known only from two locations in the Arbuckle Mountains physiographic subregion (Table 5): one at Turner Falls Park (Ross 1938a), and the other at Pennington Creek (Bowles and Mathis 1992). I made several collections from these locations, but did not encounter it. These locality records, and other material collected from Dolan Springs on the Devils River near Del Rio, Texas, suggest that this species is probably restricted to spring habitats in the region.

***Ochrotrichia (Ochrotrichia) tarsalis* (Hagen)**

Fig. 299

Hydroptila tarsalis Hagen 1861:275.

Type Locality.- Canada, St. Lawrence River.

Regional Distribution.- Watersheds 9, 28, 39, 48, 49, 60, 61, 62, 96, 100, 107, 122, 124, 129.

Nearctic Distribution.- US: AL, AR, AZ, FL, IA, IL, IN, KS, KY, LA, MI, MN, MO, MS, NC, NY, OH, OK, SC, TX, VA, VT, WI, WV; CANADA: MB, ON; MEXICO.

Discussion.- Males differ from the preceding species in having process D of tergum X sharply curved mesad (Fig. 299). Bowles and Mathis (1992) reported *O. potomus* Denning from Oklahoma. This western species is believed to be a variant of *O. tarsalis* (Frazer and Harris 1991); however no formal synonymy has been attempted. *Ochrotrichia tarsalis* is widely distributed throughout the region in a variety of stream types (Table 5). Adults were collected April to September (Table 6). Ross (1944) described the larva and female.

***Ochrotrichia (Ochrotrichia) unio* (Ross)**

Fig. 291

Polytrichia unio Ross 1941b:56.

Type Locality.- Illinois, Alto Pass, Union Spring.

Regional Distribution.- Watersheds 106, 113, 118, 121, 122.

MISSOURI: Dade Co., Sac River, MO Hwy 245, S Dadeville, 21-V-1992, S.R. Moulton and D.E. Baumgardner, 2 ♂♂; same but Sons Creek, US Hwy 160, 1 mi E Lockwood, 1 ♂; Douglas Co., Beaver Creek, MO Hwy 14, 4 mi NW Ava, 8-VI-1991, S.R. Moulton, 2 ♂♂; St. Clair Co., Briley Creek, 2 mi SW Iconium, 22-V-1992, S.R. Moulton and D.E. Baumgardner, 29 ♂♂.

Nearctic Distribution.- US: IL, KY, MO, OH, TN.

Discussion.- Males of this species are most similar to those of *O. xena* in having elongated inferior appendages and a relatively simple, unmodified

tergum X. It differs from that species by possessing only an apicomeral patch of black spinules on each inferior appendage, and by the finger-like configuration of tergum X (Fig. 291). This species appears to favor a range of temporary and permanent streams (Table 5). Adults were collected only during the late spring and early summer (Table 6) using sweep nets and UV light trap. Ross (1944) described and illustrated the larva and female. He noted that although larvae occurred in large numbers in several temporary Illinois Ozark streams, adults were rarely collected.

***Ochrotrichia (Ochrotrichia) weddleae* Ross**

Figs. 292, 293

Ochrotrichia weddleae Ross 1944:274.

Ochrotrichia weedleae: misspelling, Unzicker et al. (1970:172), Bowles and Mathis (1989:239; 1992:32).

Type Locality.- Oklahoma, Cloudy, Cloudy Creek.

Regional Distribution.- Watersheds 77, 80. OKLAHOMA: Pushmataha Co., Crumb Creek, OK Hwy 2, 1.5 mi S Stanley, 27-IV-1991, S.R. Moulton and J. Kennedy, 1 ♂; same but, Patterson Creek, 2 mi N Moyers, many ♂♂.

Nearctic Distribution.- US: AR, OK.

Discussion.- This species is endemic to the Ouachita Mountain physiographic subregion. Males are readily distinguished by the short, broad inferior appendages, each having a posterior emargination and a stout mesal

spine on the upper lobe (Fig. 293). The apex of tergum X resembles the barbed apex of a fish hook (Fig. 292). Bowles and Mathis (1989) commented on its good abundance at Lake Wilhelmina in Polk Co., Arkansas. I have collected it from second and third-order tributaries of the Kiamichi River in southeastern Oklahoma (Table 5). Adults were present during the spring only (Table 6).

***Ochrotrichia xena* (Ross)**

Fig. 290

Polytrichia xena Ross 1938a:122.

Type Locality.- Illinois, Herod, Gibbons Creek.

Regional Distribution.- Watersheds 106, 118. MISSOURI: Dade Co., Sons Creek, US Hwy 160, 1 mi E Lockwood, 21-V-1992, S.R. Moulton and D.E. Baumgardner, 3 ♂♂.

Nearctic Distribution.- US: AR, IL, IN, KY, MO, TN.

Discussion.- This species is closely related to *O. unio*. Males differ in having both apico- and preapicomesal patches of stout spinules on each inferior appendage (Fig. 290). Bowles and Mathis (1989) listed it as rare, based on 3 ♂♂ collected in a small stream of the Ozark National Forest, 30 mi S Prairie Grove, Arkansas. My only collection came from a third-order stream in the Springfield Plateau subregion of Missouri (Table 5); that record represents a new state record. Emergence occurs in the spring (Table 6).

Genus *Orthotrichia* Eaton

Morse (1993) recorded six species of this genus from North America; I have documented three in the Interior Highlands. According to Wiggins (1977), larvae inhabit submerged beds of macrophytes in lentic habitats or slow-flowing river margins. The larval labrum has an asymmetrical triangular process on the anterior margin. It has been suggested that this modification may play a major role in piercing and feeding on more robust algal filaments (Nielsen 1948). According to Marshall (1979), this is a more efficient method than that seen in the related genera *Agraylea*, *Hydroptila*, and *Oxyethira*. The larval case is constructed entirely of silk and has five longitudinal ridges on its dorsal surface (Fig. 32). Adults are readily identified by their 0-3-4 tibial spur count and absence of ocelli. They were often abundant in UV light trap samples. Males are best recognized by the asymmetry of tergum X. Unlike other hydroptilid genera, the male phallus is of little taxonomic value and even varies in structure in some species (Kingsolver and Ross 1961). Kingsolver and Ross (1961) provided the most recent review of this genus in North America.

KEY TO THE MALES OF *Orthotrichia*

1. Bilobed process with long, slender arms, each tipped with a stout seta; curved, ribbon-like internal process surrounding the phallus but not attached to it (Fig. 332) ***Orthotrichia aegerfasciella* (Chambers)**

- Bilobed process with short arms or indistinct; curved ribbon-like internal process absent (Figs. 331. 333) 2
2. Median process of sternite VII reduced, without dense covering of stout setae; inferior appendages in ventral view subcircular; bilobed process with distinct (Fig. 333) ***O. instabilis* Denning**
- Median process of sternite VII well developed, with dense covering of stout setae; inferior appendages horn-like; bilobed process indistinct (Fig. 331) ***O. cristata* Morton**

***Orthotrichia aegerfasciella* (Chambers)**

Fig. 332

Clymene aegerfasciella Chambers 1873:114.

Orthotrichia americana Banks 1904a:116.

Oxyethira dorsalis Banks 1904b:216.

Orthotrichia brachiata Morton 1905:70.

Ochrotrichia americana Banks: generic misplacement, Unzicker *et al.* (1970:172).

Type Locality.- Kentucky.

Regional Distribution.- Watersheds 6, 9, 10, 24, 39, 46, 48, 49, 51, 53, 57, 60, 62, 70, 74, 77, 80, 81, 90, 116, 118, 119, 122, 129.

Nearctic Distribution.- US: AL, AR, CT, DC, DE, FL, GA, IL, IN, KS, KY, LA, MA, MD, ME, MN, MO, MS, NC, NH, NJ, NY, OH, OK, PA, SC, TN, TX, VA,

WI; CANADA: ON, PQ; MEXICO; CUBA.

Discussion.- Males are unique in having a curved, ribbon-like process surrounding the phallus but not attached to it (Kingsolver and Ross 1961). It differs further from the other two regional species by the slender, elongated arms of the bilobed process (=subgenital plate)(Fig. 332). This is the most common and widely distributed species of *Orthotrichia* in the region. It was collected from a wide range of lotic and lentic habitats (Table 5). Adults were present throughout the year except winter (Table 6). Ross (1944) described the larva and female.

***Orthotrichia cristata* Morton**

Fig. 331

Orthotrichia cristata Morton 1905:75.

Type Locality.- Illinois, Lake Forest.

Regional Distribution.- Watersheds 116, 118, 122. MISSOURI: Dade Co., Sac River, MO Hwy 245, S Dadeville, 21-V-1992, S.R. Moulton and D.E. Baumgardner, 2 ♂♂; same but Sons Creek, US Hwy 160, 1 mi E Lockwood, 1 ♂.

Nearctic Distribution.- US: AL, AR, DE, FL, GA, IL, IN, KS, KY, LA, ME, MI, MN, MO, MS, MT, NH, NY, OH, OK, PA, TN, TX, VA, WI; CANADA: MB, ON, PQ; CUBA; JAMAICA.

Discussion.- Males are readily identified by the black, horn-like inferior appendages (in ventral view), and the well developed median process on sternite VII (Fig. 331). Bowles and Mathis (1989) reported it as uncommonly collected from small streams in Arkansas. My records also include collections from large rivers (Table 5). Adults were collected from May to September (Table 6).

***Orthotrichia instabilis* Denning**

Fig. 333

Orthotrichia instabilis Denning 1948:

Type Locality.- Florida, Winter Park.

Regional Distribution.- Watershed 6, 46. ARKANSAS: Lafayette Co., tributary to Bodcaw Creek, E Lewisville Airport, 18-V-1992, J. Rader, 1 ♂; Saline Co., North Fork Saline River, AR Hwy 298, 30-V-1992, H.W. Robison, 2 ♂♂.

Nearctic Distribution.- US: AL, AR, FL, NH, SC.

Discussion.- Males differ from the other regional species by the smaller, less setose median process on sternite VII, and the shorter, rounded lobes of the bilobed process (Fig. 333). This species is known only from one stream each in the Ouachita Mountain and Gulf Coastal Plain physiographic subregions (Table 5). Bowles and Mathis (1989) reported an additional record from the North Fork Saline River in Saline Co., Arkansas. My records were collected with UV light traps during May and August (Table 6).

Genus *Oxyethira* Eaton

This is among the most diverse of hydroptilid genera and is found in every biogeographic region (Kelley 1986). Twelve of the 41 North American species of *Oxyethira* (Morse 1993) are recorded from the Interior Highlands.

Oxyethira larvae are easily identified by their elongated meso- and metathoracic legs, each of which is about 2.5x longer than the forelegs (Fig. 205). They are also unique in having the terminal instar larval case flask-shaped and made entirely of silk (Fig. 33). The anterior end of the case tapers to a small circular opening while the posterior end is broad and open. Larvae inhabit a wide range of lotic and lentic aquatic habitats. They utilize green algae as a food source (Marshall 1979). Adults are similar to those of *Ithytrichia* except that the posterodorsal margin of the mesoscutellum touches the posterior margin in middle. Only anecdotal information has been published about life histories of the regional *Oxyethira* species. Extensive revisionary work of this genus was done by Kelley (1984, 1985, 1986). Kelley and Morse (1982) presented an illustrated key to the females, which included all the species treated herein except *O. coercens*. Males are identified by structural differences of abdominal segments VIII, IX, and the phallus; the inferior appendages are reduced and apparently fused with the posteroventral margin of IX (Kelley 1984). My illustrations of male genitalia were redrawn from Kelley (1983).

KEY TO THE MALES OF *Oxyethira*

1. Sternite IX produced posterad into a long, apically bifurcated, process
(Figs. 309 - 312) 2
Sternite IX not produced posterad into a long process 3
2. Sternite IX process fork-like, arms separated by a width about equal to
that of the constriction before the fork (Fig. 309) . . . ***O. azteca* (Mosely)**
Sternite IX process tapering to apex, arms separated by a distance
about equal to the width of arm (Fig. 311), apices of each in lateral view
with a small mesal lobe directed dorsad (Fig. 312) . . . ***O. janella* Denning**
3. Apical one-half of phallus produced into 3, intertwined, curved processes
(Fig. 314) ***O. pallida* (Banks)**
Phallus variable, not divided as above 4
4. Phallus with a long spiral process that encircles the shaft 1 - 2x, apex
expanded or not, but bearing 2 short, acute or rounded tooth-like
processes (Fig. 316, 318, 320) 5
Phallus without a long spiraled process (Fig. 322), or if process present,
then closely appressed to long needle-like phallus (Fig. 328) 7
5. Posterolateral margin of tergum VIII with 1 or 4 dark spines (Figs. 317,
319) 6
Posterolateral margin of tergum VIII without spines (Fig. 315)
. ***O. novasota* Ross**
6. Inferior appendages prominent, much produced beyond IX and curved

- dorsad; apicolateral margin of VIII with 4 dark spines (Fig. 319)
 **O. coercens Morton**
- Inferior appendages less prominent, not produced beyond IX;
 apicolateral margin of VIII with a single, dark spine (Fig. 317)
 **O. rivicola Blicke and Morse**
7. Dorsolateral margins of tergum VIII produced into a pair of straight,
 slender, tapered processes that extend to the rounded posterior margin
 of IX (Fig. 321); phallus finger-like, tipped with a claw-like process (Fig.
 322) **O. aculea Ross**
- Dorsolateral margins of tergum VIII not produced into straight tapered
 processes 8
8. Ninth segment largely internal with a long, narrow ventral portion that is
 produced anterad to segment VI (Fig. 325) **O. zeronia Ross**
- Ninth segment with internal ventral portion broader and produced
 anterad at most to the anterior margin of VII (Fig. 323, 327) 9
9. Tergum VIII with a pair of stout, dorsolateral processes curving dorsad,
 each process bifurcated at apex forming 2 sharp points; apex of phallus
 bent 90° (Fig. 324) **O. glasa (Ross)**
- Tergum VIII without a pair of stout, basolateral processes; apex of
 phallus not bent 90° 10
10. Phallus long, needle-like, with tip flared, basal one-third with accessory
 process indistinct, closely appressed to shaft (Fig. 328)

- ***O. forcipata* Mosely**
- Phallus robust, widened in apical one-third, apex tipped with a
 membranous lobe bearing internal spines, basal accessory process
 absent (Fig. 330) ***O. dualis* Morton**

***Oxyethira aculea* Ross**

Figs. 321, 322

Oxyethira aculea Ross 1941b:53.

Type Locality.- Oklahoma, Murray Co., Turner Falls Park, Honey Creek.

Regional Distribution.- Watersheds 128, 129. OKLAHOMA: Murray Co., see type locality, 2-VI-1937, H.H. Ross, holotype ♂, paratypes 4 ♂♂; Travertine Creek, Chickasaw National Rec. Area, Sulphur, 29-VIII-1992, S.R. Moulton, 2 ♂♂.

Nearctic Distribution.- US: AZ, NM, OK, TX; MEXICO.

Discussion.- Males are readily distinguished by the pair of slender, dorsolateral extensions of tergum VIII, which extend nearly to the broadly rounded posterior margin of IX (Fig. 321). The phallus is simple, finger-like (Fig. 322). This typically southwestern species is regionally restricted to the Arbuckle Mountains subregion. It occurs there in small, spring-fed, streams (Table 5), and adults emerge during the summer (Table 6). Bowles and Mathis (1992) reported an additional collection record from Pennington Creek in nearby Johnston Co., Oklahoma.

***Oxyethira azteca* (Mosely)**

Figs. 309, 310

Loxotrichia azteca Mosely 1937:165.**Type Locality.**- Mexico.

Regional Distribution.- Watershed No. 129. OKLAHOMA: Murray Co., Travertine Cr., Chickasaw Nat. Rec. Area, Sulphur, 29-30-VIII-1992, S.R. Moulton, UV light trap, 1 ♂.

Nearctic Distribution.- US: NC, SC, OK, TX; MEXICO; SOUTH AMERICA.

Discussion.- Males are similar to those of *O. janella*, differing chiefly in the broader apical separation of sternite IX (Fig. 309) and the absence of apicomesal lobes on this structure (Fig. 310). The above record in the Arbuckle Mountain subregion is the first for the region and Oklahoma (Table 5). This area probably represents its northern-most distributional limit.

***Oxyethira coercens* Morton**

Figs. 319, 320

Oxyethira coercens Morton 1905:70.**Type Locality.**- New York, Ithaca.

Regional Distribution.- Watersheds 23, 38, 55, 60, 77, 100, 124. ARKANSAS: Searcy Co., Buffalo River, US Hwy 65, Tyler Point, 10-X-1991, P. Yeager, 1 ♂; Stone Co., Gunner Pool Rec. Area, North Sylamore Creek, 5-VIII-

1982, D. Koym, 1 ♂; MISSOURI: Shannon Co., Jacks Fork River, MO Hwy 106, W Eminence, 24-IX-1992, 1 ♂; OKLAHOMA: Pushmataha Co., Mud Creek, Ok Hwy 2, 5 mi N Moyers, 27-IV-1991, S.R. Moulton and J. Kennedy, 1 ♂.

Nearctic Distribution.- US: AL, AR, IL, IN, ME, MN, MO, MT, NH, NY, OK, TX, VA, WI; CANADA: PQ.

Discussion.- Males are quite distinct from the other regional species in having the inferior appendages dark, prominent and upturned in lateral view; the apicolateral margins of VIII possess 4 dark, stout spines (Fig. 319). The phallus is flared apically with two, triangular spur-like processes (Fig. 320). Additional regional records were given by Bowles and Mathis (1989, 1992) and Mathis and Bowles (1992). *Oxyethira coercens* was uncommonly collected from a wide range of permanent and spring-fed lotic habitats (Table 5). Adults were present during April to October (Table 6).

***Oxyethira dualis* Morton**

Figs. 329, 330

Oxyethira dualis Morton 1905:71.

Oxyethira allosi Blicke 1980:101.

Type Locality.- New Mexico, Las Vegas.

Regional Distribution.- Watersheds 53, 68, 81, 95, 100, 116, 118, 122, 124, 125. MISSOURI: Dade Co., Lynn Branch, Stockton Lake, US Hwy 160, 21-V-1992, S.R. Moulton and D.E. Baumgardner, 2 ♂♂; Dallas Co., Bennett

Spring, Bennett Spring State Park, 7-VI-1991, S.R. Moulton, 3 ♂♂; Douglas Co., Bryant Creek, at spring off MO Hwy 5, W Bryant, 25-IX-1992, S.R. Moulton, 3 ♂♂; Shannon Co., Alley Spring, MO Hwy 106, W Eminence, 24-IX-1992, S.R. Moulton, 4 ♂♂; Round Spring, MO Hwy 19, N Eminence, 24-IX-1992, S.R. Moulton, 21 ♂♂.

Nearctic Distribution.- US: AL, AR, AZ, CA, CO, IL, IN, KS, MO, MT, NH, NM, NY, OH, OK, OR, TN, TX, UT, VA, VT, WY.

Discussion.- Males are distinguished by the expanded phallic apex which bears 4 curved spines in a membranous lobe (Fig. 330). It was infrequently collected from small to medium sized streams and high-volume springs (Table 5). Adults were present from May to October (Table 6). Ross (1944) reported it from Meremec Spring near St. James, Missouri.

***Oxyethira forcipata* Mosely**

Figs. 327, 328

Oxyethira forcipata Mosely 1934b:153.

Type Locality.- New York.

Regional Distribution.- Watersheds 85, 116, 122. MISSOURI: Dallas Co., Bennett Spring, Bennett Spring State Park, 7-VI-1991, S.R. Moulton, 1 ♂.

Nearctic Distribution.- US: AL, AR, CT, GA, KY, IL, ME, MI, MN, MO, NC, NH, NY, OH, PA, SC, TN, VA, WI; CANADA: ON, PQ.

Discussion.- Males are readily identified by the long, needle-like phallus with its lateral process long and closely appressed to shaft (Fig. 328). It was collected from medium sized rivers and high-volume springs in the Ozark Mountains (Table 5). Adults were present during the summer (Table 6). Kelley (1986) noted that larvae may inhabit areas of slow current in rivers. The extension of *Oxyethira forcipata* into the Appalachian Mountains and their eastern foothills is probably due to adaptation by the larvae to depositional areas of cold rivers (Kelley 1986).

***Oxyethira glasa* (Ross)**

Figs. 323, 324

Loxotrichia glasa Ross 1941b:70.

Type Locality.- Oklahoma, Murray Co., Turner Falls Park, Honey Creek.

Regional Distribution.- Watersheds 129. OKLAHOMA: see type locality, 2-VI-1937, H.H. Ross, ♂.

Nearctic Distribution.- US: AL, FL, GA, LA, MS, OK, SC; CUBA.

Discussion.- Males differ from all other regional species by possessing a pair of dorsolateral processes on VIII, that curve dorsad and terminate in a dark spine (Fig. 323). The phallus is angled 90° at the apex and bears a preapical spine; the ejaculatory duct is free (Fig. 324). This species is known in the region only from the type series, designated by Ross (1941b) from the Arbuckle Mountains (Table 5). Numerous attempts to collect it again from

there were unsuccessful. Harris *et al.* (1991) observed that it primarily occurred in the coastal plain streams of Alabama, with some isolated populations above the fall line.

***Oxyethira janella* Denning**

Figs. 311, 312

Oxyethira janella Denning 1948:397.

Oxyethira neglecta Flint 1964b:57.

Type Locality.- Florida, Winter Park.

Regional Distribution.- Watersheds 58, 61. ARKANSAS: Clark Co., Terre Noir Creek, AR Hwy 26, 8 mi E Antoine, 21-VI-1992, S.R. Moulton, 1 ♂; Pike Co., Wolf Creek, AR Hwy 301, 1 mi S Antoine, 21-VI-1992, S.R. Moulton, 1 ♂.

Nearctic Distribution.- US: AL, AR, FL, GA, LA, MS, SC; CENTRAL AND SOUTH AMERICA.

Discussion.- Males resemble those of *O. azteca*, but are distinguished by the shallow, narrow apical notch of the fused inferior appendages (Fig. 311), and the presence of a pair of small mesal lobes anterad of this notch (Fig. 312). The records above are the first ones for Arkansas and the region. These creeks are permanent, third-order systems in the transitional zone between the Gulf Coastal Plain and Ouachita Mountain physiographic subregions (Table 5).

Adults were collected in June (Table 6). Kelley (1984) reported its range as the southeastern United States to the Amazon.

***Oxyethira novasota* Ross**

Figs. 315, 316

Oxyethira novasota Ross 1944:138.

Type Locality.- Texas, Marquez, Novasota River.

Regional Distribution.- Watersheds 9, 17, 48, 62, 74. ARKANSAS: Ouachita Co., Pedron Lake (oxbow of Ouachita River), 2 mi SE Camden, 3-VI-1980, H.W. Robison, 10 ♂♂; Polk Co., Cross Creek, 5 mi W Grannis, 25-VI-1992, H.W. Robison, 1 ♂; Sevier/Howard Cos., Saline River, AR Hwy 24, 5 mi E Lockesburg, 26-VI-1982, H.W. Robison and D. Koym.

Nearctic Distribution.- US: AL, AR, FL, GA, LA, MS, OH, SC, TX.

Discussion.- Males are similar to *O. rivicola* but lack a dark spine on the posterolateral margins of tergum VIII (Fig. 315). Collected primarily from medium to large streams and rivers, and oxbows in the Gulf Coastal Plain and Ouachita Mountain physiographic subregions (Table 5). Kelley (1985) noted that it was endemic to the coastal plain region of the southeastern United States. Bowles and Mathis (1989) also provided a record from Little Piney Creek in the Boston Mountains subregion. Most of their records were from "sluggish, silt-laden streams in Clark County", Arkansas. I collected adults in UV light traps during the summer and fall (Table 6).

***Oxyethira pallida* (Banks)**

Figs. 313, 314

Orthotrichia pallida Banks 1904a:215.*Oxyethira viminalis* Morton 1905:71.*Oxyethira cibola* Denning 1947a:12.**Type Locality.**- Potomac River.**Regional Distribution.**- Watersheds 1, 4, 6, 23, 24, 27, 34, 35, 38, 39, 48, 49, 55, 61, 68, 74, 77, 80, 81, 85, 95, 96, 97, 100, 107, 116, 117, 118, 122, 124, 128.**Nearctic Distribution.**- US: AL, AR, AZ, CA, DC, DE, FL, GA, IL, IN, KS, KY, LA, MD, ME, MI, MN, MO, MS, NE, NH, NY, OH, OK, SC, TX, VA, WI, WV, WY; CANADA: NB, PQ.**Discussion.**- This species is the most common and widely distributed of the regional *Oxyethira*. Males are distinguished by the three, intertwined, blade-like processes that make up the apical one-half of the phallus (Fig. 314). Collected from a wide range of lotic and lentic habitats (Table 5) during April to October (Table 6).***Oxyethira rivicola* Blicke and Morse**

Figs. 317, 318

Oxyethira rivicola Blicke and Morse 1954:121.**Type Locality.**- New Hampshire, Lee.

Regional Distribution.- Watersheds 1, 31, 35. ARKANSAS: Pope Co., Dare Creek, 0,5 mi N Hector, 10-VI-1989, H.W. Robison, 1 ♂; Scott Co., Rock Creek, U.S. Hwy 270, 7 mi E "Y" City, 23-X-1991, S.R. Moulton, 2 ♂♂.

Nearctic Distribution.- US: AL, AR, GA, ME, MN, NH, TN, VA, WI;
CANADA: PQ.

Discussion.- Males closely resemble *O. novasota* except for the presence of a single dark spine on the posterolateral margins of tergum VIII (Fig. 317). It was infrequently collected from second and third-order, permanent streams in the Ouachita Mountain and Boston Mountain subregions (Table 5). Adults were present during the summer and fall (Table 6). Kelley (1985) included this species in a group that occupied an endemic area stretching from southern Canada to the southern Appalachian Mountains and midwestern United States.

***Oxyethira zeronia* Ross**

Figs. 325, 326

Oxyethira zeronia Ross 1941a:15.

Oxyethira walteri Denning 1947a:17.

Type Locality.- Michigan.

Regional Distribution.- Watersheds 1, 17, 39, 46, 56, 74, 77, 80, 85, 128. ARKANSAS: Nevada Co., Brushy Creek, AR Hwy 19, 9 mi N Prescott, 21-VI-1992, S.R. Moulton, 2 ♂♂; Pike Co., Little Missouri River, 15-VIII-1992, J.S.

Rader, 2 ♂♂; Polk Co., Big Creek, U.S. Hwy 270, 3 mi W Acorn, 24-X-1991, S.R. Moulton, 2 ♂♂; Saline Co., North Fork Saline River, AR Hwy 298, 30-V-1992, H.W. Robison, 2 ♂♂; Scott Co., Big Cedar Creek, 300 m upstream AR Hwy 28, 24-X-1991, S.R. Moulton, 2 ♂♂; OKLAHOMA: Pushmataha Co., Mud Creek, OK Hwy 2, 5 mi N Moyers, 27-IV-1991, S.R. Moulton and J. Kennedy, 1 ♂.

Nearctic Distribution.- US: AL, AR, FL, GA, IL, KS, KY, LA, ME, MI, MN, MO, MS, NC, NH, NJ, OH, OK, SC, TN, VA, WI; CANADA: NS, PQ.

Discussion.- Cleared males are distinguished by the internal elongation of sternite IX that reaches anterad to VI (Fig. 325). It was collected from small to medium sized, intermittent and permanent streams (Table 5). Adults were collected during April to October (Table 6).

Genus *Paucicalcaria* Mathis and Bowles

This recently described genus, originally reported as "Hydroptilidae Genus A (nr. *Hydroptila*)" (Bowles and Mathis 1989), is endemic to the Interior Highlands and consists solely of the type species, *P. ozarkensis* Mathis and Bowles. Mathis and Bowles (1989) indicated that it is probably most closely related to other members of the Hydroptilini tribe. It is readily distinguished from all other hydroptilid genera by its 0-1-2 tibial spur count (incorrectly designated in Mathis and Bowles (1989) as "tarsal spurs"). The arrangement of the metatibial spurs is especially unique since there is one apical and one

preapical spur. Mathis and Bowles (1989) indicated that, of the two specimens they examined, the metascutellum was either semicircular or pentagonal. Four males examined by us exhibited a semicircular metascutellum. The males examined from Fane Creek in Franklin Co., Arkansas had hindwings that were greatly reduced and filamentous.

***Paucicalcaria ozarkensis* Mathis and Bowles**

Fig. 334

Paucicalcaria ozarkensis Mathis and Bowles 1989:188.

Type Locality.- Arkansas, Logan Co., Gutter Rock Creek, (Magazine Mt.).

Regional Distribution.- Watersheds 10, 44, 74; ARKANSAS: Franklin Co., Fane Cr., AR 23 at Cass, 19-V-1983, UV light, Robison and Koym, 2 ♂♂; Polk Co., East Fork Powell Cr., 7 mi W Mena, 23-V-1991, Ewing, 1 ♂; same but, base of Mena District Rifle Range, approximately 10 mi NW Mena, 11-VI-1991, Ewing, 1 ♂.

Nearctic Distribution.- Known only from the type locality and additional regional locations indicated above.

Discussion.- This species is rare and known only from 10 specimens. It is among the smallest hydroptilids in the region, with a forewing length of about 2 mm. My illustration of the male genitalia was redrawn from Mathis and Bowles (1989). The female and immature stages have recently been

associated. Morphology of the life stages suggests an affinity with *Hydroptila* (M. L. Mathis pers. communication).

Genus *Stactobiella* Martynov

Five species are known from North America (Morse 1993). Two of these, *S. delira* and *S. palmata*, are reported from the Interior Highlands. Larvae inhabit rock surfaces in swift, small streams (Wiggins 1977). Like *Dibusa angata*, *Stactobiella* larvae have tarsal claws angled sharply at the base, each with a stout basal process. They differ from that genus in possessing slender abdominal setae that lack a basal sclerite. According to Wiggins (1977), the larval case is similar to that of *Hydroptila* species. Observations on larval maturation (Ross 1944) and collection data suggest that the regional species are probably univoltine with adults emerging in the spring. Adults possess an apical spur on the protibiae, have ocelli, and the mesoscutellum is rectangular. Adults were infrequently collected using UV light traps. Wiggins (1977) noted that populations of all species are evidently local in occurrence. My records support this observation. My illustrations of the male genitalia were redrawn from Ross (1944).

KEY TO THE MALES OF *Stactobiella*

1. Bracteole short, undivided; inferior appendages long, slender (Fig. 337)
 ***S. delira* (Ross)**

Bracteole longer, divided apically into 3 fingers; inferior appendages short, irregular (Figs. 335, 336) ***S. palmata* (Ross)**

***Stactobiella delira* (Ross)**

Fig. 337

Stactobia delira Ross 1938a:115.

Type Locality.- Wisconsin, Spooner, Namakagon River.

Regional Distribution.- Watersheds 44, 55, 74, 122. ARKANSAS: Franklin Co., Mulberry River, AR Hwy 23, Turners Bend, 1.5 mi S Cass, 19-V-1983, H.W. Robison and D. Koym, 1 ♂; Searcy Co., Buffalo River, Woolum Access, 17-III-1992, R.W. Killam, many ♂♂.

Nearctic Distribution.- US: AL, AR, CA, CO, ID, IL, IN, KS, KY, ME, MN, MO, MT, NC, NH, OH, OK, OR, PA, SC, TN, VA, WA, WI, WV, WY; CANADA: BC.

Discussion.- Males differ from those of *S. palmata* in having long slender inferior appendages, and shorter, unbranched bracteoles (Fig. 337). Collected from medium to large rivers (Table 5) during the spring (Table 6). Ross (1944) illustrated the female genitalia.

***Stactobiella palmata* (Ross)**

Figs. 335, 336

Stactobia palmata Ross 1938a:116.

Type Locality.- Wisconsin, Merrill, Wisconsin River.

Regional Distribution.- Watersheds 34, 55, 90, 115. ARKANSAS:

Cleburne Co., Cadron Creek, 22-V-1982, H.W. Robison, 4 ♂♂; Logan Co., Six Mile Creek, 23-V-1986, H.W. Robison, 4 ♂♂; Newton Co., Little Buffalo River, 20-V-1983, H.W. Robison, 9 ♂♂; Sebastian Co., Vache Crasse Creek, 21-VI-1984, H.W. Robison, 2 ♂♂; MISSOURI: Dade Co., Sac River, MO Hwy 245, S Dadeville, 21-V-1992, S.R. Moulton, 1 ♂; Polk Co., Pomme de Terre River, MO Hwy 32 and Rte. AA, E Bolivar, 22-V-1992, S.R. Moulton and D.E. Baumgardner, 1 ♂.

Nearctic Distribution.- US: AL, AR, IL, KS, KY, ME, MN, MO, NH, OH, OK, OR, SD, TN, VA, WI; CANADA: AB, MB.

Discussion.- Males differ from those of *S. delira* by the short, irregular inferior appendages, and the digitate apices of the elongated, curved bracteols. Adults were collected from medium to large permanent rivers (Table 5) during the late spring (Table 6). Ross (1944) reported that in Illinois populations, larvae matured in early spring.

CHAPTER 9

FAMILY LEPIDOSTOMATIDAE

This family is represented in North America by two genera, *Theliopsyche* Banks and *Lepidostoma* Rambur (Weaver 1988). Only the genus *Lepidostoma* is known from the Interior Highlands. Weaver (1988) provided an excellent review of the North American fauna. Larvae are similar to those of the Limnephilidae and Uenoidae, but may be readily distinguished by the position of the antenna on the anterior edge of the eye. Separation of larvae can at best be made to the subgenus and species group levels. Adults, especially the males, are rather distinctive among caddisflies, exhibiting unusual secondary sexual characters. These include structural and setational modifications of the maxillary palpi, antennal scapes, legs and wings. Females carry egg masses for some time in an abdominal concavity created by the contraction of sternites VII and VIII prior to oviposition (Weaver 1988).

Genus *Lepidostoma* Rambur

Seventy species are known from North America (Morse 1993, Bowles et al. 1994). Six species occur in the Interior Highlands; two of these, *L. lescheni*

and *L. ozarkense*, are endemic to the region (Bowles et al. 1994). Adults of most species, except *L. togatum*, are seasonal in appearance (Table 6).

KEY TO THE MALES OF *Lepidostoma*

1. Tergum X with paired setal warts (Fig. 338) 2
 Tergum X without paired setal warts (Fig. 344, 345) 5
2. Apical segment of each maxillary palpus appearing club-shaped in lateral view, in ventral view, apical one-half angled mesad (Fig. 341);
 tergum X in lateral view with posterior margin broadly rounded, its ventral margin produced into a finger-like lobe directed caudad (Fig. 342) ***L. griseum* (Banks)**
 Apical segment of each maxillary palpus straight or slightly sinuate, never angled mesad (Fig. 340) 3
3. Inferior appendages each with a sickle-shaped, dorso-basal process curved caudad (Figs. 338, 339) 4
 Inferior appendages without such a sickle-shaped process, dorsal, finger-like lobe as long as ventral lobe (ie. apical one-half deeply envaginated)(Fig. 343) ***L. carrolli* Flint**
4. Sickle-shaped process of each inferior appendage large, approximately one-half the length of the appendage (Fig. 338) ***L. libum* Ross**
 Sickle-shaped process of each inferior appendage small, much shorter than one-half the length of appendage (Fig. 339)

- ***L. lescheni* Bowles, Mathis, and Weaver**
5. Inferior appendages each with a straight, dorso-basal lobe, directed caudad past apex of ventral lobe; lateral processes of X gently curving dorsad (Fig. 344) ***L. ozarkense* Flint and Harp**
- Inferior appendages each with a sinuate, baso-mesal, finger-like process directed dorso-caudad; apex of tergum X in lateral view heavily sclerotized and curved ventrad (Fig. 345) ***L. togatum* (Hagen)**

***Lepidostoma carrolli* Flint**

Fig. 343

Lepidostoma carrolli Flint 1958:22.

Type Locality.-New Jersey, Lakehurst.

Regional Distribution.- Watershed 74. ARKANSAS: Polk Co., Ewing Farm, 7 mi W Mena, 1-2-X-1991, B. Ewing, 3 ♂♂; same but 1-X-1992, 3 ♂♂.

Nearctic Distribution.- US: AR, CT, MD, ME, NC, NJ, OH, PA, SC, TN.

Discussion.- This species is a member of the typically Appalachian subgenus *Mormomyia*. Its presence in the Ouachita Mountain subregion represents a significant western disjunction from its main range in the eastern United States. The only known regional collection reported here was made in early October from a small, permanent, headwater stream (< 3m wide) with a gravel/cobble substrate (Tables 5, 6). The immature stages are unknown (Weaver 1988).

***Lepidostoma griseum* (Banks)**

Figs. 341, 342

Phanopsyche griseum Banks 1911:357.**Type Locality.-** New York, Fulton Co., Woodsworth's Lake.**Regional Distribution.-** Watershed 55. ARKANSAS: Newton Co., Mill Cr. below Dogpatch and Ozark House Spring (M. L. Mathis, personal communication).**Nearctic Distribution.-** US: AL, AR, CT, DE, GA, KY, MA, ME, MI, NC, NH, NJ, NY, OH, PA, SC, TN, VA, VT, WI, WV; CANADA: NS, ON, PQ.**Discussion.-** Like the previous species, *L. griseum* occurs as a disjunct population from its main range in the eastern United States. Herrmann et al. (1986) reported this species from Colorado, but this record was later found to be in error (Weaver 1988). In the Boston Mountains subregion, it occurs in first and second order, spring-fed streams (Table 5). Males are readily distinguished from other regional species by having the apical segment of each maxillary palpus sharply angled mesad (Fig. 341). Terminal instar larvae construct four-sided, panel cases from hexagonal pieces of bark (Weaver 1988). Males were collected in September (Table 6).***Lepidostoma lescheni* Bowles and Mathis**

Figs. 339, 340

Lepidostoma lescheni Bowles, Mathis and Weaver 1994:IN PRESS.

Lepidostoma species B: Bowles and Mathis 1989:240.

Type Locality.- Arkansas, Logan Co., Magazine Mountain, Slocum Spring.

Regional Distribution.- Watershed 10. ARKANSAS: see type locality, 4-X-1987, R. Leschen, holotype ♂.

Nearctic Distribution.- US: AR.

Discussion.- This species is known only from the male holotype, which is deposited at the NMNH. It was collected on 4 October 1987 from under a rock near the type locality at an elevation of 625 m (Bowles *et al.* 1994). Several unsuccessful attempts to collect additional material have been made by us, and D. E. Bowles (pers. communication).

***Lepidostoma libum* Ross**

Fig. 338

Lepidostoma liba Ross 1941b:120.

Type Locality.- Illinois, Elgin, Botanical Garden.

Regional Distribution.- Watersheds 25, 36, 44, 122. ARKANSAS: Johnson Co., Cole Creek, AR Hwy 103, 4 mi N jct. AR Hwy 164, 25-IX-1991, S.R. Moulton, 1 ♀; Madison Co., War Eagle Creek, AR Hwy 23, 8 mi N St. Paul, 25-IX-1991, S.R. Moulton, 1 ♀; Washington Co., spring seep, AR Hwy 16, 1 mi W Savoy, 25-X-1991, S.R. Moulton, many larvae; MISSOURI: Pulaski Co., Roam Farm near Swedeborg, 24-IV-1987, M.L. Mathis, 3 ♂♂.

Nearctic Distribution.- US: AR, IL, MO, WI.

Discussion.- Known from small spring-seeps in the Boston Mountains, Springfield Plateau, and Osage-Gasconade Hills subregions (Table 5). Unlike other members of the *L. (Mormomyia)* subgenus that build a panel case, larvae of this species construct a tubular case of sand and small pebbles. However, in some populations the panel design may occur but at a low frequency (Weaver 1988). Larvae and pupae were often found on the undersides of small cobbles and woody debris. Males are distinguished from other regional species by the large, sickle-like dorso-basal process of each inferior appendage (Fig. 338). Adults were collected during the spring and fall (Table 6).

***Lepidostoma ozarkense* Flint and Harp**

Figs. 38, 344

Lepidostoma ozarkense Flint and Harp 1990:81.

Lepidostoma species A (nr. *ontario*): Bowles and Mathis (1989):240.

Type Locality.- Arkansas, Independence Co., unnamed tributary of Salado Cr., US Hwy 167, 5.6 km N Pleasant Plains.

Regional Distribution.- Watersheds 8, 10, 14, 69, 74, 80. ARKANSAS: Independence Co., unnamed tributary of Salado Creek, US Hwy 167, 4.5 mi N Pleasant Plains, 13-III-1991, S.R. Moulton and J.C. Abbott, many ♂♂♀♀ (reared); Logan Co., Gutter Rock Creek, at low water bridge, 7-IV-1990, S.R.

Moulton, many ♂♂♀♀ mmt; same but 13-III-1992, many larvae, ♂♂♀♀; Searcy Co., spring seep along AR Hwy 27, 8 mi S AR Hwy 333, 12-III-1991, S.R.

Moulton and J.C. Abbott, 12 ♂♂, 14 ♀♀ (reared).

Nearctic Distribution.- US: AR, OK.

Discussion.- This recently described species is endemic to the Interior Highlands and a sister species to the more northern *L. ontario* Ross. Larvae construct four-sided, square panel cases and inhabit temporary, spring-fed headwater streams (Table 5). Swarms of adults were often encountered along these streams during March and April (Table 6). Pupae were easily reared in the laboratory. I have many associated larvae, but have been unable to find characters to separate them from *L. ontario* and other related species.

***Lepidostoma togatum* (Hagen)**

Fig. 345

Mormomyia togata Hagen 1861:273.

Silo pallidus Banks 1897:29.

Pristosilo canadensis Banks 1899:212.

Type Locality.- Washington; St. Lawrence River, Canada.

Regional Distribution.- Watersheds 23, 28, 38, 47, 49, 68, 69, 72, 80, 93, 100, 116, 123, 124.

Nearctic Distribution.- US: AL, AR, CT, DC, DE, GA, KY, MA, MD, ME, MI, MN, MO, NC, ND, NH, NJ, NY, OH, OK, PA, RI, TN, VA, VT, WI, WV;

CANADA: AB, MB, NF, NS, NT, ON, PQ, SK.

Discussion.- This was the most common and widely distributed lepidostomatid in the region, and according to Weaver (1988), the most widely distributed in North America. This species is particularly common in several of the regional high-volume springs (Table 5). Adults emerge throughout most of the year (Table 6).

CHAPTER 10

FAMILY LEPTOCERIDAE

The Leptoceridae is one of the largest families in the Interior Highlands with 43 species distributed among seven genera presently known there.

Larvae and adults of this family are readily recognized by their long antennae.

In the adults, the antennae are often two to three times the length of the

forewings. The larval antennae, except in some members of *Ceraclea*, are at least six times as long as wide (Wiggins 1977). Leptocerid adults were

particularly diverse and abundant in UV light trap samples. The generic keys were modified from Wiggins (1977) for larvae, and Ross (1944) for adults.

KEYS TO THE GENERA AND SPECIES OF LEPTOCERIDAE

larvae

1. Mesotarsal claw stout and hooked (Fig. 346); tubular case of silk, transparent
. ***Leptocerus americanus* (Banks)**
Mesotarsal claw slender, gently curved (Figs. 347, 348); case of various designs constructed with plant, detritus, or mineral materials 2

2. Anal opening bordered laterally by sclerotized, concave plates with marginal spines (Fig. 351); case tubular of sand grains or pebbles
 **Setodes oxapius (Ross)**
- Anal opening not bordered by any such spinous plates, although patches of spines or setae may be present 3
3. Maxillary palpi extending far beyond labrum (Fig. 349); mandibles long and blade-like **Oecetis MacLachlan**
- Maxillary palpi extending at most, to edge of labrum; mandibles short, with a central concavity bordered by teeth 4
4. Mesonotum with a pair of dark sclerotized bars (Figs. 361, 366); gills usually clustered; case tubular, usually cornucopia-shaped (Fig. 365) or with lateral and dorsal flanges (Fig. 369), constructed of a variety of materials including freshwater sponge **Ceraclea Stephens**
- Mesonotum without a pair of dark curved bars; gills usually single or absent; case usually long and slender, with or without sticks attached laterally (Figs. 34, 35) 5
5. Ventral apotome of head triangular (Fig. 353); tibiae of metathoracic legs without an apparent constriction in the middle (Fig. 347); case elongate, usually with a twig attached laterad and extending beyond anterior end of case (Fig. 35) **Nectopsyche Müller**
- Ventral apotome of head rectangular (Fig. 352); tibiae of each metathoracic leg with a pale constriction in middle that divides the tibia

- (Fig. 348) 6
6. Metathoracic legs with numerous, close-set, long setae used for swimming; case slender, evenly tapered and constructed spirally of plant pieces (Fig. 34) ***Triaenodes MacLachlan***
- Metathoracic legs with only a few setae (Fig. 348); case irregular of plant materials and small pebbles ***Mystacides sepulchralis (Walker)***

adults

1. Forewings with stem of M absent (Fig. 354) . . . ***Triaenodes MacLachlan***
- Forewings with stem of M present (Fig. 355) 2
2. Forewings with M unbranched (Fig. 355) ***Oecetis MacLachlan***
- Forewings with M branched into M₁ and M₂ (Fig. 356) 3
3. Epicranial stem suture well developed, lateral sutures poorly developed or absent (Fig. 358) 4
- Epicranial stem suture absent or indistinct, lateral sutures well developed (Fig. 357) 5
4. Wings straw-colored; small, 5 - 6 mm ***Setodes oxapius (Ross)***
- Wings dark brown or black; large, 9 mm
 ***Mystacides sepulchralis (Walker)***
5. Mesepimeron largely membranous (Fig. 360); wings white with patches of black setae (Fig. 393) ***Nectopsyche Müller***
- Mesepimeron with a wide sclerotized strap (Fig. 359); wings straw-

- colored to dark brown 6
6. Protibiae with 2 apical spurs **Ceraclea Stephens**
- Protibiae without spurs **Leptocerus americanus (Banks)**

Genus *Ceraclea* Stephens

Thirty-eight species of *Ceraclea* are known from North America, primarily from the eastern half of the continent (Morse 1993). I have documented twelve species from the Interior Highlands. Species in this genus were previously treated under *Athripsodes* Billberg (Ross 1944). Morse and Wallace (1974) and Morse (1975) redefined *Ceraclea* based on behavioral and morphological characteristics between it and *Athripsodes*, and in the process, transferred all known Nearctic species to the former genus. *Athripsodes* is an old world group and together with *Ceraclea* form the tribe Athripsodini (Morse and Wallace 1974). *Ceraclea* larvae are distinguished from other leptocerid genera by the dark, evenly rounded or angled mesonotal bars. They inhabit a variety of aquatic habitats and some even have a close association with the freshwater sponge, *Spongilla* (Resh 1976a, b). Larval cases are generally tubular but vary in composition and structure. Adults are similar to those of *Nectopsyche* and *Leptocerus*, but are distinguished by the presence of a wide sclerotized strap on the mesepimeron, and two apical spurs on each protibia. I often encountered as many as six or seven congeners in a single light trap sample.

Morse (1975) and Resh (1976a) reviewed the adult and larval taxonomy, respectively. The following key to males is the first to include the regional endemic *C. maccalmonti*. The larval key to species was modified from Resh (1976a); larvae of *C. ophioderus* and *C. protonepha* are unknown.

KEY TO THE SPECIES OF *Ceraclea*

larvae

1. Parafrontal areas absent; mesonotal bars bicolorous (Fig. 361); sponge feeders 2
 Parafrontal areas present; mesonotal bars unicolorous (Fig. 366); usually detritus feeders 3
2. Pronotum with contrasting spots ***C. resurgens* (Walker)**
 Pronotum without contrasting spots (Fig. 361) ***C. transversa* (Hagen)**
3. Abdominal tergum IX with two pairs of long setae 4
 Abdominal tergum IX with one pair of setae, or setae absent 8
4. Anal prolegs each with dorsolateral sclerite rod-like (Fig. 362) 5
 Anal prolegs each with dorsolateral sclerite not rod-like or absent 7
5. Width of frontoclypeus along anterior margin equal to width at posterior origin of parafrontal sutures 6
 Width of frontoclypeus along anterior margin much wider than posterior origin of parafrontal sutures ***C. punctata* (Banks)**
6. Mesonotal bars curved (Fig. 363) ***C. cancellata* (Betten)**

- Mesonotal bars sharply angled (Fig. 364) ***C. maculata* (Banks)**
7. Case constructed of organic materials ***C. tarsipunctata* (Vorhies)**
- Case constructed of sand grains ***C. nepha* (Ross)**
8. Case with lateral and anterior flanges, concealing larva from above (Fig. 369) 9
- Case cornucopia-shaped, made of sand grains and pebbles (Fig. 365); known only from Bennett Spring, Missouri
- ***C. maccalmonti* Moulton and Stewart**
9. Outline of mesonotal bars smooth (Fig. 368) ***C. flava* (Banks)**
- Outline of mesonotal bars jagged (Fig. 367) ***C. ancylus* (Vorhies)**

males

1. Inferior appendages with basoventral lobes approximately the same length as the dorsally directed arms and bearing a stout, apical spine (Figs. 370 - 373) 2
- Inferior appendages with basoventral lobes much shorter, never more than half the length of the dorsally directed arms (Fig. 374) 3
2. Outer margin of basoventral lobes of inferior appendages in ventral view angled (Fig. 371), left appendage with a preapico-ventral accessory spine (Fig. 370) ***C. flava* (Banks)**
- Outer margin of basoventral lobes of inferior appendages evenly rounded, without accessory spines (Figs. 372, 373)

- **C. ancylus (Vorhies)**
3. Tergum X with a pair of heavily sclerotized, basolateral lanceolate processes that curve dorsad (Figs. 376, 377, 379) 4
- Tergum X without such processes 6
4. Tergum X with basolateral processes approximately half the length the tergite (Fig. 376) **C. nepha (Ross)**
- Tergum X with basolateral processes about three-fourths as long as tergum (Figs. 377, 379) 5
5. Phallic paramere spine straight, not bent dorsad at apex (Fig. 380); apex of tergum X narrow (Fig. 379) **C. tarsipunctata (Vorhies)**
- Phallic paramere spine bent dorsad at apex (Fig. 378); apex of tergum X broad (Fig. 377) **C. protonepha Morse and Ross**
6. Harpago of each inferior appendage reduced, tooth-like (Figs. 374, 375); known only from Bennett Spring in Missouri
- **C. maccalmonti Moulton and Stewart**
- Harpago of each inferior appendage lanceolate (Figs. 386 - 389) 7
7. Tergum X divided apically into three short lobes (Fig. 382) 8
- Tergum X entire 9
8. Mesal surface of each inferior appendage in caudal view with a single stout spine (Fig. 383) **C. transversa (Hagen)**
- Mesal surface of each inferior appendage in caudal view without such a spine (Fig. 385) **C. resurgens (Walker)**

9. Inferior appendages with a short basoventral lobe (Figs. 385, 386) . . . 10
 Inferior appendages without a basoventral lobe (Figs. 387, 388) 11
10. Harpago stout (Fig. 385) ***C. punctata* (Banks)**
 Harpago slender (Fig. 386) ***C. maculata* (Banks)**
11. Tergum X short (Fig. 387) ***C. cancellata* (Betten)**
 Tergum X elongate with a rod-like process projecting from beneath it
 (Fig. 388) ***C. ophioderus* (Ross)**

***Ceraclea ancylus* (Vorhies)**

Figs. 366, 372, 373

Leptocerus ancylus Vorhies 1909:691.

Type Locality.- Wisconsin, Dane County.

Regional Distribution.- Watersheds 1, 9, 23, 34, 35, 43, 44, 46, 49, 56, 66, 69, 73, 77, 80, 97, 103, 106, 115, 116, 118, 120, 122, 123.

Nearctic Distribution.- US: AL, AR, DE, GA, IL, IN, KS, KY, MA, ME, MN, MO, NC, ND, NY, OH, OK, SC, TN, PA, VA, WI; CANADA: MB, ON, PQ.

Discussion.- This species is most closely related to *C. flava*. Males differ in the more rounded outer margins of the inferior appendages in ventral view, and the absence of a preapicoventral accessory spine on the left inferior appendage (Figs. 373, 373). Larvae differ in the more jagged outline of the mesonotal bars (Fig. 367). According to Resh (1976a), larvae are detritus feeders and live on the sides of rocks where they construct a flattened case

with lateral and anterior flanges. This species exhibits a univoltine life cycle and a single, distinct larval cohort from the time of egg hatching to pupal emergence (Resh 1976b). I collected it from a wide range of permanent streams (Table 5). Adults were collected during April to August (Table 6).

***Ceraclea cancellata* (Betten)**

Figs. 362, 388

Leptocerus cancellatus Betten 1934:256.

Athripsodes improcerus Edwards 1956:15.

Type Locality.- New York, Albany, Saranac Inn.

Regional Distribution.- Watersheds 4, 27, 31, 35, 38, 39, 43, 46, 49, 52, 56, 69, 73, 77, 80, 81, 96, 97, 103, 106, 107, 115, 116, 118, 120, 121, 122, 123, 124.

Nearctic Distribution.- US: AL, AR, CT, DE, FL, GA, IL, IN, KS, KY, LA, MA, ME, MI, MN, MO, MS, MT, ND, NH, OH, OK, PA, SC, TN, VA, WI, WV; CANADA: BC, MB, NF, ON, PQ.

Discussion.- Males of this species are most similar in appearance to those of *C. maculata*, but lack a basoventral lobe on each inferior appendage (Fig. 388). Larvae differ from those of *C. maculata* by the gently curved mesonotal bars (Fig. 363)). They are detritus feeders and construct a cornucopia-shaped case of sand grains (Resh 1976a). It was commonly

collected in large numbers with *C. maculata*, from a variety of lotic habitats (Table 5). Adults were present for most of the spring and summer (Table 6).

***Ceraclea flava* (Banks)**

Figs. 368, 370, 371

Leptocerus flavus Banks 1904b:212.

Type Locality.- Virginia, Falls Church.

Regional Distribution.- Watersheds 4, 39, 43, 46, 48, 49, 63, 77, 81, 88, 106, 107, 122.

Nearctic Distribution.- US: AL, AR, DC, DE, IA, IL, IN, KS, KY, MI, MN, MO, MS, NC, NH, NY, OH, OK, PA, SC, TN, TX, VA, WI, WV; CANADA: ON.

Discussion.- Males are most similar to those of *C. ancylus*, but are unique in having more angular margins of the inferior appendages in ventral view (Fig. 371), and by the presence of a preapicoventral accessory spine on the left appendage (Fig. 370). Larvae differ from those of *C. ancylus* in the smoother outer margin of the mesonotal bars (Fig. 368). They construct a dorsoventrally flattened case similar to the latter species, and are apparently univoltine (Resh 1976a).

***Ceraclea maccalmonti* Moulton and Stewart**

Figs. 357, 359, 365, 366, 374, 375

Ceraclea maccalmonti Moulton and Stewart 1992:361.

Type Locality.- Missouri, Dallas Co., Bennett Spring.

Regional Distribution.- Watershed 116. MISSOURI: see type locality, 7-VI-1991, S.R. Moulton, holotype ♂.

Nearctic Distribution.- US: MO.

Discussion.- This species is the only member of the *C. annulicornis* Group known to occur in the Interior Highlands (Moulton and Stewart 1992). It appears to be endemic to Bennett Spring in central Missouri, and is most closely related to the northern transcontinental *C. annulicornis* (Stephens) and *C. excisa* (Morton). I suspect that *C. maccalmonti* was derived from a relict population of one of these species after becoming isolated by glacial retreat. Moulton and Stewart (1992) described the larva and pupa. They found it abundant on large cobbles along riffle margins. The larval case is cornucopia-shaped and constructed of sand grains and large pebbles (Fig. 365). Some adults were reared from larvae in the laboratory. Males are distinct from the other regional species in having a short, tooth-like harpago curved mesad on each inferior appendage (Figs. 374, 375). It differs from its closest relative, *C. annulicornis*, by the unswollen phallobase. The holotype is deposited in the NMNH.

***Ceraclea maculata* (Banks)**

Figs. 364, 387

Leptocerus maculatus Banks 1899:214.

Leptocerus inornatus Banks 1914:263.

Leptocerus transversus: *sensu* Ross (1944:233), *nec* Hagen (1861:279).

Type Locality.- Washington, D.C.

Regional Distribution.- Watersheds 4, 6, 9, 10, 17, 23, 24, 31, 34, 39, 47, 48, 49, 56, 58, 61, 62, 63, 70, 77, 80, 93, 107, 115, 119, 120, 122, 124.

Nearctic Distribution.- US: AL, AR, CA, CO, CT, DC, DE, FL, GA, IA, ID, IL, IN, KS, KY, LA, MA, ME, MI, MO, MS, MT, NC, ND, NH, NJ, NY, OH, OK, OR, PA, SC, TN, TX, VA, VT, WI, WV; CANADA: BC, NB, PQ.

Discussion.- Males most closely resemble those of *C. cancellata* and *C. punctata*, but are distinguished by the configuration of tergum X and inferior appendages (Fig. 387). Larvae differ from those of *C. cancellata* in the more sharply angled mesonotal bars (Fig. 364). According to Resh (1976a), the long adult emergence period and the presence of several larval instars during the winter suggests that some populations may have more than one cohort. I collected it from a wide range of lotic habitats (Table 5) during the spring, summer, and fall (Table 6).

***Ceraclea nepha* (Ross)**

Fig. 376

Athripsodes nephus Ross 1944:230.

Type Locality.- Illinois, Rosecrans, Des Plaines River.

Regional Distribution.- Watersheds 4, 6, 9, 34, 44, 63, 77, 80, 106, 115, 118, 119.

Nearctic Distribution.- US: AL, AR, DE, FL, GA, IL, KS, KY, MI, MN, MO, MS, NC, OK, SC, TN.

Discussion.- This species is closely related to *C. protonepha*. Males are distinguished by the shorter basolateral processes of tergum X (Fig. 376). I have observed varying degrees of curvature in this structure, but its length is never longer than one-half the length of tergum X. It was collected from a wide range of stream types (Table 5) and is reported here for the first time from Missouri. I often collected it in large numbers in UV light traps along with *C. protonepha* and *C. tarsipunctata*. Resh (1976a) noted that it was often found in aquatic habitats with a high tannic acid content. Larvae are morphologically similar to those of *C. tarsipunctata*. Unlike the latter species, they construct cases entirely of sand grains (Resh 1976a).

***Ceraclea ophioderus* (Ross)**

Fig. 389

Athripsodes ophioderus Ross 1938a:157.

Type Locality.- Illinois, Elizabethtown.

Regional Distribution.- Watersheds 39, 62, 106, 121. ARKANSAS: Clark Co., Little Missouri River, AR Hwy 53, 17-VI-1988, E.J. Bacon, 2 ♂♂; Ouachita Co., Ouachita River at Tates Bluff, 4-VII-1987, E.J. Bacon, 1 ♂; same

but 18-VII-1987, 16 ♂♂; same but, 25-V-1988, 25 ♂♂; MISSOURI: Douglas Co., Beaver Creek, MO Hwy 14, 4 mi NW Ava, 8-VI-1991, S.R. Moulton, 1 ♂.

Nearctic Distribution.- US: AL, AR, FL, IL, IN, LA, MO, MS, WV.

Discussion.- Males of this distinctive species have tergum X elongate and terminating in a thumb-like lobe; beneath this lobe arises a slender tubular process (Fig. 389). The records listed above are the first for the region as new state records for Arkansas and Missouri. Most of the material that I examined was collected from the Ouachita River near the confluence with the Little Missouri River in south central Arkansas. This location is characterized as a large, coastal plain river (Table 5). The larva is unknown.

***Ceraclea protonepha* Morse and Ross**

Figs. 377, 378

Ceraclea protonepha Morse and Ross, in Morse 1975:37.

Type Locality.- Virginia, Norfolk Co., Lake Drummond, Dismal Swamp.

Regional Distribution.- Watersheds 6, 9, 17, 34, 56, 63, 77, 80, 116, 118, 119.

Nearctic Distribution.- US: AL, AR, DE, FL, GA, KS, KY, LA, MO, MS, NC, OK, SC, TN, VA.

Discussion.- This species was often collected with the closely related *C. nepha* and *C. tarsipunctata*. The watersheds listed above include the first regional and state records for Arkansas, Missouri, and Oklahoma (Table 5).

Adults were present during the spring and summer (Table 6). Males are distinguished from *C. nepha* by the longer basolateral processes of tergum X (Fig. 377); they differ from *C. tarsipunctata* by the upturned apex of the phallic paramere spine (Fig. 378).

***Ceraclea punctata* (Banks)**

Fig. 386

Mystacides punctata Banks 1894:180.

Type Locality.- Kansas, Douglas Co.

Regional Distribution.- Watersheds 39, 60, 77, 80, 81, 102, 107, 126.

ARKANSAS: Ouachita Co., Little Missouri River, Red Hill, 24-VI-1988, E.J.

Bacon, 1 ♂; MISSOURI: Gasconade River, Helds Island Access, 28-VIII-1990,

B.C. Poulton, 1 ♂; OKLAHOMA: LeFlore Co., Kiamichi River, Whitesboro, 18-

VII-1993, D.E. Baumgardner, 2 ♂♂; Pushmataha Co., Kiamichi River, old US

Hwy 271, 2.3 mi E Tuskahoma, 13-VI-1991, R. Tucker, 19 ♂♂; same but 2.5 mi

E Albion, 12-VI-1991, 1 ♂.

Nearctic Distribution.- US: AR, DC, IL, KS, KY, MD, ME, MI, MO, NH, NY, OH, OK, TN, VA, WI; CANADA: PQ.

Discussion.- Males are similar to those of *C. cancellata* and *C. maculata*, but are distinguished from them by the long, stout harpago of each inferior appendage (Fig. 386). Larvae construct a cornucopia-shaped case of pebbles (Resh 1976a). They differ from the previously mentioned species in

having the anterior width of the frontoclypeus wider than its posterior width at the origin of the parafrenal areas. Resh (1976a) reported that it occupies a wide range of aquatic habitats and is often found in deep water. My records came from large rivers (Table 5). Adults were collected during the summer (Table 6) using UV light traps.

***Ceraclea resurgens* (Walker)**

Figs. 384, 385

Leptocerus resurgens Walker 1852:70.

Leptocerus variegatus Hagen 1861:278.

Leptocerus aspinosus Betten 1934:255.

Type Locality.- St. Martin's Falls, Albany River, Hudson's Bay.

Regional Distribution.- Watershed 77.

Nearctic Distribution.- US: AL, CO, CT, DC, FL, IL, IN, KY, LA, ME, MI, MN, MT, ND, NH, NJ, NY, OH, OK, OR, PA, SC, TN, VA, WI; CANADA: BC, MB, ON, PQ, SK.

Discussion.- This species was not collected during this study. Ross (1944) reported it from Oklahoma, based on a single isolated record from the Kiamichi Mountains in the western Ouachita Mountains physiographic subregion. I was unable to locate Ross's material and cannot comment further on its regional habitat affinities. Resh (1976a) reported that it was found in freshwater sponges and is distributed throughout North America. Its single

cohort life cycle is similar to the first sponge-feeding cohort of *C. transversa*. Morse (1975) noted considerable east-west variation in this northern transcontinental species. Males are similar in some respects to those of *C. transversa*, but differ in lacking a stout spine on the mesocaudal surface of each inferior appendage (Fig. 385).

***Ceraclea tarsipunctata* (Vorhies)**

Figs. 379, 380

Leptocerus tarsipunctatus Vorhies 1909:694.

Type Locality.- Wisconsin.

Regional Distribution.- Watersheds 1, 6, 9, 10, 17, 23, 24, 34, 35, 38, 39, 41, 43, 46, 47, 48, 49, 52, 53, 56, 61, 63, 66, 68, 69, 74, 77, 80, 81, 84, 96, 97, 102, 103, 104, 106, 107, 115, 116, 118, 120, 121, 122, 123.

Nearctic Distribution.- US: AL, AR, CA, CT, FL, GA, ID, IL, IN, KS, KY, LA, MA, ME, MI, MN, MO, MS, MT, NC, ND, NH, NY, OH, OK, OR, PA, SC, SD, TN, VA, VT, WI, WV, WY; CANADA: MB, NB, ON, PQ, SK.

Discussion.- This was the most common and widely distributed of the regional *Ceraclea*, occurring in a variety of stream habitats (Table 5). Males closely resemble those of *C. nepha* and *C. protonepha*, but differ in the apical configuration of tergum X (Fig. 379). Resh (1976a) described the larva and pupa. The larval case is made of plant materials interspersed with sand grains. This species appears to be univoltine with a major spring emergence (Resh

1976a). On a few occasions during May, I encountered enormous swarms of this species during the day along stream margins.

***Ceraclea transversa* (Hagen)**

Figs. 360, 381, 382, 383

Leptocerus transversus Hagen 1861:279.

Leptocerus angustus Banks 1914:263.

Type Locality.- Washington, D.C.

Regional Distribution.- Watersheds 1, 4, 6, 9, 10, 17, 20, 23, 31, 34, 39, 48, 52, 69, 77, 80, 100, 103, 107, 115, 117, 118, 119, 121, 122, 124.

Nearctic Distribution.- US: AL, AR, CT, DC, DE, FL, ID, IL, IN, KS, KY, LA, MA, ME, MI, MN, MO, MS, MT, NC, ND, NH, NY, OH, OK, PA, SC, TN, VA, VT, WI, WV; CANADA: MB, NF, ON, PQ.

Discussion.- Males resemble those of *C. resurgens* in a number of respects but are distinguished by the presence of a short mesal spine on the caudal surface of each inferior appendage (Fig. 383). It was collected from a variety of stream habitats (Table 5). Resh (1976b) reported a detailed, life history of this species in a Kentucky stream. He documented a univoltine life cycle that included two sponge-feeding cohorts, with the second cohort overwintering as detritus feeders following sponge gemmulation.

Genus *Leptocerus* Leach

This genus is represented in North America by a single species,
Leptocerus americanus (Morse 1993).

Leptocerus americanus (Banks)

Figs. 346, 416

Setodes americana Banks 1899:215.

Setodes grandis Banks 1907a:128.

Type Locality.- Washington D.C.

Regional Distribution.- Watersheds 6, 23, 24, 49, 77, 80, 106.

ARKANSAS: Cross Co., Village Creek, Village Creek State Park, 8-VI-1985, H.W. Robison, 1 ♂; Lafayette Co., Lake Erling, 1992, T. Jennings, 1 ♂; Montgomery Co., Smith Creek, AR Hwy 8, NW Caddo Gap, 19-V-1982, H.W. Robison and D. Koym, 2 ♀♀; Stone Co., Gunner Pool Rec. Area, North Sylamore Creek, 5-VIII-1982, D.D. Koym, 1 ♀; OKLAHOMA: Pushmataha Co., Mud Creek, OK Hwy 2, 5 mi N Moyers, 27-IV-1991, S.R. Moulton and J. Kennedy, 3 ♂♂.

Nearctic Distribution.- US: AL, AR, CT, DC, DE, FL, IL, IN, KS, LA, MA, ME, MI, MN, MS, NC, ND, NH, NY, OH, OK, PA, SC, TN, TX, VA, WI, WV; CANADA: ON, PQ.

Discussion.- This species was uncommonly collected from small to medium sized streams and lakes (Table 5). Larvae are readily recognized by

the transparent silk case which is long and tubular, and by the stout, hook-shaped mesotarsal claws (Fig. 346). Wiggins (1977) illustrated the larval habitus. Adults are easily recognized using generic characters. Males are distinctive in having spatulate inferior appendages and an elongated, narrowly tapered tergum X in lateral view (Fig. 416). Ross (1944) noted that larvae were collected from water horsetail in glacial lakes and slow streams. Wiggins (1977) noted large numbers of larvae associated with *Ceratophyllum* in lentic habitats.

Genus *Mystacides* Berthold

This genus is represented in North America by three species (Morse 1993). Only *Mystacides sepulchralis* is known from the Interior Highlands. Yamamoto and Wiggins (1964) provided a thorough taxonomic treatment of the three North American species. Larvae are similar to those of *Triaenodes* but lack the dense arrangement of long swimming hairs on each metathoracic leg. Adults are readily recognized in the field by their long antennae and black bodies (Yamamoto and Wiggins 1964). Adult activity appears to be greatest during the early morning and pre-dusk period; their activity is reduced at night and consequently they are infrequently collected in light traps (Yamamoto and Wiggins 1964). During this study, only two males were collected using UV light traps. Sweeping riparian vegetation yielded the largest number of specimens.

***Mystacides sepulchralis* (Walker)**

Figs. 347, 352, 358, 417, 418

Leptocerus sepulchralis Walker 1852:70.**Type Locality.**- Ontario.**Regional Distribution.**- Watersheds 9, 17, 41, 44, 53, 56, 81, 100.

ARKANSAS: Franklin Co., Fane Creek, AR Hwy 23, Cass, 19-V-1983, H.W.

Robison and D. Koym, 1 ♂; Johnson Co., Bowman Hollow at AR Hwy 123, 23-

IX-1992, S.R. Moulton, 1 ♂, 1 ♀; Montgomery Co., Little Missouri River, Albert

Pike Rec. Area, 22-V-1981, K.J. Tennessen, 1 ♀; Polk Co., Board Camp Creek,

AR Hwy 8, 1 mi W Board Camp, 21-V-1982, H.W. Robison, 1 ♂; Sharp Co.,

Mill Creek, AR Hwy 56, N Evening Shade, 24-VI-1991, H.W. Robison, 1 ♂;

OKLAHOMA: Sequoyah Co., Cato Creek, 1 mi W OK Hwy 82, Buzzards Roost

Nature Trail, 5-VI-1991, S.R. Moulton, 1 ♂.

Nearctic Distribution.- US: AK, AL, AR, CA, CT, DE, GA, IL, IN, KY, MA, ME, MI, MN, MO, MT, NC, ND, NH, NJ, NY, OH, OK, PA, SC, SD, TN, VA, VT, WI, WV, WY; CANADA: AB, BC, MB, NB, NF, NS, NT, ON, PQ, SK, YT.**Discussion.**- This species was infrequently collected from small streams (Table 5) during the spring and summer (Table 6). Males are readily distinguished by the complex of blade-like processes that make up tergum X (Fig. 417), and the forked posterior extension of sternum IX (Fig. 418). Females have a pair of prominent lobes extending posteroventrad from IX; these structures may initially be mistaken as male genitalia by workers unfamiliar with

the genus. Yamamoto and Ross (1966) and Wiggins (1977) illustrated the larval habitus. Larvae lack abdominal gills and have much of the head and pronotum patterned with broad dark bands. The larval case is tubular, rough-textured, and usually has twigs or pine needles attached longitudinally and extending well past the ends of the case (Wiggins 1977, Fig. 9.3C).

Yamamoto and Ross (1966) hypothesize that the *M. sepulchralis* Group originated primarily in the vicinity of eastern Asia and Western North America. The nominate species is Holarctic. In North America, most of the distributional records for this species center around the northeastern United States and all Canadian Provinces; its southern most distribution appears limited to the Interior Highlands and southern Appalachian Mountains (Yamamoto and Wiggins 1964). It is reported here for the first time from Oklahoma. *Mystacides sepulchralis*, though infrequently collected from small headwater streams, may be locally abundant. Larvae were never collected during this study.

Genus *Nectopsyche* Müller

Fifteen species are known in North America (Morse 1993). Five species are recorded here from the Interior Highlands, of which only three were commonly collected. Prior to 1974, species were treated under the genus *Leptocella* Banks (Haddock 1977). Larvae are similar to those of *Mystacides* and *Triaenodes* but differ in the triangular ventral apotome of the head capsule. Many of them have long swimming hairs on the metathoracic legs and can

often be seen swimming in isolated pools or in white enamel trays containing kick-net sample debris. I was most successful in collecting larvae in submerged root systems of undercut banks. The tubular larval case is slender and made of mineral and organic debris; they often have a long stick attached longitudinally which projects well past the anterior end of the case (Fig. 35). Adults are immediately recognized in the field by their long, pale-colored wings that may have a pattern of dark hair patches. These hairs patterns are diagnostic at the species level, and therefore, it is recommended that some specimens be pinned dry. Material kept in alcohol, especially bulk light trap samples, often becomes denuded through abrasion. Species may also be distinguished by male genitalia and size differences in the eyes and body. Adults were often abundant at UV lights but rarely collected with sweep nets. Haddock (1977) reviewed the biosystematics of *Nectopsyche* provided detailed accounts of the oviposition behavior of a few species.

KEY TO THE MALES OF *Nectopsyche*

1. Ninth sternite produced into a cup-like flap beneath the inferior appendages (Fig. 394) ***N. pavida* (Hagen)**
- Ninth sternite not cup-like, instead produced into slender process, either short (Figs. 390, 391) or long (Fig. 392) 2
2. Base of inferior appendages broad and plate-like (Figs. 395, 396) 3
- Base of inferior appendages narrow, not plate-like (Figs. 390, 392) . . . 4

3. Eyes large, in ventral aspect their width about equal to interocular distance (Fig. 398) ***N. spiloma* (Ross)**
- Eyes small, in ventral aspect their width 2 - 3x less than the interocular distance (Fig. 397) ***N. diarina* (Ross)**
4. Paired processes of sternum IX short or not apparent (Figs. 390, 391); forewings without straw-colored, transverse bars in membranes
 ***N. candida* (Hagen)**
- Paired processes of sternum IX long, apparent laterally or ventrally (Fig. 392); forewings with straw-colored bars in membranes (Fig. 393)
 ***N. exquisita* (Walker)**

***Nectopsyche candida* (Hagen)**

Figs. 390, 391

Setodes candida Hagen 1861:280.

Type Locality.- Florida.

Regional Distribution.- Watersheds 9, 10, 24, 27, 31, 47, 56, 58, 61, 62, 68, 77, 80, 81, 100, 103, 106, 107.

Nearctic Distribution.- US: AL, AR, FL, GA, IA, IL, IN, KS, KY, LA, ME, MI, MN, MO, MS, MT, NC, ND, NH, NJ, OH, OK, PA, SC, TN, TX, VA, WI, WV;
 CANADA: ON, PQ.

Discussion.- This species was commonly associated with *N. exquisita* and *N. pavidata*. It was widely distributed throughout the region in a variety of

stream types (Table 5). Adults were primarily collected during the late spring and summer (Table 6). Males are distinguished by the narrow base of each inferior appendage and by the short, sometimes asymmetrical, apical processes on sternum IX (Fig. 391).

***Nectopsyche diarina* (Ross)**

Figs. 349, 353, 395, 397

Leptocella diarina Ross 1944:218.

Type Locality.- Illinois, Havana.

Regional Distribution.- Watersheds 95, 107, 116, 120, 124, 128, 129.

MISSOURI: Douglas Co., Bryant Creek, at spring off MO Hwy 5, W Bryant, 25-IX-1992, S.R. Moulton, 10 ♀♀; Shannon Co., Round Spring, Mo Hwy 19, N Eminence, 24-IX-1992, S.R. Moulton, 1 ♂, 1 ♀; OKLAHOMA: Johnston Co., Blue River, OK Hwy 99, 3 mi S Pontatoc, 25-IV-1992, 5 larvae; Murray Co., Travertine Creek, Chickasaw National Wildlife Refuge, Sulphur, 29-30-VIII-1992, S.R. Moulton, many ♂♂, ♀♀.

Nearctic Distribution.- US: CO, ID, IL, IN, KS, MI, MN, MO, MT, ND, NE, NY, OH, OK, SD, TX, UT, VA, VT, WI, WY; CANADA: MB, ON, SK.

Discussion.- Adults of this species were most often collected around high-volume springs and medium-sized spring-fed streams (Table 5) during the spring and summer (Table 6). The forewings are generally white to straw-colored, without any distinct hair pattern. Males are similar to *N. spiloma* in

having the basal portion of each inferior appendage broad and plate-like (Fig. 395), but differ in the smaller eye width relative to the interocular distance in ventral view (Fig. 397).

***Nectopsyche exquisita* (Walker)**

Figs. 360, 392, 393

Leptocerus exquisita Walker 1852:72.

Setodes piffardii MacLachlan 1863b:160.

Type Locality.- Georgia.

Regional Distribution.- Watersheds 20, 27, 28, 35, 39, 41, 43, 48, 49, 52, 56, 62, 73, 77, 80, 91, 95, 100, 102, 104, 107, 115, 116, 118, 121, 122, 124.

Nearctic Distribution.- US: AL, AR, CT, DC, DE, FL, GA, IL, IN, KS, KY, MA, MD, ME, MI, MN, MO, MS, NC, ND, NE, NH, NJ, NY, OH, OK, PA, SC, TN, TX, VA, VT, WI, WV; CANADA: MB, NB, NS, ON, PQ.

Discussion.- This was a commonly collected species in light traps, usually with *N. candida* and *N. pavidus*. Collected from a wide range of lotic habitats in both upland and lowland areas (Table 5). Adults were most often encountered during the spring and summer (Table 6). Males are similar to those of *N. candida* except for the long, paired ventral processes of sternum IX (Fig. 392) and transverse, straw-colored markings in the forewing membranes (Fig. 393).

***Nectopsyche pavid* (Hagen)**

Fig. 394

Setodes pavid Hagen 1861:282.**Type Locality.**- Washington, D.C.**Regional Distribution.**- Watersheds 4, 20, 24, 27, 28, 31, 35, 39, 42, 43, 46, 49, 57, 58, 60, 61, 62, 63, 66, 67, 68, 74, 77, 80, 81, 97, 100, 106, 107, 115, 116, 118, 121, 122, 124.**Nearctic Distribution.**- US: AL, AR, CT, DC, FL, GA, IL, IN, KS, KY, LA, MA, MD, ME, MI, MN, MO, MS, NC, NH, NJ, NY, OH, OK, SC, TN, TX, VA, WI, WV; CANADA: ON, PQ; MEXICO; CENTRAL AMERICA.**Discussion.**- Commonly encountered with *N. exquisita* and *N. candida* (Table 5). Adults were present from early spring through the fall (Table 6). Males are easily distinguished from all other regional species by the cup-like extension of sternum IX (Fig. 394). In general, adults are small (7 - 9 mm) and have straw-colored wings with no apparent markings in alcohol.***Nectopsyche spiloma* (Ross)**

Figs. 396, 398

Leptocella spiloma Ross 1944:219.**Type Locality.**- Kansas, Junction City.**Regional Distribution.**- Watersheds 81, 84, 128.

Nearctic Distribution.- US: AL, AR, IL, KS, LA, MO, MS, OK, SD, TX; MEXICO; CENTRAL AND SOUTH AMERICA.

Discussion.- I did not encounter this species in my collections, but it has been reported from various locations throughout the region by Bowles and Mathis (1992), Haddock (1977), and Ross (1944). It is closely related to *N. diarina*. Males are readily distinguished by the eye diameter being subequal to the interocular distance in ventral view (Fig. 398). According to Haddock (1977), this species inhabits lowland rivers. Literature records indicate that adults are present during May to August (Table 6).

Genus *Oecetis* MacLachlan

Morse (1993) recorded 27 species from North America. Recently, Moulton and Stewart (1993b) added two additional species, thereby increasing this total to 29. I have documented 10 species from the Interior Highlands, two of which *O. ouachita* and *O. ozarkensis*, are endemic to this region. This genus has been the focus of recent revisionary work of the world fauna by E. Chen (Clemson University). In addition, Floyd (1993) reviewed the biology and distribution of the larvae in North America. According to Ross (1944), some *Oecetis* species are among the most widely distributed caddisflies in North America. Larvae construct a variety of tubular case designs from various organic and inorganic materials, and inhabit lotic and/or lentic habitats (Floyd 1993). *Oecetis* larvae are readily distinguished from other leptocerids by their

long, blade-like mandibles and maxillary palpi which extend well past the anterior margin of the labrum (Fig. 349). They are generally regarded as predators (Wiggins 1977). Adults are recognized by the unbranched M vein in each forewing (Fig. 355). They are generally tawny to brown in color and may be recognized in the field by the darkened apical crossveins in each forewing. Adults were readily collected in large numbers in UV light traps. It was not uncommon in this study to encounter five or six congeners in a single sample. A comprehensive review of the North American fauna is being prepared by M. Floyd (pers. communication). Moulton and Stewart (1993b) reviewed the six members of the Nearctic *Oecetis scala* Group and presented a key to males.

KEY TO THE MALES OF *Oecetis*

1. Tenth tergite formed by a pair of elongated, sclerotized rods that bear a total of 2 - 4 stout spine-like setae at or near the apex (Figs. 399 - 401) 2
 - Tenth tergite produced into a semimembranous shelf or if elongated, then not bearing stout spine-like setae near apex (Figs. 404, 407) 4
2. Inferior appendages each in lateral view with the apicodorsal margin produced into a finger-like process (Fig. 399)
 - ***O. ouachita* Moulton and Stewart**
 - Inferior appendages subrectangular in lateral view, apicodorsal margin not finger-like (Figs. 400, 401) 3
3. Inferior appendages each in lateral view with a basomesal lanceolate

- process; tergal X rods each bearing a single, apical spine-like seta (Fig. 400) **O. ozarkensis Moulton and Stewart**
- Inferior appendages without an basomesal lanceolate process; tergal X rods each with 1 preapical and 1 apical spine-like setae (Fig. 401) **O. eddlestoni Ross**
4. Tenth tergite elongated, its length about as long as inferior appendages (Figs. 402, 404) 5
- Tenth tergite shorter than inferior appendages 6
5. Tenth tergite slender, its width about the same throughout its length (Fig. 402); phallus with 3 sickle-shaped and 2 blade-like paramere spines (Fig. 403) **O. persimilis (Banks)**
- Tenth tergite consisting of a pair of lanceolate structures that are widest basally then taper ventrad; apex of phallus foot-shaped (Fig. 404) **O. osteni Milne**
6. Inferior appendages in lateral view with posteroventral margin produced into a finger-like process directed dorsad (Fig. 408); phallus with a beak-like extension (Figs. 405, 409, 412) 7
- Inferior appendages in lateral view bean-shaped; phallus without a spiraled paramere spine (Fig. 407); forewings straw-colored with scattered spots of black hairs **O. avara (Banks)**
7. Phallus in lateral view subspherical with a spiraled paramere spine making one coil (Fig. 409, 412) 8

- Phallus in lateral view not subspherical and bent ventrad at middle,
coiled paramere spine absent (Fig. 405) ***O. cinerascens* (Hagen)**
8. Posteromesal margin of ninth sternite produced into a truncated lobe
separating the inferior appendages basally (Fig. 410); posteroventral
beak of phallus short (Fig. 409) ***O. inconspicua* (Walker)**
- Posteromesal margin of ninth sternite not forming such a lobe (Fig. 413,
415); posteroventral beak of phallus long (Fig. 412) 9
9. Inferior appendages in ventral view with apical processes finger-like (Fig.
415) ***O. nocturna* Ross**
- Inferior appendages in ventral view with apical processes wide and
gradually tapering (Fig. 413) ***O. ditissa* Ross**

***Oecetis avara* (Banks)**

Fig. 407

Setodes avara Banks 1895:316.

Type Locality.- Canada, Sherbrooke.

Regional Distribution.- Watersheds 4, 17, 24, 38, 39, 43, 47, 49, 56, 60,
61, 62, 63, 66, 68, 77, 81, 84, 85, 91, 96, 97, 100, 102, 107, 109, 115, 117, 121,
122, 123, 124, 128, 129, 130.

Nearctic Distribution.- US: AL, AR, CO, DC, DE, GA, IA, ID, IL, IN, KS,
KY, MA, MD, ME, MI, MN, MO, MS, MT, NC, ND, NH, NJ, NM, NY, OH, OK,

OR, PA, SC, TN, TX, UT, VA, VT, WI, WV, WY; CANADA: BC, MB, NS, ON, PQ, SK; MEXICO; CENTRAL AND SOUTH AMERICA.

Discussion.- This is a common and widely distributed species in the region. I found it associated with a wide variety of stream types (Table 5). Adults were present for much of the year (Table 6), and were readily identified in the field by their pale wings covered with several small "dots" of dark hairs. Males have a characteristic configuration of inferior appendages that resembles a kidney bean (Fig. 407). Ross (1944) described the larva and reported that the case was horn-shaped and constructed of large sand grains.

***Oecetis cinerascens* (Hagen)**

Figs. 405, 406

Setodes cinerascens Hagen 1861:282.

Oecetina florida Banks 1899:216.

Oecetina fumosa Banks 1899:216.

Type Locality.- Washington.

Regional Distribution.- Watersheds 1, 6, 24, 35, 39, 48, 56, 74, 77, 80, 90, 104, 105, 106, 131.

Nearctic Distribution.- US: AL, AR, CT, DC, DE, FL, GA, IL, IN, KS, KY, LA, MA, MD, ME, MI, MN, MO, MS, ND, NJ, NY, OH, OK, PA, SC, SD, TN, TX, VA, VT, WI, WV; CANADA: NB, NS, ON, PQ, SK; MEXICO.

Discussion.- Infrequently collected from small to medium order streams

(Table 5). Males resemble those of *O. ditissa*, *O. inconspicua*, and *O. nocturna* in some respects, but differ in having a non-spherical phallus bent ventrad in middle, and longer finger-like apices of the inferior appendages (Figs. 405, 406). These fingers are directed dorsad in lateral view and mesad in ventral view. Ross (1944) illustrated the larva and its case. The case is of the "log-cabin" variety, being constructed of transversely aligned stems and debris.

***Oecetis ditissa* Ross**

Figs. 411, 412, 413

Oecetis ditissa Ross 1966:13.

Type Locality.- Illinois, Jackson Co., Grand Tower.

Regional Distribution.- Watersheds 1, 6, 10, 13, 24, 35, 39, 44, 46, 48, 49, 55, 56, 66, 67, 69, 70, 73, 74, 80, 94, 95, 103, 115, 116, 121, 122, 128, 129.

Nearctic Distribution.- US: AL, AR, FL, IL, IN, KS, KY, LA, MA, MO, MS, NC, OH, OK, PA, SC, TN, TX, VA.

Discussion.- This species was commonly collected in UV light traps with *O. nocturna* and *O. inconspicua*. Collection records indicate a wide preference for various lotic habitats (Table 5). Males are most similar to those of *O. nocturna*, but differ in the wider inferior appendages in ventral view (Fig. 413). Floyd (1993) has tentatively associated the larva. The case is apparently made of sand grains with ballast stones attached laterally.

***Oecetis eddlestoni* Ross**

Fig. 401

Oecetis eddlestoni Ross 1938a:160.**Type Locality.-** Pennsylvania, Sayre, Susquehanna River.**Regional Distribution.-** Watersheds 17, 27, 31, 35, 42, 48, 56, 58, 60, 74, 77, 80.**Nearctic Distribution.-** US: AR, IL, KS, OH, OK, PA, VT.**Discussion.-** This species is one of the three regional species that belong to the *O. scala* Group (Moulton and Stewart 1993b). It was infrequently collected from medium-sized streams in the Ouachita Mountains, Boston Mountains, and Gulf Coastal Plain subregions (Table 5). Specific collection localities in these areas were provided by Moulton and Stewart (1993b). Adults were collected during the spring and summer (Table 6). It is most closely related to *O. ozarkensis*, but differs chiefly in the presence of a preapical spine on each tergum X rod, and by the absence of a free, anteromesal, blade-like process on each inferior appendage (Fig. 401). Ross (1944) described the larva and female.***Oecetis inconspicua* (Walker)**

Figs. 355, 408, 409, 410

Leptocerus inconspicua Walker 1852:71.*Setodes flaveolata* Hagen 1861:282.

Setodes micans Hagen 1861:283.

Setodes sagitta Hagen 1861:284.

Setodes incerta Provancher 1877:

Oecetina flavida Banks 1899:216.

Oecetina floridana Banks 1899:216.

Oecetina parvula Banks 1899:215.

Oecetina apicalis Banks 1907a:129.

Oecetina inornata Banks 1907a:128.

Type Locality.- Georgia.

Regional Distribution.- Watersheds 1, 4, 6, 9, 17, 18, 23, 24, 27, 35, 38, 39, 43, 44, 46, 47, 48, 52, 53, 55, 56, 57, 66, 67, 69, 70, 73, 74, 77, 80, 81, 85, 89, 90, 94, 95, 96, 100, 102, 103, 105, 106, 116, 118, 119, 121, 122, 124, 125, 126, 128, 129.

Nearctic Distribution.- US: AK, AL, AR, AZ, CA, CO, CT, DC, DE, FL, GA, IA, IL, IN, KS, KY, LA, MA, MD, ME, MI, MN, MO, MS, MT, NC, ND, NE, OK, OR, PA, SC, SD, TN, TX, UT, VA, VT, WI, WV, WY; CANADA: AB, BC, MB, NB, NF, NS, NT, ON, PQ, SK, YT; MEXICO; CENTRAL AND SOUTH AMERICA.

Discussion.- This was one of the most common and widely distributed caddisfly species in the region (Table 5). Adults were collected from April to October (Table 6). It appears to be most closely related to *O. ditissa* and *O. nocturna*. Males are distinguished from these species by the spherical phallus which bears a weakly developed posteroventral "beak" (Fig. 409), and by the

truncated, mesal lobe of sternum IX (Fig. 410). I have observed some variation in the size of males within a population and in the shape of their inferior appendages. This variability coupled with its wide geographic distribution has led some workers to consider *O. inconspicua* as a complex of cryptic species (Floyd 1993). Ross (1944) described the larva and female.

***Oecetis nocturna* Ross**

Figs. 414, 415

Oecetis nocturna Ross 1966:11.

Type Locality.- Missouri, Hollister.

Regional Distribution.- Watersheds 10, 17, 24, 35, 39, 43, 49, 56, 61, 62, 63, 67, 70, 74, 77, 80, 81, 102, 107, 115, 116, 117, 118, 122, 131.

Nearctic Distribution.- US: AL, AR, DC, GA, IL, IN, KS, KY, LA, MO, MS, OH, OK, PA, SC, TN, TX, VA, VT, WV; CANADA: PQ.

Discussion.- This species is most closely related to *O. ditissa*. Males differ from those of *O. ditissa* by the more slender inferior appendages in ventral view and from *O. inconspicua* by the larger posteroventral phallic "beak" (Fig. 414), and the absence of a truncated mesal lobe of sternum IX (Fig. 415). It was collected from a variety of lotic habitats (Table 5). Floyd (1993) has associated the larva and described its sand grain case as "flattened dorsoventrally with ballast stones attached laterally".

***Oecetis osteni* Milne**

Fig. 404

Oecetis osteni Milne 1934:17.**Type Locality.-** New York, Alexandria Bay.**Regional Distribution.-** Watersheds 6, 17, 74, 77. ARKANSAS:

Columbia Co., Big Creek, US Hwy 82, 1 mi W Magnolia, 22-VI-1992, S.R.

Moulton and H.W. Robison, 3 ♂♂; Lafayette Co., Bodcau Creek, US Hwy 82, W

Stamps, 22-VI-1992, S.R. Moulton and H.W. Robison, 8 ♂♂; Polk Co., Ewing

Farm, 7 mi W Mena, 26-27-VI-1991, B. Ewing, 3 ♂♂; same but 7-VII-1991, 1 ♂;

OKLAHOMA: Pushmataha Co., Mud Creek, OK Hwy 2, 5 mi N Moyers, 27-IV-

1991, S.R. Moulton and J. Kennedy, 1 ♂.

Nearctic Distribution.- US: AL, AR, CT, FL, IL, IN, LA, MA, ME, MI, MN, MS, NH, NJ, NY, OH, OK, PA, SC, VA, WI; CANADA: NB, NF, ON, PQ.**Discussion.-** This species is apparently confined to medium sized streams in the Gulf Coastal Plain and Ouachita Mountain subregions (Table 5). Ross (1944) noted an affinity for lentic habitats. It is reported here for the first time from the Interior Highlands as new state records for Arkansas and Oklahoma. Males are distinguished from the other regional species by the boot-shaped phallus, and subrectangular inferior appendages which taper to a point on the ventral margin (Fig. 404). Floyd (1993) associated the larva, and Ross (1944) described the female.

***Oecetis ouachita* Moulton and Stewart**

Fig. 399

Oecetis ouachita Moulton and Stewart 1993b:222.

Type Locality.- Arkansas, Ouachita Co., Ouachita River at confluence with Little Missouri River.

Regional Distribution.- Watersheds 39, 49, 62, 77.

Nearctic Distribution.- US: AR, OK.

Discussion.- This species is one of three species occurring in the Interior Highlands that belongs to the Nearctic *O. scala* Group (Moulton and Stewart 1993b). It was reported from Arkansas by Bowles and Mathis (1989) as *O. scala* (Milne). It is most closely related to *O. morsei* Bueno-Soria, *O. scala*, and *O. sphyra* Ross, but can be readily distinguished from these species on the basis of the shorter apicodorsal finger-like process of each inferior appendage (Fig. 399). *Oecetis ouachita* is known only from large streams and rivers in the Gulf Coastal Plain and Ouachita Mountains foothill regions of Arkansas and Oklahoma (Table 5). The larva remains unknown despite attempts by M. Floyd (pers. communication) to collect it at the type locality. He suspects that it inhabits submerged root systems along banks. The holotype and some paratypes are deposited in the NMNH.

***Oecetis ozarkensis* Moulton and Stewart**

Fig. 400

Oecetis ozarkensis Moulton and Stewart 1993b:222.

Type Locality.- Arkansas, Stone Co., Gunner Pool Rec. Area, North Sylamore Creek (T16N R12W Sec 17).

Regional Distribution.- Watersheds 23, 85, 97. ARKANSAS: see type locality, 22-VII-1987, C.E. Carlton; same but 5-VIII-1982, D.D. Koym; MISSOURI: Christian Co., Finley Cr., 1.5 km N MO Hwy 14, Bruner, 8-VI-1991, S.R. Moulton.

Nearctic Distribution.- US: AR, MO.

Discussion.-This species is known only from its type locality in Arkansas and a location in southwestern Missouri. It is probably the same species that was reported by Mathis and Bowles (1992) as *O. sp. nr. eddlestoni* from the East Fork Black River at Johnson's Shut-Ins. It is presently considered endemic to the Ozark Mountain region. *Oecetis ozarkensis* is a member of the *O. scala* Group and most closely related to *O. eddlestoni*. It is distinguished from the latter by the hour-glass shape of the inferior appendages, the presence of a free anteromesal, lanceolate process on each inferior appendage, and the presence of a single spine-like apical seta on each rod of tergum (Fig. 400). Adult records are from June-August (Table 6). The larva is unknown despite attempts to collect it from the type locality by M. Floyd (pers. communication). The 5 ♂♂ paratypes deposited at the INHS by Moulton and Stewart (1993b) have apparently been lost or misplaced (K. Methven pers. communication). The holotype is deposited at the NMNH.

***Oecetis persimilis* (Banks)**

Figs. 402, 403

Oecetina persimilis Banks 1907a:129.

Type Locality.- Maryland, High Island; Virginia, Glencarlyn.

Regional Distribution.- Watersheds 17, 23, 27, 39, 49, 52, 54, 56, 58, 60, 62, 63, 66, 70, 74, 77, 80, 81, 97, 100, 115, 116, 118, 122, 124.

Nearctic Distribution.- US: AL, AR, CT, DE, FL, GA, IL, IN, KS, KY, LA, MA, MD, ME, MI, MN, MO, MS, NC, NH, NY, OH, OK, PA, SC, TN, TX, VA, VT, WI, WV; CANADA: NF, ON, PQ.

Discussion.- This species was commonly collected in a variety of upland lotic systems (Table 5). Males are differentiated by the configuration of the inferior appendages (Fig. 402) and five blade-like paramere spines, three of which are sickle-shaped (Fig. 403). Floyd (1993) associated the larva, and noted that they inhabit submerged root systems, woody debris, and other aquatic vegetation. Ross (1944) described the female.

Genus *Setodes* Rambur

Currently eight species of *Setodes* are known from North America (Holzenthal 1982, Morse 1993). One species, *Setodes oxapius*, is known from the Interior Highlands and is endemic to this region (Holzenthal 1982, Mathis and Bowles 1992). Holzenthal (1982) illustrated and keyed males and females for all eight species. The larval taxonomy is currently being examined (V.

Nations, pers. communication). Larvae are readily distinguished from all other leptocerid genera by the sclerotized spinous plates surrounding the anal opening (Fig. 351). They construct a slightly curved, tubular case of sand grains. Merrill and Wiggins (1971) first described from reared material, the larva and pupa of this genus, and gave an excellent account of various larval behaviors. They speculated that the heavy sclerotization of the anal region may serve as a mechanism for deterring intruders that would otherwise have easy entrance into the widely opened posterior end of the case. Larvae are infrequently collected probably, as a result of their burrowing behavior. However, according to Merrill and Wiggins (1971) and V. Nations (pers. communication), larvae can be collected with some ease by sieving sandy deposits on the leeward side of large rocks in streams. Adults are similar to *Mystacides* in having the epicranial stem well developed and the lateral sutures poorly developed or absent. They differ greatly from that genus in being smaller and straw-colored.

***Setodes oxapius* (Ross)**

Figs. 419, 420

Leptocerus oxapia Ross 1938b:88.

Type Locality.- Oklahoma, Ellerville.

Regional Distribution.- Watersheds 38, 47, 68, 81, 85, 95, 100, 104, 107, 116, 120, 122, 123, 124. MISSOURI: Dallas Co., Bennett Spring, Bennett

Spring State Park, 7-VI-1991, S.R. Moulton, 2 ♂♂, 10 ♀♀; Maries Co., Gasconade River, Paydown Access, Hwy 42 SW Belle, 15-VII-1990, B.C. Poulton; Osage Co., Gasconade River, Hwy 89 at Rollins Ferry Access, 27-IX-1990, B.C. Poulton, 2 ♀♀; same but Helds Island Access, 28-VIII-1990, 1 ♂; Shannon Co., Jacks Fork River, Mo Hwy 106, W Eminence, 24-IX-1992, S.R. Moulton, 2 ♂♂, 2 ♀♀; OKLAHOMA: Cherokee Creek, Town Branch Creek, OK Hwy 82, Tahlequah, 5-VI-1991, S.R. Moulton, 1 ♂, 2 ♀♀.

Nearctic Distribution.- US: AR, MO, OK.

Discussion.- Until recently, the larva of this species was unknown; it is in the process of being described by V. Nations. The adults are relatively small (5-6 mm) and have straw-colored wings. During the examination of several different collections of males, it became evident that there were two variations of inferior appendage length in relation to superior appendage length. In one case the two structures are approximately equal in length (Fig. 419); in the other case, the inferior appendage length was almost twice that of the superior appendage (Fig. 420). This variation occurred within the same population. Adults were present during the spring and summer (Table 6). It was collected from a wide range of lotic habitats, including high-volume springs (Table 5).

Genus *Triaenodes* MacLachlan

In North America, this genus is comprised of 24 species (Morse 1993). Of those, 14 are known to occur in the Interior Highlands. A revision of the

North American species is being prepared by K. Manuel (pers. communication). Larvae are most similar to those of *Mystacides*, but are distinguished by the numerous long setae on each metathoracic leg that aids in swimming. The larval case is also diagnostic in being spirally constructed from longitudinal pieces of macrophytes (Fig. 34)); it may be dextrally or sinistrally spiraled (Merril 1969). Larvae are generally associated with macrophytes in a wide range of lotic and lentic aquatic habitats (Wiggins 1977). Adults are readily distinguished from all other leptocerid genera by the absence of a stem on the M vein in each forewing. Adults are generally yellow to light brown, with some patterning of darker hairs in the forewings. Males and females exhibit tremendous genitalic complexity compared to most other caddisfly groups. They are best collected with UV lights but usually occur in low numbers.

KEY TO THE MALES OF *Triaenodes*

1. Apex of tenth tergite bifurcate in dorsal view (Fig. 433) 2
 - Apex of tenth tergite vestigial (Fig. 427) or elongate, but never bifid (Figs. 432, 435, 437) 3
2. Arms of tenth tergite very long, thin, and parallel (Fig. 422)
 - ***T. ignitus* (Walker)**
 - Arms of tenth tergite shorter, stout, and divergent (Figs. 423, 424)
 - ***T. injustus* (Hagen)**

3. Tenth tergite elongate, its apex in lateral view trifold (Fig. 425)
. ***T. tridentatus* Ross**
Tenth tergite shorter with apex vestigial or if elongate then never trifold . 4
4. Tergum X vestigial (Fig. 427) 5
Tergum X elongated (Fig. 432) 6
5. Lateral lobe of each inferior appendage long, extending to or just past
the apex of the mesal lobe (Fig. 426) ***T. nox* Ross**
Lateral process of each inferior appendage short, scarcely projecting
beyond its origin (Fig. 427) ***T. abus* Milne**
6. Inferior appendages without lateral or mesal lobes (Figs. 428, 429) . . . 7
Inferior appendages with lateral and mesal lobes (Figs. 430, 434) 8
7. Left, curved, basal process widens near apex then tapers to a point, the
right one slender throughout its length (Fig. 429) ***T. pernus* Ross**
Curved, basal processes of inferior appendages slender and similar in
structure; in lateral view, dorsal margin of each inferior appendage
concave in middle (Fig. 428) ***T. ochraceus* (Betten and Mosely)**
8. Lateral lobe of inferior appendages small, at most as long as mesal lobe
(Figs. 430, 431, 433) 9
Lateral lobe of inferior appendages very long, at least twice as long as
mesal (Figs. 434, 436, 438) 12
9. Lateral lobe of each inferior appendage tooth-like and much shorter than
mesal lobe, basal curved processes very long and filamentous (Fig. 430)

- ***T. melacus* Ross**
- Lateral lobe of each inferior appendage about as long as mesal lobe and projected ventrad to it, basal curved processes stouter (Figs. 431, 433) 10
10. Mesal lobe arched in middle in lateral view; superior appendages less than half the length of X (Fig. 431) ***T. flavescens* Banks**
- Mesal lobe not arched in middle; superior appendages at least half as long as X (Fig. 433) 11
11. Mid-ventral margin of phallus notched; lateral lobe of each inferior appendage slender, shorter than mesal lobe (Fig. 433) ***T. dipsius* Ross**
- Mid-ventral margin of phallus even; lateral lobe of each inferior appendage robust, extending to tip of mesal lobe (Fig. 421)
 ***T. smithi* Ross**
12. Apex of X in dorsal view with a prominent hook directed to the left (Fig. 437); lateral lobe of each inferior appendage strongly curving dorsad beginning midway along its length (Fig. 436)
 ***T. cumberlandensis* Etnier and Way**
- Apex of X without a prominent hook (Figs. 435, 439); lateral lobe of each inferior appendage only slightly curved dorsad near apex or straight (Figs. 434, 438) 13
13. Extreme apex of X upturned; lateral lobe of each inferior appendage slightly bent dorsad near apex (Figs. 438, 439) . . ***T. marginatus* Sibley**

Apex of X tapering to a point, not upturned; lateral lobe of each inferior appendage straight (Figs. 434, 435) ***T. tardus* Milne**

***Triaenodes abus* Milne**

Fig. 427

Triaenodes aba Milne 1935:20.

Type Locality.- Massachusetts, New Bedford.

Regional Distribution.- Watersheds 6, 25. ARKANSAS: Lafayette Co., Lake Erling, VI-1992, T. Jennings, 1 ♂.

Nearctic Distribution.- US: AL, AR, DE, FL, IL, IN, KY, LA, MA, ME, MI, MN, MS, NC, NH, OH, SC, TN, WI; CANADA: MB, ON, PQ.

Discussion.- Unzicker *et al.* (1970) reported *T. abus* from War Eagle Creek in Washington Co., Arkansas. Its regional presence is based solely on that record and the one listed above. One locality is on the Springfield Plateau, while the other is in the Gulf Coastal Plain subregion (Table 5). Harris *et al.* (1991) observed a similar rarity of material and distribution for populations in Alabama. Ross (1944) reported it from marshes in Illinois. It appears to be most associated with lentic habitats. Adults were collected during the late spring (Table 6). Males are distinguished by the minute lateral process and rounded posterior margin of each inferior appendage, and the rounded, lobe-like apex of each curved, basal process (Fig. 427).

***Triaenodes cumberlandensis* Etnier and Way**

Figs. 436, 437

Triaenodes cumberlandensis Etnier and Way 1973:427.

Type Locality.- Tennessee, Cumberland Co., Plateau Experiment Station.

Regional Distribution.- Watersheds 57, 74, 77. ARKANSAS: Garland Co., Cooper Creek, at AR Hwy 171, 23-VIII-1990, H.W. Robison, 1 ♂; Polk Co., Ewing Farm slough, 11 km W Mena, 27-VI-1991, B. Ewing, 1 ♂, ?2 ♀♀; same but 6-VII-1991, 1 ♂, ?1 ♀; OKLAHOMA: LeFlore Co., Big Cedar Creek, US Hwy 259, 3 mi N Big Cedar, 19-VI-1993, D.E. Baumgardner, 2 ♂♂.

Nearctic Distribution.- US: AL, AR, GA, OK, TN.

Discussion.- This species was previously known only from the Cumberland Plateau region of the southeastern United States and is reported here from the region as new state records for Arkansas and Oklahoma. My records represent a westward extension of its range by several hundred miles to parts of the Ouachita Mountain physiographic subregion (Table 5). My material was confirmed by K. Manuel. Adults were present during the summer (Table 6). Males appear most similar to those of *T. marginatus*, but are readily distinguished by the more upturned inferior appendages (Fig. 436) and the hooked apex of tergum X (Fig. 437).

***Triaenodes dipsius* Ross**

Fig. 433

Triaenodes dipsia Ross 1938b:89.**Type Locality.**- Ohio, Athens.**Regional Distribution.**- Watersheds 69, 74, 77, 80. ARKANSAS:

Independence Co., Piney Creek, 8 km E Pleasant Plains, 31-V-1986, H.W.

Robison, 1 ♂; Polk Co., East Fork Powell Creek, Ewing Farm, 11 km W Mena,

16-VI-1992, H.W. Robison, UV light, 1 ♂; OKLAHOMA: Pushmataha Co.,

Patterson Creek, at OK Hwy 2, N Moyers, 27-IV-1991, S.R. Moulton and J.

Kennedy, UV light, 6 ♀♀; same as previous but Crumb Creek, S Stanley, 1 ♂, 6

♀♀.

Nearctic Distribution.- US: AL, AR, KS, MN, ND, OH, OK, PA, WI;

CANADA: PQ.

Discussion.- This species was infrequently collected from small headwater streams, some of which may be temporary (Table 5). Harris *et al.* (1991) reported a single male from a small headwater stream in the Cumberland Plateau subregion of northern Alabama. Adults were collected from April-July (Table 6). Males are similar to those of *T. smithi*, but differ chiefly in the configuration of the inferior appendages and the presence of a mid-ventral phallic notch (Fig. 433).

***Triaenodes flavescens* Banks**

Figs. 431, 432

Triaenodes flavescens Banks 1900a:257.**Type Locality.**- Florida; New Jersey, New Brunswick.**Regional Distribution.**- Watershed 122. MISSOURI: Pulaski Co., "Cave spring site", Roam Farm, near Swedeborg, 28-VIII-1987, M. Mathis, UV light, 1 ♂.**Nearctic Distribution.**- US: AL, CT, FL, IL, IN, KY, ME, MI, MN, MO, MS, NJ, NY, OH, OK, PA, TN, TX, VA, WI, WV; CANADA: ON, PQ.**Discussion.**- The regional presence of this species is based on a single male reported by Mathis and Bowles (1992) from Missouri (Table 5). This male was examined by us and is illustrated herein. The Bowles and Mathis (1992) report from Oklahoma was based on a distributional record found in Harris *et al.* (1991), but its validity is uncertain since no specific location information was available. Males differ from the previous species by the configuration of the inferior appendages (Fig. 431); tergum X is finger-like and tapered at the apex (Fig. 432).***Triaenodes ignitus* (Walker)**

Fig. 422

Leptocerus ignitus Walker 1852:72.*Triaenodes dentatus* Banks 1914:261.

Type Locality.- Georgia.

Regional Distribution.- Watersheds 4, 17, 35, 48, 49, 52, 66, 67, 69, 70, 74, 95, 96, 103, 105, 115, 116, 118, 119, 122.

Nearctic Distribution.- US: AL, AR, DE, FL, GA, IL, IN, KY, LA, MA, ME, MI, MO, MS, NC, NH, NJ, NY, OH, OK, SC, TN, VA, WI, WV; CANADA: PQ.

Discussion.- This was the most common and widely distributed of the regional *Triaenodes*. It occurred in a wide range of stream types (Table 5). Harris *et al.* (1991) observed a similar plasticity for stream habitats in Alabama. Bowles and Mathis (1989) reported it as "uncommon" in Arkansas. Males are distinguished by the bifurcated tergum X, the lateral arms of which are very long and slender (Fig. 422). Adults were collected from May to September (Table 6).

***Triaenodes injustus* (Hagen)**

Figs. 423, 424

Setodes injusta Hagen 1861:283.

Triaenodes connata Ross 1959:44.

Type Locality.- Canada, St. Lawrence River.

Regional Distribution.- Watersheds 4, 17, 49, 77, 80, 85, 100, 107, 122, 129, 131.

Nearctic Distribution.- US: AL, AR, CT, DE, IL, IN, KS, KY, MA, ME, MI, MN, MO, NC, NH, NY, OH, OK, PA, TN, TX, VA, VT, WI, WV; CANADA: AB, BC, NF, NS, PQ.

Discussion.- This species is widely distributed throughout the region; it was mainly found in smaller streams (Table 5). Males also have tergum X forked, but the lateral arms are shorter and robust; their apices vary somewhat in whether or not sclerotized points are present (Fig. 424).

***Triaenodes marginatus* Sibley**

Figs. 438, 439

Triaenodes marginatus Sibley 1926a:80.

Type Locality.- New York.

Regional Distribution.- Watersheds 10, 38, 49, 53, 68, 77, 80, 100.
 ARKANSAS: Montgomery Co., Buttermilk Springs, 3 mi Caddo Gap, T4S R24W SEC6, 19-V-1982, H.W. Robison and D.D. Koym, 1 ♂; MISSOURI: Shannon Co., Alley Spring, MO Hwy 106, W Eminence, 24-IX-1992, S.R. Moulton, 1 ♂; OKLAHOMA: LeFlore Co., Billy Creek, nr. Billy Creek Rec. Area, 18-VII-1993, D.E. Baumgardner, 1 ♂.

Nearctic Distribution.- US: AL, AR, DE, IL, IN, KS, MA, ME, MI, MN, MO, MS, NC, ND, NJ, NY, OH, OK, SC, SD, TN, VA, WI, WV; CANADA: AB, BC, NF, NS, PQ.

Discussion.- This species was rarely collected, from small headwater stream and high volume springs (Table 5). Males are similar to those of *T. cumberlandensis* except that the extreme apex of tergum X is not hooked laterad (Fig. 439), and the apex of each inferior appendage is angled slightly dorsad (Fig. 438). Adults were collected during May to September (Table 6).

***Triaenodes melacus* Ross**

Fig. 430

Triaenodes melaca Ross 1947:155.

Type Locality.- Illinois, Rudement, Blackmans Creek.

Regional Distribution.- Watershed 94, 119. MISSOURI: Jasper Co., North Fork Spring River, at Rte. M approximately 3 mi W US Hwy 71, 21-V-1992, S.R. Moulton and D.E. Baumgardner, 1 ♂; ILLINOIS: Alexander Co., Cooper Creek, SW Mill Creek, 24-V-1975, 2 ♂♂.

Nearctic Distribution.- US: AL, IL, IN, KS, KY, MO, MS, OH.

Discussion.- The type series of this species was collected from mid May to early June. Ross (1947) indicated that it is the one designated as "*Triaenodes* species a" in his 1944 treatment of the Illinois fauna. He further noted that it occurred in the small, rapid streams of the Illinois Ozarks. My collections were taken with a UV light trap. The Missouri record is the first one for that state. Males are distinguished by the configuration of the inferior appendages and the long, curved, thread-like basal processes (Fig. 430).

***Triaenodes nox* Ross**

Fig. 426

Triaenodes nox Ross 1941b:96.**Type Locality.-** Ontario, Swansea.**Regional Distribution.-** Watershed 96. MISSOURI: Christian Co., Swan Creek, Hwy 125, Garrison, 9-VIII-1988, Tedder and Mathis, UV light, 1 ♂.**Nearctic Distribution.-** US: AL, CT, FL, IN, MA, ME, MN, MO, MS, NH, OH, PA, WI; CANADA: BC, ON, PQ.**Discussion.-** The regional presence of this species is based on the single male reported by Mathis and Bowles (1992) for Missouri. My illustration of the male (Fig. 426) was drawn from that specimen. Swan Creek is a fourth order stream in the White River Hill physiographic subregion (Table 5). Harris *et al.* (1991) reported *T. nox* as widely distributed in Alabama, but noted that it was rare in collections.***Triaenodes ochraceus* (Betten and Mosely)**

Fig. 428

Triaenodella ochraceus Betten and Mosely 1940:77.**Type Locality.-** Georgia.**Regional Distribution.-** Watershed 6. ARKANSAS: Lafayette Co., Bodcau Creek, 10 km NW Stamps, E Midway Oil Field, 15-V-1992, J.S. Rader, UV light, 3 ♂♂; same but 9 km NW Stamps, 1 ♂, 13 ♀♀; same as former but

18-V-1992, 1 ♂, 183 ♀♀; same but tributary to Bodcau Cr., E Lewisville airport,
18-V-1992, 2 ♂♂, 6 ♀♀.

Nearctic Distribution.- US: AL, AR, GA, DE, MS, SC, TN.

Discussion.- This species occurred in large numbers in the Bodcau Creek drainage of the Gulf Coastal Plain physiographic subregion (Table 5). I include it here as a new state record for Arkansas and consider it extralimital with the possibility of being found in some of the relict transitional habitats bordering the southern edge of the Ouachita Mountains. Harris *et al.* (1991) collected it from small streams in the coastal plain and mountainous regions of Alabama. Adults were collected in May (Table 6).

***Triaenodes pernus* Ross**

Fig. 429

Triaenodes perna Ross 1938a:159.

Type Locality.- Illinois, Eichorn, Hick's Branch.

Regional Distribution.- Watersheds 17, 48, 60, 67, 69, 74, 77.

ARKANSAS: Polk Co., Ewing Farm, 7 mi W Mena, 12-VI-1991, H.W. Robison, 1 ♂; OKLAHOMA: Pushmataha Co., Crumb Creek, OK Hwy 2, 10 mi S Clayton, 16-VII-1993, D.E. Baumgardner, 21 ♂♂.

Nearctic Distribution.- US: AL, AR, DE, FL, IL, LA, MS, NH, OH, OK, SC, TN, TX, VA, WV; CANADA: PQ.

Discussion.- This species was infrequently collected from small

headwater streams (Table 5). The majority of my records came from such streams in the Ouachita Mountains. Males are readily distinguished by the twisted apical widening of the right basal process (Fig. 429). Adults were collected from May to September (Table 6).

***Triaenodes smithi* Ross**

Fig. 421

Triaenodes smithi Ross 1959:40.

Type Locality.- Illinois, Wolf Lake, McCann School Spring

Regional Distribution.- Watershed 89. ILLINOIS; see type locality, 6-VI-1951, Ross and Richards, holotype ♂.

Nearctic Distribution.- US: AL, IL, MS.

Discussion.- The only regional record of this rare species was from a small spring at the base of some limestone bluffs in the Illinois Ozarks (Ross 1959, 1965). Allen (1990) listed it as endemic to the Interior Highlands, but records from from Alabama and Mississippi discount this claim. Males resemble those of *T. dipsius* and *T. flavescens*, but differ by the wider apex of tergum X (Ross 1959); they are further distinguished from the former by the absence of a mid-ventral phallic notch (Fig. 421).

***Triaenodes tardus* Milne**

Figs. 434, 435

Triaenodes tardus Milne 1934:12.

Triaenodes vorhiesi Betten 1934:286.

Triaenodes mephitus Milne 1936:59.

Type Locality.- Ontario, Toronto.

Regional Distribution.- Watersheds 23, 80, 88, 95, 105, 116, 122, 131.

ARKANSAS: Stone Co., Gunner Pool Rec. Area, at North Sylamore Creek, 5-VIII-1982, D.D. Koym, 2 ♂♂; MISSOURI: Boone Co., Columbia, 24-IV-1990, B.C. Poulton, 2 ♂♂; Dallas Co., unnamed tributary to Lindley creek, US Hwy 65, 2 mi S Louisburg, 22-V-1992, S.R. Moulton and D.E. Baumgardner; OKLAHOMA: Comanche Co., West Cache Creek, OH Hwy 49, Wichita Mountains, 13-V-1993, K.D. Alexander, 1 ♂.

Nearctic Distribution.- US: AL, AR, AZ, CO, CT, DC, DE, GA, IL, IN, KS, KY, MA, ME, MI, MN, MO, MT, NC, ND, NH, NJ, NY, OH, OK, OR, PA, TN, UT, VA, VT, WA, WI, WV, WY; CANADA: BC, MB, NB, ON, PQ.

Discussion.- This species was widely distributed throughout the region but was infrequently collected from small headwater streams (Table 5). Males resemble those of *T. marginatus*, but have tergum X tapering to a point (Fig. 435), and the lateral lobe of each inferior appendage is shorter and straight (Fig. 434).

***Triaenodes tridontus* Ross**

Fig. 425

Triaenodes tridonta Ross 1938a:158.**Type Locality.**- Oklahoma, Pushmataha Co.**Regional Distribution.**- Watershed 77. OKLAHOMA: see type locality, 28-IV-1934, C.A. Soeler, holotype ♂.**Nearctic Distribution.**- US: AL, OK.**Discussion.**- The current status of this species in the region is unknown.

To my knowledge, it has not been collected from the Interior Highlands since the type series on 28 May 1934 (Ross 1938). Other workers (Harris and Lago 1990, and K. Manuel pers. communication) have located other populations in southern Alabama and the Florida panhandle. Harris *et al.* (1991) commented that it was collected from cool, gravel-bottom streams of the Lime Hills region of the southern Alabama Gulf Coastal Plain. Pushmataha Co., Oklahoma lies in both the Kiamichi Mountains of the western Ouachita Mountain subregion, and the Gulf Coastal Plain subregion. Streams of the nature described by Harris *et al.* (1991) are present in this area, but without specific historical data on the type locality, attempts to relocate it have been difficult. Vaughn (1992) surveyed 10 locations in the Kiamichi drainage (the main one draining the county) and contacted SRM to identify the material. No *T. tridonta* were found; however, specimens of *T. dipsius*, *T. injustus*, and *T. pernus* were in the samples. Males of *T. tridonta* are quite distinctive with the trifold apex of tergum

X when viewed laterally (Fig. 425). I examined the pinned male holotype and have illustrated it herein. The genitalia are in good condition and placed in a microvial of glycerin.

CHAPTER 11

FAMILY LIMNEPHILIDAE

This is the second largest family in North America with approximately 294 species (Morse 1993). They are widely distributed throughout the continent, but their greatest diversity occurs in high latitudes and elevations. This family is poorly represented in the Interior Highlands; only 13 species in seven genera have been documented. Unlike several caddisfly families that are restricted to a particular type of aquatic habitat, limnephilids are found in a wide range of lotic and lentic habitats. In a few species, the immature stages are even known to be terrestrial during portions of their development. Larvae construct a diverse array of tubular cases from organic and inorganic materials (Wiggins 1977). Aside from this behavior and their generally large size, limnephilid larvae may be recognized by having the mesonotum largely sclerotized, lateral humps on abdominal segment I, and the antennae situated midway between the eye and the anterior margin of the head capsule. Larvae of the regional species of *Neophylax* (Family Uenoidae) also exhibit these characters, as they were once placed in the Limnephilidae. However, regional limnephilids lack the anteromedian emargination of the mesonotum as seen in

Neophylax. Life histories of much of the regional fauna are unknown except for generalized aspects that apply to the family. Flint (1960) reviewed the larval taxonomy for a number of the eastern United States species treated here. Adults range from 10 to 22 mm in forewing length. Males possess three segmented maxillary palpi, while those of the females are five segmented.

KEYS TO THE GENERA AND SPECIES OF LIMNEPHILIDAE

larvae

1. Most abdominal gills single (Fig. 26) 2
 - Most abdominal gills with 3, 4 or more branches (Fig. 27) 3
2. Posterobasal portion of each lateral abdominal hump with a sclerite (may be light colored) that is as wide as the hump (Fig. 26)
 - ***Pycnopsyche* Banks**
 - Posterobasal portion of each lateral abdominal hump without a sclerite
 - ***Pseudostenophylax uniformis* (Betten)**
3. Most abdominal gills with 3 branches, none with more than 4 4
 - Most abdominal gills with more than 4 branches (Fig. 27)
 - ***Ironoquia* Banks**
4. Anterior margin of pronotum (Fig. 21) and lateral sclerite of anal proleg with short, stout setae 5
 - Pronotum and lateral sclerite of anal proleg without short, stout setae . . 6
5. Tibiae and tarsi of legs with dark banding (Fig. 23); known only from

- Meramec Spring in Missouri ***Glyphopsyche missouri* Ross**
- Tibiae and tarsi of legs without banding ***Frenesia missa* (Milne)**
6. Prosternal horn very long, reaching anteroventral edge of head capsule
and mentum ***Platycentropus radiatus* (Say)**
- Prosternal horn much shorter than above (Fig. 22)
. ***Limnephilus submonilifer* Walker**

adults

1. Forewings with vein 2A incomplete, not forming a loop with vein 3A (Fig.
440) ***Platycentropus radiatus* (Say)**
- Forewings with vein 2A complete and forming a loop with vein 3A (Figs.
441 - 450) 2
2. Forewings with R_1 deeply bowed at apex and curving parallel to R_2 (Figs.
441, 442) 3
- Forewings with R_1 not deeply bowed at apex and not curving parallel to
 R_2 (Fig. 446) 4
3. Forewings with R_s branching in basal one-third, and with more extensive
dark pigmentation (Fig. 441); scattered distribution in small springs . . .
. ***Frenesia missa* (Milne)**
- Forewings with R_s branching in middle, dark pigmentation mainly in
posterior one-half (Fig. 442); known only from Meramec Spring in
Missouri ***Glyphopsyche missouri* Ross**

4. Last tarsal segment of all legs without black spines 5
- Last tarsal segment of all legs with at least 1 black spine on inner surface 6
5. Forewings with R_{2+3} branching more basad of R_{4+5} , speckled with small pale spots (Fig. 443) ***Ironoquia* Banks**
- Forewings with R_{2+3} and R_{4+5} branching at approximately the same distance, uniformly dark brown (Fig. 444)
- ***Pseudostenophylax uniformis* (Betten)**
6. Forewings brown with numerous, small areas of dark mottling (Fig. 445); head and thorax with large blade-like setae; unconfirmed from region
- ***Limnephilus submonilifer* Walker**
- Forewings brownish-orange, dark mottling restricted to a few areas (Figs. 446 - 450); head and thorax without enlarged, blade-like setae; common and widely distributed ***Pycnopsyche* Banks**

Genus *Frenesia* Betten & Mosely

In North America this genus is comprised of two species, *F. difficilis* (Walker) and *F. missa* (Milne). Only the latter is represented in the Interior Highlands.

***Frenesia missa* (Milne)**

Figs. 441, 453, 454

Chilostigma missa Milne 1935:35.

Type Locality.- Massachusetts, Readville.

Regional Distribution.- Watersheds 36, 55, 122. ARKANSAS:

Washington Co., unnamed spring, 1 mi W Savoy off AR 16, 25-X-1991, S.R.

Moulton, 2 pupae, 2 ♂♂ reared 11-XI and 2-XII-1991, 1 ♀ reared 12-XII-1991.

Nearctic Distribution.- US: AR, CT, DC, DE, IA, IL, IN, MD, ME, MI, MN, MO, ND, NH, NY, OH, PA, VA, VT, WI; CANADA: ON, PQ.

Discussion.- This species was found only in spring seeps of the Springfield Plateau and Osage-Gasconade Hills subregions (Table 5). Ross (1944) described the larva. Pupae were hand picked from a small gravel sink into which a spring seep drained at the Washington Co., Arkansas location noted above. Adults were reared (see above) from some of these pupae in the laboratory, at 13-14°C, 16 to 47 days after collection. Flint (1956) reviewed its life history and biology, and M. L. Mathis studied its regional life history (pers. communication, unpublished data). Other caddisflies collected with *F. missa* at this location included *Diplectrona modesta* and *Lepidostoma libum*. Emergence occurs from September to January (Table 6).

Genus *Glyphopsyche* Banks

According to Morse (1993) this genus is comprised of two species in North America, *G. irrorata* (Fabricius) and *G. missouri*. *Glyphopsyche missouri* is the only species known to occur in the region.

***Glyphopsyche missouri* Ross**

Figs. 20, 21, 23, 442, 455, 456

Glyphopsyche missouri Ross 1944:200.**Type Locality.-** Meramec Spring, St. James, MO.**Regional Distribution.-** Watershed 125. MISSOURI: Phelps Co., see type locality, 19-VIII-1990, S.R. Moulton, 1 ♀, 6 ♀ mmt, 40 larvae; same data but 28-IX-1991, 33 ♂♂, 8 ♀♀, 11 pupae, 24 larvae.**Nearctic Distribution.-** US: MO.**Discussion.-** This is a sister species to the more northern *G. irrorata* (Fabricius). Its presence in the region is likely the result of a glacial advance and retreat. Though restricted to Meramec Spring (Table 5), it is quite abundant and is a dominant component of the benthic community. Ross (1944) stated that the larvae can be found "paving" the substrate. I visited this location during August, 1990, and September, 1991, and found the larvae to be very abundant. It has been granted endangered and category 2 status by the Missouri Department of Conservation and U.S. Fish and Wildlife Service, respectively (Anonymous 1992). Larvae construct tapered cases of small pebbles. Living hydrobiid snails were incorporated at the anterior end of some cases upon pupation. Emergence occurs from September to January (Table 6).

Genus *Ironoquia* Banks

This genus is represented in eastern North America by four species (Morse 1993). It is represented in the Interior Highlands proper by a single species, *I. punctatissima*. A second species, *I. kaskaskia* (Ross) described from the Kaskaskia River in southwestern Illinois, is included here as extralimital. Wiggins (1977) illustrated an unidentified larva and case from Franklin Co., Missouri; they agree with other larval material from the Ozarks and are likely to be *I. punctatissima*. Species in this genus were previously considered under *Caborius* Navás (Ross 1944, Wiggins 1977). *Ironoquia punctatissima* generally inhabits temporary streams and pools (Ross 1944, Wiggins 1977). Flint (1958b) observed that summer aestivating larvae of *I. parvula* (Banks) were found under leaves after the stream had dried up.

KEY TO THE MALES OF *Ironoquia*

1. Inferior appendages widest basally, tapering towards middle then widening apically; tergum X with a pair of small knobs (Fig. 457)
 *I. punctatissima* (Walker)
- Inferior appendages widest basally, but tapering to a slender, needle-like apex; tergum X with a pair of sinuate, finger-like processes (Fig. 458) . .
 *I. kaskaskia* (Ross)

***Ironoquia kaskaskia* (Ross)**

Fig. 458

Caborius kaskaskia Ross 1944:198.*Ironoquia brysoni* Flint 1972:80.**Type Locality.**- Illinois, New Memphis, along Kaskaskia River.**Regional Distribution.**- Watershed 105. ILLINOIS: see type locality, 25-IX-1939, Frison and Ross, holotype ♀ (Ross 1944).**Nearctic Distribution.**- US: AL, DE, IN, IL, LA, MS, TN, WV.**Discussion.**- This species has not been collected from the Interior Highlands proper. Ross (1944) described it from females collected in late September along the Kaskaskia River in southwestern Illinois. This river, along with the Big Muddy River, constitute my watershed No. 105. Both rivers drain the western edge of the Illinois Ozarks subregion. I include it here with the suspicion that it may eventually be found in the region. Males are quite distinctive in having long, slender inferior appendages, sinuate, lanceolate processes arising from X, and the postero-lateral margins of tergum VIII acutely produced (Fig. 458). Some females have been found in the headwaters of the Kiamichi River in Leflore Co., Oklahoma that resemble the female type illustrated by Ross (1944). However, I found only *I. punctatissima* males with these females. The male illustrated herein was drawn from a specimen collected in eastern Tennessee.

***Ironoquia punctatissima* (Walker)**

Figs. 443, 457

Halesus punctatissimus Walker 1852:17.**Type Locality.-** Nova Scotia.**Regional Distribution.-** Watershed Nos. 1, 4, 10, 44, 53, 58, 68, 74, 80, 81, 95, 100, 122.**Nearctic Distribution.-** US: AK, AL, AR, CT, DE, FL, IL, IN, KS, KY, LA, MA, MD, ME, MI, MN, MO, MS, NC, NH, NJ, NY, OH, OK, PA, SC, TN, VA, VT, WI, WV; CANADA: NS, ON, PQ.**Discussion.-** This species is commonly collected during the fall (Table 6) in small numbers from UV light traps; in this study, it was often collected with *Pycnopsyche* spp. Larvae construct a cylindrical case of woody debris that is slightly bowed (see also Wiggins 1977); I found them in a wide range of stream types (Table 5). They were most often collected during the spring from undercut banks and slow-moving depositional areas having rooted aquatic vegetation.**Genus *Limnephilus* Leach**

This genus has approximately 110 Nearctic species, and they are primarily found in the cool to cold water habitats of the continent. Presently only one species, *L. submonilifer*, has been documented from the Ozark Mts of Arkansas. McGary and Harp (1972), reported a single larva of *Limnephilus* sp.

from the cold tailwater section on the Little Red River below Greers Ferry Reservoir. This specimen could not be located for confirmation. A revision of the North American fauna is near completion (D.E. Ruitter, pers. communication).

***Limnephilus submonilifer* Walker**

Figs. 445, 461, 462

Limnephilus submonilifer Walker 1852:33.

Limnephilus pudicus Hagen 1861:262.

Type Locality.- North America.

Regional Distribution.- Watershed 45. ARKANSAS: Washington Co., Cove Creek, 15 mi south of Prairie Grove, October (Unzicker et al. 1970).

Nearctic Distribution.- US: AR, CO, CT, DC, DE, IL, IN, MA, MD, ME, MI, MN, NC, ND, NH, NJ, NY, OH, PA, RI, SD, TN, VA, VT, WA, WI, WV;
CANADA: MB, NF, NS, ON, PQ.

Discussion.- Unzicker *et al.* (1970) provided the only record of this species from the Interior Highlands. I consider this record to be tentative until confirmed regional specimens are located. Ross (1944) indicated that it was common in many of the temporary ponds and marshes in Illinois. He also noted that it exhibited a bivoltine life cycle with emergences occurring prior to and after pond desiccation in the summer. *Limnephilus submonilifer* is widely distributed throughout the Northeast, and westward to South Dakota (Ross

1944). If it does occur in the region, its absence from recent collections may be a result of inadequate sampling of temporary lentic habitats. My illustrations of the forewing (Fig. 445) and male genitalia (Figs. 461, 462) were drawn from a specimen from Ohio.

Genus *Platycentropus* Ulmer

This Nearctic genus is comprised of three species known only from the eastern half of North America (Wiggins 1977). It is represented in the Interior Highlands by a single species, *P. radiatus* (Say). Larvae of this genus construct a cylindrical case by arranging reeds of grasses and other plant materials transversely around the opening. The best diagnostic character used to identify larvae is the unusually long prosternal horn that projects anteriorly to the edge of the head capsule. At first glance, adults of *P. radiatus* can be mistaken for those of *Pycnopsyche*. However, examination of the forewings will reveal the second anal vein to be incomplete, and not forming a loop with the third anal vein.

***Platycentropus radiatus* (Say)**

Figs. 440, 451, 452

Phryganea radiata Say 1824:308.

Limnephilus indicans Walker 1852:23.

Halesus maculipennis Kolenati 1859b:176.

Halesus hostis Hagen 1861:266.

Type Locality.- Illinois.

Regional Distribution.- Watersheds 56, 74. ARKANSAS: Polk Co., spring on Rich Mountain, 14-V-1991, H.W. Robison, 1 ♂; same data but spring W Pioneer Cemetery, 2 ♂♂.

Nearctic Distribution.- US: AL, AR, CT, DE, GA, IL, IN, KY, MA, MD, ME, MI, MN, MS, NC, ND, NJ, NY, OH, PA, SC, TN, VA, WA, WI, WV; CANADA: MB, NS, NT, ON, PQ.

Discussion.- This species is recorded here for the first time from Arkansas and the region. It is widely distributed throughout the Eastern United States and Canada. Holzenthal *et al.* (1982) and Harris *et al.* (1991) provided records from coastal plain streams in Mississippi and Alabama, respectively. Wiggins (1977) illustrated the larva and case for *P. radiatus* and indicated that it inhabited a wide range of aquatic habitats and thermal regimes. The specimens collected in this study came from a small spring seepage on Rich Mountain in Arkansas near the Oklahoma border (H.W. Robison pers. communication)(Table 5). Males were collected only during the spring (Table 6).

Genus *Pseudostenophylax* Martynov

Three species of *Pseudostenophylax* are known from North America; two eastern and one western (Wiggins 1977). In the Interior Highlands, this genus

is represented by a single species, *P. uniformis* (Betten). Species were previously treated under *Drusinus* Betten (Ross 1944, Wiggins 1977).

***Pseudostenophylax uniformis* (Betten)**

Figs. 444, 459, 460

Drusinus uniformis Betten 1934:360.

Type Locality.- New York, Ithica, Hamburg.

Regional Distribution.- Watersheds 116, 122. MISSOURI: Dallas Co., Bennett Spring, Bennett Spring State Park, 19-V-1990, B. McCalmont, 1 ♀; Pulaski Co., Cave Spring and unnamed spring on Roam Farm, near Swedeborg, Road T-740, 22-V-1987, M.L. Mathis, 2 ♂♂.

Nearctic Distribution.- US: CT, IL, IN, KY, MA, ME, MN, MO, NC, NH, NY, OH, PA, SC, TN, VT, WI, WV; CANADA: ON, PQ.

Discussion.- This species is apparently restricted to spring habitats (Table 5). Mathis and Bowles (1992) indicated an April to June emergence (Table 6). Its regional life history was studied by M. L. Mathis (pers. communication, unpublished data). Flint (1957) first described the larva and pupa. He reported that larvae first appeared in early August, overwintered as growing larvae, and pupated under rocks during the spring.

Genus *Pycnopsyche* Banks

Seventeen species are known in this genus from North America

(Wojtowicz 1982). They are primarily distributed across the eastern half of the continent, but two species, *P. guttifer* and *P. subfasciata*, occur as far west as the Rocky Mountains (Wiggins 1977). In the Interior Highlands five species are known. Three of these species (*P. indiana*, *P. lepida*, and *P. subfasciata*) belong to the *P. lepida* Group. According to Wojtowicz (1982), this group is problematic with some characters showing considerable variation. Ideally, I suggest that workers examine numerous, cleared males and compare them to reference material if available. Bowles and Mathis (1989) reported *Pycnopsyche scabripennis* from Arkansas; I later discovered this record to be *P. rossi*. However, because of its wide distribution, I key and discuss *P. scabripennis* herein in the event that it may eventually be found in the region. *Pycnopsyche* species tend to exhibit a slow, univoltine lifecycle. In the temperate deciduous forest, egg hatching coincides with the pulse of leaf material entering streams in the fall (Ross 1963, Wiggins 1977). In early summer, mature larvae aestivate prior to pupation to avoid summer temperature extremes and drying. Adults are fall emergers (Table 6). It was not uncommon to collect one hundred or more individuals comprising two or three species from a single UV light trap sample.

KEY TO THE MALES OF *Pycnopsyche*

1. Postero-lateral lobes of VIII well developed with outer margins rounded, with or without minute black spines (Figs. 463, 465) 2

- Postero-lateral lobes of VIII hook-like or absent, not rounded (Fig. 474) 4
2. Posterolateral lobes arising from ventral margin of tergum VIII (Figs 463)
 ***P. guttifer* (Walker)**
- Posterolateral lobes arising from middle of tergum VIII in lateral view
 (Fig. 465) 3
3. Inferior appendages with apex forming a point (Fig. 466) ***P. rossi* Betten**
 Inferior appendages with apex emarginate or cleft (Fig. 467); forewings
 with extensive brown mottling, not yet reported from region
 ***P. scabripennis* (Rambur)**
4. Posterodorsal margin of tergum VIII with a deep, mesal notch bordered
 by patches of dense black spines (Fig. 468) ***P. lepida* (Hagen)**
 Posterodorsal margin of tergum VIII entire or with a very shallow notch 5
5. Inferior appendages with distinct shoulder (Fig. 468); apical one-half of
 phallus in lateral view with dorsal margin arched high (Fig. 471)
 ***P. indiana* (Ross)**
 Inferior appendages without a shoulder, tapering evenly to a point (Fig.
 473) or with small shoulder set close to the mesal finger-like process;
 dorsal margin of phallus not arched as above (Fig. 472)
 ***P. subfasciata* (Say)**

***Pycnopsyche guttifer* (Walker)**

Figs. 446, 463, 464

Halesus guttifer Walker 1852:16.

Pycnopsyche similis Banks 1907a:122.

Type Locality.- Georgia.

Regional Distribution.- Watersheds 23, 67, 68, 95, 100, 104, 116, 124.

Nearctic Distribution.- US: AR, CO, CT, DE, FL, GA, IL, IN, KS, KY, LA, MA, ME, MI, MN, MO, MT, NC, ND, NH, NJ, NY, OH, PA, SC, SD, TN, VA, VT, WA, WI, WV, WY; CANADA: AB, MB, NF, NS, ON, PQ, SK.

Discussion.- *Pycnopsyche guttifer* is the most widespread species in the genus, being found throughout eastern and North Central North America. It inhabits small woodland streams and lakes in northern areas to larger rivers in both the northern and southern portions of its range (Wojtowicz 1982). In this study, it was often the dominant limnephilid found in light trap samples from high volume springs in Arkansas and Missouri (Table 5). This species is readily distinguished from other regional *Pycnopsyche* by having the posterolateral lobes of VIII tipped with dense black spines and arising from the ventral margin of the tergum (Fig. 463). Wojtowicz (1982) noted that the wing color pattern may be variable among populations. Larvae identified by Wojtowicz (1982), as well as those examined in this study, constructed cylindrical cases of longitudinally arranged sticks that usually projected beyond each end of the case. Summer diapausing larvae collected from Bennett Spring, Dallas Co., Missouri on 7 June 1991 were successfully reared in the laboratory, emerging from 19 September to 11 October 1991.

***Pycnopsyche indiana* (Ross)**

Figs. 449, 471

Stenophylax indiana Ross 1938d:121.**Type Locality.-** Indiana, Rogers.

Regional Distribution.- Watersheds 1, 19, 56, 74, 100. ARKANSAS:
 Polk Co., Ouachita River, US Hwy 71, Acorn, 24-X-1991, S.R. Moulton, 3 ♂♂;
 Scott Co., Little Cedar Creek, AR Hwy 28, 1 mi W Cedar Creek (town), 24-X-
 1991, S.R. Moulton, 6 ♂♂.

Nearctic Distribution.- US; AL, AR, DE, GA, FL, IL, IN, KY, LA, MO, NY,
 OH, SC, TN, VA, WV.

Discussion.- This species is a member of the *P. lepida* Group and is
 may be confused with *P. lepida* and *P. subfasciata*. It is reported here for the
 first time from the region as new state records for Arkansas and Missouri.
 Males of *P. indiana* are most often distinguished by having a shallow mesal
 notch on the posterior margin of tergum VIII and a more pronounced mesal
 hump of the phallus, as seen in lateral view (Fig. 471). Wojtowicz (1982) noted
 that forewing color pattern was "variable and somewhat vague" among males
 and females. He further noted that key characters of *P. indiana* were quite
 variable and showed considerable overlap with those of *P. lepida*. I have
 experienced, on occasion, some trouble in identifying these two species from
 the Interior Highlands. Wojtowicz (1982) suggested that until sufficient
 evidence is acquired to show that they were not reproductively isolated they

should be considered distinct. Larvae of *P. indiana* from St. Tammany Parish, Louisiana, constructed cylindrical cases of either organic materials or a combination of mineral and organic materials (Wojtowicz 1982). Adults were collected during the fall (Table 6) from a wide range of stream sizes and flow permanences (Table 5).

***Pycnopsyche lepida* (Hagen)**

Figs. 448, 468, 469, 470

Enoicyla lepida Hagen 1861:269.

Type Locality.- Pennsylvania.

Regional Distribution.- Watersheds 1, 4, 9, 17, 38, 41, 47, 53, 56, 67, 68, 74, 80, 87, 90, 95, 100, 104, 125.

Nearctic Distribution.- US: AL, AR, CT, DE, GA, IL, IN, KY, LA, MA, MD, ME, MI, MN, MO, MS, NC, ND, NH, NJ, NY, OH, OK, PA, SC, TN, TX, VA, VT, WI, WV; CANADA: MB, NF, NS, ON, PQ.

Discussion.- *Pycnopsyche lepida* is a common and widely distributed species in the Interior Highlands. It is reported here from Arkansas for the first time. In North America, it is widely distributed in the eastern half of the continent, with some records as far west as eastern Texas (Wojtowicz 1982, Moulton unpublished data). It is best distinguished from other members of the *P. lepida* Group in having a deep dorsomesal notch on tergum VIII bordered by patches of small black spines (Fig. 468). Larvae construct a cylindrical case

of sand grains and small pebbles, and may have small twigs attached that extend posteriorly (Fig. 37). Cummins (1964) reported that terminal instar larvae burrowed into the substrate prior to pupation. It was collected from a wide of stream sizes and flow permanences (Table 5).

***Pycnopsyche rossi* Betten**

Figs. 447, 465, 466

Pycnopsyche rossi Betten 1950:520.

Type locality.- Illinois, Wolf Lake, McCann Spring.

Regional Distribution.- Watersheds 55, 68, 100. ARKANSAS: Benton Co., 2 mi SE Siloam Springs, 11-X-1988, Bowles & Mathis, UV light, 5 ♂♂; Newton Co., spring tributary to Cecil Cr. (T17N R21W Sec 32 NE ¼), 18-X-1990, M.L. Mathis, UV light, 2 ♂♂; same data as previous except, S.R. Moulton, 1 ♀ reared 24-X-1990; MISSOURI: Ripley Co., Malden Spring at Rec. Area off Rte. Y, W Doniphan, MO, 24-IX-1992, 1 ♂; Shannon Co., Alley Spring, off MO Hwy 106, W Eminence, MO, 24-IX-1992, 22 ♂♂.

Nearctic Distribution.- US: AR, IL, IN, MO.

Discussion.- This species was commonly collected from small spring seepages in the Ozark Mountains of Arkansas and Missouri (Table 5). Males were usually collected singly while sweeping riparian vegetation. The Missouri collections above represent a new state record. Bowles and Mathis (1989) previously reported it from Arkansas as *P. scabripennis* (see discussion for that

species). *Pycnopsyche rossi* is distinguished from *P. guttifer* and *P. scabripennis* by having the posterolateral lobes of VIII arise from the middle of the tergum in lateral view (Fig. 465) and the apices of each inferior appendage tapering to a point (Fig. 466). Wojtowicz (1982) indicated that larvae of *P. rossi* may be confused with those of the *P. lepida* Group. Even though their cases are similarly constructed of pebbles, I have noticed that one case from a reared female *P. rossi* was constructed of much larger pebbles without incorporating any sticks.

***Pycnopsyche scabripennis* (Rambur)**

Fig. 467

Limnephilus scabripennis Rambur 1842:488.

Pycnopsyche perplexa Betten & Mosely 1940:149.

Type locality.- "North America".

Discussion.- This species was originally reported from a spring-run, 2 mi E Siloam Springs, Benton Co., Arkansas by Bowles and Mathis (1989). However, I examined this material and found that the specimens were actually those of *P. rossi*. Thus, there have been no confirmed examples of *P. scabripennis* from the Interior Highlands. Recent collections from sandy-bottomed, spring-runs in the piney-woods of east Texas have yielded many specimens. It is likely to occur in similar habitats found in the Coastal Plain region of southern Arkansas. I am treating it here as extralimital for that

reason. *Pycnopsyche scabripennis* is distinguished from other members of the genus by having the forewings completely speckled with small brown spots and the apex of each inferior appendage cleft (Fig. 467). Betten (1950) noted considerable variation in the clefted apices but the specimens from east Texas have a tri-lobed appearance.

***Pycnopsyche subfasciata* (Say)**

Figs. 449, 472, 473, 474

Phryganea subfasciata Say 1828:44.

Type Locality.- Illinois, McHenry.

Regional Distribution.- Watersheds 1, 55, 74, 80, 116, 122.

ARKANSAS: Perry Co., Nimrod Dam, at jct. of Fourche la Fave River, 21-X-1993, H.W. Robison, 1 ♂; Polk Co., Ewing Farm, 7 mi W Mena, 12-X-1991, H.W. Robison, 2 ♂♂; Scott Co., Rock Creek, US Hwy 270, 7 mi E "Y" City, 23-X-1991, S.R. Moulton, 3 ♂♂; MISSOURI: Shannon Co., Jacks Fork River, MO Hwy 106, W Eminence, 24-IX-1992, S.R. Moulton, 1 ♂.

Nearctic Distribution.- US: AR, CO, DE, GA, IL, IN, KS, MA, MD, MI, MN, MO, NC, NH, NJ, NY, OH, OK, PA, SC, VA, VT, WI, WV, WY; CANADA: AB, MB, NT, ON, PQ.

Discussion.- This species is a third member of the *P. lepida* Group to occur in the Interior Highland region. It is often collected in approximately equal numbers with the closely allied *P. indiana*. It may be differentiated from

the latter by having a posterolateral extension of tergum VIII hook-like (Fig. 474). In many of the regional examples, the inferior appendages lack a distinct outer shoulder (Fig. 473). However, some males have been identified from the Ouachita Mts. that have a small shoulder set closely to the mesal process. I believe this to be variation, as other genitalic characters and wing patterns are consistent with *P. subfasciata*. Adults were collected during the fall (Table 6) from a wide range of stream types (Table 5).

CHAPTER 12

FAMILY MOLANNIDAE

The Molannidae are represented in the Interior Highlands by a single genus, *Molanna*. Molannids are closely allied with leptocerids but can be readily identified by the presence of two preapical spurs on the middle tibia and shorter antennae that approximate the length of the forewings. My keys to species were modified from those of Sherberger and Wallace (1971) for larvae and Ross (1944) for males. Roy and Harper (1980) described and keyed the females of Nearctic *Molanna*.

Genus *Molanna* Curtis

This genus is represented in the region by three of the five Nearctic species listed by Morse (1993). Adults are dark in color, and were infrequently collected from a wide range of lotic habitats from small spring seeps to large rivers. One species, *M. uniophila* is apparently found in ponds and lakes (Vorhies 1909, Sherberger and Wallace 1971). I did not encounter any *Molanna* in my pond sampling. Adults were most often collected during the spring and fall using UV light traps and by sweeping riparian vegetation in the

early morning. Cases and larvae were sampled by sieving sandy, depositional areas of streams through a 1 mm mesh screen. Larval cases have often been described as "mummy-shaped", consisting of a flattened tube, with lateral and anterior flanges (Fig. 36). They are composed of sand, and depending on the species, may have larger pebbles incorporated laterally.

KEYS TO THE SPECIES OF *Molanna*

larvae

1. Spinous process on apicoventral margin of protibia with basal portion ending well short of the tibiotarsal junction (Fig. 476), or if past this junction, then apical spine no longer than three times its width; case of sand grains with larger pebbles incorporated laterally (Fig. 36) 2
 Spinous process on apicoventral margin of protibia with basal portion extending well past tibiotarsal junction and apical spine at least 5 times longer than wide (Fig. 478); case entirely of sand grains
 ***M. blenda* Sibley**
2. Spinous process of protibia with basal portion ending well short of the tibiotarsal junction and shorter than its apical spine (Fig. 476); head capsule with a dark "U" shaped band following the frontoclypeal suture (Fig. 475) ***M. ulmerina* Navás**
 Spinous process of protibia with basal portion extending well past the tibiotarsal junction and longer than its apical spine; head capsule with a

dark, "Y" shaped marking following the frontoclypeal and coronal sutures
(Fig. 477) ***M. uniophila* Vorhies**

adults

1. Hindwings with a furrow of stout black setae (Fig. 484)
..... ***M. ulmerina* Navás**
Hindwings without a furrow of stout black setae 2
2. Males (Figs 479, 480) 3
Females 4
3. Males with ventral margin of X strongly arched dorsad (Fig. 480)
..... ***M. blenda* Sibley**
Males with ventral margin of X slightly arched (Fig. 478)
..... ***M. uniophila* Vorhies**
4. Subgenital plate emarginate on posterior margin (Fig. 481)
..... ***M. blenda* Sibley**
Subgenital plate dome-like on posterior margin (Fig. 482)
..... ***M. uniophila* Vorhies**

***Molanna blenda* Sibley**

Figs. 478, 480, 482

Molanna blenda Sibley 1926b:105.

Type Locality.- New York.

Regional Distribution.- Watersheds 36, 44, 47, 49, 55, 122.

ARKANSAS: Johnson Co., spring Oark, 5 mi W AR Hwy 215, VIII-1987, D.E. Bowles, 6 ♂♂; Tate Spring, 3 mi N Oark, Forest Service Road 1404, 29-VI-1993, G. Leeds, 2 ♂♂; Selby Spring, 2 mi S Catalpa, 6-VII-1993, G. Leeds, 1 ♂, 1 ♀; Montgomery Co., Buttermilk Springs, 3 mi from Caddo Gap, 19-V-1982, H.W. Robison and D. Koym, 1 ♂; Newton Co., unnamed spring to Mill Creek, near AR Hwy 7, Pruitt Access Buffalo River National Forest, 18-X-1990, S.R. Moulton and M.L. Mathis, 1 larva; unnamed spring to Cecil Creek, Buffalo River National Forest, 26-IX-1991, S.R. Moulton, 3 larvae; Washington Co., spring seep, AR Hwy 16, 1 mi W Savoy, 25-X-1991, S.R. Moulton, 4 larvae.

Nearctic Distribution.- US: AL, AR, CT, DE, GA, IL, IN, KY, LA, MA, MI, MN, MO, MS, NC, NH, NY, OH, PA, SC, TN, VA, VT, WI, WV; CANADA: NF, ON, PQ.

Discussion.- This species was most often encountered in small, first or second order, spring seeps or streams (Table 5). Sherberger and Wallace (1971) described and illustrated the larva. They reported that the larval gut contents consisted mainly of diatoms and microcrustaceans. Larvae are distinguished by the long, slender spinous process on the protibia (Fig. 478). Males differ from the other regional species by the strongly arched ventral margin of tergum X (Fig. 480); females differ by the emarginate posterior margin of the subgenital plate (Fig. 482).

***Molanna ulmerina* Navás**

Figs. 36, 53, 475, 476, 481, 484

Molanna ulmerina Navás 1934:23.*Molanna musetta* Betten 1934:248.**Type Locality.**- Massachusetts, Framingham.**Regional Distribution.**- Watersheds 9, 47, 60, 74. ARKANSAS:

Johnson Co., spring 5 mi W Oark, IV-1987, D.E. Bowles, 1 ♂; Pope Co., Big

Piney Creek, Long Pool Rec. Area, 25 mi N Russellville, 24-IV-1992, H.W.

Robison, 1 ♂; MISSOURI: Oregon Co., Eleven Point River, MO Hwy 142, Calm,

24-IX-1992, S.R. Moulton, 1 larva, 1 ♂.

Nearctic Distribution.- US: AL, AR, CT, DE, FL, IL, IN, LA, MA, MD, ME, MI, MN, MO, MS, NC, NH, NY, OH, OK, PA, TN, VA, VT, WI; CANADA: ON, PQ.**Discussion.**- Bowles and Mathis (1989) reported this species from Arkansas as *M. musetta* which had been previously established as a junior synonym of *M. ulmerina* (Schuster 1979). It is reported here for the first time from Missouri. Adults are readily distinguished from the other regional *Molanna* by having a long furrow of short, black setae in each hindwing (Fig. 484). Males are similar to those of *M. ulmerina* but differ in subtle configurations of the genitalia (Fig. 481). Larvae have the spinous process on each protibia with the basal portion ending before the tibiotarsal junction (Fig. 476). My records are from a wide range of stream sizes, most of which have some spring

influence (Table 5). Adults were collected during the spring and late summer (Table 6).

***Molanna uniophila* Vorhies**

Figs. 477, 479, 483

Molanna uniophila Vorhies 1909:705.

Type Locality.- Wisconsin.

Regional Distribution.- Watersheds 45, 74. ARKANSAS: Washington Co., Cove Cr., 15 mi S Prairie Grove, May (Unzicker *et al.* 1970); OKLAHOMA: McCurtain Co., Mountain Fork River, US Hwy 259, 1 mi W Broken Bow, Beavers Bend State Park, 20-VI-1992, N.L. Witt and B.S. Gambill, 3 ♀♀.

Nearctic Distribution.- US: AR, IL, IN, MA, ME, MI, MN, NC, NH, NY, OH, OK, PA, TN, VA, VT, WI; CANADA: MB, NB, NF, ON, PQ.

Discussion.- I was unable to confirm the original report of this species from Arkansas by Unzicker *et al.* (1970). However, I have identified females in a collection from the Mountain Fork River in southeastern Oklahoma. Adults differ from those of *M. ulmerina* by the absence of a furrow of black setae in each hindwing. Males have the ventral margin of tergum X slightly arched (Fig. 479); females are distinguished by the dome-like posterior margin of the subgenital plate (Fig. 483). The male I have illustrated was collected 26-VIII-1937 from Put-In-Bay, Ohio; it was determined by Ross (1944) and Fuller and Wiggins in 1985, and is deposited in the INHS. Ross (1944) provided a

description of the larva, based on reared material collected from lentic habitats in Illinois. My treatment of the larva of *M. uniophila* in the key above is based on information presented by Sherberger and Wallace (1971). Larvae have the basal portion of each protibial spinous process, extending well past the tibiotarsal junction, and the apical spine is shorter than in *M. blenda* (no longer than three times its width).

**BIODIVERSITY OF CADDISFLIES (TRICHOPTERA) OF THE
INTERIOR HIGHLANDS OF NORTH AMERICA
VOLUME II**

DISSERTATION

Presented to the Graduate Council of the
University of North Texas in Partial
Fulfillment of the Requirements

For the Degree of

DOCTOR OF PHILOSOPHY

By

Stephen R. Moulton II, B.S., M.S.

Denton, Texas

August, 1994

TABLE OF CONTENTS

VOLUME I

	Page
LIST OF TABLES	vi
LIST OF FIGURES	vii
CHAPTER	
1. INTRODUCTION	1
2. MATERIALS AND METHODS	12
3. RESULTS	20
4. FAMILY BRACHYCENTRIDAE	42
5. FAMILY GLOSSOSOMATIDAE	52
6. FAMILY HELICOPSYCHIDAE	64
7. FAMILY HYDROPSYCHIDAE	72
8. FAMILY HYDROPTILIDAE	121
9. FAMILY LEPIDOSTOMATIDAE	211
10. FAMILY LEPTOCERIDAE	219
11. FAMILY LIMNEPHILIDAE	277
12. FAMILY MOLANNIDAE	299

VOLUME II

13. FAMILY ODONTOCERIDAE	306
14. FAMILY PHILOPOTAMIDAE	310
15. FAMILY PHRYGANEIDAE	323
16. FAMILY POLYCENTROPODIDAE	333
17. FAMILY PSYCHOMYIIDAE	362
18. FAMILY RHYACOPHILIDAE	369
19. FAMILY UENOIDAE	380
20. BIOGEOGRAPHY OF INTERIOR HIGHLAND TRICHOPTERA . . .	386
BIBLIOGRAPHY	398
TABLES	421
FIGURES	447

LIST OF TABLES

Table No.	Page No.
1.	Number of caddisfly species from states occupying the Interior Highland region and those peripheral to it 421
2.	List of the 131 natural watershed subdivisions of the Interior Highlands shown in Fig. 16 (modified from Poulton and Stewart 1991) 422
3.	Trichoptera species richness, number of endemic species, and percent of total (N) for each of the 17 physiographic subregions depicted in Fig. 2 423
4.	Number and percent similarity of Interior Highland caddisfly species (N=229) shared with other regions (after Poulton and Stewart 1991) in North America including Mexico and the neotropics 424
5.	Interior Highlands Trichoptera summary table, including total number of collection records (N), and associations with different physiographic subregions, stream orders, stream widths, flow permanence types, substrate types, and vegetation types. A (?) denotes unknown information. 425
6.	Seasonal presence of Interior Highland caddisfly adults. Dotted lines represent larval collections only 435

LIST OF FIGURES

Figure No.	Page No.
1.	Physiographic regions of the Eastern United States (after Ross 1965) 447
2.	Natural physiographic subregions of the Interior Highlands (modified from Poulton and Stewart 1991) 449
3.	Mean monthly water temperatures of Interior Highland streams, 1990 - 1992 451
4.	Janes Creek, in the Central Plateau subregion, Randolph Co., Arkansas. Note the dense growths of waterwillow, a common rooted aquatic macrophyte in the Interior Highlands 453
5.	A small spring creek with dense growths of watercress 453
6.	The Boston Mountains in northern Arkansas 453
7.	Pittman Creek, a "losing stream" in the Caddo River headwaters, Montgomery Co., Arkansas 453
8.	Big Spring, a high-volume spring on the Current River near Van Buren, Carter Co., Missouri 453
9.	Big Spring, a small spring seep near the town of Big Spring, Stone Co., Arkansas 453
10.	Honey Creek, an Arbuckle Mountain stream at Turner Falls, Murray Co., Oklahoma 455
11.	Typical intermittent stream in the Ozark Mountains during the summer 455
12.	North Sylamore Creek, a pristine fourth-order stream in the Ozark National Forest, Stone Co., Arkansas 455
13.	Gunner Pool at North Sylamore Creek, Stone Co., Arkansas 455

14.	Confluence of the Ouachita and Little Missouri Rivers in the Gulf Coastal Plain subregion, Ouachita Co., Arkansas	455
15.	Clear-cut forest in the Ouachita Mountains, Arkansas	455
16.	Natural watershed subdivisions of the Interior Highlands (modified from Poulton and Stewart 1991)	457
17.	Regional counties of Arkansas, Illinois, Missouri, and Oklahoma, and states peripheral to the Interior Highlands	459
18.	Distribution of species richness among the 16 caddisfly families present in the Interior Highlands	461
19.	Detrended correspondence analysis clusters of faunistically similar watersheds of the Interior Highlands based on presence or absence of regional caddisfly species	463
20.	Larval head of <i>Glyphopsyche missouri</i> , dorsal	465
21.	Larval thoracic nota and abdominal segment I of <i>Glyphopsyche missouri</i> , dorsal	465
22.	Larval head and prothorax, lateral view	465
23.	Components of the larval leg	465
24.	Prothoracic leg of larval Polycentropodidae	467
25.	Prothoracic leg of larval Psychomyiidae	467
26.	Characters of larval abdominal segments I - IV in lateral view	467
27.	A branched, larval abdominal gill	467
28.	Lateral view of head capsule of larval Lepidostomatidae	467
29.	Pro- and mesonotum of larval Uenoidae	467

30.	Larval case of <i>Helicopsyche borealis</i> (Helicopsychidae)	469
32.	Larval case of <i>Orthotrichia</i> sp (Hydroptilidae)	469
33.	Larval case of <i>Oxyethira</i> sp (Hydroptilidae)	469
31.	Larval case of <i>Agapetus illini</i> (Glossosomatidae)	469
34.	Larval case of <i>Triaenodes</i> sp (Leptoceridae)	469
35.	Larval case of <i>Nectopsyche diarina</i> (Leptoceridae)	469
36.	Larval case of <i>Molanna ulmerina</i> (Molannidae)	469
37.	Larval case of <i>Pycnopsyche lepida</i> Group (Limnephilidae)	469
38.	Larval case of <i>Lepidostoma ozarkense</i> (Lepidostomatidae)	469
39.	Lateral view of <i>Rhyacophila kiamichi</i> male (Rhyacophilidae), wings omitted	471
40.	Head and thorax of <i>Rhyacophila kiamichi</i> (dorsal)	471
41.	Fore- (top) and hindwing (bottom) venation of <i>Rhyacophila kiamichi</i> male	471
42.	Mesonotum of <i>Dibusa angata</i> (Hydroptilidae)	473
43.	Mesonotum of <i>Hydropsyche bidens</i> (Hydropsychidae)	473
44.	Mesonotum of <i>Polycentropus crassicornis</i> (Polycentropodidae) . . .	473
45.	Mesonotum of <i>Ceraclea cancellata</i> (Leptoceridae)	473
46.	Mesonotum of <i>Micrasema ozarkana</i> (Brachycentridae)	473
47.	Adult head of <i>Chimarra obscura</i> (Philopotamidae)(dorsal)	473
48.	Adult head of <i>Helicopsyche limnella</i> (Helicopsychidae)(dorsal)	473

49.	Adult head (dorsal), pro- and mesonotum of <i>Marilia flexuosa</i> (Odontoceridae)	473
50.	Maxillary palp of <i>Chimarra obscura</i> (Philopotamidae)	473
51.	Maxillary palp of <i>Rhyacophila kiamichi</i> (Rhyacophilidae)	473
52.	Maxillary palp of <i>Hydropsyche bidens</i> (Hydropsychidae)	473
53.	Maxillary palp of <i>Molanna ulmerina</i> (Molannidae)	473
54.	Hindwing of <i>Neophylax fuscus</i> (Uenoidae)	473
55.	Larval head of <i>Brachycentrus numerosus</i> , dorsal	475
56.	Larval head of <i>B. lateralis</i> , dorsal	475
57.	Metathoracic leg of <i>B. numerosus</i>	475
58.	Metathoracic leg of <i>B. lateralis</i>	475
59.	Larval head of <i>Micrasema rusticum</i> , dorsal	475
60.	Larval head of <i>M. ozarkana</i> , dorsal	475
61.	Forewing of <i>Micrasema</i> sp	477
62.	Forewing of <i>Brachycentrus</i> sp	477
63.	Male genitalia of <i>B. numerosus</i> , lateral	477
64.	Apex of tergum X of <i>B. numerosus</i> , dorsal	477
65.	Male genitalia of <i>B. lateralis</i> , lateral	477
66.	Apex of tergum X of <i>B. lateralis</i> , dorsal	477
67.	Male genitalia of <i>M. ozarkana</i> , lateral	477

68.	Apex of tergum X of <i>M. ozarkana</i> , dorsal	477
69.	Male genitalia of <i>M. rusticum</i> , lateral	477
70.	Apex of tergum X <i>M. rusticum</i> , dorsal	477
71.	Male genitalia of <i>M. wataga</i> , lateral	477
72.	Apex of tergum X of <i>M. wataga</i> , dorsal	477
73.	Larval mesonotum of <i>Agapetus</i> sp	479
74.	Larval mesonotum of <i>Protophila</i> sp	479
75.	Adult head of <i>Agapetus</i> sp., dorsal	479
76.	Adult head of <i>Glossosoma intermedium</i> , dorsal	479
77.	Male genitalia of <i>A. artesus</i> , lateral	479
78.	Inferior appendage of <i>A. artesus</i> , ventral	479
79.	Male genitalia of <i>A. medicus</i> , lateral	479
80.	Inferior appendage of <i>A. medicus</i> , ventral	479
81.	Male genitalia of <i>A. illini</i> , lateral	479
82.	Male genitalia of <i>G. intermedium</i> , lateral	479
83.	Sternite VIII of <i>P. tenebrosa</i> , ventral	481
84.	Sternite VIII of <i>P. maculata</i> , ventral	481
85.	Male genitalia of <i>P. tenebrosa</i> , lateral	481
86.	Male genitalia of <i>P. maculata</i> , lateral	481
87.	Male genitalia of <i>P. lega</i> , lateral	481

88.	Male genitalia of <i>P.</i> species A, lateral	481
89.	Male genitalia of <i>Helicopsyche borealis</i> , lateral	483
90.	Female genitalia of <i>H. borealis</i> , ventral	483
91.	Male genitalia of <i>H. limnella</i> , lateral	483
92.	Female genitalia of <i>H. limnella</i> , ventral	483
93.	Female sternite VI of <i>H. limnella</i>	483
94.	Larval head of <i>H. limnella</i> , dorsal	483
95.	Male genitalia of <i>H. piroa</i> , lateral	483
96.	Female sternite VI of <i>H. piroa</i>	483
97.	Larval head of <i>H. piroa</i> , dorsal	483
98.	Larval prosternum of <i>Hydropsyche</i> spp	485
99.	Larval prosternum of <i>Cheumatopsyche</i> spp	485
100.	Larval mandible of <i>Cheumatopsyche</i> sp., dorsal	485
101.	Dorsal abdominal setae of some <i>Hydropsyche</i> spp	485
102.	Larval mandible of <i>Potamyia flava</i> , dorsal	485
103.	Larval head of <i>P. flava</i> , ventral	485
104.	Larval abdominal sternites VIII and IX of <i>P. flava</i>	485
105.	Larval abdominal sternites VIII and IX of <i>Cheumatopsyche</i> sp	485
106.	Larval abdominal sternite VIII of <i>Smicridea fasciatella</i>	485
107.	Larval head of <i>Diplectrona modesta</i> , dorsal	487

108.	Larval head of <i>D. metaqui</i> , dorsal	487
109.	Larval head of <i>D. modesta</i> , ventral	487
110.	Larval head of <i>Macrostemum carolina</i> , dorsal	487
111.	Larval head of <i>Homoplectra doringa</i> , dorsal	487
112.	Larval foreleg of <i>M. carolina</i> , dorsal	487
113.	Forewing of <i>M. carolina</i>	489
114.	Forewing of <i>S. fasciatella</i>	489
115.	Hindwing of <i>D. modesta</i>	489
116.	Adult abdominal sternites IV - VI of <i>D. modesta</i>	489
117.	Hindwing of <i>H. doringa</i>	489
118.	Adult abdominal sternite V of <i>H. doringa</i>	489
119.	Fore- (top) and hindwing (bottom) of <i>C. robisoni</i> NEW SPECIES . . .	489
120.	Fore- (top) and hindwing (bottom) of <i>P. flava</i>	489
121.	Postero-apical margin of forewing of <i>Hydropsyche</i> sp	489
122.	Postero-apical margin of forewing of <i>Ceratopsyche</i> sp	489
123.	Adult head of <i>D. modesta</i> , dorsal	491
124.	Adult head of <i>D. metaqui</i> , dorsal	491
125.	Adult head of <i>H. betteni</i> , dorsal	491
126.	Adult head of <i>H. doringa</i> , dorsal	491
127.	Larval head of <i>Ceratopsyche morosa</i> , dorsal	491

128.	Larval head of <i>C. piatrix</i> , dorsal (redrawn from Schuster and Etnier 1978)	491
129.	Larval head of <i>C. slossonae</i> , dorsal	491
130.	Male genitalia of <i>C. piatrix</i> , lateral	493
131.	Phallus of <i>C. piatrix</i> , lateral	493
132.	Male genitalia of <i>C. slossonae</i> , lateral	493
133.	Phallus of <i>C. slossonae</i> , lateral	493
134.	Phallus of <i>C. cheilonis</i> , lateral	493
135.	Male genitalia of <i>C. bronta</i> , lateral	493
136.	Phallus of <i>C. bronta</i> , lateral	493
137.	Male genitalia of <i>C. morosa</i> , lateral	493
138.	Phallus of <i>C. morosa</i> , east-central form, lateral	493
139.	Phallus of <i>C. morosa</i> , west-central form, lateral	493
140.	Male genitalia of <i>Cheumatopsyche sordida</i> , lateral	495
141.	Male tergum X of <i>C. sordida</i> , caudal	495
142.	Male genitalia of <i>C. minuscula</i> , lateral	495
143.	Male tergum X of <i>C. minuscula</i> , caudal	495
144.	Male genitalia of <i>C. comis</i> , lateral	495
145.	Male tergum X of <i>C. comis</i> , caudal	495
146.	Male genitalia of <i>C. harwoodi enigma</i> , lateral	495

147.	Male tergum X of <i>C. harwoodi</i> <i>enigma</i> , caudal	495
148.	Male genitalia of <i>C. rossi</i> , holotype, lateral	495
149.	Male tergum X of <i>C. rossi</i> , holotype, caudal	495
150.	Male genitalia of <i>C. robisoni</i> NEW SPECIES, lateral	495
151.	Male inferior appendage of <i>C. robisoni</i> NEW SPECIES, caudal	495
152.	Male tergum X of <i>C. robisoni</i> NEW SPECIES, caudal	495
153.	Male genitalia of <i>C. speciosa</i> , lateral	497
154.	Male tergum X of <i>C. speciosa</i> , caudal	497
155.	Male genitalia of <i>C. pettiti</i> , lateral	497
156.	Male tergum X of <i>C. pettiti</i> , caudal	497
157.	Male genitalia of <i>C. pasella</i> , lateral	497
158.	Male tergum X of <i>C. pasella</i> , caudal	497
159.	Male genitalia of <i>C. lasia</i> , lateral	497
160.	Male tergum X of <i>C. lasia</i> , caudal	497
161.	Male genitalia of <i>C. campyla</i> , lateral	497
162.	Male tergum X of <i>C. campyla</i> , caudal	497
163.	Male genitalia of <i>C. burksi</i> , lateral	497
164.	Male tergum X of <i>C. burksi</i> , caudal	497
165.	Male genitalia of <i>C. gracilis</i> , lateral	499
166.	Male tergum X of <i>C. gracilis</i> , caudal	499

167.	Male genitalia of <i>C. halima</i> , lateral	499
168.	Male tergum X of <i>C. halima</i> , caudal	499
169.	Male genitalia of <i>C. aphantia</i> , lateral	499
170.	Male tergum X of <i>C. aphantia</i> , caudal	499
171.	Male genitalia of <i>C. oxa</i> , lateral	499
172.	Male tergum X of <i>C. oxa</i> , caudal	499
173.	Male inferior appendage of <i>C. oxa</i> , caudal	499
174.	Larval head of <i>Hydropsyche orris</i> , dorsal	501
175.	Larval head of <i>H. orris</i> , lateral	501
176.	Larval head of <i>H. bidens</i> , dorsal	501
177.	Larval head of <i>H. scalaris</i> , dorsal	501
178.	Left side of abdominal sternite IX and anal proleg of <i>H. scalaris</i> , ventral	501
179.	Larval head of <i>H. betteni</i> , lateral	501
180.	Larval head of <i>H. simulans</i> , dorsal	501
181.	Male genitalia of <i>H. arinale</i> , lateral	503
182.	Phallus of <i>H. arinale</i> , ventral	503
183.	Phallus of <i>H. arinale</i> , lateral	503
184.	Male genitalia of <i>H. rossi</i> , lateral	503
185.	Phallus of <i>H. rossi</i> , ventral	503

186.	Phallus of <i>H. rossi</i> , lateral	503
187.	Male genitalia of <i>H. simulans</i> , lateral	503
188.	Phallus of <i>H. simulans</i> , lateral	503
189.	Male genitalia of <i>H. orris</i> , lateral	503
190.	Phallus of <i>H. orris</i> , ventral	503
191.	Male genitalia of <i>H. scalaris</i> , lateral	503
192.	Phallus of <i>H. scalaris</i> , ventral	503
193.	Phallus of <i>H. scalaris</i> , lateral	503
194.	Phallus of <i>H. bidens</i> , lateral	503
195.	Phallus of <i>H. bidens</i> , ventral	503
196.	Phallus of <i>H. alvata</i> , ventral	503
197.	Phallus of <i>H. betteni</i> , lateral	503
198.	Male genitalia of <i>Macrostemum carolina</i> , lateral	505
199.	Male tergum X of <i>M. carolina</i> , dorsal	505
200.	Male genitalia of <i>H. doringa</i> , lateral	505
201.	Male genitalia of <i>D. modesta</i> , lateral	505
202.	Male genitalia of <i>S. fasciatella</i> , lateral	505
203.	Male genitalia of <i>P. flava</i> , lateral	505
204.	Larval habitus of <i>L. pictipes</i> , dorsal	507
205.	Larval legs of <i>Oxyethira</i> sp., dorsal	507

206.	Posterior end of larval abdomen of <i>Hydroptila</i> sp., dorsal	507
207.	Larval prothoracic leg of <i>Dibusa angata</i> , dorsal	507
208.	Larval mesonotum of <i>Hydroptila</i> sp., lateral	507
209.	Larval mesonotum of <i>Ochrotrichia</i> sp., lateral	507
210.	Larval head of <i>Mayatrichia</i> sp., dorsal	507
211.	Dorsal abdominal seta of larval <i>D. angata</i>	507
212.	Larval habitus of <i>Ithytrichia clavata</i> , lateral	507
213.	Male genitalia of <i>D. angata</i> , lateral	509
214.	Phallus of <i>I. clavata</i> (redrawn from Ross 1944)	509
215.	Male genitalia of <i>I. clavata</i> , ventral (redrawn from Ross 1944)	509
216.	Male genitalia of <i>I. mazon</i> , ventral (redrawn from Ross 1944)	509
217.	Male genitalia of <i>M. ayama</i> , lateral (redrawn from Ross 1944)	509
218.	Male genitalia of <i>L. pictipes</i> , lateral (redrawn from Flint 1972)	509
219.	Male genitalia of <i>M. ponta</i> , lateral (redrawn from Ross 1944)	509
220.	Male genitalia of <i>H. virgata</i> , lateral (redrawn from Ross 1944)	511
221.	Male abdominal sternite VII process of <i>H. virgata</i> , lateral (redrawn from Ross 1944)	511
222.	Phallus of <i>H. virgata</i> (redrawn from Ross 1944)	511
223.	Phallus of <i>H. hamata</i> (redrawn from Ross 1944)	511
224.	Male abdominal sternite VII process of <i>H. hamata</i> , lateral (redrawn from Ross 1944)	511

225.	Male genitalia of <i>H. artesa</i> , lateral (redrawn from Mathis and Bowles 1990)	511
226.	Male tergum X of <i>H. artesa</i> , dorsal (redrawn from Mathis and Bowles 1990)	511
227.	Phallus of <i>H. artesa</i> (redrawn from Mathis and Bowles 1990)	511
228.	Male tergum X of <i>H. oneili</i> , dorsal (redrawn from Harris 1985)	511
229.	Phallus of <i>H. remita</i>	511
230.	Male tergum X of <i>H. sandersoni</i> , dorsal (redrawn from Mathis and Bowles 1990)	511
231.	Male genitalia of <i>H. sandersoni</i> , lateral (redrawn from Mathis and Bowles 1990)	511
232.	Phallus of <i>H. sandersoni</i> (redrawn from Mathis and Bowles 1990)	511
233.	Male tergum X of <i>H. amoena</i> , dorsal (redrawn from Harris 1985)	511
234.	Male genitalia of <i>H. spatulata</i> , lateral (redrawn from Ross 1944)	513
235.	Apex of phallus of <i>H. spatulata</i> (redrawn from Ross 1944)	513
236.	Male genitalia of <i>H. armata</i> , lateral (redrawn from Ross 1944)	513
237.	Apex of phallus of <i>H. armata</i> , lateral (redrawn from Ross 1944)	513
238.	Male genitalia of <i>H. vala</i> , lateral (redrawn from Ross 1944)	513
239.	Male genitalia of <i>H. grandiosa</i> , lateral (redrawn from Ross 1944)	513
240.	Male genitalia of <i>H. delineata</i> , ventral (redrawn from Ross 1944)	513
241.	Male genitalia of <i>H. waubesiana</i> , ventral (redrawn from Ross 1944)	513
242.	Phallus of <i>H. quinola</i> (redrawn from Ross 1947)	515

243.	Male genitalia of <i>H. quinola</i> , ventral (redrawn from Ross 1947)	515
244.	Male genitalia of <i>H. broweri</i> , ventral (redrawn from Blickle 1963)	515
245.	Phallus of <i>H. broweri</i> (redrawn from Blickle 1963)	515
246.	Phallus of <i>H. scolops</i> (redrawn from Ross 1944)	515
247.	Male genitalia of <i>H. scolops</i> (redrawn from Ross 1944)	515
248.	Inferior appendages of <i>H. bernerii</i> , ventral (redrawn from Ross 1941b)	515
249.	Phallus of <i>H. bernerii</i> (redrawn from Ross 1941b)	515
250.	Phallus of <i>H. strepha</i> (redrawn from Ross 1941b)	515
251.	Inferior appendages of <i>H. strepha</i> , ventral (redrawn from Ross 1941b)	515
252.	Male genitalia of <i>H. melia</i> , lateral (redrawn from Ross 1938a)	517
253.	Male tergum X of <i>H. melia</i> , dorsal (redrawn from Ross 1938a)	517
254.	Phallus of <i>H. melia</i> (redrawn from Ross 1938a)	517
255.	Male genitalia of <i>H. tusculum</i> , lateral (redrawn from Ross 1947)	517
256.	Male genitalia of <i>H. tusculum</i> , ventral (redrawn from Ross 1947)	517
257.	Male genitalia of <i>H. albicornis</i> , lateral (redrawn from Ross 1944)	517
258.	Inferior appendages of <i>H. albicornis</i> , ventral (redrawn from Ross 1944)	517
259.	Phallus of <i>H. albicornis</i> (redrawn from Ross 1944)	517
260.	Inferior appendages of <i>H. angusta</i> , ventral (redrawn from Ross 1944)	517

261.	Phallus of <i>H. angusta</i> (redrawn from Ross 1944)	517
262.	Male genitalia of <i>H. consimilis</i> , ventral (redrawn from Ross 1944) . .	519
263.	Phallus of <i>H. consimilis</i> (redrawn from Ross 1944)	519
264.	Male tergum X of <i>H. protera</i> , dorsal (redrawn from Ross 1938a) . . .	519
265.	Phallus of <i>H. protera</i> (redrawn from Ross 1938a)	519
266.	Male tergum X of <i>H. perdita</i> , dorsal (redrawn from Ross 1944)	519
267.	Inferior appendages of <i>H. perdita</i> , ventral, (redrawn from Ross 1944)	519
268.	Phallus of <i>H. perdita</i> , (redrawn from Ross 1944)	519
269.	Male genitalia of <i>H. ajax</i> , lateral, (redrawn from Ross 1944)	519
270.	Phallus of <i>H. ajax</i> , (redrawn from Ross 1944)	519
271.	Inferior appendages of <i>H. ajax</i> , ventral, (redrawn from Ross 1944) . .	519
272.	Inferior appendages of <i>H. icona</i> , ventral, (redrawn from Ross 1944)	519
273.	Male genitalia of <i>Neotrichia kitae</i> , lateral, (redrawn from Ross 1944)	521
274.	Male genitalia of <i>N. kitae</i> , ventral, (redrawn from Ross 1944)	521
275.	Male genitalia of <i>N. collata</i> , ventral, (redrawn from Ross 1944)	521
276.	Phallus of <i>N. collata</i> , (redrawn from Ross 1944)	521
277.	Phallus of <i>N. riegeli</i> , (redrawn from Ross 1944)	521
278.	Male genitalia of <i>N. riegeli</i> , ventral, (redrawn from Ross 1944)	521

279.	Male genitalia of <i>N. okopa</i> , ventral, (redrawn from Ross 1944)	521
280.	Phallus of <i>N. arkansasensis</i> , (redrawn from Mathis and Bowles 1990)	521
281.	Male genitalia of <i>N. arkansasensis</i> , ventral, (redrawn from Mathis and Bowles 1990)	521
282.	Male genitalia of <i>N. minutisimella</i> , lateral, (redrawn from Ross 1944)	523
283.	Inferior appendages of <i>N. minutisimella</i> , ventral, (redrawn from Ross 1944)	523
284.	Male genitalia of <i>N. vibrans</i> , ventral, (redrawn from Ross 1944)	523
285.	Phallus of <i>N. vibrans</i> , (redrawn from Ross 1944)	523
286.	Phallus of <i>N. edalis</i> , (redrawn from Ross 1944)	523
287.	Male genitalia of <i>N. edalis</i> , ventral, (redrawn from Ross 1944)	523
288.	Male genitalia of <i>Ochrotrichia (Metrichia) nigritta</i> , lateral	525
289.	Phallus of <i>O. (M.) nigritta</i>	525
290.	Male genitalia of <i>O. xena</i> , dorsal	525
291.	Male genitalia of <i>O. unio</i> , dorsal	525
292.	Male tergum X of <i>O. weddleae</i> , dorsal	525
293.	Male genitalia of <i>O. weddleae</i> , lateral	525
294.	Male genitalia of <i>O. robisoni</i> , lateral, (redrawn from Frazier and Harris 1991)	525
295.	Male tergum X of <i>O. robisoni</i> , dorsal, (redrawn from Frazier and Harris 1991)	525

296.	Male tergum X of <i>O. contorta</i> , dorsal, (redrawn from Frazier and Harris 1991)	525
297.	Male tergum X of <i>O. anisca</i> , dorsal, (redrawn from Frazier and Harris 1991)	525
298.	Male tergum X of <i>O. shawnee</i> , dorsal, (redrawn from Frazier and Harris 1991)	525
299.	Male tergum X of <i>O. tarsalis</i> , dorsal, (redrawn from Frazier and Harris 1991)	525
300.	Male tergum X of <i>O. stylata</i> , dorsal, (redrawn from Ross 1938a) . . .	525
301.	Male genitalia of <i>O. riesi</i> , dorsal, (redrawn from Ross 1944)	527
302.	Inferior appendages of <i>O. riesi</i> , ventral, (redrawn from Ross 1944) .	527
303.	Male genitalia of <i>O. spinosa</i> , dorsal, (redrawn from Ross 1944) . . .	527
304.	Inferior appendages of <i>O. spinosa</i> , ventral, (redrawn from Ross 1944)	527
305.	Male genitalia of <i>O. eliaga</i> , dorsal, (redrawn from Ross 1944)	527
306.	Inferior appendages of <i>O. eliaga</i> , ventral, (redrawn from Ross 1944)	527
307.	Male genitalia of <i>O. arva</i> , dorsal, (redrawn from Ross 1944)	527
308.	Inferior appendages of <i>O. arva</i> , ventral, (redrawn from Ross 1944) .	527
309.	Male genitalia of <i>Oxyethira azteca</i> , ventral, (redrawn from Kelley 1982)	529
310.	Male genitalia of <i>O. azteca</i> , lateral, (redrawn from Kelley 1982)	529
311.	Male genitalia of <i>O. janella</i> , ventral, (redrawn from Kelley 1982) . . .	529

312.	Male genitalia of <i>O. janella</i> , lateral, (redrawn from Kelley 1982)	529
313.	Male genitalia of <i>O. pallida</i> , lateral, (redrawn from Kelley 1982)	529
314.	Phallus of <i>O. pallida</i> , (redrawn from Kelley 1982)	529
315.	Male genitalia of <i>O. novasota</i> , lateral, (redrawn from Kelley 1982) . .	531
316.	Phallus of <i>O. novasota</i> , (redrawn from Kelley 1982)	531
317.	Male genitalia of <i>O. rivicola</i> , lateral, (redrawn from Kelley 1982) . . .	531
318.	Phallus of <i>O. rivicola</i> , (redrawn from Kelley 1982)	531
319.	Male genitalia of <i>O. coercens</i> , lateral, (redrawn from Kelley 1982) . .	531
320.	Phallus of <i>O. coercens</i> , (redrawn from Kelley 1982)	531
321.	Male genitalia of <i>O. aculea</i> , lateral, (redrawn from Kelley 1982)	531
322.	Phallus of <i>O. aculea</i> , (redrawn from Kelley 1982)	531
323.	Male genitalia of <i>O. glasa</i> , lateral, (redrawn from Kelley 1982)	533
324.	Phallus of <i>O. glasa</i> , (redrawn from Kelley 1982)	533
325.	Male genitalia of <i>O. zeronia</i> , lateral, (redrawn from Kelley 1982) . . .	533
326.	Phallus of <i>O. zeronia</i> , (redrawn from Kelley 1982)	533
327.	Male genitalia of <i>O. forcipata</i> , lateral, (redrawn from Kelley 1982) . .	533
328.	Phallus of <i>O. forcipata</i> , (redrawn from Kelley 1982)	533
329.	Male genitalia of <i>O. dualis</i> , lateral, (redrawn from Kelley 1982)	533
330.	Phallus of <i>O. dualis</i> , (redrawn from Kelley 1982)	533
331.	Male genitalia of <i>Orthotrichia cristata</i> , ventral,	535

332.	Male genitalia of <i>O. aegerfasciella</i> , ventral, (redrawn from Ross 1944)	535
333.	Male genitalia of <i>O. instabilis</i> , ventral	535
334.	Male genitalia of <i>Paucicalcaria ozarkensis</i> , lateral, (redrawn from Mathis and Bowles 1989)	535
335.	Male genitalia of <i>Stactobiella palmata</i> , ventral	535
336.	Bracteole of <i>S. palmata</i> , lateral	535
337.	Male genitalia of <i>S. delira</i> , ventral	535
338.	Male genitalia of <i>Lepidostoma libum</i> , lateral	537
339.	Male genitalia of <i>L. lescheni</i> , lateral, (redrawn from Bowles <i>et al.</i> 1994)	537
340.	Head of adult male <i>L. lescheni</i> , lateral, (redrawn from Bowles <i>et al.</i> 1994)	537
341.	Head of adult male <i>L. griseum</i> , lateral	537
342.	Male genitalia of <i>L. griseum</i> , lateral	537
343.	Male genitalia of <i>L. carrolli</i> , lateral	537
344.	Male genitalia of <i>L. ozarkense</i> , lateral	537
345.	Male genitalia of <i>L. togatum</i> , lateral	537
346.	Larval mesothoracic leg of <i>Leptocerus americanus</i> , posterior	539
347.	Larval metathoracic leg of <i>Nectopsyche diarina</i> , posterior	539
348.	Larval metathoracic leg of <i>Mystacides sepulchralis</i> , posterior	539
349.	Larval head of <i>Oecetis</i> sp., dorsal	539

350.	Larval head of <i>N. diarina</i> , dorsal	539
351.	Anal region of larval <i>Setodes oxapius</i> , ventrocaudal	539
352.	Larval head of <i>M. sepulchralis</i> , ventral	539
353.	Larval head of <i>N. diarina</i> , ventral	539
354.	Forewing of male <i>Triaenodes dipsius</i>	541
355.	Forewing of male <i>O. inconspicua</i>	541
356.	Forewing of male <i>Ceraclea maccalmonti</i>	541
357.	Head of male <i>C. maccalmonti</i> , dorsal	541
358.	Head of male <i>M. sepulchralis</i> , dorsal	541
359.	Mesopleuron of <i>C. maccalmonti</i>	541
360.	Mesopleuron of <i>N. exquisita</i>	541
361.	Larval head, pro- and mesonotum of <i>C. transversa</i> , (redrawn from Resh 1976a)	543
362.	Anal proleg of <i>C. punctata</i> , lateral, (redrawn from Resh 1976a)	543
363.	Larval mesonotum of <i>C. cancellata</i> , (redrawn from Resh 1976a)	543
364.	Larval mesonotum of <i>C. maculata</i> , (redrawn from Resh 1976a)	543
365.	Larval case of <i>C. maccalmonti</i> (from Moulton and Stewart 1992)	543
366.	Larval head, pro- and mesonotum of <i>C. maccalmonti</i> , (modified from Moulton and Stewart 1992)	543
367.	Larval mesonotum of <i>C. ancylus</i> , (redrawn from Resh 1976a)	543
368.	Larval mesonotum of <i>C. flava</i> , (redrawn from Resh 1976a)	543

369.	Larval case of <i>C. flava</i>	543
370.	Male genitalia of <i>C. flava</i> , lateral	545
371.	Inferior appendages of <i>C. flava</i> , ventral	545
372.	Inferior appendages of <i>C. ancylus</i> , ventral	545
373.	Male genitalia of <i>C. ancylus</i> , lateral	545
374.	Male genitalia of <i>C. maccalmonti</i> , lateral	545
375.	Inferior appendage of <i>C. maccalmonti</i> , caudal	545
376.	Male genitalia of <i>C. nepha</i> , lateral	545
377.	Male genitalia of <i>C. protonepha</i> , lateral	545
378.	Phallus of <i>C. protonepha</i> , lateral	545
379.	Male genitalia of <i>C. tarsipunctata</i> , lateral	545
380.	Phallus of <i>C. tarsipunctata</i> , lateral	545
381.	Male genitalia of <i>C. transversus</i> , lateral	545
382.	Inferior appendage of <i>C. transversus</i> , caudal	547
383.	Male tergum X of <i>C. transversus</i> , dorsal	547
384.	Male genitalia of <i>C. resurgens</i> , lateral	547
385.	Inferior appendage of <i>C. resurgens</i> , caudal	547
386.	Male genitalia of <i>C. punctata</i> , lateral	547
387.	Male genitalia of <i>C. maculata</i> , lateral	547
388.	Male genitalia of <i>C. cancellata</i> , lateral	547

389.	Male genitalia of <i>C. ophioderus</i> , lateral	547
390.	Male genitalia of <i>Nectopsyche candida</i> , lateral	549
391.	Male sternite IX processes of <i>N. candida</i> , ventral	549
392.	Male genitalia of <i>N. exquisita</i> , lateral	549
393.	Forewing of <i>N. exquisita</i>	549
394.	Male genitalia of <i>N. pavidata</i> , lateral	549
395.	Male genitalia of <i>N. diarina</i> , lateral	549
396.	Male genitalia of <i>N. spiloma</i> , lateral	549
397.	Male head of <i>N. diarina</i> , ventral	549
398.	Male head of <i>N. spiloma</i> , ventral	549
399.	Male genitalia of <i>Oecetis ouachita</i> , lateral	551
400.	Male genitalia of <i>O. ozarkensis</i> , lateral	551
401.	Male genitalia of <i>O. eddiestoni</i> , lateral	551
402.	Male genitalia of <i>O. persimilis</i> , lateral	551
403.	Phallus of <i>O. persimilis</i> , lateral	551
404.	Male genitalia of <i>O. osteni</i> , lateral	551
405.	Male genitalia of <i>O. cinerascens</i> , lateral	551
406.	Inferior appendages of <i>O. cinerascens</i> , ventral	551
407.	Male genitalia of <i>O. avara</i> , lateral	551
408.	Male genitalia of <i>O. inconspicua</i> , lateral	553

409.	Phallus of <i>O. inconspicua</i> , lateral	553
410.	Inferior appendages of <i>O. inconspicua</i> , ventral	553
411.	Male genitalia of <i>O. ditissa</i> , lateral	553
412.	Phallus of <i>O. ditissa</i> , lateral	553
413.	Inferior appendages of <i>O. ditissa</i> , ventral	553
414.	Male genitalia of <i>O. nocturna</i> , lateral	553
415.	Inferior appendages of <i>O. nocturna</i> , ventral	553
416.	Male genitalia of <i>Leptocerus americanus</i> , lateral	555
417.	Male genitalia of <i>Mystacides sepulchralis</i> , lateral	555
418.	Male sternite IX of <i>M. sepulchralis</i>	555
419.	Male genitalia of <i>Setodes oxapius</i> , lateral	555
420.	Male genitalia of <i>S. oxapius</i> , variant, lateral	555
421.	Male genitalia of <i>Triaenodes smithi</i> , lateral, (redrawn from Ross 1959)	555
422.	Male genitalia of <i>T. ignitus</i> , lateral	557
423.	Male genitalia of <i>T. injustus</i> , lateral	557
424.	Male tergum X of <i>T. injustus</i>	557
425.	Male genitalia of <i>T. tridontus</i> , lateral	557
426.	Male genitalia of <i>T. abus</i> , lateral	557
427.	Male genitalia of <i>T. nox</i> , lateral	557

428.	Male genitalia of <i>T. ochraceus</i> , lateral	557
429.	Male genitalia of <i>T. pernus</i> , lateral	557
430.	Male genitalia of <i>T. melacus</i> , lateral	559
431.	Male genitalia of <i>T. flavescens</i> , lateral	559
432.	Male tergum X of <i>T. flavescens</i>	559
433.	Male genitalia of <i>T. dipsius</i> , lateral	559
434.	Male genitalia of <i>T. tardus</i> , lateral	559
435.	Male tergum X of <i>T. tardus</i>	559
436.	Male genitalia of <i>T. cumberlandensis</i> , lateral	559
437.	Male tergum X of <i>T. cumberlandensis</i>	559
438.	Male genitalia of <i>T. marginatus</i> , lateral	559
439.	Male tergum X of <i>T. marginatus</i>	559
440.	Forewing of male <i>Platycentropus radiatus</i>	561
441.	Forewing of male <i>Frenesia missa</i>	561
442.	Forewing of male <i>Glyphopsyche missouri</i>	561
443.	Forewing of male <i>Ironoquia punctatissima</i>	561
444.	Forewing of male <i>Pseudostenophylax uniformis</i>	561
445.	Forewing of male <i>Limnephilus submonilifer</i>	561
446.	Forewing of male <i>P. guttifer</i>	561
447.	Forewing of male <i>P. rossi</i>	561

448.	Forewing of male <i>P. lepida</i>	561
449.	Forewing of male <i>P. indiana</i>	561
450.	Forewing of male <i>P. subfasciata</i>	561
451.	Male genitalia of <i>P. radiatus</i> , lateral	563
452.	Phallus of <i>P. radiatus</i> , lateral	563
453.	Male genitalia of <i>F. missa</i> , lateral	563
454.	Phallus of <i>F. missa</i> , lateral	563
455.	Male genitalia of <i>G. missouri</i> , lateral	563
456.	Phallus of <i>G. missouri</i> , lateral	563
457.	Male genitalia of <i>I. punctatissima</i> , lateral	565
458.	Male genitalia of <i>I. kaskaskia</i> , lateral	565
459.	Male genitalia of <i>P. uniformis</i> , lateral	565
460.	Phallus of <i>P. uniformis</i> , lateral	565
461.	Male genitalia of <i>L. submonilifer</i> , lateral	565
462.	Phallus of <i>L. submonilifer</i> , lateral	565
463.	Male genitalia of <i>P. guttifer</i> , lateral	567
464.	Inferior appendage of <i>P. guttifer</i> , caudal	567
465.	Tergum VIII of male <i>P. rossi</i> , lateral	567
466.	Inferior appendage of <i>P. rossi</i> , caudal	567
467.	Inferior appendage of <i>P. scabripennis</i> , caudal	567

468.	Tergum VIII of male <i>P. lepida</i> , dorsal	567
469.	Inferior appendage of <i>P. lepida</i> , caudal	567
470.	Phallus of <i>P. lepida</i> , lateral	567
471.	Phallus of <i>P. indiana</i> , lateral	567
472.	Phallus of <i>P. subfasciata</i> , lateral	567
473.	Inferior appendage of <i>P. subfasciata</i> , caudal	567
474.	Male genitalia of <i>P. subfasciata</i> , lateral	567
475.	Larval head of <i>Molanna ulmerina</i> , dorsal	569
476.	Larval prothoracic leg of <i>M. ulmerina</i>	569
477.	Larval head of <i>M. uniophila</i> , dorsal	569
478.	Larval prothoracic leg of <i>M. blenda</i>	569
479.	Male genitalia of <i>M. uniophila</i> , lateral	569
480.	Male genitalia of <i>M. blenda</i> , lateral	569
481.	Male genitalia of <i>M. ulmerina</i> , lateral	569
482.	Subgenital plate of female <i>M. blenda</i> , ventral	569
483.	Subgenital plate of female <i>M. uniophila</i> , ventral	569
484.	Hindwing of <i>M. ulmerina</i> , dorsal	569
485.	Male genitalia of <i>Marilia flexuosa</i> , lateral	571
486.	Phallus of <i>M. flexuosa</i> , lateral	571
487.	Forewing of male <i>M. flexuosa</i> , dorsal	571

488.	Larval head of <i>M. flexuosa</i> , dorsal	571
489.	Larval head of <i>M. sp. A</i> , dorsal	571
490.	Larval head of <i>M. sp. A</i> , ventral	571
491.	Larval thorax of <i>M. sp. A</i> , dorsal	571
492.	Larval case of <i>M. sp. A</i>	571
493.	Larval head of <i>Chimarra sp.</i> , dorsal	573
494.	Larval head of <i>Wormaldia sp.</i> , dorsal	573
495.	Hindwing of <i>Chimarra sp</i>	573
496.	Hindwing of <i>Wormaldia sp</i>	573
497.	Male genitalia of <i>C. obscura</i> , lateral	573
498.	Male genitalia of <i>C. feria</i> , lateral	573
499.	Inferior appendage of <i>C. feria</i> , caudal	573
500.	Male genitalia of <i>C. aterrima</i> , lateral	573
501.	Inferior appendage of <i>C. aterrima</i> , caudal	573
502.	Male genitalia of <i>C. parasocia</i> , lateral	575
503.	Dorsal phallic rod of <i>C. parasocia</i> , lateral	575
504.	Male genitalia of <i>C. socia</i> , lateral	575
505.	Dorsal phallic rod of <i>C. socia</i> , lateral	575
506.	Male genitalia of <i>C. moselyi</i> , lateral	575
507.	Phallus of <i>C. moselyi</i> , dorsal	575

508.	Male genitalia of <i>W. moesta</i> , lateral	575
509.	Male genitalia of <i>W. strota</i> , lateral	575
510.	Male tergum X of <i>W. strota</i> , dorsal	575
511.	Male genitalia of <i>W. shawnee</i> , lateral	575
512.	Male tergum X of <i>W. shawnee</i> , dorsal	575
513.	Male genitalia of <i>Agrypnia vestita</i> , lateral	577
514.	Phallus of <i>A. vestita</i> , lateral	577
515.	Male genitalia of <i>Phryganea sayi</i> , lateral	577
516.	Phallus of <i>P. sayi</i> , lateral	577
517.	Male genitalia of <i>Ptilostomis ocellifera</i> , lateral	577
518.	Phallus of <i>P. ocellifera</i> , lateral	577
519.	Male genitalia of <i>P. postica</i> , lateral	577
520.	Phallus of <i>P. postica</i> , lateral	577
521.	Anteroapical margin of female forewing of <i>P. postica</i>	579
522.	Anteroapical margin of female forewing of <i>A. vestita</i>	579
523.	Vaginal apparatus of <i>P. ocellifera</i> , lateral	579
524.	Vaginal apparatus of <i>P. postica</i> , lateral	579
525.	Female genitalia of <i>P. sayi</i> , ventral	579
526.	Female genitalia of <i>A. vestita</i> , ventral	579
527.	Larval head of <i>Neureclipsis crepuscularis</i> , dorsal	581

528.	Larval anal proleg of <i>N. crepuscularis</i> , lateral	581
529.	Larval anal claw of <i>Nyctiophylax</i> sp., lateral	581
530.	Larval anal proleg of <i>Cyrnellus fraternus</i> , dorsal	581
531.	Larval anal proleg of <i>Polycentropus</i> sp., dorsal	581
532.	Larval anal proleg of <i>Polycentropus</i> sp., lateral	581
533.	Larval anal proleg of <i>P. crassicornis</i> , lateral	581
534.	Larval head and pronotum of <i>P. crassicornis</i> , dorsal	581
535.	Forewing of male <i>Phylocentropus placidus</i>	583
536.	Male genitalia of <i>P. placidus</i> , lateral	583
537.	Inferior appendage of <i>P. placidus</i> , caudal	583
538.	Fore- and hindwing of <i>P. centralis</i>	583
539.	Hindwing of <i>P. harpi</i>	583
540.	Hindwing of <i>N. crepuscularis</i>	583
541.	Maxillary palpus of <i>C. fraternus</i> , lateral	583
542.	Maxillary palpus of <i>N. affinis</i> , lateral	583
543.	Male genitalia of <i>P. nascotius</i> , lateral, (redrawn from Ross 1941) . . .	583
544.	Male genitalia of <i>Cernotina calcea</i> , lateral	585
545.	Male genitalia of <i>C. spicata</i> , lateral	585
546.	Male genitalia of <i>C. oklahoma</i> , lateral	585
547.	Male genitalia of <i>C. fraternus</i> , lateral	585

548.	Inferior appendage of <i>C. fraternus</i> , caudal	585
549.	Male genitalia of <i>N. crepuscularis</i> , lateral	585
550.	Male genitalia of <i>N. serratus</i> , lateral	585
551.	Posteroapical margin of tergum X of male <i>N. serratus</i> , lateral	585
552.	Male genitalia of <i>N. affinis</i> , lateral	585
553.	Inferior appendage of <i>N. affinis</i> , caudal	585
554.	Male genitalia of <i>N. moestus</i> , lateral, (redrawn from Morse 1972)	585
555.	Inferior appendage of <i>N. moestus</i> , caudal, (redrawn from Morse 1972)	585
556.	Dorsobasal process of inferior appendage of <i>P. centralis</i> , caudal	587
557.	Dorsobasal process of inferior appendage of <i>P. stephani</i> , caudal	587
558.	Male genitalia of <i>P. chelatus</i> , lateral	587
559.	Phallus of <i>P. chelatus</i> , lateral	587
560.	Male genitalia of <i>P. stephani</i> , lateral, paratype	587
561.	Phallus of <i>P. stephani</i> , lateral, paratype	587
562.	Male genitalia of <i>P. confusus</i> , lateral	587
563.	Phallus of <i>P. confusus</i> , lateral	587
564.	Male genitalia of <i>P. centralis</i> , lateral	587
565.	Phallus of <i>P. centralis</i> , lateral	587
566.	Male genitalia of <i>P. crassicornis</i> , lateral	587

567.	Male genitalia of <i>P. cinereus</i> , lateral	587
568.	Phallus of <i>P. cinereus</i> , dorsal	587
569.	Phallus of <i>P. harpi</i> , dorsal, paratype	587
570.	Male genitalia of <i>P. harpi</i> , lateral, paratype	587
571.	Larval habitus of <i>Paduniella nearctica</i> , dorsal	589
572.	Larval head of <i>Psychomyia flavida</i> , dorsal	589
573.	Adult maxillary palpus of male <i>P. nearctica</i> , lateral	589
574.	Hindwing of <i>P. flavida</i>	589
575.	Hindwing of <i>Lype diversa</i>	589
576.	Male genitalia of <i>P. flavida</i> , lateral	589
577.	Male tergum X of <i>P. flavida</i> , caudal	589
578.	Male genitalia of <i>L. diversa</i> , lateral	589
579.	Male genitalia of <i>P. nearctica</i> , lateral	589
580.	Larval head of <i>Rhyacophila glaberimma</i> , dorsal	591
581.	Larval maxillary palpus of <i>R. glaberimma</i>	591
582.	Larval head of <i>R. lobifera</i> , dorsal	591
583.	Larval anal claw of <i>R. lobifera</i> , lateral	591
584.	Larval head of <i>R. banksi</i> , dorsal	591
585.	Larval anal claw of <i>R. banksi</i> , lateral	591
586.	Larval head of <i>R. fenestra</i> , dorsal	591

587.	Larval maxillary palpus of <i>R. fenestra</i>	591
588.	Larval head of <i>R. kiamichi</i> , dorsal	591
589.	Male genitalia of <i>R. glaberimma</i> , lateral	593
590.	Phallus of <i>R. glaberimma</i> , lateral	593
591.	Male genitalia of <i>R. lobifera</i> , lateral	593
592.	Phallus of <i>R. lobifera</i> , lateral	593
593.	Male genitalia of <i>R. banksi</i> , lateral	593
594.	Male genitalia of <i>R. kiamichi</i> , lateral	593
595.	Phallus of <i>R. kiamichi</i> , lateral	593
596.	Male genitalia of <i>R. fenestra</i> , lateral	593
597.	Phallus of <i>R. fenestra</i> , lateral	593
598.	Male genitalia of <i>R. ledra</i> , lateral	595
599.	Phallus of <i>R. ledra</i> , lateral	595
600.	Female sternite VIII of <i>R. lobifera</i>	595
601.	Female sternite VIII of <i>R. glaberimma</i>	595
602.	Female sternite VIII of <i>R. banksi</i>	595
603.	Female tergite VIII of <i>R. fenestra</i>	595
604.	Female tergite VIII of <i>R. kiamichi</i>	595
605.	Male genitalia of <i>Neophylax concinnus</i> , lateral	597
606.	Female genitalia of <i>N. concinnus</i> , ventral	597

607.	Larval head of <i>N. concinnus</i> , lateral	597
608.	Larval head of <i>N. concinnus</i> , dorsal	597
609.	Male genitalia of <i>N. fuscus</i> , lateral	597
610.	Female genitalia of <i>N. fuscus</i> , ventral	597
611.	Larval head of <i>N. fuscus</i> , dorsal	597
612.	Distributions of five endemic Annulipalpia species. <i>Agapetus artesus</i> (solid circle), <i>Agapetus medicus</i> (solid square), <i>Protoptila</i> species A (solid triangle), <i>Rhyacophila kiamichi</i> (open circle), <i>Wormaldia strota</i> (open square)	599
613.	Distributions of five endemic Annulipalpia species. <i>Ceratopsyche piatrix</i> (solid circle), <i>Cheumatopsyche robisoni</i> (solid square), <i>Cheumatopsyche rossi</i> (solid triangle), <i>Polycentropus stephani</i> (open circle), <i>Paduniella nearctica</i> (open square)	599
614.	Distributions of seven endemic Annulipalpia. <i>Hydroptila artesa</i> (solid circle), <i>Neotrichia arkansasensis</i> (solid square), <i>Neotrichia kitae</i> (solid triangle), <i>Ochrotrichia contorta</i> (open circle), <i>Ochrotrichia robisoni</i> (open square), <i>Ochrotrichia weddleae</i> (open triangle), <i>Paucicalcaria ozarkensis</i> (asterisk)	599
615.	Distributions of six endemic Integripalpia species. <i>Ceraclea maccalmonti</i> (solid circle), <i>Helicopsyche limnella</i> (solid square), <i>Marilia</i> sp. A (solid triangle), <i>Oecetis ouachita</i> (open circle), <i>Oecetis ozarkana</i> (open square), <i>Setodes oxapius</i> (open triangle)	601
616.	Distributions of four endemic Integripalpia species. <i>Glyphopsyche missouri</i> (asterisk), <i>Lepidostoma lescheni</i> (solid circle), <i>Lepidostoma ozarkense</i> (solid square), <i>Micrasema ozarkana</i> (solid triangle)	601

CHAPTER 13

FAMILY ODONTOCERIDAE

This family is represented in the Interior Highlands by a single genus *Marilia*. Larval odontocerids differ from the other regional Leptoceroidea by having the antennae situated at or near the anterior margin of the head capsule. Larvae of the Sericostomatidae have this feature, but also have the foretrochantin enlarged and hooked. The family Sericostomatidae has not been reported from the region. Adults of Odontoceridae are distinguished by the single large wart that covers most of the mesoscutellum (Fig. 49).

Genus *Marilia* Müller

Marilia is primarily a neotropical genus with two known species occurring in North America (Wiggins 1977). *Marilia flexuosa* Ulmer is known primarily from the southwestern United States, although a couple of records have been reported for Vermont and Ontario; *M. nobscæ* Milne is known only from the southwestern United States. Larvae of this genus construct a portable tube case of sand grains that is curved and tapers posterad (Wiggins 1977).

B. J. Armitage is examining relationships among portions of the world fauna (pers. communication).

KEY TO THE SPECIES OF *Marilia**

larvae

1. Head capsule round in dorsal view, dark with a pale region in the posterior corner of the frontoclypeus and around the eyes, lateral carinae passing through each eye (Fig. 488) ***M. flexuosa* Ulmer**
 Head longer than wide, pale except for a dark V-shaped band that follows the frontoclypeal suture, lateral carinae absent (Fig. 489)
 ***M. sp. A***

* The adults are unknown for *M. sp. A*.

***Marilia flexuosa* Ulmer**

Figs. 49, 485, 486, 487, 488

Marilia flexuosa Ulmer 1905b:70.

Anisocentropus fusca Banks 1905a:19.

Type Localities.- Texas, Brazil.

Regional Distribution.- Watersheds 4, 66, 81, 96, 97, 100, 102, 119.

MISSOURI: McDonald Co., Elk River, MO Hwy 43, 2 mi N jct. MO Hwy 10 (Cowskin Access), 6-VI-1991, S.R. Moulton, 2 ♀♀; Little Sugar Creek, MO Hwy 90, 1.5 mi E Jane, 6-VI-1991, S.R. Moulton, 2 ♀♀; Big Sugar Creek, Rte. E,

Powell, 6-VI-1991, S.R. Moulton, 2 ♂♂, several hundred ♀♀; OKLAHOMA: Delaware Co., Battle Branch, 25-VI-1983, M. Ernst, 6 ♂♂, 7 ♀♀; same but 22-VII-1983, 49 ♂♂, 18 ♀♀; same but 9-IX-1983, 13 ♂♂, 6 ♀♀; same but 27-XI-1982, 5 larvae.

Nearctic Distribution.- US: AR, AZ, CA, MO, NM, OK, TX, VT;
CANADA: ON; MEXICO; SOUTH AMERICA.

Discussion.- This species is locally abundant in medium to large-sized streams of the tri-state region of Arkansas, Missouri, and Oklahoma (Table 5). Males of this species are readily recognized in the field by their enlarged compound eyes which nearly meet dorsad. Although males were rarely encountered, females sometimes occurred in enormous numbers in UV light trap samples. Wiggins (1977) illustrated a larval habitus and commented that gut contents of a few larvae consisted primarily of arthropods, with some plant material. Larvae differ from the following undescribed species by the more rounded head, which is uniformly dark except for a pale area on the posterior corner of the frontoclypeus (Fig. 488).

***Marilia* species A**

Figs. 489, 490, 491, 492

Regional Distribution.- Watersheds 53. ARKANSAS: Fulton Co., near Hardy (T20N R5W SEC36), 2-IX-1978, R. Mauer, 6 larvae; Forty Islands Creek, above Lake Sherwood, N Hardy, 23-IX-1993, S.R. Moulton, 1 empty larval case.

Discussion.- Larvae of this species are known only from two populations; one in the Spring River drainage near Hardy, AR and the other in the Cove Creek drainage west of Fayetteville, AR (M.L. Mathis, pers. communication). I revisited the Fulton County location in September, 1993, in an attempt to locate additional larvae and to rear adults. The stream site was approximately 10 m wide and characterized by an extensive limestone bedrock formation with veins of fine gravel and sand. After searching the finer substrates for 2 hours, I managed to collect a single empty case. This case matched perfectly the cases in the ASUMZ collection. Two larvae were deposited in the ROM. It is believed that these larvae belong to the genus *Marilia* due to some morphological similarities with *M. nobisca* Milne (Glenn B. Wiggins pers. communication). Interestingly, the dorsal head capsule coloration superficially resembles that of a *M. fusca* Kimmins, a species known from Australia. However, the pigmentation around the frontoclypeal suture is much more extensive in that species (Drecktrah 1990). Discontinuity in cases, a condition common in odontocerid cases (Wiggins 1977) was not observed in these larval cases (Fig. 492).

CHAPTER 14

FAMILY PHILOPOTAMIDAE

The Philopotamidae is represented in the Interior Highlands by two genera, *Chimarra* and *Wormaldia*. The genus *Dolophilodes* is not known from this region, but is widely distributed throughout the eastern United States. Armitage (1991) compiled a diagnostic atlas to the males of the North American species, from which my keys were adapted.

KEY TO THE GENERA OF PHILOPOTAMIDAE

larvae

1. Anterior margin of frontoclypeus with a well developed, asymmetrical notch (Fig. 493) ***Chimarra* Stephens**
Anterior margin of frontoclypeus entire (Fig. 494)
. ***Wormaldia* MacLachlan**

adults

1. Hind wing with vein 2A curved up and fusing with 1A to form a large loop (Fig. 495) ***Chimarra* Stephens**

Hind wing with vein 2A absent beyond crossvein a2 (Fig. 496)
 **Wormaldia McLachlan**

Genus *Chimarra* Stephens

This genus is represented in the Interior Highlands by six species.

Larvae are readily identified by the asymmetrical notch on the anterior margin of the frontoclypeus (Fig. 493). Adults are distinguished by having the second anal vein of the hindwing curved up to meet the first anal vein thereby forming a loop (Fig. 495). Species of *Chimarra* are commonly collected throughout the region year round. Adults are particularly common during the winter around springs. Their jet-black color makes them quite conspicuous on various substrates. Ross (1944) and Armitage (1983) reported *C. angustipennis* Banks from Arkansas. This record was later found to be in error as a result of the misinterpretation of the type locality data which read "Hot Springs, AZ" (Lago and Harris 1987). Lago and Harris (1987) reviewed the taxonomy of the eastern United States species.

KEY TO THE MALES OF *Chimarra*

1. Mesal process of sternite IX long and narrow (Fig. 497)
 ***C. obscura* (Walker)**

- Mesal process of sternite IX short and triangular or spatulate in lateral view (Figs. 498, 502) 2
2. Mesal process of IX triangular (Fig. 498) 3
- Mesal process of IX spatulate (Fig. 502) 4
3. Inferior appendages in caudal view with dorsomesal process appearing concave (Fig. 499) **C. feria Ross**
- Inferior appendages in caudal view with dorsomesal process appearing straight (Fig. 500) **C. aterrima Hagen**
4. Posteroapical margin of inferior appendages rounded (Fig. 506); ventral phallic rods divergent apically (Fig. 507) **C. moselyi Denning**
- Posteroapical margin of inferior appendages produced into a mesal spine; ventral phallic rods sinuate or evenly curved (Figs. 503, 505) . . . 5
5. Inferior appendages widening abruptly at apex producing a lobe directed posterad; ventromesal process of IX short, less than one-half the length of the inferior appendages (Fig. 502); each dorsal phallic rod bifurcate at apex (Fig. 503) **C. parasocia Lago & Harris**
- Inferior appendages not much widened at apex; ventromesal process of IX one half as long as inferior appendages (Fig. 504); each dorsal phallic rods simple at apex (Fig. 505) **C. socia Hagen**

***Chimarra aterrima* Hagen**

Figs. 500, 501

Chimarra aterrima Hagen 1861:297.

Type Locality.- Pennsylvania.

Regional Distribution.- Watersheds 4, 23, 32, 38, 47, 53, 65, 67, 68, 80, 81, 91, 118, 122.

Nearctic Distribution.- US: AL, AR, CT, DC, DE, FL, GA, IL, IN, KY, LA, MA, MD, ME, MI, MN, MO, MS, NC, NH, NJ, NY, OH, OK, PA, SC, TN, TX, VA, VT, WI, WV; CANADA: MB, NB, NF, ON, PQ.

Discussion.- This species was commonly collected from medium-sized streams in the region (Table 5) throughout most of the year (Table 6). Males are most similar to those of *C. feria*, but differ in having the dorsomesal process of each inferior appendage straight, in caudal view (Fig. 500). Moulton *et al.* (1993) reported a mean critical thermal maximum of 33.6°C for larvae collected from the Castor River, Missouri that had been acclimated to 19°C. Bowles and Allen (1992) observed at least a bivoltine life cycle, with overlapping generations in a third-order reach of the Mulberry River, Arkansas; they also estimated its annual secondary production at 0.09 g/m²/yr (Bowles and Allen 1991).

***Chimarra feria* Ross**

Figs. 498, 499

Chimarra feria Ross 1941b:51.

Type Locality.- Illinois, Vienna.

Regional Distribution.- Watersheds 1, 4, 9, 17, 27, 31, 35, 39, 44, 48, 49, 52, 53, 56, 57, 60, 67, 68, 69, 70, 72, 73, 74, 77, 80, 81, 90, 91, 94, 106, 110, 128, 129.

Nearctic Distribution.- US: AL, AR, IL, IN, KS, KY, MI, MN, MO, MS, NE, OK, TX, WI; CANADA: NF, ON, PQ.

Discussion.- This species is very common in the region and was often collected with *C. obscura*. It is most closely related to *C. aterrima*. Males are distinguished from *C. aterrima* by the concave dorsal margin of the inferior appendages, viewed caudally (Fig. 499). I collected *C. feria* from a wide range of stream types (Table 5) during most of the year (Table 6).

***Chimarra moselyi* Denning**

Figs. 506, 507

Chimarra moselyi Denning 1947b:251.

Type Locality.- Georgia, Macon.

Regional Distribution.- MISSOURI (specific location unknown).

Nearctic Distribution.- US: AL, FL, GA, IL, IN, KY, LA, MO, MS, NC, OH, SC, TN, VA.

Discussion.- This species was reported from Missouri by Lago and Harris (1987) and Armitage (1991), but since no voucher specimens have been located, its presence in the Interior Highlands is considered tentative. I did not collect it in the region during this study, but have collected large numbers in

sand-bottomed streams of the piney woods of the East Texas Gulf Coastal Plain along with *C. parasocia*.

***Chimarra obscura* (Walker)**

Figs. 47, 50, 497

? *Beraea obscura* Walker 1852:121.

Wormaldia plutonis Banks 1911:358.

Chimarra lucia Betten 1934:175.

Type Locality.- Ontario, St. Martin's Falls, Albany River, Hudson Bay.

Regional Distribution.- Watersheds 1, 4, 9, 13, 14, 17, 23, 27, 28, 31, 34, 35, 38, 39, 42, 43, 44, 45, 46, 47, 48, 49, 53, 54, 56, 58, 60, 61, 62, 66, 67, 68, 69, 70, 74, 77, 80, 81, 88, 89, 90, 92, 94, 95, 96, 97, 99, 100, 102, 103, 105, 106, 107, 109, 110, 115, 116, 117, 118, 119, 121, 122, 124, 128, 129.

Nearctic Distribution.- US: AL, AR, CT, DE, FL, GA, IL, IN, KS, KY, MA, MD, ME, MI, MN, MO, MS, NE, NH, NJ, NY, OH, OK, PA, SC, TN, TX, VA, VT, WI, WV; CANADA: MB, NF, NS, ON, PQ.

Discussion.- This species was one of the most commonly collected caddisflies in the Interior Highlands (Table 5). It was not unusual to collect several hundred adults in a single light trap sample. It was also readily collected from bridges and by sweeping riparian vegetation. Males are readily distinguished from the other regional species by the long, mesal process on the ninth sternite (Fig. 497). Bowles and Allen (1992) reported that it was at

least bivoltine in the Mulberry River, Arkansas. They observed that the first generation emerged in late spring with the second emerging in late summer. In this same river system, Bowles and Allen (1991) estimated its secondary production to be 1.24 g/m²/yr and that it contributed about 48% of the total secondary production of net-spinning caddisflies in their study. They further noted that 97% of the production by this species was contributed by instars III - V. Moulton *et al.* (1993) reported a range of mean critical thermal maximum (CTM) for three acclimation groups (12, 19, and 26°C) from 31.4 to 38.6°C in the Brazos River, Palo Pinto Co., Texas. They found that the CTM increased as acclimation temperature increased.

***Chimarra parasocia* Lago and Harris**

Figs. 502, 503

Chimarra parasocia Lago and Harris 1987:240.

Type Locality.- Mississippi, Wilkinson Co., Buffalo River at Hwy 61.

Regional Distribution.- Watershed 63. ARKANSAS: Bradley Co., Saline River, AR Hwy 172, 2-VII-1981, E.J. Bacon, 8 ♂♂.

Nearctic Distribution.- US: AL, AR, KY, LA, MO, MS, TN.

Discussion.- The original regional record for this species (Lago and Harris 1987) was actually a misidentified specimen of *C. socia* from the Albert Pike Recreation Area in Montgomery Co., Arkansas (Lago *et al.* 1989). Since then, I have recovered males (noted above) from a medium-sized river in the

Gulf Coastal Plain subregion of Arkansas. P.K. Lago has also found additional populations in southern Arkansas (Bowles *et al.* 1993). It probably inhabits sluggish, sand-bottom streams, similar to those in the piney woods of East Texas. Males closely resemble those of *C. socia*, but differ in having the inferior appendages widening abruptly at apex and producing a lobe directed posterad (Fig. 502). The dorsal phallic rods are bifurcate at apex, and the ventromesal process of IX is shorter and less robust (Fig. 503).

***Chimarra socia* Hagen**

Figs. 504, 505

Chimarra socia Hagen 1861:297.

Wormaldia femoralis Banks 1911:358.

Type Locality.- Washington, D.C.

Regional Distribution.- Watersheds 17, 48, 49, 74, 97, 107, 117, 122.

ARKANSAS: Howard Co., Bakers Creek, AR Hwy 4, 28-VI-1989, S. Speight, 1 ♂; Montgomery Co., Smith Creek, AR Hwy 8, 0.5 mi NW Caddo Gap, 19-V-1982, H.W. Robison and D. Koym, 17 ♂♂; Little Missouri River, Albert Pike Rec. Area, N Langley, 28-VII-1982, H.W. Robison, 16 ♂♂; Polk Co., East Fork Powell Creek, Ewing Farm, 7 mi W Mena, 26-VI-1991, B. Ewing, 3 ♂♂; MISSOURI: Christian Co., Finley Creek, low water bridge, 2 mi N MO Hwy 14, Brunner, 8-VI-1991, S.R. Moulton, 1 ♂; Maries Co., Gasconade River, US Hwy 63, Morelands Resort, 10-IX-1990, B.C. Poulton, 6 ♂♂.

Nearctic Distribution.- US: AL, AR, DC, IN, KY, MA, MD, ME, MI, MN, MO, NC, NH, NJ, NY, OH, PA, TN, VA, WI, WV; CANADA: MB, NB, NF, NS, ON, PQ.

Discussion.- The male paratype previously designated for *C. parasocia* (Lago and Harris 1987) was actually this species (Lago *et al.* 1989). Collections by us and those of Lago *et al.* (1989) have documented populations scattered throughout medium to large-sized streams in the Ouachita Mountains of Arkansas and the various Ozark Mountain subregions of Missouri (Table 5). Its presence in the region likely represents a disjunct distribution from its main range in the eastern United States. Males differ from those of the previous species by the simple apices of the dorsal phallic rods (Fig. 505), and the configuration of the inferior appendages (Fig. 504).

Genus *Wormaldia* MacLachlan

This genus is represented in the Interior Highlands by three species. Larvae are easily distinguished from those of *Chimarra* by having the anterior margin of the frontoclypeus evenly rounded (Fig. 494). The hind wing of the adults lack the second anal vein beyond the second anal crossvein (Fig. 496). Adults of *Wormaldia* were collected using sweep nets and UV light traps.

KEY TO THE MALES OF *Wormaldia*

1. Sternites VII and VIII with long, narrow mesal processes (Fig. 508)

- ***W. moesta* (Banks)**
- Sternites VII and VIII with mesal processes absent or shorter and triangular in shape (Fig. 511) 2
2. Mesal processes absent from sternites VII and VIII (Fig. 509); apex of tergite X truncated (Fig. 510) ***W. strota* (Ross)**
- Mesal processes short and triangular (Fig. 511); apex of tergite X acute (Fig. 512) ***W. shawnee* (Ross)**

***Wormaldia moesta* (Banks)**

Fig. 508

Paragapetus moesta Banks 1914:202.

Dolophilus breviatus Banks 1914:254.

Type Locality.- North Carolina, Black Mt., North Fork Swannanoa River.

Regional Distribution.- Watersheds 9, 10, 14, 44, 49, 56, 74, 77, 80, 91, 113, 122. ARKANSAS: Logan Co., Cove Creek, AR Hwy 309, Magazine Mountain, 23-V-1990, S.R. Moulton, 4 ♂♂, 11 ♀♀; Montgomery Co., Buttermilk Springs, 3 mi from Caddo Gap, 19-V-1982, H.W. Robison and D. Koym, 1 ♂; Polk Co., Mill Creek, AR Hwy 8, 8-VI-1989, H.W. Robison, 1 ♂; unnamed spring on Rich Mountain, Queen Wilhelmina State Park, 14-V-1991, 7 ♂♂; ILLINOIS: Union Co., unnamed tributary, 1.7 mi E Wolf Lake, 4-V-1986, E.A. Lisowski, 1 ♂; St Clair Co., Briley Creek, 2 mi S Iconium, 22-V-1992, S.R. Moulton and D.E. Baumgardner, 2 ♂♂, 7 ♀♀.

Nearctic Distribution.- US: AL, AR, CT, DE, FL, GA, IL, IN, KY, MA, ME, MN, MO, MS, NC, NH, NJ, NY, OH, OK, PA, SC, TN, VA, VT, WI, WV; CANADA: MB, NB, NF, NS, ON, PQ.

Discussion.- Males are distinguished from the other regional species by the long mesal processes on sternites VII and VIII, and the shorter inferior appendages (Fig. 508). I collected it from small headwater streams (Table 5). Bowles and Allen (1992) observed a univoltine life cycle in a third order reach of the Mulberry River, Arkansas. In their study, larvae were prevalent during the winter months and early spring, with first instars collected in small numbers throughout most of the year. To account for this, they suggested the possibility of delayed egg hatching as a mechanism for overcoming stressful summer periods. A secondary production estimate of 0.01 g/m²/yr and a cohort production interval of 11 months was reported in the Mulberry River (Bowles and Allen 1991).

***Wormaldia shawnee* (Ross)**

Figs. 511, 512

Dolophilus shawnee Ross 1938a:133.

Type Locality.- Illinois, Herod, Gibbons Creek.

Regional Distribution.- Watersheds 94, 105, 106, 122. ILLINOIS: Pope Co., Gibbons Creek, 0.8 mi NW Herod, 3-VI-1986, E.A. Lisowski, 1 ♂;

MISSOURI: Pulaski Co., Cave Spring, Wayne Roam farm, near Swedeborg, S Road T-740 (Mathis and Bowles 1992).

Nearctic Distribution.- US: AL, IL, KY, MO, NC, NH, OH, PA, SC, TN, VA.

Discussion.- This species is rare in the Interior Highlands. I did not collect it during this study, but Mathis and Bowles (1992) reported it from a small spring in south central Missouri during June. Ross (1944) reported that it was abundant, but infrequently collected in the swift temporary streams of the Illinois Ozarks. Males resemble those of *W. strota* but are distinguished by the short, triangular processes on sternites VII and VIII (Fig. 511), and the acute apex of tergum X in dorsal view (Fig. 512). My illustrations were drawn from a specimen collected in the Illinois Ozarks; it is deposited in the INHS.

***Wormaldia strota* (Ross)**

Figs. 509, 510

Dolophilus strotus Ross 1938d:118.

Type Locality.- Oklahoma, Page.

Regional Distribution.- Watersheds 9, 18, 35, 56, 69, 74, 77, 80, 96.

ARKANSAS: Independence Co., Piney Creek, 5 mi E Pleasant Plains, 31-V-1986, H.W. Robison, 68 ♂♂, 57 ♀♀; Johnson Co., Gee Creek, near Haw Creek Rec. Area, 22-V-1981, B.J. Armitage, 1 ♂; Perry Co., Bear Creek, AR Hwy 7, 2 mi S Hollis, 11-VI-1983, H.W. Robison, 1 ♂; Polk Co., Board Camp Creek, AR

Hwy 8, 1 mi W Board Camp, 21-V-1982, H.W. Robison, 2 ♂♂; Pope Co., Dare Creek, 0.5 mi N Hector, 10-VI-1989, H.W. Robison, 15 ♂♂, 3 ♀♀; MISSOURI: Christian Co., Swan Creek, Rte. DD, 1 mi W Keltner, 8-VI-1991, S.R. Moulton, 1 ♂.

Nearctic Distribution.- US: AR, MO, OK.

Discussion.- Males resemble those of *W. shawnee* except that they lack mesal processes on sternites VII and VIII (Fig. 509), and the apex of tergum X is truncate (Fig. 510). This species is endemic to the Interior Highlands and is reported here from Missouri for the first time. Bowles and Mathis (1989) reported that it had a scattered distribution but was locally abundant. I collected it from small headwater streams (Table 5) during the late spring and summer (Table 6).

CHAPTER 15

FAMILY PHRYGANEIDAE

The family Phryganeidae is represented in the Interior Highlands by four species distributed among three genera. They are among the largest caddisflies in the region ranging from 18 - 25 mm in forewing length. The omnivorous larval stages occupy a wide range of temporary and permanent aquatic habitats (Wiggins 1977). Larvae of the Interior Highland species construct tubular cases from pieces of leaves or bark that are arranged concentrically or spirally. Mature larvae of these species may range from 30 - 43 mm in length; their cases are up to 60 mm in length (Wiggins 1977). Regional life histories of the four species treated here are unknown. Bowles *et al.* (1990) reported on a novel method of using fermenting molasses traps to attract and capture adult phryganeids. Their bait consisted of a molasses and water mixture (3:1 ratio) filled halfway up into a small plastic cup, that was placed about 2 m above ground. Traps were placed in a heavily wooded area in eastern Oklahoma, approximately 200 m from the nearest water source.

KEYS TO THE GENERA AND SPECIES OF PHRYGANEIDAE

larvae

1. Ventral combs of procoxae conspicuous, their teeth apparent at 50x;
 case constructed spirally 2
 Ventral combs of procoxae inconspicuous, their teeth not evident at 50x;
 case constructed in ring fashion ***Ptilostomis Kolenati***
2. Triangular sclerite (sternellum) present between procoxae
 ***Agrypnia vestita (Walker)***
 Sternellum absent between procoxae ***Phryganea sayi Milne***

adults

1. Maxillary palpi four segmented (males) 2
 Maxillary palpi five segmented (females) 4
2. Sternum IX produced posteriorly into a shelf-like structure bearing stout
 spines (Figs. 517, 519) ***Ptilostomis Kolenati***
 Sternum IX not produced as above 3
3. Inferior appendages with an apicodorsal process obliquely directed
 posterad, tergum X shelf-like, without short, stout spines (Fig. 513); apex
 of phallus with numerous needle-like spines (Fig. 514)
 ***Agrypnia vestita (Walker)***
 Inferior appendages without an apicodorsal process, tergum X robust
 with short stout spines (Fig. 515); apex of phallus membranous (Fig.

- 516) ***Phryganea sayi* Milne**
4. Forewings with R₁ straight or nearly so (Fig. 521); wings golden with scattered brown markings ***Ptilostomis Kolenati***
- Forewings with R₁ sigmoidal near stigmal region (Fig. 522); wings more fuscus 5
5. Ninth sternite constricted in middle with posterior margin emarginate (Fig. 526) ***Agrypnia vestita* (Walker)**
- Ninth sternite narrowing abruptly to approximately one half its width at middle, posterior half divided into three slender processes (Fig. 525) . . .
- ***Phryganea sayi* Milne**

Genus *Agrypnia* Curtis

Ten species are known from North America (Morse 1993). Only *A. vestita* is known from the Interior Highlands. *Agrypnia* larvae construct tubular cases of rectangular pieces of leaves arranged spirally. Wiggins (1977) noted that larval gut contents consisted entirely of arthropod parts. Larvae measure up to 30 mm, with cases up to 50 mm (Wiggins 1977).

***Agrypnia vestita* (Walker)**

Figs. 513, 514, 522, 526

Neuronia vestita Walker 1852:10.

Neuronia commixta Walker 1852:10.

Type Locality.- Georgia.

Regional Distribution.- Watersheds 24, 38, 49, 56, 62, 77, 80, 95, 107, 124. ARKANSAS: Montgomery Co., Jones Creek, AR Hwy 8, Caddo Gap, 12-IX-1980, H.W. Robison, 1 ♂; Nevada Co., White Oak Lake, 2 mi SE Bluff City, 1-IX-1978, Munford and Gann, 1 ♀; Polk Co., Ouachita River, US Hwy 71, Acorn, 24-X-1991, S.R. Moulton, 1 ♂; MISSOURI: Douglas Co., Bryant Creek, MO Hwy 76, 4 mi W Rte. C, 25-IX-1992, S.R. Moulton, 1 ♀; same as previous but Indian Creek, MO Hwy 76; Osage Co., Gasconade River, Hwy 89, Rollins Ferry Access, 27-IX-1990, B.C. Poulton, 1 ♀; OKLAHOMA: Le Flore Co., Kiamichi River, US Hwy 259, 1 mi S Big Cedar, 17-IX-1993, D.E. Baumgardner, 1 ♀; Pushmataha Co., Crumb Creek, OK Hwy 2, 10 mi S Clayton, 16-VII-1993, D.E. Baumgardner, 1 ♀; Pine Creek, Wadena, 14-X-1993, D.E. Baumgardner, 1 ♀.

Nearctic Distribution.- US: AL, AR, CT, DC, DE, FL, GA, IL, IN, KS, KY, MA, ME, MI, MN, MO, MS, NC, ND, NH, NJ, NY, OH, OK, OR, PA, SC, TN, VA, VT, WI, WV; CANADA: AB, BC, MB, NF, NT, ON, PQ.

Discussion.- Adults may be field identified by the contrasting dark band on the distal margin of the hindwings. Male inferior appendages are prominent, with distinct dorsal and ventral lobes; the phallic apex has numerous needle-like spines (Fig. 514). Female sternum IX is constricted in middle, lobate distally (Fig. 526). This species is infrequently collected from small to medium sized lotic and lentic habitats (Table 5). Adults emerge during

the late summer and fall (Table 6). Bowles and Mathis (1989) reported a March to May collection period. Although they did not specify, I suspect that at least their early spring dates were based on larval collections. Ross (1944) and Board (1987) provided records for Illinois and Arkansas, respectively, that were collected through the summer. Harp and Harp (1980) reported it from swamp habitats in the Mississippi Alluvial physiographic subregion during October. Ross (1944) described the larva and noted that the Illinois populations may be multivoltine.

Genus *Phryganea* Linnaeus

This genus is represented in North America by two species, *P. cinerea* Walker and *P. sayi* Milne (Morse 1993). Only the latter is represented in the Interior Highlands. Larvae resemble those of *Agrypnia*, except that the sternellum is absent, and the coxal combs are larger (Wiggins 1977). The case is of the spiral design as in *Agrypnia*. Mature larvae and their cases measure up to 43 and 56 mm, respectively (Wiggins 1977).

***Phryganea sayi* Milne**

Figs. 515, 516, 525

Phryganea interrupta Say 1828:44 (preoccupied).

Phryganea sayi Milne 1931:228.

Type Locality.- New Jersey.

Regional Distribution.- Watersheds 28, 94, 122. ILLINOIS: Johnson Co., Little Cache Creek, 4 mi NE Vienna, 3-IX-1975, Brigham and Unzicker, 1 ♂; MISSOURI: Barry Co., Roaring River, at low water bridge (T21N R26W SEC6), 17-VIII-1990, S.R. Moulton, 1 ♀.

Nearctic Distribution.- US: AL, AR, CT, DC, DE, IL, IN, KS, KY, MA, MD, ME, MI, MO, NC, ND, NJ, NY, OH, PA, SC, TN, VA, WI, WV; CANADA: ON, PQ, SK.

Discussion.- Adults may be identified in the field by the contrasting dark coloration in the distal one-third of the hind wing. The male inferior appendages are broadly rounded, each with a prominent postero-ventral spine; tergum X robust with stout apical spines (Fig. 515). Females have a characteristic trifold, posterior extension of sternum IX (Fig. 525). This species was rarely encountered. My single ♀ collected came from a location downstream of the high-volume spring at Roaring River State Park in southwestern Missouri (Table 5). Mathis and Bowles (1992) reported it from a spring near Swedeborg, Missouri. Board (1987) reported the only known record from Arkansas at an unknown location north of Batesville. Adults were present during the summer (Table 6).

Genus *Ptilostomis* Kolenati

Morse (1993) recorded four species from North America, two of which are represented in the Interior Highlands. Larvae differ from the other regional

genera by the inconspicuous coxal combs and the concentric, ring design of the case. According to Wiggins (1977) there is a single generation per year. Farris and Harp (1982) collected larvae from an acid bog on Crowleys Ridge having a Ph around 5 and a mean water depth of 10.4 cm. Larvae are inseparable at present.

KEY TO THE SPECIES OF *Ptilostomis*

1. Maxillary palpi 4 segmented (males) 2
 Maxillary palpi 5 segmented (females) 3
2. Apicoventral margin of phallus produced into a heavily sclerotized point
 (Figs. 520) ***P. postica* (Walker)**
 Apex of phallus not produced as above, but with two sclerotized, blade-
 like structures (Figs. 518) ***P. ocellifera* (Walker)**
3. Ventral margin of vaginal apparatus in lateral view produced into a long,
 thumb-like process (Fig. 523) ***P. ocellifera* (Walker)**
 Ventral margin of vaginal apparatus in lateral view produced into a short,
 triangular process (Fig. 524) ***P. postica* (Walker)**

***Ptilostomis ocellifera* (Walker)**

Figs. 517, 518, 523

Neuronia ocellifera Walker 1852:8.

Neuronia simulans Betten and Mosely 1940:107.

Type Locality.- Nova Scotia.

Regional Distribution.- Watersheds 6, 34, 35, 44, 58, 74, 80, 89, 91, 105. ARKANSAS: Columbia Co., Magnolia, 23-IV-1984, H.W. Robison, 1 ♂; Franklin Co., Fane Creek, AR Hwy 23, Cass, 19-V-1983, H.W. Robison and D. Koym, 1 ♀; Polk Co., Ewing Farm, 7 mi W Mena, 6-VII-1991, B. Ewing, 2 ♀♀; Pope Co., Dare Creek, 0.5 mi N Hector, 10-VI-1989, H.W. Robison, 1 ♀; Van Buren Co., Cadron Creek, AR Hwy 124, 3.5 mi E Gravesville, 22-V-1982, H.W. Robison, 2 ♂♂; ILLINOIS: Union Co., 13 mi SE Carbondale, 13-V-1976, Unzicker and Brigham, 1 ♂.

Nearctic Distribution.- US: AK, AL, AR, CT, DC, DE, GA, IL, IN, KY, LA, MA, ME, MI, MN, MO, MS, NC, ND, NH, NJ, NY, OH, OK, OR, PA, SC, TM, VA, VT, WI, WV; CANADA: BC, MB, NF, NS, ON, PQ.

Discussion.- Males differ from those of *P. postica* by the two blade-like sclerites in the apex of the phallus (Fig. 518), and by the more produced, scoop-like ninth sternite (Fig. 517). Females differ in having a long, blunt ventral process on the vaginal apparatus (Fig. 523). Adults were collected in low numbers with UV light traps near a variety of stream types (Table 5).

***Ptilostomis postica* (Walker)**

Figs. 519, 520, 521, 524

Neuronia postica Walker 1852:9.

Type Locality.- Georgia.

Regional Distribution.- Watersheds 6, 24, 62, 77, 80, 105, 124.

ARKANSAS: Arkansas Co., Lake Gut, White River National Wildlife Refuge, 29-IX-1990, S. Chordas, 1 ♂, 4 ♀♀; Columbia Co., Big Creek, 2 mi W McNiel, 12-IX-1978, Munford and Gann, 1 ♂; LaFayette Co., Bodcaw Creek, 6.1 mi NW Stamps, 18-V-1992, J. Rader, 1 ♀; Nevada Co., White Oak Lake, 2 mi SE Bluff City, 1-IX-1978, Munford and Gann, 1 ♀; MISSOURI: Dent Co., roadside pond off Rte. YY, 1 mi S jct. Rte. E, 15-III-1991, S.R. Moulton and J.C. Abbott, 1 larva (♂ reared 25-V-1991); OKLAHOMA: LeFlore Co., Billy Creek, 1 mi from Billy Creek Rec. Area, 18-VII-1993, D.E. Baumgardner, 1 ♀; Pushmataha Co., Albion Creek, Albion, 18-IX-1993, D.E. Baumgardner, 2 ♀♀.

Nearctic Distribution.- US: AL, AR, CT, DC, DE, FL, GA, IL, IN, KY, LA, MA, MD, ME, MI, MO, MS, NC, NH, NJ, NY, OH, OK, PA, TN, VA, WV;
CANADA: MB, NS, PQ.

Discussion.- Males differ in the pointed apicoventral phallic spur (Fig. 520) and the less produced ninth sternite (Fig. 519). Females only have a small protuberance on the ventral margin of the vaginal apparatus (Fig. 524). It was collected from a variety of lotic and lentic habitats (Table 5), and is reported here for the first time from Missouri. Adults were taken most of the year, especially in the fall (Table 6). The reared ♂ noted above emerged in the laboratory 71 days after collection at a water temperature of 19°C. It cannibalized two other *Agrypnia* larvae during this period. McGonigle and Howard (1987) studied its ovipositional behavior in temporary autumnal pools

in southcentral Pennsylvania. They found that after a dry summer, multiple egg masses were clustered in the deepest portion of the dry pool basin; in moister basins, egg masses were distributed throughout the basin.

CHAPTER 16

FAMILY POLYCENTROPODIDAE

This family is represented in the Interior Highlands by 16 species distributed in six genera. In some of the older literature (e.g. Ross 1944, Flint 1964a), it has been treated as a subfamily in the Psychomyiidae. Larvae construct fixed, tubular retreats, and according to Wiggins (1977), these are more diverse than those of any other net-spinning family. They are largely detritivores with a few predacious genera and species. Respiration is accommodated through undulatory movements of the abdomen, which causes oxygenated water to flow over the body. According to Wiggins (1977), this is probably one mechanism that enables some genera to occur in lentic habitats. Larvae occur in a wide range of lotic and lentic habitats including temporary vernal pools (Wiggins 1973). Regional life histories are unknown for all of the species considered here, except for *Polycentropus centralis* (Bowles and Allen 1991, 1992). Larvae differ from the Psychomyiidae primarily by the acutely tapered apex of the fore trochantin (Fig. 24). Characters necessary to reliably separate the larvae to species in many of the larger genera are unknown. Adults are generally medium in size (5 - 10 mm) and tawny to dark brown.

Except for species of *Cernotina*, they differ from the Psychomyiidae in possessing a preapical spur on the protibiae; they differ from the Hydropsychidae in possessing a pair of setal warts on the mesoscutum (Fig. 44). Various workers have presented adult keys to species (Armitage and Hamilton 1990, Morse 1972, 1990, Schuster and Hamilton 1984). My keys to genera and species have been modified from those of Morse and Holzenthal (1984) and Wiggins (1977) for larvae, and Armitage and Hamilton (1990) for adults, except where noted.

KEYS TO THE GENERA OF POLYCENTROPODIDAE

larvae

1. Tarsi of each leg flat and broader than tibiae
 *Phylocentropus placidus* (Banks)
- Tarsi of each leg more cylindrical and narrower than tibiae 2
2. Anal claw with 4 to 6 conspicuous teeth on ventral margin (Fig. 529) . .
 *Nyctiophylax Brauer*
- Anal claw without ventral teeth or with 10 or more minute spines along
 ventral margin (Fig. 528) 3
3. Basal segment of anal proleg approximately the same length as the
 distal segment; ventral margin of anal claw with many minute spines
 (Fig. 528) *Neureclipsis crepuscularis* (Walker)
- Basal segment of anal proleg obviously larger than distal segment;

- ventral margin of anal claw without teeth or minute spines (Fig. 532) . . . 4
4. Area between dorsum of anal claw and sclerite of distal segment with 2 dark bands separated, nearly parallel for some distance (Fig. 530)
 ***Cyrnellus fraternus* (Banks)**
- Area between dorsum of anal claw and sclerite of distal segment with 2 dark bands contiguous mesally, forming an X (Fig. 531) 5
5. Protarsi broad, one-half as long as protibiae, or anal claw obtusely curved, or anal claw with 2 or 3 dorsal accessory spines (Figs. 532, 533)
 ***Polycentropus sensu lato***
- Protarsi narrow, at least two-thirds as long as protibiae, and anal claws angled 90° with a single dorsal accessory spine ***Cernotina* Ross**

adults

1. Protibiae without a preapical spur ***Cernotina* Ross**
- Protibiae with a preapical spur 2
2. Fore- and hindwings with R_2 and branching from R_3 at radial crossvein (Fig. 535) ***Phylocentropus placidus* (Banks)**
- Fore- and hindwings with R_{2+3} unbranched, or branching near the margin of the wing (Fig. 538) 3
3. Hindwing with M three-branched (Fig. 540)
 ***Neureclipsis crepuscularis* (Walker)**
- Hindwing with M two-branched (Fig. 539) 4

4. Fore- or hindwings, or both with R_{2+3} branching near wing margin (Fig. 538) ***Polycentropus sensu lato***
 Fore- and hindwings with R_{2+3} unbranched 5
5. Maxillary palpi each with second nearly as long as third segment (Fig. 541) ***Cyrnellus fraternus* (Banks)**
 Maxillary palpi each with second segment short, one-third the length of the third segment (Fig. 542) ***Nyctiophylax* Brauer**

Genus *Cernotina* Ross

Thirteen species have been recorded for North America (Morse 1993).

Three have been documented in the Interior Highlands. The larvae were unknown until Hudson *et al.* (1981) used metamorphotypes to positively associate all of the life stages, except egg, of *Cernotina spicata*. Larvae are similar to those of *Polycentropus sensu lato* (in the broad sense)(Morse and Holzenthal 1984), but differ in having the protarsi narrower, and the anal claw angled at 90° with only one dorsal accessory spine. Adults are readily identified by the absence of a preapical spur on the protibiae. Hudson *et al.* (1981) experienced some difficulty in detecting and observing larval retreats due to siltation. They noted, however, that retreats covered small depressions in rock surfaces, with one or both openings flared outward. All three regional species have holotypes and/or some paratypes that were collected from Honey Creek at Turner Falls Park in the Arbuckle Mountains (Ross 1938a).

KEY TO THE MALES OF *Cernotina*

1. Inferior appendages with dorsal arms directed dorsad; 3-4 long, black teeth present at base of each preanal appendage (Fig. 544)
 ***C. calcea* Ross**
 Inferior appendages with dorsal arms directed obliquely; black teeth as above absent 2
2. Tergum X with two, dark, spur-like processes arising from beneath (Fig. 545); ***C. spicata* Ross**
 Tergum X without such spurs (Fig. 546); known only from the Arbuckle Mts. ***C. oklahoma* Ross**

***Cernotina calcea* Ross**

Fig. 544

Cernotina calcea Ross 1938a:137.

Type Locality.- Illinois, Kankakee, Kankakee R.

Regional Distribution.- Watersheds 23, 24, 28, 31, 42, 43, 46, 48, 49, 56, 57, 59, 60, 66, 74, 77, 80, 81, 96, 116, 118, 122, 128, 129.

Nearctic Distribution.- US: AL, AR, FL, IL, KS, KY, LA, MO, MS, OK, TX; MEXICO; NICARAGUA.

Discussion.- Males differ from the other two regional species in having the dorsal arm of each inferior appendage set perpendicular to the long axis of the appendage and by the presence of three to four long, black teeth basad of

each preanal appendage (Fig. 544). It has been collected from a wide range of stream and lake habitats (Table 5). To my knowledge, the larva is unknown. Adults were collected only in UV light trap samples during May to September (Table 6). This was the most commonly encountered *Cernotina* species.

***Cernotina oklahoma* Ross**

Fig. 546

Cernotina oklahoma Ross 1938a:137.

Type Locality.- Oklahoma, Murray Co., Turner Falls Park, Honey Creek.

Regional Distribution.- Watershed 129. OKLAHOMA: see type locality, 2-VI-1937, H.H. Ross, ♂ holotype, 57 ♂♂ paratypes.

Nearctic Distribution.- US: ?OH, OK, TX.

Discussion.- This species is known in the region only from its original collection by Ross (1938a). I examined some males in the type series and all are deposited in the INHS. Males are distinguished by the stouter preanal appendages and absence of spur-like processes arising beneath tergum X (Fig. 546). The larva is unknown. I have also collected it from spring-fed stream habitats on the Edwards Plateau of Texas.

***Cernotina spicata* Ross**

Fig. 545

Cernotina spicata Ross 1938a:138.

Type Locality.- Oklahoma, Murray Co., Turner Falls Park, Honey Creek.

Regional Distribution.- Watersheds 48, 59, 80, 128. ARKANSAS:

Johnson Co., Horsehead Lake, 30-VII-1986, C. Rowbotham, many ♂♂.

Nearctic Distribution.- US: AL, AR, CT, DE, FL, GA, IL, KS, LA, MA, ME, MI, MS, NC, NH, OK, SC, VA; CANADA: ON.

Discussion.- Although I did not collect this species, I was able to borrow and examine the above record from M. L. Mathis. Bowles and Mathis (1989, 1992) reported additional locality records for Arkansas and Oklahoma, respectively. It is collected from medium-sized streams, lakes, and ponds (Table 5). Adults were collected during the summer (Table 6). Hudson *et al.* (1981) described the larva and pupa from material collected in southeastern United States impoundments. They most often encountered larvae at depths between 0.5 and 4.0 m, and their analysis of late instar larval guts indicated that it is predacious on midge larvae and microcrustaceans (Hudson *et al.* 1981).

Genus *Cyrnellus* Banks

This genus is represented in the Nearctic region by a single species, *Cyrnellus fraternus* (Wiggins 1977). Larvae are similar to those of *Polycentropus sensu lato*, but may be distinguished by the separated, nearly parallel, dark bars on the dorsal plate of each anal proleg (Fig. 530). The larval retreat consists of a circular, silken roof covering a depression on a rock; the

roof has both entry and exit openings (Wiggins 1977). Both males and females are small and golden in color, similar to *Nyctiophylax*. They differ from *Nyctiophylax* by the third maxillary palp segment being slightly longer than the second (Fig. 541).

***Cyrnellus fraternus* (Banks)**

Figs. 530, 541, 547, 548

Cyrnus fraternus Banks 1905a:17.

Nyctiophylax marginalis Banks 1930:231.

Nyctiophylax zernyi Mosely 1934a:142.

Type Locality.- Maryland, Plummer's Island.

Regional Distribution.- Watersheds 4, 6, 9, 24, 28, 38, 39, 48, 57, 63, 68, 69, 70, 74, 77, 80, 89, 90, 100, 105, 106, 107, 115, 119, 122.

Nearctic Distribution.- US: AL, AR, DE, FL, GA, IA, IL, IN, KS, KY, LA, MD, ME, MI, MN, MO, MS, NC, NE, NY, OH, OK, PA, SC, TN, TX, VA, WI, WV; MEXICO; CENTRAL AND SOUTH AMERICA.

Discussion.- This species was commonly collected from a wide range of lotic and lentic habitats (Table 5). Males are distinguished by the heavily sclerotized, preapico mesal triangular process on each inferior appendage (Fig. 548). Adults were collected from April to October (Table 6).

Genus *Neureclipsis* McLachlan

Six species are recorded for North America (Morse 1993). Only one species, *N. crepuscularis*, occurs in the region. Larvae are distinguished by the subequal lengths of the basal and distal anal proleg segments (the former lacking setae), and the presence of a row of minute spinules along the ventral margin of each anal claw (Fig. 528). Length of mature larvae is 10 - 12 mm. One striking feature of some larvae is the irregular purple maculations on the meso- and metanotum and dorsal abdominal segments. *Neureclipsis* larvae are predacious and construct trumpet-shaped filtering retreats on submerged macrophytes and snag habitats in areas of low current speed (Cudney and Wallace 1980, Wiggins 1977). Adults are brown and have the forewing R_{2+3} branching near the wing margin, and M three-branched (Fig. 540).

***Neureclipsis crepuscularis* (Walker)**

Figs. 527, 528, 540, 549

Brachycentrus crepuscularis Walker 1852:87.

Neureclipsis parvula Banks 1907b:163.

Type Locality.- Ontario.

Regional Distribution.- Watersheds 1, 24, 28, 60, 70, 74, 80, 81, 104, 106, 107. ARKANSAS: Arkansas Co., India Bayou, AR Hwy 1, White River National Wildlife Refuge, 1-IX-1990, S. Chordas, 2 ♂♂, 5 ♀♀; Craighead Co., Coopers Pond, AR Hwy 351, Jonesboro, 12-VIII-1991, S.R. Moulton, J.C. Abbott, and G.L. Harp, 1 ♂; Polk Co., 6.4 mi W Mena, 27-VI-1990, H.W.

Robison, 1 ♂; Scott Co., Little Cedar Creek, AR Hwy 28, 1 mi W Cedar Creek, 24-X-1991, S.R. Moulton, 1 ♂; MISSOURI: Gasconade Co., Gasconade River, Hells Island Access, 28-VIII-1990, B.C. Poulton, 1 ♂, 1 ♀; OKLAHOMA: Cherokee Co., Town Branch Creek, OK Hwy 82, Tahlequah, 5-VI-1991, S.R. Moulton, 3 ♂♂.

Nearctic Distribution.- US: AL, AR, CT, DC, DE, FL, GA, IA, IL, IN, KS, KY, LA, MA, MD, ME, MI, MN, MO, MS, MT, NC, NH, NY, OH, OK, PA, SC, TN, TX, VA, VT, WI, WV; CANADA: AB, MB, NB, NF, NS, ON, PQ, SK.

Discussion.- The larval meso- and metanotum and abdomen have patches of purple coloration; their head and pronotum are straw colored, with brown muscle scars (Fig. 527). Males (Fig. 549) are similar to those of *N. piersoni* Frazer and Harris, but that species is restricted to Gulf Coastal Plain streams in Alabama. *N. crepuscularis* was infrequently collected, and has a scattered distribution throughout the region. It was collected in this study from permanent streams (Table 5) during April to October (Table 6). Nimmo (1986) reported that adults emerged "from small sluggish creeks to larger, turbulent rivers". Cudney and Wallace (1980) observed that it was bivoltine in the lower Savannah River, Georgia. They reported larvae overwintering in instars III - V, with peak adult emergence in the spring and late summer.

Genus *Nyctiophylax* Brauer

Morse (1993) reported 10 species from North America. Three of these

have been recorded in the Interior Highlands. Neboiss (1993) presented evidence that tentatively supports the transferal of all North American species into the genus *Paranyctiophylax* Tsuda. However, until a more definite decision is made on this matter, I am conserving the usage of *Nyctiophylax* to prevent any unnecessary confusion. Larvae are distinguished from other regional polycentropodid genera by possessing four to six, well developed teeth on the ventral margin of each anal claw (Fig. 529). Larvae construct simple retreats consisting of a silken roof covering a depression on wood or rock; beneath this is a tubular chamber opened at each end (Wiggins 1977). Larvae are predacious and occupy a wide range of lotic and lentic habitats, particularly pools and areas of low current (Nimmo 1986, Wiggins 1977). Wiggins (1977) illustrated the larval habitus of an undetermined species from northwestern Arkansas. Adults are brown and measure 5-6 mm. Morse (1972, 1990) has extensively revised and updated the systematics and male taxonomy. My key to males was modified from Morse (1990).

KEY TO THE MALES OF *Nyctiophylax*

1. Apical edges of tergal X plates oblique and serrated at 100X magnification (Figs. 550, 551) ***N. serratus* Lago and Harris**
- Apex of tergum X membranous or lightly sclerotized, not forming serrated plates as above (Figs. 552, 554) 2
2. Lateral lobe of each inferior appendage in caudal view shorter than

- mesal lobe (Fig. 553); paraproctal processes short and tapering to a slightly hooked apex (Fig. 552) ***N. affinis* (Banks)**
- Lateral lobe of each inferior appendage in caudal view as least as long as, and diverging from mesal lobe (Fig. 555); paraproctal processes longer, more slender, not hooked apically (Figs. 554)
 ***N. moestus* Banks**

***Nyctiophylax affinis* (Banks)**

Figs. 542, 552, 553

Polycentropus affinis Banks 1897:30.

Nyctiophylax zelenus Denning 1950:99.

Type Locality.- Canada, Ontario and New York, Buffalo.

Regional Distribution.- Watersheds 1, 6, 10, 17, 28, 34, 35, 38, 39, 44, 49, 53, 56, 57, 66, 70, 74, 77, 80, 81, 85, 87, 89, 96, 100, 105, 106, 107, 109, 110, 112, 115, 118, 119, 121, 122, 124, 129, 131.

Nearctic Distribution.- US: AL, AR, DE, FL, GA, IL, IN, KS, KY, LA, MA, ME, MI, MN, MO, MS, MT, NC, ND, NH, NJ, NY, OH, OK, PA, SC, SD, TN, TX, VA, WI, WV, WY; CANADA: BC, MB, NF, NS, ON, PQ, SK.

Discussion.- This was the most common and widely distributed regional species of *Nyctiophylax*. It was collected from spring-fed headwater streams to large rivers (Table 5). Adults were collected in UV light traps during April to October (Table 6). Males are most similar to those of *N. affinis*. They differ in

having the lateral lobe of each inferior appendage (in caudal view) shorter than the mesal lobe (Fig. 553), and by the shorter paraproctal processes which are tapered and slightly hooked apicad (Fig. 552). According to Morse (1972), there is considerable variation in the configuration of the inferior appendage lobes; he illustrated eight different variations. Ross (1944) listed this species as a junior synonym of *N. vestitus* (Hagen), but it was later reinstated by Morse (1972) as a result of his designation of the lectotype female of *N. vestitus* as a *nomen dubium*.

***Nyctiophylax moestus* Banks**

Figs. 554, 555

Nyctiophylax moestus Banks 1911:359.

Nyctiophylax vestitus: (*nec* Hagen), Ross (1944:70).

Neureclipsis vestitus: Unzicker *et al.* (1970:170), generic misplacement.

Type Locality.- British Columbia, Peachland.

Regional Distribution.- Watersheds 94, 105, 106, 126. ILLINOIS: Union Spring, Alto Pass; Lusk Creek, Eddyville; Herod; Kaskaskia River, Venedy Station (Ross 1944).

Nearctic Distribution.- US: AK, AL, AR, CT, DE, FL, IL, IN, MA, ME, MI, MN, MT, NC, NH, NY, OH, OK, OR, PA, SC, TN, VA, WI, WV; CANADA: AB, BC, NB, NS, ON, PQ, SK.

Discussion.- I did not encounter this species in my collections. Its

regional taxonomic status has been somewhat problematic. According to Morse (1972), the male described and illustrated by Ross (1944) as *N. vestitus* is actually *N. moestus*. Following this discovery, it seems likely that the record of *N. vestitus* by Unzicker *et al.* (1970)(see above synonymy) was based on Ross' misapplication of names. Ross (1944) and Morse (1972) reported it from various locations throughout the Ozarks with regional state records for Arkansas, Illinois, and Oklahoma. Ross (1944) gave specific locations from the Illinois Ozark physiographic subregion and adult collection dates from 19 May to 20 September. Bowles and Mathis (1989, 1992) did not include *N. moestus* in their checklists for Arkansas and Oklahoma, nor attempt to clarify the confusion associated with the Unzicker *et al.* (1970) record. Ross (1944) reported it from a wide range of streams adult emergence spanning May to September (Table 6). Males are most similar to *N. affinis*, but have the lateral and mesal lobes of each inferior appendage subequal in length and diverging (Fig. 555); the paraproctal processes are longer and not hooked apicad (Fig. 554).

***Nyctiophylax serratus* Lago and Harris**

Figs. 550, 551

Nyctiophylax serratus Lago and Harris 1985:16.

Type Locality.- Alabama, Baldwin Co., Farris Creek, Hwy 59.

Regional Distribution.- Watersheds 34, 46, 58, 67, 77, 116, 118.

ARKANSAS: Clark Co., Terre Noir Creek, AR Hwy 26, 8 mi E Antoine, 21-VI-1992, S.R. Moulton, 2 ♂♂; Independence Co., Curia Creek, 4 mi NE Charlotte, 19-VII-1986, H.W. Robison, 1 ♂; Polk Co., 6.4 mi W Mena, 27-VI-1990, H.W. Robison, 1 ♂; Saline Co., South Fork Saline River, N Nance, 15-VIII-1980, H.W. Robison and S. Winters, 1 ♂; Van Buren Co., Cadron Creek, AR Hwy 124, 3.5 mi E Gravesville, 22-V-1982, H.W. Robison, 1 ♂; MISSOURI: Dade Co., Lynn Branch, Stockton Lake, US Hwy 160, 21-V-1992, S.R. Moulton and D.E. Baumgardner, 1 ♂; Dallas Co., Bennett Spring, Bennett Spring State Park, 7-VI-1991, S.R. Moulton, 1 ♂; OKLAHOMA: Pushmataha Co., Kiamichi River, 2.5 mi E Albion, 12-VI-1991, R. Tucker, 1 ♂.

Nearctic Distribution.- US: AL, AR, MO, MS, OK.

Discussion.- Males are distinct from the other regional species by the oblique, serrated posterior margin of the sclerotized plates that comprise tergum X (Fig. 550). These serrations are best viewed at 100x power (Fig. 551). This species was previously known primarily from the coastal plain region of Alabama and Mississippi (Harris *et al.* 1991); it is now known for the first time from the region in Arkansas, Missouri, and Oklahoma. It was collected from small permanent and spring-fed streams (Table 5) during May, June, and August (Table 6). The larva and female are unknown, but I have collected females in association with this species and *N. affinis* that could belong to either.

Genus *Phylocentropus* Banks

Five North American species are known in this genus (Schuster and Hamilton 1984). Only *P. placidus* has been reported from the Interior Highlands. A second species, *P. lucidus* (Hagen), may eventually be found in the adjacent Gulf Coastal Plain physiographic subregion. This genus has been placed in the Hyalopsychidae (Schmid) by some workers or Dipseudopsidae (Ross 1967).

Phylocentropus larvae are unique in having the tarsi on all legs, broad and flat. The labium is produced into a long, narrow tube which is probably a specialization for applying silk to retreat tubes (Wiggins 1977). The retreat consists of a branching tube of silk covered with sand and detritus. Retreats are constructed in depositional areas of sand-bottomed streams and lakes. The larval mesonotum is expanded laterad and humped dorsad. Adults have R_2 branching from R_3 at the radial crossvein in both the fore- and hindwings (Fig. 535). Schuster and Hamilton (1984) revised the North American species of this genus, and provided illustrated keys to males and females.

***Phylocentropus placidus* (Banks)**

Figs. 535, 536, 537

Holocentropus placidus Banks 1905:15.

Phylocentropus maximus Vorhies 1909:711.

Phylocentropus irroratus Navas 1934:20.

Phylocentropus hansonii Root 1965:85.

Type locality.- Washington D.C.

Regional Distribution.- Watersheds 1, 6, 27, 39, 46, 56, 58, 73, 74, 77, 80, 106. ARKANSAS: Clark Co., Terre Noir creek, AR Hwy 26, 8 mi E Antoine, 21-VI-1992, S.R. Moulton, 11 ♂♂; Scott Co., Mill Creek, Mill Creek Rec. Area, off US Hwy 270, 4.5 mi E "Y" City, 23-X-1991, S. R. Moulton, 2 ♂♂; OKLAHOMA: Latimer Co., Robbers Cave State Park, off OK Hwy 2, 27-IV-1991, S.R. Moulton and J. Kennedy, 6 ♀♀; Pushmataha Co., Jack Fork River, OK Hwy 2, 1 mi N Clayton, 27-IV-1991, S.R. Moulton and J. Kennedy, 2 ♂♂.

Nearctic Distribution.- US: AL, AR, CT, DC, DE, FL, GA, IL, IN, KY, LA, MA, ME, MI, MN, MO, MS, NC, NH, NJ, NY, OH, OK, PA, RI, SC, TN, TX, VA, VT, WI, WV; CANADA: MB, NB, NS, ON, PQ.

Discussion.- This species was infrequently collected from small and medium sized streams, primarily in bottomland areas (Table 5). Adults were only collected with UV light traps during April to October (Table 6). Since this is the only species in the genus known from the region, generic wing characters will serve to identify it. The male inferior appendages are longer than wide in ventral aspect with a prominent mesal band of stout black setae (Fig. 537). The phallus is flared basad and curved ventrad (Fig. 536). Wallace *et al.* (1976) studied its retreat-making behavior and feeding ecology in a small, sand-bottomed stream in Georgia. According to their observations, larvae fed on FPOM that was circulated through the tube-retreat system via abdominal

undulations.

Genus *Polycentropus* Curtis

Morse (1993) recorded 77 species from North America. Recent descriptions of *P. harpi* (Moulton and Stewart 1993a) and *P. stephani* (Bowles *et al.* 1993) bring that number to 79. Eight species are documented here for the Interior Highlands, one of which is endemic to that region. Old World and pre-1944 taxonomy recognized three genera which are considered by most North American workers to represent an unnatural assemblage of species belonging to *Polycentropus sensu lato* (in the broad sense) (Armitage and Hamilton 1990). I follow Armitage and Hamilton (1990) in recognizing these taxa as subgenera, and include these distinctions for clarification with the existing taxonomic literature. The subgenus *Holocentropus* is not represented in the Interior Highlands. The subgenera *Plectronemia* and *Polycentropus sensu stricto* (in the strict sense), each have four regional species.

Larvae are most similar to those of *Cernotina*. They construct a silken tubular or bag-like retreat (Wiggins 1977). They inhabit a variety of lotic and lentic habitats, and are the only genus of retreat-makers to inhabit temporary vernal pools (Wiggins 1973).

KEY TO THE MALES OF *Polycentropus*

1. Hindwings each with R_{2+3} unbranched and discoidal cell closed

- ***P. (Holocentropus)****
- Hindwings each with R_{2+3} branched, discoidal cell open (Fig. 538) or closed (Fig. 539) 2
2. Hind wings with discoidal cell closed (Fig. 539) . . . ***P. (Plectronemia)***...3
- Hind wings with discoidal cell open (Fig. 538) . . . ***P. (Polycentropus)***...6
3. Ventral margin of sternite IX produced into a shelf-like process (Fig. 566) ***P. crassicornis* Walker**
- Ventral margin of sternite IX not produced 4
4. Inferior appendages each with dorsal margin produced into a prominent thumb-like lobe (Fig. 543) ***P. nascotius* Ross**
- Inferior appendages each with dorsal margin straight, not produced (Figs. 567, 569) 5
5. Inferior appendages each with a shallow posterior emargination (Fig. 567); phallus with left paramere spine straight (Fig. 568) ***P. cinereus* Hagen**
- Inferior appendages each with a deep posterior emargination (Fig. 569); phallus with left paramere spine angled to the left at apex (Fig. 570) . . . ***P. harpi* Moulton and Stewart**
6. Dorsobasal process of each inferior appendage with a distinct neck region ending apically in a short head (Fig. 556) . . . ***P. centralis* Banks**
- Dorsobasal process of each inferior appendage with a short neck region and a long head (Fig. 557) 7

- 7. Apex of phallus curved ventrally and bearing many minute spines (Fig. 563); inferior appendages not forming a chelate structure (Fig. 562) ***P. confusus* Hagen**
- Apex of phallus without minute spines (Fig. 561); inferior appendages with dorsobasal and ventral processes long and forming a chelate structure (Figs. 558, 560) 7
- 7. Basoventral swelling of phallus with a spur (Figs. 561) ***P. stephani* Bowles, Mathis, and Hamilton**
- Basoventral swelling of phallus without a spur (Figs. 559) ***P. chelatus* Ross and Yamamoto**

* The adults of this subgenus have not yet been collected in the region.

***Polycentropus (Polycentropus) centralis* Banks**

Figs. 538, 556, 564, 565

Polycentropus centralis Banks 1914:258.

Type Locality.- Missouri, St. Louis.

Regional Distribution.- Watersheds 1, 4, 9, 10, 13, 14, 17, 23, 28, 31, 35, 38, 39, 44, 46, 48, 49, 56, 57, 60, 66, 67, 69, 74, 77, 80, 81, 85, 94, 95, 96, 100, 102, 104, 105, 107, 115, 116, 118, 121, 122, 129.

Nearctic Distribution.- US: AL, AR, IL, IN, KS, KY, MN, MO, MS, NY, OH, OK, PA, TN, TX, WI; CANADA: NF, NS, ON.

Discussion.- This is the most commonly collected species of

Polycentropus in the Interior Highlands. Ross (1944) described the larva and female; Nimmo (1986) described the female. Males are readily distinguished from the other regional species by the longer neck region of the dorsobasal process of each inferior appendage (Fig. 556). I collected it in large numbers from UV light traps set near a wide range of stream types (Table 5). Adults were present from March to October (Table 6). Bowles and Allen (1992) indicate that it exhibits a bivoltine life cycle in a third order reach of the Mulberry River, Johnson Co., Arkansas. They found that larvae of most instars were found throughout the year. Bowles and Allen (1991) studied its secondary production from the same location and reported a 0.04 g/m²/yr estimate.

***Polycentropus (Polycentropus) chelatus* Ross and Yamamoto**

Figs. 558, 559

Polycentropus chelatus Ross and Yamamoto 1965:

Type Locality.- Tennessee, Decatur Co., Sugar Tree, along Kentucky Lake, tributary of Morgan Creek.

Regional Distribution.- Watershed 122. MISSOURI: Pulaski Co., Cave Spring, Wayne Roam Farm, 25-IV-1986, M.L. Mathis, many ♂♂.

Nearctic Distribution.- US: AL, IN, KY, MO, TN.

Discussion.- Mathis and Bowles (1992) collected the only known regional records of this species from a small Missouri spring during April and

May (Tables 5, 6). My illustration of the male was drawn from their material, which is deposited at Central Arkansas University. Males are most similar to those of *P. stephani*, but do not have a spur on the basoventral swelling of the phallus (Fig. 559). The larva and female are unknown.

***Polycentropus (Plectronemia) cinereus* Hagen**

Figs. 567, 568

Polycentropus cinereus Hagen 1861:293.

Polycentropus canadensis Banks 1897:31.

Holocentropus flavicornis Banks 1907b:162.

Plectronemia pallescens Banks 1930:231.

Plectronemia lutea Betten 1934:219.

Type Locality.- Canada, St. Lawrence River.

Regional Distribution.- Watersheds 10, 13, 23, 28, 35, 38, 66, 77, 81, 85, 103, 108, 109, 115, 118, 122, 123.

Nearctic Distribution.- US: AL, AK, AR, CO, CT, DC, DE, FL, ID, IL, IN, KS, KY, LA, MA, MD, ME, MI, MN, MO, MS, MT, NC, ND, NH, NY, OH, OK, OR, PA, SC, SD, TN, TX, UT, VA, WA, WI, WV; CANADA: AB, BC, MB, NB, NF, NS, NT, ON, PQ, SK.

Discussion.- Males are most similar to *P. harpi*; they differ in the shallower posterior emargination of each inferior appendage (Fig. 567) and the straighter left phallic rod (Fig. 568). It was never collected with that species.

Ross (1944) described the larva and female; Nimmo (1986) described the female. I collected it throughout the region from a wide range of streams (Table 5). Adults were usually collected in low numbers from UV light traps, during April to October (Table 6).

***Polycentropus (Polycentropus) confusus* Hagen**

Figs. 562, 563

Polycentropus confusus Hagen 1861:293.

Polycentropus confuses Hagen: misspelling (Unzicker *et al.* 1970:170)

Type Locality.- Washington.

Regional Distribution.- Watersheds 4, 23, 47, 53, 66, 95, 102, 116, 118.

ARKANSAS: Stone Co., Gunner Pool at North Sylamore Creek, 24-V-1990, S.R. Moulton, 3 ♂♂; same but Mirror Lake at Blanchard Springs Rec. Area, 2 ♂♂, 2 ♀♀; MISSOURI: Dade Co., Sac River, MO Hwy 245 S Dadeville, 21-V-1992, S.R. Moulton, 2 ♂♂; Douglas Co., Bryant Creek, at spring off MO Hwy 5, W Bryant, 25-IX-1992, S.R. Moulton, 8 ♂♂; Clever Creek, MO Hwy 76, 1 mi E jct. Rte. C, 25-IX-1992, S.R. Moulton, 1 ♂; Laclede Co., Bennett Spring, Bennett Spring State Park, 7-VI-1991, S.R. Moulton, 1 ♂; McDonald Co., Bentonville Hollow Branch, spring off MO Hwy 90, 2 mi S Powell, 6-VI-1991, S.R. Moulton, 4 ♂♂; Newton Co., Indian Creek, Rte. DD, 3 mi NW Stella, 6-VI-1991, S.R. Moulton, 1 ♂.

Nearctic Distribution.- US: AL, AR, CT, DC, DE, GA, IN, KY, MA, ME,

MI, MN, MO, MS, NC, NH, NJ, NY, OH, OK, PA, SC, TN, VA, VT, WI, WV;
CANADA: NB, NF, NS, ON, PQ.

Discussion.- Males are distinguished by the configuration of the inferior appendages (Fig. 562) and the strongly arched phallus, its apex directed ventrad and bearing numerous small spines (Fig. 563). Ross (1944) and Nimmo (1986) described the female. I collected it from a wide range of stream types (Table 5). Adults were collected in UV light traps from April to October (Table 6).

***Polycentropus (Plectronemia) crassicornis* Walker**

Figs. 44, 533, 534, 566

Polycentropus crassicornis Walker 1852:101.

Plectronemia australis Banks 1907a:131.

Plectronemia adironica Banks 1914:256.

Type Locality.- Georgia.

Regional Distribution.- Watersheds 10, 56, 80, 89, 116, 118.

ARKANSAS: Logan Co., temporary vernal pool along AR Hwy 309, on top of Magazine Mountain, 14-III-1992, Z. Johnson, P. Wagner, N. Witt, 15 larvae; same but, 13-III-1994, S.R. Moulton, many larvae, ♂♂♀♀ (reared); Polk Co., Lake Wilhelmina, 11-V-1988, C.E. Carlton, 1 ♂; Ouachita River, 5.5 mi E jct. AR Hwy 272 & US Hwy 270, 10-VI-1990, H.W. Robison, 1 ♂; Washington Co., 2 mi SW West Fork, 20-V-1988, C.E. Carlton, 1 ♂; MISSOURI: Dade Co., Sons

Creek, US Hwy 260, 1 mi E Lockwood, 21-V-1992, S.R. Moulton & D.E.

Baumgardner, 1 ♂; Dallas Co., tributary to Lindley Creek, US Hwy 65, 2 mi S
Louisburg, 22-V-1992, S.R. Moulton & D.E. Baumgardner, 2 ♂♂.

Nearctic Distribution.- US: AL, AR, CT, DC, DE, FL, GA, ID, IL, IN, KS, KY, LA, MA, ME, MI, MN, MO, MS, NC, NH, NY, OH, OK, PA, SD, TN, WI; CANADA: NS, ON, PQ, SK.

The larva is described here for the first time.

Larva (Figs. 533, 534): Length of mature larva 14 - 15 mm. Head capsule with golden laterad and posterad, dotted with small brown muscle scars; darker centrally except for a lighter pale area on frontoclypeus; clypeus golden; labrum darker. Pronotum golden with scattered brown muscle scars on posterior one-half, posterior margin black. Thoracic legs golden; protarsi as long as protibiae. Abdomen with dense lateral fringe of silky setae; dorsum with a purple tinge, venter pale. Claw of anal proleg angled 90°, dorsum with 2 minute accessory spines.

Discussion.- *Polycentropus crassicornis* is reported here for the first time from Missouri. Males are readily differentiated from the other regional species by the well developed shelf-like extension of sternite IX (Fig. 566). Ross (1944) and Nimmo (1986) described the female. The larva was associated and described from reared material collected in late March from a vernal pool on Magazine Mountain, Logan Co., Arkansas. Adults emerged in the laboratory in mid-April. I also collected adults from third order, permanent

streams (Table 5). Adults were present from April to August (Table 6), with the majority of records coming during May. Wiggins (1973) surmised that it probably does not go through a summer diapause in temporary vernal pools in Ontario.

***Polycentropus (Plectronemia) harpi* Moulton and Stewart**

Figs. 539, 569, 570

Polycentropus harpi Moulton and Stewart 1993a:35.

Type Locality.- Texas, Kendall Co., Boerne, Cibolo Creek.

Regional Distribution.- Watersheds 9, 44, 49, 56, 74, 77, 80, 96.

ARKANSAS: Johnson Co., Dripping Vat Hollow Spring, 1 mi E Catalpa, 29-VI-1993, G. Leeds, 1 ♂; same but O-Deer Spring, 1 mi E Oark, 1 ♂; same but Schoolhouse Spring, 0.5 mi E Catalpa, 1 ♂; Polk Co., spring, Rich Mountain, Queen Wilhelmina State Park, 14-V-1991, H.W. Robison, 5 ♂♂; MISSOURI: Christian Co., Swan Creek, Rte. DD, 1 mi W Keltner, 8-VI-1991, S.R. Moulton, 1 ♂; OKLAHOMA: Latimer Co., Robbers Cave State Park, OK Hwy 2, 27-IV-1991, S.R. Moulton & J. Kennedy, 1 ♂; Pushmataha Co., Patterson Creek, OK Hwy 2, 2 mi N Moyers, 27-IV-1991, S.R. Moulton & J. Kennedy, 1 ♂.

Nearctic Distribution.- US: AR, MO, OK, TX.

Discussion.- Males are most closely related to *P. cinereus*, but is readily distinguished from it on the basis of the deeper posterior emargination of the inferior appendages (Fig. 569) and distally angled left phallic rod (Fig. 570).

The female and immature stages are unknown (Moulton and Stewart 1993a). The holotype is deposited in the NMNH. I have collected it from spring-fed head water streams (Table 5) during April to June and September (Table 6). It is reported here for the first time from Missouri and Oklahoma.

***Polycentropus (Plectronemia) nascotius* Ross**

Fig. 543

Polycentropus nascotius Ross 1941b:73.

Type Locality.- Nova Scotia, Hubbard.

Regional Distribution.- Watershed 59. OKLAHOMA: Marshall Co., Lake Texoma, University of Oklahoma Lake Texoma Biological Station, 28-IV-?1974-1976.

Nearctic Distribution.- US: AL, DE, GA, IN, KS, MA, ME, MN, NC, NH, OH, OK, PA, SC, TX, WI, CANADA: NB, NS, PQ.

Discussion.- Resh *et al.* (1978) reported a single male collected from Lake Texoma on the Oklahoma/Texas border. This location is characterized by a large, silt laden impoundment on the Red River (Table 5). I was unable to locate this specimen, but feel confident that the determination by V.H. Resh (D.S. White, pers. communication) is accurate. My illustration of the male (Fig. 543) was redrawn from Ross (1941b).

Polycentropus (Polycentropus) stephani

Bowles, Mathis and Hamilton

Figs. 557, 560, 561

Polycentropus stephani Bowles, Mathis and Hamilton 1993:31.

Polycentropus species B and C: (Bowles and Mathis 1989:237).

Type Locality.- Arkansas, Logan Co., Gutter Rock Creek (Magazine Mountain).

Regional Distribution.- Watersheds 10, 45, 69. ARKANSAS: Independence Co., unnamed tributary to Salado Creek, 5.6 km N Pleasant Plains, US Hwy 167, 18-IV-1987, P. Harp.

Nearctic Distribution.- US: AR.

Discussion.- This recently described species is tentatively considered endemic to the Interior Highlands. Males are similar to a number of species, but the phallus is most similar to that of *P. chelatus*, differing chiefly in the prominent spur located on the basoventral swelling (Fig. 561). Bowles *et al.* (1993) described and illustrated the female. In addition to the localities noted above, Bowles *et al.* (1993) provided two additional localities from Washington Co., Arkansas. One of these was from Devil's Den State Park, the other from a location 2 mi N Bugscuffle; both records were collected in late April with a UV light. The holotype was deposited in the NMNH. I illustrated the male from the Independence Co., Arkansas record noted above. According to Bowles *et al.*

(1993), small intermittent streams are the probable larval habitat (Table 5).

Nothing is known about its life history.

***Polycentropus* species A**

Polycentropus species A: Ross (1944:66).

Polycentropus species A: Unzicker *et al.* (1970:170), Bowles and Mathis (1989:237).

Discussion.- The taxonomic status of this record is in doubt. Ross (1944) reported a single female (collected 10-V-1935) from Herod in the Illinois Ozarks subregion. He illustrated the female genitalia and commented that it was either the female of *P. carolinensis* Banks or an undescribed species. Unzicker *et al.* (1970) reported a record from Big Clifty (T19N R27W SEC4), Carroll Co., Arkansas in May. No additional information regarding their record was given. I was unable to locate either voucher specimen for further comparisons and evaluation.

CHAPTER 17

FAMILY PSYCHOMYIIDAE

The family Psychomyiidae is represented in the Interior Highlands by three species in three genera. Larvae are similar in structure to those of the Polycentropodidae. The best diagnostic feature is the broad, hatchet-shaped trochantin at the base of the prothoracic leg (Fig. 25). Retreats are located on rock or woody substrates and consist of a silken tube covered with sand (Wiggins 1977). Mature larvae measure up to 10 mm in length. Adults of the regional species are generally straw-colored and easily collected throughout the day and night using a variety of methods. My larval key to species includes for the first time the recently discovered larva of *Paduniella nearctica*. The adult key was modified from Armitage and Hamilton (1990).

KEYS TO THE GENERA AND SPECIES OF PSYCHOMYIIDAE

larvae

1. Ventral margin of anal claw with well developed teeth (Fig. 571) 2
Ventral margin of anal claw without teeth *Lype diversa* (Banks)
2. Anterior margin of frontoclypeus nearly straight; meso- and metanotum and

- dorsum of abdomen with a wide, dark, mesal stripe, visible with eye (Fig. 571) ***Paduniella nearctica* Flint**
- Anterior margin of frontoclypeus with a shallow, median notch (Fig. 572); meso- and metanotum and dorsum of abdomen without a mesal stripe ***Psychomyia flavida* Hagen**

adults

1. Maxillary palpi six-segmented (Fig. 573); labial palpi four-segmented ***Paduniella nearctica* Flint**
- Maxillary palpi five-segmented; labial palpi three-segmented 2
2. Apex of hind wing tapering; mid-costal margin obtusely angled (Fig. 574); male tergum X broad, cup-like, with numerous, stout, mesal setae (Figs. 576, 577) ***Psychomyia flavida* Hagen**
- Apex of hind wing evenly rounded; mid-costal angle absent (Fig. 575); male tergum X with a dorsomesal process that projects posterad (Fig. 578) ***Lype diversa* (Banks)**

Genus *Lype* McLachlan

The genus *Lype* is represented in North America by a single species, *L. diversa* (Wiggins 1977, Morse 1993). It is confined to the eastern half of the continent. Adults are readily distinguished from the other regional species by the rounded apex of the hindwing and absence of a mid-costal angle (Fig. 575).

Larvae are readily distinguished by the absence of ventral teeth on each anal claw. Wiggins (1977) noted that the larval retreat was well camouflaged, consisting of an arched silken tube and detritus, covering a groove in a piece of wood.

***Lype diversa* (Banks)**

Figs. 575, 578

Psychomyia diversa Banks 1914:253.

Lype griselda Betten 1934:229.

Type Locality.- North Carolina, Black Mountain, North Fork Swannoa River.

Regional Distribution.- Watersheds 23, 27, 49, 74, 92, 95, 110, 113, 118, 123. ARKANSAS: Montgomery Co., Caddo River, AR Hwy 8, 4.5 mi W Black Springs, 15-III-1992, S.R. Moulton, 1 ♂, 1 ♀; Polk Co., 6.4 mi W Mena, 27-VI-1990, H.W. Robison, 1 ♂; Stone Co., Big Spring, at Big Spring (town, T15N R12W SEC33), 13-III-1991, S.R. Moulton and J.C. Abbott, 1 ♂; MISSOURI: Barry Co., Flat Creek, MO Hwy 248, 1 mi S Jenkins, 18-VIII-1990, S.R. Moulton, 2 ♂♂; Dade Co., Lynn Branch, Stockton Lake, US Hwy 160, 21-V-1992, S.R. Moulton and D.E. Baumgardner, 1 ♂; Sac River, MO Hwy 245, S Dadeville, 21-V-1992, S.R. Moulton and D.E. Baumgardner, 2 ♂♂; Dent Co., Montauk Spring, Montauk State Park, 15-III-1991, S.R. Moulton and D.E. Baumgardner, 1 ♂; Douglas Co., Bryant Creek, MO Hwy 76, 4 mi W jct. C, 25-IX-1992, S.R. Moulton, 1 ♂; Washington Co., Flat Creek, MO Hwy 21, 4 mi N Caledonia, 24-V-1992, S.R. Moulton, 1 ♂.

Nearctic Distribution.- US: AL, AR, CT, DE, FL, GA, IL, IN, KY, LA, MA, ME, MI, MN, MO, MS, NC, NH, NY, OH, PA, SC, TN, VA, VT, WI, WV; CANADA: AB, NB, ON, PQ.

Discussion.- The male inferior appendages are elongate and tergum X has a mid-dorsal process (Fig. 578) that may vary in its development (see Ross 1944, p. 75). The regional males that we examined had a short process. It was collected from a wide range of lotic habitats (Table 5).

Genus *Paduniella* Ulmer

The discovery of *P. nearctica* in North America by Flint (1967) was significant as it marked the first New World record of the Paduniellinae. Previously, members of this subfamily had been known only from Africa, India, and southeast Asia (Flint 1967). What is more interesting is its wide distribution but apparent isolation in the Interior Highlands.

***Paduniella nearctica* Flint**

Figs. 571, 573, 579

Paduniella nearctica Flint 1967:310.

Type Locality.- Arkansas, Washington Co., Devil's Den State Park.

Regional Distribution.- Watersheds 23, 38, 42, 45, 53, 100, 110, 117. ARKANSAS: Crawford Co., Lee Creek, at Natural Dam, off AR Hwy 59, 29-V-1985, H.W. Robison, 1 ♂; Fulton Co., Myatt Creek, 4 mi NE Camp (town), 25-V-1990, 5

♂♂; Searcy Co., Little Red River, US Hwy 65, 2 mi SE Leslie, 14-VI-1984, H.W. Robison, 1 ♂; Stone Co., North Sylamore Creek, Blanchard Springs Rec. Area, 24-V-1990, S.R. Moulton, 1 ♂; same but Barkshed Rec. Area, 12-III-1991, S.R. Moulton and J.C. Abbott, many larvae; MISSOURI: Douglas Co., Noblett Creek, below Noblett Lake, 25-V-1990, S.R. Moulton, 3 ♂♂; Washington Co., Flat Creek, MO Hwy 21, 4 mi N Caledonia, 24-V-1992, S.R. Moulton, 10 ♂♂.

Nearctic Distribution.- US: AR, MO.

Discussion.- Bowles and Allen (1988) first described the female. Mathis *et al.* (1990) recently discovered the larva. Larvae differ from *P. flavida* in having the submental sclerites wider than long, and by lacking a median notch on the anterior margin of the frontoclypeus (Fig. 571). Larvae may be identified in the field by the presence of a wide, dark, median band that runs dorsally along the meso- and metanotum, and abdominal segments (Fig. 571). The larval retreat and habitat consists of an encrusted sand grain tube on the surface of large boulders found along quiet margins of headwater streams (Table 5). I have found a large population of larvae inhabiting such a habitat in North Sylamore Creek at the Barkshed Rec. Area, Stone Co., Arkansas. Mathis and Bowles (1992) provided additional Missouri records for the Jacks Fork and Niangua Rivers.

Genus *Psychomyia* Pictet

Three species are recorded from North America (Wiggins 1977, Morse 1993). *Psychomyia flavida* is the only regional representative. Adults differ from

those of *Lype* by the tapered apex and obtuse mid-costal angle of each hind wing (Fig. 574). Larvae most closely resemble those of *Paduniella* but differ in having the submental sclerites longer than wide. The larval retreat consists of a silken tube covered with sand grains. I have found retreats on a variety of rock and woody substrates.

***Psychomyia flavida* Hagen**

Figs. 572, 574, 576, 577

Psychomyia flavida Hagen 1861:294.

Psychomyia pulchella Banks 1899:217.

Psychomyia moesta Banks 1907a:131.

Type Locality.- Canada, St. Lawrence River.

Regional Distribution.- Watersheds 4, 14, 17, 23, 28, 38, 41, 47, 49, 52, 53, 54, 55, 56, 66, 68, 80, 81, 85, 91, 93, 95, 96, 97, 99, 100, 102, 103, 107, 110, 115, 116, 117, 118, 120, 121, 122, 123, 124, 128.

Nearctic Distribution.- US: AL, AR, CA, CO, CT, DC, DE, FL, ID, IL, IN, KS, KY, MD, ME, MI, MN, MO, MT, NC, ND, NH, NJ, NY, OH, OK, OR, PA, SC, TN, UT, VA, VT, WI, WV, WY; CANADA: AB, BC, MB, NB, NS, ON, PQ, SK; SIBERIA; MONGOLIA.

Discussion.- This is the most common and widely distributed psychomyiid in the region. It was collected from a wide range of lotic habitats (Table 5). Adults were collected throughout most of the year (Table 6). They were easily

captured during the day with sweep nets or at night in UV light traps. Their numbers in light traps often approached or exceeded 1000. Corbet (1966) indicated that it is probably facultatively parthenogenetic. Larval retreats were found on both rock and woody substrates. Larvae are distinguished from those of *P. nearctica* by the presence of a shallow median notch on the anterior margin of the frontoclypeus (Fig. 572), and the absence of a wide, dark band on the meso- and metanotum and dorsal abdominal segments. Wiggins (1977) reported that some larval gut contents contained vascular plant tissue and FPOM.

CHAPTER 18

FAMILY RHYACOPHILIDAE

This primitive family is represented in North America by two genera. *Himalopsyche* Banks occurs in the coastal mountain ranges of the western United States (Wiggins 1977); *Rhyacophila* is widespread throughout North America, and is the most diverse genus of caddisflies with 123 species (Morse 1993). Ross (1956) reviewed the systematics and biogeography of the world fauna. Further discussion of *Rhyacophila* is provided below.

Genus *Rhyacophila* Pictet

This genus is represented by six species in the region, one of which, *R. kiamichi*, is endemic. Their larvae are the only caddisflies to remain free-living throughout larval growth. They are considered to be largely predacious, although some species may be herbivorous (Smith 1968). Larvae may be found in a wide range of temporary and permanent stream types, but most are encountered in headwater reaches having swift riffles. Prior to pupation, they seek out locations on the undersides of cobbles and spin an elliptical, silk puparium which is covered by a dome housing of small pebbles. Adults are

generally dark brown and, depending on the species, emerge in the spring or fall. Although life histories are largely unknown for many species (Manuel and Folsom 1982), collection data suggest that most are probably univoltine. Unzicker *et al.* (1982) reported that species in North and South Carolina are univoltine, with larvae overwintering as late instars. My keys were modified after those of Weaver & Sykora (1979) for larvae, and Ross (1944) for adults.

KEYS TO THE SPECIES OF *Rhyacophila*

larvae

1. Anal proleg a free basoventral hook (Fig. 583); head straw colored with distinct pattern of brown muscle scars (Fig. 582) . . . ***R. jobifera* Betten**
 Anal proleg without a free basoventral hook 2
2. Second segment of maxillary palps subequal in length to first segment (Fig. 581); dorsum of head light with a darker V-shaped area on posterior one-half (Fig. 580) ***R. glaberimma* Ulmer**
 Second segment of maxillary palps longer than first segment (Fig. 587) 3
3. Anal claw with 2 ventral teeth (Fig. 585); head capsule parallel sided and dark brown (Fig. 584) ***R. banksi* Ross**
 Anal claw without ventral teeth; head widening posterad (Figs. 586, 588) 4
4. Head with conspicuous pattern of light and dark areas, frontoclypeus with central pale area (Fig. 586) ***R. fenestra* Ross, *R. ledra* Ross**

Head nearly uniformly golden; may be darkened on posterior one-third
(Fig. 588) ***R. kiamichi* Ross**

adults

1. (males) 2
(females) 6
2. Tergum X produced into a long acute process in lateral view; inferior appendages long, with distal articles wedge-shaped, not emarginate
(Fig. 589) ***R. glaberimma* Ulmer**
Tergum X not as above; inferior appendages variable 2
2. Tergum X enlarged; distal article of each inferior appendage with a deep, broad emargination, the dorsal process of which is long and acute
(Fig. 591) ***R. lobifera* Betten**
3. Tergum X produced into a short thumb-like process; distal article of each inferior appendage with a deep, narrow emargination and rounded processes, the ventral process with a dorso-mesal pad of stout setae
(Fig. 593) ***R. banksi* Ross**
Tergum X not thumb-like; distal article of each inferior appendage emarginate or not 4
4. Distal article of each inferior appendage undivided, wedge-shaped (Fig. 594) ***R. kiamichi* Ross**
Distal article of each inferior appendage forked (Figs. 596, 598) 5

5. Distal article of each inferior appendage with mesal surface having a setose, flap (Fig. 596); stout teeth-like spines present on apices of lateral phallic arms (Fig. 597) ***R. fenestra* Ross**
- Distal article of each inferior appendage without a mesal setose flap (Fig. 598); small patch of spines present on apices of lateral phallic arms (Fig. 599) ***R. ledra* Ross**
6. Posteromesal portion of sternite VIII produced into a plate that is distinct from rest of segment (Fig. 600) ***R. lobifera* Ross**
- Posteromesal portion of sternite VIII not so produced 7
7. Posterior margin of sternite VIII more or less straight (Fig. 601)
- ***R. glaberimma* Ulmer**
- Posterior margin of sternite VIII emarginate 8
8. Posterior margin of sternite VIII with three concavities (Fig. 602)
- ***R. banksi* Ross**
- Posterior margin of sternite VIII with a single concavity 9
9. Posterior margin of tergite VIII with a deep V-shaped notch (Fig. 603) . .
- ***R. fenestra* Ross**
- Posterior margin of tergite VIII with a shallow emargination (Fig. 604) . .
- ***R. kiamichi* Ross**

***Rhyacophila banksi* Ross**

Figs. 584, 585, 593, 602

Rhyacophila banksi Ross 1944:268.

Type Locality.- New Hampshire, Warren.

Regional Distribution.- Watersheds 36, 124. ARKANSAS: Washington Co., spring seep, AR Hwy 16, 1 mi W Savoy, 25-V-1991, S.R. Moulton, 1 larva ; MISSOURI: Dent Co., Montauk Spring (at source), Montauk State Park, 15-III-1991, S.R. Moulton and J.C. Abbott, 1 ♀, 14 larvae; same but, 24-IX-1992, 1 ♂.

Nearctic Distribution.- US: AR, MO, NH, OH, PA, TN, VA, VT, WV;
CANADA: PQ.

Discussion.- This species was collected from small springs in the Central and Springfield Plateau subregions (Table 5). A single male was collected by sweeping riparian vegetation at Montauk spring in late September, 1992. Mature larvae, believed to be this species, were collected in March from the same location. This species is generally Appalachian in distribution and I am reporting it in the Interior Highlands the first time. New state records include Arkansas and Missouri. Weaver and Sykora (1979) reported it from similar spring habitats that were 0.3 - 1.2 m wide in Pennsylvania. They collected larvae during the spring and adults later in the summer. The regional populations are probably univoltine. Males are distinguished by the thumb-like extension of tergum X in lateral view, bifurcated in dorsal view; the ventral lobe of each inferior appendage bears a dorsomesal pad of stout setae (Fig. 593). Females are tentatively distinguished by the three concavities on the posterior margin of sternite VIII (Fig. 602). Larvae differ in having the head uniformly

dark and by the presence of two ventral teeth (1 large, 1 small) on each anal claw (Fig. 585). This species was also collected at Lost Valley Rec. Area in the Buffalo River watershed by M. L. Mathis (pers. communication). He examined my male and agreed that the two were the same species, but thinks that they might represent a new species closely related to *R. banksi* and other species in the *R. invaria* Group. This problem is being studied by Mathis.

***Rhyacophila fenestra* Ross**

Figs. 586, 587, 596, 597, 603

Rhyacophila fenestra Ross 1938a:102.

Type Locality.- Illinois, Herod, Gibbons Creek.

Regional Distribution.- Watersheds 52, 67, 69, 88, 89, 94, 95, 101, 105, 106, 108, 112, 113, 115, 116, 118, 119, 122.

Nearctic Distribution.- US: AL, AR, IL, IN, KY, MO, NC, OH, SC, TN, VT.

Discussion.- This species is common in a variety of temporary and permanent stream types in the Ozark Mountains (Table 5); it was not collected from the Ouachita Mountains. Ross (1944) commented on its abundance in the swift, cool streams of the Illinois Ozarks. *Rhyacophila fenestra* is closely related to *R. ledra*. Males differ in having a setose mesal flap on each inferior appendage (Fig. 596) and by the presence of stout, teeth-like spines on the apices of each lateral phallic arm (Fig. 597). Females have tergum VIII forming

a deep, V-shaped emargination (Fig. 603). Larvae are indistinguishable from those of *R. ledra* at the present time. Ross (1944) illustrated the larval and female habitus. This species is likely univoltine with larvae overwintering as later instars and adults emerging in the Spring (Table 6). Adults were collected by sweeping vegetation during the day, and with UV light traps at night. They were often found in large numbers resting on bridges and their supports. Pupae were easily reared in the laboratory within one to two weeks after collection at a water temperature of 14°C.

***Rhyacophila glaberimma* Ulmer**

Figs. 580, 581, 589, 590, 601

Rhyacophila glaberimma Ulmer 1907b:85.

Rhyacophila fairchildi Banks 1930:130.

Rhyacophila andrea Betten 1934:127.

Type Locality.- Georgia.

Regional Distribution.- Watersheds 1, 14, 17, 55, 74, 89, 105, 106.

ARKANSAS: Montgomery Co., Little Missouri River, Falls Rec. Area, 15-III-1992, D.E. Baumgardner, 1 larva; Polk Co., East Fork Powell Creek, Ewing Farm, 7 mi W Mena, 3-X-1991, B. Ewing, 10 ♂♂; Scott Co., Rock Creek, US Hwy 270, 7 mi E "Y" City, 23-X-1991, S.R. Moulton, 1 ♂; ILLINOIS: Union Co., unnamed creek, 13 mi SE Carbondale, 13-V-1976, J.D. Unzicker, 2 larvae.

Nearctic Distribution.- US: AL, AR, CT, GA, IL, IN, KY, MA, ME, MO, MS, NC, NH, NY, OH, PA, SC, TN, VA, VT, WV; CANADA: NS, PQ.

Discussion.- This species was collected from first and second order, spring-fed streams in the region (Table 5). Males are distinguished by the long, acute tergum X, the rectangular basal article and wedge-shaped, distal article of each inferior appendage (Fig. 589), and by the reduced phallus which bears a pair of membranous lateral arms, each terminating in a setose, forked process (Fig. 590). The female sternite VIII is straight or slightly convex (Fig. 601). Larvae differ in having the first and second maxillary palpal segments subequal in length (Fig. 581); the head capsule is light in color with a darker V-shaped marking on the posterior one-half (Fig. 580). Mature larvae were collected in the spring and summer, while adults were collected primarily in the fall (Table 6) with UV light traps.

***Rhyacophila kiamichi* Ross**

Figs. 39, 40, 41, 51, 588, 594, 595, 604

Rhyacophila kiamichi Ross 1944:37.

Type Locality.- Oklahoma, near Cloudy, Cloudy Creek.

Regional Distribution.- Watersheds 9, 10, 35, 44, 56, 60, 69, 74, 77, 79, 80, 81, 122. ARKANSAS: Franklin Co., Mulberry River, AR Hwy 23, Turners Bend, 1.5 mi S Cass, 19-V-1983, 2 ♂♂; Independence Co., Piney Creek, 5 mi E Pleasant Plains, 31-V-1986, H.W. Robison, 1 ♂; Logan Co., Cove Creek, AR

Hwy 309, Magazine Mountain, 23-V-1990, S.R. Moulton, 4 ♂♂; Gutter Rock Creek, at low water bridge, 14-III-1992, S.R. Moulton, many larvae, ♂♂♀♀; Polk Co., Ouachita River, US Hwy 71, Acorn, 5-VI-1981, H.W. Robison, 7 ♂♂; Pope Co., Dare Creek, 0.5 mi N Hector, 10-VI-1989, H.W. Robison, 1 ♂, 2 ♀♀; MISSOURI: Pulaski Co., Roubidoux Creek, 18-VI-1974, J.H. Howland, 1 larva; OKLAHOMA: Latimer Co., Robbers Cave State Park, OK Hwy 2, 27-IV-1991, S.R. Moulton and J. Kennedy, 4 ♂♂, 1 ♀; McCurtain Co., Yanubee Creek, US Hwy 259, N Broken Bow, 22-V-1990, S.R. Moulton, 1 ♂; Pushmataha Co., Patterson Creek, OK Hwy 2, 2 mi N Moyers, 27-IV-1991, S.R. Moulton and J. Kennedy, 5 ♂♂.

Nearctic Distribution.- US: AR, MO, OK.

Discussion.- This regional endemic is reported here for the first time from Missouri, based on a larva determined by O.S. Flint, Jr. Males are similar to those of *R. fenestra* and *R. ledra*, but differ in having the distal article of each inferior appendage undivided and wedge-shaped (Fig. 594). Females differ in having the posterior margin of tergum VIII shallowly emarginate (Fig. 604). The larval head capsule is uniformly golden, with the posterior one-third possibly slightly darker (Fig. 588). I collected it from small headwater streams in the Ozark and Ouachita Mountains, some of which dry up during the summer (Table 5). Adults emerged in the spring (Table 6).

***Rhyacophila ledra* Ross**

Figs. 598, 599

Rhyacophila ledra Ross 1939a:165.

Type Locality.- Tennessee, Jasper.

Regional Distribution.- Watershed 94. ILLINOIS: Alto Pass, Union Spring, 26-V-1940, Mohr and Burks, 2 ♂♂ mmt (Ross 1944).

Nearctic Distribution.- US: AL, DE, GA, IL, IN, KY, MI, NC, OH, PA, TN, WV.

Discussion.- This species is only known from the record noted above, which was first reported by Ross (1944). Therefore its distribution in the Interior Highlands is restricted to the Illinois Ozark subregion (Table 5). I attempted to collect additional specimens at Union Spring in Alto Pass, Illinois in early June, 1992, but were only able to find mature pupae of *R. fenestra*. Males differ from those of *R. fenestra* by the absence of a mesal setose flap on the apical article of each inferior appendage (Fig. 598), and the absence of teeth-like spines on the apices of each lateral phallic arm (Fig. 599). My illustration of the male was redrawn from Ross (1944).

***Rhyacophila lobifera* Betten**

Figs. 582, 583, 591, 592, 600

Rhyacophila lobifera Betten 1934:131.

Type Locality.- Illinois, south branch of Pettibone's Creek near Lake Bluff.

Regional Distribution.- Watersheds 58, 89, 94, 100, 105, 106, 110. ILLINOIS: Clay Lick Creek, Carbondale, 17-IV-1935, Ross and Mohr, 16 ♂♂♀♀

mmt; MISSOURI: Boone Co., Perche Creek, MO Hwy 124, 3 mi E Harrisburg, date unknown, B.C. Poulton, 4 larvae; Shannon Co., Jacks Fork River, MO Hwy 19, Eminence, 7-I-1984, B.C. Poulton, 3 larvae; St. Francois Co., 30-IV-1975, J.H. Howland, 8 ♂♂, 1 ♀.

Nearctic Distribution.- US: AL, AR, IL, IN, KS, KY, MO, OH, OK, PA, TN, WV; CANADA: ON.

Discussion.- This species is reported here for the first time from Arkansas and Missouri. Ross (1944) previously reported it from small, temporary streams in the Illinois Ozarks. Some of my records are from medium to large-sized rivers (Table 5). I did not encounter it in my sampling, but larvae were well represented in the ASUMZ collection. Adults emerge in the spring (Table 6), and populations appear to be locally distributed. Males differ markedly from the other regional species by the long inferior appendages, each having the distal article deeply concave (Fig. 591). Ross (1956) considered it to be one of the most primitive species in the genus based on its comparatively simple phallus. Females are readily distinguished by the broadly rounded, plate-like extension of sternite VIII (Fig. 600). Larvae are identified by the free basoventral hook on each anal claw (Fig. 583) and by the straw-colored head capsule with scattered dark musclescars (Fig. 582).

CHAPTER 19

FAMILY UENOIDAE

This family is represented in the Interior Highlands by a single genus, *Neophylax*. Evidence from larval and adult morphology was presented by Vineyard and Wiggins (1988) to include the limnephilid subfamily Neophylacinae (genera *Neophylax* and *Oligophlebodes* Ulmer), as a member of the family Uenoidae.

Genus *Neophylax* McLachlan

Twenty-five species are recorded for North America (Morse 1993). The majority of these species are distributed in the eastern and western areas of the continent. Only two species are recorded here for the Interior Highlands. During the spring, larvae are commonly found grazing on cobbles or algal mats in riffles. Their tubular cases consist of sand with small pebbles incorporated to serve as ballast in swift riffles. Prior to pupation in late summer, larvae pass the summer in a diapausing state and are often found in dense aggregations on the undersides of large cobbles. This behavior presumably prevents a majority of the individuals from desiccating. Ross

(1944) noted this for *N. concinnus* in some intermittent streams of the Illinois Ozarks. Similarly in my study, diapausing larvae collected from streams in Missouri during late May did not emerge until mid September in the laboratory. This diapausing behavior, though found in other caddisfly species (e.g. *Pycnopsyche* spp.), was used in addition to other morphological characters by Vineyard and Wiggins (1988), to support monophyly of *Neophylax* in the Uenoidae. Larvae are readily distinguished from limnephilid larvae by the median emargination of the mesonotal plates. Adults are distinguished from those of the Limnephilidae by the presence of two stout, basocostal setae (= frenulum of Vineyard and Wiggins (1988)) on each hindwing. Beam and Wiggins (1987) provided excellent life history accounts of *N. concinnus* and *N. fuscus* from streams in Ontario. They reported univoltine life cycles for both species.

KEYS TO THE SPECIES OF *Neophylax*

larvae

1. Frontoclypeus with a median tubercle (Fig. 607); head dark brown (Fig. 608) ***N. concinnus* McLachlan**
- Frontoclypeus without a median tubercle; head straw-colored to light brown with pale muscle scars (Fig. 611) ***N. fuscus* Banks**

adults

1. Maxillary palpi 3 segmented (males) 2
 Maxillary palpi 5 segmented (females) 3
2. Tergum X short, not approaching posterior margin of inferior
 appendages; mesal surface of each inferior appendage not produced
 (Fig. 609) ***N. fuscus* Banks**
 Tergum X elongate, extending to posterior margin of inferior
 appendages; mesal surface of each inferior appendage with a stout
 projection (Fig. 605) ***N. concinnus* McLachlan**
3. Subgenital plate formed by a pair of apically emarginate, lateral lobes
 and a mesal, thumb-like lobe (Fig. 610) ***N. fuscus* Banks**
 Subgenital plate formed by two pairs of prominent lobes (Fig. 606)
 ***N. concinnus* McLachlan**

***Neophylax concinnus* McLachlan**

Figs. 605, 606, 607, 608

Neophylax concinnus McLachlan 1871:171.*Neophylax autumnus* Vorhies 1909:669.**Type Locality.**- New York.

Regional Distribution.- Watersheds 1, 8, 10, 14, 55, 69, 94, 105, 106, 122, 125. ARKANSAS: Logan Co., Gutter Rock Creek, low water bridge, 1 mi SW AR Hwy 309, 14-V-1992, S.R. Moulton, many larvae; Newton Co., unnamed

spring to Cecil Creek, T17N R21W SEC32, 18-X-1990, S.R. Moulton, 1 ♀; same but 26-IX-1991, 2 ♀♀; Mill Creek, off AR Hwy 7, Pruitt Access Buffalo River, 14-VIII-1991, S.R. Moulton and J.C. Abbott, 2 larvae; Polk Co., unnamed tributary to Mine Creek, 3 mi E Shady, 14-III-1990, S.R. Moulton, many larvae; ILLINOIS: Johnson Co., Dixon Spring at Dixon Spring State Park, Hwy 146, 25-V-1992, S.R. Moulton and D.E. Baumgardner, many larvae.

Nearctic Distribution.- US: AL, AR, CT, DE, FL, GA, IL, IN, KY, MA, MD, ME, MI, MN, MO, MT, NH, NJ, NY, OH, PA, RI, SC, TN, VA, VT, WI, WV, WY; CANADA: ON, PQ.

Discussion.- This was the most common and widely distributed of the two regional species. Larvae differ from those of *N. fuscus* by the raised point on the dorsal surface of the head, best viewed laterally (Fig. 607). The larval head is generally dark, with small, scattered pale muscle scars (608). Males are recognized by the finger-like extension of tergum X and the angular apex of each inferior appendage in lateral view (Fig. 605). The female subgenital plate is formed by two pairs of lobes (Fig. 606). Adults are straw-colored.

Neophylax concinnus was found only in first and second order streams of all four permanence types (Table 5). Adults were primarily collected during the fall (Table 6) after a summer larval diapause. Beam and Wiggins (1987) noted that egg masses were common on grasses over hanging banks, exposed tree root systems, and beneath loosely embedded bank rocks. They also reported that larval gut contents contained high proportions of FPOM.

***Neophylax fuscus* Banks**

Figs. 54, 609, 610, 611

Neophylax fuscus Banks 1903:242.

Type Locality.- Michigan and Franconia, New Hampshire.

Regional Distribution.- Watersheds 87, 102, 122, 123, 125.

ARKANSAS: Independence Co., Little Creek, AR Hwy 25, 1 mi S Co. line, 14-III-1991, S.R. Moulton and J.C. Abbott, 5 larvae; MISSOURI: Cole Co., Bois Brule Creek, Rte. H, 4 mi N Henley, 23-V-1992, S.R. Moulton and D.E. Baumgardner, many larvae, ♂♂♀♀ (reared); Dade Co., Lynn Branch, Stockton Lake, US Hwy 160, 22-V-1992, S.R. Moulton and D.E. Baumgardner, 1 larva; McDonald Co., Elk River, MO Hwy 43, 2 mi N jct. Hwy 43 & 10, Cowskin Access, 6-VI-1991, S.R. Moulton, 1 larva; Texas Co., Big Piney River, MO Hwy 17, 3 mi W Houston, 25-IX-1992, S.R. Moulton, many larvae (reared).

Nearctic Distribution.- US: AR, IN, KY, MA, ME, MI, MN, MO, NH, NY, OH, TN, VA, VT, WI; CANADA: ON.

Discussion.- This species was only collected in the subregions comprising the Ozark Mountains of Arkansas and Missouri (Table 5); it is reported here for the first time from Arkansas. I found it in larger streams than *N. concinnus*. This was also observed by Beam and Wiggins (1987). Larval heads of *N. fuscus* lack a dorsal tubercle and have more extensive pale areas, most notably, a V-shaped marking outlining the posterior margin of the frontoclypeus (Fig. 611). The male tergum X is not produced into a long,

finger-like process, and the inferior appendages are rounded apically (Fig. 609). The female subgenital plate consists of a pair of lateral lobes, emarginate on the posterior margin, and flanking a median, thumb-like lobe (Fig. 610). Adults were darker brown than those of *N. concinnus*. In the laboratory, we reared many diapausing larvae collected in late May. Emergence of adults began in late August and September (Table 6). Beam and Wiggins (1987) observed that *N. fuscus* oviposited furthest away from the water (≤ 0.5 m) of the five species they studied. Late instar larvae had higher proportions of diatoms in their guts (Beam and Wiggins 1987).

CHAPTER 20

BIOGEOGRAPHY OF INTERIOR HIGHLAND TRICHOPTERA

Pliocene and Pleistocene Conditions

The evolution of the Interior Highland insect fauna has received considerable attention (Ross 1965, Ross and Yamamoto 1967, Ross and Ricker 1971, Allen 1990, Hamilton and Morse 1990a,b, Flint and Harp 1990, and Moulton and Stewart 1992). These studies focused primarily on how the Pleistocene glaciations affected speciation and dispersal. Allen (1990) noted that, although the Interior Highlands have been a positive feature in North America since the Pennsylvanian, some 320 million years ago, there has been virtually no examination of pre-Pleistocene events as possible mechanisms in the evolution of the regional insect fauna.

During the Pliocene epoch, areas along the Rocky Mountains, Interior Highlands, Cincinnati Arch, and Appalachian Mountains were alternately uplifted and degraded (Bretz 1965, Ross 1965). Increases in regional stream gradients and the concomitant effects brought about by erosion caused a breaching of the water table that subsequently formed numerous springs (Ross 1965). These events created numerous suitable habitats for the east-west

dispersal of a number of animal groups along a northern corridor that exists between the Appalachian Mountains and Interior Highlands (Branson 1985). The narrowest portion of this corridor is represented by the Illinois Ozarks (Ross and Ricker 1971)(Fig. 1).

It is well established that the Interior Highlands were not affected physically by the forces of the Pleistocene glaciations (Pflieger 1971, Mayden 1985, Alien 1990)(see Fig. 1). As a result, this region has been available for inhabitation by terrestrial and aquatic organisms throughout the periodic (geologically speaking) isolation and recombination with other areas in North America (Allen 1990). However, the regional climate and aquatic thermal regimes probably experienced considerable cooling and warming (Pielou 1979). The Pleistocene epoch consisted of four main glacial advances, each of which was separated by a warmer interglacial period of about 10,000 years (Udvardy 1969). The Wisconsin glaciation, the most recent, retreated approximately 10,000 years ago (Poulton and Stewart 1991). The Kansian glaciation was the closest to reaching the Interior Highlands and stopped just north of the Missouri River (Fig. 1).

Origins of the Regional Fauna

The Interior Highland caddisfly fauna is most closely allied with faunas in the southeastern and eastern United States (Table 6). Poulton and Stewart (1991) and Mayden (1988) observed the same for the regional stonefly and fish faunas, respectively. According to Hamilton and Morse (1990b), the number of

shared caddisfly species in the Interior Highlands, Eastern Highlands, and southeastern Gulf Coastal Plain is so great that relationships among the three are masked. Proper exploration of the origins of many species is usually not possible due to a lack of sound phylogenetic analyses (Allen 1990, Hamilton and Morse 1990b). Ross (1965) noted that no extensive lineages of the aquatic insect fauna appear to have originated in the Interior Highlands, indicating that its fauna is relatively young. This, coupled with its size and the observation that it is the most arid, low level mountain region in North America (Ross 1965, Rafferty 1985), may explain why its total caddisfly diversity is lower in the Interior Highlands than are those of other intra-continental mountainous areas.

Distributional patterns of the Interior Highland caddisfly fauna parallel those observed by Poulton and Stewart (1991) for stoneflies in the region. These patterns include 1) endemic species, 2) widespread species with continuous distributions or open dispersal routes via chiefly the Illinois Ozarks corridor, and 3) species whose distributions are discontinuous such that their regional populations are geographically separated from their main ranges.

1. Endemic Species. According to Allen (1990) there are over 200 species of plants and animals that appear endemic to the Interior Highlands. Of these, approximately one-third are insects. This tremendous amount of endemism supports the claim that the Interior Highlands have played a major role in the evolution of the insect fauna of North America (Allen 1990). The

amount of caddisfly endemism in the Interior Highlands has been variously estimated (Allen 1990, Hamilton and Morse 1990b, Mathis and Bowles 1992). Allen (1990) listed 21 species, of which only 14 could truly be considered endemic. Hamilton and Morse (1990b) reported 13 species, to which Mathis and Bowles (1992) added three species, thereby increasing this number to 16. In light of the recent discoveries of nine species by us and other workers, and the distributional reevaluations of *Ceratopsyche piatrix* and *Cheumatopsyche rossi* (see respective discussions), 11 more species were added which further increases the number of endemic Trichoptera to 27. The number of regionally endemic Trichoptera is proportionately lower (27 of 229 species, or 12%) than that of the regionally endemic Plecoptera (25 of 88 species, or 28%) (Poulton and Stewart 1991). Hocutt and Wiley (1986) reported 27 endemic fish species from the Interior Highlands. Eleven of the sixteen families represented in the region have at least one endemic species. These include one brachycentrid, one helicopsychid, three glossosomatids, two hydropsychids, seven hydroptilids (including one endemic genus), two lepidostomatids, four leptocerids, one limnephilid, one odontocerid, one philopotamid, and one rhyacophilid.

Four regional endemic caddisflies have sister species that are more northern in distribution and do not occur in the Interior Highlands. *Ceraclea maccalmonti* (Fig. 615), was apparently derived from the northern transcontinental populations of either *C. annulicornis* or *C. excisa* (Moulton and

Stewart 1992). *Ceratopsyche piatrix* (Fig. 613), *Glyphopsyche missouri* (Fig. 616) and *Lepidostoma ozarkense* (Fig. 616) are sister species to boreal populations of *C. vexa*, *G. irrorata*, and *L. ontario*, respectively (Ross 1965, Allen 1990, Flint and Harp 1990). These sister species probably migrated south ahead of the glaciers, at which time, they repopulated areas of suitable climatic conditions and water temperatures. Upon deglaciation and subsequent warming of the region, their populations retreated north, except for isolated relict populations. These relicts inhabited suitable refugia (e.g. cold springs) and in time, underwent speciation.

Hamilton and Morse (1990b) summarized phylogenetic evidence using reduced area cladograms, that linked some Interior Highland endemic species to sister species in the southern Eastern Highlands. *Helicopsyche limnella* (Fig. 615) is most closely allied with *H. paralimnella* in the southern Eastern Highlands. However, prior to the discovery of the latter species it was thought *H. limnella* was more closely related to *H. mexicana*, and that this represented a type of Interior Highland/Mexico vicariance pattern (Allen 1990).

Rhyacophila kiamichi (Fig. 612) forms a sister relationship with *R. ledra* and *R. fenestra* in the *R. carolina* Group. This group is restricted to the Appalachian Mountains region, except for *R. fenestra* and *R. ledra* whose distributions "bottleneck" or terminate in the Illinois Ozarks, respectively. *Rhyacophila kiamichi* probably resulted from a western isolation in the range of a common ancestor shared with *R. ledra*. Ross (1956) hypothesized that

dispersal of the *R. carolina* Group during the mid-Cenozoic era, was associated with the division of the northern temperate forests into eastern and western areas following increasingly arid conditions in middle North America. Other regional caddisfly groups exhibiting obvious eastern and western North America faunal elements include the *Agapetus celatus* and *Wormaldia anilla* Groups.

Twenty-three species comprising the *Agapetus celatus* Group are distributed equally into eastern and western mountainous regions (Ross 1956). Two of the eastern species are endemic to the region. *Agapetus artesus* (Fig. 612) is restricted to a few of the cold, high-volume Ozark springs in Missouri, while *A. medicus* (Fig. 612) occurs in permanent or temporary, headwater streams in the Ozark and Ouachita Mountains. A third species in this group, *A. illini*, was once thought to be endemic to the Ozarks (Ross 1944, Allen 1990), but has subsequently been found in the peripheral hilly regions of Indiana and Kentucky.

Wormaldia strota (Fig. 612) belongs to a monophyletic lineage of five Nearctic species within the *Wormaldia anilla* Group (Ross 1956). This species is locally abundant throughout the region, while its sister species *W. shawnee*, occurs primarily in the Illinois Ozarks except for one population in a small Missouri Ozark spring (Mathis and Bowles 1992). A third related species, *W. occidea* occurs in the western United States. This triplet of species was derived from one of two independent, transcontinental, ancestral populations

that were isolated into eastern and western areas (Allen 1990). The other ancestral population produced two species, *W. hamata* (eastern) and *W. thyria* (western), neither of which occur in the region.

Some regional endemics have sister species that are restricted to the southeastern Gulf Coastal Plain (Hamilton and Morse 1990b). *Micrasema ozarkana* (Fig. 616), a common inhabitant of the regional high-volume springs, is closely related to an undescribed species occurring in Alabama (Chapin 1978). *Setodes oxapius* (Fig. 615) occurs in locally abundant populations throughout the region, and is most closely related to *S. dixiensis* Holzenthal (Holzenthal 1982).

The monophyletic *Oecetis scala* Group (Moulton and Stewart 1993) is represented in the Interior Highlands by three species, two of which are endemic. *Oecetis ouachita* (Fig. 615) is restricted to large rivers in the ecotonal region of the Gulf Coastal Plain and Ouachita Mountains. Species most closely related to it, *O. morsei*, *O. scala*, and *O. sphyra* all occur in the southern Appalachian Mountains and Gulf Coastal Plain. *Oecetis ozarkensis* (Fig. 615) is known only from a few locations in the southern Ozarks and appears most closely related to *O. eddlestoni* which also occurs in the region. The latter species is distributed throughout the northeastern United States. Until a detailed phylogeny of the *O. scala* Group can be examined, speciation events associated with this group cannot be addressed.

Three of the six species comprising the monophyletic *Ochrotrichia shawnee* Group (Frazer and Harris 1991) occur in the Interior Highlands. Two of these, *O. contorta* (Fig. 614) and *O. robisoni* (Fig. 614), are endemic. This group is generally confined to the Interior Highlands and states on its eastern periphery. However, two species extend into the New England states, and a third is endemic to Alabama.

The closely related endemic species *Cheumatopsyche robisoni* (Fig. 613) and *C. rossi* (Fig. 613) are restricted primarily to spring habitats in the Ouachita and Ozark Mountains, respectively. *Cheumatopsyche rossi* is related to three other species that comprise the monophyletic *C. rossi* Group (Gordon 1974). Two of these, *C. smithi* and *C. logani*, are distributed in the northwestern United States, while the third, *C. pettiti*, is widely distributed throughout the continent (Allen 1990). Allen (1990) suggested that *C. rossi* may share a common intermediate ancestor with the two northwestern species. However, the wide distribution of *C. pettiti* and discovery of *C. robisoni* complicates the determination and timing of the vicariance that produced these endemic species. A new phylogenetic analysis incorporating *C. robisoni* is needed to resolve this problem.

One of the most peculiar regional caddisfly discoveries with respect to endemic taxa was that of *Paduniella nearctica* (Fig. 613)(Flint 1967). Its apparent sister species, *P. sanghamitra* Schmid, is from Ceylon (Flint 1967). The remainder of *Paduniella* species are restricted to Africa, India, and

southeast Asia, so it seems likely that this distribution resulted from some pre-Cretaceous event (Allen 1990). The timing of major tectonic events, the harsh, unforested environment of the Siberian land bridge does not seem to support a Beringian dispersal.

Discussion on the origins of the remaining endemic species is not possible at this time since they are either undescribed (*Marilia* sp. A, Fig. 615; *Protoptila* sp. A, Fig. 612) or are part of phylogenetic studies that have not been completed to determine their sister species relationships (*Polycentropus stephani*, Fig. 613; *Hydroptila artesa*, *Neotrichia arkansasensis*, *N. kitae*, *Ochrotrichia weddleae*, *Paucicalcaria ozarkensis*, Fig. 614; *Lepidostoma lescheni*, Fig. 616).

2. Continuous Ranges and Dispersal Routes. It is apparent from the high degree of faunal similarity with areas east of the Mississippi River (Table 5), that the Interior Highlands contain a large number of widespread species, which may be placed into two categories.

The first category includes species whose ranges are continuous, without any obvious gaps due to physiographic barriers or a decreased frequency of suitable habitat requirements. Unlike the second category, they are generally large river species and may be considered "ecological generalists". Regional examples of this category include *Cheumatopsyche campyla*, *C. pettiti*, *Oecetis avara*, *O. inconspicua*, *Orthotrichia aegerfasciella*, *Oxyethira pallida*, and *Potamyia flava*. These species were exceedingly

common in regional collections throughout the year.

The second category of widespread distributions includes species whose ranges follow an open dispersal route or corridor across an area that would otherwise be impassible due to unsuitable habitat requirements. Most recognizable of these corridors is the narrow band of uplifted terrain in the Illinois Ozarks subregion. This area contains streams with sufficient gradient and suitable thermal regimes to permit the east-west dispersal of many animal groups. This has been well documented for various aquatic insect taxa (Ross 1965, Ross and Yamamoto 1967, Ross and Ricker 1971, Poulton and Stewart 1991). Examples of regional caddisfly species that appear to have distributional "bottlenecks" in this area include *Agapetus illini*, *Hydroptila vala*, *Neotrichia riegeli*, *Ochrotrichia anisca*, *O. unio*, *O. xena*, *Wormaldia shawnee*, *Rhyacophila fenestra*, *R. ledra*, and *Triaenodes melacus*. Some eastern species such as *Neotrichia collata* and *Ochrotrichia shawnee*, have ranges that extend into the Illinois Ozark corridor, but do not cross the Mississippi River. In the case of these species, the Illinois Ozarks are serving as a filter barrier. Poulton and Stewart (1991) observed this for two regional stonefly species.

3. Species with Discontinuous Ranges. According to Poulton and Stewart (1991), discontinuous distributions resulting from isolated refugia are of biogeographic interest and can be ecologically or historically based. There are several noteworthy examples of species common throughout various portions of the Eastern Highlands that also have isolated regional populations. Our

recent discovery of *Triaenodes cumberlandensis* in the Ouachita Mountains represents the first known occurrence of this species west of the Mississippi River. The known regional populations are centered around Mena, Arkansas at nearly the same latitude (34.5°) as the type locality on the Cumberland Plateau. Disjunct regional populations of *Lepidostoma carrolli* have also been found in this area. Its main range extends from the New England states south to South Carolina and Tennessee. *Hydroptila broweri* occurs in scattered localities throughout the various Ozark Mountains physiographic subregions. These populations are separated by approximately 1200 miles from other populations in Maine and New Hampshire. This inspite of our relatively thorough knowledge of caddisfly faunas in the intervening areas. *Chimarra socia* similarly exists as disjunct populations in Arkansas and Missouri from its main range in the northeastern United States. Lago *et al.* (1989) suggested that, in light of its absence in intervening areas, the Interior Highlands populations represent relicts of a once more widely distributed species rather than a simple range extension. Other regional species having similar distributional patterns include *Lepidostoma griseum* and *Rhyacophila banksi*.

A small contingency of species occurring primarily in the Arbuckle Mountains subregion appear to be disjunct from their main ranges in the Edwards Plateau and Trans Pecos regions of Texas and other southwestern mountainous areas. The ranges of a few extend southward into Central and South America. Some of these species include *Cernotina oklahoma*,

Cheumatopsyche comis, *Hydroptila melia*, *H. protera*, *Ochrotrichia* (*Metrichia*) *nigritta*, *Oxyethira aculea*, and *O. azteca*. This disjunction is probably due to an absence of suitable stream habitats and water quality in the intervening prairie and high plains regions of north Texas. To date, our collections in these regions have not produced examples of those species.

Trichoptera Absent from the Region

Two caddisfly taxa that are common and widespread in eastern and western mountainous areas are noticeably absent from the Interior Highlands, including the Illinois Ozark corridor. Most notable among these taxa are the limnephilid genus *Limnephilus* and the philopotamid genus *Dolophilodes*. Although *L. submonilifer* has been reported from a single location in the Ozark Mountains, we consider this record to be tentative. The vast majority of eastern *Limnephilus* occur in previously glaciated areas to the north. The absence of *Dolophilodes* in the region probably does not relate to the unavailability of suitable aquatic habitats since there are three regional species of *Wormaldia* that generally have more strenuous habitat requirements. Rather, this absence seems best explained by low dispersal capabilities. Females of the eastern species *D. distinctus* (Walker) are apterous and as a result incapable of long distance dispersal flights. Unlike the previous species, females of *D. major* (Banks) have fully developed wings. However, this species is highly localized in cold spring seeps of some eastern states and are therefore unlikely to disperse great distances.

BIBLIOGRAPHY

- Allen, R. T. 1983. Distribution patterns among arthropods of the north temperate deciduous forest biota. *Ann. Missouri Bot. Gard.* 70:616-628.
- Allen, R. T. 1990. Insect endemism in the Interior Highlands of North America. *Florida Entomol.* 73:539-569.
- Anderson, N. H. and J. R. Bourne. 1974. Bionomics of three species of glossosomatid caddisflies (Trichoptera: Glossosomatidae) in Oregon. *Can. J. Zool.* 52:405-411.
- Anonymous. 1992. The checklist of rare and endangered species of Missouri. Missouri Dept. of Cons., Jefferson City, MO. 44 pp.
- Anonymous. 1994. Interior Highlands: a new sense of stewardship. *Sierra*, March/April p. 122.
- Armitage, B. J. 1983. Diagnostic Atlas of the North American Caddisfly Adults. I. Philopotamidae. The Caddis Press. Athens, AL. 99 pp.
- Armitage, B. J. 1991. Diagnostic Atlas of the North American Caddisfly Adults. I. Philopotamidae. 2nd ed. The Caddis Press. Athens, AL. 72 pp.
- Armitage, B. J. and S. W. Hamilton. 1990. Diagnostic Atlas of the North American Caddisfly Adults. II. Ecnomidae, Polycentropodidae, Psychomyiidae, and Xiphocentronidae. The Caddis Press. Athen, AL. 152 pp.
- Banks, N. 1894. On a collection of neuropteroid insects from Kansas. *Entomol. News* 5:178-180.
- Banks, N. 1895. New neuropteroid insects. *Trans. Amer. Entomol. Soc.* 22:313-316.
- Banks, N. 1897. New North American neuropteroid insects. *Trans. Amer. Entomol. Soc.* 24:21-31.

- Banks, N. 1899. Descriptions of new North American neuropteroid insects. Trans. Amer. Entomol. Soc. 25:199-218.
- Banks, N. 1900. New genera and species of Nearctic neuropteroid insects. Trans. Amer. Entomol. Soc. 26:239-259.
- Banks, N. 1903a. Neuropteroid insects from Arizona. Proc. Entomol. Soc. Wash. 5:237-245.
- Banks, N. 1903b. Some new neuropteroid insects. J. N. Y. Entomol. Soc. 11:236-243.
- Banks, N. 1904a. Two species of Hydroptilidae. Entomol. News 15:116.
- Banks, N. 1904b. A list of neuropteroid insects, exclusive of Odonata, from the vicinity of Washington, D.C. Proc. Entomol. Soc. Wash. 6:201-217.
- Banks, N. 1905. Descriptions of new Nearctic neuropteroid insects. Trans. Amer. Entomol. Soc. 32:1-20. 2 pls.
- Banks, N. 1907a. Descriptions of new Trichoptera. Proc. Entomol. Soc. Wash. 8:117-133. pls. 8-9.
- Banks, N. 1907b. New Trichoptera and Psocidae. J. N. Y. Entomol. Soc. 15:162-166.
- Banks, N. 1911. Descriptions of new species of North American neuropteroid insects. Trans. Amer. Entomol. Soc. 37:335-360. pls. 11-13.
- Banks, N. 1914. American Trichoptera-notes and descriptions. Can. Entomol. 46:149-156, 201-205, 252-258, 261-268, pls. 9, 10, 15, 20.
- Banks, N. 1930. New neuropteroid insects from the United States. Psyche 37:223-233. 15 figs.
- Beam, B. D. and G. B. Wiggins. 1987. A comparative study of the biology of five species of *Neophylax* (Trichoptera: Limnephilidae) in southern Ontario. Can. J. Zool. 65:1741-1754.
- Beckett, D. C. 1982. Phenology of *Hydropsyche orris* (Trichoptera: Hydropsychidae) in the Ohio River: changes in larval age structure and substrate colonization rates. Environ. Entomol. 11:1154-1158.

- Benke, A. C. 1990. A perspective on Americas vanishing streams. *J. N. Am. Benthol. Soc.* 9:77-88.
- Benke, A. C. and J. B. Wallace. 1980. Trophic basis of production among net-spinning caddisflies in a southern Appalachian stream. *Ecology*. 61:108-118.
- Betten, C. 1934. The caddis flies or Trichoptera of New York State. *Bull. N. Y. St. Mus.* 292.
- Betten, C. 1950. The genus *Pycnopsyche* (Trichoptera). *Ann. Entomol. Soc. Amer.* 43:508-522.
- Betten, C. and M. E. Mosely. 1940. The Francis Walker types of Trichoptera in the British Museum. *British Mus. Nat. Hist.* 248 pp.
- Blickle, R. L. 1963. New species of Hydroptilidae (Trichoptera). *Bull. Brooklyn Entomol. Soc.* 68:17-22.
- Blickle, R. L. 1979. Hydroptilidae (Trichoptera) of America North of Mexico. New Hampshire Agricultural Experiment Station, University of New Hampshire, Durham, Bull. No. 509.
- Blickle, R. L. 1980. A new *Oxyethira* (Hydroptilidae, Trichoptera) of the *aeola* Ross group; with a key to separate five males of the group. *Pan Pacif. Entomol.* 56:101-104.
- Blickle, R. L. and D. G. Denning. 1977. New species and a new genus of Hydroptilidae (Trichoptera). *J. Kan. Entomol. Soc.* 50:287-300.
- Blickle, R. L. and W. J. Morse. 1954. New species of Hydroptilidae (Trichoptera). *Bull. Brooklyn Entomol. Soc.* 49:121-127.
- Board, V. 1987. Selected families of Trichoptera in Arkansas. *Proc. Ark. Acad. Sci.* 41:98-99.
- Bowles, D. E. and R. T. Allen. 1988. Description of the female of *Paduniella nearctica* (Trichoptera: Psychomyiidae). *Entomol. News* 99:7-9.
- Bowles, D. E. and R. T. Allen. 1991. Secondary production of net-spinning caddisflies (Trichoptera: Curvivalpia) in an Ozark stream. *J. Freshwat. Ecol.* 6:93-100.

- Bowles, D. E. and R. T. Allen. 1992. Life histories of six species of caddisflies (Trichoptera) in an Ozark stream, U.S.A. *J. Kan. Entomol. Soc.* 65:174-184.
- Bowles, D. E., O. S. Flint, Jr., and S. R. Moulton, II. 1993. Records of *Chimarra holzenthali* and *C. parasocia* (Trichoptera: Philopotamidae) from eastern Texas. *Entomol. News* 104:263-264.
- Bowles, D. E. and M. L. Mathis. 1989. Caddisflies (Insecta: Trichoptera) of mountainous regions in Arkansas, with new state records for the order. *J. Kan. Entomol. Soc.* 62:234-244.
- Bowles, D. E. and M. L. Mathis. 1992. A preliminary checklist of the caddisflies (Insecta: Trichoptera) of Oklahoma. *Insecta Mundi* 6:29-35.
- Bowles, D. E., M. L. Mathis, and S. W. Hamilton. 1993. A new species of *Polycentropus* (Trichoptera: Polycentropodidae) from Arkansas. *Entomol. News* 104:31-34.
- Bowles, D. E., M. L. Mathis, and J. S. Weaver, III. 1994. A new species of *Lepidostoma* (*Mormomyia*) (Trichoptera: Lepidostomatidae) from mountainous Arkansas, U.S.A. *Aquatic Insects*, IN PRESS.
- Bowles, D. E., K. Stephan, and M. L. Mathis. 1990. A new method for collecting adult phryganeid caddisflies (Trichoptera: Phryganeidae). *Entomol. News* 106:222-224.
- Branson, B. A. 1985. Aquatic distributional patterns in the Interior Low Plateau. *Brimleyana* 11:169-189.
- Bretz, J. H. 1965. Geomorphic history of the Ozarks of Missouri. *Missouri Geol. Surv. Wat. Res., 2nd Serv.* 41:1-147.
- Chambers, V. T. 1873. Micro-Lepidoptera. *Can. Entomol.* 5:110-115, 124-128.
- Chang, D. H. S. and H. G. Gauch. 1986. Multivariate analysis of plant communities and environmental factors in Ngari, Tibet. *Ecology* 67:1568-1575.
- Chapin, J. W. 1978. Systematics of Nearctic *Micrasema* (Trichoptera: Brachycentridae). Ph.D. Diss., Clemson Univ., Clemson, SC, 136 pp.
- Corbet, P. S. 1966. Parthenogenesis in caddisflies (Trichoptera). *Can. J. Zool.* 44:981-982.

- Crunkilton, R. L. and R. M. Duchrow. 1990. Impact of a massive crude oil spill on the invertebrate fauna of a Missouri Ozark stream. *Environ. Poll.* 63:13-31.
- Cudney, M. D. and J. B. Wallace. 1980. Life cycles, microdistribution and population dynamics of six species of net-spinning caddisflies in a large southeastern (U.S.A.) river. *Holarctic Ecol.* 3:169-182.
- Culp, J. M. and R. W. Davies. 1980. Reciprocal averaging and polar ordination as techniques for analyzing lotic macroinvertebrate communities. *Can. J. Fish. Aquat. Sci.* 37:1358-1364.
- Cummins, K. W. 1964. Factors limiting the micro-distribution of larvae of the caddisflies *Pycnopsyche lepida* (Hagen) and *Pycnopsyche guttifer* (Walker) in a Michigan stream (Trichoptera: Limnephilidae). *Ecol. Monog.* 34:271-295.
- Denning, D. G. 1947a. Hydroptilidae (Trichoptera) from southern United States. *Can. Entomol.* 79:12-20.
- Denning, D. G. 1947b. New species of Trichoptera from the United States. *Entomol. News* 58:249-257.
- Denning, D. G. 1948. New species of Trichoptera. *Ann. Entomol. Soc. Amer.* 41:397-401.
- Denning, D. G. 1950. Records and descriptions of nearctic caddis flies. Part 1. *Bull. Brooklyn Entomol. Soc.* 45:97-104.
- Denning, D. G. 1956. Trichoptera. *In Aquatic Insects of California*, ed. R. L. Usinger, pp. 237-270. Univ. California Press, Berkeley and Los Angeles.
- Drecktrah, H. G. 1990. Larval and pupal descriptions of *Marilia fusca* (Trichoptera: Odontoceridae). *Entomol. News* 101:1-8.
- Duchrow, R. M. 1983. Effects of lead tailings on benthos and water quality of three Ozark streams. *Trans. Mo. Acad. Sci.* 17:5-17.
- Edwards, S. W. 1956. The Trichoptera of Reelfoot Lake with descriptions of three new species. *J. Tenn. Acad. Sci.* 31:7-19.
- Edwards, S. W. and C. R. Arnold. 1961. The caddisflies of the San Marcos River. *Texas J. Sci.* 13:398-415.

- Edwards, S. W. 1973. Texas caddisflies. *Texas J. Sci.* 24:491-516.
- Etnier, D. A. and G. A. Schuster. 1979. An Annotated list of Trichoptera (caddisflies) of Tennessee. *J. Tenn. Acad. Sci.* 54:15-22.
- Etnier, D. A. and Way. 1973. New southern Trichoptera. *J. Kan. Entomol. Soc.* 46:422-430.
- Farris, J. L. and G. L. Harp. 1982. Aquatic macroinvertebrates of three acid bogs on Crowleys Ridge in northeast Arkansas. *Proc. Ark. Acad. Sci.* 36:23-27.
- Flint, O. S., Jr. 1956. The life history and biology of the genus *Frenesia* (Trichoptera: Limnephilidae). *Bull. Brooklyn Entomol. Soc.* 51:93-108.
- Flint, O. S., Jr. 1957. Description of the immature stages of *Drusinus uniformis* Betten (Trichoptera: Limnephilidae). *Bull. Brooklyn Entomol. Soc.* 52:1-4.
- Flint, O. S., Jr. 1958a. Descriptions of several species of Trichoptera. *Bull. Brooklyn Entomol. Soc.* 53:21-24.
- Flint, O. S., Jr. 1958b. The larva and terrestrial pupa of *Ironoquia parvula* (Trichoptera: Limnephilidae). *J. N. Y. Entomol. Soc.* 66:59-62.
- Flint, O. S., Jr. 1960. Taxonomy and biology of Nearctic limnephilid larvae (Trichoptera), with special reference to the species in eastern United States. *Entomol. Amer.* 60:1-117.
- Flint, O. S., Jr. 1962. Larvae of the caddisfly genus *Rhyacophila* in eastern North America (Trichoptera: Rhyacophilidae). *Proc. U.S. Nat. Mus.* 113:465-493.
- Flint, O. S., Jr. 1964a. Notes on some Nearctic Psychomyiidae with special reference to their larvae (Trichoptera). *Proc. U.S. Nat. Mus.* 115:467-481.
- Flint, O. S., Jr. 1964b. The caddisflies (Trichoptera) of Puerto Rico. University of Puerto Rico, Agricultural Experimental Station, Technical Paper No. 40.
- Flint, O. S., Jr. 1967. The first record of the Paduniellini in the new world (Trichoptera: Psychomyiidae). *Proc. Entomol. Soc. Wash.* 69:310-311.

- Flint, O. S. 1968. The caddisflies of Jamaica (Trichoptera). Bulletin Institute of Jamaica, No. 19.
- Flint, O. S., Jr. 1970. Studies of Neotropical caddisflies, X: *Leucotrichia* and related genera from North and Central America (Trichoptera: Hydroptilidae). Smithsonian Cont. Zool. No. 60, 64 pp.
- Flint, O. S., Jr. 1972. Three new caddisflies from the southern United States. J. Georgia Entomol. Soc. 7:79-82.
- Flint, O. S., Jr. 1974. Studies of Neotropical caddisflies, XVII: the genus *Smicridea* from North and Central America (Trichoptera: Hydropsychidae). Smithsonian Cont. Zool. No. 167.
- Flint, O. S., Jr., J. R. Voshell, Jr., and C. R. Parker. 1979. The *Hydropsyche scalaris* Group in Virginia, with the description of two new species (Trichoptera: Hydropsychidae). Proc. Biol. Soc. Wash. 92:837-862.
- Flint, O. S., Jr. 1984. The genus *Brachycentrus* in North America, with a proposed phylogeny of the genera of Brachycentridae (Trichoptera). Smithsonian Cont. Zool. No. 398, 58 pp.
- Flint, O. S., Jr., and J. Bueno-Soria. 1982. Studies of Neotropical caddisflies, XXXII: the immature stages of *Macronema variipenne* Flint and Bueno, with the division of *Macronema* by the resurrection of *Macrostemum* (Trichoptera: Hydropsychidae). Proc. Biol. Soc. Wash. 95:358-370.
- Flint, O. S., Jr., and P. A. Harp. 1990. *Lepidostoma (Nosopus) ozarkense* (Trichoptera: Lepidostomatidae), a new species from Arkansas. Entomol. News 101:81-87.
- Flint, O. S., Jr. and L. Reyes. Studies of Neotropical caddisflies, XLVI: the Trichoptera of the Rio Moche basin, Department of La Libertad, Peru. Proc. Biol. Soc. Wash. 104:474-492.
- Floyd, M. A. 1992. New microcaddisfly (Trichoptera: Hydroptilidae) records for Kentucky. Trans. Ky. Acad. Sci. 53:50.
- Floyd, M. A. 1993. The biology and distribution of *Oecetis* larvae in North America (Trichoptera: Leptoceridae). Proc. Seventh Int. Symp. Trichoptera, 1992, Backhuys Publishers, Leiden, Netherlands pp. 87-91.

- Floyd, M. A. and G. A. Schuster. 1990. The caddisflies (Insecta: Trichoptera) of the Buck Creek System, Pulaski County, Kentucky. *Trans. Ky. Acad. Sci.* 51:127-134.
- Franklin, J. F. 1988. Structural and Functional Diversity in Temperate Forests, p. 166-175. *In Biodiversity*, eds. E.O. Wilson and F.M. Peter. National Academy Press, Washington D.C., 521 pp.
- Frazer, K. S. and S. C. Harris. 1991. Cladistic analysis of the *Ochrotrichia shawnee* Group (Trichoptera: Hydroptilidae) and a description of a new member from the Interior Highlands of northwestern Arkansas. *J. Kan. Entomol. Soc.* 64:363-371.
- Frazer, K. S., H. W. Robison, and S. C. Harris. 1991. New state records of Hydroptilidae (Trichoptera) from the Interior Highlands of northwestern Arkansas. *J. Kan. Entomol. Soc.* 64:445-447.
- Fremling, C. R. 1960. Biology and possible control of nuisance caddisflies of the upper Mississippi River. *Res. Bull. Iowa St. Univ., Agri. Home Econom. Exp. Sta.* 483:856-879.
- Garono, R. J. and D. B. MacLean. 1988. Caddisflies (Trichoptera) of Ohio wetlands as indicated by light-trapping. *Ohio J. Sci.* 88:143-151.
- Gauch, H. G. 1982. *Multivariate analysis in community ecology*. Cambridge Studies in Ecology. Cambridge University Press, Cambridge, England.
- Gordon, A. E. 1974. A synopsis and phylogenetic outline of the Nearctic members of *Cheumatopsyche*. *Proc. Acad. Nat. Sci. Phila.* 126:117-160.
- Haddock, J. D. 1977. The biosystematics of the caddisfly genus *Nectopsyche* in North America with emphasis on the aquatic stages. *Amer. Midl. Nat.* 98:382-421.
- Haefner, J. D. and B. J. Wallace. 1981. Production and potential seston utilization by *Parapsyche cardis* and *Diplectrona modesta* (Trichoptera: Hydropsychidae) in two streams draining contrasting southern Appalachian watersheds. *Environ. Entomol.* 10:433-441.
- Hagen, H. A. 1861. Synopsis of the Neuroptera of North America, with a list of the South American species. *Smithson. Inst. Misc. Collect.* 347 pp. Trichoptera, pp. 249-298, 328-329.

- Hagen, H. A. 1868. Monographie der Gattung *Dasytoma* Rambur. Stettiner Entomologische Zeitung 29:267-273.
- Hamilton, S. W. and R. W. Holzenthal. 1984. The caddisfly genus *Helicopsyche* in America north of Mexico (Trichoptera: Helicopsychidae). Abstract. p. 167 In J. C. Morse (ed.), Proc. Fourth Int. Symp. Trichoptera, Series Entomologica 30. Dr. W. Junk Publishers, The Hague. 486 pp.
- Hamilton, S. W. and J. C. Morse. 1990a. Symposium: origins of the southeastern arthropod fauna. Florida Entomol. 73:527-528.
- Hamilton, S. W. and J. C. Morse. 1990b. Southeastern caddisfly fauna: origins and affinities. Florida Entomol. 73:578-600.
- Hamilton, S. W., G. A. Schuster, and M. B. Dubois. 1983. Checklist of the Trichoptera of Kansas. Trans. Kan. Acad. Sci. 86:10-23.
- Harris, S. C. 1985. New microcaddisflies (Trichoptera: Hydroptilidae) from Alabama. Proc. Entomol. Soc. Wash. 87:606-621.
- Harris, S. C. and R. B. Carlson. 1977. New records for Trichoptera in North Dakota. Entomol. News 88:217.
- Harris, S. C. and A. Contreras-Ramos. 1989. *Ithytrichia mexicana*, (Trichoptera: Hydroptilidae), a new species of caddisfly from Mexico. Entomol. News 100:176-178.
- Harris, S. C., P. K. Lago, and R. W. Holzenthal. 1982. An annotated checklist of the caddisflies (Trichoptera) of Mississippi and southeastern Louisiana, part II: Rhyacophiloidea. Proc. Entomol. Soc. Wash. 84:509-512.
- Harris, S. C., P. E. O'Neil, P. K. Lago. 1991. Caddisflies of Alabama. Geol. Surv. Alabama Bull. 142, 442 pp.
- Hill, M. O. 1979. Decorana - a Fortran program for detrended correspondence analysis and reciprocal averaging. Cornell University, Ithaca, NY.
- Hill, M. O. and H. G. Gauch. 1980. Detrended correspondence analysis: an improved ordination technique. Vegetatio 47:47-58.
- Hilsenhoff, W. L. 1987. An improved biotic index of organic stream pollution. Great Lakes Entomol. 20:31-39.

- Hocutt, C. H. and E. O. Wiley. 1986. The zoogeography of North American freshwater fishes. John Wiley and Sons. New York, NY. 866 pp.
- Holzenthal, R. W. 1982. The caddisfly genus *Setodes* in North America (Trichoptera: Leptoceridae). J. Kan. Entomol. Soc. 55:253-271.
- Holzenthal, R. W., S. C. Harris, and P. K. Lago. 1982. An annotated checklist of the caddisflies (Trichoptera) of Mississippi and southeastern Louisiana, part III: Limnephiloidea and conclusions. Proc. Entomol. Soc. Wash. 84:513-520
- Jones, J. R., B. H. Tracy, J. L. Sebaugh, D. H. Hazelwood, M. M. Smart. 1981. Biotic index tested for ability to assess water quality of Missouri Ozark streams. Trans. Amer. Fish. Soc. 110:627-637.
- Kelley, R. W. 1982. The micro-caddisfly genus *Oxyethira* (Trichoptera: Hydroptilidae): morphology, biogeography, evolution, and classification. Ph.D. Diss., Clemson Univ., Clemson, SC, 433 pp.
- Kelley, R. W. 1984. Phylogeny, morphology and classification of the micro-caddisfly genus *Oxyethira* Eaton (Trichoptera: Hydroptilidae). Trans. Amer. Entomol. Soc. 110:435-463.
- Kelley, R. W. 1985. Revision of the micro-caddisfly genus *Oxyethira* (Trichoptera: Hydroptilidae). Part II: subgenus *Oxyethira*. Trans. Amer. Entomol. Soc. 111:223-253.
- Kelley, R. W. 1986. Revision of the micro-caddisfly genus *Oxyethira*. Part III: subgenus *Holarctotrichia*. Proc. Entomol. Soc. Wash. 88:777-785.
- Kelley, R. W. and J. C. Morse. 1982. A key to the females of the genus *Oxyethira* (Trichoptera: Hydroptilidae) from the southern United States. Proc. Entomol. Soc. Wash. 84:256-269.
- Kingsolver, J. M. and H. H. Ross. 1961. New species of Nearctic *Orthotrichia* (Hydroptilidae: Trichoptera). Trans. Ill. Acad. Sci. 54:28-33.
- Klapálek, F. 1892. Trichopterologický Vyzkum Cech v.r. 1891. Česká akademie císaře Frantiska Josefa pro vědy, slovesnost a umění v Praze Rozpravy 5:1-22.
- Knoke, D. and P.J. Burke. 1980. Log-linear Models. In: Quantitative applications in the social sciences, J.L. Sullivan and R.G. Niemi, Eds. Sage Publications, Beverly Hills. 80 pp.

- Knutson, L. 1989. On the diversity of nature and the nature of diversity. *Bull. Entomol. Soc. Am.* 35:7-11.
- Kolenati, F. A. 1859. *Genera et species Trichopteroum. Pars altera*, pp. 143-296, 5 pls. Moscow.
- Kovach, W. L. 1993. MVSP: a multivariate statistics package for the IBM PC and compatibles. Kovach Computing Services, Wales, U.K.
- LaFontaine, G. 1981. *Caddisflies*. Winchester Press. Piscataway, NJ. 336 pp.
- Lago, P. K. and S. C. Harris. 1985. A new species of *Nyctiophylax* (Trichoptera: Polycentropodidae) from Alabama and Mississippi. *Entomol. News* 96:16-18.
- Lago, P. K. and S. C. Harris. 1987. The *Chimarra* (Trichoptera: Philopotamidae) of eastern North America with descriptions of three new species. *J. N. Y. Entomol. Soc.* 95:225-251.
- Lago, P. K., R. W. Holzenthal, and S. C. Harris. 1982. An annotated checklist of the caddisflies (Trichoptera) of Mississippi and southeastern Louisiana, part I: introduction and Hydropsychoidea. *Proc. Entomol. Soc. Wash.* 84:495-508.
- Lago, P. K., M. L. Mathis, and D. E. Bowles. 1989. Records of *Chimarra socia* (Trichoptera: Philopotamidae) from Interior Highland streams in Arkansas and Missouri. *J. N. Y. Entomol. Soc.* 97:482-483.
- Lea, I. 1834. Observations on the naiades and descriptions of a new species of that and other families. *Trans. Am. Phil. Soc., n.s.* 4:63-121.
- Lehland, H. V., J. L. Carter and S. V. Fend. 1986. Use of detrended correspondence analysis to evaluate factors controlling spatial distribution of benthic insects. *Hydrobiologia* 132:113-123.
- MacLachlan, R. 1853b. Notes on North American Phryganeidae, with special reference to those contained in the collection of the British Museum. *Entomologist's Annual* 1863:155-163.
- MacLachlan, R. 1871. On new forms, etc., of extra-European trichopterous insects. *J. Linnaean Soc. London, Zoology* 11:98-141.

- Mackay, R. J. 1979. Life history patterns of some species of *Hydropsyche* (Trichoptera: Hydropsychidae) in southern Ontario. *Can. J. Zool.* 57:963-975.
- Mackay, R. J. 1986. Life cycles of *Hydropsyche riola*, *H. slossonae* and *Cheumatopsyche pettiti* (Trichoptera: Hydropsychidae) in a spring-fed stream in Minnesota. *Amer. Midl. Nat.* 115:19-24.
- Manuel, K. L. and T. C. Folsom. 1982. Instar sizes, life cycles, and food habits of five *Rhyacophila* (Trichoptera: Rhyacophilidae) species from the Appalachian Mountains of South Carolina, U.S.A. *Hydrobiologia* 97:281-285.
- Marshall, J. E. 1979. A review of the genera of the Hydroptilidae (Trichoptera). *Bull. Br. Mus. Nat. Hist. (Ent.)* 39:135-239.
- Marshall, J. S. and D. J. Larson. 1982. The adult caddisflies (Insecta: Trichoptera) of insular New Foundland. *Mem. New Foundland Occas. Pap. Biol.* 85 pp.
- Mathis, M. L. and D. E. Bowles. 1989. A new microcaddisfly genus (Trichoptera: Hydroptilidae) from the Interior Highlands of Arkansas, U.S.A. *J. N. Y. Entomol. Soc.* 97:187-191.
- Mathis, M. L. and D. E. Bowles. 1990. Three new species of microcaddisflies (Trichoptera: Hydroptilidae) from the Ozark Mountains, U.S.A. *Proc. Entomol. Soc. Wash.* 92:86-92.
- Mathis, M. L. and D. E. Bowles. 1991. A preliminary survey of the Trichoptera of the Ozark Mountains, Missouri, U.S.A. *Entomol. News* 103:19-29.
- Mathis, M. L., D. E. Bowles, and G. B. Wiggins. 1990. Observations on immature stages of *Paduniella nearctica* (Trichoptera: Psychomyiidae). *Bull. N. Amer. Benthol. Soc.* 7:77. (Abstract)
- Matlock, J. K. and O. E. Maughan. 1988. Effects of clear cut logging on benthic assemblages in southeastern Oklahoma. *Proc. Okla. Acad. Sci.* 68:85-86.
- Matthews, W. J. and H. W. Robison. 1988. The distribution of the fishes of Arkansas: a multivariate analysis. *Copeia* 1988:358-374.
- Mayden, R. L. 1985. Biogeography of Ouachita Highland fishes. *Southwest. Nat.* 30:195-211.

- Mayden, R. L. 1988. Vicariance biogeography, parsimony, and evolution in North American freshwater fishes. *Syst. Zool.* 37:329-355.
- McCafferty, W. P. 1981. *Aquatic Entomology: The fisherman's and ecologist's illustrated guide to insects and their relatives.* Jones and Bartlett Publishers, Inc., Boston. 448 pp.
- McGary, J. L. and G. L. Harp. 1972. The benthic macroinvertebrate community of the Greer's Ferry Reservoir cold tailwater, Little Red River, Arkansas. *Proceedings of the 26th Annual conference of the Southeast. Assoc. Game and Fish Comm.* 26: 490-500.
- McGonigle, J. V., Jr., and F. O. Howard. 1987. Ovipositional behavior of the caddisfly *Ptilostomis postica* (Trichoptera: Phryganeidae) in temporary pools in south central Pennsylvania. *Proc. Penn. Acad. Sci.* 61:31-34.
- Merrill, D. 1969. The distribution of case recognition in ten families of caddis larvae (Trichoptera). *Anim. Behav.* 17:486-493.
- Merrill, D. and G. B. Wiggins. 1971. The larva and pupa of the caddisfly genus *Setodes* in North America (Trichoptera: Leptoceridae). *Life Sci. Occ. Pap., Royal Ont. Mus. No. 19* pp. 1-12.
- Milne, L. J. 1931. Three new Canadian *Prophryganea*. *Can. Entomol.* 63:228-232.
- Milne, L. J. 1934. *Studies in North American Trichoptera. Pt. 1,* pp. 1-19. Cambridge, Mass.
- Milne, L. J. 1935. *Studies in North American Trichoptera. Pt. 2,* pp. 20-55. Cambridge, Mass.
- Milne, L. J. 1936. *Studies in North American Trichoptera. Pt. 3,* pp.56-128. 2 pis. Cambridge, Mass.
- Milne, M. J. 1938. The "metamorphotype method" in Trichoptera. *J. N. Y. Entomol. Soc.* 46:435-437.
- Morse, J. C. 1972. The genus *Nyctiophylax* in North America. *J. Kan. Entomol. Soc.* 45:172-181.
- Morse, J. C. 1975. A phylogeny and revision of the caddisfly genus *Ceraclea* (Trichoptera: Leptoceridae). *Cont. Amer. Entomol. Inst.* 11:1-97.

- Morse, J. C. 1988. *Protoptila morettii* (Trichoptera: Glossosomatidae), a new caddisfly species from the southern United States. *Riv. Idrobiol.* 27:299-308.
- Morse, J. C. 1990. *Nyctiophylax barrorum* (Trichoptera: Polycentropodidae), a new species from Alabama. *J. Kan. Entomol. Soc.* 63:133-137.
- Morse, J. C. 1993. A checklist of the Trichoptera of North America, including Greenland and Mexico. *Trans. Amer. Entomol. Soc.* 119:47-93.
- Morse, J. C., S. W. Hamilton, and K. M. Hoffman. 1989. Aquatic insects of Lake Jocassee catchment in North and South Carolina, with descriptions of four new species of caddisflies (Trichoptera). *J. Elisha Mitchell Sci. Soc.* 105:14-33.
- Morse, J. C. and R. W. Holzenthal. 1984. Trichoptera Genera, p. 312-347. *In* Introduction to the Aquatic Insects of North America 2nd edition, eds. R.W. Merritt and K.W. Cummins. Kendall/Hunt Publishing, Dubuque, IA. 722 pp.
- Morse, J. C. and I. D. Wallace. 1974. *Athripsodes* Billberg and *Ceraclea* Stephens, distinct genera of long-horned caddisflies (Trichoptera, Leptoceridae). *Proc. First Int. Symp. Trichoptera*, Dr. Junk, The Hague, 213 pp.
- Morton, K. J. 1905. North American Hydroptilidae. *N.Y. State Mus. Bull.* 86:63-85. pls. 13-15.
- Mosely, M. E. 1934a. Some new exotic Trichoptera. *Stylops* 3:139-142. 13 figs.
- Mosely, M. E. 1934b. New exotic Hydroptilidae. *Roy. Entomol. Soc. Lond. Trans.* 82:137-163.
- Mosely, M. E. 1937. Mexican Hydroptilidae (Trichoptera). *Roy. Entomol. Soc. Lond. Trans.* 86:151-190.
- Moulton, S. R., II, T. L. Beitinger, K. W. Stewart, and R. J. Currie. 1993. Upper temperature tolerance of four species of caddisflies (Insecta: Trichoptera). *J. Freshwat. Ecol.* 8:193-198.
- Moulton, S. R., II, D. Petr, and K. W. Stewart. 1993. Caddisflies (Insecta: Trichoptera) of the Brazos River in North Central Texas. *Southwest. Nat.* 38:19-23.

- Moulton, S. R., II, and K. W. Stewart. 1992. A new species of *Ceraclea* (Trichoptera: Leptoceridae) from the Ozark Mountains of Missouri, U.S.A. Proc. Entomol. Soc. Wash. 94:361-365.
- Moulton, S. R., II, and K. W. Stewart. 1993a. A new species in the *Polycentropus cinereus* Group (Trichoptera: Polycentropodidae) from Arkansas and Texas. Entomol. News 104:35-38.
- Moulton, S. R., II, and K. W. Stewart. 1993b. Nearctic *Oecetis scala* Group (Trichoptera: Leptoceridae) with the description of two new species from the Interior Highlands. Ann. Entomol. Soc. Amer. 86:221-227.
- Navás, L. 1934. Décadas de insectos nuevos. Brotéria-Ciências Naturais 3:15-24.
- Neboiss, A. 1993. Revised definitions of the genera *Nyctiophylax* Brauer and *Paranyctiophylax* Tsuda (Trichoptera: Polycentropodidae). Proc. Seventh Int. Symp. Trichoptera, 1992, Backhuys Publishers, Leiden, Netherlands, pp.107-111.
- Nielsen, A. 1948. Postembryonic development and biology of the Hydroptilidae. Kgl. Danske, Videsk. Selsk. Biol. Skr. 5(1).
- Nimmo, A. P. 1966. A list of Trichoptera taken at Montreal and Chambly, Quebec, with descriptions of three new species. Can. Entomol. 98:688-693.
- Nimmo, A. P. 1986. The adult Polycentropodidae of Canada and adjacent United States. Quaest. Entomol. 22:143-252.
- Nimmo, A. P. 1987. The adult Arctopsychoidea and Hydropsychidae of Canada and adjacent United States. Quaest. Entomol. 23:1-189.
- NRC (National Research Council). 1980. Research Priorities in Tropical Biology. National Academy of Sciences. Washington, D.C. 116 pp.
- Office of Technology Assessment Task Force. 1988. Technologies to maintain biological diversity. Science Information Resource Center. Philadelphia, PA. 334 pp.
- Palmer, M. W. 1993. Putting things into even better order: the advantages of canonical correspondence analysis. Ecology 74:2215-2230.

- Palmer, T. 1986. Endangered rivers and the conservation movement. Univ. California Press, Berkeley.
- Patterson, G. 1990. Who speaks for wildlife? Arkansas Game and Fish Magazine, 21:6-9.
- Petersen, J. C. 1992. Trends in stream water quality data in Arkansas during several time periods between 1975 and 1989. U.S. Geol. Surv. Wat.-Res. Invest. Report 92-4044. 182 pp.
- Pflieger, W. L. 1971. A distributional study of Missouri fishes. Mus. Natur. Hist., Univ. Kansas Publ. 20:225-570.
- Pflieger, W. L. 1975. The fishes of Missouri. Missouri Dept. Cons., Jefferson City. 343 pp.
- Phillippi, M. A. and G. A. Schuster. 1987. New records of caddisflies (Trichoptera) from Kentucky. Entomol. News 98:113-116.
- Pielou, E. C. 1979. Biogeography. John Wiley and Sons, Inc. New York, NY. 351 pp.
- Poulton, B. C. and K. W. Stewart. 1991. The stoneflies (Plecoptera) of the Ozark and Ouachita Mountains. Mem. Amer. Entomol. Soc. No. 38.
- Provancher, M. A. 1877. Petite faune entomologique du Canada. Trichoptères. Le Naturaliste Canadien 9:212-217, 241-244, 257-269.
- Rambur, J. P. 1842. Histoire naturelle des insectes. Nevrotères. 17+534 pp., 12 pls. Paris.
- Rafferty, M. D. 1985. The Ozarks Outdoors. University of Oklahoma Press. Norman, OK. 389 pp.
- Resh, V. H. 1975. A distributional study of the caddisflies of Kentucky. Trans. Kentucky Acad. Sci. 36:6-16.
- Resh, V. H. 1976a. The biology and immature stages of the caddisfly genus *Ceraclea* in eastern North America (Trichoptera: Leptoceridae). Ann. Entomol. Soc. Amer. 69:1039-1061.
- Resh, V. H. 1976b. Life histories of coexisting species of *Ceraclea* caddisflies (Trichoptera: Leptoceridae): the operation of independent functional units in a stream ecosystem. Can. Entomol. 108:1303-1318.

- Resh, V. H. and R. E. Houp. 1986. Life history of the caddisfly *Dibusa angata* and its association with the red alga *Lemanea australis*. J. N. Amer. Benthol. Soc. 5:28-40.
- Resh, V. H., D. S. White, and S. J. White. 1978. Lake Texoma caddisflies (Insecta: Trichoptera): 1. species present and faunal changes since impoundment. Southwest. Nat. 23:381-388.
- Rhame, R. E. and K. W. Stewart. 1976. Life cycles and food habits of three Hydropsychidae (Trichoptera) species in the Brazos River, Texas. Trans. Amer. Entomol. Soc. 112:65-99.
- Ricker, W. E. 1964. Distribution of Canada stoneflies. Gew. Abw. 34/35:50-71.
- Robison, H. W. and T. M. Buchanan. 1988. The Fishes of Arkansas. University of Arkansas Press, Fayetteville. 498 pp.
- Root, D. W. 1965. A new northeastern caddisfly species of the genus *Phylocentropus* (Trichoptera: Psychomyiidae). Bull. Brooklyn Entomol. Soc. 59-60:85-87.
- Ross, D. H. and J. B. Wallace. 1983. Longitudinal patterns of production, food consumption, and seston utilization by net-spinning caddisflies (Trichoptera) in a southern Appalachian stream (USA). Holarct. Ecol. 6:270-284.
- Ross, H. H. 1938a. Descriptions of nearctic caddis flies (Trichoptera) with special reference to the Illinois species. Bull. Ill. Nat. Hist. Surv. 21:101-183.
- Ross, H. H. 1938b. Descriptions of new leptocerid Trichoptera. Ann. Entomol. Soc. Amer. 31:88-91.
- Ross, H. H. 1938c. Lectotypes of North American caddis flies in the Museum of Comparative Zoology. Psyche 45:1-61. 10 pls.
- Ross, H. H. 1938d. Descriptions of new North American Trichoptera. Proc. Entomol. Soc. Wash. 40:117-124. 2 pis.
- Ross, H. H. 1939a. New species of Trichoptera from the Appalachian region. Proc. Entomol. Soc. Wash. 41:65-72.
- Ross, H. H. 1939b. Three new species of Nearctic Trichoptera. Ann. Entomol. Soc. Amer. 32:628-631.

- Ross, H. H. 1941a. New species of Trichoptera from Canada and northern United States. *Can. Entomol.* 73:15-19. 1 pi.
- Ross, H. H. 1941b. Descriptions and records of North American Trichoptera. *Trans. Amer. Entomol. Soc.* 67:35-126. 13 pls.
- Ross, H. H. 1944. The caddisflies, or Trichoptera, of Illinois. *Bull. Ill. Nat. Hist. Surv.* 23:1-326.
- Ross, H. H. 1947. Descriptions and records of North American Trichoptera, with synoptic notes. *Trans. Amer. Entomol. Soc.*, 73:125-168, 8 pis.
- Ross, H. H. 1956. *Evolution and Classification of the Mountain Caddisflies.* University of Illinois Press, Urbana. 213 pp.
- Ross, H. H. 1959. The relationships of three new species of *Triaenodes* from Illinois and Florida (Trichoptera). *Entomol. News* 70:39-45.
- Ross, H. H. 1963. Stream Communities and terrestrial biomes. *Arch. Hydrobiol.* 59:235-242.
- Ross, H. H. 1964. Evolution of caddisworm cases and nets. *Am. Zool.* 4:209-220.
- Ross, H. H. 1965. Pleistocene events and insects. pp. 583-596, in H. E. Wright, Jr. and D. G. Frey, eds. *The Quaternary of the United States.* Princeton Univ. Press, New Jersey, 922 pp.
- Ross, H. H. 1966. Two new species of *Oecetis* occurring in eastern North America (Trichoptera: Leptoceridae). *Trans. Ill. Acad. Sci.* 59:11-14.
- Ross, H. H. 1967. The evolution and past dispersal of the Trichoptera. *Ann. Rev. Entomol.* 12:169-206.
- Ross, H. H. 1970. Hydropsychid genus A, *Diplectrona* (Trichoptera: Hydropsychidae). *J. Georgia Entomol. Soc.* 5:229-231.
- Ross, H. H. and W. E. Ricker. 1971. The Classification, evolution, and past dispersal of the winter stonefly genus *Allocapnia*. *Ill. Biol. Mono.* 45. Univ. Ill. Press, Chicago. 66 pp.
- Ross, H. H. and J. D. Unzicker. 1965. The *Micrsema rusticum* Group of caddisflies (Brachycentridae, Trichoptera). *Proc. Biol. Soc. Wash.* 78:251-258.

- Ross, H. H. and J. D. Unzicker. 1977. The relationships of the genera of American Hydropsychinae as indicated by phallic structures (Trichoptera, Hydropsychidae). *J. Georgia Entomol. Soc.* 12:298-312.
- Ross, H. H. and T. Yamamoto. 1965. New species of the caddisfly genus *Polycentropus* from eastern North America (Trichoptera: Psychomyiidae). *Proc. Biol. Soc. Wash.* 78:241-246.
- Ross, H. H. and T. Yamamoto. 1967. Variations in the winter stonefly *Allocapnia granulata* as indicators of Pleistocene faunal movements. *Ann. Entomol. Soc. Amer.* 60:447-458.
- Roy, D. and P. P. Harper. 1980. Females of the Nearctic *Molanna* (Trichoptera: Molannidae). *Proc. Entomol. Soc. Wash.* 82:229-236.
- Say, T. 1823. Descriptions on insects belonging to the order Neuroptera Linné and Latreille, collected by the expedition under the command of Major Long. *West. Quart. Report* 2:160-165. Cincinnati.
- Say, T. 1824. From the narrative of the expedition to the source of the St. Peter's River, etc., under the command of Stephen H. Long, Major U.S.T.E. 2:268-378. Philadelphia.
- Say, T. 1828. American entomology, or descriptions of the insects of North America. 3, pls. 37-54. Philadelphia.
- Scheffer, P. A. and G. B. Wiggins. 1986. A systematic study of the nearctic larvae of the *Hydropsyche morosa* group (Trichoptera: Hydropsychidae). *Roy. Ont. Mus. Life Sci. Misc. Publ.*, Toronto, Canada. 94 pp.
- Scheffer, P. A. and G. B. Wiggins. 1987. Setal characters in larval diagnoses for some Nearctic species of *Cheumatopsyche* (Trichoptera: Hydropsychidae). pp. 39-42. *Proc. Fifth Int. Symp. Trichoptera*, M. Bournaud and H. Tachet (eds.), Dr. W. Junk Publishers, The Hague.
- Schmid, F. 1980. Genera des Trichopteres du Canada et des Etats adjacents. Les insectes et arachnides du Canada, partie 7. *Agriculture Canada* 1692:1-296.
- Schmude, K. L. and W. L. Hilsenhoff. 1986. Biology, ecology, larval taxonomy, and distribution of Hydropsychidae (Trichoptera) in Wisconsin. *Great Lakes Entomol.* 19:123-145.

- Schuster, G. A. 1979. On the identity of *Molanna ulmerina* Navas (Trichoptera: Molannidae). Entomol. News 90:249-250.
- Schuster, G. A. 1984. *Hydropsyche?* - *Symphitopsyche?* - *Ceratopsyche?*: a taxonomic enigma. Proc. Fourth Int. Symp. Trichoptera, Series Entomologica, Vol. 30, J. C. Morse (ed.), Dr. W. Junk Publishers, The Hague pp. 339-345.
- Schuster, G. A. and D. A. Etnier. 1978. A manual for the identification of the larvae of the caddisfly genera *Hydropsyche* Pictet and *Symphitopsyche* Ulmer in eastern and central North America (Trichoptera: Hydropsychidae). United States Environmental Protection Agency Report 600/4-78-060. 129 pp.
- Sherberger, F. F. and J. B. Wallace. 1971. Larvae of the southeastern species of *Molanna*. J. Kan. Entomol. Soc. 44:217-224.
- Sibley, C. K. 1926a. New species of New York caddis flies. J. N. Y. Entomol. Soc. 34:79-81.
- Sibley, C. K. 1926b. Trichoptera, in A preliminary biological survey of the Lloyd-Cornell Reservation. Lloyd Library of Botany, Pharmacy and Materia Medica Bull. 27 (Ent. Series 5):102-108, 185-221, pls. 8-13.
- Smith, S. D. 1968. The *Rhyacophila* of the Salmon River drainage of Idaho with special reference to larvae. Ann. Entomol. Soc. Amer. 61:655-674.
- Stroud, H. B. and G. T. Hanson. 1981. Arkansas Geography: The physical landscape and the historical-cultural setting. Library of Congress, N.Y. pp. 11-38.
- Thornbury, W. D. 1965. Regional geomorphology of the United States. John Wiley and Sons, New York.
- Udvardy, M. F. D. 1969. Dynamic zoogeography, with special reference to land animals. Van Nostrand Reinhold Co., New York. 455 pp.
- Ulmer, G. 1905. Neue und wenig bekannte aussereuropäischer Trichopteren, hauptsächlich aus dem Wiener Museum. Naturhistorischen Hofmuseums Wien Annalen 20:59-98. 75 figs.
- Ulmer, G. 1907. Trichoptera. Genera Insectorum 60. 259 pp. 41 pls.

- Unzicker, J. D., L. Aggus, and L. O. Warren. 1970. A preliminary list of the Arkansas Trichoptera. *J. Georgia Entomol. Soc.* 5:167-174.
- Unzicker, J. D., V. H. Resh, and J. C. Morse. 1982. Trichoptera, pp. 9.1-9.138. *In* A. R. Brigham, W. V. Brigham, and A. Gnilka, eds. Aquatic insects and oligochaetes of North and South Carolina. Midwest Aquatic Enterprises, Mahomet, Illinois.
- Vaughn, C. C. 1985a. Life history of *Helicopsyche borealis* (Hagen)(Trichoptera: Helicopsychidae) in Oklahoma. *Amer. Midl. Nat.* 113:76-83.
- Vaughn, C. C. 1985b. Evolutionary ecology of case architecture in the snailcase caddisfly, *Helicopsyche borealis*. *Fresh. Invert. Biol.* 4:178-186.
- Vaughn, C. C. 1986. The role of periphyton abundance and quality in the microdistribution of a stream grazer, *Helicopsyche borealis* (Trichoptera: Helicopsychidae). *Fresh. Biol.* 16:485-493.
- Vaughn, C. C. 1987. Substratum preference of the caddisfly *Helicopsyche borealis* (Hagen)(Trichoptera: Helicopsychidae). *Hydrobiol.* 154:201-205.
- Vaughn, C. C. 1992. Survey for the three-toothed long-horned caddisfly (*Triaenodes tridonta*) in Oklahoma. Status Report submitted to the U.S. Fish and Wildlife Service, Tulsa, OK
- Vineyard, R. N. and G. B. Wiggins. 1988. Further revision of the caddisfly family Uenoidae (Trichoptera): evidence for the inclusion of Neophylacinae and Thremmatidae. *Syst. Entomol.* 13:361-372.
- Vorhies, C. T. 1909. Studies on the Trichoptera of Wisconsin. *Wis. Acad. Sci. Trans.* 16:647-738. pls. 52-61.
- Walker, F. 1852. Catalogue of the specimens of neuropterous insects in the collections of the British Museum. Pt. 1, 192 pp. London.
- Wallace, J. B., W. R. Woodall, and A. A. Staats. 1976. The larval dwelling tube, capture net and food of *Phylocentropus placidus* (Tricoptera: Polycentropodidae). *Ann. Entomol. Soc. Amer.* 69:149-154.
- Ward, R., E. G. Zimmerman, and T. L. King. 1990. Multivariate analyses of terrestrial reptilian distribution in Texas: an alternate view. *Southwest. Nat.* 35:441-445.

- Weaver, J. S. 1985. A new species and new generic synonym of the Nearctic caddisfly genus *Homoplectra* (Trichoptera: Hydropsychidae). *Entomol. News* 96:71-77.
- Weaver, J. S. III. 1988. A synopsis of the North American Lepidostomatidae (Trichoptera). *Contr. Am. Entomol. Inst.* 24:1-141.
- Weaver, J. S. and J. C. Morse. 1986. Evolution of feeding and case-making behavior in Trichoptera. *J. N. Amer. Benthol. Soc.* 5:150-158.
- Weaver, J. S. and J. L. Sykora. 1979. The *Rhyacophila* of Pennsylvania, with larval descriptions of *R. banksi* and *R. carpenteri* (Trichoptera: Rhyacophilidae). *Ann. Carnegie Museum* 48:403-423.
- Wiggins, G. B. 1973. A contribution to the biology of caddisflies (Trichoptera) in temporary pools. *Life Sci. Cont.*, Royal Ontario Museum, No. 88.
- Wiggins, G. B. 1977. Larvae of the North American Caddisfly Genera (Trichoptera). Univ. Toronto Press, Toronto, Ontario, Canada. 401 pp.
- Wiggins, G. B. 1984. Trichoptera, p.271-311. In . Introduction to the Aquatic Insects of North America 2nd edition, eds. R.W. Merritt and K.W. Cummins. Kendall/Hunt Publishing, Dubuque, Iowa. 722 pp.
- Wiggins, G. B. 1990. Systematics of North American Trichoptera: present status and future prospect, p. 203-210. In Systematics of the North American Insects and Arachnids: Status and Needs, ed. M. Kosztarab and C.W. Schaefer. Virginia Agricultural Experiment Station Information Series 90-1. Blacksburg: Virginia Polytechnic Institute and State University.
- Wiggins, G. B. and R. J. Mackay. 1978. Some relationships between systematics and trophic ecology in nearctic aquatic insects with special reference to Trichoptera. *Ecology* 59:1211-1220.
- Wiggins, G. B., R. J. Mackay, and I. M. Smith. 1980. Evolutionary and ecological strategies of animals in annual temporary pools. *Arch. Hydrobiol./Suppl.* 58:97-206.
- Wiggins, G. B. and C. R. Parker. 1984. Beringian Trichoptera, a preliminary report. *Proc. Fourth Int. Symp. Trichoptera, Series Entomologica*, Vol. 30, ed. J. C. Morse, Dr. W. Junk Publishers, The Hague.

- Williams, N. E. 1991. Geographical and environmental patterns in caddisfly (Trichoptera) assemblages from coldwater springs in Canada. Mem. Entomol. Soc. Can. 155:107-124.
- Wilson, E. O. 1988. The Current State of Biological Diversity, p.3-18. In: E.O. Wilson, ed., Biodiversity, National Academy Press, Washington, D.C. 521 pp.
- Wilson, E. O. 1989. Threats to biodiversity. Sci. Amer. 261:108-116.
- Wilson, J. H., ed. 1984. Rare and endangered species of Missouri. Missouri Dept. of Cons., Jefferson City, MO. 171 pp.
- Wojtowicz, J. A. 1982. A review of the adults and larvae of the genus *Pycnopsyche* (Trichoptera: Limnephilidae) with revision of the *Pycnopsyche scabripennis* (Rambur) and *Pycnopsyche lepida* (Hagen) complexes. Ph.D. Dissertation, University of Tennessee. 292 pp.
- Yamamoto, T. and H. H. Ross. 1966. A phylogenetic outline of the caddisfly genus *Mystacides* (Trichoptera: Leptoceridae). The Can. Entomol. 98:627-632.
- Yamamoto, T. and G. B. Wiggins. 1964. A comparative study of the North American species in the caddisfly genus *Mystacides* (Trichoptera: Leptoceridae). Can. J. Zool. 42:1105-1126.

Table 1. Number of caddisfly species from states occupying the Interior Highland region and those peripheral to it.

State	No. Spp.	Reference(s)
Arkansas	153	Unzicker <i>et al.</i> (1970), Bowles and Mathis (1989)
Illinois	183	Ross (1944)
Kansas	104	Hamilton <i>et al.</i> (1983)
Kentucky	198	Resh (1975), Phillippi and Schuster (1987), Floyd and Schuster (1990), Floyd (1992)
Louisiana/ Mississippi	131	Harris <i>et al.</i> (1982), Holzenthal <i>et al.</i> (1982), Lago <i>et al.</i> (1982)
Missouri	134	Mathis and Bowles (1992)
Oklahoma	135	Bowles and Mathis (1992)
Tennessee	298	Etnier and Schuster (1979)
Texas	106	Edwards (1973), Moulton <i>et al.</i> (1993)

Table 2. List of the 131 Interior Highland watershed subdivisions shown in Fig. 16.

1. Upper Fourche la Fave R.	45. Lee Cr.	89. MississippiR. (upland)
2. Piney Cr.	46. Upper Saline R.	90. Arkansas R.
3. Big Cr.	47. Eleven Point R.	91. Big Cr.
4. Flint Cr.	48. Saline R.	92. Flat Cr.
5. Lower Poteau R.	49. Caddo R.	93. Little Piney Cr.
6. Bodcau Cr.	50. Middle Saline R.	94. Cache R.
7. Maumelle R.	51. Lower Moro Cr.	95. Bryant Cr.
8. Richland & Bear Crs.	52. Strawberry R.	96. Bull Cr. & Swan Cr.
9. Big Piney Cr.	53. Spring R.	97. Finley Cr.
10. Magazine Mountain	54. Lower Little Red R.	98. Little Black R.
11. Cypress Cr.	55. Buffalo R.	99. Curtois Cr. & Huzzah Cr.
12. Cornie Cr.	56. Upper Ouachita R. - I	100. Jack's Fork R.
13. Upper Ouachita R. - II	57. Middle Ouachita R. - I	101. Moreau R.
14. Cossatot R.	58. Middle Ouachita R. - II	102. Elk R.
15. Caney Cr.	59. Red R. & Sulphur R.	103. Shoal Cr.
16. Upper Moro Cr.	60. Little R.	104. St. Francis R.
17. Upper Little Missouri R.	61. Antoine R.	105. Kaskaskia R. & Big Muddy R.
18. South Fourche la Fave R.	62. Lower Ouachita R.	106. Lower Ohio R.
19. Little Petit Jean Cr.	63. Lower Saline R.	107. Lower Gasconade R.
20. Frog Bayou	64. Tulip Cr.	108. Bourbouse R.
21. South Cadron Cr.	65. Kings R.	109. Lower Meramec R.
22. Fourche Cr.	66. Sugar Cr.	110. Big R
23. Sylamore Cr.	67. Lower Black R.	111. Maries R.
24. MississippiR. (lowland)	68. Lower Current R.	112. Lamine R. & Petit Saline R.
25. War Eagle Cr.	69. Lower White R. - II	113. Upper Osage R.
26. Crooked Cr.	70. Crowley's Ridge	114. Lower Sac R.
27. Point Remove Cr.	71. Upper White R.	115. Pomme de Terre R.
28. Beaver, Table Rock, Taneycomo Res.	72. Lower White R. - I	116. Niangua R.
29. Terre Rouge Cr.	73. Upper Poteau R.	117. Osage Fork Gasconade R.
30. Smackover Cr.	74. Mountain Fork R.	118. Upper Sac R.
31. Rolling Fork Cr.	75. Lower Arkansas R.	119. Spring R.
32. Bull Shoals Res.	76. Brushy Cr.	120. James R.
33. Middle Fourche la Fave R.	77. Kiamichi R.	121. Beaver Cr.
34. North Cadron Cr.	78. Upper Little R.	122. Upper Gasconade R.
35. Illinois Bayou	79. Glover R.	123. Big Piney Cr.
36. Upper Illinois R.	80. Fourche Maine Cr.	124. Upper Current R.
37. Upper Petit Jean Cr.	81. Lower Illinois R.	125. Upper Meramec R.
38. North Fork White R.	82. Canadian R.	126. Saline R.
39. Lower Little Missouri R.	83. Spavinaw Cr.	127. Clear & Muddy Boggy Crs.
40. Cypress Bayou & Bayou des Arc	84. Lower Neosho R.	128. Blue R.
41. South fork Spring R.	85. Upper Black R.	129. Washita R.
42. Middle Fork Little Red R.	86. Castor R. & Whitewater R.	130. Caddo Cr.
43. South Fork Little Red R.	87. Lower Osage R.	131. Wichita Mts.
44. Mulberry R.	88. Missouri R.	

Table 3. Trichoptera species richness, number of endemic species, and percent of total (N) for each of the 17 physiographic subregions depicted in Fig. 2.

Subregion	Endemics Species (N=27)		Species Richness (N=229)	
	Total	%	Total	%
1. Ouachita Mountains	13	48	134	59
2. Boston Mountains	10	37	99	43
3. Springfield Plateau	7	26	120	52
4. White River Hills	7	26	87	38
5. Central Plateau	9	33	117	51
6. Osage-Gasconade Hills	2	7	81	35
7. Curtois Hills	8	30	90	39
8. St. Francois Mountains	3	11	40	17
9. Missouri River Border	1	4	56	24
10. Mississippi River Border	0	0	3	1
11. Illinois Ozarks	0	0	55	24
12. Crowley's Ridge	0	0	22	10
13. Mississippi Alluvial Plain	0	0	36	16
14. Gulf Coastal Plain	2	7	75	33
15. Arkansas River Valley	0	0	16	7
16. Arbuckle Mountains	0	0	50	22
17. Wichita Mountains	0	0	5	2

Table 4. Number and percent similarity of the Interior Highland caddisfly species (N = 229) shared with other regions (after Poulton and Stewart 1991) in North America including Mexico and the neotropics.

Region	Annulipalpia Species	Integripalpia Species	Total	%
Northcentral U.S. & Canada	74	50	124	54
Southern U.S.	108	62	170	74
Eastern U.S.	103	63	166	72
Western U.S. & Canada	37	19	56	24
Mexico & neotropics	18	8	26	11

Table 5. Interior Highland Trichoptera summary table, including total number of collection records (N) and associations with different physiographic subregions, stream orders, stream widths, flow permanence types, substrate types and vegetation types. A (?) denotes unknown information.

Species	N	Physiographic Subregion	Stream Order	Stream Width	Flow Perm	Substrate Type	Vegetation Type
<i>Agapetus artemus</i>	6	5, 7	1	3, 4	4	3	1, 2
<i>Agapetus illini</i>	82	1-9, 11, 14, 16	1-5	1-3, 5	1, 3, 4	2-6	1, 2
<i>Agapetus medicus</i>	9	1	1-3	1, 3	2, 3	2-4	1
<i>Agrypnia vestita</i>	18	1, 3, 5, 9, 13, 14	2-4	3, 4	2, 3	1, 3, 4	1-3
<i>Brachycentrus lateralis</i>	2	5, 9	5	5	3, 4	3	2
<i>Brachycentrus numerosus</i>	5	5, 7, 13	4, 5	5	3, 4	3	2
<i>Ceraclea ancylus</i>	34	1-6, 11	2-5	3-5	3	2, 3	1, 2
<i>Ceraclea cancellata</i>	45	1-7, 9, 11	1-5	3-5	3, 4	2, 3	1, 2
<i>Ceraclea flava</i>	16	1, 3, 6, 9, 11, 14	5	4	3	2	1
<i>Ceraclea maccalmonti</i>	3	5	1	3	4	3	2
<i>Ceraclea maculata</i>	49	1-7, 9, 12-14	1-5	2-5	3, 4	1-3	1-3
<i>Ceraclea nepha</i>	23	1-3, 11, 14	2-5	2, 3, 5	3	2, 3	1, 2
<i>Ceraclea ophiderus</i>	6	1, 4, 11, 14	3, 5	2, 5	3	2, 3	2, 3
<i>Ceraclea protonepha</i>	19	1-3, 5, 14	2-5	2, 3, 5	3	2, 3	1, 2
<i>Ceraclea punctata</i>	9	1-3, 11	4, 5	3-5	3	3	2
<i>Ceraclea resurgens</i>	1	1	?	?	?	?	?
<i>Ceraclea tarsipunctata</i>	70	1-7, 9, 11, 13, 14	1-6+	2-5	3, 4	2, 3	1, 2
<i>Ceraclea transversa</i>	49	1-7, 9, 14	2-5	3-5	3	2, 3	1-3
<i>Ceratopsyche bronita</i>	33	2-8	1-5	3-5	3, 4	2, 3	1, 2
<i>Ceratopsyche morosa (east)</i>	25	3-9	1-4	2-5	3, 4	2, 3	1, 2
<i>Ceratopsyche morosa (west)</i>	9	16	1-4	1-4	3, 4	2-4, 6	2
<i>Ceratopsyche piatrix</i>	11	5, 7	1, 4	2, 3, 5	4	2, 3	1, 2
<i>Ceratopsyche sfossoneae</i>	7	4, 5	1-3	3, 4	4	3	1, 2

Table 5. Continued.

Species	N	Physiographic Subregion	Stream Order	Stream Width	Flow Perm	Substrate Type	Vegetation Type
<i>Cerrotina calcea</i>	29	1-6, 13, 14, 16	1-5	2, 3, 5	3, 4	2, 3	2
<i>Cerrotina oklahoma</i>	1	16	3	3	3	6	2
<i>Cerrotina spicata</i>	3	1, 16	3	3	3	1, 6	2
<i>Cheumatopsyche aphanita</i>	28	1-5, 8, 9, 14	1, 4	3, 4	3, 4	3	2
<i>Cheumatopsyche burksi</i>	15	1, 12-15	2-5	3, 5	3	1, 3, 4	1-3
<i>Cheumatopsyche campyla</i>	64	1-9, 11-14, 16	1-6+	1-5	3, 4	1-3	1-3
<i>Cheumatopsyche conis</i>	1	16	1	1	4	2	2
<i>Cheumatopsyche gracilis</i>	13	1, 3, 4, 7, 9	1, 2	3, 4	3, 4	3	2
<i>Cheumatopsyche halima</i>	1	2	?	?	?	?	?
<i>Cheumatopsyche harwoodi enigma</i>	3	3, 4, 8	4	3	3	3	2
<i>Cheumatopsyche lasia</i>	6	3, 7, 16	3-5	3-5	3	1-4	2
<i>Cheumatopsyche minuscula</i>	48	1-7, 14	2-5	2-5	3	2, 3	2
<i>Cheumatopsyche oxa</i>	63	1-7, 11, 13	1-4	1-4	3, 4	1-3	1, 2
<i>Cheumatopsyche pasella</i>	17	1, 3, 5, 12-14	1-5	2-4	3	1-3	1-3
<i>Cheumatopsyche pettiti</i>	117	1-7, 9, 11-14, 16	1-5	2-5	2-4	1-4, 6	1-3
<i>Cheumatopsyche robbisoni</i>	8	1	1-3	1-3	3, 4	3	1, 2
<i>Cheumatopsyche rossi</i>	4	1, 5, 7	1	3	4	3	2
<i>Cheumatopsyche sordida</i>	31	2-9	1-6+	2-5	3, 4	3	1, 2
<i>Cheumatopsyche speciosa</i>	7	2-7	3, 4	3, 4	3	3	2
<i>Chimarra aterrima</i>	21	1-8	2-4	2-4	3, 4	3, 4	2
<i>Chimarra feria</i>	89	1-5, 7, 8, 11-16	1-5	1-5	2-4	1-4, 6	1-3
<i>Chimarra obscura</i>	158	1-16	1-6+	2-5	2-4	1-4	1-3
<i>Chimarra parasocia</i>	1	14	5	5	3	2	1, 2
<i>Chimarra socia</i>	12	1, 4, 5, 6, 9, 14	4	4	3	3	1, 2
<i>Cynellius fraternus</i>	38	1-7, 9, 11-15	1-5	2-5	1, 3, 4	1-4	2, 3
<i>Dibusa angata</i>	5	1-3	2, 5	3, 4	3	3, 4	1, 2

Table 5. Continued.

Species	N	Physiographic Subregion	Stream Order	Stream Width	Flow Perm	Substrate Type	Vegetation Type
<i>Diplectrona metaqui</i>	2	6, 11	1	1, 2	4	3, 4	2
<i>Diplectrona modesta</i>	22	1-3, 6, 11	1, 2	1-3	2-4	1-4	1, 2
<i>Frenesia missa</i>	3	3, 6	1	1	4	2	2
<i>Glossosoma intermedium</i>	11	5, 7	1, 4	2-5	4	2, 3	1, 2
<i>Glyphopsyche missouri</i>	3	7	1	4	4	3	2
<i>Helicopsyche borealis</i>	103	1-9, 11, 16, 17	1-6+	1-6	3, 4	1-4, 6	1, 2
<i>Helicopsyche limnella</i>	38	1-4, 14	1-5	2-4	3, 4	2-4	1, 2
<i>Helicopsyche piroa</i>	6	1-3, 14, 16	1, 3-5	2-4	3	3	2
<i>Homoptera doringa</i>	3	1-3	1	1	1, 4	3-5	1
<i>Hydropsyche alvata</i>	3	1, 5, 9	?	?	3	3	2
<i>Hydropsyche arinata</i>	27	1-3, 5, 8, 14, 16	3-5	3-5	3	2-4	1, 2
<i>Hydropsyche beffeni</i>	29	1-7, 9, 13	1-4	2-4	3, 4	3, 4	1, 2
<i>Hydropsyche bidens</i>	9	1, 3, 7, 11, 13-15	2-5	2-4	3	1	3
<i>Hydropsyche orris</i>	34	1-3, 5, 7, 11-16	1-5	2, 4, 5	3, 4	1-3	1-3
<i>Hydropsyche rossi</i>	18	1, 5, 12-14	1-5	2, 4	3	1-3	1-3
<i>Hydropsyche scalaris</i>	33	1, 3-7, 9, 14, 16	1-5	2, 5	3, 4	2, 3	1, 2
<i>Hydropsyche simulans</i>	26	1, 3, 5-7, 9, 10, 14, 16	1-5	3-5	3, 4	2-4, 6	1, 2
<i>Hydroptila ajax</i>	10	3, 5, 6, 9, 16	1-5	2-5	3, 4	3	1, 2
<i>Hydroptila albicornis</i>	23	3, 5, 6, 7, 9	1-4	2-5	3, 4	2, 3	1, 2
<i>Hydroptila amoena</i>	7	1, 3-5, 11, 16	1-3	2, 3	3	1, 3, 4, 6	2
<i>Hydroptila angusta</i>	14	2-4, 6, 9, 16	1-6+	2, 4, 5	3	2, 3	2
<i>Hydroptila armata</i>	52	1-7, 9, 14, 16	1-5	2-5	3, 4	2-4, 6	1, 2

Table 5. Continued.

Species	N	Physiographic Subregion	Stream Order	Stream Width	Flow Perm	Substrate Type	Vegetation Type
<i>Hydroptila artesa</i>	12	4, 5, 7	1-4	2, 3, 5	4	2, 3	1, 2
<i>Hydroptila bernerii</i>	2	1	1, 2	2, 3	3, 4	2, 3	1, 2
<i>Hydroptila broweri</i>	11	2-5, 7, 8	1-5	2-5	3, 4	2, 3	1, 2
<i>Hydroptila consimilis</i>	29	3-7, 9, 16	1-4	1-5	3, 4	2-4, 6	1, 2
<i>Hydroptila delinzeata</i>	2	14	3, 5	4	3	3	1
<i>Hydroptila grandiosa</i>	56	1-9, 14, 16	1-6+	2-5	2-4	1-4	1, 2
<i>Hydroptila hamata</i>	75	1-9, 11, 14, 16	1-5	2-5	2-4	1-4, 6	1, 2
<i>Hydroptila icona</i>	2	16	3	3	3, 4	3, 4	2
<i>Hydroptila melia</i>	1	16	3	3	3, 4	6	2
<i>Hydroptila onelli</i>	1	1	?	?	3	3	2
<i>Hydroptila perdita</i>	53	1-9	1-5	2-5	3, 4	1-4	1, 2
<i>Hydroptila protera</i>	1	16	3	3	3, 4	6	2
<i>Hydroptila quinola</i>	11	1, 2, 14	1-3	4	3, 4	2	1, 3
<i>Hydroptila remita</i>	5	1, 14	2-4	2-4	2, 3	1, 4	1
<i>Hydroptila sandersoni</i>	14	1-5, 7	1-4	2-5	2-4	1-4	1, 2
<i>Hydroptila spatulata</i>	13	1, 5-7, 9	4	4	3	3	2
<i>Hydroptila strepha</i>	6	3-5, 7, 8	2-4	2-5	3, 4	2, 3	2
<i>Hydroptila tusculum</i>	1	7	1	3	4	3	2
<i>Hydroptila vala</i>	6	1, 2, 4, 11	2	2	3, 4	3	2
<i>Hydroptila virgata</i>	30	1-4, 7-9, 11, 14	1-3	2, 3	3, 4	3	2
<i>Hydroptila waubesiana</i>	26	1-3, 5, 6, 12, 14-16	1-5	1-5	3, 4	2-4	1, 2
<i>Isonoquia kaskaskia</i>	1	11	?	?	3	?	2
<i>Isonoquia punctatissima</i>	19	1-7, 14	1-4	1-5	1, 3, 4	2-4	1, 2
<i>Ithytrichia clavata</i>	9	1, 5, 7, 9	3-5	3-6	3, 4	2, 3	1, 2
<i>Ithytrichia mazon</i>	1	15	3	3	3	3	2
<i>Lepidostoma carrolli</i>	1	1	1, 2	1, 2	3	2, 3	1, 2
<i>Lepidostoma griseum</i>	2	2	1, 2	1, 2	4	2, 3	2

Table 5. Continued.

Species	N	Physiographic Subregion	Stream Order	Stream Width	Flow Perm	Substrate Type	Vegetation Type
<i>Lepidostoma lescheni</i>	1	1	1	1	1, 4	3	1, 2
<i>Lepidostoma libum</i>	5	2, 3, 6	1	1, 2	3, 4	2, 3	2
<i>Lepidostoma ozarkense</i>	10	1-3, 5	1	1, 2	1, 4	2, 5	1, 2
<i>Lepidostoma togatum</i>	22	1, 3-5, 7	1-5	2-5	3, 4	2, 4	1, 2
<i>Leptocerus americanus</i>	8	1, 4, 11, 13, 14	2	3	3	1-3	1, 3
<i>Leucotrichia pictipes</i>	7	7	4	3	3	6	2
<i>Limnephilus submonilifer</i>	1	2	?	?	?	?	?
<i>Lype diversa</i>	12	1-5, 8	1-5	2-5	3, 4	2, 3, 6	1, 2
<i>Macrostemum carolina</i>	17	1, 5, 7, 13, 14	4, 5	4, 5	3, 4	1	2, 3
<i>Marilia flexuosa</i>	19	2-4, 7	3-5	3-5	3	3	2
<i>Marilia sp. A</i>	2	3, 5	2, 3	3	3	6	2
<i>Mayatrichia ayama</i>	5	1, 14, 16	2, 4	3	3	1-3	1
<i>Mayatrichia ponta</i>	6	16	1-3	2, 3	3, 4	3, 6	2
<i>Micrasema ozarkana</i>	8	5, 7	1, 4	3, 5	4	2, 3	1, 2
<i>Micrasema rusticum</i>	8	1, 2, 5, 7	2	3	3	4	1
<i>Micrasema wataga</i>	1	3	?	?	3	?	2
<i>Molanna bienda</i>	8	1-3, 6, 7	1	1	4	2, 3	2
<i>Molanna ulmerina</i>	4	1, 2, 5, 14	1, 3, 5	1-5	3, 4	2, 3	2
<i>Molanna uniophila</i>	3	1, 3	3, 4	3	3	3	2, 3
<i>Mystacides sepulchralis</i>	10	1-3, 5, 7	2	2, 3	3	3, 4, 6	2

Table 5. Continued.

Species	N	Physiographic Subregion	Stream Order	Stream Width	Flow Perm	Substrate Type	Vegetation Type
<i>Nectopsyche candida</i>	19	1-3, 5, 7, 9, 11, 13, 14	1-5	2-4	3, 4	1-3	1-3
<i>Nectopsyche diatrina</i>	9	4, 5, 7, 9, 16	1-4	2-4	3, 4	2, 3, 6	2
<i>Nectopsyche exquisita</i>	44	1-9, 11-15	1-5	3-5	3, 4	2, 3	1-3
<i>Nectopsyche pavida</i>	43	1-7, 9, 11, 13, 14	1-5	2-5	3, 4	1-3	1, 2
<i>Nectopsyche spifoma</i>	2	3, 5, 11, 16	?	?	3	?	2, 3
<i>Neophylax concinnus</i>	11	1, 2, 5-7, 11	1, 2	1, 2	1-4	2-5	1, 2
<i>Neophylax fuscus</i>	6	3, 5, 7, 9	2-5	3, 5	3	2, 3	2
<i>Neotrichia arkansensis</i>	6	1, 2, 4, 5	1-4	2, 3	3, 4	3	2
<i>Neotrichia collata</i>	1	11	3	3	3, 4	3	1, 2
<i>Neotrichia edalis</i>	1	16	3	3	3, 4	3	1, 2
<i>Neotrichia kitae</i>	1	4	?	?	?	?	?
<i>Neotrichia minutissima</i>	4	3, 5, 7	3-5	3-5	3, 4	3, 4	2
<i>Neotrichia okopa</i>	4	2-4, 11, 16	1, 4	3	3, 4	3	2
<i>Neotrichia riegei</i>	4	1, 11	2	2	3, 4	3	1, 2
<i>Neotrichia vibrans</i>	11	1, 3-7, 9	1-5	1-5	3, 4	3	2
<i>Neureclipsis crepuscularis</i>	14	1, 3, 4, 7, 9, 11-13	2, 3	3, 4	3	1, 3	1-3
<i>Nyctiophylax affinis</i>	57	1-9, 11, 12, 14, 16, 17	1-6+	2-5	3, 4	2-4, 6	1-3
<i>Nyctiophylax moestus</i>	4	11	1-3	1-3	3	3, 4	2
<i>Nyctiophylax serratus</i>	4	1-3, 5, 14	1-3, 5	2, 3, 5	3, 4	1, 3	1, 2
<i>Ochrotrichia arisca</i>	46	1-6, 9, 11	1-5	2-5	3, 4	2-4	1, 2
<i>Ochrotrichia arva</i>	2	5	1, 5	1, 5	4	3	1, 2
<i>Ochrotrichia contorta</i>	1	7	1	?	4	3	1, 2
<i>Ochrotrichia eliaga</i>	11	2-6, 11	1-4	2, 3	3, 4	2, 3	1, 2
<i>Ochrotrichia nigritta</i>	6	16	1, 2	1-3	4	2, 3	2

Table 5. Continued.

Species	N	Physiographic Subregion	Stream Order	Stream Width	Flow Perm	Substrate Type	Vegetation Type
<i>Ochrotrochia riesi</i>	6	2, 6, 7	1	2	4	3	2
<i>Ochrotrochia robisoni</i>	4	1, 2	2-4	2-5	1, 3	3, 4	1, 2
<i>Ochrotrochia shawnee</i>	1	11	2	2	3	3	2
<i>Ochrotrochia spinosa</i>	19	1, 3-8, 16	1-3	1-3, 5	3, 4	3, 4	1, 2
<i>Ochrotrochia stylata</i>	2	16	2, 3	3	3, 4	3, 6	2
<i>Ochrotrochia tarsalis</i>	34	1-4, 6, 7, 9, 14, 16	1-4	2-5	3, 4	1-4	1, 2
<i>Ochrotrochia unio</i>	11	3-6, 11	3-5	2, 3, 5	3	2, 3	2
<i>Ochrotrochia weddellae</i>	6	1	2	3	3	3	1
<i>Ochrotrochia xena</i>	3	3, 11	3	3	3	3	2
<i>Oecetis avara</i>	65	1-9, 13, 14, 16	1-6+	2-5	3, 4	2, 3, 6	1, 2
<i>Oecetis cinerascens</i>	20	1-3, 7, 11, 13-15, 17	2-4	3, 4	2, 3	1, 3, 4	1-3
<i>Oecetis ditissa</i>	54	1-6, 11-14, 16	1-5	1-4	2, 4	1-4, 6	1-3
<i>Oecetis eddlestoni</i>	17	1, 2, 14	3, 4	3, 4	3	1-3	1, 2
<i>Oecetis inconspicua</i>	104	1-16	1-5	1-5	1-4	1-4	1-3
<i>Oecetis nocturna</i>	46	1-6, 9, 12-14, 17	1-5	2-5	3, 4	1-4	1-3
<i>Oecetis osteni</i>	9	1, 14	2-4	3, 4	3	3	1, 3
<i>Oecetis ouachita</i>	9	1, 14	5	4	3	2	1
<i>Oecetis ozarkensis</i>	3	4, 8	1, 4	4	3	3	2
<i>Oecetis persimilis</i>	29	1-7, 12, 14	1-5	2-5	3, 4	1-3	1, 2
<i>Orthotrichia aegerfasciella</i>	48	1-3, 5, 6, 12-16	1-5	1-5	3, 4	1-3	1-3
<i>Orthotrichia cristata</i>	8	3, 5, 6	3-5	3, 5	3	2, 3	2
<i>Orthotrichia instabilis</i>	3	1, 14	4	4, 5	3	2, 3	2
<i>Oxyethira aculea</i>	3	16	1	2	4	3, 6	2
<i>Oxyethira coerzens</i>	11	1, 3-5, 7	2-5	3-5	3, 4	2, 3	1, 2
<i>Oxyethira dualis</i>	13	3-7	1-4	2, 3, 5	3, 4	2, 3	1, 2
<i>Oxyethira forcipata</i>	5	5, 6, 8	1, 3, 4	3-5	3, 4	3	1, 2
<i>Oxyethira glasa</i>	1	16	3	3	3	6	2

Table 5. Continued.

Species	N	Physiographic Subregion	Stream Order	Stream Width	Flow Perm	Substrate Type	Vegetation Type
<i>Oxyethira janella</i>	2	1, 14	3	3, 4	3	1-3	1, 2
<i>Oxyethira novasota</i>	5	1, 2, 14	3-5	3-5	3	1-3	1
<i>Oxyethira pallida</i>	45	1-9, 13, 14, 16	1-5	2-5	3, 4	1-3	1, 2
<i>Oxyethira azteca</i>	1	16	1	2	4	3, 6	2
<i>Oxyethira invicola</i>	4	1, 2	2, 3	3	3	3	1, 2
<i>Oxyethira zeronia</i>	16	1, 8, 14, 16	1-4	2, 4	2, 3	1, 3, 4	1
<i>Peduniella nearctica</i>	10	2, 5, 7, 8	2, 3	3	3	3, 6	2
<i>Paucicalcaria ozarkensis</i>	4	1, 2	1-3	1-3	1, 3, 4	3-5	1, 2
<i>Phryganea sayi</i>	3	4, 6, 11	3	3	3, 4	3	2
<i>Phylocentropus placidus</i>	19	1, 2, 11-14	2-4	2-4	3	1, 3, 4	1-3
<i>Platycentropus radiatus</i>	2	1	1	1	4	1, 2	1, 2
<i>Polycentropus centralis</i>	118	1-9, 11, 13, 14, 16	1-4	1-5	2-4	2, 4	1, 2
<i>Polycentropus chelatus</i>	1	6	1	2	4	3	2
<i>Polycentropus cinereus</i>	20	1-6, 8, 9, 15	1-6+	2-5	3, 4	2, 4	1, 2
<i>Polycentropus confusus</i>	19	3-5, 7	1-5	2-5	3, 4	2, 4	1, 2
<i>Polycentropus crassicornis</i>	7	1, 3, 5, 11	3	3	3	3	2
<i>Polycentropus harpi</i>	13	1, 2, 4	1-4	3	3, 4	3	1, 2
<i>Polycentropus nascoctius</i>	1	14	6+	6	3	1, 2	2
<i>Polycentropus stephani</i>	5	1-3	1	1, 2	1, 3, 4	3-5	1, 2
<i>Potamyia flava</i>	46	1-16	1-4	2-5	3, 4	1-3	1-3
<i>Protophila lega</i>	21	1, 3, 5-7, 9, 14	5	4, 5	3, 4	2, 3	1, 2
<i>Protophila maculata</i>	17	3-7, 9	3-6+	4, 5	3	2, 3	2

Table 5. Continued.

Species	N	Physiographic Subregion	Stream Order	Stream Width	Flow Perm	Substrate Type	Vegetation Type
<i>Protophila tenebrosa</i>	12	4,7	1-5	2-6	3,4	2,3	1,2
<i>Protophila sp. A</i>	3	7	1	2	4	3	2
<i>Pseudostenophylax uniformis</i>	3	5,6	1,2	1-3	4	3	2
<i>Psychomyia flavida</i>	97	1-9, 16	1-6+	2-6	3,4	2-4,6	1,2
<i>Ptilostomis ocellifera</i>	13	1,2,8,11,14	1-4	2-4	3,4	2,3	1,2
<i>Ptilostomis postica</i>	7	1,5,13,14	2,4	2-4	2,3	1,4	1,2
<i>Pycnopsyche guttifer</i>	12	3-5,7,8	1-4	2,3,5	3,4	1-3	1,2
<i>Pycnopsyche indiana</i>	7	1,7	2,4	2-5	2-4	2,4	1,2
<i>Pycnopsyche lepida</i>	30	1-5,7-9,15	1-5	1-6	1-4	1-4	1-3
<i>Pycnopsyche rossi</i>	4	2,5,7	1	1-3	4	2-4	2
<i>Pycnopsyche subfasciata</i>	11	1,3,5,6	2-5	2,4	3	3,4	1,2
<i>Rhyacophila banksi</i>	4	3,5	1	1,3	4	2,3	1,2
<i>Rhyacophila fenestra</i>	25	3,5,6,8,9,11	1-5	1-5	2-4	2-4,6	2
<i>Rhyacophila glaberrima</i>	6	1-3,10,11	1,2	1-3	3,4	4	1,2
<i>Rhyacophila kiamichi</i>	28	1-3,6	1,2	1-3	1,3	3-5	1,2
<i>Rhyacophila ledra</i>	1	11	1	1,2	4	3,4	1,2
<i>Rhyacophila lobifera</i>	4	3,5,8,11,14	1-4	1-4	3,4	3,4	2
<i>Setodes oxapius</i>	26	2-9	1-5	2-5	3,4	1-4	1,2
<i>Smicridea fasciatella</i>	1	16	3,4	3,4	3,4	3,4	1,2
<i>Stactobiella delira</i>	5	1-3,6	3,5	4	3	3	2
<i>Stactobiella palmata</i>	8	2,3,15	3-5	3-5	3	3	2

Table 5. Continued.

Species	N	Physiographic Subregion	Stream Order	Stream Width	Flow Perm	Substrate Type	Vegetation Type
<i>Trienodes abus</i>	2	3, 14	?	?	3	1, 2	3
<i>Trienodes cumberlandensis</i>	4	1	2, 3	2, 3	3	3	1, 2
<i>Trienodes dipsius</i>	6	1, 2	1-3	2, 3	1-3	3	1
<i>Trienodes flavescens</i>	1	6	1	2	4	3	2
<i>Trienodes ignitus</i>	24	1-6, 12-14	1-5	2-5	3, 4	2, 3, 6	1, 2
<i>Trienodes injustus</i>	15	1, 3, 6-9, 16, 17	2, 3	2, 3	3, 4	2, 3	1, 2
<i>Trienodes marginatus</i>	7	1, 5, 7	1, 2	2, 3	3, 4	3, 4	1, 2
<i>Trienodes melacus</i>	2	3, 11	3, 5	4	3, 4	3, 4	2
<i>Trienodes nox</i>	1	4	4	4	3	3	2
<i>Trienodes ochraceus</i>	4	14	3, 4	4	3	1, 2	3
<i>Trienodes pernus</i>	10	1, 13, 14	1-3	2, 3	3	3, 4	1, 2
<i>Trienodes tardus</i>	7	1, 3-6, 9, 11, 17	2, 3	3	3, 4	3	2
<i>Trienodes tridontus</i>	1	1	?	?	?	?	1
<i>Wormaldia moesta</i>	19	1, 2, 5, 6, 8, 11	1-3	2, 3	3, 4	3-5	1, 2
<i>Wormaldia shawnee</i>	15	6, 11	1-3	2, 3	3, 4	2-4	2
<i>Wormaldia strota</i>	17	1, 2, 4	1-3	1-3	3	3	1, 2

Physiographic Subregion: Refer to Fig. 2.

Stream Order: 1 - 6+

Stream Order: 1 (<1m), 2 (1-3m), 3 (4-10), 4 (11-25), 5 (26-50), 6 (>50)

Flow Permanence: 1 (dry bed for part of year), 2 (intermittent), 3 (permanently flowing), 4 (permanently flowing with heavy spring input)

Substrate Type: 1 (sand/mud), 2 (sand/gravel), 3 (gravel/cobble), 4 (cobble), 5 (boulder), 6 (bedrock)

Vegetation Type: 1 (upland pine), 2 (upland hardwood), 3 (bottomland hardwood)

Table 6. Seasonal presence of Interior Highland Trichoptera adults.

Species	JAN	FEB	MAR	APR	MAY	JUN	JUL	AUG	SEP	OCT	NOV	DEC
<i>Agapetus artemus</i>	—											
<i>Agapetus illini</i>												
<i>Agapetus medicus</i>												
<i>Agrypnia vestita</i>												
<i>Brachycentrus lateralis</i>												
<i>Brachycentrus numerosus</i>												
<i>Ceraclea ancylus</i>												
<i>Ceraclea cancellata</i>												
<i>Ceraclea flava</i>												
<i>Ceraclea maccalmonti</i>												
<i>Ceraclea maculata</i>												
<i>Ceraclea nepha</i>												
<i>Ceraclea ophioderus</i>												
<i>Ceraclea protonepha</i>												
<i>Ceraclea punctata</i>												
<i>Ceraclea resurgens</i>												
<i>Ceraclea tarsipunctata</i>												
<i>Ceraclea transversa</i>												
<i>Ceratopsyche bronta</i>												
<i>Ceratopsyche morosa</i>												
<i>Ceratopsyche piatrix</i>												
<i>Ceratopsyche slossonae</i>												

Table 6. Continued.

Species	JAN	FEB	MAR	APR	MAY	JUN	JUL	AUG	SEP	OCT	NOV	DEC
<i>Chimarra feria</i>												
<i>Chimarra obscura</i>												
<i>Chimarra parasocia</i>												
<i>Chimarra socia</i>												
<i>Cynellus fraternus</i>												
<i>Dibusa angata</i>												
<i>Diplectrona metaqui</i>												
<i>Diplectrona modesta</i>												
<i>Frenesia missa</i>												
<i>Glossosoma intermedium</i>												
<i>Glyphopsyche missouri</i>												
<i>Helicopsyche borealis</i>												
<i>Helicopsyche limnella</i>												
<i>Helicopsyche piroa</i>												
<i>Homoplectra doringa</i>												
<i>Hydropsyche alvata</i>												
<i>Hydropsyche arinale</i>												
<i>Hydropsyche betteni</i>												
<i>Hydropsyche bidens</i>												

Table 6. Continued.

Species	JAN	FEB	MAR	APR	MAY	JUN	JUL	AUG	SEP	OCT	NOV	DEC
<i>Hydropsyche orris</i>												
<i>Hydropsyche rossi</i>												
<i>Hydropsyche scalaris</i>												
<i>Hydropsyche simulans</i>												
<i>Hydroptila ajax</i>												
<i>Hydroptila albicornis</i>												
<i>Hydroptila amoena</i>												
<i>Hydroptila angusta</i>												
<i>Hydroptila armata</i>												
<i>Hydroptila artesa</i>												
<i>Hydroptila berneri</i>												
<i>Hydroptila broweri</i>												
<i>Hydroptila consimilis</i>												
<i>Hydroptila delineata</i>												
<i>Hydroptila grandiosa</i>												
<i>Hydroptila hamata</i>												
<i>Hydroptila icona</i>												
<i>Hydroptila melia</i>												
<i>Hydroptila oneili</i>												
<i>Hydroptila perdita</i>												

Table 6. Continued.

Species	JAN	FEB	MAR	APR	MAY	JUN	JUL	AUG	SEP	OCT	NOV	DEC
<i>Hydroptila protera</i>												
<i>Hydroptila quinola</i>												
<i>Hydroptila remita</i>												
<i>Hydroptila sandersoni</i>												
<i>Hydroptila spatulata</i>												
<i>Hydroptila strepha</i>												
<i>Hydroptila tusculum</i>												
<i>Hydroptila vala</i>												
<i>Hydroptila virgata</i>												
<i>Hydroptila waubesiana</i>												
<i>Ironoquia punctatissima</i>												
<i>Ithytrichia clavata</i>												
<i>Ithytrichia mazon</i>												
<i>Lepidostoma carrolli</i>												
<i>Lepidostoma griseum</i>												
<i>Lepidostoma lescheni</i>												
<i>Lepidostoma libum</i>												
<i>Lepidostoma ozarkense</i>												
<i>Lepidostoma togatum</i>												
<i>Leptocerus americanus</i>												

Table 6. Continued.

Species	JAN	FEB	MAR	APR	MAY	JUN	JUL	AUG	SEP	OCT	NOV	DEC
<i>Leucotrichia pictipes</i>												
<i>Limnephilus submonilifer</i>												—
<i>Lype diversa</i>												—
<i>Macrostemum carolina</i>												—
<i>Marilia flexuosa</i>												—
<i>Marilia</i> sp. A											
<i>Mayatrichia ayama</i>												—
<i>Mayatrichia ponta</i>												—
<i>Micrasema ozarkana</i>												—
<i>Micrasema rusticum</i>												—
<i>Micrasema wataga</i>												—
<i>Molanna blenda</i>												—
<i>Molanna ulmerina</i>												—
<i>Molanna uniophila</i>												—
<i>Mystacides sepulchralis</i>												—
<i>Nectopsyche candida</i>												—
<i>Nectopsyche diarina</i>												—
<i>Nectopsyche exquisita</i>												—
<i>Nectopsyche pavida</i>												—
<i>Nectopsyche spiloma</i>												—

Table 6. Continued.

Species	JAN	FEB	MAR	APR	MAY	JUN	JUL	AUG	SEP	OCT	NOV	DEC
<i>Neophylax concinnus</i>												—
<i>Neophylax fuscus</i>												—
<i>Neotrichia arkansasensis</i>					—	—	—	—	—	—	—	—
<i>Neotrichia collata</i>					—							
<i>Neotrichia edalis</i>					—							
<i>Neotrichia kitae</i>					—							
<i>Neotrichia minutisimella</i>												—
<i>Neotrichia okopa</i>												—
<i>Neotrichia riegeli</i>												—
<i>Neotrichia vibrans</i>												—
<i>Neureclipsis crepuscularis</i>												—
<i>Nyctiophylax affinis</i>												—
<i>Nyctiophylax moestus</i>												—
<i>Nyctiophylax serratus</i>												—
<i>Ochrotrichia anisca</i>												—
<i>Ochrotrichia arva</i>												—
<i>Ochrotrichia contorta</i>												—
<i>Ochrotrichia eliaga</i>												—
<i>Ochrotrichia nigritta</i>												—
<i>Ochrotrichia riesi</i>												—
<i>Ochrotrichia robisoni</i>												—

Table 6. Continued.

Species	JAN	FEB	MAR	APR	MAY	JUN	JUL	AUG	SEP	OCT	NOV	DEC
<i>Polycentropus harpi</i>												
<i>Polycentropus nascotius</i>												
<i>Polycentropus stephani</i>												
<i>Potamyia flava</i>												
<i>Protoptila lega</i>												
<i>Protoptila maculata</i>												
<i>Protoptila tenebrosa</i>												
<i>Protoptila</i> sp. A												
<i>Pseudostenophylax uniformis</i>												
<i>Psychoyia flavida</i>												
<i>Ptilostomis ocellifera</i>												
<i>Ptilostomis postica</i>												
<i>Pycnopsyche guttifer</i>												
<i>Pycnopsyche indiana</i>												
<i>Pycnopsyche lepida</i>												
<i>Pycnopsyche rossi</i>												
<i>Pycnopsyche subfasciata</i>												
<i>Rhyacophila banksi</i>												
<i>Rhyacophila fenestra</i>												
<i>Rhyacophila glaberrima</i>												

Fig. 1. Physiographic regions of the Eastern and Central United States (modified from Ross 1965).

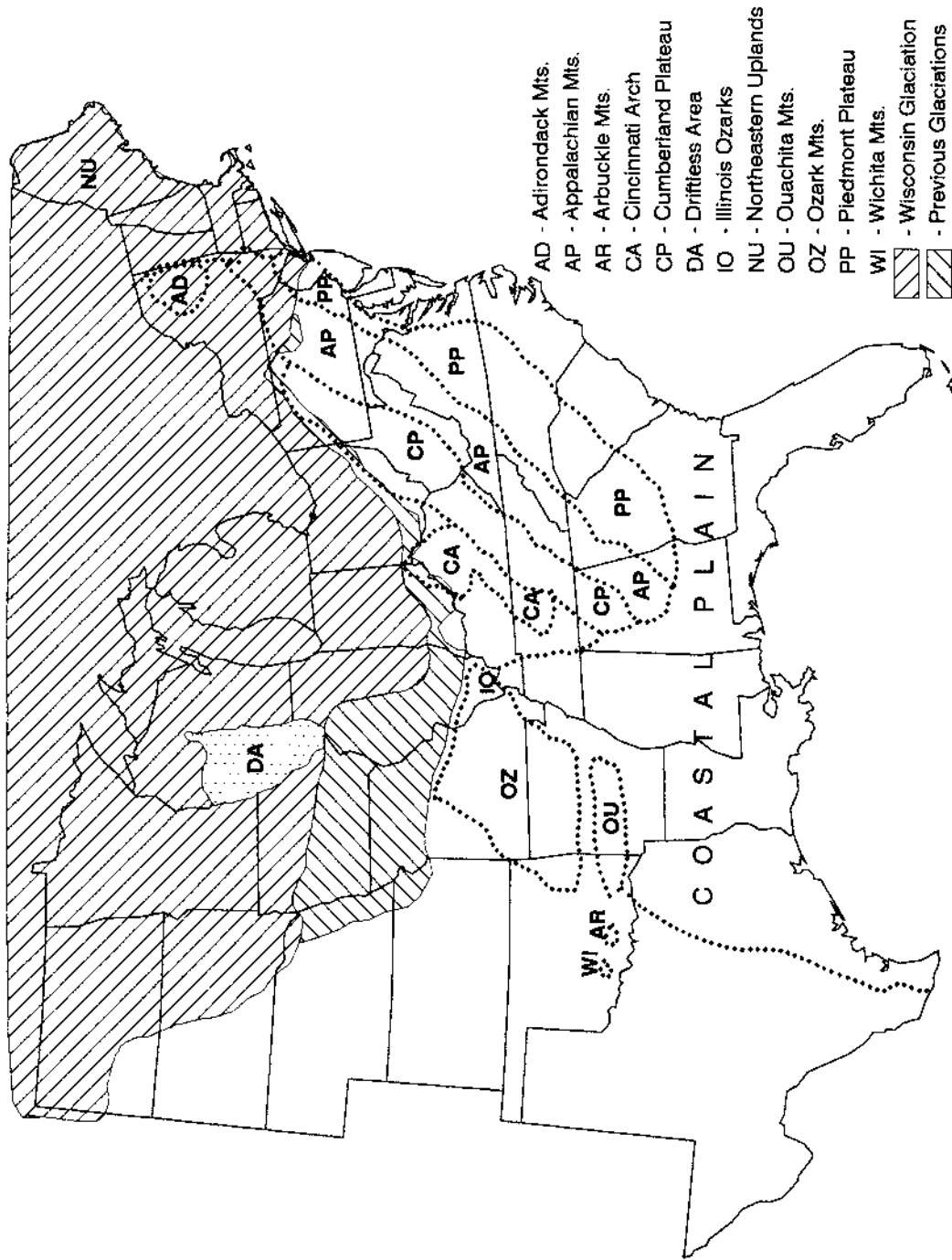

Fig. 2. Natural physiographic subregions of the Interior Highlands
(modified from Poulton and Stewart 1991).

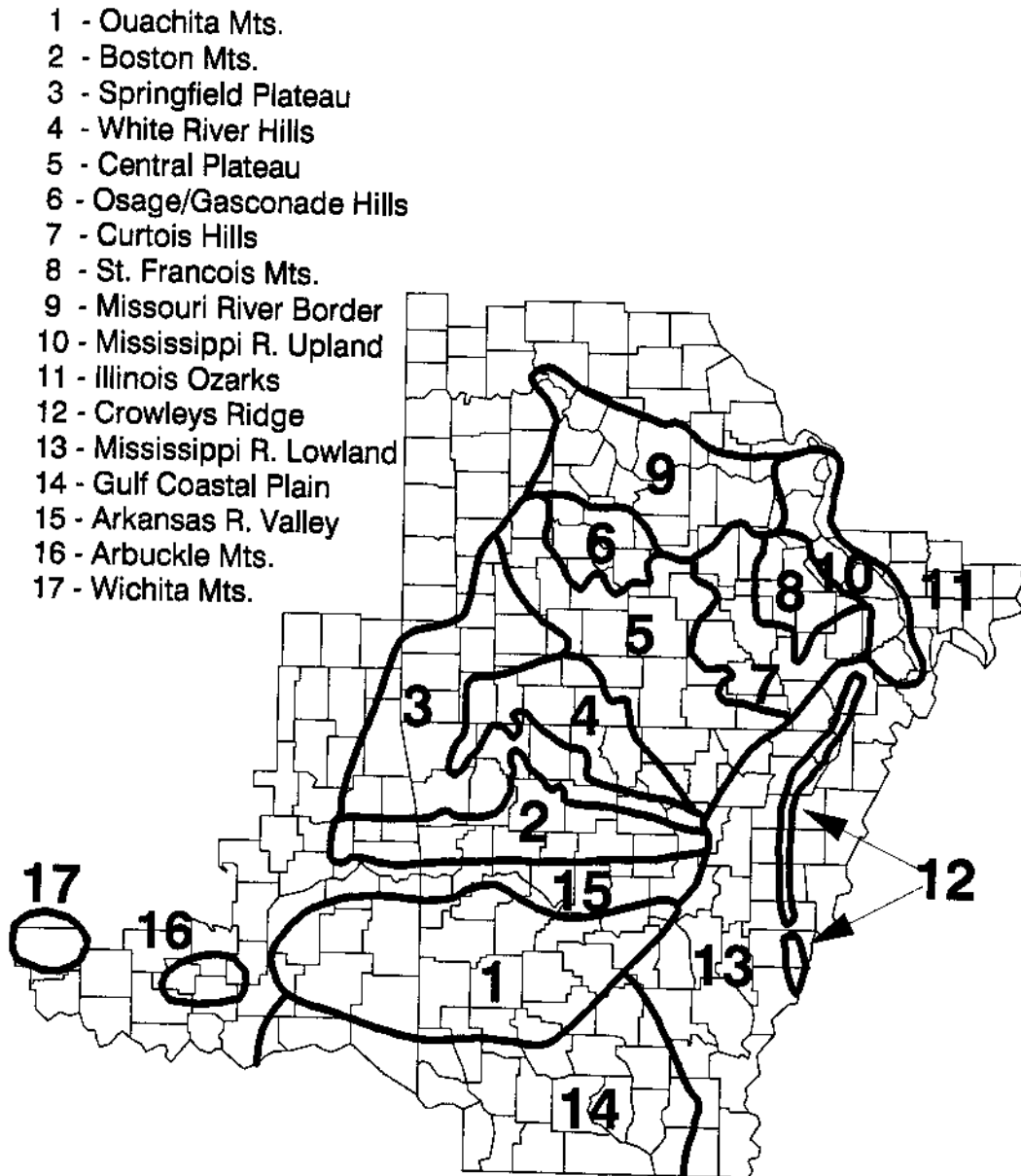
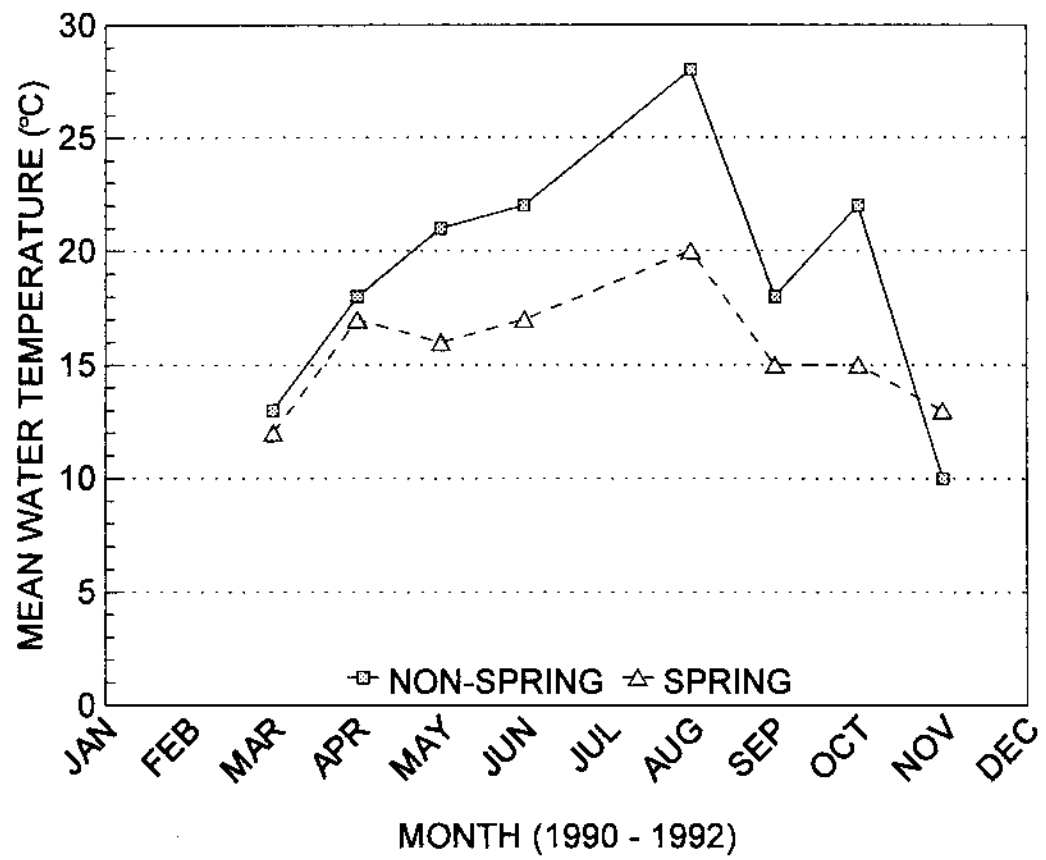

Fig. 3. Mean monthly water temperatures of Interior Highlands streams, 1990 - 1992.



Figs. 4 - 9. Aquatic and terrestrial habitats of the Interior Highlands. 4. Janes Creek, in the Central Plateau subregion, Randolph Co., AR (note: dense growths of waterwillow along stream margin). 5. watercress in a small spring creek. 6. Boston Mts. of northern AR. 7. Pittman Creek, Ouachita Mt. subregion, Montgomery Co., AR. 8. Big Spring, near Van Buren, Carter Co., MO. 9. Big Spring, Stone Co., AR.



Figs. 10 - 15. Aquatic and terrestrial habitats of the Interior Highlands.
10. Honey Creek, Arbuckle Mt. subregion, Murray Co., OK. 11. an intermittent Ozark stream during the summer. 12. North Sylamore Creek, Stone Co., AR.
13. Gunner Pool, on North Sylamore Creek, Stone Co., AR. 14. confluence of Ouachita and Little Missouri Rivers, Gulf Coastal Plain subregion, Ouachita Co., AR. 15. clearcut forest in the Ouachita Mts.



Fig. 16. Natural watershed subdivisions of the Interior Highlands (modified from Poulton and Stewart 1991). Numbers correspond to those listed in Table 2.

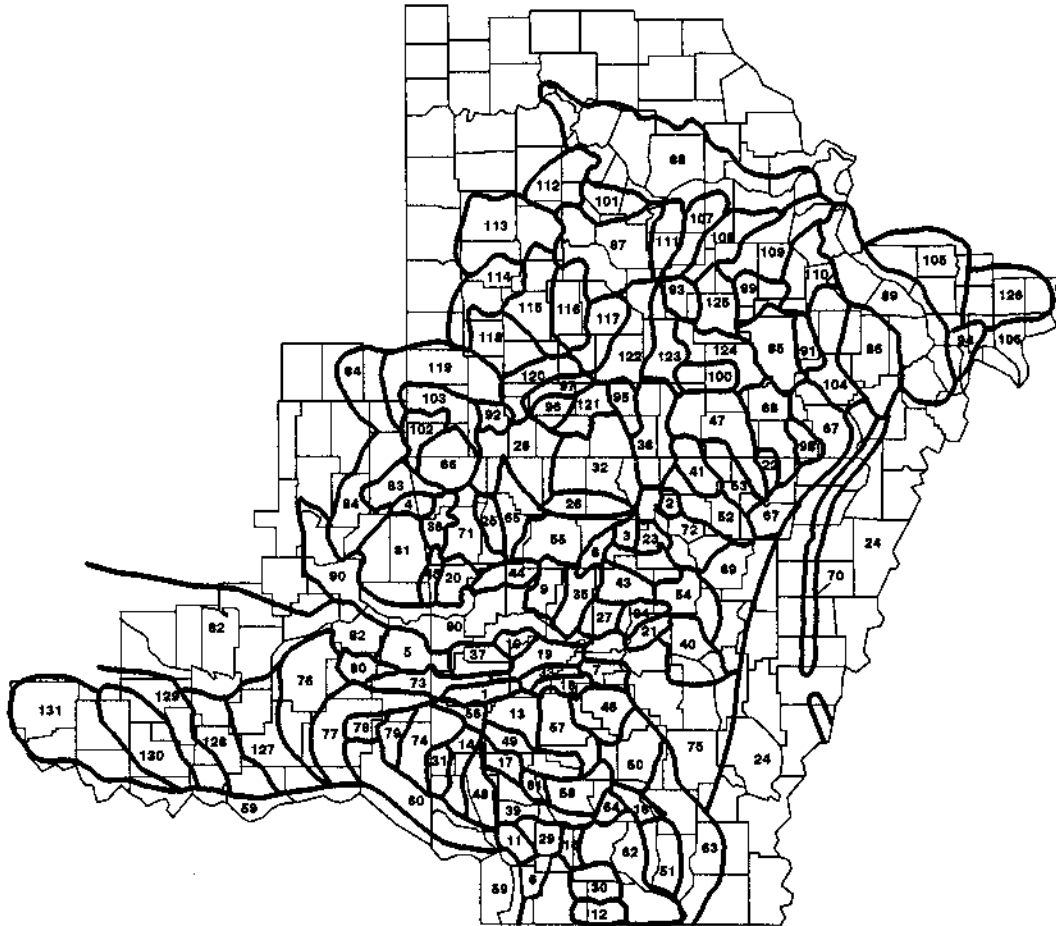

Fig. 17. Regional counties of Arkansas, Illinois, Missouri, and Oklahoma, and states peripheral to the Interior Highlands.

Fig. 18. Species richness among the 16 Trichoptera families represented in the Interior Highlands.

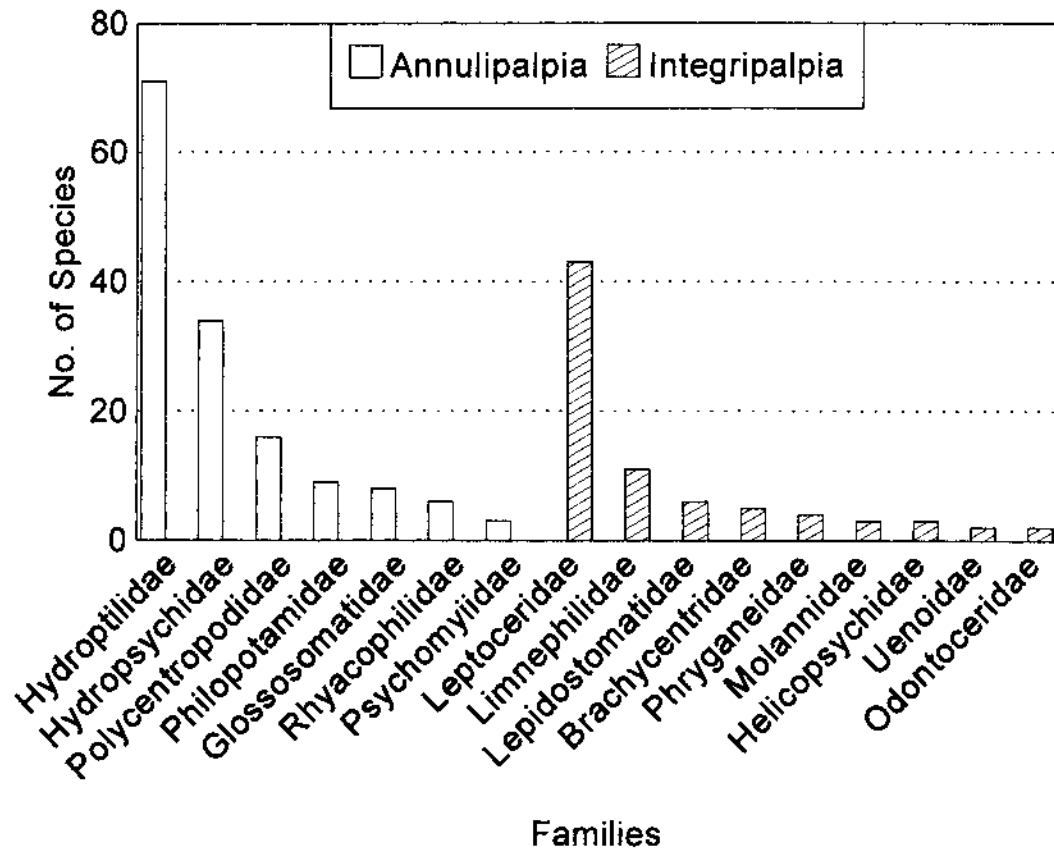
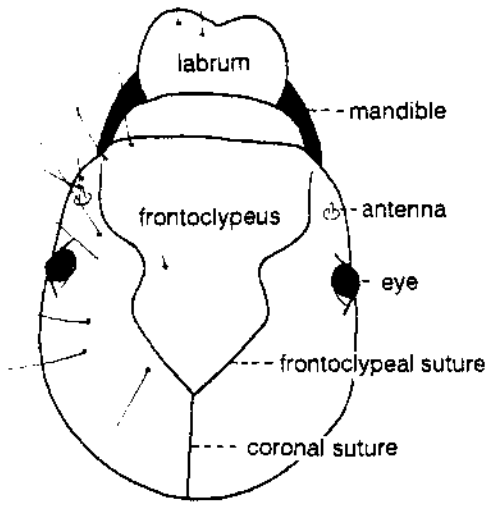

Fig. 19. Detrended correspondence analysis clusters of faunistically similar watersheds of the Interior Highlands based on presence or absence of regional caddisfly species.



Figs. 20-23. Larval morphology of *Glyphopsyche missouri* (Limnephilidae). 20. Larval head, dorsal. 21. Larval thoracic nota and abdominal segment I, dorsal. 22. Larval head and prothorax, lateral view. 23. Larval metathoracic leg.



20

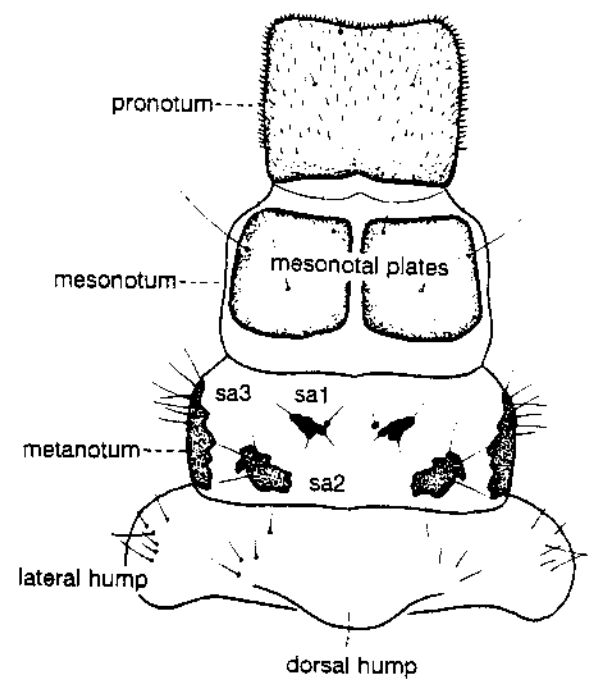

21

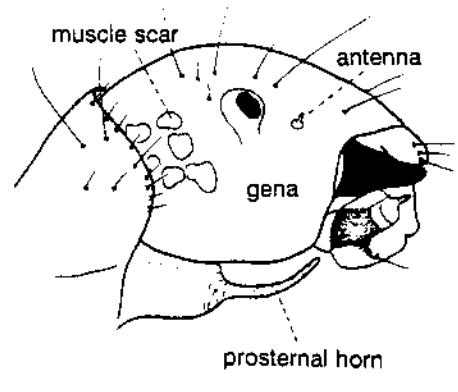

22

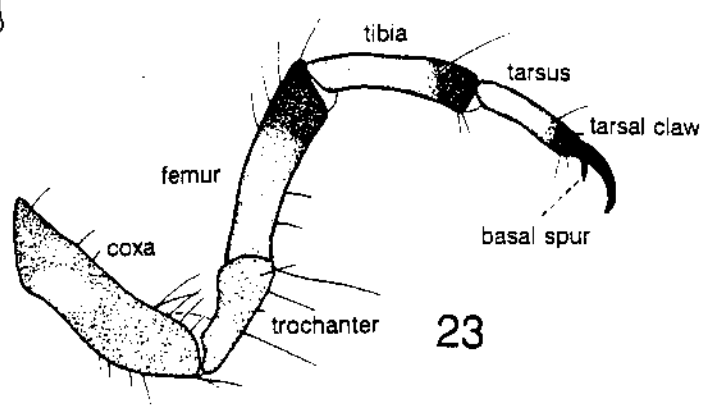

23

Figs. 24-29. Larval morphology of Trichoptera. 24-25. Prothoracic legs. 24. Polycentropodidae. 25. Psychomyiidae. 26. Larval abdominal morphology, segments I - IV, lateral. 27. Abdominal gill of larval Hydropsychidae. 28. Head capsule of larval Lepidostomatidae, lateral. 29. Pro- and mesonotum of larval Uenoidae.

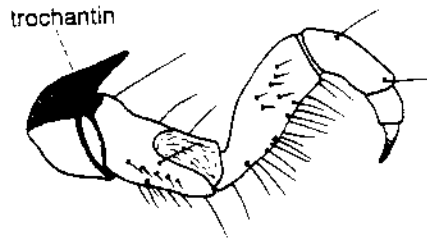

24

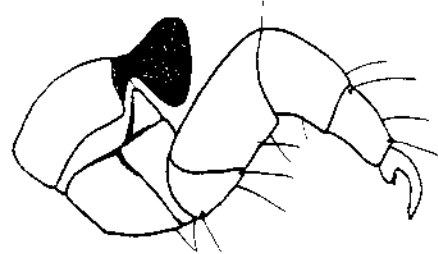

25

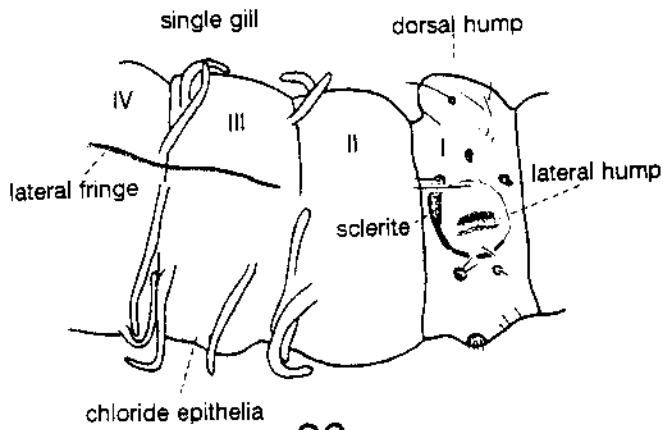

26



27

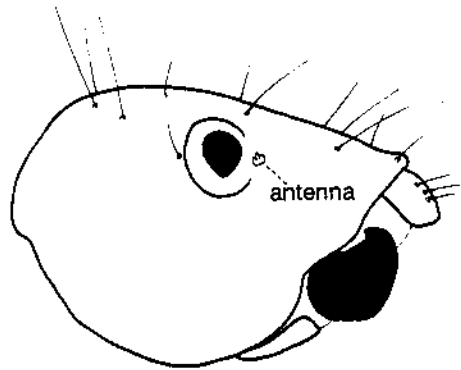

28

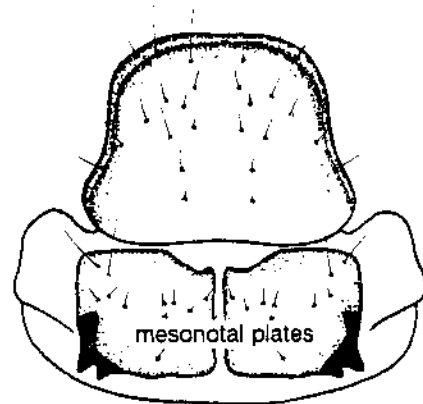

29

Figs. 30-39. Larval cases of Trichoptera. 30. *Helicopsyche borealis* (Helicopsychidae). 32. *Orthotrichia* sp. (Hydroptilidae). 33. *Oxyethira* sp. (Hydroptilidae). 31. *Agapetus illini* (Glossosomatidae). 34. *Triaenodes* sp. (Leptoceridae). 35. *Nectopsyche diarina* (Leptoceridae). 36. *Molanna ulmerina* (Molannidae). 37. *Pycnopsyche lepida* Group (Limnephilidae). 38. *Lepidostoma ozarkense* (Lepidostomatidae).

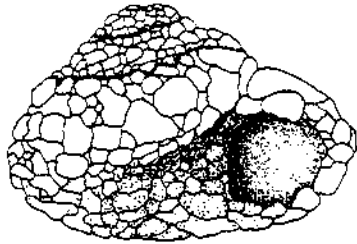

30

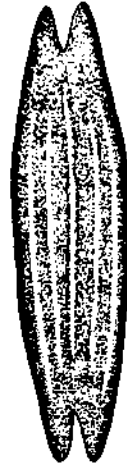

32



33

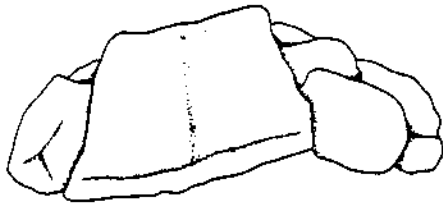

31



34



35

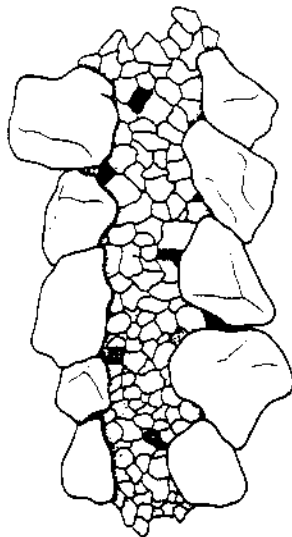

36

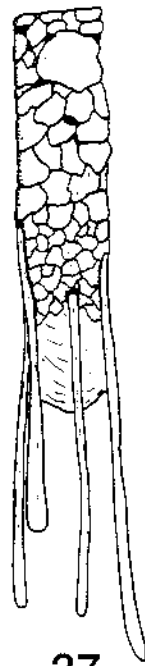

37



38

Figs. 39-41. Morphology of adult male *Rhyacophila kiamichi* (Rhyacophilidae). 39. Male habitus (wings omitted), lateral. 40. Head and thorax, dorsal. 41. Fore- (top) and hindwing (bottom).

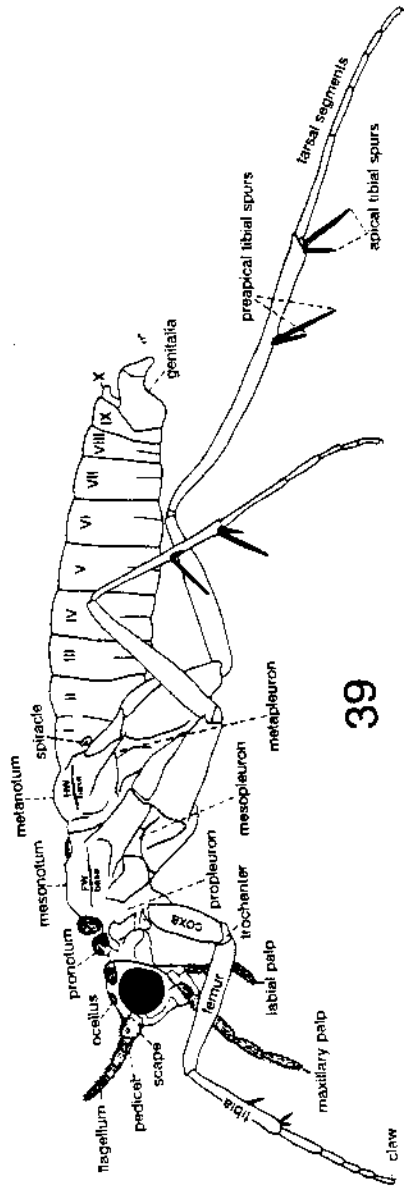

39

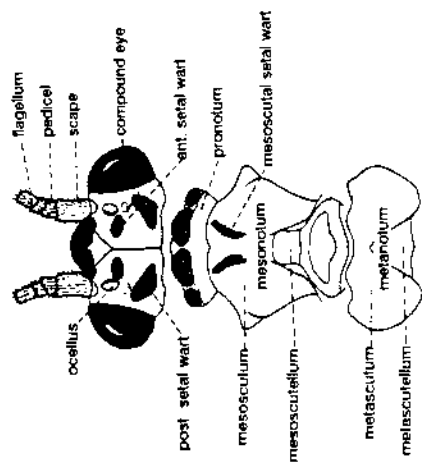

40

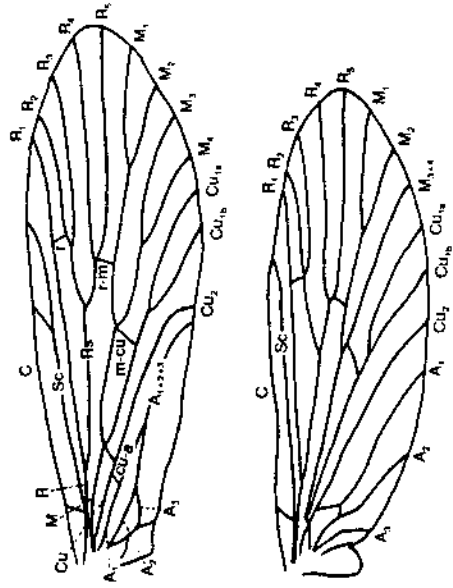

41

Figs. 42-54. Adult morphology of Trichoptera. 42-46. Mesonota. 42. *Dibusa angata* (Hydroptilidae). 43. *Hydropsyche bidens* (Hydropsychidae). 44. *Polycentropus crassicornis* (Polycentropodidae). 45. *Ceraclea cancellata* (Leptoceridae). 46. *Micrasema ozarkana* (Brachycentridae). 47-48. Heads, dorsal. 47. *Chimarra obscura* (Philopotamidae). 48. *Helicopsyche limnella* (Helicopsychidae). 49. Head, pro- and mesonotum of *Marilia flexuosa* (Odontoceridae), dorsal. 50-53. Maxillary palpi. 50. *Chimarra obscura* (Philopotamidae). 51. *Rhyacophila kiamichi* (Rhyacophilidae). 52. *Hydropsyche bidens* (Hydropsychidae). 53. *Molanna ulmerina* (Molannidae). 54. Hindwing of *Neophylax fuscus* (Uenoidae).

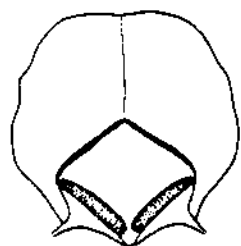

42

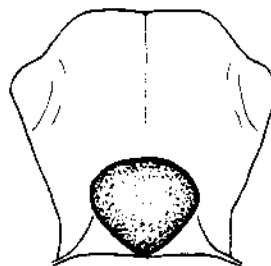

43

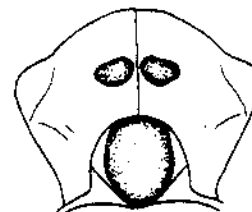

44

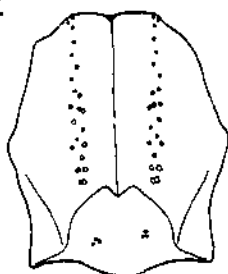

45

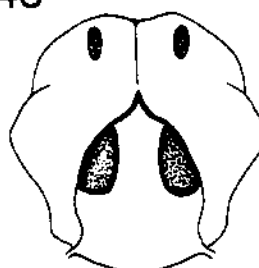

46

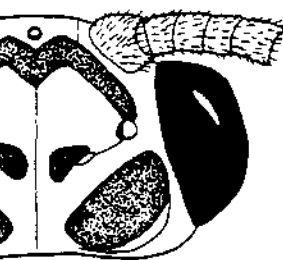
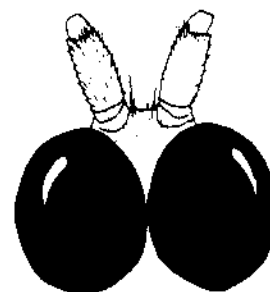

47



48



49

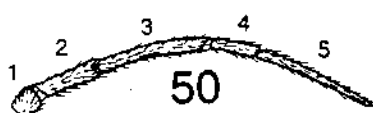

50

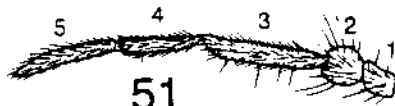

51

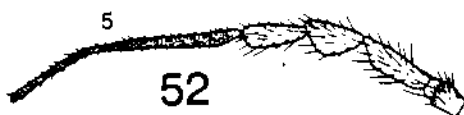

52



53

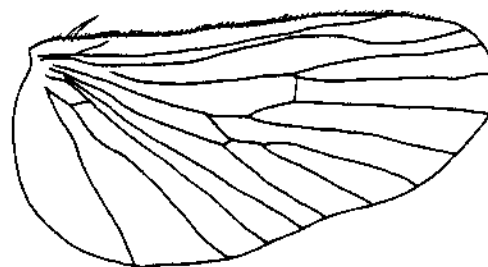

54

Figs. 55-60. Larval Brachycentridae. 55-56. *Brachycentrus* heads, dorsal. 55. *B. numerosus*. 56. *B. lateralis*. 57-58. *Brachycentrus* metathoracic legs. 57. *B. numerosus*. 58. *B. lateralis*. 59-60. *Micrasema* heads, dorsal. 59. *M. rusticum*. 60. *M. ozarkana*.

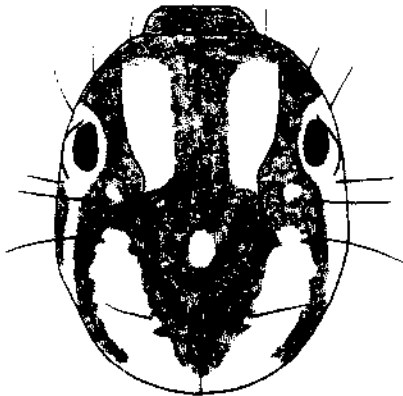

55

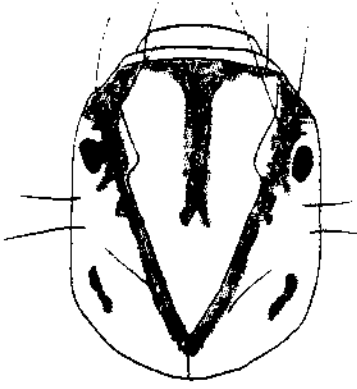

56

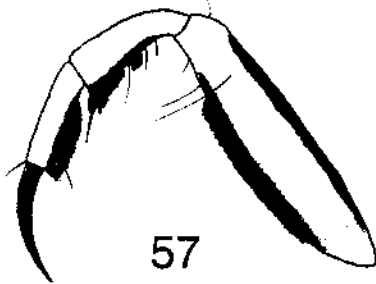

57

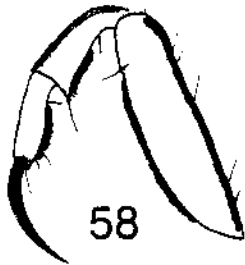

58

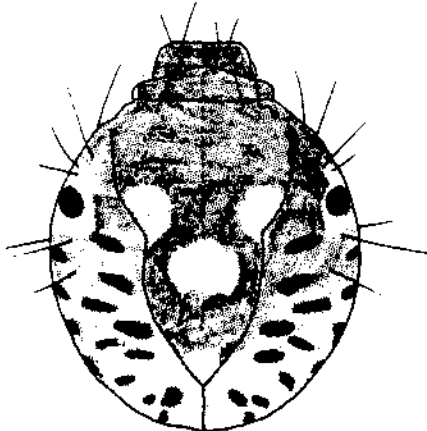

59

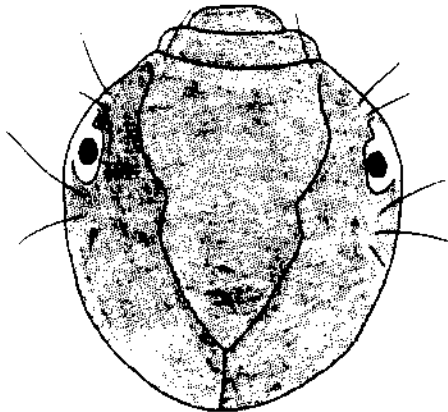

60

Figs. 61-72. Adult Brachycentridae. 61-62. Forewings. 61. *Micrasema* sp. 62. *Brachycentrus* sp. 63-66. *Brachycentrus* males. 63-64. *B. numerosus*. 63. Genitalia, lateral. 64. Tergum X, dorsal. 65-66. *B. lateralis*. 65. Genitalia, lateral. 66. Tergum X, dorsal. 67-72. *Micrasema* males. 67-68. *M. ozarkana*. 67. Genitalia, lateral. 68. Tergum X, dorsal. 69-70. *M. rusticum*. 69. Genitalia, lateral. 70. Tergum X, dorsal. 71-72. *M. wataga*. 71. Genitalia, lateral. 72. Tergum X, dorsal.

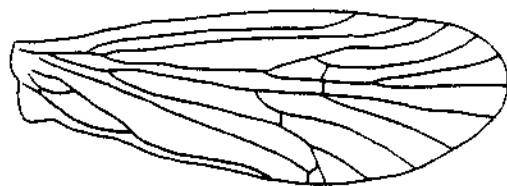

61

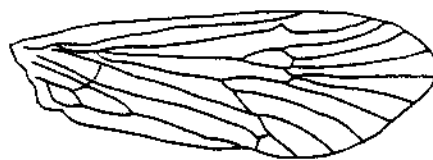

62

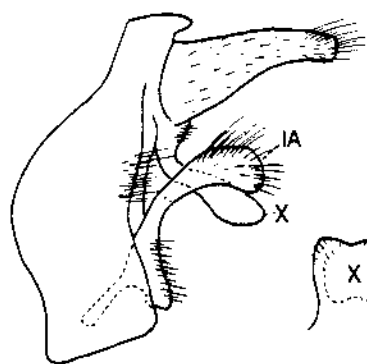

63



64

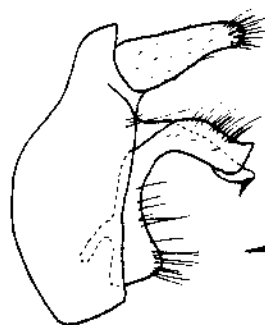

65



66

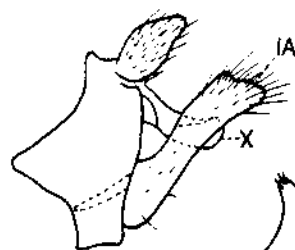

67



68

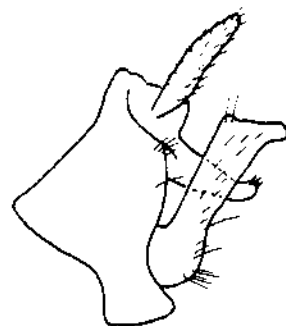

69



70

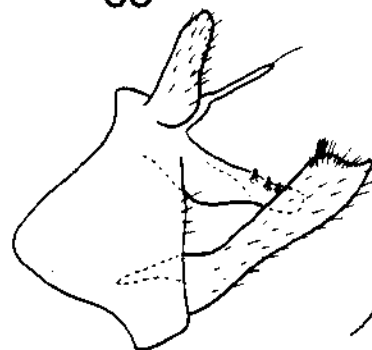

71



72

Figs. 73-82. Glossosomatidae. 73-74. Larval mesonota. 73. *Agapetus* sp. 74. *Protoptila* sp. 75-76. Adult heads, dorsal. 75. *Agapetus* sp. 76. *Glossosoma intermedium*. 77-81. *Agapetus* males. 77-78. *A. artesus*. 77. Genitalia, lateral. 78. Inferior appendage, ventral. 79-80. *A. medicus*. 79. Genitalia, lateral. 80. Inferior appendage, ventral. 81. *A. illini* genitalia, lateral. 82. *G. intermedium* male genitalia, lateral.

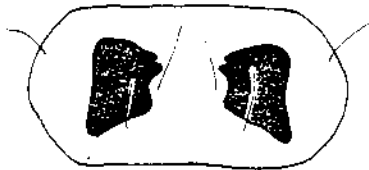

73



74

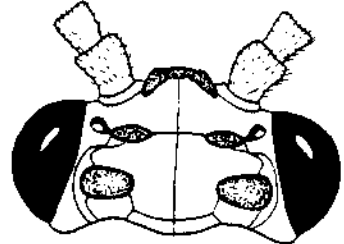

75

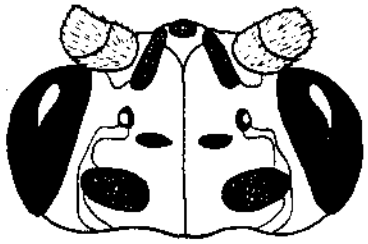

76

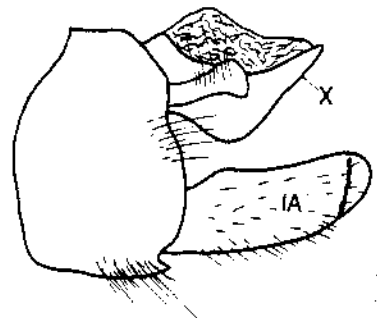

77

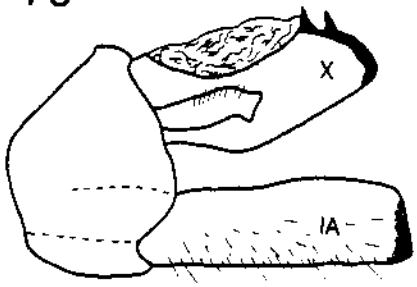

79



78



80

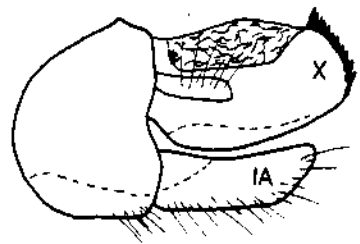

81

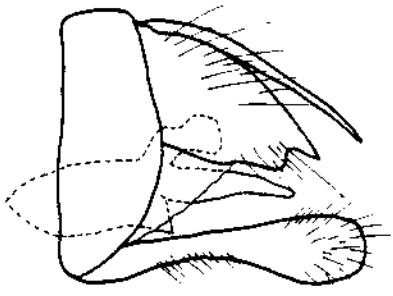

82

Figs. 83-88. *Protophila* males. 83-84. Sternite VIII, ventral. 83. *P. tenebrosa*. 84. *P. maculata*. 85-88. Genitalia, lateral. 85. *P. tenebrosa*. 86. *P. maculata*. 87. *P. lega*. 88. *P. sp. A*.



83



84

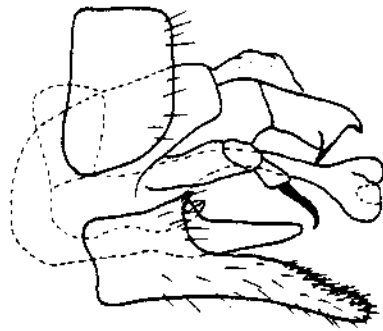

85

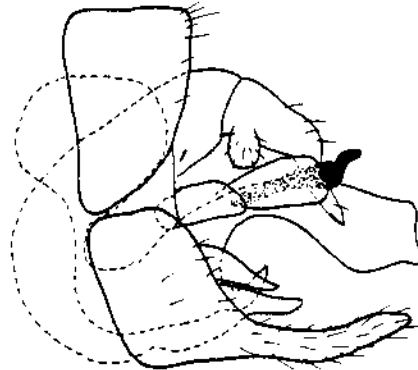

86

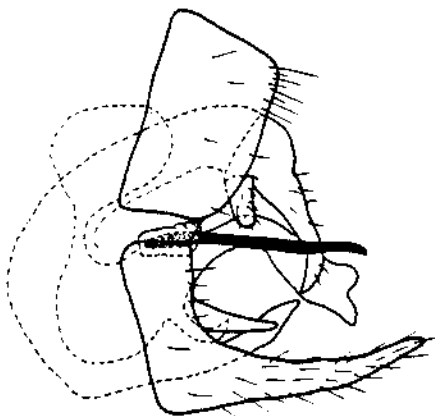

87



88

Figs. 89-97. *Helicopsyche* males, females, and larvae. 89-89. *H. borealis*. 89. Male genitalia, lateral. 90. Female genitalia, ventral. 91-94. *H. limnella*. 91. Male genitalia, lateral. 92. Female genitalia, ventral. 93. Female sternite VI. 94. Larval head, dorsal. 95-97. *H. piroa*. 95. Male genitalia, lateral. 96. Female sternite VI. 97. Larval head, dorsal.

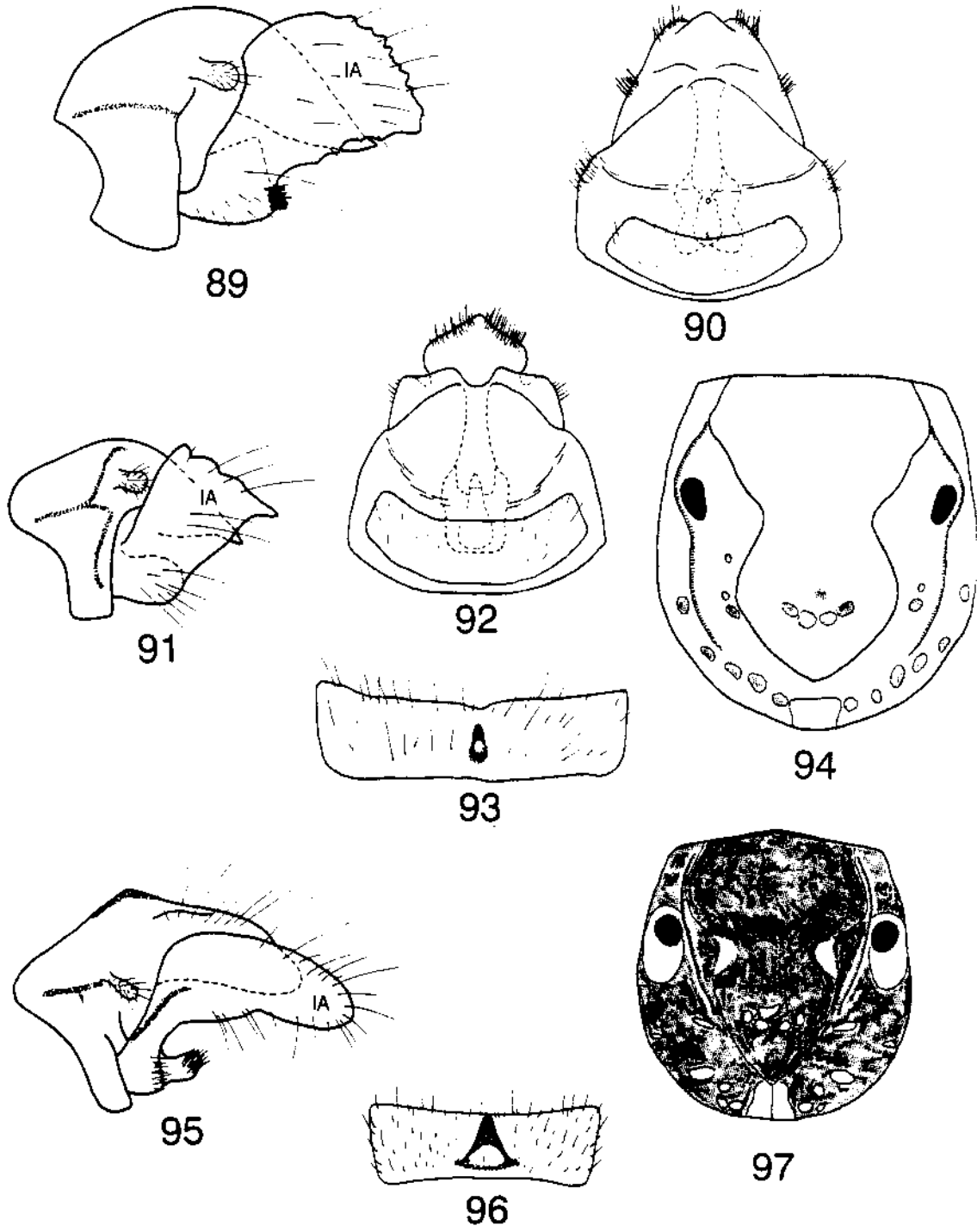

Figs. 98-106. Larval Hydropsychidae. 98-99. Prosterna. 98. *Hydropsyche* sp. 99. *Cheumatopsyche* sp. 100. *Cheumatopsyche* sp. mandible, dorsal. 101. *Hydropsyche* sp., dorsal abdominal setae. 102-104. *Potamyia flava*. 102. Mandible, dorsal. 103. Head, ventral. 104. Abdominal sternites VIII and IX. 105. *Cheumatopsyche* sp. abdominal sternites VIII and IX. 106. *Smicridea fasciatella* abdominal sternite VIII.

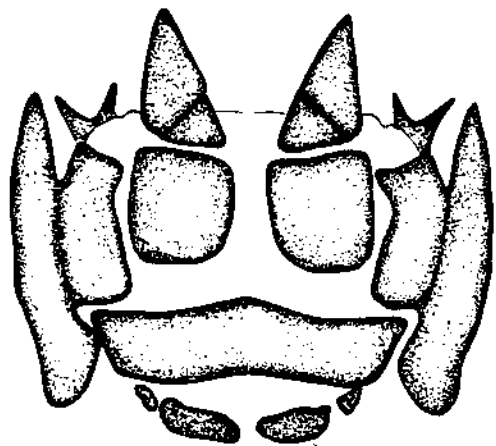

98 prosternal plate



99

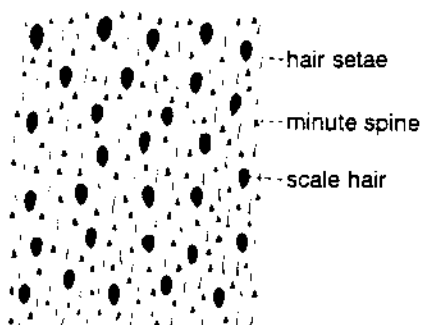

101

---hair setae
---minute spine
---scale hair

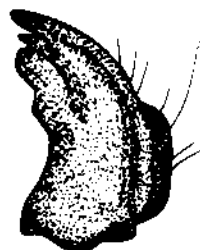

102



100

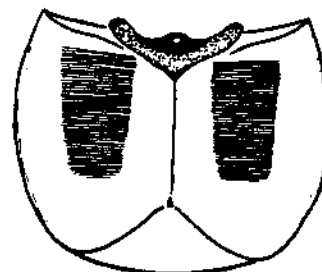

103

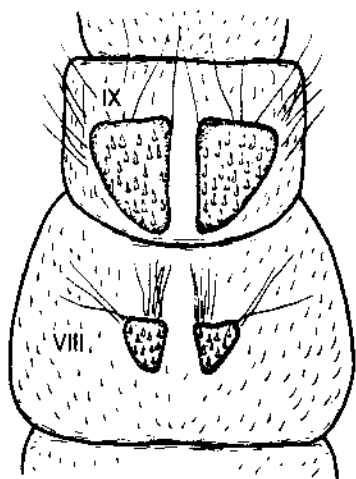

104

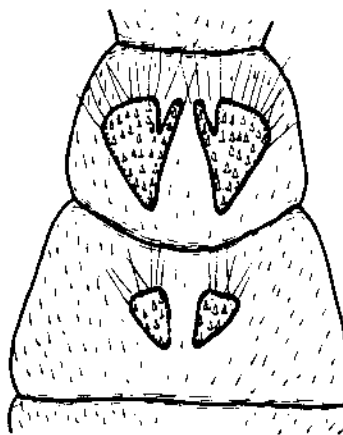

105

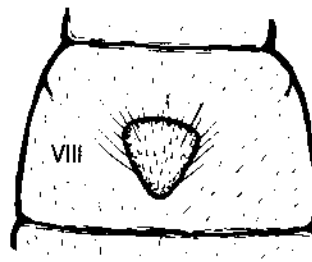

106

Figs. 107-112. Larval Hydropsychidae. 107-111. Heads. 107. *Diplectrona modesta*, dorsal. 108. *D. metaqui*, dorsal. 109. *D. modesta*, ventral. 110. *Macrostemum carolina*, dorsal. 111. *Homoplectra doringa*, dorsal. 112. *M. carolina* foreleg, dorsal.

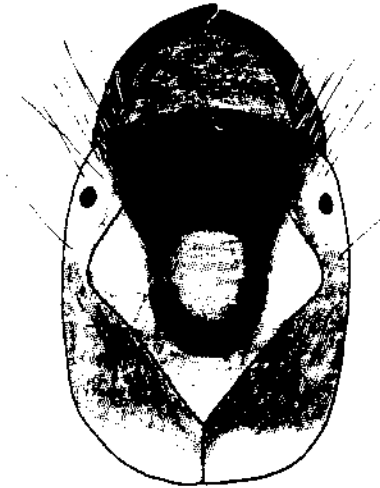

107

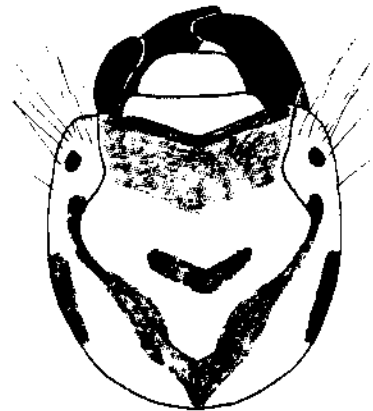

108

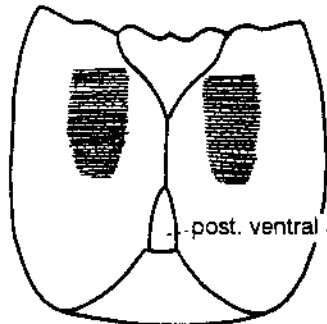

109

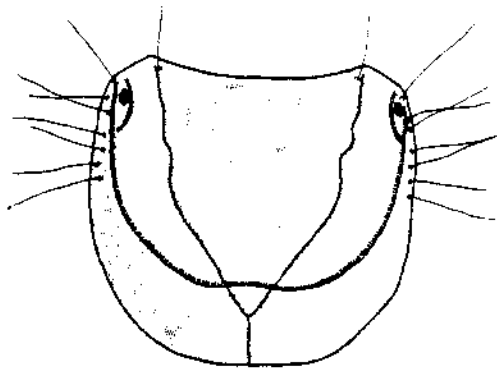

post. ventral apotome

110

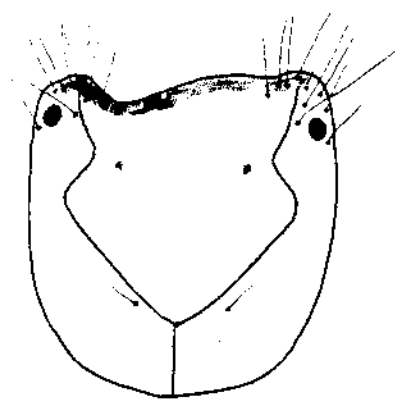

111

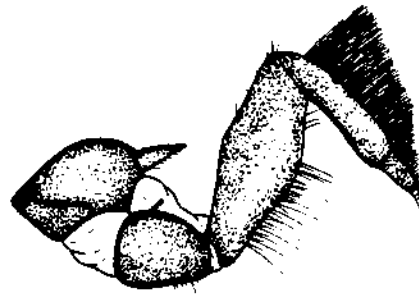

112

Figs. 113-122. Adult Hydropsychidae. 113-114. Forewings. 113. *M. carolina*. 114. *S. fasciatella*. 115-116. *D. modesta*. 115. Hindwing. 116. Abdominal sternites IV - VI. 117-118. *H. doringa*. 117. Hindwing. 118. Abdominal sternite V. 119-120. Fore- (top) and hindwings (bottom). 119. *Cheumatopsyche robisoni* n. sp. 120. *Potamyia flava*. 121-122. Posteroapical margin of forewings. 121. *Hydropsyche* sp. 122. *Ceratopsyche* sp.



113

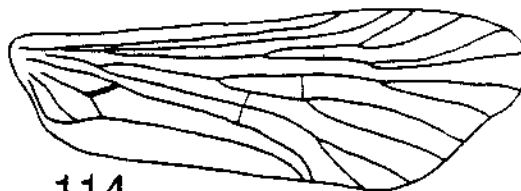

114

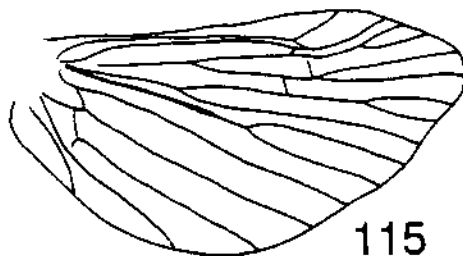

115

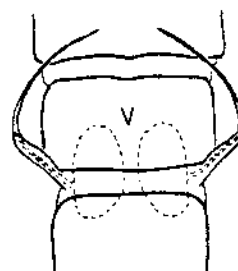

116

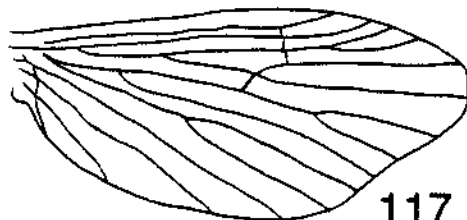

117

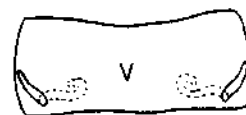

118

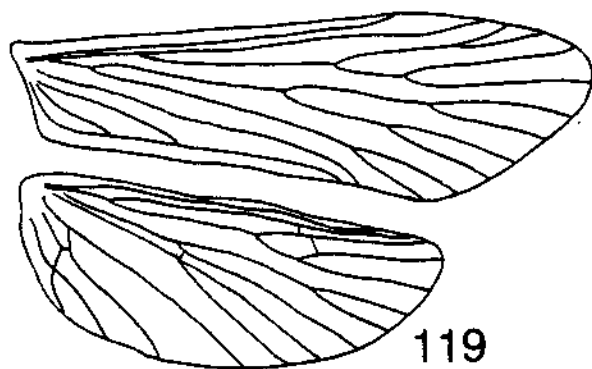

119

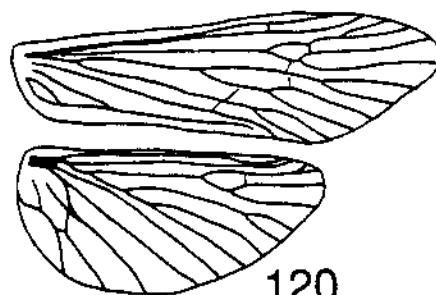

120

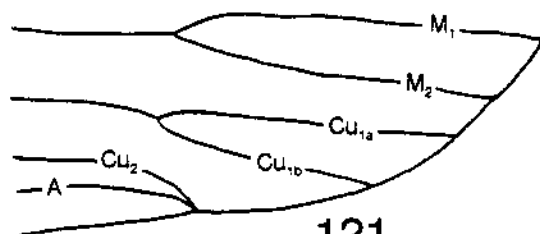

121

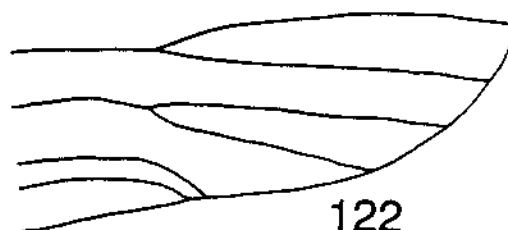

122

Figs. 123-129. Adult and larval heads of Hydropsychidae, dorsal. 123-126. Adults. 123. *D. modesta*. 124. *D. metaqui*. 125. *H. betteni*. 126. *H. doringa*. 127-129. Larvae. 127. *C. morosa*. 128. *C. piatrix* (redrawn from Schuster and Etnier 1978). 129. *C. slossonae*.

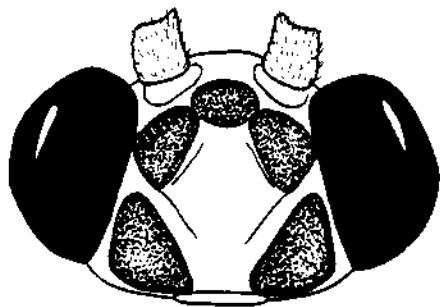

123

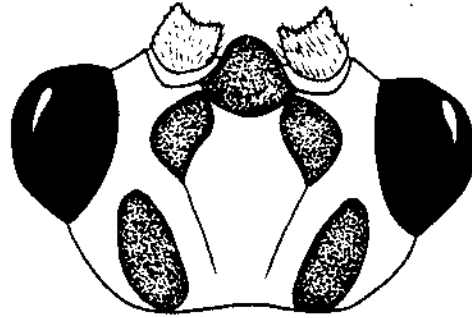

124



125

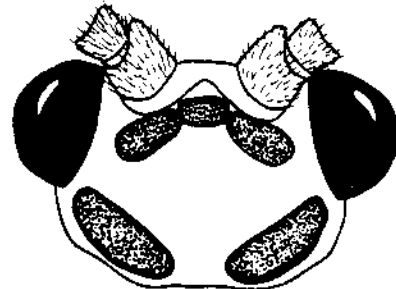

126

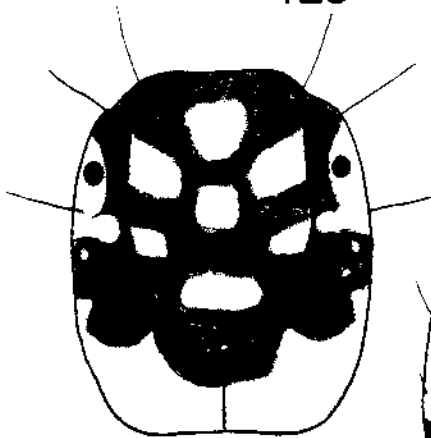

127

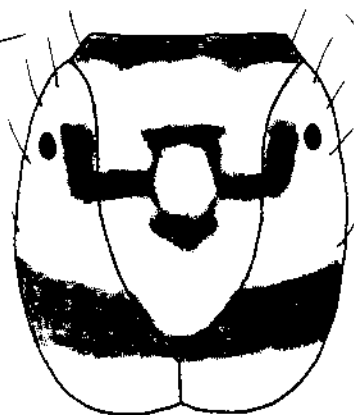

128

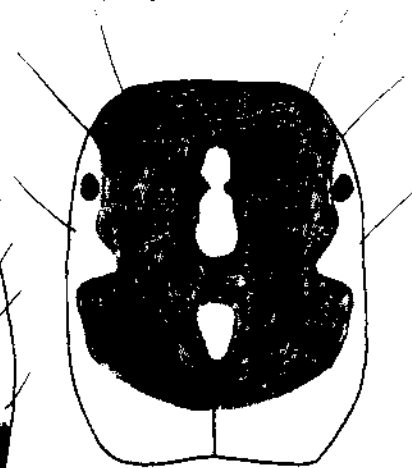

129

Figs. 130-139. *Ceratopsyche* male genitalia. 130-131. *C. piatrix*. 130. Lateral. 131. Phallus, lateral. 132-133. *C. slossonae*. 132. Lateral. 133. Phallus, lateral. 134. *C. cheilonis* phallus, lateral. 135-136. *C. bronta*. 135. Lateral. 136. Phallus, lateral. 137-139. *C. morosa*. 137. Lateral. 138. Phallus, east-central form, lateral. 139. Phallus, west-central form, lateral.

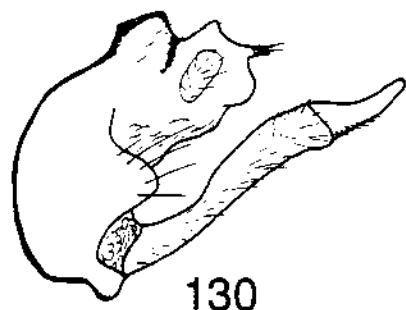

130

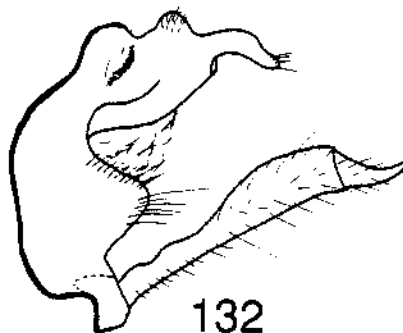

132

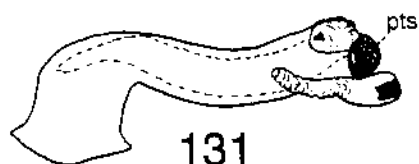

131

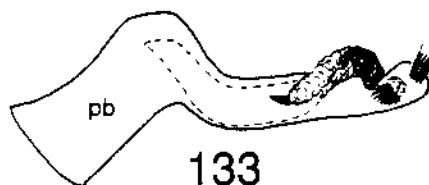

133

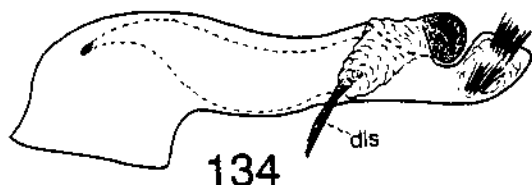

134

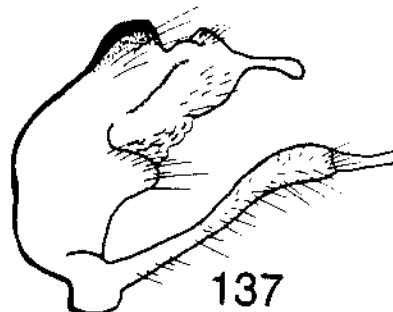

137

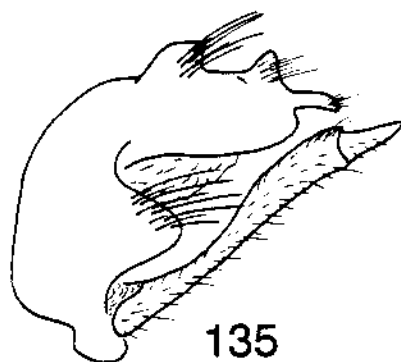

135

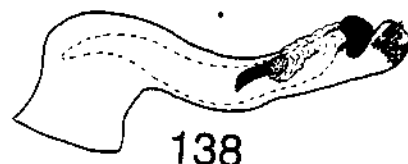

138

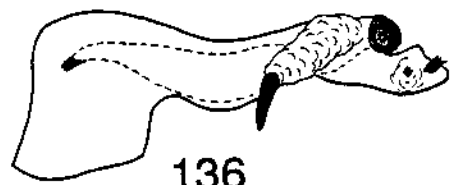

136

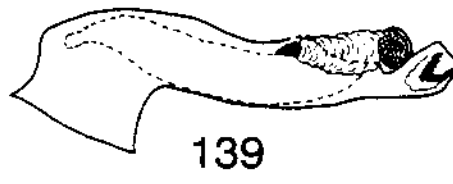

139

Figs. 140-152. *Cheumatopsyche* male genitalia. 140-141. *C. sordida*. 140. Lateral. 141. Tergum X, caudal. 142-143. *C. minuscula*. 142. Lateral. 143. Tergum X, caudal. 144-145. *C. comis*. 144. Lateral. 145. Tergum X, caudal. 146-147. *C. harwoodi enigma*. 146. Lateral. 147. Tergum X, caudal. 148-149. *C. rossi*, holotype. 148. Lateral. 149. Tergum X, caudal. 150-152. *C. robisoni* n. sp. 150. Lateral. 151. Inferior appendage, caudal. 152. Tergum X, caudal.

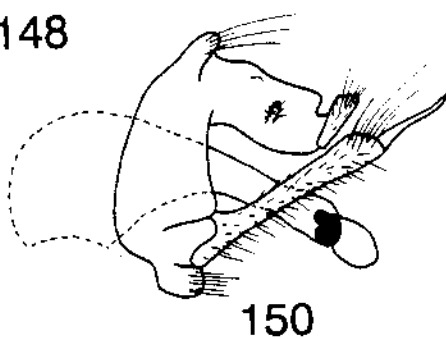
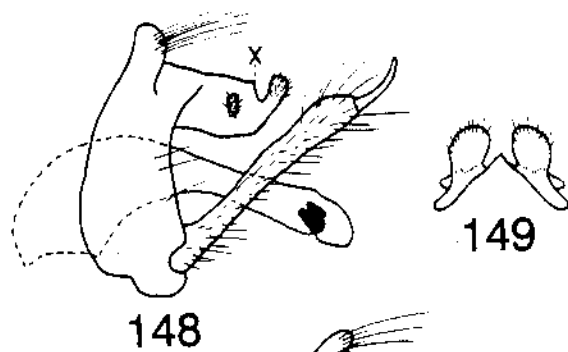
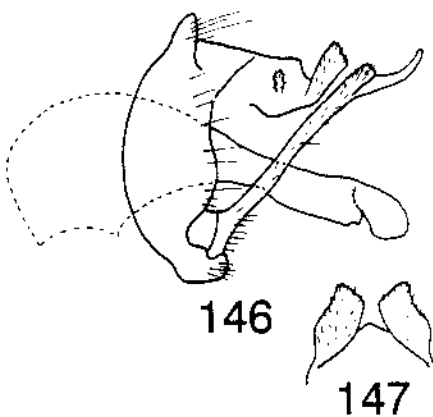
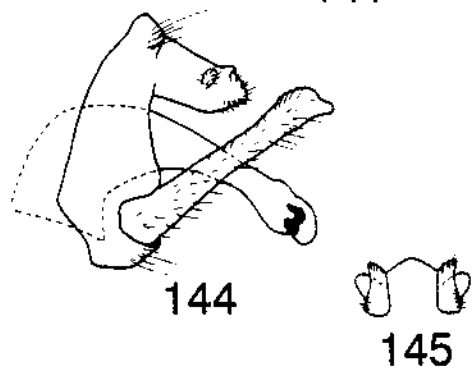
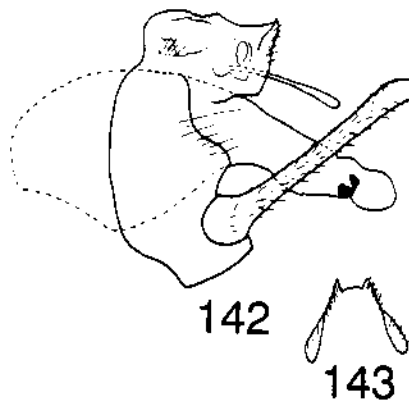
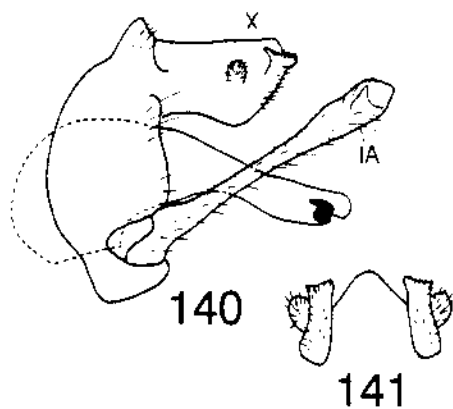

Figs. 153-164. *Cheumatopsyche* male genitalia. 153-154. *C. speciosa*. 153. Lateral. 154. Tergum X, caudal. 155-156. *C. pettiti*. 155. Lateral. 156. Tergum X, caudal. 157-158. *C. pasella*. 157. Lateral. 158. Tergum X, caudal. 159-160. *C. lasia*. 159. Lateral. 160. Tergum X, caudal. 161-162. *C. campyla*. 161. Lateral. 162. Tergum X, caudal. 163-164. *C. burksi*. 163. Lateral. 164. Tergum X, caudal.

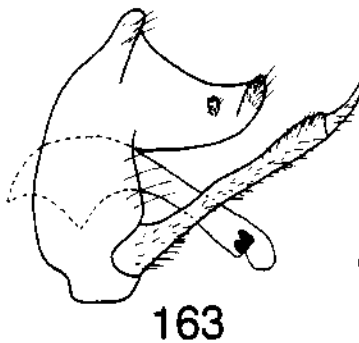
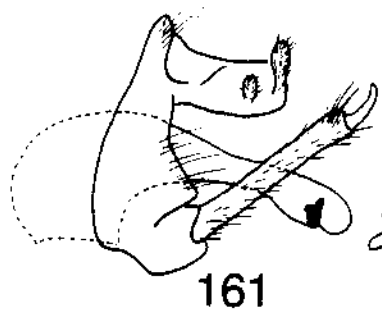
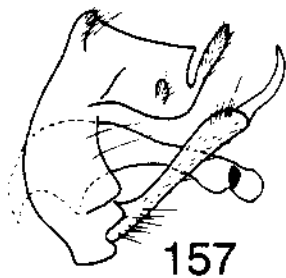
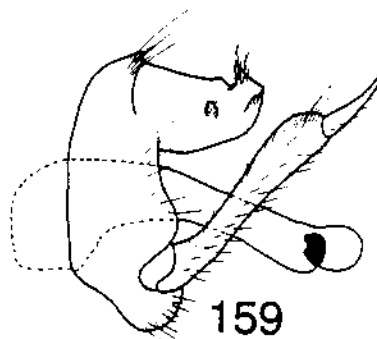
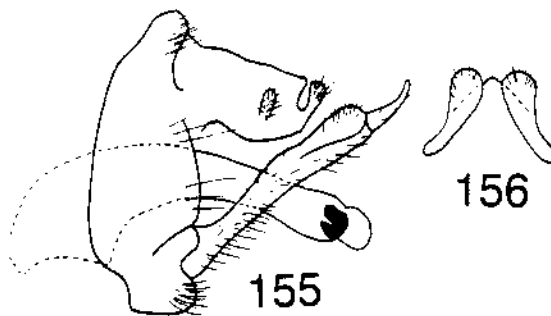
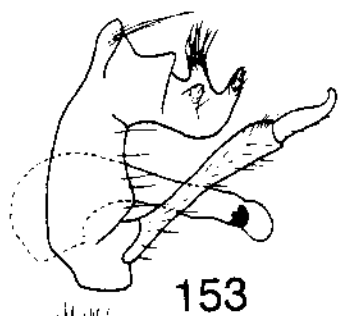

Figs. 165-173. *Cheumatopsyche* male genitalia. 165-166. *C. gracilis*. 165. Lateral. 166. Tergum X, caudal. 167-168. *C. halima*. 167. Lateral. 168. Tergum X, caudal. 169-170. *C. aphanta*. 169. Lateral. 170. Tergum X, caudal. 171-173. *C. oxa*. 171. Lateral. 172. Tergum X, caudal. 173. Inferior appendage, caudal.

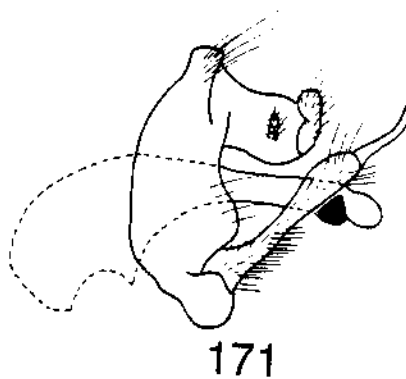
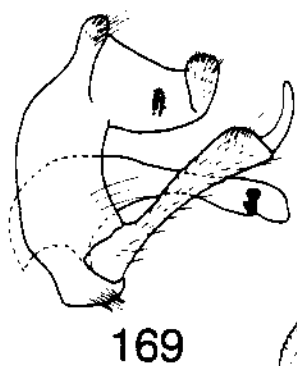
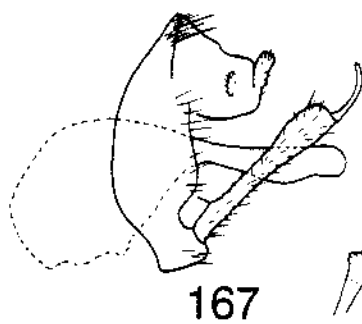
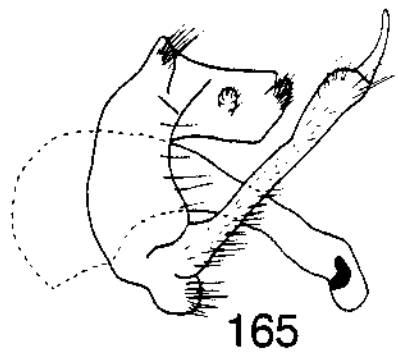

Figs. 174-181. Larvae of *Hydropsyche*. 174-175. *H. orris*. 174. Head, dorsal. 175. Head, lateral. 176. *Hydropsyche bidens* head, dorsal. 177-178. *H. scalaris*. 177. Head, dorsal. 178. Abdominal sternite IX, anal proleg, left ventral. 179. *H. betteni* head, lateral. 180. *H. simulans* head, dorsal.

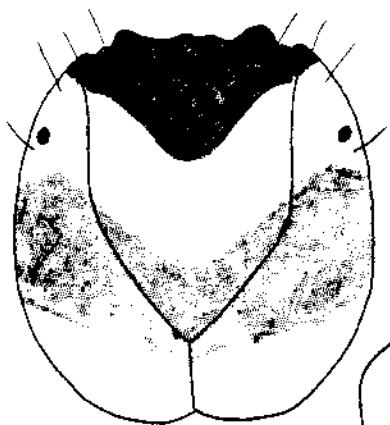

174

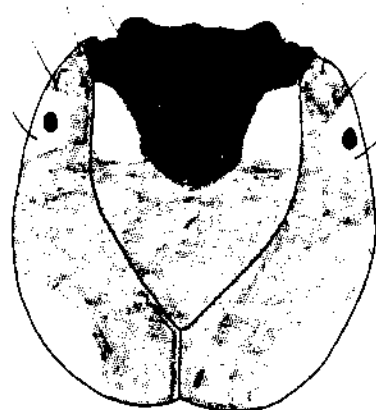

176

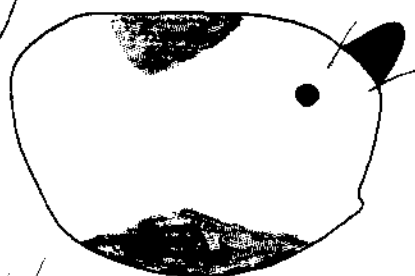

175

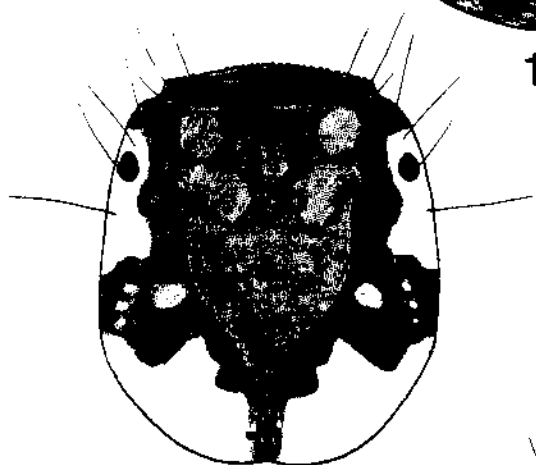

177

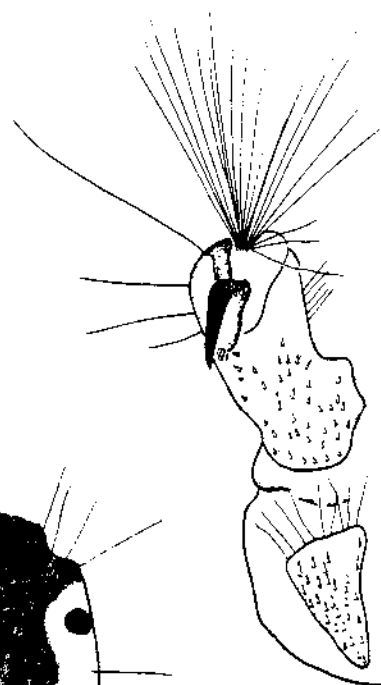

178

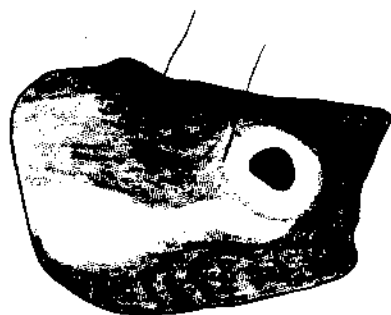

179

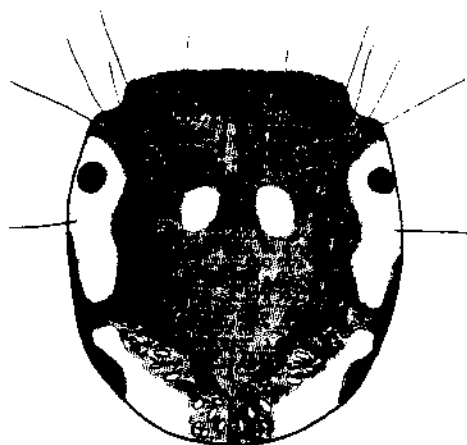

180

Figs. 181-197. *Hydropsyche* male genitalia. 181-183. *H. arinale*. 181. Lateral. 182. Phallus, ventral. 183. Phallus, lateral. 184-186. *H. rossi*. 184. Lateral. 185. Phallus, ventral. 186. Phallus, lateral. 187-188. *H. simulans*. 187. Lateral. 188. Phallus, lateral. 189-190. *H. orris*. 189. Lateral. 190. Phallus, ventral. 191-193. *H. scalaris*. 191. Lateral. 192. Phallus, ventral. 193. Phallus, lateral. 194-195. *H. bidens*. 194. Phallus, lateral. 195. Phallus, ventral. 196. *H. alvata* phallus, ventral. 197. *H. betteni* phallus, lateral.

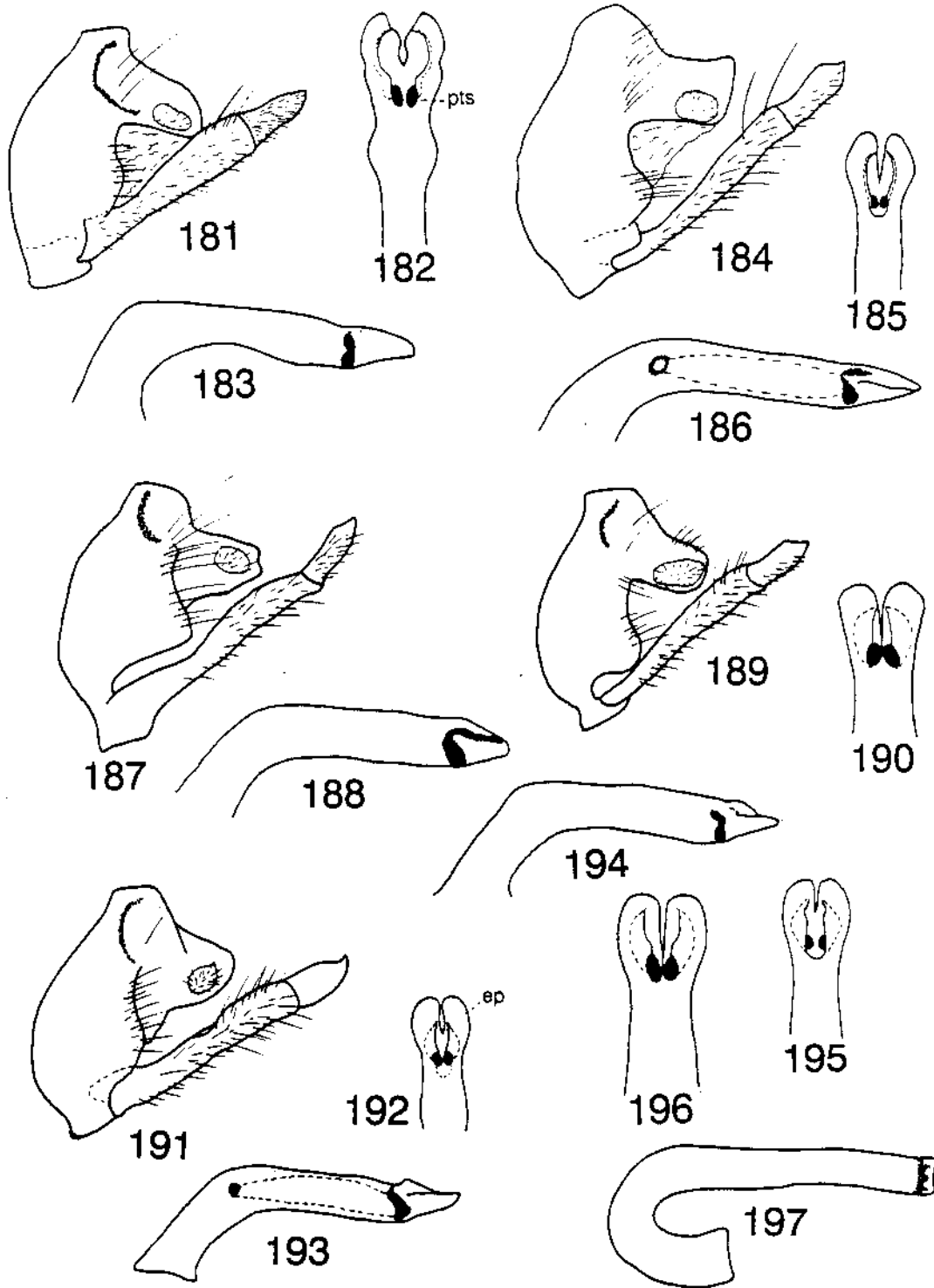

Figs. 198-203. Hydropsychidae male genitalia. 198-199. *M. carolina*. 198. Lateral. 199. Tergum X, dorsal. 200. *H. doringa*, lateral. 201. *D. modesta*, lateral. 202. *S. fasciatella*, lateral. 203. *P. flava*, lateral.

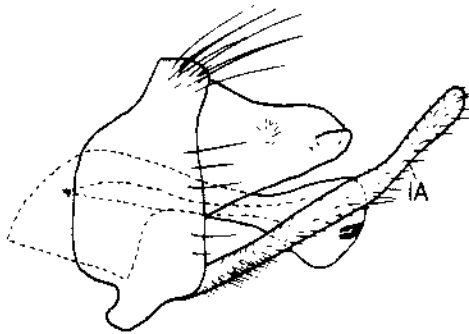

198

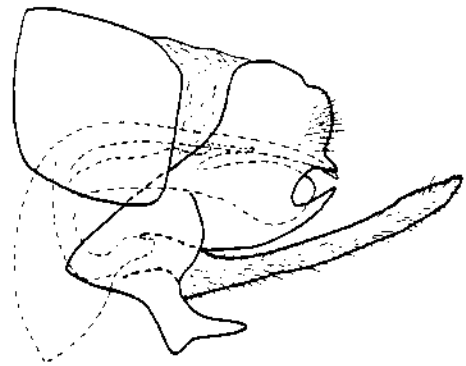

200

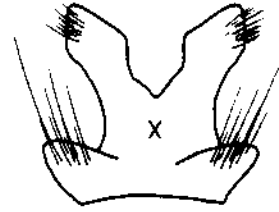

199

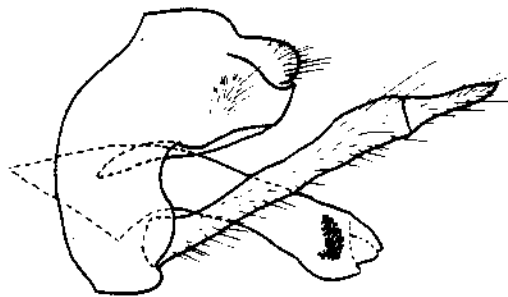

201

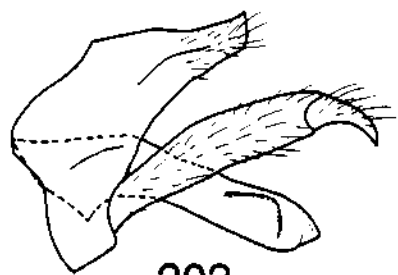

202

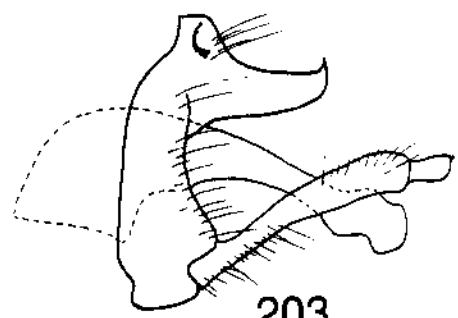

203

Figs. 204-212. Larval Hydroptilidae. 204. *Leucotrichia pictipes* habitus, dorsal. 205. *Oxyethira* sp. thoracic legs, dorsal. 206. *Hydroptila* sp. abdomen, posterodorsal. 207. *Dibusa angata* prothoracic leg, dorsal. 208-209. *Mesonota*, lateral. 208. *Hydroptila* sp. 209. *Ochrotrichia* sp. 210. *Mayatrichia* sp. larval head, dorsal. 211. *D. angata* abdominal seta. 212. *Ithytrichia clavata* habitus, lateral.

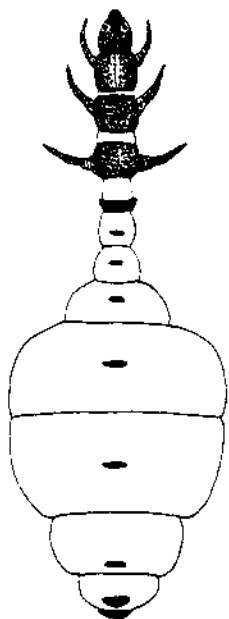

204

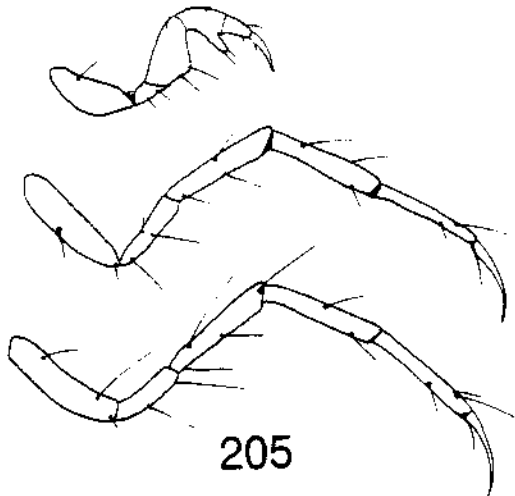

205

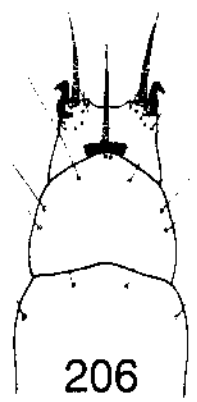

206



207

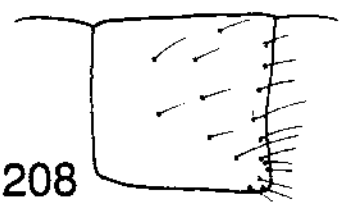

208

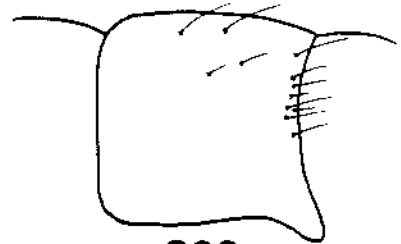

209

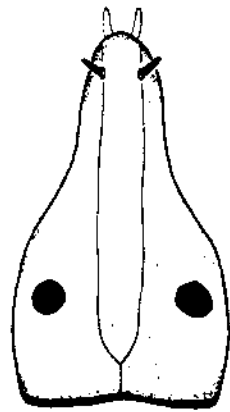

210



211

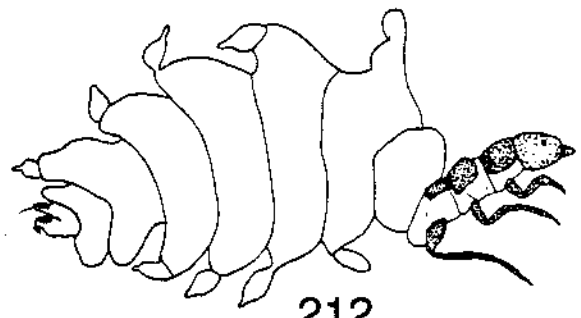

212

Figs. 213-219. *Dibusa*, *Ithytrichia*, *Leucotrichia*, and *Mayatrichia* male genitalia. 213. *D. angata*, lateral. 214. *I. clavata*, phallus. 215. *I. clavata*, ventral. 216. *I. mazon*, ventral. 217. *M. ayama*, lateral. 218. *L. pictipes*, lateral. 219. *M. ponta*, lateral. (Figs. 214-217, 219 redrawn from Ross 1944; Fig. 218 redrawn from Flint 1972)

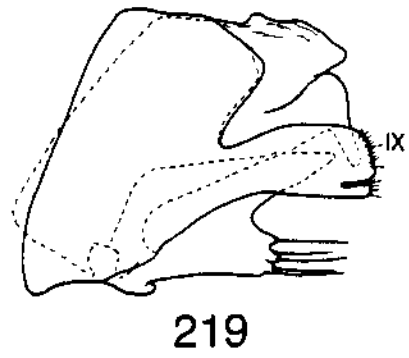
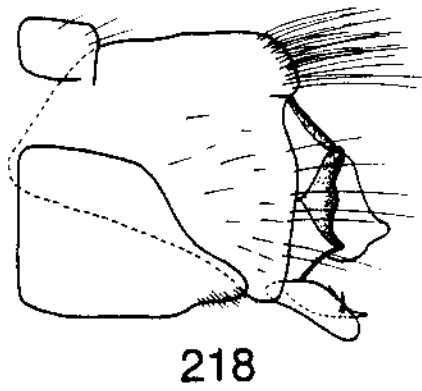
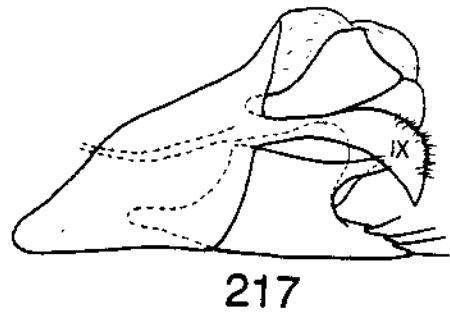
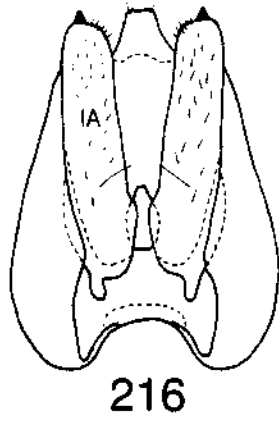
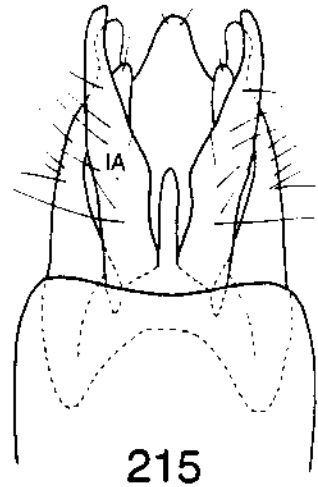
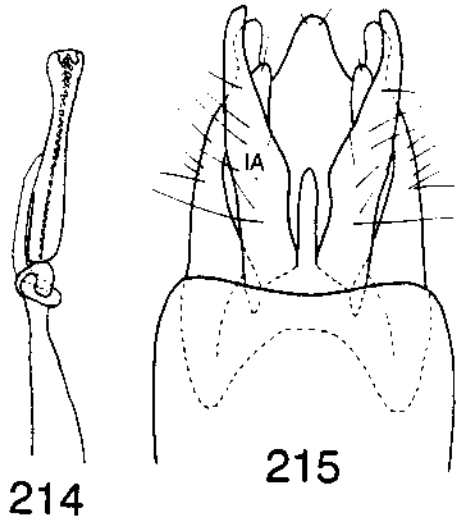
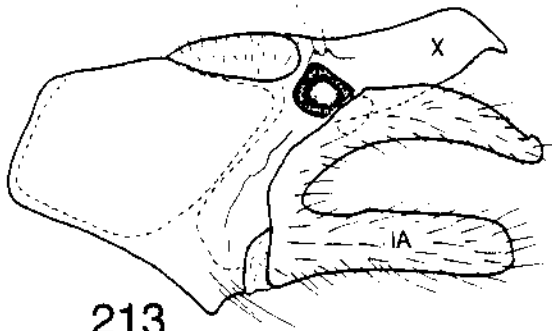

Figs. 220-233. *Hydroptila* male genitalia. 220-222. *H. virgata*. 220. Lateral. 221. Abdominal sternite VII process, lateral. 222. Phallus. 223-224. *H. hamata*. 223. Phallus. 224. Abdominal sternite VII process, lateral. 225-227. *H. artesa*. 225. Lateral. 226. Tergum X, dorsal. 227. Phallus. 228. *H. oneilli* tergum X, dorsal. 229. *H. remita* phallus. 230-232. *H. sandersoni*. 230. Tergum X, dorsal. 231. Lateral. 232. Phallus. 233. *H. amoena* tergum X, dorsal. (Figs. 220-224 redrawn from Ross 1944; Figs. 225-227, 230-232 redrawn from Mathis and Bowles 1990; Figs. 228, 233 redrawn from Harris 1985)

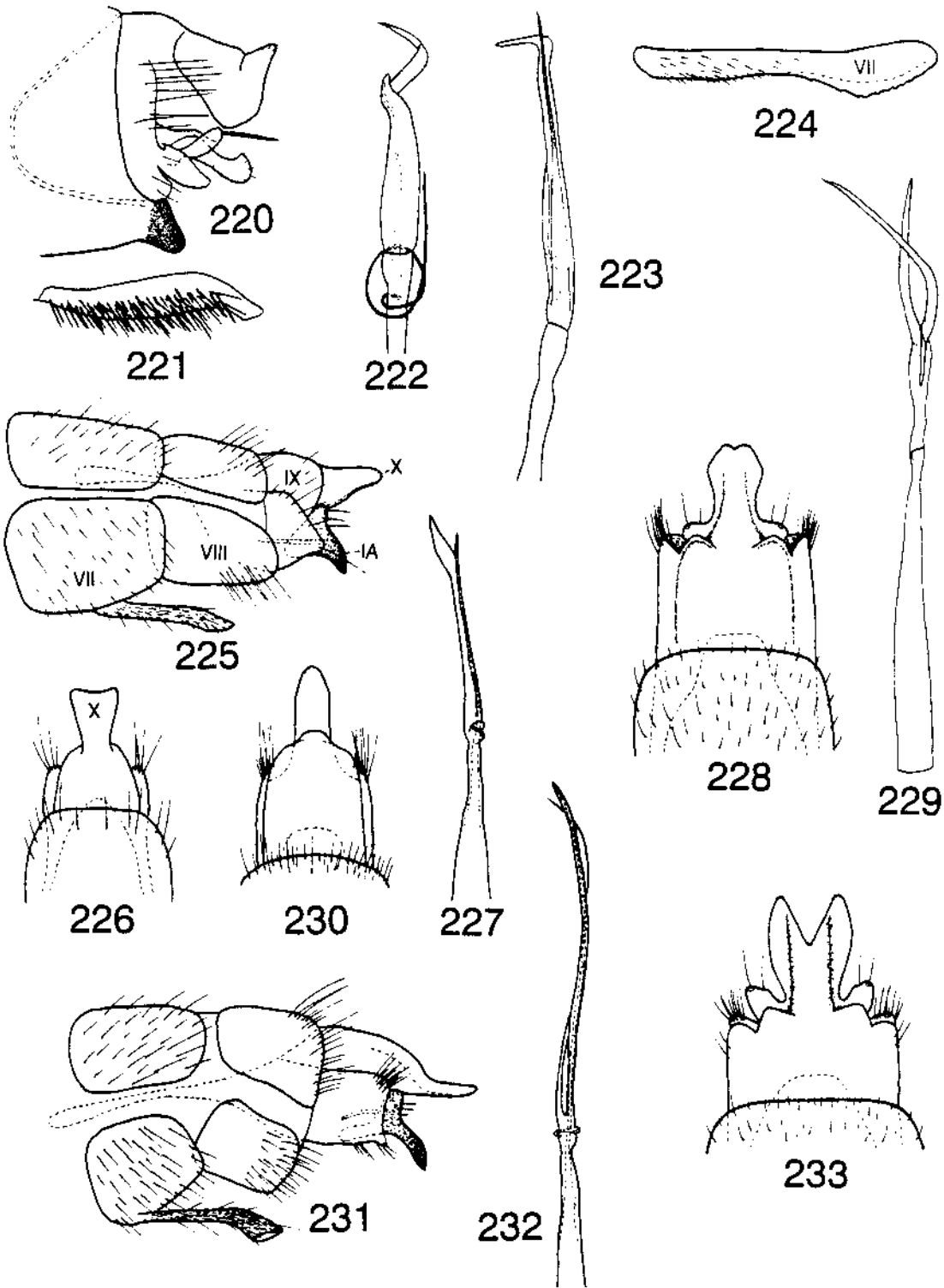

Figs. 234-241. *Hydroptila* male genitalia. 234-235. *H. spatulata*. 234. Lateral. 235. Apex of phallus. 236-237. *H. armata*. 236. Lateral. 237. Apex of phallus, lateral. 238. *H. vala*, lateral. 239. *H. grandiosa*, lateral. 240. *H. delineata*, ventral. 241. *H. waubesiana*, ventral. (all redrawn from Ross 1944)

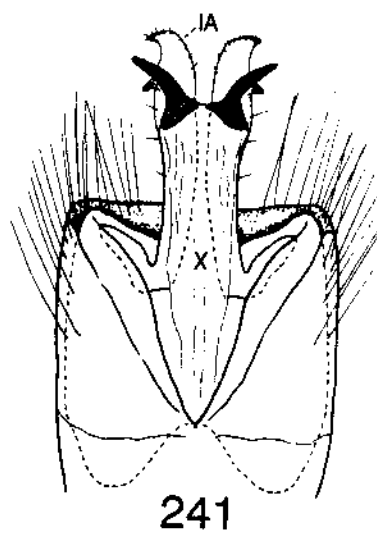
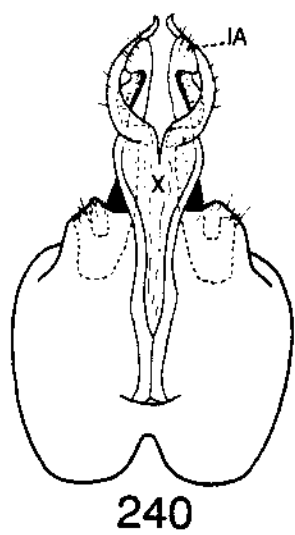
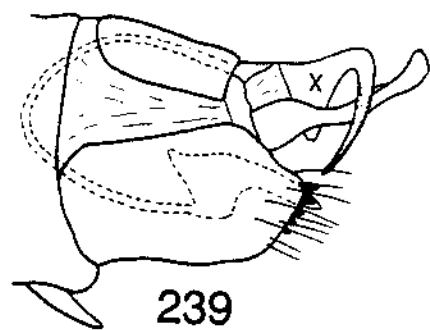
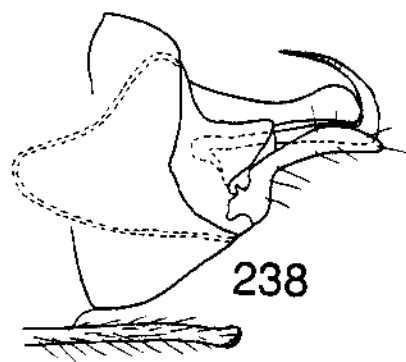
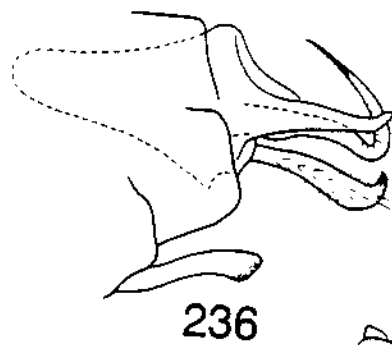
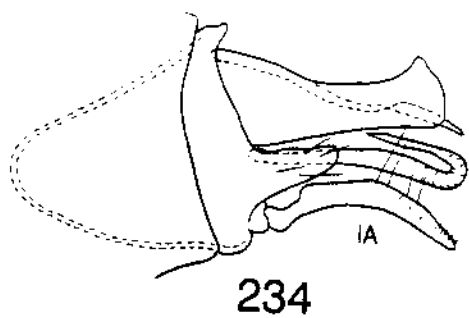

Figs. 242-251. *Hydroptila* male genitalia. 242-243. *H. quinola*. 242. Phallus. 243. Ventral. 244-245. *H. broweri*. 244. Ventral. 245. Phallus. 246-247. *H. scolops*. 246. Phallus. 247. Inferior appendages, ventral. 248-249. *H. bernerii*. 248. Inferior appendages, ventral. 249. Phallus. 250-251. *H. strepha*. 250. Phallus. 251. Inferior appendages, ventral. (Figs. 242-243, 246-251 redrawn from Ross 1941b, 1944, 1947, Figs. 244-245 redrawn from Blicke 1963).

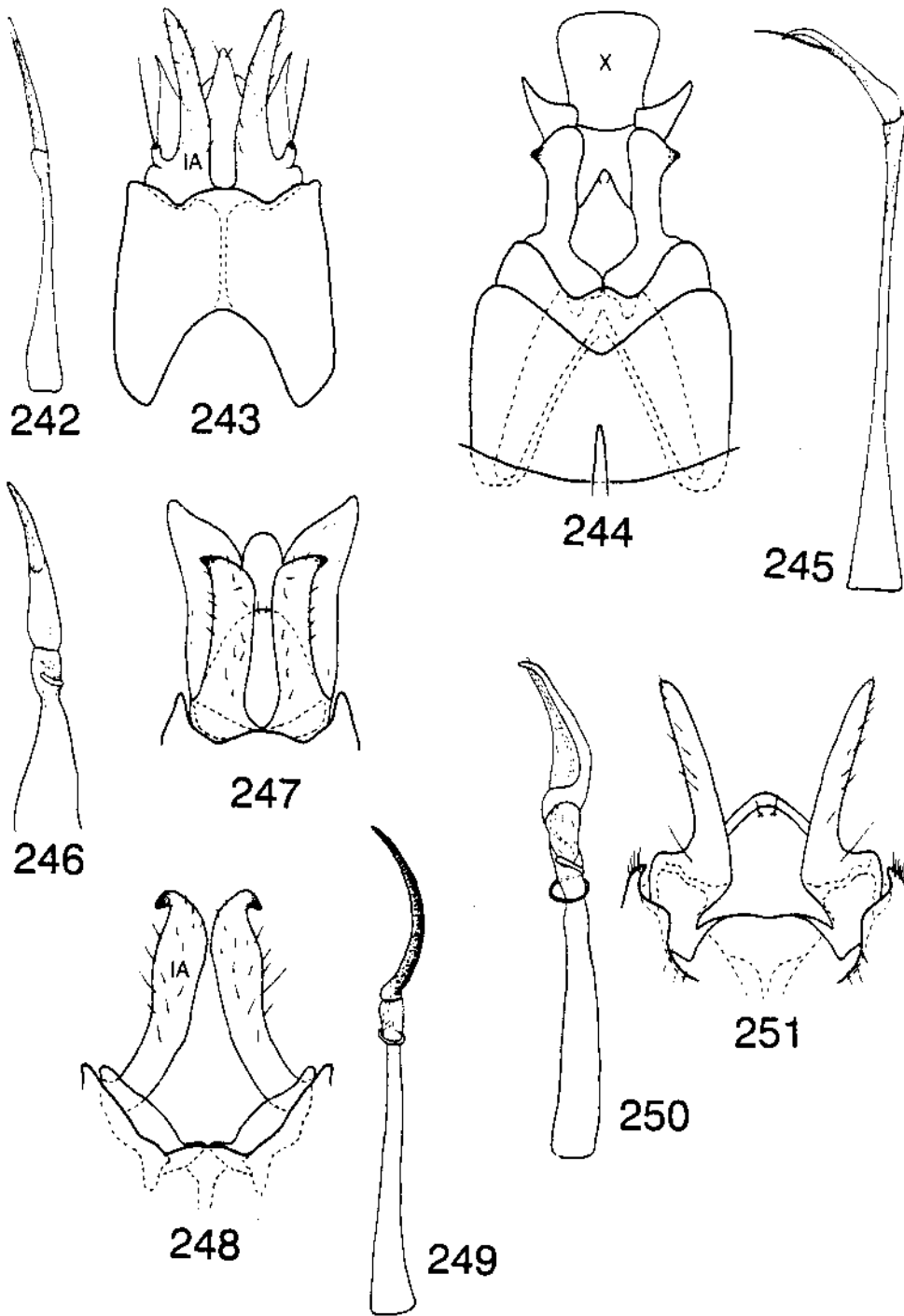

Figs. 252-261. *Hydroptila* male genitalia. 252-254. *H. melia*. 252. Lateral. 253. Tergum X, dorsal. 254. Phallus. 255-256. *H. tusculum*. 255. Lateral. 256. Ventral. 257-259. *H. albicornis*. 257. Lateral. 258. Inferior appendages, ventral. 259. Phallus. 260-261. *H. angusta*. 260. Inferior appendages, ventral. 261. Phallus. (all redrawn from Ross 1938a, 1944, 1947).

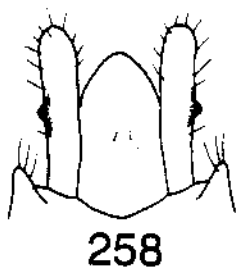
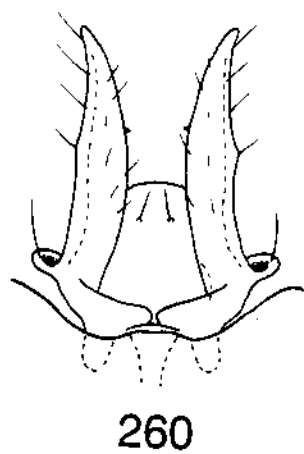
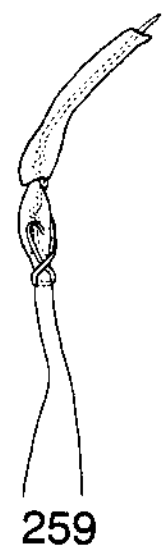
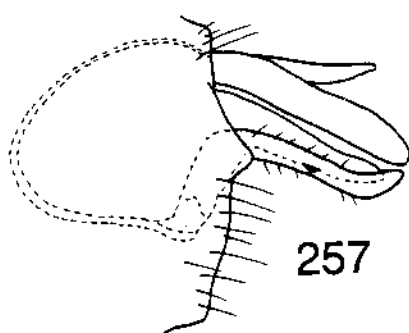
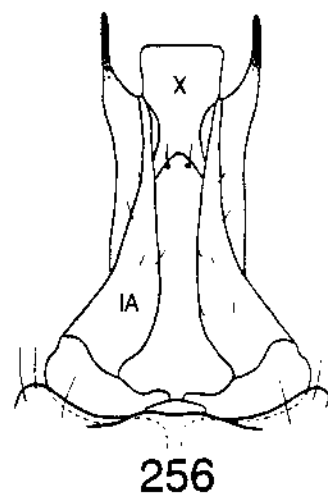
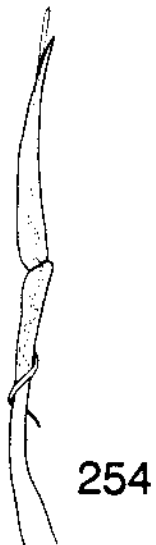
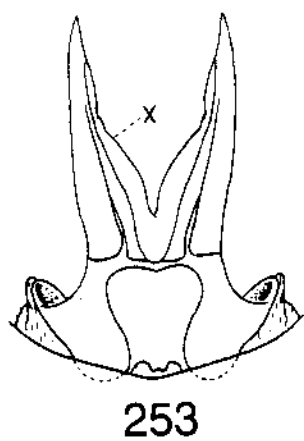
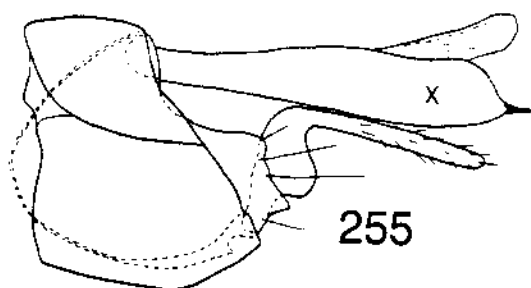
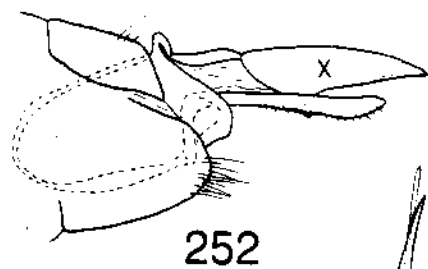

Figs. 262-272. *Hydroptila* male genitalia. 262-263. *H. consimilis*. 262. Male Ventral. 263. Phallus. 264-265. *H. protera*. 264. Tergum X, dorsal. 265. Phallus. 266-268. *H. perdita*. 266. Tergum X, dorsal. 267. Inferior appendages, ventral. 268. Phallus. 269-271. *H. ajax*. 269. Lateral. 270. Phallus. 271. Inferior appendages, ventral. 272. *H. icona* inferior appendages, ventral. (all redrawn from Ross 1938a, 1944).

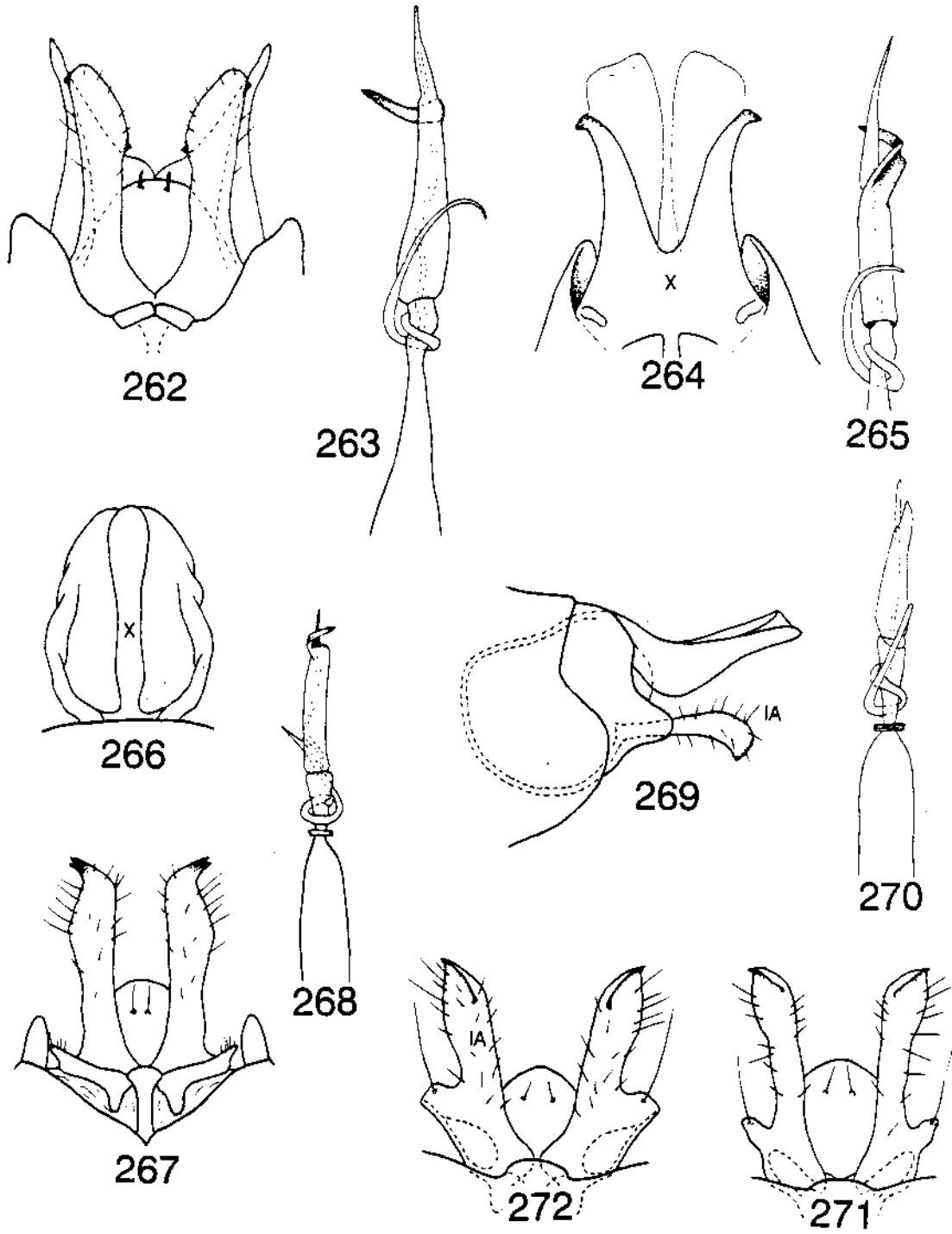

Figs. 273-281. *Neotrichia* male genitalia. 273-274. *N. kitae*. 273. Lateral. 274. Ventral. 275-276. *N. collata*. 275. Ventral. 276. Phallus. 277-278. *N. riegeli*. 277. Phallus. 278. Ventral. 279. *Neotrichia okopa*, ventral. 280-281. *N. arkansasensis* (redrawn from Mathis and Bowles 1990). 280. Phallus. 281. Ventral. (all, except Figs. 280-281, redrawn from Ross 1944).

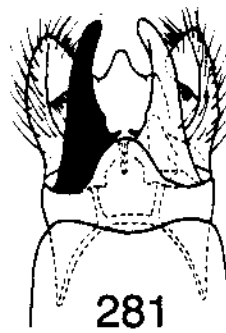
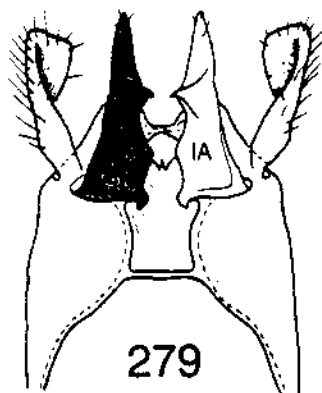
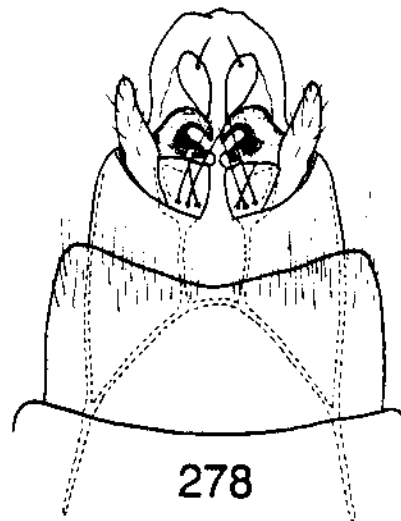
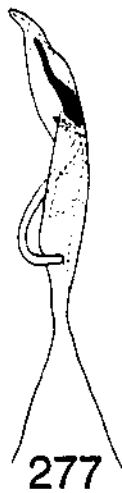
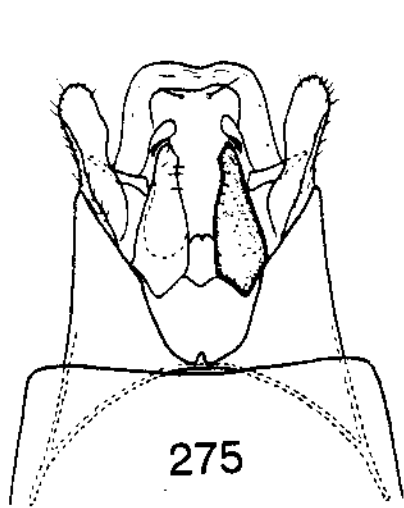
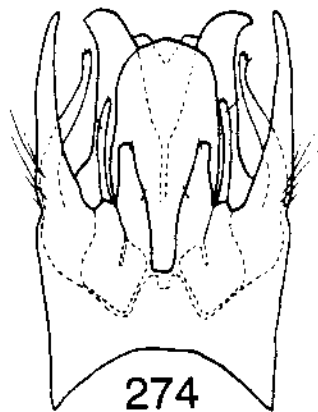
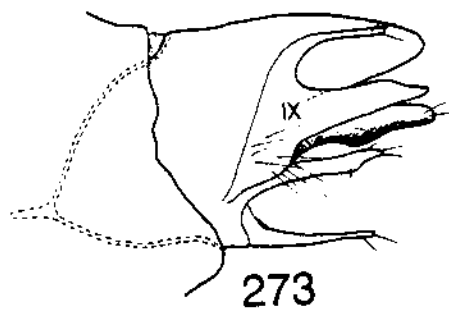

Figs. 282-287. Neotrichia male genitalia. 282-283. *N. minutisimella*. 282. Lateral. 283. Inferior appendages, ventral. 284-285. *N. vibrans*. 284. Ventral. 285. Phallus. 286-287. *N. edalis*. 286. Phallus. 287. Ventral. (all redrawn from Ross 1944).

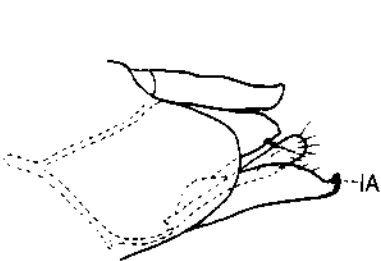

282

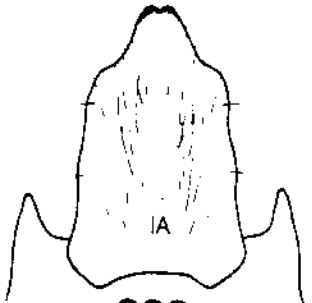

283

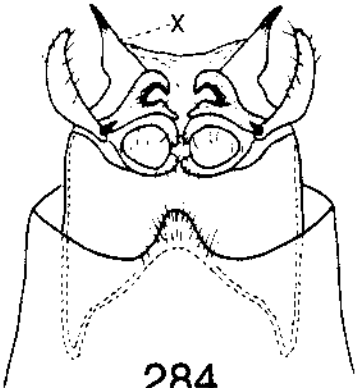

284

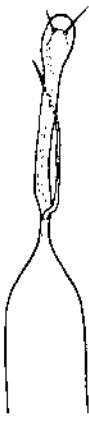

285

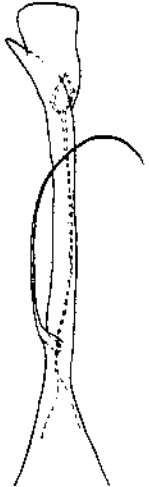

286

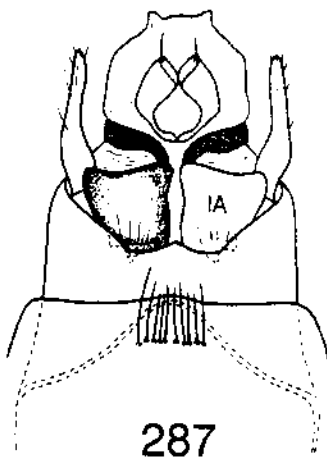

287

Figs. 288-300. *Ochrotrichia* male genitalia. 288-289. *O. (Metrichia) nigritta*. 288. Lateral. 289. Phallus. 290. *O. xena*, dorsal. 291. *O. unio*, dorsal. 292-293. *O. (Ochrotrichia) weddleae*. 292. Tergum X, dorsal. 293. Lateral. 294. *O. (O.) robisoni*, lateral. 295-300. Terga X, dorsal. 295. *O. (O.) robisoni*. 296. *O. (O.) contorta*. 297. *O. (O.) anisca*. 298. *O. (O.) shawnee*. 299. *O. (O.) tarsalis*. 300. *O. (O.) stylata*. (Figs. 294-300, redrawn from Frazer and Harris 1991)

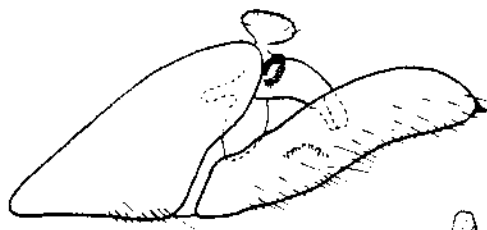

288



292



289

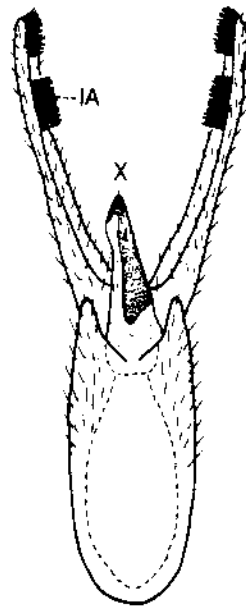

290

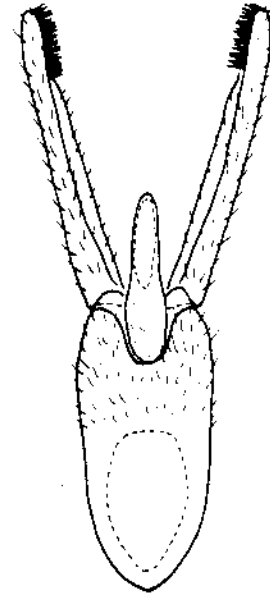

291

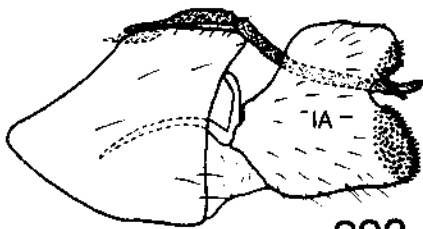

293

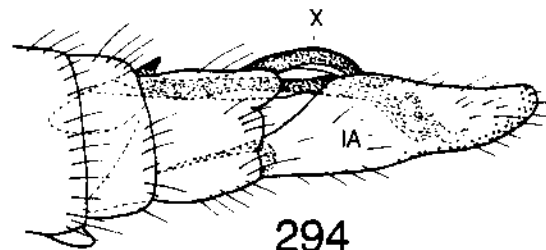

294



295

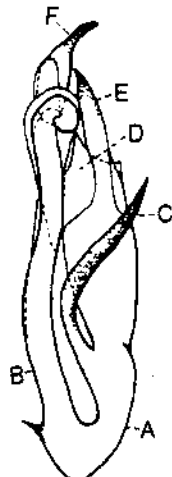

296



297



298

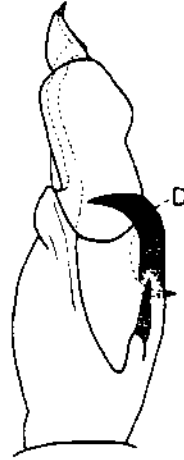

299



300

Figs. 301-308. *Ochrotrichia* male genitalia. 301-302. *O. (O.) riesi*. 301. Lateral. 302. Inferior appendages, ventral. 303-304. *O. (O.) spinosa*. 303. Lateral. 304. Inferior appendages, ventral. 305-306. *O. (O.) eliaga*. 305. Lateral. 306. Inferior appendages, ventral. 307-308. *O. (O.) arva*. 307. Lateral. 308. Inferior appendages, ventral. (all redrawn from Ross 1944).

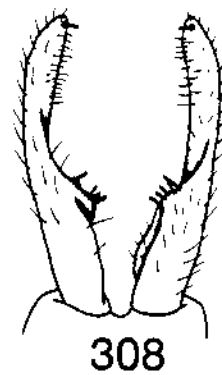
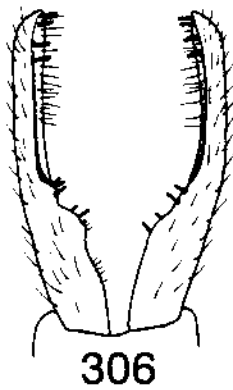
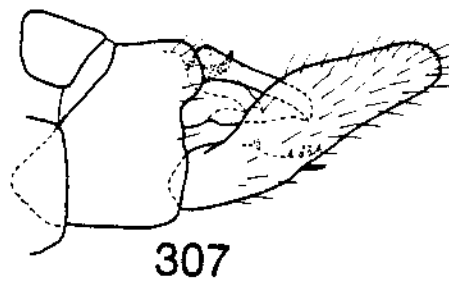
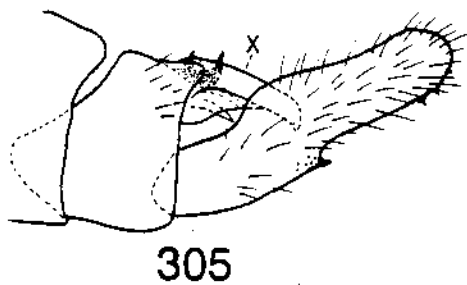
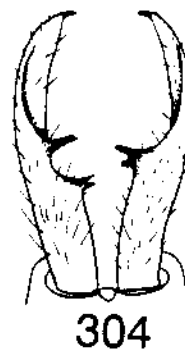
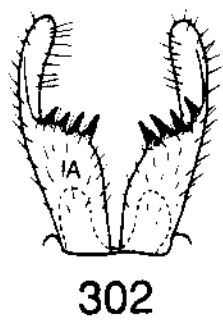
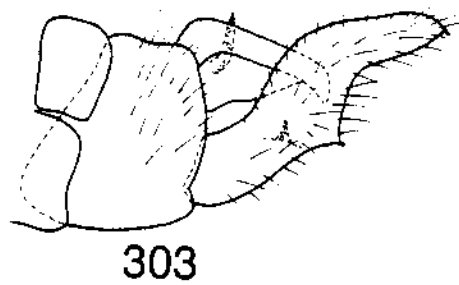
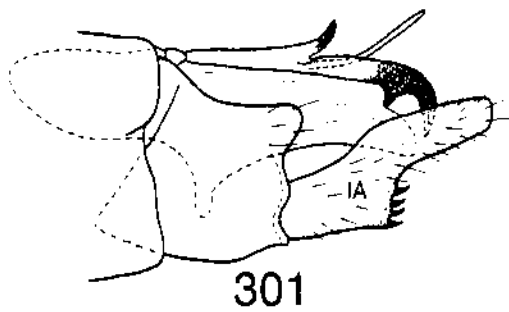

Figs. 309-314. *Oxyethira* male genitalia. 309-310. *O. azteca*. 309. Ventral. 310. Lateral. 311-312. *O. janella*. 311. Ventral. 312. Lateral. 313-314. *O. pallida*. 313. Lateral. 314. Phallus. (all redrawn from Kelley 1982).

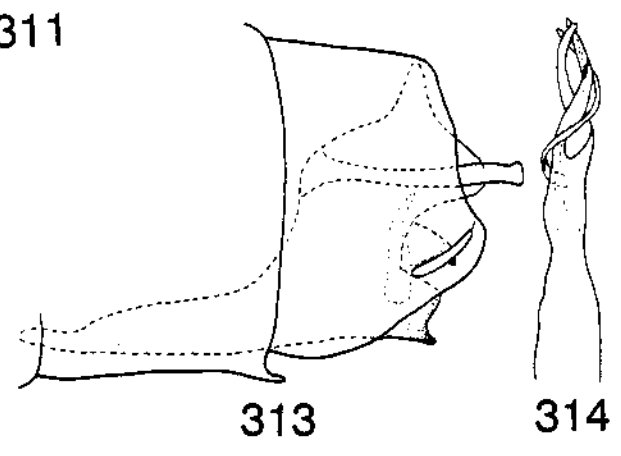
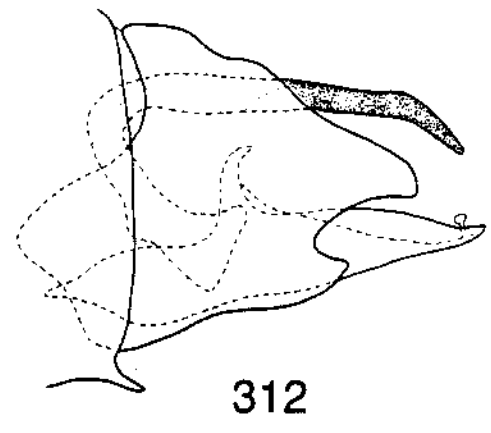
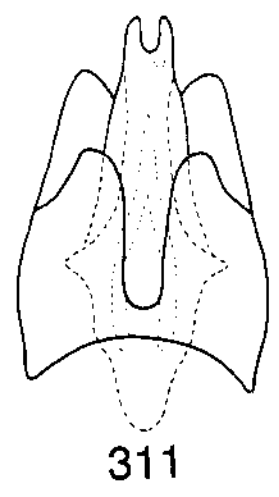
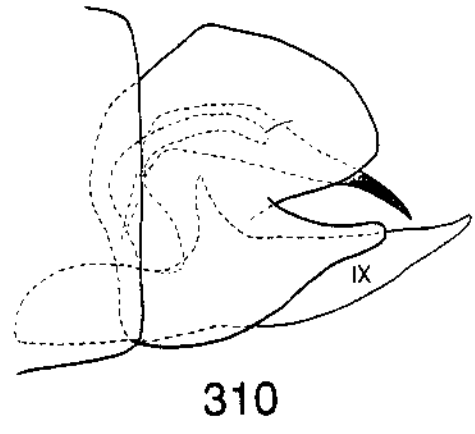
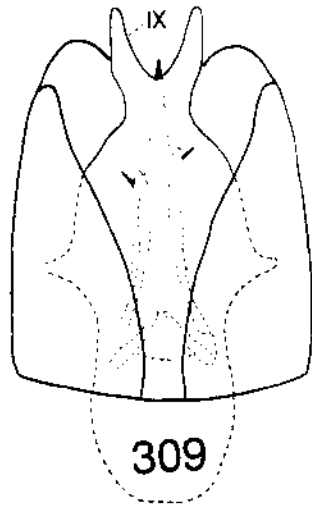

Figs. 315-322. *Oxyethira* male genitalia. 315-316. *O. novasota*. 315. Lateral. 316. Phallus. 317-318. *O. rivicola*. 317. Lateral. 318. Phallus. 319-320. *O. coercens*. 319. Lateral. 320. Phallus. 321-322. *O. aculea*. 321. Lateral. 322. Phallus. (all redrawn from Kelley 1982).

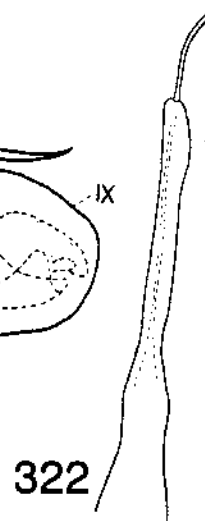
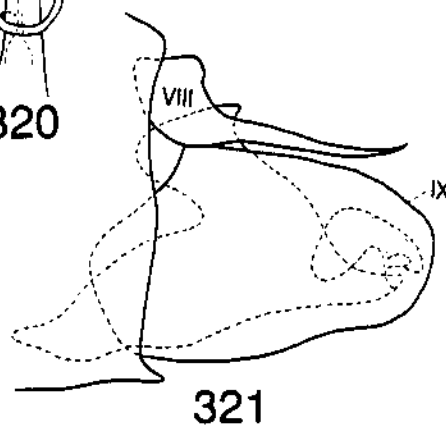
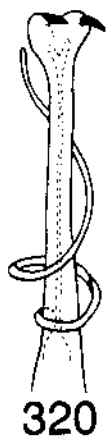
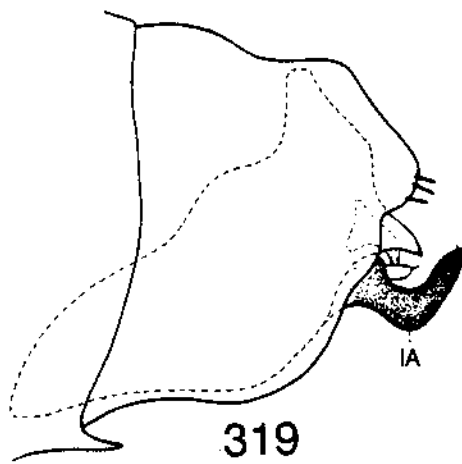
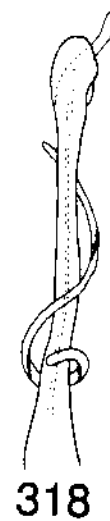
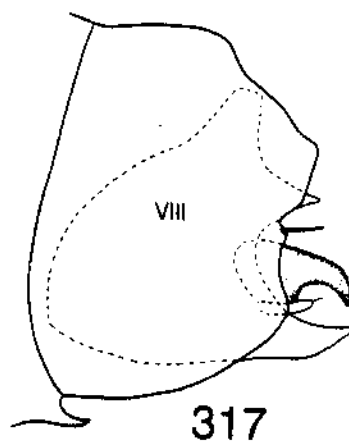
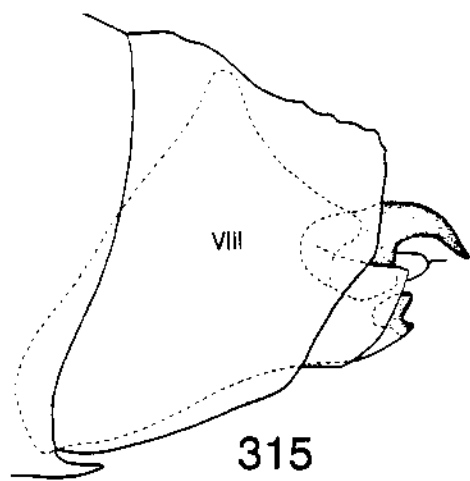

Figs. 323-330. *Oxyethira* male genitalia. 323-324. *O. glasa*. 323. Lateral. 324. Phallus. 325-326. *O. zeronia*. 325. Lateral. 326. Phallus. 327-328. *O. forcipata*. 327. Lateral. 328. Phallus. 329-330. *O. dualis*. 329. Lateral. 330. Phallus. (all redrawn from Kelley 1982).

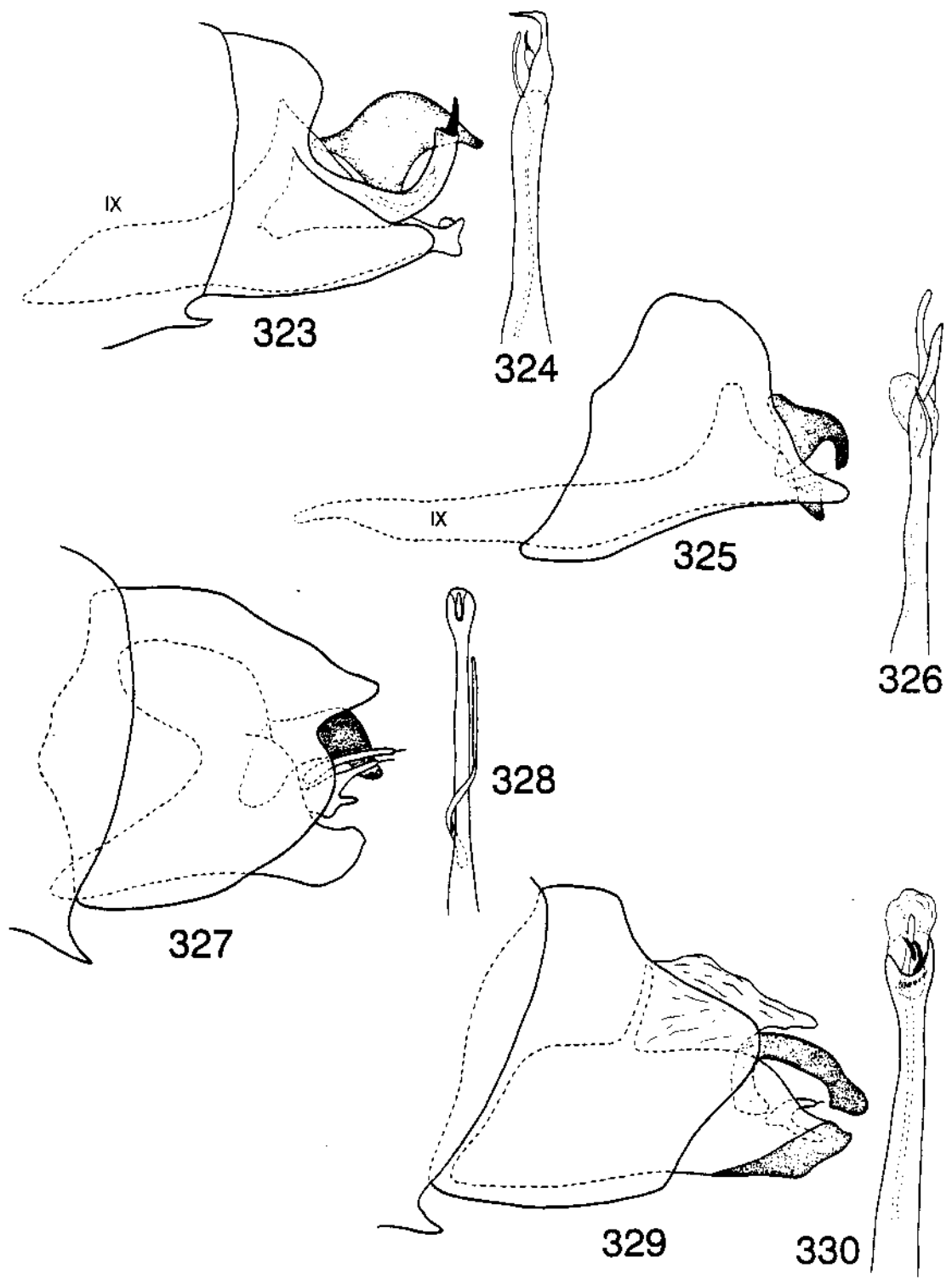

Figs. 331-337. *Orthotrichia*, *Paucicalcaria*, and *Stactobiella* male genitalia. 331. *O. cristata*, ventral. 332. *O. aegerfasciella*, ventral. 333. *O. instabilis*, ventral. 334. *P. ozarkensis*, lateral. 335. *S. palmata*, ventral. 336. Bracteole of *S. palmata*, lateral. 337. *S. delira*, ventral. (Fig. 332 redrawn from Ross 1944; Fig. 334 redrawn from Mathis and Bowles 1989).

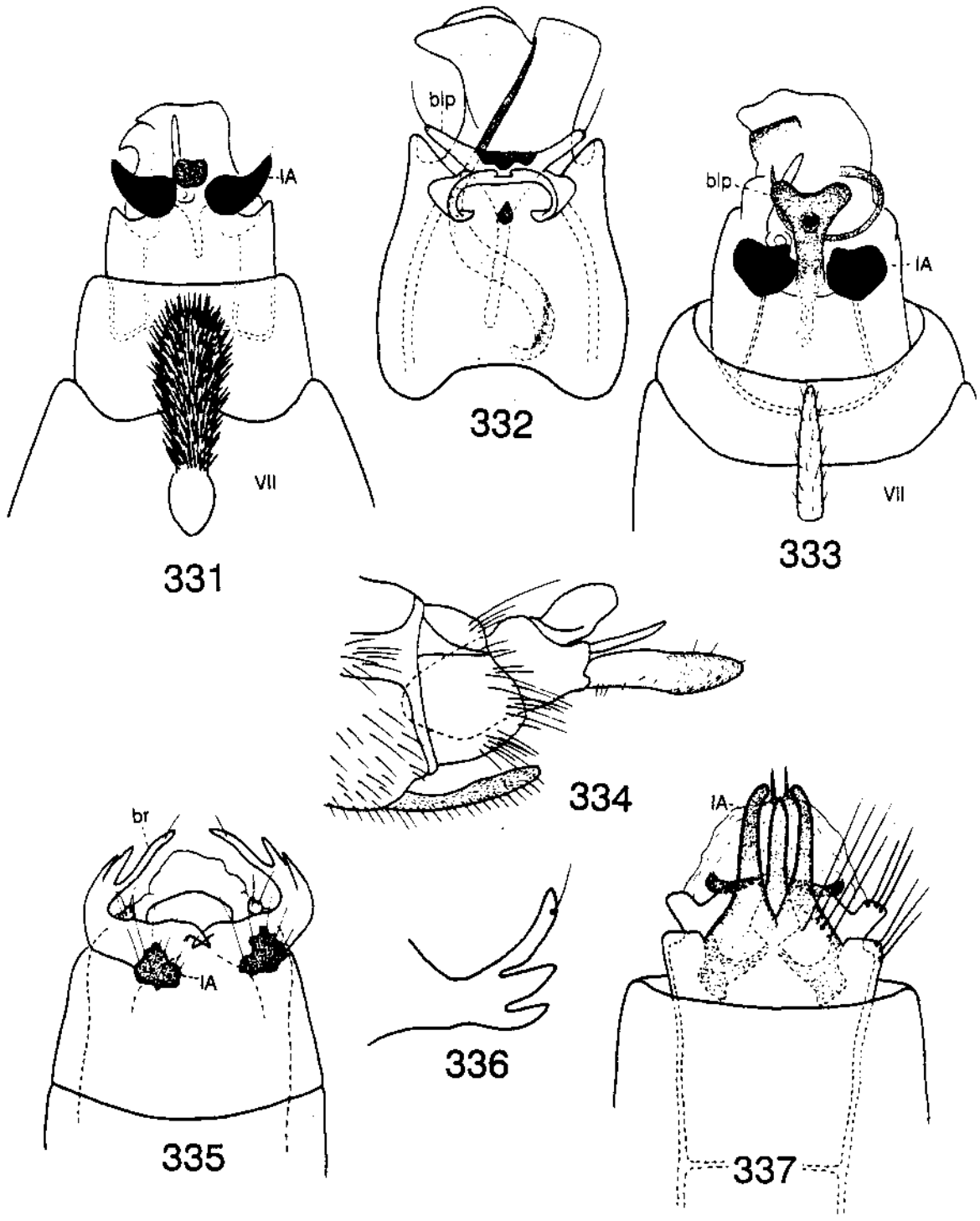

Figs. 338-345. *Lepidostoma* male genitalia and heads. 338. *L. libum*, lateral. 339. *L. lescheni*, lateral. 340. *L. lescheni* head, lateral. 341. *L. griseum* head, lateral. 342. *L. griseum*, lateral. 343. *L. carrolli*, lateral. 344. *L. ozarkense*, lateral. 345. *L. togatum*, lateral. (Figs. 339-340 redrawn from Bowles *et al.* 1994).

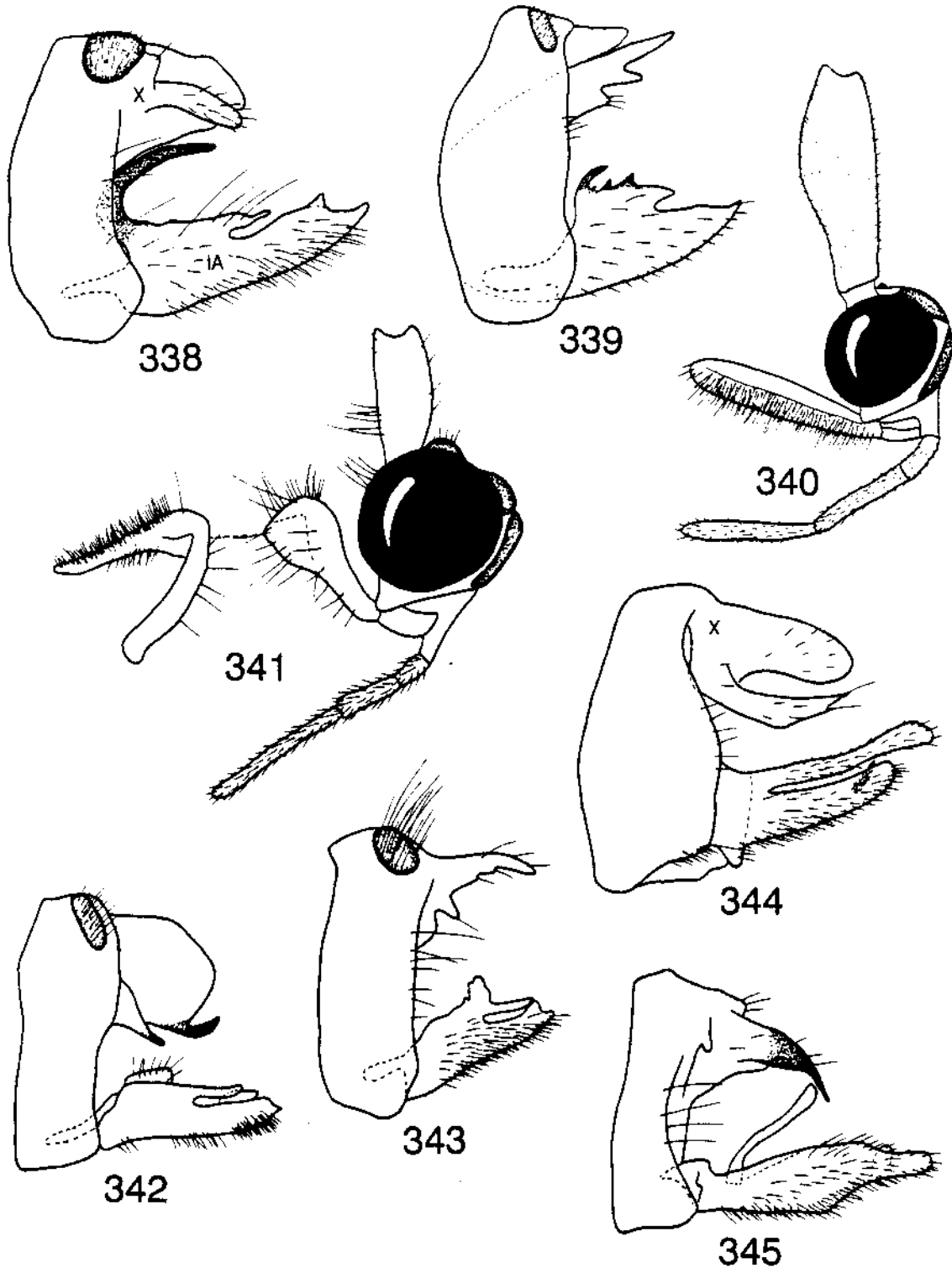

Figs. 346-353. Larval Leptoceridae. 346. *Leptocerus americanus* mesothoracic leg, posterior. 347. *Nectopsyche diarina* mesothoracic leg, posterior. 348. *Mystacides sepulchralis* metathoracic, posterior. 349. *Oecetis* sp. head, dorsal. 350. *N. diarina* head, dorsal. 351. *Setodes oxapius* anal region, ventrocaudal. 352. *M. sepulchralis* head, ventral. 353. *N. diarina* head, ventral.

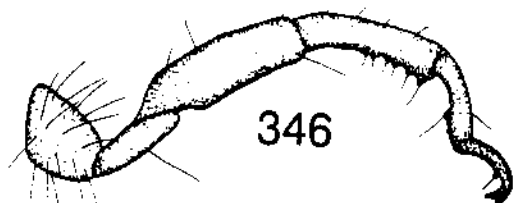

346

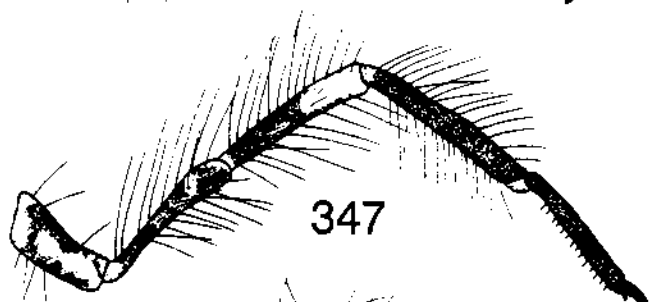

347

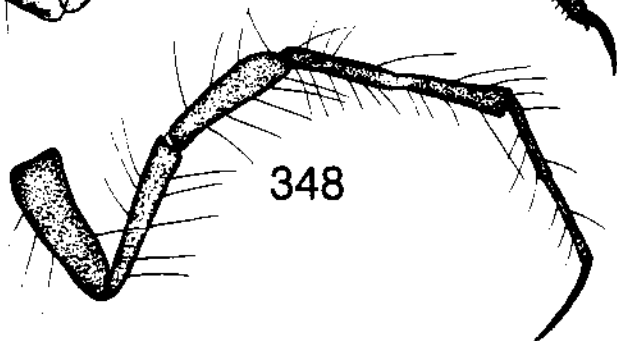

348

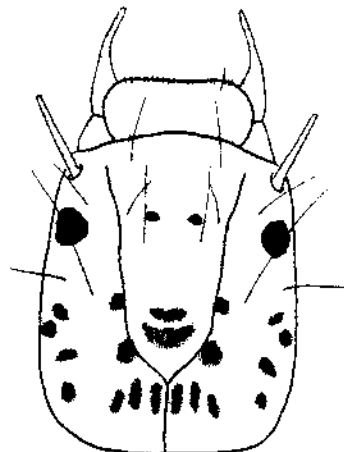

349

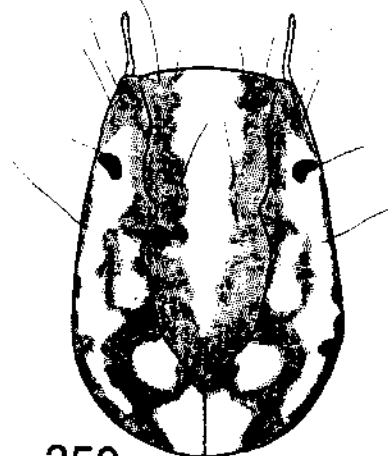

350

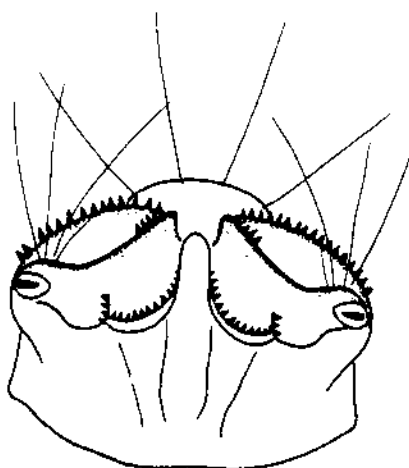

351

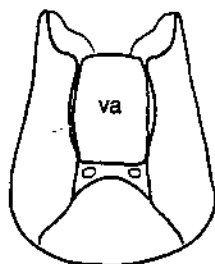

352

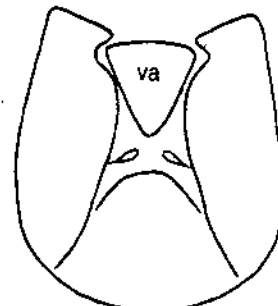

353

Figs. 354-360. Adult Leptoceridae. 354. *Triaenodes dipsius* forewing. 355. *O. inconspicua* forewing. 356. *Ceraclea maccalmonti*, forewing. 357. *C. maccalmonti* head, dorsal. 358. *M. sepulchralis* head, dorsal. 359. *C. maccalmonti* mesopleuron. 360. *N. exquisita* mesopleuron.



354



355



356

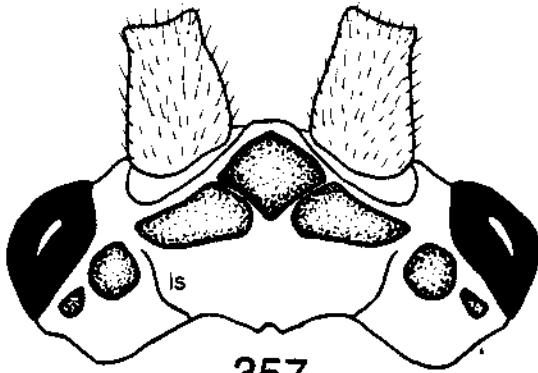

357

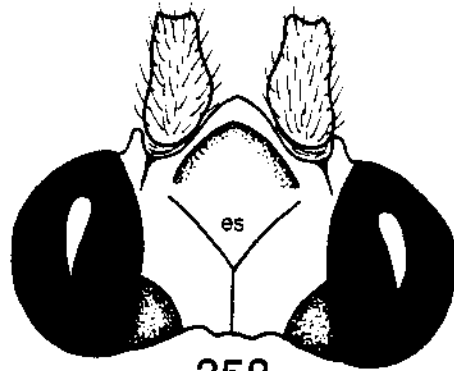

358



359



360

Figs. 361-369. Larval *Ceraclea*. 361. *C. transversa* head, pro- and mesonotum. 362. *C. punctata* anal proleg, lateral. 363. *C. cancellata* mesonotum. 364. *C. maculata* mesonotum. 365-366. *C. maccalmonti*. 365. Case. 366. Head, pro- and mesonotum. 367. *C. ancylus* mesonotum. 368. *C. flava* mesonotum. 369. *C. flava* case. (Figs. 361-364, 367-369 redrawn from Resh 1976a, Figs. 365, 366 redrawn from Moulton and Stewart 1992).

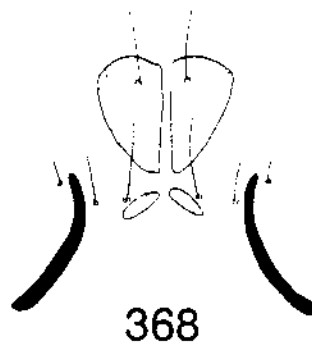
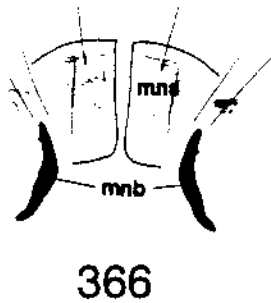
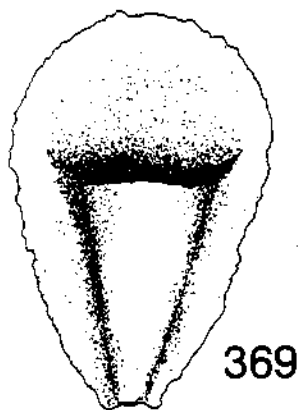
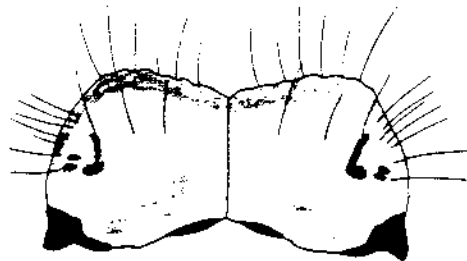
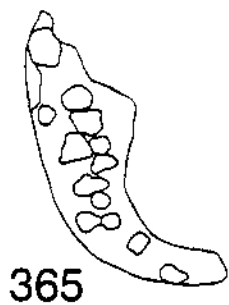
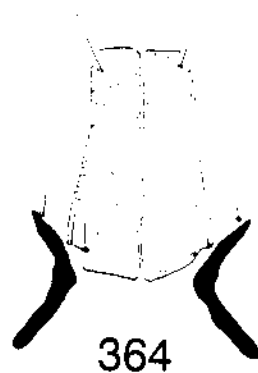
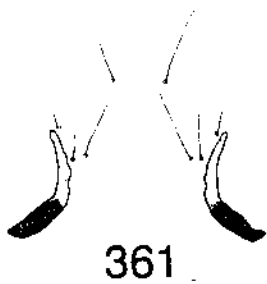
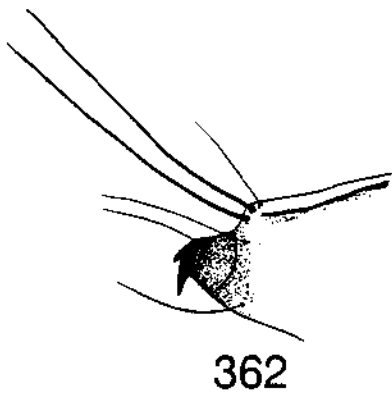
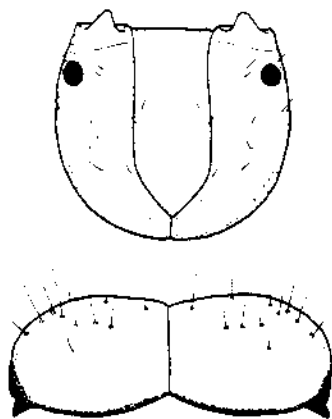

Figs. 370-380. *Ceraclea* male genitalia. 370-371. *C. flava*. 370. Lateral. 371. Inferior appendages, ventral. 372-373. *C. ancylus*. 372. Inferior appendages, ventral. 373. Lateral. 374-375. *C. maccalmonti*. 374. Lateral. 375. Inferior appendage, caudal. 376. *C. nepha*, lateral. 377-378. *C. protonepha*. 377. Lateral. 378. Phallus, lateral. 379-380. *C. tarsipunctata*. 379. Lateral. 380. Phallus, lateral.

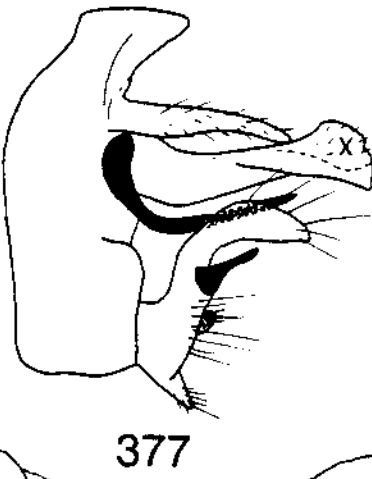
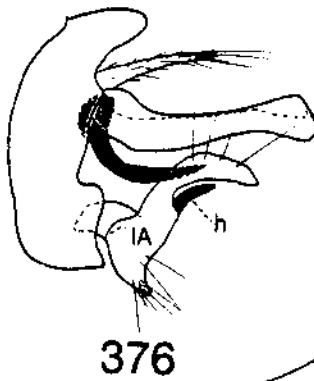
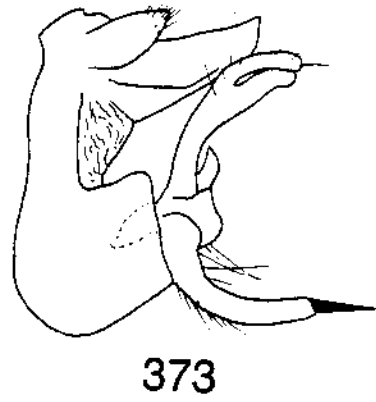
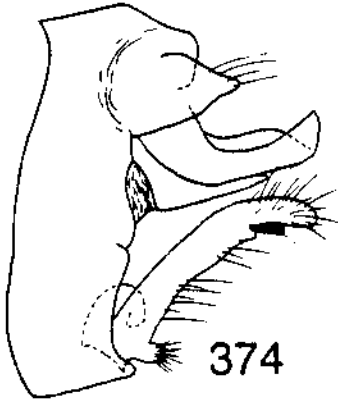
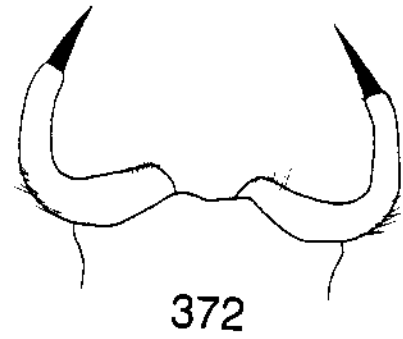
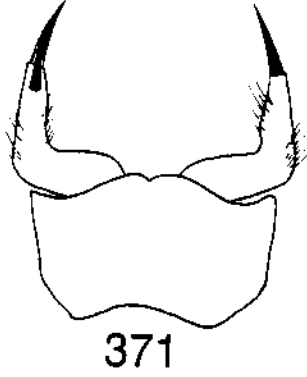
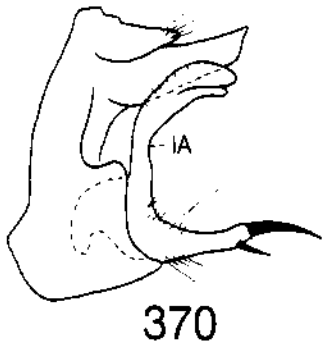

Figs. 381-389. *Ceraclea* male genitalia. 381-383. *C. transversus*. 381. Lateral. 382. Inferior appendage, caudal. 383. Tergum X, dorsal. 384-385. *C. resurgens*. 384. Lateral. 385. Inferior appendage, caudal. 386. *C. punctata*, lateral. 387. *C. maculata*, lateral. 388. *C. cancellata*, lateral. 389. *C. ophioderus*, lateral.

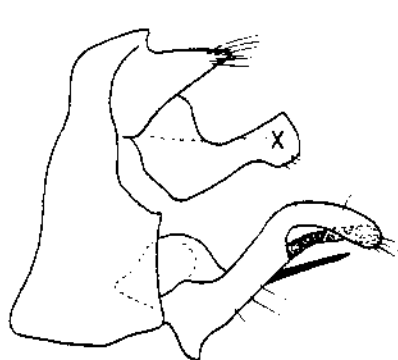

381

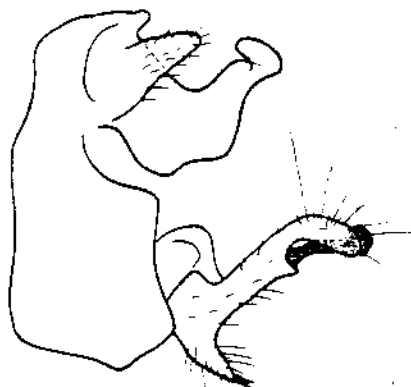

384



383

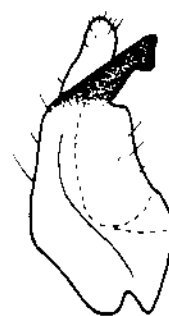

385

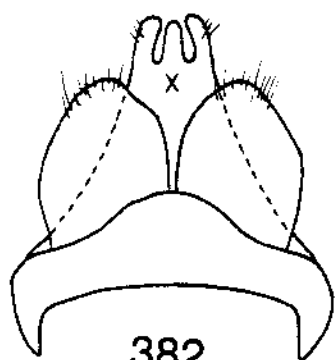

382



386

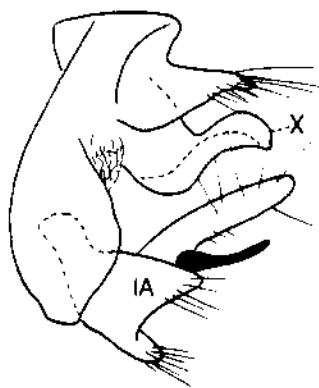

387

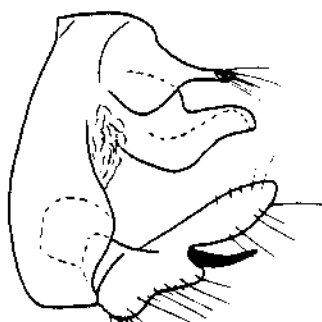

388

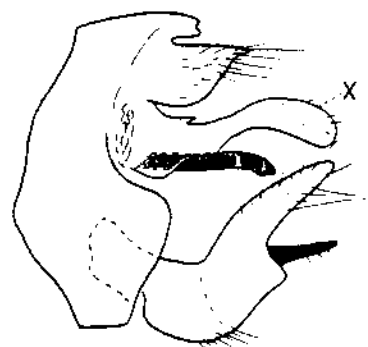

389

Figs. 390-398. *Nectopsyche* males. 390-391. *N. candida*. 390. Lateral. 391. Sternite IX processes, ventral. 392-393. *N. exquisita*. 392. Lateral. 393. Forewing. 394. *N. pavidata* genitalia, lateral. 395-396. Genitalia, lateral. 395. *N. diarina*. 396. *N. spiloma*. 397-398. Heads, ventral. 397. *N. diarina*. 398. *N. spiloma*.

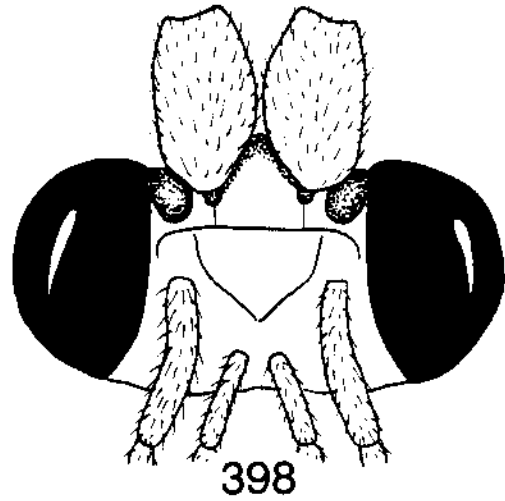
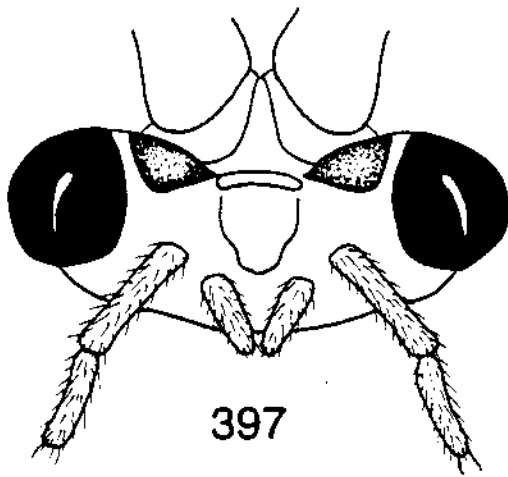
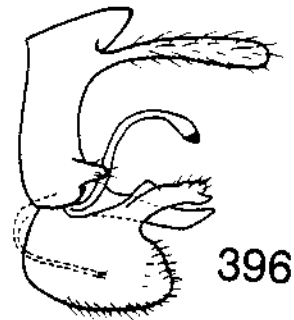
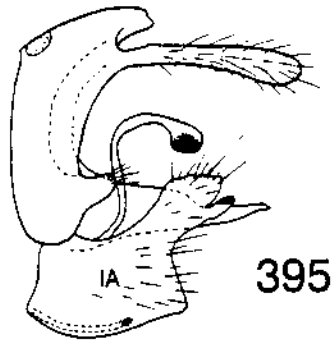
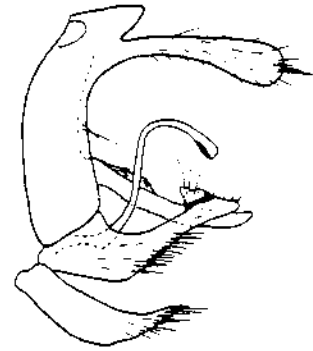
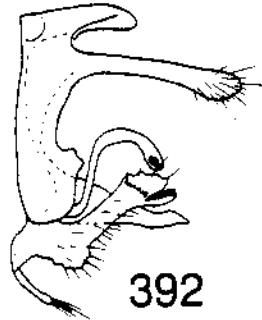
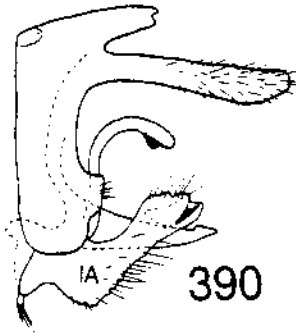

Figs. 399-407. *Oecetis* male genitalia. 399. *O. ouachita*, lateral. 400. *O. ozarkensis*, lateral. 401. *O. eddlestoni*, lateral. 402-403. *O. persimilis*. 402. lateral. 403. Phallus. 404. *O. osteni*, lateral. 405-406. *O. cinerascens*. 405. Lateral. 406. Inferior appendages, ventral. 407. *O. avara*, lateral.

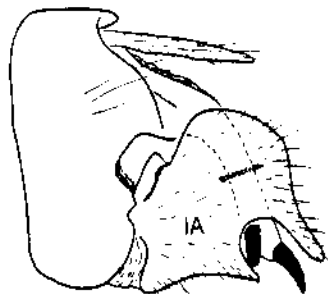

399

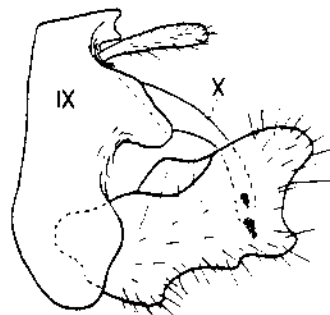

401

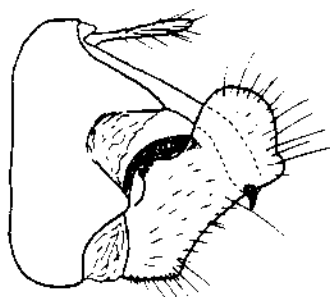

400

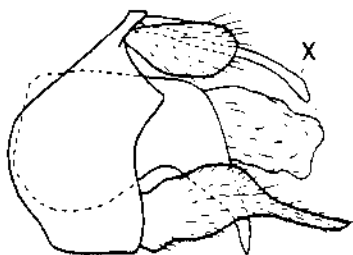

402

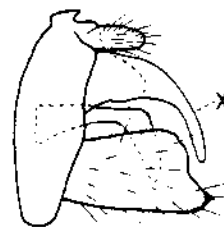

404



403

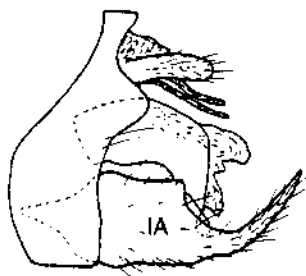

405



407

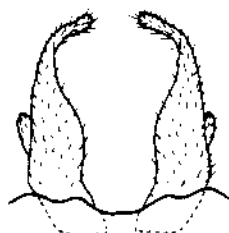

406

Figs. 408-415. *Oecetis* male genitalia. 408-410. *O. inconspicua*. 408. Lateral. 409. Phallus, lateral. 410. Inferior appendages, ventral. 411-413. *O. ditissa*. 411. Lateral. 412. Phallus, lateral. 413. Inferior appendages, ventral. 414-415. *O. nocturna*. 414. Lateral. 415. Inferior appendages, ventral.

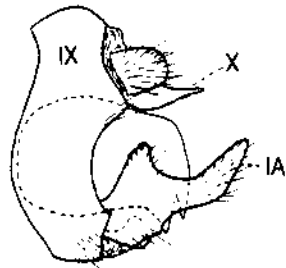

408

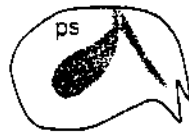

409

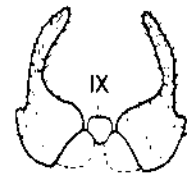

410

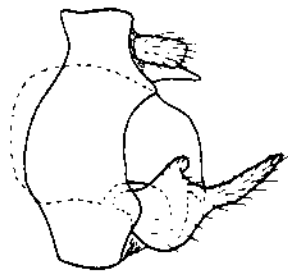

411



412



413

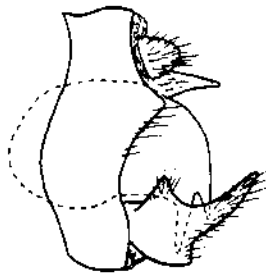

414



415

Figs. 416-421. *Leptocerus*, *Mystacides*, *Setodes*, and *Triaenodes* male genitalia. 416. *L. americanus*, lateral. 417-418. *M. sepulchralis*. 417. Lateral. 418. Sternite IX, ventral. 419-420. *S. oxapius*. 419. Lateral. 420. Variant, lateral. 421. *T. smithi*, lateral. (Fig. 421 redrawn from Ross 1959).

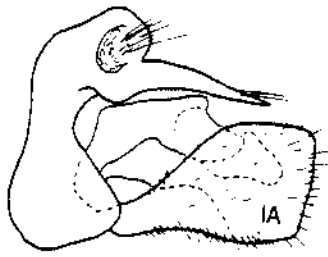

416

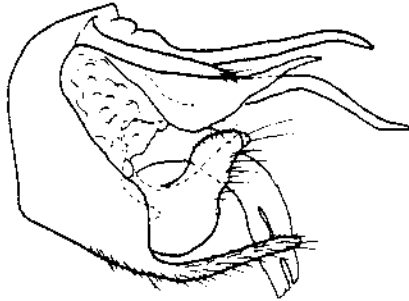

417

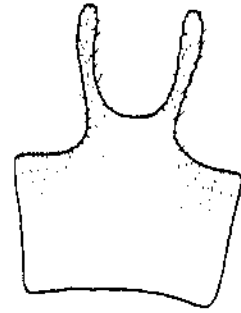

418

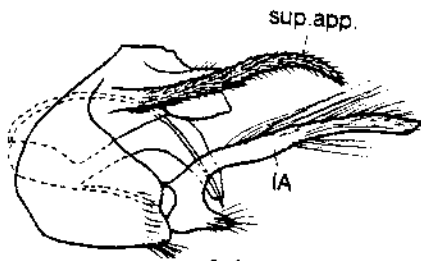

419

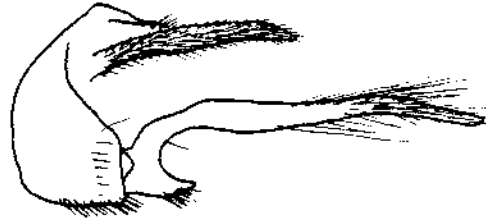

420

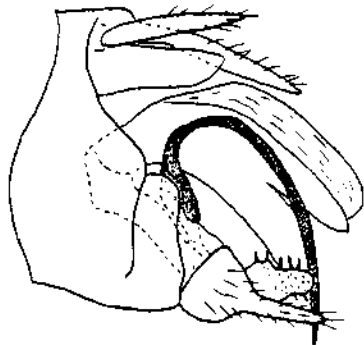

421

Figs. 422-429. *Triaenodes* male genitalia. 422. *T. ignitus*, lateral. 423-424. *T. injustus*. 423. Lateral. 424. Tergum X, lateral. 425. *T. tridentatus* holotype, lateral. 426. *T. abus*, lateral. 427. *T. nox*, lateral. 428. *T. ochraceus*, lateral. 429. *T. pernus*, lateral.

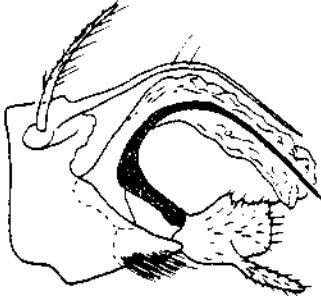

422

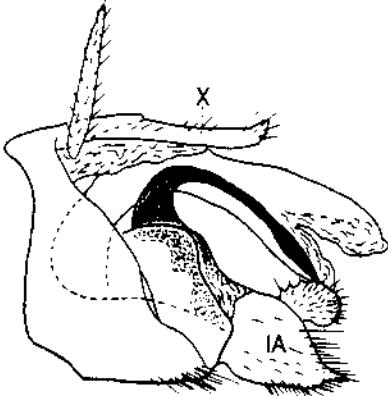

423

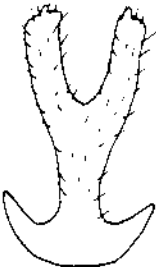

424

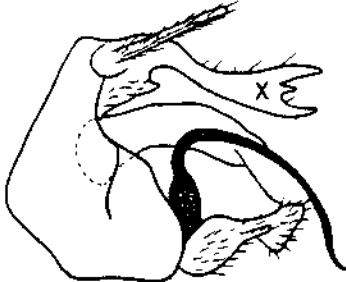

425

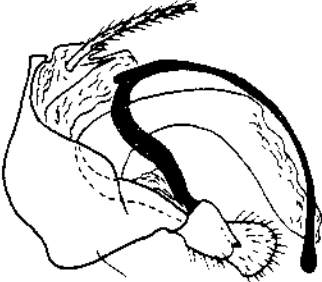

427

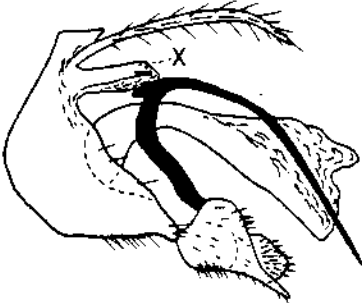

426

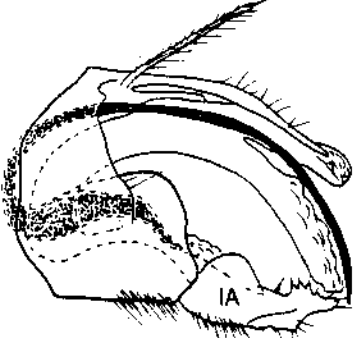

428

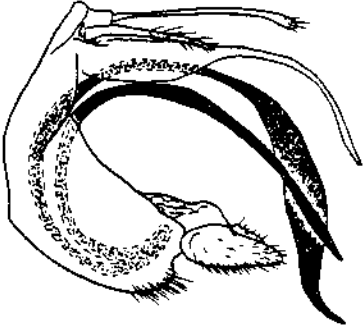

429

Figs. 430-439. *Triaenodes* male genitalia. 430. *T. melacus*, lateral. 431-432. *T. flavescens*. 431. Lateral. 432. Tergum X, dorsal. 433. *T. dipsius*, lateral. 434-435. *T. tardus*. 434. Lateral. 435. Tergum X, dorsal. 436-437. *T. cumberlandensis*. 436. Lateral. 437. Tergum X, dorsal. 438-439. *T. marginatus*. 438. Lateral. 439. Tergum X, dorsal.

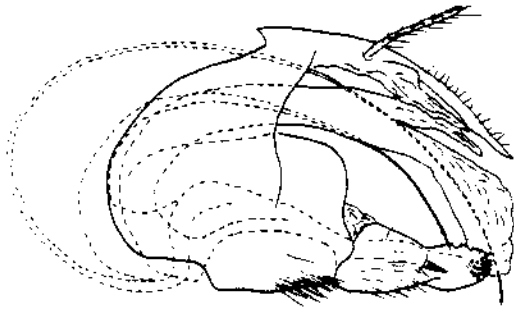

430

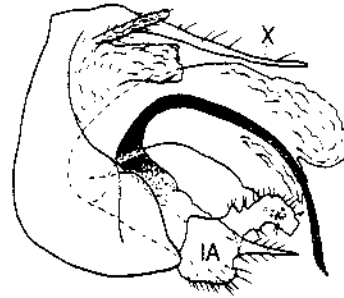

431

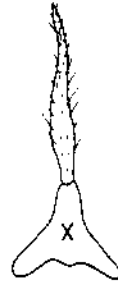

432

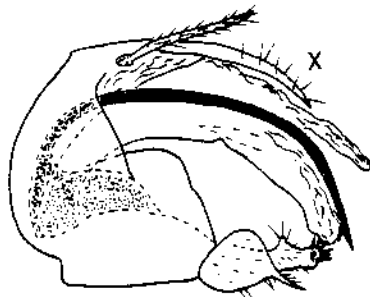

433

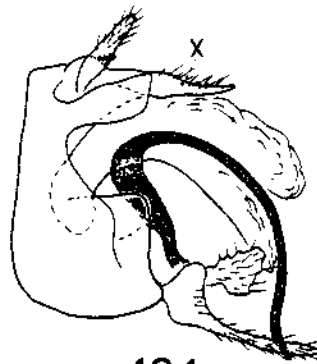

434



435

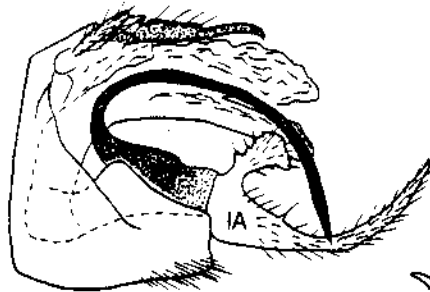

436

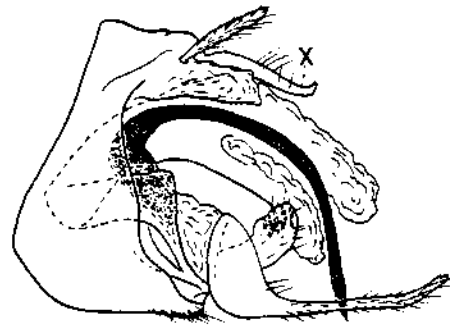

438



437

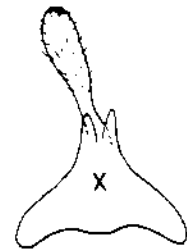

439

Figs. 440-450. Limnephilidae male forewings. 440. *Platycentropus radiatus*. 441. *Frenesia missa*. 442. *Glyphopsyche missouri*. 443. *Ironoquia punctatissima*. 444. *Pseudostenophylax uniformis*. 445. *Limnephilus submonilifer*. 446. *Pycnopsyche guttifer*. 447. *P. rossi*. 448. *P. lepida*. 449. *P. indiana*. 450. *P. subfasciata*.

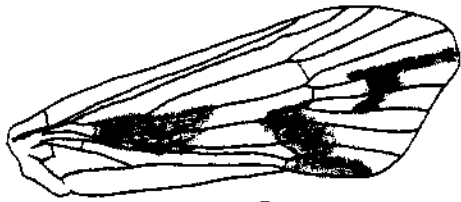

440

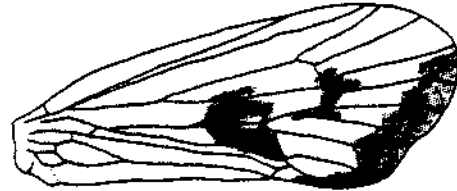

446

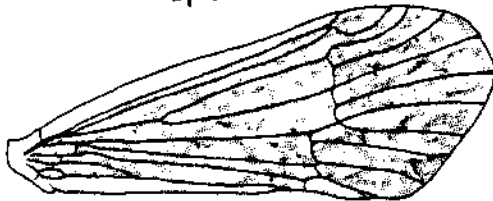

441



447

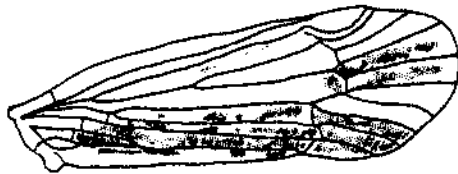

442

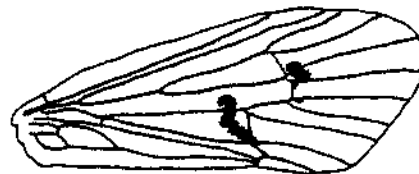

448



443



449



444



450



445

Figs. 451-456. *Platycentropus*, *Frenesia*, and *Glyphopsyche* male genitalia. 451-452. *P. radiatus*. 451. Lateral. 452. Phallus, lateral. 453-454. *F. missa*. 453. Lateral. 454. Phallus, lateral. 455-456. *G. missouri*. 455. Lateral. 456. Phallus, lateral.

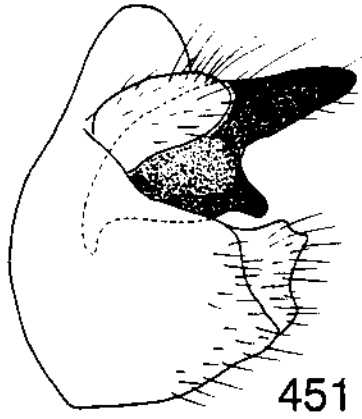

451

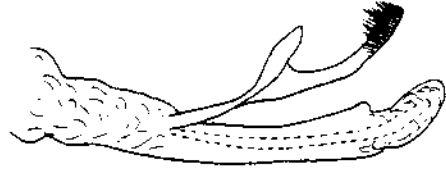

452

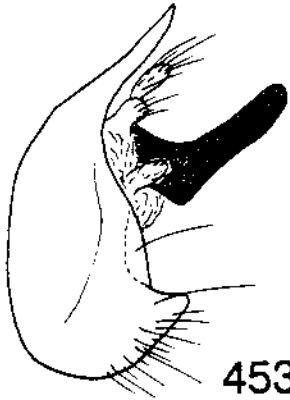

453

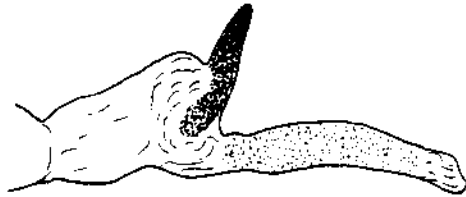

454

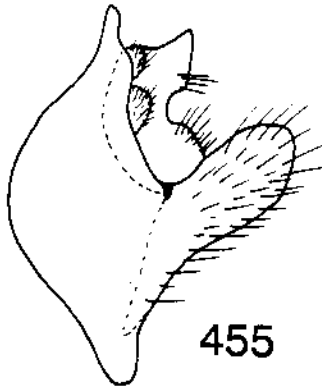

455



456

Figs. 457-462. *Ironoquia*, *Pseudostenophylax*, and *Limnephilus* male genitalia. 457. *I. punctatissima*, lateral. 458. *I. kaskaskia*, lateral. 459-460. *P. uniformis*. 459. Lateral. 460. Phallus, lateral. 461-462. *L. submonilifer*. 461. Lateral. 462. Phallus, lateral.

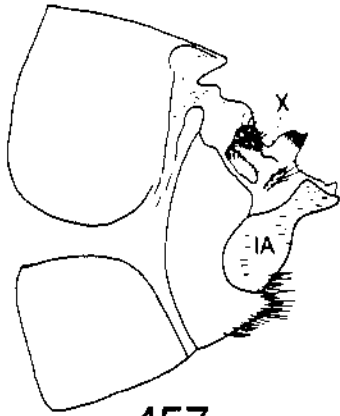

457

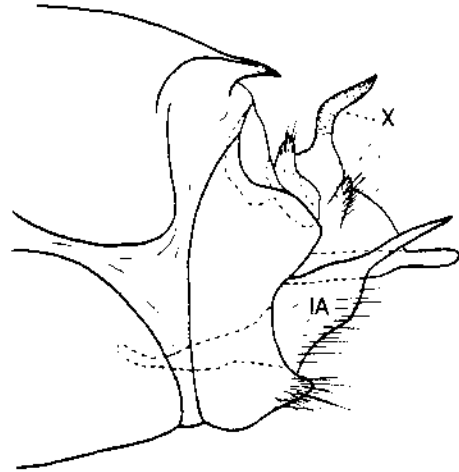

458

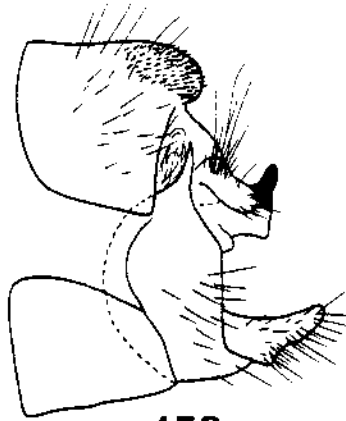

459

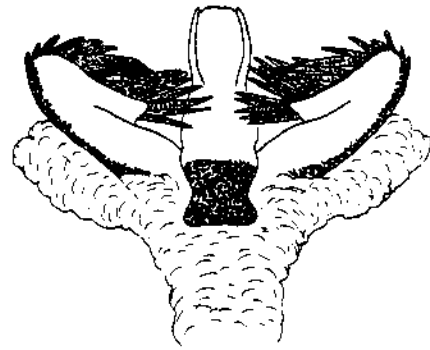

460

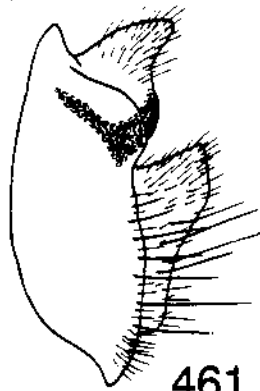

461

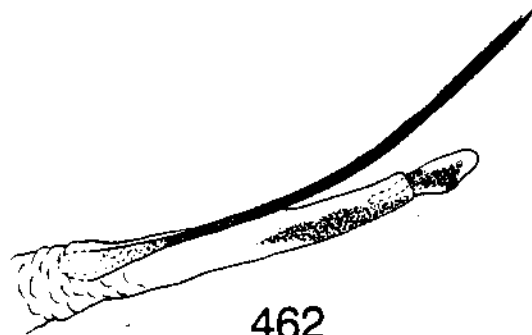

462

Figs. 463-474. *Pycnopsyche* male genitalia. 463-464. *P. guttifer*. 463. Lateral. 464. Inferior appendage, caudal. 465-466. *P. rossi*. 465. Tergum VIII, lateral. 466. Inferior appendage, caudal. 467. *P. scabripennis* inferior appendage, caudal. 468-470. *P. lepida*. 468. Tergum VIII, dorsal. 469. Inferior appendage, caudal. 470. Phallus, lateral. 471. *P. indiana* phallus, lateral. 472-474. *P. subfasciata*. 472. Phallus, lateral. 473. Inferior appendage, caudal. 474. Lateral.

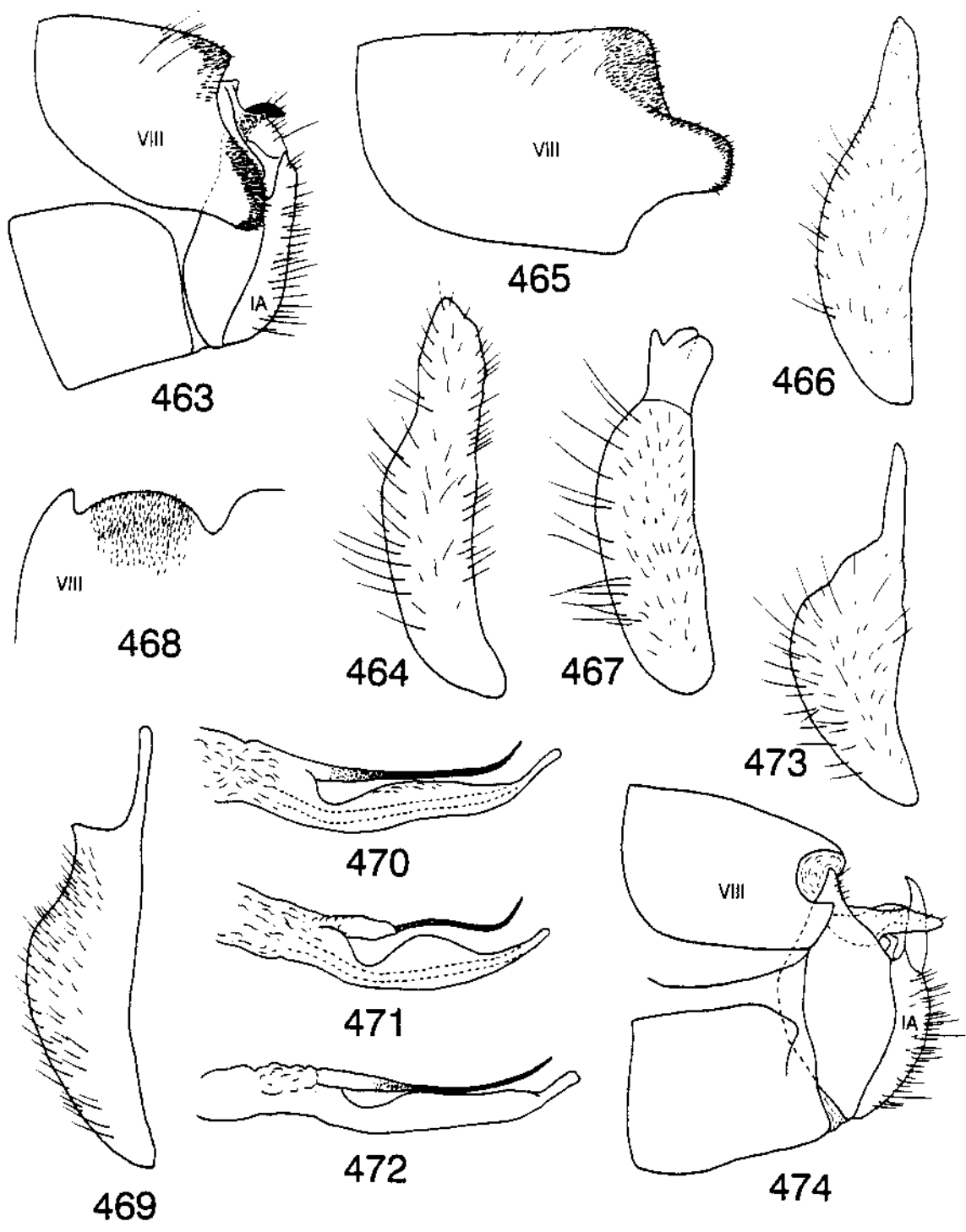

Figs. 475-484. *Molanna*. 475-476. *M. ulmerina*. 475. Larval head, dorsal. 476. Larval prothoracic leg. 477. *M. uniophila* head, dorsal. 478. *M. blenda* larval prothoracic leg. 479-481. Male genitalia, lateral. 479. *M. uniophila*. 480. *M. blenda*. 481. *M. ulmerina*. 482-483. Female subgenital plate, ventral. 482. *M. blenda*. 483. *M. uniophila*. 484. *M. ulmerina* hindwing.

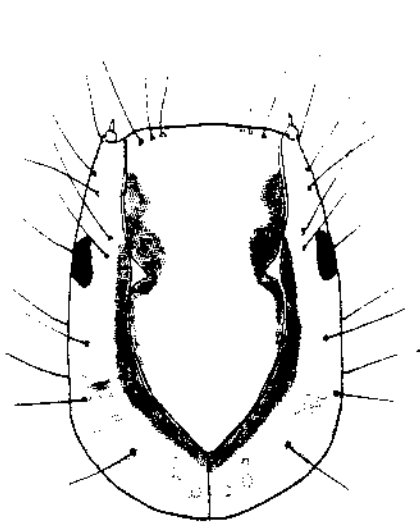

475

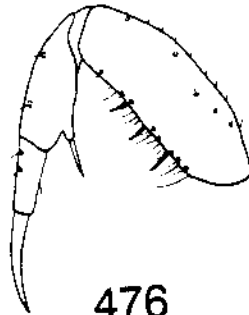

476

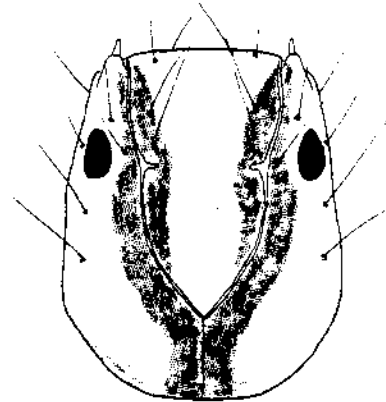

477

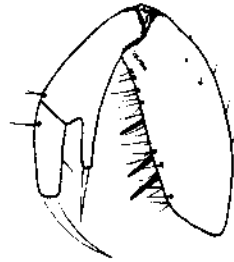

478

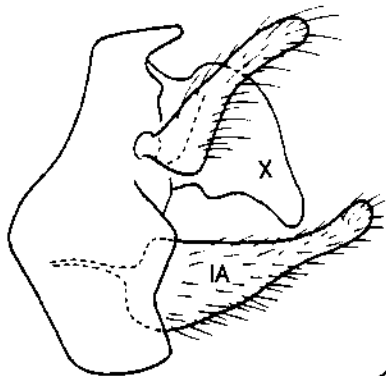

479

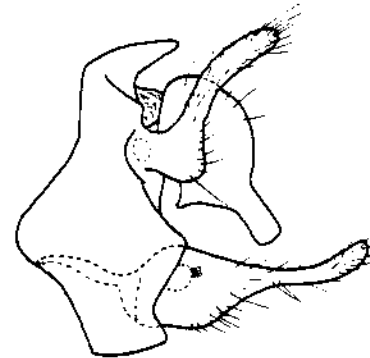

481

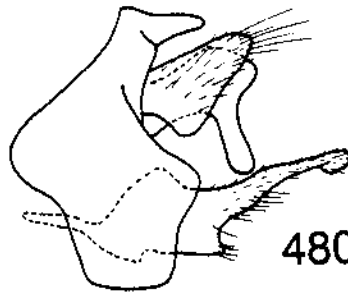

480

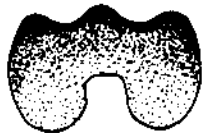

482

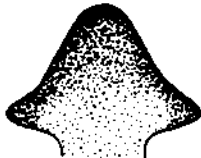

483



484

Figs. 485-492. *Marilia*. 485-488. *M. flexuosa*. 485. Male genitalia, lateral. 486. Phallus, lateral. 487. Forewing. 488. Larval head, dorsal. 489-492. *M. sp A.*, larva. 489. Head, dorsal. 490. Head, ventral. 491. Thoracic nota. 492. Case.

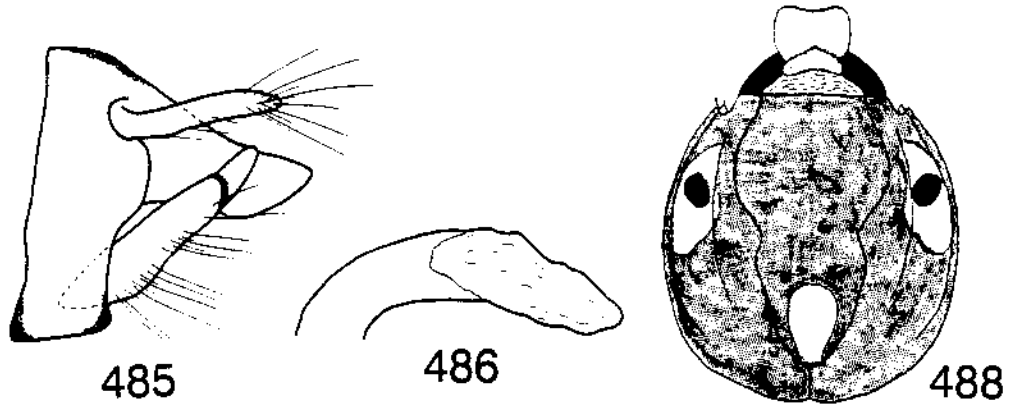

485

486

488

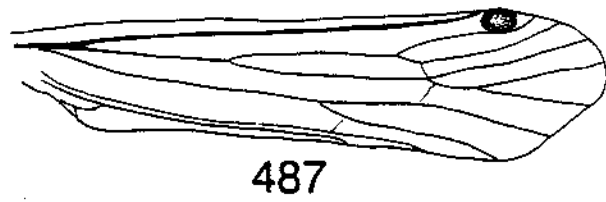

487

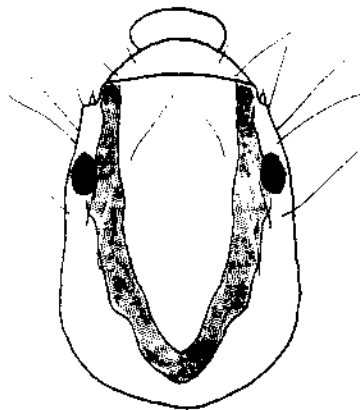

489

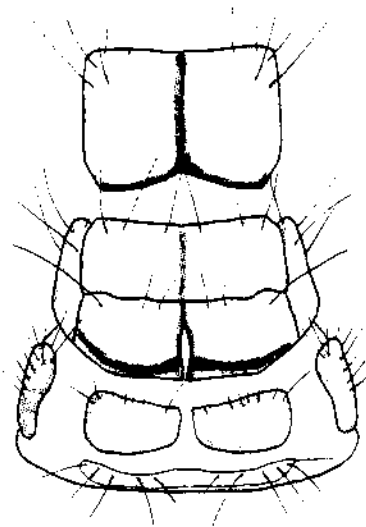

491

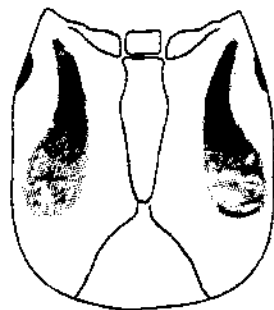

490

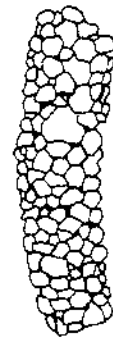

492

Figs. 493-501. *Chimarra* and *Wormaldia*. 493-494. Larval heads, dorsal. 493. *Chimarra* sp. 494. *Wormaldia* sp. 495-496. Hindwings. 495. *Chimarra* sp. 496. *Wormaldia* sp. 497-501. Male genitalia. 497. *C. obscura*, lateral. 498. *C. feria*, lateral. 499. *C. feria* inferior appendage, caudal. 500. *C. aterrima*, lateral. 501. *C. aterrima* inferior appendage, caudal.

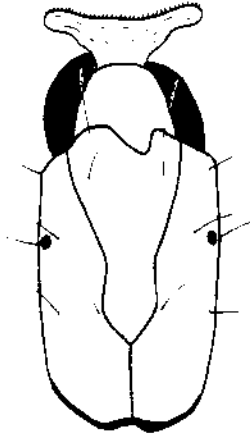

493

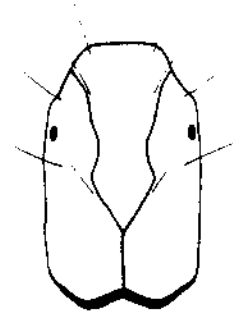

494



495



496

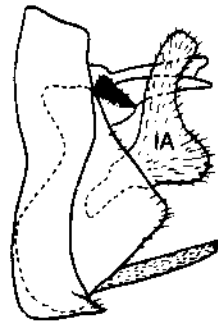

497

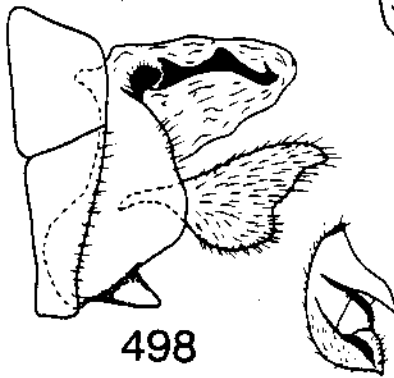

498



499



500

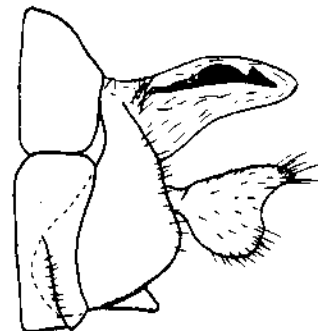

501

Figs. 502-512. *Chimarra* and *Wormaldia* male genitalia. 502-503. *C. parasocia*. 502. Lateral. 503. Dorsal phallic rod, lateral. 504-505. *C. socia*. 504. Lateral. 505. Dorsal phallic rod, lateral. 506-507. *C. moselyi*. 506. Lateral. 507. Phallus, dorsal. 508. *W. moesta*, lateral. 509-510. *W. strota*. 509. Lateral. 510. Tergum X, dorsal. 511-512. *W. shawnee*. 511. Lateral. 512. Tergum X, dorsal.

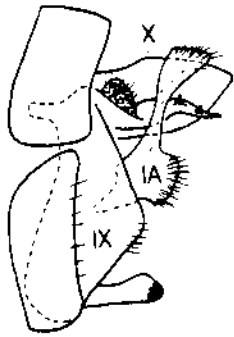

502



503



504



505



506

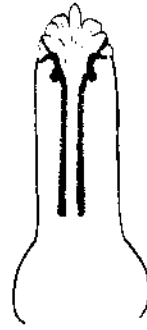

507

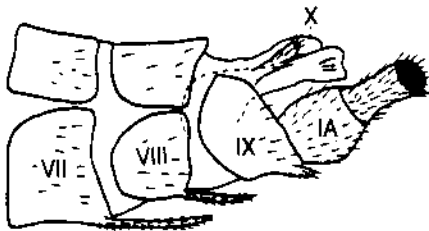

508

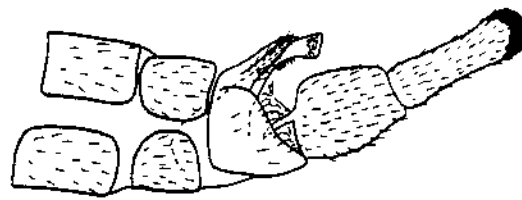

509

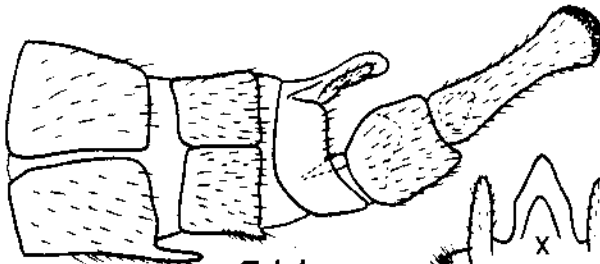

511

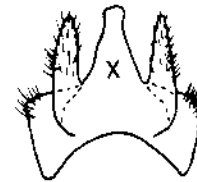

510



512

Figs. 513-520. Phryganeidae male genitalia. 513-514. *A. vestita*. 513. Lateral. 514. Phallus, lateral. 515-516. *Phryganea sayi*. 515. Lateral. 516. Phallus, lateral. 517-520. *Ptilostomis* male genitalia. 517-518. *P. ocellifera*. 517. Lateral. 518. Phallus, lateral. 519-520. *P. postica*. 519. Lateral. 520. Phallus, lateral.

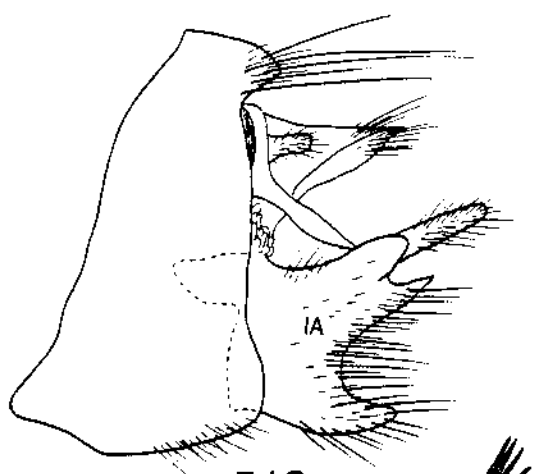

513



514

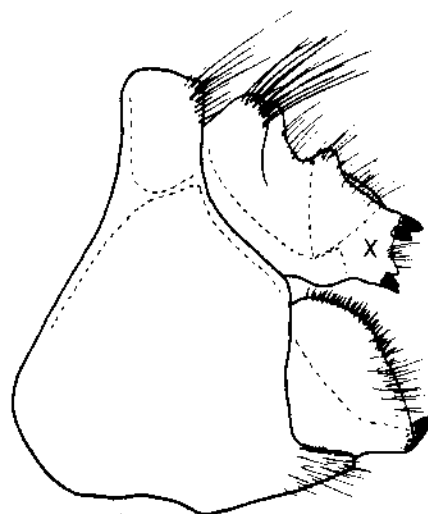

515

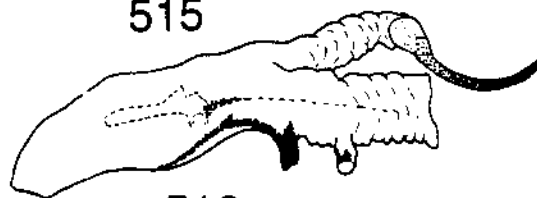

516

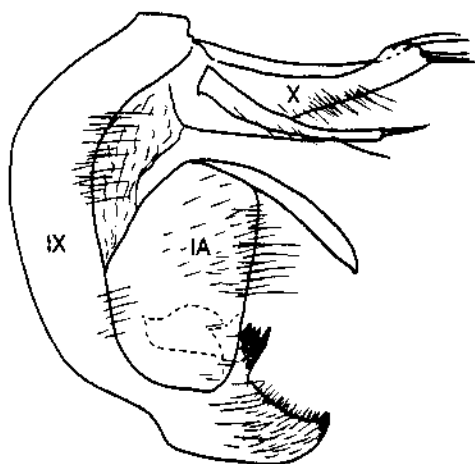

517



518

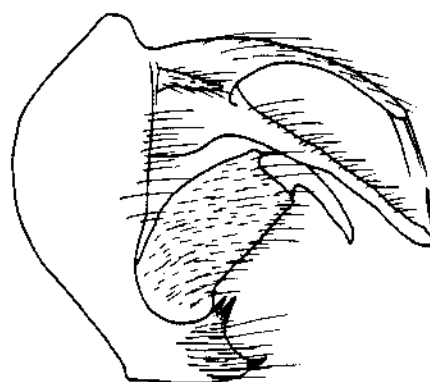

519



520

Figs. 521-526. Phryganeidae females. 521-522. Anteroapical margin of forewings. 521. *Ptilostomis postica*. 522. *Agrypnia vestita*. 523-524. *Ptilostomis* vaginal apparatus, lateral. 523. *P. ocellifera*. 524. *P. postica*. 525-526. Genitalia, ventral. 525. *Phryganea sayi*. 526. *A. vestita*.

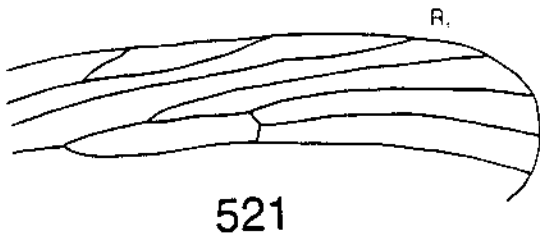

521

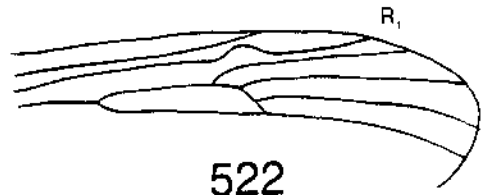

522

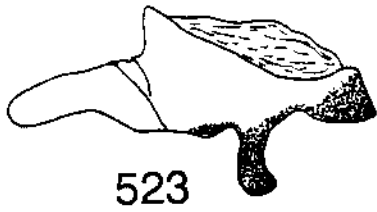

523



524

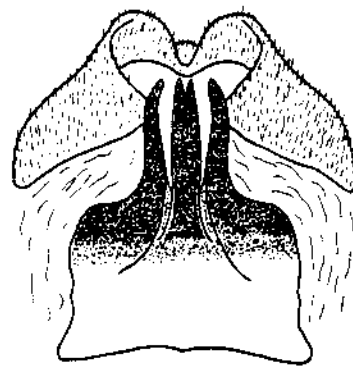

525

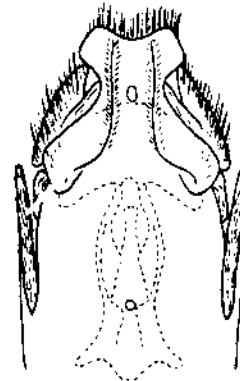

526

Figs. 527-534. Larval Polycentropodidae. 527-528. *Neureclipsis crepuscularis*. 527. Head, dorsal. 528. Anal proleg, lateral. 529. *Nyctiophylax* sp. anal claw, lateral. 530. *Cyrnellus fraternus* anal proleg, dorsal. 531-532. *Polycentropus* sp. anal proleg. 531. Dorsal. 532. Lateral. 533-534. *P. crassicornis*. 533. Anal proleg, lateral. 534. Head and pronotum, dorsal.

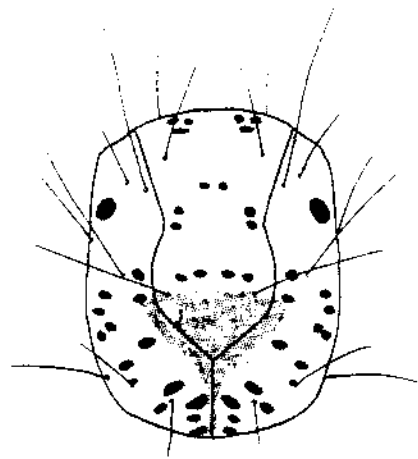

527

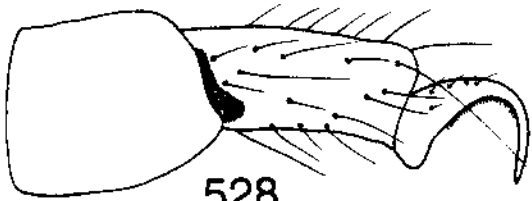

528

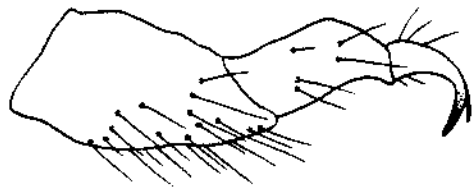

532

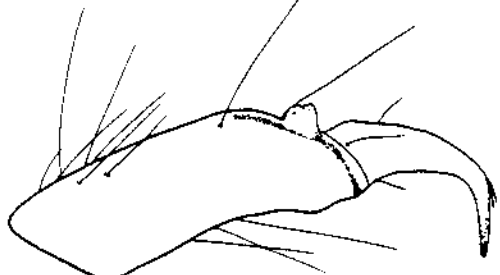

533



529

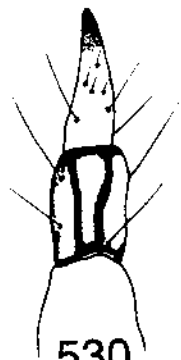

530

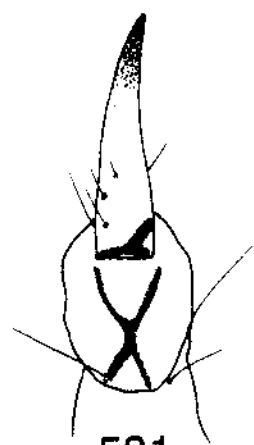

531

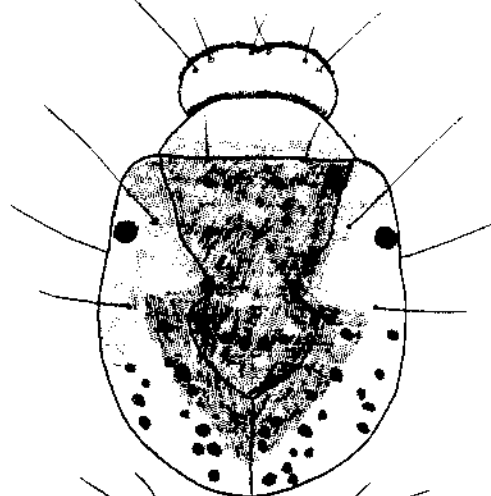

534

Figs. 535-543. Adult Polycentropodidae. 535-537. *Phylocentropus placidus*, male. 535. Forewing. 536. Genitalia, lateral. 537. Inferior appendage, caudal. 538-540. *Polycentropus* and *Neureclipsis* wings. 538. *P. centralis* fore- and hindwing. 539. *P. harpi* hindwing. 540. *N. crepuscularis* hindwing. 541-542. Maxillary palpi, lateral. 541. *Cyrnellus fraternus*. 542. *Nyctiophylax affinis*. 543. *Polycentropus nascotius* male genitalia, lateral. (Fig. 543 redrawn from Ross 1941).

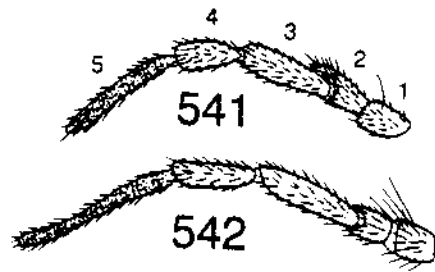
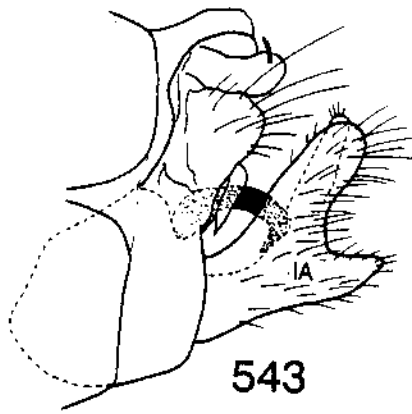
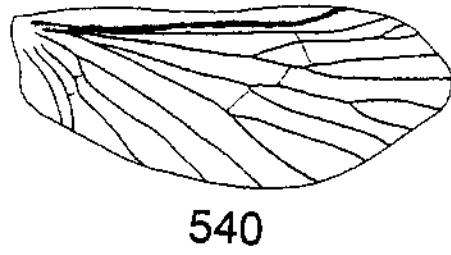
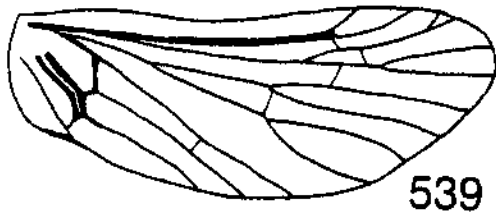
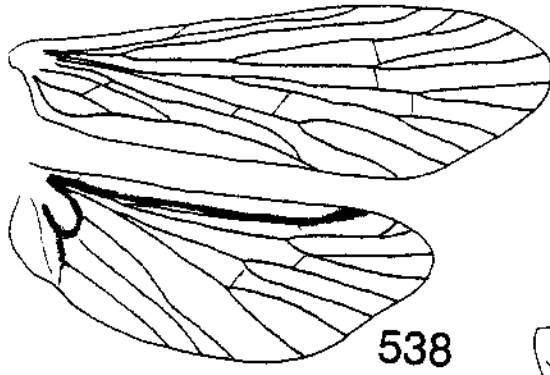
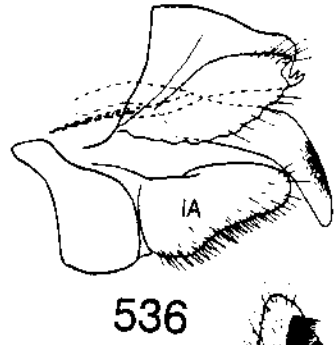
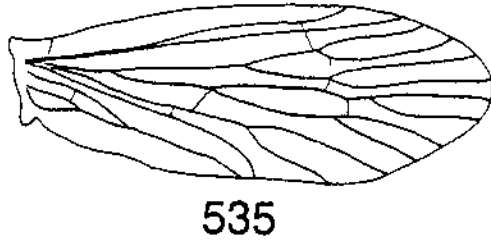

Figs. 544-555. Polycentropodidae male genitalia. 544-545. *Cernotina*, lateral. 544. *C. calcea*. 545. *C. spicata*. 546. *C. oklahoma*. 547-548. *Cyrnellus fraternus*. 547. Lateral. 548. Inferior appendage, caudal. 549. *Neureclipsis crepuscularis*, lateral. 550-555. *Nyctiophylax* spp. 551-552. *N. serratus*. 550. Lateral. 551. Posteroapical margin of tergum X, lateral. 552-553. *N. affinis*. 552. Lateral. 553. Inferior appendage, caudal. 554-555. *N. moestus*. 554. Lateral. 555. Inferior appendage, caudal. (Figs 554-555 redrawn from Morse 1972).

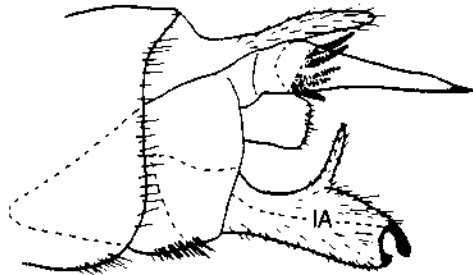

544

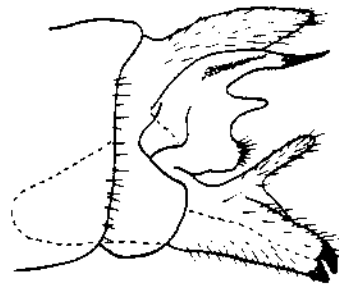

545

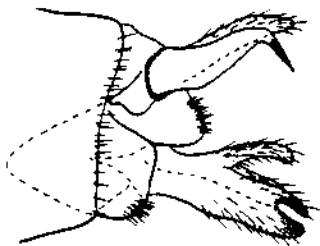

546

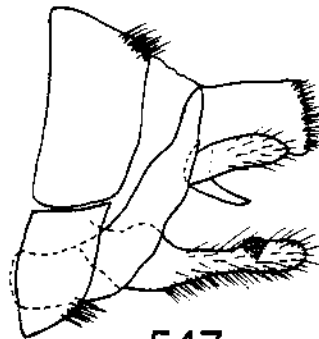

547



548

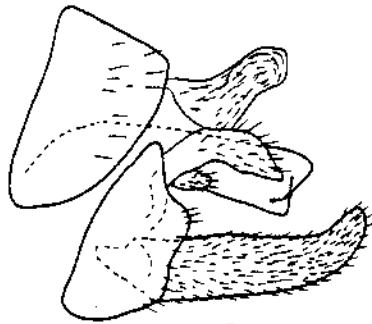

549

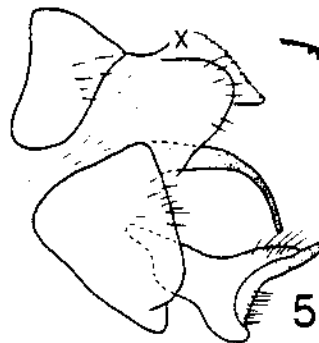

550



551

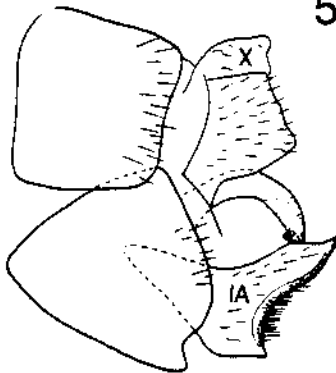

552

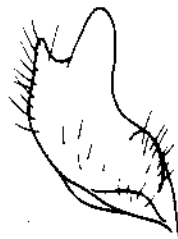

553

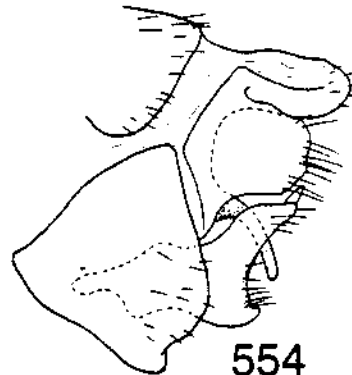

554

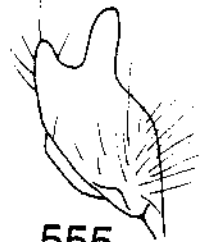

555

Figs. 556-570. *Polycentropus* male genitalia. 556-557. Dorsobasal process of inferior appendages, caudal. 556. *P. centralis*. 557. *P. stephani*. 558-559. *P. chelatus*. 558. Lateral. 559. Phallus, lateral. 560-561. *P. stephani*, paratype. 560. Lateral. 561. Phallus, lateral. 562-563. *P. confusus*. 562. Lateral. 563. Phallus, lateral. 564-565. *P. centralis*. 564. Lateral. 565. Phallus, lateral. 566. *P. crassicornis*, lateral. 567-568. *P. cinereus*. 567. Lateral. 568. Phallus, dorsal. 569-570. *P. harpi*, paratype. 569. Phallus, dorsal. 570. Lateral.

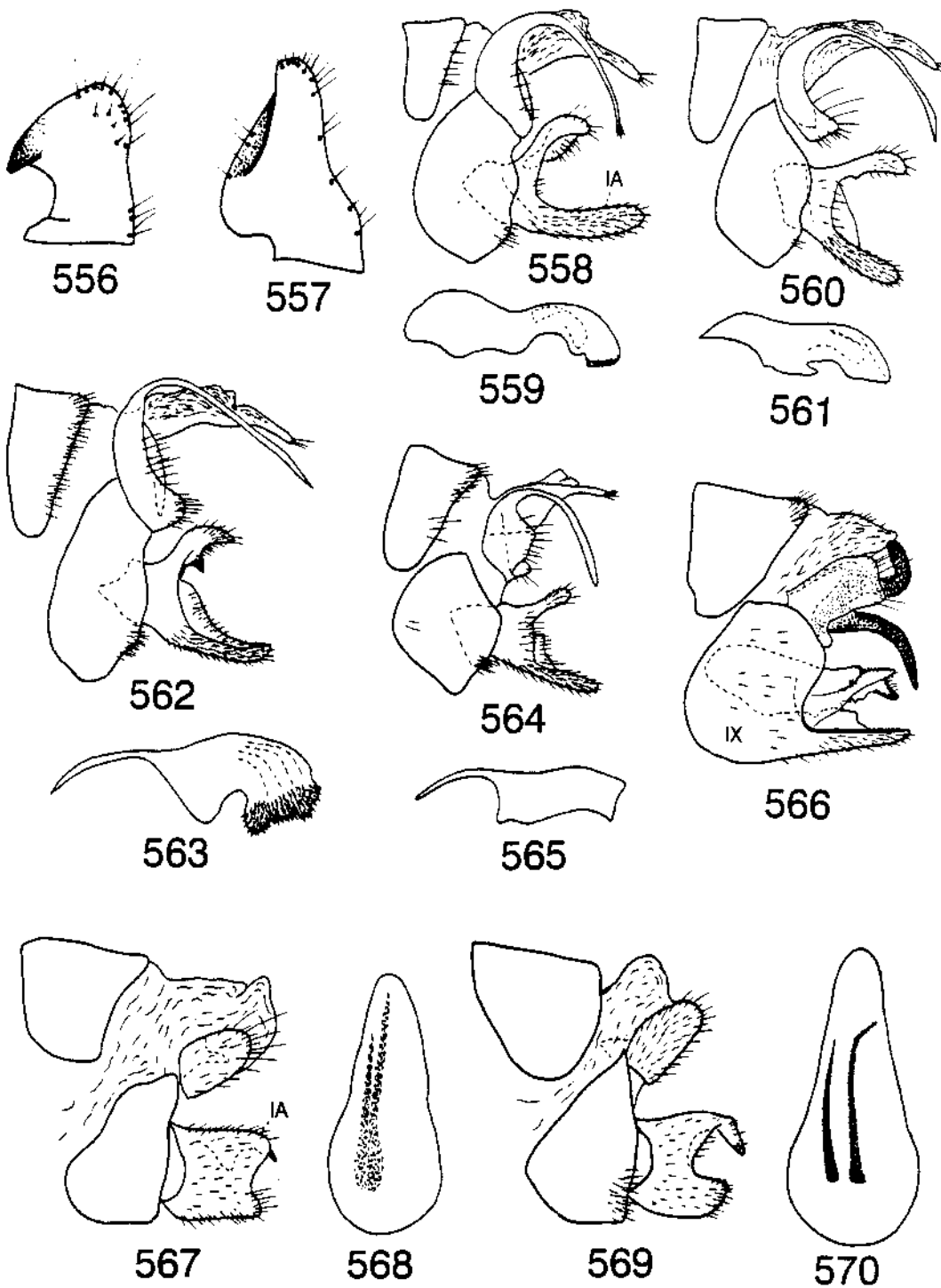

Figs. 571-579. Psychomyiidae. 571. *Paduniella nearctica* larval habitus, dorsal. 572. *Psychomyia flavida* larval head, dorsal. 573. *P. nearctica* maxillary palpus, lateral. 574. *P. flavida* hindwing. 575. *Lype diversa* hindwing. 576-579. Male genitalia. 576-577. *P. flavida*. 576. Lateral. 577. Tergum X, caudal. 578. *L. diversa*, lateral. 579. *P. nearctica*, lateral.

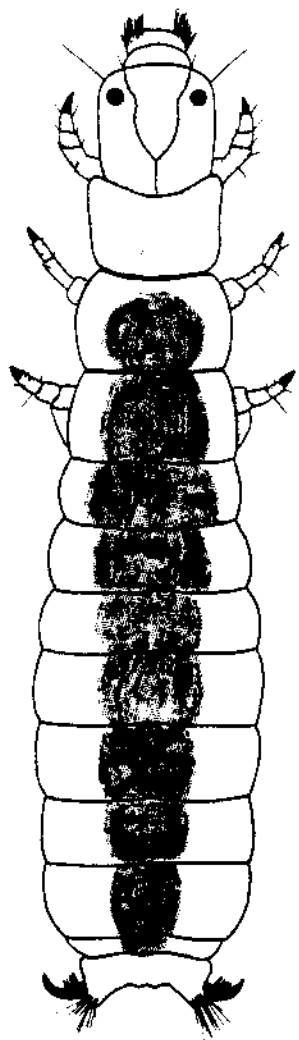

571

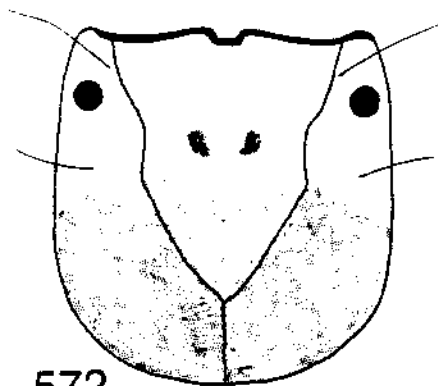

572

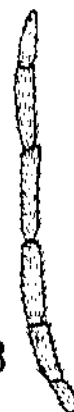

573

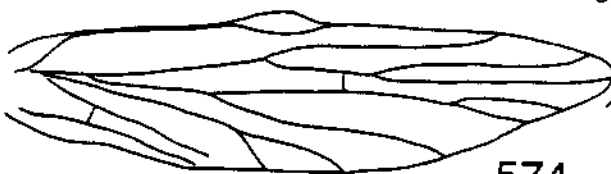

574



575

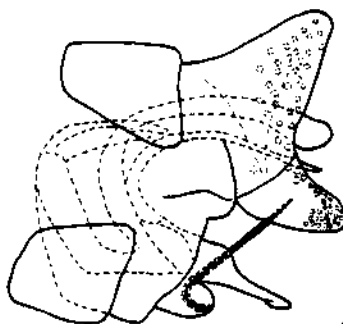

576



577

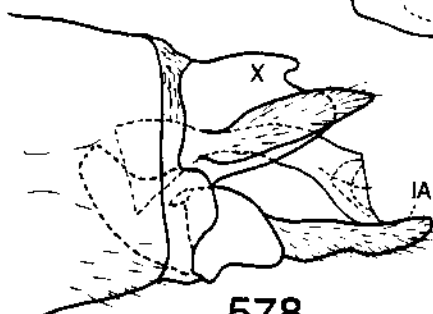

578

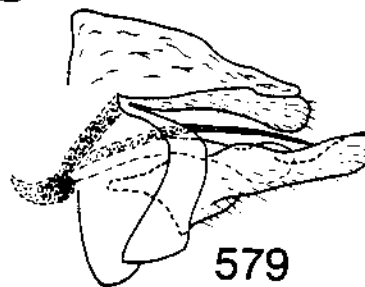

579

Figs. 580-588. Larval *Rhyacophila*. 580-581. *R. glaberimma*. 580. Head, dorsal. 581. Maxillary palpus. 582-583. *R. lobifera*. 582. Head, dorsal. 583. Anal claw, lateral. 584-585. *R. banksi*. 584. Head, dorsal. 585. Anal claw, lateral. 586-587. *R. fenestra*. 586. Head, dorsal. 587. Maxillary palpus. 588. *R. kiamichi* head, dorsal.

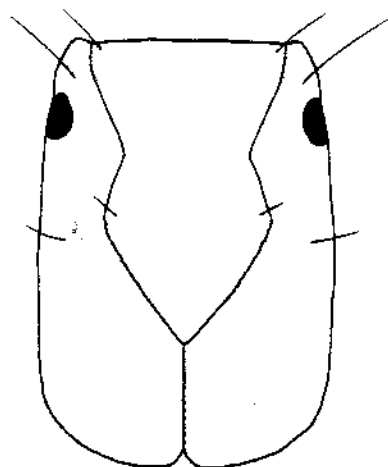

580



581

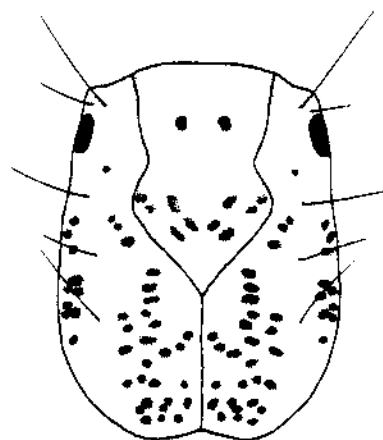

582

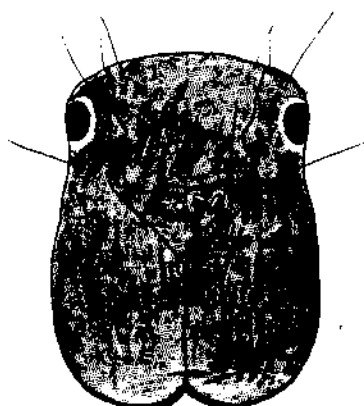

584

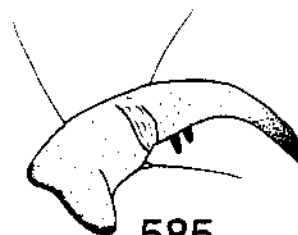

585

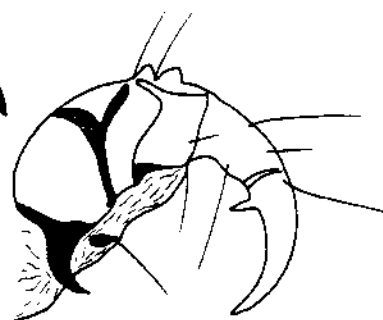

583

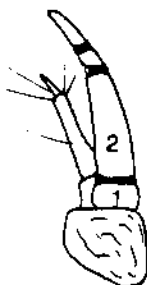

587

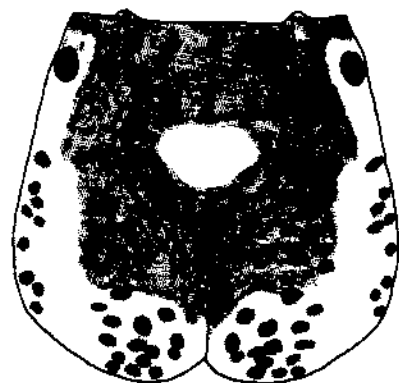

586

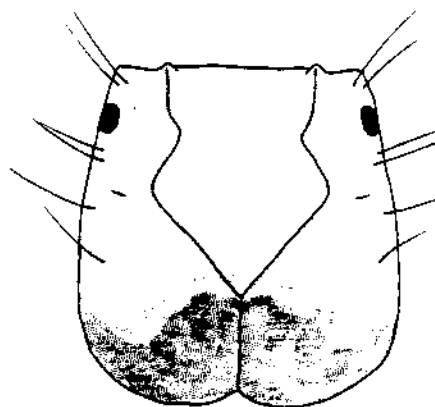

588

Figs. 589-597. *Rhyacophila* male genitalia. 589-590. *R. glaberimma*. 589. Lateral. 590. Phallus, lateral. 591-592. *R. lobifera*. 591. Lateral. 592. Phallus, lateral. 593. *R. banksi*, lateral. 594-595. *R. kiamichi*. 594. Lateral. 595. Phallus, lateral. 596-597. *R. fenestra*. 596. Lateral. 597. Phallus, lateral.

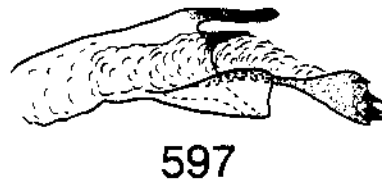
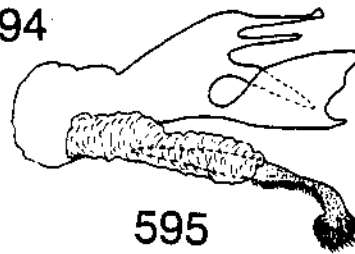
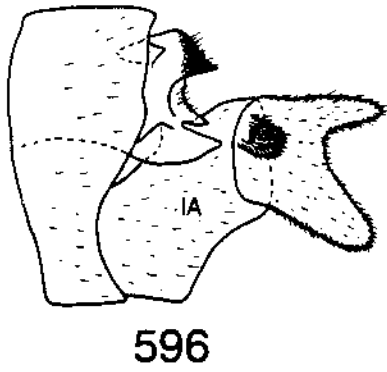
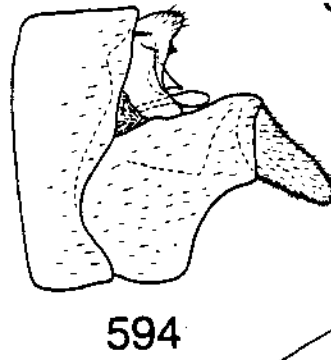
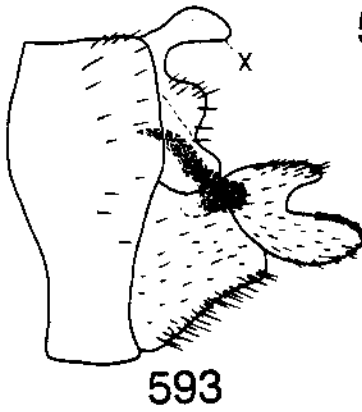
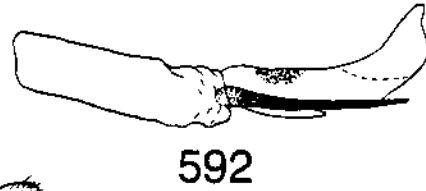
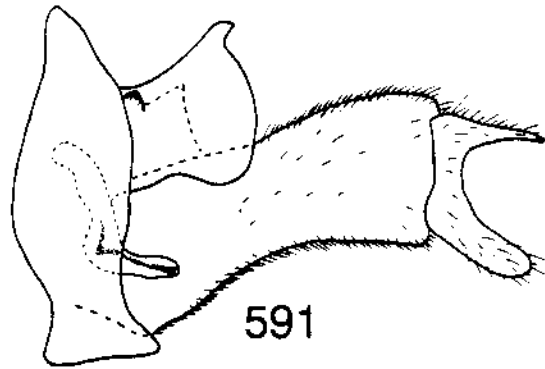
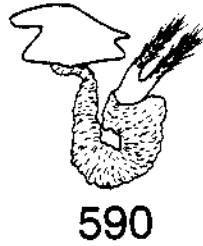
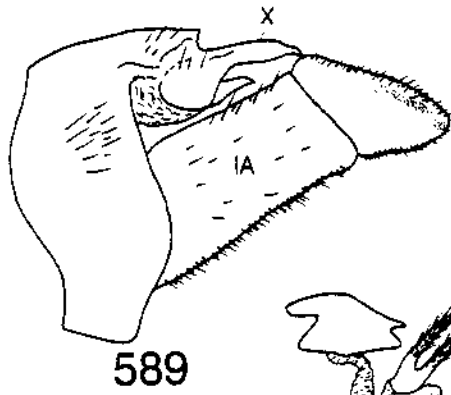

Figs. 598-604. *Rhyacophila* male and female genitalia. 598-599. *R. ledra* male. 598. Lateral. 599. Phallus, lateral. 600-602. Female sternite VIII. 600. *R. lobifera*. 601. *R. glaberimma*. 602. *R. banksi*. 603-604. Female tergite VIII. 603. *R. fenestra*. 604. *R. kiamichi*.

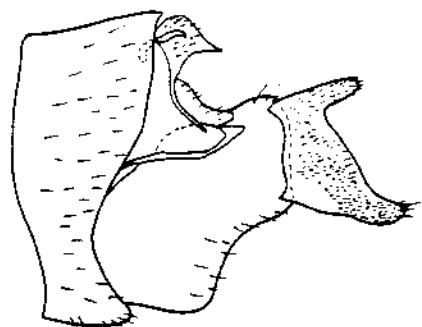

598

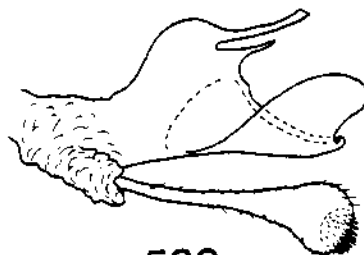

599

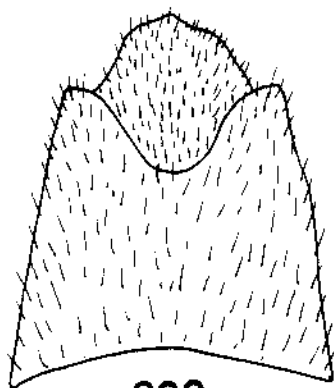

600

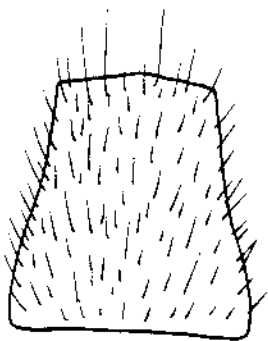

601

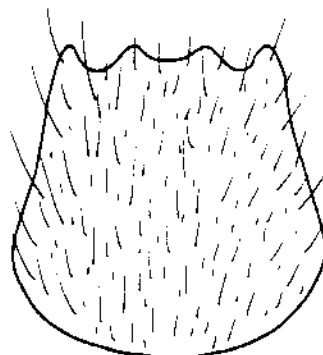

602

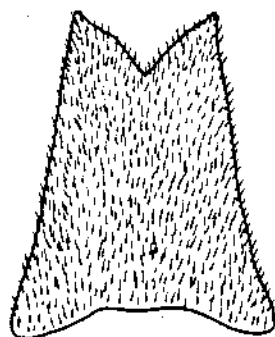

603

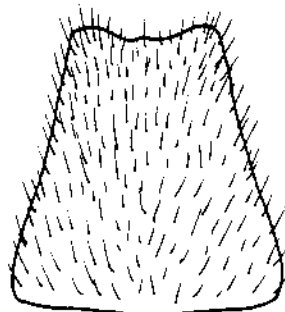

604

Figs. 605-611. Uenoidae. 605-608. *N. concinnus*. 605. Male genitalia, lateral. 606. Female genitalia, ventral. 607. Larval head, lateral. 608. Larval head, dorsal. 609-611. *N. fuscus*. 609. Male genitalia, lateral. 610. Female genitalia, ventral. 611. Larval head, dorsal.

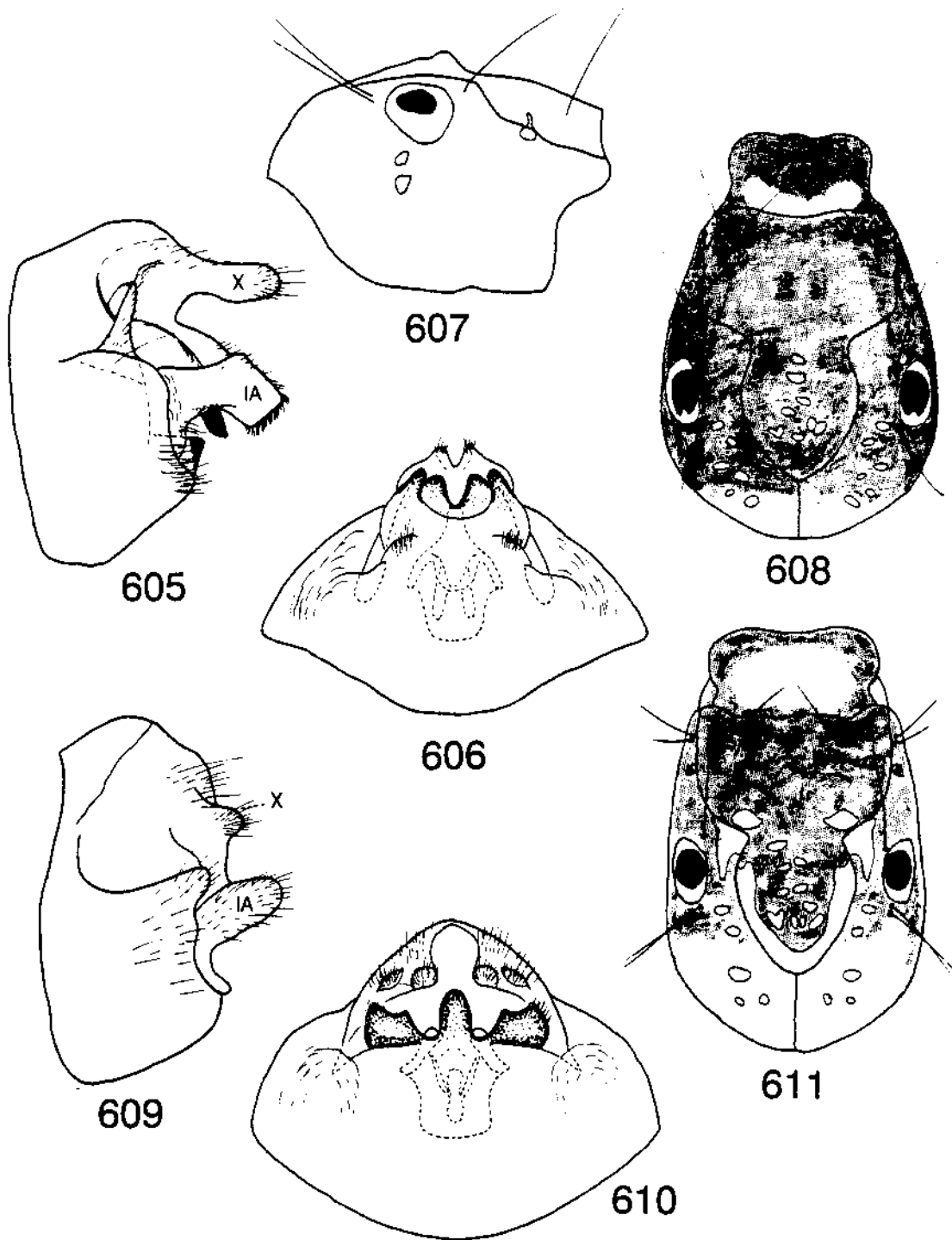

Figs. 612-614. Distributions of endemic Interior Highland Annulipalpia.
612. *Agapetus artesus* (solid circle), *A. medicus* (solid square), *Protoptila* sp. A (solid triangle), *Rhyacophila kiamichi* (open circle), *Wormaldia strota* (open square). Fig. 613. *Ceratopsyche piatrix* (solid circle), *Cheumatopsyche robisoni* (solid square), *C. rossi* (solid triangle), *Polycentropus stephani* (open circle), *Paduniella nearctica* (open square). Fig. 614. *Hydroptila artesa* (solid circle), *Neotrichia arkansasensis* (solid square), *N. kitae* (solid triangle), *Ochrotrichia contorta* (open circle), *O. robisoni* (open square), *O. weddleae* (open triangle), *Paucicalcaria ozarkensis* (asterisk).

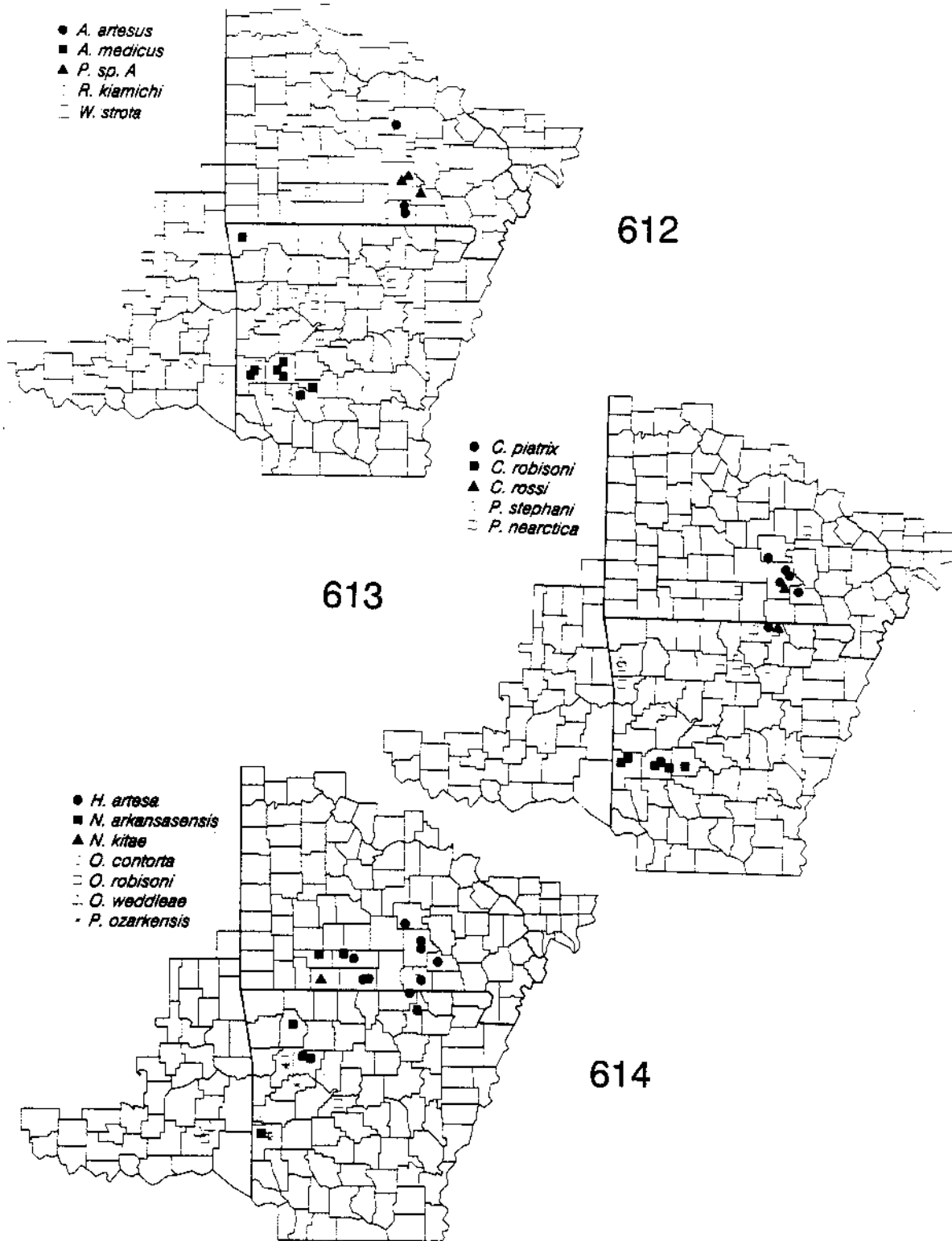

Figs. 615-616. Distributions of endemic Interior Highland Integripalpia.
615. *Ceraclea maccalmonti* (solid circle), *Helicopsyche limnella* (solid square),
Marilia sp. A (solid triangle), *Oecetis ouachita* (open circle), *O. ozarkana* (open
square), *Setodes oxapius* (open triangle). Fig. 616. *Glyphopsyche missouri*
(asterisk), *Lepidostoma lescheni* (solid circle), *L. ozarkense* (solid square),
Micrasema ozarkana (solid triangle).

