

# AMERICAN MUSEUM *Novitates*

PUBLISHED BY THE AMERICAN MUSEUM OF NATURAL HISTORY  
CENTRAL PARK WEST AT 79TH STREET, NEW YORK, NY 10024  
Number 3673, 27 pp., 10 figures November 30, 2009

## A New Genus of Microteiid Lizard from the Caparaó Mountains, Southeastern Brazil, with a Discussion of Relationships among Gymnophthalminae (Squamata)

MIGUEL TREFAUT RODRIGUES,<sup>1,2</sup> JOSÉ CASSIMIRO,<sup>2</sup> DANTE PAVAN,<sup>2</sup>  
FELIPE FRANCO CURCIO,<sup>2</sup> VANESSA KRUTH VERDADE,<sup>2</sup> AND  
KÁTIA CRISTINA MACHADO PELLEGRINO<sup>3</sup>

### ABSTRACT

A new genus and species of microteiid lizard is described based on a series of specimens obtained at Parque Nacional do Caparaó (20°28'S, 41°49'W), southeastern Brazil, along the division line between the States of Minas Gerais and Espírito Santo. The new lizard occurs in isolated high-altitude, open, rocky habitats above the altitudinal limits of the Atlantic forest. It is characterized by the presence of prefrontals, frontoparietals, parietals, interparietal, and occipital scales; ear opening and eyelid distinct; three pairs of genials; absence of collar; lanceolate and mucronate dorsal scales; six regular transverse and longitudinal series of smooth ventrals that are longer than wide, with the lateral ones narrower. Maximum parsimony (MP) and partitioned Bayesian (PBA) phylogenetic analyses based on morphological and molecular characters with all known genera of Gymnophthalminae (except for *Scriptosaura*) plus *Rhachisaurus* recovered this new lizard in a clade having *Colobodactylus* and *Heterodactylus* as its closest relatives. Both analyses recovered the monophyly of Gymnophthalminae and Gymnophthalmini. The monophyly of the Heterodactylini received moderate support in MP analyses but was not recovered in PBA. To eliminate classification controversy between these results, the present concept of Heterodactylini is restricted to accommodate the new genus, *Colobodactylus* and *Heterodactylus*, and a new tribe Iphisiini is proposed to allocate *Alexandresaurus*, *Iphisa*, *Colobosaura*, *Acratosaura*, and *Stenolepis*. Current

<sup>1</sup> Division of Vertebrate Zoology (Herpetology), American Museum of Natural History.

<sup>2</sup> Universidade de São Paulo, Instituto de Biociências, Departamento de Zoologia, Caixa Postal 11.461, CEP 05422-970, São Paulo, Brazil (mturodri@usp.br; geckoides@yahoo.com.br; dtpavan@usp.br; ffcurcio@yahoo.com; vverdade@usp.br).

<sup>3</sup> Universidade Federal de São Paulo, Campus Diadema, Departamento de Ciências Biológicas, Diadema, São Paulo, Brazil (katia.pellegrino@unifesp.br).

phylogenetic knowledge of Gymnophthalminae suggests that fossoriality and increase of body elongation arose as adaptive responses to avoid extreme surface temperatures, either cold or hot, depending on circumstances.

## INTRODUCTION

Mountains are traditionally recognized sites of animal and plant endemism and this is also the situation in eastern Brazil (papers in Vanzolini and Heyer, 1988). Several endemic frogs, lizards, snakes, fishes, and plants, among several other groups have been described from high mountain areas in the Atlantic forest or in the Serra do Espinhaço, the last one a mountain range that extends along the states of Minas Gerais and Bahia in eastern Brazil (e.g. Cunha, 1966; Vanzolini, 1982; Sazima and Bokermann, 1983; Caramaschi and Sazima, 1984, 1985; Giulliete and Pirani, 1988; Pinna, 1992; Heyer, 1999; Pugliese et al., 2004; Rodrigues et al., 2006; Napoli and Juncá, 2006; Lugli and Haddad, 2007a, 2007b). The Serra do Caparaó, in the eastern Atlantic forest domain at the border of the states of Minas Gerais and Espírito Santo, is one such area.

About 30 years ago William Ronald Heyer and Paulo Vanzolini undertook an expedition to the Caparaó mountains. At the time they were mainly focused on obtaining representative samples of the frog and lizard genera they were studying (respectively *Cycloramphus* and *Colobodactylus*), both characterized by the presence of endemic species in other mountain areas of the Atlantic forest. Between 28 November and 5 December 1980, they collected two new endemic species of *Hylodes* (Heyer, 1982), a new *Cycloramphus* (Heyer, 1983), and two specimens of a new gymnophthalmid lizard that remained undescribed until now. At the time, Vanzolini personally told the senior author that the description of the new taxon was not an easy task because it involved complications, probably in the synonymy of the genera *Colobosaura* and *Colobodactylus*. It is important to say that this actually was a fairly good approximation of its relationships because microteiid systematics was chaotic due to the widespread use of convergent morphological traits in the classification of the family (see Rodrigues et al., 2005). It was only recently, in the process of describing the new gymnophthalmid genus *Alexandresaurus* Rodrigues et al., 2007, that the senior author discovered that these spec-

imens (MZUSP 55926 and USNM 008080–field number) along with other specimens of *Colobosaura* and *Heterodactylus* were in very bad condition. Although they were almost completely rotten it was possible to say that they were representatives of another genus, related to *Colobodactylus* and *Heterodactylus*, that had not been formally described. We immediately planned a trip to the area to get new specimens and data on its natural history. Our success in these goals allows us to formally describe the new lizard and to comment upon its natural history and relationships.

The rediscovery of this new genus also gives us the opportunity to discuss in more detail the relationships among Gymnophthalmidae. The family currently includes the subfamilies Alopoglossinae, Rhachisaurinae, Gymnophthalminae, and Cercosaurinae, according to Pellegrino et al. (2001) and Rodrigues et al. (2005, 2007). Castoe et al. (2004) also attributed subfamilial rank to the Ecleopinae<sup>4</sup> contrary to the tribal rank among the Cercosaurinae proposed by Pellegrino et al. (2001) and Rodrigues et al. (2005, 2007). Although the Gymnophthalminae is strongly supported as a monophyletic assemblage, there is controversy regarding the monophyly of Heterodactylini and Gymnophthalmini, the two tribes within the subfamily. Pellegrino et al. (2001), following a molecular maximum parsimony analysis of both nuclear and mitochondrial genes (2379 bp), considered these tribes reciprocally monophyletic. Castoe et al. (2004), based on Bayesian analyses of a slightly improved molecular dataset than those used by Pellegrino et al. (2001), dissolved the tribes because monophyly of Gymnophthalmini was not recovered. Contrarily, Rodrigues et al. (2005, 2007), based on a combined analyses of molecular and morphological characters, bring support to this basic division in Gymnophthalminae. However, as the last study was addressed to recover the position of *Alexandresaurus* among the Heterodactylini, and not to

<sup>4</sup> We thank Darrel Frost for alerting us that the collective correct form for Ecleopinae (from *Ecleopus*) is actually Ecleopodinae.

test its monophyly, only two of the eight genera of Gymnophthalmini admitted at the time were represented in those analyses. In order to further contribute to this matter, herein we present a reanalysis of Gymnophthalminae relationships based on combined morphological and molecular characters, which now includes all known genera of Gymnophthalminae, except for the recently described eyelid-less *Scriptosaura*, which has been suggested to be sister to *Calyptommatius* (Rodrigues and Santos, 2008).

## MATERIAL AND METHODS

Snout-vent length was measured to the nearest mm with a ruler; scale counts and osteological data on cleared and double-stained specimens (appendix 1) were taken with the aid of a stereomicroscope. Scale counts and scale nomenclature are according to Rodrigues et al. (2007) and osteological nomenclature follows Presch (1980), Estes et al. (1988), Bell et al. (2003), and Rodrigues et al. (2005, 2007). We considered occipitals the one or two pairs of transversely enlarged scales following interparietal and parietals. Sex was determined by the presence/absence of femoral pores and confirmed by dissection in previously opened specimens. All comparative data were taken from preserved specimens housed at MZUSP (Museu de Zoologia, Universidade de São Paulo). Statistical analyses were done using SPSS 13.0 for Windows. Altitudes and coordinates were taken with a GPS Garmin 12. The temperature data presented in the natural history section were taken with a data logger model HOBO Pro, from 28 December 2004 to 17 November 2005; temperatures were recorded at continuous intervals of four hours. Appendix 1 presents the 18 species used in the present study, including the new one herein described. It includes all genera of known Gymnophthalminae (except for *Scriptosaura*), plus *Rhachisaurus brachylepis* (Rhachisaurinae) and *Alopoglossus atriventris* (Alopoglossinae), both formally recognized and strongly supported as basal to all other clades of Gymnophthalmidae (*Alopoglossus*) and of Gymnophthalminae (*Rhachisaurus*) (Pellegrino et al., 2001; Castoe et al., 2004; Rodrigues et al., 2007). *Rhachisaurus* was allowed to “float”

among the Gymnophthalminae genera and *Alopoglossus* was assigned as outgroup. External morphological characters included in appendix 2 were selected among those not presenting intraspecific polymorphism based on examination of the MZUSP collections.

For the phylogenetic analyses, we used DNA sequences collected by Pellegrino et al. (2001) for the mitochondrial 16S and ND4 and the nuclear c-mos and 18S regions, to which we added sequences for the new taxon herein described as well as a partial ND4 sequence for *Vanzosaura rubricauda* (GenBank accession numbers EU620438–620442). The present molecular partition is composed of 2013 bp of aligned sequences; some adjustments on the original Pellegrino et al. (2001) alignments for the ribosomal 16S and 18S and c-mos regions were performed manually on the reduced matrix used here to accommodate the new sequences and exclude unnecessary gaps.

First we conducted separate analyses on the morphological partition followed by a combined analysis with the molecular partition under equally weighted parsimony (MP) in PAUP\* v4.0b10 (Swofford, 2002). For a matrix of 77 morphological characters (appendix 3), with all character states coded as unordered and all transformations uniformly weighted, a search with the branch-and-bound algorithm was performed. The analysis of the combined data set included an MP heuristic search with 10,000 replicates of random stepwise addition and TBR branch-swapping.

Nodal support was assessed by bootstrap analysis (BS; Felsenstein, 1985) with 10,000 random stepwise additions per bootstrap pseudoreplicate, and TBR branch-swapping, in both branch-and-bound (morphology) and heuristic (combined data) searches; bootstrap values greater than 70% (Hillis and Bull, 1993) were interpreted as strong support for a node. Total and partitioned Bremer support (PBS) values (Baker and DeSalle, 1997), the latter representing the contribution of each specified data partition to each node, were calculated for all nodes of the combined MP topology using the program TreeRot v.2.0 (Sorenson, 1999).

Modeltest v.3.06 (Posada and Crandall, 1998) was used to select the appropriate model



Fig. 1. *Caparaonia itaiquara*, n. sp., an adult male photographed by F.F. Curcio at Parque Nacional do Caparaó, State of Minas Gerais, Brazil.

of evolution for each molecular-data partition through hierarchical likelihood ratio tests: 16S (TrN + I +  $\Gamma$ ), ND4 (TVM + I +  $\Gamma$ ), 18S (K80 + I +  $\Gamma$ ) and c-mos (K80 +  $\Gamma$ ). A partitioned Bayesian analysis using a combined matrix composed of molecular and morphological characters was implemented in Mr.Bayes 3.1.2. (Huelsenbeck and Ronquist, 2001) under the best-fit models of substitution for individual gene regions and morphological data set as "standard." Two independent runs with 4,000,000 generations, four chains and trees sampled at intervals of 100 generations, were conducted. Trees prior to stationary (10,000 trees) were discarded as "burn-in," and a 50% majority-rule consensus tree was obtained from 39,900 data points. Nodes on consensus trees from both runs with posterior probability (PP values)  $> 0.95$  were considered as evidence of significant support for clades (Huelsenbeck and Ronquist, 2001).

## RESULTS

### TAXON DESCRIPTION

#### *Caparaonia*, new genus

**DEFINITION:** An elongate gymnophthalmid (maximum SVL 60 mm) with distinctive ear opening and eyelid, long tail (1.5–2.5 times SVL), and slender pentadactyl limbs (fig. 1); first toe lacking claw. Frontonasal single; prefrontals, frontoparietals, parietals, interparietal, and a pair of occipitals present. Parietals longer than wide. Collar fold absent. Three pairs of chin shields and three supraoculars. Dorsal and lateral scales lanceolate, strongly keeled, with sides of scales almost juxtaposed. Ventrals longer than wide, smooth, in six regular transverse rows, the lateral ones narrower. Males with a continuous series of pores without gap between preanal and femoral

ones; 2–5 inconspicuous preanal pores in females. Hemipenis not totally everted, with a series of naked W-shaped and continuous transverse flounces ending in bifurcate end-free protuberances as wide as and continuous with the flounces; sulcus spermaticus apparently single, edged by an extensive naked area.

CONTENT: *Caparaonia itaiquara*, new species, monotypic.

ETYMOLOGY: Named for the Caparaó mountains, the type locality, and meaning “from Caparaó.”

COMPARISONS: Most character states for the taxa compared here are summarized in appendix 2. The Heterodactylini consists of two strongly supported groups of genera: the *Heterodactylus–Colobodactylus* clade and all the other Heterodactylini [*Alexandresaurus*, *Acratosaura*, *Colobosaura*, *Iphisa*, and *Stenolepis*] (Rodrigues et al., 2007). In addition to molecular characters, the two assemblages are supported by the condition of the supratemporal fenestra, the lateral expansion of the parietals, the postorbital width, the shape of the postfrontal, and the shape and size of the parietal scale (Rodrigues et al., 2007). The assemblage *Colobodactylus–Heterodactylus* also differs from the remaining Heterodactylini by their more elongated body and higher degree of limb reduction.

The following characters place *Caparaonia* squarely among the Heterodactylini: interclavicle cross shaped, with a central area extremely reduced; lateral process of interclavicle long, straight, and pointed; glossohyal fused to basihyal; nasals in slight contact with premaxilla, wide, divergent, and in contact at midline but broadly separated anteriorly by the subtriangular lamina of the premaxillary (Rodrigues et al., 2007).

The presence of an opened supratemporal fenestra, a narrow postorbital covering the postfrontal, and the absence of lateral expansion on parietal bones associate *Caparaonia* with the *Colobodactylus–Heterodactylus* assemblage. Another possible character linking *Caparaonia* to *Colobodactylus* and *Heterodactylus* is the condition of the parietals. These scales are wider than long in *Colobodactylus* and *Heterodactylus* whereas they are longer than wide in all other Heterodactylini. As previously reported this difference is

probably due to a scale rearrangement in *Heterodactylus* and *Colobodactylus* in which parietals (and the interparietal in *Colobodactylus*) are divided and their posterior regions incorporated into the highly conspicuous occipitals that characterize both genera (Rodrigues et al., 2005). The parietals of *Caparaonia* are not so reduced as those of *Colobodactylus* and *Heterodactylus*, but they are certainly shorter than those of other Heterodactylini. This suggests that although the parietals of *Caparaonia* may not be strictly homologous with those of *Colobodactylus* or *Heterodactylus*, they are strikingly different from the other genera of the tribe.

*Caparaonia* differs from *Colobodactylus* and *Heterodactylus* (data for the latter genera in parenthesis) by having a distinctive first finger (absent), distinctive prefrontal scales (absent), three pairs of chin shields (two pairs), and by having naked W-shaped flounces terminating by bifurcate free-ending extremities in the hemipenis (only V-shaped naked flounces). *Caparaonia* further differs from *Colobodactylus* by having ventral scales longer than wide (wider than long) disposed in 6 longitudinal rows (4), the lateralmost being the narrowest (the wider), and from *Heterodactylus* by the presence of an interparietal (absent or extremely reduced), by presenting a distinctive ear opening (absent), and a slightly elongate body (extremely elongate). From the other Heterodactylini *Caparaonia* differs by having no spines and naked W flounces on the hemipenis (spines present and flounces with conspicuous combs of spines). *Caparaonia* differs from *Iphisa* by having three pairs of genials (one pair), several rows of lanceolate and keeled dorsal scales (only two longitudinal smooth scale rows), ventral scales longer than wide, regularly transverse and in six longitudinal rows (not in transverse rows and in only two very enlarged longitudinal rows), and regularly transverse rows of mostly small gulars irregularly disposed in longitudinal rows (gulars very enlarged in only two rows neither regularly transverse or longitudinal). From *Colobosaura*, *Acratosaura*, *Stenolepis*, and *Alexandresaurus*, it can be distinguished by having six longitudinal and regularly transverse rows of laterally juxtaposed ventral scales that are longer than wide (four rows of imbricate

quadrangular ventral scales, not regularly transverse). It additionally differs from *Stenolepis* by presenting prefrontals (absent), and by having small dorsal neck scales (large, in 3–4 longitudinal rows) and from *Stenolepis*, *Alexandresaurus*, and *Colobosaura* by having three pairs of genials (two pairs).

Finally, although the hemipenes are not totally everted and we lack data from *Stenolepis*, some differences are apparent. The flounces of the hemipenis of *Caparaonia*, *Colobodactylus*, and *Heterodactylus* are continuous, but in *Alexandresaurus*, *Acratosaura*, *Colobosaura*, and *Iphisa* the flounces are interrupted by a naked area on the side of organ opposite to the sulcus as well as medially on the right and left side.

*Caparaonia* further differs from all other Gymnophthalmini except *Tretioscincus* by the presence of a distinctive eyelid. *Tretioscincus*, like all other Gymnophthalminae, have characteristic skinklike scales, which are absent in *Caparaonia*.

*Caparaonia itaiquara*, new species

Figures 2–5

HOLOTYPE: MZUSP 96093, an adult male from (20°28'S, 41°49'W): Parque Nacional do Caparaó: states of Minas Gerais and Espírito Santo: Brazil, collected by J. Cassimiro on 2 January 2005, field number MTR 10919.

PARATYPES: MZUSP 95053–65, 97619, from 24–30 October 2004; MZUSP 96088–92, 97620, from 24 December 2004 to 5 January 2005; MZUSP 95635, 98050–58, from November 2005; all from Parque Nacional do Caparaó: states of Minas Gerais and Espírito Santo: Brazil, collected by J. Cassimiro and M.T. Rodrigues.

ETYMOLOGY: The specific epithet is from the Tupi language, meaning “the one that inhabits rocks” in reference to the habitat where this lizard is most frequently found.

DIAGNOSIS: A gymnophthalmid with ear opening and eyelid, and a slender pentadactyl limb lacking the claw on first toe. Frontonasal single; prefrontals, frontal, frontoparietals, parietals, and interparietals present. Parietals longer than wide. Collar fold absent. Three pairs of chin shields; three supraoculars, first

smaller. Dorsal scales in 36–40 rows, anteriorly smooth, isodiametric or subrectangular in occipital region, becoming progressively narrower, more elongate and rounded at the arm level, and more posteriad lanceolate, strongly keeled, with sides almost juxtaposed. Occipitals present. Ventrals longer than wide, smooth, in six regular longitudinal and 21–27 transverse rows, identical in size. Scales around body 36–39; 10–14 and 15–20 infradigital lamellae under finger IV and toe IV, respectively. Males with a series of 9–10 pores without gap between preanal and femoral; femoral pores absent in females.

DESCRIPTION OF THE HOLOTYPE (fig. 2): Rostral scale broad, wider than high, contacting first supralabial, nasal, and frontonasal. Frontonasal pentagonal, almost twice as wide as long, contacting rostral scale, nasals, loreals, and prefrontals. Prefrontals slightly wider than long, in broad contact at midline. Frontal hexagonal, with slightly divergent lateral margins, longer than wide, slightly wider posteriorly; anteriorly indenting the prefrontal and posteriorly the frontoparietal sutures. Frontoparietals pentagonal, slightly larger than prefrontals, in slight medial contact, strongly indented by the interparietal, and in contact with second and third supraoculars. Interparietal longer than wide, as long as but much narrower than frontal, as long as but narrower than parietals. Parietals hexagonal, edged laterally by two enlarged temporal scales with approximately the same size as each other, anteriorly by the third supraocular and frontoparietal, medially by the interparietal, and posteriorly by an enlarged occipital. Posterior margin of parietals almost straight, that of interparietal rounded and extending slightly posteriorly to the parietals. A pair of distinctively enlarged occipitals separated at midline by one scale. A second pair of smaller scales following the first pair of occipitals. Three supraoculars, first the smallest, second the largest, with its largest suture with frontal, third slightly longer than second, in broad contact with frontoparietal. Nasal above first supralabial, large, slightly longer than high, with the nostril in the center and lower part of the scale, indenting suture with labial. Loreal posterior to nasal, narrower, and diagonally oriented; contacting posteriorly the first superciliary and first supraocular, a preocular, and a frenocular. Frenocular small, below preocular, followed posteriorly by four

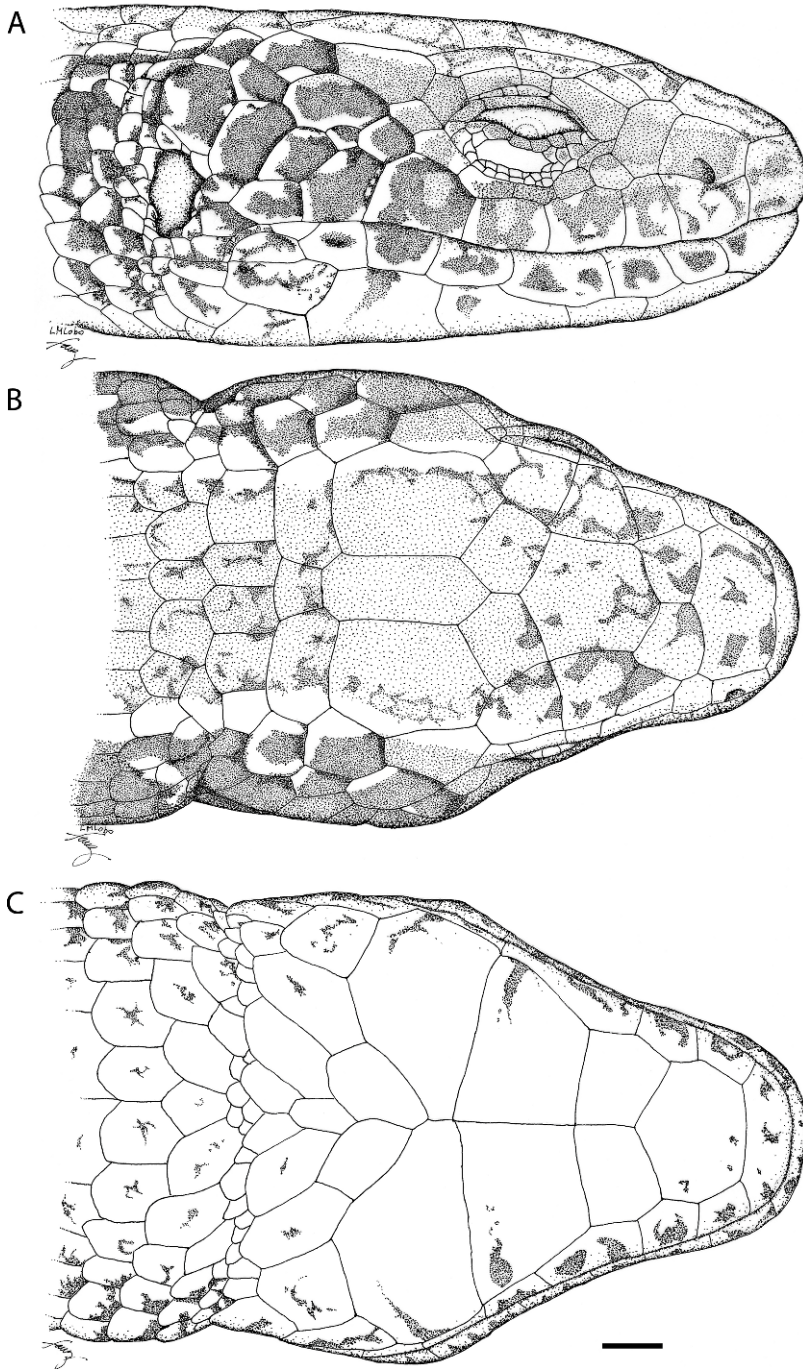

Fig. 2. Lateral (A), dorsal (B), and ventral (C) views of the head of the holotype of *Caparaonia itaiquara* (MZUSP 96093). Scale for each = 1 mm.

suboculars, the first three elongate, the fourth wider. Seven supralabials, fourth under the center of the eye, fifth the largest contacting fourth subocular, second the smallest; seventh separated from the granules surrounding anterior margin of the ear by an enlarged scale. Three superciliaries, first largest, wider anteriorly, longer than first supraocular, contacting preocular, loreal, first and second supraoculars, second superciliary and upper eyelid; second superciliary the smallest. An enlarged quadrangular scale follows the third superciliary. Central part of eyelid with a semitransparent undivided disc surrounded by small and slightly pigmented granular smooth scales. Lower eyelid with seven strongly pigmented palpebrals. A small postocular between quadrangular scale following third superciliary and fourth subocular. Temporal region with smooth and juxtaposed scales, irregular in size and shape, between parietals and supralabials; the larger with about the same size the fifth supralabial. Ear opening surrounded by a series of very small and juxtaposed rounded granules; external auditory meatus large, tympanum distinct, subovoid. Lateral surface of neck with 10 transverse rows of smooth, slightly imbricate and rhomboid enlarged granules. All head scales smooth and juxtaposed with scattered sensorial organs.

Mental broad, wider than high. Postmental heptagonal, wider than long. Three pairs of genials, all contacting infralabials; the first smaller, third largest, first and second in broad contact at midline; third pair contacting only anteriorly. Two series of enlarged but much smaller and symmetric, flat, and chevronlike preular scutes follow third pair of chin shields preventing their contact posteriorly. Six infralabials, third the largest. Gulars smooth, imbricate, rounded posteriorly, in seven transverse rows; third to sixth rows with some enlarged scales that are wider than long, other scales much smaller, longer than wide. Gulars decreasing progressively in size towards side of neck. A distinct interbrachial region with nine scales that are longer than wide, elongate, smooth, and longer than the gular scales. Collar fold absent.

Dorsal scales imbricate and disposed in regular transverse rows; smooth, isodiametric or subrectangular, and rounded posteriorly in occipital region, becoming progressively nar-

rower, lanceolate, strongly keeled, with sides almost juxtaposed. Thirty-six transverse rows of dorsals between interparietal and the posterior level of hind limbs. Lateral scales as long as, slightly wider than, and more diagonally disposed than dorsals, keeled, strongly imbricate laterally. A distinctive area with small, smooth, and rounded granules surrounds the area of arm insertion. Thirty-eight scales around midbody. Ventral scales smooth, longitudinally imbricate, laterally juxtaposed, longer than wide, rounded posteriorly, in six longitudinal and 21 transverse rows from interbrachials (excluded) to pre-anals. Six scales in preloacal region, central and paramedials the largest. Total pores 10, opening in the center of scale, continuous, with no gap between femoral and preanal ones.

Scales of tail smaller than midbody dorsals, otherwise identical to them; keeled, lanceolate, strongly imbricate longitudinally; those near the base of the tail larger, but in the posterior and ventral part of tail, becoming gradually identical around tail.

Forelimbs with large, smooth, and imbricate scales; those from ventral part of brachium and forearm much smaller, rounded, rhomboid, juxtaposed. Anterior and ventral parts of hind limbs with irregularly large, smooth and imbricate scales, identical to the corresponding parts of the forelimbs. Posterior part of hind limbs with granular, juxtaposed scales, grading progressively to larger, imbricate and keeled scales on dorsal part of tibia. Carpal and tarsal scales large, imbricate; supradigital lamellae smooth, imbricate. Palmar and plantar surfaces with smooth, small granules; infradigital lamellae single, 11 on finger IV and 17 on toe IV. Toes and fingers, except for finger I, clawed, and respectively in the following relative sizes:  $1 < 2 = 5 < 3 = 4$ , and  $1 < 2 < 5 < 3 < 4$ .

Dorsal surfaces of body and tail and lateral part of tail dark brown with an irregularly distributed darker punctuation generally between some dorsal scales. A cream to white longitudinal line, more conspicuous anteriorly, extends paradorsally from the occipitals to the anterior third of the tail. Flanks darker, strongly mottled by an irregular pattern of cream to yellow spots that extend to the lateral



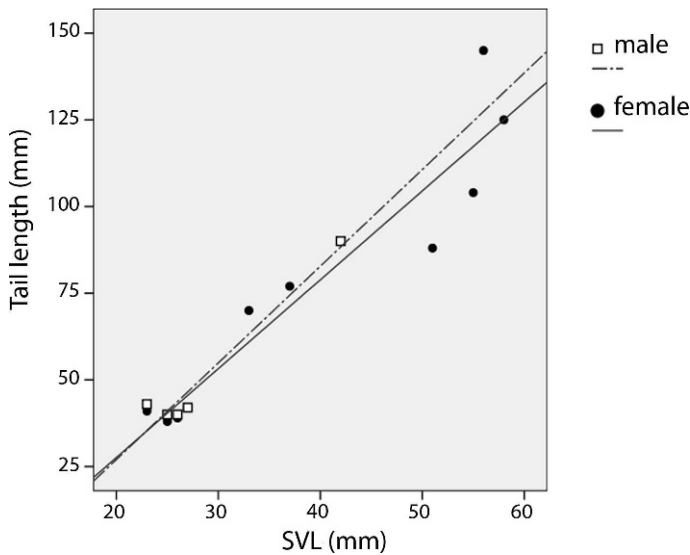

Fig. 3. Regression lines between body length (SVL) and tail length for males ( $r^2$  0.94,  $n = 5$ ) and females ( $r^2$  0.91,  $n = 12$ ) of *Caparaonia itaiquara* from Parque Nacional do Caparaó, Brazil.

part of the tail where they become diffuse. Lateral parts of head with a similar pattern; irregular black blotches concentrated in the central parts of the supra and infralabials, yellow on their sutures. Ventral parts of body and tail predominantly cream to yellow with irregularly black spots concentrated in the central part of the scales. Ventral part of tail darker near the extremity. Limbs dark brown dorsally, irregularly mottled with a cream to yellow pattern similar to that of flanks; ventrally, cream to yellow with dark pigmentation in the center of the scales.

Hemipenis almost totally everted at preservation except for the apex; bilobation not evident; sulcus spermaticus apparently single, edged by an enlarged naked area. A series of 10–12 series transverse chevronlike, undulate, and continuous naked flounces on the opposite side of the organ. The 5–6 apical flounces end in almost free and distally bifurcate protuberances. Spines absent inside or outside flounces.

**MEASUREMENTS OF THE HOLOTYPE:** Snout-vent length: 53 mm; tail length: 100 mm (tip broken).

**VARIATION:** Males are slightly smaller and have slightly longer tails than females: maximum SVL for males and females was respectively 55 mm and 60 mm. Tail length varied

respectively in males and females from 1.53 to 2.14 and 1.50 to 2.58 times SVL ( $r^2$  males 0.94,  $n = 5$ ;  $r^2$  females 0.91,  $n = 12$ ; fig. 3). No sexual differences were found in squamation. Variation in meristic characters ( $n = 24$ ) was the following (mean and standard deviation, respectively, in the parenthesis): dorsal rows, 36–40 ( $37.9 \pm 1.19$ ); ventrals 21–27 ( $23.9 \pm 1.41$ ); scales around midbody 36–39 ( $37.5 \pm 0.94$ ); infradigital lamellae under finger IV 10–14 ( $11.5 \pm 1.03$ ); and infradigital lamellae under toe IV 15–20 ( $16.9 \pm 1.37$ ). All specimens show 3 supraoculars as well as 4 superciliaries except for MZUSP 95061, 97619, and 96088 where only 3 superciliaries are present. All the specimens have 7 supralabials and 7 infralabials except for MZUSP 98055, which has 8 supralabials, and MZUSP 95061, which has 6 infralabials. The distinctively enlarged pair of occipitals may be separated at midline by 1 or 2 scales. Gular rows vary between 7 and 8. Total number of pores varies between 9 and 10 in males and 2–5 in females. Femoral pores are present only in males, preanal pores are present both in males and females but are much more conspicuous in males. Pores are highly conspicuous, placed in distinctively elevated scales, aligned on each side without gaps between preanal and femoral.

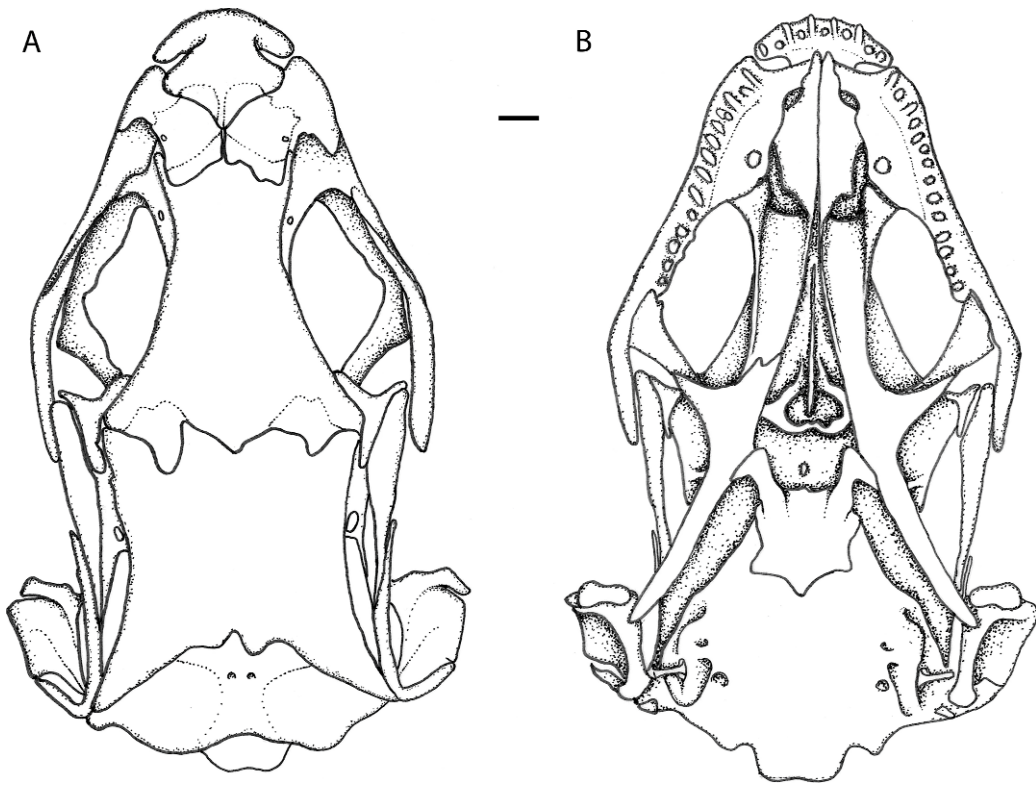

Fig. 4. Dorsal (A) and ventral (B) views of the skull of *Caparaonia itaiquara* (MZUSP 95054). Scale = 1 mm.

**OSTEOLOGY** (figs. 4 and 5): The following description is based on three alizarin-prepared skeletons (MZUSP 95054, 97619, and 97620). Premaxillary as long as wide, touching but not articulating laterally with the maxillary. Dorsal lamina of premaxillary triangular posteriorly, long, covering slightly anteriorly the nasals and indenting deeply their suture preventing their anterior contact. Eleven premaxillary conical teeth. Nasals large, slightly longer than wide, wider anteriorly, diagonally disposed, widely separated anteriorly, in midline contact in posterior third, covering anteriorly the frontal. Frontal longer than wide, strongly constricted between orbits, wider posteriorly, covering anteriorly the parietal and articulating laterally with it by a pair of frontoparietal tabs. Parietal longer than wide, wider and concave posteriorly, covering laterally the occipital region. Lateral expansion of parietal absent leaving the supratemporal fenestra open. Epipterygoid

contacting externally a descending epipterygoid process of the parietal. Maxillary contacting dorsally nasal, lateral parts of frontal and lacrimal without overlapping, and covering extensively prefrontal and jugal; 14 maxillary teeth. Prefrontal large, its posterior process long but not reaching the level of middle of orbit; in broad contact with frontal. Lacrimal small, rod shaped, very conspicuous, contacting prefrontal and maxillary along the inferoanterior part of orbit. Postfrontal and postorbital single. Postfrontal roughly triangular, contacting jugal, frontal, postorbital, and parietal, closing posteriorly the orbit. Posterior part of postfrontal wider, longer, almost straight, preventing contact between frontal/parietal and postorbital and covered by the postorbital. Postorbital long and narrow, not expanded, contacting posteriorly squamosal and leaving supraorbital fenestra widely open. Squamosal long, posteriorly curved and fitting at the top of the quadrate.

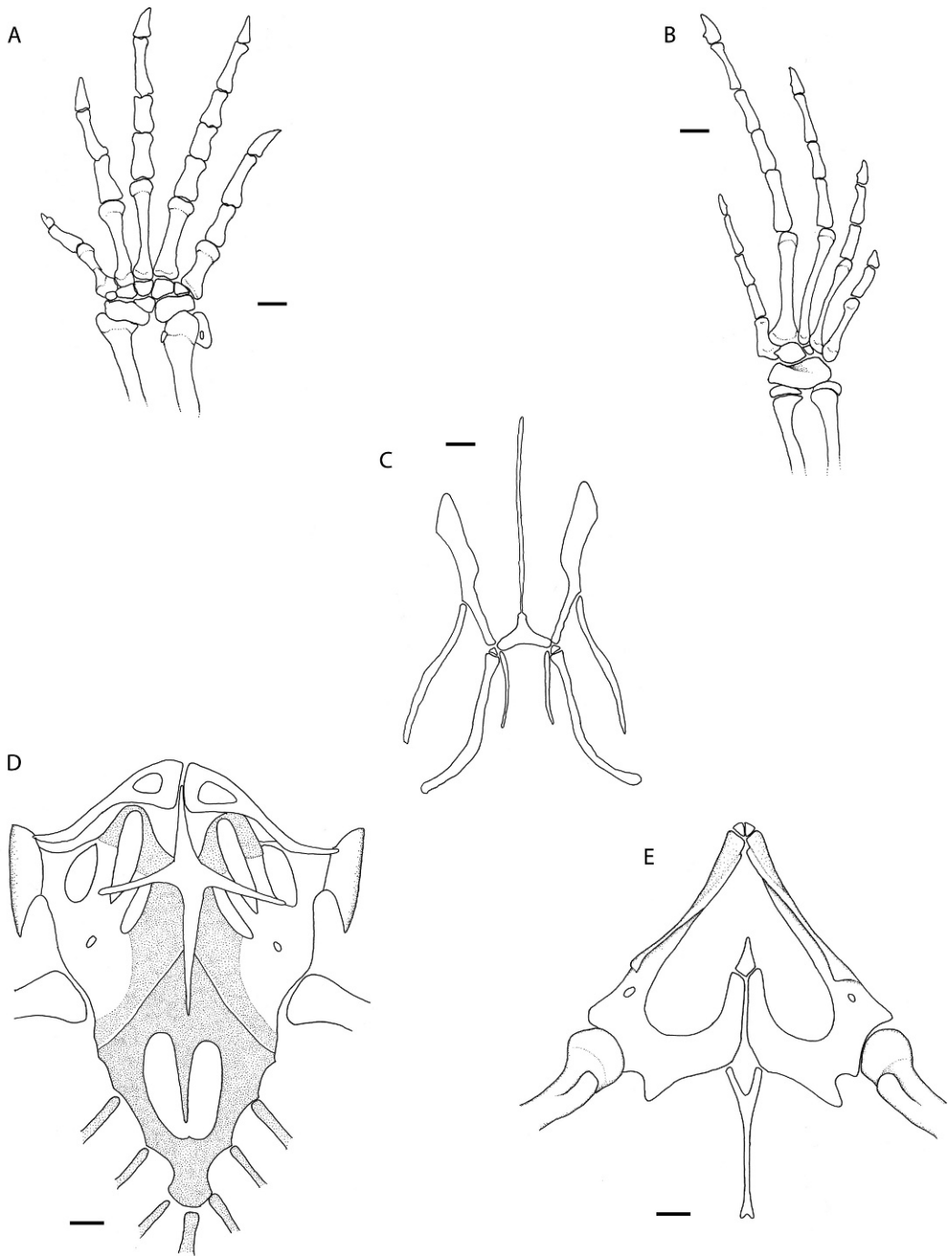

Fig. 5. Right hand (A), left foot (B), hyoid (C), pectoral (D), and pelvic girdles (E) of *Caparaonia itaiquara* (MZUSP 95054). Scale = 1 mm.

Supratemporal fenestra widely opened, not constrained laterally by lateral expansions of parietal and postorbital, which are absent. Supratemporal present, small, in straight contact with posterior part of parietal and squamosal. Fifteen scleral ossicles in the eyeball. Vomer, palatine, pterygoid, and ectopterygoid present. Vomer, palatine, premaxillary, and maxillary in contact restricting the fenestra exochoanalis. Infraorbital fenestra large, bordered posteriorly by ectopterygoid and pterygoid. Pterygoid teeth absent. Stapes rodlike, wider, and rounded at base. Sutures between supraoccipital, exoccipital, basioccipital, and the otic area of the skull are not well visible in the articulated skeleton, nor are those eventually between basioccipital and basisphenoid.

In the lower jaw dentary, articular, splenial, angular, and suprangular are distinct; there are 17 dentary teeth, conical anteriorly, bicuspid or tricuspid posteriorly.

Glossohyal long, fused to basihyal. First ceratobranchial curved posteriorly; hypohyal and ceratohyal present. A second short pair of ceratobranchials is present and is positioned parallel to the anterior part of the trachaea.

Anterior part of clavicle very enlarged, flattened, enclosing a fenestra. Interclavicle long, cruciform, with very long lateral processes reaching the sternum but not sternal fenestra. Scapulocoracoid with coracoid, scapular, and scapulocoracoid fenestrae; suprascapula present. Sternum with a large fenestrum, and receiving three sternal ribs and a xiphisternum with two inscriptional ribs. Ilium, ischium, and pubis present, the latter with a conspicuous pectinate apophysis. Hypoischium long, wider at the base, almost reaching the preanal border; a small elongate preischium and a small quadrangular ossified prepubis are present.

Thirty procelous presacral vertebrae; neural spines low, higher anteriorly; hipapophyses present on first eight vertebrae; zigantrum-zygosphene present. Last presacral vertebra lacking ribs. Two sacral vertebrae. First four caudal vertebrae lacking autotomic processes, with long and wide transverse processes, and with wide and high neural spines. From the fifth vertebra on intravertebral autotomic septa are present, transverse processes are narrow and neural spines become lower.

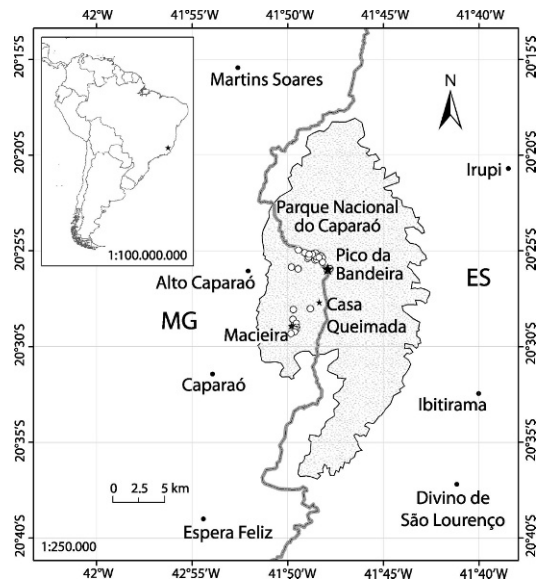

Fig. 6. Distribution of *Caparaonia itaiquara* (open circles). Parque Nacional do Caparaó (shaded area) between the states of Minas Gerais (MG) and Espírito Santo (ES). Reference localities indicated by stars; neighboring municipalities, by black dots.

Humerus and femur slightly larger than radius and ulna and tibia and fibula. Remaining elements of fore- and hind limbs as in figure 5.

#### HABITAT, DISTRIBUTION, AND NATURAL HISTORY

*Caparaonia itaiquara* is currently known only from and considered endemic to the mountains of Parque Nacional do Caparaó, an area with 168,000 km<sup>2</sup> near the border of the states of Minas Gerais and Espírito Santo (fig. 6), Brazil. This highly elevated and deeply dissected mountainous area is formed by middle to late Tertiary uplifted blocks of igneous or high-grade metamorphic rocks and includes the three highest mountains of eastern tropical South America: Pico da Bandeira (2890 m), Pico do Calçado (2840 m), and Pico do Cristal (2780 m), respectively the third, fourth, and sixth highest mountains in Brazil (Safford, 1999a, 1999b). The high elevation, plus their exposure to southern polar fronts, makes these mountains the coldest spots in eastern South America. These conditions confer to this area a

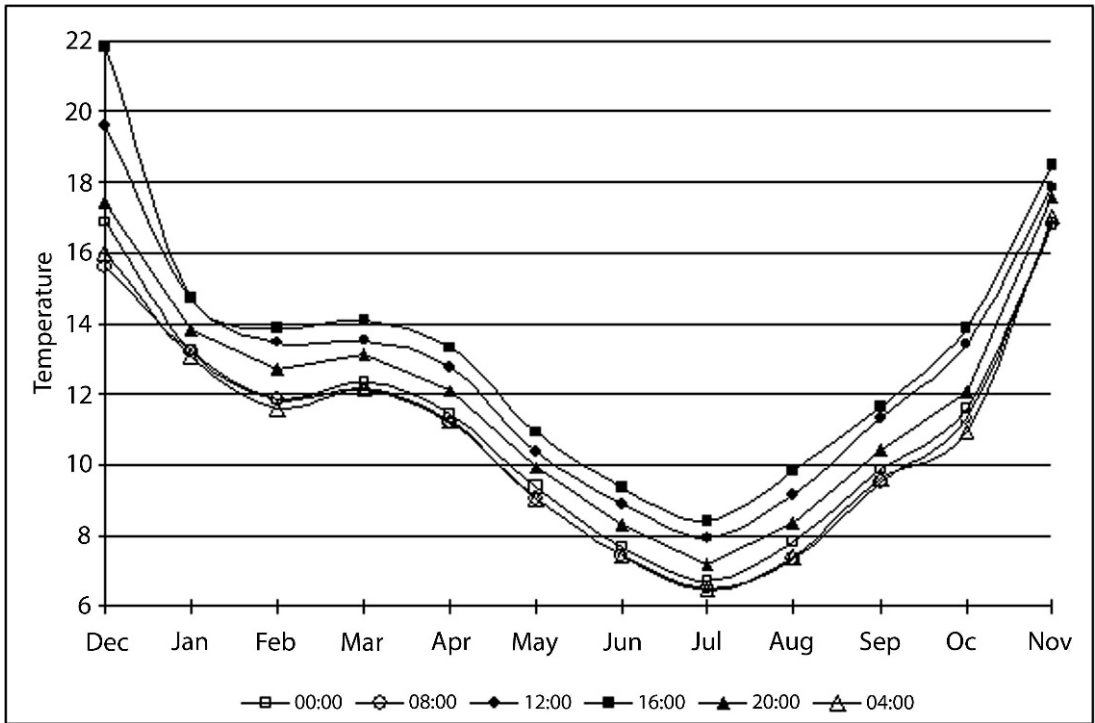

Fig. 7. Daily mean temperature variation recorded from 28 December 2004 to 17 November 2005 by a data logger left at 2400 m elevation at Parque Nacional do Caparaó, near the trail leading to the Pico da Bandeira.

cool and humid climate, and patterns of rainfall, temperature, and frost that are distinctly seasonal (Safford, 1999a). Dry season extends from March to September and rainy season extends from November to January; annual mean precipitation varies between 1250 and 1500 mm; June and July are the coolest months, December the hottest. There are no climatic stations in the highest mountains, but according to IBAMA (Instituto Brasileiro do Meio Ambiente e dos Recursos Naturais Renováveis), the Brazilian environmental agency, the maximum and minimum annual temperatures vary respectively from 34° to 36° C and -4° to 0° C. Estimated annual mean temperatures calculated after regional elevational temperature gradients (ca. 0.55° C/100 m) and verified by soil temperatures measured at less than 70 cm indicates that annual mean temperatures fluctuate around 10.5° C at 2400 m, and 8.5° C at 2800 m (Safford, 1999b). We left a data logger at 2400 m altitude, at a relatively protected site near Pico da Bandeira, between December 2004

and November 2005. It registered an annual average temperature of 11.1° C, a minimum temperature of 2.5° C in July, and a maximum of 30.7° C in December. The daily mean temperature range varied around 2°–3° C throughout the year, with the hottest hours of day happening from midday to 4:00 PM (fig. 7). The wider range for December 2004 reached 6° C, but it was probably due to the fact that temperatures were recorded for four days only.

Two main habitat types occur at Parque Nacional do Caparaó. The Atlantic rainforest and a less diverse and gradually lower montane forest are the dominant physiognomy up to about 1800–2000 m elevation. These forested habitats were severely affected by fires and the expansion of coffee plantations in the past and are presently restricted to a few isolated spots. Above 2000 m the Caparaó massif is characterized by open and rocky areas dominated by shrubs and grasses referred to as *campos de altitude* or *campos rupestres* (fig. 8A–D). They are currently isolated open areas on top of the Atlantic



Fig. 8. Habitat of *Caparaonia itaiquara* at Parque Nacional do Caparaó. General view of Pico da Bandeira (A), general view of the *campos rupestres* (B), rocks under which the specimens may be found (C), exact place where we found a specimen (D).

forest domain. Landscape in these open areas consists of roughly rounded hilltops, plateaus of variable extension and deeply dissected valleys with stream courses. The entire area is characterized by the presence of rocky outcrops or considerable extensions of bare rock; high cliffs are also very typical in areas of sharp relief. Soils are humid and dark colored (Modenesi, 1988) and support a diverse flora characterized by a high degree of endemism. Local vegetation, like tussock grasses, rosette-forming plants, sclerophyllous shrubs, and ground-hugging cushion plants, are morphologically similar to those found in most tropical highland environments with low mean temperatures, diurnal freeze-thaw cycles, and relatively moderate seasonal variations in temperature (Smith and Young, 1987; Smith, 1994). Shrubs (especially species of *Baccharis*, *Vernonia*, various Eupatorieae, *Tibouchina*, *Leandra*, and Myrtaceae) and small copses of short, often stunted trees (e.g., *Escallonia*,

*Weinmannia*, *Rapanea*, *Symplocos*, *Maytinus*, *Roupala*) are common and coexist with a more continuous coverage of buchgrasses (*Cortaderia*, *Calamagrostis*, *Andropogon*) and large thickets of bamboo (*Chusquea* sp.). At some places a sparse understory of herbs and pteridophytes might be present. There is almost no zonation of the vegetation in response to elevation (Safford, 1999a).

All specimens of *Caparaonia itaiquara* were found in the highland open areas between 1873 m and 2770 m elevation from 9 AM to 6:45 PM. Figure 6 shows a map of the area with all localities where specimens were seen. Of the 25 specimens observed and apparently resting, 22 were found under rocks, two under tree trunks, and one inside a small termite mound. Only one specimen was moving actively among tickets of *Chusquea* and other vegetation at 2:15 PM. Twenty (90%) of the 22 specimens obtained under rocks were under rocks situated on extensive rocky outcrops,

the other two under isolated rocks on loose soil with grasses and small bushes. The termite mound that was sheltering one specimen was built between a small rock and an extensive rocky floor. We also found eggs and egg shells, all under rocks situated in extensive rocky floors. Rocks sheltering specimens and/or eggs varied in dimensions from 0.25–1.43 m long  $\times$  0.22–0.59 m wide  $\times$  0.14–0.33 m high; mean dimensions for length, width, and height were respectively, 0.65 m, 0.42 m, and 0.22 m. Underneath these rocks a thin, soft, and generally humid soil layer, almost always with roots of the surrounding vegetation, was usually present. In some cases part of the rock was in direct contact with the rock outcrop. Lizards were generally seen immobile, immediately after the rocks were overturned, inside small and irregular soil cavities connected to superficial galleries. Eggs/eggshells were always found in pairs (minimum of 2) in small cavities under rocks. When more than two eggs or eggshells were discovered, the shell condition clearly indicated that they could be assembled in pairs and these pairs attributed to different clutches probably laid at different times. The maximum number of developing eggs found under a rock was four, the two pairs clearly laid at different times; the maximum number of eggs/eggshells observed under the same rock was 10. In one case, the clutch consisted of 2 developing eggs plus 4 pairs of eggshells; in the other, 5 pairs of eggshells were found beside an adult female. These observations suggest that, as usual in microteiid, clutch size in *Caparaonia itaiquara* is limited to two eggs, and that egg-laying sites are frequently reused. Our data are also suggestive that communal nests occur under the same rock and/or females return to the same place to lay their eggs. As we have almost no life-history data on these lizards, we cannot give a conclusive answer to these questions. The first hypothesis seems more probable considering the climate of unsuitable conditions for multiple clutches per season due to the restricted period of reproductive activity of these high-altitude lizards and their probably short life expectancy.

Ants, beetles, spiders, earthworms, or myriapods were sometimes found near the lizards

or inside the small soil cavities where they frequently take refuge, and may serve as their prey. The only other lizard occurring with *Caparaonia itaiquara* in the open areas in the highlands of Parque Nacional do Caparaó is an isolated population of the viviparous skink that we provisionally identify as *Mabuya dorsivittata*, which is active on sunny days on the ground and on thickets of vegetation.

## PHYLOGENETIC ANALYSES

Separate and combined analyses of morphology and molecular data were performed to determine the phylogenetic placement of *Caparaonia itaiquara*. Analyses under maximum parsimony was conducted on the morphological partition composed of 77 morphological characters (59 of which are parsimony informative; appendix 3) with all states coded as unordered. This analysis recovered 16 most parsimonious trees; the strict consensus topology (L = 148; CI = 0.77 and RI = 0.85) is presented at figure 9A. *Caparaonia itaiquara* is recovered as a member of the Heterodactylini radiation (BS = 88; Bremer value = 3) and as the sister taxon of the sister relationship *Colobodactylus taunayi*–*Heterodactylus imbricatus* (BS = 77; Bremer value = 2). This clade is sister to another well-supported clade within Heterodactylini that groups *Alexandresaurus camacan*, *Iphisa elegans*, *Colobosaura modesta*, *Acratosaura mentalis*, and *Stenolepis ridleyi* (BS = 99; Bremer value = 6), although the relationships among these taxa are recovered as an unresolved polytomy.

This consensus topology (fig. 9A) based on morphology also recovered a well-supported Gymnophthalmini (BS = 98; Bremer value = 6). Within Gymnophthalmini a poorly supported clade groups *Tretioscincus oriximinesis*, *Micrablepharus maximiliani*, *Gymnophthalmus vanzoi*, *Psilophthalmus paeminosus*, *Procellosaurinus erythrocerus*, and *Vanzosaura rubricauda* (BS, 50%; Bremer value = 1), which is sister to the strongly supported *Nothobachia ablephara*–*Calyptommatius leiolepis* group (BS = 100; Bremer value = 22). The monophyly of the Gymnophthalminae is also supported by the morphological partition (BS = 83; Bremer value = 2), with *Rhachisaurus brachylepis* as its sister taxon.

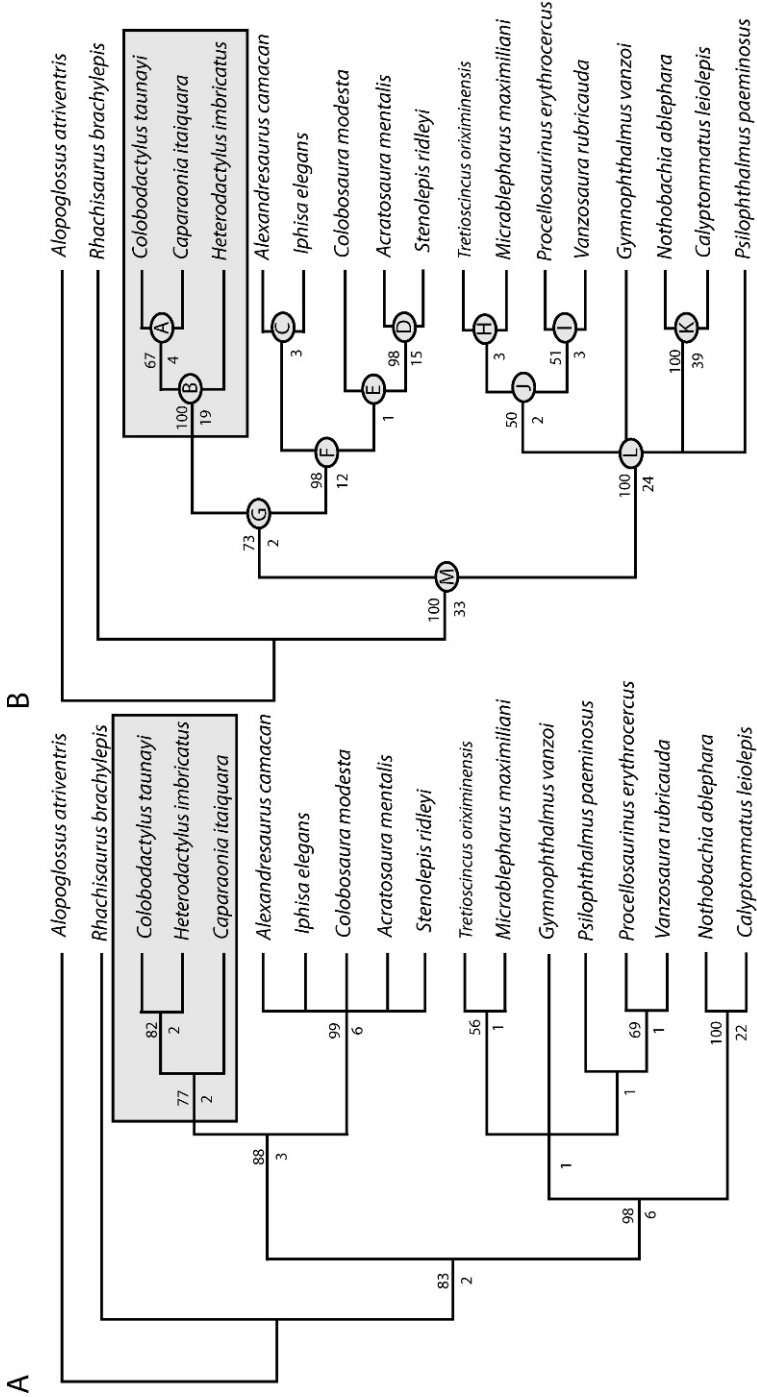

50 changes

Fig. 9. Phylogenetic trees inferred from maximum parsimony analyses. (A) Strict consensus of 16 equally parsimonious trees based on morphological characters (L = 148; CI = 0.77; RI = 0.85). (B) Strict consensus of two equally parsimonious trees from combined analyses of morphology and molecular partitions (L = 1868; CI = 0.50; RI = 0.45). The internal nodes are identified by letters (in circles) and the partitioned Bremer support indexes are listed in appendix 4 for each node. Bootstrap support values (>50%) and decay indexes are presented above and below branches, respectively. The inset includes *Caparaonia itaiquara* and its closest relatives.



Combined analyses of morphological and molecular partitions resulted in two most parsimonious trees of 1868 steps, 449 parsimony-informative characters, and CI = 0.50 and RI = 0.45 (fig. 9B). The Heterodactylini was recovered as a moderately supported clade (node G: BS = 73, Bremer value = 2; see appendix 4), and within it *Caparaonia itaiquara* appears as the sister taxon of *Colobodactylus taunayi*, but this relationship is only poorly supported (node A: BS = 67; Bremer value = 4). There are two well-supported clades within Heterodactylini: (1) (*Colobodactylus taunayi* + *Caparaonia itaiquara*) + *Heterodactylus imbricatus* (node B: BS = 100, Bremer value = 19; fig. 9B, appendix 4), and (2) (*Alexandresaurus camacan* + *Iphisa elegans*) + (*Colobosaura modesta* + *Acratosaura mentalis* + *Stenolepis ridleyi*) (node F: BS = 98, Bremer value = 12; fig. 9B, appendix 4).

Monophyly of the Gymnophthalmini is highly supported (node L: BS = 100; Bremer value = 24; fig. 9B) by the combined analysis, but most relationships within it are left unresolved. There is a poorly supported clade (node J: BS = 50; Bremer value = 2) grouping *Tretioscincus oriximinensis* + *Micrablepharus maximiliani* (node H: BS <50; Bremer value = 3) and *Procellosaurinus erythrocerus* + *Vanzosaura rubricauda* (node I: BS = 51; Bremer value = 3), a highly supported sister relationship between *Nothobachia ablephara* + *Calyptommatus leiolepis* (node K: BS = 100; Bremer value = 39), and the unresolved placement of *Psilophthalmus paeminus* and *Gymnophthalmus vanzoi* was recovered (fig. 9B).

The analyses under the partitioned Bayesian method incorporating the molecular and morphological data set produced a majority-rule consensus tree (fig. 10), significantly different from that recovered on the basis of parsimony analysis (fig. 9B). The major difference refers to the paraphyly of the Heterodactylini with respect to Gymnophthalmini, with this alternative topology strongly supported by posterior probabilities (PP = 0.98). Similar to the topology recovered from analysis of morphological characters (fig. 9A), *Caparaonia itaiquara* appears as the sister taxon to the sister clade *Colobodactylus taunayi* + *Heterodactylus imbricatus* (PP = 0.79), with strong support (PP = 1.0). Monophyly of the Gymnophthalmini is

also highly supported (PP = 1.0) by Bayesian analyses and, different from MP analysis, relationships within it were better resolved. Clades strongly supported (PP = 1.0) were those that group (*Tretioscincus* + *Micrablepharus*; PP = 0.61) + (*Procellosaurinus* + *Vanzosaura*; PP = 1.0), and *Nothobachia* + *Calyptommatus* (fig. 10).

In all combined analyses, either under parsimony or Bayesian methods, *Rhachisaurus brachylepis* is consistently recovered as the sister taxon of the Gymnophthalmini (figs. 9B and 10).

## DISCUSSION

This study is the first to investigate relationships of the Heterodactylini, including all but one (*Scriptosaura*) genera of Gymnophthalmini presently recognized. Combined analyses of morphological and molecular characters under MP analyses recovered the monophyly of Gymnophthalmini and their primary tribal division (sensu Pellegrino et al., 2001). Nevertheless, although the Gymnophthalmini received high support in both analyses (respectively for morphological and combined analysis BS = 98 and 100 and Bremer values = 6 and 24; fig. 9A and node L, fig. 9B), the support for the monophyly of Heterodactylini was not strongly recovered in all analyses. The morphological partition (fig. 9A) supported Heterodactylini monophyly with higher values (BS = 88 vs. 58) than those previously obtained, which had been based on a less diverse taxonomic (7 vs. 8 genera) and character (42 vs. 77 characters) sampling (Rodrigues et al., 2007). By contrast, in combined analysis the support for a monophyletic Heterodactylini was lower (node G: BS = 73, Bremer value = 2; fig. 9B) in the present study than that obtained previously (BS = 96, Bremer value = 11; Rodrigues et al., 2007). Morphological and combined analyses also indicate that the Heterodactylini consists of two well-supported clades (*Colobodactylus*, *Heterodactylus* and *Caparaonia*) and (*Alexandresaurus*, *Iphisa*, *Colobosaura*, *Acratosaura*, and *Stenolepis*), although details differ across analyses. The morphological partition recovers *Caparaonia* as the sister taxon to *Colobodactylus* + *Heterodactylus*; shared character states sup-

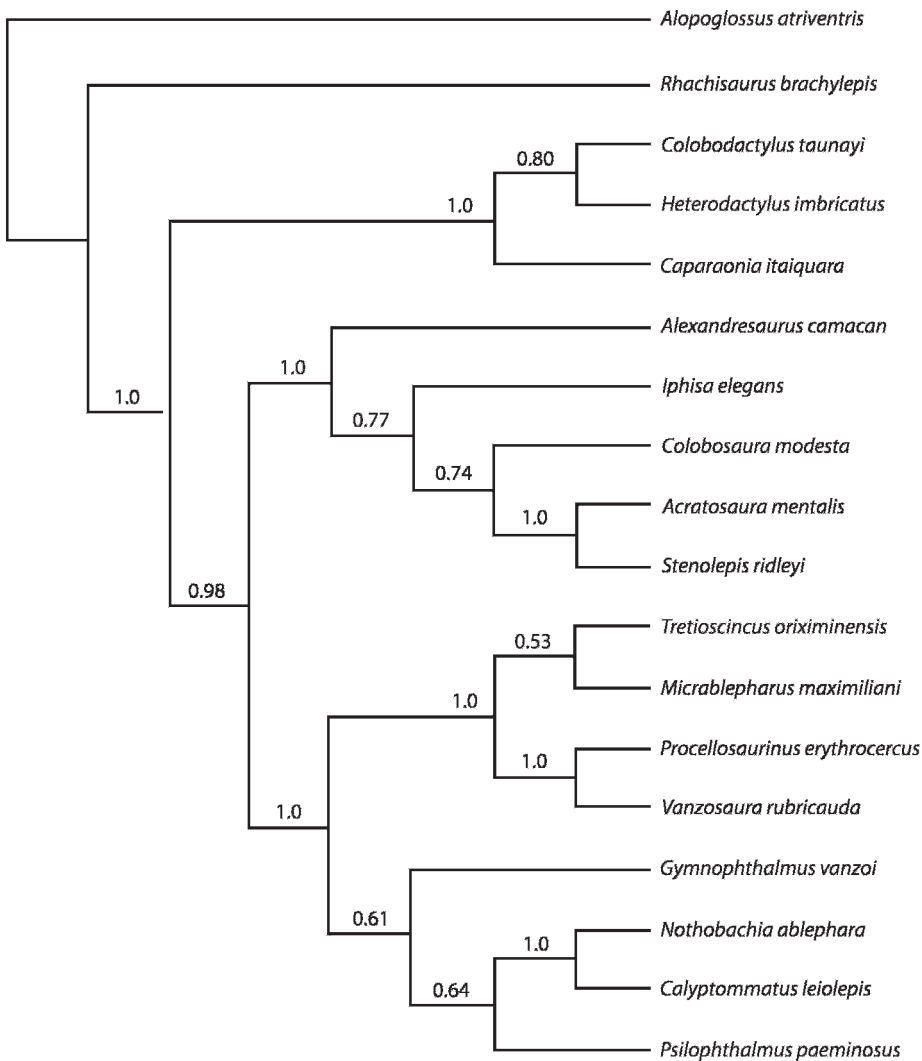

Fig. 10. Phylogenetic topology estimated under Bayesian method for the combined morphology and molecular data set. Values above nodes represent posterior probabilities for clades recovered at the 50% majority-rule consensus tree.

porting the relationship between the latter genera are the reduction in number of fingers to four (five in *Caparaonia*) and the presence of two pairs of chin shields (three in *Caparaonia*). By contrast, in the combined MP analysis *Heterodactylus* is the sister species of *Colobodactylus* + *Caparaonia*, indicating a different evolutionary history for both characters. Reversibility in the evolution of scale characters is widespread in squamates, but this was not admitted until recently in the case of digit loss. A recent study with the

gymnophthalmid genus *Bachia* strongly suggests that lost digits can reappear (Kohlsdorf and Wagner, 2006). The other Heterodactylini clade is recovered as a polytomy on morphological grounds (fig. 9A) but as a highly supported clade (Clade F, fig. 9B) in combined analysis. Internally, only the sister relationship between *Acratosaura* and *Stenolepis* received high support, a result similar to that obtained previously (Rodrigues et al., 2007). Our results also indicate that the major support to the monophyly of clade F (fig. 9B) within Hetero-

dactylini and that of clade G, which recovers a monophyletic Heterodactylini, comes from contribution of the morphological partition (see appendix 4). Except for the highly supported sister relationship between *Nothobachia* and *Calyptommatius*, relationships within Gymnophthalmini were unresolved in both morphological and combined analyses under the MP method.

Partitioned Bayesian analysis recovered the monophyly of Gymnophthalminae and that of Gymnophthalmini, but failed to find a monophyletic Heterodactylini (fig. 10). The clades (*Caparaonia* (*Colobodactylus*, *Heterodactylus*)) and ((*Alexandresaurus*, *Iphisa*) (*Colobosaura* (*Acratosaura*, *Stenolepis*))) received high posterior probabilities (PP = 1.0) but are paraphyletic relative to Gymnophthalmini, the second being its sister clade and the first sister to that group. Contrary to the results of MP analyses with the morphological partition our Bayesian analysis recovered a closer relationship between *Colobodactylus* and *Heterodactylus* instead of between *Colobodactylus* and *Caparaonia* but with little support (PP = 0.80). *Colobosaura* was recovered as the sister taxon of *Acratosaura* + *Stenolepis*. Finally, the position of *Iphisa elegans* and *Alexandresaurus camacan* differs between combined MP and Bayesian analysis, but alternative topologies both have weak support. The relationships within Gymnophthalmini were better resolved, and highly supported clades were recovered (fig. 10).

The paraphyly of Heterodactylini was also found in a previous molecular Bayesian analysis conducted by Castoe et al. (2004), which, based on their results, dissolved tribes within Gymnophthalminae. More recently, Rodrigues et al. (2007), based on a combined morphological and molecular data set under MP, obtained evidence for the Heterodactylini monophyly and kept the former tribal arrangement. They obtained results similar to those of Castoe et al. (2004) under a Bayesian analysis but with no support.

Our study shows that despite the inclusion of additional sampling and morphological characters neither the results of combined MP nor those from partitioned Bayesian analyses produced topologies with robust support for monophyly of the tribe Heterodactylini sensu Pellegrino et al. (2001). Considering the strong-

ly supported monophyly of the Gymnophthalmini and that of the two clades presently allocated in Heterodactylini, we propose to restrict the Heterodactylini to *Heterodactylus*, *Colobodactylus*, and *Caparaonia* and the new tribe Iphisiini to accommodate the genera *Alexandresaurus*, *Iphisa*, *Colobosaura*, *Acratosaura*, and *Stenolepis*. This proposal eliminates controversy and recognizes the strongly supported phylogenetic structure of Gymnophthalminae. Hopefully future analyses including additional genes and other characters will improve the knowledge of inter- and intratribal relationships of these lizards.

The discovery of *Caparaonia itaiquara*, and its endemism to the highland open areas of the Caparaó massif, confirm previous hypotheses suggesting restricted distribution and a basal position of Atlantic forest Iphisiini and Heterodactylini lizards when compared to those occurring in Amazonia or the Cerrado, like *Iphisa* or *Colobosaura* (Rodrigues et al., 2007; Vanzolini and Ramos, 1977). Furthermore, considering the present restriction of *Caparaonia* to highland habitats and its close relationship with *Colobodactylus* and *Heterodactylus*, we assume that currently isolated higher-elevation open habitats of southern Brazil were connected previously under climates cooler than the present one. For this reason it should be interesting to compare populations of different species from isolated high-elevation open habitats from southern Brazil.

Our study also reveals that three lineages of Gymnophthalminae show accentuated body elongation and a high level of fossoriality. *Rhachisaurus brachylepis* is predominantly found in soil galleries under rocks at high elevation (above 1000 m) of Serra do Espinhaço, State of Minas Gerais. Most representatives of the Heterodactylini, *Caparaonia itaiquara*, *Heterodactylus lundii*, *Heterodactylus imbricatus*, and *Colobodactylus dalcyanus* have similar habitats, being fossorial and living in soil galleries both at high elevation and latitudes (between 700 and 2800 m) in the states of São Paulo, Minas Gerais, Rio de Janeiro, and Espírito Santo. *Colobodactylus taumayi* is the only representative of this clade present at lower altitudes but is identical in habitats and body form to its congener and is restricted to high latitudes in the states of São Paulo and

Paraná. The third lineage is formed by the genera *Calyptommatius*, *Nothobachia*, and *Scriptosaura*, which present the highest level of body elongation and fossoriality among Gymnophthalmini (Rodrigues, 1991a, 1991b, 1996; Rodrigues and Santos, 2008). All are psammophilic and endemic to the sand dune region of Rio São Francisco in the State of Bahia or from sandy habitats in the State of Pernambuco. The general picture is that the first two lineages are restricted to extremely cold regions, at least considering the climatic standards for eastern South America, and that the third is endemic to extremely hot, sandy regions in northeastern Brazil. This pattern strongly suggests that fossoriality and body elongation are associated in these lineages and could have arisen as adaptations to avoid extremes of surface temperatures. This hypothesis is further reinforced in the case of *Calyptommatius* because, contrary to the remaining taxa of its clade, these species also became nocturnal, an additional way to avoid extremely high temperatures. A detailed analysis of other elongated and/or fossorial squamates under an explicit phylogenetic hypothesis could illuminate this further.

#### ACKNOWLEDGMENTS

We thank Fundação de Amparo à Pesquisa do Estado de São Paulo (FAPESP), Conselho Nacional de Desenvolvimento Científico e Tecnológico (CNPq), and IBAMA for support and collection permits (numbers 094/2004, 185/2005, and 238/2006). We also thank Estevão Marchesini, director of the Parque Nacional do Caparaó, for support; Silvia Geurgas and Mariana Favero for helping with lab work and data analyses; Luciana Lobo for the drawing; Eduardo Navarro for expertise with Tupi language; Hussam Zaher and Carolina Castro-Mello for access to specimens; and Daniel Munari, Lilian Duarte, and especially our dedicated field guide in Caparaó National Park, Paraíba, for their help in the field.

#### REFERENCES

- Baker, R.H., and R. DeSalle. 1997. Multiple sources of character information and the phylogeny of Hawaiian drosophilids. *Systematic Biology* 46: 654–673.
- Bell, C.J., S.E. Evans, and J.A. Maisano. 2003. The skull of the gymnophthalmid lizard *Neusticurus ecpleopus* (Reptilia: Squamata). *Zoological Journal of the Linnean Society* 139: 283–304.
- Caramaschi, U., and I. Sazima. 1984. Uma nova espécie de *Thoropa* da Serra do Cipó, Minas Gerais, Brasil (Amphibia, Leptodactylidae). *Revista Brasileira de Zoologia* 2: 139–146.
- Caramaschi, U., and I. Sazima. 1985. Uma nova espécie de *Crossodactylus* da Serra do Cipó, Minas Gerais, Brasil (Amphibia, Leptodactylidae). *Revista Brasileira de Zoologia* 3: 43–49.
- Castoe, T.A., T.M. Doan, and C.L. Parkinson. 2004. Data partitions and complex models in Bayesian analysis: the phylogeny of gymnophthalmid lizards. *Systematic Biology* 53: 448–469.
- Cunha, O.R. 1966. Sobre uma nova espécie de lagarto do estado de Minas Gerais *Placosoma cipoense* sp. n. (Lacertilia, Teiidae). *Boletim do Museu Paraense Emílio Goeldi Série Zoologia* 61: 1–11.
- Estes, R., K. de Queiroz, and J. Gauthier. 1988. Phylogenetic relationships within Squamata. In R. Estes and G.K. Pregill (editors), *Phylogenetic relationships of the lizard families*. Stanford, CA: Stanford University Press, 119–281.
- Felsenstein, J. 1985. Confidence limits on phylogenies: an approach using the bootstrap. *Evolution* 39: 783–791.
- Gatesy, J., and P. Arctander. 2000. Hidden morphological support for the phylogenetic placement of *Pseudoryx nghetinhensis* with bovine bovids: a combined analysis of gross anatomical evidence and DNA sequences from five genes. *Systematic Biology* 49: 515–538.
- Giulietti, A.M., and J.R. Pirani. 1988. Patterns of geographic distribution of some plant species from the Espinhaço range, Minas Gerais and Bahia, Brazil. *Anais da Academia Brasileira de Ciências*: 39–69.
- Heyer, W.R. 1982. Two new species of the frog genus *Hylodes* from Caparaó, Minas Gerais, Brasil (Amphibia: Leptodactylidae). *Proceedings of the Biological Society of Washington* 95: 377–385.
- Heyer, W.R. 1983. Variation and systematics of frogs of the genus *Cycloramphus* (Amphibia, Leptodactylidae). *Arquivos de Zoologia (São Paulo)* 30: 235–339.
- Heyer, W.R. 1999. A new genus and species of frog from Bahia, Brazil (Amphibia: Anura: Leptodactylidae) with comments on the zoogeography of the Brazilian campos rupestres. *Proceedings of the Biological Society of Washington* 112: 19–39.
- Hillis, D.M., and J.J. Bull. 1993. An empirical test of bootstrapping as a method for assessing

- confidence in phylogenetic analysis. *Systematic Biology* 42: 182–192.
- Huelsenbeck, J.P., and F. Ronquist. 2001. MrBayes: Bayesian inference of phylogeny. *Bioinformatics* 17: 754–755.
- Kohlsdorf, T., and G.P. Wagner. 2006. Evidence for the reversibility of digit loss: a phylogenetic study of limb evolution in *Bachia* (Gymnophthalmidae: Squamata). *Evolution* 60: 1896–1912.
- Lugli, L., and C.F.B. Haddad. 2007a. A new species of *Bokermannohyla* (Anura, Hylidae) from central Bahia, Brazil. *Journal of Herpetology* 40: 7–15.
- Lugli, L., and C.F.B. Haddad. 2007b. A new species of the *Bokermannohyla pseudopseudis* group from Central Bahia, Brazil (Amphibia, Hylidae). *Herpetologica* 62: 453–462.
- Modenesi, M.C. 1998. Significado dos depósitos correlativos quaternários em Campos do Jordão–São Paulo: implicações paleoclimáticas e paleoecológicas. *Boletim do Instituto Geológico* 7: 1–155.
- Napoli, M.F., and F.A. Juncá. 2006. A new species of the *Bokermannohyla circumdata* group (Amphibia: Anura: Hylidae) from Chapada Diamantina, State of Bahia, Brazil. *Zootaxa* 1244: 57–68.
- Pellegrino, C.K.M., M.T. Rodrigues, Y. Yonenaga-Yassuda, and J.W. Sites Jr.. 2001. A molecular perspective on the evolution of South American microteiid lizards (Squamata, Gymnophthalmidae), and a new classification for the family. *Biological Journal of the Linnean Society* 74: 317–340.
- Pinna, M.C.C. 1992. A new subfamily of Trichomycteridae (Teleostei, Sioluriformes), lower loricaroid relationships and a discussion on the impact of additional taxa for phylogenetic analysis. *Zoological Journal of the Linnean Society* 106: 175–229.
- Posada, D., and K.A. Crandall. 1998. Modeltest: testing the model of DNA substitution. *Bioinformatics* 14: 817–818.
- Presch, W. 1980. Evolutionary history of the South American microteiid lizards (Teiidae: Gymnophthalminae). *Copeia* 1980: 36–56.
- Pugliese, A., J.P. Pombal Jr., and I. Sazima. 2004. A new species of *Scinax* (Anura: Hylidae) from rocky montane fields of the Serra do Cipó, southeastern Brazil. *Zootaxa* 688: 1–15.
- Rodrigues, M.T. 1991a. Herpetofauna das dunas interiores do Rio São Francisco: Bahia: Brasil. I. Introdução à área e descrição de um novo gênero de microteídeo (*Calyptommatius*) com notas sobre sua ecologia, distribuição e especiação (Sauria, Teiidae). *Papéis Avulsos de Zoologia* (São Paulo) 37: 285–320.
- Rodrigues, M.T. 1991b. Herpetofauna das dunas interiores do Rio São Francisco: Bahia: Brasil. III. *Procellosaurinus*: um novo gênero de microteídeo sem pálpebra, com a redefinição do gênero *Gymnophthalmus* (Sauria, Teiidae). *Papéis Avulsos de Zoologia* (São Paulo) 37: 329–342.
- Rodrigues, M.T. 1996. Lizards, snakes, and amphibiaenians from the Quaternary sand dunes of the middle Rio São Francisco, Bahia, Brazil. *Journal of Herpetology* 30: 513–523.
- Rodrigues, M.T., E.M.X. Freire, K.C.M. Pellegrino, and J.W. Sites, Jr. 2005. Phylogenetic relationships of a new genus and species of microteiid lizard from the Atlantic forest of northeastern Brazil (Squamata, Gymnophthalmidae). *Zoological Journal of Linnean Society* 144: 543–557.
- Rodrigues, M.T., M.A. Freitas, T.F.S. Silva, and C.E.V. Bertolotto. 2006. A new species of lizard genus *Enyalius* (Squamata, Leiosauridae) from the highlands of Chapada Diamantina, State of Bahia, Brazil, with a key to species. *Phyllomedusa* 5: 11–24.
- Rodrigues, M.T., et al. 2007. A new genus of microteiid lizard from the Atlantic forests of State of Bahia, Brazil, with a new generic name for *Colobosaura mentalis*, and a discussion of relationships among the Heterodactylini (Squamata, Gymnophthalmidae). *American Museum Novitates* 3565: 1–27.
- Rodrigues, M.T., and E.M. Santos. 2008. A new genus and species of eyelid-less and limb reduced gymnophthalmid lizard from northeastern Brazil (Squamata, Gymnophthalmidae). *Zootaxa* 1873: 50–60.
- Safford, H.D. 1999a. Brazilian Paramos I. An introduction to the physical environment and vegetation of the campos the altitude. *Journal of Biogeography* 26: 693–712.
- Safford, H.D. 1999b. Notas sobre a ecologia e a preservação de *Notochilus coccineus* (Scrophulariaceae), espécie endêmica do maciço do Caparaó, MG/ES, Brasil. *Acta Botânica Brasileira* 13: 175–185.
- Sazima, I., and W.C.A. Bokermann. 1983. Anfíbios da Serra do Cipó, Minas Gerais, Brasil. 5. *Hylodes otavioi* sp. n. (Anura, Leptodactylidae). *Revista Brasileira de Biologia* 42: 767–771.
- Smith, A.P. 1994. Introduction to tropical alpine vegetation: tropical alpine environments. In P.W. Rundel, A.P. Smith and F.C. Meinzer (editors), *Plant form and function*. Cambridge: Cambridge University Press, 1–19.
- Smith, A.P., and T.P. Young. 1987. Tropical Alpine plant ecology. *Annual Review of Ecology and Systematics* 18: 137–158.
- Sorenson, M.D. 1999. TreeRot, version 2. Computer software and documentation. Boston: Boston University.

Swofford, D. 2002. PAUP\*: phylogenetic analysis using parsimony (\*and other methods), Beta Version 4.0.b10. Sunderland, MA: Sinauer.

Vanzolini, P.E. 1982. A new *Gymnodactylus* from Minas Gerais, Brasil, with remarks on the genus, on the area and on montane endemisms in Brasil (Sauria, Gekkonidae). *Papéis Avulsos de Zoologia* (São Paulo) 34: 403–413.

Vanzolini, P.E., and A.M.M. Ramos. 1977. A new species of *Colobodactylus*, with notes on the distribution of a group of stranded microteiid lizards (Sauria, Gymnophthalmidae). *Papéis Avulsos de Zoologia* (São Paulo) 31: 19–47.

Vanzolini, P.E. and W.R. Heyer (editors). 1988. *Proceedings of a workshop on Neotropical distribution patterns*. Rio de Janeiro: Academia Brasileira de Ciências.

## APPENDIX 1

### ADDITIONAL SPECIMENS EXAMINED

**Alcohol.** *Acratosaura mentalis*: MZUSP 56933, Grão Mogol, Minas Gerais. *Alexandresaurus camacan*: MZUSP 93179–93200, Una, Bahia. *Alopoglossus atriventris*: MZUSP 13922–13924, Estiron, Rio Ampiyacu, Peru. *Calyptommatius leiolepis*: MZUSP 68305–68341, Ibiraba, Bahia. *Colobodactylus taunayi*: MZUSP 91446–91448, Pinhalão, Paraná. *Colobosaura modesta*: MZUSP 81346–81362, Caldas Novas, Goiás. *Gymnophthalmus vanzoi*: MZUSP 70354–70356, Fazenda Salvamento, Roraima; MZUSP 95214–95216, Boa Vista, Roraima. *Heterodactylus imbricatus*: MZUSP 89185–89186, Parque Estadual da Cantareira (Núcleo Pedra Grande), São Paulo; MZUSP 3309 Santa Bárbara, Serra do Caraça, Minas Gerais. *Iphisa elegans*: MZUSP 82654–82676, Aripuanã, Mato Grosso. *Micrablepharus maximiliani*: MZUSP 50172–50174, Exú, Pernambuco. *Nothobachia ablephara*: MZUSP 63545–63550, São Raimundo Nonato, Piauí. *Procellosaurinus tetradactylus*: MZUSP 71598–71604, Alagoado, Bahia. *Psilophthalmus paeminosus*: MZUSP 68497–68499, Santo Inácio, Bahia. *Rhachisaurus brachylepis*: MZUSP 54897, 54898, Serra do Cipó, Minas Gerais. *Stenolepis ridleyi*: MZUSP 78724, Mulungú (Sitio Lorena), Ceará. *Tretioscincus oriximinensis*: MZUSP 77427–77428,

77467, 79585, Oriximiná, Pará. *Vanzosaura rubricauda*: MZUSP 71844–71899, Ibiraba, Bahia. **Cleared and stained.** *Acratosaura mentalis*: MZUSP 79557, Maracás Bahia; MZUSP 66231, Cabaceiras, Paraíba. *Alexandresaurus camacan*: MZUSP 94252–94253, Ilhéus; MZUSP 95054, Una, Bahia. *Alopoglossus atriventris*: MZUSP 13922, Peru, Loreto, Rio Ampiyacu. *Calyptommatius leiolepis*: MZUSP 79545, Ibiraba; MZUSP 79546–79548, Alagoado, Bahia. *Colobodactylus taunayi*: MZUSP 94254, Salesópolis, São Paulo. MNRJ 9968, no further data. *Colobosaura modesta*: MZUSP 93420, Serra da Mesa, Goiás. *Gymnophthalmus vanzoi*: MZUSP 79561, Roraima. *Heterodactylus imbricatus*: MZUSP 79562, no further data; MZUSP 94255, Caucaia, Ibiúna, São Paulo. *Iphisa elegans*: MZUSP 82654, 82658, Aripuanã, Mato Grosso. *Micrablepharus maximiliani*: MZUSP 66233, João Pessoa, Paraíba; MZUSP 79589–79591, no further data. *Nothobachia ablephara*: MZUSP 79574, Alagoado, Bahia. *Procellosaurinus tetradactylus*: MZUSP 77878–77879, Alagoado, Bahia. *Psilophthalmus paeminosus*: MZUSP 74958–74959, 79584, Santo Inácio, Bahia. *Rhachisaurus brachylepis*: MZUSP 55533, Serra do Cipó, Minas Gerais. *Stenolepis ridleyi*: MZUSP 66049, Serra dos Cavalos, Pernambuco. *Tretioscincus oriximinensis*: MZUSP 79585, Oriximiná, Pará; MZUSP 79586, Reservas INPA–WWF (km 41), Amazonas. *Vanzosaura rubricauda*: MZUSP 79587–79593, Vacaria, Bahia.

## APPENDIX 2

## MORPHOLOGICAL CHARACTERS AND CHARACTER STATES USED FOR PHYLOGENETIC ANALYSES

## Pectoral girdle

1. Clavicle: (0) wide, flattened anteriorly and enclosing a fenestra; (1) simple, boomerang shaped, fenestra absent; (2) widely flattened anteriorly, fenestra absent
2. Scapulocoracoid complex: (0) normal, primary and secondary coracoid and scapulocoracoid fenestrae present; (1) very reduced, presenting only a vestigial secondary coracoid fenestra
3. Interclavicle: (0) cross shaped, central area extremely enlarged, lateral processes wide and pointed; (1) cruciform, central area reduced, lateral processes extremely long and straight; (2) cruciform, central area reduced, lateral processes posteriorly oriented; (3) a longitudinal rodlike structure with lateral processes reduced or absent; (4) transversal rodlike structure, clavicular and sternal process absent
4. Sternal process of the interclavicle: (0) long, reaching the fontanelle; (1) short, not reaching the fontanelle
5. Number of sternal ribs: (0) three; (1) two; or (2) one
6. Xiphisternum: (0) rodlike, receiving 2 or 3 ribs; (1) Y- or X-shaped, connected to a single rib
7. Postxiphisternum: (0) absent; (1) present
8. Sternal fontanelle process: (0) absent; (1) present

## Pelvic girdle

9. Puboischiatic fenestra: (0) as wide as high; (1) wider than high
10. Pectinate apophysis of pubis: (0) present; (1) absent

## Vertebrae

11. Lumbar vertebrae: (0) present, one; (1) absent
12. Presacral vertebrae: (0) less than 40; (1) 40 or more

## Skull

13. Supratemporal fenestra: (0) almost closed by parietal and postorbital; (1) open
14. Postorbital: (0) distinct; (1) fused to postfrontal
15. Postorbital postfrontal contact: (0) postorbital covers postfrontal; (1) postorbital contacts postfrontal without overlap.
16. Lateral expansions of the parietal: (0) absent; (1) present

17. Shape of postfrontal: (0) irregular, posteriorly wider and longer; (1) triangular; (2) boomerang shaped
18. Postorbital width: (0) wide; (1) narrow
19. Nasals: (0) wide, almost parallel, in broad contact under and with premaxillary; (1) wide, divergent, in contact at midline posteriorly but broadly separated anteriorly by the subtriangular lamina of premaxillary; (2) reduced, widely separated at midline
20. Premaxillary dorsal lamina: (0) wide, posteriorly triangular; (1) subtriangular posteriorly elongate but not touching frontal; (2) large, subrectangular, contacting frontal
21. Maxilla-premaxilla contact: (0) absent; (1) present
22. Squamosal: (0) angulose, extremely curved at the end; (1) slightly curved
23. Frontal: (0) normal; (1) anteriorly divided
24. Glossohyal: (0) separated from basihyal; (1) fused
25. Ectopterygoid process of jugal: (0) reduced, not contacting pterygoid; (1) long, in contact with pterygoid
26. Postfrontal lap joints: (0) absent; (1) present
27. Lateral face of quadrate: (0) not expanded; (1) expanded
28. Lingual process of maxillary: (0) absent; (1) present
29. Basispterygoid process of basisphenoid: (0) very long; (1) reduced
30. Pterygoid: (0) not expanded; (1) expanded
31. Frontal: (0) long, longer than wide; (1) short, as wide as long
32. Parasphenoid process of basisphenoid: (0) reduced; (1) large and long
33. Columella auris: (0) normal, long and thin; (1) short and thick
34. Ventral projection of parietal: (0) no projection; (1) moderately to strongly developed
35. Jugal: (0) simple; (1) triradiate
36. Infraorbital fontanelle: (0) open; (1) closed
37. Pterygoid teeth: (0) present; (1) absent
38. Number of premaxillary teeth: (0) 14; (1) 13; (2) 11; (3) 10; (4) 9; (5) 7
39. Number of maxillary teeth: (0) 25–29; (1) 18–23; (2) 13–17; (3) 9–12; (4) 5–8
40. Number of dentary teeth: (0) 30; (1) 23–26; (2) 19–22; (3) 18; (4) 16; (5) 13.
41. Number of scleral ossicles: (0) 14–15; (1) 13; (2) 11; (3) 5

## External Morphology and Scalation

42. Eyelid: (0) present; (1) absent
43. Ocular scale: (0) present; (1) absent
44. External ear opening: (0) present; (1) absent

45. Ornamentation of head scales: (0) smooth; (1) rugose
46. Posterior margin of head scutes: (0) not straight; (1) straight
47. Prefrontal scales: (0) present; (1) absent
48. Frontal scale: (0) present; (1) absent
49. Lateral margins of frontal scale: (0) lateral margins slightly concave; (1) lateral margins parallel; (2) lateral margins converge posteriorly
50. Frontoparietal scales: (0) present; (1) absent
51. Superciliary scales: (0) four; (1) three; (2) two; (3) one
52. Pairs of enlarged genials: (0) three; (1) two; (2) one
53. Semitransparent disc on lower eyelid: (0) divided; (1) single
54. Position of nostril: (0) in nasal border; (1) in center of nasal
55. Interparietal scale: (0) present; (1) absent
56. Shape of interparital: (0) rectangular; (1) subtriangular with lateral margins converging posteriorly
57. Parietal scales: (0) longer than wide; (1) as wide as long; (2) wider than long
58. Shape of rostral scale: (0) normal; (1) prominent
59. Shape/position of loreal: (0) longer than wide, diagonally disposed, reaching dorsal part of head; (1) as wide as long, or wider than long, never disposed diagonally or reaching dorsal face of the head
60. Loreal scale: (0) present; (1) absent
61. Number of supraocular scales: (0) four; (1) three; (2) two; (3) one; (4) none
62. Position of supraocular scales: (0) arranged longitudinally; (1) arranged diagonally
63. Relative size of first supraocular: (0) small; (1) very large
64. Frenocular scale: (0) present; (1) absent
65. Preocular scale: (0) present; (1) absent
66. Tibial scales: (0) keeled; (1) smooth
67. Shape and sculpture of dorsal scales at mid-body: (0) quadrangular, smooth; (1) leaf shaped, broad, keeled; (2) lanceolate, narrow, keeled; (3) cycloid, keeled; (4) cycloid, smooth
68. Anterior dorsal scales: (0) cycloid; (1) never cycloid
69. Flank scales: (0) lanceolate, imbricate; (1) quadrangular, smooth, imbricate; (2) quadrangular, juxtaposed; (3) cycloid
70. Longitudinal rows of ventral scales: (0) more than two; (1) two
71. First finger: (0) normal; (1) present but without nail; (2) first finger vestigial; (3) first finger absent externally
72. Femoral pores: (0) present; (1) absent
73. Distribution of femoral pores in males: (0) covering the total area of the thigh; (1) restricted to the proximal one third of thigh
74. Sexual dichromatism in flank pattern: (0) present; (1) absent
75. Tail coloration: (0) brown or gray; (1) brilliant red; (2) brilliant blue
- Hemipenis
76. Chevron-shaped flounces: (0) present; (1) absent
77. Ornamentation of chevron-shaped flounces: (0) a comblike series of calcareous spines present; (1) absent



APPENDIX 3  
 MATRIX OF MORPHOLOGICAL CHARACTERS  
 Characters 1–77 are defined in appendix 2.

Species/Characters	1	2	3	4	5	6	7	8	9	10	11	12	13	14	15	16	17	18	19	20	21	22	23	24	25		
<b>Ingroup</b>																											
<i>Alexandresaurus camacan</i>	0	0	1	1	0	0	0	1	0	0	0	0	0	0	0	1	1	0	1	0	0	0	0	1	0		
<i>Acratosaura mentalis</i>	0	0	1	1	0	0	0	1	0	0	0	0	0	0	0	1	1	0	1	0	0	0	1	1	0		
<i>Caparaonia itaiquara</i>	0	0	1	1	0	0	0	1	0	0	0	0	1	0	0	0	0	1	1	0	0	0	0	1	0		
<i>Colobosaura modesta</i>	0	0	1	1	0	0	0	1	0	0	0	0	0	0	0	0	1	1	0	1	0	0	0	1	0		
<i>Colobodactylus taunayi</i>	0	0	1	1	0	0	0	1	0	0	0	0	1	0	0	0	0	1	1	0	0	0	0	1	0		
<i>Heterodactylus imbricatus</i>	0	0	1	1	1	0	1	1	0	0	0	0	1	0	0	0	0	1	1	0	0	0	0	1	0		
<i>Iphisa elegans</i>	0	0	1	1	0	0	0	1	0	0	0	0	0	0	0	0	1	1	0	1	0	0	0	0	1		
<i>Stenolepis ridleyi</i>	0	0	1	1	0	0	0	1	0	0	0	0	0	0	0	0	1	1	0	1	0	0	0	0	1		
<i>Calyptommatius leirolepis</i>	1	1	4	1	1	1	1	1	1	1	1	1	0	1	?	0	?	1	2	2	1	0	0	0	0		
<i>Gymnophthalmus vanzoi</i>	1	0	2	1	0	0	0	1	0	0	0	0	0	1	0	1	0	0	1	2	2	0	0	0	0		
<i>Micrablepharus maximiliani</i>	1	0	2	1	0	0	0	1	0	0	0	0	1	0	1	0	0	1	2	2	0	0	0	0	0		
<i>Nothobachia ablephara</i>	1	0	3	1	2	1	1	1	1	0	1	1	1	0	1	0	0	1	2	2	1	0	0	0	0		
<i>Procellosaurinus erythrocerus</i>	1	0	2	1	0	0	0	1	0	0	0	0	1	0	1	0	2	1	2	2	0	0	0	0	1		
<i>Psilophthalmus paeminus</i>	1	0	2	1	1	0	0	1	0	0	0	0	1	0	1	0	0	1	2	2	0	0	0	0	0		
<i>Tretioscincus oriximinensis</i>	1	0	2	1	0	0	0	1	0	0	0	0	1	0	1	0	0	1	2	2	0	0	0	0	0		
<i>Rhachisaurus brachylepis</i>	2	0	2	1	0	0	0	1	0	0	0	0	0	0	0	0	0	1	0	1	0	1	0	0	0		
<i>Vanzosaura rubricauda</i>	1	0	2	1	0	0	0	1	0	0	0	0	1	0	1	0	2	1	2	2	0	0	0	0	1		
<b>Outgroup</b>																											
<i>Alopoglossus atriventris</i>	0	0	0	0	0	0	0	0	0	0	0	0	0	1	?	0	?	0	2	1	0	1	0	0	0		
Species/Characters	26	27	28	29	30	31	32	33	34	35	36	37	38	39	40	41	42	43	44	45	46	47	48	49	50	51	
<b>Ingroup</b>																											
<i>Alexandresaurus camacan</i>	0	0	0	0	0	0	0	0	0	0	0	0	1	1	1	0	1	0	0	0	0	0	0	1	0	1	
<i>Acratosaura mentalis</i>	0	0	0	0	0	0	0	0	0	0	0	0	1	1	1	0	1	0	0	0	0	0	0	1	0	1	
<i>Caparaonia itaiquara</i>	0	0	0	0	0	0	0	0	0	0	0	0	1	2	2	2	0	1	0	0	0	0	0	1	0	1	
<i>Colobosaura modesta</i>	0	0	0	0	0	0	0	0	0	0	0	0	1	1	1	0	1	0	0	0	0	0	0	1	0	1	
<i>Colobodactylus taunayi</i>	0	0	0	0	0	0	0	0	0	0	0	0	1	2	2	2	0	1	0	0	0	0	1	0	1	0	
<i>Heterodactylus imbricatus</i>	0	0	0	0	0	0	0	0	0	0	0	0	1	2	2	2	0	1	0	1	0	0	1	0	1	1	
<i>Iphisa elegans</i>	0	0	0	0	0	0	0	0	0	0	0	0	1	1	1	0	1	0	0	0	0	0	0	1	0	1	
<i>Stenolepis ridleyi</i>	0	0	0	0	0	0	0	0	0	0	0	0	1	1	1	0	1	0	0	0	0	1	0	1	0	1	
<i>Calyptommatius leirolepis</i>	1	1	1	1	1	1	1	1	1	1	1	1	5	4	5	3	0	1	1	0	0	1	1	2	1	3	
<i>Gymnophthalmus vanzoi</i>	0	0	0	0	0	0	0	0	0	0	0	0	3	2	2	0	0	0	0	0	0	0	0	2	1	2	
<i>Micrablepharus maximiliani</i>	0	0	0	0	0	0	0	0	0	0	0	0	3	1	2	0	0	0	0	0	0	0	1	0	2	0	
<i>Nothobachia ablephara</i>	1	1	1	1	1	0	1	1	1	0	0	1	4	4	4	2	0	0	1	0	0	1	0	2	1	2	
<i>Procellosaurinus erythrocerus</i>	0	0	0	0	0	0	0	0	0	0	0	0	4	2	3	0	0	0	0	0	0	0	0	2	0	1	
<i>Psilophthalmus paeminus</i>	0	0	0	0	0	0	0	0	0	0	0	0	4	3	3	1	0	0	0	0	0	0	0	2	1	1	
<i>Tretioscincus oriximinensis</i>	0	0	0	0	0	0	0	0	0	0	0	0	3	1	2	0	1	0	0	0	0	0	0	2	0	1	
<i>Rhachisaurus brachylepis</i>	0	0	0	0	0	0	0	0	0	0	0	0	4	2	2	0	1	0	1	0	0	0	0	0	1	0	
<i>Vanzosaura rubricauda</i>	0	0	0	0	0	0	0	0	0	0	0	0	3	2	3	0	0	0	0	0	0	0	0	2	1	1	
<b>Outgroup</b>																											
<i>Alopoglossus atriventris</i>	0	0	0	0	0	0	0	0	0	0	0	0	0	0	0	0	1	0	0	1	1	0	0	0	0	0	



## APPENDIX 4

## MEASURES OF SUPPORT FOR ALL INTERNAL NODES OF MOST PARSIMONIOUS TREE RECOVERED FROM THE COMBINED ANALYSIS OF MORPHOLOGY (MORPH) AND MOLECULAR PARTITIONS (FIG. 9B)

Columns present the bootstrap proportions, total and partitioned Bremer values; positive and negative partitioned values indicate support for a given relationship in the combined analysis over the alternative relationship in separate analyses, and contradictory evidence for a particular relationship in the combined analysis, respectively. Zero score indicates the indifference of a given data set at a specific node (Baker and DeSalle, 1997; Gatesy and Arctander, 2000). Nodes A and B, highlighted in bold, show the support for the relationship between *Caparaonia itaquara* and its closest relatives (*Colobodactylus taunayi* and *Heterodactylus imbricatus*, respectively (see fig. 9B).

Node Label	Bootstrap support	Bremer support	Partitioned Bremer				
			16S	ND4	18S	Cmos	Morph
<b>A</b>	<b>67</b>	<b>4</b>	<b>-0.2</b>	<b>7.3</b>	<b>0.0</b>	<b>-0.7</b>	<b>-2.5</b>
<b>B</b>	<b>100</b>	<b>19</b>	<b>4.8</b>	<b>9.3</b>	<b>-0.3</b>	<b>-1.0</b>	<b>6.2</b>
C	<50	3	1.2	2.2	0.0	0.2	-0.6
D	98	15	2.0	8.8	1.0	3.2	0.0
E	<50	1	-0.5	0.0	0.0	1.0	0.5
F	98	12	0.0	1.0	0.0	4.0	7.0
G	73	2	-1.5	1.0	0.0	-2.0	4.5
H	<50	3	-0.8	0.8	0.0	1.0	2.0
I	51	3	-0.5	-2.3	0.0	2.7	3.2
J	50	2	-0.5	0.0	0.0	2.0	0.5
K	100	39	3.9	5.3	4.0	3.6	22.2
L	100	24	2.5	5.0	0.0	7.0	9.5
M	100	33	12.5	8.0	1.0	6.0	5.5

Complete lists of all issues of the *Novitates* and the *Bulletin* are available at World Wide Web site <http://library.amnh.org/pubs>. Inquire about ordering printed copies via e-mail from [scipubs@amnh.org](mailto:scipubs@amnh.org) or via standard mail from: American Museum of Natural History, Library—Scientific Publications, Central Park West at 79th St., New York, NY 10024. TEL: (212) 769-5545. FAX: (212) 769-5009.