

# Dipterists Digest

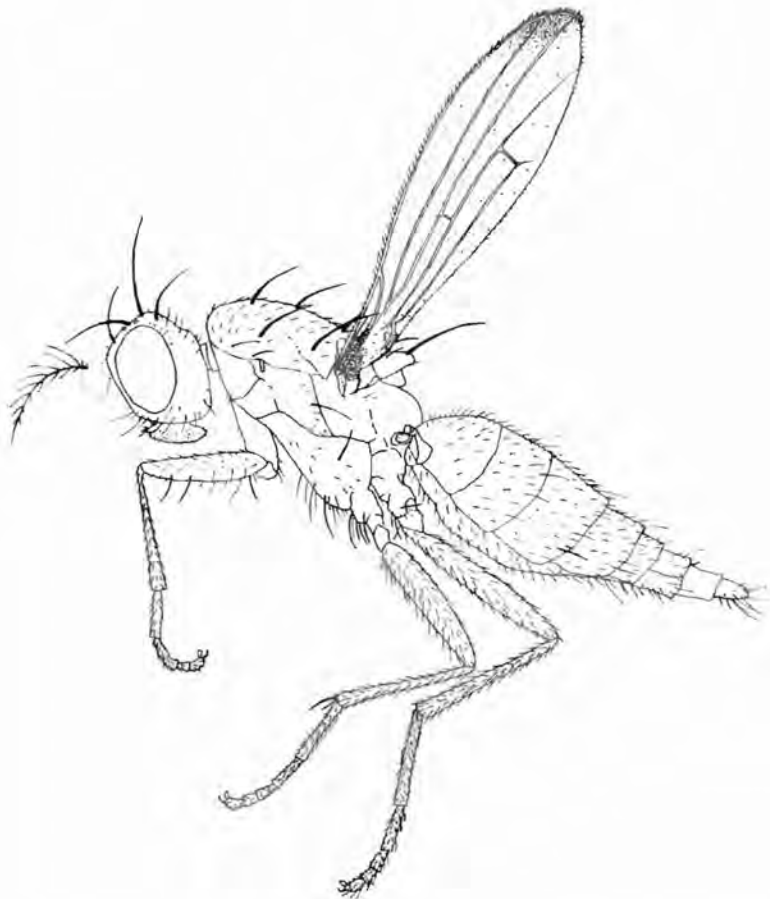

No. 2

1989

**Dipterists Digest** is a popular journal aimed primarily at field dipterists in the UK, Ireland and adjacent countries, with interests in recording ecology, natural history, conservation and identification of British and NW European flies.

Articles may be of any length up to 3000 words. Items exceeding this length may be serialised or printed in full, depending on the competition for space. They should be in clear concise English, preferably typed double spaced on one side of A4 paper. Only scientific names should be underlined. Tables should be on separate sheets. Figures drawn in clear black ink, about twice their printed size and lettered clearly.

Enquiries about photographs and colour plates — please contact the Production Editor in advance as a charge may be made.

References should follow the layout in this issue.

**Initially the scope of Dipterists Digest will be:-**

- Observations of interesting behaviour, ecology, and natural history.
- New and improved techniques (e.g. collecting, rearing etc.).
- The conservation of flies and their habitats.
- Provisional and interim reports from the Diptera Recording Schemes, including provisional and preliminary maps.
- Records of new or scarce species for regions, counties, districts etc.
- Local faunal accounts, field meeting results, and 'holiday lists' with good ecological information/interpretation.
- Notes on identification, additions, deletions and amendments to standard key works and checklists.
- News of new publications/references/literature scan.

---

Texts concerned with the Diptera of parts of continental Europe adjacent to the British Isles will also be considered for publication, if submitted in English.

### **Editorial Panel 1988/89**

Peter Chandler, Weston Research Labs, Vanwall Road, Maidenhead, Berks. SL6 4UF.

Roy Crossley, 1 The Cloisters, Birker Lane, Wilberfoss, York YO4 5RF.

(Empids & Dollies)

Graham Rotheray, Royal Museum of Scotland, Chambers St., Edinburgh EH1 1JF.

(Hoverflies)

Peter Skidmore, Museum and Art Gallery, Chequer Road, Doncaster DN1 2AE.

Keith Snow, Dept. of Biology, N.E. London Polytechnic, Romford Rd., London E15 4LZ.

(Mosquitoes)

Alan Stubbs, Nature Conservancy Council, Northminster House, Peterborough PE1 1UA.

Derek Whiteley, 730 Ecclesall Road, Sheffield S11 8TB. (Production and Marketing)

# Dipterists Digest

**No. 2**

**1989**

*Edited by:* Derek Whiteley

*Published by:*

Derek Whiteley - Sheffield - England

for the

Diptera Recording Scheme

*ISSN 0953-7260*

# CONTENTS

The Council of Europe and the Conservation of Diptera.	3
Martin C. D. Speight	
Some Interesting Diptera Collated in Pitfall Traps	7
in Norfolk Breckland.	P. Withers
Behavioural Ecology of Hoverflies.	8
Jon Heal	
Overwintering Behaviour of the Larva of <u>Myiatropa</u>	11
<u>florea</u> (L.) (Diptera : Syrphidae).	Caroline Greig
The Agromyzidae of Warwickshire	17
John Robbins	
Notes on Irish Trichoceridae (Insecta : Diptera) Including	31
Two Species New to Ireland.	P. Ashe & J. P. O'Connor
<u>Callicera aenea</u> in Wolverhampton	33
Guy T. Knight	
<u>Sphaerophoria fatarum</u> in the British Isles (Syrphidae)	34
Martin C. D. Speight	
An Additional British <u>Sphaerophoria</u> Discovered in	34
Devon	Alan E. Stubbs
Some Modifications to Commercially-Made Suck-Pooters	36
For Use in Diptera Collecting	D. K. Clements
A Remarkable Addition to the British Moth-fly Fauna	38
P. Withers	
Some Old Records of <u>Chorisops nagatomii</u> Rozkošný	39
(Stratiomyidae)	Roy Crossley
<u>Geomyza agustipennis</u> Zetterstedt (Opomyzidae) in	40
Gwent : Third British Record	D. Gibbs
Records of Some Local or Scarce Hoverflies in South	42
Cleveland	Chris Bentley
Dual Courtship Strategies in <u>Criorhina asilica</u> (SYRPHIDAE)	43
Alan Stubbs	
<u>Phytomyza scolopendri</u> R.-D. (Diptera : Agromyzidae) -	44
New to Scotland	K. P. Bland

## THE COUNCIL OF EUROPE AND THE CONSERVATION OF DIPTERA

*Martin C. D. Speight*

If anyone had the urge to carry out a popularity poll, to discover which sorts of organism were most beloved by humanity, flies would probably gain fewer votes than almost any other sort of animal, being popularly perceived as little better than airborne colonies of "germs". Some years ago, a certain Minister's Deputy was horrified to discover that as part of the day's agenda, the Committee of Ministers of the Council of Europe was expected to debate recommendations on the conservation of butterflies. He was convinced that this would make the Ministers look ridiculous. And butterflies are among the most acceptable invertebrates one can imagine, eclipsed only by gastronomically attractive items like the lobster. Many entomologists have become apathetic about insect conservation in the face of the difficulties which have to be overcome. Others have avoided involvement in efforts to conserve insects, in order to themselves avoid ridicule (Speight, 1986a).

The prejudices, priorities and structure of the European conservation movement do not favour invertebrate animals (Speight 1985, 1986b). And, somehow or another, as an item in conservation activities, all invertebrates have usually been lumped together, as equivalent to "the mammals" or "the flowering plants". However manifestly absurd this grouping of the multifarious invertebrate phyla may be, it represents a second important consideration in any attempt to appreciate the place occupied by the Diptera in current moves to conserve Europe's flora and fauna.

To date, but few international projects have been concerned with the conservation of European invertebrates. The most important so far being the Charter on Invertebrates, adopted by the Council of Europe in 1986, and, during 1987, the incorporation of selected invertebrates into the Conservation of European Wildlife and Natural Habitats. The Charter on Invertebrates is discussed in detail by Pavan (1986) and this is not the place to consider it at length. But for those who are not familiar with its content its opening statement bears repetition here:

"Invertebrates are the most important component of wild fauna, both in number of species and biomass"

It closes with the words "No plant or animal species must be allowed to disappear because of man's activities". It is all very well saying, "Yes, but what has been done about conservation of Diptera as a result?" The question is more "What have YOU done about the conservation of Diptera since this watershed document appeared?" To judge by achievements so far, if Europe's dipteran fauna has to rely upon Europe's dipterists for its survival, we can look forward to large numbers of fly species becoming extinct!

The 50 or so insect species now incorporated into Appendix II of the Bern Convention, which provides for the special habitat protection of the listed species, is based on the list proposed by Collins and Wells (1987), which included no species of Diptera. But it is significant that any invertebrates are now named in this European Convention, and the way now lies open for species of Diptera to be considered for inclusion at a future date. However, reference to one of the criteria employed by Collins and Wells (1987), in drawing up their list of candidate species, shows how Diptera might be expected to fare badly in any such listing: "The species must be reasonably easy to identify, and preferably familiar to members of the public". They go on to add "the listing of obscure and cryptic insects will only serve to alienate the cause of insect conservation from the people of Europe". However one might dispute this logic, it is easy to see that

its adoption automatically rules out the vast majority of insects, including all Diptera, from consideration, however close they may be to extinction in the continent. Hopefully, wiser council will prevail when criteria are being drawn up in any similar listing exercise carried out in future.

The booklet "Management of Europe's natural heritage: twenty-five years of activity" (Council of Europe, 1987) provides an overview of the gamut of activities conducted by the council in relation to conservation. A scan of that booklet shows that many of these activities indirectly have a bearing on conservation of Diptera, but only one, the study on "Saproxylic Invertebrates and their conservation" (Speight 1989), goes as far to name species of Diptera in danger of extinction in Europe. Sixty-odd species of old forest Diptera are listed there, as being sufficiently localised in Europe that their occurrence in a forest can be regarded as suggesting that forest may be of international scientific interest for nature conservation. Those species are listed here in Appendix 1 of this text. Arising from that study, the Committee of Ministers of the Council of Europe issued recommendations to the Governments of member states, on the protection of saproxylic organisms and their biotopes. These recommendations are repeated here in Appendix 2. Such recommendations may not be binding in international law, as are the provisions of the Bern Convention to its signatories, but they do represent formal acknowledgement that a problem exists and that there is need to take action, internationally, to improve the situation.

The following UK forests are listed in the Saproxylic Invertebrates study, as being of international importance for the conservation of saproxylic organisms

Abernethy (Inverness): *Pinus*  
Epping (Essex): *Carpinus/Fagus/Quercus*  
Moccas Pk. (Hereford/Worcester): *Fagus/Quercus*  
New Forest (Hampshire): *Fagus/Quercus*  
Windsor Forest/Windsor Gt. Pk. (Berkshire): *Fagus/Quercus*

For the conservation of Diptera, it is arguable that the New Forest, for example, is as important as any other site in Great Britain. But the conservation movement has yet to achieve adequate protection for either the New Forest or most of the other forests listed. One can only hope that these Committee of Ministers' recommendations will be used to increase the pressure on the relevant authorities to take action to secure the future of forests such as these.

If this present text is published around the date expected, it will appear during a period when another piece of international legislation critically important to European wildlife is in preparation, the EEC draft directive on the protection of habitats and wildlife. It is intended that that document, also, shall list invertebrate species requiring special measures to be taken for their protection, in this instance throughout the European Economic Community. It is up to dipterists to ensure that Diptera which can validly be listed there do get included in the listings. At present, there is no European Society or Association concerned with the study or conservation of Diptera. Neither is there any European grouping for insect conservation. IUCN has not even got a European office for European conservation matters in general, let alone an office for conservation of the European insect fauna. The overworked officers of the IUCN Conservation Monitoring Centre, although including an entomologist, have to concern themselves with the entire world. In the European Invertebrate Survey we have set up a project on the invertebrates added to the Appendices of the Bern Convention, but we have no groups focused on Diptera and their conservation.

So what are dipterists going to do, to promote the conservation of Diptera internationally, at the European level? If they do nothing they will not be missed, because to-date dipterists have done so little to draw attention to the plight of

Europe's Diptera fauna. Each time they fail to present a case for the conservation of Diptera, in an international forum concerned with the future of Europe's wildlife, dipterists reinforce the notion that Diptera can be ignored and dipterists have nothing to offer.

**References**

- Collins, N.M. (1987) Invertebrates in need of special protection in Europe. **Nature & Environment Series, No 35**, Council of Europe, Strasbourg, 1-162.
- & Wells, S.M.
- Council of Europe (1987) Management of Europe's natural heritage: twenty-five years of activity. **Council of Europe**, Strasbourg, 1-127.
- Pavan, M. (1986) A European cultural revolution: the Council of Europe's "Charter on Invertebrates". **Council of Europe**, Strasbourg, 1-51.
- Speight, M.C.D. (1985) European insects. **Naturopa, No 49**: 4-6.
- Speight, M.C.D. (1986a) Attitudes to insects and insect conservation. **Proc. 3rd Eur. Cong. Ent., Amsterdam**, pt 3: 369-385.
- Speight, M.C.D. (1986) La conservation des invertebrates: folie ou necessite, illusion ou realite. **Bull. Rech. Agron., Gembloux**, 21(2): 245-254.
- Speight, M.C.D. (1989) **Saproxylic invertebrates and their conservation. Nature & Environment Series, No 42**, Council of Europe, Strasbourg.

**Appendix 1: Saproxylic Diptera listed in Speight (1989), as so localised in their European distribution that they can now be regarded as indicators of forests of international importance.**

**Canthylosceldidae:** *Hyperoscelis eximia* (Boheman)

**Coenomyiidae:** *Coenomyia ferruginea* (Scopoli)

**Keroplatidae:** *Keroplatus tipuloides* Bosc

**Pachyneuridae:** *Pachyneura fasciata* Zetterstedt

**Stratiomyiidae:** *Berkshiria hungarica* (Kertész); *Odontomyia annulata* (Meigen);

*Clitellaria ephippium* (Fabricius)

**Syrphidae:** *Brachyopa bicolor* (Fallen); *B.ferruginea* (Fallen); *B.panzeri* Goffe;

*B.vitata* Zetterstedt; *Brachypalpus chrysites* Egger; *B.valgus* (Panzer);

*Caliprobola speciosa* (Rossi); *Callicera aenea* (Fabricius); *C.aurata* (Rossi);

*C.loewi* Verrall in Collin; *C.macquarti* Rondani; *C.rufa* Schummel; *C.spinolae*

Rondani; *Ceriana conopoides* (L.); *Chalcosyrphus eunotes* (Loew); *C.femoratus*

(L.); *C.jakobsoni* (Stackelberg); *C.pigra* (Fabricius); *C.valgus* (Gmelin);

*Criorhina pachynetra* Egger; *Doros destillatorius* Mik; *Ferdinandea aurea*

Rondani; *F.ruficornis* (Fabricius); *Lejota ruficornis* (Zetterstedt); *Mallota*

*dusmeti* Andreu; *M.fuciformis* (Fabricius); *M.negilliformis* (Fallen); *Milesia*

*crabromiformis* (Fabricius); *M.semiluctifera* (Villeneuve); *Myolepta difformis*

Czerny & Strobl; *M.helvetica* (Wainwright); *M.nigritarsis* Coe; *M.obscura*

Becher; *M.potens* (Harris); *M.vara* (Panzer); *Pocota personata* (Harris); *Psarus*

*abdominalis* (Fabricius); *Psilota anthracina* Meigen; *Sphecomyia vespiformis*

Gorski; *Sphiximorpha subsessilis* (Illiger in Rossi); *Spilomyia boschmai* Lucas;

*S.digitata* (Rondani); *S.diopthalma* (L.); *S.manicata* (Rondani); *S.saltuum*

(Fabricius); *Temnostoma apiforme* (Fabricius); *Xylota fulviventris* Bigot; *X.meigeniana* (Stackelberg); *X.suecicia* (Ringdahl)  
**Tipulidae:** *Ctenophora elegans* (Meigen); *C.festiva* Meigen; *C.flaveolata* (Fabricius); *C.guttata* Meigen; *C.ornata* Meigen; *Tanyptera nigricornis* (Meigen)  
**Xylomyiidae:** *Solva interrupta* Pleske; *S.maculata* (Meigen)

**Appendix 2: Extract from Recommendation R<sup>88</sup>10 of the Committee of Ministers of the Council of Europe, on the protection of saproxylic organisms and their biotopes.**

The Committee of Ministers:

RECOMMENDS THE GOVERNMENTS OF THE MEMBER STATES OF THE COUNCIL OF EUROPE TO:

1. give particular consideration to forests known to possess a well-defined fauna or flora of saproxylic organisms when deciding protection priorities in natural woodlands;
2. bearing in mind their essential role for the conservation of saproxylic organisms, protect all ancient natural forests;
3. consider survey of saproxylic organisms in assessing the quality of forests for nature conservation purposes, particularly where the intention is to re-establish natural forest conditions within a protected area;
4. manage protected forests according to local conditions and in such a way as to maintain their saproxylic fauna and flora, for instance by
  - avoidance of the removal of firewood, fallen timber and dead trees wherever possible;
  - avoidance of undue human interference in protected natural and ancient forests which are important for the conservation of saproxylic invertebrates;
  - enlargement of the protected area when it contains only small enclaves of ancient trees;
  - delimitation of adequate areas where wood and fallen trees can be left untouched in forests where these practices may not seem desirable for the whole forest;
5. appeal to the cooperation and skills of forest managers; provide them with information on the positive role of saproxylic organisms in forest dynamics and to the consideration of old trees and dead wood as important elements within the forest ecosystem rather than sources of disease, particularly in cases where the old trees are deciduous species within commercial conifer forest or vice versa;
6. take steps to encourage the in-depth study of the ecology of poorly known threatened saproxylic species, so that further management practices appropriate for promoting the survival of these species can be identified;
7. take steps to re-establish threatened saproxylic species in parts of Europe from which they have disappeared;



8. encourage and promote education of the public visiting forests in the interest of saproxylic organisms and the importance of not disturbing fallen timber or dead trees;

9. consider for integration in the European network of biogenetic reserves, the forests mentioned in the above-mentioned study, in view of their potential international importance because of the saproxylic organisms which they shelter;

10. ensure, in States where the maintenance of moribund and dead trees would be in conflict with legal requirements for access to land by the public, that selected sites can be exempted from such legal requirements, so that the trees can be allowed to die naturally of old age

*Martin C.D. Spight, Research Branch, Wildlife Service, Sidmonton Place, Bray, Co. Wicklow, Ireland.*

### Some Interesting Diptera Collected in Pitfall Traps in Norfolk Breckland

*P. Withers*

A small collection of diptera obtained in pitfall traps set for coleoptera in the Stanford battle area of the Breckland in Norfolk (TL 89) contained some unusual material, including several brachypterous species.

The chloropid *Crassivenula brachyptera* (Thalhammer) was added to the British list by Ismay (1979, Entomologist's mon. Mag. 115: 225-227) on the basis of specimens found on a number of occasions on Suffolk heathlands. The capture of a male at Stanford in a sample from 6.iii-27.iii.88 is thus not too surprising. The species is NCC category 3.

Brachyptery is not unusual among certain sphaerocerids associated with small mammals and their runs, and the comprehensive recent treatment of this family by Pitkin (1988, Handbk. Ident. Br. Insects 10 5e) has enabled their determination with a far greater degree of confidence than ever before. *Spelobia pseudonivalis* (Dahl) is recorded from vole and mouse runs, and its rarity is demonstrated by the few (4) specimens which Pitkin was able to examine. One male was found among material collected 6.iii-27.iii.88. *Minilimosina gemella* Rohacek was added to the British list by Pitkin *et al* (1985, The Naturalist 110:81-90) from a small series taken in pitfall traps in upland localities. Since the holotype was also collected at altitude in the Alps, the implication might seem to be that this species is part of the boreal element of our fauna. It is therefore extraordinary that two males of this species were taken in the examined Norfolk material between 27.iii and 10. iv.88.

Perhaps the most remarkable find was two males of *Nostima semialata* (Collin). Since its discovery at Tubey, Oxon. (1913, Entomologist 46:1-3), this ephydrid with drastically abbreviated and narrow wings has only been found at Brettenham Heath, Norfolk (A.G. Irwin, personal communication) and Bredon Hills, Worcs. (M. Drake, personal communication). This latter record is based on a specimen caught by a D-Vac suction device. These localities are calcareous/neutral short-turfed grassland, biotypically identical to much of the Breck around Stanford. This species is NCC Category 1.

*P. Withers, 27 Beech Way, Dickleburgh, Diss, Norfolk.*

## BEHAVIOURAL ECOLOGY OF HOVERFLIES

Jon Heal

Normal patterns of animal behaviour are closely adapted to the habitats in which each species is most commonly found. While hovering is a behaviour that characterises syrphid flies, not all syrphid species use their hovering abilities to the same extent. Ecological studies of *Eristalis* species have revealed considerable differences, or at least different tactics, in the normal style of mating behaviour. Courtship, as such, does not appear to occur; unreceptive females will reject attempts to mate. It is the manner in which receptive females are sought that varies. As females may only need one mating to ensure fertilisation of all their eggs, there is obviously a premium on locating females within the first day or two after emerging from the puparium.

Basically, there are two approaches used by *Eristalis* males- either to seek females at their feeding sites, or to catch them along flight routes. The most commonly observed mating strategy is the prolonged hovering at a fixed point in space that is done by male *Eristalis pertinax*. However this requires rapid expenditure of energy, and only occurs in warm conditions. A less energetic form of behaviour is the "perch and dart" method. The male perches on the foliage of a tree or bush, and darts out at passing insects, although most of the ones chased will not be *E. pertinax* females, and the chases are discontinued after a few seconds; the male often returns to the same - or a nearby - spot. Transitions between "perch and dart" and continuous hovering can often be seen on summer days as the male warms up. The same strategies, and the same transitions between the more and less energetically demanding types of behaviour, are seen in well-known and abundant species of hoverfly such as *Syrphus ribesii* and *Episyrphus balteatus*. None of these species seek out females around patches of flowers, although they may often be using aphid honeydew on leaves as a source of food.

Other *Eristalis* species use patches of flowers as the site for mate-searching. The most specific behaviour is used by male *E. nemorum*; this is illustrated in the frontispiece of "British Hoverflies" by Stubbs and Falk. The male hovers about 1-2 cm above a feeding female, but does not attempt to mate while she is still feeding. Males may hover in this way for as long as a minute, though sometimes they may bounce down on the female, presumably in an effort to disturb her. Female *E. nemorum* have light brown oval patches at each side of tergite 2, but these blacken as the female ages. It would be interesting to know if the males can detect the difference in colour pattern, since mature females will certainly have mated and are almost certain to reject further attempts to mate. I have never seen *E. nemorum* show any other type of mate-searching behaviour; it seems to be an invariable feature of this species. The closely related *E. rupium* replaces *E. nemorum* at higher altitudes; observations on *E. rupium* would make an interesting comparison.

There is a range of intermediate approaches used by the other common *Eristalis*. Prolonged hovering is also used by *E. intricarius*, but this is usually located around feeding sites, often bramble bushes, rather than along flight paths into woodland areas. *E. horticola* is often found in similar bushy habitats, though its strategy is more of a mixed one. Males may patrol flowers, and sometimes fly towards feeding insects. But they may also perch on the foliage, or hover close by; again, hovering is the more prevalent when the weather is at its warmest. *E. arbustorum* males fly around clumps of flowers, making visits to insects of about the right size. Mating attempts are only made when the feeding insect leaves the flower, and such attempts are a common sight on warm days. However nearly all

attempts are unsuccessful, and sometimes the fly chased is not even of the right species.

It is rather curious that species such as *E. arbustorum* and *E. pertinax* seem to spend such a lot of energy in seeking potential mates, while the behaviour that I have observed in *E. tenax* is quite different. Although I have spent many years observing *E. tenax* in the wild, and have bred several thousand in the laboratory when studying the genetics of colour patterns, I have seen very few cases of mating behaviour of any sort, and have hardly any records of paired flies. Laboratory crosses were often successful, so mating took place, but I conclude that the females do indeed only mate the once that is required, and also that mate-searching is limited in time to a few preferred circumstances. Observations have suggested that its behaviour is most akin to that of *E. horticola*. Occasionally I have noticed a particular slow flight of females, with a male following at a distance of about 40 cm. I suspect that the slower flight is a sign of receptivity, yet have not seen the pairing ensue. The published account of *E. tenax* by Wellington and Fitzpatrick (1981) presents quite a different story, and though Canadian climates bring out different patterns of behaviour from the species' repertoire, I think it more likely that they have just not studied the species for a sufficient length of time to interpret successfully the observations recorded. One of the problems in recent years has been a tendency to discuss insect "territories" in the same terms as bird territories, but this is not really fair - hoverflies, in particular, lack both the memory and the population stability to be territorial in any sense that lasts more than a few minutes. Use of the word "lek" has been misleading when discussing aggregations of hovering syrphids. As Francis Gilbert has demonstrated recently (see Gilbert 1984), this type of activity has a lot to do with the requirements of thermoregulation.

The reason for writing this article was to point out that species evolve patterns of behaviour that fit their own habitats. For example, *E. pertinax* can be found at woodland edge and hedgerow, and is to be found at bushes in parks and gardens, not in open areas of waste ground. Thus using a bushy perch as a look-out post makes sense, particularly as this species may often use muddy ground in woods as a breeding site, so that newly emerged females will at times have to emerge from the woodland to look for floral feeding sites. In contrast, *E. tenax* is to be found in more urban areas, particularly open areas of waste ground, on which it seems to visit preferentially colonising Compositae such as the yellow-flowered Coltsfoot and Oxford Ragwort. In this situation flight paths would be unpredictable and so searching around flowers would be more effective. The same applies to *E. arbustorum*, often to be found in the same places as *E. tenax*, though rather more widespread in its distribution. *E. nemorum*, occurring on low vegetation in fairly open rural habitats, would also be easiest to locate at flowers. One species it often frequents is the knapweed *Centaurea nigra*, which can produce large amounts of food at times and so detains feeding flies longer than, say, a capitulum of Oxford Ragwort. The choice of flowers, which is partly dependent on the choice of habitat in the first place, then may influence the optimal behaviour for males seeking females. For male *E. nemorum* it seems as if one strategy has evolved which is better than any other in all its natural situations.

The story does not end here, because all these flies are large and conspicuous day-flying insects, palatable to birds, and so at risk from predation. Most *Eristalis* species have evolved a resemblance to bees or wasps, this being a case of Batesian mimicry. On the whole, species that patrol patches of flowers have yellow and black markings e.g., males of *E. arbustorum* and *E. horticola*. This waspish colouration will suit them, as their movements also resemble the behaviour of wasps searching for insect prey on flowers. The females behave differently. In the case of *E. arbustorum* the female looks different too. The

female pattern is darker, and also darkens further with age, so the old females look very much like solitary bees of the genera *Colletes*, *Andrena* and *Halictus*. These bees also forage at the same sorts of flowers.

There are many other points of difference between the species of this genus e.g., sites and techniques of oviposition. To understand why species differ, a knowledge of their ecology is needed. Pinned specimens just aren't enough.

#### References

- Gilbert, F.S. 1984 Thermoregulation and the structure of swarms in *Syrphus ribesii* (Syrphidae). *Oikos* 42: 249-255
- Wellington, W.G. & Fitzpatrick, S.M. 1981 Territoriality in the drone fly, *Eristalis tenax* (Diptera, Syrphidae) *Canadian Entomologist* 113: 695-704.

#### Appendix

Selected observations:

##### *Eristalis arbustorum*

Only record of pairing: 9.7.75 (Liverpool). Unsuccessful attempts seen on many occasions.

##### *Eristalis horticola*

Most records of mate seeking behaviour are from June and July. 19.6.79: Full course of pairing seen, as follows. (i) Female feeding at hawthorn blossom. (ii) Male perched on same group of flowers. (iii) Female flew away. (iv) Male pursued, from a standing start, and caught female. (v) Female allowed mating to take place. (vi) Pair returned to hawthorn flowers to mate. (vii) After 10 minutes, the pair flew off, but were still joined together.

##### *Eristalis nemorum*

Hovering of male over feeding female: most records are for June, July and August. Many observations of males poised above wrong species too e.g., *Apis*, *Bombus*, *Andrena*, *Syrphus*, *Eristalis iniricarius*. 9.7.77 na 9.6.79: 3 males hovering above a single female *E. nemorum*, each trying to keep its position above the female, but with no signs of positive interactions between the males (no "aggression"). Only record of a mating pair: 22.8.77 (Keele).

##### *Eristalis pertinax*

Most observations of hovering males were made in May and June. Records of mating: 19.4.75 (Aldermaston), 14.9.77 (Keele) - flies paired for over 10 minutes.

##### *Eristalis tenax*

Only mating seen in the wild, during a Test Match (England v New Zealand) at Trent Bridge, Nottingham, 11.8.78. Attempted mating - of another male - seen in Liverpool, 21.9.75. Only other records of definite attempts to mate, at Keele University, 10.11.77. and 11.10.79. "Perch and dart" behaviour - from ground level perches - on 8.10.79 (patch of sand) and 25.8.81 (grass lawn).

*Jon Heal, 22 Russell Street, Wolstanton, Newcastle-under-Lyme, Staffs.*

## Overwintering Behaviour of the Larva of *Myiatropa florea* (L.) (Diptera: Syrphidae)

Caroline Greig

### Introduction

Understanding how insect larvae cope with winter is important. In temperate regions, particularly, mortality rates are high during this time (Varley et al. 1973). The rat-tailed larva of *Myiatropa florea* (L.) lives in rot-holes of various deciduous trees (Hartley 1960). These rot-holes form where rain-water accumulates, either at the base of branches or among the surface roots of a tree. Fallen leaves and other debris fall into these pockets and rot to form a rich, organic detritus on which *M. florea* feed (Roberts 1970). By November, in the British Isles, most larvae have reached the third and final stage and are in diapause (Hartley 1961, Roberts 1970). Nonetheless preliminary observations showed that diapausing larvae were remarkably active. In this paper activity patterns and locomotory behaviour of the diapausing larva of *M. florea* are examined in relation to winter survival.

### Winter survivorship

The effect of winter conditions on survival was examined by comparing the numbers of larvae in rot-holes before and after winter. Rot-holes in *Fagus sylvaticus* L. and *Acer pseudoplatanus* L. at Corstorphine Hill, Edinburgh (GR 2074) were sampled in the autumn (25/26.xi & 1.xii.1986) and in the following spring (30.iv.1987). For each of the 27 rot-holes the approximate area of the mouth, maximum depth (mouth to the bottom of the detritus), depth of standing water, depth of detritus and the number of larvae present were recorded. Other rot-holes were investigated on a casual basis at several sites in and around the Edinburgh area during winter 1986/7.

Rot-holes varied considerably in size (Table 1). Numbers of larvae per rot-hole varied from 0-41 with a mean of 7.85 (Table 1). Fifteen percent of rot-holes contained no larvae.

Correlation coefficients were estimated for each parameter against the number of larvae present in each rot-hole. Maximum depth and depth of water were the only parameters which showed a correlation with the number of larvae present ( $r = 0.69$  and  $0.61$  respectively,  $P < 0.05$ ).

When rot-holes were re-examined in the spring mean survivorship was low at  $5.3 \pm 3.3\%$ , but out of 16 rot-holes re-sampled only three had larvae in them. The majority of rot-holes ( $n=15/16$ ) had dried up and often contained centipedes (Chilopoda) and rove beetles (Staphylinidae).

### Locomotion of the diapausing larva of *M. florea*

Observation in the field suggested that the larva of *M. florea* spends most of its time buried in the detritus at the bottom of the rot-hole. To investigate whether larvae actively bury themselves artificial rot-holes comprising glass jars (diameter 80mm, height 115mm) containing detritus and pondwater were set up in daylight and larvae placed individually at the surface of the water.

At the end of a 15 min. period the majority of larvae tested ( $n=28/35$ ) were completely buried, except for the breathing tube.

A typical sequence of movements led to burial. Within a few minutes of being placed in the water most larvae sank. Those that floated became active, moving the body from side to side and up and down. Occasionally they became enveloped around their breathing tubes. Eventually such larvae sank. On the

surface of the detritus, larvae crawled about with the anterior end moving from side to side against the substrate. The head was the first part of the body to penetrate the detritus (Fig 1a). The waves of muscular contraction that pass along the body during movement served to push the larva into the detritus with the prolegs and crochets gripping the surface to prevent slippage. Additional force to help bury the larva was sometimes provided by lifting the body into a perpendicular position once the anterior end was buried (Fig 1b) and coiling the breathing tube similar to a cork screw (Fig 1c). When completely buried, movement ceased. The breathing tube, if not already extended, was soon elevated to the water surface (Fig 1d).

The nature of the substrate affects burrowing efficiency. When sand replaced detritus in the jars, none of the 6 larvae tested were buried after 60 mins. All the larvae appeared to make attempts to penetrate the substrate by pushing against the sand with the anterior end. However, sand seemed to be too compact a substrate for the larva of *M. florea*.

A negative response to light could be the underlying stimulus eliciting sinking and burrowing. To test sensitivity to light 15 larvae were individually presented with a choice between light (light source was a 60 watt white bulb =  $2500\text{mW/m}^2$ ) and dark sides of a water-filled Petri dish. After 15 min all larvae were on the darkened side. Thus diapausing larva of *M. florea* appear to be negatively phototactic.

Although negative phototaxis may elicit sinking it is not the important stimulus underlying burrowing because the same proportion of larvae burrow under light and dark conditions (Table 2).

On the surface of the detritus, burrowing behaviour could be elicited from low thigmokinesis ie. high levels of contact stimulation result in low levels of activity, (Fränkel and Gunn 1961)- a response known in other groups of larval syrphids (Rotheray and Martinat 1984). To test whether the larva of *M. florea* is low thigmokinetic 4 lengths of 5cm long capillary tubing, decreasing in diameter from 8-7-5-4mm were joined end to end. A larva was introduced into the open end of the 8mm tube and the apparatus kept in darkened conditions. Every 5min the position of the larva was recorded until movements ceased. All of the 14 larvae tested were motionless after 15min. Ten had settled in the 5mm tube and one each in the 7mm and 8mm tubes: they were curled round the inside. Further indication of the importance of low thigmokinesis was suggested when 15 larvae were placed in a jar containing water alone. They rapidly aggregated together at the bottom of the jar and wrapped themselves around each other.

To see if there was diurnal variation in burrowing ten larvae were monitored every hour for 72 hours in artificial rot-holes, 5 larvae per jar. Jars were placed outdoors but sheltered from the rain. The position of each larva ie. whether buried or floating, the number of breathing tubes visible at the water surface, the temperature of the water and the light intensity were recorded each hour.

All larvae remained buried throughout the three days. The only sign of their presence were breathing tubes breaking the water surface. A diurnal variation in the appearance of the breathing tubes ie. when they broke the water surface, was recorded with peak activity in the late afternoon and early evening (Fig 2). Breathing tube apparatus was correlated to water temperature for the first two days ( $r = .38$  for day 1  $P < 0.10$  and  $r = .54$  for day 2  $P < 0.01$ ) but not on the third day ( $r = 0.34$   $P > 0.10$ ). On day 3 temperatures were low all day which may have effected activity (Fig 2c). Breathing tube appearance was not correlated to light intensity although water temperature and light intensity were themselves correlated.

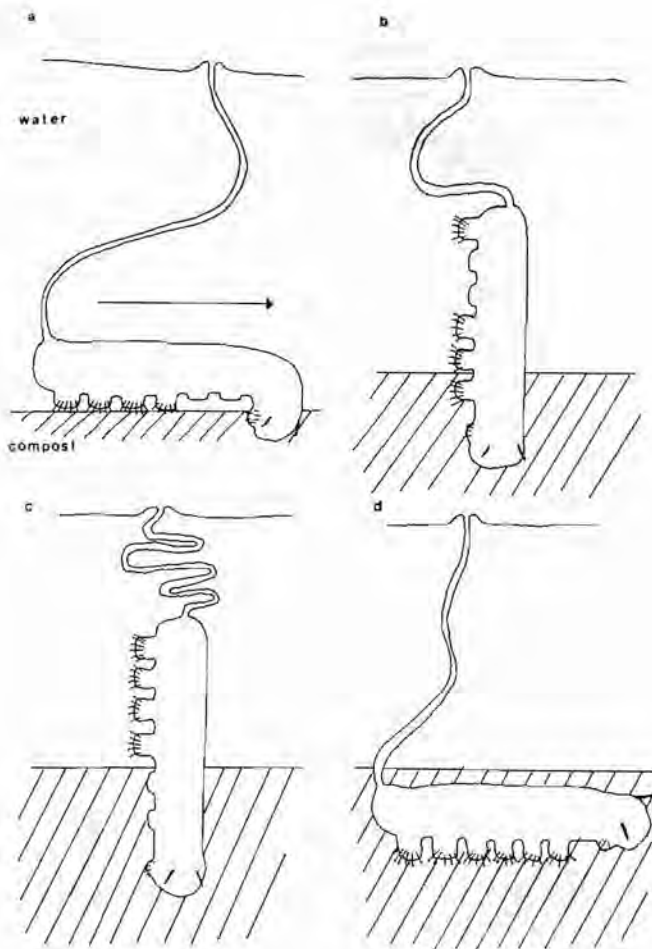

Fig 1 The method used by the larva of *M. florea* to bury itself. a) the larva "scans" the substrate for a penetration site and the anterior end enters first (arrow indicates direction of movement); b) the larva orientates itself perpendicular to the soil surface; c) the breathing tube may be thrown into a series of loops; d) the larva rests under the detritus with its breathing tube extended.

## Discussion

During this study it was assumed that *M. florea* larvae collected from the field were in diapause. The fact that no puparia formed either in the laboratory or in the field during the study period suggests that development is truly arrested during winter.

Diapausing larvae of *M. florea* spend most of their time buried in the detritus at the bottom of the rot-hole. Two behavioural mechanisms appear to lead to burial. In response to negative phototaxis larvae may sink to the bottom of the water. The mechanism causing sinking is probably the same as in morphologically similar *Eristalis tenax* L. larva. Buckton (1985) showed that air contained in the tracheal tubes acts as a buoyancy aid and to sink, larvae expel this air. Floating *M. florea* larvae always had the tip of their breathing tubes above water and air in the tube may similarly buoy larvae up in the water. The negative response to light may simply consist of expelling air from the breathing tube which results in the larvae sinking. The very active twisting and turning seen in floating larvae immediately prior to sinking, could be part of the means whereby air is expelled from the breathing tube. At the bottom of the water additional locomotion occurs in response to low thigmokinesis with the result that larvae become buried in the detritus (Fig 1).

There are at least two disadvantages to floating in the water of a rot-hole as opposed to being buried. At the surface larvae are more likely to be exposed to predators and it is where ice first forms.

In being buried, larvae avoid having to float to the surface whenever they breathe by the retaining action of the detritus. Otherwise when air enters the breathing tube the consequent increase in buoyancy could result in movement towards the surface of the rot-hole. Furthermore, when a rot-hole dries out, which was a common event at Corstorphine Hill, it is the bottom of the detritus that retains moisture for the longest period. Both in the field and laboratory larvae were always concentrated towards the bottom centre of dried out rot-holes.

When temperatures are low respiratory activity may also be reduced. Presumably during freezing a reduced need to respire is advantageous because ice would block access to the air. Rot-hole water contains very low amounts of dissolved oxygen (Roberts 1970), so it seems unlikely that gaseous exchange could take place to any significant extent underneath the ice.

The picture that emerges from this preliminary study is one of a larva utilizing mechanisms to help it survive the winter. It spends most time buried in the detritus at the bottom of the rot-hole and probably finds its way into the detritus using negative phototaxis and low thigmokinesis. Within the detritus it is out of sight from predators and respire, when not too cold, using its extendible breathing tube. Most larvae occur in deep rot-holes which are the least likely to dry out and are most likely to have a thick layer of detritus, although the larva of *M. florea* has some ability to tolerate these conditions.

In dried up rot-holes larvae may be vulnerable to predation from other invertebrates and possibly birds. Such predators may be the chief cause of the huge overwintering mortality observed in this study.

## Acknowledgements

I would like to thank Dr. Graham E. Rotheray of the Royal Museum of Scotland, Edinburgh for his individual help and encouragement during the course of this investigation.



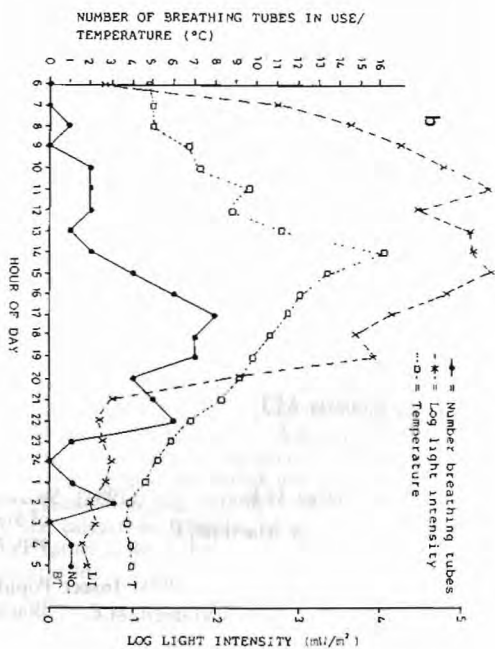
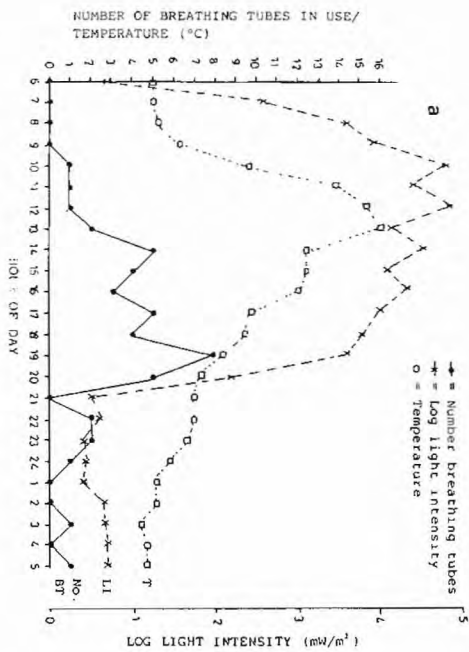
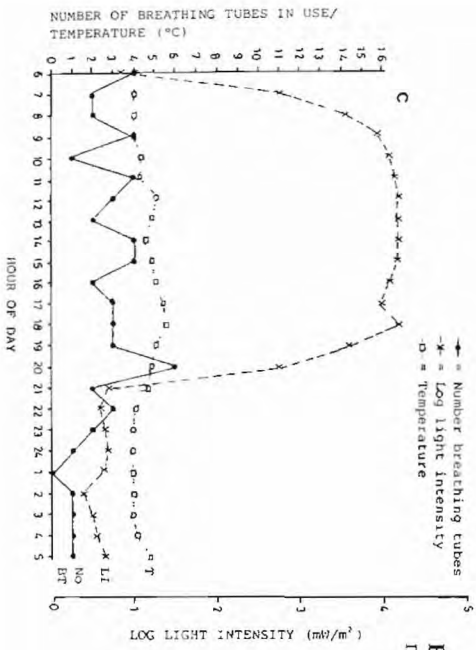

Fig 2 Diurnal variation in the mean number of breathing tubes in use each hour measured over a three day period (N = 10) a = day 1; b = day 2; c = day 3.

Table 1. Rot-hole characteristics on *Acer pseudoplatanus* and *Fagus sylvatica* trees at Corstorphine Hill, Edinburgh (N = 27, unless otherwise stated)

rot-hole character	mean	SD	range
area of rot-hole mouth mm <sup>2</sup>	20531.8	16941	3926.9 - 70607.3
max.depth mm	134.9	69.7	40 - 350
water depth mm	94.3	50.1	12 - 225
deiritus depth mm (N = 11)	50.2	37.1	15 - 110
no. larvae recorded	7.85	10.6	0 - 41

Table 2. Effect of intensity of illumination on the number of larvae buried after 900 seconds (N = 25 per light treatment)

illumination	no. of larvae buried <900secs	no. of larvae buried >900secs
light (2500mW/m <sup>2</sup> )	20	5
dark	19	6

#### References

- Buckton, G.B. (1895) **The Natural History of Eristalis tenax or the Drone-fly** London. Macmillan.
- Fraenkel, G.S. (1961) **The Orientation of Animals: Kineses, Taxes and Compass Reactions.** Dover Publications, Inc., New York.
- Hartley, J.C. (1960) A taxonomic account of the larvae of some British Syrphidae. **Proc. Zool. Soc. Lond.** 136: 505-573.
- Roberts, M.J. (1970) The structure of the mouthparts of syrphid larvae (Diptera) in relation to feeding habits. **Acta Zool.** 51: 43-65.
- Rotheray, G.E. (1984) Searching behaviour in relation to starvation of *Syrphus ribesii* (Dipt., Syrphidae). **Entomol. exp. appl.** 35: 141-145.
- Varley, G.C. (1973) **Insect Population Ecology, an analytical approach.** Blackwell Scientific Publications. Oxford.
- Gradwell, G.R. & Hassell, M.P.

Caroline Greig\*, Department of Zoology, University of Edinburgh, West Mains Road, Edinburgh.

\* correspondence: 7 Ryeland Close, Ancells Farm, Fleet, Hants.

## THE AGROMYZIDAE OF WARWICKSHIRE

John Robbins

### Introduction

In the R.E.S. Handbook Spencer (1972) remarked that of the 313 British species there listed two-thirds were known only from S.E. England, though he may have used that term to cover a rather larger area than others might include in it; but it is clear that the family was then (and still is) not well known over most of the British Isles. For the Midlands in particular knowledge was sparse indeed, and for Warwicks. (V-C. 38) it has been possible to discover a mere ten species in local collections or otherwise recorded up to 1970. However, during the last decade, and especially from 1981, many discoveries have been made and the county fauna now stands at 162 accepted species, one of the largest in Britain. This increase has not arisen from any special search for members of the family but from a general study on all leaf-miners (Robbins 1983-89). Furthermore, there have been some probable, but unconfirmed, records for a few other species, and also more than twenty unidentified mine types that can be assigned to some dipterous causer; in most instances this will be Agromyzid. These mine types represent either species whose biology is not yet known, of which there are several on the British list, species new to the British Isles, or perhaps in a few instances abnormal productions or even zenophagy by known species.

In presenting this paper my prime concern has been to get published information additional to that presented by Spencer (1972), who later gave supplementary information that added three species to the British list (Spencer 1976). Most of the new information is distributional, indicating that many species are more widely distributed than was implied in the earlier work. Indeed, the Warwickshire fauna includes no less than 18 species recorded from only a single county by Spencer and a further 21 species recorded from only two counties. There are also records for five species that have been added to the British list since Spencer wrote. Further, there is new information on food plants, with records of species and genera not yet previously recorded as being mined in Britain, and in a very few instances apparently not even in Europe (*vide* Hering, 1957); and it has also been possible to indicate which hosts are preferred by some miners. New information, in one category or another, is available for some 85 species; just over half the county fauna. But I have decided to list all the species, as this will give naturalists in neighbouring counties a very good idea of what they may expect to find. Studies (unpublished) on various groups (chiefly Lepidoptera) have shown that most of the species of southern England also occur in the county, whereas the northern element of our fauna is very sparsely represented. Thus the fauna of Warwickshire is a reasonably good guide to that of lowland Britain generally.

This fauna is still imperfectly known. Another forty, perhaps even fifty, species of Agromyzidae remain to be found within the county. A relatively high proportion of these are species whose larvae feed in stems and are thus difficult to find in the field (*Melanagromyza*, *Napomyza*, *Ophiomyia*, *Phytobia* etc.). Also, species that cannot normally be identified from their mines or their puparia, but which have to be bred out, are under-recorded, either because the mines were vacated when found (the usual situation!) or because breeding attempts have been unsuccessful. A further point to note is that calcareous habitats, lying chiefly in the southern part of the county, have been rather little visited and that therefore miners of calcicole plants are also under-recorded.

Details of the Warwickshire studies on leaf-miners can be found in Robbins (1983-89). For those who wish to essay study of this family they can note that about 85% of the family are leaf-miners and much of the most effective field

technique is to look for their mines. For the minority that feed in stems etc. recourse will normally have to be made to netting in the neighbourhood of the relevant food plants. Nearly all the miners can be identified from their mines alone or from the mines together with the characteristics of the puparia (sometimes of the larvae). Amongst species of known biology, rearing the imagines is required for only a very few; but there are several species on the British list whose biology is not yet known and which will have to be reared (if one is fortunate enough to find their mines whilst they are still occupied). Unfortunately, the only complete keys to identification are those of Hering (1957), which are getting rather out of date. Robbins (1985) produced some provisional keys to the British fauna, but these did not include the miners of grasses, an important group. Some revised keys are being prepared and may become available later in 1990.

In addition to the known fauna I have included, in brackets, a few species whose presence in Warwicks. is probable but not yet proven, and also one or two species recorded in Kent for which there is new information. Where a species was recorded by Spencer (1972) from three counties or less they are listed, also in brackets. The listings of host plants are complete for some species, but not for all; in particular the listings for miners of grasses are very incomplete, whilst for the polyphagous species, *Liriomyza strigata*, *Phytomyza horticola* and *P. syngenesiae*, the information will be the subject of a separate paper. Host species or genera additional to those listed by Spencer (1972) are indicated by \* after their names.

Various symbols have been used to indicate status and distribution within the county:

W = Widespread	C = common
L = Local	VC = Very Common
VL = Very Local	f.C = Fairly Common
f = fairly	Unc = Uncommon
l = locally	Sc = Scarce
v.l. = very locally	R = Rare
Prob. = Probably	

## The Fauna

Sub-Family: AGROMYZINAE

Genus: AGROMYZA FALLEN

- A. abiens* Zett. (= *rufipes* Mg.) L & Unc.  
*Hosts have included Echinum, Pulmonaria officinalis\** (in gardens),  
*Symphytum x uplandicum\** and *S. officinale*.
- A. albipennis* Mg. Prob. W & I.C.  
 Not so restricted as *Phalaris* as previously thought. Warwicks. hosts have included: *Brachypodium\**, *Bromus\**, *Dactylis\**, *Glyceria\** and *Milium\**.
- A. alnibutalae* Hendel W & C.  
 Equally in *Betula pendula\** and *B. pubescens*.
- A. ahivora* Spencer W & I.C.  
 Uncommon according to Spencer. *Alnus glutinosa\** is the main host and there are also records from *A. cordata\**.
- A. alunulata* (Hendel) VL & R. (Surrey)
- A. anthracina* Mg. l.f.C.
- A. bicophaga* Hering VL & Sc. (Surrey)  
 Also recorded in E. Kent. Mines in *Vicia cracca*, may lie in the lower leaves and be hidden by other vegetation.
- A. bromi* Spencer VL, f.C. (Kent, Suffolk)  
 Mines were in *Bromus (Zerna) ramosus\** which, although new, is likely to be the main host in Britain as it is a common native plant. The *B.*

- (*Ceratochloa uniolooides*, listed by Spencer, is an introduced and very local plant.
- A. cinerisens* Macq. L & Sc.  
*A. demejerei* Hendel VC in gardens.  
*A. dipsaci* (Hendel) Not in Warwicks. (Hants, Middx, Surrey)  
 Recorded from E. Kent.  
*A. filipendulae* Spencer I.C. (None)  
 This is the species mentioned, but not then named, by Spencer on p.108. It mines herbaceous Rosaceae and prefers sites where the vegetation is rather lush. Its main host is *Filipendula ulmaria*\*, but there are also records from *Potentilla anserina*\*, *Preptans*\*, *Rubus idaeus*\* and *Sanguisorba officinalis*\*.  
*A. flaviceps* Fall. Possibly f.W, I.C.  
*A. flavipennis* Hendel L, not Unc. (Bucks, Surrey)  
 The normal host is *Lamium album*, but at one site a few were also found in *Glechoma hederacea*\*, where it was growing amongst *Lamium*. This is a completely new host (vide Hering 1957).  
*A. frontella* Rond. I.f.C. (Essex,Kent, Surrey)  
 The main host has been *Melilotus*\* (chiefly *M. officinalis*), not listed by Spencer (1972) though given by Hering (1957).  
*A. hendeli* Griffiths VL, f.C at one site. (Cambs, Hunts, Oxon)  
*A. johannae* de Meij. W & I.C.  
*A. lathyri* Hendel L & Sc. (Kent, Surrey)  
 The few records have been from *Lathyrus latifolius* in gardens.  
*A. lucida* Hendel W & I.C.  
 Common in woodlands in *Deschampsia caespitosa*; less often in other grasses in other habitats. *Dactylis*\* is one additional host.  
*A. mobilis* Mg. Prob. f.W & F.C (see nb.to *A. nigrella*).  
 Hosts have included *Holcus*\*, *Bromus ramosus*\* and *Agropyron repens*\*.  
*A. myosotidis* Kalt. VL & Unc. (Herts,Oxon,Suffolk)  
 From *Myosotis sylvatica*\* including garden cultivars  
*A. nana* Mg. I.f.c.  
*A. nigrella* Rond. I.f.C.  
 This species normally has to be reared to confirm its presence as its mining period (July) overlaps with that of the second generation of *A. mobilis*, and the two species cannot be separated by either mines or puparia. But in 1986 the long cold spring forced *A. mobilis* to mine later than usual (in June) and its second generation did not appear until August. This enabled both species to be recorded from several localities, whereas previously we only had the mine type.  
*A. nigrescens* Hendel VL; C at one site.  
*A. nigripes* Mg. Possibly I.C.  
 There have been few confirmed records, but a I.C mine type in *Glyceria* is thought to belong to this species.  
*A. nigrociliata* Hendel L & Unc. (Cornwall,London,Surrey)  
 Records fom *Dactylis*, *Phalaris arundinacea*\* and a *Phalaris*\* cultivar in a garden.  
*A. potentillae* (Kalt.) (= *spiraeae* Kalt.) W & I.C.  
 Mines herbaceous Rosaceae, chiefly in open sites with low-growing vegetation. The main host has been *Potentilla reptans*\*; but there are also records from *Agrimonia eupatorium*, *Filipendula ulmaria*, *Fragaria x ananassa*\*, *Geum urbanum*, *P. anserina* and *Rubus idaeus*.  
*A. pseudoreptans* Now. L, but prob. not Unc.  
 In the past this species has had to be separated from the common *A. reptans* by larval characteristics or by breeding out. Recent observations indicate that the summer generation (if not the autumn) may be distinguishable by its mine.  
*A. pseudorufipes* Now. VL; I.C at one site. (Surrey, Yorks, Wales)

Fairly common in *Myosotis arvensis*\*, growing amongst corn. The species may thus prefer dry habitats unlike other miners of *Myosotis*. Also a few in *M. sylvatica*.

*A. pulla* Mg. VL. f.C at one site. (Oxon, Middx.)

Mining *Spartium junceum*\*, a previously unrecorded host, in a garden. The normal host is native *Genista tinctoria*.

*A. reptans* Fall. W & C.

*A. sulfuriceps* Strobl f.W, l.C.

Prefers wooded or shady sites, where *Rubus idaeus* has been the main host. Others are: *Filipendula ulmaria*, *Fragaria vesca*\*, *E x arnanassa*\*, *Potentilla anserina*\*, *P. reptans*, *P. sterilis*\*, *Rubus fruticosus*\* and *Sanguisorba minor*\*. It has also been recorded from *Rosa*\* (probably *R. canina*), a previously unrecorded genus (Hering 1957). The mine is incorrectly described in Hering and specimens will not always key out.

*A. varicornis* Stobl. l.C in gardens.

All records have been from *Lathyrus latifolius*.

*A. vicifoliae* Hering L, f.C. (Surrey, Dumbartons.)

Although *Vicia sepium* is the main host there have also been records from *V. cracca*\* and *V. hirsuta*\*

Genus: HEXOMYZA Enderlein

The three British species all cause galls.

*H. schineri* (Giraud) VL, f.C at one site. (Herts.)

Recorded in 1982 in *Populus nigra* at one site, but not seen there since. In 1988 fairly common in *P. tremula* at a second site.

Genus: MELANAGROMYZA Hendel

This is primarily a genus of stem-borers, whose larvae live in the pith and give little or no external signs of their presence. Badly under-recorded in Warwickshire where netting has not been attempted, or not recently.

*M. dettmeri* Hering One record only.

From the stems of *Tragopogon porrifolius*\*

Genus: OPHIOMYZA Braschnikov

The leaf-mining members of the genus are fairly well recorded; but the stem-miners, which form the majority, are poorly recorded; their mines having been relatively little looked for, whilst those of several species are inconspicuous.

*O. beckeri* (Hendel) L & rather Unc.

All mining records have been from *Sonchus oleraceus*

*O. cunctata* (Heendel) L & rather Unc.

Most records have been from *Lapsana* or *Taraxacum*; but an isolated record from *Bellis perennis*\* is quite exceptional, since the species normally mines only the Liguliflorae.

(*O. galii* Hering) Not in Warwicks. (Suffolk, Surrey)

Recorded in E. Kent.

*O. heringi* Stary) not in Warwicks. (London)

Recorded in E. Kent from *Campanula trachelium*\*.

*O. labiatarum* Hering One record only.

An unusual record: the larva mined up the petiole into a leaf of *Lamium album*\*, following the mine track of *Liriomyza strigata*, later forming its own corridor in the leaf.

*O. melandricaulis* Hering L and not Unc. (Hunts, Monmouth)

*O. orbiculata* (Hendel) One record only.

From *Lathyrus latifolius*\*

*O. pulicaria* Mg. f.W, not Unc.

Mines have been from *Hieracium*, *Sonchus* (including *S. oleraceus*\*) and *Taraxacum*.

Sub-Family: PHYTOMYZINAE

Genus: AMAUROMYZA Hendel.

*A. flavifrons* (Mg.) W & C.

Main native host is *Silene dioica* (= *Melandrium rubrum*), with the occasional record from *Stellaria holstea* or *Saponaria officinalis*\*, also *Silene alba* in E. Kent. In gardens it is locally common in *Dianthus barbatus*\*, *D. x allwoodii*\*, *Lychnis coronaria*\* and *Agrostemma githago*\*.

*A. labiatarum* (Hendel) W & C.

Occurs chiefly in *Lamium* and *Stachys* (including *S. sylvatica*\* and *S. palustris*\*) and occasionally in *Galeopsis* (*G. tetrahit*\*).

*A. lamii* (Kalt.) VL & Sc (NONE).

Not listed by Spencer (1972), though since Hering (1957) included Great Britain in his distribution he presumably had seen British material. Recorded from one Warwicks. site, mining *Glechoma*\*.

*A. morionella* (Zett.) L & Unc. (Kent, Hants, Surrey)

Mosy Warwicks records have been from *Lamium*\* (*L. album*) and *Stachys* (*S. sylvatica*), with solitary ones from *Ballota nigra* and *Ajuga reptans*\*.

*A. verbasci* (Bouche) L & Sc.

In *Buddleia* and *Verbascum thapsus*.

Genus: CALYCOMYZA Hendel

*C. artemisiae* (Kalt.) W & I.C.

*C. humeralis* VL & R.

Genus: CERONDONTHA Rondani

*C. angulata* (Loew) I.f.C.

Hosts have included *Carex otrubae*\* and *C. paniculata*.

*C. capitata* (Zett.) One record only.

*C. caricicola* (Hering) VL & Sc.

Mines were in *Carex pendula*. Also recorded from *Cardigans*.

*C. calosoma* Hendel R: one record only. (Argyll)

Found mining *Agropyron repens*\*, which thus becomes the only known host. The puparium resembles that of *C. incisa*, but it is a shiny brown, instead of a very shiny violet-black. It was figured by Spencer (1976).

(*C. denticornis* (Panzer)). Probable but not confirmed.

*C. flavocingulata* (Strobl) L & Sc.

*Arrhenatherum elatius* has been one host.

*C. geniculata* (Fall.) VL: one record only. (Bucks, Herefords)

*C. incisa* (Mg.) L. but not Unc.

Chiefly in *Agropyron repens*\*, but also from *Bromus ramosus*\* and *Dactylis*\*.

*C. ireos* (R-D) I.C.

Normally in *Iris pseudacorus* but there have been two records from *Typha* (*T. latifolia*), the first for Britain.

*C. lateralis* (Macq.) L. & Unc. (Hunts, Suffolk)

From *Dactylis*\*.

*C. luctuosa* (Mg.) L & Sc.

*C. muscina* (Mg.) Apparently R; one record only.

From *Agropyron repens*\*.

*C. phalaridis* Now. f.W. I.C. (Norfolk, Suffolk)

Much commoner than suggested by Spencer.

*C. phragmitidis* Now. VL Unc.

*C. pygmaea* (Mg.) W & C.

Main hosts are *Agropyron repens*\* and *Deschampsia caespitosa*. Others have included: *Arrhenatherum elatius*, *Brachypodium sylvaticum*, *Bromus ramosus*\*, *Festuca ovina* and *Phalaris arundinacea*\*.

*C. suturalis* (Hendel) L., but not Unc. (Cambs, Suffolk)

Recorded from *Carex sylvatica*\* and *C. pendula*. Additionally I know of records from W. Sussex (V-C 13).

Genus: GALIOMYZA Spencer

*G. morio* (Brischke) R: one record only. (Bucks, Surrey)

From *Galium aparine*\*. Listed under *Liriomyza* by Spencer (1972).

Genus: LIRIOMYZA Mik

- L. amoena* (Mg.) W & I.C.  
Normally bivoltine, but if the summer is cool the second generation is almost entirely suppressed, the flies overwintering in the puparia of the first generation until the following summer.
- L. artemisicola* de Meij. W & f.C.
- L. centaureae* Hering W, but rather Unc.  
Normally in *Centaurea nigra*, occasionally in *C. montana*\* in gardens and once in *C. scabiosa*.
- L. cicerina* (Rond.) l.f.C. (Kent, Surrey)  
Both Hering (1957) and Spencer (1972) give only *Ononis* as the Host; but nearly all the Warwicks. records have been from *Melilotus*\* (*M. officinalis* and, once, *M. alba*), which enables the species to extend into non-calcareous habitats.
- L. congesta* (Becker) W & I.C.  
Recorded from several native hosts: *Anthyllis*\*, *Lathyrus*, *Medicago* (*M. lupulina*\*), *Melilotus* and *Trifolium* (including *T. pratense*\*). It also occurs occasionally in gardens in *L. odoratus*\*, *Pisum sativum* or *Vicia faba*.
- L. demejerei* Hering f.W, Unc. (London area)
- L. equiseti* de Meij. L & Unc. (Herts)
- L. erucifolii* de Meij. L & R. (Middx)
- L. eupatorii* (Kalt.) VL & Unc. (Cambs, Dorset, Surrey)
- L. flaveola* (Fall.) Prob W & f.C.  
Has an undoubted preference for difficult to identify grasses!
- (*L. graminivora* Hering) (NONE)  
Mines shewing the very distinctive frass pattern of this species have been found in *Arrhenatherum*. Under this name the species is new, but I have a strong suspicion that expert investigation may shew it to be a junior synonym of *L. phryne*.
- L. hieracii* (Kalt.) Rare; one record only. (Wales)  
In *Hieracium perpropinquum*\*.
- L. melampyga*: see *Phytoliriomyza melampyga*.
- L. millefolii* Hering: see *L. ptarmicae* below.
- (*L. orbona* (Mg.)) Probable, but unproven, in Warwicks.
- L. phryne* Hendel L: f.C at one site.
- L. pisivora* Hering L & Unc in gardens. (Kent, Herts, Surrey)
- L. ptarmicae* de Meijere W, I.C.  
Spencer (1972) and Hering (1957) list two species: *L. millefolii* in *Achillea millefolium* and *L. ptarmicae* in *A. ptarmica*; but Spencer equates them, with *L. ptarmicae* having priority. However, there are some differences between the mine descriptions for *L. ptarmicae* by Hering and actual observations of local mines in *A. millefolium* that make one want to question the equation of the two species. Also, from a reference I have mislaid I have a note that the puparia have different colours. However, mines in *A. millefolium* are common in Warwickshire and there is a solitary record of a mine in *A. ptarmica*.
- L. pusilla* (Mg.) L and rather Unc.  
Hosts have been *Aster* sp., *Bellis* and *Solidago x canadensis*, the first and last in gardens.
- L. pusio* (Mg.) L. & Unc. (Hunts, Devon)  
*Agrostis*\* sp. (probably *A. tenuis*) has been one local host.
- L. sonchi* Hendel f.W, I.C. (London, Berks, Ireland)  
Normally in *Sonchus* (*S. arvensis*, *S. asper* and *S. oleraceus*), sometimes in *Lapsana*\*.
- L. soror* Hendel R; one record only. (Kent)  
From *Cirsium arvense*.
- L. strigata* (Mg.) W & I.C.  
Polyphagous; it is proposed to record its hosts in a later paper.
- L. tanacetii* de Meij. L & rather Unc. (Surrey, Ireland)



In *Tanacetum vulgare*; also in *Artemisia vulgaris*\*, in which mines have not always been successful.

*L. taraxaci* Hering L & R.

*L. tragopogonis* de Meij. VL; from one site only.

In one year several were recorded in a garden in *Tragopogon porrifolius*\*. It has not recurred there and has not yet been found in the county in native *T. pratensis*.

Genus: METOPOMYZA Enderlein

(*M. flavontata* (Haliday)). Very probable at one site.

*M. scutellata* (Fallen) (= *flavoscutellaris* auctt. nec Zett.) (Dorset, Suffolk, Moray)

VL, several in one area, mining *Carex*.

Genus: NAPOMYZA Westwood

Most species are stem-borers and have thus not been recorded during the recent studies.

*N. evanescens* (Hendel) One record only.

*N. lateralis* (Fall.) One record only.

This species is variable in its biology as its larvae can sometimes be found in inflorescences or mining leaves. The one record was in *Cirsium arvense*\*.

Genus: PARAPHYTOMYZA Enderlein

*P. buhri* (de Meij.) VL.

A stem-miner in *Galium* that is under-recorded.

*P. cornigera* Griffiths (= *lonicerae* auctt) L & Unc.

*P. fulvicomis* (Hendel) R; one record only. (Kent, Surrey)

*P. hendeliana* Hering W & often VC.

*P. heringi* VL & Unc. (Herts, Middx, Surrey)

From one site only. Also recorded in E. Kent.

*P. populi* (Kalt.) L, sometimes f.C.

*P. populicola* (Walker) f.W & f.C. (Bucks)

Much commoner than Spencer's records suggest.

*P. similis* (Brischke) Unc; from one site only.

*P. tremulae* (Hering) I.C. (London, Surrey, Bucks)

*P. tridentata* (Loew) L, but not Unc.

*Salix fragilis*\* is an additional host.

Genus: PHYTOLIRIOMYZA Hendel

*P. hilarella* (Zett.) f.W, not Unc.

*P. melampyga* (Loew) L. f.C. (London, Cumhria, Ireland)

All records have been in *Impatiens glandulifera*\*.)

(*P. pteridii* Spencer may possibly occur amongst the local populations of *P. hilarella*; but imagines must either be captured or reared to be sure of this).

Genus: PHYTOMYZA Fallen

Griffiths (1974) transferred certain species to the genus *Chromatomyia* Hardy. Since the definition of the genus is based upon the characteristics of the male genitalia there is no clear distinguishing feature to separate the females from those of *Phytomyza* s.s. Nonetheless the group is a natural one and it does exhibit an immediately obvious ecological criterion in that virtually all members pupate within their own mines in (normally) pale puparia, whereas almost all members of *Phytomyza* s.s. pupate externally in well-coloured, often black, puparia. The group is here treated as a sub-genus, indicated by (C.) in the specific name.

*P. aconitii* Hendel VL & Sc (in gardens).

*P. adjuncta* Hering VL, but not Unc. (Middex.)

In both *Pimpinella major* and *P. saxifraga*.

*P. agromyzinu* Mg. f.W, I.C.

*P. angelicae* Kalt. W & C also once in *Aegopodium*\*.

*P. angelicastris* Hering f.W v.), C also once in *Aegopodium*.

*P. (C.) aprilina* Gour.: see *P. (C.) xylostei* (R-D).

*P. aquilegiae* Hardy I.C in gardens.

(*P. archangelicae* Hering) (NONE)

Not on the British list, but mines corresponding to those of this species have been found at one site in N. Warwicks. and another in S. Staffs. Since this species occurs in the Faeroes it might be worth looking for in northern localities, mining in *Angelica sylvestris*.

*P. artemisivora* Spencer W & C.

*P. autumnalis* Griffiths L & Sc.

Spencer (1972) confused this species with the commoner *P. spinaciae* q.v. but later (1976) recognised them as separate. *P. autumnalis* is restricted to *Centaurea* as a host and, as its trivial name implies, it mines late in the year (Oct.-Nov.), though there is one Warwicks record from July that suggests that the species may be partly bivoltine. Local hosts have included *C. nigra* and (in gardens) *C. montana*\*

*P. calthophila* Hendel VL, but not Unc.

*P. cecidonomia* Hering VL & R.

*P. chaerophylli* Kalt. W & I. VC.

Very common in *Anthriscus*, less often in *Chaerophyllum*, and occasional in *Torilis japonica*\* and *Daucus carota*.

*P. cinerea* Hendel From one site only. (Derbys.)

A species that may well prove to be commoner if looked for in those places its only host, *Centaurea scabiosa*, grows.

*P. cirsii* Hendel W & C.

*P. conii* Hering l.f.C. (Hunts, Suffolk)

*P. continua* Hendel VL & Sc; from one site only.

*P. conyzae* Hendel R; from one site only.

*P. corvumontana* Hering VL; f.C at one site. (Cumbria, Middx, Perth)

*P. crassiseta* Zett. L & not v.C.

*P. cytisi* Brischke Common in gardens.

*P. erigerophila* Hering VL, Unc. (NONE)

Not mentioned by Spencer (1972) but has since been added to the British list. The first local record was of a solitary mine in *Erigeron acris*\* in 1983; but in 1988 at a second site several mines were found in *E. acris* and one in *E. canadensis*\* (= *Conyza canadensis*).

*P. eupatorii* Hendel VL & Sc.

*P. fallaciosa* Brischke f.W, not Unc.

Most records are from *Ranunculus repens*, but some are from *R. bulbosus*\*

*P. fulgens* Hendel v.l.C. (Surrey)

Recorded by Spencer from only a single British site; but in 1985 I found it to be common at three sites in Warwicks. and also three in E. Kent. Scores, even hundreds, of mines were found in *Clematis vitalba*.

*P. (C.) fuscula* Zett. L. and not very C. (NONE)

A species NEW to Britain. Mines, with larvae or puparia, have now been found half-a-dozen times in Warwicks., most of them at one site in the Coventry municipal area. In all about 30 mines have been found; but of ten specimens that have been collected, six have produced parasites, one an imago and three nothing. The imago and one parasite unfortunately got lost in transit to the British Museum; but whereas imagines can be difficult to separate from those of the common *P. nigra* the puparia are easily identified (Hering 1957, Griffiths 1980), and the local count has been based upon puparia. All but two records have been from *Holcus* or *Arrhenathenum*, indicating a fairly strong host preference; one of the others was in *Milium*. The species has an holarctic, and to some extent a boreal, distribution (Griffiths 1980), and thus its occurrence in Britain is not unexpected, though it is possible that it may not occur in southern England. In ecology the species differs from *P. nigra* in that all but one of the records have been from open sites with little or no shade. The first generation can be looked for from mid-May onwards, according as we have an early or a late spring.

*P. (C.) gentianae* Hendel l.f.C.

This species should be re-named. Recent research by Dr. K.A. Spencer has shown that there actually three sibling species mining Gentianaceae and the name *P. (C.) gentianae* should be reserved for the miner of *Gentiana* and *Gentianella*, the miner in *Centaurium*, which appears to be the commonest of the three in Britain, will become *P. (C.) centaurii* Spencer when that name is officially published. This is yet another example of the great ease of identifying species by means of their larval ecology whilst the imagines are difficult to tell apart.

*P. glechomae* Kalt v.l.C.

*P. heracleana* Hering W & C.

Recorded by Spencer from S.W. and N. England, Wales, Scotland and Ireland; but these new records show that the species is common in the Midlands.

*P. heringiana* Hendel VL & Sc. (Kent)

*P. (C.) horticola* (Gour.) W & C.

Polyphagous; it is proposed to record its hosts in a later paper.

*P. ilicis* Curtis W & l.v.C.

*P. lappae* Gour. f.W. l.C.

*P. leucanthemi* Hering L & rather Unc. (Herts, Surrey, Perth)

Occurs occasionally in *Leucanthemum maximum*\* as well as in *L. vulgare*.

*P. (C.) loniceræ* R.-D. W & C.

*P. marginella* Fall. W & l.C.

Recorded from *Sonchus* (including *S. arvensis*\* and *S. asper*\*); also from *Hieracium* (including *H. perproinquum*\* and *H. pilosella*\*) and *Lapsana*, with isolated records also from *Crepis*\* and *Taraxacum*\*.

*P. melana* Hendel l.f.C. (Surrey)

In *Pimpinella major*. Also from S. Staffs. (V-C 39)

*P. (C.) milii* Kalt l.C.

Chiefly in *Milium* in woods, but can occur in other hosts and habitats.

*P. minuscula* Gour. C in gardens.

In the Coventry/Bedworth area it is estimated that about 60% of *Aquilegia* in gardens are attacked by this fly, though not sufficiently to be detrimental. Surprisingly, there are no records from *Thalictrum*, even when it occurs in the same garden as *Aquilegia*.

*P. myostica* Now. R; one record only (Hants, Oxon, Surrey)

*P. (C.) nigra* Mg. W & l.v.C.

Occurs mainly in woodlands or partly shaded places, mining a wide range of grasses: new hosts include: *Agropyron repens*\*, *Deschampsia caespitosa*\*, *Holcus mollis*\*, *Helictotrichon*\* and *Poa pratensis*\*.

(*P. obscura* Hendel) Not in Warwicks. (Oxon.)

Recorded from two localities in E. Kent. Restricted to calcareous habitats.

*P. obscurella* Fall. W, but rather Unc.

(*P. (C.) paraciliata* Godfray) One possible record only. (NONE)

In *Leucanthemum maximum*\*. Not recorded by Spencer (1972), only recently described and added to the British list by Godfray.

*P. pastinacæ* Hendel Status uncertain; see *P. spondylii*.

*P. pauliloewi* Hendel L & Sc. (Yorks)

In *Pimpinella major*\* and *P. saxifraga*.

*P. (C.) perichlymeni* de Meij. L & Unc. (Surrey, Ireland)

*P. petoei* Hering l.f.C. (London, Glos., Surrey)

Mines *Mentha* in dry localities, especially gardens. Recorded from *M. spicata* and *M. villosa* var *alopecuroides*\*. British specimens will key out as the unidentified species No. 3295 in Hering (1957) and not as his *P. petoei*; an example of geographical variation in mine form.

*P. pimpinellæ* Hendel l.f.C. (Middex.)

- All mines have been in *Pimpinella major*.
- P. plantaginis* R.-D. L and not very C.  
Although Spencer lists four of the five British species of plantain as the hosts nearly all Warwicks. records have been from *Plantago lanceolata*; it is rare in *P. major*.
- P. (C.) primulae* R.-D. W & I.C.  
Mines Section *Vernales* of the genus *Primula*, which includes *P. veris*, *P. vulgaris* and some cultivated species. Other Sections, which include several garden species, seem immune from attack.
- P. pullula* Zett. (= *matricariae* Hendel) rather L. & Unc.  
Local hosts have been: *Achillea millefolium*, *Tripleurospermum maritimum* and *Tanacetum vulgare*, all members of the Anthemideae.
- P. ranunciei* (Schränk) W & C.  
Mines most *Ranunculus*; *R. bulbosus*\* is a new British host.
- P. ranunculivora* Hering L. & Unc. (Middx., Surrey, S. Wales)  
Also from one site in E. Kent.
- P. rufipes* Mg. L & Sc.  
Mines cultivars of *Brassica*; locally in *B. oleracea* and *B. napus*\*.
- P. silai* Hering VL & Sc. (Cambs., Surrey)
- P. spondylii* R.-D. W & VC.  
Records will include a proportion of *P. pastinacae*. The old distinction, of mines in *Heracleum* being this species and those in *Pastinaca* being *P. pastinacae*, is no longer valid according to Griffiths, both miners having been obtained from both hosts. Breeding to determine the proportion of *P. pastinacae* in Warwicks has not yet been carried out.
- P. sphondyliivora* Spencer W & f.C.  
Clearly not confined to the south as suggested by Spencer.
- P. spinaciae* Hendel W & I.C.  
Confused with *P. autumnalis* by Spencer; this is, in fact, the common species, bivoltine, mining both *Cirsium* (*C. arvense*, *C. palustre* & *C. vulgare*) and *Centaurea* (*C. montana*\* & *C. nigra*).
- P. symphyti* Hendel R; one record only.
- P. syngenesiae* (Hardy) W & I.V.C.  
Essentially oligophagous in Compositae, with c. 95% of records from *Sonchus*. A detailed list of food plants will be the subject of a later contribution.
- P. tanacetii* Hendel I.C. (Surrey, Ireland)
- P. tetrasticha* Hendel R; one record only.  
Mines *Mentha* in damp places; c.f. *P. petoei*
- P. tussilaginis* Hendel f.W, I.C.
- P. vitalbae* Kalt. f.W, I.C.
- P. (C.) xylostei* R.-D. (= *aprilina* Gour.) W & I.v.C.
- Genus: PSEUDONAPOMYZA
- P. atra* (Mg.) VL & Sc.  
Mines Gramineae, but recorded locally only from *Holcus*\*

## Discussion

The Agromyzidae are by far the largest family of British leaf-miners, accounting for about 27% of our mining fauna. (The Coleophoridae, the next largest group, account for only 10%). Unlike the miners of other orders they occur primarily in herbaceous plants and only a few species will mine shrubs or trees. Thus during the summer months (late-May to Sept.) most of the mines found in herbs will be dipterous, and the majority of them will be Agromyzid. The woodland fauna is quite sparse, except in glades or along the margins; but the urban fauna is unexpectedly large. A comparison (unpublished) between leaf-miners of the city of Coventry and those of the neighbouring countryside disclosed that very nearly as many dipterous miners could be found within the city as outside it. This is

partly because there are several species of Agromyzidae that occur mainly or only in garden plants (see below); but the mining fauna of weeds, waste places, railway cuttings, canal banks etc. is also quite rich, especially in the miners of grasses. Agromyzid miners can thus be found almost anywhere, even in city centres, wherever weeds may grow. In the country-side road verges can provide a useful range of species, though in this regard Warwickshire does not match Kent where I recorded 47 species from (or mainly from) road verges in the course of a single walk in July 1985.

Many - perhaps most - naturalists neglect the faunas of gardens or of field crops (apart from certain pests that cannot be ignored); but with the Agromyzidae it is important to pay attention to them as there are several species that are established entirely or almost entirely in gardens: *Agromyza demijerei* and *Phytomyza cytisi* (in *Laburnum*), *A. lathyri* and *A. varicornis* (in *Lathyrus latifolius*), *Liriomyza pisivora* (in *Lathyrus* and *Pisum*), *P. aconiti* (in *Aconitum*), *P. aquilegiae* and *P. minuscula* (in *Aquilegia*). *P. rufipes* (in *Brassica*) has been found in both gardens and field crops. Four species have so far been recorded only from gardens; but they should eventually be found in native hosts: *A. pulla*, *Melanagromyza detmeri*, *Ophiomyia orbiculata* and *L. tragopogonis*. *Amauromyza flavifrons* can be common in gardens, but it is also common elsewhere. In addition upwards of a dozen other species have been recorded from garden plants, but with the exception of *L. pusilla* they have been recorded more often from native hosts. *P. horticola* is common in some garden plants and *L. strigata* will also occur, but *P. syngenesiae* rarely attacks garden plants in Warwickshire. Tansy, *Tanacetum vulgare*, will of course be attacked by its normal miners if grown in gardens.

Spencer (1972 p.10) mentions a number of actual or potential pests that may damage plants. The Warwickshire observations suggest that damage by Agromyzidae to garden plants or crops rarely, if ever, occurs in the county. *P. ilicis* is common in Holly (*Ilex*), but can hardly be said to be damaging. *P. aquilegiae* and *P. minuscula* are common in *Aquilegia* in gardens, but mature plants can suffer quite heavy attack and yet continue to flower strongly year after year. *A. flavifrons* does not occur in sufficient numbers for attack to be serious and the same seems to be true for *P. rufipes*. *L. congesta* rarely occurs in gardens, preferring native hosts, whilst *P. horticola*, also mentioned by Spencer as a potential pest of peas and beans, is certainly not that; its main garden hosts are Wallflower (*Cheiranthus*), Toadflax (*Linaria*) and species of *Centaurea*; and even to these damage, if it occurs at all, will only be to small seedlings. *P. syngenesiae*, elsewhere recorded as damaging *Chrysanthemum* cultivars, does not normally attack that host in Warwickshire, where it occurs almost entirely in species of *Liguliflorae*, with over 90% of its numbers in native *Sonchus*. Of the other species listed by Spencer, *L. bryoniae* (Kält.) and *O. simplex* (Loew) are not known in Warwicks, though the latter could occur locally, whilst the presence of *Phytobia* species has not yet been investigated. Amongst the potential pests of cereal crops neither *A. rondensis* Strobl nor *A. ambigua* Fall. have yet been recorded in the county (though the former should certainly occur), and *A. nigrociliata* is scarce. *A. nigrella* has been recorded only in native grasses. Indeed, limited field observations have shewn that cereals are rarely mined in Warwickshire, the margins of the fields being more productive of miners than the crops themselves. (In this regard it should be noted that the reaping of cereals in August prevents the bivoltine miners, with the possible exception of *A. mobilis*, from becoming established, as the cutting of the crops effectively kills the second generation).

Individually most of the Agromyzidae are small and thus numbers of larvae must be large for significant plant damage to occur, except to small seedlings. (The Cambium miners of the genus *Phytobia* may be exceptions to this in that damage

to their long-lived hosts may sometimes accumulate over the years from only a few miners). The physically much larger species of Anthomyiidae, of Tephritidae and possibly also of Scathophagidae, are potentially more dangerous. *Delia cardui* (Mg.), for example, is sometimes sufficiently common in over-wintering plants of *Dianthus barbatus* to reduce somewhat their subsequent flowering vigour, whilst *D. echinata* (Seguy) can kill individual shoots. *Pegomya flavifrons* (Walker) will attack the same hosts as *Amrauomyza flavifrons*; indeed, the two species can sometimes be recorded from the same plant. But the only records of real damage, other than the occasional small seedling, by an Agromyzid mine: have not been to any garden plant, but to a weed, Groundsel (*Senecio vulgaris*), by *Liriomyza strigata*, with some assistance from *P. horticola*, the Tephritid *Thypeta zoe* Mg., and a miner yet to be identified. *S. vulgaris* is of course an annual; perennial plants with a well developed rootstocks or root systems, although they may be disfigured in one year by heavy mining, are unlikely to suffer permanently unless the mining should persist.

At present the comital fauna stands at 162 species. Some species whose identities have not been fully confirmed and some definitely novel mine types attributable to Agromyzid causers, together indicate the presence of at least another 20 species. Also, there are another 50 species that are either widespread, at least in the south, or have been recorded from other Midlands counties; and it is likely that most, though not all, will eventually be found in Warwickshire. These figures suggest a true comital fauna of around 220 species, about two thirds of the present British list. It will take a long while, indeed many years, to approach this figure because, on the one hand, the numbers of stem- or bark- feeders that have yet to be discovered and, on the other, the difficulties of not only finding new mine types during short periods of the year when they are occupied but also of successfully rearing the imagines. However, each year has brought new discoveries, though in decreasing numbers. Most other English counties should also have faunas of 200 species or more of Agromyzidae, but there are few from which even half this number are currently known.

#### Species new to the British Isles

Several species either not noticed at all or not officially listed as British by Spencer (1972) have been included in the preceding list. These fall into two categories: Species now accepted as British and Species whose presence in these islands is indicated but which have not yet been fully accepted.

##### A. Accepted Species

Five species were not included in his list by Spencer (1972).

*Agromyza filipendulae*

*Amrauomyza lamii*

*Phytomyza erigerophila*

*P. pauliloewi*

*P. (C.) fuscula*

Of these *A. filipendulae* was described by Spencer (1976) from material that was partly British, and its mine had previously been figured on p. 108 of Spencer (1972). A new list of British Agromyzidae is currently being prepared by Dr. B.R. Pitkin of the British Museum (Natural History) and he informs me (*in litt.*) that the next three species are now also accepted as British. Indeed, the Warwickshire records are not the first intimations of their presence in Britain. Hering (1957) included Great Britain in his distribution note for *A. lamii*; mines attributable to *P. erigerophila* were found in S. Wales by Griffiths, though the record may not have been published; while Spencer (1972) figured a mine which he previously attributed to *P. pauliloewi*, an attribution with which I would agree, though in these cases where a whole leaf is mined out such attributions may be no more than highly probable. The evidence for *P. (C.) fuscula* has been presented above.

##### B. Species not yet fully accepted

*Agromyza buhriella*  
*Liriomyza graminivora*  
*Phytomyza archangelicae*

For *A. buhriella* see Addend. The very distinctive frass pattern in its mines would normally justify the acceptance of *L. graminivora*. However, on the principle of William of Occam that entities should not be multiplied unnecessarily I am loth to admit it until the possibility of its conspecificity with *L. phryne* has been examined. Dr. Pitkin informs me (*in litt.*) that the species are listed as distinct in the Palaearctic catalogue, but I am suspicious of a situation such as we have in Britain where of two grass-mining species one is known as an imago but its larval biology has not yet been described while the other is clearly present at the larval stage but is not yet apparently known as an imago. Both species are stated to have six bulbs on the posterior spiracles, a further indication that they may perhaps be conspecific. Only vacated mines have been found for *P. archangelicae* and one would probably need puparia to justify its full acceptance as British.

#### Acknowledgements

For assistance in the field, and in particular for the collection of specimens in parts of the county I have not myself been able to visit, I am indebted to: Miss M. Gunn, Mrs N. Jardine, and Messrs. G.A. Arnold, M.A. Arnold, P. Cooke, L.J. Evans, J.A. Hardman and R.J. Thomas. For some identifications and for information on changes in the British list I must thank Mr. D.J. de C. Henshaw and Dr. B.R. Pitkin (British Museum, Natural History).

#### References

- Griffiths, G.C.D. (1974) Studies on Boreal Agromyzidae (Diptera) V: On the genus *Chromatomyia* Hardy, with a revision of the Caprifoliaceae-mining species. **Quaest Ent.** 10: 35-69
- Griffiths, G.C.D. (1980) Studies on Boreal Agromyzidae (Diptera) XIV: *Chromatomyia* miners on Monocotyledons: **Ent. Scand. Suppl.** 13: 1-61.
- Hering, E.M. (1957) **Bestimmungstabellen der Blattminen von Europa.** Junk, Holland.
- Robbins, J. (1983-89) Leaf-mining insects in Warwickshire, Parts 1 to 5. **Proc. Birm. Nat. Hist. Soc.** 25: 5-30, 71-87, 155-157 & 200-206, and 26: 46-8.
- Spencer, K.A. (1972) Diptera: Agromyzidae. **Handbk. Ident. Br. Insects.** 10. 5(g). R.E.S., London.
- Spencer, K.A. (1976) **The Agromyzidae of Fenno-Scandia and Denmark.** Fauna Entomologica Scandinavica, Denmark.

#### Addendum

Apart from a few essential revisions the text is as it was written early in 1988. But during the summer and autumn of that year there were some new findings that are worthy of independent mention.

Firstly, three species were reared from previously unidentified mine types. Species "A". From a corridor mine in *Lathyrus latifolius*, recorded quite often in Coventry gardens. This has proved to be a previously unrecorded variant of *Agromyza varicornis*, otherwise recorded from stem-wings.

Species "B". Makes a corridor-blotch mine, of which over 20 have been recorded from a number of sites; most of them in *Trifolium pratense*, but one in *Melilotus altissima*. Identification of the one specimen reared is still awaited; but examination of the Hering collection in the British Museum (Natural History) has disclosed that his series of mines attributed to *Agromyza nana* covers two types, those attributed here to *A. nana* and to Species "B". It is possible, therefore, that my attributions may be wrong and Species "B" may be the true *A. nana*, while the other is an unknown species.

Species "C". A corridor in *Milium effusum* with puparium at the end of the mine. Quite common in one wood and uncommon in a second. Both mine and puparium suggest a species of *Phytomyza* sub-genus *Chromatomyia*.

Secondly, two additional mine types have been found in *Artemisia vulgaris*, bringing the number of dipterous miners recorded from that host to eleven for Warwicks, and twelve for the British Isles. The mines may have been overlooked before through a superficial resemblance in colour, and in one instance also in size, to those of *Calycomyza artemisiae*. It is thought that the smaller mine may refer to *Paraphytomyza discrepans* (Wulp), whose host was unknown to Spencer (1972), but which has since been reared from *A. vulgaris* by Dr. P.K. Bland, though, as he informs me *in litt.*, he failed to note the mine details. The second mine is much larger and shows clear feeding lines, while the puparium is usually stout, red-brown when fresh, and assignable to the genus *Agromyza*. The only species that fits these data is *A. rufipes* Mg. (= *buhriella* Hering), the only member of its genus known to mine Compositae in Europe. The one Warwicks mine is closely matched by specimens in the Hering collection. This is the first indication of the presence of this species in the British Isles.

#### Leaf-Mining Diptera

Dr. B.R. Pitkin of the British Museum (Natural History) and myself are working on a publication that will cover the Agromyzidae together with other leaf-mining Diptera. It is apparent that current knowledge of the distributions of most species in the British Isles is poor: indeed, Surrey and Warwickshire are the only two counties whose faunas can be said to be reasonably well known! We should like, therefore, to receive records from any reader who may have any, especially for areas outside the Home counties, with locality and date if these are known. Information on any accumulation or collection, whether catalogued or not, would also be welcome. There is no space to give a full list, but the more important groups are: Agromyzidae (all), *Scaptomyza* (Drosophiidae), *Hydrellia* (Ephydriidae), *Chirosia* and *Pegomya* (Anthomyiidae). Details should be sent for preference to Dr. Pitkin (Cromwell Road, London, SW7 5BD), who is building up a computerized data bank. For my part I shall be pleased to receive specimens of mines for identification, provided that return postage is paid.

*John Robbins, 123b Parkgate Road, Coventry CV6 4GF.*



## NOTES ON IRISH TRICHO CERIDAE (INSECTA: DIPTERA) INCLUDING TWO SPECIES NEW TO IRELAND

P. Ashe and J.P. O'Connor

Although Haliday (1833) records four species of Trichoceridae, i.e. *Trichocera hiemalis* (De Geer), *T. fuscata* Meig. [= *T. saltator* (Harris)], *T. annulata* Meig. and *T. regelationis* (L.), from Ireland, little subsequent work has been carried out on the group here. Carpenter (1912) mentions *T. saltator* (sub *T. fuscata*) as feeding on swedes while Rhynehart (1924) reports *T. regelationis* as feeding on the same vegetables. The latter author gives an excellent account of the ecology and morphology of the immature stages of *T. regelationis*.

The adults of Trichoceridae are popularly known as winter gnats, the adults occurring mainly in the spring and/or autumn and during the winter in temperate or warm temperate regions. The larvae occur in moist or wet biotopes and are saprophagous. They live on plant debris, decaying leaves, fungi, animal droppings and carrion; in winter, the group constitutes an important element of the carrion fauna when blowfly (Calliphoridae) fauna is absent (Dahl and Alexander 1976, Smith 1986). Since Smith (op. cit.) shows trichocerids to be useful indicators in forensic entomology, a checklist of the known Irish species is given below. Nomenclature follows Dahl and Alexander (op. cit.).

Freeman's (1950) key to the British trichocerids recognises a total of 10 species and one variety in two genera, *Diazosma* with one species and *Trichocera* with nine species and one variety. Subsequently Laurence (1957) demonstrated that two of the species treated by Freeman (op. cit.) were synonymous with one another (i.e. *T. fuscata* is a junior synonym of *T. saltator*), and he also provided an updated version of Freeman's key to the British *Trichocera* species. One further change is that the variety *T. rufilenta* Edwards is regarded as a synonym of *T. saltator* (Dahl and Alexander 1976). These changes result in a total of nine species of Trichoceridae with the genus *Diazosma* containing one species and *Trichocera* with eight species.

The species *T. rufescens* Edwards has had a confusing history over the last 30 years from being generally accepted as a valid species (Freeman 1950, Laurence 1957) until it was synonymized with *T. regelationis* (Dahl 1966, Hutson and Vane-Wright 1969) but more recently it has been regarded as a valid species (Dahl and Alexander 1976).

The known Irish fauna consists of six species of which two, *T. major* Edwards and *T. rufescens*, are recorded from Ireland for the first time. Three of the species occurring in Great Britain, *Diazosma hirtipennis* Siebke, *T. maculipennis* Meigen and *T. parva* Meigen, have yet to be recorded from Ireland. The Irish national grid reference (six or four figure reference) is given, whenever possible, followed by the Universal Transverse Mercator (UTM) 50 km grid reference in parenthesis. Voucher specimens of all the Irish species are deposited in the National Museum of Ireland.

Abbreviations; P. Ashe = P.A.; R. Blackith = R.B.; K.G.M. Bond = K.B.; G.H. Carpenter = G.H.; L. Gibson = L.G.; J.N.R. Grainger = J.G.; J.P. O'Connor = J.O.C.; J.P. and M.A. O'Connor = J.M.O.C.; W. Rutledge = W.R.; J. Scharff = J.S.; M.C.D. Speight = M.S. and A.W. Stelfox = A.S.

### *Trichocera annulata* Meigen, 1818

First recorded by Haliday (1833) from near Holywood, county Down (UF.1) and probably collected between 1827-1832. Three male Haliday specimens without any locality data but correctly identified are in the collections of the National Museum of Ireland. New records:- Cork: 24-27 January 1986, W781713 (NT.1)

Fota Island Wildlife Park, K.B.; Dublin: 1 November 1981, O033245 (PV.4) Slade of Saggart, J.M.O.C.; 28 February 1987, O089386 (PV.4) River Tolka, Abbotstown, J.O.C.; Kildare: 14 November 1981, N9326 (PV.4) Grand Canal near Straffan, J.O.C.; 12 September 1982, N9326 (PV.4) Grand Canal near Straffan, J.M.O.C.; 27 December 1987, N9993 (PV.3) Ryevale, Leixlip, J.O.C.; Mayo: 30 March 1923, M2668 (MV.4) Hollymount, W.R.; Wicklow: 3 October 1986, O2611 (PU.3) Glen of the Downs, J.M.O.C.; Wexford 17 January 1980, T1103 (PT.3) Carnsore area, L.G.

*T. hiemalis* (De Geer, 1776)

New records:- Wicklow: September 1894, (PU.3) Avoca, collector unknown; 8 November 1981, T112964 (PU.3) Glendalough, J.O.C.; 2 March 1984, O234119 (PU.3) near Calary Lower, J.O.C.; Wexford: 21 December 1980-4 January 1981, T1103 (PT.3) Carnsore area, L.G.

*T. major* Edwards, 1921

This species is new to Ireland. Cork: 24-27 January 1986, W781713 (NT.2) Fota Island Wildlife Park, K.B.; Wexford: 4 January 1981, T1103 (PT.3) Carnsore area, L.G.

*T. regelationis* (Linnaeus, 1758)

A re-examination of Haliday's insect collection in the National Museum of Ireland confirms Haliday's (1833) record of the species from near Holywood (UF.1), Co. Down- no collecting data specified but probably between 1827-1832. The only other published records for this species in Ireland are given in Rhynhart (1924) with the following details: February 1921, Dublin (PV.4); February 1922, Albert Agricultural College, Glasnevin, Dublin (PV.4). New records:- Cavan: 1 March 1987, N5987 (PV.1) near Virginia, J.O.C.; Clare: 30 March 1986, M308107 (MU.3) Green Road, Corker Pass, Burren, J.O.C.; Dublin: 31 March 1902 (PV.4) Dundrum, G.C.; March 1904, (PV.4) Dublin, G.C.; 13 November 1928, O1432 (PV.4) Mayfield, Harold's Cross, A.W.Stelfox; 24 April 1986, 27 February 1987, O089377 (PV.4) Beech Park Crescent, Castleknock, J.O.C.; 25 October 1987, O2938 (PV.4) Howth, J.O.C.; Kildare: 14 November 1981, N937266 (PV.4) Grand Canal near Straffan, J.O.C.; 8 March 1987, N8332 (PV.2) Donadea Forest Park, J.O.C.; Mayo: 28 March 1923, 5 April 1923, M2668 (HV.4) Hollymount, W.R.; Meath: 1 March 1987, O0341 (PV.4) Clonee, J.O.C.; Wicklow: 11 March 1984, O234119 (PU.3) near Calary Lower, J.O.C.; Wexford: 21 December 1980 - 4 January 1981, T1103 (PT.3) Carnsore area, L.G.; Wicklow: April 1918, O2314 (PU.3) Rocky Valley, near Kilmacanogue, J.S.

*T. rufescens* Edwards, 1921

New to Ireland. Dublin: 1 November 1981, O033245 (PV.4) Slade of Saggart, J.M.O.C.

*T. saltator* (Harris, 1776)

New records:- Dublin: O1328 (PV.4) Butterfield Avenue, J.G.; Wicklow: 3 October 1986, O2611 (PU.3) Glen of the Downs, J.M.O.C.

**Acknowledgements**

We are most grateful to all those cited above who so kindly provided us with specimens.

**References**

- Carpenter, G.H. (1912) Injurious insects and other animals observed in Ireland during the year 1911. *Econ.Proc R. Dubl. Soc.* 2; 53-78.

- Dahl, C. (1966) Notes on the taxonomy and distribution of Swedish Trichoceridae (Dipt. Nemat.) *Opusc. ent.* 31: 93-118.
- Dahl, C. (1976) A world catalogue of Trichoceridae Kertész, 1902 (Diptera). *Ent. scand.* 7: 7-18.
- & Alexander, C.P.
- Freeman, P. (1950) Family Trichoceridae, pp.67-69. In Coe, R.L.; Freeman, P. and Mattingly, P.F. *Diptera 2. Nematocera: families Tipulidae to Chironomidae.* *Handbk. Ident. Br. Insects* 9(2): 1-216.
- Haliday, A.H. (1833) Catalogue of Diptera occurring about Holywood in Downshire. *Ent. Mag.* 1: 147-180.
- Hutson, A.M. and Vane-Wright, R.I. (1969) Corrections and additions to the list of British Nematocera (Diptera) since Kloet and Hincks' "A check list of British Insects" (1945). *Entomologist's Gaz.* 20:231-256.
- Laurence, B.R. (1957) The British species of *Trichocera* (Diptera: Trichoceridae). *Proc. R. ent. Soc. Lond.* (A) 32: 132-138.
- Rhynehart, J.G. (1924) The larva and pupa of *Trichocera regelationis* L. (Diptera, Rhyphidae). *Proc. Belfast nat. Hist. Soc.* 1922-3: 36-46.
- Smith, K.G.V. (1986) *A manual of forensic entomology.* British Museum (Nat.Hist.) 205pp.

*P. Ashe, Department of Zoology, Trinity College, Dublin 2.*

*J.P. O'Connor National Museum of Ireland, Dublin, 2.*

### Callicera aenea in Wolverhampton

*Guy T. Knight*

On the 17th August 1988a female specimen of *Callicera aenea* (Fabricius) was caught in our garden. It was hovering above a bed of sunflowers (*Helianthus*), sweet peas (*Lathyrus odoratus*), and tobacco plant (*Nicotiana*) at about midday. The weather was hot and the site where the fly was captured is a sun trap at midday. There was at least one other of the same species present, probably two. These were also hovering, about 4 feet away from the captured fly but as soon as they were startled they flew up about 40 feet over our house in a south easterly direction.

Our garden is about a mile and a half to the west of Wolverhampton town centre and is surrounded by many trees including Ash (*Fraxinus*), Poplar (*Populus*), Lime (*Tilia*), and many old fruit trees mainly Apple (*Malus*). So far no obvious rot holes have been found and so no larvae, however, a close watch will be kept next year for the adult and larvae.

## **Sphaerophoria fatarum in the British Isles (Syrphidae)**

*Martin C.D. Speight*

Publication of descriptions of four new European *Sphaerophoria* species, by Goeldlin (1989), makes necessary the re-examination of specimens consigned to *S. abbreviata* (Zett.) and *S. philantha* (Mg.). All of the material of "*S. abbreviata*" I have seen from both Great Britain and Ireland is referable to *S. fatarum* Goeldlin. *S. abbreviata* itself appears to be confined to northern parts of Scandinavia, from the information presented by Goeldlin (l.c.). Two further species extremely similar to *S. fatarum*, *S. bankowskiae* Goeldlin and *S. laurae* Goeldlin, occur with *S. fatarum* in the Alps, with *S. bankowskiae* primarily at lower altitudes and *S. laurae* at higher altitudes. Either or both of these additional species might well occur in the British Isles and would previously have been confused with *S. abbreviata*. It is also possible that further taxa require to be isolated from within this species complex - material collected from NW Ireland, although at present consigned to *S. fatarum*, shows differences (figured by Goeldlin) whose significance cannot yet be judged, given the limited number of specimens involved.

At higher altitudes in the Alps, *S. philantha* is replaced by *S. boreoalpina* Goeldlin, which is extremely similar to *S. philantha*. Goeldlin's four new species can at present only with ease be recognised in the male sex, using the figures of male terminalia provided by Goeldlin (1989). A further component of Goeldlin's paper which should be noted is that he provides convincing evidence that the type of *S. menthastri* (L.) has been misinterpreted, showing that the correct name for the species now normally referred to as *S. menthastri* is *S. interrupta* (Fabricius).

### **Reference**

- Goeldlin, P. (1989) Sur plusieurs espèces de *Sphaerophoria* (Dipt., Syrphidae) nouvelles ou méconnues des régions paléarctique et néarctique. *Bull. Soc. ent. Suisse*, 62: 41-66.

*Martin C.D. Speight, Research Branch, Wildlife Service, Sidmonton Place, Bray, Co. Wicklow, Ireland.*

## **An Additional British *Sphaerophoria* Discovered In Devon**

*Alan E. Stubbs*

Notes and a key enabling recognition of various European *Sphaerophoria* were provided by Dr. Martin Speight in *Dipterist's Digest* No 1, : 23-4. Subsequently the species below has been found in Britain so a *British Hoverflies* style account is provided.

The data are as follows

- 1 male 11 June 1989 Common Moor SSSI, East Putford, Devon. A.E. Stubbs.
- 1 male 11 June 1989 Common Moor SSSI, East Putford, Devon. I. Perry.
- 1 male 11 June 1989 Beaford Moor SSSI, Devon. J. Mousley.
- 1 male 11 June 1989 Beaford Moor SSSI, Devon. A. Brackenbury.

**Sphaerophoria potentillae** Claussen, 1984

The males resemble those of *batava* and allied species with a yellow band on tergite 2, differing in the presence of microtrichia over the entire surface of the second basal and anal cells. The genitalia have a particularly short triangular lower lobe. It is a rather small species. Wing length 4.5mm.

Discovery of *S. potentillae* was achieved in 1989 when it was taken at two localities in NW Devon during a Diptera field meeting. Here it was found on Culm commons with wet *Molinia* heath, though dry at the time due to prolonged drought. This habitat (and variants towards bog or fen) on Culm Measures is a notable feature of North Devon, now much reduced due to agricultural improvement. Specimens were found by sweeping flowers of *Potentilla erecta*. The species was only previously known from a series of bogs in NW Germany where association with *Potentilla erecta* was noted. In North Devon it was not found on the valley and plateau bogs that were visited nor on a wide range of other habitats. June (June-August in Germany).

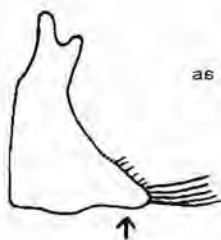

view of genitalia, orientation  
as in British Hoverflies pp 70-72

↑  
SHORT, TRIANGULAR

**A Record of *Sphegina elegans*** (Schummel, 1843) (= *kimakowiczi*) (Diptera: Syrphidae) in Cumbria (VC 69).

A female specimen of *Sphegina elegans* was taken by me when sweeping low vegetation on 17 June 1989 in Rigg Wood near Nibthwaite, Cumbria (34/301922). The standard works on British Syrphidae indicate that this species, though widespread, is generally rare. I do not know of any previous records for Cumbria.

The late A.E.Wright in his "List of the Syrphidae of North Lancashire and South Westmorland" (in *The North Western Naturalist* (1940) XV: 242-247) lists only *Sphegina clunipes* (Fallen, 1816) as "Grange, scarce. From May to September. Six only." I have taken *Sphegina clunipes*, uncommonly, in the Grange-over Sands area.

It may be significant that the presently recorded specimen was taken in mixed woodland on acid soil overlying Silurian slate. The Grange specimens of which I have knowledge were taken in mixed woodland but on Carboniferous Limestone giving an alkaline soil.

*S. elegans* (as *kimakowiczi* Strobl, 1897) is recorded from VCs 58 and 59 by Kidd and Brindle in "The Diptera of Lancashire and Cheshire. (Lancashire and Cheshire Fauna Committee, 1959).

*Dr Neville L. Birkett, Beardwood, Carter Road, Grange-over-Sands, Cumbria LA11 7JG.*

## SOME MODIFICATIONS TO COMMERCIALY-MADE SUCK-POOTERS FOR USE IN DIPTERA COLLECTING

*D.K. Clements*

Pooters are used by a wide variety of invertebrate scientists, and a surprising number of specialised types have been developed to suit differing requirements. However, the majority in use amongst the dipterological contingent are standard, commercially-made suck-pooters, sold in the most basic and unrefined form possible and intended to meet the disparate needs of many users.

Basic pooters come in two principle designs:

a) the **Compact or Pocket pooter** - where both the inlet and the outlet (suction) tubes pierce the same bung, which is inserted into interchangeable, flat-bottomed, glass specimen tubes;

b) the **Through-pooter** - which has a large diameter barrel with a bung in each end, one of which is pierced by the inlet tube, and the other by the outlet tube.

There are advantages and disadvantages to both types, but one universal problem is that of "crawl-out". As any dipterist who has used a pooter in the field will know, unless the inlet tube is kept sealed between periods of sucking, many of the smaller captives (particularly those more given to walking than flying) will quickly locate the interior opening of the inlet tube and will crawl to freedom. To some extent this can be reduced by ensuring that the tube projects well beyond the inner surface of the bung, making the opening less easy to find. However, most entomologists grimly make do with plugs of cotton wool, corks or bits of vegetation picked in the field and pressed into service. These plugs must be removed when using the pooter, and this can be very tricky when both hands (and teeth!) are occupied holding, respectfully, the sweep net, the pooter and the pooter sucking-tube. The simple valve described below effectively overcomes these problems. It could be adapted for both compact and through-pooters, although the author has only so far tested it on the former, which has the advantage that the collecting tubes can be freely removed, corked and replaced by a fresh tube as one moves from site to site, or from habitat to habitat within a site.

An easily available model is the Watkins and Doncaster pocket pooter, which has several basic flaws when used for collecting Diptera. Firstly, the inlet tube is only about 12 cm long, being bent at the middle at an angle of about 45 degrees, leaving a short outer-arm of about 5-6 cm. This means that the body of the pooter and the fist holding it are close to the collecting aperture of the inlet tube. The target insect often sees the looming bulk of the hand and pooter before it comes into the range of the collecting aperture. Also, the tip of the tube is difficult to manipulate around the inside of a sweep net with any dexterity, being so short, particularly if the rubber sucking tube is also on the short side. Ideally, the short inlet tube should be discarded and replaced with one as shown in figure 1. Such a replacement can be made by cutting a winemaker's siphon tube (as supplied by Boots the Chemist) to the appropriate length, and bending it in the flame of a butane blowtorch. The longer outer-arm helps to overcome the problems alluded to above.

The construction of the non-return valve requires that the inner arm of the inlet tube is drawn back into the bung until its opening lies flush with the bung's inner surface. The valve itself consists of a small square of cellophane, measuring about 1 cm x 1 cm. The slightly-rigid cellophane used to wrap cigarette packets is ideal. The cellophane square lies over the inner aperture of the inlet tube, and is

secured at the edge by a narrow strip of acetate sheet, as shown in figures 2-3. Two 1 cm long pins are driven through the acetate strip and cellophane, and finally into the rubber or cork of the bung. Acetate sheet is available from model-makers' suppliers, although the small quantity required can usually be scavenged from other sources. In use, the valve is seen to "flutter" when suction is applied, so offering no resistance to an insect passing through it, no matter how small it may be. When suction ceases, the inherent rigidity and static charge of the cellophane causes it to drop back over the inlet aperture, effecting a seal sufficient to deter all but the most determined of escapees. The acetate strip acts as a reinforcement to the edge of the cellophane, as well as adding an element of "spring".

The system works well in the field, and the valve has good longevity. Replacement is a simple affair, and the materials are readily available. Both the cellophane and the acetate sheet are inert to ethyl acetate, surviving prolonged immersion unscathed, and so the practice of introducing the fumes into the potter to stupefy the captives is still practicable.

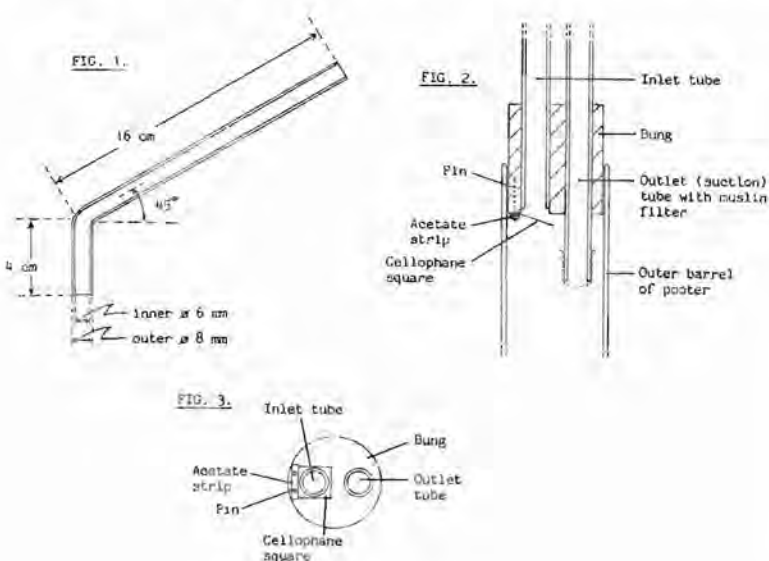

Fig.1. Modified inlet tube for use with compact potter.

Fig.2. Compact potter in section, showing non-return valve.

Fig.3. Internal surface of potter bung, showing valve.

## A Remarkable Addition to the British Moth-fly Fauna

P. Withers

The study of European moth-flies (Diptera, Psychodidae) has benefited enormously from the number of workers active during the last decade. The number of palaeartic species now described has more than doubled in this time, and it is thus not too surprising that the British fauna has seen some recent additions (e.g. Withers, 1986, 1987). It was predictable that this process would continue as more collectors obtained material, and it is pleasant to report a further addition, albeit unexpected in view of its known range.

A quantity of psychodids preserved in alcohol were passed to me by Peter Chandler, representing his considerable collecting efforts throughout 1987. Among them was a small collection from the Leckford estate, Hants. (SU3737) taken by Parson's Brook, a carr woodland near the River Test. Four males were immediately remarkable for unusual features of the terminalia, and these structures, along with the heads, were mounted on slides. Further specimens were found later in another sample from this locality, identified as reserve D. (I am informed that this sample was collected either along a disused railway line or along a track bordering a poplar plantation.) These specimens were fully retained and dissected. After clearing and examination, they were all found to be specimens of *Telmatoscopus (Panimerus) miksici* (Krek), hitherto unknown only as a unique specimen collected in Yugoslavia.

The essential details of the genital complex are shown in figure 1. The most obvious feature, visible in whole specimens even under low magnification, is the unique subgenital plate. This is extended posteriorly into two tapering lobes, beneath the outcurved sickle-shaped gonapophyses. The median furca is heavily pigmented. Also notable are the very long feathery retinacula, which unusually for any moth-fly are longer than the cercopodia. The antennal structures known as ascoids are also extraordinarily long and curved (figure 2).

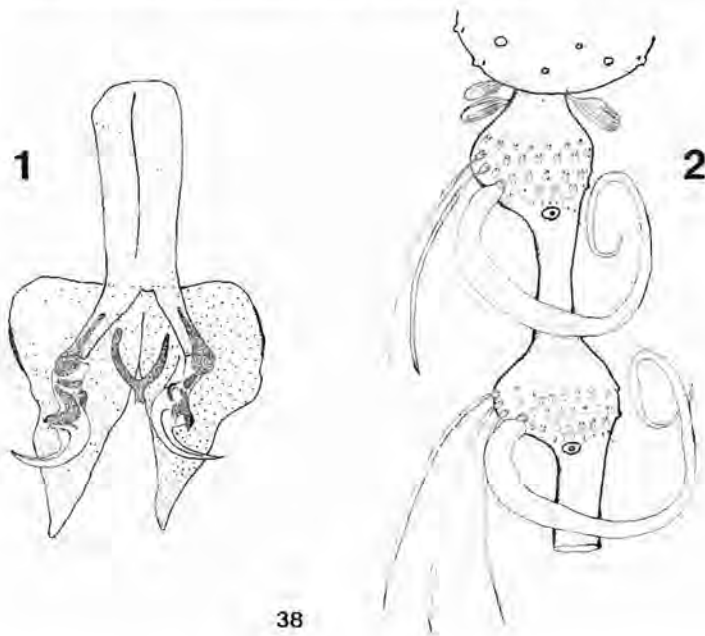



Krek (1979) states that the holotype male was taken by a tributary stream of the Sana River, near Kozara. The Leckford material was collected on 14.vi.87. One has been deposited in the British Museum (Natural History); others are in the collections of Dr. Wagner of Schlitz, Prof. Vaillant of Grenoble and Dr. Duckhouse of Adelaide. The remainder are in my own collection.

*T. miksici* shares some features with other *Telmatoscopus* found in Britain. The feathery retinacula in particular are characteristic of a small group (*adventus* Eaton and *laurencei* Freeman) which are known to breed in tree rot-holes, and one might speculate that *miksici* will be found in similar circumstances. Peter Chandler is deserving of both thanks and congratulation for dutifully collecting this material in (for him) an unfamiliar medium, enabling this communication to be made.

#### References

- Krek, S. 1979 Eine neue Psychodinae-art aus Bosnien und Herzegowina. *Gl. Zem. muz. Sarajevo* 18:161-164.
- Withers, P. 1986 Recent records of Norfolk mothflies, including a species new to science and five species new to Britain. *Trans. Norfolk Norwich Nat. Soc.* 27(3):227-231.
- Withers, P. 1987 *Telmatoscopus ellisi*, a further new species of moth fly (Diptera, Psychodidae) from Norfolk. *Trans. Norfolk Norwich Nat. Soc.* 27(5):381-383.

#### Some Old Records of *Chorisops nagatomii* Rozkošný (Stratiomyidae)

During a recent examination of Stratiomyidae in the Diptera of Liverpool Museum, six specimens of *Chorisops nagatomii* Rozkošný have been identified in the series standing under *C. tibialis* (Mg.). There are three females and a male labelled "N. Forest", collected by F.C. Adams between 13 August 1907 and 21 August 1910; these were originally in the collection of the Liverpool School of Tropical Medicine.

The two remaining specimens are a female collected by J.J. Collins at Wytham (?Oxon), on 7 September 1935, and a female taken by E.G. Hancock at Leighton Moss, Lancs., on 22 August 1973.

Examination of other collections may reveal more examples of *C. nagatomii*, which was described in 1979, (Rozkošný, R. 1979. Revision of the Palearctic species of *Chorisops*, including the description of a new species (Diptera, Stratiomyidae). *Acta ent. bohemoslav.* 76: 127-136.

I am obliged to Mr. A.E. Stubbs for kindly confirming my determination of two of the Adams' specimens, and to Mr Steve Judd, Assistant Keeper of Invertebrate Zoology, Liverpool Museum, (National Museums and Galleries on Merseyside), for making it possible for me to examine the collection.

Roy Crossley, 1 The Cloisters, Birker Lane, Wilberfoss, York, YO4 5RF.

*Geomyza angustipennis* Zetterstedt. (Opomyzidae) in Gwent: Third British Record.

David Gibbs

In July and August 1985 I did some survey work for the Nature Conservancy Council in Lady Park Wood in the Wye Valley, Gwent. Part of the survey involved laying a series of water traps through the wood to obtain some quantitative data on invertebrates. Among the diptera trapped was a small female Opomyzid.

The fly is clearly a *Geomyza* possessing long hairs on the arista, small basal scutellars and bare disc of the scutellum. It runs to couplet 2(3) of Collin (1945) having one pre- and two post-sutral dorsocentrals. However, although lacking a long distinct peristomal bristle like *G. breviseta* Czerny it has a yellow thorax and legs and less shading on the very narrow wings.

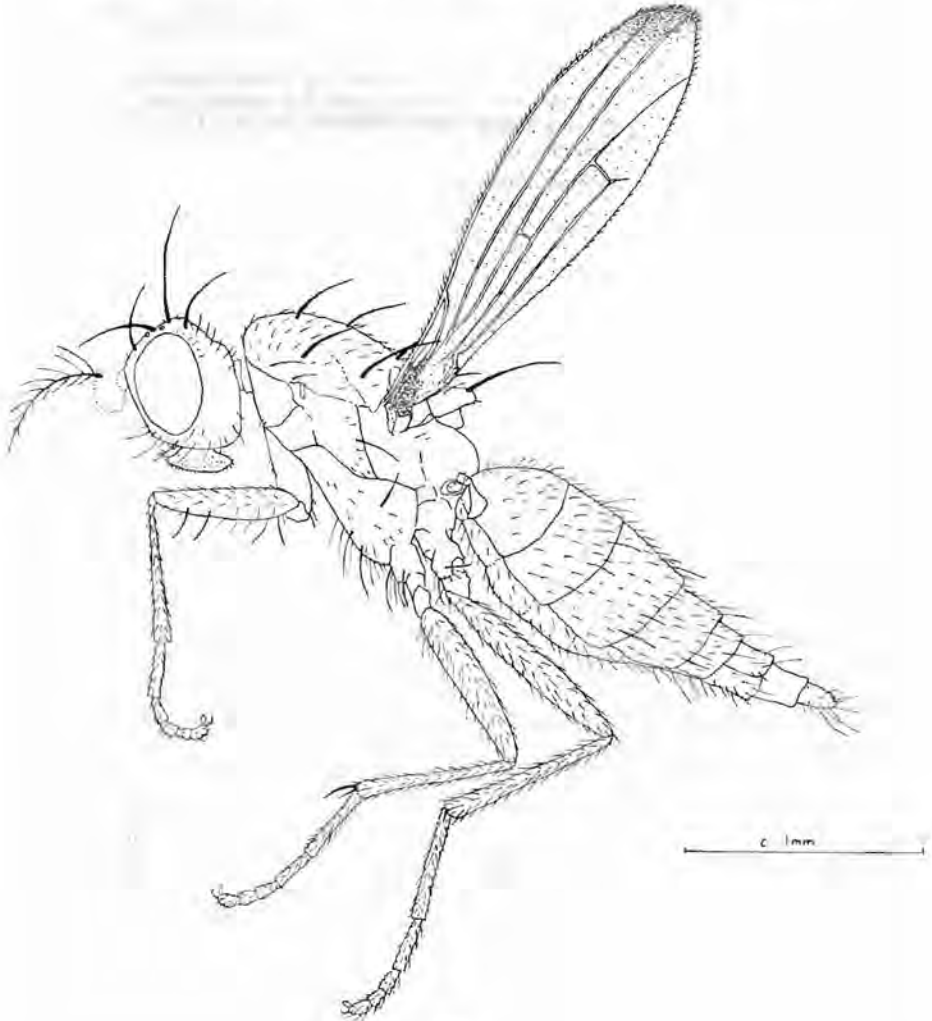

Denis Unwin suggested that it may be *G. angustipennis* Zetterstedt, a species unrecorded in this country when Collin wrote his key. This has now been confirmed by Martin Drake who has seen the specimen.

*Geomyza angustipennis* Zetterstedt can be distinguished from other members of the genus by the following combination of characteristics.

One pre- and two post-sutral dorsocentrals, wings with both cross veins completely unclouded, and a small apical cloud not extending much below cubital vein.

Description of female *Geomyza angustipennis* Zetterstedt from Lady Park Wood, Gwent 1 August 1985.

**HEAD:** Orangey brown, paler yellowish on jowls below eyes, antennae pale yellow, long black arista with long hairs on dorsal and ventral surfaces. Proboscis and palpi orangey brown. No strong peristomal bristle. (N.B. the head of my specimen has partly collapsed largely concealing the antennae so it is not possible to be sure of their shape.)

**THORAX:** Mostly yellow, browner on the humeri and notopleuron, palest on sternopleuron, moderately shining. Acrostichals short, hairlike, biserial and disappearing rearward. Similar hairs scattered over dorsal surface. Scutellum with strong convergent apicals and fine hair-like sub-basals. Haltere white.

**ABDOMEN:** Tergites brown to blackish some more yellowish about base, especially proximally. Apical segments pale yellowish, last sternite dark brown, chitinised. Last two segments dulled but rest of tergites shiny. Black haired except for penultimate segment which is glabrous.

**LEGS:** Entirely pale yellow, of moderate length, two posterior pairs relatively more slender than anterior pair.

**WINGS:** Short, very narrow and slightly yellowish, no alula. Venation complete, mostly pale whitish yellow except at extreme base and at leading edge of wing tip where membrane darkened. Crossveins entirely clear.

The species was added to the British list by C. Andrews who collected one at Soakham, Kent on 20 August 1964. This specimen is now in the Hope Collection, Oxford. A second was taken at Spey Bridge, Grampian on 18 June 1982 (S. Falk pers. comm.). Unfortunately the collector/determiner of the latter specimen is not known, if you have it please get in touch.

Lady Park Wood, where my specimen was taken on 1 August 1985, is a deciduous woodland on a steep north and east facing slope above the River Wye near Symonds Yat. Much of the floor is heavily shaded having been undisturbed for some forty years resulting in an under story of little more than brambles (*Rubus*). Where the wood has been managed more recently open areas have allowed the growth of a more diverse herbaceous understory.

Although the site produced some interesting records the dipterous fauna did not suggest that the site was particularly unique. From this and the very widely separated records, Kent, Grampian and Gwent, it seems highly unlikely that the rarity of this species is due to specialised habitat requirements. Rather, it will no doubt prove, it is an overlooked species. Perhaps more pitfall and water trapping would produce far more records of this ground dwelling species which looks as if it is barely able to fly.

I am most grateful to Denis Unwin and Martin Drake for determining the specimen and providing me with much of the above information.

## References

- Collin, J.E. 1945. The British species of Opomyzidae (Diptera) *Ent. Rec.* 15: 13-16.
- Czerny, L. 1928. Opomyzidae, in Lindner. *Die Fliegen der Palearktischen Region*. 54c: 1-15.
- Hackman, W. 1958. The Opomyzidae (Dipt.) of Eastern Fennoscandia. *Notulae Entomologicae* 38: 114-126.
- Gibbs, D.J. 1985. Lady Park Wood, Insects. Unpublished report.
- Unwin, D.M. Key to British Opomyzidae. Unpublished.

*David Gibbs. 34, Broome Grove, Wivenhoe, Colchester, Essex, CO7 9QU.*

## Records of some Local or Scarce Hoverflies in South Cleveland

*Chris Bentley*

The species below were collected during 1987 as part of an insect survey of the Lazenby Bank Conservation Area, which comprises a range of habitats from moor to mature woodland in an area of roughly 250 acres. The site, which is about 7 miles east of Middlesbough in south Cleveland, belongs to the I.C.I., but is to be managed by Cleveland County Council for purposes of conservation and recreations. All of the species were from either Castle Gill, which is about 200m south west of Wilton village (NZ 58 19), or from a site near the neighbouring village of Lazenby (NZ 57 19), and descriptions of these sites are given below. Notes in speech marks are taken from Stubbs, A.E. and Falk, S.J. (1986) *British Hoverflies* B.E.N.H.S.

### Castle Gill

A strip of woodland, of about 7 acres, running from south west to north east on either side of a steep sided gully, at the bottom of which is a small beck. The main tree type is Elm, most of which is dead or dying, but Sycamore, Oak and Sweet Chestnut also occur, and some young planted Beech are present at the south western end. To the east is arable land, and to the west a larch plantation. Ground flora is mainly Nettle and Dogs Mercury, with Bramble, Hogweed and Creeping Buttercup.

### *Platycheirus tarsalis*

"Uncommon." Quite common during May in Castle Gill. Observed feeding on Red Campion and Hedge Woundwort. Early May - mid June.

### *Dasysyrphus frulienis*

This species, which is believed to be associated with conifer plantations, has only been recognised as British since 1979. From the available literature an individual caught in Castle Gill (where the species turned out to be quite common) on 5th May appears to be the earliest and most northerly record to date. 5th May - 28th June. Peak mid-May.

### *Heringia heringi*

"Very local." A single female on 29th May netted hovering low down among Nettles.

### *Pipiza fenestrata*

"Relatively scarce." Two males of the four - spot form observed in Castle Gill on 30th hovering above a Bramble/Nettle patch, next to a clump of young elms.

*Arctophila fulva*

"A very local species in northern and western Britain". Few records for the east of England. A single female observed on an unidentified species of Compositae on 21st September.

**Lazenby**

A 1 acre block of woodland just south of the village of Lazenby. Mainly Horse Chestnuts, but with some Sycamore and Scots Pine. Verges dominated by Hogweed. To the south is arable land and woodland, to the north a very large chemical plant.

*Brachypalpoidea lenta*

"Local and rather common in southern forests." A male was observed on Hogweed at NZ 572 195 on 30th June.

*Criorhina berberina*/*C. floccosa*

"Scarce." Very common in the same general area as the above species, also on Hogweed, from 28th June - 30 June. However, before and after this, both species were very uncommon. The latter species was also observed feeding on Rhododendron in Castle Gill. *C. berberina* - Early May-early June. *C. floccosa* - Late May-early July.

## DUAL COURTSHIP STRATEGIES IN *Criorhina asilica* (SYRPHIDAE)

*Alan Stubbs*

On 27 May 1988 a visit was made to Nursted Copse, near Petersfield, Hants in company with Matthew Oates. This is a rather densely shaded north facing woodland with *Alnus*, *Fraxinus*, *Quercus* and *Corylus*. The observations below were made between 16.45 and 17.00 hours BST on a sunny day.

In a small shaft of sunlight, the base of a *Fraxinus* coppice stool was attractive to *Criorhina asilica*. A male was seen to move about slowly in a semi-hovering flight and to settle on the main coppice trunk (about 45cm in diameter and mossy at the base). Whilst hovering again, a female approached closely and the male intercepted; both tumbled into short grass but soon the female flew off. The male continued to patrol within 0.5 sq metres and for a short time was accompanied by two other males. There was no attempt at fighting off other males but when their slow manoeuvring brought them very close to each other there was a brief scuffle. Within a few minutes only one male remained. All this activity was within 30-50cm of the ground. The opposite side of the coppice stool had a large cavity with moist wood debris at the base.

A short distance away (about 40m) within the wood there was a very small glade. Here a male *C. asilica* was very actively patrolling sunny leaves of *Corylus* at 2m above ground and also nearby *Urtica* leaves at about 30-50cm above ground. Its length of patrol was about 10m, going back and forth like a large solitary bee.

Whilst dual courtship strategies have been reported before, it is of particular interest that both strategies were operative at the same time of day in close proximity. Also it might have been supposed that the males would have defended a larger discrete territory at the coppice stool, though in some other dead wood genera (eg. *Brachyopa*) males are very tolerant of one another. For further reference on this topic, see "British Hoverflies", 1986 Appendix p.11.

Phytomyza scolopendri R.-D. (Diptera: Agromyzidae) - New To Scotland

K.P. Bland

On 9.iii.1988 the distinctive tortuous mines (Fig 1) of the agromyzid *Phytomyza scolopendri* Robineau-Desvoidy were found in fronds of Hart's Tongue Fern, *Phyllitis scolopendrium* (L.) Newm. at Dunglas Dean, Berwickshire (NT7772, V.C. 81).

Previously, the most northerly record for this species was Ambleside, Westmoreland (Spencer, K.A. (1972) Handbk. Ident. Br. Insects. 10 (5g)). However on 25.iv.1974, the BBC TV programme "Bellamy's World", showed close-up film of Hart's Tongue Fern at Castle Eden Dean, Co. Durham. One of the ferns showed the characteristic mines of *P. scolopendri*. A comfortable armchair by the fire is not always an unproductive way of recording!

Hart's Tongue Fern is a scarce and very local plant in S.E. Scotland but grows in abundance on the sides and bottom of this deep shaded dean. The mines were particularly abundant on the south side but also occurred on the northern slope of the dean. As the burn is the V.C. boundary, this extends its distribution into East Lothian (V.C. 82). Therefore the present records extend the distribution of *P. scolopendri* well into southern Scotland.

The fly seems to prefer plants growing on the steepest rocky walls of the dean, spurning the more luxuriant plants growing on the gentle slopes. Most infested plants had several mines in each frond. Although many of the mines were well advanced when collected, the larvae fed up slowly and it was a month later (21.vi.1988) before most of them started to form puparia within the mine. Imagines emerged 10 to 15.v.1988. Some material has been deposited in the Royal Museum of Scotland, the rest is in the collection of the author.

K.P. Bland 35 Charterhall Road, Edinburgh, EH9 3HS.

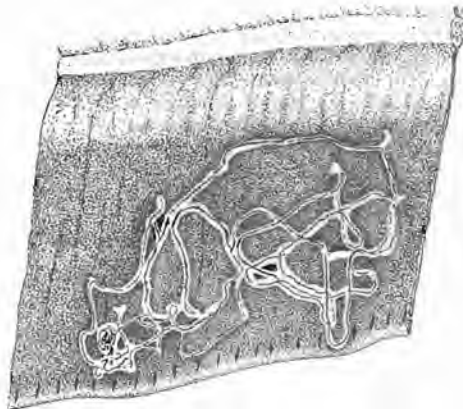

Fig 1. Part of the frond of *P. scolopendrium* with mines of the agromyzid, *Phytomyza scolopendri*.



