

Dell™ XPS™ L702X Service Manual

Regulatory model: P09E series

Regulatory type: P09E002



Notes, Cautions, and Warnings



NOTE: A NOTE indicates important information that helps you make better use of your computer.



CAUTION: A CAUTION indicates potential damage to hardware or loss of data if instructions are not followed.



WARNING: A WARNING indicates a potential for property damage, personal injury, or death.

Information in this document is subject to change without notice.

© 2010 Dell Inc. All rights reserved.

Reproduction of these materials in any manner whatsoever without the written permission of Dell Inc. is strictly forbidden.

Trademarks used in this text: Dell™, the DELL logo, and XPS™ are trademarks of Dell Inc.; Microsoft®, Windows® and the Windows start button logo  are either trademarks or registered trademarks of Microsoft corporation in the United States and/or other countries; Bluetooth® is a registered trademark owned by Bluetooth SIG, Inc. and is used by Dell under license.

Other trademarks and trade names may be used in this document to refer to either the entities claiming the marks and names or their products. Dell Inc. disclaims any proprietary interest in trademarks and trade names other than its own.

Regulatory model: P09E series

Regulatory type: P09E002

January 2011

Rev. A00

Contents

1	Before You Begin	9
	Recommended Tools	9
	Turning Off Your Computer	9
	Before Working Inside Your Computer	10
2	Battery	13
	Removing the Battery	13
	Replacing the Battery	14
3	Module Cover	15
	Removing the Module Cover	15
	Replacing the Module Cover	16
4	Memory Module(s)	17
	Removing the Memory Module(s)	17
	Replacing the Memory Module(s)	18
5	Wireless Mini-Card(s)	21
	Removing the Mini-Card(s)	21

	Replacing the Mini-Card(s)	23
6	Hard Drive(s)	27
	Removing the Hard Drive(s)	27
	Replacing the Hard Drive(s)	30
7	Optical Drive	33
	Removing the Optical Drive	33
	Replacing the Optical Drive	34
8	Palm-Rest Assembly	37
	Removing the Palm-Rest Assembly	37
	Replacing the Palm-Rest Assembly	40
9	Keyboard	43
	Removing the Keyboard	43
	Replacing the Keyboard	45
10	Power-Button Board	47
	Removing the Power-Button Board	47
	Replacing the Power-Button Board	48

11	Coin-Cell Battery	51
	Removing the Coin-Cell Battery	51
	Replacing the Coin-Cell Battery	52
12	Display	55
	Display Assembly	55
	Removing the Display Assembly	55
	Replacing the Display Assembly	58
	Display Bezel	59
	Removing the Display Bezel	59
	Replacing the Display Bezel	60
	Display Panel	60
	Removing the Display Panel	60
	Replacing the Display Panel	63
	Display Cable	64
	Removing the Display Cable	64
	Replacing the Display Cable	66
	Display-Panel Brackets	66
	Removing the Display-Panel Brackets	66
	Replacing the Display-Panel Brackets	67
	Display Hinges	68
	Removing the Display Hinges	68
	Replacing the Display Hinges	69
13	IR Emitter Board	71
	Removing the IR Emitter Board	71

	Replacing the IR Emitter Board	72
14	Camera Module	77
	Removing the Camera Module	77
	Replacing the Camera Module	80
15	Top Cover	83
	Removing the Top Cover	83
	Replacing the Top Cover	87
16	Subwoofer	91
	Removing the Subwoofer	91
	Replacing the Subwoofer	92
17	AC-Adapter Connector	95
	Removing the AC-Adapter Connector	95
	Replacing the AC-Adapter Connector	96
18	Fan	99
	Removing the Fan	99
	Replacing the Fan	101

19 Heat Sink	105
Removing the Heat Sink	105
Replacing the Heat Sink	107
20 Processor Module	111
Removing the Processor Module	111
Replacing the Processor Module	113
21 I/O Board	115
Removing the I/O Board	115
Replacing the I/O Board	117
22 TV Antenna Connector	119
Removing the TV Antenna Connector	119
Replacing the TV Antenna Connector	120
23 USB Board	123
Removing the USB Board	123
Replacing the USB Board	124
24 System Board	127
Removing the System Board	127

	Replacing the System Board	129
	Entering the Service Tag in the BIOS	131
25	Speakers	133
	Removing the Speakers	133
	Replacing the Speaker.	135
26	Flashing the BIOS	137

Before You Begin

This manual provides procedures for removing and installing the components in your computer. Unless otherwise noted, each procedure assumes that the following conditions exist:

- You have performed the steps in "Turning Off Your Computer" on page 9 and "Before Working Inside Your Computer" on page 10.
- You have read the safety information that shipped with your computer.
- A component can be replaced or—if purchased separately—installed by performing the removal procedure in reverse order.

Recommended Tools

The procedures in this document may require the following tools:

- Small flat-blade screwdriver
- Phillips screwdriver
- Plastic scribe
- BIOS executable update program available at support.dell.com







Turning Off Your Computer

 **CAUTION: To avoid losing data, save and close all open files and exit all open programs before you turn off your computer.**

- 1 Save and close all open files and exit all open programs.
- 2 To shut down the operating system, click **Start**  and then click **Shut Down**.
- 3 Ensure that the computer is turned off. If your computer did not automatically turn off when you shut down the operating system, press and hold the power button until the computer turns off.

Before Working Inside Your Computer

Use the following safety guidelines to help protect your computer from potential damage and to help to ensure your own personal safety.

-  **WARNING:** Before working inside your computer, read the safety information that shipped with your computer. For additional safety best practices information, see the Regulatory Compliance Homepage at www.dell.com/regulatory_compliance.
-  **CAUTION:** To avoid electrostatic discharge, ground yourself by using a wrist grounding strap or by periodically touching an unpainted metal surface (such as a connector on your computer).
-  **CAUTION:** Handle components and cards with care. Do not touch the components or contacts on a card. Hold a card by its edges or by its metal mounting bracket. Hold a component such as a processor by its edges, not by its pins.
-  **CAUTION:** Only a certified service technician should perform repairs on your computer. Damage due to servicing that is not authorized by Dell™ is not covered by your warranty.
-  **CAUTION:** When you disconnect a cable, pull on its connector or on its pull-tab, not on the cable itself. Some cables have connectors with locking tabs; if you are disconnecting this type of cable, press in on the locking tabs before you disconnect the cable. As you pull connectors apart, keep them evenly aligned to avoid bending any connector pins. Also, before you connect a cable, ensure that both connectors are correctly oriented and aligned.
-  **CAUTION:** To avoid damaging the computer, perform the following steps before you begin working inside the computer.
 - 1 Ensure that the work surface is flat and clean to prevent the computer cover from being scratched.
 - 2 Turn off your computer (see "Turning Off Your Computer" on page 9) and all attached devices.
-  **CAUTION:** To disconnect a network cable, first unplug the cable from your computer and then unplug the cable from the network device.
 - 3 Disconnect all telephone or network cables from the computer.
 - 4 Press and eject any installed cards from the Media Card Reader.
 - 5 Disconnect your computer and all attached devices from their electrical outlets.

6 Disconnect all attached devices from your computer.





 **CAUTION: To help prevent damage to the system board, remove the main battery (see "Removing the Battery" on page 13) before working inside the computer.**

7 Remove the battery (see "Removing the Battery" on page 13).

8 Turn the computer top-side up, open the display, and press the power button to ground the system board.

 **CAUTION: Before touching anything inside your computer, ground yourself by touching an unpainted metal surface, such as the metal at the back of the computer. While you work, periodically touch an unpainted metal surface to dissipate static electricity, which could harm internal components.**

Battery

-  **WARNING:** Before working inside your computer, read the safety information that shipped with your computer. For additional safety best practices information, see the Regulatory Compliance Homepage at www.dell.com/regulatory_compliance.
-  **CAUTION:** Only a certified service technician should perform repairs on your computer. Damage due to servicing that is not authorized by Dell™ is not covered by your warranty.
-  **CAUTION:** To avoid electrostatic discharge, ground yourself by using a wrist grounding strap or by periodically touching an unpainted metal surface (such as a connector on your computer).
-  **CAUTION:** To avoid damage to the computer, use only the battery designed for this particular Dell computer. Do not use batteries designed for other Dell computers.

Removing the Battery

- 1 Follow the instructions in "Before You Begin" on page 9.
- 2 Turn the computer over.
- 3 Slide the battery release latch to the side.
- 4 Lift the battery up at an angle and remove it from the battery bay.



1 battery

2 battery release latch





Replacing the Battery



CAUTION: To avoid damage to the computer, use only the battery designed for this particular Dell computer.

- 1 Follow the instructions in "Before You Begin" on page 9.
- 2 Align the tabs on the battery with the slots in the battery bay and press the battery down until it clicks into place.

Module Cover

-  **WARNING:** Before working inside your computer, read the safety information that shipped with your computer. For additional safety best practices information, see the Regulatory Compliance Homepage at www.dell.com/regulatory_compliance.
-  **CAUTION:** Only a certified service technician should perform repairs on your computer. Damage due to servicing that is not authorized by Dell™ is not covered by your warranty.
-  **CAUTION:** To avoid electrostatic discharge, ground yourself by using a wrist grounding strap or by periodically touching an unpainted metal surface (such as a connector on your computer).
-  **CAUTION:** To help prevent damage to the system board, remove the main battery (see "Removing the Battery" on page 13) before working inside the computer.

Removing the Module Cover

- 1 Follow the instructions in "Before You Begin" on page 9.
- 2 Remove the battery (see "Removing the Battery" on page 13).
- 3 Loosen the captive screw that secures the module cover to the base cover.
- 4 Use your fingertips to release the tabs on the module cover from the slots on the base cover and lift it off the base cover.

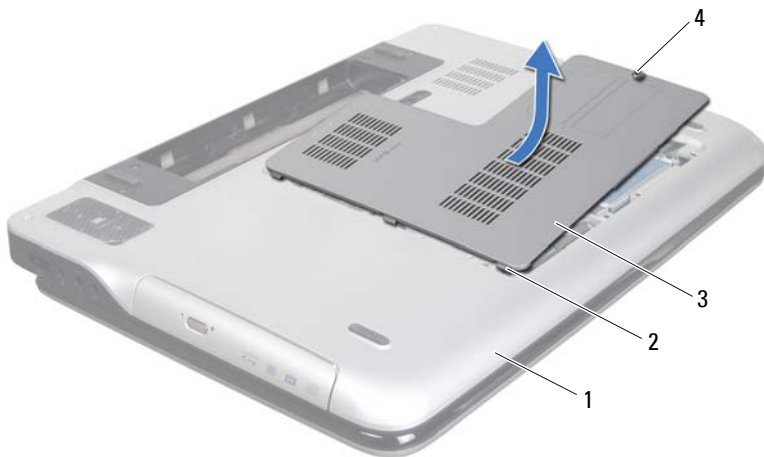



- | | | | |
|---|--------------|---|---------------|
| 1 | base cover | 2 | tabs |
| 3 | module cover | 4 | captive screw |

Replacing the Module Cover

- 1 Follow the instructions in "Before You Begin" on page 9.
- 2 Align the tabs on the module cover with the slots on the base cover and snap the module cover into place.
- 3 Tighten the captive screw that secures the module cover to the base cover.
- 4 Replace the battery (see "Replacing the Battery" on page 14).

Memory Module(s)

 **WARNING:** Before working inside your computer, read the safety information that shipped with your computer. For additional safety best practices information, see the Regulatory Compliance Homepage at www.dell.com/regulatory_compliance.

 **CAUTION:** Only a certified service technician should perform repairs on your computer. Damage due to servicing that is not authorized by Dell™ is not covered by your warranty.

 **CAUTION:** To avoid electrostatic discharge, ground yourself by using a wrist grounding strap or by periodically touching an unpainted metal surface (such as a connector on your computer).

 **CAUTION:** To help prevent damage to the system board, remove the main battery (see "Removing the Battery" on page 13) before working inside the computer.

You can increase your computer memory by installing memory modules on the system board. See "Specifications" in the *Setup Guide* that shipped with your computer or at support.dell.com/manuals for information on the type of memory supported by your computer.

 **NOTE:** Memory modules purchased from Dell are covered under your computer warranty.

Your computer may have two or four user-accessible SODIMM connectors depending on the configuration of your computer.

Removing the Memory Module(s)

- 1 Follow the instructions in "Before You Begin" on page 9.
- 2 Remove the battery (see "Removing the Battery" on page 13).
- 3 Remove the module cover (see "Removing the Module Cover" on page 15).

 **CAUTION:** To help prevent damage to the memory-module connector, do not use tools to spread the memory module securing clips.

- 4 Use your fingertips to carefully spread apart the securing clips on each end of the memory-module connector until the memory module pops up.

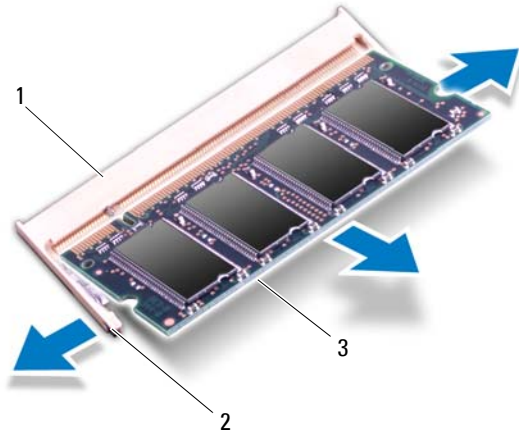

- 1 memory-module connector 2 securing clips (2)
3 memory module

5 Remove the memory module from the memory-module connector.

Replacing the Memory Module(s)

1 Follow the instructions in "Before You Begin" on page 9.

CAUTION: Install memory modules in the memory-module connectors as indicated in the following table depending on the number of memory modules you are installing. Your computer may not boot, if you fail to install the memory modules as indicated in the table.

Memory-Module Connector

Number of Memory Modules	DIMM A	DIMM B	DIMM C	DIMM D
1	X			
2	X	X		
3	X		X	
4	X	X	X	X

- 2 Align the notch in the memory module with the tab in the memory-module connector.
- 3 Slide the memory module firmly into the memory-module connector at a 45-degree angle, and press the memory module down until it clicks into place. If you do not hear the click, remove the memory module and reinstall it.

 **NOTE:** If the memory module is not installed properly, the computer may not boot.

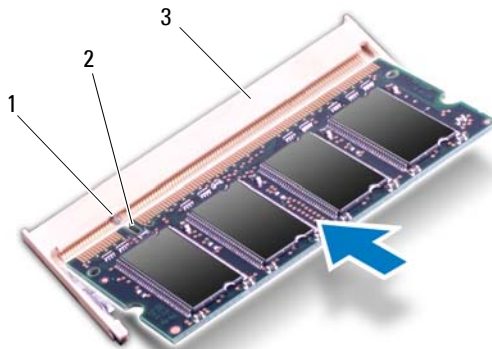



Wireless Mini-Card(s)

 **WARNING:** Before working inside your computer, read the safety information that shipped with your computer. For additional safety best practices information, see the Regulatory Compliance Homepage at www.dell.com/regulatory_compliance.

 **CAUTION:** Only a certified service technician should perform repairs on your computer. Damage due to servicing that is not authorized by Dell™ is not covered by your warranty.

 **CAUTION:** To avoid electrostatic discharge, ground yourself by using a wrist grounding strap or by periodically touching an unpainted metal surface (such as a connector on your computer).

 **CAUTION:** To help prevent damage to the system board, remove the main battery (see "Removing the Battery" on page 13) before working inside the computer.

 **NOTE:** Dell does not guarantee compatibility or provide support for Mini-Cards from sources other than Dell.

If you ordered a wireless Mini-Card with your computer, the card is already installed.

Your computer has one full Mini-Card slot and one half Mini-Card slot:

- One full Mini-Card slot — supports a Wireless Wide Area Network (WWAN) card or TV tuner module.
- One half Mini-Card slot — supports a Wireless Local Area Network (WLAN) and bluetooth combo card or Worldwide Interoperability for Microwave Access (WiMax) card.

 **NOTE:** Depending on the configuration of the computer when it was sold, the Mini-Card slot may or may not have a Mini-Card installed.

Removing the Mini-Card(s)

- 1 Follow the instructions in "Before You Begin" on page 9.
- 2 Remove the battery (see "Removing the Battery" on page 13).
- 3 Remove the module cover (see "Removing the Module Cover" on page 15).

- 4 Remove the optical drive (see "Removing the Optical Drive" on page 33).
- 5 Remove the palm-rest assembly (see "Removing the Palm-Rest Assembly" on page 37).
- 6 Remove the keyboard (see "Removing the Keyboard" on page 43).
- 7 Disconnect the antenna cables from the Mini-Card(s).
- 8 Remove the screw that secures the Mini-Card to the system board.

 **NOTE:** Your computer can only support either a WWAN Mini-Card or a TV tuner module in the full Mini-Card slot at a time.

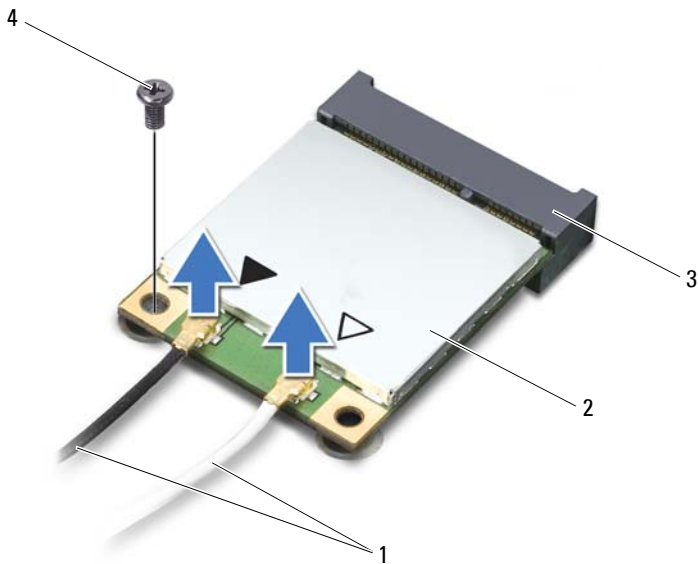

- | | | | |
|---|------------------------|---|-----------|
| 1 | antenna cables (2) | 2 | Mini-Card |
| 3 | system-board connector | 4 | screw |

- 9 Lift the Mini-Card(s) out of the system-board connector.

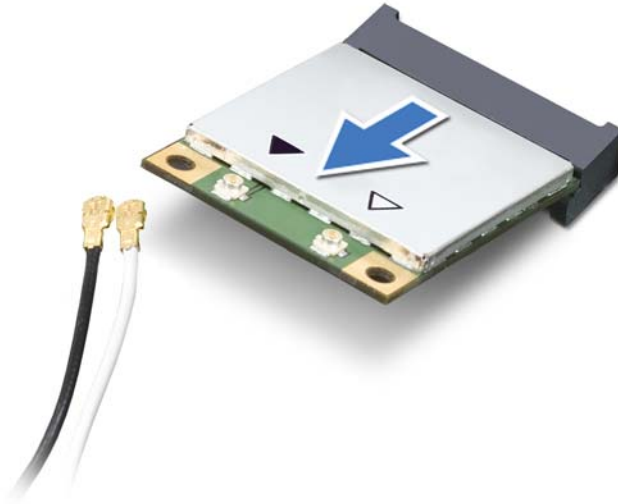

- △ **CAUTION:** When the Mini-Card is not in the computer, store it in protective antistatic packaging. For more information, see "Protecting Against Electrostatic Discharge" in the safety information that shipped with your computer.

Replacing the Mini-Card(s)

- 1 Follow the instructions in "Before You Begin" on page 9.
 - 2 Remove the new Mini-Card from its packaging.
- △ **CAUTION:** Use firm and even pressure to slide the card into place. If you use excessive force, you may damage the connector.
- △ **CAUTION:** The connectors are keyed to ensure correct insertion. If you feel resistance, check the connectors on the card and on the system board, and realign the card.
- △ **CAUTION:** To avoid damage to the Mini-Card, never place cables under the card.

- 3 Insert the Mini-Card connector at a 45-degree angle into the system-board connector.
- 4 Press the other end of the Mini-Card down into the slot on the system board and replace the screw that secures the Mini-Card to the system board.
- 5 Connect the appropriate antenna cables to the Mini-Card(s) you are installing. The following table provides the antenna cable color scheme for the Mini-Cards supported by your computer.

Connectors on the Mini-Card	Antenna Cable Color Scheme
WLAN + Bluetooth (2 antenna cables)	
Main WLAN + Bluetooth (white triangle)	white
Auxiliary WLAN + Bluetooth (black triangle)	black
WWAN (2 antenna cables)	
Main WWAN (white triangle)	white with gray stripe
Auxiliary WWAN (black triangle)	black with gray stripe
TV tuner (1 antenna cable)	black

- 6 Replace the keyboard (see "Replacing the Keyboard" on page 45).
- 7 Replace the palm-rest assembly (see "Replacing the Palm-Rest Assembly" on page 40).
- 8 Replace the optical drive (see "Replacing the Optical Drive" on page 34).
- 9 Replace the module cover (see "Replacing the Module Cover" on page 16).
- 10 Replace the battery (see "Replacing the Battery" on page 14).

 **CAUTION: Before turning on the computer, replace all screws and ensure that no stray screws remain inside the computer. Failure to do so may result in damage to the computer.**

- 11 Install the drivers and utilities for your computer, as required.

 **NOTE:** If you are installing a communication card from a source other than Dell, you must install the appropriate drivers and utilities.

Hard Drive(s)

 **WARNING:** Before working inside your computer, read the safety information that shipped with your computer. For additional safety best practices information, see the Regulatory Compliance Homepage at www.dell.com/regulatory_compliance.

 **WARNING:** If you remove the hard drive from the computer when the drive is hot, *do not touch* the metal housing of the hard drive.

 **CAUTION:** Only a certified service technician should perform repairs on your computer. Damage due to servicing that is not authorized by Dell™ is not covered by your warranty.

 **CAUTION:** To avoid electrostatic discharge, ground yourself by using a wrist grounding strap or by periodically touching an unpainted metal surface (such as a connector on your computer).

 **CAUTION:** To help prevent damage to the system board, remove the main battery (see "Removing the Battery" on page 13) before working inside the computer.

 **CAUTION:** To prevent data loss, turn off your computer (see "Turning Off Your Computer" on page 9) before removing the hard drive. Do not remove the hard drive while the computer is On or in Sleep state.

 **CAUTION:** Hard drives are extremely fragile. Exercise care when handling the hard drive.

 **NOTE:** Dell does not guarantee compatibility or provide support for hard drives from sources other than Dell.

 **NOTE:** If you are installing a hard drive from a source other than Dell, you need to install an operating system, drivers, and utilities on the new hard drive.

Removing the Hard Drive(s)

- 1 Follow the instructions in "Before You Begin" on page 9.
- 2 Remove the battery (see "Removing the Battery" on page 13).
- 3 Remove the module cover (see "Removing the Module Cover" on page 15).
- 4 Remove hard drive 1 and/or hard drive 2 from the computer base:

- Remove the four screws that secure the hard-drive assembly to the computer base.
- Using the pull-tab, slide the hard-drive assembly to disconnect it from the connector on the system board.
- Lift the hard-drive assembly out of the computer base.

△ CAUTION: When the hard drive is not in the computer, store it in protective antistatic packaging (see "Protecting Against Electrostatic Discharge" in the safety instructions that shipped with your computer).

Hard drive 1



- 1 pull-tab
- 3 screws (4)

- 2 hard-drive assembly

Hard drive 2



1 pull-tab

2 hard-drive assembly

3 screws (4)

- 5 Remove the four screws that secure the hard-drive bracket to the hard drive.
- 6 Lift the hard-drive bracket off the hard drive.

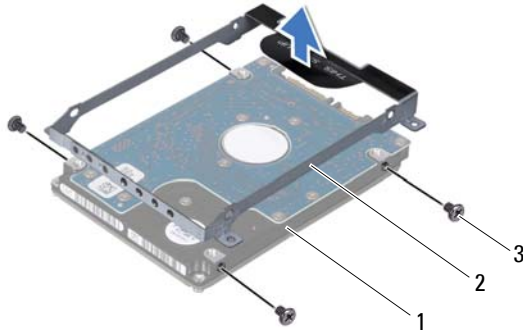

- | | | | |
|---|------------|---|--------------------|
| 1 | hard drive | 2 | hard-drive bracket |
| 3 | screws (4) | | |

Replacing the Hard Drive(s)

- 1 Follow the instructions in "Before You Begin" on page 9.
- 2 Remove the new hard drive from its packaging.
Save the original packaging for storing or shipping the hard drive.
- 3 Place the hard-drive bracket on the hard drive.
- 4 Replace the four screws that secure the hard-drive bracket to the hard drive.
- 5 Replace hard drive 1 and/or hard drive 2 in the computer base:
 - Place the hard-drive assembly in the computer base.
 - Using the pull-tab, slide the hard-drive assembly into the connector on the system board.
 - Replace the four screws that secure the hard-drive assembly to the computer base.
- 6 Replace the module cover (see "Replacing the Module Cover" on page 16).

7 Replace the battery (see "Replacing the Battery" on page 14).





CAUTION: Before turning on the computer, replace all screws and ensure that no stray screws remain inside the computer. Failure to do so may result in damage to the computer.

Optical Drive

 **WARNING:** Before working inside your computer, read the safety information that shipped with your computer. For additional safety best practices information, see the Regulatory Compliance Homepage at www.dell.com/regulatory_compliance.

 **CAUTION:** Only a certified service technician should perform repairs on your computer. Damage due to servicing that is not authorized by Dell™ is not covered by your warranty.

 **CAUTION:** To avoid electrostatic discharge, ground yourself by using a wrist grounding strap or by periodically touching an unpainted metal surface (such as a connector on your computer).

 **CAUTION:** To help prevent damage to the system board, remove the main battery (see "Removing the Battery" on page 13) before working inside the computer.

Removing the Optical Drive

- 1 Follow the instructions in "Before You Begin" on page 9.
- 2 Remove the battery (see "Removing the Battery" on page 13).
- 3 Remove the module cover (see "Removing the Module Cover" on page 15).
- 4 Remove the screw that secures the optical drive to the base cover.
- 5 Slide the optical drive out of the optical-drive bay.

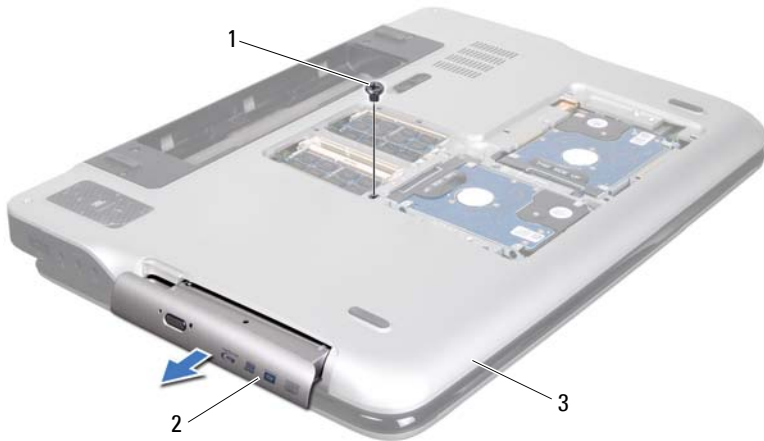

1 screw
3 base cover

2 optical drive

Replacing the Optical Drive

- 1 Follow the instructions in "Before You Begin" on page 9.
- 2 Slide the optical drive into the optical-drive bay until it is fully seated.
- 3 Replace the screw that secures the optical drive to the base cover.
- 4 Replace the module cover (see "Replacing the Module Cover" on page 16).
- 5 Replace the battery (see "Replacing the Battery" on page 14).



CAUTION: Before turning on the computer, replace all screws and ensure that no stray screws remain inside the computer. Failure to do so may result in damage to the computer.

Palm-Rest Assembly

 **WARNING:** Before working inside your computer, read the safety information that shipped with your computer. For additional safety best practices information, see the Regulatory Compliance Homepage at www.dell.com/regulatory_compliance.

 **CAUTION:** Only a certified service technician should perform repairs on your computer. Damage due to servicing that is not authorized by Dell™ is not covered by your warranty.

 **CAUTION:** To avoid electrostatic discharge, ground yourself by using a wrist grounding strap or by periodically touching an unpainted metal surface (such as a connector on your computer).

 **CAUTION:** To help prevent damage to the system board, remove the main battery (see "Removing the Battery" on page 13) before working inside the computer.

Removing the Palm-Rest Assembly

- 1 Follow the instructions in "Before You Begin" on page 9.
- 2 Remove the battery (see "Removing the Battery" on page 13).
- 3 Remove the module cover (see "Removing the Module Cover" on page 15).
- 4 Remove the optical drive (see "Removing the Optical Drive" on page 33).
- 5 Remove the three screws that secure the palm-rest assembly to the base cover.

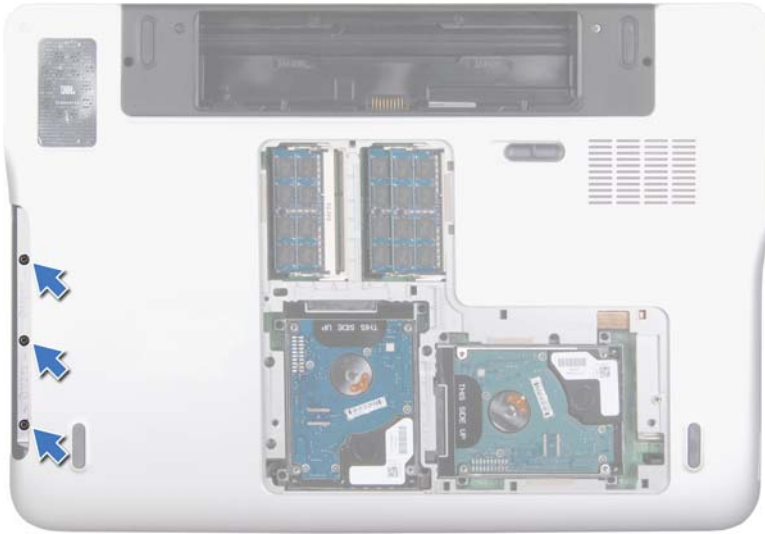

- 6 Turn the computer over and open the display as far as possible.
- 7 Using your fingertip, gently push the tab to release the palm-rest assembly from the top cover.

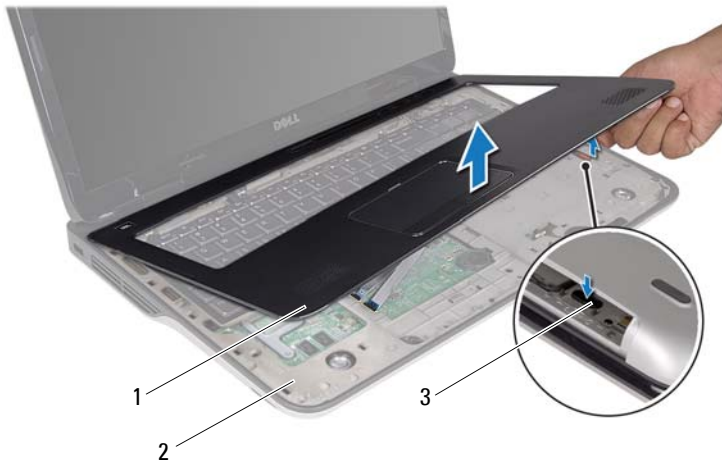

- 1 palm-rest assembly 2 top cover
3 tab

⚠ CAUTION: Carefully separate the palm-rest assembly from the top cover to avoid damage to the palm-rest assembly.

- 8** Using your fingertips, gently ease the palm-rest assembly from the top cover.
- 9** Without pulling hard on the palm-rest assembly, turn the palm-rest assembly over and place it on the top cover.
- 10** Lift the connector latch and pull the pull-tab to disconnect the control-strip cable from the system-board connector.
- 11** Lift the connector latch and pull the pull-tab to disconnect the touch-pad cable from the system-board connector.
- 12** Lift the palm-rest assembly off the top cover.

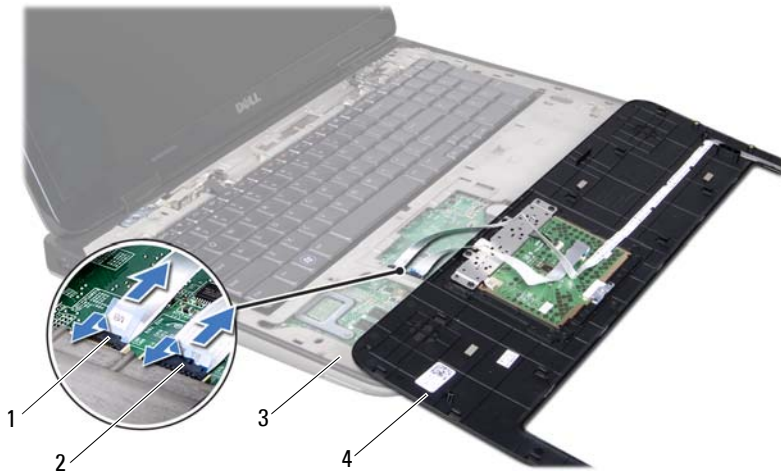

- | | | | |
|---|-------------------------------|---|---------------------------|
| 1 | control-strip cable connector | 2 | touch-pad cable connector |
| 3 | top cover | 4 | palm-rest assembly |

Replacing the Palm-Rest Assembly





- 1 Follow the instructions in "Before You Begin" on page 9.
- 2 Slide the touch-pad cable into the system-board connector and press down on the connector latch to secure the cable.
- 3 Slide the control-strip cable into the system-board connector and press down on the connector latch to secure the cable.
- 4 Place the palm-rest assembly on the top cover and gently snap the palm-rest assembly into place.
- 5 Close the display and turn the computer over.
- 6 Replace the three screws that secure the palm-rest assembly to the base cover.
- 7 Replace the optical drive (see "Replacing the Optical Drive" on page 34).

- 8 Replace the module cover (see "Replacing the Module Cover" on page 16).
- 9 Replace the battery (see "Replacing the Battery" on page 14).





CAUTION: Before turning on the computer, replace all screws and ensure that no stray screws remain inside the computer. Failure to do so may result in damage to the computer.

Keyboard

-  **WARNING:** Before working inside your computer, read the safety information that shipped with your computer. For additional safety best practices information, see the Regulatory Compliance Homepage at www.dell.com/regulatory_compliance.
-  **CAUTION:** Only a certified service technician should perform repairs on your computer. Damage due to servicing that is not authorized by Dell™ is not covered by your warranty.
-  **CAUTION:** To avoid electrostatic discharge, ground yourself by using a wrist grounding strap or by periodically touching an unpainted metal surface (such as a connector on your computer).
-  **CAUTION:** To help prevent damage to the system board, remove the main battery (see "Removing the Battery" on page 13) before working inside the computer.

Removing the Keyboard

- 1 Follow the instructions in "Before You Begin" on page 9.
 - 2 Remove the battery (see "Removing the Battery" on page 13).
 - 3 Remove the module cover (see "Removing the Module Cover" on page 15).
 - 4 Remove the optical drive (see "Removing the Optical Drive" on page 33).
 - 5 Remove the palm-rest assembly (see "Removing the Palm-Rest Assembly" on page 37).
 - 6 Without pulling hard on the keyboard, carefully lift the keyboard and slide the keyboard tabs out of the slots on the top cover.
-  **CAUTION:** The keycaps on the keyboard are fragile, easily dislodged, and time-consuming to replace. Be careful when removing and handling the keyboard.
 -  **CAUTION:** Be extremely careful when removing and handling the keyboard. Failure to do so could result in scratching the display panel.



- 1 keyboard
- 3 top cover

2 tabs (6)

- 7 Turn the keyboard over and place it on the top cover.
- 8 Lift the connector latch and pull the pull-tab to disconnect the keyboard backlight cable from the system-board connector.
- 9 Lift the connector latch and pull the pull-tab to disconnect the keyboard cable from the system-board connector.

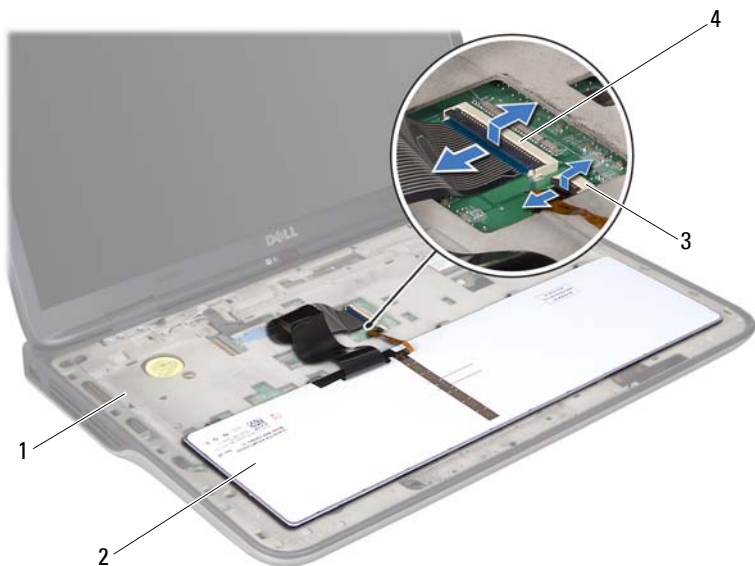

- | | | | |
|---|------------------------------------|---|--------------------------|
| 1 | top cover | 2 | keyboard |
| 3 | keyboard backlight cable connector | 4 | keyboard cable connector |

10 Lift the keyboard off the top cover.

Replacing the Keyboard





- 1 Follow the instructions in "Before You Begin" on page 9.
- 2 Slide the keyboard cable into the system-board connector and press down on the connector latch to secure the cable.
- 3 Slide the keyboard backlight cable into the system-board connector and press down on the connector latch to secure the cable.
- 4 Slide the tabs on the keyboard into the slots on the top cover and lower the keyboard into place.

- 5 Replace the palm-rest assembly (see "Replacing the Palm-Rest Assembly" on page 40).
- 6 Replace the optical drive (see "Replacing the Optical Drive" on page 34).
- 7 Replace the module cover (see "Replacing the Module Cover" on page 16).
- 8 Replace the battery (see "Replacing the Battery" on page 14).



CAUTION: Before turning on the computer, replace all screws and ensure that no stray screws remain inside the computer. Failure to do so may result in damage to the computer.

Power-Button Board

-  **WARNING:** Before working inside your computer, read the safety information that shipped with your computer. For additional safety best practices information, see the Regulatory Compliance Homepage at www.dell.com/regulatory_compliance.
-  **CAUTION:** Only a certified service technician should perform repairs on your computer. Damage due to servicing that is not authorized by Dell™ is not covered by your warranty.
-  **CAUTION:** To avoid electrostatic discharge, ground yourself by using a wrist grounding strap or by periodically touching an unpainted metal surface (such as a connector on your computer).
-  **CAUTION:** To help prevent damage to the system board, remove the main battery (see "Removing the Battery" on page 13) before working inside the computer.

Removing the Power-Button Board

- 1 Follow the instructions in "Before You Begin" on page 9.
- 2 Remove the battery (see "Removing the Battery" on page 13).
- 3 Remove the module cover (see "Removing the Module Cover" on page 15).
- 4 Remove the optical drive (see "Removing the Optical Drive" on page 33).
- 5 Remove the palm-rest assembly (see "Removing the Palm-Rest Assembly" on page 37).
- 6 Turn the palm-rest assembly over.
- 7 Lift the connector latch and pull the pull-tab to disconnect the power-button board cable from the connector on the power-button board.
- 8 Remove the two screws that secure the power-button board to the palm-rest assembly.
- 9 Lift the power-button board off the palm-rest assembly.

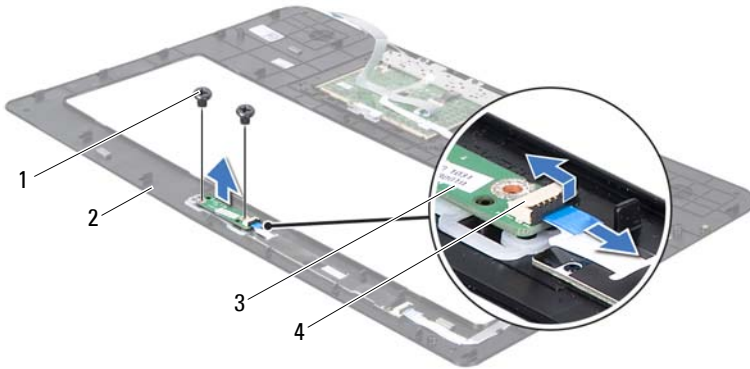

- | | | | |
|---|--------------------|---|------------------------------------|
| 1 | screws (2) | 2 | palm-rest assembly |
| 3 | power-button board | 4 | power-button board cable connector |

Replacing the Power-Button Board

- 1 Follow the instructions in "Before You Begin" on page 9.
- 2 Use the alignment posts to place the power-button board on the palm-rest assembly.
- 3 Replace the two screws that secure the power-button board to the palm-rest assembly.
- 4 Slide the power-button board cable into the connector on the power-button board and press down on the connector latch to secure the cable.
- 5 Replace the palm-rest assembly (see "Replacing the Palm-Rest Assembly" on page 40).
- 6 Replace the optical drive (see "Replacing the Optical Drive" on page 34).
- 7 Replace the module cover (see "Replacing the Module Cover" on page 16).
- 8 Replace the battery (see "Replacing the Battery" on page 14).





CAUTION: Before turning on the computer, replace all screws and ensure that no stray screws remain inside the computer. Failure to do so may result in damage to the computer.

Coin-Cell Battery

 **WARNING:** Before working inside your computer, read the safety information that shipped with your computer. For additional safety best practices information, see the Regulatory Compliance Homepage at www.dell.com/regulatory_compliance.

 **CAUTION:** Only a certified service technician should perform repairs on your computer. Damage due to servicing that is not authorized by Dell™ is not covered by your warranty.

 **CAUTION:** To avoid electrostatic discharge, ground yourself by using a wrist grounding strap or by periodically touching an unpainted metal surface (such as a connector on your computer).

 **CAUTION:** To help prevent damage to the system board, remove the main battery (see "Removing the Battery" on page 13) before working inside the computer.

Removing the Coin-Cell Battery

- 1 Follow the instructions in "Before You Begin" on page 9.
- 2 Remove the battery (see "Removing the Battery" on page 13).
- 3 Remove the module cover (see "Removing the Module Cover" on page 15).
- 4 Remove the optical drive (see "Removing the Optical Drive" on page 33).
- 5 Remove the palm-rest assembly (see "Removing the Palm-Rest Assembly" on page 37).
- 6 Using a plastic scribe, gently pry the coin-cell battery out of the battery socket on the system board.



1 coin-cell battery 2 plastic scribe

Replacing the Coin-Cell Battery

- 1 Follow the instructions in "Before You Begin" on page 9.
- 2 With the positive side facing up, snap the coin-cell battery into the battery socket on the system board.
- 3 Replace the palm-rest assembly (see "Replacing the Palm-Rest Assembly" on page 40).
- 4 Replace the optical drive (see "Replacing the Optical Drive" on page 34).
- 5 Replace the module cover (see "Replacing the Module Cover" on page 16).
- 6 Replace the battery (see "Replacing the Battery" on page 14).



CAUTION: Before turning on the computer, replace all screws and ensure that no stray screws remain inside the computer. Failure to do so may result in damage to the computer.

Display

 **WARNING:** Before working inside your computer, read the safety information that shipped with your computer. For additional safety best practices information, see the Regulatory Compliance Homepage at www.dell.com/regulatory_compliance.

 **CAUTION:** Only a certified service technician should perform repairs on your computer. Damage due to servicing that is not authorized by Dell™ is not covered by your warranty.

 **CAUTION:** To avoid electrostatic discharge, ground yourself by using a wrist grounding strap or by periodically touching an unpainted metal surface (such as a connector on your computer).

 **CAUTION:** To help prevent damage to the system board, remove the main battery (see "Removing the Battery" on page 13) before working inside the computer.

Display Assembly

Removing the Display Assembly

- 1 Follow the instructions in "Before You Begin" on page 9.
- 2 Remove the battery (see "Removing the Battery" on page 13).
- 3 Remove the module cover (see "Removing the Module Cover" on page 15).
- 4 Remove the two screws that secure the display assembly to the base cover.



- 5 Remove the optical drive (see "Removing the Optical Drive" on page 33).
- 6 Remove the palm-rest assembly (see "Removing the Palm-Rest Assembly" on page 37).
- 7 Remove the keyboard (see "Removing the Keyboard" on page 43).
- 8 Disconnect the antenna cables from the Mini-Card(s) (see "Removing the Mini-Card(s)" on page 21).

 **CAUTION: Be extremely careful when opening the display to prevent damaging the display assembly.**

- 9 Turn the computer over and open the display as far as possible.
- 10 Note the routing of the Mini-Card antenna cables and remove the cables from the routing guides.

 **NOTE:** The touch-screen board is optional and may not be present in your computer.

- 11 Pull the pull-tab to disconnect the touch-screen cable from the system-board connector.

- 12 Loosen the captive screw that secures the display grounding cable to the top cover.
- 13 Pull the pull-tab to disconnect the display cable from the system-board connector.
- 14 Note the routing of the display cable and remove the cable from the routing guides.



- 1 captive screw
- 3 display cable
- 5 antenna cables (2)

- 2 display grounding cable
- 4 touch-screen cable connector

- 15 Remove the four screws that secure the display assembly to the top cover.
- 16 Lift the display assembly off the computer base.

Replacing the Display Assembly

- 1 Follow the instructions in "Before You Begin" on page 9.
- 2 Place the display assembly in position and replace the four screws that secure the display assembly to the top cover.
- 3 Route the display cable through the routing guides.
- 4 Connect the display cable to the system-board connector.
- 5 Tighten the captive screw that secures the display grounding cable to the top cover.
- 6 Connect the touch-screen cable to the system-board connector, if applicable.
- 7 Route the Mini-Card antenna cables through the routing guides.
- 8 Connect the appropriate antenna cables to the Mini-Cards(s) on your computer (see "Replacing the Mini-Card(s)" on page 23).
- 9 Replace the keyboard (see "Replacing the Keyboard" on page 45).
- 10 Replace the palm-rest assembly (see "Replacing the Palm-Rest Assembly" on page 40).
- 11 Close the display and turn the computer over.
- 12 Replace the optical drive (see "Replacing the Optical Drive" on page 34).
- 13 Replace the two screws that secure the display assembly to the base cover.
- 14 Replace the module cover (see "Replacing the Module Cover" on page 16).
- 15 Replace the battery (see "Replacing the Battery" on page 14).



CAUTION: Before turning on the computer, replace all screws and ensure that no stray screws remain inside the computer. Failure to do so may result in damage to the computer.

Display Bezel

Removing the Display Bezel

⚠ CAUTION: The display bezel is extremely fragile. Be careful when removing it to prevent damaging the bezel.

- 1 Follow the instructions in "Before You Begin" on page 9.
- 2 Remove the display assembly (see "Removing the Display Assembly" on page 55).
- 3 Push the display bezel outwards to release it from the tabs that secure the display bezel to the back cover.
- 4 Using your fingertips gently pry the outside edge of the display bezel off the back cover.
- 5 Lift the display bezel off the display assembly.



- 1 display bezel

Replacing the Display Bezel

- 1 Follow the instructions in "Before You Begin" on page 9.
- 2 Align the display bezel with the display back cover, and gently snap it into place.
- 3 Replace the display assembly (see "Replacing the Display Assembly" on page 58).



CAUTION: Before turning on the computer, replace all screws and ensure that no stray screws remain inside the computer. Failure to do so may result in damage to the computer.

Display Panel

Removing the Display Panel

- 1 Follow the instructions in "Before You Begin" on page 9.
- 2 Remove the display assembly (see "Removing the Display Assembly" on page 55).
- 3 Remove the display bezel (see "Removing the Display Bezel" on page 59).
- 4 Remove the camera module (see "Removing the Camera Module" on page 77).



NOTE: The touch-screen board is optional and may not be present in your computer.

- 5 Remove the touch-screen board, if applicable:
 - a Pull the pull-tab to disconnect the touch-screen board cable from the connector on the touch-screen board.

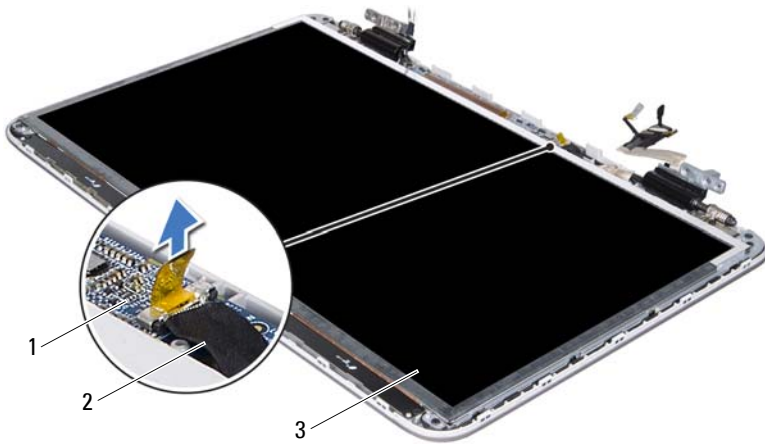

1 touch-screen board

2 touch-screen board cable

3 display panel

- b** Remove the eight screws that secure the display panel to the display back cover.

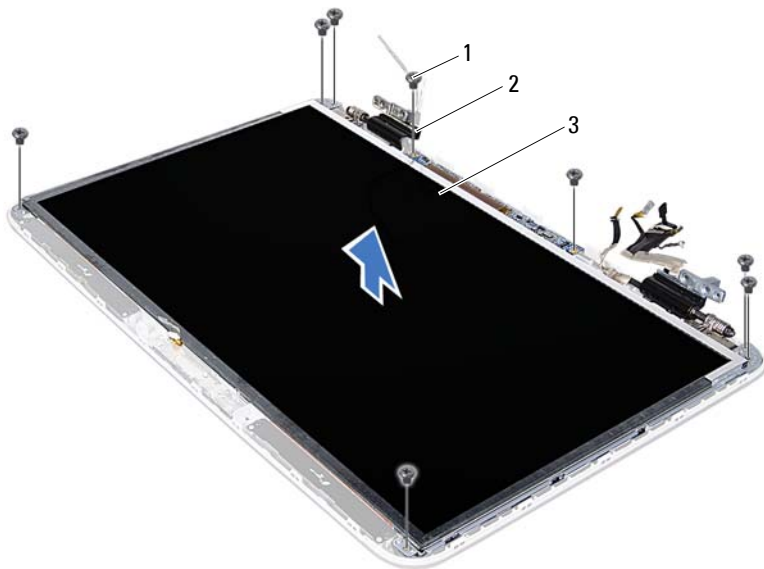

- 1 screws (8)
- 2 hinges (2)
- 3 display panel

NOTE: The IR emitter board is optional and may not be present in your computer.

- 6 Remove the IR emitter board, if applicable:
 - a Pull the pull-tab to disconnect the IR emitter board cable from the connector on the IR emitter board.

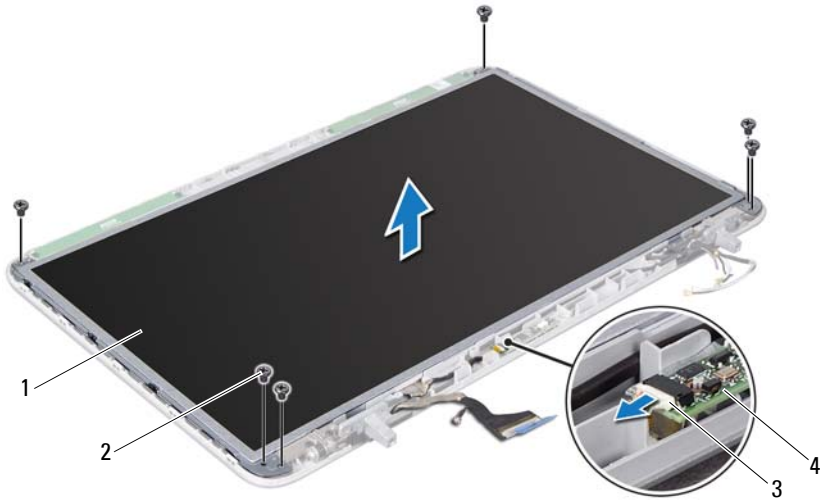

- | | | | |
|---|------------------------|---|------------------|
| 1 | display panel | 2 | screws (6) |
| 3 | IR emitter board cable | 4 | IR emitter board |

- b** Remove the six screws that secure the display panel to the display back cover.
- 7** Note the routing of the antenna cables and remove them from the routing guide on the right display hinge.
- 8** Note the routing of the display cable and remove it from the routing guide on the left display hinge.
- 9** Lift the display panel off the display back cover.

Replacing the Display Panel

- 1** Follow the instructions in "Before You Begin" on page 9.

- 2 Place the display panel over the display back cover.
- 3 Route the display cable through the routing guide on the left display hinge.
- 4 Route the antenna cables through the routing guide on the right display hinge.
- 5 Replace the touch-screen board, if applicable:
 - a Connect the touch-screen board cable to the connector on the touch-screen board.
 - b Replace the eight screws that secure the display panel to the display back cover.
- 6 Replace the IR emitter board, if applicable:
 - a Connect the IR emitter board cable to the connector on the IR emitter board.
 - b Replace the six screws that secure the display panel to the display back cover.
- 7 Replace the camera module (see "Replacing the Camera Module" on page 80).
- 8 Replace the display bezel (see "Replacing the Display Bezel" on page 60).
- 9 Replace the display assembly (see "Replacing the Display Assembly" on page 58).



CAUTION: Before turning on the computer, replace all screws and ensure that no stray screws remain inside the computer. Failure to do so may result in damage to the computer.

Display Cable

Removing the Display Cable

- 1 Follow the instructions in "Before You Begin" on page 9.
- 2 Remove the display assembly (see "Removing the Display Assembly" on page 55).
- 3 Remove the display bezel (see "Removing the Display Bezel" on page 59).
- 4 Remove the camera module ("Removing the Camera Module" on page 77).

- 5 Remove the display panel (see "Removing the Display Panel" on page 60).
- 6 Turn the display panel over and place it on a clean surface.
- 7 Gently peel off the tape from the display panel.
- 8 Pull the pull-tab to disconnect the display cable from the connector on the display panel.

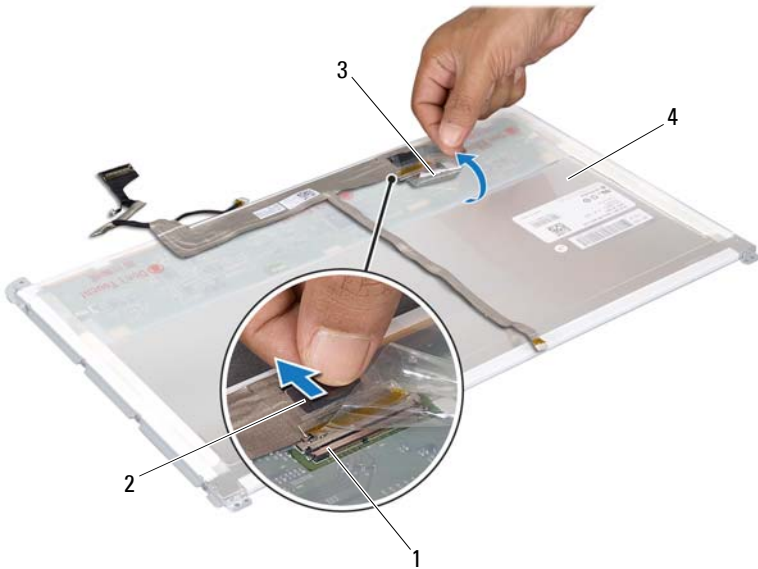

- | | |
|---------------------------|-----------------------------|
| 1 display-cable connector | 2 pull tab |
| 3 tape | 4 back of the display panel |

- 9 Gently peel off the display cable from the back of the display panel.

Replacing the Display Cable

- 1 Follow the instructions in "Before You Begin" on page 9.

- 2** Adhere the display cable along the edge of the display panel.
- 3** Connect the display cable to the connector on the display panel.
- 4** Replace the display panel (see "Replacing the Display Panel" on page 63).
- 5** Replace the camera module (see "Replacing the Camera Module" on page 80).
- 6** Replace the display bezel (see "Replacing the Display Bezel" on page 60).
- 7** Replace the display assembly ("Replacing the Display Assembly" on page 58).

Display-Panel Brackets

Removing the Display-Panel Brackets

- 1** Follow the instructions in "Before You Begin" on page 9.
- 2** Remove the display assembly (see "Removing the Display Assembly" on page 55).
- 3** Remove the display bezel (see "Removing the Display Bezel" on page 59).
- 4** Remove the camera module ("Removing the Camera Module" on page 77).
- 5** Remove the display panel (see "Removing the Display Panel" on page 60).
- 6** Remove the eight screws (four on each side) that secure the display-panel brackets to the display panel.
- 7** Remove the display-panel brackets off the display panel.

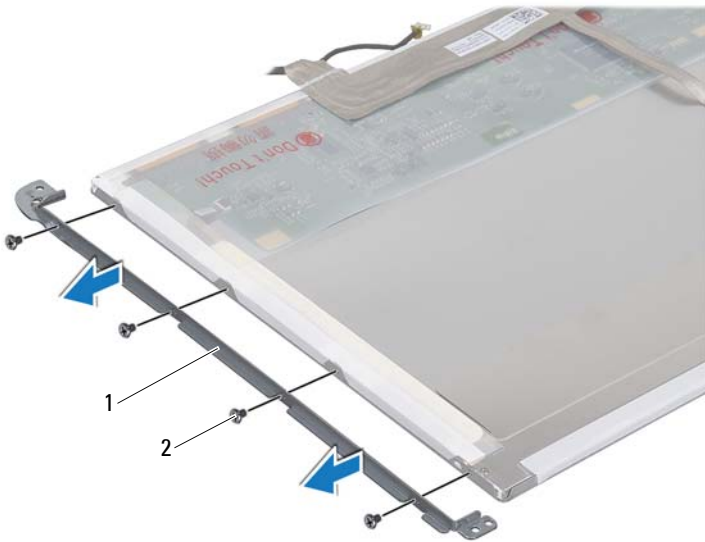

- 1 display panel brackets (2)
- 2 screws (8)

Replacing the Display-Panel Brackets

- 1 Follow the instructions in "Before You Begin" on page 9.
- 2 Place the display-panel brackets in position.
- 3 Replace the eight screws (four on each side) that secure the display-panel brackets to the display panel.
- 4 Replace the display panel (see "Replacing the Display Panel" on page 63).
- 5 Replace the camera module (see "Replacing the Camera Module" on page 80).
- 6 Replace the display bezel (see "Replacing the Display Bezel" on page 60).
- 7 Replace the display assembly ("Replacing the Display Assembly" on page 58).



CAUTION: Before turning on the computer, replace all screws and ensure that no stray screws remain inside the computer. Failure to do so may result in damage to the computer.

Display Hinges

Removing the Display Hinges

- 1 Follow the instructions in "Before You Begin" on page 9.
- 2 Remove the display assembly (see "Removing the Display Assembly" on page 55).
- 3 Remove the display bezel (see "Removing the Display Bezel" on page 59).
- 4 Remove the camera module ("Removing the Camera Module" on page 77).
- 5 Remove the display panel (see "Removing the Display Panel" on page 60).
- 6 Remove the four screws (two on each side) that secure the display hinges to the display back cover.
- 7 Remove the display hinges off the display back cover.

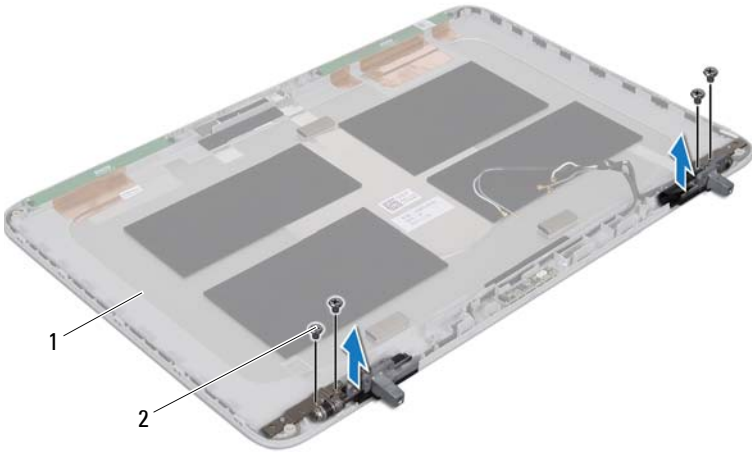

- 1 display back cover 2 screws (4)





Replacing the Display Hinges

- 1 Follow the instructions in "Before You Begin" on page 9.
- 2 Place the display hinges in position.
- 3 Replace the four screws (two on each side) that secure the display hinges to the display back cover.
- 4 Replace the display panel (see "Replacing the Display Panel" on page 63).
- 5 Replace the camera module (see "Replacing the Camera Module" on page 80).
- 6 Replace the display bezel (see "Replacing the Display Bezel" on page 60).
- 7 Replace the display assembly ("Replacing the Display Assembly" on page 58).



CAUTION: Before turning on the computer, replace all screws and ensure that no stray screws remain inside the computer. Failure to do so may result in damage to the computer.

IR Emitter Board

-  **WARNING:** Before working inside your computer, read the safety information that shipped with your computer. For additional safety best practices information, see the Regulatory Compliance Homepage at www.dell.com/regulatory_compliance.
-  **CAUTION:** Only a certified service technician should perform repairs on your computer. Damage due to servicing that is not authorized by Dell™ is not covered by your warranty.
-  **CAUTION:** To avoid electrostatic discharge, ground yourself by using a wrist grounding strap or by periodically touching an unpainted metal surface (such as a connector on your computer).
-  **CAUTION:** To help prevent damage to the system board, remove the main battery (see "Removing the Battery" on page 13) before working inside the computer.

Removing the IR Emitter Board

- 1 Follow the instructions in "Before You Begin" on page 9.
- 2 Remove the battery (see "Removing the Battery" on page 13).
- 3 Remove the module cover (see "Removing the Module Cover" on page 15).
- 4 Remove the optical drive (see "Removing the Optical Drive" on page 33).
- 5 Remove the palm-rest assembly (see "Removing the Palm-Rest Assembly" on page 37).
- 6 Remove the keyboard (see "Removing the Keyboard" on page 43).
- 7 Remove the display assembly (see "Removing the Display Assembly" on page 55).
- 8 Remove the display bezel (see "Removing the Display Bezel" on page 59).
- 9 Pull the pull-tab to disconnect the IR emitter board cable from the connector on the IR emitter board.
- 10 Lift the IR emitter board off the display back cover.

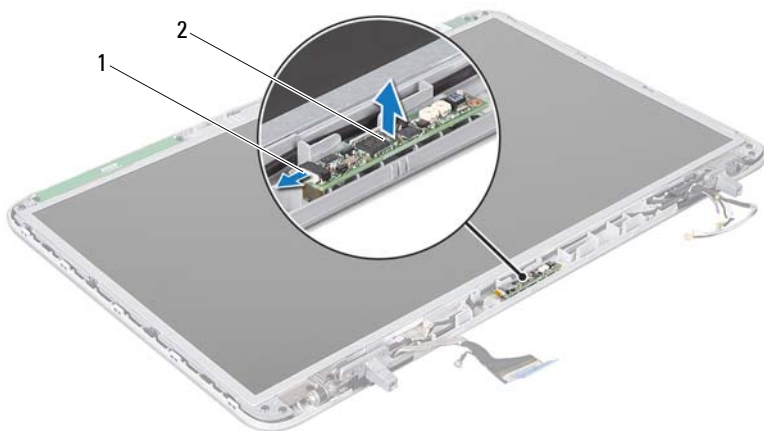

1 IR emitter board cable

2 IR emitter board

Replacing the IR Emitter Board





- 1 Follow the instructions in "Before You Begin" on page 9.
- 2 Connect the IR emitter board cable to the connector on the IR emitter board.
- 3 Use the alignment posts to place the IR emitter board on the display back cover.
- 4 Replace the display bezel (see "Replacing the Display Bezel" on page 60).
- 5 Replace the display assembly (see "Replacing the Display Assembly" on page 58).
- 6 Replace the keyboard (see "Replacing the Keyboard" on page 45).
- 7 Replace the palm-rest assembly (see "Replacing the Palm-Rest Assembly" on page 40).
- 8 Replace the optical drive (see "Replacing the Optical Drive" on page 34).
- 9 Replace the module cover (see "Replacing the Module Cover" on page 16).

10 Replace the battery (see "Replacing the Battery" on page 14).



CAUTION: Before turning on the computer, replace all screws and ensure that no stray screws remain inside the computer. Failure to do so may result in damage to the computer.

Camera Module

-  **WARNING:** Before working inside your computer, read the safety information that shipped with your computer. For additional safety best practices information, see the Regulatory Compliance Homepage at www.dell.com/regulatory_compliance.
-  **CAUTION:** Only a certified service technician should perform repairs on your computer. Damage due to servicing that is not authorized by Dell™ is not covered by your warranty.
-  **CAUTION:** To avoid electrostatic discharge, ground yourself by using a wrist grounding strap or by periodically touching an unpainted metal surface (such as a connector on your computer).
-  **CAUTION:** To help prevent damage to the system board, remove the main battery (see "Removing the Battery" on page 13) before working inside the computer.

Removing the Camera Module

- 1 Follow the instructions in "Before You Begin" on page 9.
- 2 Remove the battery (see "Removing the Battery" on page 13).
- 3 Remove the module cover (see "Removing the Module Cover" on page 15).
- 4 Remove the optical drive (see "Removing the Optical Drive" on page 33).
- 5 Remove the palm-rest assembly (see "Removing the Palm-Rest Assembly" on page 37).
- 6 Remove the keyboard (see "Removing the Keyboard" on page 43).
- 7 Remove the display assembly (see "Removing the Display Assembly" on page 55).
- 8 Remove the display bezel (see "Removing the Display Bezel" on page 59).
- 9 Carefully lift the camera module off the display back cover.

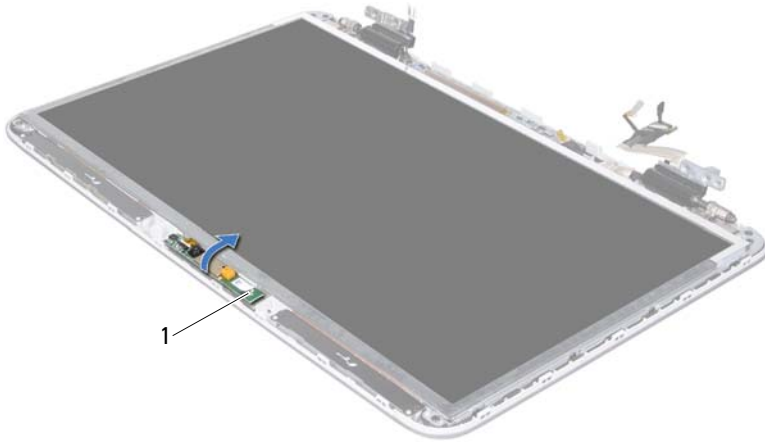

1 camera module

10 Gently peel the tape that secures the camera cable to the camera module.

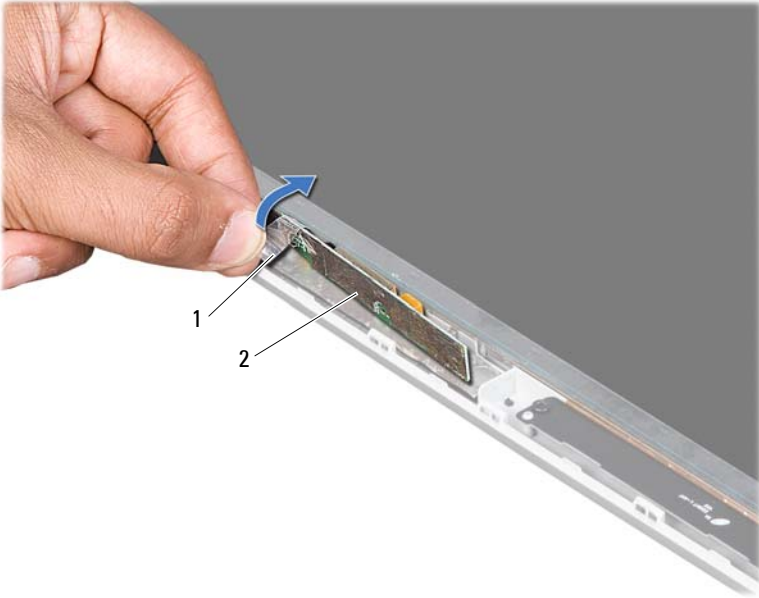

1 tape

2 camera module

- 11** Pull the pull-tab to disconnect the camera cable from the connector on the camera module.
- 12** Lift the camera module off the display back cover.

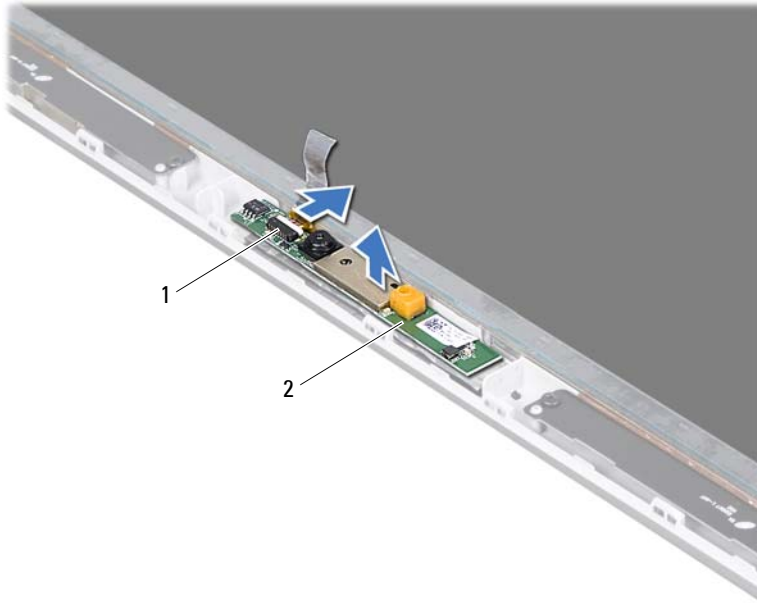

1 camera-cable connector

2 camera module

Replacing the Camera Module





- 1 Follow the instructions in "Before You Begin" on page 9.
- 2 Connect the camera cable to the connector on the camera module.
- 3 Adhere the tape that secures the camera cable to the camera module.
- 4 Use the alignment posts to place the camera module on the display back cover.
- 5 Replace the display bezel (see "Replacing the Display Bezel" on page 60).
- 6 Replace the display assembly (see "Replacing the Display Assembly" on page 58).
- 7 Replace the keyboard (see "Replacing the Keyboard" on page 45).

- 8 Replace the palm-rest assembly (see "Replacing the Palm-Rest Assembly" on page 40).
- 9 Replace the optical drive (see "Replacing the Optical Drive" on page 34).
- 10 Replace the module cover (see "Replacing the Module Cover" on page 16).
- 11 Replace the battery (see "Replacing the Battery" on page 14).



CAUTION: Before turning on the computer, replace all screws and ensure that no stray screws remain inside the computer. Failure to do so may result in damage to the computer.

Top Cover

-  **WARNING:** Before working inside your computer, read the safety information that shipped with your computer. For additional safety best practices information, see the Regulatory Compliance Homepage at www.dell.com/regulatory_compliance.
-  **CAUTION:** Only a certified service technician should perform repairs on your computer. Damage due to servicing that is not authorized by Dell™ is not covered by your warranty.
-  **CAUTION:** To avoid electrostatic discharge, ground yourself by using a wrist grounding strap or by periodically touching an unpainted metal surface (such as a connector on your computer).
-  **CAUTION:** To help prevent damage to the system board, remove the main battery (see "Removing the Battery" on page 13) before working inside the computer.

Removing the Top Cover

- 1 Follow the instructions in "Before You Begin" on page 9.
- 2 Press and eject any installed cards from the Media Card Reader.
- 3 Remove the battery (see "Removing the Battery" on page 13).
- 4 Remove the module cover (see "Removing the Module Cover" on page 15).
- 5 Remove the optical drive (see "Removing the Optical Drive" on page 33).
- 6 Remove the palm-rest assembly (see "Removing the Palm-Rest Assembly" on page 37).
- 7 Remove the keyboard (see "Removing the Keyboard" on page 43).
- 8 Remove the display assembly (see "Removing the Display Assembly" on page 55).
- 9 Remove the ten screws that secure the top-cover assembly to the base cover.

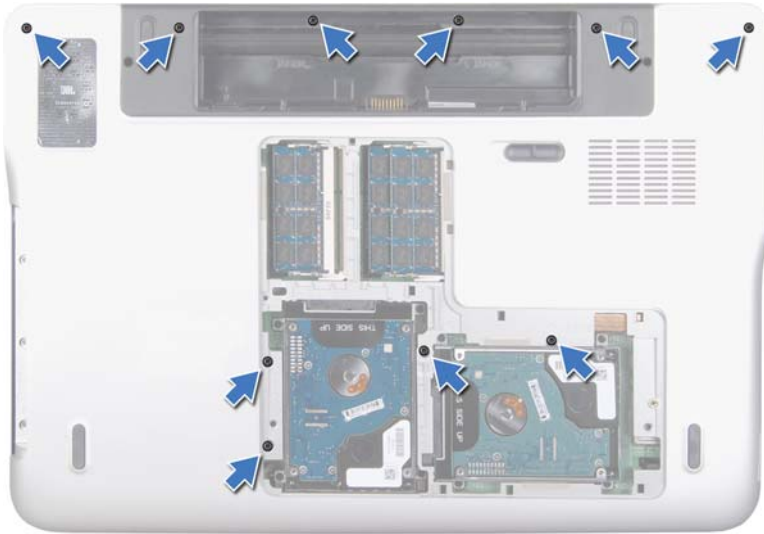

- 10** Turn the computer over.
- 11** Remove the ten screws that secure the top-cover assembly to the base cover.
- 12** Disconnect the subwoofer cable from the system-board connector.

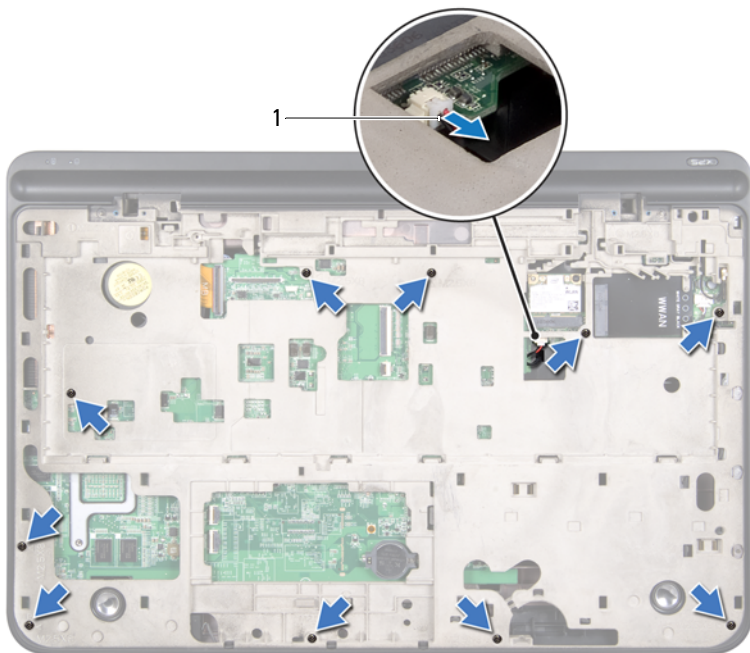

1 subwoofer cable

13 Using your fingertips, gently ease the top-cover assembly from the base cover.

14 Lift the top cover assembly off the base cover.

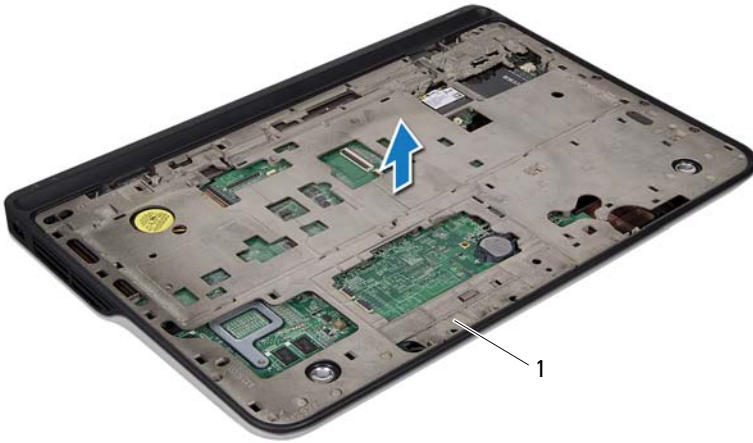

1 top-cover assembly

- 15** Remove the AC-adapter connector (see "Removing the AC-Adapter Connector" on page 95).
- 16** Remove the USB board (see "Removing the USB Board" on page 123).
- 17** Remove the fan (see "Removing the Fan" on page 99).
- 18** Remove the heat sink (see "Removing the Heat Sink" on page 105).
- 19** Remove the processor module (see "Removing the Processor Module" on page 111).
- 20** Remove the I/O board (see "Removing the I/O Board" on page 115).
- 21** Remove the TV antenna connector (see "Removing the TV Antenna Connector" on page 119).
- 22** Remove the system board (see "Removing the System Board" on page 127).
- 23** Remove the speakers (see "Removing the Speakers" on page 133).





Replacing the Top Cover

- 1 Follow the instructions in "Before You Begin" on page 9.
- 2 Replace the speakers (see "Replacing the Speaker" on page 135).
- 3 Replace the system board (see "Replacing the System Board" on page 129).
- 4 Replace the TV antenna connector (see "Replacing the TV Antenna Connector" on page 120).
- 5 Replace the I/O board (see "Replacing the I/O Board" on page 117).
- 6 Replace the processor module (see "Replacing the Processor Module" on page 113).
- 7 Replace the heat sink (see "Replacing the Heat Sink" on page 107).
- 8 Replace the fan (see "Replacing the Fan" on page 101).
- 9 Replace the AC-adaptor connector (see "Replacing the AC-Adapter Connector" on page 96).
- 10 Replace the USB board (see "Replacing the USB Board" on page 124).
- 11 Route the subwoofer cable through the slot on the top cover.
- 12 Connect the subwoofer cable to the system-board connector.
- 13 Align the tabs on the top cover with the slots on the base cover and snap the top-cover assembly onto the base cover.
- 14 Replace the ten screws that secure the top-cover assembly to the base cover.
- 15 Turn the computer over and replace the ten screws that secure the top-cover assembly to the base cover.
- 16 Replace the display assembly (see "Replacing the Display Assembly" on page 58).
- 17 Replace the keyboard (see "Replacing the Keyboard" on page 45).
- 18 Replace the palm-rest assembly (see "Replacing the Palm-Rest Assembly" on page 40).
- 19 Replace the optical drive (see "Replacing the Optical Drive" on page 34).
- 20 Replace the module cover (see "Replacing the Module Cover" on page 16).
- 21 Replace any blank or card you removed from the Media Card Reader slot.
- 22 Replace the battery (see "Replacing the Battery" on page 14).



CAUTION: Before turning on the computer, replace all screws and ensure that no stray screws remain inside the computer. Failure to do so may result in damage to the computer.

Subwoofer

-  **WARNING:** Before working inside your computer, read the safety information that shipped with your computer. For additional safety best practices information, see the Regulatory Compliance Homepage at www.dell.com/regulatory_compliance.
-  **CAUTION:** Only a certified service technician should perform repairs on your computer. Damage due to servicing that is not authorized by Dell™ is not covered by your warranty.
-  **CAUTION:** To avoid electrostatic discharge, ground yourself by using a wrist grounding strap or by periodically touching an unpainted metal surface (such as a connector on your computer).
-  **CAUTION:** To help prevent damage to the system board, remove the main battery (see "Removing the Battery" on page 13) before working inside the computer.

Removing the Subwoofer

- 1 Follow the instructions in "Before You Begin" on page 9.
- 2 Remove the battery (see "Removing the Battery" on page 13).
- 3 Remove the module cover (see "Removing the Module Cover" on page 15).
- 4 Remove the memory module(s) (see "Removing the Memory Module(s)" on page 17).
- 5 Follow the instructions in step 4 in "Removing the Hard Drive(s)" on page 27.
- 6 Remove the optical drive (see "Removing the Optical Drive" on page 33).
- 7 Remove the palm-rest assembly (see "Removing the Palm-Rest Assembly" on page 37).
- 8 Remove the keyboard (see "Removing the Keyboard" on page 43).
- 9 Remove the display assembly (see "Removing the Display Assembly" on page 55).
- 10 Remove the Mini-Card(s) (see "Removing the Mini-Card(s)" on page 21).

- 11 Follow the instructions from step 9 to step 14 in "Removing the Top Cover" on page 83.
- 12 Remove the four screws that secure the subwoofer to the base cover.
- 13 Lift the subwoofer along with the cable off the base cover.



- | | | | |
|---|------------|---|-----------|
| 1 | screws (4) | 2 | subwoofer |
| 3 | base cover | | |

Replacing the Subwoofer





- 1 Follow the instructions in "Before You Begin" on page 9.
- 2 Align the screw holes on the subwoofer with the screw holes on the base cover.
- 3 Replace the four screws that secure the subwoofer to the base cover.
- 4 Follow the instructions from step 11 to step 15 in "Replacing the Top Cover" on page 87.

- 5 Replace the Mini-Card(s) (see "Replacing the Mini-Card(s)" on page 23).
- 6 Replace the display assembly (see "Replacing the Display Assembly" on page 58).
- 7 Replace the keyboard (see "Replacing the Keyboard" on page 45).
- 8 Replace the palm-rest assembly (see "Replacing the Palm-Rest Assembly" on page 40).
- 9 Replace the optical drive (see "Replacing the Optical Drive" on page 34).
- 10 Follow the instructions in step 5 in "Replacing the Hard Drive(s)" on page 30.
- 11 Replace the memory module(s) (see "Replacing the Memory Module(s)" on page 18).
- 12 Replace the module cover (see "Replacing the Module Cover" on page 16).
- 13 Replace the battery (see "Replacing the Battery" on page 14).



CAUTION: Before turning on the computer, replace all screws and ensure that no stray screws remain inside the computer. Failure to do so may result in damage to the computer.

AC-Adapter Connector

-  **WARNING:** Before working inside your computer, read the safety information that shipped with your computer. For additional safety best practices information, see the Regulatory Compliance Homepage at www.dell.com/regulatory_compliance.
-  **CAUTION:** Only a certified service technician should perform repairs on your computer. Damage due to servicing that is not authorized by Dell™ is not covered by your warranty.
-  **CAUTION:** To avoid electrostatic discharge, ground yourself by using a wrist grounding strap or by periodically touching an unpainted metal surface (such as a connector on your computer).
-  **CAUTION:** To help prevent damage to the system board, remove the main battery (see "Removing the Battery" on page 13) before working inside the computer.

Removing the AC-Adapter Connector

- 1 Follow the instructions in "Before You Begin" on page 9.
- 2 Remove the battery (see "Removing the Battery" on page 13).
- 3 Remove the module cover (see "Removing the Module Cover" on page 15).
- 4 Remove the memory module(s) (see "Removing the Memory Module(s)" on page 17).
- 5 Follow the instructions in step 4 in "Removing the Hard Drive(s)" on page 27.
- 6 Remove the optical drive (see "Removing the Optical Drive" on page 33).
- 7 Remove the palm-rest assembly (see "Removing the Palm-Rest Assembly" on page 37).
- 8 Remove the keyboard (see "Removing the Keyboard" on page 43).
- 9 Remove the display assembly (see "Removing the Display Assembly" on page 55).
- 10 Remove the Mini-Card(s) (see "Removing the Mini-Card(s)" on page 21).

- 11 Follow the instructions from step 9 to step 14 in "Removing the Top Cover" on page 83.
- 12 Turn the top-cover assembly over.
- 13 Make note of the AC-adapter connector cable routing and remove the cable from the routing guides.
- 14 Disconnect the AC-adapter connector cable from the system-board connector.
- 15 Remove the screw that secures the AC-adapter connector to the top cover.
- 16 Lift the AC-adapter connector off the top cover.

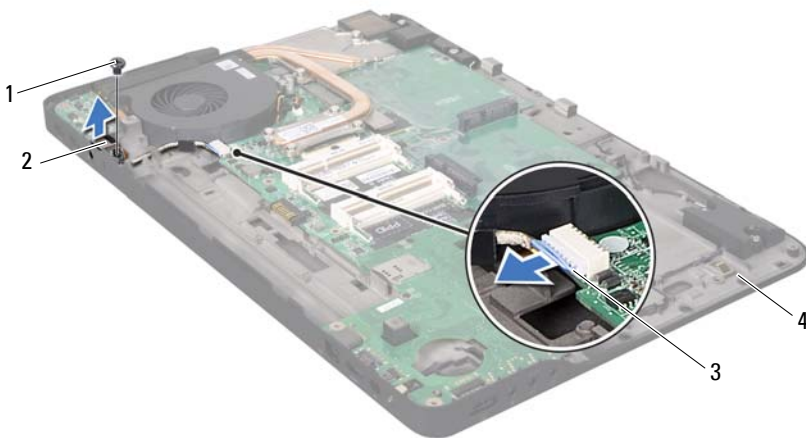

- | | | | |
|---|----------------------------|---|----------------------|
| 1 | screw | 2 | AC-adapter connector |
| 3 | AC-adapter connector cable | 4 | top cover |

Replacing the AC-Adapter Connector





- 1 Follow the instructions in "Before You Begin" on page 9.

- 2 Align the screw hole on the AC-adapter connector with the screw hole on the top cover.
- 3 Replace the screw that secures the AC-adapter connector to the top cover.
- 4 Route the AC-adapter connector cable through the routing guides.
- 5 Connect the AC-adapter connector cable to the system-board connector.
- 6 Follow the instructions from step 11 to step 15 in "Replacing the Top Cover" on page 87.
- 7 Replace the Mini-Card(s) (see "Replacing the Mini-Card(s)" on page 23).
- 8 Replace the display assembly (see "Replacing the Display Assembly" on page 58).
- 9 Replace the keyboard (see "Replacing the Keyboard" on page 45).
- 10 Replace the palm-rest assembly (see "Replacing the Palm-Rest Assembly" on page 40).
- 11 Replace the optical drive (see "Replacing the Optical Drive" on page 34).
- 12 Follow the instructions in step 5 in "Replacing the Hard Drive(s)" on page 30.
- 13 Replace the memory module(s) (see "Replacing the Memory Module(s)" on page 18).
- 14 Replace the module cover (see "Replacing the Module Cover" on page 16).
- 15 Replace the battery (see "Replacing the Battery" on page 14).



CAUTION: Before turning on the computer, replace all screws and ensure that no stray screws remain inside the computer. Failure to do so may result in damage to the computer.

Fan

-  **WARNING:** Before working inside your computer, read the safety information that shipped with your computer. For additional safety best practices information, see the Regulatory Compliance Homepage at www.dell.com/regulatory_compliance.
-  **WARNING:** If you remove the fan from the computer when the heat sink is hot, *do not touch* the metal housing of the heat sink.
-  **CAUTION:** Only a certified service technician should perform repairs on your computer. Damage due to servicing that is not authorized by Dell™ is not covered by your warranty.
-  **CAUTION:** To avoid electrostatic discharge, ground yourself by using a wrist grounding strap or by periodically touching an unpainted metal surface (such as a connector on your computer).
-  **CAUTION:** To help prevent damage to the system board, remove the main battery (see "Removing the Battery" on page 13) before working inside the computer.

Removing the Fan

- 1 Follow the instructions in "Before You Begin" on page 9.
- 2 Remove the battery (see "Removing the Battery" on page 13).
- 3 Remove the module cover (see "Removing the Module Cover" on page 15).
- 4 Remove the memory module(s) (see "Removing the Memory Module(s)" on page 17).
- 5 Follow the instructions in step 4 in "Removing the Hard Drive(s)" on page 27.
- 6 Remove the optical drive (see "Removing the Optical Drive" on page 33).
- 7 Remove the palm-rest assembly (see "Removing the Palm-Rest Assembly" on page 37).
- 8 Remove the keyboard (see "Removing the Keyboard" on page 43).

- 9 Remove the display assembly (see "Removing the Display Assembly" on page 55).
- 10 Remove the Mini-Card(s) (see "Removing the Mini-Card(s)" on page 21).
- 11 Follow the instructions from step 9 to step 14 in "Removing the Top Cover" on page 83.
- 12 Turn the top-cover assembly over.
- 13 Disconnect the fan cable from the system-board connector.
- 14 Remove the two screws that secure the fan to the top cover.
- 15 Disconnect the AC-adapter connector cable from the system-board connector.
- 16 Release the AC-adapter cable from the routing guide on the fan.
- 17 Lift the fan away from the top cover.

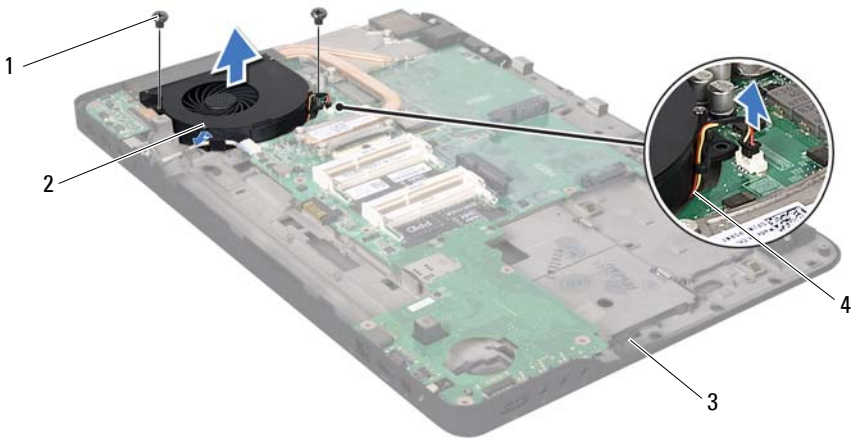

- 1 screws (2)
- 3 top cover

- 2 fan
- 4 fan cable





Replacing the Fan

- 1 Follow the instructions in "Before You Begin" on page 9.
- 2 Align the screw holes on the fan with the screw holes on the top cover.
- 3 Replace the two screws that secure the fan to the top cover.
- 4 Connect the fan cable to the system-board connector.
- 5 Connect the AC-adapter connector cable to the system-board connector.
- 6 Follow the instructions from step 11 to step 15 in "Replacing the Top Cover" on page 87.
- 7 Replace the Mini-Card(s) (see "Replacing the Mini-Card(s)" on page 23).
- 8 Replace the display assembly (see "Replacing the Display Assembly" on page 58).
- 9 Replace the keyboard (see "Replacing the Keyboard" on page 45).
- 10 Replace the palm-rest assembly (see "Replacing the Palm-Rest Assembly" on page 40).
- 11 Replace the optical drive (see "Replacing the Optical Drive" on page 34).
- 12 Follow the instructions in step 5 in "Replacing the Hard Drive(s)" on page 30.
- 13 Replace the memory module(s) (see "Replacing the Memory Module(s)" on page 18).
- 14 Replace the module cover (see "Replacing the Module Cover" on page 16).
- 15 Replace the battery (see "Replacing the Battery" on page 14).



CAUTION: Before turning on the computer, replace all screws and ensure that no stray screws remain inside the computer. Failure to do so may result in damage to the computer.

Heat Sink

-  **WARNING:** Before working inside your computer, read the safety information that shipped with your computer. For additional safety best practices information, see the Regulatory Compliance Homepage at www.dell.com/regulatory_compliance.
-  **WARNING:** If you remove the heat sink from the computer when the heat sink is hot, *do not touch* the metal housing of the heat sink.
-  **CAUTION:** Only a certified service technician should perform repairs on your computer. Damage due to servicing that is not authorized by Dell™ is not covered by your warranty.
-  **CAUTION:** To avoid electrostatic discharge, ground yourself by using a wrist grounding strap or by periodically touching an unpainted metal surface (such as a connector on your computer).
-  **CAUTION:** To help prevent damage to the system board, remove the main battery (see "Removing the Battery" on page 13) before working inside the computer.

Removing the Heat Sink

- 1 Follow the instructions in "Before You Begin" on page 9.
- 2 Remove the battery (see "Removing the Battery" on page 13).
- 3 Remove the module cover (see "Removing the Module Cover" on page 15).
- 4 Remove the memory module(s) (see "Removing the Memory Module(s)" on page 17).
- 5 Follow the instructions in step 4 in "Removing the Hard Drive(s)" on page 27.
- 6 Remove the optical drive (see "Removing the Optical Drive" on page 33).
- 7 Remove the palm-rest assembly (see "Removing the Palm-Rest Assembly" on page 37).
- 8 Remove the keyboard (see "Removing the Keyboard" on page 43).

- 9 Remove the display assembly (see "Removing the Display Assembly" on page 55).
- 10 Remove the Mini-Card(s) (see "Removing the Mini-Card(s)" on page 21).
- 11 Follow the instructions from step 9 to step 14 in "Removing the Top Cover" on page 83.
- 12 Turn the top-cover assembly over.
- 13 In sequential order (indicated on the heat sink), loosen the six captive screws that secure the heat sink to the system board.
- 14 Lift the heat sink away from the top cover.

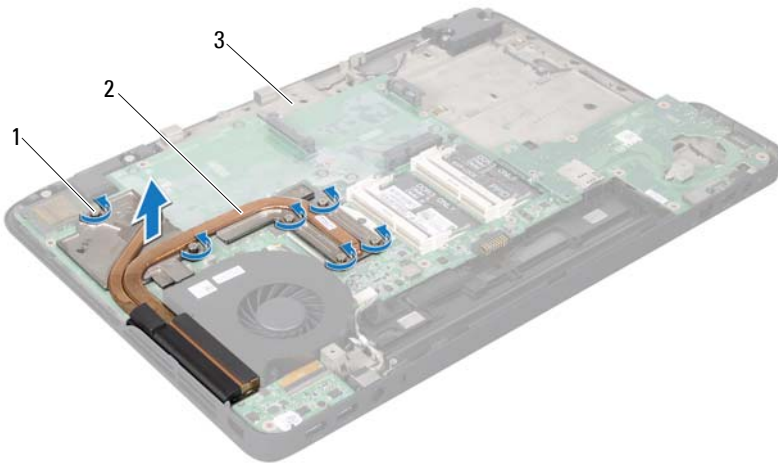

- 1 captive screws (6)
- 3 top cover

2 heat sink

Replacing the Heat Sink







NOTE: The original thermal grease can be reused if the original processor and heat sink are reinstalled together. If either the processor or the heat sink is replaced, use the thermal pad provided in the kit to ensure that thermal conductivity is achieved.

- 1 Follow the instructions in "Before You Begin" on page 9.
- 2 Clean the thermal grease from the bottom of the heat sink and reapply it.
- 3 Align the six captive screws on the heat sink with the screw holes on the system board and tighten the screws in sequential order (indicated on the heat sink).
- 4 Follow the instructions from step 11 to step 15 in "Replacing the Top Cover" on page 87.
- 5 Replace the Mini-Card(s) (see "Replacing the Mini-Card(s)" on page 23).
- 6 Replace the display assembly (see "Replacing the Display Assembly" on page 58).
- 7 Replace the keyboard (see "Replacing the Keyboard" on page 45).
- 8 Replace the palm-rest assembly (see "Replacing the Palm-Rest Assembly" on page 40).
- 9 Replace the optical drive (see "Replacing the Optical Drive" on page 34).
- 10 Follow the instructions in step 5 in "Replacing the Hard Drive(s)" on page 30.
- 11 Replace the memory module(s) (see "Replacing the Memory Module(s)" on page 18).
- 12 Replace the module cover (see "Replacing the Module Cover" on page 16).
- 13 Replace the battery (see "Replacing the Battery" on page 14).



CAUTION: Before turning on the computer, replace all screws and ensure that no stray screws remain inside the computer. Failure to do so may result in damage to the computer.

Processor Module

-  **WARNING:** Before working inside your computer, read the safety information that shipped with your computer. For additional safety best practices information, see the Regulatory Compliance Homepage at www.dell.com/regulatory_compliance.
-  **CAUTION:** Only a certified service technician should perform repairs on your computer. Damage due to servicing that is not authorized by Dell™ is not covered by your warranty.
-  **CAUTION:** To avoid electrostatic discharge, ground yourself by using a wrist grounding strap or by periodically touching an unpainted metal surface (such as a connector on your computer).
-  **CAUTION:** To help prevent damage to the system board, remove the main battery (see "Removing the Battery" on page 13) before working inside the computer.

Removing the Processor Module

- 1 Follow the instructions in "Before You Begin" on page 9.
- 2 Remove the battery (see "Removing the Battery" on page 13).
- 3 Remove the module cover (see "Removing the Module Cover" on page 15).
- 4 Remove the memory module(s) (see "Removing the Memory Module(s)" on page 17).
- 5 Follow the instructions in step 4 in "Removing the Hard Drive(s)" on page 27.
- 6 Remove the optical drive (see "Removing the Optical Drive" on page 33).
- 7 Remove the palm-rest assembly (see "Removing the Palm-Rest Assembly" on page 37).
- 8 Remove the keyboard (see "Removing the Keyboard" on page 43).
- 9 Remove the display assembly (see "Removing the Display Assembly" on page 55).
- 10 Remove the Mini-Card(s) (see "Removing the Mini-Card(s)" on page 21).

- 11 Follow the instructions from step 9 to step 14 in "Removing the Top Cover" on page 83.
- 12 Turn the top-cover assembly over.
- 13 Remove the heat sink (see "Removing the Heat Sink" on page 105).
- △ **CAUTION: To prevent intermittent contact between the ZIF-socket cam screw and the processor when removing or replacing the processor, press to apply slight pressure to the centre of the processor while turning the cam screw.**
- △ **CAUTION: To avoid damage to the processor, hold the screwdriver so that it is perpendicular to the processor when turning the cam screw.**
- 14 To loosen the ZIF socket, use a small, flat-blade screwdriver and rotate the ZIF-socket cam screw counterclockwise until it comes to the cam stop.

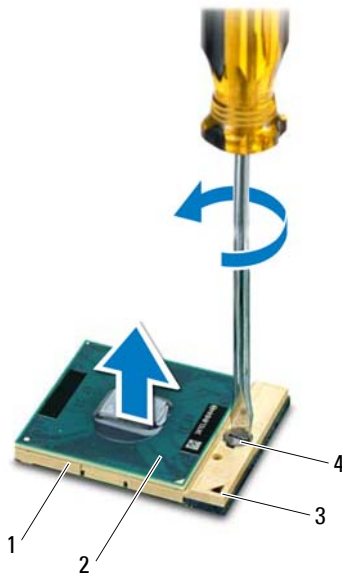

- | | | | |
|---|--------------|---|----------------------|
| 1 | ZIF socket | 2 | processor module |
| 3 | pin-1 corner | 4 | ZIF-socket cam screw |

 **CAUTION:** To ensure maximum cooling for the processor module, do not touch the heat transfer areas on the processor thermal-cooling assembly. The oils in your skin can reduce the heat transfer capability of the thermal pads.

 **CAUTION:** When removing the processor module, pull the module straight up. Be careful not to bend the pins on the processor module.

- 15 Lift the processor module off the ZIF socket.

Replacing the Processor Module

 **NOTE:** If a new processor module is installed, you will receive a new thermal-cooling assembly, which will include an affixed thermal pad, or you will receive a new thermal pad along with documentation to illustrate proper installation.

- 1 Follow the instructions in "Before You Begin" on page 9.
- 2 Align the pin-1 corner of the processor module with the pin-1 corner of the ZIF socket.

 **NOTE:** The pin-1 corner of the processor module has a triangle that aligns with the triangle on the pin-1 corner of the ZIF socket.

- 3 Place the processor module lightly in the ZIF socket and ensure that the processor module is positioned correctly.

 **CAUTION:** To avoid damage to the processor module, hold the screwdriver perpendicular to the processor module when turning the cam screw.





- 4 Tighten the ZIF socket by turning the cam screw clockwise to secure the processor module to the system board.
- 5 Replace the heat sink (see "Replacing the Heat Sink" on page 107).
- 6 Follow the instructions from step 11 to step 15 in "Replacing the Top Cover" on page 87.
- 7 Replace the Mini-Card(s) (see "Replacing the Mini-Card(s)" on page 23).
- 8 Replace the display assembly (see "Replacing the Display Assembly" on page 58).
- 9 Replace the keyboard (see "Replacing the Keyboard" on page 45).

- 10 Replace the palm-rest assembly (see "Replacing the Palm-Rest Assembly" on page 40).
- 11 Replace the optical drive (see "Replacing the Optical Drive" on page 34).
- 12 Follow the instructions in step 5 in "Replacing the Hard Drive(s)" on page 30.
- 13 Replace the memory module(s) (see "Replacing the Memory Module(s)" on page 18).
- 14 Replace the module cover (see "Replacing the Module Cover" on page 16).
- 15 Replace the battery (see "Replacing the Battery" on page 14).



CAUTION: Before turning on the computer, replace all screws and ensure that no stray screws remain inside the computer. Failure to do so may result in damage to the computer.

I/O Board

-  **WARNING:** Before working inside your computer, read the safety information that shipped with your computer. For additional safety best practices information, see the Regulatory Compliance Homepage at www.dell.com/regulatory_compliance.
-  **CAUTION:** Only a certified service technician should perform repairs on your computer. Damage due to servicing that is not authorized by Dell™ is not covered by your warranty.
-  **CAUTION:** To avoid electrostatic discharge, ground yourself by using a wrist grounding strap or by periodically touching an unpainted metal surface (such as a connector on your computer).
-  **CAUTION:** To help prevent damage to the system board, remove the main battery (see "Removing the Battery" on page 13) before working inside the computer.

Removing the I/O Board

- 1 Follow the instructions in "Before You Begin" on page 9.
- 2 Remove the battery (see "Removing the Battery" on page 13).
- 3 Remove the module cover (see "Removing the Module Cover" on page 15).
- 4 Remove the memory module(s) (see "Removing the Memory Module(s)" on page 17).
- 5 Follow the instructions in step 4 in "Removing the Hard Drive(s)" on page 27.
- 6 Remove the optical drive (see "Removing the Optical Drive" on page 33).
- 7 Remove the palm-rest assembly (see "Removing the Palm-Rest Assembly" on page 37).
- 8 Remove the keyboard (see "Removing the Keyboard" on page 43).
- 9 Remove the display assembly (see "Removing the Display Assembly" on page 55).
- 10 Remove the Mini-Card(s) (see "Removing the Mini-Card(s)" on page 21).

- 11 Follow the instructions from step 9 to step 14 in "Removing the Top Cover" on page 83.
- 12 Disconnect the speaker cable from the connector on the I/O board.

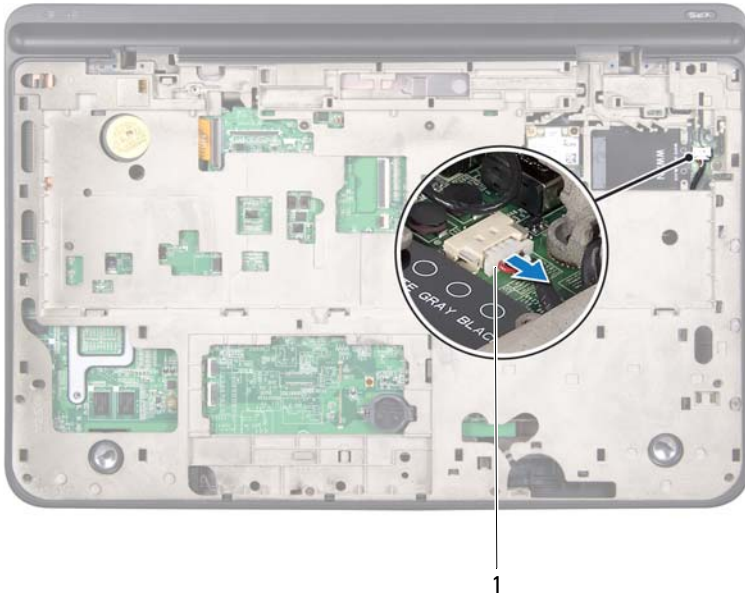

1 speaker cable connector

- 13 Turn the top-cover assembly over.
- 14 Remove the three screws that secure the I/O board to the top cover.
- 15 Carefully ease the connectors on the I/O board out of the slots in the top cover, and lift the I/O board off the top cover.

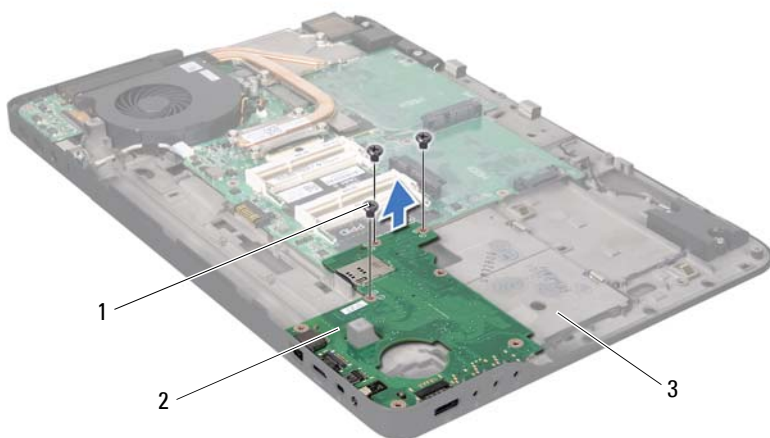

- | | | | |
|---|------------|---|-----------|
| 1 | screws (3) | 2 | I/O board |
| 3 | top cover | | |

Replacing the I/O Board





- 1 Follow the instructions in "Before You Begin" on page 9.
- 2 Align the connectors on the I/O board with the slots on the top cover and place the I/O board on the top cover.
- 3 Press the I/O board down to connect it to the system-board connector.
- 4 Replace the three screws that secure the I/O board to the top cover.
- 5 Connect the speaker cable to the connector on the I/O board.
- 6 Follow the instructions from step 11 to step 15 in "Replacing the Top Cover" on page 87.
- 7 Replace the Mini-Card(s) (see "Replacing the Mini-Card(s)" on page 23).
- 8 Replace the display assembly (see "Replacing the Display Assembly" on page 58).

- 9 Replace the keyboard (see "Replacing the Keyboard" on page 45).
- 10 Replace the palm-rest assembly (see "Replacing the Palm-Rest Assembly" on page 40).
- 11 Replace the optical drive (see "Replacing the Optical Drive" on page 34).
- 12 Follow the instructions in step 5 in "Replacing the Hard Drive(s)" on page 30.
- 13 Replace the memory module(s) (see "Replacing the Memory Module(s)" on page 18).
- 14 Replace the module cover (see "Replacing the Module Cover" on page 16).
- 15 Replace the battery (see "Replacing the Battery" on page 14).



CAUTION: Before turning on the computer, replace all screws and ensure that no stray screws remain inside the computer. Failure to do so may result in damage to the computer.

TV Antenna Connector

-  **WARNING:** Before working inside your computer, read the safety information that shipped with your computer. For additional safety best practices information, see the Regulatory Compliance Homepage at www.dell.com/regulatory_compliance.
-  **CAUTION:** Only a certified service technician should perform repairs on your computer. Damage due to servicing that is not authorized by Dell™ is not covered by your warranty.
-  **CAUTION:** To avoid electrostatic discharge, ground yourself by using a wrist grounding strap or by periodically touching an unpainted metal surface (such as a connector on your computer).
-  **CAUTION:** To help prevent damage to the system board, remove the main battery (see "Removing the Battery" on page 13) before working inside the computer.

Removing the TV Antenna Connector

- 1 Follow the instructions in "Before You Begin" on page 9.
- 2 Remove the battery (see "Removing the Battery" on page 13).
- 3 Remove the module cover (see "Removing the Module Cover" on page 15).
- 4 Remove the memory module(s) (see "Removing the Memory Module(s)" on page 17).
- 5 Follow the instructions in step 4 in "Removing the Hard Drive(s)" on page 27.
- 6 Remove the optical drive (see "Removing the Optical Drive" on page 33).
- 7 Remove the palm-rest assembly (see "Removing the Palm-Rest Assembly" on page 37).
- 8 Remove the keyboard (see "Removing the Keyboard" on page 43).
- 9 Remove the display assembly (see "Removing the Display Assembly" on page 55).
- 10 Remove the Mini-Card(s) (see "Removing the Mini-Card(s)" on page 21).

- 11 Follow the instructions from step 9 to step 14 in "Removing the Top Cover" on page 83.
- 12 Remove the I/O board (see "Removing the I/O Board" on page 115).
- 13 Make note of the TV antenna connector cable routing and remove the cable from the routing guides.
- 14 Remove the two screws that secure the TV antenna connector to the top cover.
- 15 Carefully ease the TV antenna connector off the slot in the top cover and lift it off the top cover.

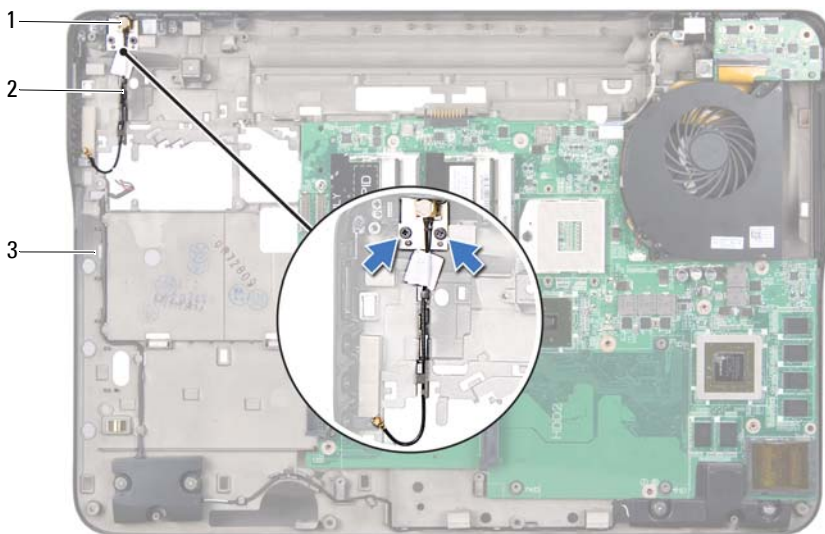

- 1 TV antenna connector
- 2 TV antenna connector cable
- 3 top cover

Replacing the TV Antenna Connector





- 1 Follow the instructions in "Before You Begin" on page 9.

- 2 Align the TV antenna connector with the slot on the top cover and place the TV antenna connector on the top cover.
- 3 Replace the two screws that secure the TV antenna connector to the top cover.
- 4 Route the TV antenna connector cable through the routing guides.
- 5 Replace the I/O board (see "Replacing the I/O Board" on page 117).
- 6 Follow the instructions from step 11 to step 15 in "Replacing the Top Cover" on page 87.
- 7 Replace the Mini-Card(s) (see "Replacing the Mini-Card(s)" on page 23).
- 8 Replace the display assembly (see "Replacing the Display Assembly" on page 58).
- 9 Replace the keyboard (see "Replacing the Keyboard" on page 45).
- 10 Replace the palm-rest assembly (see "Replacing the Palm-Rest Assembly" on page 40).
- 11 Replace the optical drive (see "Replacing the Optical Drive" on page 34).
- 12 Follow the instructions in step 5 in "Replacing the Hard Drive(s)" on page 30.
- 13 Replace the memory module(s) (see "Replacing the Memory Module(s)" on page 18).
- 14 Replace the module cover (see "Replacing the Module Cover" on page 16).
- 15 Replace the battery (see "Replacing the Battery" on page 14).



CAUTION: Before turning on the computer, replace all screws and ensure that no stray screws remain inside the computer. Failure to do so may result in damage to the computer.

USB Board

-  **WARNING:** Before working inside your computer, read the safety information that shipped with your computer. For additional safety best practices information, see the Regulatory Compliance Homepage at www.dell.com/regulatory_compliance.
-  **CAUTION:** Only a certified service technician should perform repairs on your computer. Damage due to servicing that is not authorized by Dell™ is not covered by your warranty.
-  **CAUTION:** To avoid electrostatic discharge, ground yourself by using a wrist grounding strap or by periodically touching an unpainted metal surface (such as a connector on your computer).
-  **CAUTION:** To help prevent damage to the system board, remove the main battery (see "Removing the Battery" on page 13) before working inside the computer.

Removing the USB Board

- 1 Follow the instructions in "Before You Begin" on page 9.
- 2 Remove the battery (see "Removing the Battery" on page 13).
- 3 Remove the module cover (see "Removing the Module Cover" on page 15).
- 4 Remove the memory module(s) (see "Removing the Memory Module(s)" on page 17).
- 5 Follow the instructions in step 4 in "Removing the Hard Drive(s)" on page 27.
- 6 Remove the optical drive (see "Removing the Optical Drive" on page 33).
- 7 Remove the palm-rest assembly (see "Removing the Palm-Rest Assembly" on page 37).
- 8 Remove the keyboard (see "Removing the Keyboard" on page 43).
- 9 Remove the display assembly (see "Removing the Display Assembly" on page 55).
- 10 Remove the Mini-Card(s) (see "Removing the Mini-Card(s)" on page 21).

- 11** Follow the instructions from step 9 to step 14 in "Removing the Top Cover" on page 83.
- 12** Turn the top-cover assembly over.
- 13** Lift the connector latch and disconnect the USB-board cable from the connector on the USB board.
- 14** Remove the screw that secures the USB board to the top cover.
- 15** Carefully ease the connectors on the USB board out of the slots in the top cover, and lift the USB board off the top cover.

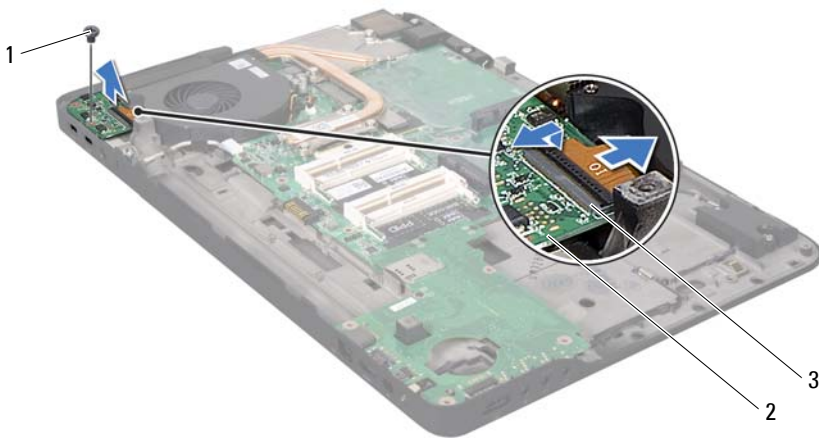

- | | | | |
|---|---------------------------|---|-----------|
| 1 | screw | 2 | USB board |
| 3 | USB-board cable connector | | |

Replacing the USB Board





- 1** Follow the instructions in "Before You Begin" on page 9.
- 2** Align the connectors on the USB board with the slots on the top cover and place the USB board on the top cover.

- 3** Replace the screw that secures the USB board to the top cover.
- 4** Slide the USB-board cable into the connector on the USB board and press the connector latch down to secure the cable.
- 5** Follow the instructions from step 11 to step 15 in "Replacing the Top Cover" on page 87.
- 6** Replace the Mini-Card(s) (see "Replacing the Mini-Card(s)" on page 23).
- 7** Replace the display assembly (see "Replacing the Display Assembly" on page 58).
- 8** Replace the keyboard (see "Replacing the Keyboard" on page 45).
- 9** Replace the palm-rest assembly (see "Replacing the Palm-Rest Assembly" on page 40).
- 10** Replace the optical drive (see "Replacing the Optical Drive" on page 34).
- 11** Follow the instructions in step 5 in "Replacing the Hard Drive(s)" on page 30.
- 12** Replace the memory module(s) (see "Replacing the Memory Module(s)" on page 18).
- 13** Replace the module cover (see "Replacing the Module Cover" on page 16).
- 14** Replace the battery (see "Replacing the Battery" on page 14).



CAUTION: Before turning on the computer, replace all screws and ensure that no stray screws remain inside the computer. Failure to do so may result in damage to the computer.

System Board

-  **WARNING:** Before working inside your computer, read the safety information that shipped with your computer. For additional safety best practices information, see the Regulatory Compliance Homepage at www.dell.com/regulatory_compliance.
-  **CAUTION:** Only a certified service technician should perform repairs on your computer. Damage due to servicing that is not authorized by Dell™ is not covered by your warranty.
-  **CAUTION:** To avoid electrostatic discharge, ground yourself by using a wrist grounding strap or by periodically touching an unpainted metal surface (such as a connector on your computer).
-  **CAUTION:** To help prevent damage to the system board, remove the main battery (see "Removing the Battery" on page 13) before working inside the computer.
-  **CAUTION:** Handle components and cards by their edges, and avoid touching pins and contacts.

Removing the System Board

- 1 Follow the instructions in "Before You Begin" on page 9.
- 2 Remove any installed card or blank from the Media Card Reader.
- 3 Remove the battery (see "Removing the Battery" on page 13).
- 4 Remove the module cover (see "Removing the Module Cover" on page 15).
- 5 Remove the memory module(s) (see "Removing the Memory Module(s)" on page 17).
- 6 Follow the instructions in step 4 in "Removing the Hard Drive(s)" on page 27.
- 7 Remove the optical drive (see "Removing the Optical Drive" on page 33).
- 8 Remove the palm-rest assembly (see "Removing the Palm-Rest Assembly" on page 37).
- 9 Remove the keyboard (see "Removing the Keyboard" on page 43).

- 10 Remove the display assembly (see "Removing the Display Assembly" on page 55).
- 11 Remove the Mini-Card(s) (see "Removing the Mini-Card(s)" on page 21).
- 12 Remove the coin-cell battery (see "Removing the Coin-Cell Battery" on page 51).
- 13 Lift the connector latch and pull the pull-tab to disconnect the USB-board cable from the system-board connector.

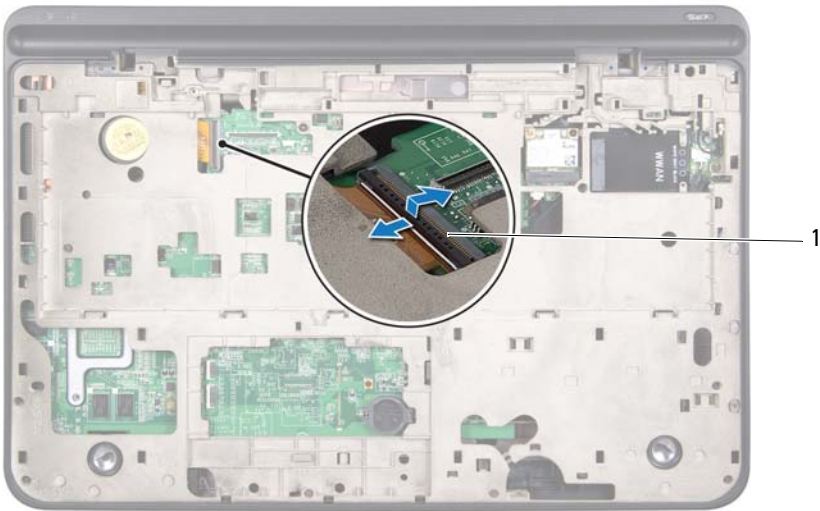

1 USB-board cable connector

- 14 Follow the instructions from step 9 to step 14 in "Removing the Top Cover" on page 83.
- 15 Remove the heat sink (see "Removing the Heat Sink" on page 105).
- 16 Remove the processor module (see "Removing the Processor Module" on page 111).
- 17 Remove the I/O board (see "Removing the I/O Board" on page 115).

- 18 Disconnect the fan cable and AC-adapter connector cable from their connectors on the system board.
- 19 Lift the system board off the top cover.

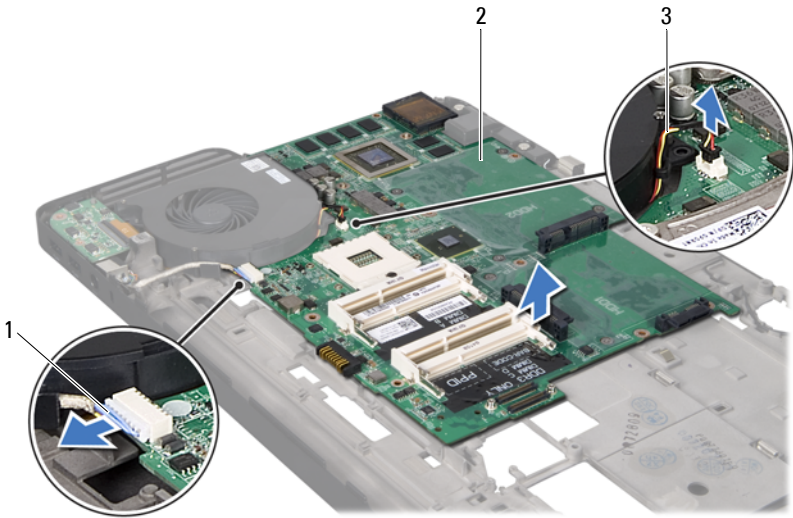

- | | | | |
|---|----------------------------|---|--------------|
| 1 | AC-adapter connector cable | 2 | system board |
| 3 | fan cable | | |

Replacing the System Board

- 1 Follow the instructions in "Before You Begin" on page 9.
- 2 Place the system board on the top cover.
- 3 Connect the fan cable and AC-adapter connector cable to their connectors on the system board.
- 4 Replace the I/O board (see "Replacing the I/O Board" on page 117).
- 5 Replace the processor module (see "Replacing the Processor Module" on page 113).

- 6 Replace the heat sink (see "Replacing the Heat Sink" on page 107).
- 7 Follow the instructions from step 11 to step 15 in "Replacing the Top Cover" on page 87.
- 8 Slide the USB-board cable into the system-board connector and press down on the connector latch to secure the cable.
- 9 Replace the coin-cell battery (see "Replacing the Coin-Cell Battery" on page 52).
- 10 Replace the Mini-Card(s) (see "Replacing the Mini-Card(s)" on page 23).
- 11 Replace the display assembly (see "Replacing the Display Assembly" on page 58).
- 12 Replace the keyboard (see "Replacing the Keyboard" on page 45).
- 13 Replace the palm-rest assembly (see "Replacing the Palm-Rest Assembly" on page 40).
- 14 Replace the optical drive (see "Replacing the Optical Drive" on page 34).
- 15 Follow the instructions in step 5 in "Replacing the Hard Drive(s)" on page 30.
- 16 Replace the memory module(s) (see "Replacing the Memory Module(s)" on page 18).
- 17 Replace the module cover (see "Replacing the Module Cover" on page 16).
- 18 Replace the battery (see "Replacing the Battery" on page 14).
- 19 Replace any blank or card you removed from the Media Card Reader.



CAUTION: Before turning on the computer, replace all screws and ensure that no stray screws remain inside the computer. Failure to do so may result in damage to the computer.

- 20 Turn on the computer.







NOTE: After you have replaced the system board, enter the computer Service Tag in the BIOS of the replacement system board.

- 21 Enter the service tag (see "Entering the Service Tag in the BIOS" on page 131).

Entering the Service Tag in the BIOS

- 1 Ensure that the AC adapter is plugged in and that the main battery is installed properly.
- 2 Turn on the computer.
- 3 Press <F2> during POST to enter the system setup program.
- 4 Navigate to the security tab and enter the service tag in the **Set Service Tag** field.

Speakers

-  **WARNING:** Before working inside your computer, read the safety information that shipped with your computer. For additional safety best practices information, see the Regulatory Compliance Homepage at www.dell.com/regulatory_compliance.
-  **CAUTION:** Only a certified service technician should perform repairs on your computer. Damage due to servicing that is not authorized by Dell™ is not covered by your warranty.
-  **CAUTION:** To avoid electrostatic discharge, ground yourself by using a wrist grounding strap or by periodically touching an unpainted metal surface (such as a connector on your computer).
-  **CAUTION:** To help prevent damage to the system board, remove the main battery (see "Removing the Battery" on page 13) before working inside the computer.

Removing the Speakers

- 1 Follow the instructions in "Before You Begin" on page 9.
- 2 Remove the battery (see "Removing the Battery" on page 13).
- 3 Disconnect the speaker cable from the I/O board connector.



- 1 speaker cable
- 4 Remove the system board (see "Removing the System Board" on page 127).
- 5 Make note of the speakers cable routing and remove the cable from the routing guides.
- 6 Remove the four screws (two on each speaker) that secure the speakers to the top cover.
- 7 Lift the speakers along with the cable off the top cover.

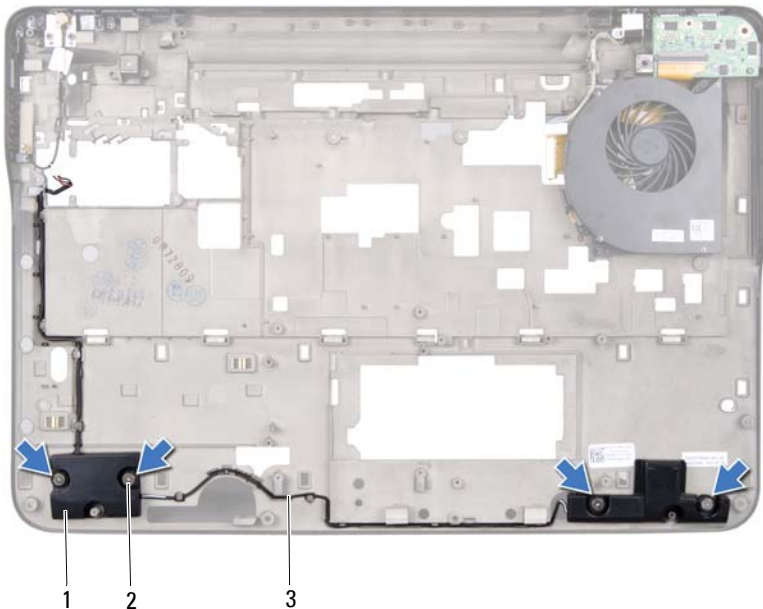

- 1 speakers (2)
- 2 screws (4)
- 3 speaker cable

Replacing the Speaker

- 1 Follow the instructions in "Before You Begin" on page 9.
- 2 Route the speakers cable through the routing guides
- 3 Align the screw holes on the speakers with the screw holes on the top cover.
- 4 Replace the four screws (two on each speaker) that secure the speakers to the base cover.
- 5 Replace the system board (see "Replacing the System Board" on page 129).
- 6 Connect the speaker cable to the system-board connector.
- 7 Replace the battery (see "Replacing the Battery" on page 14).



CAUTION: Before turning on the computer, replace all screws and ensure that no stray screws remain inside the computer. Failure to do so may result in damage to the computer.

Flashing the BIOS

The BIOS may require flashing when an update is available or when replacing the system board. To flash the BIOS:

- 1 Turn on the computer.
- 2 Go to support.dell.com/support/downloads.
- 3 Locate the BIOS update file for your computer:



NOTE: The Service Tag for your computer is located on a label at the bottom of your computer.

If you have your computer's Service Tag:

- a Click **Enter a Tag**.
- b Enter your computer's Service Tag in the **Enter a service tag:** field, click **Go**, and proceed to step 4.

If you do not have your computer's Service Tag:

- a Click **Select Model**.
- b Select the type of product in the **Select Your Product Family** list.
- c Select the product brand in the **Select Your Product Line** list.
- d Select the product model number in the **Select Your Product Model** list.



NOTE: If you have selected a different model and want to start over again, click **Start Over** on the top right of the menu.

- e Click **Confirm**.
- 4 A list of results appear on the screen. Click **BIOS**.
- 5 Click **Download Now** to download the latest BIOS file. The **File Download** window appears.
- 6 Click **Save** to save the file on your desktop. The file downloads to your desktop.
- 7 Click **Close** if the **Download Complete** window appears. The file icon appears on your desktop and is titled the same as the downloaded BIOS update file.

- 8 Double-click the file icon on the desktop and follow the instructions on the screen.