

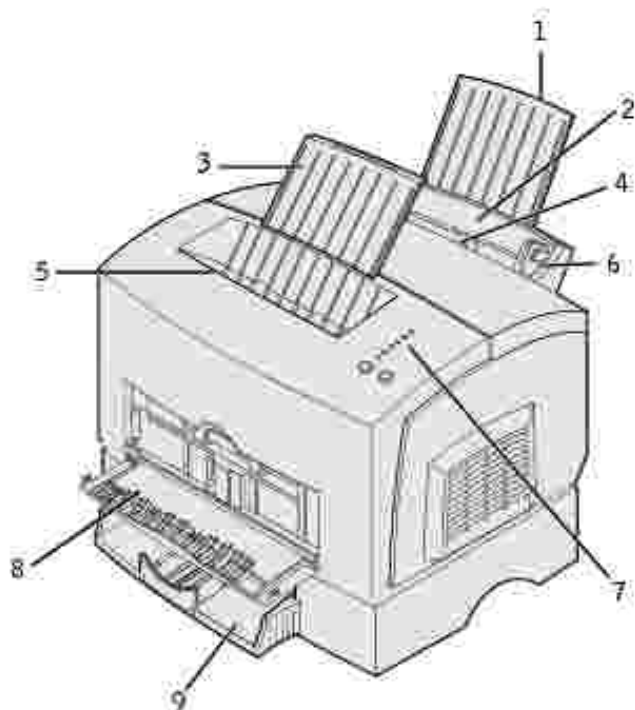

Dell™ Laser Printer P1500 User's Guide

Click the links to the left for information on the features and operation of your printer. For information on other documentation included with your printer, see [Finding information](#).





1	Rear paper support	6	Paper guide
2	Tray 1	7	Operator panel lights
3	Front paper support	8	Front output door
4	Manual feed	9	Optional 250-sheet tray
5	Top output bin		

To order replacement toner cartridges, contact Dell at www.dell.com/supplies.

 **NOTE:** Dell does not recommend that you use toner cartridges from a third-party refiller. Print quality and printer reliability cannot be guaranteed if you do. For best results, use Dell supplies.

Notes, Notices, and Cautions

 **NOTE:** A NOTE indicates important information that helps you make better use of your printer.

 **NOTICE:** A NOTICE indicates either potential damage to hardware or loss of data and tells you how to avoid the problem.

 **CAUTION:** A CAUTION indicates a potential for property damage, personal injury, or death.

Information in this document is subject to change without notice.
© 2003 Dell Computer Corporation. All rights reserved.

Reproduction in any manner whatsoever without the written permission of Dell Computer Corporation is strictly forbidden.

Trademarks used in this text: Dell and the DELL logo are trademarks of Dell Computer Corporation; Microsoft, Windows, and Windows NT are registered trademarks of Microsoft Corporation; ENERGY STAR is a registered trademark of the U.S. Environmental Protection Agency. As an ENERGY STAR Partner, Dell Computer Corporation has determined that this product meets the ENERGY STAR guidelines for energy efficiency.

Other trademarks and trade names may be used in this document to refer to either the entities claiming the marks and names or their products. Dell Computer Corporation disclaims any proprietary interest in trademarks and trade names other than its own.

UNITED STATES GOVERNMENT RESTRICTED RIGHTS

This software and documentation are provided with RESTRICTED RIGHTS. Use, duplication or disclosure by the Government is subject to restrictions as set forth in subparagraph (c)(1)(ii) of the Rights in Technical Data and Computer Software clause at DFARS 252.227-7013 and in applicable FAR provisions: Dell Computer Corporation, One Dell Way, Round Rock, Texas, 78682, USA.

FCC emissions information



This equipment has been tested and found to comply with the limits for a Class B digital device, pursuant to Part 15 of the FCC rules.



Refer to the *Drivers and Utilities CD* for details.

March 2003 Rev. A01 SRV 6Y468

Finding information

[Software overview](#)

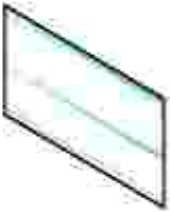
What are you looking for?	Find it here
<ul style="list-style-type: none">• Drivers for my printer• My <i>User's Guide</i>	<p><i>Drivers and Utilities CD</i></p>  <p>Documentation and drivers are already installed on your printer when shipped from Dell. You can use the CD to uninstall/reinstall drivers or access your documentation.</p> <p>Readme files may be included on your CD to provide last-minute updates about technical changes to your printer or advanced technical reference material for experienced users or technicians.</p>
<ul style="list-style-type: none">• Safety information• How to set up and use my printer• Warranty information	<p><i>Owner's Manual</i></p>  <p> NOTICE: Read and follow all safety instructions in your <i>Owner's Manual</i> prior to setting up and operating your printer.</p>
How to set up my printer	Setup diagram

	
Express Service Code and Service Tag number	<p>Express Service Code and Service Tag number</p>  <p>This label is located on your printer</p>
<ul style="list-style-type: none"> • Latest drivers for my printer • Answers to technical service and support questions • Documentation for my printer 	<p>Dell Support Website</p> <p>The Dell Support Website provides several online tools, including:</p> <ul style="list-style-type: none"> • Solutions - Troubleshooting hints and tips, articles from technicians, and online courses • Upgrades - Upgrade information for components, such as memory • Customer Care - Contact information, order status, warranty, and repair information • Downloads - Drivers • Reference - Printer documentation and product specifications <p>You can access Dell Support at support.dell.com. Select your region on the WELCOME TO DELL SUPPORT page, and fill in the requested details to access help tools and information.</p>

Software overview

Use the Drivers and Utilities CD that came with your printer to install a combination of software applications, depending on your operating system.

Operating System	Status Monitor	Printing Status Window	Toner Reorder Application	Desktop icon to order supplies
Microsoft® Windows 98 Windows ME	Y	N	N	Y*
Windows NT® 4.0	N	N	N	Y*
Windows 2000 Windows XP	N	Y	Y	Y

*Available in HTML format.

 **NOTE:** If you purchased your printer and computer separately, you must use the *Drivers and Utilities CD* to install these software applications.

Status Monitor

The Status Monitor alerts you when an error or warning occurs. For example, when the top cover is open or toner is running low.

The Status Monitor launches when you send a print job to the printer and only appears on the computer screen when an error or warning occurs.

Printing Status window

The Printing Status window displays the status of the printer (Printer Ready, Printer Offline, and Error - Check Printer) and the name of the job when you send a job to print.

The Printing Status window also displays the level of toner so you can:

- Monitor the toner level for your printer.
- Click Order Toner to order replacement toner cartridges.

See [Toner Re-order window](#) for more information.

Toner Re-order window

The Order Toner Cartridges dialog can be launched from the Printing Status window, the Programs window, or the desktop icon.

You can order toner by phone or from the Web.

1. Click Start → Programs → Dell Printers → Dell Laser Printer P1500 → Dell Toner Re-Order Application.

The Order Toner Cartridges window appears.

2. If ordering from the Web:
 - a. Choose your printer model from the drop-down list on the screen.
 - b. Enter your Dell printer Service Tag number in the field provided.

Your Service Tag number is located on your printer.

- c. Click Visit Dell's cartridge ordering web site.
3. If ordering by phone, call the number that appears under the By Telephone heading.

About your printer

- [Understanding printer features](#)
 - [Using the operator panel buttons](#)
 - [Printing the Printer Settings Configuration sheet](#)
 - [Choosing the right cable](#)
-

Understanding printer features

Your Dell™ Laser Printer P1500 offers the following features:

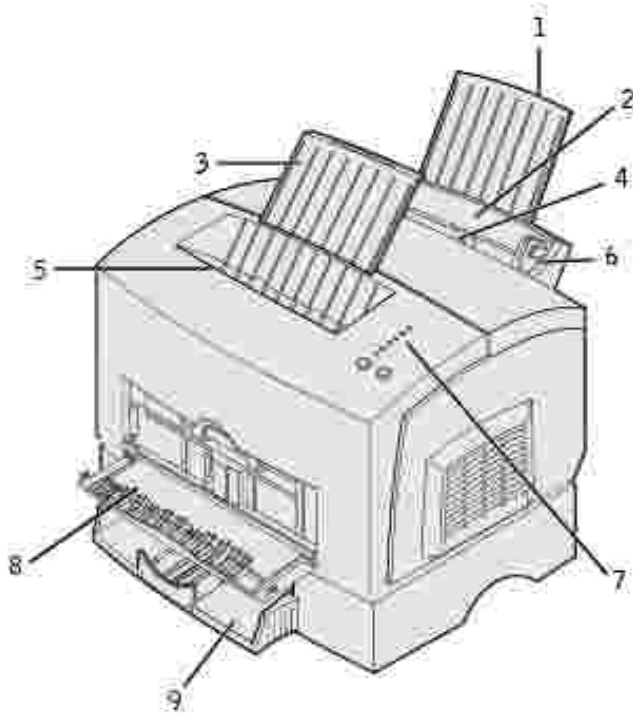

1	Rear paper support	6	Paper guide
2	Tray 1	7	Operator panel lights
3	Front paper support	8	Front output door
4	Manual feed	9	Optional 250-sheet tray
5	Top output bin		

Use this feature:	When you want to:
Tray 1	Load up to 150 sheets of paper or 10 sheets of specialty media.
Rear paper support	Support media in tray 1.
Front paper support	Support media in the top output bin.
Manual feed	Load a single sheet of paper or other media, such as transparencies, labels, envelopes, and card stock.
Paper guides	Adjust the width of the media in tray 1 and the manual feed.
Operator panel lights	Check the status of your printer.
Top output bin	Stack printed documents face down.
Front output door	Print on specialty media, such as card stock or labels.
Optional 250-sheet drawer	Increase your paper capacity.

Using the operator panel buttons

The operator panel has six lights and two buttons.

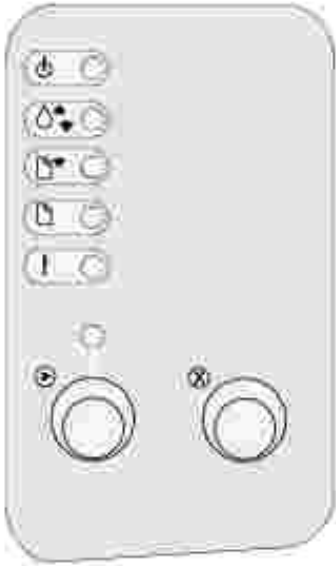

- Press and release Continue to resume printing.
- Press and release Continue twice quickly to display an error code.
- Press and release Cancel to cancel the job currently printing.

- Press and hold Cancel until all of the lights come on to reset the printer.
-

Printing the Printer Settings Configuration sheet

To print the Printer Settings Configuration sheet:

1. Turn the printer off.
2. Open the upper front door.
3. Press and hold Continue as you turn the printer on.

All the lights cycle.

4. Release Continue.
5. Close the upper front door.
6. The light sequence that represents the Home menu is displayed.
7. Press and release Continue until all the lights cycle.

A Printer Settings Configuration sheet prints.

Choosing the right cable

Your Dell™ Laser Printer P1500 interconnection cable must meet the following requirements:

Connection	Cable certification
USB	USB 2.0
Parallel	IEEE-1284

Replacing the toner cartridge

- [Conserving supplies](#)
 - [Ordering replacement toner cartridges](#)
 - [Replacing the toner cartridge](#)
-

Conserving supplies

Conserving supplies lowers printing costs.

- When printing drafts, conserve toner by changing the Print Darkness setting in your printer driver. The settings range from Very Light to Very Dark. Selecting the Very Light setting conserves toner.
 - Reduce paper consumption by printing on both sides of the paper.
-

Ordering replacement toner cartridges

To order replacement toner cartridges, contact Dell at www.dell.com/supplies.

In addition to the toner level indicator that is displayed each time you send a job to print, the printer operator panel light sequences tell you about the status of your supplies.

When the Toner Low light comes on (in this example, the light is on while the printer is busy receiving data or printing), check that you have a new toner cartridge available.

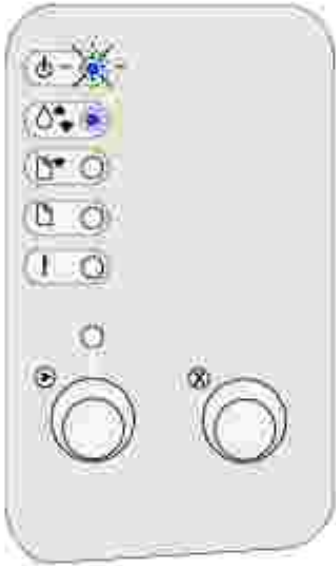

To use the remaining toner, remove the toner cartridge, shake it gently back and forth, and reinsert it. When the print fades or no longer prints satisfactorily, replace the toner cartridge.

 **NOTE:** Dell does not recommend that you use toner cartridges from a third-party refiller. Print quality and printer reliability cannot be guaranteed if you do. For best results, use Dell supplies.

Replacing the toner cartridge

Removing the old toner cartridge

1. Use the finger tab to pull down the printer cover.

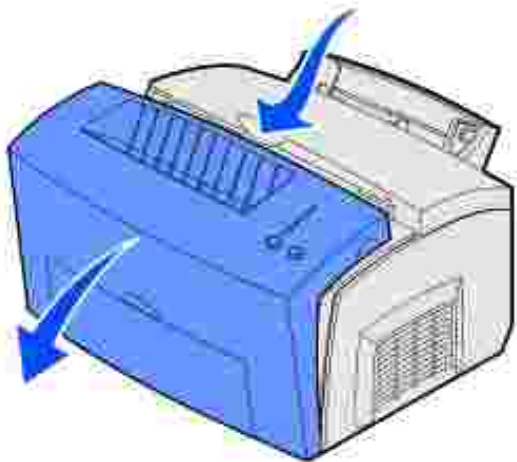

2. Grasp the cartridge handle and pull the toner cartridge straight up (it may be warm).

 **NOTE:** Do not touch the photoconductor drum on the bottom of the toner cartridge.

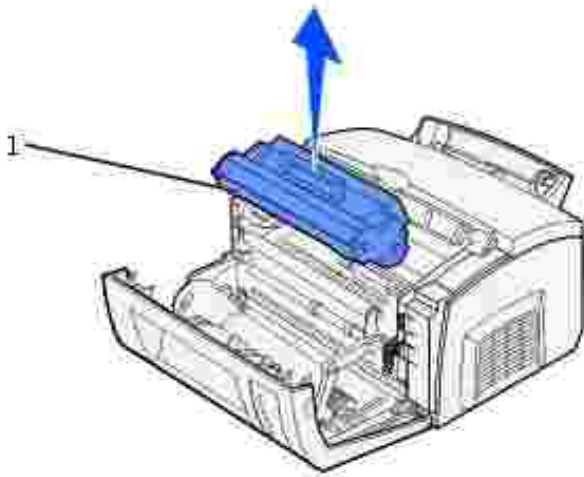

1	Photoconductor drum
---	---------------------

3. Set the toner cartridge aside.

 **NOTE:** Dell cannot guarantee print quality or printer reliability if you use refilled cartridges from a third party. The printer warranty does not cover damage caused by using refilled cartridges.

Installing the new toner cartridge

1. Take the new toner cartridge out of the bag.
2. Pull off the plastic piece attached to the ends of the toner cartridge, and remove the foam protective liner.

 **NOTE:** Do not touch the photoconductor drum on the bottom of the toner cartridge.

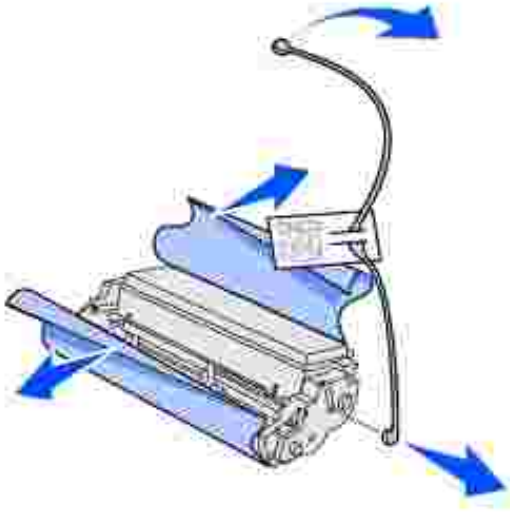

3. Gently shake the cartridge to distribute the toner evenly.
4. Insert the toner cartridge.
 - a. Align the colored arrows on either side of the toner cartridge with the corresponding arrows in the printer.
 - b. Holding the handle, tilt the cartridge down and guide it between the toner cartridge grooves.

 **CAUTION:** Avoid touching the fuser; it may be hot!

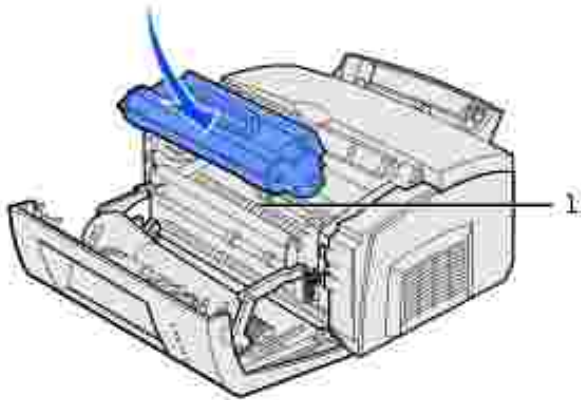

1	Fuser
---	-------

- c. Push down on the cartridge until it is firmly in place.
5. Close the printer cover.

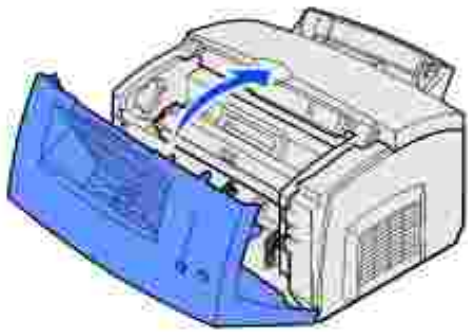

To get the maximum benefit from your toner cartridge:

- Do not remove the toner cartridge from its packaging until you are ready to install it.
- Store toner cartridges in the same environment as the printer.
- Do not remove the toner cartridge from the printer except to replace it or to clear a paper jam.

Printing

- [Using the operator panel lights](#)
 - [Setting up a print job](#)
 - [Canceling a print job](#)
 - [Sharing printers](#)
-

Using the operator panel lights

The operator panel has six lights and two operator panel buttons.



When the:	The printer:
Ready/Data light is on	Is ready to receive and process data.
Ready/Data light is blinking	Is busy receiving or processing data.
Toner Low light is on	Alerts you that the toner is getting low.
Load Paper light is on	Prompts you to load media in tray 1, manual feed, or the optional 250-sheet tray (if installed).
Paper Jam light is on	Detects a jam.
Error light is on	Cover is open or the toner cartridge is not installed.
Press Continue light is on	Prompts you to press Continue to resume printing.
Error light and Press Continue light are both on	Alerts you that a secondary error occurred.

Setting up a print job

Once your printer is set up and your drivers are installed, you are ready to print.

For example, if you have plain paper loaded in tray 1, but you want to print a letter on letterhead paper and an envelope:

1. Load letterhead with the top of the page pointing down facing you in tray 1.

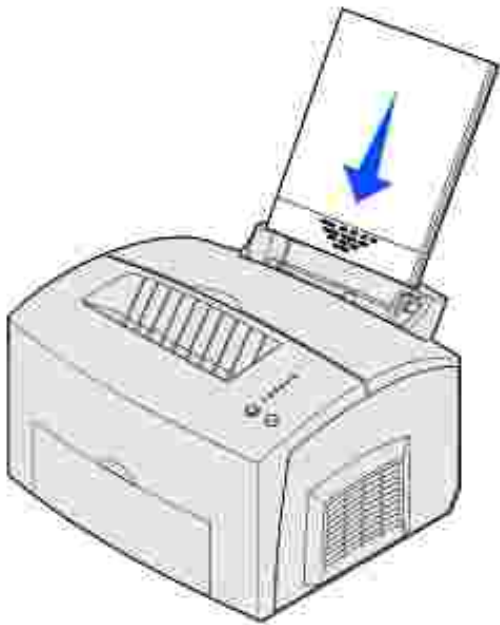

2. From your software program, open the file you want to print.
3. From the File menu, select Print (or Printer) Setup to open your printer driver.
4. Verify the correct printer is selected in the dialog box.
5. In the Print Setup dialog box, click Properties, Options, or Setup (depending on the program), to change the paper setting to Letterhead, and then click OK.
6. Click OK or Print.

Now print the envelope:

1. Load an envelope vertically, flap side down, with the stamp area in the top left corner in the manual feed.

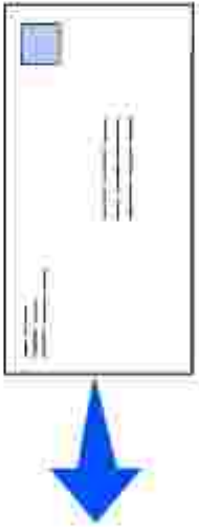

2. From the File menu, select Print (or Printer) Setup to open your printer driver.
3. In the Print Setup dialog box, click Properties, Options or Setup (depending on the program) and select the size of envelope you want from the Paper Type setting.
4. Change Orientation to Landscape.
5. In the Print dialog box, click OK.

 **NOTE:** To change printer settings not available from your printer driver, install the Local Printer Setup Utility from the *Drivers and Utilities CD* (see [Using the Local Printer Setup Utility](#)).

If you need an explanation about a printer setting:

- Click the Help box in the bottom right corner of any dialog box.
- Move your cursor to the setting in question and press F1 or right-click your mouse.

Canceling a print job

From the printer operator panel

Press and release Cancel to cancel the job currently printing.

From your computer

1. Minimize all programs to display the desktop.
2. Double-click the My Computer icon.
3. Double-click the Printer icon.

A list of available printers appears.

4. Double-click the printer you are using to print the job.

A list of print jobs appears.

5. Select the job you want to cancel.
6. Press the Delete key on the keyboard.

Sharing printers

Setting up the printer for sharing (Windows 95, 98, NT 4.0, Windows Me, and Windows 2000)

1. Click Start → Settings → Printers.
2. Select the printer you just created.
3. Click File → Sharing.
4. Check the Shared check box, and then enter a name in the Shared Name text box.
5. In the Alternate Drivers section, select the operating systems of all the network clients that will print to the printer.
6. Click OK.

 **NOTE:** If you are missing files, you may be prompted to provide the server operating system CD.

7. Check the following to make sure the printer was successfully shared.
 - o The printer object in the Printers folder now has a shared indicator. For example, in Windows NT 4.0, a hand appears under the printer object.
 - o Browse Network Neighborhood. Find the host name of the server and look for the shared name you assigned to the printer.

The printer is now shared and ready to be installed on network clients.

Setting up the printer for sharing (Windows XP)

1. Click Start → Control Panel → Printers and Other Hardware → Printers and Faxes.
2. Select the printer you just created.
3. Click File → Sharing.
4. Select the Network setup wizard.
5. Click OK.
6. Browse Network Neighborhood. Find the host name of the server and look for the shared name you assigned to the printer.

The printer is now shared and ready to be installed on network clients.

Installing a shared printer on network clients

Using the point and print method

This method is usually the best use of system resources. The server handles driver modifications and the print job processing. This lets network clients return to programs much faster.

With this method, a subset of driver information is copied from the server to the client computer. This is just enough information to send a print job to the printer.

1. On the Windows desktop of the client computer, double-click Network Neighborhood.
2. Locate the host name of the server computer, and then double-click the host name.
3. Right-click the shared printer name, and then click Install.

Wait for the driver information to copy from the server computer to the client computer, and for a new

printer object to be added to the Printers folder. The time this takes varies, based on network traffic and other factors.

4. Close Network Neighborhood.
5. Print a test page to verify printer installation.
 - a. Click Start → Settings → Printers.
 - b. Select the printer you just created.
 - c. Click File → Properties.
 - d. On the General tab, click Print Test Page.

When a test page prints successfully, printer installation is complete.

Using the peer-to-peer method

With this method, the printer driver is fully installed on each client computer. Network clients retain control of driver modifications. The client computer handles the print job processing.

1. Click Start → Settings → Printers.
2. Click Add Printer to launch the Add Printer wizard.
3. Click Network Print Server.
4. Select the network printer from the Shared printers list. If the printer is not listed, enter the path of the printer in the text box.

The path will look similar to the following:

```
\\<server host name>\<shared printer name>
```

The server host name is the name of the server computer that identifies it to the network. The shared printer name is the name assigned during the server installation process.

5. Click OK.

 **NOTE:** If this is a new printer, you may be prompted to install a printer driver. If no system driver is available, then you will need to provide a path to available drivers.

6. Select whether you want this printer to be the default printer for the client, and then click Finish.
7. Print a test page to verify printer installation.
 - a. Click Start → Settings → Printers.
 - b. Select the printer you just created.

c. Click File → Properties.

d. On the General tab, click Print Test Page.

When a test page prints successfully, printer installation is complete.

Paper handling

- [Locating printer media sources](#)
 - [Loading paper](#)
 - [Loading transparencies](#)
 - [Loading envelopes](#)
 - [Loading labels](#)
 - [Loading card stock](#)
 - [Printing on both sides of the paper](#)
-

Locating printer media sources

Your printer has two standard paper sources: an automatic paper feeder (tray 1), which holds up to 150 sheets of plain paper, and a single-sheet manual feed. Use tray 1 for most print jobs. Use the manual feed for a single piece of paper, transparency, envelope, label, or index card.

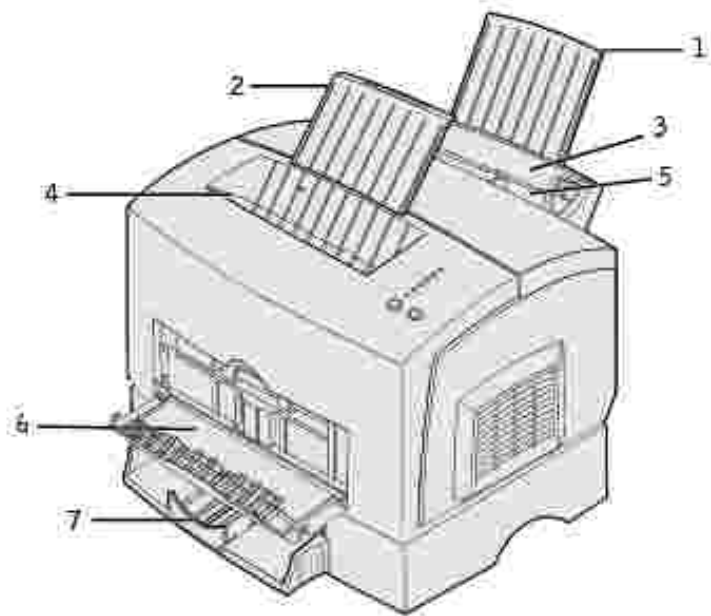

1	Paper support	5	Manual feed
2	Paper support	6	Front output door
3	Tray 1	7	Optional 250-sheet tray
4	Top output bin		

An exit output bin on top of the printer holds up to 100 sheets. The single-sheet front output door provides a straight-through paper path for special media, such as transparencies, envelopes, labels, card stock or index cards, reducing curling and potential paper jams.

To increase paper capacity, you can purchase the optional 250-sheet tray.

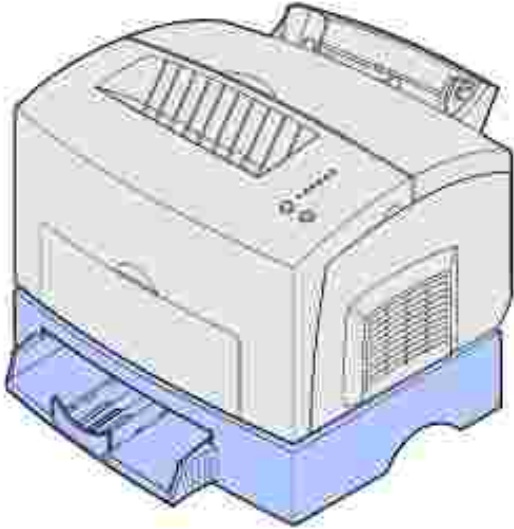

Loading paper

Tray 1

1. Extend the rear paper support until you hear a *click*.



2. Flex the sheets back and forth to loosen them, fan the sheets on all four sides, and flex them again.

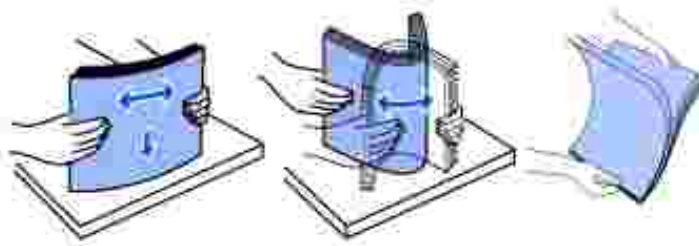

3. If loading letterhead paper, insert letterhead with the top of the page pointing down, facing you.

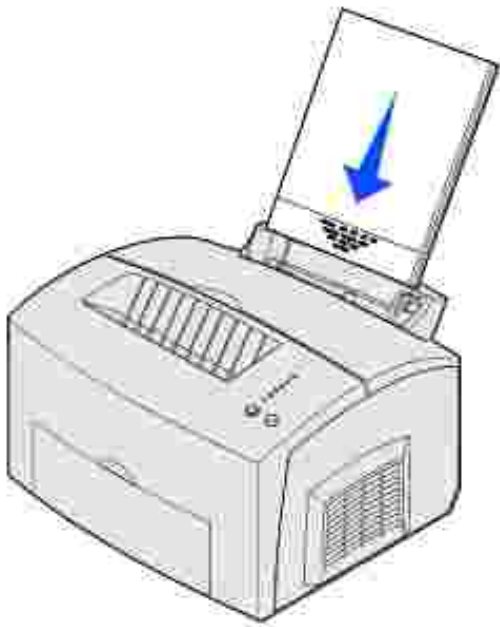

 **NOTE:** Preprinted papers such as letterhead must be able to withstand temperatures up to 200°C (392°F) without melting or releasing hazardous emissions.

4. Slide the paper guides against the edges of the paper.

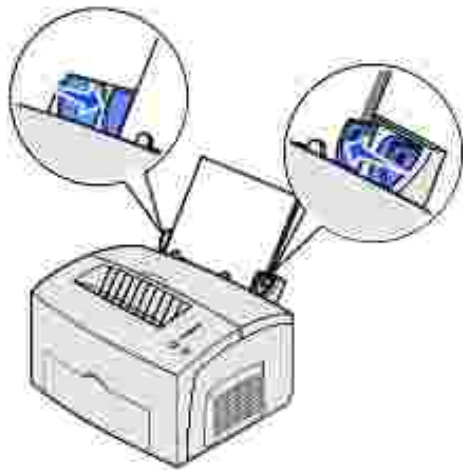

5. Extend the front paper support on the top output bin until you hear a *click*. If you are printing on legal size paper, completely extend the front paper support.

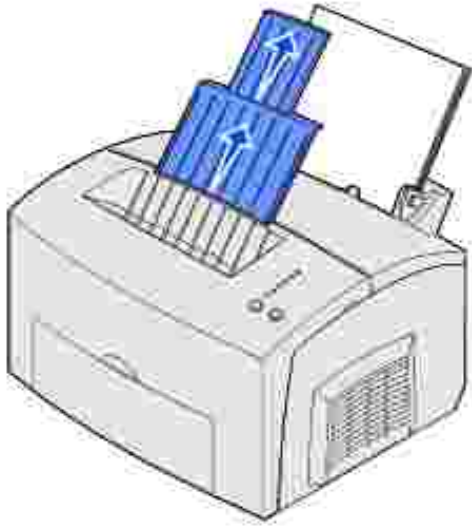

6. Select the paper size and type from your software program.
7. Start your print job.

Manual feed

Use the manual feed to print one sheet of paper at a time.

1. If loading letterhead paper, insert one sheet of letterhead with the top of the page pointing down, facing you.
2. Slide the paper guides flush against the edges of the paper.

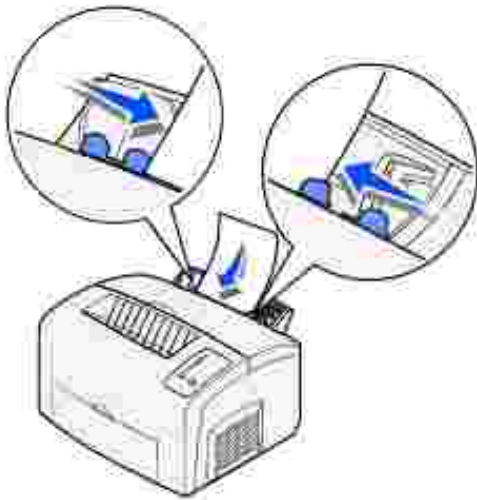

3. Select the paper size and type from your software program.

4. Start your print job.
5. Press and release Continue to resume printing.
6. When the Load Paper light blinks and the Press Continue light comes on, place another sheet in the manual feed.



7. Press Continue.

Optional 250-sheet tray

1. Grasp the tabs on either side of the tray and pull it completely out of the printer.

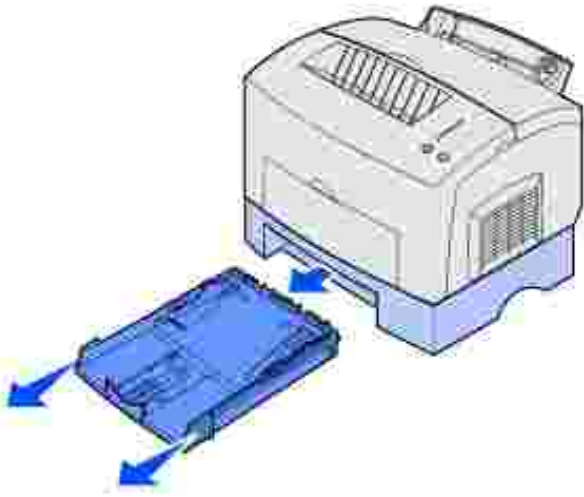

2. Before loading paper, push down on the metal plate until it locks into place.

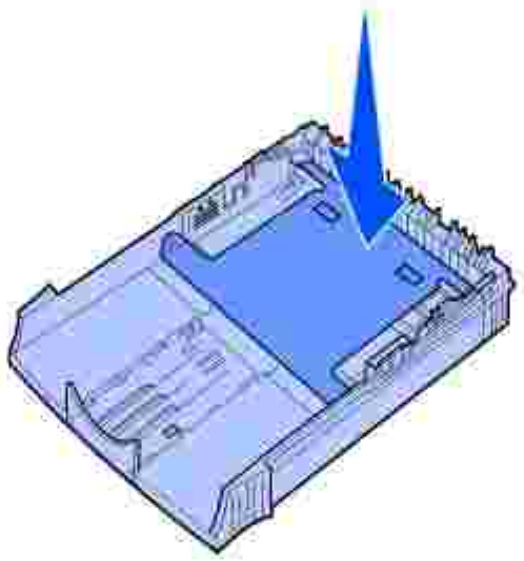

3. If loading A4 or legal size paper, extend the paper support.

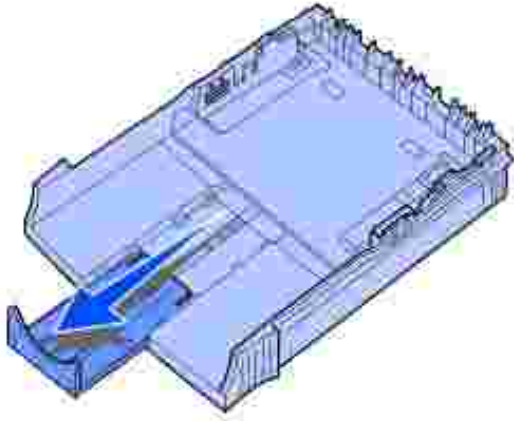

4. Flex the sheets back and forth to loosen them, fan the sheets on all four sides, and flex them again.

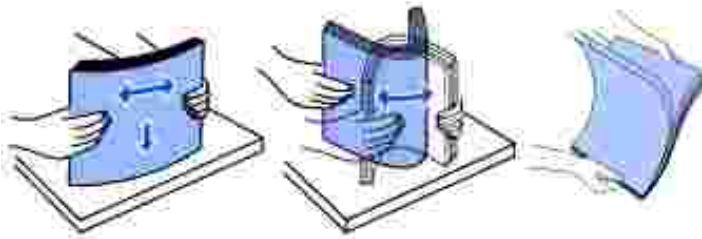

5. If loading letterhead paper, insert letterhead face down with the top of the page entering the printer first.
6. Do not exceed the stack height indicator; overfilling the tray may cause paper jams.

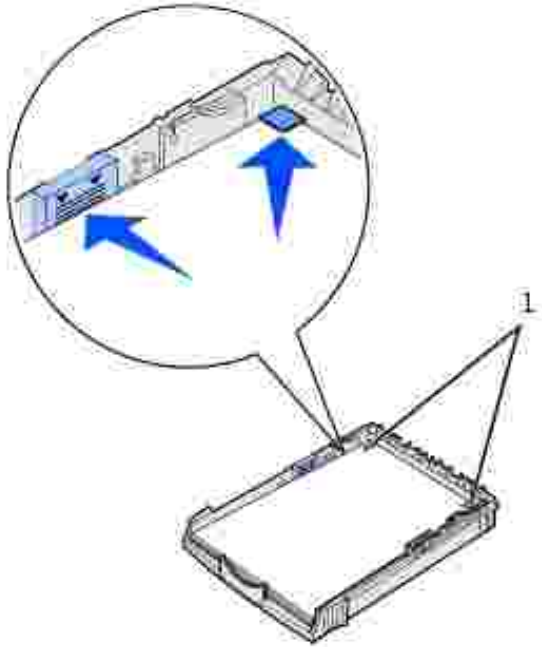

1 Corner bucklers

7. Make sure the paper is under both corner bucklers and lying flat in the tray.
8. Slide the paper guides flush against the edges of the media.
9. Reinstall the tray firmly into the printer.

If the tray is not pushed all the way in, the paper may not feed properly.

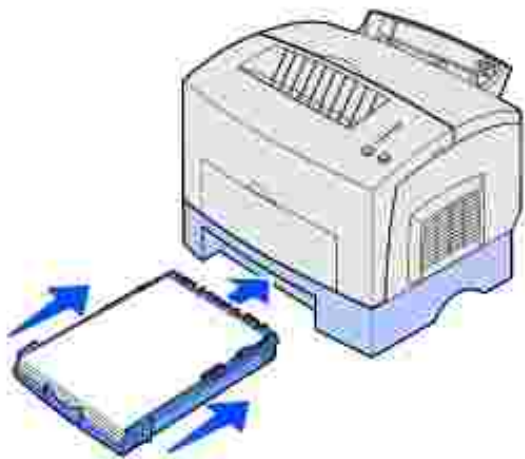

10. Select the paper size from your software program.
11. Start your print job.

Loading transparencies

When printing on transparencies, use transparencies designed for laser printers.

Tray 1

1. Extend the rear paper support until you hear a *click*.



2. To reduce curling or potential jams, open the front output door for a straight paper path.

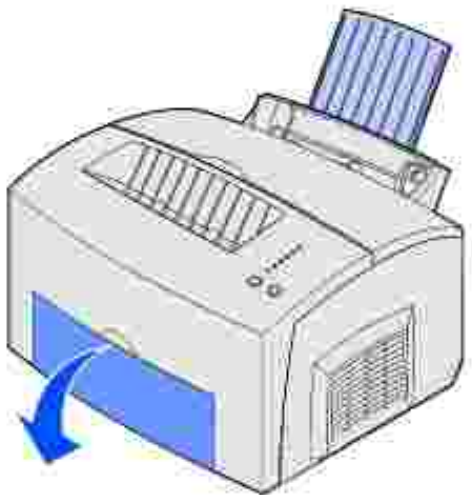

3. Flex the sheets back and forth to loosen them, fan the sheets on all four sides, and flex them again.

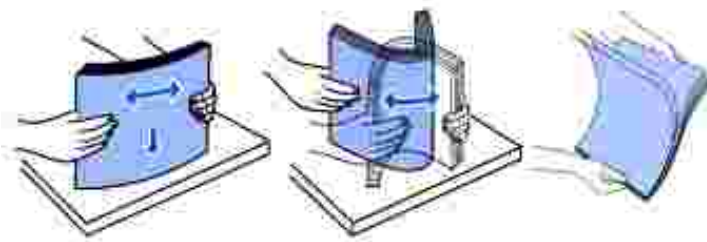

4. Load up to 10 transparencies with the side on which you want to print facing you.

 **NOTE:** Transparencies must be able to withstand temperatures of 200°C (392°F) without melting or releasing hazardous emissions.

5. Slide the paper guides against the edges of the transparencies.

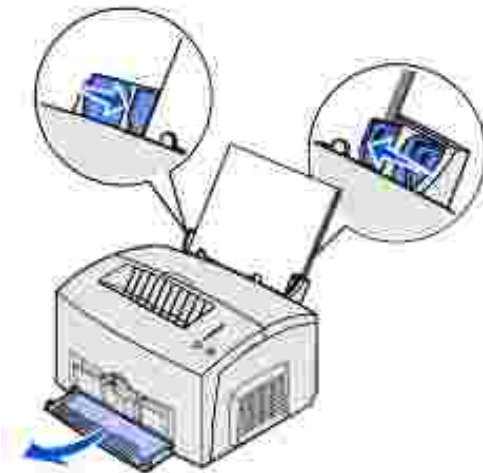

6. Select the paper type from your software program.

7. Start your print job.

Manual feed

Use the manual feed to print one transparency at a time.

1. To reduce curling or potential jams, open the front output door for a straight paper path.

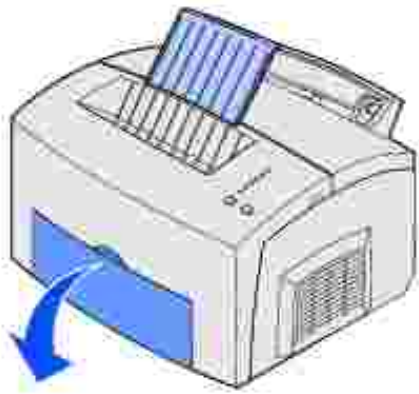

2. Slide the paper guides flush against the edges of the transparency.

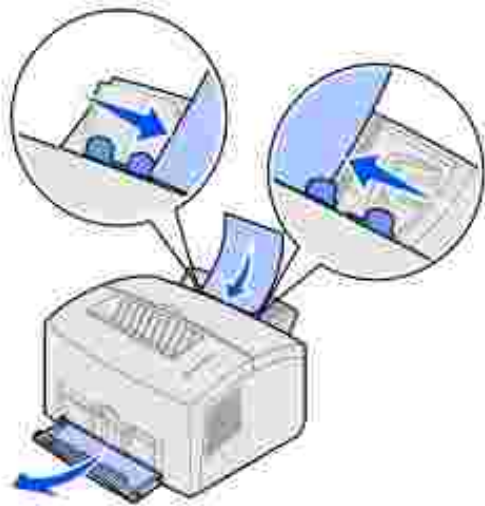

3. Select the paper size and type from your software program.
4. Start your print job.
5. Press and release Continue to resume printing.
6. When the Load Paper light blinks and the Press Continue light comes on, place another transparency in the manual feed.

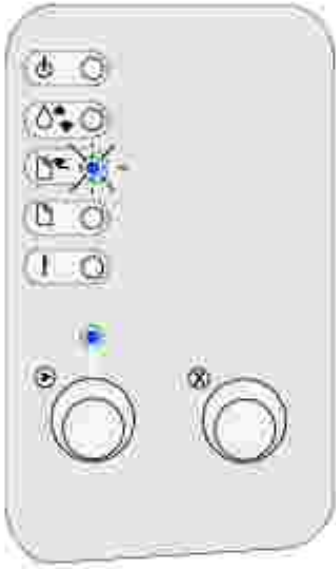

7. Press Continue.

Loading envelopes

Load up to 10 envelopes in tray 1 or load envelopes one at a time in the manual feed.

Tray 1

1. Extend the rear paper support until you hear a *click*.



2. Open the front output door for a straight paper path.

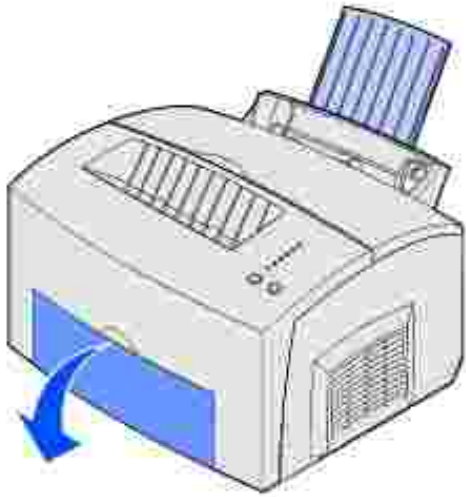

3. Load up to 10 envelopes in the *center* of tray 1 and adjust the paper guides to fit the width of the envelopes.

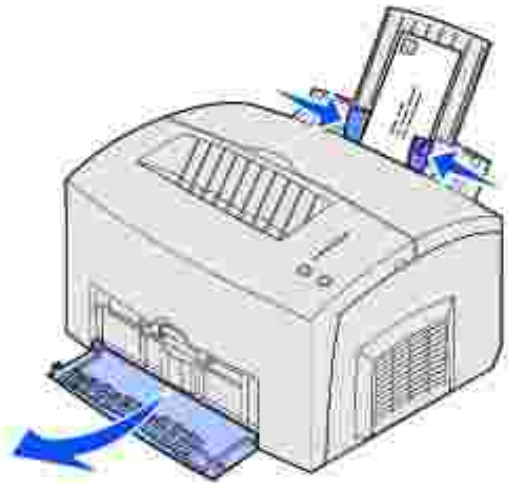

 **NOTE:** Use envelopes that can withstand temperatures of 200°C (392°F) without sealing, excessive curling, wrinkling or releasing hazardous emissions.

4. Select the paper type from your software program.
5. Start your print job.

Manual feed

Use the manual feed to print one envelope at a time. If you experience problems feeding envelopes in tray 1, try printing them one at a time from the manual feed.

1. Open the front output door for a straight paper path.



2. Load an envelope in the *center* of the manual feed and adjust the paper guides to fit the width of the envelope.

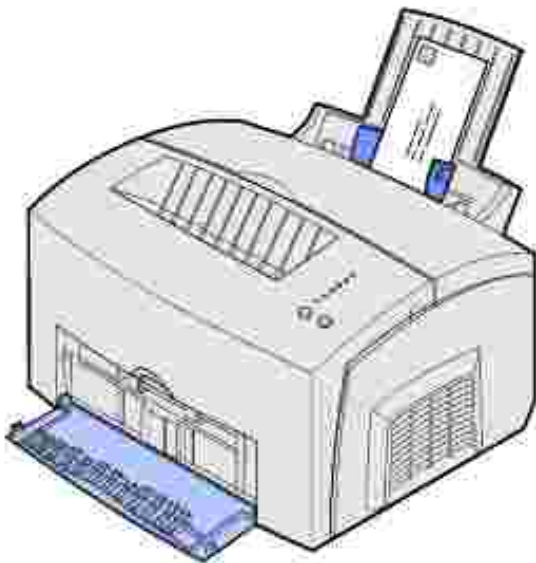

3. Select the paper size and type from your software program.
4. Start your print job.
5. Press and release Continue to resume printing.

6. When the Load Paper light blinks and the Press Continue light comes on, place another envelope in the manual feed.



7. Press Continue.

Loading labels

For occasional label printing, use paper labels designed for laser printers. You can load labels one at a time from the manual feed, or you can load up to 10 sheets of labels in tray 1.

Tray 1

1. Extend the rear paper support until you hear a *click*.



2. To reduce curling or potential jams, open the front output door for a straight paper path.

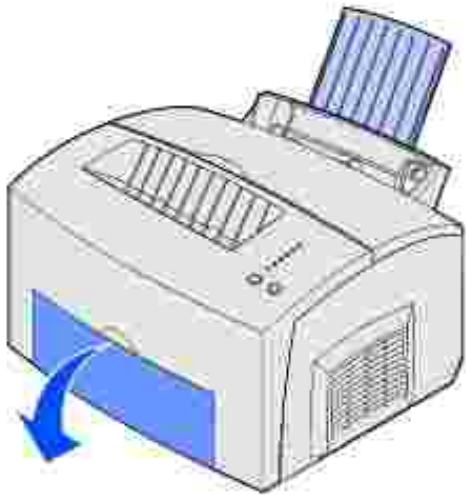

3. Flex the sheets back and forth to loosen them, fan the sheets on all four sides, and flex them again.



4. Load up to 10 label sheets with the side you want to print on facing you.



 **NOTE:** Use labels with a pressure of 25 psi that can withstand temperatures of 200°C (392°F) without releasing hazardous emissions.

5. Slide the paper guides against the edges of the label sheets.

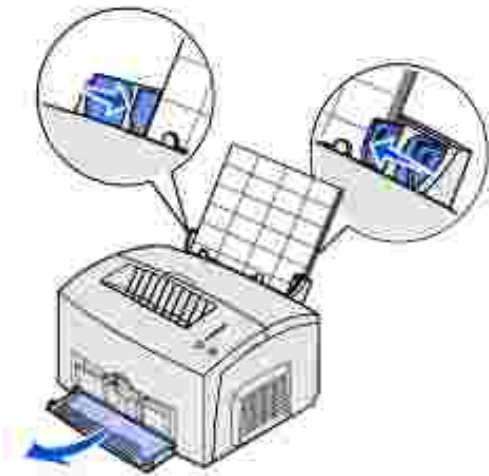

6. Select the paper size and type from your software program.
7. Start your print job.

Manual feed

Use the manual feed to print one label sheet at a time. If you experience problems feeding labels in tray 1, try printing one sheet at a time from the manual feed.

1. Extend the front paper support on the top output bin until you hear a *click*.

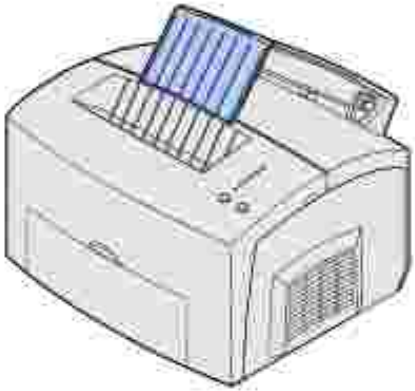

2. Open the front output door for a straight paper path.

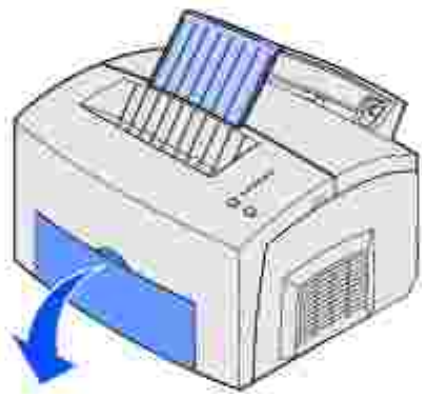

3. Load the label sheet with the side on which you want to print facing you.



4. Slide the paper guides against the edges of the label sheet.

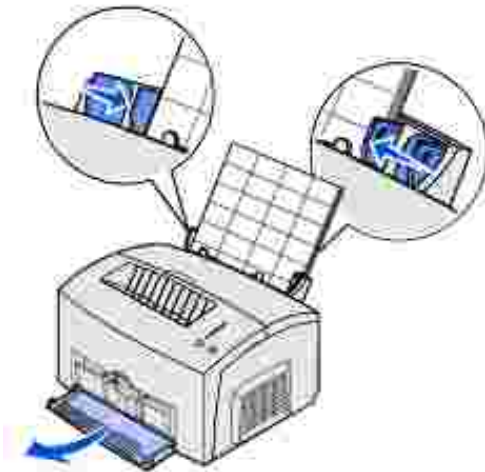

5. Select the paper size and type from your software program.
6. Start your print job.
7. Press and release Continue to resume printing.
8. When the Load Paper light blinks and the Press Continue light comes on, place another label sheet in the manual feed.



9. Press Continue.

Loading card stock

For occasional printing on index Bristol or tag card stock, load up to 10 sheets of card stock or index cards in tray 1. Load one sheet of card stock or one index card at a time in the manual feeder.

Tray 1

1. Extend the rear paper support until you hear a *click*.



2. For best results, open the front output door for a straight paper path.

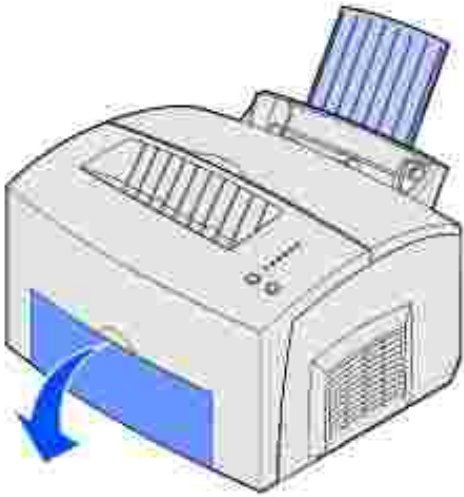

3. Load up to 10 sheets of card stock or 10 index cards with the print side facing you.

 **NOTE:** Use card stock with a pressure of 25 psi that can withstand temperatures of 200°C (392°F) without releasing hazardous emissions.

4. Slide the paper guides against the edges of the card stock.

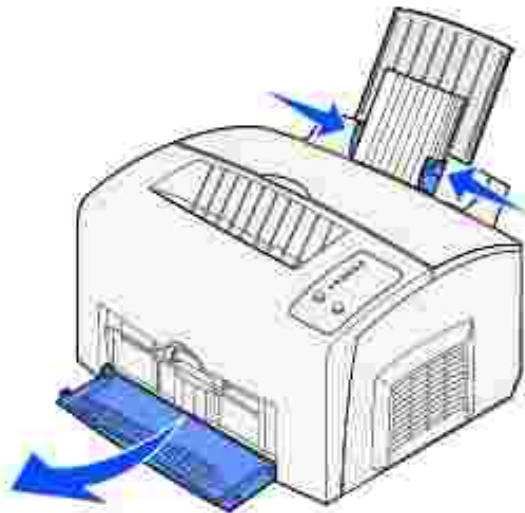

5. Select the paper size and type from your software program.
6. Start your print job.

Manual feed

Use the manual feed to print one sheet of card stock or one index card at a time. If you experience problems feeding index cards in tray 1, try printing them one at a time from the manual feed.

1. Open the front output door for a straight paper path.

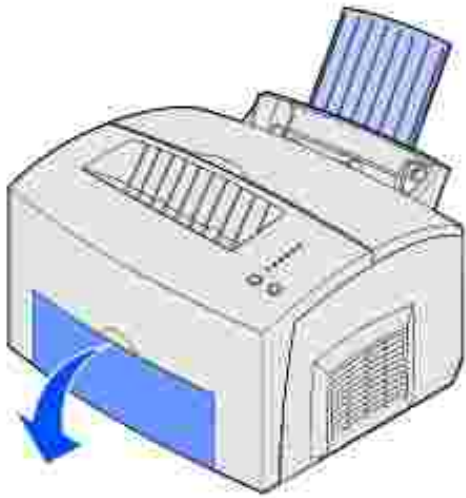

2. Load an index card with the print side facing you.
3. Slide the paper guides against the edges of the index card.

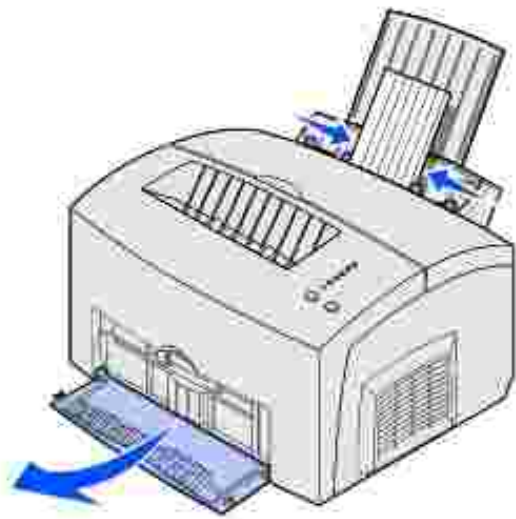

4. Select the paper size and type from your software program.

5. Start your print job.
6. Press and release Continue to resume printing.
7. When the Load Paper light blinks and the Press Continue light comes on, place another index card in the manual feed.



8. Press Continue.

Printing on both sides of the paper

Printing on both sides of the paper reduces printing costs. Select Duplex from your printer driver to format your job to print every other page of the document first. Once the first side of your job prints, the Load Paper light comes on and the Press Continue light blinks. Follow the instructions from your driver pop-up menu to print the corresponding back side to each page.

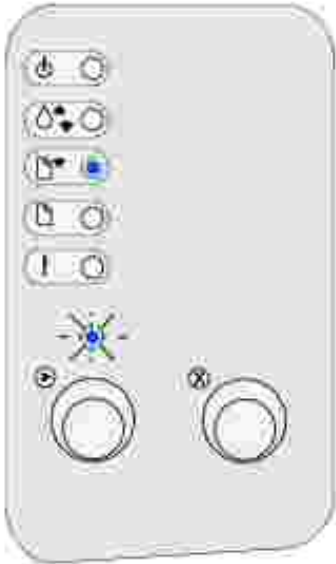

NOTE: Manual duplex is only available on Windows NT 4.0, Windows 2000, and Windows XP.

Although you can use tray 1 or the optional 250-sheet tray to print the first side of the duplex job, only use tray 1 to print the second side.

You can also choose how you want your job duplexed: Long Edge or Short Edge.

Long Edge means pages are bound along the long edge of the page (left edge for portrait, top edge for landscape).

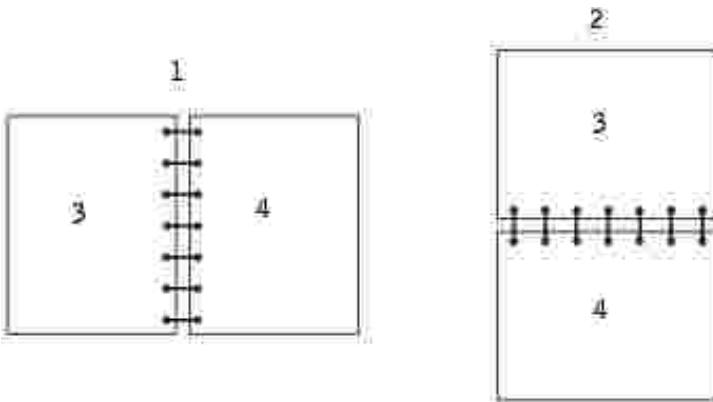

1	Portrait
2	Landscape
3	Back of sheet
4	Front of next sheet

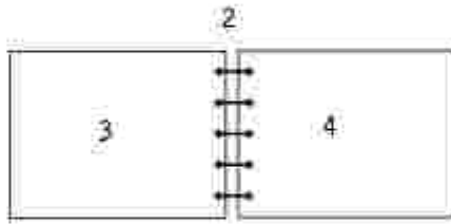
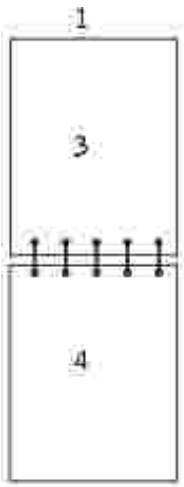

Short Edge means pages are bound along the short edge of the page (top edge for portrait, left edge for landscape).









1	Portrait
2	Landscape
3	Back of sheet
4	Front of sheet

Understanding the operator panel lights



























The operator panel lights mean different things, depending on their sequence. Lights that are off, on, and/or blinking indicate printer conditions such as printer status, intervention (for example, out of paper), or service.

Key:			
Off	On	Slow blink	Fast blink
			



























The following table shows the most common light sequences. Click the links in the right column for more information on what it means and what you can do.















Common light sequences:							
Ready/Data	Toner Low	Load Paper	Paper Jam	Error	Press Continue	Printer condition:	Click here for more information:
						<ul style="list-style-type: none"> • Ready • Power Saver 	The printer is ready to receive and process data.
						<ul style="list-style-type: none"> • Ready and toner low • Power saver and toner low 	The printer is ready to receive and process data. In addition, the toner in the toner cartridge is getting low.
						Not ready (printer is offline)	The printer is not ready to receive or process data, or the printer ports are offline.
						Not ready and toner low	The printer is not ready to receive or process data, or the printer

							ports are offline. In addition, the toner in the toner cartridge is getting low.
						<ul style="list-style-type: none"> • Busy • Defragmenting flash • Formatting flash • Programming flash • Printing a directory • Printing menu settings page(s) • Printing Print Quality Test Pages 	The printer is busy receiving and processing data or printing.
						Busy and toner low	The printer is busy receiving or processing data, or printing a test page. In addition, the toner in the toner cartridge is getting low.
						Waiting	The printer is waiting until a print timeout occurs, or until it receives additional data.
						Waiting and toner low	The printer is waiting until a print timeout occurs, or until it receives additional data. In addition, the toner in the toner cartridge is getting low.
						<ul style="list-style-type: none"> • Flushing • Resolution reduced 	The printer is flushing corrupted print data.
						<ul style="list-style-type: none"> • Flushing and toner low • Resolution reduced and toner low 	The printer is flushing corrupted print data. In addition, the toner in the toner cartridge is









							getting low.
						Load manual feed	The printer prompts you to load a single sheet of media in the manual feed.
						Load tray 1 or the optional 250-sheet tray	The printer is out of media, or the media did not feed properly.
						Print side two of your duplex print job	Print the other side of your duplex print job.
						Top cover open	The printer top cover is open.
						<ul style="list-style-type: none"> • Toner cartridge error • Toner cartridge is not installed 	The toner cartridge is not installed, or the printer detects a toner cartridge error.
						Change invalid toner cartridge	The toner cartridge you are using was not designed for your printer.
						Hex Trace Ready	The printer is in the Ready mode and Hex Trace is active.
						Hex Trace Ready and toner low	The printer is in the Ready mode, Hex Trace is active, and the toner in the toner cartridge is getting low.
						<ul style="list-style-type: none"> • Cancel job • Reset printer • Restore factory defaults 	The current print job is canceled.
						Service error	The printer has a service error and printing has stopped.

When the Error and Press Continue lights are both on, a secondary error occurred. Press and release Continue twice quickly to display secondary error code light sequences. The following table shows what these light sequences mean and what you can do.

Secondary error code light sequences							
Ready/Data	Toner Low	Load Paper	Paper Jam	Error	Press Continue	Printer condition:	Click here for more information:
						Secondary error code	Secondary error code
						Insufficient collation area	The printer memory does not have the free space necessary to collate the print job.
						Memory full	The printer is processing data, but the memory used to store pages is full.
						Complex page	The page may not print correctly because the print information on the page is too complex.
						Short paper	The paper length is too short to print the formatted data.
						Font error	The printer has received a request for a PPDS font which is not installed.
						Insufficient printer memory	The printer does not have enough memory to save the data in the buffer.
						Flash full	There is not enough free space in the flash memory to store the data you are trying to download.

				 		Defective flash	The printer detects defective flash memory.
				 		Unformatted flash	The printer detects unformatted flash memory.
				 		Insufficient defrag memory	The printer has insufficient memory to free up unused space in flash memory.
						<ul style="list-style-type: none"> • Invalid network code • Invalid engine code 	The code in an internal print server has not been programmed, or the programmed code is not valid.
				 		Error communicating with the host computer	The printer has lost the connection to an external print server (also called an external network adapter or ENA).
			 			Network interface errors	The printer cannot establish communication with the network.

Secondary error code light sequences for jams

Ready/Data	Toner Low	Load Paper	Paper Jam	Error	Press Continue	Printer condition:	Click here for more information:
						Jam	Clearing jams
						Jam occurs just as it starts to feed from the tray	Clearing a tray 1 jam
						Jam occurs as it exits the tray into the printer	Clearing a fuser jam

						Jam occurs as a printed job exits the tray	Clearing a top output bin jam
--	--	---	---	--	---	--	---

What this light sequence means:

- The printer is ready to receive and process data.
- The printer is in Power Saver mode.

What you can do:

- Send a print job.
- Press and release Continue to print the menu settings pages for a list of current printer settings.
- Press and hold Cancel to reset the printer.

 **NOTE:** If you want to change the Power Saver setting, it can only be set from the Local Printer Setup Utility (see [Using the Local Printer Setup Utility](#)).

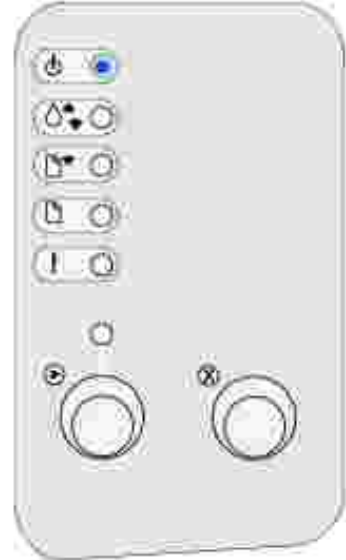

What this light sequence means:

The printer is ready to receive and process data. In addition, the toner in the toner cartridge is getting low.

What you can do:

- Send a print job.
- Press and release Continue to print the menu settings page for a list of current printer settings.
- [Remove the toner cartridge](#) and gently shake it to extend the life of the cartridge.
- [Replace the toner cartridge](#).
- Press and hold Cancel to reset the printer.

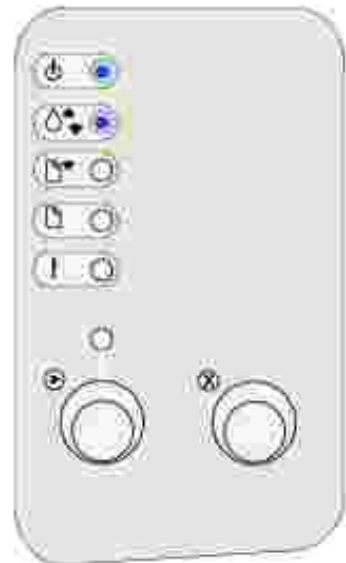

What this light sequence means:

The printer is not ready to receive or process data, or the printer ports are offline.



What you can do:

- Press and release Continue to return to the Ready or Busy state.
- Press and release Cancel to cancel the print job.
- Press and hold Cancel to reset the printer.

What this light sequence means:

The printer is not ready to receive or process data, or the printer ports are offline. In addition, the toner in the toner cartridge is getting low.

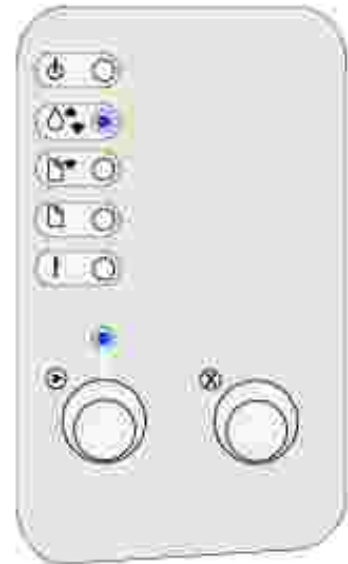

What you can do:

- Press and release Continue to return to the Ready or Busy state.
- Press and release Cancel to cancel the print job.
- Press and hold Cancel to reset the printer.

What this light sequence means:

- The printer is busy receiving and processing data or printing.
- The printer is defragmenting the flash memory to reclaim storage space occupied by deleted resources.
- The printer is formatting the flash memory.
- The printer is storing resources, such as fonts or macros, in flash memory.
- The printer is printing a directory, font list, menu settings pages, or Print Quality Test Pages.

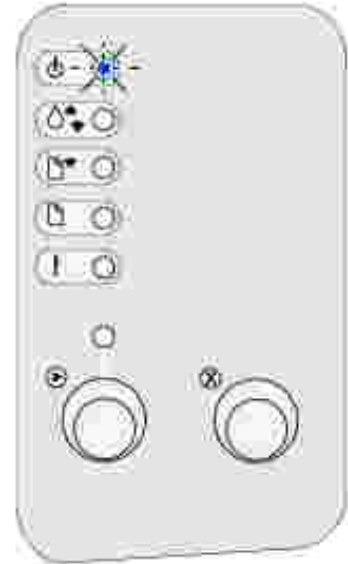

What you can do:

- Busy:
 - Wait for the message to clear.
 - Press and release Cancel to cancel the print job.
 - Press and hold Cancel to reset the printer.
- Defragmenting flash, formatting flash, or programming flash:
 - Wait for the message to clear.
- 🔔 **NOTICE:** Do not turn the printer off while this message is displayed.
- Printing a directory, a font list, menu settings pages, or Print Quality Test Pages:
 - Wait for the pages to print. The Busy message is displayed as the pages print. The Ready/Data light is on when printing stops.
 - Press and release Cancel to cancel printing.
 - Press and hold Cancel to reset the printer.
- Receiving/processing data from a host interface:
 - Wait for the message to clear.
 - Press and release Cancel to stop processing.
 - Press and hold Cancel to reset the printer.

What this light sequence means:

The printer is busy receiving or processing data, or printing a test page. In addition, the toner in the toner cartridge is getting low.

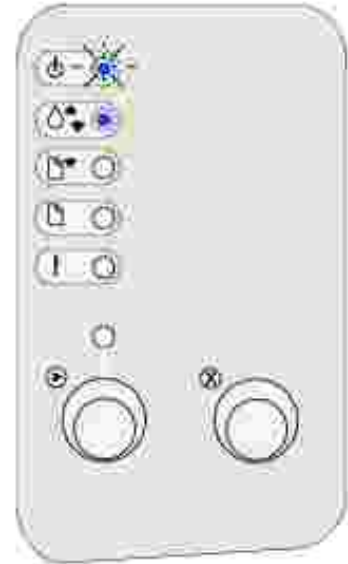

What you can do:

- [Remove the toner cartridge](#) and gently shake it to extend the life of the cartridge.
- [Replace the toner cartridge](#).
- Press and release Cancel to cancel the print job.
- Press and hold Cancel to reset the printer.

What this light sequence means:

The printer is waiting until a print timeout occurs, or until it receives additional data.



What you can do:

- Press and release Cancel to cancel the print job.
- Press and release Continue to print the contents of the print buffer.
- Press and hold Cancel to reset the printer.

What this light sequence means:

The printer is waiting until a print timeout occurs, or until it receives additional data. In addition, the toner in the toner cartridge is getting low.

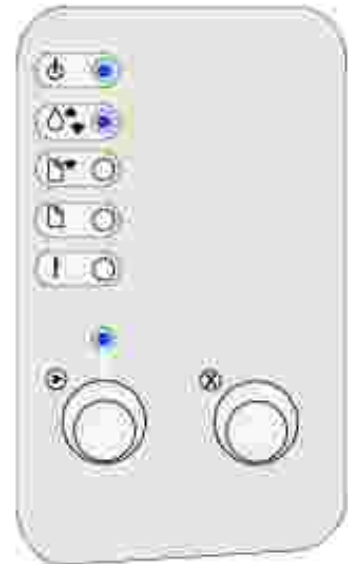

What you can do:

- [Remove the toner cartridge](#) and gently shake it to extend the life of the cartridge.
- [Replace the toner cartridge](#).
- Press and release Continue to print the contents of the print buffer.
- Press and release Cancel to cancel the print job.
- Press and hold Cancel to reset the printer.

What this light sequence means:

- The printer is flushing corrupted print data.
- The printer is processing data or printing pages, but the resolution of a page in the current print job is reduced from 600 dots per inch (dpi) to 300 dpi in order to prevent a memory full error.



What you can do:

- Wait until the operator panel returns to Ready/Data to print other jobs.
- Press and release Cancel to cancel the print job.
- Press and hold Cancel to reset the printer.

What this light sequence means:

The printer is flushing corrupted print data. In addition, the toner in the toner cartridge is getting low.



What you can do:

- Wait until the operator panel returns to Ready/Data to print other jobs.
- [Remove the toner cartridge](#) and gently shake it to extend the life of the cartridge.
- [Replace the toner cartridge](#).

What this light sequence means:

The printer prompts you to load a single sheet of media in the manual feed.

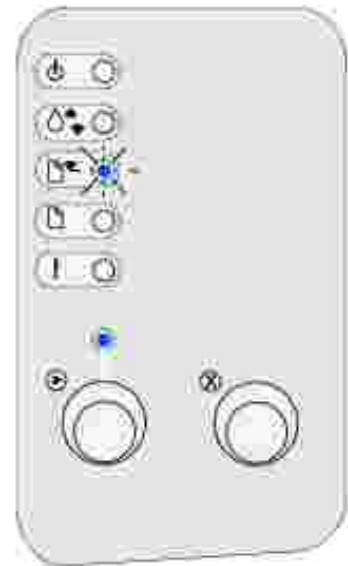

What you can do:

- Load media, with the side to be printed facing the front of the printer, into the manual feed.
- Press and release Continue to resume printing.

What this light sequence means:

The printer is out of media, or the media did not feed properly.

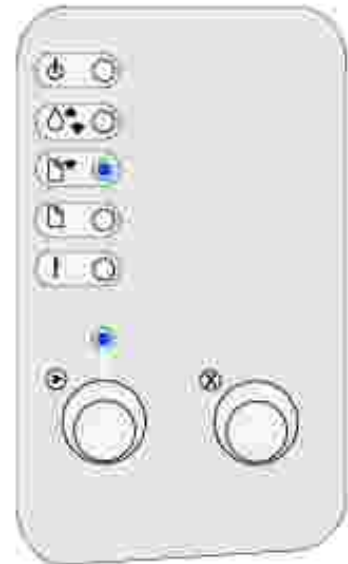

What you can do:

- Load media into tray 1 or the optional 250-sheet tray and press and release Continue to resume printing.
- Check that the media is loaded correctly in tray 1 or the optional 250-sheet tray.
- Press and release Cancel to cancel the print job.

What this light sequence means:

Print the other side of your duplex print job.

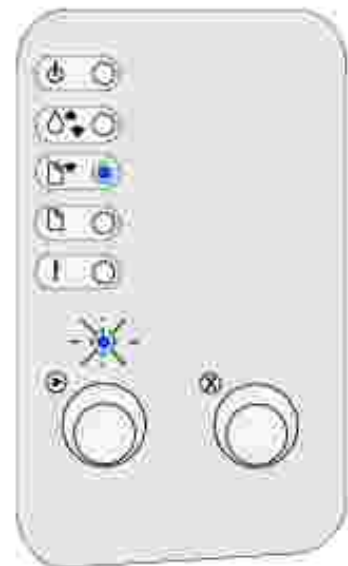

What you can do:

Re-insert your print job in tray 1 using the instructions in the driver pop-up menu to orient the pages correctly.

What this light sequence means:

The printer top cover is open.

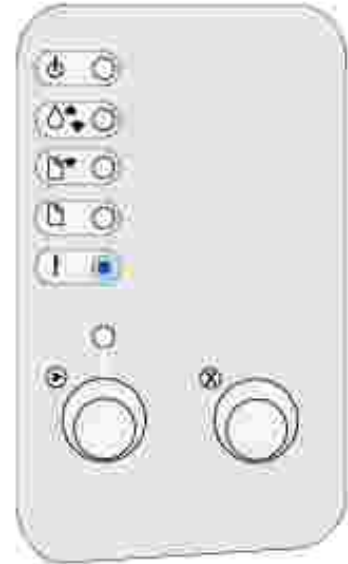

What you can do:

Close the cover to display the light sequence that appeared before the cover was opened.

What this light sequence means:

The toner cartridge is not installed, or the printer detects a toner cartridge error.

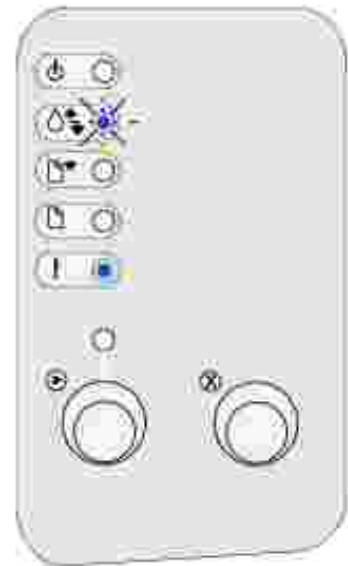

What you can do:

- If the toner cartridge is not installed, install it.
- If the toner cartridge is installed, remove it and install a new toner cartridge (see [Replacing a toner cartridge](#)).

What this light sequence means:

The toner cartridge you are using was not designed for your printer.

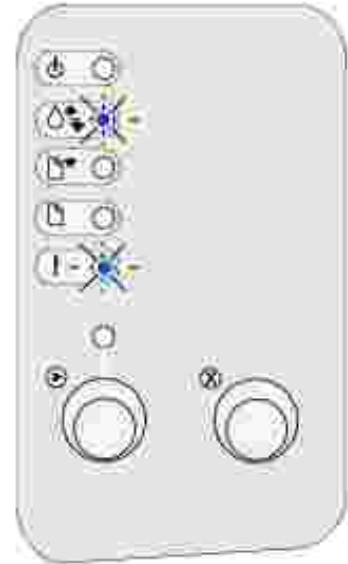

What you can do:

Install a toner cartridge made for your printer (see [Ordering replacement toner cartridges](#)).

What this light sequence means:

The printer is in the Ready mode and Hex Trace is active.

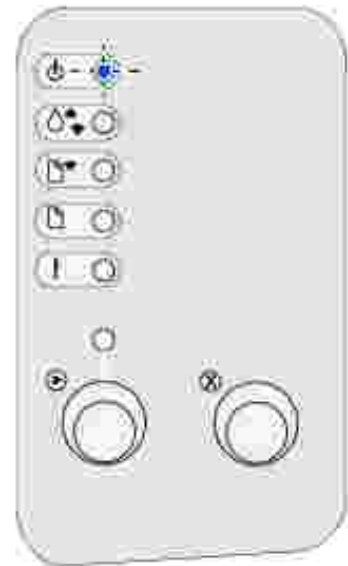

What you can do:

Advanced users can use Hex Trace to help troubleshoot printing problems. After resolving the problem, turn off the printer to exit Hex Trace.

What this light sequence means:

The printer is in the Ready mode, Hex Trace is active, and the toner in the toner cartridge is getting low.

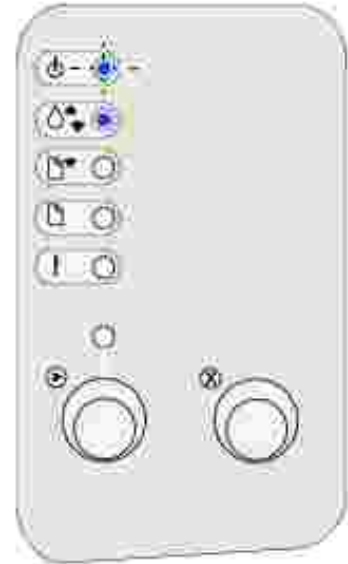

What you can do:

- Advanced users can use Hex Trace to help troubleshoot printing problems. After resolving the problem, turn off the printer to exit Hex Trace.
- [Remove the toner cartridge](#) and gently shake it to extend the life of the cartridge.
- [Replace the toner cartridge](#).

What this light sequence means:

- The current print job is canceled.
- The printer is resetting to the user default settings. Any active print jobs are canceled. A user default setting remains in effect until you change it or until you restore the factory default settings.

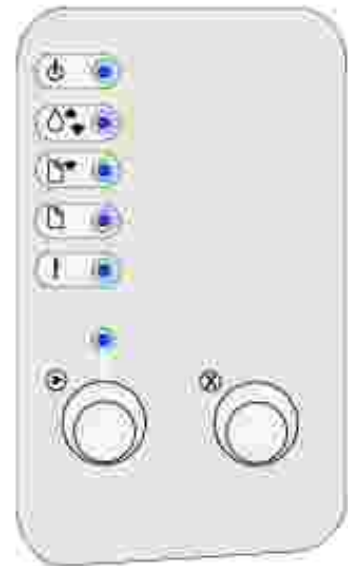

What you can do:

Wait for the message to clear.

What this light sequence means:

The printer has a service error and printing has stopped.

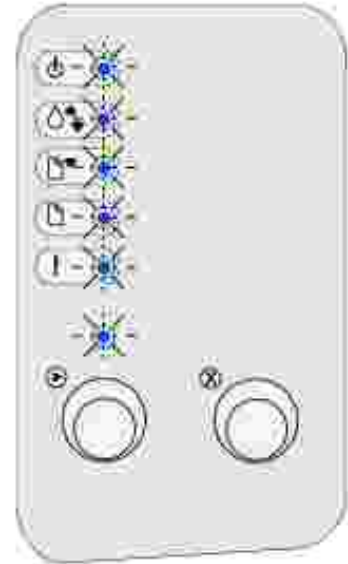

What you can do:

Turn the printer off and back on. If the lights are still blinking, contact Dell.

Secondary error code

What this light sequence means:

The printer has one of the following errors:

- Memory is full.
- A page is too complex to print.
- A page is shorter than the set page margins.
- Resolution of a formatted page is reduced to 300 dpi before printing.
- A font error occurred.
- Memory is insufficient to save what is in the buffer.
- Printer memory is insufficient to defragment flash memory.
- Communication with the host computer is lost.



What you can do:

- Press and release Continue twice quickly to see the secondary message.
- Press and release Continue to clear the secondary message.

Secondary error code

What this light sequence means:

The printer memory does not have the free space necessary to collate the print job.

This may happen due to one of these errors:

- Memory is full.
- A page is too complex to print.
- A page is shorter than the set page margins.
- Memory is insufficient to save what is in the buffer.

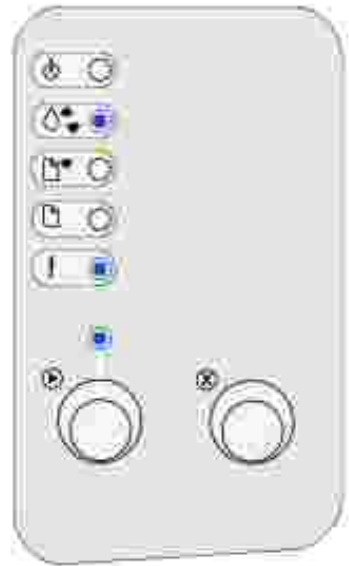

What you can do:

- Press and release Continue to clear the message and continue printing the job (the job may not print correctly.)
- Press and release Cancel to cancel the print job.
- Press and hold Cancel to reset the printer.
- To avoid this error in the future:
 - Simplify the print job. Reduce the complexity of the page by reducing the amount of text or graphics on the page and deleting unnecessary downloaded fonts or macros.
 - Install additional printer memory (refer to the *Owner's Manual* for instructions).

Secondary error code

What this light sequence means:

The printer is processing data, but the memory used to store pages is full.

What you can do:

- Press and release Continue to clear the message and continue printing the job (the job may not print correctly).
- Press and release Cancel to cancel the print job.
- Press and hold Cancel to reset the printer.
- To avoid this error in the future:
 - Simplify the print job. Reduce the complexity of the page by reducing the amount of text or graphics on the page and deleting unnecessary downloaded fonts or macros.
 - Install additional printer memory (refer to the *Owner's Manual* for instructions).

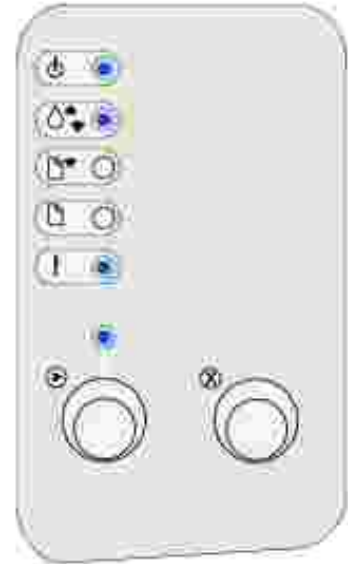

Secondary error code

What this light sequence means:

The page may not print correctly because the print information on the page is too complex.

What you can do:

- Press and release Continue to clear the message and continue processing the print job (some of the print data may be lost).
- To avoid this error in the future:
 - Reduce the complexity of the page by reducing the amount of text or graphics on the page and deleting unnecessary downloaded fonts or macros.
 - Set [Page Protect](#) to On in the Local Printer Setup Utility.
 - Install additional printer memory (refer to the *Owner's Manual* for instructions).



Secondary error code

What this light sequence means:

The paper length is too short to print the formatted data.

This occurs when the printer does not know the media size loaded in the tray, or there is a problem feeding the media.

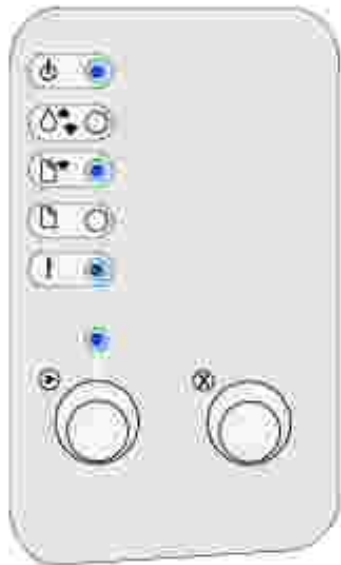

What you can do:

- Make sure the print media you loaded is large enough.
- Open the printer cover, clear the paper path and close the cover to resume printing (see [Clearing jams](#)).
- Press and release Continue to clear the message and continue printing the job.
- Press and release Cancel to cancel the print job.

Secondary error code

What this light sequence means:

The printer has received a request for a PPDS font which is not installed.

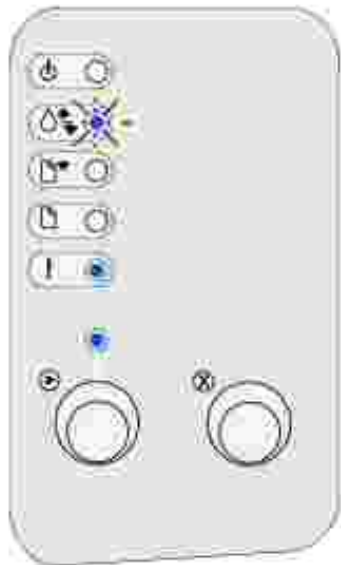

What you can do:

- Press and release Cancel to cancel the print job.
- Press and hold Cancel to reset the printer.
- Press and release Continue to clear the message and continue printing.

Secondary error code

What this light sequence means:

The printer does not have enough memory to save the data in the buffer.

What you can do:

- Install additional memory (refer to the *Owner's Manual* for instructions).
- Press and release Continue to continue printing the job.
- Press and release Cancel to cancel the print job.



Secondary error code

What this light sequence means:

There is not enough free space in the flash memory to store the data you are trying to download.

What you can do:

- Delete fonts, macros, and other data stored on the flash memory to free up space.
- Press and release Continue to clear the message and continue printing. Downloaded fonts and macros not previously stored in flash memory are deleted.
- Install flash memory with more storage capacity. Refer to the *Owner's Manual* for instructions to install flash memory.
- Press and release Cancel to cancel the print job.
- Press and hold Cancel to reset the printer.



Secondary error code

What this light sequence means:

The printer detects defective flash memory.

What you can do:

- Press and release Continue to clear the message and continue printing. Downloaded fonts and macros not previously stored in flash memory are deleted.
- Refer to the *Owner's Manual* for instructions to install flash memory.

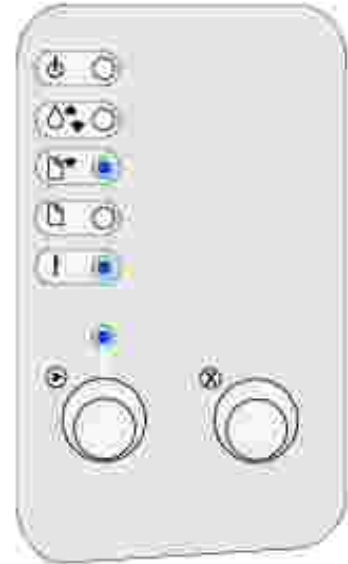

Secondary error code

What this light sequence means:

The printer detects unformatted flash memory.

What you can do:

- Press and release Continue to clear the message and continue printing. The job may not print correctly.
- Reformat the flash memory.
- If the error message remains, the flash memory may be defective and should be replaced.

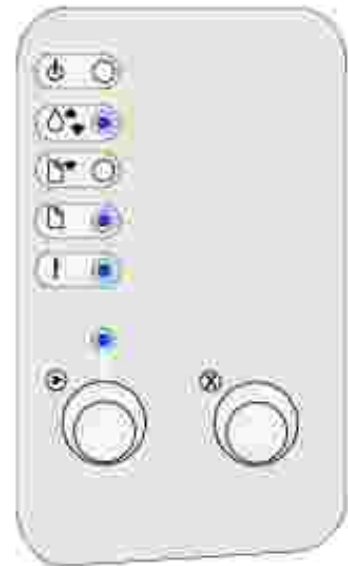

Secondary error code

What this light sequence means:

The printer has insufficient memory to free up unused space in flash memory.

What you can do:

- Delete fonts, macros, and other data in RAM.
- Install additional printer memory.



What this light sequence means:

The code in an internal print server has not been programmed, or the programmed code is not valid.

What you can do:

Download valid network code to the internal print server.



Secondary error code

What this light sequence means:

The printer has lost the connection to an external print server (also called an external network adapter or ENA).

This light sequence is displayed if your printer is connected to the network, but it cannot detect the print server when you turn on the printer.

What you can do:

- Make sure the cable connecting the ENA and the printer is securely attached. Turn the printer off and then on to reset the printer.
- Press and hold Cancel to reset the printer.

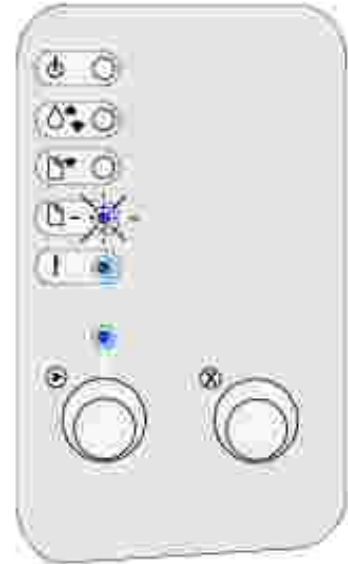

Secondary error code

What this light sequence means:

The printer cannot establish communication with the network.

What you can do:

Press and release Continue to clear the message and continue printing (the job may not print correctly).

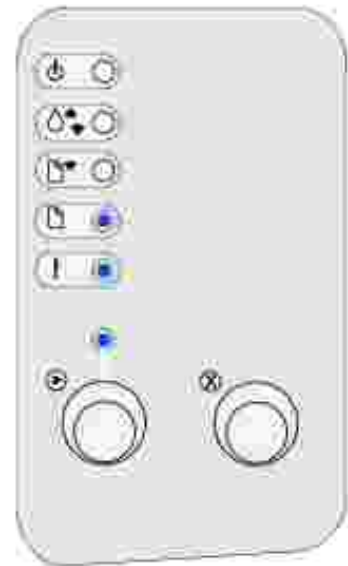

Understanding the printer menus

- [Printing the Printer Settings Configuration sheet](#)
 - [Menus overview](#)
 - [Using the Local Printer Setup Utility](#)
-

Printing the Printer Settings Configuration sheet

To help resolve printing problems or to change printer configuration settings, advanced users can print the Printer Settings Configuration sheet for instructions on scrolling through the menus to select and save new settings.

To print the Printer Settings Configuration sheet:

1. Turn the printer off.
2. Open the upper front door.
3. Press and hold Continue as you turn the printer on.

All the lights cycle.

4. Release Continue.
5. Close the upper front door.
6. The light sequence that represents the Home menu is displayed.
7. Press and release Continue until all the lights cycle.

A Printer Settings Configuration sheet prints.

Menus overview

Menus are represented by Ready/Data, Toner Low, Load Paper, and Paper Jam light sequences. Menu items and their settings are indicated by Error and Press Continue light sequences.

- Press and release Cancel to scroll through menus and menu items.
- Press and release Continue to advance to the setting you need.
- Press and hold Continue until all of the lights cycle to save a setting.

- Press and hold Cancel until all of the lights cycle to return to the Home menu.
- Turn off the printer to exit the menus.

Utilities menu

Use the Utilities menu to troubleshoot printer problems.

Reset Factory Defaults

Use this setting to: return your printer settings to the factory default values. Sometimes resetting the printer to the original settings solves formatting problems. All menu items are reset to the factory default values except:

- Display Language.
- All settings in the Parallel menu and USB menu.

All downloaded resources (fonts, macros, and symbol sets) in printer memory (RAM) are deleted. Resources in flash memory are unaffected.

Hex Trace

Use this setting to: help isolate printing problems when unexpected characters print or characters are missing. Hex Trace helps you determine if there is a problem with the language interpreter or the cable by telling you what information your printer is receiving. To exit Hex Trace, turn off the printer.

Print Quality Test Pages

Use this setting to: help isolate print quality problems, such as streaking. When you select this setting, three pages print to help you evaluate print quality:

- A text page with printer information, cartridge information, current margin settings, and a graphic.
- Two pages with graphics.

Setup menu

Use the Setup menu to configure how the printer formats the end of a line depending on the computer system being used.

Auto CR after LF

Use this setting to: specify whether the printer automatically performs a carriage return after a line feed control command.

Values:

Off (factory default)

On

Auto LF after CR

Use this setting to: specify whether the printer automatically performs a line feed after a carriage return control command.

Values:

Off (factory default)

On

Parallel menu

Use the Parallel menu to change printer settings on jobs sent through a parallel port.

NPA Mode

Use this setting to: send print jobs to the printer and query printer status information simultaneously.

Values:

Off

On

Auto (factory default)

Protocol

Use this setting to: receive information at a much higher transmission rate if your printer is set to Fastbytes (if your computer supports Fastbytes) or receive information at a normal transmission rate if your printer is set to Standard.

Values:

Standard

Fastbytes (factory default)

Mode 2

Use this setting to: determine whether the parallel port data is sampled on the leading (On) or trailing (Off) edge of strobe.

Values:

Off

On (factory default)

MAC Binary PS

Use this setting to: configure the printer to process Macintosh binary PostScript print jobs.

Values:

Off - The printer filters PostScript print jobs using standard protocol.

On - The printer processes raw binary PostScript print jobs from computers using the Macintosh operating system. This setting often causes Windows print jobs to fail.

Auto (factory default) - The printer processes print jobs from computers using either Windows or Macintosh operating systems.

USB menu

Use the USB menu to change printer settings on jobs sent through a Universal Serial Bus (USB) port.

NPA Mode

Use this setting to: send print jobs to the printer and query printer status information simultaneously.

Values:

Off

On

Auto (factory default)

MAC Binary PS

Use this setting to: configure the printer to process Macintosh binary PostScript print jobs.

Values:

Off - Printer filters PostScript print jobs using standard protocol.

On - Printer processes raw binary PostScript print jobs from computers using the Macintosh operating system. This setting often causes Windows print jobs to fail.

Auto (factory default) - Printer accepts print jobs from computers using either Windows or Macintosh operating systems.

Network menu

Use the Network menu to change printer settings on jobs sent through a network port (either Standard Network or Network Opt <x>).

NPA Mode

Use this setting to: send print jobs to the printer and query printer status information simultaneously.

Values:

Off

On

Auto (factory default)

MAC Binary PS

Use this setting to: configure the printer to process Macintosh binary PostScript print jobs.

Values:

Off - Printer filters PostScript print jobs using standard protocol.

On - Printer processes raw binary PostScript print jobs from computers using the Macintosh operating system. This setting often causes Windows print jobs to fail.

Auto (factory default) - Printer processes print jobs from computers using either Windows or Macintosh operating systems.

Set Network Port Speed

Use this setting to: automatically detect the connection speed of your network. You can disable this setting to set the speed manually.

Values:

Auto (factory default) - The printer detects current network speed.

10 Megabits per second (Mbps), Half Duplex - Forces the printer to try to connect to the network only at 10Mbps, Half Duplex.

10Mbps, Full Duplex - Forces the printer to try to connect to the network only at 10Mbps, Full Duplex.

100Mbps, Half Duplex - Forces the printer to try to connect to the network only at 100Mbps, Half Duplex.

100Mbps, Full Duplex - Forces the printer to try to connect to the network only at 100Mbps, Full Duplex.

Using the Local Printer Setup Utility

The Local Printer Setup Utility, located on the *Drivers and Utilities CD*, lets you change printer settings not available from your printer driver (for example, activating Alarm Control if you want the printer to sound an alarm when it needs attention).

The Local Printer Setup Utility is provided on the *Drivers and Utilities CD*, and is also installed on your computer. Click Start → Programs → Dell Printers → Dell Laser Printer P1500 → Local Printer Setup Utility.

You can change the following settings using the Local Printer Setup Utility:

Paper Settings	Finishing Settings	PCL Emulation Settings
Paper Source	Duplex	Orientation
Paper Size (per supported sources)	Duplex Bind	Lines Per Page
Paper Type (per supported sources)	Copies	A4 Width
Custom Types (per custom type number)	Blank Pages	Tray Renumber (per supported sources)
Substitute Size	Collation	Auto CR after LF
Configure MP	Separator Sheets	Auto LF after CR
Paper Texture (per supported media)	Separator Source	
Paper Weight (per supported media)	Multipage Print	
Paper Loading (per supported media)	Multipage Order	
	Multipage View	
	Multipage Border	

PostScript Settings Print PS Error Font Priority	Quality Settings Print Resolution Toner Darkness PQET PictureGrade	Parallel Settings PCL SmartSwitch PS SmartSwitch Parallel Buffer Advanced Status Honor Init
Setup Settings Printer Language Power Saver Resource Save Download Target Print Timeout Wait Timeout Auto Continue Jam Recovery Page Protect Print Area Display Language Alarm Control Toner Alarm	USB Settings PCL SmartSwitch PS SmartSwitch USB Buffer	

Troubleshooting

- [Solving printing problems](#)
 - [Solving basic printer problems](#)
 - [Solving print quality problems](#)
 - [Clearing jams](#)
 - [Calling for service](#)
-

Solving printing problems

Use the following tables to find solutions for printing problems you encounter. If you cannot fix the problem, contact Dell at support.dell.com. You may have a printer part that requires cleaning or replacement by a service technician.

Problem	What to do
The media skews or buckles.	<ul style="list-style-type: none">Do not overfill tray 1 or the optional 250-sheet tray (see media capacities in the Media types and sizes table).Make sure the paper guides are flush against the edges of the media.
The paper sticks together/printer feeds multiple sheets of paper.	<ul style="list-style-type: none">Remove the paper from tray 1 or the optional 250-sheet tray and fan the paper.Do not overfill tray 1 or the optional 250-sheet tray (see media capacities in the Media types and sizes table).
The paper fails to feed from tray 1.	<ul style="list-style-type: none">Remove the paper from tray 1 and fan the paper.Make sure tray 1 is selected from the printer driver.Do not overfill the tray.
The paper fails to feed from the optional 250-sheet tray.	<ul style="list-style-type: none">Make sure the optional 250-sheet tray is selected from the printer driver.Make sure the tray is pushed all the way in.Make sure the metal plate is pressed down before inserting the tray into the printer.

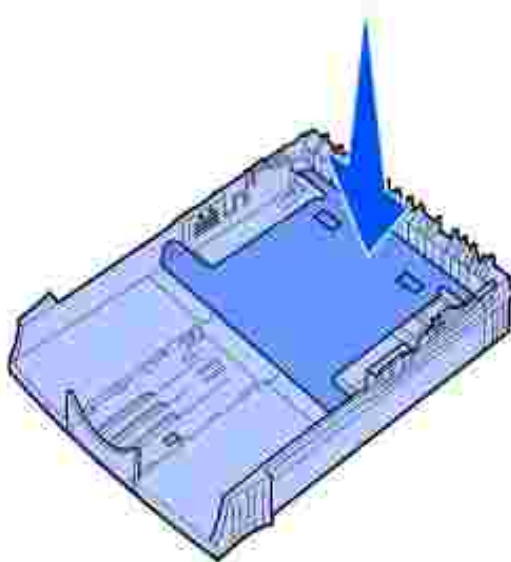

NOTE: After the tray is inserted, the metal plate springs back up so the paper can feed into the printer.

- Make sure the paper does not exceed the stack height indicator.
- Make sure the paper is under both corner bucklers (see [Loading paper](#)).
- Remove the paper from the optional 250-sheet tray and fan the paper.

The Jam light is still on, even though you cleared the jam.

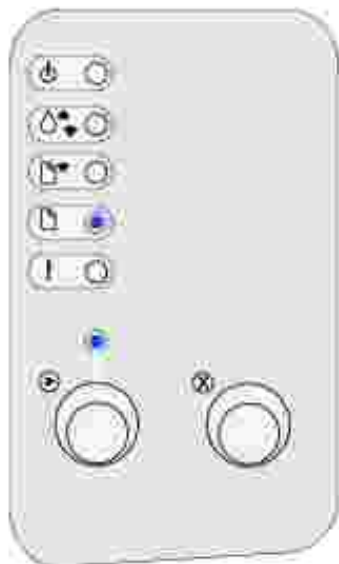

- Make sure you cleared all jams.
- Press and release Continue, or open and close the printer cover to restart the printer.
- Make sure the toner cartridge is installed.

While using manual duplex, the printer gets a paper jam.	<p>A paper jam interrupts the duplex process. As a result, the information on the page that jammed is lost.</p> <ul style="list-style-type: none"> • Press and release Cancel to cancel the print job. • Press and hold Cancel to reset the printer. • Resend your print job.
You keep getting paper jams while using manual duplex.	Try using 20 lb xerographic paper or 80 g/m ² A4 paper.

Solving basic printer problems

Use the following tables to find solutions for printing problems you encounter. If you cannot fix the problem, contact Dell at support.dell.com. You may have a printer part that requires cleaning or replacement by a service technician.

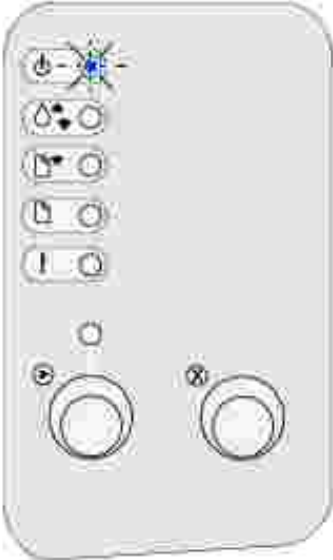
Problem	What to do
<p>The print is getting light, but the Toner Low light is not on.</p> 	<ul style="list-style-type: none"> • Remove the toner cartridge and gently shake it from side to side to use the remaining toner. • Replace the toner cartridge.
The Toner Low light is on.	<ul style="list-style-type: none"> • Remove the toner cartridge and gently shake it to use the remaining toner. • Replace the toner cartridge.

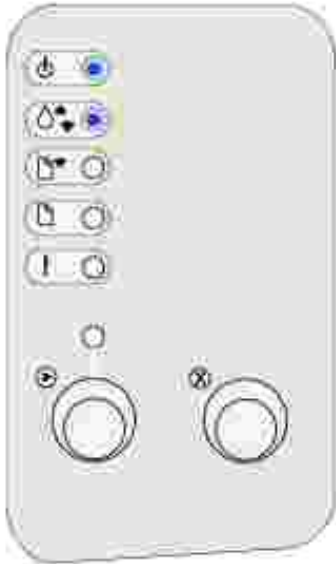

Pages are blank.

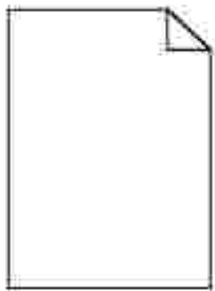

- The toner cartridge may be out of toner. Replace the cartridge.
- You may have a software error. Try turning the printer off and back on.

The printer has missing or damaged parts.

- Contact Dell at support.dell.com.

The operator panel lights do not come on when the printer is turned on.

- Wait to see if the lights come on. This may take a few seconds.
- Make sure the power cord is firmly plugged in at the back of the printer and at the electrical outlet.

You cannot close the top cover.

- Make sure the toner cartridge is positioned correctly.

The printer is on, but nothing prints.

- Make sure the toner cartridge is installed.
- Make sure the parallel or USB cable is firmly plugged into the connector on the back of the printer.
- Press and release Continue to print a menu settings page to determine if the problem is with the printer or the computer.
 - If you can print a menu settings page, the problem is in the computer or the software program.
 - If you cannot print a menu settings page, contact Dell at support.dell.com.

The Toner Low light is on and printing stops.

- If the Toner Low alarm is enabled, the printer stops printing until you replace the toner cartridge.

NOTE: To change the Toner Low Alarm setting, install the Local Printer Setup Utility from the *Drivers and Utilities CD* (see [Using the Local Printer Setup Utility](#)).

The printer is on and the Error light is on.

- Make sure the printer cover is closed.

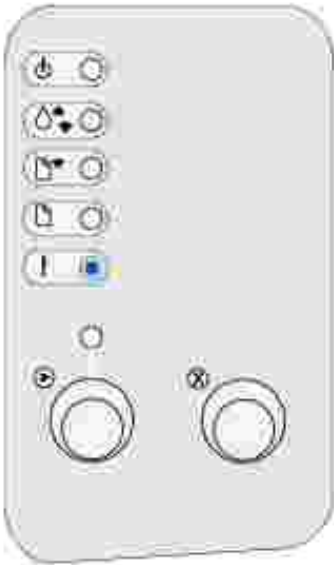

The printer is on, the Toner Low light is blinking, and the Error light is on.

- Make sure the toner cartridge is installed.
- Install a new toner cartridge.

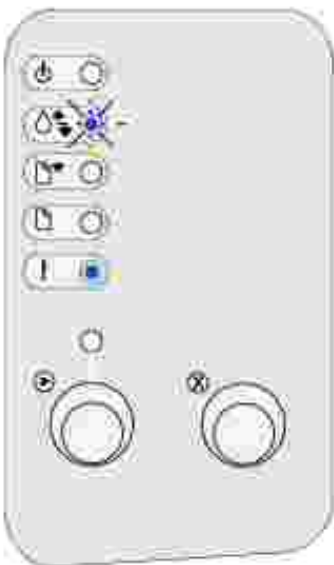

The Load Paper light is on, even though there

- Make sure the tray is pushed all the way in.

is paper loaded in the optional 250-sheet tray.

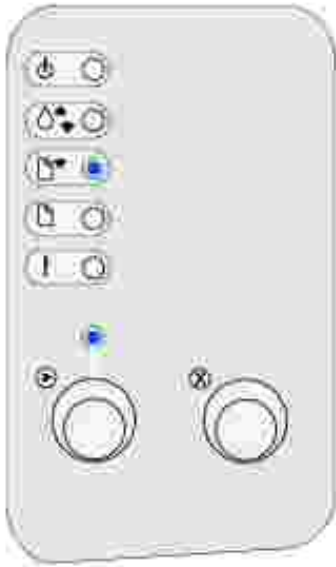

Jobs are not printing and the Error light remains on.

- Make sure the toner cartridge is installed.
- Make sure the printer top cover is closed.

While in PostScript 3 emulation, the printer is flushing data (Ready/Data and Error indicator lights are blinking).

- Make sure you are using the correct PostScript driver.
- The printer does not have enough memory to print the job. Install more memory.

You want to use manual duplex but cannot find it on your printer driver.

- Your printer driver may not support manual duplex.

Solving print quality problems

Use the following tables to find solutions for printing problems you encounter. If you cannot fix the problem, contact Dell at support.dell.com. You may have a printer part that requires cleaning or replacement by a service technician.

Problem	What to do
Light or blurred characters.	<p>The toner cartridge may be getting low on toner:</p> <ol style="list-style-type: none"> 1. Remove the toner cartridge. 2. Gently shake it from side to side to use the remaining toner.



3. Reinstall it.

- Make sure you are using recommended print media (see [Media types and sizes.](#))
- If you are printing on special media, for example, card stock or labels, be sure you selected the correct paper type in the printer driver.
- The printer detects a toner cartridge error. Replace it.

Toner smudges appear on the front or back of the page.

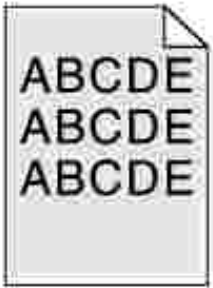

- Make sure the paper is straight and unwrinkled.
- Replace the toner cartridge.

Vertical or horizontal streaks appear on the page.

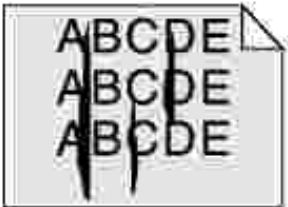

- Replace the toner cartridge.

Toner smears or rubs off the page.

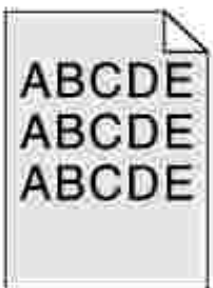

- Try a different kind of paper. Paper designed for copiers gives the best quality.
- If you are printing on specialty media (for example, card stock or labels), be sure you selected the correct paper type in the printer driver.
- Try changing the media weight to a heavier setting and the texture to a rougher setting. To change these settings, install the Local Printer Setup Utility from the *Drivers and Utilities CD* (see [Using the Local Printer Setup Utility](#)).

<p>Solid black areas appear on transparencies or paper contains white streaks.</p>	<ul style="list-style-type: none"> • Choose a different fill pattern in your software program. • Try a different type of paper. Paper designed for copiers gives the best quality. • Remove the toner cartridge and gently shake it from side to side to use the remaining toner. • Replace the toner cartridge.
<p>Faint images or repetitive spots appear on the page.</p>	<ul style="list-style-type: none"> • Try a different type of paper. Paper designed for copiers gives the best quality. • Replace the toner cartridge.
<p>Unexpected characters print or characters are missing.</p>	<ul style="list-style-type: none"> • Make sure you are using the correct printer driver. • Press and hold Continue until all the lights come on to reset the printer to your user default settings. • Select Hex Trace to help you troubleshoot the problem. • Reset the printer to the factory default settings (see Reset Factory Defaults). • Make sure the parallel cable or USB cable is firmly plugged in at the back of the printer.
<p>A bar code reader cannot read the bar code you printed.</p>	<ul style="list-style-type: none"> • Make the point size much larger until the bar code is readable, and then decrease it to find the minimum size that is reliably readable. • Verify that the data starts and ends with an asterisk. • Verify that no asterisk is included within the data. • Verify that only valid bar code characters are used within the data.
<p>Text on envelopes has voids, or quality is poor.</p>	<ul style="list-style-type: none"> • Make sure the Paper Type is set to Envelopes in your printer driver. • If you are using textured (rather than smooth) envelopes, change the paper texture setting to Cus 6–Rough Env in your printer driver or through the Local Printer Setup Utility.

Clearing jams

If media jams in the printer, the Paper Jam light prompts you to clear the paper path.

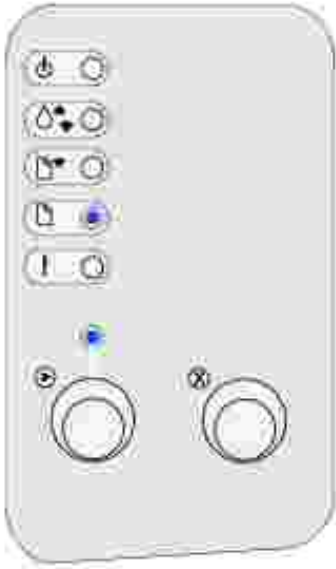

Clearing a tray 1 jam

If media has just started to feed from tray 1 when the jam occurs:

1. Pull the media straight up out of tray 1.



2. Press Continue or open and close the printer cover to resume printing.

Clearing a fuser jam

If the jam occurs in the fuser:

1. Open the printer cover.
2. [Remove the toner cartridge](#) (it may be warm).

 **NOTE:** The photoconductor drum on the bottom of the toner cartridge may be damaged if it is exposed to light. Cover the cartridge or store it in a clean, dark place if you take it out of the printer for an extended period of time.

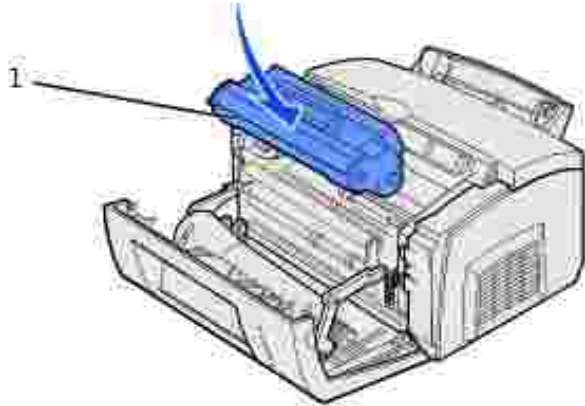

1	Photoconductor drum
---	---------------------

3. Gently pull out the media.

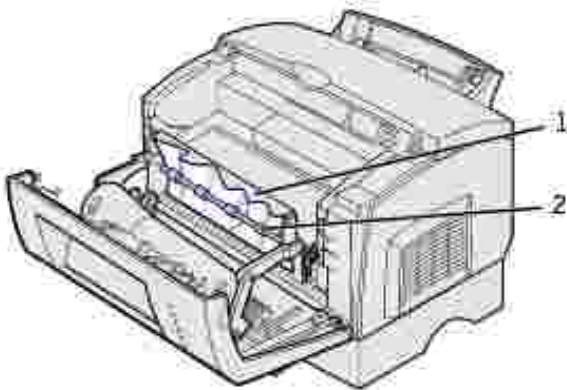

1	Fuser
2	Roller

 **CAUTION:** Avoid touching the fuser; it may be hot!

4. If the media is jammed tightly behind the roller, or if you cannot get a grip on it, close the cover, open

the front output door, and pull out the paper.

5. Make sure there is no more media in the printer.
6. Reinstall the toner cartridge.

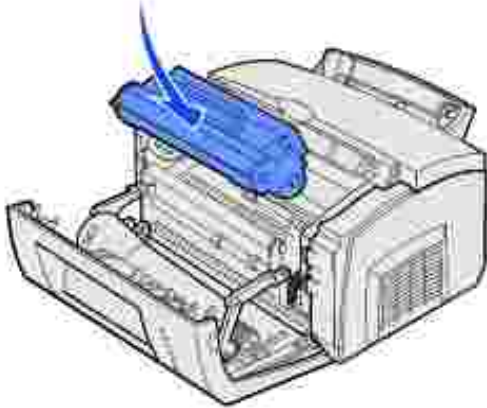

7. Close the printer cover to resume printing.

Clearing a top output bin jam

A jam may occur if the top output bin is too full and the media is unable to exit the printer:

1. Remove the media from the top output bin.
2. Clear the jam.

If a jam occurs while printing labels from tray 1 or the manual feed:

1. Be sure the labels remain attached to the backing sheet after clearing the jam.
2. Before resuming label printing, load paper in tray 1.
3. Press Continue and print 10 or more menu settings pages.

The paper removes any remaining adhesive in or on the fuser.



NOTICE: Serious damage to your printer may occur if adhesive labels remain in the fuser. Contact Dell at support.dell.com.

If the jam occurs as the paper exits the optional 250-sheet tray into the printer:

1. Open the printer cover.

2. Remove the toner cartridge (the cartridge may be warm).
3. Gently pull the paper toward you.

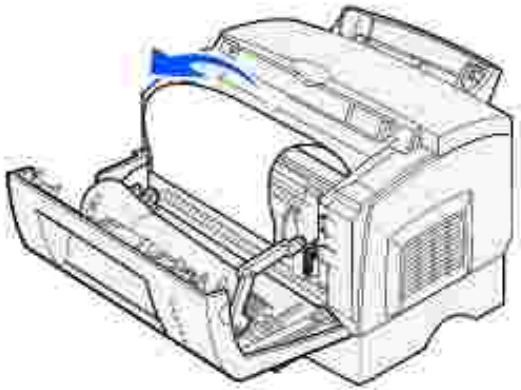

4. Reinstall the toner cartridge.
5. Close the printer cover to resume printing.

If you cannot reach the paper easily:

1. Turn off the printer.

 **NOTE:** You will lose the rest of the print job.

2. Lift the printer off the base.

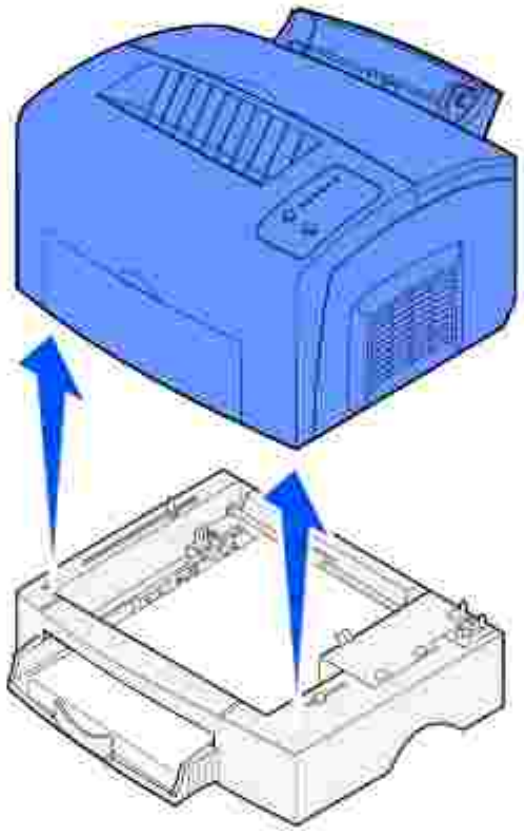

3. Clear the jam.
4. Align the printer with the front of the base and place it on top of the base.
5. Turn on the printer and resend your print job.

If the jam occurs just after the paper feeds from the 250-sheet tray:

1. Pull the 250-sheet tray all the way out.

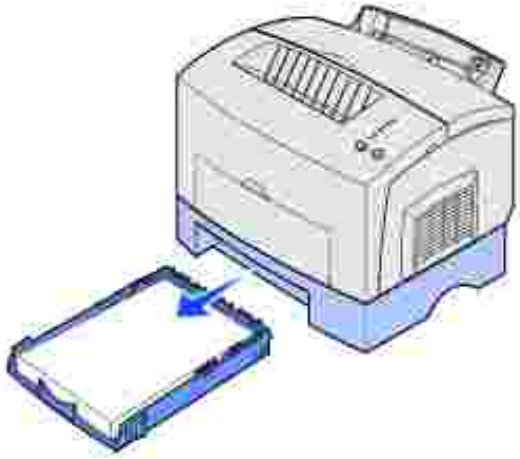

2. Reach inside and gently pull the paper toward you.
3. Reinstall the tray and resume printing.

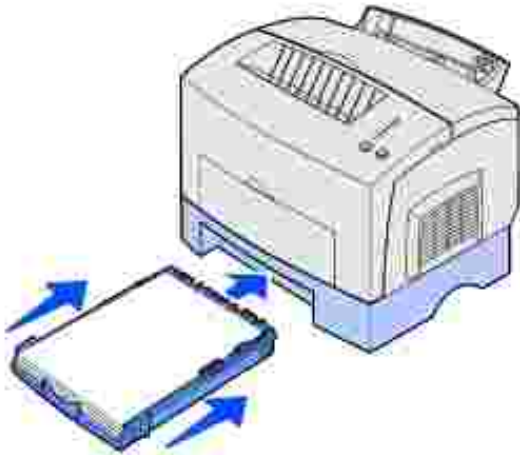

Calling for service

Before calling for service, check the following:

- Is the power cord plugged into the printer?
- Is the power cord plugged directly into a properly grounded electrical outlet?
- Is your printer properly connected to your computer?
- Are all other devices attached to your printer plugged in and turned on?
- Is the electrical outlet turned off by any switches?

- Did a fuse blow?
- Has a power outage occurred in your area?
- Is a toner cartridge installed in your printer?
- Is the printer cover closed completely?

If all else fails, try turning your printer off and back on again. If your printer is still not operating properly, call for service. If you are able to print, press and release Continue to print a menu settings page, which lists the printer model type and other information the service representative may need to know.

Contact Dell at support.dell.com for more information.

Uninstalling drivers

- [Windows Installer](#)
- [Driver Profiler](#)
- [Fonts](#)
- [Local Printer Setup Utility](#)
- [Uninstall software utility](#)

The *Drivers and Utilities CD* contains drivers and utilities, the Dell Diagnostics, and user's guides for your computer and optional devices. Dell ships your computer to you with required drivers and utilities already installed-no further installation or configuration is needed. If you ever need to uninstall a driver or utility, run diagnostics tests on your computer, or access the user's guides, use the *Drivers and Utilities CD*. The CD may also contain printer utilities, screen fonts, and additional documentation, such as:

- Windows Installer
 - Driver Profiler
 - Fonts
 - Local Printer Setup Utility
 - Uninstall software utility
-

Windows Installer

The Windows Installer utility gives you centralized installation for all software and drivers shipped on the *Drivers and Utilities CD*.

Driver Profiler

The Driver Profiler lets you create driver profiles that contain custom driver settings.

A driver profile can contain a group of saved printer driver settings and other data for things such as:

- Print orientation and N-Up (document settings)
- Installation status of an output tray (printer options)
- User-defined paper sizes (custom papers)
- Simple text and watermarks

- Overlay references
- Font references
- Form associations

The Driver Profiler program and printer drivers located on the *Drivers and Utilities CD* are used to create driver profiles.

Profiles are stored in Driver Configuration Files (DCF). The individual profiles inside the DCF are identified by a short description. During installation, the user can point to the DCF that contains the profiles to use when creating a customized printer object.

A DCF can contain profiles for any number of printer models and any number of different drivers (PostScript or PCL, Windows 98, Windows Me, Windows 2000, Windows NT 4.0, or Windows XP). Profiles can be added to an existing DCF by specifying an existing configuration file in the Driver Profiler when creating a profile. New profiles are always appended to an existing configuration file. No two profiles in the same DCF can have the same short description.

Fonts

Screen Fonts are fonts you install in Windows to match your printer scalable resident fonts. Selecting resident printer fonts improves printing performance. The screen fonts allow the documents displayed on the computer screen to match the output from your printer. When you install the screen fonts, you will have access to the full set of resident printer fonts by Windows programs for PCL emulation. Choose your printer model when prompted, and the program automatically installs the True Type screen fonts for your printer in Windows.

Your printer also has five bar code fonts:

- OCR-A
- OCR-B
- C39 Narrow (3 of 9)
- C39 Regular (3 of 9)
- C39 Wide (3 of 9)

For information on using these fonts, refer to the *Drivers and Utilities CD*.

Local Printer Setup Utility

The Local Printer Setup Utility, a printer configuration utility, gives you the ability to change and save printer settings on a locally (USB and Parallel) connected printer. These user default settings remain in effect until you make another selection and apply it, or until you restore the original printer settings (called preset factory default settings). The configurable settings are organized according to menu, much like a printer operator panel.

You can change these settings by starting the utility, making the changes you want, and directly applying the new changes. You can also save these changes in a command file for future distribution to designated printers by using the Save As Command File option. Changes made using the Local Printer Setup Utility create settings that apply to all print jobs. Use the printer driver to make changes to settings for individual print jobs, which will override the default settings on the printer.

Uninstall software utility

Use the Uninstall software utility to remove any currently installed printer software or printer objects.

You can access the Uninstall software utility two ways:

1. Click Start → Settings → Printers.
 - a. Select the printer object to uninstall, and then right-click the mouse.
 - b. Select Dell Software Uninstall.
 - c. Select the components to uninstall, and then click Next.
 - d. Click Uninstall Now.
 - e. Click OK when the uninstall is complete.
2. Click Start → Programs → Dell Printers → Dell Laser Printer P1500 → Dell Printer Software Uninstall.
 - a. Select the components to uninstall, and then click Next.
 - b. Click Uninstall Now.
 - c. Click OK when the uninstall is complete.

Printer specifications

- [Memory](#)
 - [Emulation, compatibility, and connectivity](#)
 - [Cartridge and printer life](#)
 - [Environmental](#)
 - [Choosing the right print media](#)
 - [Cables](#)
 - [Certifications](#)
-

Memory

Base memory	16MB
Maximum memory	144MB

Emulation, compatibility, and connectivity

Emulations	PostScript 3, PCL 6
Compatibility	Windows 98/Me, Windows 2000, Windows NT 4.0, Windows XP
Connectivity	Parallel and USB

Cartridge and printer life

Ships with toner cartridge yield at approximately 5% coverage	3,000 pages
Duty cycle (average)	800 pages/month
Duty cycle (maximum)	10,000 pages/month
Printer life	120,000 pages or 5 years (Letter size, 5% coverage)

Environmental

Humidity

Temperature	Relative humidity (non-condensing)
15.6° C (60° F)	8%
15.6° C (60° F)	80%
25.6° C (78° F)	80%
32.2° C (90° F)	8%
32.2° C (90° F)	45%

Storage

Temperature range: -4°F to 104°F (-20°C to 40°C)

Unpacked humidity range: 8% RH to 80% RH (non-condensing)

Storage (packed) humidity range: 8% RH to 95% RH (non-condensing)

Altitude

Operating: up to 2,500 m (8200 feet)

Storage (packed): 0.25 atmospheric pressure (equivalent to 10,300 m or 34,000 feet)

Vibration

Operating: 0.2G

Idle: 0.5G

Shock

Withstand a drop from 3 cm height

Tilt

Choosing the right print media

Selecting the right paper or other media reduces printing problems. For best print quality, try a sample of the paper or specialty media you are considering before buying large quantities.

 **NOTICE:** Your product uses a printing process that heats the print media, and heat can cause certain media to release emissions. You must understand the section in your operating instructions that discusses the guidelines for selecting appropriate print media to avoid the possibility of harmful emissions.

- Use 20 lb (75 g/m²) xerographic paper.
- Use transparencies designed for laser printers.
- Use envelopes made from 24 lb (90 g/m²) bond paper. To reduce paper jams, do not use envelopes that:
 - Have excessive curl
 - Are stuck together
 - Are damaged in any way
 - Contain windows, holes, perforations, cutouts, or embossing
 - Use metal clasps, string ties, or metal folding bars
 - Have postage stamps attached
 - Have any exposed adhesive when the flap is in the sealed position
- Do not use labels that have exposed adhesive on the sheets.
- Do not print a large number of labels continuously.
- Use card stock with a maximum weight of 163 g/m² and a minimum size of 76.2 x 127 mm (3 x 5 in.).

Media types and sizes

Media	Size	Weight	Capacity
Paper	A4, A5, B5, letter, legal, executive, folio	17–43 lb (64–163 g/m ²)	Tray 1: 150 sheets (20 lb paper)
		16–43 lb (60–163 g/m ²)	Manual feed: 1 sheet
		16–24 lb (60–90 g/m ²)	Optional 250-sheet tray: 250 sheets (20 lb paper)
Transparencies	A4, letter	N/A	Tray 1: 10 sheets Manual feed: 1 sheet
Envelopes	Monarch (7 3/4), 9, Com-10, C5, B5, DL	24 lb (90 g/m ²)	Tray 1: 10 envelopes Manual feed: 1 envelope
Labels (Paper)	Minimum: 8.3 x 11 in. (210 mm x 279 mm)	17–43 lb (64–163 g/m ²)	Tray 1: 10 sheets Manual feed: 1 sheet
	Maximum: 8.5 x 11.7 in. (216 mm x 297 mm)		
Index Bristol	Minimum: 3 x 5 in. (76.2 x 127 mm)	67–90 lb Index Bristol (120–163 g/m ²)	Tray 1: 10 cards Manual feed: 1 card
Tag card stock	Maximum: 8.5 x 14 in. (216 mm x 356 mm)	50–100 lb tag (75–163 g/m ²)	

Cables

Your Dell™ Laser Printer P1500 interconnection cable must meet the following requirements:

Connection	Cable certification
USB	USB 2.0
Parallel	IEEE-1284

Certifications

- Novell
- USB-IF

Safety and Regulatory Information

[Safety Information](#)

[Regulatory Information](#)

Safety Information

 **NOTICE:** Read and follow all safety instructions in your *Owner's Manual* prior to setting up and operating your printer.

Regulatory Information

FCC Notices

Federal Communications Commission (FCC) compliance information statement

Your printer has been tested and found to comply with the limits for a Class B digital device, pursuant to Part 15 of the FCC Rules. Operation is subject to the following two conditions: (1) this device may not cause harmful interference, and (2) this device must accept any interference received, including interference that may cause undesired operation.

The FCC Class B limits are designed to provide reasonable protection against harmful interference in a residential installation. This equipment generates, uses and can radiate radio frequency energy and, if not installed and used in accordance with the instructions, may cause harmful interference to radio communications. However, there is no guarantee that interference will not occur in a particular installation. If this equipment does cause harmful interference to radio or television reception, which can be determined by turning the equipment off and on, the user is encouraged to try to correct the interference by one or more of the following measures:

- Reorient or relocate the receiving antenna.
- Increase the separation between the equipment and receiver.
- Connect the equipment into an outlet on a circuit different from that to which the receiver is connected.
- Consult your service representative for additional suggestions.

The manufacturer is not responsible for any radio or television interference caused by using other than recommended cables or by unauthorized changes or modifications to this equipment. Unauthorized changes or modifications could void the user's authority to operate this equipment.

 **NOTE:** To assure compliance with FCC regulations on electromagnetic interference for a Class B computing device, use a properly shielded and grounded cable. Use of a substitute cable not properly shielded and grounded may result in a violation of FCC regulations.

Industry Canada compliance statement

This Class B digital apparatus meets all requirements of the Canadian Interference-Causing Equipment Regulations.

Avis de conformité aux normes d'Industrie Canada

Cet appareil numérique de la classe B respecte toutes les exigences du Règlement sur le matériel brouilleur du Canada.

European Community (EC) directives conformity

This product is in conformity with the protection requirements of EC Council directives 89/336/EEC and 73/23/EEC on the approximation and harmonization of the laws of the Member States relating to electromagnetic compatibility and safety of electrical equipment designed for use within certain voltage limits.

This product satisfies the Class B limits of EN 55022 and safety requirements of EN 60950.

The United Kingdom Telecommunications Act 1984

This apparatus is approved under the approval number NS/G/1234/J/100003 for the indirect connections to the public telecommunications systems in the United Kingdom.

Noise Emissions Levels

The following measurements were made in accordance with ISO 7779 and reported in conformance with ISO 9296.

1-meter average sound pressure, dBA	
Printing	49 dBA
Idling	35 dBA

Laser Notice

The printer is certified in the U.S. to conform to the requirements of DHHS 21 CFR Subchapter J for Class I (1) laser products, and elsewhere is certified as a Class I laser product conforming to the requirements of IEC 60825-1.

Class I laser products are not considered to be hazardous. The printer contains internally a Class IIIb (3b) laser that is nominally a 5 milliwatt gallium arsenide laser operating in the wavelength region of 770-795 nanometers. The laser system and printer are designed so there is never any human access to laser radiation above a Class I level during normal operation, user maintenance, or prescribed service condition.

ENERGY STAR



The EPA ENERGY STAR™ Office Equipment program is a partnership effort with office equipment manufacturers to promote the introduction of energy-efficient products and to reduce air pollution caused by power generation.

Companies participating in this program introduce products that power down when they are not being used. This feature will cut the energy used by up to 50 percent. Dell is proud to be a participant in this program.

As an ENERGY STAR Partner, Dell Computer Corporation has determined that this product meets the ENERGY STAR guidelines for energy efficiency.

Appendix

- [Dell technical support policy](#)
 - [Contacting Dell](#)
 - [Warranty and Return Policy](#)
-

Dell technical support policy

Technician-assisted technical support requires the cooperation and participation of the customer in the troubleshooting process and provides for restoration of the Operating System, application software and hardware drivers to the original default configuration as shipped from Dell, as well as the verification of appropriate functionality of the computer unit and all Dell-installed hardware. In addition to this technician assisted technical support, online technical support is available at Dell Support. Additional technical support options may be available for purchase.

Dell provides limited technical support for the printer and any Dell-installed software and peripherals. Support for third-party software and peripherals is provided by the original manufacturer, including those purchased and/or installed through Software & Peripherals (DellWare), ReadyWare, and Custom Factory Integration (CFI/DellPlus).

Contacting Dell

You can access Dell Support at support.dell.com. Select your region on the WELCOME TO DELL SUPPORT page, and fill in the requested details to access help tools and information.

You can contact Dell electronically using the following addresses:

- World Wide Web
www.dell.com/
www.dell.com/ap/ (for Asian/Pacific countries only)
www.euro.dell.com (for Europe only)
www.dell.com/la/ (for Latin American countries)
- Anonymous file transfer protocol (FTP)
[ftp.dell.com/](ftp://ftp.dell.com/)
Log in as user: anonymous, and use your e-mail address as your password.
- Electronic Support Service
mobile_support@us.dell.com
support@us.dell.com
apsupport@dell.com (for Asian/Pacific countries only)
support.euro.dell.com (for Europe only)
- Electronic Quote Service

sales@dell.com
apmarketing@dell.com (for Asian/Pacific countries only)

- Electronic Information Service
info@dell.com

Warranty and Return Policy

Dell Computer Corporation ("Dell") manufactures its hardware products from parts and components that are new or equivalent to new in accordance with industry-standard practices. For information about the Dell warranty for your printer, refer to the *Owner's Manual*.

Licensing notice

The printer resident software contains:

- Software developed and copyrighted by Dell and/or third parties
- Dell modified software licensed under the provisions of the GNU General Public License version 2 and the GNU Lesser General Public License version 2.1
- Software licensed under the BSD license and warranty statements

Click the title of the document you want to review:

- [BSD License and Warranty statements](#)
- [GNU License](#)

The Dell modified GNU licensed software is free software; you can redistribute it and/or modify it under the terms of the licenses referenced above. These licenses do not provide you any rights to the Dell- or third-party-copyrighted software in this printer.

Since the GNU licensed software that the Dell modifications are based upon is supplied explicitly without warranty, use of the Dell modified version is similarly provided without warranty. See the warranty disclaimers in the referenced licenses for additional details.

To obtain source code files for the Dell modified GNU licensed software, launch the *Drivers and Utilities CD* that shipped with your printer and click Contact Dell.