



User Manual

Wireless N 150 Home Router

Preface

D-Link reserves the right to revise this publication and to make changes in the content hereof without obligation to notify any person or organization of such revisions or changes.

Manual Revisions

Revision	Date	Description
1.0	April 21, 2013	DIR-600 Revision D1
4.10	October 13, 2014	add power usage

Trademarks

D-Link and the D-Link logo are trademarks or registered trademarks of D-Link Corporation or its subsidiaries in the United States or other countries. All other company or product names mentioned herein are trademarks or registered trademarks of their respective companies.

Copyright © 2014 by D-Link Systems, Inc.

All rights reserved. This publication may not be reproduced, in whole or in part, without prior expressed written permission from D-Link Systems, Inc.

Power Usage

This device is an Energy Related Product (ErP) with High Network Availability (HiNA), and automatically switches to a power-saving Network Standby mode within 1 minute of no packets being transmitted. It can also be turned off through a power switch to save energy when it is not needed.

Network Standby: 2.39 watts



Switched Off: 0.19 watts

Table of Contents

Product Overview	1	Wireless Basics	23
Package Contents.....	1	Wi-Fi Protected (WPS) Setup	25
System Requirements	2	Advanced Wireless	26
Features.....	3	Wireless Repeater	28
Hardware Overview	4	Advanced	30
Connections	4	Access Control List.....	30
LEDs	5	Port Triggering.....	31
Installation	6	URL Block.....	32
Before You Begin.....	6	Dynamic DNS	33
Wireless Installation Considerations.....	7	Traffic Control.....	34
Connect to Cable/DSL/Satellite Modem.....	8	UPnP	36
Connect to Another Router	9	Virtual Server	37
Getting Started.....	11	Maintenance	39
Configuration	12	Reboot	39
Web-based Configuration Utility	12	Firmware Upgrade.....	40
Setup.....	13	Backup/Restore	41
Wizard	13	Admin	42
Local Network	17	Time and Date.....	43
LAN Interface Setup.....	18	Status	44
DHCP Server Settings.....	19	Device Info	44
DHCP Static IP Configuration	20	Active Client Table	45
Setup.....	21	Statistics	46
Internet Setup.....	21	Help	47
Wireless	23	Wireless Security	48
		What is WPA?	48

Connect to a Wireless Network.....	49
Using Windows® 7	49
Configure WPS	52
Using Windows Vista®	56
Configure Wireless Security	57
Using Windows® XP	59
Configure WPA-PSK.....	60
Troubleshooting	62
Wireless Basics	66
What is Wireless?.....	67
Tips.....	69
Wireless Modes.....	70
Networking Basics	71
Check your IP address.....	71
Statically Assign an IP address	72
Technical Specifications	73

Package Contents

DIR-600 Wireless N 150 Home Router	
Power Adapter	
Ethernet Cable	

Note: Using a power supply with a different voltage rating than the one included with the DIR-600 will cause damage and void the warranty for this product.

System Requirements

Network Requirements	<ul style="list-style-type: none">• An Ethernet-based Cable or DSL modem• IEEE 802.11n or 802.11g wireless clients• 10/100 Ethernet
Web-based Configuration Utility Requirements	<p>Computer with the following:</p> <ul style="list-style-type: none">• Windows®, Macintosh, or Linux-based operating system• An installed Ethernet adapter <p>Browser Requirements:</p> <ul style="list-style-type: none">• Internet Explorer 6 or higher• Firefox 3.0 or higher• Safari 3.0 or higher• Chrome 2.0 or higher <p>Windows® Users: Make sure you have the latest version of Java installed. Visit www.java.com to download the latest version.</p>

Features

- **Faster Wireless Networking** - The DIR-600 provides wireless connection of up to 150Mbps* for other 802.11n wireless clients. This capability allows users to participate in real-time activities online, such as video streaming, online gaming, and real-time audio.
- **Compatible with 802.11b and 802.11g Devices** - The DIR-600 is fully compatible with the IEEE 802.11b and IEEE 802.11g standard, so it can connect with existing 802.11b and IEEE 802.11g PCI, USB and FireWire adapters.
- **Advanced Firewall Features** - The Web-based user interface displays a number of advanced network management features including:
 - **Content Filtering** - Easily applied content filtering based on URL.
 - **Secure Multiple/Concurrent Sessions** - The DIR-600 can pass through VPN sessions. It supports multiple and concurrent PPTP sessions, so users behind the DIR-600 can securely access corporate networks.
- **User-friendly Setup Wizard** - Through its easy-to-use Web-based user interface, the DIR-600 lets you control what information is accessible to those on the wireless network, whether from the Internet or from your company's server. Configure your router to your specific settings within minutes.

* Maximum wireless signal rate derived from IEEE Standard 802.11g and Draft 802.11n specifications. Actual data throughput will vary. Network conditions and environmental factors, including volume of network traffic, building materials and construction, and network overhead, lower actual data throughput rate. Environmental conditions will adversely affect wireless signal range.

Hardware Overview

Connections

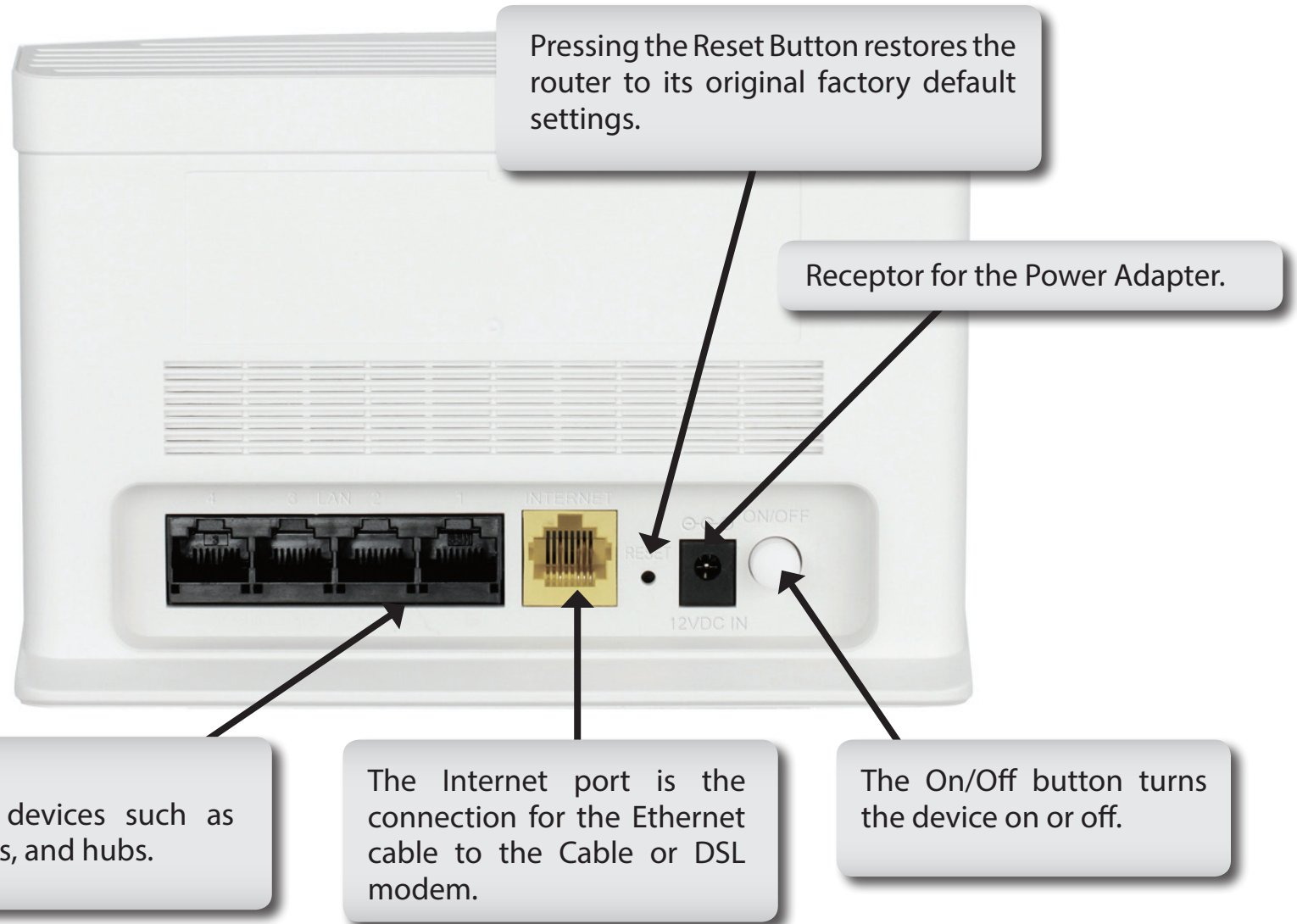

Hardware Overview

LEDs

INTERNET

A solid light indicates connection on the WAN port.

Power LED

A solid light indicates a proper connection to the power supply.



Installation

This section will walk you through the installation process. Placement of the router is very important. Do not place the router in an enclosed area such as a closet, cabinet, or in the attic or garage.

Before You Begin

- Please configure the router with the computer that was last connected directly to your modem.
- You can only use the Ethernet port on your modem. If you were using the USB connection before using the router, then you must turn off your modem, disconnect the USB cable and connect an Ethernet cable to the Internet port on the router, and then turn the modem back on. In some cases, you may need to call your ISP to change connection types (USB to Ethernet).
- If you have DSL and are connecting via PPPoE, make sure you disable or uninstall any PPPoE software such as WinPoet, Broadjump, or Enternet 300 from your computer or you will not be able to connect to the Internet.
- When running the Setup Wizard, make sure the computer is connected to the Internet and online or the wizard will not work. If you have disconnected any hardware, re-connect your computer back to the modem and make sure you are online.

Wireless Installation Considerations

The D-Link wireless router lets you access your network using a wireless connection from virtually anywhere within the operating range of your wireless network. Keep in mind, however, that the number, thickness and location of walls, ceilings, or other objects that the wireless signals must pass through, may limit the range. Typical ranges vary depending on the types of materials and background RF (radio frequency) noise in your home or business. The key to maximizing wireless range is to follow these basic guidelines:

1. Keep the number of walls and ceilings between the D-Link router and other network devices to a minimum - each wall or ceiling can reduce your adapter's range from 3-90 feet (1-30 meters). Position your devices so that the number of walls or ceilings is minimized.
2. Be aware of the direct line between network devices. A wall that is 1.5 feet thick (.5 meters), at a 45-degree angle appears to be almost 3 feet (1 meter) thick. At a 2-degree angle it looks over 42 feet (14 meters) thick! Position devices so that the signal will travel straight through a wall or ceiling (instead of at an angle) for better reception.
3. Building Materials make a difference. A solid metal door or aluminum studs may have a negative effect on range. Try to position access points, wireless routers, and computers so that the signal passes through drywall or open doorways. Materials and objects such as glass, steel, metal, walls with insulation, water (fish tanks), mirrors, file cabinets, brick, and concrete will degrade your wireless signal.
4. Keep your product away (at least 3-6 feet or 1-2 meters) from electrical devices or appliances that generate RF noise.
5. If you are using 2.4 GHz cordless phones or X-10 (wireless products such as ceiling fans, lights, and home security systems), your wireless connection may degrade dramatically or drop completely. Make sure your 2.4 GHz phone base is as far away from your wireless devices as possible. The base transmits a signal even if the phone is not in use.

Connect to Cable/DSL/Satellite Modem

If you are connecting the router to a cable/DSL/satellite modem, please follow the steps below:

1. Place the router in an open and central location. Do not plug the power adapter into the router.
2. Unplug the modem's power adapter. Shut down your computer.
3. Unplug the Ethernet cable (that connects your computer to your modem) from your computer and place it into the Internet port on the router.
4. Plug an Ethernet cable into one of the four LAN ports on the router. Plug the other end into the Ethernet port on your computer.
5. Plug in your modem. Wait for the modem to boot (about 30 seconds).
6. Plug the power adapter to the router and connect to an outlet or power strip.
7. Use the power switch to power on the router. Wait about 30 seconds for the router to boot.
8. Turn on your computer.
9. Refer to "Getting Started" on page 11 to configure your router.

Connect to Another Router

If you are connecting the D-Link router to another router to use as a wireless access point and/or switch, you will have to do the following before connecting the router to your network:

- Disable UPnP™
- Disable DHCP
- Change the LAN IP address to an available address on your network. The LAN ports on the router cannot accept a DHCP address from your other router.

To connect to another router, please follow the steps below:

1. Plug the power into the router and use the power switch to power up the router. Connect one of your computers to the router (LAN port) using an Ethernet cable. Make sure your IP address on the computer is 192.168.0.xxx (where xxx is between 2 and 254). Please see the **Networking Basics** section for more information. If you need to change the settings, write down your existing settings before making any changes. In most cases, your computer should be set to receive an IP address automatically in which case you will not have to do anything to your computer.
2. Open a web browser and enter **http://192.168.0.1** and press **Enter**. When the login window appears, set the user name to **Admin** and leave the password box empty. Click **Log In** to continue.
3. Click on **Advanced** and then click **UPnP**. Uncheck the **Enable** checkbox. Click **Apply Changes** to continue.
4. Click **Setup** and then click **Local Network**. Under **DHCP Server Settings**, select **None** in the **DHCP Mode** pulldown menu. Click **Apply Changes** to continue.
5. Remaining in **Local Network**, go to **LAN Interface Setup** and enter an available IP address and the subnet mask of your network. Click **Apply Changes** to save your settings. Use this new IP address to access the configuration utility of the router in the future. Close the browser and change your computer's IP settings back to the original values as in Step 1.

6. Disconnect the Ethernet cable from the router and reconnect your computer to your network.
7. Connect an Ethernet cable in one of the **LAN** ports of the router and connect it to your other router. Do not plug anything into the Internet (WAN) port of the D-Link router.
8. You may now use the other 3 LAN ports to connect other Ethernet devices and computers. To configure your wireless network, open a web browser and enter the IP address you assigned to the router. Refer to the **Configuration** and **Wireless Security** sections for more information on setting up your wireless network.

Getting Started

The DIR-600 will run a Setup Wizard when you first use it. Follow the simple steps below to run the Setup Wizard to guide you quickly through the installation process.

Select your WAN network type, then enter your wireless SSID and key.

Click the **Save and Connect** button when you are finished.

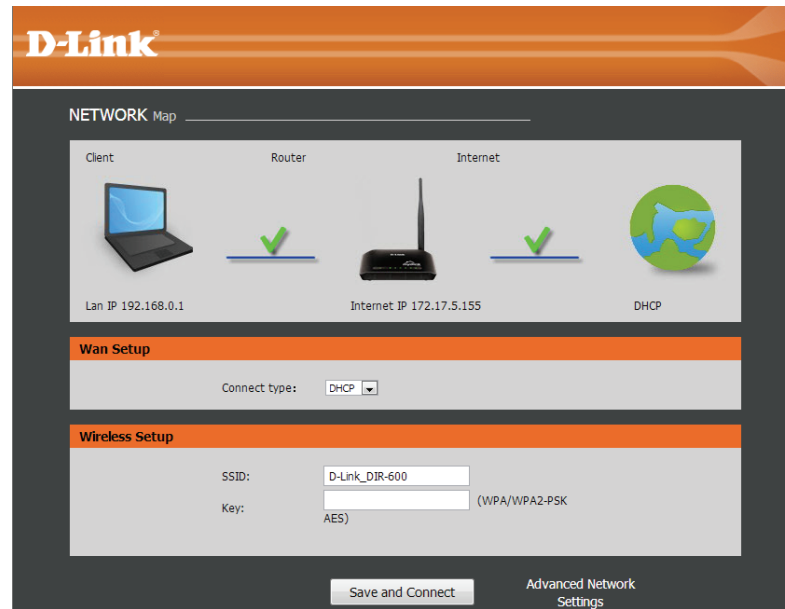

Note: It is recommended to write down the SSID and security key, followed by the login password.

Configuration

This section will show you how to configure your new D-Link wireless router using the web-based configuration utility.

Web-based Configuration Utility

To access the configuration utility, open a web-browser such as Internet Explorer and enter the IP address of the router (192.168.0.1).

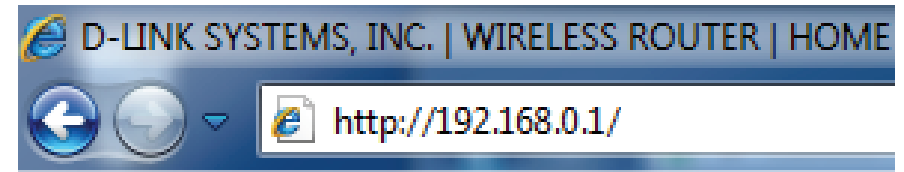

Enter **Admin** in the User Name field. Leave the password blank as the default password.

If you get a **Page Cannot be Displayed** error, please refer to the **Troubleshooting** section for assistance.

A screenshot of the "LOGIN" page for the D-Link wireless router configuration utility. The page has an orange header with the word "LOGIN" in white. Below the header, the text "Login to the router :" is displayed. There are two input fields: "User Name" with the text "admin" entered, and "Password" which is empty. A "Login" button is located to the right of the password field.

Setup Wizard

You can configure your WAN network connection using a wizard or manually. Click **Next** to use the Setup Wizard, or click **Manual** to configure the WAN connection manually, which will take you to the **Setup > Internet Setup** page. Setup Wizard will be explained in the next pages and Internet Setup will be explained in the **Internet Setup** section.

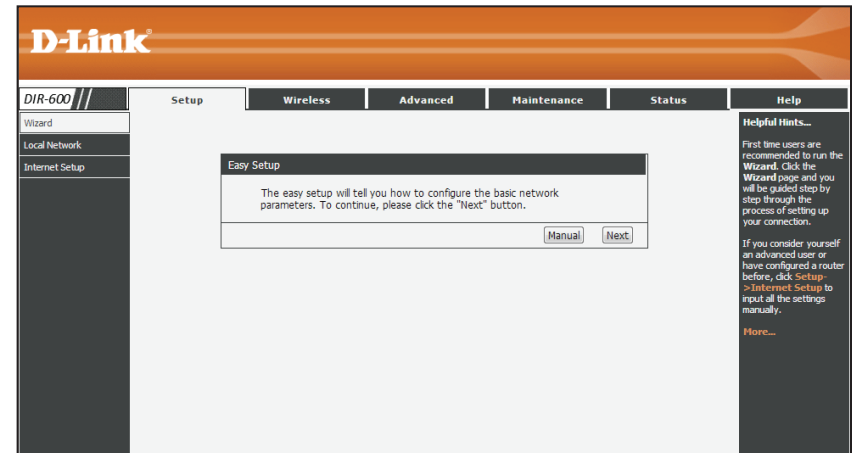

Select the connection type for your WAN and click **Next** to continue.

Easy Setup - WAN Connection Type

The Easy Setup supports three popular types of connection. To make sure the connection type your ISP provides, please refer to the ISP.

- PPPoE - Usually for ADSL Modem and you will need a PPPoE username and password from your ISP.
- Dynamic IP - Usually for Cable Modem and the router will automatically obtain an IP address from the DHCP server.
- Static IP - This type of connection uses a permanent, fixed (static) IP address that your ISP assigned.

If you selected PPPoE, enter your PPPoE username and password twice and click **Next** to continue. Click the **Account Validate** button to validate the account.

Easy Setup - PPPoE

Enter the account username and password provided by your ISP.

User Name:

Password:

Confirm Password:

If you selected Static IP, enter your IP address, Subnet Mask, Default Gateway, Primary DNS, and Secondary DNS, and click **Next** to continue.

Easy Setup - Static IP

Enter the IP parameters provided by your ISP.

IP Address:

Subnet Mask:

Default Gateway:

Primary DNS: (Optional)

Secondary DNS: (Optional)

You can also configure the wireless network and security settings. If you prefer not to, click **Disable the wireless radio**. Click **Next** to continue.

SSID: Enter the SSID name.

Channel: Use the dropdown menu to select the wireless channel.

Mode: Use the dropdown menu to specify the wireless mode

Channel Width: Use the dropdown menu to select the channel bandwidth. If you selected the 802.11n, 802.11 b/g, or 802.11 b/g/n wireless modes, the available options are 20 MHz and 20/40MHz. For the others, 20MHz is the only option.

Disable Security: You can also choose to not use security by selecting this, but this is not recommended.

WPA/WPA2-Personal: If you select this, enter a passkey in the box below the field.

Easy Setup - Wireless

You can configure the wireless parameters and security settings of router on this step.

Disable the wireless radio.

SSID:

Channel:

Mode:

Channel Width:

Wireless Security:

It is recommended strongly that you choose one of following options to enable security, and select WPA-PSK/WPA2-PSK AES encryption.

Disable Security

WPA-PSK/WPA2-PSK AES

WPA/WPA2 - Personal: (You can enter ASCII characters between 8 and 63 or Hexadecimal characters between 8 and 64.)

Click **Finish** to complete the setup process. When the router has finished saving, the **Status > Device Info** window will open.

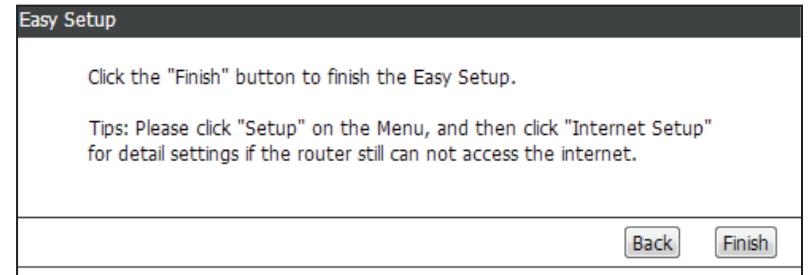

Local Network

This section will allow you to change the local network settings of the router and to configure the DHCP settings.

LAN Interface: Use this section to configure the Router's local network settings.

DHCP Server Settings: Use this section to configure the DIR-600's built-in DHCP server settings.

DHCP Static IP Configuration: Use this section to add a new DHCP Static IP configuration.

DHCP Static IP Table: Displays information about the devices that have a static DHCP assigned from the DIR-600. The information includes the *IP Address* and *MAC Address*. You can delete or edit an existing Static IP configuration in the table.

The screenshot displays the D-Link DIR-600 web management interface. The top navigation bar includes 'Setup', 'Wireless', 'Advanced', 'Maintenance', 'Status', and 'Help'. The left sidebar shows 'Wizard', 'Local Network', and 'Internet Setup'. The main content area is titled 'LAN Interface Setup' and contains the following sections:

- LAN Interface Setup:** This page is used to configure the LAN interface of your Wireless Router. Here you may change the setting for IP address, subnet mask, etc..
- DHCP Server Settings:** This page can be used to config the DHCP mode:None or DHCP Server.
 - (1) Enable the DHCP Server if you are using this device as a DHCP server. This page lists the IP address pools available to hosts on your LAN. The device distributes numbers in the pool to hosts on your network as they request Internet access. If you choose "None", then the router will do nothing when the hosts request a IP address.
 - (2) This page lists the fixed IP/MAC address on your LAN. The device distributes the number configured to hosts on your network as they request Internet access.

The 'LAN Interface Setup' section includes input fields for 'IP Address' (192.168.0.1) and 'Subnet Mask' (255.255.255.0), with an 'Apply Changes' button below. The 'DHCP Server Settings' section includes a 'DHCP Mode' dropdown menu set to 'DHCP Server', an 'IP Pool Range' (192.168.0.2 - 192.168.0.254), 'Max Lease Time' (120 minutes), and fields for 'Domain Name', 'DNS Server 1' (192.168.0.1), 'DNS Server 2', and 'DNS Server 3'.

Helpful Hints...

- The IP address of your router is the same IP address you will use to access the web management interface of your router.
- If you already have a DHCP server on your network or are using static IP addresses on all the devices on your network, select DHCP Mode to to disable this feature.
- If you have devices on your network that should always have fixed IP addresses, add a Static DHCP for each such device.

[More...](#)

Local Network LAN Interface Setup

IP Address: Enter the IP address of the router. The default IP address is 192.168.0.1.

If you change the IP address, once you click **Apply**, you will need to enter the new IP address in your browser to get back into the configuration utility.

Default Subnet Mask: Enter the Subnet Mask. The default subnet mask is 255.255.255.0.

LAN Interface Setup

IP Address: 192.168.0.1

Subnet Mask: 255.255.255.0

Apply Changes

Click the **Apply Changes** button to save any changes made.

Local Network

DHCP Server Settings

DHCP stands for Dynamic Host Control Protocol. The DIR-600 has a built-in DHCP server. The DHCP Server will automatically assign an IP address to the computers on the LAN/private network. Be sure to set your computers to be DHCP clients by setting their TCP/IP settings to "Obtain an IP Address Automatically." When you turn your computers on, they will automatically load the proper TCP/IP settings provided by the DIR-600. The DHCP Server will automatically allocate an unused IP address from the IP address pool to the requesting computer. You must specify the starting and ending address of the IP address pool.

DHCP Mode: Choose the **DHCP Server** option in the pulldown menu to enable the DHCP server on your router. Choose **None** to disable this function.

IP Pool Range: Enter the starting and ending IP addresses for the DHCP server's IP assignment.

Note: *If you statically (manually) assign IP addresses to your computers or devices, make sure the IP addresses are outside of this range or you may have an IP conflict.*

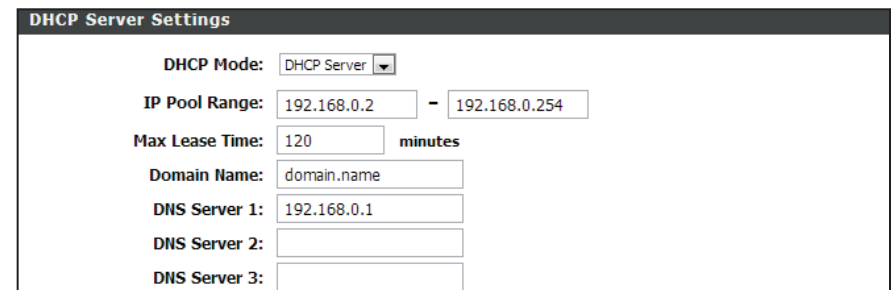

DHCP Server Settings	
DHCP Mode:	DHCP Server
IP Pool Range:	192.168.0.2 - 192.168.0.254
Max Lease Time:	120 minutes
Domain Name:	domain.name
DNS Server 1:	192.168.0.1
DNS Server 2:	
DNS Server 3:	

Max Lease Time: The maximum length of time for the IP address lease. Enter the Lease time in minutes.

Domain Name: Enter the domain name.

DNS Server 1: Enter the IP address of the first DNS Server.

DNS Server 2: Enter the IP address of the second DNS Server, if there is one.

DNS Server 3: Enter the IP address of the third DNS Server, if there is one.

When you have finished configuring the new DHCP Server Settings, click the **Apply Changes** button.

Local Network

DHCP Static IP Configuration

If you want a computer or device to always have the same IP address assigned, you can create a DHCP reservation. The router will assign the IP address only to that computer or device.

Note: This IP address must be within the DHCP IP Address Range.

IP Address: Enter the IP address you want to assign to the computer or device. This IP Address must be within the DHCP IP Address Range.

MAC Address: Enter the MAC address of the computer or device.

DHCP Static IP Configuration

IP Address:

Mac Address: (ex. 00E086710502)

When you have finished configuring the new DHCP Reservation, click the **Add** button to activate your reservation. It will then be displayed in the DHCP Static IP Table below.

DHCP Static IP Table

Select	IP Address	MAC Address
<input checked="" type="radio"/>	192.168.0.14	00:00:40:30:05:70

The DHCP Static IP Table displays the IP reservations that have been created. To make any changes, select a reservation in the table by clicking the circle next to it and click **Update**. To delete a reservation, select a reservation and click **Delete Selected**.

Setup

Internet Setup

This section allows you to manually configure your Router's Internet WAN settings.

WAN Access Type: Select the WAN interface type.

If you choose DHCP Client, please configure the following fields:

Host Name: Enter the host name of the router.

MTU Size: Enter the MTU size.

Attain DNS Automatically: Click this if the DNS is to be obtained automatically.

Set DNS Manually: Click this to specify a DNS Server. You can enter up to three DNS servers.

MAC Clone: Select the default MAC address, the PC's, or enter it manually.

The screenshot shows the 'WAN Interface Setup' page in the D-Link DIR-600 web interface. The page is divided into several sections:

- WAN Interface Setup:** This section contains a message: "This page is used to configure the parameters for Internet network which connects to the WAN port of your Access Point. Here you may change the access method to static IP, DHCP or PPPoE by click the item value of WAN Access type." Below this is a dropdown menu for 'WAN Access Type' set to 'DHCP Client'.
- Host Name:** A text input field containing 'hostname'.
- MTU Size:** A text input field containing '1500'.
- Attain DNS Automatically:** A radio button that is selected, with a note: "(Need to repair the connection of your PC if DNS configuration changed.)".
- Set DNS Manually:** An unselected radio button.
- DNS Server 1, 2, and 3:** Three text input fields, each containing '0.0.0.0'.
- MAC Clone:** A section with three radio buttons: 'Default MAC' (selected), 'MAC from PC', and 'MAC manual'. Below these is a text input field containing 'C8:D3:A3:D9:B1:3E'.
- Buttons:** 'Apply Changes' and 'Reset' buttons are located at the bottom right of the form.

When you have finished configuring the WAN settings, click the **Apply Changes** button.

If you choose Static IP, please configure the following fields;

IP Address: Enter the IP address of the router.

Subnet Mask: Enter the subnet mask.

Default Gateway: Enter the default gateway.

MTU Size: Enter the MTU size.

DNS Server 1, 2, 3: Enter up to three DNS Server IP addresses.

When you have finished configuring the WAN settings, click the **Apply Changes** button.

If you choose PPPoE, please configure the following fields:

User Name: Enter a user name.

Password: Enter a password.

Service Name: Enter the PPPoE Server name. This is optional.

MTU Size: Enter the MTU size.

Connection Type: Select the Connection Type.

Attain DNS Automatically: Click this if the DNS is to be obtained automatically.

Set DNS Manually: Click this to specify a DNS Server. You can enter up to three DNS servers.

When you have finished configuring the WAN settings, click the **Apply Changes** button.

Wireless

Wireless Basics

This page allows you to configure the wireless LAN settings. You can also configure the wireless encryption and wireless network parameters.

Enable SSID Broadcast: Enable SSID broadcast if you want the router to transmit its SSID publicly so other wireless devices can discover it.

Enable Wireless Isolation: Enable wireless isolation to prevent connected wireless devices from connecting to other wireless devices that are also connected to the router.

Name (SSID): Enter the SSID name of the router.

Mode: Use the dropdown menu to specify the wireless mode.

Channel: Use the dropdown menu to select the wireless channel.

Band Width: Use the dropdown menu to select the channel bandwidth. If you selected the 802.11n, 802.11 b/g, or 802.11 b/g/n wireless modes, the available options are 20 MHz and 20/40MHz. For the others, 20MHz is the only option.

Max Transmission Rate: Select the maximum transmission rate for the wireless network.

Security Options: Select a wireless security encryption option. You can also choose to not use one by selecting **None**, but this is not recommended.

The screenshot shows the 'Wireless Basics' configuration page for a D-Link DIR-600 router. The page is divided into two main sections: 'Wireless Network' and 'Security Options'. In the 'Wireless Network' section, 'Enable SSID Broadcast' is checked, and 'Enable Wireless Isolation' is unchecked. The SSID name is 'D-Link_DIR-600'. The mode is set to '802.11b/g/n', the channel is 'Auto', and the bandwidth is 'Auto 20/40M'. The maximum transmission rate is 'Auto'. In the 'Security Options' section, the security option is set to 'None'. There are 'Apply' and 'Cancel' buttons at the bottom of the form. On the right side, there is a 'Helpful Hints...' section with a note about agency compliance and a section titled 'Placement of the Router to Optimize Wireless Connectivity' which provides advice on router placement.

If you select WEP as the security option, the following settings below will appear.

Authentication

Type: Select the authentication type.

Encryption

Strength: Select the encryption strength.

Security

Encryption

(WEP) Key: Select up to four WEP keys.

If you have selected any WPA option, the following setting will appear.

Pre-shared Key: Enter a pre-shared key.

Click the **Apply** button to save any changes made.

The screenshot shows a configuration window titled "Security Options" with three main sections:

- Security Options:** A dropdown menu is set to "WEP".
- Security Encryption(WEP):** Contains two dropdown menus: "Authentication Type" set to "Automatic" and "Encryption Strength" set to "64 bits".
- Security Encryption(WEP) Key:** Contains four key input fields labeled "Key 1" through "Key 4". "Key 1" is selected with a radio button and contains the text "0000000000". The other three keys are unselected and empty.

At the bottom of the window are "Apply" and "Cancel" buttons.

Wi-Fi Protected (WPS) Setup

Wi-Fi Protected Setup (WPS) System is a simplified method for securing your wireless network during the “Initial setup” as well as the “Add New Device” processes. The Wi-Fi Alliance (WFA) has certified it across different products as well as manufacturers. The process is just as easy, as pressing a button for the Push-Button Method or correctly entering the 8-digit code for the Pin-Code Method. The time reduction in setup and ease of use are quite beneficial, while the highest wireless security setting of WPA2 is automatically used.

Click the **Next** button to enter the WPS Setup wizard.

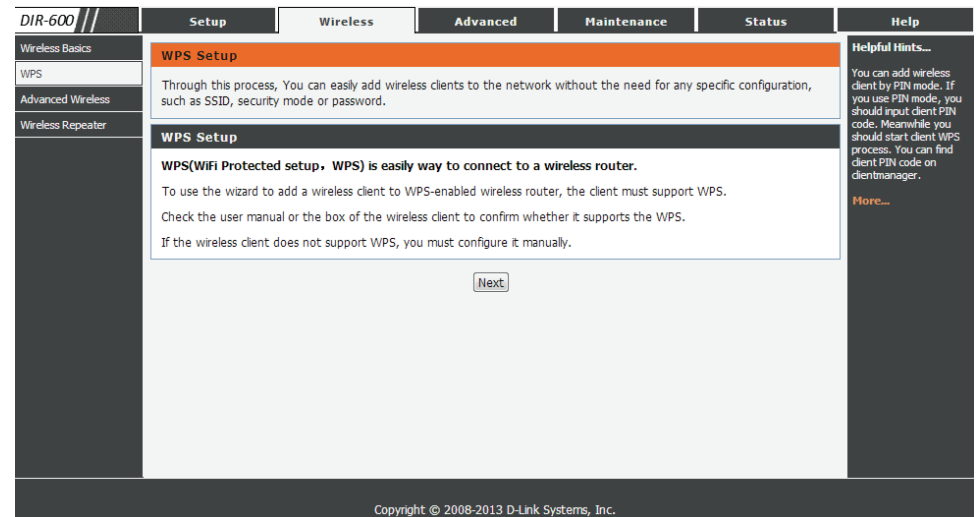

Select: Enter the PIN for the wireless NIC and click **Start PIN**. If successful, you will then be taken to another screen and a message will tell you to run WPS in the client device within 2 minutes.

Advanced Wireless

Enable Wireless: Enable wireless on your network.

Fragment Threshold (256-2346): The fragmentation threshold, which is specified in bytes, determines whether packets will be fragmented. Packets exceeding the 2346 byte setting will be fragmented before transmission. 2346 is the default setting.

RTS Threshold (1-2347): This value should remain at its default setting of 2346. If inconsistent data flow is a problem, only a minor modification should be made.

Preamble Type: Set the transmit power of the antennas in percentage.

Radio Power: Use the dropdown menu to specify whether the Router should use the **Short Preamble** or **Long Preamble** type. The preamble type defines the length of the CRC (Cyclic Redundancy Check) block for communication between the Router and roaming wireless adapters.

HT20/40 Coexistence: Use the radio buttons to enable or disable HT20/40 Coexistence.

Click the **Apply Changes** button to save any changes made.

The screenshot shows the 'Advanced Wireless Settings' page for a DIR-600 router. The page is divided into several sections:

- Advanced Wireless Settings:** This section contains the following options:
 - Enable Wireless:
 - Fragment Threshold(256-2346): 2346
 - RTS Threshold(1-2347): 2347
 - Preamble Type: Short Preamble
 - Radio Power (Percent): 100%
 - HT20/40 Coexistence: Enabled Disabled
- WPS Setup:** This section contains the following options:
 - PIN of the router: 14048111
 - Enable WPS:
 - Disable PIN:
 - Keep current configuration:
- Access Control List:** This section contains an 'ACL Setup' button.

At the bottom of the page, there is an 'Apply Changes' button.

WPS Setup

PIN of the router: The WPS PIN will be displayed here.

Enable WPS: Check the box to enable WPS.

Disable PIN: Check to disable WPS PIN.

Keep current configuration: Check to keep the current configuration.

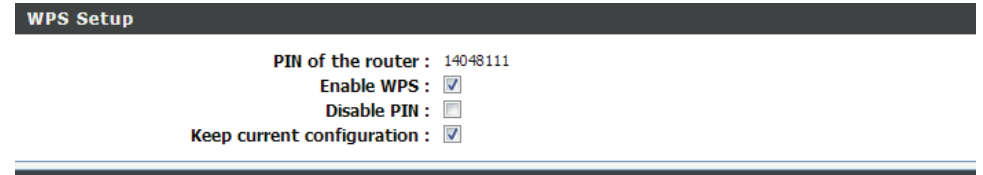

WPS Setup

PIN of the router : 14048111

Enable WPS :

Disable PIN :

Keep current configuration :

Access Control List

Click the **ACL Setup** button to edit the ACL (Access Control List). This takes you to the screen below.

Enable Wireless Access Control Mode: Click to enable Wireless Access Control Mode. In this mode, only listed wireless devices will be allowed to connect to the wireless network.

Click the **Apply** button when you are done.

MAC Address: Enter the MAC Address of a device you wish to allow access for to the WLAN.

Click the **Add** button when you are done. This will add the device's MAC Address to the table above.

Click the **Delete** button and the button in the Select field to delete the device.

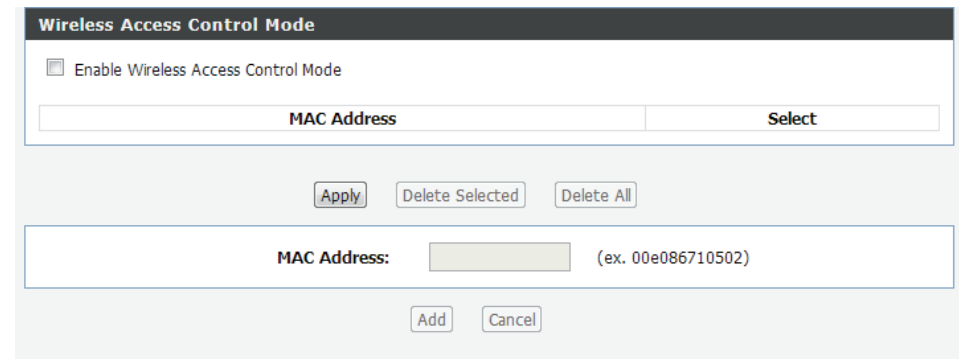

Wireless Access Control Mode

Enable Wireless Access Control Mode

MAC Address	Select

Apply Delete Selected Delete All

MAC Address: (ex. 00e086710502)

Add Cancel

Wireless Repeater

This page allows you to configure wireless repeater settings for the DIR-600.

Repeater Enabled: Enable wireless on your network.

SSID of AP: Click the **Site Survey** button to enable the router to search for nearby wireless networks. This will take about 30 seconds.

The screenshot shows the 'Wireless Repeater Setup' page in the DIR-600 web interface. The 'Repeater Enabled' checkbox is checked, with a note: '(DHCP mode will be set to "none" if the repeater is enabled.)'. Below it, the 'SSID of AP' field is empty, and a 'Site Survey' button is present. An 'Apply' button is at the bottom right. The left sidebar shows navigation options: Wireless Basics, WPS, Advanced Wireless, and Wireless Repeater. The top navigation bar includes Setup, Wireless, Advanced, Maintenance, Status, and Help. A 'Helpful Hints...' section on the right explains the bridge function of the wireless repeater.

This screenshot shows the same 'Wireless Repeater Setup' page, but with a list of detected wireless networks displayed below the 'Site Survey' button. The 'Repeater Enabled' checkbox remains checked. The table lists various networks with their SSIDs, MAC addresses, channels, and signal strengths.

#	SSID	MAC Address	Channel	Signal	Security	Select
1	notatplink	d8:5d:4c:cd:54:6e	6	100%	WPA2-PSK(TKIP)	<input type="radio"/>
2	d-link-07725	14:d6:4d:d2:29:f0	10	100%	WPA-PSK(AES/TKIP)/WPA2-PSK(AES/TKIP)	<input type="radio"/>
3	dlink-57D0	34:08:04:ce:57:d0	9	100%	None	<input type="radio"/>
4	D-Link	1cbd:b9:c3:8f:50	11	100%	None	<input type="radio"/>
5	SWSW	f0:7d:68:7f:a3:d0	9	100%	WPA-PSK(AES/TKIP)/WPA2-PSK(AES/TKIP)	<input type="radio"/>
6	3310-dlink	00:11:a3:1b:e7:22	1	100%	WPA-PSK(AES/TKIP)/WPA2-PSK(AES/TKIP)	<input type="radio"/>
7	apptest	5cd9:98:6c:b4:ee	6	100%	WPA-PSK(AES/TKIP)/WPA2-PSK(AES/TKIP)	<input type="radio"/>
8	DIR508Laaaaa	90:94:e4:f0:fc:49	11	100%	None	<input type="radio"/>
9	D-Link	1cbd:b9:c3:8e:90	11	100%	None	<input type="radio"/>

A list of wireless networks that have been found will then appear. Select a network and click the **Next** button to move to the next step.

You can then set up wireless security for the network.

If you select WEP as the security option, the following settings below will appear.

Authentication

Type: Select the authentication type.

Encryption

Strength: Select the encryption strength.

Security Encryption (WEP) Key: Select up to four WEP keys.

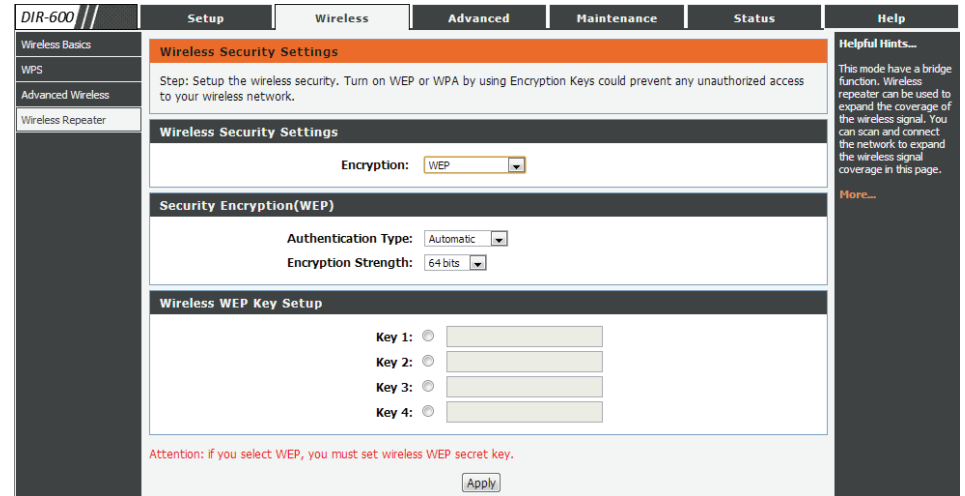

If you have selected any WPA option, the following setting will appear.

Pre-shared Key: Enter a pre-shared key.

Click the **Apply** button to save any changes made. You will be taken to the next page.

You can then set up wireless security for the network.

IP Address: Enter the IP address.

Subnet Mask: Enter the subnet mask.

Click the **Finish** button to save the configuration.

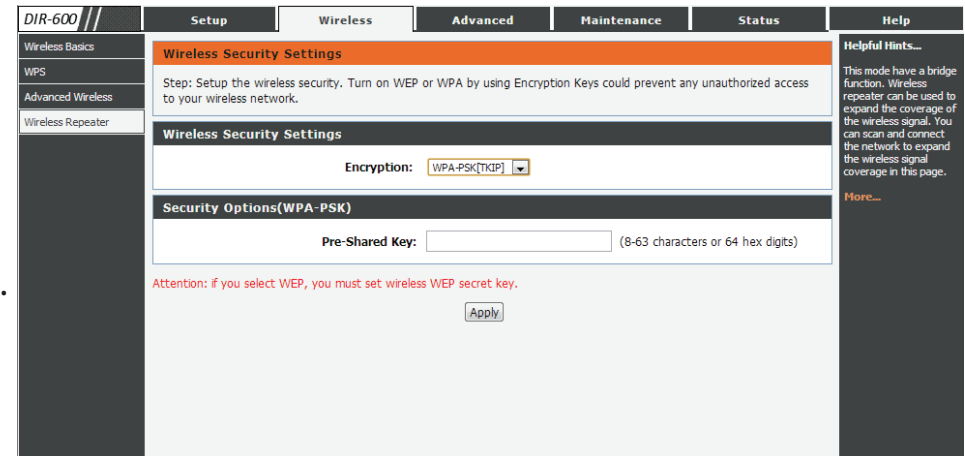

Advanced

Access Control List

This page allows you to set up an Access Control List to restrict the types of data packets that can enter the network from the Internet.

WAN Setting: Use the pulldown menu to select either WAN or IP Address.

IP Address: This option will only be seen if you have selected IP Address above. Enter the IP address range.

Services Allowed: Select the type of Internet service from which packets can be allowed into the network.

The screenshot shows the 'Advanced' configuration page for a DIR-600 router, specifically the 'WAN ACL Configuration' section. The page has a navigation menu at the top with 'Setup', 'Wireless', 'Advanced', 'Maintenance', 'Status', and 'Help'. On the left, there is a sidebar menu with options like 'Access Control List', 'Port Triggering', 'DMZ', 'URL Block', 'Dynamic DNS', 'Traffic Control', 'UPnP', 'Telnet', and 'Virtual Server'. The main content area is titled 'WAN ACL Configuration' and contains the following elements:

- A header bar with the title 'WAN ACL Configuration'.
- An introductory text: 'Entries in this ACL table are used to permit certain types of data packets from Internet network to the Gateway. Using of such access control can be helpful in securing or restricting the Gateway management.'
- A section titled 'ACL Settings' containing:
 - 'WAN Setting': A dropdown menu currently set to 'IP Address'.
 - 'IP Address': Two input fields separated by a hyphen, with a note '(The IP 0.0.0.0 represent any IP)'.
 - 'Services Allowed': Two checkboxes, 'web' and 'ping', both of which are currently unchecked.
 - 'Add' and 'Reset' buttons.
- A section titled 'Current ACL Table' which is currently empty, with a table structure showing columns for 'Select', 'IP Address/Interface', 'Service', 'Port', and 'Action'.

Click the **Add** button to save and add these settings to the Current ACL table.

Port Triggering

This page allows you to enable port triggering to specify inbound traffic to be sent to specific ports while other ports are in use for outbound traffic.

NAT Port Trigger: Enable or disable the Nat Port Trigger.

Click the **Apply Changes** button to save any changes made.

Usual Application Name: Select an application from the pulldown list.

User-defined Application Name: Enter the name of an application.

Start Match Port: Enter a start match port.

End Match Port: Enter an end match port.

Trigger Protocol: Select a protocol from the pulldown menu.

Start Relate Port: Enter a start relate port.

End Relate Port: Enter an end relate port.

Open Protocol: Select a protocol from the pulldown menu.

Nat Type: Select whether it will be outgoing or incoming.

Click the **Apply Changes** button to save any changes made.

The application will then be added to the Current Porttrigger Table. Click the **Delete** button in the Action field for an application type if you wish to delete it.

The screenshot shows the configuration interface for the DIR-600 router. The 'Port Triggering' section is active, showing the 'Port Triggering Status' where the 'Nat Port Trigger' is currently set to 'Disable'. Below this, the 'Application Type' section allows users to select between 'Usual Application Name' (a dropdown menu) and 'User-defined Application Name' (a text input field). A table below these options has columns for 'Start Match Port', 'End Match Port', 'Trigger Protocol' (set to 'UDP'), 'Start Relate Port', 'End Relate Port', 'Open Protocol' (set to 'UDP'), and 'Nat Type' (set to 'outgoing'). At the bottom, the 'Current Port Triggering Table' is shown with columns for 'ServerName', 'Trigger Protocol', 'Direction', 'Match Port', 'Open Protocol', 'Relate Port', and 'Action'. A 'Helpful Hints...' sidebar on the right explains that the router monitors outgoing traffic to trigger specific ports on the local network.

URL Block

This page allows you to block specific websites or keywords in order to prevent network clients from accessing them.

URL Blocking Capability: Enable or disable URL Blocking.

The screenshot shows the DIR-600 web interface with the 'URL Blocking Configuration' page selected. The page has a navigation menu at the top with tabs for Setup, Wireless, Advanced, Maintenance, Status, and Help. The main content area is divided into several sections:

- URL Blocking Configuration:** A header section with an orange background. Below it, a text box states: "This page is used to configure the filtered keyword. Here you can add/delete filtered keyword."
- URL Blocking Capability:** A section with the text "URL Blocking Capability:" followed by two radio buttons: "Disable" (selected) and "Enable". Below this is an "Apply Changes" button.
- Keywords:** A section with a "Keyword:" label and an input field. Below the input field are two buttons: "AddKeyword" and "Delete Selected Keyword".
- URL Blocking Table:** A table with two columns: "Select" and "Filtered Keyword".

On the right side of the interface, there is a "Helpful Hints..." section with text explaining the feature and a "More..." link.

Click the **Apply Changes** button to save any changes made.

Keyword: Type a keyword or a URL site that you want to prevent network users from accessing.

Click the **Add Keyword** button to save any changes made.

The keyword will then be added to the URL Blocking Table below. To delete a keyword, select the keyword in the table and click the **Delete Selected Keyword** button.

Dynamic DNS

The DDNS (Dynamic Domain Name System) feature allows you to host a server (Web, FTP, Game Server) using a domain name that you have purchased (www.whateveryournameis.com) with your dynamically assigned IP address. Most broadband Internet Service Providers assign dynamic (changing) IP addresses. Using a DDNS service provider, your friends can enter your domain name to connect to your server no matter what your IP address is.

Enable: Check the box to enable DDNS.

DDNS Provider: Choose your DDNS provider from the dropdown menu.

Host Name: Enter the Host Name that you registered with your DDNS service provider.

Username: Enter the Username for your DDNS account.

Password: Enter the Password for your DDNS account.

The screenshot shows the 'Dynamic DNS Configuration' page in the DIR-600 web interface. The page is titled 'Dynamic DNS Configuration' and includes a navigation menu at the top with options: Setup, Wireless, Advanced, Maintenance, Status, and Help. The main content area is divided into sections:

- Dynamic DNS Configuration:** This section contains a message: "This page is used to configure the Dynamic DNS address from dlinkddns.com(Free), DynDNS.org, TZO, or www.oray.com. Here you can Add/Remove to configure Dynamic DNS."
- DDNS Configuration:** This section contains the following fields:
 - Enable:** A checkbox that is currently unchecked.
 - DDNS provider:** A dropdown menu with 'dlinkddns.com(Free)' selected.
 - Hostname:** An empty text input field.
 - Account Settings:**
 - Username:** An empty text input field.
 - Password:** An empty text input field.
- Buttons:** Below the account settings are 'Add' and 'Remove' buttons.
- Dynamic DDNS Table:** A table with the following columns: Select, State, Service, Hostname, and Username. The table is currently empty.

On the right side of the page, there is a 'Helpful Hints...' section with the following text: "You can configure dynamic DNS for DynDNS.org, TZO or Oray. You can add / delete a dynamic DNS. The account provided by DDNS service providers. More..."

Click the **Add** button to save any changes made. The DDNS Configuration will then be added to the Dynamic DDNS Table below. To delete an existing DDNS Configuration, select a configuration in the table and click the **Remove** button.

Traffic Control

This page allows you to configure traffic bandwidth and rules for network traffic.

Total Bandwidth (0, Unlimited): Enter the total bandwidth.

Auto Traffic Shaping: Click to enable auto traffic shaping.

The screenshot shows the DIR-600 web interface. The navigation menu on the left includes: Access Control List, Port Triggering, URL Block, Dynamic DNS, Traffic Control (selected), UPnP, and Virtual Server. The main content area is titled 'Traffic Control' and contains the following elements:

- A header bar with 'Traffic Control' and a sub-header: 'This page is used to configure traffic bandwidth and rules.'
- Fields for 'Total Bandwidth(0, Unlimited):' with 'UP Stream' and 'Down Stream' both set to '0' kbps.
- An 'Auto Traffic Shaping' checkbox, which is currently unchecked.
- An 'Apply' button.
- A 'QoS Rules' section with a table for configuring rules.

Protocol	Source Port	Dest Port	Source IP	Dest IP	Garanted Bandwidth(Kbps)		Max Bandwidth(Kbps)		Delete
					Up Floor	Down Floor	Up Ceiling	Down Ceiling	

At the bottom of the QoS Rules section, there are 'Add' and 'Delete' buttons.

QoS Rules

Click the **Add** button once to view the QoS Rules settings.

Protocol: Select the data protocol which you want to set a QoS rule for.

Source IP: Enter the source IP.

Dest IP: Enter the destination IP.

Source Port: Enter the source port number if applicable. This box will be greyed out for certain protocols.

Up Floor: Enter the minimum upload speed.

Down Floor: Enter the minimum download speed.

Source Netmask: Enter the source netmask.

Dest Netmask: Enter the destination netmask.

Dest Port: Enter the destination port.

Up Ceiling: Enter the maximum upload speed.

Down Ceiling: Enter maximum download speed.

Click the **Add** button to save any changes made. The QoS Rule will then be added to the QoS Rules Table. To delete an existing QoS Rule, select it in the QoS rules Table and click the **Delete** button.

UPnP

This page allows you to enable the Universal Plug and Play (UPnP) feature.

UPnP: Click **Enable** to use the UPnP feature. UPnP provides compatibility with networking equipment, software and peripherals.

The screenshot shows the web interface for a DIR-600 router. The navigation menu includes Setup, Wireless, Advanced, Maintenance, Status, and Help. The 'Advanced' tab is selected, and the 'UPnP Configuration' page is displayed. The page contains the following information:

UPnP Configuration
 This page is used to configure UPnP. The system acts as a daemon when you enable UPnP.

UPnP: Disable Enable

Current UPnP Table

Active	Protocol	Internal Port	External Port	IP Address	Description
Yes	UDP	35868	35868	192.168.0.2	Skype UDP at 192.168.0.2 <input type="checkbox"/>
Yes	TCP	35868	35868	192.168.0.2	Skype TCP at 192.168.0.2 <input type="checkbox"/>

Apply Changes

Helpful Hints...
 You can configure UPnP on this page. It will run in the background if enabled.
[More...](#)

Click the **Apply Changes** button to save any changes made.

Virtual Server

The DIR-600 can be configured as a virtual server so that remote users accessing Web or FTP services via the public IP address can be automatically redirected to local servers in the LAN (Local Area Network).

The DIR-600 firewall feature filters out unrecognized packets to protect your LAN network so all computers networked with the DIR-600 are invisible to the outside world. If you wish, you can make some of the LAN computers accessible from the Internet by enabling Virtual Server. Depending on the requested service, the DIR-600 redirects the external service request to the appropriate server within the LAN network.

The DIR-600 is also capable of port-redirection, meaning that incoming traffic to a particular port may be redirected to a different port on the server computer.

For a list of ports for common applications, please visit http://support.dlink.com/faq/view.asp?prod_id=1191.

The Virtual Server page allows you to open a single port. If you would like to open a range of ports, refer to the next page.

Usual Service Select an application from the drop-down menu or
Name: type a name in the next field.

User-defined Enter a service name.
Service Name:

Protocol: Select **TCP** or **UDP** from the **Protocol** drop-down menu.

WAN Port: Enter the WAN port number.

LAN Open Port: Enter the LAN Open port number.

LAN IP Address: Enter the IP address of the computer on your local network that you want to allow the incoming service to.

The screenshot shows the 'Virtual Server' configuration page in the DIR-600 web interface. The 'Service Type' section has 'Usual Service Name' selected with a dropdown menu showing 'AUTH'. The 'User-defined Service Name' field is empty. The 'Protocol' is set to 'TCP'. The 'WAN Port' is 113, and the 'LAN Open Port' is also 113. The 'LAN Ip Address' field is empty. An 'Apply Changes' button is located below the form. Below the form is a table titled 'Current Virtual Server Forwarding Table' with the following columns: ServerName, Protocol, Local IP Address, Local Port, WAN Port, State, and Action.

ServerName	Protocol	Local IP Address	Local Port	WAN Port	State	Action
------------	----------	------------------	------------	----------	-------	--------

Click the **Apply Changes** button to save any changes made. The virtual server will then be added to the Current Virtual Server Forwarding Table below. To delete or disable a virtual server, click the **Delete** or **Disable** buttons in the Action field of the virtual server in the table.

Maintenance

Reboot

This page allows you to reboot your system with the current setting or reset it to the factory default setting.

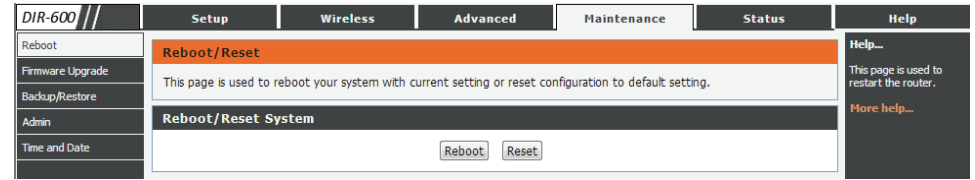

Click the **Reboot** button to reboot the system. To reset the system to the factory default setting, click the **Reset** button.

Firmware Upgrade

This page allows you to upgrade the firmware of the Router. If you plan to install new firmware, make sure the firmware you want to use is on the local hard drive of the computer. Please check the D-Link support site for firmware updates at <http://support.dlink.com>. You can download firmware upgrades to your hard drive from the D-Link support site.

Choose File: After you have downloaded the new firmware, click **Browse** to locate the firmware update on your hard drive.

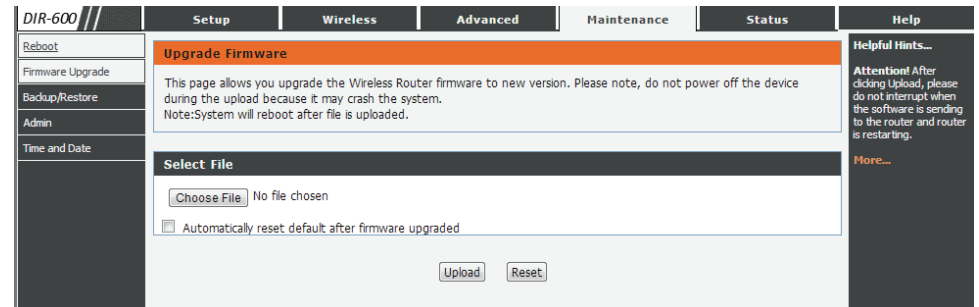

The screenshot shows the 'Upgrade Firmware' page in the D-Link DIR-600 web interface. The page has a dark sidebar on the left with navigation links: Reboot, Firmware Upgrade, Backup/Restore, Admin, and Time and Date. The main content area has a top navigation bar with tabs: Setup, Wireless, Advanced, Maintenance, Status, and Help. The 'Upgrade Firmware' section is highlighted in orange. It contains a warning message: 'This page allows you upgrade the Wireless Router firmware to new version. Please note, do not power off the device during the upload because it may crash the system. Note: System will reboot after file is uploaded.' Below this is a 'Select File' section with a 'Choose File' button and the text 'No file chosen'. There is also a checkbox labeled 'Automatically reset default after firmware upgraded'. At the bottom of the form are 'Upload' and 'Reset' buttons. On the right side, there is a 'Helpful Hints...' section with an 'Attention!' warning: 'After clicking Upload, please do not interrupt when the software is sending to the router and router is restarting.' and a 'More...' link.

Click the **Upload** button to upload a file to the router after you have selected it, or click the **Reset** button to cancel the selection.

Backup/Restore

This page allows you to save the router's current configuration file onto your computer's hard drive or load a saved file from your hard drive.

The screenshot shows the web interface for the DIR-600 router. The top navigation bar includes 'Setup', 'Wireless', 'Advanced', 'Maintenance', 'Status', and 'Help'. The left sidebar contains 'Reboot', 'Firmware Upgrade', 'Backup/Restore', 'Admin', and 'Time and Date'. The main content area is titled 'Backup/Restore Settings' and contains the following text: 'This page allows you backup and restore Settings.' Below this, there are two sections: 'Save Settings To File' with a 'Save...' button, and 'Load Settings From' with a 'Choose File' button, the text 'No file chosen', and an 'Upload' button. On the right side, there is a 'Helpful Hints...' section with the text: 'You should save the configuration of the router to a file on your computer. So you can restore the router settings from the file if the router goes down.' and a 'More...' link.

Click the **Save** button to download the current configuration settings as a file onto your hard drive.

To load a previously saved settings file, click the **Choose File** button to locate the file on your hard drive, then click the **Upload** button.

Admin

This page allows you to add a user account to the router's Web server. You can also delete or modify existing accounts.

User Name: Enter a username.

Privilege: The user has Root privilege.

Old Password: Enter the current password of the account.

New Password: Enter the new password for the account.

Confirm Password: Retype the new password.

The screenshot shows the 'User Account Configuration' page in the DIR-600 Web interface. The page has a navigation menu at the top with tabs for Setup, Wireless, Advanced, Maintenance, Status, and Help. The main content area is divided into a configuration form and a table. The configuration form has the following fields: User Name (text input), Privilege (dropdown menu set to 'Root'), Old Password (text input), New Password (text input), and Confirm Password (text input). Below the form are buttons for 'Add', 'Modify', 'Delete', and 'Reset'. The 'User Account Table' below the form has the following structure:

Select	User Name	Privilege
<input type="radio"/>	Admin	root

On the right side of the page, there is a 'Helpful Hints...' section with an 'Attention!' warning: 'The password is not your ISP account password, but is the admin password to log into the router setup interface. The password must be written down and saved in a safe place. You have to reset the route if you forget the password and re-configure from scratch.' There is also a 'More...' link.

Click the **Add** button to save any changes made. The user account will also be added to the User Account Table below. To modify an existing user account, click the **Select** tab next to the user account in the table, edit the user settings you wish to change, and then click the **Modify** button.

To delete an existing account, click the **Select** tab next to the user account in the table and then click the **Delete** button.

Time and Date

This page allows you to edit the system time and Network Time Protocol (NTP). You can configure, update, and maintain the correct time on the system clock, and configure Daylight Saving.

System Time: Enter the correct year, month, day, and time.

Daylight Saving Offset: Select the daylight saving offset if Daylight Saving time will be used.

Click the **Apply Changes** button to save the changes and apply them.

State: Select Enable to enable the NTP server.

Server: Enter the name of the NTP server.

Server2: Enter the name of the second NTP server.

Interval: Enter the time period that you want the NTP server to synchronize time with the devices on the network. The default value is one hour.

Time Zone: Select the time zone you are in from the pulldown menu.

GMT Time: This shows the current GMT (Greenwich Mean Time) time.

Click the **Apply Changes** button to save any changes made.

To start the NTP, click the **Get GMT Time** button to obtain the GMT time.

The screenshot shows the 'System Time Configuration' page in the DIR-600 web interface. The page is divided into several sections:

- System Time Configuration:** This section contains a text box with instructions: "This page is used to configure the system time and Network Time Protocol(NTP) server. Here you can change the settings or view some information on the system time and NTP parameters." Below this are input fields for System Time (Year: 1970, Month: Jan, Day: 1, Hour: 24, Min: 58, Sec) and Daylight Saving Offset (0:00). There are 'Apply Changes' and 'Reset' buttons.
- NTP Configuration:** This section includes a 'State' dropdown menu (set to 'Disable'), 'Server' and 'Server2' text boxes, an 'Interval' dropdown menu (set to 'Every 1 hours'), and a 'Time Zone' dropdown menu (set to '(GMT+08:00) China, Hong Kong, Australia Western, Singapore, Taiwan, Russia'). Below these is the 'GMT time' display showing 'Thu Jan 1 0:24:58 1970'. There are 'Apply Changes' and 'Reset' buttons.
- Start NTP:** This section contains a single button labeled 'Get GMT Time'.

Status

Device Info

This page displays the current status and basic settings of the router.

System: Displays the router's time and firmware version.

LAN Configuration: Displays the MAC address and the private (local) IP settings for the router.

WLAN Configuration: Displays the wireless MAC address and your wireless settings such as SSID and Channel.

WAN Configuration: Displays the MAC address and the public IP settings for the router.

Setup		Wireless		Advanced		Maintenance		Status		Help	
Wireless Router Status This page shows the current status and some basic settings of the device.											
System											
Product Name		DIR-600									
Uptime		0 days, 19:55:10									
Date/Time		Thu Jan 1 19:55:10 1970									
Firmware version		1.00									
Serial Number		C8D3A3D9B13D									
LAN Configuration											
IP Address		192.168.0.1									
Subnet Mask		255.255.255.0									
DHCP Server		Enable									
MAC Address		C8:D3:A3:D9:B1:3D									
WLAN Configuration											
Wireless		Enabled									
Mode		AP									
SSID		D-Link_DIR-600									
Encryption		None									
Channel		1									
Broadcast SSID		Enabled									
WPS		Enabled									
Repeater Status		Disconnected									
WAN Configuration											
Interface		Protocol		IP Address		Gateway		DNS		Status	
WAN		DHCP		172.17.5.138		172.17.5.254		192.168.168.249 192.168.168.201 192.168.168.250		Link Up(DHCP Client)	

Click the **Refresh** button to view the most current information.

Active Client Table

This page displays lists of all wired and wireless clients. The IP address and MAC address of each client is displayed in the tables.

Active Wired Client Table: This table displays all active wired clients.

Active Wireless Client Table: This table displays all active wireless clients.

The screenshot shows the DIR-600 web interface. The top navigation bar includes 'Setup', 'Wireless', 'Advanced', 'Maintenance', 'Status', and 'Help'. The left sidebar has 'Device Info', 'Active Client Table', and 'Statistics'. The main content area is titled 'Active Client Table' and contains a sub-table for 'Active Wired Client Table' with the following data:

Name	IP Address	MAC Address
07537PCWin7E	192.168.0.2	00:24:7e:02:20:f3

Below this is an empty 'Active Wireless Client Table' and a 'Refresh' button.

Click the **Save Settings** button to save any changes made.

Statistics

This page displays the statistics for packets that have been transmitted and received on the network on the router's WAN and LAN ports, and wireless bands.

The screenshot shows the DIR-600 router's web interface. The top navigation bar includes Setup, Wireless, Advanced, Maintenance, Status, and Help. The left sidebar contains Device Info, Active Client Table, and Statistics. The main content area is titled 'Statistics' and contains a table with the following data:

Interface	Rx pkt	Rx err	Rx drop	Tx pkt	Tx err	Tx drop
LAN1						
LAN2	44194	0	0	42260	0	0
LAN3						
LAN4						
WAN	43581	0	0	39582	0	0
WLAN	16896	0	0	268	0	352

Below the table is a 'Refresh' button. To the right of the main content area is a 'Helpful Hints...' section with a 'More...' link.

Click the **Refresh** button to refresh the router's traffic statistics.

Help

D-Link

DIR-600 // Setup Wireless Advanced Maintenance Status Help

Menu
Setup
Wireless
Advanced
Maintenance
Status

Help Menu

- [Setup](#)
- [Wireless](#)
- [Advanced](#)
- [Maintenance](#)
- [Status](#)

Setup Help

- [Wizard](#)
- [Local Network](#)
- [Internet Setup](#)

Wireless Help

- [Wireless Basics](#)
- [Wlups](#)
- [Advanced Wireless](#)
- [Wireless Repeater](#)

Advanced Help

- [Access Control List](#)
- [Port Triggering](#)
- [URL Block](#)
- [DDNS](#)
- [Traffic Control](#)
- [UPnP](#)
- [Virtual Server](#)

Maintenance Help

- [Reboot](#)
- [Firmware Upgrade](#)
- [Backup/Restore](#)
- [Admin](#)
- [Time and Date](#)

Status Help

- [Device Info](#)
- [Active Client Table](#)
- [Statistics](#)

Wireless Security

This section will show you the different levels of security you can use to protect your data from intruders. The DIR-600 offers the following types of security:

- WPA2 (Wi-Fi Protected Access 2)
- WPA (Wi-Fi Protected Access)
- WPA2-PSK (Pre-Shared Key)
- WPA-PSK (Pre-Shared Key)

What is WPA?

WPA (Wi-Fi Protected Access), is a Wi-Fi standard that was designed to improve the security features of WEP (Wired Equivalent Privacy).

The 2 major improvements over WEP:

- Improved data encryption through the Temporal Key Integrity Protocol (TKIP). TKIP scrambles the keys using a hashing algorithm and, by adding an integrity-checking feature, ensures that the keys haven't been tampered with. WPA2 is based on 802.11i and uses Advanced Encryption Standard (AES) instead of TKIP.
- User authentication, which is generally missing in WEP, through the extensible authentication protocol (EAP). WEP regulates access to a wireless network based on a computer's hardware-specific MAC address, which is relatively simple to be sniffed out and stolen. EAP is built on a more secure public-key encryption system to ensure that only authorized network users can access the network.

WPA-PSK/WPA2-PSK uses a passphrase or key to authenticate your wireless connection. The key is an alpha-numeric password between 8 and 63 characters long. The password can include symbols (!?*&_) and spaces. This key must be the exact same key entered on your wireless router or access point.

WPA/WPA2 incorporates user authentication through the Extensible Authentication Protocol (EAP). EAP is built on a more secure public key encryption system to ensure that only authorized network users can access the network.

Connect to a Wireless Network Using Windows® 7

It is recommended to enable wireless security (WPA/WPA2) on your wireless router or access point before configuring your wireless adapter. If you are joining an existing network, you will need to know the security key or passphrase being used.

1. Click on the wireless icon in your system tray (lower-right corner).

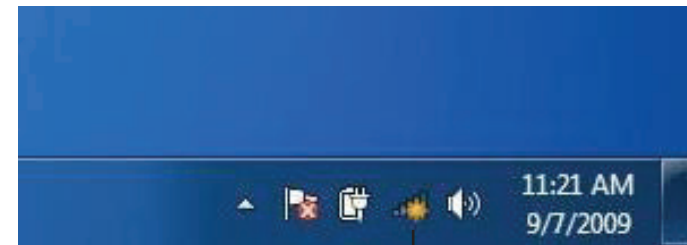

Wireless Icon

2. The utility will display any available wireless networks in your area.



3. Highlight the wireless network (SSID) you would like to connect to and click the **Connect** button.

If you get a good signal but cannot access the Internet, check your TCP/IP settings for your wireless adapter. Refer to the Networking Basics section in this manual for more information.



4. The following window appears while your computer tries to connect to the router.

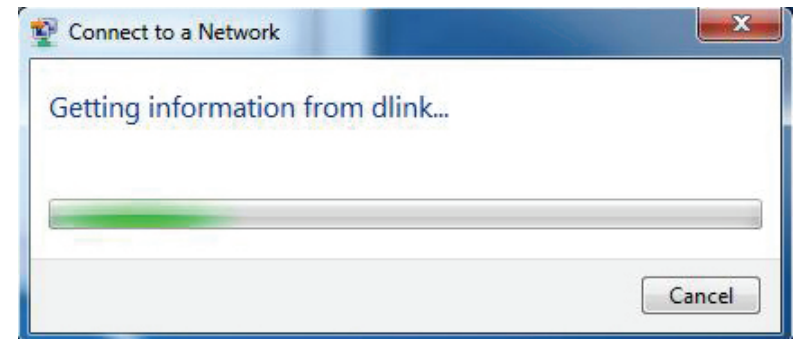

5. Enter the same security key or passphrase that is on your router and click **Connect**. You can also connect by pushing the WPS button on the router.

It may take 20-30 seconds to connect to the wireless network. If the connection fails, please verify that the security settings are correct. The key or passphrase must be exactly the same as on the wireless router.

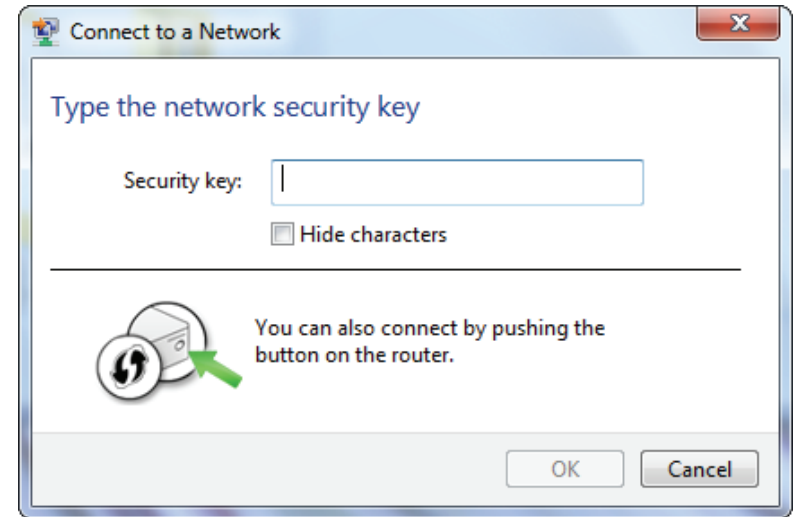

Configure WPS

The WPS feature of the router can be configured using Windows® 7. Carry out the following steps to use Windows® 7 to configure the WPS feature of the router:

1. Click the **Start** button and select **Computer** from the Start menu.

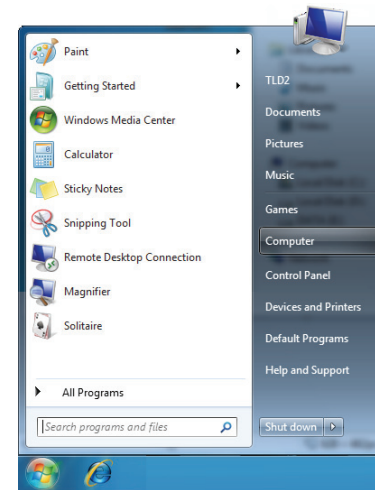

2. Click the **Network** option.

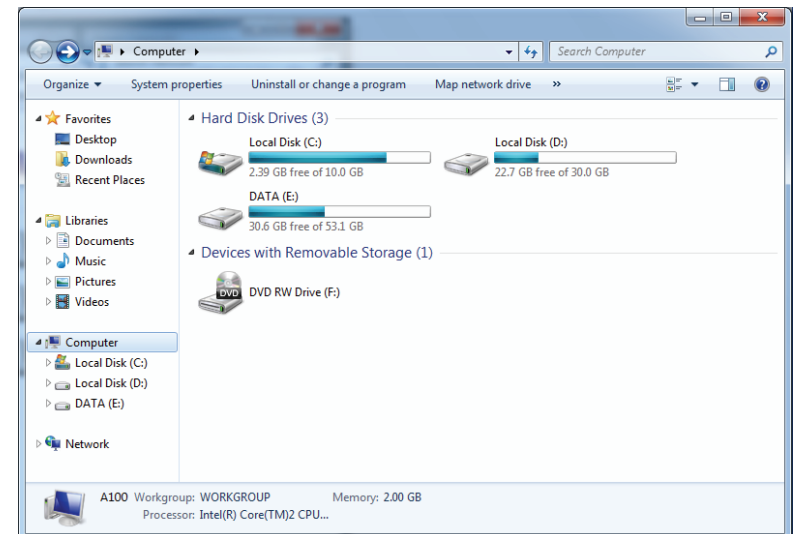

3. Double-click the DIR-600.

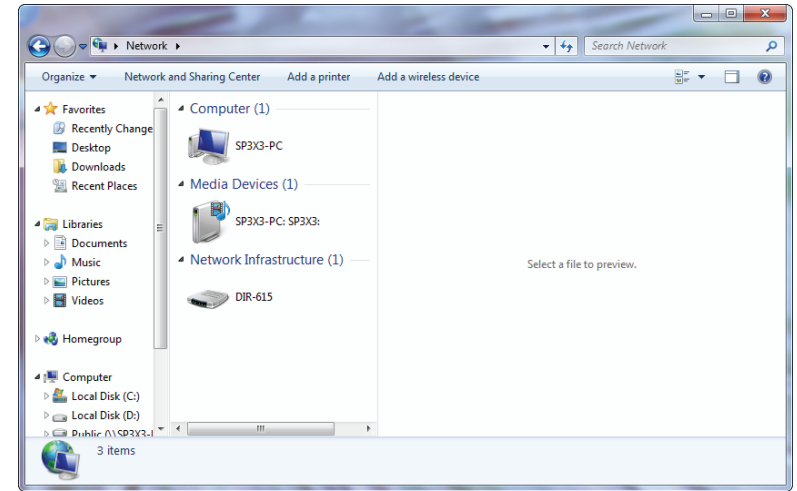

4. Input the WPS PIN number (on the Router label) in the **Setup > Wireless Setup** menu in the Router's Web UI and click **Next**.

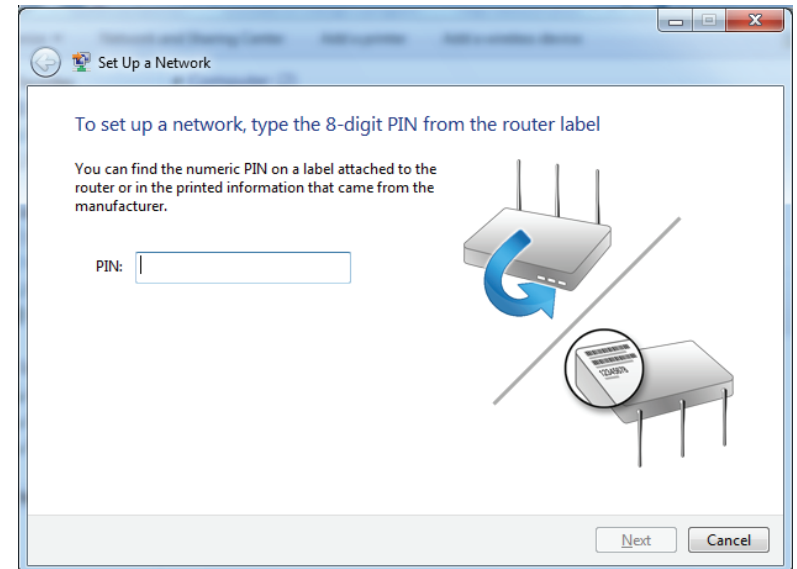

5. Type a name to identify the network.

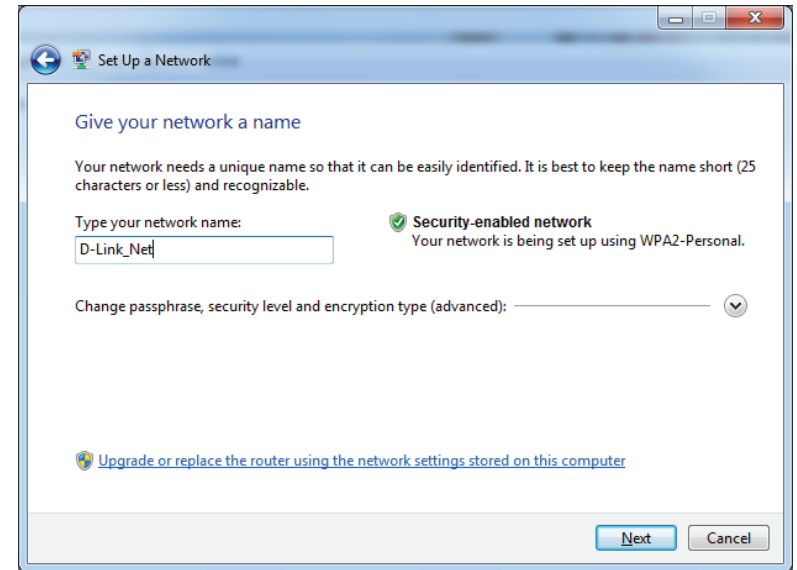

6. To configure advanced settings, click the  icon.

Click **Next** to continue.

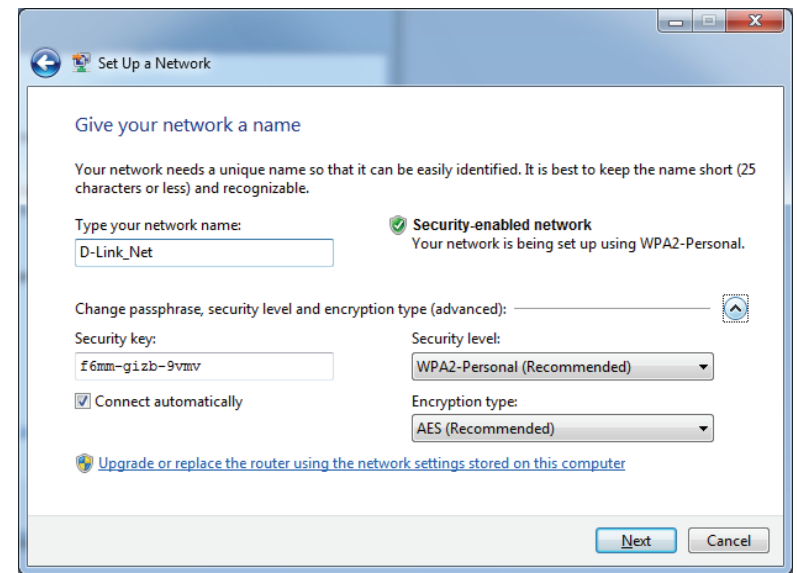

7. The following window appears while the Router is being configured.

Wait for the configuration to complete.

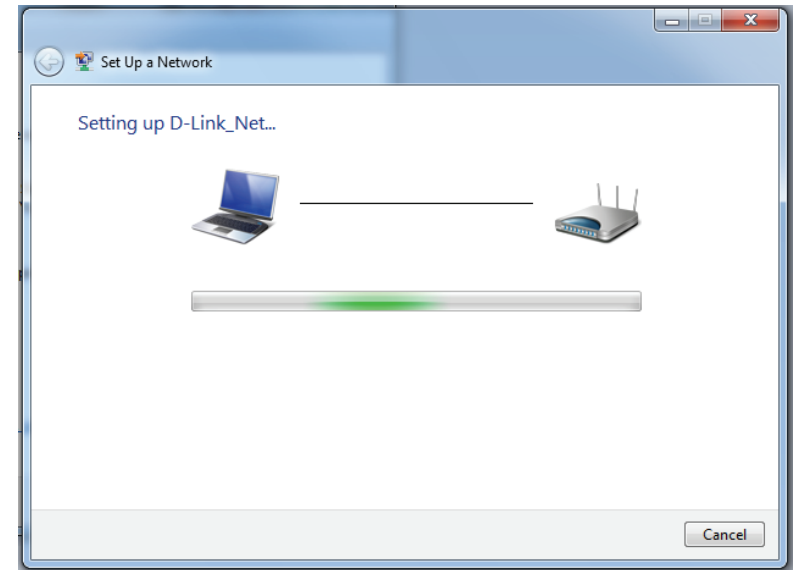

8. The following window informs you that WPS on the DIR-600 has been setup successfully.

Make a note of the security key as you may need to provide this security key if adding an older wireless device to the network in the future.

9. Click **Close** to complete WPS setup.

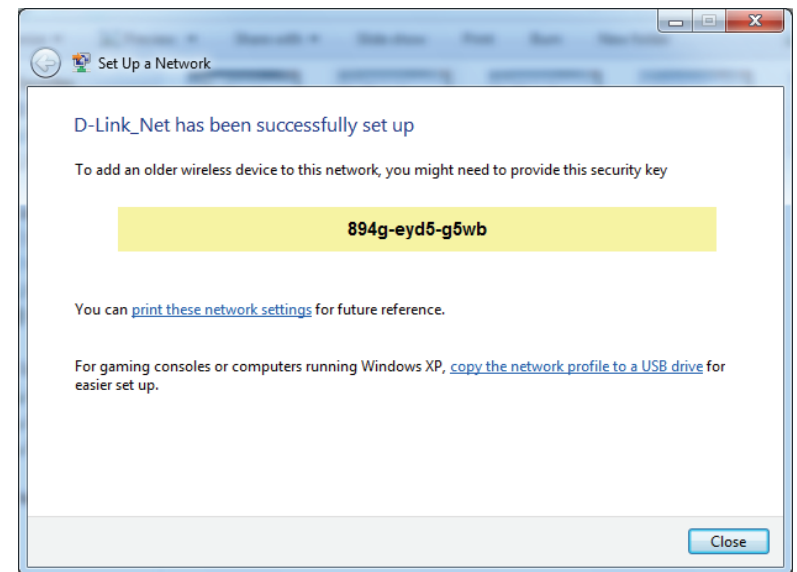

Using Windows Vista®

Windows Vista® users may use the built-in wireless utility. If you are using another company's utility or Windows® 2000, please refer to the user manual of your wireless adapter for help with connecting to a wireless network. Most utilities will have a "site survey" option similar to the Windows Vista® utility as seen below.

If you receive the **Wireless Networks Detected** bubble, click on the center of the bubble to access the utility.

or

Right-click on the wireless computer icon in your system tray (lower-right corner next to the time). Select **Connect to a network**.

The utility will display any available wireless networks in your area. Click on a network (displayed using the SSID) and click the **Connect** button.

If you get a good signal but cannot access the Internet, check you TCP/IP settings for your wireless adapter. Refer to the **Networking Basics** section in this manual for more information.

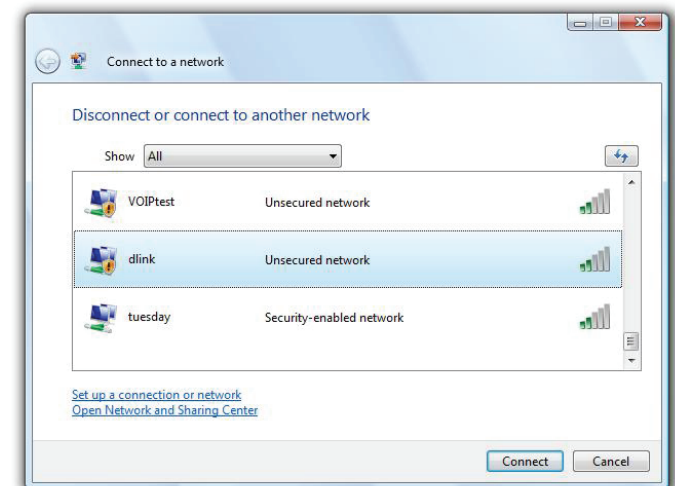
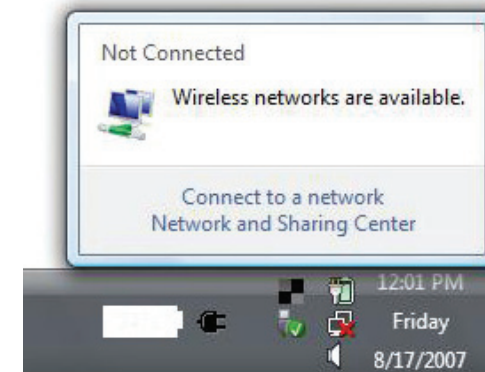

Configure Wireless Security

It is recommended to enable wireless security (WPA/WPA2) on your wireless router or access point before configuring your wireless adapter. If you are joining an existing network, you will need to know the security key or passphrase being used.

1. Open the Windows Vista® Wireless Utility by right-clicking on the wireless computer icon in your system tray (lower right corner of screen). Select **Connect to a network**.

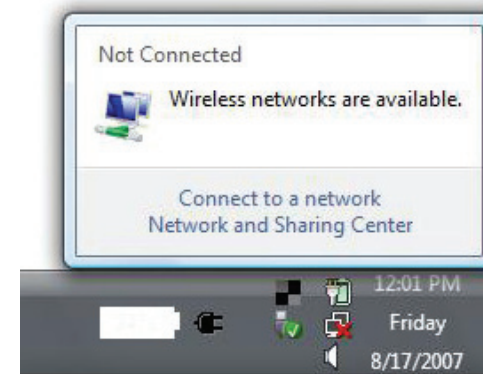

2. Highlight the wireless network (SSID) you would like to connect to and click **Connect**.

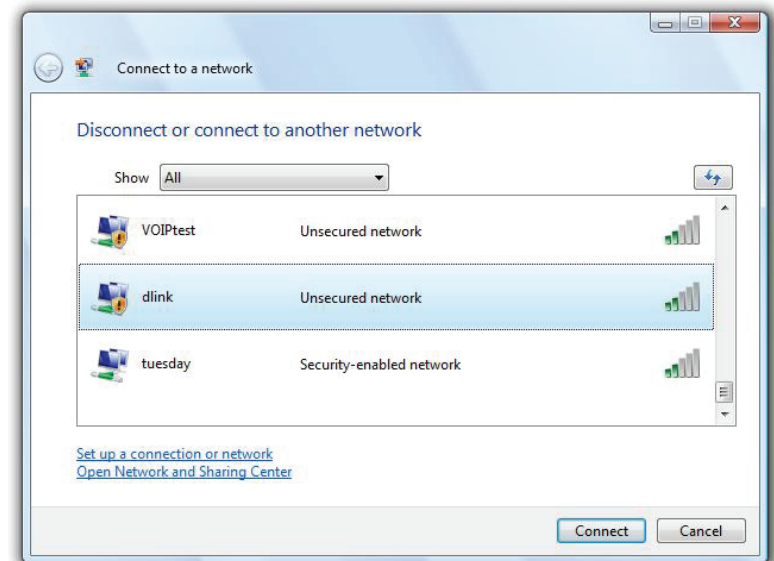

3. Enter the same security key or passphrase that is on your router and click **Connect**.

It may take 20-30 seconds to connect to the wireless network. If the connection fails, please verify that the security settings are correct. The key or passphrase must be exactly the same as on the wireless router.

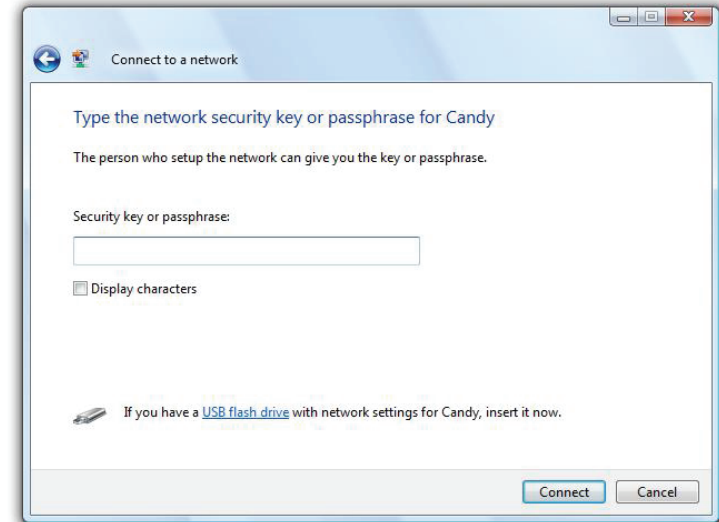

Using Windows® XP

Windows® XP users may use the built-in wireless utility (Zero Configuration Utility). The following instructions are for Service Pack 2 users. If you are using another company's utility or Windows® 2000, please refer to the user manual of your wireless adapter for help with connecting to a wireless network. Most utilities will have a "site survey" option similar to the Windows® XP utility as seen below.

If you receive the **Wireless Networks Detected** bubble, click on the center of the bubble to access the utility.

or

Right-click on the wireless computer icon in your system tray (lower-right corner next to the time). Select **View Available Wireless Networks**.

The utility will display any available wireless networks in your area. Click on a network (displayed using the SSID) and click the **Connect** button.

If you get a good signal but cannot access the Internet, check you TCP/IP settings for your wireless adapter. Refer to the **Networking Basics** section in this manual for more information.

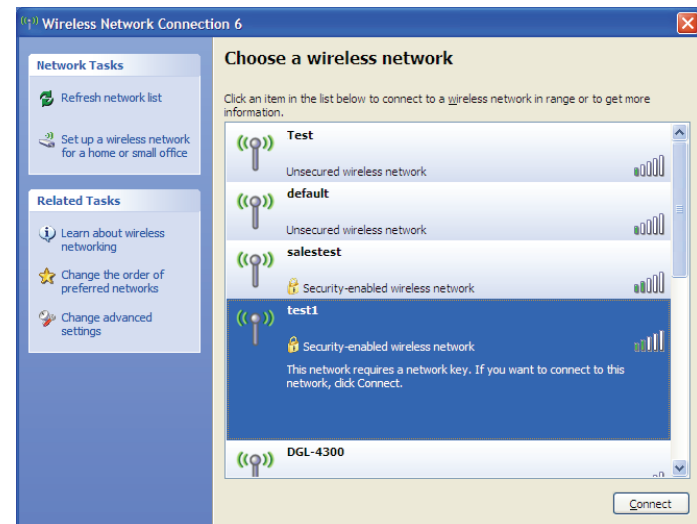
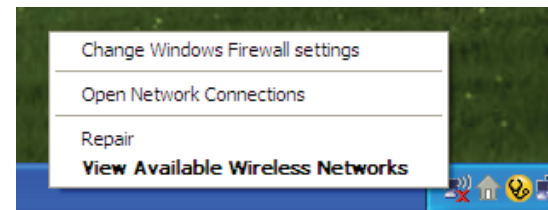
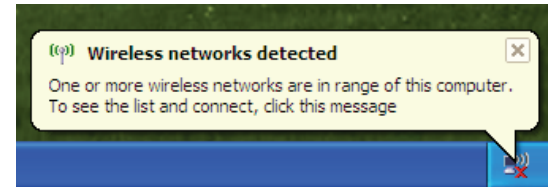

Configure WPA-PSK

It is recommended to enable WPA on your wireless router or access point before configuring your wireless adapter. If you are joining an existing network, you will need to know the WPA key being used.

1. Open the Windows® XP Wireless Utility by right-clicking on the wireless computer icon in your system tray (lower-right corner of screen). Select **View Available Wireless Networks**.
2. Highlight the wireless network (SSID) you would like to connect to and click **Connect**.

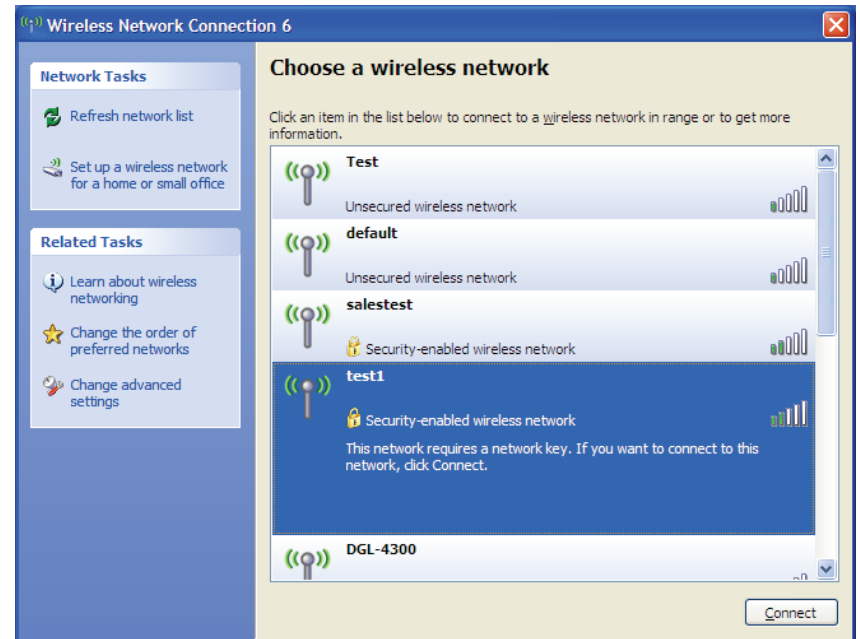
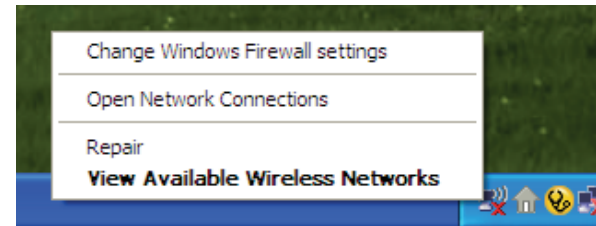

3. The **Wireless Network Connection** box will appear. Enter the WPA-PSK passphrase and click **Connect**.

It may take 20-30 seconds to connect to the wireless network. If the connection fails, please verify that the WPA-PSK settings are correct. The WPA-PSK passphrase must be exactly the same as on the wireless router.

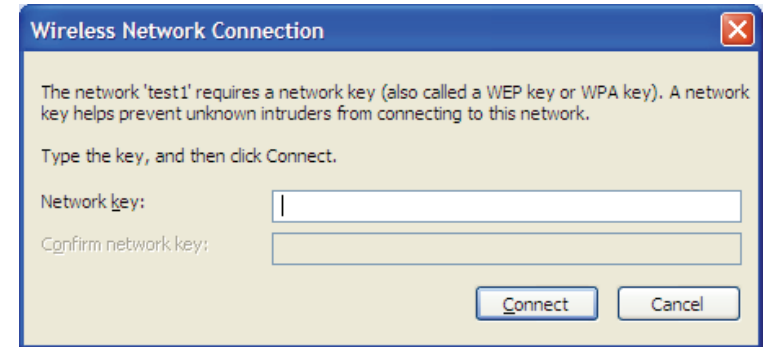

Troubleshooting

This chapter provides solutions to problems that can occur during the installation and operation of the DIR-600. Read the following descriptions if you are having problems. The examples below are illustrated in Windows® XP. If you have a different operating system, the screenshots on your computer will look similar to the following examples.

1. Why can't I access the web-based configuration utility?

When entering the IP address of the D-Link router (192.168.0.1 for example), you are not connecting to a website nor do you have to be connected to the Internet. The device has the utility built-in to a ROM chip in the device itself. Your computer must be on the same IP subnet to connect to the web-based utility.

- Make sure you have an updated Java-enabled web browser. We recommend the following:
 - Microsoft Internet Explorer® 6.0 and higher
 - Mozilla Firefox 3.0 and higher
 - Google™ Chrome 2.0 and higher
 - Apple Safari 3.0 and higher

- Verify physical connectivity by checking for solid link lights on the device. If you do not get a solid link light, try using a different cable or connect to a different port on the device if possible. If the computer is turned off, the link light may not be on.

- Disable any Internet security software running on the computer. Software firewalls such as Zone Alarm, Black Ice, Sygate, Norton Personal Firewall, and Windows® XP firewall may block access to the configuration pages. Check the help files included with your firewall software for more information on disabling or configuring it.

- Configure your Internet settings:

- Go to **Start > Settings > Control Panel**. Double-click the **Internet Options** icon. From the **Security** tab, click the button to restore the settings to their defaults.
 - Click the **Connection** tab and set the dial-up option to Never Dial a Connection. Click the LAN Settings button. Make sure nothing is checked. Click **OK**.
 - Go to the **Advanced** tab and click the button to restore these settings to their defaults. Click **OK** three times.
 - Close your web browser (if open) and open it.
- Access the web management. Open your web browser and enter the IP address of your D-Link router in the address bar. This should open the login page for your web management.
 - If you still cannot access the configuration, unplug the power to the router for 10 seconds and plug back in. Wait about 30 seconds and try accessing the configuration. If you have multiple computers, try connecting using a different computer.

2. What can I do if I forgot my password?

If you forgot your password, you must reset your router. Unfortunately this process will change all your settings back to the factory defaults.

To reset the router, locate the reset button (hole) on the rear panel of the unit. With the router powered on, use a paperclip to hold the button down for 10 seconds. Release the button and the router will go through its reboot process. Wait about 30 seconds to access the router. The default IP address is 192.168.0.1. When logging in, the username is **admin** and leave the password box empty.

3. Why can't I connect to certain sites or send and receive emails when connecting through my router?

If you are having a problem sending or receiving email, or connecting to secure sites such as eBay, banking sites, and Hotmail, we suggest lowering the MTU in increments of ten (Ex. 1492, 1482, 1472, etc).

Note: AOL DSL+ users must use MTU of 1400.

To find the proper MTU Size, you'll have to do a special ping of the destination you're trying to go to. A destination could be another computer, or a URL.

- Click on **Start** and then click **Run**.
- Windows® 95, 98, and Me users type in **command** (Windows® NT, 2000, and XP users type in **cmd**) and press **Enter** (or click **OK**).
- Once the window opens, you'll need to do a special ping. Use the following syntax:

ping [url] [-f] [-l] [MTU value]

Example: **ping yahoo.com -f -l 1472**

```
C:\>ping yahoo.com -f -l 1482
Pinging yahoo.com [66.94.234.13] with 1482 bytes of data:
Packet needs to be fragmented but DF set.
Packet needs to be fragmented but DF set.
Packet needs to be fragmented but DF set.
Packet needs to be fragmented but DF set.

Ping statistics for 66.94.234.13:
    Packets: Sent = 4, Received = 0, Lost = 4 (100% loss),
    Approximate round trip times in milli-seconds:
        Minimum = 0ms, Maximum = 0ms, Average = 0ms

C:\>ping yahoo.com -f -l 1472
Pinging yahoo.com [66.94.234.13] with 1472 bytes of data:
Reply from 66.94.234.13: bytes=1472 time=93ms TTL=52
Reply from 66.94.234.13: bytes=1472 time=109ms TTL=52
Reply from 66.94.234.13: bytes=1472 time=125ms TTL=52
Reply from 66.94.234.13: bytes=1472 time=203ms TTL=52

Ping statistics for 66.94.234.13:
    Packets: Sent = 4, Received = 4, Lost = 0 (0% loss),
    Approximate round trip times in milli-seconds:
        Minimum = 93ms, Maximum = 203ms, Average = 132ms

C:\>
```

You should start at 1472 and work your way down by 10 each time. Once you get a reply, go up by 2 until you get a fragmented packet. Take that value and add 28 to the value to account for the various TCP/IP headers. For example, lets say that 1452 was the proper value, the actual MTU size would be 1480, which is the optimum for the network we're working with (1452+28=1480).

Once you find your MTU, you can now configure your router with the proper MTU size.

To change the MTU rate on your router follow the steps below:

- Open your browser, enter the IP address of your router (192.168.0.1) and click **OK**.
- Enter your username (admin) and password (blank by default). Click **OK** to enter the web configuration page for the device.
- Click on **Setup** and then click **Manual Configure**.
- To change the MTU enter the number in the MTU field and click **Save Settings** to save your settings.
- Test your email. If changing the MTU does not resolve the problem, continue changing the MTU in increments of ten.

Wireless Basics

D-Link wireless products are based on industry standards to provide easy-to-use and compatible high-speed wireless connectivity within your home, business or public access wireless networks. Strictly adhering to the IEEE standard, the D-Link wireless family of products will allow you to securely access the data you want, when and where you want it. You will be able to enjoy the freedom that wireless networking delivers.

A wireless local area network (WLAN) is a cellular computer network that transmits and receives data with radio signals instead of wires. Wireless LANs are used increasingly in both home and office environments, and public areas such as airports, coffee shops and universities. Innovative ways to utilize WLAN technology are helping people to work and communicate more efficiently. Increased mobility and the absence of cabling and other fixed infrastructure have proven to be beneficial for many users.

Wireless users can use the same applications they use on a wired network. Wireless adapter cards used on laptop and desktop systems support the same protocols as Ethernet adapter cards.

Under many circumstances, it may be desirable for mobile network devices to link to a conventional Ethernet LAN in order to use servers, printers or an Internet connection supplied through the wired LAN. A Wireless Router is a device used to provide this link.

What is Wireless?

Wireless or Wi-Fi technology is another way of connecting your computer to the network without using wires. Wi-Fi uses radio frequency to connect wirelessly, so you have the freedom to connect computers anywhere in your home or office network.

Why D-Link Wireless?

D-Link is the worldwide leader and award winning designer, developer, and manufacturer of networking products. D-Link delivers the performance you need at a price you can afford. D-Link has all the products you need to build your network.

How does wireless work?

Wireless works similar to how cordless phones work, through radio signals to transmit data from one point A to point B. But wireless technology has restrictions as to how you can access the network. You must be within the wireless network range area to be able to connect your computer. There are two different types of wireless networks Wireless Local Area Network (WLAN), and Wireless Personal Area Network (WPAN).

Wireless Local Area Network (WLAN)

In a wireless local area network, a device called an Access Point (AP) connects computers to the network. The access point has a small antenna attached to it, which allows it to transmit data back and forth over radio signals. With an indoor access point, the signal can travel up to 300 feet. With an outdoor access point the signal can reach out up to 30 miles to serve places like manufacturing plants, industrial locations, college and high school campuses, airports, golf courses, and many other outdoor venues.

Wireless Personal Area Network (WPAN)

Bluetooth is the industry standard wireless technology used for WPAN. Bluetooth devices in WPAN operate in a range up to 30 feet away.

Compared to WLAN the speed and wireless operation range are both less than WLAN, but in return it doesn't use nearly as much power which makes it ideal for personal devices, such as mobile phones, PDAs, headphones, laptops, speakers, and other devices that operate on batteries.

Who uses wireless?

Wireless technology has become so popular in recent years that almost everyone is using it, whether it's for home, office, business, D-Link has a wireless solution for it.

Home

- Gives everyone at home broadband access
- Surf the web, check email, instant message, etc.
- Gets rid of the cables around the house
- Simple and easy to use

Small Office and Home Office

- Stay on top of everything at home as you would at office
- Remotely access your office network from home
- Share Internet connection and printer with multiple computers
- No need to dedicate office space

Where is wireless used?

Wireless technology is expanding everywhere not just at home or office. People like the freedom of mobility and it's becoming so popular that more and more public facilities now provide wireless access to attract people. The wireless connection in public places are usually called "hotspots".

Using a D-Link Cardbus Adapter with your laptop, you can access the hotspot to connect to the Internet from remote locations like: Airports, Hotels, Coffee Shops, Libraries, Restaurants, and Convention Centers.

Wireless network is easy to setup, but if you're installing it for the first time it could be quite a task not knowing where to start. That's why we've put together a few setup steps and tips to help you through the process of setting up a wireless network.

Tips

Here are a few things to keep in mind, when you install a wireless network.

Centralize your router or Access Point

Make sure you place the router/access point in a centralized location within your network for the best performance. Try to place the router/access point as high as possible in the room, so the signal gets dispersed throughout your home. If you have a two-story home, you may need a repeater to boost the signal to extend the range.

Eliminate Interference

Place home appliances such as cordless telephones, microwaves, and televisions as far away as possible from the router/access point. This would significantly reduce any interference that the appliances might cause since they operate on same frequency.

Security

Don't let you next-door neighbors or intruders connect to your wireless network. Secure your wireless network by turning on the WPA or WEP security feature on the router. Refer to product manual for detail information on how to set it up.

Wireless Modes

There are basically two modes of networking:

- **Infrastructure** – All wireless clients will connect to an access point or wireless router.
- **Ad-Hoc** – Directly connecting to another computer, for peer-to-peer communication, using wireless network adapters on each computer, such as two or more DIR-600 wireless network Cardbus adapters.

An Infrastructure network contains an Access Point or wireless router. All the wireless devices, or clients, will connect to the wireless router or access point.

An Ad-Hoc network contains only clients, such as laptops with wireless cardbus adapters. All the adapters must be in Ad-Hoc mode to communicate.

Networking Basics

Check your IP address

After you install your new D-Link adapter, by default, the TCP/IP settings should be set to obtain an IP address from a DHCP server (i.e. wireless router) automatically. To verify your IP address, please follow the steps below.

Click on **Start > Run**. In the run box type **cmd** and click **OK**. (Windows® 7/Vista® users type *cmd* in the **Start Search** box.)

At the prompt, type **ipconfig** and press **Enter**.

This will display the IP address, subnet mask, and the default gateway of your adapter.

If the address is 0.0.0.0, check your adapter installation, security settings, and the settings on your router. Some firewall software programs may block a DHCP request on newly installed adapters.

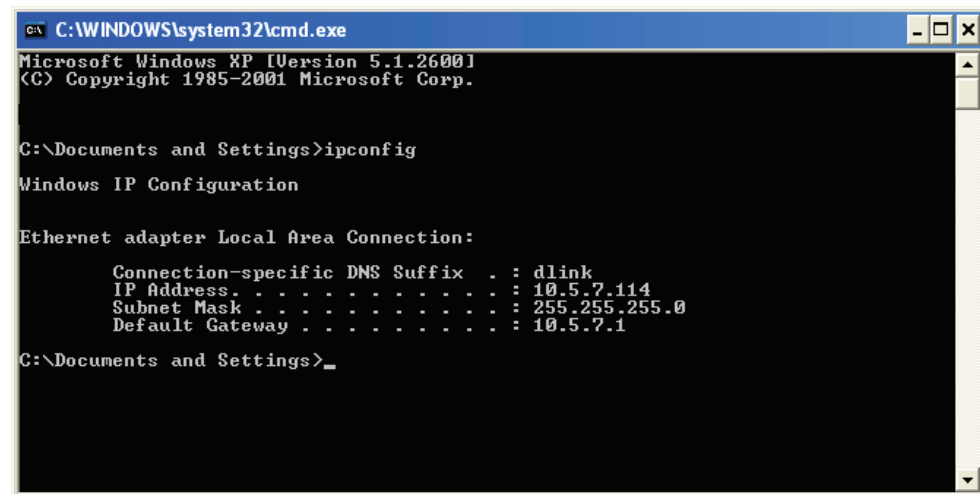

```
C:\WINDOWS\system32\cmd.exe
Microsoft Windows XP [Version 5.1.2600]
(C) Copyright 1985-2001 Microsoft Corp.

C:\Documents and Settings>ipconfig

Windows IP Configuration

Ethernet adapter Local Area Connection:

    Connection-specific DNS Suffix  . : dlink
    IP Address . . . . . : 10.5.7.114
    Subnet Mask . . . . . : 255.255.255.0
    Default Gateway . . . . . : 10.5.7.1

C:\Documents and Settings>_
```

Statically Assign an IP address

If you are not using a DHCP capable gateway/router, or you need to assign a static IP address, please follow the steps below:

Step 1

Windows® 7 - Click on **Start > Control Panel > Network and Internet > Network and Sharing Center > Change Adapter Setting.**

Windows Vista® - Click on **Start > Control Panel > Network and Internet > Network and Sharing Center > Manage Network Connections.**

Windows® XP - Click on **Start > Control Panel > Network Connections.**

Windows® 2000 - From the desktop, right-click **My Network Places > Properties.**

Step 2

Right-click on the **Local Area Connection** which represents your network adapter and select **Properties.**

Step 3

Highlight **Internet Protocol (TCP/IP)** and click **Properties.**

Step 4

Click **Use the following IP address** and enter an IP address that is on the same subnet as your network or the LAN IP address on your router.

Example: If the router's LAN IP address is 192.168.0.1, make your IP address 192.168.0.X where X is a number between 2 and 99. Make sure that the number you choose is not in use on the network. Set Default Gateway the same as the LAN IP address of your router (192.168.0.1).

Set Primary DNS the same as the LAN IP address of your router (192.168.0.1). The Secondary DNS is not needed or you may enter a DNS server from your ISP.

Step 5

Click **OK** twice to save your settings.

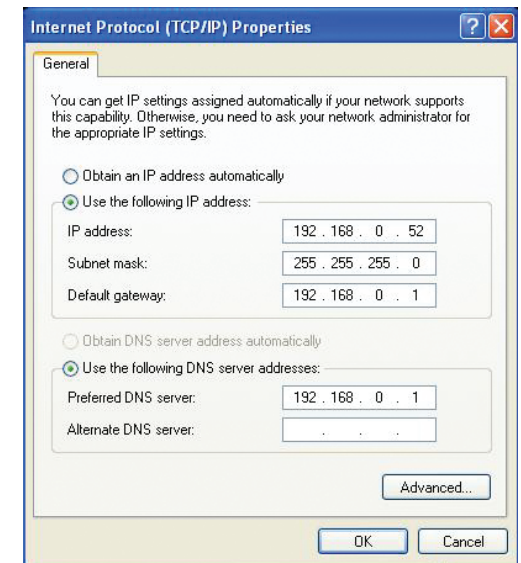

Technical Specifications

Standards

- Compatible with IEEE 802.11n
- IEEE 802.11g
- IEEE 802.3
- IEEE 802.3u

Security

- WEP™
- WPA™ - Personal/Enterprise
- WPA2™ - Personal/Enterprise

Wireless Signal Rates¹

IEEE 802.11n:

20MHz Channel:

- 1Nss: 65/72.2 Mbps (max)

40MHz Channel:

- 1Nss: 135/150 Mbps (max)

IEEE 802.11g:

- | | | |
|-----------|-----------|-----------|
| • 54 Mbps | • 48 Mbps | • 36 Mbps |
| • 24 Mbps | • 18 Mbps | • 12 Mbps |
| • 11 Mbps | • 9 Mbps | • 6 Mbps |

Wireless Frequency Range² (Europe)

- 2.4 GHz to 2.4835 GHz (802.11g/n)

Operating Temperature

- 0 °C to 40 °C (32 °F to 104 °F)

Storage Temperature

- -20 °C to 65 °C (-4 °F to 149 °F)

Humidity

- 10% minimum (non-condensing)
- 95% maximum (non-condensing)

Safety & Emissions

- CE
- FCC
- Wi-Fi Certified

Dimensions

- L = 160 mm (6.3 inches)
- W = 120 mm (4.72 inches)
- H = 59 mm (2.32 inches)

¹ Maximum wireless signal rate derived from IEEE Standard 802.11b, 802.11g and 802.11n specifications. Actual data throughput will vary. Network conditions and environmental factors, including volume of network traffic, building materials and construction, and network overhead, lower actual data throughput rate. Environmental factors will adversely affect wireless signal range.

² Frequency Range varies depending on country's regulation