

Thousand Cankers Disease Survey Guidelines for 2016



United States Department of Agriculture: Forest
Service (FS) and Plant Protection and
Quarantine (PPQ)

April 2016

Table of Contents

Introduction.....	1
Background.....	1
Symptoms	3
Survey	3
Roles	4
Data Collection	4
Methods	4
Sample Collection and Handling	5
Supplies.....	5
Instructions for Collecting Tree Sample	5
Trap Placement and Monitoring	6
Purpose of Trapping.....	6
Where to Locate Traps.....	7
When to Trap	7
Materials and Supplies Needed.....	7
Installing Traps	7
Maintaining and Servicing the Traps in the Field.....	7
Collection of Trap Catches	8
Determining Presence of WTB or <i>Geosmithia morbida</i>	8
WTB in trap catches.....	9
<i>Collecting and Isolating Geosmithia morbida</i>	9
Outreach.....	10
List of Appendices	11

Introduction

These guidelines were developed by the United States Department of Agriculture's Forest Service (FS) and Plant Protection and Quarantine (PPQ) with input from State agencies. The goal of this document is to provide guidance on standardized techniques for USDA-FS-, USDA-PPQ-, and State-supported surveys for thousand cankers disease (TCD). The focus of the surveys should be on symptomatic walnut or butternut trees; however, these guidelines should not be considered the only possible survey process.

Background

In May 2008, walnut mortality, originally observed in Utah and Oregon (1990's) and New Mexico (2001) and Colorado (2003), was attributed to numerous cankers of the phloem developing in association with insect galleries. The new disease complex was named "thousand cankers disease" (TCD) and is considered to be native to the southwestern United States.

TCD results from the combined activity of a fungus, *Geosmithia morbida*, and the walnut twig beetle, *Pityophthorus juglandis*. While TCD was originally described from scattered locations throughout western states, it became clear that the disease was more widespread in the West than previously thought. In many of these states, it appears that walnut twig beetle (WTB) and, by association, TCD, is present wherever susceptible walnut species grow. The known geographical and host range of the WTB has expanded over the past two decades and, coupled with *G. morbida*, walnut mortality has occurred in California, Oregon, Washington, Idaho, Utah, Arizona, New Mexico, Nevada, and Colorado. In the West, the WTB occurs from southern New Mexico to northern Idaho and Washington, and from coastal California and Oregon to eastern Colorado.

In July 2010, TCD was reported in Knoxville, Tennessee, causing dieback on black walnut. The Tennessee infestation is believed to be at least 10 years old and was previously attributed to drought stress. As of 2016, WTB has been trapped in over 20 counties in Tennessee. The find in Knoxville was the first report east of the 100th meridian, raising concerns that large native populations of black walnut in the eastern United States may suffer severe decline and mortality. In July and August 2011, TCD was reported in Richmond, Virginia, and Doylestown, Pennsylvania. Surveys for the pathogen and beetle around Richmond revealed that the disease was present in five additional counties. In 2012, the WTB was trapped northwest of Cincinnati, Ohio, and the pathogen was isolated from branch material collected in North Carolina near its border with Tennessee. TCD was later confirmed in Ohio and North Carolina when both organisms were found in these states. In late 2013, WTB were collected in Cecil County, Maryland, and *G. morbida* was detected in this county in August 2014. In 2014 and 2015, the pathogen and WTB were discovered in Brown and Franklin Counties, respectively, in Indiana. In September 2013, TCD was confirmed in northeastern Italy on black walnuts of different ages: 80-year-old plants growing in a garden and 17-year-old trees belonging to a nearby walnut

plantation for timber production. Later, TCD was also reported on English walnut in Italy. These findings emphasize that we do not know the true distribution of this insect/disease association across the USA and/or that new introductions may still be occurring in the East. While TCD has caused dieback and mortality across various climatic zones and among several walnut species, the extent of risk and impact to black walnut within its native range is still unknown.

2015 Walnut Twig Beetle (WTB) Trap Survey -DRAFT (March 21, 2016)

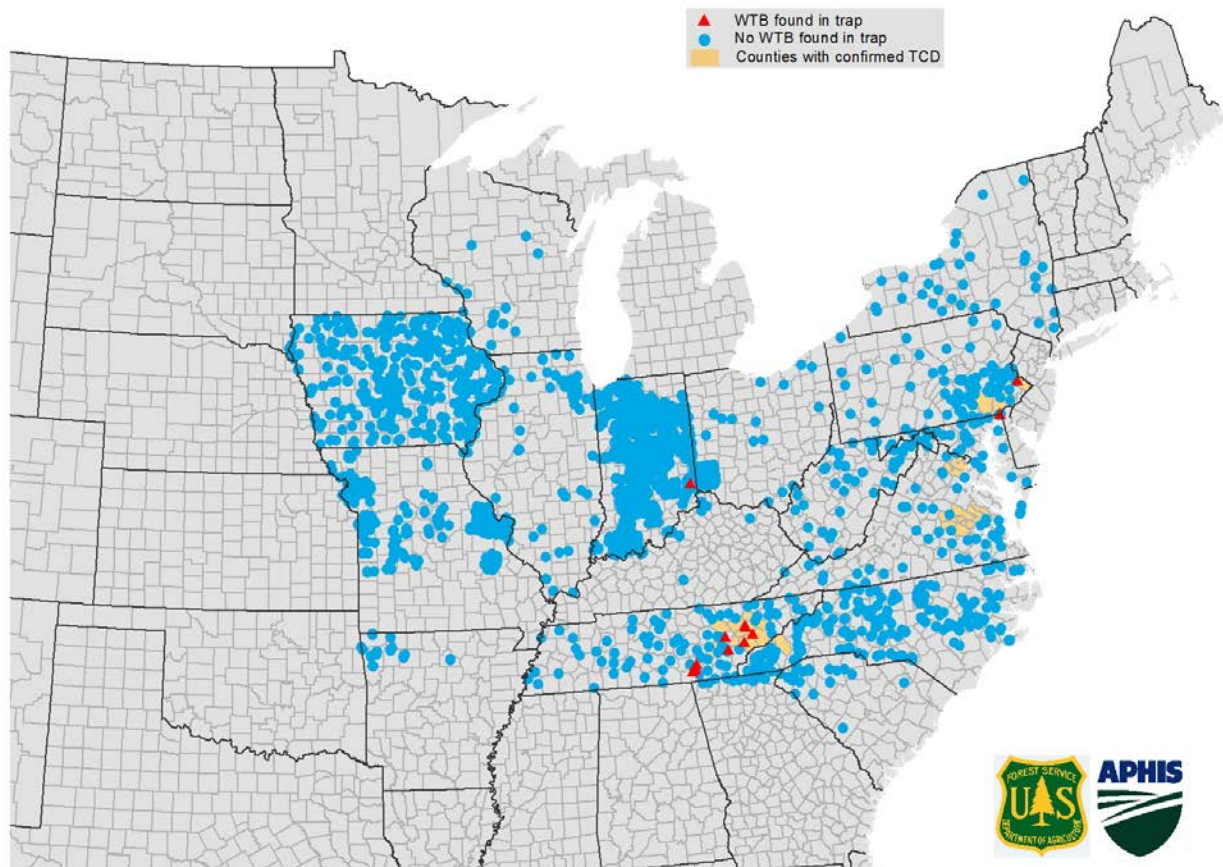

Black walnut is a significant economic, social and environmental resource, and appears to be highly susceptible to TCD. Black walnuts exhibit little to no resistance to the pathogen or the vector (WTB). In 2011, WTB was collected and *G. morbida* was isolated from a butternut tree, *Juglans cinerea*, at a private residence in Lane County, Oregon. While no trees to date have been found with TCD within the native range of butternut, the apparent susceptibility of the species to TCD is troubling from a conservation perspective. The survival of butternut is already seriously threatened by butternut canker, among other issues. The only other known host for WTB and *G. morbida* is wingnut (*Pterocarya* spp.) based on collection records from California. Laboratory and field research with *G. morbida* have shown that all walnuts, butternut, and

wingnut show significant amounts of dead phloem in response to controlled inoculations of the pathogen. Three species of hickories (including pecan) that were tested are not susceptible.

Symptoms

The three major symptoms of this disease are branch mortality, numerous small cankers on branches and the bole, and evidence of tiny bark beetles. The earliest symptom is yellowing foliage that progresses rapidly to brown wilted foliage, then finally branch mortality (Figure 1). The fungus causes distinctive circular to oblong cankers in the phloem (i.e., just under the outer bark), which eventually kill the cambium (Figure 2). The bark surface may have no symptoms, or a dark amber stain or cracking of the bark may occur directly above a canker. Numerous tiny bark beetle entrance and emergence holes may be visible on dead and dying branches (Figure 3), and bark beetle galleries are often found within the cankers. In the final stages of disease, even the main stem may exhibit beetle attacks and cankers. (Taken from USFS Pest Alert: Thousand Cankers Disease, February 2013 – Appendix 1)



Figure 1. Wilting black walnut in the last stages of TCD.



Figure 2. Small branch cankers caused by *G. morbida*.



Figure 3. Emergence holes made by adult WTB.

Survey

The first step in detection is to locate walnut trees at risk by utilizing existing city tree inventories to delineate the urban walnut resource, and by identifying the locations of intensively managed stands of walnut trees. Because the WTB may be transported beneath the bark on logs, burls, or large branches, walnut trees may also be at risk if they are growing near sites where enterprises such as walnut veneer or sawmills import and stockpile this material. Once walnut

trees are identified, symptomatic trees with thinning crowns and fading leaves (i.e., yellow or bronze in color) should be evaluated in early to mid-summer, with special attention given to the upper portion of the crown of suspected diseased trees. A field identification guide for WTB and TCD is available (Appendix 2).

If TCD is suspected, the surveying agency may take a sample (see below) and elect to install a pheromone-baited, multiple funnel trap to target the WTB near walnut trees on the site (see below and refer to Appendices 8 and 9 or videos available at <http://ipm.ucdavis.edu/PMG/menu.thousandcankers.html>). A short, pheromone-baited walnut branch section may be installed below the trap or on a nearby pole to lure live beetles to aid in the detection of the *Geosmithia* pathogen (Appendix 11).

A decision tree is attached to this protocol to illustrate the visual survey process (Appendix 3).

Roles

Resources provided by the Forest Service should focus on surveys of walnut trees and WTB trapping in forested areas. Resources provided by PPQ should focus on surveys of walnut trees and WTB trapping in urban, residential, and industrial settings.

In addition, plantation and nursery owners, city foresters, and other tree care professionals should be encouraged to survey their walnut trees for TCD and report any suspicious trees to their State Forester, State Plant Health Director, or Cooperative Extension Office.

Data Collection

It is important that any surveys for TCD are documented to keep a record of both positive and negative TCD locations. All surveyors (FS, PPQ, and State) should collect data on the “Walnut Twig Beetle Trap Result Reporting” spreadsheet (Appendix 4). FS will post the state specific datasheets to use at http://www.fs.fed.us/foresthealth/technology/survey_tcd.shtml. Please follow the instructions on the first tab and submit your data to Bruce Moltzan bmoltzan@fs.fed.us prior to November 1. Though latitude and longitude are requested, individual data points will not be made available outside the agencies sponsoring the collection or recording of that particular data (Federal and State).

Methods

To help determine if TCD is present, ask yourself or the property owner the following questions.

1. Is this a walnut (*Juglans* sp.) tree? (Be aware that butternut trees may be susceptible to TCD in addition to butternut canker; wingnut trees may also be susceptible). See Appendices 5 and 6 for guides to assist in identifying *Juglans nigra* and other *Juglans* sp..
2. Are there other possible causes?
 - a. Any recent root disturbances?
 - b. Any recent pesticide use?

- c. Any leaf diseases (anthracnose) or target-like (*Nectria*) cankers?
 - d. Any toothpick-like sawdust projections from the bark (caused by ambrosia beetles)?
 - e. Insect entrance or emergence holes larger or differently shaped than those of WTB?
 - f. Any other nearby activity or unusual weather patterns that may have affected tree health?
3. Do symptoms match TCD?
 - a. Are there yellowing, wilting, or flagging leaves high in the crown?
 - b. Did symptoms begin in late spring or early summer?
 - c. Are the symptoms worse on the south and west sides of the trees?
 - d. Do browning leaves remain attached to twigs?
 - e. Are the limbs dying back starting at the top and moving downward?
 - f. Are new sprouts growing from tree roots?
 4. Are affected limbs easily accessible?
 - a. Are numerous tiny reddish-brown beetles (1.5-2 mm long) and/or tunneling present beneath the bark?
 - b. Are pin-sized holes visible in the bark of affected limbs?
 - c. If you remove the bark, are numerous brown cankers visible?
 - d. If cankers are visible, are small beetle tunnels present in the center of them?

Sample Collection and Handling

If you determine that TCD is a possibility, prepare to take a sample from the tree and consider the location for installation of a WTB trap (see below).

Supplies

- Strong knife
- Tools to collect sample branches
- Tools to collect insect samples (e.g., aspirator, jewelers forceps or flexible insect forceps)
- Small glass or plastic vials containing 70% ethanol
- Paper towels
- Gallon Ziploc bags

Instructions for Collecting Tree Sample

1. Use whatever means necessary to collect samples from the affected limbs safely (e.g., pole pruner, bucket truck, etc.).
2. If possible, collect samples from the south or west exposure.
3. Look for pin-sized, round holes. Carefully peel thin layers of the bark away with a sturdy knife on affected branch. Avoid cutting into the cambium and wood.
4. If holes or dark cankers and beetle galleries are present, prepare to collect a sample.
 - a. Find the transition zone between healthy and damaged or dead wood.
 - b. Ideally, cut 2-4 different branches 2-4 inches in diameter into 6 -12 inch long sections each that include healthy and damaged wood.

- c. Trim off excess twigs and branches.
- d. If any tiny (1.5-2 mm long), reddish-brown adult beetles (figure 4) or larvae are found during inspection or sampling, collect them in a leak-proof vial of 70% ethanol.
- e. Wrap each branch in paper towels. Double bag the sample in two Ziploc bags while on site and seal both bags. Multiple segments (maximum of 3) from the same branch can be packaged together as a single sample.
- f. Record sample information on “TCD Sample Collection Datasheet” (Appendix 7).
- g. Sterilize tools before collecting additional samples.

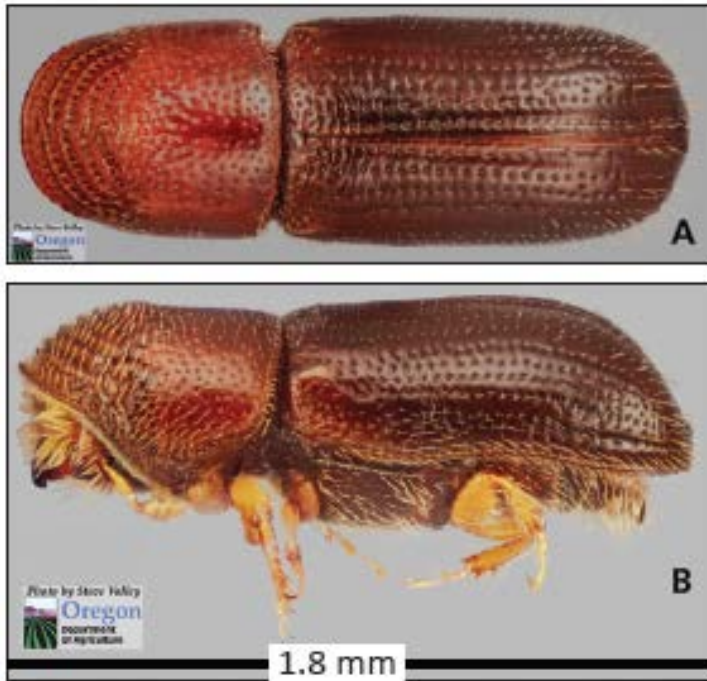

Figure 4. Walnut twig beetle: top view (A) and side view (B).

Credit: Steve Valley, Oregon Department of Agriculture

USFS Pest Alert: Thousand Cankers Disease, February 2013 (Appendix 1)

Trap Placement and Monitoring

The following information is excerpted from detailed trapping guidelines (Appendix 8) entitled: *Detecting and Identifying the Walnut Twig Beetle: Monitoring Guidelines for the Invasive Vector of Thousand Cankers Disease of Walnut*. A short version of these guidelines for field use is also available (Appendix 9). Users are encouraged to read these guidelines completely prior to initiating a trapping program.

Purpose of Trapping

The aggregation pheromone lure can be used to detect an incipient population of WTB, or, in areas where TCD or WTB has been recently discovered, to delimit a known population.

Where to Locate Traps

For detection of WTB across a large area, such as a state-wide survey, a much lower density of traps is more feasible than the higher density needed to assess the extent of a known population. Costs of trapping (e.g., materials, labor, and travel) are important factors to consider in determining the number of baited traps that can be deployed.

Sites previously identified to have black walnut trees with unexplained dieback would be logical locations for trap placement in a detection survey program. Wood waste utilization sites, firewood lots, and saw or veneer mill sites with walnut logs and branches are also appropriate locations. In a delimitation survey to determine the extent of a population, a grid system may be useful for systematic placement of a larger number of traps.

Regardless of purpose, baited traps can be used near walnut trees in various types of sites, including residential areas, parklands, and roadways in urban areas; walnut plantations, arboreta, or orchards; and bottom-land or riparian forests in rural areas.

When to Trap

Ideally, pheromone-baited traps can be deployed whenever WTB are active; i.e., from March through November when ambient air temperatures are greater than 65° F. More likely, however, limited resources will require that state agencies involved in trapping limit trap deployment to a shorter time period. Two possible scenarios are:

- 1) Trapping for about six weeks from either late August through mid-October or from late April through mid-June. Starting dates in the spring will be earlier for more southerly states.
- 2) Trapping for three weeks in May/June and three weeks in September/October.

Materials and Supplies Needed

Materials and supplies needed for each trap (multiple funnel trap, lure, and antifreeze) are given in Table 3 on page 6 of Appendix 8. Additional items needed for hanging traps from poles are also included.

Installing Traps

The recommended approach to placing a trap on a site is to locate it about 9 to 15 ft. from the main stem of suspect walnut tree, 5 to 10 ft. from the live branches of that tree's crown, and hang the trap on a 10-ft pole so that the top of the trap is located about 9 ft. above the ground. Do not hang traps directly on trees as this may bring the tree under attack by WTB. Detailed installation instructions are provided in Appendix 8. Once hung, check the trap to ensure that it is hanging vertically and all funnels are fully separated.

Maintaining and Servicing the Traps in the Field

Routine checks and servicing of traps and collection cups – Traps should be checked every 7 to 14 days. Ensure trap is upright, not damaged or broken, and rainwater has not diluted the

antifreeze or caused cup contents to overflow. If the latter has happened, remove trap catch as soon as possible. It is critical to use antifreeze that does not contain ethanol (=ethyl alcohol) or ethylene glycol in the trap cup. See Appendix 8 for details.

Lure replacement – Lures should be replaced approximately every 2 to 3 months. Each lure lasts for 2 months when the air temperature is 86° F constantly over a 24 hour period, so the replacement schedule will vary by season and location.

Collection of Trap Catches

Inspect the trap collection cups every 7 to 14 days to determine if beetles are present. Bag and preserve the catch as instructed in Appendix 8. Bag labels (written with pencil, not ink) should include the following information: Trapping site name/identification (County, Municipality, or other); trap number for that site; date trap period began; date sample was collected; and trap collector's name, agency affiliation and contact information (telephone number and email address at a minimum).

Upon return to the office, place catches in freezer (e.g., -10° F) for a minimum of 72 hours. After this freeze treatment, beetle samples may be shipped in a crush-proof box or directly delivered to the designated individual responsible for screening the sample in that state for WTB.

Determining Presence of WTB or *Geosmithia morbida*

Ideally, each state will have individuals or laboratories with sufficient expertise to process branch samples from suspect trees, including isolation of fungi from the samples and bark removal to obtain any potential WTB. These individuals or laboratories may also have the expertise to identify *Geosmithia morbida* or WTB. If so, this screening and identification is sufficient for confirmation. If not, screening aids to help identify both organisms are included in Appendix 8 and 10 (WTB) and Appendix 12 (*G. morbida*). Pure sub-cultures of suspect *G. morbida* cultures also may be sent to a regional lab with such expertise. Suspect WTB that cannot be confirmed in-house may be placed in small, screw-top glass vials filled half way with 70% ethanol and shipped to a designated identifier (see Appendix 13).

If WTB are identified in trap catch (es) at site(s) not previously reported to have TCD, the trap catch collector for each site (or other trained individual) should return to the site(s) and inspect black walnut trees in the vicinity of the trap(s) yielding the WTB. Branches exhibiting symptoms of TCD, including branches with apparently healthy foliage but WTB-size entry or exit holes, should be collected and submitted to a plant diagnostic lab to assay for presence of *G. morbida* from bark cankers. In cases where the population of WTB is low, branches infected with *G. morbida* have been difficult to obtain in the field, so it may be more efficient to apply the pheromone-baited walnut branch technique to lure live WTB (Appendix 11). These beetles inoculate the fungus into the phloem of the branch section, which can be analyzed subsequently

for *Geosmithia* in the laboratory (Appendix 12). Cankers may not be observed in the laboratory on the bait branches submitted, but isolation of *G. morbida* from WTB found in galleries or from walls of the galleries is possible. TCD is confirmed by both the capture of the WTB and the isolation of the pathogen.

WTB in trap catches

Screening and Identification of WTB in Trap Catches

All trap catch collections received by the designated screening individual or laboratory should be stored in a freezer until processed. The suggested steps for screening catch samples are listed below:

1. Carefully examine folded filter and any other included material in the sample (e.g., leaves or large insects) or collection bag.
2. Sort out small insects (less than 3 mm long) from the larger insects.
3. Examine all small insects with a stereo dissection microscope (40 to 60 X power) and use Appendix 8 or 10 to focus on and sort through the small beetles and weevils.
4. Divide the above into either:
 - a. Obviously not a bark beetle or not WTB-like → discard (or save if needed for a separate study)
 - b. If potentially a WTB → proceed to next step.
5. Record number of potential WTBs found on Datasheet for Screening Individual (Appendix 13)
6. Transfer suspect insects to small screw-cap vial that is half full with 70% ethanol.
7. Label vial (using pencil) with state, site identifier, trap number, date sample was collected (or date range for trapping), name of the collector and name of the screener
8. Photocopy trap catch data sheet with recorded numbers
9. Deliver or mail labeled vials with specimens plus appropriate datasheet(s) to the designated state or regional identifier (also see Appendix 12).

State/Regional Identifier Report

1. Examine submitted vials with suspect WTB
2. Record determination of WTB; record determination of other beetles, if desired and/or able to do (Appendix 14 – Identified WTB Trap Catch datasheet)
3. If WTB found, notify the State Plant Regulatory Official.

Collecting and Isolating Geosmithia morbida

In addition to collecting samples of potential *Geosmithia*-infected walnut branches from the crowns or stem sprouts of trees, freshly cut, healthy walnut branch sections can be placed in the field to lure in the WTB. These smooth-barked branch sections (18 inches long x 1-2 inch diameter, ~45 cm x 3-6 cm) can be baited with the WTB pheromone lure and suspended by wire from the funnel trapping pole or from a separate pole. When left in the field for 2-4 weeks

during the peak flight period (May-June or Aug. – Oct.), WTB will find and colonize the branch section. When sufficient entrance holes have been observed on the trap branch sections (10-20 holes), the branch sections can be harvested from the field and handled subsequently like a branch sample taken from a tree suspected to have TCD. In areas with low population densities of WTB, the branch sections may need to be left in the field longer to accumulate sufficient WTB entrance holes.

For those who do not have the capacity to identify *G. morbida* or if screening is inconclusive (see Appendix 12), samples may be sent to a member laboratory of the National Plant Diagnostic Network. Locations of these laboratories can be found at www.npdn.org.

Instructions for Shipping Tree or Fungus Samples to NPDN

1. Suspect plant material, in double Ziploc bags, should be stored in a refrigerator awaiting shipment to a diagnostic facility. It is recommended that samples be frozen for 72 hours prior to shipment to kill any potential WTB in the sample. The preferred method for shipment is triple packaging, two Ziploc bags and an outer container. Tubes and plates should be sealed with tape. Shatter-proof containers should be used for the cultures. The outer shipping container should be an approved cardboard shipping box, and the seams of the box should be closed with approved shipping tape.
2. If submitted by regulatory personnel, the inspector will label and complete the appropriate forms. The inspector should record the State, identifier, the grower's license number (if applicable), the host(s), the inspector's initials as well as the location and date of inspection. If submitted by the State's Department of Agriculture, please include the Department of Agriculture designation: XXX-state-XXX. Upon receipt of the sample, this number will be placed in the notes section of the laboratory's database program so that it can be cross referenced with NAPIS.
3. It is suggested that samples be accompanied by a supplementary data sheet indicating the number of hosts present at each site. Save this data sheet in accordance with the NPDN format.
4. Samples should be shipped via overnight delivery or hand delivered to the diagnostic facility.
5. Many of the NPDN regions have established FedEx accounts that can be used to ship samples to expert labs. Please check with your regional center before forwarding samples.
6. Call the NPDN lab ahead of time or send an email so laboratory staff will be expecting sample. Mail packages early in the week to avoid having samples at unrefrigerated temperatures over the weekend.

Results from the identification of submitted samples will be reported directly to the submitting agency and will not be shared with other states without the permission of the submitting agency.

Outreach

Educating plantation and nursery owners, city foresters, and other tree care professionals about TCD should be considered an essential part of any survey or trapping plan. By collaborating

with stakeholders and sharing these survey guidelines, more trees can be surveyed with the limited resources available. List of Appendices

Appendix 1 – USFS Pest Alert: Thousand Cankers Disease, February 2013 (NA-PR-02-10). http://na.fs.fed.us/pubs/palerts/cankers_disease/thousand_cankers_disease_screen_res.pdf

Appendix 2 – Graves, A.D., Coleman, T.W., Flint, M.L., and Seybold, S.J. 2009. Walnut twig beetle and thousand cankers disease: Field identification guide, UC-IPM Website Publication, 2 pp., Nov. 21, 2009, http://www.ipm.ucdavis.edu/PDF/MISC/thousand_cankers_field_guide.pdf

Appendix 3 – Thousand Cankers Disease Survey Decision Tree

Appendix 4 – Walnut Twig Beetle Trap Result Reporting Spreadsheet

Appendix 5 – Key Identification Features of *Juglans* species

Appendix 6 – ID Guide for *Juglans nigra* (black walnut)

Appendix 7 – TCD Sample Collection Datasheet

Appendix 8 – Seybold, S.J., Dallara, P.L., Hishinuma, S.M., and Flint, M. L. 2013. Detecting and identifying the walnut twig beetle: Monitoring guidelines for the invasive vector of thousand cankers disease of walnut, University of California Agriculture and Natural Resources, Statewide Integrated Pest Management Program, 13 pp. http://www.ipm.ucdavis.edu/PDF/PESTNOTES/WTB_trapping.pdf

Appendix 9 – Seybold, S.J., Dallara, P.L., Hishinuma, S.M., and Flint, M. L. 2013. Quick guide: Installing, maintaining, and servicing walnut twig beetle pheromone-baited traps, University of California Agriculture and Natural Resources, Statewide Integrated Pest Management Program, 2 pp., March 2013, http://www.ipm.ucdavis.edu/PDF/MISC/WTBtrapping_quickguide.pdf

Appendix 10 – A Screening Aid for the Identification of the Walnut Twig Beetle, *Pityophthorus juglandis* Blackman

Appendix 11 – A field technique for detecting *Geosmithia morbida* with walnut branches baited with the aggregation pheromone of the walnut twig beetle, *Pityophthorus juglandis*

Appendix 12 – Isolation and Morphological Identification of *Geosmithia morbida*

Appendix 13 – Names and Contact Information for Expert Identifiers of *Pityophthorus juglandis* by USDA Forest Region

Appendix 14 – Datasheet for WTB Trap Catch Screening Individuals

Appendix 15 – Datasheet for Identified Walnut Twig Beetles Obtained from Trap Catch Samples

Pest Alert

United States
Department of Agriculture
Forest Service
Northeastern Area
State and Private Forestry
NA–PR–02–10
Revised February 2013

Thousand Cankers Disease

Dieback and mortality of eastern black walnut (*Juglans nigra*) in several Western States have become more common and severe during the last decade. A tiny bark beetle is creating numerous galleries beneath the bark of affected branches and the main stem, resulting in fungal infection and canker formation. The large numbers of cankers associated with dead branches and the stem suggest the disease's name—*thousand cankers disease*.

The principal agents involved in this disease are a newly identified fungus (*Geosmithia morbida*) and the walnut twig beetle (*Pityophthorus juglandis*). Both the fungus and the beetle only occur on walnut species and on a closely related tree called wingnut (*Pterocarya* sp.). Infested trees can die within 3 years of initial symptoms.

Thousand cankers disease has been found in nine Western States (figure 1). Since 2010, the fungus and the beetle have also been found east of the Great Plains. This disease is expected to spread in eastern forests because of the widespread distribution of eastern black walnut, the susceptibility of this tree species to the disease, and the capacity of the fungus and beetle to invade new areas and survive under a wide range of climatic conditions in the West.

Disease Symptoms

The three major symptoms of this disease are branch mortality, numerous small cankers on branches and the bole, and evidence of tiny bark beetles. The earliest symptom is yellowing foliage that progresses rapidly to brown wilted foliage, then finally branch mortality (figure 2). The fungus causes distinctive circular to oblong cankers in the phloem under the bark, which eventually kill the phloem and cambium (figure 3). The bark surface may have no symptoms, or a dark amber to black stain or cracking of the bark may occur directly above a canker. Numerous tiny bark beetle entrance and exit holes are visible on dead and dying branches (figure 4), and bark beetle galleries are often found within the cankers. In the final stages of disease, even the main stem has beetle attacks and cankers.

Geosmithia morbida

Members of the genus *Geosmithia* have not been considered to be important plant pathogens, but *Geosmithia morbida* appears to be much more virulent than related species. Aside from causing cankers, the fungus is inconspicuous. Currently, either culturing on an agar

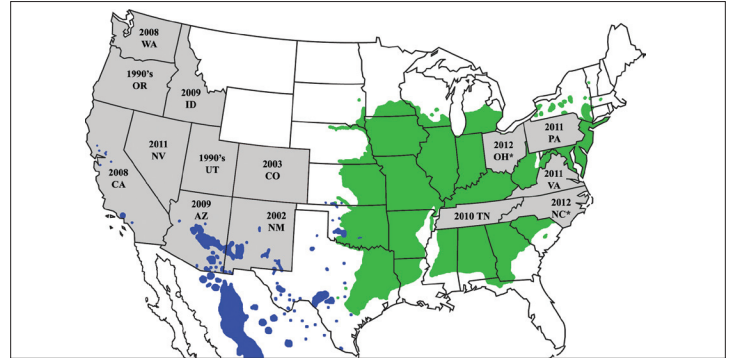

Figure 1. Thousand cankers disease occurs in nine Western and five Eastern States (shaded gray); the year in which the disease was confirmed is noted. Since 2010, TCD has been confirmed in PA, TN, and VA, whereas the beetle alone and the pathogen alone have been found in OH and NC, respectively (denoted with asterisks). The map shows the native ranges of eastern black walnut (dark green) and four western black walnut species (blue). Eastern black walnut is widely planted in the West, but this map does not depict these western locations.



Figure 2. Wilting black walnut in the last stages of thousand cankers disease.



Figure 3. Small branch cankers caused by *Geosmithia morbida*.

UGA5024084

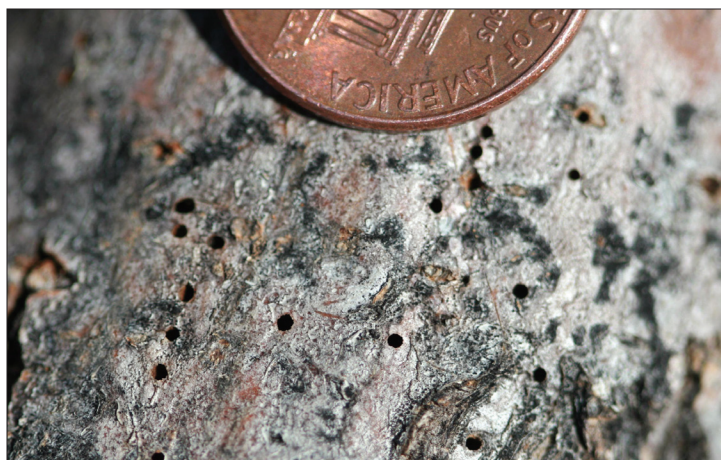

Figure 4. Exit holes made by adult walnut twig beetles.

medium or DNA analysis is required to confirm its identity. Adult bark beetles carry fungal spores that are then introduced into the phloem when they construct galleries. Small cankers develop around the galleries; these cankers may enlarge and coalesce to completely girdle the branch or stem. Trees die as a result of these canker infections that form at each of the thousands of beetle attack sites.

Walnut Twig Beetle

The walnut twig beetle is native to Arizona, California, and New Mexico. It has invaded Colorado, Idaho, Nevada, Oregon, Utah, and Washington where eastern black walnut has been widely planted. Since 2010, established populations have also been detected in Pennsylvania, Tennessee, and Virginia; North Carolina and Ohio also likely harbor populations, pending confirmation. Historically, the beetle has not caused significant branch mortality by itself. Through its association with this newly identified fungus, it appears to have greatly increased in abundance and distribution. Adult beetles are very small (1.5 to 2.0 mm long or about $\frac{1}{16}$ in) and are reddish brown in color (figure 5). This species is a typical-looking bark beetle that is characterized by its very small size and four to six concentric ridges on the upper surface of the pronotum (the shield-like cover behind and over the head) (figure 5A). Like most bark beetles, the larvae are white, C-shaped, and found in the phloem. For this species, the egg galleries created by the adults are horizontal (across the grain) and the larval galleries tend to be vertical (along the grain) (figure 6).

Survey and Samples

Visually inspecting walnut trees for dieback is currently the best survey tool for detecting the disease in the Eastern United States. A pheromone-baited trap placed near (but never on) walnut trees is also available for detecting the beetle (<http://www.ipm.ucdavis.edu/PMG/menu.thousandcankers.html>). Look for declining trees with the

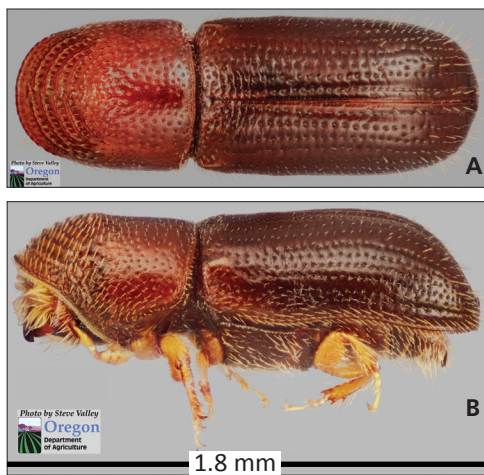

Figure 5. Walnut twig beetle: top view (A) and side view (B).



Figure 6. Walnut twig beetle galleries under the bark of a large branch.

symptoms described above. If you suspect that your walnut trees have thousand cankers disease, collect a branch 2 to 4 inches in diameter and 6 to 12 inches long that has visible symptoms. Please submit branch samples to your State's plant diagnostic clinic. Each State has a clinic that is part of the National Plant Diagnostic Network (NPDN). They can be found at the NPDN Web site (www.npdn.org). You may also contact your State Department of Agriculture, State Forester, or Cooperative Extension Office for assistance.

Prepared by:

Steven Seybold, Research Entomologist, U.S. Forest Service, Pacific Southwest Research Station

Dennis Haugen, Forest Entomologist, and Joseph O'Brien, Plant Pathologist, U.S. Forest Service, Northeastern Area State and Private Forestry

Andrew Graves, Forest Entomologist, U.S. Forest Service, Region 3 State and Private Forestry

Photographs:

Figure 1: Andrew Graves

Figure 2: Manfred Mielke, U.S. Forest Service

Figures 3, 4, 6: Whitney Cranshaw, Colorado State University, www.forestryimages.org

Figure 5: Steve Valley, Oregon Department of Agriculture

USDA is an equal opportunity provider and employer.



Published by:

USDA Forest Service
Northeastern Area
State and Private Forestry
11 Campus Boulevard
Newtown Square, PA 19073
www.na.fs.fed.us

Walnut Twig Beetle and Thousand Cankers Disease: Field Identification Guide

The walnut twig beetle, *Pityophthorus juglandis* Blackman (WTB), is native to California, the southwestern U.S., and Mexico, where its original hosts were western black walnut trees. Widespread ornamental plantings of eastern black walnut and English walnut in the western U.S. have provided new hosts for the WTB, and have permitted a range expansion of the beetle into additional western states. WTB may expand its range further into the eastern U.S., where it is not known to occur. Historically, this tiny beetle was not considered a pest of walnut trees, and was often overlooked due to its size (A) and its behavior of colonizing branches. WTB is associated with a newly described fungus, *Geosmithia* sp., which colonizes and kills the phloem of walnut branches and stems, and causes the formation of oozing bark cankers. This so-called “thousand cankers disease” only occurs on walnut.



What to Look For: From a distance, initial symptoms of thousand cankers disease can include flagging and branch dieback (B). Closer examination of the bark surface of tree branches reveals pinhole-sized WTB entrance or emergence holes and sap staining, which are frequently near cankers in the underlying phloem (C,D). Populations of WTB attempt numerous feeding and reproductive galleries, around which fungal cankers form, coalesce, and girdle branches and stems (E).





Successful WTB galleries are about 1-2 inches long and are etched against the grain on the surface of the wood (F). Often there is dark brown to black-colored boring dust in these galleries. When cankers accumulate, the crown of the tree dies and the tree attempts to resprout branches from the stem (G). WTB may also colonize and inoculate the fungus in the main stem of declining trees (H-K). At mill sites in the eastern U.S., when examining large logs for symptoms of thousand cankers disease, first look for evidence of old sap staining on the bark surface. This is illustrated (H,I) where the staining in black walnut may appear only as a slight discoloration in the bark furrows. In smooth-barked English walnut (J,K), sap staining of the stem is very apparent from a distance. At mill sites, bark should be removed from sawlogs to verify the presence of the WTB galleries (F).

If you suspect thousand cankers infection of your walnut trees, contact your state department of agriculture or county extension office. Diseased trees should be removed and the stem and branches should be burned as quickly as possible.

Andrew D. Graves, Department of Plant Pathology, University of California, Davis, CA
 Tom W. Coleman, USDA Forest Service, Forest Health Protection, San Bernardino, CA
 Mary Louise Flint, Department of Entomology, University of California, Davis, CA
 Steven J. Seybold, USDA Forest Service, Pacific Southwest Research Station, Davis, CA

Please cite this document as: *Graves, A.D., Coleman, T.W., Flint, M.L., and Seybold, S.J. 2009. Walnut twig beetle and thousand cankers disease: Field identification guide, UC-IPM Website Publication, 2 pp., Nov. 21, 2009, http://www.ipm.ucdavis.edu/PDF/MISC/thousand_cankers_field_guide.pdf*



Appendix 3 - Thousand Cankers Disease Survey Decision Tree

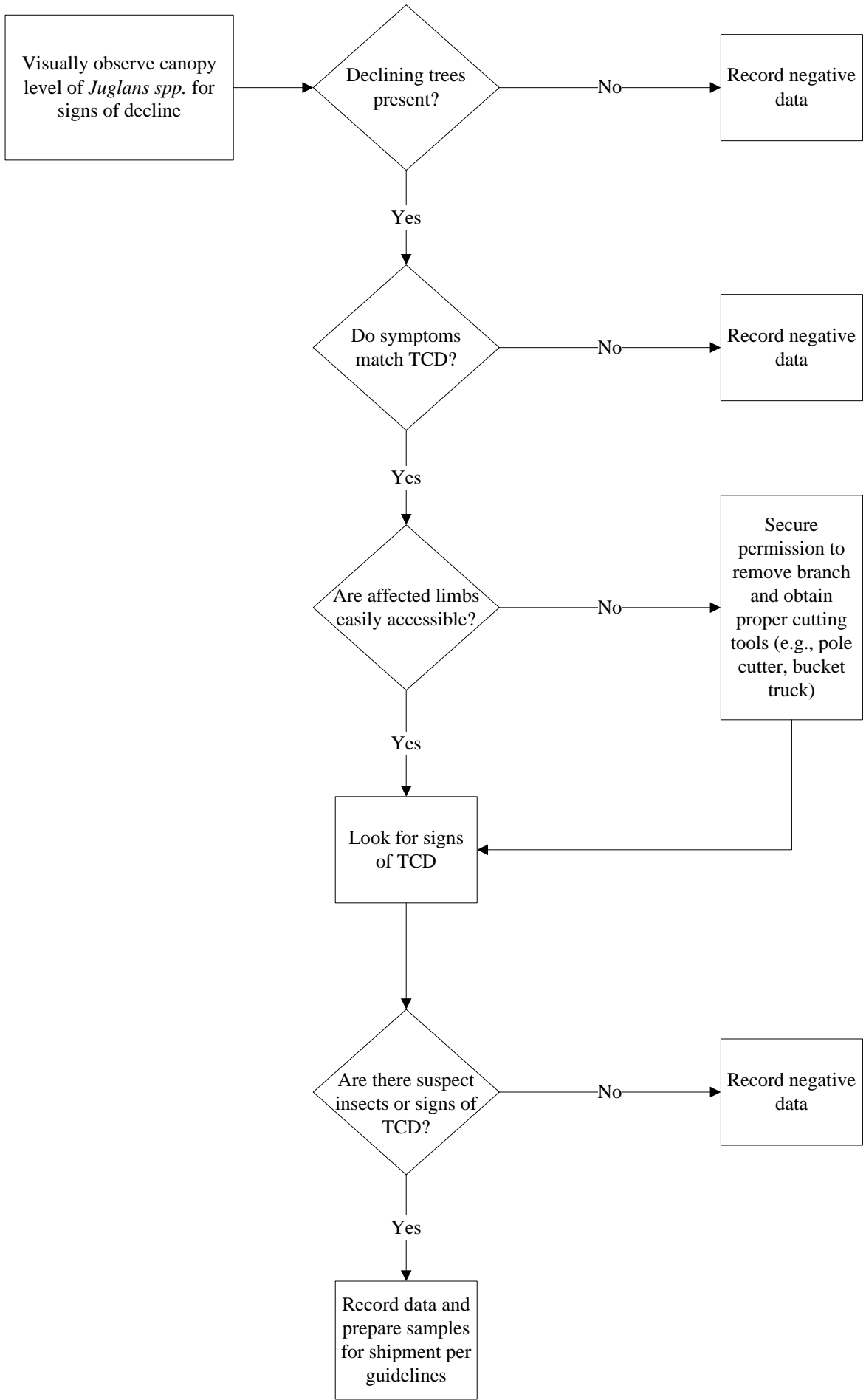

Key Identification Features of Juglans species

Leaves are alternate, with 9-23 leaflets that are pinnately compound and each leaflet is sessile or nearly sessile. The leaflets are serrated with a stout rachis which is usually hairy. The base of leaflet is nonsymmetrical and the tips gradually taper to a sharp tip. The leaflets are rounded at the base but are elongated out to the tip.



Black Walnut leaves. Source: Steven Baskauf, Vanderbilt University, 2005



Butternut leaves. Source: Steven Baskauf, Vanderbilt University, 2002



Persian Walnut leaves. Source: Cristina Comanici, 2008

Bark is somewhat diamond shaped though more so in *J. nigra* and *J. regia* and varies from dark brown to grayish black to ashy gray.



Black Walnut bark. Source: Ji-Hyun Park, University of Minnesota, 2011



Butternut bark. Source: Dr. Andrew Nelson, SUNY, 2009

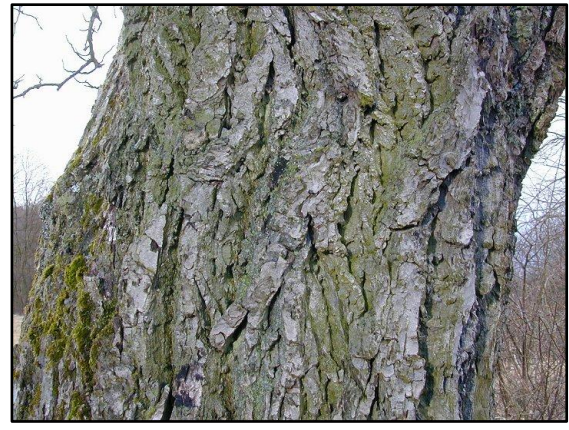

Persian Walnut bark. Source: Gerhard Elsner, 2007

Twigs are stout with an acrid taste, hairy or naked; pith is chambered after the first season except between season's growth, stellate in transverse section; terminal buds with few scales, often appearing naked; lateral buds regularly occur one on top of the other, leaf scars with groups of three equidistant U-shaped bundle scars.



Black Walnut Twig. Source: Steven J. Baskauf, Vanderbilt University, 2002



Butternut Twig. Source: Dr. Andrew Nelson, SUNY, 2009

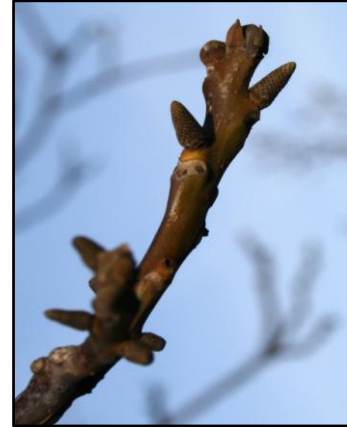

Persian Walnut Twig. Source: Sten Porse, 2008

Fruit are drupaceous; outer shell is semifleshy, and when ripe will remain unopened, the core is nutlike, with thick walls, wrinkled or deeply grooved; seed is sweet and usually oily.



Black Walnut fruit. Source: Steven J. Baskauf, Vanderbilt University, 2002



Butternut fruit. Source: Karren Wcisel, 2005



Persian Walnut fruit. VegTalk.org, 2007

Descriptive text taken from:

Harlow, William M. and Harrar, Elwood S. "Textbook of Dendrology" 5th ed. McGraw – Hill, Inc., New York. 1968.

Common name: Black Walnut

Scientific name: *Juglans nigra*

Species Identification Features:



Juglans nigra
(Black Walnut)
form

Leaves are alternate, pinnately compound, 12-24 inches long. **Leaflets** total 9-21, and are broadly lanceolate, uneven at base, finely serrate, 2.4-5.1 inches long, dark green, glabrous above and soft-hairy below.



1/

Twigs are thick, gray, finely hairy when young, with raised 3-lobed leaf scars, and chambered brown pith. End bud single, narrow, with paired gray hairy scales.



1/

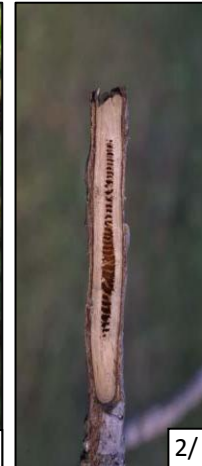

2/

Bark gray to dark brown, becoming deeply furrowed into scaly ridges.



3/

Fruits are often in pairs, 1.6 - 2.4 inches in diameter, with a thick and pulpy husk.



1/

1/ Photos courtesy of Virginia Tech Department of Forest Resources and Envir. Conserv.

2/ Photo by Steven J. Baskauf, Dept. of Bio. Sci., Vanderbilt University

3/ Photo by Ji-Hyun Park, Ph.D. Student, University of Minnesota Department of Plant Pathology

Online guide to black walnut: <http://www.tn.gov/agriculture/regulatory/tcdchecklist.html>

Site ID: _____

Appendix 7 – TCD Sample Collection Datasheet

(Please complete Walnut Decline/Dieback Reconnaissance Survey Datasheet (FS) or NAPIS TCD Datasheet (PPQ) for each site from which samples are taken)

Sample ID: _____

Site ID – Sample #

Name of Sampler: _____

Date of Sample: _____

GPS Location: Lat: _____

Waypoint Recorded? Yes No

Long: _____

Waypoint Name / #: _____

Preferred: Decimal Degrees (DD.DDDDD); WGS 84

Species: *J. nigra* *J. cinerea* *Unknown* *Other Juglans sp.* _____

Crown Class: *Dominant* *Co-dominant* *Intermediate* *Suppressed* *Open grown*

% Crown Affected: < 10% 10-25% 25-50% 50-75% > 75%

Tree DBH: _____ inches

Tree Height: _____ ft

Type of Sample: *Stem* *Branch* *Adult Beetle(s)*

Aspect of Sampled Branch: _____ Diameter of Branch: _____ inches Height of Branch _____ ft

Symptoms/Signs: *Entrance/Exit Holes (pin-size)* *Beetle Galleries* *Yellowing Leaves*

(Check all Present on Tree)

Wilting Leaves *Brown Leaves Still Attached* *Dieback*

Recently Dead Branches *Cankers (Vascular Tissue)* *Cankers (Outer Bark)*

Other:

Number of Branch Segments in Bag / Package: _____

Sample Description: _____

WTB Lure and Multi-Funnel Traps Installed on Site *Yes* *No*

If yes, please complete WTB Lure/Trap Catch Datasheet (Appendix 7)

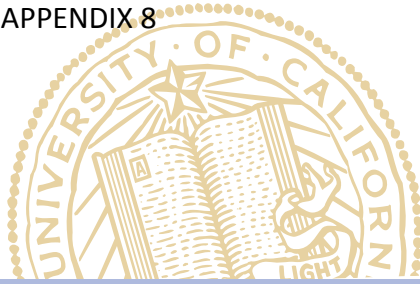

DETECTING AND IDENTIFYING WALNUT TWIG BEETLE: Monitoring Guidelines for the Invasive Vector of Thousand Cankers Disease of Walnut

STEVEN J. SEYBOLD, USDA Forest Service, Pacific Southwest Research Station, Davis, Calif.;
PAUL L. DALLARA, Entomology, UC Davis; **STACY M. HISHINUMA**, Entomology, UC Davis;
MARY LOUISE FLINT, Entomology, UC Davis and UC Statewide IPM Program

Walnut twig beetle (WTB), *Pityophthorus juglandis*, (Figure 1) is a small native phloeophagous (phloem-feeding) insect recently associated with the fungus *Geosmithia morbida* (Kolařík et al. 2011). This fungus and WTB are the principal agents involved in thousand cankers disease (TCD) (Seybold et al. 2013). Walnut and butternut are the primary hosts (Utley et al. 2013). This disease is fatal to walnut trees and is responsible for the gradual decline of several species of black walnut in the western United States during the past decade (Graves et al. 2009; Flint et al. 2010; Tisserat et al. 2011). The disease has spread widely in the western United States and has been detected in eastern states—including Tennessee in June 2010, Virginia in May 2011, and Pennsylvania in August 2011—threatening the highly valuable native timber stands of eastern black walnut, *Juglans nigra* (Newton and Fowler 2009).

The beetle is now distributed discontinuously in the United States from eastern Pennsylvania to western Oregon and from northern Idaho to southern New Mexico in the West (Seybold et al. 2012a). It was trapped in southwestern Ohio in July 2012. Populations of WTB have been invariably associated with the fungus: this type of dieback of walnut has been found only where the beetle is present. Thus, capturing and identifying the tiny beetle is the key to early detection of the disease in new areas.

This publication provides detailed guidelines for using pheromone-baited traps to detect and monitor WTB. A two-page guide for field use and instructional videos are also available at <http://www.ipm.ucdavis.edu/thousandcankers>. The purpose of this trapping is to detect an incipient population of WTB or delimit a known population of WTB where it has been recently discovered.

The trap and guidelines described here were developed in Northern California walnut orchard ecosystems with high population densities of WTB. Subsequently, however, the trapping methodology has been field tested and demonstrated in a variety of urban and wildland landscapes in California, Idaho, Pennsylvania, Tennessee, Utah, and Virginia with low to intermediate population densities of WTB. The system uses a small multiple-funnel trap (Figure 2) baited with the male-produced aggregation pheromone (Seybold et al. 2012b). The trap captures both sexes of the WTB while attracting few other insect species, including only low numbers of most other bark or ambrosia beetles (Coleoptera: Scolytidae) (Tables 1 and 2), making detection of WTB easier.



S. M. Hishinuma, UC Davis

Figure 1. Adult male WTB, lateral profile.



S. J. Seybold, USDA Forest Service

Figure 2. Four-unit funnel trap.

The baited traps have been used primarily to detect WTB populations. Little information is available on how the traps could be used to assess population levels. If WTB is detected in traps, a survey of nearby walnut trees is warranted to assess the extent of beetle infestation and other TCD symptoms (Graves et al. 2009).

TRAPPING STRATEGY

A primary consideration when selecting locations for traps and choosing a density of traps in the landscape is whether the objective is to detect an incipient population or delimit a known population. A higher density of traps would be used if the extent of an introduced population is to be assessed. If the goal is to detect a new population of WTB over a large land area (e.g., an entire state), only a much lower density of traps would be economically feasible. Whatever the overall goal, traps must be placed near walnut trees. WTB is completely dependent on walnut trees as hosts, and the emerging adult males (and soon thereafter the females) colonize branches of all sizes, but generally not those smaller than 1/2 to 3/4 inch (1.5 to 2 cm) in diameter. Unlike many other species of twig beetles (*Pityophthorus*), WTB will colonize even the main stem of trees in advanced stages of decline. It is never solely a twig-infesting beetle, even in its putative native host (*J. major*) and range (Arizona and New Mexico), where it also colonizes the larger branches and main stem of trees.

WHEN SHOULD I TRAP?

Ideally, pheromone-baited WTB traps should be deployed from March through November when ambient air temperatures exceed 65°F (18° to 19°C). Depending on available resources, more targeted detection protocols may include:

- Trapping for about six weeks from late August through mid-October or late April through mid-June
- Trapping for three weeks during May and June and three weeks during September and October

In California, WTB has been caught in pheromone-baited flight traps during every month although at extremely low

Table 1. Scolytidae other than WTB detected in pheromone-baited survey traps in Indiana, Missouri, Pennsylvania, Tennessee, and Virginia (2010-2012).¹

Name	Location	Relative abundance ²
<i>Ambrosiodmus tachygraphus</i>	VA	very low
<i>Araptus dentifrons</i>	MO	very low
<i>Carphoborus bifurcus</i>	TN	very low
<i>Cyclorhipidion bodoanum</i>	TN	very low
<i>Cyclorhipidion pelliculosus</i>	VA	very low
<i>Dryocoetes granicollis</i>	TN	very low
<i>Dryoxylon onoharaensis</i>	TN, VA	low
<i>Euwallacea validus</i>	PA, VA	very low
<i>Hylastes porculus</i>	VA	very low
<i>Hylocurus bicornus</i>	PA	very low
<i>Hylocurus rudis</i>	MO, TN, VA	low
<i>Hylesinus aculeatus</i>	PA	high
<i>Hylesinus fasciatus</i>	PA	very low
<i>Hypothenemus eruditus</i>	TN	very low
<i>Hypothenemus seriatus</i>	VA	very low
<i>Ips avulsus</i>	TN	very low
<i>Ips grandicollis</i>	MO	very low
<i>Micrasis suturalis</i>	TN	very low
<i>Monarthrum fasciatum</i>	MO, PA, VA	low
<i>Monarthrum mali</i>	MO, TN	very low
<i>Phloeotribus dentifrons</i>	VA	very low
<i>Phloeotribus frontalis</i>	MO, TN	very low
<i>Phloeotribus liminaris</i>	MO, PA, TN, VA	high
<i>Pityogenes hopkinsi</i>	PA, TN	very low
<i>Pityophthorus crinalis</i>	MO, PA, TN, VA	very low
<i>Pityophthorus lautus</i>	IN, MO, PA, TN	very low ³
<i>Pityophthorus puberulus</i>	TN	very low
<i>Pityophthorus pulicarius</i>	VA	very low
<i>Pseudopityophthorus minutissimus/pruinusos</i>	TN, VA	very low
<i>Scolytus multistriatus</i>	MO, TN	low
<i>Scolytus muticus</i>	VA	low
<i>Scolytus rugulosus</i>	MO, TN, VA	low
<i>Scolytus schevyrewi</i>	MO	low
<i>Xyleborinus saxeseni</i>	MO, PA, TN, VA	high
<i>Xyleborus affinis</i>	TN, VA	low
<i>Xyleborus atratus</i>	PA, TN, VA	high
<i>Xyleborus celsus</i>	VA	very low
<i>Xyleborus ferrugineus</i>	TN, VA	low
<i>Xyleborus impressus</i>	TN, VA	low
<i>Xyleborus xylographus</i>	PA, VA	low
<i>Xylosandrus crassiusculus</i>	PA, TN, VA	low
<i>Xylosandrus germanus</i>	TN, VA	low
<i>Xyloterinus politus</i>	VA	very low

¹Researchers also expected to catch *Pityophthorus liquidambarus* in the survey traps, but this species has not been recovered to date.

²Relative abundance was based on the catches in about 20 survey traps per state during one flight season: very low (<5 specimens), low (5-15 specimens), and high (>15 specimens).

³Relative abundance of this species in Indiana was extremely high in one instance when a survey trap was placed near a typical host (*Cercus* sp.); otherwise, catches of this species have been quite low.

levels in December and January. In 2011 and 2012, WTB was trapped in December and January not only in California but also in Tennessee and Virginia. In more northern U.S. locations, winter trap catches are unlikely.

WHERE SHOULD I TRAP?

There will be a high probability of detection if the trap is placed close to, but never in, healthy or declining walnut trees and positioned near the larger branches of these trees (Figures 3 and 4). For instance, during a demonstration trial in Utah, a trap placed near a pecan tree for most of the summer and fall did not catch any WTB. The nearest source of WTB in this instance may have been English walnut trees growing within a 1-mile radius of the trap—apparently too far away for beetles to find the trap. High population densities of WTB may be associated with declining walnut trees, so placing traps near dying trees would increase the likelihood of detecting the beetle.

Traps may be deployed in residential areas (particularly in older neighborhoods), parks, and arboreta; along rural roads; in or adjacent to walnut orchards; or in wildland forest habitats. Look for riparian areas where walnut trees often grow in higher densities, then place traps about 9 to 15 feet from the main stem of the tree, 5 to 10 feet away from live branches, and about 9 feet above the ground (Figures 3 and 4). Placing baited traps closer than the recommended distance may result in WTB infesting an uninfested branch or the main stem. Avoid placing traps near yard sprinklers and heavily trafficked locations.

Other locations where populations of WTB may be found include green waste facilities, firewood lots, or hardwood mills where walnut stems and branches might be brought for storage or processing. These sites concentrate potential WTB host material from many sources, so traps placed at these locations may have a higher probability of capturing the beetle. If host material is accumulated from various sources, a trace-back analysis might be necessary to establish the actual origin of the infested host material.

Table 2. Scolytidae other than WTB detected in pheromone-baited survey traps in Arizona, California, Idaho, Nevada, and Utah (2010-2012).

Name	Location	Relative abundance ²
<i>Cyclorhipidion bodoanum</i>	CA	very low
<i>Dendrocranus curcubitae</i>	CA	low
<i>Gnathotrichus pilosus</i>	CA	very low
<i>Hylastes asperatus</i>	AZ	very low
<i>Hylastes gracilis</i>	CA	very low
<i>Hylesinus californicus</i>	UT	low
<i>Hylocurus hirtellus</i>	CA	very low ²
<i>Hylurgops subcostulatus subcostulatus</i>	AZ	very low
<i>Hylurgus ligniperda</i>	CA	very low
<i>Hypothenemus californicus/eruditus</i>	CA	very low ³
<i>Ips pini</i>	UT	very low
<i>Monarthrum scutellare</i>	CA	very low
<i>Phloeosinus cristatus</i>	CA	very low
<i>Phloeosinus scopulorum neomexicanus</i>	AZ	very low
<i>Phloeotribus pruni</i>	AZ	low
<i>Pityophthorus confertus confertus</i>	NV, UT	very low
<i>Pseudopityophthorus agricola/pubipennis</i>	CA	very low
<i>Scolytus multistriatus</i>	CA	very low
<i>Scolytus rugulosus</i>	CA	low
<i>Scolytus schevyrewi</i>	CA, ID, NV, UT	low
<i>Xyleborinus saxeseni</i>	CA, ID, NV, UT	high ³
<i>Xyleborus dispar</i>	UT	very low

¹Relative abundance was based on the catches in about 20 survey traps per state during one flight season: very low (<5 specimens), low (5-15 specimens), and high (>15 specimens).

²This species can be locally abundant in coastal Northern California.

³These relative abundances have increased dramatically and undesirably when antifreeze with ethanol has been used in the trap cups.



J. Keener, Tennessee Dept. of Agriculture
Figure 3. Placement of a four-unit funnel trap in a residential yard near a small black walnut in Knoxville, Tenn.



P. L. Dallara, UC Davis
Figure 4. Placement of a four-unit funnel trap in a residential yard near a large black walnut in North Ogden, Utah.

Research data are not available regarding the optimal trap density necessary to detect an incipient population of WTB. The current detection recommendation is to deploy one trap near each target walnut tree and then determine the number of target trees according to the budget of the detection agency. If trees are absent near log storage facilities or firewood lots, then place one or more traps near piles of walnut branches, stems, or cut slabs but on the property perimeter and away from heavy equipment pathways.



S. M. Hishinuma, UC Davis
Figure 5. A 2- by 4-inch bubble cap formulation of WTB lure from Contech Enterprises Inc.

WHAT DO I NEED TO GET STARTED?

The Trap

The recommended detection system begins with a black plastic multiple-funnel (Lindgren) trap (wet cup option) (Figure 2), which is commercially available from several vendors (e.g., Contech Enterprises Inc., Synergy Semiochemicals). These traps have been used for many years for trapping bark- and wood-boring insects in forest and urban habitats and are familiar to those across the United States who have participated in Cooperative Agricultural Pest Survey and Early Detection Rapid Response programs. Thus, many detection agencies may already have a large supply of the traps. For convenience and to minimize cost, use the four-unit funnel trap, but those with a larger number of funnels will also capture WTB.

Various sticky-coated and other barrier-type traps do not rival the funnel trap for ease, convenience, and consistency. Specimens caught in funnel traps are ready for immediate evaluation under the microscope and require little cleanup. Bycatches (i.e., catches of other bark and ambrosia beetles, aphids, flies, thrips, and wasps) have been minimal in funnel traps baited with WTB pheromone. Color does not appear to influence the response of WTB, so the standard black plastic funnel trap is a good choice. The vagaries of various commercial formulations of adhesive and the difficulties inherent in cleaning and processing the trap catches for identification make sticky-coated traps more difficult to use. These obstacles are not an issue with funnel trapping.

The Lure

The lure (Figure 5) is a proprietary formulation of the male-produced aggregation pheromone of WTB in a passive slow-release device. This small plastic bubble cap has been tested in California and Tennessee during studies of the effect of pheromone release rate and in California during a test of lure longevity. The active ingredient, when released at a higher rate in a previous formulation, was effective in Idaho, Nevada, Pennsylvania, Tennessee, Utah, and Virginia in trapping surveys. In 2012, traps baited with the lure detected WTB to establish new county records in Tennessee and Virginia as well as in Butler County, Ohio. The lure is attached directly to the trap inside the funnel column. (See Putting it All Together and Figure 9.) The vendor for the lures is Contech Enterprises Inc., <http://www.contech-inc.com>. When ordering, specify the walnut twig beetle lure.

The Trap Cup and Propylene Glycol Trapping Agent

Captured beetles fall into a white trap cup that is attached with a bayonet-type fitting to the lowest funnel. The preferred version of the wet cup has a solid molded-plastic bottom. Because of potential leakage, it is less preferable to use a cup with a bottom drain hole plugged with a No. 5 rubber stopper. Request a wet cup or wet trap version when ordering traps from the manufacturer. Research in other bark beetle systems suggests that wet-cup trapping retains more target insects than dry-cup trapping; it also preserves the specimens better for later identification and curation in museum or survey collections. Some wet cups have a screened overflow hole located in the upper side of the trap cup. Because of the small size of WTB, check to make sure the mesh size on this overflow hole is fine enough to prevent the loss of specimens.

Add 1 to 2 inches of recreational vehicle or marine antifreeze to the bottom of the cup to immobilize insects (Figure 6). This antifreeze



S. M. Hishinuma, UC Davis

Figure 6. Pouring antifreeze from the bottle into the trap cup.

solution, available from many vendors, is usually pink and consists of propylene glycol dissolved in water. Read the antifreeze label to ensure the product contains propylene glycol, which has very low toxicity, and **not** ethylene glycol, which is highly toxic to wildlife, and that the product does not contain ethanol, ethyl alcohol, isopropyl alcohol, or a corrosion inhibitor package. Ethanol will attract ambrosia beetles, complicating trap catch processing and positive identification of WTB. There is no evidence that ethanol attracts WTB; rather, preliminary evidence indicates it may reduce trap catches. For large-scale use and to eliminate completely the potential for ethanol contamination, food-grade propylene glycol (99.5% pure) can be purchased from chemical supply companies and diluted with water to a 25 to 30% solution. *Do not use automobile antifreeze, even if it is pink, as it typically contains ethylene glycol.*

Materials for Suspending the Trap

Since traps should not be placed on trees, the recommended method of installation is on poles. For consistency, users should suspend traps from the top of a 10-foot length of 1/2-inch thin-walled galvanized steel conduit (EMT) (Figure 7), available at most hardware stores for a few dollars. These conduit poles slip over a 3- to 4-foot length of 1/2-inch rebar used as a stake. The conduit poles have about a 3/4-inch outer diameter and a 1/2-inch inner diameter, so make sure they fit over the rebar before taking them out in the field. Do not install poles or service traps during periods of potential lightning storms, and do not install poles near overhead electrical or telephone cables. Preliminary research in California suggests that baited traps suspended 10 feet or even higher above the ground will capture more beetles than traps placed at head height.



S. M. Hishinuma, UC Davis

Figure 7. Materials for suspending traps: steel conduit (EMT), rebar, and a sledgehammer.

Recently manufactured funnel traps come with an eyebolt attachment in the top of the trap (Figures 8 and 9). When used to secure the trap to the pole, the eyebolt attachment provides wind stability. A strong heavy-gauge (12-gauge or thicker) wire can be attached to this eyebolt and threaded through a 3/16-inch or larger hole drilled through both walls of the pole, about 1 1/2 inches from the top. Cut the wire long enough so it can be wound around the pole and reattached to the trap. (See Putting it All Together.) Older traps without such an attachment can be modified by installing a 1/4-inch eyebolt, fender washers, and a locknut in the top of the trap.

For a complete list of materials, see Table 3.



S. M. Hishinuma, UC Davis

Figure 8. Lid from a four-unit funnel trap showing the eyebolt and heavy-gauge wire.

PUTTING IT ALL TOGETHER

Assembling the Trapping System

Once a specific location for trapping has been selected, use a small sledgehammer to drive the stake into the ground about 1 foot or more, depending upon the soil type, to provide a stable base for the pole. Leather or fabric gloves should be worn when handling and installing rebar. Avoid placing traps near overhead electrical or telephone cables and underground irrigation lines or other buried objects, and do not place the trap near an automatic sprinkler that might flood the trap cup or knock the trap over. Try to position the trap 5 to 10 feet from the lower foliage of the target walnut tree so the foliage and branches do not impede the flight of incoming beetles and so incoming WTB do not attack live branches.

Once the stake is in place, wire the eyebolt in the top of the trap to the top of the pole with heavy-gauge wire (Figure 9). Make sure that the funnels of the trap are fully extended, then use light-gauge wire (e.g., 16-gauge) or zip

ties to fasten the lowest strut or the molded plastic tabs at the bottom of the funnel to a location further down on the pole (Figure 9). This will keep the trap vertical, reducing the risk of wind damage. Some of the newer traps have holes in the side of the lid that can be wired to the pole as well. When installed, the lid of the trap should be about 8 to 9 inches from the top of the pole.

Next, attach the lure so it hangs in the middle of the trap (Figure 9). The most effective odor plume is thought to be produced when the lure is inside the funnel column. For a four-unit funnel trap, attach the lure to the funnel strut so it rests on the inside surface of the third funnel but not so low that it blocks the central axis (interior hole) of the trap. That cylindrical space should be kept clear so the beetles can fall down freely into the trap cup. When using 12-unit traps, hang the lure from the strut above the sixth funnel.

Once the trap is baited, add antifreeze to the trap cup to a depth of about 1 to 2 inches (Figure 6) and reattach it to the trap. Finally, place the pole, with the trap attached, over the stake (Figure 10). Check the trap to ensure it is approximately vertical and all funnels are fully separated.



For more information, see the video clip *Installing Walnut Twig Beetle Traps* at <http://www.ipm.ucdavis.edu/thousandcankers>.

Table 3. Equipment/Supply Checklist.

To install the trap
Four-unit black plastic multiple-funnel (Lindgren) trap with wet cup
Lure (male-produced WTB aggregation pheromone in a slow-release device)
Heavy-gauge wire and light-gauge wire or zip ties
Wire cutters or fencing pliers
Propylene glycol-based antifreeze, marine or RV (no ethyl alcohol, ethanol, or ethylene glycol)
3- to 4-foot length of 1/2-inch rebar
Drill and 3/16-inch drill bit
Sledgehammer
10 feet of 1/2-inch thin-walled galvanized steel conduit (EMT)
Leather or fabric gloves
To maintain and service the trap
Quart-sized zipper lock plastic bags
Replacement antifreeze
Laser-printed or penciled slips of paper for labels (no ink)
Conical paper paint strainers with nylon mesh inserts, one per trap catch
Secondary container (e.g., a large yogurt container) to catch antifreeze during filtration
Plastic container with cap for waste antifreeze
Plastic funnel
Gallon-sized zipper lock plastic bags
Plastic cooler with frozen blue ice for transporting trap catches and baits
Spare wire
Sledgehammer
Wire cutters or fencing pliers
Replacement lures, if necessary

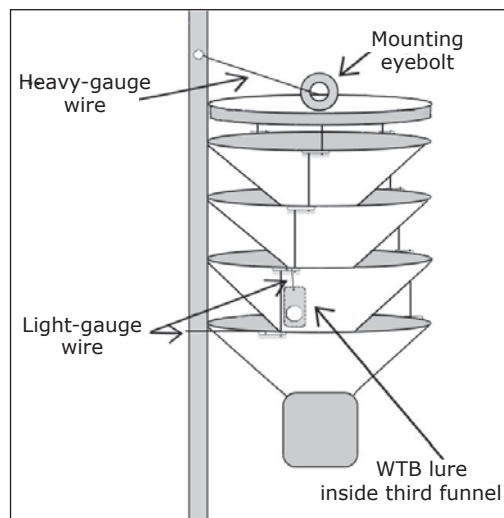

J. A. King, UC Davis

Figure 9. Schematic of a four-unit funnel trap showing the attachment between the eyebolt and pole with heavy-gauge wire, attachment and placement of the lure, and attachment of the lowest funnel strut to the pole with light-gauge wire.



S. J. Seybold, USDA Forest Service

Figure 10. A four-unit funnel trap in place at the top of a pole.

MAINTAINING THE TRAPPING SYSTEM

Maintenance for the trapping system is fairly simple. Check traps periodically during routine servicing and specifically following major weather events (e.g., heavy rains, high winds, and so forth) to make sure the trap is upright and undamaged and that rain has not diluted the antifreeze or caused the liquid in the trap cup to overflow; if the cup has accumulated rainwater or irrigation water, it should be emptied and the trap catch collected and placed in a freezer as soon as possible. (See Servicing the Traps.) Highly diluted antifreeze will cause specimens to decay rapidly, and in some cases the specimens will fragment, possibly preventing accurate identification of WTB.

Another aspect of maintenance is periodic replacement of the lures. The lure sleeve is loaded with enough material to last about two months when exposed to a constant temperature of 86°F, but the actual longevity of the lure will depend on the mean ambient temperature during the service period. Conservatively, if temperatures are moderate (i.e., not continuously 86°F for an entire 24-hour period), lures would need to be replaced every three months or longer during the service period. Therefore, lures could be left in the field longer during the spring and fall and replaced more frequently between June and September. Order enough lures in the spring to accommodate three to four changes during the trapping season, depending on regional mean temperatures and the duration of the detection survey.



For more information, see the video clip *Maintaining Walnut Twig Beetle Traps* at <http://www.ipm.ucdavis.edu/thousandcankers>.



S. M. Hishinuma, UC Davis

Figure 11. Paint strainer.

Servicing the Traps

Traps should be serviced every 7 to 14 days. Do not service traps during periods of potential lightning storms. Materials necessary for servicing include a supply of quart-sized zipper lock plastic bags, fresh antifreeze, some laser-printed or penciled slips of paper for labels, conical paper paint strainers with nylon mesh inserts, a secondary

container to catch the antifreeze during filtration, and a plastic container with a cap for waste antifreeze. Paint strainers (Figure 11) can be obtained from paint or hardware stores or in bulk from other vendors (e.g., <http://www.toolrage.com>, Astro Pneumatic product No. AST-4583). The mesh portion of the filter should be constructed of nylon, not cotton, and a medium to fine mesh size (e.g., 226 to 190 microns) should be used to allow liquid to flow easily through the filter. Do not use mesh sizes larger than 226 microns, as WTB may slip through the filter.

Detach the trap cup and pour the contents through the paint strainer, catching the liquid in a second container such as a large yogurt container (Figure 12). A plastic funnel can be used to support the paint strainer. Because the beetles are so small, they may get lodged around the cork or any indentations in the bottom of the cup. To be sure all beetles are collected, wash the cup several times with the same antifreeze before discarding the liquid. Carefully transfer **all** contents within the cup including leaves and other vegetation (Figure 13); nothing should be discarded in the field.

Once all of the trap cup contents have been transferred into the paper paint strainer and the excess antifreeze has been drained completely, fold the filter and place it along with a paper label into a quart-sized



S. M. Hishinuma, UC Davis

Figure 12. Pouring trap catch contents in propylene glycol antifreeze through a paint strainer.



S. M. Hishinuma, UC Davis

Figure 13. Trap catch in antifreeze in a trap cup.



S. M. Hishinuma, UC Davis

Figure 14. Folded paint strainer and paper label in a quart-sized zipper lock bag.

zipper lock plastic bag (Figure 14). Labels should include information about the trap location, start and end dates of the trapping period, and the name of the collector. Label information should be laser printed or written in pencil, as antifreeze will dissolve most ink. Collect the filtered antifreeze in the capped plastic container for later disposal. Next, check the trap for broken parts, make sure the mounting eyebolt is snug, and clear spider webs and other debris from the funnels and cup. Finally, add new antifreeze to the cup, reattach the cup, and reinstall the trap.

Plastic bags containing individual catches should be completely sealed, grouped, and placed into a gallon-sized zipper lock bag; transported in a plastic cooler in the field; then frozen in the lab for a minimum of 72 hours to ensure all insects are dead. Because the insects are easily crushed, do not stack objects on bagged catches. After freezer treatment, catches may be shipped for processing in a corrugated cardboard shipping container (e.g., a FedEx medium box) to prevent damage to specimens. For long-term storage, keep samples in a freezer or transfer to 70% ethanol.



For more information, see the video clip *Maintaining Walnut Twig Beetle Traps* at <http://www.ipm.ucdavis.edu/thousandcankers>.

IDENTIFYING WTB

Trap catches will include other insects and arthropods as well as vegetative debris funneled into the cup (Figure 13). Use a stereo dissecting microscope (40X to 60X magnification) to sort through this material to find and identify WTB (Figure 15). Be sure to examine vegetative debris and large insects carefully for any hidden or attached WTB. In demonstration trials in the eastern and western United States, thousands of WTB have been trapped in WTB pheromone-baited survey traps, whereas low numbers of about 45 other bark and ambrosia beetle species were trapped (Tables 1 and 2). To minimize the extent of this bycatch, use antifreeze without ethanol in the trap cup.

This guide will not provide the morphological details necessary to allow a user to distinguish all other species of *Pityophthorus* from WTB. If the user is not sufficiently familiar with the distinctive morphology of the WTB, expert identification should be sought, especially to confirm new state or county records. Prior to reading this section the user should become acquainted with some of the general features of the external morphology of bark and ambrosia beetles (Figure 16). Some basic identification guidelines for WTB follow:

- WTB is 1.5 to 2 millimeters long, has a relatively narrow body (about three times longer than wide), and has a reddish-brown to brown cuticle (outer “skin”) (Figure 17).
- The frons of the female WTB contains a round brush of golden setae (short hairs) that are no longer than half the distance between the eyes (Figure 17B), whereas the male frons has very sparse setae, sometimes consisting of a narrow brush of short setae immediately above the mandibles (Figure 17A).
- The anterior half of the pronotum is sloped upward from the frons (Figures 17A and B), reaches an apex before the midpoint (Figures 17A and B), and features four to six concentric arcs of asperities (ridges) (Figure 18). These arcs of ridges may be discontinuous and overlapping, especially near the median. Small teeth line the anterior edge of the pronotum (Figure 18).
- The elytra (hardened forewings) have closely spaced punctures and sparse, short setae. The elytral apex is rounded (Figure 17), and the declivity (depression at the rear end) is very shallow and often shiny.
- The female declivity is smooth (Figure 17B), whereas the male declivity features rows of minute granules on the first and third interstrial spaces (Figure 17C).



S. M. Hishinuma, UC Davis

Figure 15. Sorting a funnel trap catch in the lab at a dissecting microscope.

The bark beetle that is most likely to be confused with WTB is *Pityophthorus lautus*, (Figure 19), a native species that colonizes eastern hardwoods:

- *P. lautus* is 1.2 to 1.7 millimeters long (typically shorter than WTB) and is about 2.6 times longer than wide. It is similar in color to WTB (Figure 19E).
- The frons of both male and female *P. lautus* contains very sparse setae (Figure 19C), both sexes are very similar in appearance, and neither sex has the pronounced round brush of golden setae present in female WTB (Figure 19A).
- The anterior half of the pronotum features broken concentric arcs of asperities, similar to WTB. When viewed from above, the pronotum of *P. lautus* is somewhat triangular with a more pronounced taper toward the head than in the pronotum of WTB (Figure 19B).
- The elytral declivity is different from that of WTB (Figures 19D and 19F). The area between the first and third interstitial spaces is more depressed in *P. lautus* (Figure 19F, white arrows) than in WTB (Figure 19D), and the interstriae of *P. lautus* do not feature granules (Figure 19F).

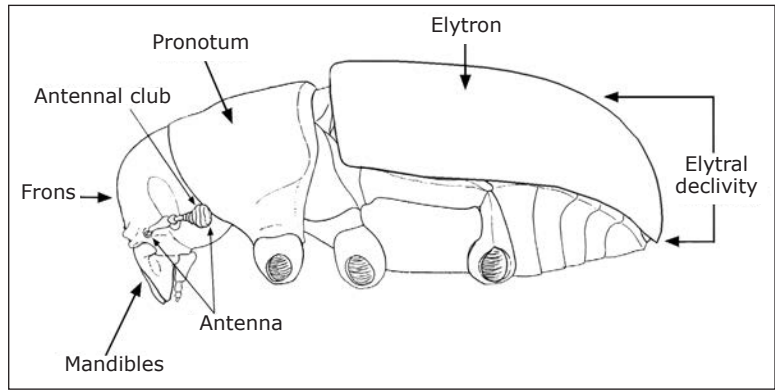

Adapted from Hopkins 1909 by S. M. Hishinuma

Figure 16. Lateral view of a scolytid beetle (without legs) showing general features of the external morphology.

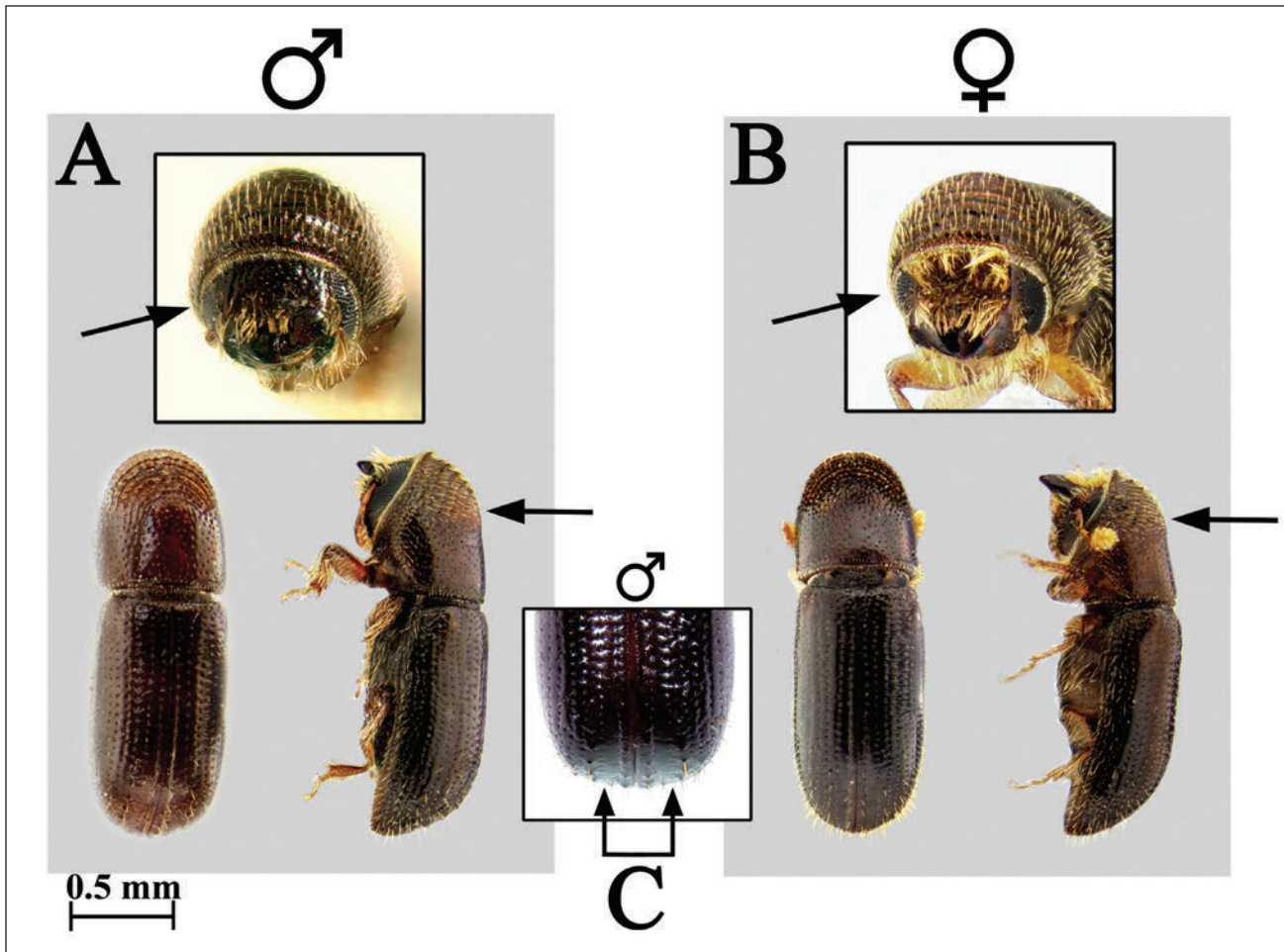

S. M. Hishinuma, UC Davis and A. D. Graves, USDA Forest Service

Figure 17. Comparison of morphological characters of male (A) and female (B) WTB. Arrows indicate the degree of pubescence on the male and female frons; the apex, which occurs before the midpoint on the anterior half of the pronotum of males and females; and granules on the male elytral declivity (C).

Some of the other bark and ambrosia beetles that have been trapped along with WTB provide useful contrasts for identification (Figure 20 and Tables 1 and 2):

- The fruit-tree pinhole borer, *Xyleborinus saxeseni*, is perhaps the most common ambrosia beetle trapped in WTB pheromone-baited traps (Figures 20 and 21).
- All scolytids have a clubbed elbowed antenna. In WTB the club is entire, whereas in *X. saxeseni* it is truncated (cut off at the tip) (Figure 21). In *Phloeotribus liminaris* the clubbed antenna is pseudolamellate (layerlike) (Figure 20 inset).
- The pattern of asperities on the pronotum of *X. saxeseni* (Figure 21) is relatively random when contrasted with the concentric arc pattern in WTB (Figures 17-21), *P. lautus* (Figure 19), and *P. crinalis* (Figure 20).
- Although the elytral declivity of male WTB has small granules, neither sex has true spines, which are present in that location on some ambrosia beetles (e.g., *X. saxeseni*) (Figure 21).

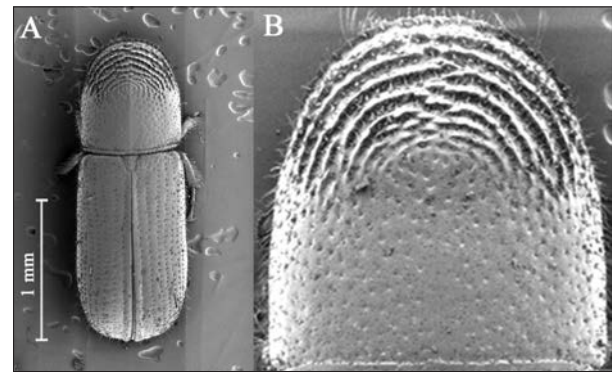

A. D. Graves, USDA Forest Service

Figure 18. Scanning electron micrograph of the dorsal profile of a female WTB (A) and close up showing pronotal asperities (B).

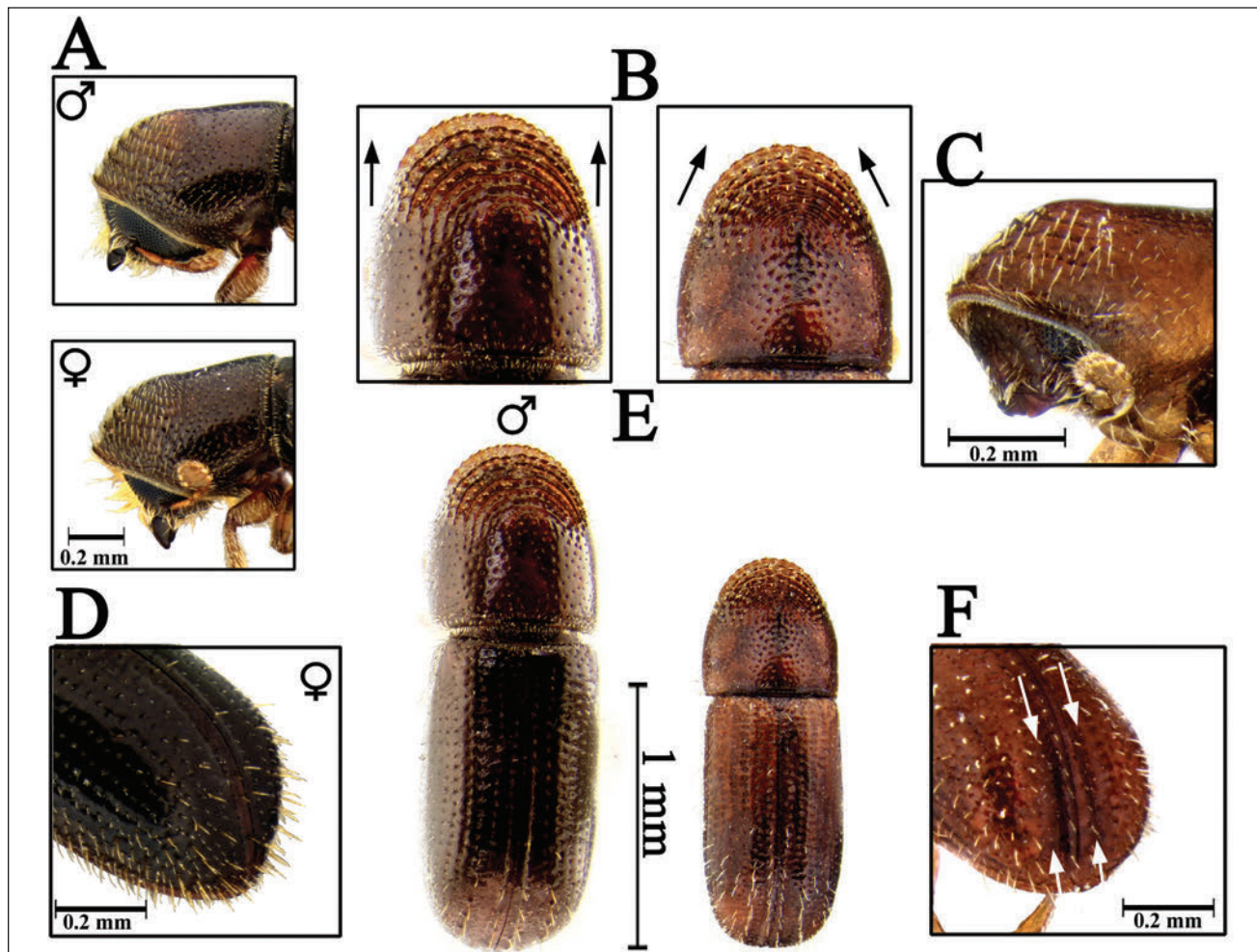

S. M. Hishinuma, UC Davis

Figure 19. Comparison of dorsal profiles (E) of male WTB and *Pityophthorus lautus*, showing the difference in body length. Close-up photographs of the heads illustrate the dense pubescence associated with female WTB (A) that is absent in both sexes of *P. lautus* (C). Close-up photographs of the dorsal view of the pronota (B) illustrate the more triangular and tapered shape in *P. lautus* (see arrows). Close-up photographs of the elytral declivity of female WTB (D) and *P. lautus* (F) illustrate the more deeply impressed surface of the declivity (white arrows) and absence of granules in *P. lautus*.

- The rounded elytral apex of WTB differs from the pointed elytral apex of *Hylocurus hirtellus*, *H. rudis*, and other *Hylocurus* spp. (Figures 20 and 22).
- The sparse vestiture (collection of setae) on the wing covers of WTB contrasts with the bi-layered and heavy vestiture of oak bark beetles, *Pseudopityophthorus* spp. (Figure 20).
- As their Latin names suggest, WTB and oak bark beetles are very similar in many other morphological characteristics.

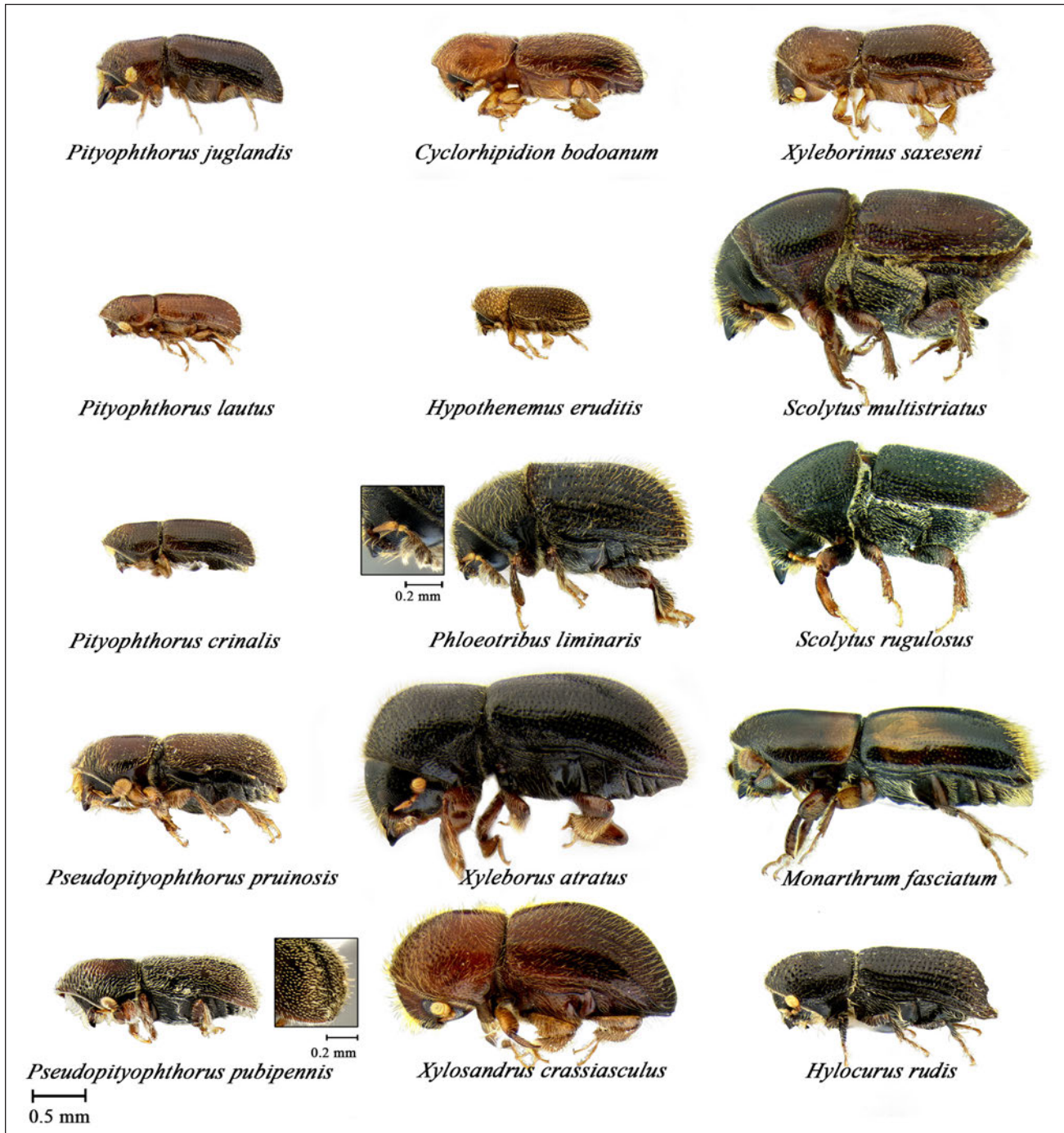

S. M. Hishinuma, UC Davis

Figure 20. Comparison of lateral profiles of female WTB, *Pityophthorus lautus*, *Pityophthorus crinalis*, *Pseudopityophthorus pruinosis*, *Pseudopityophthorus pubipennis*, *Cyclorhipidion bodoanum*, *Hypothenemus eruditus*, *Phloeotribus liminaris*, *Xylosandrus atratus*, *Xylosandrus crassiusculus*, female *Xyleborinus saxeseni*, *Scolytus multistriatus*, *Scolytus rugulosus*, *Monarthrum fasciatum*, and *Hylocurus rudis*.

ACKNOWLEDGEMENTS

The authors appreciate technical reviews of earlier drafts of this document by J. H. Borden (Contech Enterprises Inc., Delta, BC, Canada), D. E. Bright (Colorado State University, Fort Collins, Colo.), D. LeDoux and C. Wamsley (Missouri Department of Agriculture), J. Keener (Tennessee Department of Agriculture), and three members of the USDA Forest Service Forest Health Protection staff: A. D. Graves (Albuquerque, New Mexico), B. Moltzan (Washington, D.C.), and A. S. Munson (Ogden, Utah). The authors also thank D. E. Bright for identifying the scolytids other than WTB caught in survey traps. The authors also appreciate the USDA Animal and Plant Health Inspection Service's Center for Plant Health Science and Technology program and the USDA Forest Service Forest Health Protection, Washington Office, for supporting the discovery of the male-produced aggregation pheromone and the development of the detection tool.

REFERENCES

Dallara, P. L., M. L. Flint, and S. J. Seybold. 2012. An analysis of the larval instars of the walnut twig beetle, *Pityophthorus juglandis*, in northern California black walnut, *Juglans hindsii*, and a new host record for *Hylocurus hirtellus*. *Pan-Pacific Entomologist* 88:338–366.

Doane, R. W., E. C. Van Dyke, W. J. Chamberlain, and H. E. Burke. 1936. *Forest Insects*. New York: McGraw-Hill Book Co. Inc.

Flint, M. L., A. D. Graves, and S. J. Seybold. 2010. Thousand cankers disease of walnuts spreads in California. *CAPCA Adviser* 8(3):36–39.

Graves, A. D., T. W. Coleman, M. L. Flint, and S. J. Seybold. 2009. *Walnut Twig Beetle and Thousand Cankers Disease: Field Identification Guide*. UC IPM. Also available online, http://www.ipm.ucdavis.edu/PDF/MISC/thousand_cankers_field_guide.pdf.

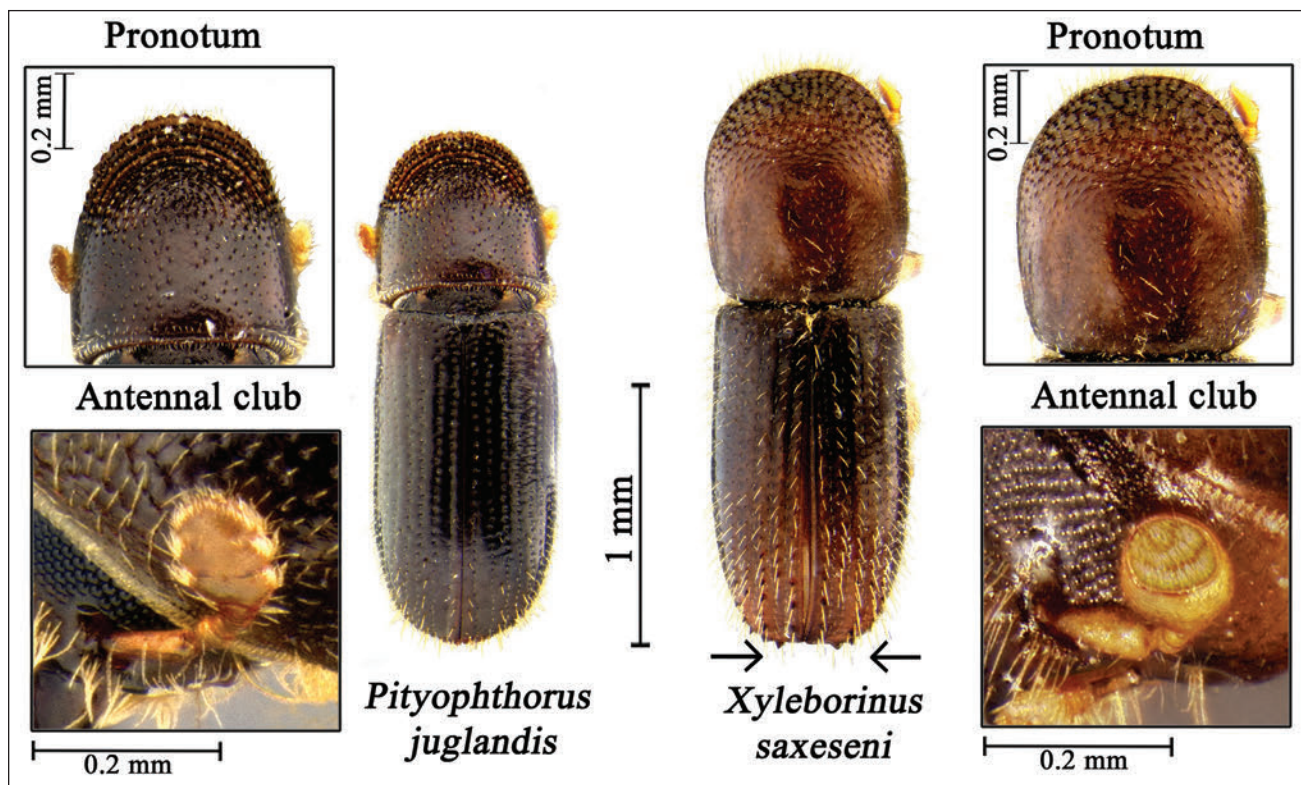

S. M. Hishinuma, UC Davis

Figure 21. Comparison of dorsal profiles, close up of pronota, and antennal clubs of female WTB and female *Xyleborinus saxeseni*. Arrows indicate spines in the elytral declivity and the truncated antennal club of *X. saxeseni*.

Hopkins, A. D. 1909. Practical information on the Scolytid beetles of North American forests. I. Barkbeetles of the genus *Dendroctonus*. USDA Bureau of Entomology Bulletin No. 83.

Kolařík, M., E. Freeland, C. Utley, and N. Tisserat. 2011. *Geosmithia morbida* sp nov., a new phytopathogenic species living in symbiosis with the walnut twig beetle (*Pityophthorus juglandis*) on *Juglans* in USA. *Mycologia* 103:325–332.

Newton, L., and G. Fowler. 2009. Pathway Assessment: *Geosmithia* sp. and *Pityophthorus juglandis* Blackman movement from the western into the eastern United States. Washington, D.C.: U.S. Dept. of Ag. Animal and Plant Health Inspection Service.

Seybold, S. J., D. Haugen, J. O'Brien, and A. D. Graves. 2013. *Thousand cankers disease*. Newtown Square, Pa.: USDA Forest Service Pest Alert NA-PR-02-10. Also available online, <http://www.na.fs.fed.us/pubs/detail.cfm?id=5225>.

Seybold, S. J., T. W. Coleman, P. L. Dallara, N. L. Dart, A. D. Graves, L. Pederson, and S.-E. Spichiger. 2012a. Recent collecting reveals new state records and the extremes in the distribution of the walnut twig beetle, *Pityophthorus juglandis* Blackman (Coleoptera: Scolytidae), in the United States. *Pan-Pacific Entomologist* 88:377–380.

Seybold, S. J., P. L. Dallara, L. J. Nelson, A. D. Graves, S. M. Hishinuma, and R. Gries. 2012b. Methods of monitoring and controlling the walnut twig beetle, *Pityophthorus juglandis*. Patent application filed with the U.S. Patent and Trademark Office, U.S. Dept. of Commerce, July 13, 2012, U.S Patent Application No. 13/548.319.

Tisserat N., W. Cranshaw, M. Putnam, J. Pscheidt, C. A. Leslie, M. Murray, J. Hoffman, Y. Barkely, K. Alexander, and S. J. Seybold. 2011. *Thousand cankers disease is widespread on black walnut, Juglans nigra, in the western United States*. St. Paul, Minn.: Plant Management Network Plant Health Prog. doi:10.1094/PHP-2011-0630-01-BR.

Utley, C., T. Nguyen, T. Roubtsova, M. Coggeshall, T. C. Ford, L. J. Graulke, A. D. Graves, C. A. Leslie, J. McKenna, K. Woeste, M. A. Yagmour, W. Cranshaw, S. J. Seybold, R. M. Bostock, and N. A. Tisserat. 2013. Susceptibility of walnut and hickory species to *Geosmithia morbida*. *Plant Disease* 0(ja). Also available online, <http://dx.doi.org/10.1094/PDIS-07-12-0636-RE>.

This publication is available online at <http://www.ipm.ucdavis.edu/thousandcankers>. Published March 13, 2013. Development of this publication was partly supported by USDA Forest Service Agreement No. 10-JV-112721-092. Products mentioned in this guide are intended to provide the user with the specific information necessary to efficiently detect WTB but are not meant to be endorsements of specific products by the University of California or the USDA Forest Service.

Bibliographic citation: Seybold, S. J., P. L. Dallara, S. M. Hishinuma, and M. L. Flint. 2013. *Detecting and identifying the walnut twig beetle: Monitoring guidelines for the invasive vector of thousand cankers disease of walnut*. UC IPM Program, University of California Agriculture and Natural Resources. 13 pp. <http://www.ipm.ucdavis.edu/thousandcankers>.

For more information about pests and pest management, visit the University of California Statewide IPM Program Web site at <http://www.ipm.ucdavis.edu>.

The University of California prohibits discrimination or harassment of any person in any of its programs or activities. The complete nondiscrimination policy statement can be found at <http://ucanr.org/sites/anrstaff/files/107734.doc>. Inquiries regarding the university's equal employment opportunity policies may be directed to Linda Marie Manton, Affirmative Action Contact, University of California, Davis, Agriculture and Natural Resources, One Shields Avenue, Davis, CA 95616, (530) 752-0495.

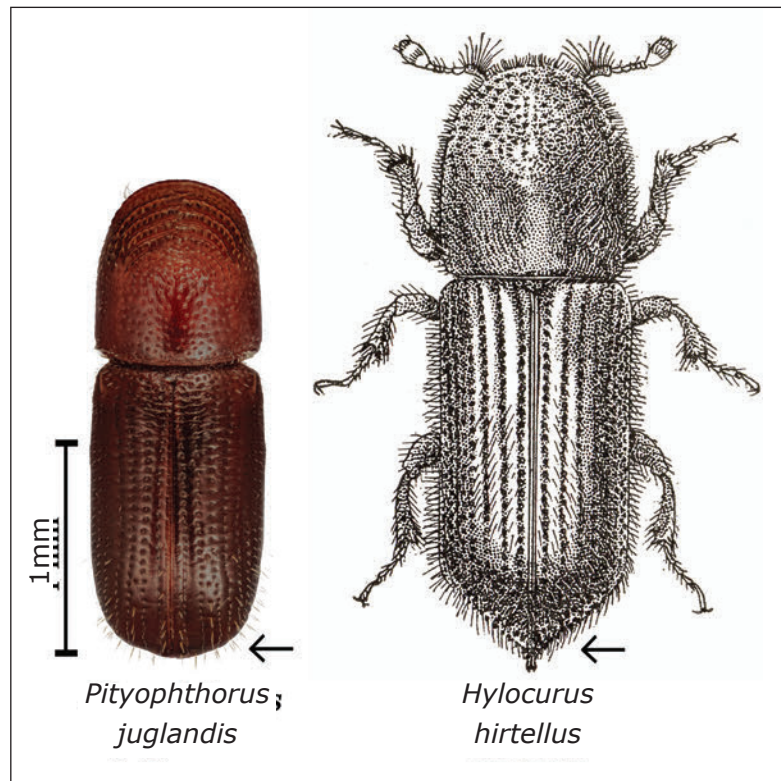

Figure 22. Comparison of dorsal profiles of WTB (S. Valley, Oregon Department of Agriculture) and *Hylocurus hirtellus* (engraving by E. C. Van Dyke in Doane et al. 1936, biology in Dallara et al. 2012) showing differences in the apex of the elytra, indicated by arrows.

QUICK GUIDE

Installing, Maintaining, and Servicing Walnut Twig Beetle Pheromone-baited Traps

Complete in-depth guidelines with photos and videos for setting up traps and monitoring for walnut twig beetles are available online at <http://www.ipm.ucdavis.edu/thousandcankers>. It is helpful to read these before using this Quick Guide.

INSTALLING THE TRAPS

Traps for walnut twig beetles (WTB) can be set out whenever beetles are most active, usually between March and November. Before installation, collect the necessary materials and select good sites near walnut trees, preferably those showing crown decline.

Materials for Installing Traps

Trap	A four-unit black plastic multiple-funnel (Lindgren) trap with a wet cup that has a molded solid-plastic bottom.	Available from several vendors (e.g., Contech Enterprises Inc., Synergy Semiochemicals). When ordering, request traps with a wet cup and a solid bottom.
Lure	Male-produced WTB aggregation pheromone in a bubble cap.	Available from Contech Enterprises Inc.
Marine or RV antifreeze	Do not use automobile antifreeze. Read the label to make sure the product contains propylene glycol and does not contain ethanol, ethyl alcohol, ethylene glycol, or a corrosion inhibitor.	Available from auto parts stores as a pink solution. Antifreeze with ethanol (ethyl alcohol) attracts too many other types of beetles; antifreeze with ethylene glycol is very attractive and toxic to wildlife.
Pole and rebar stake	A 10-foot length of thin-walled galvanized steel conduit (EMT) and a 3- to 4-foot length of rebar—both 1/2 inch in diameter.	Drill a 3/16-inch, or larger, hole through both sides of the pole about 1 to 1 1/2 inches from the top to thread the wire for hanging the trap.
Wire	Heavy- and light-gauge wire.	For attaching the trap to the pole and the lure to the trap.
Tools	Wire cutters, a small sledgehammer, and leather or fabric gloves.	

Choose a Good Site

- Look for declining walnut trees in residential areas and parks, along rural roads, in or adjacent to orchards, near hardwood mills, or in wildland forest habitats.
- Place the trap about 9 to 15 feet from the main stem of the tree, 5 to 10 feet away from live branches, and 9 feet above the ground.
- Do not place the trap where it can easily be knocked over or near a sprinkler that might flood the trap cup.

Install the Pole

- Use a small sledgehammer to drive the rebar into the ground about 1 foot or more deep to provide a stable base for the conduit pole. Place the pole over the rebar stake.
- Wear gloves when handling and installing rebar.

Attach the Trap to the Pole

- Wire the mounting eyebolt that is on top of the trap to the pole using heavy-gauge wire. The lid of the trap should be about 8 to 9 inches from the top of the pole.
- Make sure the funnels of the trap are fully extended and the trap is hanging vertically.
- Use light-gauge wire (e.g., 12-gauge or heavier) to fasten the lowest strut or the molded plastic tabs at the bottom of the funnel to a location farther down on the pole. This will keep the trap vertical and reduce the risk of wind damage.

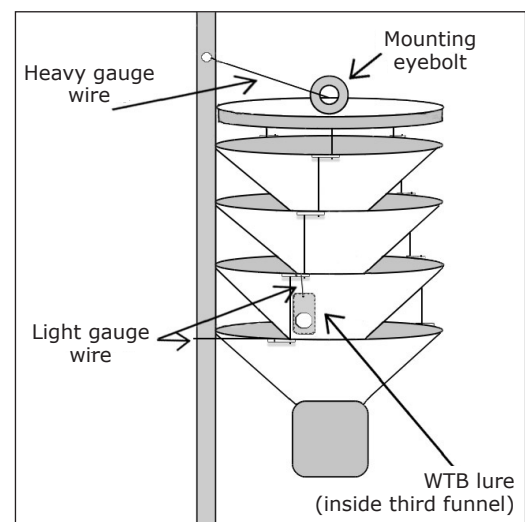

Attach the Bait and Add Antifreeze to the Cup

- Attach the lure with light-gauge wire to the plastic strut between the second and third funnel so the lure rests on the inside surface of the third funnel, but not so low that it blocks the funnel holes.
- Add antifreeze to the trap cup to a depth of about 1 to 2 inches and reattach it.

Raise the Pole and Trap

- Place the pole, with the trap attached, over the rebar. Check the trap to ensure it is fairly vertical and all funnels are fully separated.

MAINTAINING AND SERVICING THE TRAPS

Check the traps every 7 to 14 days, or sooner after major weather events.

- Make sure the trap is upright and unbroken, and that rain has not filled the cup.
- Check the trap for broken parts.
- Make sure the mounting eyebolt is snug.
- Clear spider webs and other debris from the funnels and cup.
- Replace the lures every three months.

Maintenance and Servicing Materials

- Quart- and gallon-sized zipper lock plastic bags
- Fresh RV or marine antifreeze
- Laser-printed or penciled slips of paper for labels
- Conical disposable paper paint strainers with nylon mesh inserts—one strainer per trap
- A secondary container such as a large yogurt container to catch the antifreeze during filtration
- A plastic container with a cap for waste antifreeze
- A small sledgehammer, wire cutters, and a plastic funnel
- Replacement lures, if necessary
- A cooler for transporting samples

Service the Traps Every 7 to 14 Days to Determine if Beetles are Present

1. Detach the trap cup and pour the contents through the paint strainer, catching the liquid in a second container. A plastic funnel can be used to support the paint strainer.
2. Once all the trap cup contents have been transferred into the strainer, fold the filter and place it into the zipper lock bag together with a laser-printed or penciled paper label.
3. Collect the filtered antifreeze in the plastic container for later disposal.
4. Lastly, add 1 to 2 inches of new antifreeze to the cup, reattach the cup, and reinstall the trap.

Bag and Preserve the Catch

- Plastic bags containing individual catches should be completely sealed, grouped, placed into a gallon-sized zipper lock bag, and frozen for a minimum of 72 hours to ensure all insects are killed.
- For long-term storage, keep samples in a freezer or transfer to 70% ethanol.

Steven J. Seybold, USDA Forest Service, Pacific Southwest Research Station, Davis, Calif.; **Paul L. Dallara**, Entomology, UC Davis; **Stacy M. Hishinuma**, Entomology, UC Davis; **Mary Louise Flint**, Entomology, UC Davis and UC Statewide IPM Program

We thank J. H. Borden (Contech Enterprises Inc., Delta, BC, Canada), D. LeDoux (Missouri Department of Agriculture), A. D. Graves (USDA Forest Service Forest Health Protection, Albuquerque, New Mexico), J. Keener (Tennessee Department of Agriculture), and A. S. Munson (USDA Forest Service Forest Health Protection, Ogden, Utah) for technical reviews of this document. We also appreciate the support of the USDA Animal and Plant Health Inspection Service's Center for Plant Health Science and Technology program and the USDA Forest Service Forest Health Protection, Washington Office, for supporting the discovery of the male-produced aggregation pheromone and the development of the detection tool.

This publication is available online at <http://www.ipm.ucdavis.edu/thousandcankers>. Published March 13, 2013. Development of this publication was partly supported by USDA Forest Service Agreement No. 10-JV-112721-092. Products mentioned in this guide are intended to provide the user with the specific information necessary to efficiently detect WTB but are not meant to be endorsements of specific products by the University of California or the USDA Forest Service.

For more information about pests and pest management, visit the University of California Statewide IPM Program Web site at <http://www.ipm.ucdavis.edu>.

The University of California prohibits discrimination or harassment of any person in any of its programs or activities. The complete nondiscrimination policy statement can be found at <http://ucanr.org/sites/anrstaff/files/107734.doc>. Inquiries regarding the university's equal employment opportunity policies may be directed to Linda Marie Manton, Affirmative Action Contact, University of California, Davis, Agriculture and Natural Resources, One Shields Avenue, Davis, CA 95616, (530) 752-0495.

A Screening Aid for the Identification of the Walnut Twig Beetle, *Pityophthorus juglandis* Blackman

James R. LaBonte¹,
Robert J. Rabaglia²

¹ Plant Division, Oregon Dept. of Agriculture, Salem, OR;
² USDA Forest Service, Forest Health Protection, Arlington, VA .

Introduction: The walnut twig beetle (WTB), *Pityophthorus juglandis* Blackman (Scolytidae), is a small (~2 mm long) bark beetle native to the southwestern United States (AZ, CA and NM) and northern Mexico (Chihuahua). Recently, WTB has been linked to decline and death of walnut trees (*Juglans*) in several western states, including states outside its native range, e.g., CO and OR. Twig, branch, and eventual tree death (known as thousand cankers disease, TCD) is the result of WTB attack and canker development around beetle galleries caused by a fungal associate (*Geosmithia morbida*). WTB and TCD have recently been detected in TN, raising concerns about the impacts on eastern black walnut and butternut in their native ranges. The early detection and identification of WTB is important to the successful prevention and management of TCD in the east and other areas of North America where these pests are unknown. This screening aid will help differentiate WTB from other bark beetles in trap samples or specimens collected from suspect walnut trees.

Reality check: *Pityophthorus* is a large genus (>100 species in North America) and identification to species can be difficult since these are very small beetles and the distinguishing characters are often hard to discern without high magnification and good optics. Suspect specimens should be submitted to an identification specialist for verification.



Key:

1. Total body length less than 3 mm.....2
- Total body length greater than 3 mm.....NOT *P. juglandis*

2. The pronotal asperities from the middle to the anterior margin form two or more well-defined concentric rows, adjacent asperities in each row normally in contact basally (2a).....3
 Pronotum lacking asperities (2b-c) or, if asperities present, those from the middle to the anterior margin not in well-defined concentric rows (2d-f), if rows more or less evident, adjacent asperities in each row not in contact (2g-h).....NOT *P. juglandis*

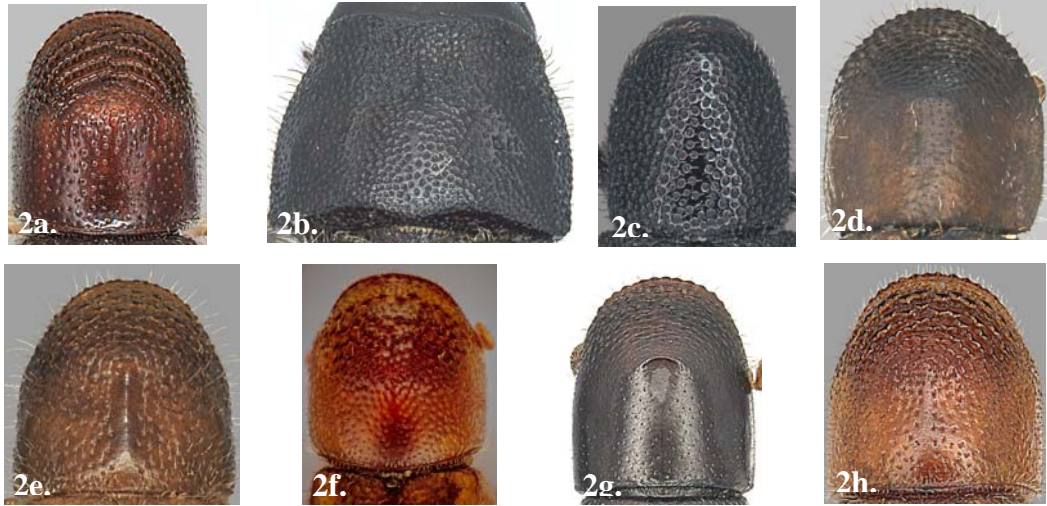

3. Apex of elytra evenly rounded (3a).....4
 Apex of elytra not evenly rounded (3b-c).....NOT *P. juglandis*



4. Apical elytral declivity flattened on either side of suture laterad of impressed striae 1 and striae 2 not impressed (4a), declivity finely roughened and dull (3a).....5
 Apical elytral declivity distinctly depressed on either side of suture laterad of striae 1 and striae 2 deeply impressed, declivity shiny (4b-c).....NOT *P. juglandis*

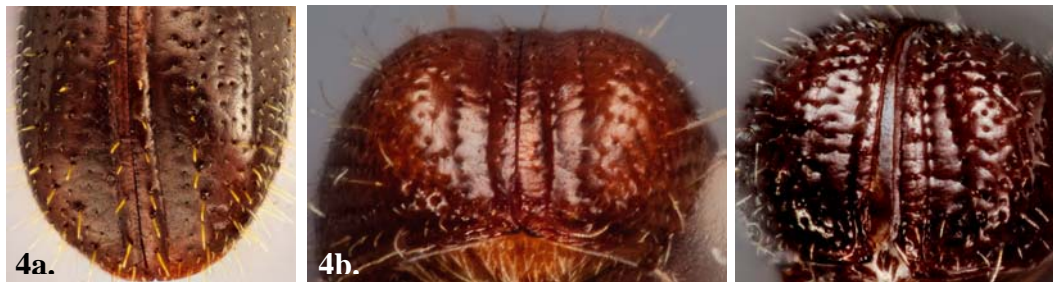

5. Anterior margin of pronotum with more than 12 asperities (5a).....YES – *P. juglandis*
*Two rarely collected species from the desert Southwest shrub *Franseria* might key here but these are so unlikely to be encountered that it is not worth trying to differentiate between them and *P. juglandis*.
Anterior margin of pronotum with no more than 12 asperities (5b-c).....NOT *P. juglandis*

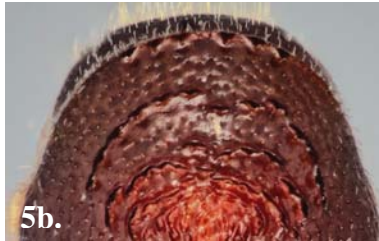

Demonstration of a field technique for detecting *Geosmithia morbida* with walnut branches baited with the aggregation pheromone of the walnut twig beetle

Steven J. Seybold¹, Tatiana V. Roubtsova², Tivonne Nyugen², James Keener³,
and Richard M. Bostock²

¹USDA Forest Service
Pacific Southwest Research Station
Davis, CA 95616

²Department of Plant Pathology
UC-Davis
Davis, CA 95616

³Tennessee Department of Agriculture
Division of Consumer and Industry Services
Plant Certification Section
Knoxville, TN 37920

Background:

Freshly cut, healthy walnut branch sections baited with the walnut twig beetle (WTB) aggregation pheromone can be placed in the field to attract the WTB for subsequent isolation of *Geosmithia morbida*. This provides an efficient means of concentrating live WTB in the fresh phloem of *Juglans* and yields a good source of inoculated *G. morbida* for isolation. The confirmation of both the beetle and the pathogen are usually necessary for establishing that thousand cankers disease (TCD) is present in a state or county.



Walnut twig beetle entrance and emergence holes and sap stains on bark surface from *Geosmithia morbida* infection in hybrid black walnut, *Juglans hindsii* × *nigra* (Stacy Hishinuma, Photo, UC-Davis).

Method:

Prepare 6 to 12 branch sections (18 inches long x 1-2 inch diameter, ~45 cm x 3-6 cm) by harvesting healthy branches from *Juglans nigra*, *Juglans hindsii*, or other *Juglans* sp. (below left). Select sections that have a smooth bark surface; discriminate against larger diameter pieces with corky or rough bark. Seal the end of each branch section by dipping it once or twice into melted paraffin wax and letting it dry (below right).



James Keener, Photo, Tennessee Dept. of Agriculture.



Hans Chaudhury, Photo, Tennessee Dept. of Agriculture.

Attach an eyehole screw to the cut surface at each end of the branch section (below left) and suspend the branch section horizontally by wire from a pole so that the branch section rests at about 4-6 ft (1.5-2 m) above the ground (below right).



Eyehole screw attached to the waxed end of a branch section from northern California black walnut, *Juglans hindsii* (Stacy Hishinuma, Photo, UC-Davis).



Branches are suspended horizontally at ~4-6 ft above the ground (Steven Seybold, Photo, USDA FS PSW).

Attach a WTB aggregation pheromone lure to the underside in the center of the branch section by pinning it at the periphery of the lure with several push pins (right). This is the same lure that is used in the multiple funnel traps for the beetle survey. When placed 9-15 ft (3-5 m) from the stem of an infested walnut tree or near any previous site of detection of WTB, the branch section will likely be found and colonized by WTB.



Andrea Hefty, Photo, University of Minnesota.

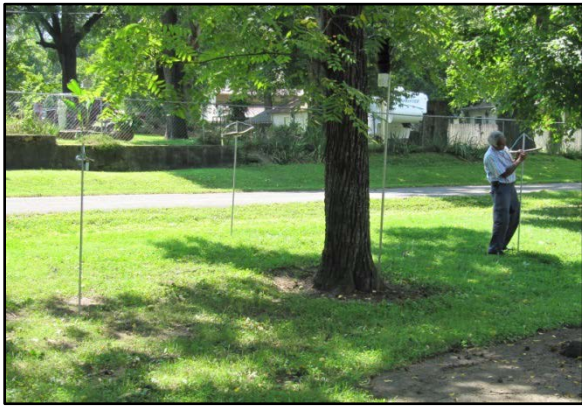

James Keener, Photo, Tennessee Dept. of Agriculture.

Establish as many baited branch section stations as is practical for the cooperating plant pathologist to process. Typically place 2-3 stations near a suspect walnut tree (left).

Leave the baited branch sections in the field for 2-4 wks during the peak flight period (May-June or Aug.-Oct.).

Harvesting Infested Walnut Branches:

When sufficient entrance holes have been observed on the bark surface of the trap branch sections (10-20 holes), the branch sections can be harvested from the field and handled subsequently like a branch sample taken from a tree suspected to have TCD. In areas with low population densities of WTB, the branch sections may need to be left in the field longer to accumulate sufficient WTB entrance holes. Shipping infested branch samples to another state for analysis may require a USDA APHIS shipping permit.

Trials in California and Tennessee suggest that approximately 60% of branch sections and 20% of entrance holes can be positive for *G. morbida* after a 5-12 day (California) or 30 day (Tennessee) field exposure period.

Appendix 12 - Isolation and Morphological Identification of *Geosmithia morbida*

Largely taken from National Plant Diagnostic Network Standard Operating Procedure for Plant Diagnostic Laboratories Thousand Cankers Disease of Black Walnut *Geosmithia morbida* and its vector, *Pityophthorus juglandis*. Modified from: Tisserat N. 2009. Diagnosing Thousand Cankers Disease of Walnuts. Colorado State University. Isolation protocol for insect galleries, holes and from WTB specimens developed by Juzwik and Banik, U.S. Forest Service.

Isolations:

From bark cankers -

- Gently peel away outer bark to expose discolored phloem.
- Identify samples most symptomatic for *Geosmithia morbida*. These samples should have brown to black cankers ranging from a few millimeters up to 3 cm or greater. *Geosmithia morbida* can be isolated from cankers of any size. The cankers are often elongate to oval with a shallow tunnel near the center of the canker produced by the WTB.
- Place small bark chips on ¼ PDA++.
- Seal plates with parafilm and incubate at 25°C. Colonies will grow rapidly.

From WTB galleries or entrance/emergence holes -

- Examine for whitish, fungal hyphae growing in egg or larval galleries and in WTB entrance or emergence holes
- Flame and cool fine needle probe
- Remove whitish hyphae found in galleries and/or hole and transfer to ¼ PDA ++
- Seal and incubate as in above

From WTBs emerged from colonized branch segments -

- Store emerged beetles singly in 1.5 ml sterile micro-centrifuge tubes at -10 or -20 C until processed.
- To process:
 - Thaw beetle and add 40µl sterile dH₂O to each tube and thoroughly grind with a sterile, plastic mini-pestle.
 - Add 300 µ dH₂O to create a first dilution. Cap and mix well (vortex).
 - Pipette transfer 20 µl of first dilution into 320 µl in a second 1.5 µl sterile micro-centrifuge tube. Cap and mix (vortex).
 - Pipette 100 µl of each dilution onto three ¼-PDA ++ plates and spread with a sterile bent glass rod or plastic spreader.
 - Place inverted in a small plastic bag and fold closed. Incubate at 25 C at room temperature.

Identifying *Geosmithia morbida*:

- The fungus initially grows very rapidly out of the wood chips or from plated hyphae. Colonies commonly exceed 20-40 mm in diameter after 3-5 days at 25 °C. For plating of macerated insect suspensions, the fungus may first appear as a yeast-like colony but then shift to mycelial state after six or more days.
- Fungal colonies on half strength PDA are cream-colored to tan, and tan to yellow-tan on the reverse side of the plate.
- The fungus sporulates profusely in culture producing dry conidia on multi-branched, verticillate, verrucose conidiophores. Conidiophore morphology is similar in appearance to *Penicillium* although these genera are not closely related.
- Geosmithia sp.* conidia are tan en masse, cylindrical to ellipsoid, 2 to 6 x 6 to 14 (mean 2.7 x 6.5) µm, and form in chains

Culture Maintenance:

Geosmithia morbida can be transferred and maintained on ½ strength PDA or malt agar.

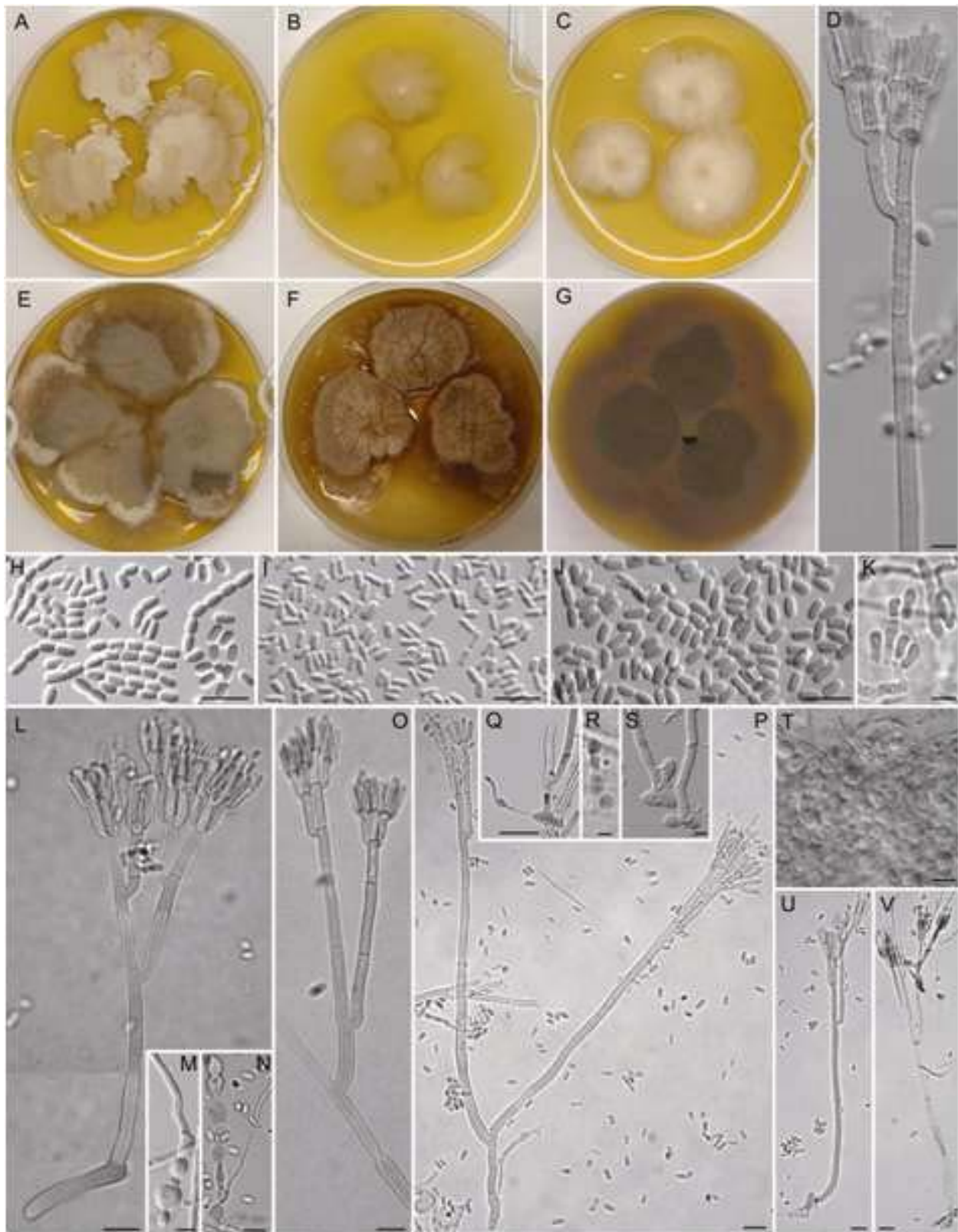

Geosmithia from *Juglans nigra*. Two-week old colonies grown on malt extract agar (A–C) and Czapek yeast agar (E, G) (at 25°C unless otherwise noted. Conidiophores (D, L, O, P, U, V) Conidia (H, I, J). Substrate conidia (K). Conidiophore bases (M, Q, S). Monilliod mycelium and budding and inflated cells forming the basis of the colony

(N). Yeast stage (T). Bars: D, K, R, S = 5 μm ; H–J, L–Q, T–V = 10 μm . Photo courtesy of Miroslav Kolařík *Institute of Microbiology; Czech Republic*. Reprinted with permission from *Mycologia*.

Media Recipes

1. ¼ strength Potato Dextrose Agar with streptomycin sulfate and chloramphenicol (¼ PDA++)

- a. Dissolve 7.6g Potato dextrose agar and 5g granulated agar into 1000ml distilled water.
- b. Autoclave mixture for 30 minutes (121°/15psi).
- c. Cool to around 50°C.
- d. Add 100mg streptomycin sulfate and chloramphenicol to sterilized agar mix.
- e. Pour into sterilized plates.

2. ½ strength Potato Dextrose Agar (½ PDA)

- a. Dissolve 19.5g Potato dextrose agar and 7.9g granulated agar into 1000ml distilled water.
- b. Autoclave mixture for 30 minutes (121°/15psi)
- c. Cool to around 50°C
- d. Pour into sterilized plates.

3. Malt Agar (MA)

- a. Dissolve 20g granulated agar and 25g Malt extract* into 1000ml distilled water.
- b. Autoclave mixture for 30 minutes (121°/15psi)
- c. Cool to around 50°C
- d. Add 1ml Lactic Acid (25%)
- e. Pour into sterilized plates.

*34g Malt agar can be used in place of granulated agar and malt extract.

Appendix 13 - Expert Identifiers for *P.juglandis*

Revised April 2016

NOTE: Those participating in walnut twig beetle surveys must first screen trap catches and send to local or state level identifiers for identification before contacting the identifiers listed below. The following identifiers should only be contacted if local or state level identification efforts are inconclusive.

Region 2 (CO, KS, NE, SD, WY)

Whitney Cranshaw

C201 Plant Sciences
1177 Campus Delivery
Fort Collins, CO 80523
(970) 491-6781

Region 5 – (CA)

Steve Seybold

Forest Sciences Laboratory
1731 Research Park Drive
Davis, CA 95618
(530) 219-8717

Region 3 – (AZ, NM)

Andy Graves

333 Broadway Boulevard, SE
Albuquerque, NM 87102
(505)842-3287

Region 6 (OR, WA)

Jim LaBonte

Oregon Dept of Ag
635 Capitol St., NE
Salem, OR 97301
(503) 986-4636

Region 8 (AL, AR, FL, GA, KY, LA, MS, NC, OK, SC, TN, TX, VA)

Norm Dart

VDACS Plant Pathology Lab
600 North 5th Street, Room 229
Richmond, VA 23219
(804) 371-5086

E. Richard Hoebeke

Collection of Arthropods, Georgia Museum of Natural History
University of Georgia
Athens, GA 30602, USA
Tel (work): 607-255-6530

Scott Schlarbaum

Forest Biology
282 Ellington Plant Sciences Building
2431 Joe Johnson Drive
Knoxville, TN 37996-4522
(865) 974-7993

Region 9 / Northeastern Area (CT, DE, IA, IL, IN, MA, ME, MD, MI, MN, MO, NH, NJ, NY, OH, PA, RI, VT, WI, WV)

Jennifer Juzwik

Northern Research Station
USDA Forest Service
1561 Lindig Street
St. Paul, MN 55108
(651) 649 5114

Sharon Reed

108 Waters Hall
Division of Plant Sciences
University of Missouri
Columbia, MO 65211-0001
(573) 882-3019

Anthony Cognato

445A Natural Science
Michigan State University
243 Natural Sciences Building
East Lansing MI 48824
(517) 432-2369

Appendix 14: Datasheet for Screening Individual

Sample Tracking Information:	Sample Processing Information:
<i>Date received</i> - _____	<i>Date processed</i> - _____
<i>Received from - (trap catch collector)</i>	<i>Screening Individual's information</i>
Name - _____	Name - _____
Telephone no. - _____	Telephone no. - _____
Email address - _____	Email address - _____
Affiliation (agency/institution) - _____	Affiliation (agency/institution) - _____
City/State - _____	City/State - _____

Data Recorded During Sample Processing

Sample number	Collection site identifier/name	Trap number (at site)	Date sample collected	Results of Screening					
				Possible WTB? (circle answer)		Other insects? (circle answer)		Approx. numbers of insects found	
				yes	no	yes	no	poss. WTB	Other
1				yes	no	yes	no		
2				yes	no	yes	no		
3				yes	no	yes	no		
4				yes	no	yes	no		
5				yes	no	yes	no		
6				yes	no	yes	no		
7				yes	no	yes	no		
8				yes	no	yes	no		
9				yes	no	yes	no		
10				yes	no	yes	no		

Appendix 15—Identified Walnut Twig Beetle Trap Catch Data Sheet

Identifier _____

Date of notification to State Ag Dept _____

Date Verified _____

Service Period	State/County (GPS Coords.)	Date Start	Date Collected	Walnut Twig Beetle ¹ (number of individuals)			Other Bark and Ambrosia Beetles ² (number of individuals)				Notes /Comments	
				Male	Female	Unsexed						
(#)												
Totals												

¹*Pityophthorus juglandis*, if able/desirable to identify...examples include: *Hylocurus* sp., *Hypothenemus* sp., *Phloeotribus liminarius*, *Pityophthorus* sp., *Pseudopityophthorus* sp., *Scolytus* sp., *Xyleborus* sp., *Xyleborinus saxeseni*, *Xylosandrus* sp.