





<b>Technical Writing</b>	
rapidograph	7
isograph	10
Inks and accessories	13
ArtPen	14
rapid PRO / rotring 300	15
Tikky Liner	17
Tikky Graphic / Tikky Rollerpoint	18
Tikky 3 in 1 / Tikky Ballpoint	19
Tikky Mechanical pencils	20
Fine leads / Erasers / Refills	21
<b>Compasses</b>	
COMPACT	23
CENTRO	24
CONVEX	25
Compass accessories	27
<b>Drawing Aids</b>	
CENTRO	29
rulers, set squares, protractors etc.	
Triangular reduction scales	31
<b>Drawing Boards</b>	
rapid	33
profil	34
Accessories	35
Collegeboard	36
Drawing table / T-square-set	37
<b>Lettering Stencils and Templates</b>	
Lettering stencils	39
Templates	40

## An idea makes history

The idea came in 1928 - the perfect writing instrument. One that would write evenly, make carbon copies, and not drip or blot. No small matter in the pre-ballpoint era! The result was an inkpen that used a tube instead of a nib - the rotring Tiku or Inkograph. It became a byword for precision writing.

The Tiku was an innovative solution and since then the meeting of writing and drawing challenges through innovation has become the hallmark of the rotring company

Hence, in 1950 a dialogue with draftsmen and designers gave rise to the idea of further developing the Tiku tubular tip to create the world's first technical pen - the original Rapidograph. It was refillable, created precise sharp-edged lines and had a capillary ink feed that gave a consistently smooth flow of ink. It set the standard, and indeed became synonymous with technical drawing.

Over the years the Rapidograph was followed by many other drawing products. Rotring created an interlinking system for the professional drafter, from compasses and templates to the latest generation of the Rapidograph.

Functionality and technical perfection make rotring drawing instruments symbols for quality and precision. They continue on in the tradition laid down by founder Wilhelm Riepe back in 1928.



The Tiku Patent

Today, rotring drawing instruments can be found wherever individuals actively create their own lifestyles. People who understand the power of their thoughts and visions, and express them.



Tikky fine-lead pencil

This need to create, understand, and express is an integral part of the development of every rotring drawing instrument. Today rotring provides a comprehensive system of products offering the optimum solution for every application within technical drawing and design, for professional drafters, students and private individuals alike.

The perfection of technology, ergonomics and design creates a universe that is ideal for drawing, also enhancing the perfect expression of ideas and visions.





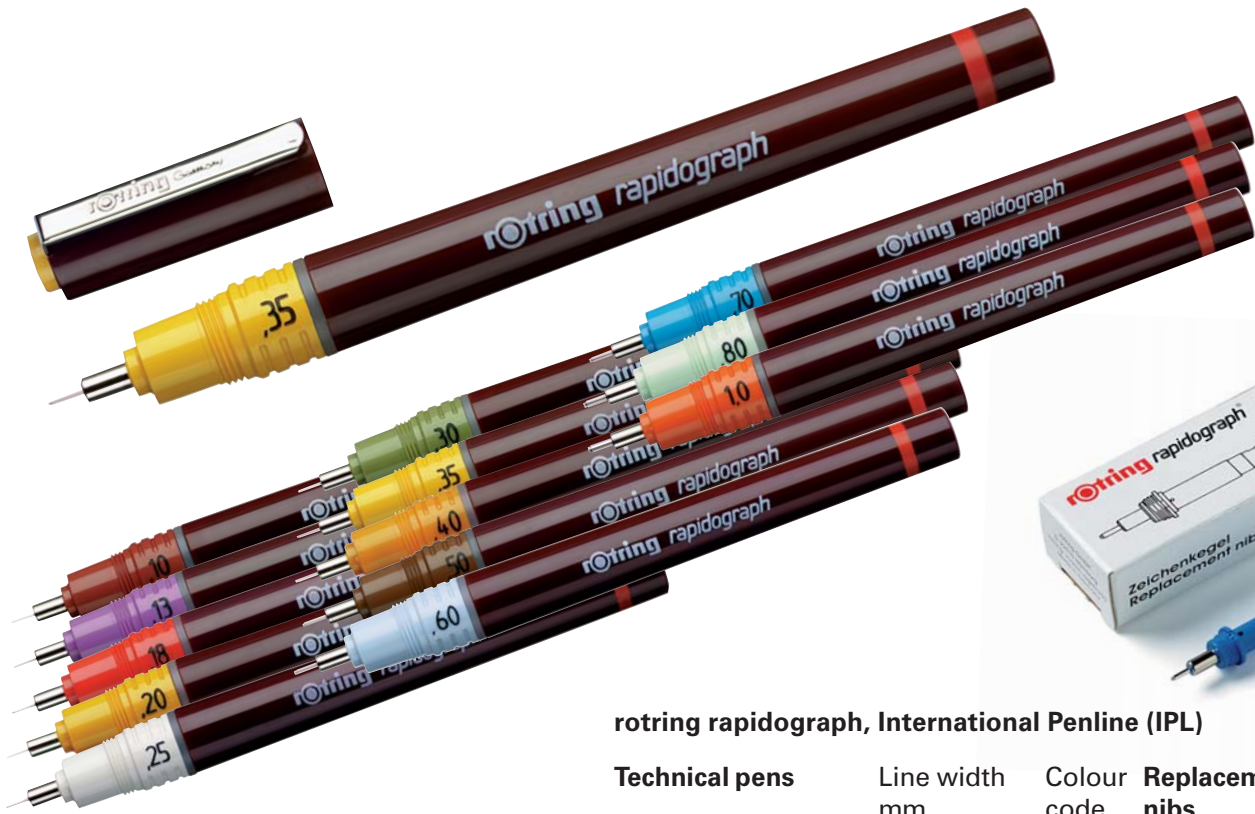

**rotring rapidograph**

**For tracing paper, vellum drawing paper and lineboard.**

The rapidograph uses rotring's unique capillary cartridge. The pressure-equalization system, including ink helix is part of the ink cartridge which ensures that every time you change the cartridge, you get a clean new ink helix. This means that you never need to clean the ink helix and top reliability is guaranteed.

**rotring rapidograph, International Penline (IPL)**

Technical pens	Line width mm	Colour code	Replacement nibs
S0203000 (R155010)	0.1	[Red]	S0218960 (R755010)
S0203070 (R155013)	0.13 *	[Purple]	S0219030 (R755013)
S0203150 (R155018)	0.18 *	[Red]	S0219110 (R755018)
S0203230 (R155020)	0.2	[Yellow]	S0219200 (R755020)
S0194270 (R155025)	0.25 *	[Green]	S0219270 (R755025)
S0203430 (R155030)	0.3	[Light Green]	S0219360 (R755030)
S0194290 (R155035)	0.35 *	[Yellow]	S0219430 (R755035)
S0203630 (R155040)	0.4	[Orange]	S0219520 (R755040)
S0203700 (R155050)	0.5 *	[Brown]	S0219590 (R755050)
S0203780 (R155060)	0.6	[Light Blue]	S0219670 (R755060)
S0203850 (R155070)	0.7 *	[Blue]	S0219740 (R755070)
S0203930 (R155080)	0.8	[Light Green]	S0219820 (R755080)
S0204000 (R155100)	1.0 *	[Orange]	S0219890 (R755100)

\* Line widths for drawing per ISO 128 and DIN 15 and for lettering per ISO 3098/I-DIN 6776.

Drawing tube in 3 mm dia. metal bushing.

The double helix built into the capillary cartridge guarantees optimum pressure compensation.

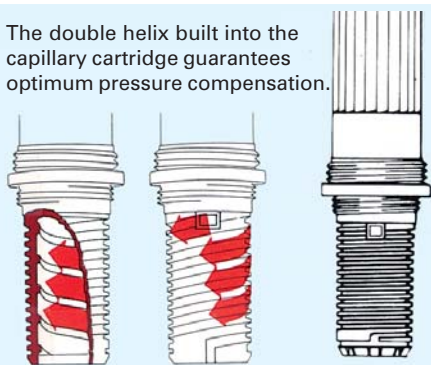

**rotring rapidograph capillary cartridges**  
(Box of 3)

Product features see page 13.

	Ink Colour
S0215710 (R590503)	red [Red]
S0215870 (R590509)	blue [Blue]
S0194640 (R590517)	black [Black]



### rotring rapidograph

Set of 4

**S0204440\***

(R155743)

—	0.25
—	0.35
—	0.5
—	0.7

### rotring rapidograph with pen station

The rapidograph work sets with pen stations keep your technical pens ready to draw instantly. Simply place the pen in the pen station with light pressure. The ideal horizontal position and a grip flexible double seal prevent the pen from drying. Individual pen stations can be taken from the set and affixed to table or drawing board with double-sided tape (provided with the work set).

\* All sets include compass attachment for 3.5/4 mm dia. and stencilling joint.



## Junior Set

Contents: 3 rapidograph pens, 1 Tikky burgundy 0.5, 6 ink cartridges



S0699460 S0699470 S0699480 S0699490

—	0.1
—	0.2
—	0.3

—	0.2
—	0.3
—	0.5

—	0.25
—	0.35
—	0.5

—	0.2
—	0.4
—	0.6

## College Set (Pen Station)

Contents: 3 rapidograph pens, 1 Tikky burgundy 0.5, 12 hi-Polymer HB leads, 1 B20 eraser, 3 pen stations, 3 ink cartridges, 1 compass attachment



S0699530 S0699550

—	0.25
—	0.35
—	0.5

—	0.2
—	0.4
—	0.8

## College Set

Contents: 3 rapidograph pens, 1 Tikky burgundy 0.5, 12 hi-Polymer HB leads, 1 B20 eraser, 6 ink cartridges, 1 compass attachment



S0699500 S0699510 S0699520 S0699540

—	0.1
—	0.3
—	0.5

—	0.2
—	0.35
—	0.5

—	0.25
—	0.35
—	0.5

—	0.2
—	0.4
—	0.6

## College Set (4 pens)

Contents: 4 rapidograph pens, 12 hi-Polymer HB leads, 1 B20 eraser, 6 ink cartridges, 1 compass attachment



S0699560 S0699570

—	0.1
—	0.2
—	0.3
—	0.5

—	0.25
—	0.35
—	0.5
—	0.7

## Master Set

Contents: 3 rapidograph pens, 1 Tikky burgundy 0.5, 12 hi-Polymer HB leads, 1 B20 eraser, 6 ink cartridges, 1 Centro compass, 1 compass attachment



S0699590 S0699600 S0699610

—	0.1
—	0.3
—	0.5

—	0.2
—	0.3
—	0.5

—	0.25
—	0.35
—	0.5



## rotring isograph

For tracing paper, vellum drawing paper and lineboard.

The isograph has a refillable ink reservoir. Its innovative push-on sleeve makes for easy access to the ink helix for fast cleaning.

\* Line widths for drawing per ISO 128 and DIN 15 and for lettering per ISO 3098/I-DIN 6776.

Drawing tube in 3 mm dia. metal bushing.

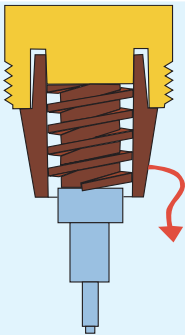

The push-on sleeve can be easily removed to facilitate cleaning, even when the ink reservoir is full.

### rotring isograph, International Penline (IPL)

Technical pens	Line width mm	Colour code	Replacement nibs
S0201850 (R151010)	0.1	Red	S0217870 (R751010)
S0201910 (R151013)	0.13 *	Purple	S0217940 (R751013)
S0201990 (R151018)	0.18 *	Orange	S0218020 (R751018)
S0202070 (R151020)	0.2	Yellow	S0218100 (R751020)
S0202130 (R151025)	0.25 *	Green	S0218170 (R751025)
S0202210 (R151030)	0.3	Light Green	S0218250 (R751030)
S0202270 (R151035)	0.35 *	Yellow-Green	S0218320 (R751035)
S0202350 (R151040)	0.4	Orange	S0218400 (R751040)
S0202410 (R151050)	0.5 *	Brown	S0218460 (R751050)
S0202490 (R151060)	0.6	Blue	S0218540 (R751060)
S0202550 (R151070)	0.7 *	Dark Blue	S0218600 (R751070)
S0202630 (R151080)	0.8	Light Blue	S0218680 (R751080)
S0202690 (R151100)	1.0 *	Red	S0218740 (R751100)

### Drawing inks for paper

rotring drawing inks in bottles and cartridges (Box of 5).

Product features see page 13.

Product	Volume	Ink Colour
S0216040 (R591003)	23 ml	red
S0216200 (R591007)	23 ml	green
S0216280 (R591009)	23 ml	blue
S0194660 (R591017)	23 ml	black
S0216550 (R591018)	23 ml	white
S0216630 (R591217)	250 ml	black
S0215630 (R590217)	Cartridges	black



**rotring isograph  
Sets of 4**

**S0202940\***  
(R151973)

—	0.25
—	0.35
—	0.5
—	0.7

**S0226890\***  
(R151983)

—	0.2
—	0.3
—	0.4
—	0.5



**rotring isograph  
Sets of 8  
S0958760\***

—	0.1
—	0.2
—	0.3
—	0.4
—	0.5
—	0.6
—	0.8
—	1.0

**rotring isograph with pen stations**

The isograph work sets with pen stations keep your technical pens ready to draw instantly. Simply place the pen in the pen station with light pressure. The ideal horizontal position and a flexible double seal prevent the pen from drying.

Individual pen stations can be taken from the set and affixed to table or drawing board with double-sided tape (provided with the work set).

\* All sets include compass attachment for 3.5/4 mm dia. and stenciling joint and 23 ml bottle of drawing ink.



# isograph Combi Sets



### Junior Set

Contents: 3 isograph pens, 1 Tikky burgundy 0.5, 4 ink cartridges

**S0699300 S0699310 S0699320**

—	0.1
—	0.2
—	0.3

—	0.1
—	0.3
—	0.5

—	0.2
—	0.3
—	0.5

**S0699330 S0699340**

—	0.25
—	0.35
—	0.5

—	0.2
—	0.4
—	0.6

### College Set

Contents: 3 isograph pens, 1 Tikky burgundy 0.5, 12 hi-polymer HB leads, 1 B20 eraser, 1 bottle of ink 23ml, 1 compass attachment

**S0699350 S0699360 S0699370 S0699380**

—	0.1
—	0.2
—	0.3

—	0.1
—	0.3
—	0.5

—	0.2
—	0.3
—	0.5

—	0.25
—	0.35
—	0.5

**S0699390 S0706970 S0699400**

—	0.2
—	0.4
—	0.6

—	0.2
—	0.4
—	0.8

—	0.2
—	0.35
—	0.7



### Master Set

Contents: 3 isograph pens, 1 Tikky burgundy 0.5, 12 hi-polymer HB leads, 1 B20 eraser, 1 Centro compass, 1 bottle of ink 23ml, 1 compass attachment

**S0699410 S0699420 S0699430**

—	0.1
—	0.2
—	0.3

—	0.1
—	0.3
—	0.5

—	0.2
—	0.3
—	0.5

**S0699440 S0699450**

—	0.25
—	0.35
—	0.5

—	0.2
—	0.4
—	0.6





## Capillary cartridges for rotring rapidograph

For tracing paper, vellum drawing paper and lineboard. (Box of 3)

### Special characteristics:

For tracing paper, vellum drawing paper and lineboard. Easy flowing, high opacity, good adhesion, smudge-proof when dry, not erasable with rotring pencil erasers B20 or B30, lightfast, suitable for all forms of reproduction.

### Ink Colour

<b>S0215710</b> (R590503)	red	
<b>S0215870</b> (R590509)	blue	
<b>S0194640</b> (R590517)	black	



## rotring pen cleaning unit for technical pens

For cleaning technical pens overnight. Fill cup half-full with water, add cleaner concentrate, place disassembled pen parts in the basket, and screw shut. Turning the unit over causes the cleaning solution to rinse through the pen parts, for thorough cleaning of even the most stubborn ink residues.

**R S0215490** (R585281) with 10 sachets of cleaner concentrate

### rotring cleaner concentrate

For cleaning dirty, encrusted technical pens and nibs. Dissolve concentrate in water in the rotring pen cleaning unit. Cleaning time will depend on how dirty the pens are.

**S0215340** (R585270) Pack of 10 sachets



## rapid-eraser B20 / B30

For erasing polymer/graphite pencil lines from all drawing media. The elastic white plastic eraser contains no abrasives, so it will not affect ink lines. It works by rolling up graphite and dirt particles in eraser dust. The erased surface stays clean, with no smears or marks. The dust brushes easily off the media surface.

### rapid-eraser B20

**S0194570** (R551120A)  
(box of 20)

### rapid-eraser B30

**S0233921** (R551130A)  
(box of 30)









## Drawing inks for paper for rotring isograph and Variant (II)

rotring drawing inks in bottles and cartridges (Box of 5)

### Special characteristics:

Suitable for tracing paper, vellum, drawing paper and lineboard. Easy-flowing, high opacity, good adhesion. Smudge-proof when dry, not erasable with rotring pencil erasers B20 or B30, lightfast, suitable for all forms of reproduction, coloured inks can be mixed with one another, high colour purity.

### Ink Colour

<b>S0216040</b> (R591003)	23 ml	red	
<b>S0216200</b> (R591007)	23 ml	green	
<b>S0216280</b> (R591009)	23 ml	blue	
<b>S0194660</b> (R591017)	23 ml	black	
<b>S0216550</b> (R591018)	23 ml	white	
<b>S0216630</b> (R591217)	250 ml	black	
<b>S0215630</b> (R590217)	Cartridges	black	



## rotring cleaning fluid for technical pens

For cleaning drawing instruments used with non-etching drawing inks.

**S0215410** (R585280) 100 ml



## rapid-eraser TB20

Combined eraser for pencil and ink lines.

$\frac{2}{3}$  for erasing non-etching drawing ink,  $\frac{1}{3}$  for erasing polymer/graphite pencil lines from all drawing media.

### S0194611

(R551320A)  
(box of 20)







### rotring ArtPen

Writing is also an art. Our hectic daily lifestyle often makes us forget this. The rotring ArtPen breathes new life into this art form. Its calligraphy nibs, crafted from the finest stainless steel, turn every piece of writing into a small work of art. This pen is a must for people who also want to put a personal stamp on their written work.



### Brilliant ink

<b>S0194751</b>	(R598217N)	ArtPen ink, black
<b>S0194681</b>	(R598205N)	royal blue
<b>S0216961</b>	(R598207N)	brown



### rotring converter

**S0227850** (R251300)

### rotring ArtPen

<b>S0204980</b>	(R250000)	Sketch	EF
<b>S0205070</b>	(R250001)	Sketch	F
<b>S0205160</b>	(R250100)	Lettering	M
<b>S0205250</b>	(R250101)	Lettering	B
<b>S0205340</b>	(R250201)	Calligraphy	1.1
<b>S0205510</b>	(R250203)	Calligraphy	1.5
<b>S0205600</b>	(R250205)	Calligraphy	1.9
<b>S0205690</b>	(R250207)	Calligraphy	2.3
<b>S0205870</b>	(R250292)	Calligraphy-Set	

### rotring ArtPen front sections

<b>S0270810</b>	(R251000)	Sketch	EF
<b>S0270820</b>	(R251001)	Sketch	F
<b>S0270830</b>	(R251100)	Lettering	M
<b>S0324620</b>	(R251101)	Lettering	B
<b>S0270850</b>	(R251201)	Calligraphy	1.1
<b>S0270870</b>	(R251203)	Calligraphy	1.5
<b>S0270880</b>	(R251205)	Calligraphy	1.9
<b>S0270890</b>	(R251207)	Calligraphy	2.3

*Greetings*

Sketch EF

*Festival*

Sketch F

*New York PARTY*

Lettering M

Lettering B

*Richard*

Calligraphy 1.1

*Maria*

Calligraphy 1.5

*Musik*

Calligraphy 1.9

*Menu*

Calligraphy 2.3



**rotring rapid PRO**

The perfect professional tool for all sketching, writing and drawing applications!

Solid metal, hexagonal barrel shape and the knurled grip underline its technical expertise. Available in satin & shiny chrome plated & matt black powder coated.

**2.0 mm pencil**

With innovative push mechanism for controlled lead transportation that provides unlimited drawing precision and features a sharpener integrated in the push cap.

**Mechanical pencils 0,5 & 0,7 mm**

Equipped with a cushion point mechanism and sliding pipe to support a convenient and highly comfortable long writing distance.

**Ballpoint pen**

Retractable, with document proof giant refill in M, blue.

**rotring rapid PRO**

<b>S0914520</b>	pencil HB	chrome	0.5 mm
<b>S0914530</b>	pencil HB	chrome	0.7 mm
<b>S0914540</b>	pencil HB	chrome	2.0 mm
<b>S0949330</b>	ballpoint pen	chrome	M
<b>S0949350</b>	pencil HB	black	0.5 mm
<b>S0949360</b>	pencil HB	black	0.7 mm
<b>S0949370</b>	pencil HB	black	2.0 mm
<b>S0949340</b>	ballpoint pen	black	M



**rotring 300 clutch pencil**

2.0 mm clutch pencil with adjustable lead hardness grade indicator and a sharpener integrated in the push cap. Hexagonal barrel shape and knurled grip - the economical 2.0 mm alternative.

**rotring leads for clutch pencils, 12 pcs.**

<b>S0230351</b>	(R505206N)	2B	2.0 mm
<b>S0230401</b>	(R505207N)	B	2.0 mm
<b>S0230451</b>	(R505208N)	HB	2.0 mm
<b>S0230491</b>	(R505210N)	H	2.0 mm
<b>S0230541</b>	(R505211N)	2H	2.0 mm

**rotring 300, clutch pencil, plastic**

**S0207300** (R502320) HB 2.0 mm



Rotring Tikker

0.5

Rotring



## Tikky Liner

Smooth & precise writing performance with constant line quality.

Tikky Liner with needlepoint tip in different line width and gel ink technology. Metal pen barrel & cap - satin chrome plated, with an ergonomical waved, transparent grip zone for comfortable writing experience and ink level control.

Precise and functional - perfect for daily writing and drawing use.

## Tikky Liner

<b>S0919070</b>	0.3 mm
<b>S0919080</b>	0.5 mm
<b>S0919090</b>	0.7 mm

## Tikky Liner Refills

<b>S0919110</b>	0.3 mm	<b>Colour</b> gel ink, black
<b>S0919120</b>	0.5 mm	gel ink, black
<b>S0919130</b>	0.7 mm	gel ink, black



### rotring Tikky Graphic

A fine fibre-tip pen with non-fading water resistant pigmented ink and a metal-jacketed fibre-tip nib for precise, fine sketching and accurate drawing on straight edges.

Graphic	Ink Colour	Line width
S0814730	black	0.1 mm
S0814740	black	0.2 mm
S0814750	black	0.3 mm
S0814760	black	0.4 mm
S0814770	black	0.5 mm
S0814780	black	0.7 mm
S0814790	black	0.8 mm



### rotring Tikky Rollerpoint

A Needlepoint tip pen that combines the advantages of a practical, exact writing and drawing tool with smooth and consistent line performance.

Rollerpoint	Ink Colour	Line width
S0940680	black	EF
S0940710	black	F
S0940690	blue	EF
S0940720	blue	F
S0940700	red	EF
S0940730	red	F

### Free Ink – The intelligent solution

Free ink technology is a perfect example of rotring's innovative force.

Our free ink writing instruments have clear advantages: The ink feed module gives a free yet controlled flow of ink from the reservoir onto the paper, eliminating the need for a conventional ink storage plug.

This makes it possible to use 100% of the ink contents, with consistent line quality down to the very last drop.

The ink level window shows the amount of ink left in the reservoir at any time.





### Tikky 3 in 1 Multipen

TIKKY 3in1 Multipen is the ultimate all-round talent! Ergonomical design and convincing functionality through a technically advanced "magic view" mechanism. Easy to use, TIKKY 3 in 1 is a technical and efficient multi-functional tool for all writing, drawing and sketching needs.

### Magic View

This highly convenient mechanism turns the multipen optionally into a mechanical pencil, a ballpoint pen to highlight or a ballpoint pen to write. Holding the pen in your hand, just look at the desired mode icon, press the push button and ..... simply write!

Also available as Tikky ballpoint with Jumbo refill.



### Tikky 3 in 1

BP blue / BP red / PCL 0.7 mm

S0891150 black

S0891170 white

BP black / BP red / PCL 0.5 mm

S0891160 black

S0891180 white

### Tikky Ballpoint

S0770890 white

S0770910 black

S0770920 blue

S0770900 red

S0770930 yellow



## Tikky





The ergonomic wave-form grip area offers a good hold. With its classic design, the Tikky is the ideal mechanical pencil for school and office. The fixed sleeve offers an unimpeded view of the page, making the Tikky excellent for drawing with a straight-edge or template.

The professional tool in classic black and burgundy. Additional colour coding analogous to ISO 3098 displays the available line widths at a glance: 0.35/0.5/0.7/1.0

Hi-Polymer leads ensure high flexibility and durability while keeping the lead-support tip clean.



### Tikky, black barrel with colour-coding

S0770490		0.35 mm
S0770500		0.5 mm
S0770510		0.7 mm
S0770520		1.0 mm
Set of 3		
S0801310		0.35 / 0.5 / 0.7 mm

### Tikky, burgundy barrel with colour-coding

S0770450		0.35 mm
S0770460		0.5 mm
S0770470		0.7 mm
S0770480		1.0 mm

### Tikky 0.5 mm

S0770530	white
S0770550	black
S0770560	blue
S0770540	red
S0770570	yellow



**Tikky fine leads**

High-polymer fine leads are a solid foundation for you to build on. Their extra-strong formula turns your mechanical pencil into something more than just a refillable pencil.

**Tikky fine leads, high-polymer**

<b>S0312400</b>	(R505307N)	B		0.35 mm
<b>S0312410</b>	(R505308N)	HB		0.35 mm
<b>S0312630</b>	(R505506N)	2B		0.5 mm
<b>S0312640</b>	(R505507N)	B		0.5 mm
<b>S0312650</b>	(R505508N)	HB		0.5 mm
<b>S0312660</b>	(R505510N)	H		0.5 mm
<b>S0312670</b>	(R505511N)	2H		0.5 mm
<b>S0231230</b>	(R505706N)	2B		0.7 mm
<b>S0312680</b>	(R505707N)	B		0.7 mm
<b>S0312690</b>	(R505708N)	HB		0.7 mm
<b>S0312700</b>	(R505908N)	HB		1.0 mm



**Jumbo refills for ballpoints**

<b>S0195360</b>	(R074450)	blue
<b>S0195390</b>	(R074456)	black



**Tikky erasers**

The Tikky erasers can be relied upon to remove pencil and coloured pencil lines without a trace. By using dirt-catching additives and avoiding hard abrasives, they make sure that the media surface always remains clean.

**Tikky erasers**



<b>Tikky 20</b>	<b>S0195831</b>	(R551420A)
<b>Tikky 30</b>	<b>S0234101</b>	(R551430A)
<b>Tikky 40</b>	<b>S0234151</b>	(R551440A)

**Eraser refills for mechanical pencils**

**S0271220** (R502721)



**D1 refills for Tikky 3 in 1**

<b>S0891220</b>	blue
<b>S0891230</b>	black
<b>S0891240</b>	red





**Rapid adjustment compass**

Fast and precise radius adjustment  
 Mobility of the spindle can be fixed by set screw  
 Both legs with joint  
 Ergonomic plastic application and handhold depressions  
 Circles up to Ø 360 mm  
 Pivot: Ø 4.0 mm  
 Length: 170 mm  
 Lead box and spare needle  
**S0676580**



**Giant Universal Compass**

Fast and smooth radius adjustment  
 Both legs with joint  
 Ergonomic plastic applications and handhold depressions  
 Circles up to Ø 360 mm  
 Pivot: Ø 3.5 mm  
 Length: 160 mm  
 Lead box and spare needle  
**S0676550**



**Geometry Compass**

Precision radius adjustment through central wheel spindle  
 Both legs with joint  
 Ergonomic plastic applications and handhold depressions  
 Circles up to Ø 360 mm  
 Pivot: Ø 4.0 mm  
 Length: 170 mm  
 Lead box and spare needle  
**S0676570**



**Compass Set (6-pieces)**

Contents: giant universal compass, stable extension bar, compass attachment with universal holding device, drawing pen, drawing pen holder, lead box and spare needle  
 Circles up to Ø 520 mm  
**S0676560**



**Universal Compass**

Fast and smooth radius adjustment  
 Convenient handhold depressions  
 Circles up to Ø 320 mm  
 Pivot: Ø 3.5 mm  
 Length: 130 mm  
 Lead box  
**S0676530**



**Universal Compass Set**

Contents: Universal compass, extension bar, compass attachment with universal holding device and lead box  
 Circles up to Ø 480 mm  
**S0676540**





### Giant bow compass with rapid adjustment

Infinitely variable radius setting through convenient button mechanism  
Precision adjustment through central spindle  
Both legs with joint  
Pivot:  $\varnothing$  4.0 mm  
Length: 170 mm  
Lead box and spare needle

**S0214470** without extension bar  
(R530115) circles up to 400 mm dia.  
**S0214540** with extension bar  
(R530116) circles up to 640 mm dia.

### Geometry Compass

Precision radius adjustment with central wheel spindle  
Spindle with end stop  
Circles up to  $\varnothing$  250 mm  
Length: 160 mm  
Lead box and spare needle

**S0233300**  
(R529130)



### Universal Compass

Fast and smooth running radius adjustment  
Insert leg with joint  
Circles up to  $\varnothing$  380 mm  
Pivot:  $\varnothing$  3.5 mm  
Length: 140 mm  
Lead box and spare needle

**S0214320**  
(R529117)

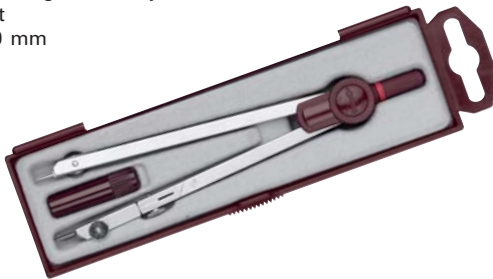

### Universal Compass Set

Contents: universal compass, extension bar, drawing pen, drawing pen holder, lead box and spare needle  
Circles up to  $\varnothing$  540 mm

**S0214390**  
(R529118)

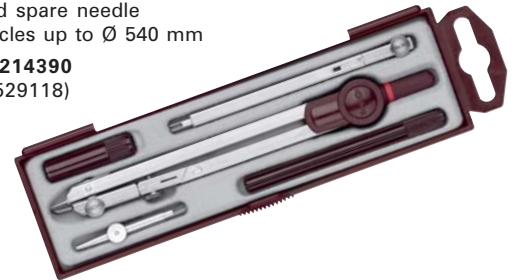

### Compass Set (8 pieces)

Contents: universal compass, extension bar, dividers, small bow compass, bow compass, drawing pen, drawing pen holder, lead box and spare needle  
Circles up to  $\varnothing$  540 mm

**S0233410**  
(R529216)



### Compass Set (7 pieces)

Contents: universal compass, extension bar, dividers, small bow compass, drawing pen, drawing pen holder, lead box and spare needle  
Circles up to  $\varnothing$  540 mm

**S0233370**  
(R529215)



**Giant bow compass with rapid adjustment and extension bar**

Infinitely variable radius adjustment through high-quality button mechanism  
 Precision fine adjustments through central wheel  
 Both legs with joint  
 Circles up to Ø 640 mm  
 Pivot: Ø 4.0 mm  
 Length: 170 mm  
 Lead box and spare needle  
**S0233800**  
 (R530224)



**Giant bow compass with rapid adjustment and pen adaptor**

Infinitely variable radius adjustment through high-quality button mechanism  
 Precision fine adjustments through central wheel  
 Swivelling pen adaptor with fine lead insert 0.5 mm  
 Insert leg with joint  
 Length: 182 mm  
 Lead box and spare needle  
**S0233750** with extension bar,  
 (R530147) circles up to Ø 620 mm



### Geometry Compass

Precision radius adjustment through central wheel spindle

Both legs with joint

Pivot:  $\varnothing$  4.0 mm

Length: 160 mm

Lead box and spare needle

**S0233601** without extension bar,  
(R5301350) circles up to  $\varnothing$  400 mm

**S0233631** with extension bar,  
(R5301360) circles up to  $\varnothing$  640 mm



### Universal Compass with Telescopic Extension

Quick and smooth running radius adjustment

Convenient integrated extension bar

Insert leg with joint

Circles up to  $\varnothing$  520 mm

Pivot:  $\varnothing$  3.5 mm

Length: 150 mm

lead box and spare needle

**S0233471**  
(R5301090)

### Compass Set (8 pieces)

Contents: universal compass, small dividing compass, extension bar, dividers, bow compass, drawing pen, drawing pen holder, lead box and spare needle

Circles up to  $\varnothing$  600 mm

Pivot:  $\varnothing$  3.5 mm

**S0233821**  
(R5302260)





**Dual compass attachment**

With stepped peg to fit 3.5 and 4.0 mm dia.  
Peg slot adjustable by 90°.

**S0322070**  
(R533345)



**Lead inserts with button mechanism**

For master bow and pump compasses with pen adaptor.  
Brass mechanism in burgundy plastic housing.

**S0271530** (R538235) with 0.5 mm lead



**Compass attachment with universal holding device**

for CENTRO and CONVEX series  
With stepped peg to fit 3.5 mm and 4.0 mm dia.

**S0451450** (R5333600)



**Compass attachment with universal holding device**

for COMPACT series  
With stepped peg to fit 4.0 mm dia.

**S0830620**  
With stepped peg to fit 3.5 mm dia.  
**S0897800**

The universal holding devices takes pens/pencils up to 11.5 mm dia.



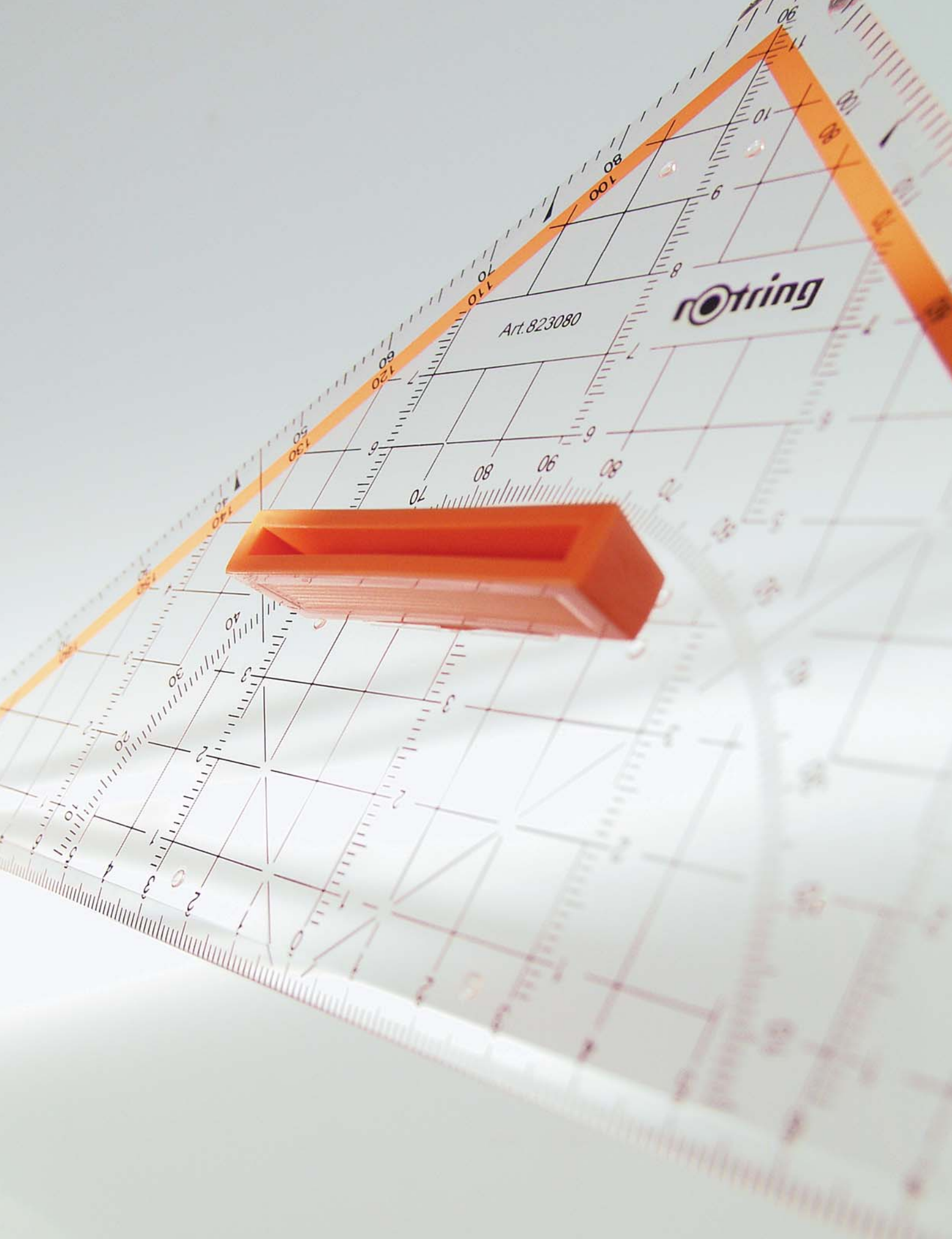

rotring

Art. 823080

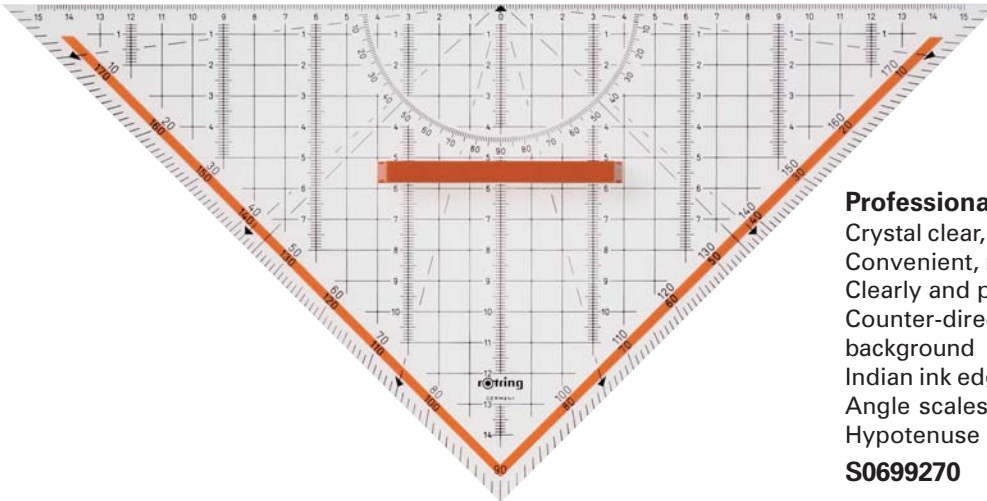

**Professional Set Square**

Crystal clear, robust plastic  
 Convenient, removable grip  
 Clearly and precisely embossed  
 Counter-directional numbering with coloured background  
 Indian ink edges and naps  
 Angle scales 180°/1°  
 Hypotenuse 32 cm with 30 cm / 1 mm scale  
**S0699270**

**Large Geometry Set Square with Handle**

Crystal-clear, stable plastic  
 Robust handle  
 Contrary scale with coloured background  
 Bevelled edges and ink naps  
 Hypotenuse 23 cm with 20 cm/1 mm scale  
**S0903950**



**Professional Set Square**

High-quality plexiglas  
 Convenient removable handle  
 Clear and precise fine imprinting  
 Contrary scale with coloured background  
 Tracing edges and ink naps  
 Angle scale 180°/1°  
 Hypotenuse 25 cm with 22cm/1 mm scale  
**S0451820 (R823080)**



**Geometry Set Square**

Crystal-clear, stable plastic  
 Contrary scale with coloured background  
 Bevelled edges and ink naps  
 Hypotenuse 16 cm with 14 cm/1 mm scale  
**S0237630 (R823028)**

**Geometry Set Square with Handle**

Crystal-clear, stable plastic  
 Robust removable handle  
 Contrary scale with coloured background  
 Bevelled edges and ink naps  
 Hypotenuse 16 cm with 14 cm/1 mm scale  
**S0903940**



**Geometry Set (4 pieces)**

Crystal-clear, stable plastic  
Bevelled edges and/or tracing edges

**Contents:** 30 cm ruler,  
semicircular protractor  
set square 30°/60°, hypotenuse 23 cm,  
set square 45°, hypotenuse 20 cm

**S0221370** (R823509)

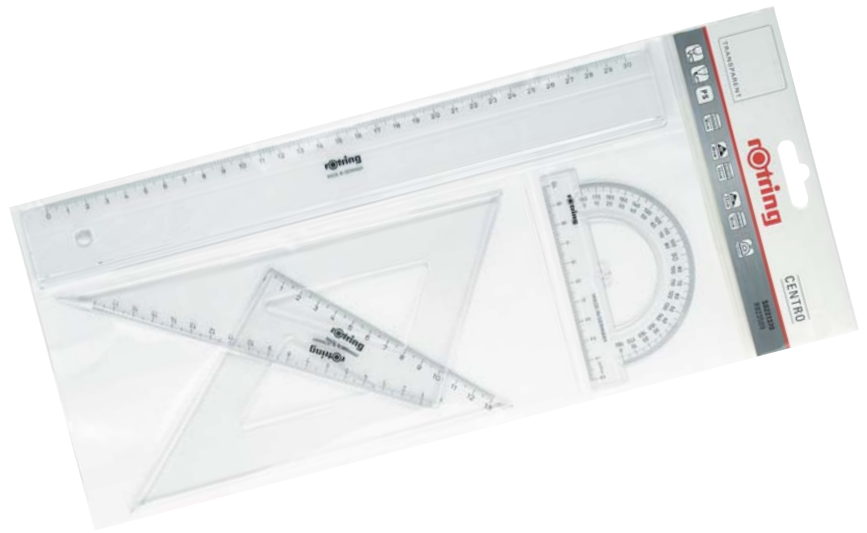
**Semicircular Protractor**

Crystal-clear, stable plastic  
Contrary scale  
Centring point and bevelled edges  
Scaling: 10 cm

**S0221230** (R823301)

**Set Square 30°/60°**

Crystal-clear, stable plastic  
tracing edges all round  
Angles: 30°/60°  
Hypotenuse 23 cm, 18 cm/1 mm scale

**S0221090** (R823202)

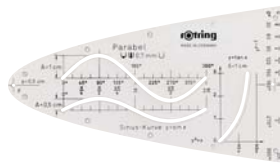
**Standard Parabola ( $y = x^2$ )**

Crystal-clear, stable plastic  
Bevelled edges on the outside contours  
Sine/cosine curves  $A = 1$  and  $A = 0.5$   
Tangent curve  
Size: 123 × 70 × 1.8 mm

**S0673400**

All set squares have 0 point directly  
on tracing edge to enable direct  
measurement of line segments.

**Set Squares Sets of 2  
one 45° and one 30°/60° set square**

Crystal-clear, stable plastic  
Tracing edges all round  
1 mm scale

**S0237840** 45°, hypotenuse 25 cm  
(R823523) 30°/60°, hypotenuse 29 cm

**S0237870** 45°, hypotenuse 32 cm  
(R823530) 30°/60°, hypotenuse 37 cm

**S0237900** 45°, hypotenuse 36 cm  
(R823547) 30°/60°, hypotenuse 41 cm





**Burmester Curves Set  
(3 pieces)**

For drawing of universal curves  
Crystal-clear, stable plastic  
Double-sided tracing edges all round  
**S0221301** (R8234000)



**Flat Ruler**

Crystal-clear, stable plastic  
Bevelled edge and tracing edge  
1 mm increments

- S0220870** (R823103)      Scaling: 16 cm
- S0220950** (R823127)      Scaling: 30 cm
- S0221450** (R823578)      Scaling: 40 cm
- S0221500** (R823585)      Scaling: 50 cm

**Plate Ruler**

Crystal-clear, stable plastic  
Textured plate  
Scale on both sides  
1 × 1-mm scale  
1 × 0.5-mm scale

**S0221020** (R823141)      Scaling: 30 cm



**Wooden Ruler**

Natural beech wood  
Bevelled edge  
1 mm increments

- S0237930** (R823593)      Scaling: 17 cm
- S0237950** (R823594)      Scaling: 30 cm

**Triangular reduction scales**

Of white dimensionally stable plastic.  
The precision divisions are numerated both ways.  
Dimension markings in cm and m for easier working.  
With 2 coloured flutings.



**S0236961**    Engineer/DIN ISO 5455  
(R8020190)  
5 : 1    2 : 1    1 : 1    DIN  
1 : 2    1 : 5    1 : 10  
1 : 20    1 : 50    1 : 100  
1 : 500

**S0220481**    Architect  
(R8020200)  
1 : 10    1 : 20    1 : 25    1  
1 : 50    1 : 75    1 : 100  
1 : 125    1 : 200    1 : 250  
1 : 500    1 : 750    1 : 1250

**S0220561**    School  
(R8020210)  
1 : 10    1 : 20    1 : 25    2  
1 : 33<sup>1</sup>/<sub>3</sub>    1 : 50    1 : 75  
1 : 100    1 : 200    1 : 250  
1 : 500    1 : 750

**S0220641**    Architect  
(R8020220)  
1 : 10    1 : 20    1 : 25    4  
1 : 30    1 : 40    1 : 50  
1 : 100    1 : 200    1 : 250  
1 : 300    1 : 400    1 : 500

**S0220721**    Surveying  
(R8020230)  
1 : 25    1 : 50    1 : 100    6  
1 : 125    1 : 150    1 : 200  
1 : 250    1 : 500    1 : 1000  
1 : 1250    1 : 1500    1 : 2000  
1 : 2500

**S0237031**    Mechanical design  
(R8020240)  
1 : 10    1 : 15    1 : 20    9  
1 : 25    1 : 33<sup>1</sup>/<sub>3</sub>    1 : 50  
1 : 100    1 : 200    1 : 150  
1 : 250    1 : 500



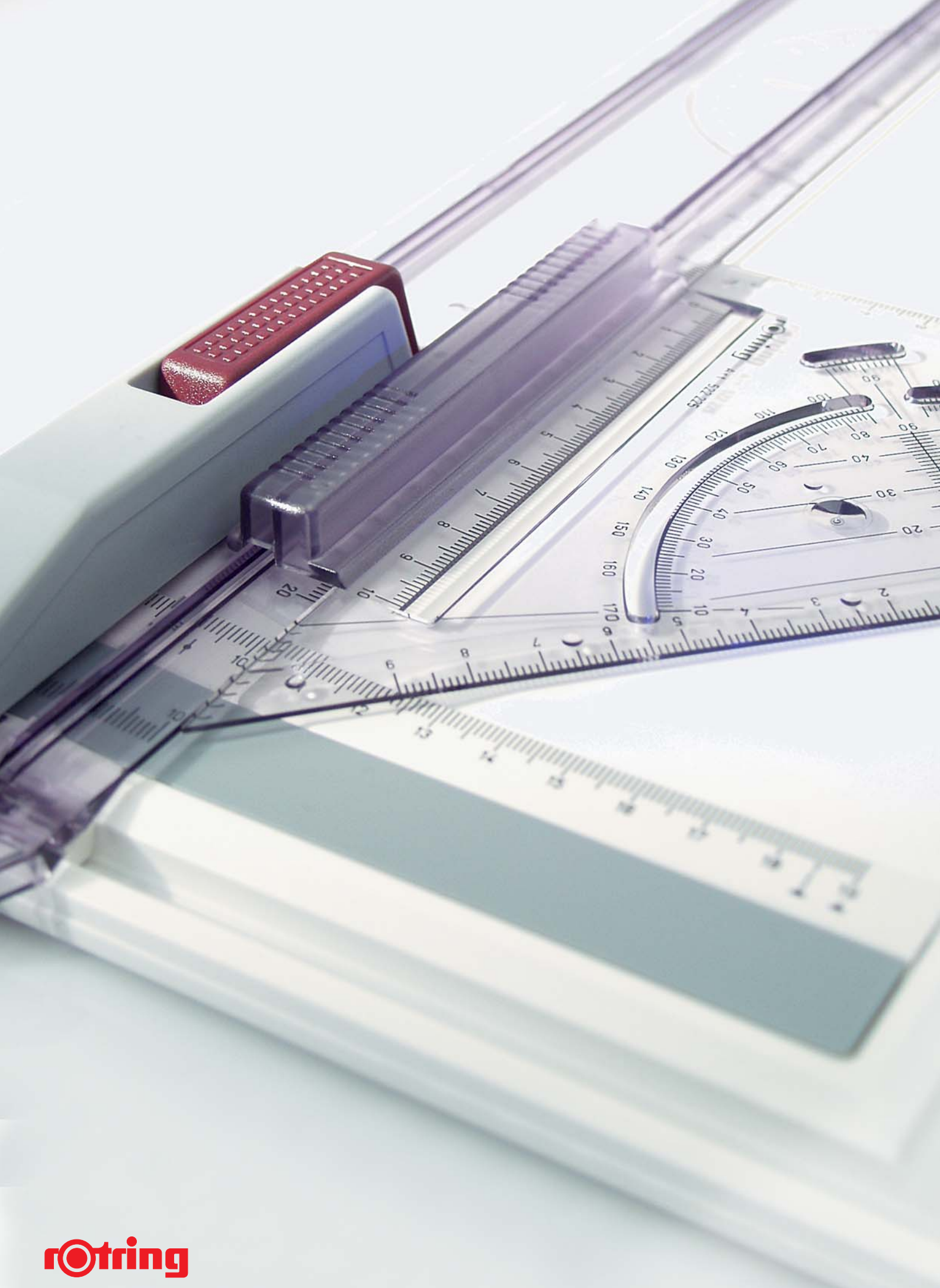



**rotring rapid drawing board**

The full-featured drawing board for speed, precision and ease of use.

- Robust board of unbreakable, non-warping material.
- Ergonomic design for easy, comfortable working.
- Parallel straight-edge with STOP-and-GO locking/unlocking action.
- **The L-system straight-edge design** - allows drawing along the top edge of the straight-edge right down to the bottom of the sheet, with full accuracy and stability.
- Two magnetic clamp strips with central pushbutton operation plus additional corner clamp, for exact media positioning and absolutely secure holding.
- Guide rails designed for permanently smooth, featherlight straight-edge movement.
- End lock on A3 straight-edge for added stability.
- Comes complete with rapid set square for drawing vertical and horizontal lines and angles.
- Includes tilters for comfortable working.



**rotring rapid drawing boards**

- S0213910** (R522403) rapid A3
- S0232710** (R522404) rapid A4



**rotring rapid drawing boards in the college case**

This rigid case features guides to hold drawing board securely, as well as space for utensils, books, etc.

- S0232980** (R523403) rapid A3 + college case



### rotring profil drawing board

For precise drawings and easy, comfortable working.

- Robust board of unbreakable, non-warping material.
- Ergonomic design for easy, comfortable working.
- Parallel straight-edge with STOP-and-GO locking/unlocking action.
- **The L-system straight-edge design** - allows drawing along the top edge of the straight-edge right down to the bottom of the sheet, with full accuracy and stability.
- Magnetic clamp strip plus additional corner clamp to hold media securely.
- Guide rails designed for permanently smooth, featherlight straight-edge movement.
- End lock on A3 straight-edges for added stability.
- Can be used with tilters (purchased separately) for added working comfort.



### rotring profil drawing boards

**S0213750** (R522231) profil A3  
**S0232430** (R522241) profil A4



**Tilters** for profil and rapid drawing boards. Enable board to be tilted at either of two angles for comfortable working.

**S0232330** (R522227) 1 pair

### Professional drawing head

with automatic setting every 15° and locking of any angle in between, plus free-swinging setting. Contra-rotating 0-90° scale, brake mechanism to lock in position on straight-edge.

**S0213830** (R522346)



### Junior drawing head

with 15° ratchet action.

**S0213680**

(R522230)

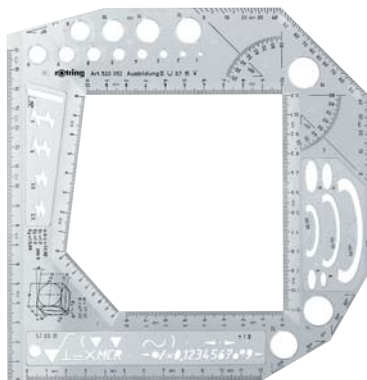

### Multipurpose drawing template II

With 15°, 30°, 45°, 60°, 90° angles, circles with diameters from 1 - 15 mm in steps of 1 mm, ellipses with large axes 12, 15, 20, 25, 30, 35, 40, 50 mm, surface symbols, dimensioning arrows, line device for standard lettering, 7°/42° angles for dimetric projection.

**S0232590** (R522352)

180 x 180 x 1,6 mm

0.7 - 0.5 mm

### Rapid set square

For direct measurement and drawing of vertical and horizontal lines and angles, and for hatching.

**S0232240** (R522225)

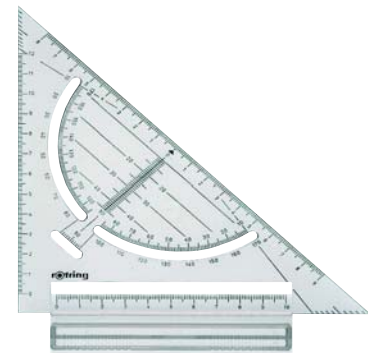

### rotring college case, empty

This rigid case features guides to hold drawing board securely, as well as space for drawing instruments.

**S0232510** (R522273) for A3 boards

**S0232550** (R522274) for A4 boards





**rotring collegeboard A3**

For sheet sizes up to 450 x 325 mm.

- Magnetic clamp with scale.
- Straight-edge guide slots on all four sides with signal humps.
- Parallel straight-edge with grip area and STOP-and-GO button.
- Additional metal clamp.

**S0213660** (R522110)

**Protective carry bag**

Tough weatherproof nylon.  
Has detachable shoulder strap and  
space for books and utensils.

**S0232160** (R522213)

for A3 boards

**S0232200** (R522214)

for A4 boards





**rotring A2 drawing table**

A complete drawing system with drawing board laminated on all sides, **anodized aluminium guide track with plastic guide coating**, parallel straight-edge with STOP-and-GO mechanism, drawing head with STOP-and-GO mechanism and adjustable plastic tilter.

**S0213920** (R522433) A2 (board size 700 x 600 x 16 mm)

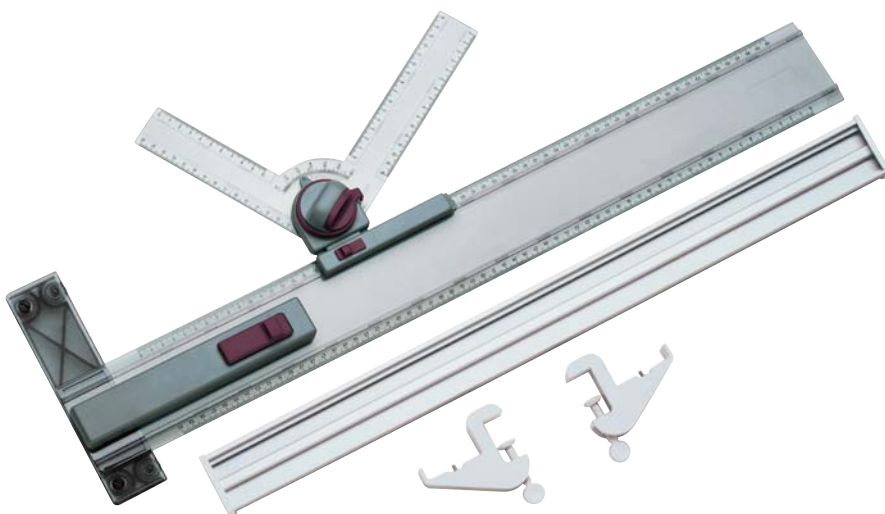

**rotring T-square-set A2**

With precision anodised-aluminium guide track and plastic glide coating. Fast, simple mounting on drawing board or other work surface with special clamps.

- Parallel straight-edge with STOP-and-GO mechanism.
- Drawing head with STOP-and-GO mechanism.
- 2 special clamps made of plastic.
- Without drafting table

**S0232880** (R522442) A2



## Lettering - as neatly as if printed

A precise technical drawing is not complete without true-to-standard lettering, and for that you need rotring's precision lettering stencils. The rotring lettering stencils are stamped with markings to show the line width and character height. This ensures that the right pen and the right stencil are used together for true-to-standards lettering.

rotring lettering stencils are made of high-quality plastic and are especially resistant to warping and breakage. The clear, yellow-tinted material provides for high contrast so that even the finest lines are clearly visible. All edges are highly precise.

rotring lettering stencils are available with H-profile and Z-profile.



## Lettering stencils in Z-profile per ISO 3098/I, lettering type B

Roman	Character height	rapido-graph	iso-graph	Colour code
<b>S0228430</b> (R342025)	2.5 mm	S0194270	S0202130	white
<b>S0228480</b> (R342035)	3.5 mm	S0194290	S0202270	yellow
<b>S0228530</b> (R342050)	5.0 mm	S0203700	S0202410	brown
<b>S0228580</b> (R342070)	7.0 mm	S0203850	S0202550	blue

## duo-combi Lettering stencil for fibre-tip pens and fine-lead mechanical pencils

2 character heights: 3.5 and 5 mm, roman lettering per ISO 3098/I B. Includes several frequently-used Greek characters.

**S0228181** (R3400050)

244 x 75 x 1 mm  
 Ψ 0.3-0.5-0.7-0.9  
 Ψ 0.1-0.3-0.5-0.7



## H-profile lettering stencils Type 1451

Roman	Character height	rapido-graph	iso-graph
<b>S0227961</b> (R3060300)	3.0 mm	S0203430	S0202210
<b>S0228021</b> (R3060400)	4.0 mm	S0203630	S0202350
<b>S0228061</b> (R3060500)	5.0 mm	S0203700	S0202410
<b>S0228111</b> (R3060600)	6.0 mm	S0203780	S0202490







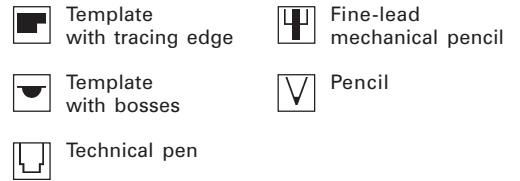

**rotring technical templates**

rotring precision templates are robust and non-warping, with perfectly formed, true-to-standards symbols selected for the most varied applications.

The transparent, yellow-tinted material leaves even the finest of lines (e. g. ones drawn with a rotring fine-lead pencil) clearly visible through the template.



**“Studio” electrical engineering angle template**

A drawing aid for metalworking students. With 15°, 30°, 45°, 60°, 75°, and 90° angles, mm coordinate graduation, protractor, circles from 1-18 mm dia., and holes for hatching. Symbols and easy-to-combine symbol elements per DIN 40700, Latin and Greek characters in 3.5 mm and numerals in 3.5 and 5.0 mm sizes per ISO 3098/I Bv.

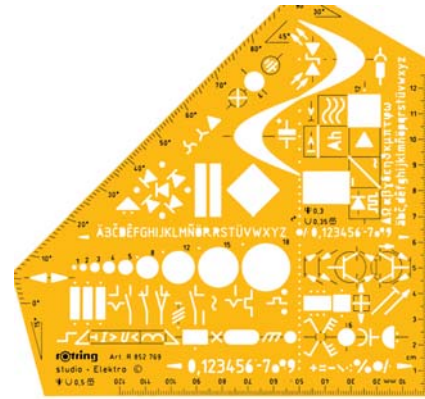
**S0238591**   
(R8527690)  
162 x 160 x 1 mm  
□ 0.35   0.3



**Circles templates**

Circles of 1-30 mm dia. in 1 mm increments. With polygon guides and protractor. Radii 4, 6, 10, 16 mm. With millimetre ruler and fingerlift.

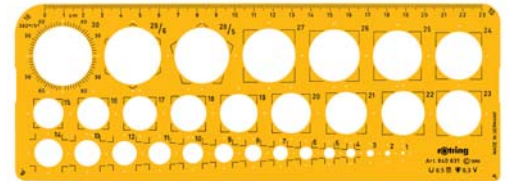
**S0221621**   
(R8406310)  
255 x 92 x 1.6 mm  
□ 0.5   V



**Circles templates**

Circles of 1-36 mm dia. in 1 mm increments. With polygon guides and protractor. Radii 6, 10, 16, 20 mm. With millimetre ruler and fingerlift.

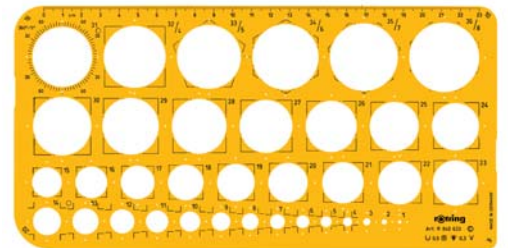
**S0221691**   
(R8406330)  
255 x 129 x 1.6 mm  
□ 0.5   V

**Radii templates**

48 radii from 0.5-40 mm, 0.5-2 mm in 0.1 mm increments, radii per DIN 250 underlined. Built-in semicircular protractor. With surface symbols.

**S0238341**   
(R8426830)  
∅ 160 x 1.6 mm  
□ 0.5-0.35   V



## Architect's combination template

Separate layout of symbols for furniture, sanitary fittings, electrical fittings, door openings, level and direction symbols, insulation.

**S0238711** ▼  
(R8537780)  
**Scale 1:50**  
250 x 150 x 1.2 mm  
U 0.35 mm

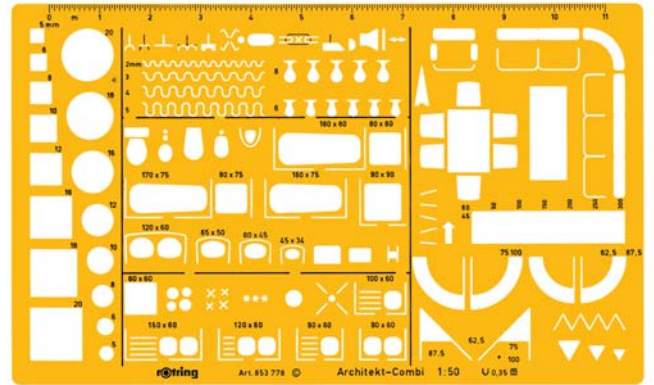

See above

**S0238781** ▼  
(R8537790)  
**Scale 1:100**  
190 x 95 x 1.2 mm  
U 0.35 mm

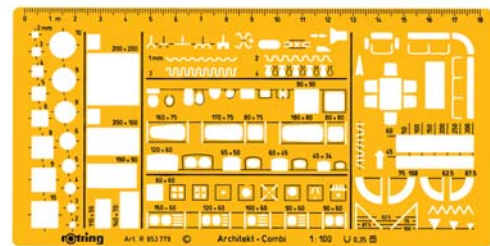

## Furniture templates

Modern furnishings for living room, bedroom, kitchen, bathroom and toilet.

**S0238921** ▼  
(R8537830)  
**Scale 1:50**  
300 x 155 x 1.2 mm  
U 0.5 mm

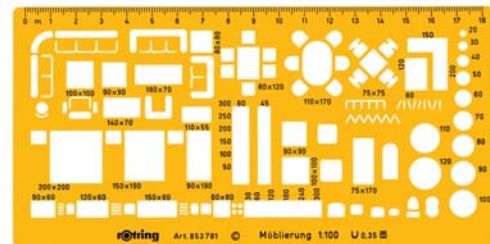

**S0238851** ▼  
(R8537810)  
**Scale 1:100**  
190 x 95 x 1.1 mm  
U 0.35 mm

## ISOMETRIC ellipses template

Axial ratio 0.707 : 1.225 (1 : 1.732)/35° 16', isometric axes 2-60 mm.

The template edges are designed to enable the ellipses to be positioned in the major isometric planes.

**S0238021** ▼  
(R8316450)  
295 x 145 x 1.2 mm  
U 0.5 mm

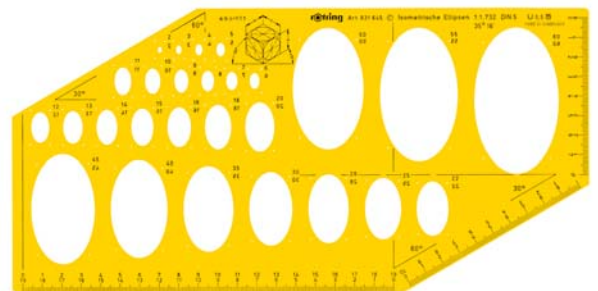







***Newell Rubbermaid***<sup>TM</sup>  
Brands That Matter

**Sanford GmbH**  
P. O. Box 54 10 60  
D - 22510 Hamburg  
  
Tel. 0049 40 85 55 0  
Fax. 0049 40 850 13 96

**Newell Rubbermaid**  
Halifax Avenue  
Fradley Park  
Lichfield  
Staffordshire  
WS13 8SS

Telephone: +44 1543447002  
Fax: +44 1915167889

**[www.rotring.com](http://www.rotring.com)**