

# **Agilent U2722A/U2723A USB Modular Source Measure Units**

## **User's Guide**



**Agilent Technologies**

# Notices

© Agilent Technologies, Inc., 2009

No part of this manual may be reproduced in any form or by any means (including electronic storage and retrieval or translation into a foreign language) without prior agreement and written consent from Agilent Technologies, Inc. as governed by United States and international copyright laws.

## Manual Part Number

U2722-90011

## Edition

Second Edition, May 15, 2009

Agilent Technologies, Inc.  
5301 Stevens Creek Blvd.  
Santa Clara, CA 95052 USA

## Warranty

**The material contained in this document is provided “as is,” and is subject to being changed, without notice, in future editions. Further, to the maximum extent permitted by applicable law, Agilent disclaims all warranties, either express or implied, with regard to this manual and any information contained herein, including but not limited to the implied warranties of merchantability and fitness for a particular purpose. Agilent shall not be liable for errors or for incidental or consequential damages in connection with the furnishing, use, or performance of this document or of any information contained herein. Should Agilent and the user have a separate written agreement with warranty terms covering the material in this document that conflict with these terms, the warranty terms in the separate agreement shall control.**

## Technology Licenses

The hardware and or software described in this document are furnished under a license and may be used or copied only in accordance with the terms of such license.

## Restricted Rights Legend

U.S. Government Restricted Rights. Software and technical data rights granted to the federal government include only those rights customarily provided to end user customers. Agilent provides this customary commercial license in Software and technical data pursuant to FAR 12.211 (Technical Data) and 12.212 (Computer Software) and, for the Department of Defense, DFARS 252.227-7015 (Technical Data - Commercial Items) and DFARS 227.7202-3 (Rights in Commercial Computer Software or Computer Software Documentation).

## Safety Notices

### CAUTION

A **CAUTION** notice denotes a hazard. It calls attention to an operating procedure, practice, or the like that, if not correctly performed or adhered to, could result in damage to the product or loss of important data. Do not proceed beyond a **CAUTION** notice until the indicated conditions are fully understood and met.

---

















### WARNING

A **WARNING** notice denotes a hazard. It calls attention to an operating procedure, practice, or the like that, if not correctly performed or adhered to, could result in personal injury or death. Do not proceed beyond a **WARNING** notice until the indicated conditions are fully understood and met.

---

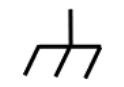
## Safety Symbols

The following symbols on the instrument and in the documentation indicate precautions which must be taken to maintain safe operation of the instrument.

	Direct current (DC)		Equipment protected throughout by double insulation or reinforced insulation
	Alternating current (AC)		Off (supply)
	Both direct and alternating current		On (supply)
	Three-phase alternating current		Caution, risk of electric shock
	Earth (ground) terminal		Caution, risk of danger (refer to this manual for specific Warning or Caution information)
	Protective conductor terminal		Caution, hot surface
	Frame or chassis terminal		Out position of a bi-stable push control
	Equipotentiality		In position of a bi-stable push control

## General Safety Information

### WARNING

- **Do not use the device if it is damaged. Before you use the device, inspect the casing. Look for cracks or missing plastic. Do not operate the device around explosive gas, vapor, or dust.**
  - **Always use the device with the cables provided.**
  - **Observe all markings on the device before establishing any connection.**
  - **Turn off the device and application system power before connecting to the I/O terminals.**
  - **When servicing the device, use only the specified replacement parts.**
  - **Do not operate the device with the cover removed or loosened.**
  - **Do not connect any terminal block or cables prior to performing self-test process.**
  - **Use only the power adapter provided by the manufacturer to avoid any unexpected hazards.**
- 

### CAUTION

- Electrostatic discharge (ESD) can cause damage to the components in the instrument and accessories. The cables or wires should be connected to the plug-in connectors first and covered with the cable casing prior to plugging it into the output connector to prevent ESD from occurring. For more information on the cable installation, refer to "[Cable Installation](#)" on page 27.
  - If the device is used in a manner not specified by the manufacturer, the device protection may be impaired.
  - Always use dry cloth to clean the device. Do not use ethyl alcohol or any other volatile liquid to clean the device.
  - Do not permit any blockage of the ventilation holes of the device.
-

## Environmental Conditions

This instrument is designed for indoor use and in an area with low condensation. The table below shows the general environmental requirements for this instrument.







Environmental conditions	Requirements
Operating temperature	0 °C to 50 °C
Operating humidity	20% to 85% RH non-condensing
Storage temperature	-20 °C to 70 °C
Storage humidity	5% to 90% RH non-condensing

### NOTE

The U2722A/U2723A USB Modular Source Measure Units complies with the following safety and EMC requirements:

- IEC 61326-1:2005/EN61326-1:2006
- Canada: ICES-001:2004
- Australia/New Zealand: AS/NZS CISPR11:2004
- IEC 61010-1:2001/EN 61010-1:2001 (2nd Edition)
- Canada: CAN/CSA-C22.2 No. 61010-1-04
- USA: ANSI/UL 61010-1:2004

## Regulatory Markings

	<p>The CE mark is a registered trademark of the European Community. This CE mark shows that the product complies with all the relevant European Legal Directives.</p>		<p>The C-tick mark is a registered trademark of the Spectrum Management Agency of Australia. This signifies compliance with the Australia EMC Framework regulations under the terms of the Radio Communication Act of 1992.</p>
<p><b>ICES/NMB-001</b></p>	<p>ICES/NMB-001 indicates that this ISM device complies with the Canadian ICES-001. Cet appareil ISM est conforme a la norme NMB-001 du Canada.</p>		<p>This instrument complies with the WEEE Directive (2002/96/EC) marking requirement. This affixed product label indicates that you must not discard this electrical or electronic product in domestic household waste.</p>
	<p>The CSA mark is a registered trademark of the Canadian Standards Association.</p>		

## Waste Electrical and Electronic Equipment (WEEE) Directive 2002/96/EC

This instrument complies with the WEEE Directive (2002/96/EC) marking requirement. This affixed product label indicates that you must not discard this electrical or electronic product in domestic household waste.

Product Category:

With reference to the equipment types in the WEEE directive Annex 1, this instrument is classified as a “Monitoring and Control Instrument” product.

The affixed product label is as shown below.



**Do not dispose in domestic household waste**

To return this unwanted instrument, contact your nearest Agilent Technologies, or visit:

[www.agilent.com/environment/product](http://www.agilent.com/environment/product)

for more information.

## In This Guide...

### 1 Getting Started

This chapter provides an overview of the U2722A/U2723A USB Modular Source Measure Units, which includes the product outlook, product dimensions, and product layout. This chapter also contains instructions on how to install and configure the U2722A/U2723A.

### 2 Operation and Features

This chapter describes the source voltage and source current operation mode of the U2722A/U2723A USB Modular Source Measure Units. It also explains the importance of remote sense and guarding when performing low current measurements. There is a section that provides information on extending the U2722A/U2723A output power.

### 3 Characteristics and Specifications

This chapter specifies the characteristics, environmental conditions, and specifications of the U2722A/U2723A.

## Appendixes **Appendix A: List of Self-Test Return Codes**

The following table contains the list of codes you will obtain when performing self-test. The interpretation for each code is also provided.

### **Appendix B: Time-out Settings**

The following procedure provides the instructions on how to set the time-out value in the Agilent IO Libraries.





**Agilent Technologies**

**DECLARATION OF CONFORMITY**  
According to EN ISO/IEC 17050-1:2004



**Manufacturer's Name:** Agilent Technologies Microwave Products (M) Sdn. Bhd  
**Manufacturer's Address:** Bayan Lepas Free Industrial Zone,  
11900, Bayan Lepas, Penang, Malaysia

**Declares under sole responsibility that the product as originally delivered**

**Product Name:** Agilent USB Modular Source Measure Unit  
**Models Number:** U2722A, U2723A  
**Product Options:** This declaration covers all options of the above product(s)

**complies with the essential requirements of the following applicable European Directives, and carries the CE marking accordingly:**

Low Voltage Directive (2006/95/EC)  
EMC Directive (2004/108/EC)

**and conforms with the following product standards:**

EMC	Standard	Limit
	<b>IEC61326-1:2005 / EN61326-1:2006</b>	
	▪ CISPR 11:2003 / EN 55011:2007	Class A Group 1
	▪ IEC 61000-4-2:2001 / EN 61000-4-1:1998+A1:1998+A2:2001	4 kV CD, 8 kV AD
	▪ IEC 61000-4-3:2002 / EN 61000-4-3:2002	3 V/m (80 MHz-1.0 GHz) 3 V/m (1.4 GHz-2.0 GHz) 1 V/m (2.0 GHz-2.7 GHz)
	▪ IEC 61000-4-4:2004 / EN 61000-4-4:2004	1 kV signal lines, 2 kV power lines
	▪ IEC 61000-4-5:2001 / EN 61000-4-5:1995:A1:2001	1 kV line-line, 2 kV line-ground
	▪ IEC 61000-4-6:2003 / EN 61000-4-6:2007	3 V, 0.15-80 MHz
	▪ IEC 61000-4-11:2004 / EN 61000-4-11:2004	100% Dip (1 cycle) 60% Dip (10 cycles) 30% Dip (25 cycles) 100% short interruptions (250 cycles)
	Canada: ICES-001:2004 Australia/New Zealand: AS/NZS CISPR11:2004	

The product was tested in a typical configuration with Agilent Technologies test systems.

**Safety** IEC 61010-1:2001 / EN 61010-1:2001  
USA: ANSI/UL 61010-1:2004  
Canada: CAN/CSA-C22.2 No. 61010-1-04



**This DoC applies to above-listed products placed on the EU market after:**

4-May-2009

Date

**Tay Eng Su**

Quality Manager

For further information, please contact your local Agilent Technologies sales office, agent or distributor,  
or Agilent Technologies Deutschland GmbH, Herrenberger Straße 130, 71034 Böblingen, Germany.

Template: A5971-5302-2, Rev. E00

U2722A

DoC Revision A

## Product Regulations

EMC	Standards	Performance Criteria
	<b>IEC61326-1:2005 / EN61326-1:2006</b>	
	<ul style="list-style-type: none"><li>▪ CISPR 11:2003 / EN 55011:2007</li><li>▪ IEC 61000-4-2:2001 / EN 61000-4-2:1995+A1:1998+A2:2001</li><li>▪ IEC 61000-4-3:2002 / EN 61000-4-3:2002</li><li>▪ IEC 61000-4-4:2004 / EN 61000-4-4:2004</li><li>▪ IEC 61000-4-5:2001 / EN 61000-4-5:1995+A1:2001</li><li>▪ IEC 61000-4-6:2003 / EN 61000-4-6:2007</li><li>▪ IEC 61000-4-11:2004 / EN 61000-4-11:2004<ul style="list-style-type: none"><li>○ 100% Dip (1 cycle)</li><li>○ 60% Dip (10 cycles)</li><li>○ 30% Dip (25 cycles)</li><li>○ 100% Short Interruptions (250 cycles)</li></ul></li></ul>	Group 1 Class A A A A A A A A A C

### <sup>1</sup>Performance Criteria:

A Pass - Normal operation, no effect.

B Pass - Temporary degradation, self recoverable.

C Pass - Temporary degradation, operator intervention required.

D Fail - Not recoverable, component damage.

N/A – Not applicable

### Notes:

#### **Regulatory Information for Canada**

ICES/NMB-001:2004

This ISM device complies with Canadian ICES-001.

Cet appareil ISM est conforme à la norme NMB-001 du Canada.

#### **Regulatory Information for Australia/New Zealand**

This ISM device complies with Australian/New Zealand AS/NZS CISPR11:2004

 N10149

# Contents

## 1 Getting Started

Introduction	2
Product at a Glance	4
Product outlook	4
Product Dimensions	7
Dimensions without bumpers	7
Dimensions with bumpers	8
Standard Purchase Items	9
Inspection and Maintenance	10
Initial inspection	10
Electrical check	10
Ventilation	10
General maintenance	11
Installation and Configuration	12
Installation	12
A. Check your system	13
B. Install the IO Libraries Suite	14
C. Install the module driver	15
D. Install the Agilent Measurement Manager	16
E. Connect the module to your PC	17
F. Verify your module connection	21
G. Launch your Agilent Measurement Manager	23
Instrument Configuration	25
Cable Installation	27
Chassis Installation	29

### 2 Operation and Features

Power Up	30
Sourcing and Measurement	31
Source voltage operation	32
Source current operation	36
Channel control using SCPI commands	39
Remote sense and guard	41
Making measurements	44
System-Related Operation	47
Self-test	47
Self-calibration	47
Error conditions	48
SCPI commands for system-related tasks	48
Extending the Output Power	49
Series connections	49
Parallel connections	50
Memory List	51
Memory list configuration	51
Memory list commands storing and restoring	52
Memory list delay setup	53
Memory list commands execution	54
Memory list commands execution state	58

### 3 Characteristics and Specifications

Product Characteristics	52
Product Specifications	53

### 4 Appendixes

Appendix A: List of Self-Test Return Codes	58
Appendix B: Time-out Settings	60

## List of Figures

- Figure 1-1 Output connectors 25
- Figure 1-2 55-pin backplane connector pin configuration 26
- Figure 2-1 U2722A/U2723A fundamental concepts 31
- Figure 2-2 Panel view of the Agilent Measurement Manager 32
- Figure 2-3 Turning on the U2722A/U2723A 33
- Figure 2-4 Turning off the U2722A/U2723A 33
- Figure 2-5 Source voltage positive operating boundaries 34
- Figure 2-6 Source voltage operation 35
- Figure 2-7 Source current positive operating boundaries 37
- Figure 2-8 Source current operation 38
- Figure 2-9 Local sense connection 41
- Figure 2-10 Remote sense connection 42
- Figure 2-11 Guarded connection 43
- Figure 2-12 Commands that control measurement time 45
- Figure 2-13 U2722A/U2723A outputs connected in series 49
- Figure 2-14 U2722A/U2723A outputs connected in parallel 50
- Figure 2-15 Channel state and Status Operation Condition register bit for external trigger 59
- Figure 2-16 Channel state and Status Operation Condition register bit for remote trigger 59

## List of Figures

## List of Tables

Table 1-1	SSI connector pin description	26
Table 2-1	Type of commands that can be saved into the memory list	52
Table 2-2	Time delay set for each range when auto delay is enabled	54
Table 4-1	List of system-related return codes	58
Table 4-2	Time-out settings	60

## List of Tables





# 1 Getting Started

Introduction	2
Product at a Glance	4
Product outlook	4
Product Dimensions	7
Dimensions without bumpers	7
Dimensions with bumpers	8
Standard Purchase Items	9
Inspection and Maintenance	10
Initial inspection	10
Electrical check	10
Ventilation	10
General maintenance	11
Installation and Configuration	12
Installation	12
A. Check your system	13
B. Install the IO Libraries Suite	14
C. Install the module driver	15
D. Install the Agilent Measurement Manager	16
E. Connect the module to your PC	17
F. Verify your module connection	21
G. Launch your Agilent Measurement Manager	23
Instrument Configuration	25
Cable Installation	27
Chassis Installation	29

This chapter provides an overview of the U2722A/U2723A USB Modular Source Measure Units, which includes the product outlook, product dimensions, and product layout. This chapter also contains instructions on how to install and configure the U2722A/U2723A.



## Introduction

The Agilent U2722A/U2723A USB Modular Source Measure Units (SMU) can operate as a standalone or modular unit when used in a chassis. The U2722A/U2723A has three outputs.

The voltage range is  $-20\text{ V}$  to  $20\text{ V}$ , whereas the maximum current output per channel is  $120\text{ mA}$ . The U2722A/U2723A is controlled remotely over a USB interface via the Agilent Measurement Manager software. The U2722A/U2723A can also be programmed using the provided drivers or via SCPI commands.

The U2722A/U2723A has the following features.

- voltage source or current source operation
- measurement capability for low current down to nA levels
- high resolution current setting for the low current range at  $100\text{ pA}$

The U2722A/U2723A has the following capabilities.

- voltage and current programming/readback
- programming syntax error detection
- user calibration and self-test capability

### **U2723A USB Modular Source Measure Unit**

The U2723A USB Modular Source Measure Unit has the following features and capabilities in addition to the U2722A USB Modular Source Measure Unit:

- embedded test script (able to support three channels with coherent source and measurement capabilities)
- IV Curve application support in the Agilent Measurement Manager software
- Increased (faster) rise/fall time

**WARNING**

Floating the U2722A/U2723A output more than  $\pm 60$  VDC from the chassis presents an electric shock hazard to the operator. Do not float the outputs more than  $\pm 60$  VDC when uninsulated sense wires are used to connect the OUTPUT+ to the SENSE+ and the OUTPUT- to the SENSE- terminals of the unit.

---

## Product at a Glance

### Product outlook

Top view

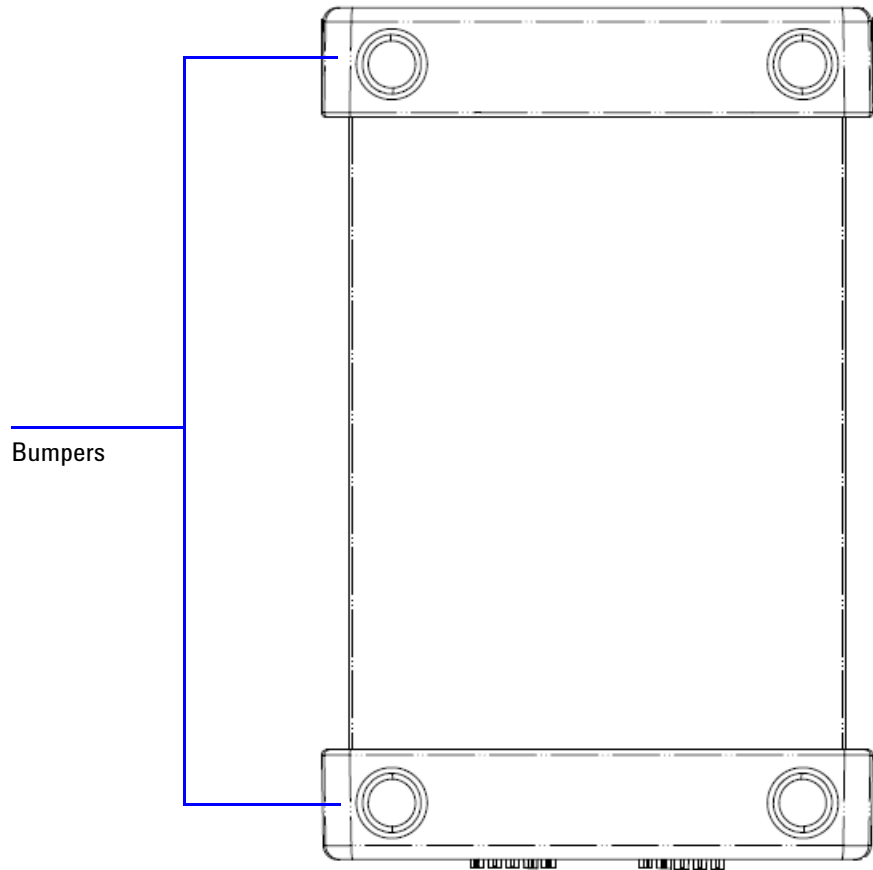

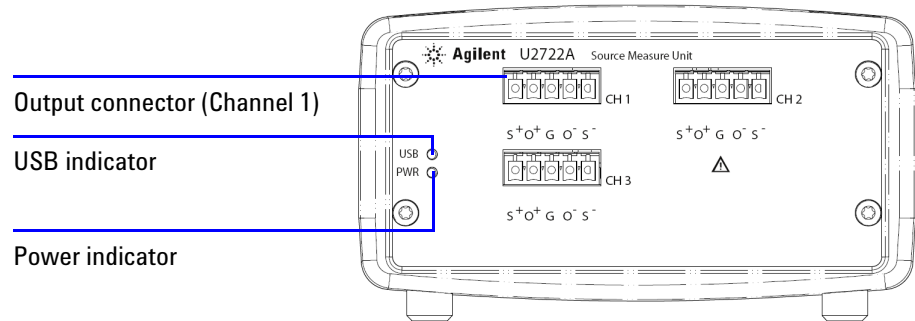
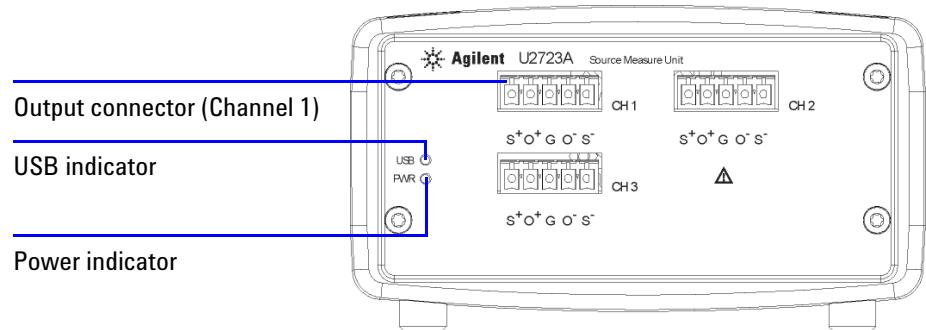
**U2722A USB Modular Source Measure Unit front view****U2723A USB Modular Source Measure Unit front view**

**U2722A USB Modular Source Measure Unit rear view**

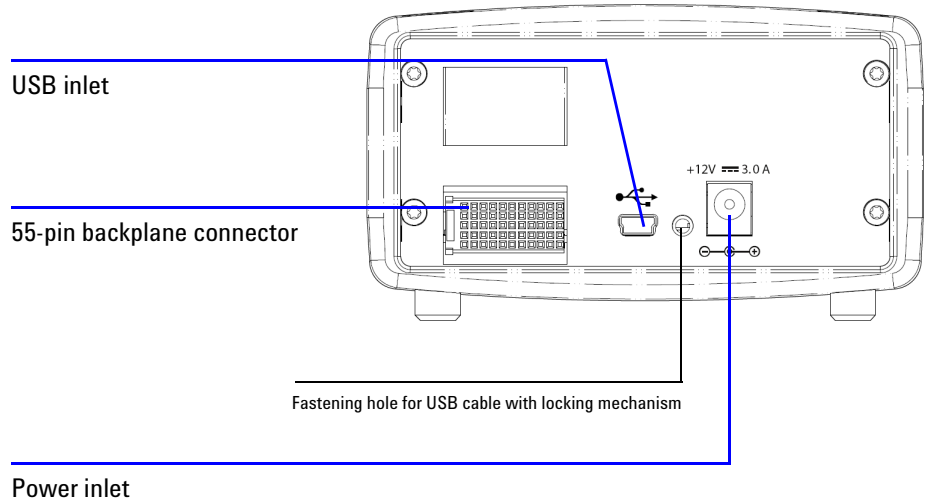

**U2723A USB Modular Source Measure Unit rear view**

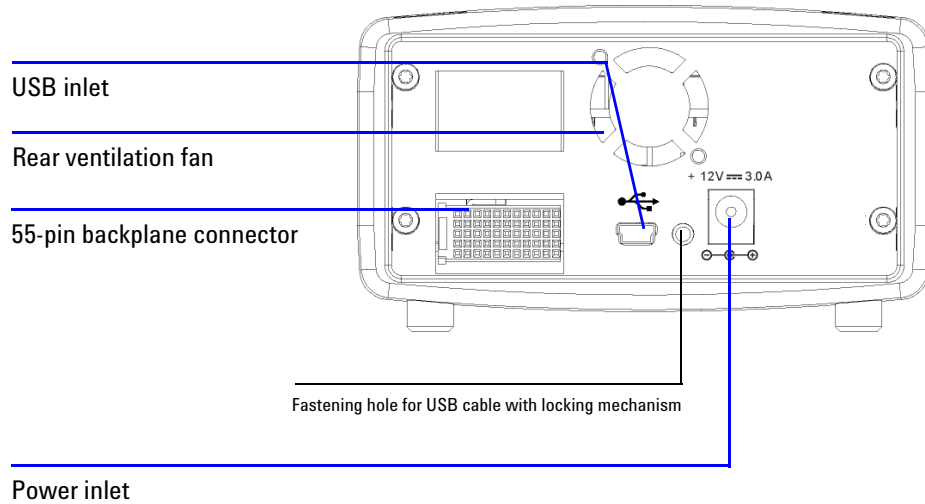

# Product Dimensions

## Dimensions without bumpers

Top view

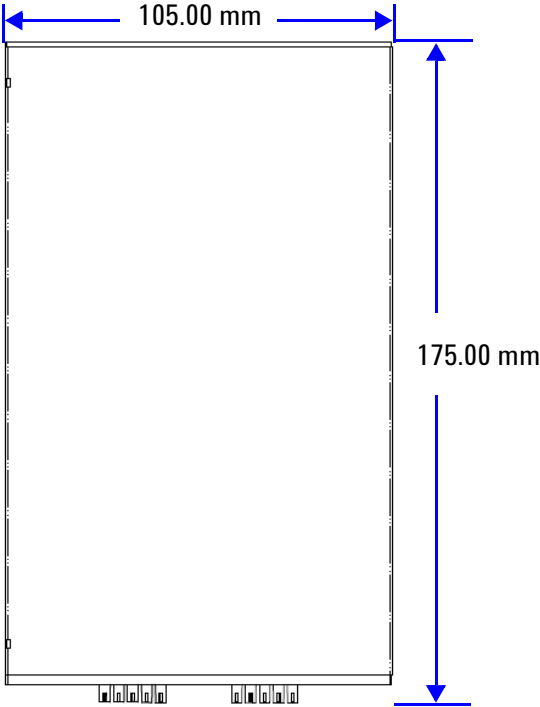

Front view

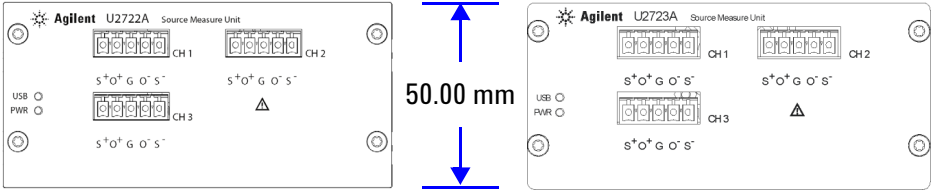

## Dimensions with bumpers

Top view

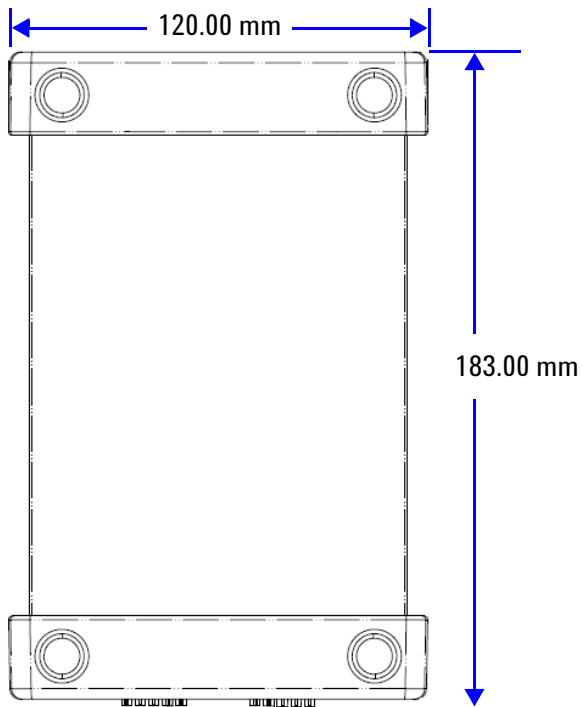

Rear view

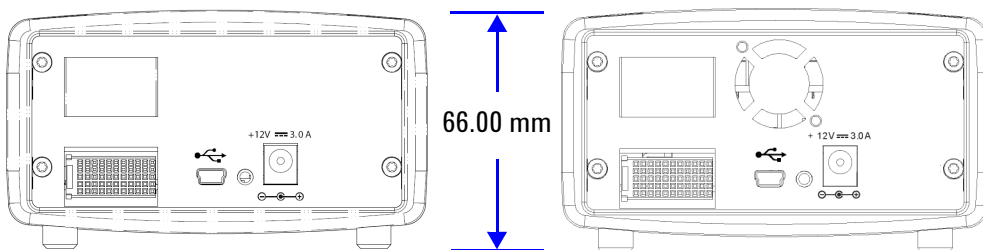



## Standard Purchase Items

Verify that you have received the following items with your unit. If anything is missing or damaged, please contact the nearest Agilent Sales Office.

- ✓ 12 V, 3 A AC/DC adapter
- ✓ Power cord
- ✓ Plug-in connectors and cable casing
- ✓ USB Standard-A to Mini-B interface cable
- ✓ L-Mount kit (used with the modular instrument chassis)
- ✓ Agilent Automation-Ready CD-ROM (contains the Agilent IO Libraries Suite)
- ✓ Agilent USB Modular Products Quick Start Guide
- ✓ Agilent USB Modular Products Reference CD-ROM
- ✓ Agilent Measurement Manager Quick Reference Card
- ✓ Certificate of Calibration

## Inspection and Maintenance

### Initial inspection

When you receive your U2722A/U2723A, inspect the unit for any obvious damage such as broken terminals or cracks, dents, and scratches on the casing that may occur during shipment. If any damage is found, notify the nearest Agilent Sales Office immediately. The front of this manual contains the warranty information.

Keep the original packaging in case the U2722A/U2723A has to be returned to Agilent in the future. If you return the U2722A/U2723A for service, attach a tag identifying the owner and model number. Also include a brief description of the problem.

### Electrical check

The *U2722A/U2723A USB Modular Source Measure Units Service Guide* will provide the complete verification procedure. The procedure will verify to a high level of confidence that the U2722A/U2723A is operating according to its specifications.

### Ventilation

The U2722A/U2723A can operate within the temperature range of 0°C to 50°C. A fan cools the U2722A/U2723A by drawing and exhausting air through the sides (and rear<sup>[1]</sup>).

Your U2722A/U2723A must be installed in a location that allows sufficient space at the sides (and rear<sup>[1]</sup>) of the U2722A/U2723A for adequate air circulation.

For the use of your U2722A/U2723A in the U2781A instrument chassis, it comes with two cooling fans that help to improve the air circulation.

[1] The U2723A USB Modular Source Measure Unit comes with two cooling fans, one located at the side, the other located at the rear.

## General maintenance

**NOTE**

Any repair that is not covered in your modular product manuals should only be performed by qualified personnel.

---

- 1 Power off your module and remove the power cord and I/O cable from your device.
- 2 Remove your module from the bumper casing.
- 3 Shake out any dirt that may have accumulated on the module.
- 4 Wipe your module with a dry cloth and install the bumper back in place.

# Installation and Configuration

## Installation

Follow the step-by-step instructions shown in the following flowchart to get started with the preparations and installations of your U2722A/U2723A.

**NOTE**

You need to install the IVI-COM driver if you are going to use the U2722A/U2723A with Agilent VEE Pro, LabVIEW, or Microsoft® Visual Studio®.

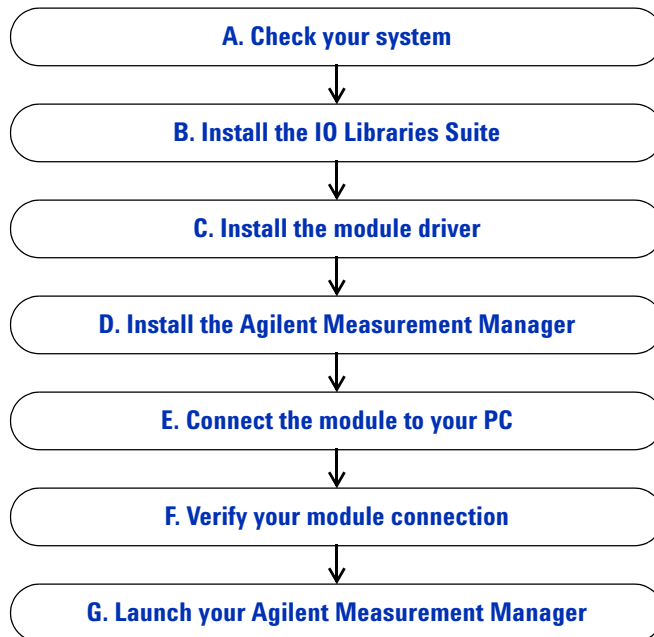

## A. Check your system

Prior to any installation or configuration, please ensure that your PC meets the following minimum system requirements.

**Processor** 1.6 GHz Pentium® IV or higher

**Operating system** Windows® XP Professional or Home Edition (Service Pack 1 or later) or Windows® Vista 32-bit (Business, Ultimate, Enterprise, Home Basic, and Home Premium Edition)

**Browser** Microsoft® Internet Explorer 5.01 or higher

**Available RAM** 512 MB or higher recommended

**Hard-disk space** 1 GB

**Video** Super VGA 800 × 600 (1024 × 768 recommended)

**Prerequisites** Agilent IO Libraries Suite 15.1<sup>[1]</sup> or higher, Agilent T&M Toolkit Runtime version 2.1<sup>[2]</sup>, Agilent T&M Toolkit Redistributable Package 2.1 patch<sup>[2]</sup>, Microsoft® .NET Framework version 1.1 and 2.0<sup>[2]</sup>

[1] Available on the *Agilent Automation-Ready CD-ROM*.

[2] Bundled with Agilent Measurement Manager software application installer.

## B. Install the IO Libraries Suite

The IO Libraries Suite 15.1 or higher is available on the *Agilent Automation-Ready CD-ROM* that comes with the standard purchase of a U2722A USB Modular Source Measure Unit or U2723A USB Modular Source Measure Unit.

### NOTE

- If you do not have the *Agilent Automation-Ready CD-ROM*, obtain the IO Libraries Suite 15.0 or higher at <http://www.agilent.com/find/iolib>.
- Disconnect any USB instruments or connectivity interface from your PC.

- 1 Close all other applications on your PC, insert the *Agilent Automation-Ready CD-ROM* into your CD-ROM drive, and follow the instructions on your screen.
- 2 If the IO Libraries Suite installation does not start automatically, go to **Start > Run** (on the Windows Start menu) and type <drive>:\autorun\auto.exe where <drive> is your CD-ROM drive location.
- 3 If you obtain the IO Libraries Suite from the web, save the self-extracting zip file (\*.exe) to any location on your hard disk.
- 4 Double-click the installation file to launch the installation.
- 5 Follow the instructions on your screen to proceed with the installation.
- 6 After the installation has completed, you will see the IO Control icon on the Windows taskbar notification area as shown below.



### NOTE

For detailed installation instructions, refer to the *Agilent IO Libraries Suite Getting Started Guide* at <http://www.agilent.com/find/iolib>.

## C. Install the module driver

### NOTE

Please ensure that there are no instruments connected to the PC when installing the driver.

- 1 Verify that your PC meets the minimum system requirements as stated in “A. Check your system” on page 13.
- 2 Insert the *Product Reference CD-ROM* into your CD-ROM drive.
- 3 The installer will automatically launch the **Agilent Modular Products Installation Menu**. Click **Hardware Driver** to begin the installation.

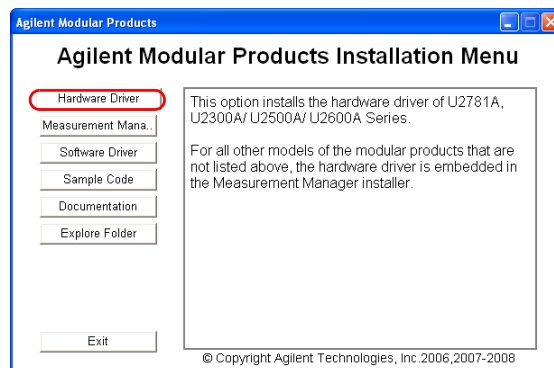

- 4 If the menu does not launch automatically, go to **Start > Run** (on the Windows Start menu) and type `<drive>:\Driver\Hardware\setup_Hw.exe` where `<drive>` is your CD-ROM drive location. Click **OK** to begin the installation.
- 5 Follow the instructions on the screen and click **Next** to proceed.
- 6 Click **Install** to begin the installation. Follow the instructions on the screen to proceed with the installation.
- 7 Click **Finish** when the installation has completed.

## D. Install the Agilent Measurement Manager

- 1 If you have done “C. Install the module driver” on page 15, proceed to Step 2. If not, close all other applications on your PC and insert the *Product Reference CD-ROM* into your CD-ROM drive.
- 2 Click **Measurement Manager** on the **U2722A/U2723A Installation Menu** to begin the installation.

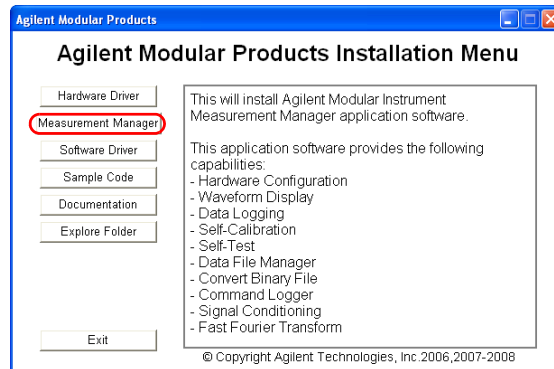

- 3 If the installation menu does not appear after a few seconds, go to **Start > Run** and type `<drive>:\Application\Modular Instruments Measurement Manager\setup.exe` where `<drive>` is your CD-ROM drive location.
- 4 Click **OK** to begin the installation.
- 5 If you do not have any of the prerequisites installed, the InstallShield Wizard software prerequisite will appear.
- 6 Click **OK** to begin the installation of the listed missing prerequisites.
- 7 Once the above installation has completed, installation of the Measurement Manager software will proceed as normal.
- 8 The **Measurement Manager InstallShield Wizard** dialog will appear. Click **Next** to begin.
- 9 Read the License Agreement and select **I accept the terms in the License Agreement** to proceed. You may click **Print** to print a hardcopy of the Agilent License Terms for reference. Click **Next** to proceed.
- 10 Fill in the Customer Information Form accordingly and click **Next**.



- 11 Click **Next** to install to the specified folder or click **Change** to install to a different folder.
- 12 Click **Install** to begin the installation of the Measurement Manager.
- 13 Click **Finish** when the installation has completed.
- 14 A shortcut to this software will be created to your desktop.

**NOTE**

USING THE LICENSED MATERIALS INDICATES YOUR ACCEPTANCE OF THE LICENSE TERMS. IF YOU DO NOT AGREE TO ALL OF THESE TERMS, YOU MAY RETURN ANY UNOPENED LICENSED MATERIAL FOR A FULL REFUND, IF THE LICENSED MATERIALS ARE BUNDLED OR PRE-LOADED WITH ANOTHER PRODUCT, YOU MAY RETURN THE ENTIRE UNUSED PRODUCT FOR A FULL REFUND.

## E. Connect the module to your PC

**NOTE**

Ensure that the Agilent Measurement Manager is installed before proceeding.

- 1 After all the installations have completed, connect the power cord to the AC/DC power adapter. The AC/DC power adapter requirements are 100 to 240 VAC, 50/60 Hz, with an output voltage of +12 VDC.
- 2 Insert the DC output plug from the AC/DC power adapter to the power jack on the rear panel of the U2722A/U2723A.
- 3 Connect the U2722A/U2723A to any USB port on your PC with the bundled USB cable.
- 4 Your PC will automatically detect the connected unit and the **Found New Hardware Wizard** window will appear. Select **Yes, this time only** and click **Next** to proceed.

## 1 Getting Started



5 Select **Install the software automatically (Recommended)** and click **Next**.

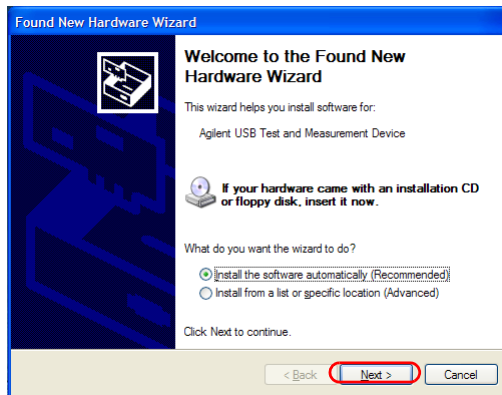

6 A warning message will appear on the **Hardware Installation** window. Click **Continue Anyway** to proceed with the installation of the U2722A/U2723A.

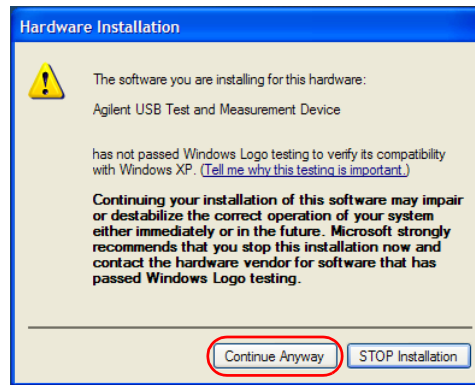
**NOTE**

If you do not wish to receive similar warning messages in the future, follow the instructions below.

- 1 Go to **Start > Control Panel** and double-click **System**.
- 2 Select the **Hardware** tab and click **Driver Signing** on the **Drivers** panel. The **Driver Signing Options** dialog box will appear.
- 3 Select **Ignore** to disable the warning message.

- 7 Click **Finish** to complete the installation.

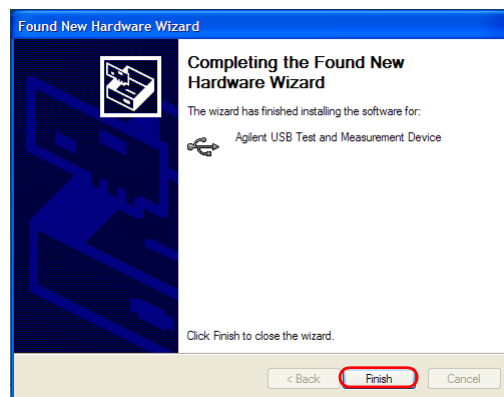

- 8 The **Assign USB device alias** window may appear. Each time the U2722A/U2723A is plugged in, this dialog box will appear. To disable this dialog, select the **Never show this dialog** option in the **Show this dialog** panel and click **OK**.

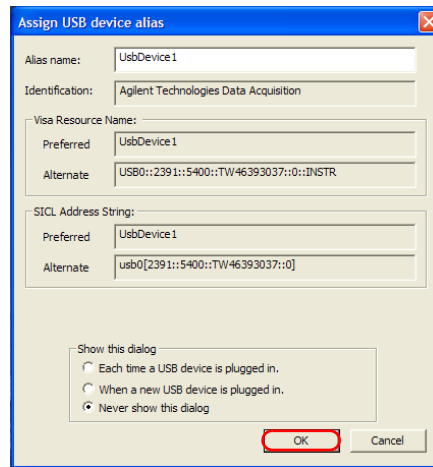

- 9 For modules other than the U2300A Series, U2500A Series, U2600A Series, and U2781A, the system will perform a firmware version check on your connected module.
- a If the module firmware version is the same as the installed version on the PC, it will not perform any firmware download and the U2722A/U2723A is now ready for use.
  - b If the module firmware version differs from the installed version on the PC, the following message box will appear. Firmware versions (V1.00 and V1.01) in the figure are for illustration purpose only, it might vary depending on the device and PC firmware version.

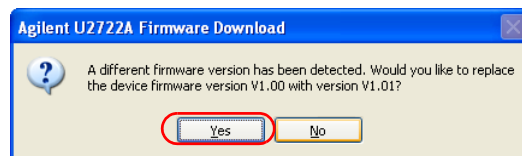

- c Click **Yes** to begin the firmware download. The following message box will appear indicating the download in progress.

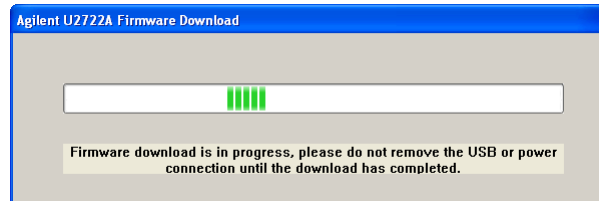

#### NOTE

Ensure that you do not remove the USB and power connection until the firmware download has completed.

- d Your U2722A/U2723A is ready for use once the firmware download has completed.

## F. Verify your module connection

The Agilent Connection Expert is one of the utilities of the IO Libraries. The Connection Expert configures the connected instruments and enables communication. It is able to automatically detect the U2722A/U2723A devices plugged into the PC.

- 1 Go to **Start > All Programs > Agilent IO Libraries Suite > Agilent Connection Expert** to launch the Connection Expert.
- 2 The detected U2722A/U2723A will be visible on the **Instrument I/O on this PC** explorer pane. Right-click on the U2722A/U2723A instrument on the explorer pane.
- 3 A context menu will appear as shown below and select **Send Commands To This Instrument**.

## 1 Getting Started

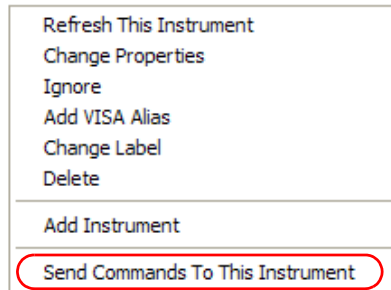

- 4 The **Agilent Interactive IO** dialog box will appear. Click **Send & Read** to send the \*IDN? default command. The instrument's response should appear in the **Instrument Session History** panel.

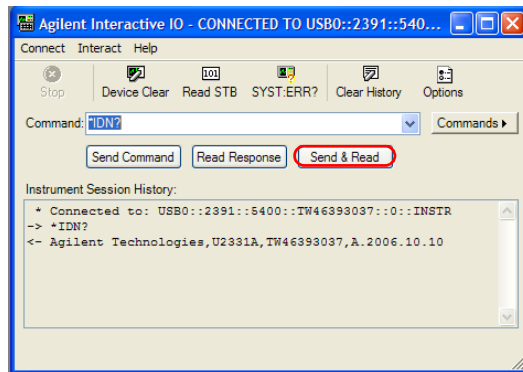

- 5 If the Connection Expert can successfully communicate with the U2722A/U2723A, this indicates that the instrument is installed correctly.

## G. Launch your Agilent Measurement Manager

### NOTE

- The IO Control will launch automatically when you start your PC.
- Launching the Measurement Manager without the IO Control running will cause failure of the Measurement Manager to detect or establish any connection with the U2722A/U2723A connected to your PC.
- To run the IO Control, go to **Start > All Programs > Agilent IO Libraries Suite > Utilities > IO Control**.

- 1 Double-click the Measurement Manager software icon on your desktop or go to **Start > All Programs > Agilent > Modular Products > Agilent Measurement Manager** to launch the software.
- 2 The Measurement Manager welcome screen will appear.



- 3 The **Select USB Device** dialog box will appear displaying the connected U2722A/U2723A devices. To start the application, select a U2722A/U2723A device and click **OK** to establish the connection.

## 1 Getting Started

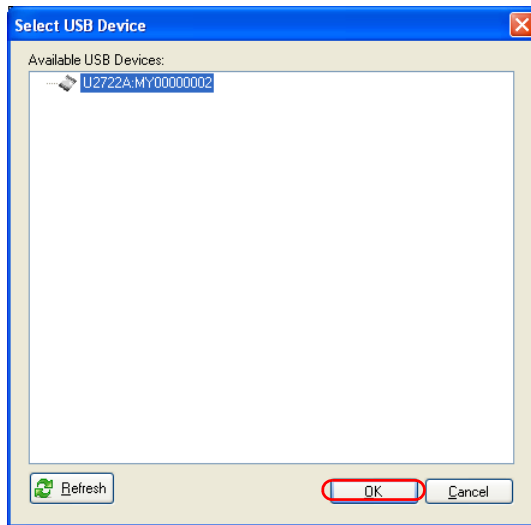

### NOTE

For more information on how to use the Measurement Manager, refer to the *Agilent Measurement Manager Help File*.

---



# Instrument Configuration

## Connector configuration

The U2722A/U2723A is equipped with output connectors as shown in Figure 1-1.

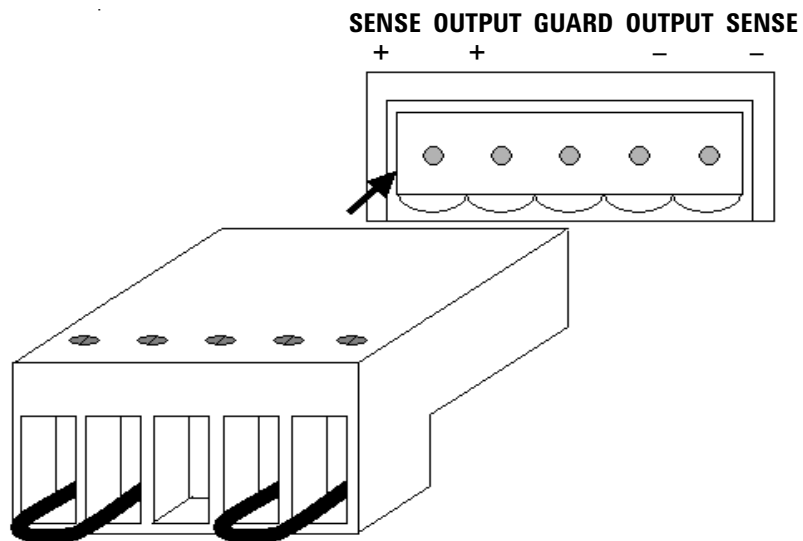

Figure 1-1 Output connectors

### NOTE

The SENSE outputs must not be left unconnected. It must be connected locally or remotely.

### 55-pin backplane connector pin configuration

The 55-pin backplane connector is used when the U2722A/U2723A module is inserted into the U2781A USB modular instrument chassis. For more details, refer to the *Agilent U2781A USB Modular Instrument Chassis User's Guide*.

GND	GND	GND	GND	GND	GND	GND	GND	GND	GND	GND	F
NC	NC	NC	NC	NC	NC	NC	NC	VBUS	GND	USB_D-	E
GND	TRIG3	GND	TRIG2	GND	TRIG1	GND	TRIG0	GND	GND	USB_D+	D
TRIG4	GND	TRIG5	GND	TRIG6	GND	TRIG7	GND	+12 V	+12 V	GND	C
nBPUB	CLK10M	GND	STAR_TRIG	GA2	GA1	GA0	NC	+12 V	+12 V	+12 V	B
NC	NC	NC	NC	NC	NC	NC	NC	+12 V	+12 V	+12 V	A
11	10	9	8	7	6	5	4	3	2	1	

**Figure 1-2** 55-pin backplane connector pin configuration

**Table 1-1** SSI connector pin description

SSI timing signal	Functionality
GND	Ground
NC	Not connected
VBUS	USB bus power sensing input
USB_D+, USB_D-	USB differential pair
TRIG0~TRIG7	Trigger bus
+12 V	+12 V power with 4 A current
nBPUB	USB backplane input detect
CLK10M	10 MHz clock source
STAR_TRIG	Star trigger
GA0,GA1,GA2	Geographical address pin

## Cable Installation

This section provides the recommended procedure for connecting the cables to the connector.

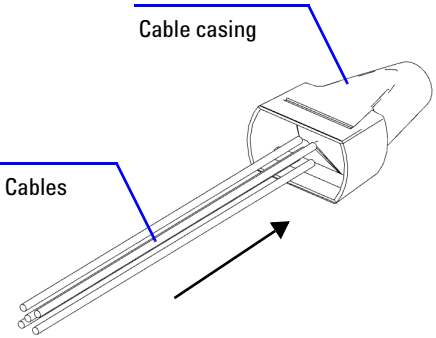
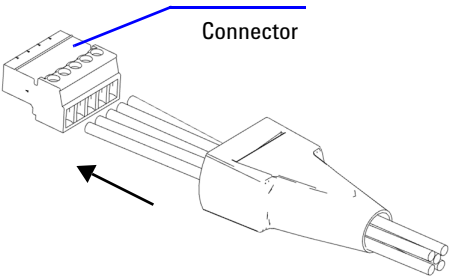
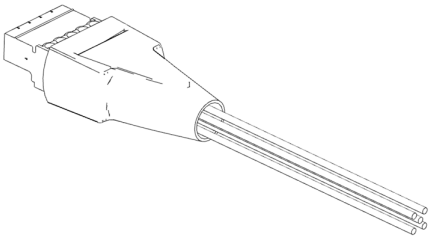
 <p>A line drawing of a cable casing with four cables being inserted into it. A blue line points to the casing with the label "Cable casing". Another blue line points to the cables with the label "Cables". A black arrow points from the cables towards the casing.</p>	<p>Push the cables through the cable casing.</p>
 <p>A line drawing of a connector with four cables being inserted into it. A blue line points to the connector with the label "Connector". A black arrow points from the cables towards the connector.</p>	<p>Then, insert the cables into the cable connector and fasten it.</p>
 <p>A line drawing of the cable casing being pushed towards the connector. The casing is shown partially covering the connector.</p>	<p>Push the cable casing towards the output connector until it firmly envelops the connector.</p>

## 1 Getting Started

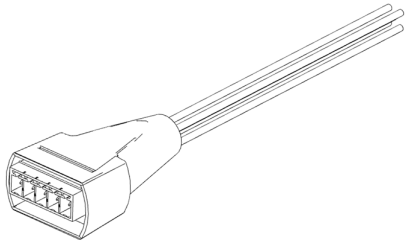

The connector should be enveloped by the cable casing as shown.

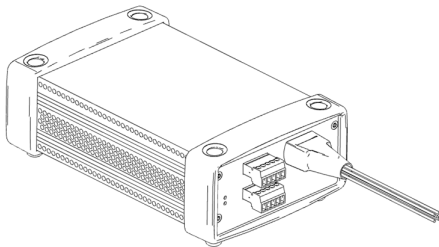

This figure provides the full view of the connected cables to the instrument's connector.

## Chassis Installation

The L-Mount kit is to be installed to your U2722A/U2723A module. The following instructions describe the simple procedure of installing the L-Mount kit and your module in the chassis.

- 1** Unpack the L-Mount kit from the packaging.
- 2** Remove your U2722A/U2723A module from the bumper casing.
- 3** Using a Phillips screwdriver, fasten the L-Mount kit to your U2722A/U2723A module.
- 4** Insert your U2722A/U2723A module into the U2781A chassis with the 55-pin backplane connector positioned at the bottom of the module.
- 5** Once you have slotted in the module, tighten the screws of the L-Mount kit to secure the connection.

## **1 Getting Started**

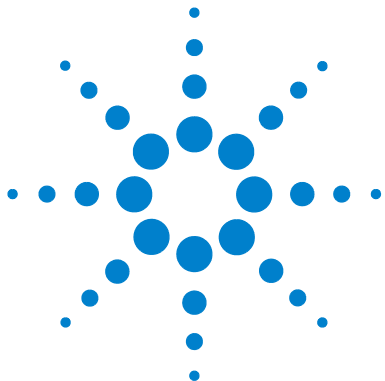

## 2 Operation and Features

Power Up	30
Sourcing and Measurement	31
Source voltage operation	32
Source current operation	36
Channel control using SCPI commands	39
Remote sense and guard	41
Making measurements	44
System-Related Operation	47
Self-test	47
Self-calibration	47
Error conditions	48
SCPI commands for system-related tasks	48
Extending the Output Power	49
Series connections	49
Parallel connections	50
Memory List	51
Memory list configuration	51
Memory list commands storing and restoring	52
Memory list delay setup	53
Memory list commands execution	54
Memory list commands execution state	58

This chapter describes the source voltage and source current operation mode of the U2722A/U2723A USB Modular Source Measure Units. It also explains the importance of remote sense and guarding when performing low current measurements. There is a section that provides information on extending the U2722A/U2723A output power.



# Power Up

Take note of the following when you power up the U2722A/U2723A.

- The U2722A/U2723A can only be operated via the USB interface.
- Before you can control the U2722A/U2723A, you need to install the hardware driver and the IO Libraries Suite 14.2 or higher. Both of these are included when you purchase the U2722A/U2723A. Refer to “[B. Install the IO Libraries Suite](#)” on page 14 and “[C. Install the module driver](#)” on page 15 for the installation procedure.
- On the front panel of the U2722A/U2723A, there are two LED indicators. Refer to “[Product outlook](#)” on page 4.
- Power indicator lights up once the U2722A/U2723A is powered up. It will blink if there is a system error.
- USB indicator will only blink when there is data exchange activity between the U2722A/U2723A and the PC.



## Sourcing and Measurement

The fundamental concepts of the U2722A/U2723A are as shown in [Figure 2-1](#). When programmed to **source voltage** mode, the ammeter ( $I_{\text{meter}}$ ) is connected in series with the voltage source ( $V_{\text{source}}$ ) and the output. If the U2722A/U2723A is programmed to **source current** mode, the voltmeter ( $V_{\text{meter}}$ ) is connected across the current source ( $I_{\text{source}}$ ) and the output.

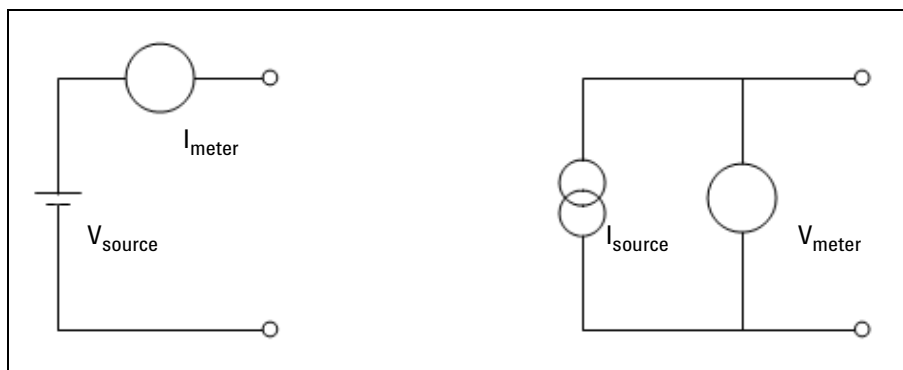

**Figure 2-1** U2722A/U2723A fundamental concepts

## Source voltage operation

To set up the U2722A/U2723A for source voltage operation, proceed as follows.

### Agilent Measurement Manager operation

#### 1 Connect a load to the output terminals.

Turn off the U2722A/U2723A power. Connect a load to the OUTPUT+ and OUTPUT- terminals of an output channel.

#### 2 Turn on the U2722A/U2723A.

The U2722A/U2723A will go into a power-on or reset state; the output is disabled. Ensure that the USB interface has already been connected between the U2722A/U2723A and PC. Run the Agilent Measurement Manager software to control the U2722A/U2723A remotely.

On the application panel as shown in [Figure 2-2](#), select the channel that you have connected. Select the required voltage and current ranges. Otherwise, enable **Auto Range** for both voltage and current. Proceed to select **Source Voltage**.

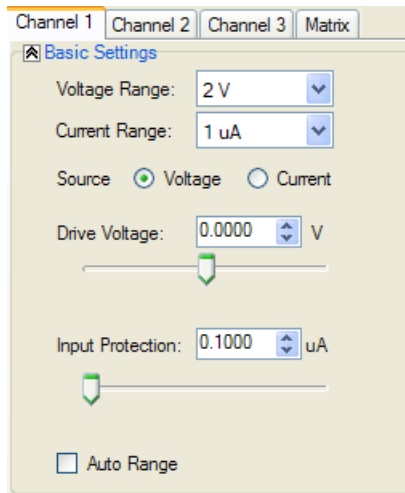

**Figure 2-2** Panel view of the Agilent Measurement Manager

Click **Output** to enable the output as shown in Figure 2-3. The button will turn green. Clicking **Output** again disables the output and the button will turn to gray.



**Figure 2-3** Turning on the U2722A/U2723A



**Figure 2-4** Turning off the U2722A/U2723A

In **source voltage** mode, the U2722A/U2723A will maintain a constant output voltage based on the set value. The output current will vary according to the load. The input protection current settings represents the limit value.

### 3 Adjust the slider for the desired output voltage.

Adjust the slider or key in the desired output voltage value at the **Drive Voltage** text box.

### 4 Real time display of measured voltage and current.

The application display panel will show the real time values of both the voltage and current.

## 2 Operation and Features

The positive operating quadrant of the U2722A/U2723A during source voltage mode is as shown in [Figure 2-5](#). The input protection current line represents the input protection current settings. The source voltage line represents the source voltage settings. These lines are the boundaries that the U2722A/U2723A will operate within.

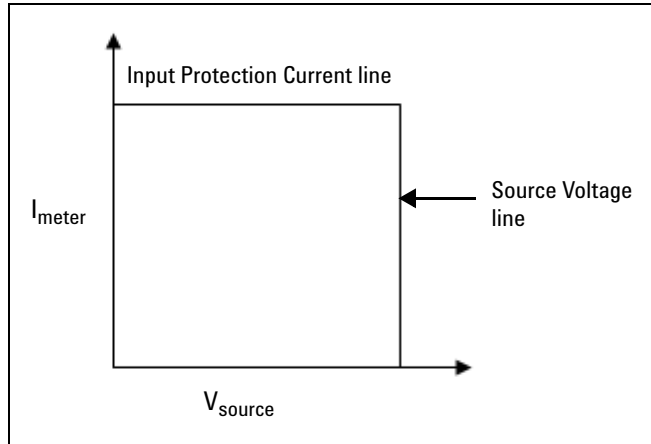

**Figure 2-5** Source voltage positive operating boundaries

[Figure 2-6](#) shows the operation with different resistive loads, which are 1 k $\Omega$  and 100  $\Omega$  respectively. In these examples, the U2722A/U2723A is having a source voltage of 15 V and an input protection current of 50 mA.

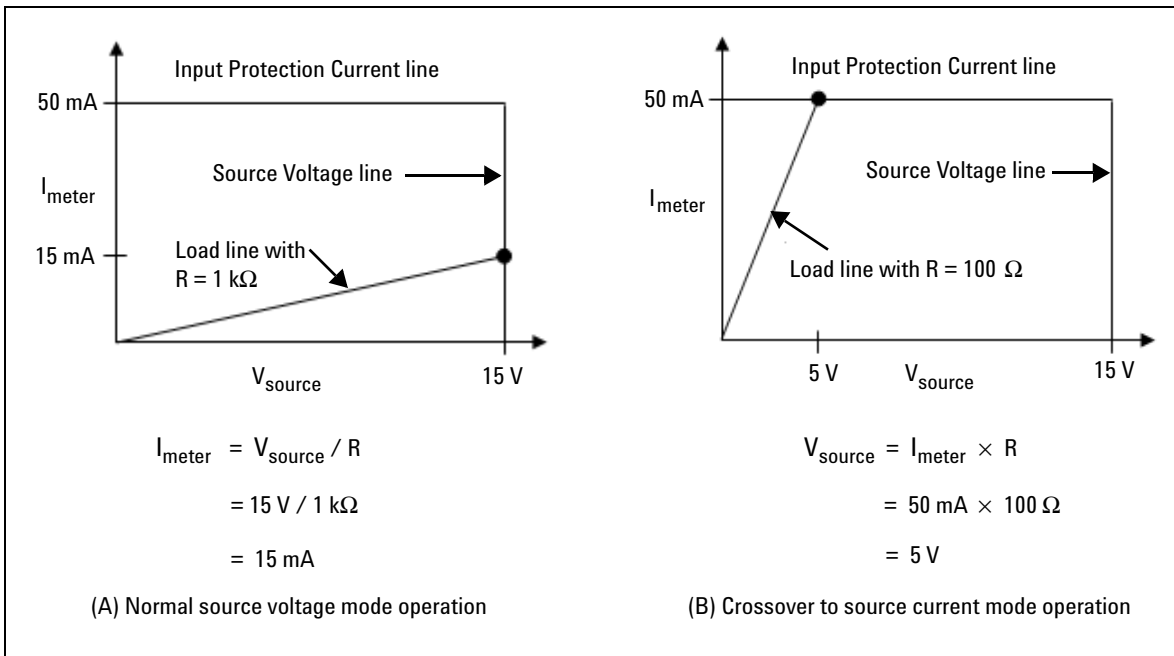

**Figure 2-6** Source voltage operation

In [Figure 2-6 \(A\)](#), the U2722A/U2723A is having a source voltage of 15 V to a 1 kΩ load and it is measuring 15 mA. As long as the DUT load line intersects the source voltage line, it will be in source voltage mode and the voltage will maintain at 15 V. However in [Figure 2-6 \(B\)](#), it shows that when the resistance of the load decreases to 100 Ω the load line intersects the input protection current line. This forces the U2722A/U2723A to go into source current mode. Since the input protection current setting is set at 50 mA and the U2722A/U2723A cannot operate out of the boundary, the voltage changes to 5 V instead.

## Source current operation

To set up the U2722A/U2723A for source current operation, proceed as follows.

### Agilent Measurement Manager operation

#### 1 Connect a load to the output terminals.

With power-off, connect a load to the OUTPUT+ and OUTPUT- output terminals of any channel.

#### 2 Turn on the U2722A/U2723A.

The U2722A/U2723A will go into a power-on or reset state; the output is disabled. Ensure that the USB interface has already been connected between the U2722A/U2723A and PC. Load the Agilent Measurement Manager software to control the U2722A/U2723A remotely.

On the application panel, choose the channel you have connected the load to, set the voltage range to either 2 V or 20 V, and select the current range. Otherwise, enable **Auto Range** for both voltage and current. Proceed to select **Source Current** and click **Output** to enable the output. The button will turn green. Clicking **Output** again disables the output and it will turn to gray. Refer to [Figure 2-2](#), [Figure 2-3](#), and [Figure 2-4](#) for the details.

In **source current** mode, the current values between the meter and limit modes are the same, but the voltage values are not. The changes you make to the voltage only set the input protection values.

#### 3 Adjust the slider for the desired output current.

Adjust the slider or key in the value at **Drive Current** for the desired output current.

#### 4 Real time display of the measured voltage and current.

The application display panel will show the real time values of both the voltage and current of that channel as shown in [Figure 2-3](#).

The positive operating quadrant of the U2722A/U2723A during source current mode is as shown in Figure 2-7. The current limit load line represents the source current settings. The input protection voltage load line represents the input protection voltage settings. These load lines are the boundaries which the U2722A/U2723A will operate within.

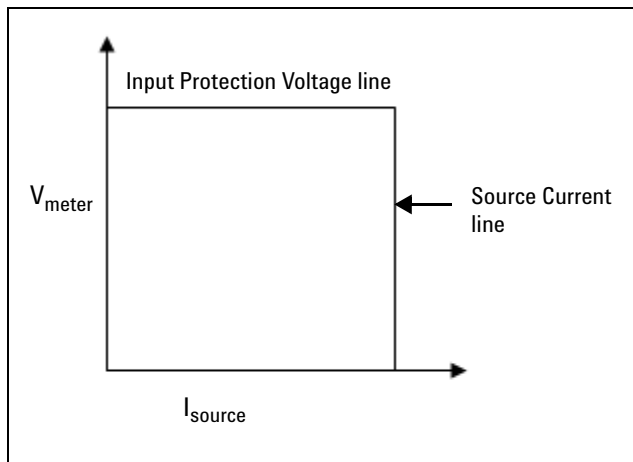

**Figure 2-7** Source current positive operating boundaries

Figure 2-8 shows the operation with different resistive loads, which are 1 k $\Omega$  and 100  $\Omega$  respectively. In these examples, the U2722A/U2723A is having a source current of 20 mA and an input protection voltage of 15 V.

## 2 Operation and Features

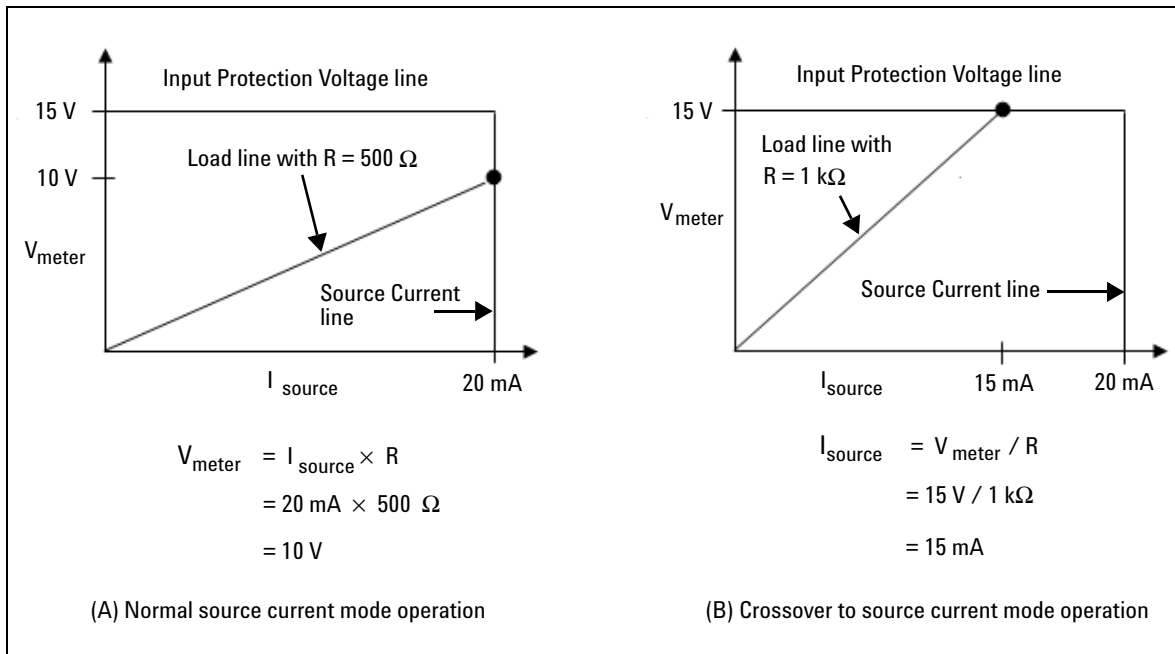

**Figure 2-8** Source current operation

In [Figure 2-8 \(A\)](#), the U2722A/U2723A is having a source current of 20 mA to a  $500 \Omega$  load and it is measuring 10 V. As long as the DUT load line intersects the source current line, it will be in source current mode and the current will maintain at 20 mA. However in [Figure 2-8 \(B\)](#), it shows that when the resistance of the DUT increases to  $1 \text{ k}\Omega$ , the DUT load line intersects the input protection voltage line. This forces the U2722A/U2723A to go into source voltage mode. Since the voltage setting is clamped at 15 V and the U2722A/U2723A cannot operate out of the boundary, the current then changes to 15 mA instead.



## Channel control using SCPI commands

The following SCPI commands shows a sample procedure of controlling a single channel.

To source voltage, the following sequence must be followed.

- a** Set voltage & current range (without any particular priority in sequence).
- b** Set CURRENT limit using `[:SOURce]:CURRent:LIMit <current>, (@1|2|3)`, where <current> is the value in amperes.
- c** Drive VOLTAGE using `[:SOURce]:VOLTage[:LEVel][:IMMediate][:AMPLitude] <voltage>, (@1|2|3)`, where <voltage> is the value in volts.

### Example 1, Set drive voltage at channel 1

→ *CLS; *RST	<i>Resets the source to the default power-on state. This command can be ignored if this operation is not required.</i>
→ SOUR:VOLT:RANG R20V, (@1)	<i>Sets voltage range of channel 1 to 20 V.</i>
→ SOUR:CURR:RANG R10mA, (@1)	<i>Sets current range of channel 1 to 10 mA.</i>
→ SOUR:CURR:LIM 8mA, (@1)	<i>Sets current range of channel 1 to 8 mA.</i>
→ SOUR:VOLT 5, (@1)	<i>Sets channel 1 to output 5 V.</i>
→ OUTP ON, (@1)	<i>Turns on output for channel 1.</i>
→ MEAS:VOLT? (@1)	<i>Queries the voltage for channel 1.</i>
← 4.99	

To source current, the following sequence must be followed.

- a** Set voltage & current range (without any particular priority in sequence).
- b** Set VOLTAGE limit using `[:SOURce]:VOLTage:LIMit <voltage>, (@1|2|3)`, where <voltage> is the value in volts.
- c** Drive CURRENT using `[:SOURce]:CURRent[:LEVel][:IMMediate][:AMPLitude] <current>, (@1|2|3)`, where <current> is the value in amperes.

## 2 Operation and Features

### Example 2, Set drive current at channel 1

→ *CLS; *RST	<i>Resets the source to the default power-on state. This command can be ignored if this operation is not required.</i>
→ SOUR:VOLT:RANG R20V, (@1)	<i>Sets voltage range of channel 1 to 20 V.</i>
→ SOUR:CURR:RANG R10mA, (@1)	<i>Sets current range of channel 1 to 10 mA.</i>
→ SOUR:VOLT:LIM 10V, (@1)	<i>Sets voltage limit of channel 1 to 10 V.</i>
→ SOUR:CURR 5mA, (@1)	<i>Sets channel 1 to output 5 mA.</i>
→ OUTP ON, (@1)	<i>Turns on output for channel 1.</i>
→ MEAS:CURR? (@1)	<i>Queries the current for channel 1.</i>
← 5.0E-03	

## Remote sense and guard

### Remote sense

The U2722A/U2723A has both local and remote sensing capabilities. When remote sensing is applied, the sense lines can be directly connected to the DUT. When the U2722A/U2723A is in source voltage mode, remote sensing enables the voltage to be sensed at the load and it will result in better regulation. If the remotely sensed voltage at the DUT is lower than the programmed voltage level, the actual output voltage will be increased until the sensed voltage matches the programmed voltage. This ensures that the exact programmed voltage appears at the DUT.

Remote sensing is especially useful in source voltage mode with load impedances that vary or have significant lead resistance. It has no effect in source current mode.

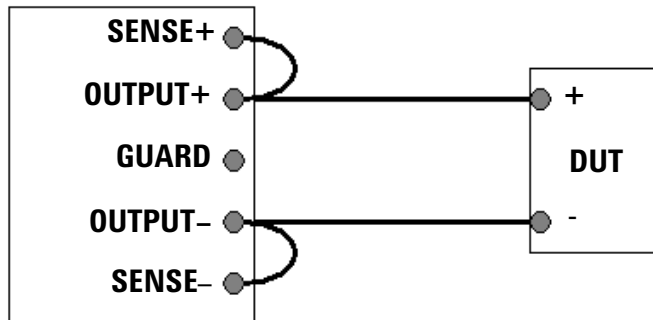

**Figure 2-9** Local sense connection

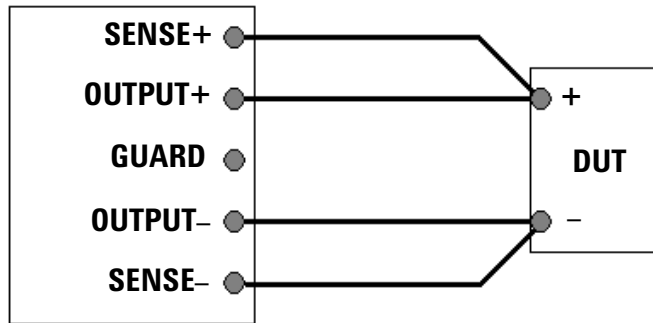

**Figure 2-10** Remote sense connection

### Guard

To perform low current measurement, it is important to enclose the OUTPUT+ and SENSE+ lines with the potential of the GUARD terminal as far as possible. This is illustrated in [Figure 2-11](#). Use coaxial cables for such connections to improve the shielding.

The potential of the GUARD terminal is the same as the OUTPUT+ and SENSE+ terminal voltage.

By using GUARD, there is no potential difference between the OUTPUT+ and SENSE+ lines and the GUARD line. Therefore, there will not be any leakage current flowing from either the OUTPUT+ and SENSE+ lines. The leakage current from the GUARD does not affect the measurement results because it does not flow into the  $I_{\text{meter}}$ .

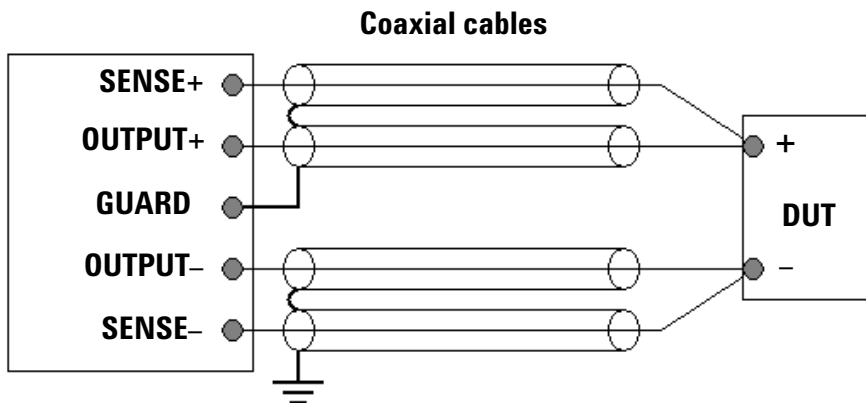

**Figure 2-11** Guarded connection

**WARNING**

**GUARD terminal potential is equal to the output.**

**CAUTION**

Never connect the GUARD terminal to any other output, including circuit common, chassis ground, or the GUARD terminal of any other unit. Doing so may result in damage to the unit.

## Making measurements

The U2722A/U2723A has an excellent output voltage and current measurement capability. All the measurements are performed by digitizing the instantaneous output voltage or current for a defined number of samples and sample interval, storing the results in a buffer, and then calculating the measured result. The programmable parameters include the number of samples and time interval between each sample.

### NOTE

There is a trade-off between the programmable parameters and the speed, accuracy, and stability of the measurements in the presence of noise.

### Voltage and current measurements

To measure the voltage or current for any output, use the following commands.

```
MEAS:VOLT? (@<ch>)
```

```
MEAS:CURR? (@<ch>)
```

The result of MEAS:CURR? or MEAS:VOLT? is dependent on

- NPLC setting for voltage or current  
(SENSe:VOLTagE[:DC]:NPLCycles <integer>, (@1|2|3) or  
SENSe:CURRent[:DC]:NPLCycles <integer>, (@1|2|3)) where  
integer is from 0 to 255
- line frequency selection (SYSTem:LFREQuency <F50HZ|F60HZ>,  
(@1|2|3)) prior to making the measurement
- latency time from many executable levels in the PC.

The maximum total time taken for measurements to complete if NPLC = 255 and Line Frequency = 50 Hz is calculated according to the following formula.

$$\textit{Aperture time} = \frac{\textit{NPLC}}{\textit{Line frequency}} = \frac{255}{50} = 5.1 \text{ s}$$

However, due to the latency of approximately 15 ms, the total time taken for the measurement to complete and return the value would be approximately 5.115 s. Hence, it is recommended that the time-out settings for communicating with the U2722A/U2723A is set to more than 5.115 s, else time-out error would likely occur.

### Controlling measurement samples

You can vary the number of data points in a measurement sample and the time between samples. Refer to [Figure 2-12](#).

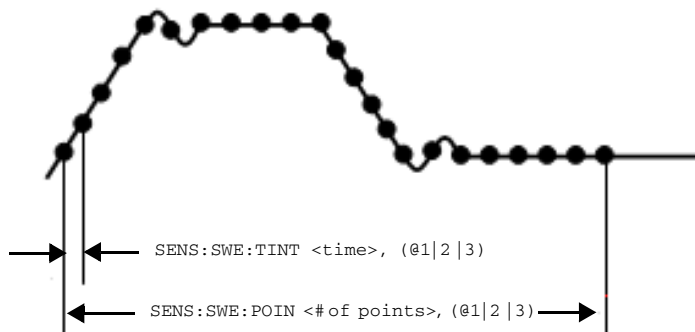

**Figure 2-12** Commands that control measurement time

When the instrument is turned on and at \*RST, the output voltage or current sampling period is calculated using the `SENSe:SWEep:TINTerval <integer>, (@1|2|3)` command and the measurement buffer size is set to a value ranging from 1 up to 4096 data points. Thus, the expected time taken to fill up the data points set in the data buffer is governed by the following formula,

$$\text{Expected time, } t = \text{points} \times \text{time interval}$$

You can vary the data sampling rate with these commands.

```
SENS:SWE:TINT <sample_period>, (@1|2|3)
```

```
SENS:SWE:POIN <points>, (@1|2|3)
```

## 2 Operation and Features

For example, to set the time interval to 40 ms per measurement with 1500 samples, use the following command.

```
SENS:SWE:TINT 40, (@1); :SENS:SWE:POIN 1500, (@1)
```

Only the `MEASure:ARRay:VOLTage[:DC]? (@1|2|3)` and `MEASure:ARRay:CURREnt[:DC]? (@1|2|3)` commands are governed by the number of data points and time interval settings.

### NOTE

You are required to configure the time-out settings via the Agilent IO Libraries when different values of the sweep points and time interval are set. For more information on how to set the time-out and what are the recommended time-out settings, refer to [“Appendix B: Time-out Settings”](#) on page 60.

---



## System-Related Operation

This section provides information on system-related topics such as executing a self-test, performing a self-calibration routine, and reading error conditions.

### Self-test

To perform the self-test, proceed as follows.

#### Agilent Measurement Manager operation

**Disconnect all connections from the output terminals.**

Ensure that the output terminals are not connected to any loads. Turn on the U2722A/U2723A. On the application panel, select **Tools > Self-Test**.

If the self-test fails, an error is recorded in the instrument error queue.

Use the `SYSTem:ERRor?` query from the remote interface (see the *Agilent U2722A/U2723A USB Modular Source Measure Units Programmer's Reference*). A list of the possible self-test errors is given on [page 58](#).

- If repair is required, contact an Agilent Service Center.
- If all tests pass, you have a high confidence (~90%) that the instrument is operational.

### Self-calibration

To perform a self-calibration, proceed as follows.

#### Agilent Measurement Manager operation

**Disconnect all connections from the output terminals.**

Unplug any cables connected to the U2722A/U2723A before performing the self-calibration to prevent the occurrence of process failure. On the application panel, select **Tools > Self-Calibration**.

#### NOTE

It is recommended that the source is powered-up for at least 20 minutes before performing the self-calibration.

### Error conditions

A record of up to 20 errors can be stored in the U2722A/U2723A's error queue. Refer to the programming guide for more information on the error messages.

#### Agilent Measurement Manager operation

A message box will appear once an error occurs while operating the U2722A/U2723A using the Agilent Measurement Manager.

### SCPI commands for system-related tasks

The following examples show the SCPI commands for performing certain system-related tasks.

#### Example 3, Performing system-related tasks

→ *CLS; *RST	<i>Resets the source to the default power-on state. This command can be ignored if this operation is not required.</i>
→ *TST?	<i>Executes the self-test.</i>
← +0	<i>Returns a +0 if the test pass, else it returns other numbers in correspond with the failure (refer to "<a href="#">Appendix A: List of Self-Test Return Codes</a>" on page 58).</i>
→ *CAL?	<i>Executes the self-calibration.</i>
← +0	<i>Returns a +0 if the test pass, else it returns a +1 if it fails.</i>
→ SYST:ERR?	<i>Returns the error number and its corresponding message string from the error queue.</i>
← +0, "No Error"	

## Extending the Output Power

The U2722A/U2723A is equipped with three dedicated channels of up to 20 V and 120 mA per channel.

### Series connections

To increase the output voltage, tie two or more of the outputs in series as shown in [Figure 2-13](#). This is to obtain a higher voltage than that available from a single output. Series connected outputs can be operated with one load across the connected outputs or with a separate load for each output.

When a series connection is used, the output voltage is the sum of the voltages of the individual output. The current is the current of any one output. Each of the individual outputs must be adjusted to obtain the total output voltage.

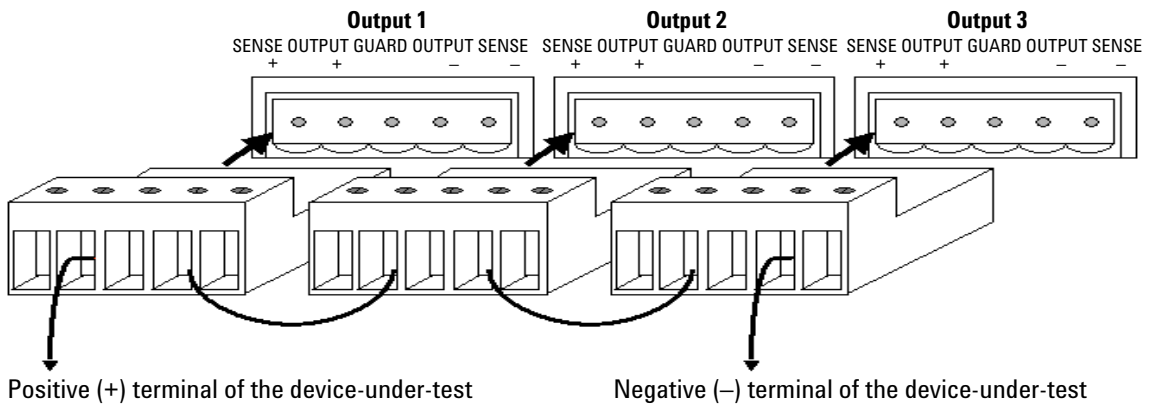

**Figure 2-13** U2722A/U2723A outputs connected in series

#### NOTE

- Ensure that the voltage (when source current) or the current (when source voltage) is not clamped.
- Preferably, both are at the same current range.

## Parallel connections

A parallel connection is used to increase the output current. Connect two or more of the outputs in parallel as in [Figure 2-14](#). For a parallel connection, the output current is the sum of the currents of the individual output. The voltage is from any of the outputs. Each of the individual outputs must be adjusted to obtain the total output current.

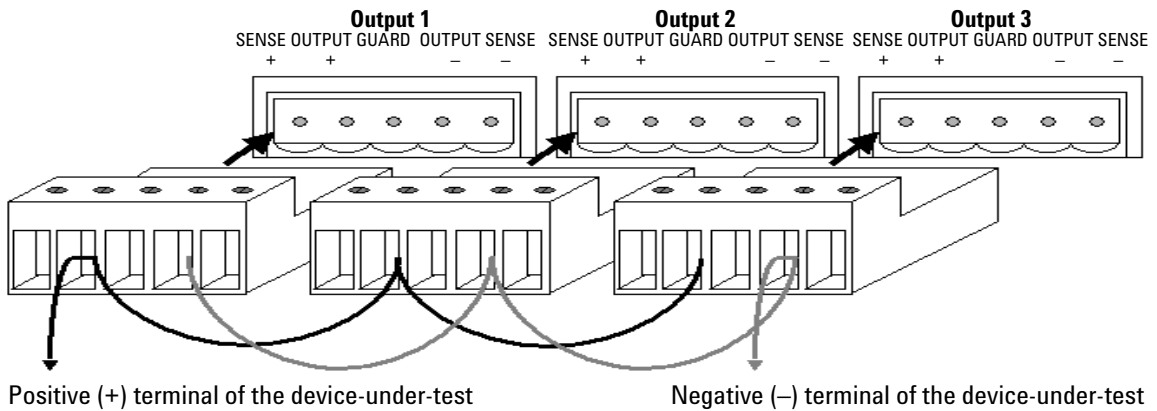

**Figure 2-14** U2722A/U2723A outputs connected in parallel

### NOTE

- Ensure that the voltage (when source current) or the current (when source voltage) is not clamped.
- Preferably, both are at the same voltage range.

## Memory List

The U2723A USB Modular Source Measure Unit contains an additional memory list feature. Each channel in the U2723A USB Modular Source Measure Unit is allocated two memory list, each capable of storing up to 200 commands and results individually.

Once the commands are loaded into the active memory and the list is executed, the stored commands at each memory point is executed while the measurement results obtained are automatically stored at the result buffer.

This eliminates several processes in the command execution, such as transferring commands from your PC through a USB interface, checking the command syntax, and converting commands to the internal codes.

As a result, the test measurement throughput is increased and the instrument is able to function as a fast test sequencer. Multiple settings can also be implemented in a sweep.

For example, the first few commands in the memory list may source current and measure voltage, the next few commands may source voltage and measure current, and the last few commands may source voltage and measure current again but at a lower range.

This allows customization for each sweep point with specific settings instead of being tied to one set of settings for all sweep points.

Since two memory lists are available for each channel, this allows two different test scripts to be stored and switched in a channel.

### Memory list configuration

Each channel has two memory lists. When a memory list is selected, all parameter settings and operations will only be based on the active list until it is switched to another list. The first command in the memory list is set as the start point and the last command in the memory list is set as the end point by default. However, you can specify a particular command to be the start point and another to be the end point. You may also set the number of times this range of commands is to be executed. The default loop set is 1 and the maximum loop number is 1000.

## Memory list commands storing and restoring

Only 11 selected type of commands can be stored in the memory list. [Table 2-1](#) summarizes the type of commands that can be saved into the memory list. Commands in the memory list can be stored in and restored from the nonvolatile memory. When the U2723A USB Modular Source Measure Unit is powered up, existing commands from the memory list is restored from the nonvolatile memory automatically.

### NOTE

After changing the measurement range command, a clamp command should be added subsequently into the memory list.

**Table 2-1** Type of commands that can be saved into the memory list

Remote SCPI command	AMM command equivalent	Description
[SOURce:]MEMory:CURRent:LIMit	CurrentLimit	Set the current limit
[SOURce:]MEMory:CURRent:MEASure	MeasureCurrent	Make a current measurement
[SOURce:]MEMory:CURRent:SOURce	SourceCurrent	Set the drive current
[SOURce:]MEMory:CURRent:RANGe	CurrentRange	Set the current range
[SOURce:]MEMory:VOLTage:LIMit	VoltageLimit	Set the voltage limit
[SOURce:]MEMory:VOLTage:MEASure	MeasureVoltage	Make a voltage measurement
[SOURce:]MEMory:VOLTage:SOURce	SourceVoltage	Set the drive voltage
[SOURce:]MEMory:VOLTage:RANGe	VoltageRange	Set the voltage range
[SOURce:]MEMory:SOURce:DELAy:AUTO	AutoDelay	Enable (ON) or disable (OFF) the auto delay mode
[SOURce:]MEMory:SOURce:DELAy	GlobalDelay	Set the global delay value
	LocalDelay	Set the local delay value
[SOURce:]MEMory:OUTPut	Output	Enable (ON) or disable (OFF) the instrument output

For more information, refer to the *Agilent U2722A/U2723A USB Modular Source Measure Units Programmer's Reference*.

## Memory list delay setup

Generally, the duration spent at each command in the memory list only consists of the time it takes to execute the commands. But for source commands, a source delay may be included. The source delay is used to allow the source to settle before the measurement is made. The total time period of the source delay can include an auto delay and/or a user programmed delay.

**Total delay time = auto delay time + user programmed delay time.**

If auto delay is enabled, a certain duration of delay, which depends on the source and measurement range, is performed. Auto delay is used to ensure that there is enough rising time for the source to reach the specified level. [Table 2-2](#) shows the time delay set for each range when auto delay is enabled. There are two type of user programmable source delay: the global delay and single delay. When the global delay is added, all the subsequent source action will perform the same time period of delay. When the single delay is added, only the next subsequent source action will be affected while the other commands are not. When the global and single delay are used together, only the next subsequent source action for the single delay is affected by the single delay, while the other source actions will take effect from the global delay.

### NOTE

You can use these programmable delays to perform an even or uneven sweep.

**Table 2-2** Time delay set for each range when auto delay is enabled

I-range	Auto delay (ms)			
	Source V		Source I	
	2 V range	20 V range	2 V range	20 V range
1 $\mu$ A	10	10	20	20
10 $\mu$ A	4	4	20	20
100 $\mu$ A	0.8	0.8	20	20
1 mA	0.5	0.5	1	1
10 mA	0.5	0.5	1	1
120 mA	0.5	0.5	1	1

## Memory list commands execution

Since each channel runs independently, if one channel is executing commands from its active memory list, the other channels will remain in idle state. When a channel is busy executing the active memory list commands, any command sent to this channel will be ignored by the instrument. There are two ways to execute the commands in the active memory list: through an external trigger or a remote trigger command.

### Execute commands from memory list using an external trigger

To perform an external triggering, the U2723A USB Modular Source Measure Unit must be slotted into a U2781A chassis. Next, the channel needs to be configured and armed. An external trigger pulse is sent to the backplane of the chassis to trigger the channel, and the channel will start to execute commands from the memory list (when trigger signal is received). If the channels are armed and triggered at the same time, they will run in parallel.



**Example 1**

This example stores the source voltage and measure current commands into the active memory list (memory list 1) for channel 1 and arms it.

To perform the function above, follow the sequence below.

- a** Select an active memory list.
- b** Clear the content of the active memory list.
- c** Store the “set voltage range” command into the active memory list.
- d** Store the “set current range” command into the active memory list.
- e** Store the “set current limit” command into the active memory list.
- f** Store the “drive voltage” command into the active memory list.
- g** Store the “set output on” command into the active memory list.
- h** Store the “measure current” command into the active memory list.
- i** Configure the trigger setting.
- j** Arm the channel.

- |                                      |  |
|--------------------------------------|--|
| → SOUR:MEM:LIST 1, (@1)              | <i>This command selects memory list 1 as the active memory list for channel 1. This command can be omitted if the default active memory list has not been changed.</i> |
| → SOUR:MEM:LIST:CLE, (@1)            | <i>This command clears all the content in the active memory list of channel 1.</i>   |
| → SOUR:MEM:VOLT:RANG R20V,<br>(@1)   | <i>This command stores the “set voltage range to 20 V” command into the active memory list of channel 1.</i>   |
| → SOUR:MEM:CURR:RANG<br>R120mA, (@1) | <i>This command stores the “set current range to 120 mA” command into the active memory list of channel 1.</i>   |
| → SOUR:MEM:CURR:LIM 0.12,<br>(@1)    | <i>This command stores the “set current limit to 120 mA” command into the active memory list of channel 1.</i>   |
| → SOUR:MEM:VOLT:SOUR 20,<br>(@1)     | <i>This command stores the “drive voltage 20 V” command into the active memory list of channel 1.</i>  |

## 2 Operation and Features

- SOUR:MEM:OUTP ON, (@1) *This command stores the “set output on” command into the active memory list of channel 1.*
- SOUR:MEM:CURR:MEAS, (@1) *This command stores the “measure current” command into the active memory list of channel 1.*
- SOUR:MEM:LIST:STOR, (@1) *This command stores all commands from the active memory list of channel 1 into the nonvolatile memory. This command can be omitted if this operation is not required.*
- SOUR:TRIG:STRG *This command configures the backplane trigger to star trigger.*
- SOUR:MEM:ARM (@1) *This command sets the arm type of channel 1 to the memory list arm.*
- INIT:TRAN, (@1) *This command arms channel 1.*

### **Execute commands from memory list using the remote trigger command**

Commands from the memory list can be executed by sending the remote trigger command. There will be some small time delay between the channels if two or three channels are triggered by the remote command at the same time. The channel execution sequence will start in the order of channel 1, channel 2, and channel 3.

## Example 2

This example stores the source current and measure voltage commands into the active memory list (memory list 1) for channel 1 and executes them when a remote trigger command is received.

To perform the function above, follow the sequence below.

- a** Select an active memory list.
- b** Clear the content of the active memory list.
- c** Store the “set voltage range” command into the active memory list.
- d** Store the “set current range” command into the active memory list.
- e** Store the “set voltage limit” command into the active memory list.
- f** Store the “drive current” command into the active memory list.
- g** Store the “set output on” command into the active memory list.
- h** Store the “measure voltage” command into the active memory list.
- i** Trigger the execution of commands in the active memory list.

- |                                      |  |
|--------------------------------------|--|
| → SOUR:MEM:LIST 1, (@1)              | <i>This command selects memory list 1 as the active memory list for channel 1. This command can be omitted if the default active memory list has not been changed.</i> |
| → SOUR:MEM:LIST:CLE, (@1)            | <i>This command clears all the content in the active memory list of channel 1.</i>   |
| → SOUR:MEM:VOLT:RANG R20V,<br>(@1)   | <i>This command stores the “set voltage range to 20 V” command into the active memory list of channel 1.</i>   |
| → SOUR:MEM:CURR:RANG<br>R120mA, (@1) | <i>This command stores the “set current range to 120 mA” command into the active memory list of channel 1.</i>   |
| → SOUR:MEM:VOLT:LIM 20,<br>(@1)      | <i>This command stores the “set voltage limit to 20 V” command into the active memory list of channel 1.</i>   |
| → SOUR:MEM:CURR:SOUR 0.12,<br>(@1)   | <i>This command stores the “drive current to 120 mA” command into the active memory list of channel 1.</i>   |

## 2 Operation and Features

- |                            |  |
|----------------------------|--|
| → SOUR:MEM:OUTP ON, (@1)   | <i>This command stores the “set output on” command into the active memory list of channel 1.</i>   |
| → SOUR:MEM:VOLT:MEAS, (@1) | <i>This command stores the “measure voltage command” into the active memory list of channel 1.</i>   |
| → SOUR:MEM:LIST:STOR, (@1) | <i>This command stores all commands from the active memory list of channel 1 into the nonvolatile memory. This command can be omitted if this operation is not required.</i> |
| → SOUR:MEM:TRIG (@1)       | <i>This command executes all the commands from the active memory list of channel 1.</i>  |

### NOTE

- 1 When the measurement results reaches 200, the next result will wrap back and replace the first result at the buffer.
- 2 When the last executing command in the memory list is to change the source range, this command will not take effect at the output until subsequent source command is executed.
- 3 When a command is stored into the memory list, the active voltage and current range at that time is stored as well. If a command in the memory list is executed, these ranges will be restored to the active ranges.

## Memory list commands execution state

Figure 2-15 and Figure 2-16 shows the states that a channel goes through when executing commands from the memory list using the external trigger or remote trigger command, and the status operation condition register bit that is involved. The WTG bit set indicates that the channel is armed and waiting for trigger. The DTG bit set indicates that the channel is busy and will ignore all incoming commands.

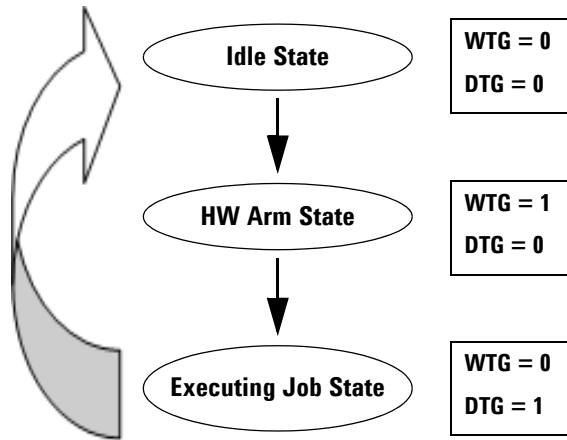

**Figure 2-15** Channel state and Status Operation Condition register bit for external trigger

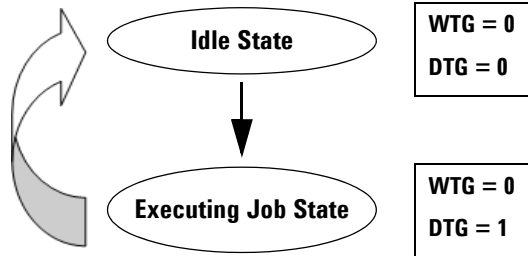

**Figure 2-16** Channel state and Status Operation Condition register bit for remote trigger

## 2 Operation and Features



### 3 Characteristics and Specifications

Product Characteristics 52

Product Specifications 53

This chapter specifies the characteristics, environmental conditions, and specifications of the U2722A/U2723A.



## Product Characteristics

---

### REMOTE INTERFACE

- Hi-Speed USB 2.0
- USBTMC 488.2 Class device

---

### POWER CONSUMPTION

- +12 VDC, 3 A maximum
- Isolated ELV power source

---

### OPERATING ENVIRONMENT

- Operating temperature from 0 °C to +50 °C
- Relative humidity at 20% to 85% RH (non-condensing)
- Altitude up to 2000 meters
- Pollution degree 2
- For indoor use only

---

### STORAGE COMPLIANCE

- -20 °C to 70 °C
- Relative humidity at 5% to 90% RH (non-condensing)

---

### SAFETY COMPLIANCE

Certified with:

- IEC 61010-1:2001/EN61010-1:2001 (2nd Edition)
- Canada: CAN/CSA-C22.2 No. 61010-1-04
- USA: ANSI/UL 61010-1:2004

---

### EMC COMPLIANCE

- IEC 61326-1:2005/EN61326-1:2006
- Canada: ICES-001:2004
- Australia/New Zealand: AS/NZS CISPR11:2004

---

### SHOCK AND VIBRATION

Tested to IEC/EN 60068-2

---

### I/O CONNECTOR

Output connectors

---

### DIMENSIONS (W × D × H)

- 120.00 × 183.00 × 66.00 mm (with bumpers)
- 105.00 × 175.00 × 50.00 mm (without bumpers)

---

### WEIGHT

- 700 g (with bumpers)
- 650 g (without bumpers)

---

### WARRANTY

One year

---



# Product Specifications

## General

	U2722A/U2723A
Number of outputs	3
<b>Output ratings (at 0 °C to 50 °C)</b>	
Voltage	-20 V to 20 V
Current	-120 mA to 120 mA

## U2722A USB Modular Source Measure Unit performance specifications

	Range	Accuracy <sup>[1]</sup>	Resolution
<b>Voltage programming</b> 12 months (at 25 °C ± 3 °C), ± (% of output + offset)	± 2 V	0.075% + 1.5 mV	0.1 mV
	± 20 V	0.05% + 10 mV	1 mV
<b>Current programming</b> 12 months (at 25 °C ± 3 °C), ± (% of output + offset)	± 1 µA	0.085% + 0.85 nA	100 pA
	± 10 µA	0.085% + 8.5 nA	1 nA
	± 100 µA	0.075% + 75 nA	10 nA
	± 1 mA	0.075% + 750 nA	100 nA
	± 10 mA	0.075% + 7.5 µA	1 µA
	± 120 mA	0.1% + 100 µA	20 µA
<b>Voltage readback</b> 12 months (over USB with respect to the actual output at 25 °C ± 3 °C), ± (% of output + offset)	± 2 V	0.075% + 1.5 mV	0.1 mV
	± 20 V	0.05% + 10 mV	1 mV
<b>Current readback</b> 12 months (over USB with respect to the actual output at 25 °C ± 3 °C), ± (% of output + offset)	± 1 µA	0.085% + 0.85 nA	100 pA
	± 10 µA	0.085% + 8.5 nA	1 nA
	± 100 µA	0.075% + 75 nA	10 nA
	± 1 mA	0.075% + 750 nA	100 nA
	± 10 mA	0.075% + 7.5 µA	1 µA
	± 120 mA	0.1% + 100 µA	20 µA

[1] Accuracy measurements are based on NPLC 10.

### 3 Characteristics and Specifications

#### U2723A USB Modular Source Measure Unit performance specifications

	Range	Accuracy <sup>[1]</sup>	Resolution
<b>Voltage programming</b> 12 months (at 23 °C ± 5 °C), ± (% of output + offset)	± 2 V	0.075% + 1.5 mV	0.1 mV
	± 20 V	0.05% + 10 mV	1 mV
<b>Current programming</b> 12 months (at 23 °C ± 5 °C), ± (% of output + offset)	± 1 µA	0.085% + 0.85 nA	100 pA
	± 10 µA	0.085% + 8.5 nA	1 nA
	± 100 µA	0.075% + 75 nA	10 nA
	± 1 mA	0.075% + 750 nA	100 nA
	± 10 mA	0.075% + 7.5 µA	1 µA
	± 120 mA	0.1% + 100 µA	20 µA
<b>Voltage readback</b> 12 months (over USB with respect to the actual output at 23 °C ± 5 °C), ± (% of output + offset)	± 2 V	0.075% + 1.5 mV	0.1 mV
	± 20 V	0.05% + 10 mV	1 mV
<b>Current readback</b> 12 months (over USB with respect to the actual output at 23 °C ± 5 °C), ± (% of output + offset)	± 1 µA	0.085% + 0.85 nA	100 pA
	± 10 µA	0.085% + 8.5 nA	1 nA
	± 100 µA	0.075% + 75 nA	10 nA
	± 1 mA	0.075% + 750 nA	100 nA
	± 10 mA	0.075% + 7.5 µA	1 µA
	± 120 mA	0.1% + 100 µA	20 µA

[1] Accuracy measurements are based on NPLC 10.

## Performance characteristics

Rise/fall time (ms) <sup>[1]</sup>		
<b>U2723A USB Modular Source Measure Unit</b> For resistive measurement <sup>[2]</sup>	± 1 µA	15.0
	± 10 µA	5.0
	± 100 µA	1.0
	± 1 mA	1.0
	± 10 mA	1.0
	± 120 mA	1.0
<b>U2722A USB Modular Source Measure Unit</b> For resistive measurement <sup>[2]</sup>	± 1 µA	170.0
	± 10 µA	18.0
	± 100 µA	6.0
	± 1 mA	1.0
	± 10 mA	1.0
	± 120 mA	1.0

[1] Drive 50% of 1 V or 10 V output with a resistive load. Rise time is from 10% to 90% of program voltage change at maximum current. Fall time is from 90% to 10% of program voltage change at maximum current.

[2] Measurements obtained are per default bandwidth setting.

## Noise 10 Hz to 20 MHz (Peak-peak)

Voltage range	Current range					
	1 µA	10 µA	100 µA	1 mA	10 mA	120 mA
2 V	50 mV	50 mV	50 mV	50 mV	30 mV	30 mV
20 V	50 mV	50 mV	50 mV	50 mV	30 mV	30 mV

### 3 Characteristics and Specifications

<b>Remote sense operating range</b>	Ensure that the maximum voltage between the OUTPUT+ and SENSE+, OUTPUT– and SENSE– does not exceed 3 V.
<b>Temperature coefficient</b>	Maximum change in output/readback per °C after a 30-minute warm-up is 0.15.
<b>Guard output resistance</b>	0.2 kΩ
<b>Output voltage overshoot, ±(% of output + offset)<sup>[1]</sup></b>	During turn-on or turn-off, the output plus overshoot <0.1% + 10 mV.
<b>Maximum sense lead resistance</b>	1 MΩ for rated accuracy
<b>Voltage line regulation</b>	0.01% of range
<b>Voltage load regulation</b>	0.01% + 100 μV
<b>Current line regulation</b>	0.04% of range
<b>Current load regulation</b>	0.04% + 100 μA
<b>Programming language</b>	Standard Commands for Programmable Instruments (SCPI)
<b>Recommended calibration interval</b>	One year

[1] Measurements obtained are per default bandwidth setting.

#### NOTE

- All channels are isolated from the ground and from each other. Isolation is +60 VDC, Category I.
- Three hours warm-up time recommended.
- The measurement accuracy value is  $x(1 + a \times y)$  where,
  - $x$  = accuracy specification at room temperature<sup>[1]</sup>,
  - $a$  = temperature coefficient, and
  - $y$  = temperature change for U2722A USB Modular Source Measure Unit: 22 °C to 0 °C, 28 °C to 50 °C  
temperature change for U2723A USB Modular Source Measure Unit: 18 °C to 0 °C, 28 °C to 50 °C

[1] Typical room temperature is measured at 23 °C.



## Appendixes

Appendix A: List of Self-Test Return Codes 58

Appendix B: Time-out Settings 60



## Appendix A: List of Self-Test Return Codes

The following table contains the list of codes you will obtain when performing self-test. The interpretation for each code is also provided.

**Table 4-1** List of system-related return codes

Return code	Code description		
	Channel 1	Channel 2	Channel 3
+0	Pass	Pass	Pass
+1	Fail Source V/I	Pass	Pass
+2	Fail Source Limit V/I	Pass	Pass
+16	Pass	Fail Source V/I	Pass
+17	Fail Source V/I	Fail Source V/I	Pass
+18	Fail Source Limit V/I	Fail Source V/I	Pass
+32	Pass	Fail Source Limit V/I	Pass
+33	Fail Source V/I	Fail Source Limit V/I	Pass
+34	Fail Source Limit V/I	Fail Source Limit V/I	Pass
+256	Pass	Pass	Fail Source V/I
+257	Fail Source V/I	Pass	Fail Source V/I
+258	Fail Source Limit V/I	Pass	Fail Source V/I
+272	Pass	Fail Source V/I	Fail Source V/I
+273	Fail Source V/I	Fail Source V/I	Fail Source V/I
+274	Fail Source Limit V/I	Fail Source V/I	Fail Source V/I
+288	Pass	Fail Source Limit V/I	Fail Source V/I
+289	Fail Source V/I	Fail Source Limit V/I	Fail Source V/I
+290	Fail Source Limit V/I	Fail Source Limit V/I	Fail Source V/I
+512	Pass	Pass	Fail Source Limit V/I
+513	Fail Source V/I	Pass	Fail Source Limit V/I
+514	Fail Source Limit V/I	Pass	Fail Source Limit V/I
+528	Pass	Fail Source V/I	Fail Source Limit V/I
+529	Fail Source V/I	Fail Source V/I	Fail Source Limit V/I

**Table 4-1** List of system-related return codes (continued)

Return code	Code description		
	Channel 1	Channel 2	Channel 3
+530	Fail Source Limit V/I	Fail Source	Fail Source Limit V/I
+544	Pass	Fail Source Limit V/I	Fail Source Limit V/I
+545	Fail Source	Fail Source Limit V/I	Fail Source Limit V/I
+546	Fail Source Limit V/I	Fail Source Limit V/I	Fail Source Limit V/I

## Appendix B: Time-out Settings

The following procedure provides the instructions on how to set the time-out value in the Agilent IO Libraries.

- 1 To launch your Agilent Connection Expert, go to **Start > All Programs > Agilent IO Libraries Suite > Agilent Connection Expert**.
- 2 On the **Instrument I/O on this PC** panel, select your device in the USB expanded list and right-click.
- 3 Select **Send Commands To This Instrument** and the **Agilent Interactive IO** window will appear.
- 4 Go to **Interactive IO > Options** and the **Options** dialog box will appear.
- 5 Configure the time-out value based on the table provided below.

**Table 4-2** Time-out settings

Points	Tint (ms)	Time-out range (ms)
1 to 10	1 to 100	Std IO 5000
	101 to 32767	Assign 110% of t
11 of 50	1 to 50	Std IO 5000
	51 to 32767	Assign 120% of t
51 to 100	1 to 10	Std IO 5000
	11 to 32767	Assign 120% of t
101 to 500	1 to 5	Std IO 5000
	6 to 500	Assign 130% of t
	501 to 32767	Assign 110% of t
501 to 1000	1 to 500	Assign 310% of t
	501 to 32767	Assign 120% of t
1001 to 4096	1 to 500	Assign 310% of t
	501 to 32767	Assign 110% of t

### NOTE

- *Expected time,  $t = \text{Points} \times \text{Tint}$*
- The *Points* is set using the `SENSE:SWEep:POINTs` command and the *Tint* is set using the `SENSE:SWEep:TINTerval` command.



# Index

## A

- AC/DC power adapter
  - output voltage, 17
  - requirements, 17
- Agilent
  - Automation-Ready CD-ROM, 9, 13, 14
  - Connection Expert, 21
  - Interactive IO, 22
  - IO Control, about, 14, 23
  - IO Libraries Suite, 9, 13, 14, 21, 23
  - T&M Toolkit Redistributable Package, 13
  - T&M Toolkit Runtime, 13, 16
  - U27722A USB Modular SMU, 2, 10, 15
  - U2781A USB Modular Instrument
    - Chassis, 26
- Agilent Measurement Manager,
  - installation, 16
  - launching, 23, 23
  - operations, making measurements, 44, 44, 45, 46
  - operations, self calibration, 47
  - operations, self test, 47
- Agilent Modular Products Installation Menu
  - Hardware Driver, 15
  - Measurement Manager, 16
- ammeter, 31
- aperture time. *See time, aperture*

## B

- browser, 13

## C

- \*CAL, 48
- \*CLS, 39, 48
- calibration, self, 47

- channel control, SCPI 39, 39
- configuration
  - connector pins, 26
  - instrument 25, 26
- current operation, source
  - input protection voltage settings, 36, 37
  - positive operating quadrant, 37
  - source current settings, 36, 36, 37, 37, 38
- controlling measurement samples
  - data sampling rate, 45
  - SENS:SWE:POIN, 45
  - SENS:SWE:TINT, 45
- current
  - high resolution setting, 2
  - limit load line, 37
  - maximum output, 2
  - programming accuracy, 53
  - programming resolution, 53
  - readback accuracy, 53
  - readback resolution, 53

## D

- data sampling rate, 45
- DUT, 35, 38, 41, 42

## E

- electrical check, 10
- EMC compliance, 52
- error conditions, 48

## F

- firmware, 20, 21
- flowchart, 12

## G

- guard, 25, 41, 42, 43

## H

- high resolution current setting. *See current*

## I

- I/O connector, 52
- inspection, initial, 10
- installation,
  - Agilent Measurement Manager, 16
  - chassis, 29
  - IO Control. *See IO Libraries Suite*
  - IO Libraries Suite, 14
  - Module Driver, 15

## L

- latency time. *See time, latency*
- LED indicator, 30
- L-Mount kit, 9, 29
- local sensing, 41

## M

- maintenance, general, 11
- MEAS:CURR?, 40, 44, 44
- MEAS:VOLT?, 39, 44, 44
- measurement capability, 2
- Measurement Manager InstallShield Wizard, 16
- measurement manager. *See Agilent Measurement Manager*

## Index

- measurements
  - current, 42, 44
  - controlling samples, 45, 46
  - making, 44
  - voltage, 44
- memory list
  - commands, 52
  - commands execution, 54
  - commands execution state, 58
  - configuration, 51
  - delay setup, 53
- Microsoft®
  - .NET Framework, 13, 16
  - Internet Explorer. *See browser*
- module driver
  - installation, 15
  - connecting, 17, 17, 18
  - verifying, 21, 21
- N**
- nBPUB, 26
- NC, 26
- O**
- operating environment
  - altitude, 52
  - humidity, 52
  - pollution degree, 52
  - temperature, 52
- operating system, 13
- OUTP ON, (@1), 39
- output
  - button, 33
  - channel, 32
  - connectors, 25, 36, 52
  - current, 33, 36, 50
  - number, 53
  - terminals, 32, 36, 47, 47
  - voltage, 17, 33, 41, 44, 45, 49
- output power, extending
  - series connection, 49
  - parallel connection, 50
- output voltage overshoot, 56
- P**
- parallel connection. *See output power*
- positive operating quadrant, 34, 37
- power adapter. *See AC/DC power adapter*
- power consumption, 52
- power up, U2722A/U2723A, 30
- prerequisites, 13, 16
- processor, 13
- product
  - characteristics, 52
  - dimensions, with bumper, 8
  - dimensions, without bumper, 7
  - outlook, front view, 5
  - outlook, top view, 4
  - specifications, 53, 54
- programming language. *See SCPI commands*
- purchase items, standard, 9
- R**
- \*RST, 39, 48
- real time display, 33, 36
- recommended calibration interval, 56
- relative humidity, 52
- remote interface, 52
- remote sensing, 41, 41
  - operating range, 56
- return code, 58
- rise/fall time, 55
- S**
- safety compliance, 52
- SCPI commands
  - channel control, 39, 39
  - system-related tasks, 48
- SENSe:CURRent[:DC]:NPLCycles <integer>, (@1 | 2 | 3), 44
- SENS:SWE:POIN, 45
- SENS:SWE:TINT, 45
- SENSe:VOLTage[:DC]:NPLCycles <integer>, (@1 | 2 | 3), 44
- series connection. *See output power*
- shock and vibration, 52
- source
  - current settings. *See current operation, source*
  - voltage settings. *See voltage operation, source*
- Standard Commands for Programmable Instruments. *See SCPI commands*
- star trigger. *See STAR\_TRIG*
- STAR\_TRIG, 26
- storage compliance, 52
- SYST:ERR?, 48
- SYST:LFREQ <F50HZ | F60HZ>, 44
- T**
- temperature
  - coefficient, 56
  - range. *See operating environment*
- test, self, 47
- time
  - aperture, 44
  - latency, 44
  - total, 45
- U**
- U2722A/U2723A Installation Menu. *See Agilent Modular Products Installation Menu*
- V**
- ventilation, 10
- voltage
  - programming accuracy, 53
  - programming resolution, 53
  - readback accuracy, 53
  - readback resolution, 53
- voltage operation, source
  - input protection current settings, 33, 34
  - positive operating quadrant, 34
  - source voltage settings, 32, 32, 33, 34, 34
- voltmeter, 31

## W

Windows®

2000 Professional. *See operating system*

Home Edition. *See operating system*

Vista™. *See operating system*

XP Professional. *See operating system*

**www.agilent.com**

**Contact us**

To obtain service, warranty or technical assistance, contact us at the following phone or fax numbers:

United States:

(tel) 800 829 4444 (fax) 800 829 4433

Canada:

(tel) 877 894 4414 (fax) 800 746 4866

China:

(tel) 800 810 0189 (fax) 800 820 2816

Europe:

(tel) 31 20 547 2111

Japan:

(tel) (81) 426 56 7832 (fax) (81) 426 56 7840

Korea:

(tel) (080) 769 0800 (fax) (080) 769 0900

Latin America:

(tel) (305) 269 7500

Taiwan:

(tel) 0800 047 866 (fax) 0800 286 331

Other Asia Pacific Countries:

(tel) (65) 6375 8100 (fax) (65) 6755 0042

Or visit Agilent World Wide Web at:

[www.agilent.com/find/assist](http://www.agilent.com/find/assist)

Product specifications and descriptions in this document are subject to change without notice. Always refer to Agilent Web site for the latest revision.

© Agilent Technologies, Inc., 2009

Second Edition, May 15, 2009  
U2722-90011



**Agilent Technologies**