



New Items 2020 / 2021



WWW.BGSTechnic.com

QUICKFINDER SINGLE SIZES

Sockets
Bit Sockets
Bits
Adaptors / Extensions / T-Bars / Flexible Handles
Spanners



QF1-5
QF6-8
QF9
QF10
QF11-13

HAND TOOLS**1**

Workshop Trolleys & Accessories	1-8
Socket Sets & Tool Assortments	9
Sockets	10-15
Bit Sockets & Bits	16-19
Ratchets, Extensions, Adaptors & Accessories	20-23
Torque Tools	24-28
Hand Tools	29-58
Pneumatic Tools	59-61
Electric / Cordless Battery Tools	62-63

AUTOMOTIVE TOOLS**64**

Speciality Tools Motorbike	64
Speciality Tools SUV and Trucks	65-66
Speciality Tools Car	67-124
Workshop Equipment	125-151

MISCELLANEOUS TOOLS & SMALL PARTS**152**

Industrial Safety	152
Industrial Chemicals	152
House & Garden	152
Sales Aids	153-155

NOVELTIES AFTER EDITORIAL DEADLINE**156-169**

Alphabetical Index	170-172
Numerical Index	173-176

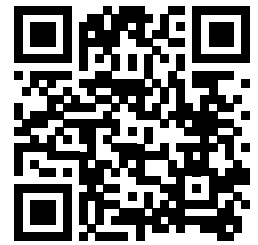

Head Office

BGS technic's headquarter is located in Wermelskirchen, next to the A1 highway exit. Modern offices, large-scale storage capacity, spacious show rooms and a fully equipped repair shop cover an area of 15,000 m².

Supported by modern electronic data processing equipment, we are ready for future expansion and look forward to working with you.



Warehouse

Sophisticated planning and a steady flow of goods management enable us to handle large amounts of merchandise. Cutting-edge process optimization, extensive storage facilities with modern highrise racks allow perfect order processing and a 24 hour delivery service.



BGS technic® Sales Stands

BGS offers sales stands perfectly adapted to your customer's needs, including all necessary accessories. Contact us for further information regarding the available stands and ask us for individually planned sales stands.

BGS technic® - a brand for perfect tools!

Since the early 1970, the BGS technic brand is a symbol of fine quality tools and constant innovation every year, in over 100 countries worldwide. The BGS technic brand stands for high quality, long lasting hand tools and air tools for daily workshop use.

Our overall aim is to offer fast service, a comprehensive product range and product innovations at the very best value for money for the benefit of our customers. More than 7000 quality tools are supplied directly from our modern distribution center, and come in an appealing and self explanatory sales packaging in German and English language.



Sockets Hexagon Pro Torque®

mm	6.3mm □ 1/4"		10mm □ 3/8"		12.5mm □ 1/2"		20mm □ 3/4"	25mm □ 1"
	short	deep	short	deep	short	deep	short	short
3,5	2473							
4	2474	10504						
4,5	2475							
5	2476	10505						
5,5	2477	10503						
6	2478	10506						
7	2479	10507						
8	2480	10508		10528	2908	9355		
9	2481	10509			2909			
10	2482	10510	10610	10530	2910	10550		
11	2483	10511	10611	10531	2911	10551		
12	2484	10512	10612	10532	2912	10552		
13	2485	10513	10613	10533	2913	10553		
14	2486	10514	10614	10534	2914	10554		
15			10615	10535	2915	10555		
16			10616	10536	2916	10556		
17			10617	10537	2917	10557		
18			10618	10538	2918	10558		
19			10619	10539	2919	10559	3419	
20					2920	10560		
21					2921	10561	3421	
22					2922	10562	3422	
23							3423	
24					2924	10564	3424	
26					2926	10566	3426	
27			10627		2927	10567	3427	
28					2928	10568		
30					2930	10570	3430	
32					2932	10572	3432	
33							3433	
34					2934		3434	
35					2935		3435	
36					2936		3436	3736
38					9845	9846	3438	
41					2941		3441	3741
42							3442	
44							3444	
46					2946-1		3446	3746
48							3448	
50							3450	3750
55							3455	3755
60							1207-60	3760
65								3765
70								3770
75								3775
80								3780



Quick-Finder

Sockets

Quick-Finder

Sockets Hexagon Pro Torque® | Inch sizes

Inch	6.3mm □ 1/4"		12.5mm □ 1/2"
	short	deep	short
5/32"	10650		
3/16"	10651		
7/32"	10652		
1/4"	10653	10670	
9/32"	10654		
5/16"	10655	10671	
11/32"	10656		
3/8"	10657	10672	2770
7/16"	10658	10673	2771
1/2"	10659	10674	2772
9/16"			2773
5/8"			2774
11/16"			2775
3/4"			2776
13/16"			2777
7/8"			2778
15/16"			2779

Inch	12.5mm □ 1/2"
	short
1"	2787
1.1/16"	2784
1.1/8"	2788
1.1/4"	2786



QF1

Sockets 12-point

mm	6.3mm \square 1/4"		12.5mm \square 1/2"		20mm \square 3/4"	
	short	deep	short	deep	short	
4	10774	10702				
4,5	10773					
5	10775	10704				
5,5	10772	10705				
6	10776	10706				
7	10777	10707				
8	10778	10708	10628	9356		
9	10779	10709	10629			
10	10780	10710	10630	10680		
11	10781	10711	10631	9357		
12	10782	10712	10632	10662		
13	10783	10713	10633	10681		
14	10784		10634	10664		
15			10635	10682		
16			10636	10683		
17			10637	10684		
18			10638	10685		
19			10639	10686	7419	
20			10640	9359		
21			10641	9360	7421	
22			10642	10687	7422	
23			10643			
24			10644	10688	7424	
26			10626	10663		
27			10645	9363	7427	
28			10625	10689		
30			10646		7430	
32			10647		7432	
34			10648		7434	
36			10649		7436	
38					7438	
41			10650-1		7441	
46			10651-1		7446	
50					7450	
55					7455	
60					7459	
65					7465	
70					7466	



Sockets 12-point | Inch sizes

mm	short
5/32"	10870
3/16"	10871
7/32"	10872
1/4"	10873
9/32"	10874
5/16"	10875
11/32"	10876
3/8"	10877
7/16"	10878
15/32"	10879
1/2"	10880
9/16"	10881



Sockets Super Lock

mm	6.3m □ 1/4"		10m □ 3/8"		12.5m □ 1/2"	
	short	deep	short	deep	short	deep
4	2344	2964				
4,5	2339					
5	2345	2965				
5,5	2343					
6	2346	2966	2366			
7	2347	2967	2367			
8	2348	2968	2368	2610	2408	10268
9	2349	2969	2369	2611	2409	
10	2350	2970	2370	2600	2410	10270
11	2351	2971	2371	2601	2411	10271
12	2352	2972	2372	2602	2412	10272
13	2353	2973	2373	2603	2413	2943
14	2354	2974	2374	2604	2414	2944
15			2375	2605	2415	2945
16			2376	2606	2416	2946
17			2377	2607	2417	2947
18			2378	2608	2418	2948
19			2379	2609	2419	2949
20			2380		2420	9358
21			2381		2421	2951
22			2382		2422	2952
23					2423	
24			2384		2424	9361
27					2427	9362
28					2428	2956
30					2430	
32					2432	



Quick-Finder

Sockets

Quick-Finder

Sockets Gear Lock

mm	6.3m □ 1/4"		10m □ 3/8"		12.5m □ 1/2"	
	short	deep	short	deep	short	deep
4	10104	10154				
4,5	10101					
5	10105	10155				
5,5	10102					
6	10106	10156				
7	10107	10157				
8	10108	10158			10208	
9	10109	10159			10209	
10	10110	10160	10310	10350	10210	
11	10111	10161	10311	10351	10211	
12	10112	10162	10312	10352	10212	
13	10113	10163	10313	10353	10213	
14	10114		10314	10354	10214	10254
15			10315	10355	10215	10255
16			10316		10216	10256
17			10317		10217	10257
18			10318		10218	10258
19			10319		10219	10259
20					10220	
21					10221	
22					10222	
24					10224	
27					10227	
30					10230	
32					10232	



Sockets E-Type

mm	6.3mm $\square \frac{1}{4}"$	10mm $\square \frac{3}{8}"$	12.5mm $\square \frac{1}{2}"$	
	short	short	short	deep
E4	6404	2710		
E5	6405	2711		
E6	6406	2712		
E7	6407	2713		
E8	6408	2714		
E10	6430	6410	6460	6440
E11	6431	6411	6461	
E12		6412	6462	6442
E14		6414	6464	6444
E16		6416	6466	6446
E18		6417	6418	6448
E20		2715	6420	6450
E22			6422	
E24			6424	



Impact Sockets Pro Torque®, hexagon

mm	12.5mm $\square \frac{1}{2}"$		20mm $\square \frac{3}{4}"$		25mm $\square 1"$	
	short	deep	short	deep	short	deep
8	5205-8	7248				
10	5210	7210				
11	5211	7211				
12	5212	7212				
13	5213	7213				
14	5214	7214				
15	5215	7215				
16	5216	7216				
17	5217	7217	5617	5717		5500-17
18	5218	7218	5618	5718		
19	5219	7219	5619	5719		5500-19
21	5221	7221	5621	5721		5500-21
22	5222	7222	5622	5722		5500-22
24	5224	7224	5624	5724		5500-24
26			5626	5726		
27	5227	7227	5627	5727	5827	5500-27
30	5230	7230	5630	5730	5830	5500-30
32	5232	7232	5632	5732	5832	5500-32
33	5205-33		5633	5733	5833	5500-33
34	5205-34		5634	5734	5834	5500-34
35			5635		5835	
36	5205-36	7236	5636	5736	5836	5500-36
38	5205-38		5638	5738	5838	5500-38
39					5839	
40			5640			
41	5233		5641	5741	5841	5500-41
46			5646	5746	5846	5500-46
48			5648			
50			5650	5750	5850	5500-50
52	70012					
55			5655	5755	5855	5500-55
56					5856	
60			5660	5760	5860	5500-60
65					5865	5500-65
70					5870	5500-70
75					5875	5500-75
80					5880	5500-80
85					5885	5500-85
90					5890	5500-90
95					5895	5500-95
100						5500-100
105					5905	5500-105
110					5910	5500-110
115					5915	5500-115
120					5920	



Impact Sockets 12-point

mm	12.5mm 1/2"		20mm 3/4"	
	deep	deep	deep	deep
17				5345
19				5346
21	5353			
24	5343			
27	5336			
28	5352			
30	5337			
32	5338			
33	5339			
34	5340			
35	5341			
36	5342			
38	5344			
39	5351			
46	5234			



Impact Sockets E-Type

mm	12.5mm 1/2"		20mm 3/4"	
	short	deep	deep	deep
E4				
E5				
E6				
E7				
E8				
E10	9779-10	5204-10		
E11		5204-11		
E12	9779-12	5204-12		
E14	9779-14	5204-14		
E16	9779-16	5204-16		
E18	9779-18	5204-18	5347	
E20	9779-20	5204-20	5348	
E22	9779-22	5204-22		
E24	9779-24	5204-24	5349	
E26			5250-E26	
E28			5250-E28	
E30			5250-E30	
E32			5250-E32	



Special Socket / Screw Extractor

mm	10mm 3/8"		12.5mm 1/2"		20mm 3/4"	
	short	short	deep	short	short	short
8		5269-8				
10	5270	5266-10				
11	5271	5266-11				
12	5272	5266-12				
13	5273	5266-13				
14	5274	5266-14				
15	5275	5266-15				
16	5276	5266-16				
17	5277	5266-17	5264-17			
18	5278					
19	5279	5266-19	5264-19			
21		5269-21	5264-21			
22		5268-22	5264-22			
24		5268-24				
27		5268-27				
32		5268-32				
36					5268-36	
41					5268-41	











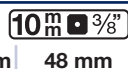

Quick-Finder

Special Socket / Screw Extractor

Quick-Finder

Bit Sockets

	 CV	 CV-S2	 6.3mm \square 1/4"	 10mm \square 3/8"	 12.5mm \square 1/2"	 20mm \square 3/4"							
	25 mm	38 mm	300 mm	48 mm	55 mm	70 mm	100 mm	140 mm	160 mm	200 mm	240 mm	800 mm	85 mm
Inch 	3/32"		2740										
	1/8"		2741		2720								
	5/32"		2742		2721								
	3/16"		2743		2722								
	7/32"		2744		2723	2732							
	1/4"		2745		2725	2733							
	9/32"		2746		2730	2734							
	5/16"		2747		2727	2735							
	3/8"		2748		2729	2736							
	15/32"					2737							
	9/16"						2738						
	5/8"						2751						
	11/16"						2752						
	13/16"						2753						
	3/4"						2754						
	Metric 	1,5 mm		5152									
2 mm			5153										
2,5 mm			5154										
3 mm			2497		2576								
3,5 mm			5155										
4 mm			2498		2577	4250		4259					
5 mm			2499		2578	4251		4260	4270		4275	4215	
5,5 mm			9466			9467							
6 mm			2500		2579	4252		4261	4271		4276	4216	
7 mm			2501		2580	4253		4262	4217		4277	5184-H7	
8 mm			2502		2581	4254		4263	4272		4278	4218	
9 mm					2583	4340		4268					
10 mm				2161-10		2582	4255		4264	5184-H10		4279	
11 mm									4266	5184-H11			
12 mm				2161-12		2584	4256		4265	4273		4280	
13 mm									4267	5184-H13			
14 mm						4257	5052-14	4296	4274			5189-H14	
16 mm							5052-16						
17 mm						5184-H17	5052-17					5189-H17	
18 mm							5052-18						
19 mm						5184-H19	5052-19					5189-H19	
22 mm						5184-H22	4295					5189-H22	
24 mm						5184-H24							
Internal hexagon with ball head 	3 mm				5110								
	4 mm			9833	5111								
	5 mm				5112				4258-5	5184-HB5			
	5,5 mm				5113								
	6 mm				5114				4258-6				
	7 mm								4258-7				
	8 mm					5115			4258-8				
10 mm								4258-10					
12 mm								4258-12					
Spline (for XZN) 	M4		5105-M4										
	M5		5105-M5			4350		4359	4330		9350		
	M6		5105-M6			4351		4360	4331		9351		
	M7					4355			4432				
	M8		2503		5105-M8	4352		4361	4332		4334	4227	
	M9					4349		5184-M9	4333		9352		
	M10		2506			4353		4362	5184-M10		4335	4228	
	M12		2507		2587	4354		4363	5184-M12		4336	4229	
	M14					4344		4364	5184-M14		4337	4233	
	M16					4346							
Spline Tamperproof (for XZN) 	M16					5180-M17							
	M17					4347							
TS-Star Tamper-proof (for Torx) 	M18					4356			4357				
	M18							4365					
	TS 10		5184-TS10										
	TS 15	2355-TS15	5184-TS15										
	TS 20	2355-TS20	5184-TS20										
	TS 25	2355-TS25	5184-TS25										
	TS 27	2355-TS27	5184-TS27										
	TS 30	2355-TS30	5184-TS30										
	TS 40	2355-TS40	5184-TS40										
	TS 45		5184-TS45										
TS 50	2355-TS50	5184-TS50											

QF Quick-Finder

Bit Sockets

QF Quick-Finder

Bit Sockets

	CV	CV-S2	6.3 ^m 1/4"	10 ^m 3/8"	12.5 ^m 1/2"	20 ^m 3/4"	110 mm									
	38 mm	75 mm	100 mm	400 mm	48 mm	100 mm	55 mm	100 mm	120 mm	140 mm	200 mm	240 mm	300 mm	80 mm		
Plain Slot	4,0 mm	2493														
	5,5 mm	2494														
	6,5 mm	2495														
	7,0 mm	2496														
	PH#0	2504														
PH	PH#1	2487														
	PH#2	2488														
	PH#3	2489														
	PZ#0	2505														
PZ	PZ#1	2490														
	PZ#2	2491														
	PZ#3	2492														
	T7	2557														
T8	2589															
T9	2588															
T10	2590															
T15	2591															
T20	2592															
T25	2593															
T27	2594															
T30	2595															
T35	2565	2565-75														
T40	2596															
T45	2164-T45															
T50	2164-T50															
T55																
T60																
T70																
T80																
T90																
T100																
T8	2356															
T9	2364															
T10	2357															
T15	2358															
T20	2359															
T25	2360															
T27	2361															
T30	2362															
T40	2363															
T45	2165-T45															
T50	2165-T50															
T55																
T60																
T70																
T80																
T90																
T100																
M5																
M6																
M7																
M8																
M9																
M10.3																
M10																
M12																
M13																
M14																











Bit Sockets















Bit Socket | T-Star for VAG polyDrive cylinder head bolts

CV		12.5^m 1/2"	168 mm	
	polyDrive	T52	9386	

Impact Bit Sockets

			12.5^m 1/2"			20^m 3/4"	CV	CRO MO	
 T-Star (for Torx)	42 mm	55 mm	75 mm	100 mm	140 mm	55 mm			
	T20	5486-T20	5369	5480-T20	5469				
	T25	5486-T25	5370	5480-T25	5470				
	T27	5486-T27	5367		5467				
	T30	5486-T30	5371	5480-T30					
	T40	5486-T40	5372	5480-T40					
	T45	5486-T45	5373	5480-T45			5545		
	T47		5378						
	T50	5486-T50	5374	5480-T50	5474		5550		
	T55	5486-T55	5375	5480-T55	5475		5555		
	T60	5486-T60		5480-T60			5560		
T65						5565			
T70	5486-T70		5480-T70			5570			
T80	5486-T80		5480-T80			5580			
T90						5590			
T100						5600			
 Internal hexagon	5 mm		5481-M5						
	6 mm	5485-6		5481-M6	4286				
	7 mm	5485-7		5481-M7					
	8 mm	5485-8		5481-M8					
	9 mm	5485-9							
	10 mm	5485-10		5481-M10					
	11 mm	5485-11							
	12 mm	5485-12		5481-M12			5054-12		
	13 mm	5485-13							
	14 mm	5485-14		5481-M14			5054-14		
	17 mm	5334-H17		5481-M17			5054-17		
19 mm			5481-M19			5054-19			
21 mm						5054-21			
22 mm						5054-22			
23 mm						5054-23			
24 mm						5054-24			
 Spline (for XZN)	M 4	5487-M4		5482-M4					
	M 5	5487-M5		5482-M5					
	M 6	5487-M6		5482-M6					
	M 8	5487-M8		5482-M8	4358				
	M 9			5482-M9					
	M 10	5487-M10		5482-M10	4462				
	M 12	5381-M12		5482-M12		4463			
	M 14	5381-M14		5482-M14					
	M 16	5381-M16		5482-M16			5054-M16		
	M 18	5381-M18		5184-M18			5054-M18		
M 24						5054-M24			
 Ribe (for Ribe)	M 5			5483-M5					
	M 6			5483-M6					
	M 7			5483-M7					
	M 8			5483-M8					
	M 9			5483-M9					
	M 10			5483-M10					
	M 12			5483-M12					
M 13			5483-M13						
M 14			5483-M14						

Bits

	6.3 _m  1/4"		8 _m  5/16"		10 _m  3/8"		14 _m 	
	25 mm	50 mm	30 mm	30 mm	75 mm	100 mm	75 mm	
 T-Star (for Torx)	T7	8217						
	T8	8208						
	T9	8209						
	T10	8190		8160	4866	4566		
	T15	8191	4590	8161	4868	4568		
	T20	8192	4591	8167	4869	4569		
	T25	8193	4592	8162	4870	4570		
	T27	8194		8169	4867	4567		
	T30	8195	4593	8163	4871	4571		
	T35	4735						
	T40	8196		8164	4872	4572		
	T45	8197		8165	4873	4573		
	T50			8166	4874	4574		
	T55			8168	4875	4575		
T60			4456	4876	4598		4576	
T70			4457				4581	
 T-Star Tamperproof (for Torx)	T7	2436						
	T8	2437						
	T9	2438						
	T10	2439		4410	4610	4710		
	T15	2440		4415	4615			
	T20	2441		4420	4620			
	T25	2442		4425	4625			
	T27	2443		4427	4627	4727		
	T30	2444		4430	4630			
	T35	4736						
	T40	2445		4440	4640			
	T45			4445	4645			
	T50			4450	4650			
	T55			4455	4655			
T60			4460	4660				
T70			4458	4670				
 PH	PH # 1	8185						
	PH # 2	8186			4601			
	PH # 3	8187		4383	4602			
	PH # 4	8188		4384				
 PZ	PZ # 1	8170	4596					
	PZ # 2	8172	4595					
	PZ # 3	8173	4597	4385				
	PZ # 4	8174		4386				
 Plain Slot	4,5 mm	8198						
	5,5 mm	8199						
	7 mm	8189						
	8 mm	8183		4380	4599			
	10 mm			4381	4600			
12 mm			4382					
 Internal Hexagon	3 mm	8176						
	4 mm	8177			4950	4959		
	5 mm	8178			4951	4960		
	6 mm	8179			4952	4961		
	7 mm	8182		4387	4953	4962		
	8 mm	8180		4388	4954	4963		
	10 mm	8181		4389	4955	4964		
	12 mm			4390	4956	4965		
14 mm			4391	4957	4966			
 Spline (for XZN)	M5			4850	4859			
	M6			4851	4860			
	M8			4852	4861			
	M10			4853	4862			
	M12			4854	4863			
M14				4864				
 Spline (for Ribe)	M5			4760		4770		
	M6			4761		4771		
	M7			4762		4772		
	M8			4763		4773		
	M9			4764		4774		
	M10			4765		4775		
	M10,3					4776		
	M11			4766		4777		
	M12			4767		4778		
	M13			4768		4779		
	M14					4780		



Quick-Finder

Bits

Quick-Finder

QF9

Socket Adaptor

External	Internal					
	6.3m □ 1/4"	10m □ 3/8"	12.5m □ 1/2"	20m □ 3/4"	25m □ 1"	38m □ 1 1/2"
6.3m □ 1/4"		269				
Impact		171	9778			
10m □ 3/8"	271		270			
Impact	172		173			
12.5m □ 1/2"		280		274		
Impact		174		275		
20m □ 3/4"			272			
Impact			279		196	
25m □ 1"				195		7468



Extension Bars

	6.3m □ 1/4"		10m □ 3/8"		12.5m □ 1/2"		20m □ 3/4"		25m □ 1"	
	Wobble		Wobble		Wobble		Impact		Impact	
50 mm	2336	2232	296		233					
75 mm			294	242	236		192			
100 mm	2335	2231						264	5651	
125 mm				246	3120	234	193			
150 mm	2338	2220	295	243						
200 mm	9842	9844						266	5652	372
250 mm		2219		244	3121	235	194			
300 mm	2210									
375 mm					248					
380 mm	2314									
400 mm								268		374
450 mm	2319			247	3138					
500 mm	2211					249				
600 mm					3139					
610 mm			3132		3134					
750 mm					2121					



Sliding T-Bars

	6.3m □ 1/4"	10m □ 3/8"	12.5m □ 1/2"	20m □ 3/4"	25m □ 1"
115 mm	276				
200 mm		277			
250 mm			273		
450 mm				263	
500 mm					
560 mm					375

Sliding T-Bars

	10m □ 3/8"	12.5m □ 1/2"	20m □ 3/4"	25m □ 1"
250 mm	Repair Set	265	265-Repair	Repair Set
450 mm	9880	9880-REP	6851	Repair Set
610 mm		267	267-Repair	Repair Set
630 mm				283
1020 mm				283-1
				376
				377

Spanners | Combination Spanners

Metric	       						
	hot forged, Type A, ring end 15° offset	cold forged, Type A, ring end 15° offset	satin finish, Type A, ring end 15° offset	extra deep, mirror polished, Type A, ring end 15° offset	cold forged, Type B, deep offset	extra short, stubby Type	hot forged opening end 15° cranked burnished
4 mm		30554					
4,5 mm		30553					
5 mm		30552					
5,5 mm		30555					
6 mm	1056	30556	30506	1228-6	30106		34206
7 mm	1057	30557	30507	1228-7	30107		34207
8 mm	1058	30558	30508	1228-8	30108		34208
9 mm	1059	30559	30509	1228-9	30109		34209
10 mm	1060	30560	30510	1228-10	30110	30761	34210
11 mm	1061	30561	30511	1228-11	30111	30760	34211
12 mm	1062	30562	30512	1228-12	30112	30762	34212
13 mm	1063	30563	30513	1228-13	30113	30763	34213
14 mm	1064	30564	30514	1228-14	30114	30764	34214
15 mm	1065	30565	30515	1228-15	30115	30775	34215
16 mm	1066	30566	30516	1228-16	30116	30776	34216
17 mm	1067	30567	30517	1228-17	30117	30765	34217
18 mm	1068	30568	30518	1228-18	30118	30778	34218
19 mm	1069	30569	30519	1228-19	30119	30779	34219
20 mm	1070	30570	30520		30120		
21 mm	1071	30571	30521	1229-21	30121		34221
22 mm	1072	30572	30522	1229-22	30122		34222
23 mm		30573	30523		30123		34223
24 mm	1074	30574	30524	1229-24	30124		34224
25 mm	1075		30525		30125		34225
26 mm	1076		30526		30126		
27 mm	1077	30577	30527	1229-27	30127		34227
28 mm			30528		30128		
29 mm					30129		
30 mm	1080	30578	30530	1229-30	30130		34230
32 mm	1082	30579	30532	1229-32	30132		34232
34 mm		1084			30134		34234
36 mm		1086			30136		34236
38 mm		1088					34238
41 mm		1091			30141		34241
46 mm		1096			30146		34246
50 mm							34250
55 mm					30155		34255
60 mm		1100			30160		34260
65 mm							34265
70 mm							34270
75 mm							34275
80 mm							34280
85 mm							34285
90 mm							34290
95 mm							34295



 Spanners





Hot Forging

Traditional hot forging at temperatures of up to 1200° C. Perfect formability and stability.



Cold Forging

A high quality steel mixture is formed “cold” without heating the steel externally. This allows an even higher quality and very little dimension tolerances.

Spanners | Double Ring Spanner

QF Quick-Finder

Spanners

QF Quick-Finder

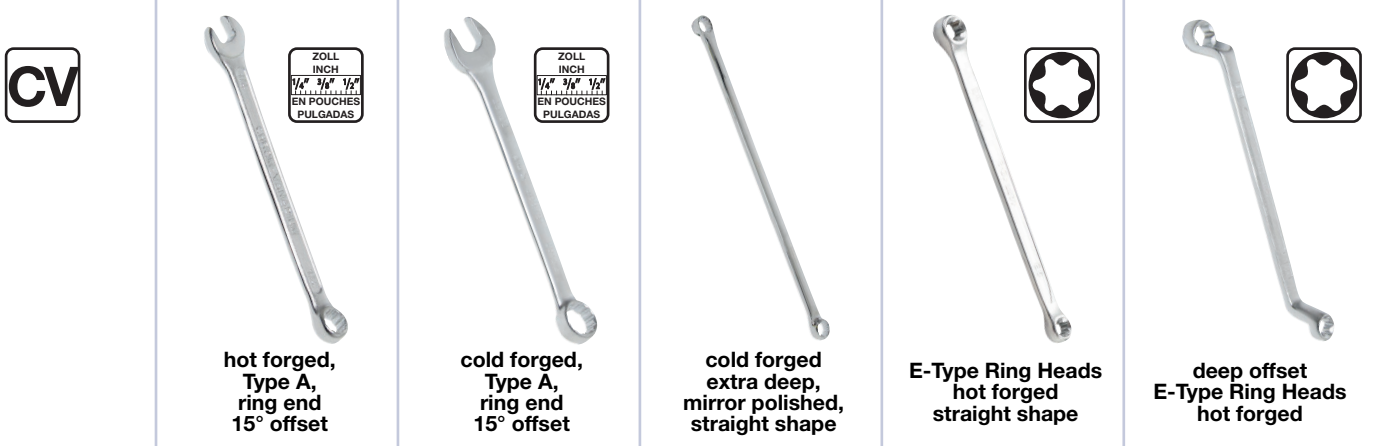

CV					
	hot forged, Type A, ring end 15° offset	cold forged, Type A, ring end 15° offset	cold forged extra deep, mirror polished, straight shape	E-Type Ring Heads hot forged straight shape	deep offset E-Type Ring Heads hot forged
1/4"	30188				
5/16"	30189				
3/8"	30190				
7/16"	30191				
1/2"	30192				
9/16"	30193				
5/8"	30194				
11/16"	30195				
3/4"	30196				
13/16"	30197				
7/8"	30198				
15/16"	30199				
19/32"		30673			
25/32"		30675			
1"		30680			
1 1/32"		30681			
1 1/8"		30683			
1 1/4"		30685			
10x11 mm			1186-10x11		
12x14 mm			1186-12x14		
13x15 mm			1186-13x15		
16x18 mm			1186-16x18		
17x19 mm			1186-17x19		
21x23 mm			1186-21x23		
22x24 mm			1186-22x24		
E6xE8				2260	2281-6X8
E7xE11				2265	
E10xE12				2261	2281-10X12
E14xE18				2262	2281-14X18
E16xE22				2266	
E20xE24				2263	2281-20X24

Spanners | Double Ring and Double Open End Spanners

CV



Metric	DIN 838, hot forged, deep offset	DIN 838, cold forged, deep offset	C-Type, cold forged	S-Type, cold forged	extra flat, cold forged	DIN 3110, hot forged	DIN 3110, cold forged
5x5,5 mm							30605
6x7 mm	1214-6x7	30206			30330	1184-6x7	30606
8x9 mm	1214-8x9	30208			30331	1184-8x9	30608
8x10 mm			30721				
10x11 mm	1214-10x11	30210		30741	30332	1184-10x11	30610
10x13 mm		30211				1184-10x13	30613
11x13 mm			30722				
12x13 mm	1214-12x13	30212		30742	30333	1184-12x13	30612
13x17 mm		30213					
14x15 mm	1214-14x15	30214	30723	30743	30334	1184-14x15	30614
14x17 mm		30215					30611
16x17 mm	1214-16x17	30216		30744	30335	1184-16x17	30616
17x19 mm		30217	30724				30617
18x19 mm	1214-18x19	30218		30745	30336	1184-18x19	30618
19x22 mm		30223					30623
20x21 mm							
20x22 mm	1214-20x22	30220			30337	1184-20x22	30620
21x22 mm			30725				
21x23 mm	1214-21x23	30221				1184-21x23	30621
22x24 mm							30622
24x27 mm	1214-24x27	30224			30338	1184-24x27	30624
25x28 mm	1214-25x28					1184-25x28	30625
27x30 mm							30627
30x32 mm	1214-30x32	30230			30339	1184-30x32	30630
27x32 mm							30632
30x34 mm							30631
36x41 mm		30236				1184-36x41	30636
46x50 mm		30246					

Quick-Finder Double Ring / Open End Spanners Quick-Finder



Hot Forging

Traditional hot forging at temperatures of up to 1200° C.
Perfect formability and stability.



Cold Forging

A high quality steel mixture is formed "cold" without heating the steel externally. This allows an even higher quality and very little dimension tolerances.





Workshop Trolley | 7 Drawers | with 215 Tools

- consisting of workshop trolley BGS 2001 incl. 3 tool trays, 3/3, made from high-resistance foam (dimensions 567 x 408 x 32 mm)
 - Socket Set | 192 pcs. (BGS 4036)
 - Combination Spanners and E-Type Spanners Assortment | 22 pcs. (BGS 4012)
 - Beer, Chips and Peanuts | 9 pcs. | 9 pcs. (BGS 4190)
 - Microfibre Cloth | 400 x 400 mm (BGS TOUCH)
-
- Number of Drawers: 7
 - Drawer pull-out: 100 %
 - Drawer width: 569 mm
 - Drawer depth: 409 mm
 - Drawer height: 5 x 52 | 2 x 130 mm
 - Width: 680 mm
 - Height: 1000 mm
 - Depth: 458 mm
 - Weight: 78.7 kg

Item #
4104

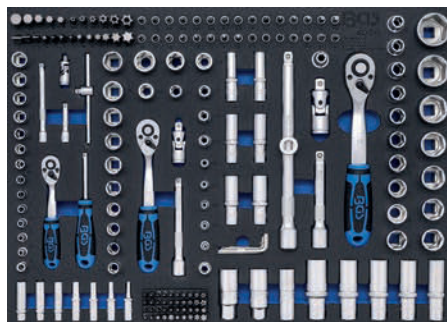

Workshop Trolleys & Accessories

Workshop Trolley | 7 Drawers | with 227 Tools

- consisting of workshop trolley BGS 2001 incl.
- 4 tool trays(1/3), dimensions 189 x 408 x 32 mm
- 1 tool tray (2/3), dimensions 378 x 408 x 32 mm
- 2 tool trays(3/3), dimensions 567 x 408 x 32 mm
- made from high-resistance foam
- Screwdriver Set T-Star (for Torx) | 6 pcs. (BGS 4078)
- Combination Spanner Set | 6 - 22 mm | 12 pcs. (BGS 4082)
- Stoning and Machinist's Hammer Set | 2 pcs. (BGS 4046)
- Pliers Set | 3 pcs. (BGS 4042)
- 12-piece Screwdriver Set (BGS 4122)
- Socket Set | 192 pcs. (BGS 4036)
- Beer, Chips and Peanuts | 9 pcs. (BGS 4190)

- Number of Drawers: 7
- Drawer pull-out: 100 %
- Drawer width: 569 mm
- Drawer depth: 409 mm
- Drawer height: 5 x 52 | 2 x 130 mm
- Width: 680 mm
- Height: 1000 mm
- Depth: 458 mm
- Weight: 83.5 kg

Item #
4069

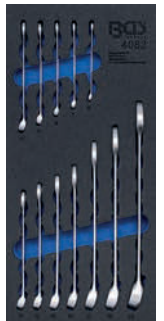

Workshop Trolley | 11 Drawers | empty

- heavy duty workshop finish
- wall thickness body: 1.2 mm
- wall thickness drawers: 0.8 mm
- heavy duty 125 mm ball bearing castors, thereof 2 castors lockable
- lockable through central lock
- each drawer individually secured, with safety lock
- 11 smooth running, ball bearing drawers:
 - drawer 1 - 10 drawer capacity: each 20 kg
 - 11th drawer capacity: 30 kg
- stable top shelf with 5 storage compartments, load capacity up to 50 kg
- max. capacity 230 kg
- side storage compartment: 78 x 370 x 75 mm (H x W x D)
- side mounted handle
- width: 724 mm
- height: 1033 mm
- depth: 470 mm
- weight: 79 kg
- number of drawers: 11
- drawer pull-out: 100%
- drawer width: 569 mm
- drawer depth: 409 mm
- drawer height: 10 x 54, 1 x 170 mm



Item #

4103

Workshop Trolley | 8 Drawers | empty

- high quality workshop type
- wall thickness body: 1.6 mm
- wall thickness drawers: 1.3 mm
- heavy duty 125 mm ball bearing castors, thereof 2 castors lockable
- lockable through central lock
- each drawer individually secured, with safety lock
- 8 smooth running, ball bearing drawers
- stable top plastic support with 8 storage compartments, load capacity up to 45 kg
- BGS Logo with red LEDs on the front panel, switch is inside the side panel
- side door individually lockable
- side storage with 2 trays e.g. for cans, tools or bottles and a tool board inside the door with hook holes for tools
- rear board individually lockable and extendable
- hook holes on the rear board for tools (10 hooks included), control panel with control device and bluetooth speaker with internal antenna incl. USB charging cable
- easy connection via bluetooth with mobile phone or other devices
- side mounted handle
- width: 752 mm
- height: 984 mm
- depth: 540 mm
- number of drawers: 8
- drawer width: 568 mm
- drawer depth: 409 mm
- drawer height: 7 x 58 | 1 x 139 mm
- drawer pull-out: 100%



Item #
4108

Tool Tray 1/3: Bit Socket Set | Internal Hexagon | 24 pcs.

12.5 mm 1/2"

- knurled
- 9 bit sockets, length 55 mm, 12.5 mm (1/2") drive, internal hexagon 5 - 6 - 7 - 8 - 10 - 12 - 14 - 17 - 19 mm
- 8 bit sockets, length 100 mm, 12.5 mm (1/2") drive, internal hexagon 5 - 6 - 7 - 8 - 10 - 11 - 12 - 13 mm
- 7 bit sockets, length 140 mm, 12.5 mm (1/2") drive, internal hexagon 5 - 6 - 7 - 8 - 10 - 12 - 14 mm



Item #	Description
4116	Tool Tray 1/3: Bit Socket Set Internal Hexagon 24 pcs.
4116-1	Tool Tray 1/3 empty for BGS 4116



Tool Tray 1/3: Bit Socket Set | T-Star (for Torx) | 26 pcs.

12.5  1/2

- knurled
- 10 bit sockets, 12.5 mm (1/2") drive, T-Star (for Torx) T20 - T25 - T27 - T30 - T40 - T45 - T50 - T55 - T60 - T70, length 55 mm
- 10 bit sockets, 12.5 mm (1/2") drive, T-Star (for Torx) T20 - T25 - T27 - T30 - T40 - T45 - T50 - T55 - T60 - T70, length 100 mm
- 6 bit sockets, 12.5 mm (1/2") drive, T-Star (for Torx) T40 - T45 - T50 - T55 - T60, length 100 mm



Item #	Description
4119	Tool Tray 1/3: Bit Socket Set T-Star (for Torx) 26 pcs.
4119-1	Tool Tray 1/3 empty for BGS 4119



Tool Tray 1/3: Bit Socket Set | Spline (for RIBE) | 25 pcs.

12.5  1/2

- knurled
- 9 bit sockets, length 55 mm, 12.5 mm (1/2") drive, Spline (for RIBE) M5 - M6 - M7 - M8 - M9 - M10 - M12 - M13 - M14
- 9 bit sockets, length 100 mm, 12.5 mm (1/2") drive, Spline (for RIBE) M5 - M6 - M7 - M8 - M9 - M10 - M12 - M13 - M14
- 7 bit sockets, length 140 mm, 12.5 mm (1/2") drive, Spline (for RIBE) M8 - M9 - M10 - M10,3 - M12 - M13 - M14



Item #	Description
4117	Tool Tray 1/3: Bit Socket Set Spline (for RIBE) 25 pcs.
4117-1	Tool Tray 1/3 empty for BGS 4117



Tool Tray 1/3: Bit Socket Set | Spline (for XZN) | 22 pcs.

12.5  1/2

- knurled
- 8 bit sockets, length 55 mm, 12.5 mm (1/2") drive, Spline (for XZN) M5 - M6 - M8 - M9 - M10 - M12 - M14 - M16
- 7 bit sockets, length 100 mm, 12.5 mm (1/2") drive, Spline (for XZN) M5 - M6 - M8 - M9 - M10 - M12 - M14
- 7 bit sockets, length 140 mm, 12.5 mm (1/2") drive, Spline (for XZN) M5 - M6 - M8 - M9 - M10 - M12 - M14



Item #	Description
4118	Tool Tray 1/3: Bit Socket Set Spline (for XZN) 22 pcs.
4118-1	Tool Tray 1/3 empty for BGS 4118

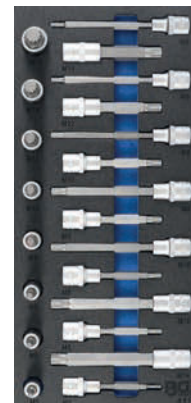

Tool Tray 1/3: Bit Socket Set | various profiles | 36 pcs.

12.5  1/2

- knurled
- 9 bit sockets, length 55 mm, 12.5 mm (1/2") drive, internal hexagon 5 - 6 - 7 - 8 - 10 - 12 - 14 - 17 - 19 mm
- 10 bit sockets, length 55 mm, 12.5 mm (1/2") drive, T-Star (for Torx) T20 - T25 - T27 - T30 - T40 - T45 - T50 - T55 - T60 - T70
- 8 bit sockets, length 55 mm, 12.5 mm (1/2") drive, Spline (for XZN) M5 - M6 - M8 - M9 - M10 - M12 - M14 - M16
- 9 bit sockets, length 55 mm, 12.5 mm (1/2") drive, Spline (for RIBE) M5 - M6 - M7 - M8 - M9 - M10 - M12 - M14 - M16

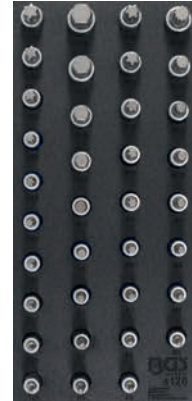

Item #	Description
4120	Tool Tray 1/3: Bit Socket Set various profiles 36 pcs.
4120-1	Tool Tray 1/3 empty for BGS 4120

Tube Bender and Brake Line Clamps Set | 4.75 + 6 mm

- for clamping the old and new brake pipe during the bending process
- perfect for cable assembly
- allows exact reproduction of the old brake pipe
- parallel clamping and bending do not change the diameter of the line
- suitable for steel, copper and plastic coated brake lines
- for 4.75 mm (3/16") or 6 mm line diameter

scope of delivery:

- tube bending pliers, 4.75 + 6 mm (Art. 8229)
- brake line clamps set, 4 pcs. (Art. 9533-1)
- tool tray 1/3, empty, for item 9533 (Art. 9533-2)

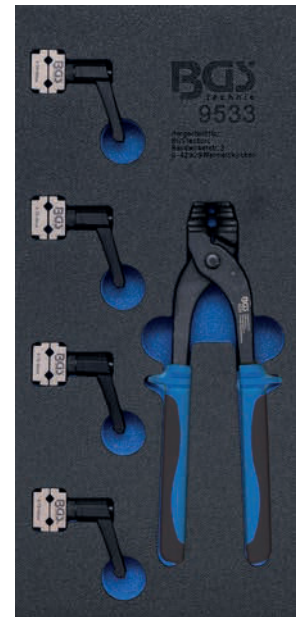

Item #	Description
9533	Tool Tray 1/3: Tube Bender and Brake Line Clamps Set 4.75 + 6 mm
9533-1	Brake Line Clamps Set 4.75 mm (3/16") 4 pcs.
9533-2	Tool Tray 1/3 empty for BGS 9533

Tool Tray 3/3: Special Tools for Tyre Service | 18 pcs.

6.3  1/4 12.5  1/2

- 4 plastic scrapers: 19 - 22 - 25 - 38 mm
- 1 pliers for wheel balancing weights
- 1 thread retapper for tire valves
- 1 special socket for steel tire valves, 6.3 mm (1/4") drive
- 4 protective impact sockets with plastic sleeves, 12.5 mm (1/2") drive: 15 - 17 - 19 - 21 mm
- 2 valve core torque tools: 0.25 - 0.45 Nm
- 2 tire valve insert tools
- 1 tire valve replacing tool, flexible
- 1 workshop torque wrench, 40 - 200 nm, 12.5 mm (1/2") drive, ratcheting head, reversible, 48 teeth, accuracy: +- 4%, incl. test certificate
- 1 tire lever with plastic protection cover, 500 mm
- width: 567 mm
- height: 32 mm
- depth: 408 mm



Item #	Description
4035	Tool Tray 3/3: Special Tools for Tyre Service 18 pcs.
4035-1	Tool Tray 3/3 empty for BGS 4035

Tool Tray 2/3: Double Ring Spanner Set | 10 x 11 - 22 x 24 mm | 6 pcs.

- cold forged
- extra long
- straight type
- profile: 12-point
- surface finish: chrome plated, polished
- width: 378 mm
- height: 32 mm
- depth: 408mm

scope of delivery:

- double ring spanner, extra long, 10 x 11 mm, length: 290 mm, BGS 1186-10x11
- double ring spanner, extra long, 12 x 14 mm, length: 330 mm, BGS 1186-12x14
- double ring spanner, extra long, 13 x 15 mm, length: 370 mm, BGS 1186-13x15
- double ring spanner, extra long, 16 x 18 mm, length: 410 mm, BGS 1186-16x18
- double ring spanner, extra long, 17 x 19 mm, length: 410 mm, BGS 1186-17x19
- double ring spanner, extra long, 22 x 24 mm, length: 435 mm, BGS 1186-22x24
- tool tray 2/3, empty, BGS 4194-1



Item #	Description
4194-1	Tool Tray 2/3 empty for BGS 4194
4194	Tool Tray 2/3: Double Ring Spanner Set 10 x 11 - 22 x 24 mm 6 pcs.

Air Tools Holder | 15 kg

- suitable for impact wrenches, air inflators, blow guns, spray guns and other air tools
- with 3 individually lockable sideward fork openings
- easy to assemble on workbench or tool cabinet
- 4 drill holes for screws (not included in scope of delivery) for easy assembling
- rated load capacity: 15 kg



Item #

9578

Magnetic Holder | for Screwdrivers, Wrenches

- magnetic tool holder with 6 extra strong magnets and 18 hooks
- black powder coated
- suitable for workshop trolleys
- space saving, flat design
- load capacity max. 6 kg
- length: 230 mm
- width: 450 mm



Item #

9895

Magnetic Screwdriver Holder

- magnetic holder for max. 9 screwdrivers
- for 5 screwdrivers with blade-Ø up to 9.5 mm
- for 4 screwdrivers with blade-Ø up to 7.5 mm
- black powder coated
- suitable for workshop trolleys
- space saving
- load capacity max. 2 kg
- length: 240 mm
- width: 48 mm
- depth: 28 mm



Item #

67157

Socket Set / Tool Assortment | 67 pcs.

6.3 mm 1/4"

scope of delivery:

- BGS system case
- reversible ratchet, fine tooth, 6.3 mm (1/4"), length: 155 mm
 - curved type, satin chrome plated, 2-component handle
- spinner handle for bits, 6.3 mm (1/4"), length: 200 mm, 2-component handle, magnetic bit holder (BGS 217)
- extension bar, 6.3 mm (1/4"), length: 50 mm, satin chrome plated (BGS 2336)
- universal joint, 6.3 mm (1/4"), chrome plated (BGS 250)
- bit adaptor with retaining ball, 6.3 mm (1/4") drive, internal hexagon 6.3 mm (1/4"), satin chrome plated (BGS 8213)
- sockets, pro torque®, hexagon, 6.3 mm (1/4") drive, satin chrome plated, knurled: 4 - 4.5 - 5 - 5.5 - 6 - 7 - 8 - 9 - 10 - 11 - 12 - 13 - 14 mm
- sockets, hexagon, pro torque®, deep, 6.3 mm (1/4") drive, satin chrome plated, matt, knurled: 9 - 10 - 11 - 12 - 13 mm
- bits, 6.3 mm (1/4") drive, length 25 mm:
 - slot SL 3 - 4 - 5 - 6 mm
 - cross slot PH1 - PH2 - PH3
 - cross slot PZ1 - PZ2 - PZ3
 - internal hexagon 3 - 4 - 5 - 6 mm
 - T-Star (for Torx) T10 - T15 - T20 - T25 - T27 - T30
- combination pliers, 175 mm, 2-component handles, nickel plated, matt (BGS 370)
- long nose pliers, straight, 200 mm, 2-component handles, nickel plated, matt (BGS 389)
- screwdriver, cross slot PH1, blade length 80 mm (BGS 4935)
- screwdriver, cross slot PH2, blade length 100 mm (BGS 4936)
- screwdriver, slot SL 4 mm, blade length 80 mm (BGS 4929)
- screwdriver, slot SL 5.5 mm, blade length 125 mm (BGS 4930)
- screwdriver, slot SL 6.5 mm, blade length 150 mm (BGS 4931)
- precision screwdriver set, 6 pcs. (BGS 9151)
 - black finished tips
 - 2-component anti-slip handles
 - screwdrivers, slot SL: 2 - 3 - 4 mm
 - screwdrivers, cross slot PH: PH00 - PH0 - PH1
 - blade length: 75 mm
 - surface finish: satin chrome plated
- water pump pliers, box-joint type, 240 mm (Art. 75111)
 - forged and hardened
 - black lacquered finish
 - polished jaws and joint
 - dip insulated handles
 - max. opening width 38 mm
- L-type wrench set, short, internal hexagon 1.5 - 10 mm, 9 pcs. (BGS 807)
 - short type
 - in foldable holder
 - sizes 1.5 - 2 - 2.5 - 3 - 4 - 5 - 6 - 8 - 10 mm
- machinist's hammer, hickory handle, DIN 1041, 300 g (BGS 52303)



Item #
2217



Impact Socket Set E-Star | 12.5 mm (1/2") Drive | E10 - E24 mm | 8 pcs.

12.5  1/2

- for both manual and impact wrenches
- can be fixed on impact wrench by pin and O-ring
- on socket rail
- 8 impact sockets, 12.5 mm (1/2") Drive, E-type: E10 - E12 - E14 - E16 - E18 - E20 - E22 - E24



Item #
9779



Protective Impact Socket Set | 12.5 mm (1/2") Drive | 17 / 19 / 21 / 22 mm | 4 pcs.

12.5  1/2

- for both manual and impact wrenches
- can be fixed on impact wrench by pin and O-ring
- plastic cover and plastic sleeve for protection of aluminium rims
- different surface colors help to indicate the right size
- 4 protective impact sockets, 12,5 mm (1/2") drive, length: 85 mm, 17 - 19 - 21 - 22 mm



Item #
9847



Socket Set, T-Star Plus (for Torx Plus) | 6.3 mm (1/4") Drive | 6EP - 12EP | 6 pcs.

6.3  1/4

- on socket rail
- T-Star Plus sockets, 6.3 mm (1/4") drive: 6EP - 7EP - 8EP - 10EP - 11EP - 12EP



Item #
9588



Socket Set, E-Type | 6.3 mm (1/4") Drive | E4 - E11 | 7 pcs.

6.3  1/4

- knurled
- on metal rail
- profile: E-type
- surface finish: satin chrome plated
- E-type socket, 6.3 mm (1/4") drive: E4, E5, E6, E7, E8, E10, E11



Item #
6402



Socket Set, Hexagon, extra deep | 10 mm (3/8 ") Drive | SW 8 - 14 mm | 5 pcs. 10 3/8

- suitable for nuts on extra long threaded bolts, for e.g. bumpers, rear lamps and door hinge fittings
- suitable for parking brake cable adjusters on VAG, Opel / Vauxhall, BMW and Ford
- drive profile: internal square
- drive profile size, metric: 10 mm
- drive profile size, inch: 3/8"
- output profile: hexagon
- length: 120 mm
- surface finish: chrome plated
- 5 sockets, hexagon, 8 - 10 - 12 - 13 - 14 mm



Item #	
9863	

Universal Joint Socket Set, Hexagon | 10 mm (3/8") Drive | 3/8" - 3/4" | Inch Sizes | 7 pcs. 10 3/8

- on socket rail

scope of delivery:

- 7 universal joint sockets 3/8" - 7/16" - 1/2" - 9/16" - 5/8" - 11/16" - 3/4"



Item #			
9501			

Socket Set, T-Star Plus (for Torx Plus) | 10 mm (3/8") Drive | 10EP - 20EP | 7 pcs. 10 3/8

- on socket rail
- T-Star Plus sockets, 10 mm (3/8") drive: 10EP - 11EP - 12EP - 14EP - 16EP - 18EP - 20EP



Item #		
9587		

Screw and Nut Extractor Set | 10 mm (3/8") | Metric | 11 pcs. 10 3/8

- special sockets for loosening rounded off external hexagon screw heads and nut, sizes: 8 - 9 - 10 - 11 - 12 - 13 - 14 - 15 - 16 - 17 - 19 mm (also for tightening screws)
- drive profile: internal square
- drive profile size, metric: 10 mm
- drive profile size, inch: 3/8"
- surface finish: satin chrome plated



Item #	
8383	

Twist Socket Set (Spiral Profile) / Screw Extractor | 12.5 mm (1/2") Drive | 17 - 26 mm | 7 pcs. 12.5 1/2

- for loosening damaged screws and nuts
- suitable for impact wrenches
- the innovative spiral profile digs itself into the head of a damaged screw/ nut allowing to loosen it securely
- special twist sockets, 12.5 mm (1/2") drive: 17 - 18.5 - 20 - 21.5 - 23 - 24.5 - 26 mm
- surface finish: black burnished



Item #
5291



Tool Tray 1/6: Rim Lock Socket Set for Mercedes-Benz | 35 pcs.

- for installation and dismantling of Mercedes-Benz rim locks
- in workshop trolley tray
- 32 rim lock sockets to be used as OEM #301 - #302 - #303 - #304 - #305 - #306 - #307 - #308 - #309 - #310 - #311 - #312 - #313 - #314 - #315 - #316 - #317 - #318 - #319 - #320 - #321 - #322 - #323 - #324 - #325 - #326 - #327 - #328 - #329 - #330 - #331 - #332
- 1 socket to be used as holder
- 1 pin punch
- 1 wheel hub hook puller



Item #
9469



Tool Tray 1/6: Rim Lock Socket Set for Opel / Vauxhall (Version A) | 20 pcs.

- for installation and dismantling of Vauxhall rim locks (version A)
- in workshop trolley tray
- drive: 17 mm external hexagon
- 20 rim lock sockets in the sizes: #101 - #102 - #103 - #104 - #105 - #106 - #107 - #108 - #109 - #110 - #111 - #112 - #113 - #114 - #115 - #116 - #117 - #118 - #119 - #120



Item #
9556



Tool Tray 1/6: Rim Lock Socket Set for Opel / Vauxhall (Version B) | 20 pcs.

- for installation and dismantling of Vauxhall rim locks (version B)
- in workshop trolley tray
- drive: 17 mm external hexagon
- 20 rim lock sockets in the sizes: #181 - #182 - #183 - #184 - #185 - #186 - #187 - #188 - #189 - #190 - #191 - #192 - #193 - #194 - #195 - #196 - #197 - #198 - #199 - #200



Item #
9557



Tool Tray 1/6: Rim Lock Socket Set for Opel / Vauxhall (Version C) | 20 pcs.

- for installation and dismantling of Vauxhall rim locks (version c)
- in workshop trolley tray
- drive: 17 mm external hexagon
- 20 rim lock sockets in the sizes:
#121 - #122 - #123 - #124 - #125 - #126 - #127 - #128 - #129 - #130 -
#131 - #132 - #133 - #134 - #135 - #136 - #137 - #138 - #139 - #140

Item #	CV		1/6
9558			



Tool Tray 1/6: Rim Lock Socket Set for Opel / Vauxhall (Version D) | 7 pcs.

- for installation and dismantling of Vauxhall rim locks (version D)
- in workshop trolley tray
- drive: 17 mm external hexagon
- 7 rim lock sockets in the sizes:
#7461 - #7462 - #7463 - #7464 - #7465 - #7466 - #7467

Item #	CV		1/6
9559			



Tool Tray 1/6: Rim Lock Socket Set for Land Rover | 10 pcs.

- for installation and dismantling of Land Rover rim locks
- in workshop trolley tray
- drive: 17 mm external hexagon
- length: 37 mm
- 10 rim lock sockets in the sizes:
#A - #B - #C - #D - #E - #F - #G - #H - #I - #J

Item #	CV		1/6
9553			



Tool Tray 1/6: Rim Lock Socket Set for Volvo | 20 pcs.

- for installation and dismantling of Volvo rim locks
- in workshop trolley tray
- hex drive: 19 mm
- length: 42,5 mm
- 20 rim lock sockets in sizes:
#944L - #945L - #946L - #947L - #948L - #949L - #950L - #951L -
#952L - #953L - #065P - #071P - #072P - #076P - #079P - #121P -
#651P - #944P - #945P - #951P

Item #	CV		1/6
9653			



Sockets

Tool Tray 1/6: Rim Lock Socket Set for Volvo | 20 pcs.

- for installation and dismantling of Volvo rim locks
- in workshop trolley tray
- hex drive: 19 mm
- length: 36 mm
- 20 rim lock sockets in sizes:
 #7601 - #7602 - #7603 - #7604 - #7605 - #7606 - #7607 - #7608 -
 #7609 - #7610 - #7611 - #7612 - #7613 - #7614 - #7615 - #7616 -
 #7617 - #7618 - #7619 - #7620



Item #	CV	1/6
9652		

Tool Tray 1/6: Rim Lock Socket Set for VAG | 20 pcs.

- for mounting and dismantling of VAG rim locks
- rim lock dismantling sockets with 17 mm hexagon drive
- to be used as OEM T20213
- in workshop trolley tray
- 20 rim lock sockets in sizes:
 #541, #542, #543, #544, #545, #546, #547, #548, #549, #550, #551,
 #552, #553, #554, #555, #556, #557, #558, #559, #560



Item #	CV	1/6
6659		

Demo Block for Multi Socket

- for demonstration of benefits of Multi Socket, 10 mm (3/8") drive, 9 - 21 mm, BGS 2533 or Multi Socket, 12.5 mm (1/2") drive, 11 - 32 mm, BGS 2531



Item #
9635

Demo Block | for Gear Lock Sockets

- to demonstrate the multiple uses of the Gear Lock profile
- the supplied nut (19 mm) fits perfectly on all permanently installed screw heads: hexagonal, 12-point, inch, E-profile, square, multi-tooth and finished nuts with a damaged flank



Item #
56

Special Wheel Nut Socket | for Porsche 911 (991) | for Center Lock Wheel

20  3/4

- suitable for Porsche 911 models (991) with center lock nut (OEM 99136108190):
 - GT3 / GT3 RS / Turbo / Turbo S (as of 2010) / Carrera GTS (as of 2011)
- drive: 20 mm (3/4")
- material: aluminum alloy
- not suitable for impact wrenches



Item #
9769

Impact Sockets, Hexagon, deep | 20 mm (3/4") Drive

20  3/4

- for both manual and impact wrenches
- can be fixed on impact wrench by pin and O-ring
- profile: hexagon
- length: 100 mm
- surface finish: phosphated



Item #	Description
9812	Impact Socket, Hexagon, deep 20 mm (3/4") Drive 38 mm for FUSO / Mitsubishi
9813	Impact Socket, Hexagon, deep 20 mm (3/4") Drive 41 mm for FUSO / Mitsubishi

Bit and Socket Set | 6.3 mm (1/4") / 10 mm (3/8") Drive | 42 pcs.

10  3/8

scope of delivery:

- 1 electric drill adaptor, 50 mm, 6.3 mm (1/4") drive, external hexagon 6.3 mm (1/4")
- 1 magnetic bit holder, length 75mm
- 36 bits, external hexagon 6.3 mm (1/4") drive
 - 3 bits, cross slot PH2, length 50 mm
 - 1 bit, T-Star tamperproof (for Torx) T15, length 50 mm
 - 2 bits, T-Star tamperproof (for Torx) T20, length 50 mm
 - 2 bits, T-Star tamperproof (for Torx) T25, length 50 mm
 - 2 bits, square S2, length 50 mm
 - 1 bit, square S3, length 50 mm
 - 1 bit, slot SL 6 mm, length 50 mm
 - 1 bit, T-Star tamperproof (for Torx) T15, length 25 mm
 - 3 bits, T-Star tamperproof (for Torx) T20, length 25 mm
 - 3 bits, T-Star tamperproof (for Torx) T25, length 25 mm
 - 1 bit, T-Star tamperproof (for Torx) T30 , length 25 mm
 - 3 bits, cross slot PH2, length 25 mm
 - 1 bit, internal hexagon 3 mm, length 25 mm
 - 1 bit, internal hexagon 4 mm, length 25 mm
 - 1 bit, internal hexagon 5 mm, length 25 mm
 - 1 bit, internal hexagon 6 mm, length 25 mm
 - 1 bit, internal hexagon 7 mm, length 25 mm
 - 1 bit, slot SL 6 mm, length 25 mm
 - 1 bit, slot SL 8 mm, length 25 mm
 - 2 bits, cross slot PH1, length 25 mm
 - 2 bits, cross slot PH2, length 25 mm
 - 2 bits, cross slot PH3, length 25 mm
- 4 sockets, hexagon, deep, 10 mm (3/8") drive, 8 - 9 - 10 - 12 mm



Item #
4810



Drill and Bit Set | 6.3 mm (1/4") Drive | 55 pcs.

scope of delivery:

- 1 automatic bit holder, length 70 mm
- 1 magnetic bit holder, length 77 mm
- 43 bits, external hexagon 6.3 mm (1/4") drive
 - 2 bits, cross slot PH2, length 50 mm
 - 1 bit, internal hexagon 5 mm, length 50 mm
 - 1 bit, internal hexagon 6 mm, length 50 mm
 - 2 bits, T-Star tamperproof (for Torx) T20, length 50 mm
 - 2 bits, T-Star tamperproof (for Torx) T25, length 50 mm
 - 1 bit, T-Star tamperproof (for Torx) T30, length 50 mm
 - 1 bit, slot SL 6 mm, length 50 mm
 - 1 bit, slot SL 8 mm, length 50 mm
 - 4 bits, slot SL 6 mm, length 25 mm
 - 4 bits, slot SL 8 mm, length 25 mm
 - 1 bit, internal hexagon 1.5 mm, length 25 mm
 - 2 bits, internal hexagon 2 mm, length 25 mm
 - 1 bit, internal hexagon 2.5 mm, length 25 mm
 - 2 bits, internal hexagon 3 mm, length 25 mm
 - 2 bits, internal hexagon 4 mm, length 25 mm
 - 1 bit, internal hexagon 5 mm, length 25 mm
 - 1 bit, internal hexagon 5.5 mm, length 25 mm
 - 1 bit, internal hexagon 6 mm, length 25 mm
 - 1 bit, internal hexagon 8 mm, length 25 mm
 - 4 bits, cross slot PH1, length 25 mm
 - 4 bits, cross slot PH2, length 25 mm
 - 4 bits, cross slot PH3, length 25 mm
- 3 impact sockets, for electric drills, 6 - 8 - 10 mm
- 7 HSS twist drills with hexagon drive, 6.3 mm (1/4") drive, Ø 1.0 - 1.5 - 2 - 2.5 - 3 - 3.2 - 5 mm



Item #		
4811		

Bit Socket Set | 12.5 mm (1/2") Drive | TP-Star (for Torx Plus) TP20 - TP70 | 32 pcs. 12.5 1/2

- knurled
- with flat flanks compared to standard T-Star (for Torx)
- for Torx-Plus screws

scope of delivery:

- 10 bit sockets TP20 - TP25 - TP27 - TP30 - TP40 - TP45 - TP50 - TP55 - TP60 - TP70, length: 55 mm
- 10 bit sockets TP20 - TP25 - TP27 - TP30 - TP40 - TP45 - TP50 - TP55 - TP60 - TP70, length: 100 mm
- 6 bit sockets TP40 - TP45 - TP50 - TP55 - TP60 - TP70, length: 140 mm
- 6 bit sockets TP40 - TP45 - TP50 - TP55 - TP60 - TP70, length: 200 mm



Item #	
5190	

Bit Socket Set | 12.5 mm (1/2") Drive | TPS-Star tamperproof (for Torx Plus) TPS20 - TPS70 | 32 pcs. 12.5 \square 1/2

- knurled
- with flat flanks compared to standard T-Star (for Torx)
- for Torx-Plus screws with pin

scope of delivery:

- 10 bit sockets TPS20 - TPS25 - TPS27 - TPS30 - TPS40 - TPS45 - TPS50 - TPS55 - TPS60 - TPS70, length: 55 mm, tamperproof
- 10 bit sockets TPS20 - TPS25 - TPS27 - TPS30 - TPS40 - TPS45 - TPS50 - TPS55 - TPS60 - TPS70, length: 100 mm, tamperproof
- 6 bit sockets TPS40 - TPS45 - TPS50 - TPS55 - TPS60 - TPS70, length: 140 mm, tamperproof
- 6 bit sockets TPS40 - TPS45 - TPS50 - TPS55 - TPS60 - TPS70, length: 200 mm, tamperproof

Item #	
5191	



Bit Socket Set | 10 mm (3/8") Drive | 4-point Profile (for MTS-Mortorq) MTS0 - MTS04 | 5 pcs. 10 \square 3/8

- 10 mm (3/8") internal square drive with ball reception
- surface finish: satin chrome plated
- on metal rail
- 5 bit sockets, 4-point (for Mortorq), 10 mm (3/8") drive: #0, #1, #2, #3, #4

Item #	
9756	



Bit Socket Set | 6.3 mm (1/4") Drive | Internal Hexagon Tamperproof 2 - 7 mm | 8 pcs. 6.3 \square 1/4

- knurled
- on socket rail
- surface finish: satin chrome plated
- 8 bit sockets, length: 38 mm, 6,3 mm (1/4") drive, internal hexagon tamperproof 2 - 2.5 - 3 - 4 -5 -5.5 - 6 - 7 mm

Item #	
5156	



Bit Socket and Socket Set | E-Type / T-Star (for Torx) / T-Star tamperproof (for Torx) / TP-Star (for Torx Plus) | 52 pcs.

6.3  10  12.5 

scope of delivery:

- 12 bit sockets, T-Star tamperproof (for Torx)
 - 6,3 mm (1/4") drive: T8 - T10 - T15 - T20 - T25 - T27 - T30
 - 10 mm (3/8") drive: T40 - T45 - T50 - T55
 - 12,5 mm (1/2") drive: T60
- 15 bit sockets, T-Star (for Torx):
 - 6,3 mm (1/4") drive: T6 - T8 - T10 - T15 - T20 - T25 - T27 - T30
 - 10 mm (3/8") drive: T40 - T45 - T47 - T50 - T55
 - 12,5 mm (1/2") drive: T60 - T70
- 12 bit sockets, TP-Star (for Torx Plus):
 - 6,3 mm (1/4") drive: TP8 - TP10 - TP15 - TP20 - TP25 - TP27 - TP30
 - 10 mm (3/8") drive: TP40- TP45 - TP50 - TP55
 - 12,5 mm (1/2") drive: TP60
- 13 sockets, E-type:
 - 6,3 mm (1/4") drive: E4 - E5 - E6 - E7 - E8
 - 10 mm (3/8") drive: E10 - E12 - E14 - E16
 - 12,5 mm (1/2") drive: E18 - E20 - E22 - E24

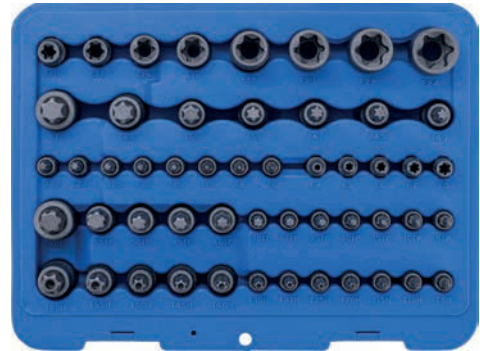

Bit Socket | length 54 mm | 12.5 mm (1/2") Drive | for VAG Polydrive

12.5 

- special socket for loosening and tightening of camshaft adjusting screws on VAG 4-Cyl. injection engines (2.0 l direct injection engines)
- special spline profile
- to be used as OEM: T40080
- knurled
- size: M10
- length: 54 mm
- surface finish: satin chrome plated



Bit Socket | 6.3 mm (1/4") Drive | T-Star (for Torx) T30

6.3 

- knurled
- ideal for working in tight spaces
- length: 130 mm
- surface finish: satin chrome plated

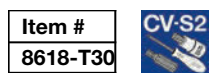

Reversible Ratchets | Fine Tooth

6.3  1/4 | 10  3/8 | 12.5  1/2

- straight type, "extra slim"
- fine toothed (72 tooth)
- with quick release
- anti-slip ergonomically shaped 2-component handle
- BGS 610: 6.3 mm (1/4"), length: 135 mm
- BGS 611: 10 mm (3/8"), length: 195 mm
- BGS 612: 12.5 mm (1/2"), length: 250 mm



Item #	Description
610	Reversible Ratchet Fine Tooth 6.3 mm (1/4")
611	Reversible Ratchet Fine Tooth 10 mm (3/8")
612	Reversible Ratchet Fine Tooth 12.5 mm (1/2")



Reversible Ratchets | Fine Tooth

6.3  1/4 | 10  3/8 | 12.5  1/2

- curved type
- fine toothed (90 tooth)
- with quick release
- anti-slip ergonomically formed 2-component handle
- BGS 600: 6.3 mm (1/4"), length: 155 mm
- BGS 601: 10 mm (3/8"), length: 205 mm
- BGS 602: 12.5 mm (1/2"), length: 255 mm



Item #	Description
600	Reversible Ratchet finely toothed 6.3 mm (1/4")
601	Reversible Ratchet Fine Tooth 10 mm (3/8")
602	Reversible Ratchet finely toothed 12.5 mm (1/2")
600-REPAIR	Repair Kit for Ratchet Head for BGS 600
601-REPAIR	Repair Kit for Ratchet Head for BGS 601
602-REPAIR	Repair Kit for Ratchet Head for BGS 602



Reversible Ratchet Set | Fine Tooth | 6.3 mm (1/4") - 10 mm (3/8") - 12.5 mm (1/2") | 3 pcs. 6.3 1/4 10 3/8 12.5 1/2

- curved type
- fine tooth with 72 teeth
- with quick release function
- anti-slip ergonomically shaped 2-component handle

scope of delivery:

- Reversible Ratchet | Fine Tooth | 6,3 mm (1/4"), length: 150 mm (BGS 618)
- Reversible Ratchet | Fine Tooth | 10 mm (3/8") , length: 200 mm (BGS 619)
- Reversible Ratchet | Fine Tooth | 12.5 mm (1/2"), length: 250 mm (BGS 620)



Item #	Description
621	Reversible Ratchet Set Fine Tooth 6.3 mm (1/4") - 10 mm (3/8") - 12.5 mm (1/2") 3 pcs.
618	Reversible Ratchet Fine Tooth 6.3 mm (1/4")
619	Reversible Ratchet Fine Tooth 10 mm (3/8")
620	Reversible Ratchet Fine Tooth 12.5 mm (1/2")
618-1	Ratchet Head Repair Kit for BGS 618
619-1	Ratchet Head Repair Kit for BGS 619
620-1	Ratchet Head Repair Kit for BGS 620

Reversible Ratchet | 20 mm (3/4") | 550 mm

20 3/4

- no. of teeth in ratchet head: 24
- with quick release



Item #	
9765	

Reversible Ratchet, extendable | 20 mm (3/4") | 600 - 985 mm

20 3/4

- forged steel type
- with extra wide handle
- max. capacity: 1400 Nm
- length adjustable in 8 steps 600 - 655 - 710 - 765 - 815 - 875 - 925 - 985 mm



Item #	
213	

Push-through Ratchet | 20 mm (3/4")

20  3/4

- length: 500 mm
- surface finish: satin chrome plated
- without square head



Item #	Description
9622	Push-through Ratchet 20 mm (3/4")
9623	Square Part external square 20 mm (3/4") for BGS 9622



Scaffolding Ratchet | 4-in1 | 19 x 22 mm

- reversible
- versatile 4-in-1 with four functions
- with forged hammer head
- with hinged nail iron on the head
- pointed handle
- sizes 19 and 22 mm
- versatile
- helps to avoid the change of tools through more functions
- no. of teeth in ratchet head: 28
- output profile: 12-point
- length: 312 mm



Item #		
6696		

Bit Ratchet | extra long | 10 mm (3/8") | 240 mm

10  3/8

- fine tooth with 72 ttooth
- for 10 mm bits
- anti-slip ergonomically shaped 2-component handles
- profile: internal hexagon
- drive profile size, metric: 10 mm
- drive profile size, inch: 3/8"
- length: 240 mm

Item #		
6656		



Square Part | external square 12.5 mm (1/2") | for BGS 312

12.5  1/2

- suitable for BGS 312
- length: 43 mm

Item #		
313-1		



Electric Drill Adaptor Set | 6.3 mm (1/4") Drive | 3 pcs.

6.3 mm 1/4" 10 mm 3/8" 12.5 mm 1/2"

- for electric drill use
- 6.3 mm (1/4") external hexagon drive
- surface: sandblasted

scope of delivery:

- Electric drill adaptor, 65 mm, external square 6.3 mm (1/4") (BGS 9685-1)
- Electric drill adaptor, 65 mm, external square 10 mm (3/8") (BGS 9685-2)
- Electric drill adaptor, 72 mm, external square 12.5 mm (1/2") (BGS 9685-3)



Item #	Description
9685	Electric Drill Adaptor Set 6.3 mm (1/4") Drive 3 pcs.
9685-1	Electric Drill Adaptor 6.3 mm (1/4") Drive / 6.3 mm (1/4")
9685-2	Electric Drill Adaptor 6.3 mm (1/4") Drive / 10 mm (3/8")
9685-3	Electric Drill Adaptor 6.3 mm (1/4") Drive / 12.5 mm (1/2")



Ratchets, Extensions, Adapters & Accessories

Torque Wrench Set | 6.3 mm (1/4") | 10 - 50 Nm | 10 pcs.

6.3 1/4

- with interchangeable heads
- reversible ratchet head with external square 6.3 mm (1/4")
- 8 open end spanner heads in following sizes: 7 - 8 - 9 - 10 - 11 - 12 - 13 - 14 mm
- no. of teeth in ratchet head: 48
- accuracy: +/- 4%, incl. test certificate
- torque range: 10 - 50 Nm
- fine scale: 0.5 Nm
- viewing window for torque value



Item #
2813



Torque Wrench | for 9 x 12 mm Insert Tools

- suitable for tightening screw connections with right-hand thread
- fits for insert tools with 9 x 12 mm outer square
- click signal when the set torque value is reached
- accuracy: +/- 4%
- fine scale: 0.5 Nm
- BGS 2809 torque: 10 - 50 Nm
- BGS 2810 torque: 20 - 100 Nm



Item #	Description
2809	Torque Wrench 10 - 50 Nm for 9 x 12 mm Insert Tools
2810	Torque Wrench 20 - 100 Nm for 9 x 12 mm Insert Tools

Torque Wrench | for 14 x 18 mm Insert Tools

- suitable for tightening screw connections with right-hand thread
- fits for insert tools with 14 x 18 mm outer square
- click signal when the set torque value is reached
- accuracy: +/- 4%
- fine scale: 1 Nm
- BGS 2809 torque: 20 - 100 Nm
- BGS 2810 torque: 60 - 340 Nm



Item #	Description
2811	Torque Wrench 40 - 200 Nm for 14 x 18 mm Insert Tools
2812	Torque Wrench 60 - 340 Nm for 14 x 18 mm Insert Tools

Reversible Insert Ratchet | Fine Tooth | Square Size 9 x 12 mm

- rectangular shaft
- square size: 9 x 12 mm
- with locking pin
- fine tooth with 72 teeth
- with quick release
- drive: square according to DIN 3120 | ISO 1174-1
- surface finish: satin chrome plated
- for use with torque wrench BGS 2809, BGS 2810



Item #	Description
2819	Reversible Insert Ratchet 6.3 mm (1/4") Square Size 9 x 12 mm
2820	Reversible Insert Ratchet 10 mm (3/8") Square Size 9 x 12 mm
2821	Reversible Insert Ratchet 12.5 mm (1/2") Square Size 9 x 12 mm



Open-End Push Fit Spanner | Square Size 9 x 12 mm

- rectangular shaft
- square size 9 x 12 mm
- with locking pin
- surface finish: satin chrome plated



Item #	Description
6900-7	Open-End Push Fit Spanner 7 mm Square Size 9 x 12 mm
6900-8	Open-End Push Fit Spanner 8 mm Square Size 9 x 12 mm
6900-9	Open-End Push Fit Spanner 9 mm Square Size 9 x 12 mm
6900-10	Open-End Push Fit Spanner 10 mm Square Size 9 x 12 mm
6900-11	Open-End Push Fit Spanner 11 mm Square Size 9 x 12 mm
6900-12	Open-End Push Fit Spanner 12 mm Square Size 9 x 12 mm
6900-13	Open-End Push Fit Spanner 13 mm Square Size 9 x 12 mm
6900-14	Open-End Push Fit Spanner 14 mm Square Size 9 x 12 mm
6900-15	Open-End Push Fit Spanner 15 mm Square Size 9 x 12 mm
6900-16	Open-End Push Fit Spanner 16 mm Square Size 9 x 12 mm
6900-17	Open-End Push Fit Spanner 17 mm Square Size 9 x 12 mm
6900-18	Open-End Push Fit Spanner 18 mm Square Size 9 x 12 mm
6900-19	Open-End Push Fit Spanner 19 mm Square Size 9 x 12 mm



Push Fit Ring Spanner | Square Size: 9 x 12 mm

- rectangular shaft
- square size: 9 x 12 mm
- with locking pin
- surface finish: satin chrome plated



Item #	Description
6902-7	Push Fit Ring Spanner 7 mm Square Size 9 x 12 mm
6902-8	Push Fit Ring Spanner 8 mm Square Size 9 x 12 mm
6902-10	Push Fit Ring Spanner 10 mm Square Size 9 x 12 mm
6902-11	Push Fit Ring Spanner 11 mm Square Size 9 x 12 mm
6902-12	Push Fit Ring Spanner 12 mm Square Size 9 x 12 mm
6902-13	Push Fit Ring Spanner 13 mm Square Size 9 x 12 mm
6902-14	Push Fit Ring Spanner 14 mm Square Size 9 x 12 mm
6902-15	Push Fit Ring Spanner 15 mm Square Size 9 x 12 mm
6902-16	Push Fit Ring Spanner 16 mm Square Size 9 x 12 mm
6902-17	Push Fit Ring Spanner 17 mm Square Size 9 x 12 mm
6902-18	Push Fit Ring Spanner 18 mm Square Size 9 x 12 mm
6902-19	Push Fit Ring Spanner 19 mm Square Size 9 x 12 mm
6902-21	Push Fit Ring Spanner 21 mm Square Size 9 x 12 mm
6902-22	Push Fit Ring Spanner 22 mm Square Size 9 x 12 mm



Reversible Insert Ratchet | Square Size 14 x 18 mm

- rectangular shaft
- square size: 14 x 18 mm
- with locking pin
- with 48 teeth
- BGS 2822 with quick release
- drive: square according to DIN 3120 | ISO 1174-1
- surface finish: satin chrome plated
- for use with torque wrench BGS 2811, BGS 2812



Item #	Description
2822	Plug-in Reversible Ratchet 12.5 mm (1/2") Square Size 14 x 18 mm
2823	Reversible Insert Ratchet 20 mm (3/4") Square Size 14 x 18 mm



Open-End Push Fit Spanner | Square Size 14 x 18 mm

- rectangular
- square size: 14 x 18 mm
- with locking pin
- surface finish: satin chrome plated



Item #	Description
6901-13	Open-End Push Fit Spanner 13 mm Square Size 14 x 18 mm
6901-14	Open-End Push Fit Spanner 14 mm Square Size 14 x 18 mm
6901-15	Open-End Push Fit Spanner 15 mm Square Size 14 x 18 mm
6901-16	Open-End Push Fit Spanner 16 mm Square Size 14 x 18 mm
6901-17	Open-End Push Fit Spanner 17 mm Square Size 14 x 18 mm
6901-18	Open-End Push Fit Spanner 18 mm Square Size 14 x 18 mm
6901-19	Open-End Push Fit Spanner 19 mm Square Size 14 x 18 mm
6901-21	Open-End Push Fit Spanner 21 mm Square Size 14 x 18 mm
6901-24	Open-End Push Fit Spanner 24 mm Square Size 14 x 18 mm
6901-27	Open-End Push Fit Spanner 27 mm Square Size 14 x 18 mm
6901-30	Open-End Push Fit Spanner 30 mm Square Size 14 x 18 mm
6901-32	Open-End Push Fit Spanner 32 mm Square Size 14 x 18 mm
6901-34	Open-End Push Fit Spanner 34 mm Square Size 14 x 18 mm
6901-36	Open-End Push Fit Spanner 36 mm Square Size 14 x 18 mm
6901-38	Open-End Push Fit Spanner 38 mm Square Size 14 x 18 mm
6901-41	Open-End Push Fit Spanner 41 mm Square Size 14 x 18 mm



Push Fit Ring Spanner | Square Size 14 x 18 mm

- rectangular
- square size: 14 x 18 mm
- with locking pin
- profile: 12-point
- surface finish: satin chrome plated



Item #	Description
6903-13	Push Fit Ring Spanner 13 mm Square Size 14 x 18 mm
6903-14	Push Fit Ring Spanner 14 mm Square Size 14 x 18 mm
6903-15	Push Fit Ring Spanner 15 mm Square Size 14 x 18 mm
6903-16	Push Fit Ring Spanner 16 mm Square Size 14 x 18 mm
6903-17	Push Fit Ring Spanner 17 mm Square Size 14 x 18 mm
6903-18	Push Fit Ring Spanner 18 mm Square Size 14 x 18 mm
6903-19	Push Fit Ring Spanner 19 mm Square Size 14 x 18 mm
6903-21	Push Fit Ring Spanner 21 mm Square Size 14 x 18 mm
6903-22	Push Fit Ring Spanner 22 mm Square Size 14 x 18 mm
6903-24	Push Fit Ring Spanner 24 mm Square Size 14 x 18 mm
6903-27	Push Fit Ring Spanner 27 mm Square Size 14 x 18 mm
6903-30	Push Fit Ring Spanner 30 mm Square Size 14 x 18 mm
6903-32	Push Fit Ring Spanner 32 mm Square Size 14 x 18 mm
6903-34	Push Fit Ring Spanner 34 mm Square Size 14 x 18 mm
6903-36	Push Fit Ring Spanner 36 mm Square Size 14 x 18 mm
6903-41	Push Fit Ring Spanner 41 mm Square Size 14 x 18 mm



Push Fit Ring Spanner | open Type | Square Size 9 x 12 mm

- rectangular shaft
- square size 9 x 12 mm
- with locking pin
- surface finish: satin chrome plated



Item #	Description
6904-10	Push Fit Ring Spanner open Type 10 mm Square Size 9 x 12 mm
6904-11	Push Fit Ring Spanner open Type 11 mm Square Size 9 x 12 mm
6904-12	Push Fit Ring Spanner open Type 12 mm Square Size 9 x 12 mm
6904-13	Push Fit Ring Spanner open Type 13 mm Square Size 9 x 12 mm
6904-14	Push Fit Ring Spanner open Type 14 mm Square Size 9 x 12 mm
6904-16	Push Fit Ring Spanner open Type 16 mm Square Size 9 x 12 mm
6904-17	Push Fit Ring Spanner open Type 17 mm Square Size 9 x 12 mm
6904-18	Push Fit Ring Spanner open Type 18 mm Square Size 9 x 12 mm
6904-19	Push Fit Ring Spanner open Type 19 mm Square Size 9 x 12 mm
6904-21	Push Fit Ring Spanner open Type 21 mm Square Size 9 x 12 mm
6904-22	Push Fit Ring Spanner open Type 22 mm Square Size 9 x 12 mm



Torque Wrench Set | 12.5 mm (1/2") | 40 - 200 Nm

- tire change service set
- ideal for wheel changing on most popular rims
- colour coded protective impact sockets suitable for manual and impact wrench operation
- incl. torque extension for pre-tightening wheel bolts and nuts with impact wrenches
- automatic tightening stop prevents damage to rims and screws

scope of delivery:

- torque wrench
 - ratcheting head, reversible, 48 teeth
 - suitable on screws with right hand thread
 - viewing window for torque value
 - resolution: +/- 4%, incl. test certificate
 - torque range: 40 - 200 Nm
 - fine scale: 0.5 Nm
 - length: 537 mm
- Protective Impact Socket | 12.5 mm (1/2") Drive | 17 mm (BGS 7201)
- Protective Impact Socket | 12.5 mm (1/2") Drive | 19 mm (BGS 7202)
- Protective Impact Socket | 12.5 mm (1/2") Drive | 21 mm (BGS 7203)
- Torsion Bar | 120 Nm | length: 195 mm (BGS 185-120), the tolerance when using the torsion bar is approx. 10% if using an impact wrench with 250Nm within 5 seconds



Item #
2818



Universal Deburring Tool

- 4 multi purpose blades for use on a variety of materials, e. g. steel, aluminium, brass, copper and plastic
- ideal tool for plumbers, mechanic engineers
- 4 lockable blades, following types:
 - blade for use on steel, aluminum and plastic
 - blade for use on brass and cast iron
 - blade for deburring from 1 to 10.4 mm
 - special blade for tool and die makers



Item #
6751



Aluminum Hammer | 500 g

- for damage-free mounting of parts
- length: 360 mm
- head diameter: 45 mm
- material: aluminum



Item #
894

Dead Blow Hammer | Hickory Handle | Ø 30 mm

- with nylon faces



Item #
1859-30

Aluminum / Plastic Hammer | extra long Head | 300 g

- with replaceable plastic head
- flat / crowned design
- does not damage other objects
- length: 310 mm
- head diameter: 30 mm
- total head length: 150 mm
- plastic tip length: 24 mm
- head weight: 300 g
- material: aluminum
- material handle: wood



Item #
6664

STI Short Machine Taps | HSS-G

- with straight groove
- suitable for regrooving right internal threads in already drilled holes

Item #	Description
1952-3	STI Short Machine Tap HSS-G M5 x 0.8
1953-3	STI Short Machine Tap HSS-G M6 x 1.0
9431-3	STI Short Machine Tap HSS-G M7 x 1.0
9427-3	STI Short Machine Tap HSS-G M8 x 1.0
1954-3	STI Short Machine Tap HSS-G M8 x 1.25
9435-3	STI Short Machine Tap HSS-G M9 x 1.25
1958-3	STI Short Machine Tap HSS-G M10 x 1.0
9428-3	STI Short Machine Tap HSS-G M10 x 1.25
1955-3	STI Short Machine Tap HSS-G M10 x 1.5
9436-3	STI Short Machine Tap HSS-G M11 x 1.5
9437-3	STI Short Machine Tap HSS-G M12 x 1.0
9429-3	STI Short Machine Tap HSS-G M12 x 1.5
1956-3	STI Short Machine Tap HSS-G M12 x 1.75
1957-3	STI Short Machine Tap HSS-G M14 x 1.25
9430-3	STI Short Machine Tap HSS-G M14 x 1.5
9432-3	STI Short Machine Tap HSS-G M16 x 1.5
9433-3	STI Short Machine Tap HSS-G M18 x 1.5
9434-3	STI Short Machine Tap HSS-G M20 x 1.5
9438-3	STI Short Machine Tap HSS-G M24 x 2.0



Tap Sets | Starter, Plug, Bottoming Tap | HSS-G | 3 pcs.

- made of HSS-G steel
- includes starter, plug and bottoming tap
- for thread/incline:

- BGS 920: M3 x 0.5
- BGS 921: M4 x 0.7
- BGS 922: M5 x 0.8
- BGS 927: M14 x 2.0
- BGS 928: M16 x 2.0



Item #	Description
920	Tap Set Starter, Plug, Bottoming Tap HSS-G M3 x 0.5 3 pcs.
921	Tap Set Starter, Plug, Bottoming Tap HSS-G M4 x 0.7 3 pcs.
922	Tap Set Starter, Plug, Bottoming Tap HSS-G M5 x 0.8 3 pcs.
927	Tap Set Starter, Plug, Bottoming Tap HSS-G M14 x 2.0 3 pcs.
928	Tap Set Starter, Plug, Bottoming Tap HSS-G M16 x 2.0 3 pcs.



Universal Outside Thread Chaser | Ø 35 - 130 mm

- for regrooving and cleaning external threads on axle tubes, thrust rods, steering rods, etc.
- no need to use different taps
- quick thread insert changes possible
- can be attached to any undamaged thread position and regrooves the thread from this position
- no damage of the thread due to the soft holding guides
- suitable for metric and imperial right and left hand threads
- infinitely adjustable

scope of delivery:

- thread chaser
- regrooving insert (metric), for thread pitches 1.0 - 1.25 - 1.5 - 1.75 mm
- regrooving insert (metric), for thread pitches 2.0 - 2.5 - 3.0 - 3.5 mm
- regrooving insert (inch), for thread pitches 4 - 5 - 6 - 7
- regrooving insert (inch), for thread pitches 7.5 - 9 - 11 - 11.5
- regrooving insert (inch), for thread pitches 8 - 10 - 12 - 14
- regrooving insert (inch), for thread pitches 16 - 18 - 20 - 24



Hand Tools

Item #
9816

Tap Adaptor Socket Set | 6,3 mm (1/4") / 10 mm (3/8") Drive | 8 pcs.

6.3 1/4 10 3/8

- internal square 1/4" (6.3 mm) and 3/8" (10 mm) drive
- works with a ratchet or sliding handle
- suitable for taps: 1.5 mm - 12 mm, 1/16" - 1/2" NF/NC
- with magnet for holding the tap
- ideal in tight places where a tap holder cannot be used
- on metal rail



Item #
9771



HSS Milling Cutter Set, extra short | 5 pcs.

- suitable for drilling and milling machines
- for grinding and shaping wood, plastic, aluminium, copper, etc.
- shaft diameter: 3 mm
- material: HSS steel
- max. drive speed.: 50.000 rpm
- shaft length: 23,5 mm
- 1 HSS milling cutter, spherical, shaft Ø 3 mm
- 2 HSS milling cutter, cylindrical, shaft Ø 3 mm
- 2 HSS milling cutter, conical, shaft Ø 3 mm



Item #
9596



Machinist's Files | Hand | 1st, 2nd, 3rd Cut | 150 - 200 mm

- DIN 7261
- form A
- 1st, 2nd, 3rd cut (coarse - middle - fine)
- rectangular file with pivot and cut on three sides
- labor saving file teeth
- universally applicable e.g. for surface machining, deburring etc.
- non-slip 2-component handle
- length: 150 - 200 mm (without handle)



Item #	Description
6570	Machinist's File Hand 1st Cut 150 mm
6571	Machinist's File Hand 2nd Cut 150 mm
6572	Machinist's File Hand 3rd Cut 150 mm
6550	Machinist's File Hand 1st Cut 200 mm
6551	Machinist's File Hand 2nd Cut 200 mm
6552	Machinist's File Hand 3rd Cut 200 mm

Machinist's Files | Halfround | 1st, 2nd, 3rd Cut | 150 - 200 mm

- DIN 7261
- form E
- 1st, 2nd, 3rd cut (coarse - middle - fine)
- halfround files with pivot and cut on two sides
- labor saving file teeth
- universally applicable e.g. for surface machining, deburring etc.
- non-slip 2-component handle
- length: 150 - 200 mm (without handle)



Item #	Description
6573	Machinist's File Halfround 1st Cut 150 mm
6574	Machinist's File Halfround 2nd Cut 150 mm
6575	Machinist's File Halfround 3rd Cut 150 mm
6553	Machinist's File Halfround 1st Cut 200 mm
6554	Machinist's File Halfround 2nd Cut 200 mm
6555	Machinist's File Halfround 3rd Cut 200 mm

Machinist's Files | Round | 1st, 2nd, 3rd Cut | 150 - 200 mm

- DIN 7261
- form F
- 1st, 2nd, 3rd cut (coarse - middle - fine)
- round files with framed cut
- labor saving file teeth
- universally applicable e.g. for surface machining, deburring etc.
- non-slip 2-component handle
- length: 150 - 200 mm (without handle)



Item #	Description
6576	Machinist's File Round 1st Cut 150 mm
6577	Machinist's File Round 2nd Cut 150 mm
6578	Machinist's File Round 3rd Cut 150 mm
6556	Machinist's File Round 1st Cut 200 mm
6557	Machinist's File Round 2nd Cut 200 mm
6558	Machinist's File Round 3rd Cut 200 mm

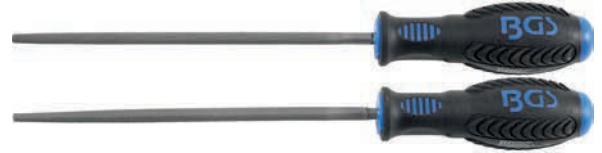

Machinist's Files | Square | 1st, 2nd, 3rd Cut | 150 - 200 mm

- DIN 7261
- form D
- 1st, 2nd, 3rd cut (coarse - middle - fine)
- square files with cut on four sides
- labor-saving file teeth
- universally applicable e.g. for surface machining, deburring etc.
- non-slip 2-component handle
- length: 150 - 200 mm (without handle)



Item #	Description
6579	Machinist's File Square 1st Cut 150 mm
6590	Machinist's File Square 2nd Cut 150 mm
6591	Machinist's File Square 3rd Cut 150 mm
6559	Machinist's File Square 1st Cut 200 mm
6560	Machinist's File Square 2nd Cut 200 mm
6561	Machinist's File Square 3rd Cut 200 mm



Machinist's Files | Triangular | 1st, 2nd, 3rd Cut | 150 - 200 mm

- DIN 7261
- form C
- 1st, 2nd, 3rd cut (coarse - middle - fine)
- triangle, cuspid files with cut on three sides
- labor-saving file teeth
- universally applicable e.g. for surface machining, deburring etc.
- non-slip 2-component handle
- length: 150 - 200 mm (without handle)



Item #	Description
6592	Machinist's File Triangular 1st Cut 150 mm
6593	Machinist's File Triangular 2nd Cut 150 mm
6594	Machinist's File Triangular 3rd Cut 150 mm
6562	Machinist's File Triangular 1st Cut 200 mm
6563	Machinist's File Triangular 2nd Cut 200 mm
6564	Machinist's File Triangular 3rd Cut 200 mm

Steel Brushes | 6.3 mm (1/4") Drive | 3 pcs.

- for cleaning and deburring cylinders, bushings, pipes, etc.
- also for use on electric and air powered drills

Item #	Description
3078-8-S	Steel Brush 8 mm 6.3 mm (1/4") Drive 3 pcs.
3078-9-S	Steel Brush 9 mm 6.3 mm (1/4") Drive 3 pcs.
3078-10-S	Steel Brush 10 mm 6.3 mm (1/4") Drive 3 pcs.
3078-11-S	Steel Brush 11 mm 6.3 mm (1/4") Drive 3 pcs.
3078-12-S	Steel Brush 12 mm 6.3 mm (1/4") Drive 3 pcs.
3078-13-S	Steel Brush 13 mm 6.3 mm (1/4") Drive 3 pcs.
3078-14-S	Steel Brush 14 mm 6.3 mm (1/4") Drive 3 pcs.
3078-15-S	Steel Brush 15 mm 6.3 mm (1/4") Drive 3 pcs.
3078-16-S	Steel Brush 16 mm 6.3 mm (1/4") Drive 3 pcs.
3078-17-S	Steel Brush 17 mm 6.3 mm (1/4") Drive 3 pcs.
3078-18-S	Steel Brush 18 mm 6.3 mm (1/4") Drive 3 pcs.
3078-19-S	Steel Brush 19 mm 6.3 mm (1/4") Drive 3 pcs.



Brass Brushes | 6.3 mm (1/4") Drive | 3 pcs.

- for cleaning and deburring cylinders, bushings, pipes, etc.
- also for use on electric and air powered drills

Item #	Description
3078-8-M	Brass Brush 8 mm 6.3 mm (1/4") Drive 3 pcs.
3078-9-M	Brass Brush 9 mm 6.3 mm (1/4") Drive 3 pcs.
3078-10-M	Brass Brush 10 mm 6.3 mm (1/4") Drive 3 pcs.
3078-11-M	Brass Brush 11 mm 6.3 mm (1/4") Drive 3 pcs.
3078-12-M	Brass Brush 12 mm 6.3 mm (1/4") Drive 3 pcs.
3078-13-M	Brass Brush 13 mm 6.3 mm (1/4") Drive 3 pcs.
3078-14-M	Brass Brush 14 mm 6.3 mm (1/4") Drive 3 pcs.
3078-15-M	Brass Brush 15 mm 6.3 mm (1/4") Drive 3 pcs.
3078-16-M	Brass Brush 16 mm 6.3 mm (1/4") Drive 3 pcs.
3078-17-M	Brass Brush 17 mm 6.3 mm (1/4") Drive 3 pcs.
3078-18-M	Brass Brush 18 mm 6.3 mm (1/4") Drive 3 pcs.
3078-19-M	Brass Brush 19 mm 6.3 mm (1/4") Drive 3 pcs.



Hand Tools

Nylon Brushes | 6.3 mm (1/4") Drive | 3 pcs.

- for cleaning and deburring cylinders, bushings, pipes, etc.
- also for use on electric and air powered drills

Item #	Description
3078-8-N	Nylon Brush 8 mm 6.3 mm (1/4") Drive 3 pcs.
3078-9-N	Nylon Brush 9 mm 6.3 mm (1/4") Drive 3 pcs.
3078-10-N	Nylon Brush 10 mm 6.3 mm (1/4") Drive 3 pcs.
3078-11-N	Nylon Brush 11 mm 6.3 mm (1/4") Drive 3 pcs.
3078-12-N	Nylon Brush 12 mm 6.3 mm (1/4") Drive 3 pcs.
3078-13-N	Nylon Brush 13 mm 6.3 mm (1/4") Drive 3 pcs.
3078-14-N	Nylon Brush 14 mm 6.3 mm (1/4") Drive 3 pcs.
3078-15-N	Nylon Brush 15 mm 6.3 mm (1/4") Drive 3 pcs.
3078-16-N	Nylon Brush 16 mm 6.3 mm (1/4") Drive 3 pcs.
3078-17-N	Nylon Brush 17 mm 6.3 mm (1/4") Drive 3 pcs.
3078-18-N	Nylon Brush 18 mm 6.3 mm (1/4") Drive 3 pcs.
3078-19-N	Nylon Brush 19 mm 6.3 mm (1/4") Drive 3 pcs.



Handle | for Bits, Brushes, etc. | internal Hexagon 6.3 mm (1/4")

- 6.3 mm (1/4") drive
- quick lock
- suitable for brush set (BGS 3078)
- can be used with all bits 6.3 mm (1/4")



Item #
3078-2



Extension | for Bits, Brushes, etc. | internal Hexagon 6.3 mm (1/4") Drive | 150 mm

- length: 150 mm
- suitable for brush set (BGS 3078)
- can be used with all bits 6.3 mm (1/4")

Item #
3078-3



Battery Pole and Clamp Cleaning Brush | 85 mm

- for removing contact corrosion and acid deposits on battery terminals and pole terminals
- suitable for interior and exterior cleaning
- external brush Ø 23 mm
- internal brush Ø 20 mm
- material: metal bristles - housing: plastic

Item #
6742



Drill Chuck Adaptor | 1/2" x 20 UNF | for SDS chuck

- for SDS chuck
- 1/2" x 20 UNF
- also suitable for drill chuck Art. 9937

Item #
9766



Angled Drill Head with Keyless Chuck

- suitable for drills & bits with 6,3 mm (1/4") shaft
- for drilling and screwing at 90° angles in hard-to-reach places
- ideal for narrow work areas or angles
- ball bearing guide
- extra heavy and stable design
- 3 bits PH1 - PH2 - PZ1 included
- 6.3 mm (1/4") drive
- length: 155 mm
- head length: 31 mm

Item #
9758



Quick Release Nut | for Angle Grinder | M14

- for quick and toolless changing
- to be used only with cutting and grinding discs
- for standard angle grinders with M14 spindle thread
- usable with disc diameters up to 230 mm and disc thickness up to max. 6 mm
- material: tool steel



Item #
9549



HSS Twist Drill Set | Core Hole Sizes | Ø 2.5 - 10.2 mm | 7 pcs.

- pointed angle: 135° cross cut
- milled
- 7 twist drills with core hole sizes 2.5 - 3.3 - 4.2 - 5.0 - 6.8 - 8.5 - 10.2 mm



Item #
9580



Step Drill and Twist Drill Set | Ø 4 - 12 / 4 - 20 mm | 2 - 5 mm | 10 pcs.

- material: HSS steel
- step drill Ø 4-12 mm
- step drill Ø 4-20 mm
- 2 twist drills 2 mm
- 2 twist drills 3 mm
- 2 twist drills 4 mm
- 2 twist drills 5 mm



Item #
1686



Blind Rivet Drill Set | HSS | 2.4 - 6.4 mm | 15 pcs.

- milled
- pointed angle: 135° cross cut
- suitable for rivet holes, screw holes, thin sheet metal holes in body and metal construction

scope of delivery:

- 2 blind rivet drills 2.4 mm
- 3 blind rivet drills 3.2 mm
- 5 blind rivet drills 4.0 mm
- 4 blind rivet drills 4.8 mm
- 1 blind rivet drills 6.4 mm



Item #
2097

Inner Bearing Puller

- for disassembling of pilot bearings (guide bearing of gearbox input shaft)
- inner width (outrigger): 74 mm
- total width: 94 mm
- threaded bolt M12, length 180 mm
- hexagon nut, 19 mm
- BGS 9462: clamping width: 15 - 31 mm, max. bearing width: up to 19,1 mm
- BGS 9463: clamping width: 24 - 51 mm, max. bearing width: up to 25,4 mm



Item #	Description
9462	Inner Bearing Puller for Ø 15 - 31 mm
9463	Inner Bearing Puller for Ø 24 - 51 mm

Drift Punch / Center Punch Set | 120 mm | 1 - 5 mm | 6 pcs.

- hardened, coloured shaft
- regrindable tip
- 10 mm octagonal shaft
- in plastic holder

scope of delivery:

- drift punch, 120 mm, 8-pt, Ø 1 mm (DIN 6458D)
- drift punch, 120 mm, 8-pt, Ø 2 mm (DIN 6458D)
- drift punch, 120 mm, 8-pt, Ø 3 mm (DIN 6458D)
- drift punch, 120 mm, 8-pt, Ø 4 mm (DIN 6458D)
- drift punch, 120 mm, 8-pt, Ø 5 mm (DIN 6458D)
- center punch 120 mm, 8-pt, Ø 4 mm (DIN 7250)



Item #	Description
9409	Drift Punch / Center Punch Set 120 mm 1 - 5 mm 6 pcs.
9409-1	Drift Punch DIN 6458D 120 mm Ø 1 mm
9409-2	Drift Punch DIN 6458D 120 mm Ø 2 mm
9409-3	Drift Punch DIN 6458D 120 mm Ø 3 mm
9409-4	Drift Punch DIN 6458D 120 mm Ø 4 mm
9409-5	Drift Punch DIN 6458D 120 mm Ø 5 mm
9409-6	Center Punch DIN 7250 4 x 10 x 120 mm

Crimping Pliers Set | hydraulic | 16 - 400 mm²

- for crimping of aluminum and copper tube connectors and terminals on cables with large cross-section
- professional hexagon pressing
- prevents high transition resistance
- automatically adjusting pressure
- crimping range (aluminum): 35 - 300 mm²
- crimping range (copper): 16 - 400 mm²
- max. pressure: 16 t
- max. stroke: 24 mm

scope of delivery:

- crimping tool
- 12 interchangeable crimping jaws for wire cross section: 16, 25, 35, 50, 70, 95, 120, 150, 185, 240, 300, 400 mm²



Item #
9573

Connector Assortment | Superseal 1.5 | 350 pcs.

- for repairing of existing cabling and for new wiring with Superseal 1.5 splash water protected and dustproof connectors
- 50 green F1.0 wire seals for outer diameter 1.2 - 1.8 mm
- 50 yellow F1.4 wire seals for outer diameter 1.6 - 2.4 mm
- 50 male terminals for cable cross section 0.3 - 0.5 mm²
- 50 female terminals for cable cross section 0.3 - 0.5 mm²
- 50 male terminals for cable cross section 0.85 - 1.25 mm²
- 50 female terminals for cable cross section 0.85 - 1.25 mm²
- 6 male housings (1 pole)
- 6 female housings (1 pole)
- 6 male housings (2 pole)
- 6 female housings (2 pole)
- 4 male housings (3 pole)
- 4 female housings (3 pole)
- 4 male housings (4 pole)
- 4 female housings (4 pole)
- 3 male housings (5 pole)
- 3 female housings (5 pole)
- 2 male housings (6 pole)
- 2 female housings (6 pole)
- wire seal material: silicone, seal outer diameter: 6.1 mm
- terminal material: brass
- housing material: PA66+GF
- temperature range: -40°C to 120°C



Item #
9634

Nut Riveter | M3 - M8 | 7 pcs.

- for rivet nuts M3 - M4 - M5 - M6 - M8
- two lever arms with ergonomic handles for two-hand operation with immaculate transmission of power
- 1 riveter
- 1 connecting nut with rivet nut holder M3 for drill hole diameter Ø 5.0 mm
- 1 connecting nut with rivet nut holder M4 for drill hole diameter Ø 6.0 mm
- 1 connecting nut with rivet nut holder M5 for drill hole diameter Ø 7.0 mm
- 1 connecting nut with rivet nut holder M6 for drill hole diameter Ø 9.0 mm
- 1 connecting nut with rivet nut holder M8 for drill hole diameter Ø 11.0 mm
- 1 installation wrench for nosepiece / mandrel pairs



Item #
404

Rivet Nut Attachment | M6 / M8 / M10

- converts any drill into a rivet gun
- works with standard electric drills (reversible, torque 50 - 100 Nm)
- with mounting key
- with threaded mandrels and nosepieces in M6 - M8 - M10



Item #
9655

Hose Stripping Pliers | Locking Type | 202 mm

- for easy separating of hose connections with firm grip on the line
- jaws for 4.8 mm (3/16"), 6.4 mm (1/4") und 9.5 mm (3/8") pipes
- suitable for hoses connected on smooth pipes on which pulling with drag force is not possible
- with jaw lock
- extra flat version for working in areas with limited spaces
- special jaw lock for secure gripping
- dip insulated handles
- hardness: 43-47 HRC
- width: 94 mm



Item #
9737



Hose Clamp Pliers | 0 - 40 mm | 440 mm

- for working in hard-to-reach places
- opening width min.: 0 mm
- opening width max.: 40 mm
- dip coated handles
- with ratchet locking mechanism



Item #
6675



Hose Clamp Pliers | with interchangeable Bowden Cables | 635 - 670 mm

- for mounting and disassembly of different flexible belt clamps from 0 - 75 mm
- for use even in narrow spaces with interchangeable bowden cables
- special design for easy and quick change of the tensioning head unit for different hose clamps
- surface finish: burnished

scope of delivery:

- hose clamp pliers with bowden cable
- 670 mm bowden cable with clamp head for standard hose clamps, opening range 3 to 52 mm
- 635 mm bowden cable with clamp head for Clic-R type hose clamps, opening range 0 to 24 mm
- 670 mm bowden cable with dual side clamp head for spring type & truck hose clamps, opening range 0 to 75 mm



Item #
9815



Circlip Pliers Set | 250 mm | 4 pcs.

- for loosening an and fastening of snap rings
- dip insulated handles with non-slip surface
- packed in a solid wallet

scope of delivery:

- circlip pliers, angled, for outside circlips, 250 mm, opening width max. 36 mm
- circlip pliers, angled, for inside circlips, 250 mm, opening width max. 31 mm
- circlip pliers, straight, for inside circlips, 250 mm, opening width max. 39 mm
- circlip pliers, straight, for outside circlips, 250 mm, opening width max. 39 mm



Item #
652

Circlip Pliers | angled | for outside Circlips

- for loosening an and fastening of snap rings
- dip insulated handles with non-slip surface
- surface finish: nickel plated

BGS 450-1

- pliers tip Ø 1.5 mm
- opening width max. 36 mm
- length: 150 mm

BGS 447-1

- pliers tip Ø 2.0 mm
- opening width max. 30 mm
- length: 175 mm

BGS 650-1

- pliers tip Ø 2.4 mm
- opening width max. 36 mm
- length: 225 mm

BGS 651-1

- pliers tip Ø 3.2 mm
- opening width max. 39 mm
- length: 250 mm

BGS 652-1

- pliers tip Ø 2.4 mm
- opening width max. 36 mm
- length: 300 mm



Item #	Description
450-1	Circlip Pliers angled for outside Circlips 150 mm
447-1	Circlip Pliers angled for outside Circlips 175 mm
650-1	Circlip Pliers angled for outside Circlips 225 mm
652-1	Circlip Pliers angled for outside Circlips 250 mm
651-1	Circlip Pliers angled for outside Circlips 300 mm

Circlip Pliers | angled | for inside Circlips

- for loosening an and fastening of snap rings
- dip insulated handles with non-slip surface
- pliers tip Ø 2.0 mm
- opening width max. 30 mm
- surface finish: nickel plated

BGS 450-4

- pliers tip Ø 1.5 mm
- opening width max. 31 mm
- length: 150 mm

BGS 447-4

- pliers tip Ø 2.0 mm
- opening width max. 30 mm
- length: 175 mm

BGS 650-4

- pliers tip Ø 2.4 mm
- opening width max. 31 mm
- length: 225 mm

BGS 652-4

- pliers tip Ø 2.4 mm
- opening width max. 31 mm
- length: 250 mm

BGS 651-4

- pliers tip Ø 3.2 mm
- opening width max. 59 mm
- length: 300 mm



Item #	Description
450-4	Circlip Pliers angled for inside Circlips 150 mm
447-4	Circlip Pliers angled for inside Circlips 175 mm
650-4	Circlip Pliers angled for inside Circlips 225 mm
652-4	Circlip Pliers angled for inside Circlips 250 mm
651-4	Circlip Pliers angled for inside Circlips 300 mm



Circlip Pliers | straight | for inside Circlips

- for loosening an and fastening of snap rings
- dip insulated handles with non-slip surface
- surface finish: nickel plated

BGS 450-2

- pliers tip Ø 1.5 mm
- opening width max. 36 mm
- length: 150 mm

BGS 447-2

- pliers tip Ø 2.0 mm
- opening width max. 38 mm
- length: 175 mm

BGS 650-2

- pliers tip Ø 2.4 mm
- opening width max. 36 mm
- length: 225 mm

BGS 652-2

- pliers tip Ø 2.4 mm
- opening width max. 36 mm
- length: 250 mm

BGS 651-2

- pliers tip Ø 3.2 mm
- opening width max. 68 mm
- length: 300 mm



Item #	Description
450-2	Circlip Pliers straight for inside Circlips 150 mm
447-2	Circlip Pliers straight for inside Circlips 175 mm
650-2	Circlip Pliers straight for inside Circlips 225 mm
652-2	Circlip Pliers straight for inside Circlips 250 mm
651-2	Circlip Pliers straight for inside Circlips 300 mm

Circlip Pliers | straight | for outside Circlips

- for loosening and fastening of snap rings
- dip insulated handles with non-slip surface
- pliers tip Ø 2.0 mm
- 39 mm
- surface finish: nickel plated

BGS 450-3

- pliers tip Ø 1.5 mm
- opening width max. 39 mm
- length: 150 mm

BGS 447-3

- pliers tip Ø 2.0 mm
- opening width max. 39 mm
- length: 175 mm

BGS 650-3

- pliers tip Ø 2.4 mm
- opening width max. 39 mm
- length: 225 mm

BGS 652-3

- pliers tip Ø 2.4 mm
- opening width max. 39 mm
- length: 250 mm

BGS 651-3

- pliers tip Ø 3.2 mm
- opening width max. 48 mm
- length: 300 mm



Item #	Description
450-3	Circlip Pliers straight for outside Circlips 150 mm
447-3	Circlip Pliers straight for outside Circlips 175 mm
650-3	Circlip Pliers straight for outside Circlips 225 mm
652-3	Circlip Pliers straight for outside Circlips 250 mm
651-3	Circlip Pliers straight for outside Circlips 300 mm



Circlip Pliers | angled | 500 mm

- for loosening and fastening of snap rings
- heavy-duty type
- with ratchet locking mechanism
- dip insulated handles with non-slip surface
- pliers tip Ø 3.5 mm
- opening width min. 165 mm
- opening width max. 300 mm
- surface finish: nickel plated
- BGS 6738: for inside circlips
- BGS 6739: for outside circlips

Item #	Description
6738	Circlip Pliers angled for inside Circlips 500 mm
6739	Circlip Pliers angled for outside Circlips 500 mm



Circlip Pliers | straight | 500 mm

- for loosening an and fastening of snap rings
- heavy-duty type
- dip insulated handles with non-slip surface
- with ratchet locking mechanism
- pliers tip Ø 3.5 mm
- opening width min. 165 mm
- opening width max. 300 mm
- surface finish: nickel plated
- BGS 6736: for outside circlips
- BGS 6737: for inside circlips

Item #	Description
6736	Circlip Pliers straight for outside Circlips 500 mm
6737	Circlip Pliers straight for inside Circlips 500 mm



Water Pump Pliers | Box-Joint Type | 150 mm

- safety handles
- forged and hardened
- black lacquered finish
- polished jaws and joint
- handles dip insulated
- max. opening width 25 mm

Item #	Image
75109	



Water Pump Pliers Set | Locking Type | 175 / 300 / 400 mm | 3 pcs.

- safety handles
- forged and hardened
- black lacquered finish
- polished jaws and joint
- handles dip insulated
- packed in a wallet
- the opening width is locked and can be unlocked for adjustments by a push button
- Water Pump Pliers, Locking Type, 175 mm, max. opening width 32 mm (Art. 9541)
- Water Pump Pliers, Locking Type, 240 mm, max. opening width 36 mm (Art. 9542)
- Water Pump Pliers, Locking Type, 300 mm, max. opening width 52 mm (Art. 9543)



Item #	Description
9545	Water Pump Pliers Set Locking Type 175 / 240 / 300 mm 3 pcs.
9541	Water Pump Pliers Locking Type 175 mm
9542	Water Pump Pliers Locking Type 240 mm
9543	Water Pump Pliers Locking Type 300 mm
9544	Water Pump Pliers Locking Type 400 mm



L-Type Wrench Set | extra long | internal Hexagon / internal Hexagon with Ball Head 1.5 - 10 mm | 13 pcs.

- long side with ball point
- in foldable holder

scope of delivery:

- L-type wrench internal hexagon / internal hexagon with ball point 1.5 mm, length (short side): 16 mm, blade length (long side): 89 mm
- L-type wrench internal hexagon / internal hexagon with ball point 2 mm, length (short side): 18 mm, blade length (long side): 100 mm
- L-type wrench internal hexagon / internal hexagon with ball point 2.5 mm, length (short side): 20 mm, blade length (long side): 112 mm
- L-type wrench internal hexagon / internal hexagon with ball point 3 mm, length (short side): 23 mm, blade length (long side): 126 mm
- L-type wrench internal hexagon / internal hexagon with ball point 4 mm, length (short side): 24 mm, blade length (long side): 140 mm
- L-type wrench internal hexagon / internal hexagon with ball point 4.5 mm, length (short side): 31 mm, blade length (long side): 155 mm
- L-type wrench internal hexagon / internal hexagon with ball point 5 mm, length (short side): 32 mm, blade length (long side): 160 mm
- L-type wrench internal hexagon / internal hexagon with ball point 5.5 mm, length (short side): 35 mm, blade length (long side): 174 mm
- L-type wrench internal hexagon / internal hexagon with ball point 6 mm, length (short side): 38 mm, blade length (long side): 182 mm
- L-type wrench internal hexagon / internal hexagon with ball point 7 mm, length (short side): 40 mm, blade length (long side): 193 mm
- L-type wrench internal hexagon / internal hexagon with ball point 8 mm, length (short side): 44 mm, blade length (long side): 200 mm
- L-type wrench internal hexagon / internal hexagon with ball point 9 mm, length (short side): 47 mm, blade length (long side): 215 mm
- L-type wrench internal hexagon / internal hexagon with ball point 10 mm, length (short side): 50 mm, blade length (long side): 230 mm



Item #		
9799		

L-Type Wrench Set | extra long | Inch Sizes | internal Hexagon / internal Hexagon with Ball Head 0.05" - 3/8" | 13 pcs.

- long side with ball point
- in foldable holder
- inch sizes

scope of delivery:

- L-type wrench internal hexagon / internal hexagon with ball point 0.5", blade length (short side): 16 mm, blade length (long side): 80 mm
- L-type wrench internal hexagon / internal hexagon with ball point 1/16", blade length (short side): 17 mm, blade length (long side): 90 mm
- L-type wrench internal hexagon / internal hexagon with ball point 5/64", blade length (short side): 18 mm, blade length (long side): 100 mm
- L-type wrench internal hexagon / internal hexagon with ball point 3/32", blade length (short side): 20 mm, blade length (long side): 112 mm
- L-type wrench internal hexagon / internal hexagon with ball point 7/64", blade length (short side): 22 mm, blade length (long side): 115 mm
- L-type wrench internal hexagon / internal hexagon with ball point 1/8", blade length (short side): 23 mm, blade length (long side): 126 mm
- L-type wrench internal hexagon / internal hexagon with ball point 9/64", blade length (short side): 25 mm, blade length (long side): 132 mm
- L-type wrench internal hexagon / internal hexagon with ball point 5/32", blade length (short side): 26 mm, blade length (long side): 140 mm
- L-type wrench internal hexagon / internal hexagon with ball point 3/16", blade length (short side): 29 mm, blade length (long side): 163 mm
- L-type wrench internal hexagon / internal hexagon with ball point 7/32", blade length (short side): 34 mm, blade length (long side): 167 mm
- L-type wrench internal hexagon / internal hexagon with ball point 1/4", blade length (short side): 37 mm, blade length (long side): 182 mm
- L-type wrench internal hexagon / internal hexagon with ball point 5/16", blade length (short side): 41 mm, blade length (long side): 205 mm
- L-type wrench internal hexagon / internal hexagon with ball point 3/8", blade length (short side): 45 mm, blade length (long side): 230 mm



Radiator Spud Wrench | 12.5 mm (1/2") Drive | 4 steps

- 10 mm (3/8") - 12,5 mm (1/2") - 20 mm (3/4") - 25 mm (1")
- suitable for ratchet BGS 312



Universal Switchboard Key

- for opening and closing technical locks of switchboards control devices, a/c, ventilation, access panels, service doors
- also for opening service doors of street lights, garbage cans etc.
- for industry, handcraft, town councils, energy suppliers, public services, DIY, sanitary, building, janitors and many more
- internal square: 6 - 8 mm
- internal spread: 8 - 9 mm
- two-way key bit: 3 - 5 mm
- dimensions: 72 x 72 mm
- weight 52 g



Item #
9803



Gasket Scraper | angled | 155 mm

- for cleaning cylinder heads / valve covers and carburetor cover gaskets
- extra-long design for hard to reach areas
- scraper blade made of metal, width 15 mm
- angled blade head, approx. 50°
- handle type: 2 component handle
- total length: 275 mm



Item #	Description
6665	Gasket Scraper angled 155 mm
6665-1	Spare Blades Set for BGS 6665 5 pcs.

Sanding Pads Set | Grain Size 120 | Silicone Carbide | 10 pcs.

- suitable for cylindrical grinders, eccentric grinders, angle grinders
- diameter: 125 mm
- pads are held by a hook-and-loop system
- suitable for metal/wood

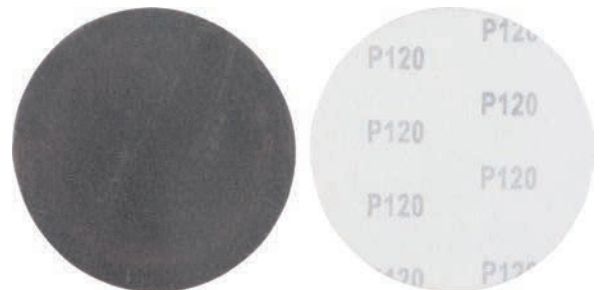

Item #
42025

Sanding Pads Set | Grain Size 240, fine | Silicone Carbide | 10 pcs.

- suitable for cylindrical grinders, eccentric grinders, angle grinders
- diameter: 125 mm
- pads are held by a hook-and-loop system
- suitable for metal/wood

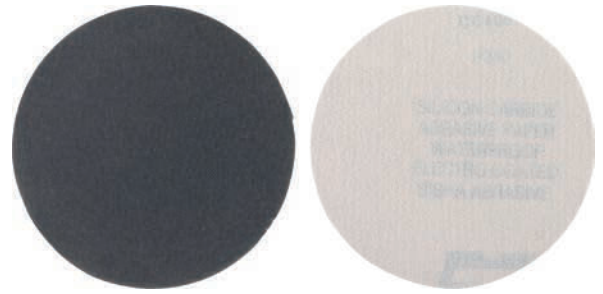

Item #
42026

Sanding Pads Set | Grain Size 60 | Aluminium Oxide | 10 pcs.

- suitable for cylindrical grinders, eccentric grinders, angle grinders
- outer diameter: 125 mm
- bore diameter: 22 mm
- suitable for metal



Item #	Description
42027	Sanding Pads Set Grain Size 60 Aluminium Oxide 10 pcs.
42028	Sanding Pads Set Grain Size 100 Aluminium Oxide 10 pcs.

Sanding Pads Set | for Drywall Sanders | Silicone Carbide / Aluminium Oxide | 10 pcs.

- diameter: 150 mm
- pads are held by a hook-and-loop system
- suitable for metal/wood

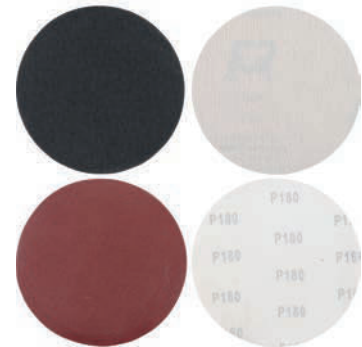

Item #	Description
42031	Sanding Pads Set for Drywall Sanders Grain Size 100 Silicone Carbide 10 pcs.
42032	Sanding Pads Set for Drywall Sanders Grain Size 180 Silicone Carbide 10 pcs.
42016	Sanding Pads Set for Drywall Sanders Grain Size 100 Aluminium Oxide 10 pcs.
42015	Sanding Pads Set for Drywall Sanders Grain Size 180 Aluminium Oxide 10 pcs.

Foil Eraser | Ø 90 mm

- use with electric drills
- for the removal of adhesive residues, etc. from metallic surfaces
- drive shaft: 6 mm, length: 18 mm
- incl. adaptor 5/16" x 24 to 6.0 mm shaft diameter, length: 40 mm
- max. 4000 rpm
- diameter: 90 mm
- thickness: 15 mm



Item #
3999-1

Foil Eraser | WAVE-Design | Ø 88 mm

- use with electric drills
- for the removal of adhesive residues, etc. from metallic surfaces
- drive shaft: 6 mm, length: 18 mm
- incl. adaptor 5/16" x 24 to 6.0 mm shaft diameter, length: 40 mm
- max. 4000 rpm
- diameter: 88 mm
- thickness: 15 mm



Item #
6654

Magnetiser / Demagnetiser

- for magnetising screwdriver tips, tools and small ferruginous parts
- screws and other small ferruginous parts stick on the tool smoothly after magnetizing
- uncomplicated recovery of magnetic effect with multiple moves



Item #
9560



VDE Pliers / Screwdriver Set | 12 pcs.

- 2-component anti-slip handles
- insulated according to DIN EN 60900
- VDE screwdrivers with suspension hole
- in zipper hanging bag
- 1 Voltage tester | 120 - 250 V | Blade Length 140 mm (BGS 725)
- 1 VDE Screwdriver | Slot SL 3 mm | Blade Length 75 mm (BGS 4925)
- 1 VDE Screwdriver | Slot SL 4 mm | Blade Length 100 mm (BGS 4924)
- 1 VDE Screwdriver | Slot SL 5.5 mm | Blade Length 125 mm (BGS 4940)
- 1 VDE Screwdriver | Slot SL 6.5 mm | Blade Length 150 mm (BGS 4941)
- 1 VDE Screwdriver | Cross Slot PH0 | Blade Length 75 mm (BGS 4942)
- 1 VDE Screwdriver | Cross Slot PH1 | Blade Length 80 mm (BGS 4926)
- 1 VDE Screwdriver | Cross Slot PH2 | Blade Length 100 mm (BGS 4927)
- 1 VDE Combination Pliers | 180 mm (BGS 7150)
- 1 VDE Side Cutter | 160 mm (BGS 7154)
- 1 VDE Long Nose Pliers | 160 mm (BGS 7151)
- 1 VDE Long Nose Pliers | 200 mm (BGS 7152)



Item #
7140



Combination Spanners | SAE

- DIN 3113-B
- cold forged
- matt chrome plated
- ring end 15° angled
- profile ring end: 12-point



Item #	Description
30680	Combination Spanner SAE 1"
30681	Combination Spanner SAE 1 1/32"
30683	Combination Spanner SAE 1 1/8"
30685	Combination Spanner SAE 1 1/4"

Combination Spanner Set | Open End with Ratchet Function | 8 - 21 mm | 13 pcs.

- cold forged spanners
- matt chrome plated
- open end with special profile: "Ratchet Function"
- ring end 15° angled
- profile ring end: 12-point
- packed in a tetron wallet
- combination spanners, open Ends with ratchet function: 8 - 9 - 10 - 11 - 12 - 13 - 14 - 15 - 16 - 17 - 18 - 19 - 21 mm



Item #
8914

Slogging Ring Spanners

- heavy duty type
- hot forged
- DIN 7444
- profile: 12-point
- surface finish: black burnished



Item #	Description
35124	Slogging Ring Spanner 24 mm
35127	Slogging Ring Spanner 27 mm
35130	Slogging Ring Spanner 30 mm
35132	Slogging Ring Spanner 32 mm
35134	Slogging Ring Spanner 34 mm
35136	Slogging Ring Spanner 36 mm
35138	Slogging Ring Spanner 38 mm
35141	Slogging Ring Spanner 41 mm
35146	Slogging Ring Spanner 46 mm
35150	Slogging Ring Spanner 50 mm
35155	Slogging Ring Spanner 55 mm
35160	Slogging Ring Spanner 60 mm
35165	Slogging Ring Spanner 65 mm
35170	Slogging Ring Spanner 70 mm
35175	Slogging Ring Spanner 75 mm
35180	Slogging Ring Spanner 80 mm



Slogging Ring Spanners | E-Type (for Torx) | with 2 Striking Faces

20  3/4

- for Torx screws on brake calliper screw connections on front axles and trailing axles of commercial vehicles
- use of the wrench for assembly and disassembly of the brake calliper screw connections makes disassembly of the steering tie lever unnecessary
- can be used with a torque wrench in accordance with the manufacturer's specifications
- 20 mm (3/4") drive
- E18 (Art. 35318)
 - suitable for **MAN** TGL TGM
- E20 (Art. 35320)
 - suitable for **MAN** TGL TGM
- E24 (Art. 35324) suitable for:
 - suitable for **MAN** TGA TGS TGX
 - suitable for **MERCEDES-BENZ** Atego 970-976 - trucks with air suspension / brake calliper screw connections on the rear axle



Item #	Description
35318	Slogging Ring Spanner E-Type (for Torx) with 2 Striking Faces E18
35320	Slogging Ring Spanner E-Type (for Torx) with 2 Striking Faces E20
35324	Slogging Ring Spanner E-Type (for Torx) with 2 Striking Faces E24

Slogging Ring Spanner | 12-point | with 2 Striking Faces

20  3/4

- for brake calliper fittings on commercial vehicles
- can be used with a torque wrench in accordance with the manufacturer's specifications
- 20 mm (3/4") drive
- BGS 35334: 24 mm, suitable for **SAF**-brake calliper on **MERCEDES-BENZ** Atego und Actros
- BGS 35336: 26 mm, suitable for DAF - XF95 / XF105 / XF



Item #	Description
35334	Slogging Ring Spanner 12-point with 2 Striking Faces 24 mm
35336	Slogging Ring Spanner 12-point with 2 Striking Faces 26 mm

Slogging Open End Spanners

- heavy duty type
- hot forged
- DIN 133
- surface finish: black burnished



Item #	Description
35230	Slogging Open End Spanner 30 mm
35232	Slogging Open End Spanner 32 mm
35236	Slogging Open End Spanner 36 mm
35241	Slogging Open End Spanner 41 mm
35246	Slogging Open End Spanner 46 mm
35250	Slogging Open End Spanner 50 mm
35255	Slogging Open End Spanner 55 mm
35260	Slogging Open End Spanner 60 mm
35265	Slogging Open End Spanner 65 mm
35270	Slogging Open End Spanner 70 mm
35275	Slogging Open End Spanner 75 mm
35280	Slogging Open End Spanner 80 mm
35285	Slogging Open End Spanner 85 mm
35290	Slogging Open End Spanner 90 mm
35295	Slogging Open End Spanner 95 mm



Pipe Wrench | open Type | 8-in-1 | 8 - 19 mm

- flexible swivel range allows working in small areas
- suitable for pipes and other tube fittings
- drive: hexagon, open (slotted)
- sizes: 8 - 10 - 11 - 12 - 13 - 14 - 17 - 19 mm



Ratchet Combination Wrench Set | 8 - 19 mm | 12 pcs.

- 72 teeth
- surface finish: satin chrome plated
- ratchet combination wrenches: 8 - 9 - 10 - 11 - 12 - 13 - 14 - 15 - 16 - 17 - 18 - 19 mm



Ratchet Combination Wrench Set | 8 - 19 mm | 8 pcs.

- 72 teeth
- surface finish: satin chrome plated
- ratchet combination wrenches: 8 - 10 - 12 - 13 - 14 - 15 - 17 - 19 mm



Item #
6540



Ratchet Combination Wrench Set | 8 - 32 mm | 13 pcs.

- 72 teeth
- surface finish: satin chrome plated
- ratchet combination wrenches: 8 - 10 - 12 - 13 - 14 - 17 - 19 - 21 - 22 - 24 - 27 - 30 - 32 mm



Item #
6542



Ratchet Combination Wrench

- 72 teeth
- output profile: 12-point
- surface finish: satin chrome plated



Item #	Description
6508	Ratchet Combination Wrench 8 mm
6509	Ratchet Combination Wrench 9 mm
6510	Ratchet Combination Wrench 10 mm
6511	Ratchet Combination Wrench 11 mm
6512	Ratchet Combination Wrench 12 mm
6513	Ratchet Combination Wrench 13 mm
6514	Ratchet Combination Wrench 14 mm
6515	Ratchet Combination Wrench 15 mm
6516	Ratchet Combination Wrench 16 mm
6517	Ratchet Combination Wrench 17 mm
6518	Ratchet Combination Wrench 18 mm
6519	Ratchet Combination Wrench 19 mm
6521	Ratchet Combination Wrench 21 mm
6522	Ratchet Combination Wrench 22 mm
6524	Ratchet Combination Wrench 24 mm
6527	Ratchet Combination Wrench 27 mm
6530	Ratchet Combination Wrench 30 mm
6532	Ratchet Combination Wrench 32 mm



Ratchet Wrench | adjustable

- ratchet is continuously adjustable up to 180° offset
- 72 teeth
- jaw 15°
- profile: 12-point
- surface finish: satin chrome plated



Item #	Description
6708	Ratchet Combination Wrench adjustable 8 mm
6709	Ratchet Combination Wrench adjustable 9 mm
6710	Ratchet Combination Wrench adjustable 10 mm
6711	Ratchet Combination Wrench adjustable 11 mm
6712	Ratchet Combination Wrench adjustable 12 mm
6713	Ratchet Combination Wrench adjustable 13 mm
6714	Ratchet Combination Wrench adjustable 14 mm
6715	Ratchet Combination Wrench adjustable 15 mm
6716	Ratchet Combination Wrench adjustable 16 mm
6717	Ratchet Combination Wrench adjustable 17 mm
6718	Ratchet Combination Wrench adjustable 18 mm
6719	Ratchet Combination Wrench adjustable 19 mm



Ratchet Combination Wrench | reversible

- 72 teeth
- jaw 15°
- ring side offset at 15°
- profile: 12-point
- surface finish: satin chrome plated



Item #	Description
6608	Ratchet Combination Wrench reversible 8 mm
6609	Ratchet Combination Wrench reversible 9 mm
6610	Ratchet Combination Wrench reversible 10 mm
6611	Ratchet Combination Wrench reversible 11 mm
6612	Ratchet Combination Wrench reversible 12 mm
6613	Ratchet Combination Wrench reversible 13 mm
6614	Ratchet Combination Wrench reversible 14 mm
6615	Ratchet Combination Wrench reversible 15 mm
6616	Ratchet Combination Wrench reversible 16 mm
6617	Ratchet Combination Wrench reversible 17 mm
6618	Ratchet Combination Wrench reversible 18 mm
6619	Ratchet Combination Wrench reversible 19 mm



Bench Vice Jaw Protector | plastic | 100 mm | 2 pcs.

- allows gentle clamping of sensitive workpieces such as aluminium, copper, etc.
- with magnetic stripe for holding the jaw protector on bench vice
- horizontally and vertically V-shaped profile

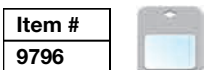

Countersinks | DIN 335 - C - HSS

- cutting direction: right-hand cutting
- countersink angle: 90°
- shank: cylindrical shank
- thinning: shape C
- edges: 3
- material: HSS steel



Item #	Description
1997-4	Countersink HSS DIN 335 Form C Ø 12.4 mm
1997-5	Countersink HSS DIN 335 Form C Ø 16.5 mm
1997-6	Countersink HSS DIN 335 Form C Ø 20.5 mm

Nylon Belt Pouch

- particularly convenient for storing frequently required tools
- 7 compartments in different sizes
- hammer loop
- belt loop on the back



Item #
3319

Empty Case for 1/6 BGS Tool Trays

- for easy transport and spotlessly clean storage of tool trays
- suitable for 1/6 tool trays
- inner dimensions: 189 x 204 x 32 mm



Item #		
BOX16		

Empty Case for 1/3 BGS Tool Trays

- for easy transport and spotlessly clean storage of tool trays
- suitable for 1/3 tool trays
- with embedded, lagged handle
- inner dimensions: 189 x 408 x 32 mm



Item #		
BOX13		

Empty Case for 2/3 BGS Tool Trays

- for easy transport and spotlessly clean storage of tool trays
- suitable for 2/3 tool trays
- with embedded, lagged handle
- inner dimensions: 378 x 408 x 32 mm

Item #
BOX26



Face Pin Wrench Set | adjustable | Ø 2.5 - 9 mm

- face pin wrench, length: 245 mm
- carbon steel, hardened, zinc-plated
- with 4 exchangeable pins - only one wrench needed for all standard pins
- pin diameters: 2.5 - 4 / 3 - 5 / 6 - 8 / 7 - 9 mm
- max. opening width 102 mm
- double open end spanner 10 x 11 mm
- in plastic case

Item #
9602



Suction and Air Blow Gun | reversible | 9 pcs.

- applicable for sucking up dirt and dust particles into the collection bag as well as for blowing surfaces clean
- especially for difficult to access areas
- with one-hand reversing switch
- robust plastic housing
- interchangeable brush attachments:
 - tube attachment (round), Ø 28.5 mm, length 200 mm
 - tube attachment (flat), 14.5 mm x 32.5 mm, length 190 mm
 - telescope attachment, flexible, length 300 - 900 mm
 - nozzle attachment, Ø 8.5 mm, length 83 mm
- suction power: 9 cmHg (vacuum)
- air consumption: 96 L/min
- operating pressure: 6.3 Bar
- compressed air connection: 6.3 mm (1/4")
- recommended internal hose diameter: 10 mm (3/8")
- noise level (suction mode): LpA = 90 dB(A)
- noise level (blow gun mode): LpA = 100 dB(A)
- dimensions (pistol): 150 x 160 x 44 mm



Item #
3292

CV Boot Air Assembly Tool | 20 - 110 mm

- suitable for universally applicable and original vehicle axle collars
- with 8 sturdy spreader arms
- the arms are spread open by compressed air
- spreading width: 20-110 mm
- operating pressure: 5-8 bar (72-116 PSI)
- max. pressure: 8 bar (116 PSI)
- compressed air inlet: 6.3 mm (1/4")
- material: polyamide 6 with 30% glass fiber (PA 6 GF30)
- weight: 2.2 kg



Item #
9825

Air Impact Wrench | angled | 12.5 mm (1/2") | 550 Nm

12.5 mm 1/2"

- compact design with a device length of only 69 mm, allows use in places with limited space
- length (incl. square drive): 88 mm
- ring switch allows one-handed switching of the rotation direction
- adjustable torque in 3 steps for clockwise rotation
- low weight and low vibration for fatigue-free working
- jumbo hammer allows loosening of hard-to-loosen screw connections
- non-slip handle
- air outlet direction is adjustable at the handle
- impact mechanism: jumbo hammer
- square drive: 12.5 mm (1/2")
- free speed: 8500 rpm
- working torque: 27 - 231 Nm
- max. torque (clockwise): 325 Nm
- max. loosening torque (counterclockwise): 550 Nm
- air consumption: 113 L/min
- working pressure: 6.3 bar (90 PSI)
- air inlet: 6.3 mm (1/4")
- recommended hose-Ø: 10 mm (3/8")
- sound pressure level: LpA: 87.9 dB (A)
- sound power level: LwA: 98.9 dB (A)
- vibration level: ahd = 9.96 m/s² / K = 2.10 m/s²
- weight: 1.16 kg



Item #
6684

Retractable Air Hose Reel | Automatic | 12 m + 2 m

- with automatic reel stop, can be unlocked by briefly pulling the hose
- swivel holder
- for wall mounting, with mounting bracket
- max pressure: 20 bar (300 psi)
- hose material: pvc fabric
- outside diameter: 18 mm
- internal diameter: 12 mm
- compressed air connection: 6.3 mm (1/4")
- max. operating pressure: 20 bar
- connecting hose length: 2 m
- hose length: 12 m



Item #
3323

Die Grinder | extra short | 120 mm

- heavy and robust air die grinder for universal use - for contour grinding, cutting, polishing, shaping, deflashing and keying
- easy and handy to use
- extra short
- straight type
- 6 mm chuck
- length: 120 mm
- compressed air inlet: 6.3 mm (1/4")
- weight: 340 g
- working pressure: 6.2 bar
- idle speed: 25000 rpm
- air consumption: 68 l/min
- sound pressure level: LpA= 88 dB(A)
- sound power level: LwA= 99 dB(A)
- vibration level: ahd= 1.82 m/s² | K= 0.68 m/s²

Item #
9656



Die Grinder | extra short | 90° angle | 126 mm

- heavy and robust air die grinder for universal use - for contour grinding, cutting, polishing, shaping, deflashing and keying
- easy and handy to use
- extra short
- angled type
- 6 mm chuck
- length: 126 mm
- compressed air inlet : 6.3 mm (1/4")
- weight: 475 g
- working pressure: 6.2 bar
- idle speed: 18000 rpm
- air consumption: 79,6 l/min
- sound pressure level: LpA= 89 dB(A)
- sound power level: LwA= 103 dB(A)
- vibration level: ahd= 4.3 m/s² | K= 0.92 m/s²

Item #
9657



Cordless Grease Gun | 18 V | 2.0 Ah

- with rechargeable battery for mobile working - ideal for cars and machines, perfect equipment for all service teams
- max. operating pressure: 551 bar (8000 psi)
- grease output: 85 g/min @ 69 bar (1000 psi)
- grease reservoir capacity: 411g
- grease hose length: 700 mm
- operating temperature range: -18C° to +50C°
- operating current: 4 A
- battery: 18 V, 2000 mAh, Li-ion
- charger input: 90 - 230 V~, 50 - 60 Hz, 45W
- charger output: 7.2 - 18 V, 1500 mA
- charging time: 1 hour
- weight: 3150g

scope of delivery:

- cordless grease gun
- charger for grease gun
- battery, 18 V, 2000 mAh, Li-ion



Item #	Description
3175	Cordless Grease Gun 18 V 2.0 Ah
3175-1	Replacement Battery Li-Ion 18 V / 2.0 Ah
3175-2	Flexible Delivery Tube 700 mm for Grease Gun BGS 3175
3175-3	Charger for Grease Gun BGS 3175

Repair Staples | 100 pcs.

- suitable for plastic repair set BGS 873



Item #	Description
873-4	Repair Staples L-Type Ø 0.6 mm 100 pcs.
873-5	Repair Staples L-Type Ø 0.8 mm 100 pcs.
873-6	Repair Staples W-Type Ø 0.6 mm 100 pcs.
873-7	Repair Staples W-Type Ø 0.8 mm 100 pcs.
873-8	Repair Staples V-Type Ø 0.6 mm 100 pcs.



Spacer | for BGS 868, 873

- for regulating the melting depth of the repair brackets in the plastic
- prevents pushing through the workpiece during melting

Item #
6707

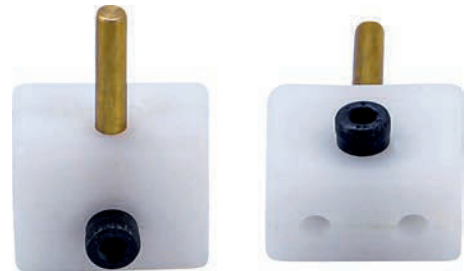

Induction Coil Set for Induction Heater | for BGS 2169 | 12 pcs.

- for heating screws, nuts, shafts, etc.
- suitable for induction heater BGS 2169

scope of delivery:

- 1 Induction Coil | flat (BGS 2169-5)
- 1 Induction Coil | for Tie Rods (BGS 2169-10)
- 1 Induction Coil | for small surfaces (BGS 2169-9)
- 1 Ferrite Core for BGS 2169-9
- 1 Retaining Spring for BGS 2169-9
- 1 Induction Coil | with ceramic protection (BGS 2169-8)
- 1 Induction Coil | 20 mm | angled 90°
- 1 Induction Coil | 23 mm | angled 90°
- 1 Induction Coil | 26 mm | angled 90°
- 1 Induction Coil | 32 mm | angled 90° (BGS 2169-1-32)
- 1 Induction Coil | 38 mm | angled 90° (BGS 2169-1-38)
- 1 Induction Coil | 45 mm | angled 90° (BGS 2169-1-45)

Item #
2169-11

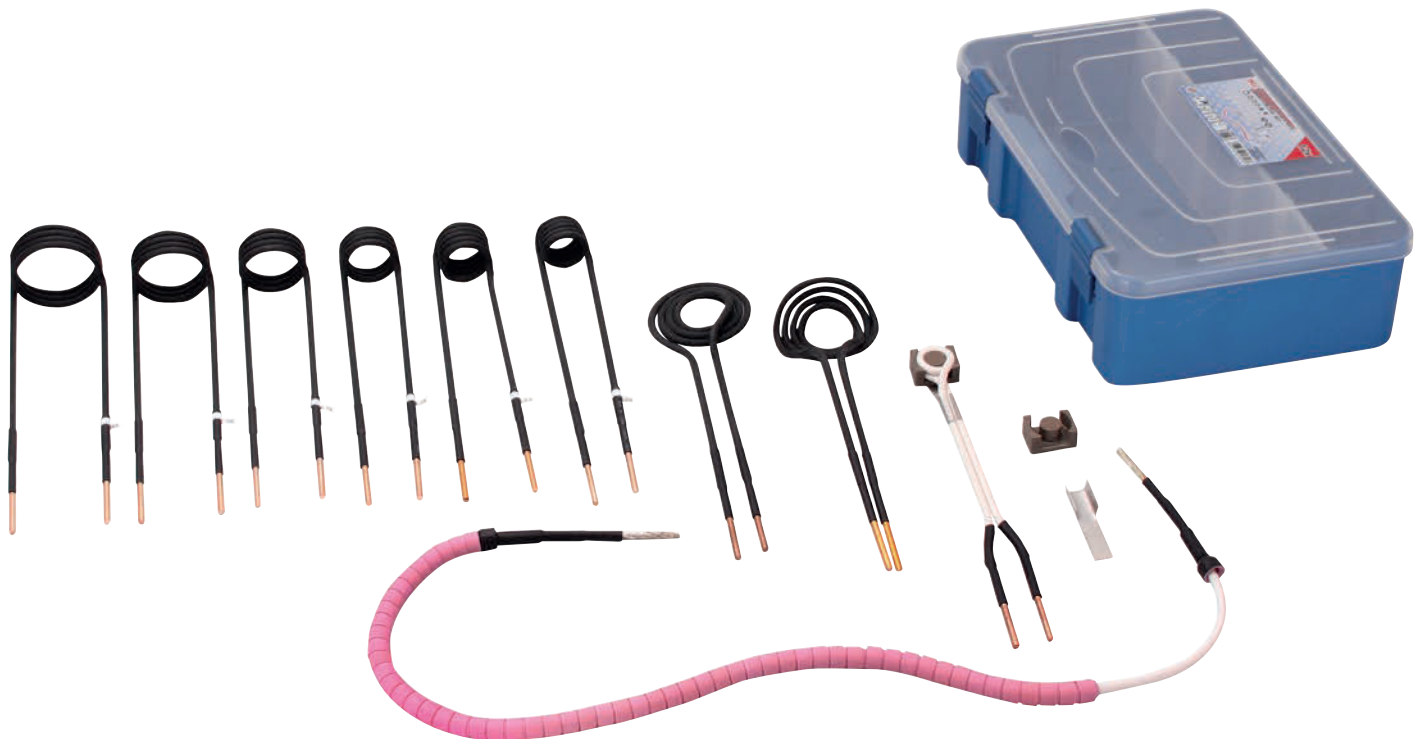

Electric / Cordless Battery Tools

Impact Socket, Hexagon / 12-point | for Ducati Wheel Fixings | 12,5 mm (1/2") Drive | 30 / 55 mm 12.5 1/2

- double size socket with 55 mm 12-point and 30 mm hexagon
- for removing both rear and front wheel fixings
- suitable for overtightened or seized wheel fixings

suitable for the following Ducati models:

- Superbike 1098, 1198, 1199, Panigale, Streetfighter 1098, Multistrada 1200 and Diavel
- for both manual and impact wrenches
- Material: alloyed SCM440 steel



Item #
6658



Groove Nut Socket for Wheel Hubs | external pins | for Mercedes-Benz, Nissan, Opel, Renault, VW 20 $\frac{3}{4}$

- for loosening the groove nut on rear wheel hubs
- suitable for following vehicles:
 - Volkswagen Crafter/LT, Opel/Vauxhall Movano, Renault Master, Nissan Interstar, Mercedes-Benz Sprinter (with twin wheel) rear axle 741.130,-131,-413,-414,-416,-420,-422,-453,-454,-455,-429
- to be used as OEM VW T50017, Opel/Vauxhall CH50112, Mercedes-Benz 906589000700
- drive profile: Internal square
- drive profile size, metric: 20 mm
- drive profile size, inch: 3/4"
- length: 74 mm



Item #		
9617		

Axle Nut Socket | 12-Point | for Mercedes-Benz | 95 mm

- suitable for hand and impact wrench operation
- designed for high tightening and release torques
- for Mercedes-Benz trailer axle nut
- wrench size: 95 mm
- drive profile: external hexagon
- drive profile size: 36 mm
- profile: 12-point
- length: 155 mm
- external diameter: 125 mm



Item #
6704

Tool Tray 1/6: Crankshaft Rotating Tool | for Iveco

- to rotate the crankshaft when setting the engine or doing other repairs
- to be positioned in the flywheel housing and engages into sprocket of the flywheel

suitable for models:

- Euro Cargo, Cargo 150E27R PR, FPR, 320E27T, PT Euro Tech, Eurostar
- engine identification: 8360.46/F3A/F3B

scope of delivery:

- crankshaft rotating tool, to be used as OEM 99360321



Item #		
9686		

Injector Puller | for Volvo Trucks FM12 / FM440 / FH500

- for removing injector nozzle units
- especially suitable for firmly burned and overheated injector units



Item #
9860

Tool Tray 1/3: Clutch Aligning Tool Set | for Trucks | 6 pcs.

- for centering of the clutch disc
- required when replacing truck single and double clutch discs

scope of delivery:

- centering mandrel (for clutch disc), 42 - 52 mm
- centering mandrel (for clutch disc), 36 - 45 mm
- centering sleeve (for pilot bearing), 30 mm
- centering sleeve (for pilot bearing), 27 mm
- centering sleeve (for pilot bearing), 25 mm
- centering sleeve (for pilot bearing), 20 mm
- replacement O-rings



Item #
6667



Double Flaring Tool Kit with Pipe Cutter | 10 pcs.

- special tool for creating single D-type flares, double E-type flares (SAE) and double F-type flares
- suitable for pipes with wall thickness up to 1 mm
- 1 pipe clamp
- 1 spreader
- 1 pipe cutter
- 7 dies 1/4" - 1/2" - 4,75 - 5 - 6 - 8 - 10 mm



Item #
3058

Tube Bender and Brake Line Clamps Set | 4.75 + 6 mm

- for clamping the old and new brake pipe during the bending process
- perfect for cable assembly
- allows exact reproduction of the old brake pipe
- parallel clamping and bending do not change the diameter of the line
- suitable for steel, copper and plastic coated brake lines
- for 4.75 mm (3/16") or 6 mm line diameter

scope of delivery:

- tube bending pliers, 4.75 + 6 mm (Art. 8229)
- brake line clamps set, 4 pcs. (Art. 9533-1)
- tool tray 1/3, empty, for item 9533 (Art. 9533-2)

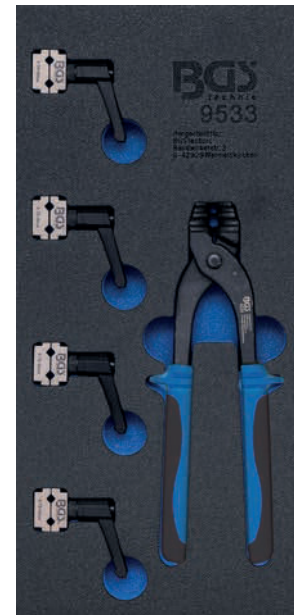

Item #	Description
9533-2	Tool Tray 1/3 empty for BGS 9533
9533	Tool Tray 1/3: Tube Bender and Brake Line Clamps Set 4.75 + 6 mm
9533-1	Brake Line Clamps Set 4.75 mm (3/16") 4 pcs.

Tool Tray 1/6: Flaring Tool | SAE and DIN 4.75 / 5 / 6 mm

- for creating DIN F type flarings on brake pipes with a diameter of 4.75 - 5 - 6 mm
- can also be used on installed brake lines
- 2-component handle

- base with 2-component handle and claws, with visual bore
- punch (DIN F) 4.75 mm
- punch (DIN F) 5 and 6 mm
- positioning bolt
- flaring grease



Item #
9838



Tool Tray 1/6: Flaring Tool | DIN 4.75 mm (3/16")

- for easy and fast flaring of 4.75 mm (3/16") brake pipes, according to DIN F
- can also be used on installed brake lines
- 2-component handle
- incl. combination spanner 10 mm, combination spanner 17 mm and flaring grease



Item #	CV	1/6
6683		

Brake Bleeder Wrench Set | N-Type | 7 - 11 mm | 5 pcs.

- suitable brake for bleeder screws, also in small areas
- special shape
- ring head cranked and offset
- for bleeding the brakes without dismantling the wheels
- brake bleeder wrench, N-Type, 7 mm
- brake bleeder wrench, N-Type, 8 mm
- brake bleeder wrench, N-Type, 9 mm
- brake bleeder wrench, N-Type, 10 mm
- brake bleeder wrench, N-Type, 11 mm



Item #	CV
9633	

Brake Bleeder Wrench Set | 7 - 8 - 9 - 10 - 11 - 12 mm | 7 pcs.

- for easy bleeding of hydraulic clutch systems and brake systems without removing the wheels
- allows one-person bleeding
- consists of 6 brake bleeding wrenches, 22-point, sizes: 7 - 8 - 9 - 10 - 11 - 12 mm
- 120 cm silicone hose with non-return valve
- suitable for universal bleeder nipples



Item #
66516

Fuel Pipe Wrench | flexible | 11 mm

10 3/8

- required when disassembling / assembling injection nozzles
- for screw connections on fuel lines
- bendable, flexible up to 45°
- compact design for use in confined spaces
- max. torque: 30 Nm
- drive profile size, metric: 10 mm
- drive profile size, inch: 3/8"
- wrench size: 11 mm
- surface finish: black phosphated



Item #
6741

Brake Calliper Socket | 10-point | for VAG and Porsche | 15 mm

- for assembling and disassembling of brake callipers
- for fitting of multi piston brake callipers
- suitable for following models: Audi Q7, S8, Porsche Macan, Cayenne, Cayman
- size 10 mm
- 10-pt.
- 10 mm (3/8") drive
- length 30 mm



Brake Calliper Socket | 10-point | for VAG and Porsche | 20 mm

12.5  1/2

- for assembling and disassembling of brake callipers
- for fitting of multi piston brake callipers
- suitable for following models: Audi Q7, S8, Porsche Macan, Cayenne, Cayman
- size 20 mm
- 10-pt.
- 12.5 mm (1/2") drive
- length 30 mm



Tool Tray 1/3: Brake Piston Reset Tool | with Ratchet Function | 7 pcs.

- for damage-free resetting of brake pistons
- allows centered, tilt-free resetting
- no damage to seals, pistons and cylinders
- required for maintenance and brake pad replacement
- suitable for almost all vehicle types with 1 up to 8 floating pistons and fixed callipers without integrated handbrake function
- spindle ratchet mechanism (reversible) reduces the effort
- solid construction with hardened resetting plates
- two additional resetting plates with magnet for easy installation on reset tool
- plastic handle
- working range from 40 - 68 mm / 49 - 77 mm
- length: 270 mm

scope of delivery:

- brake piston reset tool, basic unit with ratchet function, reversible
- resetting plate set 116 x 60 mm
- resetting plate set 147 x 60 mm
- resetting plate set 176 x 60 mm



Cable Installation Tool Set | 5 pcs.

- multifunctional tool set for professional cable installation
- to install cables and automotive wiring harness easily
- suitable for laying tracks in most of the vehicles
- cable installation tool, inflexible, blade length 145 mm, head with hook and drill hole to install and enforce cables
- cable installation tool, inflexible, blade length 395 mm, head with hook and drill hole to install and enforce cables
- cable installation tool, flexible, loop length 1020 mm, head with hook and drill hole to install cables
- cable installation tool with loop head, blade length 85 mm, to cross cables
- piercing awl, 100 mm, to cross under carpet, rubber seals and many more
- the cable is subsequently pulled in through the handle and through the piercing screw
- handle length: 98 mm



Item #
9495



Tool Tray 2/3: Radio Removal Tool Set | 52 pcs.

- for the assembly of radios and GPS systems, for most car types and brands:
- Blaupunkt, Becker, Grundig, Clarion, Kenwood, Sony
- original radios in Porsche models
- original radios in Mercedes-Benz models
- original radio in Audi models
- original radio in Ford models
- original radio in BMW und Opel models
- original radio in VW models
- original radio in Skoda models
- original radio in Fiat Bravo, Brava models



Item #
9144



Terminal Tool Kit | universal | 3 pcs.

- for a damage-free and professional unlocking of connector pins
- suitable for terminals in e. g. BMW, Chrysler, Fiat, Ford, MAN, Mazda, Mercedes-Benz, Opel, PSA, Renault, Saab, VAG, etc.
- safety cap with special design for safe use and storage
- unlocking tip made of steel

scope of delivery:

- cable release tool for flat contact plugs and flat pin-in sleeves, suitable for terminals from AMP Tyco JPT, AMP Tyco JT, AMP Tyco SPT, AMP Tyco ST, plug width 2.8 mm, 4.8 mm, 5.8 mm and 6.3 mm
- cable release tool for round contact plugs and round pin-in sleeves, suitable for terminals from AMP Tyco CI2, AMP Tyco Mate-N-Lok, GHW RAM, GHW RSA2, plug diameter 1.5 mm and 3.5 mm
- cable release tool for flat contact plugs and flat pin-in sleeves, suitable for terminals from AMP Tyco MT I, AMP Tyco MT II, plug width 1.6 mm



Item #
9807

Cylinder Head Temperature Sensor Socket | 15 mm | for Ford 1.8 / 2.0 / 2.3 / 2.4 / 3.2 Diesel 12.5 \square 1/2

- suitable for Ford diesel engines Lynx and Puma (2002 - 2007), built in e.g. Mondeo, Focus, Transit and Fiesta
- to be used as OEM 303-680
- drive profile: Internal square
- drive profile size, inch: 1/2"
- drive profile size, metric: 12.5 mm
- output profile: 12-point
- wrench size: 15 mm
- length: 40 mm
- surface finish: black phosphated



Item #
6677



Lambda Sensor Tester & Simulator

- for testing heated and non-heated O2 sensors with 1 to 4 cables
- LED indicator indicates the O2 sensor signal
- simulates O2 sensor signal rich or lean, to test the ECU response
- suitable for engines with zirconium and titanium O2 sensors
- the tester identifies the connected cable, mass, heater or ECU voltage (if available)
- cable piercing clip for easy connection
- low battery indicator
- sealed switches for workshop environment
- durable ABS housing
- battery: 9V, 6F22 or equivalent, alkaline (included)
- operating environment: -10°C to 50°C /



Item #
9454

Short Circuit & Cable Detector

- is used to detect / track cables and checking for short and open circuits
- a signal is fed into the circuit to be tested via the transmitter unit; this signal is detected by the receiver probe along side the cable and emitted by the receiver as an acoustic signal
- suitable for 12 & 24 volts DC vehicle electrics
- receiver sensitivity adjustable

scope of delivery:

- transmitter unit with test cables
- receiver unit with flexible probe



Item #
6644

Differential Groove Nut Key | external Pins | for Mercedes-Benz 72 mm

- for removing and installing the differential
- made to withstand high fastening and loosening torque
- number of studs: 6
- drive profil: external hexagon
- drive profile size, metric: 32 mm
- wrench size: 72 mm

suitable for the following models:

- Mercedes-Benz Citaro, EvoBus



Item #
9861

Differential Flange & Insert Nut Tool Set | for BMW E70, E82, E90, E91, E92, E93

- for removing and installing the drive shaft nut
- allows inserting of the rear differential O-Ring
- suitable for BMW vehicles with rear and four wheel drive

scope of delivery:

- open end spanner 50 mm, to be used as OEM 33 5 040, BMW E70, E88, E90, E91, E92
- flange holding tool, to be used as OEM 23 0 020, BMW E70, E82, E88, E90, E91, E92, etc.
- multi-point ring spanner 65 mm, to be used as OEM 33 5 050, BMW E70, E82, E90, E91, E92, E93
- multi-point socket 34T, to be used as OEM 3 35 060, BMW E70, E82, E90, E91, E92, E93
- seal ring drift, to be used as OEM 3 35 080, BMW differential: HAG 215 Sp, HAG 220kom, HAG 225kom, HAG type G



Item #
9859

Spring Strut Sockets | for VAG

10 3/8

- for disassembling suspension struts on VAG cars
- for counterholding the securing nut on the spring strut
- for repair work in the spring area, e. g. coil springs, shock absorbers, spring struts, etc.
- double-sided usage for 6-point and 8-point nuts
- with flexible head
- surface finish: satin chrome plated
- extension bar, 80 mm
- BGS 9826: special socket, 6-point and 8-point, 13 mm, 10 mm (3/8") drive
- BGS 9827: special socket, 6-point and 8-point, 14 mm, 10 mm (3/8") drive



Item #	Description
9826	Spring Strut Socket 13 mm for VAG
9827	Spring Strut Socket 14 mm for VAG

Ball Joint Tool Set | with C-Frame

- to replace ball joints, universal joints, brake anchor bolts
- suitable for SUVs, vans and other vehicles with large parts

scope of delivery:

- step washer plate with large bore
- step washer plate with small bore
- C-frame with spindle
- sleeve, inner diameter: 44.4 mm, outer diameter: 50.8 mm, length: 45 mm
- sleeve, inner diameter: 56.6 mm, outer diameter: 63.4 mm, length: 45 mm
- sleeve, inner diameter: 69 mm, outer diameter: 76.1 mm, length: 56 mm



Item #
8263

Mounting Lever for DSG Gearbox | for VAG

- used to operate the engaging lever during dismantling and mounting of the mechatronic unit on 7 speed dual clutch gearboxes OAM

suitable for following models:

- VW Golf 2004>, Golf 2009>, Audi A3 2004>, Eos 2006, Passat 2006>, Passat CC 2009>
- to be used as OEM T10407



Item #
9537



Clutch Aligning Tool Set | 11 pcs.

- for centering of the clutch disc

Scope of Delivery:

- 8 centering bushes (crankshaft bore / pilot bearing)
- diameters: 12.1 - 14.2 - 15.1 - 16.1 - 17.1 - 18.0 - 19.0 - 20.1 mm
- 3 clutch disc centering pins
- diameters: 14.9 - 19.7 mm; 19.8 - 27.2 mm ; 22.8 - 36.0 mm



Item #
9572

Flywheel Blocking Tool | for Honda, Ford, Mitsubishi, Toyota

- for locking flywheels of manual geaboxes when loosening and tightening, clutch discs on automatic gearboxes etc.
- suitable for engines in e.g. Honda, Ford, Mitsubishi Toyota, etc.



Item #
9649

Clutch Retaining Bolt for DSG Gearbox | for VAG (02E)

- for installing and adjusting dual clutches on VAG DSG 6-speed direct shift gearbox
- suitable for gearboxes with code 02E
- to be used as OEM T10303



Item #
9640

Clutch Centering Mandrel Set | for BMW

- for centering the clutch disc while installing an already pretensioned self adjusting clutch (SAC)
- suitable for BMW clutches
- clutch centering mandrel, outer diameter 15 x 23.0 mm, incl. bolt M8 x 1.25 x length 65 mm
- clutch centering mandrel, outer diameter 15 x 26.5 mm, incl. bolt M8 x 1.25 x length 65 mm
- clutch centering mandrel, outer diameter 15 x 28.0 mm, incl. bolt M8 x 1.25 x length 65 mm
- clutch centering mandrel, outer diameter 15 x 32.5 mm, incl. bolt M8 x 1.25 x length 65 mm
- clutch centering mandrel, outer diameter 15 x 34.0 mm, incl. bolt M8 x 1.25 x length 65 mm
- centering sleeve, inner diameter 15 mm, outer diameter 32.5 mm, incl. bolt M5 x 0.8 x length 54 mm



Item #
6670

Intake Manifold / Intake Pipe Release Tool | for VAG | 2 pcs.

- for the professional and non-destructive release of quick couplings on the intake manifold
- prevents damage to the suction pipes or connections
- allows easy and quick disconnection

suitable for e. g. the following models:

- VW Golf (2013-), Audi A3 (2013-), Seat Leon (2013-), Skoda Octavia (2013-) with 4 cyl. injection engine 1.2l / 1.4l direct injection, turbocharger
- to use used as OEM T10527



Item #
6731



Drop Arm Puller | for Land Rover | 57.5 mm

- for pulling off the drop arm from steering box on Land Rover Defender
- also suitable for drop arms which are difficult to remove due to corrosion
- protects steering box and shaft seal
- drive: external hexagon 24 mm



Item #
9525

Rear Axle Tracking Adjustment Tool | for MINI

12.5 □ 1/2

- for adjusting the rear toe angle on MINI models of 1st generation (2002-2006)
- to be used as OEM 32 4 200
- drive profile: Internal square
- drive profile size, inch 1/2"
- drive profile size, metric 12.5 mm



Item #
9904



Wheel Hub Grinder | Aluminum Bell with Steel Core | Inner-Ø 80 mm

12.5 □ 1/2

- suitable for quick and easy removal of dirt and rust from wheel hubs and brake discs with wheel bolt support
- quick and rust-proof cleaning of contact surfaces
- prevents the falsification of the wheel bolt tightening torque through corrosion
- interchangeable and long-live grinding wheels
- grinding wheel is fixed on aluminum sleeve with hook and loop tape and synthetic felt
- suitable for impact wrenches, 12.5 mm (1/2") drive
- 1 aluminum bell with steel core
- 1 grinding wheel, inner-Ø 80 mm, outer-Ø 150 mm



Item #	Description
9746	Wheel Hub Grinder Aluminum Bell with Steel Core Inner-Ø 80 mm
9747	Grinding Wheel Set for BGS 9746 3 pcs.
9748	Hook and Loop Tape for BGS 9746 2 pcs.

Wheel Hub Rim Hole Grinder | Outer-Ø 110 mm

- grinder for wheel hub rim hole
- bristles made from nylon fiber with silicon carbide and diamond abrasive grain
- variation of speed (r.p.m.) influences hardness and aggressivity of the abrasive brush
- 1 wheel hub rim hole grinder
- 1 adapter for electric drill



Item #
9749

Wheel Hub Grinder Set | for Studs and Wheel Nut Bolts | 14 pcs.

- for quick and easy cleaning of the contact surface from rust and dirt
- for use on wheel hubs and brake discs and wheel hubs with stud bolts, e. g. on Ford, Porsche, Volvo, etc.
- reduces sparking
- low dust development due to open-pore abrasive and cup-shaped sanding pad
- wear-resistant - maximum service life (approx. 50 vehicles per wheel)
- can be used with drills and cordless screwdrivers (maximum speed 3.000 rpm)

scope of delivery:

- 1 grinding wheel with round drive shaft Ø 6.3 mm (1/4 ") for electric drills / adaptors
- 3 replacement hook and loop pads with self-adhesive back
- 5 coarse-grained cleaning discs, outer diameter 40 mm
- 5 fine-grained cleaning discs, outer diameter 40 mm, inner diameter 16.5 mm



Item #
9736



Tire Change Service Set | 7 pcs.

12.5 1/2

- can be used for wheel changing on most popular rims

scope of delivery:

- Cordless Impact Wrench | 520 Nm | max. 2.000 rpm | 18 V (BGS 9919)
 - for loosening and tightening of screws and nuts, esp. wheel nuts
 - 18V li-ion battery for long operation time and high power
 - rated voltage: 18V DC
 - rated speed: 0 - 2.000 rpm
 - rated impact: 0 - 3.200 bpm
 - drive: 12.5 mm (1/2") square
 - max. torque: 520 Nm
 - noise level: LpA: 99.6 dB(A) K= 3dB(A) LwA: 110.6 dB(A) K= 3dB(A)
 - vibration level: ah: 17.95 m/s² K=1.5 m/s²
 - battery pack: 18V / 4.000 mAh Li-Ion
 - mains charger: input 100-240V AC / 50Hz / 75W output 18V DC / 2.500 mA charging time: 100 min delivered in a handy carrying case
- Protective Impact Socket Set | 12.5 mm (1/2") Drive | 17 / 19 / 21 mm | 3 pcs. (BGS 7200)
 - for both manual use and impact wrenches
 - can be fixed on impact wrench by pin and O-ring
 - plastic cover and plastic sleeve for protection of aluminium rims
 - colour coded sockets help to indicate the right size
 - protective impact sockets, 12.5 mm (1/2") drive: 17 - 19 - 21 mm
 - length: 85 mm
- Torque Wrench | 12.5 mm (1/2") | 42 - 210 Nm (BGS 965)
 - reversible ratchet with automatic release via click signal
 - set torque is locked by sliding bush
 - high precision
 - delivered with calibration certificate
 - profile: external square
 - drive profile size, metric: 12.5 mm
 - drive profile size, inch: 1/2"
 - max. torque: 210 Nm
 - min. torque: 42 Nm
- Mechanic's Gloves | Size 10 (XL) (BGS 9954)
 - PU part coating
 - good fit and secure grip
 - good sense of touch
 - knitwrist
 - suitable for: tire service
- Microfibre Cloth | 400 x 400 mm (BGS TUCH)
- BGS® Football (BGS BALL)
- BGS® Coffee Mug (BGS BECHER)



Item #

9927

Tire Change Service Set | 9 pcs.

12.5  1/2

- can be used for wheel changing on most cars

scope of delivery:

- Torque Wrench + Adaptor + Extension Bar | 12.5 mm (1/2") | 28 - 210 Nm (BGS 98)
 - reversible ratchet with automatic release via click signal
 - set torque is locked by stop screw
 - adaptor 12.5 mm (1/2") drive, 10 mm (3/8") external square
 - extension bar 12.5 mm (1/2") drive, length: 125 mm
- Protective Impact Socket Set | 12.5 mm (1/2") Drive | 17 / 19 / 21 mm | 3 pcs. (BGS 7200)
 - for both manual use and impact wrenches
 - can be fixed on impact wrench by pin and O-ring
 - plastic cover and plastic sleeve for protection of aluminium rims
 - colour coded sockets help to indicate the right size
 - length: 85 mm
- Knee Protector Pad | 450 x 210 x 30 mm (BGS 4801)
 - with storage compartment, prevents rolling away of tools and parts
 - acid-resistant EPE foam
- Mechanic's Gloves | Size 10 (XL) (BGS 9954)
 - partly PU coated
 - good fit and secure grip
 - good sense of touch
 - knitwrist
 - suitable for: tire service
- Wheel Wrench | for Cars | Square | 17 x 19 x 21 x 12.5 mm (1/2") (BGS 1459)
 - with reinforced middle plate
 - hardened
 - according to DIN 3119
 - arm length: 355 mm
 - square 12.5 mm (1/2")
 - hexagon 17 x 19 x 21 mm

Item #
9679



Tire Change Service Set with Floor Jack 1.5 t | 10 pcs.

12.5  1/2

- can be used for wheel changing on most cars

scope of delivery:

- Torque Wrench + Adaptor + Extension Bar | 12.5 mm (1/2") | 28 - 210 Nm (BGS 98)
 - reversible ratchet with automatic release via click signal
 - set torque is locked by stop screw
 - adaptor 12.5 mm (1/2") drive, 10 mm (3/8") external square
 - extension bar 12.5 mm (1/2") drive, length: 125 mm
- Protective Impact Socket Set | 12.5 mm (1/2") Drive | 17 / 19 / 21 mm | 3 pcs. (BGS 7200)
 - for both manual use and impact wrenches
 - can be fixed on impact wrench by pin and O-ring
 - plastic cover and plastic sleeve for protection of aluminium rims
 - colour coded sockets help to indicate the right size
 - length: 85 mm
- Knee Protector Pad | 450 x 210 x 30 mm (BGS 4801)
 - with storage compartment, prevents rolling away of tools and parts
 - acid-resistant EPE foam
- Mechanic's Gloves | Size 10 (XL) (BGS 9954)
 - partly PU coated
 - good fit and secure grip
 - good sense of touch
 - knitwrist
 - suitable for: tire service
- Wheel Wrench | for Cars | Square | 17 x 19 x 21 x 12.5 mm (1/2") (BGS 1459)
 - with reinforced middle plate
 - hardened
 - according to DIN 3119
 - arm length: 355 mm
 - square 12.5 mm (1/2")
 - hexagon 17 x 19 x 21 mm
- Floor Jack | hydraulic | Aluminium-Steel Construction | 1.5 t (BGS 2897)
 - dual piston hydraulic
 - durable and lightweight aluminum-steel construction
 - lever tube partly with protector, prevents damage to the vehicle
 - low headroom, thus particularly suitable for vehicles with low ground clearance
 - length: 554 mm
 - max. lifting height 358 mm
 - min. lifting height 90 mm
 - weight: 15.5 kg
 - rated load capacity: 1.5 t



Item #
9680

Headlamp Adjustment Tool | for Mercedes-Benz, Audi

10  3/8

- for spotlight and clearance adjustment against front bumper face bar and engine bonnet after car body repair or spotlight exchange
- special harmonized tool to use in areas with narrow space

suitable for following models:

- Mercedes-Benz 205 C-Klasse, > 2014
- Audi A7

- drive profile: internal square
- drive profile size, metric: 10 mm
- drive profile size, inch: 3/8"
- output profile size: external hexagon
- wrench size: 14 mm
- material: chrome vanadium steel
- surface finish: satin chrome plated
- total length: 195 mm



Item #
9593



Pin Wrench for Distance Sensor | for Mercedes-Benz

10  3/8

- for assembling and disassembling of distance sensors which are integrated into the front and rear bumper
- allows tightening sensor nut with stipulated torque
- suitable for Mercedes-Benz S-Class (W140) und E-Class (W210)



Item #
9591

Special Wrench for Fender Screws | 12-point | for Ford | 10 mm

- for use on hard-to-reach wing screws
- extra-long and extra-thin designed version
- serviceable from both sides
- with plastic protection cover
- for manual operation
- surface finish: satin chrome plated



Item #
9641



Tool Tray 1/6: Hole Punch Set | for Parking Sensors | Ø 17 - 32 mm

- this tool kit is used to cut holes for park distance control sensors in plastic bumpers

scope of delivery:

- punching tool Ø 17 mm / 19 mm, consists of head plate, punch and die
- punching tool Ø 18 mm / 20 mm, consists of head plate, punch and die
- punching tool Ø 18.2 mm / 22.5 mm, consists of head plate, punch and die
- punching tool Ø 26.7 mm / 24 mm, consists of head plate, punch and die
- punching tool Ø 26 mm / 32 mm, consists of head plate, punch and die
- HSS drill Ø 10.2 mm
- punching spindle with nut - external hexagon 12 mm drive



Item #		1
9739		6

Hammer Set with Interchangeable Heads | Ø 28 mm | 11 pcs.

- for car body repair work
- the different heads automatically snap into the locking
- 1 hammer, length 235 mm
- 10 interchangeable hammer heads, each flat and half round, Ø 28 mm, in different colors:
 - 2 plastic heads, white
 - 2 aluminum heads, orange
 - 2 copper heads, copper
 - 2 metal heads, blue
 - 2 stainless steel heads, silver
- in plastic case



Item #
9768

Single Hand Rubber Suction Lifter | ABS | Ø 70 mm

- for lifting, carrying and holding
- with quick release lever
- practical one-hand operation
- well suited for adjusting and setting mirror glasses
- max. capacity 8 kg



Item #	
9626	

Windshield Seal Cutting Wire | 25 m | 160 daN

- material: synthetic fibers
- for damage-free cutting of glued windshields
- excellent cutting performance, comparable to conventional metal-cutting wires
- soft and flexible for preventing damage to painted and sensitive surfaces
- special fabric with extremely high tensile strength of 160 daN
- suitable for windshield removal tools BGS 69500, 69505, 8003, 8004 and others
- diameter: 0.85 mm



Item #
9856

Windshield Seal Cutting Wire | 25 m | 200 daN

- material: synthetic fibers
- for damage-free cutting of glued windshields
- excellent cutting performance, comparable to conventional metal-cutting wires
- soft and flexible for preventing damage to painted and sensitive surfaces
- special fabric with extremely high tensile strength of 200 daN
- suitable for windshield removal tools BGS 69500, 69505, 8003, 8004 and other
- diameter: 1.05 mm



Item #
9857

Dent Repair Pads | for BGS 865 | 33 pcs.

- suitable for BGS 865, BGS 865-6 and 865-7

scope of delivery:

dent repair pads, blue

- 1 dent repair pad, rectangular, large: 48.5 x 32.5 mm
- 1 dent repair pad, round, extra large: Ø 40.5 mm
- 1 dent repair pad, round, large: Ø 35.5 mm
- 1 dent repair pad, round, middle size: Ø 32 mm
- 1 dent repair pad, round, small: Ø 25.5 mm
- 1 dent repair pad, round, extra small: Ø 20.5 mm
- 1 dent repair pad, mini: Ø 15.5 mm
- 2 dent repair pads, rectangular: 30 x 20 mm
- 1 dent repair pad, rectangular: 30 x 23.5 mm
- 1 dent repair pad, oval, large: 48.5 x 32.5 mm
- 1 dent repair pad, oval: 40.5 x 27.5 mm
- 1 dent repair pad, oval: 33.5 x 23 mm
- 1 dent repair pad, oval, rounded edges, large: 39.5 x 24.5 mm
- 1 dent repair pad, oval, rounded edges, small: 29.5 x 19.5 mm

dent repair pads, flexible head, blue

- 1 dent repair pad, oval, large: 48.5 x 32.5 mm
- 1 dent repair pad, round, extra large: Ø 40.5 mm
- 1 dent repair pad, round, large: Ø 35.5 mm
- 1 dent repair pad, round, middle size: Ø 32 mm
- 1 dent repair pad, round, small: Ø 25.5 mm
- 1 dent repair pad, round, extra small: Ø 20.5 mm
- 1 dent repair pad, mini: Ø 15.5 mm

dent repair pads, black

- 1 dent repair pad, round, extra large: Ø 40.5 mm
- 1 dent repair pad, round, large: Ø 35.5 mm
- 1 dent repair pad, round, middle size: Ø 32 mm
- 1 dent repair pad, round, small: Ø 25.5 mm
- 1 dent repair pad, round, extra small: Ø 20.5 mm
- 1 dent repair pad, round, extra small: Ø 20.5 mm
- 1 dent repair pad, round: Ø 23.5 mm
- 1 dent repair pad, mini: Ø 15.5 mm
- 1 dent repair pad, oval, large: 48.5 x 32.5 mm
- 1 dent repair pad, oval, middle size: 40.5 x 38 mm
- 1 dent repair pad, oval, rounded edges, mini: 25 x 12.5 mm



Item #

9571

Dent Repair Pads | for BGS 865 | 6 pcs.

- suitable for BGS 865, BGS 865-6 and 865-7
- length: 22 mm
- material: aluminum

- 1 dent repair pad, rectangular, large: 32 x 16 mm
- 1 dent repair pad, round, large: diameter Ø 32 mm
- 1 dent repair pad, round, middle: diameter Ø 19 mm
- 1 dent repair pad, round, small: diameter Ø 13 mm
- 1 dent repair pad, oval: 32 x 13 mm
- 1 dent-pad, star-shaped: max. Ø 14 mm



Item #
9583

Dent Removal Pen

- for pushing out small dents, e.g. hail damage, etc.
- made of plastic, front rounded
- length: 120 mm
- diameter: 18 mm
- material: plastic

Item #
8684



Cylinder Lock Installation Tool | for VAG

- for fast and professional repair of VAG door locks
- suitable for key patterns with internal spring for the following models:
VW Passat, Vento, Beetle, Lupo, Golf IV (not Golf Cabrio), Seat, Skoda
- length: 65 mm

Item #
9589

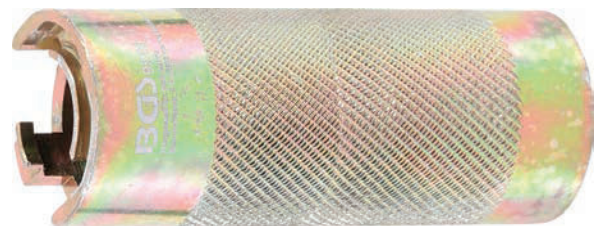

Panel Clip Pliers | 175 mm

- for removing panel clips and automotive interior moulding clips
- with cut-off function
- ground blades
- with 45° offset head, especially for small areas
- spring loaded opening mechanism for ease of use
- PVC dipped handles

Item #
9673



Needles, Hooks and Scrapers Set | 9 pcs.

- ergonomic 2-component plastic handles

scope of delivery:

- hook tip, bent, 165 mm
- hook tip, bent, 240 mm
- hook tip, 45°, 165 mm
- hook tip, 45°, 240 mm
- hook tip, 90°, 165 mm
- hook tip, 90°, 240 mm
- needle tip, straight, 165 mm
- needle tip, straight, 240 mm
- scraper, 20 mm x 230 mm



Item #		
8487		

Grab Handle Release Tool | for VAG

- to release and remove the roof grab handle in the interior without damage
- to be used as OEM T10518A, T10518, T10517

suitable for the following models:

- Volkswagen Golf (as of 2013)
- VW Golf Variant (as of 2013)
- Tiguan (as of 2016)
- Seat Ateca (as of 2016)
- Skoda Octavia (as of 2013)



Item #	
9831	

Door Trim Removing Tool | 290 mm

- for removal of trim clips on car bodies
- coated tip, prevents damage to plastic and painted parts
- can be used for nearly all brands
- slot width: 7 mm
- slot length: 20 mm
- opening size: 12 mm
- handle type: 2 component handle



Item #		
3109		

Heater Hose Disconnect Tool | for Ford

- for disconnecting of the heater hose connectors
- the connectors are between firewall and engine and are very difficult to disconnect without this tool
- suitable for Ford Focus 2.0L (2012- 2016), Kuga / Escape 2.0L EcoBoost (2013-2016) and other models



Item #
6757

Cooling System Cleaning Gun

- for quick and professional cleaning and rinsing of the cooling system
- no solvents or aggressive chemicals required
- works with water pressure and with compressed air, increasing the cleaning efficiency
- to be used in connection with a water hose
- incl. connecting nipple for water hose quick couplings
- 5-step nozzle with diameter Ø 19 - 29 - 32 - 36.5 - 40 mm
- suitable for most standard cooling hoses
- light construction made of special reinforced plastic material
- compressed air inlet: 6.3 mm (1/4")
- operating pressure: 6.3 bar



Item #
9638



Antifreeze Tester Hydrotemp

- robust and break-proof type
- for checking the radiator antifreeze quality
- usable for antifreeze/water mixture based on ethylene-glycol-(ethandiol)
- display accuracy: 0.5°C
- suction bulb made of elastomer is flexible at all times and guarantees function in all temperature ranges
- hydrostatic block prevents automatic discharge and retightening of air the display
- display is immediately stable
- non-drip suction tube
- all temperature twin measuring element, swivable 360°
- for direct reading
- measuring scale in Celsius
- measuring range 0 up to -40°C

Item #
9670



Exhaust Gas Temperature Sensor Special Socket Set (EGT / NOx) | 6 pcs.

10  3/8

- for disassembly and assembly of exhaust gas temperature sensors
- suitable for cars, light commercial vehicles and trucks
- sizes: 13 - 14 - 17 mm in straight and offset design
- output profile: hexagon, hexagon slotted
- drive profile: internal square
- drive profile size, metric: 10 mm
- drive profile size, inch: 3/8"
- surface finish black phosphate / satin chrome plated



Item #
6678



Injector Repair Kit | for Common-Rail | 8 pcs.

12.5  1/2

- to loosen and remove the injector's internal fixings
- for professional repair of injectors
- applicable for Bosch, Denso and Siemens injectors
- 3 Injector ball valve lapping tools incl. centre adaptor
- 1 bit socket, 12.5 mm (1/2") drive / 21 mm external hexagon, internal hexagon (with hole) 10 mm - Inner Ø (tamperproof) 6.6 mm
- 1 bit socket, 12.5 mm (1/2") drive / 21 mm external hexagon, internal hexagon (with hole) 10 mm - Inner Ø (tamperproof) 7.6 mm
- 1 socket, 12.5 mm (1/2") drive, 8-pt. for Bosch-CR-injectors
- 1 socket, 17 mm external hexagon, with three drift pins for internal valve seats of Denso Common Rail injectors
- 1 centering device, 12.5 mm (1/2") drive, 4-teeth socket to open the internal split nut of Siemens Common Rail injectors



Item #
9639



Petrol Injector Tool | for BMW N43, N53, N54

- for dismantling petrol injectors on BMW engines N43, N53, N54
- access directly below injector
- fixation by thumbscrew
- suitable for following BMW models:
 - 1 series (E81/E82/E87/E88)
 - 3 series (E90/E91/E92/E93)
 - 5 series (F10/F11)
 - 6 series (E63/E64)
 - 7 series (F01/F02/F04)
 - X6 (E71)
 - Z4 (E89)
- 1 injector puller hook
- 1 sliding hammer
- to be used as OEM 1 30 180



Item #
9614

Tool Tray 1/6: Injector Puller | for Bosch CDI Injectors | 6 pcs.

- to remove CDI injectors on Mercedes-Benz CDI engines 611, 612, 613 and other vehicles
- sliding hammer can be mounted on three different points of the injector using the included adaptors
- sliding hammer bolt, M16 x 1.5
- sliding hammer weight, 1650 g, Ø 79 mm
- adaptor for fuel line connection, internal thread M16 x 1.5
- assembling screw, M12 x 1.0 for mounting the adapter in the fuel line connection
- adaptor for electromagnetic unit, internal thread M27 x 1.0 / internal thread M16 x 1.5
- injector puller hook, 12.9 mm with internal thread M16 x 1.5



Item #		1
9632		6

CDI Injector Extractor | Land Rover 2.7L V6 & 3.6L V8 TDi

- for extracting common rail injectors

suitable for the following models:

- Jaguar and Land Rover 2.7 TDi V6 (276DT & 7G) & 3.6 TDi V8 (368DT) Diesel engines, Land Rover Discovery 3, Discovery 4, new Range Rover, Range Rover Sport and Jaguar X200 S-type, X250 XF, X350 XJ
- to be used as OEM 303-1127

Item #
9865



Petrol Injector Pull-out Tool | for Jaguar, Land Rover 5.0L V8

- especially for disassembling the long gasoline injectors

suitable for the following models:

- Jaguar and Land Rover 5.0L V8 petrol engines, Jaguar X150, XK Series, X250 (XF), XJ models and Land Rover Discovery 4, new Range Rover, Range Rover Sport
- to be used as OEM 310-197

Item #
9878



Fuel Injector Extractor Set | for Ford, Volvo

- for removing the petrol injection nozzles
- to be used as Ford OEM 310-206 / Volvo OEM 9997410

suitable for the following models:

- Volvo S60 (2011-2016), V40 (2013-2016); engine: 1.6 T4
- Ford Fiesta, Focus, Focus RS, Fusion, Mustang, GT, Transit, Transit Connect, Explorer, Expedition, etc.; engines: 1.0
- EcoBoost, 1.5 EcoBoost I4, 1.6 EcoBoost Sigma, 2.0 GTDI, 2.0 Duratec-HE M14, 2.0 EcoBoost M14, 2.3 EcoBoost, 2.3
- EcoBoost M14, 2.7 EcoBoost, 3.5 GTDI, 3.5 EcoBoost
- Lincoln Navigator, Continental, MKS, MKT, MKX, MKZ, MKC; engines: 2.0 EcoBoost M14, 2.3 EcoBoost, 2.7 EcoBoost, 3.0 EcoBoost, 2.0 GTDI, 3.5 GTDI



Item #

9874

Fuel Injector Tool | for BMW B36 / B38 / B48

- for removing and mounting of fuel injector nozzles
- petrol injector removing tool, to be used as OEM 2358417
- distance gauge for installing injectors, to be used as OEM 2358022



Item #

9866

Petrol Injector Puller Set | for Ford EcoBoost 1.0 - 2.0l

- for extraction of injectors
- suitable for Ford 1.0L to 2.0L EcoBoost petrol direct injection engines
- suitable for injectors with e. g. original part number CM5G-9F593-FA
- to be used as OEM 310-206



Item #

9864

Common Rail Return Pressure Diagnosis Kit | for Piezo Common Rail Injectors

- for testing the return flow pressure of common rail systems with piezo injectors from Bosch, VDO / Siemens and Delphi
- determined pressure values allow a condition assessment of the piezo injectors
- pressure gauge for Bosch and VDO Siemens Piezo-Injectors, measuring range: -1 to +15 bar
- pressure gauge for Delphi Piezo-Injectors, measuring range: -1 to +3 bar
- transparent body with drain valve for visual inspection for air bubbles, two quick couplings and drain hose
- connecting hose set for VDO Siemens Piezo-Injectors
- connecting hose set for Bosch piezo injectors
- connecting hose set for Delphi piezo injectors
- brass double cone



Item #
9879

Gasoline Injector Puller | for Ford

- for removing Bosch GDI injectors on all standard Ford EcoBoost petrol engines 1.0 - 3.7 liter capacity
- to be used as Ford OEM 310-206

suitable for the following models:

- B-MAX 2012-, C-MAX 2011-, Ecosport 2013-, Edge 2012-, Escape 2013-, Explorer 2012-, F-150 2011-, Fiesta 2013-, Flex 2010-, Focus 2010-, Focus ST 2011-, Fusion 2013-, Galaxy 2006-, Kuga 2013-, MKS 2010-, MKT 2010-, MKX 2012-, MKZ 2013-, Mondeo 2007-, Mustang 2015-, Police Interceptor 2013-, S-MAX 2006-, Taurus 2010-, Transit Connect / Tournee Connect 2014-, Transit Courier / Tournee Courier 2014-

with engine codes:

- M1JA, M1JE, M1JH, SFJA, SFJB, SFJC, SFJD, M1DA, M2DA, M1DD, M2DC, M1JC, M1JJ, P4JA, P4JB, P4JC, P4JD, XMJA, XMJB, XMJC, XMJD, YYJA, TLB, M2DB, SFDB, M2GA, M2GB, M1CA, M1CB, SFCA, SFCB, SFCC, SFCD
- M8DB, M9DB, UEJB, M8DA, M9DA, UNCJ, UNCK, M8MA, M9MA, UNCA, UNCB, UNCC, UNCD, UNCE, UNCF
- HXDA, HXDB, SIDA, JQDA, JQDB, JTDA, JTDB, IQDA, IQDB, PNDA, XTDA, MUDA, PNDD, XTDB, MUDD, HXJA, HXJB, HXJE, RVJA, U5JA, IQJA, IQJC, IQJE, IQDC, JQGA, JQMA, JQMB, JTMA, JTBA, JTBB, KGBA, PNBA, RHBA
- MGDA, XQDA, R9CD, R9CI, TNBA, TNBB, TPBA, R9CB, R9CF, R9CH, TNCC, TNCD, TNCF

scope of delivery:

- sliding hammer with internal thread M10 x 1.5 (1430 g, length: 390 mm)
- sliding hammer weight: 840 g, Ø 45 mm
- puller with external thread M10 x 1.5
- pull-off hook opening 13 mm - 20 mm

Item #
6692



Injection Pump Sprocket Holding Tool | for Ford 2.2 & 3.2 TDCi Duratorq (Puma)

- allows removal of Diesel injection pump without disturbing the engine timing
- holds pump sprocket and timing chain in position
- removing of the timing chain is not required

suitable for following models:

- Ford Transit 2.2 Duratorq as of 2006
- Ford Transit 3.2 Duratorq as of 2006
- Ford Ranger 2.2 Duratorq as of 2011
- additional tool for engine timing tool set (BGS 9010)
- incl. mounting screws
- to be used as OEM 303-1317



Item #
9498

Fuel Sensor Wrench | for Peugeot / Citroen

12.5 1/2

- for removing and installing the fuel sensor fixing ring
- drive profile 1: Internal square
- drive profile size 1, metric: 12.5 mm
- drive profile size 1, inch: 1/2"
- drive profile 2: outer 6-point
- drive profile size 2, metric: 21 mm



Item #
6758

Fuel Pipe Wrenches | for Toyota & Honda

10 3/8

- for loosening / tightening petrol pipes on fuel filters
- open ring spanner, reinforced
- 10 mm (3/8") drive
- length: 94 mm
- BGS 6671: 14 mm
- BSG 6672: 17 mm



Item #	Description
6671	Fuel Pipe Wrench for Toyota & Honda 14 mm
6672	Fuel Pipe Wrench for Toyota & Honda 17 mm

Alternator Freewheel Tool Set | 14 pcs.

12.5  1/2

- for disassembly and assembly of the alternator freewheel
- suitable for alternators made by Nippon Denso, Valeo, Bosch and Magneti-Marelli

scope of delivery:

- ratchet ring wrench, 15 mm
- ratchet ring wrench, 10 mm
- sleeve socket, external hexagon 15 mm drive, external hexagon size 28 mm
- 3 pin sleeve sockets, external hexagon 32 mm
- bit, 10 mm (3/8") drive, internal Hexagon 8 mm
- sleeve spline socket, 15 mm external hexagon drive, 33 teeth
- bit, long type, 10 mm (3/8") drive, internal hexagon 8 mm
- bit, long type, 10 mm (3/8") drive, Spline (for XZN) M10
- bit, long type, 10 mm (3/8") drive, T-Star (for Torx) T50
- bit socket, 12.5 mm (1/2") drive, internal hexagon 10 mm, with sleeve, external hexagon 17 mm drive
- bit adaptor with retaining ball | 12.5 mm (1/2") drive, internal hexagon 10 mm (3/8")
- socket, 12-point, 12.5 mm (1/2") drive, 12 mm
- bit socket, 12.5 mm (1/2") drive, T-Star (for Torx) T50, with sleeve, 15 mm external hexagon drive, 31 teeth
- bit socket, 12.5 mm (1/2") drive, spline (for XZN) M10, with sleeve, 15 mm external hexagon drive, 31 teeth



Item #	 
6657	

Tool Tray 2/3: Engine Timing Tool Set | for BMW M42, M43, M50, M52, M60, M51

- for checking and adjusting the engine timing

suitable for:

- BMW petrol engines M42, M43, M50, M52, M60
- BMW diesel engine M51
- includes required tools to set camshafts, crankshafts and Vanos unit
- crankshaft locking bolt, to be used as OEM 112300
- camshaft alignment tool, to be used as OEM 113240
- camshaft alignment tool, to be used as OEM 113190
- camshaft alignment tool, to be used as OEM 113320
- wrench for Vanos unit, to be used as OEM 115490
- tensioner locking pin set, to be used as OEM 113290
- chain pre-tensioner tool, to be used as OEM 114220
- chain pre-tensioner tool, to be used as OEM 113390

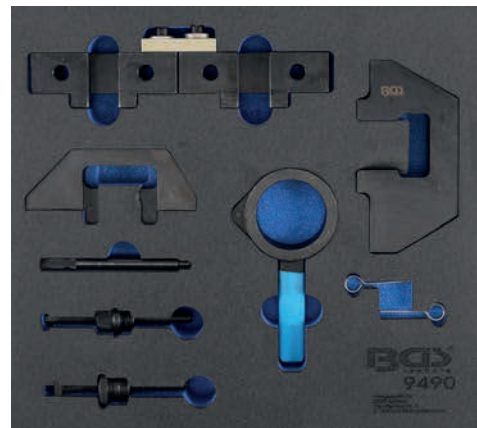

Item #	 
9490	

Tool Tray 2/3: Engine Timing Tool Set | for BMW M40, M44, M50, M52, M54, M56

- for checking and adjusting the engine timing

suitable for following BMW models:

- 3 series (E30, E36, E46)
- 5 series (E34, E39, E60, E61)
- 7 series (E32, E38, E65, E66)
- 8 series (E31)
- X3 (E83)
- X5 (E53)
- Z3, Z4 (E85)

engines codes:

- M40B16, M42B18, M43B16, M43B18, M43TUB19OL, M43TUB19UL, M44B19, M50B20, M50B20TU, M50B25, M50B25TU, M52B20, M52B20TU, M52B25, M52B25TU, M52B28, M52B28TU, M54B22, M54B25, M54B30, M56

scope of delivery:

- crankshaft locking bolt, to be used as OEM 112300
- camshaft alignment tool, to be used as OEM 113190
- camshaft alignment tool, to be used as OEM 113240
- Vanos alignment tool, to be used as OEM 116180
- double Vanos alignment tool, to be used as OEM 116150
- chain pre-tensioner tool, to be used as OEM 114220
- wrench for Vanos unit, to be used as OEM 115490
- compressed air connector, to be used as OEM 113450
- tensioner locking set, to be used as OEM 113290, consisting of locking clip, to be used as OEM 113291 & locking pin, to be used as OEM 113292

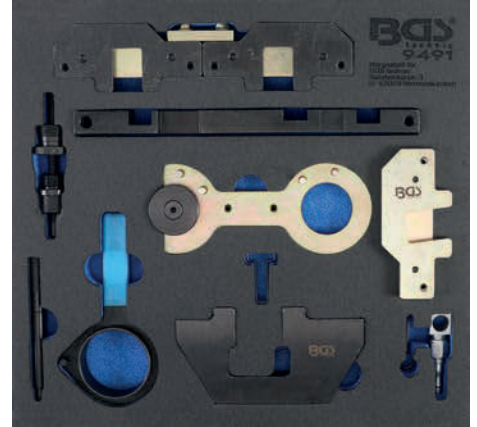

Item #		2/3
9491		

Camshaft Mounting Tool | for BMW N53, N54

- for depressing the valve spring when assembling the camshafts
- avoids breaking of the camshaft

scope of delivery:

- camshaft installation tool, to be used as OEM 11 8 550, consists of:
 - valve spring depressor, to be used as OEM 11 8 551
 - fixing bolts, to be used as OEM 11 8 552

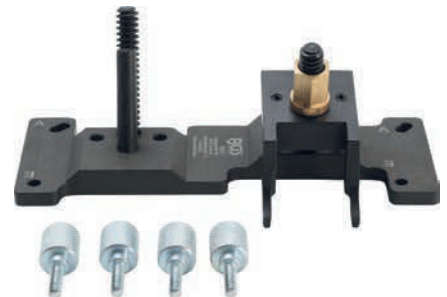

Item #
9647

Special Socket for ATF Filler Plug | T-Star (for Torx) T55 | for MINI

- for easy assembly and disassembly of the filler plug when checking / changing or adding auto transmission fluid on MINI vehicles
- the small distance between filler plug and servo steering makes it difficult for standard tools to be used
- output profile: T-Star (for TORX) T55
- drive profile: external hexagon, 17 mm



Item #
9648



Crankshaft Locking Tool | for BMW N47

- for locking the crankshaft in timing position
- required when replacing one of both timing chains

suitable for BMW N47 engines with engine codes:

- 1.6 N47 C16U1, C16K1, C16A/U1, D16C, D16
- 2.0 N47 C20K1, C20U1, C20A/K1, D20B/D/T0, D20C/K1, D20C, D20C/U1, D20C/O1, D20D, D20D/T1, D20O1, D20C/O, D20A, D20C/01, D20U0
- to be used as OEM 2285671, 83302285671

Item #
9868



Flywheel Blocking Tool | for BMW N55, N20, N26

- for locking the flywheels on BMW engines N55, N20, N26 with automatic transmissions when loosening and tightening the pulley central bolt
- suitable for BMW engines N55, N20, N26
- to be used as BMW OEM 118660



Item #
9867



Tool Tray 1/3: Engine Timing Tool Set | for BMW, MINI 1.5, 2.0 Diesel

- for checking and adjusting the engine timing

suitable for the following models:

- BMW:
 - 114d / 116d / 118d / 125d (F20/21) 2015-2017
 - 214d / 216d / 218d / 220d / 225d (F22 / 23 / 45 / 46), 2014-2017
 - 316d / 318d / 320d / 325d (F30 / 31 / 34), 2015-2017
 - 420d / 425d / 418d (F32 / 33 / 36), 2015-2017
 - 518d / 520d (F10 / 11), 2014-2017
 - 520d / 525d (G30 / 31 / F90) 2016-
 - 620d GT (G32GT) 2018-
 - 725d / 725Ld (G11/12) 2016-
 - X1 16d / 18d / 20d / 25d (F48), 2015-2017
 - X2 18d / 18dX / 20dX / 25dX (F39) 2018-
 - X3 18d / 20dX (F25), 2014-2017
 - X3 20dX / 25dX (G01) 2017-
 - X4 20dX (F26) 2014-2017
 - X4 20dX / 25dX (G02) 2018-
 - X5 25d (F15) 2015-
- MINI:
 - Cooper D 1.5 (F55 / 56 / 57) 2014
 - One D 1.5 (F55 / 56) 2014-
 - One D 1.5 (F54) 2015-
 - Cooper D 2.0 (F64 / 61) 2015-
 - Cooper SD 2.0 (F55 / 56 / 57) 2013-
 - Cooper SD 2.0 (F54 / 60) 2015-
- suitable for the following engines B37 D15A, B37 C15A and B47 D20A, B47 D20B, B47 C20A, B47 C20B

scope of delivery:

- camshaft alignment tool, to be used as OEM 11 8 760
- crankshaft holding tool, to be used as OEM 2 357 904
- flywheel timing pin, to be used as OEM 2 288 380
- drive plate timing pin adaptor, to be used as OEM 2 365 488
- fuel pump sprocket removal tool, to be used as OEM 11 8 030
- tensioner locking pin, to be used as OEM 11 4 120



Item #		
6685		

Timing Chain Tensioner Locking Pin Set | for BMW

- for locking the chain tensioner
- suitable for engine codes: M43, N47, N47S, N51, N52, N52K, N53, N54, etc.

scope of delivery:

- 1 pin 3 mm, to be used as BMW OEM 114120 / 83300491012
- 1 pin 4 mm, to be used as BMW OEM 113340 / Land Rover OEM LRT 12114 / Opel OEM KM-823

Item #
6734



Tensioner Wrench Set | for Flat Belts | for MINI

- for releasing the tensioner when removing and installing the serpentine belt
- suitable for the following MINI models: >2007, engines EP3, EP6, N12, N14, N16 and N18
- to be used as OEM 116210
- to be used with V-ribbed belt tensioning arms from following manufacturers:
 - Dayco APV2465, Febi 33136, Gates T39127, INA 534031810, Ruville 55999, SKF VKMA33400, SNR GA350.67

scope of delivery:

- 1 tensioner wrench 21 mm, 12-point drive
- 1 tensioner wrench 30 mm, 12-point drive



Item #
6688

High Pressure Pump Puller / Sprocket Supporting Sleeve | for BMW N47 / N57

- for removing the high pressure pump sprocket
- holds the pump sprocket and timing chain in position when removing the high pressure pump
- suitable for BMW engines N47, N47S, N57, N57S
- built in the following models:
 - 116D, 118D, 120D, 123D, type E81, E82, E87, E88, F20
 - 316D, 318D, 320D, 325D, 330D, type E90, E91, E92, E93, F30
 - 520D, 525D, 530D, 530D GT, 535D, 535D GT, M550D, type E60, E61, F07, F10, F11
 - 640D, type F12
 - 730D, 740D, 750D, type F01
 - X1-1.8D, 2.0D, 2.3D, type E84
 - X3-1.8D, 2.0D, 3.0D, 3.5D, type E83, F25
 - X5-3.0D, 4.0D, M550D, type E70
 - X6-3.0D, 4.0D, M500D, type E71
- to be used as OEM 118740 - 118741 - 118742



Item #
8724-1



Tool Tray 2/3: Engine Timing Tool Set | for BMW and MINI, 1.5 & 2.0L Diesel

- for checking and setting the engine timing

suitable for the following models with 1.5 & 2.0L diesel engines:

- BMW 114d, 116d 118d, 214d 125d (2015-2017)
- BMW 216d, 218d, 220d, 225d (2014-2017)
- BMW 316d, 320d, 325d (2015-2017)
- BMW 420d, 425d, 418d (2014-2017)
- BMW 518d (2015-2017)
- BMW X1, X3, X4, X5, Efficient Dynamics, xDrive and sDrive (2014-2017)
- MINI One D, Cooper D/SD (2014-2017)

engine codes:

- 1.5 liter (B37 D15A, B37 C15A)
- 2.0 liter (B47 D20A, B47 D20B, B47 C20A, B47 C20B)

scope of delivery:

- camshaft adjusting tool, to be used as OEM 11 8 760
- crankshaft locking tool, to be used as OEM 2 357 904
- flywheel adjusting pin, to be used as OEM 2 288 380
- adaptor plate for adjusting pin, to be used as OEM 2 365 488
- high pressure pump sprocket puller, to be used as OEM 11 8 740, 11 8 741, 11 8 742
- tensioner locking pin, to be used as OEM 11 4 120
- spacer with screw, to be used as OEM 11 9 265
- special bit socket, to be used as OEM 11 4 180



Specialty Tools Car

Item #		
6775		

Tool Tray 1/3: Engine Timing Tool Set for Jeep 3.0 V6 Diesel

- for adjusting the engine timing when replacing the timing chain, cylinder head gasket

suitable for following vehicles:

- Jeep Grand Cherokee 3.0 V6 CRD (2011-2015), engine code: EXF VM23D
- Jeep Grand Cherokee 3.0 Multijet (2011-2015), engine code: EXF VM44D

scope of delivery:

- camshaft locking tool for right cylinder head, to be used as OEM VM10338-1
- camshaft locking tool for left cylinder head, to be used as OEM VM10338-2
- tensioner locking pin, to be used as OEM VM1039a
- crankshaft timing pin, to be used as OEM VM10339



Item #		
9695		

Engine Timing Tool Set | for Alfa Romeo, Fiat 1.4 MultiAir

- for checking and setting the engine timing when replacing the tooth belt

suitable for the following models:

- Alfa Romeo Giulietta, Mito / Fiat Punto, Punto Evo 1.4 (Turbo) MultiAir (105/135/163/170PS)
- engine codes: 940A2.000 / 940A2.000 / 955A8.000 / 955A8.000 / 940A2.000 / 955A8.000 / 955A2.000 / 955A7.000 / 955A6.000 / 955A8.000
- camshaft timing tool incl. 3 fastening screws, to be used as OEM 2000034400
- crankshaft locking tool incl. 4 fastening screws, to be used as OEM 2000004500
- tensioner pulley adjusting tool, to be used as OEM 1860987000

Item #		1 3
9876		

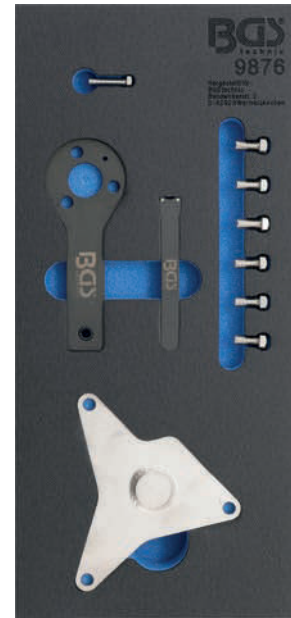

Tool Tray 1/3: Engine Timing Tool Set | for Alfa Romeo / Lancia 1.75

- for checking and setting the engine timing
- suitable for Alfa Romeo Giulietta, 159, Spider, Brera 1.75L Tbi and Lancia Delta 1.75L DI Turbo Jet
- engine codes: 940A1.000, 939B1.000

scope of delivery:

- camshaft locking tool, to be used as OEM 2000033500
- crankshaft locking tool, to be used as OEM 2000003000, EN-46788, 1860771000, 1860905000, 1860905010, 2192543000
- flywheel locking tool, to be used as OEM 2000033600, 1820630000, 1820007000, 1820228000, 1820240000, 1860898000, 1820240000

Item #		1 3
6774		



Tool Tray 1/6: Camshaft Holding Tool and Crankshaft Sealing Ring Tool Set | for Ford & Volvo 2.5 Turbo

- for holding the camshaft while setting the tappet and for installing the front crankshaft oil sealing
- suitable for: Ford & Volvo 2.5L Duratec-VE (VI5) Turbo petrol engines
- for following models:
 - Ford Focus (2005-2011)
 - Galaxy (2006-2010)
 - Ford Kuga (2009-2013)
 - Mondeo (2007-2010)
 - S-Max (2006-2010)
 - Volvo C30 (2006-2013)
 - C70 (2006-2013)
 - S40 (2003-2012)
 - S60 (2003-2016)
 - S80 (2003-2012)
 - Volvo V40 (2012-2015)
 - V50 (2004-2012)
 - V70 (2002-2012)
 - XC60 (2014-2016)
 - XC70 (2002-2007)
 - XC90 (2002-2014)
- engine codes: HYDA, HYDB, HUBA, B5254T10, B5254T11, B5254T12, B5254T14, B5254T2, B5254T3, B5254T4, B5254T5, B5254T6, B5254T7, B5254T8, B5254T9

scope of delivery:

- camshaft holder, to be used as OEM 303-1183, 9995765
- crankshaft seal driver, to be used as OEM 303-1180
- crankshaft seal guide, to be used as OEM 303-1180



Item #		
9605		

Tool Tray 1/6: Camshaft Setting Tool | for Ford 1.6 EcoBoost

- for locking camshafts when removing / replacing the timing chain

suitable for following Ford models:

- 1.6L EcoBoost (Sigma)
- Galaxy, S-Max, Mondeo, C-Max, Focus, Fiesta, Kuga, Transit, Tourneo Connect

scope of delivery:

- camshaft setting bar, to be used as OEM 303-1552



Item #		
9692		

Tool Tray 1/3: Engine Timing Tool Set | for Ford 2.5, Volvo 1.6 - 2.5 & 2.4D

- for setting the camshaft and crankshaft timing when replacing the cylinder head gasket

suitable for following models:

- Ford
 - Focus 2.5 RS / ST, Mondeo 2.5, S-Max 2.5, Galaxy 2.5 ST (2005-)
 - engine codes: 2.5 Turbo (Euro 4), HUBA / HUWA / HYDA / JZDA
- Volvo
 - C30 (06-10), C70 (98-10), S40 (96-10), S60 (00-09), S70 (97-07), S80 (98-06), V40 (96-10), V50 (04-10), V70 (97-07), XC70 (02-07), XC90 (02-10)
 - engine codes: 1.6 (B4164S), 1.8 (B4184S), 1.9T (B4194T), 2.0 (B4204S / B4204T), 2.0T (B5204T3 / B5204T4 / B5204T5), 2.3 (B5234FS), 2.3T (B5234T3 / B5234T7 / B5234T9), 2.4 (B5244S / B5244S2 / B5244S4 / B5244S5 / B5244S7), 2.4T (B5244T / B5244T3 / B5244T4 / B5244T5 / B5244T7), 2.5R (B5254FS), 2.4D (D5244T9 / D5244T8 / D5244T13)

scope of delivery:

- crankshaft pulley holding tool, to be used as OEM 999 5433 / 303-1179
- camshaft alignment tool, to be used as OEM 303-1178
- crankshaft alignment tool, to be used as OEM 303-1182
- camshaft holder, to be used as OEM 303-1183



Item #		
9738		

Tool Tray 1/3: Engine Timing Tool Set | for Ford 2.0TDCi EcoBlue

- for checking and setting the engine timing on e.g. Ford Transit and Tourneo (2016-)
- engine codes: YLFS, YLF6, YMFS, YMF6, YNFS, YNF6, YLR6, YMR6, YNR6, YMR6, YNR6

scope of delivery:

- 1 flywheel locking tool, to be used as OEM 303-1643
- 1 crankshaft alignment tool, to be used as OEM 303-1637
- 2 timing belt installation tools, to be used as OEM 303-1650
- 2 camshaft locking pins
- 1 tensioner locking pin

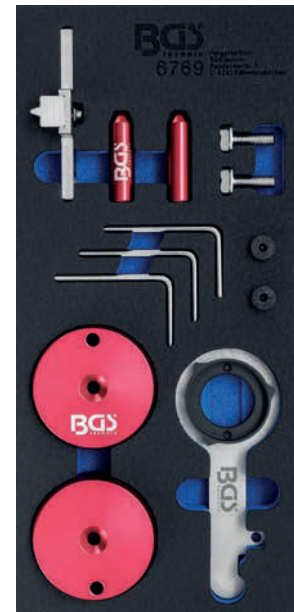

Item #		
6769		

Speciality Tools Car

Flywheel Locking Tool | for Ford

- is needed for loosening and tightening the flywheel and crankshaft pulley

suitable for the following Ford models:

- models: Ford C-MAX (2007-2017), S-MAX (2006-2017), EcoSport (2013-2017), Edge (2015-2017), Fiesta (2013-2017), Focus (2004-2017), Galaxy (2006-2017), Kuga (2008-2017), Mondeo (2007-2017)
- engines:
 - 1.5L (UEJB, UEJE, UEJB, ENUE),
 - 1.6L (IQDA, IQDB, PNDA, XTDA, MUDA, PNDD, XTDB, MUDD, IQJA, IQJC, IQJE, IQDC, KGBA, PNBA, RHBA)
 - 2.0L (G6DA, G6DB, G6DC, G6DD, G6DE, G6DF, G6DG, IXDA, TXDA, TXDB, TYDA, UFDB, UKDB, T7DB, T8DA, T8DE, T8CM, T9CE, T7DA, AZWA, AZWC, KLWA, QXWA, QXWB, TXWA, TYWA, UFWA, UKWA, T7CJ, T7CK, T7CL, T8CH, T8CI, T8CJ, UFCA, UFCB, T9CB, T9CC, UFDA, UKDA, T7MA, T7MB, T8MA, T8MB, TXMA, UFMA, UKMA, XRMA, XRMB, AZBA, AZBC, KLBA, LPBA, QXBA, QXBB, TXBA, TYBA, UFBA, UKBA, UKBB, T7CE, T8CC, T8CD, T8CL, T9CA),
 - 2.2L (KNWA, Q4BA, Q4WA, KNBA, KNBB)
- to be used as OEM 21-168, 303-1272, 303-393, 303-393-01, 303-393-02

scope of delivery:

- baseplate
- fixing screw
- pawl, 11 mm
- pawl, 29 mm
- pawl, 42 mm



Item #
9819

Tool Tray 1/3: Engine Timing Tool Set | for Land Rover 3.6 TD V8

- for adjusting the engine timing when replacing the timing chain and cylinder head gasket

suitable for following models:

- Range Rover (L332) 3.6 TD V8 (2006-2011), engine code: 368DT
- Rover Sport L320 3.6 TD V8 (2006-2011), engine code: 369DT

scope of delivery:

- camshaft alignment tools (2x) with fixing screws, to be used as OEM 303-1236
- flywheel locking tool, to be used as OEM 303-1243
- crankshaft timing pin, to be used as OEM 303-1238
- camshaft rotating pin, to be used as OEM 303-1239



Item #		
9694		3

Tool Tray 1/6: Balance Shaft Adjusting Tool Set | for Mercedes-Benz OM651

- for adjusting the balancer shafts
- to be used with Engine Timing Tool Set for Mercedes-Benz OM651 (BGS 62633)

suitable for following Mercedes-Benz models:

- A-class W176 180/200/220 CDI
- B-class W246 200/220 CDI
- C-class W/S/C 204 180/200/220/250 CDI
- C-class W205 220/250
- CLA C117 200/220 CDI
- CLS C/X 218 220/250
- E-class W/S 212 200/220/250 CDI
- E-class C/A 207 220/250 CDI
- E-class W212 250/300 BlueTEC
- GLA X156 200/220 CDI
- GLK X 204 200/220/250 CDI
- ML W166 250
- SLK R172 250 CDI
- Sprinter W906 210/310/510/213/313 CDI
- Sprinter W906 513/216/316/416/516 CDI
- V-Class W/V 447 200/220/250 CDI
- Viano W/V 639 2.0/2.2CDI
- Vito W/V 639 110/113/116 CDI

scope of delivery:

- balance shaft locking forks
- balance shaft locking bar
- fixing screws
- to be used as OEM 651 589 02 63 00



Item #	
9693	

Ribbed Belt tensioner | for Mercedes-Benz W169 & W245

- for tensioning and loosening the damper spring
- prevents damage to the tensioner element and injuries
- spindle with ball head, drive: inner hexagon 10 mm
- to be used as OEM 266589003100

suitable for the following vehicles with start-stop function and/or air conditioning:

- A-Class W169 2004-2012 (A150, A160, A170, A180, A200, A200T)
- B-Class W245 2005-2011 (B150, B160, B170, B180, B200, B200T)



Item #
9811

Tool Tray 1/6: Engine Timing Tool Set | for Mercedes-Benz M642

- for holding the camshaft when adjusting the engine timing
- suitable for Mercedes-Benz engines M642

suitable for the following models:

- C-Class W203 / S203 (2000-2007), W204 / S204 (2007-)
- CLK C209 / A209 (2002-2010)
- CLS C218 / C219 (2004-)
- E-Class W211 / S211 (2002-2009), W212 / S212 (2009-), C207 / A207 (2009-)
- S-Class W221 / W222 (2005-)
- M-Class W164 / W166 (2005-)
- R-Class W251 / V251 (2006-)
- G-Class W461 / W463 (2009-)
- GL-Class X164 / X166 (2006-)
- Viano W639 (2003-)
- Sprinter 906 (2006-)
- Vito V639 (2006-)

scope of delivery:

- 2 camshaft holding tools incl. 8 fixing screws, to be used as OEM 642 589 00 31 00



Item #		
6689		1/6

Timing Chain Hold-Down Device | for Mercedes-Benz

- absolutely necessary in order not to damage the camshaft and cylinder head when rotating of the engine
- to be used as OEM 642589014000



Item #
6687

Tool Tray 1/6: Engine Timing Tool Set | for GM, Opel, Vauxhall, Saab 2.0 Turbo

- for checking / adjusting the engine timing

suitable for the following vehicles:

- Vauxhall / Opel Signum Turbo, Vectra-C Turbo (2002-2008)
- Saab 9-3 1.8 Turbo (2002-2011)
- Saab 9-3 1.8 Turbo BioPower (2002-2011)
- Saab 9-3 2.0 Turbo (2002-2012)
- Saab 9-3 2.0 Turbo BioPower (2010-2012)
- Saab 9-3XT (2009-2011)

engine codes:

- Z20NET, B207, B207L, B207, B207L, B207, B207L, B207, B207L, B207, B207L

scope of delivery:

- crankshaft pulley holding tool, to be used as OEM KMJ38122-A, 8396210
- inlet camshaft alignment tool, to be used as OEM KM6362-1, EN-48366-001
- exhaust camshaft alignment tool, to be used as OEM KM6362-2, EN-48366-002
- chain tensioner locking pin, to be used as OEM KM6077, 8396392



Item #		
9637		

Engine Timing Tool Set | for Opel / Vauxhall 1.6 CDTi ecoFLEX

- for setting and checking the engine timing when replacing the cylinder head gasket, timing chain, etc.

suitable for following vehicles:

- Opel / Vauxhall Astra J, Astra K, Mervia B, Mokka, Zafira C Tourer

engine codes:

- LVL / B16DTN, LVM / B16DTC, LWQ / B16DTE, LVL / B16, LVL / B16DTJ

scope of delivery:

- drive belt tensioner locking pin, to be used as OEM EN-6349, EN-6130
- camshaft adjusting pin, to be used as OEM EN-51143
- crankshaft alignment tool (incl. screws), to be used as OEM EN-51140
- chain tensioner unit locking pin, to be used as OEM EN-50513
- camshaft sprocket retaining tool (incl. screws), to be used as OEM EN-51188



Item #
9621

Tool Tray 1/6: Engine Timing Tool Set | for Opel, Saab, Buick, Cadillac, Chevrolet 2.8L / 3.6L V6

- for checking and setting the engine timing

suitable for following models:

- Buick Enclave 3.6, engine code: LY7
- Cadillac SRX, STS, CTS 3.6, engine code: LY7, LLT
- Chevrolet Camaro 2.8, engine code: LTT, LFX
- Opel Insignia 2.8 V6 Turbo, engine code: LAU/A28NER
- Opel Antara 3.2 V6 (as of 2007), engine code: Z32SE
- Saab 9-5 2.8 (2009-2013), engine code: LAU/A28NER

scope of delivery:

- camshaft alignment tool, to be used as OEM EN-48383-1, EN-48383-2, EN-48383-3
- flywheel locking tool, to be used as OEM EN-46106
- crankshaft setting tool, to be used as OEM EN-46111



Item #		
9754		

Tool Tray 1/3: Engine Timing Tool Set | for Opel / Vauxhall 1.6 SIDI

- for checking and setting the engine timing when replacing the timing chain

suitable for following Opel / Vauxhall models:

- Cascada, Astra J, Zafira C, Insignia (2013-2016)

engines:

- SIDI, SIDI Turbo, SIDI Turbo EcoFLEX

engine codes:

- LVP/A16XHT, LWC/A16SHT, LVP/B16XHT, LWC/B16SHT, LWC/A16SHL

scope of delivery:

- camshaft alignment tool, to be used as OEM EN-51148
- crankshaft pulley holding tool, to be used as OEM EN-51147
- balance shaft sprocket locking tools, to be used as OEM EN-51153
- chain tensioner locking pin, to be used as OEM EN-50513



Item #		
9688		

Tool Tray 1/6: Camshaft Timing Tool Set | for Opel / Vauxhall 2.0 CDTi

- for removing / replacing the timing chain inside the cylinder head
- suitable for 2.0 CDTi / EcoFLEX engines (as of 2014)
- engine code: LFS/B20DTH

suitable for following Opel / Vauxhall models:

- Cascada 2.0 CDTi (2015-2017)
- Insignia 2.0 CDTi (2014-2017)
- Insignia Country Tourer 2.0 CDTi (2014-2017)
- Zafira-C Tourer 2.0 CDTi (2014-2017)

scope of delivery:

- camshaft alignment tool, to be used as OEM EN-51415
- chain tensioner locking pin, to be used as OEM EN-51418



Item #		
9690		

Engine Timing Tool Set | for Opel / Vauxhall 2.0 CDTi / EcoFLEX

- for checking and setting the engine timing when e.g. replacing the timing belt

suitable for the following Opel / Vauxhall models:

- Cascada (15-17)
- Insignia / Country Tourer (14-17)
- Zafira C Tourer (14-17) with 2.0 CDTi engine
- EcoFLEX engine (engine code: LFS/B20DTH)

scope of delivery:

- high-pressure fuel pump sprocket locking tool, to be used as OEM EN-51413
- auxiliary drive belt tensioner locking pin, to be used as OEM EN-955-2
- crankshaft timing tool, 3-piece, to be used as OEM EN-51412
- camshaft locking pin, to be used as OEM EN-51414
- crankshaft pulley holding tool (automatic transmission), to be used as OEM EN-51411



Item #		
9858		

Tool Tray 1/3: Engine Timing Tool Set | for Opel 1.0, 1.4 L Petrol Engines

- for checking and setting the engine timing
- suitable for Opel 1.0 / 1.4 L petrol engines with turbocharger and 1.4 L naturally aspirated petrol engines
- suitable for Opel 1.0 L 3-cylinder turbo engines (LE1/B10XFL, LE1/B10XFT, LE1/B10XHL), 1.4 L 4-cylinder naturally aspirated engines (LV7/B14XE) and 1.4 L 4-cylinder turbo engines (LE2/B14XHL, LE2/B14XHT), built in e. g. Opel / Vauxhall Adam, Adam Rocks, Astra K, Corsa E (2014-2017) Turbo / SIDI / Ecoflex

scope of delivery:

- camshaft alignment tool (1), for 1.4 L naturally aspirated engines, to be used as OEM EN-51632
- camshaft alignment tool (2), for 1.0 L & 1.4 L turbocharger engines, to be used as OEM EN-51367
- balancer shaft alignment tool (3), to be used as OEM EN-51298

Item #		
6686		



Tooth Belt Tensioning Tool | for Citroen & Peugeot

- timing belt locking tool
- suitable for Citroen and Peugeot models
- to be used as OEM 0188-J2, 0188J2



Item #
8152-7

Tool Tray 1/6: Crankshaft Locking Tool | for Porsche Boxster, 911 M96

- for locking the crankshaft pulley and tensioning the camshaft adjustment

suitable for the following Porsche models:

- Boxster (986) 2.5
- Boxster (986) 2.7
- Boxster (986) 3.2
- 911 (996) 3.4

engine codes:

- M96/20, M96/22, M96/21, M96/01, M96/01S

Scope of Delivery:

- locking bolt for crankshaft pulley, to be used as 9595/1, 00072195951
- 2 tensioning screws (left hand thread), to be used as 9632/1, 00072196321
- 2 tensioning screws (right-hand thread), to be used as 9632, 00072196320

Item #		
9624		



Engine Timing Tool Set | for Porsche 911, Cayman, Boxster with MA1 Engine

- for turning and aligning crankshaft and camshaft when removing or replacing the timing chain
- in a BGS system case with EPE foam tray

suitable for following Porsche models:

- 911 Coupe / Cabrio / Targa 3.6 (997) (253 KW), engine code MA1/02
- 911 Coupe S / Cabrio S / Targa S 3.8 (997) (283 KW), engine code MA1/01
- 911 Coupe / Cabrio / Targa 3.6 (997) (254 KW), engine code MA1/02
- 911 Coupe S / Cabrio S / Targa S 3.8 (997) (283 / 300 KW), engine code MA1/01
- 911 Turbo 3.8 (997) (368 KW), engine code MA1/70
- 911 Turbo 3.8 (997) (368 / 390 KW), engine code MA1/70
- 911 S 3.8 (991) (294 KW), engine code MA1/03
- 911 3.4 (991) (257 KW), engine code MA1/04
- 911 GT3 3.8 (991) (350 KW), engine code MA1/75
- 911 GT3 RS 4.0 (991) (373 KW), engine code MA1/76
- 911 Turbo 3.8 (991) (383 KW), engine code MA1/71
- 911 Carrera 3.6 (997) (239 KW), engine code MA1/02
- 911 Carrera S 3.8 (997) (283 / 300 KW), engine code MA1/01 / MA1/01S
- 911 Turbo / Turbo S 3.8 (997) (368 / 390 KW), engine code MA1/70 / MA1/70S
- Boxster 2.9 (987) (155 / 188 KW), engine code MA1/20
- Boxster S / Spyder 3.4 (987) (228 / 235 KW), engine code MA1/21 / MA1/21C
- Boxster 2.7 (981) (155 / 195 KW), engine code MA1/22
- Boxster 3.4 (981) (232 KW), engine code MA1/3
- Boxster 3.4 (981) (232 KW), engine code MA1/23
- Cayman / S 2.9 / 3.4 (987) (155 / 195 KW), engine code MA1/20C
- Cayman 2.7 (981) (155 / 202 KW), engine code MA1/22C
- Cayman S 3.4 (981) (239 KW), engine code MA1/23C

scope of delivery:

- camshaft alignment tool, to be used as OEM 9772
- crankshaft pulley turning tool, to be used as OEM 9773
- crankshaft timing pin, to be used as OEM 9595/1
- crankshaft pulley holding tool, to be used as OEM 9775

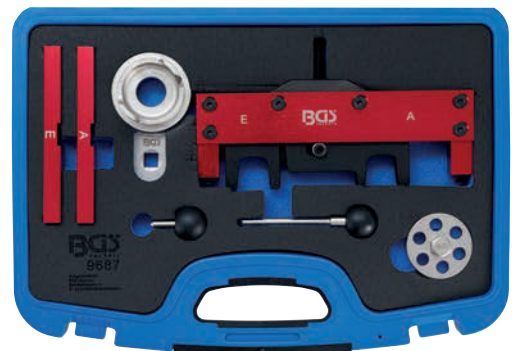

Item #
9687

Tool Tray 1/3: Flywheel / Crankshaft Pulley Locking and Chain Cover Separating Tool Set | for Renault, Nissan

- for locking the flywheel and front pulley and separating the chain cover when replacing the timing chain

suitable for following models:

- Renault 1.4 / 1.6 / 2.0 / 2.5 / 3.5L petrol engines with timing chain
- petrol engines 1.4 L (H4JT) / 1.6 L (M5M) / 2.0L (M4R) / 2.5 L (2TR) / 3.5 L (V4Y)
- for locking the flywheel on Diesel engines 2.0 L (M9R) / 2.3 L (M9T), use with BGS 8421

scope of delivery:

- crankshaft pulley holding tool, to be used as OEM MOT 2019 / MOT 1789
- flywheel locking tool, to be used as OEM MOT 919-02
- flywheel locking tool, to be used as OEM MOT 14314
- timing chain cover separating tool, to be used as OEM MOT 1716



Item #		
9699		

Engine Timing Tool Set | for MINI, Citroen, Peugeot 1.6L Diesel

- for checking and adjusting the engine timing

suitable for following models with 1.6 l diesel engines:

- BMW MINI / MINI Clubman, series R55 / R56 / R57
- Citroen C2 / C3 / C4 / C5 / Grand Picasso, Berlingo (MK3) / Xsara Picasso
- Peugeot 206 / 206cc / 207 / 207cc / 1007 / 307 / 308 / 308cc / 3008 / 5008 / Partner (MK3)

engine codes:

- BMW: W16D16 (9HZ) / W16D16UO
- PSA: 9HZ / 9HX / 9HY (DV6TED4)

scope of delivery:

- crankshaft timing pin, to be used as OEM PSA 0194A / BMW 119790
- camshaft timing pin / high pressure fuel pump timing pin, to be used as OEM PSA 0194B / BMW 110300
- flywheel holding tools, to be used as OEM PSA 0194C / BMW 119850, 119851, 119852



Item #	
9601	

Tool Tray 1/6: Balance Shaft Adjusting Tool Set | for Land Rover, Citroen, Mitsubishi, Peugeot, Ford 2.2 DOHC Diesel Engines

- for adjusting the balancer shaft

suitable for following models:

- Land Rover Discovery, Discovery Sport, Freelander 2, eD4, TD4, TD4e (2009-2015)
engine codes: 224DT, DW12CTED4/224DT, DW12BTED4/224DT
- Citroen C5, C5 II, C5 III, C6, C8, C-Crosse HDi (200-2015)
engine codes: 4HX (DW12CTED4), 4HP (DW12BTED4), 4HX (DW12TED4), 4HW (DW12TED4/L4)
- Mitsubishi Outlander DI-D, DI-DC (2007-2013)
engine codes: 4HK, 4HN
- Peugeot 4007, 407, 607, 807, 406, 508, 607, HDi, GT Hdi (2000-2015)
engine codes: DW12MTED4 (4HK), DW12MTED4 (4HN), DW12BTED4 (4HP), DW12BTED4 (4HR), DW12BTED4 (4HT), DW12TED4/L4 (4HW), DW12BTED4 (4HS), DW12ATED (4HZ), DW12ATED4 (4HX), DW12ATED (4HZ), DW12CTED4 (4HL)
- Ford Galaxy, Mondeo, S-Max, TDCI, TCI (2008-2015)
engine codes: KNBB, KNBA, KNWA, Q4BA

scope of delivery:

- balance shaft locking tool, to be used as OEM 303-1329
- backlash lever, to be used as OEM 303-1330
- balance shaft setting tool, to be used as OEM 303-1328, 0190D



Item #		1
9606		6

Inlet Camshaft Gear Alignment Tool

- for aligning the teeth on split gears with spring mechanism
- aligns the two gear halves to each other, thereby facilitating the disassembly and assembly of the camshaft
- suitable for Opel / Vauxhall 1.3L diesel Corsa E (2015-), engine codes: LKU / B13DTE, LKU / B13DTR, LKV / B13DTC, BMW 1.5L diesel 1 series (2015-), 2er (2014-), X1 (2015-), MINI One (2014-), engine codes: B37 C15A, B367 D15A
- to be used as OEM Opel EN-50509 and BMW, MINI 11 5 370

Item #
9877



Holding Wrench | for Crankshaft Belt Pulleys | for Honda | 500 mm

- for counter holding the crankshaft pulley when loosening / tightening the central bolt and for fixing the balancer shaft when working on the engine timing
- length: 500 mm

suitable for the following modells:

- Honda Accord 1.8 / 2.0 / 2.2 V-TEC
- Honda Accord Coupe / Aerodeck 2.0 / 2.2
- Honda Accord 2.3 (1993-2003)
- Prelude 2.0 (1997-2003)
- Shuttle 2.2i / 2.3i (1995-2001)
- engine codes: F18A3, F18B2, F20B3, F20B6, F20Z1, F20Z2, F20Z3, F22B5, F22B6, F22Z2, F23Z5, F20A4, F20B5, F22B8, F23A7
- to be used as OEM 07JAB-0010200 / 07JAB-0010202B



Item #
9786

Camshaft Timing Tool Set | for VAG | 3 pcs.

- to secure the camshaft during inspection and adjusting the valve control times
- suitable for 1.2 / 1.4 TSi / TFSi engines with active cylinder management ACT or COD
- engine codes: CPTA, CZEA
- e. g. installed in the following models:
 - Audi A1 (2013-), A3 (2013-), Q3 (2014-)
 - VW Passat (2012), Golf (2012-), Polo (2015-)
 - Seat Leon (2014-), Ibiza (2013-)
 - Skoda Superb (2015-)

scope of delivery:

- camshaft adjusting tool, to be used as OEM T10504
- camshaft adjusting pin, to be used as OEM T10504/1
- camshaft inspection pin, to be used as OEM T10504/2



Item #
9493

High Pressure Pump Sprocket Locking Tool for VAG V6 & V8 CR TDI

- for locking the high pressure pump sprocket when replacing the timing tooth belt
- suitable for 2.7L - 3.0L - 4.0L - 4.2L TDI engines
 - V6 TDI common rail, engine codes: CANA, CANB, CANC, CAND, CDYA, CDYB, CDYC, CASA, CASB, CAMA, CAMB, CCWA, CCWB, CGKA, CGKB, CCLA, CARA, CEXA, CASA, CASB, CASC, CATA, CCMA
 - V8 TDI common rail, engine codes: CCFA, CCFC, CDSB, CTEC
- to be used as OEM 40135



Item #
9584



Flywheel Counterholder | for VAG

- for locking the flywheel during loosening / tightening of the crankshaft belt, pulley and flywheel
- consists fastening bolts and locking claw
- to be used as OEM 3067

Item #
9616



Crankshaft Locking Tool | for VAG 1.4, 1.6, 2.0 TDI (EA288)

- for adjusting / locking the crankshaft when working on camshaft drive or replacing cylinder head gasket
- suitable for:
 - TDI Common Rail engine EA288
- for following vehicles:
 - 1.4 TDI Audi A1
 - 1.4 TDI Seat Ibiza, Toledo IV
 - 1.4 TDI Skoda Fabia III, Rapid (2012)
 - 1.4 TDI VW Polo V
 - 1.6 TDI Audi A1, A3 8V, A4 B9, Q2
 - 1.6 TDI Seat Leon III, Toledo IV, Ateca
 - 1.6 TDI Skoda, Octavia III, Rapid (2012), Superb III, Karoq
 - 1.6 TDI VW Beetle, Golf VII, Jetta VI, Tiguan, Touran II, T-Roc, Passat B8, CC, Scirocco III
 - 2.0 TDI Audi A3 8V, A4 B9, Q2
 - 2.0 TDI Seat Leon III, Ateca, Alhambra II
 - 2.0 TDI Skoda Octavia III, Superb III, Kodiaq, Karoq
 - 2.0 TDI VW Beetle, Golf VII, Jetta VI, Tiguan, Touran II, T-Roc, Sharan II, Passat B8, CC, Scirocco III, Arteon, T6, Caddy, Crafter, Amarok
- to be used as OEM T10490

Item #
9625



Camshaft Locking Tool | for VW LT 2.8D

- for securing the camshaft during inspection and adjusting the valve control timing
- suitable for VW LT 2.8D (1996-2006)
- suitable for following engine codes:
 - AGK, ATA, AUH, BCQ
- to be used as OEM 3445

Item #
9753



Tool Tray 1/3: Camshaft Counterholding Tool Set | for VAG

- for counter-holding when loosening and fastening oil pump and camshaft sprocket bolts
- also suitable for turning the crankshaft when checking the engine timing

suitable for the following EA211 engines:

- 1.0 MPI, engine codes: CHYA, CHYC, CPGA, CHYB
- 1.0 TSI, engine codes: CHZE, CHZK, CHZA, CHZB, CHZC, CHZD, CHZJ
- 1.2 TSI, engine codes: CJZB, CJZC, CYVA, CJZA, CJZD, CYVB
- 1.4 TSI, engine codes: CPWA, CZCC, CMBA, CZCA, CHPA, CPTA, CZDA, CVNA, CZEA

built in the following VAG models:

- Audi A1, A3 (8V), A4 (B9), A5 (F5), Q2, Q3 (8U)
- Seat Alhambra II, Arona, Ateca, Ibiza (Typ 6J/6P), Ibiza (6F), Leon III, Toledo IV
- Volkswagen Beetle, Golf VII, Passat (B8), Polo V, Polo VI, Sharan II, Tiguan I, Tiguan II, Touran II, T-Roc, up!
- Skoda Citigo, Fabia III, Karoq, Kodiaq, Mii, Octavia III, Rapid, Superb III, Yeti
- also suitable for 1.2 / 1.4 / 1.6 / 2.0 TDI Common-Rail Diesel, 1.9 / 2.0 Pump-Nozzle and 1.6 MPI

scope of delivery:

- camshaft sprocket holding tool, to be used as OEM T10172A
- holding tool adaptor, to be used as OEM T10554
- holding pin set, Ø 4.8 mm
- holding pin set, Ø 6.0 mm
- holding pin set, Ø 15 mm, length 12 mm
- holding pin set, Ø 15 mm, length 6 mm
- holding pin set, 3-step, Ø 5.7 mm, Ø 9.7 mm, Ø 11.7 mm
- holding pin set, Ø 11.7 mm
- holding pin set, M10
- holding pin set, M12
- holding pin set, Ø 13 mm, length 17 mm
- holding pin set, Ø 13.1 mm, length 20 mm



Item #		1
9696		3

Tool Tray 1/3: Timing Chain Testing Tool Set | for VAG 1.2 / 1.4 TFSi | 4 pcs.

- for checking the timing chain elongation on VAG 1.2 and 1.4L TFSi engines
- prevents costly repairs by skipping of the timing chain

suitable for following models:

- Audi: A1 (12-15), A1 Sportback (12-15), A3 (13-15), A3 (13-15), A3 Sportback (12-15)
- Seat: Ibiza (12-17), Leon (12-15), Toledo (12-17)
- Skoda: Fabia II (10-15), Fabia III (14-17), Octavia II (10-13), Octavia III (10-15), Praktik (10-15), Roomster (10-15), Rapid (15-17)
- Volkswagen: Golf VI & VII (08-15), Golf VII Kombi (08-17), Jetta (12-17), Polo (12-17), Sportsvan (14-17)

scope of delivery:

- timing chain test tool set, to be used as OEM T10550
- consisting of the following tools:
 - camshaft retainer, to be used as OEM T10550/1
 - pointer, to be used as OEM T10550/2
 - measuring gauge with crankshaft pulley plate, to be used as OEM T10550/3



Item #		
9689		

Tensioner Wrench | for Audi / VW Engines | 3.7L / 4.2L V8

- for adjusting the tooth belt tensioner

suitable for e. g. following models:

- Audi A6, A8, S6 and VW Touareg, Phaeton with 3.7L and 4.2L V8 engines

engine codes:

- AKC, ANK, AQF, AQG, AQJ, ARS, ARU, ASG, AUW, AVN, AWN, AXQ, BGH, BGJ, BHX
- to be used as OEM T40009



Item #	
6735	

Belt Pulley Puller & Assembly Set | for GM, Chrysler, Ford, Mitsubishi | 6 pcs.

- for removing and installing pulleys
- removing of the radiator is not required

suitable for following models:

- General Motors
 - 5.7L V8 engines as of 1997, e.g. Camaro, Corvette, Firebird
 - 4.8L / 5.3L / 6.0L / 8.1L V8 engines as of 2000
 - 4.5L / 4.6L / 4.9L V8 engines as of 1988, e.g. Cadillac
 - 4.0L V8 engines as of 1995, e.g. Oldsmobile
 - 4.2L V6 engines as of 2003
 - 3.5L V5 engines as of 2004
 - 2.8L V4 engines as of 2005
- Chrysler
 - 2.0L / 2.4L 4-Cylinder engines as of 1990
 - 2.5L / 2.7L / 3.3L / 3.5L / 3.8L V6 engines as of 1990
- Ford
 - V8 engines as of 1995 with 3-spoke pressed-on dampener
- Mitsubishi
 - 2.0L DOHC engine 1995-1999, e.g. Eclipse (not Turbo)

scope of delivery:

- 1 three-jaw puller, 20 mm (3/4") drive
- 3 forcing rods, with different lengths
- 1 forcing screw, 10 mm (3/8") drive
- 1 harmonic balancer holding tool for Chrysler



Item #

7761

Belt Pulley Puller & Assembly Set | for GM, Ford | 13 pcs.

- for removing and installing pulleys
- removal of radiator is not required
- suitable for following engines:
 - General Motors 3.1, Quad 4
 - Ford 4.6 and others

scope of delivery:

- puller jaws
- puller body
- bearing
- thrust washer
- thrust piece
- retainer sleeve
- jackscrew
- puller pin for GM 3.1
- puller pin for Quad 4
- screw installer for GM 3.1
- screw installer for Quad 4
- screw installer for Ford 4.6
- screw installer for other models

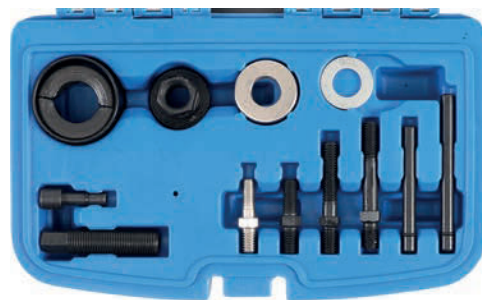

Item #

7754

Tool Tray 1/3: Vibration Damper Tool Set | for VAG 1.8 & 2.0 TFSI

- prevents twisting of the timing chain sprocket during disassembling and assembling of vibration damper

suitable for the following models:

- Volkswagen, Audi, Skoda and Seat with 1.8 and 2.0L TFSI engines with chain drive
- engine codes 1.8L TFSI:
 - BZB, CDAA, BPU, BYT, CABA, CABB, CDHA, CDHB, CABD, DAJB, CJSA, CJSB, CJEB, CJEE, CJED, CYGA, CDAC, CJSC, CGYA, DAJA
- engine codes for 2.0L TFSI:
 - CAWB, CCZA, CBFA, CCTA, CDNB, CDNC, CDND, CJXA, CJXE, CJXH, CHHB, CHHA, CULA, CFKA, DEDA, CHJA, CAWA, CCZC, CCZD, CPSA, CJKK, CJKB, CESA, CETA, CFPA, CNCD, CPLA, CYRB, CYRC; CNCE, CYNB, CYPA, CULB, CULC, CNCB, CWZA, CJXF, CJXC, CJXB, CJXG, CHHC, CCZB

scope of delivery:

- vibration damper holding tool, to be used as OEM T10531/1
- crankshaft pulley spanning bolt, to be used as OEM T10531/2
- nut for vibration damper holding tool, to be used as OEM T10531/3
- adapter piece for vibration damper holding tool, to be used as OEM T10531/4



Double Hook for Removal Tool for Shaft Gaskets | 295 mm

- 295 mm long lever arm for fast and easy disassembly of radial sealing rings
- hardened pulling lever for long product life time
- handle type: 2-component-handle



Injection Pump Sprocket Remover | for Hyundai / KIA 2.0 / 2.2 CRDI

- used to remove the sprocket on high pressure diesel pumps
- suitable for Hyundai & KIA 2.0 / 2.2 CRDI engines with a timing chain
- to be used as OEM 09331-1M100

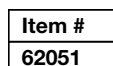

Crankshaft Holding Tool | for Ford

suitable for the following models:

- Mondeo and Transit with 2.0 / 2.2 / 2.4 / 3.2 Duratorq Di, TDDi, TDCi Diesel and 2.3 Duratec HE petrol
- to be used as OEM 303-1310
- length: 665 mm

Item #
9691



Tool Tray 1/3: Crankshaft Pulley Tool Set | for MINI Cooper engines W11

- allows a safe disassembly and assembly of the crankshaft pulley (vibration damper) on 1.6l MINI Cooper and MINI Cooper S engines (type W11)
- slots in the puller disc allow disassembling of both types of W11 pulleys
- includes a thrust pin that prevents damage to the crankshaft nose
- to be used as OEM 118450 / 118441 / 118270

scope of delivery:

- puller disc
- mounting thrust piece
- thrust pin
- pulling spindle
- mounting spindle
- 6 fastening screws

Item #		
9808		



Flywheel Holding Tool | for Citroen / Peugeot

- for holding the flywheel when loosening the central screw of the crankshaft pulley

suitable for the following models:

- Citroen Xsara, Xantia 1.8/2.0 (XU7JP/JB) Gasoline engines
- Citroen Xsara 1.8 16V (XU7JP4) Gasoline engines
- Citroen ZX, Xantia, XM 2.0 16V (XU10J4) Gasoline engines
- Citroen Xantia 1.9D/TD (XUD9BTF) Diesel engines
- Citroen Xantia, XM2.1TD XUD11BTE Diesel engines
- Peugeot 406 1.8/2.0 (XU7JP/JB) Gasoline engines
- Peugeot 406 1.8 16V (XU7JP4) Gasoline engines
- Peugeot 306, 405, 605 2.0 16V (XU10J4) Gasoline engines
- Peugeot 406 1.9D/TD (XUD9BTF) Diesel engines
- Peugeot 406, 605 2.1TD (XUD11BTE) Diesel engines
- to be used as OEM 0134Q, 0153A, 0153AF, 0188-F, 7044-T, 9004-T, 9022-TM, 9044-T

Item #	
9832	



Front Crankshaft Seal Tool Set | for BMW N20 / N26

- for removing and installing the front crankshaft seal in the timing chain case on BMW N20 and N26 engines
- suitable for removing the front crankshaft seal on many other BMW engines
- front crankshaft seal removal tool, to be used as OEM 110370 (110371 / 110372)
- front crankshaft seal mounting tool, to be used as OEM 119231
- front crankshaft seal adapter, incl. 3 screws, to be used as OEM 2212822
- nut for crankshaft adapter spindle, to be used as OEM 119233



Item #

9862

Engine Lowering Bolt Set | for Smart | 4 pcs.

- for lowering the engine / subframe by approx. 20 cm
- original subframe bolts will be replaced by countersunk screws during installing, the engine/gearbox must be supported
- needed during repair jobs such as changing the turbocharger, starter, etc.
- suitable for Smart Coupe and Convertible, diesel and petrol, Pure, Pulse, Passion, Brabus
- to be used as OEM 450589006200

scope of delivery:

- 2 lowering bolts, M12 x 1.5, length 260 mm, 19 mm external hexagon drive
- 2 lowering bolts, M12 x 1.5, length 300 mm, 19 mm external hexagon drive



Item #

6643

Water Pump Tester Set | 8 pcs.

- for testing the function of mechanically driven cooling system water pumps when the engine is running
- helps identifying pump issues due to damaged impellers, seized impeller shafts or drive slippage on water pump belts

scope of delivery:

- 1 gauge (0-15psi)
- 2 rubber pipe seals
- 2 blanking plugs
- 1 pipe connector body (two-piece)
- 1 hose, Ø 6 mm, length 2 m
- 1 male hose connector

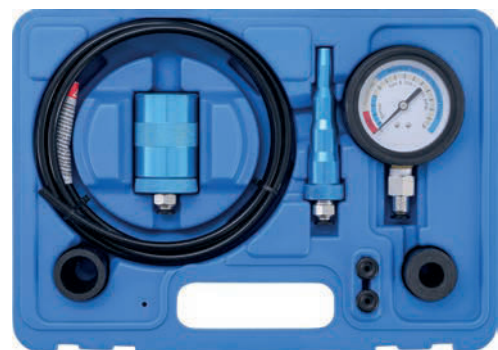

Item #

6750

Crankshaft Pulley Puller | universal

- for the damage-free disassembly of crankshaft pulleys
- suitable for many vehicles like VW T4, Audi A3, etc.

to be used as:

- 3-arm puller for 3-/6-hole mounting with bolt circle Ø 48-114 mm
- 2-arm puller for 4-hole mounting with bolt circle Ø 48-114 mm or 61-114 mm
- 3-arm puller for 5-hole mounting with bolt circle Ø 48-114 mm

scope of delivery:

- puller plate with 8 grooves for holding the puller arms and pull-off bolts
- removal spindle 17 mm, with freely rotating centering tip, 19 mm hexagon drive
- 3 extractor arms, length 33 mm
- 3 extractor bolts M8, length 50 mm
- 3 extractor bolts M10, length 50 mm



Item #
6646

Tool Tray 1/3: Cylinder Head Drilling Gauge Tool Set | 28 pcs.

- for drilling out broken or torn off M8 and M10 studs and bolts
- suitable for using on screw connections of exhaust manifolds, intake manifolds, cylinder heads, gearboxes, differentials, etc.
- also usable on engines and housings on passenger vehicles, motorcycles and commercial vehicles

scope of delivery:

- 1 3-arm drilling jig, adjustable
- 1 guide bushing for 4 mm drill
- 1 guide bushing for 6.5 mm drill
- 1 guide bushing for 8.5 mm drill
- 1 drill stop for 4 mm drill
- 1 drill stop for 6.5 mm drill
- 1 drill stop for 8.5 mm drill
- 2 hexagon nuts M10 x 1.5
- 2 hexagon nuts M8 x 1.25
- 1 alignment sleeve M8
- 1 alignment sleeve M10
- 1 HSS drill 4 mm
- 1 HSS drill 8.5 mm
- 1 HSS drill 6.5 mm
- 3 guide sleeves M8
- 3 guide sleeves M10
- 3 alignment pins, conical on both sides
- 1 internal hexagon key 2 mm
- 1 internal hexagon key 4 mm
- 1 internal hexagon key 5 mm



Item #
6682



Turbo Charger Diagnosis Tool Set | 17 pcs.

- to be used for passenger vehicles and trucks with turbo engines, diesel and petrol engines
- for checking the charging system components when installed
- time saving and professional locating of leakages on air intercooler and charging system components
- can also be used for leakage test exhaust gas recirculation valves (EGR)
- pressure loss can be located easily by hand or leakage spray
- to be used with standard air inflators, pressure loss is identified directly with air inflator
- suitable for internal hose diameters 31.0 - 110.0 mm
- double stage offset sealing plug and air adaptor for hoses without bayonet fitting
- includes high pressure safety valve, up to 1.8 bar
- gradation/sizes:
 - double stage inlet adaptor, 31 x 38 mm
 - double stage inlet adaptor, 46 x 51 mm
 - double stage inlet adaptor, 55 x 60 mm
 - double stage inlet adaptor, 65 x 70 mm
 - double stage inlet adaptor, 75 x 80 mm
 - double stage inlet adaptor, 85 x 90 mm
 - double stage inlet adaptor, 95 x 100 mm
 - double stage inlet adaptor, 105 x 110 mm
 - 1 universal air inlet adaptor with hose



Item #
9585

V-ribbed Belt Bit Socket | 12.5 mm (1/2"), external hexagon 22 mm | T-Star (for Torx) T60 12.5 1/2

- special socket for VAG 6-cylinder TDI common rail engines to release V-ribbed belt
- to be used as OEM T40087
- 12.5 mm (1/2") drive and external hexagon 22 mm

Item #	 
9532	



V-Ribbed Belt Tensioner Tool Set | for Citroen, Peugeot, Fiat, Ford 1.4L & 1.6L Diesel

- facilitates pretensioning and locking the clamping piece of the V-ribbed belt
- allows to remove and install the V-ribbed belt
- can also be used under narrow space conditions
- incl. locking pin to lock the clamping unit

scope of delivery:

- 1 belt tensioner spanner
- 1 belt tensioner locking pin
- 1 spanner adaptor



Item #
9555

Serpentine Belt Tool | for VAG 1.4 TSI / TFSI

- for tensioning the poly V-belt tensioning element
- suitable for following models and engines:
 - 1.4l direct injection TSi / TFSi Blue Motion engines on:
 - VW Beetle, Eos, Golf, Jetta, Passat, Polo, Scirocco, Tiguan, Touran
 - Audi A1
 - Skoda Octavia, Yeti
- to be used as OEM T10447
- wrench size: 16 mm



Item #
9642



Belt Pulley Wrench for Ribbed Belts | for BMW N54 / N55

- for replacing the serpentine belts
- both ends with T-Star (for Torx) T60
- suitable for BMW engines N54 / N55
- material: S45 Steel



Item #
9615

Loosening Tool | for HENN-type Hose Clamps

- to release clamps from air pressure hoses or radiator hoses
- for opening HENN-clamps
- with plastic T-handle
- special steel

suitable for the following passenger vehicles:

- VW, Audi, Seat, Skoda, BMW, Peugeot, Citroen, Dacia, Fiat, Ford, Kia, Lexus, Mazda, Mercedes-Benz, Nissan, Opel / Vauxhall, Porsche, Renault, Toyota, Volvo



Item #
9592



Spark Plug Socket Set Hexagon | 12.5 mm (1/2") Drive | 14 - 21 mm | 5 pcs.

12.5 1/2

- with rubber inlay
- surface finish: satin chrome plated
- 1 spark plug socket, hexagon, 14 mm
- 1 spark plug socket, hexagon, 16 mm (BGS 2472)
- 1 spark plug socket, hexagon, thin walled, 16 mm
- 1 spark plug socket, hexagon, 18 mm
- 1 spark plug socket, hexagon, 21 mm (BGS 2470)



Item #
6641



Glow Plug Socket Pliers | angled | for Opel / Vauxhall 1.7 Diesel

- for removing the coated glow plug connectors
- extra narrow pliers head

suitable for the following Opel / Vauxhall models:

- Astra H (2004-2009)
- Astra J (2009-2014)
- Meriva A (2003-2010)
- Meriva B (2010-2014)
- Corsa D (2006-2014)
- Zafira B (2009-2014)

- to be used as OEM EN-48558
- length: 160 mm



Item #
6693

Spark Plug Socket Puller | for VAG / Mercedes-Benz | 320 mm

- for removing and installing of spark plug connectors with sheet metal coating
- blade length: 290 mm
- head inner diameter: 19 mm
- head outer diameter: 23 mm
- to be used as OEM T10112, T10112A

suitable for the following models:

- VW Golf IV & V 1.6, Bora, Beetle, Mercedes-Benz, Smart



Item #
2460



Honing Tools | flexible | Grit 120

- for honing of engine cylinders
- grit: 120
- material: silicon carbide
- max. speed: 300 rpm
- BGS 1260: working diameter: 68 - 70 mm, shaft diameter: 6.5 mm
- BGS 1261: working diameter: 75 - 77 mm, shaft diameter: 6.5 mm
- BGS 1262: working diameter: 81 - 83 mm, shaft diameter: 7.8 mm
- BGS 1263: working diameter: 87 - 89 mm, shaft diameter: 7.8 mm
- BGS 1264: working diameter: 94 - 96 mm, shaft diameter: 7.8 mm



Item #	Description
1260	Honing Tool flexible Grit 120 68 - 70 mm
1261	Honing Tool flexible Grit 120 75 - 77 mm
1262	Honing Tool flexible Grit 120 81 - 83 mm
1263	Honing Tool flexible Grit 120 87 - 89 mm
1264	Honing Tool flexible Grit 120 94 - 96 mm

Honing Tool | flexible | Grit 180

- for honing of engine cylinders
- grit: 180
- material: silicon carbide
- max. speed: 300 rpm
- BGS 1265: working diameter: 68 - 70 mm, shaft diameter: 6.5 mm
- BGS 1266: working diameter: 75 - 77 mm, shaft diameter: 6.5 mm
- BGS 1267: working diameter: 81 - 83 mm, shaft diameter: 7.8 mm
- BGS 1268: working diameter: 87 - 89 mm, shaft diameter: 7.8 mm
- BGS 1269: working diameter: 94 - 96 mm, shaft diameter: 7.8 mm



Item #	Description			
1265	Honing Tool	flexible	Grit 180	68 - 70 mm
1266	Honing Tool	flexible	Grit 180	75 - 77 mm
1267	Honing Tool	flexible	Grit 180	81 - 83 mm
1268	Honing Tool	flexible	Grit 180	87 - 89 mm
1269	Honing Tool	flexible	Grit 180	94 - 96 mm

Glow Plug Tool and Thread Repair Kit | M8, M10 | 41 pcs.

- for assembly and disassembly of glow plugs and professional repair of glow plug threads
- thread cutter for regrinding glow plug threads M8 x 1 and M10 x 1
- tools for cleaning the filament bore in the cylinder head
- ratcheting tap holder

scope of delivery:

- 5 taps 1/4 "x 28UNF - 12 x 28UNF - M8 x 1.0 - M10 x 1.0 - M8 x 1.0
- 4 twist drills 2.6 - 3.4 - 3.4 - 4.4 mm
- 3 step drills for drilling out torn off glow plugs
4.4 x 7 - 5.4 x 7 - 5.5 x 9 mm
- 2 tie bolts
- 2 tension spindles
- 4 drill centering sleeves 2.6 - 3.7 mm
- 3 L-type wrenches, hexagon 2 - 2.5 - 3 mm
- 2 round steel brushes 5 x 300 - 7 x 300 mm
- 2 tap holders
- 1 centering device with ball bearing and pulling spindle
- 2 spindle nuts
- 2 twist drill holders
- 1 centering sleeve
- 1 pull-out sleeve
- 6 calibration inserts for glow plug electrodes, 6.3 mm (1/4 ") square drive, 2.6 - 3.2 - 3.5 - 4.5 - 6.5 - 8.25 mm
- 1 socket, square drive 10 mm (3/8 "), E-Star E10



Item #
9565

Fluid Flask with flexible Spout and Lid | 6 L

- material: HDPE
- suitable for brake fluid, battery fluid and non-acidic liquids
- incl. flexible nozzle and lockable cask cover
- with threaded nozzle for fillers
- colour: white / transparent

- BGS 9569: capacity: 6 l
- BGS 9570: capacity: 8 l

Item #	Description
9569	Fluid Flask with flexible Spout and Lid 6 L
9570	Fluid Flask with flexible Spout and Lid 8 L



Hand Pump | 500 ml

- suitable for engine, transmission, sanitary applications and water
- embossed level indicator on transparent housing for checking fluids
- sealing ring made of NBR
- tank capacity: 500 ml
- hose length: 300 mm
- internal hose diameter: Ø 8 mm
- external hose diameter: Ø 12 mm

Item #
9582

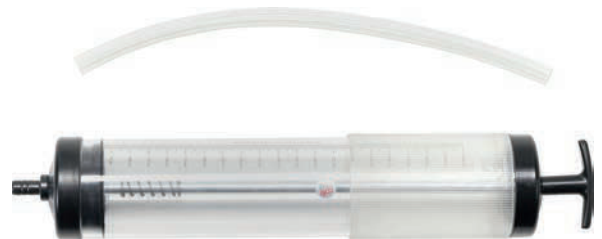

Fluid Hand Pump Set | 350 ml | 3 pcs.

- for extraction by suction, re-filling and decanting
- suitable for brake fluid, cooling system antifreeze, servo steering fluid, transmission oil, engine oil
- fluid hand pump 350 ml with back pressure valve and hose coupler
 - incl. hose 11 x 300 mm
 - plastic tube 9.8 x 300 mm
 - dimensions: 381 x 75 x 75 mm
- 2 fluid hand pumps 350 ml with decanting function and hose coupler
 - for sucking fluids into the screwed 1 l reservoir tank or in any other reservoir
 - incl. hose 13 x 370 mm & 15 x 150 mm
 - dimensions (incl. 1 l reservoir tank): 381 x 225 x 102 mm
- with useful and easy to assemble plastic wall bracket
- not suitable for flammable fluids like fuel

Item #
9496



Lever Barrel Pump | for Urea (AUS32)

- for transferring fluids
- suitable for 60 / 200 / 220 l barrels
- suitable for the following liquids: AUS32, water, lubricants, windshield washer fluid, antifreeze, mild detergents, agricultural chemicals, etc.
- delivery volume: 0.5 l per stroke
- flow rate 20l / min.
- pluggable suction tube 350 - 980 mm
- with 2 m flexible hose
- temperature range: -5°C - +45°C
- main materials: polypropylene, polyethylene, fluor elastomer seals



Item #

8332

Hand Pump | 1500 ml | with Adaptor Set

- for retrieving excess fuels from the fuel lines
 - also suitable for engine oil, gear oil, antifreeze and water
 - eliminates the risk of fuel spills
 - fits on many newer and older petrol and diesel vehicles
 - stroke: 260 mm
 - cylinder-external-Ø: 100 mm
 - hose length: 400 mm
 - tank capacity: 1.5l
 - housing material: plastic
-
- hand pump with shut-off valve, 1.5l
 - adaptor 8 mm (5/16") (outside) to 8 mm (5/16") (outside)
 - adaptor 10 mm (3/8") (outside) to 8 mm (5/16") (outside)
 - adaptor with hose connector to 8 mm (5/16") (outside)
 - connecting hose 10 mm (3/8") (outside), length: 395 mm
 - 2 adaptor hoses 10 mm (3/8") (outside) to 8 mm (5/16") (inside)
 - connectors for PSA/Vauxhall/Opel vehicles and universal connectors for older cars



Item #

9782

Hand Transfer Pump | 550 ml

- to extract and transfer water, for Urea (AUS32), diesel, petrol, brake fluid, antifreeze, motor oil, gearbox oil and power steering oil
 - pump head with built-in two-way valve enables an easy and clean transfer of liquids
 - transfer quantity: 550 ccm per double stroke
 - stroke: 205 mm
 - pump housing: Ø 62 mm
 - dimensions: 450 x 90 mm
 - material: polypropylene (PP)
-
- hand transfer pump
 - PVC hose, inner diameter 10 mm (3/8"), outer diameter 13.5 mm, length 500 mm
 - PVC hose, inner diameter 10 mm (3/8"), outer diameter 13.5 mm, length 1000 mm
 - nylon hose, inner diameter 7 mm, outer diameter 10 mm (3/8"), length 360 mm



Item #

9835

Suction Gun | 500 ml

- suitable for oil and antifreeze
- be used for gearbox, engine rear axle and hydraulic oil (viscosity from 30 to 68)
- includes transparent PVC hose, length 280 mm, for suction / drainage
- overall length (without hose): 330 mm
- diameter 56.4 mm
- hose inner diameter 9 mm
- hose outer diameter 12 mm
- capacity: 500 ml
- surface finish: chrome plated
- material: sheet steel, galvanized



Item #

9823

Ramp Set | Plastic | extra flat | 2 pcs.

- made of plastic
- extra flat design
- can be used on front or rear tire
- light and sturdy to safely hold keep the weight of the car
- rise height: 65 mm
- max. load capacity: 2.5 t
- for tyres up to 195 mm width
- dimensions: 700 x 200 x 80 mm
- to be used by pair only



Item #

9759

Floor Jack | hydraulic | extra flat | 2.5 t

- steel construction
- easy to manoeuvre and transport
- low height clearance, especially suitable for lowered racing cars
- max. lifting capacity: 2500 kg
- wheels made of aluminium alloy
- length: 722 mm
- width of lift side: 250 mm
- width of shunting side: 350 mm
- min. height: 75 mm
- max. height: 515 mm
- rated load capacity: 2 t



Item #

9777

Hydraulic Bottle Jacks | 2t - 20t

- with safety valve
 - incl. plug-in telescopic piston rod
 - massive steel construction
- BGS 9881: spindle length: 48 mm, max. height: 316 mm, min. height: 100 mm, lifting height: 100 mm, rated load capacity: for up to 2 t
 - BGS 9882: spindle length: 60 mm, max. height: 363 mm, min. height: 188 mm, lifting height: 115 mm, rated load capacity: for up to 3 t
 - BGS 9883: spindle length: 70 mm, max. height: 402 mm, min. height: 207 mm, lifting height: 125 mm, rated load capacity: for up to 5 t
 - BGS 9884: spindle length: 80 mm, max. height: 447 mm, min. height: 222 mm, lifting height: 145 mm, rated load capacity: for up to 8 t
 - BGS 9885: spindle length: 80 mm, max. height: 447 mm, min. height: 222 mm, lifting height: 145 mm, rated load capacity: for up to 10 t
 - BGS 9886: spindle length: 80 mm, max. height: 457 mm, min. height: 227 mm, lifting height: 150 mm, rated load capacity: for up to 12 t
 - BGS 9887: spindle length: 80 mm, max. height: 457 mm, min. height: 227 mm, lifting height: 150 mm, rated load capacity: for up to 15 t
 - BGS 9888: spindle length: 60 mm, max. height: 445 mm, min. height: 235 mm, lifting height: 150 mm, rated load capacity: for up to 20 t



Item #	Description
9881	Hydraulic Bottle Jack 2 t
9882	Hydraulic Bottle Jack 3 t
9883	Hydraulic Bottle Jack 5 t
9884	Hydraulic Bottle Jack 8 t
9885	Hydraulic Bottle Jack 10 t
9886	Hydraulic Bottle Jack 12 t
9887	Hydraulic Bottle Jack 15 t
9888	Hydraulic Bottle Jack 20 t

Rubber Pad | for Auto Lifts | Ø 145 mm

- inner diameter: 108 mm
- outer diameter: 145 mm
- height: 24 mm
- ShA 80°
- SBR rubber
- suitable for Ravaglioli and OMCN

Item #

6473



Rubber Pad | for Auto Lifts | Ø 140 mm

- inner diameter: 103 mm
- outer diameter: 140 mm
- height: 25 mm
- ShA 80°
- SBR rubber
- suitable for OMCN

Item #

6477



Rubber Pad | for Auto Lifts | Ø 100 mm

- inner diameter: 80 mm
- outer diameter: 100 mm
- height: 21 mm
- ShA 80°
- SBR rubber
- suitable for Ravaglioli

Item #

6470



Rubber Pad | for Auto Lifts | Ø 160 mm

- inner diameter: 135 mm
- outer diameter: 160 mm
- height: 28 mm
- ShA 80°
- SBR rubber
- suitable for Intertech 225 and 227

Item #

6475



Rubber Pad | for Auto Lifts | Ø 150 mm

- inner diameter: 128/13 mm
- outer diameter: 150 mm
- height: 25 mm
- ShA 80°
- SBR rubber
- suitable for Ravaglioli and OMCN

Item #
6478



Rubber Pad | for Auto Lifts | Ø 120 mm

- inner diameter: 108 mm
- outer diameter: 120 mm
- height: 26 mm
- ShA 80°
- SBR rubber
- suitable for Grazia, UB, Ravaglioli

Item #
6471



Rubber Pad | for Auto Lifts | Ø 120 mm

- inner diameter: 110 mm
- outer diameter: 120 mm
- height: 26 mm
- 3 fixation points
- ShA 80°
- SBR rubber
- suitable for Ravaglioli

Item #
6472



Rubber Pad | for Auto Lifts | Ø 145 mm

- inner diameter: 135 mm
- outer diameter: 145 mm
- height: 26 mm
- ShA 80°
- SBR rubber
- suitable for Ravaglioli

Item #
6474



Automotive Clip Assortment | Universal | 192 pcs.

- material: nylon
- 30 wiring harness clips, Ø 6.4 mm
- 15 wiring harness clips, Ø 7.1 mm
- 20 wiring harness clips, Ø 7.8 mm
- 20 wiring harness clips, Ø 9.0 mm
- 10 wiring harness clips, Ø 9.5 mm
- 10 wiring harness clips, Ø 10.0 mm
- 20 blind rivets with collar, Ø 6.3 mm
- 20 fender spreader clips, Ø 8.0 mm / head Ø 20.0 mm
- 12 air baffle / chassis spreader clips, Ø 8.0 mm / head Ø 20.0 mm
- 10 bumper cover spreader clips, Ø 9.0 mm / head Ø 18.0 mm
- 15 push-type clips, Ø 10.0 mm / head Ø 20.0 mm
- 10 push-type clips, Ø 10.0 mm / head Ø 20.0 mm



Item #
9780



Automotive Clip Assortment for Honda | 418 pcs.

- 30 grille clips, to be used as OEM 75103SJ4003
- 8 front and rear bumper push-type retainers, to be used as OEM 91502SSP0003
- 15 push-type retainers, to be used as OEM 90675SB003
- 20 trim panel retainers, to be used as OEM 91566SP0003
- 50 hood seal retainers, to be used as OEM 91513SE003
- 40 weatherstrip retainers, to be used as OEM 91530ST5003
- 20 pillar garnish, side and truck lining push-type retainers, to be used as OEM 91550SH3003
- 25 centre pillar screw grommets, to be used as OEM 91620SR2003
- 5 radiator grille clips, to be used as OEM 91578SV4003
- 30 retaining clips, to be used as OEM 38529689A6300
- 15 front fender push-type retainers, to be used as OEM 91512SX0003
- 30 front fender push-type retainers, to be used as OEM 90683SA5003
- 15 front fender push-type retainers, to be used as OEM 91808SM4000
- 15 retaining clips, to be used as OEM 906876710030
- 30 retaining clips, to be used as OEM 90687SA50030
- 20 retaining clips, to be used as OEM 90672671003
- 30 body side moulding clips, to be used as OEM 91534SEO000
- 20 side marker clips, to be used as OEM 34355SD2003



Item #
9059



Automotive Clip Assortment for Mazda | 475 pcs.

- 20 push-type retainers, to be used as OEM 2042301
- 25 push-type retainers, to be used as OEM N30413356A
- 15 push-type retainers, to be used as OEM B09251833
- 25 grommets for body side fittings, to be used as OEM 999100402
- 20 retaining clips, to be used as OEM B0016830200
- 40 retaining clips, to be used as OEM 992640543A
- 50 retaining clips, to be used as OEM 99249051B
- 5 bumper retainers, to be used as OEM BF6750033
- 20 rod end clips (left), to be used as OEM 992780405
- 20 rod end clips (right), to be used as OEM 992780404
- 30 hood insulation retainers, to be used as OEM 6508197AA
- 50 hood insulation retainers, to be used as OEM 992640543A
- 50 hood insulation retainer clips, to be used as OEM B45556741
- 5 bumper cover retainers, to be used as OEM BF8250233
- 20 interior trim push-type retainers, to be used as OEM B1016825200
- 50 weatherstrip retainers, to be used as OEM G03158762
- 15 push-type retainers, to be used as OEM BC1DSA145
- 15 push-type retainers for bumper cover and wheel housing, to be used as OEM 9046709139



Workshop Tools

Item #	
9050	

Automotive Clip Assortment for Mitsubishi | 370-tlg.

- 50 grille clips, to be used as OEM Honda 75103SJ4003, Toyota 9046712020, Mitsubishi 8942180270
- 50 screw nuts, to be used as OEM Mitsubishi 9018905013
- 30 grommets, to be used as OEM Mitsubishi MU480033, Toyota / Lexus 9018906001
- 30 screw grommets, to be used as OEM Toyota 9018906001, Nissan 128100231
- 30 screw grommets, to be used as OEM Mitsubishi MU480034
- 10 push-type retainers, to be used as OEM Mitsubishi MR138807
- 15 push-type retainers, to be used as OEM Mitsubishi MB253964
- 40 push-type retainers, to be used as OEM Mitsubishi HB121467
- 15 grommets, to be used as MB271999
- 40 retainers, to be used as Mitsubishi MB696120
- 20 push-type retainers, to be used as Mitsubishi / Honda MR200300
- 40 rocker panel retainers, to be used as MB846992



Item #	
9142	

Automotive Clip Assortment for Nissan | 408 pcs.

- 30 retaining clips, to be used as OEM 76906T300
- 40 retaining clips, to be used as OEM 0155300172
- 50 retaining clips, to be used as OEM 62869N4700
- 25 trim panel retainers, to be used as OEM 90667SA70030
- 25 screws nuts, to be used as OEM 68425H5000
- 15 push-type retainers, to be used as OEM 75521611000
- 15 grille grommets, to be used as OEM 62380U7400
- 15 inner fender push-type retainers, to be used as OEM 6384401A00
- 20 body side moulding push-type retainers, to be used as OEM 7688257A00
- 30 push-type retainers, to be used as OEM 1099830880
- 10 push-type retainers, to be used as OEM 6387801E10
- 20 push-type retainers, to be used as OEM 6384801G00
- 15 front bumper fascia push-type retainers, to be used as OEM 6385401A00
- 40 cowl grille retainers, to be used as OEM 6684101G00
- 8 bumper cover retainers, to be used as OEM 0155301393
- 10 nylon U shaped nuts for fender, to be used as OEM 63848D400
- 15 drain plugs
- 25 screws , to be used as OEM 78856R4301



Item #
9143



Automotive Clip Assortment for Audi, VW, Toyota, Mercedes-Benz, BMW | 400 pcs.

- 25 metal trim fasteners (centre star) for VAG, to be used as OEM N90335004, N90335006
- 25 metal trim fasteners (6 slot) for VAG, Ford, to be used as OEM N90796501
- 50 metal trim fasteners (U nut) No. 8 x 21 mm
- 30 metal trim fastener screws with washer
- 20 metal trim fastener screws with washer, to be used as OEM 07119916946, N914031006203
- 30 metal trim fasteners, to be used as 07147129160
- 30 trim rivets metal 5.7 hole x 12.8 mm flange, to be used as 9026905065
- 35 trim rivets metal 4.0 hole x 12.0 mm flange
- 50 trim rivets metal 3.8 hole x 6.2 mm flange, to be used as 9026904051
- 50 trim rivets metal 4.0 hole x 8.7 mm flange, to be used as 9026904053
- 25 trim rivets metal 4.9 hole x 12.7 mm flange, to be used as 9026905054
- 30 trim rivets metal 3.9 hole x 12.1 mm flange



Item #
9058



Plastic Connector Set | T-Shape | 20 pcs.

- connector / return nipple
- black
- for 5.0 mm hose inner diameter



Item #
8107-20

Plastic Connector Set | L-Shape | 30 pcs.

- connector / return nipple
- black
- for 5.0 mm hose inner diameter



Item #
8107-22

Spring Strip Hose Clamp Assortment | 80 pcs.

- for use with BGS 470, 472, 473
- one-piece, screwless hose clamp
- equal elasticity
- self tensioning
- ideal round
- area of application: fuel line exhaust system, cooling and heating water circuit
- 10 hose clamps Ø 6.5 mm
- 10 hose clamps Ø 8 mm
- 10 hose clamps Ø 10 mm
- 10 hose clamps Ø 11 mm
- 10 hose clamps Ø 12 mm
- 10 hose clamps Ø 14 mm
- 10 hose clamps Ø 16 mm
- 10 hose clamps Ø 18 mm

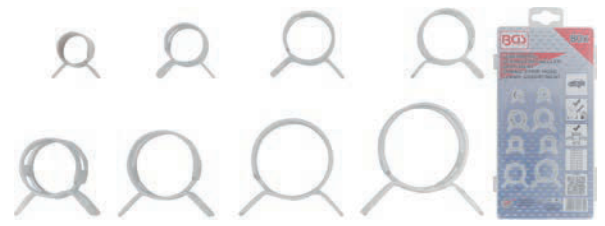

Item #
9475



Hose Clamp Assortment | 80 pcs.

- in plastic storage case
- 15 hose clamps Ø 13 - 16 mm
- 15 hose clamps Ø 12 - 20 mm
- 10 hose clamps Ø 16 - 22 mm
- 10 hose clamps Ø 19 - 25 mm
- 10 hose clamps Ø 25 - 35 mm
- 10 hose clamps Ø 30 - 40 mm
- 5 hose clamps Ø 35 - 45 mm
- 5 hose clamps Ø 35 - 50 mm

Item #
9547



Spacer Screw and Hexagon Nut Assortment | Nylon | 300 pcs.

- metric
- many applications
- spacer screws made from plastic, saves weight compared to metal
- in plastic storage case
- material: Nylon

scope of delivery:

- 40 screws, white M3 x 9 mm
- 40 screws, black M3 x 9 mm
- 40 nuts, white M3
- 40 nuts, black M3
- 10 spacer, female-female, white M3 x 6 mm
- 10 spacer, female-female, black M3 x 6 mm
- 10 spacer, female-female, white M3 x 8 mm
- 10 spacer, female-female, black M3 x 8 mm
- 10 spacer, female-female, white M3 x 10 mm
- 10 spacer, female-female, black M3 x 10 mm
- 5 spacer, female-female, white M3 x 12 mm
- 5 spacer, female-female, black M3 x 12 mm
- 10 spacer screws, male-female, white M3 x 12 mm
- 10 spacer screws, male-female, black M3 x 12 mm
- 10 spacer screws, male-female, white M3 x 14 mm
- 10 spacer screws, male-female, black M3 x 14 mm
- 10 spacer screws, male-female, white M3 x 16 mm
- 10 spacer screws, male-female, black M3 x 16 mm
- 5 spacer screws, male-female, white M3 x 18 mm
- 5 spacer screws, male-female, black M3 x 18 mm

Item #
9402



Grub Screw Assortment | Inch Sizes | 160 pcs.

- made of steel
- according to DIN 913
- grub screws with regular type screw thread:
 - 15 pcs. 5/32 UNC 32 x 3/16"
 - 15 pcs. 1/8" UNC 40 x 3/16"
 - 10 pcs. 3/16" UNC 24 x 1/4"
 - 15 pcs. 1/4" UNC 28 x 1/4"
 - 20 pcs. 5/16" UNC 18 x 3/8"
 - 20 pcs. 1/4" UNC 20 x 1/4"
 - 10 pcs. 3/8" UNC 16 x 3/8"
 - 10 pcs. 3/8" UNC 16 x 1/2"
 - 10 pcs. 5/16" UNC 18 x 1/2"
 - 10 pcs. 1/4" UNC 20 x 3/8"
 - 15 pcs. 5/32 UNC 32 x 3/16"
 - 15 pcs. 1/8" UNC 40 x 3/16"
 - 10 pcs. 3/16" UNC 24 x 1/4"
 - 15 pcs. 1/4" UNC 28 x 1/4"
 - 20 pcs. 5/16" UNC 18 x 3/8"
 - 20 pcs. 1/4" UNC 20 x 1/4"
 - 10 pcs. 3/8" UNC 16 x 3/8"
 - 10 pcs. 3/8" UNC 16 x 1/2"
 - 10 pcs. 5/16" UNC 18 x 1/2"
 - 10 pcs. 1/4" UNC 20 x 3/8"
- grub screws with fine pitch thread:
 - 10 pcs. 5/16 UNF 24 x 3/8"
 - 15 pcs. 5/16 UNF 24 x 3/8"
 - 10 pcs. 5/16 UNF 24 x 3/8"
 - 15 pcs. 5/16 UNF 24 x 3/8"



Item #	
14136	

Cylinder Head Screw Assortment | internal Hexagon | 106 pcs.

- according to DIN 912
- ISO 4762
- tensile strength: 8.8
- in plastic storage case

scope of delivery:

- 25 cylinder head screws M4 x 0.7 mm, length: 12 mm
- 25 cylinder head screws M5 x 0.8 mm, length: 12 mm
- 20 cylinder head screws M5 x 0.8 mm, length: 25 mm
- 10 cylinder head screws M6 x 1.0 mm, length: 12 mm
- 10 cylinder head screws M6 x 1.0 mm, length: 25 mm
- 5 cylinder head screws M8 x 1.25 mm, length: 25 mm
- 5 cylinder head screws M8 x 1.25 mm, length: 40 mm
- 3 cylinder head screws M10 x 1.5 mm, length: 25 mm
- 3 cylinder head screws M10 x 1.5 mm, length: 40 mm



Item #	
14140	

Glass Fuse Assortment | 120 pcs.

- in plastic storage case
- trigger characteristics: idle

scope of delivery:

- 20 glass fuses 5A Ø 6x 30 mm
- 20 glass fuses 10A Ø 6x 30 mm
- 20 glass fuses 15A Ø 6x 30 mm
- 20 glass fuses 20A Ø 6x 30 mm
- 20 glass fuses 25A Ø 6x 30 mm
- 20 glass fuses 30A Ø 6x 30 mm



Item #
14125



Vehicle Front Protection Cover

- protects against pollution from grease, oil, water and other materials
- can be easily cleaned by wiping off with a damp cloth or sponge
- made from soft, resistant polyester
- suitable for mobile use with practical carrying bag
- easily foldable and thus space-saving



Item #
9636

Wheel Balancing Weight Assortment | 36 pcs.

- for steel rims
- use with wheel balancing weight pliers BGS 1539
- in reusable assortment box
- material: zinc-plated steel

scope of delivery:

- 5 pcs. each of 5, 10, 15, 20 g
- 3 pcs. each of 25, 30 g
- 2 pcs. each of 35, 40, 45, 50, 55 g



Item #
9449



Wheel Nut Cap Pliers | 200 mm

- for loosening and fastening of nut caps
- specially shaped pliers tip for the easy removal of wheel bolt protective caps
- 2-component handles
- surface finish: satin chrome plated



Item #
1537



Tyre Bead Retainer

- special design ensures that the tire bead remains under the rim flange during installation of new tires
- PVC coating prevents damage to the rim surface
- suitable for on-road, offroad, cars, motorcycle and truck tires of all sizes
- solid metal core with resistive, highly visible yellow coating
- usable with mounting bars



Item #
8637

Tyre Lever | with Plastic Protection Sleeve 535 mm

- for non-damaging assembling of tyres on aluminium rims
- optimized structure (reinforced, rounded, stump edges) to avoid damages on tyre carcass
- plastic protection sleeve prevents scratching of the wheel rim and also protects against slippage
- reinforced tyre walls on run-flat tyres and low profile tyres are significantly more rigid than the casing of conventional tyres
- using regular tyre levers may lead to tyre damage
- total length: 535 mm



Item #
9586



Tyre Repair Kits | Ø 4.5 - 8.0 - 10.0 mm

- hemispherical combo repair kits
- suitable for radial and bias ply tires
- only use in connection with vulcanization compound
- genuine US product

scope of delivery:

- each set has 24 combo repair kits Ø 4.5 - 8.0 - 10.0 mm



Item #	Description
8925	Tyre Repair Kit Ø 4.5 mm 24 pcs.
8926	Tyre Repair Kit Ø 8.0 mm 24 pcs.
8927	Tyre Repair Kit Ø 10.0 mm 24 pcs.

Tyre Repair Kit | 54 pcs.

- basic assortment for tire repair
- incl. tyre repair plugs for use with stitch awl & mounting paste
- for quick and easy repair of tubeless tires for cars, quads, trailers, garden tractors and scooters
- tyre repair plugs: original US product

scope of delivery:

- 50 Tyre Repair Plugs | 102 mm | 50 pcs. (BGS 8900)
- 1 Mounting Paste for installing tyre repair plugs (BGS 8901)
- 1 Stitch Awl (BGS 8904)
- 1 Insert Installing Tool (BGS 8906)
- 1 safety knife with snap-off blade



Item #
8911

Battery Acid Tester Hydrovolt

- robust and break-proof type
- for checking acid density and charge condition of rechargeable batteries
- for direct reading
- extra low total height for measuring without any difficulty in small areas
- measuring scale with colored sectors
- easy filling of measuring chamber without air bubbles
- hydrostatic reverse lock



Item #
9671



Borescope Colour Camera with LCD Monitor

- to inspect difficult access areas and cavities
- to be used in range of e.g. automotive, installation, mechanical engineering

- 90 mm (3.5") TFT-LCD, 30 steps adjustable brightness
- display resolution: 320 x 240 pixel
- white balance: automatically
- contortion: - 3,7%
- camera angle: 54°
- camera: CMOS Sensor
- protection class: IP 67
- camera diameter: 5,5 mm
- gooseneck: 100 cm
- 4 LEDs, 6-level adjustable brightness
- battery type: 4 x AA | 1,5 V
- power consumption: 1,8 to 2,6 W



Item #
63247

Flushing Liquid | for BGS 8037

- suitable for carbon dioxide leak tester for engines BGS 8037



Item #
8037-2

Exhaust Gas Counter-Pressure Tester

- for testing of the exhaust back pressure
- to be connected to oxygen sensor thread of the exhaust system or to flange of exhaust gas recirculation valve
- allows conclusions on blockages or constrictions, such as e.g. clogged catalyts or particulate filters, thereby preventing expensive repair costs due to damage to the turbocharger
- 1 adaptor for oxygen sensor thread M12x1.25
- 1 adaptor for oxygen sensor thread M18x1.5
- 1 flange adaptor for exhaust gas recirculation valve (EGR)
- 1 pressure gauge, 57 mm with two ranges in psi & kg/cm²
- 1 braided stainless steel casing hose, length 1.9 m



Item #
9468

Compression Tester Kit for Petrol Engines

- for compression measurements with hose adaptor or rubber-cone measuring tube
- spark plug thread adaptor:
 - M10x1.0 - M12x1.25 - M14x1.25 - M18x1.5
- analogous pressure gauge
- pressure gauge scale: 0 - 300 psi / 0 - 2000 kpa (0 - 20 bar)
- with pressure release valve

scope of delivery:

- pressure gauge with quick coupling & pressure release valve
- connecting hose with quick coupler
- compression test pipe, angled type
- compression test pipe, straight type
- spark plug thread adapter M18 x 1.5
- spark plug thread adapter M14 x 1.25
- spark plug thread adapter M12 x 1.25
- spark plug thread adapter M10 x 1.0

Item #
9669



Aligator-Clip Cable Box | automatic reel | 15 m

- alligator clips, red and black
- automatic reel
- for use with multimeters, testing lights etc.
- length: 15 m



Item #
9401

Petrol Injector Tester

- for checking of 12V petrol injectors
- 4 pulse modes for locating stuck, leaking or burnt-out injectors
 - mode 1: admits 1 pulse after triggering, pulse width about 250ms
 - mode 2: admits 50 pulses after triggering, pulse width about 7ms
 - mode 3: admits 100 pulses after triggering, pulse width about 3.5ms
 - mode 4: admits pulses continuously at the rate of 50 pulses per 1450ms, every pulse's pulse width about 7ms
- power supply: 12V vehicle battery
- operation environment: 0°C - 40°C, relative humidity



Item #
9791

Oil Tub / Drip Pan | extra flat | 7 l

- due to its low height particularly suitable for motorcycles and scooters
- for oil change and collecting oil when working on e.g. clutch, gear, etc.
- resistant to most solvents up to a temperature of -30 - 50 °C, acids, alkalis, alcohols, oil, gasoline
- net capacity: 7 l
- width: 940 mm
- length: 630 mm
- height: 30 mm
- material: high density polyethylene (HDPE)
- weight: 670 g



Item #
9579

Gear Oil Filling Hose for VAG DSG

- is needed when replacing the DSG transmission oil
- with adaptor for 1 litre gear oil
- built-in valve prevents oil spillage
- suitable for containers of VAG, Motul, Liqui Moly, Meyle, etc.
- to be used as OEM VAS 6262
- length: 150 cm

Item #
1403



Oil Drain and Filling Set for Automatic Transmission | for Mercedes-Benz 9G-Tronic

- for filling and draining automatic transmission oil on transmission type 725.0

scope of delivery:

- assembly tool, to be used as OEM 725 589 02 90 00
- adapter, to be used as OEM 725 589 00 90 00

Item #
9873



Oil Funnel Adaptor Set | Plastic Type | 15 pcs.

- allows fast oil filling without spillage
- ideal for many new vehicle models
- 2 litre funnel, fits all adaptors for wide application range
- colour-coded adaptors for oil filler hole
- angled extension with swivel feature for hard-to-reach places

scope of delivery:

- bayonet adaptor for Audi, BMW, Mercedes-Benz, Porsche, Volvo, VW
- bayonet adaptor for Toyota & Lexus 3.0 & 3.3L V6
- threaded adaptor M30 x 3.0 for Dodge Cummins
- threaded adaptor M32 x 3.5 for Acura, Dodge, Ford, Honda, Jaguar, Jeep, Land Rover, Mazda, Nissan
- threaded adaptor M35 x 4.0 for Ford, Jaguar, Land Rover, Mazda
- threaded adaptor M37 x 3.0 (short type) for Lotus, Pontiac, Scion, Toyota
- threaded adaptor M37 x 3.0 (long type) for Lotus, Pontiac, Scion, Toyota
- threaded adaptor M42 x 4.5 for Subaru
- threaded adaptor (1/2 turn) for Mazda 3 / 6 / CX-5
- threaded adaptor (1/2 turn) for Cadillac, Chevy, Ford, GMC, Hyundai, Jaguar, Land Rover, Mazda, Saab, Mercury
- threaded adaptor (1/4 turn) for new oil filling lids as of 2008 on Audi, Seat, Skoda, VW with EA888 engine
- threaded adaptor (1/2 turn) for Dodge Hemi 6.4L (2011-) & 3.6L (> 2014)
- oil funnel, adaptor, extension

Item #
8505-2



Oil Drain Screw Sealing Surfaces Cutter Set | 8 pcs.

- for milling damaged oil drain plug sealing surfaces on oil pans
- allows a perfect seal on oil drain plugs
- suitable for oil drain screw threads M12 x 1.5 - M13 x 1.5 - M14 x 1.5 - M15 x 1.5 - M16 x 1.5 - M17 x 1.5 (e. g. BGS 156, 157, 158)

scope of delivery:

- sealing surface cutter
- centering bolt wrench
- centering bolt M12 x 1.5
- centering bolt M13 x 1.5
- centering bolt M14 x 1.5
- centering bolt M15 x 1.5
- centering bolt M16 x 1.5
- centering bolt M17 x 1.5



Item #
6674

Universal Drain Plug Key Set | for Plastic Oil Drain Screws | external hexagon 6.3 mm (1/4") drive, 10 mm (3/8") | 5 pcs. 10 3/8

- special profile inserts
- with T-handle for manual operation
- for mounting and dismounting the plastic oil drain plug on plastic oil pans
- high accuracy of fit for professional oil change
- suitable for Peugeot, Citroen, Ford, BMW, VAG

scope of delivery:

- 1 T-handle, 10 mm (3/8") drive, length 100 mm
- 1 bit holder, 10 mm (3/8") square drive, 6.3 mm (1/4") bits
- 1 special socket wrench bit, 10 mm (3/8") drive, for plastic oil drain plugs, suitable for PSA
- 1 oil drain plug bit, 6.3 mm (1/4") hexagon drive, for plastic oil drain plugs, suitable for VAG
- 1 oil drain plug bit, 6.3 mm (1/4") hexagon drive, for plastic oil drain plugs, suitable for BMW, 10 mm



Item #
9843



Oil Filter Wrench | 71 mm | für Toyota, Lexus, Daihatsu, Subaru

10  3/8

- especially developed for Toyota models with cartridge type oil filter
- suitable for cartridge type oil filters of Toyota, Lexus, Scion, Daihatsu, Subaru, Pontiac
- will not slip or stuck on the filter housing
- drive profile size, metric: 10 mm
- drive profile size, inch: 3/8"
- BGS 9528: size: 71 mm
- BGS 9529: size: 80 mm



Item #	Description
9528	Oil Filter Wrench 71 mm für Toyota, Lexus, Daihatsu, Subaru
9529	Oil Filter Wrench 80 mm for Toyota, Lexus, Scion

Oil Filter Wrench Set | Ø 60 - 80 / 80 - 96 mm | 4 pcs

- suitable for disassembly and assembly of sheet metal housing filters
- the more torque applied the stronger the grip
- spring loaded, self contracting
- drive: 10 mm (3/8")

scope of delivery:

- oil filter wrench 60 to 80 mm, 3/8" drive, for clockwise rotation
- oil filter wrench 60 to 80 mm, 3/8" drive, for counterclockwise rotation
- oil filter wrench 80 to 96 mm, 3/8" drive, for clockwise rotation
- oil filter wrench 80 to 96 mm, 3/8" drive, anti-clockwise rotation



Item #
9792

Rotary Drum Pump

- for pumping liquids from barrels
- suitable for oil and antifreeze (not suitable for fuels), as well as for urea acids (AUS)
- with three-part telescopic tube
- manual rotation with high transmission ratio
- for barrels up to 200 liters
- flow rate per turn: 280 ccm
- flow rate per minute: approx. 20 L (72 turns)
- adaptor thread size: 2" NPT
- material: polypropylene



Item #
9698

Magnetic Pick-Up Tool | 660 mm | Capacity 0.6 kg

- with extendible telescope shaft
- head diameter 7 mm
- with nozzle cleaner (below the protection cap)
- incl. clip holder
- surface finish: chrome plated, polished

Item #
9546



Car Window Cleaning Nozzle and Adjusting Tool

- with sturdy, needle-like setting tip
- for cleaning and adjusting disc washers
- suitable for adjusting the washing nozzles on the headlight
- incl. protective caps
- length: 95 mm
- material: aluminium

Item #
9697



Heavy-Duty Magnetic Holder | L-Type

- 3 separate magnetic areas
- ideal help tool for welding work
- precise fixing of steel and workpiece
- triple use, 60°, 90° and 120°

Item #
9683



LED Battery Bonnet Lamp

- engine compartment lighting with 120 SMD LED, switchable to 60 SMD LEDs
- horizontally or vertically usable
- foot (two-sided), 200° swiveling & 30° rotatable
- 3 magnets per side
- hook (on both sides), 360° swiveling
- off / on switch (on both sides)
- 120 SMD LED
- power: 24 W
- brightness: 800 lm
- battery: Lithium-Ion, 2000 mAh
- operating time: approx. 3-4 hours
- charging time: approx. 6 hours
- protection class: IPX4
- dimensions: 1180 x 120 x 160 mm
- handle type: 2-component handle
- housing material: ABS-plastic
- total weight: 780 g (with charger) / 680 g (without charger)

scope of delivery:

- LED battery-powered light
- 230V charger
- 12V car adaptor

Item #
9757



COB LED Bonnet Lamp with Battery and Telescopic Bar | 2 COB-LED-Handheld Work Lamps

- for illuminating the engine during engine service
- suitable for the most car models
- telescopic holders with expander function incl. large and 360° adjustable hooks
- hooks protect the hood from scratches, covered with soft foam
- robust and foldable aluminum frame facilitates transport and storage
- equipped with two separate COB-LED hand work lamps, which can be used individually
- incl. fold-out and swivel hook for hanging
- COB-LED: 15 W (x2)
- brightness (step 1): 750 lumens
- brightness (step 2): 1500 lumens
- working time (step 1): 2 hours
- working time (step 2): 4 hours
- accumulator type: Li-ion
- accumulator voltage: 3.7 V
- accumulator power (electric charge): 2 x 3600 mAh
- operating temperature: -5 °C to 47 °C
- charging connector: Micro-USB (5.0 V DC)
- charging time: approx. 4 hours
- bracket range: 122 - 196 cm (48" - 77")
- net weight: 2 Kg (4.3 lbs)
- dimensions: 66 x 28 x 10 cm (26" x 11" x 4")

scope of delivery:

- 2 COB LED battery bonnet lamps with 2 lithium-ion batteries
- 1 telescopic bar

Item #
85306



COB-LED / UV Handheld Work Lamp | ultra flat Type

- extra flat design especially suitable for illuminating narrow areas
- switchable to ultraviolet light (UV)
- suitable for detecting using in connection with fluorescent leak detector spray
- brightness continuously adjustable through control knob
- 1 swivel hanging hook
- swivel base with powerful magnet
- light source: 10 W COB LED (main light)
- LED-brightness: 800 lumen
- accumulator type: Li-ion
- accumulator power (electric charge): 3350 mAh
- accumulator charging time: 3.5 h
- working time: 3 h
- charger input: micro USB (charging cable includes)
- load indicator: LED red/blue
- working temperature: -5 °C - 50 °C
- storage temperature: -20 °C - 70 °C
- dimensions: 477 x 50 x 40 mm
- weight: ca. 295 g

scope of delivery:

- COB-LED / UV Work Handheld Lamp
- USB charger (output: DC 5 V 2000 mA, input: AC 100 - 240 V 50/60 Hz)
- USB-charging cable



Item #
9767

COB-LED Handheld Work Lamp | LED Cold White & Yellow | ultra flat Type

- extra flat design especially suitable for illuminating narrow areas
- 3-step-switchable light color from white to yellow and a combination of white and yellow
- yellow light is perfect for detecting dents
- brightness continuously adjustable through control knob
- 1 folding and swivel hanging hook
- swivel base with powerful magnet
- light source: COB LED
- LED brightness: white 620 lumens, yellow 600 lumens, white and yellow 770 lumens
- accumulator type: Li-Ion
- accumulator power (electric charge): 3350 mAh
- working time: 3.5 h
- charger input: micro USB (charging cable includes)
- charging indicator: LED red/blue
- working temperature: -5 °C - 50 °C
- dimensions: 477 x 50 x 40 mm
- weight: ca. 295 g

scope of delivery:

- COB-LED Work Handheld Lamp
- USB charger (output: DC 5 V 2000 mA, input: AC 100 - 240 V 50/60 Hz)
- USB charging cable



Item #
6660

COB LED Workshop Lamp with Magnet and Hook

- for perfect illumination of dark work areas
- ABS plastic housing with roughened, rubberized surface for a secure hold of the lamp in the hand
- 2 fold-out and 360° swiveling hooks on the back of the housing
- 180° rotatable handle lockable in 8 steps
- LED charging indicator on the back of the housing (red / green)
- with hooks for fixing the lamp in many places
- strong magnet on base and two magnets on the back allow to fix on most metallic surfaces
- switchable from main to top light
- LED type (main light): COB LED
- LED type (top light): SMD LED
- brightness (main light): 400 lumens
- brightness (top light): 120 lumens
- operating time (main light): approx. 3 hours
- operating time (top light): approx. 9 hours
- accumulator type: Li-ion
- accumulator voltage: 3.7 V
- accumulator power (electric charge): 2200 mAh
- charging time: approx. 3.5 hours
- charging input: 5 V 1 A (Micro-USB)
- dimensions: 254 x 45 x 55 mm
- weight: 310 g
- protection degree: IP54
- operating temperature: -10 °C to +40 °C



Item #
85324



SMD-LED Work Lamp | foldable

- for perfect illumination of dark work areas
- compact design for use in confined spaces
- plastic housing
- 1 fold-out and 360° swiveling hook on the back of the housing
- 180° rotatable handle locked in 5 steps
- holding magnet with additional rubber coating, on backside of the case
- with practical belt clip on case back
- 3-step switch function 100% / 50% / off
- LED type: SMD-LED
- brightness (100%): 300 lumens
- brightness (50%): 150 lumens
- operating time (100%): approx. 3 hours
- operating time (50%): approx. 6 hours
- color temperature: 6000 Kelvin
- accumulator type: Li-ion
- accumulator voltage: 3.7 V
- accumulator power (electric charge): 1500 mAh
- charging time: approx. 3 hours
- charging input: 5V 1A (Micro-USB)
- dimensions: 127 x 32 x 62 mm
- weight: 170g
- protection degree: IP54
- operating temperature: -20°C to +50°C



Item #
85326



Delivery Tip for Grease Gun | angled

- for use with pressure hose
- thread 1/8" PT
- 90 ° angled
- for use with grease nipple and grease gun

Item #
9403



Two-Hand Cartridge Grease Gun | 500 g

- for easy, clean and safe lubrication of axles, bearings, bushes, etc.
- allows quick and clean cartridge changes
- enables complete emptying of the cartridge
- fill levels can be checked at all times
- ergonomic, anti-slip handles
- cartridge type: 500 g
- grease class: NLGI 2
- with flexible armored hose
- operating pressure: 500 bar
- grease gun bursting pressure: 675 bar
- delivery tube bursting pressure: 675 bar
- system bursting pressure: 850 bar
- output: max. 0,8 g per stroke
- pumping piston diameter: 8,5 mm
- hose connecting thread: M10 x 1.0
- total length: 675 mm
- tube length: 300 mm
- optional accessories: flexible delivery tube BGS 3066-1

Item #
6650



Hydraulic Cylinder | 700 bar

- hollow piston with 20 mm bore
- cylinder capacity: 10000 psi (700 bar)
- 13.0 t. (metric)
- stroke: 42 mm
- oil capacity: 77.7 cm³
- retracted height: 120 mm
- extended height: 162 mm
- flange thread: 2-3/4" x 16
- length of flange thread: 30 mm
- external diameter: 70 mm
- weight: 2.8 kg

Item #
9530



Hydraulic Workshop Press | 10 t

- facilitates renewal of e. g. wheel bearings, gear shaft bearings, rubber bushings etc.
- large work area with individually adjustable supporting surface pressure
- big pressure gauge range: 0 - 1000 psi (0 - 14500 bar)
- working range from 0 to 300 mm (adjustable in 3 steps)
- pressing pressure: 10 t
- stroke: 130 mm
- net weight 42 kg
- length: 690 mm
- width: 400 mm
- height: 1020 mm

Item #
9790



Mechanic's Gloves | Size 7 (S)

- partly PU coated
- good fit and secure grip
- good sense of touch
- knitwrist
- suitable for: tire service
- size: 7 (S)



Item #
9795

Adhesive Repair Kit | 2-component glue | 20g industrial adhesive / 20g granulate

- suitable for bonding rubber, plastic, steel and metals as well as EPDM
- sticks fast
- waterproof, temperature and chemical resistant, sandable and recoatable
- in practical bottle with drip closure
- temperature resistance: max. -50 °C to + 80 °C
- low viscosity
- viscosity 20 °C: 3 - 10 mPa.s
- tensile shear strength according to DIN 53283: 22 N/mm²



Item #
80617

Laser Distance Meter

- allows various measurements and calculations
- area and volume calculation method
- pythagorean theorem calculation method
- addition/subtraction function
- continuous measurement
- delay measurement
- height difference
- storage of historical data
- built-in buzzer
- range of measurement: 5 cm - 60 m
- measurement accuracy: +/- 1.5mm
- measurement unit selection: m / inch / feet
- battery type: 2 AAA
- battery life: approx. 10,000 single measurements
- battery life: approx. 2.5 h operating time
- laser class: II
- operating temperature: -5 - 40°C
- storage temperature: -20 - 60°C
- weight: 125g
- dimension: 108 x 53 x 28 mm



Item #
9852

BGS® Vintage T-Shirts

- crew neck
- washable at 40° C
- two-tone, vintage design
- fit: regular
- material: 100% semi-combed ring-spun cotton

Item #	Description
90012	BGS® Vintage T-Shirt Size S
90013	BGS® Vintage T-Shirt Size M
90014	BGS® Vintage T-Shirt Size L
90015	BGS® Vintage T-Shirt Size XL
90016	BGS® Vintage T-Shirt Size XXL
90017	BGS® Vintage T-Shirt Size 3XL
90018	BGS® Vintage T-Shirt Size 4XL
90019	BGS® Vintage T-Shirt Size 5XL



BGS® T-Shirt

- crew neck
- easy care
- suitable for industrial washing according to ISO 1579
- preshrunk
- washable at 60 °C
- two-tone, sporty design
- fit: comfort fit
- material: MikraLinar®, single jersey made of 50% cotton and 50% polyester, 160 g/m²

Item #	Description
90022	BGS® T-Shirt Size S
90023	BGS® T-Shirt Size M
90024	BGS® T-Shirt Size L
90025	BGS® T-Shirt Size XL
90026	BGS® T-Shirt Size XXL
90027	BGS® T-Shirt Size 3XL
90028	BGS® T-Shirt Size 4XL



BGS® Polo Shirt

- 3 hole-placket
- easy care
- suitable for industrial washing according to ISO 1579
- preshrunk
- washable at 60 °C
- two-tone, sporty design
- fit: comfort fit
- material: MikraLinar®, pique made of 50% cotton and 50% polyester, 200 g/m²

Item #	Description
90032	BGS® Polo Shirt Size S
90033	BGS® Polo Shirt Size M
90034	BGS® Polo Shirt Size L
90035	BGS® Polo Shirt Size XL
90036	BGS® Polo Shirt Size XXL
90037	BGS® Polo Shirt Size 3XL
90038	BGS® Polo Shirt Size 4XL



BGS® Sweatshirt

- easy care
- suitable for industrial washing according to ISO 1579
- preshrunk
- washable at 60 °C
- fit: Comfort Fit
- material: MikraLinar®, knitwear made of 50% cotton and 50% polyester, 300 g/m²



Item #	Description
90042	BGS® Sweatshirt Size S
90043	BGS® Sweatshirt Size M
90044	BGS® Sweatshirt Size L
90045	BGS® Sweatshirt Size XL
90046	BGS® Sweatshirt Size XXL
90047	BGS® Sweatshirt Size 3XL
90048	BGS® Sweatshirt Size 4XL

BGS® Softshell Jacket

- breathable
- waterproof
- washable at 30 °C
- fit: comfort fit
- material: Softshell made of interlock 2-layer laminate made of 100% polyester, 170 g/m²



Item #	Description
90052	BGS® Softshell Jacket Size S
90053	BGS® Softshell Jacket Size M
90054	BGS® Softshell Jacket Size L
90055	BGS® Softshell Jacket Size XL
90056	BGS® Softshell Jacket Size XXL
90057	BGS® Softshell Jacket Size 3XL
90058	BGS® Softshell Jacket Size 4XL

BGS® Work Trousers | long

- deep pocket openings
- knee section made of sturdy CORDURA®
- inserted kneepads
- reflectors
- wide belt loops with hook-and-loop for extra bag
- pocket for folding rule, pens and mobile phone pocket
- washable at 60 °C
- material: 65% polyester and 35% cotton, 260 g/m²



Item #	Description
90060	BGS® Work Trousers long Size 44
90061	BGS® Work Trousers long Size 46
90062	BGS® Work Trousers long Size 48
90063	BGS® Work Trousers long Size 50
90064	BGS® Work Trousers long Size 52
90065	BGS® Work Trousers long Size 54
90066	BGS® Work Trousers long Size 56
90067	BGS® Work Trousers long Size 58
90068	BGS® Work Trousers long Size 60
90069	BGS® Work Trousers long Size 62

BGS® Work Trousers | short

- 7 trouser pockets
- trouser pockets made of sturdy CORDURA®
- washable at 60 °C
- material: 65% polyester and 35% cotton, 260 g/m²



Item #	Description
90070	BGS® Work Trousers short Size 44
90071	BGS® Work Trousers short Size 46
90072	BGS® Work Trousers short Size 48
90073	BGS® Work Trousers short Size 50
90074	BGS® Work Trousers short Size 52
90075	BGS® Work Trousers short Size 54
90076	BGS® Work Trousers short Size 56
90077	BGS® Work Trousers short Size 58
90078	BGS® Work Trousers short Size 60
90079	BGS® Work Trousers short Size 62



Novelties after editorial deadline



Novelties after editorial deadline

Workshop Trolley | 8 Drawers | with 263 Tools



Item # 4106

Workshop Trolley | 2x 5 Drawers | 1 Cabinet | empty



Item # 4199

Tool Tray 1/3: Extension Bar, Adaptor and Universal Joint Set | 17 pcs.



Item # 4144

Tool Tray 1/3: Handheld Lamp and Magnetic Lifter | 3 pcs.



Item # 4146

Tool Tray 2/3: Ratchet Wrenches | adjustable | 8 - 19 mm | 12 pcs.



Item # 4195

Tool Tray 1/3: Ratchet Combination Wrench Set | 8 - 19 mm | 12 pcs.



Item # 4196

Tool Tray 1/3: Machinist's File Set | 5 pcs.



Item # 4197

Ratchet Wrench Set | 8 - 13 mm | 6 pcs.



Item # 6502

Magnetic Can Storage Tray | 210 mm



Item # 67167

Tool Tray 1/3: Differential Cage Bearing Puller



Item # 6932

Adaptor Set for Compression and Pressure Loss Tester | 30 pcs.



Item # 6960

Drip Tray | Stainless Steel | 600 x 400 mm



Item # 7892

Tool Tray 1/6: Crowfoot Spanner Set | 10 mm (3/8") | 10 - 19 mm | 11 pcs.



Item # 9817

Tool Tray 1/3: Crowfoot Spanner Set | 10 mm (3/8") / 12.5 mm (1/2") / 20 mm (3/4") | 10 pcs.



Item # 9818

Double-Joint Circlip Pliers Set | Exchangeable Tips | 345 mm



Item # 9836

Magnetic Shell | foldable | Ø 120 / 220 mm



Item # 9896

Sanitation / Heating Tool Set | 29 pcs.



Item # 1433

Foam Tray for BGS BOXSYS1 & 2: Socket Set 6.3 mm (1/4") / 12.5 mm (1/2") | BGS systainer® | 65 pcs.

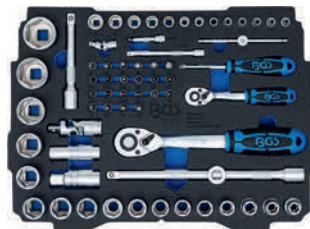

Item # 3351

Foam Tray for BGS BOXSYS1 & 2: Hammer, Pliers, Screwdriver Set | 12 pcs.



Item # 3353

Socket Set | 6.3 mm (1/4") / 12.5 mm (1/2") | in system case | BGS systainer® | 65 pcs.



Item # 3354

VDE Socket Set / Tool Assortment | 26 pcs.



Item # 7130

VDE Socket Set | 10 mm (3/8") Drive | 7 - 22 mm | 12 pcs.



Item # 7133

VDE Socket Set | 12.5 mm (1/2") Drive | 10 - 24 mm | 11 pcs.

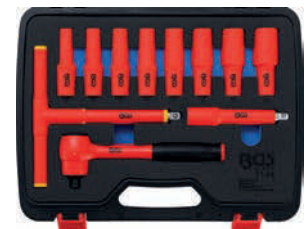

Item # 7134

System Case | BGS systainer® T-Loc 1



Item # BOXSYS1

System Case | BGS systainer® T-Loc 2



Item # BOXSYS2

Socket, Hexagon, deep | 12.5 mm (1/2") Drive | 23 mm



Item # 10563

Extractor Cap Set for damaged hexagon Nuts and Bolts | 12 pcs.



Item # 1245

Socket, E-Type | 10 mm (3/8") Drive | E14



Item # 6264

Screw Extractor & Left Cutting Drill Set | HSS | titanium nitrated | 2 - 7.5 mm | 10 pcs.



Item # 6780

Screw Extractor Set | 6.3 mm (1/4") / 10 mm (3/8") Drive | for damaged Internal Hexagon 3 - 10 mm | 8 pcs.



Item # 6847

Socket Set, 12-point, deep | 10 mm (3/8") Drive | Inch Sizes | 11 pcs.



Item # 6859

Pipe Line Wrench Set | flexible | 5 changeable heads | 10 mm (3/8") Drive | 11 - 17 mm



Item # 6895

Rim Lock Dismantling Tool Set | for BMW, MINI | 4 pcs.



Item # 6928

Flexible Socket Driver | E-type E 4 - E 8 | Blade Length 150 mm



Item # 70020 - 70024

Socket Set, E-Type | XXL | 10 mm (3/8") Drive | E6 - E20 | 10 pcs.



Item # 70026

Special Impact Double-Sided Socket Set / External Hexagon & Screw Extractors 17 - 19 - 21 mm | 12.5 mm (1/2") | 3-tlg.



Item # 7467

Protective Impact Socket Set | Ultra Slim | 12.5 mm (1/2") Drive | 17 / 19 / 21 mm | 3 pcs.



Item # 7500

Groove Nut Socket Set | inside taps | KM4 - KM12 | 9 pcs.



Item # 8327

Groove Nut Socket | inside taps | KM4 - KM12



Item # 8327-4 - 8327-12

Groove Nut Socket Set | outside taps | KM4 - KM12 | 9 pcs.



Item # 8337

Groove Nut Socket | outside taps | KM4 - KM12



Item # 8337-4 - 8337-12

Multi Socket with Adaptor Set | 10 mm (3/8") Drive | 9 - 21 mm | 3 pcs.



Item # 92533

Universal-/Security Bit Set | 6.3 mm (1/4") Drive | 208 pcs.



Item # 20103

VDE Bit Socket Set | 12.5 mm (1/2") Drive | T-Star (for Torx) T20 - T55 | 10 pcs.



Item # 7131

VDE Bit Socket Set | 10 mm (3/8") / 12.5 mm (1/2") Drive | Internal Hexagon 4 - 10 mm | 10 pcs.



Item # 7132

Reversible Ratchet | finely toothed | 6,3 mm (1/4") - 12.5 mm (1/2")



Item # 600 - 602

Socket Holders | 3 pcs.



Item # 67158

Bit Holder / Socket Adaptor Set | 16 pcs.



Item # 6779

Scaffolding Ratchet | round shaft | 19 x 22 mm



Item # 6907

VDE Reversible Ratchet | Fine Tooth | 10 mm (3/8") | 1000 V



Item # 701

VDE Reversible Ratchet | 12.5 mm (1/2") | 1000 V



Item # 702

Torque Wrench | 5 - 25 Nm | for 9 x 12 mm Insert Tools



Item # 2814

Torque Wrench | 10 - 100 Nm | for 9 x 12 mm Insert Tools



Item # 2815

Torque Wrench | 20 - 200 Nm | for 14 x 18 mm Insert Tools



Item # 2816

Torque Wrench | 40 - 340 Nm | for 14 x 18 mm Insert Tools



Item # 2817

Digital Torque Wrench | 12.5 mm (1/2") | 40 - 200 Nm - 6.3 mm (1/4") | 6 - 30 Nm



Item # 950 - 952

Double Swivel Head Ratchet Wrench | 10 x 11 mm - 17 x 19 mm



Item # 1541-10X11 - 1541-17X19

Pliers for Axle Boot Clamps | for use with Torque Wrench | 90° angled



Item # 163-2

Tap Set | Starter & Plug Tap | M4 x 0.7 | 2 pcs.



Item # 1900-M4X0.7-B

Tap Set | Starter & Plug Tap | M5 x 0.8 | 2 pcs.



Item # 1900-M5X0.8-B

Screwdriver Set with interchangeable Blades | T-Star (for Torx) / T-Star tamperproof (for Torx) | 8 pcs.



Item # 2326

Combination Spanner Set | 4 - 10 mm | 9 pcs.



Item # 30551

Slogging Ring Spanner Set | 12-Point / E-Type (for Torx) | 5 pcs.



Item # 35310

Nut Riveter | long arm | M3 - M10



Item # 408-1

Riveter Set | for Standard, Nut and Stud Rivets



Item # 438

Grinding Wheels / Sanding Pad Set | Ø 50 mm | 35 pcs.



Item # 6649

Side Cutter | for Hard Wire | 160 mm



Item # 670

Heavy Duty Diagonal Side Cutter | for Piano Wire | 200 mm



Item # 671

Long Nose Pliers | with Cutting Edge | straight | 200 mm



Item # 672

Bent Nose Pliers | with Cutting Edge | 200 mm



Item # 673

Combination Pliers | with Facet and Cutting Edge | 180 mm



Item # 674

Heavy Duty Combination Pliers | with cutting Edge | Evo Plus | 190 mm



Item # 675

Fuel Line Pliers | with Bowden Cable | 650 mm



Item # 6756

Water Pump Pliers | „SpeedyPlus“ | 250 mm



Item # 676

Outer / Inner Deburring Tool & File Set | 5 pcs.



Item # 6773

Holder for Combination Spanners | 12 supports



Item # 6781

Holder for Combination Spanners | 8 supports



Item # 6782

Gaspipe Pliers | 25 mm - 1" - 50 mm - 2" Swedish Type



Item # 6788 - 6790

External / internal Puller Set, 2/3-legs | 75 - 150 mm | 3 pcs.



Item # 6792

HSS Drill Set | 10 - 11 - 12 - 13 - 15 mm | 5 pcs.



Item # 6801

HSS Drill Set | 26 - 28 mm | 2 pcs.



Item # 6802

Locking Grip Pliers | „2-IN-1“ | 200 mm



Item # 6803

Screwdriver Set | with Bit Assortment | in a Plastic Stand | 29 pcs.



Item # 6825

Screwdriver Set | T-Star tamperproof (for Torx) | T6 - T10 | 5 pcs.



Item # 6826

Novelties after editorial deadline

Screwdriver Set | T-Star (for Torx) T6 - T10 | 7 pcs.



Item # 6828

Thread Insert Assortment | self-tapping | 32-pcs.



Item # 6844

Thread Insert Assortment | self-tapping | 32-pcs.



Item # 6845

Ratchet Combination Wrench | short | adjustable | 8 mm - 19 mm



Item # 6908 - 6919

Crow Foot Wrench Set | 12.5 mm (1/2") Drive | flexible | 6 pcs.



Item # 6931

Crimping Pliers Set | for Solar Connectors MC3 / MC4 / Tyco | 4-piece



Item # 70003

Hose Clamp Pliers for Turbo Charger Hose Clips | for VAG



Item # 70015

Tap and Die Set | M3 - M12 | 56 pcs.



Item # 70104

Tap and Die Set | Inch Sizes | 1/4" - 1" | 56 pcs.



Item # 70105

Wooden Mallet | 230 g



Item # 7083

Screwdriver Set | with 6.3 mm (1/4") Internal Square | 12 pcs.



Item # 7896

Bench Vice Jaw Protector Set | Aluminium | 125 mm | 8 pcs.



Item # 8442-1

Bench Vice Jaw Protector Set | Aluminium | 150 mm | 8 pcs.



Item # 8442-2

Thread Repair Kit for Wheel Studs & Wheel Nuts | M12 & M14 | 8 pcs.



Item # 8692

Thread Repair Kit for wheel bolts | for Trucks

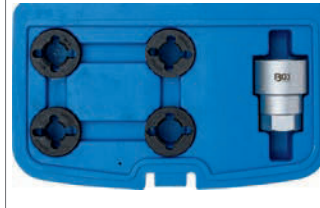

Item # 8696

Bolt Cutter with Hardened Jaws | 300 mm - 900 mm



Item # 908 - 915

Tube Cutter | Ø 3 - 30 mm



Item # 9521

Pneumatic Valve Lapper | 13 pcs.



Item # 3327

Pneumatic Soda Spray Gun | 1 l



Item # 6655

Pistol-Grip Air Inflator | digital | 0 - 8 bar



Item # 6794

Novelties after editorial deadline

Air Impact Wrench | 12.5 mm (1/2") | 1200 Nm



Item # 6829

Air Blow Gun | with Turbo Venturi Nozzle



Item # 6875

Mini Air Blow Gun



Item # 6876

Induction Heater | Trucks / Agricultural Machines | liquid cooled



Item # 2170

Cable Reel | 15 m - 50 m 3x1,5 mm² | 4 Socket Outlets | IP 20 | 3000 W



Item # 3360 - 3362

Automatic Cable Reel | 15 m



Item # 3379

Induction Heater | 1.1 kW



Item # 3390

Induction Heater | 2.0 kW | for Dent Removal



Item # 70106

Cordless Polisher Set | max. 2800 rpm | 12 V | 1500 mAh



Item # 9294

Electric Polisher | max. 3000 rpm | 1300 W | Ø 180 mm



Item # 9337

Electric Eccentric Polisher | max. 6000 rpm | 900 W



Item # 9345

Cordless Impact Wrench | extra short | 250 Nm | max. 2.500 rpm | 18 V



Item # 9928

Motorcycle Special Socket | 10 mm (3/8") | 12 - 24 mm



Item # 5058-1

Clutch Basket Holding Tool | for Ducati | Steel Version

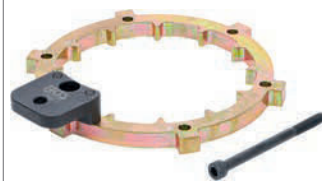

Item # 5064-1

Camshaft Locking Pin Set | for Ducati



Item # 6720

Camshaft Locking Pin Set | for Ducati



Item # 6721

Valve Shim Tool | for Honda



Item # 6722

Rocker Arm Pin Extractor Set | for Ducati



Item # 6723

Fork Cap Wrench | for Ohlins Forks | for Ducati



Item # 6724

Fork Cap Wrench | for Sachs Forks | for Ducati



Item # 6725

Novelties after editorial deadline

Fork Cap Wrench | for Marzocchi Forks | for Ducati



Item # 6726

Fork Cap Wrench | for Ohlins Forks | for Ducati



Item # 6727

Brake Piston Reset Tool | for Motor Cycles



Item # 70010

Injector Extractor Set | for Trucks | 4pcs.



Item # 6662

Twin Wheel Separating Tool Set | 4 pcs.



Item # 6679

Universal Axle Cap and Groove Nut Wrench Set



Item # 6746

Heavy-Duty Universal Joint Puller | for Commercial Vehicles



Item # 6894

Fuel Line Disconnect Tool Set | 4-pcs. | for commercial vehicles (USA) MaxxForce engines 11 & 13



Item # 6898

Valve Spring Compressor | for Ford (USA) 3-Valve Engines



Item # 6922

Oil Filter Socket | for Mercedes-Benz Actros / Atego / Axor / Eonic | 46 mm



Item # 6948

Flywheel Rotating Tool | for Renault



Item # 6949

Flywheel / Crankshaft Rotater | for Volvo / Renault MP8 / MP10 / D13A



Item # 6950

Crankshaft Rotating Tool | for Volvo



Item # 6952

Flywheel / Crankshaft Rotater | for Iveco



Item # 6953

Crankshaft Rotating Tool | for Scania



Item # 6954

Crankshaft Front Oil Seal Installer | for DAF (CF 85)



Item # 6955

Flywheel Rotation Tool | for MAN engines



Item # 6957

Flywheel / Crankshaft Rotater | for Mercedes-Benz / MAN



Item # 6958

Transmission Bearing Puller Set | for Trucks



Item # 6961

Main Transmission Shaft Nut Socket | for Scania 10 Speed Automatic Transmission | 64 x 79 mm



Item # 6963

Novelties after editorial deadline

Axle Nut Socket | 6-Point | for SAF Trailer Axles | 85 mm



Item # 6966

Hub Socket | for ROR Trailer Axles



Item # 6967

Rear Axle Cap Socket | for BPW Rear Axle Caps | 110 mm



Item # 6972

Axle Cap Socket | for BPW 16 t Trailer Axle Caps | 110 mm



Item # 6974

Roller Bearing Axle Nut Socket | for BPW 6.5 - 9 t | 65 mm



Item # 6975

Roller Bearing Axle Nut Socket | for BPW 12 t | 80 mm



Item # 6977

Wheel Hub Nut Socket | 8-point | for BPW 12 t Axles | 109 mm



Item # 6978

Transmission Groove Nut Socket | for Scania 310 / 320



Item # 6981

Hub Nut Socket | for Scania 420 | 90 x 119 mm



Item # 6982

Hub Socket | 12-point | for IVECO Trucks & SAF / BPW Trailers | 85 mm



Item # 6984

Axle Clamp Nut Wrench | for DAF, MAN, Mercedes-Benz, Kässbohrer, Setra | 56 mm



Item # 6989

Drive Axle Groove Nut Socket | for MAN & Mercedes-Benz Trucks | 101.5 x 110 mm



Item # 6992

Axle Clamp Nut Socket | for DAF, MAN, Mercedes-Benz, Kässbohrer, Setra | 60 mm



Item # 6993

Rear Axle Groove Nut Socket | for Mercedes-Benz Citaro | 122 x 139 mm



Item # 6994

Transmission Groove Nut Socket | for MAN



Item # 6996

Drive Shaft Nut Socket | for MAN TGA 460 Axles



Item # 6997

Rear Wheel Shock Absorber Spring Washer Removal Socket | 20 mm (3/4") Drive | for Scania



Item # 6999

Rear Wheel Shock Absorber Spring Washer Removal Socket | for Scania | 34 x 46 mm



Item # 7002

Crankshaft Seal Ring Mounting Tool | for VW



Item # 1246

Flaring, Bending & Cutting Tool Set | for 4.75 mm (3/16") Brake Pipes



Item # 1270

Novelties after editorial deadline

Brake Calliper Socket | 10-point | for VAG and Porsche | 11.5 mm



Item # 5292

Intermediate Levers Slide Block | for BMW B38 / B48



Item # 6035

Intermediate Lever Spring Tool | for BMW B38 / B48



Item # 6036

Injector Sealing Surfaces Cutter Set | 19 pcs.



Item # 62607

Ball Joint Separator Set | hydraulic | 12 t



Item # 6645

OBD 2 (EOBD) Error Code Diagnostic Tool



Item # 6648

Alternator Freewheel Tool Set | 14 pcs.



Item # 6657

Brake Piston Reset Adaptor Set | universal | with 2 & 3 Pins | 2 pcs.



Item # 6661

Brake Piston Reset Adaptor Set | universal | with 2 Pins



Item # 6661-2

Brake Piston Reset Adaptor Set | universal | with 3 Pins



Item # 6661-3

Plastic Double Ring Spanner & Pry Bar Set | 5 pcs.



Item # 6663

Flywheel Locking Tool | for BMW / MINI



Item # 6694

Brake Calliper Socket Set | 11 pcs.



Item # 6697

Door Handle Dismantling Tool | for VAG



Item # 6699

Strut Nut Wrench & Holding Tool | for Volvo



Item # 6703

Air Spark Plug Cleaner



Item # 6705

Special Socket | for Audi S5 / Q5 Brake Callipers



Item # 6706

Hook Wrench for Window Mechanism | for BMW E60, E81, E82 and MINI R50, R52, R53



Item # 6730

Brake Disc Puller | Ø 170 - 400 mm



Item # 6743

Brake Piston Reset Tool | universal Type



Item # 6755

Fuel Tank Sensor Wrench | for Audi

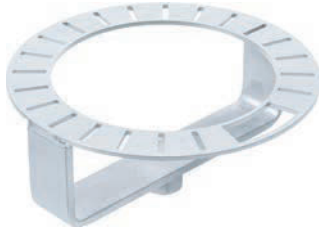

Item # 6767

Spark Plug Socket, 12-point, with Retaining Spring | 10 mm (3/8") Drive | 18 mm



Item # 6849

Spark Plug Socket Set 12-Point | 10 mm (3/8") Drive | 14 - 16 - 18 mm | 3 pcs.



Item # 6858

Flywheel Counterholder | for Opel



Item # 6886

Ripped Belt Holder



Item # 6889

Trailing Arm Bush Tool | for Honda

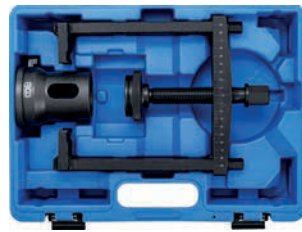

Item # 6890

Crankshaft Rear Oil Seal Tool | for Jaguar, Land Rover



Item # 6891

Oil & Fuel Filter Removal Tool | for Mann, Mahle, Knecht



Item # 6892

Belt Tensioner Wrench | for Opel / Vauxhall, Chevrolet



Item # 6893

Brake Spring Installer | for Toyota Parking Brake | 185 mm



Item # 6896

Air Conditioner Line Couplings Release Tool | for VAG



Item # 6897

Special Wrench for Coolant Cap | for BMW



Item # 6899

Special Wrench for Coolant Cap | for Ford, Land Rover, Mazda, Volvo



Item # 6901

Timing Chain Tensioning Lever | for VAG 1.8L / 2.0L TFSI / TSI



Item # 6902

Injector Sleeve Tool Set | for Volvo FM12



Item # 6904

Injector Tube Seal Ring Installation Tool | for PSA 1.6 Diesel



Item # 6906

Diesel Fuel Filter Wrench | for VW & Volvo



Item # 6920

Injection Pump Locking Pin | for Nissan 2.2 & 2.5 Diesel



Item # 6924

Fuel Pump Solenoid Wrench | for Ford Duratorq



Item # 6925

Flexible Belt Assembly/Disassembly Tool



Item # 6927

Novelties after editorial deadline

Drive Shaft Removing Tool | for VAG



Item # 6930

Turbocharger System Pressure Tester Set | 13 pcs.



Item # 6933

Injector Gasket Puller | 370 mm | Heavy Duty



Item # 6959

Camshaft Locking Tool | for VAG



Item # 70013

Universal 3-Arm Tank Sensor Wrench | 90 - 200 mm



Item # 70014

Petrol Injector Puller Tool | for Mercedes-Benz petrol direct injection engines



Item # 70016

Straight Edge | for VAG



Item # 70034

Sliding Block Fixing Tool | for BMW, MINI, Citroën, Peugeot



Item # 70036

Valve Spring Compressor | for BMW, MINI, Citroën, Peugeot

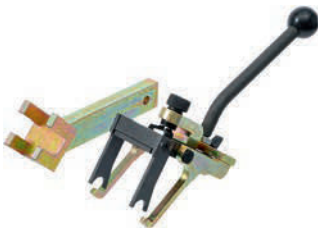

Item # 70037

Sliding Block Fixing Tool | for BMW



Item # 70038

Silicon Water Remover | flexible | 300 mm



Item # 70058

Fuel Line Disconnect Set



Item # 7024

Fuel Tank Locking Ring Tool | for Fiat / Jeep



Item # 7026

Fuel Sensor Wrench | for Opel, Mercedes-Benz, BMW, Volvo



Item # 7028

Fuel Sensor Wrench | for Alfa Romeo, Fiat, Lancia, Ferrari, Maserati

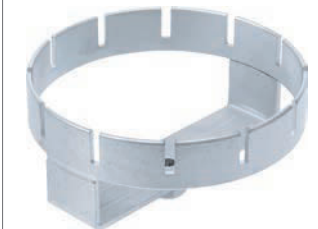

Item # 7029

Contour Gauge | 250 mm | lockable



Item # 7081

Valve Spring Compressor Set | 7 pcs.



Item # 8255

Braking Pipe Ratchet Cutter | 4.75 mm (3/16")



Item # 8339

Timing Chain Riveting Tool | for Mercedes-Benz



Item # 8848

Engine Timing Tool Set | for VAG 1.4 / 1.6 / 2.0 TDI Common Rail



Item # 9208

Engine Support Bracket | for Seat



Item # 9644

Tire Change Service Set with Floor Jack 2.5 t | 10 pcs.



Item # 9681

Injector Puller Set | for VAG | universal



Item # 9824

Oil Filter Wrench | for VW Crafter & Volvo 2.0 / 2.5L Diesel



Item # 1241

Flexible Delivery Tube for Grease Gun | 300 mm



Item # 3066-1

Digital Tyre Pressure Gauge & Tyre Depth Gauge | „2-IN-1“



Item # 6647

Battery Plug Turning Tool | with T-Handle



Item # 6744

Flexible Joint Pry Bar | 260 mm - 615 mm



Item # 6752 - 6754

Plastic Pipe & Connector Assortment | 95 pcs.



Item # 6776

Powerful Double Magnetic Holder | adjustable Angle | 22,7 kg



Item # 6784

Oil Filter Wrench Set | 19 pcs.



Item # 6786

Workshop Seat | with 2 shelf plates | ABS | 440 x 350 mm



Item # 6820

Shrink Tube Box | black | Ø 2.5 mm | 10 m, Ø 5 mm | 6 m, Ø 8 mm | 5 m, Ø 3.2 mm | 10 m



Item # 6846 - 6923

Shrink Tube Box | red | Ø 2.5 mm | 10 m, Ø 5 mm | 6 m, Ø 8 mm | 5 m, Ø 3.2 mm | 10 m



Item # 6846-1 - 6923-1

Ultrasonic Parts Cleaner | 3.2 l, 6.5 l, 15 l, 30 l



Item # 6879 - 6882

Tire Tread Depth & Brake Pad Thickness Gauge



Item # 6888

Oil Filter Wrench | 6 teeth | for Hyundai & Kia 2.0L / 2.2L Diesel



Item # 6903

Brake Fluid Tester | Boiling Point Measuring System



Item # 6905

Oil Filter Wrench | 16-point | Ø 86 mm | for Volvo



Item # 6926

Transmission Oil Discharge System Set | for Automatic Transmission | for Mercedes-Benz & BMW | 5 pcs.



Item # 6929

Novelties after editorial deadline

ABS and Brake Pressure Gauge

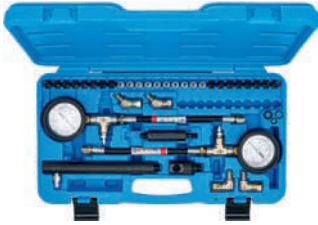

Item # 6964

Oil Filter Pliers | self-adjusting | Ø 60 - 120 mm | 30° offset jaws



Item # 70011

COB LED Workshop Lamp with Magnet and Hook | foldable



Item # 70051

Rubber Pad | for Auto Lifts |



Item # 7036 - 7051

Automatic Transmission Exchange and Flushing machine | with Adaptor Set



Item # 7082

LED Head Lamp with Focus | 3 W



Item # 85327

COB-LED Work Lamp | 10 W



Item # 85328

COB-LED Work Lamp | 30 W



Item # 85329

COB LED Workshop Lamp with Magnet and Hook | foldable | with Wireless Charging function



Item # 85331

COB LED Working Flood Light | 40 W | with internal Speakers



Item # 85332

Cordless Bendy Lamp | COB-LED | 5 W



Item # 85334

COB-LED Work Lamp | foldable



Item # 85335

COB-LED Handheld Work Lamp | Dual LED | ultra flat Type



Item # 85337

Floor Jack | hydraulic | 3 t | with Quick Lift Pedal



Item # 9251

Multi Purpose Funnel | for Urea (AUS 32) | straight



Item # 9702

Multi Purpose Funnel | for Urea (AUS 32) | angled



Item # 9731

Wireless Color Borescope with LED lighting



Item # 9853

Multi Purpose Funnel | heavy duty 260 x 170 mm



Item # 9934

Transmission Oil Filling Adaptor Set | 13 pcs.



Item # 9992-4

Wheel Chock | 250 x 160 x 185 mm | for Cars / Trucks



Item # 7015

Novelties after editorial deadline

Description



123

12-Point Sockets	158
------------------	-----

A

ABS And Brake Pressure Gauges	169
Adaptor for Electric Drills	23
Adaptor Set for Compression and Pressure Loss Tester	157
Adhesive Repair Sets	152
Air Blow Guns	59, 162
Air Conditioner Tools	166
Air Die Grinders	61
Air hoses	60
Air Impact Wrench	60, 162
Air Spark Plug Cleaner	165
Air Suction Guns	59
Air Tools	59-61, 161-162
Air Tools Holder	8
Air Tyre Inflator Guns	161
Air Valve Lapping Tool	161
Alligator Clips	141
Alternator Freewheel Tools	93
Alternator Tool Sets	165
Aluminium Hammer	29
Angled Drill Heads	36
Antifreeze Tester Hydrotemp	87
Assembly Tools for Brake Springs	166
Assembly Tools for Crankshaft Front Oil Seal Rings	163
ATF Filler Plug Sockets	95
Auto Lift Supports	169
Auto Lifts Rubber Pads	129-130
Automatic Cable Reels	162
Automatic Transmission Exchange and Flushing Machines	169
Automotive Clip Assortment	131-133
Axle Boot Assembly Tools	59
Axle Boot Clamp Pliers	159
Axle Cap Sockets	163-164
Axle Clamp Nut Wrenches	164
Axle Socket Tools	65, 164

B

Balance Shaft Adjusting Tools	103
Ball Joint Ejectors	165
Ball Joint Tools	74
Battery Acid Tester Hydrovolt	139
Battery Plug Turning Tools	168
Battery Pole Cleaning Brushes	36
Belt Pouchs	57
Belt Pulley Puller & Assembly Sets	116
Belt Pulley Wrench for V-Belt Pulleys	122
Belt Tensioner Wrenches	166
Bench Vice Jaw Protectors	56, 161
Bendy Lamps	169
Bit Adaptors / Socket Wrench Adaptors	159
Bit Assortment	16-17
Bit Ratchets	22
Bit Sets	158
Bit Socket Assortment	16-19
Bit Sockets	QF6-8, 4-6
Bit Sockets Internal Hexagons	4
Bit Sockets Spine (RIBE)	5
Bit Sockets Spine Internal serration (for XZN)	5
Bits	QF9
Bit-Socket T-Star (for Torx)	5
Blind Rivet Drills	37
Blow Guns	162
Boiling Point Brake Fluid Testers	168
Bolt Cutter	161
Bonnet Lamps with Rechargeable Battery	146-147
Borescopes	139, 169
Bottle Car Jack	128
Brake Bleeder Wrenches	68
Brake Calliper Sockets	69, 165
Brake Disc Pullers	165
Brake Fluid Tester	168
Brake Line Clamp Sets	6, 67
Brake Line Cutters	167
Brake Pad Thickness Gauges	168
Brake Piston Reset Tools	163
Brake Piston Wind Back Adaptors	165
Brake Piston Wind Back Sets	69, 165
Brake Pressure Gauges	169
Brake Service	67-68
Brake Spring Assembly Tools	166
Brass Brushes	35
Brush Extension Bars	36
Brush Handles	35
Brushes	34-35

Description



Bumping Hammers	82
-----------------	----

C

Cable Detectors	72
Cable Drums	162
Cable Installation Tools	70
Cable Release Tools	71
Camshaft Alignment Tools	93-115
Camshaft Locking Pins	162
Camshaft Locking Tools	167
Car Window Cleaning Nozzle and Adjusting Tools	145
Center Punches	38
Chock Sets	169
Circlip Pliers	41-46, 157
Clamp Cleaning Brushes	36
Cleaning Guns for Cooling Systems	87
Cleaning Nozzle and Adjusting Tools	145
Clip Assortment	131-133
Clutch Cage Holding Tools	162
Clutch Tools	66, 74-75
Colour Borescopes	169
Combination Pliers	160
Combination Spanner Sets	159
Combination Spanners	QF11, 52
Commercial Vehicle Tools	162-164
Common Rail Return Pressure Diagnosis	91
Common Rail Return Pressure Diagnosis Kits	91
Compression Tester	140
Compression Tester Adaptor	157
Connector Assortment	168
Connectors	39
Contour Gauges	167
Control Cabinet Key	49
Coolant Cap Wrenches	166
Cooling System Cleaning Guns	87
Cordless Grease Guns	62
Cordless Tools	162
Counteracting Spanner	112
Countersinks	57
Crankshaft Locking Tools	95, 108
Crankshaft Pulley Pullers	120
Crankshaft Radial Seal Tools	166
Crankshaft Rotating Tools	163
Crankshaft Seal Ring Mounting Tools	163, 164
Crankshaft Tools	65, 118-120
Crimping Tools	38, 161
Crowfoot Spanner	161
Crowfoot Spanner Sets	157
Cutter	31
Cutting Wires	83
Cylinder Head Drilling Jigs Tools	120
Cylinder Head Screws	136
Cylinder Head Temperature Sensor Sockets	71
Cylinder Lock Installation Tools	85

D

Deburring Tool	29, 160
Demagnetisers	51
Demo Blocks	14
Dent Removal Pens	85
Dent Repair Pads	84-85
Dent Repair Tools	82-85
Diagonal Side Cutters	160
Die Grinders	61
Diesel Fuel Filter Wrenches	166
Differential Cage Bearing Pullers	157
Differential Flange & Insert Nut Tools	73
Distance Meters	152
Door Handle Dismantling Tools	165
Door Trim Removal Tools	86
Double Open End Ratchet and Flexible Spanners	159
Double Open End Spanner	QF13
Double Ring Spanner	QF12-13, 7
Double Ring Spanners made of Plastic	165
Double-Joint Circlip Pliers	157
Drain Pans	141, 157
Drain Plug Sockets	143-144
Drift Punch	38
Drill Adaptors	23
Drill Chuck Adaptors	36
Drills	37, 158, 160
Drive Shaft Groove Nut Wrenches	164
Drive Shaft Removal Tools	167
Drive-On Ramps	127
Drop Arm Pullers	76
Drum Pumps	126, 144
DSG Transmission Oil Filling Hoses	142

Description



E

Eccentric Polishing Machines	162
Electric Polishing Machines	162
Empty Case for Tool Trays	57-58
Engine Adjustment Tools	93-115
Engine Lowering Bolts	119
Engine Supports	168
Engine Timing Tool Sets	167
E-type Sockets	QF4-5, 158
Exhaust Gas Counter-Pressure Testers	140
Exhaust Gas Temperature Sensor Special Sockets	88
Extension Bar Sets	QF10
Extension Bar, Adaptor and Joint Sets	156
Extension Cables	162
External / Internal Deburring Tools	160
Extractor for Common Rail Injector Needles	167
Extractors	11-12

F

Fault Diagnostic Devices	165
Fibre Grinding Discs	50
Files	32-34, 160
Filling Flasks	125
Filling Sets for Automatic Transmissions	142
Flap Foil Eraser	50-51
Flaring Tools	67-68
Flaring, Bending & Cutting Tool Sets	164
Flexible Belt Mounting / Removal Tools	166
Flexible Joint Pry Bar	168
Fluid Flasks	125
Fluid Pumps	125-127
Flushing Liquid	140
Flywheel Blocking Tools	75, 95
Flywheel Counterholder	113, 166
Flywheel Fixing Tools	118
Flywheel Locking Tools	102, 165
Flywheel Rotating Tools	163
Foil Erasers	50-51
Fork Cap Wrenches	162-163
Fork Ring Spanner Sets	159
Fork Ring Spanners	QF11, 52
Front Protection Cover	137
Fuel Filter Removal Tools	166
Fuel Filter Wrenches	166
Fuel Line Disconnect Tools	163
Fuel Line Pliers	160
Fuel Line Tools	167
Fuel Line Wrenches	68, 92
Fuel Pump Solenoid Valve Wrenches	166
Fuel Tank Circlip Tools	167
Funnel	169
Funnel	169
Fuses	137

G

Gasket Scraper	49
Gaspipie Wrenches	160
Gear Lock Sockets	QF3
Gear Oil Filling Hoses	142
Glass Fuses	137
Gloves	152
Glow Plug Socket Pliers	123
Glow Plug Tools	123-124
Grease Gun Reinforced Hoses	168
Grinding Discs	50
Grinding Discs / Sanding Pads	160
Groove Nut Sockets	65
Groove Nut Wrenches	72, 158, 163
Grub Screws	136

H

Hammer, Pliers, Screwdriver Sets	157
Hammers	161
Hand Pumps	125-127
Hand Riveter Sets	160
Handheld Lamp and Magnetic Lifter Lamps	156
Handheld Lights	169
Handle	QF10
HD Side Cutters	160
Head Lamps	169
Headlamps Adjustment Tools	81
Heater Hose Disconnect Tools	87
Heavy Duty Combination Pliers	160
Heavy Duty Magnetic Holders	145
HENN Clamps Removal Tools	122
Hexagon Sockets	158
High Pressure Pump Pullers	97
High Pressure Pump Sprocket Locking Tools	112

Description	
Holder for Magnets	8
Holder for Open-end/ Ring Spanners	160
Holder for Socket Wrench Sockets	159
Hole Punch for Parking Sensors	82
Honing Tools	123-124
Hook Wrench for Window Lifts	165
Hooks	86
Hose Clamp Pliers	40-41, 161
Hose Clamps	134-135
Hose Coupling Removal Tools	122
Hose Scraper Pliers	40
HSS Cutters	31
HSS Drills	37, 160
Hub Sockets	164
Hydraulic Cylinders	150
Hydraulic Floor Jack	128, 169
Hydrotemp Antifreeze Testers	87
Hydrovolt Battery Acid Testers	139

I	
Impact Sockets	QF4-5
Impact Wrenches	60, 162
Inch Socket	QF1-2
Induction Coils	63
Induction Heaters	162
Industrial Adhesives	152
Injection Nozzle Removal Tools	89-91
Injection Nozzle Tube Seal Ring Mounting Tools	166
Injection Pump Locking Pins	166
Injection Pump Wheel Puller	117
Injection Pumps Sprocket Holding Tools	92
Injector Puller Sets	163, 168
Injector Pullers	66, 89
Injector Repair Kit Sets	88
Injector Sealing Surfaces Cutters	165
Injector Sleeve Tool Sets	166
Injector Testers	141
Injector Tools	88-91
Inlays for Workshop Trolleys	156-157
Inner Bearing Pullers	38
Insert Tools for Torque Wrenches	24-28
Insert Tools Torque Wrenches	159
Intake Manifold Release Tool	75
Intake Pipe Release Tools	75
Interchangeable Head Hammers	82
Intermediate Lever Spring Tools	165
Intermediate Levers Slide Blocks	165
Internal Hexagon Bit Sockets	QF6, QF8, 4
Internal Hexagon Bits	QF9
Internal Hexagon L-Key Sets	47-48
Internal Hexagon Star Bit Sockets (for XZN)	5

J	
Jack	128, 169
Joint Sockets	11

L	
Lamps	147-149, 169
Laser Distance Meter	152
Leaf Spring Wrenches	164
LED Bonnet Lamp with Rechargeable Battery	146-147
LED Lamps	147-149, 169
Left Cutting Drill Sets	158
Lever Grease Guns	62, 150
Levers	138
Lights	147-149, 169
Line Coupling Tools	166
Line Wrenches	54, 92
L-Key	47-48
Locking Pin for Injection Pumps	166
Locking Pliers for Oil Filter	169
Lowering Bolts for Engines	119

M	
Magnetic Holders	8, 145, 168
Magnetic Jaw Covers for Bench Vises	161
Magnetic Pick Up Tools	145
Magnetic Shells	157
Magnetic Spray Can Trays	157
Magnetic Tray	157
Magnetisers	51
Main Transmission Shaft Nut Sockets	163
Mechanics Gloves	152
Mini Cordless Polishing Machine	162
Mini Polishing Machine	162
Motorcycle Sockets	64
Motorcycle Special Sockets	162
Motorcycle Tools	162
MTS-Mortorq Sockets	18

Description	
Mudguards Screw Wrenches	81
Multi Sockets	158
Multi-purpose Funnel for Urea	169

N	
Nut Sets	157
Nuts	QF1-5, 10-15
Nylon Brushes	35

O	
OBD 2 (EOBD) Error Code Diagnostic Tools	165
Oil & Fuel Filter Removal Tools	166
Oil Drain Screw Sealing Surfaces Cutters	143
Oil Draining & Filling Sets for Automatic Transmission	142
Oil Drip Pans	141
Oil Filling Funnels	142
Oil Filter Pliers	169
Oil Filter Wrench	144, 163, 168
Open End Spanner	QF13
Open-End / Ring Spanner Holders	160
Outside Thread Chasers	31
Oxygen Sensor Testers	72

P	
Panel Removal Tools	86
Parking Sensor Hole Punches	82
Parts Cleaner	168
Petrol Injector Pullers	117
Petrol Injector Tester	141
Petrol Injector Tools	88-91
PH-Bits	QF9
Pin Wrench	58
Pin Wrenches for Spacer Sensors	81
Pipe Line Wrench Sets	158
Plastic Connectors	134
Plastic Double Ring Spanner	165
Plastic Hammer	29
Plastic Pipe & Connector Assortment	168
Plastic Repair Staples	62
Pliers	51, 160
Pliers for Axle Boot Clamps	159
Pliers for Fuel Lines	160
Pliers for Glow Plugs	123
Pliers for Trim Clips	85
Pliers, Hammer, Screwdriver Sets	157
Pneumatic Soda Blasting Guns	161
Polishing Machine	162
Power Cable	162
Pressure Gauge for Tyres	168
Protective Impact Socket Sets	10, 158
Protective Socket Sets	158
Pry Bar Sets	165
Pry Bars	168
Puller for Brake Discs	165
Puller for Crankshaft Pulleys	120
Puller for Drop Arms	76
Puller for Injection Pump Wheels	117
Puller for Petrol Injectors	167
Puller for Transmission Bearings	163
Puller for Turbochargers	167
Puller for Universal Joints	163
Puller Set for Injectors	168
Puller Sets	160
	38, 76, 117, 120, 123, 160, 163, 165
Pullers	
Push-through Ratchet	22
PZ-Bits	QF9

Q	
Quick Action Drill Chuck	37

R	
Radial Seal Hooks	117
Radio Removal Tools	70
Ratchet Combination Spanner	54-56, 161
Ratchet Combination Spanners Sets	157
Ratchet Joint Wrench	159
Ratchets	20-22, 159
Ratchets for Brake Line Cutters	167
Ratchets for Scaffolders	159
Rear Axle Groove Nut Wrenches	164
Rear Axle Leaf Spring Bolt Wrenches	164
Rear Axle Nut Spanners	164
Rear Axle Track Adjustment Tools	76
Rear Wheel Shock Absorber Removal Sockets	164
Reinforced Hoses for Grease Guns	168
Removal Cap Sets	158

Description	
Removal Tools for Door Handles	165
Removal Tools for Door Trims	86
Removal Tools for Drive Shafts	167
Removal Tools for Fuel Lines	163
Removal Tools for Hose Couplings	122
Repair Plugs for Tyres	138-139
Reversible Ratchets	20-22, 159
Rim Lock Dismantling Socket Sets	158
Rim Lock Sockets	10, 12-14
Ring Spanners	QF12-13
Ring Spanners made of Plastic	165
Rivet Nut Attachments	40
Rivet Nut Pliers	39, 159
Rocker Arm Pin Extractors	162
Roller Bearing Axle Nut Sockets	164
Roller Cabinets	1-4, 156
Rotary Drum Pump	144
Rubber Pads	169
Rubber Pads for Auto Lifts	129-130

S	
Sanitation / Heating Tool Sets	157
Scaffolding Ratchets	22, 159
Screw Extractor Set	QF5, 12, 158
Screwdriver Holders	8
Screwdriver, Hammer, Pliers Sets	157
Screwdrivers	51, 158-161
Sealing Seam (Adhesive)	152
Seats	168
Seats for Workshops	168
Security Bit Sets	158
Self Grip Pliers	160
Serpentine Belt Tool	122
Shock Absorber Removal Sockets	164
Short-Circuit Detectors	72
Shrink Tubes	168
Silicon Water Remover	167
Single Hand Rubber Suction Cups	82
Sliding Block Fixing Tools	167
Sliding T-Bars	QF10
Slogging Ring Spanners	52-54, 159
Slot Bits	QF9
Socket Adaptors	QF10
Socket for Gear Locks	QF3
Socket Holders	159
Socket Sets	9, 157
Socket Wrench Adaptors	QF10
Socket Wrench Adaptors / Bit Adaptors	159
Sockets	QF1-5, 10-15, 158
Sockets E-Type (Torx)	QF4-5
Sockets for Axle Caps	164
Sockets for Axle Nuts	164
Sockets for Brake Callipers	165
Sockets for Fork Caps	162-163
Sockets for Hubs	164
Sockets for Main Transmission Shaft Nuts	163
Sockets for Oil Filters	163, 168
Sockets for Rear Axle Caps	164
Sockets for Socket Sets	QF1-5
Sockets for Spark Plugs	166
Sockets, 12-point	QF1-5
Sockets, Hexagon	QF1-5
Sockets, Inch sizes	QF1-2
Soda Blasting Guns	161
Soft Head Hammers	29
Solenoid Valve Wrenches	166
Spacer for Plastic Repairs	62
Spacer Sensor for Pin Wrenches	81
Spacers	135
Spanners	QF11-13, 52
Spark Plug Ball Joint Sockets	166
Spark Plug Cleaners	165
Spark Plug Socket Puller	123
Spark Plug Sockets	122, 166
Special Sockets	QF5, 10-15
Special Sockets for ATF Filler Plugs	95
Special Wrench for Coolant Caps	166
Spline (for XZN)	QF9
Spline Bit Sockets	QF6, QF8
Spline Bit Sockets (for Ribe)	QF7-8, 5
Spline Bits (for Ribe)	QF9
Splines for Supporting	169
Spring steel Hose Clamps	134-135
Spring Strut Sockets	73
Sprocket Holding Tools	92
Sprocket Supporting Sleeves	97
Spud Wrench	48
Square Drive	22
Staples for Plastic Repairs	62
Steel Brushes	34
Step Drills	37

Description	
Straight Edges	167
Suction and Pressure Sprayers	127
Suction Lifters	82
Suction Valve Grinders	161
Supersal Connectors	39
Suspension Strut Nut Spanners & Holding Tools	165
Swivel Joint Handle	QF10
Systainer	157-158
System Case	157-158

T

Tank Sensor Wrenches	92, 166, 167
Tap Adaptor Sockets	31
Tap and Die Sets	161
Taps	30, 159
Telephone Pliers	160
Temperature Sensor Sockets	71
Tensioner Pulley Wrench	97, 115
Thread Inserts	161
Thread Repair Kits	161
Threaded Inserts	158
Threading Dies	30
Timing Chain Hold-Down Devices	104
Timing Chain Riveting Tools	167
Timing Chain Tensioner Lever	166
Timing Chain Tensioner Locking Pins	96
Timing Chain Testing Tools	115
Tool Assortment	9
Tool Box	157-158
Tool Sets for Disconnection of Fuel Lines	167
Tools for Motorcycles	162-163
Tooth Belt Tensioning Tools	108
Torque Wrench	24, 28, 159
Trailing Arm Bushing Tools	166
Transmission Bearing Pullers	163
Transmission Groove Nut Sockets	164
Transmission Mounting Levers	74
Transmission Oil Discharge System Sets	168
Transmission Oil Filling Adaptors	169
Trays for Spray Cans	157
Trim Clip Pliers	85
Truck Tools	162-164
T-Star (for Torx) Bit Sockets	5
T-Star Bit Sockets	QF6
T-Star Bit Sockets (for Torx)	QF6-8
T-Star Bits (for Torx)	QF9
Tube Benders	6, 67
Tube Cutter	161
Turbo Charger Diagnostics System Test Case	121
Turbocharger Test Sets	167
Twin Wheel Separating Tools	163
Twist Drills	37
Tyre Bead Retainer	138
Tyre Change Service Sets	78-80
Tyre Depth Gauge	168
Tyre Inflator Guns	161
Tyre Levers	138
Tyre Repair Plugs	138-139
Tyre Service Tools	7
Tyre Tread Depth Gauges	168

U

Ultrasonic Parts Cleaner	168
Universal / Security Bit Sets	158
Universal Axle Cap Sockets	163
Universal Joint Pullers	163
Unlocking Tools for Air Conditioner Line Couplings	166
Urea Multi-purpose Funnel	169

V

Valve Play Adjustment Tools	162
Valve Spring Compressors	163, 167
VDE Bit Socket Sets	158
VDE Ratchets	159
VDE Reversible Ratchets	159
VDE Socket Sets	157
VDE Tools	51, 157-159
Vibration Damper Tool Sets	117
V-ribbed Belt Bit Sockets	121
V-ribbed Belt Holders	166
V-ribbed Belt Tensioner Tools	121
V-ribbed Belt Tensioners	103
V-ribbed Belt Tools	122

W

Water Pump Pliers	46, 160
Water Pump Testers	119
Water Remover	167
Wheel Balancing Weights	137

Description	
Wheel Change Service Sets	78-80, 168
Wheel Hub Grinders	76-77
Wheel Hub Rim Hole Grinders	76
Wheel Hub Sockets	164
Wheel Nut Cap Pliers	137
Wind Back Tools for Brake Pistons	163
Window Lift Hook Wrench	165
Windshield Cutting Wires	83
WLAN Colour Borescopes	169
Wooden Mallets	161
Work Clothing	153-155
Worklights	147-149, 169
Workshop File Sets	157
Workshop Files	32-34
Workshop Lights	169
Workshop Press	151
Workshop Seats	168
Workshop Trolley Tool Trays	4-7, 82, 89, 93-120, 156-157

Art.		Art.		Art.		Art.		Art.		Art.		Art.	
56	14	673	160	1229-24	QF11	2369	QF3	2565	QF7	2815	159	3121	QF10
117	117	674	160	1229-27	QF11	2370	QF3	2565-75	QF7	2816	159	3132	QF10
163-2	159	675	160	1229-30	QF11	2371	QF3	2567	QF7	2817	159	3134	QF10
171	QF10	676	160	1229-32	QF11	2372	QF3	2568	QF7	2818	28	3175	62
172	QF10	701	159	1241	168	2373	QF3	2571	QF7	2819	25	3175-1	62
173	QF10	702	159	1245	158	2374	QF3	2572	QF7	2820	25	3175-2	62
174	QF10	873-4	62	1246	164	2375	QF3	2573	QF7	2821	25	3175-3	62
192	QF10	873-5	62	1260	123	2376	QF3	2574	QF7	2822	26	3292	59
193	QF10	873-6	62	1261	123	2377	QF3	2575	QF7	2823	26	3319	57
194	QF10	873-7	62	1262	123	2378	QF3	2576	QF6	2908	QF1	3323	60
195	QF10	873-8	62	1263	123	2379	QF3	2577	QF6	2909	QF1	3327	161
196	QF10	894	29	1264	123	2380	QF3	2578	QF6	2910	QF1	3351	157
213	21	908 - 915	161	1265	124	2381	QF3	2579	QF6	2911	QF1	3353	157
233	QF10	920	30	1266	124	2382	QF3	2580	QF6	2912	QF1	3354	157
234	QF10	921	30	1267	124	2384	QF3	2581	QF6	2913	QF1	3360 - 3362	162
235	QF10	922	30	1268	124	2408	QF3	2582	QF6	2914	QF1	3379	162
236	QF10	927	30	1269	124	2409	QF3	2583	QF6	2915	QF1	3390	162
242	QF10	928	30	1270	164	2410	QF3	2584	QF6	2916	QF1	3419	QF1
243	QF10	950 - 952	159	1403	142	2411	QF3	2587	QF6	2917	QF1	3421	QF1
244	QF10	1056	QF11	1433	157	2412	QF3	2588	QF7	2918	QF1	3422	QF1
246	QF10	1057	QF11	1537	137	2413	QF3	2589	QF7	2919	QF1	3423	QF1
247	QF10	1058	QF11	1541-10X11 -	159	2414	QF3	2590	QF7	2920	QF1	3424	QF1
248	QF10	1059	QF11	1541-17X19	159	2415	QF3	2591	QF7	2921	QF1	3426	QF1
249	QF10	1060	QF11	1686	37	2416	QF3	2592	QF7	2922	QF1	3427	QF1
263	QF10	1061	QF11	1859-30	29	2417	QF3	2593	QF7	2924	QF1	3430	QF1
264	QF10	1062	QF11	1900-M4X0.7-B	159	2418	QF3	2594	QF7	2926	QF1	3432	QF1
265	QF10	1063	QF11	1900-M5X0.8-B	159	2419	QF3	2595	QF7	2927	QF1	3433	QF1
265-Repair	QF10	1064	QF11	1952-3	30	2420	QF3	2596	QF7	2928	QF1	3434	QF1
266	QF10	1065	QF11	1953-3	30	2421	QF3	2597	QF7	2930	QF1	3435	QF1
267	QF10	1066	QF11	1954-3	30	2422	QF3	2599	QF7	2932	QF1	3436	QF1
267-Repair	QF10	1067	QF11	1955-3	30	2423	QF3	2600	QF3	2934	QF1	3438	QF1
268	QF10	1068	QF11	1956-3	30	2424	QF3	2601	QF3	2935	QF1	3441	QF1
269	QF10	1069	QF11	1957-3	30	2427	QF3	2602	QF3	2936	QF1	3442	QF1
270	QF10	1070	QF11	1958-3	30	2428	QF3	2603	QF3	2941	QF1	3444	QF1
271	QF10	1071	QF11	1997-4	57	2430	QF3	2604	QF3	2943	QF3	3446	QF1
272	QF10	1072	QF11	1997-5	57	2432	QF3	2605	QF3	2944	QF3	3448	QF1
273	QF10	1074	QF11	1997-6	57	2436	QF9	2606	QF3	2945	QF3	3450	QF1
274	QF10	1075	QF11	2097	37	2437	QF9	2607	QF3	2946	QF3	3455	QF1
275	QF10	1076	QF11	2161-10	QF6	2438	QF9	2608	QF3	2946-1	QF1	3736	QF1
276	QF10	1077	QF11	2161-12	QF6	2439	QF9	2609	QF3	2947	QF3	3741	QF1
277	QF10	1080	QF11	2164-T45	QF7	2440	QF9	2610	QF3	2948	QF3	3746	QF1
279	QF10	1082	QF11	2164-T50	QF7	2441	QF9	2611	QF3	2949	QF3	3750	QF1
280	QF10	1084	QF11	2165-T45	QF7	2442	QF9	2710	QF4	2951	QF3	3755	QF1
283	QF10	1086	QF11	2165-T50	QF7	2443	QF9	2711	QF4	2952	QF3	3760	QF1
283-1	QF10	1088	QF11	2169-11	63	2444	QF9	2712	QF4	2956	QF3	3765	QF1
294	QF10	1091	QF11	2170	162	2445	QF9	2713	QF4	2964	QF3	3770	QF1
295	QF10	1096	QF11	2210	QF10	2460	123	2714	QF4	2965	QF3	3775	QF1
296	QF10	1100	QF11	2211	QF10	2473	QF1	2715	QF4	2966	QF3	3780	QF1
313-1	22	1184-6x7	QF13	2217	9	2474	QF1	2720	QF6	2967	QF3	3999-1	50
372	QF10	1184-8x9	QF13	2219	QF10	2475	QF1	2721	QF6	2968	QF3	4035	7
374	QF10	1184-10x11	QF13	2220	QF10	2476	QF1	2722	QF6	2969	QF3	4035-1	7
375	QF10	1184-10x13	QF13	2231	QF10	2477	QF1	2723	QF6	2970	QF3	4069	2
376	QF10	1184-12x13	QF13	2232	QF10	2478	QF1	2725	QF6	2971	QF3	4103	3
377	QF10	1184-14x15	QF13	2260	QF12	2479	QF1	2727	QF6	2972	QF3	4104	1
404	39	1184-16x17	QF13	2261	QF12	2480	QF1	2729	QF6	2973	QF3	4106	156
408-1	159	1184-18x19	QF13	2262	QF12	2481	QF1	2730	QF6	2974	QF3	4108	4
438	160	1184-20x22	QF13	2263	QF12	2482	QF1	2732	QF6	3058	67	4116	4
447-1	42	1184-21x23	QF13	2265	QF12	2483	QF1	2733	QF6	3066-1	168	4116-1	4
447-2	44	1184-24x27	QF13	2266	QF12	2484	QF1	2734	QF6	3078-2	35	4117	5
447-3	45	1184-25x28	QF13	2281-6X8	QF12	2485	QF1	2735	QF6	3078-3	36	4117-1	5
447-4	43	1184-30x32	QF13	2281-10X12	QF12	2486	QF1	2736	QF6	3078-8-M	35	4118	5
450-1	42	1184-36x41	QF13	2281-14X18	QF12	2487	QF7	2737	QF6	3078-8-N	35	4118-1	5
450-2	44	1186-10x11	QF12	2281-20X24	QF12	2488	QF7	2738	QF6	3078-8-S	34	4119	5
450-3	45	1186-12x14	QF12	2326	159	2489	QF7	2740	QF6	3078-9-M	35	4119-1	5
450-4	43	1186-13x15	QF12	2335	QF10	2490	QF7	2741	QF6	3078-9-N	35	4120	6
600	20	1186-16x18	QF12	2336	QF10	2491	QF7	2742	QF6	3078-9-S	34	4120-1	6
600 - 602	159	1186-17x19	QF12	2338	QF10	2492	QF7	2743	QF6	3078-10-M	35	4141	QF7
600-REPAIR	20	1186-21x23	QF12	2339	QF3	2493	QF7	2744	QF6	3078-10-N	35	4142	QF7
601	20	1186-22x24	QF12	2343	QF3	2494	QF7	2745	QF6	3078-10-S	34	4143	QF7
601-REPAIR	20	1207-60	QF1	2344	QF3	2495	QF7	2746	QF6	3078-11-M	35	4144	156
602	20	1214-6x7	QF13	2345	QF3	2496	QF7	2747	QF6	3078-11-N	35	4145	QF7
602-REPAIR	20	1214-8x9	QF13	2346	QF3	2497	QF6	2748	QF6	3078-11-S	34	4146	156
610	20	1214-10x11	QF13	2347	QF3	2498	QF6	2751	QF6	3078-12-M	35	4150	QF7
611	20	1214-12x13	QF13	2348	QF3	2499	QF6	2752	QF6	3078-12-N	35	4151	QF7
612	20	1214-14x15	QF13	2349	QF3	2500	QF6	2753	QF6	3078-12-S	34	4152	QF7
618	21	1214-16x17	QF13	2350	QF3	2501	QF6	2754	QF6	3078-13-M	35	4153	QF7
618-1	21	1214-18x19	QF13	2351	QF3	2502	QF6	2760	QF7	3078-13-N	35	4154	QF7
619	21	1214-20x22	QF13	2352	QF3	2503	QF6	2761	QF7	3078-13-S	34	4155	QF7
619-1	21	1214-21x23	QF13	2353	QF3	2504	QF7	2770	QF1	3078-14-M	35	4156	QF7
620	21	1214-24x27	QF13	2354	QF3	2505	QF7	2771	QF1	3078-14-N	35	4157	QF7
620-1	21	1214-25x28	QF13	2355-25	QF6	2506	QF6	2772	QF1	3078-14-S	34	4158	QF7
621	21	1214-30x32	QF13	2355-TS15	QF6	2507	QF6	2773	QF1	3078-15-M	35	4159	19
650-1	42	1228-6	QF11	2355-TS20	QF6	2541	QF7	2774	QF1	3078-15-N	35	4160	QF7
650-2	44	1228-7	QF11	2355-TS27	QF6	2542	QF7	2775	QF1	3078-15-S	34	4161	QF7
650-3	45	1228-8	QF11	2355-TS30	QF6	2543	QF7	2776	QF1	3078-16-M	35	4162	QF7
650-4	43	1228-9	QF11	2355-TS40	QF6	2544	QF7	2777	QF1	3078-16-N	35	4163	QF7
651-1	42	1228-10	QF11	2355-TS50	QF6	2545	QF7	2778	QF1	3078-16-S	34	4165	QF7
651-2	44	1228-11	QF11	2356	QF7	2546	QF7	2779	QF1	3078-17-M	35	4166	QF7
651-3	45	1228-12	QF11	2357	QF7	2547	QF7	2784	QF1	3078-17-N	35	4167	QF7
651-4	43	1228-13	QF11	2358	QF7	2548	QF7	2786	QF1	3078-17-S	34	4168	QF7
652	41	1228-14	QF11	2359	QF7	2549	QF7	2787	QF1	3078-18-M	35	4173	QF7
652-1	42	1228-15	QF11	2360	QF7	2550	QF7	2788	QF1	3078-18-N	35	4174	QF7
652-2	44	1228-16	QF11	2361	QF7	2551	QF7	2809	24	3078-18-S	34	4176	QF7
652-3	45	1228-17	QF11	2362	QF7	2552	QF7	2810	24	3078-19-M	35	4177	QF7
652-4	43	12											

Art.	Art.	Art.	Art.	Art.	Art.	Art.	Art.	Art.
4372	4763	5184-H7	5268-27	5485-12	5760	6559	6719	56
4373	4764	5184-H10	5268-32	5485-13	5827	6560	6720	162
4374	4765	5184-H11	5268-36	5485-14	5830	6561	6721	162
4375	4766	5184-H13	5268-41	5486-T20	5832	6562	6722	162
4376	4767	5184-H17	5269-8	5486-T25	5833	6563	6723	162
4377	4768	5184-H19	5269-21	5486-T27	5834	6564	6724	162
4378	4770	5184-H22	5270	5486-T30	5835	6570	6725	162
4379	4771	5184-H24	5271	5486-T40	5836	6571	6726	163
4380	4772	5184-HB5	5272	5486-T45	5838	6572	6727	163
4381	4773	5184-M9	5273	5486-T50	5839	6573	6730	165
4382	4774	5184-M10	5274	5486-T55	5841	6574	6731	75
4383	4775	5184-M12	5275	5486-T60	5846	6575	6734	96
4384	4776	5184-M14	5276	5486-T70	5850	6576	6735	115
4385	4777	5184-M18	5277	5486-T80	5855	6577	6736	46
4386	4778	5184-R7	5278	5487-M4	5856	6578	6737	46
4387	4779	5184-R8	5279	5487-M5	5860	6579	6738	45
4388	4780	5184-R9	5291	5487-M6	5865	6590	6739	45
4389	4810	5184-R10	5292	5487-M8	5870	6591	6741	68
4390	4811	5184-T30	5334-H17	5487-M10	5875	6592	6742	36
4391	4850	5184-T40	5336	5500-17	5880	6593	6743	165
4410	4851	5184-T45	5337	5500-19	5885	6594	6744	168
4415	4852	5184-T50	5338	5500-21	5890	6608	6746	163
4420	4853	5184-T55	5339	5500-22	5895	6609	6750	119
4425	4854	5184-T60	5340	5500-24	5905	6610	6751	29
4427	4859	5184-T70	5341	5500-27	5910	6611	6752 - 6754	168
4430	4860	5184-TB30	5342	5500-30	5915	6612	6755	165
4432	4861	5184-TB80	5343	5500-32	5920	6613	6756	160
4440	4862	5184-TS10	5344	5500-33	6035	6614	6757	87
4445	4863	5184-TS15	5345	5500-34	6036	6615	6758	92
4450	4864	5184-TS20	5346	5500-36	6264	6616	6767	166
4455	4866	5184-TS25	5347	5500-38	6402	6617	6769	101
4456	4867	5184-TS27	5348	5500-41	6404	6618	6773	160
4457	4868	5184-TS30	5349	5500-46	6405	6619	6774	99
4458	4869	5184-TS40	5351	5500-50	6406	6641	6775	98
4460	4870	5184-TS45	5352	5500-55	6407	6643	6776	168
4462	4871	5184-TS50	5353	5500-60	6408	6644	6779	159
4463	4872	5189-H14	5367	5500-65	6410	6645	6780	158
4467	4873	5189-H17	5369	5500-70	6411	6646	6781	160
4468	4874	5189-H19	5370	5500-75	6412	6647	6782	160
4469	4875	5189-H22	5371	5500-80	6414	6648	6784	168
4470	4876	5189-T60	5372	5500-85	6416	6649	6786	168
4471	4950	5189-T70	5373	5500-90	6417	6650	6788 - 6790	160
4472	4951	5189-T80	5374	5500-95	6418	6654	6792	160
4473	4952	5189-T90	5375	5500-100	6420	6655	6794	161
4474	4953	5189-T100	5378	5500-105	6422	6656	6801	160
4475	4954	5190	5381-M12	5500-110	6424	6657	6802	160
4476	4955	5191	5381-M14	5500-115	6430	6657	6803	160
4477	4956	5204-10	5381-M16	5545	6431	6658	6820	168
4479	4957	5204-11	5381-M18	5550	6440	6659	6825	160
4480	4959	5204-12	5467	5555	6442	6660	6826	160
4481	4960	5204-14	5469	5560	6444	6661	6828	161
4482	4961	5204-16	5470	5565	6446	6661-2	6829	162
4483	4962	5204-18	5474	5570	6448	6661-3	6844	161
4484	4963	5204-20	5475	5580	6450	6662	6845	161
4485	4964	5204-22	5480-T20	5590	6460	6663	6846 - 6923	168
4566	4965	5204-24	5480-T25	5600	6461	6664	6846-1 -	168
4567	4966	5205-8	5480-T30	5617	6462	6665	6923-1	168
4568	5003	5205-33	5480-T40	5618	6464	6665-1	6847	158
4569	5007	5205-34	5480-T45	5619	6466	6667	6849	166
4570	5010	5205-36	5480-T50	5621	6470	6670	6851	QF10
4571	5052-14	5205-38	5480-T55	5622	6471	6671	6858	166
4572	5052-16	5210	5480-T60	5624	6472	6672	6859	158
4573	5052-17	5211	5480-T70	5626	6473	6674	6875	162
4574	5052-18	5212	5480-T80	5627	6474	6675	6876	162
4575	5052-19	5213	5481-M5	5630	6475	6677	6879 - 6882	168
4576	5054-12	5214	5481-M6	5632	6477	6678	6886	166
4581	5054-14	5215	5481-M7	5633	6478	6679	6888	168
4590	5054-17	5216	5481-M8	5634	6502	6680	6889	166
4591	5054-19	5217	5481-M10	5635	6508	6682	6890	166
4592	5054-21	5218	5481-M12	5636	6509	6683	6891	166
4593	5054-22	5219	5481-M14	5638	6510	6684	6892	166
4595	5054-23	5221	5481-M17	5640	6511	6685	6893	166
4596	5054-24	5222	5481-M19	5641	6512	6686	6894	163
4597	5054-M16	5224	5482-M4	5646	6513	6687	6895	158
4598	5054-M18	5227	5482-M5	5648	6514	6688	6896	166
4599	5054-M24	5230	5482-M6	5650	6515	6689	6897	166
4600	5058-1	5232	5482-M8	5651	6516	6692	6898	163
4601	5064-1	5233	5482-M9	5652	6517	6693	6899	166
4602	5103-TB70	5234	5482-M10	5655	6518	6694	6900-7	25
4610	5103-TB80	5250-E26	5482-M12	5660	6519	6696	6900-8	25
4615	5103-TB90	5250-E28	5482-M14	5717	6521	6697	6900-9	25
4620	5103-TB100	5250-E30	5482-M16	5718	6522	6699	6900-10	25
4625	5105-M4	5250-E32	5483-M5	5719	6524	6703	6900-11	25
4627	5105-M5	5264-17	5483-M6	5721	6527	6704	6900-12	25
4630	5105-M6	5264-19	5483-M7	5722	6530	6705	6900-13	25
4640	5105-M8	5264-21	5483-M8	5724	6532	6706	6900-14	25
4645	5110	5264-22	5483-M9	5726	6540	6707	6900-15	25
4650	5111	5266-10	5483-M10	5727	6541	6708	6900-16	25
4655	5112	5266-11	5483-M12	5730	6542	6709	6900-17	25
4660	5113	5266-12	5483-M13	5732	6550	6710	6900-18	25
4670	5114	5266-13	5483-M14	5733	6551	6711	6900-19	25
4710	5115	5266-14	5485-5	5734	6552	6712	6901	166
4727	5152	5266-15	5485-6	5736	6553	6713	6901-13	27
4735	5153	5266-16	5485-7	5738	6554	6714	6901-14	27
4736	5154	5266-17	5485-8	5741	6555	6715	6901-15	27
4760	5155	5266-19	5485-9	5746	6556	6716	6901-16	27
4761	5156	5268-22	5485-10	5750	6557	6717	6901-17	27
4762	5180-M17	5268-24	5485-11	5755	6558	6718	6901-18	27

Art.		Art.		Art.		Art.		Art.		Art.		Art.		Art.	
6901-19	27	6996	164	8196	QF9	9493	112	9683	145	9861	72	10355	QF3	10674	QF1
6901-21	27	6997	164	8197	QF9	9495	70	9685	23	9862	119	10503	QF1	10680	QF2
6901-24	27	6999	164	8198	QF9	9496	125	9685-1	23	9863	11	10504	QF1	10681	QF2
6901-27	27	7002	164	8199	QF9	9498	92	9685-2	23	9864	90	10505	QF1	10682	QF2
6901-30	27	7015	169	8208	QF9	9501	11	9685-3	23	9865	89	10506	QF1	10683	QF2
6901-32	27	7024	167	8209	QF9	9521	161	9686	65	9866	90	10507	QF1	10684	QF2
6901-34	27	7026	167	8217	QF9	9525	76	9687	109	9867	95	10508	QF1	10685	QF2
6901-36	27	7028	167	8255	167	9528	144	9688	106	9868	95	10509	QF1	10686	QF2
6901-38	27	7029	167	8263	74	9529	144	9689	115	9873	142	10510	QF1	10687	QF2
6901-41	27	7036 - 7051	169	8327	158	9530	150	9690	107	9874	90	10511	QF1	10688	QF2
6902-166	166	7081	167	8327-4 -		9532	121	9691	118	9876	99	10512	QF1	10689	QF2
6902-7	26	7082	169	8327-12	158	9533	6, 67	9692	100	9877	111	10513	QF1	10702	QF2
6902-8	26	7083	161	8332	126	9533-1	6	9693	103	9878	89	10514	QF1	10704	QF2
6902-10	26	7130	157	8337	158	9533-2	6	9694	102	9879	91	10528	QF1	10705	QF2
6902-11	26	7131	158	8337-4 -		9535	48	9695	98	9880	QF10	10530	QF1	10706	QF2
6902-12	26	7132	159	8337-12	158	9537	74	9696	114	9880-REP	QF10	10531	QF1	10707	QF2
6902-13	26	7133	157	8339	167	9541	46	9697	145	9881	128	10532	QF1	10708	QF2
6902-14	26	7134	157	8383	11	9542	46	9698	144	9882	128	10533	QF1	10709	QF2
6902-15	26	7140	51	8442-1	161	9543	46	9699	110	9883	128	10534	QF1	10710	QF2
6902-16	26	7210	QF4	8442-2	161	9544	46	9702	169	9884	128	10535	QF1	10711	QF2
6902-17	26	7211	QF4	8487	86	9545	46	9731	169	9885	128	10536	QF1	10712	QF2
6902-18	26	7212	QF4	8505-2	142	9546	145	9736	77	9886	128	10537	QF1	10713	QF2
6902-19	26	7213	QF4	8618-T30	19	9547	135	9737	40	9887	128	10538	QF1	10722	QF2
6902-21	26	7214	QF4	8637	138	9549	37	9738	101	9888	128	10539	QF1	10773	QF2
6902-22	26	7215	QF4	8684	85	9553	13	9739	82	9895	8	10550	QF1	10774	QF2
6903	168	7216	QF4	8692	161	9555	121	9746	76	9896	157	10551	QF1	10775	QF2
6903-13	27	7217	QF4	8696	161	9556	12	9747	76	9904	76	10552	QF1	10776	QF2
6903-14	27	7218	QF4	8724-1	97	9557	12	9748	76	9927	78	10553	QF1	10777	QF2
6903-15	27	7219	QF4	8848	167	9558	13	9749	76	9928	162	10554	QF1	10778	QF2
6903-16	27	7221	QF4	8911	139	9559	13	9753	113	9934	169	10555	QF1	10779	QF2
6903-17	27	7222	QF4	8914	52	9560	51	9754	106	9992-4	169	10556	QF1	10780	QF2
6903-18	27	7224	QF4	8925	138	9565	124	9756	18	10101	QF3	10557	QF1	10781	QF2
6903-19	27	7227	QF4	8926	138	9569	125	9757	146	10102	QF3	10558	QF1	10782	QF2
6903-21	27	7230	QF4	8927	138	9570	125	9758	36	10104	QF3	10559	QF1	10783	QF2
6903-22	27	7232	QF4	9050	132	9571	84	9759	127	10105	QF3	10560	QF1	10784	QF2
6903-24	27	7236	QF4	9058	133	9572	74	9765	21	10106	QF3	10561	QF1	10870	QF2
6903-27	27	7248	QF4	9059	131	9573	38	9766	36	10107	QF3	10562	QF1	10871	QF2
6903-30	27	7419	QF2	9142	132	9578	8	9767	148	10108	QF3	10563	158	10872	QF2
6903-32	27	7421	QF2	9143	133	9579	141	9768	82	10109	QF3	10564	QF1	10873	QF2
6903-34	27	7422	QF2	9144	70	9580	37	9769	15	10110	QF3	10566	QF1	10874	QF2
6903-36	27	7424	QF2	9208	167	9582	125	9771	31	10111	QF3	10567	QF1	10875	QF2
6903-41	27	7427	QF2	9251	169	9583	85	9777	128	10112	QF3	10568	QF1	10876	QF2
6904	166	7430	QF2	9294	162	9584	112	9778	QF10	10113	QF3	10570	QF1	10877	QF2
6904-10	28	7432	QF2	9337	162	9585	121	9779	10	10114	QF3	10572	QF1	10878	QF2
6904-11	28	7434	QF2	9345	162	9586	138	9779-10	QF5	10115	QF3	10610	QF1	10879	QF2
6904-12	28	7436	QF2	9348	QF7	9587	11	9779-12	QF5	10155	QF3	10611	QF1	10880	QF2
6904-13	28	7438	QF2	9349	QF7	9588	10	9779-14	QF5	10156	QF3	10612	QF1	10881	QF2
6904-14	28	7441	QF2	9350	QF6	9589	85	9779-16	QF5	10157	QF3	10613	QF1	14125	137
6904-16	28	7446	QF2	9351	QF6	9591	81	9779-18	QF5	10158	QF3	10614	QF1	14136	136
6904-17	28	7450	QF2	9352	QF6	9592	122	9779-20	QF5	10159	QF3	10615	QF1	14140	136
6904-18	28	7455	QF2	9353	QF7	9593	81	9779-22	QF5	10160	QF3	10616	QF1	20103	158
6904-19	28	7459	QF2	9354	QF7	9596	31	9779-24	QF5	10161	QF3	10617	QF1	30106	QF11
6904-21	28	7465	QF2	9355	QF7	9601	110	9780	131	10162	QF3	10618	QF1	30107	QF11
6904-22	28	7466	QF2	9356	QF2	9602	58	9782	126	10163	QF3	10619	QF1	30108	QF11
6905	168	7467	158	9357	QF2	9603	117	9786	112	10208	QF3	10625	QF2	30109	QF11
6906	166	7468	QF10	9358	QF3	9605	100	9790	151	10209	QF3	10626	QF2	30110	QF11
6907	159	7500	158	9359	QF2	9606	111	9791	141	10210	QF3	10627	QF1	30111	QF11
6908 - 6919	161	7754	116	9360	QF2	9614	88	9792	144	10211	QF3	10628	QF2	30112	QF11
6920	166	7761	116	9361	QF3	9615	122	9795	152	10212	QF3	10629	QF2	30113	QF11
6922	163	7892	157	9362	QF3	9616	113	9796	56	10213	QF3	10630	QF2	30114	QF11
6924	166	7896	161	9363	QF2	9617	65	9799	47	10214	QF3	10631	QF2	30115	QF11
6925	166	8037-2	140	9364	QF7	9621	105	9801	48	10215	QF3	10632	QF2	30116	QF11
6926	168	8107-20	134	9365	QF7	9622	22	9803	49	10216	QF3	10633	QF2	30117	QF11
6927	166	8107-22	134	9386	QF8	9623	22	9807	71	10217	QF3	10634	QF2	30118	QF11
6928	158	8152-7	108	9401	141	9624	108	9808	118	10218	QF3	10635	QF2	30119	QF11
6929	168	8160	QF9	9402	135	9625	113	9811	103	10219	QF3	10636	QF2	30120	QF11
6930	167	8161	QF9	9403	150	9626	82	9812	15	10220	QF3	10637	QF2	30121	QF11
6931	161	8162	QF9	9409	38	9627	QF7	9813	15	10221	QF3	10638	QF2	30122	QF11
6932	157	8163	QF9	9409-1	38	9628	QF7	9815	41	10222	QF3	10639	QF2	30123	QF11
6933	167	8164	QF9	9409-2	38	9629	69	9816	31	10224	QF3	10640	QF2	30124	QF11
6948	163	8165	QF9	9409-3	38	9631	69	9817	157	10227	QF3	10641	QF2	30125	QF11
6949	163	8166	QF9	9409-4	38	9632	89	9818	157	10230	QF3	10642	QF2	30126	QF11
6950	163	8167	QF9	9409-5	38	9633	68	9819	102	10232	QF3	10643	QF2	30127	QF11
6952	163	8168	QF9	9409-6	38	9634	39	9823	127	10254	QF3	10644	QF2	30128	QF11
6953	163	8169	QF9	9427-3	30	9635	14	9824	168	10255	QF3	10645	QF2	30129	QF11
6954	163	8170	QF9	9428-3	30	9636	137	9825	59	10256	QF3	10646	QF2	30130	QF11
6955	163	8172	QF9	9429-3	30	9637	105	9826	73	10257	QF3	10647	QF2	30132	QF11
6957	163	8173	QF9	9430-3	30	9638	87	9827	73	10258	QF3	10648	QF2	30134	QF11
6958	163	8174	QF9	9431-3	30	9639	88	9831	86	10259	QF3	10649	QF2	30136	QF11
6959	167	8176	QF9	9432-3	30	9640	75	9832	118	10268	QF3	10650	QF1	30141	QF11
6960	157	8177	QF9	9433-3	30	9641	81	9833	QF6	10270	QF3	10650-1	QF2	30146	QF11
6961	163	8178	QF9	9434-3	30	9642	122	9835	127	10271	QF3	10651	QF1	30155	QF11
6963	163	8179	QF9	9435-3	30	9644	168	9836	157	10272	QF3	10651-1	QF2	30160	QF11
6964	169	8180	QF9	9436-3	30	9647	94	9838	67	10310	QF3	10652	QF1	30188	QF12
696															

Art.		Art.		Art.		Art.	
30211	QF13	30636	QF13	35295	54	90067	154
30212	QF13	30673	QF12	35310	159	90068	154
30213	QF13	30675	QF12	35318	53	90069	154
30214	QF13	30680	QF12,	35320	53	90070	155
30215	QF13		52	35324	53	90071	155
30216	QF13	30681	QF12,	35334	53	90072	155
30217	QF13		52	35336	53	90073	155
30218	QF13	30683	QF12,	42015	50	90074	155
30220	QF13		52	42016	50	90075	155
30221	QF13	30685	QF12,	42025	49	90076	155
30223	QF13		52	42026	50	90077	155
30224	QF13	30721	QF13	42027	50	90078	155
30230	QF13	30722	QF13	42028	50	90079	155
30236	QF13	30723	QF13	42031	50	92533	158
30246	QF13	30724	QF13	42032	50	BOX13	57
30330	QF13	30725	QF13	62051	117	BOX16	57
30331	QF13	30741	QF13	62607	165	BOX26	58
30332	QF13	30742	QF13	63247	139	BOXSYS1	157
30333	QF13	30743	QF13	66516	68	BOXSYS2	158
30334	QF13	30744	QF13	67157	8		
30335	QF13	30745	QF13	67158	159		
30336	QF13	30760	QF11	67167	157		
30337	QF13	30761	QF11	70003	161		
30338	QF13	30762	QF11	70010	163		
30339	QF13	30763	QF11	70011	169		
30506	QF11	30764	QF11	70012	QF4		
30507	QF11	30765	QF11	70013	167		
30508	QF11	30775	QF11	70014	167		
30509	QF11	30776	QF11	70015	161		
30510	QF11	30778	QF11	70016	167		
30511	QF11	30779	QF11	70020 -			
30512	QF11	34206	QF11	70024	158		
30513	QF11	34207	QF11	70026	158		
30514	QF11	34208	QF11	70034	167		
30515	QF11	34209	QF11	70036	167		
30516	QF11	34210	QF11	70037	167		
30517	QF11	34211	QF11	70038	167		
30518	QF11	34212	QF11	70051	169		
30519	QF11	34213	QF11	70058	167		
30520	QF11	34214	QF11	70104	161		
30521	QF11	34215	QF11	70105	161		
30522	QF11	34216	QF11	70106	162		
30523	QF11	34217	QF11	75109	46		
30524	QF11	34218	QF11	80617	152		
30525	QF11	34219	QF11	85306	147		
30526	QF11	34221	QF11	85324	149		
30527	QF11	34222	QF11	85326	149		
30528	QF11	34223	QF11	85327	169		
30530	QF11	34224	QF11	85328	169		
30532	QF11	34225	QF11	85329	169		
30551	159	34227	QF11	85331	169		
30552	QF11	34230	QF11	85332	169		
30553	QF11	34232	QF11	85334	169		
30554	QF11	34234	QF11	85335	169		
30555	QF11	34236	QF11	85337	169		
30556	QF11	34238	QF11	90012	153		
30557	QF11	34241	QF11	90013	153		
30558	QF11	34246	QF11	90014	153		
30559	QF11	34250	QF11	90015	153		
30560	QF11	34255	QF11	90016	153		
30561	QF11	34260	QF11	90017	153		
30562	QF11	34265	QF11	90018	153		
30563	QF11	34270	QF11	90019	153		
30564	QF11	34275	QF11	90022	153		
30565	QF11	34280	QF11	90023	153		
30566	QF11	34285	QF11	90024	153		
30567	QF11	34290	QF11	90025	153		
30568	QF11	34295	QF11	90026	153		
30569	QF11	35124	52	90027	153		
30570	QF11	35127	52	90028	153		
30571	QF11	35130	52	90032	153		
30572	QF11	35132	52	90033	153		
30573	QF11	35134	52	90034	153		
30574	QF11	35136	52	90035	153		
30577	QF11	35138	52	90036	153		
30578	QF11	35141	52	90037	153		
30579	QF11	35146	52	90038	153		
30605	QF13	35150	52	90042	154		
30606	QF13	35155	52	90043	154		
30608	QF13	35160	52	90044	154		
30610	QF13	35165	52	90045	154		
30611	QF13	35170	52	90046	154		
30612	QF13	35175	52	90047	154		
30613	QF13	35180	52	90048	154		
30614	QF13	35230	54	90052	154		
30616	QF13	35232	54	90053	154		
30617	QF13	35236	54	90054	154		
30618	QF13	35241	54	90055	154		
30620	QF13	35246	54	90056	154		
30621	QF13	35250	54	90057	154		
30622	QF13	35255	54	90058	154		
30623	QF13	35260	54	90060	154		
30624	QF13	35265	54	90061	154		
30625	QF13	35270	54	90062	154		
30627	QF13	35275	54	90063	154		
30630	QF13	35280	54	90064	154		
30631	QF13	35285	54	90065	154		
30632	QF13	35290	54	90066	154		



**Are you looking for a local dealer?
Send us an Email mail@bgs-technic.de**

Sales only via specialist retailers!

Offer exclusively for commercial customers.

Explanation of pictogram: ✓ = usable with (not identical)

All images, texts and graphics Copyright© BGS technic KG; further use only with written consent.

BGS technic®, Kraftmann® & ProTorque® are registered trademarks of BGS technic KG.

XZN®, Ribe® and Torx® are registered trademarks of the respective trademark holders.

BGS "T-Profile" is compatible with Torx®. All item information, in particular configuration and layout, can change unannounced in the course of continuous development and is non-binding.

Please refer to our internet site www.bgstechinc.com for the current version of each article.

Contact: BGS technic KG, Postfach 1450, 42907 Wermelskirchen;

HR Köln HRA 26256, Registered office: Wermelskirchen