

MFC-9840CDW

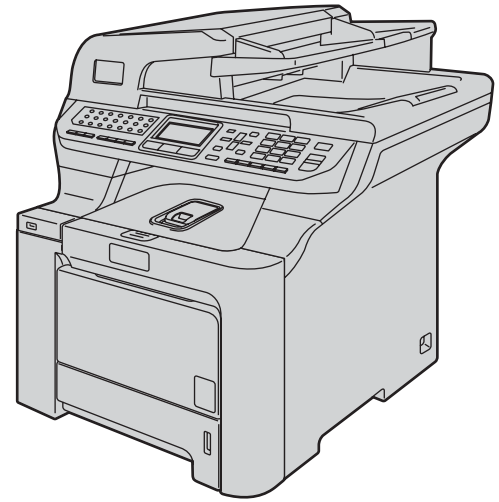

Before you can use the machine, you must set up the hardware and install the driver. Please read this 'Quick Setup Guide' for proper set up and installation instructions.

STEP 1

Setting Up the Machine







STEP 2

Installing the Driver & Software

Setup is Complete!

Keep this 'Quick Setup Guide' and the supplied CD-ROM in a convenient place for quick and easy reference at all times.

Symbols used in this guide

 Warning	 Caution	 Improper Setup
Warnings tell you what to do to prevent possible personal injury.	Cautions specify procedures you must follow or avoid to prevent possible damage to the machine or other objects.	Improper Setup icons alert you to devices and operations that are not compatible with the machine.
 Note	 User's Guide, Software User's Guide or Network User's Guide	
Notes tell you how you should respond to a situation that may arise or give tips about how the current operation works with other features.	Indicates reference to the User's Guide, Software User's Guide or Network User's Guide which is on the CD-ROM we have supplied.	

Getting Started

Carton components	2
Control panel	3

STEP 1 – Setting Up the Machine

Remove the packing materials from the machine	4
Installing the toner cartridges	5
Load paper in the paper tray	6
Release the Scanner Lock	6
Install the power cord and phone line	7
Setting the date and time	8
Setting your station ID	9
Tone and pulse dialling mode	9
Selecting a receive mode	10
Dial Prefix	10
Setting the LCD contrast	11

STEP 2 – Installing the Driver & Software

Windows®

For USB Interface Cable Users	14
For Wired Network Interface Users	17
Firewall settings	20
For Wireless Network Interface Users in infrastructure mode	22
Using the SecureEasySetup™ software to configure your machine for a wireless network	24
Using the Setup Wizard from the control panel LAN menu for wireless network configuration	25
For Windows Server® 2003 see the Network User's Guide on the CD-ROM.	
Firewall settings	30

Macintosh®

For USB Interface Cable Users	32
For Wired Network Interface Users	34
For Wireless Network Interface Users in infrastructure mode	37
Using the SecureEasySetup™ software to configure your machine for a wireless network	39
Using the Setup Wizard from the control panel LAN menu for wireless network configuration	40

For Network Users

BRAdmin Light utility (For Windows® users)	45
Installing the BRAdmin Light configuration utility	45
Setting your IP address, Subnet Mask and Gateway using BRAdmin Light	45
BRAdmin Light utility (For Mac OS® X users)	46
Setting your IP address, Subnet Mask and Gateway using BRAdmin Light	46
Web Based Management (web browser)	47
Restoring the network settings to factory default	47
Entering text	48

Consumables and Options





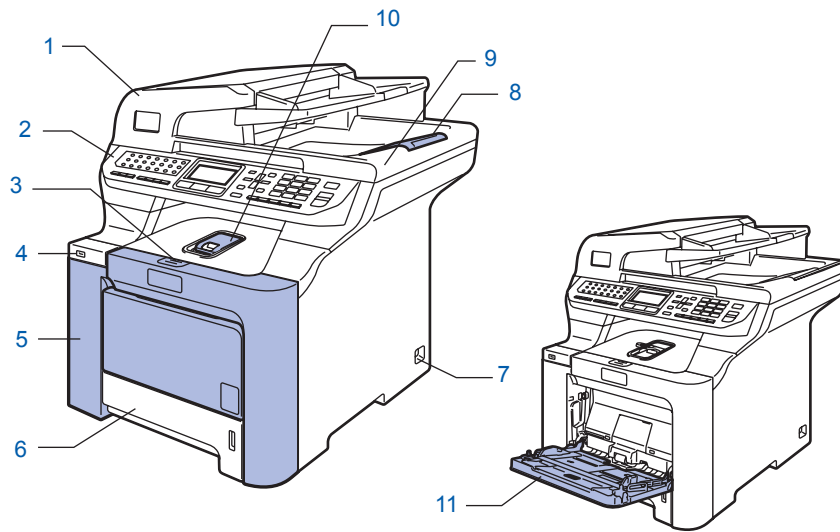

Options	49
Consumables	49

Carton components

Carton components may vary from one country to another. Save all packing materials and the carton in case for any reason you must ship your machine.

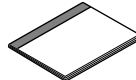
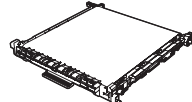

- | | |
|-----------------------------------|------------------------------------|
| 1 Automatic Document Feeder (ADF) | 7 Power Switch |
| 2 Control Panel | 8 ADF Document Output Support Flap |
| 3 Front Cover Release Button | 9 Document Cover |
| 4 USB Direct Interface | 10 Face-down Output Tray Support |
| 5 Front Cover | 11 Multi-purpose tray (MP tray) |
| 6 Paper Tray | |

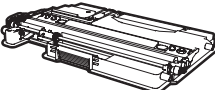
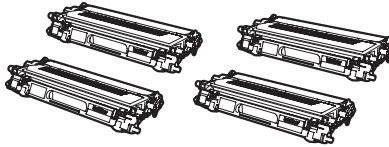
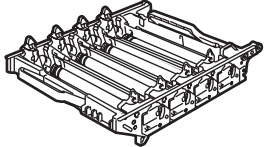
 CD-ROMs For Windows® For Macintosh®	 Quick Setup Guide	 User's Guide	 Belt Unit (pre-installed)
 AC Power Cord	 USB interface cable	 Telephone line Cord	 Insertion Sheet and Plastic bag for repacking
 Waste Toner Box (pre-installed)	 Toner cartridges (Black, Cyan, Magenta and Yellow)		 Drum Unit (pre-installed)

- To ensure safe operation the supplied plug must be inserted only into a standard power outlet that is properly grounded through the standard electrical wiring. Non grounded equipment may cause an electrical shock hazard, and may cause excessive electrical noise radiation.
- A network cable is not a standard accessory. You need to purchase an appropriate network cable.
- Do NOT connect the interface cable at this time. Connecting the interface cable is done during the software installation process.
- USB interface cable
Please make sure you use a USB 2.0 interface cable that is no longer than 2 metres. When you use a USB cable, make sure you connect it to the USB port of your computer and not to a USB port on a keyboard or non-powered USB hub.
- Network cable
Use a straight-through Category5 (or greater) twisted-pair cable for 10BASE-T or 100BASE-TX Fast Ethernet Network.

Control panel

MFC-9840CDW

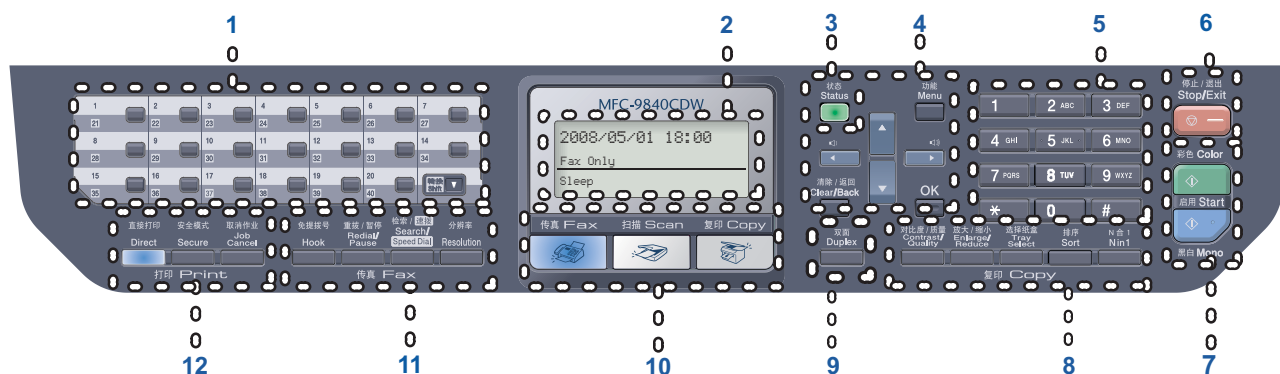

- | | |
|--------------------------------|---------------------------|
| 1 One Touch keys | 7 Start keys |
| 2 LCD (Liquid Crystal Display) | 8 Copy keys |
| 3 Status LED | 9 Duplex key |
| 4 Menu keys | 10 Mode Keys |
| 5 Dial Pad | 11 Fax and Telephone keys |
| 6 Stop/Exit key | 12 Print keys |

 For the details of the control panel, see Control panel overview in Chapter 1 of the User's Guide.

Note

This machine is heavy and weighs 38 kg (83.6 lb). To prevent injuries use at least two people to lift the machine. Be careful not to pinch your fingers when you set the machine back down.

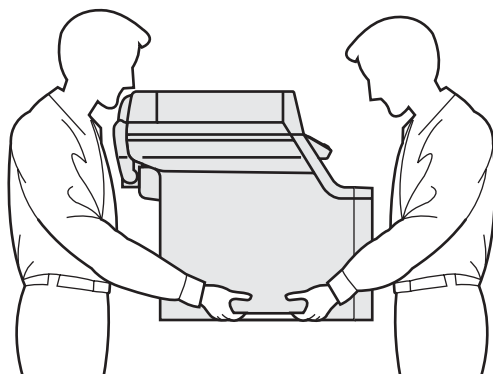

1 Remove the packing materials from the machine

Important

Save all packing materials and the carton in case you have to ship your machine.

⊘ Improper Setup

DO NOT plug in the AC power cord yet.

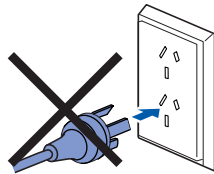

1 Remove the packing tape from the outside of the machine.

2 Press the front cover release button and open the front cover.

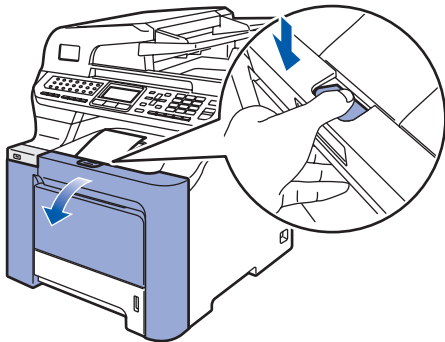

3 Remove the four pieces of orange packing material as shown in the illustration below.

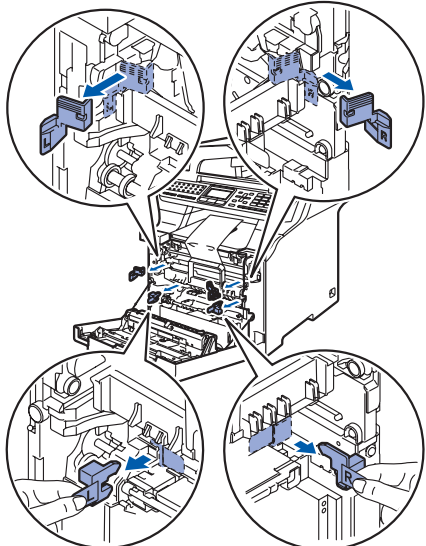

4 Hold the green handle of the drum unit. Lift the drum unit up and then pull it out until it stops.

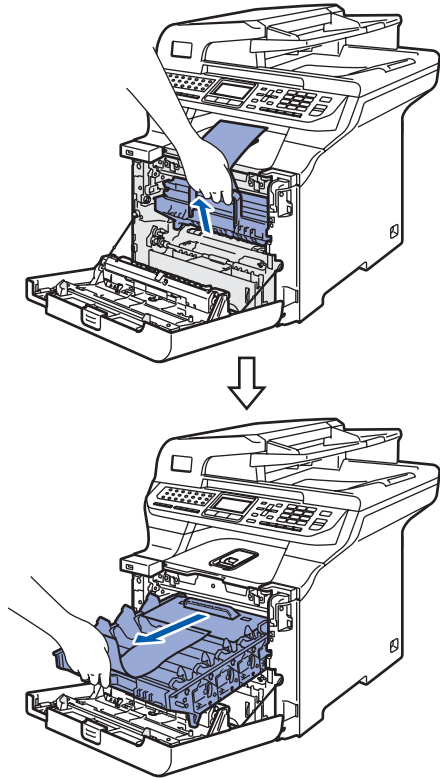

5 Remove the orange packing material as shown in the illustration below.

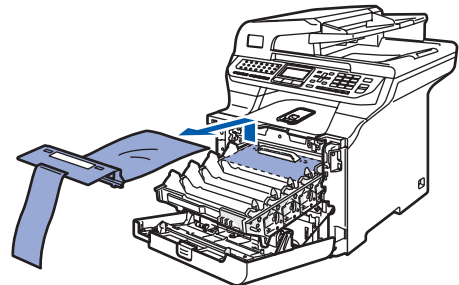

2 Installing the toner cartridges

- 1** Unpack the toner cartridges and gently shake each toner cartridge from side to side 5 to 6 times.

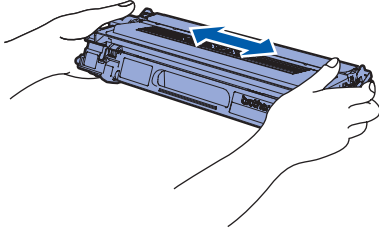

- 2** Pull off the protective cover.

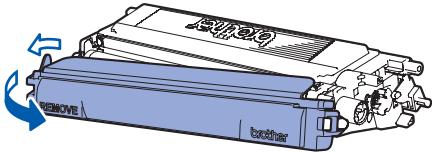

- 3** Hold the handle of the toner cartridge and slide it into the drum unit. Make sure that you match the toner cartridge colour to the same colour label on the drum unit, and make sure that you fold down the toner cartridge handle (1) once the toner cartridge is in place.

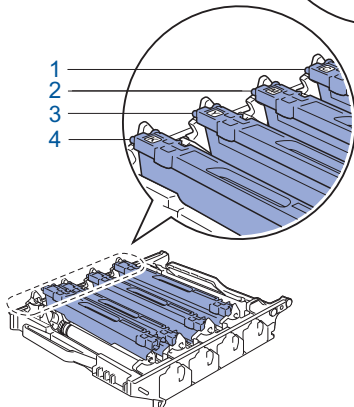
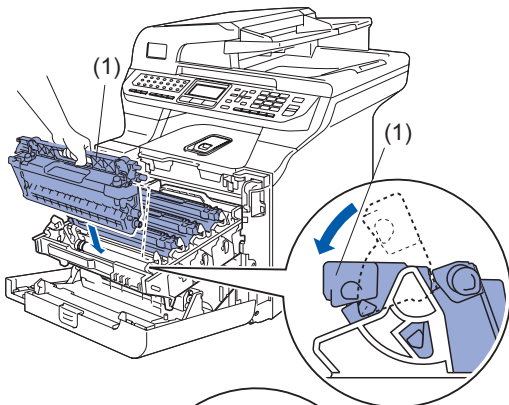

- 1 **C** — Cyan
- 2 **M** — Magenta
- 3 **Y** — Yellow
- 4 **K** — Black

- 4** Repeat steps **1** through **3** for the remaining toner cartridges.

- 5** Put the drum unit back into the machine.

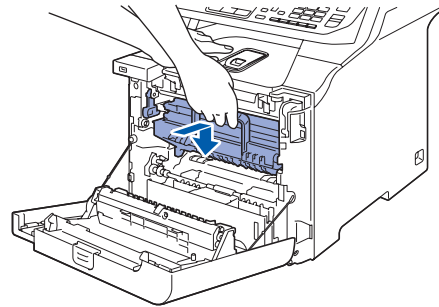

- 6** Close the front cover of the machine.

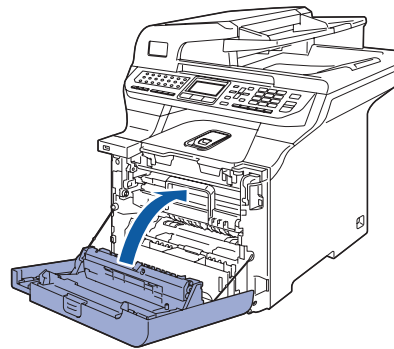

3 Load paper in the paper tray

⊘ Improper Setup

DO NOT connect the interface cable.
Connecting the interface cable is done during the software installation process.

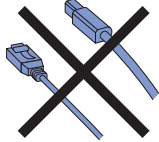

- 1 Pull the paper tray completely out of the machine.

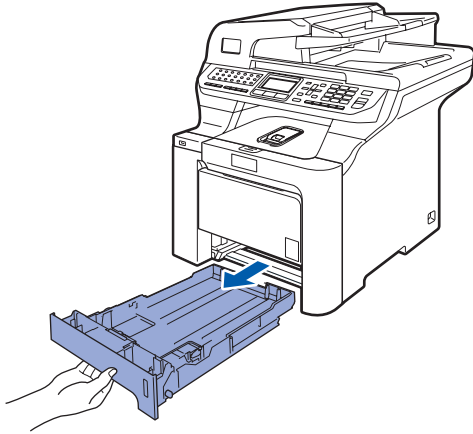

- 2 While pressing the green paper-guide release lever (1), slide the paper guides to fit the paper size. Make sure that the guides are firmly in the slots.

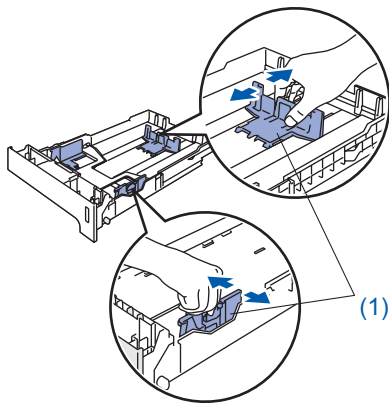

- 3 Fan the stack of paper well to avoid paper jams and misfeeds.

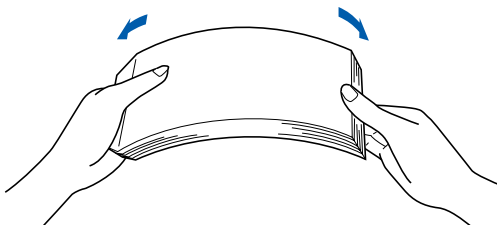

- 4 Put paper in the paper tray. Make sure that the paper is flat in the tray and below the maximum paper mark.

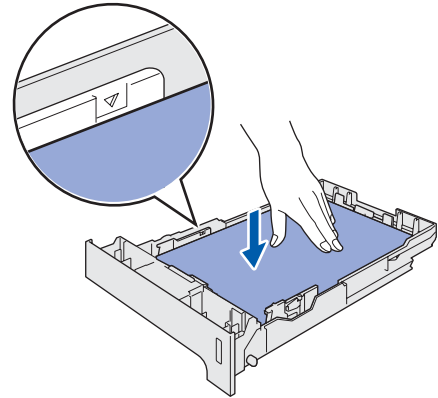

- 5 Put the paper tray firmly back into the machine.

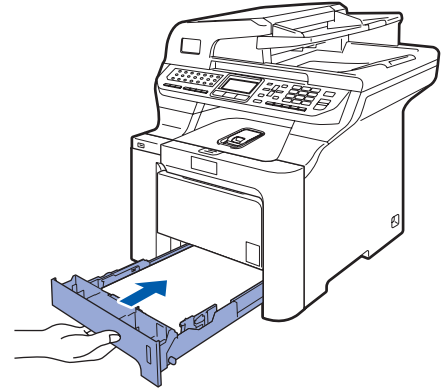

4 Release the Scanner Lock

- 1 Push the lever (1) in the direction shown to unlock the scanner.
(The grey scanner lock lever is located at the back left side, under the document cover (2))

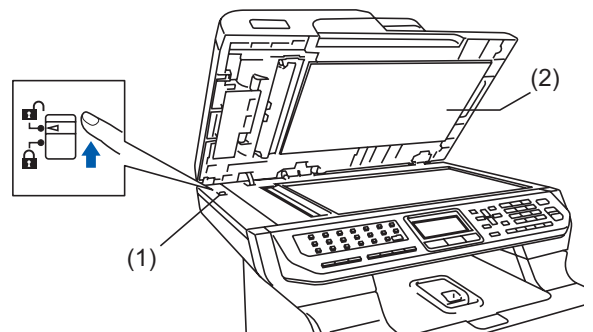

5 Install the power cord and phone line

- 1 Make sure that the machine's power switch is off. Remove the label covering the AC power inlet.

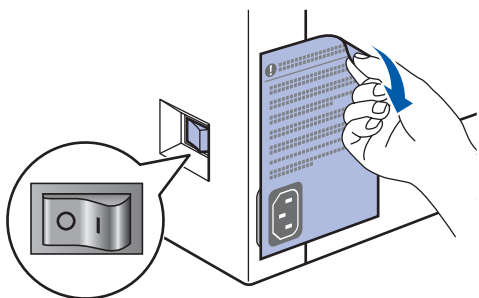

- 2 Connect the AC power cord to the machine.

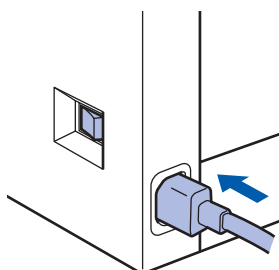

- 3 Plug the AC power cord into an AC outlet. Turn the power switch on.



- 4 Connect one end of the telephone line cord to the socket on the machine marked **LINE** and the other end to a modular wall socket.

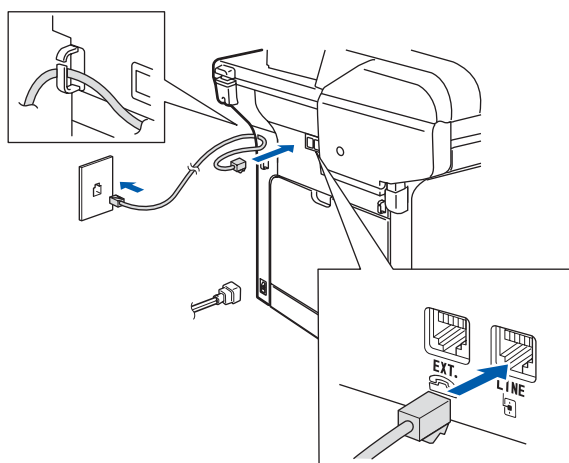

Warning

- The machine must be fitted with an earthed plug.
- Since the machine is grounded through the power outlet, you can protect yourself from potentially hazardous electrical conditions on the telephone network by keeping the power cord connected to your machine when you connect it to a telephone line. Similarly, you can protect yourself when you want to move your machine by disconnecting the telephone line first and then the power cord.

Note

If you are sharing one phone line with an external telephone, connect it as shown below.

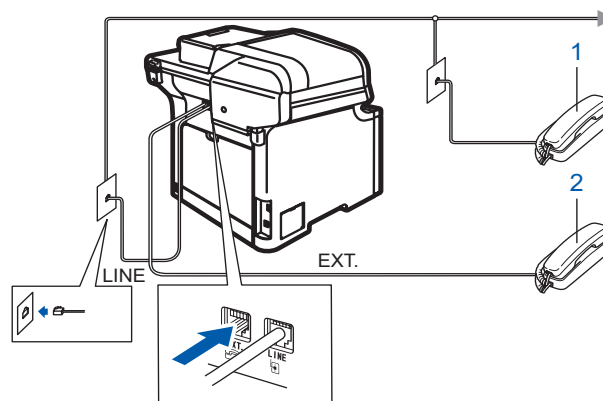

- 1 Extension telephone
- 2 External telephone

Note

If you are sharing one phone line with an external telephone answering device, connect it as shown below.

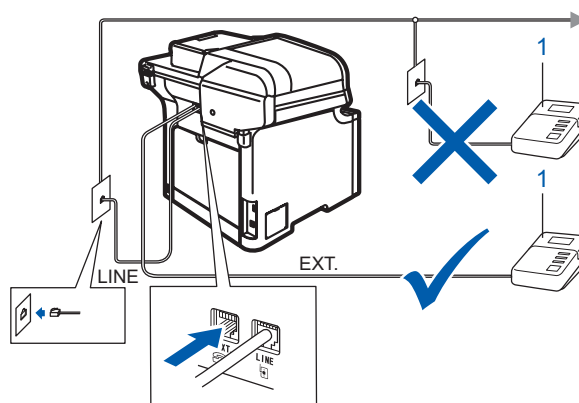

- 1 TAD



Please set the receive mode to *External TAD*.
For more details, see *Selecting a receive mode* on page 10 and *Connecting an external TAD* in Chapter 7 of the User's Guide.

6 Setting the date and time

The machine displays the date and time, and if you set up the station ID it will add it to each fax you send.

- 1 Press **Menu**.
- 2 Press **0**.
- 3 Press **2**.
- 4 Enter the last two digits of the year on the dial pad, and then press **OK**.

02.Date&Time 25/03/2008
Year:2008
Enter & OK Key

(e.g. Enter **0, 8** for 2008.)

- 5 Enter the two digits for the month on the dial pad, and then press **OK**.

02.Date&Time XX/XX/2008
Month:03
Enter & OK Key

(e.g. Enter **0, 3** for March.)

- 6 Enter the two digits for the day on the dial pad, and then press **OK**.

02.Date&Time XX/03/2008
Day:25
Enter & OK Key

(e.g. Enter **2, 5**.)

- 7 Enter the time in 24-hour format on the dial pad, and then press **OK**.

02.Date&Time 25/03/2008
Time:15:25
Enter & OK Key

(e.g. Enter **1, 5, 2, 5** for 3:25 P.M.)

- 8 Press **Stop/Exit**.



Note

If you make a mistake, press **Stop/Exit** to start from step 1.

7 Setting your station ID

You should store your name and fax number to be added on all fax pages that you send.

- 1 Press **Menu**.
- 2 Press **0**.
- 3 Press **3**.
- 4 Enter your fax number (up to 20 digits) on the dial pad, and then press **OK**.

```

03.Station ID
      Fax: _
Enter & OK Key
    
```

- 5 Enter your tel number (up to 20 digits) on the dial pad, and then press **OK**. To enter a "+" for international dialling codes, press *. For example, to enter the China dialling code "+86", press *, **8**, **6**, and then the rest of your number.

```

03.Station ID
      Fax: +86XXXXXXXXX
      Tel: _
Enter & OK Key
    
```

- 6 Use the dial pad to enter your name (up to 20 characters), and then press **OK**.

```

03.Station ID
      Fax: +86XXXXXXXXX
      Tel: +86XXXXXXXXX
      Name: _
Enter & OK Key
    
```



Note

- Refer to the following chart for entering your name.
- If you need to enter a character that is on the same key as the previous character, press **→** to move the cursor to the right.
- If you entered a letter incorrectly and want to change it, press **←** to move the cursor to the incorrect character, press **Clear/Back**.

Press key	One time	Two times	Three times	Four times	Five times
2	A	B	C	2	A
3	D	E	F	3	D
4	G	H	I	4	G
5	J	K	L	5	J
6	M	N	O	6	M
7	P	Q	R	7	P
8	T	U	V	8	T
9	W	X	Y	9	W



For more details, see *Entering text* on page 48.

- 7 Press **Stop/Exit**.

8 Tone and pulse dialling mode



Your machine comes set for Tone dialling service. If you have Pulse dialling service (rotary), you need to change the dialling mode.

- 1 Press **Menu**.
- 2 Press **0**.
- 3 Press **4**.
- 4 Press **▲** or **▼** to select Pulse (or Tone). Press **OK**.
- 5 Press **Stop/Exit**.

9 Selecting a receive mode

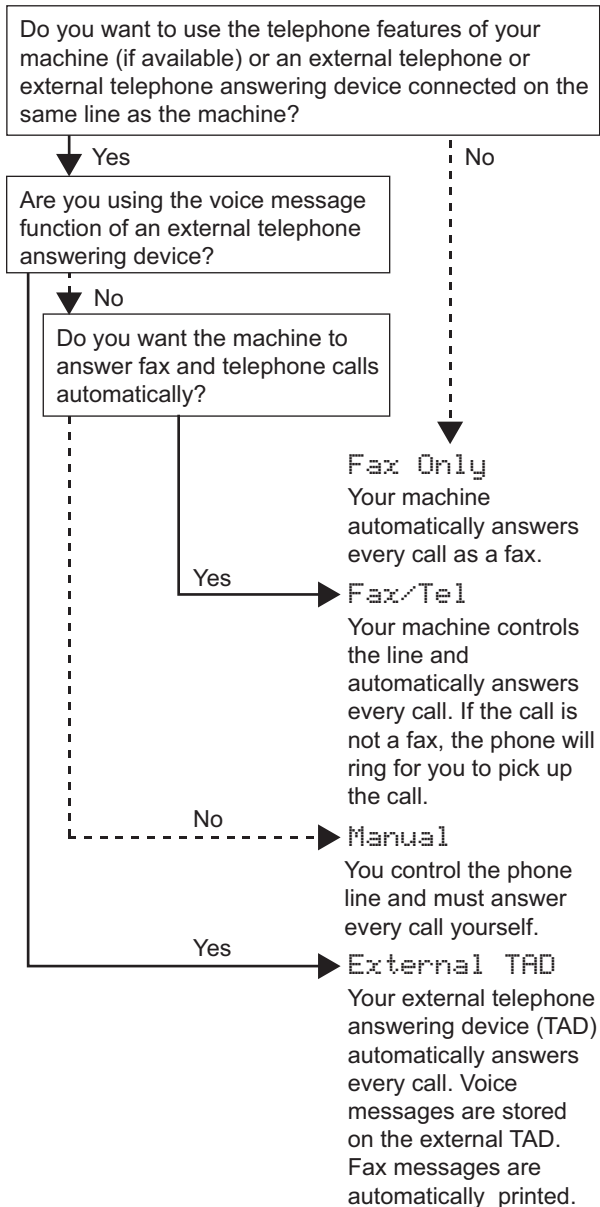
There are four possible receive modes: *Fax Only*, *Fax/Tel*, *Manual* and *External TAD*. Choose the *Receive Mode* which best suits your needs.





- 1 Press **Menu**.
- 2 Press **0**.
- 3 Press **1**.
- 4 Press  or  to select the mode. Press **OK**.
- 5 Press **Stop/Exit**.

 For more details, see *Receiving a fax* in Chapter 6 of the *User's Guide*.

10 Dial Prefix

The dial prefix setting will automatically dial a predefined number before every fax number you dial. For example: If your phone system requires a 9 to dial an outside number this setting will automatically dial 9 for every fax you send.

- 1 Press **Menu**.
- 2 Press **0**.
- 3 Press **6**.
- 4 Press  or  to choose *On* or *Off* and press **OK**.

Do one of the following:

- If you chose *On*, go to step 5.
- If you chose *Off*, go to step 7.

- 5 Press **1** or **2** to choose *1. Change* or *2. Exit*. Do one of the following:
 - If you chose *1. Change*, go to step 6.
 - If you chose *2. Exit*, go to step 7.



Note

The default setting is "9".

- 6 Enter the prefix number (up to 5 digits) on the dial pad, and then press **OK**.



Note

- You can use numbers 0 to 9, #, and !. (Press **Hook** to display "!".)
- You cannot use ! with any other numbers or characters.
- If the pulse dialing mode is on, # and * are not available to use.

- 7 Press **Stop/Exit**.

11 Setting the LCD contrast

You can change the contrast to help the LCD look lighter or darker.

1 Press **Menu**.

2 Press **1**.

3 Press **7**.

4 Press  to increase the contrast.

—OR—

Press  to decrease the contrast.

Press **OK**.

5 Press **Stop/Exit**.

Supplied CD-ROM 'MFL-Pro Suite'

Windows®

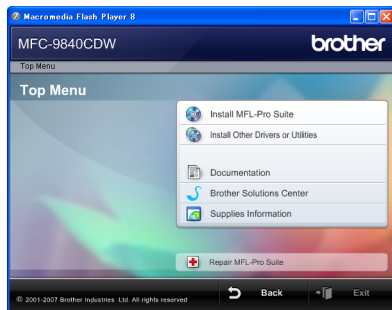

Install MFL-Pro Suite

You can install the MFL-Pro Suite software and multifunction drivers.

Install Other Drivers or Utilities

You can install additional MFL-Pro Suite software utilities, install without Presto!® PageManager® or install the driver only.

Documentation

View the User's Guide, Software User's Guide and Network User's Guide in HTML format. You can also view the manuals in PDF format by accessing the Brother Solutions Center. (Internet access required) The Software User's Guide and Network User's Guide include instructions for features available when connected to a computer. (eg. printing, scanning and networking details)

Brother Solutions Center

Access the Brother Solutions Center for FAQs, User's Guide, driver updates and tips for using your machine. (Internet access required)

Supplies Information

Visit our site for original/genuine Brother supplies at <http://www.brother.com/original/>.

Repair MFL-Pro Suite (For USB users only)

If an error occurred during the installation of the MFL-Pro Suite, use this selection to automatically repair and re-install the MFL-Pro Suite.

Note

MFL-Pro Suite includes the Printer Driver, Scanner Driver, Brother ControlCenter3 and Presto!® PageManager®. Presto!®

PageManager® is a document management application for scanning and viewing documents.

Macintosh®



Start Here OSX

You can install the MFL-Pro Suite that includes the printer driver, scanner driver, the Brother ControlCenter2 and BRAdmin Light for Mac OS® X 10.2.4 or greater.

Documentation

View the User's Guide, Software User's Guide and Network User's Guide in HTML format. You can also view the manuals in PDF format by accessing the Brother Solutions Center. (Internet access required) The Software User's Guide and Network User's Guide include instructions for features available when connected to a computer. (eg. printing, scanning and networking details)

Brother Solutions Center

Access the Brother Solutions Center for FAQs, User's Guide, driver updates and tips for using your machine. (Internet access required)

Presto! PageManager

You can install Presto!® PageManager® to add OCR capability to the Brother ControlCenter2 and easily scan, share and organize photos and documents.

Utilities

You can find the following additional Utilities from this folder.

- Wireless Device Setup Wizard
- Presto!® PageManager® Uninstaller
- BRAdmin Light

STEP 2

Installing the Driver & Software

Follow the instructions on this page for your operating system and interface.
For the latest drivers, documentation, and to find the best solution for your problem, access the Brother Solutions Center directly from the CD-ROM / Driver or visit <http://solutions.brother.com>.

Windows®



For USB Interface Cable Users 14



For Wired Network Interface Users 17
For Windows Server® 2003, see Chapter 5 of the Network User's Guide



For Wireless Network Interface Users (in infrastructure mode) 22
For other setup methods supported, see the Network User's Guide on the CD-ROM for installation details.

Macintosh®



For USB Interface Cable Users 32



For Wired Network Interface Users 34



For Wireless Network Interface Users (in infrastructure mode) 37
For other setup methods supported, see the Network User's Guide on the CD-ROM for installation details.

For USB Interface Cable Users (For Windows® 2000 Professional/XP/ XP Professional x64 Edition/Windows Vista™)

Important

Make sure that you have finished the instructions from step 1 *Setting Up the Machine* on pages 4 through 11.

Note

- Please close any applications running before installing the MFL-Pro Suite.
- The supplied CD-ROM includes Presto!® PageManager®. This software supports Windows® 2000 (SP4 or greater), XP (SP2 or greater), XP Professional x64 Edition and Windows Vista™ only. Please update to the latest Windows® Service Pack before installing MFL-Pro Suite.

- 1 Turn off and unplug the machine from the AC outlet and disconnect it from your computer, if you already connected an interface cable.

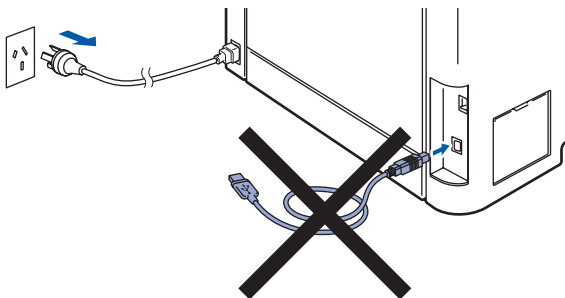

- 2 Turn on your computer. (You must be logged on with administrator rights.)
- 3 Put the supplied CD-ROM for Windows® into your CD-ROM drive. If the model name screen appears, choose your machine. If the language screen appears, choose your language.

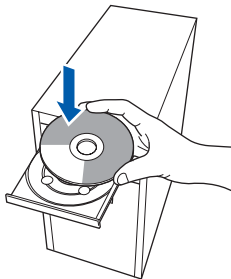

- 4 The CD-ROM main menu will appear. Click **Install MFL-Pro Suite**.



Note

- If this window does not appear, use Windows® Explorer to run the **start.exe** program from the root folder of the Brother CD-ROM.
- For Windows Vista™, when the User Account Control screen appears, click **Allow**.

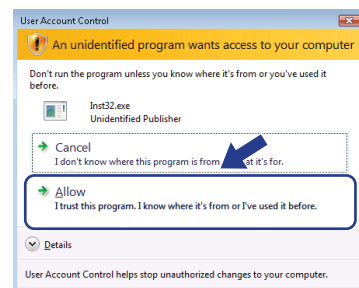

- 5 Choose **Local Connection (USB)**, and then click **Next**. The installation will continue.

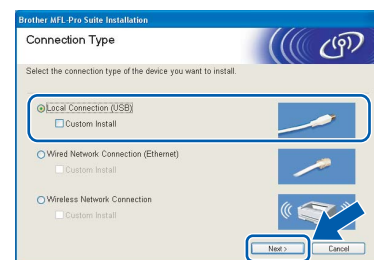

Note

If you want to install the PS driver (Brother's BR-Script Driver), choose **Custom Install** and then follow the on-screen instructions. When the **Select Features** screen appears, check **PS Printer Driver**, and then continue following the on-screen instructions.

- 6** After reading and accepting the Presto!® PageManager® License Agreement, click **Yes**.

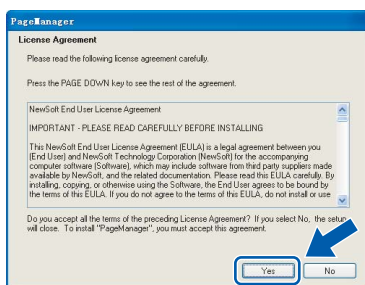

The installation of Presto!® PageManager® will automatically start and is followed by the installation of MFL-Pro Suite.

- 7** When the Brother MFL-Pro Suite Software License Agreement window appears, click **Yes** if you agree to the Software License Agreement.

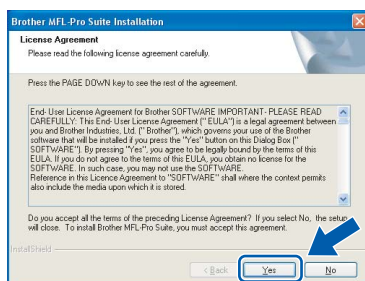

Note

For Windows Vista™, when this screen appears, click the check box and click **Install** to complete the installation properly.

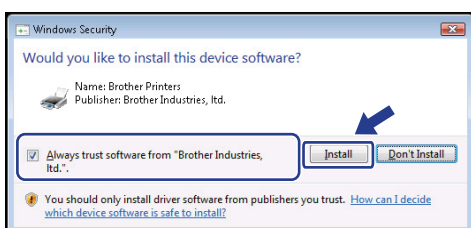

- 8** When this screen appears, remove the label covering the USB port on the machine. Connect the interface cable to your computer, and then connect it to the machine.

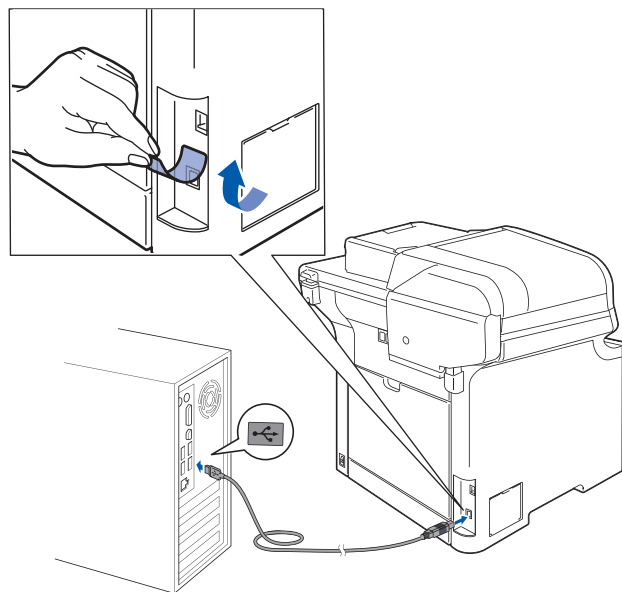
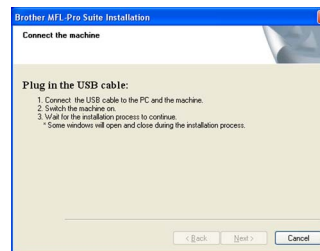

Improper Setup

DO NOT connect the machine to a USB port on a keyboard or a non-powered USB hub. Brother recommends that you connect the machine directly to your computer.

- 9** Plug the AC power cord into an AC outlet. Turn the power switch on.



The installation of the Brother drivers will automatically start. **The installation screens appear one after another, please wait for a while.**

Improper Setup

DO NOT try to cancel any of the screens during this installation.

- 10** When the On-Line Registration screen is displayed, make your selection and follow the on-screen instructions.

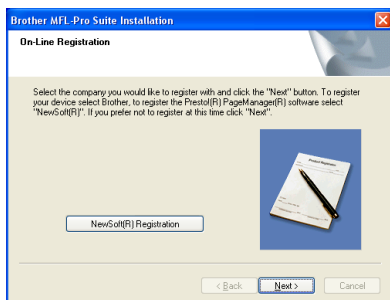

- 11** Click **Finish** to restart your computer. (After restarting the computer, you must be logged on with Administrator rights.)

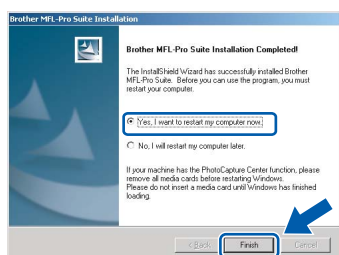

Note

- **XML Paper Specification Printer Driver**
The XML Paper Specification Printer Driver is the most suitable driver when printing from the applications that use the XML Paper Specification documents. Please download the latest driver by accessing the Brother Solutions Center at <http://solutions.brother.com>.
- After restarting the computer, the **Installation Diagnostics** will run automatically. If the installation is unsuccessful, the installation results window will be shown. If the **Installation Diagnostics** shows a failure, please follow the on-screen instruction or read the on-line help and FAQs in **Start/All Programs/ Brother/ MFC-XXXX**.



The MFL-Pro Suite (including printer driver and scanner driver) has been installed and the installation is now complete.

For Wired Network Interface Users (For Windows® 2000 Professional/XP/ XP Professional x64 Edition/Windows Vista™)

Important

Make sure that you have finished the instructions from step 1 *Setting Up the Machine* on pages 4 through 11.

Note

The supplied CD-ROM includes Presto!® PageManager®. This software supports Windows® 2000 (SP4 or greater), XP (SP2 or greater), XP Professional x64 Edition and Windows Vista™ only. Please update to the latest Windows® Service Pack before installing MFL-Pro Suite.

- 1 Turn off and unplug the machine from the AC outlet.
- 2 Connect the network interface cable to the machine, and then connect it to your network.

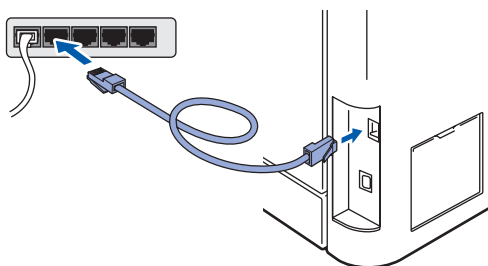

- 3 Plug the AC power cord into an AC outlet. Turn the power switch on.



- 4 Turn on your computer. (You must be logged on with Administrator rights.) Close any applications running before installing the MFL-Pro Suite.

Note

Before installation, if you are using personal firewall software, disable it. After the installation, restart your personal firewall software.

- 5 Put the supplied CD-ROM into your CD-ROM drive. If the model name screen appears, choose your machine. If the language screen appears, choose your language.

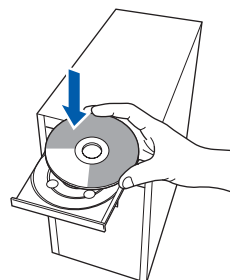

- 6 The CD-ROM main menu will appear. Click **Install MFL-Pro Suite**.

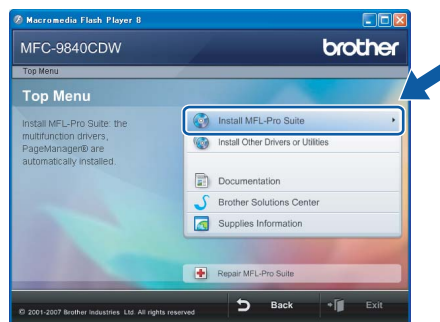

Note

- If this window does not appear, use Windows® Explorer to run the **start.exe** program from the root folder of the Brother CD-ROM.
- For Windows Vista™, when the User Account Control screen appears, click **Allow**.

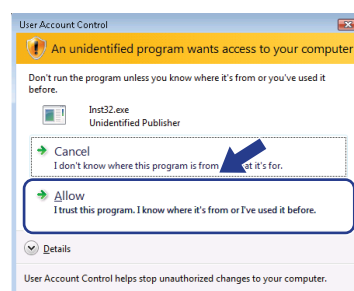

- 7** Choose **Network Connection (Ethernet)**, and then click **Next**.

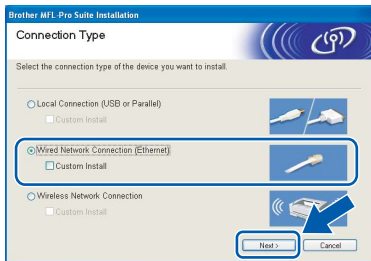

Note

If you want to install the PS driver (Brother's BR-Script Driver), choose **Custom Install** and then follow the on-screen instructions. When the **Select Features** screen appears, check **PS Printer Driver**, and then continue following the on-screen instructions.

- 8** After reading and accepting the Presto!® PageManager® License Agreement, click **Yes**.

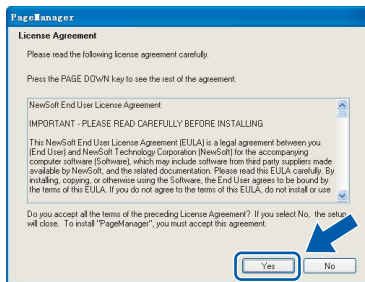

The installation of Presto!® PageManager® will automatically start and is followed by the installation of MFL-Pro Suite.

- 9** When the Brother MFL-Pro Suite Software License Agreement window appears, click **Yes** if you agree to the Software License Agreement.

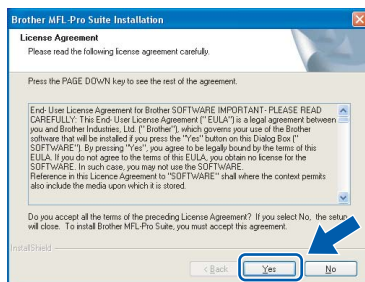

- 10** If the machine is configured for your network, choose the machine from the list, and then click **Next**. This window will not appear if there is only one machine connected to the network, it will be chosen automatically.

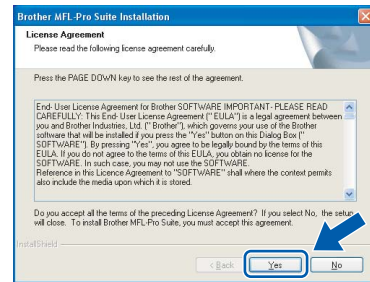

If your machine shows **APIPA** in the **IP Address Field**, click **Configure IP Address** and enter an IP address for your machine that is suitable for your network.

Note

If the machine is not yet configured for use on your network, the following screen appears.



Click **OK**. The **Configure IP Address** window will appear. Enter an IP address for your machine that is suitable for your network.

- 11** The installation of the Brother drivers will automatically start. **The installation screens appear one after another, please wait for a while.**

Improper Setup

DO NOT try to cancel any of the screens during this installation.

Note

For Windows Vista™, when this screen appears, click the check box and click **Install** to complete the installation properly.

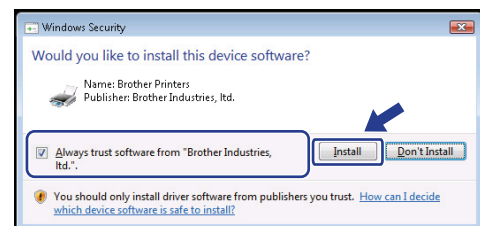

- 12** When the On-line Registration screen is displayed, make your selection and follow the on-screen instructions.

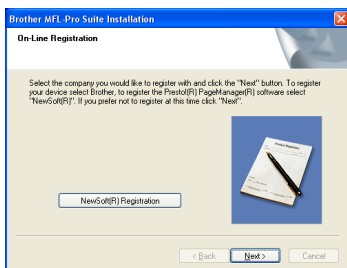

- 13** Click **Finish** to restart your computer.
(After restarting the computer, you must be logged on with Administrator rights.)

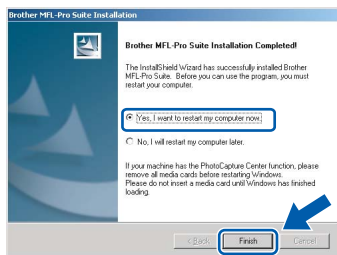

The MFL-Pro Suite has been installed and the installation is now complete.



Note

- **XML Paper Specification Printer Driver**
The XML Paper Specification Printer Driver is the most suitable driver when printing from the applications that use the XML Paper Specification documents. Please download the latest driver by accessing the Brother Solutions Center at <http://solutions.brother.com>.

- MFL-Pro Suite includes the Network Printer Driver, Network Scanner Driver, Brother ControlCenter3 and Presto!® PageManager® with OCR.

Presto!® PageManager® is a document management application for viewing scanned documents.

- After restarting the computer, the **Installation Diagnostics** will run automatically. If the installation is unsuccessful, the installation results window will be shown. If the **Diagnostics** shows a failure, please follow the on-screen instructions or read the on-line help and FAQ's in **Start/All Programs /Brother/MFC-XXXX**.
- Once you are sure that you can print after the installation, restart your firewall software.
- Firewall settings on your PC may reject the necessary network connection for Network Scanning and Printing.
Follow the instructions on the following page to configure your Windows® Firewall. If you are using personal firewall software, see the User's Guide for your software or contact the software manufacturer.

Firewall settings

Firewall settings on your PC may reject the necessary network connection for Network Scanning and Printing. If you are using the Windows® Firewall follow the instructions for Windows® XP SP2 or Windows Vista™. If you are using personal firewall software, see the User's Guide for your software or contact the software manufacturer.

■ For Windows® XP SP2 users:

- 1 Click the **Start** button, **Control Panel**, **Network and Internet Connections** and then **Windows Firewall**.
Make sure that Windows Firewall on the **General** tab is set to On.
- 2 Click the **Advanced** tab and **Settings...** button.

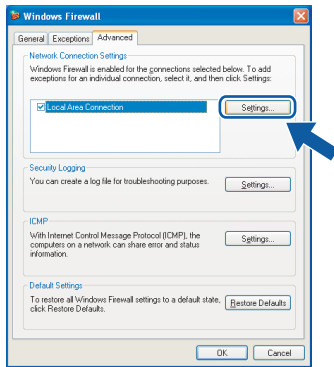

- 3 Click the **Add** button.
- 4 To add port **54925** for network scanning, enter the information below:
 1. In **Description of service**:
- Enter any description, for example "Brother Scanner".
 2. In **Name or IP address (for example 192.168.0.12) of the computer hosting this service on your network**:
- Enter "Localhost".
 3. In **External Port Number for this service**:
- Enter "54925".
 4. In **Internal Port number for this service**:
- Enter "54925".
 5. Make sure **UDP** is selected.
 6. Click **OK**.

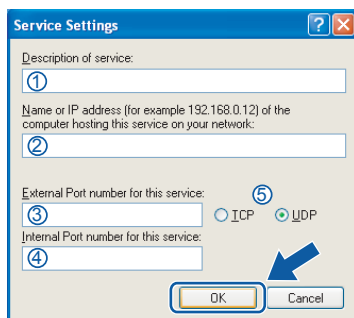

- 5 Click the **Add** button.
- 6 To add port **54926** for network PC-Fax, enter the information below:
 1. In **Description of service**:
- Enter any description, for example "Brother PC-Fax".
 2. In **Name or IP address (for example 192.168.0.12) of the computer hosting this service on your network**:
- Enter "Localhost".
 3. In **External Port Number for this service**:
- Enter "54926".
 4. In **Internal Port number for this service**:
- Enter "54926".
 5. Make sure **UDP** is selected.
 6. Click **OK**.
- 7 If you still have trouble with your network connection, click the **Add** button.
- 8 To add port **137** for network scanning, Network PC-Fax receiving and Network printing by entering the information below:
 1. In **Description of service**:
- Enter any description, for example "Brother Network Print".
 2. In **Name or IP address (for example 192.168.0.12) of the computer hosting this service on your network**:
- Enter "Localhost".
 3. In **External Port Number for this service**:
- Enter "137".
 4. In **Internal Port number for this service**:
- Enter "137".
 5. Make sure **UDP** is selected.
 6. Click **OK**.
- 9 Make sure that the new settings are added and checked, and then click **OK**.

■ **For Windows Vista™ users:**

- 1 Click the **Start** button, **Control Panel**, **Network and Internet**, **Windows Firewall** and click **change settings**.
Make sure that Windows Firewall on the **General** tab is set to On.
- 2 When the **User Account Control** screen appears, do the following.
 - For users who have administrator rights: Click **Continue**.

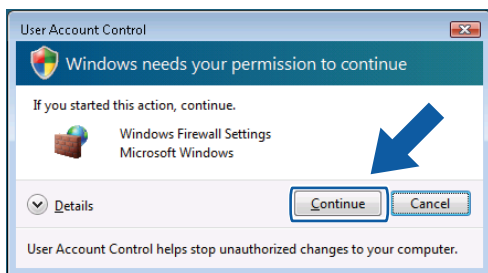

- For users who do not have administrator rights: Enter the administrator password and click **OK**.

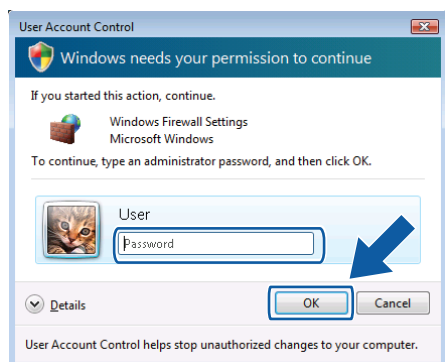

- 3 Make sure that Windows Firewall on the **General** tab is set to On.
- 4 Click the **Exceptions** tab.

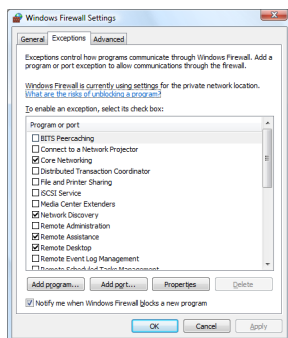

- 5 Click the **Add port...** button.

- 6 To add port **54925** for network scanning, enter the information below:

1. In **Name**: Enter any description, for example "Brother Scanner".
2. In **Port number**: Enter "54925".
3. Make sure **UDP** is selected. Then, click **OK**.

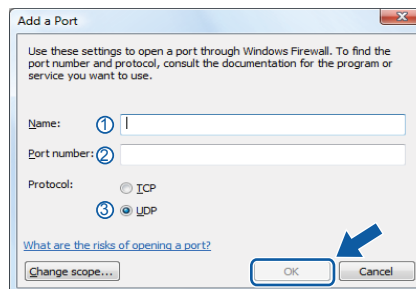

- 7 Click the **Add port...** button.
- 8 To add port **54926** for Network PC-Fax, enter the information below:
 1. In **Name**: Enter any description, for example "Brother PC-Fax".
 2. In **Port number**: Enter "54926".
 3. Make sure **UDP** is selected. Then, click **OK**.
- 9 Make sure that the new setting is added and is checked, and then click **OK**.
- 10 If you still have trouble with your network connection such as Network Scanning or Printing, check the **File and Printer Sharing** box in the Exceptions tab and then click **OK**.

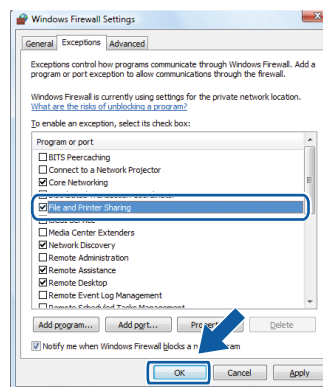

For Wireless Network Interface Users (For Windows® 2000 Professional/XP/ XP Professional x64 Edition/Windows Vista™) in infrastructure mode

Connecting your wireless machine and wireless network together and installing the printer driver in infrastructure mode

First you must configure the wireless network settings of your machine to communicate with your network access point (router). After the machine is configured to communicate with your access point (router) computers on your network will have access to the machine. To use the machine from these computers, you will need to install the MFL-Pro Suite. The following steps will guide you through the configuration and installation process.

To achieve optimum results with normal every day document printing, place the Brother machine as close to the network access point (router) as possible with minimal obstructions. Large objects and walls between the two devices as well as interference from other electronic devices can affect the data transfer speed of your documents.

Due to these factors, wireless may not be the best method of connection for all types of documents and applications. If you are printing large files, such as multi-page documents with mixed text and large graphics, you may want to consider choosing wired Ethernet for a faster data transfer, or USB for the fastest throughput speed.

Important

The following instructions will offer two methods for installing your Brother machine in a wireless network environment. Both methods are for infrastructure mode, using a wireless router or access point that uses DHCP to assign IP addresses. If your wireless router/access point supports SecureEasySetup™ follow the steps on page 24 *Using the SecureEasySetup™ software to configure your machine for a wireless network*. If your wireless router/access point does not support SecureEasySetup™ follow the steps on page 25 *Using the Setup Wizard from the control panel LAN menu for wireless network configuration*. To set up your machine in any other wireless environment you can find instructions in the Network User's Guide on the CD-ROM.

You can view the Network User's Guide by following the instructions below.

- 1 Turn on your computer. Insert the Brother CD-ROM into your CD-ROM drive.
- 2 If the language screen appears, click your language. The CD-ROM main menu will appear.
- 3 Click the **Documentation**.
- 4 Click the **HTML documents**.
- 5 Click the **NETWORK USER'S GUIDE**.

Note

- If you are going to connect the printer to your network, we recommend that you contact your system administrator prior to installation.
- If you are using personal firewall software (e.g. Windows® Firewall), disable it. Once you are sure that you can print, restart your personal firewall software.

Confirm your network environment

The setup process will be different depending on your network environment.

■ Installation using SecureEasySetup™ .

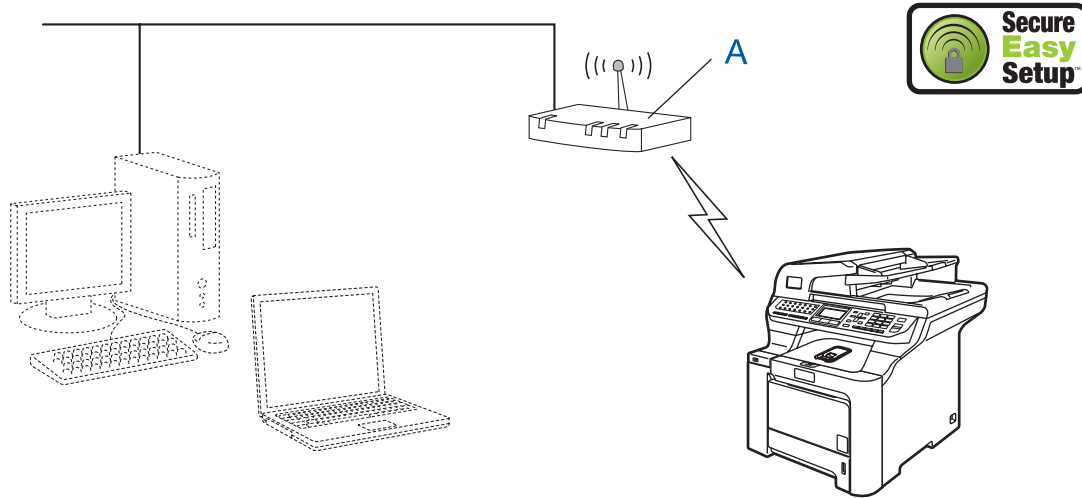

If your wireless access point (A) supports SecureEasySetup™ , you do not need to use a computer to configure the machine. The access point (router) and your machine can automatically negotiate using the SecureEasySetup™ procedure.
For instructions, go to page 24.

■ Infrastructure Mode

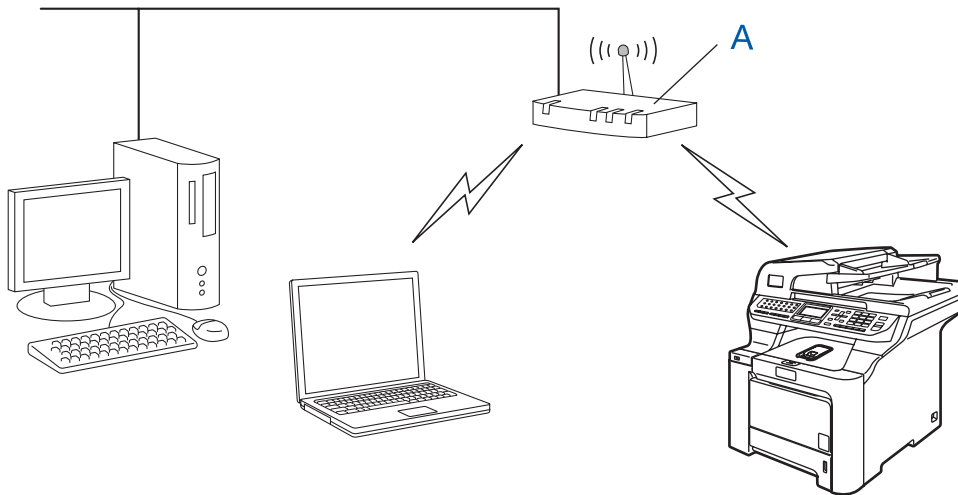

If your wireless access point (A) does not support SecureEasySetup™ , follow the instructions, on page 25.

Using the SecureEasySetup™ software to configure your machine for a wireless network

The SecureEasySetup™ software allows you to configure the wireless network easier than configuring it manually. By pushing a button on the wireless router or access point, you can setup the wireless network and security settings. Your router or access point must also support SecureEasySetup™. See the user's guide for your wireless LAN router or access point for instructions to configure your machine for a wireless network. If your wireless router or access point does not support SecureEasySetup™ go to the next page for installation instructions.

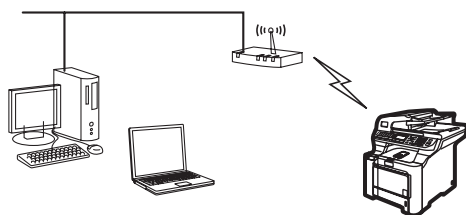

Note

Routers or access points that support SecureEasySetup™ have the SecureEasySetup™ symbol as shown below.



- 1 Plug the AC power cord into an AC outlet. Turn the power switch on.



⊘ Improper Setup

If you have previously configured the wireless settings of the machine you must reset the network (LAN) settings before you can configure the wireless settings again. Press **Menu, 7, 2, 5** (or **Menu, 7, 0**) and then press **1** to accept the change.

- 2 Place the Brother machine close to the SecureEasySetup™ router or access point.

- 3 Push the SecureEasySetup™ button on your wireless router or access point. See the user's guide for your wireless router or access point for instructions.
- 4 Press **Menu, 7, 2, 3** on the control panel of the Brother machine.

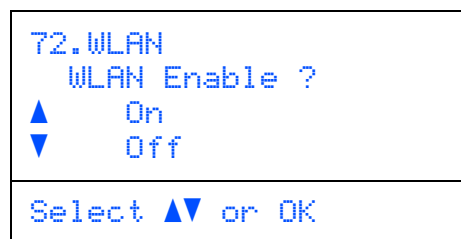

Press or to choose On, then press **OK**. The wired network interface will become inactive with this setting.

- 5 The wireless network connection status using the SecureEasySetup™ software will be displayed: Connecting WLAN, Connected or Connection error.

Connecting WLAN is displayed when the print server is trying to make connections to your router or access point. Wait till either Connected or Connection error is displayed.

Connected is displayed when the print server is successfully connected to your router or access point. You can now use your machine in a wireless network.

Connection error is displayed when the print server has not successfully connected to your router or access point. Try starting from step 2 again. If the same message is displayed again, reset the print server back to the default factory settings and try again. (See *Restoring the network settings to factory default* on page 47.)



Wireless setup is now complete. To install the MFL-Pro suite, continue to step 14 on page 27.

Using the Setup Wizard from the control panel LAN menu for wireless network configuration

Important

Make sure that you have finished the instructions from step 1 *Setting Up the Machine* on pages 4 through 11.

These instructions will install your Brother machine in a typical small office or home wireless network environment in infrastructure mode, using a wireless router or access point that uses DHCP to assign IP addresses.

If you want to setup your machine in any other wireless environment you can find instructions in the Network User's Guide on the CD-ROM.

You can view the Network User's Guide by following the instructions below.

- 1 Turn on your PC. Insert the Brother CD-ROM labeled Windows® into your CD-ROM drive.
- 2 If the language screen appears, click your language. The CD-ROM main menu will appear.
- 3 Click **Documentation**.
- 4 Click the **HTML document**.
- 5 Click the **Network User's Guide**.

Note

If the window does not appear, use Windows® Explorer to run the setup.exe program from the root directory of the Brother CD-ROM.

For example:

64-bit	Uses 5 text characters.
ASCII:	e.g. "Hello" (this is case sensitive)
64-bit	Uses 10 digits of hexadecimal data.
Hexadecimal:	e.g. "71f2234aba"
128-bit	Uses 13 text characters.
ASCII:	e.g. "Wirelesscomms" (this is case sensitive)
128-bit	Uses 26 digits of hexadecimal data.
Hexadecimal:	e.g. "71f2234ab56cd709e5412aa3ba"

WPA-PSK enables a Protected Access Pre-shared key that allows the Brother wireless machine to associate with access points using TKIP and AES encryption. WPA-PSK uses a Pre-Shared Key that is 8 or more characters in length, up to a maximum of 63 characters. See Chapter 3 of the Network User's Guide for more details.



Before you begin you must know your wireless network settings.

- 1 Write down the wireless network settings of your access point or wireless router.
SSID (Service Set ID or Network name)

WEP Key (if needed)

WPA-PSK (if needed)

The WEP key is for 64-bit encrypted networks or 128-bit encrypted networks and can contain both numbers and letters. If you do not know this information you should see the documentation provided with your access point or wireless router. This key is a 64-bit or 128-bit value that must be entered in an ASCII or HEXADECIMAL format.

- 2** Plug the AC power cord into an AC outlet. Turn the power switch on.



⊘ Improper Setup

If you have previously configured the wireless settings of the machine you must reset the network (LAN) settings before you can configure the wireless settings again. Press Menu, 7, 2, 5 (or Menu, 7, 0) and then press 1 to accept the change.

- 3** On your machine, press **Menu, 7, 2, 2**.

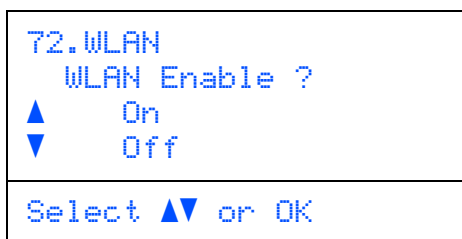

Press or to choose On, then press **OK**. The wired network interface will become inactive with this setting.

- 4** The machine will search for your network and display a list of available SSIDs. You should see the SSID you wrote down earlier. If the machine finds more than one network use the or keys to choose your network, then press **OK**. Go to step 8.

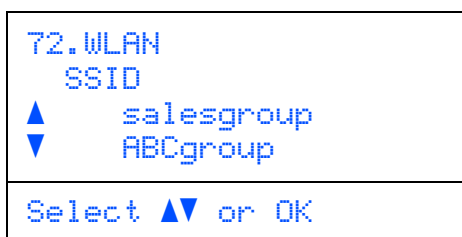

Note

It will take several seconds to display a list of available SSIDs.

If your access point is set to not broadcast the SSID you will have to manually add the SSID name. Go to step 5.

- 5** Select <New SSID> using or and press **OK**. Go to step 6.

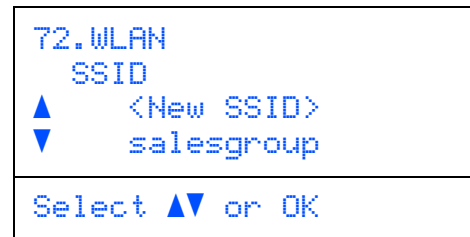

- 6** Enter a new SSID and press **OK**. For information how to type text, see *Entering text* on page 48.

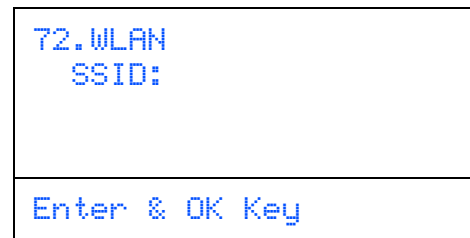

- 7** Press or to choose Infrastructure, then press **OK**.

- 8** Use the , and **OK** keys to choose one of the options below: If your network is configured for Authentication and Encryption you must match the settings used for your network.

No Authentication or Encryption: Choose Open System, press **OK** then choose None for Encryption Type and press **OK**. Then press or to choose 1. Yes and press **OK** to apply your settings. Go to step 12.

No Authentication with WEP Encryption: Choose Open System, press **OK** then use the or to choose WEP for the Encryption Type and press **OK**. Go to step 9.

Authentication with WEP Encryption: Choose Shared Key, press **OK**. Go to step 9.

Authentication with WPA-PSK (TKIP or AES Encryption): Choose WPA/WPA2-PSK, press **OK**. Go to step 10.

Authentication with LEAP: Choose LEAP, press **OK**. Go to step 11.

- 9** Choose the appropriate key number and press **OK**.

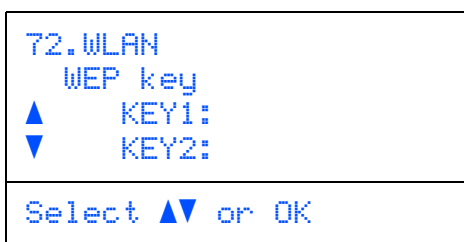

Enter the WEP key you wrote down in step 1 using the dial pad. You can use the **←** and **→** keys to move the cursor. For example, to enter the letter a, press the **2** key on the dial pad once. To enter the number 3, press the **3** key on the dial pad seven times.

The letters appear in this order: lower case, upper case and numbers.

Press **OK** when you have entered all the characters, then choose **1. Yes** and press **OK** to apply your settings. Go to step 12.

Most access points and routers can store more than one key, but they will only use one at any time for authentication and encryption.

- 10** Press **▲** or **▼** to choose TKIP or AES for Encryption Type and press **OK**. Enter the WPA-PSK Password you wrote down in step 1 using the dial pad. You can use the **←** and **→** keys to move the cursor. For example, to enter the letter a, press the **2** key on the dial pad once. To enter the number 3, press the **3** key on your dial pad seven times.

Press **OK** when you have entered all the characters, then choose **1. Yes** and press **OK** to apply your settings. Go to step 12.

- 11** Enter the user and press **OK**. You can use **←** and **→** keys to move the cursor. For example, to enter the letter a, press the **2** key on the dial pad once.

Enter the password and press **OK**, and then choose **1. Yes** and press **OK** to apply your settings. Go to step 12.
(Use the chart on *Entering text* on page 48.)

- 12** Your machine will now try to connect to your wireless network using the information you have entered. If successful, *Connected* will appear briefly on the LCD.

Connection error is displayed when the print server has not successfully connected to your router or access point. Try starting from step 3 again. If the same message is displayed again, reset the print server back to the default factory settings and try again. (See *Restoring the network settings to factory default* on page 47.)

- 13** The machine will automatically acquire the correct TCP/IP address information from your access point (router) if DHCP is enabled (DHCP is normally enabled as default for most access point routers).

If your access point does not have DHCP enabled you will need to manually configure the IP address, subnet mask and gateway of the machine to suit your network. See the Network User's Guide for details.

- OK!** **Wireless setup is now complete. To install the MFL-Pro Software suite, continue to step 14.**

Note

The supplied CD-ROM includes the Presto!® PageManager®. This software supports Windows® 2000 (SP4 or greater), XP (SP2 or greater), XP Professional x64 Edition and Windows Vista™ only. Please update to the latest Windows® Service Pack before installing MFL-Pro Suite.

- 14** Turn on your computer. (You must be logged on with Administrator rights.) Close any applications running before installing the MFL-Pro Suite.

Note

Before installation, if you are using personal firewall software, disable it. After the installation, restart your personal firewall software.

- 15** Put the supplied CD-ROM into your CD-ROM drive. If the model name screen appears, choose your machine. If the language screen appears, choose your language.

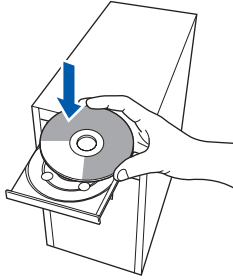

- 16** The CD-ROM main menu will appear. Click **Install MFL-Pro Suite**.



Note

- If this window does not appear, use Windows® Explorer to run the **start.exe** program from the root folder of the Brother CD-ROM.
- For Windows Vista™, when the User Account Control screen appears, click **Allow**.

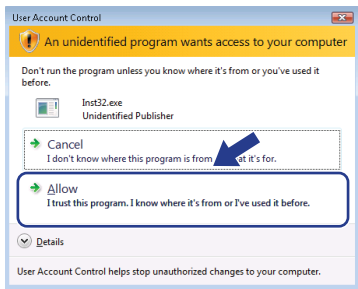

- 17** Choose **Wireless Network Connection**, and then click **Next**.

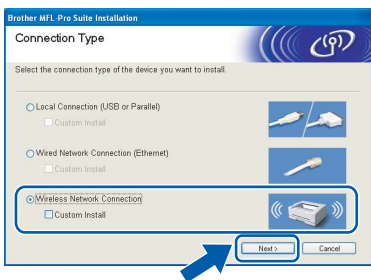

Note

If you want to install the PS driver (Brother's BR-Script Driver), choose **Custom Install** and then follow the on-screen instructions. When the **Select Features** screen appears, check **PS Printer Driver**, and then continue following the on-screen instructions.

- 18** Click on the **Checked and confirmed** check box, and then click **Next**. Follow the on screen instructions.

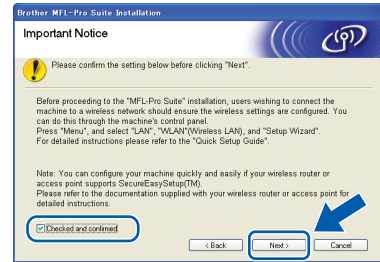

- 19** After reading and accepting the Presto!® PageManager® License Agreement, click **Yes**.

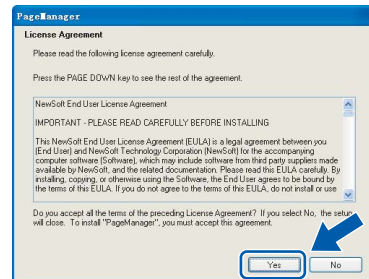

The installation of Presto!® PageManager® will automatically start and is followed by the installation of MFL-Pro Suite.

- 20** When the Brother MFL-Pro Suite Software License Agreement window appears, click **Yes** if you agree to the Software License Agreement.



Windows®
Wireless
Network

21 If the machine is configured for your network, choose the machine from the list, and then click **Next**. This window will not appear if there is only one machine connected on the network, it will be chosen automatically.

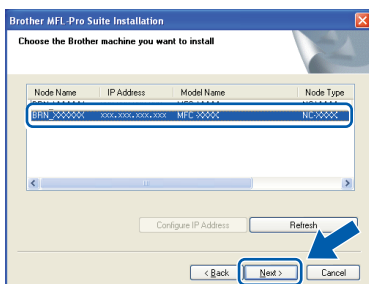

If your machine shows **APIPA** in the **IP Address** field, click **Configure IP Address** and enter an **IP address** for your machine that is suitable for your network.



Note

If the machine is not yet configured for use on your network, the following screen appears.

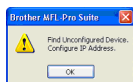

Click **OK**.

The **Configure IP Address** window will appear. Enter an **IP address** for your machine that is suitable for your network by following the on-screen instructions.

22 The installation of the Brother drivers will automatically start. **The installation screens appear one after another, please wait for a while.**

Improper Setup

DO NOT try to cancel any of the screens during this installation.



Note

For Windows Vista™, when this screen appears, click the check box and click **Install**.

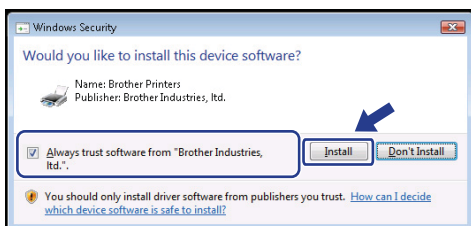

23 When the On-line Registration screen is displayed, make your selection and follow the on-screen instructions.

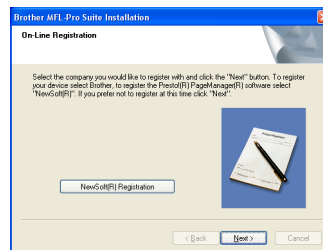

24 Click **Finish** to restart your computer. (You must be logged on with Administrator rights.)

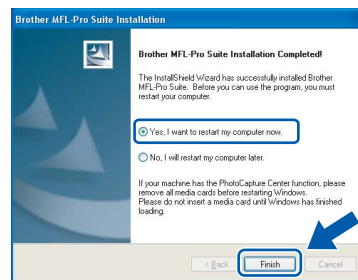

The MFL-Pro Suite has been installed and the installation is now complete.



Note

- **XML Paper Specification Printer Driver**
The XML Paper Specification Printer Driver is the most suitable driver when printing from the applications that use the XML Paper Specification documents. Please download the latest driver by accessing the Brother Solutions Center at <http://solutions.brother.com>.
- MFL-Pro Suite includes the Network Printer Driver, Network Scanner Driver, Brother ControlCenter3, Presto!® PageManager® and True Type® fonts.
Presto!® PageManager® is a document management application for viewing scanned documents.
- After restarting the computer, the **Installation Diagnostics** will run automatically. If the installation is unsuccessful, the installation results window will be shown. If the **Diagnostics** shows a failure, please follow the on-screen instructions or read the on-line help and FAQ's in **Start/All Programs/Brother/MFC-XXXX**.
- Once you are sure that you can print after the installation, restart your Firewall software.



- Firewall settings on your PC may reject the necessary network connection for Network Scanning and Printing. Follow the instructions on the following page to configure your Windows® Firewall. If you are using personal firewall software, see the User's Guide for your software or contact the software manufacturer.

Firewall settings

Firewall settings on your PC may reject the necessary network connection for Network Scanning and Printing. If you are using the Windows® Firewall follow the instructions for Windows® XP SP2 or Windows Vista™. If you are using personal firewall software, see the User's Guide for your software or contact the software manufacturer.

■ For Windows® XP SP2 users:

- 1 Click the **Start** button, **Control Panel**, **Network and Internet Connections** and then **Windows Firewall**. Make sure that Windows Firewall on the **General** tab is set to On.
- 2 Click the **Advanced** tab and **Settings...** button.

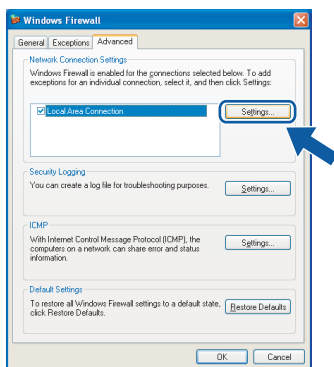

- 3 Click the **Add** button.
- 4 To add port **54925** for network scanning, enter the information below:
 1. In **Description of service**:
- Enter any description, for example "Brother Scanner".
 2. In **Name or IP address (for example 192.168.0.12) of the computer hosting this service on your network**:
- Enter "Localhost".
 3. In **External Port Number for this service**:
- Enter "54925".
 4. In **Internal Port number for this service**:
- Enter "54925".
 5. Make sure **UDP** is selected.
 6. Click **OK**.

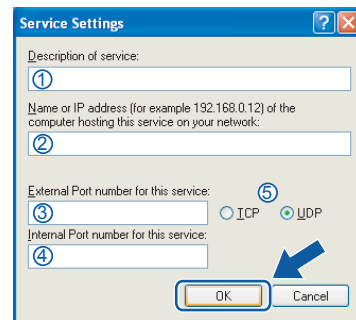

- 5 Click the **Add** button.
- 6 To add port **54926** for network PC-Fax, enter the information below:
 1. In **Description of service**:
- Enter any description, for example "Brother PC-Fax".
 2. In **Name or IP address (for example 192.168.0.12) of the computer hosting this service on your network**:
- Enter "Localhost".
 3. In **External Port Number for this service**:
- Enter "54926".
 4. In **Internal Port number for this service**:
- Enter "54926".
 5. Make sure **UDP** is selected.
 6. Click **OK**.
- 7 If you still have trouble with your network connection, click the **Add** button.
- 8 To add port **137** for network scanning, Network PC-Fax receiving and Network printing by entering the information below:
 1. In **Description of service**:
- Enter any description, for example "Brother Network Print".
 2. In **Name or IP address (for example 192.168.0.12) of the computer hosting this service on your network**:
- Enter "Localhost".
 3. In **External Port Number for this service**:
- Enter "137".
 4. In **Internal Port number for this service**:
- Enter "137".
 5. Make sure **UDP** is selected.
 6. Click **OK**.
- 9 Make sure that the new settings are added and checked, and then click **OK**.

■ **For Windows Vista™ users:**

1 Click the **Start** button, **Control Panel**, **Network and Internet**, **Windows Firewall** and click **change settings**.
Make sure that Windows Firewall on the **General** tab is set to On.

2 When the **User Account Control** screen appears, do the following.
■ For users who have administrator rights: Click **Continue**.

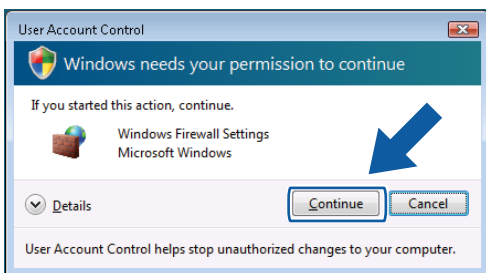

■ For users who do not have administrator rights: Enter the administrator password and click **OK**.

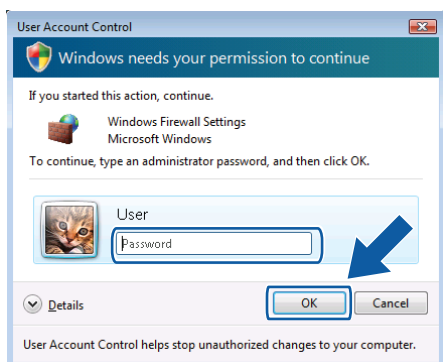

3 Make sure that Windows Firewall on the **General** tab is set to On.

4 Click the **Exceptions** tab.

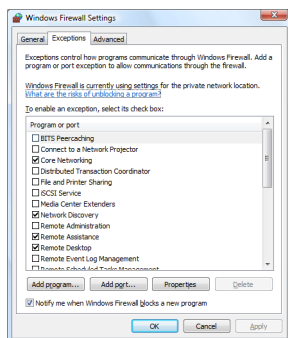

5 Click the **Add port...** button.

6 To add port **54925** for network scanning, enter the information below:

1. In **Name**: Enter any description, for example "Brother Scanner".
2. In **Port number**: Enter "54925".
3. Make sure **UDP** is selected. Then, click **OK**.

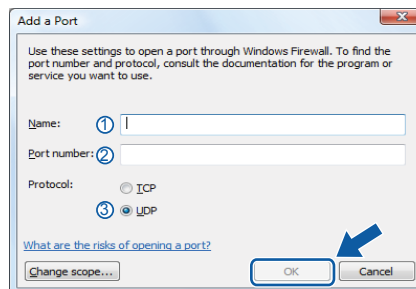

7 Click the **Add port...** button.

8 To add port **54926** for Network PC-Fax, enter the information below:

1. In **Name**: Enter any description, for example "Brother PC-Fax".
2. In **Port number**: Enter "54926".
3. Make sure **UDP** is selected. Then, click **OK**.

9 Make sure that the new setting is added and is checked, and then click **OK**.

10 If you still have trouble with your network connection such as Network Scanning or Printing, check the **File and Printer Sharing** box in the Exceptions tab and then click **OK**.

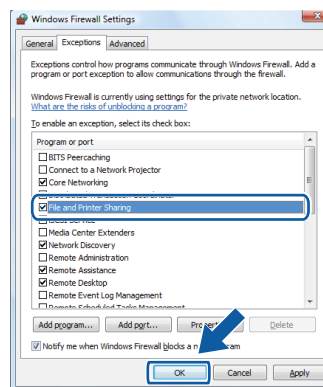

For USB Interface Cable Users

For Mac OS® X 10.2.4 or greater

Important

Make sure that you have finished the instructions from step 1 *Setting Up the Machine* on pages 4 through 11.

Note

For Mac OS® X 10.2.0 to 10.2.3 users, upgrade to Mac OS® X 10.2.4 or greater. (For the latest information for Mac OS® X, visit <http://solutions.brother.com>)

- 1 Remove the label covering the USB port on the machine. Connect the interface cable to your computer, and then connect it to the machine.

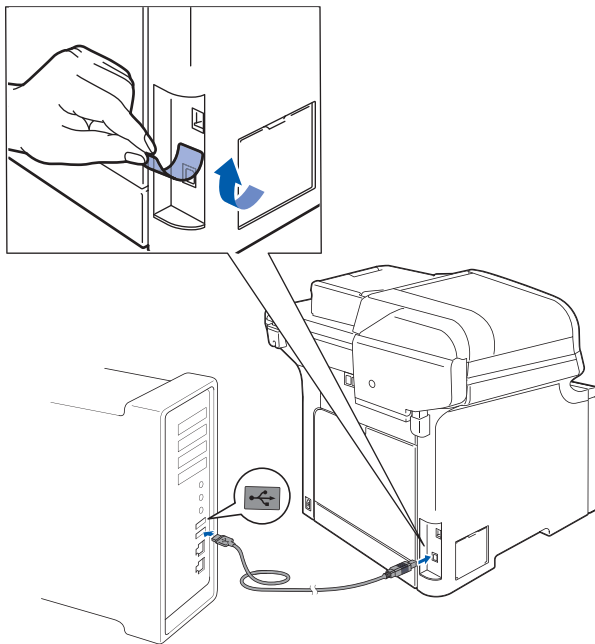
**Improper Setup**

DO NOT connect the machine to a USB port on a keyboard or a non-powered USB hub. Brother recommends that you connect the machine directly to your computer.

Note

Make sure that the machine is turned on by connecting the power cord.

- 2 Turn on your Macintosh®.

- 3 Put the supplied CD-ROM for Macintosh® into your CD-ROM drive.

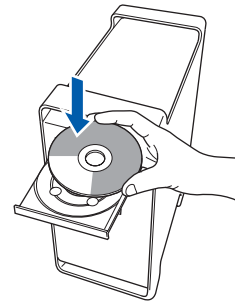

- 4 Double-click the **Start Here OSX** icon to install. Follow the on-screen instructions.

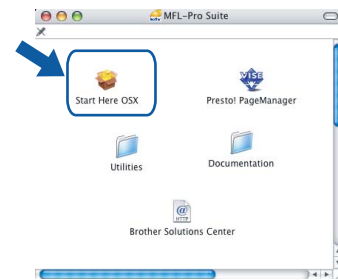
**Note**

Please see the *Software User's Guide* on the CD-ROM to install the PS driver.

- 5 Choose **Local Connection (USB)**, and then click **Next**. The installation will continue.

**Note**

Please wait, it will take a few seconds for the software to install. After the installation, click **Restart** to finish installing the software.

- 6 The Brother software will search for the Brother device. During this time the following screen will appear.

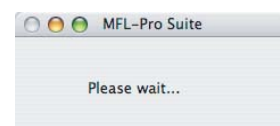

7 When this screen appears, click **OK**.



OK! For Mac OS® X 10.3.x or greater users: The MFL-Pro Suite, Brother printer driver, scanner driver and Brother ControlCenter2 have been installed and the installation is now complete. Go to step 12.

8 For Mac OS® X 10.2.4 to 10.2.8 users: Click **Add**.

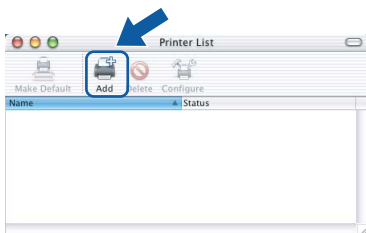

9 Choose **USB**.

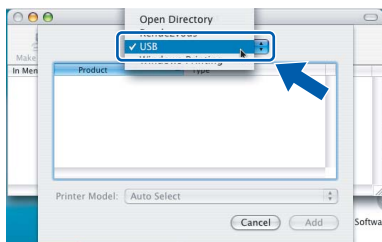

10 Choose your model name, and then click **Add**.

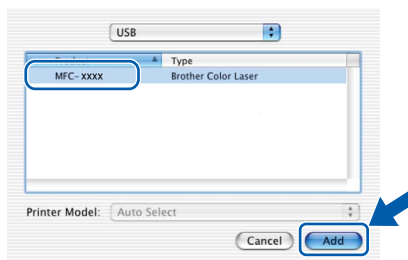

11 Click **Print Center**, then **Quit Print Center**.

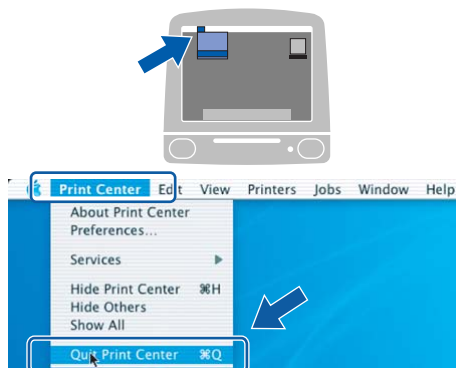

OK! The MFL-Pro Suite, Brother printer driver, scanner driver and Brother ControlCenter2 have been installed and the installation is now complete.

12 To install Presto!® PageManager®, double-click the **Presto! PageManager** icon and follow the on-screen instructions.

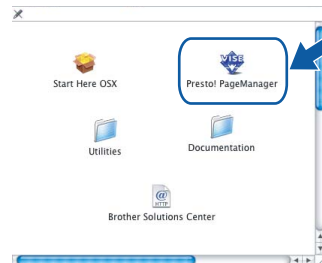

Note

When Presto!® PageManager® is installed OCR capability is added to the Brother ControlCenter2. You can easily scan, share and organize photos and documents using Presto!® PageManager®.

OK! Presto!® PageManager® has been installed and the installation is now complete.

For Wired Network Interface Users

For Mac OS® X 10.2.4 or greater

Important

Make sure that you have finished the instructions from step 1 *Setting Up the Machine* on pages 4 through 11.

- 1 Connect the network interface cable to the machine, and then connect it to your network.

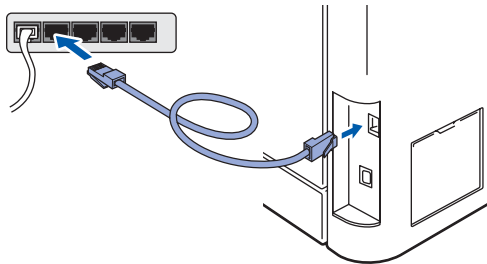

Note

Make sure that the machine is turned on by connecting the power cord.

- 2 Turn on your Macintosh®.
- 3 Put the supplied CD-ROM for Macintosh® into your CD-ROM drive.

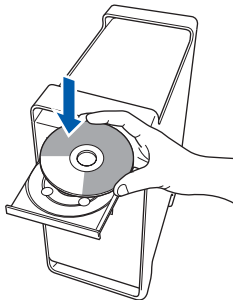

- 4 Double-click the **Start Here OSX** icon to install. Follow the on-screen instructions.

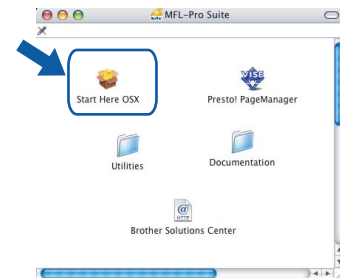

Note

Please see the *Network User's Guide on the CD-ROM* to install the PS driver.

- 5 Choose **Wired Network Connection (Ethernet)**, and then click **Next**.

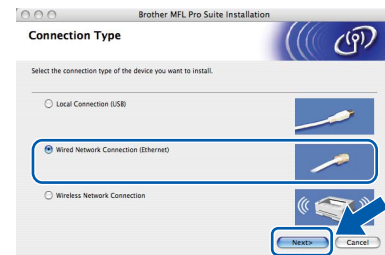

Note

Please wait, it will take a few seconds for the software to install. After the installation, click **Restart** to finish installing the software.

- 6** The Brother software will search for the Brother device. During this time the following screen will appear.

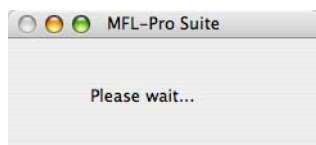

Note

- If the machine is configured for your network, choose the machine from the list, and then click **OK**. This window will not appear if there is only one machine connected on the network, it will be chosen automatically. Go to step 7.

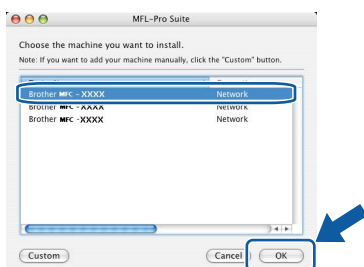

- If this screen appears click **OK**.



Enter a name for your Macintosh® in **Display Name** up to 15 characters long and click **OK**. Go to step 7. The name can be any name you want.

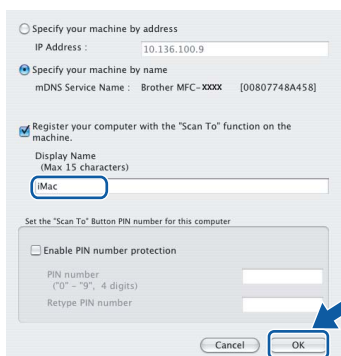

- If you want to use the machine's Scan key to scan over the network you must check the **Register your computer with the "Scan To" function on the machine box**.
- The name you enter will appear on the machine's LCD when you press the **Scan** key and choose a scan option. (For more information, see *Network Scanning in the Software User's Guide on the CD-ROM*.)

- 7** When this screen appears, click **OK**.

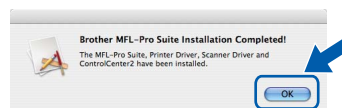

- OK!** For Mac OS® X 10.3.x or greater users: The MFL-Pro Suite, Brother printer driver, scanner driver and Brother ControlCenter2 have been installed and the installation is now complete. Go to step 12.

- 8** For Mac OS® X 10.2.4 to 10.2.8 users: Click **Add**.

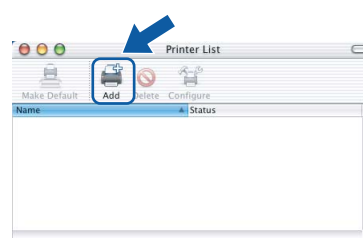

- 9** For Mac OS® X 10.2.4 to 10.2.8 users: Make the selection shown below.

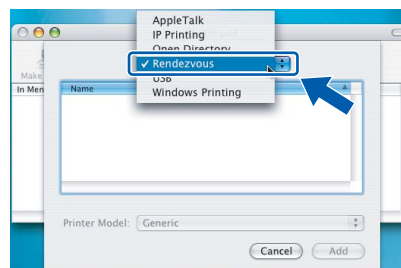

- 10** Choose your model name, and then click **Add**.

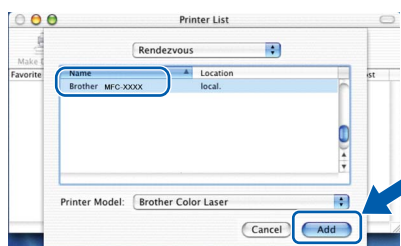

- 11** Click **Print Center**, then **Quit Print Center**.

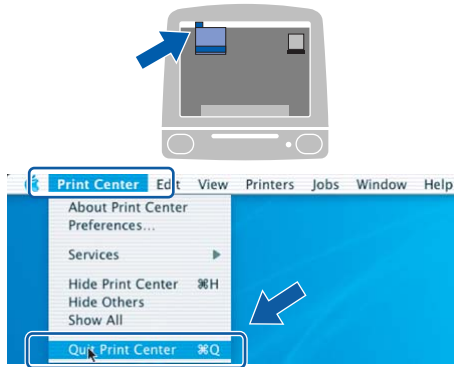

- OK!** The **MFL-Pro Suite**, **Brother printer driver**, **scanner driver** and **Brother ControlCenter2** have been installed and the installation is now complete.

- 12** To install **Presto!® PageManager®**, double-click the **Presto! PageManager** icon and follow the on-screen instructions.

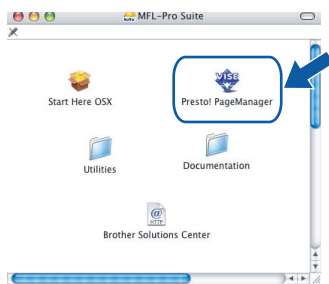

Note

*When **Presto!® PageManager®** is installed **OCR** capability is added to the **Brother ControlCenter2**. You can easily scan, share and organize photos and documents using **Presto!® PageManager®**.*

- OK!** **Presto!® PageManager®** has been installed and the installation is now complete.

For Wireless Network Interface Users (For Mac OS® X 10.2.4 or greater) in infrastructure mode

Connecting your wireless machine and wireless network together and installing the printer driver in infrastructure mode

First you must configure the wireless network settings of your machine to communicate with your network access point (router). After the machine is configured to communicate with your access point (router) computers on your network will have access to the machine. To use the machine from these computers, you will need to install the MFL-Pro Suite. The following steps will guide you through the configuration and installation process.

To achieve optimum results with normal every day document printing, place the Brother machine as close to the network access point (router) as possible with minimal obstructions. Large objects and walls between the two devices as well as interference from other electronic devices can affect the data transfer speed of your documents.

Due to these factors, wireless may not be the best method of connection for all types of documents and applications. If you are printing large files, such as multi-page documents with mixed text and large graphics, you may want to consider choosing wired Ethernet for a faster data transfer, or USB for the fastest throughput speed.

Important

The following instructions will offer two methods for installing your Brother machine in a wireless network environment. Both methods are for infrastructure mode, using a wireless router or access point that uses DHCP to assign IP addresses. If your wireless router/access point supports SecureEasySetup™ follow the steps on page 39 *Using the SecureEasySetup™ software to configure your machine for a wireless network*. If your wireless router/access point does not support SecureEasySetup™ follow the steps on page 40 *Using the Setup Wizard from the control panel LAN menu for wireless network configuration*. To set up your machine in any other wireless environment you can find instructions in the Network User's Guide on the CD-ROM.

You can view the Network User's Guide by following the instructions below.

- 1 Turn on your Macintosh®. Insert the Brother CD-ROM into your CD-ROM drive.
- 2 If the language screen appears, click your language. The CD-ROM main menu will appear.
- 3 Double-click the **Documentation**.
- 4 Double-click the **HTML documents**.
- 5 Double-click the **NETWORK USER'S GUIDE**.

Note

- *If you are going to connect the printer to your network, we recommend that you contact your system administrator prior to installation.*
- *If you are using personal firewall software (e.g. Windows® Firewall), disable it. Once you are sure that you can print, restart your personal firewall software.*

Confirm your network environment

The setup process will be different depending on your network environment.

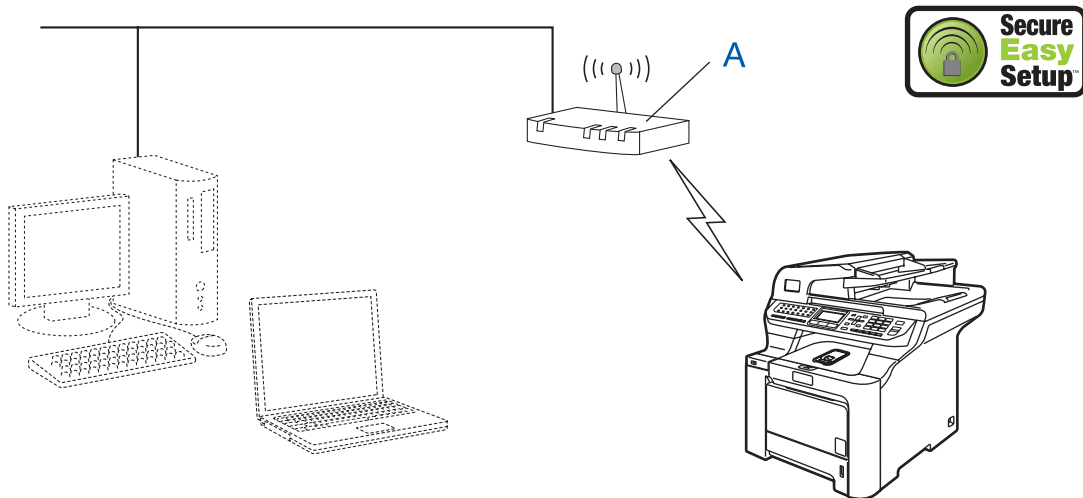
■ Installation using SecureEasySetup™ .

If your wireless access point (A) supports SecureEasySetup™ , you do not need to use a computer to configure the machine. The access point (router) and your machine can automatically negotiate using the SecureEasySetup™ procedure.

For instructions, go to page 39.

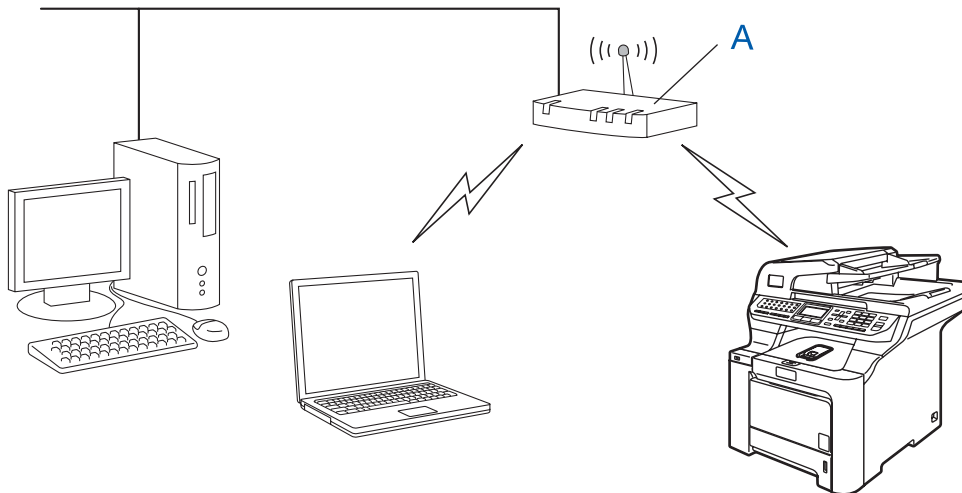
■ Infrastructure Mode

If your wireless access point (A) does not support SecureEasySetup™ , follow the instructions on page 40.

Using the SecureEasySetup™ software to configure your machine for a wireless network

The SecureEasySetup™ software allows you to configure the wireless network easier than configuring it manually. By pushing a button on the wireless router or access point, you can complete setup and secure the wireless network. Your router or access point must also support SecureEasySetup™. See the user's guide for your wireless LAN router or access point for instructions to configure your machine for a wireless network. If your wireless router or access point does not support SecureEasySetup™ go to the next page for installation instructions.

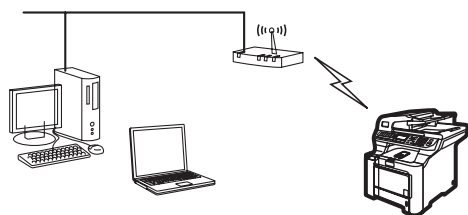

Note

Routers or access points that support SecureEasySetup™ have the SecureEasySetup™ symbol as shown below.



- 1 Plug the AC power cord into an AC outlet. Turn the power switch on.





⊘ Improper Setup

If you have previously configured the wireless settings of the machine you must reset the network (LAN) settings before you can configure the wireless settings again. Press **Menu, 7, 2, 5** (or **Menu, 7, 0**) and then press **1** to accept the change.

- 2 Place the Brother machine close to the SecureEasySetup™ router or access point.

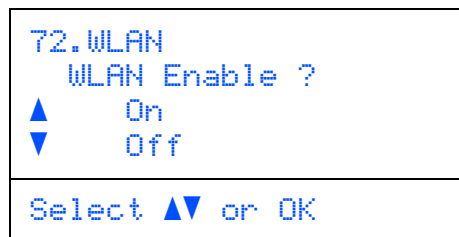
- 3 Push the SecureEasySetup™ button on your wireless router or access point. See the user's guide for your wireless router or access point for instructions.
- 4 Press **Menu, 7, 2, 3** on the control panel of the Brother machine.



Press  or  to choose **On**, then press **OK**. The wired network interface will become inactive with this setting.

- 5 The wireless network connection status using the SecureEasySetup™ software will be displayed: `Connecting WLAN`, `Connected` or `Connection error`.

`Connecting WLAN` is displayed when the print server is trying to make connections to your router or access point. Wait till either `Connected` or `Connection error` is displayed.

`Connected` is displayed when the print server is successfully connected to your router or access point. You can now use your machine in a wireless network.

`Connection error` is displayed when the print server has not successfully connected to your router or access point. Try starting from step 2 again. If the same message is displayed again, reset the print server back to the default factory settings and try again. (See *Restoring the network settings to factory default* on page 47.)



Wireless setup is now complete. To install the MFL-Pro suite, continue to step 14 on page 42.

Using the Setup Wizard from the control panel LAN menu for wireless network configuration

Important

Make sure that you have finished the instructions from step 1 *Setting Up the Machine* on pages 4 through 11.

These instructions will install your Brother machine in a typical small office or home wireless network environment in infrastructure mode, using a wireless router or access point that uses DHCP to assign IP addresses.

If you want to setup your machine in any other wireless environment you can find instructions in the Network User's Guide on the CD-ROM.

You can view the Network User's Guide by following the instructions below.

- 1 Turn on your Macintosh®. Insert the Brother CD-ROM into your CD-ROM drive.
- 2 Double-Click **Documentation**.
- 3 Double-Click your language folder.
- 4 Double-Click the **HTML document**.
- 5 Double-Click the **Network User's Guide**.



Before you begin you must know your wireless network settings.

- 1 Write down the wireless network settings of your access point or wireless router.
SSID (Service Set ID or Network name)

WEP Key (if needed)

WPA-PSK (if needed)

The WEP key is for 64-bit encrypted networks or 128-bit encrypted networks and can contain both numbers and letters. If you do not know this information you should see the documentation provided with your access point or wireless router. This key is a 64-bit or 128-bit value that must be entered in an ASCII or HEXADECIMAL format.

For example:

64-bit	Uses 5 text characters.
ASCII:	e.g. "Hello" (this is case sensitive)
64-bit	Uses 10 digits of hexadecimal data.
Hexadecimal:	e.g. "71f2234aba"
128-bit	Uses 13 text characters.
ASCII:	e.g. "Wirelesscomms" (this is case sensitive)
128-bit	Uses 26 digits of hexadecimal data.
Hexadecimal:	e.g. "71f2234ab56cd709e5412aa3ba"

WPA-PSK enables a Protected Access Pre-shared key that allows the Brother wireless machine to associate with access points using TKIP and AES encryption. WPA-PSK uses a Pre-Shared Key that is 8 or more characters in length, up to a maximum of 63 characters. See Chapter 3 of the Network User's Guide for more details.

- 2** Plug the AC power cord into an AC outlet. Turn the power switch on.



⊘ Improper Setup

If you have previously configured the wireless settings of the machine you must reset the network (LAN) settings before you can configure the wireless settings again. Press Menu, 7, 2, 5 (or Menu, 7, 0) and then press 1 to accept the change.

- 3** On your machine, press **Menu, 7, 2, 2**.

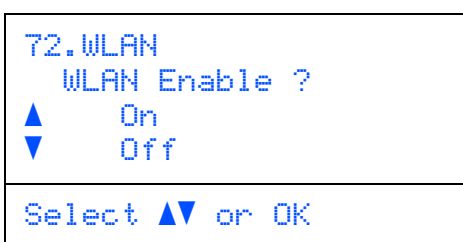

Press or to choose On, then press **OK**. The wired network interface will become inactive with this setting.

- 4** The machine will search for your network and display a list of available SSIDs. You should see the SSID you wrote down earlier. If the machine finds more than one network use the or keys to choose your network, then press **OK**. Go to step 8.

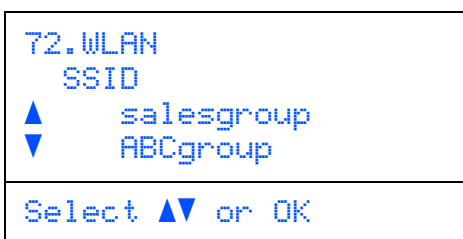

Note

It will take several seconds to display a list of available SSIDs.

If your access point is set to not broadcast the SSID you will have to manually add the SSID name. Go to step 5.

- 5** Select <New SSID> using or and press **OK**. Go to step 6.

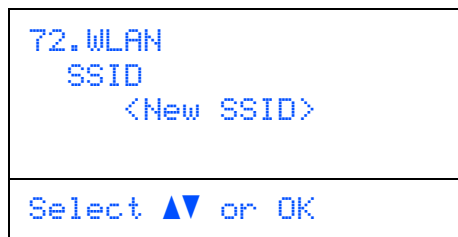

- 6** Enter a new SSID and press **OK**. For information how to type text, see *Entering text* on page 48.

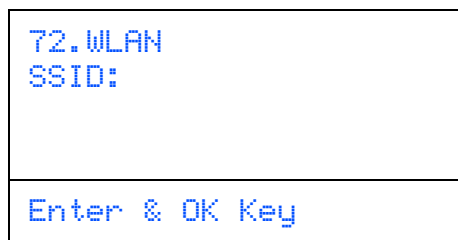

- 7** Press or to choose Infrastructure, then press **OK**.

- 8** Use the , , and **OK** keys to choose one of the options below: If your network is configured for Authentication and Encryption you must match the settings used for your network.

No Authentication or Encryption: Choose Open System, press **OK** then choose None for Encryption Type and press **OK**. Then press or to choose 1. Yes and press **OK** to apply your settings. Go to step 12.

No Authentication with WEP Encryption: Choose Open System, press **OK** then use the or to choose WEP for the Encryption Type and press **OK**. Go to step 9.

Authentication with WEP Encryption: Choose Shared Key, press **OK**. Go to step 9.

Authentication with WPA/WPA2-PSK (TKIP or AES Encryption): Choose WPA/WPA2-PSK, press **OK**. Go to step 10.

Authentication with LEAP: Choose LEAP, press **OK**. Go to step 11.

- 9** Choose the appropriate key number and press **OK**.

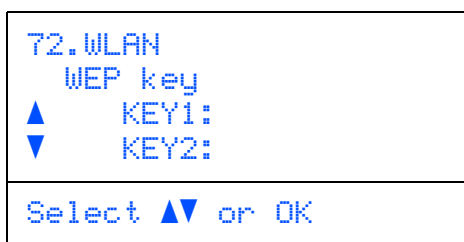

Enter the WEP key you wrote down in step 1 using the dial pad. You can use the **▲** and **▼** keys to move the cursor. For example, to enter the letter a, press the **2** key on the dial pad once. To enter the number 3, press the **3** key on the dial pad seven times.

The letters appear in this order: lower case, upper case, numbers and then special letters.

Press **OK** when you have entered all the characters, then choose **1. Yes** and press **OK** to apply your settings. Go to step 12.

Most access points and routers can store more than one key, but they will only use one at any time for authentication and encryption.

- 10** Press **▲** or **▼** to choose TKIP or AES for Encryption Type and press **OK**. Enter the WPA-PSK Password you wrote down in step 1 using the dial pad. You can use the **▲** and **▼** keys to move the cursor. For example, to enter the letter a, press the **2** key on the dial pad once. To enter the number 3, press the **3** key on your dial pad seven times.

Press **OK** when you have entered all the characters, then choose **1. Yes** and press **OK** to apply your settings. Go to step 12.

- 11** Enter the user and press **OK**. You can use **▲** and **▼** keys to move the cursor. For example, to enter the letter a, press the **2** key on the dial pad once.

Enter the password and press **OK**, and then choose **1. Yes** and press **OK** to apply your settings. Go to step 12.

- 12** Your machine will now try to connect to your wireless network using the information you have entered. If successful, **Connected** will appear briefly on the LCD.

Connection error is displayed when the print server has not successfully connected to your router or access point. Try starting from step 3 again. If the same message is displayed again, reset the print server back to the default factory settings and try again. (See *Restoring the network settings to factory default* on page 47.)

- 13** The machine will automatically acquire the correct TCP/IP address information from your access point (router) if DHCP is enabled (DHCP is normally enabled as default for most access point routers).

If your access point does not have DHCP enabled you will need to manually configure the IP address, subnet mask and gateway of the machine to suit your network. See the Network User's Guide for details.

- OK!** **Wireless setup is now complete. To install the MFL-Pro Software suite, continue to step 14.**

- 14** Turn on your Macintosh®.

- 15** Put the supplied CD-ROM into your CD-ROM drive.

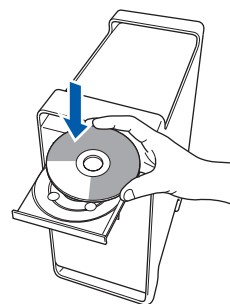

- 16** Double-click the **Start Here OSX** icon to install. Follow the on-screen instructions.

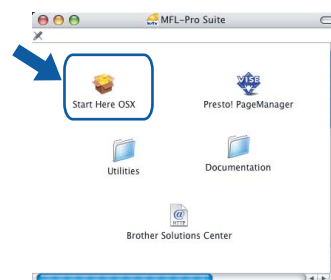

Please wait, it will take a few seconds for the software to install. After the installation, click **Restart** to finish installing the software.

- 17** Choose **Wireless Network Connection**, and then click **Next**.

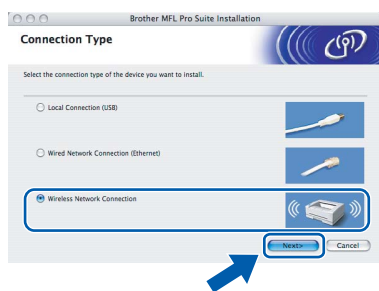

- 18** Click on the **Checked and confirmed** check box, and then click **Next**. Follow the on screen instructions.



Please wait, it will take a few seconds for the software to install. After the installation, click **Restart** to finish installing the software.

- 19** The Brother software will search for the Brother device. During this time the following screen will appear.

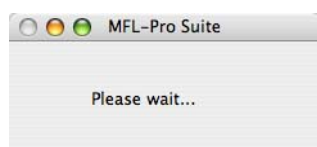

Note

- If the machine is configured for your network, choose the machine from the list, and then click **OK**. This window will not appear if there is only one machine connected on the network, it will be chosen automatically. Go to step 20.

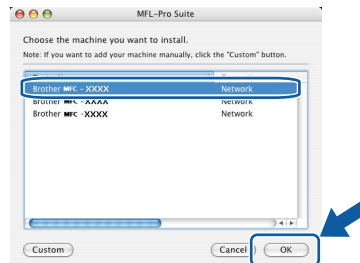

- If this screen appears click **OK**.



Enter a name for your Macintosh® in **Display Name** up to 15 characters long and click **OK**. Go to step 20. The name can be any name you want.

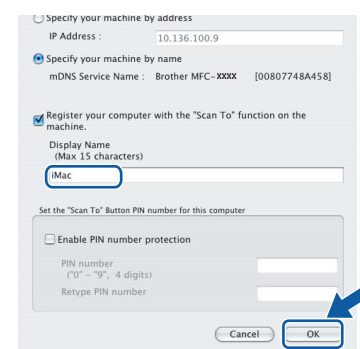

- If you want to use the machine's Scan key to scan over the network you must check the **Register your computer with the "Scan To" function on the machine** box.
- The name you enter will appear on the machine's LCD when you press the **Scan** key and choose a scan option. (For more information, see *Network Scanning in the Software User's Guide on the CD-ROM.*)

20 When this screen appears, click **OK**.



OK!

For Mac OS® X 10.3.x or greater users: The MFL-Pro Suite, Brother printer driver, scanner driver and Brother ControlCenter2 have been installed and the installation is now complete. Go to step 25.

21 For Mac OS® X 10.2.4 to 10.2.8 users: Click **Add**.

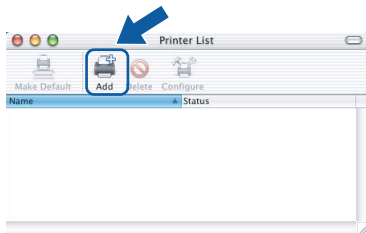

22 For Mac OS® X 10.2.4 to 10.2.8 users: Make the selection shown below.

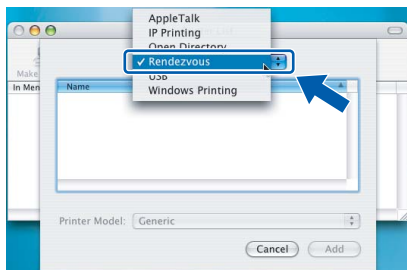

23 Choose your model name, and then click **Add**.

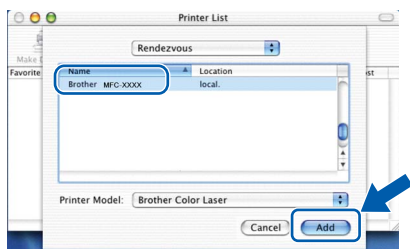

24 Click **Print Center**, then **Quit Print Center**.

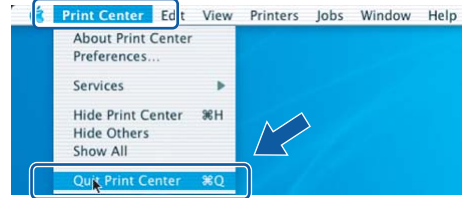
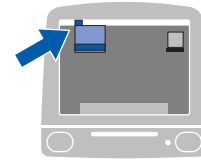

OK!

The MFL-Pro Suite, Brother printer driver, scanner driver and Brother ControlCenter2 have been installed and the installation is now complete.

25 To install Presto!® PageManager®, double-click the **Presto! PageManager** icon and follow the on-screen instructions.

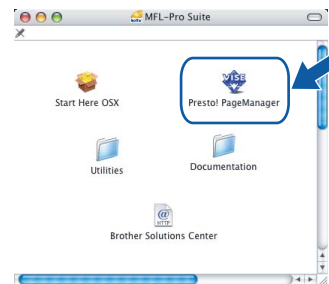

Note

When Presto!® PageManager® is installed OCR capability is added to the Brother ControlCenter2. You can easily scan, share and organize photos and documents using Presto!® PageManager®.

OK!

Presto!® PageManager® has been installed and the installation is now complete.

BRAdmin Light utility (For Windows® users)

The BRAdmin Light is a utility for initial setup of Brother network connected devices. It also can search for Brother products on your network, view the status and configure basic network settings, such as IP address. For more information on BRAdmin Light, visit us at <http://solutions.brother.com>.

Note

If you require more advanced printer management, use the latest Brother BRAdmin Professional utility version that is available as a download from <http://solutions.brother.com>.

Installing the BRAdmin Light configuration utility

Note

The default password for the print server is 'access'. You can use BRAdmin Light to change this password.

- 1 Click **Install Other Drivers or Utilities** on the menu screen.

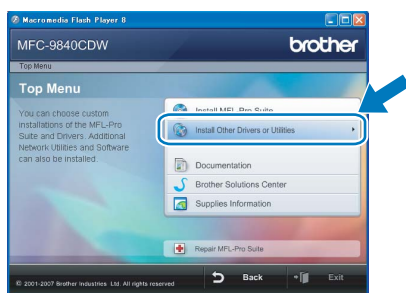

- 2 Click **BRAdmin Light** and follow the on-screen instructions.



Setting your IP address, Subnet Mask and Gateway using BRAdmin Light

Note

If you have a DHCP/BOOTP/RARP server in your network, you don't have to do the following operation. The print server will automatically obtain its own IP address.

- 1 Start BRAdmin Light. It will search for new devices automatically.

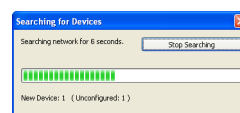

- 2 Double-click the unconfigured device.

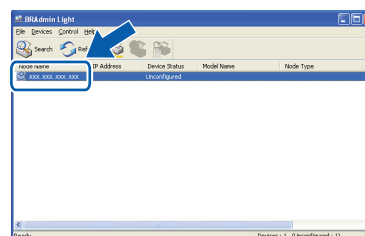

- 3 Choose **STATIC** for the **Boot Method**. Enter the **IP Address**, **Subnet Mask** and **Gateway**, and then click **OK**.

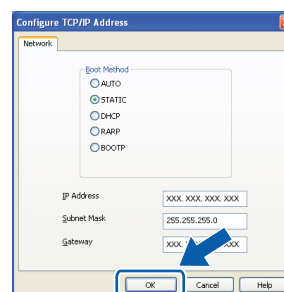

- 4 The address information will be saved to the machine.

BRAdmin Light utility (For Mac OS[®] X users)

The BRAdmin Light is a utility for initial setup of Brother network connected devices. It also can search for Brother products on your network, view the status and configure basic network settings, such as IP address from a computer running Mac OS[®] X 10.2.4 or greater.

The BRAdmin Light software will be installed automatically when you install the printer driver. If you have already installed the printer driver, you don't have to install it again. For more information on BRAdmin Light, visit us at <http://solutions.brother.com>.

Setting your IP address, Subnet Mask and Gateway using BRAdmin Light

Note

- If you have a DHCP/BOOTP/RARP server in your network, you don't have to do the following operation. The print server will automatically obtain its own IP address.
- Make sure that version 1.4.1_07 or later of Java™ client software is installed on your computer.
- The default password for the print server is 'access'. You can use BRAdmin Light to change this password.

- 1 Double-click the **Macintosh HD** icon on your desktop.

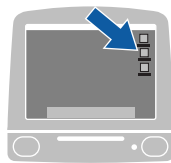

- 2 Choose **Library, Printers, Brother** and then **Utilities**.

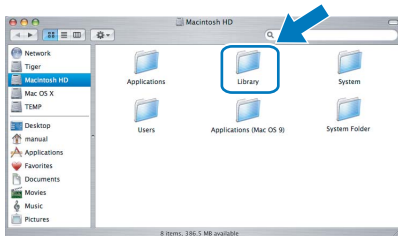

- 3 Double-click the file **BRAdmin Light.jar** and run the software. BRAdmin Light will then search for new devices automatically.

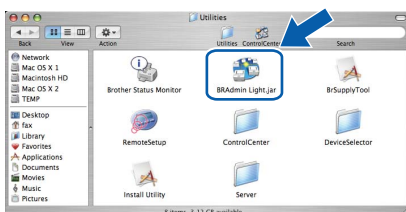

- 4 Double-click the unconfigured device.

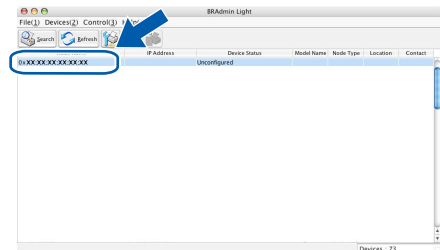

- 5 Choose **STATIC** for the **Boot Method**. Enter the **IP Address**, **Subnet Mask** and **Gateway**, and then click **OK**.

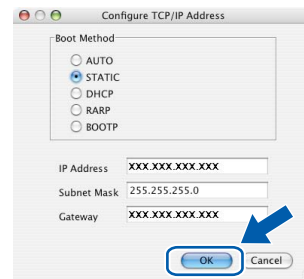

- 6 The address information will be saved to the machine.

Web Based Management (web browser)

The Brother print server is equipped with a web server that allows you to monitor its status or change some of its configuration settings, using HTTP (Hyper Text Transfer Protocol).

Note

- The User Name is **'admin'** and the default password is **'access'**. You can use a web browser to change this password.
- We recommend Microsoft Internet Explorer 6.0[®] (or higher) or Firefox[®] 1.0 (or higher) for Windows[®] and Safari[™] 1.0 for Macintosh[®]. Please also make sure that JavaScript and Cookies are always enabled in whichever browser you use. We recommend you upgrade to Safari[™] 1.2 or higher to enable JavaScript. To use a web browser, you will need to know the IP address of the print server.

- 1 Open your browser.
- 2 Type `http:// printer_ip_address /` into your browser (Where "printer_ip_address" is the IP address of the printer or the print server name).
 - For example `http://192.168.1.2/`

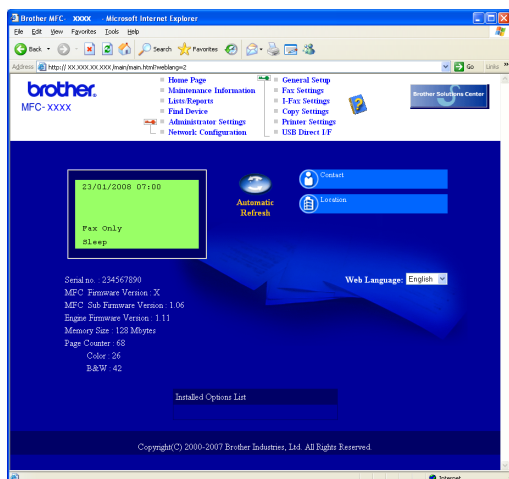

See Chapter 2 of the Network User's Guide.

Restoring the network settings to factory default

To restore all network settings of the internal Print/Scan server to factory default, please follow the steps below.

- 1 Make sure the machine is not in use, then disconnect all the cables from the machine (except power cable).
- 2 Press **Menu, 7, 0**.
- 3 Press **1** to select **Reset**.
- 4 Press **1** to select **Yes**.
- 5 The machine will restart. Re-connect cables once this is complete.

Entering text

When setting certain menu selections, such as the Station ID, you will need to type text characters. The dial pad keys have letters printed on them. The keys: **0**, **#** and ***** do *not* have printed letters because they are used for special characters.

Press the appropriate dial pad key the required number of times to access the characters below:

For setting an E-mail address, a node name, Scan to FTP menu options and Setup IFAX menu options (**Menu, 7, 3**).

Press Key	one time	two times	three times	four times	five times	six times	seven times	eight times
2	a	b	c	A	B	C	2	a
3	d	e	f	D	E	F	3	d
4	g	h	i	G	H	I	4	g
5	j	k	l	J	K	L	5	j
6	m	n	o	M	N	O	6	m
7	p	q	r	s	P	Q	R	S
8	t	u	v	T	U	V	8	t
9	w	x	y	z	W	X	Y	Z

(For setting other menu selections)

Press Key	one time	two times	three times	four times
2	A	B	C	2
3	D	E	F	3
4	G	H	I	4
5	J	K	L	5
6	M	N	O	6
7	P	Q	R	S
8	T	U	V	8
9	W	X	Y	Z

Inserting spaces

To enter a space in a fax number, press **►** once between numbers. To enter a space in a name, press **►** twice between characters.

Making corrections

If you entered a letter incorrectly and want to change it, press **◀** to move the cursor to the incorrect character, and then press **Clear/Back**.

Repeating letters

To enter a character on the same key as the previous character, press **►** to move the cursor right before pressing the key again.

Special characters and symbols

Press *****, **#** or **0**, then press **◀** or **►** to move the cursor to the symbol or character you want. Press **OK** to choose it. The symbols and characters below will appear depending on your menu selection.

Press ***** for (space) ! " # \$ % & ' () * + , - . / €
 Press **#** for ; < = > ? @ [] ^ _ ` ~ ' | { }
 Press **0** for Ä Ë Ö Ü À Ç È É 0

Options

The machine has the following optional accessories. You can expand the capabilities of the machine by adding these items.

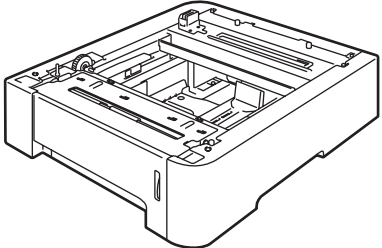
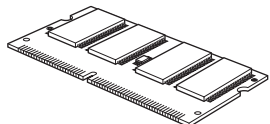
Lower Tray Unit	DIMM Memory
<p align="center">LT-100CL</p>	
 <p>The lower paper tray unit can hold up to 500 sheets of paper. When the lower tray unit is installed, the machine expands total input capacity up to 800 sheets. Please refer to Chapter B of User's Guide for more details.</p>	 <p>You can expand the memory by installing a (144-pin SO-DIMM) memory module. Please refer to Chapter B of User's Guide for more details.</p>

Consumables

When the time comes to replace consumable items, an error message will be indicated on the LCD. For more information about the consumables for your machine, visit us at <http://solutions.brother.com> or contact your local Brother reseller.

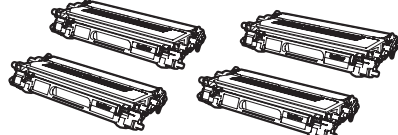
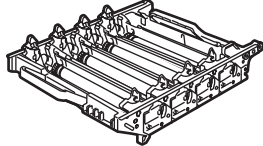
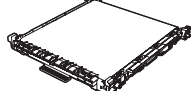
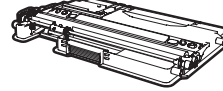
<p align="center">Toner Cartridge</p>	<p align="center">Drum Unit</p>
<p><Standard Toner> TN-170C/TN-170M/TN-170Y/TN-170BK <High-Yield Toner> TN-175C/TN-175M/TN-175Y/TN-175BK</p>	<p align="center">DR-170CL</p>
	
<p align="center">Belt Unit (BU-100CL)</p>	<p align="center">Waste Toner Box (WT-100CL)</p>
	

Trademarks

The Brother logo is a registered trademark of Brother Industries, Ltd.

Brother is a registered trademark of Brother Industries, Ltd.

Multi-Function Link is a registered trademark of Brother International Corporation.

Microsoft, Windows and Windows Server are registered trademarks of Microsoft Corporation in the United States and other countries. Windows Vista is either a registered trademark or a trademark of Microsoft Corporation in the United States and other countries.

Macintosh and TrueType are registered trademarks of Apple Inc.

Postscript and Postscript 3 are registered trademarks or trademarks of Adobe Systems Incorporated.

Presto! PageManager is a registered trademark of NewSoft Technology Corporation.

BROADCOM, SecureEasySetup and the SecureEasySetup logo are trademarks or registered trademarks of Broadcom Corporation in the United States and/or other countries.

Each company whose software title is mentioned in this manual has a Software License Agreement specific to its proprietary programs.

All other brand and product names mentioned in this manual are trademarks or registered trademarks of their respective companies.

Compilation and Publication

Under the supervision of Brother Industries Ltd., this manual has been compiled and published, covering the latest product descriptions and specifications.

The contents of this manual and the specifications of this product are subject to change without notice.

Brother reserves the right to make changes without notice in the specifications and materials contained herein and shall not be responsible for any damages (including consequential) caused by reliance on the materials presented, including but not limited to typographical and other errors relating to the publication.

This product is designed for use in a Professional Environment.

brother®