

ThinkPad

User Guide

ThinkPad X1 and X1 Hybrid

Notes: Before using this information and the product it supports, be sure to read the following:

- *Safety and Warranty Guide*
- *Regulatory Notice*
- “Important safety information” on page vi
- Appendix C “Notices” on page 159

The *Safety and Warranty Guide* and the *Regulatory Notice* have been uploaded to the Web site. To refer to them, go to <http://www.lenovo.com/support>, and then click **User Guides & Manuals**.

Fourth Edition (November 2011)

© Copyright Lenovo 2011.

LIMITED AND RESTRICTED RIGHTS NOTICE: If data or software is delivered pursuant a General Services Administration “GSA” contract, use, reproduction, or disclosure is subject to restrictions set forth in Contract No. GS-35F-05925.

Contents

Read this first	v	Using the TrackPoint pointing device	31
Important safety information	vi	Using the touch pad.	32
Conditions that require immediate action	vii	Behavior of the UltraNav and an external mouse	34
Safety guidelines	vii	Adding the UltraNav icon to the system tray	34
Chapter 1. Product overview	1	Power management	34
Locating computer controls, connectors, and indicators.	1	Checking battery status	35
Front view.	2	Using the ac power adapter.	35
Right-side view.	5	Charging the battery	35
Left-side view	6	Maximizing battery life	36
Bottom view	7	Managing your battery power	36
Rear view	8	Power-saving modes	36
Status indicators	9	Connecting to the network	37
Locating important product information	12	Ethernet connections	37
Machine type and model label.	12	Wireless connections	38
FCC ID and IC Certification number label	13	Using an external display	44
Certificate of Authenticity label	14	Changing display settings	44
Features	14	Connecting an external display	44
Specifications	16	Using dual displays	46
Operating environment	16	Using a color profile	47
ThinkVantage Technologies.	17	Using audio features	47
Accessing applications in Windows 7	17	Using an integrated camera	48
Access Connections	19	Using the media card reader	48
Active Protection System.	19	Inserting a flash media card.	49
Client Security Solution	19	Removing a flash media card	49
Fingerprint Software.	19	Chapter 3. You and your computer	51
Lenovo Solution Center	19	Accessibility and comfort	51
Lenovo ThinkVantage Tools	20	Ergonomic information.	51
Lenovo ThinkVantage Toolbox.	20	Adjusting your computer to fit you	52
Message Center Plus	20	Accessibility information	53
Password Manager	20	FullScreen Magnifier function	53
Power Manager	20	Traveling with your computer	54
Product Recovery	21	Travel tips.	54
Rescue and Recovery	21	Travel accessories	54
System Update	21	Chapter 4. Security	55
Chapter 2. Using your computer	23	Attaching a mechanical lock	55
Registering your computer	23	Using passwords.	55
Frequently asked questions	23	Passwords and sleep mode.	56
Instant Media Mode	25	Typing passwords	56
Special keys and buttons	26	Power-on password.	56
ThinkVantage button	26	Hard disk passwords	57
Function key combinations	26	Supervisor password	59
Volume and mute buttons	28	Hard disk security	61
Windows key and other function keys.	30	Setting the security chip	61
Using the UltraNav pointing device.	30	Using a fingerprint reader	63

Notice on deleting data from your hard disk drive or solid state drive	66	Installing the driver for USB 3.0	101
Using and understanding firewalls	66	Installing ThinkPad Monitor File for Windows 2000/XP/Vista/7	101
Protecting data against viruses	67	Installing Intel Chipset Support for Windows 2000/XP/Vista/7	102
Chapter 5. Recovery overview	69	Installing other device drivers	102
Creating and using recovery media	69	ThinkPad Setup	102
Creating recovery media	70	Config menu.	103
Using recovery media	70	Date/Time menu	104
Performing backup and recovery operations	70	Security menu	104
Performing a backup operation	70	Startup menu	105
Performing a recovery operation	71	Restart menu	107
Using the Rescue and Recovery workspace	71	ThinkPad Setup items	107
Creating and using a rescue medium	72	Updating your system UEFI BIOS	115
Creating a rescue medium	72	Using system management.	116
Using a rescue medium	72	System management	116
Reinstalling preinstalled applications and device drivers	73	Setting management features	117
Solving recovery problems	74	Chapter 9. Preventing problems	119
Chapter 6. Replacing devices	75	General tips for preventing problems	119
Static electricity prevention.	75	Making sure device drivers are current	120
Before replacing CRU	75	Getting the latest drivers from the Web site.	120
Replacing the hard disk drive or solid state drive	76	Getting the latest drivers using System Update	120
Replacing the keyboard	78	Taking care of your computer	121
Replacing the memory module	81	Cleaning the cover of your computer	122
Replacing the PCI Express Mini Card for wireless LAN/WiMAX connection	83	Chapter 10. Troubleshooting computer problems	125
Installing and replacing the PCI Express Mini Card for wireless WAN connection	85	Diagnosing problems	125
Installing and replacing the mSATA solid state drive.	87	Troubleshooting	126
Replacing the backup battery.	89	Computer stops responding	126
Replacing the SIM card	90	Spills on the keyboard	126
Chapter 7. Enhancing your computer	93	Error messages	127
Finding ThinkPad options	93	Errors without messages	129
ThinkPad Battery 39+ (6-cell slice battery)	93	Beep errors	130
ThinkPad Battery 39+ top view	93	Memory problems	130
ThinkPad Battery 39+ bottom view	94	Networking	131
Attaching a ThinkPad Battery 39+	94	Keyboard and other pointing devices	133
Detaching a ThinkPad Battery 39+	96	Display and multimedia devices	133
Charging a ThinkPad Battery 39+	97	Fingerprint reader problems.	138
Chapter 8. Advanced configuration.	99	Battery and power	139
Installing a new operating system	99	Drives and other storage devices	142
Before you begin	99	Software problems	142
Installing Windows 7	100	Ports and connectors	143
Installing device drivers	101	Chapter 11. Getting support	145
Installing the driver for the 4-in-1 Media Card Reader	101	Before you contact Lenovo	145
		Registering your computer	145
		Downloading system updates	145
		Recording information	145

Getting help and service	146
Using diagnostic programs	146
Lenovo Support Web site.	146
Calling Lenovo	147
Purchasing additional services	147

Appendix A. Regulatory information 149

Wireless related information	149
Location of the UltraConnect wireless antennas	150
Locating wireless regulatory notices	151
Export classification notice.	151
Electronic emission notices.	151
Federal Communications Commission Declaration of Conformity	151
Industry Canada Class B emission compliance statement	152
European Union - Compliance to the Electromagnetic Compatibility Directive	152
German Class B compliance statement	152
Korea Class B compliance statement	153
Japanese VCCI Class B statement	153
Japan compliance statement for products which connect to the power mains with rated current less than or equal to 20 A per phase	153

Lenovo product service information for Taiwan	153
Additional regulatory information	153

Appendix B. WEEE and recycling statements 155

Important WEEE information	155
Japan recycling statements	155
Recycling information for Brazil	156
Battery recycling information for Taiwan.	156
Battery recycling information for the United States and Canada.	156
Battery recycling information for the European Union	157

Appendix C. Notices. 159

Trademarks	160
----------------------	-----

Appendix D. Restriction of Hazardous Substances Directive (RoHS) 161

China RoHS.	161
Turkish RoHS	161
Ukraine RoHS	161
India RoHS	162

Read this first

Be sure to follow the important tips given here to continue to get the most use and enjoyment out of your computer. Failure to do so might lead to discomfort or injury, or cause your computer to fail.

Protect yourself from the heat that your computer generates.



When your computer is turned on or the battery is charging, the base, the palm rest, and some other parts may become hot. The temperature they reach depends on the amount of system activity and the level of charge in the battery.

Extended contact with your body, even through clothing, could cause discomfort or even a skin burn.

- Avoid keeping your hands, your lap, or any other part of your body in contact with a hot section of the computer for any extended time.
- Periodically take hands from using the keyboard by lifting your hands from the palm rest.

Protect yourself from the heat generated by the ac power adapter.



When the ac power adapter is connected to an electrical outlet and your computer, it generates heat.

Extended contact with your body, even through clothing, may cause a skin burn.

- Do not place the ac power adapter in contact with any part of your body while it is in use.
- Never use it to warm your body.

Prevent your computer from getting wet.



- To avoid spills and the danger of electrical shock, keep liquids away from your computer.

Protect the cables from being damaged.

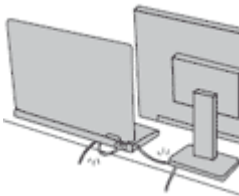

Applying strong force to cables may damage or break them.

- Route communication lines, or the cables of an ac power adapter, a mouse, a keyboard, a printer, or any other electronic device, so that they cannot be walked on, tripped over, pinched by your computer or other objects, or in any way subjected to treatment that could interfere with the operation of your computer.

Protect your computer and data when moving it.

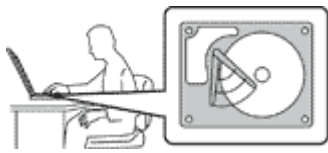

Before moving a computer equipped with a hard disk drive, do one of the following, and make sure that the power switch is off or is blinking:

- Turn it off.
- Put it in sleep mode.
- Put it in hibernation mode.

This will help to prevent damage to the computer, and possible loss of data.

Handle your computer gently.



- Do not drop, bump, scratch, twist, hit, vibrate, push, or place heavy objects on your computer, display, or external devices.

Carry your computer carefully.



- Use a quality carrying case that provides adequate cushioning and protection.
- Do not pack your computer in a tightly packed suitcase or bag.
- Before putting your computer in a carrying case, make sure that it is off, in sleep mode, or in hibernation mode. Do not put a computer in a carrying case while it is turned on.

Important safety information

Note: Read important safety information first.

This information can help you safely use your notebook personal computer. Follow and retain all information included with your computer. The information in this document does not alter the terms of your purchase agreement or the Lenovo® Limited Warranty. For more information, see “Warranty Information” in the *Safety and Warranty Guide* comes with your computer.

Customer safety is important. Our products are developed to be safe and effective. However, personal computers are electronic devices. Power cords, power adapters, and other features can create potential safety risks that can result in physical injury or property damage, especially if misused. To reduce these risks, follow the instructions included with your product, observe all warnings on the product and in the operating instructions, and review the information included in this document carefully. By carefully following the information contained in this document and provided with your product, you can help protect yourself from hazards and create a safer computer work environment.

Note: This information includes references to power adapters and batteries. In addition to notebook computers, some products (such as speakers and monitors) ship with external power adapters. If you have such a product, this information applies to your product. In addition, computer products contain a coin-sized internal battery that provides power to the system clock even when the computer is unplugged, so the battery safety information applies to all computer products.

Conditions that require immediate action

Products can become damaged due to misuse or neglect. Some product damage is serious enough that the product should not be used again until it has been inspected and, if necessary, repaired by an authorized servicer.

As with any electronic device, pay close attention to the product when it is turned on. On very rare occasions, you might notice an odor or see a puff of smoke or sparks vent from your product. Or you might hear sounds like popping, cracking or hissing. These conditions might merely mean that an internal electronic component has failed in a safe and controlled manner. Or, they might indicate a potential safety issue. However, do not take risks or attempt to diagnose the situation yourself. Contact the Customer Support Center for further guidance. For a list of Service and Support phone numbers, see the following Web site:

<http://www.lenovo.com/support/phone>

Frequently inspect your computer and its components for damage or wear or signs of danger. If you have any question about the condition of a component, do not use the product. Contact the Customer Support Center or the product manufacturer for instructions on how to inspect the product and have it repaired, if necessary.

In the unlikely event that you notice any of the following conditions, or if you have any safety concerns with your product, stop using the product and unplug it from the power source and telecommunication lines until you can speak to the Customer Support Center for further guidance.

- Power cords, plugs, power adapters, extension cords, surge protectors, or power supplies that are cracked, broken, or damaged.
- Signs of overheating, smoke, sparks, or fire.
- Damage to a battery (such as cracks, dents, or creases), discharge from a battery, or a buildup of foreign substances on the battery.
- A cracking, hissing or popping sound, or strong odor that comes from the product.
- Signs that liquid has been spilled or an object has fallen onto the computer product, the power cord or power adapter.
- The computer product, power cord, or power adapter has been exposed to water.
- The product has been dropped or damaged in any way.
- The product does not operate normally when you follow the operating instructions.

Note: If you notice these conditions with a product (such as an extension cord) that is not manufactured for or by Lenovo, stop using that product until you can contact the product manufacturer for further instructions, or until you get a suitable replacement.

Safety guidelines

Always observe the following precautions to reduce the risk of injury and property damage.

For more information, see “Important safety information” in the *Safety and Warranty Guide* comes with your computer.

Service and upgrades

Do not attempt to service a product yourself unless instructed to do so by the Customer Support Center or your documentation. Only use a Service Provider who is approved to repair your particular product.

Note: Some computer parts can be upgraded or replaced by the customer. Upgrades typically are referred to as options. Replacement parts approved for customer installation are referred to as Customer

Replaceable Units, or CRUs. Lenovo provides documentation with instructions when it is appropriate for customers to install options or replace CRUs. You must closely follow all instructions when installing or replacing parts. The Off state of a power indicator does not necessarily mean that voltage levels inside a product are zero. Before you remove the covers from a product equipped with a power cord, always make sure that the power is turned off and that the product is unplugged from any power source. If you have any questions or concerns, contact the Customer Support Center.

Although there are no moving parts in your computer after the power cord has been disconnected, the following warnings are required for your safety.

CAUTION:

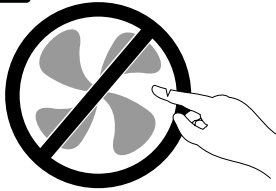

Hazardous moving parts. Keep fingers and other body parts away.

CAUTION:



Before replacing any CRUs, turn off the computer and wait three to five minutes to let the computer cool before opening the cover.

Power cords and power adapters



DANGER

Use only the power cords and power adapters supplied by the product manufacturer.

The power cords shall be safety approved. For Germany, it shall be H05VV-F, 3G, 0.75 mm², or better. For other countries, the suitable types shall be used accordingly.

Never wrap a power cord around a power adapter or other object. Doing so can stress the cord in ways that can cause the cord to fray, crack, or crimp. This can present a safety hazard.

Always route power cords so that they will not be walked on, tripped over, or pinched by objects.

Protect power cord and power adapters from liquids. For instance, do not leave your power cord or power adapter near sinks, tubs, toilets, or on floors that are cleaned with liquid cleansers. Liquids can cause a short circuit, particularly if the power cord or power adapter has been stressed by misuse. Liquids also can cause gradual corrosion of power cord terminals and/or the connector terminals on a power adapter, which can eventually result in overheating.

Always connect power cords and signal cables in the correct order and ensure that all power cord connectors are securely and completely plugged into receptacles.

Do not use any power adapter that shows corrosion at the AC input pins or shows signs of overheating (such as deformed plastic) at the AC input or anywhere on the power adapter.

Do not use any power cords where the electrical contacts on either end show signs of corrosion or overheating or where the power cord appears to have been damaged in any way.

Extension cords and related devices

Ensure that extension cords, surge protectors, uninterruptible power supplies, and power strips that you use are rated to handle the electrical requirements of the product. Never overload these devices. If power strips are used, the load should not exceed the power strip input rating. Consult an electrician for more information if you have questions about power loads, power requirements, and input ratings.

Plugs and outlets



If a receptacle (power outlet) that you intend to use with your computer equipment appears to be damaged or corroded, do not use the outlet until it is replaced by a qualified electrician.

Do not bend or modify the plug. If the plug is damaged, contact the manufacturer to obtain a replacement.

Do not share an electrical outlet with other home or commercial appliances that draw large amounts of electricity; otherwise, unstable voltage might damage your computer, data, or attached devices.

Some products are equipped with a three-pronged plug. This plug fits only into a grounded electrical outlet. This is a safety feature. Do not defeat this safety feature by trying to insert it into a non-grounded outlet. If you cannot insert the plug into the outlet, contact an electrician for an approved outlet adapter or to replace the outlet with one that enables this safety feature. Never overload an electrical outlet. The overall system load should not exceed 80 percent of the branch circuit rating. Consult an electrician for more information if you have questions about power loads and branch circuit ratings.

Be sure that the power outlet you are using is properly wired, easily accessible, and located close to the equipment. Do not fully extend power cords in a way that will stress the cords.

Be sure that the power outlet provides the correct voltage and current for the product you are installing.

Carefully connect and disconnect the equipment from the electrical outlet.

Power supply statement



Never remove the cover on a power supply or any part that has the following label attached.



Hazardous voltage, current, and energy levels are present inside any component that has this label attached. There are no serviceable parts inside these components. If you suspect a problem with one of these parts, contact a service technician.

External devices

CAUTION:

Do not connect or disconnect any external device cables other than Universal Serial Bus (USB) and 1394 cables while the computer power is on; otherwise, you might damage your computer. To avoid possible damage to attached devices, wait at least five seconds after the computer is shut down to disconnect external devices.

Notice for lithium coin cell battery



DANGER

Danger of explosion if battery is incorrectly replaced.

When replacing the lithium coin cell battery, use only the same or an equivalent type that is recommended by the manufacturer. The battery contains lithium and can explode if not properly used, handled, or disposed of.

Do not:

- Throw or immerse into water
- Heat to more than 100°C (212°F)
- Repair or disassemble

Dispose of the battery as required by local ordinances or regulations.

The following statement applies to users in the state of California, U.S.A.

California Perchlorate Information:

Products containing CR (manganese dioxide) lithium coin cell batteries may contain perchlorate.

Perchlorate Material - special handling may apply, See www.dtsc.ca.gov/hazardouswaste/perchlorate

Notice for built-in rechargeable batteries



DANGER

Do not attempt to replace the internal rechargeable lithium ion batteries. Contact Lenovo Support for factory replacement.

Notice for optional external slice rechargeable battery pack



DANGER

Do not attempt to disassemble or modify the optional external slice rechargeable battery pack. Attempting to do so can cause an explosion, or liquid leakage from the battery pack. A battery pack other than the one specified by Lenovo, or a disassembled or modified battery pack is not covered by the warranty.

If the optional external slice rechargeable battery pack is incorrectly replaced, there is danger of an explosion. The battery pack contains a small amount of harmful substances. To avoid possible injury:

- Replace only with a battery pack of the type recommended by Lenovo.
- Keep the battery pack away from fire.
- Do not expose it to water or rain.
- Do not attempt to disassemble it.
- Do not short-circuit it.
- Keep it away from children.
- Do not drop the battery pack.

Do not put the battery pack in trash that is disposed of in landfills. When disposing of the battery, comply with local ordinances or regulations.

The battery pack should be stored at room temperature, charged to approximately 30 to 50% of capacity. We recommend that battery pack be charged about once per year to prevent overdischarge.

Heat and product ventilation



DANGER

Computers, ac power adapters, and many accessories can generate heat when turned on and when batteries are charging. Notebook computers can generate a significant amount of heat due to their compact size. Always follow these basic precautions:

- When your computer is turned on or the battery is charging, the base, the palm rest, and some other parts may become hot. Avoid keeping your hands, your lap, or any other part of your body in contact with a hot section of the computer for any extended length of time. When you use the keyboard, avoid keeping your palms on the palm rest for a prolonged period of time. Your computer generates some heat during normal operation. The amount of heat depends on the amount of system activity and the battery charge level. Extended contact with your body, even through clothing, could cause discomfort or even a skin burn. Periodically take breaks from using the keyboard by lifting your hands from the palm rest; and be careful not to use the keyboard for any extended length of time.
- Do not operate your computer or charge the battery near flammable materials or in explosive environments.
- Ventilation slots, fans and/or heat sinks are provided with the product for safety, comfort, and reliable operation. These features might inadvertently become blocked by placing the product on a bed, sofa, carpet, or other flexible surface. Never block, cover, or disable these features.
- When the ac power adapter is connected to an electrical outlet and your computer, it generates heat. Do not place the adapter in contact with any part of your body while using it. Never use the ac power adapter to warm your body. Extended contact with your body, even through clothing, may cause a skin burn.

For your safety, always follow these basic precautions with your computer:

- Keep the cover closed whenever the computer is plugged in.
- Regularly inspect the outside of the computer for dust accumulation.
- Remove dust from vents and any perforations in the bezel. More frequent cleanings might be required for computers in dusty or high-traffic areas.
- Do not restrict or block any ventilation openings.
- Do not operate your computer inside furniture, as this might increase the risk of overheating.
- Airflow temperatures into the computer should not exceed 35°C (95°F).

Electrical current safety information



Electric current from power, telephone, and communication cables is hazardous.

To avoid a shock hazard:

- Do not use your computer during a lightning storm.
- Do not connect or disconnect any cables or perform installation, maintenance, or reconfiguration of this product during an electrical storm.
- Connect all power cords to a properly wired and grounded electrical outlet.
- Connect to properly wired outlets any equipment that will be attached to this product.
- Whenever possible, use one hand only to connect or disconnect signal cables.
- Never turn on any equipment when there is evidence of fire, water, or structural damage.
- Disconnect all attached cables and disable batteries before opening any accessible device covers unless instructed otherwise in the installation and configuration procedures.
- Do not use you computer until all internal parts enclosures are fastened into place. Never use the computer when internal parts and circuits are exposed.



Connect and disconnect cables as described in the following procedures when installing, moving, or opening covers on this product or attached devices.

To connect:

1. Turn everything OFF.
2. First, attach all cables to devices.
3. Attach signal cables to connectors.
4. Attach power cords to outlets.
5. Turn devices ON.

To disconnect:

1. Turn everything OFF.
2. First, remove power cords from outlets.
3. Remove signal cables from connectors.
4. Remove all cables from devices.

The power cord must be disconnected from the wall outlet or receptacle before installing all other electrical cables connected to the computer.

The power cord may be reconnected to the wall outlet or receptacle only after all other electrical cables have been connected to the computer.

Liquid crystal display notice

CAUTION:

For products with mercury-containing fluorescent lamps (i.e., non-LED)

- The fluorescent lamp in the liquid crystal display contains mercury; dispose according to local, state, or federal laws.
- The Liquid crystal display (LCD) is made of glass, and rough handling or dropping the computer can cause the LCD to break. If the LCD breaks and the internal fluid gets into your eyes or on your hands, immediately wash the affected areas with water for at least 15 minutes; if any symptoms are present after washing, get medical care.

Using headphones or earphones

If your computer has both a headphone connector and an audio-out connector, always use the headphone connector for headphones (also called a headset) or earphones.

CAUTION:

Excessive sound pressure from earphones and headphones can cause hearing loss. Adjustment of the equalizer to maximum increases the earphone and headphone output voltage and the sound pressure level. Therefore, to protect your hearing, adjust the equalizer to an appropriate level.

Excessive use of headphones or earphones for a long period of time at high volume can be dangerous if the output of the headphone or earphone connectors do not comply with specifications of EN 50332-2. The headphone output connector of your computer complies with EN 50332-2 Sub clause 7. This specification limits the computer's maximum wide band true RMS output voltage to 150 mV. To help protect against hearing loss, ensure that the headphones or earphones you use also comply with EN 50332-2 (Clause 7 limits) for a wide band characteristic voltage of 75 mV. Using headphones that do not comply with EN 50332-2 can be dangerous due to excessive sound pressure levels.

If your Lenovo computer came with headphones or earphones in the package, as a set, the combination of the headphones or earphones and the computer already complies with the specifications of EN 50332-1. If different headphones or earphones are used, ensure that they comply with EN 50332-1 (Clause 6.5 Limitation Values). Using headphones that do not comply with EN 50332-1 can be dangerous due to excessive sound pressure levels.

Additional safety information



Plastic bags can be dangerous. Keep plastic bags away from babies and children to avoid danger of suffocation.

Notice for Tablet PC users

Safety Notice for users in Australia:



Do not connect phone line while using tablet mode.

Notice for users in the U.S.A.

Many PC products and accessories contain cords, cables or wires, such as power cords or cords to connect the accessory to a PC. If this product has such a cord, cable or wire, then the following warning applies:

WARNING

Handling the cord on this product or cords associated with accessories sold with this product will expose you to lead, a chemical known to the State of California to cause cancer, and birth defects or other reproductive harm. Wash hands after handling.

Save these instructions.

Chapter 1. Product overview

This chapter provides information about the locations of connectors, locating important product information, computer features, specifications, operating environment, and preinstalled software programs.

This chapter contains the following topics:

- “Locating computer controls, connectors, and indicators” on page 1
- “Locating important product information” on page 12
- “Features” on page 14
- “Specifications” on page 16
- “Operating environment” on page 16
- “ThinkVantage Technologies” on page 17

Locating computer controls, connectors, and indicators

This topic introduces the hardware features of your computer.

- “Front view” on page 2
- “Right-side view” on page 5
- “Left-side view” on page 6
- “Rear view” on page 8
- “Bottom view” on page 7
- “Status indicators” on page 9

Front view



- | | |
|---|---|
| 1 UltraConnect™ wireless antennas (left) | 2 Integrated camera |
| 3 UltraConnect wireless antennas (right) | 4 Computer display |
| 5 Built-in microphone | 6 Status indicators |
| 7 Power switch | 8 ThinkVantage® button |
| 9 Volume control buttons | 10 PCI Express Mini Card slot for wireless LAN/WiMAX |
| 11 Fingerprint reader | 12 Bluetooth antenna |
| 13 PCI Express Mini Card slot for wireless WAN card, mSATA solid state drive, or Instant Media Mode card | 14 Touch pad |
| 15 TrackPoint® buttons | 16 TrackPoint pointing stick |
| 17 Memory-upgrade slot | |

Figure 1. ThinkPad X1 front view

1 3 UltraConnect wireless antennas

The built-in antennas for the wireless communication are located at the top left and the top right portions of your computer display.

For the specific locations of each antenna, refer to “Location of the UltraConnect wireless antennas” on page 150.

2 Integrated camera

Your computer has an integrated camera. By using this camera, you can take pictures or hold a video conference.

For more information about how to use the camera, refer to “Using an integrated camera” on page 48.

4 Computer display

The high-resolution thin-film transistor (TFT) premium display provides clear and brilliant text and graphics.

For details, refer to the instructions in “Changing display settings” on page 44.

5 Built-in microphone

The built-in microphone captures sound and voice when it is used with an application program capable of handling audio.

6 System status indicators

Your computer has a hard disk drive access indicator.

If your computer is shipped with a wireless LAN feature, a wireless WiMAX feature, a wireless WAN feature, and a Bluetooth, it also has a Wireless LAN/WAN/WiMAX status indicator and a Bluetooth status indicator.

7 Power switch

The power switch is lit whenever the computer is on and is not lit when the computer is in sleep mode.

Use the power switch to turn on the computer. To turn off your computer, use the Start menu Shut Down options.

If you cannot turn off the computer by this method, press and hold the power switch for 2 seconds.

If your computer stops responding and you cannot turn it off, press and hold the power switch for 4-6 seconds. If the computer still does not respond, remove the ac power adapter and reset the computer by inserting a needle or a straightened paper clip into the emergency reset hole to turn off the computer. To locate the emergency reset hole, refer to “Bottom view” on page 7.

The power switch also can be programmed through Power Manager to turn off the computer or put the computer into sleep or hibernation mode.

8 ThinkVantage button

You can use the ThinkVantage button to interrupt the startup sequence of your computer and start the Rescue and Recovery[®] workspace, which runs independently of the Windows[®] operating system and is hidden from it.

9 Volume control buttons

The built-in volume buttons enable you to quickly adjust the volume of the sound from your computer, mute the sound entirely, or set the microphone to mute.

For details, refer to the instructions in “Volume and mute buttons” on page 28.

10 PCI Express Mini Card slot for wireless LAN/WiMAX (some models)

Your computer might include a PCI Express Mini Card for wireless LAN/WiMAX in the PCI Express Mini Card slot which enables wireless LAN/WiMAX communications.

11 Fingerprint reader

Your computer has a fingerprint reader. The fingerprint authentication technology enables you to use your fingerprint to start the computer and enter the ThinkPad[®] Setup.

For details, refer to the instructions in “Using a fingerprint reader” on page 63.

12 Bluetooth antenna (some models)

If your computer comes with the integrated Bluetooth features, the antenna is located under the right side of the palm rest.

13 PCI Express Mini Card slot for wireless WAN card, mSATA solid state drive, or Instant Media Mode card (some models)

Your computer might include a PCI Express Mini Card in the PCI Express Mini Card slot which enables wireless WAN communications.

Some models are equipped with an mSATA solid state drive for data storage.

On some models, an Instant Media Mode card is installed to provide you with a secondary operating environment besides the Windows 7 operating system. For more information, refer to “Instant Media Mode” on page 25.

UltraNav

14 Touch pad

15 TrackPoint buttons

16 TrackPoint pointing stick

The keyboard contains the unique TrackPoint pointing device. Pointing, selecting, and dragging are all part of a single process that you can perform without moving your fingers from the typing position.

Move your fingertip across the UltraNav® touch pad to move the pointer.

The TrackPoint pointing stick and TrackPoint buttons provide functions similar to those of a mouse and its buttons.

17 Memory-upgrade slot

You can increase the amount of memory in your computer by installing a memory module in the memory bay. Memory modules are available as options.

Right-side view



1 4-in-1 Media Card Reader

2 Built-in stereo speakers (right)

3 Wireless radio switch

Figure 2. ThinkPad X1 right-side view

1 4-in-1 Media card reader

You can install an SD Card, an SDHC Card, an SDXC Card, or an MMC Card (MultiMediaCard), in the Media card reader of your computer.

For details, refer to the instructions in “Using the media card reader” on page 48.

Note: Your computer does not support the Content Protection for Recordable Media (CPRM) feature for SD card.

2 Built-in stereo speaker (right)

The stereo speakers are built into your computer.

For details, refer to the instructions in “Volume and mute buttons” on page 28.

3 Wireless radio switch

You can use this switch to enable or disable the wireless radio of all the wireless devices on your computer in the Windows 7 operating system environment and in Instant Media Mode.

Left-side view



1 Built-in stereo speaker (left)

2 USB connector (left)

3 Combo audio jack

4 Fan louvers

Figure 3. ThinkPad X1 left-side view

1 Built-in stereo speaker (left)

The stereo speakers are built into your computer.

For details, refer to the instructions in “Volume and mute buttons” on page 28.

2 USB connector (left)

The Universal Serial Bus (USB) connector is used for connecting USB interface-compatible devices, such as a printer or digital camera.

Note: Your computer is compatible with USB 2.0.

3 Combo audio jack

Your computer has a combo audio jack. To listen to the sound from your computer, connect a headphone or a headset, that has a 3.5 mm 4-pole plug, to the combo audio jack.

The combo audio jack does not support a conventional microphone. For more information about the audio devices supported by the combo audio jack of your computer, see “Using audio features” on page 47.

Note: If you are using a headset with a function switch, for example, a headset for an iPhone® mobile digital device, do not press this switch while using the headset. If you press it, the headset microphone will be disabled, and the internal microphone will be enabled instead.

4 Fan louvers

The internal fan and louvers enable air to circulate in the computer and cool the central processor.

Note: To avoid impeding airflow, do not place any obstacle in front of the fan.

Bottom view

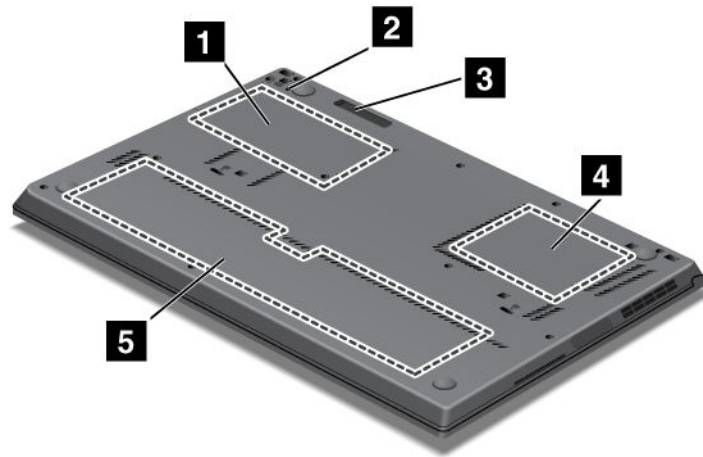

- 1** Hard disk drive or solid state drive
- 3** Slice battery connector
- 5** Battery

- 2** Emergency reset hole
- 4** Fan

Figure 4. ThinkPad X1 bottom view

1 Hard disk drive or solid state drive

Your computer may have a large-capacity, customer-upgradable hard disk drive that can meet a variety of storage demands. To keep the data on your drive safe, Active Protection System™ is installed on your computer. For details, refer to “Active Protection System” on page 19.

With Lenovo technologies advancing to provide you with the best engineered systems, some models are equipped with a solid state drive for data storage. This cutting-edge technology enables notebook computers to be lighter and faster.

Note: The hidden service partition is the reason why there is less free space than expected on your hard disk drive.

2 Emergency reset hole

If your computer stops responding and you cannot turn it off by pressing the power switch, remove the ac power adapter and reset the computer by inserting a needle or a straightened paper clip into the emergency reset hole to turn off the computer.

3 Slice battery connector

By installing a slice battery you can extend the operating time of the computer. For more information, refer to “ThinkPad Battery 39+ (6-cell slice battery)” on page 93.

Slice batteries are available as options and you can purchase one from Lenovo. See “Finding ThinkPad options” on page 93.

4 Fan

The internal fan and louvers enable air to circulate in the computer and cool the central processor.

Note: To avoid impeding airflow, do not place any obstacle in front of the fan.

5 Battery

Use your computer with battery power whenever ac power adapter is unavailable.

You can use Power Manager to adjust your power setting as needed. For details, refer to the instructions in “Power Manager” on page 20.

Rear view

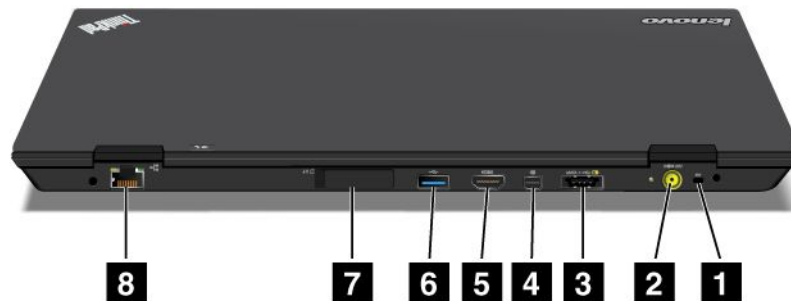

1 Security keyhole

2 Power jack

3 eSATA/Always on USB combo connector (rear)

4 Mini DisplayPort connector

5 HDMI port

6 USB connector (rear)

7 SIM card slot

8 Ethernet connector

Figure 5. ThinkPad X1 rear view

1 Security keyhole

Your computer comes with a security keyhole that requires a 15 mm diameter cable lock.

You can buy a 15 mm diameter Lenovo Security Cable Lock to fit this keyhole. For more information, refer to “Finding ThinkPad options” on page 93.

2 Power jack

The ac power adapter cable connects to the computer power jack to provide power to the computer and charge the battery.

An indicator to the left of the connector shows the status of ac power. When the ac power adapter is connected, the indicator is lit and green.

3 eSATA/Always on USB combo connector (rear)

This combo connector is used for connecting USB interface-compatible devices, such as a printer or digital camera, or connecting an external SATA device, such as an external hard disk drive.

Note: To avoid damaging the connector, be careful when you attach a cable from the external SATA device to the connector.

By default, even if your computer is in sleep mode, the Always On USB connector still enables you to charge some devices, such as iPod®, iPhone, and BlackBerry® smartphones, by attaching the devices to this connector.

However, with the ac power adapter attached, if you want to charge these devices when your computer is in hibernation mode or powered off, you will need to open the Power Manager program and configure corresponding settings to enable the Always On USB connector function. For details about how to enable the Always On USB connector function, refer to the on-line help of the Power Manager program.

Note: Your computer is compatible with USB 2.0.

4 Mini DisplayPort connector

Your computer has a Mini DisplayPort connector, a next-generation digital display interface, which supports adapters that can plug into a VGA, DVI, or HDMI port.

5 HDMI port

Your ThinkPad notebook computer supports the high-definition multimedia interface (HDMI) port, a next-generation digital audio or video interface that enables you to connect it to a compatible digital audio device or video monitor such as an HDTV.

6 USB connector (rear)

The Universal Serial Bus (USB) connector is used for connecting USB interface-compatible devices, such as a printer or digital camera.

Note: This blue USB connector is compatible with USB 3.0.

7 SIM card slot

If your computer has a wireless WAN feature, it may require a SIM (Subscriber Identification Module) card to establish a wireless WAN (Wide Area Network) connections. Depending on the country of delivery, the SIM card may be already installed in the SIM card slot.

8 Ethernet connector

Connect your computer to a LAN with the Ethernet connector.

Two indicators, to the upper left and the upper right of the connector, show the status of the network connection. When your computer connects to a LAN and a session with the network is available, the upper left indicator is solid green. While data is being transmitted, the upper right indicator blinks yellow.



To avoid the risk of electrical shock, do not connect the telephone cable to the Ethernet connector. You can only connect an Ethernet cable to this connector.

Status indicators

The status indicators show the current status of your computer.

System-status indicators

Your computer has system-status indicators. The following shows the location and the meaning of each indicator.



1 Device Access status indicator

A solid state drive, a hard disk drive, or an mSATA solid state drive is being used to read or write data.

When this indicator is blinking, do not put the computer into sleep mode or turn off the computer.

2 Power On status indicator

The computer is on and ready to use. The power switch stays lit whenever the computer is on, blinks when the computer is in sleep mode, and is not lit when the computer is off.

Power status indicator

Your computer has an indicator that shows the status of ac power.

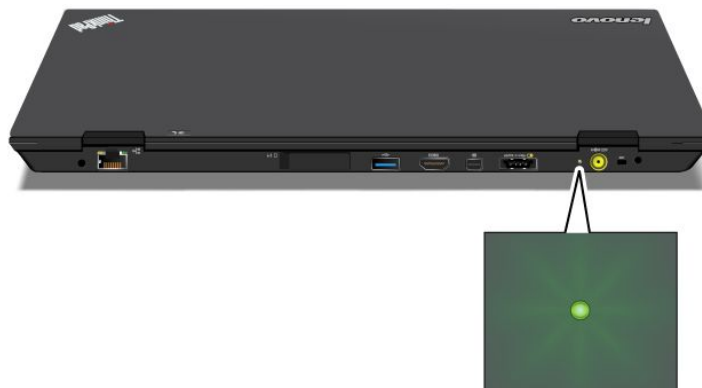

The meaning of the indicator is as follows:

- **Green:** The ac power adapter is connected.
- **Off:** The ac power adapter is not connected.

The computer has status indicators that show the mode (sleep, hibernation, or normal) and the status of the battery. The following shows the location and the meaning of the indicators:

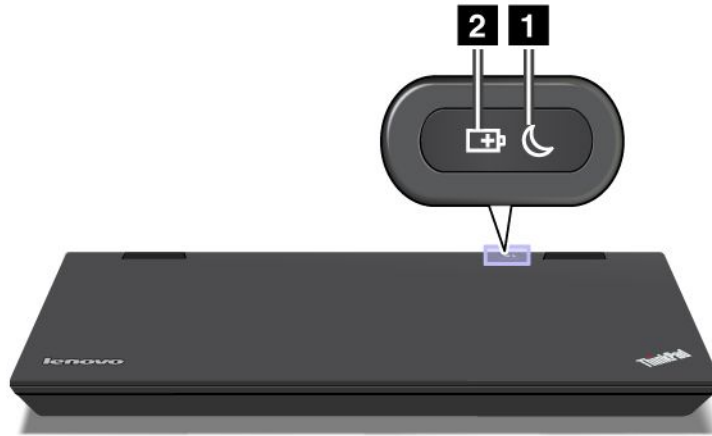

1 Sleep status indicator

- **Green:** The computer is in sleep mode.
- **Blinking green:** The computer is entering sleep or hibernation mode, or is resuming normal operation.

2 Battery status indicator

- **Green:** The battery charge level is 20% or more.
- **Orange:** The battery charge level is between 5% and 20%.
- **Fast blinking orange:** The battery charge level is 5% or less.

Note: The battery may be charging.

- **Slow blinking orange:** The battery is being charged. When the charge level reaches 20%, the blinking color changes to green.
- **Slow blinking green:** The battery charge level is between 20% and 80%, and charging is continuing. When the battery charge level reaches 80%, the battery status indicator stops blinking, but the charging may continue until the battery is 100% charged.

Note: If the computer is operating on battery power, the battery status indicator does not work while the computer is turned off or is in sleep mode or hibernation mode.

You can use the following indicators if your computer supports the corresponding function.



3 Bluetooth status indicator

- **Green:** The feature is on, and the radio link is ready for use.
- **Blinking green:** Data is being transmitted.

4 Wireless LAN/WAN/WiMAX status indicator

- **Green:** The wireless feature is on, and the radio link is ready for use.
- **Blinking green:** Data is being transmitted.

Locating important product information

This section provides information to help you locate your machine type and model label, FCC ID and IC Certification label, and Windows Certificate of Authenticity.

Machine type and model label

The machine type and model label identifies your computer. If you contact Lenovo for help, the machine type and model number will help support technicians to identify your computer and provide the highest level of service.

You can find the machine type and model of your computer in the label as shown below:

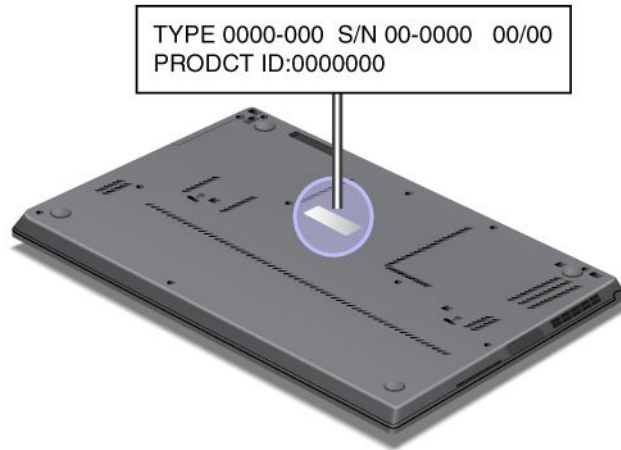

FCC ID and IC Certification number label

There is no FCC ID or IC Certification number for the PCI Express Mini Card shown on the enclosure of your computer. The FCC ID and IC Certification number label is affixed on the card installed in the Mini PCI Express Card slot of your computer.

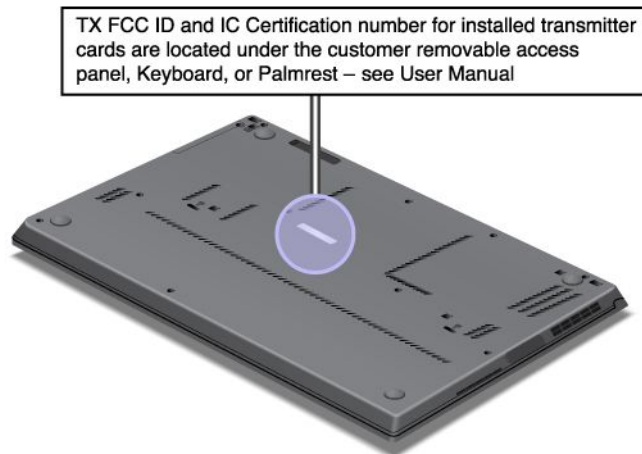

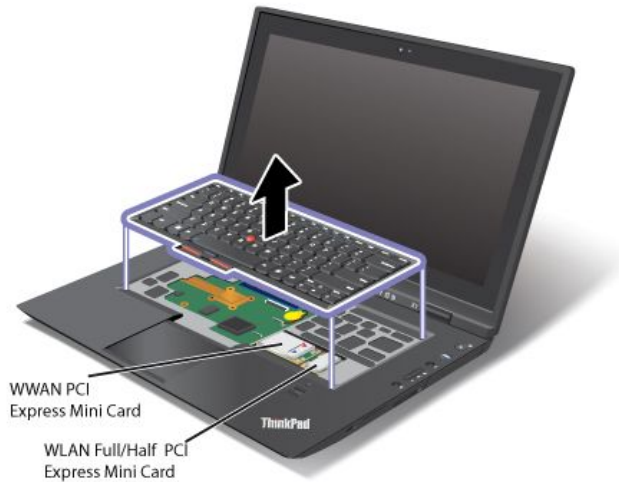

If no integrated wireless PCI Express Mini Card has been preinstalled in your computer, you can install one. To do this, follow the procedure in “Replacing the PCI Express Mini Card for wireless LAN/WiMAX connection” on page 83 or “Installing and replacing the PCI Express Mini Card for wireless WAN connection” on page 85.

Certificate of Authenticity label

The Microsoft Certificate of Authenticity label for the preinstalled operating system is attached. Printed on this label are the product ID and the product key information for your computer. Record this information and keep it in a safe place. You might need these numbers, to start your computer or reinstall the operating system.

The Certificate of Authenticity label of your computer is shown as below:

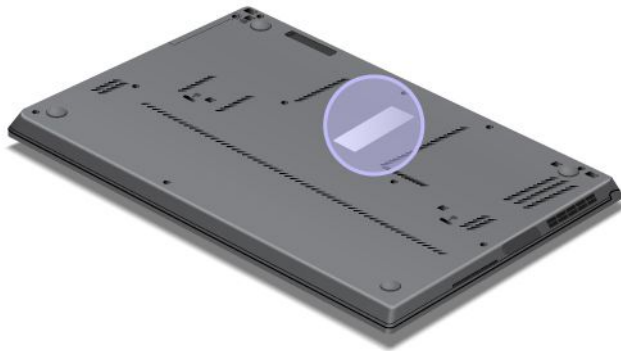

Features

Processor

- To see the system properties of your computer, click **Start**, right-click **Computer**; then from the pull down menu select **Properties**.

Memory

- Double data rate 3 (DDR3) synchronous dynamic random access memory

Storage device

- 2.5-inch (7 mm height) hard disk drive or 2.5-inch (7 mm height) solid state drive
- mSATA solid state drive (on some models)

Display

The color display uses TFT technology:

- Size: 13.3 inch (338 mm)
- LCD resolution: up to 1366-by-768
- Brightness control
- Integrated camera
- Built-in digital dual array microphones
- Built-in stereo speakers

Keyboard

- 6-row full size backlit keyboard
- UltraNav (TrackPoint and touch pad)
- Fn key function
- ThinkVantage button
- Volume control buttons
- Speaker mute button
- Microphone mute button

Interface

- External monitor connectors (Mini DisplayPort)
- One HDMI port
- Combo audio jack
- One Universal Serial Bus 3.0 (USB) connector
- One Universal Serial Bus (USB) connector
- One eSATA/Always on Universal Serial Bus (USB) connector
- RJ45 Ethernet connector

Card slot

- 4-in-1 Media card reader (SD/SDHC/SDXC/MMC)

Wireless features

- Integrated wireless LAN
- Integrated *Bluetooth* (on some models)
- Integrated wireless WAN (on some models)
- Integrated WiMAX (on some models)

Security features

- Fingerprint reader

Specifications

Size

- Width: 337 mm (13.3 inch)
- Depth: 231.1 mm (9.1 inch)
- Height: 16.5 to 21.3 mm (0.65 to 0.84 inch)

Heat output

- 90 W (307 Btu/hr) maximum

Power source (ac power adapter)

- Sine-wave input at 50 to 60 Hz
- Input rating of the AC adapter: 100 to 240 V AC, 50 to 60 Hz

Battery life

- For percentage of remaining battery power, see the Power Manager Battery Gauge in the task bar.
- The Power Manager also displays a green, yellow and red indication.

Operating environment

This section provides information about your computer operating environment.

Environment:

- Maximum altitude without pressurization: 3048 m (10,000 ft)
- Temperature
 - At altitudes up to 2438 m (8000 ft)
 - Operating: 5.0°C to 35.0°C (41°F to 95°F)
 - Storage: 5.0°C to 43.0°C (41°F to 109°F)
 - At altitudes above 2438 m (8000 ft)
 - Maximum temperature when operating under the unpressurized condition: 31.3°C (88°F)
- **Note:** When you charge the battery pack, its temperature must be at least 10°C (50°F).
- Relative humidity:
 - Operating: 8% to 80%
 - Storage: 5% to 95%

If possible, place your computer in a well-ventilated and dry area without direct exposure to sunshine.

Keep electrical appliances such as an electric fan, radio, high-powered speakers, air conditioner, and microwave oven away from your computer because the strong magnetic fields generated by these appliances can damage the monitor and data on the hard disk or solid state drive.

Do not place any beverages on top of or beside the computer or other attached devices. If liquid is spilled on or in the computer or an attached device, a short circuit or other damage might occur.

Do not eat or smoke over your keyboard. Particles that fall into your keyboard can cause damage.

ThinkVantage Technologies

Lenovo preinstalls on your PC useful and helpful software applications to help you get started, to stay productive while on the move and to keep you and your computer working. Lenovo offers enhanced security, wireless computing, data-migration and other solutions for your computer.

Following sections provide information about ThinkVantage Technologies offered by Lenovo.

- “Accessing applications in Windows 7” on page 17
- “Access Connections” on page 19
- “Active Protection System” on page 19
- “Client Security Solution” on page 19
- “Fingerprint Software” on page 19
- “Lenovo ThinkVantage Tools” on page 20
- “Lenovo ThinkVantage Toolbox” on page 20
- “Message Center Plus” on page 20
- “Password Manager” on page 20
- “Power Manager” on page 20
- “Product Recovery” on page 21
- “Rescue and Recovery” on page 21
- “System Update” on page 21

Note: To learn more about ThinkVantage Technologies and other computing solutions offered by Lenovo, go to <http://www.lenovo.com/support>.

Accessing applications in Windows 7

If you are using Windows 7, you can access applications by following one of the methods below:

- You can get the applications from the Lenovo ThinkVantage Tools.
Click **Start** → **All Programs** → **Lenovo ThinkVantage Tools**. Then depending on the application you want to access, double-click the corresponding icon.

Note: If an application icon in the Lenovo ThinkVantage Tools application navigation window is dimmed, it indicates that you need to install the application manually. To install the application manually, double-click the application icon. Then, follow the instructions on the screen. When the installation process completes, the application icon will be activated.

Table 1. Applications on Lenovo ThinkVantage Tools

Application	Icon name
Access Connections™	Internet Connection
Active Protection System	Airbag Protection
Fingerprint Software	Fingerprint Reader
Lenovo ThinkVantage Toolbox or Lenovo Solution Center	System Health and Diagnostics
Mobile Broadband Activate	3G Mobile Broadband
Password Manager	Password Vault

Table 1. Applications on Lenovo ThinkVantage Tools (continued)

Application	Icon name
Power Manager	Power Controls
Recovery Media	Factory Recovery Disks
Rescue and Recovery	Enhanced Backup and Restore
System Update	Update and Drivers
ThinkVantage GPS	GPS
Lenovo SimpleTap	SimpleTap
Lenovo Screen Reading Optimizer	Reading Optimization
Lenovo Communication Utility	Web Conferencing

- You can also get the applications from Control Panel.

Click **Start** → **Control Panel**. Depending on the application you want to access, click the corresponding section and then click the corresponding green text.

Note: If you do not find the application you need in Control Panel, open the Lenovo ThinkVantage Tools application navigation window and double-click the dimmed icon to install the application you need. Then, follow the instructions on the screen. When the installation process completes, the application icon will be activated, and you can find the application in Control Panel.

The sections in Control Panel, the green texts, and the applications are listed in the following table.

Table 2. Applications in Control Panel

Application	Control Panel section	Green text in Control Panel
Access Connections	Network and Internet	Lenovo - Internet Connection
Active Protection System	System and Security Hardware and Sound	Lenovo - Airbag Protection
Communications Utility	Hardware and Sound	Lenovo - Web Conferencing
Fingerprint Software	System and Security Hardware and Sound	Lenovo - Fingerprint Reader or Lenovo - Notebook Fingerprint Reader
Lenovo Solution Center or Lenovo ThinkVantage Toolbox	System and Security	Lenovo - System Health and Diagnostics
Mobile Broadband Activate	Network and Internet	Lenovo - 3G Mobile Broadband
Password Manager	System and Security User Accounts and Family Safety	Lenovo - Password Vault
Power Manager	Hardware and Sound System and Security	Lenovo - Power Controls
Recovery Media	System and Security	Lenovo - Factory Recovery Disks
System Update	System and Security	Lenovo - Update and Drivers
Rescue and Recovery	Network and Internet System and Security	Lenovo - Enhanced Backup and Restore
ThinkVantage GPS	Network and Internet System and Security	Lenovo - GPS

Table 2. Applications in Control Panel (continued)

Application	Control Panel section	Green text in Control Panel
Lenovo Screen Reading Optimizer	Appearance and Personalization	Lenovo - Reading Optimization
ThinkVantage AutoLock	System and Security	Lenovo - Camera-enhanced security

Note: Depending on your computer model, some applications might not be available.

Access Connections

Access Connections is a connectivity assistant program for creating and managing location profiles. Each location profile stores all the network and Internet configuration settings needed for connecting to a network infrastructure from a specific location such as a home or an office.

By switching between location profiles as you move your computer from place to place, you can quickly and easily connect to a network with no need to reconfigure your settings manually and restart the computer each time.

Active Protection System

The Active Protection System protects your hard disk drive when the shock sensor inside your computer detects a condition that could damage the drive, such as system tilt, excessive vibration, or shock. The hard disk drive is less vulnerable to damage when it is not operating; so the system stops it from spinning, and may also move the read/write heads of the drive to areas that do not contain data. As soon as the shock sensor senses that the environment is stable again (minimal change in system tilt, vibration, or shock), it turns the hard disk drive on.

Client Security Solution

The Client Security Solution program helps protect your computer and your personal information so that you know that your sensitive data is secure. It can also help manage your passwords, help recover a forgotten password, or help you monitor security settings on your computer and suggest how to enhance your computer security.

These convenient features are made more secure by a built-in security chip, a powerful computer chip dedicated to the security functions of your computer.

For details, refer to the Help for the program.

Note: Client Security Solution is not preinstalled on your system. You can download the latest Client Security Solution from the Web site <http://www.lenovo.com/support>.

Fingerprint Software

If your system comes with a fingerprint reader, the Fingerprint Software program enables you to enroll your fingerprint and associate it with your Windows password. As a result, the fingerprint authentication can replace your password and enable simple and secure user access.

Lenovo Solution Center

Note: Depending on the date when your computer was manufactured, your computer is preinstalled with either the Lenovo Solution Center program or the Lenovo ThinkVantage Toolbox program for diagnostic purposes. For additional information about the Lenovo ThinkVantage Toolbox program, see “Lenovo ThinkVantage Toolbox” on page 20.

The Lenovo Solution Center program enables you to troubleshoot and resolve computer problems. It combines diagnostic tests, system information collection, security status, and support information, along with hints and tips for maximum system performance. See “Diagnosing problems” on page 125 for detailed information.

Lenovo ThinkVantage Tools

The Lenovo ThinkVantage Tools program helps you work more easily and securely by providing easy access to various technologies, such as:

- Lenovo Solution Center or Lenovo ThinkVantage Toolbox (depending on the date of manufacture)
- Power Manager
- Rescue and Recovery
- System Update

To access the Lenovo ThinkVantage Tools program, click **Start → All Programs → Lenovo ThinkVantage Tools**.

Note: Lenovo ThinkVantage Tools is available only on models preinstalled with the Windows 7 operating system. If your Windows 7 model is not preinstalled with the program, you can download it from <http://www.lenovo.com/support>.

Lenovo ThinkVantage Toolbox

Note: Depending on the date when your computer was manufactured, your computer is preinstalled with either the Lenovo Solution Center program or the Lenovo ThinkVantage Toolbox program for diagnostic purposes. For additional information about the Lenovo Solution Center program, see “Lenovo Solution Center” on page .

To open Lenovo ThinkVantage Toolbox , see “Accessing applications in Windows 7” on page 17.

For additional information about running the Lenovo ThinkVantage Toolbox program, refer to the Lenovo ThinkVantage Toolbox help system.

Message Center Plus

The Message Center Plus program displays messages to inform you about helpful software that has been preinstalled on your computer. The software enables you to manage wired and wireless connections, protect your data in the event of a problem and automatically diagnose and resolve potential problems with your computer. The Message Center Plus can also provide messages about new updates available to keep your computer current.

Password Manager

The Password Manager program enables users to manage and remember all their sensitive and easy-to-forget application and Web site login information, such as user IDs, passwords, and other personal information.

Power Manager

The Power Manager program provides convenient, flexible, and complete power management for your computer. By using the Power Manager program, you can adjust your power settings to give you the best balance between performance and power saving.

Product Recovery

This program enables you to create recovery media to restore the contents of the system drive or hard disk drive to the same state as when the computer was originally shipped from the factory.

For information about how to open and use this program, refer to “Creating and using recovery media” on page 69.

Rescue and Recovery

The Rescue and Recovery program is a one button recovery and restore solution that includes a set of self-recovery tools to help you diagnose computer problems, get help, and recover from system crashes, even if you cannot start the Windows operating system.

For information about how to open and use this program, refer to “Creating and using recovery media” on page 69.

System Update

The System Update program helps you keep the software on your computer up-to-date by downloading and installing software packages (ThinkVantage applications, device drivers, UEFI BIOS updates, and other third party applications). Some examples of software that you should keep updated are programs provided by Lenovo, such as the Rescue and Recovery program.

Chapter 2. Using your computer

This chapter provides information on using your computer from the following aspects:

- “Registering your computer” on page 23
- “Frequently asked questions” on page 23
- “Instant Media Mode” on page 25
- “Special keys and buttons” on page 26
- “Using the UltraNav pointing device” on page 30
- “Power management” on page 34
- “Connecting to the network” on page 37
- “Using an external display” on page 44
- “Using a color profile” on page 47
- “Using audio features” on page 47
- “Using an integrated camera” on page 48
- “Using the media card reader” on page 48

Registering your computer

When you register your computer, information is entered into a database, which enables Lenovo to contact you in case of a recall or other severe problem. In addition, some locations offer extended privileges and services to registered users.

When you register your computer with Lenovo, you will also receive the following benefits:

- Quicker service when you call Lenovo for help
- Automatic notification of free software and special promotional offers

To register your computer with Lenovo, go to <http://www.lenovo.com/register>. Then follow the instructions on the screen.

Frequently asked questions

Here are a few tips that will help you optimize the use of ThinkPad notebook.

To ensure that you receive the best performance from your computer, browse the following Web page to find information such as aids for troubleshooting and answers to frequently asked questions at:
<http://www.lenovo.com/support/faq>

Can I get my user guide in another language?

- To download the user guide in another language, go to <http://www.lenovo.com/support>. Then follow the instructions on the screen.

On the go and need to use battery power more effectively?

- To conserve power, or to suspend operation without exiting applications or saving files, see the explanation about power-saving modes.

- To achieve the best balance between performance and power saving, create and apply power plans by use of Power Manager.
- If your computer will be turned off for an extended period of time, follow the instructions in “Before replacing CRU” on page 75 to disable the internal built-in battery so as to prevent battery power from draining.

Concerned about security or need to securely dispose of data stored on your hard disk or solid state drive?

- Study Chapter 4 “Security” on page 55 to find out how you can protect your computer from theft and unauthorized use.
- Before you dispose of the data on the hard disk drive or the solid state drive, be sure to read “Notice on deleting data from your hard disk drive or solid state drive” on page 66.

Getting connected in different locations is a challenge?

- To troubleshoot a wireless networking issue, see <http://www.lenovo.com/support/faq>.
- Take advantage of the networking features by use of Access Connections.
- To learn more about using the wireless features of your computer, refer to “Wireless connections” on page 38.
- To travel more confidently, be sure to check the tips in “Traveling with your computer” on page 54.
- Press Fn+F5, or use the wireless radio switch to enable or disable the wireless features.

Need to give presentations or attach an external monitor often?

- Use Fn+F7 key combination to switch display output location.
- Make sure that you follow the procedure of “Attaching an external monitor” on page 44.
- With the Extend desktop function, you can display output on both the computer display and an external monitor.

Need to attach or replace a device?

- See Chapter 6 “Replacing devices” on page 75 for more information about replacing the devices of your computer.
- See Chapter 7 “Enhancing your computer” on page 93 for more information about enhancing the features of your computer.

You have been using your computer for some time already, and it is getting slower?

- Follow the general tips for preventing problems introduced in “General tips for preventing problems” on page 119.
- You can diagnose problems yourself by following the instructions in “Diagnosing problems” on page 125.
- Also Recovery tool is provided on your computer hard disk or solid state drive. For more information, see Chapter 5 “Recovery overview” on page 69.

Print the following sections and keep them with your computer in case you are unable to access this online help when necessary.

- “Installing a new operating system” on page 99
- “Computer stops responding” on page 126
- “Power problems” on page 140

Instant Media Mode

If your computer is preinstalled with an Instant Media Mode card, the computer supports Instant Media Mode. You can quickly switch between the Windows 7 operating system and Instant Media Mode depending on your needs.

Instant Media Mode provides the following benefits for you:

- Much longer battery life
In Instant Media Mode, the computer consumes much less power; therefore, it can maximize your battery life.
- WiFi connectivity
A WiFi adapter is integrated in the Instant Media Mode card for wireless Internet access.

Notes:

- When the computer is turned on, the Windows 7 operating system is active.
- When you are using the Windows 7 operating system, the Instant Media Mode card is displayed as a USB mass storage drive in **Computer**. You can double-click the drive letter to access the data stored on the card.
- In Instant Media Mode, external devices, such as the external monitor, USB mouse, and external keyboard, are disabled.
- To shut down your computer, you need to return to the Windows 7 operating system environment.

Entering and exiting Instant Media Mode

Your computer comes with an Instant Media Mode Launcher gadget on the desktop of the Windows 7 operating system. Applications in Instant Media Mode are listed on the Instant Media Mode Launcher menu.

To enter Instant Media Mode, click an option on the Instant Media Mode Launcher menu. The application will start, and you will be in Instant Media Mode.

In Instant Media Mode, you can see a status bar at the top of the screen. To exit Instant Media Mode, click **Exit** on the status bar to return to the Windows 7 operating system environment.

Status bar

The status bar presents the following information:

- Time
- Battery status
- WiFi status
- Windows power status
- Four control buttons:
 - **Back**: Go back to the previous page.
 - **Home**: Go to the Instant Media Mode Home screen.
 - **Menu**: Display the main menu of the active application.
 - **Exit**: Exit Instant Media Mode and return to the Windows 7 operating system environment.

Applications in Instant Media Mode

The following applications are supported in Instant Media Mode:

- Web browser
- Picture viewer
- E-mail system
- Video player

Note: When you switch to another application, the video being played is paused.

- Music player

Note: In Instant Media Mode, background music playback is supported. You can switch to another application with music playback uninterrupted.

Special keys and buttons

Your computer has several special keys and buttons.

ThinkVantage button

You can use the ThinkVantage button to interrupt the startup sequence of your computer and start the Rescue and Recovery workspace, which runs independently of the Windows 7 operating system and is hidden from it. If the Windows 7 operating system is not running properly, you may need to do the following:

- Get the current system information.
- Rescue a file from your Windows environment or restore back-up files, provided you have made backups by use of the Rescue and Recovery program.
- Configure your computer or start the ThinkPad Setup.

All these can be achieved from the Rescue and Recovery workspace. Turn on the computer; then, while the “To interrupt normal startup, press the blue ThinkVantage button” message is displayed at the lower-left of the screen, press the ThinkVantage button. The Rescue and Recovery program opens.

Function key combinations

By setting the function keys, you can change operational features instantly. To use this function, press and hold the Fn key **1**, then press one of the function keys **2**.



Security

- **Fn+F2**

Lock your computer.

Power conservation

- **Fn+F3** (for Windows 7 only)

Select a power plan that has been created by Power Manager, or adjust the power level by using the slider control. When you press this combination of buttons, a panel for selecting a power plan or adjusting the power level appears.

- **Fn+F4**

Put your computer in sleep mode. To return to normal operation, press the Fn key only, without pressing a function key.

Alternatively, a quick press of the power button will also put your computer in sleep mode.

Note: If you want to use the combination to put the computer into hibernation mode or do-nothing mode, change the settings in Power Manager.

Switching a display output location

- **Fn+F7** (for Windows 7 only)

Switch between the computer display and an external monitor. Windows will show these display options:

- Computer display only (LCD)
- Computer display and external monitor (same image)
- Computer display and external monitor (extended desktop function)
- External monitor only

Note: To switch between the computer display and an external monitor, the Windows+P key combination is also available.

Enabling or disabling the wireless features

- **Fn+F5**

Enable or disable the built-in wireless networking features. In the Windows 7 operating system, if you press Fn+F5, a list of wireless features is displayed. You can quickly change the power state of each feature in the list.

If you want to use Fn+F5 to enable or disable the wireless features, the following device drivers must be installed on your computer beforehand:

- Power Management driver
- OnScreen Display Utility
- Wireless device drivers

In Instant Media mode, if you press Fn+F5, the WiFi settings interface will be displayed. You can set the WiFi credentials and other wireless connection parameters in the WiFi settings interface.

For information on the wireless features, refer to “Wireless connections” on page 38.

Launching the camera and audio settings

- **Fn+F6**

If you press Fn+F6, the camera and audio settings window is displayed and the camera preview is turned on.

From this window, you can change the camera and audio settings.

Note: The camera settings area only appears if your computer has an integrated camera. For more information, see “Using an integrated camera” on page 48.

Multimedia control

- **Fn+F10:** Previous track/scene
- **Fn+F11:** Play or pause
- **Fn+F12:** Next track/scene

Other functions

- **Fn+Spacebar:** Your computer has a backlit keyboard. This combination is used to control the keyboard backlight.

There are three states for the keyboard backlight: **On (Low)**, **On (High)**, and **Off**.

Press Fn+Spacebar once to turn on the keyboard backlight in low brightness level. To adjust the backlight to a high brightness level, press the key combination again. Pressing the key combination for a third time turns off the keyboard backlight.

- **Fn+F8:** The computer display becomes dimmer.

The purpose of this method is to change the brightness level temporarily. To change the default brightness level, change the settings of the Power Option in Control Panel or use Power Manager.

- **Fn+F9:** The computer display becomes brighter.

The purpose of this method is to change the brightness level temporarily. To change the default brightness level, change the settings of the Power Option in Control Panel or use Power Manager.

Volume and mute buttons

You can adjust the sound level of the built-in speakers by using the following three buttons:



- 1 Microphone mute**
- 2 Volume control button**
- 3 Speaker mute button**

If you mute the sound and then turn off your computer, the sound will remain muted when you turn on your computer again. To turn on the sound, press the plus (+) or minus (-) button.

Setting the volume

Each device has volume controls, which you can set.

To open the window for adjusting the output volume or the recording volume, do the following:

1. Click **Start → Control Panel → Hardware and Sound → Sound**. The Sound window appears.
2. Click the **Playback** tab or **Recording** tab, and then click a device, which you want to customize.
3. Click the **Properties** button.
4. Click the **Levels** tab, and then change the volume by moving the slider.

Notes:

- You can also get access to the desktop volume control by using the volume icon in the task bar at the lower right of the screen. To open the Volume Control window, click the volume icon. To control the volume, move the volume control slider up or down. To turn off the sound, select **Mute speakers**.
- The names of windows or fields are slightly different depending on the operating system you use.
- For details about controlling volume, refer to your Windows online help.

Setting the microphone mute button

By default, you can toggle all of your recording devices between the mute state and the un-mute state by pressing the microphone mute button.

If you want to toggle one of the recording devices between the mute state and the un-mute state, do the following:

1. Press Fn+F6. The Communications settings window opens.
2. Click the **Manage Settings** button. The Communications Utility window opens.

3. On the **VoIP Call Settings** tab, click **Microphone mute button settings**. The Setting for Microphone Mute window opens.
4. Select **Only the recording device selected below**: and then select the recording device from the drop-down list box.
5. Click **OK**.

Windows key and other function keys



1 PrtSc key (for Windows 7 only)

Press this key to take a snapshot of your computer screen and copy it to the clipboard.

2 Windows key

Press this key to display or hide the Windows Start menu.

If you press this key and another key at the same time, the System Properties window or the Computer window is displayed. For details, refer to the Help in the Windows 7 operating system.

Function keys in Instant Media Mode:

3 Esc: Go back to the previous page.

4 Home: Go to the Instant Media Mode Home screen.

5 End: Open the search tool.

6 Insert: Display the main menu of the active application.

Using the UltraNav pointing device

Your computer may come with the UltraNav pointing device. The UltraNav pointing device consists of the TrackPoint and the touch pad, each of which is itself a pointing device with both basic and extended functions. You can configure both devices by choosing the settings you prefer as follows:

- **Set both the TrackPoint and the touch pad as pointing devices.**

This setting enables the use of all the basic and extended functions of the TrackPoint and the touch pad.

- **Set the TrackPoint as the main pointing device and the touch pad for extended functions only.**

This setting enables the use of all basic and extended functions with the TrackPoint while limiting the use of the touch pad to scrolling, tap zones, and slow-motion pointer functions.

- **Set the touch pad as the main pointing device and the TrackPoint for the extended functions only.**

This setting enables the use of all basic and extended functions with the touch pad while limiting the use of the TrackPoint to scrolling and Magnifying Glass functions.

- **Set the TrackPoint as the main pointing device, and disable the touch pad.**

- **Set the touch pad as the main pointing device, and disable the TrackPoint.**

Changing the UltraNav settings

You can change your UltraNav settings in the **UltraNav** tab of the Mouse Properties window. To open it, use one of the following methods:

- Click **Start** → **Control Panel** → **Hardware and Sound** → **Mouse** → **UltraNav**.

You can also change the UltraNav settings by clicking the **UltraNav** icon on the system tray. To display the UltraNav icon on the system tray, see “Adding the UltraNav icon to the system tray” on page 34.

Using the TrackPoint pointing device

The TrackPoint pointing device consists of a pointing stick **1** on the keyboard and three click buttons at the bottom of the keyboard. To move the pointer **5** on the screen, you apply pressure to the nonslip cap on the pointing stick in any direction parallel to the keyboard; the pointing stick itself does not move. The speed at which the pointer moves depends on the pressure you apply to the pointing stick. The functions of the left **4** and right **2** click buttons correspond to those of the left and right mouse buttons on a conventional mouse. The TrackPoint center button **3**, called the scroll bar, enables you to scroll Web pages or documents in any direction with no need to use the graphic scroll bars on the side of the window.

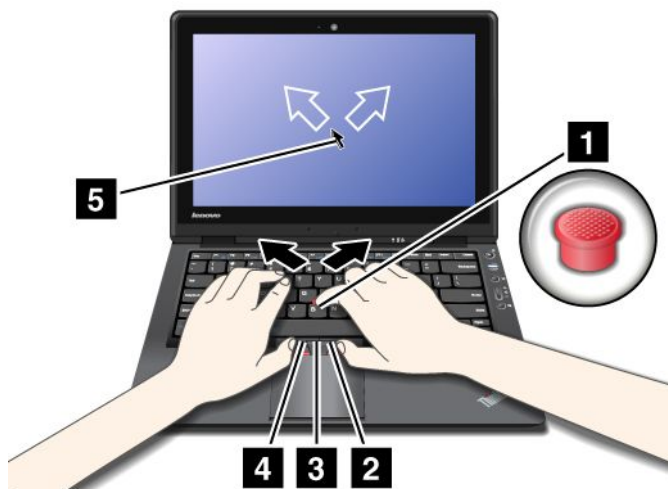

If you are not familiar with the TrackPoint, these instructions will help you get started:

1. Place your hands in the typing position, and press gently with either index finger on the pointing stick in the direction in which you want the pointer to move.

To move the pointer, press the pointing stick away from you to move it up, toward you to move it down, to one side or the other to move it sideways.

Note: The pointer might drift. This is not a defect. Stop using the TrackPoint for a few seconds; the pointer will stop moving.

2. To select and drag as required by your software, press the left or right click button with either thumb and move the TrackPoint pointing stick.

By enabling Press-to-Select, you can make the TrackPoint pointing stick function the same as the left or right click button.

Customizing the TrackPoint

You can customize the TrackPoint pointing device and its buttons as follows:

- Switch the functions of the left and right buttons.
- Change the sensitivity of the TrackPoint.
- Enable the Press-to-Select function.
- Enable the Magnifying Glass.
- Enable the TrackPoint scrolling function.
- Enable the TrackPoint Scrolling Tips.

To customize the TrackPoint, do as follows:

1. Click **Start → Control Panel → Hardware and Sound → Mouse → UltraNav**. A panel for UltraNav Device Settings pops up.
2. Click **Manage Settings** to open the Mouse properties window.
3. Click the **UltraNav** tab. Under TrackPoint, proceed to changing the settings.

For details, refer to the Help in the Utility.

Changing the cap

The cap **1** on the end of the TrackPoint pointing stick is removable. You can replace it as shown in the drawing.



Note: If you replace the keyboard, a new keyboard is shipped with the default cap. If you wish, you can keep the cap from your old keyboard and use it on the new one.

Using the touch pad

The touch pad is a pad **1** below the TrackPoint buttons at the bottom of the keyboard. To move the pointer **2** on the screen, slide your fingertip over the pad in the direction in which you want the pointer to move.

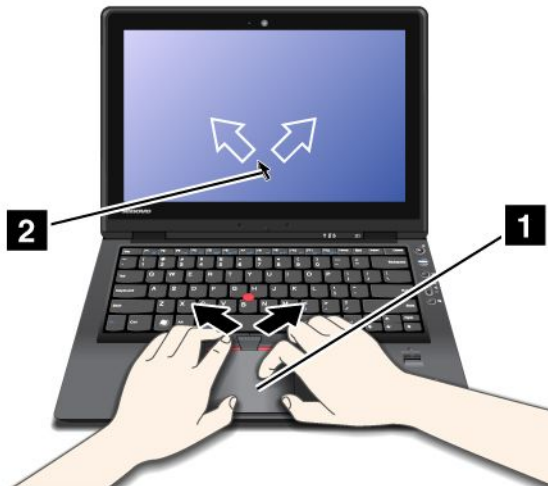

The whole touch pad **1** is an active area sensitive to finger movement. The bottom area of the touch pad consists of a left click zone **3** and a right click zone **2**.

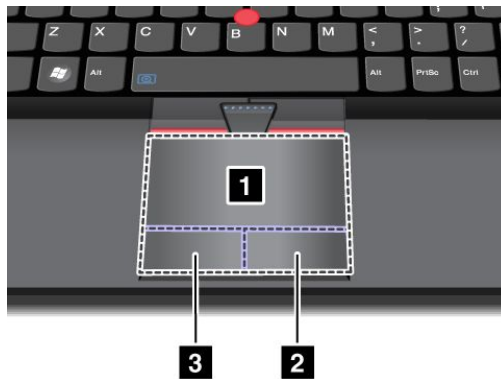

Movement on the touch pad emulates operations on the mouse. Before interacting with the touch pad, make sure the cursor stays on the object that you want to operate.

- **Left click:** To mimic a single left click on a mouse, tap anywhere on the touch pad once or press the left click zone **3** once. To mimic a double click on a mouse, tap anywhere on the touch pad twice or press the left click zone **3** twice.
- **Right click:** To mimic a right click on a mouse, press the right click zone **2** once.
- **Left click and drag:** To mimic a left click and drag on a mouse, do either of the following:
 - Tap anywhere on the touch pad twice and hold the finger on the touch pad, slide the same finger or another finger on the touch pad, whichever is more convenient and then release the finger(s).
 - Press the left click zone **3** and hold the finger on the touch pad, slide another finger on the touch pad, and then release both fingers.
- **Right click and drag:** To mimic a right click and drag on a mouse, press the right click zone **2** and hold the finger on the touch pad, slide another finger on the touch pad, and release both fingers.

Using the multi-touch touch pad

The touch pad of your computer supports multi-touch with which you can zoom in, zoom out, scroll or rotate on the screen while browsing the Internet or reading or editing a document.

For details, refer to the Help in UltraNav.

Customizing the touch pad

To customize the touch pad, do as follows:

1. Click **Start → Control Panel → Hardware and Sound → Mouse → UltraNav**. A panel for UltraNav Device Settings pops up.
2. Click **Manage Settings** to open the Mouse properties window.
3. Click the **UltraNav** tab and proceed to customizing the touch pad.

For details, refer to the Help in the Utility.

Behavior of the UltraNav and an external mouse

By default, the TrackPoint and the touch pad are set to **Enabled**.

Disabling the TrackPoint or the touch pad

If you want to disable the TrackPoint or the touch pad, do the following:

Configure settings in UltraNav properties window:

1. Click **Start → Control Panel → Hardware and Sound → Mouse**.
2. Click the **UltraNav** tab.
3. To disable the TrackPoint, clear the check box for **Enable TrackPoint**.
To disable the touch pad, clear the check box for **Enable touch pad**.
4. Click **OK**.

Notes:

- You can also open the UltraNav properties window by clicking the **UltraNav** icon in the task bar. For details, refer to the instructions in “Adding the UltraNav icon to the system tray” on page 34.

Adding the UltraNav icon to the system tray

For easy access to the UltraNav properties, you can add the **UltraNav** icon to the system tray.

To enable the display of the **UltraNav** icon on the system tray, do as follows:

1. Click **Start → Control Panel → Hardware and Sound → Mouse → UltraNav**. A panel headed UltraNav Device Settings pops up.
2. Click **Manage Settings** to open the Mouse properties window.
3. Click the **UltraNav** tab.
4. Select the check box for **Show UltraNav icon on the system tray**.
5. Click **OK** or **Apply**.
6. Click **Show hidden icons** in the task bar. The UltraNav icon is displayed. To add it to the task bar permanently, click **Customize** and proceed to customize the settings.

You can now change the properties of UltraNav by clicking the **UltraNav** icon on the system tray.

Power management

When you need to use your computer away from electrical outlets, you depend on battery power to keep your computer running. Different computer components consume power at different rates. The more you use the power-intensive components, the faster you consume battery power.

Do more, save more and spend more time unplugged with ThinkPad batteries. Mobility has revolutionized business by allowing you to take your work where ever you go. With ThinkPad batteries, you will be able to work longer without being tied to an electrical outlet.

Checking battery status

The Power Manager Battery Gauge in the task tray displays the percentage of battery power remaining.

The rate at which you use battery power will determine how long you can use the battery of your computer between charges. Because each computer user has different habits and needs, it is difficult to predict how long a battery charge will last. There are two main factors:

- How much energy is stored in the battery when you begin to work.
- The way you use your computer: how often you access the hard disk drive or the solid state drive, how bright you make the computer display.

Using the ac power adapter

The power to run your computer can come either from the lithium-ion (Li-ion) battery pack provided with it, or from ac power through the ac power adapter. While you use ac power, the battery charges automatically.

The ac power adapter that comes with your computer has two basic components:

- The transformer pack that converts ac power adapter for use with the computer.
- The power cord that plugs into the AC outlet and into the transformer pack.

Attention: Using an improper power cord could cause severe damage to your computer.

To use the ac power adapter, do the following. Be sure to take these steps in the order in which they are given here.

1. Connect the ac power adapter to the power jack of the computer.
2. Connect the power cord to the transformer pack.
3. Plug the power cord into an electrical outlet.

You can check the status of your battery at any time by looking at the battery meter at the bottom of your display.

Notes:

- When the ac power adapter is not in use, disconnect it from the electrical outlet.
- Do not bind the power cord tightly around the ac power transformer pack when it is connected to the transformer.
- Charge the battery in any of the following conditions:
 - When a new battery is installed
 - If the battery status indicator starts blinking
 - If the battery has not been used for a long time

Before you charge the battery, make sure that its temperature is at least 10°C (50°F).

Charging the battery

When you check battery status and find that the percentage of power remaining is low or when the power alarm alerts you that remaining power is low, you need to charge your battery.

If an ac outlet is convenient, plug the ac power adapter into it, and then insert the jack into the computer. The battery will charge in about 1.5 hours. This is affected by the battery size and the physical environment. The battery status indicator will let you know that the battery is charging, and will turn off when battery is fully charged.

Note: To increase the life of the battery, the computer does not start recharging the battery if the remaining power is greater than 95%.

Maximizing battery life

To maximize the life of the battery, do the following:

- For a new battery or a battery that you have not used recently, recharge the battery completely before using it.
- Always use power management features such as power modes, screen blank, sleep, and hibernation.

Managing your battery power

With Power Manager, you can adjust your power settings to give you the best balance between performance and power saving.

To start the utility program, refer to “Accessing applications in Windows 7” on page 17.

For more information about the Power Manager program, refer to the on-line help of the program.

Power-saving modes

There are several modes that you can use at any time to conserve power. This section introduces each mode and gives tips on the effective use of the battery power.

Introducing the power-saving modes

- **Screen blank.**

The computer display requires considerable battery power. To turn off power to the display, do as follows:

1. Press Fn+F3. A panel for selecting a power plan appears.
2. Select **Power off display (keep current power plan)**.

Notes: You can also turn off the computer display as follows:

1. Press Fn+F3. A panel for selecting a power plan appears.
2. Select **Fn+F3 Settings**.
3. Select **Power off display**.
4. Click **OK**. The next time you press Fn+F3, you can turn off the computer display.

- **Sleep**

In sleep mode, your work is saved to memory, and then the solid state drive or the hard disk drive and the computer display are turned off. When your computer wakes up, your work is restored within seconds.

To put your computer into sleep mode, press Fn+F4. To return from sleep mode, press the Fn key.

- **Hibernation**

By using this mode, you can turn off your computer completely without saving files or exiting from any applications that are running. When you enter hibernation, all open applications, folders, and files are saved to the hard disk, and then the computer turns off. To enter hibernation in the Windows 7 operating system, do as follows:

1. Click **Start**.

2. Click the triangle mark on the right side of the **Shut down** icon, then select **Hibernate**.

Note: If the computer is in Instant Media Mode, you need to switch back to the Windows 7 operating system environment before entering hibernation.

When you are not using the wireless features, such as *Bluetooth* or wireless LAN, turn them off. This will help conserve power. To turn off the wireless features, press Fn+F5.

Enabling the wakeup function

If you put your computer into hibernation mode, and the wakeup function is disabled (this is the default setting), the computer does not consume any power. If the wakeup function is enabled, it consumes a small amount of power. To enable the function, do as follows:

1. Click **Start → Control Panel → System and Security**.
2. Click **Administrative Tools**.
3. Click **Task Scheduler**. If you are prompted for an administrator password or confirmation, type the password or provide confirmation.
4. From the left pane, select the task folder for which you want to enable the wakeup function. The scheduled tasks are displayed.
5. Click a scheduled task, and then click the **Conditions** tab.
6. Under **Power**, select the check box for **Wake the computer to run this task**.

Enabling the battery alarm

You can program your computer so that when the battery power falls below a certain level, three events occur: the alarm goes off, a message is displayed, and the LCD is turned off.

To enable the battery alarm, do as follows:

1. Start Power Manager.
2. Click the **Global Power Settings** tab.
3. For **Low battery alarm** or **Critically low battery alarm**, set the percentage of the power level and set the action.

Note: If your computer enters sleep or hibernation mode when the battery is low, but the alarm message has not yet appeared, the message will appear when the computer resumes. To resume normal operation, press **OK**.

Connecting to the network

Your computer has one or more network adapters for connecting to the Internet and to your company's wired LAN or wireless LAN network.

Note: Some models come with a built-in wireless WAN card enabling you to establish wireless connections over remote public or private networks.

The Access Connections program is a connectivity assistant program for creating and managing location profiles. Each location profile stores all the network and Internet configuration settings needed for connecting to a network infrastructure from a specific location such as a home or an office.

Ethernet connections

You can connect to your network or a broadband connection, such as DSL or CATV, by use of the Ethernet feature built into your computer. This feature enables you to do 1Gbps half or full duplex data transmission.

To connect to a network via Ethernet, you can use Access Connections.

Wireless connections

Wireless connection is the transfer of data without the use of cables by means of radio waves only.

Depending on the frequency used for data transmission, the area covered, or the type of the device used for data transfer, the following categories of wireless networks may be available to you:

Wireless LAN

A wireless local area network covers a relatively small geographic area, such as an office building or a house. Devices based on the 802.11 standards can connect to this network.

Wireless WAN

A wireless wide area network covers a broader geographic area. Cellular networks are used for data transmission, and access is provided by a wireless service carrier.

Bluetooth

One of a number of technologies used to create a wireless personal area network. *Bluetooth* can connect devices a short distance from one another, and is commonly used for connecting peripheral devices to a computer, transferring data between hand-held devices and PC, or remotely controlling and communicating with devices such as mobile phones.

WiMAX (Worldwide Interoperability for Microwave Access)

This long-range wireless data transmission technology based on the 802.16 standard is expected to provide the user a “last mile” broadband connectivity similar to that provided by cable or ADSL, but without the need to physically connect a cable to the PC.

Making wireless LAN connections

Your computer comes with a built-in wireless networking card and a configuration utility to help you make wireless connections and monitor the status of your connection, so that you can stay connected to your network while you are in the office, in a meeting room, or at home, with no need for a wired connection.

Attention:

- If you carry your computer with the wireless LAN feature into an airplane, check the services with the airline before boarding the airplane.
- If there are restrictions on the use of computers on an airplane with the wireless feature, you need to disable it before boarding. To disable it, refer to the instructions in “Enabling or disabling the wireless feature” on page 43.

Note: You can purchase a wireless networking card as an option. For more information, refer to “Finding ThinkPad options” on page 93.

Tips for using the wireless LAN feature

- Place your computer so that there are as few obstacles as possible between the wireless LAN access point and the computer.
- For the best connection of the wireless LAN feature, open your computer display to an angle of slightly more than 90 degrees.
- If you use the wireless feature (the 802.11 standard) of your computer simultaneously with a *Bluetooth* option, data transmission speed can be delayed and the performance of the wireless feature can be degraded.

Wireless networking setup

To use the built-in wireless networking card (the 802.11 standard) to communicate, start the Access Connections program.

Note: Before you start setting up wireless networking connections by using the Access Connections program, obtain a Network Name (SSID) and your encryption information from your network administrator.

The Access Connections program, a connectivity assistant program, can easily enable one network adapter and disable the other adapters on demand. After setting up your wireless networking connection, you can use the program to quickly switch the network settings.

If no WiFi credentials are stored on the Instant Media Mode card, when you switch your computer to Instant Media Mode, a pop-up dialog box will be displayed to request the WiFi credentials. Input your WiFi credentials to set up the wireless connection.

Note: If the computer is connected to a wireless network when you are using the Windows 7 operating system, after switching to Instant Media Mode, the Instant Media Mode card will automatically attempt to connect to the wireless network that was previously in use in the Windows 7 operating system environment.

If WiFi credentials are stored on the Instant Media Mode card, when you switch your computer to Instant Media Mode, the wireless connection will be automatically established using the credentials stored on the Instant Media Mode card. You can update your credentials and other wireless connection parameters in the WiFi settings interface.

Wireless security features

Advances in wireless technology require that we manage your security more reliably than ever. Therefore, Lenovo has extended its Embedded Security Subsystem called the Trusted Platform Module (TPM) to encompass virtually all of our ThinkPad and desktop computer lines. This security subsystem helps protect data, hardware, network access and communications, both wired and wireless, on select ThinkPad and desktop PCs.

The Embedded Security Subsystem provides hardware-based protection of critical security information, including passwords, encryption keys, and electronic credentials. It also helps identify computer users involved in transactions, and helps establish that data transmissions are authentic, confidential and intact.

For both types of network, the Client Security Solution and TPM ensure data confidentiality and availability by providing a hardware- and software-based architecture for better protection of the sensitive keys, identity information, and confidential data. Also, for wireless networks the TPM hardware provides enhanced authentication and session confidentiality by concealing authentication credentials for industry-standard 802.1x protocols and Cisco LEAP.

Note: Client Security Solution is not preinstalled on your system. To download Client Security Solution, go to <http://www.lenovo.com/support>.

For more information on wireless security offerings, click the following link:
<http://www.lenovo.com/thinkvantagetech/security>

Wireless upgradeable ThinkPad models

Your computer can be wireless upgradeable. This means that your computer has an antenna that can support wireless LAN access when wireless LAN access points are available. Wireless devices are available from Lenovo. For more information, refer to “Finding ThinkPad options” on page 93.

Using wireless WAN connections

Wireless Wide Area Network (wireless WAN) enables you to establish wireless connections over remote public or private networks. These connections can be maintained over a large geographical area, such as

a city or an entire country, by use of multiple antenna sites or satellite systems maintained by wireless service providers.

Some ThinkPad notebooks come with a built-in wireless WAN card integrating some wireless WAN technologies, such as 1xEV-DO, HSPA, 3G or GPRS. You can connect to the Internet or your company network with the built-in wireless WAN card and the configuration utility to make a wireless WAN connection and monitor its status.

Note: Wireless WAN service is provided by authorized service providers in some countries.

To find the location of the wireless WAN antenna on your computer, refer to “Location of the UltraConnect wireless antennas” on page 150.

To use the wireless WAN feature, start Access Connections.

Using *Bluetooth*

If your computer is equipped with the Integrated *Bluetooth* features, you can enable or disable the features by pressing Fn+F5. If you press Fn+F5, a list of wireless features is displayed. You can enable or disable the *Bluetooth* features with a single click.

To configure a *Bluetooth* device or manage connection settings, you can use **Bluetooth Devices** in Control Panel.

1. Click **Start → Control Panel**.
2. Click **Hardware and Sound**.
3. Click **Devices and Printers**.

To send data to a *Bluetooth*-enabled device, do as follows:

1. Right-click the data that you want to send.
2. Select **Send To → Bluetooth Devices**.

For details, refer to the Windows online help.

Note: If you use the wireless feature (the 802.11 standard) of your computer simultaneously with a *Bluetooth* option, data transmission speed can be delayed and the performance of the wireless feature can be degraded.

Using the Microsoft *Bluetooth* software

For information about how to use the *Bluetooth* function, do as follows:

1. Press Fn+F5 to turn on *Bluetooth*.
2. Click **Start → Control Panel**.
3. Click **Printers and Other Hardware**.
4. Click **Bluetooth Devices**.
5. Click the **Options** tab.
6. Click **Learn more about Bluetooth Settings**.

Using ThinkPad *Bluetooth* with Enhanced Data Rate Software

If ThinkPad *Bluetooth* with Enhanced Data Rate Software is installed on your computer, two icons are displayed on the screen:

- **My Bluetooth Places** on the desktop

- **Bluetooth Configuration** in the system tray of the task bar

My Bluetooth Places

To use the *Bluetooth* features, do the following:

1. Double-click the **My Bluetooth Places** icon on the desktop. A list of the devices on which *Bluetooth* has been enabled appears.
2. Click the device to which you want access. A list of the services available on that device appears as follows:
 - *Bluetooth* keyboard and mouse (Human interface devices)
 - Printer (HCRP)
 - Audio gateway
 - Headset
 - PIM synchronization
 - File transfer
 - PIM item transfer
 - Dial-up networking
 - Network access
 - *Bluetooth* serial port
 - Bluetooth Imaging
 - Hands Free
 - AV profile
3. Click the service you want.

For more information, press the F1 key to open the online help for *Bluetooth*.

Bluetooth Configuration

To use the configuration features of *Bluetooth*, right-click the icon. A pop-up menu appears. Select **Bluetooth Setup Wizard** or **Advanced Configuration**.

The *Bluetooth* Setup Wizard has the following capabilities:

- Finding all *Bluetooth*-enabled devices that can provide services
- Finding a specific *Bluetooth*-enabled device that you want to use, and configuring the services on that device
- Configuring the *Bluetooth*-enabled services on your computer that are provided for remote devices
- Configuring the name and device type of your computer

The Advanced Configuration has the following functions:

- Configuring the name and device type of your computer
- Configuring your computer settings so that remote *Bluetooth*-enabled devices can find your computer
- Configuring your computer settings so that your computer can find remote *Bluetooth*-enabled devices
- Configuring, on your computer, the *Bluetooth*-enabled services provided for remote devices
- Configuring the services on remote *Bluetooth*-enabled devices
- Displaying information about *Bluetooth* hardware

For details, refer to the help for *Bluetooth*. To see the help, double-click **My Bluetooth Places**, and click **Help** and then **Bluetooth help**. Another way to start the help is to right-click **Bluetooth Configuration** in the system tray of the task bar, and click **Advanced Configuration** and then **Help**.

Using WiMAX

Some ThinkPad notebooks come with a built-in wireless LAN card integrating WiMAX technology.

WiMAX, a long-range wireless data transmission technology based on the 802.16 standard, provides you with a “last mile” broadband connectivity similar to that offered by cable or ADSL, but without the need to physically connect a cable to the PC.

To use the WiMAX feature, start Access Connections.

To start the Access Connections wizard, see “Accessing applications in Windows 7” on page 17.

Checking wireless connection status





Access Connections Gauge

The Access Connections Gauge in the task bar displays the signal strength and status of your wireless connection.





Note: To display Access Connections Gauge in the task bar, see the Help in Access Connections.

You can find more detailed information about the signal strength and status of your wireless connection by opening Access Connections or by right-clicking the Access Connections Gauge in the task bar and selecting **View Status of Wireless Connection**.

- Access Connections Gauge states: wireless LAN

-  Power to the wireless radio is off or no signal.
-  Power to the wireless radio is on. The signal strength of the wireless connection is poor. To improve signal strength, move your system closer to the wireless access point.
-  Power to the wireless radio is on. The signal strength of the wireless connection is marginal.
-  Power to the wireless radio is on. The signal strength of the wireless connection is excellent.

- Access Connections Gauge states: wireless WAN

-  No signal
-  Signal level 1
-  Signal level 2
-  Signal level 3

Note: For more information about Access Connections Gauge, see the Help in Access Connections.















Access Connections icon and wireless status icon

The Access Connections icon displays general connection status.

The wireless status icon displays the signal strength and status of your wireless connection.

You can find more detailed information about the signal strength and status of your wireless connection either by opening Access Connections or by double-clicking the Access Connections wireless status icon in the task bar.

Note: To display the Access Connections status icon and the wireless status icon in the system tray, refer to the Access Connections on-line help.

- Access Connections icon states
 -  No location profile is active or none exists.
 -  Current location profile is disconnected.
 -  Current location profile is connected.
- Wireless status icon states: wireless LAN
 -  Power to the wireless radio is off.
 -  Power to the wireless radio is on. No association.
 -  Power to the wireless radio is on. No signal.
 -  Power to the wireless radio is on. The signal strength of the wireless connection is excellent.
 -  Power to the wireless radio is on. The signal strength of the wireless connection is marginal.
 -  Power to the wireless radio is on. The signal strength of the wireless connection is poor. To improve signal strength, move your system closer to the wireless access point.
- Wireless status icon states: wireless WAN
 -  Power to the WAN radio is off
 -  No association
 -  No signal
 -  Signal level 1
 -  Signal level 2
 -  Signal level 3

Note: If you have trouble in making a connection, try moving your computer closer to your wireless access point.

Enabling or disabling the wireless feature

To enable or disable the wireless feature, press Fn+F5. A list of wireless features is displayed. You can turn the feature on and off with a single click.

You can also enable or disable the feature by the following procedures.

To enable the wireless feature, do as follows:

1. Click the Access Connections wireless status icon in the system tray.
2. Click **Power On Wireless Radio**.

To disable the wireless feature, do as follows:

- Click the Access Connections wireless status icon in the system tray.
- Click **Power Off Wireless Radio**.

Notes:

- You can use the wireless radio switch to disable the wireless radio of all the wireless devices on your computer.
- To display the Access Connections status icon and the wireless status icon in the system tray, refer to the Access Connections on-line help.

Using an external display

Your computer comes with many features to increase the enjoyment of your computer and help you give presentations with confidence.

Changing display settings

You can change the display settings, such as font size or color mode.

Font size

To make a font size larger, do as follows:

1. Right-click on the desktop, and click **Personalize**.
2. Click **Display** at the left.
3. Select the **Medium** or **Larger** radio button.
4. Click **Apply**. The change will take effect after you log off.

Connecting an external display

This section includes the following topics:

- “Attaching an external monitor” on page 44
- “Using the Mini DisplayPort connector” on page 46

Attaching an external monitor

Your computer can support a maximum video resolution of up to 1366x768 (with an external monitor attached to the Mini DisplayPort connector), provided that the external monitor also supports that resolution. For more details, refer to the manuals provided with your monitor.

You can set any resolution for either the computer display or the external monitor. When you use both at the same time, the resolution of both is the same. If you set a higher resolution for the computer display, you can see only part of the screen at a time. You can see other parts by moving the image with the TrackPoint or another pointing device.

You can move the display output to the computer display, the external monitor, or both in the Display Settings window.

Connecting an external monitor

To attach an external monitor, do as follows:

1. Connect the external monitor to the monitor connector; then connect the monitor to an electrical outlet
2. Turn on the external monitor.
3. Change the display output location by pressing Fn+F7. This allows you to switch between viewing output on the external display, the computer display, and both displays.

Note: If your computer cannot detect the external monitor, right-click on the desktop, then select **Screen resolution**. Click the **Detect** button.

Notes:

- Do not change the display output location while a moving picture is being drawn, for example, while playing a movie or a game, or viewing a business presentation. Close the application before changing the display output location, or change the display mode before you open an MPEG file to play.
- If you are attaching an external monitor that supports only VGA mode (640x480 resolution), do not view output on both the computer display and the external monitor. Doing so would cause the external monitor screen to be scrambled and the output not to be displayed; in addition, it could cause damage to the screen. Use the external monitor only.
- If the external TFT monitor you connect has an analog interface, flickers or ripples may appear on some displays, such as the shutdown screen of Windows. This is caused by the external TFT monitor, and cannot be fixed by adjusting the external TFT monitor or the computer side settings.

Setting the monitor types

To set your monitor type, do as follows:

1. Connect the external monitor to the monitor connector, and then connect the monitor to an electrical outlet.
2. Turn on the external monitor.
3. Right-click on the desktop, and click **Screen resolution**.

Note: If your computer cannot detect the external monitor, click the **Detect** button.

4. Set **Resolution**.
5. Click **Advanced Settings**.
6. Click the **Monitor** tab. Check the monitor information window to make sure that the monitor type is correct. If it is, click **OK** to close the window; otherwise do as follows.
7. If more than two monitor types are displayed, select **Generic PnP Monitor** or **Generic Non-PnP Monitor**.
8. Click **Properties**. If you are prompted for an administrator password or confirmation, type the password or provide confirmation.
9. Click the **Driver** tab.
10. Click **Update Driver**.
11. Click **Browse my computer for driver software**, and then click **Let me pick from a list of device drivers on my computer**.
12. Clear the **Show compatible hardware** check box.
13. Select **Manufacturer** and **Model** for your monitor. If you cannot find your monitor in the list, stop the installation of this driver and use the driver shipped with your monitor.
14. After updating the driver, click **Close**.
15. Click **OK**.

Note: To change the color settings, right-click on the desktop, and click **Screen resolution**. Click **Advanced Settings**, select the **Monitor** tab, then set **Colors**.

Considerations for attaching an external monitor

- When installing an operating system, you must install the display driver for your monitor that is supplied with the computer, and the Monitor INF file that is supplied with the external monitor.
- If you set a resolution higher than the resolution you are using on the panel, and use a panel that does not support that resolution, take advantage of the virtual screen function, which enables you to display only a part of the high-resolution screen image your computer produces. You can see other parts of the image by moving the screen with the TrackPoint or other pointing device.

- If the external monitor you are using is outdated, the resolution and the refresh rate may be limited.

Using the Mini DisplayPort connector

Your computer has a Mini DisplayPort connector, the latest digital display interface for connection to various external devices. This compact connector enables a plug-and-play setup and supports adaptors that can plug into DVI, VGA, or HDMI port.

The Mini DisplayPort connector of your computer supports audio as well as video streaming.

Using dual displays

This section introduces the Extend desktop function which enables you to display output (the same or different) on both the computer display and an external monitor.

Using the Extend desktop function

Your computer supports a function named the Extend desktop. With the Extend desktop function, you can display output on both the computer display and an external monitor. You can also display different desktop images on each monitor.

You can use the Extend desktop function without changing any settings. If the function does not work, refer to “Enabling the Extend desktop function” on page 46 to enable it.

Considerations for using the Extend desktop function

- If your computer has the Intel® display adapter, you can designate the other display as the primary display by doing the following:
 1. Press Ctrl+Alt+F12. The Intel CUI window opens.
 2. Select **Extended Desktop**.
 3. Change the setting to designate the primary display.
- When an application using the DirectDraw or the Direct3D is played in full-screen mode, it is shown only on the primary display.
- You cannot use the display switching function when you are in the Extend desktop mode.

Enabling the Extend desktop function

To enable the Extend desktop function, do as follows:

1. Connect the external monitor to the monitor connector; then connect the monitor to an electrical outlet.
2. Turn on the external monitor.
3. Press Fn+F7, then select **Extend**.

To change the resolution for each monitor, do as follows:

1. Right-click on the desktop, and click **Screen resolution**.
2. Click the **Monitor-1** icon (for the primary display, the computer display).
3. Set the resolution for the primary display.
4. Click the **Monitor-2** icon (for the secondary display, the external display).
5. Set the resolution for the secondary display.
6. Place the icons for the monitors so that they touch.

Note: You can set the monitors in any relative position, but the icons must touch each other.

7. Click **OK** to apply the changes.

Note: To change the color settings, right-click on the desktop, and click **Screen resolution**. Click **Advanced Settings**, select the **Monitor** tab, then set **Colors**.

Using a color profile

The display provides a color profile that can work with the Microsoft Image Color Management (ICM) function. If the graphics software you are using is compatible with ICM, you can display a color image on your monitor and match it, with the same quality, on another device, such as a scanner or a printer.

For details on Microsoft ICM, refer to the manuals provided with the Windows operating system.

Note: The color profile for ThinkPad LCD has been pre-installed in your computer already. If you need to install a different color profile, see “Installing ThinkPad Monitor File for Windows 2000/XP/Vista/7” on page 101.

Using audio features

Your computer is equipped with the following:

- Combo audio jack, 1/8 inch (3.5 mm) in diameter
- Built-in stereo speakers
- Built-in dual array digital microphone

Your computer also has an audio chip that enables you to enjoy various multimedia audio features:

- Compliant with Intel High Definition Audio.
- Recording and playback of PCM and WAV files in 16-bit or 24-bit format.
- Playback of a WAV file at a sample rate of 44.1KHz to 192 KHz.
- Playback of MIDI files through a Wave table synthesizer under Microsoft Windows operating systems.
- Playback of MP3 files through the Windows Media Player or a software MP3 player.
- Recording from various sound sources, such as an external microphone.

Note: The combo audio jack does not support a conventional microphone. If a conventional headphone is attached to it, the headphone function is supported. If a headset with a 3.5 mm 4-pole plug is attached to it, both headphone and microphone functions are supported.

Beam Forming feature

A built-in dual array digital microphone is mounted at the bottom of the display. Whereas a conventional single-element microphone captures sounds from all around, the built-in dual array digital microphone is designed to capture the sound from an exceptionally limited angle, through the combination of a specialized microphone array with a capability of digital signal processing. Therefore the microphone captures sounds from the area in front of the system clearly, but blocks out almost all the sounds from outside the capturing range. Thus the speech of a user sitting in front of the system is input to the system without interference from noise in the surrounding area. To record your speech most clearly, you should speak directly in front of the computer.

Configuring for sound recording

To configure the microphone for optimized sound recording, open the SmartAudio window as follows:

Click **Start** → **Control Panel** → **Hardware and Sound** → **SmartAudio**. The SmartAudio window opens.

Using an integrated camera

If your computer has an integrated camera, when you press Fn+F6 to open the Communications settings window, the camera will be launched and the green camera-in-use indicator will turn on automatically. In the Communications settings window, you can preview your video image and take a snapshot of your current image.

You can also use the integrated camera with other programs that provide features such as photographing, video capturing, and video conferencing. To use the integrated camera with other programs, open one of the programs and start the photographing, video capturing, or video conferencing function. Then, the camera will start automatically and the green camera-in-use indicator will turn on. For more information about using the camera with a program, refer to the documentation that came with the program.

If you do not want the camera to be launched automatically when you press Fn+F6 or when you use a program, press Fn+F6 to open the Communications settings window and click the **Hide my video image** button to disable the camera.

Configuring camera settings

You can configure the camera settings to meet your needs, such as adjusting the quality of the video output.

To configure the camera settings, do the following:

1. Press Fn+F6. The Communications settings window opens.
2. Click the **Manage Settings** button. The Communications Utility window opens.
3. In the Communications Utility window, configure the camera settings depending on your individual needs.

Adjusting the video output of your camera

You can adjust the quality of the video output of your camera by changing the settings for image quality and frame rate in the camera property window. The following values are available:

Speed Priority: This is the default setting. It gives you a faster frame rate for the best real-time video conferencing during the day. However, at night or in a dark environment, the image does not have the best quality.

Balance: This gives you a balance between speed and image quality. The image obtained at night or in a dark environment is better than with Speed Priority.

Image quality priority: This gives you a high-quality video and the best image at any time of the day. The image is very clear even at night or in a dark environment, but at the expense of frame rate. The video streaming may slow down.

Using the media card reader

Your computer has a media card reader slot. It supports the following cards:

- SD card
- SDHC card
- SDXC card
- MultiMediaCard (MMC)

Notes:

- Your computer does not support the Content Protection for Recordable Media (CPRM) feature for the SD card.
- When transferring data to or from a flash media card, such as an SD card, do not put your computer in sleep or hibernation mode before the data transfer is complete. To do so might cause damage to your data.

For more information on ExpressCards, smart cards, and flash media cards, refer to any of the following topics:

- “Inserting a flash media card” on page 49
- “Removing a flash media card” on page 49

Inserting a flash media card

Attention:

- Before you start installing a flash media card, touch a metal table or a grounded metal object. This action reduces any static electricity from your body. The static electricity could damage the card.

For information about the location of the flash media card reader slot, see “Locating computer controls, connectors, and indicators” on page 1.

To insert a flash media card into the 4-in-1 media card reader slot, do the following:

- Make sure that the card is correctly oriented.
- Insert the card firmly into the 4-in-1 media card reader slot. The card may stop before it is completely installed into the slot.

If the flash media card is not Plug and Play, do the following:

1. Open Control Panel.
2. Click **Hardware and Sound**.
3. Click **Device Manager**. If you are prompted for an administrator password or confirmation, type the password or provide confirmation.
4. From the **Action** menu, select **Add legacy hardware**. The Add Hardware Wizard starts.
5. Follow the instructions on the screen.

Removing a flash media card

For information about the location of the flash media card reader slot, see “Locating computer controls, connectors, and indicators” on page 1.

To remove a flash media card, do the following:

- Click **Show hidden icons** in the task bar.
- Right-click the **Safely Remove Hardware and Eject Media** icon.
- Select corresponding item to eject the card from the Windows operating system.
- Press the card to eject it from your computer.
- Remove the card from your computer and store it safely for future use.

Note: If you do not remove the card from your computer after you eject the card from the Windows operating system, the card can no longer be accessed. To access the card, you must remove it first, then insert it again.

Chapter 3. You and your computer

This chapter provides you information about accessibility and traveling with your computer.

This chapter contains the following topics:

- “Accessibility and comfort” on page 51
- “Traveling with your computer” on page 54

Accessibility and comfort

Because your computer enables you to work in so many places, it is important that you remain attentive to good posture, good lighting and proper seating. By keeping these considerations in mind, you can improve performance and achieve greater comfort.

Lenovo is committed to providing the latest information and technology to our customers with disabilities. Refer to our accessibility information which outlines our efforts in this area.

Ergonomic information

Working in the virtual office may mean adapting to frequent changes in your environment. Following some simple rules will make things easier and bring you the maximum benefits of your computer. Keeping in mind such basics as good lighting and proper seating, for example, can help you improve your performance and achieve greater comfort.

Note: This example shows someone in a conventional setting. Even when not in such a setting, you can follow many of these tips. Develop good habits, and they will serve you well.

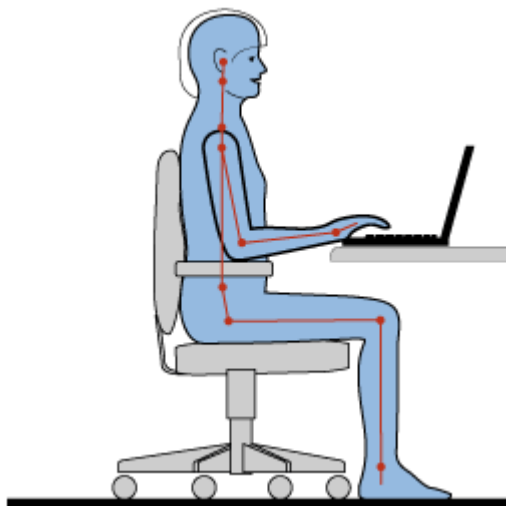

General Posture: Below are some general recommendations for assuming a healthy working posture. It is best to periodically make minor modifications in your working posture to deter the onset of discomfort caused by long periods of working in the same position. Frequent, short breaks from your work will also help to prevent any minor discomfort associated with your working posture.

Display: Position the display to maintain a comfortable viewing distance of 510-760 mm (20-30 inch). Avoid glare or reflections on the display from overhead lighting or outside sources of light. Keep the display screen

clean and set the brightness to levels that enable you to see the screen clearly. Press Fn+F8 or Fn+F9 to adjust display brightness.

Head Position: Keep your head and neck in a comfortable and neutral (vertical, or upright) position.

Chair: Use a chair that gives you good back support and seat height adjustment. Use chair adjustments to best suit your desired posture.

Arm and Hand Position: If available, utilize chair arm rests or an area on your working surface to provide weight support for your arms. Keep your forearms, wrists, and hands in a relaxed and neutral (horizontal) position. Type with a soft touch without pounding the keys.

Leg Position: Keep your thighs parallel to the floor and your feet flat on the floor or on a footrest.

What if you are traveling?

It may not be possible to observe the best ergonomic practices when you are using your computer while on the move or in a casual setting. Regardless of the setting, try to observe as many of the tips as possible. Sitting properly and using adequate lighting, for example, will help you maintain desirable levels of comfort and performance.

Questions about vision?

ThinkPad notebook's visual display screens are designed to meet the highest standards and to provide you with clear, crisp images and large, bright displays that are easy to see, yet easy on the eyes. Of course, any concentrated and sustained visual activity can be tiring. If you have questions on eye fatigue or visual discomfort, consult a vision care specialist for advice.

Adjusting your computer to fit you

Because your computer enables you to work in so many places, it is important that you remain attentive to good posture, good lighting and proper seating. Refer to the following tips to improve performance and achieve greater comfort:

Active sitting and rest breaks: The longer you sit and work with your computer the more important it is to observe your working posture. Following general recommendations for maintaining a healthy working posture suggested in “Ergonomic information” on page 51 and practicing “active sitting” are the best ways to avoid discomfort associated with your working postures. Making minor voluntary postural changes and taking short frequent work breaks are the key ingredients for healthy computing. Your computer is a light and mobile system; remember that it can easily be repositioned on your working surface to accommodate many posture modifications you might wish to make.

Work area setup options: Familiarize yourself with all of your office furniture so that you know how to adjust your work surface, seat, and other work tools to accommodate your preferences for comfort. If your work area is not in an office setting, be sure to take special note of employing active sitting and utilizing work breaks. Note that there are many ThinkPad product solutions available to help you modify and expand your computer to best suit your needs. Access the following Web site to view some of these options: <http://www.lenovo.com/accessories/services/index.html>. Explore your options for docking solutions and external products that can provide the adjustability and features that you want.

ThinkPad features that promote comfort: ThinkPad features can help make your computer more comfortable to use. For more information, refer to Chapter 2 “Using your computer” on page 23.

Accessibility information

Lenovo is committed to providing people with disabilities greater access to information and technology. As a result, the following information provides ways to help users that have hearing, vision, and mobility limitations get the most out of their computer experience.

Assistive technologies enable users to access information in the most appropriate way. Some of these technologies are already provided in your operating system, others can be purchased through vendors, or accessed through the World Wide Web.

Assistive technologies

Some accessibility technologies are available through the Accessibility Options program. Depending on your operating system, the number of accessibility options available varies. In general, accessibility options enhance the way users with hearing, vision, or mobility limitations navigate and use their computer. For example, some users might not have the fine motor skills required to use a mouse or select key combinations. Other users might require larger fonts or high-contrast display modes. In some cases, magnifiers and built-in speech synthesizers are available. For detailed information about each of these features, consult the Microsoft help system.

To use the Accessibility Options program, do as follows:

1. Click **Start**, and then click **Control Panel**.
2. Click **Ease of Access**.
3. Click **Ease of Access Center**.

This help system supports the accessibility features provided by your Windows operating system, screen readers designed to operate in the Windows environment, and Windows keyboard navigation. For a complete listing of Microsoft Windows Keyboard Guide, go to:
<http://www.microsoft.com/enable/Products/altkeyboard.aspx>

Screen reader technologies are primarily focused on software application interfaces, help systems, and a variety of online documents. However, in the case where a screen reader cannot read documents, the document must first go through a conversion process. One solution converts Adobe PDF files into a format that is read by the screen-reader programs. This solution is a Web-based service provided by Adobe Systems Incorporated. Through <http://access.adobe.com>, Adobe PDF documents can be converted to HTML or plain text in many languages. One conversion option converts PDF documents on the Internet. A second option enables users to submit the URL of an Adobe PDF file through e-mail to convert it to HTML or ASCII text. Adobe PDF files on a local hard disk drive, local CD-ROM, or local area network (LAN) can also be converted by attaching the Adobe PDF file to an e-mail message.

FullScreen Magnifier function

Your computer supports the FullScreen Magnifier function, which enlarges the active window and makes it easier for you to use the computer display.

To enable the FullScreen Magnifier function, click **Start → FullScreen Magnifier**. The active window is magnified and the FullScreen Magnifier icon is displayed in the system tray at bottom right of your screen. Then you can change the zoom resolution. Click the FullScreen Magnifier icon and make your choice.

To disable the FullScreen Magnifier function, click the FullScreen Magnifier icon and select **Exit**.

Traveling with your computer

This topic provides information to help you work with your computer when you are travelling with your computer abroad.

Travel tips

Use the following travel tips to travel more confidently and efficiently with your computer.

1. While it is safe to allow your computer to go through the x ray machines at airport security stations, it is important to keep your eyes on the computer at all times to prevent theft.
2. Consider bringing an airplane or automobile adapter for your computer.
3. If you carry an ac power adapter, detach the ac cord from it to avoid damaging the cord.

Travel tips on airplanes

If you carry your computer into an airplane, check the travel tips.

Attention:

- For using onboard computer or wireless (such as Internet, *Bluetooth*, etc.) service, check the services with the airline before boarding the airplane.
- If there are restrictions on the use of computers with the wireless feature on an airplane, you need to disable it before boarding. To disable it, refer to the instructions in “Enabling or disabling the wireless feature” on page 43.

Follow the tips below.

1. Be careful about the seat in front of you on airplanes. Angle your computer display so that it does not get caught when the person in front of you leans back.
2. Remember to hibernate or turn off your computer when taking off.

Travel accessories

Here is a checklist of things to consider packing when you are going to be away from the office:

Travel Essentials

- ThinkPad ac power adapter
- External mouse, if you are accustomed to using one
- Ethernet cable
- Extra slice battery, charged
- A quality carrying case that provides adequate cushion and protection

If you are traveling to another country you might want to consider these items

- An ac power adapter for the country that you are traveling to
- An adapter to connect to a phone line in that country

Other items you may wish to consider

- ThinkPad AC/DC Combo Adapter
- External storage device

Chapter 4. Security

This chapter provides information about how to protect your computer from theft and unauthorized use.

- “Attaching a mechanical lock” on page 55
- “Using passwords” on page 55
- “Hard disk security” on page 61
- “Setting the security chip” on page 61
- “Using a fingerprint reader” on page 63
- “Notice on deleting data from your hard disk drive or solid state drive” on page 66
- “Using and understanding firewalls” on page 66
- “Protecting data against viruses” on page 67

Attaching a mechanical lock

Your computer has a security keyhole that requires a cable lock with a 15 mm diameter head. You can attach a 15 mm diameter mechanical lock to your computer to help prevent it from being removed without your permission.

Note: Using a cable lock with a head diameter larger than 15 mm will prevent the LCD from being opened successfully, and may damage your LCD.

Attach a 15 mm diameter mechanical cable lock to the keyhole of the computer, then secure the chain on the lock to a stationary object. For detailed method, refer to the instructions shipped with the mechanical cable lock.

Note: You are responsible for evaluating, selecting, and implementing the locking devices and security features. Lenovo makes no comments, judgments, or warranties about the function, quality, or performance of locking devices and security features.

Using passwords

By using passwords, you can help prevent your computer from being used by others. Once you set a password, a prompt appears on the screen each time you power on the computer. Enter your password at the prompt. You cannot use the computer unless you type the correct password.

Make sure that only authorized individuals access your computer. Establishing different kinds of passwords requires that other possible users know the proper passwords in order to access your computer or your data.



If this icon appears, enter the Power-on password or the Supervisor password.



If this icon appears, enter the Hard disk password.

Note: If this icon appears, type a user hard disk password. If you want to type a master hard disk password, press F1 and type a master hard disk password.



If this icon appears, enter the Supervisor password.

Click on the items below to find out more about passwords and how to use them to protect your computer.

- “Passwords and sleep mode” on page 56
- “Typing passwords” on page 56
- “Power-on password” on page 56
- “Hard disk security” on page 61
- “Supervisor password” on page 59

Passwords and sleep mode

If you have set passwords and you put your computer into sleep mode by pressing Fn+F4, the procedure for resuming operation is as follows:

- You are not prompted to type the password when resuming operation.
- If any hard disk or the solid state drive has a hard disk password, it is unlocked automatically when you resume operation.

Typing passwords



If this icon appears, type the power-on password or the supervisor password.



If this icon appears, type the user hard disk password. If you want to type the master hard disk password, do the following:

1. Press F1. The icon changes to this: 
2. Now type the master hard disk password.

Note: To return to the first icon, press F1 again.



If this icon appears, type the supervisor password.

Note: You can press Backspace if you press a wrong key while you are typing your password.

Power-on password

You can set a power-on password to help protect your computer against access by unauthorized users.

If you set a power-on password, the password prompt appears on the screen whenever you turn on the computer. You must enter the correct password to start using the computer.

Setting a power-on password

1. Print these instructions.
2. Save all open files, and exit all applications.
3. Turn your computer off and then turn it on again.
4. When the logo screen is displayed, press F1. The ThinkPad Setup opens.
5. Select **Security**, using the cursor directional keys to move down the menu.
6. Select **Password**.
7. Select **Power-on Password**.

8. Choose your power-on password, and type it within the brackets in the **Enter New Password** field.

Note: You can set the minimum length of a power-on password on the **ThinkPad Setup** menu. For details, refer to “Security menu” on page 104.

9. Press Enter once to move to the next line. Retype the password you just entered, to verify it.
10. Commit your password to memory.

Note: You might want to note your power-on password in a safe place. Otherwise, if you forget it, you have to take your computer to a Lenovo reseller or a marketing representative to have the password canceled.

11. Press F10 to exit.
12. Select **Yes** in the Setup Confirmation window.

Changing or removing the power-on password

To change the power-on password, follow the steps 1 through 9. Enter your current password. When the **Enter New Password** field opens, type a new password in the field and then retype it to verify. To remove the password, follow steps 1 through 9. Type your current password. When the **Enter New Password** field opens, leave it blank and press Enter twice.

Hard disk passwords

Two types of hard disk passwords help protect the information stored on the hard disk:

- User hard disk password
- Master hard disk password, which requires a user hard disk password

If a user hard disk password has been set, but no master hard disk password has been, the user must enter the user hard disk password in order to gain access to files and applications on the hard disk.

The master password can be set and used only by a system administrator. Like a master key, it enables the administrator to get access to any hard drive in a system. The administrator sets the master password; no one else knows it. Then the administrator sets a user password for each computer in the network, and tells each user the password for his or her computer. The user can then change the user password as desired, but the administrator can still get access by using the master password.

Setting a hard disk password

1. Print these instructions.
2. Save all open files, and exit all applications.
3. Turn your computer off and then on again.
4. When the logo screen is displayed, press F1. The ThinkPad Setup opens.
5. Select **Security**, using the cursor directional keys to move down the menu.
6. Select **Password**.
7. Select **Hard Disk x Password**, where **x** is the number of the hard disk drive for which you want to set a password.
8. A Setup Confirmation window opens. You are prompted to select **User** or **User+Master**. Select **User** if you want to set only one hard disk password. If you are an administrator or supervisor, you can select **User+Master** to set two passwords. (The user can change the user password later.)
9. If you select **User + Master**, go to step 12.
10. If you select **User** only, a new-password window opens. Type your new password in the **Enter New Password** field.

Notes:

- You can set the minimum length of a hard disk password in the ThinkPad Setup menu. For details, refer to “Security menu” on page 104.
 - If you set a hard disk password of over seven characters, the hard disk drive can be used only with a computer that can recognize a hard disk password of over seven characters. If you then install the hard disk drive in a computer that cannot recognize a hard disk password that contains more than seven characters, you cannot get access to the drive.
11. Press Enter once to move to the next line. Retype the password you just entered to verify it. Go to step 18 to complete the procedure.
 12. If you select **User+ Master**, a message window opens and prompts you to set up a user hard disk password first. Click **Continue**.
 13. A new hard disk user password window opens. Type your new password in the **Enter New Password** field.
 14. Press Enter once to move to the next line. Retype the password you just entered to verify it.
 15. A message window opens and prompts you to set the master hard disk password. Click **Continue**.
 16. A new master hard-disk password window opens. Type your new password in the **Enter New Password** field.
 17. Press Enter once to move to the next line. Retype the password you just entered to verify it.
 18. Commit your password to memory and press Enter. A Setup Notice window is displayed.

Attention: You might want to note your passwords and keep them in a safe place. Otherwise, if you forget the user-only password, or both user and master passwords, Lenovo cannot reset your passwords or recover data from the hard disk. You must take your computer to a Lenovo reseller or a marketing representative to have the hard disk drive replaced. Proof of purchase is required, and a fee will be charged for parts and service.

19. Press F10 to exit from the Setup Notice window.

The next time you turn on your computer, you will have to type the user or master hard disk password in order to start your computer and get access to your operating system.

Changing or removing a hard disk password

Follow steps 1 through 7 listed in “Setting a hard disk password” on page 57, typing your password to get access to the ThinkPad Setup program.

To change or remove the **User** hard disk password, do as follows:

- To change the hard disk password, type the current password in the **Enter Current Password** field. Then type the new password in the **Enter New Password** field, and retype the password you just entered to verify it in the **Confirm New Password** field. Press Enter, and a Setup Notice window is displayed. Press F10 to exit from the Setup Notice window. The user hard disk passwords will be changed.
- To remove the hard disk password, type the current password in the **Enter Current Password** field. Then leave the **Enter New Password** and **Confirm New Password** fields blank, and press Enter. A Setup Notice window is displayed. Press F10 to exit from the Setup Notice window. The user hard disk passwords will be removed.

To change or remove the **User + Master** hard disk password, select **User HDP** or **Master HDP**.

If you choose **User HDP**, do one of the following:

- To change the user hard disk password, type the current user hard disk password or the current master hard disk password in the **Enter Current Password** field. Then type the new user hard disk password in

the **Enter New Password** field, and retype the password you just entered to verify it in the **Confirm New Password** field. Press Enter, and a Setup Notice window is displayed. Press F10 to exit from the Setup Notice window. Both the user and master hard disk passwords will be changed.

- To remove the user hard disk password, type the current master hard disk password in the **Enter Current Password** field. Then leave the **Enter New Password** and **Confirm New Password** fields blank, and press Enter. A Setup Notice window is displayed. Press F10 to exit from the Setup Notice window. Both the user and master hard disk passwords will be removed.

If you choose **Master HDP**, do one of the following:

- To change the master hard disk password, type the current master hard disk password in the **Enter Current Password** field. Then type the new master hard disk password in the **Enter New Password** field, and retype the password you just entered to verify it in the **Confirm New Password** field. Press Enter, and a Setup Notice window is displayed. Press F10 to exit from the Setup Notice window. Both the user and master hard disk passwords will be changed.
- To remove the master hard disk password, type the current master hard disk password in the **Enter Current Password** field. Then leave the **Enter New Password** and **Confirm New Password** fields blank, and press Enter. A Setup Notice window is displayed. Press F10 to exit from the Setup Notice window. Both the user and master hard disk passwords will be removed.

Supervisor password

The supervisor password protects the system information stored in the ThinkPad Setup. Without it, no one can change the configuration of the computer. It provides the following security features:

- If a supervisor password is set, a password prompt appears when you try to start the ThinkPad Setup. Unauthorized users cannot get access to configuration data.
- The system administrator can use the supervisor password to get access to a computer even if the user of that computer has set a power-on password. The supervisor password overrides the power-on password.
- If both a supervisor password and a power-on password are set, you can do the following only if you have the supervisor password:
 - Deleting the power-on password
 - Changing or deleting the supervisor password
 - Enabling or disabling the Wake on LAN and Flash over LAN features
 - Enabling or disabling the Internal Network Option ROM feature
 - Changing date and time
 - Enabling or disabling the Lock UEFI BIOS Setting feature
 - Enabling or disabling the Password at unattended boot
 - Specifying the minimum length for power-on passwords and hard disk passwords
 - Changing the setting for the security chip
 - Enabling or disabling the Boot Device List F12 Option
 - Enabling or disabling the Boot Order Lock
 - Enabling or disabling the Flash BIOS Updating by End-Users feature
 - Enabling or disabling the Internal Network device
 - Enabling or disabling the Internal Wireless device
 - Enabling or disabling the Internal *Bluetooth* device
 - Enabling or disabling the Internal Wireless WAN device
 - Enabling or disabling the Security mode

- Enabling or disabling the Reader priority
- Erasing the fingerprint data

Notes:

- The system administrator can set the same supervisor password on many ThinkPad notebooks to make administration easier.
- By enabling the Lock UEFI BIOS Settings in the Password menu when you set the supervisor password, you make it impossible for anyone but you to make changes.

Setting a supervisor password

Only a system administrator will be able to apply this procedure.

1. Print these instructions.
2. Save all open files, and exit all applications.
3. Turn your computer off and then turn it on again.
4. When the logo screen is displayed, press F1. The ThinkPad Setup opens.
5. Select **Security**, using the cursor directional keys to move down the menu.
6. Select **Password**.
7. Select **Supervisor Password**.
8. A window opens that prompts you to enter a new password.
9. Choose your supervisor password and type it in the **Enter New Password** field; then press Enter.
10. Press Enter to move to the next line. Retype the password you just entered to verify it.
11. Commit your password to memory and press Enter. A Setup Notice window is displayed.

Attention: You might want to note your password and keep it in a safe place. If you forget your supervisor password, Lenovo can not reset your password. You must take your computer to a Lenovo reseller or a Lenovo marketing representative to have the system board replaced. Proof of purchase is required, and a fee will be charged for parts and service.

12. Press F10 to exit from the Setup Notice window.

The next time you open the ThinkPad Setup, you will be prompted to type your password to proceed.

Changing or removing the supervisor password

To change or remove the supervisor password, follow steps 1 through 8 listed in “Setting a supervisor password” on page 60, typing your password to get access to the ThinkPad Setup.

To change the password, do the following:

1. In the **Enter Current Password** field, type the current supervisor password.
2. In the **Enter New Password** field, type the new supervisor password; then retype the password you just entered to verify it in the **Confirm New Password** field.
3. Follow step 11 and step 12 in “Setting a supervisor password” on page 60 to change your supervisor password.

To remove the password, do the following:

1. In the **Enter Current Password** field, type the current supervisor password.
2. Leave the **Enter New Password** and **Confirm New Password** fields in blank.
3. Follow step 11 and step 12 in “Setting a supervisor password” on page 60 to remove your supervisor password.

Hard disk security

Your computer supports an enhanced security solution for solid state drive or hard disk drive. To protect passwords from unauthorized security attacks, several of the latest technologies and algorithms are integrated into UEFI BIOS and hardware design of ThinkPad notebooks.

To maximize security, do the following:

1. Set a power-on password as well as a hard disk password for your internal solid state drive or hard disk drive. Refer to the procedures in “Power-on password” on page 56 and “Hard disk passwords” on page 57. For security, a longer password is recommended.
2. To provide reliable security for UEFI BIOS, use the security chip and a security application with a Trusted Platform Module management feature. Refer to “Setting the security chip” on page 61.
3. If a Disk Encryption hard disk drive or an Encryption solid state drive is installed in your computer, be sure to protect the contents of your computer memory from unauthorized access by use of drive encryption software, such as Microsoft Windows BitLocker® Drive Encryption in Windows 7. Refer to “Using Windows BitLocker Drive Encryption” on page 61.
4. Before you dispose of, sell, or hand over your computer, make sure to delete data stored on it. Refer to “Notice on deleting data from your hard disk drive or solid state drive” on page 66.

Note: The hard disk drive built into your computer can be protected by UEFI BIOS.

Using Windows BitLocker Drive Encryption

To help protect your computer from being subject to unauthorized access, be sure to use drive encryption software, such as Windows BitLocker Drive Encryption.

Windows BitLocker Drive Encryption is an integral security feature of Windows 7. It is supported in Ultimate and Enterprise editions of Windows 7. It can help you protect the operating system and data stored in your computer data, even if your computer is lost or stolen. BitLocker works by encrypting all user and system files, including the swap and hibernation files.

BitLocker uses a Trusted Platform Module to provide enhanced protection for your data and to ensure early boot component integrity. A compatible TPM is defined as a V1.2 TPM.

To check the BitLocker status, click **Start → Control Panel → System and Security → BitLocker Drive Encryption**.

For details about Windows BitLocker Drive Encryption, go to the Help and Support for Windows 7, or search for “Microsoft Windows BitLocker Drive Encryption Step-by-Step Guide” on the Microsoft web site.

Disk Encryption hard disk drive and Encryption solid state drive

Some models contain the Disk Encryption hard disk drive or Encryption solid state drive. This feature helps to protect your computer against security attacks on media, NAND flash or device controllers by use of a hardware encryption chip. For the efficient use of the encryption feature, be sure to set a hard disk password for the internal storage device.

Setting the security chip

Strict security requirements are imposed on network client computers that transfer confidential information electronically. Depending on the options you ordered, your computer might have an embedded security chip, a cryptographic microprocessor. With the security chip and Client Security Solution, you can do the following:

- Protect your data and system

- Strengthen access controls
- Secure communications

Note: Client Security Solution is not preinstalled on your system. To download Client Security Solution, go to <http://www.lenovo.com/support>.

Setting the Security Chip

The choices offered in the Security Chip submenu under the **Security** menu of the ThinkPad Setup are as follows:

- **Security Chip:** activates, inactivates, or disables the Security Chip.
- **Security Reporting Options:** enables or disables each Security Reporting Option.
- **Clear Security Chip:** clears the encryption key.

Notes:

1. Be sure that the Supervisor password has been set in the ThinkPad Setup. Otherwise anyone can change the settings for the Security Chip.
2. If you are using Client Security Solution, handle the Security Chip as follows:
 - Do not clear the Security Chip. If you do, the functions assigned to the keys will be erased.
 - Do not disable the Security Chip. If you do, Client Security Solution will not work.
3. If the Security Chip is removed or replaced, or a new one has been added, the computer will not start. You will hear 4 cycles of 4 beeps each, or you see error message 0176 or 0192.
4. If the Security Chip is inactive or disabled, Clear Security Chip not be displayed.
5. When you clear the Security chip, be sure to turn your computer off and then turn it on again after you set the Security chip to Active. Otherwise, the choice of Clear Security Chip is not displayed.

To set an item in the Security Chip submenu:

- Print these instructions. To set the Security Chip, you must turn your computer off and then on again.
- Save all open files, and exit all applications.
- Turn your computer off and then turn it on again.
- When the logo screen is displayed, press F1. The ThinkPad Setup opens.
- Using the cursor keys, move to **Security**. The **Security** menu opens.
- Using the cursor keys, move to **Security Chip**, and press Enter. The Security Chip submenu opens.
- Using the cursor keys, move to an item you want to set. When the item you want is highlighted, press Enter.
- Set the items you want to set.
- Press F10 to exit.
- Click **Yes** in the Setup Confirmation window.

To set the Security Chip, you have to open the Client Security Solution, and follow the instructions on the screen.

Note: Client Security Solution is not preinstalled on your system. To configure the security chip, you need to download the latest version of Client Security Solution from the Lenovo Web site. To download Client Security Solution, go to <http://www.lenovo.com/support>. Then follow the instructions on the screen.

Using a fingerprint reader

Depending on the options you ordered, your computer may have an integrated fingerprint reader. By enrolling your fingerprint and associating it with a power-on password, a hard disk password, or both passwords beforehand, you can start the computer, log on to the system, and enter the ThinkPad Setup by swiping your finger over the reader, without typing a password. Thus fingerprint authentication can replace passwords and enable simple and secure user access.

For more advanced security, Client Security Solution can be installed. The software is compatible with a variety of user authentication mechanisms, such as those involving fingerprint authentication. This fingerprint reader can work with the software.

Note: Client Security Solution is not preinstalled on your system. To download Client Security Solution, go to <http://www.lenovo.com/support>.

Enrolling your fingerprint

1. Turn on your computer.
2. To start Lenovo Fingerprint software, refer to “Fingerprint Software” on page 19.
3. Follow the instructions on the screen to enroll your fingerprint. For details, refer to the Help for the program.

LED behavior of the fingerprint reader



Table 3. LED behavior of fingerprint reader

Indicator	Description
LED blinks green.	The fingerprint is being authenticated or has been authenticated.
LED is solid green.	The fingerprint reader is ready to swipe.
LED blinks amber.	The fingerprint could not be authenticated.

Swiping your finger over the reader

To swipe your finger over the reader, do as follows:

1. Place the ball of your finger, that is, the central part of the fingerprint, on the small circle above the reader. Make sure that the entire top joint of the finger is on the reader.

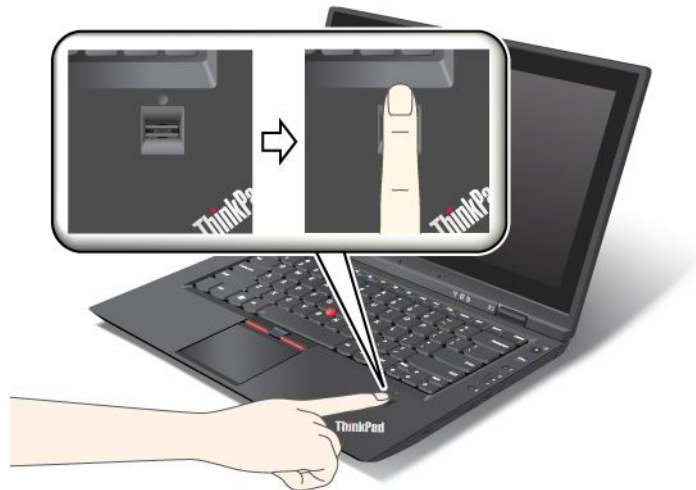

2. Apply light pressure and swipe your finger across the reader in one smooth motion.

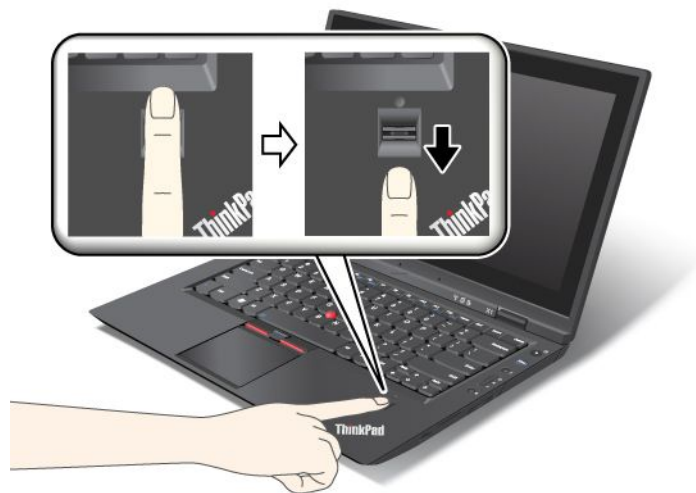

Logging on to the system

After you enroll your fingerprint, log on to the system as follows:

1. Set a power-on password or a hard disk security password, or both.
2. Turn your computer off and then on again.
3. When prompted, swipe your finger over the reader.
4. On request, type your power-on password, your hard disk password, or both. The enrolled fingerprint is now associated with your power-on password, your hard disk password, or both.

The next time you start the computer, you can log on to the system by swiping your finger over the reader once.

Attention: If you always use your fingerprint to log on to the system, you may forget your password. Write down your password, and keep it in a safe place. If you forget it and for some reason you cannot swipe your finger across the reader—for example, if you injure that finger—you cannot start the computer or change the password. If you forget your power-on password, you must take your computer to a Lenovo authorized servicer or a marketing representative to have the password canceled.

If you forget your hard disk password, Lenovo cannot reset your password or recover data from the hard disk. You must take your computer to a Lenovo authorized servicer or a marketing representative to have the hard disk drive replaced. Proof of purchase is required, and a fee will be charged for parts and service.

Setting the fingerprint reader

If you want to change the settings of the fingerprint reader, follow the procedure below.

The fingerprint submenu under the Security menu of the ThinkPad Setup offers the following choices:

- **Predesktop Authentication:** Enables or disables fingerprint authentication before the operating system is loaded.
- **Reader Priority:** Defines the priority for fingerprint readers if an external fingerprint reader is attached.
- **Security Mode:** Specifies the settings of the security mode.
- **Password Authentication:** Enables or disables password authentication.

Note: This item appears if High security mode is selected.

- **Reset Fingerprint Data:** By choosing this item, you erase all of the fingerprint data stored in either the internal or external fingerprint reader.

To set an item in the fingerprint submenu:

1. Print these instructions. To configure the fingerprint reader, you must turn your computer off and then on again.
2. Save all open files, and exit all applications.
3. Turn your computer off and then on again.
4. When the logo screen is displayed, press F1. The ThinkPad Setup opens.
5. Using the cursor keys, move to **Security**, and press Enter. The Security menu opens.
6. Using the cursor keys, move to **Fingerprint**, and press Enter. The Fingerprint submenu opens.
7. Using the cursor keys, move to an item you want to set. When that item is highlighted, press Enter.
8. Set the items you want to set.
9. Press F10 to exit.
10. In the Setup Confirmation window, select **Yes**.

Care for the fingerprint reader

The following actions could damage the fingerprint reader or cause it not to work properly:

- Scratching the surface of the reader with a hard, pointed object.
- Scraping the surface of the reader with your fingernail or anything hard.
- Using or touching the reader with a dirty finger.

If you notice any of the following conditions, gently clean the surface of the reader with a dry, soft, lint-free cloth:

- The surface of the reader is dirty or stained.
- The surface of the reader is wet.
- The reader often fails to enroll or authenticate your fingerprint.

If your finger has any of the following conditions, you may not be able to register or authenticate it:

- Your finger is wrinkled.
- Your finger is rough, dry, or injured.

- Your finger is very dry.
- Your finger is stained with dirt, mud, or oil.
- The surface of your finger is very different from when you enrolled your fingerprint.
- Your finger is wet.
- A finger is used that has not been enrolled.

To improve the situation, try the following:

- Clean or wipe your hands to remove any excess dirt or moisture from the fingers.
- Enroll and use a different finger for authentication.
- If your hands are too dry, apply lotion to them.

Notice on deleting data from your hard disk drive or solid state drive

As computers spread into every corner of life, they process more and more information. The data on your computer, some of which is sensitive, is stored on a storage device, either a hard disk drive or the solid state drive. Before you dispose of, sell, or hand over your computer, make sure to delete data stored on it.

Handing your computer over to someone else without deleting the loaded software, such as operating systems and application software, may even violate License Agreements. You are advised to check the terms and conditions of those Agreements.

There are methods that seem to delete the data:

- Move the data to the recycle bin, and then choose the Empty recycle bin command.
- Use the Delete command.
- Format your hard disk drive or solid state drive, using the software for initializing it.
- Using the recovery program, provided by Lenovo, bring the hard disk drive or the solid state drive back to factory-ship state.

These operations, however, only change the file allocation of the data; they do not delete the data itself. In other words, the data retrieval processing is disabled under an operating system such as Windows. The data is still there, even though it seems to be lost. Thus, it is sometimes possible to read the data by use of special software for data recovery. There is a risk that people of bad faith may read and misuse the critical data on hard disk drives or solid state drives for unexpected purposes.

To prevent leakage of data, it becomes very important that you take responsibility for deleting all the data from the hard disk drive or solid state drive when you dispose of, sell, or hand over your computer. You can destroy the data physically by smashing the hard disk drive with a hammer, or magnetically by means of strong magnetic power, thus making the data unreadable. But we recommend that you make use of the software (payware) or service (pay service) specifically developed for the purpose.

For disposing of data on the hard disk drive, Lenovo provides such software as the Secure Data Disposal tool. Software provides the interface for full erasure of the contents of a hard disk. To download either application, go to <http://www.lenovo.com/support>.

Note: Running the application will take a couple of hours.

Using and understanding firewalls

If your system is preinstalled with a firewall program, it protects against computer Internet security threats, unauthorized access, intrusions, and Internet attacks. It also protects your privacy.

For more information about how to use the firewall program, refer to the on-line help that comes with the program.

Protecting data against viruses

Your computer is preinstalled with an antivirus program so you can detect and eliminate viruses. The antivirus program is designed to help you detect and eliminate viruses.

Lenovo provides a full version of antivirus software on your computer with a free 30-day subscription. After 30 days, you must renew the license to continue receiving the antivirus software updates.

For more information about how to use your antivirus software, refer to the help system of your antivirus software.

Chapter 5. Recovery overview

This chapter provides information about the recovery solutions provided by Lenovo.

This chapter contains the following topics:

- “Creating and using recovery media” on page 69
- “Performing backup and recovery operations” on page 70
- “Using the Rescue and Recovery workspace” on page 71
- “Creating and using a rescue medium” on page 72
- “Reinstalling preinstalled applications and device drivers” on page 73
- “Solving recovery problems” on page 74

Notes:

1. There are a variety of methods to choose from when considering how to recover in the event of a software- or hardware-related problem. Some methods vary depending on the type of your operating system.
2. The product on the recovery media may be used only for the following purposes:
 - Restore the product preinstalled on your computer
 - Reinstall the product
 - Modify the product using the Additional Files

Notes: To prevent potential performance risks or unexpected behavior that might be caused by the new hard disk drive technology, it is recommended that you use one of the following back-up software programs:

- ThinkVantage Rescue and Recovery version 4.3 or later
- Symantec Norton Ghost version 15 or later

Notes: To use this program, do the following:

1. Click **Start** → **Run**. The Run window opens.
2. Type `cmd` in the field. Then click **OK**.
3. Type `ghost -align=1mb` and press Enter.

- Acronis True Image 2010 or later
- Paragon Backup & Recovery 10 Suit or later, Paragon Backup & Recovery 10 Home or later

Creating and using recovery media

You can use recovery media to restore the hard disk drive to the factory default settings. Recovery media are useful if you transfer the computer to another area, sell the computer, recycle the computer, or put the computer in an operational state after all other methods of recovery have failed. As a precautionary measure, it is important to create recovery media as early as possible.

Note: The recovery operations you can perform using recovery media vary depending on the operating system from which the recovery media were created. The recovery media might contain a boot medium and a data medium. Your Microsoft Windows license permits you to create only one data medium, so it is important that you store the recovery media in a safe place after you have made them.

Creating recovery media

This section provides instructions on how to create recovery media on the Windows 7 operating system.

Note: On the Windows 7 operating system, you can create recovery media using discs or external USB storage devices by doing as follow:

- Click **Start → All Programs → Lenovo ThinkVantage Tools → Factory Recovery Disks**. Then, follow the instructions on the screen.

Using recovery media

This section provides instructions on how to use recovery media on different operating systems.

- On the Windows 7 operating system, you can use recovery media to restore the computer to the factory default settings only. You can use recovery media to put the computer in an operational state after all other methods of recovery have failed.

Attention: When you use recovery media to restore the computer to the factory default settings, all the files currently on the hard disk drive will be deleted and replaced by the factory default settings.

To use recovery media on the Windows 7 operating system, do the following:

1. Connect the boot medium (memory key or other USB storage device) to the computer.
2. Repeatedly press and release the F12 key when turning on the computer. When the **Startup Device Menu** opens, release the F12 key.
3. Select the desired startup device and press Enter. The restore process begins.
4. Follow the instructions on the screen to complete the operation.

Notes:

1. After restoring your computer to the factory default settings, you might have to reinstall device drivers for some devices. See “Reinstalling preinstalled applications and device drivers” on page 73.
2. Some computers come with Microsoft Office or Microsoft Works preinstalled. If you need to recover or reinstall your Microsoft Office or Microsoft Works applications, you must use the *Microsoft Office CD* or *Microsoft Works CD*. These discs are provided only with computers preinstalled with Microsoft Office or Microsoft Works.

Performing backup and recovery operations

The Rescue and Recovery program enables you to back up all your hard disk drive contents including the operating system, data files, software programs, and personal settings. You can designate where the Rescue and Recovery program stores the backup:

- In a protected area of your hard disk drive
- On the secondary hard disk drive if a secondary hard disk drive is installed in your computer
- On an attached external USB hard disk drive
- On a network drive

After you have backed up the contents on the hard disk drive, you can restore the complete contents of the hard disk drive, restore only the selected files, or restore only the Windows operating system and applications.

Performing a backup operation

This section provides instructions on how to perform a backup operation using the Rescue and Recovery program on different operating systems.

- To perform a backup operation using the Rescue and Recovery program on the Windows 7 operating system, do the following:
 1. From the Windows desktop, click **Start → All Programs → Lenovo ThinkVantage Tools → Enhanced Backup and Restore**. The Rescue and Recovery program opens.
 2. In the Rescue and Recovery main window, click the **Launch advanced Rescue and Recovery** arrow.
 3. Click **Back up your hard drive** and select backup operation options. Then, follow the instructions on the screen to complete the backup operation.

Performing a recovery operation

This section provides instructions on how to perform a recovery operation using the Rescue and Recovery program on different operating systems.

- To perform a recovery operation using the Rescue and Recovery program on the Windows 7 operating system, do the following:
 1. From the Windows desktop, click **Start → All Programs → Lenovo ThinkVantage Tools → Enhanced Backup and Restore**. The Rescue and Recovery program opens.
 2. In the Rescue and Recovery main window, click the **Launch advanced Rescue and Recovery** arrow.
 3. Click the **Restore your system from a backup** icon.
 4. Follow the instructions on the screen to complete the recovery operation.

For more information about performing a recovery operation from the Rescue and Recovery workspace, see “Using the Rescue and Recovery workspace” on page 71.

Using the Rescue and Recovery workspace

The Rescue and Recovery workspace resides in a protected, hidden area of your hard disk drive that operates independently from the Windows operating system. This enables you to perform recovery operations even if you cannot start the Windows operating system. You can perform the following recovery operations from the Rescue and Recovery workspace:

- **Rescue files from your hard disk drive or from a backup** The Rescue and Recovery workspace enables you to locate files on your hard disk drive and transfer them to a network drive or other recordable media, such as a USB device or a disc. This solution is available even if you did not back up your files or if changes were made to the files since your last backup operation. You can also rescue individual files from a Rescue and Recovery backup located on your local hard disk drive, a USB device, or a network drive.
- **Restore your hard disk drive from a Rescue and Recovery backup** If you have backed up your hard disk drive using the Rescue and Recovery program, you can restore the hard disk drive from a Rescue and Recovery backup, even if you cannot start the Windows operating system.
- **Restore your hard disk drive to the factory default settings** The Rescue and Recovery workspace enables you to restore the complete contents of your hard disk drive to the factory default settings. If you have multiple partitions on your hard disk drive, you have the option to restore the factory default settings to the C: partition and leave the other partitions intact. Because the Rescue and Recovery workspace operates independently from the Windows operating system, you can restore the factory default settings even if you cannot start the Windows operating system.

Attention: If you restore the hard disk drive from a Rescue and Recovery backup or restore the hard disk drive to the factory default settings, all files on the primary hard disk drive partition (usually drive C:) will be deleted in the recovery process. If possible, make copies of important files. If you are unable to start the Windows operating system, you can use the rescue files feature of the Rescue and Recovery workspace to copy files from your hard disk drive to other media.

To start the Rescue and Recovery workspace, do the following:

1. Make sure the computer is turned off.
2. Repeatedly press and release the F11 key when turning on the computer. When you hear beeps or see a logo screen, release the F11 key.
3. If you have set a Rescue and Recovery password, type your password when prompted. The Rescue and Recovery workspace opens after a short delay.

Note: If the Rescue and Recovery workspace fails to open, see “Solving recovery problems” on page 74.

4. Do one of the following:
 - To rescue files from your hard disk drive or from a backup, click **Rescue files** and follow the instructions on the screen.
 - To restore your hard disk drive from a Rescue and Recovery backup or to restore your hard disk drive to the factory default settings, click **Restore your system** and follow the instructions on the screen.

For more information about the features of the Rescue and Recovery workspace, click **Help**.

Notes:

1. After restoring your hard disk drive to the factory default settings, you might have to reinstall device drivers for some devices. See “Reinstalling preinstalled applications and device drivers” on page 73.
2. Some computers come with Microsoft Office or Microsoft Works preinstalled. If you need to recover or reinstall your Microsoft Office or Microsoft Works applications, you must use the *Microsoft Office CD* or *Microsoft Works CD*. These discs are provided only with computers preinstalled with Microsoft Office or Microsoft Works.

Creating and using a rescue medium

With a rescue medium, such as a disc or a USB hard disk drive, you can recover the computer from failures that prevent you from gaining access to the Rescue and Recovery workspace on your hard disk drive.

Note: The recovery operations you can perform using a rescue medium vary depending on the operating system.

Creating a rescue medium

This section provides instructions on how to create a rescue medium on different operating systems.

- To create a rescue medium on the Windows 7 operating system, do the following:
 1. From the Windows desktop, click **Start → All Programs → Lenovo ThinkVantage Tools → Enhanced Backup and Restore**. The Rescue and Recovery program opens.
 2. In the Rescue and Recovery main window, click the **Launch advanced Rescue and Recovery** arrow.
 3. Click the **Create Rescue Media** icon. The Create Rescue and Recovery Media window opens.
 4. In the **Rescue Media** area, select the type of the rescue medium you want to create. You can create a rescue medium using a disc, a USB hard disk drive, or a secondary internal hard disk drive.
 5. Click **OK** and follow the instructions on the screen to create a rescue medium.

Using a rescue medium

This section provides instructions on how to use the rescue medium you have created.

- If you have created a rescue medium using a USB hard disk drive, use the following instructions to use the rescue medium:
 1. Attach the USB hard disk drive to one of the USB connectors on your computer.

2. Repeatedly press and release the F12 key when turning on the computer. When the **Startup Device Menu** opens, release the F12 key.
 3. On the **Startup Device Menu**, select the USB hard disk drive as the first boot device and press Enter. The rescue medium starts.
- If you have created a rescue medium using the secondary internal hard disk drive, set the secondary internal hard disk drive as the first boot device in the startup device sequence to start the rescue medium. See “Startup menu” on page 105.

When the rescue medium starts, the Rescue and Recovery workspace opens. The help information for each feature is available from the Rescue and Recovery workspace. Follow the instructions to complete the recovery process.

Reinstalling preinstalled applications and device drivers

Your computer has provisions that enable you to reinstall selected factory-installed applications and device drivers.

Reinstalling preinstalled applications

To reinstall selected application programs, do the following:

1. Turn on your computer.
2. Use Windows Explorer or Computer to display the directory structure of your hard disk.
3. Open the C:\SWT00LS folder.
4. Open the APPS folder. In it are several subfolders named for the various preinstalled applications.
5. Open the subfolder for the application you are reinstalling.
6. Double-click **Setup**, and then follow the on-screen steps to reinstall the program.

Reinstalling preinstalled device drivers

Attention: When you reinstall device drivers, you are changing the current configuration of your computer. Reinstall device drivers only when it is necessary to correct a problem with your computer.

To reinstall a device driver for a factory-installed device, do the following:

1. Turn on your computer.
2. Use Windows Explorer or Computer to display the directory structure of your hard disk drive.
3. Open the C:\SWT00LS folder.
4. Open the DRIVERS folder. Within the DRIVERS folder are several subfolders named for the various devices installed in your computer (for example, AUDIO and VIDEO).
5. Open the subfolder for the device.
6. Reinstall the device driver by one of the following methods:
 - In the subfolder for the device, look for a text file (a file with the extension .txt). The text file contains information on how to reinstall that device driver.
 - OR-
 - If the subfolder for the device contains a file of setup information (a file with the extension .inf), you can use the Add New Hardware program (in the Windows Control Panel) to reinstall the device driver. Not all device drivers can be reinstalled by use of this program. In the Add New Hardware program, when prompted for the device driver you want to install, click **Have Disk** and **Browse**. Then select the device driver file from the device subfolder.
 - OR-

- In the subfolder for the device, look for the file for the application (a file with the extension .exe). Double-click the file, and follow the instructions on the screen.

Attention: If you need updated device drivers, do not download them from the Windows Update Web site. Obtain them from Lenovo. For more information, see “Making sure device drivers are current” on page 120.

Solving recovery problems

If you are unable to access the Rescue and Recovery workspace or the Windows environment, do one of the following:

- Use a rescue medium to start the Rescue and Recovery workspace. See “Using a rescue medium” on page 72.
- Use recovery media if all other methods of recovery have failed and you need to restore the hard disk drive to the factory default settings. See “Using recovery media” on page 70.

Note: If you are unable to access the Rescue and Recovery workspace or the Windows environment from a rescue medium or recovery media, you might not have the rescue device (an internal hard disk drive, a disc, a USB hard disk drive, or other external devices) set as the first boot device in the startup device sequence. You must first make sure that your rescue device is set as the first boot device in the startup device sequence in the Setup Utility program. See “Startup menu” on page 105 for detailed information about temporarily or permanently changing the startup device sequence. For more information about the Setup Utility program, see “ThinkPad Setup” on page 102.

It is important to create a rescue medium and a set of recovery media as early as possible and store them in a safe place for future use.

Chapter 6. Replacing devices

You can increase the capacity of the memory or the hard disk drive by replacing the original, built-in device with an optional one. Or, if you need to, you can replace the PCI Express Mini Card by following the procedures in this section.

- “Static electricity prevention” on page 75
- “Before replacing CRU” on page 75
- “Replacing the hard disk drive or solid state drive” on page 76
- “Replacing the keyboard” on page 78
- “Replacing the memory module” on page 81
- “Replacing the PCI Express Mini Card for wireless LAN/WiMAX connection” on page 83
- “Installing and replacing the PCI Express Mini Card for wireless WAN connection” on page 85
- “Installing and replacing the mSATA solid state drive” on page 87
- “Replacing the SIM card” on page 90
- “Replacing the backup battery” on page 89

Static electricity prevention

Static electricity, although harmless to you, can seriously damage computer components and options. Improper handling of static-sensitive parts can cause damage to the part. When you unpack an option or CRU, do not open the static-protective package containing the part until the instructions direct you to install it.

When you handle options or CRUs, or perform any work inside the computer, take the following precautions to avoid static-electricity damage:

- Limit your movement. Movement can cause static electricity to build up around you.
- Always handle components carefully. Handle adapters, memory modules, and other circuit boards by the edges. Never touch exposed circuitry.
- Prevent others from touching components.
- When you install a static-sensitive option or CRU, touch the static-protective package containing the part to a metal expansion-slot cover or other unpainted metal surface on the computer for at least two seconds. This reduces static electricity in the package and your body.
- When possible, remove the static-sensitive part from the static-protective packaging and install the part without setting it down. When this is not possible, place the static-protective packaging on a smooth, level surface and place the part on it.
- Do not place the part on the computer cover or other metal surface.

Before replacing CRU

To protect you from the electricity danger, before replacing any CRU, ensure you read this section and do as following:

1. Turn off your computer and disconnect the ac power adapter and all cables from the computer.
2. Turn on your computer. Press F1 to enter ThinkPad Setup when the ThinkPad logo appears.
3. Select **Config** → **Power**. The submenu will be displayed.

4. Select **Disable Built-in Battery**.
5. Click **Yes** in the Setup Warning window. Wait for a few minutes till the inside of the computer cools, and then you can replace the failed component safely.

Replacing the hard disk drive or solid state drive

Before you start, print these instructions.

You can replace the hard disk drive or solid state drive with a new one which can be purchased from your Lenovo reseller or a marketing representative. Read the following prerequisites before you replace the hard disk drive.

Note: Replace the hard disk drive or solid state drive only if you upgrade it or have it repaired. The connectors and slot of the hard disk drive or solid state drive were not designed for frequent changes, or drive swapping.

Prerequisites for the procedure

When replacing the drive, be sure to follow the precautions.

Attention:

- Do not drop the hard disk drive or solid state drive, or subject it to physical shocks. Put the drive on a material, such as soft cloth, that absorbs any physical shocks.
- Do not apply pressure to the cover of the drive.
- Do not touch the connector.

The drive is very sensitive. Incorrect handling can cause damage and permanent loss of data.

Before removing the hard disk drive or solid state drive, make a backup copy of all the information on it, and then turn the computer off.

Never remove the drive while the system is operating, in sleep mode, or in hibernation mode.

Replacing the hard disk drive

To replace the hard disk drive, do the following:

1. Enter ThinkPad Setup to stop battery discharge. Refer to “Before replacing CRU” on page 75 for detailed instruction.
2. Close the computer display, and turn the computer over.
3. Loosen the screw **1**, then flip out the cover **2** and pull it up to remove it **3**.

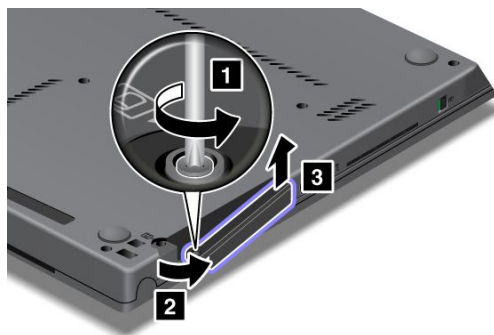

4. Remove the hard disk drive by pulling out the tab.

Note: The tab is initially bent and inserted into the space between the hard disk drive and the computer base cover.

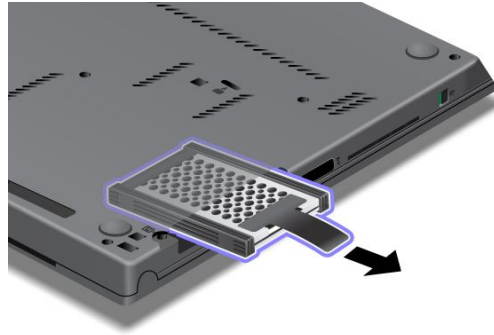

5. Detach the side rubber rails from the hard disk drive.

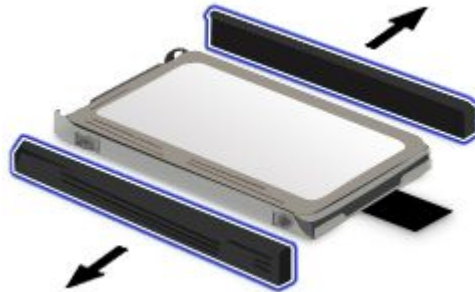

6. Attach the side rubber rails to a new hard disk drive.

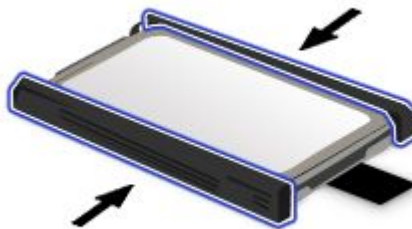

7. Insert the new hard disk drive into the hard disk drive bay, then press it firmly into place.

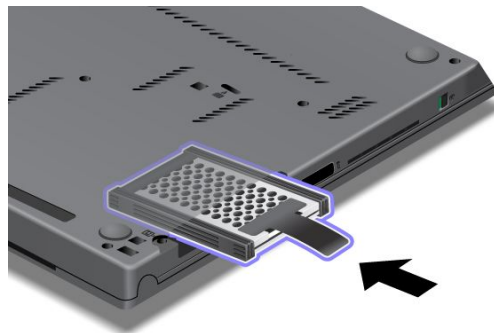

8. Insert the slot cover **1**, then slide in the cover **2** and tighten the screw **3**.

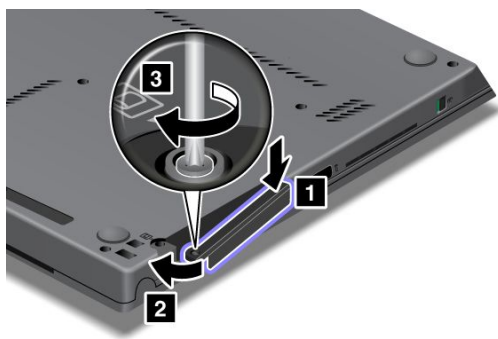

9. Turn the computer over again. Connect the ac power adapter and the cables to the computer.

Replacing the solid state drive

The replacement procedure of solid state drive is the same with the procedure of replacing the hard disk drive. Refer to “Replacing the hard disk drive” on page 76 for detailed instructions.

Note: Side spacer rails are used for solid state drive in stead of side rubber rails in step 5 and step 6.

Replacing the keyboard

Before you start, print these instructions.

You can use the following procedures to replace the keyboard with a new one, available as an option.

Prerequisites for the procedure

When installing or replacing the keyboard, be sure to follow the precautions.



During electrical storms, do not connect the cable to or disconnect it from the telephone outlet on the wall.



Electric current from power, telephone, and communication cables is hazardous. To avoid shock hazard, disconnect the cables before opening the cover of this slot.

To replace the keyboard, do the following:

Removing the keyboard

1. Enter ThinkPad Setup to stop battery discharge. Refer to “Before replacing CRU” on page 75 for detailed instruction.
2. Close the computer display, and turn the computer over.
3. Remove the two screws that secure the keyboard.

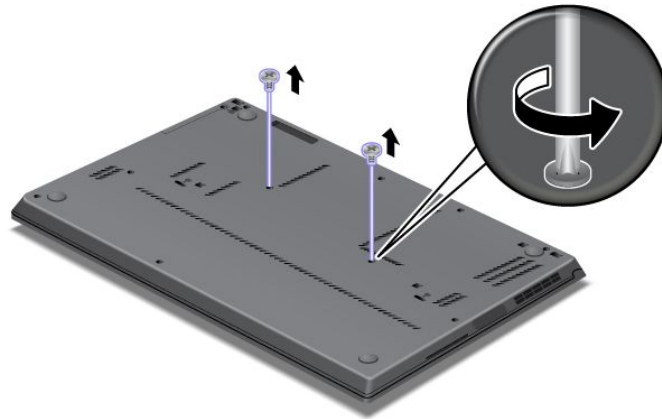

4. Turn the computer over and open the display.
5. Push in the direction shown by the arrows **1** to unlatch the front side of the keyboard. The keyboard will open up slightly. Then carefully lift up the keyboard **2** until you can see how it is connected.



6. Carefully turn the keyboard over onto the palm rest, and detach the connectors. Then remove the keyboard.

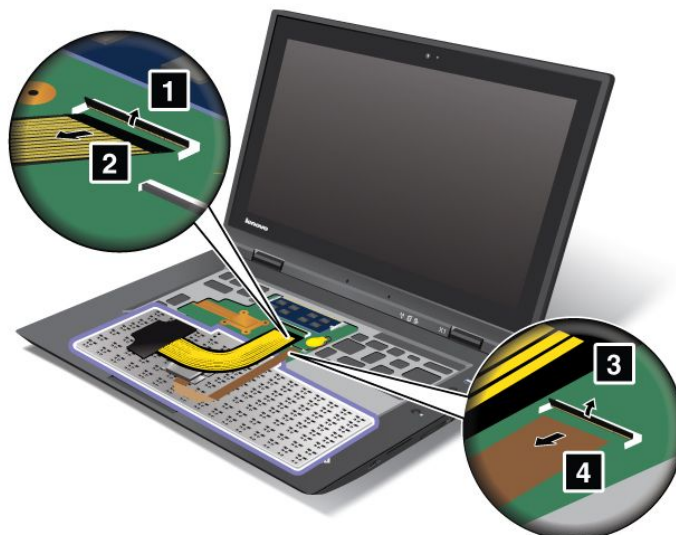

Installing the keyboard

1. Attach the connectors.

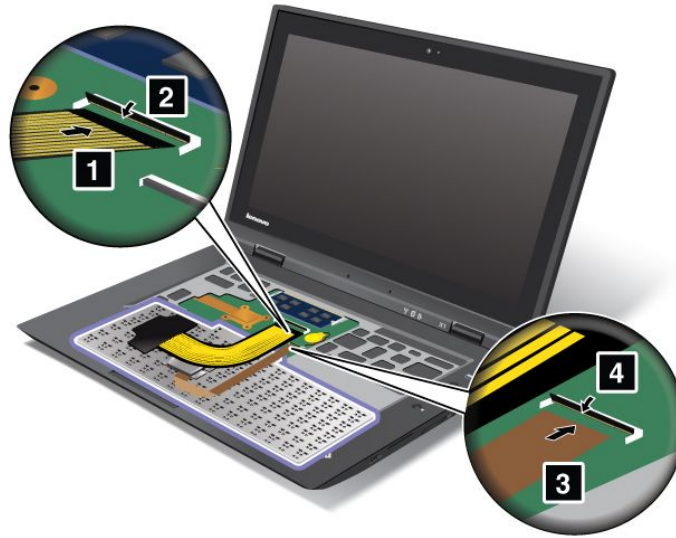

2. Insert the keyboard. Make sure that the rear edges of the keyboard are under the frame as shown by the arrows.



3. Press gently and slide the keyboard as shown by the arrows.



4. Close the computer display and turn the computer over. Then reinstall the two screws.

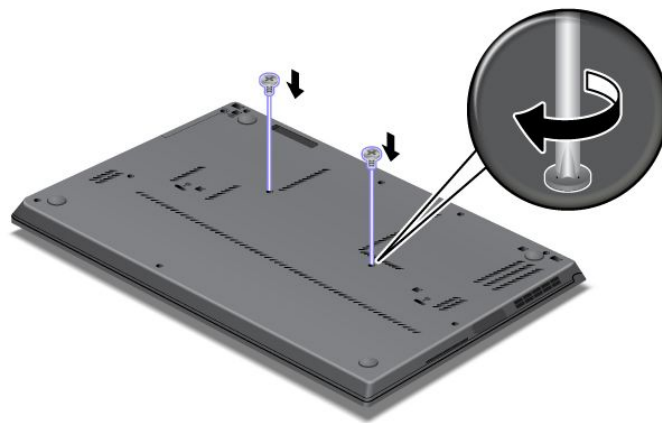

5. Turn the computer over again. Connect the ac power adapter and cables to the computer.

Replacing the memory module

Before you start, print these instructions.

Increasing memory capacity is an effective way to make programs run faster. You can increase the amount of memory in your computer by installing a double data rate three (DDR3) synchronous dynamic random access memory (SDRAM) unbuffered small outline dual inline memory module (SO-DIMM), available as an option, in the memory slot under the palm rest of the computer. SO-DIMMs with different capacities are available.

To replace memory, read the following prerequisites and follow the instruction below.

Prerequisites for the procedure

Note: The operating speed of the memory module depends on the system configuration of your computer and its combination with the memory module installed on your computer. In some conditions, the memory in your computer may not be able to operate at the maximum speed.

Attention: Before you start installing a module, touch a metal table or a grounded metal object. This action reduces any static electricity from your body. The static electricity could damage the SO-DIMM.

Replacing the memory module

To replace the SO-DIMM, do the following:

1. Enter ThinkPad Setup to stop battery discharge. Refer to “Before replacing CRU” on page 75 for detailed instruction.
2. Close the computer display, and turn the computer over.
3. Remove the keyboard. For more details, refer to “Replacing the keyboard” on page 78.
4. If the SO-DIMM is already in the memory slot, press out on the latches on both edges of the socket at the same time **1**, then remove the SO-DIMM to make room for the new one **2**. Be sure to save it for future use.

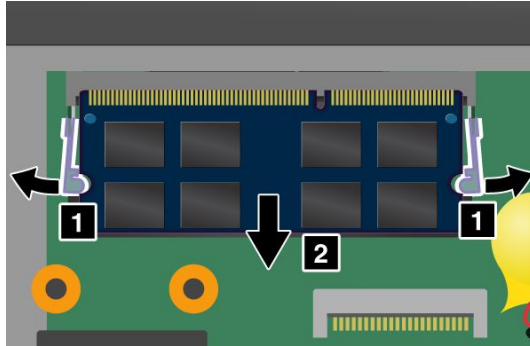

5. Find the notch on the contact edge side of the SO-DIMM you are installing.

Attention: To avoid damaging the SO-DIMM, do not touch its contact edge.

6. With the notched end of the SO-DIMM toward the contact edge side of the socket, insert the SO-DIMM **1** into the socket and press it in firmly. Then pivot the SO-DIMM downward until it snaps into place **2**.

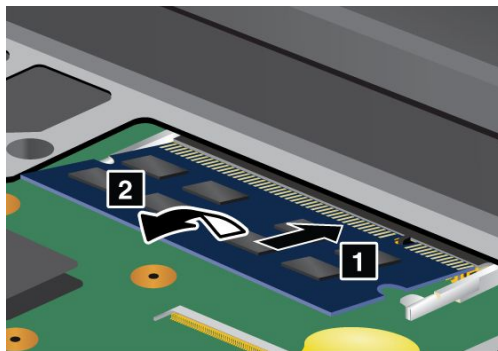

Note: Insert the SO-DIMM into the socket at an angle of about 20 degrees.

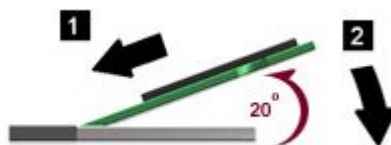

7. Make sure that the SO-DIMM is firmly fixed in the slot and cannot be moved easily.
8. Reinstall the keyboard. For more details, refer to “Replacing the keyboard” on page 78.
9. Turn the computer over again. Connect the ac power adapter and cables to the computer.

Replacing the PCI Express Mini Card for wireless LAN/WiMAX connection

Before you start, print these instructions.

Your computer has a PCI Express Mini Card slot for connection to a wireless LAN/WiMAX. To replace the PCI Express Mini Card with a new one, read the following prerequisites.

Prerequisites for the procedure

When installing or replacing the card, be sure to follow the precautions.



During electrical storms, do not connect the cable to or disconnect it from the telephone outlet on the wall.



Electric current from power, telephone, and communication cables is hazardous. To avoid shock hazard, disconnect the cables before opening the cover of this slot.

Attention: Before you start installing a PCI Express Mini Card, touch a metal table or a grounded metal object. This action reduces any static electricity from your body. The static electricity could damage the card.

Replacing the PCI Express Mini Card for wireless LAN/WiMAX connection

1. Enter ThinkPad Setup to stop battery discharge. Refer to “Before replacing CRU” on page 75 for detailed instruction.
2. Close the computer display, and turn the computer over.
3. Remove the keyboard. For more details, refer to “Replacing the keyboard” on page 78.
4. If a tool for removing connectors is included in the package with the new card, use it to disconnect the cables from the card. If no such tool is included, disconnect the cables by picking up the connectors with your fingers and gently unplugging them.

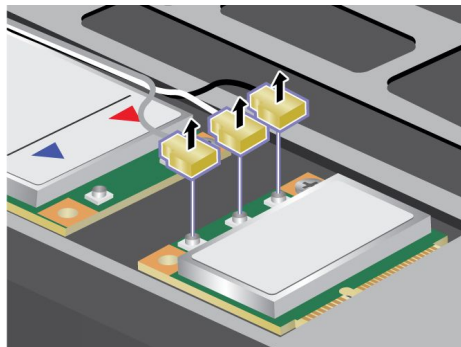

Note: Depending on the system configuration of your computer, the card may have only two connectors.

5. Remove the screw and the card will pop up.

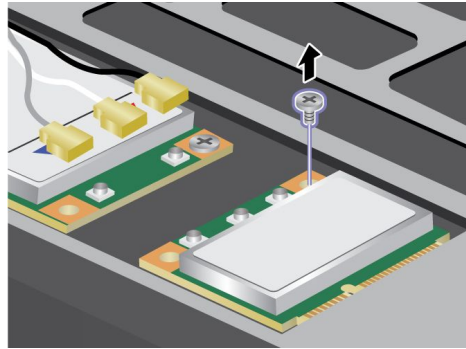

6. Remove the card.

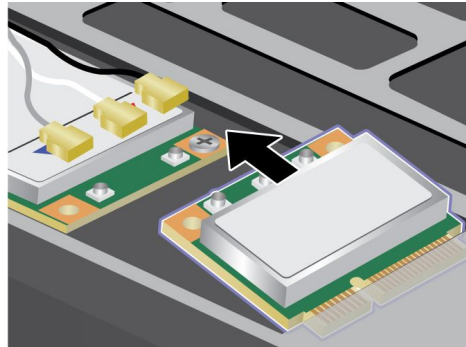

7. Align the contact edge of the new PCI Express Mini Card with the corresponding socket contact of the computer.

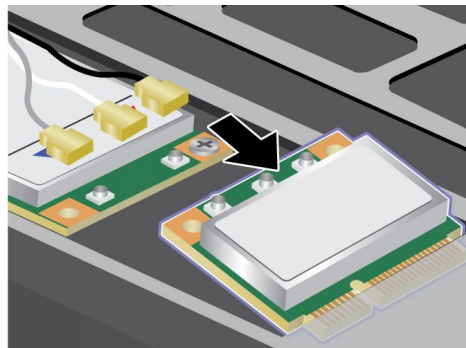

8. Pivot the card until you can snap it into place. Secure the card with the screw.

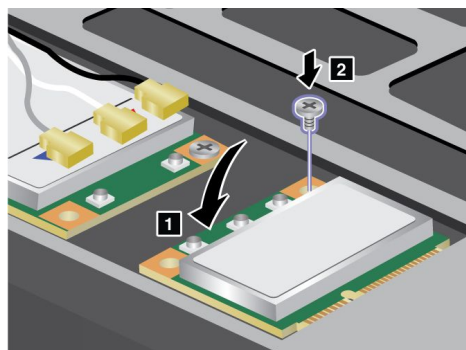

9. Connect the cables to the new PCI Express Mini Card. Be sure to attach the gray cable to the connector marked “MAIN” or “M” on the card, the white cable to the center connector, and the black cable to the connector marked “AUX” or “A.”

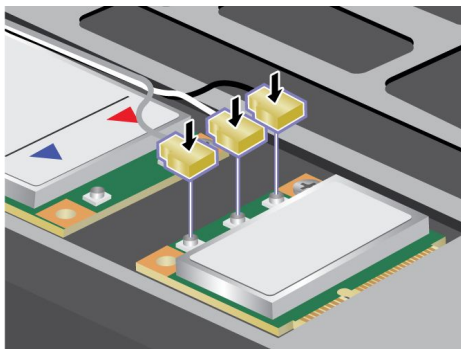

Note: If the new PCI Express Mini Card has only two connectors, be sure to attach the gray cable to the connector marked “MAIN,” and the black cable to the connector marked “AUX.” Put the white cable in the cable protection tube.

10. Reinstall the keyboard. For more details, refer to “Replacing the keyboard” on page 78.
11. Turn the computer over again. Connect the ac power adapter and cables to the computer.

Installing and replacing the PCI Express Mini Card for wireless WAN connection

Before you start, print these instructions.

Some ThinkPad models have a PCI Express Mini Card slot for connection to a wireless WAN. To replace the PCI Express Mini Card with a new one, read the following prerequisites.

Prerequisites for the procedure

When installing or replacing the card, be sure to follow the precautions.



During electrical storms, do not connect the cable to or disconnect it from the telephone outlet on the wall.



Electric current from power, telephone, and communication cables is hazardous. To avoid shock hazard, disconnect the cables before opening the cover of this slot.

Attention: Before you start installing a PCI Express Mini Card, touch a metal table or a grounded metal object. This action reduces any static electricity from your body. The static electricity could damage the card.

Replacing the PCI Express Mini Card for wireless WAN connection

If a Wireless WAN is available in your computer, to replace the PCI Express Mini Card, do as follows:

1. Enter ThinkPad Setup to stop battery discharge. Refer to “Before replacing CRU” on page 75 for detailed instruction.
2. Close the computer display, and turn the computer over.
3. Remove the keyboard. For more details, refer to “Replacing the keyboard” on page 78.

4. If a tool for removing connectors is included in the package with the new card, use it to disconnect the cables from the card. If no such tool is included, disconnect the cables by picking up the connectors with your fingers and gently unplugging them.

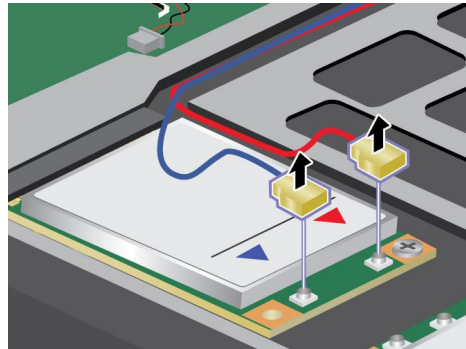

Note: Depending on the system configuration of your computer, the card may have only one connector.

5. Remove the screw and the card will pop up.

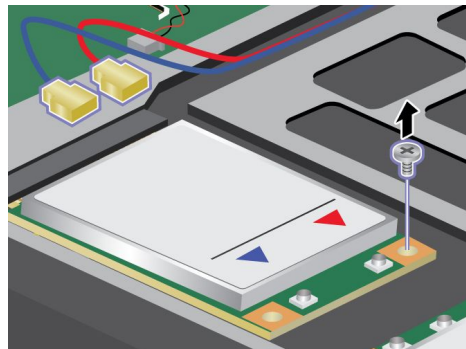

6. Remove the card.

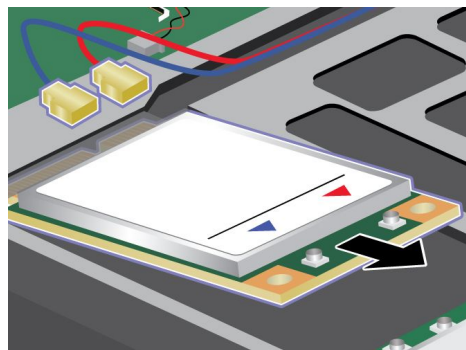

7. Align the contact edge of the new PCI Express Mini Card with the corresponding socket contact of the computer.

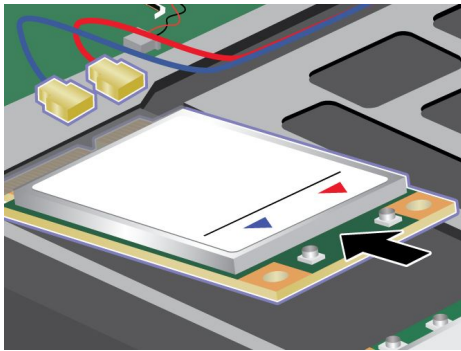

8. Pivot the card until you can snap it into place. Secure the card with the screw.



Note: You can also replace the PCI Express Mini Card for Wireless WAN with an mSATA solid state drive. Refer to “Installing and replacing the mSATA solid state drive” on page 87 for more information.

9. Connect the cables to the new PCI Express Mini Card. Make sure that the cables are not pinched by the card.

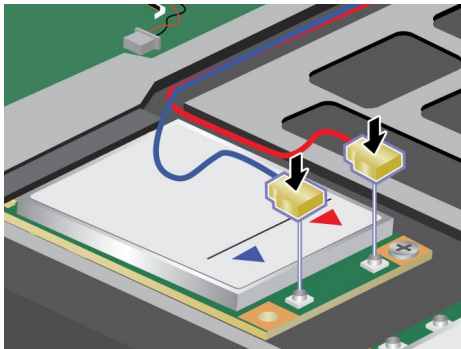

Note: Depending on the model, the marking for the connectors on your card may look different from the one shown in the illustration below. If the connectors on your card are marked as “MAIN” or “M” and “AUX” or “A,” be sure to attach the red cable to the “MAIN” or “M” connector, and the blue cable to the “AUX” or “A” connector.

10. Reinstall the keyboard. For more details, refer to “Replacing the keyboard” on page 78.
11. Turn the computer over again. Connect the ac power adapter and cables to the computer.

Installing and replacing the mSATA solid state drive

Before you start, print these instructions.

Some ThinkPad models have an mSATA solid state drive. You can replace the mSATA solid state drive with a new one which can be purchased from your Lenovo reseller or a marketing representative. To replace the mSATA solid state drive, read the following prerequisites.

Note: Replace the mSATA solid state drive only if you need to have it repaired.

Prerequisites for the procedure

When replacing the mSATA solid state drive, be sure to follow the precautions.

Attention: When you are handling an mSATA solid state drive:

- Do not drop the mSATA solid state drive or subject it to physical shocks. Put the mSATA solid state drive on a material, such as soft cloth that absorbs any physical shocks.
- Do not apply pressure to the cover of the mSATA solid state drive.

The mSATA solid state drive is very sensitive. Incorrect handling can cause damage and permanent loss of data.

Before removing the mSATA solid state drive, make a backup copy of all the information on it, and then turn the computer off.

Never remove the mSATA solid state drive while the system is operating, in sleep mode, or in hibernation mode.

Replacing the mSATA solid state drive

If an mSATA solid state drive is available in your computer, to replace the mSATA solid state drive, do as follows:

1. Enter ThinkPad Setup to stop battery discharge. Refer to “Before replacing CRU” on page 75 for detailed instruction.
2. Close the computer display, and turn the computer over.
3. Remove the keyboard. For more details, refer to “Replacing the keyboard” on page 78.
4. Remove the screw and the card will pop up.

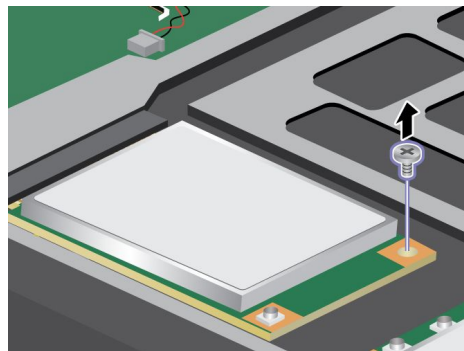

5. Remove the card.

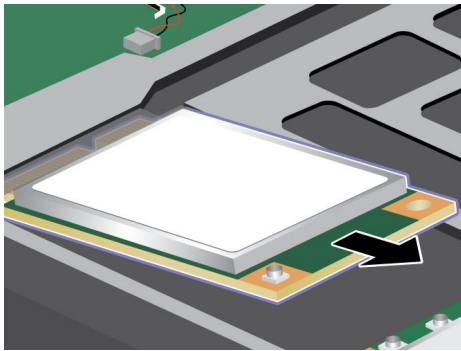

6. Align the contact edge of a new mSATA solid state drive with the corresponding socket.

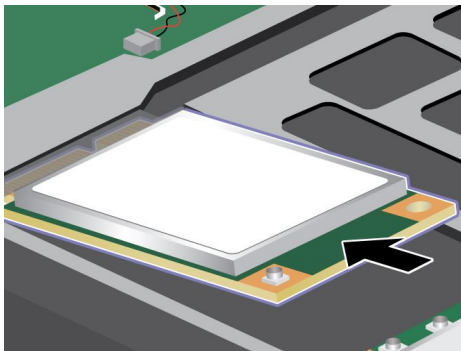

7. Pivot the card downward **1** until you can snap it into place. Secure the card with the screw **2**.

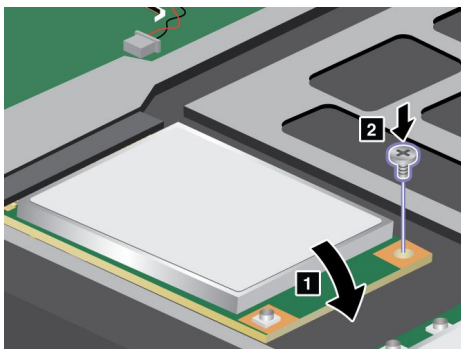

Note: You can also replace the mSATA solid state drive with a Wireless PCI Express Mini Card for Wireless WAN. For more information, refer to “Installing and replacing the PCI Express Mini Card for wireless WAN connection” on page 85.

8. Reinstall the keyboard. For more details, refer to “Replacing the keyboard” on page 78.
9. Turn the computer over again. Connect the ac power adapter and cables to the computer.

Replacing the backup battery

Before you start, print these instructions.

You can replace the backup battery when it is running out of power.

To replace the backup battery, do as follows:

1. Enter ThinkPad Setup to stop battery discharge. Refer to “Before replacing CRU” on page 75 for detailed instruction.

2. Close the computer display, and turn the computer over.
3. Remove the keyboard. For more details, refer to “Replacing the keyboard” on page 78.
4. Detach the connector and then remove the backup battery.



5. Position the new backup battery in place, then attach the connector.



6. Reinstall the keyboard. For more details, refer to “Replacing the keyboard” on page 78.
7. Turn the computer over again. Connect the ac power adapter and cables to the computer.

Replacing the SIM card

Your computer may require a SIM (Subscriber Identification Module) card to establish a wireless WAN (Wide Area Network) connection. Depending on the country of delivery, the SIM card may be already installed in your computer or will be part of the shipping contents that came with your computer.

Note: The SIM card is identified by the IC chip mounted on one side of the card.

To replace the SIM card, do the following:

1. Enter ThinkPad Setup to stop battery discharge. Refer to “Before replacing CRU” on page 75 for detailed instruction.
2. Find the SIM card slot at the rear side of the computer. Refer to “Rear view” on page 8 to locate the SIM card slot.
3. Open the SIM card slot cover.



4. Push the SIM card inward a little, the SIM card pops out. Gently slide the SIM card out of the slot.

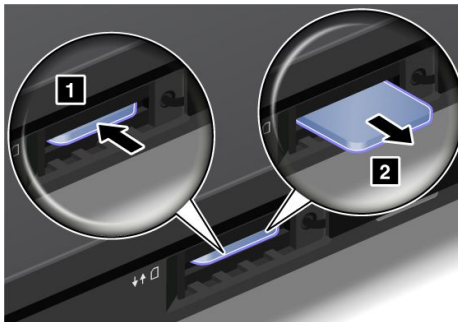

5. Insert the new SIM card firmly into the slot until you hear a click.

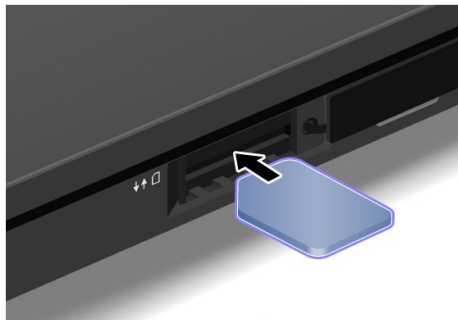

6. Close the SIM card slot cover.



Chapter 7. Enhancing your computer

This section provides information on installing devices and taking advantage of your computer's high-technology features.

- “Finding ThinkPad options” on page 93
- “ThinkPad Battery 39+ (6-cell slice battery)” on page 93

Finding ThinkPad options

If you want to expand the capabilities of your computer, Lenovo has a number of hardware accessories and upgrades to meet your needs. Options include memory modules, storage devices, modems, networking adapters, docking stations and port replicators, batteries, power adapters, printers, scanners, keyboards, mice, mechanical cable locks in all sizes, and more.

You can shop at Lenovo 24 hours a day, 7 days a week directly over the World Wide Web. All you need is an Internet connection and a credit card.

To shop at Lenovo, go to:

<http://www.lenovo.com/accessories/services/index.html>

ThinkPad Battery 39+ (6-cell slice battery)

Your computer supports the ThinkPad Battery 39+, a 6-cell slice battery which is available as an option. See “Finding ThinkPad options” on page 93.

With ThinkPad Battery 39+, you can extend the operating time of your notebook computer.

Note: When the computer is attached to the ThinkPad Battery 39+, never pick up the assembly by taking hold of the computer alone. Always hold the whole assembly.

ThinkPad Battery 39+ top view



1 Connector

The connector is used for attaching the ThinkPad computer to the ThinkPad Battery 39+.

ThinkPad Battery 39+ bottom view

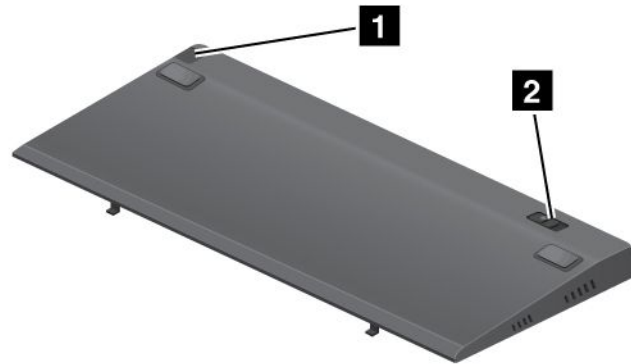

1 Eject lever

Use the eject lever to lock or unlock the ThinkPad Battery 39+.

2 Battery latch

Use the battery latch to prevent the eject lever from being released.

Attaching a ThinkPad Battery 39+

To attach a ThinkPad Battery 39+, do the following:

1. Open the slice battery connector door at the bottom side of your computer.

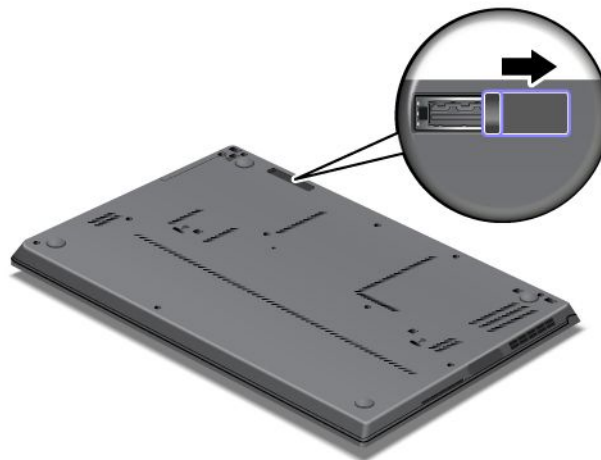

2. Insert the front hooks of the ThinkPad Battery 39+ to the corresponding notches on the computer.

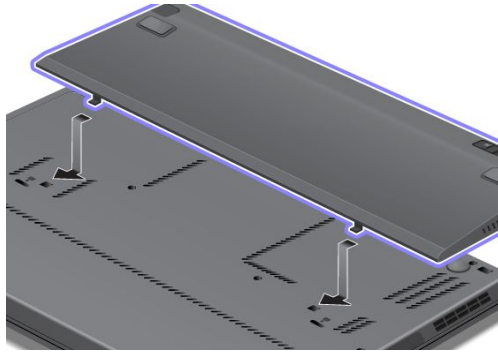

3. Pivot the ThinkPad Battery 39+ downward until the eject lever clicks into place.

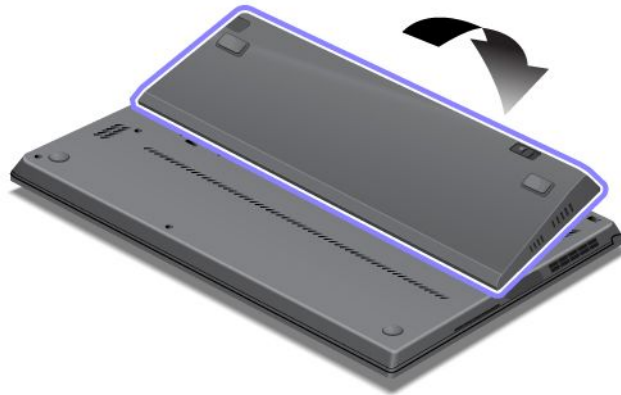

4. Slide the battery latch to the locked position.

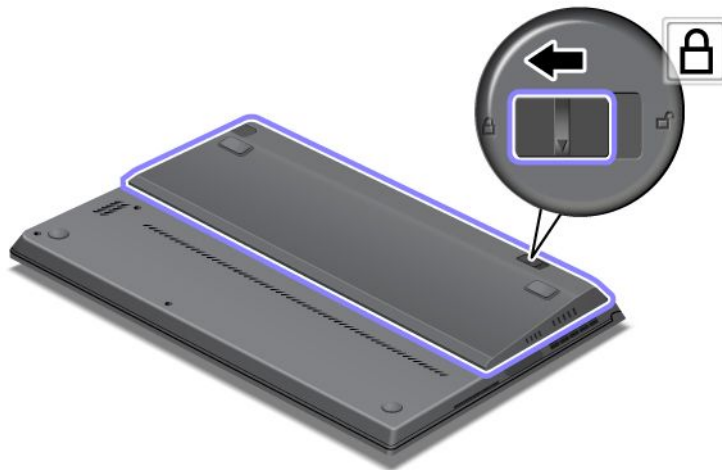

5. Push the eject lever to the locked position.

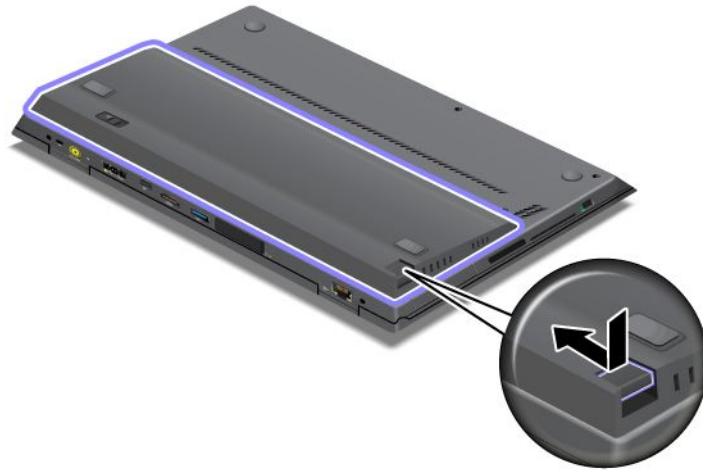

Detaching a ThinkPad Battery 39+

Note: Disconnect the ac power adapter from your computer before you detach the ThinkPad Battery 39+. The ac power adapter connector will be damaged if it remains connected to the computer during the detachment.

To detach a ThinkPad Battery 39+, do the following:

1. Unlock the battery latch by sliding it to the unlock position.

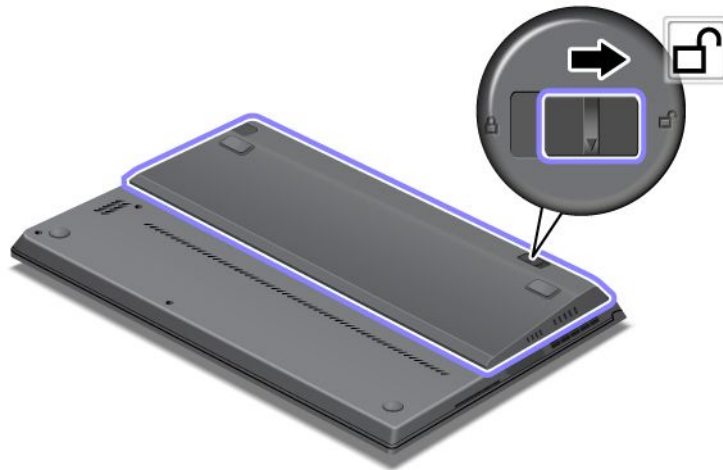

2. Pull the eject lever out a little in the horizontal direction to the unlocked position, and then pull up the eject lever to release the ThinkPad Battery 39+ from the computer.

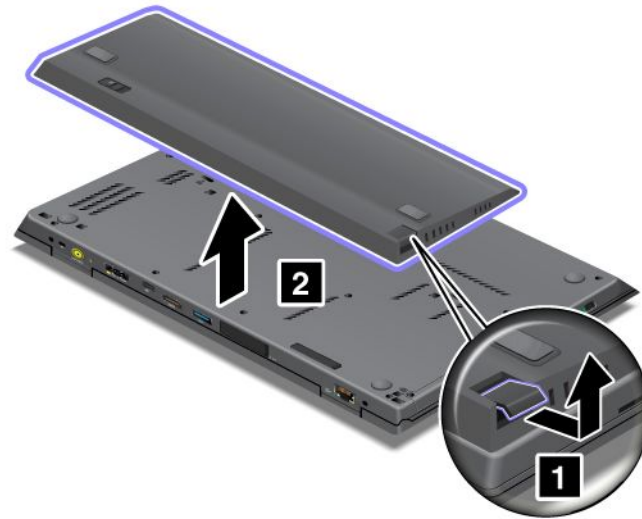

3. Close the slice battery connector door.

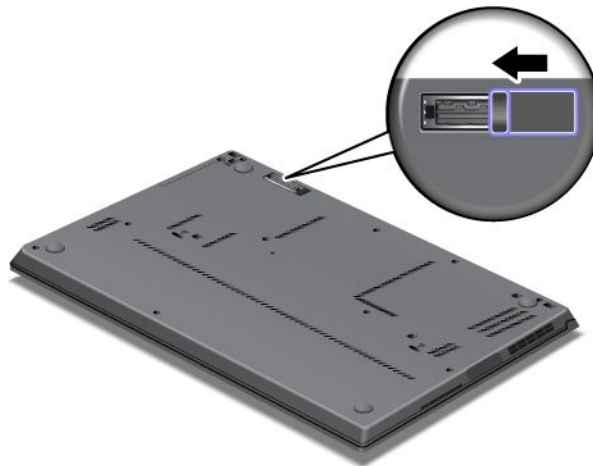

Charging a ThinkPad Battery 39+

To charge the ThinkPad Battery 39+, you need to attach the ThinkPad Battery 39+ to your computer and attach the ac power adapter, then the main battery and ThinkPad Battery 39+ will be charged sequentially.

Chapter 8. Advanced configuration

While it is important to protect files, data, and settings that are on the hard disk or on the solid state drive, you may also need to install a new operating system, install new device drivers, update your UEFI BIOS, or recover preinstalled software. This information will help you handle your computer with proper care and keep it in top working shape.

- “Installing a new operating system” on page 99
- “Installing device drivers” on page 101
- “ThinkPad Setup” on page 102
- “Using system management” on page 116

Installing a new operating system

If you install a new operating system in your computer, you need to install the Supplement files and ThinkPad device drivers for it at the same time. The necessary files are located in the following directories of your solid state drive or hard disk drive:

- The Supplement files for the operating system supported are in the C:\SWTOOLS\OSFIXES directory.
- The device drivers for the operating system supported are in the C:\SWTOOLS\DRIVERS directory.
- The preloaded software applications are in the C:\SWTOOLS\APPS directory.

Notes:

- The process of installing the new operating system deletes all the data on your hard disk, including backups or images that were stored in a hidden folder by use of the Rescue and Recovery program.
- If you cannot find the Supplement files, the device drivers, and application software you need on your hard disk drive, or if you want to receive updates and the latest information about them, go to: <http://www.lenovo.com/ThinkPadDrivers>

Before you begin

Before you install the operating system, do the following:

- Copy all the subdirectories and files in the C:\SWTOOLS directory to a removable storage device, to avoid losing files during the installation.
- Prepare and attach an external DVD drive to the computer if necessary.
- Print the sections you will be using.

Note: If you want to start Windows Recovery Environment (WinRE) using 64-bit version of Microsoft Windows Installation DVD, you should not change the initial **UEFI/Legacy Boot** setting in ThinkPad Setup. The **UEFI/Legacy Boot** setting must be the same as it was when the Windows OS image was installed. Or, you will see an error.

For the country or region code required in the installation, use one of the following:

Country or region: Code

China: SC
Denmark: DK
Finland: FI
France: FR
Germany: GR

Italy: IT
Japan: JP
Netherlands: NL
Netherlands: NL
Norway: NO
Spain: SP
Sweden: SV
Taiwan and Hong Kong: TC
United States: US

Installing Windows 7

Before you start, print these instructions.

To install Windows 7 and its related software on your computer, do as follows:

1. Start the ThinkPad Setup.
2. Select **Startup** menu.
3. Select **UEFI/Legacy Boot**.
4. Do one of the following:
 - If you want to install the Windows 7 32-bit operating system, select **Legacy Only** or **Both**.
 - If you want to install the Windows 7 64-bit operating system in Legacy mode, select **Legacy Only**.
 - If you want to install the Windows 7 64-bit operating system in UEFI mode, select **UEFI Only**.
5. Press F10.
6. To install Windows 7, insert the DVD for Windows 7 into the DVD drive, and install Windows 7 from the DVD. Then restart the computer, and follow the instructions on the screen.
7. Restore C:\SWT00LS from the backup copy you made before starting the installation.
8. Install Intel Chipset Support for Windows 2000/XP/Vista/7. See “Installing Intel Chipset Support for Windows 2000/XP/Vista/7” on page 102.
9. Install device drivers. See “Installing device drivers” on page 101 for more information.

Installing Registry Patches for Windows 7

Install the following Registry Patches:

- Registry patch enabling Wake Up on LAN from sleep for Energy Star
- Fix for Issue of HDD with HD Detection

To install these Registry Patches, go to:

<http://www.lenovo.com/support>

Installing the Windows 7 Update Module Package

The Windows 7 Update Modules are in the following directory:

C:\SWT00LS\0SFIXES\

The name of each subfolder is the number of a fix module. For information about each fix module, go to the Microsoft Knowledge Base homepage at <http://support.microsoft.com/>, type the number of the fix module you need in the search field, and click **Search**.

Note: The Web site address might change without notice. If the homepage is not displayed, search for it from the Microsoft top page.

To install a fix module, run the EXE file in a subfolder and follow the instructions on the screen.

Note: If you remove the hard disk drive from the computer with a single-core processor and install it on a computer with a dual-core processor, you can get access to the hard disk drive. The opposite, however, is not true: If you remove the hard disk drive from a computer with a dual-core processor and install it on a computer with a single-core processor, you cannot get access to the hard disk drive.

Installing device drivers

To install device drivers, go to:
<http://www.lenovo.com/support>

Installing the driver for the 4-in-1 Media Card Reader

To use the 4-in-1 media card reader, you need to download and install the Ricoh Multi Card Reader Driver for Windows 7/Vista. To download it, go to the Lenovo Web site at:

<http://www.lenovo.com/support/site.wss/document.do?sitestyle=lenovo&Indocid=HOME-LENOVO>

Installing the driver for USB 3.0

If your computer supports USB 3.0, and you have reinstalled the operating system, you need to download and install the USB 3.0 driver to use the USB 3.0. Do the following:

1. Go to Lenovo Web site:
<http://www.lenovo.com/support/site.wss/document.do?sitestyle=lenovo&Indocid=HOME-LENOVO>.
When you get to the site, find your model and display the driver links.
2. Select the USB 3.0 driver for 32-bit or 64-bit and extract it to your local hard disk.
3. Double-click Setup.exe in C:\DRIVERS\WIN\USB3.0\.
4. Click **Next**. If the device driver is already installed, click **Cancel**. Follow the instructions on the screen until the installation is finished.

Installing ThinkPad Monitor File for Windows 2000/XP/Vista/7

ThinkPad Monitor File for Windows 2000/XP/Vista/7 is usually in the following directory:
C:\SWTOOLS\DRIVERS\MONITOR.

Note: If you cannot find this directory on your hard disk drive or solid state drive, download the ThinkPad Monitor File for Windows 2000/XP/Vista/7 from the ThinkPad Web site at:
<http://www.lenovo.com/ThinkPadDrivers>

Note: Before you install this file, make sure that the correct video driver has been installed.

To install the ThinkPad Monitor File, do the following:

1. Right-click on the desktop, and click **Personalize**.
2. Click **Display** at the left.
3. Click **Change display settings**.
4. Click **Advanced Settings**.
5. Click the **Monitor** tab.
6. Click **Properties**.
7. Click the **Driver** tab.
8. Click **Update Driver**.

9. Select **Browse my computer for driver software**, and then click **Let me pick from a list of device drivers on my computer**.
10. Click **Have Disk**.
11. Specify the path where the monitor INF file is saved, then click **Open**.
12. Click **OK**.
13. Confirm the correct display type, then click **Next**.
14. Windows has finished installing. Click **Close**.
15. Click **Close** for Display Properties.
16. Click **OK** in the **Monitor** tab.
17. Click **OK** and close the Display Settings window.

Installing Intel Chipset Support for Windows 2000/XP/Vista/7

The Intel Chipset Support for Windows 2000/XP/Vista/7 is located in the C:\SWTOOLS\DRIVERS\INTELINF directory. To install it, go to the directory and run infinst_autol.exe.

Installing other device drivers

The other device drivers are provided in the C:\SWTOOLS\DRIVERS directory on your hard disk drive.

You will also need to install application software, which is provided in the C:\SWTOOLS\APPS directory on your hard disk drive. To do this, refer to the instructions in “Reinstalling preinstalled applications and device drivers” on page 73.

Note: If you cannot find the Supplement files, device drivers, and application software you need on your hard disk drive, or if you want to receive updates and the latest information about them, go to:
<http://www.lenovo.com/ThinkPadDrivers>

ThinkPad Setup

Your computer provides a program, called **ThinkPad Setup**, that enables you to select various setup parameters.

To start ThinkPad Setup, do as follows:

1. To protect yourself against accidental loss of data, back up your computer registry. See “Performing backup and recovery operations” on page 70.
2. If the diskette drive is connected to the computer, remove any diskette from the diskette drive, and then turn off the computer.
3. Turn on the computer. When the logo screen is displayed, press the F1 key. The ThinkPad Setup opens.
If you have set a supervisor password, the ThinkPad Setup menu appears after you enter the password. You can start the ThinkPad Setup by pressing Enter instead of entering the supervisor password. However, you cannot change the parameters that are protected by the supervisor password. For more information, refer to “Using passwords” on page 55.

An example of the ThinkPad Setup menu is shown as below:

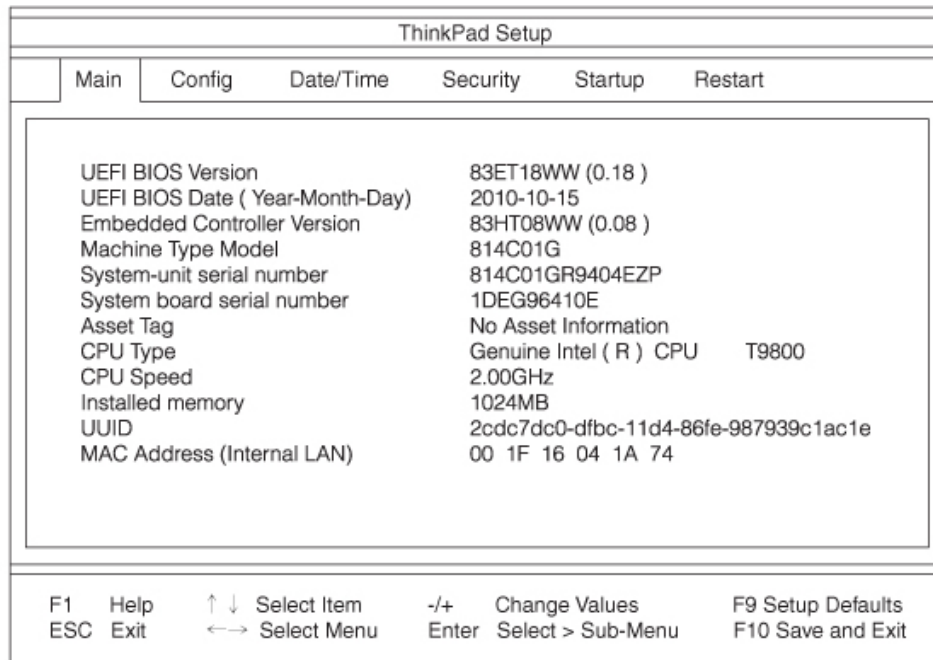

- Using the cursor keys, move to an item you want to change. When the item you want is highlighted, press Enter. A submenu is displayed.
- Change the items you wish to change. To change the value of an item, press +/- . If the item has a submenu, you can display it by pressing Enter.
- Press Esc to exit from the submenu.
- If you are in a nested submenu, press Esc repeatedly until you reach the **ThinkPad Setup** menu.

Note: If you need to restore the settings to their original state as of the time of purchase, press F9 to load the default settings. You can also select an option in the Restart submenu to load the default settings or discard the changes.

- Select **Restart**. Move the cursor to the option you want for restarting your computer; then press **Enter**. Your computer restarts.

Config menu

If you need to change the configuration of your computer, select **Config** from the ThinkPad Setup menu.

Notes:

- The default settings are already optimized for you. If you consider changing the computer configuration, proceed with extreme caution. Setting the configuration incorrectly might cause unexpected results.
- In each submenu, press Enter key to show selectable options and select a desired option by using cursor key, or type desired values from the keyboard directly.

The following submenu is displayed:

- Network:** Set the LAN related functions.
- USB:** Enable or disable USB related functions.
- Keyboard/Mouse:** Set the keyboard and the mouse related functions.
- Display:** Specify the settings for display output.
- Power:** Set power management related functions.
- Beep and Alarm:** Enable or disable the audio related functions.

- **Serial ATA (SATA):** Specify the settings for the hard disk drive.
- **CPU:** Specify the settings for the CPU.
- **Intel® AMT:** Set the Intel AMT related functions.

Date/Time menu

If you need to set the current date and time of your computer, select **Date/Time** from the ThinkPad Setup menu. The following submenu is displayed:

- System Date
- System Time

To change the date and time, do the following:

1. Using the up and down arrow keys, select the item to change, date or time.
2. Press Tab, Shift+Tab, or Enter to select a field.
3. Type the date or time.

Note: Another way to adjust date and time is pressing the “-” or “+” key.

Security menu

If you need to set the security features of your computer, select **Security** from the ThinkPad Setup menu.

Notes:

- The default settings are already optimized for you. If you consider changing the computer configuration, proceed with extreme caution. Setting the configuration incorrectly might cause unexpected results.
- In each submenu, you can enable a function by selecting **Enabled**, or disable it by selecting **Disabled**.

The following submenu is displayed:

- **Password:** Set password related functions.
- **Fingerprint:** Set the fingerprint reader related functions.
- **Security Chip:** Set the security chip related functions.
- **UEFI BIOS Update Option:** Specify the settings for Flash UEFI BIOS update.
- **Memory Protection:** Specify the settings for the Data Execution Prevention feature.
- **Virtualization:** Enable or disable the settings for Intel Virtualization Technology and Intel VT-d Feature.
- **I/O Port Access:** Enable or disable the access to individual I/O ports.
- **Anti-Theft:** Enable or disable UEFI BIOS interface to activate Anti-Theft services, such as Intel AT and Computrace.

To set password related functions, go to the Security menu and select **Password**. The following submenu is displayed:

- **Hardware Password Manager**
- **Supervisor Password**
- **Lock UEFI BIOS Settings**
- **Set Minimum Length**
- **Password at unattended boot**
- **Password at restart**
- **Power-On Password**

- **Hard Disk x Password**

Note: **Hard Disk 1** refers to the hard disk drive built into your computer.

If you select and enable **Hardware Password Manager**, you can manage your power-on password, supervisor password, and your hard disk passwords by the management server. By default, this is set to **Enabled**.

Lock UEFI BIOS Settings enables or disables the function that protects items in the ThinkPad Setup from being changed by a user who does not have the supervisor password. By default, this is set to **Disabled**. If you set the supervisor password and enable this function, no one but you can change any items in the ThinkPad Setup.

If you select **Set Minimum Length**, you can specify a minimum length for power-on passwords and hard disk passwords. By default, this is set to **Disabled**. If you set the supervisor password and specify a minimum length for passwords, no one but you can change the length.

If you select and enable **Password at unattended boot**, a password prompt is displayed when the computer is turned on, from either a power-off state or hibernation, by an unattended event such as Wake on LAN. If you select **Disabled**, no password prompt is displayed; the computer goes ahead and loads the operating system. To prevent unauthorized access, set the user authentication on the operating system.

If you select and enable **Password at restart**, a password prompt is displayed when you restart the computer. If you select **Disabled**, no password prompt is displayed; the computer goes ahead and loads the operating system. To prevent unauthorized access, set the user authentication on the operating system.

Startup menu

You may need to change the startup sequence of your computer. For example, if you have different operating systems on different devices, you can have the system start up from either of them.

Attention: After you change your startup sequence, you must be extremely careful not to specify a wrong device during a copy, a save, or a format operation. If you specify a wrong device, your data and programs might be erased or overwritten.

Attention: If you are using the BitLocker drive encryption, you should not change the startup sequence. BitLocker drive encryption detects the change of startup sequence and locks the computer from booting.

Changing the startup sequence

Select **Startup** to display the Boot submenu:

To change the startup sequence, do the following:

1. Select **Boot**; then press Enter.
 - You can use the **Boot** submenu to specify the startup sequence that runs when you turn on the power. Refer to “Boot submenu” on page 106.
 - You can use the **Network Boot** to specify the top priority boot device that runs when **Wake on LAN** is commonly used by LAN administrators in corporate networks to get remote access to your computer. Refer to “Network Boot” on page 107.

2. Select the device you want to start first.

To set the order that the UEFI BIOS will use when starting an operating system, you can press the “-” or “+” key to move the device up or down.

3. Press F10 to save the changes and restart the system.

To change the startup sequence temporarily so that the system starts up from a different drive, do the following:

1. Turn off the computer.
2. Turn on the computer; then, while the “To interrupt normal startup, press the blue ThinkVantage button” message is displayed at the lower-left of the screen, press F12.
3. Select the device you want to start first from the Boot menu.

Note: The Boot menu will be shown when the system cannot boot from any devices or operating system was not found.

Boot submenu

The following list, showing the order in which devices will be started up, is always displayed. Even devices that are not attached to or installed on your computer are listed. For each device that is attached to or installed on the computer, information about it is presented after the colon.

1. USB CD:
2. USB FDD:
3. ATAPI CD0:
4. ATA HDD0:
5. ATA HDD1:
6. ATA HDD2:
7. USB HDD:
8. PCI LAN:
9. ATAPI CD1:
10. ATAPI CD2:
11. ATA HDD3:
12. ATA HDD4:
13. Other CD:
14. Other HDD:

Priority for booting USB devices

If you attach two or more USB devices of the same type to the computer, the computer starts the devices in accordance with the boot priority order specified for the USB connectors as below:



1. The blue USB connector **3** on the rear side of your computer
2. The eSATA/Always on USB connector **2** on the rear side of your computer
3. USB connector **1** on the left side of your computer

Network Boot

Use the **Network Boot** to select the boot device when the system wakes from LAN. If **Wake on LAN** is enabled, the network administrator can turn on all of the computers in a LAN remotely by use of network management software.

Other items in the Startup menu

The following items are also displayed in the **Startup menu** of the ThinkPad Setup:

- **UEFI/Legacy Boot**: Select system boot capability.
- **UEFI/Legacy Boot Priority**: Select priority of boot option between UEFI and Legacy.
- **Boot Mode**: Enable or disable the diagnostics boot mode, used in identifying problems
- **Option Key Display**: Choose whether to show the option key message when the system is booted.
- **Boot device List F12 Option**: Choose whether to show the list of the boot devices.
- **Boot Order Lock**: Enable or disable to lock Boot Priority Order.

Restart menu

If you need to close the ThinkPad Setup and restart the system, select **Restart** from the ThinkPad Setup menu. The following submenu is displayed:

- **Exit Saving Changes**: Restart the system after saving the changes.
- **Exit Discarding Changes**: Restart the system without saving the changes.
- **Load Setup Defaults**: Load the default setting that was in effect at the time of purchase.
- **Discard Changes**: Discard the changes.
- **Save Changes**: Save the changes.

ThinkPad Setup items

The following tables show the contents of the Config menu items, the Security menu items, and the Startup menu items of the ThinkPad Setup.

Note: Some items are displayed on the menu only if the computer supports the corresponding features.

Notes:

- **Enabled** means that the function is configured.
- **Disabled** means that the function is not configured.
- Default values are in **boldface**.

Config menu items

Table 4. Config menu items

Submenu item	Selection	Comments
Network		
Wake On LAN	<ul style="list-style-type: none">• Disabled• AC only• AC and Battery	Enable the system to Power on when the Ethernet controller receives a magic packet. If you select "AC Only," Wake On LAN is enabled only when ac power adapter is attached.

Table 4. Config menu items (continued)

Submenu item	Selection	Comments
		<p>If you select “AC and Battery,” Wake On LAN is enabled with any power sources.</p> <p>Note: AC is required with magic packet type Wake On LAN.</p> <p>Note: Wake On LAN function does not work when a hard disk password is set.</p>
Ethernet LAN Option ROM	<ul style="list-style-type: none"> • Disabled • Enabled 	Load the Ethernet LAN Option ROM to enable startup from an integrated network device.
USB		
USB UEFI BIOS Support	<ul style="list-style-type: none"> • Disabled • Enabled 	Enable or disable boot support for USB diskette, USB memory key, and USB optical drive.
Always On USB	<ul style="list-style-type: none"> • Disabled • Enabled 	If you select “Enabled,” the external USB devices can be charged via USB ports even when the system is in sleep mode, hibernation mode, or power-off mode.
Always On USB Charge in off mode	<ul style="list-style-type: none"> • Disabled • Enabled 	<p>If you select “Enabled,” the Always On USB connector enables you to charge some devices, such as iPod and iPhone and BlackBerry smartphones.</p> <p>Note: If you want to charge these devices when your computer is in hibernation mode or powered off, you will need to open the Power Manager program and configure corresponding settings to enable the Always On USB connector function. For details about how to enable the Always On USB connector function, refer to the online help of the Power Manager program.</p>
Keyboard/Mouse		
TrackPoint	<ul style="list-style-type: none"> • Disabled • Enabled 	<p>Enable or disable the built-in TrackPoint.</p> <p>Note: If you want to use an external mouse, select “Disabled.”</p>
Touch Pad	<ul style="list-style-type: none"> • Disabled • Enabled 	<p>Enable or disable the built-in touch pad.</p> <p>Note: If you want to use an external mouse, select “Disabled.”</p>

Table 4. Config menu items (continued)

Submenu item	Selection	Comments
Fn and Ctrl Key swap	<ul style="list-style-type: none"> • Disabled • Enabled 	<p>If you select “Enabled,” the Fn key works as the Ctrl key, and the Ctrl key works as the Fn key.</p> <p>Note: Even when “Enabled” is selected, you need to press the Fn key to return the computer from sleep mode to normal operation.</p>
Fn Key Lock	<ul style="list-style-type: none"> • Disabled • Enabled 	<p>If you select “Enabled,” you can press the Fn key to keep it in a pressed condition, then press the desired function key. The action is equivalent to pressing the required key and the Fn key simultaneously. When you pressed the Fn key twice, the state is locked until you press the Fn key again.</p>
Display		
Boot Display Device	<ul style="list-style-type: none"> • ThinkPad LCD • Digital on ThinkPad 	<p>Select the display device that is to be active at boot time. This selection is effective for boot time, password prompt, and ThinkPad Setup.</p> <p>“Digital on Thinkpad” is the Mini DisplayPort on your computer.</p>
Power		
Intel SpeedStep® technology (Intel SpeedStep mounted models only)	<ul style="list-style-type: none"> • Disabled • Enabled <p>Mode for AC</p> <ul style="list-style-type: none"> • Maximum Performance • Battery Optimized <p>Mode for Battery</p> <ul style="list-style-type: none"> • Maximum Performance • Battery Optimized 	<p>Select the mode of Intel SpeedStep technology at runtime.</p> <ul style="list-style-type: none"> • Maximum Performance: Always highest speed • Battery Optimized: Always lowest speed • Disabled: No runtime support, lowest speed
Adaptive Thermal Management	<p>Scheme for AC</p> <ul style="list-style-type: none"> • Maximize Performance • Balanced <p>Scheme for Battery</p> <ul style="list-style-type: none"> • Maximize Performance • Balanced 	<p>Select a thermal management scheme to use.</p> <ul style="list-style-type: none"> • Maximize Performance: • Reduces CPU throttling • Balanced: • Balances sound, temperature and performance <p>Note: Each scheme affects fan sound, temperature, and performance.</p>

Table 4. Config menu items (continued)

Submenu item	Selection	Comments
CPU Power Management	<ul style="list-style-type: none"> • Disabled • Enabled 	Enable or disable the power saving feature that stop the microprocessor clock automatically when there are no system activities. Normally, it is not necessary to change the setting.
PCI Express Power Management	<ul style="list-style-type: none"> • Disabled • Enabled 	Enable or disable a feature that automatically adjusts power management when there is no PCI Express activity. Normally, it is not necessary to change the setting.
Power On with AC Attach	<ul style="list-style-type: none"> • Disabled • Enabled 	<p>Enable or disable a feature that powers on the system when AC is attached.</p> <p>If you select “Enabled,” the system is powered on when AC is attached. When the system is in hibernate state, the system resumes.</p> <p>If you select “Disabled,” the system is not powered on nor resumed when AC is attached.</p>
Disable Built-in Battery	<ul style="list-style-type: none"> • Yes • No 	<p>Temporarily disable battery for servicing the system. After selecting this item, the system will be automatically powered off. The system is then ready to be serviced.</p> <p>Note: The ac power adapter must be disconnected from the system to perform this operation.</p> <p>The battery will be automatically re-enabled when the ac power adapter is reconnected to the system.</p>
Beep and Alarm		
Power Control Beep	<ul style="list-style-type: none"> • Disabled • Enabled 	If this function is enabled, a beep sounds when the computer enters a power management mode, when it resumes operational mode, and when the ac power adapter is connected or disconnected.
Low Battery Alarm	<ul style="list-style-type: none"> • Disabled • Enabled 	Enable or disable the low battery alarm.
Password Beep	<ul style="list-style-type: none"> • Disabled • Enabled 	Enable this option to have a beep sound when the system is waiting for a power-on, hard disk, or supervisor password. Different beeps will be sounded when the entered password matches or does not match the configured password.
Keyboard Beep	<ul style="list-style-type: none"> • Enabled • Disabled 	Enable or disable keyboard beep when unmanageable key combinations are pressed.

Table 4. Config menu items (continued)

Submenu item	Selection	Comments
Serial ATA (SATA)		
SATA Controller Mode Option	<ul style="list-style-type: none"> • Compatibility • AHCI • RAID 	Select SATA controller operation mode. If your system supports RAID, select "RAID." If you select "Compatibility mode," serial SATA controller operates in compatibility mode.
CPU		
Core Multi-Processing	<ul style="list-style-type: none"> • Disabled • Enabled 	Enable or disable additional execution core units within a CPU. Note: If you are using a computer with a single-core processor, this item does not appear.
Intel® Hyper-Threading Technology	<ul style="list-style-type: none"> • Disabled • Enabled 	Enable or disable additional logical processors within a processor core.
Intel® AMT		
Intel® AMT Control	<ul style="list-style-type: none"> • Disabled • Enabled 	If you select "Enabled," Intel® AMT (Active Management Technology) is configured and additional setup items are provided in MEBx (Management Engine UEFI Extension) Setup. Note: You can enter MEBx Setup menu by pressing Ctrl-P key combination in Startup Interrupt Menu. To display the Startup Interrupt Menu, press ThinkVantage button or Enter key during POST.
CIRA Timeout	0-255	Set timeout option for CIRA connection to be established. 1 through 254 seconds are selectable. If you select "0," use 60 seconds as default timeout value. If you select "255," waiting time for establishing a connection is unlimited.
Console Type	<ul style="list-style-type: none"> • PC-ANSI • VT100+ • VT-UTF8 	Select the console type for AMT. Note: This console type should match the Intel AMT remote console.

Security menu items

Table 5. Security menu items

Submenu item	Selection	Comments
Password: Refer to "Security menu" on page 104 and "Using passwords" on page 55.		
Fingerprint		

Table 5. Security menu items (continued)

Submenu item	Selection	Comments
Predesktop Authentication	<ul style="list-style-type: none"> • Disabled • Enabled 	Enable or disable fingerprint authentication before the operating system is loaded.
Reader Priority	<ul style="list-style-type: none"> • External → Internal • Internal Only 	If External → Internal is selected, an external fingerprint reader is used if attached. Otherwise, an internal fingerprint reader is used. If Internal Only is selected, an internal fingerprint reader is used.
Security Mode	<ul style="list-style-type: none"> • Normal • High 	If fingerprint authentication fails, you can still start the computer by entering a password. If you have selected “Normal,” enter a power-on password or a supervisor password; if you have selected “High,” enter a supervisor password.
Password Authentication	<ul style="list-style-type: none"> • Disabled • Enabled 	Enable or disable password authentication. If high security mode is selected, this item appears.
Reset Fingerprint Data	<ul style="list-style-type: none"> • Enter 	This option is used to erase all fingerprint data stored in the fingerprint reader and reset settings to the factory state (ex. Power-on security, LEDs, etc.) As a result, any power-on security features previously enabled will not be able to work until they are re-enabled in the fingerprint software.
Security Chip		
Security Chip	<ul style="list-style-type: none"> • Active • Inactive • Disabled 	If you select “Active,” Security Chip is functional. If you select “Inactive,” Security Chip is visible, but is not functional. If you select “Disabled,” Security Chip is hidden and is not functional.
Security Reporting Options		<p>Enable or disable the following Security Reporting Options.</p> <ul style="list-style-type: none"> • BIOS ROM String Reporting: BIOS text string • ESCD Reporting: Extended system configuration data • CMOS Reporting: CMOS data • NVRAM Reporting: Security data stored in the Asset ID • SMBIOS Reporting: SMBIOS data
Clear Security Chip	<ul style="list-style-type: none"> • Enter 	<p>Clear the encryption key.</p> <p>Note: Only if you select “Active” for Security Chip, this item appears.</p>

Table 5. Security menu items (continued)

Submenu item	Selection	Comments
Intel® TXT Feature	<ul style="list-style-type: none"> • Disabled • Enabled 	Enable or disable Intel Trusted Execution Technology.
UEFI BIOS Update Option		
Flash BIOS Updating by End-Users	<ul style="list-style-type: none"> • Disabled • Enabled 	If you select “Enabled,” all users can update the UEFI BIOS. If you select “Disabled,” only the person who knows supervisor password can update the UEFI BIOS.
Flash Over LAN	<ul style="list-style-type: none"> • Disabled • Enabled 	Enable your computer's UEFI BIOS to be updated (flashed) over an active network connection.
Memory Protection		
Execution Prevention	<ul style="list-style-type: none"> • Disabled • Enabled 	Some computer viruses and worms cause memory buffers to overflow by running code where only data is allowed. If the Data Execution Prevention feature can be used with your operating system, then by selecting “Enabled” you can protect your computer against attacks by such viruses and worms. If after choosing “Enabled” you find that an application program does not run correctly, select “Disabled” and reset the setting.
Virtualization		
Intel® Virtualization Technology	<ul style="list-style-type: none"> • Disabled • Enabled 	If you select “Enabled,” a VMM (Virtual Machine Monitor) can utilize the additional hardware capabilities provided by Intel Virtualization Technology.
Intel® VT-d Feature	<ul style="list-style-type: none"> • Disabled • Enabled 	Intel VT-d is Intel Virtualization Technology for Directed I/O. When enabled, a VMM can utilize the platform infrastructure for I/O virtualization.
I/O Port Access		
Ethernet LAN	<ul style="list-style-type: none"> • Disabled • Enabled 	If you select “Enabled,” you can use the Ethernet LAN device.
Wireless LAN	<ul style="list-style-type: none"> • Disabled • Enabled 	If you select “Enabled,” you can use the Wireless LAN device.
WiMAX	<ul style="list-style-type: none"> • Disabled • Enabled 	If you select “Enabled,” you can use the WiMAX device.
Wireless WAN	<ul style="list-style-type: none"> • Disabled • Enabled 	If you select “Enabled,” you can use the Wireless WAN device.
<i>Bluetooth</i>	<ul style="list-style-type: none"> • Disabled • Enabled 	If you select “Enabled,” you can use the <i>Bluetooth</i> device.

Table 5. Security menu items (continued)

Submenu item	Selection	Comments
USB Port	<ul style="list-style-type: none"> • Disabled • Enabled 	If you select "Enabled," you can use the USB port.
ExpressCard Slot	<ul style="list-style-type: none"> • Disabled • Enabled 	If you select "Enabled," you can use the ExpressCard Slot.
eSATA Port	<ul style="list-style-type: none"> • Disabled • Enabled 	If you select "Enabled," you can use the eSATA Port.
Memory Card Slot	<ul style="list-style-type: none"> • Disabled • Enabled 	If you select "Enabled," you can use the Memory Card slot (SD Card/MultiMediaCard).
Integrated Camera	<ul style="list-style-type: none"> • Disabled • Enabled 	If you select "Enabled," you can use the Integrated Camera.
Microphone	<ul style="list-style-type: none"> • Disabled • Enabled 	If you select "Enabled," you can use the Microphone (Internal, External, or Line-In).
Fingerprint Reader	<ul style="list-style-type: none"> • Disabled • Enabled 	If you select "Enabled," you can use the fingerprint reader.
Anti-Theft		
Intel AT Module Activation	<ul style="list-style-type: none"> • Disabled • Enabled • Permanently Disabled 	<p>Enable or disable the UEFI BIOS interface to activate Intel AT module that is an optional Anti-Theft service from Intel.</p> <p>Note: If you set the Intel AT module activation to "Permanently Disabled," you will be unable to enable this setting again.</p>
Computrace Module Activation	<ul style="list-style-type: none"> • Disabled • Enabled • Permanently Disabled 	<p>Enable or disable the UEFI BIOS interface to activate Computrace module. Computrace is an optional monitoring service from Absolute Software.</p> <p>Note: If you set the Computrace module activation to "Permanently Disabled," you will be unable to enable this setting again.</p>

Startup menu items

Table 6. Startup menu items

Menu item	Selection	Comments
Boot: Refer to "Startup menu" on page 105.		
Network Boot: Refer to "Startup menu" on page 105.		

Table 6. Startup menu items (continued)

Menu item	Selection	Comments
UEFI/Legacy Boot	<ul style="list-style-type: none"> • Both • UEFI Only • Legacy Only 	Select system boot capability. <ul style="list-style-type: none"> • Both: System will boot by following UEFI/Legacy Boot Priority setting. • UEFI Only: System will boot from UEFI enabled OS. • Legacy Only: System will boot from any OS other than UEFI enabled OS. <p>Note: If you select UEFI Only, system cannot boot from the bootable devices which do not have UEFI enabled OS.</p>
UEFI/Legacy Boot Priority	<ul style="list-style-type: none"> • UEFI First • Legacy First 	Select priority of boot option between UEFI and Legacy.
Boot Mode	<ul style="list-style-type: none"> • Quick • Diagnostics <p>Note: You can also enter the “Diagnostic” mode by pressing Esc during POST.</p>	Screen during POST: <ul style="list-style-type: none"> • Quick: ThinkPad Logo screen is displayed. • Diagnostics: Test messages are displayed.
Option Keys display (ThinkVantage button message)	<ul style="list-style-type: none"> • Disabled • Enabled 	If you select “Disabled,” the “To interrupt normal startup, press the blue ThinkVantage button.” message is not displayed during POST.
Boot Device List F12 Option	<ul style="list-style-type: none"> • Disabled • Enabled 	If you select “Enabled,” the F12 key is recognized and the Boot menu is displayed.
Boot Order Lock	<ul style="list-style-type: none"> • Disabled • Enabled 	If you select “Enabled,” the Boot Priority Order is locked for your future use.

Updating your system UEFI BIOS

The Unified Extensible Firmware Interface (UEFI) BIOS is a part of the system programs that make up the basic layer of software built into your computer. UEFI BIOS translates the instructions from other software layers.

Your computer system board has a module called electrically erasable programmable read-only memory (EEPROM, also referred to as flash memory). You can update UEFI BIOS and the Configuration/ThinkPad Setup Program by starting your computer with a flash update tool application running on the Windows environment.

In some instances when you add software, hardware, or a device driver, you may be informed that you need to update your UEFI BIOS in order for the new addition to work properly.

To update your UEFI BIOS, go to the following Web site and follow the instructions on the screen:
<http://www.lenovo.com/ThinkPadDrivers>

Using system management

This section is intended primarily for network administrators.

Your computer is designed for manageability, so that you can redirect more of your resources to better meet your business objectives.

This manageability, or “Total Cost of Ownership” (TCO), enables you to remotely power on your computer, format the hard disk drive, install the software of your choice, and have the computer start up and function in the same way as an ordinary desktop PC.

Once the computer is configured and operational, you can manage it by use of software and manageability features already integrated into the client system and the network.

System management

Check the following topics to learn more about features of System Management:

- Desktop Management Interface
- Preboot eXecution Environment
- Wake on LAN
- Asset ID EEPROM

Desktop Management Interface

The system BIOS (UEFI BIOS) of your computer supports an interface called System Management BIOS Reference Specification (SMBIOS) V2.6.1. SMBIOS provides information about the hardware components of your system. It is the responsibility of the BIOS to supply this database with information about itself and the devices on the system board. This specification documents the standards for getting access to this BIOS information.

Preboot eXecution Environment

Preboot eXecution Environment (PXE) technology makes your computer more manageable (it is PXE 2.1-compliant) by enabling it to boot (load an operating system or another executable image) from a server. Your computer supports the PC functions that PXE requires. For example, with the appropriate LAN card, your computer can be booted from the PXE server.

Note: Remote Program Load (RPL) cannot be used with your computer.

Wake on LAN

A network administrator can use Wake on LAN to turn on a computer from a management console.

When Wake on LAN is used with network management software, many functions, such as data transfer, software updates, and Flash updates, can be performed remotely without remote attendance. This updating can be done after normal working hours and on weekends, to save time and increase productivity. Users are not interrupted during normal working hours, and LAN traffic is kept to a minimum.

If a computer is turned on by the Wake on LAN function, the **Network boot** sequence is used.

Asset ID EEPROM

The Asset ID EEPROM contains information about the system, including its configuration and the serial numbers of key components. It also includes a number of blank fields in which you can record information about the end users in your network.

Setting management features

To enable the network administrator to control your computer remotely, you must configure the network interface by setting the system-management features in the ThinkPad Setup. That utility contains the following functions:

- Wake on LAN
- Startup sequence
- Flash update

If an administrator's password (supervisor password) has been set, you will need to specify it when you start the ThinkPad Setup, so that you can use these functions.

Wake on LAN

When the Wake on LAN feature is enabled on a computer that is connected to a LAN, a network administrator can start the computer remotely from a management console, using remote network-management software.

Setting up in the ThinkPad Setup

To enable or disable Wake on LAN, go to the ThinkPad Setup menu. When your computer is not under the network administrator's system management, you can disable Wake on LAN.

To set this function, do the following:

1. Start the ThinkPad Setup menu.
2. Select **Config**.
3. The Config submenu appears.
4. Select **Network**.
5. The Network item submenu appears.
6. For Wake On LAN, select one of the following: **AC Only**, **AC and Battery**, or **Disabled**.
7. Press F10.

Network Boot sequence

When your computer is turned on remotely, system will try to boot from the device that is selected by **Network Boot** setting, and then follow the boot order list in the **Boot** menu.

To define a sequence:

1. On the ThinkPad Setup menu, select **Startup**. The Startup submenu appears.
2. Select **Network Boot** and press Enter key to show pop-up boot device list.
3. Select a boot device from the list to make it as top boot priority.
4. Press F10.

Note: If you want to initialize the setting to return to the default startup sequence, press F9. The default settings are automatically reloaded.

Flash update

When a Flash UEFI BIOS update from the network is enabled, a network administrator can remotely update the system programs in your computer from a management console. The following requirements must be met:

- Update Flash from network must also be enabled; the procedure is given below.
- Your computer must be started over the LAN.

- Your computer must be engaged in a Preboot eXecution Environment.
- Network-management software must be installed in the remote administrator's computer.

To enable or disable the Flash update from the network setting, do the following:

1. On the ThinkPad Setup menu, select **Security**. The Security submenu appears.
2. Select **UEFI BIOS Update Option**. The UEFI BIOS Update Option submenu appears.
3. For Flash Over LAN, select either **Enabled** or **Disabled**.
4. Press F10.

Chapter 9. Preventing problems

An important part of owning a ThinkPad notebook is maintenance. With proper care, you can avoid common problems. The following sections provide information that can help you to keep your computer running smoothly.

- “General tips for preventing problems” on page 119
- “Making sure device drivers are current” on page 120
- “Taking care of your computer” on page 121

General tips for preventing problems

1. Check the capacity of your hard disk drive from time to time. If the hard disk drive gets too full, Windows will slow down and might produce errors.
To check the capacity of your hard disk drive, click **Start → Computer**.
2. Empty your recycle bin on a regular basis.
3. Use disk defragment tool regularly on your hard disk drive to improve data seek and read times.
4. To free up disk space, uninstall unused application programs.

Note: You might also want to look for application program duplication or overlapping versions.
5. Clean out your Inbox, Sent, and Trash folders from your e-mail client program.
6. At least once a week, make a point to back up your data. If critical data is present, it is a good idea to perform a daily backup. Lenovo has many backup options available for your computer. Rewritable optical drives are available for most machines and are easily installed.
7. Use or schedule System Restore to take a system snapshot periodically. For more information about System Restore see Chapter 5 “Recovery overview” on page 69.
8. Update device drivers and UEFI BIOS when needed.
9. Profile your machine at <http://www.lenovo.com/think/support> to keep up to date with current drivers and revisions.
10. Keep up to date for device drivers on other non-Lenovo hardware. You might want to read the device driver information release notes prior to updating for compatibility or known issues.
11. Keep a log book. Entries might include major hardware or software changes, driver updates, minor issues you have experienced and how you resolved them.
12. If you ever need to run a recovery on your computer to return the preload onto the machine, the following tips might help along the way:
 - Remove all external devices such as the printer, keyboard, etc.
 - Make sure that your battery is charged and that you have the ac power connected.
 - Boot into the ThinkPad Setup and load the default settings.
 - Restart the machine and start the recovery.
 - If your machine uses discs as the recovery media, DO NOT remove the disc from the drive until prompted to do so.
13. For suspected hard disk drive issues, refer to “Diagnosing problems” on page 125 and run a diagnostic test of the drive prior to calling the Customer Support Center. If your computer does not start up, download the files to create a bootable self-test media from the following Web site <http://www.lenovo.com/hddtest>. Run the test and record any messages or error codes. If the test returns any failing error codes or messages, call the Customer Support Center with the codes or messages and the computer in front of you. A technician will assist you further.

14. If required, you can find your country's Customer Support Center at the following Web address: <http://www.lenovo.com/support/phone>. When calling the Customer Support Center, please make sure you have your machine model type, serial number and the computer in front of you. Also, if the machine is producing error codes, it is helpful to have the error screen on or the message written down.

Making sure device drivers are current

Device drivers are programs that contain instructions for the operating system about how to operate or “drive” a certain piece of hardware. Each hardware component on your computer has its own specific driver. If you add a new component, the operating system needs to be instructed on how to operate that piece of hardware. After you install the driver, the operating system can recognize the hardware component and understand how to use it.

Note: Because drivers are programs, like any other file on your computer, they are susceptible to corruption and might not perform properly if corruption occurs.

It is not always necessary to download the latest drivers. However, you should download the latest driver for a component if you notice poor performance from that component or if you added a new component. This may eliminate the driver as the potential cause of the problem.

Getting the latest drivers from the Web site

You can download and install updated device drivers from the Lenovo Web site by doing the following:

1. Connect to the Internet.
2. Go to <http://www.lenovo.com/support>
3. Click **Downloads**.
4. Follow the directions on the screen and install the necessary software.

Getting the latest drivers using System Update

The System Update program helps you keep the software on your system up-to-date. Update packages are stored on Lenovo servers and can be downloaded from the Lenovo Support Web site. Update packages can contain applications, device drivers, UEFI BIOS flashes, or software updates. When the System Update program connects to the Lenovo Support Web site, the System Update program automatically recognizes the machine type and model of your computer, the installed operating system, and the language of the operating system to determine what updates are available for your computer. The System Update program then displays a list of update packages and categorizes each update as critical, recommended, and optional to help you understand the importance. You have complete control of which updates to download and install. After you select the update packages you want, the System Update program automatically downloads and installs the updates without any further intervention from you.

The System Update program is preinstalled on your computer and is ready to run. The only prerequisite is an active Internet connection. You can start the program manually, or you can use the schedule feature to enable the program to search for updates automatically at specified intervals. You also can predefine scheduled updates to search by severity (critical updates, critical and recommended updates, or all updates) so the list you choose from contains only those update types that are of interest to you.

For more information about how to use the ThinkVantage System Update, refer to “System Update” on page 21.

Taking care of your computer

Although your computer is designed to function reliably in normal work environments, you need to use common sense in handling it. By following these important tips, you will get the most use and enjoyment out of your computer.

Be careful about where and how you work

- Store packing materials safely out of the reach of children to prevent the risk of suffocation from plastic bags.
- Keep your computer away from magnets, activated cellular phones, electrical appliances, or speakers (within 13 cm or 5 inch).
- Avoid subjecting your computer to extreme temperatures (below 5°C/41°F or above 35°C/95°F).
- Some appliances, such as certain portable desktop fans or air purifiers, can produce negative ions. If a computer is close to such an appliance, and is exposed for an extended time to air containing negative ions, it may become electrostatically charged. Such a charge may be discharged through your hands when you touch the keyboard or other parts of the computer, or through connectors on I/O devices connected to it. Even though this kind of electrostatic discharge (ESD) is the opposite of a discharge from your body or clothing to the computer, it poses the same risk of a computer malfunction.

Your computer is designed and manufactured to minimize any effects of electrostatic charge. An electrostatic charge above a certain limit, however, can increase the risk of ESD. Therefore, when using the computer close to an appliance that can produce negative ions, give special attention to the following:

- Avoid directly exposing your computer to the air from an appliance that can produce negative ions.
- Keep your computer and peripherals as far as possible from such an appliance.
- Wherever possible, ground your computer to facilitate safe electrostatic discharge.

Note: Not all such appliances cause a significant electrostatic charge.

Be gentle with your computer

- Avoid placing any objects (including paper) between the display and the keyboard or the palm rest.
- Your computer display is designed to be opened and used at an angle slightly greater than 90 degrees. Do not open the display beyond 180 degrees, as this might damage the computer hinge.
- Do not turn your computer over while the ac power adapter is plugged in. This could break the adapter plug.

Carry your computer properly

- Before moving your computer, be sure to remove any media, turn off attached devices, and disconnect cords and cables.
- When picking up your open computer, hold it by the bottom. Do not pick up or hold your computer by the display.

Handle storage media and drives properly

- When installing the hard disk drive, or solid state drive, follow the instructions shipped with your hardware, and apply pressure only where needed on the device.
- Turn off your computer if you are replacing the hard disk drive or solid state drive.
- When replacing the primary hard disk drive or solid state drive, reattach the cover of the drive slot.
- Store your external and removable hard disk in the appropriate containers or packaging when they are not being used.

- Before you install any of the following devices, touch a metal table or a grounded metal object. This action reduces any static electricity from your body. The static electricity could damage the device.
 - Memory module
 - Mini-PCI Card
 - Memory card, such as SD card, SDHC card, SDXC card, and MultiMediaCard.

Note: Not all listed devices are included in your computer.

This action reduces any static electricity from your body. The static electricity could damage the device.

- When transferring data to or from a flash media card, such as an SD card, do not put your computer in sleep or hibernation mode before the data transfer is complete. To do so might cause damage to your data.

Take care in setting passwords

- Remember your passwords. If you forget a supervisor or hard disk password, Lenovo will not reset it, and you might have to replace your system board, or hard disk drive or solid state drive.

Care for the fingerprint reader

The following actions could damage the fingerprint reader or cause it not to work properly:

- Scratching the surface of the reader with a hard, pointed object.
- Scraping the surface of the reader with your fingernail or anything hard.
- Using or touching the reader with a dirty finger.

If you notice any of the following conditions, gently clean the surface of the reader with a dry, soft, lint-free cloth:

- The surface of the reader is dirty or stained.
- The surface of the reader is wet.
- The reader often fails to enroll or authenticate your fingerprint.

Register your computer

- Register your ThinkPad products with Lenovo (go to <http://www.lenovo.com/register>). This can help authorities return your computer to you if it is lost or stolen. Registering your computer also enables Lenovo to notify you about possible technical information and upgrades.

Be sure not to modify your computer

- Only an authorized ThinkPad repair technician should disassemble and repair your computer.
- Do not modify or tape the latches to keep the display open or closed.

Cleaning the cover of your computer

Occasionally clean your computer as follows:

1. Prepare a mixture of a gentle kitchen-use detergent (one that does not contain abrasive powder or strong chemicals such as acid or alkaline). Use 5 parts water to 1 part detergent.
2. Absorb the diluted detergent into a sponge.
3. Squeeze excess liquid from the sponge.
4. Wipe the cover with the sponge, using a circular motion and taking care not to let any excess liquid drip.
5. Wipe the surface to remove the detergent.
6. Rinse the sponge with clean running water.

7. Wipe the cover with the clean sponge.
8. Wipe the surface again with a dry, soft lint-free cloth.
9. Wait for the surface to dry completely and remove any fibers from the cloth.

Cleaning your computer keyboard

1. Apply some isopropyl rubbing alcohol to a soft, dust-free cloth.
2. Wipe each keytop surface with the cloth. Wipe the keys one by one; if you wipe several keys at a time, the cloth may hook onto an adjacent key and possibly damage it. Make sure that no liquid drips onto or between the keys.
3. Allow to dry.
4. To remove any crumbs or dust from beneath the keys, you can use a camera blower with a brush or cool air from a hair dryer.

Note: Avoid spraying cleaner directly onto the display or the keyboard.

Cleaning your computer display

1. Gently wipe the display with a dry, soft lint-free cloth. If you see a scratchlike mark on your display, it might be a stain transferred from the keyboard or the TrackPoint pointing stick when the cover was pressed from the outside.
2. Wipe or dust the stain gently with a soft, dry cloth.
3. If the stain remains, moisten a soft, lint-free cloth with water or a 50-50 mixture of isopropyl alcohol and water that does not contain impurities.
4. Wring out as much of the liquid as you can.
5. Wipe the display again; do not let any liquid drip into the computer.
6. Be sure to dry the display before closing it.

Chapter 10. Troubleshooting computer problems

This section tells what to do if you have a computer problem.

- “Diagnosing problems” on page 125
- “Troubleshooting” on page 126

Diagnosing problems

If you experience problems with your computer, use diagnostic solutions as a starting point for solving them.

Using the Lenovo Solution Center program

Note: The Lenovo Solution Center program is available only on some models that are preinstalled with the Windows 7 operating system. If your Windows 7 model is not preinstalled with the program, you can download it from <http://www.lenovo.com/support>.

The Lenovo Solution Center program enables you to troubleshoot and resolve computer problems. It combines diagnostic tests, system information collection, security status, and support information, along with hints and tips for maximum system performance.

To start the Lenovo Solution Center program in Windows 7, see “Accessing applications in Windows 7” on page 17.

For additional information, refer to the Lenovo Solution Center help information system.

Note: If you are unable to isolate and repair the problem yourself after running the program, save and print the log files created by the program. You will need the log files when you speak to a Lenovo technical support representative.

Using the Lenovo ThinkVantage Toolbox program

The Lenovo ThinkVantage Toolbox program enables you to view symptoms of computer problems and find solutions for them. It also includes automatic notification when action is required, computing assistance, advanced diagnostics, and diagnostic history.

To run the Lenovo ThinkVantage Toolbox program, click **Start → Control Panel → System and Security → Lenovo - System Healthy and Diagnostics**.

When the application is launched, select a diagnostic test to run. If there is any problem, besides the error messages, a guidance also will be displayed to guide you to fix the problem.

For additional information, refer to the ThinkVantage Toolbox help system.

Note: If you are unable to isolate and repair the problem yourself after running the program, save and print the log files created by the program. You will need the log files when you speak to a Lenovo technical support representative.

Using the Lenovo Support Web site

If your computer has neither the Lenovo Solution Center program nor the Lenovo ThinkVantage Toolbox program installed, go to <http://www.lenovo.com/diagnose> for the latest information on diagnostics for your computer.

Note: Running any test might take up to several minutes or longer. Make sure that you have time to run the entire test. Do not interrupt the test while it is running.

Troubleshooting

If your computer has an error, it typically displays a message or an error code, or a beep sounds when you turn it on. To correct an error, first find the description of the error in the left-hand column of the chart that applies. Then click that description to get a troubleshooting procedure.

To make sure that your computer has the features or options that are introduced in the following sections, consult the online help or the list shipped with your computer.

Computer stops responding

Print these instructions now and keep it with your computer for reference later.

If your computer is completely unresponsive (you cannot use the UltraNav pointing device or the keyboard), do the following steps:

1. Push and hold the power switch to turn off the computer.
 - If the computer is turned off, restart the computer by pressing the power switch. If you can not restart the computer, go to step 2.
 - If you can not turn off your computer by pressing and holding the power switch, remove all sources of power from the computer (ac power adapter and ThinkPad Battery +39) and reset the system by inserting a straightened paper clip into the emergency reset hole. To locate the emergency reset hole, refer to “Bottom view” on page 7.
2. While the machine is turned off, remove all sources of power from the computer (ac power adapter and ThinkPad Battery +39) and reset the system by inserting a straightened paper clip into the emergency reset hole. Then hold down the power button for 10 seconds. Reattach the ac power adapter. If the computer does not turn back on, continue to step 3.

Note: If the computer starts with ac power but does not start when ac power is removed, call the Customer Support Center for support.

3. While the machine is off, remove all external devices that are attached to your computer (keyboard, mouse, printer, scanner, etc.). Repeat step 2. If step 2 is unsuccessful, continue to step 4.

Note: The following steps involve removing static sensitive components from your computer. Please make sure that you are properly grounded and remove all sources of power attached to the computer. If you are uncomfortable or unsure about removing components, please call the Customer Support Center for assistance.

4. While the computer is off, remove all sources of power and external hardware and reset the system by inserting a straightened paper clip into the emergency reset hole. Then remove any non-original memory module added to your computer. Refer to the procedure in “Replacing the memory module” on page 81 on how to remove and reseat the memory modules.

After removing the extra memory module and reseating the original memory module, repeat step 2.

If the computer still does not turn on, refer to Chapter 6 “Replacing devices” on page 75 to reseat other customer-replaceable components that are attached to your computer

If the computer still does not start up, call the Customer Support Center and a Customer Support Specialist will assist you.

Spills on the keyboard

With a mobile computer, there are increased chances of spilling liquids on the keyboard. Because most liquids conduct electricity, liquid spilled on the keyboard could create numerous short circuits, potentially causing irreparable damage to your computer.

If you spill something on your computer:

Attention: Be sure that no liquid creates a short circuit between you and the ac power adapter (if in use). Although you might lose some data or work by turning off the computer immediately, leaving the computer on might make your computer unusable.

1. Carefully unplug the ac power adapter immediately.
2. Turn off the computer immediately. If the computer does not turn off, reset the system by inserting one end of a needle or a straightened paper clip into the emergency reset hole. The more quickly you stop the current from passing through the computer the more likely you will reduce damage from short circuits.
3. Wait until you are certain that all the liquid is dry before turning on your computer.

Note: If you want to replace your keyboard, you can purchase a new one.

Error messages

Message: 0176: System Security - The System has been tampered with.

Solution: This message is displayed if you remove the Security Chip and reinstall it, or install a new one. To clear the error, enter the ThinkPad Setup. If this does not solve the problem, have the computer serviced.

Message: 0177: Bad SVP data, stop POST task.

Solution: Checksum of the supervisor password in the EEPROM is not correct. The system board should be replaced. Have the computer serviced.

Message: 0182: Bad CRC of Security Settings in EEPROM. Enter ThinkPad Setup.

Solution: Checksum of the Security settings in the EEPROM is not correct. Enter ThinkPad Setup to check Security settings, Press F10 and then press Enter to restart the system. If you still have a problem, have the computer serviced.

Message: 0183: Bad CRC of Security Settings in EFI Variable. Enter ThinkPad Setup.

Solution: Checksum of the Security settings in the EFI Variable is not correct. Enter ThinkPad Setup to check Security settings, Press F10 and then press Enter to restart the system. If you still have a problem, have the computer serviced.

Message: 0187: EAIA data access error

Solution: The access to EEPROM is failed. Have the computer serviced.

Message: 0188: Invalid RFID Serialization Information Area.

Solution: The EEPROM checksum is not correct (block # 0 and 1). The system board should be replaced, and the box serial number needs to be reinstalled. Have the computer serviced.

Message: 0189: Invalid RFID configuration information area

Solution: The EEPROM checksum is not correct (block # 4 and 5). The system board should be replaced, and the UUID needs to be reinstalled. Have the computer serviced.

Message: 0190: Critical low-battery error

Solution: The computer turned off, because the battery is low. Connect the AC adapter to the computer and charge the battery.

Message: 0191: System Security - Invalid remote change requested.

Solution: The system configuration change has failed. Confirm the operation and try again. To clear the error, enter the ThinkPad Setup.

Message: 0192: System Security - Embedded Security hardware tamper detected.

Solution: The Security Chip has been replaced with a different one. Have the computer serviced.

Message: 0199: System Security - Security password retry count exceeded.

Solution: This message is displayed if you enter a wrong supervisor password more than three times. Confirm the supervisor password and try again. To clear the error, enter the ThinkPad Setup.

Message: 0251: System CMOS checksum bad

Solution: The system CMOS might have been corrupted by an application program. The computer uses the default settings. Run ThinkPad Setup to reconfigure the settings. If you still see the same error code, have the computer serviced.

Message: 0253: EFI Variable Block Data was destroyed.

Solution: The system EFI Variable Block Data might have been corrupted.

1. Press F1 to go to the ThinkPad Setup.
2. Press F9 and then press Enter to load the default setting.
3. Press F10 and then press Enter to restart the system.

If you still have a problem, have the computer serviced.

Message: 0271: Check date and time settings

Solution: Neither the date nor the time is set in the computer. Using the ThinkPad Setup to set the date and time.

Message: 1802: Unauthorized network card is plugged in - Power off and remove the network card.

Solution: The Ethernet PCI Express Mini Card is not supported on this computer. Remove it.

Message: 1820: More than one external fingerprint readers are attached. Power off and remove all but the reader that you set up within your main operating system.

Solution: Power off and remove all but the reader that you set up within your main operating system.

Message: 2000: ThinkVantage Active Protection sensor diagnostics failed.

Solution: ThinkVantage Active Protection sensor is not working correctly. Have the computer serviced.

Message: 2100: Initialization error on HDD0 (Main hard disk drive)

Solution: The hard disk is not working. Have the hard disk serviced.

Message: 2102: Detection error on HDD2 (Mini SATA)

Solution: The Mini SATA device is not working. Have the Mini SATA device serviced.

Message: 2110: Read error on HDD0 (Main hard disk drive)

Solution: The hard disk is not working. Have the hard disk serviced.

Message: 2112: Read error on HDD2 (Mini SATA)

Solution: The Mini SATA device is not working. Have the Mini SATA device serviced.

Message: 2200: Machine Type and Serial Number are invalid.

Solution: Machine Type and Serial Number are invalid. Have the computer serviced.

Message: 2201: Machine UUID is invalid.

Solution: Machine UUID is invalid. Have the computer serviced.

Message: The power-on password prompt

Solution: A power-on password or a supervisor password is set. Type the password and press **Enter** to use the computer (refer to “Using passwords” on page 55). If the power-on password is not accepted, a supervisor password might have been set. Type the supervisor password and press **Enter**. If you still see the same error message, have the computer serviced.

Message: The hard disk password prompt

Solution: A hard disk password is set. Type the password and press **Enter** to use the computer (refer to “Hard disk passwords” on page 57).

If you still see the same error message, have the computer serviced.

Message: Hibernation error

Solution: The system configuration changed between the time your computer entered hibernation mode and the time it left this mode, and your computer cannot resume normal operation.

- Restore the system configuration to what it was before your computer entered hibernation mode.
- If the memory size has been changed, re-create the hibernation file.

Message: Fan error

Solution: Cooling fan has failed. Have the computer serviced.

Errors without messages

- **Problem:** My screen keeps blanking when I do not want it to.

Solution: You can disable any system timers, such as the LCD turn-off timer or the blank timer

1. Start Power Manager.
2. Click the **Power plan** tab, and then select **Maximum Performance** from the predefined power plans.

- **Problem:** When I turn on the machine, nothing appears on the screen and the machine does not beep while starting up.

Note: If you are not sure whether you heard any beeps, turn off the computer by pressing and holding the power switch for 4 seconds or more. Turn it on and listen again.

Solution: Make sure that:

- The ac power adapter is connected to the computer and the power cord is plugged into a working electrical outlet.
- The computer is turned on. (Turn the power switch on again for confirmation.)

If a power-on password is set:

- Press any key to display the prompt for the power-on password. If the brightness level of the screen is low, increase it by pressing the Fn+F9.
- Type the correct password and press Enter (refer to “Power-on password” on page 56).

If these items are properly set, and the screen remains blank, have the computer serviced.

- **Problem:** When I turn on the machine, only a white cursor appears on a blank screen.

Solution: If you have modified a partition on your hard disk drive or solid state drive by using a partition software, information about that partition, or the master boot record may have been destroyed.

1. Turn off the computer, and then turn it on again.
2. If you still see only the cursor on the screen, do the following:
 - If you have used the partition software, examine the partition on the hard disk drive or solid state drive by using the software, and recover the partition if required.
 - Use either the Rescue and Recovery workspace or the recovery discs to restore the system to the factory state. For details about restoring the system to the factory state, see “Creating and using recovery media” on page 69.

If the problem persists, have the computer serviced.

- **Problem:** My screen goes blank while the computer is on.

Solution: Your screen saver or power management may be enabled. Do either of the following:

- Touch the TrackPoint or the touch pad, or press a key to exit the screen saver.
- Press the power switch to resume from sleep or hibernation.

Beep errors

Table 7. Beep errors

Problem	Solution
One short beep, pause, three short beeps, pause, three more short beeps, and one short beep	Make sure that memory modules are installed correctly. If they are, and you still hear the beeps, have the computer serviced.
One long and two short beeps	The video function has a problem. Have the computer serviced.
Four cycles of four short beeps	The Security Chip has a problem. Have the computer serviced.
Five beeps	The system board has a problem. Have the computer serviced.

Memory problems

Print these instructions now and keep it with your computer for reference later.

If your memory is not operating properly, check the following items:

1. Verify that the memory is installed and seated correctly in your computer.

It may be necessary to remove all added memories to test the computer with only the factory-installed memories, and then reinstall the memory one at a time to ensure a proper connection. For the procedures to remove and reinstall a memory, refer to “Replacing the memory module” on page 81.

2. Check for error messages during startup.

Follow the appropriate corrective actions for Power-on self-test (POST) listed in “Error messages” on page 127.

3. Verify that the latest system BIOS (UEFI BIOS) for your model has been installed.

4. Verify the proper memory configuration and compatibility including the maximum memory size and the memory speed.

For details, refer to the instructions in “Replacing the memory module” on page 81.

5. Run Diagnosing problems.

Networking

The following are the most common networking problems:

Ethernet problems

- **Problem:** Your computer cannot connect to the network.

Solution: Make sure that:

- The cable is installed properly.

The network cable must be securely connected both to the Ethernet connector of your computer and to the RJ45 connector of the hub. The maximum allowable distance from the computer to hub is 100 meters. If the cable is connected and the distance is within acceptable limits but the problem persists, try a different cable.

- You are using the correct device driver.

1. Click **Start**, and then click **Control Panel**.
2. Click **Hardware and Sound**.
3. Click **Device Manager**. If you are prompted for an administrator password or confirmation, type the password or provide confirmation.
4. If the ! mark is to the left of the adapter name under Network adapters, you might not use the correct driver or the driver is not enabled. To update the driver, right-click the highlighted adapter.
5. Click **Update Driver Software**, and then follow the instructions on the screen.

- The switch port and the adapter have the same duplex setting.

If you configured the adapter for full duplex, make sure the switch port is also configured for full duplex. Setting the wrong duplex mode can degrade performance, cause data loss, or result in lost connections.

- You have installed all networking software that is necessary for your network environment.

Check with your LAN administrator for the necessary networking software.

- **Problem:** The adapter stops working for no apparent reason.

Solution: The network driver files may be corrupt or missing. Update the driver by following the procedures listed above to make sure that the correct device driver is installed in the preceding problem.

- **Problem:** If your computer is a Gigabit Ethernet model and you use the a speed of 1000 Mbps, the connection fails or errors occur.

Solution:

- Use Category 5 wiring and make sure that the network cable is securely connected.
- Connect to a 1000 BASE-T hub/switch (not 1000 BASE-X).

- **Problem:** The Wake on LAN (WOL) feature is not working.

Solution:

- Make sure that WOL is enabled in the ThinkPad Setup.
- If it is, check with your LAN administrator for the necessary settings.

- **Problem:** If your computer is a Gigabit Ethernet model, it cannot connect to the network at 1000 Mbps. Instead, it connects at 100 Mbps.

Solution:

- Try another cable.
- Make sure that the link partner is set to auto-negotiate.
- Make sure that the switch is 802.3ab-compliant (gigabit over copper).

A wireless LAN problem

- **Problem:** You cannot connect using the built-in wireless networking card.

Solution: Make sure that your wireless LAN driver is the latest version installed. Check the Web site and confirm the driver version supported by Access Connections is the latest documented in the README file.

Make sure that your computer is within range of a wireless access point.

Make sure that the wireless radio is enabled by double-clicking the Access Connections icon in the task bar.

Note: To display the Access Connections status icon and the wireless status icon in the system tray, refer to the Access Connections on-line help.

Check Network Name (SSID), and your encryption information. Use Access Connections to verify this case-sensitive information.

A wireless WAN problem

- **Message:** Unauthorized WAN card is plugged in - Power off and remove the WAN card.

Solution: The WAN card is not supported on this computer. Remove it.

Note: Depending on your computer, some models do not have a wireless WAN.

Bluetooth problems

- **Problem:** Sound does not come from the *Bluetooth* headset/headphone but comes from the local speaker even though the headset/headphone is connected using Headset profile or AV profile.

Solution: Do the following:

1. Exit the application that uses the sound device (for example, Windows Media Player).
2. Open Control Panel by clicking **Start → Control Panel**.
3. Click **Hardware and Sound → Sound**.
4. Select the **Playback** tab.
5. If you are using Headset profile, select **Bluetooth Hands-free Audio** and click the **Set Default** button. If you are using AV profile, select **Stereo Audio** and click the **Set Default** button.
6. Click **OK** to close the Sound window.

- **Problem:** PIM (Personal Information Manager) items sent from Windows 7 cannot be received correctly into the address book of any other *Bluetooth*-enabled device.

Solution: Windows 7 send PIM items in XML format, but most *Bluetooth*-enabled devices handle PIM items in vCard format. If another *Bluetooth*-enabled device can receive a file through *Bluetooth*, a PIM item sent from Windows 7 might be saved as a file with the extension .contact.

Keyboard and other pointing devices

The following are the most common keyboard and other pointing devices problems:

UltraNav problems

- **Problem:** The pointer drifts when the computer is turned on or after it resumes normal operation.

Solution: The pointer might drift when you are not using the TrackPoint during normal operation. This is a normal characteristic of the TrackPoint and is not a defect. Pointer drifting might occur for several seconds under the following conditions:

- When the computer is turned on
- When the computer resumes normal operation
- When the TrackPoint is pressed for a long time
- When the temperature changes

- **Problem:** The TrackPoint or touch pad does not work.

Solution: Make sure that the TrackPoint or touch pad is set to Enabled in the UltraNav Device Setting.

Note: To open the UltraNav Device Setting, click **Start → Control Panel → Hardware and Sound → Mouse → UltraNav**.

Keyboard problems

- **Problem:** All or some keys on the keyboard do not work.

Solution: If an external numeric keypad is connected:

1. Turn off the computer.
2. Remove the external numeric keypad.
3. Turn on the computer and try using the keyboard again.

If the keyboard problem is resolved, carefully reconnect the external numeric keypad, external keyboard, making sure that you have seated the connectors properly.

If the problem remains, make sure that the correct device driver is installed.

1. Click **Start → Control Panel**. Change the view of Control Panel from Category to Large icons or Small icons.
2. Click **Keyboard**.
3. Select the **Hardware** tab. In the Device Properties, make sure that the Device Status is **This device is working properly**.

If keys on the keyboard still do not work, have the computer serviced.

- **Problem:** All or some keys on the external numeric keypad do not work.

Solution: Make sure that the external numeric keypad is correctly connected to the computer.

Display and multimedia devices

This section includes the most common display and multimedia devices problems which are computer screen, external monitor, and audio. Check these topics to learn more information.

Computer screen problems

- **Problem:** The screen is blank.

Solution: Do the following:

- Press Fn+F7 to bring up the image.
- If you are using the ac power adapter, or using the battery and the battery status indicator is on (is green), press Fn+F9 to make the screen brighter.
- If the sleep status indicator is on (is green), press Fn to resume from the sleep mode.
- If the problem persists, do the Solution in the problem below.

- **Problem:** The screen is unreadable or distorted.

Solution: Make sure that:

- The display device driver is installed correctly.
- The screen resolution and color quality are correctly set.
- The monitor type is correct.

To check these settings, do the following:

1. Right-click on the desktop, and click **Personalize**.
2. Click **Display** at the left.
3. Select **Change display settings**. Check whether the screen resolution is correctly set.
4. Click **Advanced Settings**.
5. Click the **Adapter** tab.
6. Make sure that the correct device driver name is shown in the adapter information window.

Note: The device driver name depends on the video chip that has been installed on your computer.

7. Click the **Properties** button. If you are prompted for an administrator password or confirmation, type the password or provide confirmation. Check the “Device status” box and make sure the device is working properly. If not, click the **Troubleshoot** button. Close the **Properties** window.
8. Click the **Monitor** tab. Check whether the color quality is correctly set, make sure other information is also correct.
9. Click the **Properties** button. If you are prompted for an administrator password or confirmation, type the password or provide confirmation. Check the “Device status” box and make sure the device is working properly. If not, click the **Troubleshoot** button.

- **Problem:** Incorrect characters appear on the screen.

Solution: Did you install the operating system or application program correctly? If they are installed and configured correctly, have the computer serviced.

- **Problem:** The screen stays on even after you turn off your computer.

Solution: Press and hold the power switch for 4 seconds or over to turn off your computer; then turn it on again.

- **Problem:** Missing, discolored, or bright dots appear on the screen every time you turn on your computer.

Solution: This is an intrinsic characteristic of the TFT technology. Your computer's display contains multiple thin-film transistors (TFTs). A small number of missing, discolored, or bright dots on the screen might exist all the time.

External monitor problems

- **Problem:** The external monitor is blank.

Solution: To bring up the image, press Fn+F7 and select the desired monitor. If the problem persists, do the following:

1. Connect the external monitor to another computer to make sure it works.
2. Reconnect the external monitor to your computer.
3. Refer to the manual shipped with the external monitor to check the resolutions and refresh rates that are supported.
 - If the external monitor supports the same resolution as the computer display or a higher resolution, view output on the external monitor or on both the external monitor and the computer display.
 - If the external monitor supports a lower resolution than the computer display, view output on the external monitor only. (If you view output on the both the computer display and the external monitor, the external monitor screen will be blank or distorted.)

- **Problem:** You cannot set a higher resolution than the present one on your external monitor.

Solution:

- Make sure that monitor information is correct. Do the following:

1. Right-click on the desktop, and click **Screen resolution**.

Note: If your computer cannot detect the external monitor, click the **Detect** button.

2. Click the icon for the desired monitor (the **Monitor-2** icon is for the external monitor).
3. Click **Advanced Settings**.
4. Click the **Adapter** tab.
5. Make sure that the correct device driver name is shown in the adapter information window.

Note: The device driver name depends on the video chip that has been installed on your computer.

6. Click **OK**.

If the information is incorrect, reinstall the device driver. See below for more information.

- Check the monitor type and, if necessary, update the driver by doing the following:

1. Connect the external monitor to the monitor connector, and then connect the monitor to an electrical outlet.
2. Turn on the external monitor and the computer.
3. Right-click on the desktop, and click **Screen resolution**.

Note: If your computer cannot detect the external monitor, click the **Detect** button.

4. Click the icon for the desired monitor (the **Monitor-2** icon is for the external monitor).
5. Click **Advanced Settings**.
6. Click the **Monitor** tab. Check the monitor information window to make sure that the monitor type is correct. If it is, click **OK** to close the window; otherwise do as follows.
7. If more than one monitor type is displayed, select **Generic PnP Monitor** or **Generic Non-PnP Monitor**.
8. Click **Properties**. If you are prompted for an administrator password or confirmation, type the password or provide confirmation.
9. Click the **Driver** tab.
10. Click **Update Driver**.

11. Click **Browse my computer for driver software**, and then click **Let me pick from a list of device drivers on my computer**.
12. Clear the **Show compatible hardware** check box.
13. Select **Manufacturer** and **Model** for your monitor.
14. After updating the driver, click **Close**.
15. Set **Resolution**.

Note: To change the color settings, select the **Monitor** tab, then set **Colors**.

16. Click **OK**.

- **Problem:** The screen is unreadable or distorted.

Solution: Make sure that the monitor information is correct. (Refer to the solution for setting a higher resolution on the external monitor.)

Make sure that the appropriate monitor type is selected. (Refer to the solution for setting a higher resolution on the external monitor.)

Make sure that an appropriate refresh rate is selected by doing the following:

1. Connect the external monitor to the monitor connector, and then connect the monitor to an electrical outlet.
2. Turn on the external monitor and the computer.
3. Right-click on the desktop, and click **Screen resolution**.

Note: If your computer cannot detect the external monitor, click the **Detect** button.

4. Click the icon for the desired monitor (the **Monitor-2** icon is for the external monitor).
5. Click **Advanced Settings**.
6. Click the **Monitor** tab.
7. Select the correct screen refresh rate.

- **Problem:** Wrong characters appear on the screen.

Solution: Did you follow the correct procedure in installing the operating system or application program? If you did, have the external monitor serviced.

- **Problem:** The Extend desktop function does not work.

Solution: Enable the Extend desktop function by doing the following:

1. Connect the external monitor to the monitor connector, and then connect the monitor to an electrical outlet.
2. Turn on the external monitor and the computer.
3. Right-click on the desktop, and click **Screen resolution**.
4. Click the **Monitor-2** icon.
5. Select **Extend these displays** for Multiple displays.
6. Click the **Monitor-1** icon (for the primary display, the computer display).
7. Select the **Resolution** of the primary display.
8. Click the **Monitor-2** icon (for the external monitor).
9. Select the **Resolution** of the secondary display.
10. Set the relative position of the each monitor by dragging its icon. You can set the monitors in any relative position, but the icons must touch each other.

11. Click **OK** to apply the changes.

Note: To change the color settings, right-click on the desktop, and click **Screen resolution**. Click **Advanced Settings**, select the **Monitor** tab, then set **Colors**.

- **Problem:** Display switching does not work.

Solution: If you use the Extend desktop function, disable it, and change the display output location. If a DVD movie or a video clip is playing, stop the playback, close the application, and then change the display output location.

- **Problem:** If you use the Extend desktop function, you cannot set a higher resolution or higher refresh rate on the secondary display.

Solution: Change the resolution depth to lower settings for the primary display. Refer to the “Solution” for “The Extend desktop function does not work” above.

- **Problem:** The screen position on the external monitor is incorrect when that monitor is set for a high resolution.

Solution: Sometimes, when you use a high resolution such as 1600x1200, the image is shifted to left or right on the screen. To correct this, first make sure that your external monitor supports the display mode, that is, the resolution and the refresh rate, that you have set. If it does not, set a display mode that the monitor supports. If it does support the display mode you have set, go to the setup menu for the monitor itself and adjust the settings there. Usually the external monitor has buttons for access to the setup menu. For details, see the reference manual for the monitor.

Audio problems

- **Problem:** Wave or MIDI sound does not play correctly.

Solution: Make sure the built-in audio device is configured correctly.

1. Click **Start → Control Panel**.
2. Click **Hardware and Sound**.
3. Click **Device Manager**. If you are prompted for an administrator password or confirmation, type the password or provide confirmation.
4. Double-click **Sound, video and game controllers**.
5. Make sure the following device is enabled and configured correctly:
 - Conexant 20672 SmartAudio HD

- **Problem:** Recordings made by using the Microphone input are not loud enough.

Solution: Make sure that Microphone Boost is turned on and set as follows:

1. Click **Start → Control Panel**.
2. Click **Hardware and Sound**
3. Click **Sound**.
4. Click the **Recording** tab in the Sound window.
5. Select **Microphone**, and click the **Properties** button.
6. Click the **Levels** tab, and move the **Microphone Boost** slider upwards.
7. Click **OK**.

Note: For details about controlling volume, refer to your Windows online help.

- **Problem:** A volume or balance slider cannot be moved.

Solution: The slider might be grayed out. This means that its position is fixed by the hardware and cannot be changed.

- **Problem:** The volume sliders do not stay in place when some audio applications are used.

Solution: It is normal for the sliders to change position when certain sound applications are used. The applications are aware of the Volume Mixer window and are allowed to change the settings themselves. An example is the Windows Media Player. Usually the application has sliders available to control the sound from within the application.

- **Problem:** The balance slider cannot completely mute one channel.

Solution: The control is designed to compensate for minor differences in balance and does not completely mute either channel.

- **Problem:** There is no volume control for MIDI sound on the Volume Mixer window.

Solution: Use the hardware volume control. This is because the Built-In Synthesizer Software does not support the control.

- **Problem:** The sound cannot be turned off completely even if you set the Master volume control at minimum.

Solution: You can still hear some sound even though you have set the Master volume control at minimum. To turn off the sound completely, go to the Master volume control and select Mute speakers.

- **Problem:** When you connect a headphone to your computer while playing sound, a speaker does not produce sound in the MULTI-STREAM mode at SmartAudio.

Solution: Once the headphone is attached, the streaming is automatically redirected to it. If you want to listen to sound from the speakers again, be sure to set those speakers as the default device. The procedure is as follows:

1. Click **Start → Control Panel → All Control Panel Items**.
2. Click the **SmartAudio** icon. The SmartAudio window opens.
3. Look at the playback devices. If you have attached a headphone, the headphone will be automatically set as the default device, and the icon for that headphone will be checked.
4. To set a different device as the default, just double-click the icon for those speakers. That icon will now have a check mark.
5. Play any sound by use of a music program such as Windows Media Player. Make sure that sound comes from the speakers.

For details, refer to the Help for SmartAudio.

Fingerprint reader problems

- **Problem:** The surface of the reader is dirty, stained, or wet.

Solution: Gently clean the surface of the reader with a dry, soft, lint-free cloth.

- **Problem:** The reader often fails to enroll or authenticate your fingerprint.

Solution: If the surface of the reader is dirty, stained, or wet, gently clean the surface of the reader with a dry, soft, lint-free cloth.

If your finger has any of the following conditions, you may not be able to register or authenticate it:

- Your finger is wrinkled.
- Your finger is rough, dry, or injured.
- Your finger is very dry.

- Your finger is stained with dirt, mud, or oil.
- The surface of your finger is very different from when you enrolled your fingerprint.
- Your finger is wet.
- A finger is used that has not been enrolled.

To improve the situation, try the following:

- Clean or wipe your hands to remove any excess dirt or moisture from the fingers.
- Enroll and use a different finger for authentication.
- If your hands are too dry, apply lotion to them.

Battery and power

This section tells what to do if you have a battery and power problem.

Battery problems

- **Problem:** The battery cannot be fully charged by the power-off method in the standard charge time for your computer.

Solution: The battery might be over-discharged. Do the following:

1. Turn off the computer.
2. Connect the ac power adapter to the computer and let it charge.

If the optional Quick Charger is available, use it to charge the over-discharged battery.

If the battery cannot be fully charged in 24 hours, call Lenovo Customer Service Center to have it serviced.

- **Problem:** Your computer shuts down before the battery status indicator shows empty, **-or-** Your computer operates after the battery status indicator shows empty.

Solution: Discharge and recharge the battery.

- **Problem:** The operating time for a fully charged battery is short.

Solution: Discharge and recharge the battery. If your battery's operating time is still short, call Lenovo Customer Service Center to have it serviced.

- **Problem:** The computer does not operate with a fully charged battery.

Solution: The surge protector in the battery might be active. Turn off the computer for one minute to reset the protector; then turn on the computer again.

- **Problem:** The battery cannot be charged.

Solution: You cannot charge the battery when it is too hot. Turn off the computer and allow it to cool to room temperature. If it still cannot be charged, call Lenovo Customer Service Center to have it serviced.

AC power adapter problems

- **Problem:** The ac power adapter is connected to the computer and the working electrical outlet, but the power adapter (power plug) icon is not displayed in the task bar. Also the ac power indicator does not light up.

Solution: Do as follows:

1. Make sure that the connection of the ac power adapter is correct. For connecting the ac power adapter, see the Setup Instructions manual included in the shipping contents of your computer.
2. If the above step is correct, turn off the computer, then disconnect the ac power adapter.
3. Reconnect the ac power adapter, then turn on the computer.

4. If the power adapter icon still does not appear on the task bar and the ac power indicator does not light up, have the ac power adapter and your computer serviced.

Note: To display the power adapter (power plug) icon, click **Show hidden icons** in the task bar.

Power problems

Print these instructions now and keep it with your computer for reference later.

If your computer is getting no power at all, check the following items:

1. Verify the power switch. Refer to “System-status indicators” on page 9. The power switch is illuminated whenever the computer is on.
2. Check all power connections. Remove any power strips and surge protectors to connect the ac power adapter directly to the ac power outlet.
3. Inspect the ac power adapter. Check for any physical damage, and make sure that the power cable is firmly attached to the adapter brick and the computer.
4. Verify the ac power source is working by attaching another device to the outlet.
5. Remove all devices and then test for system power with minimal devices attached.
 - a. Disconnect the ac power adapter and all cables from the computer.
 - b. Stop the battery discharge. Refer to “Before replacing CRU” on page 75.
 - c. Close the computer display, and turn the computer over.
 - d. Remove the memory (SO-DIMM). Refer to “Replacing the memory module” on page 81.
 - e. Remove the PCI Express Mini Card. Refer to “Replacing the PCI Express Mini Card for wireless LAN/WiMAX connection” on page 83.
 - f. Remove the hard disk drive and solid state drive. Refer to “Replacing the hard disk drive or solid state drive” on page 76.
 - g. Wait for 30 seconds, and then reinstall the SO-DIMM and the ac power adapter to test the computer with minimal devices attached first.
 - h. Reinstall each device one at a time that you have removed in the earlier steps.

If your computer does not run on battery power, do the following:

1. If the battery runs out of power, attach ac power adapter to recharge the battery.
2. If the battery is charged but the computer does not run, call Lenovo Customer Service Center to have it serviced.

A power button problem

- **Problem:** The system does not respond, and you cannot turn off the computer.

Solution: Turn off the computer by pressing and holding the power button for 4 seconds or more. If the system is still not reset, remove the ac power adapter.

Startup problems

Print these instructions now and keep them with your computer for reference later.

If you receive an error message before the operating system loads, check the following item:

- Follow the appropriate corrective actions for Power-on self-test listed in “Error messages” on page 127.

If you receive an error message while the operating system is loading the desktop configuration after the POST is completed, check the following items:

1. Go to the Lenovo Support Web site at <http://www.lenovo.com/think/support> and search for the error message.
2. Visit the Microsoft Knowledge Base home page at <http://support.microsoft.com/> and search for the error message.

Sleep and hibernation problems

- **Problem:** The computer enters sleep mode unexpectedly.

Solution: If the processor overheats, the computer automatically enter sleep mode to allow the computer to cool and to protect the processor and other internal components. Check the settings for sleep mode, using Power Manager.

- **Problem:** The computer enters sleep mode (the sleep indicator turns on) immediately after Power-on self-test.

Solution: Make sure that:

- The battery is charged.
- The operating temperature is within the acceptable range. Refer to “Features” on page 14, “Specifications” on page 16, and “Operating environment” on page 16.

If the battery is charged and the temperature is within range, have the computer serviced.

- **Problem:** An error message is displayed indicating a critical low-battery error and the computer immediately turns off.

Solution: The battery power is getting low. Connect the ac power adapter to the computer and plug it into an electrical outlet.

- **Problem:** The computer display remains blank after you press Fn to return from sleep mode.

Solution: Check whether an external monitor was disconnected or turned off while the computer was in sleep mode. If you disconnected or turned off the external monitor, connect it or turn it on before resuming the computer from the sleep mode. When resuming the computer from the sleep mode without attaching the external monitor or turning it on, and the computer display remains blank, press Fn+F7 to bring up the computer display.

- **Problem:** The computer does not return from sleep mode, or the sleep indicator stays on and the computer does not work.

Solution: If the system does not return from sleep mode, it may have entered sleep or hibernation mode automatically because the battery is depleted. Check the sleep indicator.

- If the sleep indicator is on, your computer is in sleep mode. Connect the ac power adapter to the computer; then press Fn.
- If the sleep indicator is off, your computer is in hibernation mode or power-off state. Connect the ac power adapter to the computer; then press the power button to resume operation.

If the system still does not return from sleep mode, your system may stop responding and you may not be able to turn off the computer. In this case, you need to reset the computer. If you have not saved your data, it may be lost. To reset the computer, press and hold the power button for 4 seconds or more. If the system is still not responding, remove the ac power adapter and reset the system by inserting a straightened paper clip into the emergency reset hole. To locate the emergency reset hole, refer to “Bottom view” on page 7.

- **Problem:** Your computer does not enter sleep or hibernation mode.

Solution: Check whether any option has been selected to disable your computer from entering sleep or hibernation mode.

If your computer tries to enter sleep mode but the request is rejected, the device in the USB connector might be disabled. If this occurs, do a hot-unplug-and-plug operation for the USB device.

- **Problem:** The battery discharges slightly while the computer is in hibernation mode.

Solution: If the wakeup function is enabled, the computer consumes small amount of power. This is not a defect. For details, refer to “Power-saving modes” on page 36.

Drives and other storage devices

This section includes two drive problems which are hard disk drive and solid state drive.

Hard disk drive problems

- **Problem:** The hard disk drive makes a rattling noise intermittently.

Solution: The rattling noise might be heard:

- When the hard disk drive begins or finishes getting access to data.
- When you carry the hard disk drive.
- When you carry your computer.

This is a normal characteristic of a hard disk drive and is not a defect.

- **Problem:** The hard disk drive does not work.

Solution: In the startup menu of the “ThinkPad Setup” on page 102, make sure that the hard disk drive is included in the “Boot priority order” list. If it is included in the “Excluded from boot order” list, it is disabled. Select the entry for it in the list and press Shift +1. This moves the entry to the “Boot priority order” list.

- **Problem:** After setting a hard disk password on the hard disk drive of the computer, you moved the drive to another computer. Now you cannot unlock the hard disk password.

Solution: Your computer supports an enhanced password algorithm. Computers older than yours may not support such a security function.

Solid state drive problems

- **Problem:** When you compress files or folders by use of the data compression function in Windows, and then decompress them, the process of writing to or reading from the files or folders is slow.

Solution: Apply the disk defragmentation tool in Windows for faster access to the data.

Software problems

- **Problem:** An application does not run correctly.

Solution: Make sure that the problem is not being caused by the application.

Check that your computer has the minimum required memory to run the application. Refer to the manuals supplied with the application.

Check the following:

- The application is designed to operate with your operating system.
- Other applications run correctly on your computer.
- The necessary device drivers are installed.
- The application works when it is run on some other computer.

If an error message appears while you are using the application program, refer to the manuals supplied with the application.

If the application still does not run correctly, contact your place of purchase or a service representative for help.

Ports and connectors

This section includes the most common ports and connectors problems.

USB problems

- **Problem:** A device connected to the USB connector does not work.

Solution: Open the Device Manager window. Make sure that the USB device setup is correct, and that the assignment of computer resource and the installation of the device driver are correct.

To open the Device Manager window, do the following:

1. Click **Start → Control Panel**.
2. Click **Hardware and Sound**.
3. Click **Device Manager**. If you are prompted for an administrator password or confirmation, type the password or provide confirmation.

Refer to “Diagnosing problems” on page 125 and run a diagnostic test of the USB connector.

Chapter 11. Getting support

There is more to owning a ThinkPad notebook than having a powerful, portable computer. This chapter offers information about when to communicate with Lenovo and how best to do it.

- “Before you contact Lenovo” on page 145
- “Getting help and service” on page 146
- “Purchasing additional services” on page 147

Before you contact Lenovo

Often, you can solve your computer problems by referring to the information in the explanations of error codes, running diagnostic programs or by consulting the ThinkPad Web site.

Registering your computer

To register your ThinkPad products with Lenovo, go to <http://www.lenovo.com/register>. This can help authorities return your computer to you if it is lost or stolen. Registering your computer also enables Lenovo to notify you about possible technical information and upgrades.

For more information about registering your computer, refer to “Registering your computer” on page 23.

Downloading system updates

Downloading updated software might resolve problems you experience with your computer.

To download updated software, visit below Web site and follow the instructions on the screen:
<http://www.lenovo.com/ThinkPadDrivers>

Recording information

Before you talk to a Lenovo representative, record the following important information about your computer.

Record problem symptoms and details

Collect the answers to the questions below before you call for help. Then, you will be able to get help as quickly as possible.

- What is the problem? Is it continuous or intermittent?
- Is there an error message that appears? What is the error code, if any?
- What operating system are you using? Which version?
- Which software applications were running at the time of the problem?
- Can the problem be reproduced? If so, how?

Record system information

The serial number label is on the bottom of your computer. Record the machine type and the serial number.

- What is the name of your Lenovo product?
- What is the machine type?
- What is the serial number?

Getting help and service

If you need help, service, technical assistance, or just want more information about Lenovo products, you will find a wide variety of sources available from Lenovo to assist you. This section contains information about where to go for additional information about Lenovo and our products, what to do if you experience a problem with your computer, and whom to call for service should it be necessary.

Information about your computer and preinstalled software, if any, is available in the documentation that comes with your computer. That documentation includes printed books, online books, README files, and help files. In addition, information about Lenovo products is available on the World Wide Web.

Microsoft Service Packs are the latest software source for Windows product updates. They are available via Web download (connection charges may apply) or via disc. For more specific information and links, go to <http://www.microsoft.com>. Lenovo offers Up and Running technical assistance with installation of, or questions related to, Service Packs for your Lenovo-preloaded Microsoft Windows product. For information, please contact the Customer Support Center.

Using diagnostic programs

Many computer problems can be solved without outside assistance. If you experience a problem with your computer, the first place to start is the troubleshooting information of your computer documentation. If you suspect a software problem, see the documentation, including README files and online help, that comes with the operating system or application program.

ThinkPad Notebooks come with a set of diagnostic programs that you can use to help you identify hardware problems. See “Diagnosing problems” on page 125 for instructions on using the diagnostic programs.

The troubleshooting information or the diagnostic programs might tell you that you need additional or updated device drivers or other software. Lenovo maintains pages on the World Wide Web where you can get the latest technical information and download device drivers and updates.

Lenovo Support Web site

Technical support information is available on the Lenovo Support Web site at:
<http://www.lenovo.com/support>

This portal is updated with the latest information about the following subjects:

Download Drivers & Software

Download drivers, flash the BIOS, and update your software.

Diagnose & Fix

Use self-diagnostic tools to diagnose the problem yourself, search community boards, or work with our Virtual Agent to answer questions.

Product & Service Warranty

Check your warranty status and upgrade your warranty.

Product & Parts Detail

Find part numbers for replacement parts, learn how to replace parts, and view other parts information related to your product.

User Guides & Manuals

Read or download the documentation related to your product.

Research & Learn

Search the community knowledge base for your computer to share and discover information with other users.

Calling Lenovo

If you have tried to correct the problem yourself and still need help, during the warranty period, you can get help and information by telephone through the Customer Support Center. The following services are available during the warranty period:

- Problem determination - Trained personnel are available to assist you with determining if you have a hardware problem and deciding what action is necessary to fix the problem.
- Lenovo hardware repair - If the problem is determined to be caused by Lenovo hardware under warranty, trained service personnel are available to provide the applicable level of service.
- Engineering change management - Occasionally, there might be changes that are required after a product has been sold. Lenovo or your reseller, if authorized by Lenovo, will make selected Engineering Changes (ECs) that apply to your hardware available.

The following items are not covered:

- Replacement or use of parts not manufactured for or by Lenovo or nonwarranted parts

Note: All warranted parts contain a 7-character identification in the format FRU XXXXXXXX.

- Identification of software problem sources
- Configuration of UEFI BIOS as part of an installation or upgrade
- Changes, modifications, or upgrades to device drivers
- Installation and maintenance of network operating systems (NOS)
- Installation and maintenance of application programs

For the terms and conditions of the Lenovo Limited Warranty that applies to your Lenovo hardware product, see “Warranty information” in the *Safety and Warranty Guide* that comes with your computer.

If possible, be near your computer when you make your call in case the technical assistance representative needs to help you resolve a computer problem. Ensure that you have downloaded the most current drivers and system updates, run diagnostics, and recorded information before you call. When calling for technical assistance, have the following information available:

- Machine type and model
- Serial numbers of your computer, monitor, and other components, or your proof of purchase
- Description of the problem
- Exact wording of any error messages
- Hardware and software configuration information for your system

Telephone numbers

For a list of the Lenovo Support phone numbers for your country or region, go to <http://www.lenovo.com/support/phone> or refer to the *Safety and Warranty Guide* that comes with your computer.

Note: Phone numbers are subject to change without notice. The latest phone numbers are available at <http://www.lenovo.com/support/phone>. If the number for your country or region is not provided, contact your Lenovo reseller or Lenovo marketing representative.

Purchasing additional services

During and after the warranty period, you can purchase additional services, such as support for Lenovo and non-Lenovo hardware, operating systems, and application programs; network setup and configuration; upgraded or extended hardware repair services; and custom installations. Service availability and service name might vary by country.

For more information about these services, go to:

<http://www.lenovo.com/accessories/services/index.html>

Appendix A. Regulatory information

This section introduces regulatory information for users.

Wireless related information

Wireless interoperability

Wireless LAN PCI Express Mini Card is designed to be interoperable with any wireless LAN product that is based on Direct Sequence Spread Spectrum (DSSS), Complementary Code Keying (CCK), and/or Orthogonal Frequency Division Multiplexing (OFDM) radio technology, and is compliant to:

- The 802.11b/g Standard, 802.11a/b/g or 802.11n draft 2.0 on Wireless LANs, as defined and approved by the Institute of Electrical and Electronics Engineers.
- The Wireless Fidelity (WiFi) certification as defined by the Wi-Fi Alliance.

Bluetooth device is designed to be interoperable with any *Bluetooth* product that is compliant to *Bluetooth* Specification 2.1+EDR as defined by the *Bluetooth* SIG. Following profiles are supported by *Bluetooth* device:

- Generic Access
- Service Discovery
- Serial Port
- Dial-up Networking
- LAN Access using PPP
- Personal Area Network
- Generic Object Exchange
- Generic Object Push
- File Transfer
- Synchronization
- Audio Gateway
- Headset
- Printer
- Human Interface Devices (Keyboard/Mouse)
- Basic Image
- Handsfree
- AV
- Phone Book Access Profile (PBAP)
- VDP-Sync Profile

Usage environment and your health

Integrated wireless cards emit radio frequency electromagnetic energy like other radio devices. However, the level of energy emitted is far much less than the electromagnetic energy emitted by wireless devices like for example mobile phones.

Due to the fact that integrated wireless cards operate within the guidelines found in radio frequency safety standards and recommendations, Lenovo believes they are safe for use by consumers. These standards and recommendations reflect the consensus of the scientific community and result from deliberations of panels and committees of scientists who continually review and interpret the extensive research literature.

In some situation or environment, the use of integrated wireless cards may be restricted by the proprietor of the building or responsible representatives of the organization. These situations and areas may for example include:

- Using the integrated wireless cards on board of airplanes, in hospitals or near petrol stations, blasting areas (with electro-explosive devices), medical implants or body-worn electronic medical devices, e.g. pace makers.
- In any other environment where the risk of interference to other devices or services is perceived or identified as harmful.

If you are uncertain of the policy that applies on the use of wireless devices in a specific organization (e.g., airport or hospital), you are encouraged to ask for authorization to use integrated wireless cards prior to turning on the computer.

Location of the UltraConnect wireless antennas

ThinkPad models feature an integrated diversity antenna system built into the display for optimal reception, enabling wireless communication wherever you are.

The following shows the location of each built-in wireless antenna.

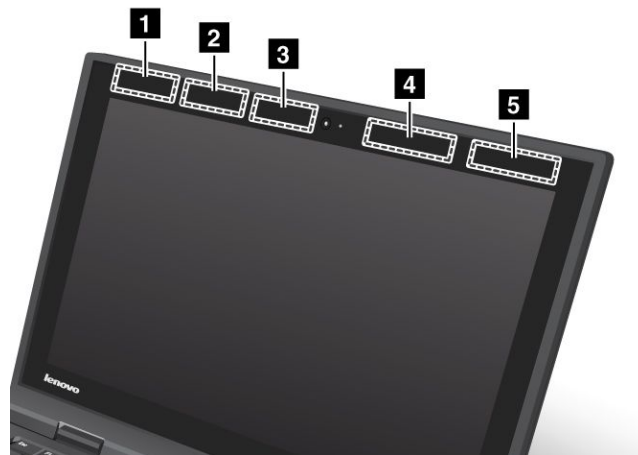

1 Wireless LAN and WiMAX combo antenna (Auxiliary)

The auxiliary antenna connected to the wireless LAN or WiMAX feature is located at the top left corner of the computer display.

2 Wireless WAN antenna (Auxiliary)

If your computer comes with a wireless WAN feature, its auxiliary transmitter antenna is located at the top left side of the computer display.

3 Wireless LAN antenna (Third)

If your computer has the Multiple Input and Multiple Output (MIMO) wireless LAN feature, the third wireless antenna is located at the top left portion of the computer display, near the center.

4 Wireless WAN antenna (Main)

If your computer comes with a wireless WAN feature, its main transmitter antenna is located at the top right side of the computer display.

5 Wireless LAN and WiMAX combo antenna (Main)

The main antenna connected to the wireless LAN or WiMAX feature is located at the top right corner of the computer display.

Locating wireless regulatory notices

For more information about the wireless regulatory notices, refer to the *Regulatory Notice* shipped with your computer.

If your computer is shipped without the *Regulatory Notice*, you can find it on the Web site <http://www.lenovo.com/support>.

To view the *Regulatory Notice* on the Web site, do the following:

1. Go to <http://www.lenovo.com/support>.
2. Click **User Guides & Manuals**, and then follow the instructions on the screen to find the *Regulatory Notice*.

Export classification notice

This product is subject to the United States Export Administration Regulations (EAR) and has an Export Classification Control Number (ECCN) of 4A994.b. It can be re-exported except to any of the embargoed countries in the EAR E1 country list.

Electronic emission notices

The following information refers to the ThinkPad X1, machine type 1286, 1291, 1292, 1293, 1294, 1295, and 1296.

Federal Communications Commission Declaration of Conformity

This equipment has been tested and found to comply with the limits for a Class B digital device, pursuant to Part 15 of the FCC Rules. These limits are designed to provide reasonable protection against harmful interference in a residential installation. This equipment generates, uses, and can radiate radio frequency energy and, if not installed and used in accordance with the instructions, may cause harmful interference to radio communications. However, there is no guarantee that interference will not occur in a particular installation. If this equipment does cause harmful interference to radio or television reception, which can be determined by turning the equipment off and on, the user is encouraged to try to correct the interference by one or more of the following measures:

- Reorient or relocate the receiving antenna.
- Increase the separation between the equipment and receiver.
- Connect the equipment into an outlet on a circuit different from that to which the receiver is connected.
- Consult an authorized dealer or service representative for help.

Lenovo is not responsible for any radio or television interference caused by using other than specified or recommended cables and connectors or by unauthorized changes or modifications to this equipment. Unauthorized changes or modifications could void the user's authority to operate the equipment.

This device complies with Part 15 of the FCC Rules. Operation is subject to the following two conditions: (1) this device may not cause harmful interference, and (2) this device must accept any interference received, including interference that may cause undesired operation.

Responsible Party:
Lenovo (United States) Incorporated
1009 Think Place - Building One
Morrisville, NC 27560
Phone Number: 919-294-5900



Industry Canada Class B emission compliance statement

This Class B digital apparatus complies with Canadian ICES-003.

Cet appareil numérique de la classe B est conforme à la norme NMB-003 du Canada.

European Union - Compliance to the Electromagnetic Compatibility Directive

This product is in conformity with the protection requirements of EU Council Directive 2004/108/EC on the approximation of the laws of the Member States relating to electromagnetic compatibility. Lenovo cannot accept responsibility for any failure to satisfy the protection requirements resulting from a nonrecommended modification of the product, including the installation of option cards from other manufacturers.

This product has been tested and found to comply with the limits for Class B Information Technology Equipment according to European Standard EN 55022. The limits for Class B equipment were derived for typical residential environments to provide reasonable protection against interference with licensed communication devices.



German Class B compliance statement

Deutschsprachiger EU Hinweis:

Hinweis für Geräte der Klasse B EU-Richtlinie zur Elektromagnetischen Verträglichkeit

Dieses Produkt entspricht den Schutzanforderungen der EU-Richtlinie 2004/108/EG (früher 89/336/EWG) zur Angleichung der Rechtsvorschriften über die elektromagnetische Verträglichkeit in den EU-Mitgliedsstaaten und hält die Grenzwerte der EN 55022 Klasse B ein.

Um dieses sicherzustellen, sind die Geräte wie in den Handbüchern beschrieben zu installieren und zu betreiben. Des Weiteren dürfen auch nur von der Lenovo empfohlene Kabel angeschlossen werden. Lenovo übernimmt keine Verantwortung für die Einhaltung der Schutzanforderungen, wenn das Produkt ohne Zustimmung der Lenovo verändert bzw. wenn Erweiterungskomponenten von Fremdherstellern ohne Empfehlung der Lenovo gesteckt/eingebaut werden.

Deutschland:

Einhaltung des Gesetzes über die elektromagnetische Verträglichkeit von Betriebsmitteln

Dieses Produkt entspricht dem „Gesetz über die elektromagnetische Verträglichkeit von Betriebsmitteln“ EMVG (früher „Gesetz über die elektromagnetische Verträglichkeit von Geräten“). Dies ist die Umsetzung der EU-Richtlinie 2004/108/EG (früher 89/336/EWG) in der Bundesrepublik Deutschland.

Zulassungsbescheinigung laut dem Deutschen Gesetz über die elektromagnetische Verträglichkeit von Betriebsmitteln, EMVG vom 20. Juli 2007 (früher Gesetz über die elektromagnetische Verträglichkeit von Geräten), bzw. der EMV EG Richtlinie 2004/108/EC (früher 89/336/EWG), für Geräte der Klasse B.

Dieses Gerät ist berechtigt, in Übereinstimmung mit dem Deutschen EMVG das EG-Konformitätszeichen - CE - zu führen. Verantwortlich für die Konformitätserklärung nach Paragraf 5 des EMVG ist die Lenovo (Deutschland) GmbH, Gropiusplatz 10, D-70563 Stuttgart.

Informationen in Hinsicht EMVG Paragraf 4 Abs. (1) 4:

Das Gerät erfüllt die Schutzanforderungen nach EN 55024 und EN 55022 Klasse B.

Korea Class B compliance statement

B급 기기(가정용 방송통신기자재)
이 기기는 가정용(B급) 전자파적합기기로서 주로 가정에서 사용하는 것을 목적으로 하며, 모든 지역에서 사용할 수 있습니다

Japanese VCCI Class B statement

この装置は、クラスB情報技術装置です。この装置は、家庭環境で使用することを目的としていますが、この装置がラジオやテレビジョン受信機に近接して使用されると、受信障害を引き起こすことがあります。

取扱説明書に従って正しい取り扱いをして下さい。

VCCI-B

Japan compliance statement for products which connect to the power mains with rated current less than or equal to 20 A per phase

日本の定格電流が 20A/相 以下の機器に対する高調波電流規制
高調波電流規格 JIS C 61000-3-2 適合品

Lenovo product service information for Taiwan

台灣 Lenovo 產品服務資訊如下：
荷蘭商聯想股份有限公司台灣分公司
台北市信義區信義路五段七號十九樓之一
服務電話：0800-666-975

Additional regulatory information

For additional regulatory information, refer to the *Regulatory Notice* that shipped with your computer.

If your computer is shipped without the *Regulatory Notice*, you can find it on the Web site at <http://www.lenovo.com/support>. For details, refer to the instructions in “Locating wireless regulatory notices” on page 151.

Appendix B. WEEE and recycling statements

Lenovo encourages owners of information technology (IT) equipment to responsibly recycle their equipment when it is no longer needed. Lenovo offers a variety of programs and services to assist equipment owners in recycling their IT products. For information on recycling Lenovo products, go to: <http://www.lenovo.com/lenovo/environment/recycling>

Important WEEE information

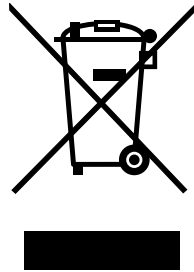

The Waste Electrical and Electronic Equipment (WEEE) mark applies only to countries within the European Union (EU) and Norway. Appliances are labeled in accordance with European Directive 2002/96/EC concerning waste electrical and electronic equipment (WEEE). The Directive determines the framework for the return and recycling of used appliances as applicable throughout the European Union. This label is applied to various products to indicate that the product is not to be thrown away, but rather reclaimed upon end of life per this Directive. Users of electrical and electronic equipment (EEE) with the WEEE marking per Annex IV of the WEEE Directive must not dispose of end of life EEE as unsorted municipal waste, but use the collection framework available to them for the return, recycle, recovery of WEEE and minimize any potential effects of EEE on the environment and human health due to the presence of hazardous substances. For additional WEEE information, go to <http://www.lenovo.com/lenovo/environment>.

Japan recycling statements

Collecting and recycling a disused Lenovo computer or monitor

If you are a company employee and need to dispose of a Lenovo computer or monitor that is the property of the company, you must do so in accordance with the Law for Promotion of Effective Utilization of Resources. Computers and monitors are categorized as industrial waste and should be properly disposed of by an industrial waste disposal contractor certified by a local government. In accordance with the Law for Promotion of Effective Utilization of Resources, Lenovo Japan provides, through its PC Collecting and Recycling Services, for the collecting, reuse, and recycling of disused computers and monitors. For details, visit the Lenovo Web site at <http://www.lenovo.com/recycling/japan>. Pursuant to the Law for Promotion of Effective Utilization of Resources, the collecting and recycling of home-used computers and monitors by the manufacturer was begun on October 1, 2003. This service is provided free of charge for home-used computers sold after October 1, 2003. For details, visit the Lenovo Web site at <http://www.lenovo.com/recycling/japan>.

Disposing of Lenovo computer components

Some Lenovo computer products sold in Japan may have components that contain heavy metals or other environmental sensitive substances. To properly dispose of disused components, such as a printed circuit board or drive, use the methods described above for collecting and recycling a disused computer or monitor.

Disposing of disused lithium batteries from Lenovo computers

A button-shaped lithium battery is installed on the system board of your Lenovo computer to provide power to the computer clock while the computer is off or disconnected from the main power source. If you want to replace it with a new one, contact your place of purchase or ask for a repair service provided by Lenovo. If you have replaced it by yourself and want to dispose of the disused lithium battery, insulate it with vinyl tape, contact your place of purchase, and follow their instructions. If you use a Lenovo computer at home and need to dispose of a lithium battery, you must comply with local ordinances and regulations.

Disposing a disused battery pack from Lenovo notebook computers

Your Lenovo notebook computer has a lithium ion battery pack or a nickel metal hydride battery pack. If you are a company employee who uses a Lenovo notebook computer and need to dispose of a battery pack, contact the proper person in Lenovo sales, service, or marketing, and follow that person's instructions. You also can refer to the instructions at <http://www.lenovo.com/jp/ja/environment/recycle/battery/>.

If you use a Lenovo notebook computer at home and need to dispose of a battery pack, you must comply with local ordinances and regulations. You also can refer to the instructions at <http://www.lenovo.com/jp/ja/environment/recycle/battery/>.

Recycling information for Brazil

Declarações de Reciclagem no Brasil

Descarte de um Produto Lenovo Fora de Uso

Equipamentos elétricos e eletrônicos não devem ser descartados em lixo comum, mas enviados à pontos de coleta, autorizados pelo fabricante do produto para que sejam encaminhados e processados por empresas especializadas no manuseio de resíduos industriais, devidamente certificadas pelos órgãos ambientais, de acordo com a legislação local.

A Lenovo possui um canal específico para auxiliá-lo no descarte desses produtos. Caso você possua um produto Lenovo em situação de descarte, ligue para o nosso SAC ou encaminhe um e-mail para: reciclar@lenovo.com, informando o modelo, número de série e cidade, a fim de enviarmos as instruções para o correto descarte do seu produto Lenovo.

Battery recycling information for Taiwan



廢電池請回收

Battery recycling information for the United States and Canada



US & Canada Only

Battery recycling information for the European Union

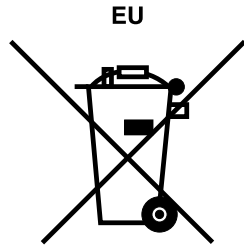

Notice: This mark applies only to countries within the European Union (EU).

Batteries or packaging for batteries are labeled in accordance with European Directive 2006/66/EC concerning batteries and accumulators and waste batteries and accumulators. The Directive determines the framework for the return and recycling of used batteries and accumulators as applicable throughout the European Union. This label is applied to various batteries to indicate that the battery is not to be thrown away, but rather reclaimed upon end of life per this Directive.

In accordance with the European Directive 2006/66/EC, batteries and accumulators are labeled to indicate that they are to be collected separately and recycled at end of life. The label on the battery may also include a chemical symbol for the metal concerned in the battery (Pb for lead, Hg for mercury, and Cd for cadmium). Users of batteries and accumulators must not dispose of batteries and accumulators as unsorted municipal waste, but use the collection framework available to customers for the return, recycling, and treatment of batteries and accumulators. Customer participation is important to minimize any potential effects of batteries and accumulators on the environment and human health due to the potential presence of hazardous substances. For proper collection and treatment, go to:
<http://www.lenovo.com/lenovo/environment>

Appendix C. Notices

Lenovo may not offer the products, services, or features discussed in this document in all countries. Consult your local Lenovo representative for information on the products and services currently available in your area. Any reference to a Lenovo product, program, or service is not intended to state or imply that only that Lenovo product, program, or service may be used. Any functionally equivalent product, program, or service that does not infringe any Lenovo intellectual property right may be used instead. However, it is the user's responsibility to evaluate and verify the operation of any other product, program, or service.

Lenovo may have patents or pending patent applications covering subject matter described in this document. The furnishing of this document does not give you any license to these patents. You can send license inquiries, in writing, to:

*Lenovo (United States), Inc.
1009 Think Place - Building One
Morrisville, NC 27560
U.S.A.
Attention: Lenovo Director of Licensing*

LENOVO PROVIDES THIS PUBLICATION "AS IS" WITHOUT WARRANTY OF ANY KIND, EITHER EXPRESS OR IMPLIED, INCLUDING, BUT NOT LIMITED TO, THE IMPLIED WARRANTIES OF NON-INFRINGEMENT, MERCHANTABILITY OR FITNESS FOR A PARTICULAR PURPOSE. Some jurisdictions do not allow disclaimer of express or implied warranties in certain transactions, therefore, this statement may not apply to you.

This information could include technical inaccuracies or typographical errors. Changes are periodically made to the information herein; these changes will be incorporated in new editions of the publication. Lenovo may make improvements and/or changes in the product(s) and/or the program(s) described in this publication at any time without notice.

The products described in this document are not intended for use in implantation or other life support applications where malfunction may result in injury or death to persons. The information contained in this document does not affect or change Lenovo product specifications or warranties. Nothing in this document shall operate as an express or implied license or indemnity under the intellectual property rights of Lenovo or third parties. All information contained in this document was obtained in specific environments and is presented as an illustration. The result obtained in other operating environments may vary.

Lenovo may use or distribute any of the information you supply in any way it believes appropriate without incurring any obligation to you.

Any references in this publication to non-Lenovo Web sites are provided for convenience only and do not in any manner serve as an endorsement of those Web sites. The materials at those Web sites are not part of the materials for this Lenovo product, and use of those Web sites is at your own risk.

Any performance data contained herein was determined in a controlled environment. Therefore, the result obtained in other operating environments may vary significantly. Some measurements may have been made on development-level systems and there is no guarantee that these measurements will be the same on generally available systems. Furthermore, some measurements may have been estimated through extrapolation. Actual results may vary. Users of this document should verify the applicable data for their specific environment.

Trademarks

The following terms are trademarks of Lenovo in the United States, other countries, or both:

- Lenovo
- Access Connections
- Active Protection System
- Rescue and Recovery
- ThinkPad
- ThinkVantage
- TrackPoint
- UltraConnect
- UltraNav

Intel and Intel SpeedStep are trademarks or registered trademarks of Intel Corporation or its subsidiaries in the United States and other countries.

Microsoft, Windows, and BitLocker are trademarks of the Microsoft group of companies.

BlackBerry, RIM, Research In Motion, SureType and related trademarks, names and logos are the property of Research In Motion Limited and are registered and/or used in the U.S. and countries around the world. Used under license from Research In Motion Limited.

Other company, product, and service names may be trademarks or service marks of others.

Appendix D. Restriction of Hazardous Substances Directive (RoHS)

China RoHS

产品中有害有毒物质或元素的名称及含量

部件名称	有害有毒物质或元素					
	铅(Pb)	汞(Hg)	镉(Cd)	六价铬(Cr(VI))	多溴联苯(PBB)	多溴二苯醚(PBDE)
印刷电路板组件*	X	O	O	O	O	O
硬盘	X	O	O	O	O	O
光驱	X	O	O	O	O	O
内存	X	O	O	O	O	O
电脑I/O 附件	X	O	O	O	O	O
电源	X	O	O	O	O	O
键盘	X	O	O	O	O	O
鼠标	X	O	O	O	O	O
机箱/附件	X	O	O	O	O	O

○:表示该有害有毒物质在该部件所有均质材料中的含量均在SJ/T11363-2006标准规定的限量要求以下
 ×:表示该有害有毒物质至少在该部件的某一均质材料中的含量超出SJ/T11363-2006标准规定的限量要求
 表中标有“×”的所有部件都符合欧盟RoHS 法规。

印刷电路板组件*: 包括印刷电路板及其零部件、电容和连接器
 根据型号的不同,可能不会含有以上的所有部件,请以实际购买机型为准



在中华人民共和国境内销售的电子信息产品必须标识此标志,标志内的数字代表在正常使用状态下的产品的环保使用期限

Turkish RoHS

The Lenovo product meets the requirements of the Republic of Turkey Directive on the Restriction of the Use of Certain Hazardous Substances in Electrical and Electronic Equipment (EEE).

Türkiye EEE Yönetmeliğine Uygunluk Beyanı

Bu Lenovo ürünü, T.C. Çevre ve Orman Bakanlığı'nın "Elektrik ve Elektronik Eşyalarda Bazı Zararlı Maddelerin Kullanımının Sınırlandırılmasına Dair Yönetmelik (EEE)" direktiflerine uygundur.

EEE Yönetmeliğine Uygundur.

Ukraine RoHS

Цим підтверджуємо, що продукція Леново відповідає вимогам нормативних актів України, які обмежують вміст небезпечних речовин

India RoHS

RoHS compliant as per E-Waste (Management & Handling) Rules, 2011.

ThinkPad®

Part Number:

Printed in

(1P) P/N:

