

Network Interface Unit User's Guide

Contents

Copyright and Trademarks

Safety Instructions

Important Safety Instructions.	4
Restrictions on copying.	5

Getting to Know Your Network Interface Unit

Package Contents.	7
Unit parts.	8

Setting Up the Network Interface Unit

Connecting the Network Interface Unit to a Network.	9
Configuring Scanning Software on Your Computer.	10
Connecting to an IPv4 Network Automatically.	10
Connecting to an IPv4 Network Manually.	11
Connecting to an IPv6 Network.	12
Using EpsonNet Config.	13
Operating Environment.	13

Scanning an Image

Configuring Scanning Software on Your Computer.	15
Configuring EPSON Scan.	15
Configuring Epson Scan 2.	16
Scanning Over a Network.	18
Scanning from the Network Interface Unit (for Windows).	18

About the Control Panel

Menu List.	20
Environment menu.	20
Display menu.	20
Energy Saving menu.	20
Network menu.	21
Timeout menu.	21
Restore settings menu.	21

Troubleshooting

Problems Indicated by Messages on the LCD Panel or Status Lights.	22
Problems and Solution.	22
The LCD screen is not displayed even when the scanner is on.	23
The scanner does not scan.	23
Cannot automatically connect to the network.	24
Web-based EpsonNet Config cannot be started or be made settings.	24

Technical Specifications

System Requirements.	25
For Windows.	25
For Mac OS X.	25
Network Interface Unit Specifications.	25
General.	25
Mechanical.	26
Electrical.	26
Environmental.	26
Interfaces.	27
Standard and Approvals.	27

Copyright and Trademarks

Copyright and Trademarks

No part of this publication may be reproduced, stored in a retrieval system, or transmitted in any form or by any means, electronic, mechanical, photocopying, recording, or otherwise, without the prior written permission of Seiko Epson Corporation. No patent liability is assumed with respect to the use of the information contained herein. Neither is any liability assumed for damages resulting from the use of the information contained herein.

Neither Seiko Epson Corporation nor its affiliates shall be liable to the purchaser of this product or third parties for damages, losses, costs, or expenses incurred by the purchaser or third parties as a result of: accident, misuse, or abuse of this product or unauthorized modifications, repairs, or alterations to this product.

Seiko Epson Corporation and its affiliates shall not be liable against any damages or problems arising from the use of any options or any consumable products other than those designated as Original Epson Products or Epson Approved Products by Seiko Epson Corporation.

EPSON® is a registered trademark, and EPSON EXCEED YOUR VISION or EXCEED YOUR VISION are trademarks of Seiko Epson Corporation. Microsoft®, Windows®, and Windows Vista® are registered trademarks of Microsoft Corporation.

Apple®, Macintosh® and Mac OS® are registered trademarks of Apple Inc.

General Notice: Other product names used herein are for identification purposes only and may be trademarks of their respective companies.

Copyright © 2021 Seiko Epson Corporation. All rights reserved.

Safety Instructions

Safety Instructions

Important Safety Instructions

In this document, notes indicate the following:

Notes

contain important information and useful tips on the operation of this product.

Read all these instructions and save them for later reference.

Follow all warnings and instructions marked on the Network Interface Unit.

- Do not spill liquid onto the Network Interface Unit.
- Except as specifically explained in this User's Guide, do not attempt to service the Network Interface Unit yourself.
- Place the product on a flat, stable surface that extends beyond the base of the product in all directions. If you place the product by the wall, leave more than 10 cm between the back of the product and the wall. The product will not operate properly if it is tilted at an angle.
- Avoid places subject to dust, shocks, or vibrations.
- Place the product close enough to the scanner for the interface cable to reach it easily. Do not place or store the product or the AC adapter outdoors, near excessive dirt or dust, water, heat sources, or in locations subject to shocks, vibrations, high temperature or humidity, direct sunlight, strong light sources, or rapid changes in temperature or humidity.
- Do not use with wet hands.
- Place the product near an electrical outlet where the adapter can be easily unplugged.
- The AC adapter cord should be placed to avoid abrasions, cuts, fraying, crimping, and kinking. Do not place objects on top of the cord and do not allow the AC adapter or the cord to be stepped on or run over. Be particularly careful to keep the cord straight at the end.
- Use only the AC adapter that comes with your product. Using any other adapter could cause fire, electrical shock, or injury.
- The AC adapter is designed for use with the product with which it was included. Do not attempt to use it with other electronic devices unless specified.
- Use only the type of power source indicated on the AC adapter's label, and always supply power directly from a standard domestic electrical outlet with the AC adapter that meets the relevant local safety standards.
- When connecting this product to a scanner with a cable, ensure the correct orientation of the connectors. Each connector has only one correct orientation. Inserting a connector in the wrong orientation may damage both devices connected by the cable.
- Avoid using outlets on the same circuit as photocopiers or air control systems that regularly switch on and off.

Safety Instructions

- If you use an extension cord with the product, make sure the total ampere rating of the devices plugged into the extension cord does not exceed the cord's ampere rating. Also, make sure the total ampere rating of all devices plugged into the wall outlet does not exceed the wall outlet's ampere rating.
- Never disassemble, modify, or attempt to repair the AC adapter or product by yourself except as specifically explained in the product's guides.
- Do not insert objects into any opening as they may touch dangerous voltage points or short out parts. Beware of electrical shock hazards.
- If damage occurs to the plug, replace the cord set or consult a qualified electrician. If there are fuses in the plug, make sure you replace them with fuses of the correct size and rating.
- Unplug the product and the AC adapter, and refer servicing to qualified service personnel under the following conditions: The AC adapter or plug is damaged; liquid has entered the product or the AC adapter; the product or the AC adapter has been dropped or the case has been damaged; the product or the AC adapter does not operate normally or exhibits a distinct change in performance. (Do not adjust controls that are not covered by the operating instructions.)
- Unplug the product and the AC adapter before cleaning. Clean with a damp cloth only. Do not use liquid or aerosol cleaners.
- If you are not going to use the product for a long period, be sure to unplug the AC adapter from the electrical outlet.
- After replacing consumable parts, dispose of them correctly following the rules of your local authority. Do not disassemble them.

Restrictions on copying

Observe the following restrictions to ensure responsible and legal use of your product.

Copying of the following items is prohibited by law:

- Bank bills, coins, government-issued marketable securities, government bond securities, and municipal securities
- Unused postage stamps, pre-stamped postcards, and other official postal items bearing valid postage
- Government-issued revenue stamps, and securities issued according to legal procedure

Exercise caution when copying the following items:

- Private marketable securities (stock certificates, negotiable notes, checks, etc.), monthly passes, concession tickets, etc.
- Passports, driver's licenses, warrants of fitness, road passes, food stamps, tickets, etc.

Note:

Copying these items may also be prohibited by law.

Responsible use of copyrighted materials

Safety Instructions

Products can be misused by improperly copying copyrighted materials. Unless acting on the advice of a knowledgeable attorney, be responsible and respectful by obtaining the permission of the copyright holder before copying published material.

Getting to Know Your Network Interface Unit

Getting to Know Your Network Interface Unit

Package Contents

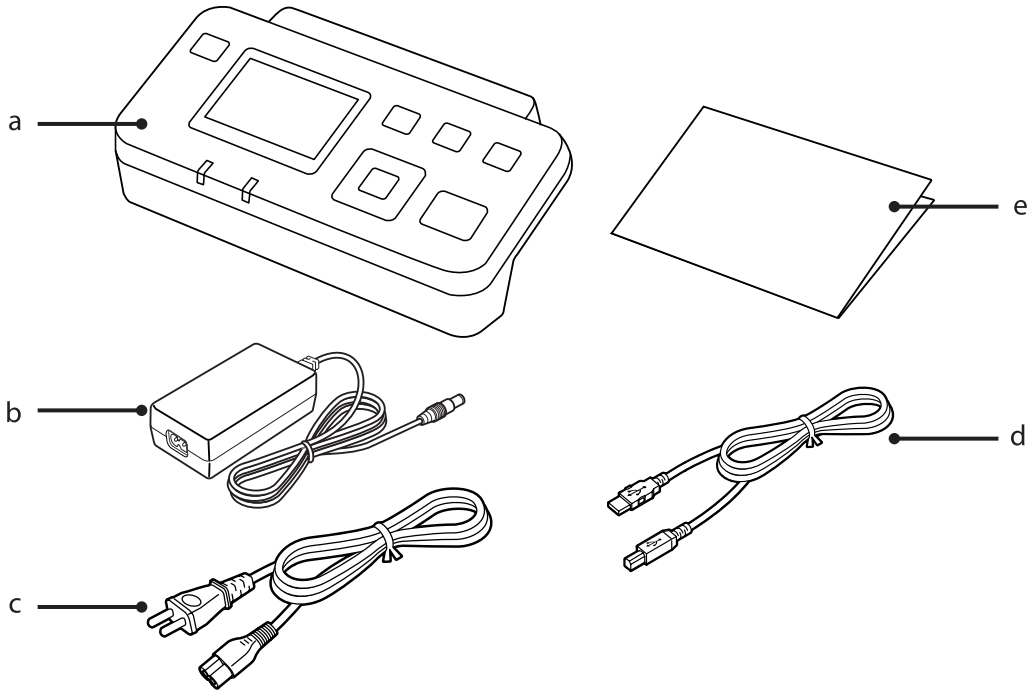

a	Network Interface Unit	This product.
b	AC adapter	Connect this to the Network Interface Unit.
c	AC power cord	Connect this to the AC adapter, and then plug it in.
d	USB cable	Connect this to the Network Interface Unit and the scanner.
e	Setup Guide	The paper manual for this product.

Getting to Know Your Network Interface Unit

Unit parts

Front view

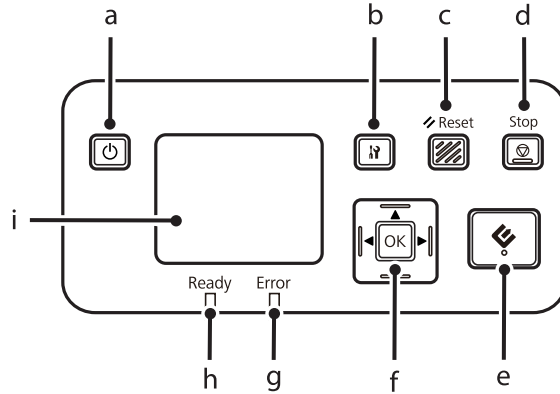

Side view

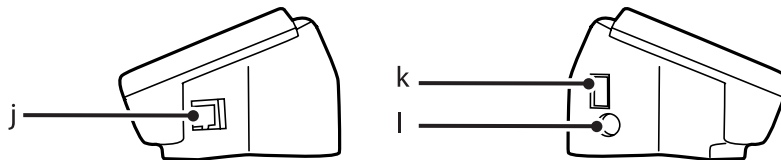

a	⏻ power button	Turns the product on or off.
b	⚙️ setting button	Make product and network settings, or perform maintenance.
c	↺ Reset button	Resets the panel to the initial screen.
d	⏹ Stop button	Cancels scanning.
e	⏪ start button	Starts scanning. In a network environment, the ⏪ start button works the same way as clicking Scan in the Document Capture Pro/Document Capture or scanner driver window.
f	OK/Arrow button	Use the arrow buttons to select an item, and then press OK to confirm the selection.
g	Error light (orange)	On when an error has occurred.
h	Ready light (green)	On when the scanner is ready. Off when the scanner is not ready.
i	LCD panel	Displays the status, operation, and error messages.
j	LAN port	Connects the network cable.
k	USB port	Connects the USB cable.
l	DC inlet	Connects the AC adapter.

Setting Up the Network Interface Unit

Setting Up the Network Interface Unit

Connecting the Network Interface Unit to a Network

1 Turn off the product and disconnect the USB cable.

2 Connect the Network Interface Unit to the scanner using the USB cable.

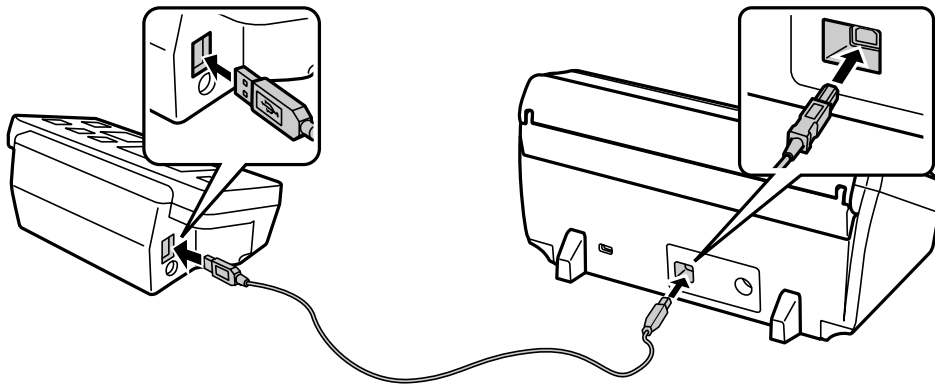

3 Connect a network cable to the Network Interface Unit.

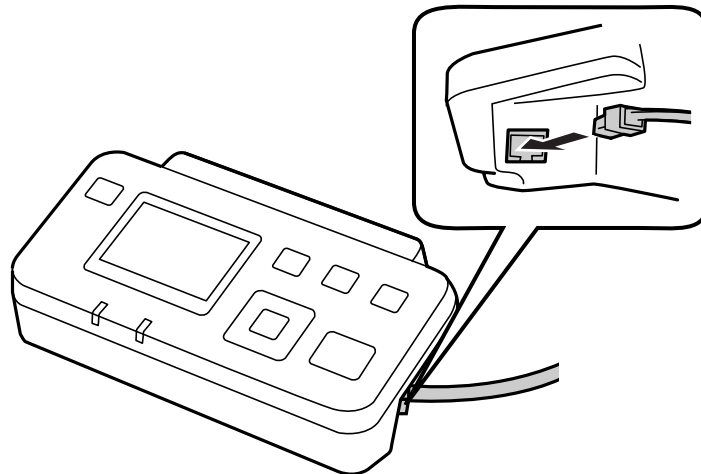

Note:

- You must use a category 5e or higher shielded twisted-pair cable to connect the Network Interface Unit to prevent malfunction.
- The network cable is not supplied with the product.

Setting Up the Network Interface Unit

- 4 Connect the AC adapter and the AC power cord to the Network Interface Unit.

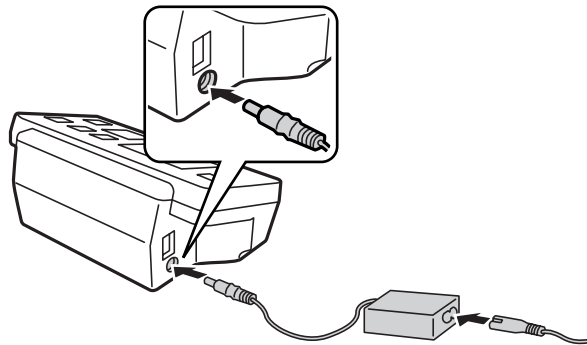

- 5 Plug in the AC power cord.

Configuring Scanning Software on Your Computer

Connecting to an IPv4 Network Automatically

Note:

To connect automatically, a DHCP server must be correctly configured on the network.

- 1 Turn on your scanner and the Network Interface Unit.
- 2 When the home screen ("Scanner is ready") is displayed, press the  setting button.

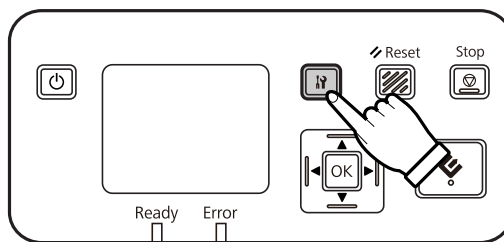

- 3 Select **Network** with the ▲ up and ▼ down buttons, and then press the OK button.

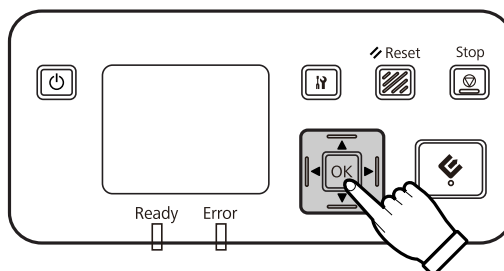

- 4 Select **IPv4** with the ▲ up and ▼ down buttons, and then press the OK button.

Setting Up the Network Interface Unit

5 Select **Auto** with the ▲ up and ▼ down buttons, and then press the OK button.

6 Press the  setting button to return to the home screen.

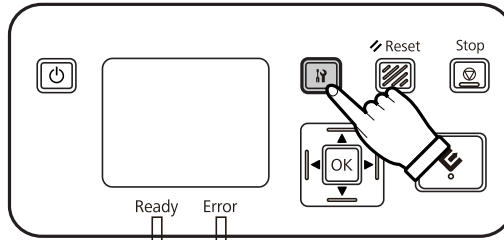

7 After "Configuring network setting" is displayed, restart the unit.

Set the password for protecting network security using Web-based EpsonNet Config.

[🔗 "Using EpsonNet Config" on page 13](#)

Connecting to an IPv4 Network Manually

1 Turn on your scanner and the Network Interface Unit.

2 When the home screen ("Scanner is ready") is displayed, press the  setting button.

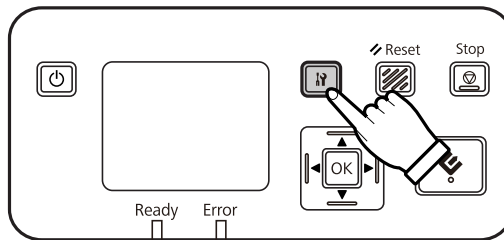

3 Select **Network** with the ▲ up and ▼ down buttons, and then press the OK button.

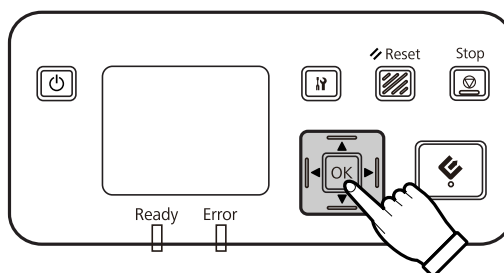

4 Select **IPv4** with the ▲ up and ▼ down buttons, and then press the OK button.

5 Select **Manual** with the ▲ up and ▼ down buttons, and then press the OK button.

6 Select **IP address** with the ▲ up and ▼ down buttons, and then press the OK button.

Setting Up the Network Interface Unit

- 7 Set the IP address with the arrow buttons, and then press the OK button.
- 8 Repeat steps 6 and 7 to set the IP subnet mask and IP default gateway settings, and then press the OK button.
- 9 Press the  setting button to return to the home screen.

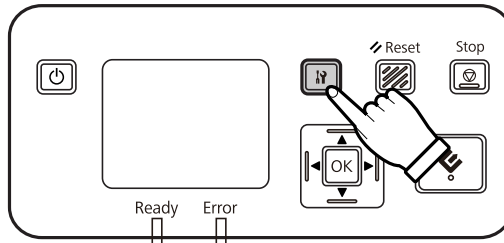

- 10 After "Configuring network setting" is displayed, restart the unit.
Set the password for protecting network security using Web-based EpsonNet Config.
[🔗 "Using EpsonNet Config" on page 13](#)

Connecting to an IPv6 Network

- 1 Turn on your scanner and the Network Interface Unit.
- 2 When the home screen ("Scanner is ready") is displayed, press the  setting button.

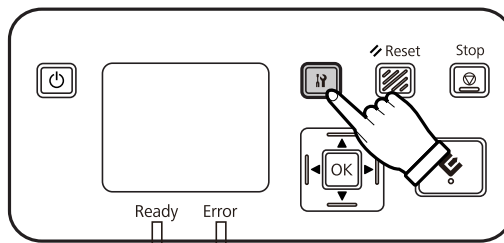

- 3 Select **Network** with the ▲ up and ▼ down buttons, and then press the OK button.

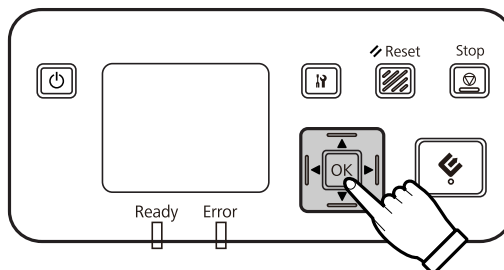

- 4 Select **IPv6 - On** with the ▲ up and ▼ down buttons, and then press the OK button.

Setting Up the Network Interface Unit

- 5 Press the  setting button to return to the home screen.

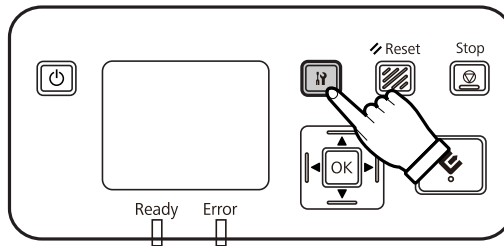

- 6 After "Configuring network setting" is displayed, restart the unit.

Note:

Use the *Web-based EpsonNet Config* to make manual settings for IPv6.

Set the password for protecting network security using Web-based EpsonNet Config.

 ["Using EpsonNet Config" on page 13](#)

Using EpsonNet Config

Web-based EpsonNet Config is software that is stored on the Network Interface Unit.

You can launch the software from a computer on the network using a Web browser and so on. You can make network interface settings (TCP/IP and so on) and scanner settings (various checks and settings).

To start Web-based EpsonNet Config, enter the IP address for this unit in the address bar of a Web browser.

Note:

- Web-based EpsonNet Config cannot be used if the IP address has not been set in the network interface.*
- See EpsonNet Config online help for more details.*

Note:

You can also use EpsonNet Config for Windows/Macintosh.

- EpsonNet Config for Windows is a Windows-based configuration utility for administrators that allows you to configure the network interface for various protocols such as TCP/IP, MS Network, AppleTalk, IPP, and SNMP.*
- EpsonNet Config for Macintosh is a Macintosh-based configuration utility for administrators that allows you to configure the network interface for TCP/IP, AppleTalk, and IPP.*

Download this software from:

<http://www.epson.com/>

Operating Environment

You can use Web-based EpsonNet Config on computers with the following Web browsers.

Setting Up the Network Interface Unit

Supported Web Browsers	Web Browser Version
Microsoft Internet Explorer	IE8.0 or later
Mozilla FireFox	Ver 3.5 or later
Safari	Ver 4.0 or later
Google Chrome	Ver 4.0 or later
Opera	Ver 10.0 or later

Scanning an Image

Scanning an Image

Configuring Scanning Software on Your Computer

Make sure your scanner and Network Interface Unit are turned on and working properly. Then follow the steps below to use the scanner driver program to enable network scanning.

Note:

Either EPSON Scan or Epson Scan 2 is come with your scanner as the scanner driver. See the user's guide of the scanner for more details.

Before you start, obtain the following information:

- A valid IP address for the Network Interface Unit. Ask your network administrator for an IP address which will not cause conflict with any other device on the network. If you are the network administrator, choose an address within the subnet which will not cause conflict with any other device.
- The MAC (Ethernet hardware) address of the Network Interface Unit. This is a unique number for your Network Interface Unit which is different from the hardware serial number of the Network Interface Unit. You can find out the MAC address on the Network Interface Unit.

Note for Windows:

Log in as a user with administrator's authority, and then install. If you are asked to enter an administrator's password, enter the password, and then continue with the operations.

Note for Mac OS X:

- Do not use the Fast User Switching function while using your scanner.
- You must log on to a Computer Administrator account.

Note:

You need to install the latest firmware for the Network Interface Unit before scanning. Go to the Epson home page to download the Epson Firmware Updater for the Network Interface Unit.

 <http://www.epson.com>

After downloading, start Epson Firmware Updater, and then follow the on-screen instructions. If the latest firmware is already installed on the Network Interface Unit, you do not need to update the firmware.

Configuring EPSON Scan

1 Obtain the IP address or host name of the Network Interface Unit from your network administrator.

2 Start EPSON Scan Settings.

Windows 10:

Click the start button, and then select **All apps > EPSON > EPSON Scan Settings**

Scanning an Image

Windows 8.1/Windows 8:

Enter the application name in the search charm, and then select the displayed icon.

Windows 7/Windows Vista/Windows XP:

Click the start button, and then select **All Programs** or **Programs > EPSON > EPSON Scan > EPSON Scan Settings**

Mac OS X:

Select **Go > Applications > EPSON Software > EPSON Scan Settings**

- 3 Select your scanner from the **Select Scanner** drop-down list.
- 4 Select **Network**, then click **Add**.

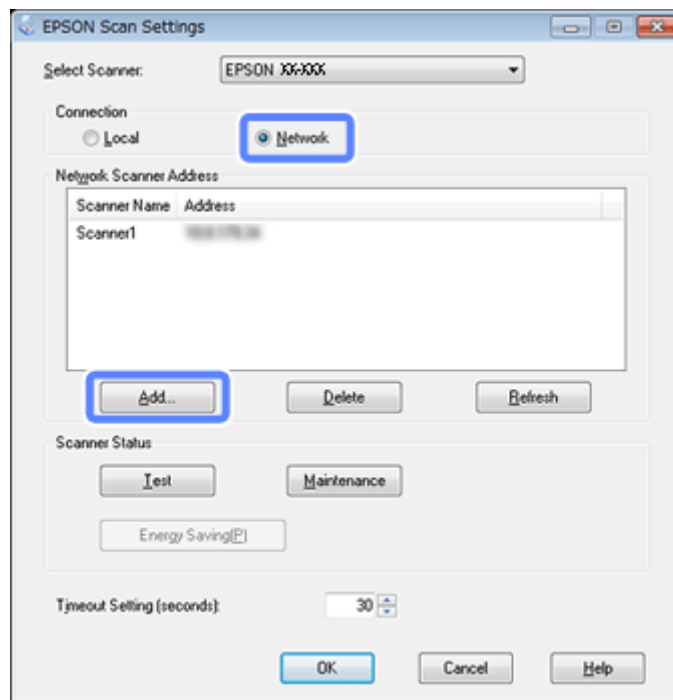

- 5 In the Add window, choose the Network Interface Unit's IP address under Search for addresses, or select **Enter address** and type in the address. Then click **OK**.
- 6 In the Epson Scan Settings window, click **Test** to check the connection. If everything works properly, you see a successful connection message appears.
- 7 Click **OK** to save the settings.

Configuring Epson Scan 2

- 1 Obtain the IP address or host name of the Network Interface Unit from your network administrator.

Scanning an Image

2 Start Epson Scan 2 Utility.

Windows 10:

Click the start button, and then select **All apps > EPSON > Epson Scan 2 Utility**

Windows 8.1/Windows 8:

Enter the application name in the search charm, and then select the displayed icon.

Windows 7/Windows Vista/Windows XP:

Click the start button, and then select **All Programs or Programs > EPSON > Epson Scan 2 > Epson Scan 2 Utility**

Mac OS X:

Select **Go > Applications > EPSON Software > Epson Scan 2 Utility**

3 Select **Settings** from the **Scanner** drop-down list on the Epson Scan 2 Utility screen.

If Epson Scan 2 Utility screen is not displayed and **Scanner Settings** screen is displayed, go to the next step.

4 In the **Scanner Settings** screen, click **Add**.

If the **Add** button is disabled, click **Enable Editing** (Windows) or + button (Mac OS X), and then click **Add** button.

5 In the **Add Network Scanner** screen, select your scanner from the **Model** drop-down list.

6 Choose the Network Interface Unit's IP address under **Search for Network**, or select **Enter address** and type in the address. Then click **Add**.

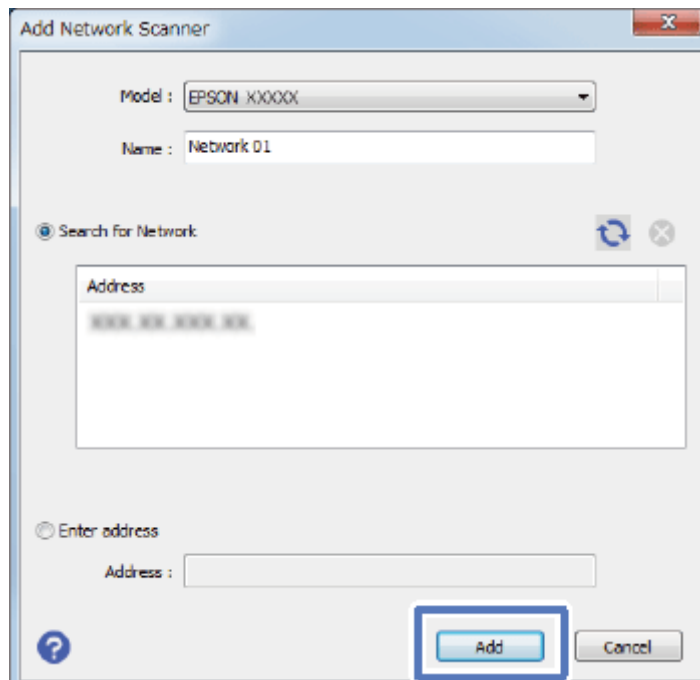

7 In the **Scanner Settings** screen, select your scanner, and then click **OK**.

Scanning an Image

Scanning Over a Network

Note:



You must set the IP address for your Network Interface Unit before you can scan using it.

Note for Windows:

You need to install the latest Document Capture Pro before scanning. Go to the Epson home page to download the latest Document Capture Pro.

 <http://www.epson.com>

If the latest software is already installed on your computer, you do not need to update the software.

- 1 Turn on your scanner, the Network Interface Unit and the client computer.
- 2 Place your original(s) in the input tray.
- 3 Start Document Capture Pro/Document Capture.
 See the user's guide of the scanner for more details.
- 4 Click  **Scan** on the Document Capture Pro/Document Capture Main window.
- 5 Make necessary settings on Main Settings, and then click **Scan**.

Scanning from the Network Interface Unit (for Windows)

Set up a job in advance.

 See the user's guide of the scanner for more details.

- 1 Turn on your scanner, the Network Interface Unit and the client computer.
- 2 Place your original(s) in the input tray.
- 3 Press the **OK** button on the unit.
The scanner searches for an available computer.
- 4 Select the computer you want to send the data to, and then press the **OK** button.
If a group is set for the scanner, you need to set the same group on the computer if you want to display it on the panel.

Scanning an Image

5 Enter the password.

If the password entry screen is not displayed, go to the next step.

 See the Document Capture Pro help for more details.

6 Select a job, and then press the OK button.

7 Check the settings, and then press the  start button.

About the Control Panel

About the Control Panel

Menu List

Environment menu

Item	Description
Network	You can check network settings such as the MAC address and IP address.
Maintenance	You can check the number of scanned sheets. If the scanner being used has an Automatic Document Feeder installed, you can check or reset the number of scanned sheets for the Roller Assembly Kit, Pickup Roller, Separation Pad, and Separation Roller.

Display menu

Item	Description
Language	Specifies the language displayed on the LCD panel.
Brightness	Adjusts the brightness of the LCD panel. Use the ▲ and ▼ buttons to set the contrast between -2 (darker) and +2 (brighter).
Contrast	Adjusts the contrast of the LCD panel. Use the ▲ and ▼ buttons to set the contrast between -2 (lowest contrast) and +2 (highest contrast).
Restore Settings	Select Yes and then press the OK button to return the settings in the Display menu to their default values.

Energy Saving menu

Note:

When connecting the Network Interface Unit, the Power Off Timer and Sleep settings are given priority over settings made in EPSON Scan Settings or Epson Scan 2 Utility.

Item	Description
Power Off Timer	Specifies the length of time before the unit and the scanner enter power off mode if no operations are made.
Sleep	Specifies the length of time before the unit and the scanner enter sleep mode if no operations are made.
Restore Settings	Select Yes and then press the OK button to return the settings in the Energy saving menu to their default values.

About the Control Panel

Network menu

Note:

This is not displayed if a password is set for this unit in EpsonNet Config.

Item	Description
IPv4	Select whether the IP address is set automatically or manually. If Manual is selected, you can set the value for IP address, IP subnet mask, and IP default gateway.
Link Speed	Specifies the transmission speed of the network interface.
IPv6	Specifies the IPv6 setting.
Mode	Normally, select Client mode.
Group	Specifies the group number of the scanner.
Restore Settings	Select Yes and then press the OK button to return the settings in the Network menu to their default values.

Timeout menu

Item	Description
Back to Home screen	Specifies the timeout setting when the control panel is in other screen than home screen. This setting is not applied when the control panel displays the some of the error message screens.
Restore Settings	Select Yes and then press the OK button to return the settings in the Timeout menu to their default values.

Restore settings menu

Select **Yes** and then press the OK button to return the settings for all menus to their default values.

Troubleshooting

Problems Indicated by Messages on the LCD Panel or Status Lights

You can check the status of the scanner and the Network Interface Unit from messages on the LCD panel and the status lights.

Clear the error according to the message displayed.

The following table explains the light patterns and the main statuses.

Ready Light	Error Light	Status
On	Off	Scanning can be performed. The scanner is in sleep mode.
Off	On	The scanner has not been recognized. A network related error has occurred. An error such as a paper jam has occurred in the scanner.
Off	Off	A job is being cancelled. The PC/server on the network has not been recognized.
Blink	Off	Scanning. Searching for or connecting to a network.
Blink	Blink	The firmware is being updated.

If the following messages are displayed, turn off the scanner and then turn it back on again. Also, check the network connection and settings.

If this does not correct the problem, see the scanner User's Guide or consult your dealer.

- Network error
- Network fatal error
- Scanner error
- No reply received

Problems and Solution

This section provides solutions to problems you may have.

Refer to the "Troubleshooting" section in the user's guide of the scanner if you have problems with the software. The online help also provides versatile tips and other information helpful for problem-solving.

Troubleshooting

If you cannot solve a problem after reading and following the information in this chapter, contact your dealer or a qualified customer support person for assistance.

The LCD screen is not displayed even when the scanner is on.

- ❑ Check that the Network Interface Unit is connected correctly.
 - 🔗 [“Connecting the Network Interface Unit to a Network” on page 9](#)
- ❑ Check that the supported scanner is connected to the Network Interface Unit.
 - 🔗 Refer to the Epson Web site for supported scanners.

The scanner does not scan.

- ❑ Check that the scanner is turned on.
 - 🔗 [“Connecting the Network Interface Unit to a Network” on page 9](#)
- ❑ Check that the scanner is compatible with the Network Interface Unit.
 - 🔗 See the user's guide of the scanner for more details.
- ❑ Check that the network cable is connected securely.
 - 🔗 [“Connecting the Network Interface Unit to a Network” on page 9](#)
- ❑ Turn off the scanner and make sure the Network Interface Unit is properly connected to your scanner and connected to the network.
 - 🔗 [“Connecting the Network Interface Unit to a Network” on page 9](#)
- ❑ Check that the network cable is working correctly by connecting it to other products.
 - 🔗 [“Connecting the Network Interface Unit to a Network” on page 9](#)
- ❑ Check that EPSON Scan Settings or Epson Scan 2 Utility have been set correctly.
 - 🔗 See the user's guide of the scanner for more details.
- ❑ Check that the scanning software has been installed correctly.
 - 🔗 See the help came with each software for more details.
- ❑ Check that the scanner used with the scanning software has been selected.
 - 🔗 See the help came with each software for more details.
- ❑ Check that Network Scanning Settings from Document Capture Pro have been set correctly.
 - 🔗 See the help came with each software for more details.

Troubleshooting

- ❑ In Network Scanning Settings, check that the Group settings for Document Capture Pro are the same as the settings for Network Interface Unit.

 See the Document Capture Pro help for more details.

 [“Scanning from the Network Interface Unit \(for Windows\)” on page 18](#)

- ❑ Check that Document Capture Pro is not being blocked by a Firewall.

 See the user's guide of the scanner for more details.

- ❑ Check that the IP address is set correctly.

 See the user's guide of the scanner for more details.

- ❑ Check that there are several network interface unit (scanner) on the network.

On your computer, recognise the scanner using MAC address of this product.

 [“Environment menu” on page 20](#)

Cannot automatically connect to the network.

- ❑ If your network environment supports DHCP, contact your network administrator. If your network environment does not support DHCP, set the IP address manually.

 [“Connecting to an IPv4 Network Manually” on page 11](#)

Web-based EpsonNet Config cannot be started or be made settings.

- ❑ Check that IPv4 address is set to this product.

To start Web-based EpsonNet Config, set IP address first. You can set from this product control panel or from EpsonNet Config for Windows/Macintosh. You can check the current setting from the control panel menu.

 [“Menu List” on page 20](#)

Technical Specifications

Technical Specifications

System Requirements

Make sure your system meets the requirements in these sections before using it with your product.

For Windows

System	Microsoft Windows 10, Windows 8.1, Windows 8, Windows 7, Windows Vista, Windows XP Home Edition, Windows XP Professional Edition, Windows XP Professional x64 Edition
--------	---

For Mac OS X

System	Mac OS X v10.5.8, 10.6.x, 10.7.x (OS X Lion), 10.8.x (OS X Mountain Lion), 10.9.x (OS X Mavericks), 10.10.x (OS X Yosemite), and 10.11.x (OS X El Capitan). Fast User Switching on Mac OS X is not supported.
--------	---

Note:

Scanner driver does not support the UNIX File System (UFS) for Mac OS X. You must install scanner driver on a disk or in a partition that does not use UFS.

Network Interface Unit Specifications

Note:

Specifications are subject to change without notice.

General

Product code	B12B808441 B12B808451 B12B808461 B12B808464 B12B808466 DSBXNW1
Display	LCD (Liquid Crystal Display)

Technical Specifications

Mechanical

Dimensions	Height: 75 mm (2.9 inches) Width: 186 mm (7.3 inches) Depth: 102 mm (4.0 inches)
Weight	Approx. 380 g (About 0.83 lb)

Electrical

Product

Power consumption	Operating: Maximum 7.5 W
Rated input voltage	DC 5 V
Rated input current	2.0 A

Note:

Power consumption varies depending on operating conditions.

AC adapter

AC adapter model	SYS1319-1005
Rated input voltage	AC 100 to 240 V
Rated input current	1.0 A
Related input frequency	50 to 60 Hz
Related output voltage	DC 5 V
Rated output current	2.0 A

Note:

Power consumption varies depending on operating conditions and whether an option is installed.

For European users, see the following Website for details on power consumption.

<http://www.epson.eu/energy-consumption>

Environmental

Temperature	Operating: 5 to 35 °C (41 to 95 °F) Storage: -25 to 60 °C (-13 to 140 °F)
-------------	--

Technical Specifications

Humidity	Operating: 10 to 85 % (without condensation) Storage: 10 to 90 % (without condensation)
Operating conditions	Ordinary office or home conditions. Avoid operating the product in direct sunlight, near a strong light source, or in extremely dusty conditions.

Interfaces

Scanner Interface	USB via USB cable
Network Interface	10BASE-T/100BASE-TX/1000BASE-T

Standard and Approvals

Product

U.S. model:

EMC	FCC Part 15 Subpart B Class B
-----	-------------------------------

European model:

EMC Directive 2004/108/EC	EN55022 Class B EN55024 EN61000-3-2 EN61000-3-3
---------------------------	--

Australian model:

EMC	AS/NZS CISPR22 Class B
-----	------------------------

AC adapter

U.S. model:

Safety	UL60950-1 CAN/CSA-C22.2 No.60950-1
EMC	FCC Part15 Subpart B Class B CAN/CSA-CEI/IEC CISPR 22 Class B

Technical Specifications**European model:**

Low Voltage Directive 2006/95/EC	EN60950-1
EMC Directive 2004/108/EC	EN55022 Class B
	EN55024
	EN61000-3-2
	EN61000-3-3

Australian model:

Safety	AS/NZS 60950.1
EMC	AS/NZS CISPR22 Class B

ZICTA Type Approval for Users in Zambia:

See the following website to check the information for ZICTA Type Approval.

<https://support.epson.net/zicta/>