

MIDLAND[®]
www.midlandeurope.com

Midland World



info@midlandeurope.com

604314 - Printed in March 2020

MOVING
COMMUNICATION



There are people who drive day and night to transport goods, they search for friends.

People who travel to unknown destinations, search for information.

People who explore nature seeking adventure, they sometimes need to search for help.

Riders who dominate curves search for security.

It doesn't matter what your story is.

Whether you are alone, in a group, or with your family.

Or if you are in the mountains, at the beach or in the middle of nowhere.

Everybody always wants to communicate:

MOVING COMMUNICATION

MIDLAND GROUP

USA
Midland Radio Corporation
Kansas City
www.midlandusa.com

ITALY
CTE International
Reggio Emilia
www.midlandeuropa.com

Germany
Alan Electronics
Dreieich
info@albrecht-midland.de
www.albrecht-midland.de

Spain
Midland Iberia
Barcelona
info@alan.es
www.midland.es

France
Alan France
Dives sur Mer
infos@alanfrance.fr
www.alan-midland.fr

Bihr S.A.S.
www.bihr.eu

Bihr S.A.S.
www.bihr.eu

Bulgaria
Alan Telecommunication
Sofia
alan.bulgaria@me.com
www.midlandeuropa.com

Poland
Alan Telekomunikacja
Warsaw
info@alan.pl
www.alan.pl

Romania
SC Online Shop
Piatra Neamt
comenzi@statie-radio.ro
www.statie-radio.ro

Ukraine
CBITAXO
Rivne
office@taho.com.ua
www.taho.com.ua

United Kingdom
Nevada UK
Portsmouth
sales@nevada.co.uk
www.nevadaradio.co.uk

United Kingdom
Bikeit
Southampton
tradesales@bikeit.co.uk
www.bikeittrade.com

Russia
Alan-Sviaz
Moscow
info@midland.ru
www.midland.ru

Japan
Links Of Japan
Osaka
info@midlandradio.jp
www.midlandradio.jp

Greece
Cobra Center Ltd
Athens
techdep@cobra-center.gr
www.cobra-center.gr

Australia
AudioXtra International
Sydney
info@audioxtra.com.au
www.audioxtra.com.au

Turkey
DNS
Istanbul
ocagman@dnsticaret.com
www.dnsonlineshop.com

Israel
Shchori Cellular Communication
Tel-Aviv
www.midland.co.il
info@midland.co.il

WARRANTY

All our products are covered by a 24-month warranty, as long as they are sent to our **Technical Service Centres** together with the tax receipt.
Contact our **Authorised Retailer** who will tell you where the nearest **Service Centre** is located.

NB: we accept the return of goods upon two conditions: the agreed authorization from **Sales Dept.** (0522 509411) or **Customer Technical Support Dept.** (0522 509535) and if costs of shipments are covered by sender. The authorization is mandatory and if lacking, products will be immediately returned to the sender.

Photo: Enrico Coppola - Illustrations: Silvano Scolari - Art Direction: Roberta Saccon
We would like to thank: Vittorio Spinelli, called lo Zingaro.

This catalogue replaces and cancels the previous ones. We reserve the right to modify and improve at any time and without notice the technical and aesthetic features of the equipment. All trademarks shown belong to their respective owners.

***A TALE OF INNOVATION
FOR OVER 60 YEARS.***

1977

First certified CB radio on the European market

1998

1st LPD Walkie-Talkie in the world

2008

1st motorcycle to motorcycle intercom in the world

2013

1st Action Cam with Wi-Fi remote control

2016

1st App that exceeds the limits
of communication between motorcyclists

2018

1st digital CB mike

2019

CB Talk App, the largest community of drivers,
with over 500,000 downloads in 1 year

MIDLAND NEVER STOPS.

3

ANALOG & DIGITAL CB RADIOS

4 THE CB RADIO BEST SUITED FOR YOUR NEEDS.

- 6 CB TALK APP
- 7 DUAL MIKE WIRELESS
- 8 DUAL MIKE
- 10 M-5
- 11 M-MINI USB
- 12 M-10
- 13 M-20
- 14 M-30
- 15 M ZERO PLUS
- 15 ALAN 100 PLUS B
- 16 ALAN QUARANTOTTO
- 17 ALAN SESSANTOTTO
- 18 ALAN 48 PRO
- 19 ALAN 78 PRO
- 20 ALAN 42 DS

21 CB ACCESSORIES

35 CB SUMMARY TABLES

37

RADIO

38 THE RIGHT WALKIE TALKIE FOR YOU.

- 40 XT10
- 40 XT30
- 41 XT50 /XT50 ADVENTURE
- 42 XT60
- 43 XT70 / XT70 ADVENTURE
- 44 G7 PRO
- 45 G9 PRO
- 46 GB1-R
- 47 G10
- 48 G11V
- 49 G15
- 50 G18
- 52 777 PRO
- 53 BR01
- 54 BR03

55 AMATEUR VHF/UHF

- 57 CT590 S
- 58 CT 890
- 59 CT 990
- 60 CT 2000
- 61 CT 3000

62 PROFESSIONAL VHF/UHF

- 62 ALAN HP108
- 63 ALAN HM135
- 63 ALAN HM106

64 NAUTICAL VHF

- 64 ARCTIC

65 RADIO ACCESSORIES

72 RADIO SUMMARY TABLES

75

VIDEO CAMERAS

JUMP STARTER-POWER BANK

- 76 BIKE GUARDIAN WI-FI
- 77 BIKE GUARDIAN
- 78 STREET GUARDIAN GPS+
- 79 STREET GUARDIAN FLAT
- 80 STREET GUARDIAN DUAL
- 81 TRUCK GUARDIAN WIRELESS
- 82 H9
- 83 H5+
- 84 H3+

85 ACTION CAM ACCESSORIES

88 VIDEO CAMERA SUMMARY TABLES

- 89 ENERJUMP MINI
- 90 ER300

91

INTERCOMS

93 AN INTERCOM FOR YOUR EVERY NEED

- 94 MIDLAND INTERCOM RANGE

THE COMPANY
MIDLAND GROUP

96

MIDLAND[®]



ANALOGIC & DIGITAL CB RADIOS

THE CB RADIO BEST SUITED FOR YOUR NEEDS.

**Are you a truck driver? Do you have a camper or an off-road vehicle?
Do you want to use the so-called "citizen band" to communicate with others?**

Below you will find a small guide for your needs.
In the following pages, you will find every detail and technical information regarding each model.

YOUR FIRST CB RADIO.

Are you looking for a CB radio that's easy to install and to use? Start with these.



CB GO USB
MIDLAND M ZERO PLUS
ALAN 100 PLUS B

THE ROAD IS YOUR CRAFT.

Are you a **trucker** or a **farmer**? If you want a perfect modulation, these models are the best for you.

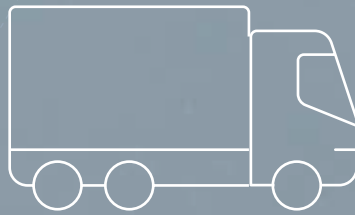

DUAL MIKE
ALAN QUARANTOTTO
ALAN 48 PRO
ALAN 78 PRO

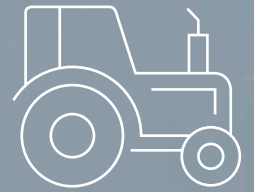

DUAL MIKE
ALAN SESSANTOTTO
M-5





TRAVELLING IS YOUR PASSION.

When you take your **camper or off-road vehicle**, you need reliability. Here are the right CB radios for you.



DUAL MIKE WIRELESS
ALAN 42 DS
CB GO USB
M-10, M-20

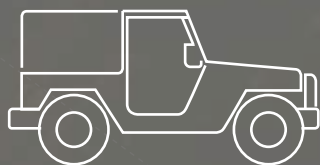

DUAL MIKE WIRELESS
M-MINI USB
M-5

I WANT THE BEST.

If you're looking for the most advanced technology, this is the right CB radio for you.



ALAN QUARANTOTTO
M-30



 **MIDLAND**[®]

CB TALK APP

A COMMUNITY THAT'S ALWAYS ONLINE



THE REVOLUTIONARY APPLICATION THAT ALLOWS YOU TO TALK TO OTHER USERS IN ANALOG OR DIGITAL MODE.

CB TALK is the free downloadable app used by over 500,000 users around the world to talk to friends and colleagues freely. The interface that appears on the App's screen closely resembles the controls found on the widespread MIDLAND ALAN 48 CB radio and the functions, although digital and advanced, are very user friendly. CB TALK becomes indispensable on many occasions; for example it is possible to insert geolocated "buoys" containing audio messages to warn other users of danger, queues, accidents, closed junctions, speed cameras, etc.

By combining the DualMike with the CBTalk App, the following exclusive features are added:

- 100 km of squelch
- 80 Channels
- DM groups
- Private groups (15 min, 5 people max.)

DOWNLOAD CB TALK APP

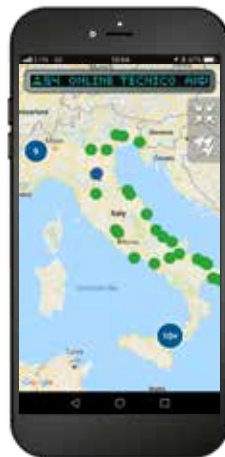

DUAL MIKE WIRELESS

THE BLUETOOTH MICROPHONE
OF THE CB TALK COMMUNITY

NEW

Bluetooth 4.2



ANALOGUE PTT
DIGITAL PTT



PRE-AMPLIFIED



SUPER BASS
LOUDSPEAKER



HANDS-FREE
PHONE



FOR A PERFECT
VOICE IN TX



LISTEN
TO MUSIC



LIGHT RING FOR
NOTIFICATIONS



LONG LASTING
BATTERY



DOUBLE USB
RECHARGE SOCKET



WIRELESS
RECHARGE



DUAL MIKE WIRELESS LOSE THE WIRE... BUT REMAIN CONNECTED!

The DUAL MIKE WIRELESS presents itself as a classical CB microphone, but is much more.

DUAL MIKE WIRELESS contains:

- the **dual PTT** to use with the analogue CB and with the CBTalk App,
- a **hands-free facility** to answer calls without having to use your hands,
- a **superb speaker** to listen to music via Bluetooth.
- new features thanks to the specifically designed CBTalk app.

FEATURES

- 3W speaker with Labyrinth™ technology that emphasizes bass tones
- Dual PTT
- Smartphone/DualMike distance up to 30m
- Bluetooth V4.2 Wireless Microphone
- Dual USB Micro Recharge socket
- Compatible with wireless charger (Via Optional DK-Dual)
- 10h hours life with volume at 50%
- Weight 153gr
- Preamplified Microphone with DSP (Digital Signal Processor) for a perfect voice
- Multifunction key
- Hands-free function

PACKAGING AND CODES

Microphone, micro-USB recharge cable, microphone holder with adhesive support
code C1363

DUAL MIKE

Bluetooth 4.2

THE FIRST DIGITAL PRE-AMPLIFIED MIKE



ANALOGUE PTT
DIGITAL PTT



PRE-AMPLIFIED



SUPER BASS
LOUDSPEAKER



HANDS-FREE
PHONE



FOR A PERFECT
VOICE IN TX



LISTEN TO MUSIC



LIGHT RING FOR
NOTIFICATIONS



LONG LASTING
BATTERY



DOUBLE USB
RECHARGE SOCKET



4 PIN "48/68"



4 PIN



6 PIN



THE CB MIKE BECOMES DUAL.

Replace your mike with DUAL MIKE and boost your CB.

DUAL MIKE contains in just one microphone:

- the **dual PTT** to use with the analogue CB and with the CBTalk App,
- a **hands-free facility** to answer calls without having to use your hands,
- a **superb speaker** to listen to music via Bluetooth.

FEATURES

- 3W speaker with Labyrinth™ technology that emphasizes bass tones
- Dual PTT
- Smartphone/DualMike distance up to 30m
- Bluetooth V4.2 Wireless Microphone
- Dual USB Micro Recharge socket
- 10h hours life with volume at 50%, 15h only CB
- Weight 290gr with cable
- Multifunction key
- Customisable Light Ring, with light indications

- Preamplified Microphone with DSP (Digital Signal Processor) for a perfect voice
- Hands-free function
- Connecting cable to the traditional CB (available in 4Pin 48, 4Pin, 6Pin versions)

PACKAGING AND CODES

Microphone, micro-USB recharge cable, microphone holder with adhesive support

code C1283 DualMike 4 Pin 48/68

code C1283.01 DualMike 4 Pin

code C1283.02 DualMike 6 Pin

DUALMIKE COMPATIBLE WITH:



**ALAN QUARANTOTTO
(4 PIN 48/68)**



MIDLAND M-10 (4 PIN)



ALAN 48 PRO (6 PIN)

DUAL MIKE WIRELESS | DUAL MIKE ACCESSORIES



DK-DUAL code C1364
Docking station: wireless recharge support

Dual Mike Wireless



ST-DUAL code C1422
Support with 12V power unit and 2 USB sockets

Dual Mike Wireless and
Dual Mike



VM-DUAL code C1407
Air vent fixed support

Dual Mike Wireless and
Dual Mike



AM-DUAL code C1408
Dual Mike adhesive support kit

Dual Mike Wireless and
Dual Mike



AL-DUAL code C1403
Voltage reducer 12V-5V and Micro USB
for Alan Quarantotto, Alan Sessantotto

Dual Mike



AL-DUAL code C1403.01
Voltage reducer 12V-5V and Micro USB
for all other Midland CB radios

Dual Mike

MIDLAND M-5

THE CB "IN THE MIKE"



BAND



EMERGENCY



DIGITAL SQUELCH



NOISE BLANKER



DUAL SPEAKER



USB PORT



2 PIN KENWOOD



EXTRA SMALL: 102x100x25mm

USB PORT

The CB world finds a new style with the **Midland M-5**, the "CB in the mike" to have everything on hand all the time, thanks to the buttons placed directly on the microphone with an LCD display to see channels, bands and settings.

The compact size and its particular configuration allow the radio to be placed in the storage compartment or even in the boot (with accessory cable extension).

A new way to enjoy the CB that allows you to drive with a minimal cabin.

FEATURES

- Band: Multi (see page 36)
- 40 AM/FM channels
- Output power: 4W AM/FM
- Die-cast metal body
- "Handy" controls on the mike
- Selectable multicolour backlight (7 colours)
- Manual squelch 28 levels
- Digital squelch at 5 levels
- RF gain
- Scan
- Indication S-meter RX-TX

- Sliding mounting bracket
- Lighter power supply
- USB socket for charging electrical devices
- 2 pin Kenwood socket (microphone)

PACKAGING AND CODES

1 radio, microphone with UP/DOWN keys, fixing screws, mounting bracket, power cord with cigarette lighter socket
code C1277

**EXPORT VERSION:
10W AM/FM - 400CH**

R74574

2 mt. long microphone extension cord for M-5/M-30/CT3000

MIDLAND M-MINI USB

THE SMALL CB RADIO WITH USB SOCKET

NEW



BAND



EMERGENCY



DIGITAL SQUELCH



NOISE BLANKER



USB RECHARGE
SOCKET



RJ45



REMOVABLE
MICROPHONE



THE BLISTER VERSION

CB GO-USB, READY IN JUST A FEW MINUTES.

A complete pack, containing: M-Mini USB, the Midland multimedia mini-transceiver, power cord with cigarette lighter plug and Midland LC29 high-performance antenna, fitted with a magnetic base.

Become a part of the CB community.

Are you looking for a CB radio that's easy to install?

M-Mini USB is your answer: essential, 40 channels, can be powered by connecting it to the cigarette lighter outlet using the power cable included in the package.

On the front, there is a practical USB socket so that you can recharge all your devices: smartphones, tablets... and a RJ45 socket, which makes the microphone removable.

The aluminium chassis is the finishing touch of **M-MINI USB**, making it robust and resistant to any movement.

FEATURES

- 40 AM/FM channels
- Selectable frequency bands: I, I2, D4, EU, EC, PL, UK, IN (see page 36)
- Output power: 4W AM/FM
- UP/DOWN keys on the microphone
- Channels scan
- LCD display with S/meter
- Double squelch mode (9 and 28 levels)
- Adjustable reception attenuator (RF gain)
- Emergency channel 9/19
- External loudspeaker socket
- Removable microphone with RG45 connector
- USB recharge socket
- Power cable with cigarette lighter plug

PACKAGING AND CODES

Box M-Mini USB

1 radio, microphone with UP/DOWN keys, power cord with cigarette lighter socket, fixing screws, mounting bracket
code C1262.04

Blister CB GO USB

CB M-Mini USB, power cord with cigarette lighter socket, LC29 antenna, magnetic base.
code C1262.05

**EXPORT VERSION:
9W AM/FM - 400CH**

MIDLAND M-10

THE FIRST MULTIMEDIA CB

USE YOUR WIRELESS CB WITH WA ACCESSORIES

WA-CB C1276

Bluetooth adapter (option)

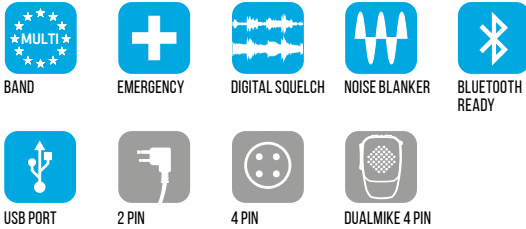

The first multimedia CB launched on the market in 2016, allows hands-free Bluetooth communication (with optional adapter). Full compatibility with traditional Midland accessories and a USB socket to charge any device.

Find below the features of the Midland M-10, the first multimedia CB produced by the people who have made CB history, Midland.

FEATURES

- Band: Multi (see page 36)
- White Bright Light™ backlight
- AM/FM switch
- Automatic digital squelch
- Selectable audio: internal, from earphones, both
- ANL: automatic noise limiter
- Noise Blanker System
- Emergency channel 9-19
- USB socket for smartphone and tablet recharging

- 2 pin socket for accessories
- External loudspeaker socket
- 4 pin microphone connector

PACKAGING AND CODES

1 radio, microphone, fixing screws, mounting bracket, power cable with car power supply code **C1185**

EXPORT VERSION:
10W AM/FM - 400CH

THE CB RADIO ALLOWING WIRELESS COMMUNICATION THANKS TO MIDLAND BLUETOOTH DONGLES

See Radio Accessories Section, page 70

WA31 C1202

Bluetooth microphone with air tube earpiece and PTT



WA21 C1201

Bluetooth headset microphone with PTT



WA29 C1203

Bluetooth headset microphone with neckband and PTT



MIDLAND M-20

THE ADVANCED MULTIMEDIA CB

USE YOUR WIRELESS CB
WITH WA ACCESSORIES

WA-CB C1276

Bluetooth adapter
(option)



BAND



EMERGENCY



DIGITAL SQUELCH



NOISE BLANKER



BLUETOOTH READY



USB PORT



2 PIN



6 PIN



DUALMIKE 6 PIN



USB PORT

WIRELESS
COMMUNICATION

Even more functions than its predecessor M10. Large LCD screen, knob to **change channel** (also on the mike), **display indicator** of the operating band are the three features that make the **M-20** model a really efficient multimedia CB. Like all Midland multimedia CBs, with this product communication is possible in wireless mode, thanks to the **Bluetooth WA accessories**, connected to the 2-pin socket.

FEATURES

- Band: Multi (see page 36)
- Large LCD display, White Bright Light™
- White Bright Light™ backlight
- AM/FM switch
- Automatic digital squelch, digital S-Meter
- Selectable audio: internal, from earphones, both
- ANL and Noise Blanker System that can be selected and disabled
- 9-19 emergency channel and selectable priority channel
- Microphone with Up/Down and priority channel

- USB socket for smartphone and tablet recharging
- 2 pin socket for accessories
- External loudspeaker socket
- External S-Meter socket
- 6 pin microphone connector

PACKAGING AND CODES

1 radio, microphone, fixing screws, mounting bracket, power cable
code C1186

EXPORT VERSION:
10W AM/FM - 400CH

MIDLAND M-30

THE TOP-OF-THE-RANGE M SERIES CB



BAND



EMERGENCY



DIGITAL SQUELCH



NOISE BLANKER



ROSMETER
S-METER



AUDIO EQUALIZER



DUAL WATCH



8 MEMORY
CHANNELS



TOT



12/24V



RJ45



If you are looking for a multi-function CB, this is the model for you.

Ready to give you the best of the M series, thanks to **6 programmable keys**, wide **multi-colour TFT display**, with **Dual Watch** function to monitor two channels at the same time. Automatic switch-on, display of the channel number or channel number plus frequency, make it **the perfect tool for communication professionals**.

FEATURES

- Band: AM/FM Multi (see page 36)
- 6 programmable keys
- Wide colour TFT display
- Supply 12V-24V

- Metal alloy radio body for better heat dissipation
- Display of the channel number or channel number + frequency.
- Automatic adjustable Digital Squelch on 9 levels
- S-Meter/SWR Meter
- RF attenuator
- Scan function, Dual Watch
- Customizable Roger Beep
- 9/19 emergency channels and priority channel
- Noise Blanker
- Audio equalizer
- Protection against polarity inversion
- 8 customizable memory channels

- TOT (Time Out Timer)
- Adjustable backlight
- Automatic switch-on
- Keypad lock
- Microphone with RJ45 connector with keys
- UP/DOWN/Priority channel

PACKAGING AND CODES

1 radio, microphone, mounting bracket, fixing screws

code C1313

EXPORT VERSION:

AMATEUR BAND 26-28MHZ 400CH 8W (AM)/15W (FM)

R74574

2 mt. long microphone extension cord for M-5/M-30/CT3000

PROGRAMMING SOFTWARE PRG-30 C1318

Complete with USB connection for PC

MIDLAND M ZERO PLUS

THE 40-AM-FM-CHANNEL CB



BAND



CHANNELS



EMERGENCY



POWER 12V



4 PIN



DUALMIKE 4 PIN



Evolution of the excellent Midland M-ZERO, the new PLUS version adds the **FM band**.

ABS body for practical and light use and with **SMD technology** for the electronic structure. With its **40 AM/FM channels**, this CB is extremely easy to use.

M-ZERO PLUS is definitely the best compromise between quality and price of the M line.

FEATURES

- Band: AM-FM (Poland-Italy)
- Channel display, black background with white texts
- UP/DOWN buttons
- Squelch
- Emergency memory channel: to immediately select the emergency channel (set by the user)
- RF Gain: sensitivity control in RX
- Quick Scan

- On/Off keypad beep
- 4-pin microphone connector

PACKAGING AND CODES

1 radio, microphone, mounting bracket, fixing screws

code C1169.01

EXPORT VERSION: 120CH

ALAN 100 PLUS B

THE ENTRY LEVEL CB



BAND



CHANNELS



EMERGENCY



POWER 12V



4 PIN



DUALMIKE 4 PIN



The CB that has accompanied car, caravan and truck drivers since 1998.

An excellent product to enter the CB world with everything that is required to communicate.

An easy communication tool for everyone.

FEATURES

- Band: AM-FM
- Emergency channel 9-19
- Display channels
- Up/down buttons
- Squelch
- Transmission and reception led
- External speaker socket
- 4-pin microphone connector

PACKAGING AND CODES

1 radio, microphone, mounting bracket, fixing screws

code C442.09

ALAN QUARANTOTTO

THE KING OF CB

SINCE 1986

THE BEST SELLER
40CH CB

**ONLY FOR
ITALIAN MARKET**



BAND



CHANNELS



NOISE BLANKER
SYSTEM



S-METER



12V



4 PIN "48/68"



DUAL MIKE
4 PIN "48/68"



The CB that made the communication history, returns completely renewed, but still faithful to the DNA of the historical product.

Thanks to its fame, very easy use and its **complete range of functions**, it has been the Italian best-seller for over 30 years. A travelling companion and an **irreplaceable work tool for those who are driving every day**.

FEATURES

- Band: AM-FM
- Noise blanker System
- MIC Gain: Mic gain control for a always perfect modulation
- RF Gain: set the gain of the antenna preamplifier
- FIL: set the intonation of the incoming signal
- ANL: automatic noise cut down
- Squelch
- PA: activating this switch the CB becomes a low frequency amplifier (with additional speaker)
- White LED backlight, for every light condition
- 4-pin microphone connector

PACKAGING AND CODES

1 radio, microphone, mounting bracket, fixing screws

code C217.09

ALAN SESSANTOTTO

THE MYTHICAL 34-CHANNEL CB

SINCE 1983

THE BEST SELLER
34CH CB

**ONLY FOR
ITALIAN MARKET**



BAND



CHANNELS



NOISE BLANKER
SYSTEM



S-METER



12V



4 PIN "48/68"



DUALMIKE
4 PIN "48/68"



The brother of the mythical Alan Quarantotto, that made communication history, returns completely renewed, but still faithful to the DNA of the historical product. Since 1983 the **sales champion** in its category.

FEATURES

- Band: AM-FM
- Noise blanker System
- MIC Gain: Mic gain control for a always perfect modulation
- RF Gain: set the gain of the antenna preamplifier
- FIL: set the intonation of the incoming signal
- ANL: automatic noise cut down
- Squelch
- PA: activating this switch the CB becomes a low frequency amplifier (with additional speaker)
- White LED backlight, for every light condition
- 4-pin microphone connector

PACKAGING AND CODES

1 radio, microphone, mounting bracket, fixing screws

code C025.09

NEW

ALAN 48 PRO

THE TOP-OF-THE-RANGE MULTIBAND



BAND



SIGNAL



EMERGENCY



DIGITAL SQUELCH



NOISE BLANKER



MEMORY



DUAL WATCH



POWER
12/24V



6 PIN



DUALMIKE 6 PIN



The new **Alan 48 Pro** is the top of the range multiband, the CB line expressly conceived for trips and routes in different European countries.

What does this mean? It means that **Alan 48 Pro** has an adjustable power – 1W/4W – to be adjusted to the frequencies and regulations of the country in which it is used.

With a power supply voltage of 12/24 V, **Alan 48 Pro** does not need reducers and it is of easy installation in the dashboard compartment, thanks to the DIN bracket (optional).

Alan 48 Pro is high tech and complete in facing all sorts of noises: it is equipped with the Digital Squelch, that eliminates the background swish and the Noise Blanker, to cancel the environmental noises.

TECHNICAL SPECIFICATIONS

- Band: Multi (see page 36)
- Output power: 1W/4W depending on the country
- **DS: Automatic Digital Squelch**
- **Noise Blanker/ANL filters**
- **Power supply voltage: 12/24V**
- Blue back-lit multifunction display
- "Precision series" microphone with UP/DOWN/LOCK buttons
- Squelch
- RF Gain: sensitivity control in RX
- MIC Gain: microphone amplification
- 5 memory positions
- Emergency channel
- SCAN function
- Dual watch function

- External S-Meter socket
- PA: by enabling this switch, the device becomes a low frequency amplifier (with the help of an additional speaker)
- External speaker socket
- 6-pin microphone connector

PACKAGING AND CODE

1 radio, microphone, mounting bracket, fixing screws

Code C422.16

EXPORT VERSION: 400CH

ALAN 78 PRO

THE COMPACT MULTIBAND

NEW



BAND



SIGNAL



EMERGENCY



DIGITAL SQUELCH



NOISE BLANKER



POWER
12/24V



6 PIN



DUALMIKE 6 PIN



The new **Alan 78 Pro** is the compact and essential CB radio dedicated to multiband: that is, to the CB frequencies related to travelling and routes in multiple European countries. What does it mean? It means that **Alan 78 Pro** has adjustable power - 1W/4W - that can be adapted to specific frequencies following the laws of the country in which you are travelling. With a 12/24 V power supply, **Alan 78 Pro** does not need reducers and can be easily installed in the dashboard compartment thanks to the DIN bracket (optional).

Alan 78 Pro is high tech and perfect even when dealing with noise: its Digital Squelch eliminates background noises, while its Noise Blanker eliminates continuous environmental noise.

FEATURES

- Band: Multi (see page 36)
- Output power: 1W/4W depending on the country
- **DS: Automatic Digital Squelch**
- **Noise Blanker/ANL filters**
- **Power supply voltage: 12/24V**
- Blue back-lit multifunction display
- "Precision series" microphone with UP/DOWN/LOCK buttons
- Squelch, SCAN
- LCR function (to recall the last channel that was used)
- External speaker socket
- External S-Meter socket
- 6-pin microphone connector

PACKAGING AND CODES

1 radio, microphone, mounting bracket, fixing screws
code C423.16

EXPORT VERSION: 400CH

ALAN 42 DS

THE PORTABLE CB WITH DS

NUMBER ONE
IN THE WORLD OF
PORTABLE CB RADIOS

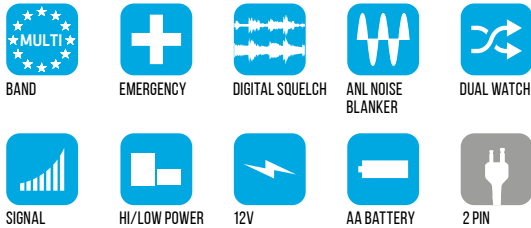

The portable CB transceiver “par excellence”, **ALAN 42 DS**, with new electronic components to give a unique audio experience.

It is fitted with **digital squelch, ANL filters and Noise Blanker** that removes all annoying noises caused by sources outside the vehicle.

A multistandard transceiver that allows selecting **any European band and operate in all EU countries.**

FEATURES

- Band: Multi (see page 36)
- Power: 1W/4W depending on the country
- Emergency channel (EMG)
- Keypad lock (LOCK)
- Battery status indicator
- High-lower power (H-L)
- Display back-lighting button
- AM-FM button selection
- SCAN function, Dualwatch
- Antenna socket: BNC
- Powered by 8 AA batteries or 12V
- 2-pin accessory socket

PACKAGING AND CODES

1 radio, wall charger for 8 AA battery pack, empty battery pack for 6 AA Alkaline battery, empty battery pack for 8 AA rechargeable batteries with charging socket, adapter for car use with external SO 239 antenna socket, scratch resistant case, antenna, belt clip, wrist strap

code C1267

EXPORT VERSION: 400CH

OPTIONAL ACCESSORIES

Alan 42 DS is compatible with straight 2-pin accessories socket, see Radio Accessories Section page 69



PB E42 - C602
Empty battery pack to charge 8 AA battery (not included)



R74593 (Alan 42 DS/Multi)
Car adapter with socket for external antenna SO239



R17365
Wall adapter



ANTEENNA HIGH PERFORMANCE ALAN 42/ALAN 42DS - C611.01
Antenna

CB FLEX B - C394
Flex antenna 53 cm



MIDLAND[®]

CB RADIO ACCESSORIES

MICROPHONES

CB MICROPHONES 4-PIN "48" CONNECTOR



**DUALMIKE
C1283**
Bluetooth **preamplified** CB microphone.
For Alan 48/68 and Midland 8001-XT

Bluetooth™ 4.2



**MDL4190
C074**
Omni directional dynamic microphone.
Impedance 500 Ohm.
For Alan 48, Alan 68S, Midland 8001-XT

FOR ITALIAN MARKET ONLY



**MIDLAND F48
C1022**
Preamplified microphone with echo.
For Alan 48/68 and Midland 8001-XT



**MDL-NC
C1155**
Omni directional dynamic microphone.
Noise-cancelling broadband microphone capsule.
Impedance 460 Ohm.
For Alan 48, Alan 68S, Midland 8001-XT



**MIKE MIDLAND
T059.01**
Omni directional dynamic microphone.
Impedance 500 Ohm.
For Alan 48, Alan 68S, Midland 8001-XT

FOR ITALIAN MARKET ONLY

CB MICROPHONES 6-PIN CONNECTOR



**DUALMIKE
C1283.02**
Bluetooth preamplified microphone for CB Multi Standard radios

Bluetooth™ 4.2



**MIKE MULTI
C714**
"Precision series" microphone with Up/down buttons, Lock button.
For series Plus Multi, Excel, Midland 248, 248 XL, 278, Alan 121 and Midland 220 (no channel change)



**MIDLAND F MULTI
C1023**
Preamplified microphone with echo for CB Multi Standard radios



**MIKE M20
C1266**
Microphone with a stylish design with Up/Down/Priority buttons for M-20. Compatible also with Plus Multi B, Excel, Midland 248, 248XL, 278 and Alan 121 (for these models the Priority button becomes Lock).



**MR120
C404.01**
Electret microphone with Up/Down buttons.
For series Plus Multi, Excel, Midland 248, 248 XL, 278, Alan 121 and Midland 220 (no channel change)

MICROPHONES, BRACKETS, HOLDERS AND CABLES

CB MICROPHONES 4-PIN CONNECTOR



DUALMIKE
C1283.01
Bluetooth **preamplified** CB microphone.
For Midland M-10, M Zero/Plus, Alan 100 Plus B, Midland 200, Midland 203



MIDLAND F100
C1021
Preamplified microphone with echo.
For Alan 100 Plus B, Midland 200, Midland 203

Bluetooth™ 4.2



R51504
Original microphone Alan 100 Plus B/Midland 203. For Alan 100 Plus B, Midland 203, Alan 199, Midland 210 DS

BRACKETS



SPM-48 DIN
C791
DIN bracket for Alan 48 Plus Multi B/Excel Multi, Midland248/248XL, Alan 48 Pro



SA 48
T769
Complete with 1 bracket, 2 slides, 2 handles, 2 screws for Alan 48, 68S



SPM-78 DIN
C792
DIN bracket for Alan 78 Plus Multi B, Midland 278, Midland M20, Alan 78 Pro



G1020.01
Dashboard kit white New Neptune



SPM-100 DIN
C807
DIN bracket for Alan 100 Plus, 100 Plus Euro, Alan 100 Plus B, 199-A, Midland 203, Midland 210, Midland M10

MICROPHONE HOLDERS



PM3
T431
Microphone-holder with screw fastening and bi-adhesive



PMF
T570
Microphone-holder with screw fastening and bi-adhesive, fluorescent

CABLES



R74574
2 mt. long mic extension cord for M-5/M-30/CT3000



T060
3-pole lead with fuse-holder. Length: 160 cm. For Alan 48, Alan 68S

SPEAKERS, VOLTAGE REDUCERS, AMPLIFIER

SPEAKERS



**AU 20
T775**
External speaker 5W max

Impedance 8 Ohm
Rated power 2 W
Maximum power 5 W
Size in mm 65x55x65



**AU 30
T682**
External speaker 12W max

Impedance 8 Ohm
Rated power 7 W
Maximum power 12 W
Size in mm 110x60x60



**AU25E
T681.01**
External speaker 5W max.
Recommended for VHF
professional mobile transceivers
Alan HM35/70/06

Impedance 8 Ohm
Rated power 3 W
Maximum power 5 W
Size in mm 100x60x60

VOLTAGE REDUCERS



**RDT 10/A
C589**
AUTOMOTIVE approval no.:
E3 02 1049

Switching technology No
Input voltage 24-28 Vcc
Output voltage 13,8 Vcc
Size in mm 64x120x112
Weight 670 g
Continuous 6 A
6'3' 10 A/-
Max peak 10 A

HF AMPLIFIER



**HF747
C882**
HF power amplifier AM-FM-
SSB-CW (for amateur use only)

Frequency HF
Power supply 12-14 Vcc
Current drain 8/10 A
Input power 0,5/10 W
Output power 100 W max
Mode AM/FM
SSB/CW
Fuse 2 x 12 A
Size in mm 109x210x35
Weight 605 g

SWR METER WATTMETERS, POWER SUPPLIES

SWR METER WATTMETERS



KW 505

C1165

KW 505 is a 2-function measurement instrument that operates on 1.5 - 150 MHz frequency range to constantly monitor any antenna.

Power reading on two levels: 0-10W and 0-100W.

RF power	10W - 100W
R.O.S.	1:1 / ∞
Impedance	52 Ohm
Frequency range	1.5 - 150 MHz
Size in mm	135x60x70
Weight	280 g
Connector	SO239



KW 520

C530

Suitable for checking transmitter power and antenna adaptation, with two separate measuring lines, one from 1.8 to 200 MHz and the other from 140 to 525 MHz. This enables the simultaneous connection of 2 systems: one in HF/VHF and the other in VHF/UHF and select which to use to take the measurements with the specific switch. The measurement line selected is seen by the specific LED. With the possibility of measuring peak or medium value, fine calibration of the index, base scale duplicator button of power from 200 to 400 W.

RF power	5W - 20W - 200W - 400W
R.O.S.	1:1 / ∞
Impedance	52 Ohm
Frequency range	1.8 - 200 MHz/140 - 525 MHz
Size in mm	155x100x60
Weight	730 g
Connector	SO239

POWER SUPPLIES



SW35

47500

Input voltage
220-230Vca-50Hz

Output voltage
13,8Vcc

Rated output current
Max 3-5A



SW79

47520

Input voltage
220-230Vca-50Hz

Output voltage
13,8Vcc

Rated output current
Max 7-9A



SW57

47510

Input voltage
220-230Vca-50Hz

Output voltage
13,8Vcc

Rated output current
Max 5-7



SW102

47530

Input voltage
220-230Vca-50Hz

Output voltage
13,8Vcc

Rated output current
Max 10-12A

CAR & TRUCK ANTENNAS



LUX 1000-S
C1258



LUX 1500-S
C1259



LUX 700-PL
C1330



LUX 1500-PL
C1257

SPACE ANTENNAS: ILLUMINATE WHEN TRANSMITTING

Midland Lux is the genesis of a new line of CB antennas, designed to make the installation of the best "CB radio" on vehicles. The antenna base is fitted with a waveguide that glows when it is crossed by radio frequency. It automatically illuminates when the radio is transmitting, thus signalling the correct operation of the device. It does not need any power and is totally waterproof. LUX1500-S and LUX 1000-S: Anti-theft and protection hinge. LUX 1500-PL e LUX 700-PL suitable for gutter, mirror, centre roof mount (accessories not included). With the KIT they become magnetic (see page 28).



X-TURBO 60
C871



X-TURBO 80
C872



ML143
C1164



ML 145
T562.01

CAR & TRUCK ANTENNAS



ALAN PC 4
T739



ALAN PC 6
T736



ALAN PC 8
T701



ALAN S9 PLUS
T638



FUNK 90
T638.04



FUNK 130
T638.05



FUNK 150
T638.06



MINI
C593

MAGNETIC CB ANTENNAS



KIT 226
LUX700-PL+120/PL



KIT 224
LUX1500-PL+120/PL



KIT 212
ML143+BASE M



KIT 007
ML145 + 120/PL
High power antenna with
magnetic base Ø 120 mm



LC29
C1018



LC65
C1020

MAGNETIC BASES



BM-MP C1182

Developed for the MP120 antenna, it is designed to withstand high speeds. Equipped with scratch resistant magnet-covering cap. Supplied with universal DV 27 base (already installed).



BM-MLC143 C1183

Developed for the ML 143 antenna, it is designed to withstand high speed. Equipped with scratch resistant magnet-covering cap. Supplied with PL mount (already installed).



BM 120/DV T057

BM 120 DV is designed to withstand high speeds. Equipped with scratch resistant magnet-covering cap. Supplied with universal DV 27 base (already installed).



120/PL T036

Designed to withstand high speeds. Equipped with scratch resistant magnet-covering cap. Supplied with attachment for PL (already installed).



BM 150/PL 6782

Designed to withstand high speeds. Equipped with scratch resistant magnet-covering cap. Supplied with attachment for PL (already installed). Diameter: 15 cm.



MINI MAGNETIC BASE 6677

Mini BNC magnetic base (Ø35mm) with enormous adhesive force to accommodate shorter rubber antennas. with 2.40m-long RG 174 cable, BNC terminal connector.

VHF/UHF ANTENNAS



NR-770R
C626
F.O.W.*



NR-770S
C625



M-285
C631



M-150 GSA
C632



VH 1
F092

* F.O.W.: Reclining structure. The reclining style guarantees that the antenna can move extensively in all directions, enabling the convenient parking of the car in the garage without removing the antenna. Equipped with a safety block for safe driving.

BASIC, BALCONY, WIDE BAND ANTENNAS



CB BASE ANTENNAS,
EQUIPPED WITH A SYSTEM
TO PROTECT AGAINST
WATER LEAK

ENERGY NEW 1/2 T241.02

Energy New 1/2 is telescopic base antenna, ground plane at 1/2 lambda, operating on 27MHz, built in anti-corrosion aluminium. All elements are telescopic and facilitate installation.



CB BASE ANTENNAS,
EQUIPPED WITH A SYSTEM
TO PROTECT AGAINST
WATER LEAK

ENERGY NEW 5/8 T242.02

Energy New 5/8 is telescopic base antenna, ground plane at 5/8 lambda, operating on 27MHz, built in anti-corrosion aluminium. All elements are telescopic and facilitate installation.

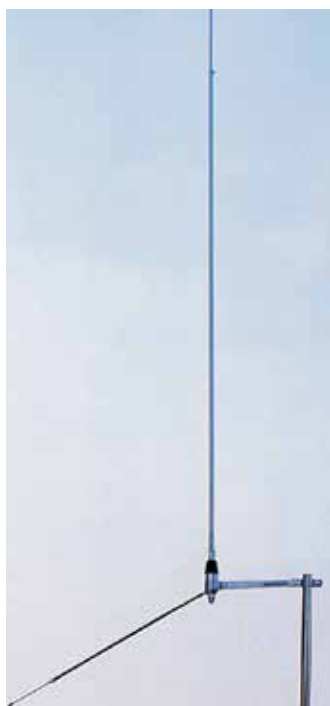

BASE STATION BALCONY
ANTENNA

BOOMERANG 6350

Balcony/fix station 1/2 wave antenna for roof or balcony fitting.

The aluminium radiants are 300cm in length. ROS calibration with adjustment of the whip on the shortest radian. Supplied with assembly kit. ROS: <1.2



BASE STATION BALCONY
ANTENNA

MINI BOOMERANG 6360

Balcony/fix station 1/4 dipole antenna.

Aluminium radiants 172cm, 173cm in radial length. Supplied with assembly kit.



BALCONY/STATION
ANTENNA

HURRICANE-STORM27 63570

1/2 wave fixed station/balcony antenna. It can be installed in attics, balconies etc.

The ROS calibration is not required but the connecting cable must have the length specified in the user manual. Supplied with assembly kit.



WIDE BAND ANTENNA

SKY BAND 6161

Sky Band allows you to receive continuous coverage up to 1300 MHz and to broadcast on all amateur bands from 144 MHz upwards. It is therefore very useful for multiband devices and "dualbanders" for Full Duplex transmissions. Stainless steel whips.

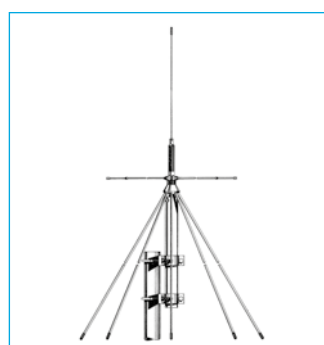

WIDE BAND ANTENNA

ALL BAND 61700

High performance antenna, usable both as receiving antenna and for transmission on various amateur radio frequencies.

Made of stainless steel, chromed brass and anodised aluminium. Easy to install.

BRACKETS, CONNECTIONS

BRACKETS



DAF XF106
C1430
CB antenna holding bracket



SCANIA
NEW GENERATION
C1430.01
CB antenna holding bracket



RENAULT T
C1430.02
CB antenna holding bracket



SCANIA R2/R3
C1430.03
CB antenna holding bracket



VOLVO FH4
C1430.04
CB antenna holding bracket



MERCEDES MP4
C1430.05
CB antenna holding bracket



MAN TGX E5-E6
C1430.06
CB antenna holding bracket



IVECO HIWAY
C1430.07
CB antenna holding bracket



GR-L
C1047
Stainless steel mount.
Size: 38x64x99mm



GR-XL
C1048
Stainless steel mount
Size: 38x100x180mm

MOUNTS



GR-F INOX
T751
Gutter mount. In stainless steel for vehicle antennas, with fixing hole reducer



GRONDA 27
T054
Gutter mount. Enables the Gutter mount installation of any mobile antenna without piercing the bodywork. The special rubber suction pad guarantees perfect adherence to the vehicle roof



SP-S INOX
T752
Gutter mount. In stainless steel for vehicle antennas, with adjustable inclination and fixing hole reducer

MOUNTS, CONNECTORS, CABLES

MOUNTS



**SP 21
T390**
Mirror mount. Enables the installation of any mobile antenna on the rear view mirror, avoiding unsightly holes in the bodywork



**DV 27 PL
T599**
Roof centre adapter DV/SO239

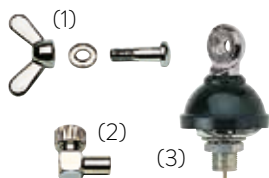

**SC 27
T441** Specific screw (1)
**LC 27/10-N
T370.01** Connector (2)

**FC 27
T478** Base for antennas (3)
Screws, connector for FC 27 and base for Midland antennas

CONNECTORS



**PL259/R
T292.02**



**UG 255
F076**
Connector for BNC/SO239



**PL 259/RL
T377**



**SA 95
T211**
SO239 connector RCA plug



**PL 259
T205**
Connector for RG8/RG213 cable

CABLES



RG58 T633 - R73895
3-piece lead for roof centre mount.
Lead type: RG58 Length: 4m
R73895 for PC antennas



**CENTRE ROOF MOUNT
T301**
Centre-roof mount for US antennas
Lead type: RG58 Length: 3.5 m



R 45/58-U T194
Connection lead for CB transceivers.
Lead type: RG58 Length: 45 cm
2 connectors PL259



R 90/58-U T193
Connection lead for CB transceivers.
Lead type: RG58 Length: 90 cm
2 connectors PL259



7581
1.5m coaxial cable extension with 2 PL259 connectors



75820
10m coaxial cable extension with 2 PL259 connectors



**RG 58-U
7460**
100m roll

ANTENNAS SPECIFICATIONS

CAR & TRUCK CB ANTENNAS

SPECIFICATIONS			
Operating frequency	26-30MHz	26-28 MHz	25-30 MHz
Number of channels	120	200	150/240/130
Maximum applicable power	600/800	800 W (max 1500)/ 1000 W (max 1700)	400/600/800 W
R.O.S. min.in centre band	<1.2	<1.2	<1.2
Length (cm)	120/170	160/180	115/160/163
Impedance (Ohm)	50	50	50
Weight (g)	503/525	670/690	450
Whip material	Steel	Steel	Steel
Antenna connection type	3 parts	3 parts	3 parts
Hole diameter (mm)	12.5	10	10
Lead (m)	4	4	4

SPECIFICATIONS	ALAN S9 PLUS	FUNK 90/130/150	MINI
Operating frequency	25-30 MHz	26-28 MHz	26÷28 MHz
Number of channels	200	-	40
Maximum applicable power	300 W	200/250/300 W	80 W
R.O.S. min. in centre band	<1.2	<1.2	1.2:1
Length (cm)	155	90/130/150	68
Impedance (Ohm)	50	50	50
Weight (g)	390	160/190/200	210
Whip material	Steel	Steel	Stainless steel inox
Antenna connection type	DV	DV	3 pezzi
Hole diameter (mm)	12,5	10	12,5
Lead (m)	4	4/4/4	4 con PL259

You can find the LUX 700-PL, LUX 1500-PL, ML143 and ML145 technical specifications in the CB magnetic antennas table.

MAGNETIC CB ANTENNAS

SPECIFICATIONS	KIT226 (LUX700-PL)	KIT224 (LUX1500-PL)	KIT212 (ML143)
Operating frequency	26-28 MHz	26-28 MHz	26-28 MHz
Number of channels	40	120	120
Maximum applicable power	600 W pep	1000 W pep	300 W pep
R.O.S. min. in centre band	<1.2	<1.2	<1.2
Length (cm)	90	164,5	170
Impedance (Ohm)	50	50	50
Weight (g)	330	358	1500
Whip material	Stainless steel	Stainless steel	Stainless steel
Mount	Magn. base 120mm with PL (SO239 antenna only)	Magn. base 120mm with PL (SO239 antenna only)	Magn. base 120mm with PL (SO239 antenna only)
Hole diameter without magn. base (mm)	16	16	16
Lead (m)	4	4	4

SPECIFICATIONS	KIT 007 (ML145)	LC29	LC65
Operating frequency	26-28 MHz	26-28 MHz	26.965-27.405 MHz
Number of channels	90	40	40
Maximum applicable power	400 W pep	10/30 W (peak)	60/300 W (peak)
R.O.S. min. in centre band	<1.2	≤ 1.2:1	≤ 1.2:1
Length (cm)	146	29	115
Impedance (Ohm)	50	50	50
Weight (g)	1600	400	1000
Whip material	Stainless steel inox	Stainless steel inox	Stainless steel inox
Mount	Magn. base 120mm with PL (SO239 antenna only)	Magn. base Ø 68 mm with PL	Magn. base Ø 120mm with PL
Hole diameter without magn. base (mm)	16	-	-
Lead (m)	2,9	4	4

ANTENNAS SPECIFICATIONS

MAGNETIC BASES

SPECIFICATIONS	BM-MP	BM-MLC143	BM 120/DV	120/PL	BM-150PL	BM MINI
Frequency range	26-460 MHz	26-460 MHz	26-460 MHz	26-460 MHz	26-460 MHz	26-460 MHz
Max. speed	80/130 Km/h	80/130 Km/h	80/130 Km/h	80/130 Km/h	80/130 Km/h	80/130 Km/h
Base diameter	Ø 120 mm	Ø 120 mm	Ø 120 mm	Ø 120 mm	Ø 150 mm	Ø 35 mm
Weight	830 gr	940 gr	750 gr	700 gr	800 gr	100 gr
Lead	4m	4m	3m	3m	3.9m	2.4m

VHF/UHF CAR & TRUCK ANTENNAS

SPECIFICATIONS	NW-2000	NR-770R	NR-770S	M-285	M150-GSA
Frequency	144/430 MHz	144/430 MHz	144/430 MHz	138-174 MHz	138-174 MHz
Type	1/2λ(144 MHz) 2x5/8λ(430 MHz)	1/23λ(144 MHz) 2x5/8λ(430 MHz)	1/4λ(144 MHz) 1/2λ(430 MHz)	5/8λ	1/4λ
Power	200 W	200 W	100 W	200 W	200 W
Length (cm)	98	98	43	100	51
Connector type	PL	PL	PL	PL	PL

SPECIFICATIONS	
Operating frequency	108:550Mhz
Maximum applicable power	100W
R.O.S. min. in centre band	1:1,2
Length (cm)	51
Impedance	50 Ohm
Weight	300 g
Whip material	Stainless steel
Connector type	PL259 (not supplied)
Hole diameter	12 mm
Lead	4m

BASE CB ANTENNAS

SPECIFICATIONS	ENERGY NEW 1/2	ENERGY NEW 5/8
Operating frequency	25-29 MHz	144-430 MHz
Maximum applicable power	500 W PEP	200 W
Impedance	50 Ohm	50 Ohm
Band R.O.S.	1,2:1	1,5:1
Length	575/ 650	170
Weight	2,1/ 2,5 Kg	0.9 Kg
Ø support pole	30-40 mm	30-35 mm
Connector	SO 239	SO239
Whip	Aluminium	Fibreglass/steel

BALCONY/STATION AND WIDE BAND ANTENNAS

SPECIFICATIONS	BOOMERANG	MINI BOOMERANG	HURRICANE-STORM27	SKY BAND*	ALL BAND
Operating frequency	27-30 MHz	27-30 MHz	25-29 MHz	70-1300MHz RX only	25 - 1300 49,5...50,5, 120...180, 215...300, 415...465, 610...650, 700...1000, 1130...1300
Number of channels	200	150	100	-	-
Maximum applicable power	600W	450W	300W	-	300W (200W VHF/ UHF)
Impedance	50 Ohm	50 Ohm	50 Ohm	50 Ohm	50 Ohm
Band R.O.S.	1:1:2	1:1:2	1: 1.5	-	1: 1.5
Length	275	172	96	66	160
Weight	880g	800g	700g	-	1140g
Ø support pole	-	-	-	1044g	25-54mm
Connector type	UHF Female	UHF Female	UHF Female	-	SD 1300 N = N-Female SD 1300 U = UHF- Female
Whip	Aluminium	Fibreglass	Aluminium	Aluminium	Aluminium, chromed brass, stainless steel, nylon

* SKY BAND is indicated for RX functioning (specific for scanners). A low SWR value is not guaranteed on the indicated frequencies and consequently the antenna will perform poorly with TX.

CB OVERVIEW TABLES

MODEL	MIDLAND M-5	MIDLAND M-MINI	MIDLAND M-10	MIDLAND M-20
Type	Vehicle multi-band CB	Vehicle multi-band CB	Vehicle multi-band CB	Vehicle multi-band CB
General				
Channels/Bands	see multi equipment table*	see multi equipment table*	see multi equipment table*	see multi equipment table*
Frequency range	26.565 - 27.99125 MHz	26.565 - 27.99125 MHz	26.565 - 27.99125 MHz	26.565 - 27.99125 MHz
Power supply voltage	12.6 V DC ± 10%	12.6 V DC ± 10%	12.6 V DC ± 10%	12,6 Vcc ± 10%
Size (WxHxD)/weight	110x120x25 mm/380 g	102x100x25 mm/450 g	122x35x195 mm/820 g	137x35x210 mm/930 g
Mic. connector	RJ45	-	4 pin	6 pin
Receiver				
Sensitivity for 20dB SINAD	<1µV	<1µV	<1µV	<1µV
Audio output power	3W+2W	4W max	4W max	4W max
Audio distortion	< 5%@1KHz	< 5%@1KHz	< 5%@1KHz	< 5%@1KHz
Transmitter				
Output power	1W/4W AM-FM	1W/4W AM-FM	1W/4W AM-FM	1W/4W AM-FM
Modulation	AM 90% ±5%, FM 2KHz	AM 90% ±5%, FM 2KHz	AM 90% ±5%, FM 2KHz	AM 90% ±5%, FM 2KHz
Max. current drain	<1600mA	<1600mA	<1600mA	<1600mA

Model	MIDLAND M-30	M ZERO PLUS	ALAN QUARANTOTTO	ALAN SESSANTOTTO
Type	Vehicle multi-band CB	Vehicle AM-FM CB	Vehicle AM-FM CB	Vehicle AM-FM CB
General				
Channels/Bands	see multi equipment table*	40 AM/40 AM -40 FM	40 AM -40 FM	34 AM-FM
Frequency range	26.565 - 27.99125 MHz	26.965 - 27.405 MHz	26.965 - 27.405 MHz	26.875 MHz - 27.265 MHz
Power supply voltage	12÷24V	12,6 Vcc ± 10%	12.6 V DC ± 10%	12,6 Vcc ± 10%
Size (WxHxD)/weight	120x37x160 mm/820 g	110 x 45 x 140 mm/665 g	165 x 55 x 205 mm/1,650Kg	165 x 55 x 205 mm/1,500Kg
Mic. connector	RJ	4 pin	4 pin "48"	4 pin "48"
Receiver				
Sensitivity for 20dB SINAD	<1µV	<1µV	<1µV	<1µV
Audio output power	4W max	2W max	4W max	4W max
Audio distortion	< 5%@1KHz	< 5% @ 1KHz	< 5%@1KHz	< 5%@1KHz
Transmitter				
Output power	4W AM-FM	4W AM-FM	4W AM-FM	4W AM-FM
Modulation	AM 90% ±5%, FM 2KHz	AM: 90% - FM 2KHz	AM 90% ±5%, FM 2KHz	AM 90% ±5%, FM 2KHz
Max. current drain	2000mA	1500mA	1500mA	1500mA

CB OVERVIEW TABLES

Model	ALAN 100 PLUS B	ALAN 48 PRO	ALAN 78 PRO	ALAN 42 DS
Type	Vehicle AM-FM CB	Vehicle multi-band CB	Vehicle multiband CB	Portable multiband CB
General				
Channels/Bands	40 AM-40 FM	see multi equipment table*	see multi equipment table*	see multi equipment table*
Frequency range	26.965 - 27.405 MHz	26.565 - 27.99125 MHz	26.565 - 27.99125 MHz	26.565 MHz - 27.99125 MHz
Power supply voltage	12,6 Vcc ± 10%	12/24Vdc	12/24Vdc	12,6 Vcc ± 10%
Size (WxHxD)/weight	124x38x190 mm/1.2 Kg	180 x 50 x 150 mm/1 Kg	180 x 35 x 140 mm/0,850 Kg	70 x 140 x 30 mm/220 g (- batt)
Mic. connector	4 pin	6 pin	6 pin	2 pin Midland
Receiver				
Sensitivity for 20dB SINAD	<1 µV	0,5±1 µV	<1 µV	<1 µV
Audio output power	4,5 W max	> 3W	> 2W	0.5W
Audio distortion	< 8% @ 1KHz	< 8% @ 1KHz	< 8% @ 1 KHz	3%@1KHz
Transmitter				
Output power	4W AM-FM	1W/4W AM-FM	1W/4W AM-FM	1W/4W AM-FM
Modulation	AM: 90%, FM: 2 KHz	AM: 90%, FM: 1.8 KHz +/- 0.2 KHz	AM: 90%, FM: 1.8 KHz +/- 0.2 KHz	AM 90% ±5%, FM 2KHz
Max. current drain	1100mA	1100mA	1100mA	900mA

TABLE OF CHANNELS/POWER/BAND FOR MULTI CB

Code	Country	MHz
I	Italy 40 CH AM / FM 4 Watt	26.965-27.405
I2	Italy 34 CH AM / FM 4 Watt	26.875-27.265
D4	Germany 80 CH FM 4 Watt / 40 CH AM 4 Watt	26.565-27.405
EU	Europe 40 CH FM 4 Watt / 40 CH AM 1 Watt	26.965-27.405
EC	CEPT 40 CH FM 4 Watt	26.965-27.405
E	Spain 40 CH AM/FM 4 Watt	26.965-27.405
F	France 40 CH FM 4 Watt / 40 CH AM 4 Watt	26.965-27.405
PL	Poland 40 CH AM/FM 4 Watt	26.960-27.400
UK	England 40 CH FM 4 Watt + EC (40 CH FM 4Watt CEPT) or + I Italy 40CH AM/FM 4W (it depends on the radio model)	27.60125-27.99125 + 26.965-27.405
Initials	Export Version	MHz
RU	Russia 400 CH AM/FM 4 Watt	25.615-30.105
PX	Poland 400 CH AM/FM 4 Watt Polish frequencies	25.610-30.100
SW	Sweden 24 CH FM 4 Watt 31 MHz	30.930-31.570
AU	Australia 40 CH AM 4 Watt	26.965-27.405
AM	Australia 10 CH AM 4 Watt	27.680-27.980
NZ	New Zealand 40 CH AM 4 Watt	26.330-26-770

NB: the multi CB radios can have different bands, as in the above table. For further information, please check the user manuals that can be downloaded on www.midlandeurope.com in the **Support** section.

The image features a dark background with a silhouette of a person on the left holding a handheld radio. The background is filled with horizontal light trails in shades of blue, green, and orange, suggesting motion or a digital environment. At the top center, the Midland logo is displayed in white, consisting of a stylized mountain peak icon followed by the word "MIDLAND" in a bold, sans-serif font with a registered trademark symbol.

MIDLAND[®]

RADIO

WALKIE TALKIE
AMATEUR VHF/UHF
PROFESSIONAL VHF/UHF
MARINE VHF

WHY BUY A RADIO AND WHICH TO CHOOSE?

Usually, emergency and security situations are associated with radios: first aid, police, firefighters, civil protection. These are just some examples of professional figures that come to mind when we talk about radios.

What if we told you that they are not the only radio users? What if we told you there are others?
The radio is widely used in **department stores, shopping malls, restaurants, hotels and beach resorts.**
What do all these activities have in common?
All of them must manage the public and need rapid communication tools over large areas.
So what are the characteristics that unite the choices of professionals so different from each other?
Walkie talkies are tough.
How many times has a smartphone proved to be delicate and easy to break?

YOUR FIRST RADIO.

Are you looking for an easy-to-use entry level radio?

XT10



RADIOS FOR BUSINESS.

Do you have a store, a club or a hotel?
Choose from these models.

777 PRO

BR01

BR03



Indestructible models for the harshest environments.

G10

G11V

G15

G18



Or perhaps it turned off because of the excessive 40° C summer heat?

Radios do not fear impacts, low or high temperatures: they are made to last.

Signal coverage: radios always have signal, anywhere.

Normally there are so-called "skip zones" in the reception of the data network, but radios are less subject to this than smartphones: the most clear examples of this are radios still working in the basements of buildings or on a mountain.

Communication speed: you can speak with the other user **by simply pressing a button or by activating the radio vocally.** There are no numbers to dial, nor long waiting times.

Predictable costs: radios have no monthly payments, nor are there any charges for calls. In Italy, a duty of 12 euros per year is expected regardless of the number of devices owned.

RADIOS FOR YOUR PASSIONS.

If you love travelling and outdoor activities, choose a model that's fun and easy to use.

XT LINE

(XT 10-30-50-60-70)

GB1-R



If your hobby is hunting or airsoft, here are the radios for you:

G7 PRO

G9 PRO



I WANT THE BEST.

If you are looking for the most advanced technology.

G11V

G18



MIDLAND®

XT10

4 KM RANGE*

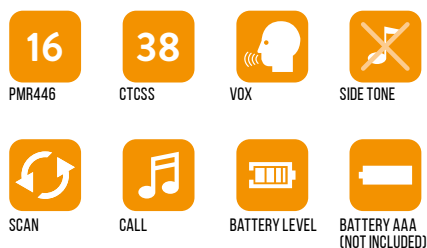

Light, very simple to use, coloured in order to avoid the usual “Hey, where did I put the walkie-talkie?”, that’s the **Midland XT10**. The entry level that combines technique, offering communications up to 4km, with simplicity and saving.

Version: PMR446
Colour: Black/Red
Channels: 8 + 8 preprogrammed
Tones: 38 CTCSS

FEATURES

- Communications up to 4 Km*
- Side tone: end transmission tone muffler
- Keypad lock
- Auto power save: automatic battery saving
- Low battery indicator
- VOX, CALL, SCAN
- Power supply: 3 AAA batteries

PACKAGING AND CODES

Blister with 2 radios, 2 belt clips
code C1176



XT30

6 KM RANGE*

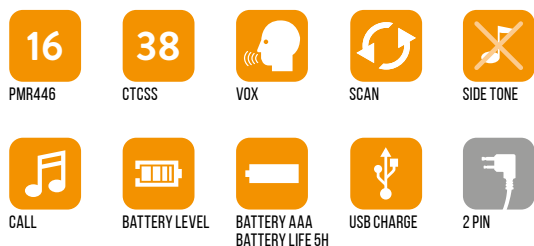

The **XT30** walkie-talkie concentrates in a light and easy to use tool everything you need to communicate up to 6 Km away. By means of a 5 hours battery life and a recharge via USB, this emerald-green jewel will make you run!

Version: PMR446
Colour: Black/Green
Channels: 8 + 8 preprogrammed
Tones: 38 CTCSS

FEATURES

- Communications up to 6 Km*
- Rechargeable via USB
- Side tone: end transmission tone muffler
- Auto power save: automatic battery saving
- Low battery indicator
- Keypad lock, VOX, CALL, SCAN
- Power supply: 3 rechargeable AAA batteries (**up to 5 hours battery life**)
- 2-pin accessory jack/USB for charging

PACKAGING AND CODES

Blister with 2 radios, 2 belt clips, 6 AAA rechargeable batteries, 2 way USB cable
code C1177



* In optimal environmental and atmospheric conditions

XT50 | XT50 ADVENTURE

8 KM RANGE*, WITH DESKTOP CHARGER

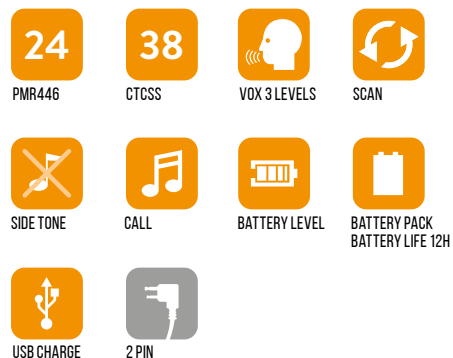

24 channels, 38 tones, communications up to 8 Km and 12 hours autonomy are just some of the features that make this **Midland XT50** walkie-talkie a real jewel of free radio-communications.

Available also in the practical Adventure version with premium case!

Version: PMR446
Colour: Blister Black/Gray
Valibox Black/Yellow
Channels: 8 + 16 preprogrammed
Tones: 38 CTCSS

FEATURES

- Communications up to 8 Km*
- Rechargeable via USB
- Side tone: end transmission tone muffler
- Keypad lock
- Auto power save: automatic battery saving
- Low battery indicator
- VOX with 3 levels of sensitivity
- CALL
- SCAN
- Power supply: Rechargeable battery pack (up to 12 hours battery life)
- 2-pin accessory jack/USB for charging

PACKAGING AND CODES

Blister:

with 2 radios, 2 belt clips, 1 double desktop charger, 2 rechargeable battery packs, USB cable

code C1178

Valibox:

with 2 radios, 2 belt clips, 1 double desktop charger, 2 rechargeable battery packs, USB cable, 1 wall adapter, 2 earphones MA21L

code C1178.01

XT60

10 KM RANGE*, WITH VOLUME KNOB AND QUICK DESKTOP CHARGER



69 LICENCE FREE LPD CHANNELS



When things get serious, when requirements increase, Midland responds and it does it with the **Midland XT60**, a dual band walkie-talkie that guarantees communications up to 10 km over 69 LPD and 24 PMR446 channels. Freedom and technology in just one tool.

Version: PMR446/LPD
Colour: Black/Light blue
Channels: 69 LPD + 24 PMR446
 (8 + 16 preprogrammed)
Tones: 38 CTCSS + 83 DCS

FEATURES

- Communications up to 10 Km*
- Advanced radio with volume knob
- Rechargeable via USB
- Night vision display
- Side tone: end transmission tone muffler
- Keypad lock
- Auto power save: automatic battery saving
- Low battery indicator
- VOX with 9 levels of sensitivity
- CALL with 5 selectable tones
- SCAN
- High/low power selection
- Fast charger (3 hours)
- Power supply: Rechargeable battery pack (**up to 12 hours battery life**)
- 2-pin accessory jack/USB for charging

PACKAGING AND CODES

Blister with 2 radios, 2 belt clips, 1 double desktop charger, 2 rechargeable battery packs, USB cable
code C1179

XT70 | XT70 ADVENTURE

12 KM RANGE*, WITH EARPHONES, VOLUME KNOB AND QUICK DESKTOP CHARGER



69 LICENCE FREE LPD CHANNELS



69 LPD and 24 PMR446 channels, 38 tones, communications up to 12 km and 18 hours autonomy. That's what the dual band **Midland XT70** walkie-talkie is, a perfect choice to communicate freely and safely. If you are also looking for an exceptional packaging, there's the Adventure version with premium case!

Version: PMR446/LPD
Colour: Blister Black/Dark gray
 Valibox Black/Yellow
Channels: 69 LPD + 24 PMR446
 (8 + 16 preprogrammed)
Tones: 38 CTCSS + 83 DCS

FEATURES

- Communications up to 12 km*
- Premium Radio with Volume Knob
- Rechargeable via USB
- Side tone: end transmission tone muffler
- Wide display
- Out of range, Baby-Sitting function
- Keypad lock
- Auto power save: automatic battery saving
- Low battery indicator
- VOX with 9 levels of sensitivity
- CALL with 5 selectable tones
- SCAN
- High/low power selection
- Fast charger (4 hours)
- Power supply: Rechargeable battery pack (up to 18 hours battery life)
- 2-pin accessory jack/USB for charging

PACKAGING AND CODES

Blister:
 with 2 radios, 2 professional belt clips, 1 double desktop charger, 2 rechargeable battery packs, USB cable, 2 earpiece microphones MA21-L
code C1180

Valibox:
 with 2 radios, 2 professional belt clips, 2 single desktop fast chargers, 2 rechargeable battery packs, 2 wall adapters, 2 USB cables, earpiece microphones MA21-Li
code C1180.01

G7 PRO

THE BEST-SELLER IN THE WHOLE WORLD

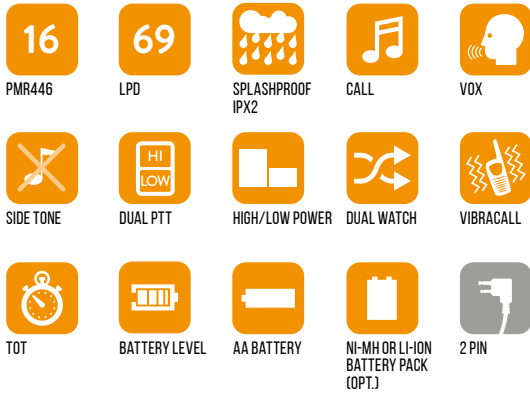

69 LICENCE FREE LPD CHANNELS



Midland G7 PRO is the radio for those who love outdoor activities. Hiking, airsoft, climbing, hunting are just a few examples of the perfect use of this walkie-talkie. A compact and elegant design that always accompanies you in your passions. Among the optional accessories you can choose the lithium battery pack to make it even lighter and more durable.

- Versions:** Dual band PMR446/LPD PMR446
- Colour:** Gray/Black - Mimetic Mossy Oak
- Channels:** PMR446 8 - LPD 69
- Tones:** 38 CTCSS + 104 DCS

The radio has both frequency bands:
 446.00625 – 446.09375
 446.00625 – 446.19375
 The procedure for selecting channels from 8 to 16 frequencies is available on midlandeurope.com on the product page, in the **Download** section.

FEATURES

- Dual watch: to monitor 2 different channels at the same time
- Double PTT hi/low power
- Vibracall
- Keypad lock
- Auto power save: automatic battery saving
- Low battery indicator
- 3 types of VOX (Vox standard - Vox Baby - Sitting - Vox Bike) adjustable to 2 levels, for hands-free communication
- CALL with 5 different melodies
- SCAN
- TOT (Time Out Timer)
- Roger beep end call switchable
- Power supply: battery pack Ni-Mh 800 mAh or Li-Ion 1200 mAh (optional), 4 AA batteries
- 2-pin accessory socket
- Compatible wall charger: MW 904

PACKAGING AND CODES

Box single pack:
 1 radio, wall charger, 4 rechargeable Ni-MH AA 1.2V/1800 mAh batteries, belt clip
code C1090.14 Dual band black version
code C1090.15 Dual band mimetic version

Box twin pack:
 2 radios, double desktop charger, wall adapter, 2800 mAh battery packs, belt clip
code C1090.13 Dual band black version

EXPORT VERSION 3W

G9 PRO

HIGH-PERFORMANCE



69 LICENCE FREE LPD CHANNELS



Midland G9 evolves and becomes **PRO**. The excellent radio used in any outdoor context. With a 30% larger display, audio improved by 30%, a more powerful antenna and a dual PTT that allows you to instantly select high and low power, your communication becomes easier and more fun. **G9 PRO** is the first to introduce the 8 new frequencies of the PMR 446 band, which are freely used all over Europe, for communications free of overlaps and congestion by other users. Among the optional accessories you can choose the lithium battery pack to make it even lighter and more durable.

Versions: Dual band PMR446/LPD
Colour: Black/Mimetic Mossy Oak®
Channels: PMR446 16 +16 mem
 LPD 69

FEATURES

- 8 new PMR446 channels
- 101 channels:
 - 32 PMR446 (16+16 pre-programmed) + 69 LPD
 - Extended frequency band: from 446.00625 to 446.19375MHz
 - 38 CTCSS tones and 104 DCS codes
 - High-performance loudspeaker
 - Wide LCD display (30% wider than the previous version)
 - Weatherproof IPX4
 - Double PTT button for high/low power
 - Emergency function
 - Out of range function
 - VOX with TalkBack™
 - Side tone: end of transmission tone silencer
 - Vibracall, Dual Watch
 - Keypad lock, Scan, Monitor
 - TOT (Time Out Timer)
 - Low battery indicator and power save
 - 12cm antenna to make the most of the full

- radio transmission power
- High-low power selection
- CALL button with 5 available tones
- Roger Beep: end of call tone (can be deactivated)
- Power supply: batteries or battery pack Ni-MH/Li-Ion (optional)
- 2-pin accessory socket
- Compatible wall charger: MW904

PACKAGING AND CODES

1 radio, desktop charger with wall adapter, 4 rechargeable AA batteries (1800 mAh), belt clip
code C1385 Dual band black version
code C1385.01 Dual band mimetic version

EXPORT VERSION 5W

GB1-R

THE PMR446 THAT LOOKS LIKE A CB

PLEASE CHECK YOUR
COUNTRY USE
RESTRICTIONS

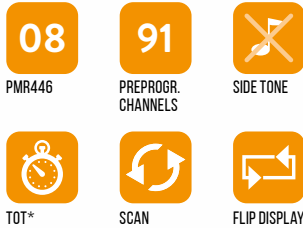

GB1-R guarantees wide-ranging communications and radio contact with other users equipped with PMR446 equipment. Superb solution for those who **travel by car or caravan**, above all due to the fact that, operating on PMR446 frequencies, it is not affected by disturbances generated by the engine of your vehicle. **GB1-R**, thanks to its very small size, integrated magnetic antenna and the supplied 12V cigarette lighter plug, can be installed and removed quickly without having to be fixed in the special compartment of the dashboard. The metal chassis makes it very robust to ensure excellent performance over the years.

Version: PMR446
Colour: Black
Channels: PMR446 8 + 91 progr.
Tones: 50 CTCSS + 104 DCS

FEATURES

- Microprocessor-controlled frequency
- 'Flip' function: the transceiver can be fitted with the speaker aimed downwards or vice-versa, the display is inverted by pressing a button
- Adjustable squelch on 9 levels
- SCAN function
- LCD display
- Integrated magnetic antenna
- TOT (Time out timer)*
- Side tone: noise blanker at end of transmission

- Monitor function
- Busy channel (BCLO-Busy Channel Lockout)*
- Broad/narrow band selection 25KHz/12.5KHz (only export version)*
- High/low power (only export version)*

PACKAGING AND CODES

1 radio, microphone, microphone holder, integrated wired magnetic antenna, mounting bracket, fixing screws, supply cable with 12V car charger

code C1198.02

EXPORT VERSION 5W

- * Software programmable only Extra UE countries

PROGRAMMING SOFTWARE PRG-GB1 - C1227

Complete with USB cable to connect to a PC.

G10

SIMPLE AND STRONG

08

PMR446

08

PREPROGR.
CHANNELS



SCAN



VOICE
ANNOUNCEMENT



BATTERY PACK



PROGRAMMABLE



2 PIN KENWOOD



MULTI CA PB-G10 - C1218

6 position multicharger (optional)

Clean and compact design, technical performance, perfect also for professional communications in low-complexity environments, this is the **Midland G10** walkie-talkie.

An entry level with great performance.

Thanks to an immediate signalling of the selected channel and the programming software, the **G10** will be the perfect partner for all your needs.

Version: PMR446

Colour: Black

Channels: 8 + 8 pre-set sub-channels

Tones: 51 CTCSS + 83 DCS
normal/inverted

FEATURES

- Output power: 500mW
- Channel spacing: 12.5KHz
- Channel scanning
- Function button beeps
- Monitor
- Auto power save
- Power supply: 1200 mAh Li-Ion battery pack
- 2-pin Kenwood accessory socket



PACKAGING AND CODES

1 radio, desktop charger, wall adapter, Li-Ion rechargeable battery pack (1200 mAh), belt clip

code C1107

EXPORT VERSION: 5W

DISCOVER THE HIGH PERFORMANCE ACCESSORIES PAGE 65-66

PROGRAMMING SOFTWARE PRG 10 - C974.01

Customisation of channels and frequencies.

G11V

INCOMPARABLE AUDIO

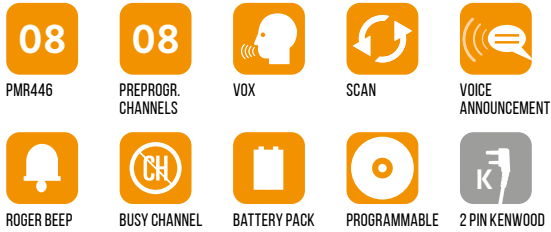

A huge attention to the smallest details is the key to guarantee high performance and maximum robustness to the **Midland G11V** walkie-talkie, that is equipped also with a metal chassis that enhances its strength, the “voice announcement” function to signal the selected channel vocally and a clear and ringing audio, for high quality communications

Version: PMR446
Colour: Black
Channels: 8 + 8 pre-set sub-channels
Tones: 50 CTCSS + 105 DCS normal/inverted

FEATURES

- Aluminium chassis
- Output power: 500mW
- Channel spacing: 12.5KHz
- VOX function (hands-free transmission)
- Voice announcement
- Channel scanning
- Function button beeps
- Roger beep
- Monitor
- TOT (Time Out Timer)
- Busy channel lock
- Auto power save
- Power supply: 1600 mAh Li-Ion battery pack
- 2-pin Kenwood accessory socket



PACKAGING AND CODES

1 radio, desktop charger, wall adapter, rechargeable Li-Ion battery pack (1600 mAh), belt clip
code C966.04

EXPORT VERSION: 5W

DISCOVER THE HIGH PERFORMANCE ACCESSORIES PAGE 65-66

PROGRAMMING SOFTWARE PRG 10 - C974.01

Customisation of channels and frequencies.

G15

THE INDESTRUCTIBLE, IP67

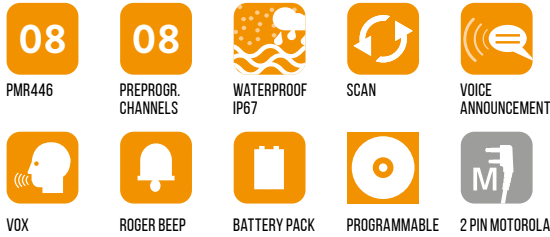

MULTI CA PB-G15 - C1251

6 position multicharger (optional)

Extreme sports, airsoft, work environments with low complexity but a high risk of damage to walkie-talkies, here are the situations where the **Midland G15** gives its best.

In fact, its metal chassis not only guarantees high impact strength but also withstands dust and immersion in water (up to 1 meter depth for 30 minutes).

Version: PMR446
Colour: Black
Channels: 8 + 8 pre-set sub-channels
Tones: 50 CTCSS + 105 DCS normal/inverted

FEATURES

- Aluminium chassis
- IP67 certified
- Output power: ≤500mW ERP
- Channel spacing: 12.5KHz
- Channel scanning
- Voice announcement
- Roger Beep, Auto power save
- Monitor, Squelch, Vox
- Power supply: Li-Ion 1600 mAh battery pack
- 2-pin Motorola accessory socket

PACKAGING AND CODES

1 radio, desktop charger, wall adapter, rechargeable Li-Ion battery pack (1600 mAh), belt clip
code C1127

EXPORT VERSION 5W

PROGRAMMING SOFTWARE PRG-G15 - C1131

Customisation of channels and frequencies.

G18

TOP OF THE RANGE, IP67

 PMR446	 PREPROGR. CHANNELS	 WATERPROOF IP67	 SCAN	 VOICE ANNOUNCEMENT
 FM RADIO	 SCRAMBLER	 COMPANDER	 VOX	 ROGER BEEP
 BATTERY PACK	 PROGRAMMABLE	 2 PIN MOTOROLA		



MULTI CA PB-G15 C1251

6 position multicharger (optional)



Sometimes in your radio communication you need an extra gear, and for this reason we have created the **G18** walkie-talkie which, in addition to the metal chassis, is IP67 certified to withstand dust and immersion in water (up to 1 meter depth for 30 minutes).

Add to this an LCD display an FM radio to guarantee superior performance to our top of the range.

Version: PMR446
Colour: Black
Channels: 8+91 (G18)
pre-set sub-channels
Tones: 50 CTCSS + 105 DCS
normal/inverted

FEATURES

- Aluminium chassis
- IP67 certified
- Output power: ≤500mW ERP
- Channel spacing: 12.5KHz
- Channel scanning
- Voice announcement
- FM radio
- Roger Beep, Auto power save
- Monitor
- Squelch
- Vox
- Scrambler and Compander
- Power supply: Li-Ion 1600 mAh battery pack
- 2-pin Motorola accessory socket

PACKAGING AND CODES

1 radio, desktop charger, wall adapter, rechargeable Li-Ion battery pack (1600 mAh), belt clip
code C1145

EXPORT VERSION 5W

PROGRAMMING SOFTWARE PRG-G15 - C1131

Customisation of channels and frequencies.



MIDLAND[®]

777 PRO

THE COOLEST WALKIE TALKIE FOR CLUB SECURITY



RESTAURANTS



FASHION STORES



HOSPITALITY



PMR446



LPD



VOX



EXTRA LOUD SPEAKER



VIBRACALL FOR NOTIFICATIONS



BATTERY PACK
14 HOURS AUTONOMY



USB RECHARGER



1 PIN

69 LICENCE FREE LPD CHANNELS



When the night comes on, rhythm dictates the laws of the evening and the fun doesn't stop, but the unexpected can always happen.

What for some is an opportunity for entertainment, for others is a serious and responsible profession.

For this a professional needs a reliable but aesthetically elegant and refined radio, like the 777 PRO, to fulfil its duty in the best possible way.

Wide black display, EDD™, with white lighting. Even more elegant and compact new high-tech design.

Versions: Dual band PMR446/LPD
Colour: Black
Channels: PMR446 16+ LPD 69
Tones: 38 CTCSS + 104 DCS

FEATURES

- 8 new PMR446 channels
- 85 channels: 16 PMR446 + 69 LPD
- Extended frequency band: from 446.00625 to 446.19375MHz
- Black EDD™ display with white lighting, 50% wider than the previous model
- Super-powerful loudspeaker
- 1000mAh Li-Ion battery pack (up to 14 hours' autonomy)
- Earpiece socket with 1.35mm pin in the upper part for greater wearability
- Recharge via micro USB side socket or use the desktop charger
- Vibracall function for notifications even in noisy environments
- VOX function with 9 selectable levels
- 38 CTCSS tones / 104 DCS codes
- 1-pin accessory jack

PACKAGING AND CODES

2 radios with belt clip, 1 dual table charger, 2 Li-Ion 1000mAh rechargeable battery packs, micro USB cable

code C1365

EXPORT 2W VERSION

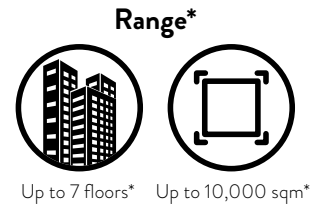

* Depends on usage conditions

NEW



BR01

FOR SMALL BUSINESS

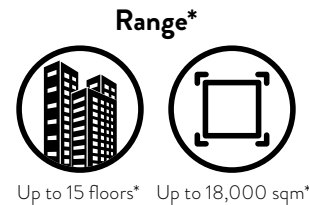

* Depends on usage conditions



BUSINESS



RESTAURANTS



HOSPITALITY



WAREHOUSING



PMR446



PREPROGR.
CHANNELS



VOICE
ANNOUNCEMENT



BATTERY PACK
BATTERY LIFE 37H



PROGRAMMABLE



2 PIN KENWOOD



Midland introduces the **BizTalk™** line, designed mainly for small businesses. Robustness, high mechanical and electronic reliability and an easy use make BR radios the perfect choice for those who need to communicate at work. **Midland BR01** stands out for its extremely compact design and simple and clean lines that allow the radio to be used in a simple and immediate way.

Version: PMR446
Colour: Black
Channels: 8 + 8 pre-programmed
Tones: 50 CTCSS + 232 DCS

FEATURES

- Monitor function
- SCAN
- Squelch with 10 selectable levels
- Voice announcement
- **37 hours of battery life**
- Li-Ion 2800 mAh 3.7V battery
- Microphone/loudspeaker jack
- 2 pin Kenwood accessories socket

PACKAGING AND CODES

1 radio, USB cable, rechargeable Li-Ion battery pack (2800 mAh), belt clip, wrist strap
code C1315

EXPORT VERSION 2W

DISCOVER THE HIGH PERFORMANCE ACCESSORIES PAGE 65-66



PROGRAMMING SOFTWARE PRG-10 - C974.01

Customizing channels and subtones, activation/deactivation of specific functionalities.

BR03

FOR FASHION BUSINESSES

Range*

Up to 22 floors* Up to 25,000 sqm*

* Depends on usage conditions



RESTAURANTS



FASHION STORES



HOSPITALITY



PMR446



PREPROGR. CHANNELS



SPLASHPROOF IPX2



VOICE ANNOUNCEMENT



VOX



SCAN



BATTERY PACK



PROGRAMMABLE



2 PIN KENWOOD



MULTI CA PB-BR03 C1353

6+6 position multicharger (optional)



BR03 is the top-of-the-range in the **BizTalk™** line. The most “fashionable” Business Radio of the BR series, by means of its refined and elegant look & feel meets all the specific needs of the “Luxury” world. Fashion stores, hotels and high-end restaurants are the perfect environments where you can communicate while maintaining rigour and style. The peculiarity of the **Midland BR03** is the customizable LED dynamic matrix display.

Version: PMR446
Colour: Black
Channels: 8 + 91 pre-programmed
Tones: 38 CTCSS + 104 DCS

FEATURES

- Splashproof IPX2
- Output power: 500mW
- Voice announcement
- VOX adjustable to 10 levels
- SCAN
- Function key beep on/off
- Roger beep
- Auto Power Save
- Squelch adjustable to 10 levels
- LED dynamic matrix display with adjustable light intensity
- Battery level audio indicator
- **33 hours of battery life**

- Li-Ion 2300 mAh 3.7V battery pack
- Programmable from PC
- 2 pin Kenwood accessories socket

PACKAGING AND CODES

1 radio with rotating belt clip, desktop charger, Li-Ion 2300 mAh 3.7V battery pack, wall adaptor with mini USB connector
code C1323



CUSTOMIZE THE DISPLAY

LED dynamic matrix with the name of your company or yours.

PROGRAMMING SOFTWARE PRG-10 - C974.01

Customisation of channels and frequencies.

A man wearing a wide-brimmed hat and a tactical vest is standing in a field at sunset. He is looking upwards and to the right. A Midland radio is mounted on his vest. The background shows a field with a body of water in the distance under a cloudy sky.

MIDLAND®

AMATEUR VHF/UHF

THE REAL RADIO AMATEURS.

They are people who, both out of passion and out of curiosity, entered the wonderful world of radio and were able to appreciate with amazement and considerable satisfaction the joy that you feel when communicating with another radio amateur thousands of kilometres away.



From a regulatory point of view, the radio amateur is a person authorized to transmit, that is, who has obtained the so-called "license" and the subsequent "general authorization". How to achieve this?

First of all, it is necessary to acquire a minimum knowledge of the radio technology necessary to obtain a license, which allows the use of all frequencies assigned internationally to the Amateur Service.

The **role that radio amateurs play in social life** is very important. Another relevant factor is how they contribute in the event of a **disaster**, by making their means and their ability available to the authorities to ensure communication between the various bodies in charge of spreading news and coordinating the relief efforts and therefore receiving from time to time sympathy and praise.



CT590 S

THE FIRST DUAL BAND WALKIE-TALKIE
FOR RADIO AMATEURS



VOX



BATTERY LEVEL



EMERGENCY



SCAN



CTCSS/DCS
SCAN



TOT



BUSY CHANNEL



HI/LOW POWER



DTMF



FM RADIO



VOICE
ANNOUNCEMENT



3 COLOUR DISPLAY



BATTERY PACK



PROGRAMMABLE



2 PIN KENWOOD



Version: VHF/UHF
Colour: Black
Frequency: 144-146MHz
(Exp. 136-174MHz)
430-440MHz
(Exp. 400-480MHz)
Output power: 5W VHF/UHF

FEATURES

- 50 tones CTCSS and 208 codes DCS
- 128 channels can be stored
- 1750Hz tone for repeater bridges
- Emergency SOS function
- Channel and dual band VHF/UHF displayed
- Operation mode: UHF/VHF, UHF/UHF, VHF/VHF
- Output power: 5W UHF/VHF
- 3-colour LCD display with selectable backlight
- FM radio receiver (87.5-108MHz)
- Scan, Dual Watch
- Channel Spacing: 25KHz/12.5KHz
- VOX adjustable on 10 levels
- Channel or frequency mode selection
- TOT (Time Out Timer)
- DTMF Function
- Reverse function
- Emergency alarm function
- Setting up and storing channel names
- CTCSS and DCS code search function
- PTT-ID
- BCLO (Busy Channel Lockout function): busy channel lock function
- High/low power selection
- Frequency step: 2.5/5/6.25/10/12.5/25KHz
- Adjustable frequency offsets: 0-69.990MHz
- Adjustable Offset Direction
- Squelch adjustable on 9 levels
- Voice announcement of the selected function
- Keypad lock
- Power Save (battery economy)
- Programmable from PC
- Li-Ion 1500 mAh battery pack
- 2-pin Kenwood Accessory socket

PACKAGING AND CODES

Radio, 1500 mAh 7.4V Li-Ion battery pack, desktop fast charger, wall adapter, antenna, belt clip
code C1354

PROGRAMMING SOFTWARE PRG10 - C974.01

Complete with USB connection cable for PC.

CT 890

INCOMPARABLE DISPLAY

VERSION WITH
**SCRAMBLER
COMPANDER**

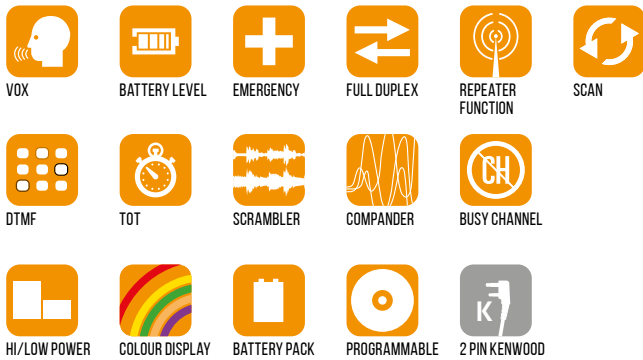

Version: Dual Band VHF/UHF
Colour: Black
Frequency: 144-146MHz
(Export 136-174MHz)
430-440MHz
(Export 400-470MHz)
Output power: 5W VHF/UHF

FEATURES

- 105+105 (I-N) codes DCS/50 CTCSS tones
- 999 channels to store
- Channel spacing: 25 KHz/12.5 KHz
- SOS emergency function
- Operating mode: UHF-UHF, VHF-VHF and VHF-UHF
- Full duplex, repeater function
- Channel and dual band VHF/UHF displayed
- FM 88÷108 MHz radio receiver
- Scrambler, Compander
- Chronometer
- Built-in torch
- Frequency step: 5/6.25/10/12.5/25/50/100KHz
- Roger Beep tone at start/end of conversation
- Frequency scan with CTCSS/DCS
- DTMF
- Shift repeater
- Vox and Scan functions
- Back-lit display
- Optional displaying of channel number, channel number + frequency or frequency only
- TOT (Time Out Timer)
- Busy channel lockout (BCLO) function

- Squelch adjustable to 9 levels
- Keypad lock
- Hi/Low power selection
- Frequency setting and keypad channels
- Voice announcement of the selected function
- Inverted frequency function
- Frequency offset: 0-69.950MHz
- Function/channel reset
- 2-pin Kenwood accessory socket

PACKAGING AND CODES

Radio, 2600 mAh Li-Ion battery pack, desktop charger, wall adapter, antenna, belt clip, wrist strap
code C1170.01

PROGRAMMING SOFTWARE PRG10 - C974.01

Complete with USB connection cable for PC.

CT 990

10W, POWER NEVER SEEN BEFORE

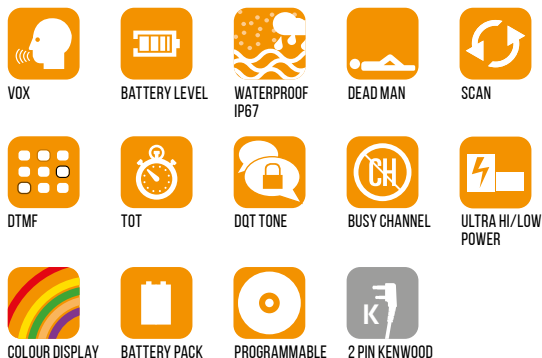

SUPPLIED WITH 2 ANTENNAS

- **Long antenna:** enhances the radio performance in TX/RX
- **Short antenna:** allows better handling



CT990 is fitted with the Dead Man function, useful when you are on your own or isolated. This function constantly monitors the status of the person wearing the radio: if a change in position of the radio from vertical to horizontal (due to illness or injury) is recorded **CT990** emits an alarm that is sent to all users tuned to its frequency.

Version: Dual Band VHF/UHF
Colour: Black
Frequency: 144-146MHz
(Export 136-174MHz)
430-440MHz
(Export 400-470MHz)
Output power: 10W VHF/UHF

FEATURES

- 257 memory channels
- 83 + 83 DCS codes and 38 CTCSS tones
- Selectable channel spacing 25/12.5 KHz
- Dual band VHF/UHF displayed
- Frequency band (settable according to country/area of use):
144-146MHz & 430-440MHz (Rx/Tx).

- Operating mode:
UHF/VHF, VHF/VHF or UHF/UHF
- Selectable channel step 25/12.5KHz
- IP67 certificate
- Dead Man function
- **DQT function (private conversation)**
- Wide colour LCD display
- Activation tones for repeater bridges
- Individual/group selective calls
- Side tone: end of transmission tone silencer
- VOX function
- Voice indication of the selected function "VOICE"
- Optional display of the channel number, channel number and frequency, channel name
- Inverted frequency function
- Scan function
- FM radio receiver
- Selectable transmission power: high (10W) or low (5W)
- Frequency offset
- Shift repeater
- "Busy channel lock" function

- Output power level indicator on the display
- Roger beep
- TOT (Time Out Timer)
- Keypad lock
- Reset of functions/channels
- Low battery voice announcement
- Li-Ion 2800mAh battery pack
- Accessory socket: 2 pin Kenwood

PACKAGING AND CODES

Radio, **long and short antennas**, Li-Ion 2800mAh battery pack, belt clip, table charger, wrist strap, wall adapter.

code C1339

PROGRAMMING SOFTWARE PRG10 - C974.01

Complete with USB connection cable for PC.

CT 2000

THE FIRST VEHICULAR VHF/UHF



WATERPROOF
IP54



POWER
25/10/5W



CHANNELS



TFT GRAPHIC
DISPLAY



TOT



SCAN



REPEATER
FUNCTION



EXTRA LOUD
SPEAKER



PROGRAMMABLE



SUPERCOMPACT 115x125x43mm

CT2000 is an amateur bi-band transceiver that works in VHF and UHF.

With a **25W output power** (adjustable), comparable to the power of professional transmitters, in spite of its very small size, a **powerful 3W loudspeaker** guaranteeing an excellent audio and a **wide multicolour graphic display** that allows seeing all set parameters clearly. **CT2000** stores up to **203 channels**, has **51 CTCSS tones and 208 DCS codes as well as the 1750/2100/1000/1450Hz tones to access repeater bridges**; it can also make selective calls. It is **IP54 certified** (protection against dust and splashes) to allow use even outdoors, such as on motorcycles or quads (ATVs). With a **compact multifunction microphone** with which the set functions can be quickly recalled.

Programmable using the optional software thanks to which you can customize the functions and buttons on the front of the radio.

Version: Dual Band VHF/UHF
Colour: Black
Frequency: 144-146MHz
(Export 136-174MHz)
430-440MHz
(Export 400-470MHz)
Output power: 25/10/5W

FEATURES

- Resistant to splashes and dust, IP54 protection.
- Operating mode: UHF/VHF, VHF/VHF or UHF/UHF
- Selectable transmission power: high (25W) medium (10W) or low (5W)
- 104 + 104 DCS codes and 51 CTCSS tones
- 203 channels can be stored
- Dual band display (VHF / UHF), channel number or channel number and frequency, transmission power level
- Colour graphic display

- Activation tones for repeaters (1000/1450/1750/2100Hz)
- Bandwidth selectable on three levels 12.5/20/25KHz
- Frequency inversion function
- Scan function
- Frequency offset and selectable offset direction
- TOT (Time Out Timer)
- Keypad lock
- Socket for external earphone

PACKAGING AND CODES

Transceiver, microphone with keypad, fixing bracket, power cable, microphone holder
code C1321

PROGRAMMING SOFTWARE PRG-510 - C1104

Complete with USB connection cable for PC.

CT 3000

THE PROFESSIONAL AMATEUR RADIO



WATERPROOF
IP54



POWER
25/10/5W



CHANNELS



TFT GRAPHIC
DISPLAY



TOT



SCAN



REPEATER
FUNCTION



EXTRA LOUD
SPEAKER



"FLIP" DISPLAY



CUSTOMIZED
BUTTONS



PROGRAMMABLE



Unlike the other models, **CT3000** can be defined "professional" as it has 6 customizable buttons on the front (P1-P6) through which you can set various functions, and not only: 2 functions can be associated to these 6 keys at the same time, divided into 2 groups of menus. To guarantee excellent communications even long range, CT3000 boasts high selectable **transmission power: 25W** (high), **10W** (medium) and **5W** (low).

Its metal chassis makes it an extremely robust radio, suitable for extreme situations, which also ensures better heat dissipation, very useful to prevent the radio from overheating. The IP54 certification ensures high protection against dust and splashes and also allows using the radio outdoors.

CT3000 boasts the «flip» function: the radio can be rotated by 180° and the display will still be correct. The display is wide and multicolour.

Version: Dual Band VHF/UHF
Colour: Black
Frequency: 144-146MHz
(Export 136-174MHz)
430-440MHz
(Export 400-470MHz)
Output power: 25/10/5W

FEATURES

- Operating mode: UHF/VHF, VHF/VHF or UHF/UHF
- Dual band display (VHF/UHF), channel number or channel number and frequency.
- Wide colour TFT display, rotating by 180°
- Scan of the stored channels
- Automatic adjustable Digital Squelch on multiple levels
- Scan function, Dual Watch, Roger Beep
- 200 customizable memory channels
- 104 + 104 DCS inverted codes and 51 CTCSS tones
- TOT (Time out Timer)
- Adjustable backlight

- Automatic switch ON/OFF
- Keypad lock
- Activation tones for repeaters (1000/1450/1750/2100Hz)
- Bandwidth selectable on three levels 12.5/20/25KHz
- Frequency inversion function
- Frequency step: 2,5/5/6,25/10/12,5/20/25/ 30/50KHz.
- Frequency offset and selectable offset direction
- Output power level indicator on the display
- 12.6V+/- 10% power supply
- Microphone with RJ45 multifunction keypad

PACKAGING AND CODES

Transceiver, microphone with keypad, fixing bracket, power cable, microphone holder, screws and protection fuse
code C1325

PROGRAMMING SOFTWARE PRG-3000 C1352

Complete with USB connection cable for PC

R74574

2 mt. long microphone extension cord for M-5/M-30/CT3000

ALAN HP108

QUALITY AND HIGH PROFESSIONAL PERFORMANCE AT A COMPETITIVE PRICE



VOX



BATTERY LEVEL



SCAN



SCRAMBLER



HI/LOW POWER



ROGER BEEP



BATTERY PACK



2 PIN



SIZE: 97x53x33mm

HP108: VHF 136-174 MHz

FEATURES

- **Protection IP54**
- 256 CH (HP108); 298 CH (HP408L)
- Breakdown of channels according to groups
- Customisable switch on message
- Backlit LCD display
- Backlit keypad
- Standard CTCSS tones and digital DCS
- Selective calling 5 tones, 5+5 tones in the

various standard formats

- Signal intensity indicator
- Built-in scrambler with 8 different selectable frequency codes
- Compander, Transponder function
- Adjustable power: max. 5W programmable at High/Low/Medium
- Battery life: up to 12 hours
- Built-in vox adjustable to 8 different sensitivity levels and 4 different delay levels
- 2-pin accessory socket

PACKAGING AND CODES

Radio, quick desktop battery charger, Li-Ion 1600 mAh rechargeable battery, antenna, belt clip

HP108 code G1176.01 VHF 136-174MHz

PROGRAMMING SOFTWARE PRG08 FOR HP08 SERIES - G1184

Complete with USB connection cable for PC.

ALAN HM135

FOR ADVANCED
COMMUNICATION SYSTEMS



EMERGENCY



SCAN



SCRAMBLER



HI/LOW POWER



HM135: VHF 136-174MHz

FEATURES

- 4 - 25W output power
- MIL STD 810 C D,E, F and IP54 (front panel only)
- More than 250 channels with usable settings
- CTCSS/DCS
- Programmable channelling
- Graphic LCD display

- 4 function buttons
- Phone book
- Standard and customised selective call
- Scrambler
- Kill/revive
- Remote use front panel
- 4W front speaker
- Standard and priority channel scan
- Talk around - Public Address function
- Flash memory

- programmable through PC
- Data transmission (compliant with ETS300-113)
- Standard DB25 accessories connector

PACKAGING AND CODES

Radio, power lead and support bracket
Complete with USB connection cable for PC.
code G934 VHF 136-174MHz

ALAN HM106

REASONABLE PRICE
PROFESSIONAL PERFORMANCE



EMERGENCY



SCAN



HI/LOW POWER



HM106: VHF 136-174MHz

FEATURES

- Output power 4 - 25W
- MIL STD 810 C D,E, F and IP54 (front panel only)
- 99 channels
- CTCSS/DCS

- Programmable channelling
- 2-digit LED display
- 4 function buttons
- Selective Call
- 4W front speaker
- Standard and priority channel scan
- Talk around

- Public Address function
- Flash memory
- PC programmable

PACKAGING AND CODES

Radio, standard microphone, power lead and support bracket
HM106 code G997 VHF 136-174MHz

PROGRAMMING SOFTWARE PRG35 FOR HM06, HM35 AND HM70 - G968

Complete with USB connection cable for PC.

ARCTIC

THE MARINE RADIO, IP67

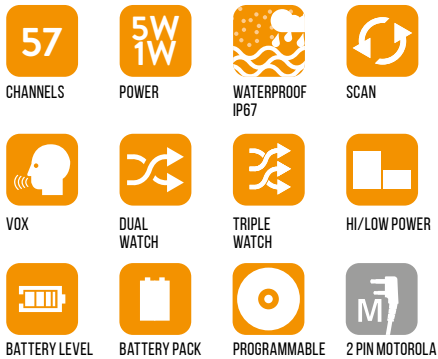

MULTI CA PB-G15 - C1251

6 position multicharger (optional)



Midland Arctic is a VHF marine portable transceiver combining professional technical features with sturdiness and reliability. Its functions are all at hand, including the **button to access emergency channel 16 straight away**. The antenna can be removed and thanks to the standard **SMA connector**, it is possible to use other types of antenna. The management of the Charlie and Alpha channels and functions takes place via optional programming software.

FEATURES

- IP67 waterproof certification
- Aluminium chassis
- Transmission power: 5W
- High/low power selection (5W/1W)
- 57 international channels
- Programmable channels (through software)
- Backlit wide LCD display
- Instant access to the emergency channel 16
- VOX, SCAN function
- Dual Watch/Triple Watch
- 10 different Squelch levels
- Priority channel
- Keypad lock
- Roger Beep (end of call tone)
- Keypad beep

PROGRAMMING SOFTWARE PRG-G15 - C1131

Complete with USB connection cable for PC.



- Flat battery indicator and automatic battery saver
- Power supply: Li-Ion battery pack
- 2-pin Motorola accessory socket

PACKAGING AND CODES

Radio, desktop charger, wall adapter, Li-Ion 1600 mAh rechargeable battery pack, belt clip
code C1240

**EXPORT VERSION:
USA/CANADA CHANNELS**

RADIO ACCESSORIES

MICROPHONES/EARPHONES WITH 1-PIN ACCESSORY SOCKET



MA21-777PRO
C1437
 Microphone earphone with PTT, 1 pin 3,5mm (Midland 777 PRO)

NEW



MA 21-SX
C709.02
 Microphone with adjustable earpiece and selectable PTT/VOX, with curly cord



MA31-777PRO
C1438
 Microphone with pneumatic earpiece and PTT, 1 pin 3,5mm (Midland 777 PRO)

NEW



MA-NC1
C983
 Fabric neck collar with integrated headset and selectable PTT/VOX (Midland 777)

MICROPHONES/EARPHONES WITH L-SHAPED 2-PIN ACCESSORY SOCKET



MA 21-L
C709.03
 Microphone with adjustable earpiece and selectable PTT/VOX, with curly cord



MA 28 - L
C559.03
 Speak/listen microphone with selectable PTT/VOX
 NB: MA28-G5 except Alan421-G5XT



MA 21-LI
C709.07
 Microphone with earpiece (no VOX)

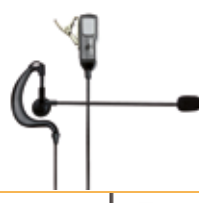

MA 30 - L
C648.03
 Microphone with adjustable arm and selectable PTT/VOX



MA 24-L
C517.02
 Speak/listen microphone with selectable PTT/VOX



MA31 - L
C732.03
 Microphone with pneumatic earpiece and selectable PTT/VOX



MA 26 - XL
C515.05
 Speaker microphone with volume control and earpiece socket



MA 35 - L
C652.02
 Headphone with microphone

MICROPHONES/EARPHONES WITH STRAIGHT 2-PIN ACCESSORY SOCKET



AE30
C851
 Microphone with arm and selectable PTT/VOX



AE38
C823
 Throat microphone with earphone, PTT and finger PTT

MICROPHONES/EARPHONES WITH 2-PIN KENWOOD ACCESSORY SOCKET



BA21
C1298
 Adjustable earpiece microphone and PTT. Ergonomic and comfortable, extremely robust cable for professional use. 2-pin "L" jack



MA 21-LKI
C1306
 Microphone with adjustable earpiece curly cord, competitive price.

HIGH PERFORMANCE

MICROPHONES/EARPHONES



**BA24
C1296**
Headset microphone.
Ergonomic and comfortable, extremely robust
cable for professional use. 2-pin "L" jack

HIGH PERFORMANCE



**MA 21-LK
C709.04**
Microphone with adjustable earpiece and PTT,
with curly cord. L-shaped 2-pin accessory
socket



**BA22
C1297**
Speaker microphone with PTT and rotating
clip. Performant speaker with PTT and 360°
rotating clip. 2-pin "L" jack

HIGH PERFORMANCE



**MA 21-XK
C709.06**
Microphone with adjustable earpiece and PTT.
2-pin "L" jack



**BA31
C1299**
Microphone with pneumatic headset and PTT.
Comfortable to wear, discreet and flexible, high
quality transparent hose. Extremely rugged
cable for professional use. 2-pin "L" jack

HIGH PERFORMANCE



**MA31-LK
C732.04**
Microphone with pneumatic earpiece.
L-shaped 2-pin accessory socket

MICROPHONES/EARPHONES WITH 2-PIN MOTOROLA ACCESSORY SOCKET



**MA 25-M
C1129**
Waterproof speaker microphone, compatible
with Midland G15/G18. 2-pin "L" jack



**MA 31-M
C732.06**
Microphone with pneumatic earpiece,
compatible with Midland G15/G18.
2-pin "L" jack



**MA 27-M
C1130**
Microphone with PTT, compatible with
Midland G15/G18. 2-pin "L" jack

EARPHONES ONLY LISTENING TOURISTIC USE (1 USE)



C1209
Earphone double ear pavilion, 3.5mm



C1243
Iphone style earphone, mono, 3.5mm



C1209.01
Earphone mono, 2.5mm



C1282
Iphone style earphone, double ear pavilion,
3.5mm



C987.01
Earphone mono, 2,5mm



C1324
Earphone, double ear pavilion, cable length
140 cm, 3.5mm

EARPIECE ACCESSORIES FOR SOFTGUNNERS

Action Line accessories stand out for their hard-wearing design, technical specifications, practicality and quality of materials. The Action Line is not compatible with Vox functions.



Speaker

Air tube earpiece

TO LISTEN WITHOUT BEING HEARD

Military headset with detachable boom microphone (it can be worn on the right or on the left), tactical PTT and dual sound system (traditional speaker or air tube earpiece).

BOW-M EVO

C1046.02
2-Pin Midland



BOW-M EVO K

C1046.03
2-Pin Kenwood



ABM TACTICAL

C855.01
Earpiece microphone with adjustable arm and tactical PTT

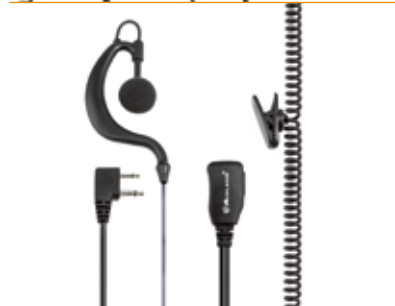

A21M

C858
Earpiece microphone with standard PTT. 2-Pin Midland

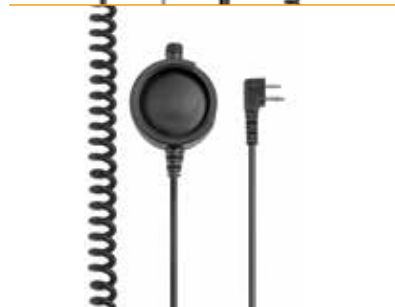

PTT+CLIP MIDLAND FOR BOW-M

C1088
2-Pin Midland



PTT+CLIP KENWOOD FOR BOW-M

C1088.01
2-Pin Kenwood

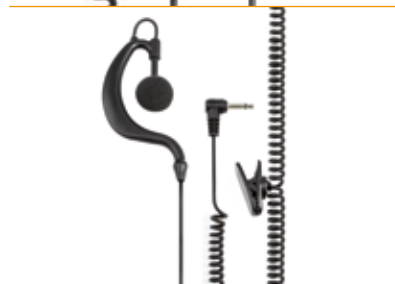

EP21

C859
Earpiece 3,5mm jack socket (not compatible with Midland 777).
LISTENING ONLY



WALKIE TALKIE | VHF/UHF | PROFESSIONAL ACCESSORIES

WALKIE TALKIE - CHARGERS



R73713
Double desktop charger
Attention: to be used only with R73168 wall charger.

G7 Pro

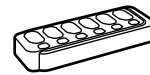

MULTI CA PB-BR03
C1353
6+6 position multicharger

BR03

R73579
Double desktop charger

Midland 777
Onda

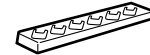

MULTI CA PB-BR02
C1295
6 position multicharger

BR02



MW904
C689
Wall charger

G9/G9 Plus,
G7XT/Pro,
G6XT, G5XT,
G8, M24-48-99



MULTI CA PB-G15
C1251
6 position multicharger

G15/G18/Arctic

MW905
C887
Wall charger

Midland/Alan
777, Onda, G12,
G5 R1, Pacific



MULTI CA PB-G10
C1218
6 position multicharger

G10

R71968
Wall charger with double jack

Midland/Alan
777, Onda



AL777
C803
Cigarette lighter power lead

Midland/Alan
777, G5 R1, G12,
Pacific



C829
To ensure the compatibility of all equipment with 1-pin - 2.5mm stereo equipment with 2-pin accessories.

G5/Midland 777

ALG7
C814
Cigarette lighter power lead

Midland G9, G8,
G7, G6, G5XT

WALKIE TALKIE - BATTERIES



PB-PRO
C1148
1200mAh Li-Ion rechargeable battery pack

G7/G9 Pro



PB-777
C783
650mAh Li-Ion rechargeable battery pack

Midland
777/ Onda

PB-X6
C1300
700mAh Ni-MH rechargeable battery pack

XT-50/60

4 PCS BATTERY KIT
R02246
650mAh Li-Ion rechargeable battery pack

Midland
777/ Onda

PB-X7
C1301
1000mAh Ni-MH rechargeable battery pack

XT-70

PB-G10
C1126
1600mAh Li-Ion rechargeable battery pack

G10

PB-BR01
R74611
2800mAh lithium battery Li-Ion rechargeable battery pack

BR-01

R74421
1600mAh Li-Ion rechargeable battery pack

G10 Mimetic

PB-777PRO
R01956
1000mAh Li-Ion rechargeable battery pack

777 PRO





NEW

PB-BR02
C1305
1800mAh Li-Ion rechargeable battery pack





BR-02

	PB-ATL/G7 C784 800mAh Ni-MH rechargeable battery pack	Midland G7, G9, Pacific		PB-BR03 R01916 2300mAh Li-Ion rechargeable battery pack	BR-03
	PB D-200 C1265 1800mAh Li-Ion rechargeable battery pack	Midland D-200		PB-G15/18 C1128 1600mAh Li-Ion rechargeable battery pack	G15/G18/Arctic
	PB G6/G8 C881 800mAh Ni-MH rechargeable battery pack	Midland G8, G6, M24/48/99-S		PB200/400 C846 1200mA Li-Ion rechargeable battery pack	G14
	PB-G11 C967 1600mAh Li-Ion rechargeable battery pack	Midland G11		BATTERY ELIMINATOR C1406 Battery eliminator with power supply cable (cigarette lighter plug)	G15/G18/Arctic

VHF/UHF

	R73725 Microphone with earpiece See other earpieces/microphones with 2-pin Kenwood accessory socket, page 65-66	CT 510		CLONING CABLE R73727 It allows the transfer of data/settings from one radio to another (not included)	CT 710 CT 890 CT590 CT690
				PB-AA890 C1212 Empty battery pack to charge 5 AA battery (not included)	CT 890
	R73642 Desktop battery charger (to be used with the USB cable, code R73644)	CT 510		PB200/400 C846 1200mAh Li-Ion rechargeable battery	CT 200/400 CT 210/410/710
	R74116 Quick desktop charger with wall adapter	CT890		R73645 1300mAh Li-Ion rechargeable battery	CT 510
	R73644 USB cable	CT 510		PB CT 890 C1172 2600mAh Li-Ion rechargeable battery	CT 890

PROFESSIONAL

	R01994 Microphone	HM35		RC45 G1066 Quick desktop charger	HP450-2A
	AU25E T681.01 External speaker max. 5W	HM35 HM70 HM06		BP0518 G811.03 1800mAh Ni-MH rechargeable battery	HP06 HP70 HP446 extra
	G1016 Remote control kit including 5 m extension lead with connectors, brackets, screws	HM35 HM70		BP08 G1192 1600mAh Li-Ion rechargeable battery	HP08

ADAPTERS AND WIRELESS HEADSETS

MIDLAND WIRELESS “WA” ACCESSORIES

The Midland Wireless “WA” range of accessories allows to use any Midland transceiver (fitted with 2 Pins) wireless. All devices have a rechargeable lithium battery, with USB cable for charging.

The WA series includes:

- **WA-DONGLE Bluetooth Adapter for 2-pin radio, including Kenwood/Motorola;**

- **Mini-WA-CB Bluetooth Adapter for M-10, M-20, M-Mini:** when connected to the portable or vehicular transceiver socket, you can choose the most suitable WA Series earphone according to your needs.
- **Bluetooth earphones WA21/WA31/WA29:** each earphone comes with a small PTT. With the WA Series earphones you can also pair any Bluetooth-equipped phone.



WA-DONGLE M C1199.02
Bluetooth adapter for Motorola 2-pin radio
WA-DONGLE K C1199.01
Bluetooth adapter for Kenwood 2-pin radio



WA29 C1203
Bluetooth headset microphone with neckband and PTT for WA-DONGLE/WA-CB



WA-CB C1276
Bluetooth mini-adapter for M-10, M-20, M-Mini



WA31 C1202
Bluetooth microphone with air tube earpiece and PTT for WA-DONGLE/WA-CB



WA21 C1201
Bluetooth headset microphone with PTT for WA-DONGLE/WA-CB

ADAPTERS AND USB CHARGERS



ERCLP04U
Power supply kit with DIN adapter (BMW) for handlebar with dual USB port - Output: 5V/3.3A



KIT243
12V power supply with cigarette lighter socket and hook to fix it to the handlebar



MP-W ADAPTER C1197
12V cigarette lighter/Din adapter (BMW)

ANTENNA ADAPTERS



51640 Adapter
SMA (male)/BNC (female)

CT510, CT710, CT890, G15, G18, G11V, D-200, ARCTIC



58610 Adapter
SMA (female)/BNC (female)

CT790, CT590, CT690, G10

WALKIE TALKIE | PROFESSIONAL ANTENNAS

G7 FLEX

C646.01

Flex antenna with adapter. Length: 35cm.
For Midland **G7 line, G8, G9, G14, G11, G15, G18**



R72770

Short antenna.
Length: 9 cm
For Midland **G11, G14, G15, G18**



R73197

Long antenna.
Length: 16 cm
For Midland **G11, G14, G15, G18**



HA105-LB1

G885.01
136-146MHz Antenna
For **HP105**



VHF/UHF ANTENNAS

ANT710

R01940

For
CT510 CT710
CT890



R74455

For
CT690 CT590
CT790 CT200
CT400



RH-707

FLEX

C635
Flex-Tilt



RH-701

C634

Flex



RH-771

C637

Flex



RH-779

C640

Telescopic-Tilt



RH-536

C644

Super Flex



SRH-536

C646

Super Flex-SMA



SPECIFICATIONS	RH-707 FLEX	RH-701	RH-771
Frequency	TX: 144/430 MHz	TX: 144/430 MHz	TX: 144/430 MHz
Type	1/4λ	1/4λ	1/4λ(144MHz) 1/2λ(430MHz)
Band	120-150/300-450 MHz 800-900 Mhz only RX	120-150/300-450 MHz 800-900 Mhz only RX	120-150/300-450 MHz 800-900 Mhz only RX
Length (cm)	21	21	40
Connector type	BNC	BNC	BNC

SPECIFICATIONS	RH-779	RH-536	SRH-536
Frequency	TX: 144/430 MHz	TX: 144/430 MHz	TX: 144/430 MHz
Type	1/4λ - (144 MHz) 1/2λ - (430 MHz)	1/4λ- (144 MHz) 1/2λ- (430 MHz)	1/4λ- (144 MHz) 1/2λ- (430 MHz)
Band	120-150/300-450 MHz 800-900 Mhz only RX	120-150/300-450 MHz 800-900 MHz only RX	300/800 MHz 900 MHz only RX
Length (cm)	14-41	36	37
Connector type	BNC	BNC	SMA

WALKIE TALKIE - LEASURE TIME OVERVIEW TABLES

MODEL	XT10-XT30	XT50	XT60	XT70
Band	PMR446	PMR446	PMR446-LPD (Dual-band)	PMR446-LPD (Dual-band)
Channels	8 + 8 pre-programmed	8 + 16 pre-programmed	PMR446: 8 + 16 pre-programmed LPD: 69	PMR446: 8 + 16 pre-programmed LPD: 69 LPD
CTCSS and DCS	38 CTCSS	38 CTCSS	38 CTCSS	38 CTCSS
Vox	1 sensitivity level	3 sensitivity levels	9 sensitivity levels	9 sensitivity levels
Power supply	3 AAA Ni-MH rechargeable batteries	3 AAA rechargeable batt. or 700mAh battery pack	3 AAA rechargeable batt. or 700mAh battery pack	3 AA rechargeable batteries or 1000mAh battery pack
Autonomy 5/5/90	Up to 5h (XT30)	Up to 12h	Up to 12h	Up to 17h
Display	Multifunction back-lit LCD	Multifunction back-lit LCD	Multifunction back-lit LCD	Multifunction back-lit LCD
Transmission power	500 mW ERP	500 mW ERP	500 mW ERP	500 mW ERP
Operating temperature	-20° +55°C	-20° +55°C	-20° +55°C	-20° +55°C
Weight (without batteries)	XT10: 73 g; XT30: 75 g	93 g	112 g	113 g
Size (WxHxD)	XT10: 48x85x30 mm XT30: 48x90x32 mm	54x103x33 mm	54x120x33 mm	58x120x33 mm
Connections	Audio accessories and USB socket (XT30)	Audio accessories and USB socket	Audio accessories and USB socket	Audio accessories and USB socket
Accessory socket type	2 pin (XT30 only)	2 pin	2 pin	2 pin
Compatible wall charger	R73487	R73487	R73487	C1254

MODEL	G7 PRO	G9 PRO	GB 1-R
Band	PMR446-LPD (Dual-band)	PMR446-LPD (Dual-band)	PMR446
Channels	PMR446: 16 LPD: 69	PMR446: 16+16 progr. LPD: 69	8+91 pre-set channels
CTCSS and DCS	38 CTCSS/104 DCS	38 CTCSS, 104 DCS	50 CTCSS, 104 DCS
Vox	6 sensitivity levels	3 sensitivity levels + talk back	-
Power supply	800mAh/1200mAh Li-Ion (opt) battery pack or 4 AA rechargeable batteries	4 AA 1800mAh rechargeable batteries or 4 AA alkaline batteries (opt)	12Vdc +/-10%
Autonomy 5/5/90	Up to 18h with battery pack 800mAh	23h with 4 1800mAh batteries	-
Display	Multifunction back-lit LCD	Multifunction back-lit LCD	Multifunction back-lit LCD
Transmission power	PMR446 500/10mW ERP (high/low) LPD 10mW	PMR446 500/10mW ERP (high/low) LPD 10mW	≤ 500mW ERP
Operating temperature	-20° +55°C	-20° +55°C	-20° +55°C
Weight (without batteries)	123 g	114 g	220 g
Size (WxHxD)	58x122x34 mm	68x120x35mm	100x85x22 mm
Connections	Socket for audio accessories, charger	Socket for audio accessories, charger	Socket for external speaker
Accessory socket type	2 pin	2 pin	3.5 mm mono
Compatible wall charger	MW904	MW904	-

WALKIE TALKIE - BUSINESS OVERVIEW TABLES

MODEL	G10	G11V	G15	G18
Band	PMR446	PMR446	PMR446	PMR446
Channels	8+8 pre-set sub-channels	8+8 pre-set sub-channels	8+8 pre-set sub-channels	8+91 pre-set channels
CTCSS and DCS	50 CTCSS 116 "N+116 "I" DCS	50 CTCSS, 105 DCS	50 CTCSS, 105 DCS	50 CTCSS, 105 DCS
Vox	-	9 sensitivity levels	9 sensitivity levels	9 sensitivity levels
Power supply	Li-Ion 1200mAh battery pack	1600mAh Li-Ion rechargeable battery pack	1600mAh Li-Ion rechargeable battery pack	1600mAh Li-Ion rechargeable battery pack
Autonomy 5/5/90	16h	22h	22h	22h
Display	-	-	-	Multifunction back-lit LCD
Transmission power	500mW ERP	500mW ERP	500mW ERP	500mW ERP (high/low level)
Operating temperature	-20° +55°C	-20° +55°C	-20° +55°C	-20° +55°C
Weight (without batteries)	171 g	209 g	192 g	240 g
Size (WxHxD)	118x60x35 mm	112x58x34 mm	100x58x33 mm	113x56x38 mm
Connections	Socket for audio accessories	Socket for audio accessories	Socket for audio accessories	Socket for audio accessories
Accessory socket type	2 pin Kenwood	2 pin Kenwood	2 pin Motorola	2 pin Motorola
Compatible wall charger	desktop charger only	desktop charger only	desktop charger only	desktop charger only

MODEL	777 PRO	BR01	BR03
Band	PMR446-LPD (Dual-band)	PMR446	PMR446
Channels	PMR446: 16 LPD: 69	8 + 8 preprogrammed	8+91 preprogrammed
CTCSS and DCS	38 CTCSS/104 DCS	50 CTCSS/232 DCS	50 CTCSS/104 DCS (N) 104 DCS (I)
Vox	9 sensitivity levels	-	10 sensitivity levels
Power supply	Li-Ion 1000mAh battery pack	Li-Ion 2800mAh battery pack	Li-Ion 2300mAh battery pack
Autonomy 5/5/90	Up to 14 h	Up to 37h	33h
Display	Liquid crystal EED™	-	Dynamic LED matrix
Transmission power	500 mW ERP	500mW ERP	500 mW erp
Operating temperature	-20° +55°C	-20° +55°C	-20 +55°C
Weight (without batteries)	65 g	101 g	83 g
Size (WxHxD)	44x85x27	57x117x33 mm	57x126x28mm
Connections	Socket for audio accessories	Socket for audio accessories	Socket for audio accessories and USB
Accessory socket type	3.5mm (4 contatti)	2 pin Kenwood	2 pin Kenwood
Compatible wall charger	desktop charger only	USB cable	C1254

VHF/UHF RADIO OVERVIEW TABLES

MODEL	CT590S	CT 890	CT990
Frequency	144-146MHz 430-440MHz	144-146MHz 430-440MHz	144-146MHz 430-440MHz
Operating temperature	-20°-+55°	-20°-+55°	-20°-+55°
Voltage supply	7.4V	7.4V	7.4V
Operating mode	Simplex or Semi-duplex	Full duplex	Simplex or Semi-duplex
Size (whitout antenna)	115x58x35,5mm	125x61x40mm	140x60x35mm
Weight (battery included)	230g	278g	310g
Antenna impedance	50Ω	50Ω	50Ω
Use cycle	5/5/90	5/5/90	5/5/90
Transmitter			
Frequency stability	±2.5PPM	±2.5PPM	±2.5PPM
Output power	VHF: 5W UHF:5W	VHF: 5W UHF:5W	10W (UHF/VHF)
Max. frequency deviation	5KHz	5KHz	5KHz
Audio distortion	≤ 3%	≤ 3%	≤ 3%
Receiver			
RF sensitivity	< 0.2μV	< 0.2μV	< 0.2μV
Audio distortion	≤ 3%	≤ 3%	≤ 3%
Audio response	300Hz ÷ 3KHz	300Hz ÷ 3KHz	300Hz ÷ 3KHz

VHF/UHF AND VHF MARINE RADIO OVERVIEW TABLES

MODEL	CT3000	CT2000	MODEL	ARCTIC
Frequency	144-146MHz 430-440MHz	144-146MHz 430-440MHz	Channels	57 international
Operating temperature	-20°-+55°	-20°-+55°	TX frequency coverage	from 156,025 to 157,425 MHz
Voltage supply	12.6V	12.6V	RX frequency coverage	from 156,300 to 162,000 MHz
Operating mode	Simplex or Semi-duplex	Simplex or Semi-duplex	Operating temperature	-15°C +55°C
Size (whitout antenna)	115x43x125mm	115x43x125mm	Size (WxHxD)	115 x 55 x 37mm
Weight (battery included)	809g	858g	Weight (transceiver only)	230 g
Antenna impedance	50Ω	50Ω	Accessory socket type	2.5mm/3.5mm Motorola
Use cycle	5/5/90	5/5/90	Programmable	Via software (PRG-G15)
Transmitter			Water protection grade	IP67
Frequency stability	±2.5PPM	±2.5PPM	Transmitter	
Output power	25W (UHF/VHF)	25W (UHF/VHF)	Output power	Selectable 1W or 5W
Max. frequency deviation	5KHz	5KHz	Frequency stability	±2.5PPM
Audio distortion	≤ 3%	≤ 3%	Audio distortion	≤ 3%
Receiver			Receiver	
RF sensitivity	< 0.2μV	< 0.2μV	Sensitivity 20dB Sinad	0,3 μV
Audio distortion	≤ 3%	≤ 3%	Audio output power	300mW @ 10% THD
Audio response	300Hz ÷ 3KHz	300Hz ÷ 3KHz	Audio distortion	< 10%

MIDLAND[®]



CAMERAS

DASH CAM
ACTION CAM

JUMP STARTER - POWER BANK

BIKE GUARDIAN WI-FI

MOTORCYCLE/CAR DASH CAM

NEW

Full HD
1080



WI-FI



CYCLE
RECORDING



DOUBLE USE:
MOTORCYCLE/CAR



WIDE ANGLE
170°



WATERPROOF
IP68



1920X1080P
(30FPS)



Bike Guardian WI-FI is the **FullHD** video camera for motorcycles and cars, featuring constant recording, very useful in the event of an accident to determine causes and responsibilities.

Connected to the motorbike USB port via the power cable provided (waterproof), it automatically begins recording when the motorbike starts and switches itself off when the motorbike is turned off. With the Visionbank application, you can control the video camera remotely using a smart phone or tablet.

Bike Guardian Wifi has a completely new look thanks to its metal case, with new finishes. It is **IP68 certified**, so it could even record up to 10 metres underwater!

MOTORBIKE/CAR MODE

Continuous recording when connected to an external power supply (car/motorbike).

INTEGRATED WIFI

Managed via app.

G-SENSOR

As it is equipped with an accelerometer, if there is an accident, recorded videos can be protected automatically.

MOTION DETECTION

Automatic recording, sensitive to the movements of those who walk in front of the camera to prevent theft and vandalism.

PACKS AND CODES

Video camera, USB cable, waterproof USB cable, fixing bracket, handlebar mounting, suction cup mounting, double-adhesive mounting consisting of: GO-PRO adaptor, screw, quick fixing, double-adhesive flat base.
code C1424



OPTIONAL WATERPROOF USB CABLE - R01988

BIKE GUARDIAN

THE FIRST MOTORCYCLE DASH CAM

Full HD
1080



CYCLE
RECORDING



WIDE ANGLE
120°



RAINPROOF
IP65



1920X1080P
(27FPS)



Bike Guardian, the motorcycle camera with **FullHD** resolution, designed and made to be another “eye” that records everything that happens while you are riding.

Highly useful in the event of an accident to prove who was involved and who was to blame **Bike Guardian** is the first motorcycle camera with continuous recording.

Connected to the motorcycle USB socket with the cable supplied, **it starts recording automatically when the bike is switched on and turns itself off when it is switched off.**

Bike guardian can be used also as a traditional **action cam** and, thanks to its integrated battery, allows up to 2 hours recording. Integrated microphone and speaker.

RAINPROOF

Bike Guardian is able to withstand bad weather, mud and dust, ensuring a video without interruptions. Even the cable, which connects the camera to the bike socket, is rainproof.



PACKAGING AND CODES

Camera, lock mount, handlebar mount, bi-adhesive flat mount, bi-adhesive curved mount, quick mount, screw, GO-PRO adaptor, strap mount, USB cable, USB rainproof cable, wrist belt.

code C1415

OPTIONAL WATERPROOF USB CABLE - C1457

STREET GUARDIAN GPS+

DASH CAM WITH BUILT-IN GPS

Full HD
1080

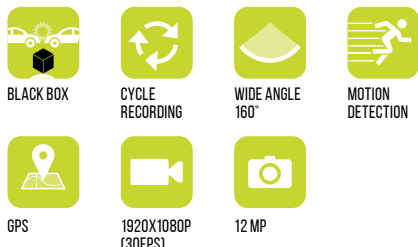

REAL SIZE

Street Guardian GPS + is the car camcorder with **built-in GPS** that identifies geographically every second of your route on a dedicated map, containing the **coordinates of all recordings**. Safety is therefore guaranteed not only by video and audio recordings (with integrated speaker and microphone) but also by monitoring the route.

Quick to install, it is placed in the centre of the windscreen thanks to the handy suction cup and connects to the power supply with the 12 V cigarette lighter socket.

BLACK BOX AND MOTION DETECTION

Like the other Street Guardian models, it is equipped with Black Box technology, which automatically saves and protects videos in the event of an accident and with Motion Detection, that starts recording any external movement within the camera range.

POSITION SIGNALLING

The built-in GPS indicates the location where you are, the speed you are going to and follows you step by step along the way.

PACKAGING AND CODES

Camcorder, suction cup mount with GPS, 12 V cigarette lighter socket, USB cable for PC connection.

code C1284.01



STREET GUARDIAN FLAT

COMPACT CAR DASH CAM

Full HD
1080



WI-FI



BLACK BOX



CYCLE
RECORDING



WIDE ANGLE
130°



MOTION
DETECTION



PARKING
FUNCTION



1920X1080P
(30FPS)



12 MP



INCLUDES 2 ADHESIVE SUPPORTS



VERY THIN 92x69x33mm



REAL SIZE

Street Guardian Flat is the thin **FullHD** camera with a discreet design for those who want to feel safe while driving, thanks to **video recordings complete with sounds**, without giving up a clean windscreen with complete vision.

Integrated microphone and speaker.

It connects to the cigarette lighter socket via the 12V cable and can be easily installed on two cars, thanks to the adhesives included in the package.

BLACK BOX AND MOTION DETECTION

The Black Box function makes the camera save and automatically protect the clips in case of an accident. The Motion Detection function allows the camera to start recording every time it detects a motion in the viewing range (requires the camera to be powered).

CAMERAS

WI-FI

It is possible to use the Wi-fi to place the camera and set it up during the assembly/ installation on the car.

The Wi-fi also allows the review and download of the clips directly onto the smartphone without having to connect the camera to a PC (thus avoiding removal from the vehicle).

Recommended apps: FinalCam and LuckyCam.

PARKING FUNCTION

The parking function enables the camcorder to automatically start recording whenever it detects a collision. No more unpleasant surprises for your parked car!

PACKAGING AND CODES

Camcorder, **2 adhesive supports**, cable with 12V cigarette lighter socket, USB cable to connect to a PC.

code C1409



79

STREET GUARDIAN DUAL

DUAL DASH CAM



BLACK BOX



NIGHT VISION
4 IR LED



CYCLE
RECORDING



WIDE ANGLE
160° OUT+120° IN



MOTION DETECTION
(OUT)



WITH GPS



1920X1080P (OUT) 12 MP
1920X1080P (IN)



REAL SIZE

**TWO CAMERAS RECORDING WHAT IS HAPPENING IN AND OUT THE CAR.
IDEAL FOR TAXIS AND PUBLIC TRANSPORT.**

The **Street Guardian Dual** is double; in fact it has **two cameras**, to film what is happening inside and outside the car. Designed to record automatically even without light, it is equipped with Night Vision technology and 4 infrared LEDs (the latter for internal shooting). **Integrated microphone and speaker.**

BLACK BOX AND MOTION DETECTION

In case of an accident, the Black Box function automatically saves the videos. The Motion Detection function uses the vision range to start recording any movements outside the car.

GPS

The built-in GPS indicates the location where you are and follows you step by step along the way.

PACKAGING AND CODES

Camcorder, suction cup mount with GPS, 12V cigarette lighter socket, USB cable for PC connection.

code C1285

OPTIONAL ADHESIVE SUPPORT C1434



TRUCK GUARDIAN WIRELESS

TRUCK AND CARAVAN VIDEO-SURVEILLANCE SYSTEM

Full HD
1080



WIRELESS
UP TO 150M



IP67 (VIDEO
CAMERA)



7" MONITOR



NIGHT VISION 12
IR LED



CYCLE
RECORDING



WIDE ANGLE
120°



2/24V DUAL
SUPPLY



REMOTE CONTROL



VIDEO RESOL.
800X480P (60FPS)

CONNECT UP TO
4 CAMERAS

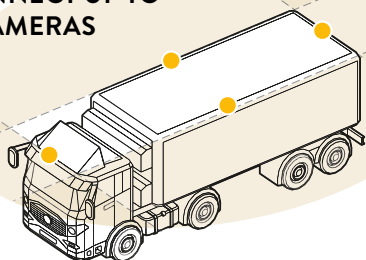

SYSTEM SUITABLE FOR VEHICLES
FOR THE TRANSPORT OF ANIMALS



Truck Guardian Wireless is the camera for trucks and caravans, designed and made to help during manoeuvres and to record what is happening around you.

Highly useful when reversing and in the event of an accident to prove causes and responsibilities.

WIRELESS

Wireless technology makes installation extremely easy, as camera and monitor do not need to be connected. Just find a 12 or 24V power source. If you want to add an additional camera (up to 4), simply power it and it will automatically be coupled to the monitor.

7" MONITOR AND REMOTE CONTROL

The large wireless monitor with recorder located inside the truck cabin, is equipped with a remote control, to control the monitor functions remotely.

NIGHT VISION THAT IS NOT AFRAID OF BAD WEATHER

The water resistant (IP67) video camera has a 120° viewing angle and it is equipped with 12 infrared LEDs for night viewing, which light up automatically

CYCLIC RECORDING

Cyclic recording allows to record continuously from one to four cameras even simultaneously.

PACKAGING AND CODES

Truck Guardian Wireless

Monitor, camera, power cable with cigarette lighter socket (for monitor), power cable (for video camera), 3 Wi-Fi antennas (2 for monitor, 1 for video camera), remote control, sunshade frame, mounting support.

code **C1331**

Additional wireless truck camera

Camera, power cable, Wi-Fi antenna.

code **C1332**



H9

THE TOP IN THE 4K ACTION CAM RANGE



WI-FI



SUBMERSIBLE
CASE 30M



2" LCD DISPLAY



VIDEO/PHOTO



EIS FEATURE
ELECTRONIC IMAGE
STABILIZER



TIME LAPSE
PHOTO



TIME LAPSE
VIDEO



WIDE ANGLE
170°



H9 is an extra-slim camera with a compact design and excellent resolution: **Real 4K!** **H9** can record films with resolution up to 4K@30fps; moreover the built-in chipset Ambarella guarantees the best ever videos! Thanks to the Panasonic sensor, H9 can take high quality photos up to 14MP.

DISPLAY LCD 2" INTEGRATED

H9 has an integrated display for framing and easily adjusting settings as well as reproducing photos and videos.

TIME LAPSE

It produces exceptional videos with advanced features: Photo Time Lapse (sequence of photos at a set time interval) and Time Lapse Video (creates accelerated videos).

REMOTE CONTROL

It is equipped with a 2.4 Ghz wrist wireless remote control, its buttons enable the switch on and off of the camera and to take videos and photos.

WATERPROOF CASE 30M

The submersible case supplied protects the action cam from water up to a depth of 30 meters, but also from mud and dust.

WI-FI

Thanks to the built-in wi-fi and high-performance chipset, **H9** connects to smartphones and tablets to watch again and share films and photos with the dedicated "Midland H9" App (iOS and Android).

PACKAGING AND CODES

Camera, 30m waterproof case, remote control, 3.7V/1000mAh Li-ion battery pack, frame (to be used without case), curved base, flat base, 2 quick-release couplings, 90° support, handlebar support, clamp, USB cable, screw, screw coupling.

code C1405



H5+

UHD BEST SELLER



WI-FI



SUBMERSIBLE CASE 30M



2" LCD DISPLAY



VIDEO/PHOTO



CAR DVR



TIME LAPSE



WIDE ANGLE 140°



ALL ACCESSORIES IN THE PACKAGE



The very small dimensions, weight - only 60 gr. - practicality and 3840x2160@25fps resolution make **H5+** perfect for the needs of all athletes and outdoor enthusiasts.

BUILT-IN 2" LCD DISPLAY

Midland **H5+** introduces the integrated display for framing, adjusting easily the settings and playing video and photos.

CAR DVR FUNCTION

Fitted with Cycle recording, it can be easily installed in the car and record continuously what is happening while you drive.

TIME LAPSE

Produces exceptional videos with advanced Time Lapse function (photo sequence at a time interval).

WIDE-ANGLE

Fitted with 140° wide-angle lens for excellent videos.

30M SUBMERSIBLE CASE

The submersible case supplied protects the action cam from water up to a depth of 30 meters, but also from mud and dust.



WI-FI

Midland H5+ thanks to built-in wi-fi connects to smartphones and tablets to see, watch again, and share movies and photos with the dedicated App "Ez i Cam" (iOS and Android).

PACKAGING AND CODES

Camera, submersible case 30 m, coloured front, 1050 mAh Li-ion battery pack, USB cable and 20 elements to be combined to create the mounting solution that best suits your needs (ex: helmet support, bicycle helmet, etc)

code **C1208.02**

H3+

THE ACTION CAM EVERYONE CAN USE

Full HD
1080



WI-FI



SUBMERSIBLE
CASE 30M



2" LCD DISPLAY



VIDEO/PHOTO



CAR DVR



ELECTRONIC IMAGE
STABILIZER



WIDE ANGLE
140°



ALL ACCESSORIES
IN THE PACKAGE



H3+ is complete with integrated Wi-Fi, Full HD, image stabilizer and waterproof case. The action cam for all your craziest moments. With the GoPlus Cam application, you can control the video camera remotely using a smart phone or tablet.

INTEGRATED 2" LCD SCREEN

Midland H3 + features the integrated display for framing, easily adjusting settings and playing videos and photos.

WI-FI

Thanks to the integrated Wi-Fi, Midland H3 + connects to smartphones and tablets to view, review and share videos and photos through the dedicated GoPlus Cam App (iOS and Android).

MOTION DETECTION

Automatic recording, sensitive to the movements of the wearer.

DASH CAM

Continuous recording when connected to an external power supply (car/motorbike).

IMAGE STABILIZER

Automatic elimination of micro vibrations

WATERPROOF CASE 30M

The submersible case supplied protects the ACTION CAM from water up to a depth of 30 metres, but also from mud and dust.

PACKAGING AND CODES

Video camera, case waterproof to 30m, frame, quick fixing, flat based mounting, photographic fixing with screw, USB cable, Li-Ion battery pack

code C1235.01



CAMERA ACCESSORIES

KIT



**ACC-H5
C1245**
Accessory set

H5

REMOTE CONTROLS



R01487
Remote control

H9



**RC-H7/H7+
C1248**
Remote control

**H7
H7+**

SURFACE



**TURNABLE HOOK
360° C1268**
Rotating hook mount 360°
for base with double-sided
tape

**H
SERIES**

GO PRO



**SPIDER
C1110**
Large base with 3M adhesive
and 45° slide for surf/
snowboard

**ALL
also Bike
Guardian
series**

GO PRO



**BASIC
C1273**
Base fixing system
(4 pieces)

**H9 /H3
H5/H5+
H7/H7+**

GO PRO



**HELMET MOUNT
C990**
Bi-adhesive helmet mount.

**XTC280
XTC270**



**BASIC
C1108**
Base fixing system
(4 pieces)

**XTC400
XTC450**



**SURF SNOW BOARD
MOUNT C1038**
270° Adjustable ABS and
stainless steel mount with
safety device to be fixed to a
surfboard or snowboard

**XTC280
XTC270**



**MINISPIDER
C1109**
Small base with 3M adhesive
and 45° slide

**ALL
also Bike
Guardian
series**

GO PRO

WEARABLE



**BELT MOUNT
C1111**
Belt mount

**XTC400
XTC450**



**GOGGLE MOUNT
C989**
Mount for goggles (ski,
motocross)

**XTC280
XTC270**



**VENTED HELMET
MOUNT
C1112**
Bicycle helmet mount













**XTC400
XTC450**



**CAP MOUNT
C1012**
Cap mount

ALL*

* Compatible with H series action cameras using Tripod Mount C1270 adapter

	HEAD STRAP MOUNT C1113 Headband mount	XTC400 XTC450		HEAD STRAP MOUNT C1040 Headband mount	XTC280 XTC270
	GOGGLE MOUNT C1114 Mount for goggles (ski, motocross)	XTC400 XTC450		VENTED HELMET MOUNT C991 Universal Velcro band for bicycle helmet, rucksack, etc.	XTC280 XTC270
VEHICLE					
	HANDLEBAR MOUNT C1117 Mount for handlebars	ALL also Bike Guardian series GO PRO		HANDLEBAR MOUNT C992 Mount for handlebars and tubes	ALL* GO PRO
	SUCTION CAP MOUNT C980.01 Suction mount for cars and motorcycles for stable recording on a vehicle, ideal for smooth (bodywork) and rough surfaces (dashboard)	ALL* GO PRO			
PROFESSIONAL/RAM					
	RAM ROLL BAR MOUNT C1042 Professional mount for tubular handlebar with a diameter from 1 to 3 cm	ALL*		RAM MOTO QUAD MOUNT C1052 Professional mount suitable for all vehicles with tubes with a diameter from 3 to 6 cm	ALL
TACTICAL/WEAPONS					
	PICATINNY MOUNT C1118 Mount for rifles and guns with Picatinny Rail	XTC400 XTC450		UNIVERSAL RIFLE MOUNT C1064.01 Universal mount for rifles	ALL
	PICATINNY MOUNT C1039 Mount for rifles and guns with Picatinny Rail	XTC280 XTC270		BOW MOUNT C1068 Bow mount	ALL
				TREE MOUNT C1062 Tree mount	
POD					
	XT-POD C1116 Multicam Monopod Aluminum body (18cm)	ALL* GO PRO		XT-POD 3S C1116.02 Telescopic multicam 3-section Monopod 100% Carbon fiber (112cm)	ALL* GO PRO
	XT-POD 2S C1116.01 Telescopic multicam 2-section Monopod 100% Carbon fiber (80cm)	ALL* GO PRO			

* Compatible with action cam H1 series using Tripod Mount Adapter C1270

ADAPTERS



**TRIPOD MOUNT
C1270**
Adapter for GOPRO.
This adapter allows to use all
screw-type accessories with
H series action cams

**H
SERIES**

GO PRO



**TRIPOD MOUNT
R73161**
Side adapter to transform
any screw mount into a side
attachment

**XTC280
XTC270**



**TRIPOD MOUNT
C1120**
Side adapter to transform
any screw mount into a side
attachment

**XTC400
XTC450**



**GOPRO ADAPTER
101854**
This adapter allows the use of
GOPRO mounts with XTC
MIDLAND cameras

ALL

GO PRO

SUBMERSIBLE CASES/LENS KIT



**WPC-H9
R01488**
Submersible case 30 m

H9

**CC-XTC300
C1031**
Case with flat lens,
up to 60 m

XTC300



**WPC-H5+
C1335**
Submersible case 30 m

**H5+
H9**

**CC-XTC280
C976.01**
Case with flat lens,
up to 60 m

**XTC280
XTC270**



**WPC-H5
C1247**
Submersible case 30 m

**H5
H3+/H3**



**ANTI-CONDENSATION
INSERTS
C1171**
18 inserts and one humidity
indicator

ALL



**WPC-H7+
C1336**
Submersible case 30 m

H7+



LENS KIT C1074
Camera lens, spherical lens,
flat lens 60 m of case and
seals

XTC300



R74447
Submersible case 30 m

H180



**FLAT LENS
R73453**
60 m flat lens

XTC300

**CC-XTC400
C1121**
Submersible case 85m

**XTC400
XTC450**

BATTERIES



**PB-H5
C1246**
900mAh 3,7V Li-Ion battery
pack

**H5/H5+
H3+/H3
H9**

**BATTERY
C1124**
3,7V 1700mAh Li-Ion
battery pack

**XTC400
XTC450**

**PB-H5+/H9
C1246.01**
1050mAh 3,7V Li-Ion
battery pack

H5+/H9

**BATTERY
R72963**
900mAh Li-Ion battery pack

**XTC280
XTC270**

R74537
1000mAh Li-Ion battery
pack

H180

CAMERA OVERVIEW TABLES

MODEL	BIKE GUARDIAN WI-FI	BIKE GUARDIAN	STREET GUARDIAN FLAT
Resolution	1920x1080 (30 fps)	1920x1080p (27fps)	1920x1080p (30fps)
Sensor	AR0330 3 MP	Sony 2 MP	2 MP
Aspect Ratio	16:9	16:9	16:9
Format	MOV	MOV	MOV
Lens	F/2.0 (f=3.15 mm)	-	6 elements
Lens angle	170°	120°	130°
Sd Card	64 GB	64 GB (Class 10)	32 GB
Battery	1050 mAh up to 120'	680mAh up to 120'	Only for finalizing video files
Wi-Fi	Si	No	Si
Photo	12MP	2 MP	12 MP
Tripod mount	Si	Si	No
Weight	98 g	78g	72g
Dimensions WxHxD	100mm Ø40 mm	86mm Ø27mm	92x69x33mm
Operating systems	Win XP, SP2, Vista 7&8, Mac OSX 10.4+		

MODEL	STREET GUARDIAN GPS+	STREET GUARDIAN DUAL	TRUCK GUARDIAN WIRELESS	
			Monitor	Camera
Resolution	1920x1080p	Fronte: 1920x1080p Retro: 1920x1080p	800x480	756x504
Sensor	3 MP	4 MP/2 MP	-	CMOS
Aspect Ratio	16:9	16:9	16:9	16:9
Format	MOV	MP4	-	-
Lens	6 elements	7 elements - 5 elements	-	-
Lens angle	160°	160° - 120°	-	120°
Sd Card	64 GB	64 GB	128 GB	-
Battery	Only for finalizing video files	Only for finalizing video files	-	-
Wi-Fi	No	No	2.4 GHz encrypted transmission	2.4 GHz encrypted transmission
Photo	12 MP	12 MP	-	-
Tripod mount	No	No	Support bracket	Support bracket
Weight	70g	87g	430g	500g
Dimensions WxHxD	88x48x34mm	102x42x42mm	180x125x25mm	85x50x40mm
Operating systems	Win XP, SP2, Vista 7&8, Mac OSX 10.4+			

MODEL	H9	H5+	H3+
Resolution	4K (30fps)	4K (25fps) - 2,7K(30fps) - 1920 x 1080p(60fps)	1920x1080 (FHD) - 1440x1080 (HD)
Sensor	Panasonic 14 MP	4 Mp	
Aspect Ratio	16:9	16:9	
Format	MP4	MOV	
Lens	7 elements	-	
Lens angle	170°	140°	120°
Sd Card	64 GB	Up to 32 GB	Up to 128 GB
Battery	1050 mAh, up to 90 minuts	1050 mAh Li-Ion, up to 90 minuts	900mAh Li-Ion, up to 110 minuts in HD
Wi-Fi	Yes	Yes	Yes
Photo	14 MP	12 Mp (interpolated)	
Tripod mount	No	No	No
Weight	65	58g	52g
Dimensions WxHxD	58x41x30mm	59,3x41x30mm	59,3x29,3x41,1mm
Operating systems	Win XP, SP2, Vista 7&8, Mac OSX 10.4+		

ENERJUMP MINI

JUMP STARTER 12V - POWER BANK



BATTERY
CABLES



USB PORT



CURRENT PEAK
400A



CAPACITY
6000MAH



100L LED
FLASHLIGHT



BATTERY
LEVEL

SMART JUMP START SYSTEM:
WITH INTELLIGENT CLAMPS



17X8.1X1.7 cm: EXTRA THIN!

Your energy reserve when you don't have the Battery you deserve.

Jump Starter for cars, bikes, ATV, etc.:

Enerjump Mini is small but powerful enough to start vehicles fitted with a 12V battery (**3000cc petrol / 2000cc diesel**).

The power bank suitable for all devices with a USB plug: Enerjump Mini has 1 USB socket to recharge smartphones, tablets, cameras, MP3 readers, etc.

Thanks to its capacity (**6000mAh**) it recharges your iPhone up to 2 times.

SMART JUMP START SYSTEM™

Enerjump Mini is fitted with Smart Jump Start System™ that allows automatic detection of the battery charge, protection against short circuits and polarity reversal.

LED TORCH AND CHARGE INDICATOR

Enerjump is fitted with a powerful LED 100L torch and charge indicator (4 signaling levels).

PACKAGING AND CODES

Enerjump Mini, starting clamps with "Smart jump start system", USB/microUSB cable.
code C1355

ER300

EMERGENCY POWER BANK



AM/FM RADIO



POWER SOURCE
DYNAMO CRANK



POWER SOURCE
SOLAR PANEL



LED
FLASHLIGHT



CHARGE
THE DEVICE
WITH USB



BATTERY
UP TO 25 HOURS



DOG WHISTLE FOR
RESCUE TEAMS



AM/FM radio



Dynamo recharge



Charge the device with USB
port

SOLAR PANEL



ER300 is a powerful powerbank capable of recharging portable devices and an **emergency device** equipped with an AM/FM receiver, designed for emergency situations, disasters and safety in which keeping in touch is essential. **ER300** is a versatile solution also for everyday use, for outdoor activities, camping or in leisure time. Rechargeable via dynamo, solar panel, batteries and USB socket. With ultrasonic call for dogs, torch.

Frequency: 531-1629KHz (AM)
87,5-108MHz (FM)

Colour: Red/Black

FEATURES

- 4 power sources: dynamo crank, solar panel, internal Li-Ion 2000 mAh battery pack or simply rechargeable batteries
- It charges external electronic devices with USB port
- Power bank with long life rechargeable battery 3,7Vdc Li-Ion 2000 mAh, lasting up to 25 hours of normal use
- It also works with 6 AA battery (not included)
- Powerful flashlight with Cree® led 130L*
- SOS Morse code flashlight beacon

- Ultrasonic dog whistle useful for rescue teams
- AM/FM radio
- Digital clock
- Headphone jack
- Telescopic antenna
- Wide, bright LCD with backlight

PACKAGING AND CODES

Radio, 2000 mAh Li-Ion battery pack,
USB/micro USB cable
code C1173

* Cree® is a registered trademark of Cree Inc

MIDLAND[®]



INTERCOM

AN INTERCOM FOR EVERY NEED

Sound development that knows no limits or compromises.

Since 2005, Midland has specialized in motorcycle communication products. In 15 years of motorcycle communication we have developed a lab of professional engineers dedicated to the daily development of technologically advanced products. After years of constant studies and tests, we can finally say that the audio of our intercoms is the most advanced ever, thanks to strict and constant QUALITY controls. A characteristic that has distinguished the company for over 60 years.

DRIVER-PASSENGER COMMUNICATION



BTGO UNI

BTGO JET

The invisible

Connections: mobile phone, music,
GPS

ONE TO ONE COMMUNICATION



BTMINI

Up to 400 m

2 people

Connections: mobile phone, music,
GPS



BTX1 PRO S

Up to 800 m

Up to 3 people

Connections: mobile phone, music,
GPS



SELECTED BY:



OFFICIAL TECHNICAL EQUIPMENT

GROUP COMMUNICATION

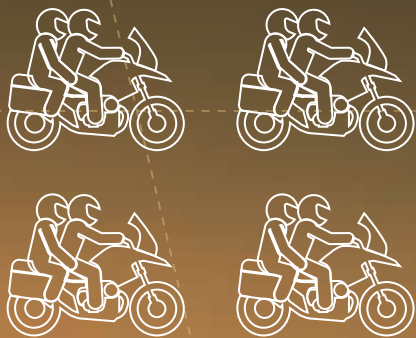

BTX2 PRO S

Up to 1200 m
Up to 8 people (4 bikes)
Connections: mobile phone, music,
GPS
Dual Core Bluetooth®
Background Stereo

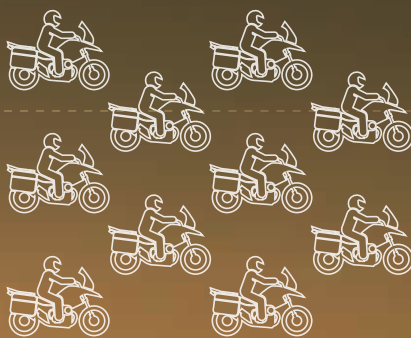

BTMESH

Up to 5 km (10 people in Dynamic
Repeat), **Up to 10 people**
Connections: mobile phone, music,
GPS
Dual Core Mesh + Bluetooth®
Background Stereo

UNLIMITED COMMUNICATION



BTT BUTTON + APP

















Unlimited distance, unlimited users.
**Connect your BTT Button to your
smartphone and use it with any
intercom brand.**



MIDLAND®

MIDLAND INTERCOM RANGE



FEATURES	BT MESH	BTX2 PRO S
 Mesh Full duplex	10 people	-
Conference	-	8 people (4 motorcycles)
 One to One	4 people	6 people
Universal Intercom	Yes	Yes
 Unlimited communication with BTT Button	Yes	Yes
 Range (in ideal conditions)	5 Km (with 10 people)	1200 m
 Music share	Yes	Yes
 FM RADIO	Yes	Yes
 Mobile connections	2	2
 Waterproof	IPX6	IPX6
 BT SET-APP	Yes	Yes
 Voice messages	Yes	Yes
 Stereo background	Yes	Yes
 Dashboard compatibility	Yes	Yes
 Helmets compatibility	Universal	Universal
 Battery life	15 h Mesh 23h Bluetooth	23 h
 AGC Automatic volume control	Yes	Yes
Single pack code	C1412	C1414
 Twin pack code	C1412.01	C1414.01

DISCOVER ALL THE FEATURES OF OUR INTERCOMS AT
WWW.MIDLANDEUROPE.COM

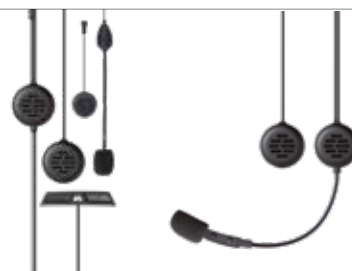

BTX1 PRO S

BT MINI

BT GO UNI | BT GO JET

-	-	-
3 people	-	-
3 people	2 people	2 people
Yes	Yes*	-
Yes	Yes	Yes
800 m	400 m	Driver-passenger
Yes	-	-
Yes	-	-
2	1	1
IPX6	IPX6	IPX6
Yes	-	-
Yes	Yes	Yes
-	-	-
Yes	Yes	Yes
Universal	Universal	Modular and integral Jet
23 h	8 h	8 h
Yes	No	-
C1411	C1410	BT GO UNI C1310.01 BT GO JET C1310
C1411.01	C1410.01	-

* available with the next firmware update



MIDLAND, a brand born in 1959 in a small factory in Kansas City, is today the world leader in the radiocommunication and consumer electronics sector.

A group that today has over **15 European and non-European subsidiaries**, between branches and strategic partners,
and a distribution in **over 90 countries**, under the guidance of the **Italian Headquarters**.

Reggio Emilia is the headquarters of Research and Development that carries out the company mission daily and with great commitment.

“Create a world where communicating is simple, fun and available to everybody.”

Design and manufacture with passion products of quality, technologically innovative and that respond to the real need of all of us: to communicate.

A success that has lasted for over 60 years.

CERTIFICATIONS

ETSI: CTE International is a credited member of ETSI - the European Telecommunications Standards Institute - which it helps define standardised technical specifications for telecommunication products and services.



ISO 9001 2015: for the design, production and installation of telecommunication systems and equipment for industrial, military, civil, marine and consumer use.



ANITEC-ASSINFORM: CTE International is part of the ANIE Federation research and innovation commission, a member of Confindustria and represents the electro-technical and electronic businesses operating in Italy.

