



Dell 3330dn Laser Printer

User's Guide

Contents

Safety information.....	9
Learning about the printer.....	11
Finding information about the printer.....	11
Printer configurations.....	12
Understanding the printer control panel.....	14
Using the standard exit bin and paper stop.....	17
Additional printer setup.....	19
Selecting a location for the printer.....	19
Installing internal options.....	20
Available internal options.....	20
Accessing the system board to install internal options.....	20
Installing a memory card	21
Installing a flash memory or firmware card.....	23
Installing hardware options.....	25
Installing an optional drawer	25
Attaching cables.....	26
Installing the printer on a wired network.....	27
Installing printer software.....	29
Verifying printer setup.....	30
Printing a menu settings page.....	30
Printing a network setup page	30
Loading paper and specialty media.....	32
Setting the Paper Size and Paper Type.....	32
Configuring Universal paper settings.....	32
Loading trays.....	33
Using the multipurpose feeder.....	38
Linking and unlinking trays.....	42
Linking trays.....	42
Unlinking trays	43
Assigning a Custom Type <x> name.....	43
Changing a Custom Type <x> name	44
Paper and specialty media guidelines.....	45
Paper guidelines.....	45

Paper characteristics.....	45
Unacceptable paper	46
Selecting paper.....	46
Selecting preprinted forms and letterhead.....	46
Using recycled paper and other office papers	47
Storing paper.....	47
Supported paper sizes, types, weights, and capacities.....	48
Paper sizes supported by the printer	48
Paper types and weights supported by the printer	49
Paper capacities.....	50
Software overview.....	51
Status Monitor Center.....	51
Driver Profiler.....	51
Dell Printer Alert Utility.....	51
Installing the optional XPS driver.....	52
Dell Toner Management System.....	53
Printing Status Window.....	53
Dell Printer Supplies Reorder Application	53
Printing.....	54
Printing a document.....	54
Printing on specialty media.....	55
Tips on using letterhead.....	55
Tips on using transparencies	56
Tips on using envelopes.....	57
Tips on using labels.....	57
Tips on using card stock.....	58
Printing confidential and other held jobs.....	58
Holding jobs in the printer	58
Printing confidential and other held jobs.....	59
Printing information pages.....	60
Printing a font sample list.....	60
Printing a directory list.....	60
Printing the print quality test pages	61
Canceling a print job.....	61
Canceling a print job from the printer control panel	61
Canceling a print job from the computer	61
Clearing jams.....	63
Avoiding jams.....	63

Accessing jam areas.....	64
200 paper jam.....	65
201 paper jam.....	66
202 paper jam.....	67
231 paper jam.....	69
233 paper jam.....	70
234 paper jam.....	70
235 paper jam.....	71
242 paper jam.....	71
251 paper jam.....	72

Understanding printer menus.....74

Menu list.....	74
Paper menu.....	75
Default Source menu.....	75
Paper Size/Type menu.....	75
Configure MP menu.....	78
Substitute Size menu.....	79
Paper Texture menu.....	79
Paper Weight menu.....	80
Paper Loading menu.....	82
Custom Types menu.....	83
Universal Setup menu.....	83
Reports menu.....	84
Reports menu.....	84
Network/Ports menu.....	85
Active NIC menu.....	85
Standard Network or Network <x> menus.....	86
Reports menu (under the Network/Ports menu).....	87
Network Card menu.....	87
TCP/IP menu.....	88
IPv6 menu.....	89
AppleTalk menu.....	89
NetWare menu.....	90
USB menu.....	91
Parallel menu.....	92
SMTP Setup menu.....	94
Security menu.....	95
Miscellaneous menu.....	95
Confidential Print menu.....	96
Security Audit Log menu.....	96

Set Date/Time menu.....	97
Settings menu.....	98
General Settings menu	98
Setup menu	101
Finishing menu.....	102
Quality menu.....	104
Utilities menu	105
XPS menu.....	105
PDF menu	106
PostScript menu	106
PCL Emul menu	106
HTML menu.....	109
Image menu.....	110
Understanding printer messages.....	111
List of status and error messages.....	111
Maintaining the printer.....	125
Cleaning the exterior of the printer.....	125
Storing supplies.....	125
Conserving supplies.....	126
Checking the status of supplies from a network computer.....	126
Ordering supplies.....	126
Printer attached to a network	126
Printer attached locally to a computer	127
Replacing supplies.....	127
Replacing the toner cartridge	127
Replacing the photoconductor kit	129
Moving the printer.....	132
Moving the printer to another location.....	132
Administrative support.....	133
Using the Embedded Web Server.....	133
Checking the virtual display.....	133
Checking the device status.....	133
Viewing reports.....	133
Configuring supply notifications.....	134
Modifying confidential print settings.....	134
Adjusting Power Saver.....	134
Setting up e-mail alerts.....	135

Restoring the factory default settings.....136

Troubleshooting.....137

Solving basic printer problems.....137

Printer control panel display is blank or displays only diamonds.....137

Solving printing problems.....137

Jobs do not print.....137

Confidential and other held jobs do not print.....138

Multiple-language PDFs do not print.....138

Job takes longer than expected to print.....139

Job prints from the wrong tray or on the wrong paper.....139

Incorrect characters print.....139

Tray linking does not work.....139

Large jobs do not collate.....140

Unexpected page breaks occur.....140

Envelope seals when printing.....140

Solving option problems.....140

Option does not operate correctly or quits after it is installed.....140

Drawers.....141

Flash memory card.....141

Memory card.....141

Solving paper feed problems.....142

Paper frequently jams.....142

Paper jam message remains after jam is cleared.....142

Page that jammed does not reprint after you clear the jam.....142

Solving print quality problems.....143

Isolating print quality problems.....143

Blank pages.....144

Characters have jagged or uneven edges.....144

Clipped images.....144

Gray background.....145

Ghost images.....145

Incorrect margins.....146

Paper curl.....146

Print is too dark.....147

Print is too light.....148

Skewed print.....149

Toner fog or background shading appears on the page.....149

Toner rubs off.....149

Toner specks.....150

Transparency print quality is poor.....150

Streaked horizontal lines.....150

Streaked vertical lines.....151

Solid black or white streaks appear on transparencies or paper.....152
Embedded Web Server does not open.....152
 Check the network connections152
 Check the network settings152

Appendix.....153

Index.....155

Safety information

Connect the power supply cord to a properly grounded electrical outlet that is near the product and easily accessible.

 **CAUTION—SHOCK HAZARD:** Do not set up this product or make any electrical or cabling connections, such as the power supply cord or telephone, during a lightning storm.

Refer service or repairs, other than those described in the user documentation, to a professional service person.

This product is designed, tested, and approved to meet strict global safety standards with the use of specific manufacturer's components. The safety features of some parts may not always be obvious. The manufacturer is not responsible for the use of other replacement parts.

 **CAUTION—SHOCK HAZARD:** Make sure that all external connections (such as Ethernet and telephone system connections) are properly installed in their marked plug-in ports.

 **CAUTION—POTENTIAL INJURY:** This product uses a laser. Use of controls or adjustments or performance of procedures other than those specified herein may result in hazardous radiation exposure.

This product uses a printing process that heats the print media, and the heat may cause the media to release emissions. You must understand the section in your operating instructions that discusses the guidelines for selecting print media to avoid the possibility of harmful emissions.

 **CAUTION—HOT SURFACE:** The fuser and the inside of the printer near the fuser may be hot. To reduce the risk of injury from a hot component, allow the surface to cool before removing paper from this area.

 **CAUTION—POTENTIAL INJURY:** Use the handholds on the sides of the printer to lift it, and make sure your fingers are not under the printer when you set it down.

 **CAUTION—POTENTIAL INJURY:** Do not twist, bind, crush, or place heavy objects on the power cord. Do not subject the power cord to abrasion or stress. Do not pinch the power cord between objects such as furniture and walls. If the power cord is misused, a risk of fire or electrical shock results. Inspect the power cord regularly for signs of misuse. Remove the power cord from the electrical outlet before inspecting it.

 **CAUTION—SHOCK HAZARD:** If you are installing an optional drawer after setting up the printer, then turn the printer off and unplug the power cord from the wall outlet before continuing.

 **CAUTION—SHOCK HAZARD:** If you are accessing the system board or installing optional hardware or memory devices sometime after setting up the printer, then turn the printer off, and unplug the power cord from the wall outlet before continuing. If you have other devices attached to the printer, then turn them off as well, and unplug any cables going into the printer.

 **CAUTION—SHOCK HAZARD:** To avoid the risk of electric shock when cleaning the exterior of the printer, unplug the power cord from the wall outlet and disconnect all cables from the printer before proceeding.

Use care when you replace a lithium battery.

 **CAUTION—POTENTIAL INJURY:** There is a danger of explosion if a lithium battery is incorrectly replaced. Replace it only with the same or equivalent type of lithium battery. Do not recharge, disassemble, or incinerate a lithium battery. Discard used batteries according to the manufacturer's instructions and local regulations.

 **CAUTION—POTENTIAL INJURY:** Before moving the printer, follow these guidelines to avoid personal injury or printer damage:

- Turn the printer off using the power switch, and then unplug the power cord from the wall outlet.
- Disconnect all cords and cables from the printer before moving it.

- Lift the printer off of the optional drawer and set it aside instead of trying to lift the drawer and printer at the same time.

Note: Use the handholds located on both sides of the printer to lift it off the optional drawer.

Learning about the printer

Finding information about the printer

What are you looking for?	Find it here
Initial setup instructions: <ul style="list-style-type: none"> • Connecting the printer • Installing the printer software 	Setup documentation—The setup documentation came with the printer.
Additional setup and instructions for using the printer: <ul style="list-style-type: none"> • Selecting and storing paper and specialty media • Loading paper • Performing printing, copying, scanning, and faxing tasks, depending on your printer model • Configuring printer settings • Viewing and printing documents and photos • Setting up and using printer software • Setting up and configuring the printer on a network, depending on your printer model • Caring for and maintaining the printer • Troubleshooting and solving problems 	<i>User's Guide</i> —The <i>User's Guide</i> is available on the <i>Software and Documentation CD</i> . For updates, check our Web site at support.dell.com .
Help using the printer software	Windows or Mac Help—Open a printer software program or application, and then click Help . Click  to view context-sensitive information. Notes: <ul style="list-style-type: none"> • The Help installs automatically with the printer software. • The printer software is located in the printer Program folder or on the desktop, depending on your operating system.
The latest supplemental information, updates, and technical support: <ul style="list-style-type: none"> • Documentation • Driver downloads • Product upgrades • Service call and repair information • Order status • Live chat support • E-mail support • Telephone support 	Dell Support Web site— support.dell.com Note: Select your region, and then select your product to view the appropriate support site. Support telephone numbers and hours of operation for your region or country can be found on the Support Web site. Have the following information ready when you contact support so that they may serve you faster: <ul style="list-style-type: none"> • Service Tag • Express Service Code Note: The Service Tag and Express Service Code appear on labels located on your printer.

What are you looking for?	Find it here
<ul style="list-style-type: none"> • Software and Drivers—Certified drivers for my printer and installers for Dell printer software • Readme files—Last-minute technical changes, or advanced technical reference material for experienced users or technicians 	<p><i>Software and Documentation CD</i></p> <p>Note: If you purchased your Dell computer and printer at the same time, documentation and drivers for your printer are already installed on your computer.</p>
<ul style="list-style-type: none"> • Supplies and accessories for my printer • Replacement cartridges 	<p>Dell Printer Supplies Web site—dell.com/supplies</p> <p>You can purchase printer supplies online, by telephone, or in select retail stores.</p>
<ul style="list-style-type: none"> • Safety information for preparing to operate my printer • Regulatory information • Warranty information 	<p><i>Product Information Guide</i></p> <div data-bbox="1068 569 1263 814" data-label="Image"> </div> <p>Note: The <i>Product Information Guide</i> may not be available in your country or region.</p>

Printer configurations

Basic model

The following illustration shows the printer front with its basic features or parts:

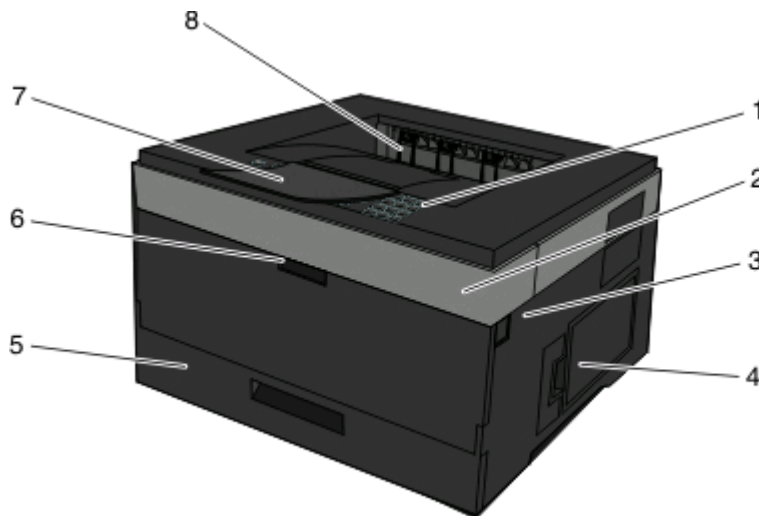

1	Printer control panel
2	Front Door
3	Front door release button

4	System board door
5	Standard 250-sheet tray (Tray 1)
6	Multipurpose feeder door
7	Paper stop
8	Standard exit bin

The following illustration shows the printer back with its basic features or parts:

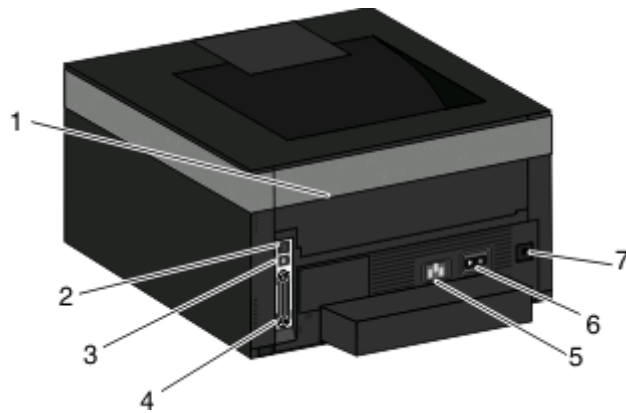

1	Rear door
2	Ethernet port
3	USB port
4	Parallel port
5	Power cord socket
6	Power switch
7	Locking device

Configured models

The following illustration shows the printer configured with an optional drawer:

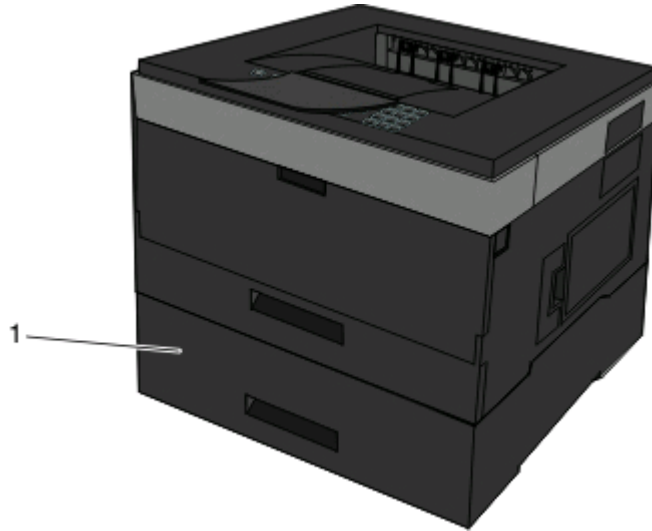

1 Optional tray (Tray 2)





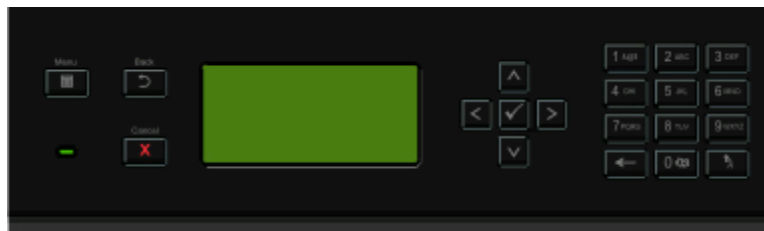

Understanding the printer control panel

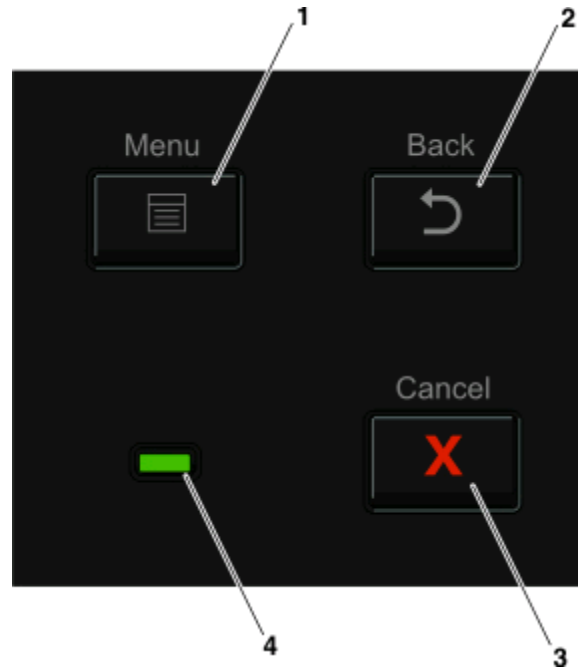
The following diagram shows the printer control panel:



The following diagrams and tables provide more information about the printer control panel items:



Item	Description	
1 Menu button  	Opens the menus Note: The menus are available only when the printer is in the Ready state.	
2 Back button  	Returns the display to the previous screen	
3 Cancel button  	Stops all printer activity When printing, pressing  causes Stopping to appear momentarily. Then the Stopped screen appears offering a list of settings that you may select.	
4 Indicator light	Indicates the printer status: <ul style="list-style-type: none"> • Off—The power is off. • Blinking green—The printer is warming up, processing data, or printing. • Solid green—The printer is on, but idle. • Solid red—Operator intervention is needed. 	

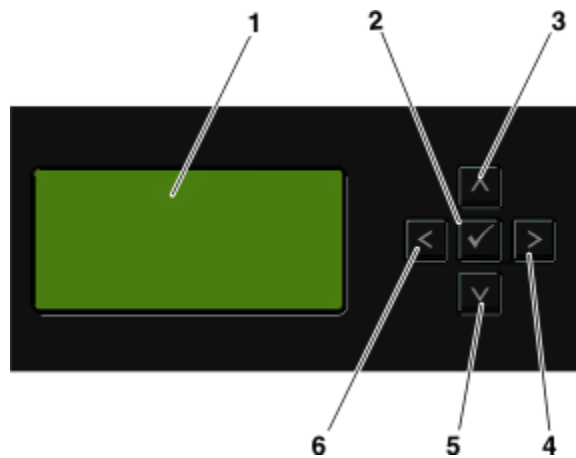

Item		Description
1	Display	Shows messages that communicate the status of the printer or that indicate possible printer problems that must be resolved. The display is also capable of showing pictures of Show Me instructions, which show you how to perform a task like clearing a jam.
2	Select button (✔)	<ul style="list-style-type: none"> Opens a menu and displays the first item in the menu (called a menu item) Opens a menu item and displays the available values or settings. The current user default setting is indicated by an asterisk (*). Saves the displayed menu item as the new user default setting <p>Note: When a new setting is saved as the user default setting, it remains in effect until new settings are saved or until factory defaults are restored. Settings chosen from a software program can also change or override the user default settings selected from the printer control panel.</p>
3, 4, 5, 6	Navigation buttons	<p>Press the up or down arrow buttons to scroll through menus, menu items, or settings (also called values or options), or to scroll between screens and menu options.</p> <p>Note: Each press of the up or down arrow buttons moves you one item in any list. Press the right or left arrow buttons to increase or decrease a value or to scroll through text that rolls to another screen.</p>



Item	Description	
1	Keypad	Enter numbers or symbols if the display screen has a field that accepts these entries.

Using the standard exit bin and paper stop

The standard exit bin holds up to 150 sheets of 20 lb paper. It collects print jobs facedown. The standard exit bin includes a paper stop that keeps paper from sliding out the front of the bin as it stacks. The paper stop also aids in neater stacking of the paper.

To open the paper stop, pull it so it flips forward.



Notes:

- Do not leave the paper stop in the open position if you are printing on transparencies. Doing so may cause creases in the transparencies.
- When moving the printer to another location, make sure the paper stop is closed.

Additional printer setup

After completing any additional printer setup, print a menu settings page to verify that all printer options are installed correctly. See “Printing a menu settings page” on page 30 for more information. The option names appear on this page if they are installed correctly. Since you have not made any setting changes yet, if you print the page now it lists all the *factory default settings*. Once you select and save other settings from the menus, when you print this page, the user default settings are listed on the page.

Saved settings are called *user default settings* because you, the user, selected the values and saved them as the new settings.

A user default setting remains in effect until you access the menu again, choose another value, and save it. An asterisk (*) appears next to each factory default setting, but once a user default setting is in effect, the asterisk appears next to the user default setting on the display.

Factory default settings can be restored. See “Restoring the factory default settings” on page 136 for more information.

Selecting a location for the printer

When selecting a location for the printer, leave enough room to open trays, covers, and doors. If you plan to install any options, leave enough room for them also. It is important to:

- Make sure airflow in the room meets the latest revision of the ASHRAE 62 standard.
- Provide a flat, sturdy, and stable surface.
- Keep the printer:
 - Away from the direct airflow of air conditioners, heaters, or ventilators
 - Free from direct sunlight, humidity extremes, or temperature fluctuations
 - Clean, dry, and free of dust
- Allow the following recommended amount of space around the printer for proper ventilation:

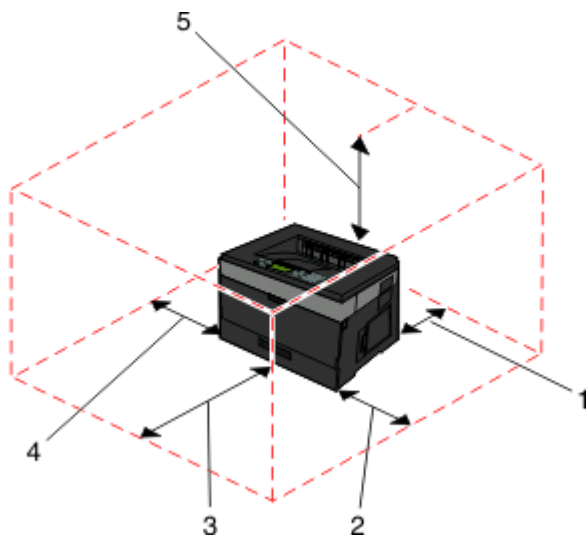

1	Rear	300 mm (12.0 in.)
2	Front	300 mm (12.0 in.)

3	Right side	200 mm (8.0 in.)
4	Left side	12.7 mm (0.5 in.)
5	Top	300 mm (12.0 in.)

Installing internal options

CAUTION—SHOCK HAZARD: If you are accessing the system board or installing optional hardware or memory devices sometime after setting up the printer, then turn the printer off, and unplug the power cord from the wall outlet before continuing. If you have other devices attached to the printer, then turn them off as well, and unplug any cables going into the printer.

You can customize your printer connectivity and memory capacity by adding optional cards. The instructions in this section explain how to install the available cards; you can also use them to locate a card for removal.

Available internal options

Memory cards

- Printer memory
- Flash memory
- Fonts

Firmware cards

- Bar Code
- Forms Card
- PrintCrypton™

Accessing the system board to install internal options

CAUTION—SHOCK HAZARD: If you are accessing the system board or installing optional hardware or memory devices sometime after setting up the printer, then turn the printer off, and unplug the power cord from the wall outlet before continuing. If you have other devices attached to the printer, then turn them off as well, and unplug any cables going into the printer.

- 1 As you face the printer, the system board door is on the right side. Open the system board door.



2 Use the following illustration to locate the appropriate connector.

Warning—Potential Damage: System board electronic components are easily damaged by static electricity. Touch something metal on the printer before touching any system board electronic components or connectors.

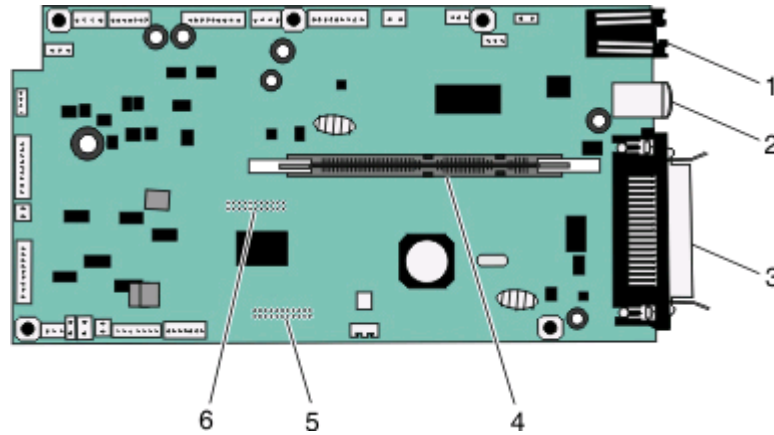

1	Ethernet connector Note: The Ethernet port is a feature on network models only.
2	USB port
3	Parallel connector
4	Memory card connector
5	Optional card connector
6	Optional card connector

Installing a memory card

CAUTION—SHOCK HAZARD: If you are accessing the system board or installing optional hardware or memory devices sometime after setting up the printer, then turn the printer off, and unplug the power cord from the wall outlet before continuing. If you have any other devices attached to the printer, then turn them off as well, and unplug any cables going into the printer.

Warning—Potential Damage: System board electronic components are easily damaged by static electricity. Touch something metal on the printer before touching any system board electronic components or connectors.

An optional memory card can be purchased separately and attached to the system board. To install the memory card:

- 1 Access the system board.



- 2 Unpack the memory card.

Note: Avoid touching the connection points along the edge of the card.

- 3 Align the memory card with its connector on the system board. Push the latches on the connector open if they are not open already.

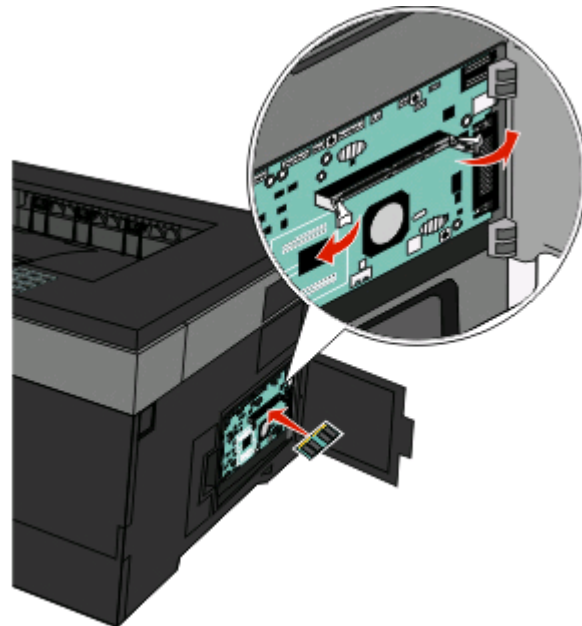

4 Push the memory card into the connector until the latches *snap* into place.

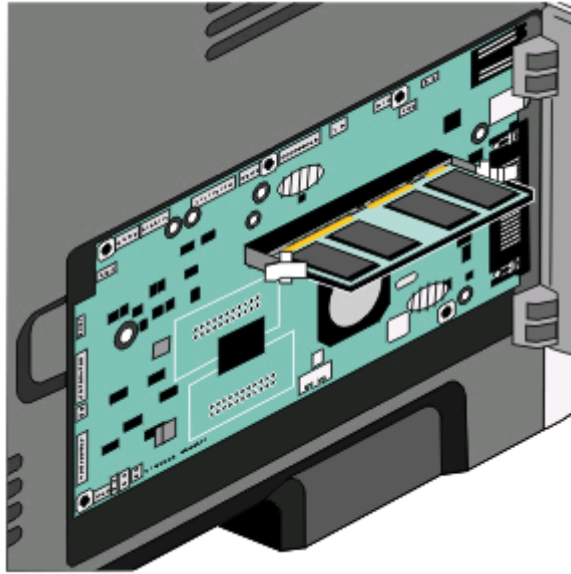

5 Close the system board door.

Installing a flash memory or firmware card

The system board has two connections for an optional flash memory or firmware card. Only one of each may be installed, but the connectors are interchangeable.

CAUTION—SHOCK HAZARD: If you are accessing the system board or installing optional hardware or memory devices sometime after setting up the printer, then turn the printer off, and unplug the power cord from the wall outlet before continuing. If you have other devices attached to the printer, then turn them off as well, and unplug any cables going into the printer.

Warning—Potential Damage: System board electronic components are easily damaged by static electricity. Touch something metal on the printer before touching any system board electronic components or connectors.

1 Open the system board door.



2 Unpack the card.

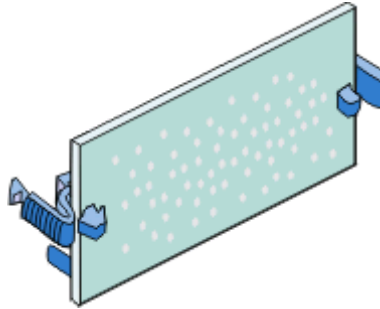

Note: Avoid touching the connection points along the edge of the card.

3 Holding the card by its sides, align the card with the connector on the system board.

4 Push the card firmly into place.

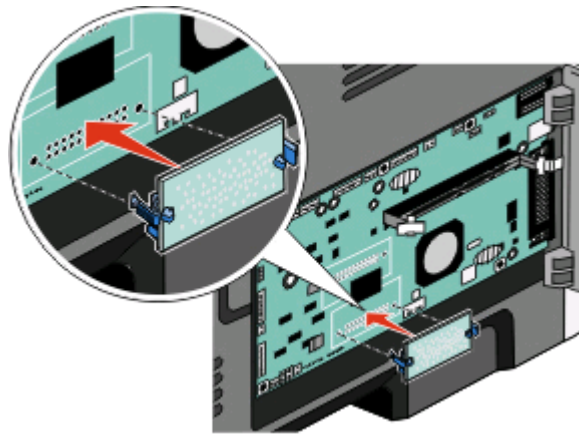

Notes:

- The entire length of the connector on the card must touch and be flush against the system board.
- Be careful not to damage the connectors.

5 Close the system board door.

Installing hardware options

Installing an optional drawer

The printer supports an optional drawer. Only one drawer may be installed on the printer at one time.

⚠ CAUTION—SHOCK HAZARD: If you are installing an optional drawer after setting up the printer, then turn the printer off and unplug the power cord from the wall outlet before continuing

- 1 Unpack the drawer, and then remove any packing material from the outside of the drawer.
- 2 Remove the tray from the support unit.

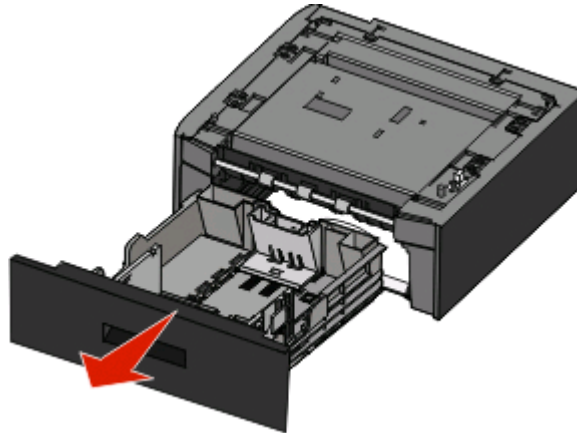

- 3 Remove any packing material and tape from inside the tray.
- 4 Insert the tray into the support unit.
- 5 Place the drawer in the location chosen for the printer.

6 Align the printer with the drawer, and then lower the printer into place.

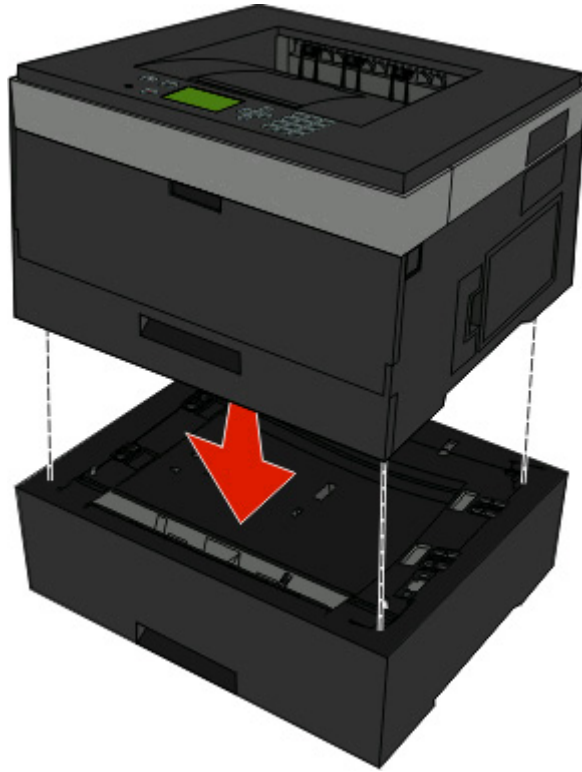

Attaching cables

- 1** Connect the printer to a computer or a network.
 - For a local connection, use a USB or parallel cable.
 - For a network connection, use an Ethernet cable.
- 2** Connect the power cord to the printer first and then to a wall outlet.

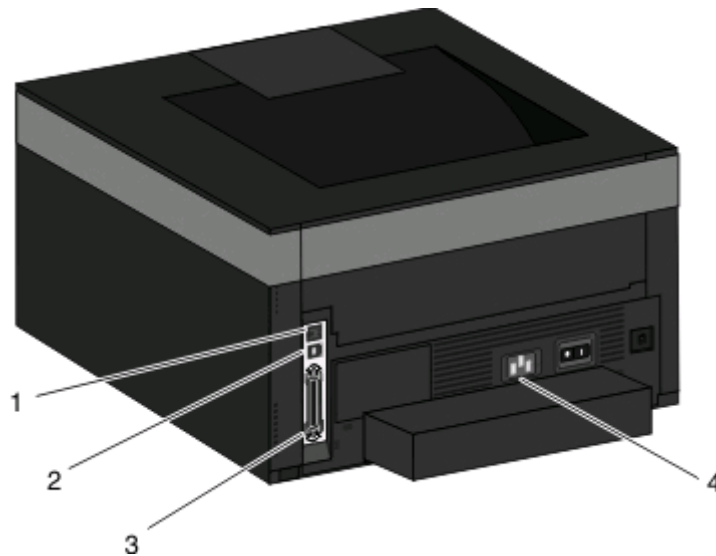

1	Ethernet port
2	USB port
3	Parallel port
4	Power cord socket

Installing the printer on a wired network

Use the following instructions to install the printer on a wired network. These instructions apply to Ethernet and fiber optic network connections.

Before you install the printer on a wired network, make sure that:

- You have completed the initial setup of the printer.
- The printer is connected to your network with the appropriate type of cable.

For Windows users

1 Insert the *Software and Documentation* CD.

Wait for the Welcome screen to appear.

If the CD does not launch after a minute, then do the following:

- Click , or click **Start** and then click **Run**.
- In the Start Search or Run box, type `D:\setup.exe`, where **D** is the letter of your CD or DVD drive.

2 Click **Install Printer and Software**.

3 Click **Agree** to agree to the License Agreement.

4 Select **Suggested**, and then click **Next**.

Note: To configure the printer using a static IP address, using IPv6, or to configure printers using scripts, select **Custom** and follow the on-screen instructions.

5 Select **Wired Network Attach**, and then click **Next**.

- 6 Select the printer manufacturer from the list.
- 7 Select the printer model from the list, and then click **Next**.
- 8 Select the printer from the list of printers discovered on the network, and then click **Finish**.

Note: If your configured printer does not appear in the list of discovered printers, click **Add Port** and follow the on-screen instructions.

- 9 Follow the on-screen instructions to complete the installation.

For Macintosh users

- 1 Allow the network DHCP server to assign an IP address to the printer.
- 2 Print the network setup page from the printer. For information on printing a network setup page, see “Printing a network setup page” on page 30.
- 3 Locate the printer IP address in the TCP/IP section of the network setup page. You will need the IP address if you are configuring access for computers on a different subnet than the printer.
- 4 Install the drivers and add the printer.

a Install a PPD file on the computer:

- 1 Insert the *Software and Documentation* CD in the CD or DVD drive.
- 2 Double-click the installer package for the printer.
- 3 From the Welcome screen, click **Continue**.
- 4 Click **Continue** again after viewing the Readme file.
- 5 Click **Continue** after viewing the license agreement, and then click **Agree** to accept the terms of the agreement.
- 6 Select a Destination, and then click **Continue**.
- 7 From the Easy Install screen, click **Install**.
- 8 Type the user password, and then click **OK**.
All the necessary software is installed on the computer.
- 9 Click **Restart** when installation is complete.

b Add the printer:

- For IP printing:

In Mac OS X version 10.5 or later

- 1 From the Apple menu, choose **System Preferences**.
- 2 Click **Print & Fax**.
- 3 Click **+**.
- 4 Click **IP**.
- 5 Type in the IP address of your printer in the Address field.
- 6 Click **Add**.

In Mac OS X version 10.4 and earlier

- 1 From the Finder desktop, choose **Go > Applications**.
- 2 Double-click **Utilities**.
- 3 Double-click **Printer Setup Utility** or **Print Center**.
- 4 From the Printer List, click **Add**.

- 5 Click **IP**.
 - 6 Type in the IP address of your printer in the Address field.
 - 7 Click **Add**.
- For AppleTalk printing:

In Mac OS X version 10.5

- 1 From the Apple menu, choose **System Preferences**.
- 2 Click **Print & Fax**.
- 3 Click **+**.
- 4 Click **AppleTalk**.
- 5 Select the printer from the list.
- 6 Click **Add**.

In Mac OS X version 10.4 and earlier

- 1 From the Finder desktop, choose **Go > Applications**.
- 2 Double-click **Utilities**.
- 3 Double-click **Print Center** or **Printer Setup Utility**.
- 4 From the Printer List, click **Add**.
- 5 Choose the **Default Browser** tab.
- 6 Click **More Printers**.
- 7 From the first pop-up menu, choose **AppleTalk**.
- 8 From the second pop-up menu, select **Local AppleTalk zone**.
- 9 Select the printer from the list.
- 10 Click **Add**.

Note: If the printer doesn't show up in the list, you may need to add it using the IP address. Contact your system support person for assistance.

Installing printer software

A printer driver is software that lets the computer communicate with the printer. The printer software is typically installed during the initial printer setup. If you need to install the software after setup, follow these instructions:

For Windows users

- 1 Close all open software programs.
- 2 Insert the *Software and Documentation* CD.
- 3 From the main installation dialog, click **Install**.
- 4 Follow the instructions on the screen.

For Macintosh users

- 1 Close all open software applications.
- 2 Insert the *Software and Documentation* CD.

- 3 From the Finder desktop, double-click the printer CD icon that automatically appears.
- 4 Double-click the **Install** icon.
- 5 Follow the instructions on the screen.

Using the World Wide Web

Updated printer software may be available at www.support.dell.com.

Verifying printer setup





Once all hardware and software options are installed and the printer is turned on, verify that the printer is set up correctly by printing the following:

- **Menu settings page**—Use this page to verify that all printer options are installed correctly. A list of installed options appears toward the bottom of the page. If an option you installed is not listed, then it is not installed correctly. Remove the option and install it again.
- **Network setup page**—If your printer is a network model and is attached to a network, print a network setup page to verify the network connection. This page also provides important information that aids network printing configuration.

Printing a menu settings page



Print a menu settings page to review the current menu settings and to verify printer options are installed correctly.

Note: If you have not made any menu item settings changes yet, then the menu settings page lists all the factory default settings. Once you select and save other settings from the menus, they replace the factory default settings as user default settings. A user default setting remains in effect until you access the menu again, choose another value, and save it. To restore the factory default settings, see “Restoring the factory default settings” on page 136.

- 1 Make sure the printer is on and **Ready** appears.
 - 2 From the printer control panel, press .
 - 3 Press the down arrow button until  **Reports** appears, and then press .
 **Menu Settings Page** appears.
 - 4 Press .
- After the menu settings page prints, **Ready** appears.

Printing a network setup page

If the printer is attached to a network, print a network setup page to verify the network connection. This page also provides important information that aids network printing configuration.

- 1 Make sure the printer is on and **Ready** appears.
- 2 From the printer control panel, press .
- 3 Press the down arrow button until  **Reports** appears, and then press .

- 4** Press the down arrow button until **✓ Network Setup Page** appears, and then press **⏴**.
After the network setup page prints, **Ready** appears.
- 5** Check the first section on the network setup page, and confirm that Status is "Connected."
If Status is "Not Connected," the LAN drop may not be active or the network cable may be malfunctioning. Consult a system support person for a solution, and then print another network setup page.







Loading paper and specialty media

This section explains how to load the paper trays and the multipurpose feeder. It also includes information about paper orientation, setting the Paper Size and Paper Type, and linking and unlinking trays.

Setting the Paper Size and Paper Type

When the Paper Size and Paper Type settings are the same for any trays, the trays are automatically linked.

Note: If you load a tray with paper that is the same size as the paper that was previously loaded in the tray, you do not need to change the Paper Size setting.

- 1 Make sure the printer is on and **Ready** appears.
- 2 From the printer control panel, press .
- ✓ **Paper Menu** appears.
- 3 Press .
- 4 Press the up or down arrow button until ✓ **Paper Size/Type** appears, and then press .
- 5 Press the up or down arrow button until the correct tray or feeder appears, and then press .
- 6 Press the left or right arrow button until the correct size appears, and then press .
- Paper Type** appears.
- 7 Press the left or right arrow button until the correct type appears, and then press .
- Submitting selection** appears, followed by **Paper Size/Type**.



Configuring Universal paper settings



The Universal Paper Size is a user-defined setting that lets you print on paper sizes that are not preset in the printer menus. Set the Paper Size for the specified tray to Universal when the size you want is not available from the Paper Size menu. Then, specify all of the following Universal size settings for your paper:

- Units of measure (inches or millimeters)
- Portrait Height and Portrait Width
- Feed Direction

Note: The smallest supported Universal size is 76.2 x 127 mm (3 x 5 in.); the largest is 216 x 356 mm (8.5 x 14 in.).

Specify a unit of measurement





- 1 Make sure the printer is on and **Ready** appears.
- 2 From the printer control panel, press .
- ✓ **Paper Menu** appears.
- 3 Press .

- 4 Press the down arrow button until **Universal Setup** appears, and then press .
- 5 Press the down arrow button until **Units of Measure** appears, and then press .
- 6 Press the down arrow button until **✓** appears next to the correct unit of measure, and then press .
Submitting selection appears, followed by the **Universal Setup** menu.

Specify the paper height and width



Defining a specific height and width measurement for the Universal paper size (in the portrait orientation) allows the printer to support the size, including support for standard features such as duplex printing and printing multiple pages on one sheet.

Note: Select **Portrait Height** to adjust the paper height setting or **Paper Width** to adjust the paper width setting, or adjust both. Instructions to adjust both follow.

- 1 From the Universal Setup menu, press the down arrow button until **✓ Portrait Width** appears, and then press .
- 2 Press the left arrow button to decrease the setting or the right arrow button to increase the setting, and then press .
Submitting selection appears, followed by the **Universal Setup** menu.
- 3 From the Universal Setup menu, press the down arrow button until **✓ Portrait Height** appears, and then press .
- 4 Press the left arrow button to decrease the setting or the right arrow button to increase the setting, and then press .
- 5 Press and release  until **Ready** appears.

Specify a feed direction

Short Edge is the factory default setting for feed direction for Universal paper settings. The Feed Direction menu will not appear from the Universal Setup menu unless Long Edge is an available setting. If necessary, specify whether the short or long edge of the paper will enter the printer first.

- 1 From the Universal Setup menu, press the down arrow button until **Feed Direction** appears, and then press .
- 2 Press the down arrow button until **✓ Short Edge** or **✓ Long Edge** appears, and then press .

Loading trays

- 1 Pull the tray completely out.

Note: Do not remove trays while a job prints or while **Busy** appears on the display. Doing so may cause a jam.

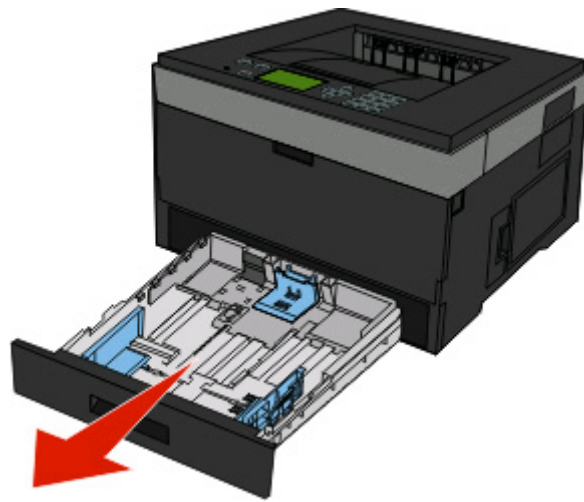

2 Squeeze and slide the guides to the correct position for the paper size you are loading.

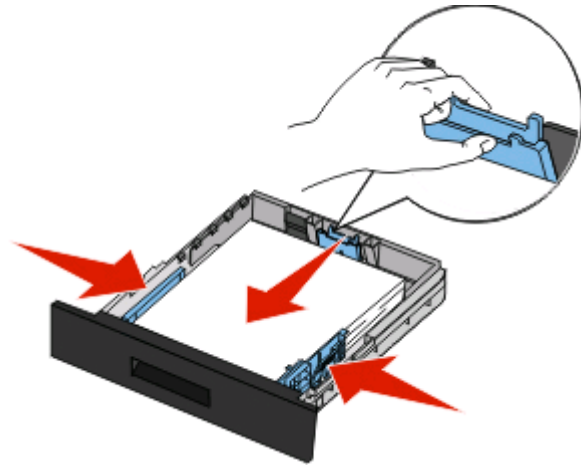

For long paper like A4 or legal, squeeze and slide the length guide backwards to accommodate the length of paper you are loading.

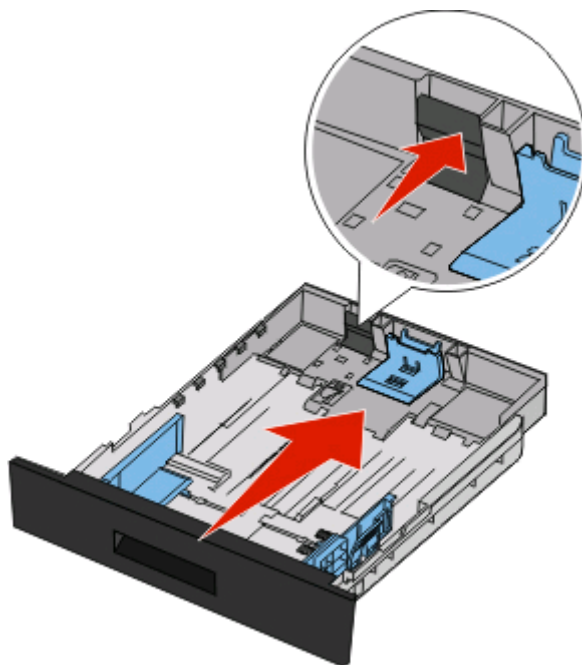

If you are loading A6-size paper:

- a** Squeeze and slide the length guide toward the center of the tray to the A5 size position.
- b** Raise the A6 backstop.

Notes:

- The standard tray accommodates only 150 sheets of A6-size paper. Notice the maximum fill line on the A6 backstop which indicates the maximum height for loading A6-size paper. Do not try to overload the tray.
- A6-size paper cannot be loaded in the optional tray.

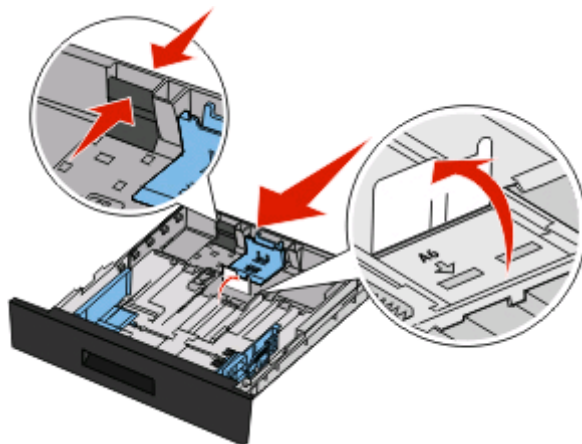

Notes:

- Use the size indicators on the bottom of the tray to help position the guide.
- For setup, load letter- or A4-size paper based on the standard size for your country or region.

- 3** Flex a stack of paper back and forth to loosen the sheets, and then fan them. Do not fold or crease the paper. Straighten the edges on a level surface.



- 4** Load the paper stack toward the back of the tray as shown with the recommended print side facedown.

Note: The maximum fill line on the width guide indicates the maximum height for loading paper. Do not load A6-size paper to the maximum fill line; the tray holds only 150 sheets of A6-size paper.

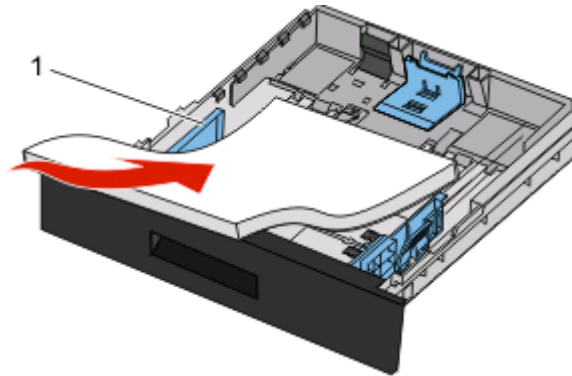

1	Maximum fill line
----------	-------------------

Load letterhead with the top edge of the sheet toward the front of the tray and the design facedown.

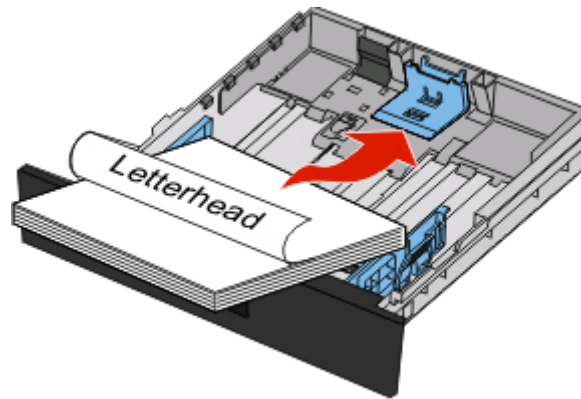

5 Squeeze and slide the guides to lightly touch the side of the stack.

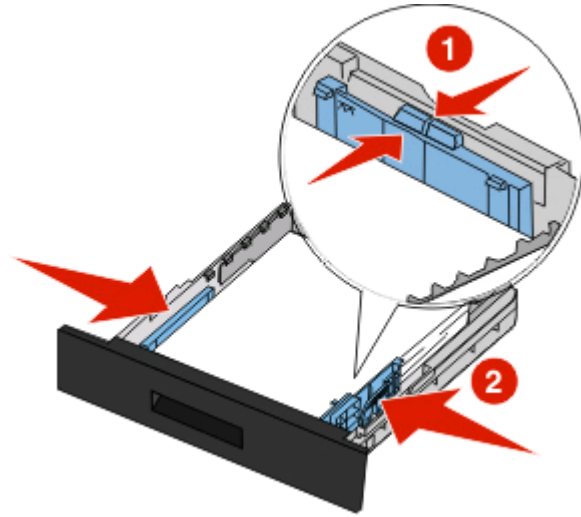

6 Insert the tray.

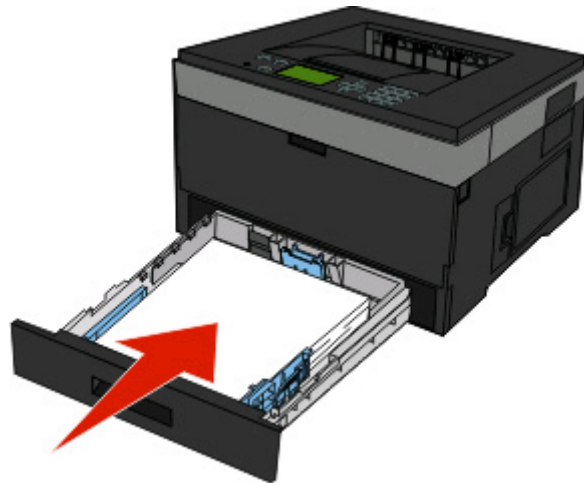

7 If the paper type you loaded differs from the type that was previously loaded in the tray, then change the Paper Type setting for the tray.

Using the multipurpose feeder

Opening the multipurpose feeder

- 1 Grasp the handle, and pull the multipurpose feeder door down.

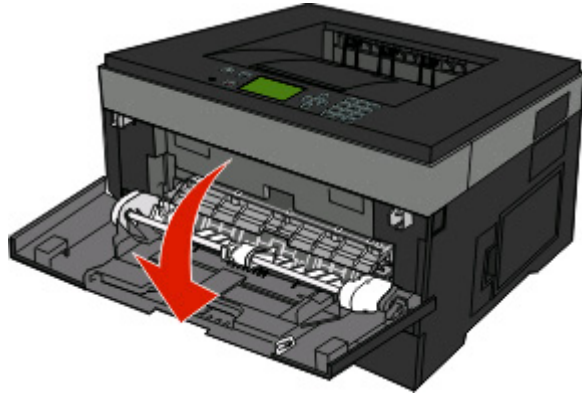

- 2 Grasp the raised handle, and pull the extension forward.

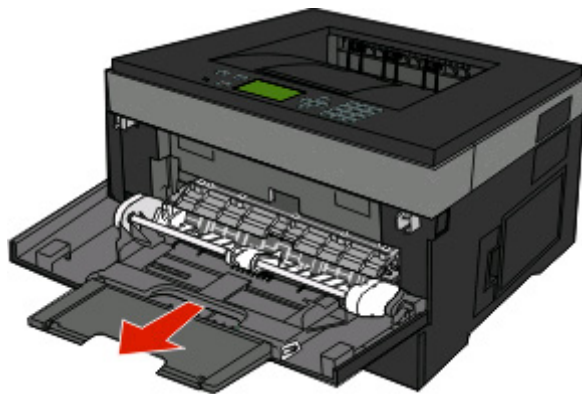

- 3 Grasp the handle, and pull the extension so it flips forward.

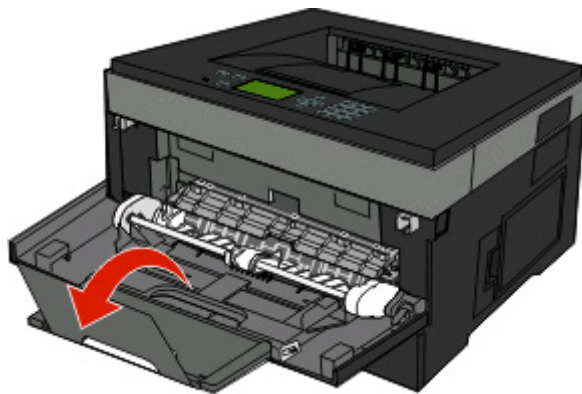

4 Guide the extension down gently so the multipurpose feeder is extended fully and open.

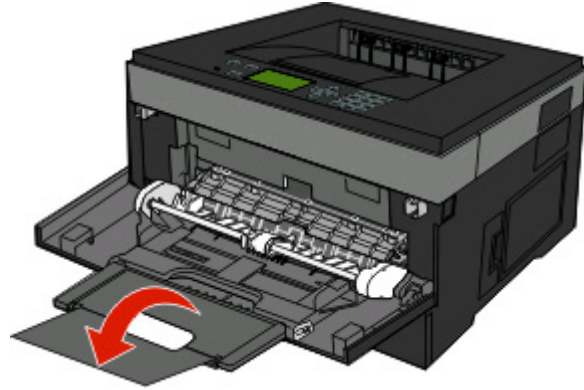

Loading the multipurpose feeder

1 Squeeze the tab located on the right width guide, and move the guides out fully.

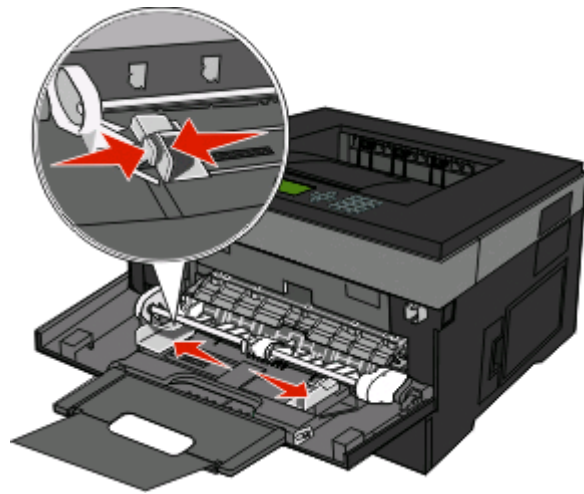

2 Prepare the paper or specialty media for loading.

- Flex sheets of paper or paper labels back and forth to loosen them, and then fan them. Do not fold or crease the paper or labels. Straighten the edges on a level surface.



- Hold transparencies by the edges, and then fan them. Straighten the edges on a level surface.

Note: Avoid touching the print side of the transparencies. Be careful not to scratch them.



- Flex a stack of envelopes back and forth to loosen them, and then fan them. Straighten the edges on a level surface.



Note: Fanning prevents the edges of envelopes from sticking together. It also helps them feed properly to avoid jams. Do not fold or crease envelopes.

3 Load the paper or specialty media.

Notes:

- Do not force any paper into the multipurpose feeder. Overfilling may cause jams.
- Do not exceed the maximum stack height by forcing paper or specialty media under the stack height limiters which are located on the guides.

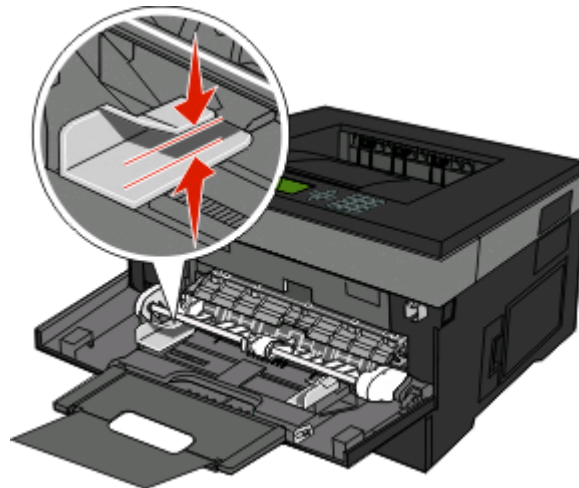

- Load paper, transparencies, and card stock with the recommended print side faceup and the top edge entering the printer first. For more information on loading transparencies, see the packaging the transparencies came in.

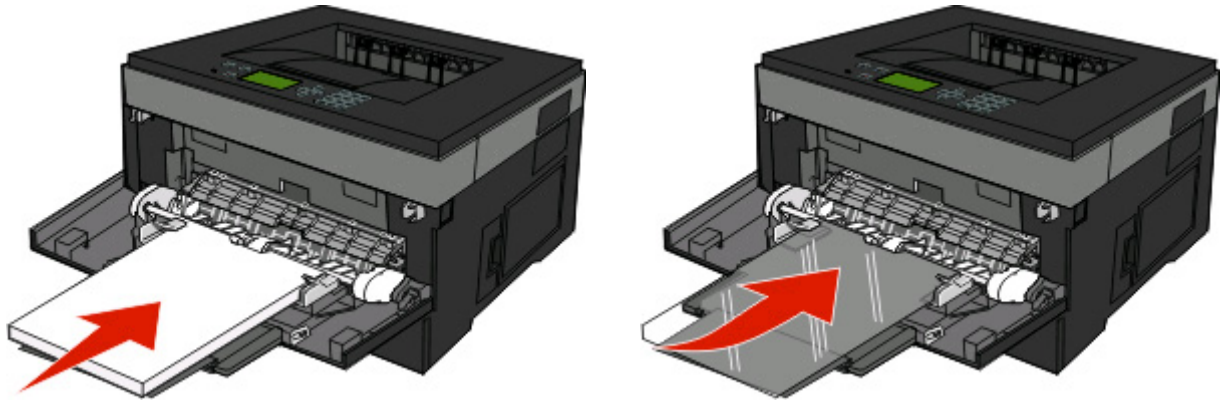

- Load letterhead with the logo faceup and the top edge entering the printer first.

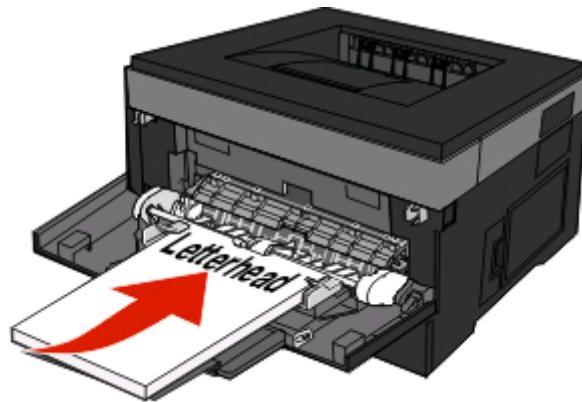

- Load envelopes with the flap side down and the stamp location in the position shown. The stamp and address are shown to illustrate the proper orientation for loading envelopes.

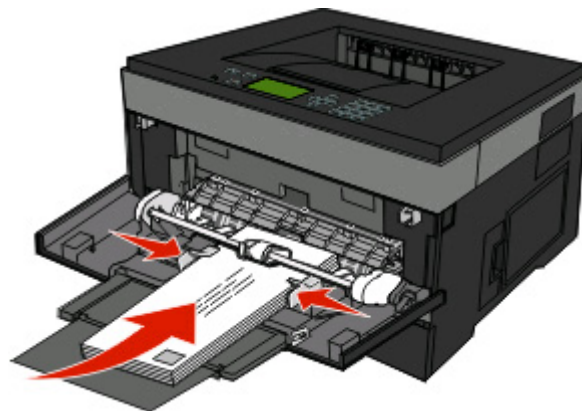

Warning—Potential Damage: Never use envelopes with stamps, clasps, snaps, windows, coated linings, or self-stick adhesives. These envelopes may severely damage the printer.

4 Squeeze the tab located on the right width guide to adjust the guides to lightly touch the sides of the stack.

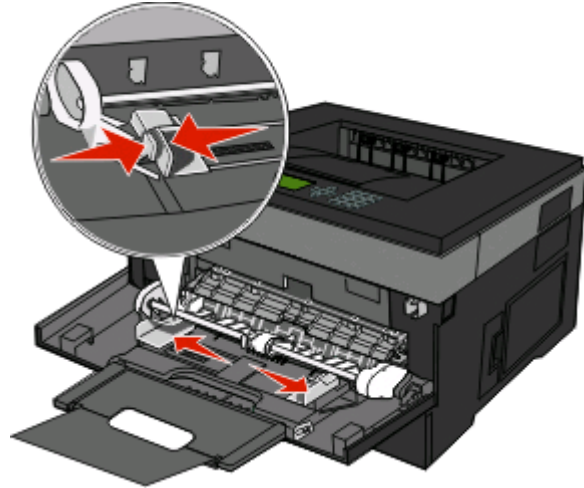

5 Slide the paper gently into the multipurpose feeder until it comes to a stop. Paper should lie flat in the multipurpose feeder. Make sure the paper fits loosely in the multipurpose feeder and is not bent or wrinkled.

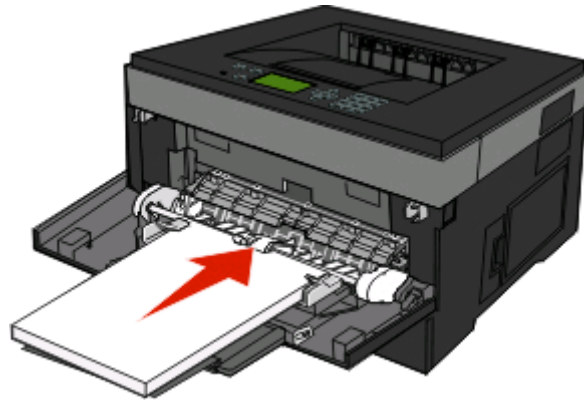

6 From the printer control panel, set the Paper Size and Paper Type.

Linking and unlinking trays

In addition to linking trays to each other, you can also link the multipurpose feeder to the trays.

Linking trays

Tray linking is useful for large print jobs or multiple copies. When one linked tray is empty, paper feeds from the next linked tray. When the Size and Type settings are the same for any trays, the trays are automatically linked. The Size and Type settings for all trays must be set from the Paper menu.

Unlinking trays

Unlinked trays have settings that are *not* the same as the settings of any other tray. To unlink a tray using the Paper menu, change the Paper Type and Paper Size settings so that they do not match the settings of any other tray.

















- 1 From the Paper menu, make sure the Type setting (for example, Plain Paper, letterhead, Custom Type <x>) for the tray you want to unlink does not match the Type setting of any other tray.
If the name that best describes your paper is used by linked trays, assign a different Paper Type name to the tray, such as Custom Type <x>, or assign your own custom name.
- 2 Make sure the Size setting (for example, letter, A4, statement) for the tray you want to unlink does not match the Size setting of any other tray.

Note: Paper Size settings are not automatic; they must be set manually from the Paper menu.

Warning—Potential Damage: Do not assign a Paper Type name that does not accurately describe the type of paper loaded in the tray. The temperature of the fuser varies according to the specified Paper Type. Paper may not be properly processed if an inaccurate Paper Type is selected.

Assigning a Custom Type <x> name

Assign a Custom Type <x> name to a tray to link or unlink it. Associate the same Custom Type <x> name to each tray that you want to link. Only trays with the same custom names assigned will link.

- 1 Make sure the printer is on and **Ready** appears.
- 2 From the printer control panel, press .
- 3 Press the down arrow button until  **Paper Menu** appears, and then press .
- 4 Press the down arrow button until  **Paper Size/Type** appears, and then press .
- 5 Press the down arrow button until  appears next to the name of the tray, and then press .
The Paper Size menu appears.
- 6 Press  again.
The Paper Type menu appears.
- 7 Press the down arrow button until  **Custom Type <x>** or another custom name appears, and then press .
Submitting selection appears, followed by **Paper Menu**.
- 8 Verify that the correct Paper Type is associated with the custom name.
Note: Plain Paper is the factory default Paper Type associated with all Custom Type <x> names and user-defined custom names.
 - a From the Paper menu, press the down arrow button until  **Custom Types** appears, and then press .
 - b Press the down arrow button until  appears next to the custom paper type name you selected in step 7 on page 43, and then press .
 - c Press the down arrow button until  appears next to the Paper Type setting you want, and then press .

Changing a Custom Type <x> name

If the printer is on a network, you can use the Embedded Web Server to define a name other than Custom Type <x> for each of the custom paper types that are loaded. When a Custom Type <x> name is changed, the menus display the new name instead of Custom Type <x>.

To change a Custom Type <x> name:

- 1 Type the printer IP address into the address field of your Web browser.

Note: If you do not know the IP address of the printer, print a network setup page and locate the address in the TCP/IP section.

- 2 Click **Settings**.

- 3 Click **Paper Menu**.

- 4 Click **Custom Name**.

- 5 Type a name for the paper type in a Custom Name <x> box.

Note: This custom name will replace a custom type <x> name under the Custom Types and Paper Size and Type menus.

- 6 Click **Submit**.

- 7 Click **Custom Types**.

Custom Types appears, followed by your custom name.

- 8 Select a Paper Type setting from the pick list next to your custom name.

- 9 Click **Submit**.

Paper and specialty media guidelines

Paper and specialty media are paper, card stock, envelopes, paper labels, and transparencies. A number of items must be considered concerning the selection of paper and specialty media before printing. This chapter provides information on making selections and caring for papers and specialty media.

It is recommended that you try a limited sample of any paper or specialty media you are considering using with the printer before purchasing large quantities.

Paper guidelines

Selecting the correct paper or specialty media reduces printing problems. For the best print quality, try a sample of the paper or specialty media before buying large quantities.

Paper characteristics

The following paper characteristics affect print quality and reliability. Consider these characteristics when evaluating new paper stock.

Weight

The printer trays can automatically feed paper weights up to 90 g/m² (24 lb bond) grain long paper. The multipurpose feeder can automatically feed paper weights up to 163 g/m² (43 lb bond) grain long. Paper lighter than 60 g/m² (16 lb) might not be stiff enough to feed properly, causing jams. For best performance, use 75 g/m² (20 lb bond) grain long paper. For paper smaller than 182 x 257 mm (7.2 x 10.1 in.), we recommend 90 g/m² (24 lb) or heavier paper.

Note: Duplex printing is supported only for 60–90 g/m² (16–24 lb bond) paper.

Curl

Curl is the tendency for paper to curl at its edges. Excessive curl can cause paper feeding problems. Curl can occur after the paper passes through the printer, where it is exposed to high temperatures. Storing paper unwrapped in hot, humid, cold, or dry conditions, even in the trays, can contribute to paper curling prior to printing and can cause feeding problems.

Smoothness

Paper smoothness directly affects print quality. If paper is too rough, toner cannot fuse to it properly. If paper is too smooth, it can cause paper feeding or print quality issues. Always use paper between 100–300 Sheffield points; smoothness between 150–250 Sheffield points produces the best print quality.

Moisture content

The amount of moisture in paper affects both print quality and the ability of the printer to feed the paper correctly. Leave paper in its original wrapper until it is time to use it. This limits the exposure of paper to moisture changes that can degrade its performance.

Condition paper before printing by storing it in its original wrapper in the same environment as the printer for 24 to 48 hours before printing. Extend the time several days if the storage or transportation environment is very different from the printer environment. Thick paper may also require a longer conditioning period.

Grain direction

Grain refers to the alignment of the paper fibers in a sheet of paper. Grain is either *grain long*, running the length of the paper, or *grain short*, running the width of the paper.

For 60–90 g/m² (16–24 lb bond) paper, grain long paper is recommended.

Fiber content

Most high-quality xerographic paper is made from 100% chemically treated pulped wood. This content provides the paper with a high degree of stability resulting in fewer paper feeding problems and better print quality. Paper containing fibers such as cotton can negatively affect paper handling.

Unacceptable paper

The following paper types are not recommended for use with the printer:

- Chemically treated papers used to make copies without carbon paper, also known as carbonless papers, carbonless copy paper (CCP), or no carbon required (NCR) paper
- Preprinted papers with chemicals that may contaminate the printer
- Preprinted papers that can be affected by the temperature in the printer fuser
- Preprinted papers that require a registration (the precise print location on the page) greater than ± 2.3 mm (± 0.9 in.), such as optical character recognition (OCR) forms

In some cases, registration can be adjusted with a software application to successfully print on these forms.

- Coated papers (erasable bond), synthetic papers, thermal papers
- Rough-edged, rough or heavily textured surface papers, or curled papers
- Recycled papers that fail EN12281:2002 (European)
- Paper weighing less than 60 g/m² (16 lb)
- Multiple-part forms or documents

Selecting paper

Using appropriate paper prevents jams and helps ensure trouble-free printing.

To help avoid jams and poor print quality:

- *Always* use new, undamaged paper.
- Before loading paper, know the recommended print side. This information is usually indicated on the package.
- *Do not* use paper, paper labels, or card stock that has been cut or trimmed by hand.
- *Do not* mix sizes, types, or weights in the same source; mixing results in jams.
- *Do not* use coated papers unless they are specifically designed for electrophotographic printing.

Selecting preprinted forms and letterhead

Use these guidelines when selecting preprinted forms and letterhead:

- Use grain long for 60–90 g/m² (16–24 lb) paper.
- Use only forms and letterhead printed using an offset lithographic or engraved printing process.
- Avoid papers with rough or heavily textured surfaces.

Use papers printed with heat-resistant inks designed for use in xerographic copiers. The ink must be able to withstand temperatures up to 230°C (446°F) without melting or releasing hazardous emissions. Use inks that are not affected by the resin in toner. Inks that are oxidation-set or oil-based generally meet these requirements; latex inks might not. When in doubt, contact the paper supplier.

Preprinted papers such as letterhead must be able to withstand temperatures up to 230°C (446°F) without melting or releasing hazardous emissions.

Using recycled paper and other office papers

- Low moisture content (4–5%)
- Suitable smoothness (100–200 Sheffield units, or 140–350 Bendtsen units, European)

Note: Some much smoother papers (such as premium 24 lb laser papers, 50–90 Sheffield units) and much rougher papers (such as premium cotton papers, 200–300 Sheffield units) have been engineered to work very well in laser printers, despite surface texture. Before using these types of paper, consult your paper supplier.

- Suitable sheet-to-sheet coefficient of friction (0.4–0.6)
- Sufficient bending resistance in the direction of feed

Recycled paper, paper of lower weight (<60 g/m² [16 lb bond]) and/or lower caliper (<3.8 mils [0.1 mm]), and paper that is cut grain-short for portrait (or short-edge) fed printers may have lower bending resistance than is required for reliable paper feeding. Before using these types of paper for laser (electrophotographic) printing, consult your paper supplier. Remember that these are general guidelines only and that paper meeting these guidelines may still cause paper feeding problems in any laser printer (for example, if the paper curls excessively under normal printing conditions).

Storing paper

Use these paper storage guidelines to help avoid jams and uneven print quality:

- For best results, store paper where the temperature is 21°C (70°F) and the relative humidity is 40%. Most label manufacturers recommend printing in a temperature range of 18 to 24°C (65 to 75°F) with relative humidity between 40 and 60%.
- Store paper in cartons when possible, on a pallet or shelf, rather than on the floor.
- Store individual packages on a flat surface.
- Do not store anything on top of individual paper packages.

Supported paper sizes, types, weights, and capacities

The following tables provide information on standard and optional paper sources, the types of paper they support, and capacities.

Note: For an unlisted paper size, select the closest *larger* listed size.

Paper sizes supported by the printer

Paper size	Dimensions	Standard 250-sheet tray	Optional tray	Multipurpose feeder	Duplex path
A4	210 x 297 mm (8.3 x 11.7 in.)	✓	✓	✓	✓
A5	148 x 210 mm (5.8 x 8.3 in.)	✓	✓	✓	X
A6¹	105 x 148 mm (4.1 x 5.8 in.)	✓	X	✓	X
Executive	184 x 267 mm (7.3 x 10.5 in.)	✓	✓	✓	X
Folio	216 x 330 mm (8.5 x 13 in.)	✓	✓	✓	✓
JIS B5	182 x 257 mm (7.2 x 10.1 in.)	✓	✓	✓	X
Legal	216 x 356 mm (8.5 x 14 in.)	✓	✓	✓	✓
Letter	216 x 279 mm (8.5 x 11 in.)	✓	✓	✓	✓
Oficio (Mexico)	216 x 340 mm (8.5 x 13.4 in.)	✓	✓	✓	✓
Statement	140 x 216 mm (5.5 x 8.5 in.)	✓	✓	✓	X
Universal²	76.2 x 127 mm (3 x 5 in.) up to 216 x 356 mm (8.5 x 14 in.)	✓	✓	✓	X³
B5 Envelope	176 x 250 mm (6.9 x 9.8 in.)	X	X	✓	X
C5 Envelope	162 x 229 mm (6.4 x 9 in.)	X	X	✓	X

¹ A6 is supported only for grain long papers.

² If a paper size you want to use is not listed, then configure a Universal paper size. For more information, see “Configuring Universal paper settings” on page 32.

³ Universal paper size has limited support in the duplex path for paper sizes 210 x 279 mm (8.3 x 11 in.) or larger.

Paper size	Dimensions	Standard 250-sheet tray	Optional tray	Multipurpose feeder	Duplex path
DL Envelope	110 x 220 mm (4.3 x 8.7 in.)	X	X	✓	X
7 3/4 Envelope (Monarch)	98 x 191 mm (3.9 x 7.5 in.)	X	X	✓	X
9 Envelope	98 x 225 mm (3.9 x 8.9 in.)	X	X	✓	X
10 Envelope	105 x 241 mm (4.1 x 9.5 in.)	X	X	✓	X
Other Envelope	216 x 356 mm (8.5 x 14 in.)	X	X	✓	X

¹ A6 is supported only for grain long papers.

² If a paper size you want to use is not listed, then configure a Universal paper size. For more information, see “Configuring Universal paper settings” on page 32.

³ Universal paper size has limited support in the duplex path for paper sizes 210 x 279 mm (8.3 x 11 in.) or larger.

Paper types and weights supported by the printer

The printer engine and the duplex path support 60–90 g/m² (16–24 lb) paper weights. The multipurpose feeder supports 60–163 g/m² (16–43 lb) paper weights.

Paper type	Standard 250-sheet tray	Optional tray	Multipurpose feeder	Duplex path
Paper	✓	✓	✓	✓
<ul style="list-style-type: none"> • Plain • Light • Heavy • Rough/Cotton • Recycled • Custom 				
Bond	✓	✓	✓	✓
Letterhead	✓	✓	✓	✓
Preprinted	✓	✓	✓	✓
Colored Paper	✓	✓	✓	✓
Card stock	X	X	✓	X
Glossy paper	X	X	X	X
Paper labels¹	✓	✓	✓	X

¹ Single-sided paper labels designed for laser printers are supported for occasional use. It is recommended to print no more than 20 pages of paper labels a month. Vinyl, pharmacy, and dual-sided labels are not supported.

² Use envelopes that lie flat when individually placed on a table facedown.

Paper type	Standard 250-sheet tray	Optional tray	Multipurpose feeder	Duplex path
Transparencies	✓	X	✓	X
Envelopes (smooth)²	X	X	✓	X

¹ Single-sided paper labels designed for laser printers are supported for occasional use. It is recommended to print no more than 20 pages of paper labels a month. Vinyl, pharmacy, and dual-sided labels are not supported.

² Use envelopes that lie flat when individually placed on a table facedown.

Paper capacities

The capacities of the trays and the multipurpose feeder are based on 75 g/m² (20 lb) paper.

Load up to	Notes
Tray 1 250 sheets of paper 150 sheets of A6-size paper 50 paper labels 50 transparencies	Note: Vinyl, pharmacy, or dual-sided labels are not supported. Use paper labels only. Single-sided paper labels designed for laser printers are supported for occasional use. It is recommended to print no more than 20 pages of paper labels per month.
Tray 2 550 sheets of paper 50 paper labels	Note: Only one optional drawer may be installed on the printer at a time.
Multipurpose feeder 50 sheets of paper 15 paper labels 10 transparencies 10 sheets of card stock 7 envelopes	Note: Feed paper into the multipurpose feeder only to the point where its leading edge can contact the paper guides. Do not force the paper into the feeder.

Software overview

Use the *Software and Documentation* CD that came with your printer to install a combination of software applications, depending on your operating system.

Note: If you purchased your printer and computer separately, you must use the *Software and Documentation* CD to install these software applications.

Note: These software applications are not available with Macintosh®.

Status Monitor Center

Note: For the local Status Monitor Center to work properly, bidirectional communication support must be in place so the printer and computer can communicate. The Status Monitor Center only works when the printer is connected to a computer locally through a USB cable.

Use the Status Monitor Center to manage multiple Status Monitors.

- Double-click a printer name to open its Status Monitor, or select **Run** to open a Status Monitor for a particular printer.
- Select **Update** to change the appearance of the list of printers.

Driver Profiler

Use the Driver Profiler to create driver profiles that contain custom driver settings. A driver profile can contain a group of saved printer driver settings and other data for such things as:

- Print orientation and N-Up (document settings)
- Installation status of an output tray (printer options)
- User-defined paper sizes (custom papers)
- Simple text and watermarks
- Overlay references
- Font references
- Form associations

Dell Printer Alert Utility

Note: This application is not available with Windows 2000.

The Dell Printer Alert Utility informs you when there are errors requiring your intervention on your printer. When there is an error, a bubble appears telling you what the error is, and points you to the appropriate recovery information.

Note: For the Dell Printer Alert Utility to work properly, bidirectional communication support must be in place so the printer and computer can communicate. An exception is added to the Windows Firewall to allow this communication.

If you opted to install the Dell Printer Alert Utility with your printer software, the utility automatically launches when the software installation is completed. The utility is active if you see  in the System Tray.

To disable the Dell Printer Alert Utility:

- 1 From the System Tray, right click the  icon.
- 2 Select **Exit**.

To re-enable the Dell Printer Alert Utility:

- 1 *In Windows Vista or later:*
 - a Click  → **Programs**.
 - b Click **Dell Printers**.
 - c Click **Dell 3330dn Laser Printer**.

In Windows XP:

Click **Start** → **Programs** or **All Programs** → **Dell Printers** → **Dell 3330dn Laser Printer**.

- 2 Click **Printer Alert Utility**.

Installing the optional XPS driver

The XML Paper Specification (XPS) driver is an optional printer driver designed to make use of the advanced XPS color and graphics features that are only available for users of Windows Vista and later Windows operating systems. In order to use XPS features, you must install the XPS driver as an additional driver after you install your printer.

Note: Before installing the XPS driver, install the printer on your computer.

To install the driver:

- 1 Click  → **Control Panel**.
- 2 Under **Hardware and Sound**, click **Printer**, and then click **Add a Printer**.
- 3 From the **Add Printer** dialog box, choose one of the following:
 - If you are using a USB connection, make sure the USB cable is connected to the computer and printer, and then do the following:
 - a Click **Add a local printer**.
 - b From the **Use an existing port:** drop-down menu, select **Virtual printer port for USB**, and then click **Next**.
- 4 Click **Have disk**.

The **Install From Disk** dialog box opens.
- 5 Click **Browse**, and then navigate to the XPS driver files on your computer:
 - a Click **Computer**, and then double-click **(C:)**.
 - b Double-click **Drivers**, and then double-click **PRINTER**.
 - c Double-click the folder that has your printer model number, and then double-click **Drivers**.
 - d Double-click **xps**, and then click **Open**.
 - e From the **Install From Disk** dialog box, click **OK**.
- 6 Click **Next** on the following two dialog boxes.

For more information on the XPS driver, see the XPS **readme** file on the *Software and Documentation* CD. The file is located in the **xps** folder with the setupxps batch file (D:\Drivers\xps\readme).

Dell Toner Management System

Printing Status Window

Note: For the Printing Status Window to work properly, bidirectional communication support must be in place so the printer and computer can communicate. An exception is added to the Windows® Firewall to allow this communication.

The Printing Status window displays the status of the printer (Printer Ready, Printer Offline, and Error-Check Printer) and the name of the job when you send a job to print.

The Printing Status window also displays the level of toner so you can:

- Monitor the toner level for your printer.
- Click **Order Supplies** to order replacement toner cartridges.

Dell Printer Supplies Reorder Application

The Order Supplies dialog box can be launched from the Printing Status window, the Programs window, or the desktop icon.

You can order toner by phone or from the Web.

- If ordering online, launch the Dell Printer Supplies Reorder Application:

1 *In Windows Vista or later:*

a Click  → **Programs**.

b Click **Dell Printers**.

c Click **Dell 3330dn Laser Printer**.

In Windows XP and 2000:

Click **Start** → **Programs** or **All Programs** → **Dell Printers** → **Dell 3330dn Laser Printer**.

2 Click **Dell Printer Supplies Reorder Application**.

The **Order Supplies** dialog box opens.

3 If **Multiple Printers Found** launches, select the printer you are ordering the supplies for.

4 Follow the instructions on the screen.

- If ordering from the Web, click the link under the **Order Online** heading.
- If ordering by phone, call the number that appears under the **Order by Phone** heading.

Printing

This chapter covers printing, printer reports, and job cancelation. Selection and handling of paper and specialty media can affect how reliably documents print. For more information, see “Avoiding jams” on page 63 and “Storing paper” on page 47.

Printing a document

- 1 Load paper into a tray or feeder.
- 2 From the Paper menu, set the Paper Type and Paper Size based on the paper that is loaded.
- 3 Do one of the following:

For Windows users

- a With a document open, click **File** → **Print**.
- b Click **Properties**, **Preferences**, **Options**, or **Setup**.
- c From the Form Source list box, select the source containing the paper you loaded.
- d From the Form Type list box, select the paper type.
- e From the Form Size list box, select the paper size.
- f Click **OK**, and then click **Print**.

For Macintosh users

In Mac OS X:

- a Customize the settings as needed in the Page Setup dialog.
 - 1 With a document open, choose **File** > **Page Setup**.
 - 2 From the Paper Size pop-up menu, choose a paper size or create a custom size to match the loaded paper.
 - 3 Click **OK**.
- b Customize the settings as needed in the Print dialog:
 - 1 With a document open, click **File** > **Print**.
If necessary, click the disclosure triangle to see more options.
 - 2 From the print options or Copies & Pages pop-up menu, choose **Printer Features**.
 - 3 From the Feature Sets pop-up menu, choose **Paper**.
 - 4 From the Paper type pop-up menu, choose a paper type.
 - 5 Click **Print**.

In Mac OS 9:

- a Customize the settings as needed in the Page Setup dialog:
 - 1 With a document open, choose **File** > **Page Setup**.
 - 2 From the Paper pop-up menu, choose a paper size or create a custom size to match the loaded paper.
 - 3 Click **OK**.

- b** Customize the settings as needed in the Print dialog:
- 1** With a document open, choose **File > Print**.
 - 2** Select a Paper Source option, and then choose the tray loaded with the appropriate paper.
 - 3** Click **Print**.

Printing on specialty media

Tips on using letterhead

Page orientation is important when printing on letterhead. Use the following table to determine which direction to load the letterhead:

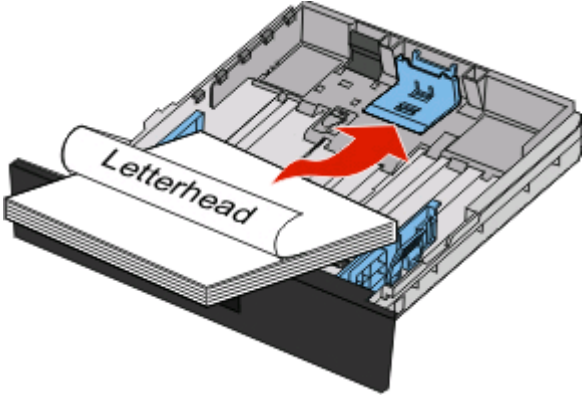
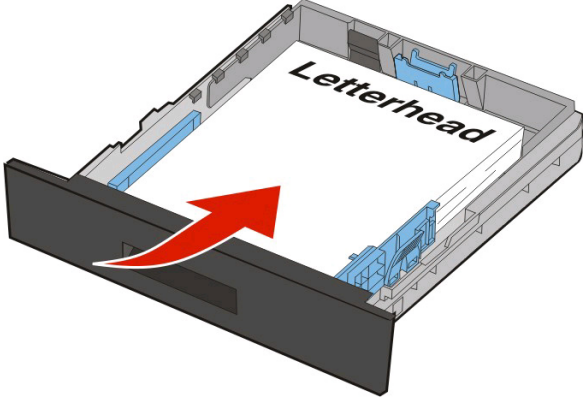
Source or process	Print side	Paper orientation
<ul style="list-style-type: none"> • Standard 250-sheet tray • Optional tray 	Printed letterhead design is placed facedown.	<p>The top edge of the sheet with the logo is placed at the front of the tray.</p> 
Duplex (two-sided) printing from trays	Printed letterhead design is placed faceup.	<p>The top edge of the sheet with the logo is placed at the back of the tray.</p> 

Note: Check with the manufacturer or vendor to determine whether the chosen preprinted letterhead is acceptable for laser printers.

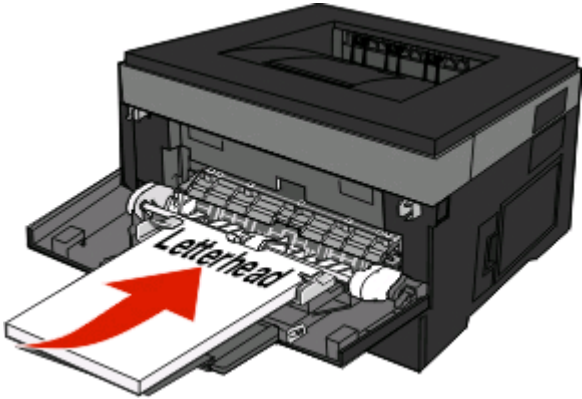
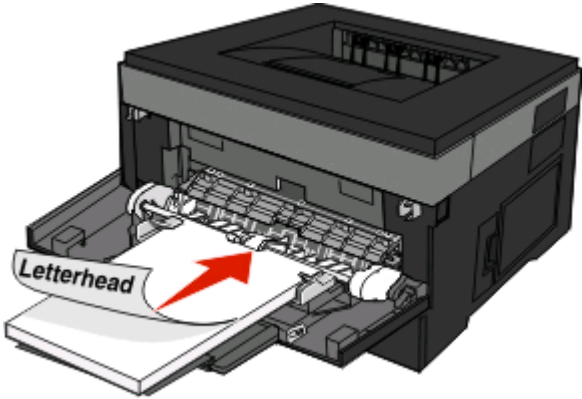
Source or process	Print side	Paper orientation
Multipurpose feeder Simplex (one-sided) printing	Preprinted letterhead design is placed faceup.	The top edge of the sheet with the logo should enter the multipurpose feeder first. 
Multipurpose feeder (duplex printing)	Preprinted letterhead design is placed facedown.	The top edge of the sheet with the logo should enter the multipurpose feeder last. 
<p>Note: Check with the manufacturer or vendor to determine whether the chosen preprinted letterhead is acceptable for laser printers.</p>		

Tips on using transparencies

Print samples on the transparencies being considered for use before buying large quantities.

When printing on transparencies:

- Feed transparencies from the standard 250-sheet tray or the multipurpose feeder.
- Use transparencies designed specifically for laser printers. Check with the manufacturer or vendor to ensure transparencies are able to withstand temperatures up to 175°C (350°F) without melting, discoloring, offsetting, or releasing hazardous emissions.

Note: Transparencies can be printed at a temperature up to 180°C (356°F) if Transparency Weight is set to Heavy and Transparency Texture is set to Rough. Select these settings using the Embedded Web Server, or from the printer control panel Paper menu.

- To prevent print quality problems, avoid getting fingerprints on the transparencies.
- Before loading transparencies, fan the stack to prevent sheets from sticking together.

Tips on using envelopes

Print samples on the envelopes being considered for use before buying large quantities.

When printing on envelopes:

- Use envelopes designed specifically for laser printers. Check with the manufacturer or vendor to ensure the envelopes can withstand temperatures up to 210°C (410°F) without sealing, wrinkling, curling excessively, or releasing hazardous emissions.
Note: Envelopes can be printed at a temperature up to 220°C (428°F) if Envelope Weight is set to Heavy and Envelope Texture is set to Rough. Select these settings using the Embedded Web Server, or from the printer control panel Paper menu.
- For the best performance, use envelopes made from 90 g/m² (24 lb bond) paper. Use up to 105 g/m² (28 lb bond) weight for envelopes as long as the cotton content is 25% or less. All-cotton envelopes must not exceed 90 g/m² (24 lb bond) weight.
- Use only new envelopes.
- To optimize performance and minimize jams, do not use envelopes that:
 - Have excessive curl or twist
 - Are stuck together or damaged in any way
 - Have windows, holes, perforations, cutouts, or embossing
 - Have metal clasps, string ties, or folding bars
 - Have an interlocking design
 - Have postage stamps attached
 - Have any exposed adhesive when the flap is in the sealed or closed position
 - Have bent corners
 - Have rough, cockle, or laid finishes
- Adjust the width guides to fit the width of the envelopes.

Note: A combination of high humidity (over 60%) and the high printing temperature may wrinkle or seal envelopes.

Tips on using labels

Print samples on the labels being considered for use before buying large quantities.

Note: Single-sided paper labels designed for laser printers are supported for occasional use. It is recommended to print 20 or fewer pages of paper labels a month. Vinyl, pharmacy, and dual-sided labels are not supported.

When printing on labels:

- Use labels designed specifically for laser printers. Check with the manufacturer or vendor to verify that:
 - The labels can withstand temperatures up to 210°C (410°F) without sealing, excessive curling, wrinkling, or releasing hazardous emissions.
Note: Labels can be printed at a higher fusing temperature up to 220°C (428°F) if Label Weight is set to Heavy. Select this setting using the Embedded Web Server, or from the printer control panel Paper menu.
 - Label adhesives, face sheet (printable stock), and topcoats can withstand up to 25 psi (172 kPa) pressure without delaminating, oozing around the edges, or releasing hazardous fumes.
- Do not use labels with slick backing material.
- Use full label sheets. Partial sheets may cause labels to peel off during printing, resulting in a jam. Partial sheets also contaminate the printer and the cartridge with adhesive, and could void the printer and cartridge warranties.

- Do not use labels with exposed adhesive.
- Do not print within 1 mm (0.04 in.) of the edge of the label, of the perforations, or between die-cuts of the label.
- Be sure adhesive backing does not reach to the sheet edge. Zone coating of the adhesive at least 1 mm (0.04 in.) away from edges is recommended. Adhesive material contaminates the printer and could void the warranty.
- If zone coating of the adhesive is not possible, remove a 1.6 mm (0.06 in.) strip on the leading and driver edge, and use a non-oozing adhesive.
- Portrait orientation works best, especially when printing bar codes.

Tips on using card stock

Card stock is heavy, single-ply specialty media. Many of its variable characteristics, such as moisture content, thickness, and texture, can significantly impact print quality. Print samples on the card stock being considered for use before buying large quantities.

When printing on card stock:

- Make sure the Paper Type is Card Stock.
- Select the appropriate Paper Texture setting.
- Be aware that preprinting, perforation, and creasing may significantly affect the print quality and cause jams or other paper handling problems.
- Check with the manufacturer or vendor to ensure the card stock can withstand temperatures up to 210°C (410°F) without releasing hazardous emissions.
- Do not use preprinted card stock manufactured with chemicals that may contaminate the printer. Preprinting introduces semi-liquid and volatile components into the printer.
- Use grain short card stock when possible.

Printing confidential and other held jobs

Holding jobs in the printer

When sending a job to the printer, you can specify that you want the printer to hold the job in memory until you start the job from the printer control panel. All print jobs that can be initiated by the user at the printer are called *held jobs*.

Note: Confidential, Verify, Reserve, and Repeat print jobs may be deleted if the printer requires extra memory to process additional held jobs.

Job type	Description
Confidential	When you send a Confidential print job to the printer, you must create a PIN from the computer. The PIN must be four digits using the numbers 0–9. The job is held in printer memory until you enter the PIN from the printer control panel and choose to print or delete the job.
Verify	When you send a Verify print job, the printer prints one copy and holds the remaining copies in printer memory. Verify lets you examine the first copy to see if it is satisfactory before printing the remaining copies. Once all copies are printed, the job is automatically deleted from printer memory.

Job type	Description
Reserve	When you send a Reserve print job, the printer does not print the job immediately. It stores the job in memory so you can print the job later. The job is held in memory until you delete it from the Held Jobs menu.
Repeat	When you send a Repeat print job, the printer prints all requested copies of the job <i>and</i> stores the job in memory so you can print additional copies later. You can print additional copies as long as the job remains stored in memory.

Other types of held jobs include:

- Forms from a kiosk
- Bookmarks
- Jobs not printed, which are called *parked jobs*

Printing confidential and other held jobs













Confidential and Verify print jobs are automatically deleted from memory after they print. Repeat and Reserve jobs continue to be held in the printer until you choose to delete them.

For Windows Users

- 1 With a document open, click **File** → **Print**.
- 2 Click **Properties, Preferences, Options, or Setup**.
- 3 Click **Other Options**, and then click **Print and Hold**.
- 4 Select your job type (Confidential, Reserve, Repeat, Verify, profiles, forms from a kiosk, bookmarks, or a parked job), and then assign a user name. For a confidential job, also enter a four-digit PIN.
- 5 Click **OK** or **Print**, and then go to the printer to release the job.
- 6 From the printer control panel, press the down arrow button until ✓ **Held jobs** appears, and then press ⏴.
- 7 Press the down arrow button until ✓ appears next to your user name, and then press ⏴.
- 8 Press the down arrow button until ✓ appears next to the job type or job name, and then press ⏴.
If you selected a job name, proceed to step 11 on page 59.
- 9 After selecting your job type, use the keypad to enter your PIN.
If you enter an invalid PIN, the Invalid PIN screen appears.
 - To re-enter the PIN, make sure ✓ **Try again** appears, and then press ⏴.
 - To cancel the PIN, press the down arrow button until ✓ **Cancel** appears, and then press ⏴.
- 10 Press the down arrow button until ✓ appears next to the job you want to print, and then press ⏴.
- 11 Press the down arrow button until ✓ appears next to the number of copies you want to print, and then press ⏴.

Note: Use the keypad to enter a number if necessary.

For Macintosh users







- 1 With a document open, choose **File > Print**.
If necessary, click the disclosure triangle to see more options.
- 2 From the print options pop-up menu, choose **Job Routing**.
- 3 Choose your job type (Confidential, Reserve, Repeat, Verify, profiles, forms from a kiosk, bookmarks, or a parked job), and then assign a user name. For a confidential job, also enter a four-digit PIN.
- 4 Click **Print**, and then go to the printer to release the job.
- 5 From the printer control panel, press the down arrow button until  **Hold jobs** appears, and then press .
- 6 Press the down arrow button until  appears next to your user name, and then press .
- 7 Press the down arrow button until  appears next to your job, and then press .
- 8 For confidential jobs, use the numeric keypad to enter your PIN.
If you enter an invalid PIN, the Invalid PIN screen appears.
 - To re-enter the PIN, make sure  **Try again** appears, and then press .
 - To cancel the PIN, press the down arrow button until  **Cancel** appears, and then press .
- 9 Press the down arrow button until  appears next to the job you want to print, and then press .

Printing information pages

See “Printing a menu settings page” on page 30 and “Printing a network setup page” on page 30 for more information on printing these pages.

Printing a font sample list

To print samples of the fonts currently available for your printer:

- 1 Make sure the printer is on and **Ready** appears.
- 2 From the printer control panel, press .
- 3 Press the down arrow button until  **Reports** appears, and then press .
- 4 Press the down arrow button until  **Print Fonts** appears, and then press .
- 5 Press the down arrow button until  appears next to **PCL Fonts** or **PostScript Fonts**, and then press .

After the font sample list prints, **Ready** appears.

Printing a directory list

A directory list shows the resources stored in flash memory.

- 1 Make sure the printer is on and **Ready** appears.
- 2 From the printer control panel, press .

- 3 Press the down arrow button until **✓ Reports** appears, and then press **↵**.
- 4 Press the down arrow button until **✓ Print Directory** appears, and then press **↵**.
After the directory list prints, **Ready** appears.

Printing the print quality test pages

Print the print quality test pages to isolate print quality problems.

- 1 Turn the printer off.
- 2 Hold down **↵** and the right arrow button while turning the printer on.
- 3 Release the buttons when the clock appears, and wait for **CONFIG MENU** to appear.
- 4 Press the down arrow button until **✓ Prt Quality Pgs** appears, and then press **↵**.
The print quality test pages print.
- 5 Press the down arrow button until **✓ Exit Config Menu** appears, and then press **↵**.
Resetting the Printer appears briefly, followed by a clock, and then **Ready** appears.

Canceling a print job

Canceling a print job from the printer control panel

If the job is formatting or already printing, and **Cancel a job** appears on the first line of the display:

- 1 Press the arrow buttons until **✓ Cancel** appears.
A list of jobs appears.
- 2 Press the arrow buttons until **✓** appears next to the job you want to cancel, and then press **↵**.

Note: Once a print job is sent, to easily cancel a job, press **✖**. The **Stopped** screen appears. Press the arrow buttons until **✓ Cancel a job** appears, and then press **↵**.

Canceling a print job from the computer

To cancel a print job, do one of the following:

For Windows users

- 1 Click **⊞**, or click **Start** and then click **Run**.
- 2 In the Start Search or Run box, type **control printers**.
- 3 Press **Enter**, or click **OK**.
The printer folder opens.
- 4 Double-click the printer icon.

- 5 Select the job to cancel.
- 6 From the keyboard, press **Delete**.

From the Windows taskbar:

When you send a job to print, a small printer icon appears in the right corner of the taskbar.

- 1 Double-click the printer icon.
A list of print jobs appears in the printer window.
- 2 Select a job to cancel.
- 3 From the keyboard, press **Delete**.

For Macintosh users

In Mac OS X version 10.5 or later:

- 1 From the Apple menu, choose **System Preferences**.
- 2 Click **Print & Fax**, and then double-click the printer icon.
- 3 From the printer window, select the job to cancel.
- 4 From the icon bar at the top of the window, click the **Delete** icon.

In Mac OS X version 10.4 and earlier:

- 1 From the Go menu, choose **Applications**.
- 2 Double-click **Utilities**, and then double-click **Print Center** or **Printer Setup Utility**.
- 3 Double-click the printer icon.
- 4 From the printer window, select the job to cancel.
- 5 From the icon bar at the top of the window, click the **Delete** icon.

Clearing jams

By carefully selecting papers and specialty media and loading it properly, you should be able to avoid most jams. For more information, see “Avoiding jams” on page 63. If jams do occur, follow the steps outlined in this chapter.

Warning—Potential Damage: Never use any tool to remove a jam. Doing so could permanently damage the fuser.

To resolve the jam messages, you must clear the entire paper path, and press  to clear the message and resume printing. The printer prints a new copy of the page that jammed if Jam Recovery is set to On or Auto; however, the Auto setting does not guarantee the page will print.

Note: Auto is the Jam recovery factory default setting. The printer reprints jammed pages unless the memory required to hold the pages is needed for other printer tasks.

Avoiding jams

The following hints can help you avoid jams:

Paper tray recommendations

- Make sure the paper lies flat in the paper tray.
- Do not remove the paper tray while the printer is printing.
- Do not load the paper tray while the printer is printing. Load it prior to printing, or wait for a prompt to load it.
- Do not load too much paper. Make sure the stack height does not exceed the indicated maximum height.
- Make sure the guides in the paper tray or the manual feeder are properly positioned and are not pressing too tightly against the paper or envelopes.
- Push the paper tray in firmly after loading paper.

Paper recommendations

- Use only recommended paper or specialty media.
- Do not load wrinkled, creased, damp, bent, or curled paper.
- Flex, fan, and straighten paper before loading it.



- Do not use paper that has been cut or trimmed by hand.
- Do not mix paper sizes, weights, or types in the same stack.
- Make sure all sizes and types are set correctly in the printer control panel menus.
- Store paper per the manufacturer's recommendations.

Accessing jam areas

Open doors and remove trays to access jam areas. The following illustration shows possible jam areas:

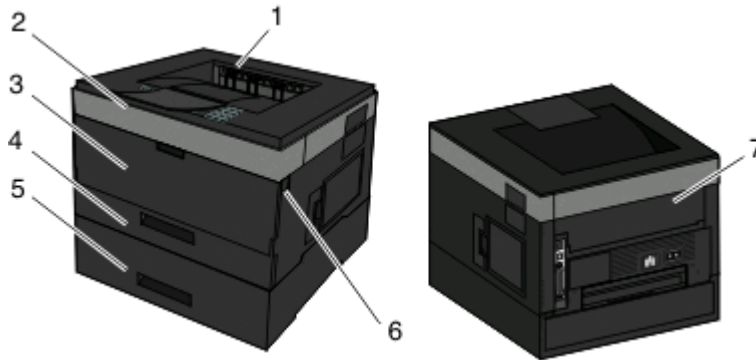

Access point	Description
1	Standard exit bin
2	Front door
3	Multipurpose feeder door
4	Standard tray (Tray 1)
5	Optional tray (Tray 2)
6	Push button to open the front door. Inside this door is the unit housing the toner cartridge and photoconductor kit.
7	Rear door

Jam message numbers and how to access each jam

Jam number	To access the jam
200	Try one or more of the following: <ul style="list-style-type: none"> Remove Tray 1. Open the front door, and then remove the photoconductor kit.
201	Open the front door, and then remove the photoconductor kit.
202	Open the front door, and then open the rear door.
231	Open the front door, and then open the rear door. Note: For alternative access to the jam, remove Tray 1, and then press the lever.
233	Remove Tray 1, and then depress the lever. Note: For alternative access to the jam, open the front door, and then open the rear door.
234	Try one or more of the following: <ul style="list-style-type: none"> Open the front door, and then open the rear door. Remove Tray 1, and then press the lever.
235	Remove the jam from the standard exit bin.
242	Remove Tray 2.

Jam number	To access the jam
251	Try one or more of the following: <ul style="list-style-type: none">• If the sheet is visible in the multipurpose feeder, gently pull it from the front of the multipurpose feeder.• If it is not visible, open the front door, and then remove the unit. Lift the flap at the front of the printer, and then remove any jammed sheets.

200 paper jam

1 Remove the tray from the printer.

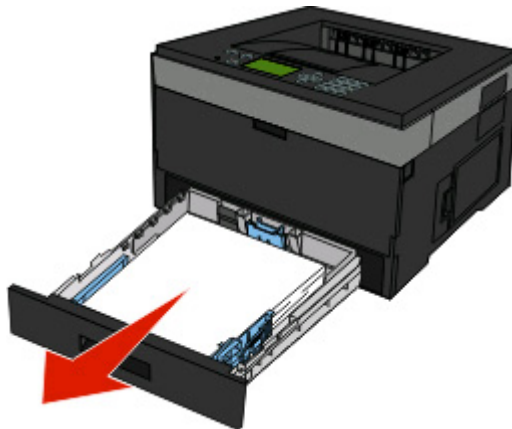

2 Remove the jam if you see it here.



3 If you do not see it, open the front door, and then remove the photoconductor kit and toner cartridge (unit).

Note: When the photoconductor kit and toner cartridge are together, they are called a unit.

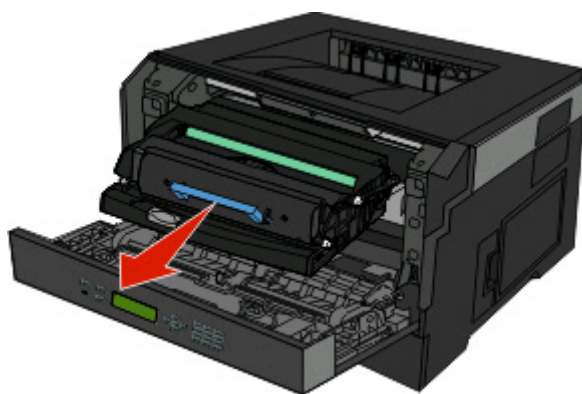

4 Lift the flap in front of the printer, and remove any jammed sheets.

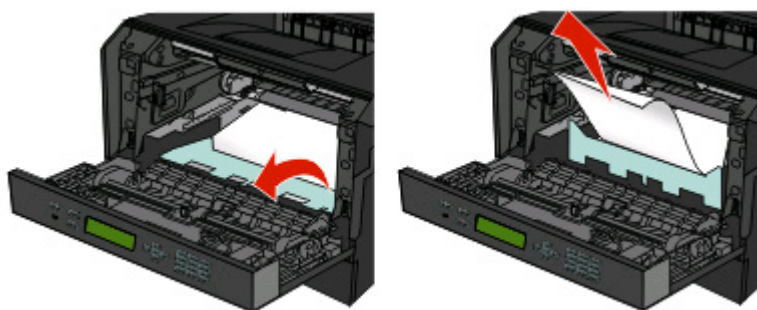

5 Align and insert the unit.

6 Close the front door.

7 Insert the tray.

8 Press .

201 paper jam

 **CAUTION—HOT SURFACE:** The fuser and the inside of the printer near the fuser may be hot. To reduce the risk of injury from a hot component, allow the surface to cool before removing paper from this area.

1 Open the front door, and then remove the unit.

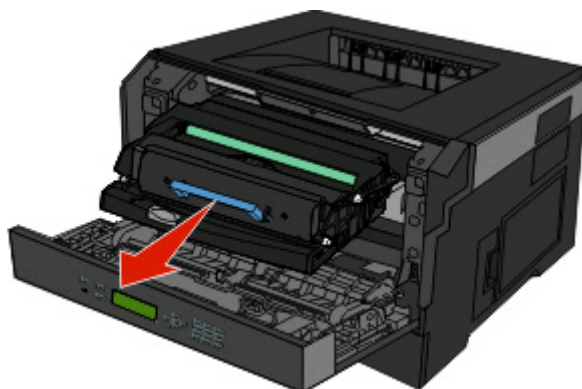

2 Lift the flap in front of the printer, and then remove any jammed sheets.

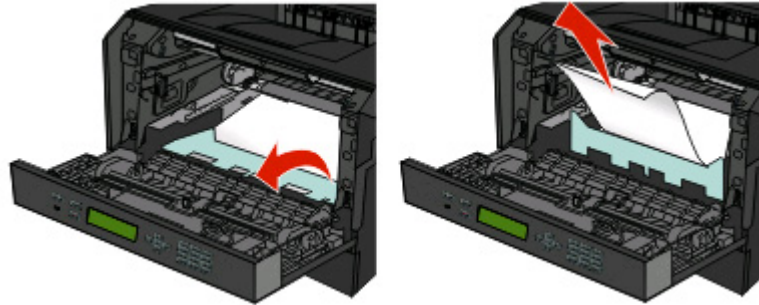

3 Align and insert the unit.

4 Close the front door.

5 Press .

202 paper jam

 **CAUTION—HOT SURFACE:** The fuser and the inside of the printer near the fuser may be hot. To reduce the risk of injury from a hot component, allow the surface to cool before removing paper from this area.

1 Open the front door, and then remove the unit.

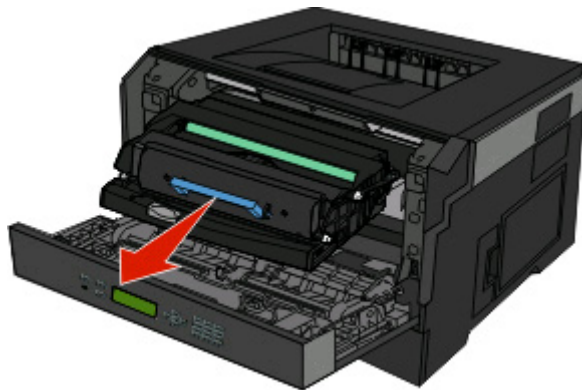

2 Lift the flap in front of the printer, and then remove any jammed sheets.

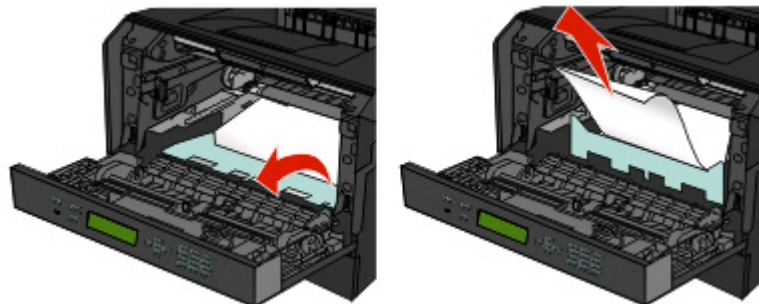

3 Open the rear door.



4 Remove the jam.

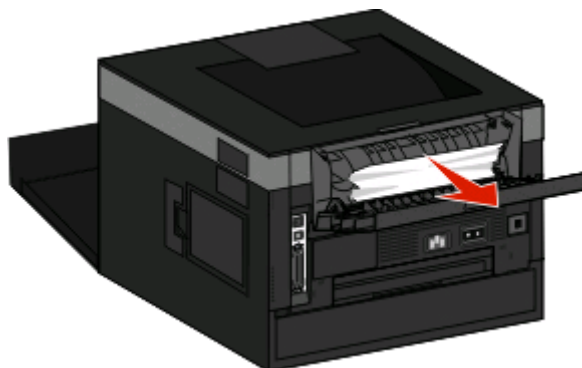

5 Close the rear door.

6 Close the front door.

7 Press .

231 paper jam

CAUTION—HOT SURFACE: The fuser and the inside of the printer near the fuser may be hot. To reduce the risk of injury from a hot component, allow the surface to cool before removing paper from this area.

- 1 Open the front door.

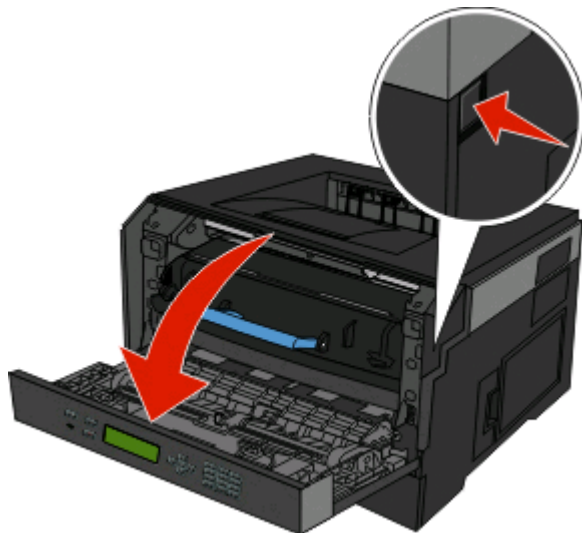

- 2 Open the rear door.
- 3 Remove the jam.

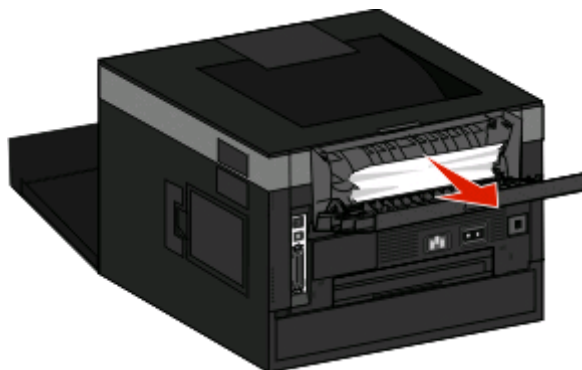
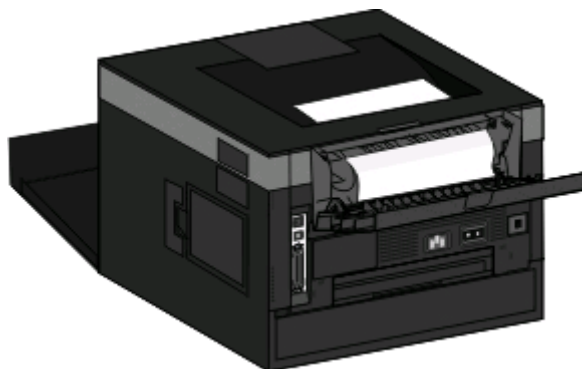

- 4 Close the rear door.

5 Close the front door.

6 Press .

If this does not clear the jam, complete the steps in “233 paper jam” on page 70.

233 paper jam

1 Remove the tray from the printer.

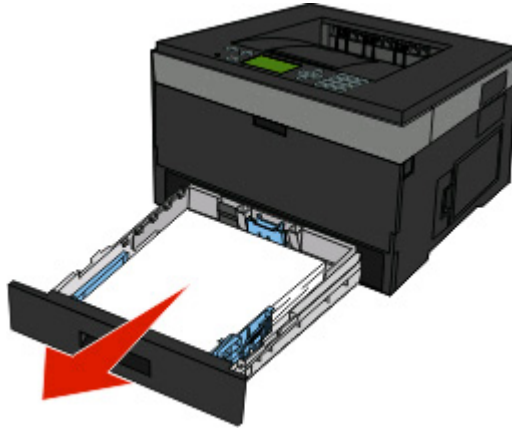

2 Locate the lever shown. Pull the lever down to release the jam.

3 Pull the jammed sheets from the duplex area.

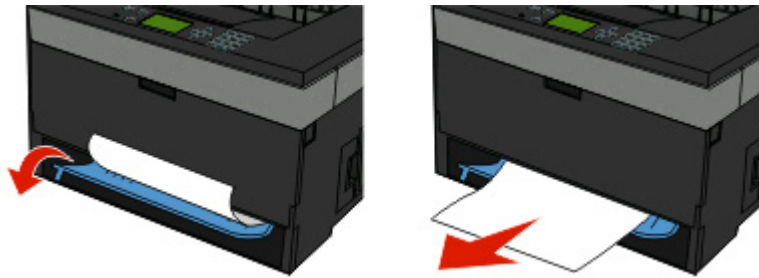

4 Insert the tray.

5 Press .

If this does not clear the jam, complete the steps in “231 paper jam” on page 69.

234 paper jam

A single jam or multiple jams are in the duplex area of the printer when the printer is turned on. To locate and remove the jammed sheets, complete all the steps in:

- “231 paper jam” on page 69
- “233 paper jam” on page 70

235 paper jam

A duplex print job was sent to the printer using a size of paper not supported for duplex printing. A sheet is jammed in the standard exit bin.

- 1 To remove the jam, gently pull the jammed sheet out of the standard exit bin.



- 2 Press .

242 paper jam

- 1 Remove the optional tray from the printer.

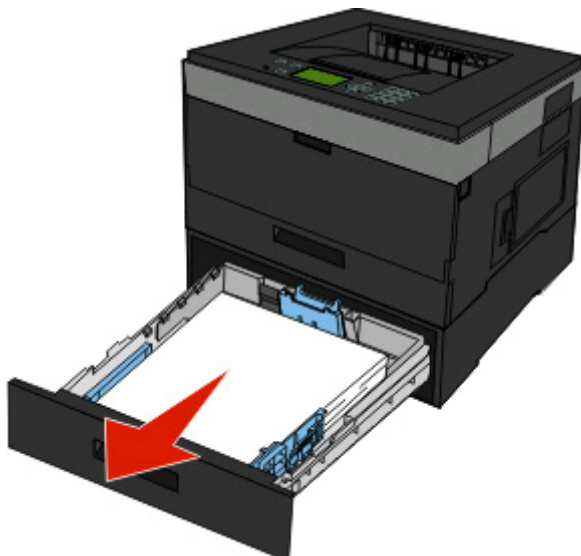

2 Remove the jam.

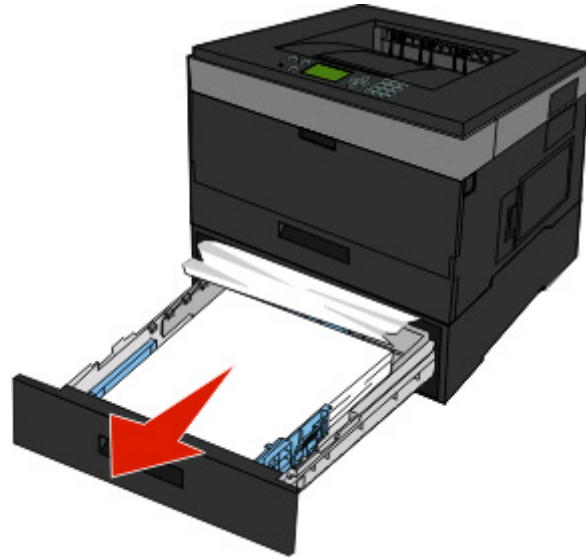

3 Insert the optional tray.

4 Press .

251 paper jam

A sheet of paper or specialty media failed to feed completely from the multipurpose feeder. Part of it may be still visible. If it is visible, gently pull the jammed sheet from the front of the multipurpose feeder.

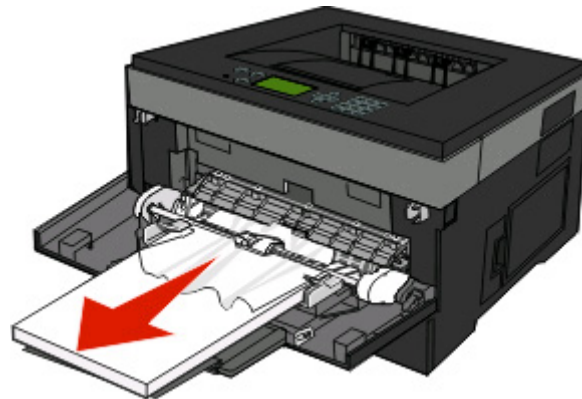

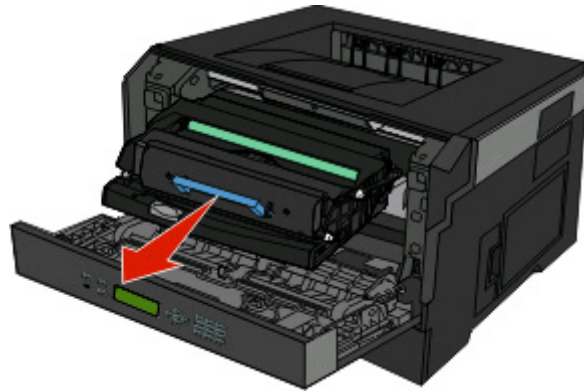

If the sheet is not visible, complete the following steps:

- 1 Open the front door, and then remove the unit.

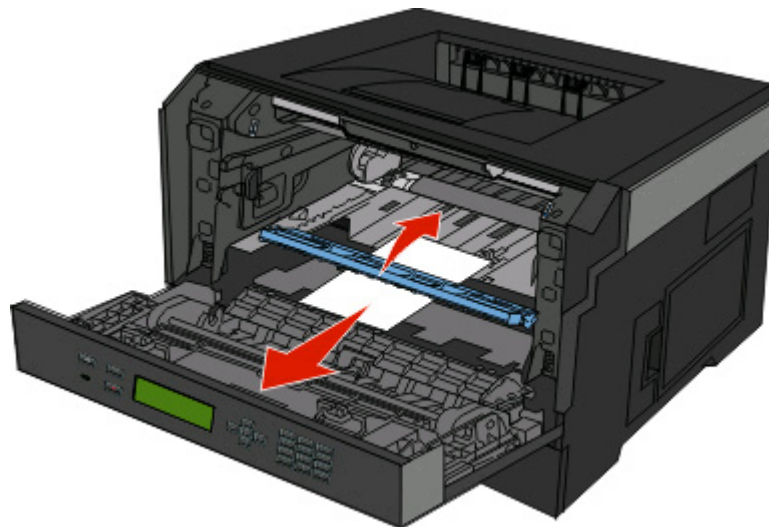

- 2 Lift the flap at the front of the printer, and then remove any jammed sheets of paper that are short lengths of paper.



- 3 Align and insert the unit.
- 4 Close the front door.
- 5 Press .

Understanding printer menus

Menus list

A number of menus and menu items are available to make it easy for you to change printer settings:

Paper Menu

- Default Source
- Paper Size/Type
- Configure MP
- Substitute Size
- Paper Texture
- Paper Weight
- Paper Loading
- Custom Types
- Universal Setup

Reports

- Menu Settings Page
- Device Statistics
- Network Setup Page
- Profiles List
- Netware Setup Page
- Print Fonts
- Print Directory
- Asset Report

Network/Ports

- Active NIC
- Network Menu
- USB Menu
- Parallel Menu
- SMTP Menu

Security

- Miscellaneous
- Confidential Print
- Security Audit Log
- Set Date/Time

Settings

- General Settings
- Setup Menu
- Finishing Menu
- Quality Menu
- Utilities Menu
- XPS Menu
- PDF Menu
- PostScript Menu
- PCL Emul Menu
- HTML Menu
- Image Menu

Paper menu

Default Source menu

Menu item	Description
Default Source Tray <x> MP Feeder Manual Paper Manual Env	Sets a default paper source for all print jobs Notes: <ul style="list-style-type: none">• From the Paper menu, Configure MP must be set to Cassette in order for MP Feeder to appear as a menu setting.• Tray 1 (standard tray) is the factory default setting.• Only an installed paper source will appear as a menu setting.• A paper source selected by a print job will override the Default Source setting for the duration of the print job.• If the same size and type of paper are in two trays and the Paper Size and Paper Type settings match, the trays are automatically linked. When one tray is empty, the job prints using the linked tray.

Paper Size/Type menu

Menu item	Description
Tray <x> Size A4 A5 A6 JIS B5 Executive Folio Legal Letter Oficio (Mexico) Statement Universal	Specifies the paper size loaded in each tray Notes: <ul style="list-style-type: none">• Letter is the US factory default setting. A4 is the international factory default setting.• If the same size and type of paper are in two trays and the Paper Size and Paper Type settings match, then the trays are automatically linked. The multipurpose feeder may also be linked. When one tray is empty, the job prints using paper from the linked tray.• The A6 paper size is supported only in Tray 1 and the multipurpose feeder.

Note: Only installed trays and feeders are listed in this menu.

Menu item	Description
<p>Tray <x> Type</p> <ul style="list-style-type: none"> Plain Paper Card Stock Transparency Recycled Labels Bond Letterhead Preprinted Colored Paper Light Paper Heavy Paper Rough/Cotton Custom Type <x> 	<p>Specifies the type of paper loaded in each tray</p> <p>Notes:</p> <ul style="list-style-type: none"> • Plain Paper is the factory default setting for Tray 1. Custom Type <x> is the factory default setting for all other trays. • If available, a user-defined name will appear instead of Custom Type <x>. • Use this menu item to configure automatic tray linking.
<p>Manual Paper Size</p> <ul style="list-style-type: none"> A4 A5 A6 Executive Folio JIS B5 Legal Letter Oficio (Mexico) Statement Universal 	<p>Specifies the size of the paper being manually loaded in the multipurpose feeder</p> <p>Notes:</p> <ul style="list-style-type: none"> • Letter is the US factory default setting. A4 is the international factory default setting. • The menu item applies only when the multipurpose feeder (MP Feeder) is configured for Manual. From the Paper menu, Configure MP must be set to Manual.
<p>Note: Only installed trays and feeders are listed in this menu.</p>	

Menu item	Description
<p>MP Feeder Size</p> <ul style="list-style-type: none"> A4 A5 A6 Executive Folio JIS B5 Legal Letter Oficio (Mexico) Statement Universal 7 3/4 Envelope 9 Envelope 10 Envelope C5 Envelope B5 Envelope DL Envelope Other Envelope 	<p>Specifies the paper size loaded in the multipurpose feeder</p> <p>Notes:</p> <ul style="list-style-type: none"> • Letter is the U.S. factory default setting. A4 is the international factory default setting. • The menu item applies only when the multipurpose feeder (MP Feeder) is configured for Cassette. From the Paper menu, Configure MP must be set to Cassette. • The multipurpose feeder does not automatically sense paper size. The paper size value must be set.
<p>MP Feeder Type</p> <ul style="list-style-type: none"> Plain Paper Card Stock Transparency Recycled Labels Bond Envelope Rough Envelope Letterhead Preprinted Colored Paper Light Paper Heavy Paper Rough/Cotton Custom Type <x> 	<p>Specifies the type of paper loaded in the multipurpose feeder</p> <p>Notes:</p> <ul style="list-style-type: none"> • Plain Paper is the factory default setting. • From the Paper menu, Configure MP must be set to Cassette in order for MP Feeder to appear as a menu item.
<p>Note: Only installed trays and feeders are listed in this menu.</p>	

Menu item	Description
Manual Paper Type Plain Paper Card Stock Transparency Recycled Labels Bond Letterhead Preprinted Colored Paper Light Paper Heavy Paper Rough/Cotton Custom Type <x>	Specifies the type of paper being manually loaded in the multipurpose feeder Notes: <ul style="list-style-type: none"> • Plain Paper is the factory default setting. • From the Paper menu, Configure MP must be set to Manual in order for Manual Paper to appear as a menu item.
Manual Env Size 7 3/4 Envelope 9 Envelope 10 Envelope C5 Envelope B5 Envelope DL Envelope Other Envelope	Specifies the size of the envelope being manually loaded in the multipurpose feeder Notes: <ul style="list-style-type: none"> • 10 Envelope is the US factory default setting. DL Envelope is the international factory default setting. • The menu item applies only when the multipurpose feeder (MP Feeder) is configured for Manual. From the Paper menu, Configure MP must be set to Manual.
Manual Env Type Envelope Custom Type <x>	Specifies the type of envelope being manually loaded in the multipurpose feeder. Notes: <ul style="list-style-type: none"> • Envelope is the factory default setting. • The menu item applies only when the multipurpose feeder (MP Feeder) is configured for Manual. From the Paper menu, Configure MP must be set to Manual.
Note: Only installed trays and feeders are listed in this menu.	

Configure MP menu

Menu item	Description
Configure MP Cassette Manual	Determines when the printer selects paper from the multipurpose feeder Notes: <ul style="list-style-type: none"> • Cassette is the factory default setting. • The Cassette setting configures the multipurpose feeder as an automatic paper source. • When Manual is selected, the multipurpose feeder can be used only for manual feed print jobs.

Substitute Size menu

Menu item	Description
Substitute Size Off Statement/A5 Letter/A4 All Listed	Substitutes a specified paper size if the requested paper size is not available Notes: <ul style="list-style-type: none"> • All Listed is the factory default setting. All available substitutions are allowed. • The Off setting indicates no size substitutions are allowed. • Setting a substitution lets the job print without a Change Paper message appearing.

Paper Texture menu

Menu item	Description
Plain Texture Smooth Normal Rough	Specifies the relative texture of the paper loaded in a specific tray Note: Normal is the factory default setting.
Card Stock Texture Smooth Normal Rough	Specifies the relative texture of the card stock loaded in a specific tray Notes: <ul style="list-style-type: none"> • Normal is the factory default setting. • Settings appear only if card stock is supported.
Transparency Texture Smooth Normal Rough	Specifies the relative texture of the transparencies loaded in a specific tray Note: Normal is the factory default setting.
Recycled Texture Smooth Normal Rough	Specifies the relative texture of the recycled paper loaded in a specific tray Note: Normal is the factory default setting.
Labels Texture Smooth Normal Rough	Specifies the relative texture of the labels loaded in a specific tray Note: Normal is the factory default setting.
Bond Texture Smooth Normal Rough	Specifies the relative texture of the bond paper loaded in a specific tray Note: Rough is the factory default setting.
Envelope Texture Smooth Normal Rough	Specifies the relative texture of the envelopes loaded in a specific tray Note: Normal is the factory default setting.

Menu item	Description
Rough Envelope Texture Rough	Specifies the relative texture of the envelopes loaded in a specific tray Note: Rough is the factory default setting.
Letterhead Texture Smooth Normal Rough	Specifies the relative texture of the letterhead paper loaded in a specific tray Note: Normal is the factory default setting.
Preprinted Texture Smooth Normal Rough	Specifies the relative texture of the preprinted paper loaded in a specific tray Note: Normal is the factory default setting.
Colored Texture Smooth Normal Rough	Specifies the relative texture of the colored paper loaded in a specific tray Note: Normal is the factory default setting.
Light Texture Smooth Normal Rough	Specifies the relative texture of the paper loaded in a specific tray Note: Normal is the factory default setting.
Heavy Texture Smooth Normal Rough	Specifies the relative texture of the paper loaded in a specific tray Note: Normal is the factory default setting.
Rough/Cotton Texture Rough	Specifies the relative texture of the paper loaded in a specific tray Note: Rough is the factory default setting.
Custom <x> Texture Smooth Normal Rough	Specifies the relative texture of the custom paper loaded in a specific tray Notes: <ul style="list-style-type: none"> • Normal is the factory default setting. • Settings appear only if the custom type is supported.

Paper Weight menu

Menu item	Description
Plain Weight Light Normal Heavy	Specifies the relative weight of the paper loaded in a specific tray Note: Normal is the factory default setting.
Card Stock Weight Light Normal Heavy	Specifies the relative weight of the card stock loaded in a specific tray Note: Normal is the factory default setting.

Menu item	Description
Transparency Weight Light Normal Heavy	Specifies the relative weight of the transparencies loaded in a specific tray Note: Normal is the factory default setting.
Recycled Weight Light Normal Heavy	Specifies the relative weight of the recycled paper loaded in a specific tray Note: Normal is the factory default setting.
Labels Weight Light Normal Heavy	Specifies the relative weight of the labels loaded in a specific tray Note: Normal is the factory default setting.
Bond Weight Light Normal Heavy	Specifies the relative weight of the paper loaded in a specific tray Note: Normal is the factory default setting.
Envelope Weight Light Normal Heavy	Specifies the relative weight of the envelopes loaded in a specific tray Note: Normal is the factory default setting.
Rough Envelope Weight Light Normal Heavy	Specifies the relative weight of the rough envelopes loaded in a specific tray Note: Normal is the factory default setting.
Letterhead Weight Light Normal Heavy	Specifies the relative weight of the paper loaded in a specific tray Note: Normal is the factory default setting.
Preprinted Weight Light Normal Heavy	Specifies the relative weight of the paper loaded in a specific tray Note: Normal is the factory default setting.
Colored Weight Light Normal Heavy	Specifies the relative weight of the paper loaded in a specific tray Note: Normal is the factory default setting.
Light Weight Light	Specifies the relative weight of the paper loaded in a specific tray
Heavy Weight Heavy	Specifies the relative weight of the paper loaded in a specific tray

Menu item	Description
Rough/Cotton Weight Light Normal Heavy	Specifies the relative weight of the paper loaded in a specific tray Note: Normal is the factory default setting.
Custom <x> Weight Light Normal Heavy	Specifies the relative weight of the custom paper type loaded in a specific tray Notes: <ul style="list-style-type: none"> • Normal is the factory default setting. • Settings appear only if the custom type is supported.

Paper Loading menu

Menu item	Description
Recycled Loading Duplex Off	Determines whether 2-sided printing occurs for all jobs that specify Recycled as the paper type Note: Off is the factory default setting.
Bond Loading Duplex Off	Determines whether 2-sided printing occurs for all jobs that specify Bond as the paper type Note: Off is the factory default setting.
Letterhead Loading Duplex Off	Determines whether 2-sided printing occurs for all jobs that specify Letterhead as the paper type Note: Off is the factory default setting.
Preprinted Loading Duplex Off	Determines whether 2-sided printing occurs for all jobs that specify Preprinted as the paper type Note: Off is the factory default setting.
Colored Loading Duplex Off	Determines whether 2-sided printing occurs for all jobs that specify Colored as the paper type Note: Off is the factory default setting.
Light Loading Duplex Off	Determines whether 2-sided printing occurs for all jobs that specify Light as the paper type Note: Off is the factory default setting.
Heavy Loading Duplex Off	Determines whether 2-sided printing occurs for all jobs that specify Heavy as the paper type Note: Off is the factory default setting.
Notes: <ul style="list-style-type: none"> • Duplex sets the printer default to 2-sided printing for every print job unless 1-sided printing is selected from Print Properties. • If Duplex is selected, all print jobs are sent through the duplex unit, including 1-sided jobs. 	

Menu item	Description
Custom <x> Loading Duplex Off	Determines whether 2-sided printing occurs for all jobs that specify Custom <x> as the paper type Notes: <ul style="list-style-type: none"> • Off is the factory default setting. • Custom <x> Loading is available only if the custom type is supported.
Notes: <ul style="list-style-type: none"> • Duplex sets the printer default to 2-sided printing for every print job unless 1-sided printing is selected from Print Properties. • If Duplex is selected, all print jobs are sent through the duplex unit, including 1-sided jobs. 	

Custom Types menu

Menu item	Description
Custom Type <x> Paper Card Stock Transparency Labels Envelope Rough/Cotton	Associates a paper or specialty media type with a factory default Custom Type <x> name or a user-defined Custom Name created from the Embedded Web Server or MarkVision™ Professional. This user-defined name displays instead of Custom Type <x> . Notes: <ul style="list-style-type: none"> • Paper is the factory default setting for the Custom Type. • The custom media type must be supported by the selected tray or feeder in order for you to print from that source.
Recycled Paper Card Stock Transparency Labels Envelope Cotton	Specifies a paper type when the Recycled setting is selected in other menus Notes: <ul style="list-style-type: none"> • Paper is the factory default setting. • The Recycled type must be supported by the selected tray or feeder in order for you to print from that source.

Universal Setup menu

These menu items are used to specify the height, width, and feed direction of the Universal Paper Size. The Universal Paper Size is a user-defined paper size. It is listed with the other paper size settings and includes similar options, such as support for duplex printing and printing multiple pages on one sheet.

Menu item	Description
Units of Measure Inches Millimeters	Identifies the units of measure Notes: <ul style="list-style-type: none"> • Inches is the US factory default setting. • Millimeters is the international factory default setting.

Menu item	Description
Portrait Width 3–14.17 inches 76–360 mm	Sets the portrait width Notes: <ul style="list-style-type: none"> • If the width exceeds the maximum, then the printer uses the maximum width allowed. • 8.5 inches is the US factory default setting. Inches can be increased in 0.01-inch increments. • 216 mm is the international factory default setting. Millimeters can be increased in 1-mm increments.
Portrait Height 3–14.17 inches 76–360 mm	Sets the portrait height Notes: <ul style="list-style-type: none"> • If the height exceeds the maximum, then the printer uses the maximum height allowed. • 14 inches is the US factory default setting. Inches can be increased in 0.01-inch increments. • 356 mm is the international factory default setting. Millimeters can be increased in 1-mm increments.
Feed Direction Short Edge Long Edge	Specifies the feed direction Notes: <ul style="list-style-type: none"> • Short Edge is the factory default setting. • Long Edge appears only if the longest edge is shorter than the maximum length supported in the tray.

Reports menu

Reports menu

To print a report, use the arrow buttons to navigate to the type of report you want, and then press .

Menu item	Description
Menu Settings Page	Prints a report containing information about paper loaded into trays, installed memory, the total page count, alarms, timeouts, the printer control panel language, the TCP/IP address, the status of supplies, the status of the network connection, and other information
Device Statistics	Prints a report containing printer statistics such as supply information and details about printed pages
Network Setup Page	Prints a report containing information about the network printer settings, such as the TCP/IP address information Note: This menu item appears only for network printers or printers connected to print servers.

Menu item	Description
Network <x> Setup Page	Prints a report containing information about the network printer settings, such as the TCP/IP address information Notes: <ul style="list-style-type: none"> • This menu item is available when more than one network option is installed. • This menu item appears only for network printers or printers connected to print servers.
Profiles List	Prints a list of profiles stored in the printer
NetWare Setup Page	Prints a report containing NetWare-specific information about the network settings Note: This menu item appears only for printers with an internal print server installed.
Print Fonts PCL Fonts PostScript Fonts	Prints a report in English of all the fonts available for the printer language currently set in the printer Note: A separate list is available for PCL and PostScript emulations. Each emulation report contains print samples and information about the available fonts for each language.
Print Directory	Prints a list of all the resources stored on an optional flash memory card Notes: <ul style="list-style-type: none"> • Job Buffer Size must be set to 100%. • The optional flash memory must be installed correctly and working properly.
Asset Report	Prints a report containing asset information including the printer serial number and model name. The report contains text and UPC barcodes that can be scanned into an asset database.

Network/Ports menu

Active NIC menu

Menu item	Description
Active NIC Auto <list of available network cards>	Notes: <ul style="list-style-type: none"> • Auto is the factory default setting. • This menu item appears only if an optional network card is installed.

Standard Network or Network <x> menus

Menu item	Description
PCL SmartSwitch On Off	Sets the printer to automatically switch to PCL emulation when a print job requires it, regardless of the default printer language Notes: <ul style="list-style-type: none"> • On is the factory default setting. • When the Off setting is used, the printer does not examine incoming data. • When the Off setting is used, the printer uses PostScript emulation if PS SmartSwitch is set to On. It uses the default printer language specified in the Setup menu if PS SmartSwitch is set to Off.
PS SmartSwitch On Off	Sets the printer to automatically switch to PS emulation when a print job requires it, regardless of the default printer language Notes: <ul style="list-style-type: none"> • On is the factory default setting. • When the Off setting is used, the printer does not examine incoming data. • When the Off setting is used, the printer uses PCL emulation if PCL SmartSwitch is set to On. It uses the default printer language specified in the Setup menu if PCL SmartSwitch is set to Off.
NPA Mode Off Auto	Sets the printer to perform the special processing required for bidirectional communication following the conventions defined by the NPA protocol Notes: <ul style="list-style-type: none"> • Auto is the factory default setting. • Changing this setting from the printer control panel and then exiting the menus causes the printer to restart. The menu selection is updated.
Network Buffer Auto 3K to <maximum size allowed>	Sets the size of the network input buffer Notes: <ul style="list-style-type: none"> • Auto is the factory default setting. • The value can be changed in 1K increments. • The maximum size allowed depends on the amount of memory in the printer, the size of the other link buffers, and whether Resource Save is set to On or Off. • To increase the maximum size range for the Network Buffer, disable or reduce the size of the parallel and USB buffers. • Changing this setting from the printer control panel and then exiting the menus causes the printer to restart. The menu selection is updated.
Mac Binary PS On Off Auto	Sets the printer to process Macintosh binary PostScript print jobs Notes: <ul style="list-style-type: none"> • Auto is the factory default setting. • The Off setting filters print jobs using the standard protocol. • The On setting processes raw binary PostScript print jobs.

Menu item	Description
Std Network Setup Reports Network Card TCP/IP IPv6 AppleTalk NetWare Net <x> Setup Reports Network Card TCP/IP IPv6 Apple Talk NetWare	For descriptions and settings of the network setup menus, see the following: <ul style="list-style-type: none"> • “Reports menu (under the Network/Ports menu)” on page 87 • “Network Card menu” on page 87 • “TCP/IP menu” on page 88 • “IPv6 menu” on page 89 • “AppleTalk menu” on page 89 • “NetWare menu” on page 90

Reports menu (under the Network/Ports menu)

The Reports menu item is available from the Network/Ports menu:

Network/Ports → Standard Network or Network <x> → Std Network Setup or Net <x> Setup → Reports

Menu item	Description
Print Setup Page Print NetWare Setup Page	Prints a report containing information about the current network setup Notes: <ul style="list-style-type: none"> • The Setup Page contains information about the network printer settings, such as the TCP/IP address. • The NetWare Setup Page menu item appears only on models that support NetWare and shows information about NetWare settings.

Network Card menu

This menu is available from the Network/Ports menu:

Network/Ports → Network Menu → Network Setup → Network Card

Menu item	Description
View Card Status Connected Disconnected	Lets you determine whether the Network Card is connected
View Card Speed	Reflects the speed of a currently active network card
Network Address UAA LAA	Lets you view the network addresses

Menu item	Description
Job Timeout 0-225 seconds	Sets the amount of time in seconds that a network print job can take before it is canceled Notes: <ul style="list-style-type: none"> • 90 seconds is the factory default setting. • A setting value of 0 disables the timeout. • If a value of 1–9 is selected, the setting is saved as 10.
Banner Page On Off	Allows the printer to print a banner page Note: Off is the factory default setting.

TCP/IP menu

Note: This menu is available only for network models or printers attached to print servers.

This menu is available from the Network/Ports menu:

Network/Ports → Network Menu → Network Setup → TCP/IP

Menu item	Description
Activate On Off	Activates TCP/IP Note: On is the factory default setting.
View Hostname	Lets you view the current TCP/IP hostname Note: This can be changed only from the Embedded Web Server.
IP Address	Lets you view or change the current TCP/IP Address information Note: Manually setting the IP address sets the Enable DHCP and Enable Auto IP settings to Off. It also sets Enable BOOTP and Enable RARP to Off on systems that support BOOTP and RARP.
Netmask	Lets you view or change the current TCP/IP Netmask information
Gateway	Lets you view or change the current TCP/IP Gateway information
Enable DHCP On Off	Specifies the DHCP address and parameter assignment setting Note: On is the factory default setting.
Enable RARP On Off	Specifies the RARP address assignment setting Note: On is the factory default setting.
Enable BOOTP On Off	Specifies the BOOTP address assignment setting Note: On is the factory default setting.
Enable Auto IP Yes No	Specifies the Zero Configuration Networking setting Note: Yes is the factory default setting.

Menu item	Description
Enable FTP/TFTP Yes No	Enables the built-in FTP server, which allows files to be transferred to the printer Note: Yes is the factory default setting.
Enable HTTP Server Yes No	Enables the built-in Web server (Embedded Web Server). When enabled, the printer can be monitored and managed remotely using a Web browser. Note: Yes is the factory default setting.
WINS Server Address	Lets you view or change the current WINS Server Address
DNS Server Address	Lets you view or change the current DNS Server Address

IPv6 menu

Use the following menu items to view or set the Internet Protocol version 6 (IPv6) information.

Note: This menu is available only for network models or printers attached to print servers.

This menu is available from the Network/Ports menu:

Network/Ports → Network Menu → Network Setup → IPv6

Menu item	Description
Enable IPv6 On Off	Enables IPv6 in the printer Note: On is the factory default setting.
Auto Configuration On Off	Specifies whether the network adapter accepts the automatic IPv6 address configuration entries provided by a router Note: On is the factory default setting.
View Hostname View Address View Router Address	Lets you view the current setting Note: These settings can be changed only from the Embedded Web Server.
Enable DHCPv6 On Off	Enables DHCPv6 in the printer Note: On is the factory default setting.

AppleTalk menu

This menu is available from the Network/Ports menu:

Network/Ports → Network Menu → Network Setup → AppleTalk

Menu item	Description
Activate On Off	Activates or deactivates AppleTalk support Note: On is the factory default setting.
View Name	Shows the assigned AppleTalk name Note: The name can be changed only from the Embedded Web Server.

Menu item	Description
View Address	Shows the assigned AppleTalk address Note: The address can be changed only from the Embedded Web Server.
Set Zone <list of zones available on the network>	Provides a list of AppleTalk zones available on the network Note: The default setting is the default zone for the network. If no default zone exists, the zone marked with an * is the default setting.

NetWare menu

This menu is available from the Network/Ports menu:

Network/Ports → Network Menu → Network Setup → NetWare

Menu item	Description
Activate Yes No	Activates or deactivates NetWare support Note: No is the factory default setting.
View Login Name	Shows the assigned NetWare login name Note: This can be changed only from the Embedded Web Server.
Print Mode	Shows the assigned NetWare print mode Note: This can be changed only from the Embedded Web Server.
Network Number	Shows the assigned NetWare network number Note: This can be changed only from the Embedded Web Server.
Select SAP Frames Ethernet 802.2 Ethernet 802.3 Ethernet Type II Ethernet SNAP	Enables the Ethernet frame type setting Notes: <ul style="list-style-type: none"> • On is the factory default setting for all menu items. • Values for each of the Ethernet frame types are On and Off.
Packet Burst Yes No	Reduces network traffic by allowing the transfer and acknowledgement of multiple data packets to and from the NetWare server Note: Yes is the factory default setting.
NSQ/GSQ Mode Yes No	Specifies the NSQ/GSQ Mode setting Note: Yes is the factory default setting.

USB menu

Menu item	Description
PCL SmartSwitch On Off	Sets the printer to automatically switch to PCL emulation when a print job received through a USB port requires it, regardless of the default printer language Notes: <ul style="list-style-type: none"> • On is the factory default setting. • When the Off setting is used, the printer does not examine incoming data. • When the Off setting is used, the printer uses PostScript emulation if the PS Smartswitch setting is On. It uses the default printer language specified in the Setup menu if the PS SmartSwitch setting is Off.
PS SmartSwitch On Off	Sets the printer to automatically switch to PS emulation when a print job received through a USB port requires it, regardless of the default printer language Notes: <ul style="list-style-type: none"> • On is the factory default setting. • When the Off setting is used, the printer does not examine incoming data. • When the Off setting is used, the printer uses PCL emulation if the PCL Smartswitch setting is On. It uses the default printer language specified in the Setup menu if the PCL SmartSwitch setting is Off.
NPA Mode On Off Auto	Sets the printer to perform the special processing required for bidirectional communication following the conventions defined by the NPA protocol Notes: <ul style="list-style-type: none"> • Auto is the factory default setting. • Changing this setting causes the printer to restart.
USB Buffer Disabled Auto 3K to <maximum size allowed>	Sets the size of the USB input buffer Notes: <ul style="list-style-type: none"> • Auto is the factory default setting. • The Disabled setting turns off job buffering. Any jobs already buffered on the disk are printed before normal processing is resumed. • The USB buffer size value can be changed in 1K increments. • The maximum size allowed depends on the amount of memory in the printer, the size of the other link buffers, and whether the Resource Save setting is On or Off. • To increase the maximum size range for the USB Buffer, disable or reduce the size of the parallel and network buffers. • Changing this setting causes the printer to restart.
Mac Binary PS On Off Auto	Sets the printer to process Macintosh binary PostScript print jobs Notes: <ul style="list-style-type: none"> • Auto is the factory default setting. • The Off setting filters print jobs using the standard protocol. • The On setting processes raw binary PostScript print jobs.

Menu item	Description
ENA Address <xxx>.<xxx>.<xxx>.<xxx>	Sets the network address information for an external print server that is attached to the printer using a USB cable Note: This menu item is available only if the printer is attached to an external print server through the USB port.
ENA Netmask <xxx>.<xxx>.<xxx>.<xxx>	Sets the netmask information for an external print server that is attached to the printer using a USB cable Note: This menu item is available only if the printer is attached to an external print server through the USB port.
ENA Gateway <xxx>.<xxx>.<xxx>.<xxx>	Sets the gateway information for an external print server that is attached to the printer using a USB cable Note: This menu item is available only if the printer is attached to an external print server through the USB port.

Parallel menu

Menu item	Description
PCL SmartSwitch On Off	Sets the printer to automatically switch to PCL emulation when a print job received through a USB port requires it, regardless of the default printer language Notes: <ul style="list-style-type: none"> • On is the factory default setting. • When the Off setting is used, the printer does not examine incoming data. • When the Off setting is used, the printer uses PostScript emulation if PS SmartSwitch is set to On. It uses the default printer language specified in the Setup menu if PS SmartSwitch is set to Off. • PCL SmartSwitch is shown only if the PostScript level is non-zero.
PS SmartSwitch On Off	Sets the printer to automatically switch to PS emulation when a print job received through a USB port requires it, regardless of the default printer language Notes: <ul style="list-style-type: none"> • On is the factory default setting. • When the Off setting is used, the printer does not examine incoming data. • When the Off setting is used, the printer uses PCL emulation if PCL SmartSwitch is set to On. It uses the default printer language specified in the Setup menu if PCL SmartSwitch is set to Off. • PS SmartSwitch is shown only if the PostScript level is non-zero.
NPA Mode On Off Auto	Sets the printer to perform the special processing required for bidirectional communication following the conventions defined by the NPA protocol Notes: <ul style="list-style-type: none"> • Auto is the factory default setting. • Changing this setting from the printer control panel and then exiting the menus causes the printer to restart. The menu selection is updated.

Menu item	Description
Parallel Buffer Disabled Auto 3K to <max size allowed>	Sets the size of the parallel input buffer Notes: <ul style="list-style-type: none"> • Auto is the factory default setting. • The Disabled setting turns off job buffering. Any jobs already buffered on the disk are printed before normal processing is resumed. • The parallel buffer size setting can be changed in 1-K increments. • The maximum size allowed depends on the amount of memory in the printer, the size of the other link buffers, and whether Resource Save is set to On or Off. • To increase the maximum size range for the Parallel Buffer, disable or reduce the size of the USB and network buffers. • Changing this setting from the printer control panel and then exiting the menus causes the printer to restart. The menu selection is updated.
Advanced Status Off On	Enables bidirectional communication through the parallel port Notes: <ul style="list-style-type: none"> • On is the factory default setting. • The Off setting disables parallel port negotiation.
Protocol Standard Fastbytes	Specifies the parallel port protocol Notes: <ul style="list-style-type: none"> • Fastbytes is the factory default setting. It provides compatibility with most existing parallel ports and is the recommended setting. • The Standard setting tries to resolve parallel port communication problems.
Honor Init On Off	Determines whether the printer honors printer hardware initialization requests from the computer Notes: <ul style="list-style-type: none"> • Off is the factory default setting. • The computer requests initialization by activating the Init signal from the parallel port. Many personal computers activate the Init signal each time the computer is turned on.
Parallel Mode 2 On Off	Determines whether the parallel port data is sampled on the leading or trailing edge of strobe Note: On is the factory default setting.
Mac Binary PS On Off Auto	Sets the printer to process Macintosh binary PostScript print jobs Notes: <ul style="list-style-type: none"> • Auto is the factory default setting. • The Off setting filters print jobs using the standard protocol. • The On setting processes raw binary PostScript print jobs.

Menu item	Description
Parallel with ENA ENA Address ENA Netmask ENA Gateway	<ul style="list-style-type: none"> • ENA Address sets the network address information for an external print server that is attached to the printer using a parallel cable • ENA Netmask sets the netmask information for an external print server that is attached to the printer using a parallel cable • ENA Gateway sets the gateway information for an external print server that is attached to the printer using a parallel cable <p>Note: Parallel with ENA is available only if the printer is attached to an external print server through the parallel port.</p>

SMTP Setup menu

Use the following menu to configure the SMTP server.

Menu item	Description
Primary SMTP Gateway Primary SMTP Gateway Port Secondary SMTP Gateway Secondary SMTP Gateway Port	Specifies SMTP server and port information <p>Note: 25 is the factory default setting for each SMTP Gateway Port menu item.</p>
SMTP Timeout 5–30	Specifies the amount of time in seconds before the server stops trying to send the e-mail <p>Note: 30 seconds is the factory default setting.</p>
Reply Address	Specifies server information. This is a required item. <p>Note: The message box has a limitation of 512 characters.</p>
Use SSL Disabled Negotiate Required	Sets the printer to use SSL for increased security when connecting to the SMTP server <p>Notes:</p> <ul style="list-style-type: none"> • Disabled is the factory default setting for Use SSL. • When the Negotiate setting is used, your SMTP server determines if SSL will be used.
SMTP Server Authentication None Plain (Simple) CRAM MD5 Digest MD5 NTLM Kerberos 5	Specifies the type of user authentication required for scan to e-mail privileges <p>Note: None is the factory default setting.</p>

Menu item	Description
Device-Initiated E-mail None Use Device Credentials User-Initiated E-mail None Use Device SMTP Credentials Device Userid Device password Kerberos 5 Realm NTLM Domain	Specifies server information Notes: <ul style="list-style-type: none"> • The message boxes have a limitation of 512 characters. • None is the factory default setting for Device-Initiated E-mail and User-Initiated E-mail.

Security menu

Miscellaneous menu

Menu item	Description
Panel Logins Login failures Failure time frame Lockout time Login timeout	Limits the number and time frames of failed login attempts from the printer control panel before <i>all</i> users are locked out Notes: <ul style="list-style-type: none"> • “Login failures” specifies the number of failed login attempts before users are locked out. Settings range from 1–50. 3 attempts is the factory default setting. • “Failure time frame” specifies the time frame during which failed login attempts can be made before users are locked out. Settings range from 1–60 minutes. 5 minutes is the factory default setting. • “Lockout time” specifies how long users are locked out after exceeding the login failures limit. Settings range from 0–60 minutes. 5 minutes is the factory default setting. 0 indicates the printer does not impose a lockout time. • “Login timeout” specifies how long the printer remains idle on the Home screen before automatically logging the user off. Settings range from 1–900 seconds. 300 seconds is the factory default setting.

Menu item	Description
Remote Logins Login failures Failure time frame Lockout time Login timeout	Limits the number and time frames of failed login attempts from a computer before <i>all</i> remote users are locked out Notes: <ul style="list-style-type: none"> • “Login failures” specifies the number of failed login attempts before users are locked out. Settings range from 1–50. 3 attempts is the factory default setting. • “Failure time frame” specifies the time frame during which failed login attempts can be made before users are locked out. Settings range from 1–60 minutes. 5 minutes is the factory default setting. • “Lockout time” specifies how long a user is locked out after exceeding the login failures limit. Settings range from 0–60 minutes. 5 minutes is the factory default setting. 0 indicates the printer does not impose a lockout time. • “Login timeout” specifies how long the remote interface remains idle before automatically logging the user off. Settings range from 1–900 seconds. 300 seconds is the factory default setting.

Confidential Print menu

Menu item	Description
Max Invalid PIN Off 2–10	Limits the number of times an invalid PIN can be entered Notes: <ul style="list-style-type: none"> • Off is the factory default setting. • Once a limit is reached, the jobs for that user name and that PIN are deleted.
Job Expiration Off 1 hour 4 hours 24 hours 1 week	Limits the amount of time a confidential job stays in the printer before it is deleted Notes: <ul style="list-style-type: none"> • Off is the factory default setting. • If the Job Expiration setting is changed while confidential jobs reside on the printer RAM, the expiration time for those print jobs does not change to the new default value. • If the printer is turned off, all confidential jobs held in printer RAM will be deleted.

Security Audit Log menu

Menu item	Description
Export Log	Enables an authorized user to export the security log Notes: <ul style="list-style-type: none"> • To export the log from the printer control panel, a flash drive must be attached to the printer. • From the Embedded Web Server, the log can be downloaded to a computer.
Delete Log Delete now Do not delete	Specifies whether audit reports of print jobs are deleted Note: Delete now is the factory default setting.

Menu item	Description
Configure Log Enable Audit Yes No Enable Remote Syslog No Yes Remote Syslog Facility 0–23 Severity of events to log 0–7	<p>Specifies whether and how the audit logs of print jobs are created:</p> <ul style="list-style-type: none"> • Enable Audit determines if the printer records events in the secure audit log and in the remote syslog. • Enable Remote Syslog determines if the printer sends logged events to a remote server. • Remote Syslog Facility determines the facility value that the printer uses when sending events to the remote syslog server. • “Severity of events to log” specifies how critical a logged event is. With this log activated, the printer logs each event with a severity value equal to or less than the setting value. <ul style="list-style-type: none"> 0 is Emergency 1 is Alert 2 is Critical 3 is Error 4 is Warning 5 is Notice 6 is Informational 7 is Debug <p>Notes:</p> <ul style="list-style-type: none"> • Yes is the factory default setting for Enable Audit. • No is the factory default setting for Enable Remote Syslog. If Enable Audit is set to No, then no records are sent to the remote syslog even if Enable Remote Syslog is set to Yes. • 4 - Security is the factory default setting for Remote Syslog Facility. • 4 is the factory default setting for Severity of events to log.

Set Date/Time menu

Menu item	Description
View Date/Time	<p>Lets you view the current date and time settings for the printer. The format for the date and time is: YYYY-MM-DD HH:MM:</p> <p>YYYY is the four-digit year MM is a two-digit month DD is a two-digit date HH is a two-digit hour MM is a two-digit minute</p>
Set Date/Time	<p>Lets you enter the date and time</p> <p>Note: Date/Time is set in YYYY-MM-DD HH:MM format.</p>
Time Zone <list of time zones>	<p>Lets you select the time zone</p> <p>Note: GMT is the factory default setting.</p>
Observe DST On Off	<p>Sets the printer to use the applicable Daylight Saving Time (DST) start and end times associated with the printer Time Zone setting.</p> <p>Note: On is the factory default setting.</p>

Menu item	Description
Enable NTP On Off	Enables Network Time Protocol, which synchronizes the clocks of devices on a network Note: On is the factory default setting.

Settings menu

General Settings menu

Menu item	Description
Display Language English Francais Deutsch Italiano Espanol Dansk Norsk Nederlands Svenska Portuguese Suomi Russian Polski Magyar Turkce Cesky Simplified Chinese Traditional Chinese Korean Japanese	Sets the language of the text appearing on the display Note: All languages may not be available for all printers.
Eco-Mode Off Energy Energy/Paper Paper	Minimizes the use of energy, paper, or specialty media Notes: <ul style="list-style-type: none"> • Off is the factory default setting. Off resets the printer to its factory default settings. • The Energy setting minimizes the power used by the printer. Performance may be affected, but print quality is not. • Paper minimizes the amount of paper and specialty media needed for a print job by printing on both sides of the paper. Performance may be affected, but print quality is not. • Energy/Paper minimizes the use of power and of paper and specialty media.

Menu item	Description
Quiet Mode Off On	Reduces the amount of noise produced by the printer Notes: <ul style="list-style-type: none"> • Off is the factory default setting. • On configures the printer to produce as little noise as possible.
Run Initial setup Yes No	Instructs the printer to run the setup wizard Notes: <ul style="list-style-type: none"> • Yes is the factory default setting. • After completing the setup wizard by selecting Done at the Country select screen, the default setting becomes No.
Paper Sizes US Metric	Sets paper sizes to use the standard US sizes, which may also be used in other countries, or to use metric sizes Notes: <ul style="list-style-type: none"> • US is the factory default setting. • Changing this setting also changes the Units of Measurement setting in the Universal Setup menu and the default size value for each paper source (tray or feeder) in the Paper Size/Type menu.
Alarms Cartridge Alarm Off Single	Sets an alarm to sound when the printer requires operator intervention Notes: <ul style="list-style-type: none"> • Off is the factory default setting for Cartridge Alarm. Off means no alarm will sound. Cartridge low appears on the display. • Single sounds three quick beeps. 88 Cartridge is Low appears on the display.
Timeouts Power Saver 1 min–240 min	Sets the amount of time the printer waits after a job is printed before it goes into a reduced power state Notes: <ul style="list-style-type: none"> • 30 minutes is the factory default setting. • Lower settings conserve more energy, but may require longer warm-up times. • Select the lowest setting if the printer shares an electrical circuit with room lighting or you notice lights flickering in the room. • Select a high setting if the printer is in constant use. Under most circumstances, this keeps the printer ready to print with minimum warm-up time.
Timeouts Screen Timeout 15 sec–300 sec	Sets the amount of time in seconds the printer waits before returning the printer display to a Ready state Note: 30 seconds is the factory default setting.

Menu item	Description
Timeouts Print Timeout Disabled 1 sec–255 sec	Sets the amount of time in seconds the printer waits to receive an end-of-job message before canceling the remainder of the print job Notes: <ul style="list-style-type: none"> • 90 seconds is the factory default setting. • When the timer expires, any partially printed page still in the printer is printed, and then the printer checks to see if any new print jobs are waiting.
Timeouts Wait Timeout Disabled 15 sec–65535 sec	Sets the amount of time in seconds the printer waits for additional data before canceling a print job Notes: <ul style="list-style-type: none"> • 40 seconds is the factory default setting. • Wait Timeout is available only when the printer is using PostScript emulation. This setting has no effect on PCL or PPDS emulation print jobs.
Print Recovery Auto Continue Disabled 5 sec –255 sec	Lets the printer automatically continue printing from certain offline situations when not resolved within the specified time period Note: Disabled is the factory default setting.
Print Recovery Jam Recovery On Off Auto	Specifies whether the printer reprints jammed pages Notes: <ul style="list-style-type: none"> • Auto is the factory default setting. The printer reprints jammed pages unless the memory required to hold the pages is needed for other printer tasks. • On sets the printer to always reprint jammed pages. • Off sets the printer to never reprint jammed pages.
Print Recovery Page Protect Off On	Lets the printer successfully print a page that may not have printed otherwise Notes: <ul style="list-style-type: none"> • Off is the factory default setting. Off prints a partial page when there is not enough memory to print the whole page. • On sets the printer to process the whole page so that the entire page prints.
Factory Defaults Do Not Restore Restore Now	Returns the printer settings to the factory default settings Notes: <ul style="list-style-type: none"> • Do Not Restore is the factory default setting. Do Not Restore keeps the user-defined settings. • Restore Now returns all printer settings to the factory default settings except Network/Ports menu settings. All downloads stored in RAM are deleted. Downloads stored in flash memory are not affected.

Menu item	Description
Custom Home Message Off IP Address Hostname Contact Name Location Zero Configuration Name Custom Text 1	Sets a pre-configured or customized message to appear on the display beside Ready Notes: <ul style="list-style-type: none"> • Off is the factory default setting. • IP address and Hostname are pre-configured messages. • Contact Name, Location, Zero Configuration Name, and Custom Text 1 are messages that can be customized by a system support person.

Setup menu

Menu item	Description
Printer Language PCL Emulation PS Emulation	Sets the default printer language Notes: <ul style="list-style-type: none"> • PCL emulation uses a PCL interpreter for processing print jobs. PostScript emulation uses a PS interpreter for processing print jobs. • PCL is the factory default printer language. • Setting a printer language as the default does not prevent a software program from sending print jobs that use another printer language.
Print Area Normal Whole Page	Sets the logical and physical printable area Notes: <ul style="list-style-type: none"> • This menu does not appear if Edge to Edge is enabled in the printer Setup menu. • Normal is the factory default setting. When attempting to print data in the non-printable area defined by the Normal setting, the printer clips the image at the boundary. • The Whole Page setting allows the image to be moved into the non-printable area defined by the Normal setting, but the printer will clip the image at the Normal setting boundary. • The Whole Page setting affects only pages printed using a PCL 5e interpreter. This setting has no effect on pages printed using the PCL XL or PostScript interpreter.
Download Target RAM Flash	Sets the storage location for downloads Notes: <ul style="list-style-type: none"> • RAM is the factory default setting. • Storing downloads in flash memory places them in permanent storage. Downloads remain in flash memory even when the printer is turned off. • Storing downloads in RAM is temporary. • This menu appears only if optional flash memory is installed.

Menu item	Description
Resource Save On Off	Specifies how the printer handles temporary downloads, such as fonts and macros stored in RAM, when the printer receives a job that requires more memory than is available Notes: <ul style="list-style-type: none"> Off is the factory default setting. Off sets the printer to retain the downloads only until memory is needed. Downloads are deleted in order to process print jobs. The On setting retains the downloads during language changes and printer resets. If the printer runs out of memory, 38 Memory full appears, and downloads are not deleted.
Print All Order Alphabetically Newest First Oldest First	Specifies the order in which held and confidential jobs are printed when Print All is selected Notes: <ul style="list-style-type: none"> Alphabetically is the factory default setting. Print jobs always appear in alphabetical order on the printer control panel.

Finishing menu

Menu item	Description
Sides (Duplex) 2 sided 1 sided	Specifies whether duplex (2-sided) printing is set as the default for all print jobs Notes: <ul style="list-style-type: none"> 1 sided is the factory default setting. To set 2-sided printing from the software program: for Windows users, click File → Print, and then click Properties, Preferences, Options, or Setup; for Macintosh users, choose File > Print, and then adjust the settings from the Print dialog and pop-up menus.
Duplex Binding Long Edge Short Edge	Defines the way duplexed pages are bound and how the printing on the back of the page is oriented in relation to the printing on the front of the page Notes: <ul style="list-style-type: none"> Long Edge is the factory default setting. Long Edge specifies that binding be placed on the left edge of portrait pages and the top edge of landscape pages. Short Edge specifies that binding be placed on the top edge of portrait pages and the left edge of landscape pages.
Copies 1–999	Specifies a default number of copies for each print job Note: 1 is the factory default setting.
Blank Pages Do Not Print Print	Specifies whether blank pages are inserted in a print job Note: Do Not Print is the factory default setting.

Menu item	Description
Collate Off (1,1,1,2,2,2) On (1,2,1,2,1,2)	Stacks the pages of a print job in sequence when printing multiple copies Notes: <ul style="list-style-type: none"> • Off is the factory default setting. No pages will be collated. • The On setting stacks the print job sequentially. • Both settings print the entire job the number of times specified by the Copies menu setting.
Separator Sheets None Between Copies Between Jobs Between Pages	Specifies whether blank separator sheets are inserted Notes: <ul style="list-style-type: none"> • None is the factory default setting. • Between Copies inserts a blank sheet between each copy of a print job if Collation is set to On. If Collation is set to Off, a blank page is inserted between each set of printed pages, such as after all page 1s and after all page 2s. • Between Jobs inserts a blank sheet between print jobs. • Between Pages inserts a blank sheet between each page of the print job. This setting is useful when printing transparencies or inserting blank pages in a document for notes.
Separator Source Tray <x> Multi-Purpose Feeder	Specifies the paper source for separator sheets Notes: <ul style="list-style-type: none"> • Tray 1 (standard tray) is the factory default setting. • From the Paper menu, Configure MP must be set to Cassette in order for Multi-Purpose Feeder to appear as a menu setting.
N-up (pages-side) Off 2-Up 3-Up 4-Up 6-Up 9-Up 12-Up 16-Up	Specifies that multiple-page images be printed on one side of a sheet of paper Notes: <ul style="list-style-type: none"> • Off is the factory default setting. • The number selected is the number of page images that will print per side.
N-up Ordering Horizontal Reverse Horizontal Reverse Vertical Vertical	Specifies the positioning of multiple-page images when using N-up (pages-sides) Notes: <ul style="list-style-type: none"> • Horizontal is the factory default setting. • Positioning depends on the number of images and whether the images are in portrait or landscape orientation.
Orientation Auto Landscape Portrait	Specifies the orientation of a multiple-page sheet Notes: <ul style="list-style-type: none"> • Auto is the factory default setting. The printer chooses between portrait and landscape. • Landscape uses Long Edge. • Portrait uses Short Edge.

Menu item	Description
N-up Border None Solid	Prints a border around each page image when using N-up (pages-sides) Note: None is the factory default setting.

Quality menu

Menu item	Description
Print Resolution 300 dpi 600 dpi 1200 dpi 1200 IQ 2400 IQ	Specifies the printed output resolution Note: 600 dpi is the factory default setting.
Toner Darkness 1–10	Lightens or darkens the printed output Notes: <ul style="list-style-type: none"> • 8 is the factory default setting. • Selecting a smaller number can help conserve toner.
Enhance Fine Lines On Off	Enables a print mode preferable for files such as architectural drawings, maps, electrical circuit diagrams, and flow charts Notes: <ul style="list-style-type: none"> • Off is the factory default setting. • To set Enhance Fine Lines from the software program: for Windows users, click File → Print, and then click Properties, Preferences, Options, or Setup, and change the settings from the Print Quality tab; for Macintosh users, choose File > Print, and then adjust the settings from the Print dialog and pop-up menus. • To set Enhance Fine Lines using the Embedded Web Server, type the network printer IP address in a browser window, and from Print Settings, click Quality Menu.
Gray Correction Auto Off	Automatically adjusts the contrast enhancement applied to images Note: Auto is the factory default setting.
Pixel Boost Off Fonts Horizontally Vertically Both Directions	Enables more pixels to print in clusters for clarity, in order to enhance pictures horizontally or vertically, or to enhance fonts Note: Off is the factory default setting.
Brightness –6–6	Adjusts the printed output either by lightening or darkening it. You can conserve toner by lightening the output. Note: 0 is the factory default setting.
Contrast 0–5	Adjusts the contrast of printed objects Note: 0 is the factory default setting.

Utilities menu

Menu item	Description
Format Flash Yes No	Formats the flash memory. Flash memory refers to the memory added by installing an optional flash memory card in the printer. Warning—Potential Damage: Do not turn off the printer while the flash memory is formatting. Notes: <ul style="list-style-type: none"> • An optional flash memory card must be installed in the printer and operating properly for this menu item to be available. The flash memory card must not be Read/Write or Write protected or defective. • No cancels the format request. • Selecting Yes deletes all data stored in flash memory.
Defragment Flash No Yes	Prepares the flash memory to receive new data by retrieving lost storage space Warning—Potential Damage: Do not turn off the printer while the flash memory is defragmenting. Notes: <ul style="list-style-type: none"> • A optional flash memory card must be installed in the printer and operating properly for this menu item to be available. The flash memory card must not be Read/Write or Write protected or defective. • No cancels the defragment request. • Selecting Yes reformats the flash memory after transferring all downloads to regular printer memory. When formatting is complete, the downloads are loaded back into flash memory.
Hex Trace Activate	Assists in isolating the source of a print job problem Notes: <ul style="list-style-type: none"> • When Activate is selected, all data sent to the printer is printed in hexadecimal and character representation and control codes are not executed. • To exit Hex Trace, turn the printer off or reset the printer.
Coverage Estimator Off On	Provides an estimate of the percentage coverage of black on a page. The estimate is printed on a separator page. Note: Off is the factory default setting.

XPS menu

Menu item	Description
Print Error Pages Off On	Prints a page containing information on errors, including XML markup errors Note: Off is the factory default setting.

PDF menu

Menu item	Description
Scale to Fit Yes No	Scales page content to fit the selected paper size Note: No is the factory default setting.
Annotations Do Not Print Print	Prints annotations in a PDF Note: Do Not Print is the factory default setting.

PostScript menu

Menu item	Description
Print PS Error On Off	Prints a page containing the PostScript error Note: Off is the factory default setting.
Font Priority Resident Flash	Establishes the font search order Notes: <ul style="list-style-type: none"> • Resident is the factory default setting. • A formatted optional flash memory card must be installed in the printer and operating properly for this menu item to be available. • The optional flash memory card cannot be Read/Write, Write, or password protected. • Job Buffer Size must not be set to 100%.

PCL Emul menu

Menu item	Description
Font Source Resident Download Flash All	Specifies the set of fonts available Notes: <ul style="list-style-type: none"> • Resident is the factory default setting. It shows the factory default set of fonts downloaded into RAM. • Download appears only if downloaded fonts exist. It shows all the fonts downloaded into RAM. • Flash appears only if an optional flash memory card containing fonts is installed. • An optional flash memory card must be properly formatted and cannot be Read/Write, Write, or password protected. • All shows all fonts available to any option.
Font Name <list of fonts>	Lets you view or change the setting from a selection list
Symbol Set <list of symbol sets>	Lets you view or change the setting from a selection list

Menu item	Description
PCL Emulation Settings Point Size 1.00–1008.00	Changes the point size for scalable typographic fonts Notes: <ul style="list-style-type: none"> • 12 is the factory default setting. • Point Size refers to the height of the characters in the font. One point equals approximately 1/72 of an inch. • Point sizes can be increased or decreased in 0.25-point increments.
PCL Emulation Settings Pitch 0.08–100	Specifies the font pitch for scalable monospaced fonts Notes: <ul style="list-style-type: none"> • 10 is the factory default setting. • Pitch refers to the number of fixed-space characters per inch (cpi). • Pitch can be increased or decreased in 0.01-cpi increments. • For nonscalable monospaced fonts, the pitch appears on the display but cannot be changed.
PCL Emulation Settings Orientation Portrait Landscape	Specifies the orientation of text and graphics on the page Notes: <ul style="list-style-type: none"> • Portrait is the factory default setting. • Portrait prints text and graphics parallel to the short edge of the page. • Landscape prints text and graphics parallel to the long edge of the page.
PCL Emulation Settings Lines per Page 1–255	Specifies the number of lines that print on each page Notes: <ul style="list-style-type: none"> • 60 is the US factory default setting. 64 is the international factory default setting. • The printer sets the amount of space between each line based on the Lines per Page, Paper Size, and Orientation settings. Select the desired Paper Size and Orientation before setting Lines per Page.
PCL Emulation Settings A4 Width 198 mm 203 mm	Sets the printer to print on A4-size paper Notes: <ul style="list-style-type: none"> • 198 mm is the factory default setting. • The 203-mm setting sets the width of the page to allow the printing of eighty 10-pitch characters.
PCL Emulation Settings Auto CR after LF On Off	Specifies whether the printer automatically performs a carriage return (CR) after a line feed (LF) control command Note: Off is the factory default setting.
PCL Emulation Settings Auto LF after CR On Off	Specifies whether the printer automatically performs a line feed (LF) after a carriage return (CR) control command Note: Off is the factory default setting.

Menu item	Description
<p>Tray Renumber</p> <p>Assign MP Feeder</p> <p>Off</p> <p>None</p> <p>0–199</p> <p>Assign Tray <x></p> <p>Off</p> <p>None</p> <p>0–199</p> <p>Assign Manual Paper</p> <p>Off</p> <p>None</p> <p>0–199</p> <p>Assign Man Env</p> <p>Off</p> <p>None</p> <p>0–199</p>	<p>Configures the printer to work with printer software or programs that use different source assignments for trays, drawers, and feeders</p> <p>Notes:</p> <ul style="list-style-type: none"> • Off is the factory default setting. • None is not an available selection. It is displayed only when it is selected by the PCL 5 interpreter. • None ignores the Select Paper Feed command. • 0–199 allows a custom setting to be assigned.
<p>Tray Renumber</p> <p>View Factory Def</p> <p>Multipurpose feeder default = 8</p> <p>Tray 1 default = 1</p> <p>Tray 2 default = 4</p> <p>Tray 3 default = 5</p> <p>Tray 4 default = 20</p> <p>Tray 5 default = 21</p> <p>Envelope default = 6</p> <p>Manual paper default = 2</p> <p>Manual envelope default = 3</p>	<p>Lets you view the factory default setting assigned to each tray, drawer, or feeder</p> <p>Notes:</p> <ul style="list-style-type: none"> • The printer supports one standard 250-sheet tray and can have only one optional drawer installed, either the 250- or 550-sheet drawer. Therefore, only Tray 1 and Tray 2 of the Tray values apply to your printer • The factory default settings appear even if the source is not installed.
<p>Tray Renumber</p> <p>Restore Defaults</p> <p>Yes</p> <p>No</p>	<p>Returns all tray, drawer, and feeder assignments to the factory default settings</p>

HTML menu

Menu item	Description	
Font Name Albertus MT Antique Olive Apple Chancery Arial MT Avant Garde Bodoni Bookman Chicago Clarendon Cooper Black Copperplate Coronet Courier Eurostile Garamond Geneva Gill Sans Goudy Helvetica Hoefler Text	Intl CG Times Intl Courier Intl Univers Joanna MT Letter Gothic Lubalin Gothic Marigold MonaLisa Recut Monaco New CenturySbk New York Optima Oxford Palatino StempelGaramond Taffy Times TimesNewRoman Univers Zapf Chancery	Sets the default font for HTML documents Note: The Times font will be used in HTML documents that do not specify a font.

Menu item	Description
Font Size 1–255 pt	Sets the default font size for HTML documents Notes: <ul style="list-style-type: none"> • 12 pt is the factory default setting. • Font size can be increased in 1-point increments.
Scale 1–400%	Scales the default font for HTML documents Notes: <ul style="list-style-type: none"> • 100% is the factory default setting. • Scaling can be increased in 1% increments.
Orientation Portrait Landscape	Sets the page orientation for HTML documents Note: Portrait is the factory default setting.
Margin Size 8–255 mm	Sets the page margin for HTML documents Notes: <ul style="list-style-type: none"> • 19 mm is the factory default setting. • Margin size can be increased in 1-mm increments.

Menu item	Description
Backgrounds Do Not Print Print	Specifies whether to print backgrounds on HTML documents Note: Print is the factory default setting.

Image menu

Menu item	Description
Auto Fit On Off	Selects the optimal paper size, scaling, and orientation Notes: <ul style="list-style-type: none"> • On is the factory default setting. • The On setting overrides scaling and orientation settings for some images.
Invert On Off	Inverts bi-tonal monochrome images Notes: <ul style="list-style-type: none"> • Off is the factory default setting. • The font size can be increased in 1-point increments. • This setting does not apply to GIF or JPEG images.
Scaling Anchor Top Left Best Fit Anchor Center Fit Height/Width Fit Height Fit Width	Scales the image to fit the selected paper size Notes: <ul style="list-style-type: none"> • Best Fit is the factory default setting. • When Auto Fit is set to On, Scaling is automatically set to Best Fit.
Orientation Portrait Landscape Rev Portrait Rev Landscape	Sets the image orientation Note: Portrait is the factory default setting.

Understanding printer messages

When **Manual Feeder** appears on the display, it refers to the multipurpose feeder.

List of status and error messages

Activating Menu Changes

Wait for the message to clear.

Busy

Wait for the message to clear.

Busy ...

Wait for the message to clear.

Calibrating

Wait for the message to clear.

Cancel not available

Wait for the message to clear.



Canceling

Wait for the message to clear.

Cartridge Low

The toner cartridge is low on toner.



Try one of the following:

- Remove the toner cartridge, shake it, and then reinstall it. Press  to clear the message and continue printing.
- Remove the toner cartridge, and then install a new one. Press  to clear the message and continue printing.

Cartridge Nearly Low

The toner cartridge low alarm is activated and the toner is low.

Try one or more of the following:



- Remove the toner cartridge, shake it, and then reinstall it. Press  to clear the message and continue printing.
- Remove the toner cartridge, and then install a new one. Press  to clear the message and continue printing.

Cartridge Life Exceeded

The toner cartridge is exhausted.

- 1 Remove the used toner cartridge, and then install a new one.
- 2 Press  to clear the message.

Change <src> to <x>

- Press the down arrow button until  **Continue** appears, and then press  if the paper was changed.
- Press the down arrow button until  **Use Current** appears, and then press the down arrow button to print on the paper currently in the printer.
- Cancel the current print job.
- For more information, select **Show Me**.

Clearing job accounting statistics

Wait for the message to clear.

Close front door

Close the front door of the printer.

Defragmenting Flash DO NOT POWER OFF

Wait for the message to clear.

Warning—Potential Damage: Do not turn the printer off while this message appears on the display.

Deletion complete

Wait for the message to clear.

Deletion failed

Your attempt to delete a file failed.

- 1 Wait for the message to clear.
- 2 Try to delete the file again.

Deleting held jobs

Wait for the message to clear.

Disabling Menus

Wait for the message to clear.

Note: While the menus are disabled, printer settings cannot be changed from the printer control panel.

DO NOT TOUCH Reading flash data DO NOT POWER OFF

As a part of this message, a bar graphic appears on one line of the display, indicating the percentage of processing time completed.

Wait for the message to clear. The message displays until all code is received and the processing is complete.

Warning—Potential Damage: If your printer is connected to a computer by a USB cable, do not touch the printer control panel while this message appears on the display. Do not turn the printer off while this message appears.

Enabling Menus

Wait for the message to clear.

Flushing buffer

Wait for the message to clear.

Formatting Flash DO NOT POWER OFF

Wait for the message to clear.

Warning—Potential Damage: Do not power off while the printer is formatting the flash memory.

Hex Trace

The printer is in Hex Trace mode.

Hex Trace Ready

The printer is in the **Ready** state, and Hex Trace is active. You can use Hex Trace to troubleshoot printer problems.

Invalid Engine Code

You need to download valid engine code for the printer.

Note: Engine code may be downloaded while this message appears on the display.

Invalid Network Code

You need to download valid network printing code for the internal print server. The internal print server is a hardware option installed inside the printer.

Note: Network code may be downloaded while this message appears on the display.

Load manual feeder with <x>

Try one or more of the following:

- Load the specified paper in the multipurpose feeder.
- Cancel the current job.

Load <src> with <x>

Try one or more of the following:

- Load the tray or other source with the correct paper type and size.
- Cancel the current job.

Maintenance

Replace the maintenance items and, if necessary, reset the printer maintenance counter.

For information on purchasing supplies, see "Ordering supplies" on page 126.

Menu access turned off by system administrator

The printer menus cannot be accessed because your system support person disabled the menus. Wait for the message to clear.

Menus are Disabled

The printer menus are disabled. The printer settings cannot be changed from the printer control panel. Contact your system support person for help.

Note: When menus are disabled, it is still possible to cancel a print job, print a confidential job, or print a held job.

Must be in Ready state to enter menus

The printer menus cannot be accessed at this time because the printer control panel does not show the **Ready** message. Wait for the printer to complete its activity. When **Ready** appears, press .

Narrow media enabled

Narrow media is enabled from the Disable Hardware menu of the Config menu. The printer ignores any sensor concerning narrow media.

To clear the message, disable narrow media from the Disable Hardware menu. Consult your system support person for help, if needed.

Network/Network <x>/Network <x>, <y>

The printer is connected to the network, so the network interface is the active communication link.

- **Network** indicates that the printer is using the standard network port built into the printer system board.
- **Network <x>** indicates that an internal print server is installed inside the printer or that the printer is connected to an external print server.
- **Network <x>, <y>** indicates a network interface is the active communication link, where <x>, <y> indicates the active interface is connected to the printer through channel y on PCI connector x. If x equals 0, then the standard network interface is active.

Note: The current interface displays on the menus settings page.

Wait for the message to clear.

No jobs to cancel

Wait for the message to clear.

Not Ready

The printer is not ready to receive or process data, or the printer ports are offline.

Parallel/Parallel <x>

The printer is connected to a parallel port. Parallel interface is the active communication link. **Parallel** indicates that the printer is using the parallel port. **Parallel <x>** indicates the active interface is connected to the printer through PCI connector x.

Note: The current interface displays on the menus settings page.

Wait for the message to clear.

PC Kit Life Warning

This is the final warning message for the photoconductor kit. The photoconductor kit is near exhaustion. The printer continues printing unless the value for the Cartridge Alarm is changed from the printer control panel or set to On from the Supply Notifications Web page (located on the Embedded Web Server).

If the setting is On, then the printer stops printing. Press  to select **Continue**. The printer continues to print until the photoconductor kit is completely exhausted. When the photoconductor kit is exhausted, replace it.

[PJL RDYMSG]

This is the Printer Job Language (PJL) Ready message. It appears after the **Ready** or **Power Saver** message. If the message string is too long, it is truncated.

Wait for the message to clear.

Power Saver

The printer is saving power while it waits for the next print job. Send a job to print to take the printer out of Power Saver mode.

Printing

Wait for the message to clear.

Programming flash DO NOT POWER OFF

Wait for the message to clear.

Warning—Potential Damage: Do not turn the printer power off while **Programming flash** appears on the display.

Programming System Code DO NOT POWER OFF

Wait for the message to clear.

Warning—Potential Damage: Do not turn the printer power off while **Programming System Code** appears on the display.

Ready

The printer is ready to receive print jobs.

Remote Management Active DO NOT POWER OFF

The printer settings are being configured. Wait for the message to clear.

Warning—Potential Damage: Do not turn the printer power off while **Remote Management Active** appears on the display.

Remove paper from standard bin

The standard exit bin has reached its capacity. Remove paper from the standard exit bin to clear the message and continue printing.

Remove paper from standard output bin

Remove the stack of paper from the standard exit bin.

Replace Cartridge

The toner cartridge is exhausted.

- 1 Remove the used toner cartridge, and then install a new one.
- 2 Press  to clear the message.

Replace PC Kit

This is the early warning message for the photoconductor kit. The printer continues printing unless the value for the Cartridge Alarm is changed from the printer control panel or set to On from the Supply Notifications Web page (located on the Embedded Web Server).

If the setting is On, then the printer stops printing. Press  to select **Continue** and continue printing.

When the **PC Kit Life Warning** appears, order a new photoconductor kit.

Resetting the printer

Wait for the message to clear.

Resetting without replacing may affect print quality.

You selected No from the “Verify PC unit replaced” screen. Wait for the message to clear.

Restoring Factory Defaults

Wait for the message to clear.

When factory default settings are restored:

- All downloaded resources in the printer memory are deleted. This includes fonts, macros, and symbol sets.
- All settings return to the factory defaults except the Display Language setting in the Setup menu and the custom settings in the Serial <x>, Network, Infrared, LocalTalk, and USB menus.

Routine maintenance needed

Standard Bin Full

Remove the stack of paper from the standard exit bin to clear the message.

Stopping

Wait for the message to clear.

Submitting selection

Wait for the message to clear.

Too many failed panel logins

The printer is now in a lockout mode because:

- You attempted to log in too many times with an incorrect PIN
- You attempted to log in using an incorrect password number for access to a printer feature, setting, or menu that you do not have access to.

Note: There is a defined limit on the number of login attempts. Once the limit is reached, this message appears and the printer enters a lockout mode. The message remains on the printer control panel, and any further attempts to enter menus is denied until the defined time out expires. The time out duration is set by your system support person.

Wait for the message to clear once the time out expires, and then:

- Enter the correct PIN to access any held jobs
- See your system support person if you need a password number to enter a specific printer feature, setting, or menu that is blocked from your use without the number.

Tray <x> disabled

The specified tray is disabled from the Disable Hardware menu of the Config menu. To clear the message, enable the specified tray through the same menu. Consult your system support person for help.

Tray <x> Missing

Insert the specified tray into the printer.

USB/USB <x>

The USB port is the active communication link. The printer is processing data through the specified USB port.

Wait for the message to clear.

Waiting, too many events ... DO NOT POWER OFF

The printer received too much information. This message appears while it sorts or processes all the information it received. Wait for the message to clear.

Warning—Potential Damage: Do not turn the printer off while **Waiting, too many events ... DO NOT POWER OFF** appears on the display.

30.yy Invalid refill, change cartridge

An unsupported, refilled toner cartridge is installed. Remove the toner cartridge, and then install a new one.

31.yy Replace defective or missing cartridge

The toner cartridge is either missing or not functioning properly.

Try one or more of the following:



- Remove the toner cartridge, and then reinstall it.
- Remove the toner cartridge, and then install a new one.

32.yy Cartridge part number unsupported by device

Remove the toner cartridge, and then install a supported one.

34 Short paper

Try one or more of the following:

- Load the appropriate paper in the tray.
- Press the down arrow button until  **Continue** appears, and then press  to clear the message and print the job using a different paper tray.
- Check tray length and width guides and make sure the paper is properly loaded in the tray.
- For Windows users, check the Print Properties settings to make sure the print job is requesting the correct paper size and type.

For Macintosh users, check the Print dialog settings to make sure the print job is requesting the correct paper size and type.

- Check that the paper size is correctly set. For example, if the MP Feeder Size is set to Universal, make sure the paper is large enough for the data being printed.
- Cancel the current print job.

35 Insufficient memory to support Resource Save feature

The printer lacks sufficient memory to save settings. Install additional memory, or press  to disable Resource Save and continue printing.

37 Insufficient memory for Flash Memory Defragment operation

Try one or more of the following:

- Press the down arrow button until **✓ Continue** appears, and then press **⏏** to stop the defragment operation and continue printing.
- Delete fonts, macros, and other data in printer memory.
- Install additional printer memory.

37 Insufficient memory to collate job

Try one or more of the following:

- Press the down arrow button until **✓ Continue** appears, and then press **⏏** to print the portion of the job already stored and begin collating the rest of the print job.
- Cancel the current print job.

37 Insufficient memory, some Held Jobs were deleted

The printer deleted some held jobs in order to process current jobs. Press the down arrow button until **✓ Continue** appears, and then press **⏏** to clear the message.

38 Memory full

Try one or more of the following:

- Press the down arrow button until **✓ Continue** appears, and then press **⏏** to clear the message.
- Cancel the current print job.
- Install additional printer memory.

39 Complex page, some data may not have printed

Try one or more of the following:

- Press the down arrow button until **✓ Continue** appears, and then press **⏏** to clear the message and continue printing.
- Cancel the current print job.
- Install additional printer memory.

42.xy Cartridge region mismatch

Install a toner cartridge that matches the region number of the printer. *x* indicates the value of the printer region. *y* indicates the value of the cartridge region. *x* and *y* can have the following values:

1	America
2	EMEA (Europe, Middle East, Africa)
3	Asia
4	Latin America
9	Undefined region

50 PPDS font error

Try one or more of the following:

- Press the down arrow button until **✓ Continue** appears, and then press **⏏** to clear the message and continue printing.
- The printer cannot find a requested font. From the PPDS menu, select **Best Fit**, and then select **On**. The printer will find a similar font and reformat the affected text.
- Cancel the current print job.

51 Defective flash detected

Try one or more of the following:

- Press the down arrow button until **✓ Continue** appears, and then press **⏏** to clear the message and continue printing.
- Cancel the current print job.

52 Not enough free space in flash memory for resources

Try one or more of the following:

- Press the down arrow button until **✓ Continue** appears, and then press **⏏** to stop the defragment operation and continue printing.
Downloaded fonts and macros not previously stored in flash memory are deleted.
- Delete fonts, macros, and other data stored in flash memory.
- Upgrade to a larger capacity flash memory card.

53 Unformatted flash detected

Try one or more of the following:

- Press the down arrow button until **✓ Continue** appears, and then press **⏏** to stop the defragment operation and continue printing.
- Format the flash memory. If the error message remains, the flash memory may be defective and require replacing.

54 Standard network software error

Try one or more of the following:

- Press the down arrow button until **✓ Continue** appears, and then press **⏏** to continue printing.
- Turn the printer off and then back on to reset the printer.
- Upgrade (flash) the network firmware in the printer or print server.

56 Standard parallel port disabled

Try one or more of the following:

- The printer discards any data received through the parallel port. Press **⏏** to clear the message and continue printing.
- Make sure the Parallel Buffer menu item is not set to Disabled.

56 Standard USB port disabled

Try one or more of the following:

- The printer discards any data received through the USB port. Press  to clear the message and continue printing.
- Make sure the USB Buffer menu item is not set to Disabled.

58 Too many flash options installed

Try one or more of the following:

- Turn the printer off, and then remove extra flash options:
 - 1 Turn the printer off.
 - 2 Unplug the power cord from the wall outlet.
 - 3 Remove the excess flash memory.
 - 4 Connect the power cord to a properly grounded outlet.
 - 5 Turn the printer back on.
- Press  to clear the message and continue printing.

80 Routine maintenance needed

The printer needs to have scheduled maintenance done. Order a maintenance kit, which contains a fuser and a transfer roller. Contact Customer Support, and report the message.

84 PC Kit life warning

The photoconductor kit is near exhaustion.

Try one or more of the following:

- Replace the photoconductor kit.
- Press  to clear the message and continue printing.

84 Replace PC Kit

The photoconductor kit is exhausted. Install a new photoconductor kit.

88.yy Cartridge is low

Replace the toner cartridge, and then press  to clear the message and continue printing.

88.yy Cartridge nearly low

The toner is low. Replace the toner cartridge, and then press  to clear the message and continue printing.

88.yy Replace cartridge

The toner cartridge is exhausted.

- 1 Replace the toner cartridge.
- 2 Press  to clear the message.

200.yy Paper jam

The message indicates either where the paper is jammed or the number of pages jammed.

- 1 To access the jam, try one or more of the following:
 - Remove Tray 1.
 - Open the front door, and then remove the photoconductor kit and toner cartridge unit.
- 2 Remove the jam.
- 3 Replace the photoconductor kit and toner cartridge unit if you removed it.
- 4 Close any open doors or trays.
- 5 Press  to continue printing.

201.yy Paper jam

The message indicates either where the paper is jammed or the number of pages jammed.

- 1 Open the front door, and then remove the photoconductor kit and toner cartridge unit.
- 2 Remove the jam.
- 3 Replace the photoconductor kit and toner cartridge unit.
- 4 Close the front door.
- 5 Press  to continue printing.

202.yy Paper jam

The message indicates either where the paper is jammed or the number of pages jammed.

- 1 Open the front door.
- 2 Open the rear door.
- 3 Remove the jam.
- 4 Close both doors.
- 5 Press  to continue printing.

231.yy Paper jam

The message indicates either where the paper is jammed or the number of pages jammed.

- 1 Open the front door.
- 2 Open the rear door.
- 3 Remove the jam.
- 4 Close both doors.
- 5 Press  to continue printing.

233.yy Paper jam

The message indicates either where the paper is jammed or the number of pages jammed.

- 1 To access the jam, try one or more of the following:
 - Remove Tray 1, and then depress the lever.
 - Open the front door, and then open the rear door.
- 2 Remove the jam.
- 3 Close any open doors or trays.
- 4 Press  to continue printing.

234.yy Paper jam

The message indicates either where the paper is jammed or the number of pages jammed.

- 1 To access the jam, try one or more of the following:
 - Open the front door, and then open the rear door.
 - Remove Tray 1, and then depress the lever.
- 2 Remove the jam.
- 3 Close any open doors or trays.
- 4 Press  to continue printing.

235.yy Paper jam

The message indicates either where the paper is jammed or the number of pages jammed.

- 1 Remove the jam from the standard exit bin.
- 2 Check the paper size to ensure that it is supported by the printer.
- 3 Press  to continue printing.

24x.yy Paper jam

The message indicates either where the paper is jammed or the number of pages jammed.

- 1 To access the jam, try one or more of the following:
 - Remove Tray 1.
 - Open the front door, and then remove the photoconductor kit and toner cartridge unit.
 - Remove Tray 2.
- 2 Remove the jam.
- 3 Replace the photoconductor kit and toner cartridge unit if you removed it.
- 4 Close any open doors or trays.
- 5 Press  to continue printing.

251.yy Paper jam

The message indicates either where the paper is jammed or the number of pages jammed.

- 1 Remove the jam from the multipurpose feeder.
- 2 Press  to continue printing.

900–999 Service <message>

- 1 Turn the printer off.
- 2 Unplug the power cord from the wall outlet.
- 3 Check all cable connections.
- 4 Connect the power cord to a properly grounded outlet.
- 5 Turn the printer back on.

If the service message appears again, contact Customer Support, and report the message.

1565 Emulation error, load emulation option

The printer automatically clears the message in 30 seconds and then disables the download emulator on the firmware card.

Maintaining the printer

Periodically, certain tasks are required to maintain optimum print quality.

Cleaning the exterior of the printer

- 1 Make sure that the printer is turned off and unplugged from the wall outlet.



CAUTION—SHOCK HAZARD: To avoid the risk of electric shock when cleaning the exterior of the printer, unplug the power cord from the wall outlet and disconnect all cables to the printer before proceeding.

- 2 Remove all paper from the printer.
- 3 Dampen a clean, lint-free cloth with water.

Warning—Potential Damage: Do not use household cleaners or detergents, as they may damage the finish of the printer.

- 4 Wipe only the outside of the printer.

Warning—Potential Damage: Using a damp cloth to clean the interior may cause damage to your printer.

- 5 Make sure all areas of the printer are dry before beginning a new print job.

Storing supplies

Choose a cool, clean storage area for the printer supplies. Store supplies right side up in their original packing until you are ready to use them.

Do not expose supplies to:

- Direct sunlight
- Temperatures above 35°C (95°F)
- High humidity above 80%
- Salty air
- Corrosive gases
- Heavy dust

Conserving supplies

Conserving supplies using the printer control panel

There are some settings you can change from the printer control panel that will help you conserve toner and paper. For more information, see the following table:

Supply	Path to menu item	Purpose of menu item
Toner	Settings → Quality Menu → Toner Darkness	Lets you adjust the level of toner released on a sheet of paper or specialty media. The values range from 1 (lightest setting) to 10 (darkest setting) with 8 being the factory default setting.
Paper or specialty media	Settings → Finishing Menu → N-up	Lets you select to print two or more page images on one side of a sheet. Values for N-up are 2-Up, 3-Up, 4-Up, 6-Up, 9-Up, 12-Up, and 16-Up.
	Settings → Finishing Menu → Sides (Duplex)	Lets you print on both sides of a sheet of paper

Conserving supplies using the printer software

If you are printing a multiple-copy job, you can conserve paper or specialty media by sending a Verify print job. A Verify print job lets you examine the first copy of a multiple-copy job to make sure it is satisfactory before you print the other copies. If the job is unsatisfactory, you can cancel the job. If the job is satisfactory, you can select to print the rest of the copies. For more information, see “Printing confidential and other held jobs” on page 58.

Checking the status of supplies from a network computer

Note: The computer must be connected to the same network as the printer.

- 1 Type the printer IP address into the address field of your Web browser.

Note: If you do not know the IP address of the printer, print a network setup page and locate the IP address in the TCP/IP section.

- 2 Click **Device Status**. The Device Status page appears, displaying a summary of supply levels.

Ordering supplies

Printer attached to a network

- 1 Type your printer IP address in your Web browser to launch the Dell Configuration Web Tool.
- 2 Click www.dell.com/supplies.

Printer attached locally to a computer

1 In Windows Vista™ and later:

- a** Click  → **Programs**.
- b** Click **Dell Printers**.
- c** Click **Dell 3330dn Laser Printer**.

In Windows® XP and 2000,

Click **Start** → **Programs** or **All Programs** → **Dell Printers** → **Dell 3330dn Laser Printer**.

2 Click **Dell Printer Supplies Reorder Application**.

The **Order Toner Cartridges** window opens.

3 Choose your printer model from the list.

4 Enter your Dell printer Service Tag number.

Note: Your Service Tag number is located inside the front cover of your printer.

5 Click **Visit Dell's cartridge ordering website**.

Replacing supplies

Replacing the toner cartridge

When **88 Cartridge low** appears, or when you experience faded print, remove the toner cartridge. Firmly shake it side-to-side and front-to-back several times to redistribute the toner, and then reinsert it and continue printing. When shaking the cartridge no longer improves the print quality, replace the toner cartridge.

Note: You can check to see approximately how much toner is left in your cartridge by printing a menu settings page.

To replace the toner cartridge:

1 Open the front door by pressing the button on the left side of the printer and lowering the door.

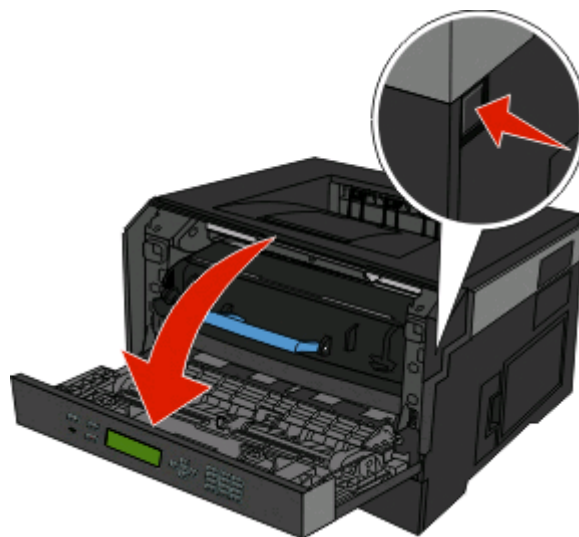

2 Press the button on the base of the photoconductor kit, and then pull the toner cartridge out using the handle.

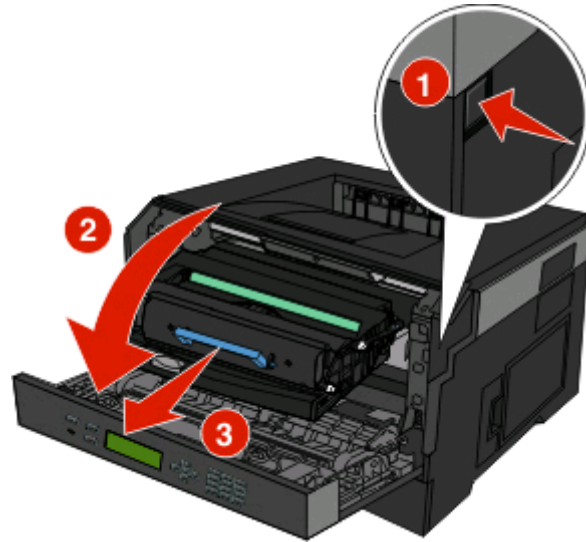

3 Unpack the new toner cartridge.

Warning—Potential Damage: When replacing a toner cartridge, do not leave the photoconductor kit exposed to direct light for an extended period of time. Extended light exposure can cause print quality problems.

4 Rotate the cartridge in all directions to distribute the toner.

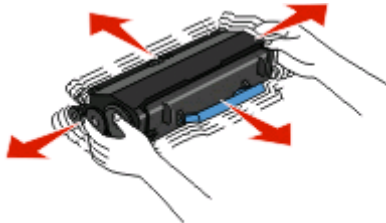

- 5 Install the new toner cartridge by aligning the rollers on the toner cartridge with the arrows on the tracks of the photoconductor kit. Push the toner cartridge in as far as it will go. The cartridge *clicks* into place when correctly installed.

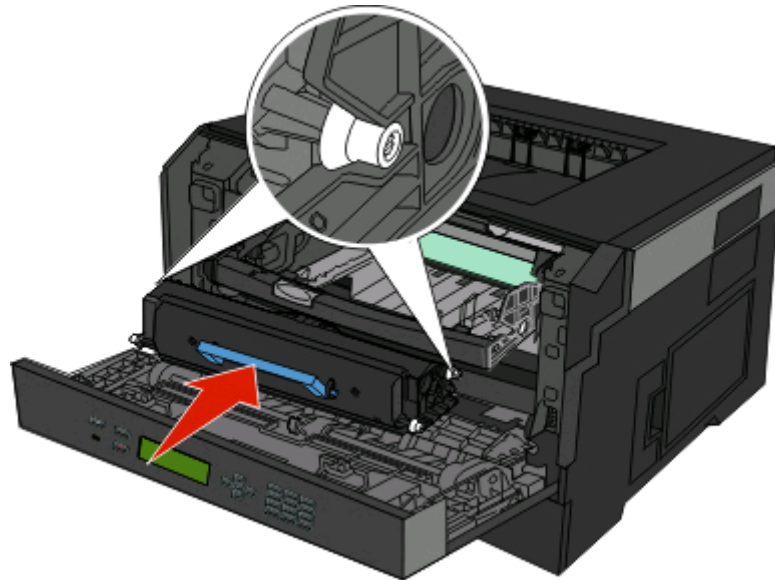

- 6 Close the front door.

Replacing the photoconductor kit

The printer automatically notifies you before the photoconductor kit reaches a page maximum by showing **84 PC Kit life warning** or **84 Replace PC Kit** on the display. You can also see the status of the photoconductor kit by printing a menu settings page.

When **84 PC Kit life warning** or **84 Replace PC Kit** first appears, you should immediately order a new photoconductor kit. While the printer may continue to function properly after the photoconductor kit has reached its official end-of-life, print quality significantly decreases.

Note: The photoconductor kit is one item only.

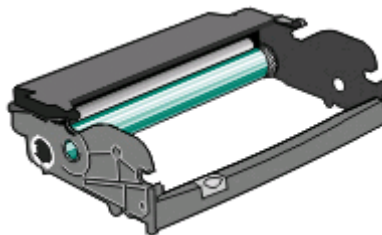

- 1 Open the front door by pressing the button on the left side of the printer and lowering the front door.
- 2 Pull the photoconductor kit and toner cartridge out of the printer as a unit by pulling on the toner cartridge handle.

Note: The photoconductor kit and toner cartridge form a unit.

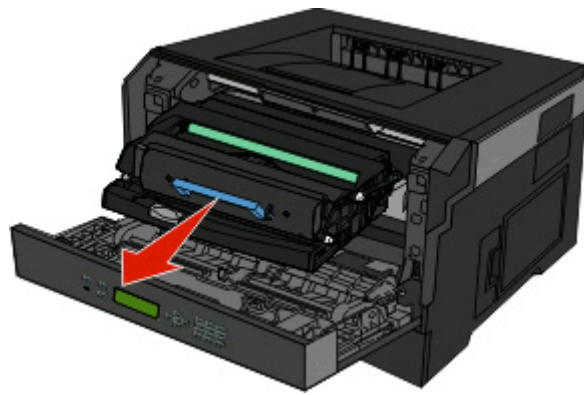

Place the unit on a flat, clean surface.

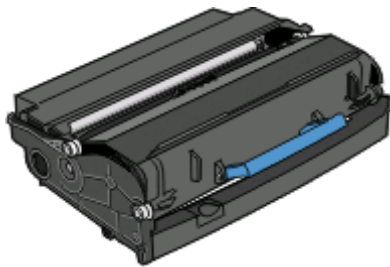

3 Press the button on the base of the photoconductor kit. Pull the toner cartridge up and out using the handle.



4 Unpack the new photoconductor kit. Be careful not to touch the photoconductor drum.

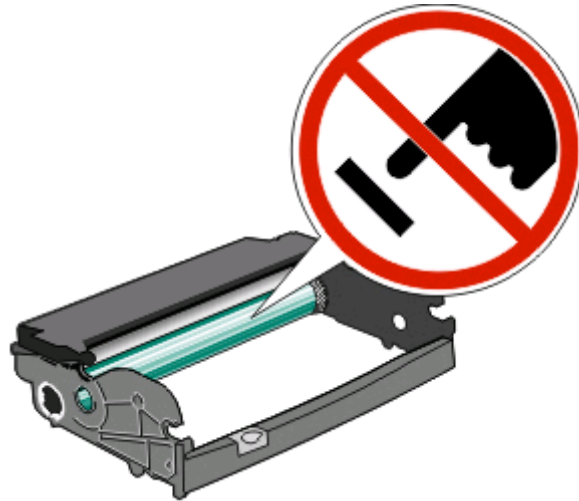

5 Insert the toner cartridge into the photoconductor kit by aligning the rollers on the toner cartridge with the tracks. Push the toner cartridge until it *clicks* into place.

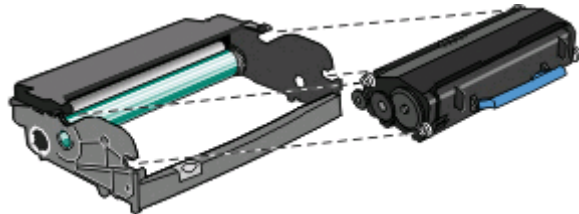

6 Install the unit into the printer by aligning the arrows on the guides of the unit with the arrows in the printer. Push the unit as far as it will go.

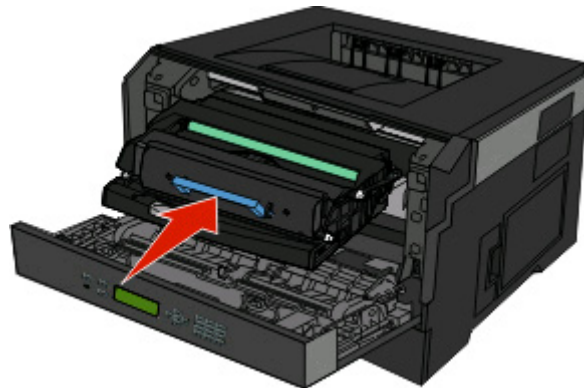

7 After you replace the photoconductor kit, reset the photoconductor counter. To reset the counter, see the instruction sheet that came with the new photoconductor kit.

Warning—Potential Damage: Resetting the photoconductor counter without replacing the photoconductor may damage your printer and void your warranty.

8 Close the front door.

Moving the printer

Moving the printer to another location

 **CAUTION—POTENTIAL INJURY:** Before moving the printer, follow these guidelines to avoid personal injury or printer damage:

- Turn the printer off using the power switch, and then unplug the power cord from the wall outlet.
- Disconnect all cords and cables from the printer before moving it.
- Lift the printer off of the optional drawer and set it aside instead of trying to lift the drawer and printer at the same time.

Note: Use the handholds located on both sides of the printer to lift it off the optional drawer.

The printer and options can be safely moved to another location by following these precautions:

- Any cart used to move the printer must have a surface able to support the full footprint of the printer. Any cart used to move the options must have a surface able to support the dimensions of the options.
- Keep the printer in an upright position.
- Avoid severe jarring movements.

Administrative support

Using the Embedded Web Server

If the printer is installed on a network, the Embedded Web Server is available for a range of functions including:

- Viewing a virtual display of the printer control panel
- Checking the status of the printer supplies
- Configuring printer settings
- Configuring network settings
- Viewing reports

To access the Embedded Web Server, type the printer IP address into the address field of your Web browser.

Note: If you do not know the IP address of the printer, then print a network setup page and locate the IP address in the TCP/IP section.

Checking the virtual display

When the Embedded Web Server is open, a virtual display appears in the top left corner of the screen. It works as an actual display would work on a printer control panel, showing printer messages.

To access the Embedded Web Server, type the printer IP address into the address field of your Web browser.

Note: If you do not know the IP address of the printer, then print a network setup page and locate the IP address in the TCP/IP section.

The virtual display appears in the top left corner of the screen.

Checking the device status

Using the Embedded Web Server, you can view paper tray settings, the level of toner in the print cartridge, the percentage of life remaining in the maintenance kit, and capacity measurements of certain printer parts. To view the device status:

- 1 Type the printer IP address in the address field of your Web browser.

Note: If you do not know the IP address of the printer, then print a network setup page and locate the IP address in the TCP/IP section.

- 2 Click **Device Status**.

Viewing reports

You can view some reports from the Embedded Web Server. These reports are useful for assessing the status of the printer, the network, and supplies.

To view reports from a network printer:

- 1 Type the printer IP address into the address field of your Web browser.

Note: If you do not know the IP address of the printer, then print a network setup page and locate the IP address in the TCP/IP section.

- 2 Click **Reports**, and then click the type of report you want to view.

Configuring supply notifications

You can determine how you would like to be notified when supplies run low or reach their end-of-life.

To configure supply notifications using the Embedded Web Server:

- 1 Type the printer IP address into the address field of your Web browser.

Note: If you do not know the IP address of the printer, then print a network setup page and locate the IP address in the TCP/IP section.

- 2 Click **Settings**.

- 3 Click **Print Settings**.

- 4 Click **Supply Notifications**.

- 5 From the drop-down box for each supply, select among the options for notification. Explanations for each option are provided.

- 6 Click **Submit** to save your selections.

Modifying confidential print settings

You can modify confidential print settings using the Embedded Web Server. You can set a maximum number of PIN entry attempts. When a user exceeds a specific number of PIN entry attempts, all of the jobs for that user are deleted.

You can set an expiration time for confidential print jobs. When a user has not printed the jobs within the designated time period, all of the jobs for that user are deleted.

Note: This functionality is available only on network printers.

To modify the confidential print settings:

- 1 Type the printer IP address into the address field of your Web browser.

Note: If you do not know the IP address of the printer, then print a network setup page and locate the IP address in the TCP/IP section.

- 2 Click **Settings**.

- 3 Under Other Settings, click **Security**.

- 4 Click **Confidential Print Setup**.

Adjusting Power Saver

Available settings range from 1–240 minutes. The factory default is 30 minutes.

To increase or decrease the number of minutes before the printer enters Power Saver mode, do one of the following:







Using the Embedded Web Server

- 1 Type the printer IP address into the address field of your Web browser.

Note: If you do not know the IP address of the printer, then print a network setup page and locate the IP address in the TCP/IP section.

- 2 Click **Settings**, and then click **General Settings**.
- 3 Click **Timeouts**.
- 4 In the Power Saver box, increase or decrease the number of minutes you want the printer to wait before it enters Power Saver mode.
- 5 Click **Submit**.

Using the printer control panel

- 1 Make sure the printer is on and **Ready** appears.
- 2 Press .
- 3 Press the arrow buttons until **Settings** appears, and then press .
- 4 Press the arrow buttons until **General Settings** appears, and then press .
- 5 Press the arrow buttons until **Timeouts** appears, and then press .
- 6 Press the arrow buttons until **Power Saver** appears, and then press .
- 7 Press the arrow buttons to increase or decrease the number of minutes before the printer enters Power Saver mode, and then press .

Setting up e-mail alerts

You can have the printer send you an e-mail when the supplies are getting low or when the paper needs to be changed, added, or unjammed.

To set up e-mail alerts:

- 1 Type the printer IP address into the address field of your Web browser.

Note: If you do not know the IP address of the printer, then print a network setup page and locate the IP address in the TCP/IP section.





- 2 Click **Settings**.
- 3 Under Other Settings, click **E-mail Alert Setup**.
- 4 Select the items for notification, and type in the e-mail addresses.
- 5 Click **Submit**.

Note: See your system support person to set up the e-mail server.

Restoring the factory default settings

If you want to retain a list of the current menu settings for reference, then print a menu settings page before you restore the factory default settings. For more information, see “Printing a menu settings page” on page 30.

Warning—Potential Damage: Restore Now returns most printer settings to the original factory default settings. Exceptions include the display language, custom sizes and messages, and Network/Port menu settings. All downloads stored in RAM are deleted. Downloads stored in flash memory are unaffected.

- 1 From the printer control panel, press .
- 2 Press the down arrow button until **Settings** appears, and then press .
- 3 Press the down arrow button until **General Settings** appears, and then press .
- 4 Press the down arrow button until **Factory Defaults** appears, and then press .
- 5 Press the down arrow button until **Restore Now** appears, and then press .

Wait for **Submitting selection** to appear momentarily, followed by **Restoring Factory Defaults**, before the printer returns to **Ready**.

Troubleshooting

Solving basic printer problems

If there are basic printer problems, or the printer is unresponsive, make sure:

- The power cord is plugged into the printer and a properly grounded electrical outlet.
- The electrical outlet is not turned off by any switch or breaker.
- The printer is not plugged into any surge protectors, uninterrupted power supplies, or extension cords.
- Other electronic equipment plugged into the outlet is working.
- The printer is turned on. Check the printer power switch.
- The printer cable is securely attached to the printer and the host computer, print server, option, or other network device.
- All options are properly installed.
- The printer driver settings are correct.

Once you have checked each of these possibilities, turn the printer off, wait for about 10 seconds, and then turn the printer back on. This often fixes the problem.

Printer control panel display is blank or displays only diamonds

The printer self test failed. Turn the printer off, wait about 10 seconds, and then turn the printer back on.

If **Performing Self Test** and **Ready** do not appear, turn the printer off and contact Customer Support.

Solving printing problems

Jobs do not print

These are possible solutions. Try one or more of the following:

MAKE SURE THE PRINTER IS READY TO PRINT

Make sure **Ready** or **Power Saver** appears on the display before sending a job to print.

CHECK TO SEE IF THE STANDARD EXIT BIN IS FULL

Remove the stack of paper from the standard exit bin.

CHECK TO SEE IF THE PAPER TRAY IS EMPTY

Load paper in the tray.

MAKE SURE THE CORRECT PRINTER SOFTWARE IS INSTALLED

Verify that you are using a compatible printer software.

MAKE SURE THE INTERNAL PRINT SERVER IS INSTALLED PROPERLY AND WORKING

- Make sure the internal print server is properly installed and that the printer is connected to the network.
- Print a network setup page, and check that the status shows **Connected**. If the status is **Not Connected**, check the network cables, and then try printing the network setup page again. Contact your system support person to make sure the network is functioning correctly.
- Copies of the printer software are also available on the Dell Web site at www.Dell.com.

MAKE SURE YOU ARE USING A RECOMMENDED USB OR ETHERNET CABLE

For more information, visit the Dell Web site at www.Dell.com.

MAKE SURE PRINTER CABLES ARE SECURELY CONNECTED

Check the cable connections to the printer and print server to make sure they are secure.

For more information, see the setup documentation that came with the printer.

Confidential and other held jobs do not print

These are possible solutions. Try one or more of the following:

PARTIAL JOB, NO JOB, OR BLANK PAGES PRINT

The print job may contain a formatting error or invalid data.

- Delete the print job, and then print it again.
- For PDF documents, recreate the PDF and then print it again.

MAKE SURE THE PRINTER HAS SUFFICIENT MEMORY

Free up additional printer memory by scrolling through the list of held jobs and deleting some of them.

Multiple-language PDFs do not print

The documents contain unavailable fonts.

- 1** Open the document you want to print in Adobe Acrobat.
- 2** Click the printer icon.
The Print dialog appears.
- 3** Select **Print as image**.
- 4** Click **OK**.







Job takes longer than expected to print

These are possible solutions. Try one or more of the following:

REDUCE THE COMPLEXITY OF THE PRINT JOB

Reduce the number and size of fonts, the number and complexity of images, and the number of pages in the job.

CHANGE THE PAGE PROTECT SETTING TO OFF

- 1 From the printer control panel, press .
- 2 Press the down arrow button until **Settings** appears, and then press .
- 3 Press the down arrow button until **General Settings** appears, and then press .
- 4 Press the down arrow button until **Print Recovery** appears, and then press .
- 5 Press the down arrow button until **Page Protect** appears, and then press .
- 6 Press the down arrow button until **Off** appears, and then press .

Job prints from the wrong tray or on the wrong paper

CHECK THE PAPER TYPE SETTING

Make sure the Paper Type setting matches the paper loaded in the tray.

Incorrect characters print

Make sure the printer is not in Hex Trace mode. If **Ready Hex** appears on the display, you must exit Hex Trace mode before you can print your job. Turn the printer off and back on to exit Hex Trace mode.

Tray linking does not work

LOAD THE SAME SIZE AND TYPE OF PAPER IN EACH TRAY

- 1 Load the same size and type of paper in each tray.
- 2 Move the paper guides to the correct positions for the paper size loaded in each tray.

MAKE SURE THE PAPER SIZE AND PAPER TYPE SETTINGS ARE THE SAME FOR EACH TRAY

- 1 Print a menu settings page and compare the settings for each tray.
- 2 If necessary, adjust the settings from the Paper Size/Type menu.

Note: None of the paper sources, trays, or feeders automatically sense the paper size. You must set the size from the Paper Size/Type menu on the printer control panel or from the Embedded Web Server.

Large jobs do not collate

These are possible solutions. Try one or more of the following:

MAKE SURE COLLATE IS SET TO ON

From Print Properties or the printer control panel Finishing menu, set Collate to On.

Note: Setting Collate to Off in the software overrides the setting in the Finishing menu.

REDUCE THE COMPLEXITY OF THE PRINT JOB











Reduce the complexity of the print job by reducing the number and size of fonts, the number and complexity of images, and the number of pages in the job.

MAKE SURE THE PRINTER HAS ENOUGH MEMORY

Add printer memory.

Unexpected page breaks occur

Increase the Print Timeout value:

- 1 From the printer control panel, press .
- 2 Press the down arrow button until  **Settings** appears, and then press .
- 3 Press the down arrow button until  **General Settings** appears, and then press .
- 4 Press the down arrow button until  **Timeouts** appears, and then press .
- 5 Press the down arrow button until  **Print Timeout** appears, and then press .
- 6 Press the left or right arrow buttons until the value you want appears, and then press .

Envelope seals when printing

Due to humidity and heat, some envelopes become sealed during the printing process. If this happens, open the rear door of the printer to allow envelopes to exit there.

Solving option problems

Option does not operate correctly or quits after it is installed

These are possible solutions. Try one or more of the following:

RESET THE PRINTER

Turn the printer off, wait for about 10 seconds, and then turn the printer on.

CHECK TO SEE IF THE OPTION IS CONNECTED TO THE PRINTER

- 1 Turn the printer off.
- 2 Unplug the printer.
- 3 Check the connection between the option and the printer.

MAKE SURE THE OPTION IS INSTALLED

Print a menu settings page and check to see if the option is listed in the Installed Options list. If the option is not listed, reinstall it.

MAKE SURE THE OPTION IS SELECTED

From the program you are using, select the option. Mac OS 9 users should make sure the printer is set up in the Chooser.

Drawers

These are possible solutions. Try one or more of the following:

MAKE SURE THE PAPER IS LOADED CORRECTLY

- 1 Pull the tray completely out.
- 2 Check for paper jams or misfeeds.
- 3 Make sure the guides are aligned against the edges of the paper.
- 4 Insert the tray.

RESET THE PRINTER

Turn the printer off, wait about 10 seconds, and then turn the printer on.

Flash memory card

Make sure the flash memory card is securely connected to the printer system board.

Memory card

Make sure the memory card is securely connected to the printer system board.

Solving paper feed problems

Paper frequently jams

These are possible solutions. Try one or more of the following:

FAN, FLEX, AND STRAIGHTEN THE PAPER IN THE TRAY OR FEEDER



Turn the stack of paper over, if possible, when you reload it into the tray or feeder.

CHECK THE PAPER

MAKE SURE THERE IS NOT TOO MUCH PAPER IN THE TRAY OR FEEDER

Make sure the stack of paper you load does not exceed the maximum stack height indicated in the tray or on the multipurpose feeder.

CHECK THE GUIDES

Move the guides in the tray to the correct positions for the paper size loaded.

LOAD PAPER FROM A FRESH PACKAGE







The paper may have absorbed moisture due to high humidity. Store the paper in its original wrapper until you use it.

Paper jam message remains after jam is cleared

The paper path is not clear. Clear jammed paper from the entire paper path, and then press .

Page that jammed does not reprint after you clear the jam

In the Settings menu, Jam Recovery is set to Off. Set Jam Recovery to Auto or On:

- 1 Press .
- 2 Press the down arrow button until  **Settings** appears, and then press .
- 3 Press the down arrow button until  **General Settings** appears, and then press .
- 4 Press the down arrow button until  **Print Recovery** appears, and then press .

- 5 Press the down arrow button until **✓ Jam Recovery** appears, and then press **⏏**.
- 6 Press the down arrow button until **✓ On** or **✓ Auto** appears, and then press **⏏**.

Solving print quality problems

The information in the following topics may help you solve print quality problems. If these suggestions still do not correct the problem, then contact Customer Support. You may have a printer part that requires adjustment or replacement.

Isolating print quality problems

To help isolate print quality problems, print the print quality test pages, but first make sure the standard tray is loaded:

- 1 Turn the printer off.
- 2 Load letter- or A4-size paper in the standard tray. Load the paper stack toward the back of the tray as shown with the recommended print side facedown. Notice the maximum fill line on the side of the tray to guide you. Do not overfill the tray.

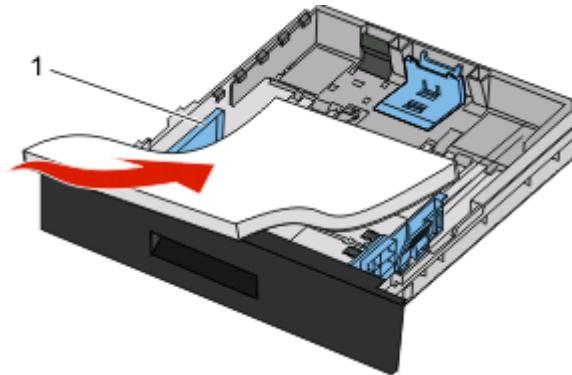

Print the print quality test pages:

- 1 Turn the printer off.
- 2 From the printer control panel, hold down **⏏** and the right arrow button while turning the printer on.
- 3 Release the buttons when the clock appears, and wait for **CONFIG MENU** to appear.
- 4 Press the down arrow button until **✓ Prt Quality Pgs** appears, and then press **⏏**.
The print quality test pages print.
- 5 Press the down arrow button until **✓ Exit Config Menu** appears, and then press **⏏**.
Resetting the Printer appears briefly, followed by a clock, and then **Ready** appears.

Blank pages

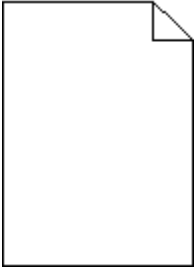

Try one or more of the following:

- Remove and reinstall the toner cartridge.
- Remove and reinstall the photoconductor kit.

If the printer still prints blank pages, it may need to be serviced. For more information, contact Customer Support.

Characters have jagged or uneven edges



If you are using downloaded fonts, verify that the fonts are supported by the printer, the host computer, and the software program.

Clipped images

These are possible solutions. Try one or more of the following:

CHECK THE GUIDES

Move the width and length guides in the tray to the correct positions for the paper size loaded.

CHECK THE PAPER SIZE SETTING

Make sure the Paper Size setting matches the paper loaded in the tray.

Gray background

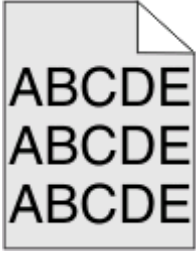

- For Windows users: From Print Properties, select a different Toner Darkness setting before sending the job to print.
- For Macintosh users: From the print options, Copies & Pages, or General pop-up menu, choose Printer Features, and then choose the setting needed from the Toner Darkness pop-up menu.
- From the printer control panel Quality menu, select a different Toner Darkness setting before sending the job to print.

Ghost images



These are possible solutions. Try one or more of the following:

THE PHOTOCONDUCTOR KIT IS DEFECTIVE

Replace the photoconductor kit.

CHECK THE MEDIA TYPE SETTING

- For Windows users: From Print Properties, make sure the Media Type setting matches the paper loaded in the tray.
- For Macintosh users: From the Print dialog, make sure the Paper Type setting matches the paper loaded in the tray.
- From the printer control panel Paper menu, make sure the Paper Type setting matches the paper loaded in the tray.

Incorrect margins



These are possible solutions. Try one or more of the following:

CHECK THE GUIDES

Move the width and length guides in the tray to the correct positions for the paper size loaded.

CHECK THE PAPER SIZE SETTING

Make sure the Paper Size setting matches the paper loaded in the tray.

CHECK THE PAGE SIZE SETTING

Before sending the job to print, specify the correct page size in Print Properties, the Print dialog, or the software program.

Paper curl

These are possible solutions. Try one or more of the following:

CHECK THE PAPER TYPE SETTING

- For Windows users: From Print Properties, make sure the Media Type setting matches the paper loaded in the tray.
- For Macintosh users: From the Print dialog, make sure the Paper Type setting matches the paper loaded in the tray.
- From the printer control panel Paper menu, make sure the Paper Type setting matches the paper loaded in the tray.

THE PAPER HAS ABSORBED MOISTURE DUE TO HIGH HUMIDITY

- Load paper from a fresh package.
- Store paper in its original wrapper until you use it.

Print is too dark



These are possible solutions. Try one or more of the following:

CHECK THE DARKNESS, BRIGHTNESS, AND CONTRAST SETTINGS

The Toner Darkness setting is too dark, the Brightness setting is too dark, or the Contrast setting is too high.

- For Windows users: From Print Properties, change these settings.
- For Macintosh users:
 - 1 Choose **File > Print**.
 - 2 Locate the drop-down box under the Orientation pictures, and then click the down button.
 - 3 Click **Printer Features**.
 - 4 Change the settings for Toner Darkness, Brightness, and Contrast.
- From the printer control panel Quality menu, change these settings.

THE PAPER HAS ABSORBED MOISTURE DUE TO HIGH HUMIDITY

- Load paper from a fresh package.
- Store paper in its original wrapper until you use it.

CHECK THE PAPER

Avoid textured paper with rough finishes.

CHECK THE PAPER TYPE SETTING

- For Windows users: From Print Properties, make sure the Media Type setting matches the paper loaded in the tray.
- For Macintosh users: From the Print dialog, make sure the Paper Type setting matches the paper loaded in the tray.
- From the printer control panel Paper menu, make sure the Paper Type setting matches the paper loaded in the tray.

THE TONER CARTRIDGE MAY BE DEFECTIVE

Replace the toner cartridge.

Print is too light



These are possible solutions. Try one or more of the following:

CHECK THE DARKNESS, BRIGHTNESS, AND CONTRAST SETTINGS

The Toner Darkness setting is too light, the Brightness setting is too light, or the Contrast setting is too low.

- From the printer control panel, change these settings from the Quality menu.
- For Windows users, change these settings from Print Properties.
- For Macintosh users, change these settings from the Print dialog and pop-up menus.

THE PAPER HAS ABSORBED MOISTURE DUE TO HIGH HUMIDITY

- Load paper from a fresh package.
- Store paper in its original wrapper until you use it.

CHECK THE PAPER

Avoid textured paper with rough finishes.

CHECK THE PAPER TYPE SETTING

Make sure the paper type setting matches the paper loaded in the tray:

- 1 From the printer control panel, check the Paper Type setting from the Paper menu.
- 2 Before sending the job to print, specify the correct type setting:
 - For Windows users, specify the type from Print Properties.
 - For Macintosh users, specify the type from the Print dialog.

THE TONER IS LOW

When **88 Cartridge Low** appears, order a new print cartridge.

THE PRINT CARTRIDGE MAY BE DEFECTIVE

Replace the print cartridge.

Skewed print

CHECK THE PAPER GUIDES

Move the guides in the tray to the correct positions for the paper size loaded.

CHECK THE PAPER

Make sure you are using paper that meets the printer specifications.

Toner fog or background shading appears on the page

These are possible solutions. Try one or more of the following:

THE TONER CARTRIDGE MAY BE DEFECTIVE

Replace the toner cartridge.

THERE IS TONER IN THE PAPER PATH

Contact Customer Support.

Toner rubs off

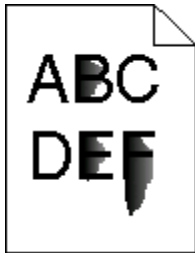

These are possible solutions. Try one or more of the following:

CHECK THE PAPER TYPE SETTING

Make sure the Paper Type setting matches the paper loaded in the tray.

CHECK THE PAPER TEXTURE SETTING

Make sure the Paper Texture setting matches the paper loaded in the tray.

Toner specks

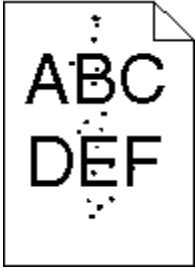

These are possible solutions. Try one or more of the following:

THE TONER CARTRIDGE MAY BE DEFECTIVE

Replace the toner cartridge.

THERE IS TONER IN THE PAPER PATH

Contact Customer Support.

Transparency print quality is poor

CHECK THE TRANSPARENCIES

Use only transparencies recommended by the printer manufacturer.

CHECK THE PAPER TYPE SETTING

Load transparencies, and make sure the Paper Type setting is set to Transparency.

Streaked horizontal lines



These are possible solutions. Try one or more of the following:

THE TONER MAY SMEAR WHEN PAPER IS FED FROM A SPECIFIC SOURCE

From Print Properties, the Print dialog, or the printer control panel, select another tray or feeder to feed the paper for the job.

THE TONER CARTRIDGE MAY BE DEFECTIVE

Replace the toner cartridge.

MAKE SURE THE PAPER PATH IS CLEAR

Paper could be caught between the photoconductor kit and the fuser. Check the paper path around the fuser area.

 **CAUTION—HOT SURFACE:** The fuser and the inside of the printer near the fuser may be hot. To reduce the risk of injury from a hot component, allow the surface to cool before removing paper from this area.

Clear any paper you see.

THERE MAY BE EXCESS TONER IN THE PAPER PATH

Contact Customer Support.

Streaked vertical lines



These are possible solutions. Try one or more of the following:

THE TONER MAY SMEAR WHEN PAPER IS FED FROM A SPECIFIC SOURCE

From Print Properties, the Print dialog, or the printer control panel, select another tray or feeder to feed paper for the job.

THE TONER CARTRIDGE IS DEFECTIVE

Replace the toner cartridge.

MAKE SURE THE PAPER PATH IS CLEAR

Paper could be caught between the photoconductor kit and the fuser. Check the paper path around the fuser area.

Warning—Potential Damage: Do not touch the photoconductor on the underside of the photoconductor kit. Use the cartridge handle whenever you are holding the cartridge.

 **CAUTION—HOT SURFACE:** The fuser and the inside of the printer near the fuser may be hot. To reduce the risk of injury from a hot component, allow the surface to cool before removing paper from this area.

Clear any paper you see.

THERE MAY BE EXCESS TONER IN THE PAPER PATH

Contact Customer Support.

Solid black or white streaks appear on transparencies or paper

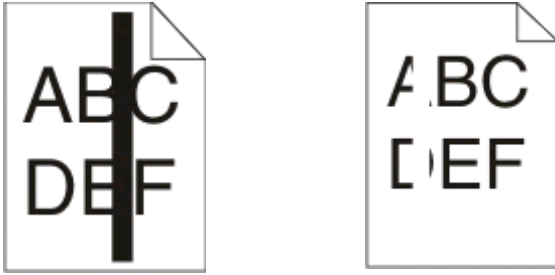

These are possible solutions. Try one or more of the following:

MAKE SURE THE FILL PATTERN IS CORRECT

If the fill pattern is incorrect, choose a different fill pattern from your software program.

CHECK THE PAPER TYPE

- Try a different type of paper.
- For transparencies, use only ones recommended by the printer manufacturer.
- Make sure the Paper Type setting matches what is loaded in the tray or feeder.
- Make sure the Paper Texture setting is correct for the type of paper or specialty media loaded in the tray or feeder.

MAKE SURE THE TONER IS DISTRIBUTED EVENLY IN THE TONER CARTRIDGE

Remove the toner cartridge and shake it from side to side to redistribute the toner to extend the life of the cartridge, and then reinstall it.

THE TONER CARTRIDGE MAY BE DEFECTIVE OR LOW ON TONER

Replace the used toner cartridge with a new one.

Embedded Web Server does not open

These are possible solutions. Try one or more of the following:

CHECK THE NETWORK CONNECTIONS

Make sure the printer and computer are turned on and connected to the same network.

CHECK THE NETWORK SETTINGS

Depending on the network settings, you may need to type `https://` instead of `http://` before the printer IP address to access the Embedded Web Server. For more information, see your system administrator.

Appendix

Dell Technical Support Policy

Technician-assisted technical support requires the cooperation and participation of the customer in the troubleshooting process and provides for restoration of the Operating System, application software and hardware drivers to the original default configuration as shipped from Dell, as well as the verification of appropriate functionality of the printer and all Dell-installed hardware. In addition to this technician assisted technical support, online technical support is available at Dell Support. Additional technical support options may be available for purchase.

Dell provides limited technical support for the printer and any Dell-installed software and peripherals. Support for third-party software and peripherals is provided by the original manufacturer, including those purchased and/or installed through Software & Peripherals (DellWare), ReadyWare, and Custom Factory Integration (CFI/DellPlus).

Contacting Dell

You can access Dell Support at **support.dell.com**. Select your region on the WELCOME TO DELL SUPPORT page, and fill in the requested details to access help tools and information.

You can contact Dell electronically using the following addresses:

- World Wide Web

www.dell.com/

www.dell.com/ap/ (Asian/Pacific countries only)

www.dell.com/jp/ (Japan only)

www.euro.dell.com (Europe only)

www.dell.com/la/ (Latin American and Caribbean countries)

www.dell.ca (Canada only)

- Anonymous file transfer protocol (FTP)

ftp.dell.com

Log in as user: anonymous, and use your email address as your password.

- Electronic Support Service

mobile_support@us.dell.com

support@us.dell.com

la-techsupport@dell.com (Latin America and Caribbean countries only)

apsupport@dell.com (Asian/Pacific countries only)

support.jp.dell.com (Japan only)

support.euro.dell.com (Europe only)

- Electronic Quote Service

apmarketing@dell.com (Asian/Pacific countries only)

sales_canada@dell.com (Canada only)

Warranty and Return Policy

Dell Inc. ("Dell") manufactures its hardware products from parts and components that are new or equivalent to new in accordance with industry-standard practices. For information about the Dell warranty for your printer, refer to the *Product Information Guide*.

Index

Numerics

1565 Emulation error, load emulation option 124
200.yy Paper jam 122
201.yy Paper jam 122
202.yy Paper jam 122
231.yy Paper jam 122
233.yy Paper jam 123
234.yy Paper jam 123
235.yy Paper jam 123
24x.yy Paper jam 123
251.yy Paper jam 124
30.yy Invalid refill, change cartridge 118
31.yy Replace defective or missing cartridge 118
32.yy Cartridge part number unsupported by device 118
34 Short paper 118
35 Insufficient memory to support Resource Save feature 118
37 Insufficient memory for Flash Memory Defragment operation 119
37 Insufficient memory to collate job 119
37 Insufficient memory, some Held Jobs were deleted 119
38 Memory full 119
39 Complex page, some data may not have printed 119
42.xy Cartridge region mismatch 119
50 PPDS font error 120
51 Defective flash detected 120
52 Not enough free space in flash memory for resources 120
53 Unformatted flash detected 120
54 Standard network software error 120
550-sheet drawer installing 25
56 Standard parallel port disabled 120
56 Standard USB port disabled 121
58 Too many flash options installed 121

80 Routine maintenance needed 121
84 PC Kit life warning 121
84 Replace PC Kit 121
88.yy Cartridge is low 121
88.yy Cartridge nearly low 121
88.yy Replace cartridge 121
900–999 Service <message> 124

Symbols

[PJL RDYMSG] 115

A

Activating Menu Changes 111
Active NIC menu 85
AppleTalk menu 89
attaching cables 26

B

Busy 111
Busy ... 111

C

cables
 Ethernet 26
 parallel 26
 USB 26
Calibrating 111
Cancel not available 111
Canceling 111
canceling a job
 from Macintosh 61
 from the printer control panel 61
 from Windows 61
card stock
 loading 38
 tips 58
Cartridge Life Exceeded 112
Cartridge Low 111
Cartridge Nearly Low 111
Change <src> to <x> 112
checking an unresponsive printer 137
checking device status
 on Embedded Web Server 133
checking virtual display
 on Embedded Web Server 133

cleaning
 exterior of the printer 125
Clearing job accounting statistics 112
Close front door 112
confidential jobs
 modifying print settings 134
Confidential print jobs 58
 printing for Macintosh users 59
 printing for Windows users 59
Confidential Print menu 96
configurations
 printer 12
Configure MP menu 78
configuring supply notifications 134
conserving supplies 126
control panel, printer 14
 factory defaults, restoring 136
custom paper type
 assigning 43
Custom Type <x>
 changing name 44
Custom Types menu 83

D

Default Source menu 75
Defragmenting Flash 112
Deleting held jobs 112
Deletion complete 112
Deletion failed 112
directory list
 printing 60
Disabling Menus 112
display troubleshooting
 display is blank 137
 display shows only diamonds 137
display, control panel 14
DO NOT TOUCH Reading flash data
DO NOT POWER OFF 113
documents, printing
 from Macintosh 54
 from Windows 54
Driver Profiler 51

E

- Embedded Web Server 133
 - checking device status 133
 - does not open 152
 - modifying confidential print settings 134
 - setting up e-mail alerts 135
- Enabling Menus 113
- envelope seals
 - when printing 140
- envelopes
 - loading 38
 - tips 57
- Ethernet networking
 - Macintosh 27
 - Windows 27
- Ethernet port 26
- exterior of the printer
 - cleaning 125
- e-mail
 - notice of low supply level 135
 - notice of paper jam 135
 - notice of paper needed 135
 - notice that different paper is needed 135

F

- factory defaults, restoring
 - printer control panel menus 136
- fiber optic
 - network setup 27
- finding
 - information 11
 - publications 11
 - Web site 11
- Finishing menu 102
- firmware card
 - installing 23
- flash memory card
 - installing 23
 - troubleshooting 141
- Flushing buffer 113
- font sample list
 - printing 60
- Formatting Flash 113

G

- General Settings menu 98

H

- held jobs 58
 - printing for Macintosh users 59
 - printing for Windows users 59
- Hex Trace 113
- Hex Trace ready 113
- HTML menu 109

I

- Image menu 110
- indicator light 14
- information, finding 11
- installing
 - printer software 29
- Invalid Engine Code 113
- Invalid Network Code 113
- IPv6 menu 89

J

- jams
 - accessing jam areas 64
 - avoiding 63
- jams, avoiding
 - cutting paper and specialty media 46
 - selecting paper and specialty media 46
- jams, clearing
 - 200 65
 - 201 66
 - 202 67
 - 231 69
 - 233 70
 - 234 70
 - 235 71
 - 242 71
 - 251 72

L

- labels, paper
 - tips 57
- letterhead
 - loading 38
 - tips 55
- light, indicator 14
- linking trays 42
- Load <src> with <x> 114
- Load manual feeder with <x> 113
- loading
 - multipurpose feeder 38

- trays 33

M

- memory card
 - installing 21
 - troubleshooting 141
- Menu access turned off by system administrator 114
- menu settings page
 - printing 30
- menus
 - Active NIC 85
 - AppleTalk 89
 - Confidential Print 96
 - Configure MP 78
 - Custom Types 83
 - Default Source 75
 - diagram of 74
 - Finishing 102
 - General Settings 98
 - HTML 109
 - Image 110
 - IPv6 89
 - Miscellaneous 95
 - NetWare 90
 - Network <x> 86
 - Network Card 87
 - Paper Loading 82
 - Paper Size/Type 75
 - Paper Texture 79
 - Paper Weight 80
 - parallel 92
 - PCL Emul 106
 - PDF 106
 - PostScript 106
 - Quality 104
 - Reports 84, 87
 - Security Audit Log 96
 - Set Date/Time 97
 - Setup 101
 - SMTP Setup menu 94
 - Standard Network 86
 - Substitute Size 79
 - TCP/IP 88
 - Universal Setup 83
 - USB 91
 - Utilities 105
 - XPS 105
- Menus are Disabled 114
- Miscellaneous menu 95
- moving the printer 132

- multipurpose feeder
 - loading 38
- Must be in Ready state to enter menus 114

N

- Narrow media enabled 114
- NetWare menu 90
- Network 114
- Network <x> 114
- Network <x> menu 86
- Network <x>, <y> 114
- Network Card menu 87
- network setup page 30
- No jobs to cancel 115
- Not Ready 115

O

- optional drawer
 - installing optional drawer 25
- options
 - 550-sheet drawer 25
 - firmware card 23
 - firmware cards 20
 - flash memory card 23
 - memory card 21
 - memory cards 20
 - optional drawer 25
- ordering supplies
 - printer attached to a network 126
 - printer locally attached to a computer 127

P

- paper
 - characteristics 45
 - letterhead 46
 - loading, multipurpose feeder 38
 - preprinted forms 46
 - recommended print side 46
 - recycled 47
 - selecting 46
 - selecting weight 80
 - setting size 32
 - setting type 32
 - storing 47
 - unacceptable 46
 - Universal Paper Size 83
 - Universal size setting 32

- paper capacities
 - trays 50
- paper capacity
 - multipurpose feeder 50
- paper feed troubleshooting
 - message remains after jam is cleared 142
 - page that jammed does not reprint 142
- paper jams
 - accessing jam areas 64
 - avoiding 63
- paper jams, clearing
 - 200 65
 - 201 66
 - 202 67
 - 231 69
 - 233 70
 - 234 70
 - 235 71
 - 242 71
 - 251 72

- Paper Loading menu 82
- Paper Size/Type menu 75
- paper sizes
 - supported by the printer 48
- paper stop, using 17
- Paper Texture menu 79
- paper types
 - duplex support 49
 - supported by printer 49
 - where to load 49
- Paper Weight menu 80
- Parallel 115
- Parallel <x> 115
- Parallel menu 92
- parallel port 26
- PC Kit Life Warning 115
- PCL Emul menu 106
- PDF menu 106
- photoconductor kit
 - replacing 129
- PostScript menu 106
- Power Saver 115
 - adjusting 134
- print job
 - canceling from Macintosh 61
 - canceling from the printer control panel 61
 - canceling from Windows 61
- print quality test pages
 - printing 61

- print quality troubleshooting
 - blank pages 144
 - characters have jagged edges 144
 - clipped images 144
 - ghost images 145
 - gray background 145
 - poor transparency quality 150
 - print is too dark 147
 - print is too light 148
 - print quality test pages 143
 - skewed print 149
 - solid black streaks 152
 - solid white streaks 152
 - streaked horizontal lines 150
 - streaked vertical lines 151
 - toner fog or background shading 149
 - toner rubs off 149
 - toner specks 150
- print quality, poor
 - avoiding by selecting paper and specialty media 46
- print troubleshooting
 - held jobs do not print 138
 - incorrect characters print 139
 - incorrect margins 146
 - job prints from wrong tray 139
 - job prints on wrong paper 139
 - job takes longer than expected 139
 - jobs do not print 137
 - Large jobs do not collate 140
 - multiple-language PDFs do not print 138
 - paper curl 146
 - paper frequently jams 142
 - tray linking does not work 139
 - unexpected page breaks occur 140
- printer
 - basic model 12
 - configurations 12
 - minimum clearances 19
 - moving 132
 - selecting a location 19
- printer alert utility 51
- printer control panel 14
 - factory defaults, restoring 136
- printer message
 - 201.yy Paper jam 122

printer messages
 1565 Emulation error, load emulation option 124
 200.yy Paper jam 122
 202.yy Paper jam 122
 231.yy Paper jam 122
 233.yy Paper jam 123
 234.yy Paper jam 123
 235.yy Paper jam 123
 24x.yy Paper jam 123
 251.yy Paper jam 124
 30.yy Invalid refill, change cartridge 118
 31.yy Replace defective or missing cartridge 118
 32.yy Cartridge part number unsupported by device 118
 34 Short paper 118
 35 Insufficient memory to support Resource Save feature 118
 37 Insufficient memory for Flash Memory Defragment operation 119
 37 Insufficient memory to collate job 119
 37 Insufficient memory, some Held Jobs were deleted 119
 38 Memory full 119
 39 Complex page, some data may not have printed 119
 42.xy Cartridge region mismatch 119
 50 PPDS font error 120
 51 Defective flash detected 120
 52 Not enough free space in flash memory for resources 120
 53 Unformatted flash detected 120
 54 Standard network software error 120
 56 Standard parallel port disabled 120
 56 Standard USB port disabled 121
 58 Too many flash options installed 121
 80 Routine maintenance needed 121
 84 PC Kit life warning 121
 84 Replace PC Kit 121
 88.yy Cartridge is low 121
 88.yy Cartridge nearly low 121
 88.yy Replace cartridge 121
 900–999 Service <message> 124
 [PJL RDYMSG] 115
 Activating Menu Changes 111
 Busy 111
 Busy ... 111
 Calibrating 111
 Cancel not available 111
 Canceling 111
 Cartridge Life Exceeded 112
 Cartridge Low 111
 Cartridge Nearly Low 111
 Change <src> to <x> 112
 Clearing job accounting statistics 112
 Close front door 112
 Defragmenting Flash 112
 Deleting held jobs 112
 Deletion complete 112
 Deletion failed 112
 Disabling Menus 112
 DO NOT TOUCH Reading flash data DO NOT POWER OFF 113
 Enabling Menus 113
 Flushing buffer 113
 Formatting Flash 113
 Hex Trace 113
 Hex Trace ready 113
 Invalid Engine Code 113
 Invalid Network Code 113
 Load <src> with <x> 114
 Load manual feeder with <x> 113
 Maintenance 114
 Menu access turned off by system administrator 114
 Menus are Disabled 114
 Must be in Ready state to enter menus 114
 Narrow media enabled 114
 Network 114
 Network <x> 114
 Network <x>, <y> 114
 No jobs to cancel 115
 Not Ready 115
 Parallel 115
 Parallel <x> 115
 PC Kit Life Warning 115
 Power Saver 115
 Printing 115
 Programming flash 115
 Programming System Code 116
 Ready 116
 Remote Management Active 116
 Remove paper from standard bin 116
 Remove paper from standard output bin 116
 Replace Cartridge 116
 Replace PC Kit 116
 Resetting the printer 116
 Resetting without replacing may affect print quality. 116
 Restoring Factory Defaults 117
 Routine maintenance needed 117
 Standard Bin Full 117
 Stopping 117
 Submitting selection 117
 Too many failed panel logins 117
 Tray <x> disabled 117
 Tray <x> Missing 117
 USB/USB <x> 117
 Waiting, too many events ... DO NOT POWER OFF 118
 printer options troubleshooting
 drawers 141
 flash memory card 141
 memory card 141
 option not working 140
 printer problems, solving
 basic 137
 printer status
 [PJL RDYMSG] 115
 Hex Trace ready 113
 not ready 115
 printer supplies reorder application 53
 Printing 115
 printing
 directory list 60
 font sample list 60
 from Macintosh 54
 from Windows 54
 installing printer software 29
 menu settings page 30
 network setup page 30
 print quality test pages 61
 printing confidential and other held jobs
 for Macintosh users 59
 for Windows users 59
 printing status window 53
 Programming flash 115

Programming System Code 116
publications, finding 11

Q

Quality menu 104

R

Ready 116
recommended print side 46
recycled paper
 using 47
Remote Management Active 116
Remove paper from standard
 bin 116
Remove paper from standard
 output bin 116
Repeat print jobs 58
 printing for Macintosh users 59
 printing for Windows users 59
Replace Cartridge 116
Replace PC Kit 116
replacing
 photoconductor kit 129
 toner cartridge 127
reports
 viewing 133
Reports menu 84, 87
Reserve print jobs 58
 printing for Macintosh users 59
 printing for Windows users 59
Resetting the printer 116
Resetting without replacing may
 affect print quality. 116
Restoring Factory Defaults 117
Routine maintenance needed 117

S

safety information 9
security
 modifying confidential print
 settings 134
Security Audit Log menu 96
Set Date/Time menu 97
setting
 paper size 32
 paper type 32
 TCP/IP address 88
 Universal Paper Size 32
setting up the printer
 on a wired network
 (Macintosh) 27

 on a wired network
 (Windows) 27
Setup menu 101
SMTP Setup menu 94
software
 Driver Profiler 51
 printer alert utility 51
 printer supplies reorder
 application 53
 printing status window 53
 Status Monitor Center 51
 XPS driver 52
specialty media
 recommended print side 46
 selecting 46
Standard Bin Full 117
standard exit bin, using 17
Standard Network menu 86
Status Monitor Center 51
status of supplies, checking 126
Stopping 117
storing
 paper 47
 supplies 125
Submitting selection 117
Substitute Size menu 79
supplies
 conserving 126
 status of 126
 storing 125
supply notifications
 configuring 134
system board
 accessing 20

T

TCP/IP menu 88
tips
 card stock 58
 envelopes 57
 labels, paper 57
 letterhead 55
 transparencies 56
toner cartridge
 replacing 127
Too many failed panel logins 117
transparencies
 loading 38
 tips 56
Tray <x> disabled 117
Tray <x> Missing 117
tray linking 43, 44

tray unlinking 43, 44
trays
 linking 42, 43
 loading 33
 unlinking 43
troubleshooting
 checking an unresponsive
 printer 137
 solving basic printer
 problems 137
troubleshooting, display
 display is blank 137
 display shows only
 diamonds 137
troubleshooting, paper feed
 message remains after jam is
 cleared 142
 page that jammed does not
 reprint 142
troubleshooting, print
 envelope seals 140
 held jobs do not print 138
 incorrect characters print 139
 incorrect margins 146
 job prints from wrong tray 139
 job prints on wrong paper 139
 job takes longer than
 expected 139
 jobs do not print 137
 Large jobs do not collate 140
 multiple-language PDFs do not
 print 138
 paper curl 146
 paper frequently jams 142
 tray linking does not work 139
 unexpected page breaks
 occur 140
troubleshooting, print quality
 blank pages 144
 characters have jagged
 edges 144
 clipped images 144
 ghost images 145
 gray background 145
 poor transparency quality 150
 print is too dark 147
 print is too light 148
 print quality test pages 143
 skewed print 149
 solid black streaks 152
 solid white streaks 152
 streaked horizontal lines 150

- streaked vertical lines 151
- toner fog or background
 - shading 149
- toner rubs off 149
- toner specks 150
- troubleshooting, printer options
 - drawers 141
 - flash memory card 141
 - memory card 141
 - option not working 140

U

- Universal Paper Size 83
 - setting 32
- Universal Setup menu 83
- unlinking trays 43
- USB menu 91
- USB port 26
- USB/USB <x> 117
- Utilities menu 105

V

- Verify print jobs 58
 - printing for Macintosh users 59
 - printing for Windows users 59
- viewing
 - reports 133
- virtual display
 - how to access 133

W

- Waiting, too many events ... DO NOT POWER OFF 118
- Web site
 - finding 11
- wired network setup
 - using Windows 27
- wired networking
 - using Macintosh 27

X

- XPS driver
 - installing 52
- XPS menu 105