

# Medical treatment of gastroesophageal reflux disease: Options and priorities

ABR THOMSON, MD, PHD, FRCPC, FACP, FACG, FRS

**ABR THOMSON. Medical treatment of gastroesophageal reflux disease: Options and priorities. Can J Gastroenterol 1993;7(4):364-379.** Gastroesophageal reflux disease (GERD) represents a spectrum of symptoms and of reflux damage to the esophagus. This reflux damage is due to prolonged acid exposure of the esophagus arising from an imbalance between protective motility factors and aggressive acid secretory factors. Initially, patients may be managed by modifying food intake and by supportive antigravity measures. However, many individuals will require drug therapy. Symptomatic relief can be achieved with prokinetic agents, antacids, sucralfate suspension, H<sub>2</sub>-receptor antagonists and H<sup>+</sup>,K<sup>+</sup>-ATPase pump blockers. There are limitations in the study design of experiments which have compared one agent with another. Accepting these design restrictions, it would appear that pump blockers lead to higher rates of endoscopic healing than the use of standard doses of H<sub>2</sub>-receptor antagonists. However, higher doses of H<sub>2</sub>-receptor antagonists will likely give higher rates of symptomatic relief and endoscopic healing of GERD. Recurrence of symptoms and esophagitis occur in a high proportion of patients with GERD, and some patients may need to be considered for maintenance therapy.

**Key Words:** Gastroesophageal reflux disease (GERD), Recurrence, Symptoms

## Traitement médical du reflux gastro-oesophagien: Options et priorités

**RÉSUMÉ:** Le reflux gastro-oesophagien se manifeste par un vaste éventail de symptômes et de lésions au niveau de l'oesophage. Les lésions attribuables au contenu gastrique régurgité résultent d'une exposition prolongée de l'oesophage

Division of Gastroenterology, Nutrition and Metabolism Research Group, Department of Medicine, University of Alberta, Edmonton, Alberta

Correspondence and reprints: Dr ABR Thomson, 519 Robert Newton Research Building, University of Alberta, Edmonton, Alberta T6G 2C2. Telephone (403) 492-6490/6284, Fax (403) 492-7964

CURRENT ADVERTISEMENTS IN THE medical literature for products to treat gastroesophageal reflux disease (GERD) highlight the severity of symptoms and the dynamic aspect of the 'fire in the esophagus' which leads to heart-burn (pyrosis). Of course, the most common cause of esophagitis is the presence of gastric acid in this tubular organ, but esophagitis has also been described in association with the presence of gastroesophageal reflux of bile and trypsin, radiation therapy, lye ingestion, lodging of pills in the esophagus or infections such as *Candida albicans* and herpes (Table 1).

Acid-induced esophagitis results from the reflux of gastric acid into the esophagus. Whether esophagitis develops depends upon the duration of acid exposure and the concentration of the acidic refluxed material; this exposure results from abnormal lower esophageal sphincter relaxation, impaired clearance of refluxed acid and a vaguely defined, but useful term, esophageal 'mucosal defence'. The acid exposure of the esophagus also is influenced by the intragastric pH (and therefore intraesophageal pH) as well as by the volume of acid in the stomach

à l'acide et à un déséquilibre entre les facteurs de motilité protecteurs et les facteurs nocifs des sécrétions acides. Initialement, les patients peuvent être traités par une modification de leur alimentation et par des mesures d'appoint anti-gravité. Cependant, plusieurs individus requerront un traitement médicamenteux. Le soulagement des symptômes peut être obtenu par des agents prokinétiques, des antiacides, des suspensions de sucralfate, des anti-H<sub>2</sub> et des inhibiteurs de la pompe à protons. Il y a des limites au niveau de la conception de l'étude portant sur des essais qui comparaient les agents entre eux. Si l'on accepte ces restrictions au niveau du modèle, il semble que les inhibiteurs de la pompe à protons amènent des taux de cicatrisation plus élevés, endoscopie à l'appui, que les doses standard d'anti-H<sub>2</sub>. Cependant, des doses plus fortes d'anti-H<sub>2</sub> sont susceptibles de générer des taux plus élevés de soulagement des symptômes et de cicatrisation, endoscopie à l'appui. La récurrence des symptômes et de l'oesophagite elle-même se produit chez une forte proportion de patients atteints de reflux gastro-oesophagien et certains d'entre eux seront des candidats au traitement d'entretien.

which, in turn, is influenced by the gastric emptying rate, and by the gastric basal and stimulated acid outputs.

Ambulatory esophageal pH monitoring has proven to be useful to study the pathogenesis and management of patients with GERD and has demonstrated, for example, the importance of daytime as well as nighttime reflux (1-6) and the aggravating effect of smoking on gastroesophageal reflux (7). The most commonly used parameters are the reflux index (percentage of the investigation time with a pH less than 4), number of episodes with a pH less than 4, number of episodes with a pH less than 4 lasting longer than 5 mins, duration of the longest episode with a pH less than 4 and the area in which the pH is less than 4 (8). Both esophageal pH and manometry can be combined (9,10), and measurements of intragastric and intraesophageal pH may be made concurrently (11), to be used to predict the therapeutic efficacy of a treatment intervention.

### PATHOGENESIS

For at least a decade it has been useful conceptually to approach the pathogenesis of peptic ulcer disease as an imbalance between aggressive and defensive factors. This is also a useful concept in considering the pathogenesis of GERD (Table 2). The reduced basal lower esophageal sphincter pressure and the increased transient lower esophageal sphincter relaxation presumably are due to defective neural control

of the smooth muscle relaxation. Clinically these motility abnormalities may readily be documented, but the molecular basis for the defective neuromuscular coordination is unknown. On the aggressive side, the pathogenesis of GERD appears to be related to the simple concept of too much acid in the wrong place. Thus, the number and duration of reflux episodes increase due to excessive lower esophageal sphincter relaxation, acid exposure time in the esophagus rises because of impaired clearance of acid and epithelial damage occurs because of defective mucosal defence. There may also be abnormalities in gastric acid secretion in some patients with GERD.

Mild, infrequent gastroesophageal reflux is a normal phenomenon – it occurs in individuals who do not complain of heartburn and who do not have esophagitis. Different criteria have been established for differentiating normal from abnormal gastroesophageal reflux, and threshold intraesophageal pHs of 4 or 5 have been designated as being associated with GERD. Abnormal

**TABLE 1**  
**Causes of esophagitis**

- Acid
- Bile/trypsin
- Radiation
- Lye
- Pills
- Infection

**TABLE 2**  
**Concepts in the pathogenesis of GERD**

Imbalance
<b>Defensive motility</b>
Lower esophageal sphincter relaxation
Clearance
Mucosal defence
<b>Aggressive secretion</b>
Intragastric/esophageal pH
Volume: Gastric emptying Secretory drive

reflux is denoted to occur if a reflux episode is associated with a pH less than 4 or a drop of interesophageal pH by 1. Similarly, interesophageal pH can be monitored over a 24 h interval. When more than 7% of interesophageal pH values are less than 4, the gastroesophageal reflux is denoted abnormal.

What is the relative contribution of the aggressive and defensive factors? Reduced lower esophageal sphincter pressure is common in patients with GERD; for example, when Klinkenberg-Knol and Meeuwissen (11) performed combined esophageal and intragastric pH monitoring, and esophageal manometry in 19 patients with 'resistant' GERD, 18 of 19 had reduced lower esophageal sphincter pressure and 12 of 19 had reduced clearance of refluxed acid.

**TABLE 3**  
**Prevalence of gastric hypersecretion and defective lower esophageal sphincter in GERD**

	Normal secretion	Hypersecretion	Total
Normal sphincter	11	10	21 (28%)
Defective sphincter	43	11	54 (72%)
Total	54 of 75 (72%)	21 of 75 (28%)	75 of 75 (100%)

Reproduced with permission from Barlow et al. Arch Surg 1989;124:937-40

**TABLE 4**  
Lifestyle considerations: Nondrug therapy in GERD

- Eating small, nonfatty meals
- Avoiding smoking
- Avoiding excess use of caffeine, chocolate, alcohol and acidic or spicy foods
- Discerning the cause of direct pain
- Remaining upright after meals
- Avoiding straining or tight-fitting garments
- Maintaining ideal weight
- Elevating head of bed

**TABLE 5**  
Medications which can lead to damage of the esophageal mucosa

- Progesterone
- Theophylline
- Prostaglandin E<sub>1</sub>
- Prostaglandin E<sub>2</sub>
- Prostaglandin A<sub>2</sub>
- Anticholinergics
- Beta-agonists
- Alpha-antagonists
- Dopamine
- Diazepam
- Opiates
- Calcium channel blockers

While it is accepted that acid in the esophagus is important for the development and perpetuation of esophagitis, it is less well-recognized that in some patients there may be a primary gastric defect leading to hypersecretion of hydrochloric acid.

Johansson and colleagues (12) reported gastric hypersecretion in 66% of 100 patients referred to a surgical clinic with symptoms suggestive of GERD. Barlow et al (13) performed pentagastrin-stimulated gastric secretory studies in 75 patients with abnormal esophageal exposure to gastric juice (proven by 24 h esophageal pH monitoring). Only those patients who had a basal acid output greater than 5.0 mmol/h and a maximal acid output greater than 30 mmol/h were defined as 'hypersecretors'. Using this definition, 40% of GERD patients had an elevated basal acid output and 49% had an elevated maximum acid output, with 28% having both increased. In that study, a mechanically defective sphincter was defined as one with a lower esophageal sphincter pressure of 6 mmHg or less, an overall length of less than 2.0 cm or an abdominal length of less than 1.0 cm. Such a defect was present in 54 of the 75 patients (72%) (Table 3). Patients with a mechanically normal sphincter had a greater prevalence of gastric hypersecretion than those with

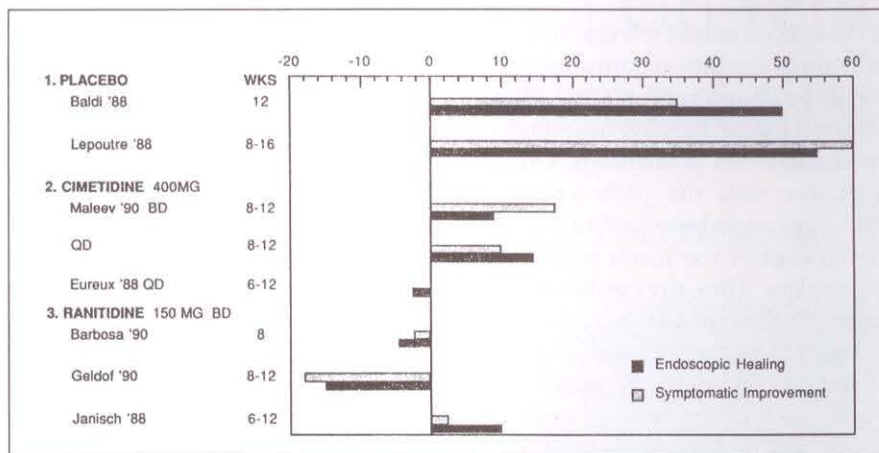

**Figure 1)** Therapeutic gain for treatment of moderately severe reflux esophagitis: cisapride 10 mg qid versus placebo, cimetidine or ranitidine. (Adapted with permission from Tytgat et al. Scand J Gastroenterol 1990;25[Suppl175]:1-12)

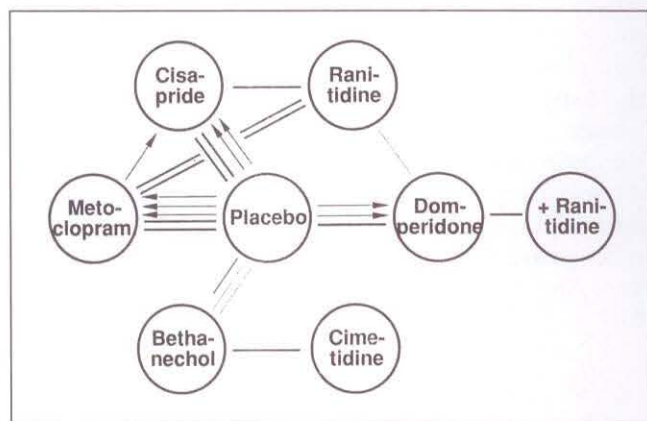

**Figure 2)** Results of randomized clinical trials showing efficacy of prokinetic drugs (metoclopramide, domperidone, bethanechol and cisapride) compared with other drugs and placebo in the management of reflux symptoms. Each connecting line (no significant difference in outcome) or arrow (significant difference in outcome pointing to the superior treatment) represents an individual study. (Adapted with permission from Koelz. Scand J Gastroenterol 1989;24[Suppl 156]:25-36)

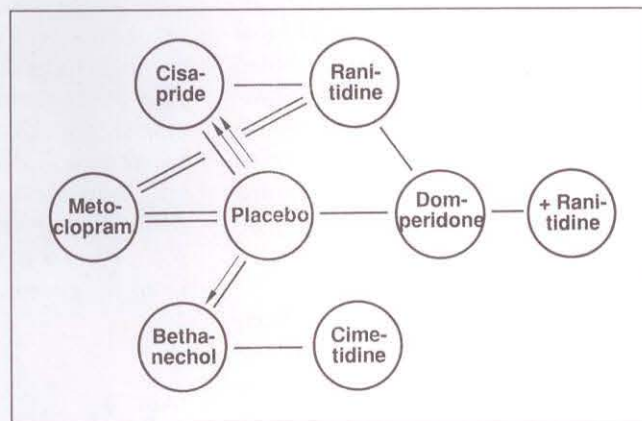

**Figure 3)** Results of randomized clinical trials efficacy of prokinetic drugs (metoclopramide, domperidone, bethanechol and cisapride) compared with other drugs and placebo in the healing of esophagitis. Each connecting line (no significant difference in outcome) or arrow (significant difference in outcome pointing to the superior treatment) represents an individual study. (Adapted with permission from Koelz. Scand J Gastroenterol 1989;24[Suppl 156]:25-36)

a defective sphincter (48 versus 20%, respectively,  $P < 0.05$ ). Some patients had defects in both aggressive and defensive factors. In GERD patients with a normal lower esophageal sphincter pressure, 10 had gastric acid hypersecretion and 11 had normal secretion. In those with reduced low esophageal sphincter pressure, more had normal (versus increased) gastric acid secretion (about one patient in four). Thus, the role of gastric acid hypersecretion is important in all patients with GERD, but is perhaps even more important in those with a normal low esophageal sphincter pressure.

Collen et al (14) examined 23 patients with GERD, 11 of whom were 'responders' (ie, were asymptomatic after ranitidine 150 mg bid for three months); the remaining 12 remained symptomatic and were termed 'non-responders'. Basal acid output and volume, and basal reflux time were greater in the nonresponders compared with responders. Interestingly, Barrett's epithelium was present in 10 of 12 nonresponders compared with only one of 11 responders – nine nonresponders had a basal acid output greater than 10 mEq/h and gastric acid output had to be reduced below 1 mEq/h for symptoms of pyrosis to disappear. Thus, it would appear that both the defensive and aggressive portions of the imbalance equation are important in patients with GERD.

## THERAPY

**Principles and limitations:** Simplistically, the therapeutic approach to the patient with GERD would be to reduce the aggressive and increase the defensive factors by reducing gastric acid secretion and enhancing esophageal and gastric motility. There is a long menu – in fact a seven-course meal! – of therapeutic agents which may be used to treat patients with GERD. However, before considering these different therapeutic agents, as well as other lifestyle measures which may be effective in many patients, one must review a basic concept.

There are a number of tests of gastroesophageal reflux as well as ways to establish the presence of reflux damage.

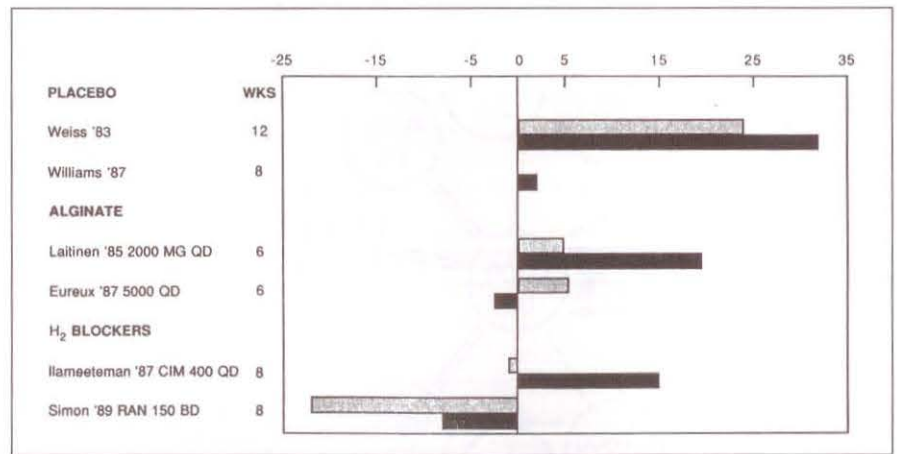

Figure 4) Therapeutic gain for treatment of moderately severe reflux esophagitis: sucralfate 1 g qid. (Adapted with permission from Tytgat et al. Scand J Gastroenterol 1990;25[Suppl 175]:1-12)

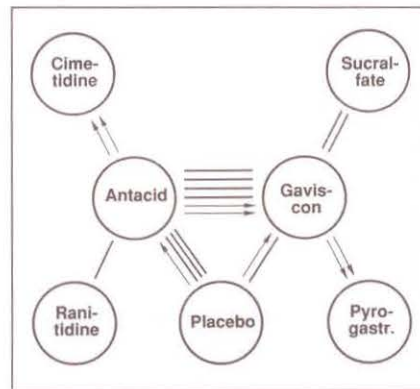

Figure 5) Results of randomized trials showing efficacy of antacids and alginate/antacid compared with other drugs and placebo in the management of reflux symptoms. Each connecting line (no significant difference in outcome) or arrow (significant difference in outcome pointing to the superior treatment) represents an individual study. (Adapted with permission from Koelz. Scand J Gastroenterol 1989;24[Suppl 156]: 25-36)

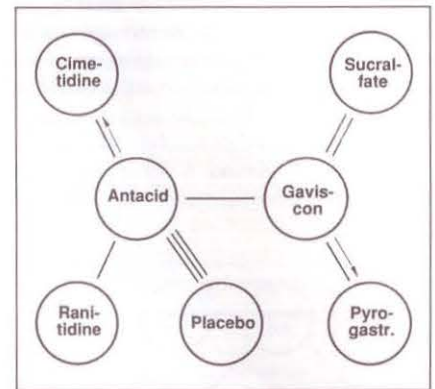

Figure 6) Results of randomized trials showing efficacy of antacids and alginate/antacid compared with other drugs and placebo in the healing of esophagitis. Each connecting line (no significant difference in outcome) or arrow (significant difference in outcome pointing to the superior treatment) represents an individual study. (Adapted with permission from Koelz. Scand J Gastroenterol 1989;24[Suppl 156]: 25-36)

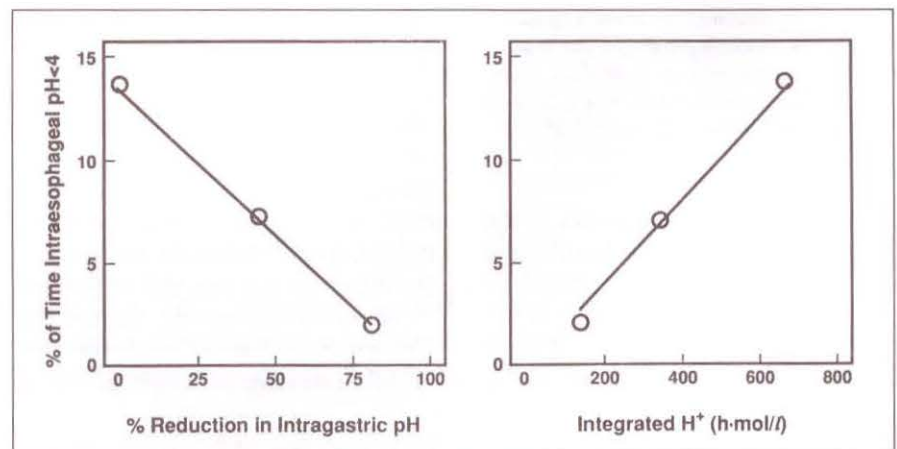
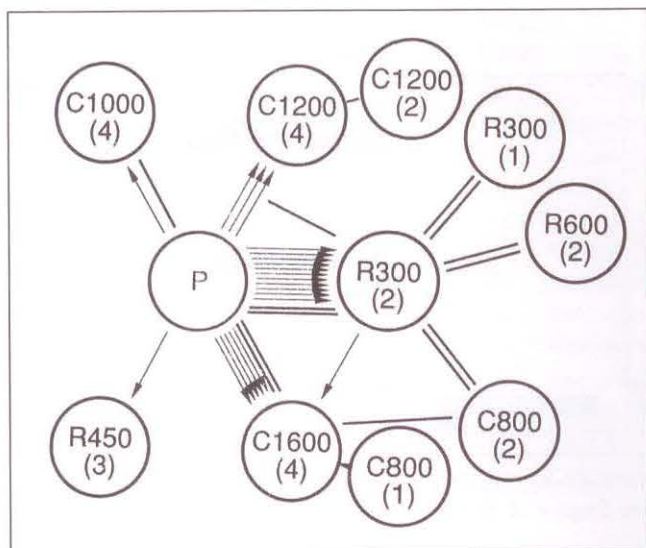
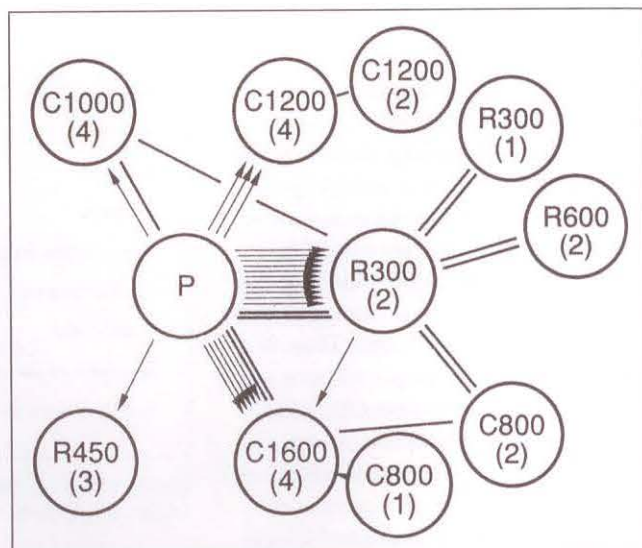

Figure 7) Effect of changes in gastric acidity on esophageal acid exposure. (Adapted with permission from Burget et al. Gastroenterology 1990;99:345-51)



**Figure 8)** Results of randomized trials depicting efficacy of histamine H<sub>2</sub>-receptor antagonists in the management of reflux symptoms. Each connecting line (no significant difference in outcome) or arrow (significant difference in outcome pointing to the superior treatment) represents an individual study. Total daily amount (in mg) of the drugs is given adjacent to the drug symbols and the number of daily doses is indicated in parentheses. C Cimetidine; P Placebo; R Ranitidine. (Adapted with permission from Koelz. Scand J Gastroenterol 1989; 24[Suppl 156]:25-36)



**Figure 9)** Efficacy of histamine H<sub>2</sub>-receptor antagonists in the healing of esophagitis. Results of randomized clinical trials are shown. Each connecting line (no significant difference in outcome) or arrow (significant difference in outcome pointing to the superior treatment) represents an individual study. (Adapted with permission from Koelz. Scand J Gastroenterol 1989; 24[Suppl 156]:25-36)

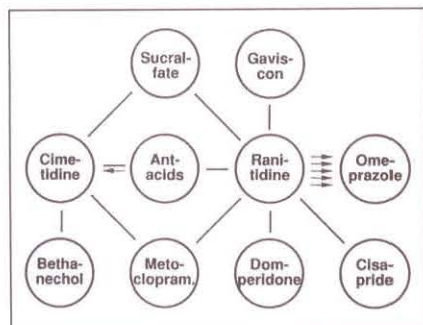

**Figure 10)** Results of randomized clinical trials depicting efficacy of histamine H<sub>2</sub>-receptor antagonists versus other drugs in the healing of reflux esophagitis. Results of randomized clinical trials. Each connecting line (no significant difference in outcome) or arrow (significant difference in outcome pointing to the superior treatment) represents an individual study. (Adapted with permission from Koelz. Scand J Gastroenterol 1989; 24[Suppl 156]:25-36)

but severity of heartburn does not correlate with severity of the reflux, nor does the severity of heartburn correlate with the degree of reflux damage. Therapy, then, should focus not only on treatment of the patient's symptoms, but also (and importantly) on treatment of the esophagitis. Without endoscopy one cannot judge the degree of esophageal damage.

Tytgat and colleagues (15) have made an urgent plea for uniformity in the staging of reflux esophagitis. This is such a simple yet fundamental concept that in order to achieve an appropriate comparison of the literature regarding therapeutic efficacy of different drugs, one needs to know whether treatment is for a patient with symptoms but no esophageal damage, versus with symptoms and mild, moderate or severe esophagitis. Indeed, from the current literature it is difficult to achieve this important objective of comparing therapeutic efficacy on the basis of similar degrees of reflux damage or esophageal acid exposure. A classification scheme has been proposed with staging, varying from normal (Stage 0) to a mild erythema and friability (Stage 1) to small

superficial erosions covering only a small portion of the distal mucosal surface (Stage II) to confluent erosions and exudate covering less than one-half of the distal mucosal surface (Stage III) to circumferential erosions with exudative lesions or deep ulceration and stricturing (Stage IV). Only when a definition system such as this has been adopted widely will it be possible to compare one therapeutic agent intelligently with another.

**LIFESTYLE CONSIDERATIONS**

Accepting these limitations, one must first consider lifestyle changes which may be useful as nondrug therapy in GERD. This involves consideration of food, gravity and the avoidance of certain drugs which may aggravate gastroesophageal reflux. The patient may be helped symptomatically by taking small, nonfatty meals, avoiding smoking and excess use of caffeine and alcohol, and working on a food-by-food basis to determine whether foods or beverages have any adverse effect on the patient's symptoms (Table 4). Patients will have less regurgitation and heartburn if they remain upright for at least 1 h after meals, avoid straining or

wearing tight-fitting garments, focus their attention away from their esophagus and towards their waistline (achieve their ideal body weight) and elevate the head of their bed to reduce the frequency of reflux episodes occurring at night. There is great individual variation in just how much effect these measures will have on the patient's pain or on the healing of esophagitis. Nonetheless, these measures are simple, safe and economical, and should be followed as initial therapy in all patients with GERD.

### MEDICATIONS

There is a long list of medications which may weaken the esophageal smooth muscle of the lower esophageal sphincter and overcome the normal defence factors against reflux (Table 5). It may not be possible for the patient to avoid these medications, and substituting other classes of drugs may not be appropriate. Some patients will not respond sufficiently well or quickly to these lifestyle changes and may require drug therapy for GERD. The three general classes of medication used in the drug therapy of GERD include prokinetic agents, mucosal coating compounds and antisecretory drugs ( $H_2$ -receptor blockers or pump blockers).

**Promotility agents:** The prokinetic agents have been reviewed recently (16). There is a growing list of indications for the use of prokinetic agents for patients with gastrointestinal disorders, including GERD, gastroparesis, post operative ileus, pseudo-obstruction and constipation. There are three groups of prokinetic agents: bethanechol (which has a direct cholinergic effect), metoclopramide and domperidone (which are antidopaminergic in action) and cisapride (which releases acetylcholine from the myenteric plexus and selectively stimulates the post ganglionic neurons of the myenteric plexus). Cisapride increases lower esophageal sphincter pressure, reduces gastroesophageal reflux and promotes gastric emptying (17-21). All these prokinetic agents will increase the lower esophageal sphincter pressure; cisapride also will effectively increase esophageal clearance of acid and accelerate gastric

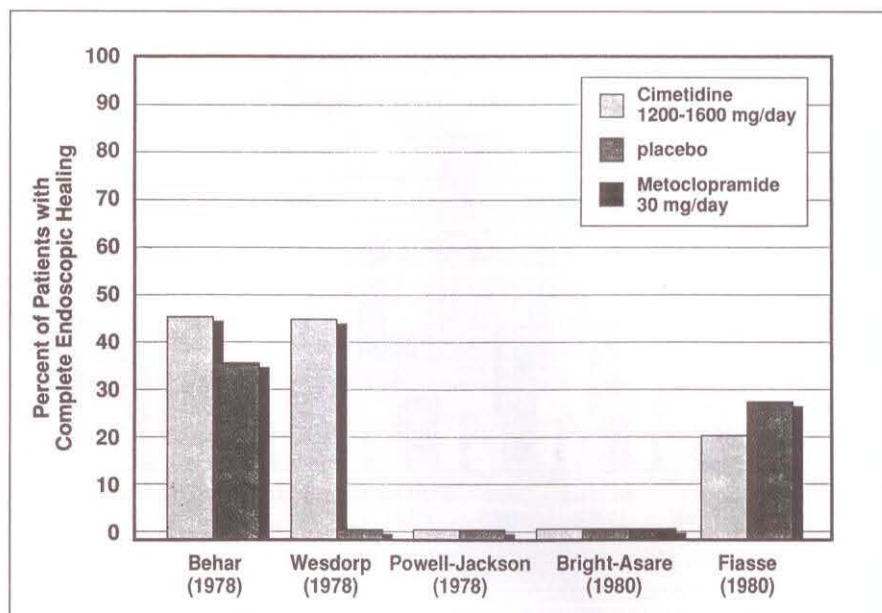

Figure 11) Reflux esophagitis healing rates with cimetidine at eight weeks. (Reprinted with permission from Sontag. *Gastroenterol Clin North Am* 1990;19:683-712)

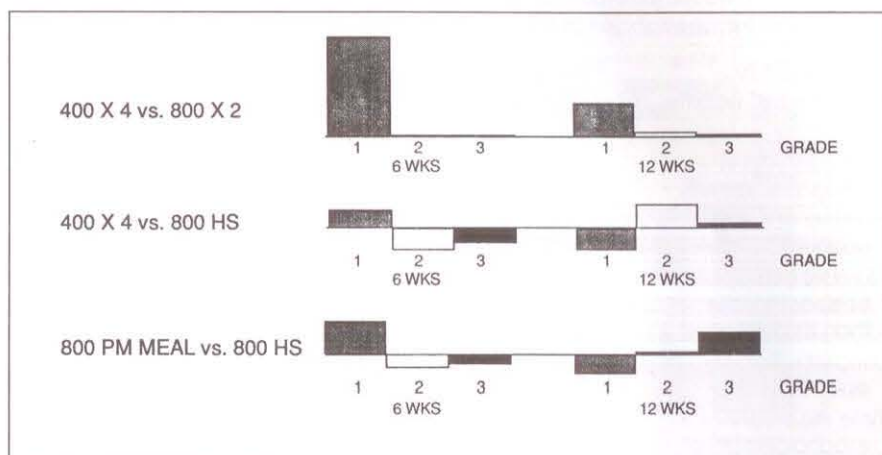

Figure 12) Therapeutic gain in endoscopic healing of grades 1 to 3 reflux esophagitis using different regimens of cimetidine. (Adapted with permission from Tytgat et al. *Scand J Gastroenterol* 1990;25[Suppl 175]:1-12)

emptying without any adverse effect on gastric acid secretion.

How effective are the promotility agents in treating patients with GERD? Cisapride 10 mg qid before meals and at bedtime is superior to placebo and is as effective as ranitidine 150 mg bid or cimetidine 400 mg qid (Figure 1) in controlling reflux symptoms and in promoting the healing of reflux esophagitis (Figures 2,3) (22,23). Cisapride may be useful as combination therapy with cimetidine or ranitidine, and may provide effective maintenance therapy against recurrent GERD.

Is there a superior promotility agent? There is no clear answer to this question because no direct clinical comparison of cisapride against domperidone or metoclopramide exists. However, cisapride has an effective role in acid clearance, while such a role is less clear for domperidone or metoclopramide, so cisapride may prove to be the promotility agent of choice.

**Antacids and suspensions of sulcrate:** Mucosal-coating drugs, such as antacid, alginic acid or sucralfate (a suspension of aluminum hydroxide and a salt of sucrose octasulphate), are effective for

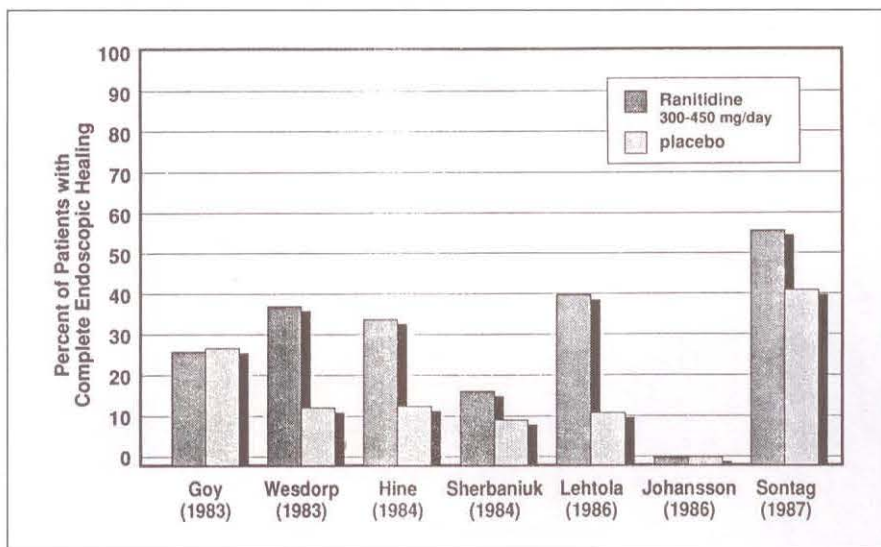

Figure 13) Reflux esophagitis healing rates with ranitidine at six to eight weeks. (Reprinted with permission from Sontag. *Gastroenterol Clin North Am* 1990;19:683-712)

TABLE 6  
Effects of ranitidine 300 mg/day, 150 mg bid and placebo on intragastric acidity and intraesophageal pH

Variable (24 h)	Placebo	Ranitidine (150 mg bid)	Ranitidine (300 mg qid)
Integrated H <sup>+</sup> activity (h·mol/L)	674 (520 to 873)	349* (270 to 453)	132* <sup>†</sup> (100 to 174)
Reduction (%) in intragastric activity	—	48.1 (25.2 to 64.0)	80.4 (71.3 to 86.6)
Number of reflux episodes	122 (82 to 182)	81 (54 to 121)	30* <sup>†</sup> (19 to 47)
Number of reflux episodes longer than 5 mins	8.6 (6.4 to 11.5)	4.4* (3.2 to 6.1)	1.9* <sup>†</sup> (1.2 to 3.1)
Longest reflux episode (mins)	28.6 (18.0 to 45.4)	15.4 (9.7 to 24.4)	9.3* (5.5 to 15.8)
Time (%) intraesophageal pH <4	13.9 (9.7 to 20.0)	7.6 (5.3 to 10.9)	2.0* <sup>†</sup> (1.3 to 3.0)

\*P<0.01 compared with placebo; <sup>†</sup>P<0.01 compared with ranitidine 150 mg bid. (Reproduced with permission from Barlow et al. *Arch Surg* 1989;124:937-40)

treating patient symptoms and for healing associated esophagitis (Figures 4-6). If the patient's symptoms persist despite use of antacids, they should consult their physician; the patient and physician may then choose to use promotility or antisecretory agents.

**Antisecretory agents:** There is a correlation between the daily ranitidine dose required to eliminate symptoms of pyrosis and the pretreatment basal acid output (14). Is there a degree of gastric acid inhibition that will reduce intraesophageal pH sufficiently to allow healing of esophagitis achieved by therapy to be predicted? Such a relationship

has been described for patients with duodenal ulcers (24). What, then, is the relationship between intragastric and intraesophageal pHs, and between intraesophageal pH and healing of GERD? Seventeen patients with moderate to severe esophagitis had three pH-metric studies in a cross-over design before and after eight days of treatment with omeprazole 20 mg od or ranitidine 300 mg bid (25). Intragastric acidity fell from 84.0 mmol/L in the basal study to 14.2 mmol/L (79% inhibition) with ranitidine and 9.3 mmol/L (84% inhibition) with omeprazole. In addition, median hourly 24 h intragastric pH was 1.8 in

the basal study, 2.9 after ranitidine and 3.4 after omeprazole. What is new and important in this study is the observation that the time with esophageal pH less than 4 dropped significantly from 23.9% in the basal study to 8.5% with ranitidine and to 7.2% with omeprazole. Both drugs reduced esophageal exposure to acid in both the supine and upright positions, but neither had any effect on esophageal acid clearance. Using the data of Barlow et al (26), it is possible to show a linear relationship between the percentage reduction in intragastric pH and the percentage of time over 24 h when the intraesophageal pH was less than 4 (Figure 7, left panel). Similarly, as the integrated hydrogen ion activity (h·mol/L) was increased, there was also an increase in the percentage of time the intraesophageal pH exceeded 4 (Figure 7, right panel). Thus, the reduction in intragastric pH is associated with, as expected, a decline in intraesophageal pH. However, how much reduction in hydrogen ion concentration in the esophagus (or stomach) is necessary to achieve acute healing or to provide effective maintenance of healing is unknown.

There are two broad classes of anti-secretory agents: the H<sub>2</sub>-receptor antagonists and H<sup>+</sup>K<sup>+</sup>-ATPase inhibitors (the 'pump blockers'). There are a number of H<sub>2</sub>-receptor antagonists, including cimetidine, ranitidine, famotidine and nizatidine, available for use in countries worldwide. The H<sub>2</sub>-receptor antagonists do not have an effect on the lower esophageal sphincter pressure and do not modify esophageal acid clearance (27), but may reduce the number of reflux episodes, resulting in fewer and shorter reflux episodes. Accepting the limitations of the lack of stratification for the severity of esophagitis in most clinical trials addressing the use of H<sub>2</sub>-blockers in GERD, there is an apparent general consensus that these drugs are useful in short term use and in 'conventional' doses (ie, those doses usually used to treat patients with duodenal ulcer disease) for the treatment of mild to moderately severe esophagitis. There is generally good symptom relief, although usually less than one-half of patients will

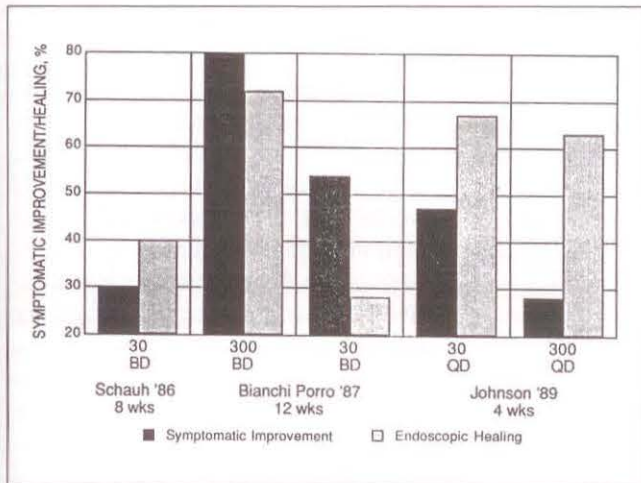

Figure 14) Ranitidine 150 mg bid versus 300 mg bid or qid in treatment of symptoms of reflux esophagitis. (Adapted with permission from Tytgat et al. Scand J Gastroenterol 1990;24[Suppl 175]:1-12)

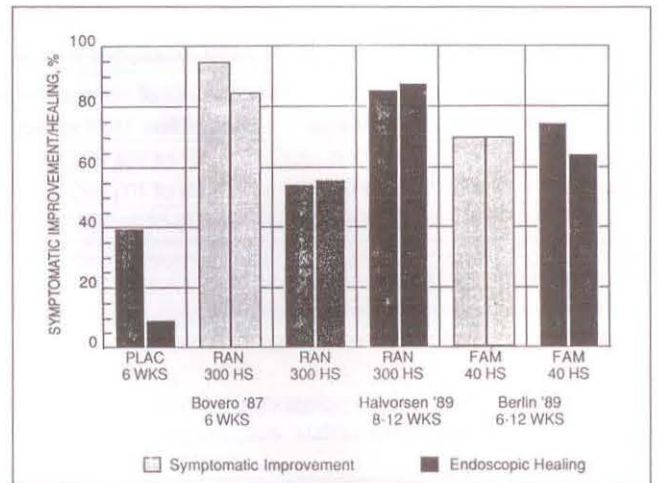

Figure 15) Reflux esophagitis: H<sub>2</sub>-receptor antagonists and symptomatic improvement. (Adapted with permission from Tytgat et al. Scand J Gastroenterol 1990;25[Suppl 175]:1-12)

achieve endoscopic healing with the H<sub>2</sub>-receptor antagonists (Figures 8-10). Because these agents are used so widely to treat patients with GERD, one should consider their individual performance.

**Cimetidine:** Three of 10 studies of the effect of cimetidine 1000 to 1600 mg/day for six to 26 weeks have shown statistically significant improvement in the endoscopic grade of esophagitis compared with placebo (28-37), but the endoscopic healing rates are variable and generally low (Figure 11). Doses of 800 to 1600 mg daily are comparable in terms of achieving healing (38). Various dosing regimens are approximately comparable (Figure 12); for example, 600 mg bid and 300 mg qid are comparable (39).

**Nizatidine:** Nizatidine 300 mg at night is not useful to treat patients with GERD, yet 150 mg bid is superior to placebo in reducing esophagitis (40). At a high dose of 300 mg bid, 12-week healing rates were 50% compared with 34% with placebo (41); a further study has confirmed the superiority of nizatidine given twice (rather than once) a day (42).

**Ranitidine:** Ranitidine reduces esophageal acid contact time, reflux episode, frequency and heartburn frequency and severity in patients with GERD (43). Compared with placebo, ranitidine 300 to 450 mg/day for six to eight weeks was associated with significant endoscopic healing in six of nine studies (44-52), but endoscopic healing was usually

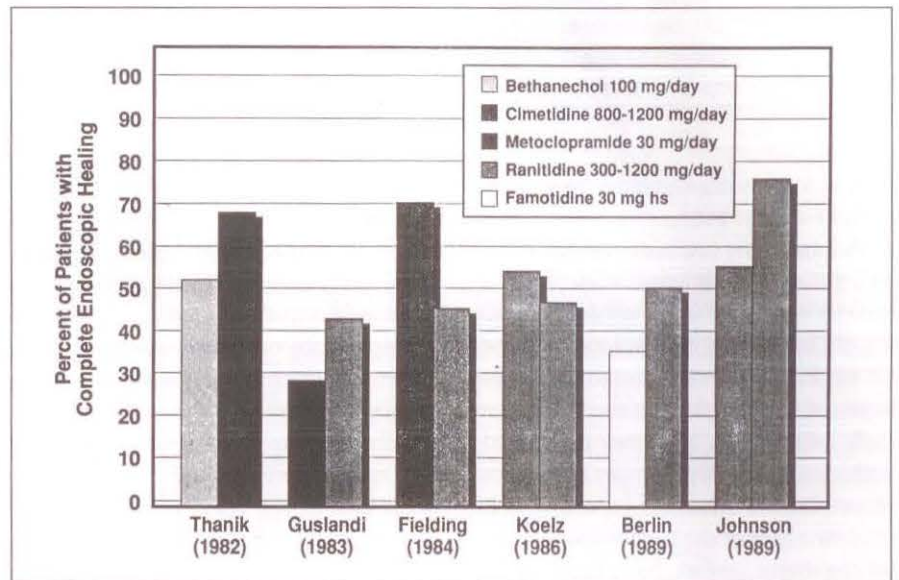

Figure 16) Reflux esophagitis healing rates with H<sub>2</sub>-receptor antagonists and prokinetics used for six to eight weeks. (Reprinted with permission from Sontag. Gastroenterol Clin North Am 1990;19:683-712)

achieved in less than one-half of patients (Figure 13).

Will higher doses of ranitidine prove to be more useful in patients with GERD, compared with 'standard' doses used to treat patients with peptic ulcer disease? Barlow et al (26) performed simultaneous 24 h monitoring of intragastric and intraesophageal pH in 12 patients with endoscopically proven erosive reflux esophagitis. With increasing doses of ranitidine from 150 mg bid to 300 mg qid, the integrated hydrogen ion activity (h<sup>+</sup>mol/L) fell, with a reduction of intragastric pH of

48.1 and 80.4%, respectively (Table 6). Higher doses are not always more effective than the standard dose of ranitidine 150 mg bid (Figure 14), but higher doses given at bedtime may give higher rates of symptomatic improvement and endoscopic healing (Figures 15 and 16). Two studies have shown that ranitidine 300 mg at bedtime is as good as 150 mg bid (53,54), and while increasing the dose to 300 mg bid was without benefit (55), increasing the dose from 150 mg bid to 300 mg qid did significantly improve the healing of moderately severe esophagitis (from 29 to



**TABLE 7**  
**Effects of ranitidine 150 and 300 mg qid, and placebo on erosive esophagitis**

Number of weeks before healing	Number (%) of patients healed by:		
	Placebo	Ranitidine 150 mg qid	Ranitidine 300 mg qid
Three	21 of 103 (20)	47 of 104 (45)*	50 of 109 (46)*
Seven	30 of 92 (33)	68 of 100 (68)*	73 of 105 (70)*
11	46 of 80 (58)	78 of 94 (83)*	83 of 102 (81)*

\* $P < 0.01$  versus placebo. (Reproduced with permission from Euler et al. *Gastroenterology* 1991;100:A161)

**TABLE 8**  
**Healing of esophagitis at endoscopy with famotidine 20 mg bid versus 40 mg bid in erosive/ulcerative reflux esophagitis; presented as number healed/number assessed**

Grade	Week 6		Week 12		Week 24	
	20 mg	40 mg	20 mg	40 mg	20 mg†	40 mg
I	43 of 76	57 of 80	59 of 73†	68 of 78†	63 of 73	69 of 78
II	41 of 94	56 of 92*	68 of 91†	68 of 92	73 of 91	74 of 92
III	10 of 39	15 of 38	14 of 37	25 of 37*†	21 of 37	28 of 37
IV	0 of 11	2 of 13	0 of 9	6 of 13†	1 of 9	8 of 13*
All	94 of 220	130 of 223*	142 of 210†	167 of 220†	158 of 210	179 of 220

\* $P < 0.05$  versus 20 mg; † $P < 0.05$  versus week 6; ‡40 mg bid from weeks 12 to 24. (Reproduced with permission from Festen et al. *Gastroenterology* 1991;100:A63)

63% at four weeks and from 54 to 75% at eight weeks) (56).

A large study has been conducted in 342 patients with erosive esophagitis treated with placebo or ranitidine 150 mg qid or 300 mg qid for four, eight or 12 weeks (57). Both ranitidine groups were superior to placebo and similar to each other. Healing rates progressed with time (Table 7); because the grades of esophagitis were not reported, it is unclear whether the higher dose of ranitidine might, in fact, have been superior if just grade III/IV patients had been examined, as was the case in the study

by Festen and colleagues (58). Thus, 12-week healing rates with higher doses of ranitidine are good, but the total daily dose may not need to be increased beyond 600 mg.

How does ranitidine compare with other agents used for the treatment of GERD? After eight weeks of therapy in a small number of patients, ranitidine 150 mg bid and cimetidine 400 mg bid were equivalent (59), with ranitidine 150 mg bid superior to metoclopramide 10 mg tid (60) but equivalent to cisapride 10 mg qid (22).

**Famotidine:** Famotidine 40 mg at night

heals 82% of patients with mild esophagitis (61). Famotidine 40 mg bid heals 48% of patients with moderate to severe esophagitis at six weeks compared with 18% with placebo (healing rates increasing to 69 and 29% at 12 weeks) (62). Twelve-week healing rates with famotidine 20 mg bid were 54%. Famotidine 40 mg at bedtime is effective in the symptomatic and endoscopic improvement of patients with GERD (Figure 15). Furthermore, two recent large multicentre studies (62,63) in patients with active erosive esophagitis showed that famotidine 20 mg bid and 40 mg bid are clinically effective in promoting healing of esophageal erosion or ulceration and relieving symptoms. In a large American study (64) comparing famotidine 20 mg bid with 40 mg at bedtime, both doses of famotidine were superior to placebo, and twice-daily dosing was superior for total relief of daytime heartburn. Festen et al (58) studied famotidine 20 mg bid and 40 mg bid at six, 12 and 24 weeks in 474 patients with grades I to IV esophagitis. Famotidine 40 mg bid was more effective and achieved faster healing than did 20 mg bid (Table 8), with the difference between the low and high dose being more marked with the increasingly severe degree of esophagitis. In addition, 12-week treatment was more effective than six-week, but extending treatment to 24 weeks had no significant additional effect. Thus, famotidine 40 mg bid for 12 weeks represents effective therapy for GERD.

What are the comparative healing

**TABLE 9**  
**24 h reflux variables before and after treatment with famotidine or ranitidine**

	Patients with GERD			
	Basal	Famotidine	Ranitidine	Control
Total time pH < 4	228 (55 to 388)*	72.3 (6 to 138)**	84.6 (12 to 181)**	44.5 (4 to 66)
Percentage of time pH < 4				
Total	17.6 (4 to 40)*	5.7 (1.3 to 10.2)**	8.2 (0.9 to 15.8)**	3.4 (0.5 to 4.9)
Upright	18.7 (3.5 to 38)*	8.5 (1 to 17.2)**	12.5 (1.5 to 21.1)*	2.8 (1.05 to 6.65)
Supine	17.2 (1.2 to 39)*	2.1 (0.5 to 4.7)**	3.5 (1 to 6.3)**	2.2 (0 to 5.3)
Number of reflux episodes > 5 mins	6 (0 to 9)	3 (0 to 6)	6 (0 to 11)	0 (0 to 2)
Number of reflux episodes	63.5 (40 to 142)	59.1 (10 to 108)	67 (15 to 146)	35.5 (11 to 96)
Longest reflux episode (mins)	55 (5 to 58.5)	15 (1 to 34)	39 (4 to 48)	2 (1 to 13)
Clearance times (mins)	1.3 (0.68 to 3.22)	1.4 (0.3 to 4.2)	1.2 (0.4 to 3.9)	1.26 (0.4 to 3)

\* $P < 0.01$  versus control; \*\* $P < 0.01$  versus basal. (Reproduced with permission from Florucci et al. *Scand J Gastroenterol* 1989;24:671-7)

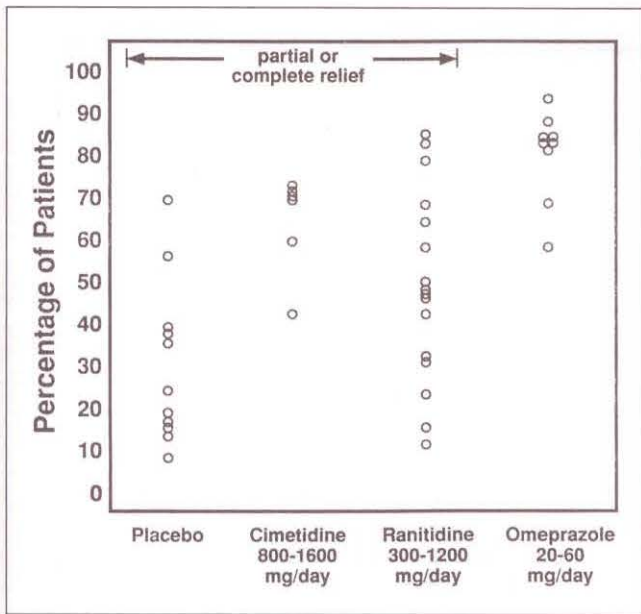

Figure 17) Reflux symptoms at six to eight weeks in patients treated with placebo, cimetidine, ranitidine or omeprazole. (Reprinted with permission from Sontag. Gastroenterol Clin North Am 1990;19:683-712)

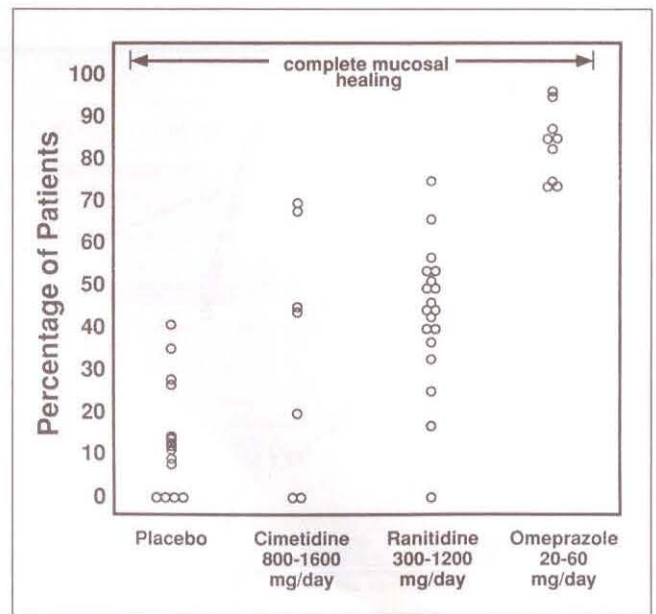

Figure 18) Endoscopic esophagitis at six to eight weeks in patients treated with placebo, cimetidine, ranitidine or omeprazole. (Reprinted with permission from Sontag. Gastroenterol Clin North Am 1990;19:683-712)

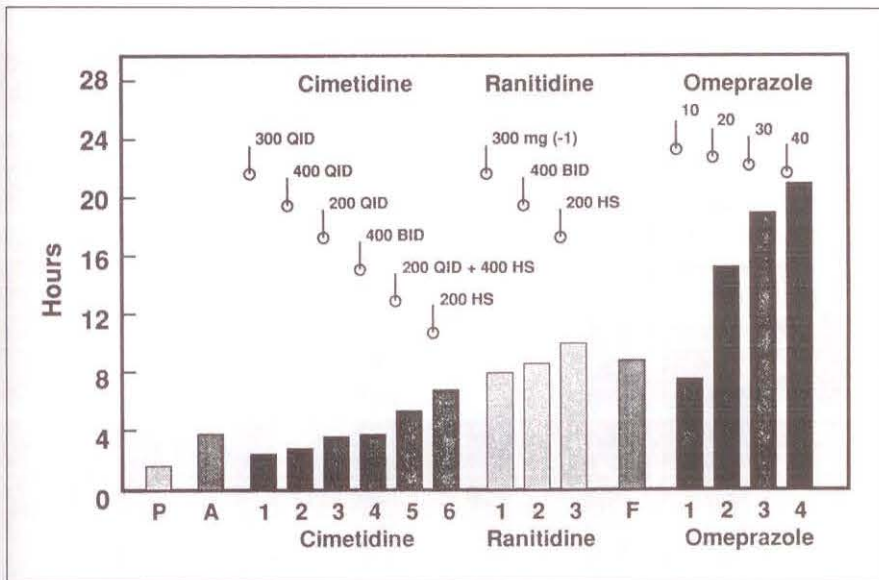

Figure 19) Hours of a 24 h day during which intragastric pH was at least 4. (Adapted with permission from Burget et al. Gastroenterology 1990;99:345-51)

rates of these four H<sub>2</sub>-receptor blockers? Ranitidine 150 mg bid and cimetidine 400 mg bid are equivalent (59). Fiorucci et al (27) demonstrated – in 19 patients with moderate esophagitis – that famotidine 40 mg and ranitidine 300 mg taken at 20:00 after the evening meal have comparative efficacy in changing reflux variables. Acid reflux was defined as a drop in esophageal pH to below 4, and reflux duration was defined as the time re-

quired for the pH to return to above 4 (65,66). Both ranitidine and famotidine significantly reduced the total time that the intraesophageal pH was less than 4 – in both the supine and the upright positions – without influencing the number of reflux episodes lasting longer than 5 mins, the number of reflux episodes, the duration of the longest reflux episode or the acid clearance time (Table 9). Nighttime dosing was effective at nighttime but

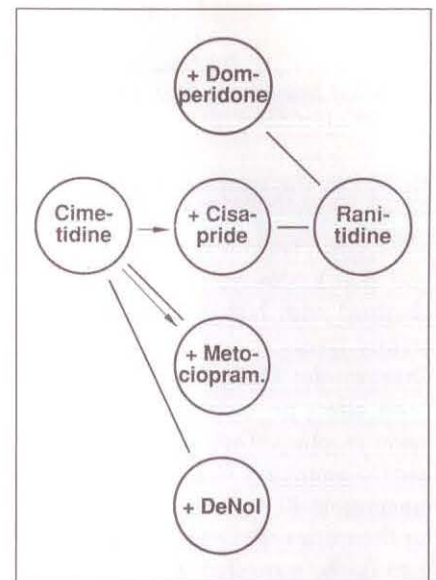

Figure 20) Results of randomized clinical trials depicting efficacy of histamine H<sub>2</sub>-receptor antagonists with and without additional prokinetic drugs or colloidal bismuth in the healing of reflux esophagitis. Each connecting line (no significant difference in outcome) or arrow (significant difference in outcome pointing to the superior treatment) represents an individual study. (Adapted with permission from Koelz. Scand J Gastroenterol 1989;24[Suppl 156]:25-36)

did not extend into daytime.

It remains unclear, however, whether one H<sub>2</sub>-receptor antagonist, given in the equivalent acid-inhibitory doses, is any better than another H<sub>2</sub>

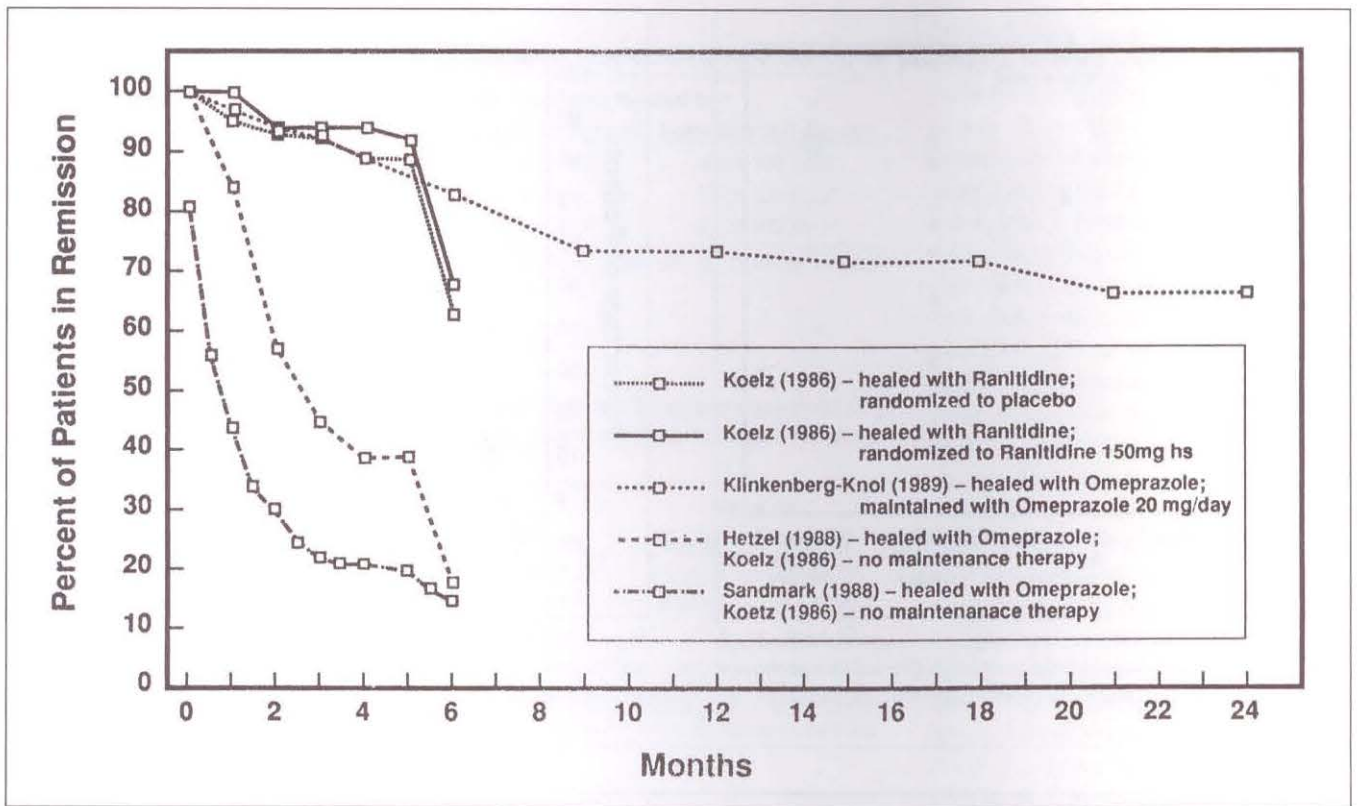

Figure 21) Maintenance therapy in patients with gastroesophageal reflux disease. (Reprinted with permission from Sontag. Gastroenterol Clin North Am 1990;19:6834-712)

blocker in the symptomatic treatment of GERD or in the healing of associated esophagitis, but the available data support that healing rates of 50% can be obtained with higher doses of antisecretory agents.

**Omeprazole:** Omeprazole has no adverse effect on esophageal peristalsis, lower esophageal sphincter pressure or gastric emptying (67,68). A dose of omeprazole 40 mg od reduces the time for the intraesophageal pH to be below 4 to 0.7%, compared with 3.1% with omeprazole 20 mg od (69). This 20 mg dose of omeprazole reduces intraesophageal pH parameters more than does ranitidine (70). Omeprazole 20 mg maintains intragastric pH greater than 4 for about 16 h each day, whereas most doses of H<sub>2</sub>-receptor antagonists maintain this level for about only 10 h each day (24). Why is this pH value of interest? It is thought that intraesophageal pH must be kept above at least 4 in order to prevent esophageal acid-induced damage.

The H<sup>+</sup>,K<sup>+</sup>-ATPase inhibitors (the 'pump blockers') may provide for higher rates of symptom relief of GERD

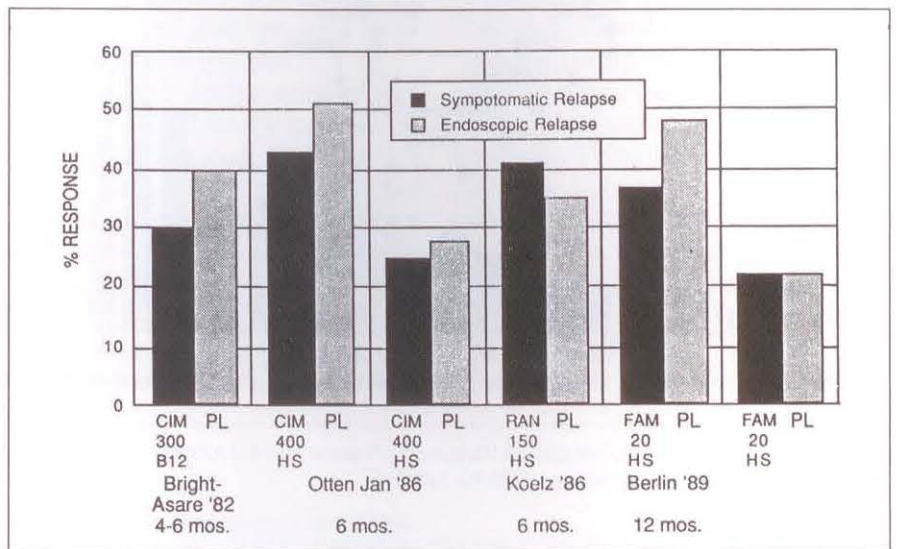

Figure 22) Placebo-controlled trials of maintenance therapy in patients with reflux esophagitis. (Adapted with permission from Tytgat et al. Scand J Gastroenterol 1990;25[Suppl 175]:1-12)

and endoscopic healing of esophagitis than do the H<sub>2</sub>-receptor antagonists. For example, symptom relief and endoscopic healing after six to eight weeks of treatment is greater with omeprazole than with cimetidine or ranitidine (Figures 17,18). With standard doses of H<sub>2</sub>-blockers, approximately

30% of patients heal their esophagitis in 12 weeks compared with approximately 80% of patients treated with doses of omeprazole varying from 20 to 80 mg daily.

Eight studies have shown superior healing rates of moderate to severe esophagitis of any grade with omeprazole

20 to 60 mg daily compared with ranitidine (70-77) or cimetidine (78). For example, in a double-blind randomized study comparing omeprazole 20 mg given once daily and ranitidine 150 mg bid in 152 patients with endoscopically verified erosive and/or ulcerative esophagitis, the four-week healing rates were 67% in the omeprazole group and 31% in the ranitidine group ( $P<0.0001$ ), with rates of 85% and 50%, respectively, after eight weeks of treatment ( $P<0.0001$ ) (74). The proportion of patients with grades 2 to 4 esophagitis pre-entry were similar. Numerous other studies have also shown faster and more substantial healing as well as improvement in reflux symptoms compared with ranitidine (personal communication) (79-83). A meta-analysis (84) of three trials comparing omeprazole 150 mg bid (73,74,79) demonstrated an approximately 30% greater healing rate for omeprazole compared with ranitidine at weeks 4 and 8 of treatment. A comparable superiority of omeprazole 20 mg has been reported compared with cimetidine 400 mg bid (83).

An understanding of the reason for these differences in clinical efficacy may be obtained from an examination of the relative efficacy of the various  $H_2$ -blockers and omeprazole on 24 h intragastric acidity (Figure 19); increasing the dose of  $H_2$ -blockers has a relatively modest effect on prolonging the number of hours that the intragastric pH is 4.0 or above, whereas increasing the dose of omeprazole has a much greater effect. It must be stressed, however, that it is unclear what threshold is required for the time to maintain the intraesophageal pH at at least 4 to achieve healing of a given severity of endoscopically demonstrated esophagitis.

Omeprazole may also be effective to treat peptic esophageal strictures (85), to achieve regression of columnar epithelium in GERD patients with Barrett's epithelium (86) and to treat erosive esophagitis refractory to high dose cimetidine or ranitidine (87,88). Better healing rates are obtained for milder esophagitis or for longer periods of therapy. Ambulatory 24 h esophageal pH measurements have been performed in

**TABLE 10**  
Famotidine 20 and 40 mg bid as maintenance therapy with healed erosive esophagitis

Time period	Relapse of erosive esophagitis <sup>†</sup>		
	20 mg bid (n=69)	40 mg bid (n=72)	Placebo (n=31)
Month 3	15.6**	7.5**	44.4
Month 6	33.7*	21.9**	66.6

Time period	Prevention of global symptomatic deterioration <sup>†</sup>		
	20 mg bid (n=69)	40 mg bid (n=72)	Placebo (n=31)
Month 3	76.8**	76.4**	58.1
Month 6	62.3**	70.8**	29.0

\* $P<0.05$ ; \*\* $P<0.01$  versus placebo; <sup>†</sup>Relapse defined as recurrence of endoscopically verified erosive esophagitis; <sup>†</sup>Prevention defined as no or slight deterioration

**TABLE 11**  
Famotidine 20 and 40 mg bid versus placebo as maintenance therapy in patients with healed erosive esophagitis

Time period	Patients with relapse of erosive esophagitis (%) <sup>†</sup>		
	20 mg bid (n=110)	40 mg bid (n=108)	Placebo (n=49)
Month 3	22.0	21.5	28.8
Month 6	29.6**	29.2**	56.5

Time period	Prevention of global symptomatic deterioration <sup>†</sup>		
	20 mg bid (n=110)	40 mg bid (n=108)	Placebo (n=49)
Month 3	82.7**	82.4**	67.3
Month 6	66.4*	68.5*	55.1

\* $P<0.05$ ; \*\* $P<0.01$  versus placebo; <sup>†</sup>Relapse defined as recurrence of endoscopically verified erosive esophagitis; <sup>†</sup>Prevention defined as no or slight deterioration

22 patients (with gastroesophageal reflux and erosive or ulcerative esophagitis) randomized into a double-blind study comparing the effect of omeprazole 20 mg od with ranitidine 150 mg bid.

Omeprazole significantly reduced the total number of reflux episodes, the number of reflux episodes lasting longer than 5 mins and the total reflux time, whereas ranitidine reduced only the reflux time (70). Of course, it is recognized that this dose of omeprazole achieves a greater percentage of intragastric pH readings over 4 than does this low dose of ranitidine (Figure 19), and higher doses of ranitidine may be needed to treat GERD. When higher doses of ranitidine are used (eg, 300 mg bid), then the two antisecretory agents show similar effects on esophageal acid exposure (27).

Fiorucci and colleagues (25) have examined a small group of patients with moderately severe esophagitis treated with ranitidine 300 mg bid or omeprazole 20 mg bid. The 24 h intragastric

pH was numerically higher in patients treated with omeprazole compared with ranitidine, but the acid secretion rate in mmol/L, while much lower than in the basal condition, was comparable in the two treatment groups. Of course one presumes that if the intragastric pH is reduced effectively, the intraesophageal pH will also decline; this was the case, with a reduction in the percentage of readings in the esophagus under pH 4 falling from 23.9 to 8.5% with ranitidine and 7.2% with omeprazole. It remains puzzling why reported healing rates between receptor blockers and pump blockers appear to be large when the differences in acid inhibition using these doses is relatively small.

**Combination therapy:** Given that the pathogenesis of GERD may result from an imbalance between motility and secretion factors, it would be reasonable to ask whether combination therapy might be useful (Figure 20). Temple et al (89) reported no difference between cimetidine 1600 mg daily compared

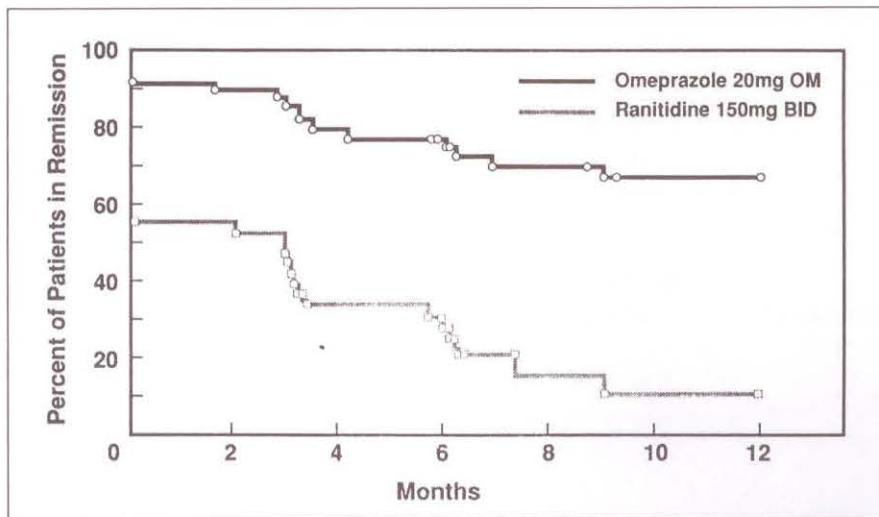

**Figure 23** Cumulative proportion of patients in symptomatic and in endoscopic remission when treated with either omeprazole (20 mg once daily) or ranitidine (150 mg twice daily) for one year after initial healing of the mucosal lesions. (Reprinted with permission from Lundell et al. *Scand J Gastroenterol* 1991;26:248-56)

with the same dose of cimetidine plus metoclopramide. And yet, Lieberman and co-workers (90) reported in cimetidine-resistant patients with GERD that the addition of cisapride to cimetidine was superior to cimetidine alone. Cisapride 10 mg bid does not improve upon the effect of ranitidine 150 mg bid (91), but did improve the rate of endoscopic healing from 46 to 70% when added to cimetidine 1 g/day (23). The use of pirenzepine 50 mg bid plus ranitidine 150 mg bid had no additional benefits over ranitidine alone in the healing of esophagitis, but did provide superior relief of heartburn and regurgitation (92). The addition of sucralfate to cimetidine alone offers no advantage (93), whereas colloidal bismuth 120 mg qid added to cimetidine 800 mg at night for patients with severe esophagitis gave better results than cimetidine alone (94).

Thus, it is possible that if an individual patient with GERD remains symptomatic after using either a promotility or an antisecretory agent, then combination therapy is worthy of a trial.

**Maintenance therapy:** Do patients with GERD heal their esophagitis and remain well for long periods? The answer appears to be no (71). Just as duodenal and gastric ulcers recur, esophagitis tends to recur after healing. For example, patients whose esophagi-

tis has been healed with a pump blocker or an H<sub>2</sub>-receptor antagonist will have a recurrence of symptoms and a recurrence of esophagitis at six months (Figure 21). Maintenance therapy, therefore, may be necessary in some patients with GERD.

H<sub>2</sub>-blockers as maintenance therapy in GERD have been disappointing when used in conventional doses (Figure 22), but symptom relief may be achieved with cimetidine 400 mg at bedtime (38). Just as it may be necessary to use higher doses for acute healing of GERD, it may also be necessary to use higher doses for maintenance therapy. This possibility has been studied; both an international and an American six-month, randomized, double-blind, placebo controlled trial demonstrated that famotidine 20 mg bid and 40 mg bid had comparable superiority over placebo in the prevention of relapse of erosive esophagitis and in the prevention of global symptomatic deterioration in patients whose GERD had previously healed with famotidine (95,96) (Tables 10,11). Thus, higher doses of H<sub>2</sub>-receptor antagonists may indeed be necessary to maintain healing of GERD.

Omeprazole is effective for maintenance therapy in patients with GERD. Lundell et al (97) studied 98 GERD patients who had been treated to en-

doscopy healing using omeprazole 40 mg od or ranitidine 600 mg daily (Figure 23). The patients were then placed on 12 months of maintenance therapy with either omeprazole 20 mg daily or ranitidine 150 mg bid. About one-quarter of the omeprazole-treated patients relapsed compared with more than one-half of ranitidine-treated individuals (Figure 23). This improvement with omeprazole was achieved without any effects on oxyntic mucosal endocrine cells and with only a marginal and biologically insignificant increase in basal serum gastrin concentrations.

Alternate day omeprazole 20 mg may also be effective in maintaining healing and alleviating symptoms in GERD (98). Interestingly, acetylsalicylic acid use may be a factor in the resistance of esophagitis to some therapies, and may also be a factor in the frequent and rapid relapse which may occur if therapy is stopped (99).

Cisapride 20 mg bid is superior to placebo in the maintenance of healing of grades I to III esophagitis previously healed with antisecretory agents (100). Two studies presented at the recent World Congresses of Gastroenterology (in Sydney, Australia in 1990) (101, 102) also suggested that cisapride 10 mg bid or 20 mg at night is superior to placebo in preventing relapse in patients with GERD. Six-month relapse rates remain high when ranitidine is taken as 300 mg at night or 150 mg bid (41 and 37.5%, respectively) and do not differ in this study from the relapse rates seen with placebo (45%) (103).

## CONCLUSIONS

GERD is a chronic disease, and treating the acute episode of esophagitis does not solve the problem of the high recurrence rate. The mechanisms of GERD focus on the importance of deranged motility patterns (104). When the esophagitis is healed, the abnormal motility (105) and, likely, the higher rates of acid secretion persist. Thus, maintenance therapy must be taken to either lower intragastric pH – and, therefore, intraesophageal acid exposure – or to enhance the barriers to acid exposure in the esophagus.

## REFERENCES

- De Caestecker JS, Blackwell JN, Pryde A, Heading RC. Daytime gastro-oesophageal reflux is important in oesophagitis. *Gut* 1987;28:519-26.
- Rokkas T, Sladen GE. Ambulatory esophageal pH recording in gastroesophageal reflux: Relevance to the development of esophagitis. *Am J Gastroenterol* 1988;83:629.
- Lieberman DA. 24-hour esophageal pH monitoring before and after medical therapy for reflux esophagitis. *Dig Dis Sci* 1988;33:166-71.
- Emde C, Cilluffo T, Bauerfeind P, Blum AL. Combined esophageal and gastric pH-metry in healthy volunteers. Influence of cable through LES and effect of misoprostol. *Dig Dis Sci* 1989;34:79-82.
- Klauser AG, Heinrich C, Schindlbeck NE, Müller-Lissner SA. Is long-term esophageal pH monitoring of clinical value? *Am J Gastroenterol* 1989;84:362.
- Kruse-Andersen S, Wallin L, Madsen T. Reflux patterns and related oesophageal motor activity in gastro-oesophageal reflux disease. *Gut* 1990;31:633-8.
- Kadakis S, Kikendall J, Maydonovitch C, Johnson L. Effect of smoking on 24 hour ambulatory esophageal pH monitoring. *Gastroenterology* 1991;100:A93.
- Vandenplas Y, Franckx-Goossens A, Pipeleers-Marichal M, Derde MP, Sacré-Smits L. Area under pH 4: Advantages of a new parameter in the interpretation of esophageal pH monitoring data in infants. *J Pediatr Gastroenterol Nutr* 1989;9:34-9.
- Robertson DAF, Aldersley MA, Shepherd H, Lloyd RS, Smith, CL. H<sub>2</sub> antagonists in the treatment of reflux oesophagitis: Can physiological studies predict the response? *Gut* 1987;28:946-9.
- Smout, AJPM, Breedijk M, Van der Zouw C, Akkermans LMA. Physiological gastroesophageal reflux and esophageal motor activity studied with a new system for 24-hour recording and automated analysis. *Dig Dis Sci* 1989;34:372-8.
- Klinkenberg-Knol EC, Meeuwissen SGM. Combined gastric and oesophageal 24-hour pH monitoring and oesophageal manometry in patients with reflux disease, resistant to treatment with omeprazole. *Aliment Pharmacol Therap* 1990;4:485-95.
- Johansson KE, Ask P, Boeryd B, Fransson S-G, Tibbling L. Oesophagitis, signs of reflux, and gastric acid secretion in patients with symptoms of gastro-oesophageal reflux disease. *Scand J Gastroenterol* 1986;21:837-47.
- Barlow AP, DeMeester TR, Ball SC, Eypasch EP. The significance of the gastric secretory state in gastroesophageal reflux disease. *Arch Surg* 1989;124:937-40.
- Collen MJ, Lewis JH, Benjamin SB. Gastric acid hypersecretion in refractory gastroesophageal reflux disease. *Gastroenterology* 1990;98:654-61.
- Tytgat GNJ, Nio CY, Schotborgh RH. Reflux esophagitis. *Scand J Gastroenterol* 1990;25(Suppl 175):1-12.
- Reynolds JC. Prokinetic agents: A key in the future of gastroenterology. *Gastroenterol Clin North Am* 1989;18:437-58.
- Richter JE. Efficacy of cisapride on symptoms and healing of gastro-oesophageal reflux disease: A review. *Scand J Gastroenterol* 1989;24 (Suppl 165):19-28.
- Collins BJ, Spence RAJ, Ferguson R, Laird J, Love AHG. Cisapride: Influence on oesophageal and gastric emptying and gastro-oesophageal reflux in patients with reflux oesophagitis. *Hepato-gastroenterol* 1987;34:113-6.
- Ceccatelli P, Janssens J, Vantrappen G, Cucchiara S. Cisapride restores the decreased lower oesophageal sphincter pressure in reflux patients. *Gut* 1988;29:631-5.
- Urbain JL, Siegel JA, Debie NC, Pauwels SP. Effect of cisapride on gastric emptying in dyspeptic patients. *Dig Dis Sci* 1988;33:779-83.
- Rezende-Filho J, Di Lorenzo C, Dooley CP, Valenzuela JE. Cisapride stimulates antral motility and decreases biliary reflux in patients with severe dyspepsia. *Dig Dis Sci* 1989;34:1057-62.
- Janisch HD, Hüttemann W, Bouzo MH. Cisapride versus ranitidine in the treatment of reflux esophagitis. *Hepato-gastroenterol* 1988;35:125-7.
- Galmiche JP, Fraïtag B, Filoche B, et al. Double-blind comparison of cisapride and cimetidine in treatment of reflux esophagitis. *Dig Dis Sci* 1990;35:649-55.
- Burget DW, Chiverton SG, Hunt RH. Is there an optimal degree of acid suppression for healing of duodenal ulcers? *Gastroenterology* 1990;99:345-51.
- Fiorucci S, Santucci L, Morelli A. Effect of omeprazole and high doses of ranitidine on gastric acidity and gastroesophageal reflux in patients with moderate-severe esophagitis. *Am J Gastroenterol* 1990;95:1458-62.
- Barlow A, Watson A, Attwood S, Dixon JS, Johnson NJ. A double-blind crossover comparison of the effects of ranitidine 300 mg qds, 150 mg bd and placebo on intragastric acidity and intraoesophageal pH. *Gastroenterology* 1991;100:A30.
- Fiorucci S, Santucci L, Perrone E, Abbritti F, Morelli A. Gastric and esophageal acidity during continuous treatment with H<sub>2</sub>-antagonists in uncomplicated esophagitis. *Scand J Gastroenterol* 1989;24:671-7.
- Behar J, Brand DL, Brown FC, et al. Cimetidine in the treatment of symptomatic gastroesophageal reflux. *Gastroenterology* 1978;74:441-8.
- Breen KJ, Desmond PV, Whelan G. A randomized, controlled evaluation of cimetidine. *Med J Aust* 1983;2:555-6.
- Bright-Asare P, El-Bassoussi M. Cimetidine, metoclopramide, or placebo in the treatment of symptomatic gastroesophageal reflux. *J Clin Gastroenterol* 1980;2:149-56.
- Brown P. Cimetidine in the treatment of reflux esophagitis. *Med J Aust* 1979;2:96-7.
- Ferguson R, Dronfield MW, Atkinson M. Cimetidine in the treatment of reflux oesophagitis with peptic stricture. *Br Med J* 1979;2:472-4.
- Festen HPM, Driessen WMM, Lamers CBH, Van Tongeren JHM. Cimetidine in the treatment of severe ulcerative reflux oesophagitis: Results of an 8-week double-blind study and of subsequent long-term maintenance treatment. *Neth J Med* 1980;23:237-40.
- Fiassé R, Hanin C, Lepot A, Descamps C, Lamy F, Dive C. Controlled trial of cimetidine in reflux esophagitis. *Dig Dis Sci* 1980;25:750-5.
- Greaney MG, Irvin TT. Cimetidine for the treatment of symptomatic gastro-oesophageal reflux. *Br J Clin Prac* 1981;35:21-4.
- Powell-Jackson P, Barkley H, Northfield TC. Effect of cimetidine in symptomatic gastro-oesophageal reflux. *Lancet* 1978;ii:1068-9.
- Wesdorp E, Bartelsman J, Pape K, Dekker W, Tytgat GN. Oral cimetidine in reflux esophagitis: A double blind controlled trial. *Gastroenterology* 1978;74:821-4.
- Kaul B, Petersen H, Erichsen H, et al. Acute and maintenance treatments with cimetidine. *Scand J Gastroenterol* 1986;21:139-45.
- Archambault AP, Farley A, Cleator IG, et al. Cimetidine therapy for gastroesophageal reflux disease. *West J Med* 1985;143:616-21.
- Cloud M, Offen W. Nizatidine 150 mg bid relieves symptoms and decreases severity of esophagitis in

- gastro-oesophageal reflux disease. *Gastroenterology* 1989;96:A91.
41. Quik RPF, Cooper MJ, Gleeson M, et al. A comparison of two doses of nizatidine versus placebo in the treatment of reflux oesophagitis. *Aliment Pharmacol Therap* 1990;4:201-11.
  42. Berges W, Lux G, Simon B, Weinbeck M, Quik R. A comparison of two doses of nizatidine in reflux oesophagitis. *Z Gastroenterol* 1989;27:156.
  43. Orr WC, Finn A, Wilson T, Russell J. Esophageal acid contact time and heartburn in acute treatment with ranitidine and metoclopramide. *Am J Gastroenterol* 1990;85:697-704.
  44. Berstad A. Overview of ranitidine in reflux oesophagitis: Its effect on symptoms, endoscopic appearance and histology. In: Misiewicz JJ, Wormsley KG, eds. *The Clinical Use of Ranitidine*. Oxford: Medicine Publishing Foundation, 1982:297-304.
  45. Goy JA, Maynard JH, McNauton WM, O'Shea A. Ranitidine and placebo in the treatment of reflux oesophagitis. *Med J Aust* 1983;2:558-61.
  46. Grove O, Bekker C, Jeppe-Hansen MG, et al. Ranitidine and high dose antacid in reflux esophagitis. A randomized placebo-controlled trial. *Scand J Gastroenterol* 1985;20:457-61.
  47. Hine KR, Holmes GKT, Melikian V, Lucey M, Fairclough PD. Ranitidine in reflux oesophagitis. *Digestion* 1984;29:119-23.
  48. Johansson KE, Boeryd B, Johansson K, Tibbling L. Double-blind crossover study of ranitidine and placebo in gastro-oesophageal reflux disease. *Scand J Gastroenterol* 1986;21:769-78.
  49. Lehtola J, Niemelä S, Martikainen J, Krekelä I. Ranitidine, 150 mg three times a day, in the treatment of reflux oesophagitis. A placebo-controlled, double-blind study. *Scand J Gastroenterol* 1986;21:175-80.
  50. Sherbaniuk R, Wensel R, Bailey R, et al. Ranitidine in the treatment of symptomatic gastroesophageal reflux disease. *J Clin Gastroenterol* 1984;6:9-15.
  51. Sontag S, Robinson M, McCallum RW, Barwick KW, Nardi R. Ranitidine therapy for gastroesophageal reflux disease. Results of a large double-blind trial. *Arch Intern Med* 1987;147:1485-91.
  52. Wesdorp ICE, Dekker E, Klinkenberg-Knol EC. Treatment of reflux oesophagitis with ranitidine. *Gut* 1983;24:921-4.
  53. Bovero E, Cheli R, Barbara L, et al. Short-term treatment of reflux oesophagitis with ranitidine 300 mg nocte, Italian multicentre study. *Hepato-gastroenterology* 1987;34:155-9.
  54. Halvorsen L, Lee FI, Wesdorp ICE, Johnson NJ, Mills JG, Wood JR. Acute treatment of reflux oesophagitis: A multi-centre study to compare 150 mg ranitidine twice daily with 300 mg ranitidine at bedtime. *Aliment Pharmacol Therap* 1989;3:171-81.
  55. Schaub N, Meyrick TJ, Misiewicz JJ, Lovell D, Trotman IF. Investigation of ranitidine 150 mg bid or 300 mg bid in the treatment of reflux disease. *Hepato-gastroenterol* 1986;33:208-13.
  56. Johnson NJ, Mills JG, Wood JR. Acute treatment of reflux oesophagitis: a multi-centre trial comparing ranitidine 150 mg bid with ranitidine 300 mg qid. *Gastroenterology* 1989;96:A242.
  57. Euler AR, Murdock RH, Wilson RH. Ranitidine is effective in healing erosive esophagitis. *Gastroenterology* 1991;100:A61.
  58. Festen HPM, Wesdorp, ICE, Dekker W, et al. The efficacy of famotidine 20 mg bid vs 40 mg bid in the treatment of erosive/ulcerative reflux esophagitis: Significance of severity of esophagitis and duration of therapy. *Gastroenterology* 1991;100:A63.
  59. Fielding JF, Doyle GD. Comparison between ranitidine and cimetidine in the treatment of reflux oesophagitis. *Ir Med J* 1984;77:356-7.
  60. Guslandi M, Testoni PA, Passaretti S, et al. Ranitidine versus metoclopramide in the medical treatment of reflux esophagitis. *Hepato-gastroenterol* 1983;30:96-8.
  61. Sekiguchi T, Nishioka T, Kogure M, et al. Once daily famotidine for reflux esophagitis. *Scand J Gastroenterol* 1987;22(Suppl 134):51-4.
  62. Berenson M, Simon TJ, Berlin RG, et al. BID regimens of an H<sub>2</sub>-receptor antagonist heal erosive esophagitis: Results of a US double-blind, randomised multicenter trial. *Gastroenterology* 1990;98:A372.
  63. Simon TJ, Berlin RG, Tipping RW, et al. Results of an international double-blind, multicenter trial comparing bid dosages of H<sub>2</sub> receptor antagonists: Relationship between pharmacodynamic effect on esophageal reflux and healing of erosive esophagitis. *Am J Gastroenterol* 1990;85:1225.
  64. Sabesin SM, Schaffner JA, Bradstreet DJ, Walton-Bowen K, Humphries TJ. Famotidine-symptomatic relief and healing in patients with reflux esophagitis: Results of a US multi-center trial. *Gastroenterology* 1990;98:A117.
  65. Johnson LR, DeMeester TR. Twenty-four hour pH monitoring of the distal esophagus: A quantitative measure of gastroesophageal reflux. *Am J Gastroenterol* 1974;62:325-33.
  66. DeMeester TR, Wang CI, Wernly JA, et al. Technique, indications and clinical use of 24 hour esophageal pH monitoring. *J Thorac Cardiovasc Surg* 1980;79:656-67.
  67. Horowitz M, Hetzel DJ, Buckle PJ, Chatterton BE, Shearman DJ. The effect of omeprazole on gastric emptying in patients with duodenal ulcer disease. *Brit J Clin Pharmacol* 1984;18:791-4.
  68. Dent J, Downton J, Buckle P, et al. Omeprazole heals peptic esophagitis by elevation of intragastric pH. *Gastroenterology* 1985;88:1363.
  69. Pasqual JC, Hémyer P, Bruley S, Galmiche JP. Comparison of the effects of two doses of omeprazole on 24-hour oesophageal pH in gastroesophageal reflux disease. *Gastroenterology* 1987;92:1567.
  70. Ruth M, Enbom H, Lundell H, Lönröth H, Sandberg N, Sandmark S. The effect of omeprazole or ranitidine treatment on 24-hour oesophageal acidity in patients with reflux esophagitis. *Scand J Gastroenterol* 1988;23:1141-6.
  71. Hetzel DJ, Dent J, Reed WD, et al. Healing and relapse of severe peptic esophagitis after treatment with omeprazole. *Gastroenterology* 1988;95:903-12.
  72. Dammann HG, Blum AL, Lux G, et al. Omeprazole is superior to ranitidine in the treatment of reflux oesophagitis. *Gastroenterology* 1986;90:1385.
  73. Zeitoun P, Desjars de Keranroué N, Isal JP. Omeprazole versus ranitidine in erosive oesophagitis. *Lancet* 1987;ii:621-2.
  74. Sandmark S, Carlsson R, Fausa O, Lundell L. Omeprazole or ranitidine in the treatment of reflux esophagitis. *Scand J Gastroenterol* 1988;23:625-32.
  75. Havelund T, Laursen LS, Skoubo-Kristensen E, et al. Omeprazole and ranitidine in treatment of reflux oesophagitis: A double blind comparative trial. *Br Med J* 1988;296:89-92.
  76. Vantrappen G, Rutgeerts L, Schurmans P, Coenegrachts JL. Omeprazole (40 mg) is superior to ranitidine in short-term treatment of ulcerative reflux esophagitis. *Dig Dis Sci* 1988;33:523-9.
  77. Klinkenberg-Knol EC, Jansen JMBJ, Festen HPM, Meuwissen, SGM, Lamers CBHW. Double-blind multicentre comparison of omeprazole and ranitidine in the treatment of reflux oesophagitis. *Lancet* 1987;ii:349-51.

78. Dehn TCB, Shepherd HA, Colin-Jones D, Kettlewell MGW, Carroll NJH. Double blind comparison of omeprazole (40 mg od) versus cimetidine (400 mg qd) in the treatment of symptomatic erosive reflux oesophagitis, assessed endoscopically, histologically and by 24 h pH monitoring. *Gut* 1990;31:509-13.
79. Blum AL, Wienbeck M, Schiessel R, Carlsson R. Omeprazole is superior to ranitidine in the treatment of reflux esophagitis. *Hepato-gastroenterology* 1989;36:F14.
80. Lundell GE, Westin IH, Sandmark S, et al. Omeprazole or high dose ranitidine in the treatment of patients with reflux esophagitis not responding to standard doses of H<sub>2</sub>-receptor antagonists. *Gastroenterology* 1989;96:A310.
81. Bate CM, Keeling PWN, O'Morain C, et al. Comparison of omeprazole and cimetidine in reflux oesophagitis: Symptomatic, endoscopic, and histological evaluations. *Gut* 1990;31:968-72.
82. Bate CM, Keeling PWN, O'Morain CA, et al. Omeprazole heals reflux oesophagitis in a greater proportion of patients than cimetidine, assessed endoscopically, histologically and symptomatically. *Hepato-gastroenterology* 1989;36:F13.
83. Bate CM, Keeling PWN, O'Morain CA, et al. Omeprazole provides faster healing and symptom relief of reflux oesophagitis than cimetidine. *Gut* 1989;30:A1493.
84. Holt S, Howden CW. Omeprazole. Overview and opinion. *Dig Dis Sci* 1991;36:385-93.
85. Ching CK, Shaheen MZ, Holmes GKT. Is omeprazole more effective in the treatment of resistant reflux oesophagitis and associated peptic stricture? *Gastroenterology* 1990;98:A30.
86. Deviere J, Buset M, Dumonceau JM, Rickaert F, Cremer M. Regression of Barrett's epithelium with omeprazole. *N Engl J Med* 1989;320:1495-7.
87. Bardhan KD, Morris P, Thompson M, et al. Omeprazole in the treatment of erosive esophagitis refractory to high dose cimetidine and ranitidine. *Gut* 1990;31:745-9.
88. Marciano-D'Amore DA, Paterson WG, DaCosta LR, Beck IT. Omeprazole in H<sub>2</sub> receptor antagonist-resistant reflux esophagitis. *J Clin Gastroenterol* 1990;12:616-20.
89. Temple JG, Bradby GVH, O'Connor F, et al. Cimetidine and metoclopramide in oesophageal reflux disease. *Br Med J* 1983;296:1863-4.
90. Lieberman DA, Keeffe EB. Treatment of severe reflux esophagitis with cimetidine and metoclopramide. *Ann Intern Med* 1986;104:21-6.
91. Wienbeck, M. Does cisapride added to H<sub>2</sub>-receptor-blocking treatment improve healing rates in patients with esophagitis? *Digestion* 1986;34:144.
92. Londong W, Phillips J, Johnson NJ, Wood JR. The effect of combined therapy with ranitidine and pirenzepine in the treatment of reflux oesophagitis. *Gastroenterology* 1991;100:A113.
93. Schotbrogh RH, Hameeteman W, Dekker W, et al. Combination therapy of sucralfate and cimetidine, compared with sucralfate monotherapy, in patients with peptic reflux esophagitis. *Am J Med* 1989;6A(Suppl):77-80.
94. Borkent MV, Beker JA. Treatment of ulcerative reflux oesophagitis with colloidal bismuth subcitrate in combination with cimetidine. *Gut* 1988;29:385-9.
95. Stein DT, Simon TJ, Berlin RG, et al. Controlling 24 hour esophageal acid exposure in patients with healed erosive esophagitis prevents endoscopic recurrence and symptomatic deterioration: Results of a 6 month, randomized, double-blind US placebo-controlled trial comparing famotidine 20 mg bid and 40 mg bid. *Gastroenterology* 1990;100:A167.
96. Simon TJ, Berlin RG, Tipping R, et al. Prevention of endoscopic recurrence of erosive esophagitis with famotidine 20 mg bid and 40 mg bid: Results of an international 6 month, randomized, double-blind, placebo-controlled trial. *Gastroenterology* 1990;100:A162.
97. Lundell GE, Backman L, Ekström P, et al. Prevention of relapse of reflux esophagitis after endoscopic healing: The efficacy and safety of omeprazole compared with ranitidine. *Scand J Gastroenterol* 1991;26:248-56.
98. Bank S, Greenberg R. Alternate day omeprazole in H<sub>2</sub> receptor-antagonist resistant reflux esophagitis. *Gastroenterology* 1990;100:A29.
99. Lanas A, Hirschowitz BI. Significant role of aspirin use in esophagitis. *Gastroenterology* 1991;100:A106.
100. Tytgat GNJ and the Scandecis Trialists. Effect of cisapride on relapse of reflux esophagitis healed with an antisecretory drug. *Gastroenterol* 1991;100:A178.
101. Blum AL. Cisapride reduces the relapse rate in reflux oesophagitis. *World Congresses of Gastroenterology*, 1990.
102. Verlinden M, Reyntjens A. Cisapride prevents relapse of reflux oesophagitis. *World Congresses of Gastroenterology*, 1990.
103. Armstrong D, Blum AL. Full dose H<sub>2</sub>-receptor antagonist prophylaxis does not prevent relapse of reflux esophagitis. *Gut* 1989;30:A1494.
104. Koelz HR. Treatment of reflux esophagitis with H<sub>2</sub>-blockers, antacids and prokinetic drugs. *Scand J Gastroenterol* 1989;24(Suppl 156):25-36.
105. Sontag SJ. The medical management of reflux esophagitis. Role of antacids and acid inhibition. *Gastroenterol Clinics North Am* 1990;19:683-712.





**Hindawi**  
Submit your manuscripts at  
<http://www.hindawi.com>

