FireGL™ X2-256t
FireGL™ X2-256
FireGL™ X1-128
FireGL™ Z1-128

User's Guide

P/N: 137-50015-40



© Copyright 2004, by ATI Technologies Inc.

All rights reserved. Reproduction of this manual, or parts thereof, in any form, without the express written permission of ATI Technologies Inc. is strictly prohibited.

ATI and all ATI product and product feature names are trademarks and/or registered trademarks of ATI Technologies Inc. All other company and/or product names are trademarks and/or registered trademarks of their respective owners. Features, performance and specifications are subject to change without notice. Product may not be exactly as shown in the diagrams.

FireGL, FIRE GL, HYDRAVISION – ATI Technologies Inc.; Athlon – Advanced Micro Devices. Inc.; Fire Wire – Apple Computer Inc.; Direct3D, Windows 2000, Windows XP – Microsoft Corp.; IEEE – The Institute of Electrical and Electronic Engineers, Inc.; AGP (Accelerated Graphics Port), Celeron, Pentium Pro, Pentium II, Pentium III – Intel Corporation; VGA – International Business Machines Corp.; OpenGL - Silicon Graphics Inc.; VESA – Video Electronics Standards Association.

Adobe and Acrobat are trademarks of Adobe Systems Incorporated, which may be registered in certain jurisdictions.

Disclaimer

While every precaution has been taken in the preparation of this document, ATI Technologies Inc. assumes no liability with respect to the operation or use of ATI hardware, software or other products and documentation described herein, for any act or omission of ATI concerning such products or this documentation, for any interruption of service, loss or interruption of business, loss of anticipatory profits, or for punitive, incidental or consequential damages in connection with the furnishing, performance, or use of the ATI hardware, software, or other products and documentation provided herein.

ATI Technologies Inc. reserves the right to make changes without further notice to a product or system described herein to improve reliability, function or design. With respect to ATI products which this document relates, ATI disclaims all express or implied warranties regarding such products, including but not limited to, the implied warranties of merchantability, fitness for a particular purpose, and non-infringement.

Documentation updates

ATI is constantly improving its product and associated documentation. To maximize the value of your ATI product, you should ensure that you have the latest documentation. ATI's documentation contains helpful installation/configuration tips and other valuable feature information.

Contents

- Getting Started..... 1**
- Using this Guide 2
 - Viewing the User's Guide Online..... 3
 - Do you Need a Printout of the Online User's Guide?..... 3
- Customer Care 4
- FireGL Card Features 5
- System Requirements and Tools 7
- Quick Installation 8
- Installing the Hardware and Software 9**
- Installing the Hardware 9
 - Preparing your Computer 10
 - Installing the Card 14
 - Connecting the Cables and Completing the Installation 20
- Installing the Software..... 23
 - Before you Start: Information, Tips, and Hints..... 24
 - Software Installation for Windows 2000 and Windows XP 25
- Using Your FireGL Card..... 27**
- Using Two Monitors..... 29
 - Using the DualScreen Tab 30
- Changing the Video Settings 31
 - How to Switch to the Display Properties 31
 - Setting Resolution, Color Depth and Refresh Rate..... 31
 - Adjusting the Monitor Display 33
- Using Application Profiles and Advanced Functions..... 36
 - Configuring Application Profiles 36
 - Setting Advanced Functions..... 39

see also
HYDRAVISION™ User's Guide

Reference 41

- Removing the FireGL Drivers..... 41
- Troubleshooting..... 43
- Technical Details 46
 - Product Specifications..... 46
 - Pin Assignments..... 48
 - Video Modes 49
- Warranty Service Information 51
- Compliance Information..... 53

CHAPTER 1

Getting Started

Your ATI FireGL card is an advanced workstation 3D graphics accelerator based on a high-bandwidth, parallel pipeline geometry and rendering architecture. The card delivers workstation-class performance to designers, engineers and animators, running the leading OpenGL and DirectX applications

Features of your FireGL workstation graphics accelerator:

- Real-time photo-realistic rendering and animation
- Stable and reliable software support for Windows® and Linux® platforms
- Optimized support for the leading workstation applications
- SMARTSHADER™ technology for creating complex visual effects
- SMOOTHVISION™ technology for advanced full-scene anti-aliasing

IN THIS CHAPTER...

- **Using this Guide** on page 2
- **FireGL Card Features** on page 5
- **System Requirements and Tools** on page 7
- **Quick Installation** on page 8

Using this Guide

Many hyperlinks provide easy access to any information you may want. To make it useful in a printed format, too, a -hyperlinked - table of contents and page numbers are provided.

Since this guide was designed to be used online and printed, the quality of some images on screen or in print may be affected.

The organization of this guide is as follows:

Installing the Hardware and Software on page 9 provides instructions for installing your FireGL card, loading the driver and connecting video output devices to your card.

Using Your FireGL Card on page 27 explains how you can take advantage of the advanced features of your FireGL card.

Reference on page 41 provides troubleshooting tips and regulatory compliance information for your card.

HYDRAVISION™ User's Guide provides information on using HYDRAVISION, a multi-monitor and desktop management utility to control multiple display desktops.

Viewing the User's Guide Online

You can easily read the User's Guide online - important hypertext links, such as Table of Contents entries, World Wide Web, and E-mail addresses are active.

Place your mouse cursor over Table of Contents entries or main headings. If the hand icon changes to a pointing index finger, simply click and you will move to that place in the document. Displaying the provided bookmark and thumbnail views may help you with the navigation in the User's Guide. Some E-mail or Web addresses inside this manual may be active as well. Go directly to a Web, FTP site, or E-mail program simply by clicking on an active link.

This manual might be displayed with slightly-reduced magnification in your Reader. If you experience any difficulty reading certain files online, use the Reader's *Zoom To* feature from the *View* menu and increase the magnification to about 150%. To view details of some screenshot images you may need to increase magnification.

Do you Need a Printout of the Online User's Guide?

You can also print this User's Guide to access it off-line. The manual then will look like any standard document with a table of contents and page numbers.

For printing the User's Guide, a print resolution of 600 dpi or higher is recommended.

Customer Care

If you require assistance to get the most out of your product, the following options are available:

- **Online:** For product information, video drivers, Frequently Asked Questions and Email support visit:
<http://www.ati.com> and select CUSTOMER CARE.
- **FireGL Workstation dedicated toll free support line:**
*866-284-2093
Available Monday through Friday, 9:00 AM - 7:00 PM EST.
*Access to Telephone Support is available to workstation users at no additional cost. For complete details please visit:
<http://www.ati.com/support/contact.html>
- **Mail:**
ATI Technologies Inc.
Attention: Customer Service
1 Commerce Valley Drive East
Markham, Ontario
Canada L3T 7X6

ATI Customer Care Product Online Registration

By registering your ATI product you will be able take advantage of driver update notification, technical updates, online store specials and promotions, contests / giveaway announcements and information specific to your product.

Product Online Registration is available at:

<http://www.ati.com/online/registration>

FireGL Card Features

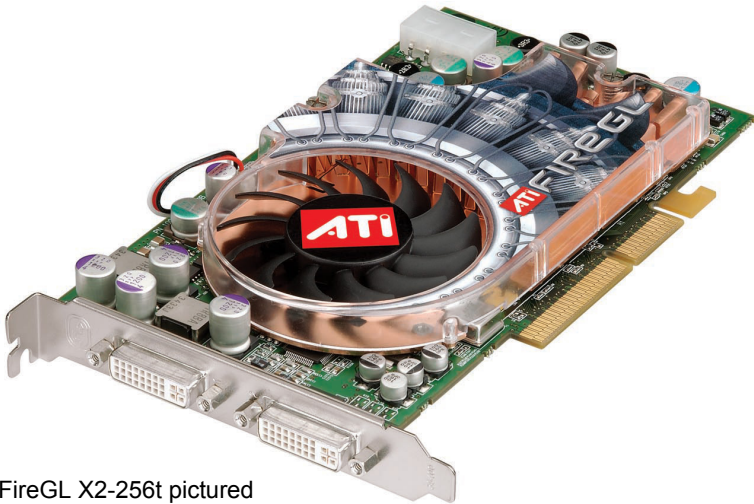

FireGL X2-256t pictured

| FireGL | VPU | Video Memory | Rendering Pipelines |
|----------------|------------|--------------|---------------------|
| FireGL X2-256t | FGL 9800XT | 256 MB | 8 |
| FireGL X2-256 | FGL 9800 | 256 MB | 8 |
| FireGL X1-128 | FGL 9700 | 128 MB | 8 |
| FireGL Z1-128 | FGL 9500 | 128 MB | 4 |

VPU: Visual Processing Unit

- Video memory: DDR SDRAM
 - unified frame buffer, Z-buffer, texture storage
 - 128-bit floating point precision frame buffer for photo-realistic renderings.
 - 256-bit memory interface for fast 3D graphics
- Pixel pipeline architecture provides enhanced rendering power.

- Supports AGP 3.0 standard (AGP 4X/8X), providing a two way high-speed interface between the graphics subsystem and the workstation
- OpenGL 1.3 with 1.4 extensions
DirectX® 9.0 functionality in OpenGL®
- Full DirectX® 9.0 support
- DDC1/2b/2b+ monitor support on all operating system platforms
- Support for two analog or digital monitors
High resolutions up to 2048 x 1536, 32-bit
Independent resolutions and refresh rates for any two connected monitors
9.1 Mpixel, 3840 x 1240 single-display support
- Application-specific display profile utilities for optimal performance
- Intel Pentium® 4 Streaming SIMD and AMD Athlon 3Dnow!™ support for Windows 2000, Windows XP and Linux operating systems.



For more detailed information on features and performance please refer to the section *Technical Details* on page 46.

System Requirements and Tools

| | |
|--|--|
| Computer system | <ul style="list-style-type: none">• Intel® Pentium® 3, Pentium® 4, Xeon® AMD® Athlon® XP/MP/Opteron or compatible• 128 MB of system memory 256 MB or more for best performance• Motherboard with free AGP slot and correct AGP chipset-driver• CD-ROM drive |
| Operating system | <ul style="list-style-type: none">• Windows®2000 with Service Pack 1 (or higher)• Windows®XP• Linux XFree86 4.X.0 |
| Service Pack Information for Windows 2000 | <p>You must be running Windows 2000, updated with Service Pack 1 (or higher) prior to installing the FireGL drivers.</p> <p>Service Packs are available from Microsoft's web site, www.microsoft.com.</p> |
| Tools | <ul style="list-style-type: none">• A screwdriver to remove and reinstall the PC cover screws and card mounting screws. See your PC manual for specific requirements.• ATI INSTALLATION CD-ROM for your FireGL card |
| Monitor | <ul style="list-style-type: none">• High-resolution MultiSync or multi-frequency monitors or other VGA monitors.• Digital flat-panel (DFP) displays or digital CRT displays |

Quick Installation

- Brief instructions on how to get to work with the FireGL card in the shortest possible time.
- Recommended for experienced users and system administrators only.
- For more detailed information on installation and operation of your graphics accelerator, please refer to Chapter 2 and Chapter 3.

Installation Steps

- 1** If you are replacing an existing graphics card, un-install the drivers and software for your old graphics card.
- 2** Disable any on-board graphics solution on the motherboard.
- 3** Shut down and disconnect your computer system.
- 4** Remove the installed (AGP or PCI) graphics card.
- 5** Install the new FireGL card.
- 6** Reassemble and connect your computer system.
- 7** Install the FireGL drivers and configuration software from the ATI INSTALLATION CD-ROM:
 - automatic **ATIS SETUP** utility or
 - **Start > Run > X:\ATIS SETUP.EXE**
where X is the drive letter of your CD-ROM drive

CHAPTER 2

Installing the Hardware and Software

IN THIS CHAPTER...

- **Installing the Hardware** on page 9
- **Installing the Software** on page 23

Installing the Hardware

The hardware installation includes the following steps:

- **Preparing your Computer**
- **Installing the Card**
- **Connecting the Cables and Completing the Installation**

Preparing your Computer

Information Before you Start

Do This First!



Install the latest AGP chipset driver for your motherboard.

- Each motherboard requires the installation of a custom-built virtual GART (AGP) driver. This chipset driver is required by your FireGL card to function correctly with your motherboard.
- You **must** install the correct AGP chipset driver **before** installing the FireGL card in your system.
- Contact your supplier or motherboard/chipset manufacturer to obtain and install the latest AGP chipset driver for your motherboard.

An incorrect or missing chipset driver can result in AGP memory not being detected or a black screen after Windows® starts.

How to determine what motherboard chipset is present on your system

- Right-click **My Computer** and select **Properties**.
- Click the **Hardware** tab and select **Device Manager**.
- Scroll to the bottom of the device list. Select **System devices**.
- Scroll through the list of **System devices** until you find a listing for the AGP controller.
- The chipset manufacturer's name will appear as the device name.



Turn off the power to your system and discharge your body's static electric charge by touching a grounded surface (for example, the metal surface of the power supply) before performing any hardware procedure.

The manufacturer assumes no liability for any damage, caused directly or indirectly, by improper installation of any components by unauthorized service personnel. If you do not feel comfortable performing the installation, consult a qualified computer technician.

Damage to system components, the accelerator card, and injury to yourself may result if power is applied during installation.

What do you need to use your FireGL card?

System Requirements and Tools

- Motherboard with free AGP 8x/4x slot:
- Correct AGP GART chipset driver installed for your motherboard.
- 128 MB of system memory
256 MB or more for best performance
- System interrupt (IRQ) which is free. This may have to be reserved in the computer's BIOS. For help with this subject, refer to the manual for your mainboard
- Intel® Pentium® 3, Pentium® 4, Xeon®; AMD® Athlon® XP/MP, or compatible
- Supported operating system
 - Windows® 2000 with Service Pack 1 (or higher)
 - Windows® XP
 - Linux XFree86 4.X.0
- A screwdriver to remove and reinstall the PC cover screws and card mounting screws. See your PC manual for specific requirements.
- ATI INSTALLATION CD-ROM for your FireGL card.

| | |
|---|--|
| What monitors do you need? | <p>Your FireGL card is configured to be combined with digital flat-panel (DFP) displays and digital CRT displays.</p> <p><i>Note:</i> Your DFP monitor must have a data cable with digital-only DVI plug (DVI-D) - but not with integrated analog/digital DVI plug (DVI-I). Check with your monitor's documentation.</p> <p>You can also connect the FireGL card to high-resolution MultiSync or multi-frequency monitors or other VGA monitors.</p> <p><i>Notes:</i> (1) You need a Plug-and-Play monitor that supports VESA's Display Channel specifications (DDC1 or DDC2) to take advantage of the DDC1/DDC2b+ features (2) You can use the full power of the graphics card only if your monitor supports the horizontal (kHz) and vertical (Hz) refresh rates as required by the graphics card. Refer to your monitor's documentation for recommended refresh rates</p> |
| Where are the drivers? | <ul style="list-style-type: none">• Windows 2000 and Windows XP drivers are provided on the ATI INSTALLATION CD-ROM. The most recent certified drivers are available from www.ati.com/FireGL.• Linux drivers and installation instructions are available for downloading from www.ati.com/support. |
| Are you planning a multi-monitor system? | <ul style="list-style-type: none">• You may connect two monitors to the FireGL™ card.• If DDC support is available, the respective resolution and refresh rate for each monitor is automatically detected.• The following multi-monitor and Desktop Management utilities are provided:<ul style="list-style-type: none">- HYDRAVISION™- DualScreen |

| | |
|---|---|
| Replacing an existing graphics card | Before you install your FireGL card, we recommend that you first uninstall the driver for your current graphics card. |
| Replacing integrated graphics | Please refer to the manual or contact your motherboard manufacturer to determine how to disable your on-board graphics. |
| Illustrations | The illustrations provided in this section are for instructional use only; the card shown may look different than the one you purchased. |
|  | Note the serial number and the part number of your FireGL card before installing it in your computer. You need these numbers for the product warranty registration. You will find the numbers on the product label on the back of your FireGL card. |

Installing the Card

To install your graphics accelerator card, follow these steps:

- 1** **Switch off your computer and all external options (monitor, printer, and others).** Then disconnect all cables from the back of your computer. Unplug all power cables from the electrical source.

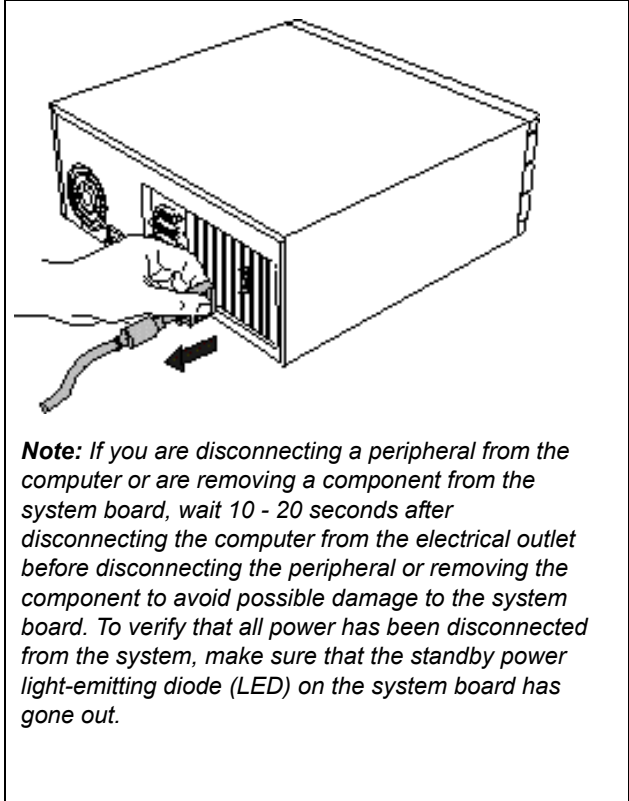

- 2** **Remove the computer cover.** If necessary, consult your computer system manual about removing the cover.

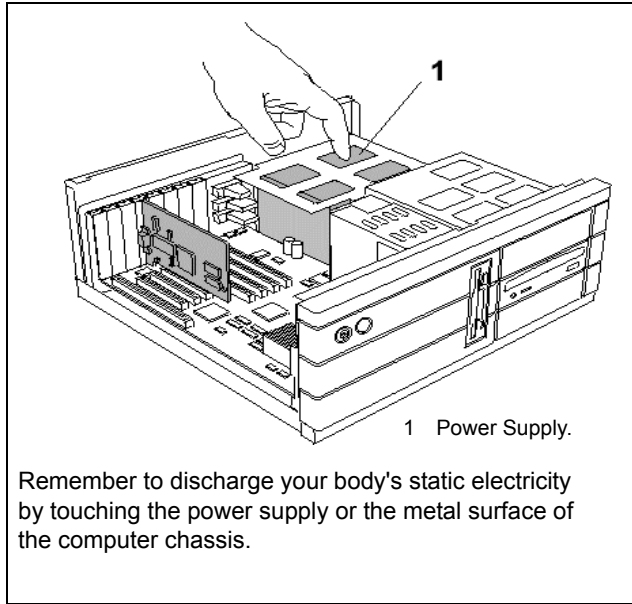

3 Remove any existing graphics card from your computer.

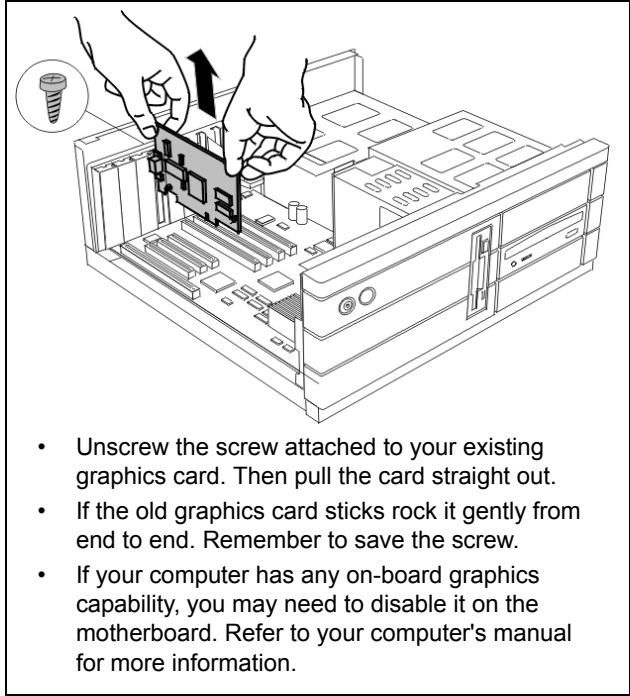

4 Connecting power to the card



The FireGL™ card requires connection to your PC's internal power supply for operation. A 300W power supply or greater is recommended to ensure normal operation where a number of other internal devices are installed.

Use the supplied Power Extension Cable to connect the FireGL™ card to the computer's hard drive power connector.

- 1 Remove the power cable from the hard drive power connector.
- 2 Connect **A** of the Power Extension Cable to the FireGL card as shown. (the cable may already be connected to the graphics card.)
- 3 Connect **B** to the power supply connector

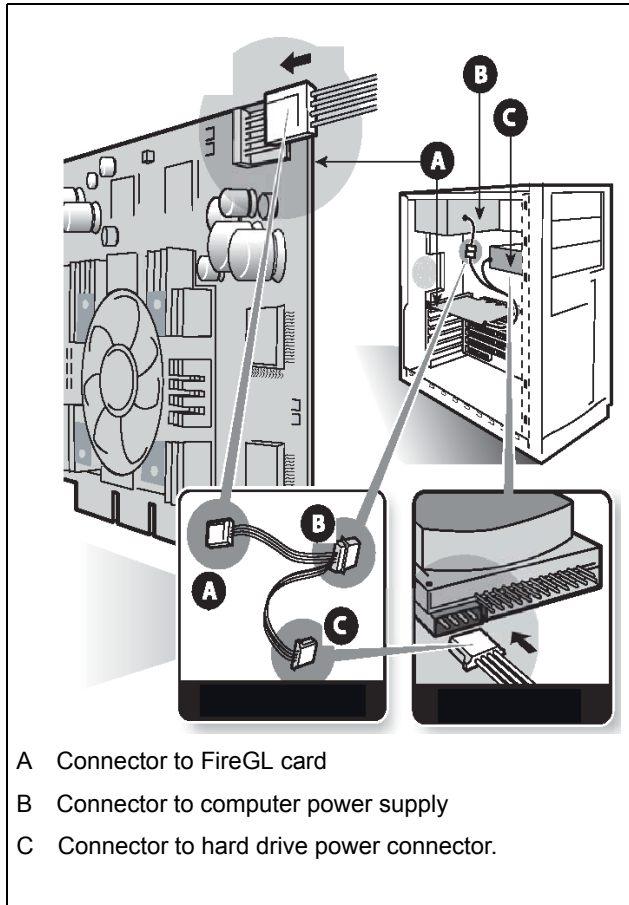
4 Connect C to the hard drive power connector.

5 Insert the card into the AGP slot.

Note: The FireGL card fits in either AGP 8x or AGP 4x slots.

- Locate the AGP slot. Refer to your computer's manual for more information.
- If necessary, remove the metal slot cover from the AGP slot. Save the screw to secure the graphics card later.
- Align the FireGL card with the AGP slot, and press it in firmly until fully seated.

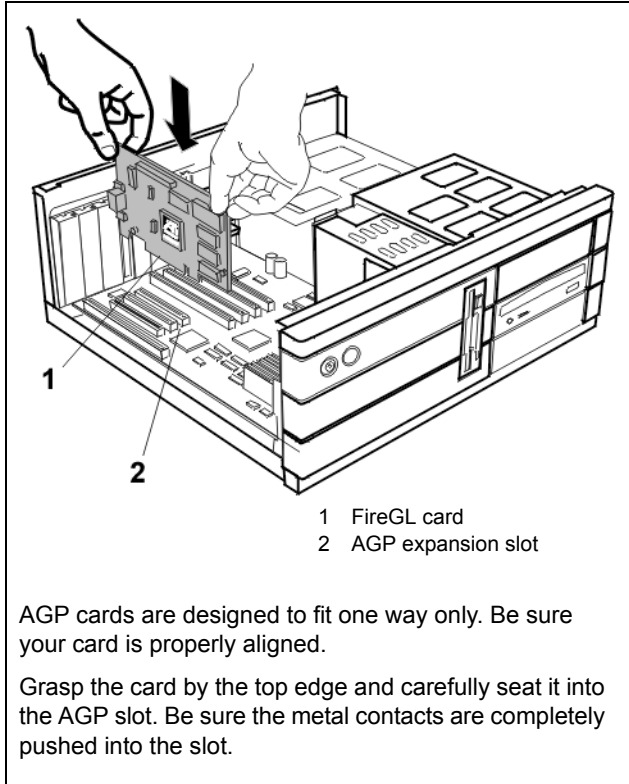

6 Replace the screw to fasten the card in place.

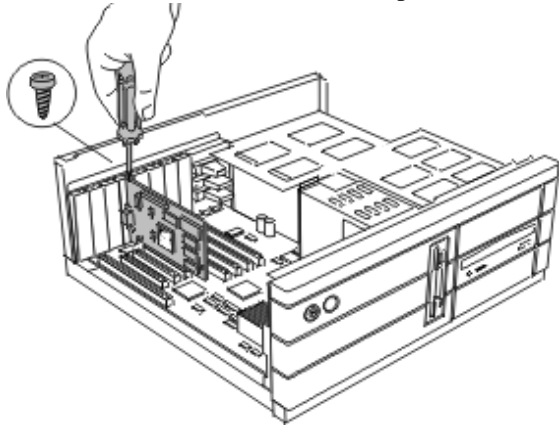

- Align the slot in the mounting bracket of the card with the screw holes in the rear panel of the computer case.
- Use the screw you removed from the expansion slot cover or a previously installed graphics card to secure the card in place.

7 Reassemble your computer.

- Secure ribbon cables and gently push them down and out of the way before you replace the system cover.
- Replace the computer cover.
- Reconnect any peripheral equipment cables you may have disconnected.

Connecting the Cables and Completing the Installation

Connecting the Monitor Cables

You may connect one or two monitors, either DFP/digital CRT or analog VGA to the FireGL™ card. Use the provided DVI-to-VGA adapters to connect monitors with a VGA connector.

 If you connect only one monitor, make sure to connect it to DVI connector (1) on the card.

Securely attach the data cable of your first monitor to the DVI output connector (1) on the card. Attach the cable to the monitor according to the monitor's instructions. Refer to the documentation that came with your monitor if you need additional installation information.

Connect the data cable of your second monitor to the DVI output connector (2) on the card.



FireGL X2-256, FireGL X1-128, FireGL Z1-128



FireGL X2-256t

Connecting analog VGA Monitors to DVI connectors

If the data cable connector on your VGA monitor does not fit into the DVI connector on the card, use the DVI-to-VGA adapters provided with your FireGL card..

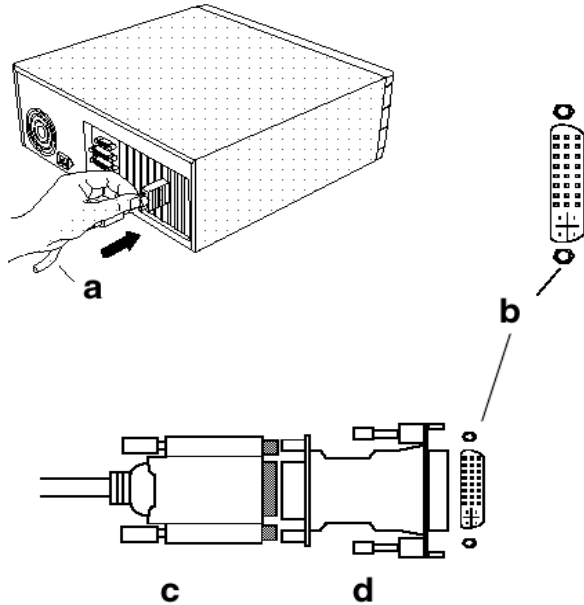

- | | | | |
|---|-----------------------|---|----------------------------|
| a | Monitor cable | c | VGA connector from monitor |
| b | DVI connector on card | d | DVI-to-VGA adapter |

Setting the Monitor Impedance

If you can switch the impedance values on your monitor, use the following recommended settings:

- RGB video input: 75 Ohm
- Sync: 2.2 kOhm

Try other 'Sync' settings if you cannot achieve a stable video image.

If the impedance setting options are 'High' and 'Low' only, try the setting that provides the most satisfactory monitor display.

Start your System

Turn on your monitor before you turn on your computer. Failing to do so could damage your monitor.

If you have correctly installed the card, operating system messages will appear on your monitor when the boot procedure is finished.



Your monitor is running in a basic video mode. Higher refresh rates are not available at this stage of the installation. After you have successfully installed the FireGL drivers you can use the tabs in the **Display Properties** menu to adjust the video settings and set up a multi-monitor configuration.

If Your System Does Not Start as it Should

- Verify that the installation instructions were properly followed.
- Check that the card is properly installed in your system and connected to your monitor.
- Refer to the documentation that came with your monitor: Check your connections to the video and power cables. Try adjusting the brightness, sharpness, and contrast controls of your monitor.
- If you have problems during start-up, restart your computer in **Safe Mode**.
While starting Windows® 2000 and Windows® XP, press and hold **F8** until you see the Windows® Advanced Options Menu. Use the arrow keys to select **Safe Mode**, and press **Enter**.
- Check the system configuration utility of your operating system for the interrupt assignments.
- Please refer to the [Troubleshooting](#) section for more information, if it appears that the card is not performing optimally.
- Contact ATI's Customer Care or your local technical support.

Installing the Software

- **Before you Start: Information, Tips, and Hints**
- **Software Installation for Windows 2000 and Windows XP**

You will need to install the FireGL drivers and software in the following cases:

- After you have installed the card in your system.
- After you have re-installed or upgraded your operating system.



(1) To install or remove the FireGL drivers, you need administrator rights or you must be logged on as a user with administrator rights under Windows 2000 and Windows XP.

(2) Information for Windows 2000:
You must have Microsoft Windows Service Pack 1 (or higher) installed prior to installing the FireGL drivers.

The Service Pack is available from Microsoft's web site, www.microsoft.com.

(3) Linux drivers and installation instructions are available for downloading from www.ati.com/support.

(4) The most recent certified FireGL drivers are available from www.ati.com/FireGL

Before you Start: Information, Tips, and Hints

Before you install the drivers for your FireGL card, make sure your monitor cable is properly attached to the card.

Do you need a special driver installation?

The software installation procedure later in this chapter describes how to install the drivers for your graphics card after you have installed the new card for the first time and have rebooted your computer.

This section offers some additional tips if you want or need to install the graphics card drivers in a special working scenario, for example, if you have re-installed your operating system, or if you want to perform a manual installation.

- You can always install the drivers using the **ATISSETUP** utility on the ATI INSTALLATION CD-ROM. The **ATISSETUP** utility will start automatically, if you insert the ATI INSTALLATION CD-ROM into your CD-ROM drive after the operating system has started. If your CD-ROM auto-run is not enabled and/or the **ATISSETUP** utility does not start automatically:
Click the **Start** button in the task bar, click **Run**, and then select **ATISSETUP.EXE** from the root directory of the ATI INSTALLATION CD-ROM. Click **OK**.
- Where are the drivers? When prompted for a driver installation CD, insert the ATI INSTALLATION CD-ROM and enter or browse to **\drivers**.
- You need your operating system installed and running before you can install the FireGL drivers.

HYDRAVISION™ Multi-monitor Management

The HYDRAVISION™ multi-monitor and desktop management software will install automatically with the **Express** driver installation of the **ATISSETUP** utility. If you do not want to install HYDRAVISION™ select the **Custom** driver installation and clear the **HYDRAVISION™** check box.

Driver installation dialog

The installation dialog will display in English if your operating system's language is not supported.

Software Installation for Windows 2000 and Windows XP

- 1** Start your system. When the **Found New Hardware Wizard** comes up, click **Cancel**. When the **System Settings Change** window asks you to restart your computer, click **No**.
- 2** Run the **ATISSETUP** utility. The **ATISSETUP** utility will start automatically, if you insert the ATI INSTALLATION CD-ROM into your CD-ROM drive after the operating system has started. If your CD-ROM auto-run is not enabled and/or the **ATISSETUP** utility does not start automatically:
Click the **Start** button in the task bar, click **Run**, and then select **ATISSETUP.EXE** from the root directory of the ATI INSTALLATION CD-ROM. Click **OK**.
- 3** Click **Install** under Software Install.
- 4** Click **Next**.
- 5** Click **Yes** to the license agreement.
- 6** ATI Easy Install starts the Installation Wizard.

- 7** Follow the Wizard's on-screen instructions to complete the installation.

*The **Express** installation option is recommended. The HYDRAVISION™ multi-monitor and desktop management software will automatically be installed, along with the ATI driver, by selecting this option.*

*Not all software components are installed using the **Express** installation. **Custom** installation allows you to select individual software components for installation.*
- 8** When the **Setup complete** message appears, select **Yes, I want to restart my computer now** and click **Finish**.
- 9** After Windows 2000/Windows XP reboots, the **Found New Hardware** message may display the **Digital Signature Not Found** message. Click **Yes** or **Continue** to complete the driver installation.
- 10** Click **Start > Settings > Control Panel > Display > Settings**, or right-click on the Windows desktop, select **Properties** and **Settings**.
- 11** Set the resolution (**Screen area**), and color depth that best suit your requirements and your monitor's performance.
- 12** Click the **Advanced** button and select the **Monitor** tab.
- 13** Set the refresh rate for the monitor connected to the FireGL card in your system.
- 14** Click **OK** until you are on the Windows desktop.



Refer to your Windows online help and documentation for further information on using the Monitor and Settings tabs.

CHAPTER 3

Using Your FireGL Card

IN THIS CHAPTER...

- [Using Two Monitors](#) on page 29
- [Changing the Video Settings](#) on page 31
- [Using Application Profiles and Advanced Functions](#) on page 36

As part of its Windows drivers, FireGL installs additional tabs to your Display Properties control panel. They are named as follows.

Information
Adjustment
DualScreen
Configuration
Advanced Settings

The **Information** tab displays card-specific hardware and driver information. This information may be helpful when contacting Tech Support. Click **Display Properties > Settings > Advanced > Information**.

Use the **Adjustment** tab to adjust the display of the connected monitor(s)

Use the **DualScreen** tab to enable the following functions:

- duplicate the display of the primary monitor on the second monitor
- special video mode for high-resolution monitors

Use the **Configuration** tab to customize application profiles for individual application settings.

Use the **Advanced Settings** tab to enable the following functions:

- SMOOTHVISION™ for enhanced image quality
- Additional operation modes for DVI monitors

Using Two Monitors

You can set resolutions, refresh rates, and display adjustment independently for any two connected displays.



For two-monitor configuration settings you need the following:

- Two monitors connected to the card
- Both monitors switched on when you start your computer

- Use the **Display Properties > Settings** tab for the basic two-monitor configuration settings. Refer to your Windows online help and documentation for further information on using the **Display Properties > Settings** tab.
- **Switching to a two-monitor display:**
In the **Display Properties > Settings** tab click the monitor icon **2**.
Select **Extend my Windows desktop onto this monitor**. Set **Screen resolution** and **Color quality** for the second monitor.
Click the **Apply** or **OK** button to enable your settings.
- **HYDRAVISION™** multi-monitor and desktop management software enables you to tailor your two-monitor desktop to the way you work. For more information on HYDRAVISION™, refer to the **HYDRAVISION™ User's Guide** located on your ATI INSTALLATION CD-ROM.
- If you want the display of the primary monitor duplicated on the second monitor, select **Clone Mode** in the **DualScreen** tab.



Options and settings in the **Monitor** and **Adjustment** tabs apply only to the monitor selected in the **Display Properties > Settings** tab. Click the corresponding monitor icon before you click **Advanced**.

Using the DualScreen Tab

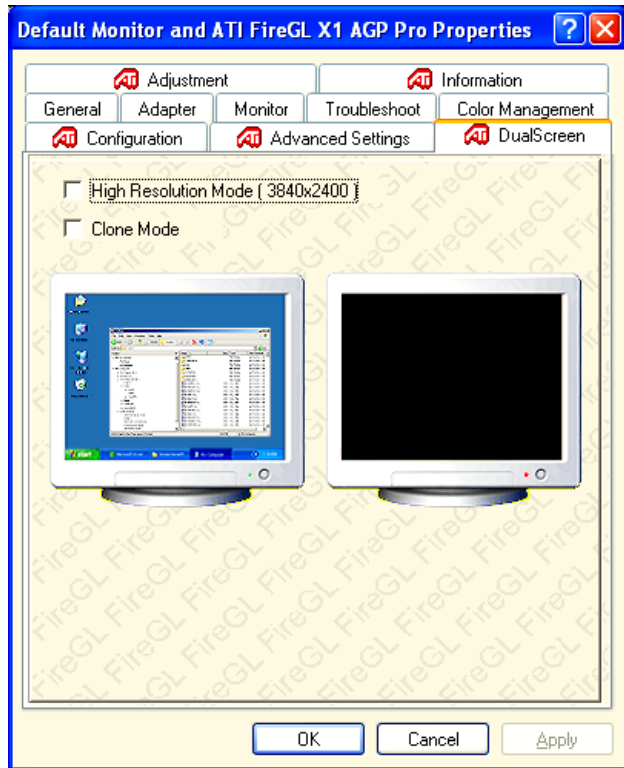

To see the **DualScreen** tab displayed, you need the following:

- Two monitors connected to the card
- Both monitors switched on when you start your computer

- 1 Select the **DualScreen** tab via **Display Properties > Settings > Advanced > DualScreen**. Refer to the context sensitive online help for more information on setting up your DualScreen configuration.
- 2 Select **High Resolution Mode** to extend the display of a high-resolution monitor to the full size of the monitor.
Note: The option **High Resolution Mode** is active only with a high-resolution monitor (9-million pixel class) connected.

- 3 Select **Clone Mode** if you want the display of the primary monitor duplicated on the second monitor.
- 4 Click the **Apply** or **OK** button to enable your **DualScreen** setting.

Changing the Video Settings

The tabs in the **Display Properties** menu allow setting and adjusting the video settings to best suit your specific requirements

- [Setting Resolution, Color Depth and Refresh Rate](#)
- [Adjusting the Monitor Display](#)

How to Switch to the Display Properties

- 1 Start Windows.
- 2 Windows 2000: Click **Start > Settings > Control Panel**.
Windows XP: Click **Start > Control Panel > Appearance and Themes**.
- 3 Double-click the **Display** icon. The **Display Properties** window appears.



- 1 You can also display the **Display Properties** window by right-clicking the Windows Desktop background and then selecting the **Properties** option from the pop-up menu.
- 2 Click the **Advanced** button in the **Settings** tab to gain access to the **Monitor**, **Information**, **Configuration**, **Adjustment**, **DualScreen**, and **Advanced Settings** tabs.

Setting Resolution, Color Depth and Refresh Rate

- 1 Select the **Settings** tab in the **Display Properties** window.
- 2 **Color depth**: Select a value from the **Colors** box.
- 3 **Resolution**: In the **Screen area** drag the slider.

- 4 Refresh Rate:** Select the **Monitor** tab via **Display Properties > Settings > Advanced > Monitor**. Select a refresh rate from the **Refresh Frequency** list (**Screen refresh rates** in Windows XP.)
- 5** Click **Apply**
- 6** To preview the new settings, click **OK**.
- 7** To accept the settings, click **Yes**; otherwise, click **No**.
- 8** If the display becomes garbled or unusable, simply wait and Windows will restore the original settings



- 1** Check the documentation of your monitor(s) and make sure that each monitor supports the planned resolution and refresh rate and color depth settings.



Warning! Selecting a resolution or refresh rate that your monitor does not support can permanently damage the monitor.

- 2** Use the **Monitor** tab (**Display Properties\ Settings\ Advanced\ Monitor**) to select and set your specific monitor settings.
- 3** Use the **DualScreen** tab (**Display Properties\ Settings\ Advanced\ DualScreen**) to enable the following functions:
 - duplicate the display of the primary monitor on the second monitor
 - special video mode for high-resolution monitors
- 4** Use the **Adjustment** tab (**Display Properties\ Settings\ Advanced\ Adjustment**) to adapt the display of the monitors connected to the FireGL card.

Adjusting the Monitor Display

Using **Adjustment** tab you can fine-tune the display of your monitor. For more information on adjusting the monitor's display refer to the context sensitive online help.

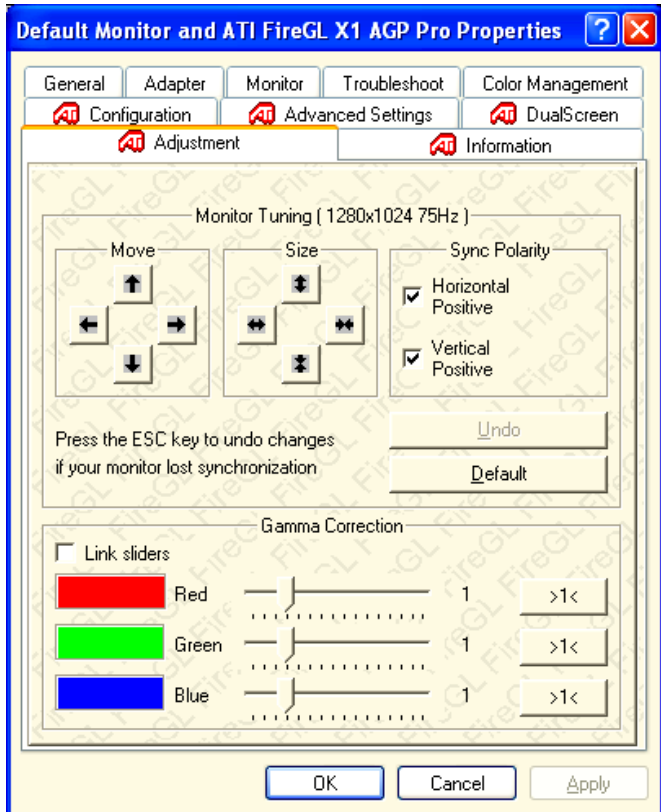

- 1 Select the **Adjustment** tab via **Display Properties > Settings > Advanced > Adjustment**.

2 Monitor Tuning - available only for VGA monitors

- With the buttons in the **Move** and **Size** sections you can tune the position and size of the monitor's display for the indicated resolution and refresh rate



- 1 First use the hardware setting controls on your monitor, if available, to adjust your display size or position. Then, if needed, use the software controls in 'Adjustment - Monitor Tuning.' Check the documentation of your monitor for information on your monitor's hardware controls
- 2 Resizing the display slightly changes the actual refresh rate. If you operate a fixed-frequency monitor check the documentation of your monitor for information on refresh rate tolerances.

- **Sync Polarity:** If you do not get a satisfactory display with the default sync polarity setting for the current resolution, you may try and change the settings.
- **Undo:** Click this button to undo the last change you made (when you clicked **Apply**). If you have made a modification that causes your screen to go blank or to be unreadable, the keyboard shortcut for 'Undo' is **Alt-U**.
- **Default:** Click this button to set the **Monitor Tuning** to the manufacturer's default settings.



- 1 Press the **ESC** key on your keyboard to undo the changes if your monitor has lost synchronization. You may also use the keyboard shortcut for 'Undo'- **Alt-U**.
- 2 If you change the resolution (in **Settings**) and/or the refresh rate (in **Monitor**), you may need to re-adjust the monitor's display.

- 3 Gamma Correction Adjustment:** Adjust the monitor's gamma correction for optimal brightness with the red, green and blue slider bars.

When these sliders are changed the gamma correction table modifies each pixel's color value.

The brightness produced at the face of the display is proportional to the input voltage raised to the power gamma. This nonlinearity must be compensated to achieve correct reproduction of the image's brightness. The effect of display gamma is to darken the midtones relative to the dark and light regions. The gamma correction adjustment affects the entire screen display. The possible setting range is 0.3 - 4.0. The default setting is 1.0.

With **Link sliders** selected, the three sliders move together as you drag any individual slider. With the check box unchecked, you can adjust colors individually by dragging the applicable slider.

Click the >1< button for each color to set the gamma correction to the default value of 1.0.

- 4** Click the **Apply** or **OK** button to enable your **Adjustment** settings.

Using Application Profiles and Advanced Functions

Use the **Configuration** tab to customize application profiles for individual application settings.

Use the **Advanced Settings** tab to enable the following functions.

- SMOOTHVISION™ for enhanced image quality
- Additional operation modes for DVI monitors

Configuring Application Profiles

Switching to Configuration

Select **Display Properties > Settings > Advanced > Configuration**

The configuration default settings typically require modification only for the following:

- diagnostic purposes
- fine-tuning a specific application/system configuration
- specific settings recommended by your hardware or software documentation
- tuning your application/system environment for best performance and memory usage

Activating a configuration profile

For some of the most popular applications the optimal configuration profile is factory-set by default. Select the application from the list in the **Configuration Profiles** section. This will add necessary Windows registry settings. Click **Apply** and, if prompted, restart Windows.

If you experience problems with your application, or if you want to try to optimize the performance of your system on specific applications, you may modify the configuration settings.

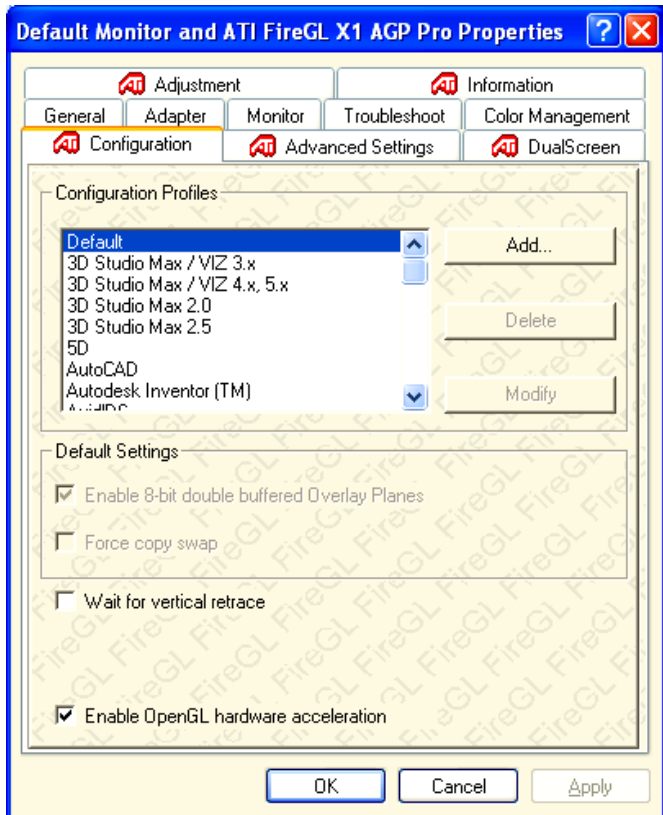

Adding a new application profile

Click the **Add** button in the **Configuration Profiles** section and enter the new application for which you want to set the configuration parameters.

Modifying the configuration parameters

To change the configuration settings of a specific application, for example, CATIA, select the application from the list in the **Configuration Profiles** section and click the **Modify** button. To remove the selected configuration profile completely, click **Delete**.

Note: You cannot delete the factory-set configuration profiles.

If you add or modify a configuration profile, select or clear the checkboxes in the **Settings** section according to your requirements.

Default Settings

Enable 8-Bit double-buffered Overlay Planes

Use 8 bits of each 32-bit frame buffer pixel as double-buffered overlay planes.

Force copy swap

Force blit copy during double-buffer swap from back to front buffer.

Wait for vertical retrace

Buffer swap 'synced' to the refresh rate of the monitor.

Enabling will lower the frame rate but reduce visual artifacts such as tearing. Disabling allows your application to run at the highest possible frame rate, regardless of the monitor's refresh rate, which is typically less than the frame rate at which the application will run.

Enable OpenGL Hardware acceleration

Always enable this setting for hardware acceleration of your OpenGL application. Disable this setting only if you experience serious rendering problems. Disabling this setting significantly reduces the OpenGL performance.

Click the **Apply** or **OK** button to enable your **Configuration** settings.

Setting Advanced Functions

Switching to Advanced Settings

Select **Display Properties > Settings > Advanced > Advanced Settings**.

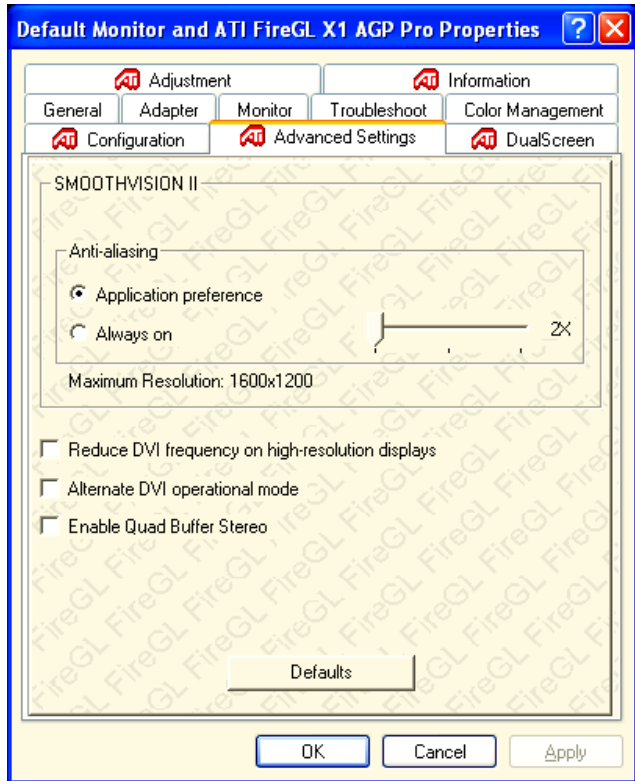

SMOOTHVISION™

SMOOTHVISION improves image quality by removing jagged edges (Anti-Aliasing) from 3D images, resulting in smoother, more natural looking objects.

Anti-aliasing:

Application Preference: This gives OpenGL/Direct 3D applications the ability to enable anti-aliasing. If an application does not specify an anti-aliasing-setting, anti-aliasing is disabled. This option will result in high quality images, with a negligible reduction in the application's performance.

Always on: You can apply anti-aliasing using different sample patterns and sample points such as 2X or 4X. Moving the slider to the right increases sampling to provide the most realistic 3D image, at the cost of some 3D performance.

Note: The **Always on** setting overrides the applications' anti-aliasing setting.

Reduce DVI frequency on high-resolution displays

Resolves display corruption or no image at high resolutions - for example, 1280x1024 at 75Hz - using a digital DVI display. This setting has no effect when using a DVI-to-VGA adapter.

Alternate DVI operational mode

Use this option if you are experiencing display corruption on your DVI flat panel monitor.



The option **Enable Quad Buffer Stereo** is available only for FireGL cards with a stereo connector.

Default

This button allows you to reset the **Advanced Settings** to the default values.

CHAPTER 4

Reference

IN THIS CHAPTER...

- **Removing the FireGL Drivers** on page 41
- **Troubleshooting** on page 43
- **Technical Details** on page 46
- **Warranty Service Information** on page 51
- **Compliance Information** on page 53

Removing the FireGL Drivers

This section describes how to properly remove your graphics card software from your system should you need to do so.



- 1 Before removing the FireGL video driver, please close all open application programs and disable any anti-virus software that is running on your computer until the driver is removed.
- 2 To install or uninstall the FireGL drivers, you need administrator rights or you must be logged on as a user with administrator rights under Windows.

- 1 Start Windows®.
- 2 Click **Start**.
- 3 Point to (**Settings >**) Control Panel.

- 4** Click **Add/Remove Programs**.
- 5** Select **ATI Display Driver** from the list of software programs.
- 6** Click **Change/Remove** button.
The **ATI uninstall** dialog appears.
- 7** Click **Yes** to remove the ATI Display Driver.
- 8** Click **Yes** to restart your computer.

After you have removed the software according to the instructions, you may remove the hardware.

- 1** Shut down your computer.
- 2** Remove the computer case as outlined in the hardware installation instructions.
- 3** Ground yourself by touching the power supply box.
- 4** To remove the graphics card, perform the hardware installation procedures in reverse order.

Troubleshooting

Your board is a complex electronic device and can only be repaired by authorized technical personnel with special equipment. Do not attempt to change or repair any parts of this product as doing so will void your warranty.

If you experience a problem using the FireGL card, check the following sections for advice on how to solve your problem.

| | |
|---|--|
| Technical Support and FAQs | <p>You may find information on Technical Support, as well as Frequently Asked Questions (FAQ) and their answers at the web sites of ATI Inc. Go to www.ati.com and select CUSTOMER CARE for BUILT BY ATI products.</p> |
| No image appears on display | <ul style="list-style-type: none"> • Make sure that the FireGL card is firmly seated in its AGP slot, and that the monitor cable is firmly and correctly connected to the card. For more information, please refer to Installing the Hardware on page 9. • Make sure that your computer and monitor are plugged into electrical outlets and receiving power. • Is the monitor turned on and receiving power?. |
| Screen image defects appear  | <ul style="list-style-type: none"> • Check if your monitor supports the resolution, horizontal (kHz) and vertical (Hz) refresh rates as required by the graphics card. • Check for your current resolution, refresh rate, and color depth settings in the Settings and Monitor tabs of the Display Properties. <p>Warning! Be sure that both video card and monitor support resolution and refresh rates you select. Incompatible resolution/refresh rate selection may result in monitor damage. Refer to your monitor's documentation for recommended resolutions and refresh rates.</p> |

Screen image is off-center, color balance is wrong, or there is no picture

- Try adjusting the brightness, sharpness, contrast, and color balance controls of your monitor.
- Try adjusting the centering and positioning controls of your monitor to position the picture on the screen.
Note: The **Monitor Tuning** settings in **Display Properties > Adjustment** tune the position of the picture on the screen via the video signal.
- Set the monitor's RGB inputs (and sync switches, if this option is available) to 75 Ohms, with the sync set to external.
- Using DFP monitors: Make sure that the DVI plug of your monitor data cable is digital-only (DVI-D) - but not integrated analog/digital (DVI-I). Refer to your monitor's documentation and contact your supplier or the manufacturer of the DFP monitor for information on how to obtain a suitable data cable plug.

Operating system warns that the video card is not configured properly

- Check the driver installation and make sure that all software is correctly loaded corresponding to your operating system and applications. For more information, please see [Installing the Software](#).
- Re-install the FireGL drivers. Please refer to [Installing the Software](#) on page 23.

How to enable a two-monitor desktop?

- You need two monitors connected to the card. Both monitors must be switched on when you start your computer.
- Check the **Monitor** tab of the **Display Properties**.

| | |
|---|--|
| Checking for address and interrupt conflicts | <ul style="list-style-type: none">• It is necessary to ensure that the I/O and memory addresses reserved for the graphics board are not used by other hardware devices.• The integrated on-board VGA controller of your FireGL card uses the following addresses (hex): I/O Address: Standard VGA I/O: 3B0-3DF Memory Addresses: Video RAM: A000-BFFF Video ROM: C000-C7FF Note: You cannot change the addresses of your FireGL card. In case of an address conflict, try to modify the I/O address of the add-on card that causes the conflict. |
| Resolving Interrupt Conflicts | To support the special graphics processor on the FireGL card the system BIOS should automatically assign a system interrupt to the AGP slot where the card is installed. However, there may be problems if your graphics card does not receive an interrupt or a system interrupt is used for more than one device. In case of problems check the system configuration utility of your operating system for the interrupt assignments. |
| Power Source Warning Message | Your FIRE GL™ card requires an internal auxiliary DC power source. If the card's internal power extension cable is disconnected, a warning message will be displayed on your screen and your system will not start. Refer to Connecting power to the card on page 16 and reconnect the internal power extension cable. |
| The card is not performing optimally? | Check the Information tab of the Display Properties . The Transfer Mode information must be AGP . The Transfer Mode is not AGP ? (for example, PCI) <ul style="list-style-type: none">• Install the latest chipset driver for the AGP chipset on your motherboard.• Contact your supplier or motherboard manufacturer for further information. |

Technical Details

- [Product Specifications](#) on page 46
- [Pin Assignments](#) on page 48
- [Video Modes](#) on page 49

Product Specifications

| | |
|------------------------------|---|
| Operating environment | Windows® 2000, Windows® XP, Linux |
| System requirements | Intel® Pentium® 3, Pentium® 4, Xeon®; AMD® Athlon® XP/MP/Opteron or compatible |
| Certifications | FCC/DOC, ICES-003, CE/DOC, SMA C-Tick, MIC, BSMI, VCCI |
| Dimensions | Length: 228.6 mm (9.0 inches) Width: 108.0 mm (4.25 inches) |
| Power requirements | + 3.3 Volts DC: 9.4 Amps + 5 Volts DC: 0.6 Amps + 12 Volts DC: 2.0 Amps maximum |

| | |
|---------------------------------|--|
| Bus System | AGP 3.0, AGP 8X/4X connector |
| Video memory | DDR SDRAM, unified frame buffer, Z-buffer, texture storage 256-bit memory interface |
| BIOS | 64 Kbyte BIOS FlashROM, re-programmable by software, 3.3 V |
| Digital/analog converter | 2x 30-bit Palette DAC DAC speed: 400 MHz |

| | |
|--------------------------------|--|
| Data width | 256 bit - graphics core 256-bit memory interface |
| Connectors | 2x DVI-I output connectors: analog and digital output, female |
| H/V Sync output signals | Separate horizontal and vertical sync at TTL levels |
| FireGL card addresses | The FireGL card is 100% IBM VGA compatible and occupies the same memory area and specific addresses in the I/O range. The memory range above 1 MB is automatically assigned through the PCI BIOS interface I/O addresses: 3B0 - 3DF (Standard VGA I/O) Video RAM: A000-BFFF Video ROM: C000-C7FF |

Pin Assignments

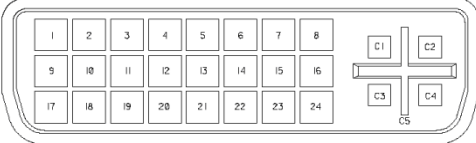
| DVI Output Connector | Pin | Function |
|--|-----|-------------------------|
|  <p data-bbox="136 485 431 511">DVI: Digital Visual Interface</p> <p data-bbox="136 527 437 553">DDC: Display Data Channel</p> <p data-bbox="136 570 458 626">T.M.D.S: Transition Minimized Differential Signal</p> <p data-bbox="136 683 320 709">MicroCross Pins:</p> <p data-bbox="136 725 418 751">C1 Analog Red Video Out</p> <p data-bbox="136 768 439 794">C2 Analog Green Video Out</p> <p data-bbox="136 810 421 836">C3 Analog Blue Video Out</p> <p data-bbox="136 852 426 878">C4 Analog Horizontal Sync</p> <p data-bbox="136 894 522 951">C5 Analog Common Ground Return (Red, Green, Blue Video Out)</p> | 1 | T.M.D.S. Data2- |
| | 2 | T.M.D.S. Data2+ |
| | 3 | T.M.D.S. Data2/4 Shield |
| | 4 | T.M.D.S. Data4- |
| | 5 | T.M.D.S. Data4+ |
| | 6 | DDC Clock |
| | 7 | DDC Data |
| | 8 | Analog Vertical Sync |
| | 9 | T.M.D.S. Data1- |
| | 10 | T.M.D.S. Data1+ |
| | 11 | T.M.D.S. Data1/3 Shield |
| | 12 | T.M.D.S. Data3- |
| | 13 | T.M.D.S. Data3+ |
| | 14 | + 5V Power |
| | 15 | ground (for + 5V) |
| | 16 | Hot Plug Detect |
| | 17 | T.M.D.S. Data0- |
| | 18 | T.M.D.S. Data0+ |
| | 19 | T.M.D.S. Data0/5 Shield |
| | 20 | T.M.D.S. Data5- |
| | 21 | T.M.D.S. Data5+ |
| | 22 | T.M.D.S. Clock Shield |
| | 23 | T.M.D.S. Clock+ |
| | 24 | T.M.D.S. Clock- |

Video Modes

All video modes comply with VESA DMT (Discrete Monitor Timing) or VESA GTF (General Timing Format) standards. The FireGL card supports HiColor, 16-bit modes and TrueColor, 32-bit (24 color, 8 alpha) modes. There is no support for 8-bit modes.

Analog and digital monitors with 15-pin VGA connector

| Resolution | Line Rate (kHz) | Refresh Rate (Hz) | Color Depth (Bits) |
|--------------|-------------------------|-------------------|--------------------|
| 640 x 480 | 31.5, 37.5, 43.3, 50.9 | 60, 75, 85, 100 | 16 / 32 |
| 800 x 600 | 37.7, 46.9, 54.1, 63.9 | 60, 75, 85, 100 | 16 / 32 |
| 1024 x 768 | 48.4, 60.0, 68.7, 81.4 | 60, 75, 85, 100 | 16 / 32 |
| 1152 x 864 | 53.7, 67.5, 77.1, 91.5 | 60, 75, 85, 100 | 16 / 32 |
| 1280 x 1024 | 64.0, 78.0, 91.1, 107.0 | 60, 75, 85, 100 | 16 / 32 |
| 1600 x 1000* | 62.1, 78.3, 89.3, 105.9 | 60, 75, 85, 100 | 16 / 32 |
| 1600 x 1024 | 63.6, 80.2, 81.3, 91.4 | 60, 75, 76, 85 | 16 / 32 |
| 1600 x 1200 | 75.0, 93.8, 106.3 | 60, 75, 85 | 16 / 32 |
| 1792 x 1344 | 83.6, 106.3 | 60, 75 | 16 / 32 |
| 1920x1080** | 67.1, 84.6 | 60, 75 | 16 / 32 |
| 1920 x 1200* | 74.5, 94.0 | 60, 75 | 16 / 32 |
| 2048 x 1536 | 95.3 | 60 | 16 / 32 |

*: Wide Screen Aspect Ratio Mode (16:10)

** : Wide Screen Aspect Ratio Mode (16:9)

Digital Monitors with DVI connector

| Resolution | Refresh Rate (Hz) | Color Depth (Bits) |
|-------------------|--------------------------|---------------------------|
| 640 x 480 | 60, 75 | 16 / 32 |
| 800 x 600 | 60, 75 | 16 / 32 |
| 1024 x 768 | 60, 75 | 16 / 32 |
| 1152 x 864 | 60, 75 | 16 / 32 |
| 1280 x 1024 | 60, 75 | 16 / 32 |
| 1600 x 1000 | 60 | 16 / 32 |
| 1600 x 1024 | 60 | 16 / 32 |
| 1600 x 1200 | 60 | 16 / 32 |

Warranty Service Information

Online Warranty Support:

Customers can place warranty service requests online using the Online Warranty Service Request Form. This form is available online at: <http://www.ati.com/online/warrantyform>

Please be prepared to enter all required information. Once completed, the form will be submitted to ATI for processing. After ATI Technical Support receives your request an RMA (Return Merchandise Authorization) number will be issued out to you. This must be obtained before you will be able to submit your defective product to ATI for repair.

Advanced Parts Replacement Service

FireGL customers have the option of Advanced Parts Replacement to minimize downtime for design professionals.

For Advanced Parts Replacement service instructions contact one of our Customer Care Representatives using one of the aforementioned means.

Warranty Information

Should the product, in ATI's opinion, malfunction within the warranty period, ATI will at its discretion repair or replace the product upon receipt with an equivalent. Any replaced parts become the property of ATI. This warranty does not apply to the software component of a product or a product which has been damaged due to accident, misuse, abuse, improper installation, usage not in accordance with product specifications and instructions, natural or personal disaster, or unauthorized alterations, repairs, or modifications.

For a detailed description of the ATI Hardware Warranty Service Statement visit:

<http://www.ati.com/online/warranty/statement>

Limitations

- All warranties for this product, expressed or implied, will expire three (3) years* from date of original purchase.
*All accompanying cables and accessories are warranted for 90 days.
- No warranties for this product, expressed or implied, shall extend to any person who purchases the product in a used condition.
- The liability of ATI in respect of any defective product will be limited to the repair or replacement of such product. ATI may use new or equivalent-to-new replacement parts. Defective product will be sent in for repair or replacement only.

ATI makes no other representations or warranties as to fitness for a particular purpose, merchantability or otherwise in respect of the product. No other representations, warranties or conditions, shall be implied by statute or otherwise.

In no event shall ATI be responsible or liable for any damages, including but not limited to the loss of revenue or profit, arising:

- from the use of the product,
- from the loss of use of the product, as a result of any event, circumstance, action or abuse beyond the control of ATI; whether such damages be direct, indirect, consequential, special or otherwise and whether such damages are incurred by the person to whom this warranty extends or a third party.

Compliance Information

FCC Compliance Information

The FireGL family of products complies with FCC Rules art 15. Operation is subject to the following two conditions

- This device may not cause harmful interference, and
- This device must accept any interference received, including interference that may cause undesired operation.

This equipment has been tested and found to comply with the limits for a Class B digital device, pursuant to Part 15 of the FCC Rules. These limits are designed to provide reasonable protection against harmful interference in a residential installation. This equipment generates, uses and can radiate radio frequency energy and, if not installed and used in accordance with manufacturer's instructions, may cause harmful interference to radio communications. However, there is no guarantee that interference will not occur in a particular installation. If this equipment does cause harmful interference to radio or television reception, which can be determined by turning the equipment off and on, the user is encouraged to try to correct the interference by one or more of the following measures:

- Re-orient or relocate the receiving antenna.
 - Increase the separation between the equipment and receiver.
 - Connect the equipment to an outlet on a circuit different from that to which the receiver is connected.
 - Consult the dealer or an experienced radio/TV technician for help.
- The use of shielded cables for connection of the monitor to the graphics card is required to ensure compliance with FCC regulations.
 - Changes or modifications to this unit not expressly approved by the party responsible for compliance could void the user's authority to operate this equipment.

Industry Canada Compliance Statement

ICES-003 This class B digital apparatus meets all requirements of the Canadian Interference-Causing Equipment Regulations.

Cet appareil numérique de la classe B respecte toutes les exigences du Règlement sur le matériel brouilleur du Canada.

CE Compliance Information

EMC Directive 89/336/EEC and amendments 91/263/EEC, 92/31/EEC and 93/68/EEC, Class B Digital Device

EN 55022:1998/CISPR 22 Class B, Limits and Methods of Measurement of Radio Interference Characteristics Information Technology Equipment.

EN 55024:1998, Immunity of Information Technology Equipment (ITE), including

EN 61000-4-2, EN 61000-4-3, EN 61000-4-4, EN 61000-4-5,

EN 61000-4-6, EN 61000-4-11

EN 60950:92 + A1:93 + A2:93 +A3:95 + A4:97

Directive EMC 89/336/CEE et amendements 91/263/CEE, 92/31/CEE et 93/68/CEE, dispositif numérique de Classe B

EN 55022:1998/CISPR 22 Classe B, Limites et méthodes de mesure des caractéristiques d'interférences radiophoniques, Matériel des technologies de l'information.

EN 55024:1998, Norme sur l'immunité de matériel des technologies de l'information, et comprenant

EN 61000-4-2, EN 61000-4-3, EN 61000-4-4, EN 61000-4-5,

EN 61000-4-6, EN 61000-4-11

EN 60950:92 + A1:93 + A2:93 +A3:95 + A4:97

EMC Richtlinie 89/336/EEC und Änderungen 91/263/EEC, 92/31/EEC und 93/68/EEC, Digitales Gerät der Klasse B

EN 55022:1998/CISPR 22 Klasse B, Beschränkungen und Verfahren der Messung von informationstechnischen Ausrüstungen mit Funkstörmerkmalen

EN 55024:1998, Unempfindlichkeits-Standard für informationstechnische Ausrüstungen, einschliesslich

EN 61000-4-2, EN 61000-4-3, EN 61000-4-4, EN 61000-4-5,

EN 61000-4-6, EN 61000-4-11

EN 60950:92 + A1:93 + A2:93 +A3:95 + A4:97

VCCI Class B ITE Compliance Information

この装置は、情報処理装置等電波障害自主規制協議会（VCCI）の基準に基づくクラスB情報技術装置です。この装置は、家庭環境で使用することを目的としていますが、この装置がラジオやテレビジョン受信機に近接して使用されると、受信障害を引き起こすことがあります。
取扱説明書に従って正しい取り扱いをして下さい。

Contact for further compliance information

ATI Research Inc.
4 Mount Royal Avenue,
Marlborough, MA
01752-1978
USA
Phone: (508) 303-3900

MIC Certification Information

B급 기기 (가정용 정보통신기기)

이 기기는 가정용으로 전자파적합등록을 한 기기로서
주거지역에서는 물론 모든지역에서 사용할 수 있습니다.

FireGL X1-128 / FireGL Z1-128

Product Name / Model: 942
Holder: ATI Technologies Inc.
Date: 2002-08-19
Manufacturer / Country of origin: ATI Technologies Inc. / China

Addendum

Waste Electrical and Electronic Equipment (WEEE) Directive Compliance

This product was manufactured by ATI Technologies Inc.



