

ACCESSORIES

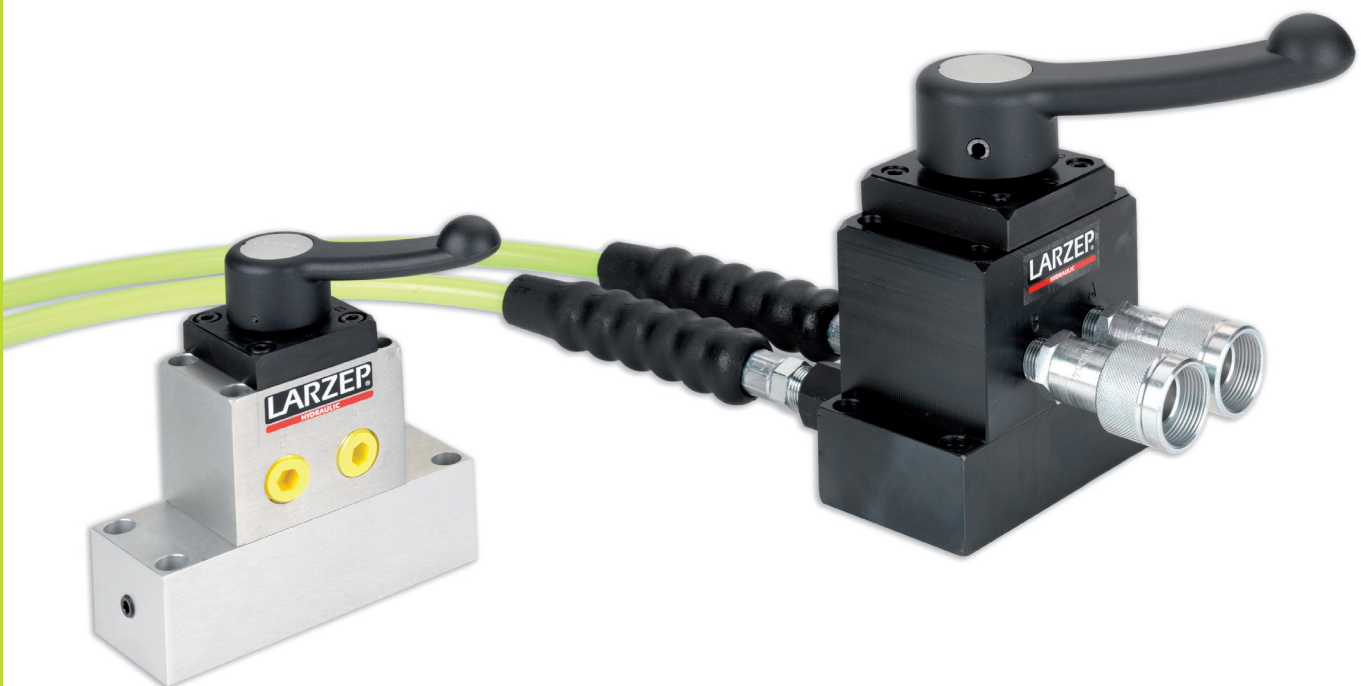







LARZEP offers a wide range of accessories to optimize our products performance: Hoses, Couplers, Tilting saddles, Hollow saddles, Flow control valves, Fittings and Manifolds, Pressure gauges and Directional control valves are available as standard.

- ✓ Wide range of standard hoses up to 100 metres and 720 bar working pressure.
Available hoses for 1.100 and 1.800 bar working pressure and Twin hoses for torque wrenches.
- ✓ Low flow and high flow quick couplers available as standard.
Working pressure: 700 bar, 1.000 bar and 1.500 bar.
- ✓ Wide range of Flow control valves: Snubber valves, Flow regulating valves with 2 or 4 outlets, Manually operated check valve, Single way flow regulating valve, Check valve, Pressure relief valve and Pilot operated check valve.
- ✓ Tilting saddles highly recommended for side load application.
Hollow saddles used in hollow piston cylinders specially in pulling and tensioning operations.
- ✓ Wide range of fittings and manifolds for multiple applications.
- ✓ Glycerine filled pressure gauges for monitoring working pressure and force.
Available digital pressure gauges and pressure transducers.
- ✓ 3- or 4- ways directional control valves for single and double acting cylinders, suitable for remote operation.



ACCESSORIES

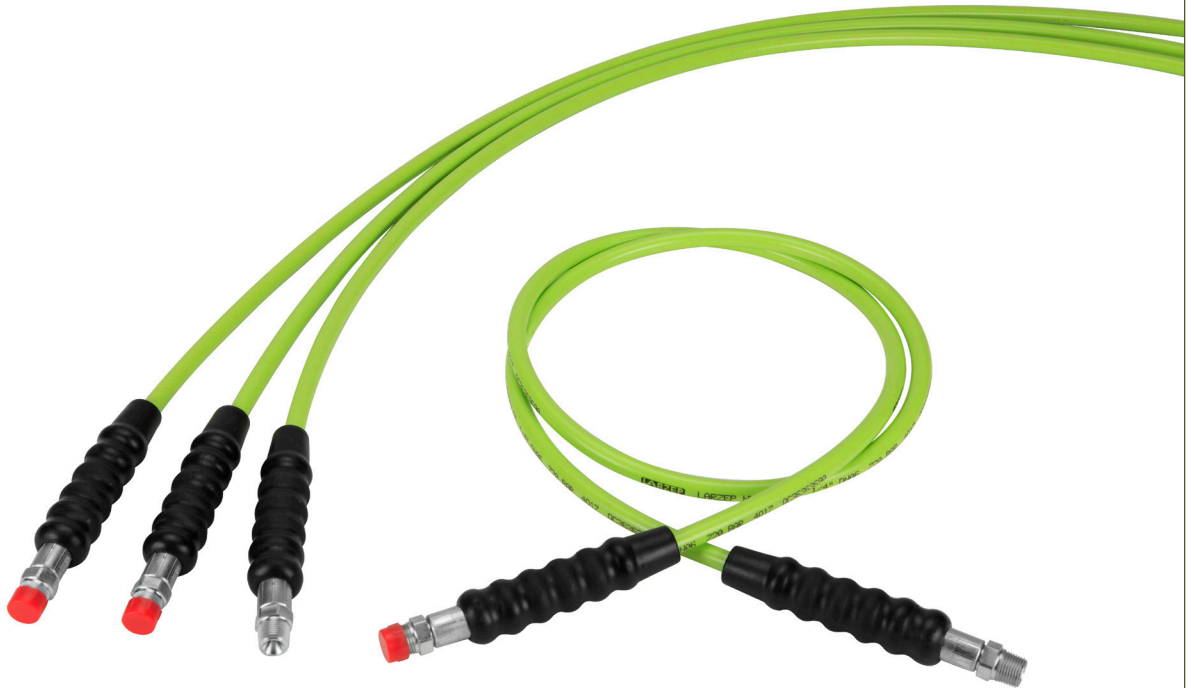

Models	Accessories type		Page
AP - AR	Hydraulic Hoses		112
AZ89	Hydraulic Oil		113
AZ3	Hydraulic Couplers		114
AZ5	Flow Control Valves		116
AZ04 - AZ05	Saddles		118
AZ1	Fittings and Manifolds		120
AZ8 - AZ9	Directional Control Valves		122
AV-AVD AT-AY	Pressure Gauges		123

HYDRAULIC HOSES

- ✓ 4:1 Safety Factor.
- ✓ Wide range of standard hoses. Hoses can be supplied in any length on request.
- ✓ Rubber Guard on both ends.
- ✓ 3/8"-NPT thread on each end. Can be supplied with couplers on one or both ends.
- ✓ Internal Diameter 6,4mm; Oil Capacity: 35 cm³ per metre.
- ✓ Internal Diameter 9,5mm; Oil Capacity: 75 cm³ per metre.
- ✓ Twin hoses for torque wrenches available. AR model.
- ✓ 1.100, 1.800 and 2.800 bar working pressure hoses available.
- ✓ Minimum Bending radius: 80 mm.

**WARNING**

**Never disconnect the hose when the system is pressurized.
Never exceed the maximum working pressure of the hose.**



Apply 2 rounds of Teflon around all 3/8" NPT threads of the system, in the thread direction, leaving the first thread uncovered to prevent the tape breaking and entering the hydraulic system. Torque: 80 Nm.



HYDRAULIC HOSES

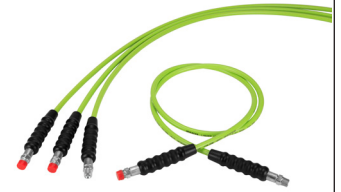

Type **AP - AR**

Capacity **0,8 - 100 m length**

Max. pressure **700 - 1.800 bar**

MAXIMUM WORKING PRESSURE 700 / 720 BAR

Int. ø mm	End		Pressure bar	Length						
	1	2		0,8 m	1,5 m	2 m	3 m	4 m	6 m	10 m
6,4	3/8"-NPT	3/8"-NPT	720	AP2008	AP2015	AP2020	AP2030	AP2040	AP2060	AP2100
6,4	3/8"-NPT	AZ3120	720	AP2008G	AP2015G	AP2020G	AP2030G	AP2040G	AP2060G	AP2100G
6,4	AZ3120	AZ3120	720	AP2008G2	AP2015G2	AP2020G2	AP2030G2	AP2040G2	AP2060G2	AP2100G2
9,5	3/8"-NPT	3/8"-NPT	700	AP4008	AP4015	AP4020	AP4030	AP4040	AP4060	AP4100
9,5	3/8"-NPT	AZ3120	700	AP4008G	AP4015G	AP4020G	AP4030G	AP4040G	AP4060G	AP4100G
9,5	AZ3120	AZ3120	700	AP4008G2	AP4015G2	AP4020G2	AP4030G2	AP4040G2	AP4060G2	AP4100G2

MAXIMUM WORKING PRESSURE : 700 BAR - TWIN HOSES AR, FOR TORQUE WRENCHES

Int. ø mm	End		Pressure bar	Length							
	Hose 1	Hose 2		0,8 m	1,5 m	2 m	3 m	4 m	6 m	8 m	10 m
6,4	2 x 3/8"-NPT	2 x 3/8"-NPT	700	AR2008	AR2015	AR2020	AR2030	AR2040	AR2060	AR2080	AR2100

MAXIMUM WORKING PRESSURE 1.100 BAR

Int. ø mm	End		Pressure bar	Length							
	1	2		0,8 m	1,5 m	2 m	3 m	4 m	6 m	8 m	10 m
6,4	3/8"-NPT	3/8"-NPT	1.100	AP3008	AP3015	AP3020	AP3030	AP3040	AP3060	AP3080	AP3100

MAXIMUM WORKING PRESSURE 1.800 BAR

Int. ø mm	End		Pressure bar	Length							
	1*	2*		0,8 m	1,5 m	2 m	3 m	4 m	6 m	8 m	10 m
6,4	1/4"-BSP	1/4"-BSP	1.800	AP5008	AP5015	AP5020	AP5030	AP5040	AP5060	AP5080	AP5100

*Cone 120°

HYDRAULIC OIL

Model	Capacity (l)	For use with
AZ8901	5	Hand Pumps, Bottle Jacks
AZ8902	5	Powerpacks



HYDRAULIC COUPLERS

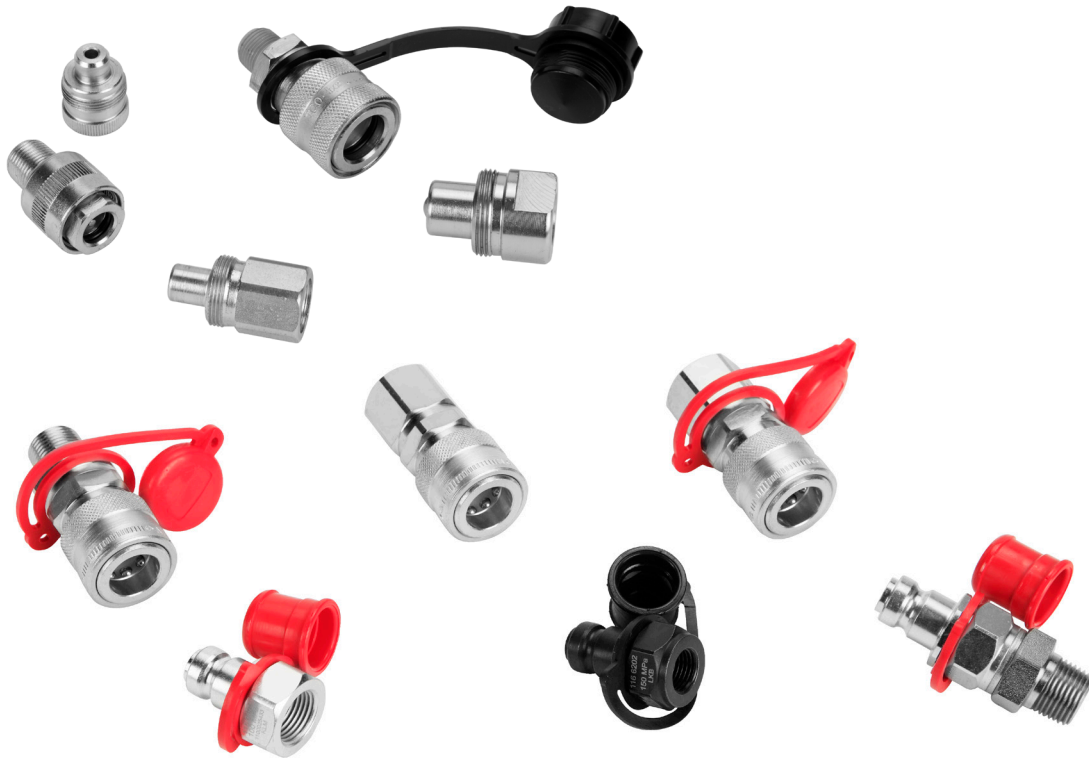

- ✓ Low flow and high flow couplers, from 6 to 40 litres/min.
- ✓ 700 and 1.000 bar couplers have 3/8"-18 NPT thread. 1.500 bar couplers have 1/4"-BSP thread.
- ✓ Male and Female couplers can be supplied separately.
- ✓ Steel dust cup available for AZ3120, AZ3140 and AZ3141 couplers.
- ✓ AZ3321, AZ3322, AZ3324, AZ3325, AZ3341, AZ3344 and AZ3345: ball quick couplers to guarantee easy and quick connection.
- ✓ AZ3120, AZ3140 and AZ3141: standard high flow couplers.
- ✓ AZ3220 and AZ3240: low flow couplers. Only used in Maintenance Sets.
- ✓ All standard cylinders are supplied with AZ3140 female coupler.
- ✓ All cutters are supplied with AZ3321 male ball coupler.



WARNING

**Never disconnect the hose when the system is pressurized.
Never exceed the maximum working pressure of the hose.**



Apply 2 rounds of Teflon around all 3/8" NPT threads of the system, in the thread direction, leaving the first thread uncovered to prevent the tape breaking and entering the hydraulic system. Torque: 80 Nm.





HIGH FLOW COUPLERS 700 BAR

AZ3120

AZ3140

AZ3141

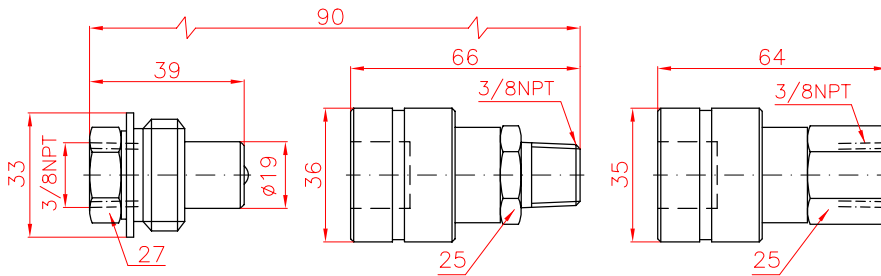

LOW FLOW COUPLERS 700 BAR

AZ3220

AZ3240

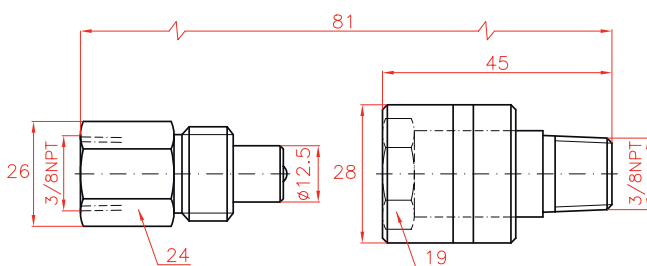

1.000 BAR BALL COUPLERS

AZ3321

AZ3341

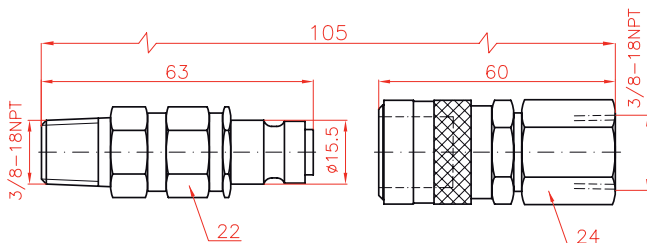

AZ3325

AZ3345

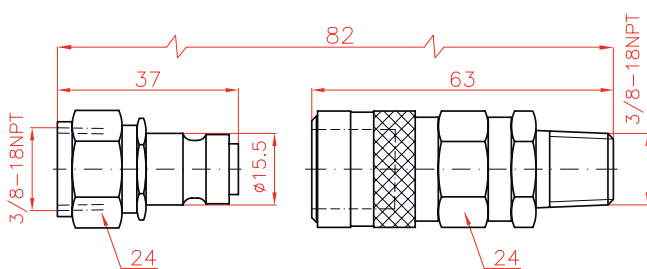

1.500 BAR BALL COUPLERS

AZ3322

AZ3324

AZ3344

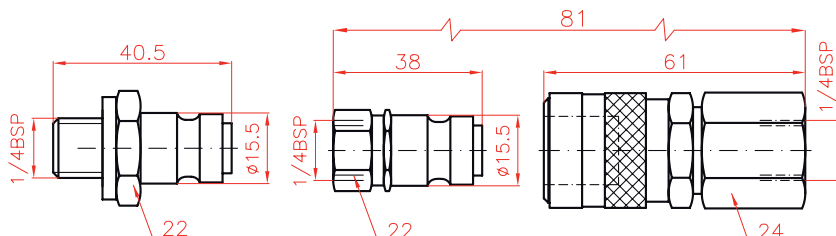

Ref. AZ3322 without valve.

Type **AZ3**

Capacity **6 - 40 l/min**

Max. pressure **700 - 1.500 bar**

Steel dust cup available:
AZ3144 for female couplers AZ3140 and AZ3141
AZ3124 for male coupler AZ3120



Plastic dust cup AZ3103 available
to suit AZ3120, AZ3140 and AZ3141 couplers



Flow l/min	Coupling	Model LARZEP	Thread	Pressure bar
40	Male	AZ3120	Female 3/8"NPT	700
	Female	AZ3140	Male 3/8"NPT	700
	Female	AZ3141	Female 3/8"NPT	700
7	Male	AZ3220	Female 3/8"NPT	700
	Female	AZ3240	Male 3/8"NPT	700
6	Male	AZ3321	Male 3/8"NPT	1.000
	Male	AZ3325	Female 3/8"NPT	1.000
	Female	AZ3341	Female 3/8"NPT	1.000
	Female	AZ3345	Male 3/8"NPT	1.000
6	Male	AZ3322	Male 1/4"BSP*	1.500
	Male	AZ3324	Female 1/4"BSP*	1.500
	Female	AZ3344	Female 1/4"BSP*	1.500

*Cone 120°

AZ3321, AZ3322, AZ3324 and AZ3325 male couplers
are connectable with
AZ3341, AZ3344 and AZ3345 female couplers

FLOW CONTROL VALVES



Model	SNUBBER VALVE	Symbol	
AZ5121	Used for flow control and load holding when closed. Also suitable for use as a gauge snubber.		

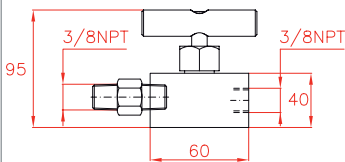

Model	MANIFOLD WITH FLOW REGULATING VALVE, 2 OUTLETS	Symbol	
AZ5122	Used for flow control of two outlets from one pressure source.		

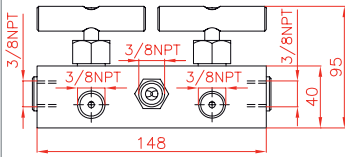

Model	MANIFOLD WITH FLOW REGULATING VALVE, 4 OUTLETS	Symbol	
AZ5124	Used for flow control of four outlets from one pressure source.		

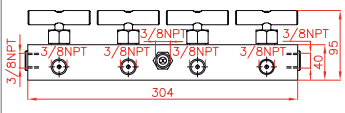

- ✓ All flow and pressure control valves are designed for 700 bar working pressure.
- ✓ All valves have 3/8"-NPT pressure ports to prevent leakage.



Type **AZ5**

Capacity -

Max. pressure **700 bar**

Model	MANUALLY OPERATED CHECK VALVE	Symbol	
AZ5200	<p>When open, allows oil flow in both directions.</p> <p>When closed, allows oil flow in one direction only, holding the load in the other one.</p>		

Model	SINGLE WAY FLOW REGULATING VALVE	Symbol	
AZ5255	<p>Similar to AZ5200, allows free oil flow in one direction and in the other, flow can be regulated or completely closed.</p>		

Model	CHECK VALVE	Symbol	
AZ5500	<p>Allows oil flow in one direction only.</p>		

Model	PRESSURE RELIEF VALVE	Symbol	
AZ5600	<p>Regulates the pressure in the hydraulic circuit. From 50 to 700 bar. Supplied with a 0.9 metre return line hose kit.</p>		

Model	PILOT OPERATED CHECK VALVE	Symbol	
AZ5700	<p>Load holding valve used with double-acting cylinders which is released by pilot pressure from the return line.</p>		

AZ5 ACCESSORIES

SADDLES



TILTING SADDLES AZ04

- ✓ Recommended for high side load applications.
- ✓ These saddles allow up to 5° tilt angle.
- ✓ Push-in or threaded to suit different cylinder models.

AZ04 TILTING SADDLES

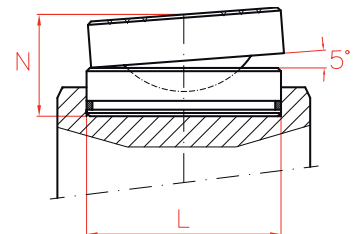

HOLLOW SADDLES AZ05

- ✓ Used in hollow piston cylinders.
- ✓ Especially used in pulling operations and as support.
- ✓ These saddles can be plain, threaded or solid.

AZ05 HOLLOW SADDLES

Standard Plain

Optional Internal Thread

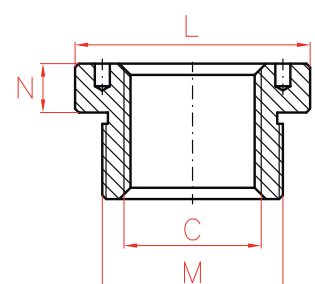
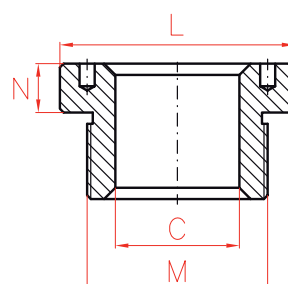

SADDLES



Type **AZ04 - AZ05**

Capacity -

Max. pressure **700 bar**

THREADED TILTING SADDLES

Model	L	M	N	E	Weight	Cylinder Model
LARZEP	mm		mm	mm	kg	
AZ0420	28	1"-8	29	43	0,2	SM010-D010
AZ0423	35	1"-8	29	49	0,3	SM015-D020
AZ0421	45	1 1/2"-16	28	50	0,4	SM023-SM030-D030
AZ0422	61	1 3/4"-12	38	58	0,7	D050-D075-D100
AZ0424	88	2 1/2"-12	47	82	2,5	D150
AZ0425	111	2 1/2"-12	52	107	4,5	D200
AZ0431	34	M28x1,5	29	44	0,3	SH012
AZ0432	48	1 9/16"-16	29	46	0,5	SH022
AZ0433	55	1 13/16"-16	37	57	0,6	SH030-SAH030-DH030-DAH030
AZ0434	80	2 3/4"-16	47	67	2,3	SH060-SAH060-DH060-DAH060
AZ0435	116	2 1/2"-12	52	76	5,5	SH100-SAH100-DH100-DAH100

AZ04 THREADED TILTING SADDLES

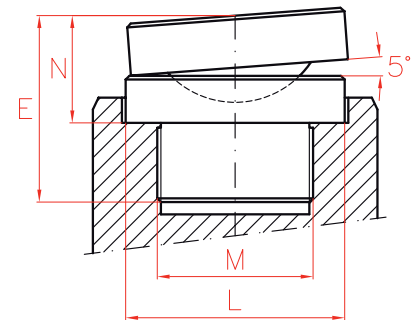

TILTING SADDLES

Model	L	N	Weight	Cylinder Model
LARZEP	mm	mm	kg	
AZ0401	45	36	0,4	SAM023-SAM030-SP030-SMP030-STR030-SAT030-SATM030
AZ0402	61	39	0,8	SM050-SM075-SAM050-SP050-SMP050-SX050-SX075-STR050-SAT050-SATM050-DDA050-DDA075-DDR050
AZ0404	88	47	2,2	SM100-SM140-SAM100-SAM140-SP100-SMP100-SPR140-SX100-SX150-STR100-STR140 SAT100-SAT140-SATM100-SATM140-SSR140-DDA100-DDA140-DDR100-DDR140
AZ0405	111	52	4,0	SM220-SAM200-SPR220-STR220-SAT200-SATM200-SSR220-DDA200-DDR220
AZ0408	178	67	13,0	SPR350-SPR430-STR350-STR430-SSR350-SSR430-DDR350-DDR430
AZ0411	200	79	19,3	SPR560-SPR670-STR560-STR670-SSR560-SSR670-DDR560-DDR670
AZ0413	250	105	40,0	SPR880-STR880-SSR880-DDR880
AZ0415	325	175	113,0	SPR1100-STR1100-SSR1100-DDR1100

HOLLOW SADDLES

Standard Plain					Cylinder Model	Optional Threaded				
Model	C	L	M	N		Model	C	L	M	N
LARZEP	mm	mm		mm		LARZEP		mm		mm
AZ0531	19,5	34	M28x1,5	7	SH012	AZ0551	3/4"-16	34	M28x1,5	7
AZ0532	27,0	48	1 9/16"-16	8	SH022-SAH022	AZ0552	1"-8	48	1 9/16"-16	8
AZ0533	33,4	55	1 13/16"-16	9	SH030-SAH030-DH030-DAH030	AZ0553	1 1/4"-7	55	1 13/16"-16	9
AZ0536	56,0	80	2 3/4"-16	12	SH060-SAH060-DH060-DAH060	AZ0556	1 5/8"-5 1/2	80	2 3/4"-16	12
AZ0540	81,0	116	4"-16	13	SH100-SAH100-DH100-DAH100	AZ0560	2 1/2"-8	116	4"-16	13
AZ0545	81,0	135	4 1/4"-16	20	DH150-DAH150	AZ0565	2 1/2"-8	135	4 1/4"-16	20

FITTINGS AND MANIFOLDS



✓ Wide range of Fittings and Manifolds for multiple applications.

HEXAGON NIPPLE



Model	A	B	C	D
LARZEP			mm	mm
AZ1102	3/8"-NPT	3/8"-NPT	45	19
AZ1103	3/8"-NPT	3/8"-NPT	66	19
AZ1104	3/8"-NPT	3/8"-NPT	100	22

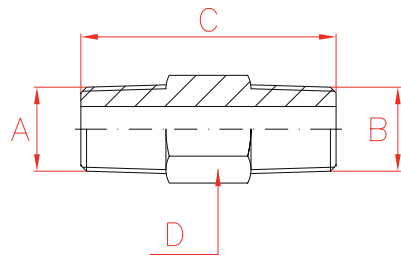

ADAPTOR



Model	A	B	C	D
LARZEP			mm	mm
AZ1112	3/8"-BSP	3/8"-NPT	36	27
AZ1113	3/8"-NPT	1/4"-BSP	36	27
AZ1114	3/8"-NPT	3/8"-BSP	36	27

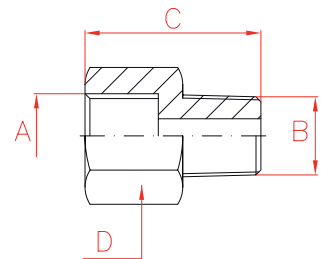

COUPLING



Model	A	B	C	D
LARZEP			mm	mm
AZ1142	3/8"-NPT	3/8"-BSP	45	27
AZ1143	3/8"-NPT	3/8"-NPT	45	27

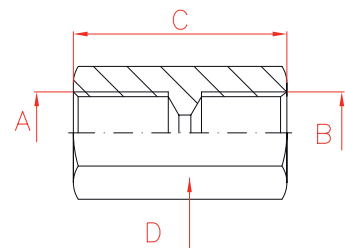



On request, LARZEP can supply other accessories to special requirements of threads and sizes.

PLUG



Model	A	C	D
LARZEP		mm	mm
AZ1182	3/8"-NPT	24	18
AZ1183	1/2"-NPT	28	22

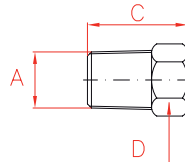

ADAPTOR ELBOW



Model	A	B	C	D
LARZEP			mm	mm
AZ1511	3/8"-NPT	3/8"-BSP	51	30
AZ1512	3/8"-NPT	3/8"-NPT	51	30

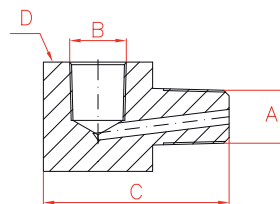

ELBOW

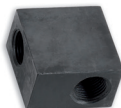

Model	A	B	C	D
LARZEP		mm	mm	mm
AZ1202	3/8"-NPT	40	25	12,5

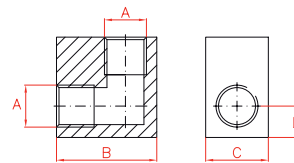

TEE



Model	A	B	C	D
LARZEP		mm	mm	mm
AZ1242	3/8"-NPT	40	25	12,5

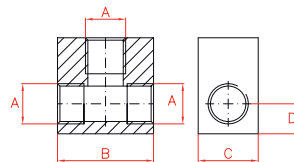

CROSS



Model	A	B	C	D
LARZEP		mm	mm	mm
AZ1282	3/8"-NPT	50	25	24

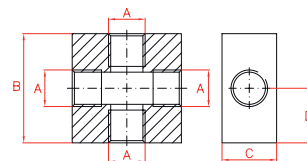

GAUGE ADAPTOR



Model	A	B	C	D
LARZEP			mm	mm
AZ1501	3/8"-NPT	3/8"-BSP	117	35
AZ1502	3/8"-NPT	1/4"-NPT	98	35
AZ1507	3/8"-NPT	1/4"-BSP	98	35

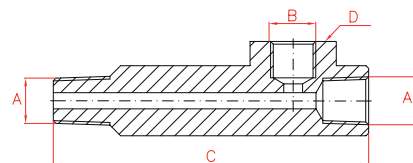

MANIFOLDS



Model	A	B	C	D	Ports
LARZEP			mm	°	No.
AZ1602	3/8"-NPT	3/8"-BSP	62	90°	2
AZ1604	3/8"-NPT	3/8"-BSP	82	60°	4
AZ1606	3/8"-NPT	3/8"-BSP	102	48°	6

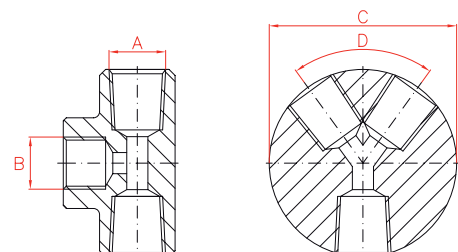

Type

AZ1

Capacity

-

Max. pressure

700 bar



DIRECTIONAL CONTROL VALVES

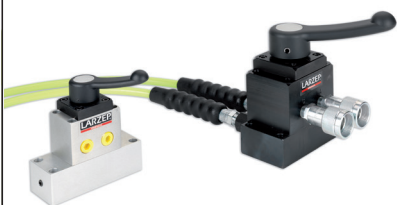

Type

AZ8 - AZ9

Capacity

4 - 30 l/min

Max. pressure

700 bar

DIRECTIONAL CONTROL VALVES



AZ8 - AZ9 ACCESSORIES

- ✓ 3- or 4- ways directional control valves for single and double acting cylinders.
- ✓ Manually operated, without spring to centre.
- ✓ Suitable for remote operation.
- ✓ Possibility to select open or closed centre.

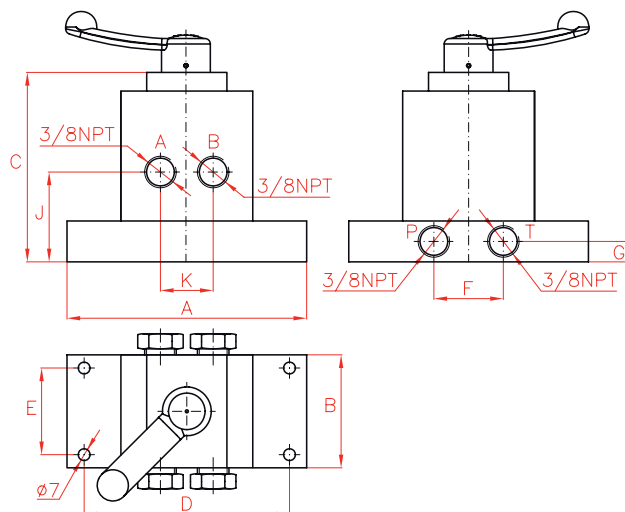

Symbol	Flow l/min	Model LARZEP	Operation Remote	Central Position	A mm	B mm	C mm	D mm	E mm	F mm	G mm	J mm	K mm
	4	AZ8300	Single act.	Open Centre	128	50	107	113	36,0	86	20	60	-
	30	AZ9300	Single act.	Open Centre	128	70	127	113	50,8	54	25	63	-
	4	AZ8301	Single act.	Closed Centre	128	50	107	113	36,0	86	20	60	-
	30	AZ9301	Single act.	Closed Centre	128	70	127	113	50,8	54	25	63	-
	4	AZ8500	Double act.	Open Centre	128	50	107	113	36,0	86	20	60	30
	30	AZ9500	Double act.	Open Centre	128	70	127	113	50,8	54	25	63	38
	4	AZ8501	Double act.	Closed Centre	128	50	107	113	36,0	86	20	60	30
	30	AZ9501	Double act.	Closed Centre	128	70	127	113	50,8	54	25	63	38



PRESSURE GAUGES

PRESSURE GAUGES



Type **AV-AVD-AT-AY**

Capacity **5 - 250 Tn**

Max. pressure **0 - 1.000 bar**

- ✓ High accuracy gauges, $\pm 1.6\%$ full scale.
- ✓ Essential for monitoring working pressure or force.
- ✓ Glycerine filled gauges.
- ✓ Available as system pressure gauges or as dual scale gauges to measure load on specific cylinders.

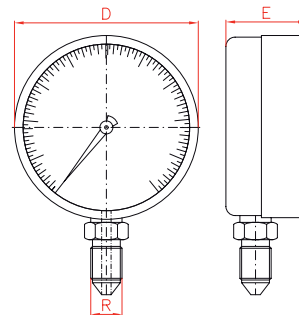

WARNING

Do not exceed the 70% of the nominal capacity of the gauge.



Digital pressure gauge: **AVD10008**
Thread: 1/4"-BSP
Gauge adaptor: **AZ1507**



Pressure gauge for Hollow Cylinders: **ATH**
Digital Pressure Transducer: **AVT**

Used with	Model	Type		Scale	D	E	R	Gauge Adaptor
		Tn	kg/cm ²					
All Cylinders	AV10006	-	1000	50	68	31	1/4"-NPT	AZ1502
	AV10008	-	1000	20	80	35	3/8"-BSP	AZ1501
	AV10010	-	1000	10	100	35	3/8"-BSP	AZ1501
Cylinders	AT00410	5 / 10	1000	-	100	35	3/8"-BSP	AZ1501
	AT01610	16 / 23	1000	-	100	35	3/8"-BSP	AZ1501
	AT03010	30 / 50	1000	-	100	35	3/8"-BSP	AZ1501
	AT07510	75 / 100	1000	-	100	35	3/8"-BSP	AZ1501
	AT15010	150 / 200	1000	-	100	35	3/8"-BSP	AZ1501
Press 10 Tn	AY01008	10	-	0,5	80	35	3/8"-BSP	AZ1501
Press 20 Tn	AY02008	20	-	0,5	80	35	3/8"-BSP	AZ1501
Press 30 Tn	AY03008	30	-	2	80	35	3/8"-BSP	AZ1501
Press 60 Tn	AY06010	60	-	2	100	35	3/8"-BSP	AZ1501
Press 120 Tn	AY12010	120	-	4	100	35	3/8"-BSP	AZ1501
Press 250 Tn	AY25010	250	-	5	100	35	3/8"-BSP	AZ1501