

Verhandelingen van de Koninklijke Nederlandse Akademie van Wetenschappen,  
Afd. Natuurkunde, Tweede Reeks, Deel 85

**PHYLOGENETIC  
SYSTEMATICS  
OF THE  
DRYNARIOIDEAE  
(POLYPODIACEAE)**

**M.C. ROOS**



ISBN 0-444-85668-4

## CONTENTS

### GENERAL PART

|   |     |
|---|-----|
| 1. INTRODUCTION, SUMMARY, AND ACKNOWLEDGEMENTS .....  | 7   |
| 2. MATERIAL AND TECHNIQUES .....  | 11  |
| 2.1. Material .....   | 11  |
| 2.2. Techniques .....   | 12  |
| 3. TAXONOMIC HISTORY OF THE DRYNARIOIDEAE .....   | 15  |
| 3.1. Introduction .....   | 15  |
| 3.2. Drynaria .....   | 15  |
| 3.3. Aglaomorpha .....  | 16  |
| 4. COMPARATIVE EVOLUTIONARY BIOLOGY: A RESEARCH PROGRAM .....   | 19  |
| 4.1. Introduction .....   | 19  |
| 4.2. Aims of comparative evolutionary biology .....   | 22  |
| 4.3. Starting points .....  | 24  |
| 4.4. Research in general .....  | 26  |
| 4.5. Scheme .....   | 30  |
| 5. ANALYSES OF INTRINSIC CHARACTERS OF THE DRYNARIOIDEAE .....  | 31  |
| 5.1. Introduction .....   | 31  |
| 5.2. Rhizome .....  | 32  |
| 5.3. Rhizome scales .....   | 39  |
| 5.4. Fronds .....   | 45  |
| 5.5. Base fronds .....  | 46  |
| 5.6. Foliage fronds .....   | 49  |
| 5.7. Frond indument .....   | 67  |
| 5.8. Sporangia .....  | 77  |
| 5.9. Spores .....   | 79  |
| 6. METHODOLOGY OF CLADISTIC ANALYSIS (co-author: M. Zandee) .....   | 81  |
| 6.1. Introduction .....   | 81  |
| 6.2. Step 1: data matrix .....  | 81  |
| 6.3. Step 2: sets .....   | 82  |
| 6.4. Step 3: cliques .....  | 83  |
| 6.5. Step 4: cladograms .....   | 84  |
| 6.6. Discussion .....   | 91  |
| 6.7. Post scriptum: Present state of affairs in the method applied .....                                      | 95  |
| 7. CLADISTIC ANALYSIS OF THE DRYNARIOIDEAE (co-author: M. Zandee) .....                                       | 99  |
| 7.1. Data matrix .....  | 99  |
| 7.2. Cladistic analysis of the Drynarioideae .....  | 99  |
| 7.3. Cladistic analysis of Aglaomorpha .....  | 105 |
| 7.4. Cladistic analysis of Drynaria .....   | 112 |
| 7.5. Choice of the cladogram of the Drynarioideae .....   | 116 |
| 8. DELIMITATION OF SPECIES AND GENERA OF THE DRYNARIOIDEAE; THE<br>SYSTEMATIC POSITION OF THE SUBFAMILY ..... | 123 |
| 8.1. Species delimitation and account for the species recognized .....  | 123 |
| 8.2. The delimitation of the genera .....   | 128 |
| 8.3. The delimitation of the Drynarioideae .....  | 130 |
| 8.4. The systematic position of the Drynarioideae .....   | 130 |

|                           |   |     |
|---------------------------|---|-----|
| 9.                        | ANALYSES OF EXTRINSIC CHARACTERS OF THE DRYNARIOIDEAE ..... | 133 |
| 9.1.                      | Introduction .....  | 133 |
| 9.2.                      | Sister group patterns .....                                 | 135 |
| 9.3.                      | Areas of endemism .....                                     | 140 |
| 9.4.                      | Biogeographic analysis .....                                | 141 |
| 10.                       | A SCENARIO OF THE PHYLOGENY OF THE DRYNARIOIDEAE .....      | 149 |
| 10.1.                     | Fossil evidence .....                                       | 149 |
| 10.2.                     | Phylogeny .....   | 149 |
| 10.3.                     | A scenario of species nos. 27--31 .....                     | 152 |
| 10.4.                     | A scenario of species nos. 10--16 .....                     | 153 |
| 11.                       | CONCLUSIONS .....   | 155 |
| 11.1.                     | Methodology .....   | 155 |
| 11.2.                     | Systematics .....   | 156 |
| 12.                       | REFERENCES .....  | 159 |
|                           | PLATES .....  | 166 |
| <br><u>TAXONOMIC PART</u> |   |     |
| 13.                       | PRESENTATION OF DATA .....                                  | 181 |
| 14.                       | KEYS TO THE GENERA AND SPECIES .....                        | 183 |
| 14.1.                     | Key to the genera .....                                     | 183 |
| 14.2.                     | Key to the species of Aglaomorpha .....                     | 183 |
| 14.3.                     | Key to the species of Drynaria .....                        | 185 |
| 15.                       | AGLAOMORPHA .....   | 187 |
| 16.                       | DRYNARIA .....  | 215 |
| <br>APPENDICES .....      |   |     |
| 1.                        | CHARACTERS STUDIED AND STATES RECOGNIZED .....              | 251 |
| 2.                        | DATAMATRIX .....  | 261 |
| 3.                        | PARTIALLY MONOTHEMIC SETS OF THE DRYNARIOIDEAE .....        | 275 |
| 4.                        | PARTIALLY MONOTHEMIC SETS OF AGLAOMORPHA .....              | 279 |
| 5.                        | PARTIALLY MONOTHEMIC SETS OF DRYNARIA .....                 | 281 |
| 6.                        | DISTRIBUTION MAPS .....                                     | 283 |
| 7.                        | HISTOGRAMS OF ALTITUDINAL RANGES .....                      | 297 |
| 17.                       | INDEX OF COLLECTIONS .....                                  | 301 |
| 18.                       | INDEX TO TAXONOMIC NAMES .....                              | 317 |

GENERAL  
PART



## 1. INTRODUCTION, SUMMARY, AND ACKNOWLEDGEMENTS

The present monograph deals with the phylogenetic systematics of the subfamily Drynarioideae of the Polypodiaceae. It includes the recognition and description of evolutionary species and emphasizes the reconstruction of their phylogeny. The study is carried out in the framework of the international project on the Systematics of Polypodiaceae.

Phylogenetic systematic studies start with the selection of an inferred holophyletic group. Within the context of systematic research on a large-sized taxon, it is the best heuristic to start with the recognition of relatively small and obvious groups as a first approximation of the taxonomic structure. Later on, the monographic work should be extended to higher hierarchical levels, including groups that are "disputed" and less obviously characterized.

The holophyly of the drynarioid ferns is undisputed since the forties (e.g. Copeland, 1947), although it has been given formal taxonomic rank only recently (Crabbe et al., 1975: subfamily Drynarioideae; Ching, 1978: family Drynariaceae). In all recent, conflicting and much disputed taxonomic systems of Polypodiaceae, the drynarioids are uniformly recognized as a natural group. This has been the main reason for selecting this group. On the other hand, all other systematic questions as regards the drynarioids, are highly controversial. For instance, the generic delimitation has always been disputed and no consensus has been attained as yet, a situation prevalent within the Polypodiaceae in particular (Hennipman, 1984), although the situation in this family is representative for the numerous systematic controversies in general.

The (scientifically) most important cause of these controversies is in the author's opinion due to insufficiently and/or only vaguely defined methodologies used. The author has a strong belief that the clear formulation of starting points and aims, followed by the selection of adequate (repeatable) methodologies, would greatly add to the further development of systematics as the central discipline in evolutionary and comparative biological research. Therefore, the purpose of the present monograph is twofold:

A) The explication of the author's point of view on the scientific inquiry of systematics and to outline an adequate comparative (cladistic) methodology. This has already been done before in a summarized way (Hennipman & Roos, 1983), but the present outline is more elaborated, comprising a few alterations that are aimed at elucidating problems which at the time remained. The methodology presently applied is also different from that used in the study of Platynerium (Hennipman & Roos, 1982). The main difference concerns the establishment of transformation series.

In the Platynerium monograph, transformation series were established in advance, using the sister group Pyrrosia as the first outgroup in outgroup comparison. In case the outgroup comparison could not be applied, transformation series have been established using ontogenetic data. Thus, the phylogeny reconstruction in Platynerium was based on a priori indicated apomorphies. In this publication, transformation series are established a posteriori being read off from the cladograms that are constructed using character state distributions in the data matrix only.

A second important difference pertains to the way the outgroup rule is applied. In the study of Platynerium, all transformation series have been

established disregarding the hierarchical level within the genus, using *Pyrrosia* for outgroup comparison. In other words, the outgroup rule was applied in a global sense. Presently, the outgroup rule has been used in the strict, local sense (Zandee, 1984). This means that at each hierarchical level, the ingroup, sistergroup, and outgroup are unambiguously defined. The ingroup is potentially holophyletic in case it possesses common similarities that are absent in both the sister- and the outgroup. These similarities are apomorphic by definition. This interpretation of the outgroup rule is consistent with the non-absolute concept of apomorphy (and, consequently, of holophyly and homology).

Phylogenetic relationships between the drynarioid species recognized were traced using a cladistic methodology. Under the covering idea of evolution as 'descent with modification', its starting points and purposes as delineated by Hennig (1966) and Wiley (1981) are superior to the other methodologies proposed by different systematic schools. Existing methods of cladistic analysis have been studied by the author. The method selected and its computer implementation (algorithm) is developed by Zandee (1985) with empirical feedback by the present author. This 4-step procedure has the following advantages:

- 1) transformation series are not a priori established,
- 2) an integration of compatibility and parsimony methods is achieved,
- 3) no data are initially discarded or weighted otherwise a priori,
- 4) all possible cladogenetic relationships are unambiguously defined and presented, and
- 5) the systematist gets the opportunity to evaluate all possible hypotheses according to several kinds of auxiliary criteria.

Furthermore, this procedure can handle the present 31 by 557 data matrix enumerating the observations made at as many structural integration levels as possible.

Before the procedure can be applied, terminal clada must be delimited, and character analyses have to be carried out. A cladon (plural: clada) is a general term for a cladogenetic entity (either or not with a formal taxonomic name) that serves as a building block for cladogram construction. Terminal clada are the smallest building blocks used (e.g. species).

The observations are summarized in a binary data matrix (step 1). Selected patterns are read off from this matrix, i.e. partially monothetic sets (step 2). These sets are sets of terminal clada defined by a set of unique character states sufficient for their characterization, and constitute clada also. Among the sets themselves, three types of relations exist: inclusion, exclusion, and overlap.

Subsequently, cliques are formed comprising partially monothetic sets that all mutually in- or exclude each other (step 3). The search procedure is for the largest cliques. The maximum clique size is  $2N-1$ , by which  $N$  is the number of terminal clada with  $N-1$  internal inclusion relations.

The largest cliques found are transformed into cladograms (step 4). These cladograms are judged according to their respective representation of the original data matrix. At first, this is done by calculating their values of 'contradiction minus support'. Support is the number of character states of which the distribution can be explained by assuming a single origin or reversal. Contradiction is the total number of origins and reversals necessary to explain the distribution patterns of the remaining character states. The supporting character states are only relevant when they represent apomorphies, which is established using outgroup comparison.

Several cladograms might show comparable low values of contradiction minus support with all clada being supported by apomorphies. Eventually, one of these is chosen as the hypothesis of cladogenetic relationships among the terminal clada that is regarded biologically most plausible. This cladogram



serves as the basis for further phylogenetic and evolutionary analyses.

B) The reconstruction of the phylogeny of the Drynarioideae using the principles and methods set forth in A, and to compare the results with those of previous authors. Presently, 30 evolutionary species are recognized. In all recently proposed classifications, 16 of these are accommodated in the genus Drynaria. The remaining 14 species are variously classified. In Copeland's (1947) classification, which is widely accepted, these species are accommodated in seven genera: Aglaomorpha (5 spec.), Merinthosorus, and Thayeria (both 2 spec.), Drynariopsis, Holostachyum, Photinopteris, and Pseudodrynaria (all monotypic). The phylogenetic relationships among these genera were ill-defined. Thus, transformation series could not be established. Nevertheless, Pichi Sermolli (1977) defended the monotypic genera as representing distinct stages of the realization and combination of phylogenetic trends in frond dimorphism and sori shape. Chandra (1982b) proposed two tribes. This subdivision is here inferred to be based on character weighting, as it is conflicting with the data he provided. Furthermore, it cannot be based on phylogenetic considerations, because the phyletic scheme presented in the same publication is incongruent with this subdivision.

These examples show the general ambiguity as far as the recognition of supraspecific taxa within the Drynarioideae is concerned. This confusion is further illustrated by a remark of Copeland (1947, p. 202), stating that nearly all Aglaomorpha (sensu lato) species have been proposed as the type of a genus. Copeland tried to explain the controversies by assuming that this is related to the relative recency and extreme plasticity of the group. But, he did not provide any evidence for these postulations, which are here refuted.

The present monograph also deals with the question which of the previous (generic) dissections really reflect the phylogeny, or whether they are based on phenetic groups.

The first cladistic analysis of all 31 terminal clada initially recognized, resulted in cladograms showing many polytomies. Interpretation of these cladograms and their supporting character states led to the recognition of two main holophyletic groups. It appeared that the 14 (formerly variously classified) species comprise a holophyletic group which is the sister group of Drynaria. Therefore, the present author proposes a classification of the Drynarioideae comprising two genera, i.e. Aglaomorpha and Drynaria, including the rejection of all other genera (also of the generally accepted Photinopteris). A phenetic analysis of the same data matrix yielded the same two groups. It further showed larger dissimilarities among Drynaria species than among Aglaomorpha species, which is contradictory to what existing classifications might suggest.

For each of these two genera, a separate cladistic analysis was carried out. These analyses resulted in the selection of a number of cladograms. The cladograms of Drynaria were all completely dichotomous. Those of Aglaomorpha showed a trichotomy of two groups of three species and a single terminal claxon. The latter is a hybrid. Next, each of these cladograms of Aglaomorpha was combined with each one of Drynaria, followed by a choice for cladogram 7.43 representing the best hypothesis of cladogenetic relationships among the drynarioid clada. The transformation series in frond dimorphism and sori shape, read off from this cladogram, contradict those proposed by Pichi Sermolli (1977).

A subsequent historical biogeographic analysis, based on the chosen cladogram, was carried out according to the method of component analysis as

described by Nelson & Platnick (1981). Starting from the distribution patterns of the drynarioid (and Platyserium) species, areas of endemism were distinguished. In the (species)cladogram, the species were replaced by the areas of endemism they inhabit respectively, yielding an area-cladogram. From this area-cladogram a general areagram was derived presenting cladistic relationships among the different areas of endemism. It appeared that Taiwan is more related to continental Asia than to Malesia, that the areas of continental Asia are mutually more related to each other than to those of Malesia, and that Borneo and the Philippines are mutually more related to each other than to the other areas of Malesia. The relations of Celebes remained uncertain.

Eventually, all data of intrinsic and extrinsic characters were used to postulate a scenario of the drynarioid ferns. According to the phylogeny hypothesized, the drynarioids show trends leading from (internal) dimorphism towards monomorphism, and from predominantly epiphytic towards more epilithic or terrestrial growth habits. Furthermore, drynarioids with a northern distribution in continental Asia are supposed to have been migrated towards high altitudes.

The present study has been published before as a thesis, fulfilling the requirements for a PhD degree in the faculty of Science, University of Utrecht.

A great many people took an active interest in my work and it is my pleasure to express my gratitude to all of them.

I tender my sincere thanks to Prof. Dr. E. Hennipman and to Dr. M. Zandee for their cooperation, stimulation, and critical comments.

Constructive critical remarks have been received from Prof. Dr. E.O. Wiley, and Dr. C.H. Humphries.

I received much help and technical assistance, which is greatly appreciated. I am much indebted to Drs. W.L.A. Hettterscheid, Mrs. G.P. Verduyn, Mr. J. Jansen, and Mr. D. Tolsma. I am grateful to Drs. L.Y.Th. Westra, Drs. R.Ch. Kruyt, Drs. G. van Uffelen, Mr. H. Rypkema, Mr. T. Schipper, Mr. P. Wartenaar, Miss M. Teeuwen, the staff of the botanical gardens at Utrecht and Leiden, and the other members of the staff of the Institute for Systematic Botany, University of Utrecht.

I am indebted to the directors and staff of the herbaria who put collections at my disposal; to Mr. A.C. Jermy, Miss J. Camus, Dr. B. Croxall, Mr. P. Edwards, and the directors and staff of the British Museum (Natural History) and the Royal Botanic Gardens and Herbarium, Kew, for their help and hospitality; to Prof. Dr. W. Greuter and Dr. B. Zimmer of the Berlin Herbarium for their help and hospitality and for the permission to publish the photograph of A. speciosa (Willd. herb.); to the directors and staff of the botanic gardens who put living collections at my disposal.

I am grateful to Prof. Dr. R.C. Ching, Dr. S.K. Shing, Prof. Dr. Zhang Mu, and the directors and staff of the herbaria of the Academia Sinica in Beijing and Kunming, for their cooperation and hospitality I received during my visit to China.

Fieldwork in Papua New Guinea was possible due to invaluable cooperation of Mr. J. Croft, Dr. R.J. Johns, and the staff of the Lae herbarium and the Papua New Guinea University of Technology, Lae.

The financial support of the "Stichting Wetenschappelijk Onderzoek van de Tropen (WOTRO)" and the "Coördinatie Commissie Wetenschappelijke en Onderwijskundige Contacten met China (KNAW, min. O&W)" is kindly acknowledged.

## 2. MATERIAL AND TECHNIQUES

### 2.1. Material

Dried specimens of + 2500 different collection numbers (part of which with many duplicates) have been studied from the following herbaria (abbreviations follow the Index Herbariorum):

- A Arnold Arboretum, Harvard University, Cambridge, Mass.
- B Botanischer Garten und Botanisches Museum Berlin-Dahlem, Berlin.
- BKF The Forest Herbarium, Royal Forest Dept., Bangkok.
- BM British Museum (Natural History), London.
- BO Herbarium Bogoriense, Bogor.
- BR Jardin botanique national de Belgique, Meise.
- BRI Queensland Herbarium, Brisbane.
- C Botanical Museum and Herbarium, Copenhagen.
- F Field Museum of Natural History, [John G. Searle Herbarium], Chicago.
- G Conservatoire et Jardin botanique, Genève.
- GH Gray Herbarium of Harvard University, Cambridge, Mass.
- K The Herbarium and Library, Royal Botanic Gardens, Kew.
- KUN Kunming Station of the Botanical Institute, Academia Sinica, Kunming.
- L Rijksherbarium, Leiden.
- LAE Division of Botany, Dept. of Forests, Lae.
- M Botanische Staatssammlung, München.
- MICH Herbarium of the University of Michigan, Ann Arbor, Michigan.
- NSW National Herbarium of New South Wales, Royal Botanic Gardens, Sydney.
- P Muséum National d'Histoire Naturelle, Laboratoire de Phanérogamie, Paris.
- PE Institute of Botany, Academia Sinica, Peking.
- PNH Philippine National Herbarium, National Museum, Manila.
- S Section for Botany, Swedish Museum of Natural History (Naturhistoriska riksmuseet), Stockholm.
- U Institute for Systematic Botany, Utrecht.
- UC Herbarium of the University of California, Dept. of Botany, Berkeley.
- US U.S. National Herbarium, (Dept. of Botany) Smithsonian Institution, Washington D.C.
- W Naturhistorisches Museum, Wien.
- WU Botanisches Institut und Botanischer Garten der Universität Wien, Wien.
- YUKU Herbarium, Yunnan University, Kunming.
- Z Botanischer Garten und Institut für Systematische Botanik der Universität Zürich, Zürich.

Living specimens have been studied from the following botanic gardens:

- Berlin-Dahlem, Botanischer Garten und Botanisches Museum.
- Brussels (Meise), Jardin botanique National de Belgique.
- Kew, Royal Botanic Gardens.
- Leiden, Botanic Garden of the University.
- LAE, Dept. of Forests, Division of Botany.
- Peking, Peking Botanical Garden.
- Utrecht, Botanical Gardens.

Living plants were further obtained through exchange of spore material and living plants via the Botanical Gardens, Utrecht. Further, the author got the opportunity to make fieldtrips in Papua New Guinea (Roos, 1984), whereas his promotor Hennipman supplied him with material from Sulawesi.

(1979) and Malaya and Queensland (1981). Therefore, it was possible to study more than two-third of the species alive.

## **2.2. Techniques**

### **Rhizome and petiole/costa**

For anatomical studies, pieces of rhizome and petiole/costa of herbarium material have been softened by boiling them in a solution of glycerine in water, whereas living material has been preserved in F.A.P.A. (Hennipman, 1977). The material has been sectioned with a slide microtome. Sections have been stained with astrablue followed by safranin following standard procedures, and embedded in canada balsam. Of each species, at least three different collections have been studied (when available).

### **Scales**

Scales situated near the rhizome apex and on the fronds have been brushed with a solution of a detergent in water (Kramer, 1957), and embedded in glycerine jelly (Hennipman, 1977). Of each species, at least 50 scales have been studied of more than five different collections.

### **Venation pattern**

To study the venation pattern, pieces of fronds from the middle and apical parts of pinnae have been cleared following Hennipman (1977), and by boiling them in a solution of 5--10% KOH in water followed by bleaching in full strength household bleach and subsequent preservation in F.A.P.A. (O'Brien & McCully, 1981). The cleared parts have been put in a jar (Hennipman, 1977) and projection photographs have been taken with a standard magnification of two times. Of each species, at least two different collections have been photographed, followed by further investigations of uncleared material.

### **Lamina**

For anatomical studies, pieces of lamina of herbarium material have been boiled in water, whereas such treatment is unnecessary for living material. Sections of the middle part of pinnae, made with a slide microtome, have been stained with astrablue and safranin, and embedded in canada balsam. Of each species, at least two different collections have been studied.

### **Laminar indument and stomata**

To study the laminar indument and stomata, pieces of the abaxial epidermis have been pulled off using a fine pair of tweezers. The unstained material has been embedded in water and enclosed by nailpolish. Three or more different collections of each species have been studied. At least 25 measurements have been made of each specimen.

### **Receptacular paraphyses**

The receptacular paraphyses (and deviating sporangia) have been studied using suites of hand made sections of sori. The unstained sections have been embedded in water and enclosed by nailpolish. Three or more different collections have been studied, and at least 10 paraphyses of each specimen have been measured.

### **Sporangia**

Sporangia have been brushed with a solution of a detergent in water, and embedded in glycerine jelly. Of each species, three or more collections have been studied. At least 25 measurements and counts have been made of each specimen.

#### Spores

Spores have been tapped off, and embedded in glycerine jelly for light microscopical studies. For S.E.M. studies, they have been fixed to a standard aluminium specimen stub with double-stick tape of which the edges have been covered by silver-glue. S.E.M. studies are based on at least two different collections of each species.



### 3. TAXONOMIC HISTORY OF THE DRYNARIOIDEAE

#### 3.1. Introduction

The taxonomic history of the drynarioids is complex. Species and generic delimitations have caused many taxonomic conflicts, although the delimitation of the drynarioids as a group has not been disputed in recent decades. Many different classifications have been constructed. Most of the (Aglaoomorpha) species have been proposed as the type of a genus as already remarked by Copeland (1947).

#### 3.2. Drynaria

Drynaria species are known for a long time. For example, Clusius (Exoticorum libri..., 1605) and Dodonaeus (Cruydt Boeck, 1644) described a Polypodium indicum, which is probably D. quercifolia or D. sparsisora. P. quercifolium L (1753; = D. quercifolia) was the first Drynaria species published. Swartz (1801) published the next species (P. rigidulum, = D. rigidula), a name that was overlooked for some time. Some years later, Brown (1810) described the same taxon as P. diversifolium, which has been widely used. Desvaux (1811) published P. sparsisorum (= D. sparsisora), which was also ignored for some time.

Drynaria, the first supraspecific drynarioid taxon recognized, was first described as Polypodium subgenus Drynaria by Bory (1825). Bory accommodated four species in it, Polypodium linnei (= Drynaria sparsisora), P. schkuhrii (= D. quercifolia), P. gaudichaudii (= D. rigidula), and P. willdenowii (= D. willdenowii). Obviously, he did not study the specimen described by Linnaeus as P. quercifolium. Knowing Linnaeus' description only (which pays mainly attention to the frond dimorphism), Bory found different plants which he considered to belong to separate species fitting into Linnaeus' description. He did not accept Linnaeus' name. He regarded P. linnei conspecific with the plant described by Linnaeus. However, this was a misinterpretation, which caused much confusion in the following years.

Presl (1836) listed Drynaria (comprising 15 species) as a subgroup without taxonomic rank in Phymatodes. A number of the species he accommodated in Drynaria are now regarded to belong to several other genera of the Polypodiaceae. Presl was followed by Hooker & Bauer (1842).

Smith (1841), treating the collections of Cuming from Malacca and the Philippines, formally raised Drynaria to generic rank, Gaudichaud's (1826) being illegitimate. Smith accepted more than 20 species in Drynaria, divided over 3 subgroups/sections. The Drynaria species were classified in the subgroups/sections Phymatodes and Dipteris. He mentioned two of Bory's species (D. quercifolia and D. rigidula). In 1842, he revised this subdivision classifying all drynarioids in Drynaria subgroup Drynaria, adding a third Drynaria species (D. propinqua) as a nomen nudum. This classification also proved heterogeneous, comprising species that are now regarded to belong to different genera.

Fée (1850-'52) emended the concept of Drynaria, incorporating, amongst others, American species now referred to Pleopeltis. He was followed by Brackenridge (1854) and Hooker (1857) as well as, at the subgeneric level, by Mettenius (1857). Not all pteridologists followed Smith in giving Drynaria generic rank, e.g. Mettenius (1856, 1866), Hooker (1864), Baker (1868), Christ (1897, 1898), and Raciborski (1898).

In the second half of the 19th century, the number of Drynaria species recognized gradually increased. Moore (1862) listed five species (adding D.

*fortunei*, but omitting *D. propinqua*) and Baker (1868) seven (the new one being *D. mollis*). Baker did not accept *D. pleuridioides* described by Mettenius (1866). In 1876, Beddome added *D. parishii* to the eight species just mentioned. Until the beginning of this century *Aglaomorpha heraclea*, *A. coronans*, and *Microsorium musaeifolium* (a microsoroid fern, considered by e.g. Copeland, 1947, to be closely related to the drynarioids because of its dilated frond base), were often incorporated in *Drynaria*, which however remained controversial.

In the first decade of the present century, subdivisions with two (Diels, 1902) or three (van Alderwerelt van Rosenburgh, 1908, 1917) subgroups/sections have been proposed. Diels divided *Drynaria* into *Eudrynaria* and *Poronema*, the first comprising all pinnatifid species, the latter *D. rigidula* with pinnate fronds. Van Alderwerelt van Rosenburgh added a third subgroup *Thayeria*, which had been given generic rank by Copeland (1906). At the same time, the number of species recognized increased, including two species of mainland Africa, and a number of Chinese and Malesian endemics. Recently, Cufodontis (1969) and Ching & Wu (1983) added one African respectively two Tibetan endemics to these, which are here regarded synonymous with existing species.

### 3.3. *Aglaomorpha*

Contrary to the delimitation of *Drynaria*, the generic delimitation of the other drynarioids has been confusing up till now. The first drynarioid taxon described at generic rank, was the monotypic genus *Aglaomorpha* (Schott, 1835 or '36). Shortly after, Presl (1836) described the same taxon as *Psygium elegans*. The recognition of *Aglaomorpha* as a distinct genus separate from *Polypodium* and *Drynaria* was widely accepted. Exceptions are Hooker (1864), Baker (1868), and Christ (1897), who all regarded it part of *Polypodium* subgenus *Drynaria*. Van Alderwerelt van Rosenburgh (1909) proposed *Aglaomorpha* as a subgroup of *Pleopeltis*.

Smith created *Dryostachyum* and *Photinopteris*, in which he accommodated two species each. Regarding *Photinopteris*, Presl (1849) increased the number of species up to 5. All these taxa are here considered to be conspecific (= *Aglaomorpha speciosa*; the nomenclature of which has been elucidated by Hennisman, 1974). Because of its striking characteristics (e.g. pinnate fronds), this genus has almost never been disputed. Only Hooker (1864), followed by Baker (1868), ranked it as a subgenus to *Acrostichum*, adding a second, pinnatifid species *A. drynarioides* (= *Aglaomorpha drynarioides*). Mettenius (1856) added to the confusion by putting *A. speciosa* in *Lomariopsis*, but he was not followed. Kuhn (1869) placed the two species in *Dryostachyum*.

Hooker (1864) and Baker (1868) did not accept the genus *Dryostachyum* separate from *Polypodium*, whereas Beddome (1883) incorporated the species referred to *Dryostachyum* in *Drynaria*. Most other pteridologists treated it as a separate genus until it was incorporated in *Aglaomorpha* (Copeland, 1911).

The concept of *Aglaomorpha* changed early in this century, as a new species (*A. brooksii*) was described and *Dryostachyum* became incorporated (Copeland, 1911). Based on differences in the fertile frond parts, Copeland subdivided *Aglaomorpha* into three different subgroups/sections (*Psygium*, *Hemistachyum*, and *Dryostachyum*), to which he added a fourth in 1914 (*Holostachyum*).

The monomorphic *Aglaomorpha heraclea* and *A. coronans* were variously classified, being accommodated in *Polypodium* as well as in *Drynaria*. For the first species, Copeland (1911) tried to solve this problem by creating



Polypodium subgenus Drynariopsis. He also described Merinthosorus in which he accommodated M. drynarioides to separate this species from A. (Photinopteris) speciosa. In 1914, he placed a second species in Merinthosorus, i.e. M. hieronymi, because of its linear acrostichoid fertile pinnae. The criteria for the classification (ranking) of the drynarioids used by Copeland, were mainly based on the gross morphology of the frond and the shape and position of the sori.

Copeland (1929) recognized five drynarioid genera (Aglaomorpha, Drynaria, Merinthosorus, Photinopteris, and Thayeria). He divided Aglaomorpha into six subgenera: Drynariopsis, Psygium, Dryostachyum, Hemistachyum, Holostachyum, as well as an unnamed one which was later named Pseudodrynaria by Christensen (1934). In 1938, Christensen raised Pseudodrynaria and Drynariopsis to generic rank. He regarded both genera monotypic, but did not make the new species combinations. This was done by Ching (1940). Christensen (1938) furthermore listed Aglaomorpha, Dryostachyum, Holostachyum, Merinthosorus, Photinopteris, and Drynaria. Ching (1940) listed one more genus, i.e. Hemistachyum.

The majority of the genera thus proposed were monotypic or comprised two species only. Copeland (1947) made a classification that is still widely accepted. He recognized eight genera, of which four are monotypic (Drynariopsis, Holostachyum, Photinopteris, Pseudodrynaria) and two comprise only two species (Merinthosorus, Thayeria), apart from Aglaomorpha (including Dryostachyum and Hemistachyum; comprising about five species) and Drynaria (about 20 species). According to him, the drynarioids constitute a conspicuous and natural group. Holttum (1954) followed Copeland's systematic arrangement and his ideas about the phylogenetic interrelations with other Polypodiaceae.

Regarding the interrelationships of the drynarioid ferns to other Polypodiaceae, there is still no consensus. The different concepts, suggested in the last century, of Drynaria and Pleopeltis as well as Drynaria and Phymatodes, can be interpreted as suggestions of relationship. These suggestions have been accepted by others, e.g. van Alderwerelt van Rosenburgh (1908: Pleopeltis and the drynarioids).

Christensen (1938) placed the drynarioids in the tribe Pleopeltideae of his subfamily Polypodioideae, regarding the Aglaomorpha species intermediate between Drynaria and Phymatodes. Ching (1940) included it in the tribe Phymatodeae of the subfamily Pleopeltioideae in his treatment of the Polypodiaceae. Many authors amalgamated these subdivisions, and regarded the group closer to Microsorium, which was formalized by Nayar (1970) when he created a subfamily Microsorioideae including the drynarioids. In contrast to his 'clear-cut' classification is his multi-interpretable scheme of interrelationships.

Only as recent as 1975, Crabbe et al. classified the species here referred to as the drynarioid ferns in a distinct subfamily Drynarioideae of the Polypodiaceae. Crabbe et al. recognized five genera: Drynaria, Merinthosorus, Photinopteris, Thayeria, and Aglaomorpha. They divided the latter into subgenera: Drynariopsis, Dryostachyum, Holostachyum, and Pseudodrynaria.

Pichi Sermolli (1977) proposed a finer generic dissection, recognizing nine genera, i.e. those proposed by Copeland (1947) and adding Dryostachyum. In his opinion, the grouping of polypodiaceous genera into tribes and subfamilies presents serious difficulties because of uncertainties about relationships between the various genera. Nevertheless, he construed 14 groups, one of which includes the drynarioid genera. Furthermore, he indicated a sister group relation between the drynarioids and the microsorioid ferns. Within the drynarioids, Pichi Sermolli recognized two main phyletic trends, resulting in 9 genera, which according to him are all

sharply distinct and represent different stages of the realization and combination of these trends. He concluded that although most of the genera are monotypic or very small, they should be regarded as distinct.

Ching (1978) proposed the family Drynariaceae. He accepted the generic dissection of Copeland (1947). Chandra (1980a, b; 1982a-d), who studied the morphology of about 15 out of the 30 drynarioid species representing the various drynarioid genera delimited by others, followed the classification as proposed by Crabbe et al. (1975), also recognizing Holostachyum without explication. He (1982b) concludes that Photinopteris (= Aglaomorpha speciosa) is closest to Drynaria, which is however not reflected by his phyletic scheme. He formalized two tribes: Drynarieae (including Drynaria and Photinopteris) and Aglaomorphae (including the other four genera accepted by him).

## 4. COMPARATIVE EVOLUTIONARY BIOLOGY: A RESEARCH PROGRAM

### 4.1. Introduction

#### 4.1.1. Position and objectives of systematics

For the purpose of method, the study of evolution can be divided into comparative evolutionary biology (character analysis of the patterns and diversity of extant and extinct living organisms; phylogeny reconstruction) and general evolutionary biology (the analysis of mechanisms of evolution, process biology of the patterns recognized; e.g. biosystematics). Regarded this way, comparative studies include traditional systematics, paleontology, biogeography, and the comparative aspects of ontogeny/embryology (cf. Nelson & Platnick, 1981). Pattern analysis and process biology together comprise systematics in the broad sense.

The subject of comparative evolutionary biology is the diversity of extant and extinct life-cycles, among which patterns of similarities and differences in character states are studied using various techniques of character analysis. The aim of comparative evolutionary biology is to recognize and reconstruct the underlying order to these patterns using techniques of cladistic (phylogenetic) analysis. The reconstruction of phylogenetic order (and not genetics *sensu lato*) is a prerequisite for explanations of the origin of this order. Comparative evolutionary biology supplies the evolutionary biologist with empirical data that can be indispensable to the evaluation of test implications from hypotheses concerning evolutionary processes (see also Roos, 1986).

Botanical systematic research can be artificially divided into local floristics, revisions, and monographic treatments. It is traditionally concerned with the delimitation of species as well as the ordering of species into groups of higher taxonomic rank. The absence of a unambiguous methodology to achieve these goals has led to elitism and is one of the reasons for the variety of conflicting classifications which are continuously published (cf. the general systems of angiosperms: Hutchinson, 1959; Takhtajan, 1969; Dahlgren, 1975; Thorpe, 1976; Carlquist, 1981). Many people regard systematics as an inventory or descriptive research, because they do not perceive systematics as a discipline contributing to the development of theories (i.e. a synthesis of form, time, and space). Floristics and revisions deal with groups of species selected (partly) on geographical grounds, an artificial criterion in an evolutionary context. Only monographics contribute to comparative evolutionary biology, because in principle they deal with groups of species selected on presumed phylogenetic relationships.

Furthermore, scientific inquiry should not be primarily evaluated according to their results, but according to the new questions arising as a corollary; questions relevant within the chosen starting-points and the covering theory (Roos, 1986). In this respect also, monographic treatments are superior to flora's and revisions. As Van Peursen (1980) put it: In sciences is the practice inferior to and only a support of the method. What comes first are perceptions, which become observations within a scientific context. Therefore, true observations are not the starting- but the end-point of scientific inquiry, being the result of methodological tracing out. The rationale operations are of main interest.

The central axiom of comparative evolutionary biology is that observed diversity is the result of historical (evolutionary) processes that have led

to descent with modification. No further assumptions need to be made concerning evolutionary processes. Consequently, systematic research can contribute to evolutionary theory, but by using an adequate methodology. In the following account, a comparative research program (describing assumptions and methods) is presented illustrated by the present monographic study of the drynarioid Polypodiaceae. Of importance is the concept that at every stage of the study the data, the criteria applied, and the decisions are explicit presented. Contrary to prior traditional work, such a research program leads to reproducible and quantitative results that are necessary for testing hypotheses of phylogenetic relationships. These hypotheses about patterns in turn can serve to search for correlations necessary in testing hypotheses concerning causal evolutionary processes. This reasoning can be summarized by means of the following sequence of procedural steps taken in phylogenetic systematics (see Fig. 4.2 for a more extensive scheme):

character analyses --> pattern analyses --> ordering (cladogram) --> testing implications of phylogenetic relations --> correlations (e.g. biogeographical patterns) --> testing implications of causal evolutionary connections

It is in the author's opinion that the lack of an adequate comparative methodology is one of the reasons that the general validity of the neo-darwinistic theory of evolution is often taken for granted as a starting-point of general evolutionary biology. And, evolutionary process research runs the risk of becoming reduced to the study of infraspecific phenomena. However, from several disciplines alternative theoretical (sub)models are proposed, e.g. molecular drive (Dover, 1982), punctuated equilibrium (Eldredge & Gould, 1972), nonequilibrium evolution (Wiley & Brooks, 1982). Whatever their value, they are all dependant on accurate pattern analyses and reconstructions of phylogenetic order.

#### 4.1.2. Historical survey

The idea of order within the biotic world has been accepted from time immemorial to the present day (cf. the use of 'birds', 'worms', 'flowering plants' in common spoken language). Linnaeus proposed a formal hierarchical system to represent the order of living organisms (cf. his *Species plantarum*, 1753) which is still used. He defined species and genera using as many characters as were necessary to him. However, his arguments to unite genera into taxa of higher rank was pragmatic and based on a few a priori weighted characters (his sexual system). His resulting classification was therefore soon regarded to be unnatural, and the conviction grew that all hierarchical levels of classifications should be based on a large number of (i.e. all) characters (cf. Adanson, *Familles des Plantes*, 1763).

Darwin's publication of the *Origin of Species* (1859) and the introduction of his idea of evolution did not really affect existing classifications. However, the concept of 'natural' changed. Before that time, postulated order was interpreted in an idealistic morphological way within a creationist background. Idealistic morphological arguments are still present in the process of delimitating species and character(-state)s. Since 1859, observed patterns have been mainly interpreted in an evolutionary sense. However, until the 1960s, starting-points, rules, and methodologies of systematic research remained ambiguous.

After the Second World War, three main schools of systematic thought developed. The first was the evolutionary school, of which Mayr and Simpson

are the main representatives. This is the more or less traditional school which aims at representing both aspects of evolution in the classification, i.e. descent as well as modification serve as criteria for ordering. Order is estimated by some measure (gained by studying morphology) of overall genetic similarity. The second, the numerical taxonomy school (instigated by Michener, Sokal, and Sneath), developed simultaneously with the development of computer techniques and algorithms. Its aim was drafting objective algorithms to produce classifications based on overall phenetic similarity. The third school is phylogenetic systematics, which is accepted by the present author as representing the most suitable way of systematic thought presently available for (comparative) evolutionary biology. It is aimed at producing classifications on the basis of genealogy.

#### 4.1.3. Phylogenetic systematics

The ideas of the German entomologist Hennig (1950, 1965, 1966) are generally considered the start of phylogenetic systematics as presently applied by an increasing number of systematists. Hennig convincingly demonstrated that only relative recency of common ancestry ('descent') can be unequivocally used as the criterion for reconstructing the order in the biotic world. Consequently, classifications should reflect the relative recency of common ancestry. At the same time, Hennig showed that there were limitations of the concept of overall (genetic or phenetic) similarity. He recognized how to deal with similarity (viz. convergences, parallelisms, and synapomorphies), by showing that phylogeny implies similarity but that similarity does not imply phylogeny. His basic principles of phylogenetic analysis have been widely accepted, even by certain prominent representatives of other taxonomic schools (e.g. Mayr, 1974, 1982). The translation of his principles into a consistent methodology has led to dispute and controversy, which are unsurpassed in biology in the past decades. However, the discussions have been successful: viz. criteria, methods, and objectives for the recognition and ordering of patterns that have since developed (e.g. Eldredge & Cracraft, 1980; Wiley, 1981; Nelson & Platnick, 1981).

These discussions so far have been mainly conducted by zoologists. Botanists were, and often still are (see Briggs & Walters, 1984), very suspicious about, or even opposed to, phylogenetics as they considered pattern recognition in plants is hampered to much by hybridization. But, initiated by Wagner (1961, 1980), Koponen (1968), and especially Bremer & Wanntorp (1978) and Humphries (1981, 1982, 1983) a.o., botanists also become more and more interested in pattern analyses of intrinsic respectively extrinsic characters for testing phylogenetic hypotheses, as much as possible eliminating the role of a priori notions about processes governing evolutionary change (scenario elements), or other predisposition of whatever kind.

#### 4.1.4. Present state of affairs

In an earlier work (Hennipman & Roos, 1982), it is tried to apply the phylogenetic methods in a strictly Hennigian manner, using a priori established transformation series. More recently, the authors' ideas about the basic tenets and the translation of the latter into an adequate methodology, implying transformations of characters to be less ad hoc, have changed. As initiated by Zandee (unpubl. ms.), the conviction grew on the authors that outgroup comparison needs a more precise definition. Transformation series are dictated by the cladogram a posteriori. Further,

it became clear that the current parsimony and compatibility methods for reconstructing phylogenies show a number of disadvantages. This has culminated in the method developed by Zandee (1985), applied for the first time here in its present state. An earlier version was applied in Geesink (1984).

Character compatibility analysis (e.g. Meacham, 1981), one of the two different strategies for phylogeny reconstruction, appears very useful to systematists because it bases the construction of cladograms, and thus the recognition of taxa, on unique character states (i.e. on support only). However, it has been seriously and rightly criticized (e.g. Farris, 1983). The criticisms mainly pertain to the selection of characters by means of cliques in order to construct trees, while as a consequence, all other (incompatible) characters are ignored.

Parsimony methods are advocated to generate hypotheses that minimize requirements for ad hoc hypotheses of homoplasy (Farris, 1983). The main disadvantage is the (practical) necessity to establish transformation series in advance. Moreover, as supporting character states are not of special relevance in generating and selecting cladograms, the different groups of taxa in the resulting cladograms are not necessarily defined by unique character states. The attitude towards unambiguous supporting character states, however, is dualistic, as support is still regarded relevant to judge the corroboration of cladograms (Riggins & Farris, 1983, p. 99).

To overcome these disadvantages a method that is regarded an integration of both strategies mentioned is applied in the present study. It is based on the recognition of groups of taxa using unique character states, while all characters are used to select optimal cladograms from all those generated.

The following account is a general outline of the basic tenets, assumptions, and operations of this method. Of particular importance is the fact that phylogeny reconstruction requires more characters in the analysis (at all structurally integratedion levels) than those necessary for the delimitation of species only. Furthermore, it is stressed that comparative evolutionary biology is aimed at evaluating general patterns of similarities, as only these may point to common historical developments. Apart from presenting an application of a new method for phylogeny reconstruction, this monograph is also meant to add to the discussions about the explicit role of comparative biology (and especially its central discipline: systematics) in the general development of theories about evolution.

## **4.2. Aims of comparative evolutionary biology**

### **4.2.1. General**

The central purpose of comparative evolutionary biology is the reconstruction of the historical development of the diversity in life-cycles (phylogeny) through the recognition of order in the observed character state patterns, leading to a classification reflecting phylogeny. Contrary to the view of Kalkman (1982), classification is not regarded here to be one of the two main systematic objectives, but it is regarded only as a corollary of the single objective of comparative evolutionary biology: the reconstruction of phylogeny.

Logical starting-points and methods for comparing and ordering are fundamental to the ultimate aim of evolutionary biology, a synthesis in which all biological knowledge is placed in a hierarchy which reflects evolution. This synthesis (summarized in the scheme given in Fig. 4.2)

comprises the following phases:

1. **Form, Time, and Space:** pattern analysis of intrinsic and extrinsic characters. This idea is developed by Croizat (1962) and formalized by Nelson & Platnick (1981).  
Form= by discontinuities separated groups of organisms with all their features throughout their life-cycle; morphology sensu lato.  
Time= the geological time scale  
Space= the ecological and geographical distribution
2. **the Dynamics of Form in Time and Space:** process analysis of the patterns recognized.  
Process= the (cause of) dynamics and changes of Form in Space in ecological time
3. **Form and Function (Structure and Organization) in Time and Space,** related to fundamental biological and geographical/ geological processes: pattern analysis of the intrinsic and extrinsic biotic and geophysical processes recognized.  
Function= the interaction of Form with the (internal and external) environment

These three phases can be made into a scenario that integrates the biological, chemical, physical, and geological levels. Integration of correlated transformation series of intrinsic characters and trends of extrinsic characters may lead to the recognition of evolutionary strategies.

4. **the explanation of the scenario using thermodynamics, systems theory, and informatics.** Regarded this way, biological entities are (parts of) semi-closed non-equilibrium systems in which irreversible energy and information streams exist (Bloch, 1984; Brooks & Wiley, 1986; Jantsch, 1981; Prigogine & Stengers, 1984; Varela, 1979; Wiley & Brooks, 1982).

#### 4.2.2. Practice

In practice, comparative evolutionary research mainly pays attention to phases 1 and 3 as circumscribed above. When it is not aimed at contributing to phase 3, systematic research remains what it was (and still is for many biologists only familiar with flora's): a descriptive inventory. However, systematic research being independent of any detailed preconceived idea of evolution, should be the major premise for the derivation of test implications for postulated evolutionary processes. In other words, phylogeny reconstruction should proceed without a priori incorporation of scenariolike ideas. As such, it can provide for each postulated actual cladogenetic or anagenetic event (correlations in) patterns of intrinsic and extrinsic characters and processes that are necessary for testing which specific process actually took place. A description of the main research issues (which will be dealt with in detail in 4.4) is given below:

##### Phase 1:

###### -Intrinsic features

###### Form

The recognition of hierarchical patterns of similarities (the construction of cladograms) followed by the reconstruction of the phylogeny. The latter is based on selected patterns of special similarities supposed to indicate genealogical relations (cladogram selection; the search for and

evaluation of general patterns in character state distributions).

#### -Extrinsic features

##### Form and Space

The reconstruction of the history of the present geographical distribution patterns of species based on selected cladograms by the construction of area- and eco-cladograms.

##### Form and Time

The analysis of the relation between transformation series as consequences of the selected cladogram, and data involving a time-factor, i.e. the ontogeny and stratigraphy.

##### Form in Space and Time

A synthesis of the foregoing three items, leading to a phylogenetic tree.

#### Phase 3:

The search for an explanation of the postulated phylogeny being the result of evolutionary and biological processes in space and time (both intrinsic and extrinsic processes).

### **4.3. Starting points**

#### **4.3.1. Covering theory**

Evolutionary biology concerns itself with unique entities (individuals at the species and organismic levels) as well as unique events (speciations). In order to be able to reconstruct the phylogeny it is necessary and sufficient to start from evolution in the broadest sense, with a general rather than specific theory of descent with modification (Platnick, 1979; Wiley, 1975, 1981). Speciations are unique historical events that can be recognized and reconstructed if they are coupled with observable and inheritable modifications (apomorphies or evolutionary novelties), or if the evolution of apomorphies proceeds at a faster rate than speciations. These unique modifications coupled with cladogenesis result in patterns of hierarchical order. In principle (although hybridization may cause disturbances), these patterns always supply the investigator with a means of reconstructing the phylogeny, i.e. the historical sequence of speciations and character modifications, irrespective of when, how, and why these events have taken place (e.g. Wiley, l.c.).

#### **4.3.2. Method of comparison**

As (biological) similarities and evolutionary relationships are non-absolute, systematic comparisons (including the levels of character analysis, evolutionary processes, and all other phenomena) should be threefold: it is only possible to make a statement about (1) A in comparison with (2) B with regard to (3) C within a system (A, B, C). At the same time assumptions are necessarily made about A + B in comparison with C, and about A + B + C. The same holds for a statement about B in comparison with A with regard to C. In case both statements are valid within the chosen domain, it is possible to make a statement about the assumption on the next higher level: A + B in comparison with C with regard to D. At the same time new assumptions are made: about A + B + C in comparison with D, and about A + B + C + D.

This is the reason why hypotheses about phylogenetic relationships can



only be relevant if they have the following formulation: claxon A is more related to claxon B than either of them is related to claxon C (with regard to claxon D; Fig. 4.1). In case of three clada, three of such (dichotomous) statements are possible. Each of these is called a 3-claxon-statement. Together with the recognition of terminal clada, these statements are the basic units of phylogeny reconstruction (see e.g. Wiley, 1981) All problems regarding the reconstruction of phylogenetic relationships between species at each hierarchical level can be reduced to (the selection of the correct) 3-claxon-statements. When the statement that A and B are mutually more related than one of them is to C cannot be rejected, A + B is a potentially holophyletic claxon at the next higher hierarchical level. It is noted that holophyly is inherently asymptotic. It is approached by rejecting non-holophyly, but it never can be ruled out that not all terminal taxa are known or involved.

A claxon is a cladogenetic unit, which serves as a building block for cladogram construction. Clada and taxa have no particular rank assigned to them, but contrary to taxa, clada bear no name. As long as (name-bearing) taxa are involved in the analytical stage of cladogram construction, they also will be referred to as clada. When the cladistic analysis terminates with the selection of a phylogenetic tree and the stage of transcription of the tree into a classification is reached, some clada may turn up as taxa as they will have a rank assigned, and a name attached to them. Most of them, however, will only 'exist' in the analysis during the stage of cladogenesis reconstruction (Zandee, 1984).

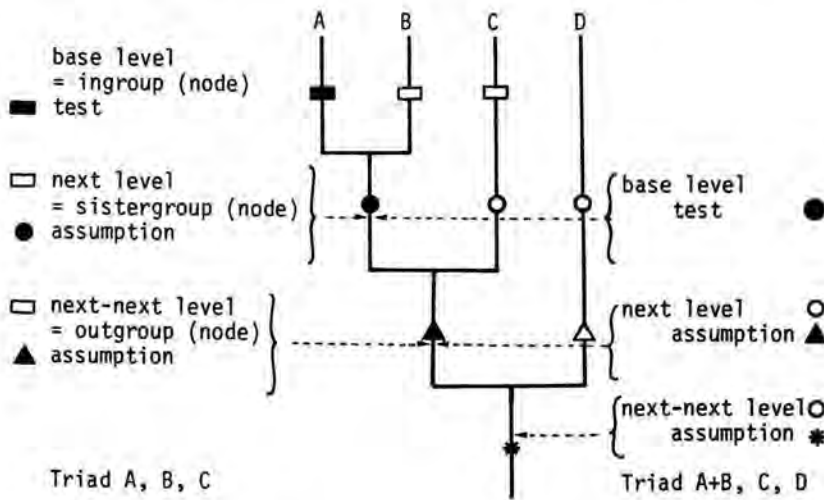

Two three-claxon-statements

Fig. 4.1

#### 4.3.3. Testing hypotheses

In both the cladistic and the biogeographic analyses as well as in the analyses at the level of speciations and constraints (i.e. the constraints in possibilities of originating evolutionary novelties due to the genotype, its morphological expression and the superimposed morphological integration), hypotheses should be tested by common, general patterns

(congruences: correlations) as only these may point to common causes.

Essential to this activity is the search for and the judgement of similarities; differences being irrelevant. Only similarities (shared character states) can indicate common ancestry; differences cannot either contribute to or refute possible relationships.

#### **4.3.4. Outgroup comparison**

The assumption of holophyly for a clade implies that some characters shared among its members are apomorphic. In order to be apomorphic, character states must follow the outgroup rule. In principle, every node in the hierarchy constitutes a sister group relation (adelpho taxa: Ax, 1984) among clada. Every sequential pair of nodes constitutes a 3-cladon-statement involving a sister group relation and its outgroup. Within each of all such 3-cladon-statements in the hierarchy, the outgroup rule applies. In other words, at each hierarchical level there is a clearly defined ingroup, sister group ('closest outgroup'), and outgroup ('next-closest outgroup'). Outgroup comparison has to be applied in this local sense, i.e. confined to one 3-cladon-statement only, in order to preserve the notion of relativity in concepts such as apomorphy, holophyly, and homology. The outgroup of a particular 3-cladon-statement only serves to test the apomorphy of the character states present in all taxa of the ingroup, i.e. the states present in the basal node of the 'subtree' of the ingroup (Fig. 4.1). Applied in a global sense, the outgroup is also (mis)used to establish transformation series at lower hierarchical levels within the ingroup (to denote polarity of character states present in the terminal clada). In the latter sense, the notion of relativity in the concept of apomorphy is destroyed as it no longer applies to a single level of universality (unless the structure of the ingroup remains unsolved). As presently defined, a supporting character state of the ingroup represents an apomorphy, in case it is absent in both the sister- and the outgroup (see Chapter 6.4).

#### **4.3.5. Reciprocal illumination**

Character analyses for all ontogenetic stages lead to statements about similarities in character states, i.e. hypotheses about homologies (synapomorphies) based on morphological criteria (Wiley, 1981: p. 130). However, there is a discrepancy between the phylogenetic definition of homology and the morphological (sensu lato) recognition of homology. This leads to homology problems, which can only be solved by reciprocal illumination. Reciprocal illumination is the continuous and careful switching between subsequent phases of the research in order to improve both the data (hypotheses about homologies based on character analyses) after contradictory patterns in the preliminary results have been found, as well as the results (hypotheses about hierarchical patterns of special similarities) using the revised data.

### **4.4. Research in general**

#### **4.4.1. Form**

##### **4.4.1.1. Character analyses of intrinsic characters**

Systematic results should in principle be based on character analyses carried out at all structurally integrated levels without a priori weighting

of characters. In practice this is difficult to achieve. In the present monograph, character analyses have been carried out at macroscopic, microscopic, and submicroscopic levels. The scope of the present study did not permit an analysis of characters at the molecular level.

#### 4.4.1.2. Cladograms

The reconstruction of holophyletic groups (sensu Ashlock, see Holmes, 1981) at each hierarchical level, characterized by the presence of unique common character states, is the basic principle of phylogenetic systematics (Hennig, 1965, 1966; Wiley, 1981; etc.). The reconstruction of the phylogeny starts with the construction of all possible patterns of hierarchical orders (cladograms) based on the given character state distributions in the data matrix. Only one of these cladograms can be the right one. The cladogram is the hypothesis about relative recency of common ancestry, from which homologies and transformation series can be read off, and the nature and historical sequence of the possible actual speciations can be interpreted.

#### 4.4.2. Form in Space

Historical biogeography starts with the recognition of areas of endemism based on the distribution patterns of the species. This is followed by the transformation of postulated (species)cladograms into a diagram showing the cladistic relationships between the distribution areas involved (described in terms of relevant areas of endemism; area-cladograms). After comparison of large numbers of such area-cladograms, consensus trees can be drafted. These consensus trees are areagrams showing the common, identical parts (in parts) of the original area-cladograms. These congruencies, common distribution patterns, are regarded as the probable results of common (a)biotic causes (e.g. vicariance events are one possible explanation; Nelson & Platnick, 1981). The results should be interpreted using geographical and geological data leading to a synthesis with the earth sciences. Incongruencies point to unique biotic causes (e.g. dispersal), only relevant for the group of organisms involved.

A further refinement of the historical biogeographical analysis seems possible to the author by comparative ecological research. In this case, ecological areas of endemism are to be recognized, and the (species)cladogram transformed into an eco-cladogram, showing the cladistic relations between the habitats involved. The assimilation of the data is similar to that of the area-cladograms.

This view implies a hierarchical order in ecological systems. This is concordant with the views expressed in recent, general treatments of the hierarchical nature of the living world (Brooks, 1985; Salthe, 1985; Eldredge, 1985).

#### 4.4.3. Form in Time

Although a cladogram is a hierarchical classification of data upon which no (absolute) time factor is incorporated, it shows the sequences of character state modifications (i.e. a very specific relative time factor). A comparison of these transformation series with ontogenetic and stratigraphic series leads to the relation between ontogeny, paleontology, and phylogeny. This subject has not received much attention in botany. Especially regarding ferns, it should be mentioned that there is a great difference between the development of a frond or other organ and the development of an individual.

The first is called ontogeny and is a more or less continuous process. The second might be called heteroblastogeny, as it often shows conspicuous morphological discontinuities. This is especially manifest during the development of fern sporophytes in which the subsequent developed fronds are different. Therefore, regarding the development of ferns, the ideas of Von Baer seem more suitable than Haeckel's biogenetic law, as was concluded by Hennipman (1977). Furthermore, Hennipman dealt in detail with one of the most interesting phenomena in this respect, i.e. the significance of paedomorphosis for the origin of the enormous variation of forms and structures. Paedomorphosis comprises the three processes (neoteny, progenesis, and post-displacement) that lead to adult morphologies in descendants similar to juvenile morphologies in ancestors (Fink, 1982). Postulated phylogenetic relations implying incongruencies between transformation- and ontogenetic series, could be indicators of such processes.

#### 4.4.4. Form in Space and Time

Synthesis of Form in Space and Time (the foregoing items) is necessary to construct a phylogenetic tree, which ultimately might differ from a cladogram as follows:

- an absolute time scale is indicated; therefore, not all terminal taxa are by definition situated horizontally in one row at the top of the tree and the distances between the subsequent branching points (nodes) need not to be uniform throughout.
- ancestor-descendant relations are indicated; therefore, not all taxa are by definition situated terminally on the branches; this means that the number of branching points will be reduced to the actual number of speciations (at least the number of recent species minus one).
- it is also possible to indicate divergence; therefore, the angle between two branches of a branching point is not by definition uniform.

In other words, the internal branches of a cladogram represent the hierarchical sequence of common possession of unique character states of terminal taxa and the branching points mark distinction between them; the terminal taxa do not necessarily represent species. On the other hand, the branches of a phylogenetic tree represent evolutionary species (see Chapter 8) and the branching points denote actual speciations.

The highest degree of resolution for hierarchical systems consists of dichotomies at all levels. However, it is possible that polytomies cannot be unambiguously resolved because of reticulate patterns of character state distributions. Such reticulate patterns might be interpreted as caused by hybridization. When polytomies remain due to a lack of supporting character states, this can be explained by multiple speciations or by the presence of ancestors.

Correlations between common patterns allows for the formulation of speciation models. For example, common geographic patterns in sistergroup relations are useful to postulate geographic speciation models (Wiley, 1981).

#### 4.4.5. Phase 3

The cladogram shows the phylogenetic importance of character states at all integration levels (e.g. high and low burden characters: Riedl, 1978). The phylogenetic tree allows for the formulation of test implications for

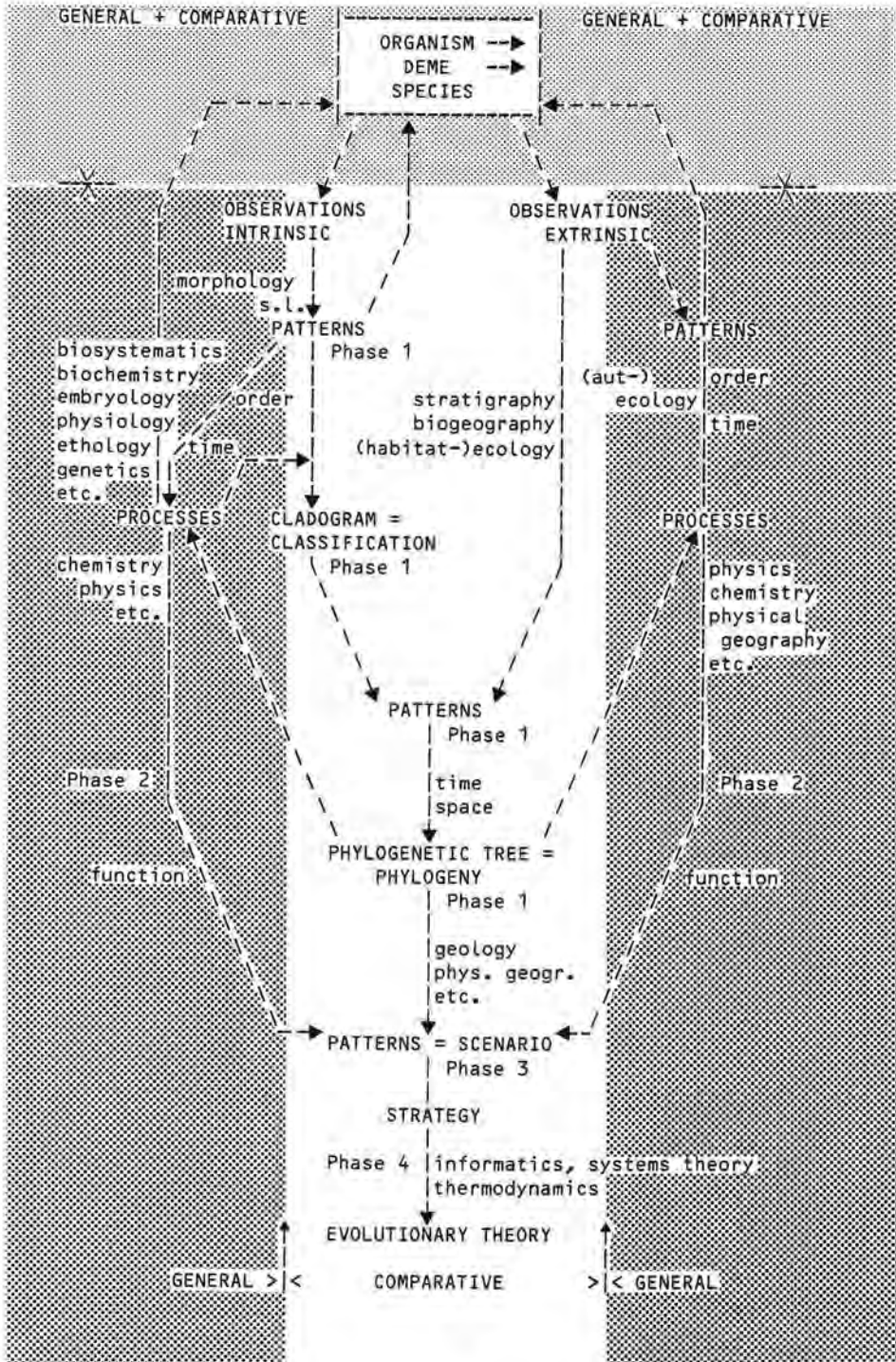

Fig. 4.2

specific speciation models based on (onto)genetic processes. A synthesis of the phylogenetic tree information with (onto)genetic data may lead to the development of new speciation models. Based on postulated phylogenetic relations, the historical development of the present patterns in distributions and habitats can be reconstructed.

The results can be refined and extended by making comparative studies of the autecology/ecophysiology of the species of selected 3-taxon-statements. Ecophysiology and autecology are concerned with phenomena that exist at the interface of intrinsic and extrinsic characters/processes respectively, i.e. they are the turning point between intrinsic and extrinsic features (like species are the crux in another context, i.e. (macro)evolution and microevolution, evolution and ecology, comparative and general biology, etc.) Such research gives the opportunity to indicate the relation between form and function, in other words, the relation between patterns and transformation series of intrinsic characters, and differences and similarities of extrinsic characters. As a result, ecological strategies and changes in habitat may be related to phylogenetic events, leading to the formulation of test implications for hypotheses about competition, selection, adaptation, and constraints. Synthesis of the results, and genetic and population biological processes may lead to the formulation of new hypotheses of speciation processes.

#### **4.5. Scheme**

It is stated here that scientific inquiry proceeds according to the following sequence (for simplicity's sake, the steps comprising starting points and reciprocal illumination are omitted):

observations--> pattern recognition--> ordering--> time-factor--> cause

Based on selected observations, patterns can be recognized. Selected patterns supply a means of ordering the observed phenomena. This order is interpreted as having developed in time. We may then explore the mechanisms that cause these patterns. This holds for the reconstruction of phylogenies as well as for analyses of biological processes.

Fig. 4.2 provides a scheme of evolutionary biology, summarising the research program as set forth in this chapter. Some important feedbacks are included. Starting from observations on individual organisms, which are then ordered into demes and species, patterns within intrinsic and extrinsic characters are searched. These patterns can be ordered according to their distribution in a holophyletic group (--> cladogram), or according to their distribution in time in one individual organism, deme, or species (--> process). The processes in turn are characters to be incorporated in the data matrix used for the construction of cladograms. Via reciprocal illumination, these patterns and processes are necessary to test the preliminary species hypotheses.

Observations on extrinsic characters, are used either to describe ecological, stratigraphical, or biogeographical distributions, or to search for patterns that are ordered in time to postulate (aut)ecological processes. The postulated phylogenetic relationships are necessary to search for patterns in the distribution of extrinsic characters, leading to a phylogenetic tree. The phylogenetic tree can provide elements for test implications of both extrinsic and intrinsic (evolutionary) processes (or restrictions for the processes to be investigated). The integration of the phylogenetic tree with intrinsic and extrinsic processes, incorporating information of, for example, the earth sciences, leads to the postulation of a scenario. General patterns in scenario's might be the result of strategies, and integration with thermodynamics, and systems and information theory will eventually lead to an overall theory of evolution.

## 5. INTRINSIC CHARACTERS OF THE DRYNARIOIDEAE

### 5.1. Introduction

Character analyses were carried out after terminal clada were recognized. As much as possible, these analyses continued without a priori knowledge concerning the present knowledge of the group regarding systematics, morphology, anatomy, etc., in order to avoid prejudice. Afterwards, information from literature was incorporated and compared to the data collected. Starting from this point, the characters were selected for the analyses after screening and comparing the terminal clada. Unlike traditional routine, the different character states (and their distribution), and not the species, have been described first.

The character analyses resulted in the recognition of 557 character states distributed over 176 characters (Appendix 1). The distribution of the different states over the terminal clada is given in Appendix 2. For each character state, the absence or presence in each species is encoded as a '0' or a '1' respectively. Characters with a continuous range are arbitrarily divided into separate states so as to represent optimally the observed discontinuities within the group. In case of characters with a meristic range, each value is usually treated as a separate character state. Sometimes, the combination of two values is regarded to represent a different character state (e.g. state no. 38). Qualitative and quantitative characters showing only two states are of course easily transcribed into a 1/0 representation with both states represented separately. The same has been done in case a character (state) is either present or absent within a terminal cladon. When a species shows variation as to a character, i.e. more states are found in one species, the presence of each state is coded separately. Often, character states have been delimited because of the extremes being distinct; confusing intermediates are scored for both extremes. When the state present in a species is unknown, all states regarded relevant are scored (i.e. those of the presumed closest relatives).

In the present publication there is a hierarchical difference only between character and character state. Various expressions of a certain character are called character states. Within these states, again various expressions can exist. In this case, the character state is a character at the next lower level and the various expressions are character states (see Eldredge & Cracraft, 1980; for a different opinion see Jardine, 1969, and Colless, 1985).

The characters selected for extensive study pertain mainly to mature sporophytes. These are the rhizome, including anatomy; the rhizome scales; the fronds, including venation and sori; the indument of the frond including scales, hairs, paraphyses, sporangiasters, and sporangial trichomes; the anatomy of rhachis/costa and of fertile and sterile pinnae, including nectaries and abscission layers; the sporangia; and the ultrastructure of the spores.

The different states recognized are described below. The numbers of the terminal clada refer to the numbers given in Table 5.1. Their sequence has been established according to preliminary intuitive ideas about possible groups early during the study. The numbers of the character states refers to the numbers of Appendices 1 and 2. Appendix 1 lists the character states, and Appendix 2 provides the complete data matrix (the original data matrix on which the cladistic analysis is based). The sequence of the character states in these two tables is more or less ad hoc, whereas the present

chapter follows the traditional descriptive sequence.

Transformation series are presented for each character. It should be noted that these series are read off from the chosen cladogram (Fig. 7.43) using local outgroup comparison. Thus, we find in this chapter a combination of the a priori ('neutral') delimitation of character states and the a posteriori established transformation series (which are the result of the cladistic analysis as described in full detail in Chapter 7). For each character state, when regarded apomorphic, the number of homoplasies implied by cladogram 7.43 is given in Table 7.5. Table 7.4 shows the most important apomorphies as read off from the cladogram. The transformation series given are generalized, i.e. reversals and deviating autapomorphies are usually omitted. Plausible sister groups are groups of Polypodiaceae that are eligible to represent the sister group of the drynarioids according to character state distributions known so far within the family (see Chapter 8.4). Character state and condition are used as synonyms.

| Terminal clada                |   |
|-------------------------------|---|
| 1. <i>Drynaria sparsisora</i> | 17. <i>Aglaomorpha</i> x <i>Leporella</i> |
| 2. <i>D. quercifolia</i>      | 18. <i>A. brooksii</i>                    |
| 3. <i>D. bonii</i>            | 19. <i>A. splendens</i>                   |
| 4. <i>D. involuta</i>         | 20. <i>A. novoguineensis</i> Gibbs 5970   |
| 5. <i>D. descensa</i>         | 21. <i>A. novoguineensis</i>              |
| 6. <i>D. laurentii</i>        | 22. <i>A. cornucopia</i>                  |
| 7. <i>D. volkensis</i>        | 23. <i>A. coronans</i>                    |
| 8. <i>D. willdenowii</i>      | 24. <i>A. heraclea</i>                    |
| 9. <i>D. pleuridioides</i>    | 25. <i>A. meyeniana</i>                   |
| 10. <i>D. rigidula</i>        | 26. <i>A. drynarioides</i>                |
| 11. <i>D. propinqua</i>       | 27. <i>A. speciosa</i>                    |
| 12. <i>D. parishii</i>        | 28. <i>A. latipinna</i>                   |
| 13. <i>D. delavayi</i>        | 29. <i>A. pilosa</i>                      |
| 14. <i>D. sinica</i>          | 30. <i>A. hieronymi</i>                   |
| 15. <i>D. mollis</i>          | 31. <i>A. parkinsonii</i>                 |
| 16. <i>D. fortunei</i>        | 32. <i>A. nectarifera</i>                 |

Table 5.1

## 5.2. Rhizome

The rhizome is stout, long-creeping, more or less frequently branched, cylindrical or rarely dorsoventrally flattened (species no. 1), densely set with conspicuous orange to dark-brown persistent scales. Two species (i.e. nos 10 and 27), have scales that break off relatively easy, associated with the rhizome being covered with a distinct whitish wax layer. The fronds are always inserted in two alternating rows situated dorsally on the rhizome. Chandra (1982a) states that the fronds of *Aglaomorpha* except for species no. 27 are arranged in one row, which is not confirmed here.

The ground tissue of the rhizome in the drynarioids is parenchymatous with a relatively complex perforated dictyostele comprising 10 to up to ca. 100 vascular bundles, which are bicollateral and mesarch, either surrounded by a bundle sheath or not so. Specialized structures in the ground tissue are generally lacking; two species show sclerenchymatous strands.



### 5.2.1. Morphology

#### Diameter (character state nos. 374--377)

The diameter of the rhizome when living is usually greater than when dried. Measurements are taken from living plants when available, otherwise measurements of dried specimens are extrapolated. The drynarioid species strikingly differ as regards rhizome diameter. In spite of overlap, four different states are recognized. The majority of the species have rhizome diameters of 1--2 cm (state no. 375), though many of them have a wider range. Especially species nos. 1, 2, and 6 show much variation, the rhizomes sometimes being more than 3 cm across. Therefore, in Drynaria no disjunction is present. In Aglaomorpha, the rhizomes of species nos. 27--31 never exceed 2 cm across, whereas species nos. 21 and 22 usually vary around 2--2.5 cm. Species nos. 17--19 and 23--26 are deviating, their rhizomes being usually 3--4 cm (or more) across. Only juveniles and ill-developed specimens may show thinner rhizomes.

Transformation series: 375 + 376--->377  
  \-->374

The two apomorphous states show two parallelisms each.

#### Growth habit (character state nos. 416--420)

Based on observations on several species in the wild (Roos, 1984: Fig. 1) and on cultivated plants in the botanic gardens at Utrecht, five different types of growth habits are recognized. The growth habits are clear cut, which makes it (usually) possible to include additional data (literature, photographs taken from the wild). Data concerning species nos. 9 and 18 only are lacking.

The majority of the species either climbs vertical-spirally up the bole of the host tree, or creeps horizontally over long distances on rocks (state no. 417). Within Aglaomorpha, this character state is subdivided into two different types. One type concerns plants loosely attached to the substratum having a more winding appearance (state no. 419). The other concerns plants regularly spirally climbing, firmly attached to the bark (state no. 420), the shell-shaped dilated frond bases forming individual humus collecting baskets (character state no. 431). Eventually, this condition is regarded structurally similar to state no. 417. A specimen of species no. 2, cultivated at the botanic gardens, Utrecht, showed base fronds with a similar growth habit as the fronds of species no. 21.

The rhizome of the other Aglaomorpha species (i.e. species nos. 17--19 and 23--26) encircles the bole of the host tree horizontally only once (rarely twice), firmly attached to the bark. The dilated frond bases are overlapping, together forming a closed ring-shaped basket around the trunk (state no. 418); inferred in species no. 18 in view of its similar overall morphology compared to these large-sized Aglaomorpha species.

Within Drynaria two different growth habits occur. Most species show state no. 417, two species (nos. 8 and 10) are unique in possessing state no. 416. Their rhizomes encircle the bole of its host tree many times +horizontally (only the first few times adressed to the substratum), forming a huge cluster of rhizomes, or she creeps on rocks, branched many times and forming a kind of crust. Species no. 6 is observed to show some variation. It usually climbs spirally (state no. 417; e.g. Johansson, 1974: Fig. 88), but sometimes it tends to encircle the tree trunk horizontally several times (Johansson, 1974: Fig. 73) giving it the appearance of state no. 416. Species no. 9 is scored for both states nos. 416 and 417 as no data are available and no auxiliary argumentation is plausible to infer its

growth habit.

Transformation series : /---(420)--> 419  
417--> 416  
  \--> 418

State no. 416 shows two parallelisms.

Phyllopodia (character state nos. 425, 426) - Plate 8

The presence of well-developed phyllopodia is an characteristic feature of species no. 22 ( and no. 32). The phyllopodia are stout side branches of the rhizome, bearing a frond at its apex. Morphological and anatomical, they are similar to the rhizome, except for the vascular bundles being arranged in a complete circle without protrusions or invaginations. A juvenile plant of species no. 22 cultivated in the botanic gardens at Utrecht, shows fronds inserted in two rows dorsally on the rhizome, the phyllopodia gradually increasing in size during the ontogeny (cf. Goebel, 1928, note to p. 122).

Transformation series: 426--> 425

Insertion of fronds (character state nos. 421, 422)

The greater part of the species have persistent (foliage and/or base) fronds inserted less than 10 cm apart. The complementary condition is fronds inserted more than (10-->)15 cm apart, in Aglaomorpha species usually more than 25 cm. Species no. 12 is unique in Drynaria, showing state no. 422 and the fronds being 10--18 cm apart. Other Drynaria species show a number of fronds inserted close to each other only near the rhizome apex, most fronds on older parts of the rhizome having decayed (e.g. species no. 11).

Transformation series: 421--> 422

Treated separately, the transformation series of Aglaomorpha and Drynaria are conflicting. In the first series state no. 421 is apomorphic and in the latter state no. 422. Outgroup comparison with a number of possible sister groups of the drynarioids, shows that state no. 422 is apomorphic within the subfamily. This still leads to two equally parsimonious hypotheses (implying 3 homoplasies). Either state no. 422 developed three times independently (in species no. 12, nos 20--22, and nos. 27--31), or it developed two times (in species no. 12 and in Aglaomorpha) followed by a reversal (in species nos. 17--19 and 23--26). The presence of state no. 422 in species no. 12 is correlated with the absence of base fronds.

Position of base fronds (character state nos. 427--429)

This character pertains to Drynaria only. Three different character states are recognized, although the species show variation. Contiguous base fronds are erect, usually adpressed to the substratum. Spreading base fronds are obliquely erect, leaving open space between the adaxial side and the substratum (when growing epiphytic). In case adjacent base fronds are overlapping and + adpressed to each other, they are called imbricate. The complete transformation series could not be established, but it should comprise combinations of two or three states. The polarity of state no. 427 is undetermined, whereas state nos. 428 and 429 are plesiomorphous.

Position of fronds with dilated bases (character state nos. 430, 431)

The two character states are clearly distinct, which is correlated to differences in e.g. growth habit.

Transformation series: 430-->431

When Aglaomorpha is taken as a closed system (Wiley, 1981), both states have to be regarded apomorphic. However, the imbricate basal parts are regarded homologous to imbricate base fronds in Drynaria (state no. 429) and therefore regarded plesiomorphic.

Persistent, glabrous rachises (character state nos. 423, 424)

When fronds die, the articulated pinnae may fall off. This phenomenon has been mainly observed in a number of Drynaria species, and is a striking feature in the pinnate species no. 10, and also in the pinnatifid species no. 8. This state is rarely reported from Aglaomorpha species. The present author observed it only once in species no. 21. However, in species with a well-developed internal dimorphism the entire fertile part of the fronds breaks off, as a rule.

Transformation series: 424---→ 423

### 5.2.2. Anatomy

A general outline of the anatomy of Polypodiaceae is given by Ogura (1972), whereas Chandra (1982b) provides a detailed though not very accurate study of the rhizome anatomy of the Drynarioideae.

Stele (character state nos. 385--389) - Fig. 5.1

Five different states of the stele are recognized. The common condition found is the perforated dictyosteles (Ogura, 1972, p. 390; Schmid, 1982, p. 863; state no. 385), rounded or slightly elliptical in cross-section. Dorsolaterally, they show a more or less conspicuous protrusion, leading to a leaf trace. Such protrusions are not found in the species illustrated by Ogura (1972, Fig. 438) and only occasionally in other species of the Polypodiaceae (Hoek, pers. comm.). This state is already present in juvenile plants. It is retained in mature plants of the majority of the species except in species nos. 17--19 and 23--26 and in species nos. 21 and 22 p.p. In the latter, large-sized Aglaomorpha species the perforated dictyosteles transforms into the 'drynariopsis' stele type (Ogura, 1972, p. 390, Fig. 68, 440; = polycyclic dictyosteles, Schmid, 1982, p. 864) during ontogeny. The 'drynariopsis' stele type (state no. 387) is very complex, comprising numerous vascular bundles. These vascular bundles form a conspicuous dorsal protrusion at both sides marked by pronounced invaginations. These invaginations may increase in size, reaching each other, which results in a dorsal circle and ventrolateral anchor-like ring. The latter may produce extensions surrounding the dorsal circle (state no. 388). The position of the dorsal protrusions at both lateral sides of the medial axis, indicate that the fronds are inserted in two rows, which confirms the observations on living plants.

In relatively thick rhizomes of e.g. species nos. 1, 2, 27, and 28, the dorsal protrusion might be enclosed by a ring of vascular bundles. This condition, especially well-developed in species nos 1 and 2, represents a polycyclic dictyosteles according to Schmid (1982) However, it is presently regarded a different character state (no. 386).

Species no. 25 shows variation as to the stele. The most common state is no. 387, but fertile specimens rarely possess a different state (no. 389) with almost ad random distributed vascular bundles.

Transformation series: 385 + 386---→ 387 + 388  
  \---→ 389

The combination of state nos. 387 and 388 is apomorphic and of nos. 385 and

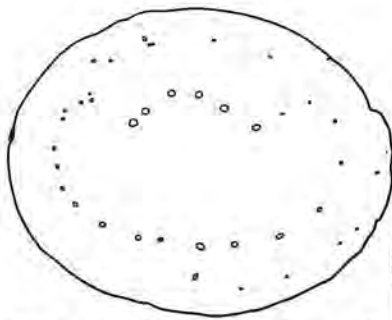

state no. 385 species no. 27

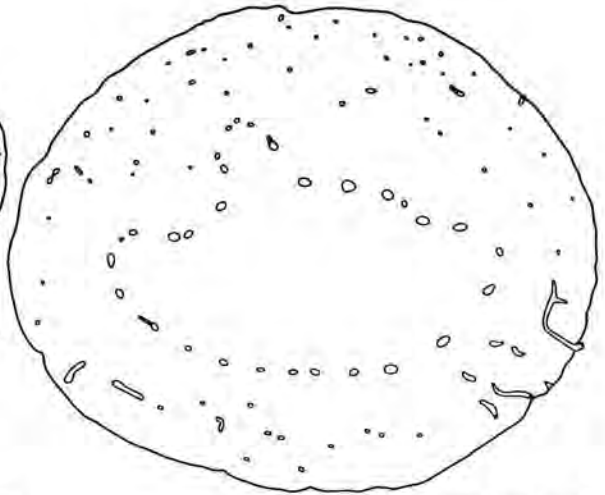

state no. 386 species no. 2

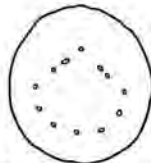
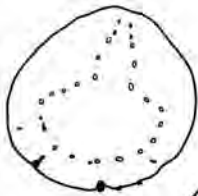

stele types in rhizome (x2.5)  
character state nos 385--389

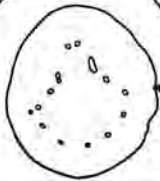

state no. 385 species no. 11 (juvenile)

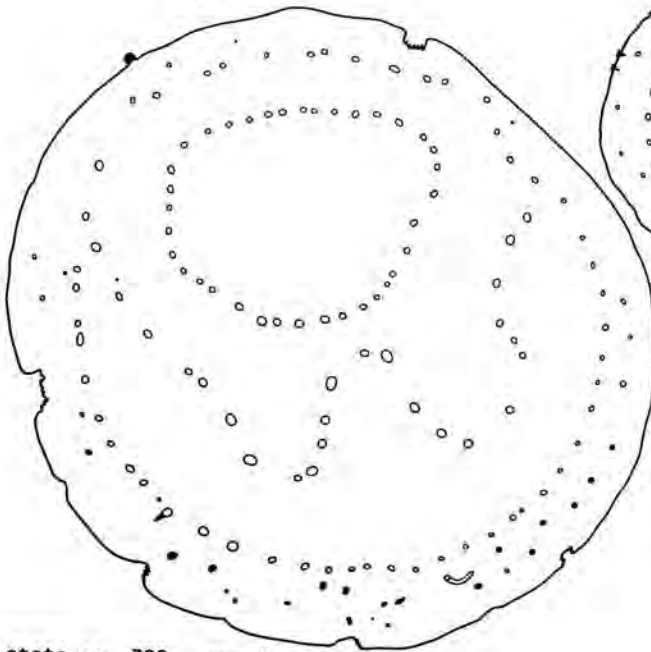

state no. 388 species no. 24

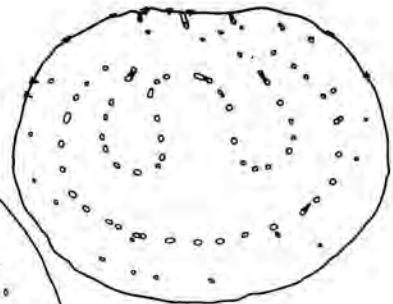

state no. 387  
species no. 26

Fig. 5.1

386 plesiomorphous.

Number of vascular bundles in cross-section (character state nos. 378--382)

This metrical character has been divided into five states, which are recognized for convenience. The rhizomes of mature drynarioids contain more than 10 vascular bundles. Species with relatively slender rhizomes, generally have 10--20 (rarely more) bundles. Large-sized rhizomes of species nos. 1 and 2 have more than 40 vascular bundles, whereas those of the giant Aglaomorpha species often contain up to 100 vascular bundles.

Transformation series: 380---> 381---> 382  
                          \---> 379---> 378

The transformation series is rather difficult to establish, several homoplasies have to be assumed. For example, no. 378 is parallel developed in species no. 11 and nos. 30 + 31; no. 380 is homoplastic in species no. 15 via reversal of no. 379.

Auxiliary vascular bundles (character state nos. 383, 384)

Apart from the vascular bundles comprising the stele, a number of species show a relatively vast number of auxiliary vascular (root?) bundles in the cortex around the stele. They are found scattered throughout the cortex, or mainly dorsally (no. 383), or exclusively ventrally (no. 384). These states are not regarded mutually structurally different, possibly related to the position of the cross-section and the size of the rhizome.

Transformation series: 383---> 384

Relative size of vascular bundles (character state nos. 414, 415)

In most species the vascular bundles comprising the stele are all + equally sized. However, in a number of species the + 4 vascular bundles forming the dorsal protrusion are larger than the others. The two states are usually quite distinct, although sometimes intermediates are found.

Transformation series: 415---> 414 (Aglaomorpha)

414---> 415 (Drynaria)

Local outgroup comparison leads to conflicting transformation series in the two genera. State no. 415 is assumed to represent the plesiomorphous condition in the Polypodiaceae (using global outgroup comparison: Hennipman, pers. comm.). Therefore, the transformation series in the Drynarioideae might be conform to the one given for Aglaomorpha, implying a reversal in Drynaria. However, a definitive transformation series can be established using local outgroup comparison.

Bundle sheath (character state nos. 390--392) - Fig. 5.2

The vascular bundles might be enclosed by bundle sheaths, which consist of surrounding parenchyma cells with deposits (of phlobaphene, a substance derived by the composition of tannin; Chandra, 1982b) on the inner tangential and the radial cell walls. The inner tangential wall becomes thickened first, followed by the radial walls.

In the greater part of the species, bundle sheaths are absent from the rhizome or only ill-developed (in the inner tangential wall). They are a striking feature of species nos. 27--31, the deposits often filling almost the whole cell lumen.

Transformation series: 390----> 391----> 392  
                          \----->-----/

The number of homoplasies implied is high, four for state no. 392, and five for no. 391.

Colour of bundle sheath (character state nos. 393--395)

The bundle sheath is usually blue-, sometimes red-coloured after staining. This difference is empirical. Most strikingly in well-developed bundle sheaths, the blue colour gradually turns to dark brownish during maturation.

Transformation series: 393----> 394  
                          \--> 395

Shape of the epidermal cells (character state nos. 396--398) - Fig. 5.2

As regards the shape of the epidermis cells, three different states are recognized, using length/width ratios. Although the extremes are distinct, species show variation and intermediates are often found. Therefore, the states are not regarded to be structurally different.

Transformation series: 397----> 396  
                          \--> 398

Both apomorphic states show many homoplasies.

Number of epidermis cells per adjacent cortex cell (character state nos. 399--402)

This character is correlated with the shape of the epidermal cells. The species show much variation. A transformation series cannot be established.

Cuticle (character state nos. 410--413)

A cuticle is generally almost absent or inconspicuous. Some species show a more distinct cuticle. As a rule, it is hyaline, but it might be slightly red-coloured when stained. Due to intermediate conditions and infraspecific variation, this character is very difficult to interpret. A transformation series cannot be established.

Sclerenchyma strands (character state nos. 407--408) - Fig. 5.2

Generally, the ground tissue of the rhizome parenchymatous throughout. Two species (nos. 8 and 10) are unique, possessing numerous conspicuous sclerenchymatous strands scattered throughout the ground tissue. These strands comprise 2-->10 cells, the cell walls of which are extremely thickened and dark brown-coloured, almost filling the whole cell lumen. Few species have sclerenchymatous cells medially in the basal part of roots.

Transformation series: 409----> 407  
                          \--> 408

Insertion of scales (character state nos. 403, 404)

Most species have the rhizome scales inserted in small, cup-shaped invaginations. Three species are unique, having the scales inserted on small protrusions of the rhizome instead.

Transformation series: 403----> 404

### 5.3. Rhizome scales

The rhizome scales of the drynarioid species show much variation as to shape, attachment, morphology, and marginal indument. In general, the scales are very densely set throughout the rhizome, at least being persistent although apical and marginal parts might break off. Species nos. 10 and 27 seem to have more or less deciduous scales. The scales are shortly stalked, the stalk being funnel-shaped, 1 or more celled. They are opaque, with a one cell-layer thick marginal zone and an often several cell-layers thick medial zone. During ontogeny, the scales start with being hyaline, then the cell walls become lignified, turning the scales to opaque.

Exposition (character state nos. 541--543) - Plate 10

Around the point of attachment, the scales are + adpressed to the rhizome. In most species, the upper part is irregularly oblique spreading. Species nos. 1 + 3--5 are unique, the upper part of the scales being spread perpendicular to the rhizome. In other species, the entire scale is adpressed to the rhizome, most conspicuously in species nos. 11 + 12, and nos 28--31.

Transformation series: 542---> 541  
                          \---> 543

Shape (character state nos. 513--517) - Fig. 5.2

Five different states are delineated as regards the shape of the rhizome scales.. Rounded scales are found in species 1 + 3--5 (and no. 32). Species no. 22 also shows scales rounded in outline, but these are unique, being cone-shaped (state no. 517). Apart from rounded scales, species nos. 1 + 3--5 have spatulate scales also, the broad basal part of which is rounded, the apical part spine-like. This state is also present in species no. 7, whereas it is ill-developed in species nos. 24 and 17. Triangular-ovate scales are present in all species (probably except species no. 32). In many of these species, also elongated, linear-filiform scales occur.

Transformation series: /---> 513  
514 + 515---> 514  
                  |\---> 516  
                  \---> 517

States nos. 514 and 515 are both plesiomorphous in the drynarioids. However, the sole occurrence of no. 514 is an apomorphy showing 4 homoplasies.

Dimorphism (character state nos. 552, 553)

Although the scales of all species show variation as to the shape, they are usually of one kind only. Species nos. 1 + 3--5 are characterized by two kinds of scales, distinctly shaped. They show rounded scales adpressed to the rhizome (rarely with a short triangular apical part), covered by spatulate scales of which the basal part is adpressed.

Transformation series: 552---> 553

Attachment (character state nos. 509--512) - Fig. 5.2

Four different types of attachment are distinguished. The difference between state nos. 509 and 510 pertains to the auricles which are overlapping in state no. 510, or separated or absent in state no. 509. These states are common in Aglaomorpha. Pseudopeltate scales with long auricles are characteristic for species nos. 27--30. Typically peltate scales are found in one Aglaomorpha species only (no. 31), whereas it is the commonest

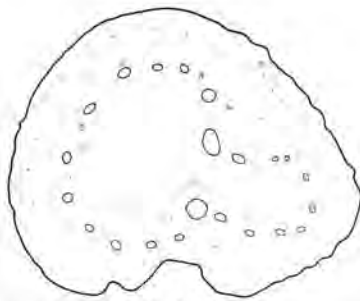

state no. 408 (x2.5)  
species no. 10

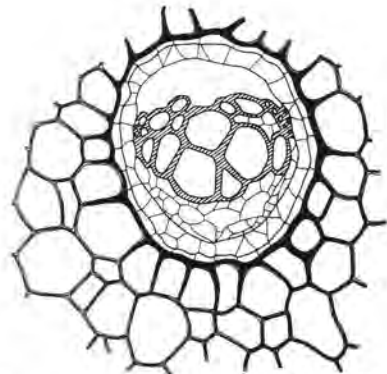

state no. 392 (x40)  
species no. 27

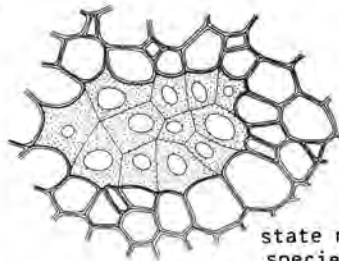

state no. 408 (x40)  
species no. 10

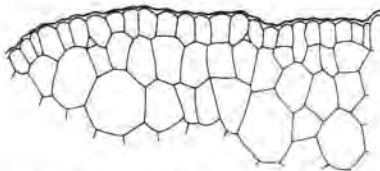

state no. 398 (x40) species no. 7



rhizome scale  
species no. 1  
(x10)  
state nos 512,  
516, 528, 532,  
533, and 551

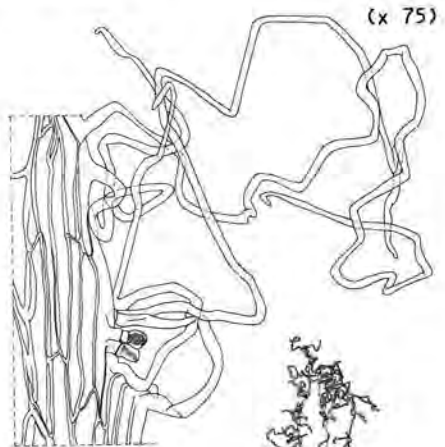

(x 75)

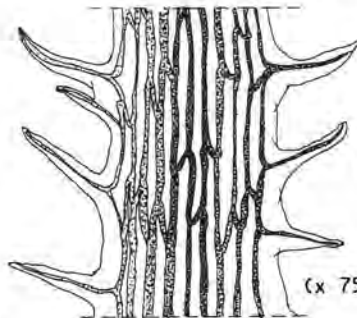

(x 75)

rhizome scale  
species no. 29  
(x10)  
state nos 511,  
514, 530, 531,  
and 550

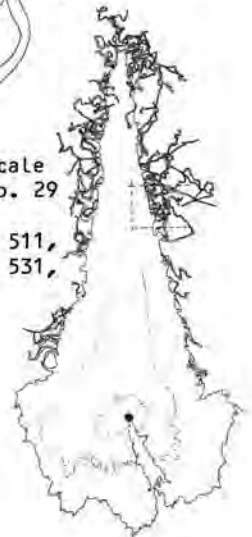

rhizome scale  
species no. 1 (x10)

Fig. 5.2



state in Drynaria.

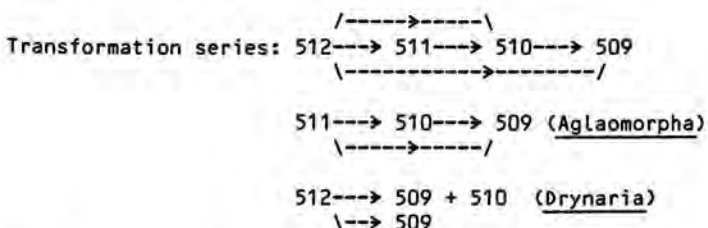

Treating the drynarioids as a closed system, the transformation series of both genera apart cannot be combined. However, as all plausible sister groups have peltate scales (state no. 512), the apomorphy of the first branch within the Drynarioideae is the presence of state no. 511 and the complete transformation can be series established. Species no. 31 shows a reversal.

#### Length (character state nos. 518--520)

Detailed measurements of the length of the rhizome scales led to the recognition of three different states, although the species show variation and overlap in this character. Generally, the scales measure up to 14 mm in length. Scales not (or only rarely) exceeding 7 mm in length, occur in species nos. 4 + 5, 11 + 12, and 28--31. Large-sized species like e.g. nos. 2, 8, and 18 + 19 + 24 have long scales, up to 22 mm or more.

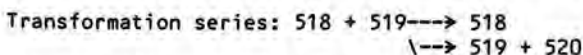

Both state nos. 518 and 519 are plesiomorphous, whereas the sole presence of no. 518 is an apomorphy. The latter condition is parallel developed in species nos. 11 + 12, nos. 4 + 5, no. 22, and nos. 28--31.

#### Index (character state nos. 521--524)

The majority of the species shows scales with an index up to 10. Some species are characterized by the presence of relatively broad scales, i.e. index up to 4, e.g. species nos. 4, 11 + 12, and 22 (+ 32). The index of the scales of species no. 29 rarely exceeds 4, whereas that of species nos. 3, 4, 28, and 30 + 31 ranges up to 6 (rarely 7). Linear or filiform scales, index  $\geq 16$  (up to 40), are common in large-sized drynarioids, e.g. species nos. 2, 8, and 23--26.

As regards species no. 8, the few herbarium collections available may indicate that specimens from Madagascar have relatively short and broad scales (length: 4--8 mm, index: 3--6), whereas the specimens of the Comores and Mascarenes show long and narrow scales (length: 7--22 mm, index: 7--25).

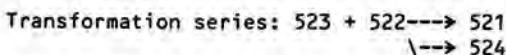

The transformation series is difficult to establish, numerous homoplasies being implied. For example, state no. 524, shows 8 homoplasies including 3 reversals.

#### Colour (character state nos. 405, 406)

The rhizome scales show differences in colour when stained, turning either blue (characteristic for species nos 8 + 9, and 13--15) or brown. This difference is empirical, but possibly correlated to the age of the

scales.

Transformation series: 405---> 406

Margin (character state nos. 527--530) - Fig. 5.2; Plate 6

In one species (no. 21), the medial part of the scales are characteristically dark-coloured, usually conspicuously contrasting with the light-coloured marginal zone. The narrow marginal zone consists of cells with + hyaline periclinal cell walls and somewhat thickened and brownish anticlinal walls, giving it a slightly clathrate appearance. In old scales, the periclinal cell walls turn brownish. This retainment of hyaline cell walls is an autapomorphy of this species.

The largest diversity is found in the marginal indument, including protrusions and glandular trichomes. Apart from the glandular trichomes dealt with below, three distinct states of protrusions of the apical and/or basal tip of marginal cells have been delimited. State no. 528 represents teeth which are short, having a stiff appearance. The other two states represent elongated and slender protuberances, either being somewhat (no. 529) or far (no. 530) longer than the marginal cells.

In the greater part of the species, the margin of the scale is toothed. Short protuberances are present in a number of species, whereas long protuberances are characteristic for species nos. 10--12 and nos. 28--30. Species no. 22 is unique, lacking distinct marginal protrusions associated with the deviating 3-dimensional scale morphology.

Transformation series: 528---> 530---> 529

\----->-----/

The expected transformation of 528---> 529---> 530 is not confirmed by the cladogram.

Marginal protrusions (character state nos. 531, 532) - Fig. 5.2; Plate 6

The teeth and protuberances can be either uniseriate, formed by protrusions of the apical tip of marginal cells, or biseriate, formed by protrusions of the apical and basal tips of adjacent marginal cells. The biseriate condition is found in most of the species, the uniseriate condition being characteristic for species nos. 6 (teeth) and 10--12 (long protuberances).

Transformation series: 532---> 531

Apex of marginal protrusions (character state nos. 533, 534)

The apex of the marginal protrusions is either rounded or T-shaped. In case the protrusions are uniseriate, the apices are always rounded. When they are biseriate, the apex is rounded when the two composing cells are united up to the tip. If not, the apex is T-shaped. For example, long biseriate protuberances are only united near the base and the apex shows the latter state.

Transformation series: 533---> 534

Length in cells of marginal protrusions (character state nos. 539, 540)

In almost all species, the teeth or protuberances are one cell long only. In a few species (especially species no. 6) the protuberances are often two or more cells long.

Transformation series: 539---> 540

Glandular indument (character state nos. 535, 536)

Glandular trichomes along the scale margin are observed in almost all species except two. However, within the drynarioids the difference between absence and presence of glandular marginal trichomes in full-grown scales is not that absolute as it looks like. This character depends on the age of the scale. In young developing scales of species nos. 24 and 26, numerous glandular trichomes are present, whereas in full grown scales they are only occasionally found. Furthermore, infraspecific differences are observed, glandular hairs being almost absent to densely set.

Transformation series: 536---> 535

Position of glandular indument (character state nos. 537, 538)

Intermediates are present between the two states recognized. In general, glandular trichomes can be found scattered all over the scale margin, though most densely set in the basal part.

Transformation series: 538---> 537

Length in cells of glandular trichomes (character state nos. 544--546)

Commonly, the trichomes are 1 or 2 cells long. Few species occasionally show trichomes that are 3 or more cells in length.

Transformation series: 544 + 545---> 546

Apical glandular trichome (character state nos. 525, 526)

The scales of species nos. 27--31 have a densely hairy apex. They are unique in lacking a distinct apical glandular trichome, present in all other drynarioids and its plausible sister groups.

Transformation series: 525---> 526

Insertion of scale indument (character state nos. 547, 548)

Teeth, protuberances, and glandular trichomes are marginally inserted in all species. However, few species have the indument inserted on the abaxial scale side as well. This condition is best-developed in species no. 1, but also characteristic for species nos. 18 + 19 + 24.

Transformation series: 547---> 548

Lignified cell walls (character state nos. 549--551) -Plate8, 10

During maturation, the cell walls in the scale become gradually impregnated with lignine, turning it from hyaline to brownish. The anticlinal walls may be the first to be impregnated, giving the scale a clathrate appearance (e.g. species no. 26). They turn to opaque later on.

In mature scales, three different types of lignification are recognized. The walls of all cells may be equally lignified, the scales being membranous and curled, and medially for the greater part only 1 cell layer thick (e.g. species no. 26). State no. 550 represents scales with the cells around the point of attachment being clearly more lignified than cells elsewhere, the scales being soft and medially for the greater part more than 1 cell layer thick. State no. 551 represents scales characterized by the medially situated cells showing conspicuous dark-coloured lignified cell walls forming a midrib, the scales being + stiff. This condition is especially well-developed in species no. 21 (and cladon no. 20).

Transformation series: 550---> 551---> 549

\----->-----/

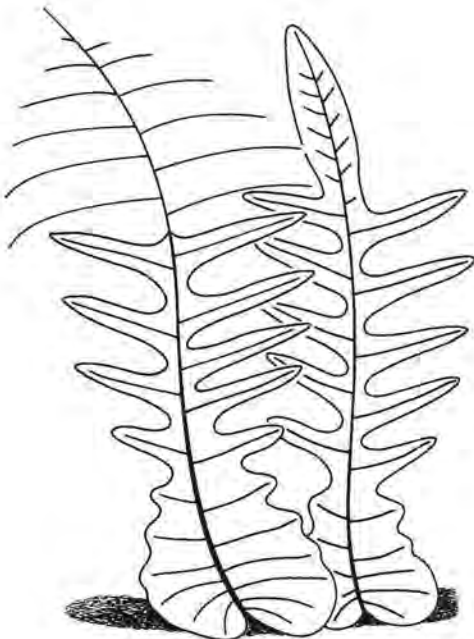

species no. 26 (x0,1)  
state nos 91, 115, 119

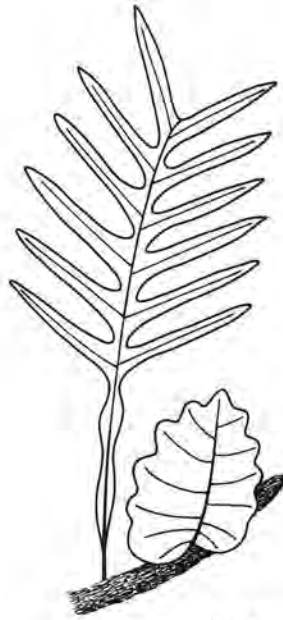

species no. 2 (x0,1)  
state nos 93, 114, 117

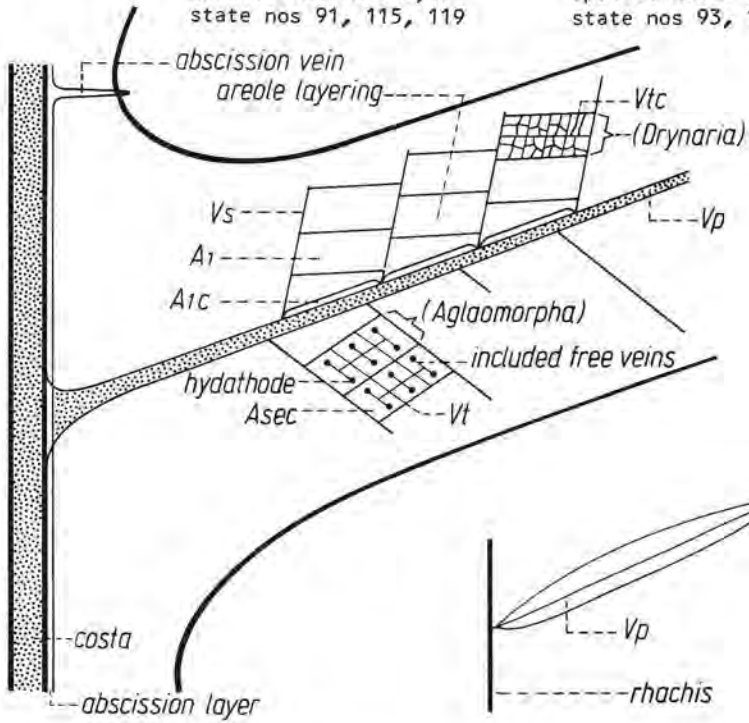

Venation pattern: explanation of terminology

Fig. 5.3

Apex (character state nos. 554--557)

Four types of scale apices are distinguished, but the species show much variation and overlap. State no. 554 represents a gradually narrowing apex, terminated by a more than 6-celled glandular trichome. State no. 555 differs from the previous mainly by the terminal hair(s) being 1--5 celled. State no. 556 shows a more or less abruptly narrowing apex, either or not terminated by a distinct glandular hair. Rounded apices occur in + elongated scales, but most conspicuously in the rounded scales of species nos. 1 + 4 + 5. In the latter type of scales, the apex can be detected by the presence of a relatively well-developed glandular trichome.

Transformation series: 555 + 556---> 554  
  \--> 557

**5.4. Fronds**

The fronds of the drynarioids show an impressive variation as to shape and morphology. These eye-catching differences have hitherto played an important role in the taxonomy and systematics of the group. The fronds of all drynarioid ferns are characterized by articulated segments (pinnae), the presence of nectaries, and the regular, complex areole layering. The terminology used for descriptions of the venation follows Hetterscheid & Hennipman (1985).

Dimorphism (character state nos. 116--120) - Fig. 5.3; Plate 1, 2, 9

Two types of frond dimorphism are recognized: base fronds (humuscollecting, relatively small-sized, lobate, brownescent; unique for Drynaria species except species no. 12) and foliage fronds (assimilating, elongated, pinnatifid or pinnate, green); and sterile and fertile foliage fronds (the pinnae of the fertile fronds being contracted; unique for species no. 31).

Drynaria species no. 12 and Aglaomorpha species nos. 23 and 24 are monomorphic. It are especially the other 11 Aglaomorpha species that show the amazing variation concerning internal dimorphism between sterile and fertile frond parts. Cladon no. 17 has often only slightly contracted fertile pinnae, a condition sometimes found in the Drynaria species nos. 8 and 9 (and rarely 14).

Transformation series: 117---> 116 (Drynaria)  
  \--> 118  
  
  /--> 116  
119---> 118 (Aglaomorpha)  
  \--> 120

Character states no. 117 is unique for Drynaria, and no. 119 is unique for Aglaomorpha. Therefore, the two transformation series cannot be combined. As all plausible sister groups and outgroups have monomorphic fronds, it is plausible that monomorphic fronds represent the plesiomorphic condition for the drynarioid ferns. The cladogram implies one reversal in Drynaria and two in Aglaomorpha, which is contradictory to general accepted intuitive ideas. For example, the condition present in species no. 24 is regarded to be plesiomorphous by a.o. Copeland (1947) and Holttum (1954).

## 5.5. Base fronds

### 5.5.1. Morphology

Base fronds are unique for Drynaria. They are + sessile, shell-shaped, short and broad, lobate, and usually sterile, the base being auriculate. It is assumed that they have a humus collecting function. Several species (e.g. nos. 1, 2, 10, and 11) rarely show otherwise normal base fronds bearing sori (also reported by Zamore & Vargas, 1973c).

Base fronds are developed rather late during the blastogeny. Although they are often preceded by some ill-developed fronds very alike base fronds, or intermediates between foliage and base fronds (see character state nos. 91--95). As a rule, base fronds do not show obvious heteroblastic changes.

Shape (character state nos. 266--269) - Plate 11--16

The overall shape of the base fronds has been divided into four different states. The common condition is ovate base fronds, which are widest near the base, whereas rounded base fronds are widest near the middle. In both states, base fronds might be somewhat longer than wide. The elliptical condition is unique to species nos. 13--15, the greatest width being situated around the middle. Elongated base fronds are widest near the base. In both latter states, base fronds are much longer than wide.

/---> 266  
Transformation series: 267---> 268  
                                  \---> 269

State nos. 266 and 269 show 3 respectively 2 parallelisms.

Index (character state nos. 270, 271)

The indices of base fronds of the species shows a disjunction between less than 1.5 and more than 1.5. Only species no. 9 shows the intermediate condition.

Transformation series: 271---> 270

Using outgroup comparison, it is not possible to establish the transformation series. However, for reasons of parsimony the transformation series given above is preferred over the alternative (implying 3 vs. 4 homoplasies).

Lobation (character state nos. 255--259) - Plate 11--16

The base fronds show considerable variation as to the depth of the incisions. A number of species (e.g. no. 11, nos. 13--15) are characterized by pronounced incisions, up to more than 2/3 of the width. Species nos. 3--5 are unique, having (almost) entire base fronds. In the other species, intermediates often occur.

/---> 255  
Transformation series: 257---> 256  
                                  +  
                                  258---> 259

Using outgroup comparison, only the transformation series of 258---> 259 is established, the polarity of the other states being undetermined. For reasons of parsimony, the combination of state nos. 257 and 258 is regarded plesiomorphous.

Margin (character state nos. 260--262)

Entire margins and denticulate margins are clearly distinct. The difference between denticulate margins, showing equally sized minute incisions near the Vs, and denticulate margins, showing unequally sized incisions at irregular intervals, is subtle.

Transformation series: 262---> 261---> 260  
                          \----->-----/

Using outgroup comparison, it is not possible to establish the complete transformation series, but for reasons of parsimony, state no. 262 is regarded plesiomorphous.

Apex of Lobes (character state nos. 263--265) - Plate 14

Unique, acuminate lobe apices are found in species no. 16. The other two states more or less depend on the lobation, well-developed lobes being usually acute, less-developed lobes and sinuses being rounded.

Transformation series: 265---> 263  
                          \--> 264

### 5.5.2. Venation

The characters studied pertain to the venation of the lobes and sinuses somewhat above the middle. In case of entire base fronds, the venation around the Vp near the margin is regarded homologous to that of lobes and sinuses of other fronds (Plate 11--16).

Secondary veins (Vs; character state nos. 211--213)

All species show base fronds with the Vs running + straight, many of them possess Vs running regularly zigzagging. The latter state represents Vs with regular and alternating angles. The third state recognized, represents Vs running irregularly zigzagging, i.e. with irregular angles at unequal distances. Contrary to that of the foliage fronds, in base fronds this character is regarded not of structural significance.

Transformation series: 211---> 212---> 213

Tertiary veins (Vt; character state nos. 214--216)

The recognition of the states delineated is often difficult, observations often being ambiguous due to intermediates. Further research including blastogenetic series is needed. As yet, the majority of the species shows the Vt branching from the Vtc running excurrent and recurrent.

Transformation series: 216---> 214  
                          \--> 215

Free veins (character state nos. 217--219)

The free ending veinlets in the Asec show variation as to their direction. Usually they are excurrent and recurrent, showing a tendency towards pointing to all directions. In two species, excurrent free included veins might prevail.

Transformation series: 218 + 219---> 217 + 218

Costal areole (A1c: along the Vp; character state nos. 220, 221)

Primary costal areoles are commonly divided into A1c and the first A1. However, in a number of species the Vtc is not (always) completely developed, the costal areole not being divided.

Transformation series: 220----> 221

The transformation series is difficult to establish. Outgroup comparison does not provide an unambiguous polarity. The transformation series given above is postulated for reasons of parsimony (implying 5 homoplasies).

Shape of A1c (character state nos. 222, 223)

Generally, the A1c in base fronds show variation. In some species regular A1c are found throughout.

Transformation series: 223----> 222

Branching points of tertiary connective vein (Vtc; character state nos. 224--226)

The A1c is enclosed by the Vp, the basal and apical Vs, and the Vtc. The Vtc might branch off from the Vs at a clear distance from the Vp. However, either at the apical Vt or the basal Vt, the Vtc might be branching off close to or at the Vp.

The species showing regularly shaped A1c are not varying as to this character. The other species show considerable variation, either within one state or showing two or more states. As yet, it is impossible to establish a transformation series.

Included venation of A1c (character state nos. 227--229)

The A1c might be lacking included veins. More commonly, the A1c contains one included vein. Two (rarely three) included veins comprise the third state. The species show much variation and overlap. A transformation series cannot be established.

Relative amount of A1c with included venation (character state nos. 230, 231)

A number of species are characterized by largely empty A1c.

Transformation series: 230----> 231

Branching of included veins in A1c (character state nos. 232--234)

The commonest conditions are veins simple and once forked. Some species show no variation, e.g. species nos. 13, 14, and 16. In others (e.g. nos. 1, 2), all states recognized are found.

Transformation series: 232 + 233 + 234----> 232  
  \--> 232 + 233

According to the outgroup rule, the combination of all three states is plesiomorphous within the subfamily. State no. 232, and the combination of 232 and 233 are independent apomorphies.

Complexity of included veins in A1c (character state nos. 235, 236)

In all species showing included venation in the A1c, the included veins are free. Many species however, possess anastomosing included veins also.

Transformation series: 235 + 236----> 235



The transformation series of characters pertaining to the A1c all are directed towards simplification.

A1c along costa (character state nos. 240--244) - PLate 11--16

Five different types of A1c along the costa of base fronds are distinguished. In species nos. 6--9 a traceable A1c is lacking. Other species show only ill-developed A1c, irregularly shaped and sometimes partly reduced or difficult to trace. These two states are regarded structurally similar. Species nos. 10 + 11 + 13--16 are unique in having conspicuous, well-developed trapezium-shaped A1c along the costa, with or without included free veins. In large-sized base fronds of species no. 10, the A1c is often ill-developed.

Transformation series: 242 + 244---> (241=)243---> 240

Shape of first order areole (A1; character state nos. 249, 250)

The greater part of the species have irregularly shaped A1, i.e. throughout the base frond, the A1 show variation as to the shape. Few species show regularly shaped A1 showing no considerable variation in shape.

Transformation series: 250---> 249

Bordering venation of A1 (character state nos. 247, 248)

The bordering venation of A1 is almost always prominent. A few specimens of species no. 10 are observed in which the bordering venation shows some irregularities. However, this is presently regarded insignificant.

Division of A1 (character state nos. 237--239)

The states recognized are distinct, but the species show much variation.

Transformation series: 238 + 239---> 237

Number of A1 in layering (character state nos. 245, 246)

This character is rather difficult to interpret in case of entire or sinusoid fronds.

Transformation series: 246---> 245

Included venation of second order areole (Asec; character state nos. 251--254)

State no. 251 represents species which lack included venation. The other states recognized represent the predominant condition present, although some species may show some variation.

Transformation series: 252 + 253---> 251---> 252  
                                  /----->-----\  
                                  \--> 254

## 5.6. Foliage fronds

### 5.6.1. Morphology

The foliage fronds of the drynarioids are not functionally articulated to the rhizome, they are characterized by the pinnae articulated to the rachis/costa instead. The drynarioids share the presence of nectaries and a unique venation type. The foliage fronds are stalked or sessile, elongated compared to the base fronds, pinnatifid or pinnate, the terminal pinnae

either or not aborted. The margin of the pinnae is usually + flat except in species no. 5 which is characterized by pronounced coarsely undulating margins (although other species may show slightly undulated margins as well). Pinnatifid and pinnate are used in the traditional sense, but pinnae is used for the segments of pinnate as well as pinnatifid fronds.

During blastogeny, the first ten or more fronds formed are entire, (shortly) stalked, the lamina being short spatulate to elliptical with notched margin in Drynaria and species nos. 23, gradually increasing in length up to + 10 cm. Fronds formed subsequently, are increasingly lobate starting from the base, soon followed by the development of abscission layers (articulation of the pinnae). Species no. 10 almost immediately becomes distinctly pinnatifid, the costa showing a narrow wing only. Subsequent fronds are pinnate.

Shape (character state nos. 91--95) - Fig. 5.3; Plate 1, 3

Pandurate foliage fronds have a dilated base, being narrowed just above the base and widest at or above the middle. This state is unique to the large-sized Aglaomorpha species. The dilated frond base has a humus collecting function (Roos, 1984), and the fronds thus show an internal functional dimorphy. Therefore, the species showing both a dilated frond base as well as internal sterile/fertile dimorphy, can be called internally trimorph. Aberrant fronds of Drynaria species might be + pandurate as well. Such exceptional fronds and intermediates between base and foliage fronds are only observed in juvenile and immature plants of species nos. 1, 5, and 6 cultivated in the botanic gardens at Utrecht. It has been reported in literature for species nos. 2 and 10 (Zamora & Vargas, 1973a).

In triangular fronds, the lamina is widest at the base, the margin being convex in outline. Quadrangular fronds are widest near the middle, the base as well as the apex of the lamina being + truncate in outline. Ovate laminas are widest between the base and the middle, gradually tapering towards the (rounded) apex. Elliptic laminas are widest near the middle, gradually tapering towards both the (blunt or acute) apex and base.

/---> 91  
Transformation series: 93 + 95---> 92  
                                  \---> 94

The transformation series is contradictory to the opinion of e.g. Copeland (1947), Holttum (1954), and Zamora & Vargas (1973a), who all regard state no. 91 to represent the plesiomorphous condition in the subfamily. Zamora & Vargas (1973a) summarize the blastogeny of Drynaria, recognizing juvenile (foliage) fronds being simple and stalked, intermediate (foliage) fronds being lobed and stalked, and adult foliage and base fronds. They observed also the aberrant fronds mentioned above, which they call transitional fronds, being intermediate between base fronds and juvenile, intermediate, or adult foliage fronds. They implicitly interpret these transitional fronds not to represent blastogenetic stages, which is agreed upon here. However, they do base their transformation series on these observations without a preceding reconstruction of the phylogeny. It is here argued that the transitional fronds can only serve as additional evidence for the homology of the two types of fronds of Drynaria and those of Aglaomorpha without any indication of polarity.

Lobation (character state nos. 96, 97) - Plate 1--4, 42, 43

Pinnate fronds possess pinnae that are inconspicuously stalked, the lamina tapering towards the base and the abscission layer being shortly elliptical. Pinnatifid fronds have sessile pinnae, the lamina of which

widened towards the base. The abscission layer is elongated, situated along the costa at the transition of the lamina. In between two pinnae, it bends perpendicular to the costa ('abscission layer'). The lamina in between conspicuously contracted fertile pinnae is reduced to a narrow wing, the fertile part being pinnate in appearance.

Transformation series: 96---> 97

Frond base and petiole (character state nos. 98--103) - Fig. 6.3; Plate 1, 3, 5

Character states pertaining to the wing of the petiole are difficult to interpret and regarded not structurally different. The eye-catching dilated frond base can be either + flat and adpressed to the substratum forming a collective (joint) basket (species nos. 17--19 + 23--26), or pronounced shell-shaped forming individual humuscollecting baskets (species nos. 21 and 22). Occasionally, they may be ill-developed, sometimes being just a broadened wing with consequently a narrowly dilated base. This is observed in species nos. 23 and 25. Dilated frond bases are sinusoid, gradually becoming lobate and then pinnatifid towards the middle part of the frond. Quadrangular extensions bearing nectaries are unique for species no. 27.

Transformation series: (99--102)---> 98  
  \--> 103

State nos. 99--102 together represent the plesiomorphous condition.

Pinna shape (character state nos. 104, 105)

Some species always or often show pinnae widest near the middle, and clearly contracted just above the base. This is characteristic for species nos. 3--5 in particular. The majority of the species shows (also) pinnae equally wide throughout.

Transformation series: 104---> 105

Contraction of fertile pinnae (character state nos. 106, 107) - Fig. 6.3; Plate 1, 2, 9, 17--29

In species showing (internal) fertile/sterile frond dimorphism, the fertile pinnae are conspicuously narrower than the sterile pinnae.

Transformation series: 107---> 106

When treated as a closed system, the transformation series in Aglaomorpha is 108---> 107. Outgroup comparison with plausible sister groups shows that state no. 107 in Aglaomorpha is developed via two reversals.

Relative size of pinnae (character state nos. 108--110)

The species showing (almost) no differentiation between sterile and fertile pinnae, still may show differences in size between apically and basally situated pinnae, the pinnae gradually decreasing in size towards the apex. The alternative state is fronds with all pinnae equally wide. The latter is the sole condition found in species nos. 1--5, 7 and 12.

Transformation series: 108 + 109---> 110

Apical pinna (character state nos. 114, 115) - Fig. 5.3; Plate 1, 3

The usual condition found in pinnate and pinnatifid Polypodiaceae, is fronds terminated by a distinct apical pinna, i.e. the  $V_p$  of the terminal pinna is the prolongation of the costa/rhachis. This condition is found in

juvenile fronds of all drynarioids and in adult fronds of all Aglaomorpha and a few Drynaria species. The majority of the Drynaria species however, is unique in having the apical pinna always or usually aborted, i.e. the costa/rhachis is abruptly terminated by a very small, 'bud'-like protrusion (the aborted top meristem), from which to one side an abscission layer originates and from the other side (characterized by a kink) the Vp of the most apically situated lateral pinna, which is obliquely bended towards the apex.

Transformation series: 115---> 114

Reversals of state no. 115 have to be assumed in species nos. 9 (rarely), 14 (occasionally), and 15 and 16 (always). During blastogeny, the first frond formed showing the apical pinna aborted, is also the first to show abscission layers. These fronds are formed soon after the first lobate fronds.

Depth of incisions (character state nos. 136--141)

The differences between the species are arranged in a number of character states, that are however more or less artificial. The variation within the species and the overlap among them is considerable. A transformation series could not be established.

Margin of pinnae (character state nos. 126--128) - Plate 33, 34, 42

The greater part of the species have mature (sterile) pinnae with entire margins. A number of Drynaria species are unique in retaining serrate margins, the incisions being situated near the Vs. As far as could be studied, such serrate margins are present in juvenile plants of all species. Two species are furthermore unique, having incisions in between subsequent Vs also.

Transformation series: 128---> 126---> 127

Two reversals are implied by the cladogram.

Apex of pinnae (character state nos. 111--113)

Acuminate pinnae are found in almost all Aglaomorpha and a few Drynaria species, being well-developed in species no. 27. Obtuse pinnae are found in Drynaria species only. However, most species show variation.

Transformation series: 111 + 113 ---> 112

Marginal strand (character state nos. 129, 130)

During the analyses of venation patterns, marginal strands became visible. Almost all species show conspicuous marginal strands, although many of them sometimes lack these. In species nos. 14 and 15, no clear marginal strands have been observed.

Transformation series: 129---> 130

Shape of contracted fertile pinnae (character state nos. 121--123)

Eye-catching contracted fertile pinnae are those of species nos. 22 and 25 (and 32) being 'string-of-beads'-like, i.e. the lamina is reduced to small, semi-circular sinuses each bearing a soral patch, the lamina in between being reduced to an almost invisible wing. In the other species showing extremely contracted fertile pinnae, the lamina might be reduced to a narrow linear wing, either with the margin entire or with slightly developed sinuses in between subsequent soral patches.

Transformation series: 122---> 121  
                          \---> 123

The two monomorphic Aglaomorpha species also have state no. 122. State no. 121 shows two homoplasies.

Position of nectaries (character state nos. 124, 125) - Plate 4, 7, 18, 43

Nectaries of a number of drynarioid species have been studied by Zamora & Vargas (1973b). Nectaries are characteristic for the Drynarioideae, identifiable as translucent spots in living fronds, or as dark brownish and blackish spots in herbarium specimens. Often nectaries are situated in groups of 2--6 together. They are usually absent in the dilated frond base or in base fronds, but often present in the lobes of petiolar wings. They mostly occur close to the junction of the costa/rhachis. In many species they are also situated in pinnae close to junctions of Vp and Vs, where they are however almost impossible to detect from herbarium specimens. In species no. 27, they are situated on specialized quadrangular extensions (state no. 103). Nectaries do not show differentiation as regards morphology and anatomy.

Holttum (1954) notes that nectaries are only active in young fronds, which could be confirmed by observation of developing adult fronds of species no. 27 cultivated in the Royal Botanic Gardens, Kew, and species no. 5 kept in the laboratory, Utrecht, from which considerable drips of fluid poured from the nectaries. However, Koptur et al. (1982) report that in species no. 10 nectaries are active in both young and full-grown fronds, and that in species no. 2, they are mainly active in full-grown fronds only. These authors also analyzed the nectar of a.o. species nos. 2 and 10. The nectar contains sucrose, fructose, glucose, small amounts of a few other sugars, and a variety of amino acids in low concentrations. According to them, the nectaries of ferns might have a similar function as those of flowering plants, e.g. to attract especially ants (which are always present in the humus collected by drynarioid plants; e.g. Paterson, 1982), because the contents of the nectar argues against an excretion function of wastes and excess. However, they might indeed serve to exude surplus metabolic byproducts with a minimal discharge of water, because as high-epiphytes these species are subxerophytic.

As regards the position of the nectaries, they are either situated acroscopic or basiscopic of the Vp (resp. Vs). State no. 125 is the most common one, whereas no. 124 is confined to a number of Drynaria species. Species no. 6 usually shows acroscopic as well as basiscopic nectaries near one Vp. Zamora & Vargas (1973b) distinguished the latter condition as a separate character state, as it is sometimes observed in other species also.

Transformation series: 125---> 124

This transformation series is contradictory to the one presented by Zamora & Vargas (1973b), who regarded both states apomorphic, the combination of the two states representing the plesiomorphy. Their transformation series is not based on postulated phylogenetic relations and could not be confirmed.

### 5.6.2. Venation pattern

The venation pattern of the foliage fronds of the drynarioid ferns shows much and interesting variation on a characteristic "groundplan" (venatio drynarii: Holttum, 1954). The data collected pertain to samples of mature

Ontogenetic series of frond shape and venation pattern (x 2)  
species no. 1

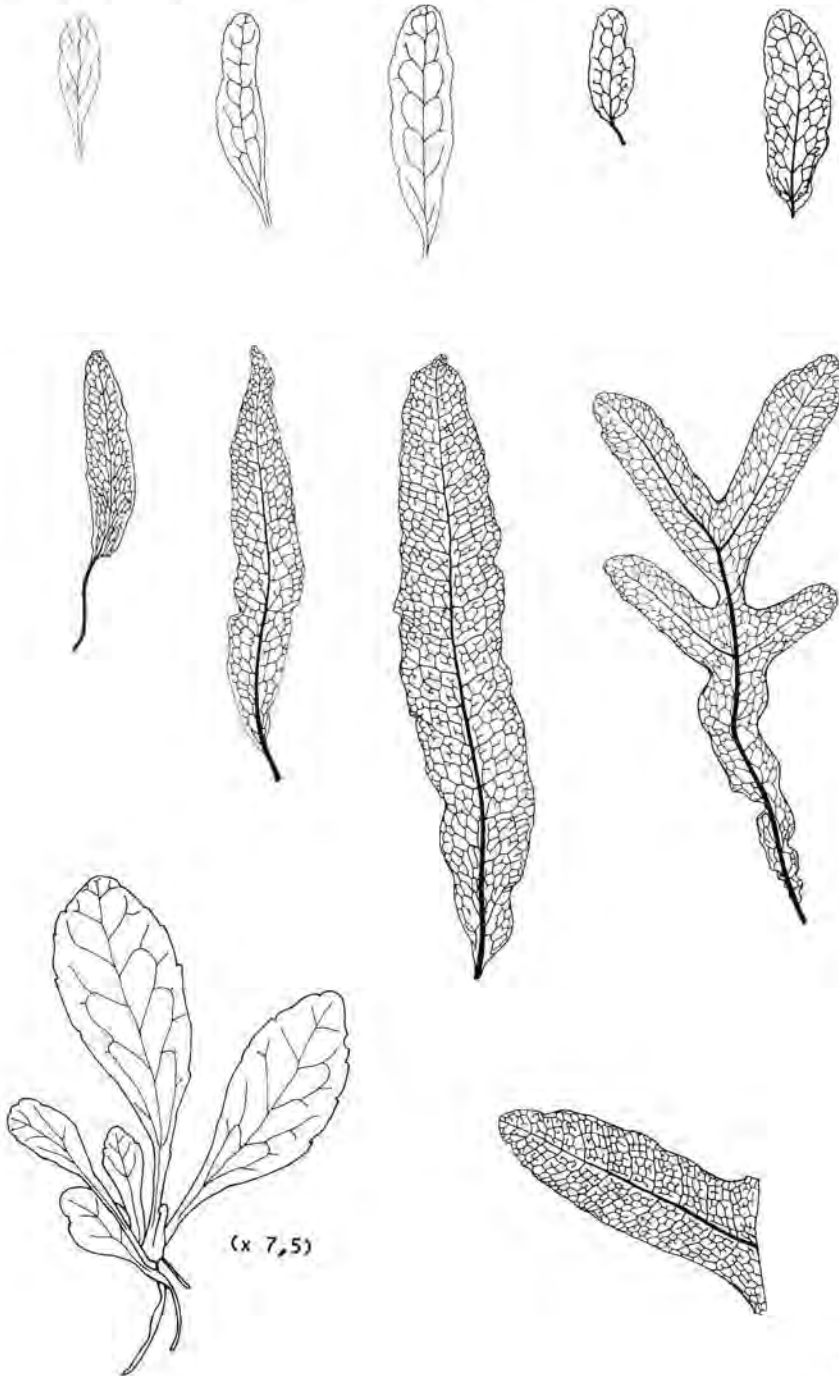

Fig. 5.4

fronds taken from the middle and apical part of well-developed fertile and sterile pinnae. The venation in the apical part of the pinnae is simple, gradually becoming more complex towards the middle, the transition possibly reflects blastogenetic stages (Hettterscheid, pers. comm.).

Chandra (1980b), who studied several characters of the venation of 15 drynarioid species, mentioned a number of differences between Aglaomorpha ("the Aglaomorpha Group and Photinopteris") and Drynaria (a.o. pertaining to included venation and presence of hydathodes). Nevertheless, he concluded (p. 182) 'that the venation pattern is remarkably constant in both groups of the drynarioid ferns (i.e. his two tribes, see Chapter 8.2), and that venation does not seem to be helpful in providing character difference...'. These conclusions (contradicted by the present study) obviously result from the impression that characters of the venation pattern do not support his subdivision of the Drynarioideae into two tribes (Chandra, 1982b). Therefore, they are ad hoc, exemplifying the need of an adequate systematic methodology.

Mitsuta (1984; in press) studied venation patterns of heteroblastic fronds of Polypodiaceae, including species nos. 1, 2, 10, 11, 23, 25, and 27. Of several other species (e.g. nos. 16, 22, 24, and 31), he studied the mature fronds only. He concludes that early blastogenetic stages do not show considerable discontinuities among the species, but that there are remarkable differences in venation patterns of mature fronds among the drynarioids. However, he did not work out the latter in further detail, except for the remark that species no. 27 exhibits a venation pattern unique within the drynarioids. This could not be confirmed in the present study.

Generally, the venation pattern of sterile pinnae of mature fronds of drynarioid ferns is complex and anastomosing, showing a regular type of areole-layering (Fig. 5.3). At regular intervals, distinct Vs branch off from the prominent Vp, reaching almost up to the margin. Distinct Vtc branch off the Vs at regular intervals too. The A1 show anastomosed included veins (Vt) forming Asec. The latter are more or less regularly arranged, either or not containing free veins.

During blastogeny (Fig. 5.4), the first frond formed possesses a main vein which is a few times branched, all veins being free. Subsequent fronds show more elaborate branching, soon forming anastomoses along the main vein (primary costal areoles), at first near the base. At the distal side of these areoles, excurrent veins branch off which become anastomosed too and thus form the initiation of areole-layering. The primary costal areoles, at the same time become divided into A1c and A1 by a recurrent veinlet from the distal side, or an excurrent vein from the basal side. Asec are developed by both excurrent and recurrent veinlets.

Secondary vein (Vs; character state nos. 1--5) - Plate 17--19, 22, 30--44

The secondary veins in the greater part of the species are running more or less straight, although often some slight and irregular zigzagging can be observed especially at the branching point of the first Vtc. Within Drynaria, species nos 9 and 16 are unique, showing conspicuously zigzagging Vs, a condition (though often somewhat less developed) commonly found among Aglaomorpha. Five species of Aglaomorpha, i.e. nos. 27--31, are unique showing the Vs running in a distinctly regular zigzagging way. Vs running irregular (especially in the proximal part) are occasionally present in some Drynaria species.

Transformation series: 1 + 2---> 4---> 3  
                                   \---> 5

Vt branching from Vtc (character state nos. 6--8)

This character is problematical to study from mature fronds, although pinna apices are valuable. Further research including blastogenetic stages of all species is needed. As yet, often predominantly excurrent Vt are found in the three Drynaria species nos. 11, (cf. Mitsuta in press), 12, and 14. In most other species, the Vt are observed to be mainly recurrent (reported by Mitsuta for species nos. 1, 2, 10, and 27). A number of species show both recurrent and excurrent Vt, a condition that Mitsuta reports to be present in species no. 23 and 25 which could not be confirmed. This character state is observed to be present in species no. 24, for which Mitsuta mentioned the presence of a distinct state presently not recognized, i.e. the Vt being distinctly reduced or simplified

Transformation series: 7---> 8---> 6

Free veinlets (character state nos. 9--12) - Fig. 5.2; Plate 17--19, 39--44

Free included veinlets predominantly running excurrent are found in one species (no. 15) only, and occasionally in species no. 12. In Drynaria and a number of Aglaomorpha species, the free veinlets are always or often diffusely directed. However, in almost all Aglaomorpha species, the free veinlets are (also) characteristically excurrent and recurrent, which is well-developed in species nos. 27--31. Species nos. 9 and 16 are unique as the included veins in A1 often develop loops.

Transformation series: 11<-?->10---> 9  
                                  \--> 12

The transformation series cannot be completed. The polarity of state nos. 10 and 11 is undetermined as the state present in plausible sister groups is unknown.

Hydathodes (character state nos. 13--15)

Hydathodes are always situated at the adaxial surface, terminal on free veins. These structures have a water excretion function (Ogura, 1972). In cross-section the distal end of free veinlets bends upwards, gradually approaching the adaxial surface of the lamina. In surface view, the hydathodes are drupe-like, with + concentric cell arrangements (cf. Ogura, 1972, Fig. 125; Chandra, 1979, Plate I: Fig. 12).

Hydathodes are present on all free veins of Aglaomorpha species. This state is also present in species nos. 9 and 16, that are deviating within Drynaria as regards many characters of the venation pattern. A number of Drynaria species have a varying but low number of free ending veinlets terminated by hydathodes, in other species hydathodes are absent. Many juvenile and some mature fronds of species nos. 27--31 show the hydathodes covered with "lime-scales", the fronds being white punctate.

Transformation series: 15---> 13 (Drynaria)  
                                  \--> 14

The state present in plausible sister groups is uncertain, and therefore the complete transformation series (including the state present in Aglaomorpha) cannot be established.

Costal areole (A1c); character state nos. 16, 17) - Plate 39--42

A1c are enclosed by the Vp, two adjacent Vs, and the first Vtc. The latter differ from the other Vtc, like A1c are different from A1. The A1c comprises characters that are of importance for the interpretation of the venation patterns of the Polypodiaceae in general (e.g. Mitsuta, 1984;



Hettterscheid & Hennipman, 1985). However, the A1c in mature fronds are often difficult to interpret, and detailed analyses of blastogenetic sequences are necessary. A1c are almost always present in mature fronds, although sometimes being clearly reduced. Exceptions are found in species nos. 24 and 26 (and cladon no. 17), in which A1c occasionally cannot be traced.

Transformation series: 16---> 17

Shape of A1c (character state nos. 18--20)

The shape of A1c is either regular (+ equally throughout) or irregular (varying considerably). Species nos. 10--16 are unique, having always regularly, + trapezium-shaped A1c.

Transformation series: 20 (+ 18)---> 19

The polarity of no. 18 is uncertain.

Branching points of Vtc and Vs (character state nos. 21--25)

Almost all species have both branching points of the Vtc and the basal resp. apical Vs clearly distant from the Vp. However, most species show variation, even those that have regularly shaped A1c only. The basal and/or the apical branching point of the Vtc might be situated close to or even on the Vp. A transformation series cannot be established.

Included venation of A1c (character state nos. 26--30)

The included venation of the A1c is a complex of characters difficult to interpret, the species showing much variation. The included venation can be either absent or present varying in complexity. In a number of *Drynaria* species and only one *Aglaomorpha* species (no. 23), many empty A1c are found. However, most of these species (except no. 12) show A1c containing one (or two) include veins also. The most common condition found in the drynarioids is two included veins, being the sole condition present in a number of relatively large-sized species.

Transformation series: 28---> 27---> 26---> 30  
                                  \---> 29

Relative amount of A1c with included venation (character state nos. 50, 51)

Species nos. 11 + 12, 14, and 15 which do not possess extensively branched included veins, predominantly show empty A1c. In all other species, the A1c usually have included venation.

Transformation series: 50---> 51

Branching of included veins in A1c (character state nos. 31--33)

Both simple and once dichotomous veins are usually present in almost all species (notable exceptions are species no. 12 lacking included venation, and no. 16 showing relatively complex included veins). Some species occasionally (e.g. nos. 29 and 30) or often (e.g. nos. 9 and 16) develop more extensively (twice or more) branched included veins.

Transformation series: 31 + 32---> 33

Many homoplasies have to be assumed.

Complexity of included veins in A1c (character state nos. 34, 35)

Six *Drynaria* species (nos. 10--15) are characterized by almost all included veins being free (and usually simple). All other species often show

anastomosed included veins.

Transformation series: 35---> 34

Subdivision of first order areoles (A1; character state nos. 36--39) - Plate 38, 44

A1 are usually complex, containing anastomosed venation that forms higher order areoles. Almost all species show A1 divided into three or four Asec, many of them (mainly large-sized species) showing more extensively subdivided A1 also. Further subdivision of the latter state is not useful. Relatively simple A1 might be found in a number of rather small-sized species and notably, in species no. 23. Simple (occasionally even undivided) A1 are characteristic for species no. 15 in particular. It is noted that in species no. 16 the A1 are often divided in two Asec only, whereas it otherwise shows relatively complex character states as to the venation.

Transformation series: 38---> 37---> 36  
                                  \---> 39

State no. 39 shows a number of homoplasies.

Number of A1 in areole-layering (character state nos. 40, 41, and nos. 42--49)

The areole-layering is developed by A1. All species have three or more A1 present between two adjacent Vs, only few species often show two layered A1 only.

In case of a detailed dissection of this character, the variation within the species is considerable. In general, the number of A1 in areole-layering is related to the width of the pinnae, which is obvious in Aglaomorpha and the group of species nos. 1--5.

Transformation series: 41---> 40

(44, 45, 46)---> 43---> 42  
                                  \---> 47---> 48---> 49

The mutual polarity of state nos. 44--46 is uncertain.

Bordering venation of A1 (character state nos. 52, 53)

The bordering veins of A1 (i.e. the Vs and Vtc) are generally prominent, i.e. conspicuously distinct from the Vt. However, especially in species nos. 11 + 12, 14 and 15, the bordering veins are not always that distinct from the Vt.

Transformation series: 52---> 53

Shape of A1 (character state nos. 54, 55)

Compared to the condition found in other Polypodiaceae, the areoles of the drynarioids are regularly shaped throughout. However, within the Drynarioideae a few species show A1 being slightly variable in shaped.

Transformation series: 54---> 55

Included venation of second order areole (Asec; character state nos. 56--59) - Fig. 5.3; Plate 17--22, 30--44

Empty Asec are mainly found in Drynaria (especially species nos. 1 and 2), and only rarely in Aglaomorpha (species no. 23). Asec containing simple veins is the common condition found in all drynarioids. More complex, i.e.

once or more branched, included veins are found in Aglaomorpha and in some Drynaria species. In Aglaomorpha species, the included veins form a characteristic pattern (see character state nos. 9--12). In the Drynaria, the expression of this state is different, being well-developed in species nos. 9 and 16.

Transformation series: 57---> 56  
                          \---> 58---> 59

Venation of fertile pinnae (character state nos. 60--64) - Plate 21, 25--34, 37, 38, 40

In Drynaria and species nos. 23 and 24, the venation of the fertile frond parts is always (+) similar to that of the sterile parts, being occasionally slightly less developed in species nos. 8 + 9 and 14. In all other Aglaomorpha species, the supporting venation of the sori or soral patches is diplodesmic (i.e. finely anastomosed forming a complex ramification). The venation in the surrounding lamina is then usually strongly reduced with significantly less free veins compared to the sterile pinnae.

Transformation series: 60 + 64---> 61 + 62 + 63

A number of (independent) reversals have to be assumed for the three apomorphous states.

### 5.6.3. Sori

Characters of the sori have been studied pertaining to number, shape and size, position on the frond and in relation to the venation. Since Hooker, the characters of the sori have been regarded very important for the systematics of the drynarioids, resulting in a number of small or monotypic genera (e.g. Copeland, 1947).

Shape (character state nos. 143--150)

All Drynaria species and species nos. 24 and 31, have (relatively small-sized) rounded sori, the commonest condition found in the Polypodiaceae. The other Aglaomorpha species show variously shaped soral patches. Sori cover only small parts of A1, whereas soral patches can become large-sized, covering (parts of) several A1, or in case of extremely contracted fertile pinnae, covering (almost) the whole remaining lamina.

In species nos. 16 and 31, sometimes two (or more) rounded sori are fused forming elliptical sori extending over two (or more) A1. Elliptic sori (one per A1) are the common condition found in species no. 23 (which shows structural irregularities as to their size; often specimens were found with almost completely-fused sori forming linear coenosori along the Vs). Linear, + acrostichoid soral patches are found in species nos. 26, 27, and 30. Specimens of these three species are found with part of the soral patches divided into rows of separate elliptical coenosori, a condition being most evident in the lower fertile pinnae. It is commonly present in species no. 30, less so in the other two.

Quadrangular soral patches are present in species nos. 18, 19, 28, and 29, whereas the soral patches are rounded species nos. 21, 22, and 25 (and no. 32). In species no. 18, the soral patches are irregularly shaped, i.e. being + fragmented. This condition is also present in cladon no. 17, and in some aberrant fronds of species no. 19 cultivated in the botanic gardens at Utrecht as well as in the Royal Botanic Gardens, Kew.

Transformation series: /--> 144 /--> 144  
 143----> 146----> 145 + 149  
                   |\--> 148  
                   \--> 150----> 147

Two reversals of 146----> 143 are implied by the cladogram.

Size (character state nos. 151--155)

As regards the size of the sori, the species show variation and overlap. Nevertheless, convenient states are recognized.

Transformation series: /----->-----\  
 151 + 152----> 153----> 154 + 155

Several reversals have to be assumed.

Sori situated in A1c (character state nos. 65, 66)

In a few species (showing small round sori and relatively broad pinnae), occasionally sori are observed situated in A1c, a condition absent in all other species.

Transformation series: 66----> 65

Distribution relative to the frond surface (character state nos. 67, 68) - Fig. 5.3; Plate 1--3, 9

In Aglaomorpha except for species nos. 23, 24, and 31, the fertile pinnae are restricted to the (specialized) upper part of the fronds. In all other species, the sori occur all over the abaxial frond surface. A specimen of species no. 24 cultivated in the Royal Botanic Gardens, Kew, is observed having sori situated in the dilated basal part almost down to the base.

Transformation series: 67----> 68

Differentiation of sori distribution relative to the pinna surface from the basal towards the apical fertile pinnae (character state nos. 69--71)

The drynarioid species show differences as regards the distribution of sori relative to the surface of the basally and apically situated fertile pinnae. A number of species often have the sori of the basal fertile pinnae situated near the costa (basal part of the pinnae) only. Subsequent pinnae towards the frond apex show more numerous sori, distributed more and more towards the apex of the pinna (well-developed in species nos. 11 + 12, and 16). This condition is restricted to Drynaria. The second state recognized, represents sori being mainly distributed in the apical part of the basal fertile pinnae. Subsequent pinnae become entirely fertile. This state is present in a number of Drynaria species and in Aglaomorpha. It might be difficult to detect in species showing internal dimorphism, which usually show entirely fertile pinnae. However, these species all show sometimes aberrant fertile pinnae with the basal part being broadened, sterile, and foliage-like, the apical part being contracted and fertile. Many Drynaria species are indifferent as to the two states recognized, i.e. they show both states as well as basal pinnae being fertile around the middle, the apical pinnae becoming fertile towards the base as well as the apex.

Transformation series: 70----> 71----> 69

Main distribution pattern (character state nos. 77--80)

Distinct states are recognized as regards the distribution of sori in relation to the main veins. The state present in the internally dimorph

Aglaomorpha species is unsure, as their large-sized soral patches cover several areoles (e.g. species nos. 18, 19, 29), or the lamina is extremely reduced and the venation pattern cannot be traced anymore (species no. 22 and 25, mistake in Appendix 2). Regarding the most common condition, i.e. sori arranged in one row on each side parallel to the Vp, the sori are distributed in the A1 closest to the Vp only. In all other states, essentially each A1 is soriferous. All four states are apomorphous according to the outgroup rule.

Distribution relative to the A1 (character state nos. 81--84)

In the species exhibiting sori situated near the Vs, the sori are arranged in one or in two rows. The latter condition is present in species no. 2 (showing regular rows) and in nos. 1 + 3--5 (showing irregularities: the sori may sometimes be distributed almost ad random over the A1 surface). In the internally dimorph Aglaomorpha species, this character cannot be studied. The complete transformation series could not be established. The apomorphous conditions are: nos. 82 + 81, nos. 83 + 81, and no. 84.

Distribution relative to the veins (character state nos. 72--76)

Sori are variously inserted on tertiary order veins. The species often show considerable variation. Generally, the supporting veins form a complex arrangement, but in Drynaria species, simple structured states may be present. In the Aglaomorpha species exhibiting state no. 76, this state is usually much more complex than that found in Drynaria.

Transformation series: 76---> 75---> 74---> 73(---> 72)

This is another transformation regarding a character of the venation pattern running from complex to simple.

Number relative to the areoles (character state nos. 85--87) FIG

Most drynarioids have one sorus per A1. Two sori per A1 is found in species no. 2 and nos. 1 + 3--5, the latter often have three (or more) sori per A1 also. Species no. 24 represents an extreme, showing 8--16 sori per A1. In species with contracted fertile pinnae, this character cannot be traced due to reduction of lamina and venation, and fusion of sori. All three states recognized are regarded apomorphous, the plesiomorphous state of the group being unknown.

Relation sori-lamina (character state nos. 88--90)

Rechecking the character analyses, the supposed discontinuities between pustulate sori and slightly pustulate sori disappeared, many intermediates being found. Therefore, these two states are regarded structurally similar, the pustulation possibly being correlated to the size of the sori. The condition found in species nos. 13--16 is different, any pustulation being absent and the position of the sori cannot be traced at the adaxial surface.

Transformation series: 89 + 90---> 88

#### 5.6.4. Anatomy

Cross-sections have been made of a number of structures of both fertile and sterile (parts of) foliage fronds including the pinna, receptacle, petiole, costa, nectary, and abscission layer. Material of the petiole and costa is sampled just above the base, and of the costa and rhachis from the middle part of the fronds (in internally dimorphic species, just below the

fertile part). Samples are taken from the middle part of pinnae.

#### 5.6.4.1. Petiole, costa, and rhachis

The petiole of stalked foliage fronds and the costa of sessile foliage fronds show considerable variation in size. On the one hand, the giant species no. 24 represents an extreme, the costa reaching up to 2.5 cm across. On the other hand, the petioles of small-sized species like e.g. no. 15 reach up to a few millimeters across only. However, This character has not been incorporated because of the large infraspecific variation.

##### Cross-section of petiole/costa (character state nos. 487--489)

Generally, the petiole/costa near the base is rounded in cross-section. However, in a number of species, it is broadly elliptic, whereas a slight dorsal invagination is often present. Abscission layers are absent.

Transformation series; 487---> 488  
                                  \--> 489

##### Number of vascular bundles (character state nos. 490--494)

Correlated to the size of the cross-section, but showing less variation, is the number of vascular bundles.

Transformation series: 490 + 491---> 494---> 492 (Drynaria)  
  \--> 493

494---> 492 + 493---> 491 (species nos. 17--26)

It is not possible to combine these two transformation series, as the conditions present in plausible sister groups are uncertain.

##### Rhachis/costa in cross-section (character state nos. 495--497)

The rhachis/costa is usually rounded. However, some species (especially nos. 21 and 22) show + angular costae. The rhachis/costa might show a slight dorsal invagination similar to that found in the previous character. In pinnatifid species, the lamina is dorso-laterally attached to the costa, the transitional zone being characterized by an abscission layer.

Transformation series: 495---> 496  
                                  \--> 497

##### Number of vascular bundles (character state nos. 498--503)

The species show much variation as to this character, possibly related to the frond size.

Transformation series: 501 + 502---> 499 + 500---> 498 (Aglaomorpha)  
  \--> 503

The transformation series could be established for Aglaomorpha only. Both combinations of two character states have been made because they usually occur together. Otherwise, it is impossible to establish a complete transformation series.

##### Bundle sheath (character state nos. 504--508; see also character state nos. 457--461)

All vascular bundles are generally surrounded by blue and/or brown bundle sheaths after staining. bundle sheaths are rarely red-coloured, or absent.

Transformation series: (505=) 504 + 508---> 506  
  \---> 507

#### 5.6.4.2. Lamina

##### Size of stomata (character state nos. 131--135)

Sen & Hennipman (1981) studied stomata of Polypodiaceae in detail. Their results are generally confirmed in the present study. All drynarioid ferns show the commonest types of stomata present in the Polypodiaceae, i.e. polo-, copolo-, and anomocytic. The frequency of these three types does not differentiate between the species. Usually, stomata are surrounded by three to four guard cells, which are sinusoid at the distal side, + similar to unspecialized epidermal cells. Stomata occur only on the abaxial surface of the lamina, rarely over the veins also. Chandra (1979) mentioned differences in density of stomata between drynarioid species. Presently, this character has not been studied, as the data of Chandra show it to be correlated to the stomata size. The size of the stomata has been measured using a grid (one point of the grid being equivalent to 60 / $\mu$ m<sup>2</sup>). Generally, the stomata of Aglaomorpha species are relatively small sized, Drynaria species may show rather large-sized stomata.

Transformation series: (131, 132, 133)---> 134---> 135

The transformation series cannot be completely established. The mutual polarity of state nos. 131--133 is unsure as the condition present in plausible sister groups is unknown as yet.

##### Unspecialized epidermal cells

Unspecialized epidermal cells of the lamina are irregularly isodiametric. The anticlinal cellwalls are prominently sinusoid in surface view. Chandra (1979) observed interspecific differentiations in shape and size. In the present study however, the infraspecific variation made it impossible to recognize different character states of the shape, whereas the size is correlated to the size of stomata. Epidermal cells situated over the veins are conspicuously elongated in the direction of the vein, and only slightly sinusoid. The cuticle is hardly developed, the reason why macerations usually failed. The cuticles found were very thin, plain and smooth, lacking any ornamentation.

##### Hypodermis (adaxially: character state nos. 432, 433

  abaxially: character state nos. 434, 435)

All Aglaomorpha species and a few Drynaria species are characterized by the presence of a single layer of deviating cells between upper epidermis and mesophyll. Such a layer is present in the majority of Aglaomorpha species between mesophyll and lower epidermis also, but lacking in Drynaria. It comprises conspicuously larger-sized, rectangular bulb-shaped cells compared to the epidermis, and is here interpreted to represent a hypodermis (and not a second epidermis layer). However, ontogenetic studies are necessary to make a definite decision. Ogura (1972) does not mention the possibility of a 2-layered epidermis within the Pteridophyta. According to him, a hypodermis is a type of mechanical tissue situated below the epidermis, comprising thick-walled cells. The latter could not be confirmed in the present study.

Transformation series: 433---> 432

As the state present in plausible sister groups is unknown, the second transformation series cannot be established.

Colour of epidermis (character state nos. 436, 437)

The species of the drynarioid ferns differ regarding the colour of the epidermis cells after staining. In Aglaomorpha and in the group comprising species nos. 1--5, the epidermis is usually red-coloured (although sometimes it might be mainly blue-coloured or with scattered blueish cells). In the other Drynaria species it is generally blue-coloured.

Transformation series: 437---> 436

Differences in hypodermis and epidermis between sterile and fertile pinnae (character state nos. 438--442)

As would be expected, Drynaria species and species nos. 23 and 24 do not show striking anatomical differences between fertile and sterile fronds (in species no. 7, occasionally the hypodermis is absent at the adaxial side of the sterile lamina, possibly in less-developed pinnae only). In Aglaomorpha species, the morphological differences between fertile and sterile frond parts are generally correlated to various anatomical differences.

Mesophyll

The mesophyll is similar in all species, being uniformly spongy throughout. This is not conform the remark of Ogura (1972, p. 127), stating that in thicker fronds (like the greater part of the drynarioid species have) the mesophyll would show differentiation. Mesophyll cells are rounded with intercellular contacts situated on cylindrical cell extensions. As a consequence, there are large intercellular spaces, which are enlarged near stomata.

When fronds are injured, injury-tissue for protection against desiccation is developed, comprising cells with brown cork-like thickened cell walls. The same tissue is developed in old receptacles of which all sporangia are shed.

Marginal sclerenchymatous strand (character state nos. 443--445)

All species have a more or less conspicuous strand of sclerenchymatous cells. A number of Drynaria species (mainly belonging to the group comprising species nos. 6--16) show ill-developed (up to 5--7, rarely 10 cells) or moderately developed (10--20 cells in cross-section) marginal strands. The remaining four Drynaria species and the species of Aglaomorpha are characterized by the presence of pronounced and well-developed marginal strands (usually more than 25 cells, sometimes up to 50; species no. 30 showing some variation).

Transformation series: 445---> 444---> 443

Differences in development of marginal strands in fertile vs. sterile pinnae (character state nos. 446--448)

In almost all Drynaria species and some Aglaomorpha species, the marginal strands in sterile and fertile pinnae are equally developed. Species nos. 8 + 9 show ill-developed strands in slightly contracted fertile pinnae. Species of Aglaomorpha commonly show differences in development of marginal strands between fertile and sterile pinnae, being most evident in species with strongly reduced fertile pinnae (nos. 22, 25, and 26). Some infraspecific variation occurs.

Transformation series: 446---> 448---> 447



Vp in cross-section (character state nos. 449, 450)

The Vp protrudes on both sides, on the upper side usually more pronounced though narrower than on the lower side. Generally, these protrusions are rounded. In some species (nos. 21 and 22 in particular) however, the Vp is angular in outline.

Transformation series: 449---> 450

Vein sheath (character state nos. 451, 452)

Just below the epidermis of the Vp, a + cylindrical tissue of sclerenchyma cells ('vein sheath': representing a hypodermis according to Ogura, 1972), is always present. It is either continuous or laterally (near the insertion of the lamina) interrupted. However, intermediate conditions are found. The vein sheath often contacts the vascular bundle. The establishment of the transformation series is impossible, due to the many homoplasies implied.

Development of vein sheath (character state no. 453, 454)

The cells of the vein sheath, especially those immediately below the (upper) epidermis, have conspicuously thickened walls and only a small lumen. The cell walls are usually brightly red-coloured. Species no. 16 is unique, the cells of the vein sheath possessing extremely thickened orange-coloured walls, the cell lumen almost lacking. This character state is ill-developed in a few other species.

Transformation series: 454---> 453

Cortex (characterstate nos. 455, 456)

The ground tissue of the Vp is usually blue, parenchymatous. In well-developed (old) fronds of a number of species, the cell walls of the ground tissue are somewhat thickened and the colour changes from blue via purplish to reddish when stained. Eventually, the cortex of the Vp may develop the appearance of a solid vein sheath (especially characteristic for species no. 16).

Transformation series: 455---> 456

Bundle sheath (character state nos. 457--461)

The vascular bundle in the Vp is always surrounded by one (rarely two, the second being irregular and interrupted) cell-layer(s) of specialized cells, i.e. the bundle sheath. In the greater part of the species, the cells of the bundle sheath have strikingly thickened, blue (rarely red-coloured or greenish) cell walls, often nearly filling the whole cell lumen. These cell wall deposits are in many species gradually replaced by dark brown (cork-like) material (similar to that found in bundle sheaths of the rhizome, character state nos. 390--395). Six *Aglaomorpha* species are unique, showing the bundle sheath containing (at least p.p.) large-sized, red-coloured sclerenchyma cells (having a large cell lumen, being distinct from the cortex cells by thicker walls). Such bundle sheath cells are at least present at the lateral sides of the vascular bundle where higher order veins may branch off.

Transformation series: 458 + 459 + 461---> 457

\---> 460

Number of vascular bundles in Vp (character states nos. 462, 463)

All species show a single vascular bundle situated somewhat dorsally of the central axis of the Vp. In species nos. 18 + 19 + 24, all being large-

sized with huge pinnae, the basal part of the Vp often shows two + equally-sized vascular bundles situated in one horizontal plane. Often, small vascular bundles are present which are side branches leading to higher order veins.

Transformation series: 462---> 463

Arrangement of xylem (character state nos. 464--466)

The most common condition within the drynarioid ferns are xylem vessels arranged in a T-shape. This character state was found in the sterile pinnae of almost all Drynaria species (except no. 15) and a number of Aglaomorpha species. The large-sized Aglaomorpha species showing a dilated frond base (usually) have xylem vessels arranged in V-shape, often also present in the Drynaria species nos. 1, 3, and (to a lesser extent) 5. Few species show a third condition, i.e. elliptic or flat U-shaped arrangements. In species nos. 18 + 19 + 24, the xylem vessels of the two vascular bundles together are arranged in an U-shape. Sometimes intermediates are found, probably correlated to the pinna size. The V-shaped arrangement is explained by the development of a vertical invagination medially in the T-shaped arrangement when vascular bundles enlarge, culminating in two bundles. The vascular bundles of the petiole, costa, and rhachis show essentially the same arrangement.

Transformation series: 464---> 465

\--> 466

Sclerenchymatous strands in vascular bundle (character state nos. 467, 468)

The vascular bundles are amphiphloic, being uniformly organized in all species of the group. Both the pericycle and the endodermis usually consist of a single cell-layer. The phloem is dark blue-coloured after staining, intermingled with some parenchymatous elements. Species no. 11 is characterized by conspicuous sclerenchymatous strands between phloem and xylem, situated at the dorsal side and in the lateral angles of the T-shaped xylem. Species nos. 19, 29 (usually), and 31 (sometimes) show some sclerenchymatous elements scattered around the xylem.

Transformation series: 468---> 467

Vp of fertile vs. sterile pinnae (character state nos. 469--475)

The species of Drynaria and species nos. 23 and 24 do not show obvious differences between the Vp of fertile and of sterile pinnae. Aglaomorpha species showing (internal) dimorphism exhibit varying anatomical differences between the Vp of fertile and of sterile pinnae. Generally, anatomical structures are less-developed in fertile compared to sterile pinnae. A transformation series cannot be established.

Sclerenchymatous sheath of secondary and higher order veins (character state nos. 476--478)

Small (secondary and higher order) veins are identically organized throughout. Generally, they are surrounded by a conspicuous red-coloured sclerenchymatous sheath, which is continuous from the lower to the upper epidermis, the hypodermis being interrupted. These vein sheaths are almost uniform in all species. In a few species some irregularities are observed, the sheath not being completely developed. Species no. 16 is deviating from all other species in having orange-coloured, extremely developed sclerenchymatous vein sheaths.

Transformation series: 476---> 477  
                          \--> 478

Shape of receptacle cells (character state nos. 479, 480)

Two species are deviating, the cells of the strikingly bulb-shaped receptacle being elongated, perpendicular to the surface.

Transformation series: 480---> 479

Number of supporting veins in cross-section per sorus (character state nos. 481--483)

The number of supporting veins in cross-section is related to the width of the sori or soral patches. Generally, Aglaomorpha species show high numbers and Drynaria species low numbers (usually one, occasionally two) of supporting veins, except for species nos. 8 + 9 which have relatively high numbers within Drynaria.

Transformation series: 482---> 481                   (Aglaomorpha)  
                          \--> 483

481---> 482---> 483 (Drynaria)

Presently, the two transformation series cannot be combined, the state present in plausible sister groups being unknown.

Sclerenchymatous sheath of supporting veins (character state nos. 484--486)

A number of species show the sheath of supporting veins equally developed and red-coloured as those of other higher order veins. However, in many species the sheath is only ill-developed and vaguely red-coloured, or absent.

                                  /----->-----\  
Transformation series: 484---> 485---> 486

As regards Aglaomorpha, no unambiguous transformation series can be established.

## 5.7. Fronnd indument

The frond indument studied includes scales and trichomes on the lamina and veins at the abaxial surface, as well as sterile structures on the receptacle and sporangia. Extensive measurements have been made resulting in the recognition of many quantitative character states. Baaijen & Hennipman (in prep.) give an extensive survey of paraphyses and frond indument of Polypodiaceae, their terminology being followed here.

### 5.7.1. Laminar glandular trichomes

Laminar glandular trichomes (character state nos. 272, 273) - Fig. - 5.5

Glandular trichomes with a narrow base cell, and ovoid, orange-coloured glandular top cell(s), are found in almost all species. In one species (no. 8), such trichomes on lamina and veins are lacking (on mature fronds). For this species, no information is available on the occurrence of trichomes in early blastogenetic stages. Species no. 10 shows (almost) no glandular trichomes on mature fronds, but early blastogenetic stages show trichomes similar to that found in other species. Generally, glandular trichomes are

Indument (x25)

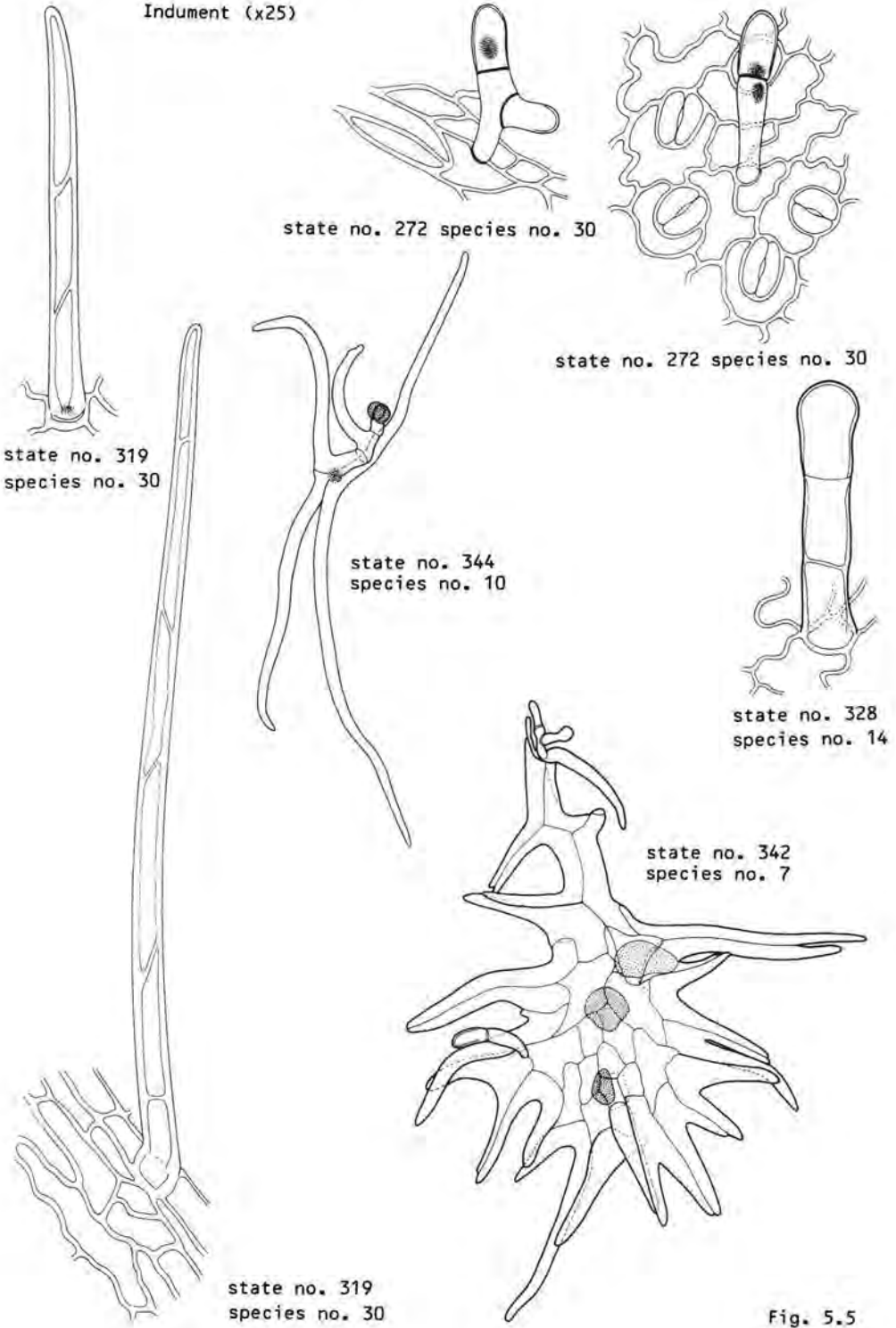

Fig. 5.5

most densely set on the lamina of young fronds, especially meristematic frond parts, and only rarely on veins. In mature fronds, the trichomes occur in varying densities, being very densely set in species no. 15.

Transformation series: 272----> 273

Branching (character state nos. 274--278)

The species show differentiation as to the ratio between branched and unbranched glandular trichomes. In the greater part of the species, branched hairs are almost completely lacking. A number of species show the ratio varying between 10 and 45%. Distinct from the other Aglaomorpha species are nos. 29--31 which show  $\pm$  2/3 of the laminar glandular trichomes being branched. The same condition is present in species no. 16 which is deviating in Drynaria.

/--> 275

Transformation series: 274----> 278----> 276

\--> 277

Length in cells (character state nos. 286--288, and 299, 300)

Almost all species show (more than 1/4 of their) laminar glandular trichomes being two cells long. A number of species show usually (no. 12), often (>25%: nos. 12, 14, 21, and 26), or occasionally trichomes of three cells in length. Longer trichomes are found in a few species only, but rarely.

Transformation series: 286----> 287----> 288

299----> 300

Total number of cells (character state nos. 289--291, and 301--303)

The greater part of the species show more than 10% (although often not exceeding 25%) of the laminar glandular trichomes being three celled. Some species, including the group of species nos. 1--5, possess (almost) solely two celled trichomes. Species no. 12 is unique in showing more than 25% four celled trichomes.

Transformation series: 290----> 289

\--> 291

301----> 302----> 303

### 5.7.2. Acicular laminar trichomes

Acicular laminar trichomes (character state nos. 318, 319) - Fig. 5.5

Acicular trichomes, found in a limited number of genera of the Polypodiaceae only, are present in more than half of the drynarioid species. They are absent in Aglaomorpha species no. 23 and in Drynaria species nos. 1--10.

Transformation series: 319----> 318 (Aglaomorpha)

318----> 319 (Drynaria)

Acicular trichomes are found in a number of Goniophlebium and Microsorium species (Baaijen & Hennipman, in prep.). In case the sister group of the drynarioids belongs to these groups, the transformation series is the first

mentioned above. However, when crypsinoid ferns represent the sister group, which lack acicular trichomes, the transformation series is the second mentioned above. In both cases, reversals have to be assumed.

Position (character state nos. 320, 321)

Commonly, acicular trichomes are set throughout, mainly inserted on veins and in tufts apically on 'abscission veins'. A number of species show acicular indument in tufts apically on abscission veins only.

Transformation series: 320--> 321 (species nos. 17--26)

The transformation series cannot be completed.

Density (character state nos. 322, 323)

The density shows considerable (also infraspecific) variation. Usually, acicular trichomes inconspicuous, being scattered to densely set. Species nos. 27--31 are unique in (usually) having very densely set acicular trichomes, the fronds being tomentose. However, species nos. 27 and 31 often show almost glabrous fronds, a phenomenon probably correlated with habitat conditions (Chapter 9).

Transformation series: 323----> 322

Length in cells (character state nos. 324--327)

The common condition is one or two celled acicular trichomes, but many species show three celled trichomes also. Species nos. 27--30 are characterized by conspicuously elongated acicular trichomes, up to 22 cells long in species nos. 27.

/--> 324

Transformation series: 324 + 325----> 326----> 327

'Type II laminar glandular trichomes' (character state nos. 328, 329) - Fig. 5.5

A second type of glandular trichomes is observed, in species nos. 14, 15, and 26 densely set throughout, in other species situated in tufts apically on the abscission veins only. They are usually inserted intermingled with acicular hairs, except in species no. 6 which lacks acicular hairs. They differ from normal glandular hairs by the + hyaline, pear-shaped top cell, and the large-sized, thick-walled basal (and intercalary) cell(s). The latter have the appearance of cells of acicular hairs.

Transformation series: 329----> 328

### 5.7.3. Frond scales

Position (character state nos. 344--346) - Plate 6

Three different states as regards the distribution of scales on the frond are recognized. All Aglaomorpha species have scales scattered on or near the costa/rhachis (and the basal part of the Vp), decreasing in density, width, and eventually in size, towards the middle part of the fronds, being almost absent in the apical part. The scales are similar to those of the rhizome. This condition is best developed in species nos. 21 + 22 and 30. It is present in the Drynaria species nos. 9 and 10. The first also shows receptacular scales, the latter has morphologically different scales on the lamina.

Species nos. 11--16 show frond scales scattered along the costa, often

the most densely near the Vp, inserted close to the abscission layer. As a rule, the scales are ± uniform throughout the frond as to size and density. Compared to rhizome scales, the frond scales are short. Species nos. 11 + 12 also have some scales scattered on the lamina, mainly inserted on the Vs and higher order veins. The latter state is well-developed in the other Drynaria species. Usually, the laminar scales are morphologically different compared to those on the rhizome, which is most obvious in species no. 10.

Transformation series: 344---> 345 (Drynaria)  
                          \---> 346

The polarity of the state present in Aglaomorpha is undetermined, as the state present in plausible sister groups is uncertain.

Attachment (character state nos. 347--350)

Variation in type of attachment is correlated with variation in size. Large-sized scales are generally pseudo-peltate or peltate, smaller-sized ones being basifix.

Transformation series: 347 + 348---> 349 (Aglaomorpha)

                          347 + 350---> 348 (Drynaria)

Shape (character state nos. 351--353)

Round frond scales is the common condition found in species no. 10. Species nos. 1--5 have triangular to ovate scales only. The other species mostly show linear to filiform frond scales, also present on the petiole of species no. 10.

                                  /--> 351  
Transformation series: 352 + 353---> 352  
                                  \--> 353

The sole presence of no. 353 (in species nos. 1--5) and of no. 352 (e.g. in species nos. 23 + 25 + 26) are both apomorphous.

Marginal protuberances (character state nos. 354, 355)

All frond scales are toothed, but in some species longer marginal protuberances are present also. This character state is well-developed in species nos. 6 and 10--12 in Drynaria, less so in the Aglaomorpha species nos. 29 and 31. State no. 354 and nos. 354 + 355 are apomorphous.

Marginal protrusions (character state nos. 356, 357)

Almost all species show biseriate marginal protrusions. Many of them show uniseriate protrusions also, a character state predominant in the species possessing protuberances (cf. the absence of no. 357 in species nos. 6 and 10). A transformation series cannot be established.

Marginal glandular trichomes (character state nos. 358, 359)

The note concerning glandular indument on the rhizome scales is also relevant for the frond scales. A distinct apical trichome is always present.

Transformation series: 359---> 358 (Aglaomorpha)

                          358---> 359 (Drynaria)

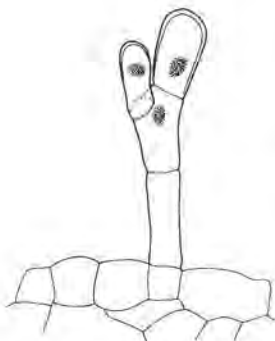

species no. 31



species no. 31

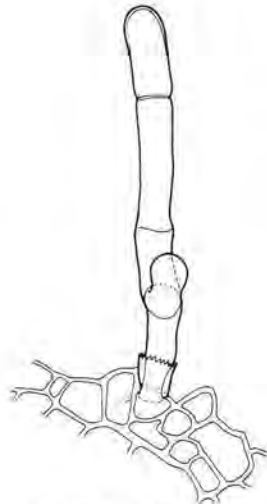

species no. 15



species no. 10

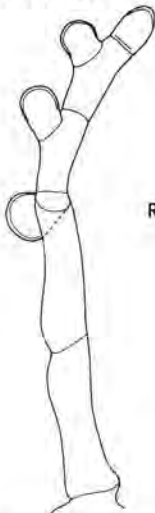

species no. 12

Receptacular (hairy) paraphyses (x25)



species no. 10

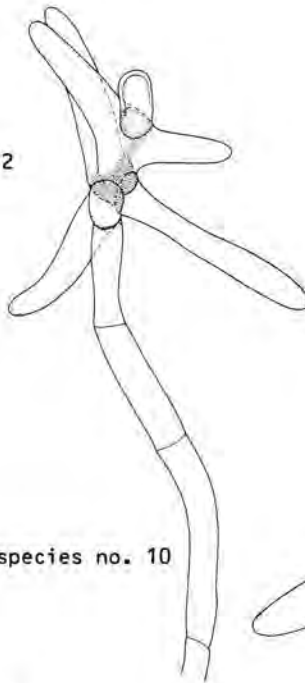

species no. 10

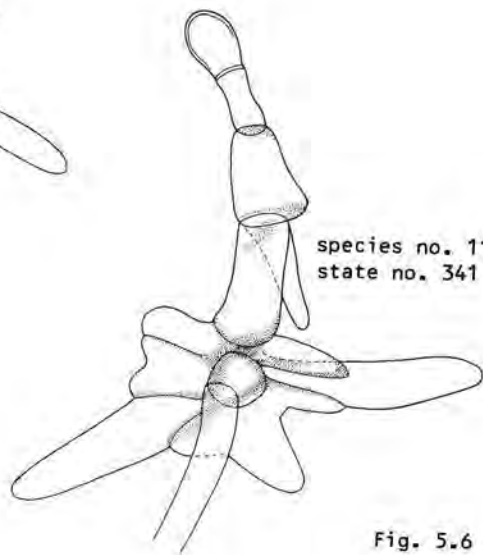

species no. 11  
state no. 341

Fig. 5.6



Position of glandular indument (character state nos. 360, 361)

As regards the frond scales, this character is more difficult to interpret than in rhizome scales. A transformation series cannot be established.

Length in cells of marginal glandular trichomes (character state nos. 362--364)

The marginal glandular trichomes are almost always one or two cells long. In species no. 3 rarely more celled trichomes are rarely found, which is an autapomorphy.

Insertion of marginal indument (character state nos. 365, 366)

The indument of the frond scales is always marginally inserted, but in species no. 18 occasionally and in species no. 3 often, the indument is abaxially inserted also.

Transformation series: 365---> 366

Lignified cell walls (character state nos. 367--369)

Generally, the frond scales do not show conspicuous lignification of cell walls. A few species might show some slightly lignified cell walls, whereas this is the common condition in species nos. 1, 18--21 (forming a midrib), and 31 (around the point of attachment).

Transformation series: 367---> 368

\--> 369

Apex (character state nos. 370--373)

The apices of frond scales generally vary from sharp acute to filiform, intermediates being often present.

Transformation series: 371 + 372---> 370

\--> 373

#### 5.7.4. Receptacular hairy paraphyses

All drynarioid species show glandular trichomes inserted on the receptacle (Fig. 5.6), interpreted as receptacular paraphyses (Baaijen & Hennipman, in prep.). As to the morphology, receptacular paraphyses show more variation compared to the laminar glandular indument. The basal cell may be strikingly larger-sized than the intercalary cells. This condition is well-developed in species no. 19, but observed in almost all other species also.

Branching (character state nos. 279--283)

The majority of the species show 90% or more of their receptacular paraphyses to be unbranched. Other species show higher percentages of branched paraphyses, best developed in species nos. 10--12, 16, and 31 which show the majority of paraphyses being branched. However, no sharp disjunction is present within the group as a whole.

/--> 280

Transformation series: 279---> 283---> 281

\--> 282

Number of glandular cells (character state nos. 284, 285)

All branches of the receptacular paraphyses are terminated by a glandular cell. Mostly one (unbranched) or two (once branched) glandular cells are present. However, some species show more extensively branched paraphyses bearing three or four glandular cells, a condition characteristic for species no. 12.

Transformation series: 284----> 285

Length in cells (character state nos. 292--296, 297, 298, and 302--307)

Receptacular paraphyses being two cells long are present in the majority of drynarioid species, many of them species showing a significant part of their paraphyses being three cells in length. Species nos. 10--12 in Drynaria and no. 19 in Aglaomorpha are unique in having numerous long paraphyses, which are only rarely found in four other Aglaomorpha species.

/--> 292

Transformation series: 293 + 294----> 296----> 295

297----> 298

304 + 305----> 306----> 307

Number of cells (character state nos. 308--311)

Commonly, the species have two or three celled receptacular paraphyses. Species nos. 10--12 and 18 are unique as they usually have more than 30% of the paraphyses with five or more cells.

Transformation series: 308 + 309----> 310----> 311

Differences between laminar trichomes and receptacular paraphyses regarding the length in cells (character state nos. 312--314)

Generally, the species have paraphyses that are equally long or only one cell longer than the laminar trichomes. Some species show the paraphyses to be two cells longer, which is best developed in species nos. 10--12 and 18.

Transformation series: 312 + 313----> 314 (Aglaomorpha)

312----> 313----> 314 (Drynaria)

The transformation series in Drynaria conforms to what is expected, in view of the idea that receptacular paraphyses are homologous to laminar trichomes, whereas that of Aglaomorpha shows some ambiguity. The state present in plausible sister groups is unknown as yet.

Differences in length between laminar trichomes and receptacular paraphyses (character state nos. 315--317)

Usually, the receptacular paraphyses are equally long or (clearly) longer than the laminar trichomes. However, in four species the paraphyses are somewhat shorter than the trichomes.

Transformation series: 315 + 317----> 316 (Aglaomorpha)

\--> 317

315----> 316 (Drynaria)

\--> 317

In Aglaomorpha, the sole presence of state no. 317 is regarded apomorphous in species nos. 29--31. The transformation series cannot be combined.

#### 5.7.5. Receptacular scaly paraphyses

Receptacular scaly paraphyses (character state nos. 338, 339) - Fig. 5.5, 5.6

Receptacular scaly paraphyses are present in species nos. 6--11. In species nos. 10 and 11, numerous scaly paraphyses are inserted among the paraphyses throughout the receptacle. In species nos. 6--9, a number of scaly paraphyses are mainly inserted along the edge of the sorus.

Transformation series: 339---> 338

State no. 339 either developed twice (followed by a reversal in species no. 12), or it arose once, followed by a reversal in species nos. 13--16 (and in no. 12). The first hypothesis is preferred, in view of differences in morphology and insertion.

Complexity of receptacular scaly paraphyses (character state nos. 340--343)

Species nos. 10 and 11 show long hairy paraphyses, long stalked simple scaly paraphyses, and all intermediates in between (with variously pronounced and varying numbers of protrusions of the apically situated cells). Species nos. 6--9 show striking differences between the hairy paraphyses and the relatively complex, shortly stalked scaly paraphyses. Species no. 7 shows some variation as to the complexity of its receptacular scales.

Transformation series: 343---> 341  
                                  \--> 342

State no. 340 is apomorphous.

#### 5.7.6. Deviating sporangia

Deviating sporangia (character state nos. 330, 331) - Fig. 5.7

Receptacular paraphyses are always uniseriate, whereas the stalks of sporangia are bi- and triseriate. Therefore, the paraphyses are regarded homologous with laminar trichomes, whereas sterile bi- and triseriate receptacular structures are inferred to represent derivations of sporangia.

Although there exists much individual variation, all species of the Drynarioideae show few to many sterile (aborted) sporangia of which the capsule is ill-developed. Still, the initiation of the capsule is easily recognized as the apical part is bulb-shaped, showing a number of indurated annulus cells. However, in some species derivations of sporangia are found, which are phallus-shaped, without any visible initiation of the capsule.

Transformation series: 331--->330

#### 5.7.7. Sporangial paraphyses

Glandular sporangial paraphyses (character state nos. 332, 333) - Fig. 5.7

A unique character state is present in species no. 13, i.e. the presence of 2-celled glandular trichomes on both sides of the sporangium capsule in almost all upper layer (i.e. the first developing) sporangia. However, this



species no. 30  
state no. 334, 336



species no. 31  
state no. 334, 336

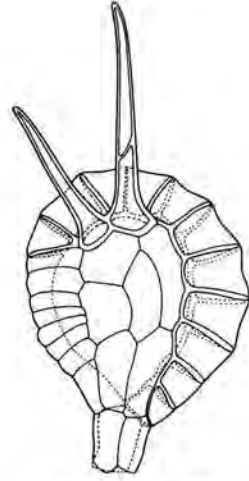

species no. 31  
state no. 334, 336

Sporangial paraphyses (x25)

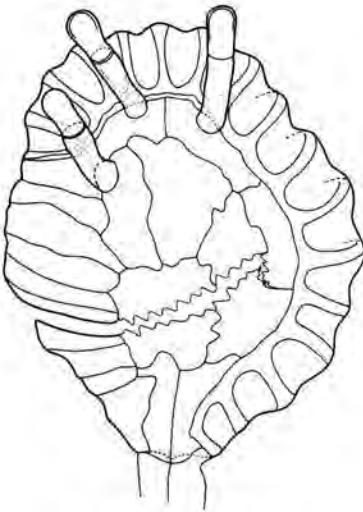

species no. 13  
state no. 332

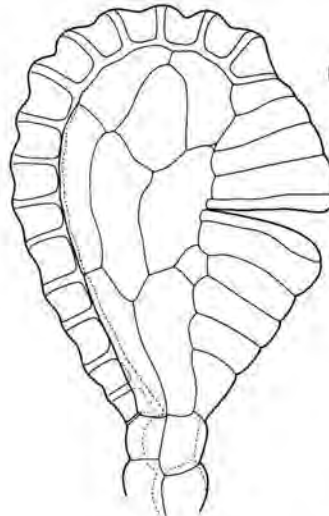

species no. 19  
state no. 333, 335

Deviating sporangia  
(x20)

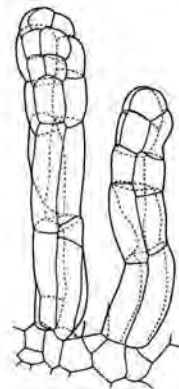

species no. 30  
state no. 330

Fig. 5.7

character state is absent in + 15% of the specimens examined. Rarely, species no. 14 shows a few identical sporangial trichomes. Apart from these unique sporangial trichomes, species no. 15 is furthermore characterized by sinusoid capsule cells, similarly shaped as unspecialized epidermal cells. All other drynarioids lack glandular sporangial indument, and have + entire capsule cells.

Transformation series: 333----> 332

Acicular sporangial paraphyses (character state nos. 334, 335, and 336, 337)  
- Fig. 5.7

Three species are unique, sharing the presence of brown one- or two-celled acicular trichomes on the sporangium capsule. This character state is most conspicuously developed in species no. 29, which has (1--3--6 trichomes situated on both sides of the capsule of almost all upper layer sporangia. These hairs have mature size (+ 125 µm) when the sporangia are young (i.e. when the differentiation between annulus- and capsule-cells is only initiated). In species nos. 30 + 31, 1-3 trichomes are situated on one side of the capsule only. The first species shows less developed acicular trichomes, which are 50--75 µm long, usually not reaching beyond the indurated annulus cells. The sporangial indument is only fairly common, being present in slightly more than half of the specimens examined in + 50% of the upper layer sporangia, the reason why they are easily overlooked. As regards the second species, the greater part of the specimens studied shows + 200 µm long trichomes in + 75% of the upper layer sporangia.

Transformation series: 335----> 334----> 336  
                                  \----> 337

Both state nos. 336 and 337 are apomorphic according to the outgroup rule.

## 5.8. Sporangia

Characters pertaining to the sporangia have always been regarded of importance to characterize the major groups of pteridophytes (cf. Jarrett, 1981). On lower hierarchical levels however, this charactercomplex is usually regarded too variable to be of use. Nevertheless, in the monograph of Platynerium (Hennipman & Roos, 1982) character states of the sporangium are used to recognise holophyletic groups at low hierarchical levels. Therefore, the present study deals in detail with characters pertaining to the annulus and capsule cells (apart from the sporangial indument, see character state nos. 332--337).

The annulus is here defined according to Wilson (1959), being the whole ring of cells + horizontally encircling the capsule and interrupted at the point of attachment. It can be divided into the indurated annulus cells (with conspicuously thickened inner cellwalls; they play the most important role in the opening mechanism of the sporangium), the epistomium (thin walled cells between the indurated cells and the stomium), the stomium (the, usually two, somewhat thicker walled cells, being linear in the horizontal plane and characteristically hyaline; they have a function for the initiation of the dehiscence by seperation from eachother), and the hypostomium (thin walled cells situated between the stomium and the stalk). Observations have always been made from the proximal side of the capsule. In accordance with Wilson (1959, p. 106) character states present in at least 10% of the sporangia counted are all represented in the table. The stomium comprises almost always two cells (very rarely three), and has therefore been ignored. The number of annulus cells shows much variation, both within

the species as well as among the species. This problem was also encountered in the study of PLatyterium (Hennipman & Roos, 1982), in which only the non-overlapping ranges were used for the phylogeny reconstruction. The drynarioids do not show disjunctions in numbers of annulus cells. However, at lower hierarchical levels disjunction might be present. Therefore, each number is regarded to represent a different character state.

Number of indurated cells (character state nos. 156--160)

The most common conditions found are 13 and 14 indurated annulus cells. Generally, Aglaomorpha species show somewhat lower numbers compared to Drynaria species. The variation in species nos. 13 and 28 is considerable.

Transformation series: 158 + 159----> 157----> 156  
                                  \----> 160

Number of epistomium cells (character state nos. 161--164)

Species no. 13 is deviating, lacking the condition of three epistomium cells which is present in all other species. The number of epistomium cells per species is usually rather constant, although e.g. species nos. 27 and 28 often show the two-celled condition.

                                  /--> 161  
Transformation series: 162----> 163----> 164

Number of hypostomium cells (character state nos. 165--168)

The most common condition found is three-celled hypostomiums, most species being remarkably constant. Few species are characterized by a considerable number of sporangia with two hypostomium cells only whereas others (nos. 13 and 18 + 19 + 24 in particular) might show four or five hypostomium cells.

                                  /--> 165  
Transformation series: 166----> 167----> 168

The transformation series pertaining to the epistomium and the hypostomium are + congruent.

Total number of annulus cells (character state nos. 169--176)

As regards the total number of annulus cells, the drynarioid species show much variation and overlap. Species nos. 25, 27, and 31 show considerably low numbers, whereas species nos. 6, 13, 19, and 25 have high numbers. The most common states are 21--23 annulus cells.

                                  /--> 170----> 169  
Transformation series:(171 + 172)----> 173----> 174----> 175----> 176

The mutual polarity of nos. 171 and 172 is unsure.

Length of capsule (character state nos. 177--183)

The length of the sporangium capsules is divided into a number of convenient states after extensive measurements. States nos. 180 and 181 are the most common, but the species show much variation (e.g. species no. 1). Some species show relatively long capsules (e.g. nos. 11, 14, 19, and 21), whereas one species is characterized by short capsules (no. 9).

Transformation series: 180 + 181----> 179----> 178----> 177  
                                  \----> 182----> 183

The state present in plausible sister groups is uncertain, but the series given is the most parsimonious.

Width of capsule (character state nos. 184--189)

Species no. 9, showing short capsules, is also deviating as regards the width, its capsules being distinctly narrow. Generally, the distribution patterns of the different states are congruent with those of the previous character.

Transformation series: 187 + 188----> 186----> 185----> 184  
                                  \--> 189

### 5.9. Spores

The spores of the Drynarioideae are monoletic and planoconvex, like those of all Polypodiaceae. Chandra & Zamora (1979) studied the spores of a number of drynarioid ferns, but their scenario-like conclusions could not be confirmed. Hennipman & Sen (in prep.) will provide an extensive survey of the spores of Polypodiaceae. Their terminology is followed here, and the character states recognized accord with their studies. Due to incomplete knowledge of character states present in plausible sister groups, the often conflicting transformation series of Aglaomorpha and Drynaria treated separately could not always be combined. Furthermore, to explain the distribution pattern of the majority of character states of the spores, it is necessary to assume many homoplasies. Further interpretation of these conflicting character state distributions and transformation series will be dealt with in a forthcoming paper by Hennipman & Roos.

Perispore (character state nos. 190, 191) - Plate 48, 56

The perispore in Aglaomorpha species is generally smooth, whereas Drynaria species usually show a verrucate perispore.

Transformation series: 190----> 191 (Aglaomorpha)  
                                  191----> 190 (Drynaria)

Ultrastructure of perispore (character state nos. 192, 193)

As a rule, the ultrastructure of the perispore is smooth. However, a few Aglaomorpha species often show it to be somewhat verruculate.

Transformation series: 192----> 193

Basal layer of perispore (character state nos. 194--196)

The perispore is usually differentiated into ornamental structures (e.g. spines) and a basal layer surrounding the exospore. In almost all Aglaomorpha species, the basal layer is inconspicuous, except species no. 25 showing a thick basal layer, and no. 22 showing it to be thin. This latter condition is usually found in Drynaria, except species nos. 7, 9, and 14 in which the basal layer is inconspicuous. Generally, thin or thick basal layers occur in species showing spines or baculae.

Transformation series: 194----> 195 (Aglaomorpha)  
                                  \--> 196  
                                  195----> 194 (Drynaria)

Spines (character state nos. 197, 198) - Plate 45--47, 51, 52, 55, 56

Spines are present in most Drynaria species, whereas they are generally lacking in Aglaomorpha.

Transformation series: 198---> 197 (Aglaomorpha)

197---> 198 (Drynaria)

Shape of spines (character state nos. 199, 200) - Plate 45, 47

Spines are either sharply pointed or show a clear apical constriction, often occurring intermingled in one spore.

Transformation series: 200---> 199 (+ 200)

The two states found in Aglaomorpha are both autapomorphies.

Baculae (character state nos. 201, 202) - Plate 53, 54

Baculae are found in some Drynaria species (nos. 10--12 in particular) and in one Aglaomorpha species only (no. 25).

Transformation series: 202---> 201

Globules (character state nos. 203, 204) - Plate 48, 50

Contrary to spines, globules are common in Aglaomorpha and rare in Drynaria.

Transformation series: 203---> 204 (Aglaomorpha)

204---> 203 (Drynaria)

Exospore (character state nos. 205--207) - Plate 49

The exospore is usually smooth or shows globular excrescences. Three species (nos. 9 and 13 + 14) are strikingly deviating showing the exospore to be verrucate, similar in appearance to spores of Polypodium species (Hennipman, pers. comm.). Such exospores are also present in abortive spores of drynarioids otherwise showing the common types of exospore (e.g. species nos. 2 and 21).

Transformation series: 206---> 207

The polarity of state no. 205 is undetermined.

Spore types (character state nos. 208--210)

The characters of the spores studied resulted in the recognition of three different spore types. The most common type in the group (the quercifolia-type) shows variation as to the perispore ornamentation (spines, globules), but it is + uniform as regards the other characters of exo- and perispore. The meyeniana-type is unique to species no. 25, characterized by a conspicuously verrucate perispore and thick basal layer, and baculae present on top of the verrucae. The pleuridioides-type is unique to three Drynaria species (nos. 9 and 13 + 14), characterized by a verrucate exospore.

Transformation series: 210---> 208

\---> 209



## 6. METHODOLOGY OF CLADISTIC ANALYSIS (Co-author: M. ZANDEE)

### 6.1. Introduction

The method here used for phylogeny reconstruction is that as developed by Zandee (1985). It is a four-step cladistic analysis representing an integration between parsimony and compatibility methods. No data are discarded or otherwise weighted a priori, no transformation series are to be established in advance, and a manageable number of alternatives can be selected allowing a judgement according to different criteria. The four steps include:

data matrix --> sets --> cliques --> cladograms

In the data matrix the observations are compiled. The sets are a transcription of the data to facilitate the elucidation of patterns. Cliques comprise groups of sets representing patterns for (alternative) orders which are visualized in cladograms. Cladograms need to be interpreted as representing a historical development for which causes can be postulated. As it is assumed that only one phylogenetic order exists, one cladogram will ultimately present the evolutionary history.

The cladistic analysis is logically independent from both character analyses (the determination which characters and character states are present) and the recognition of the terminal (basic) taxa, which are special activities of the practising systematist. However, the results of the cladistic analysis fully depend on the results of this systematic work. In other words, the quality of the character analyses and of the taxon delimitation is a restriction for the quality of the results of the cladistic analysis. The cladistic analysis cannot (directly) improve the results of this analytical phase, although reciprocal illumination between these two phases plays an extremely important role (viz. Chapter 4.3.5).

The search is for groups of terminal taxa sharing one or more unique character states. This is based on the idea that groups of taxa are possibly holophyletic (comprising the most recent common ancestor and all its descendants; for terminology see Holmes, 1981), if they share one or more unique character states, unless other groups are regarded to represent a better reconstruction of the phylogeny. As a consequence, these so-called special similarities are possible synapomorphies (i.e. they originated once in the common ancestor of all species exhibiting this character state) unless it is better (i.e. more parsimonious) to explain it otherwise. The selection of groups which share unique character states and the set of rules for judging these special similarities to reconstruct the phylogeny include the following steps.

### 6.2. Step 1: data matrix

The first step is the transcription of the data resulting from the character analyses (i.e. the character states recognized and their respective distribution over the terminal taxa) into a binary 1/0 data matrix. All character states recognized are treated as separate items. For each character state, the absence or presence in each species is encoded as a '0' or a '1' respectively.

It must be stressed that the coding used does not indicate any a priori established transformation series or order in character states (unlike a.o. Micevich, 1982). So, unlike the usual situation, a '1' in the data matrix

only means that that particular character state is present in that particular taxon. Necessarily, the 2 or more character states of one character (at a higher level) comprise the set of interdependent (complementary) character states.

### 6.3. Step 2: sets

The second step is manipulating the data matrix to expose the information in terms of groups of taxa sharing common character states (sets of -unique-character states in sets of taxa). To achieve this the data matrix is transcribed into a list of so called 'partially' monothetic sets.

A character state shared by a number of taxa defines this set of taxa. Other character states may show an identical distribution pattern over the taxa of the group under study. Consequently, a set of taxa can be defined by a set of unique character states. Character states showing the same distribution amongst the taxa represent a 'character type' (sensu Nelson & Platnick, 1981). Sets of taxa defined in this way are called 'partially' monothetic (Zandee, 1984) as the original definition of monothetic sets (monotypic sensu Beckner, 1959) is only partly applied. For clarity, these monothetic sets (monotypic sensu Beckner, 1959) are here called 'strictly' monothetic sets. Strictly following the definition of monothetic sets, sets of character states must be both necessary and sufficient for defining sets of taxa. Partially monothetic sets of taxa are only defined by a set of unique character states sufficient for their characterization. For example, the angiosperms are sufficiently characterized by the presence of flowers. However, they are necessarily also characterized by general features of (vascular) plants. In other words, strictly monothetic sets are defined by an unique combination of character states. Each character state of the defining set can be present in other sets of taxa as well, but never in the same combination, nor need any of the separate states to be unique although one or some of them might be so. Partially monothetic sets are only defined by a unique distribution of one or more character states, the defining character states being absent outside the set. It should be stressed that a listing of (partially) monothetic sets is nothing more than a representation of the original data. It has no assumptions of its own.

Table 6.1 shows a data matrix comprising four terminal taxa and 12 characters. In table 6.2 the different strictly as well as partially

| Table 6.1 |   |   |   | Table 6.2 |                     |                      |
|-----------|---|---|---|-----------|---------------------|----------------------|
| A         | B | C | D | Sets      | Strictly monothetic | Partially monothetic |
| 1         | 1 | 0 | 0 | A         | 1,5,7,8,10,11,12    | 1                    |
| 2         | 0 | 1 | 0 | B         | 2,5,8,9,10,11,12    | 2                    |
| 3         | 0 | 0 | 1 | C         | 3,6,8,9,11,12       | 3                    |
| 4         | 0 | 0 | 0 | D         | 4,6,7,9,10,12       | 4                    |
| 5         | 1 | 1 | 0 | AB        | 5,8,10,11,12        | 5                    |
| 6         | 0 | 0 | 1 | AD        | 7,10,12             | 7                    |
| 7         | 1 | 0 | 0 | BC        | 8,9,11,12           | -                    |
| 8         | 1 | 1 | 0 | BD        | 9,10,12             | -                    |
| 9         | 0 | 1 | 1 | CD        | 6,9,12              | 6                    |
| 10        | 1 | 1 | 0 | ABC       | 8,11,12             | 8,11                 |
| 11        | 1 | 1 | 1 | ABD       | 10,12               | 10                   |
| 12        | 1 | 1 | 1 | BCD       | 9,12                | 9                    |
|           |   |   |   | ABCD      | 12                  | 12                   |

monothetic sets and their defining characters present in the data matrix are shown. The sets are groups of taxa (clada), the numbers refer to the character states they have in common following each of the two definitions. Sets BC and BD do not represent partially monothetic sets. Obviously, the total number of sets partially defined is smaller than the total number of strictly monothetic sets. The total number of polythetic sets (Beckner, 1959) will be far greater. The choice for partially monothetic sets implies a preliminary selection of cladograms as it precludes all those cladograms featuring groups not supported by unique character states.

#### **6.4. Step 3: cliques**

The third step is the formation of cliques of sets of taxa. Among the members of a partially monothetic set of taxa there is only one type of relation, i.e. the shared possession of one or more unique character states. Among the sets themselves, three types of relations can be recognized: a) inclusion, e.g. {A} in {A,B} in {A,B,C}; b) exclusion, e.g. {A,B} and {C,D} in {A,B,C,D}; and c) overlap, e.g. {A,B,C} and {C,D} in {A,B,C,D}. For systematics and phylogeny reconstruction, inclusion and exclusion relations are of first importance, overlap between sets of taxa requiring additional explanations. When two states of one character (transformation series) show overlapping distribution patterns, this might be interpreted as resulting from an incomplete divergence (fixation, polymorphy). However, in case of overlap between sets defined by states of different characters (transformation series), this interpretation is impossible.

In the present study, pairs of sets of taxa that exclude or include each other are called compatible. Cliques are defined as sets of sets of taxa all mutually compatible. This interpretation of compatibility is different from that of e.g. Meacham (1981). In his concept, compatibility analysis is a search for compatible characters, and not for compatible groups of taxa, although in case of partially monothetic sets as groups of taxa and character types instead of characters, the concepts coincide. Most important is the exclusion from compatibility of overlapping character state distributions; for example, the two character state distributions 00001111 and 11111000 are compatible as characters according to Meacham's concept, but they will not result in compatible sets of taxa and are therefore excluded from the concept of group-compatibility. In the present study the search is for the most resolved cladograms, whereas traditionally character compatibility analyses will yield cladograms with the largest number of unequivocally supporting character states. Meacham (1984) however, states that (p. 154) "two undirected binary characters are compatible if and only if their smaller states are disjoint or one is a subset of the other". This concept of character compatibility is analogous to the concept of group compatibility as used in the present paper.

The search for cliques is a NP-complete problem. This means that it is impossible to construct an efficient algorithm for this procedure. As a consequence, a priori constraints are imposed in order to make the analysis feasible within the limits of available CPU time. This is done by using partially monothetic sets only. Only the largest cliques are selected. For N terminal taxa, a fully resolved, i.e. dichotomous, cladogram has N-1 internal nodes (sets of taxa) and N terminal nodes (taxa). Thus the maximum clique size is 2N-1. In case the largest cliques comprise less than 2N-1 sets, the resulting cladograms will include polytomies.

## **6.5. Step 4: cladograms**

### **6.5.1. Introduction**

The fourth step is the transformation of cliques into cladograms. Each clique yields only one particular cladogram free from taxonomic conflicts by definition. Cladograms based on different cliques are different, thus conflicting. By interpreting the resulting cladograms a judgement can be made of their respective representation of the original data matrix. This should be followed by a choice for one or only a few of them. The selection procedure of this step is the most difficult and complex one. It is executed in two phases, a purely cladistic phase and one including auxiliary biological inferences. At this stage, evolution is introduced to interpret the cladograms.

### **6.5.2. Cladistic phase**

In the cladistic phase, two different judgements are made:

- 1) the measurement of the lowest value of contradiction minus support, i.e. the minimum of the number of character state changes necessary to explain the distribution of character states over the cladogram combined with the number of fitting character states;
- 2) the application of the local outgroup comparison to establish which defining character state represents a synapomorphy.

#### **6.5.2.1. Contradiction minus support**

##### **6.5.2.1.1. Introduction**

A character state fits a cladogram if its presence can be explained by assuming a single origin in one branch (or node) of the cladogram and thus in one clade. The more character states that unequivocally fit the cladogram, the better supported the cladogram. However, this is only one part of the judgement. Fit is used here in a cladogenetic context and cladograms are interpreted as schemes denoting the sequence of origin of new character states (evolutionary novelties) in clada. This sequence, being an aspect of descent with modification (evolution), reflects (a particular) cladogenesis, or in other words, it implies a rejection of alternative cladogenetic events. Transformation series (reflecting anagenesis; cladogenesis + anagenesis = phylogeny) can be read off from the hypothesis of phylogenetic relationships (= chosen cladogram).

Character state distributions conflicting with the initial relations depicted in a particular cladogram, are (in first instance) interpreted as homoplasies. Homoplasies are character states of which the distribution can only be explained by assuming a multiple origin and/or by assuming one or more reversals. As they are ad hoc hypotheses, they can also act as a measure for the quality of a cladogram. Cladograms showing the smallest number of homoplasies are then to be preferred.

The number of fitting character state distributions and the number of homoplasies can be combined to achieve an overall judgement of the quality of equally resolved cladograms, assuming that all different character states are equivalent (commensurate) in this respect. This leads to a choice for the most supported and the least contradicted cladogram.

#### 6.5.2.1.2. Procedure

Given a cladogram, the total number of homoplasies is calculated as follows. Character states fitting the cladogram receive the value '0'. For conflicting character states, the minimum number of independent origins and reversals to explain their distribution over the species is calculated. Character states present from the basal node of the cladogram onwards and showing one reversal in an higher branch receive the value '1'. This situation is called 'fit via reversal' and incorporated in the calculation of the amount of support. When the one complementary character state also fits, it is called a 'pseudo-fit' and not calculated for the amount of support. Character states present in a 'subtree' of the cladogram showing a single reversal, character states showing homoplasious origins in the 'roots' of two separate subtrees, as well as characters present in the root of the cladogram showing two reversals are given the value '2'; and so forth. So far, this is essentially similar to the procedure of Farris (1970). But the number of homoplasies here is the number of times the character state is required to originate independently, whereas in Farris' procedure it is one less. Moreover, and unlike Farris' cladogram optimization procedure, in the present method for evaluating the number of homoplasies the state of a character once reversed is retained. This puts limits to the degree of character reversibility, although this obviously may result in not necessarily most parsimonious solutions. For example, starting from presence ('1'), one reversal is possible ( $1 \rightarrow 0$ ), but the state cannot be gained again; starting from absence ('0'), the state can be acquired, and lost, but not be regained ( $0 \rightarrow 1 \rightarrow 0$ ).

In case of polytomies, each branch is treated separately and the homoplasy value of character states present in two or more branches is equal to the number of branches in which it occurs. This is necessary because otherwise character states present in two or more branches of the polytomy are united for the moment and their homoplasy value would always be '1'. The result will be a cladogram with one node and a N-polytomy, the branches leading separately to the N-terminal taxa. Such a cladogram will then show the smallest number of homoplasies.

The amount of fit of a cladogram is the number of fitting character states plus the number of character states showing fit via reversal (excepting pseudo-fit). There is one other exception. One of the character states of a complementary set must be plesiomorphous to all others. This state is irrelevant for the amount of homoplasies, and should not be incorporated in the calculation. Therefore, when all complementary character states show zero homoplasies, the amount of fit is one less than the number of states.

The amount of homoplasy is calculated likewise. For each complementary set of character states, the state showing the highest number of homoplasies is regarded to represent the plesiomorphous condition as a first guess and of reasons of economy. The latter condition is not incorporated in the calculation for the total number of homoplasies over the whole cladogram. The remaining homoplasy values are enumerated, presenting the total amount of contradiction of the cladogram as a whole. An alternative heuristic (presently not applied) is to count per state the number of developments necessary to explain its distribution pattern in the cladogram, ignoring the reversals implied. The overall homoplasy value of the cladogram is then the sum of the counts of all states. This can be done because reversal (presence  $\rightarrow$  absence) of one state coincides with the acquirement of (one of) its complement(s). As yet, it still has to be ascertained whether these two ways of calculation of homoplasies are conceptually different.

The third selection procedure is in favour of cladograms showing the lowest values regarding contradiction minus fit. Generally, this will still lead to a number of possibilities. In the present study, the values for the subsequent cladograms are rather high (around 1300--1400), and the differences between the 'best' cladograms not very significant. As a consequence, the limit for cladograms still to be selected for further interpretation is more or less artificial. A diagram depicting the frequency of values of contradiction minus support will be helpful to find a (statistical) suitable limit (Fig. 6.11). Notice that these frequency diagrams do not show normal distributions.

#### 6.5.2.2. Outgroup comparison

Within the context of the chosen starting points, branches (nodes) of the cladograms are only relevant when they represent synapomorphies and thus define holophyletic groups. This is established using outgroup comparison. A 3-cladon-statement comprises an ingroup (A), a sistergroup (B) and an outgroup (C). According to the outgroup rule as interpreted here, A is holophyletic when it possesses character states that are absent in both B and C. Such character states are consequently apomorphic. As the (initial) clada are all partially monothetic sets characterized by unique characterstates, these defining states are absent in both the sister- and outgroup, and therefore apomorphic by definition.

#### 6.5.3. Example of cladogram construction

To illustrate the construction of cladograms, the data matrix given in Table 6.1 is used. Notice that all sets of complementary characters have only one complement. First, the matrix is transcribed into a list of partially monothetic sets (Table 6.2), followed by a search for in- and exclusion relations among these sets (group-compatibility).

|      | 1 | 2 | 3 | 4 | 5 | 6 | 7 | 8 | 9 | 10 | 11 |
|------|---|---|---|---|---|---|---|---|---|----|----|
| A    | 0 | 1 | 1 | 1 | 1 | 1 | 1 | 1 | 1 | 1  | 1  |
| B    | 1 | 0 | 1 | 1 | 1 | 1 | 1 | 1 | 1 | 1  | 1  |
| C    | 1 | 1 | 0 | 1 | 1 | 1 | 1 | 1 | 1 | 1  | 1  |
| D    | 1 | 1 | 1 | 0 | 1 | 1 | 1 | 1 | 1 | 1  | 1  |
| AB   | 1 | 1 | 1 | 1 | 0 | 0 | 1 | 1 | 1 | 0  | 1  |
| AD   | 1 | 1 | 1 | 1 | 0 | 0 | 0 | 0 | 1 | 0  | 1  |
| CD   | 1 | 1 | 1 | 1 | 1 | 0 | 0 | 0 | 0 | 1  | 1  |
| ABC  | 1 | 1 | 1 | 1 | 1 | 0 | 0 | 0 | 0 | 0  | 1  |
| ABD  | 1 | 1 | 1 | 1 | 1 | 1 | 0 | 0 | 0 | 0  | 1  |
| BCD  | 1 | 1 | 1 | 1 | 0 | 0 | 1 | 0 | 0 | 0  | 1  |
| ABCD | 1 | 1 | 1 | 1 | 1 | 1 | 1 | 1 | 1 | 1  | 0  |

Table 6.3

These in- and exclusion relations among (partially) monothetic sets can be pictured in a symmetrical binary table with zero entries in the diagonal (Table 6.3), the group-compatibility matrix. This table can also be considered to represent the connectivity matrix of a graph, in which the monothetic sets act as edges (nodes) and their compatibility relations as vertices (lines). The search for all maximally resolved cladograms is then equivalent to a search for all maximal complete subgraphs (cliques) of

maximum size, i.e. all maximal sets of mutually compatible monothetic sets. The branch and bound algorithm used to accomplish the search is that of Bron & Kerbosch (1973). In this particular example five of such cliques can be found, each comprising all terminal clada (A, B, C, D), the unique beginner (A + B + C + D), and two internal clada (Table 6.4). These cliques can be presented as five cladograms (Fig. 6.1--5).

|  |                          |
|--|--------------------------|
| 1. (A+B) [ch. no. 5] \                                     | + (A+B+C+D) [ch. no. 12] |
| + (C+D) [ch. no. 6] /                                      |                          |
| 2. (A+B) [ch. no. 5] + (A+B+C) [ch. no. 8, 11] + (A+B+C+D) |                          |
| 3. (A+B) [ch. no. 5] + (A+B+D) [ch. no. 10] + (A+B+C+D)    |                          |
| 4. (A+D) [ch. no. 7] + (A+B+D) [ch. no. 10] + (A+B+C+D)    |                          |
| 5. (C+D) [ch. no. 6] + (B+C+D) [ch. no. 9] + (A+B+C+D)     |                          |

Table 6.4

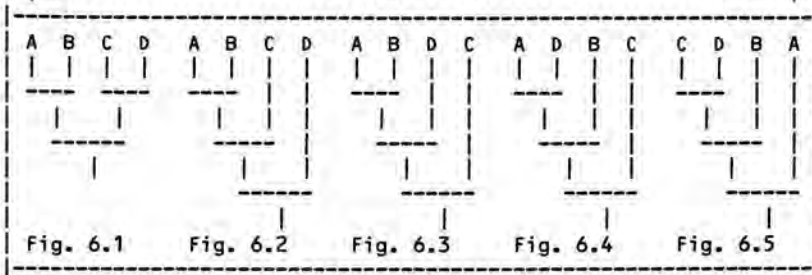

Table 6.5 presents the number of homoplasies per character (nos. 1--12) for each tree (nos. 1--5). It is obvious that states present in one species only (state nos. 1--4) always fit the cladograms (homoplasy value = 0). Furthermore, in cladogram 1 character nos. 5, 6, and (of course) 12 fit the cladogram as their distribution can be explained by a single origin in clade (A + B) and (C + D) respectively. The distribution of character no. 7 in cladogram no. 1 can be explained assuming either two independent origins in species A and D, or by two reversals in species B and C. In both cases, its homoplasy value is two. Character no. 8 in cladogram 1 can be explained by assuming one reversal in species D, therefore, this character state has the homoplasy value 1 and is counted as a fit-via-reversal. The next paragraph deals in more detail with the calculation of homoplasies.

Table 6.6 presents for each cladogram the overall values of amount of homoplasies (1), fit (2), fit-via-reversal (3), and pseudo-fit (4). As the characters are not arranged in complementary sets, no pseudo-fit is present. The last row presents the overall values of contradiction minus support [(homoplasies + pseudo-fit) - (fit + fit-via-reversal)]. Cladograms 1, 2, 3,

|   |   |   |   |   |   |   |   |   |   |    |    |    |
|---|---|---|---|---|---|---|---|---|---|----|----|----|
|   | 1 | 2 | 3 | 4 | 5 | 6 | 7 | 8 | 9 | 10 | 11 | 12 |
| 1 | 0 | 0 | 0 | 0 | 0 | 0 | 2 | 1 | 1 | 1  | 1  | 0  |
| 2 | 0 | 0 | 0 | 0 | 0 | 1 | 2 | 0 | 1 | 1  | 0  | 0  |
| 3 | 0 | 0 | 0 | 0 | 0 | 1 | 2 | 1 | 1 | 0  | 1  | 0  |
| 4 | 0 | 0 | 0 | 0 | 2 | 2 | 0 | 1 | 1 | 0  | 1  | 0  |
| 5 | 0 | 0 | 0 | 0 | 1 | 0 | 2 | 1 | 0 | 1  | 1  | 0  |

Table 6.5

|   |    |    |    |    |    |
|---|----|----|----|----|----|
|   | 1  | 2  | 3  | 4  | 5  |
| 1 | 2  | 2  | 2  | 4  | 2  |
| 2 | 7  | 8  | 7  | 7  | 7  |
| 3 | 4  | 3  | 4  | 3  | 4  |
| 4 | 0  | 0  | 0  | 0  | 0  |
|   | -9 | -9 | -9 | -6 | -9 |

Table 6.6

and 5 are according to this criterion all equally plausible (value -9). Cladogram 4 shows a higher value (-6) and is therefore regarded less plausible. Table 6.7 shows the clada of cladogram 6.2 with their respective sister- and outgroups, and the evaluation of their supporting character states (denotation of apomorphies) according to local outgroup comparison. For the lower two clada, in the present analysis no outgroup is available. Therefore, no outgroup comparison can be applied and their supporting character states cannot be indicated to represent apomorphies. For these higher hierarchical branches of the cladogram, (each of) the presumed sister group(s) of the group under study has (have) to be used for outgroup comparison.

| Cladogram 6.2 |             |              |          |
|---------------|-------------|--------------|----------|
| Cladon        | Apomorphies | Sister group | Outgroup |
| A             | 1, 7        | B            | C        |
| B             | 2           | A            | C        |
| (A+B)         | 5           | C            | D        |
| C             | 1, 2        | (A+B)        | D        |
| Support       |             |              |          |
| (A+B+C)       | 8, 11       | D            | -        |
| D             | 4           | (A+B+C)      | -        |

Table 6.7

After evaluation of the supporting characters of the cladograms (which are selected on the basis of the value of contradiction minus support), it is the systematist's task to make a choice in favour of one or a few hypotheses regarded most plausible.

#### 6.5.4. Example of homoplasy calculation

The following account illustrates more complex cases of the calculation of contradiction minus support. Fig. 6.6 shows a putative cladogram of the taxa A-J and Table 6.8 is part of the data matrix on which the cladogram is based, showing the distribution of a number of character states (Ch.st). The distribution pattern of character state no. 1 is explained by assuming a single origin (0→1) in branch c. This state fits the cladogram and its homoplasy value (H) is 0. Its complement, state no. 2, can be explained by assuming five independent origins (in branch d, h, j, k, and q). But, it is more parsimonious to assume it to be already present at the base in branch r followed by a reversal (1→0) in branch c. Its homoplasy value is then 1, representing a fit-via-reversal. However, as its complement is already counted as fit, it is therefore a pseudo-fit. The homoplasy value of this set of complements (V) is 0, the highest value being ignored as it is regarded to mark the plesiomorphy for reasons of economy. This is confirmed by applying the outgroup rule.

State no. 3 fits the cladogram, assuming a single origin in branch a. The homoplasy value of state no. 4 is 2. Its distribution is either explained by a single origin in branch e followed by a reversal in branch a, or by two independent origins in branches b and d. A choice between these two possibilities is possible using outgroup comparison. The distribution pattern of character state no. 5 is most parsimoniously explained by assuming it to be present in branch r followed by a reversal in branch e. The homoplasy value of this state is 1 and it represents a fit-via-reversal



| Ch. st | V H | A | B | C | D | E | F | G | H | I | J |
|--------|-----|---|---|---|---|---|---|---|---|---|---|
| 1      | 0   | 1 | 1 | 0 | 0 | 0 | 0 | 0 | 0 | 0 | 0 |
| 2      | 1   | 0 | 0 | 1 | 1 | 1 | 1 | 1 | 1 | 1 | 1 |
| 3      | 0   | 1 | 0 | 0 | 0 | 0 | 0 | 0 | 0 | 0 | 0 |
| 4      | 2   | 0 | 1 | 1 | 0 | 0 | 0 | 0 | 0 | 0 | 0 |
| 5      | 1   | 0 | 0 | 0 | 1 | 1 | 1 | 1 | 1 | 1 | 1 |
| 6      | 2   | 0 | 1 | 1 | 1 | 1 | 1 | 1 | 0 | 0 | 0 |
| 7      | 3   | 1 | 0 | 0 | 0 | 1 | 0 | 0 | 0 | 0 | 1 |
| 8      | 0   | 0 | 0 | 0 | 0 | 0 | 0 | 0 | 1 | 1 | 0 |
| 9      | 2   | 0 | 1 | 0 | 0 | 0 | 0 | 0 | 0 | 0 | 0 |
| 10     | 3   | 1 | 0 | 1 | 1 | 1 | 1 | 0 | 0 | 0 | 0 |
| 11     | 2   | 0 | 0 | 0 | 0 | 0 | 0 | 1 | 1 | 1 | 1 |
| 12     | 2   | 1 | 1 | 0 | 0 | 0 | 0 | 0 | 1 | 1 | 0 |
| 13     | 2   | 0 | 0 | 1 | 1 | 1 | 1 | 1 | 0 | 0 | 1 |

Table 6.8

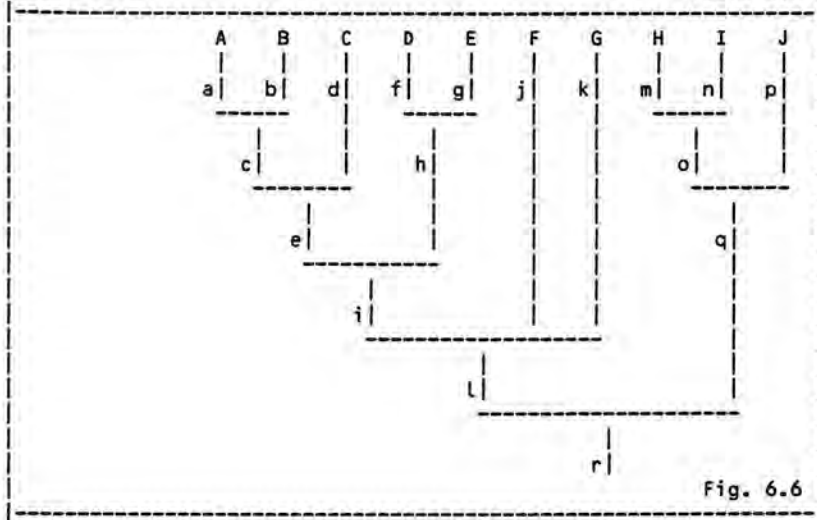

Fig. 6.6

as none of its complements is counted as a fit of the supposed reversal. The homoplasy value of this set of complements, however, is 0, because the value of no. 4 is ignored as it is the highest of the three. Following the reasoning that the highest value marks the plesiomorphy, the transformation series would be 3 ←4→ 5. However, using the outgroup rule this has to be changed into 5→ 4→ 3.

As regards character states nos. 6--8 (species E is polymorphic, showing both states nos. 6 and 7), state no. 6 is most parsimoniously explained by either its presence in branch r followed by two reversals, one in branch q and the other in branch a, or by assuming its origin in branch l followed by a reversal in a. In both cases, its homoplasy value is 2. To explain the distribution of state no. 7, three independent origins have to be postulated, in branches a, g, and p (homoplasy value 3). Character state no.

8 fits the cladogram. The homoplasy value of this set of complements is 2, and the transformation series would be  $6 \leftarrow 7 \rightarrow 8$ . Outgroup comparison shows that it should be  $6 \rightarrow 7$  (in group A--G) and  $7 \rightarrow 8$  (in group H--J).

Character state no. 9 fits the cladogram. The distribution of state no. 10 can be explained in three different ways. Either it arose in branch l followed by reversals in branch b and k, or it arose in branch i and j and reversed in branch b, or it was present in branch r already followed by three reversals. In all cases, the homoplasy value is 3. The cladogram implies two independent origins for the distribution of state no. 11, in branch k and q. The homoplasy value of this state is 2, and the transformation series is  $9 \leftarrow 10 \rightarrow 11$ . Following the outgroup rule, state no. 10 is plesiomorphous to state no. 9. This means that the group of species A--F is characterized by the presence of state no. 10, although it initially could not be defined as a partially monothetic set (by this state, which is missing in B). Permutations of the clada A--E, F, and G will lead to species A--F being grouped together, species G representing the sister group and species H--J the outgroup. According to the outgroup rule, state no. 10 is then apomorphous to state no. 11, and the transformation series is  $11 \rightarrow 10 \rightarrow 9$ . This reasoning leads to a resolution of the trichotomy of species G, F, and A--E. It results in two dichotomies via the group of species A--E with F.

Such reasoning can only be made starting from a cladogram. The main difficulty is to find groups (that are, by definition, not partially monothetic) and character states that suit this situation, i.e. one of the ultimate branches lacking a character state present in all other terminal taxa of the 'subtree' and in at the most  $n-2$  other 'subtrees' of an N-polytomy (the latter may of course also show a reversal in one of the ultimate branches, making it more complex) and absent in the sister group. In case of fully dichotomous '(sub)trees', this reasoning serves to increase the support in terms of transformation series. In 'subtrees' that are at least a sister- and outgroup node separated from each other, this character state further supports at least one of the 'subtrees'. For instance, character states nos. 12 and 13 both show a homoplasy value of 2, and based upon these values no transformation series can be established. Local outgroup comparison shows that state no. 12 is synapomorphous in species A and B, as well as in species H and I independently.

As regards the character states presented in the data matrix, the given cladogram shows a homoplasy value of 6. The amount of fit is 4, of fit-via-reversal 1, and of pseudo-fit also 1. Thus, the value of contradiction minus support is  $(6+1)-(4+1)=2$ .

#### 6.5.4. Biological inferences

At this stage it is still possible that several cladograms are of equal quality (i.e. + similar, low values of contradiction minus fit). At this stage, the problem returns to the systematist. Using biological knowledge and inferences, he/she might be able to make a choice in favour of one or only a few of the resulting cladograms. This decision can be based either on the biological quality of the supporting characterstates (as regards the infra-taxic variation and compared to discontinuities with complementary character states; character weighting), or on the denotation of the sets of data present in all or the greater part of the different cladograms (robust 'subtrees'), firmly supported so as to be undisputed. If necessary, such intuitive perception of 'natural' groups, and of biogeographical patterns, as well as assumptions of ecological, genetic, or evolutionary processes

might provide auxiliary motives to make an ultimate decision.

## 6.6. Discussion

Two strategies are possible to proceed from character analyses to the ultimate choice of a cladogram. On the one hand, starting from a data matrix comprising the 'hard-core' character states only, the procedure proposed can be followed. In the case of polytomies in the eventual cladograms, a higher resolution might be acquired using 'weaker' character states for a local analysis. On the other hand, as has been done in the present study, starting from the complete data matrix, the ultimate cladograms are given. They are judged according to the groups they depict as well as to the supporting character states. A higher resolution can be obtained, using a combination of local-outgroup-comparison and 3-cladon-permutations. In the latter case, characters are weighted a posteriori. Criteria to judge the strength of character states are: 1) variation within species; 2) differentiation among species; and 3) morphological regularity and structural complexity.

Farris, the main proponent of parsimony methods, has argued several times against the method of character compatibility (Farris, 1983; Kluge & Farris, 1979). The criticisms mainly pertain to the selection of characters on which the resulting cladogram is based. In Farris' (1983) words, character compatibility analyses are techniques that (p. 11) "... 'resolve' character conflicts by discarding as many characters as necessary ...", "At the most it might be said that the selected characters seem to suggest no genealogy other than the obvious one.", (p. 13) "Cliques are usually chosen to comprise as many mutually congruent characters as possible and any characters that must be discarded to achieve this are simply counted as excluded.", and "... excluding a character implies that all points of similarity in that character are homoplasies."

Apart from what is wrong with obvious genealogies, it must be noticed that the analysis as presently applied is not really affected by these criticisms. The search procedure is for compatible sets of terminal taxa, not for compatible characters. The cladograms are constructed using the largest cliques of compatible sets of taxa. More important, no character states have been discarded. Apart from the degree of fit, cladogram selection is based on the number of homoplasies. Therefore, the analysis applied in this thesis should be regarded as an integration of parsimony and compatibility procedures.

The present cladistic method will not only lead to 'obvious' genealogies, but also provides numerous alternatives. This gives the systematist the opportunity to compare different hypotheses according to the degree of fit and implied number of homoplasies. This is partly achieved by avoiding a priori character selection or ordering. The results of the character analyses are not regarded as absolute and have been judged according to the distribution of character states in the resulting cladograms (apart from reciprocal illumination).

Although usually not made explicit, parsimony procedures start with the indication of order in character states or even the establishment of transformation series using global outgroup comparison. This has been put most straight forward by Brooks et al. (1984) in simplifying this matter to explain it to students. Micevich expresses it as follows (1982, p. 462): "The results of a taxonomic study depend upon prior hypotheses of character evolution. Demonstrating trends ..... begin ..... with the analysis of character patterns between the taxa on a cladogram". Apart from what is exactly meant by character evolution and trends, and taxonomic results, this

reasoning is circular. On the one hand, transformation series are necessary to obtain a cladogram (obviously, this has been given priority). On the other hand, the cladogram is necessary to establish transformation series. The same attitude is present in Farris' treatment of reversals. Because of the establishment of transformation series in advance, it is also known which reversals appear. Therefore, the criticisms of the (strict) monothetic group method (Farris et al., 1982) are rather peculiar, besides of being outright unjustified. Much confusion might be caused by the usual meaning and interpretation of a '0' and a '1' in the data matrix as the presence of a plesiomorphy and apomorphy respectively. It is stressed here, that, in the present study, a '0' only means that the character state is absent, and a '1' that the character state is present.

Mickeyevich also argues that (1982, p. 462) "specifications of polarity or direction are simply hypotheses of plesiomorphy". This looks similar to the definition of the outgroup rule as given by De Jong (1980): "If a character occurs in more than one state in a monophyletic group, the state that occurs also outside the group is likely to be the plesiomorphic state." (monophyletic = holophyletic). This definition emphasizes the denotation of plesiomorphous states. However, the definition should stress the denotation of hypotheses of apomorphies. Therefore, the outgroup rule is here reformulated as: a character state is not rejected to represent a putative apomorphy in case it is present in the ingroup and absent in the sister- and outgroup. Consequently, the ingroup is potentially holophyletic. Following De Jong's definition, the states present in the sister- and outgroup should be similar, whereas when they are different no decision can be made. However, in my opinion this is too restrictive. For example, in the case when the ingroup (A), the sistergroup (B), and the outgroup (C) show three different states of a character. The state present in C is also present in the outgroup at the node one level higher (D). At the level of  $[(A+B)C]D$ , the state present in C is absent in the sister group but present in the outgroup, and therefore rejected as a representation of an apomorphy. As a consequence, it is regarded a plesiomorphy. Initially, there is no reason to reject the hypotheses of the states present in A and B as being apomorphous. One of these hypotheses eventually might be falsified at that particular level in the case when this character state is present also in the other group.

The construction of transformation series using the outgroup rule in its local sense will lead to a lower limit with respect to the number of apomorphies, and consequently to an upper limit as to the number of homoplasies. Only those character states are denoted to represent apomorphies, that are present in the entire ingroup and absent in all constituent terminal clada of both the sister- and the outgroup. Farris optimization method on the other hand, estimates the character states present at the nodes of the cladogram in order to achieve a most parsimonious solution with respect to the number of homoplasies. Using these estimates, the outgroup rule can be applied, which will lead to a larger set of apomorphies.

A choice between the strategies for establishing transformation series, which lead to different sets of apomorphies, can only be based on biological grounds, i.e. it will be ad hoc depending on the taxa and characters involved. It is here argued that cladistic analysis cannot lead to unambiguous and definitive results, but that it only can elucidate the limits of the set of possible or relevant solutions.

Therefore, methods that do not yield a set of possible alternative cladograms, are regarded insufficient. In this context, it is stressed that it is important to examine the differences in number of fitting character

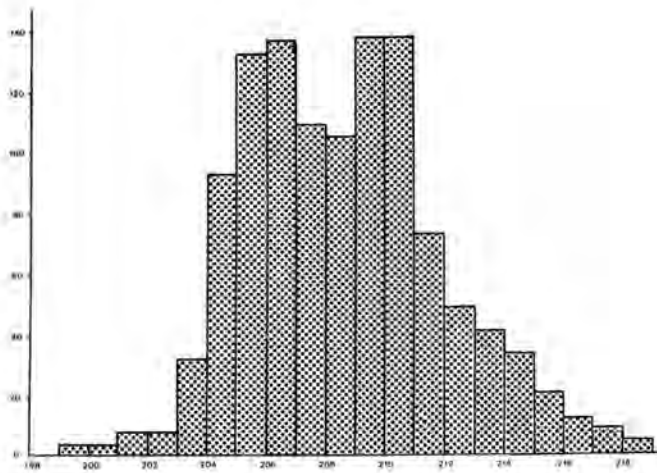

Fig. 6.7. Histogram of support (Aglamorpha cladograms); horizontally: degree of support; vertically: number of cladograms

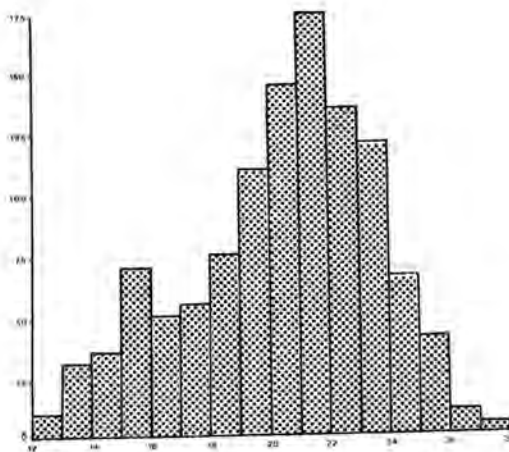

Fig. 6.8. Histogram of fit-via-reversal (Aglamorpha cladograms); horizontally: degree of fit-via-reversal; vertically: number of cladograms

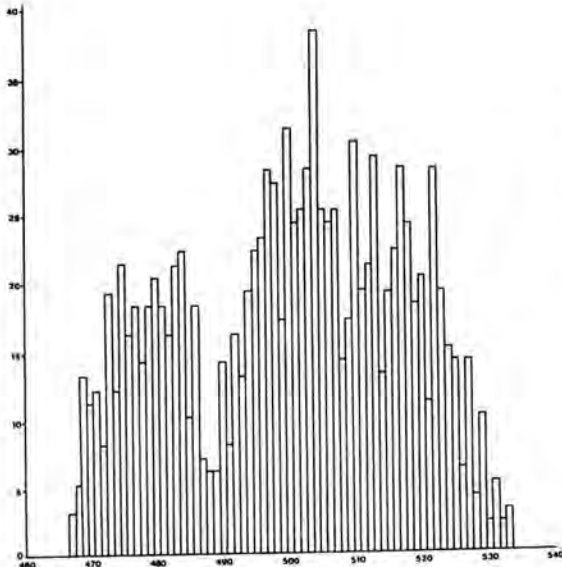

Fig. 6.9.

Histogram of homoplasies (Aglaomorpha cladograms); horizontally: degree of homoplasy; vertically: number of cladograms

Histogram of pseudo-fit (Aglaomorpha cladograms); horizontally: degree of pseudo-fit; vertically: number of cladograms

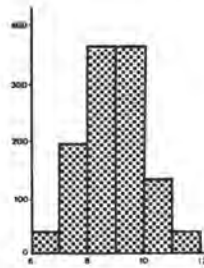

Fig. 6.10.

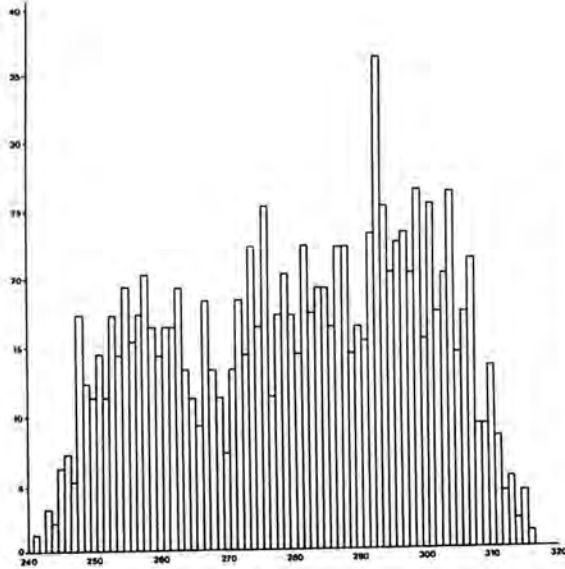

Fig. 6.11.

Histogram of contradiction minus support (Aglaomorpha cladograms); horizontally: value of contradiction minus support; vertically: number of cladograms

states and homoplasies of the possible cladograms in relation to the overall variation. The histogram (of the value of contradiction minus support) of the distribution of cladograms generated for *Aglaomorpha* (Fig. 6.11) do not depict a regular distribution pattern, but the differences in value between the best trees are insignificant in view of the overall range. Therefore, a definitive choice cannot be based on this quantitative criterion only. This problematical item has also been discussed by Fitch (1984).

It is necessary to question whether hypotheses of homoplasy and fit are of equal value for judging alternative cladograms. In other words, is a cladogram showing no (or little) fit and a low number of homoplasies, to be preferred over a cladogram with many fitting character states and a high number of homoplasies? Two basic tenets for cladistics are the search for general patterns of similarities and an evaluation of those similarities to see whether they represent apomorphies. As a consequence, Zandee (1985) proposes to judge cladograms according to both the degree of fit and number of homoplasies (i.e. those cladograms with the most support and the least contradiction). In this respect, it is interesting to quote Riggins & Farris (1983): (p. 96) "The effect of the parsimony criterion is that a suite of taxa sharing distinctive traits will, in the absence of contrary evidence, be united into a single group and will not be distributed to disparate parts of the putative genealogy. Without such a requirement, there need be no correspondence between groups and characters, and the features of taxa would be irrelevant to classification", and (p. 99) "...the groups of the tree are not well corroborated, most being distinguished by one or two features - and even those occur sporadically in other groups. These data thus do not provide strong evidence on genealogy." Obviously, proponents of the parsimony methods also try to judge the resulting cladogram in terms of supporting character states. Therefore, the present method proceeds from mere character distribution patterns to the construction of cladograms that are at first evaluated according to their fit and implied homoplasies. Parsimony methods proceed from the establishment of transformation series to the construction of cladograms that need to have unique supporting character states for corroboration and acceptance. The procedures are different, but the ultimate aims are the same.

Unlike most versions of Wagner tree methods, the present method will automatically lead to rooted cladograms. The supporting character states of the basal node only have to be compared with those present in the sister group. The root is a consequence of the inclusion and exclusion relations, which are basically the same as the concept of levels of universality.

As polarities determined from the counting of homoplasies might contradict those resulting from outgroup comparisons, it seems that a final result can be determined with a 3-cladon-permutation/outgroup-comparison algorithm. The main advantage is that it will optimize the calculation of the total amount of homoplasies per cladogram.

## **6.7. Post scriptum: Present state of affairs in the methodology applied**

### **6.7.1. Introduction**

In the time-span between the analysis as initially applied and presented in the thesis edition, and the publication of this monograph several aspects of the method were updated. These updates refer to the coding possibilities for character states in the data matrix, the derivation of clada, and the two-stage evaluation of cladograms.

Updates were needed, on the one hand because of justified criticism especially with regard to cladogram evaluation. On the other hand, they

resulted from the continuous struggle between what is theoretically required and practically feasible. This topic is inherent in each heuristic for the solution of intractable (NP-complete) problems, a category to which some of aspects of phylogeny reconstruction belong. We will now give a brief introduction to these updates.

### 6.7.2. Ad step 1: data matrix

We use the term character as a synonym for a transformation series of homologues. Each homologue corresponds to a character state. Each character state has its own column in the data matrix. Absence or presence is scored by means of the parameters 0 or 1, respectively. Neutral, or unordered, coding is applied in order to fulfil an initial condition of the method, i.e. avoidance of apriorism.

In the first step of the analysis an option is included to amend the coding for states in polymorphic taxa. Normally, polymorphism in taxa is scored as a presence for two or more states in a character (see e.g. character state nos. 13--15 and taxon no. 16 in Appendix 2). After amending, every polymorphism will be indicated in a new column added to the data matrix after the columns for the separate states, and the original codings (of the polymorphic taxa) for the separate states are replaced by zeros. This option pertains to the possibility discussed in the next section (step 2: sets) to derive all additive binary codings for each character on the basis of neutral coding.

### 6.7.3. Ad step 2: sets

In our method the volume of the results, i.e. the number of cladograms found, and its quality, i.e. how well the cladograms represent the empirical data base, both depend on the number of building blocks (clada) used in cladogram construction, and on the combinatorial complexity of the relationships (in- and exclusion) among clada. The characterization of clada has an important theoretical component; it has to do with the problematical relation between taxa (and groups of taxa) and character states. The combinatorial complexity constitutes the practical component of the problem and pertains to an item that is much less problematical from a theoretical point of view, i.e. the dictum of the structure of the Linnean hierarchy. This dictum is unescapable if mutual consistency for cladogram, phylogenetic tree, and classification is to be maintained.

This dilemma between what is theoretically accurate and practically feasible is most urgently felt in the second step of the analysis. If we adhere to a very stringent relation between character states and cladogenetic units, e.g. by application of a partially monothetic definition of clada, the combinatorial possibilities for in- and exclusion relations among these clada will be less numerous than when a strictly monothetic definition or, even worse, a polythetic definition is applied, irrespective of the (homoplaseous) complexity of the data. The latter aspect contributes independently to the combinatorial possibilities for in- and exclusion. The more contradictory distributions of character states, the more complex and numerous these possibilities are. Somewhere we have to strike a balance in order not to be overwhelmed by computational burden. The possibility of a huge computational load of the problem is caused by the fact that the search for sets of mutually in- or excluding clada is intractable (the clique problem in graph-theory is NP-complete), just like other approaches to phylogeny reconstruction are (e.g. the Steiner point problem in graph-



theory).

The balance can only be struck right if the available possibilities for clada recognition present enough gradations. In order to fill the gap between a partially and a strictly monothetic definition of clada with respect to their number and combinatorial possibilities, an option is included to enhance the data matrix with all additive binary codings possible for each character on the basis of neutral coding. Inclusion of all possible additive codings precludes the dominance of a particular order in a transformation series. In this way, one of the initial conditions of the method (avoidance of apriorism) is maintained, although from the point of view of the present implementation of algorithms, the analysis can also very well be performed on a fully or mixed aprioristic data base.

#### 6.7.4. Ad step 4: cladograms

One of the updates in this section concerns the implementation of cladogram optimization according to Farris (1970). This was done to achieve full comparability of results of our method with results as published in the literature.

Another update refers to the way homoplasies are counted within a block of homologues. So far, the state showing the highest number of homoplasies was discarded because it was considered plesiomorphous as a first guess. This handling is considered premature and inappropriate, and is now omitted and replaced by two different options.

In the first option, the number of parameter changes (0 $\rightarrow$ 1; 1 $\rightarrow$ 0) are counted as if the states are independent. The sum of these parameter changes for each state is then a record of the number of steps needed to explain the distribution of states in the cladogram. In the second option, the states are considered as interdependent within each block of homologues (character). As a consequence, reversals (0 $\rightarrow$ 1 $\rightarrow$ 0; 1 $\rightarrow$ 0 $\rightarrow$ 1) occurring in one column of a block are no longer considered as they appear as one-step gains or losses on other columns in the same block and are recorded there as a regular parameter change. In this way the sum of the number of parameter changes occurring in each block corresponds with the number of evolutionary steps among homologues.

These two options with their different interpretations are both implemented because the character states included in the data matrix may comprise a mixture of plesiomorphous and apomorphous ones. If only apomorphous states (resulting from a global outgroup comparison) are included, or if apomorphous states are strictly coded as 1 and plesiomorphous ones as 0, the first option would suffice to calculate all steps leading to the apomorphous states, as they will correspond to all steps needed to explain the distribution of states in the cladogram. In such a case, the size of the blocks with homologues is always 1.

The last update now included in the method concerns the implementation of an algorithm for 3-cladon-statement permutations conjoining local outgroup comparisons. Local outgroup comparisons (i.e. comparisons at all levels of universality in the cladogram) are preferred over one global comparison (i.e. a comparison restricted to one or more putative sister groups of the taxon under analysis), because the latter can be deceiving in case of characters with more than two states.

The algorithm evaluates for each cladogram all character states as to their possible synapomorphous status, including those with multiple origins (events of homoplasy by definition). The results are used to optimize the criterion value of contradiction (multiple origins and/or reversals) minus

support (single origins).

In the original formulation of the algorithm (Zandee, 1984), it was applied in an exhaustive search for all valid 3-cladon-statements in terms of synapomorphies, using all clada as input. In the present computationally more efficient implementation, it is used to check the validity of all 3-cladon-statements in each cladogram found, i.e. per cladogram only the clada for that cladogram are used as input.

## 7. CLADISTIC ANALYSIS OF THE DRYNARIOIDEAE (Co-author: M. ZANDEE)

### 7.1. Datamatrix

The initial taxonomic work followed by character analyses resulted in a data matrix comprising 31 terminal clada and 557 different character states (Table 5.1; Appendix 1, 2). Eventually, two of the terminal clada (nos. 17 and 20) have not been accepted as evolutionary species. The different states recognized are not to be considered of equal biological weight, although within the domain of cladistic analysis they are treated as on equal footing. There are differences among the characters studied regarding structural complexity, and the different states are not all equally distinct. However, no character(state)s have been discarded or weighted otherwise a priori; they were judged according to their position in the hierarchical order. Therefore, (almost) all observations and morphological details are incorporated in the data matrix.

### 7.2. Cladistic analysis of the Drynarioideae

From the data matrix, 501 partially monothetic sets can be read off. The far greater number of these sets are characterized by one character state. The species of relatively few sets share 2--4 states (Appendix 3). This result indicates many conflicting character state distributions.

It is possible to decrease the amount of conflicts, and thus of possible phylogenetic relationships, by a priori character weighting. This has not been done for two reasons. First, the supporting character state(s) of each group should be judged according to its position in the hierarchical pattern. Second, it is now possible to find unexpected groups in the resulting cladograms that otherwise would have been discarded from the beginning. Especially when these groups are supported by several, instead of one, 'weak' character states, they must be taken into consideration. Moreover, these 'weak' character states could possibly serve to solve polytomies for which otherwise no solution can be found. However, many partially monothetic sets are defined by only a single unique character state. Thus, the character states regarded to be rather weak also show conflicting distribution patterns.

The maximum cliques comprise 23 internal nodes and 9 terminal taxa. Only 9 of the 31 terminal taxa can be partially monothetically defined. Most of them are characterized by unique combinations of character states (i.e. as strictly monothetic sets) instead of by unique separate character states. The search procedure for cliques is NP-complete. Therefore, the search was stopped when it was expected that at least all relevant cliques were found, i.e. when 416 different cliques of the maximum size were discovered. As the maximum clique size found (32) is less than the necessary number of internal nodes ( $N-1 = 30$ ) together with the number of partially monothetically defined terminal taxa available (9), the resulting cladograms show several polytomies. Cladograms have been selected according to their degree of support and contradiction followed by an evaluation of their respective biological implications, i.e. a judgement of their supporting character states and implied homoplasies. The cladograms selected are interpreted, and the result serves as a framework for a continued cladistic analysis at lower hierarchical levels.

It needs to be stressed that this evaluation is necessary to obtain a biological interpretation and judgement of all hierarchical levels of the

alternative cladograms. It is not a search for the confirmation of groups determined a priori and intuitively perceived. For example, the grouping of the two monomorphic *Aglaomorpha* species (nos. 23 and 24) with the group of species nos. 1--5 is surprising and interesting. Nevertheless, they are rejected because of their weak support, and the homoplasious developments they imply for structurally very complex character states pertaining to the rhizome anatomy, growth habit, etc. It is also important to note that the judgement of cladograms according to their value of contradiction minus support is in principle only possible when cladograms with an equal number of internal nodes are compared.

As regards the cladograms based on these 416 cliques, the number of fitting character states varies from 65--74, the amount of fit via reversal from 7--13, the number of homoplasious developments from 1373--1480, and the amount of pseudo-fit from 4--8. This leads to overall values of contradiction (homoplasies and pseudo-fit) minus support (fit and fit via reversal) varying from 1300--1409. So, there exists considerable variation among the different cladograms. Each of the low values 1300, 1301, and 1302, is found for only one cladogram. As such small differences cannot be considered to be significant when compared to the overall variation trees with a value less than 1310 have been selected for further investigation. Anyway, it is not possible to evaluate all possible cladograms.

The selected cladograms all share the group of species nos. 1--5, of species nos. 20--22, and of species nos. 27--31. Species nos. 6--10 is present as a group in all but one cladogram. None of these groups have been recognized or given taxonomic rank by pteridologists in the past. These four groups are regarded as indisputable. A judgement of their respective supporting character states does not give a reason for their rejection from a biological point of view. This topic will be discussed later on.

Other groups which are regularly found include species nos. 11--16, nos. 20--22 + 25, 17 + 18, 1--5 + 23 (all present in the greater part of the cladograms, missing from 3 to 8 of the + 50 cladograms selected), and species nos. 1--5 + 23 + 24, nos. 1--16 + 23 + 24, and nos. 17--22 + 25--31 (all present in 20--25 of the cladograms).

In the following steps, the cladograms selected in the second term are evaluated. This is done by testing the supporting character states using outgroup comparison as well as applying biological criteria. In the cladogram showing the lowest value (1300; Fig. 7.1), the group of species no. 24 with species nos. 1--5 + 23 is based on character state no. 89, i.e. the sori being slightly pustulate. However, re-checking the outcomes of the character analyses, there appeared to be no structural difference between pustulate sori and slightly pustulate sori. Therefore, the group of species nos. 1--5 + 23 + 24 is rejected, resulting in a polytomy of species nos. 1--5 + 23, nos. 6--10, nos. 11--16, and no. 24 (Fig. 7.2). The basal node is defined by the character states no. 60 (species nos. 1--16 + 23 + 24) and nos. 11, 62, and 106 (species nos. 17--22 + 25--31) respectively. The states nos. 60 and 62, each defining a different branch of the node are considered complements. Outgroup comparison with other *Polypodiaceae* shows that state no. 60 is plesiomorphous. Therefore, the group comprising species nos. 1--16 + 23 + 24 is rejected, creating a polytomy. The other group is still supported by three character states of which nos. 62 and 106 are structurally dependant. The breakdown of the basal dichotomies leads to a basal polytomy comprising the groups of species nos. 1--5 + 23, nos. 6--10, nos. 11--16, no. 24, and nos. 17--22 + 25--31 (Fig. 7.3).

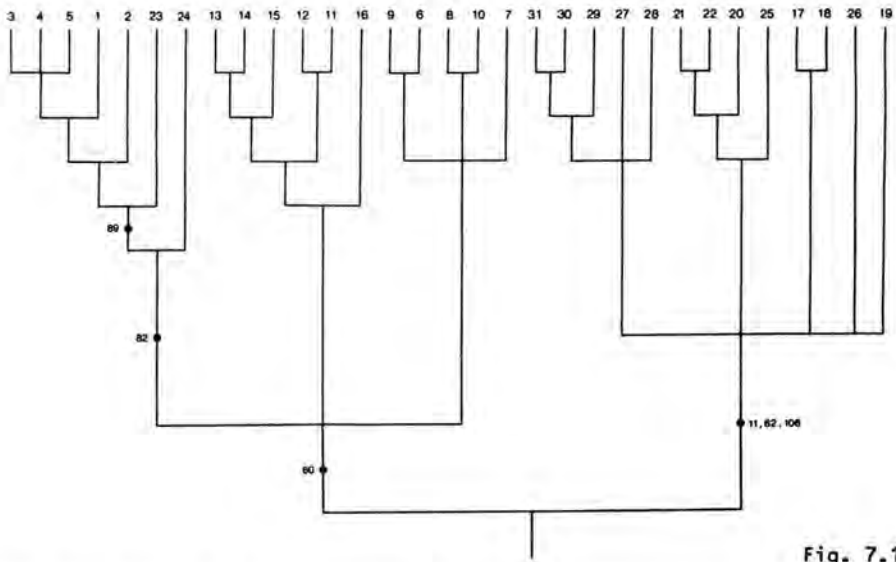

Fig. 7.1

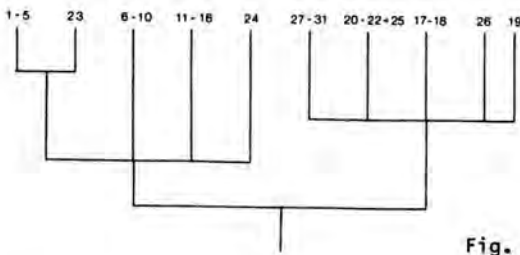

Fig. 7.2

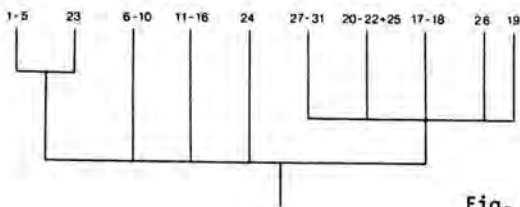

Fig. 7.3

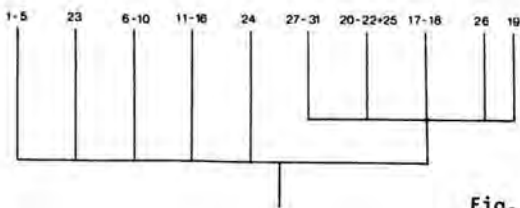

Fig. 7.4

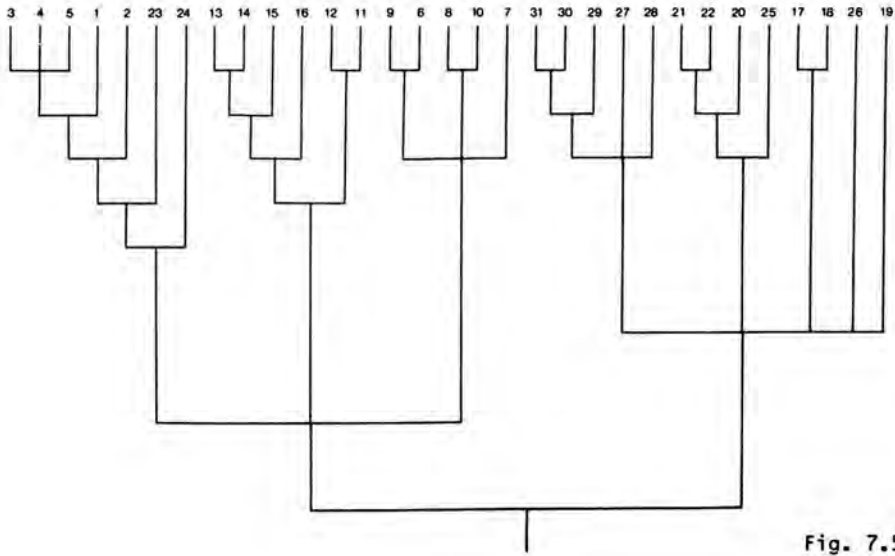

Fig. 7.5

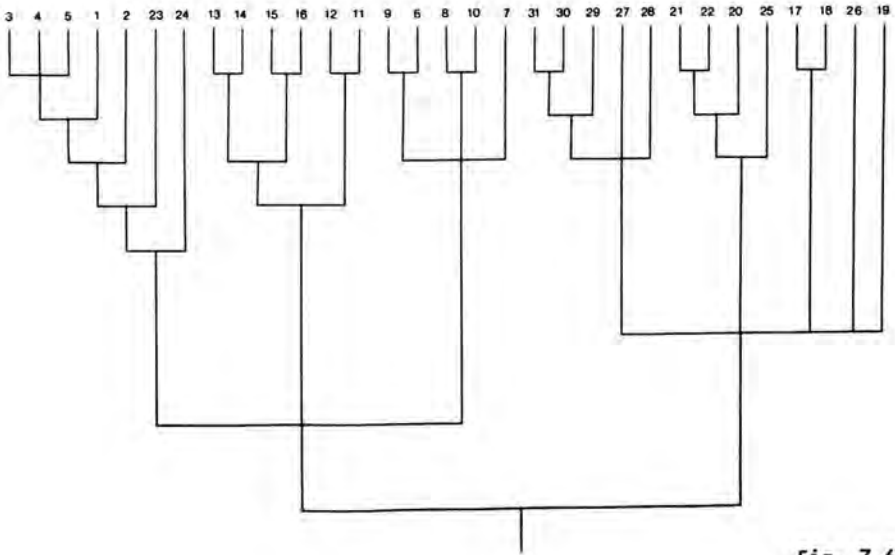

Fig. 7.6

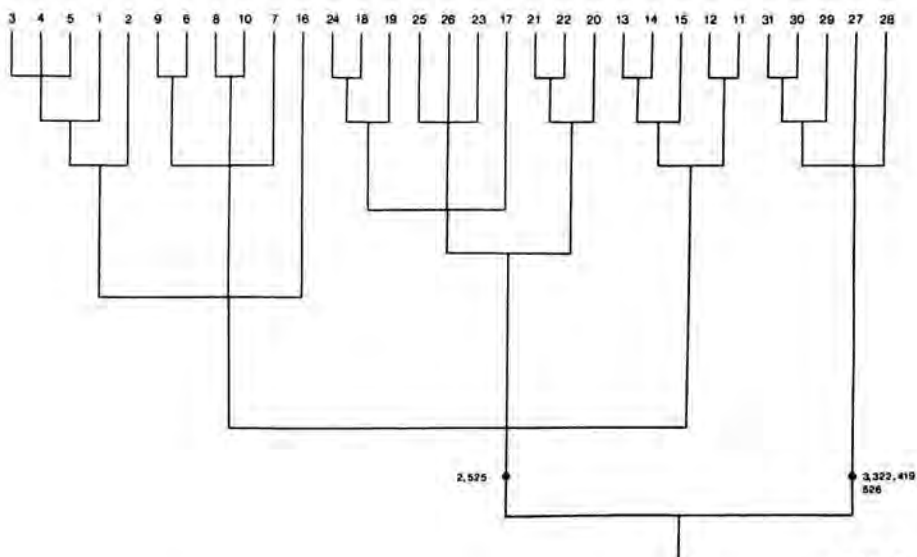

Fig.7.7

The sole defining character state of the group of species nos. 1--5 + 23 is the position of sori being situated relatively close to the Vs (state no. 82). However, this similarity is a doubtful hypothesis of homology in view of differences in correlated characters (i.e. number of sori per A1, number of rows of sori parallel to each Vs, shape of sori, and venation pattern of fertile pinnae). Therefore, this group seems only weakly supported and is at first instance rejected. This rejection is plausible also in view of the otherwise implied homoplasious developments of other, structurally more complex characters (e.g. rhizome anatomy). This results in a basal polytomy of six groups, of which the supporting character states are indisputable (Fig. 7.4).

Similar reasonings can be given for the other cladograms, e.g. the second and third best cladograms (Fig. 7.5 and 7.6; values 1301 resp. 1302), which are different regarding the configuration of the 'subtree' of species nos. 11--16. Essentially different from these cladograms is the one given in Fig. 7.7 (value 1309). The basal dichotomy is here defined by the mutually independent character states nos. 3, 322, 419, and 526 (species nos. 27--31), and nos. 2 and 525 (species nos. 1--26). States nos. 2 and 525 are considered complements of nos. 3 and 526 respectively. Outgroup comparison with other *Polypodiaceae* shows that the latter two character states should be interpreted as apomorphic and the first two as plesiomorphous. As a consequence, the basal dichotomy is broken down and a polytomy of four groups remains. These four groups are as yet indisputed.

Neither *Drynaria* nor *Aglaomorpha* (as presently understood) represent a partially monothetic set. Therefore, they are absent in the evaluated cladograms. This is, for example, due to the absence of base fronds in species no. 12 (all other *Drynaria* species show frond dimorphism of base and foliage fronds), and the absence of (internal) fertile/sterile dimorphism in species nos. 23 and 24 or the absence of a dilated frond base in species nos. 27--31.

Species no. 12 is in all cladograms grouped together with species no. 11, and nearly always in a group of species nos. 11--16, thus with Drynaria species. Using outgroup comparison, the absence of base fronds must be interpreted as an apomorphy. As a consequence, species nos. 1--16 share the presence of base fronds (including a reduction in no. 12). Outgroup comparison with other groups of Polypodiaceae shows that the base fronds are a unique feature and thus regarded to represent a synapomorphy for these species.

The situation regarding Aglaomorpha is more complex. The most common group, species 17--22 + 25--31, is characterized by the fertile-sterile dimorphism (state no. 119). Species nos. 17--19, 25, and 26, exhibit a very characteristic growth habit (state no. 418) that they share with species nos. 23 and 24. Furthermore, these seven species share with species nos. 20--22) a complex and distinct rhizome anatomy (state no. 387) and the presence of a dilated frond base (state no. 98). The first two character states are absent in other Polypodiaceae. Therefore, these character states define two compatible partially monothetic sets (i.e. species nos. 17--19 + 23--26 respectively nos. 17--26) and consequently, they represent two apomorphies. However, these sets are overlapping with the set of species nos. 17--22 + 25--31 defined by state no. 119. Homoplasious development for state no. 119 is considered more probable than homoplasious developments of both the state nos. 387 and 418. Therefore, species nos. 17--31 are regarded holophyletic, supported by state no. 119 assuming reversals in species nos. 23 and 24.

The absence of fronds with a dilated base in species nos. 27--31 is an apomorphy according to the cladogram. Consequently, a dilated frond base (present in the species nos. 17--26) is a similarity of and possibly a synapomorphy for all species of the genus. However, outgroup comparison with other Polypodiaceae shows that in case Microsorium species (e.g. M. musifolium) represent the sister group of the drynarioids, the dilated frond base is a symplesiomorphy for Aglaomorpha. The sister group relation between the microsoroids and the drynarioids has been proposed by several authors (e.g. Copeland, 1947; Holttum, 1954; Pichi Sermolli, 1977) just because of the dilated frond base. However, analyses of amongst other things (see Chapter 9) the venation pattern of polypodiaceous ferns (Mitsuta, in press; Hettterscheid, pers. comm.) may point to other groups of Polypodiaceae representing the sister group (e.g. Crypsinus species, Goniophlebium species). In these cases, the dilated frond base is to be regarded a synapomorphy of the Aglaomorpha species and homoplasious to the dilated base in Microsorium species. On the other hand, base fronds of Drynaria are usually similar in structure and shape to the dilated basal parts of the fronds of Aglaomorpha. Furthermore, juvenile plants of e.g. species nos. 1, 6, and 8 cultivated in the botanic gardens at Utrecht, sometimes show sessile foliage fronds with a dilated base similar to that found in juvenile plants of e.g. species no. 25. Similar phenomena have been described by Zamora & Vargas (1973a) for species nos. 2 and 10. Also, sterile (and juvenile?) fronds of herbarium specimens of species nos. 24, 25, and 26 have the appearance of an elongated base frond similar to Drynaria species. For these reasons, the hypothesis that the dilated fronds base might represent a plesiomorphy within the drynarioids is suggested.

The holophyly of Aglaomorpha is probably further supported by, for example, the presence of hydathodes (state no. 13), implying a homoplasious development in two Drynaria species (nos. 9 and 16) according to the cladogram.

Following this reasoning and incorporating biological inferences, the drynarioids comprise two holophyletic groups, i.e. Aglaomorpha and Drynaria. It appears that a great many character states can be found in species of one



of these two groups only. Many of the character states unique for Drynaria species pertain to the base fronds. But apart from the base fronds, both groups have about an equal number of 'unique' character states. For both groups, a large part of the latter pertain to the venation pattern and frond shape, whereas Aglaomorpha has a relatively large number of unique states in the sori and the frond anatomy and Drynaria of the indument.

### 7.3. Cladistic analysis of Aglaomorpha

At this stage, the cladograms comprising all 31 species still show a number of polytomies. To get an higher degree of resolution, the cladistic analysis has been repeated separately for the two genera. When both genera are treated separately, new partially monothetic groups of terminal taxa appear which are not present in the overall analysis. This is due to the fact that for a character state to be called unique, it now suffices to be unique for one of the two genera only, instead of for both genera taken together.

Apart from the set of all 15 terminal taxa, the analysis of Aglaomorpha resulted in 262 partially monothetic sets (Appendix 4). Compared to the overall analysis, many sets are now defined by 2 or more character states, the maximum being 9. For these 262 sets, a total of 1128 cliques comprising 28 nodes have been discovered, i.e. 14 internal nodes, and 14 terminal clada. Only one terminal cladon (i.e. no. 20) cannot be defined partially monothetically.

The resulting cladograms are all resolved dichotomously. The number of supporting character states varies from 199--218 (Fig. 6.7), the amount of fit via reversal from 12--27 (Fig. 6.8), the number of homoplasies from 467--533 (Fig. 6.9), and the amount of pseudo-fit from 6--12 (Fig. 6.10). The overall measurements of contradiction minus support varies from 241--316 (Fig. 6.11). It was decided to select cladograms with values less than 258.

A perusal of the about 50 selected cladograms, judging their supporting character states, led to three biologically well-based groups comprising the species nos. 27--31, nos. 18 + 19 + 24, and nos. 20--22 respectively. A fourth group, comprising species nos. 23 + 25 + 26, is based on only one

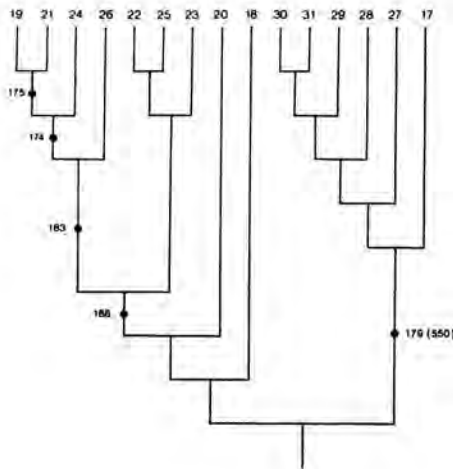

Fig. 7.8

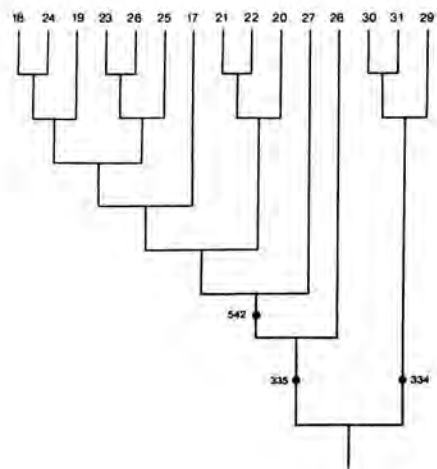

Fig. 7.9

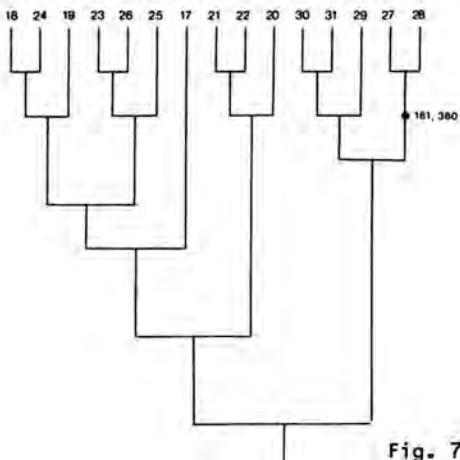

Fig. 7.10

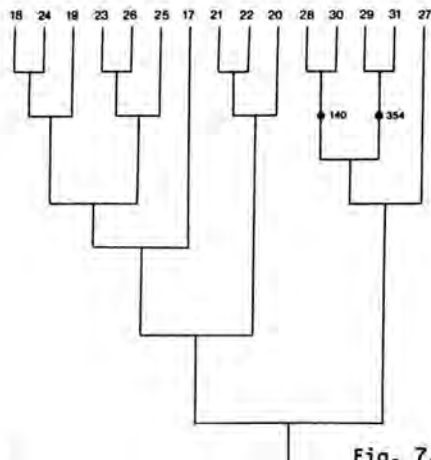

Fig. 7.11

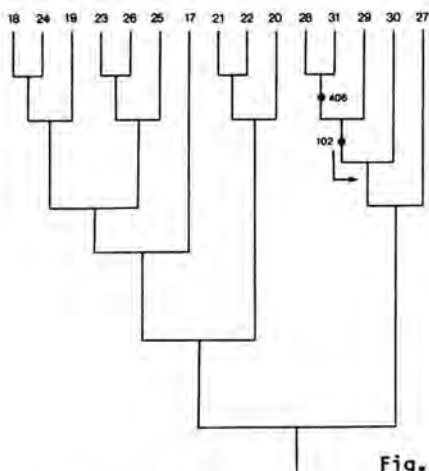

Fig. 7.12

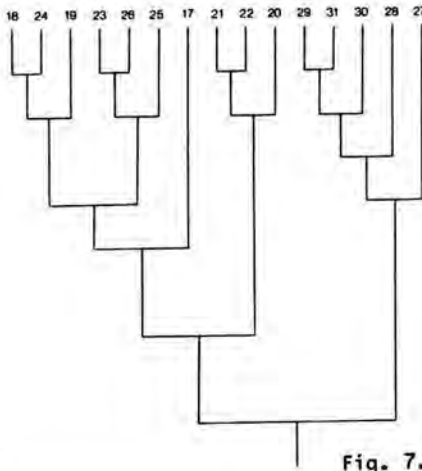

Fig. 7.13

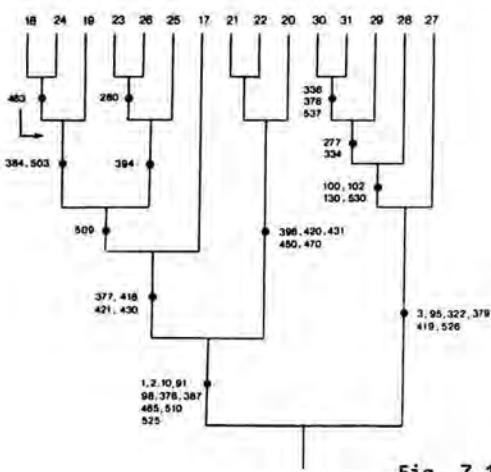

Fig. 7.14

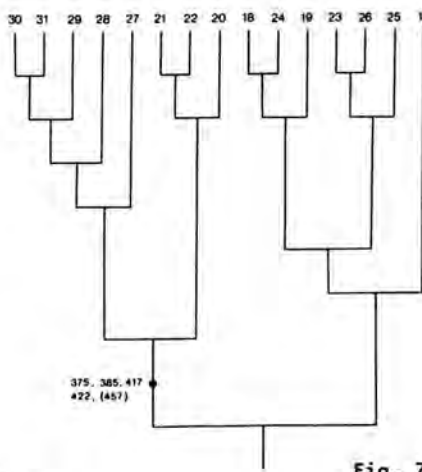

Fig. 7.15

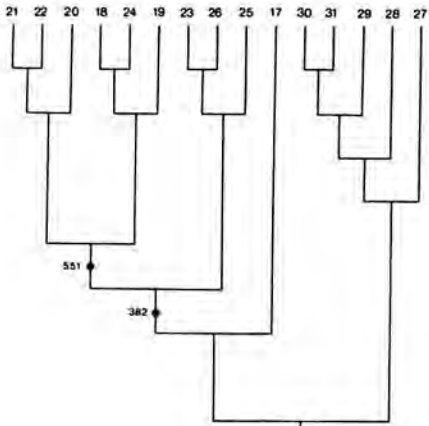

Fig. 7.16

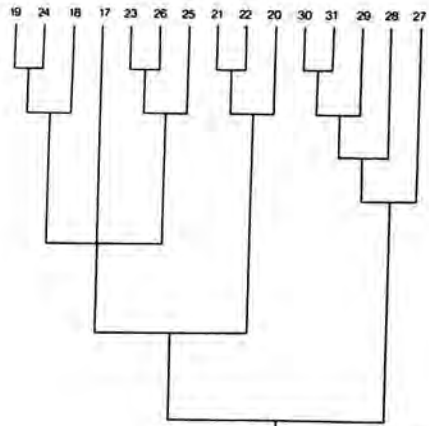

Fig. 7.17

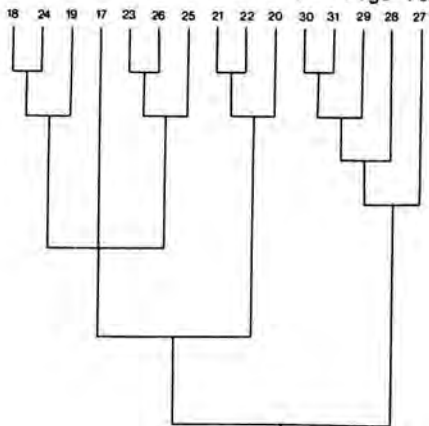

Fig. 7.18

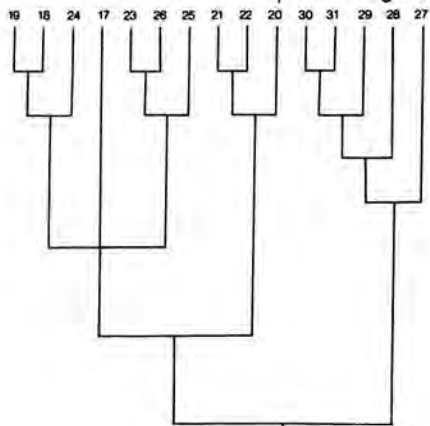

Fig. 7.19

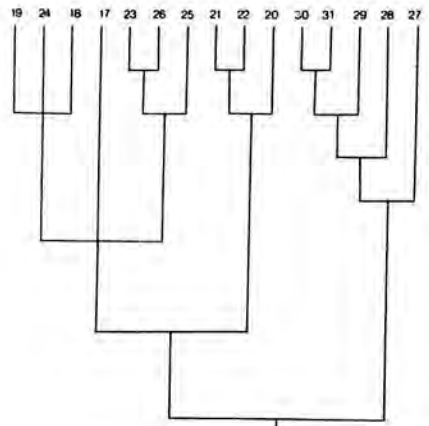

Fig. 7.20

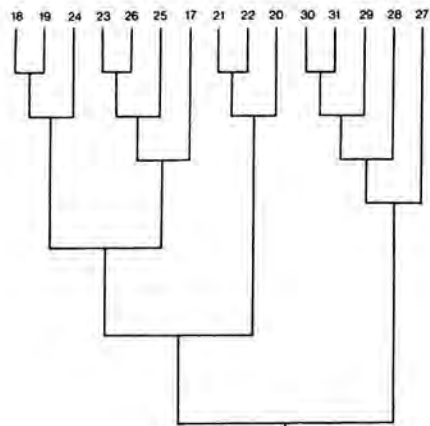

Fig. 7.21



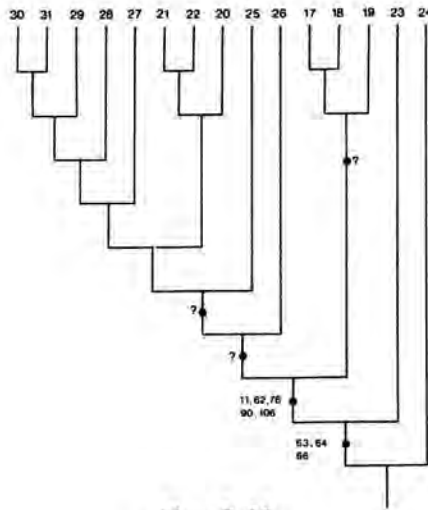

Fig. 7.28

weak character. However, alternative groups of these species found in the trees are also weakly based, apart from the conflicting implications they have for the three well-based groups.

A number of different possibilities are presented in Fig. 7.8--7.28. Cladogram 7.8 has the lowest value (241). The supporting character states of the groups of species nos. 19 + 21 (no. 175), 19 + 21 + 24 (no. 174), 19 + 21 + 24 + 26 (no. 183), and 19 + 21--26 (no. 188) all pertain to measurements of the sporangia. In view of the variation and overlap in these characters, and the lack of any further support, these groups have been rejected and, because other cladograms are supported by structurally more complex characters. The same reasoning holds for the group of species nos. 17 + 27--31 regarding its supporting character state based on the length of the sporangia (no. 179). This group is also supported by the presence of lignified cells around the point of attachment of the rhizome scales (no. 550). However, in claxon 17 this condition is only found rarely and is not different structurally from state 549.

Cladogram 7.9 (for which the value - 250 - is rather high), is essentially similar to the following cladograms, except for the position of species nos. 27 and 28. The group of species nos. 17--28 is characterized by the absence of a sporangial indument (state no. 335), whereas the group of species nos. 29--31 is defined by the complementary state (no. 334: the presence of an acicular sporangial indument). Outgroup comparison leads to the rejection of the group of species nos. 17--28 as it is based on a plesiomorphy. Species nos. 17--27 are grouped together by the presence of spreading scales (no. 542). Following the same reasoning this group is rejected. Most of the other selected cladograms have been rejected likewise. These two cases simply exemplify the way in which the cladograms have been judged and evaluated in a comparative way.

Cladograms 7.10--7.14 are similar to each other, except for the internal nodes of the subtree comprising species nos. 27--31. Of these, cladogram 7.14 shows the lowest value (245). This is one factor to favour this cladogram. An evaluation of the supporting character states of the several

possible subtrees makes its superiority even clearer. The support of species nos. 30 and 31 is based upon the sporangial indument being one-sided (state no. 336), 10--15 meristemes in the rhizome as shown in cross-section (no. 378), and the glandular indument of the rhizome scales being present near the base only (no. 537). The latter two conditions are of doubtful quality because they are based on a subdivision of a character into states, that eventually appeared not to be structurally different. However, the former state is clear-cut and qualitative. The putative sister group (species no. 29) shows a two-sided sporangial indument (state no. 337), whereas all other *Aglaomorpha* species lack sporangial indument. Using the outgroup rule shows that both the states 336 and 337 are to be regarded as apomorphic. Species 29--31 share a relatively high number of branched laminar hairs (state no. 277) and the presence of an acicular sporangial indument (no. 334). Although the first state seems to be based on a rather artificial subdivision, it is quite distinct in these three species. The latter state is a clear and unique feature. Of the supporting character states of species nos. 28--31, no. 100, (102), and no. 139 are biologically not significant. However, state no. 530, with elongated protuberances along the margin of rhizome scales, is very distinct. Therefore, there is no reason to reject this subtree.

In cladogram 7.10, the group of species nos. 27 + 28 is supported by the (occasional) presence of 2 epistomium cells (state no. 161), and the presence of glandular hairs on the laminar scales near the base only (no. 360). Both states are insignificant, either because of variation and overlap, or lack of a real structural difference.

In cladogram 7.11, the group of species nos. 28 + 30 is defined only by character state no. 140, i.e. frond incisions up to the costa. This condition does not differ from state no. 139. Based on character state no. 354 (short marginal protuberances along the margin of laminar scales), species nos. 29 + 31 form a set, also present in cladogram 7.13. In these two species, this state is poorly developed and therefore regarded insignificant compared to the supporting character states of cladogram 7.14.

Judging the supporting character states of cladogram 7.12, it appears that state no. 406 (the rhizome scales colouring blue when stained) defines the set of species nos. 28 and 31. This similarity is probably correlated with the age of the scales and as yet regarded as only weak support. Re-checking the outcomes of the character analyses, the supporting character state of the group of species nos. 28 + 29 + 31 (no. 102) was found in species no. 30 also. As a consequence, the 'subtree' for species nos. 27--31 as present in cladogram 7.14 is preferred.

The evaluation of the possible cladograms for *Aglaomorpha* as exemplified above, eventually gives three contenders (Fig. 7.14--7.16, values 245, 247, and 247 respectively). These cladograms all share the groups of species nos. 18 + 19 + 24, 23 + 25 + 26, 20--22, and 27--31. They differ regarding the position of species nos. 20--22. In tree 7.14, this group is the sister group of species nos. 17--19 + 23--26, sharing the character states nos. 1, 2, 10, 91, 98, 376, 465, 510, 525, and 387. Species 27--31 comprise the sister group of all these species, defined by states nos. 3, 95, 322, 379, 419, and 526. Among these, 1 + 2 + 3, 91 + 95, and 525 + 526 are considered complements, of which 1 + 2, 95, and 525 are plesiomorphies when applying the outgroup rule (*Drynaria* being the outgroup). The same holds for state no. 10, whereas nos. 91 and 98 are already dealt with in detail. Character state nos. 376 and 379 are subdivisions of a continuous and a metric character. Due to variation within this group and overlap with other *Aglaomorpha* species, it is insignificant evidence. For similar reasons, states nos. 465 and 510 are ignored at this level. Character state no. 387 (see explanation in Chapter 6) is distinct and unique, and is regarded as significant. In conclusion, the subdivision presented in this cladogram,

based on character states nos. 91, 98, and 387 on the one hand, and nos. 3, 322, and 526 on the other hand, is regarded biologically relevant. The same holds for cladogram 7.16.

The group of species nos. 17--19 + 23--26 is supported by character states nos. 377, 418, 421, and 430. Also, state no. 377 represents a category of the same continuous character (cross-section of the rhizome) as does no. 376 (see above). However, in this case the state is quite distinct representing an extreme almost without overlap, and therefore regarded as good evidence. State no. 418 is unique within the Polypodiaceae and biologically significant. Regarding the states nos. 421 and 430, see the discussion above of the holophyly of Aglaomorpha. Moreover, species nos. 20--22 share state no. 431, the complement of no. 430. The first state is apomorphous.

In cladogram 7.16, species nos. 20--22 and species nos. 18 + 19 + 24 are adelpho taxa, sharing character state no. 551, i.e. the presence of a midrib in the rhizome scales. This is a clear qualitative condition, and the cladogram is accepted for the time being.

Cladogram 7.15 presents species nos. 27--31 and nos. 20--22 as adelpho taxa, the outgroup comprising species nos. 17--19 + 23--26. This node is supported by character states nos. 375, 385, 417, 422, and 457, respectively nos. 377, 418, 421, and 430. Regarding the complements 375 and 377, only the latter is really distinct. No. 375 however, is usually present in species showing variation. Of the complementary states nos. 417 and 418, the uniqueness of no. 418 has just been discussed. States nos. 421 and 422 are more difficult to interpret, although outgroup comparison with Drynaria shows that no. 422 is apomorphous. The group comprising species nos. 20--22 + 27--31 is further supported by state nos. 385 (a condition found in Drynaria species also) and 457 (a unique condition within the drynarioids). The group of species nos. 17--19 + 23--26 is further supported by state no. 430, a condition present in the base fronds of all Drynaria species. In conclusion, the relevant support of this basal node consists of character state nos. 422 and 457 respectively nos. 377 and 418, and this cladogram is accepted.

The analysis of Aglaomorpha results in a choice for three cladogram possibilities, all apparently biologically significant. However, a final check of these cladograms led to two alterations. First, the supporting character state of species nos. 18 + 24 within the group of species nos. 18 + 19 + 24 (i.e. based on state no. 463) appeared to be present in species no. 19 also. On the one hand, this further supports the set comprising these three species. On the other hand, it reduces the two dichotomies to a trichotomy. For further investigations, all four possible hypotheses for this 3-cladon-problem have been taken into account, as the data matrix does not include supporting character state distributions allowing a 3-cladon-statement. The second alteration regards cladon no. 17. In cladogram 7.14 and 7.15 it is the sister group of species nos. 18 + 19 + 23--26. The latter group is characterized by state no. 509, which is eventually not considered structurally different from no. 510 and consequently irrelevant. The same holds for the node in cladogram 7.16 based on state no. 382, dividing cladon no. 17 from species nos. 18--26. In these two different 3-cladon-problems also, the four possible hypotheses have been taken into consideration.

#### 7.4. Cladistic analysis of *Drynaria*

The analysis of *Drynaria* resulted in the recognition of 361 partially monothetic sets (Appendix 5), of which quite a number of subgroups are characterized by 2--5 character states. These partially monothetic sets have been ordered into 3062 maximum cliques. However, the search procedure has not been completed and thus not all possible cliques have been examined as yet. Nevertheless, it was not regarded useful at this stage to make a more exhaustive search. The cladograms presenting the cliques already show all possible permutations among the main groups (i.e. species nos. 1--5, nos. 6--9, nos. 11 + 12, and nos. 13--15). The species within the groups comprising species nos. 6--9 and nos. 13--15, as well as of nos. 10 and 16 also show all possible permutations in the cladograms, given the possibilities determined by a partially monothetic definition of groups. Within the group of species nos. 1--5, three relevant hypotheses are possible of which only one is present in the 3062 cliques. Generating all possible cliques, including the different permutations among species nos. 1--5, would multiply the total number of cliques by a factor 3 or more, not to mention the necessary computer time. This is because each configuration of species nos. 1--5 has to be incorporated in all 3062 cliques found so far and each will yield 3062 slightly different cliques. This is regarded as unnecessary, because the relative sequence and differences in value between the three relevant permutations of species nos. 1--5 remain the same in the possible cladograms of the main groups. Therefore, in the cladograms selected out of the 3062 cliques found to be showing the lowest value of contradiction minus support as well as the biologically most significant support, the relevant permutations of species nos. 1--5 have been incorporated by hand. The number of fitting character states varies from 138--156, the amount of fit via reversal 14--27, the number of homoplasious developments from 600--721, and the amount of pseudo-fit from 8--13. This leads to overall values of 426--574, those with less than 441 being selected.

A perusal of the about 50 selected cladograms, shows that only a number of groups are biologically significant, i.e. species nos. 1--5 (also present in the overall analysis), nos. 6--9, nos. 13--15, and nos. 10--12. Species no. 16 assumes several different positions in these cladograms, also as the sister group of species no. 15 within the group of species nos. 13--16, which contradicts the group of species nos. 13--15.

The cladogram with the lowest value (426) is given in Fig. 7.29. This cladogram is nearly identical with cladogram 7.30 (with a value of 430), except for the internal nodes of species nos. 13--15. The group comprising species nos. 14 + 15 is supported by character state no. 240, a state not really different from state no. 241, and more or less correlated with small-sized base fronds. The support of species group 13 + 14 consists of character states nos. 127 and 288. The first one is clear, distinct and unique. The latter is a metric character, difficult to interpret because of overlap and variation. Nevertheless, the species pair nos. 13 + 14 is regarded better supported than the alternative species pair nos. 14 + 15.

The supporting character states of the other internal nodes of these two cladograms are all biologically significant. The sets of species nos. 1--5 and nos. 6--16 are characterized by states nos. 79, 82, 86, 89, and 298, and nos. 77, 84, 85, 297, and 436 respectively. States nos 79 and 77 are complements (no. 77 showing one exception in species no. 16 which possesses no. 78, a clear autapomorphy). Both states are absent in the outgroup *Aglomorpha*. At this time, there is no reason to reject one of the two states as being apomorphic and thus, both are accepted. Character states nos. 82 + 86 and 84 + 85 also pertain to the sorus position, and the same



reasoning can be made here as for no. 82 above. Character state 89 has been dealt with already, and of the complements nos. 297 and 298 it is difficult to establish a transformation series at this stage. In conclusion, the two groups are both well-based so far.

Within the group of species nos. 6--16, the first node divides species 6--9 from nos. 10--16 based on character states nos. 244 and 343, and no. 19 respectively. The latter is a clear and obvious, unique state. State 244 pertaining to the venation of the base fronds is difficult to interpret and after checking it appeared that there is no clear distinction from state no. 242. But state no. 343 is a unique, qualitative condition and therefore, these two groups are both well characterized. The species nos. 10--12 are characterized by very peculiar, long, and slender paraphyses (character states nos. 295, 296, 307, 311, and 314), whereas really superficial sori (state no. 88) characterize species nos. 13--16.

Within the group of species nos. 6--9, two different configurations are supported, i.e. a sister species relation between nos. 8 and 9 (cladogram 7.30), or between nos. 6 and 9 (cladogram 7.31). The first pair is supported by two character states, nos. 448 and 483. The second species pair is supported by character state no. 256 which is regarded as only weak support. State no. 483 is also regarded weak evidence, but state no. 448 indicates a structural similarity related to the tendency of the fertile pinnae being slightly contracted compared to the sterile pinnae. Species nos. 8 and 9 may also show a similar growth habit (state no. 416; see Chapter 6), which would further support this sister group relation (all cladograms generated imply a homoplasy for this character state in species no. 10). Therefore, the pair of species nos. 8 and 9 is preferred compared with the alternative group of species nos. 6 and 9.

Cladogram 7.32 shows another alternative for species nos. 13--16, i.e. nos. 15 and 16 as adelpho taxa. The set of these two species is defined by character states nos. 217 and 453. In view of the variation, no. 217 is rejected as a relevant supporting character state. As regards state no. 453, the supposed similarity appeared to be absent when checked. Therefore, this possibility is rejected in favour of the group of species nos. 13--15 defined by states nos. 268, 404, and 549. The first state pertains to an unique shape of the base fronds (although species no. 13 shows some

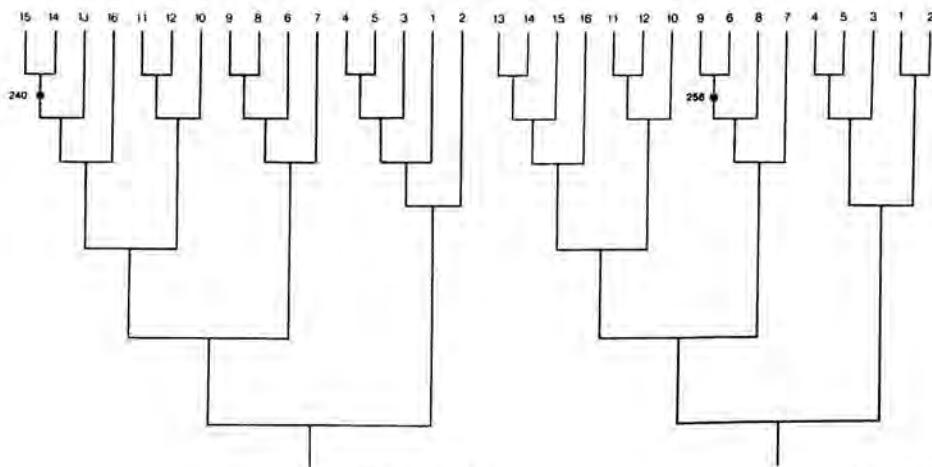

Fig. 7.29

Fig. 7.30

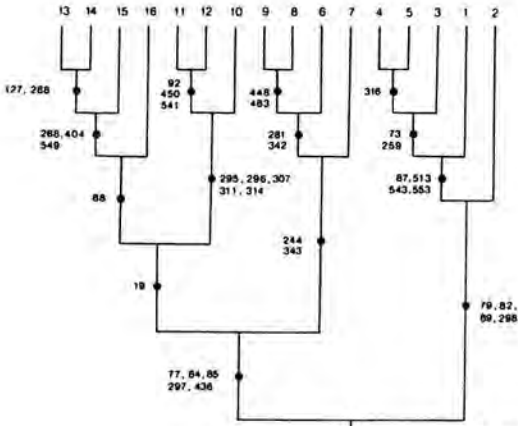

Fig. 7.31

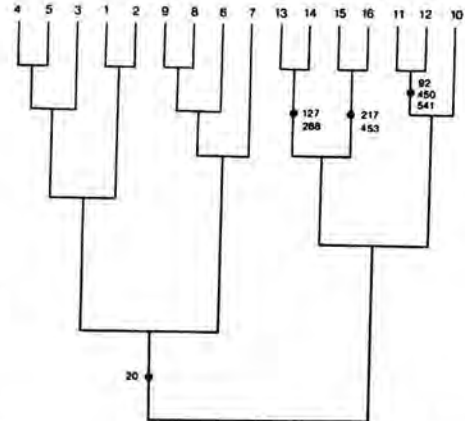

Fig. 7.32

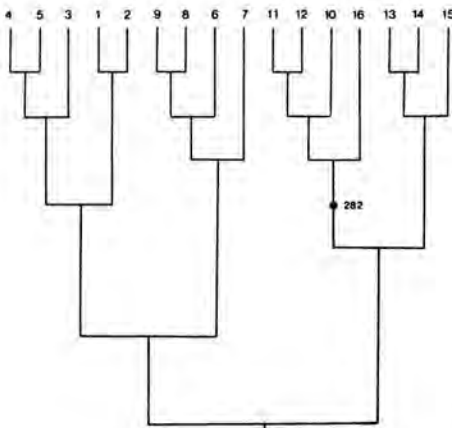

Fig. 7.33

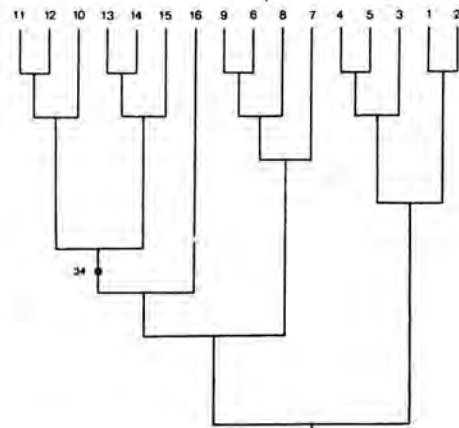

Fig. 7.34

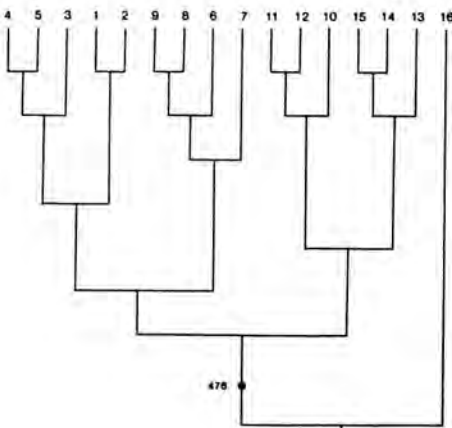

Fig. 7.35

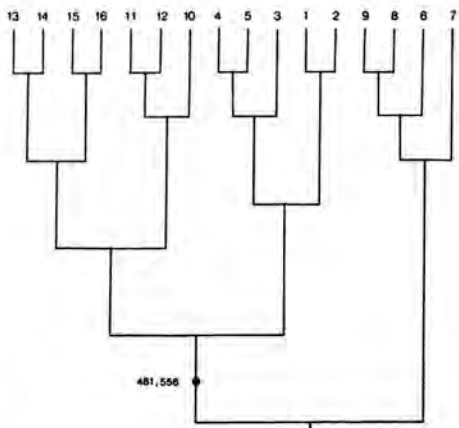

Fig. 7.36

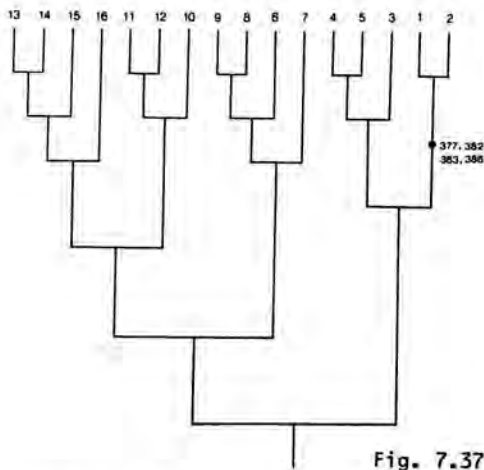

Fig. 7.37

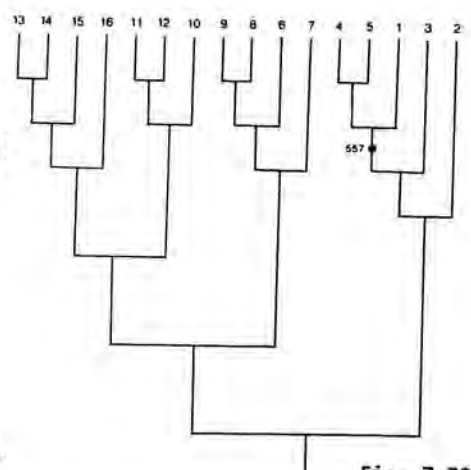

Fig. 7.38

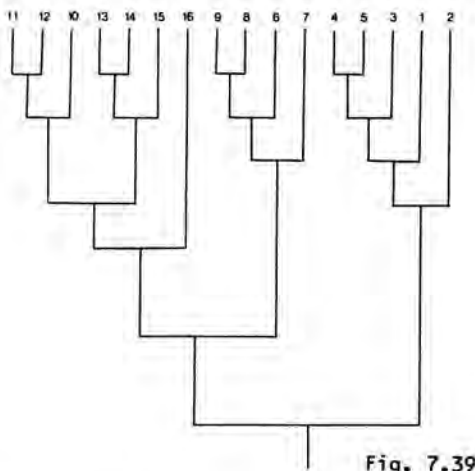

Fig. 7.39

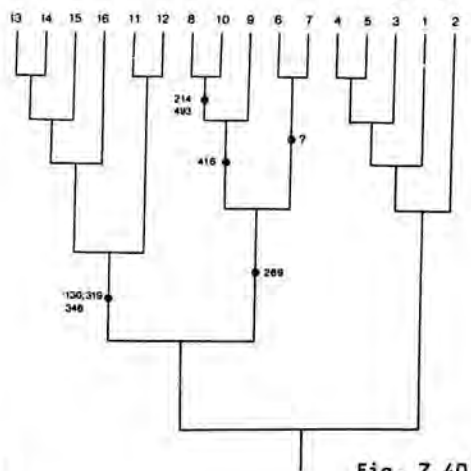

Fig. 7.40

variation in small-sized base fronds). The second one indicates the peculiar attachment of the rhizome scales on small triangular protrusions instead of the stalk being inserted in clear invaginations on the rhizome (state no. 403). The last state (absence of lignified cells in the rhizome scales) is apomorphic according to the outgroup rule, although it is present in a few *Aglaomorpha* species as parallelism.

Cladogram 7.32 further shows the group of species nos. 1--5 together with species nos. 6--9, supported by state no. 20. Its complement no. 19 defines the other main group of species nos. 10--16. Outgroup comparison shows that no. 20 represents the plesiomorphous condition and the group of species nos. 1--9 is thus rejected.

Most of the alternative cladograms of *Drynaria* mutually differ in the position of species no. 16 and of nos. 6--9. In Fig. 7.33, species no. 16 is grouped with species nos. 10--12. This is based on character state no. 282 (relatively many branched receptacular paraphyses). However, the structural differences between the paraphyses of species nos. 10--12 and those of

species no. 16 are large (see for instance state no. 340), and it is doubted on morphological grounds whether they could represent a synapomorphy.

Species nos. 10--15 form a set in cladogram 7.34 defined by character state no. 34. This state is unique and distinct within the drynarioids, and therefore this cladogram is also selected for further investigation.

In cladogram 7.35, species no. 16 is the sister species of species nos. 1--15. The latter group is defined by character state no. 476 which is also present in all *Aglaomorpha* species. Therefore, it represents a plesiomorphy and this basal node is rejected. Another possibility turned out to be species nos. 1--5 + 10--16 and nos. 6--9 representing adelpho taxa (cladogram 7.36). The supporting character states of the first group are nos. 481 and 556, i.e. the sori with 1--2 supporting veins in cross-section and the apex of the rhizome scales being acute respectively. However, for both characters the distinction between the several complements is considered not to be of structural significance. Therefore, compared to cladograms 7.30 and 7.34, this cladogram is irrelevant.

Three different relevant hypotheses of species nos. 1--5, are presented in cladograms 7.30, 7.37, and 7.38. Cladograms with the second topology, i.e. species no. 1 and nos. 3--5 representing adelpho taxa, always show the lowest values. Furthermore, the supporting character states of this hypothesis are regarded biologically more significant compared to those of the other hypotheses which are also intuitively plausible. The support of the second pertains to a state of the sorus (no. 87) and to (conspicuously distinct) states of the rhizome scales, whereas the support of the first pertains to the size of the rhizome for which species no. 1 and 2 show much variation. The third is supported by one state only (no. 557), for which species no. 3 is however not structurally different. This reasoning results in the choice of cladograms 7.30, 7.34, 7.37, and 7.39 for further investigation.

#### 7.5. Choice of the cladogram of the Drynarioideae

To the cladograms selected in the previous analyses of each of the two recognized genera, one cladogram is added for each of the two genera (i.e. Fig. 7.28 and 7.40). These latter cladograms present the intuitive impression of phylogenetic relations perceived during character analysis. Surprisingly, the 'intuitive' cladogram of *Aglaomorpha* (7.28) has a value that is 10 lower than that of the 'best' cladogram (7.19) resulting from the cladistic analysis. It is not present in the set of cladistically constructed cladograms as for the two internal nodes no support is present in the data matrix. Cladogram 7.40 presents intuitive ideas about the most likely phylogeny of *Drynaria*. The situation in *Drynaria* was found to be more complex than that in *Aglaomorpha*, in that several cladograms seemed equally plausible. This is also expressed by the large difference in the number of cladograms of the two genera. Similarly, by the fact that most of the intuitive cladograms of *Drynaria* are present in the generated cliques, i.e. unlike *Aglaomorpha* for almost all possible nodes there is some support in the data matrix. None of the intuitive cladograms were present in the selected cladograms as they all show a value higher than 441.

All combinations of cladograms of the two genera have been made, and their respective value of contradiction minus support was calculated. Notice that the value of the generic cladograms treated separately, has to be treated as an indication only. It appears that the relative sequence in 'parsimony' of the subtrees might be different from the relative sequence in "parsimony" of the overall cladograms including these 'subtrees' (Engelmann

& Wiley, 1977). This is illustrated with the data in Table 7.3. Cladogram 7.25 shows a higher value than cladogram 7.28, but the combinations of Drynaria cladograms and 7.25 show lower values than those with 7.28. This leads to one of the problems needing further study. The sequence in value of the different subtrees does not by definition lead to a parallel sequence of overall cladograms. In other words, combining the two cladograms with the lowest values is not a guarantee that the overall cladogram will also show the lowest value. However, the value of contradiction minus support is not the sole selection criterion.

|                            |      |
|----------------------------|------|
| 7.30/7.20 2x trio          | 1228 |
| 7.30/7.19 1x trio, 18 + 19 | 1216 |
| 7.30/7.18 1x trio, 18 + 24 | 1226 |
| 7.30/7.17 1x trio, 19 + 24 | 1213 |
| Table 7.1                  |      |

As regards the four alternative hypotheses of species nos. 18 + 19 + 24, neither of the three dichotomous possibilities has supporting character state distributions in the data matrix. Table 7.1 shows their (relative) values taken from the cladogram of the drynarioids combining cladograms 7.17--7.20 (Aglaomorpha) and cladogram 7.30 (Drynaria). These values are a clear illustration of the general influence of these respective cladograms on the overall cladograms of the drynarioids. The two possibilities with species nos. 18 + 19 and nos. 19 + 24 as adelpho taxa always show a striking lower value than the other two. The difference in value of contradiction minus support between the former two, is regarded not significant to base an unequivocal choice upon it. Intuitively, the present author tends to prefer the possibility with species nos. 18 and 19 to represent sister species. Moreover, for this species pair a supporting character state is found in the second term, i.e. the (either regular or irregular) quadrangular soral patches.

|   |             |
|---|-------------|
| 7.30/7.19 18 + 19, 17/18 + 19 + 24/23 + 25 + 26 in trio | 1216        |
| 7.30/7.21 18 + 19, 17/23 + 25 + 26                      | in duo 1213 |
| 7.30/7.22 18 + 19, 17/18 + 19 + 24                      | in duo 1214 |
| 7.30/7.23 18 + 19, 18 + 19 + 24/23 + 25 + 26            | in duo 1213 |
| Table 7.2   |             |

As regards the position of cladon no. 17, the values presented in Table 7.2 are combinations of cladograms 7.30, and 7.19 + 7.21--7.23, as an example for other relevant combinations. All four possible hypotheses of the 3-cladon-problem 17/18 + 19 + 24/23 + 25 + 26 are presented. Their values do not show significant differences. Moreover, there are no biological reasons for choosing any of the three dichotomous alternatives. For these reasons, no definite choice can be made. Therefore, in the final cladogram the trichotomy is presented.

Table 7.3 shows the values of a number of combinations for Aglaomorpha and Drynaria subtrees. The best cladograms are those having a value of less than 1217. The others are quantitatively less likely. Cladogram 7.28, showing the lowest value of the Aglaomorpha cladograms when treated separately, has more significant values than other Aglaomorpha cladograms when combined with Drynaria cladograms. Cladogram 7.41 is an improbable solution in terms of its value and in view of the absence of supporting

| AGLAOMORPHA |                       |      |      |      |      |      |      |      |      |             |
|-------------|-----------------------|------|------|------|------|------|------|------|------|-------------|
|             | 7.19                  | 7.17 | 7.25 | 7.24 | 7.28 | 7.27 | 7.26 | XXX  |      |             |
| D           |                       | 242  | 231  | 244  | 233  | 232  | 253  | 240  |      |             |
| R           | 7.29                  | 426  | 1207 | 1204 | 1216 | 1212 | 1224 | 1218 | 1220 | 1237 (7.41) |
| Y           | 7.30                  | 430  | 1212 | 1209 | 1221 | 1217 | 1229 | 1224 | 1220 | 1243        |
| N           | 7.34                  | 441  | 1219 | 1215 | 1228 | 1223 | 1238 | 1231 | 1226 |             |
| A           | 7.37                  | 438  | 1216 | 1213 | 1226 | 1222 | 1233 | 1227 | 1224 | 1247        |
| R           | 7.39                  | 438  | 1220 | 1216 | 1230 | 1225 | 1244 | 1233 | 1228 |             |
| I           | 7.40                  | 458  | 1222 | 1219 | 1231 | 1228 | 1241 | 1234 | 1230 | 1251        |
| A           | PHENOGRAM (7.42) 1244 |      |      |      |      |      |      |      |      |             |

Table 7.3

character states for one cladon, but it is used because it incorporates previous ideas about the position of the two monomorphic *Aglaomorpha* species nos. 23 and 24 appearing near the root of the cladogram (XXX in Table 7.3).

Cladogram 7.29/7.17 showing the lowest value (1204), was not chosen finally because of the position of species nos. 13--15 and of nos. 18 + 19 + 24. Biologically, it is less plausible than cladogram 7.30/7.19 (value 1212) for reasons outlined above. All other possible cladograms were rejected for the same reasons. The ultimate choice was cladogram 7.30/7.19 (Fig. 7.43). Based on the cladogram, a phylogenetic tree (Fig. 7.44) is postulated of which the most important apomorphies are listed in Table 7.4.

A phenogram (Fig. 7.42), based on mean character distances as a measure of overall similarity among the terminal clada and on UPGMA as a cluster criterion (Sneath & Sokal, 1973), was also included for comparison. This was done in trying to trace the criteria used by previous authors for their classifications (see p. 157, 199). Regarding its rather high value (1244), the phenogram compares unfavourably with the selected cladograms. The main agreement with the cladograms is with respect to the delimitation of *Drynaria* and *Aglaomorpha*.

Several of the cladograms present in Table 7.3 are plausible. Intuition and biological inference need a great deal of caution (see for example the difference between the cladogram 7.17/7.29 with the lowest value and the intuitive cladogram 7.41). It is often possible to favour one cladogram over others. In other words, the quantitative criterion using a strict and repeatable search procedure is necessary to be able to select a manageable number of cladograms out of the numerous possibilities. The supporting character states of the selected trees are then tested using the local outgroup comparison. Eventually, the support of the remaining cladograms are judged according to their inferred biological strength. In the last phase, subjective criteria might prevail, but the set of possibilities is then clearly defined. Probably, the quantitative criteria and those derived from biological theory belong to different domains, and are as yet incommensurable. In this thesis, it is aimed to achieve a practical consensus between the three criteria for judging cladograms, i.e. parsimony, outgroup comparison, and biological inference. It is important to make clear when and why these criteria are applicable. In summary, the search has not been merely for the cladogram showing the lowest value of contradiction minus support, but for one or more cladograms showing low values that are regarded biologically significant.

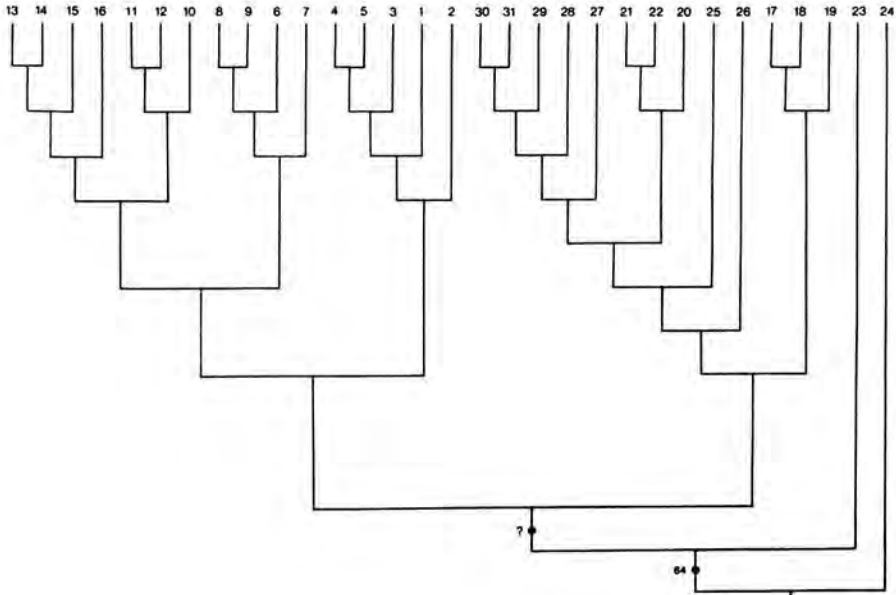
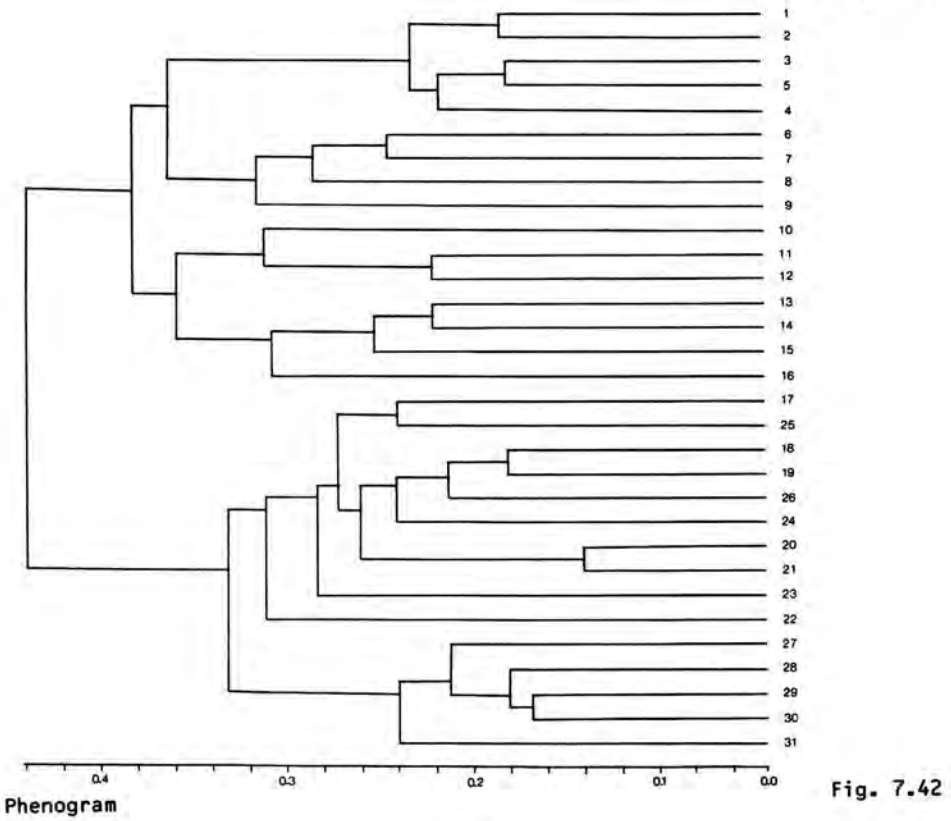

Fig. 7.41



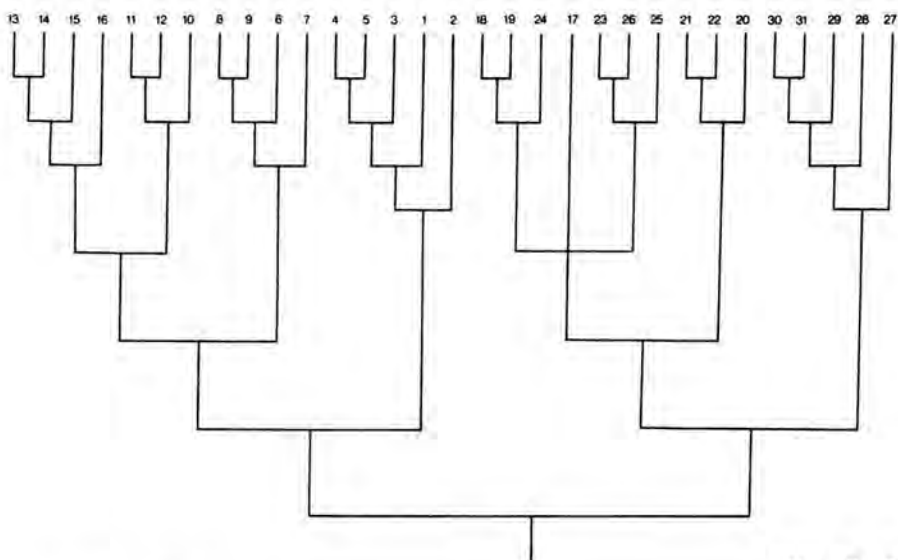

Fig. 7.43

Chosen cladogram

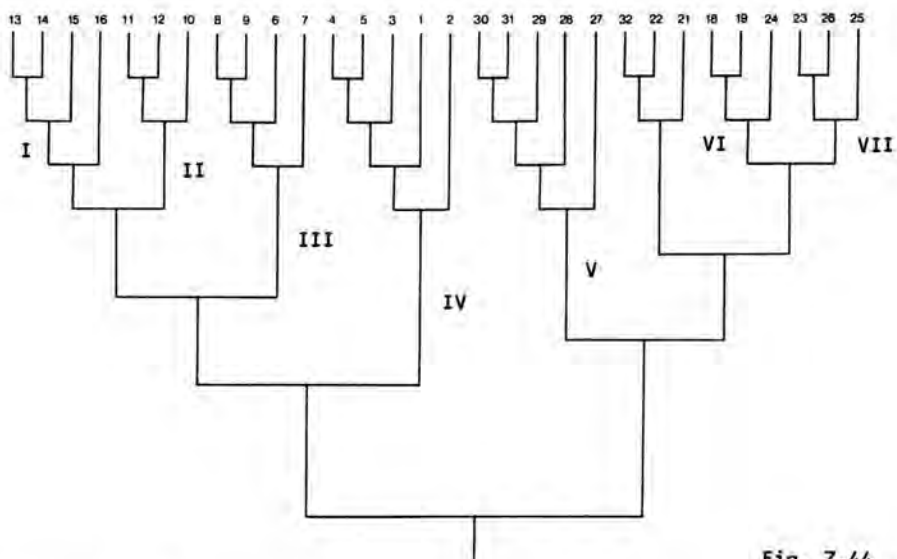

Fig. 7.44

Phylogenetic tree

For the roman numbers referring to 'subtrees' see Chapter 9.4



Table 7.4. Most important apomorphies of the holophyletic groups depicted in phylogenetic tree 7.44

bold numbers refer to the species (see Taxonomic Part)  
 other numbers refer to the character states (see Appendix 1)  
 numbers between brackets refer to character states showing one or a few homoplasies

- 13 + 14**  
 127, 174 (135, 160, 167, 168, 190, 207, 209, 252, 287, 288, 291, 488)
- 13 + 14 + 15**  
 374 (255, 264, 268, 346, 406, 443, 510, 549)
- 13—16**  
 88 (94, 232, 245, 251, 255, 524)
- 11 + 12**  
 92 (6, 30, 51, 287, 314, 348, 443, 450, 514, 518, 521, 540, 541)
- 10—12**  
 282 (105, 201, 232 + 233, 295, 296, 306, 307, 338, 340, 354, 355, 391, 530, 531, 533, 537)
- 10—16**  
 19 (8, 14, 24, 26, 34, 37, 53, 74, 130, 134, 231, 241, 278, 310, 319, 346, 379, 477)
- 8 + 9**  
 118 (235, 359, 391, 406, 407, 416, 483, 537)
- 6 + 8 + 9**  
 281, 342
- 6—9**  
 343 (153, 269, 338, 398, 482, 494, 497, 554)
- 6—16**  
 77 (69, 84, 85, 126, 163, 173, 283, 313, 423, 432, 436, 444)
- 4 + 5**  
 (58, 252, 316, 496, 518)
- 3—5**  
 (26, 73, 237, 251, 259)
- 1 + 3—5**  
 87, 543, 553 (65, 74, 81, 105, 112, 245, 513, 514, 516, 521, 551, 557)
- 1—5**  
 79 (82, 86, 89, 110, 124, 179, 213, 260, 266, 270, 289, 352)
- 1—16**  
 (56, 71, 75, 114, 117, 189)
- 18 + 19**  
 (123, 150, 154, 155, 287, 296, 306, 310, 314, 369, 395, 483, 531, 534)
- 18 + 19 + 24**  
 384 (168, 175, 176, 324, 463, 489, 503, 548)
- 23 + 26**  
 (280, 283, 534)
- 23 + 26 + 25**  
 394 (204, 278, 289, 328, 353, 447, 549)
- 18 + 19 + 23—26**  
 377, 418, 430 (59, 189, 391, 481, 509, 520, 524, 554)
- 22 + 32**  
 425
- 21 + 22 (+ 32)**  
 (123, 130, 148, 163, 298, 302, 330, 358, 369, 398, 420, 422, 431, 450, 486, 489, 496, 497, 521, 541)
- 18—26 (+ 32)**  
 91, 98, 382, 387, 465 (167, 173, 182, 551)
- 30 + 31**

- 336 (130, 378)  
 29—31  
 334 (277, 302)  
 28—31  
 (154, 155, 310, 483, 514, 518, 521, 541)  
 27—31  
 3, 322, 419, 526 (33, 157, 170, 179, 186, 278, 326, 327, 370, 379, 392,  
 395, 422, 477, 492 + 493, 498--500, 530, 531, 534)  
 18—31 (+ 32)  
 (13, 58, 61, 62, 63, 68, 106, 112, 119, 146, 153, 448, 457, 485, 511)

Table 7.4 cont.

Table 7.5. Homoplasy values of each character state according to cladogram 7.43.

Horizontally: singles  
 Vertically: tens

|    | 1  | 2  | 3 | 4  | 5  | 6 | 7 | 8 | 9  | 10 |    | 1  | 2  | 3  | 4  | 5 | 6  | 7  | 8  | 9  | 10 |
|----|----|----|---|----|----|---|---|---|----|----|----|----|----|----|----|---|----|----|----|----|----|
| 0  | 5  | 1  | 0 | 7  | 6  | 2 | 4 | 4 | 0  | 2  | 28 | 2  | 3  | 7  | 0  | 4 | 2  | 8  | 3  | 6  | 7  |
| 1  | 3  | 2  | 3 | 4  | 5  | 5 | 5 | 7 | 0  | 1  | 29 | 5  | 4  | 6  | 10 | 2 | 5  | 5  | 5  | 2  | 4  |
| 2  | 8  | 2  | 4 | 10 | 12 | 4 | 9 | 3 | 8  | 3  | 30 | 3  | 8  | 0  | 8  | 8 | 7  | 2  | 9  | 7  | 7  |
| 3  | 2  | 3  | 7 | 2  | 2  | 0 | 4 | 1 | 8  | 3  | 31 | 2  | 8  | 7  | 4  | 8 | 3  | 11 | 4  | 4  | 5  |
| 4  | 0  | 3  | 6 | 11 | 9  | 5 | 7 | 4 | 3  | 2  | 32 | 6  | 0  | 3  | 5  | 9 | 3  | 2  | 9  | 9  | 5  |
| 5  | 3  | 0  | 4 | 0  | 3  | 6 | 0 | 7 | 7  | 3  | 33 | 5  | 0  | 1  | 0  | 1 | 0  | 0  | 3  | 3  | 2  |
| 6  | 4  | 3  | 2 | 1  | 4  | 4 | 4 | 4 | 4  | 5  | 34 | 0  | 0  | 0  | 3  | 2 | 2  | 3  | 11 | 0  | 5  |
| 7  | 5  | 0  | 2 | 7  | 5  | 6 | 4 | 3 | 0  | 0  | 35 | 2  | 6  | 2  | 4  | 2 | 9  | 2  | 9  | 7  | 5  |
| 8  | 4  | 2  | 0 | 2  | 3  | 0 | 3 | 0 | 3  | 4  | 36 | 6  | 6  | 6  | 0  | 1 | 2  | 5  | 0  | 7  | 8  |
| 9  | 0  | 0  | 9 | 2  | 4  | 2 | 2 | 0 | 5  | 8  | 37 | 8  | 9  | 2  | 2  | 3 | 4  | 2  | 2  | 5  | 7  |
| 10 | 4  | 2  | 0 | 3  | 8  | 3 | 6 | 5 | 5  | 3  | 38 | 4  | 3  | 5  | 0  | 1 | 7  | 3  | 5  | 0  | 7  |
| 11 | 10 | 4  | 6 | 3  | 4  | 3 | 2 | 3 | 4  | 0  | 39 | 7  | 4  | 10 | 0  | 3 | 10 | 8  | 4  | 7  | 8  |
| 12 | 2  | 5  | 5 | 3  | 2  | 3 | 0 | 4 | 2  | 8  | 40 | 12 | 0  | 1  | 0  | 4 | 4  | 2  | 2  | 3  | 7  |
| 13 | 7  | 10 | 7 | 4  | 3  | 4 | 6 | 7 | 6  | 6  | 41 | 11 | 8  | 5  | 9  | 9 | 2  | 3  | 0  | 0  | 0  |
| 14 | 7  | 5  | 3 | 3  | 3  | 4 | 2 | 2 | 3  | 4  | 42 | 3  | 3  | 4  | 4  | 0 | 1  | 3  | 3  | 3  | 0  |
| 15 | 4  | 6  | 7 | 4  | 4  | 3 | 7 | 9 | 5  | 9  | 43 | 0  | 3  | 4  | 3  | 3 | 5  | 3  | 7  | 0  | 5  |
| 16 | 3  | 1  | 9 | 2  | 3  | 3 | 7 | 5 | 3  | 8  | 44 | 6  | 0  | 2  | 5  | 2 | 7  | 4  | 6  | 1  | 2  |
| 17 | 8  | 9  | 9 | 6  | 4  | 2 | 0 | 3 | 6  | 10 | 45 | 12 | 11 | 4  | 4  | 3 | 12 | 2  | 6  | 1  | 3  |
| 18 | 7  | 10 | 7 | 0  | 3  | 9 | 6 | 7 | 11 | 6  | 46 | 7  | 0  | 2  | 5  | 3 | 4  | 4  | 4  | 5  | 0  |
| 19 | 7  | 0  | 3 | 6  | 5  | 0 | 6 | 7 | 6  | 6  | 47 | 0  | 2  | 5  | 0  | 6 | 1  | 8  | 0  | 2  | 2  |
| 20 | 4  | 5  | 4 | 7  | 7  | 9 | 2 | 0 | 2  | 3  | 48 | 4  | 9  | 4  | 9  | 8 | 9  | 6  | 7  | 11 | 5  |
| 21 | 2  | 5  | 4 | 2  | 2  | 5 | 2 | 2 | 4  | 6  | 49 | 6  | 8  | 5  | 5  | 3 | 6  | 7  | 9  | 7  | 8  |
| 22 | 6  | 4  | 6 | 5  | 5  | 4 | 3 | 5 | 6  | 4  | 50 | 7  | 5  | 4  | 7  | 0 | 2  | 4  | 6  | 6  | 3  |
| 23 | 4  | 5  | 4 | 4  | 3  | 5 | 3 | 5 | 5  | 2  | 51 | 4  | 5  | 3  | 0  | 7 | 5  | 0  | 7  | 5  | 5  |
| 24 | 3  | 3  | 5 | 0  | 5  | 6 | 2 | 0 | 4  | 6  | 52 | 6  | 11 | 6  | 9  | 1 | 0  | 0  | 4  | 5  | 3  |
| 25 | 3  | 7  | 4 | 0  | 3  | 2 | 4 | 4 | 0  | 3  | 53 | 6  | 4  | 4  | 6  | 2 | 2  | 5  | 4  | 2  | 3  |
| 26 | 3  | 4  | 0 | 4  | 7  | 3 | 6 | 0 | 2  | 3  | 54 | 4  | 4  | 2  | 7  | 2 | 2  | 3  | 3  | 4  | 7  |
| 27 | 4  | 1  | 0 | 8  | 2  | 5 | 2 | 7 | 8  | 3  | 55 | 5  | 2  | 2  | 5  | 8 | 3  | 2  |    |    |    |

## **8. DELIMITATION OF SPECIES AND GENERA OF THE DRYMARIOIDEAE; THE SYSTEMATIC POSITION OF THE SUBFAMILY**

### **8.1. Species delimitation and account for the species recognized**

#### **8.1.1. Introduction**

The species concept adopted here is that of the evolutionary species as defined by Wiley (1981, p. 25): a single lineage of ancestor-descendant populations which maintains its identity from other such lineages and which has its own evolutionary tendencies and historical fate. It accepts that reproductive continuity (gene flow) between populations within species as well as reproductive isolation from populations outside a species are important components of species coherence, i.e. mechanisms to maintain identity. Species coherence is regarded as the result of genealogy.

The testing of species hypotheses is necessarily preceded by delimitating species using auxiliary (e.g. morphological) evidence. The evolutionary species concept places all criteria used to delimitate species (e.g. morphological disjunctions, genetic isolation) in an evolutionary context, therefore being superior to any other concept, including the biological species concept favoured by biosystematists. These criteria are used in a non-absolute sense (cf. biological species as regards the rigid use of reproductive isolation). Furthermore, it allows for species not being holophyletic by definition.

The testing of a hypothesis that a particular group of individuals comprises a species and thus represents a separate lineage evolving independently from other such lineages, is very difficult for theoretical and practical reasons. Therefore, a distinction ought to be made between the theoretical implications of a species concept which is an approach to understand the biological reality, and its implementation in practice which is an attempt to describe the reality, i.e. the postulation of species hypotheses based on, for example, morphological evidence, implies the prediction that they will stand possible tests of their evolutionary identity.

The initial species hypotheses are independent from the cladistic analysis, but an essential starting-point for phylogenetic research. For cladistic analyses, the terminal clada do not have to be necessarily evolutionary species. However, for the interpretation of the resulting cladogram, i.e. the transformation of it into a phylogenetic tree, the terminal taxa need to be interpreted as evolutionary lineages as a time-factor is introduced (cf. Wiley, 1981).

The species as delineated in the present study (cf. Table 5.1) are mainly based on morphological evidence, i.e. on discontinuities in intrinsic features. To facilitate identification, I looked for unique gross-morphological distinguishing character states of both reproductive and vegetative parts of the mature sporophyte, that could define partially monothetic sets. However, the species recognized could often be defined only as strictly monothetic sets. In some cases species differ only in characters of the fertile structures. Hybrids were identified using the criteria enumerated by Hennipman (1977, p. 93), i.e. aborted spores, morphological instability and intermediacy, and structural irregularity. The species hypotheses were not further tested as data on isolating mechanisms were unavailable.

Species delimitation within the drymarioids using the evolutionary species concept differs strikingly from concepts of previous authors (cf.

Goebel, 1928; Ching, 1983), although in practice the recognized species often coincide. In this respect, it is important to note that species delimitation should be based on a study of the holophyletic group to which they belong. Coincident species hypotheses using different concepts might be due to the material examined which was mainly herbarium material. This is a limiting factor for all systematic research of (tropical) plants. Fortunately, there are increasing possibilities to study living specimens as well. The Polypodiaceae are especially well suited for cultivation in green houses. However, there are usually not enough specimens in cultivation from the range of any single species to represent its genotypic and phenotypic variation.

Below, a number of the most problematical species hypotheses are discussed.

### 8.1.2. Terminal clada rejected as evolutionary species

#### Cladon no. 17

This terminal cladon, A. x leporella Goebel, is a spontaneous hybrid between cultivated plants at the botanic gardens of Munich. The plant has been distributed to other botanic gardens (e.g. Berlin, Utrecht) through vegetative propagation. It is an inferred hybrid because of its irregular morphology, the formation of aberrant spores (often very thick-walled and lacking cytoplasm, an obvious result of incomplete meioses). It has never been reported from the wild. Its rhizome scales are similar to those found in the species nos. 23, 25, and 26, whereas its fertile structures show resemblance to those of species nos. 18 and 19. Therefore, this cladon presumably resulted from accidental hybridization of two species out of the two groups just mentioned, kept in cultivation. This is confirmed by the phylogenetic relationships as presented in the cladogram. Species nos. 19 and 23 are regarded likely parents, as the shape of the sori of cladon no. 17 is interpreted as intermediate between that found in these two species, whereas the internal dimorphism is inconspicuous.

#### Cladon no. 20

At first, this cladon (based on one collection: Gibbs leg., Arfak mountains, New Guinea) was considered morphologically distinct from species nos. 19 and 21. In fact, it is a small-sized specimen of species no. 21 collected at the periphery of its distribution at a much higher elevation than most other collections. It is presumed to be an autotriploid, because of the larger-sized stomata (compared with typical specimens of species no. 21), and the high amount of aborted spore mother cells and aberrant spores, as compared with its structural regularity.

These two terminal clada although rejected as evolutionary species, have nonetheless been included in the cladistic analyses in an effort to trace the identity of its parent species.

### 8.1.3. Clada accepted as evolutionary species

#### 8.1.3.1. Aglaomorpha

All remaining 13 terminal clada of Aglaomorpha are accepted as evolutionary species. For reasons outlined below, another species (no. 32) is added.

Species no. 18

The unique irregular shaped sori of this species suggests of hybridity. However, the spores and stomata of all collections are perfectly normal in shape and size. Although known from only a few collections, it is considered to be a distinct species.

Species nos. 28 and 29

These two species are phenetically very similar. Their main difference concerns the sporangial indument. This is absent in species no. 28, whereas it is manifest in species no. 29. This morphological disjunction is correlated to an allopatric distribution pattern (Celebes vs. Philippines).

Species no. 32

Species no. 32 is accepted as a distinct species because of its unique frond dimorphism and rhizome scales. However, it could not be investigated in much detail as the sole record is a type specimen of Beccari. It could only be studied from the original description (including the plate), and from a few rhizome scales. Thus it could not be incorporated in the cladistic analyses. The few character states that could be analyzed show that it shares with species no. 22 unique well-developed phyllopodia and less uniquely shaped fertile pinnae, the dilated frond base, and the complex rhizome anatomy. In the cladogram, the presence of conspicuous (and apomorphic) phyllopodia defines species no. 22. In view of the absence of conflicting evidence, a sister group relation between these two species is postulated, a view already earlier expressed by Copeland (1947) when he placed these two species in Thayeria.

### 8.1.3.2. Drynaria

The 16 initially recognized terminal clada in Drynaria are all accepted as species.

Species nos. 1 and 3--5 (Table 8.1)

The recognition of species within this group is rather difficult as all of them are very similar. The differences between species nos. 3 and 4 are rather subtle, mainly pertaining to the venation pattern and the anatomy of the lamina. Species no. 1 is distinct from the other three because of the shape and size of the base fronds as well as the occasional large number of sori per primary areole (A1). Species no. 5 is recognized by its narrow pinnae with undulated margin.

The phenotypic plasticity of species no. 1 obscures specific morphological differences. This is illustrated by the following observations. Specimens of species no. 1 collected in the vicinity of Port Moresby (Papua New Guinea) and from Australia show relatively narrow pinnae, a condition resembling that of species no. 5 (except for the entire margin). However, these eastern and southern specimens are not morphologically disjunct from specimens of western Malesia and continental Asia, showing the typically larger sized base fronds. However, specimens of species no. 5 cultivated in the botanic gardens at Utrecht, form relatively large-sized and clearly sinusoid base fronds which are more elongated than those of species no. 1.

The evidence shows ambiguity. Nevertheless, the detected differences are qualitatively useful, allowing the recognition of different species. Such decisions are part of the research that necessitates the delimitation of species (the same holds for character states) entirely or mainly based on herbarium material. To claim that this process is objective would be premature.

| Species no.                         | 1              | 3               | 4            | 5                     |
|-------------------------------------|----------------|-----------------|--------------|-----------------------|
| Character                           |                |                 |              |                       |
| base fronds                         | large sinusoid | small entire    | small entire | small entire-sinusoid |
| pinnae:width                        | narrow-broad   | broad           | broad        | narrow                |
| margin                              | entire         | entire          | entire       | undulated             |
| venation                            | simple         | simple          | complex      | simple-complex        |
| hypodermis above                    | present        | absent          | present      | absent                |
| sori/A1                             | 2--7           | 2--4            | 2,3          | 2,3                   |
| bundle sheath rhizome vasc. bundles | absent         | usually present | absent       | absent                |

Table 8.1

Species nos. 6--10 (Table 8.2)

Some difficulties may occur when trying to discriminate between species pairs nos. 6 and 7, nos. 6 and 8, and nos. 8 and 9. In the sympatric species pair nos. 6 and 7, the rhizome scales show very striking and constant differences, whereas the fronds are almost identical. The differences between species nos. 6 and 9 pertain mainly to the frond shape and growth habit. However, the fronds of both species show some overlapping variation. Data regarding growth habit are rather scarce as this feature cannot be studied in herbarium specimens.

Species no. 8 is distributed in Madagascar, the Comores and the Mascarenes. All specimens are similar in detailed morphology, including submicroscopic characters of the spores. Nevertheless, the few available complete herbarium collections suggest a statistical difference in size of rhizome scales and sporangium capsules between specimens of Madagascar and those from the Comores and the Mascarenes. As yet, the scanty evidence is insufficient to recognize different species. Further study is required. Species nos. 8 and 9 have often been confused in the past because of gross similarities in habit. Apart from being obviously allopatric taxa, they are also morphologically different, e.g. in the venation pattern and rhizome anatomy (sclerenchymatic strands present in species no. 9).

Cufodontis (1969) separated *D. saccardi* from species no. 7 by the absence of base fronds. However, this character states is often reported in other *Drynaria* species. Specimens kept under certain conditions (e.g. terrestrial growth) do not always develop base fronds. For example, J. Croft (pers. comm.) observed that species no. 1 growing in terrestrial conditions near Port Moresby (Papua New Guinea) had almost no base fronds. Hennipman (pers. comm.) observed the same phenomenon in Sulawesi for species no. 2. However, it was observed at the botanic gardens of Leiden and Utrecht, that young plants of several *Drynaria* species grow vigorously without forming base fronds (e.g. nos. 1, 5, and 6). *D. saccardi* is here considered synonymous to species no. 7.

| Species nos.               | 6               | 7               | 8                  | 9                  |
|----------------------------|-----------------|-----------------|--------------------|--------------------|
| character                  |                 |                 |                    |                    |
| rhiz. scales               |                 |                 |                    |                    |
| texture                    | soft            | stiff           | soft               | soft               |
| colour                     | brown           | dark redbrown   | brown              | brown              |
| pinnae                     | all equal sized | all equal sized | decreasing in size | decreasing in size |
| growth habit               | spirally        | spirally        | encircling         | encircling         |
| sclerenchyma strands rhiz. | absent          | absent          | absent             | present            |
| venation                   |                 |                 |                    |                    |
| loops/A2                   | absent          | absent          | absent             | absent             |
| free veins                 | simple          | simple          | simple             | complex            |
|                            |                 |                 |                    | Table 8.2          |

Species nos. 11 and 12

These two species are distinct as regards differences in frond size and paraphyses, apart from the (unique) structural absence of base fronds in species no. 12.

Species nos. 13--15 (Table 8.3)

In terms of frond morphology, species no. 15 differs from species nos. 13 and 14. The recognition of the latter two as different species was problematical. The gross morphology of the fronds in species no. 14 is somewhat intermediate between species nos. 13 and 15. Some of the specimens have an apical pinna (like species no. 13), others have an aborted apical pinna (like species no. 15). The majority of specimens are recognized by the relatively slender fronds, which are different from those of species no. 15, but less different to species no. 13. The general absence of a glandular sporangial indument makes species no. 14 distinct from no. 13. However, a number of collections considered to belong to species no. 13 lacked the sporangial indument. On the other hand, a few specimens had the general appearance of species no. 14, but possessed a glandular sporangial indument. These intermediate and confusing specimens are a minority in the material studied. Species nos. 13 and 14 are considered to represent independent taxa. Hybridization between them may occur; the confusing specimens are interpreted as hybrids. This might be plausible also in terms of the biogeographical evidence. Species nos. 13 and 14 are partially sympatric, their distributions showing some overlap in Szechuan and Yunnan. They show a similar altitudinal range. Many of the intermediates were collected in Szechuan, which coincides with the area in which both species occur. The variability of these species is emphasized by Ching & Wu's (1983) descriptions of several new taxa within this species complex; none of which are accepted here.

| species no.         | 13                               | 14                             | 15            |
|---------------------|----------------------------------|--------------------------------|---------------|
| characters          |                                  |                                |               |
| frond morph.        | coarse                           | rather fine                    | fine and thin |
| shape               | broad                            | slender                        | + broad       |
|                     | elliptical                       | elliptical                     | elliptical    |
| apex                | round                            | round                          | acute         |
| pinna shape         | broad                            | slender                        | + broad       |
| apical pinna        | (almost always) aborted          | usually aborted rarely present | present       |
| sporangial indument | usually present sometimes absent | usually absent rarely present  | absent        |

Table 8.3

## 8.2. The delimitation of the genera

Taxonomic decisions above the species level are just a matter of 'chopping the tree' into holophyletic groupings. The cladogram here proposed has several possibilities for division. For example, species nos. 13--16 can be regarded to comprise a genus. As a consequence, species nos. 10--12 also comprise a genus. This will lead to several genera within the drynarioids, none of which has been recognized in the past.

Apart from the criterion of holophyly, classifications should preferably include groups of practical use. Therefore, the search is for subdivisions characterized by distinctive character states. The present author has considered the basal node of the cladogram (Fig. 7.43) as the most suitable place to chop the tree, resulting in two groups of generic rank. Ignoring a few reversals, these two groups are easily recognized by the frond dimorphism (*Drynaria*) and the contraction of the fertile pinnae (*Aglaomorpha*). The author has refrained from subdividing the two genera into taxa of lower rank because they are only of moderate size making a further taxonomic subdivision unnecessary.

The emendation of *Aglaomorpha* is contradictory to common usage and all earlier classifications. The differences between some examples of the latter and the present classification are summarized in Table 8.4. The older classifications are mainly based on differences instead of similarities. The reverse is true for *Drynaria*. This interesting coincidence means that the character state(s) grouping species nos. 1--16 as used by previous authors to delimitate *Drynaria* turn(s) out to be synapomorphic. This is an additional argument in favour of the present generic delimitation as it implies taxonomic stability based on inferred phylogenetic evidence.

The sister group of *Drynaria* should have the same rank. Therefore, the genus *Aglaomorpha* has to be emended. This genus was traditionally divided into four (Crabbe et al., 1975), seven (Copeland, 1947), or eight (Pichi Sermolli, 1977) genera (Table 8.4), most of them monotypic. These genera are mainly based on obvious differences in macroscopic characters of the sori (e.g. *Merinthosorus*: with linear coenosori), and on uniquely dissected pinnate fronds (*Photinopteris*). The generic status of the latter has never been disputed because of its characteristic frond morphology. However, its monotypic recognition is here rejected as its recognition would imply the



| Spec.no  | 1-16 | 17 | 18 | 19 | 20 | 21 | 22 | 23 | 24 | 25 | 26 | 27 | 28  | 29 | 30 | 31 | 32 |
|----------|------|----|----|----|----|----|----|----|----|----|----|----|-----|----|----|----|----|
| Roos, 85 | D    | A  | A  | A  | A  | A  | A  | A  | A  | A  | A  | A  | A   | A  | A  | A  | A  |
| Cop      | D    | A  | A  | A  | A  | A  | T  | Ps | Ds | A  | M  | Ph | M   | A  | M  | H  | T  |
| Crab     | D    | A  | A  | A  | A  | A  | T  | A  | A  | A  | M  | Ph | M   | A  | M  | A  | T  |
| P.S.     | D    | A  | A  | Dm | A  | A  | T  | Ps | Ds | A  | M  | Ph | M   | Dm | M  | H  | T  |
| Chan     | Dry  | Ag | Ag | Ag | Ag | Ag | Ag | Ag | Ag | Ag | Ag | Ag | Dry | Ag | Ag | Ag | Ag |

Cop = Copeland (1947); Crab = Crabbe et al (1975);  
P. S. = Pichi Sermolli (1977); Chan = Chandra (1982b).

A = Aglaomorpha; Ag = Aglaomorpheae; D = Drynaria;  
Dm = Dryostachyum; Dry = Drynariaceae; Ds = Drynariopsis  
H = Holostachyum; M = Merinthosorus; Ph = Photinopteris  
Ps = Pseudodrynaria; T = Thayeria.

Table 8.4

recognition of many other genera and this does not help our understanding of the evolutionary history of the group.

A subdivision of the Drynarioideae into two other groups has already been proposed by Chandra (1982b), who recognized the tribes Drynariaceae (including the genus Drynaria and Aglaomorpha speciosa) and Aglaomorpheae (including all species of Aglaomorpha except A. speciosa). This subdivision is not upheld by the present study. Moreover, classifying Drynaria together with Aglaomorpha speciosa is surprising even when considering Chandra's own data. He lists 15 "distinguishing features of the two groups of drynarioid ferns." For six of these, A. speciosa is mentioned to represent an exception within the Drynariaceae, showing similar conditions as found in the other tribe: nest fronds, hydathodes, hypodermis, venation pattern, leaf shape, soral shape, and distribution. Four are not very useful as they represent continuous morphometric characters showing overlap (the measurements of Photinopteris - A. speciosa - are not indicated): stomatal size and frequency, sporangial and spore size. Two characters were said to be different for the two groups which could not be confirmed (paleae structure and frond arrangement), one showed exceptions in the Aglaomorpheae that had a similar condition as found in the Drynariaceae (foliage leaves), and one qualitative character showed overlap (nectary type). One character coded epidermal cell size, did actually support his division. However, the two states of the latter were indicated as "large" vs. "smaller". For all of that, should his data be used, they show stronger evidence for grouping of A. speciosa with the Aglaomorpheae rather than with Drynaria.

None of the previous classifications could be confirmed, either in the present cladistic analysis, nor in the additional phenetic analysis. For example, the two species formerly included in Merinthosorus (nos. 26 and 30) do not constitute a holophyletic group (Fig. 7.43). They are not placed together in the phenogram (Fig. 7.42) either. Furthermore, the five species of Aglaomorpha sensu Copeland (1947; i.e. nos. 18, 19, 20, 25, and 28) are scattered in different groups on the cladogram (Fig. 7.43). The same holds for the phenogram, where they are spread over several groups.

Pichi Sermolli (1977) proposed one of the most extensively dissected generic classifications. He recognizes two main phyletic lines within the drynarioids as defined by Copeland (1947). One line is based on an increasing dimorphism among and within fronds. The other line is based on an inferred trend from distinct round sori via interrupted coenosori to entire coenosori and to square patches. According to Pichi Sermolli this should

result in nine genera, all sharply distinct and all representing (1977, p. 379) "different stages of the realization and combination of these tendencies". He concludes that, although most drynarioid genera are monotypic or very small, they should be regarded as distinct. Either of these phyletic trends are confirmed by the strict transformation series established in this study, nor any justification of basing taxa on intermediate stages of transformation series.

### 8.3. The delimitation of the Drynarioideae

The delimitation of the Drynarioideae has not been the main subject of the present study. In other words, it was considered at the beginning that the drynarioid ferns constitute a holophyletic group. This assumption is made because of unique similarities of the species. The group has been generally accepted since Copeland (1911) mentioned the 'Drynaria Group' for the first time (1911, p. 139: 'There is probably no group of organisms known which are more distinct in appearance but more evidently homogenetic than these are.').

Copeland (1947) more extensively discussed the delimitation of the group. According to him, the drynarioids constitute a conspicuous and natural group, characterized by the fact that the fronds are never functionally articulated to the rhizome, the pinnae are articulated to the costa/rachis, the fronds have a firm texture, with a conspicuous venation and distinct venation pattern, and possess foliar glands. Holttum (1946, 1954) also comments on the drynarioids, listing almost similar characteristic features: the rhizome (thick and fleshy), the venation (venatio drynarii), the nectaries, and the abscission layer at the base of the pinnae, apart from remarks about the sori and the hydathodes.

Only recently have the drynarioids been given formal taxonomic rank by Crabbe et al. (1975), who created the subfamily Drynarioideae. The present author accepts this subfamily, but its holophyly eventually must be tested in a cladistic analysis of the entire family, followed by a decision concerning its rank. Ching (1978) recognized the family Drynariaceae. According to Chandra (1982b), the recognition of a holophyletic group occurs only when it is presented as a formal taxon (p. 226: "Thus for the first time the drynarioid group was recognized as a conspicuous natural group of epiphytes.", pointing to the erection of the subfamily by Crabbe et al., 1975). This is simply incorrect, as e.g. Copeland (1947) made a special comment on the "Drynaria Group", regarding it as a conspicuous and natural group. He did not give it a formal taxonomic rank, but this is totally irrelevant.

Furthermore, Chandra (1982b) presents a phyletic scheme which is congruent neither with his above remark nor with his classification. The relationship of species no. 27 ('Photinopteris') is not indicated, whereas he classifies it with Drynaria. More strikingly, the scheme denotes the drynarioids to be at least biphyletic, i.e. Aglaomorpha and Drynaria evolved independently from Microsorium. This implies that the Drynarioideae do not comprise a natural group.

### 8.4. The systematic position of the Drynarioideae

The systematic position of the Drynarioideae within the Polypodiaceae has also not been the subject of this study. The present state of affairs on the systematics of Polypodiaceae (Hennipman, 1984) allows for some preliminary suggestions only, as the phylogenetic relations of the Drynarioideae to other groupings of the Polypodiaceae are still uncertain.

Up till now, the drynarioids are most commonly regarded to constitute the sister group of Microsorium and allies. Such a statement has already been made by Copeland (1911, 1947), and has been accepted by Holttum (1946, 1949, 1954). Both authors regard D. heraclea the species most like the ancestral species of the drynarioids because it has a dilated humus-collecting frond-base like Microsorium musifolium. They regard Microsorium as most 'primitive'.

This idea was formalized by Nayar (1970) in diagnosing the subfamily Microsorioideae to include the drynarioids. His classification includes paraphyletic groups as can be inferred from his scheme of interrelations. A similar view has been expressed by Pichi Sermolli (1977). On the one hand, he remarks that grouping the polypodiaceous genera into tribes and subfamilies presents serious difficulties because of uncertainties about relationships between the various genera. On the other hand, he proposes 14 groups (one of which includes the drynarioid genera) using transformation series established a priori. His phyletic scheme (1977, Fig. 6, p. 370) clearly indicates a sistergroup relation between the microsoriod and the drynarioid ferns, although his comment that "they are certainly related to the previous group" (p. 379) is an uninformative statement. The crypsinoid genera are placed as the outgroup. According to him, the microsoriods (e.g. M. linguaeforme, M. musifolium) are ancestral to the drynarioids.

Different opinions were expressed by Christensen (1938) and Ching (1940), who both apparently do not accept the holophyly of the drynarioids. They regard the species of Aglaomorpha (sensu lato) as intermediate between Drynaria and Phymatodes.

A somewhat different hypothesis was proposed by Ching (1978) for his family Drynariaceae. He regards the family as very natural and distinct, and closely related (in venation type) to the Dipteridaceae on the one hand, and to the Polypodiaceae, especially to Microsorium (e.g. M. musifolium) on the other. With the latter, the family was further related by Ching because of the dilated frond base. He stated that the drynarioid species have always been considered as a highly specialized group because of their similarities in frond shape and venation with M. musifolium. But, according to him, (p. 16) "these similarities may perhaps be the result of convergent evolution or indicate ancestry, for Drynariaceae differs from the Polypodiaceae in many important characters and also, no doubt, is much more primitive and yet more specialized in life-form than the Polypodiaceae." Unfortunately, he does not explain the phrase "much more primitive and yet more specialized in life-form".

Ching makes the very original suggestion that in Pichi Sermolli's group of the Polypodiales: "the existence of a fairly continuous phyletic line of descent starting from the Dipteridaceae... through the Cheiropleuriaceae and the Drynariaceae to the Polypodiaceae of today can be recognized". Unfortunately, he does not provide the argumentation on which the basic trends of his phylogenetic ideas are based.

Unfortunately, these different opinions are based on ambiguous reasonings in which the data used and the methodology applied are not made explicit. Also, the character analyses presently executed in the Polypodiaceae project show that many other possibilities have to be taken into consideration. Similarities in venation pattern (pers. comm. Hettterscheid), in the ultra structure of the spore wall (pers. comm. Hennipman), and the presence of opaque rhizome scales (Veldhoen, pers. comm.) may indicate a sister group relation with crypsinoid ferns. The similarities in venation pattern between microsoriod and drynarioid ferns are less obvious (Mitsuta, in press) than is supposed by Nayar (1961) and Chandra (1980b). Also, the drynarioid ferns share with the crypsinoid genus Arthromeris (and with Schellolepis) the presence of nectaries and abscission layers. Decisions at these higher

taxonomic levels can only be made based on a cladistic analysis of the entire family.

## 9. ANALYSIS OF EXTRINSIC CHARACTERS OF THE DRYNARIOIDEAE

### 9.1. Introduction

#### 9.1.1. General

This chapter deals with the geographical distribution and ecology of the drynarioid species and the historical development of the patterns. It is aimed at postulating, amongst other things, an areagram for further phylogenetic considerations of the group. The geographical distribution and habitat information have been obtained through the labels and fieldnotes of herbarium specimens, as well as personal observations made in Indonesia and Papua New Guinea and on personal communication by several colleagues who observed drynarioids in the field. Reliable data from the literature are also incorporated.

#### 9.1.2. Data

The data as regards the geographical distribution of the species are presented in Appendix 6 (summarized in Table 9.5), whereas Appendix 7 provides histograms of their altitudinal range. Table 9.4 shows for all species the percentage of specimens recorded to grow epiphytic, epilithic, and terrestrially.

The climatic conditions of the areas inhabited by the respective drynarioid ferns have been analyzed using the survey (including climatic maps) of Mueller (1982). According to him, two main systems of classifications are proposed, i.e. by Köppen and Geiger, and by Troll and Paffen. The categories of both systems relevant for the present study are enumerated in Table 9.1 (after Köppen and Geiger) and in Table 9.2 (after Troll and Paffen). Table 9.3 enumerates for all species the climatic conditions of the distribution areas.

|  |
|--|
| AFTER KÜPPEN/GEIGER                                |
| Af = tropical rain forest climate                  |
| Aw = tropical savannah climate                     |
| Cw = warm temperate rainy climate with dry winter  |
| Cf = temperate rainy climate, moist in all seasons |
| Bs = steppe climate                                |
| Bsk = cold steppe climate                          |
| Dw = cold snowy forest climate with dry winter     |
| E = ice climates                                   |

Table 9.1

AFTER TROLL/PAFFEN

|       |   |                      |
|-------|---|----------------------|
| V1    | =tropical rainy climates                        |                      |
| V2    | =tropical humid-summer climates                 |                      |
| V3    | =wet and dry tropical climates                  | tropical zone        |
| V4    | =tropical dry climates                          |                      |
| IV4   | =dry-winter climates with long summer humidity  | warm-temp.subtrop.z. |
| IV7   | =permanently humid climates with hot summer     |                      |
| III7  | =humid-and-warm summer climates                 | cool-temp. zone      |
| III11 | =humid-summer steppe climates with cold winters |                      |

Table 9.2

spec. climates (left: according to Köppen/Geiger,  
no. right: according to Troll/Paffen)

|     |                                 |   |
|-----|---------------------------------|---|
| 1.  | Af, Aw                          | V1, V2 (V3)                                 |
| 2.  | Af, Aw (Cw)                     | V1, V2, V3                                  |
| 3.  | Aw, Cw (Af)                     | V2, V3 (V1)                                 |
| 4.  | Af                              | V1  |
| 5.  | Af                              | V2 (V1)                                     |
| 6.  | Aw, Af                          | V1, V2                                      |
| 7.  | Cw, adjacent Aw                 | V2 'montane'                                |
| 8.  | Af, adjacent Cw                 | V1 (V2)                                     |
| 9.  | Af, Aw                          | V1, V2                                      |
| 10. | Af, Cf, Aw                      | V1, V1 'montane',<br>V2, V3 (IV4, IV7)      |
| 11. | Cw                              | V3, V2, IV4 (IV7, V1)                       |
| 12. | Aw, adjacent Cw, Af             | V2, V1 (V3)                                 |
| 13. | Cw, Bs (E)                      | IV4, III7                                   |
| 14. | Bs, Bsk, Dw, adjacent<br>Cw (E) | III11, III7 'montane'                       |
| 15. | Cw (E)                          | V1--V4 'montane'                            |
| 16. | Cw, Cf, (Aw, Dw, Af)            | IV7, IV4, V2 (III7)                         |
| 17. | ---                             | ---   |
| 18. | Af                              | V1  |
| 19. | Af                              | V2, V1                                      |
| 20. | ---                             | ---   |
| 21. | Cf, Af                          | V1 'montane'                                |
| 22. | Af                              | V2 (V1)                                     |
| 23. | Cw, adjacent Aw (Af,<br>Cf)     | V2, adjacent V1, adj.<br>V3, adj. IV4 (IV7) |
| 24. | Af, adjacent Aw (Cf)            | V1, adjacent V2                             |
| 25. | Af, Cf                          | V1, V2                                      |
| 26. | Cf, Af                          | V1, V1 'montane'                            |
| 27. | Af, adjacent Aw                 | V1, adjacent V2                             |
| 28. | Af                              | V1  |
| 29. | Af                              | V1, V2                                      |
| 30. | Cf, Af                          | V1 'montane'                                |
| 31. | Cf, Af                          | V1 'montane'                                |
| 32. | Af                              | V1  |

Table 9.3

| spec. no. | epiphytic % | epilithic % | terrestrial % | nos. of coll. with relevant records |
|-----------|-------------|-------------|---------------|-------------------------------------|
| 1.        | 72          | 16          | 12            | 180                                 |
| 2.        | 72          | 22          | 6             | 145                                 |
| 3.        | 29          | 63          | 8             | 73                                  |
| 4.        | 100         | -           | -             | 3                                   |
| 5.        | 57          | 14          | 29            | 7                                   |
| 6.        | 96          | 4           | -             | 47                                  |
| 7.        | 96          | 4           | -             | 103                                 |
| 8.        | 100         | -           | -             | 8                                   |
| 9.        | 100         | -           | -             | 15                                  |
| 10.       | 72          | 25          | 3             | 245                                 |
| 11.       | 51          | 45          | 4             | 110                                 |
| 12.       | 86          | 14          | -             | 22                                  |
| 13.       | 42          | 58          | -             | 88                                  |
| 14.       | 8           | 81          | 11            | 38                                  |
| 15.       | 79          | 21          | -             | 28                                  |
| 16.       | 31          | 67          | 2             | 195                                 |
| 17.       | -           | -           | -             | -                                   |
| 18.       | 100         | -           | -             | 3                                   |
| 19.       | 86          | 14          | -             | 7                                   |
| 20.       | -           | -           | -             | -                                   |
| 21.       | 86          | 7           | 7             | 14                                  |
| 22.       | 67          | -           | 33            | 3                                   |
| 23.       | 66          | 30          | 4             | 96                                  |
| 24.       | 92          | 5           | 3             | 60                                  |
| 25.       | 88          | 12          | -             | 8                                   |
| 26.       | 78          | 18          | 4             | 46                                  |
| 27.       | 57          | 39          | 4             | 44                                  |
| 28.       | 60          | 40          | -             | 5                                   |
| 29.       | 75          | -           | 25            | 4                                   |
| 30.       | 78          | -           | 22            | 18                                  |
| 31.       | 58          | 7           | 35            | 30                                  |

Table 9.4

## 9.2. Sister group patterns

### 9.2.1. Introduction

The sister group nodes based on patterns of intrinsic character states presented in the cladogram are regarded to document possible speciation processes. One might expect that these relationships are correlated with differences and similarities in extrinsic characters and that similarities may show general patterns. Therefore, descriptions of extrinsic features are given for all species arranged according to the cladogram.

### 9.2.2. AGLAOMORPHA

#### 9.2.2.1. Species nos. 27--31

Species nos. 30 and 31

These two sister species both show a limited distribution in eastern Malesia, species no. 30 is endemic to New Guinea, and no. 31 occurs in the

Moluccas, New Guinea, and on the Solomon Islands. Species no. 30 shows a somewhat smaller altitudinal amplitude and tends to grow at higher elevations than does species no. 31. However, field observations by the present author shows that both species in Papua New Guinea (Morobe Province) grow together on the same host tree (Roos, 1984). The climatic conditions are similar in the sites where these species are found. Regarding their habits, species no. 31 mostly tends to grow terrestrially or epilithically, occasionally being a dominant herb on the forest floor. This feature has never been reported for species no. 30. In general, these two species have many extrinsic characters in common, but show slightly different tendencies concerning altitude and habit.

#### Species nos. 29 and 30 + 31

Species no. 29, the allopatric adelpho species of the species pair nos. 30 + 31, occurs only in the Philippines. Data about habit and altitude are very scarce. It has been reported to grow epiphytically and terrestrially at 200--600 m elevation. Regarding its habit, it is similar to species no. 30, but it grows at lower elevations that fall within the range of species no. 31.

#### Species nos. 28 and 29 and 30 + 31

Species no. 28 is the sister species of the three species just mentioned. The data of this species are very scarce. Compared to the data given above, the relative high amount of epilithism might point to a different habit, but this is based on but five records. It might grow at higher altitudes than species no. 29, but it does not tend to grow in (sub)montane sites. The terrestrial habit of species no. 31 is unique.

#### Species nos. 27 and 28 and 29 + 30 + 31

The next sister species is no. 27, widely distributed in western Malesia, although absent from the Lesser Sunda Islands, being sympatric with species nos. 28 and 29, and allopatric with species pair nos. 30 + 31. It is mainly distributed in constantly wet areas, but it grows also in somewhat dryer conditions unlike the four previous species. A significant part of the specimens is epilithic.

#### Species nos. 27--31

These five species share a uniquely tomentose frond indument, which is a striking feature in view of their occurrence in wet areas. However, species nos. 27 and 31 show variation in this character. The author observed specimens of species no. 31 growing terrestrially in the shade that were almost glabrous, whereas specimens growing on adjacent, exposed sites were tomentose.

#### 9.2.2.2. Species nos. 18--26

##### Species nos. 18 + 19 and 24

The sister species nos. 18 and 19 are allopatric, the first one occurring in N.E.Borneo, the second throughout the Philippines. The distribution area of species no. 24 comprises the whole of Malesia including Borneo and the Philippines. As regards the altitudinal range, the available data suggests that species no. 18 grows at higher elevations than no. 19. Species no. 24 is more wide ranging, overlapping both former species. The species do not differ in climatic requirements.



#### Species nos. 23 and 26

Species no. 26 is usually an epiphytic fern of lower and middle elevations. It is found in two disjunct regions of Malesia, one comprising Malacca, Sumatra, and Borneo, the other the Moluccas, New Guinea, the Solomon Islands, and Fiji. There is a remarkable gap in between these two areas, as this species is absent from the Philippines, Celebes, Java, and the Lesser Sunda Islands. This pattern suggests that it occurs only in wet areas. Furthermore, its distribution pattern follows mountain ranges (e.g. Barisan Range, Sumatra; Crocker Range, Borneo).

Species no. 23 is often an epilithic fern, and occurs on continental S. E. Asia. Its distribution shows conspicuous differences in climatic conditions compared to that of the previous species, as it grows in dryer areas. Although the two species show a similar altitudinal range, they differ in pattern, i.e. species no. 26 is often found below 400 m and species no. 23 is only occasionally found at such low elevations.

#### Species nos. 25 and 23 + 26

Species no. 25, distributed in the northern part of the Philippines and on Taiwan, is allopatric with species no. 26, and sympatric with species no. 23 in Taiwan. Its habitat is similar to that of species no. 26, although its altitudinal range might be more restricted.

#### Species nos. 18 + 19 + 24 and 23 + 25 + 26

Among these six species, species no. 23 is unique in its habitat and climatic conditions. The data do not show other disjunctions.

#### Species no. 21 and 22 (+ 32)

The data of species no. 32 are almost absent, except that it was once collected in the Arfak mountains (Vogelkop, New Guinea), where species no. 21 (endemic to New Guinea) is also found. Species nos. 22 is allopatric with these two species, occurring in the Philippines. Other extrinsic characters are not different according to the scanty labels associated with herbarium specimens available.

### 9.2.2.3. Species nos. 18--31 (+32): Aglaomorpha

Almost all species of Aglaomorpha are confined to the Malesia, the main exception being species no. 23 which occurs in China, on Taiwan, and on the Ryukyu Islands. They show smaller amplitudes in geographical and ecological parameters compared to Drynaria, rarely exceeding 2000 m altitude, usually inhabiting the everwet tropics, and are found only occasionally occurring in subtropical and somewhat dryer areas. They are usually epiphytes inhabiting several types of forests (e.g. primary -, secondary -, araucaria forests, plantations). Some species may also grow as dominant herbs in the undergrowth.

### 9.2.3. DRYNARIA

#### 9.2.3.1. Species nos. 10--16

#### Species nos. 13 and 14

These two species are largely confined to China. Their distributions show some overlap in Szechuan and Yunnan. They inhabit sites that differ as regards climatic conditions (according to the system of Köppen/Geiger), but they show a similar altitudinal range. Both species are mainly epilithic taxa, the latter species is reported occasionally as an epiphyte.

Species nos. 13 + 14 and 15

The next adelpho clade, species no. 15, is largely allopatric to both previous species. It shows a similar altitudinal range and inhabits areas with more or less similar climates. Species no. 15 is usually growing as an epiphyte; a unique feature within this group.

Species 13--15 and 16

Species nos. 13--15 are largely allopatric to species no. 16 which is widely distributed in China. Moreover, there is a clear altitudinal allopatric pattern between these adelpho clade, nos. 13--15 growing at high altitudes, no. 16 at much lower elevations. Therefore, they show differences in climatic requirements. Species no. 16 is very often found growing on rocks.

Species nos. 11 and 12

These species are sympatric for the greater part of their distribution. Species no. 11 is confined to tropical areas, whereas species no. 12 grows in more subtropical as well as tropical areas. It can be suggested from the labels at hand that the two species tend to show different altitudinal ranges, species no. 12 generally grows around 1000 m elevation and no. 11 generally around 1600 m. Most striking is their difference in habit. Species no. 12 is usually found growing as an epiphyte, whereas about half of the records of species no. 11 report that it grows epilithically.

Species nos. 10 and 11 + 12

Species no. 10 has a wide distribution, reaching from mainland Asia into the Pacific up to Samoa. In Australia it extends beyond the tropic of Capricorn to the south. This distribution area subsumes species no. 12 completely. It is partially sympatric with species no. 11. Associated with its widespread distribution, species no. 10 inhabits a variety of climates with a preference for wet conditions (viz. its absence in the Lesser Sunda Islands). It shows a wide altitudinal range, although most specimens were collected below an elevation of 1200 m. In New Guinea its altitudinal amplitude is largest, from sea level up to more than 2000 m, often above 1500 m. In continental S. E. Asia, where it is sympatric with both species nos. 11 and 12, most records are from 500 to 1500 m. Therefore, it does not show an altitudinal allopatric pattern with the latter two species. As regards the ratio between epiphytic and epilithic habits, this species is more or less intermediate between the two species of its sister group. There is no evidence that the epilithic or epiphytic habit is correlated with altitude.

Species nos. 10--16

The two adelpho groups comprising species nos. 10--12 and nos. 13--16 respectively, are largely allopatric, their distribution only slightly overlapping in S. China. As species nos. 13--16 occur more to the north, they show different climatic requirements compared to species nos. 10--12. In general, the former group occurs at different elevations with a larger percentage of epilithism.

9.2.3.2. Species nos. 6--9

Species nos. 8 and 9

These two species are obviously allopatric. They are similar in habit, being always reported as epiphytes (although the records are very scarce). The climatic conditions of the areas which they inhabit are similar, but they differ slightly in their altitudinal range.

Species nos. 6 and 8 + 9

Species no. 6 is allopatric with both nos. 8 and 9. In habit and climatic preferences, the three species show but little differences from one another as regards altitudinal ranges.

Species nos. 7 and 6 + 8 + 9

Species no. 7 is obviously allopatric with nos. 8 and 9. It is widely distributed on mainland Africa, like species no. 6 is. However, the two species show different distribution patterns. For species no. 7 two disjunct areas are recognized, i.e. (Mount) Cameroun and Fernando Poo in the west, and the central African vulcano range and Ethiopia in the east. Species no. 6 shows a continuous range from west to east Africa. The first pattern points to a montane habitat, which is confirmed by the much higher elevations of species no. 7 compared to species no. 6 (and nos. 8 and 9). This is also reflected in its climatic preferences. Species nos. 6 and 7 thus show altitudinal allopatry. All four species are similar regarding their habit, they are (almost) always reported as epiphytes.

Species nos. 6--16

Except for species no. 8, the two groups, comprising species nos. 6--9 and nos. 10--16 respectively, are allopatric. Species no. 8 is sympatric with species no. 10 in Malesia. Species nos. 6--9 are almost always epiphytes, whereas their putative sister group shows significant percentages of epilithism.

#### 9.2.3.3. Species nos. 1--5

Species nos. 4 and 5

These two species are allopatric, occurring in areas showing slightly different climatic conditions. Although the records are very scarce, the two species probably show different preferences regarding altitude. Species no. 5 probably grows more frequently in terrestrial or epilithic habitats.

Species nos. 3 and 4 + 5

Species no. 3 is allopatric with both species nos. 4 and 5. It shows a much larger altitudinal range and growing under different climatic circumstances. This species is mainly epilithical, which is a unique feature within this group.

Species nos. 1 and 3--5

Species no. 1 is wide-spread from Ceylon and continental S.E. Asia, through Malesia, into Australia. It is absent from the Lesser Sunda Islands. This range encloses that of species nos. 4 and 5 completely, but only partly that of species no. 3. The data at hand suggest species no. 1 to be typical for everwet tropical lowlands, and is usually found below 400 m. Its ecology does not differ from those of species no. 4 and only slightly from those of species no. 5 which probably grows at higher altitudes. Species nos. 1 and 3 have different climatic preferences.

Species nos. 2 and 1 + 3--5

Species no. 2 is widely distributed from Ceylon, India, and continental S.E. Asia, through Malesia, up to N.Australia. For the greater part, it is sympatric with species no. 1. This species is present in the Lesser Sunda Islands, but found only locally in eastern Malesia. The available information suggests that it grows in slightly dryer areas as compared to species no. 1, also mainly growing at low altitudes.

#### 9.2.3.4. Species nos. 1--16: Drynaria

The species of Drynaria are widespread in the paleotropics (Africa, Madagascar, continental Asia, Malesia, Pacific islands), but also present in the subtropics of China, Taiwan, and Australia, and absent from the Ryukyu Islands. Mainly, they inhabit areas with wet tropical climates, but also areas with seasonal climates and subtropical montane zones. The species show much altitudinal variation. They grow at sea level up to 4000 m.

Many of them are epiphytes, whereas others are often recorded as epilithic or terrestrial taxa. Species of Drynaria are found everywhere: in all types of tropical and subtropical forests and shrubby vegetations (e.g. primary -, secondary -, swamp -, deciduous -, gymnosperm -, gallery forests, plantation, shrubby grasslands).

#### 9.2.4. Species nos. 1--32: Drynarioideae

Species of drynarioid ferns are distributed throughout the paleotropics and extend into the subtropics of China and Australia. The range of Drynaria is much wider than, and almost entirely enclosing the area of Aglaomorpha (except for the Ryukyu Islands). Aglaomorpha is most diversified in Malesia, whereas Drynaria is most diversified in Africa and mainland Asia. All species are recorded as epiphytes, most of them as epilithic or terrestrial taxa. They inhabit a variety of habitats and altitudinal zones in a variety of climatic conditions.

### 9.3. Areas of endemism

Historical (cladistic) biogeography is principally concerned with the spatial distribution of life through time. It is assumed that there might exist a correspondence between species-relationships and area-relationships. Therefore, comparisons between the cladistic relationships within various groups of organisms occurring in a certain region might elucidate general patterns which can be used to develop hypotheses on the historical relations of biotas (Humphries, 1982; Humphries & Parenti, 1986; Nelson & Platnick, 1981; Rosen, 1976, 1978).

Essential to such a historical biogeographic analysis is the delimitation of areas of endemism, an activity comparable to the designation of characters (series of homologous states) in the original cladistic analysis. Like some species, some areas of endemism are obvious; often associated with natural barriers, e.g. the islands of Malesia. In other cases they are very difficult to define.

Several drynarioid species have a very restricted distribution, whilst others are widespread. An evaluation of the species distributions revealed nine areas of endemism (Table 9.5), to which four miscellaneous areas are added (Table 9.6).

The situation on mainland Asia is admittedly complex due to the absence of conspicuous natural barriers and distribution patterns. Starting with China, species nos. 13 and 14 show distribution patterns that overlap in Szechuan and Yunnan. Species no. 16 shows a different distribution pattern, but narrow overlapping zones are present with both previous species in Yunnan and Szechuan. There is a slight overlap with the distributions of species in S.E. continental Asia. It is decided that China constitutes an area of endemism. The same holds for S.E. continental Asia, comprising Assam, Burma, Thailand, and Indo-China, as based on the distribution patterns of species nos. 3 and 12. Species nos. 11 and 23 are wide-spread.

|    |                                   |
|----|-----------------------------------|
| Af | : Africa                          |
| Ma | : Madagascar and adjacent islands |
| N  | : Nepal, Bhutan, and N.India      |
| C  | : China                           |
| As | : S.E. continental Asia           |
| P  | : Philippines                     |
| B  | : Borneo                          |
| S  | : Sulawesi                        |
| NG | : New Guinea and adjacent islands |

Table 9.5

|    |  |
|----|--|
| T  | : Taiwan                                       |
| M  | : Malacca, Sumatra, Java, Lesser Sunda Islands |
| I  | : India and Ceylon                             |
| Au | : Australia and Pacific islands                |

Table 9.6

In spite of the existence of obvious natural barriers, the delimitation of some areas of endemism in Malesia is problematical. Species nos. 4 and 18 are restricted to two small disjunct regions of Borneo. Species no. 5 occurs only in Luzon, whereas species nos. 9, 22, and 29 are distributed throughout the Philippines. To avoid irrelevant detail, Borneo as well as the Philippines are treated as areas of endemism without further subdivision.

As regards New Guinea and its adjacent islands, species nos. 21, 30, and 32 are confined to New Guinea, but species no. 31 occurs also on the Moluccas, Bismarck archipelago, and Solomon Islands. It is more efficient to treat New Guinea together with the latter areas as one area of endemism. These areas, for the greater part conform to those areas of endemism recognized for Platyserium by Hennipman & Roos (1982).

Taiwan is treated as a separate area of endemism, although it is not inhabited by endemic drynarioid species. It has been recognized because it comprises part of the range of the species nos. 16 and 23 which occur also on mainland Asia and of the range of species no. 25 which occurs also in the Philippines.

The remaining areas of Malesia are inhabited only by widespread species. They comprise Malacca, Sumatra, Java, and the Lesser Sunda Islands, and are here taken together as one miscellaneous area. The same holds for Australia and the Pacific islands (including New Caledonia), and for India and Ceylon.

#### 9.4. Cladistic biogeographic analysis

In terms of the areas of endemism thus defined, 19 out of the 30 species occur in one area, 3 in two areas, 2 in three areas, and 6 species show a wider distribution (Table 9.7). The resulting (reduced) area-cladograms of the subsequent parts of the phylogenetic tree (Fig. 7.44) are presented in Fig. 9.2--6 (i.e. redundant branches are united; numbers to the arrows refer to the figures in Nelson & Platnick, 1981).

As stated by Humphries (1983, p. 445), cladistic biogeography is the pursuit of a method which encompasses a code comparable to cladistics. By changing species to areas of endemism and homologies to sister groups, cladistic biogeography interprets the geographical distribution of sister

|                                 |                    |
|---------------------------------|--------------------|
| 1. I, As, M, B, P, S, NG, Au    | 18. B              |
| 2. I, N, As, M, B, P, S, NG, Au | 19. P              |
| 3. As                           | 21. NG             |
| 4. B                            | 22. P              |
| 5. P                            | 23. N, C, As, T    |
| 6. Af                           | 24. M, B, P, S, NG |
| 7. Af                           | 25. P, T           |
| 8. Ma                           | 26. M, B, NG       |
| 9. M, S                         | 27. M, B, P, S     |
| 10. As, M, B, P, S, NG, Au      | 28. S              |
| 11. N, C, As                    | 29. P              |
| 12. As                          | 30. NG             |
| 13. C                           | 31. NG             |
| 14. C                           | 32. NG             |
| 15. N                           |                    |
| 16. C, T                        |                    |

Table 9.7

groups parsimoniously. Two main approaches can be recognized, i.e. Rosen (1976, 1978) and Nelson & Platnick (1981). Rosen's method is designed to find common patterns for areas of different groups of taxa by eliminating unique or incongruent elements from the individual groups. This leads to reduced area-cladograms; reduced having a different meaning as it is used above. However, this procedure leads to a loss of information by removing areas from the analysis and is more restrictive than the one applied in the present study.

In order to trace correspondence between species-relationships and area-relationships, the reduced area-cladograms are here analysed using the method of component analysis as described by Nelson & Platnick (1981; summarized by Humphries, 1983, and Humphries & Parenti, 1986). The remaining problematical point of these general treatments is not so much the discovery of components, but the construction of areagrams. This problem can be solved by using group compatibility and the clique concept as presently applied.

Analogous to the search for similarities in homologies to find components (character types) defining sets of terminal taxa (clada) for phylogeny reconstruction, similarities in geographical distribution in sister groups (cf. clada) can be searched for to find biogeographical components. And, analogous to the search for cliques to find interested sets of taxa, cliques of biogeographical components can be searched for to elucidate the interrelationships of areas of endemism based on unique distribution patterns.

This biogeographic analysis is exemplified in Fig. 9.1 and Table 9.8--10. It will be dealt with in more detail in a forthcoming paper (Roos & Zandee, in prep.).

Areagram I (= clique I; cf. Fig. 9.1.1) is distinctly more likely than the others as it shows the most support and the least contradiction. Accepting areagram I, the following incongruencies need explanation:

- the absence of the holophyletic groups presented in cladograms 2, 3, 4, and 5 in area D
- the absence of the holophyletic group presented in cladogram 8 in area B
- the absence of the holophyletic group presented in cladogram 7 in area C
- the complete inversed relations in cladogram 9

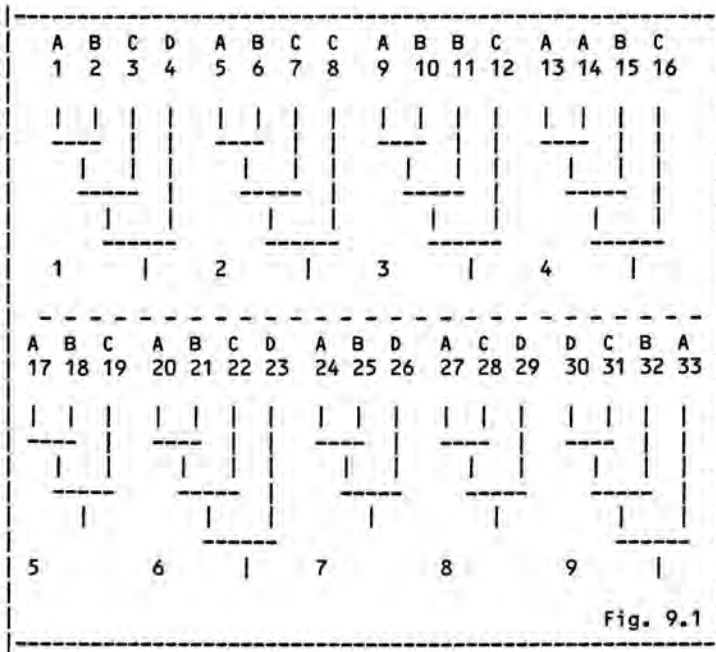

Fig. 9.1

Areas of endemism:

|                   |  |
|-------------------|--|
| A: terminal clada | 1, 5, 9, 13, 14, 17, 20, 24, 27, 33    |
| B: "              | " 2, 6, 10, 11, 15, 18, 21, 25, 28, 32 |
| C: "              | " 3, 7, 8, 12, 16, 19, 22, 28, 31      |
| D: "              | " 4, 23, 26, 29, 30                    |

Table 9.8

Components:

(numbers between brackets refer to supporting area-cladograms, Fig. 9.1)

A+B: clada 1+2 (1), 5+6 (2), 9--11 (3), 13--15 (4), 17+18 (5), 20+21 (6), 24+25 (7)

A+B+C: " 1--3 (1), 5--8 (2), 9--12 (3), 13--16 (4), 17--19 (5), 20--22 (6)

B+C+D: " 1--4 (1), 20--23 (6), 30--33 (9)

A+B+D: " 24--26 (7)

A+C: " 27+28 (8)

A+C+D: " 27--29 (8)

C+D: " 32+33 (9)

B+C+D: " 31--33 (9)

Table 9.9

| cliques:   |                          |    |            |     |    |                     |
|--|--------------------------|----|------------|-----|----|---------------------|
| I.   | {A+B}+{A+B+C}+{A+B+C+D}: | 13 | supporting | and | 4  | contradicting clada |
| II.  | {A+B}+{A+B+D}+{A+B+C+D}: | 8  | ''         | ''  | 10 | '' ''               |
| III.   | {A+B}+{C+D}+{A+B+C+D}:   | 8  | ''         | ''  | 10 | '' ''               |
| IV.  | {A+C}+{A+C+D}+{A+B+C+D}: | 2  | ''         | ''  | 16 | '' ''               |
| V.   | {C+D}+{B+C+D}+{A+B+C+D}: | 2  | ''         | ''  | 16 | '' ''               |
| multiple causation = contradiction (dispersal or extinction) |                          |    |            |     |    |                     |
| single causation = support                                   |                          |    |            |     |    |                     |

Table 9.10

At each hierarchical level, components represent the areas inhabited by the two adelpho taxa. Because of subsequent sister group relations increasing the group size, the areal components basically form interested sets of areas. When all species involved occur in only one area of endemism each, the components are obvious. But, when (some of) the species occur in two or more areas of endemism, or when holophyletic groups are lacking in some of these areas, the components are less obvious. In those cases, the analysis is carried under the assumption (Nelson & Platnick, 1981: Assumption 2) that the occurrences of species in different endemic areas might in the future be distinguished as separate taxa, then whatever is true of the one occurrence might not be true of the other occurrence. This assumption is less restrictive than its alternative (Nelson & Platnick, 1981, Assumption 1), which says that if the occurrence of species in different areas of endemism will never be distinguished as separate species, whatever is true for the one occurrence is also true for the other occurrence. The difference between assumption 1 and 2 becomes clear by supposing that future taxonomic research reveals that the populations of e.g. species no. 25 on Taiwan and the Philippines, respectively, actually represent two different species. Under assumption 1, it is presupposed that the species occurring in Taiwan and The Philippines (here confused with each other) are actually adelpho taxa or branch off the cladogram sequentially. Under assumption 2, no such presupposition exists, and both the identity and the interrelationships of one of the species are allowed to have been misconstrued (Platnick, 1982).

According to Nelson & Platnick (1981), assumption 2 is the most realistic in cases of taxonomic error and in cases where widespread species are the result of the failure of a species to speciate in response to one or more vicariance events, as well as of a species having expanded its range due to dispersal.

Starting from (sub)cladogram I (Fig. 7.44, 9.2), one area component (no. 1) can be found combining areas N and C. 'Subtree' II (Fig. 9.2) yields a second component (no. 2) combining N + C with As. 'Subtree' III (Fig. 9.2) leads to an equivocal component no. 3 (Ma with M or S), and cladogram IV (Fig. 9.3) immediately reveals component no. 4 (B + P). Further analysis reveals component no. 5.

Cladogram V (Fig. 9.4) immediately leads to component no. 7 (NG + P), but further analyses is complex as more than 4 areas and 4 taxa are involved. Therefore, species nos. 30 + 31 and no. 29 are combined, which is justified in view of the assumption made. The number of endemic areas is reduced by uniting P with M + B. This is done using the area-cladogram of *Platyserium* (Hennipman & Roos, 1982) of which the cladogram of the species of the *P. bifurcatum*-group yields component no. 9 (Fig. 9.6a). Using this component the combination is made since the alternative component (S + P) does not exist. Following this reasoning, cladogram V eventually reveals component no. 8. In cladogram VI (Fig. 9.5) component no. 4 is also present.



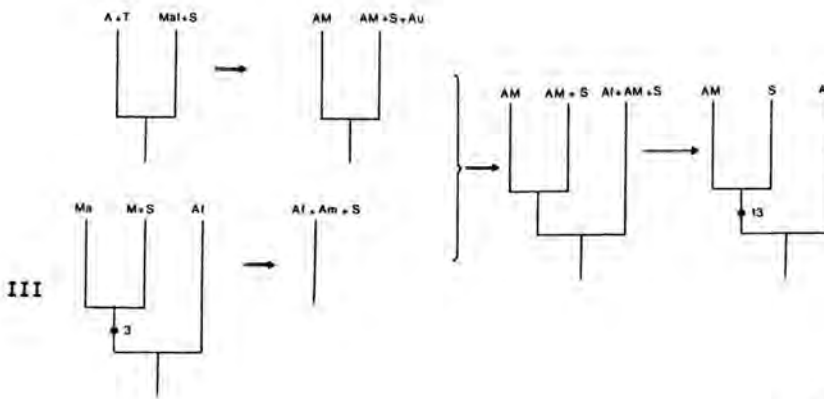
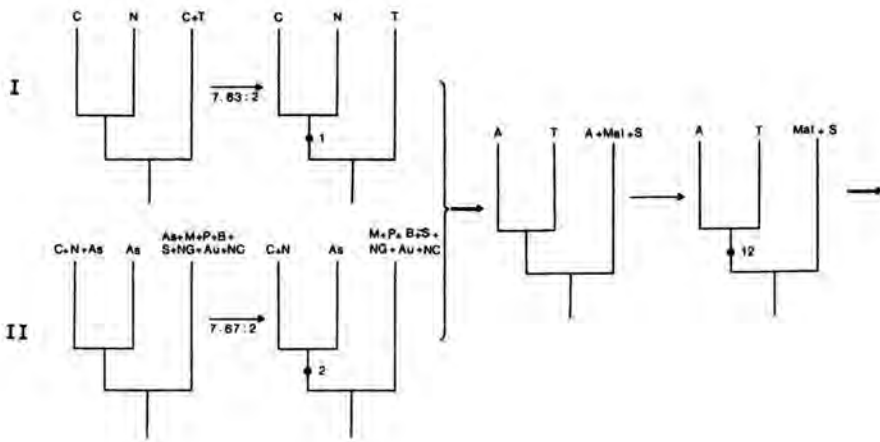

Fig. 9.2

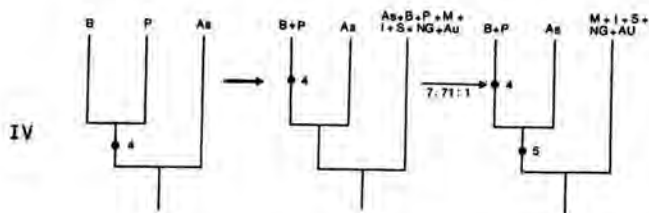

Fig. 9.3

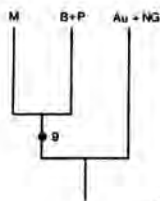
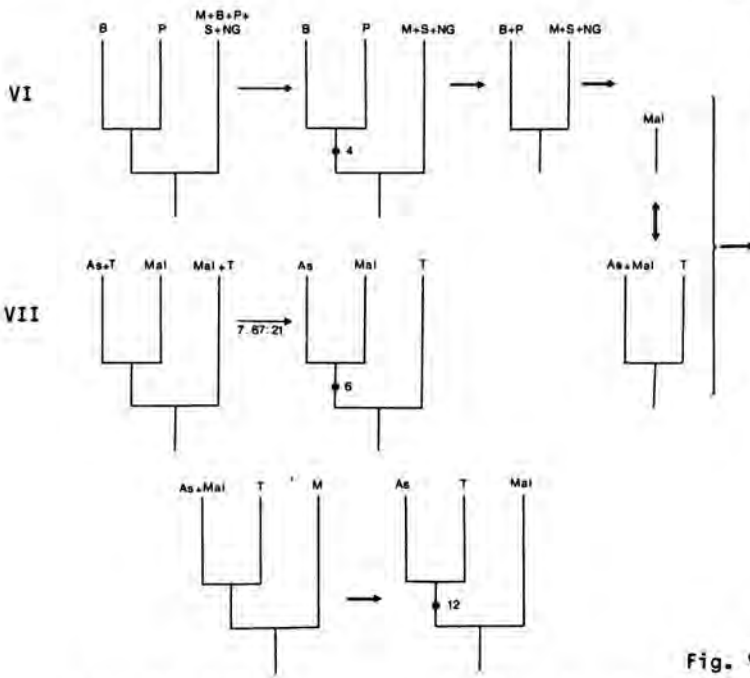
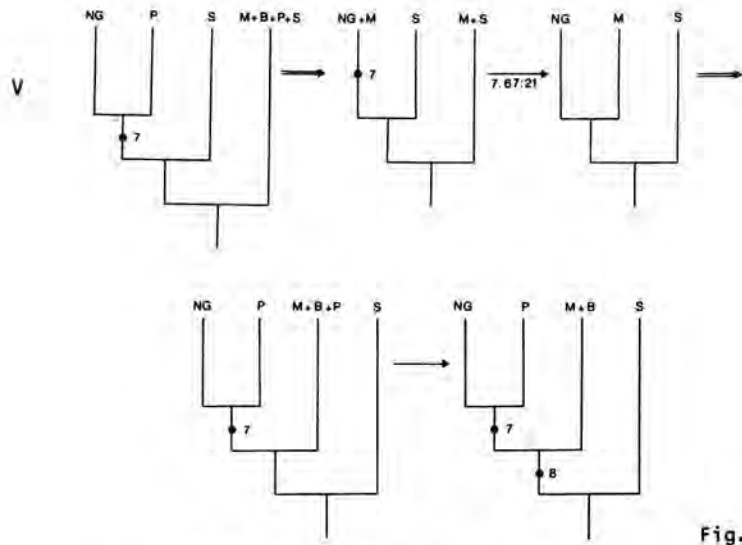

Fig. 9.6A

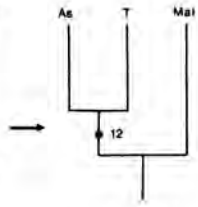

Fig. 9.5

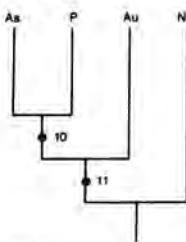

Fig. 9.6B

The cladogram of the *Platyserium* grande-group (Hennipman & Roos, 1982) shows component nos. 10 and 11 (Fig. 9.6b).

Cladogram VII (Fig. 9.5) is also complex, due to the large number of areas involved. Because of component no. 8, NG + M + P are grouped together to form Mal(esia), whereas component no. 2 is an argument in favour of the combination of N + C + As (A). Further reasoning yields component no. 6. The components found are summarized in Table 9.11.

|                  |                      |
|------------------|----------------------|
| 1 = C + N        | 6 = A + Mal          |
| 2 = C + N + As   | 7 = NG + P           |
| 3 = Ma + (M + S) | 8 = NG + P + (M + B) |
| 4 = B + P        | 9 = M + (B + P)      |
| 5 = B + P + As   | 10 = As + P          |
|                  | 11 = As + P + Au     |

Table 9.11

Further analysis reveals two more components, i.e. nos. 12 and 13 for respectively As + T and As + M + B + P + NG + S. The first one is found by combining cladograms VI and VII, I and II, the second by combining I, II, and III.

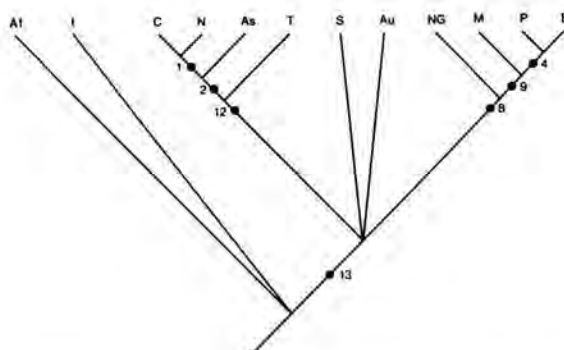

Fig. 9.7

Of the possible components, none can be regarded more general than the others. Three components (nos. 4, 7, and 12) have been found twice, of which the first two conflict with one another. As components are essentially analogous to character types, they define partially monothetic sets of areas. Therefore, they are used to form cliques following the same procedure as applied in the cladistic analysis, i.e. searching for inclusion relations. The largest clique consists of 8 internal nodes and is presented in an areagram (Fig. 9.7).

The areagram depicts that S.E. continental Asia is biogeographically more closely related to China and Nepal *sensu lato* than to Malesia, that Taiwan is more closely related to continental Asia than to Malesia, and that the Philippines and Borneo are more related to one another than either is to any other malesian area. The present data does not elucidate the relationships of S and Au with respect to continental Asia, and to western and eastern Malesia.



## 10. A SCENARIO OF THE PHYLOGENY OF THE DRYNARIOIDEAE

### 10.1. Fossil evidence

KrÄusel (1932) described a fossil of the Neogene from Palembang Province, Sumatra, probably from the Upper Miocene (ca. 10 m.y. ago). Almost certainly this is a drynarioid Polypodiaceae. The present author agrees with KrÄusel that probably it is a basal pinna of a fertile frond. KrÄusel identified it as Drynaria quercifolia, but according to the present author it is a specimen of Aglaomorpha heraclea (species no. 24). From the position of this species in the cladogram, the only conclusion that can be drawn is the minimum age of the group; in fact, one of the extant drynarioids existed at least 10 m.y. ago, and the common ancestor of the drynarioids almost certainly existed in a much earlier geological epoch.

### 10.2. Phylogeny

#### 10.2.1. Introduction

Several authors have ventured on speculations concerning the phylogeny of the drynarioid ferns, although usually in general terms. Ching (1978) following Copeland (1947) thought that the process of evolution within the group is still very active, "as illustrated by the probable newness and the extreme plasticity of members of the group with a marked tendency towards dimorphism". He considered Drynaria the most 'advanced' genus of the group, and Aglaomorpha heraclea the 'parent' species. Similar ideas have been earlier expressed by Copeland (1911, 1947) and Holttum (1954). Holttum (1946) regarded the Drynaria group "astonishingly diversified and remarkably adapted to epiphytic life. Yet the series M. [Microsorium] musifolium to Aglaomorpha heraclea and thence, separately to Drynaria and Merinthosorus [Aglaomorpha p.p.] has no serious gaps in it. Photinopteris [Aglaomorpha p.p.] is more specialized."

None of the speculative ideas proposed by pteridologists like Copeland (1947), Holttum (1954), Pichi Sermolli (1977), and Ching (1978), concerning the evolution of the drynarioids, are confirmed by the present study. The classifications until now are based on intuitive, untested statements about primitive and advanced taxa and the idea that recent species can be descendants of other recent species. The idea that taxa are primitive or advanced is meaningless in a phylogenetic context. It is only possible to denote polarity to character states. If we try to understand what they actually meant, we should take 'most advanced' in the sense of exhibiting the largest number of apomorphies. Even then, Ching's conclusion that Drynaria is the most advanced of the group is incorrect as Aglaomorpha shows more apomorphic character states than Drynaria. The probable newness of the group is contradicted by fossil evidence. Also, the marked tendency towards dimorphism is not confirmed by the cladogram (Fig. 7.43), which on the contrary shows transformations towards monomorphism.

Similar reasons can be given to reject the ideas of other authors. For example, Chandra (1980b), after studying the morphology of about 15 out of the 30 species recognized, followed these authors in regarding Microsorium as ancestral to the drynarioids. However, he proposed a biphyletic origin for the group, i.e. Aglaomorpha (but excluding species no. 27) originated independently from Drynaria. Unlike the suggestion made in his classification, his phyletic scheme did not depict the origin or

relationships of species no. 27. Chandra's treatment of *Drynaria* is too incomplete to be of significance, dealing with only three species. He regarded species no. 24 ancestral to *Aglaomorpha* which then gives rise to three groups, i.e. species no. 23, species no. 26, and a group comprising species nos. 18 + 22 + 25 + 29 + 31. Within the last group, he regards species no. 18 ancestral to species no. 25 (which in turn is ancestral to species no. 22), species no. 29, as well as to species no. 31. His scheme was based on general character trends which were postulated without any argumentation.

The next paragraphs are aimed to illustrate the integration of the foregoing analyses of intrinsic and extrinsic characters, as suggested in Chapter 4. To avoid digression, development in time and space is described only for two small-sized holophyletic groups; one from each genus.

### 10.2.2. General patterns

Generally, the ultimate branches of the cladogram represent allopatric sister groups (species) with two notable exceptions, species pairs nos. 11 + 12 and nos. 30 + 31 (Table 10.1). This suggests that allopatric speciation is the major speciation mechanism. However, higher order branches usually represent sympatric sister groups (Table 10.1). This raises the question of whether allopatric speciation has been the predominant mechanism in the past also and the patterns we see today are due to dispersal, or whether sympatric speciation has played a role. For example, the allopatric species pair nos. 18 and 19 are sympatric to their sister species no. 24. Based on their present distribution pattern, the speciation of species no. 24 and the ancestor of species nos. 18 + 19 might have been a sympatric event. On the other hand, it is also possible that this speciation event has been allopatric followed by dispersal of species no. 24 to the Philippines and Borneo. Further ecological research is needed, and the results must be compared with predictions of models concerning ecology of epiphytism (e.g. Benzing, 1983) and concerning (non-gradual) speciation (e.g. Eldredge & Gould, 1972).

| Sympatric                                | Allopatric               |
|--|--------------------------|
| 1--16 $\diamond$ 18--32                  | 3 $\diamond$ 4 + 5       |
| 1--5 $\diamond$ 6--16                    | 4 $\diamond$ 5           |
| 2 $\diamond$ 1 + 3--5                    | 6 $\diamond$ 8 + 9       |
| 10 $\diamond$ 11 + 12                    | 8 $\diamond$ 9           |
| 11 $\diamond$ 12                         | 10--12 $\diamond$ 13--16 |
| 27--31 $\diamond$ 18--26                 | 16 $\diamond$ 13--15     |
| 27 $\diamond$ 28--31                     | 15 $\diamond$ 13 + 14    |
| 31 $\diamond$ 30                         | 28 $\diamond$ 29--31     |
| 24 $\diamond$ 18 + 19                    | 29 $\diamond$ 30 + 31    |
| 21 + 22 + 32 $\diamond$ 18 + 19 + 23--26 | 21 $\diamond$ 22 + 32    |
| 23 + 26 + 25 $\diamond$ 18 + 19 + 24     | 22 $\diamond$ 32         |
| ? 1 $\diamond$ 3--5                      | 18 $\diamond$ 19         |
| ? 7 $\diamond$ 6 + 8 + 9                 | 25 $\diamond$ 23 + 26    |
| ? 14 $\diamond$ 13                       | 26 $\diamond$ 23         |
| ? 6--9 $\diamond$ 10--16                 |                          |

Table 10.1

In view of the higher order branchings being sympatric and accepting allopatry as the predominant speciation mechanism, the drynarioids show that dispersal might be a slow, long term process, although fern spores possibly have a long distance dispersal capability. This points to dispersal depending mainly on ecological factors, and not on dispersal capabilities. If this is true, then this would contradict the ideas of Benzing (1983), who regards the establishment of epiphytes mainly due to chance, i.e. the first to occupy the niche will survive.

Biogeographically, Taiwan is more closely related to (Indo-)China than to the Philippines. As a consequence, one could take the view that species no. 25 dispersed to Taiwan from the Philippines. As regards the group of species nos. 23 + 26 + 25, the first speciation event could have been sympatric implying extinction of species no. 25 in almost the whole Malesian area except the Philippines and in mainland Asia. It is regarded more plausible that this speciation event was allopatric, i.e. the Philippines vs. the rest of Malesia and mainland Asia plus Taiwan, followed by dispersal to Taiwan. The speciation of the two species nos. 23 and 26 might be the result of a vicariance event. Another possibility is that species no. 23 lost internal frond dimorphism as a corollary of dispersal to subtropical areas (an extrinsic character state unique in Aglaomorpha).

Generally, the species branching from the first node in the holophyletic groups of the drynarioids are the most widespread. This is contradictory to one of the main assumptions of evolutionary biogeography (see Wiley, 1981: p. 285, tenet 2). The area-cladograms show some patterns conforming to the progression rule, i.e. species nos. 3--5 and 6--9.

Aglaomorpha shows much diversification in Malesia, the species living in relatively uniform ecological conditions. Drynaria is most diversified in mainland Asia and in Africa, showing much variation as to geography, habitat, and altitude. Species inhabiting drier and/or subtropical climates on mainland Asia, usually show simplification of venation pattern, more epilithism, and often a loss of humus collecting capability. These phenomena represent general trends in Drynaria (e.g. species no. 3, 5, 12, 14, and 15). Furthermore, it appears that northern species occur at higher altitudes.

If the drynarioids are a geologically old group, the speciation event leading to the ancestor of the groups of species nos. 10--16 and of nos. 6--9 might be the result of a vicariance event, followed by dispersal to Malesia by species no. 9.

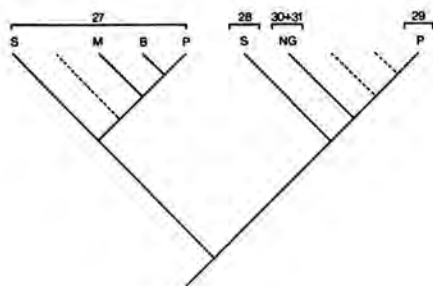

Fig. 10.1

### 10.3. A scenario of species nos. 27—31

According to the present distribution pattern, it can be inferred that the evolution of this group took place in Malesia. The first speciation might have been coupled with obvious morphological diversification (e.g. pinnate fronds, separate nectary lobes in species no. 27 vs. scale exposition in the ancestor of species nos. 28--31). As far as could be established, the recent descendants of this speciation event do not show differences in characters concerning climate, habitat, and altitude. Therefore, this speciation was possibly not coupled with ecological diversification.

The area-cladogram for these five species (Fig.10.1) is not fully congruent with the generalized areagram (Fig. 9.7). This can be explained in several ways:

- the first speciation has been sympatric, followed by extinction of species no. 27 in New Guinea, and of (the ancestor of) species nos. 28--31 in Java, Sumatra, Borneo, and Malaya. This would be in accordance with the areagram.
- speciation could have been allopatric in West Malesia and Sulawesi (no. 27) and New Guinea sensu lato (nos. 28--31), followed by subsequent dispersals to Sulawesi and to the Philippines.
- a sympatric speciation in Sulawesi and the Philippines (before New Guinea reached the malesian region?) followed by dispersal to New Guinea. As yet, no obvious general track could be detected.

The speciation of species no. 28 and the ancestor of nos. 29--31, and of no. 29 and the ancestor of nos. 30 + 31 are allopatric in terms of the present distribution patterns, either by vicariance events or by dispersal. Species nos. 30 and 31 are sympatric, often growing intermingled with one another, showing more or less similar patterns, although species no. 31 has a somewhat larger distribution area, exhibiting more variation as to altitude and habitat. The present data suggest that they are the result of a sympatric speciation process.

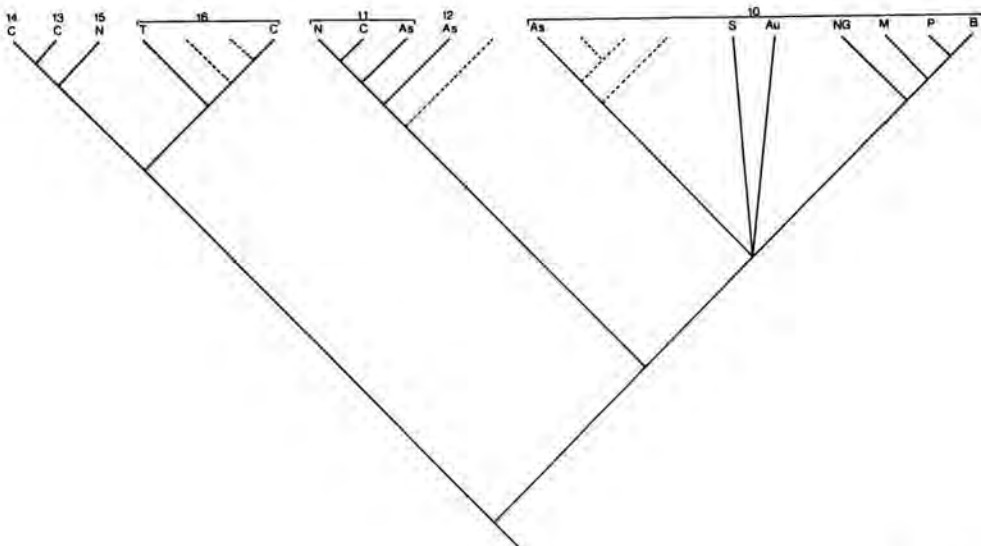

Fig. 10.2



#### **10.4. A scenario of species nos. 10—16**

The ancestor of this group had a relatively simple venation pattern and a long frond indument. Subsequent allopatric speciation events (area-cladogram Fig. 10.2, based on areagram Fig. 9.7) was coupled on the one hand with elaborations of the indument on the receptacle and the scales (ancestor of species nos. 10--12), on the other hand with further simplification of the venation pattern (nos. 13--16). The probably predominantly epilithic ancestor of species nos. 13--16 divided into a lowland species (no. 16) and the ancestor of species nos. 13--15 growing at high altitudes; the base fronds more or less lost the humus collecting as inferred from their rather foliage-like appearance and shape (cf. Diels, 1902). In view of the position in the cladogram of these mountainous asiatic species in relation to the more common tropical species growing at lower altitudes, high altitudes might have been reached via dispersal. Subsequent (allopatric?) speciation events led to species no. 15 (secondarily mainly epiphytic) and species nos. 13 and 14.

The speciation of the ancestor of species nos. 10--12 was probably allopatric (implying an independent dispersal of species nos. 10 to S.E. continental Asia) coupled with diversification in growth habit. The speciation of species nos. 11 and 12 has been sympatric as regards geography, but probably allopatric as regards ecology.



## 11. CONCLUSIONS

### 11.1. Methodology

Systematic discussions should first focus on the following items:

- 1) The methodology; The results of systematic research fully depend on and are a logical corollary of the method applied; It is stressed that only methods can be discussed, and that results following from different methods can only be compared. Secondly, it is useful to pay attention to subjects special for the group under study.
- 2) The aims; Comparative evolutionary biology should aim at contributing to the general understanding of evolution; based on an adequate methodology, its results are a prerequisite for analyses of processes.
- 3) The techniques for character analyses and observations; Techniques developed in general biology should be applied in comparative biological research as a routine as much as possible.

The present study is based on analyses of as much characters at all structurally integrated levels as possible. Such a large data matrix, avoiding a priori character weighting, supplies much information, leading to thorough morphological interpretations at each hierarchical level (e.g. more character state distribution patterns). Furthermore, the postulated phylogeny will have a greater reliability in terms of stability (standing up against 'new' character state distributions that are possibly conflicting), and it allows for comparisons between the different structurally integrated levels. The study of living plants in the field enabled important contributions to the character analyses, as is illustrated by the different growth habits recognized which play an evident role in the cladograms generated.

The data matrix (Appendix 2) shows much conflicting character state distributions. Disregarding the + 35 autapomorphies of single species, of the 176 transformation series established, an amount of + 50 fit the cladogram chosen. Other character states supply additional support. About 15 transformation series show fit via reversal, and + 40 show two or three homoplasies supporting two or three 'subtrees'. Eventually, less than 40 transformation series, pertaining to characters at all structural integration levels, show too much homoplasies and are discarded.

In the algorithm applied, there can be conspicuous differences between the first approximation of polarity among character states resulting from the estimation of the number of homoplasies in sets of (complementary) character states on the one hand, and the denotation of polarity based on local outgroup comparison (evaluation of supporting character states) on the other hand. Although this might be avoided using the second heuristic mentioned (Chapter 6.5.2.1.2), the computer program should be extended with a 3-cladon-permutation/local-outgroup-comparison algorithm to improve the calculation of the total amount of homoplasies per cladogram.

The 'best' cladograms resulting from the cladistic analyses dictate the same transformation series for (almost) all characters, differing in the (unambiguous) fit of a few character states only. They all comprise partially monothetic sets defined by character states at all structurally integrated levels studied. The cladograms resulting from separate analyses of each structurally integrated level are all mutually conflicting. Therefore, it can be predicted that characters at the molecular level in

turn would provide similar contributions to the construction of cladograms as do characters of other structurally integrated levels. It is here stated that phylogeny reconstruction should not be based on a selection of one (e.g. genetic) or a limited number of structurally integrated levels, but on characters from all levels. Firstly, because it is not possible to predict the fitting character states. Secondly, because it is necessary to evaluate fitting character states in relation to the distribution of other character states. Thirdly, because evolutionary mechanisms in principle affect (groups of) organisms, not solely characters.

Phylogeny reconstruction is a means to integrate character analyses covering all structurally integrated levels (including processes), enabling the investigation of the role that different biological (evolutionary) mechanisms play at each level in each particular evolutionary event. At each hierarchical level of the cladogram, the supporting characters have to be evaluated. It should not be the reverse, i.e. the evaluation of characters followed by a selection of support and a search for the most suitable level. Therefore, so-called evolutionary or general trends are not of use in reconstructing phylogeny.

Accepting evolutionary species as well as the phenomenon of cladogenesis, species cannot be ordered into transformation series. Consequently, species cannot be denoted as 'advanced' or 'primitive'.

Intuition and biological inferences need a great deal of caution (e.g. the difference in value of contradiction minus support of the cladograms 7.29 and 7.40), as it is often possible to supply an eloquent narrative account as regards the plausibility of a certain cladogram from a general biological point of view. In other words, the quantitative criterion using a strict and repeatable search procedure is necessary to be able to select a clearly defined and manageable number of cladograms out of the numerous possibilities. As the differences between the cladograms that show the lowest values are statistically insignificant, the search is not merely for the cladogram showing the lowest value, but for one or more cladograms showing low values that are regarded biologically the most plausible. However, the quantitative and the biological criteria belong to different domains of reasoning, each with its own set of assumptions (logical limits), and are as such not directly comparable without a detailed account as regards their rules of correspondence. Presently, it is aimed to achieve a practical consensus between the three criteria for judging trees and their support, i.e. parsimony, outgroup comparison, and biological inferences. Important is to make clear when and why these criteria apply.

The intuitive cladogram of *Aglaomorpha* is one of the cladograms of this genus showing the lowest values of contradiction minus support, whereas combinations of this cladogram with *Drynaria* cladograms show relatively high values. It is possible that for small-sized ingroups with a relatively low number of possibilities, intuitive ideas might approach parsimony criteria. For *Drynaria* being more complex (viz. the number of clique possibilities), intuition did not yield a parsimonious cladogram. In case of the entire subfamily, the situation is far too complex to rely on intuition (viz. cladogram 7.41).

## 11.2. Systematics

The phylogenetic classification proposed is based on the cladogram chosen (Fig. 7.43) and contradicts all previously suggested classifications. The latter could not be confirmed by a phenetic analysis of the same data matrix either. Furthermore, the phenetic analysis shows that the dissimilarity

among the Drynaria species is larger than among the Aglaomorpha species, which contradicts what previous classifications might suggest. Hence, these classifications must be based on a priori character weighting.

Aglaomorpha in the sense as often used before, and Merinthosorus do not constitute a holophyletic group. The large number of monotypic genera traditionally recognized does not reflect phylogeny nor any other evolutionary aspect. Monotypic genera are usually non-informative as they do not indicate any relation and they are generally based on the search for and intuitive evaluation of differences only. Consequently, obvious morphologically distinct taxa above the species level are equally disputable as all other taxa, e.g. Photinopteris.

The transformation series traditionally accepted within the drynarioids (see Copeland, 1947; Zamora & Vargas, 1973; Pichi Sermolli, 1977), regarding, for example, the internal fertile/sterile dimorphism, are all contradicted by the transformation series deduced from the chosen cladogram. In other words, the states present in species no. 24, generally regarded plesiomorphous, are presently inferred to be apomorphous. It is not refuted that similar states might indeed be plesiomorphous for the drynarioids, as it is likely that in the Polypodiaceae in general (internal) dimorphy is apomorphous (e.g. Aglaomorpha, Drynaria), but within the group they are apomorphous. General trends of use at high hierarchical levels, do not necessarily meet transformation series at the species level, and cannot be directly extrapolated as is often done.

Neither Aglaomorpha nor Drynaria can be partially monothetically defined; they constitute strictly monothetic or polythetic groups. In other words, these genera can only be understood using inferred character evolution. Thus, for the delimitation of taxa above the species level it is irrelevant to provide general rules in terms of the size of the set of defining characters.

Although the geographical analysis is based on a few area-cladograms, the areagram shows that the areas of Malesia are mutually more related than one of them is to areas of continental S. E. Asia, and that Taiwan is more closely related to the latter areas than to the first.

Within Drynaria a probable strategy is one that leads towards epilithical growth habits (viz. species no. 3 and 13, 14, 16), whereas in Aglaomorpha this might be towards terrestrials (viz. species 31). These strategies contradict the remark of Holttum (1949), stating that the drynarioids are one of the most highly evolved groups of epiphytes. The same holds for the general trend towards monomorphism in both Drynaria and Aglaomorpha, which has never been postulated before.

Postulated phylogenetic relations provide the possibilities and restrictions for research on processes. For example, the cladogram 7.43 allows for the study of the processes how A. heraclea became secondarily monomorphic. According to the cladogram, it is meaningless to study the processes how Aglaomorpha species became internally dimorphic starting from A. heraclea.

The present study mainly deals with phase 1 and with phase 3 (see Chapter 4). Future research on the drynarioids should first focus on the following items:

- a- autecological research of, for example, species nos. 27--31, with special reference to the sympatric adelpho species nos. 30 and 31, followed by the construction of eco-cladograms.

b- character analyses at the molecular level, including intrinsic processes.

## 12. REFERENCES

- Alderwerelt van Rosenburgh, C. R. W. K. van. 1908. Malayan ferns. Handbook.
- Alderwerelt van Rosenburgh, C. R. W. K. van. 1909. *Pleopeltis specierum Malaiarum enumeratio*,... Bull. Dép. Agric. Indes néerl. 27: 1--12.
- Alderwerelt van Rosenburgh, C. R. W. K. van. 1917. Malayan ferns and fern allies. Handbook. Suppl. 1.
- Ax, P. 1984. *Das phylogenetische System*. Stuttgart.
- Baker, J. G. 1868. *Polypodium*. In: Hooker, W. J. & J. G. Baker, *Synopsis Filicum*.
- Beckner, M. 1959. *The biological way of thought*. New York.
- Beddome, R. H. 1876. *Supplement to the ferns of Southern India and British India*...
- Beddome, R. H. 1883. *Handbook to the ferns of British India, Ceylon, and the Malay Peninsula*.
- Benzing, D. H. 1983. Vascular epiphytes: a survey with special reference to their interactions with other organisms. In Sutton, S. L., T. C. Whitmore, & A. C. Chadwick, *Tropical rainforest: ecology and management*. Spec. publ. 2, Brit. Ecol. Soc.
- Bloch, J. R. 1984. Entropy, ecology, and the concept of self-organization. *Eur. J. Sci. Educ.* 6(1): 11--17.
- Blume, C. L. *Enumeratio plantarum Javae et insularum adjacentium*. Fasc. II. Filices, Polypodiaceae Kaulf.
- Bory de Saint-Vincent, J. B. G. M. 1825. Sur un sous-genre à former parmi les Polypodes, sous le nom de Drynaire, *Drynaria*. *Annls Sci. nat.* 5: 463--470.
- Bower, F. O. 1928. *The Ferns (Filicales)*. 3. The Leptosporangiate ferns.
- Brackenridge, W. D. 1854. United States exploring expedition (1838--1842). XVI. Botany. Cryptogamia, Filices.
- Bremer, K. & H.-E. Wanntorp. 1978. Phylogenetic systematics in botany. *Taxon* 27(4): 317--329.
- Briggs, D. & S. M. Walters. 1984. *Plant variation and evolution*. 2nd ed. Cambridge.
- Bron, C. & J. Kerbosch. 1973. Algorithm 457: Finding all cliques of an undirected graph. *Comm. A. C. N.* 16: 575--577.
- Brooks, D. R. 1985. Historical ecology: A new approach to studying the evolution of ecological associations. *Ann. Miss. bot. Gard.* 72: 660--680.
- Brooks, D. R., J. N. Caira, T. R. Platt, & M. R. Pritchard. 1984. *Principles and methods of phylogenetic systematics. A cladistic workbook*.
- Brooks, D. R. & E. O. Wiley. 1986. *Evolution as entropy; towards a unified theory of biology*. Chicago.
- Brown, R. 1810. *Prodromus Florae Novae Hollandiae et insulae Van Diemen*.
- Chandra, S. 1979. Taxonomic use of foliar epidermis and hypodermis in drynarioid ferns. *Kalikasan, Philipp. J. Biol.* 8(2): 211--226.
- Chandra, S. 1980a. Morphology and phylogeny of drynarioid ferns. *Brenesia* 18: 171--178.
- Chandra, S. 1980b. Venation patterns of drynarioid ferns. *Brenesia* 18: 179--190.
- Chandra, S. 1982a. Structure and organization of the vascular system in the rhizome of drynarioid ferns. *Ann. Bot.* 50: 585--598.
- Chandra, S. 1982b. A new concept of drynarioid ferns. *Fern Gaz.* 12(4): 225--229.
- Chandra, S. 1982c. Some aspects of interrelationships among the drynarioid ferns. *Gard. Bull. Sing.* 34(2): 229--238.
- Chandra, S. 1982d. Notes on some ecological adaptations in Drynarioid Ferns. *Malay. Nat. J.* 35: 133--148.
- Chandra, S. & P. M. Zamora. 1979. Spore morphology in relation to taxonomy of drynarioid ferns. *Phytomorphology* 29(3-4): 252--255.

- Ching, R. C. 1940. On natural classification of the family 'Polypodiaceae'. *Sunyatsenia* 5(4): 201--268.
- Ching, R. C. 1978. The chinese fern families and genera: systematic arrangement and historical origin. *Act. Phytotax. Sin.* 16: 1--37.
- Ching, R. C. & S. K. Wu. 1983. Pteridophyta. In: Wu, C. Y., *Flora Xizangica*, vol. I.
- Christ, H. *Die Farnkruter der Erde*. Jena.
- Christ, H. *Filices Insularum Philippinarum*, coll. A. Loher. *Bull. Herb. Boissier* 6 (3): 189--210.
- Christensen, C. 1934. *Index Filicum supplementum tertium pro annis 1917--1933*.
- Christensen, C. 1938. *Filicinae*. In: Verdoorn, F. *Manual of Pteridology*. Den Haag.
- Colless, D. H. 1985. On "character" and related terms. *Syst. Zool.* 34(2): 229--233.
- Copeland, E. B. 1906. New Philippine ferns. *Philipp. J. Sci. [Bot.]* 1, suppl. 2: 143--167.
- Copeland, E. B. 1911. Bornean ferns, collected by C. J. Brooks. *Philipp. J. Sci. [Bot.]* 6(3): 133--145.
- Copeland, E. B. 1914. New Papuan ferns. *Philipp. J. Sci. [Bot.]* 9(1):1--9.
- Copeland, E. B. 1929. The oriental genera of Polypodiaceae. *Univ. Calif. Pubs Bot.* 16(2): 45--128.
- Copeland, E. B. 1947. *Genera Filicum*. Chronica Botanica Co.
- Crabbe, J. A., A. C. Jermy, & J. T. Mickel. 1975. A new generic sequence for the pteridophyte herbarium. *Fern Gaz.* 11: 141--162.
- Croizat, L. 1964. *Space, time, and form; the biological synthesis*. Caracas.
- Cronquist, A. 1981. *An integrated system of classification of flowering plants*. New York.
- Cufodontis, G. 1969. *Systematische Bearbeitung der in Sud-Aethiopien gesammelten Pflanzen. 7. teil (Expedition Frobenius-Institutes der Univ. Frankfurt a. Main, 1954--1955)*. *Senckenb. biol.* 50(3-4): 256--257.
- Dahlgren, R. 1975. A system of classification of the angiosperms to be used to demonstrate the distribution of characters. *Bot. Notiser.* 128: 119--147.
- Desvaux, A. N. 1811. *Observations sur quelques nouveaux genres de fougères*. *Gesell. Naturf. Fr. Berlin. Mag.* 5: 315.
- Diels, L. 1902. Polypodiaceae. In: Engler, A. & K. Prantl, *Die naturlichen Pflanzenfamilien* 1(4): 139--339.
- Dover, G. 1982. Molecular drive, a cohesive model of species evolution. *Nature* 299: 111--117.
- Duncan, T. & T. F. Stuessy (Eds). 1984. *Cladistics: Perspectives on the reconstruction of evolutionary history*. New York.
- Eldredge, N. 1985. *Unfinished synthesis; biological hierarchies and modern evolutionary thought*. Oxford.
- Eldredge, N. & J. Cracraft. 1980. *Phylogenetic patterns and the evolutionary process*. New York.
- Eldredge, N. & S. J. Gould. 1972. Punctuated Equilibrium: An alternative to phyletic gradualism. In Schopf, J. T. M. (Ed.), *Models in Paleobiology*: 82--115.
- Engelmann, G. F. & E. O. Wiley. 1977. The place of ancestor-descendant relationships in phylogeny reconstruction. *Syst. Zool.* 26: 1--11.
- Farris, J. S. 1970. Methods for computing Wagner trees. *Syst. Zool.* 19: 83--92.
- Farris, J. S. 1983. The logical basis of phylogenetic analysis. In: Platnick & Funk (Eds): 7--36.
- Farris, J. S., A. G. Kluge, & M. F. Mickevich. 1982. Phylogenetic analysis, the monothetic group method, and myobatrachid frogs. *Syst. Zool.* 31(3): 317--327.



- Fée, A. L. A. 1850-'52. Genera Filicum. Cinquième Mémoire sur la famille des fougères.
- Fink, W. L. 1982. The conceptual relationship between ontogeny and phylogeny. *Paleobiology* 8: 254--264.
- Fitch, W. M. 1984. Cladistic and other methods: problems, pitfalls, and potentials. In: Duncan & Stuessy (Eds): 221--252.
- Funk, V. A. & D. R. Brooks (Eds). 1981. Advances in cladistics. Proc. 1st meeting Willi Hennig Soc.
- Gaudichaud-Baupré, C. 1826. Voyage avec l'Uranie et le Physicienne, 1817--1820. Botanique.
- Geesink, R. 1984. Scala Millettiearum. Leiden Bot. Ser. no. 8. Leiden.
- Goebel, K. 1928. Weitere Untersuchungen über die Gruppe der Drynariaceen. Morphologische und Biologische Studien XIII. *Annl's Jard. bot. Buitenz.* 39: 117--162
- Hennig, W. 1950. Grundzüge einer Theorie der phylogenetischen Systematik. Berlin.
- Hennig, W. 1965. Phylogenetic Systematics. *A. Rev. Ent.* 10: 97--116.
- Hennig, W. 1966. Phylogenetic Systematics. Urbana.
- Hennipman, E. 1974. The lectotypification of *Acrostichum acuminatum* Willd. and the reinstatement of the name *Photinopteris speciosa* (Bl.) Presl. *Blumea* 22: 51--52.
- Hennipman, E. 1977. A monograph of the fern genus *Bolbitis* (Lomariopsidaceae). Leiden Bot. Ser. 2.
- Hennipman, E. 1984. A new approach to the systematics of the Polypodiaceae (Filicales). *Taxon* 33: 140--141.
- Hennipman, E. & R. Baaijen. In prep. Paraphyses of Polypodiaceae.
- Hennipman, E. & M. C. Roos. 1982. A monograph of the fern genus *Platyserium* (Polypodiaceae). *Verh. K.N.A.W. Natuurk. Ser. 2, Vol. 80.*
- Hennipman, E. & M. C. Roos. 1983. Phylogenetic systematics of the Polypodiaceae (Filicales). *Verh. naturwiss. Ver. Hamburg (NF)* 26:321--342.
- Hennipman, E. & T. Sen. In prep. Spore types in Polypodiaceae.
- Hetterscheid, W. L. A. & E. Hennipman. 1985. Venation patterns, soral characteristics, and shape of the fronds of the microsorioid Polypodiaceae. *Bot. Jahrb. (Systematik)* 105(1): 11--47.
- Holmes, E. B. 1980. Reconsideration of some systematic concepts and terms. *Evol. Theory* 5: 35--87.
- Holtum, R. E. 1946. A revised classification of leptosporangiate ferns. *J. Linn. Soc. Bot.* 53: 123--158.
- Holtum, R. E. 1949. The classification of ferns. *Biol. Rev.* 24: 267--296.
- Holtum, R. E. 1954. A revised Flora of Malaya. 2. Ferns of Malaya.
- Hooker, W. J. The Filices, Polypodiaceae. In: Champion, J. G., *Florula Hongkongensis*,... *Hook. J. Bot.* 9: 353--363.
- Hooker, W. J. 1864. *Species Filicum*,... vol. V.
- Hooker, W. J. & F. Bauer. 1842. *Genera Filicum or illustrations of the ferns*...
- Humphries, C. J. 1981. Biogeographical methods and the southern beaches (Fagaceae: *Nothofagus*). In: Funk & Brooks (Eds): 177--207.
- Humphries, C. J. 1982. Vicariance biogeography in Mesoamerica. *Ann. Miss. bot. Gard.* 69: 444--463.
- Humphries, C. J. 1983. Primary data in hybrid analysis. In: Platnick & Funk (Eds): 89--103.
- Humphries, C. J. & L. R. Parenti. 1986. Cladistic biogeography. Oxford monographs on biogeography no. 2. Oxford.
- Hutchinson, J. 1959. The families of flowering plants. Oxford.
- Jantsch, E. (Ed.). 1981. The evolutionary vision. AAAS selected symposia. Boulder, Colo.
- Jardine, N. 1969. A logical basis for biological classification. *Syst. Zool.* 18: 37--52.

- Jarrett, F. M. 1980. Studies in the classification of the Leptosporangiate ferns. I. The affinities of the Polypodiaceae sensu stricto and the Grammitidaceae. *Kew Bull.* 34: 825--833.
- Johansson, D. 1974. Ecology of vascular epiphytes in West African rain forest. *Acta Phytogeog. Suecica* 59.
- Jong, R. de. 1980. Some tools for evolutionary and phylogenetic studies. *Z. zool. Syst. Evolut.-forsch.* 18: 1--23.
- Kalkman, C. De twee vragen van de planten systematiek. *Rijksherbarium, Leiden (in dutch)*.
- Kluge, A. G. & J. S. Farris. 1979. A botanical clique. *Syst. Zool.* 28: 400--411.
- Koponen, T. 1968. Generic revision of Mniaceae Mitt. (Bryophyta). *Ann. Bot. Fenn.* 5: 117--151.
- Koptur, S., A. R. Smith, & I. Baker. 1982. Nectaries in some Neotropical species of *Polypodium* (Polypodiaceae): preliminary observations and analyses. *Biotropica* 14 (2): 108--113.
- Kramer, K. U. 1957. A revision of the genus *Lindsaea* in the New World with notes on allied genera. *Acta. Bot. Neerl.* 6: 97--290.
- Krüssel, R. 1932. Fossile Pflanzen aus dem Tertiär von Süd-Sumatra. Ein weitere Beitrag zur Kenntnis der fossilen Flora Niederländisch-Indiens. *Verh. Geol.-Mijnb. Gen. NL. Kolon. Geol. Ser. IX:* 5--7.
- Kuhn, M. 1869. Filices. [Miq.] *Annls Mus. Bot. Lug.-Bat.* 4: 276--300.
- Linnaeus, C. 1753. *Species Plantarum*.
- Löve, A. & D. Löve, & R. E. G. Pichi Sermolli. 1977. *Cytotaxonomical atlas of the Pteridophyta*.
- Mayr, E. 1974. Cladistic analysis or cladistic classification? *Z. zool. Syst. Evolut.-forsch.* 12: 94--128.
- Mayr, E. 1982. *The growth of biological thought*. Cambridge, Mass.
- Meacham, C. A. 1981. A manual method for character compatibility analysis. *Taxon* 30: 591--600.
- Meacham, C. A. 1984. Evaluating characters by character compatibility analysis. In: Duncan & Stuessy (Eds): 152--165.
- Mettenius, G. 1856. *Filices horti botanici Lipsiensis*.
- Mettenius, G. 1857. Ueber einige Farngattungen. I. *Polypodium*.
- Mettenius, G. 1866. *Filices, Praesertim Indicae et Japonicae* 2. *Annls Mus. Bot. Lug.-Bat.* 2.
- Mickevich, M. F. 1982. Transformation series analysis. *Syst. Zool.* 31(4): 461--478.
- Mitsuta, S. 1984. Studies in the venation and systematics of Polypodiaceae. II. Venation of the Polypodiaceae (2) and of some other ferns. *Mem. Fac. Science Kyoto Univ. ser. Biol.* 9: 57--85.
- Mitsuta, S. (in press). Studies in the venation and systematics of Polypodiaceae. III. Comments on generic classification of Polypodiaceae and notes on venation and systematics of the Polypodiaceae.
- Moore, T. 1862. *Index Filicum*. Synopsis of the genera of ferns.
- Mueller, M. J. 1982. Selected climatic data for a global set of standard stations for vegetation science. *Tasks for vegetation science* 5. Den Haag.
- Nayar, B. K. 1961. Ferns of India, No. 2: *Drynaria* and *Pseudodrynaria*. *Bull. natn. bot. Gdns Lucknow* 56.
- Nayar, B. K. 1970. A phylogenetic classification of the homosporous ferns. *Taxon* 19: 229--236.
- Nayar, B. K. & P. Kachroo. 1953. Studies in Polypodiaceae. I. Contributions to the Morphology of *Drynaria* Bory: *D. quercifolia* (L.) J.Sm. and *D. propinqua* (Wall.) J.Sm. *Phytomorphology* 3(4): 411.
- Nelson, G. & N. Platnick. 1981. *Systematics and Biogeography; Cladistics and Vicariance*. New York.
- Ng, F. S. P. (1980). Litter-trapping Plants. *Nature malaysiana* 5(4): 26.

- O'Brien, T. P. & M. E. McCully. 1981. The study of plant structure. Principles and selected methods. Melbourne.
- Ogura, Y. 1972. Comparative anatomy of vegetative organs of the Pteridophytes. In: Zimmermann, W., S. Carlquist, P. Ozenda, & H. D. Wulff, Handbuch der Pflanzenanatomie (2te Aufl.) 7(3).
- Paterson, S. 1982. Observations on ant associations with rainforest ferns in Borneo. Fern Gaz. 12(4): 243--245.
- Peursen, C. A. Van. 1980. De opbouw van wetenschap; een inleiding in de wetenschapsleer. Meppel.
- Pichi Sermolli, R. E. G. 1977. Tentamen Pteridophytorum genera in taxonomicum ordinem redigendi. Webbia 31: 313--512.
- Platnick, N. I. 1979. Philosophy and the transformation of cladistics. Syst. Zool. 28: 537--546.
- Platnick, N. I. 1982. Widespread taxa and biogeographic congruence. In: Funk & Brooks (Eds): 221--227.
- Platnick, N. I. & V. A. Funk (Eds). 1983. Advances in cladistics II. Proc. 2nd meeting Willi Hennig Soc.
- Presl, C. B. 1836. Tentamen Pteridographiae, seu genera filicacearum...
- Presl, C. B. 1849 (1851). Epimeliae botanicae.
- Prigogine, I. & J. Stengers. 1984. Order out of chaos. New York.
- Raciborski, M. 1898. Die Pteridophyten der Flora von Buitenzorg.
- Riedl, R. 1978. Order in living organisms. A systems analysis of evolution. New York.
- Riggins, R. & J. S. Farris. 1983. Cladistics and the roots of angiosperms. Syst. Bot. 8: 96--100.
- Roos, M. C. 1984. Observations on drynarioid Polypodiaceae in Papua New Guinea. Fl. Mal. Bull. 37: 54--57.
- Roos, M. C. 1986. The crucial role of comparative biology in evolutionary interpretations. In press.
- Roos, M. C. & M. Zandee. In prep. Group compatibility in cladistic biogeography.
- Rosen, D. E. 1976. A vicariance model of Caribbean biogeography. Syst. Zool. 24: 431--464.
- Rosen, D. E. 1978. Vicariant patterns and historical explanation in biogeography. Syst. Zool. 27: 159--188.
- Schmid, R. 1982. The terminology and classification of steles: Historical perspective and the outlines of a system. Bot. Rev. 48(4): 817--931.
- Salthe, S. N. 1985. Evolving hierarchical systems; their structure and representation. Columbia.
- Schott, H. 1834-'36. Genera Filicum.
- Sen, U. & E. Hennipman. 1981. Structure and ontogeny of stomata in Polypodiaceae. Blumea 27: 127--201.
- Smith, J. 1841. Enumeratio Filicum Philippinarum;... Hook. J. Bot. 3: 392--422.
- Smith, J. 1842. An arrangement and definition of the genera of ferns... Hook. J. Bot. 4: 147--198.
- Smith, J. 1866. Ferns, British and Foreign.
- Smith, J. 1875. Historia Filicum.
- Sneath, P. H. A. & R. R. Sokal. 1973. Numerical taxonomy; the principles and practice of numerical classification. San Francisco.
- Swartz, O. 1801. Genera et species Filicum. J. Bot. (Schrader) 1800(2).
- Takhtajan, A. 1969. Flowering plants. Origin and dispersal. Edingburgh.
- Thorne, R. F. 1976. A phylogenetic classification of the Angiospermae. Evol. Biol. 9: 35--106.
- Varela, F. J. 1979. Principles of biological autonomy. General Systems Research ser. vol. 2. New York.
- Wagner, W. H. jr. 1961. Problems in the classification of ferns. In: Recent advances in botany: 841--844.

- Wagner, W. H. jr. 1980. Origin and philosophy of the Groundplan-divergence method of cladistics. *Syst. Bot.* 5(2): 173--193.
- Watrous, L. E. & Q. D. Wheeler. 1981. The out-group comparison method of character analyses. *Syst. Zool.* 30: 1--11.
- Wiley, E. O. 1975. Karl R. Popper, systematics and classification - a reply to Walter Bock and other evolutionary taxonomists. *Syst. Zool.* 24: 233--243.
- Wiley, E. O. 1981. *Phylogenetics, the theory and practice of phylogenetic systematics.* New York.
- Wiley, E. O. & D. R. Brooks. 1982. Victims of history - A nonequilibrium approach to evolution. *Syst. Zool.* 31: 1--24.
- Wilson, K. A. 1959. Sporangia of the fern genera allied with *Polypodium* and *Vittaria*. *Contr. Gray Herb.* 185: 97--127.
- Zamora, P. M. & N. S. Vargas. 1973a. Notable variation in leaf forms of *Drynaria*. *Philipp. Agric.* 57(1-2): 55--71.
- Zamora, P. M. & N. S. Vargas. 1973b. Nectary-costule association in Philippine drynarioid ferns. *Philipp. Agric.* 57(1-2): 72--88.
- Zamora, P. M. & N. S. Vargas. 1973c. A note on an unusual nest leaf of *Drynaria*. *Philipp. Agric.* 57(1-2): 88--91.
- Zandee, M. unpubl. ms (1983). 3-Taxon-uitspraak permutaties + outgroup vergelijking = cladistische analyse (in dutch).
- Zandee, M. 1985. Three-cladon-statement permutations + local outgroup comparison = cladistic analysis. Paper read at the 4th meeting of the Willi Hennig Society, London.
- Zandee, M. 1985. C.A.F.C.A. - A collection of APL functions for cladistic analysis. Online C.A.F.C.A. documentation (internal report ITB, in dutch).
- Zandee, M. & R. Geesink. 1986. Phylogenetics and legumes: A desire for the impossible? In press.

PLATES





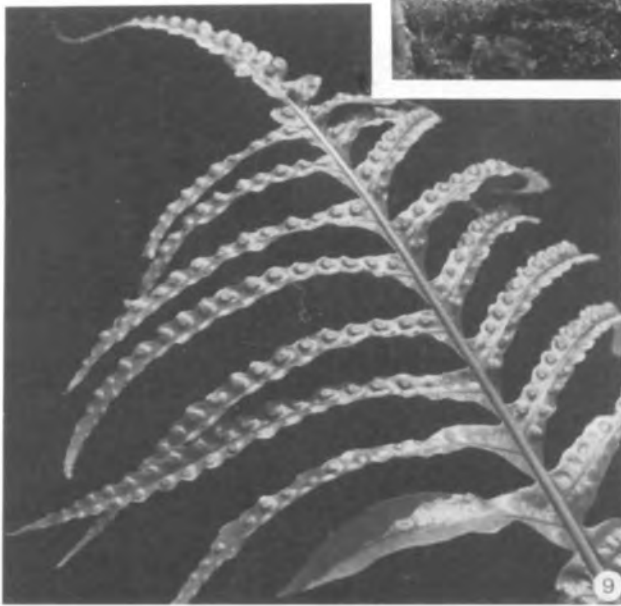
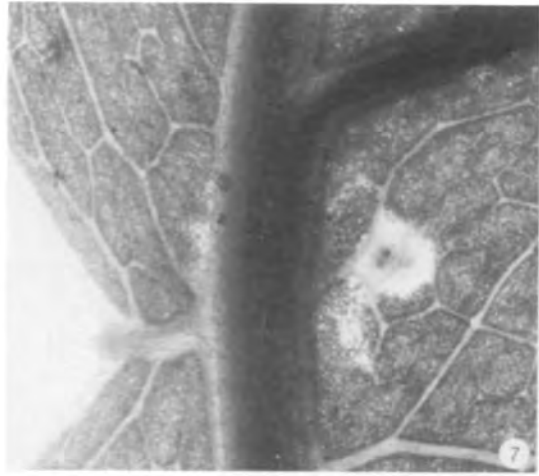



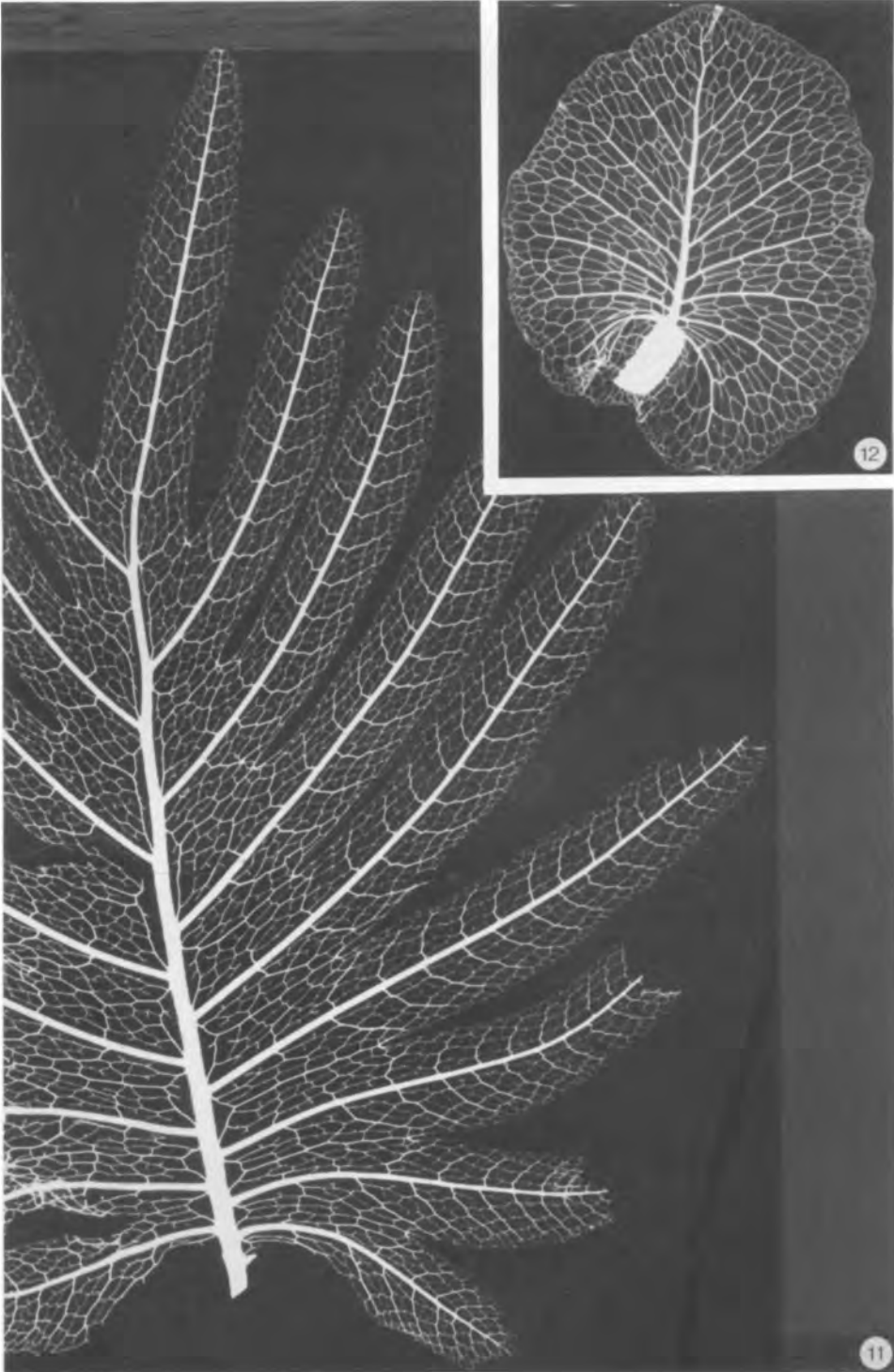

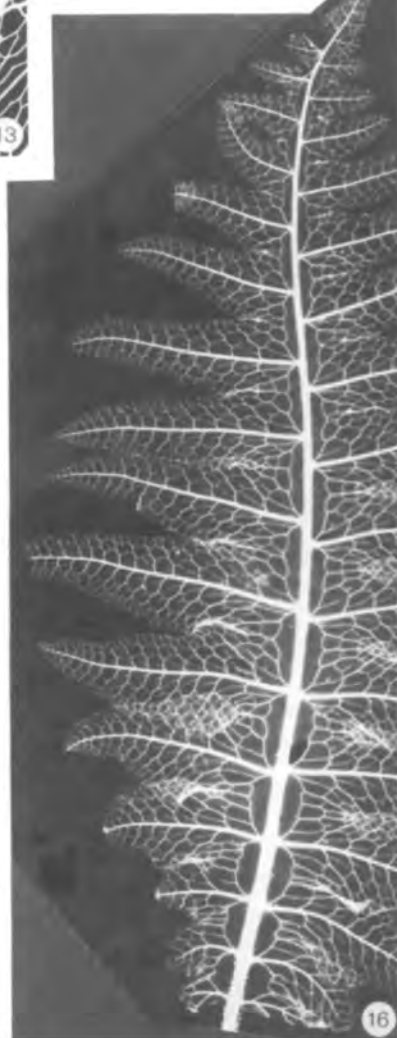
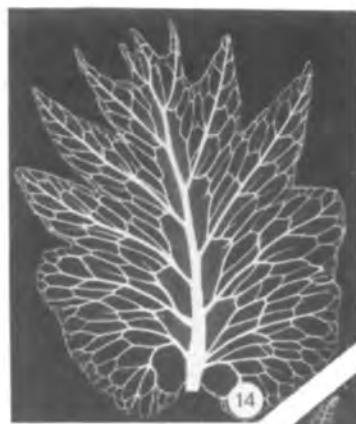

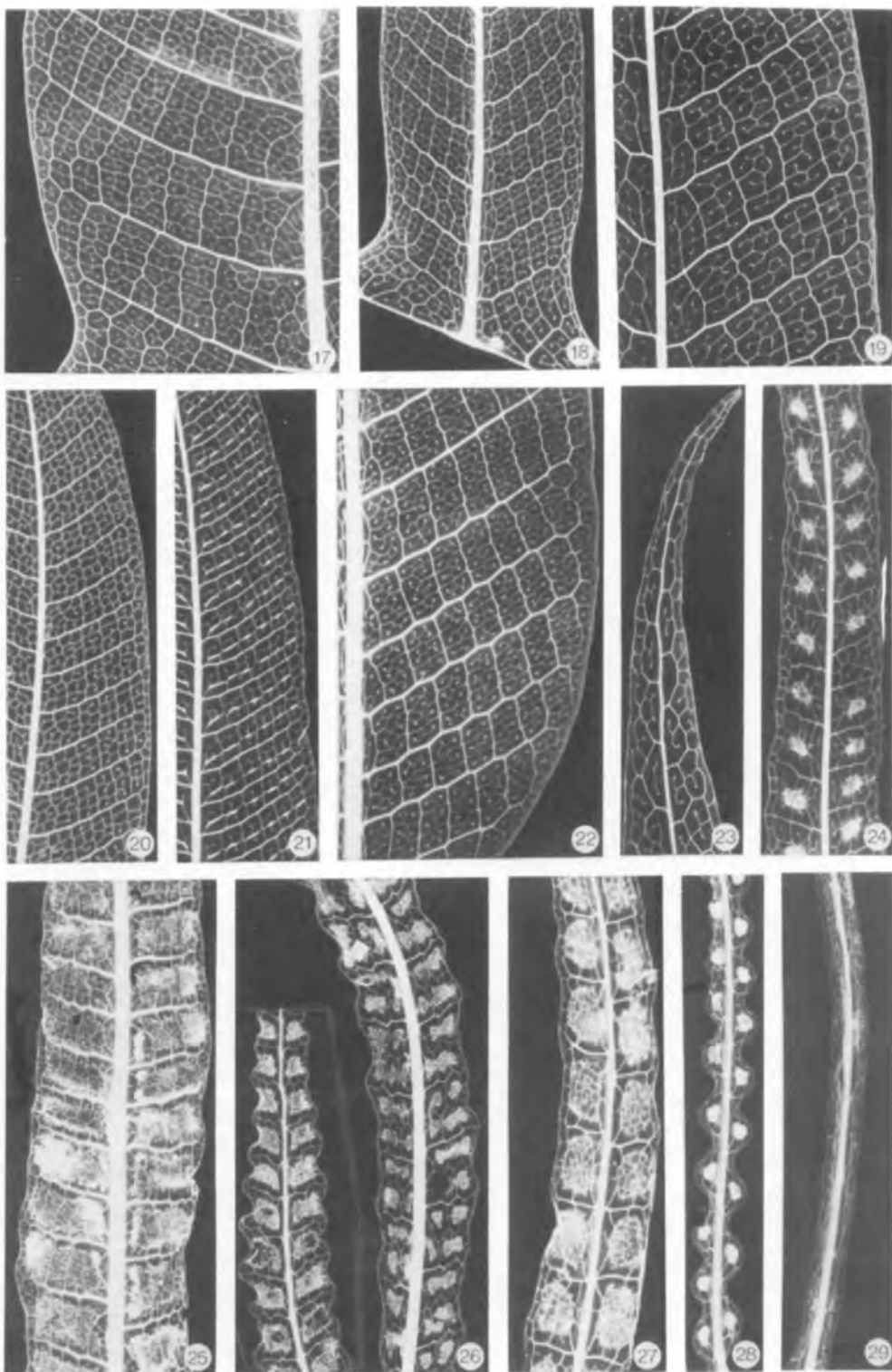

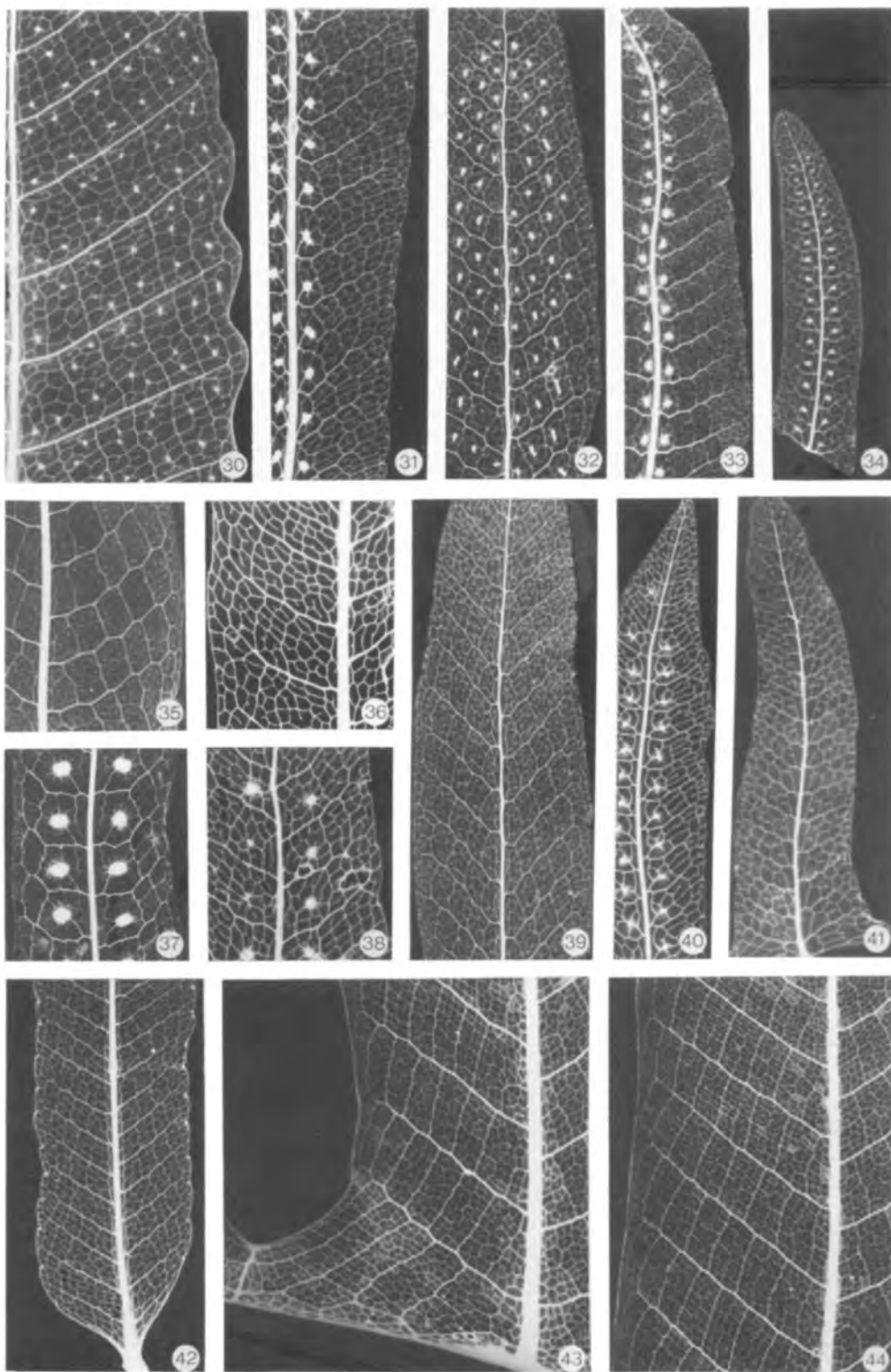

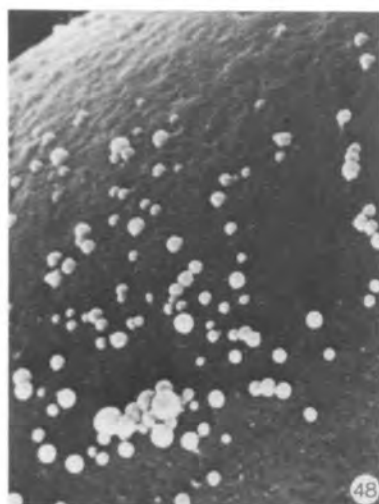
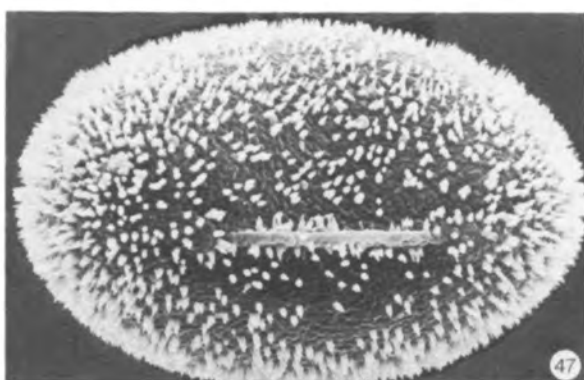
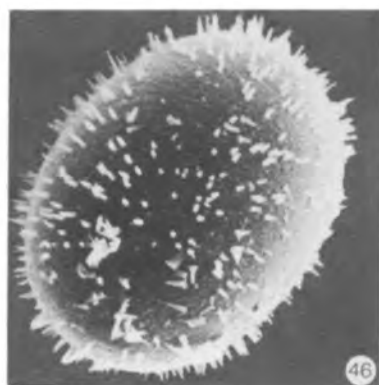
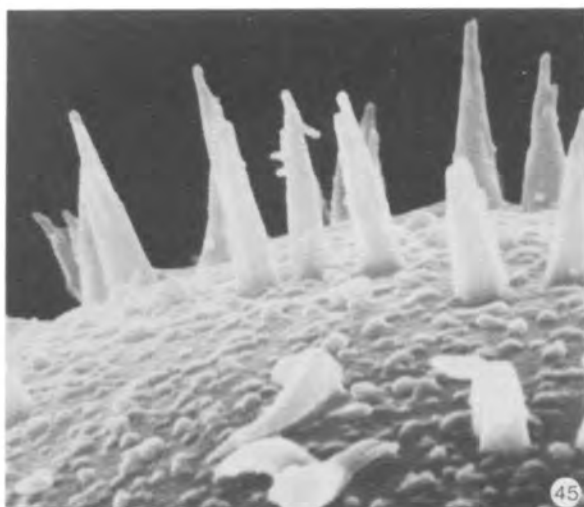

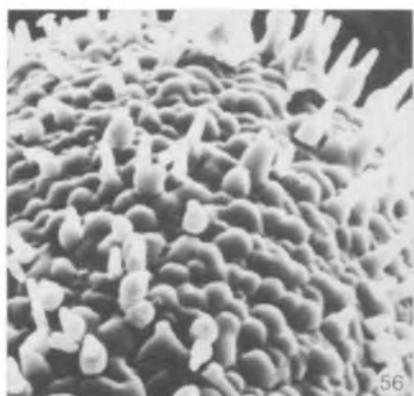
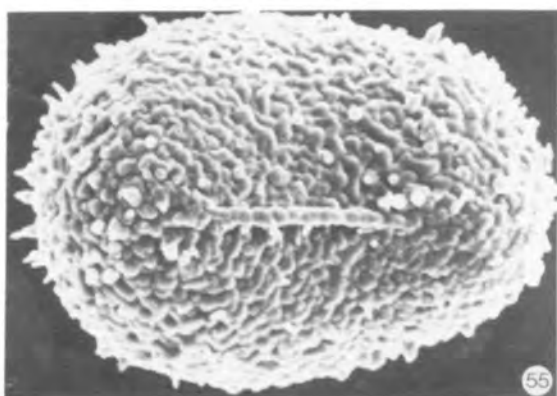
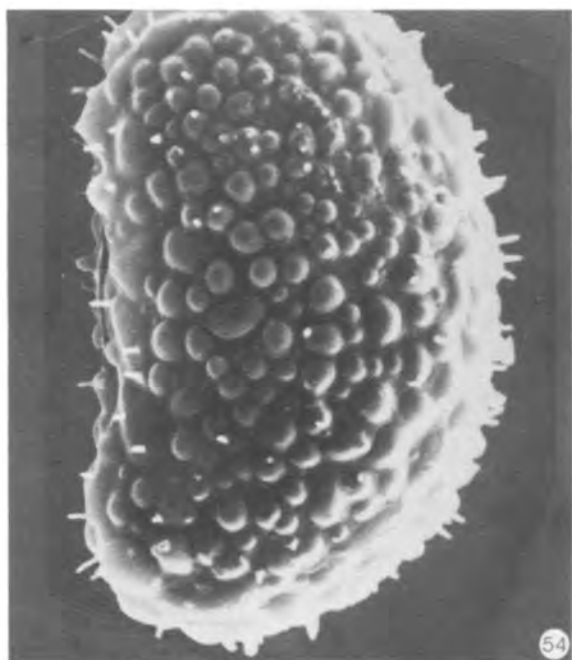
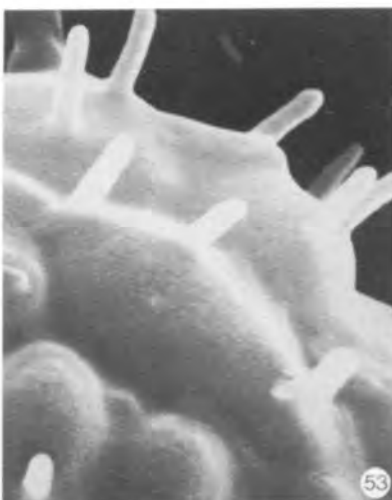
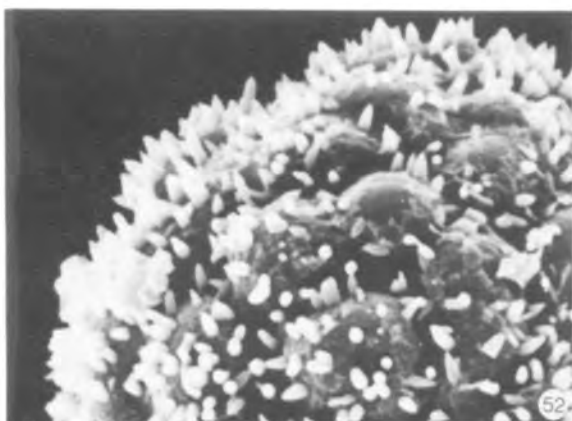
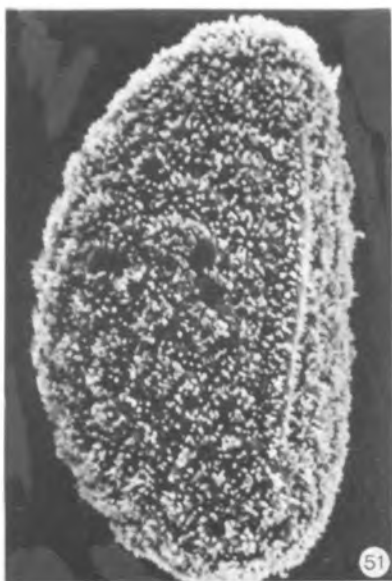

## EXPLANATION OF THE PLATES

### Pag. 167

1. A. pilosa (Cuming 90, BM). Fertile frond, x1/2. The stalked frond is internally dimorphic with the soral patches restricted to the upper part of the frond. The apical pinna is present.
2. A. splendens (Cuming 87, BM). Upper part of fertile frond, x1/4. The quadrangular soral patches are restricted to the upper part of the frond. The lower fertile pinnae are foliage-like in the basal part.
3. D. parishii (Eberhardt 79, BM). Fertile frond, x1/4. The sori are round, situated in one row parallel to the primary vein. The apical pinna is aborted.
4. A. speciosa (Herb. Willdenow 19539, B). Basal part of sterile pinna, x1. The nectary is situated on a basisopic quadrangular extension of the stalk near the insertion of the pinna.
5. D. volkensii (Volkens 735, K). Basal part of base frond, x1/4. The basal part of the base frond is auriculate similar to the dilated frond-base of Aglaomorpha species.

### Page 168

6. D. quercifolia (Hennipman 6359, U). Frond scale, x100. The frond scale is peltate with a toothed margin and scattered marginal glandular indument. A distinct apical glandular trichome is present.
7. A. heraclea (cult. hort. bot. Utrecht). Nectary, x2. The nectary is a translucent spot basisopic of the branching point of the costa and the primary vein. A perpendicularly directed 'abscission vein' separates adjacent pinnae.
8. A. cornucopia (idem). Rhizome, x1. Minute scales with a midrib are densely set on the rhizome. The young circinnate frond is inserted on a conspicuous phyllopodium.
9. A. cornucopia (idem). Upper part of foliage frond, x1/3. The frond is internally dimorphic. The soral patches are pustulate.
10. D. sparsisora (idem). Rhizome, x1. The basal part of the rhizome scales is adpressed to the rhizome. The apical part is spine-like and perpendicularly spreading. The midrib is well-developed.

### Page 169

11. D. propinqua (Garrett 812, K). Base frond, x3/2. The base frond is rounded and conspicuously lobate, the incisions reaching up to 2/3 or more of the width.
12. D. bonii (Hennipman 3118, L). Base frond, x3/2. The base frond is rounded and entire.

### Page 170

13. D. willdenowii (Humblot 341, K). Base frond, x3/2. The base frond is lobate. The lobes are blunt. Costa areoles along costa are absent.
14. D. fortunei (Steward 2661, C). Base frond, x3/2. The base frond is rounded, sinusoid in the basal part and lobate in the upper part. The apical lobes are acuminate. Conspicuous costal areoles along costa are present.
15. D. pleuridioides (Rosenstock Fil. Jav. Orient. Exsicc. 2, L). Base frond, x3/2. The base frond is lobate, the incisions reaching up to about 1/2 of the width. The lobes are blunt. Costal areoles along costa are occasionally present, but inconspicuous.
16. D. mollis (Ghose 5, P). Base frond, x3/2. The base frond is elliptic and lobate, the incisions reaching up to 2/3 or more of the width. The lobes are blunt to acute. Costal areoles along costa are conspicuous and regularly shaped.

17. *A. splendens* (Jacobs 7967, L). Sterile pinna, x2. The secondary veins are more or less straight, occasionally irregularly zigzagging. The hydathodes are small swellings, apical on free veins. The costa areole is irregularly shaped, sometimes almost absent.
18. *A. latipinna* (Kaudern 52, S). Sterile pinna, x2. The nectary is situated basicopic of the branching of the primary vein from the costa. The included free veins are characteristically ex- and recurrent. The secondary veins are regularly zigzagging.
19. *A. novoguineensis* (Hoogland & Pullen 6257, L). Sterile pinna, x2. The costal areoles are obvious, showing some variation in shape. The second order areoles are relatively large-sized.
20. *A. coronans* (Faurie 197, G). Sterile pinna, x2. The first order areoles are relatively less divided than in other *Aglaomorpha* species. Often, the second order areoles do not include free veins, which are rarely dichotomous, when present.
21. *A. coronans* (Taam 1861, NY). Fertile pinna, x2. The fertile and sterile (Plate 20) pinnae are almost similar. The receptacles are long-elliptic, showing structural irregularities in size. They form one row parallel to the secondary veins.
22. *A. speciosa* (Lörzing 14149, L). Sterile pinna, x2. An extensive areole-layering is present. The secondary veins are regularly zigzagging.
23. *A. novoguineensis* (Hoogland & Pullen 6257, L). Pinna apex, x2. The venation pattern becomes more and more simplified towards the pinna apex.
24. *A. novoguineensis* (idem). Fertile pinna, x2. The contracted fertile pinna possesses rounded soral patches. The venation pattern is diplodesmic, but remnant areole-layers can be recognized.
25. *A. splendens* (Jacobs 7967, L). Fertile pinna, x2. The soral patches are large-sized and quadrangular. Areole-layering is still apparent.
26. *A. brooksii* (Clemens 32122, GH). Fertile pinna, x2. The soral patches are often broken up within one layer of areoles. Sometimes, they are entire and quadrangular. The margin of the fertile pinna is sinusoid, the sinusses situated in between the soral patches.
27. *A. latipinna* (Kaudern 52, S). Fertile pinna, x2. The venation of the soral patches is diplodesmic. First order areoles are inconspicuous.
28. *A. cornucopia* (Copeland, P.P.E. 200, M). Fertile pinnae, x2. The fertile pinna is 'string of beads'-like with the soral patches situated on the sinusses. The venation is conspicuously reduced.
29. *A. hieronymi* (Croft 32A, L). Fertile pinna, x2. The soral patches are linear with the lamina and venation pattern extremely reduced.

30. *D. involuta* (Anderson 8529, L). Fertile pinna, x2. The sori are arranged in two irregular rows along the secondary veins. Each first order areole contains 2-4 sori.
31. *D. propinqua* (Garrett 812, K). Fertile pinna, x2. The sori are arranged in one row parallel to the primary vein. The margin is serrate.
32. *D. fortunei* (Henry 3704, US). Fertile pinna, x2. The sori are arranged in one row parallel to the secondary vein.
33. *D. delavayi* (Rock 10534, NY). Fertile pinna, x2. The margin is serrate with incisions near and in between subsequent secondary veins.
34. *D. sinica* (YU 13239, BM). Fertile pinna, x2. The venation pattern is relatively simple.
35. *D. pleuridioides* (Bünnemeyer 3728, L). Sterile pinna, x2. The secondary veins are zigzagging. The included free veins are extensively branched and often terminated by a hydathode.



36. *D. willdenowii* (Humblot 341, K). Sterile pinna. The secondary veins are more or less straight. Included free veins are usually absent.
37. *D. pleuridioides* (Bünnemeyer 3728, L). Fertile pinna. The fertile pinna is somewhat contracted if compared with the sterile pinna (35).
38. *D. willdenowii* (Humblot 341, K). Fertile pinna, x2. The fertile and the sterile (36) pinna are almost similar.
39. *D. fortunei* (Balansa 140, G). Sterile pinna, x2. The secondary veins are zigzagging. The included free veins are extensively branched and often terminated by a hydathode. They occasionally form loops in first order areoles. Costal areoles, when present, contain extensively branched free veins.
40. *D. parishii* (Garrett 1393, K). Fertile pinna, x2. Included free veins are rare. The costal areoles are regularly shaped and empty. First order areoles are usually divided into three or four second order areoles.
41. *D. mollis* (Ghose 5, P). Sterile pinna, x2. The costal areoles are regularly shaped and empty. First order areoles are often divided into two second order areoles which are either empty or include one recurrent free vein.
42. *D. rigidula* (Dockrill 148, L). Base of sterile pinna, x2. The costal areoles are regularly shaped, usually with one included vein. The pinna is shortly stalked.
43. *D. quercifolia* (Iwatsuki et al. S262, L). Base of sterile pinna, x2. An hydathode is present in the acroscopic angle of the costa and the primary vein. Abscission vein separates two adjacent pinnae. The pinna is loosened from the costa along the abscission layer.
44. *D. quercifolia* (Iwatsuki et al. S262, L). Sterile pinna, x2. The first order areoles are extensively divided into higher order areoles. Included free veins are almost absent. The costal areoles are irregularly shaped and often almost absent.

Page 173

- 45, 46. *D. bonii* (Hennipman 3333, L). Spore, x6000 resp. x600. The perispore shows sharp spines.
47. *D. sparsisora* (cult. hort. bot. Leiden). Spore, x1200. The spines often show an apical constriction.
- 48, 50. *D. heraclea* (Brass 13645, L). Spore, x2000. The perispore shows scattered globules.
49. *D. volkensii* (Mooney 9168, S). Spore, x1200. The exospore shows globular excrescences.

Page 174

- 51, 52. *D. delavayi* (Rock 10534, NY). Spore, x1200 resp. x6000. The exospore is verrucate.
- 53, 54. *A. meyeniana* (Hennipman 4151, L). Spore, x10,000 resp. x1200. The perispore is verruculate with baculae.
- 55, 56. *D. mollis* (De Haas 2632, U). Spore, x1200 resp. x6000. The perispore is verrucate.



TAXONOMIC

PART



### 13. PRESENTATION OF DATA

In the taxonomic part, the species are ordered in two alphabetically arranged genera. Within each genus, the species are presented in the same artificial sequence as in the General Part (see Chapter 5: Table 5.1). For each taxon the synonymy is listed in full. Basionyms and homotypic synonyms are listed together in chronological order, as are the heterotypic synonyms. Relevant literature is included. The names of the authors have been abbreviated as much as possible according to the Kew Index of Author Abbreviations. The greater part of the type collections have been studied; those not seen by the author are designated 'not traced' or 'n.v.' (not seen). Herbaria are abbreviated according to the Index Herbariorum. When necessary, the syntype the closest to the original description or the most complete syntype is chosen as the lectotype. Nomina nuda and illegitimate names are indicated.

The descriptions of the species pertain to character states present in adult sporophytes. When necessary additional data are presented in Notes. Apart from herbarium collections, additional living complete material of the greater part of the species (wild and cultivated) contributed essentially to the work. Numerous (>100) herbarium collections were available of species nos. 1, 2, 3, 6, 7, 10, 11, 13, 16, 23, 24, and 27. Small numbers (<25) of herbarium collections were present of species nos. 4, 5, 8, 9, (17), 18, 22, 28, and 32 (the latter represented by 1 collection only). Living plants of species nos. 1, 2, 3, 5, 6, 8, 10, 11, (15), 16, 17, 19, 21--31 are cultivated at the botanic gardens, Utrecht.

The descriptions are based on the data given in Appendix 1 and 2. They are arranged according to the sequence in character(state)s as treated in Chapter 5. This chapter further presents explanations of the character states recognized and the terminology used.

The distributions given follow political boundaries. Large countries have been subdivided. The frequency of distribution of each species throughout its geographical range can be inferred from the distribution maps (Appendix 6). The maps have been compiled from herbarium collections with precise localities. Although several atlases, indices, and miscellaneous information regarding localities and itineraries were consulted, it was not possible to spot all the localities.

The habitat is described using the -often scanty- information on the herbarium labels; a number of species have been studied in the field. Histograms of altitudinal ranges are presented in Appendix 7.

Notes are added to all species, including various kinds of additional information.

The keys are mainly based on the data given in Appendix 1 and 2. Additional distinguishing character states used are presented in the notes to the species involved. Discussions on species problematical to distinguish are presented in Chapter 8.



## 14. KEYS TO GENERA AND SPECIES

### 14.1. Key to the genera

- 1 a. At least part of the fronds pinnate ..... 2
- b. All fronds pinnatifid to lobate ..... 3
- 2 a. Fertile and sterile pinnae similar, linear-ovate, <3 cm wide, sori round, apical lobe aborted, base fronds present ..... **DRYNARIA**
- b. Sterile pinnae ovate, >>3.5 cm wide, fertile pinnae linear, 0.4--0.7 cm wide, acrostichoid, apical lobe present, base fronds absent ..... **AGLAOMORPHA**
- 3 a. Fronds dimorphous or internally dimorphous ..... 4
- b. Fronds monomorphous ..... 6
- 4 a. Fronds dimorphous, internally monomorphous ..... 5
- b. Fronds monomorphous, internally dimorphous, fertile frondparts clearly contracted ..... **AGLAOMORPHA**
- 5 a. Stalked foliage and sessile base fronds present ..... **DRYNARIA**
- b. Stalked fertile and stalked sterile foliage fronds present ..... **AGLAOMORPHA**
- 6 a. Fronds stalked ..... 7
- b. Fronds sessile ..... 10
- 7 a. Apical pinna aborted, frond apex asymmetrical..... **DRYNARIA**
- b. Apical pinna present, frond apex symmetrical..... 8
- 8 a. Fronds tomentose, hairs up to 3 mm ..... **AGLAOMORPHA**
- b. Fronds nearly glabrous to hairy, hairs less than 0.5 mm ..... 9
- 9 a. Sori round ..... **DRYNARIA**
- b. Sori quadrangular patches or linear ..... **AGLAOMORPHA**
- 10a. Fronds ovate to elliptic, entire to ovate, <40 cm long ..... **DRYNARIA**
- b. Fronds elongated, pinnatifid and lobate, >>40 cm long ..... **AGLAOMORPHA**

### 14.2. Key to the species of Aglaomorpha

- 1 a. Fronds pinnate, pinnae shortly stalked, nectaries on small quadrangular lobe-like extensions at pinna bases ..... 27. **A. speciosa**
- b. Fronds lobate to pinnatifid, pinnae sessile, nectaries immersed in widening pinna base ..... 2

- 2 a. Frond stalked, pinnatifid, base not dilated, rhizome scales adpressed, flattened, lignified cells present around the point of attachment only, margin with slender, fibril-like protuberances, fronds often tomentose, hairs usually 0.5--1.0(---3.0) mm long, juvenile fronds often with lime-scales ..... 3
- b. Fronds sessile, lobate and pinnatifid, base dilated, +cup-shaped, rhizome scales spreading, either curled, midrib absent, or stiff, midrib present, margin toothed or with short, pustulate protuberances, fronds inconspicuously hairy, hairs <0.25 mm long, lime-scales absent ..... 6
- 3 a. Fronds dimorphic, sori round, in 1 row parallel to each Vs, spread over entire frond surface, rhizome scales peltate .. 31. **A. parkinsonii**
- b. Fronds monomorphic, internally dimorphic, fertile pinnae restricted to the apical part, soral patches quadrangular or linear, in 1 row parallel to Vp, rhizome scales pseudo-peltate ..... 4
- 4 a. Soral patches linear, sometimes elliptic, acicular sporangial indument usually present, short and often inconspicuous, not reaching beyond annulus, one-sided ..... 30. **A. hieronymi**
- b. Soral patches quadrangular, acicular sporangial indument absent, or if present, conspicuous, reaching far beyond the annulus, two-sided ... 5
- 5 a. Sporangial indument absent. Sulawesi ..... 28. **A. latipinna**
- b. Sporangial indument present. Philippines ..... 29. **A. pilosa**
- 6 a. Sterile and fertile pinnae similar, sori + spread over the entire frond surface ..... 7
- b. Fertile pinnae contracted, typically restricted to apical part of frond only ..... 8
- 7 a. Sori round, in 1--2 (irregular) rows parallel to each Vtc, usually >>8 per A1, rhizome scales stiff, midrib present ..... 24. **A. heraclea**
- b. Sori elliptic, in 1 row parallel to each Vs, 1 per A1, scales soft, curled, midrib absent ..... 23. **A. coronans**
- 8 a. Fertile pinnae 'string of beads'-like, sori situated on small half-circular laminar extensions, lamina in between the sori contracted forming narrow, inconspicuous wing along Vp ..... 9
- b. Fertile pinnae entire, not contracted in between the sori ..... 10
- 9 a. Rhizome glabrous-looking, scales minute, inconspicuous, <<5 mm long, conspicuous rhizome-like phyllopodia present, fronds >20 cm apart ..... 22. **A. cornucopia**
- b. Rhizome woolly, scales conspicuous, >6 mm long, phyllopodia absent, fronds <10 cm apart ..... 25. **A. meyeniana**
- 10a. Sori round patches, rhizome scales + adpressed, stiff, midrib black, margin hyaline, fronds >20 cm apart, rhizome 1--3 cm Ø ..... 21. **A. novoguineensis**
- b. Sori quadrangular patches or linear, + acrostichoid, rhizome scales spreading, stiff, midrib brown, margin light-brown, or soft, curled, midrib absent, orange-brown, fronds <10 cm apart, rhizome 2--5 cm Ø ... 11
- 11a. Rhizome scales soft, midrib absent ..... 12
- b. Rhizome scales stiff, midrib present ..... 13



- 12a. Sori irregular +quadrangular patches, often broken up, fertile pinnae moderately contracted ..... 17. *A. x leporalla*
- b. Sori linear, fertile pinnae clearly contracted .... 26. *A. drynarioides*
- 13a. Sori regular quadrangular patches. Phillippines ..... 19. *A. splendens*
- b. Sori irregular quadrangular patches, broken up. Borneo ..... 18. *A. brooksii*

**14.3. Key to the species of Drynaria**

- 1 a. Foliage fronds once pinnate, pinnae shortly stalked, base acute ..... 10. *D. rigidula*
- b. Foliage fronds pinnatifid, pinnae widening to longitudinal attachment with costa, adjacent pinnae reaching each other ..... 2
- 2 a. Base fronds with in apical part sinus apices acuminate, sori in 1 row parallel to each Vs ..... 16. *D. fortunei*
- b. Base fronds entire or with all sinus- or lobe apices rounded (to acute), sori in 1 row parallel to each Vp or in 2 rows parallel to Vs ..... 3
- 3 a. Sori in 2 rows parallel to each Vs ..... 4
- b. Sori in 1 row parallel to each Vp ..... 8
- 4 a. Sori in 2 regular rows parallel to each Vs, 2 per A1, rhizome scales basifix to peltate, linear-triangular, spreading, brown ..... 2. *D. quercifolium*
- b. Sori in 2 irregular rows parallel to each Vs, 2 or more per A1, scales peltate, basal part rounded, adpressed, apical part usually developed, spine-like, perpendicular, red-brown to black ..... 5
- 5 a. Base fronds sinusoid to undeeply lobate, (10--15--35 cm long, 2--7 sori per A1 ..... 1. *D. sparsisora*
- b. Base fronds entire to slightly sinusoid, up to 10(--12) cm long, 2,3(4) sori per A1 ..... 6
- 6 a. Foliage pinnae 1--2.5 cm wide, with or without a slight basal constriction, margin undulate, apex obtuse ..... 5. *D. descensa*
- b. Foliage pinnae 2.5--4.5 cm wide, with a clear basal constriction, margin ± flat, apex (obtuse-->)acute to acuminate ..... 7
- 7 a. Foliage fronds with A2 empty or with 1 simple vein, rhizome scales without midrib, hypodermis absent in foliage lamina, meristeles in rhizome with bundle sheath. Continental S.E. Asia ..... 3. *D. bonii*
- b. Foliage fronds with 1 simple or once dichotomous vein, rhizome scales with midrib, hypodermis present under upper epidermis of foliage lamina, meristeles in rhizome without bundle sheath. Borneo ..... 4. *D. involuta*
- 8 a. Rhizome scales adpressed, index 2.5--4.5, base fronds absent or rounded (to ovate), index 1--1.4, lobate up to 2/3 or more of the width ..... 9
- b. Rhizome scales ± spreading, index >5 for all scales or at least for the greater part, base fronds present, either ovate to elongate, index >1.3, usually >1.5, lobate up to 1/2 of the width, or elliptical, index >1.5, lobate to 2/3 or more of the width ..... 10

- 9 a. Foliage fronds with 5--7(--8) pairs of pinnae, base fronds absent, paraphyses long glandular hairs only ..... 12. **D. parishii**  
 b. Foliage fronds with 7--15 pairs of pinnae, base fronds present, paraphyses long glandular hairs and simple scales ... 11. **D. propinqua**
- 10a. Receptacular scaly paraphyses present, frond scales scattered throughout, apical lobe of foliage fronds (almost always) aborted, base fronds elongated to ovate, >15 cm long, lobate up to 1/3 or 1/2 of the width ..... 11  
 b. Receptacular scaly paraphyses absent, frond scales situated especially laterally against costa, apical lobe of foliage fronds aborted or present, base fronds elliptic(--ovate), <15 cm long, lobate up to 2/3 of the width ..... 14
- 11a. Foliage fronds with Vs regularly zigzagging, Vt occasionally developing loops, hydathods always present, numerous, A2 containing once, twice, or more dichotomously branched veins, pinna margin entire, rhizome with sclerenchymatous strands. Malesia ..... 9. **D. pleuridioides**  
 b. Foliage fronds with Vs running straight, Vt not developing loops, hydathods absent or occasionally present, few, A2 empty or containing simple veins, pinnae serrate, rhizome without sclerenchymatous strands. Africa and Madagascar ..... 12
- 12a. Rhizome scales glossy, dark red-brown to blackish, basifix, spores smooth ..... 7. **D. volkensii**  
 b. Rhizome scales dull, brown, peltate, spores verrucate with spines or baculae ..... 13
- 13a. Pinnae clearly decreasing in size towards apex, fertile pinnae often slightly contracted, nectaries basiscopic only, laminar glandular hairs absent in mature plants, rhizome scales toothed, rhizome encircling bole many times horizontally ..... 8. **D. willdenowii**  
 b. Pinnae + equally sized all over, fertile and sterile pinnae similar, nectaries basiscopic and acroscopic, laminar glandular hairs present, rhizome scales with slender protuberances, rhizome + spirally climbing ..... 6. **D. laurentii**
- 14a. Apical lobe present ..... 15  
 b. Apical lobe aborted ..... 16
- 15a. Fronds densely hairy, all pinnae straight, + perpendicular to the costa, margin entire, fertile and sterile pinnae similar ..... 15. **D. mollis**  
 b. Fronds inconspicuously hairy, upper pinnae clearly bended to the apex, margin serrate, fertile pinnae often somewhat contracted ..... 14. **D. sinica**
- 16a. Sporangial indument usually absent, fronds 7--12 cm wide, pinnae 0.5--1.2 cm wide, sori midway on anastomosing veins or on branching points 3--4 veins ..... 14. **D. sinica**  
 b. Sporangial indument usually present, fronds 12--20 cm wide, pinnae 1.2--2 cm wide, sori on branching points of 4 or more veins ..... 13. **D. delavayi**

## 15. AGLAOMORPHA

### Aglaomorpha Schott

Aglaomorpha Schott, Gen. Fil. (1835 or '36) ad tab. 19; Kunze, Farnkr. (1840-'47) 191; J. Smith, Hook. J. Bot. 3 (1841) 398; Hook. J. Bot. 4 (1842) 62; Hook. & Bauer, Gen. Fil. (1842) t. 91; Fée, Mém. Foug. 5, Gen. Fil. (1850-'52) 266; Brackenridge, U. S. Expl. Exp. 16 (1854) 56; Mett., Fil. HB. Lips (1856) 38; T. Moore, Ind. Fil. (1862) 42; J. Smith, Hist. Fil. (1875) 109; Copel., Phil. J. Sci. [Bot.] 6, 3 (1911) 140; v. A. v. R., Mal. Ferns Suppl. (1917) 418; C. Chr., Ind. Fil. Suppl. 2 (1917) 3; Copel., Univ. Calif. Publs Bot. 16, 2 (1929) 116; Backer & Posthumus, Varenfl. Java (1939) 231; Ching, Sunyatsenia 5, 4 (1940) 262; Tardieu & C. Chr. in Lecomte, Fl. gén. Indo-Chine 7, 2 (1941) 488; Copel., Gen. Fil. (1947) 201; Holttum, Fl. Mal. 2, Ferns (1954) 185; Copel., Fern Fl. Philipp. 3 (1960) 493; De Vol in H. L. Li et al., Fl. Taiwan 1 [Pterid.] (1975) 211; Pichi Sermolli, Webbia 31, 2 (1977) 379. --- Polypodium # Pleopeltis c. Chrysopteris \*\*\*\* Aglaomorpha (Schott) v. A. v. R., Mal. Ferns (1908) 671. --- Pleopeltis # Eupleopeltis c. Chrysopteris \*\*\*\* Aglaomorpha (Schott) v. A. v. R., Bull. Dép. Agric. Indes néerl. 27 (1909) 11. --- Type: A. meyeniana Schott.

Psygium Presl, Tent. Pterid. (oct. 1836) 199. --- Aglaomorpha # Psygium (Presl) Copel., Phil. J. Sci. [Bot.] 6, 3 (1911) 140; C. Chr., Ind. Fil. suppl. 2 (1917) 3; Univ. Calif. Publs Bot. 16, 2 (1929) 117. --- Type: P. elegans.

Dryostachyum J. Smith, Hook. J. Bot. 3 (1841) 399; 4 (1842) 62; Hook. & Bauer, Gen. Fil. (1842) t. 95; Kunze, Farnkr. (1840-'47) 139; Fée, Mém. Foug. 5, Gen. Fil. (1850-'52) 275 [Dryostachyon]; Mettenius, Fil. HB. Lips (1856) 20; T. Moore, Ind. Fil. (1862) 349; J. Smith, Hist. Fil. (1875) 108; Christ, Farnkr. (1897) 121; Diels in E&P, Nat. Pfl. Fam. 1, 4 (1902) 328; Copel., Dep. int. Bur. Govern. 28 (1905) 134; C. Chr., Ind. Fil. (1906) 301; v. A. v. R., Mal. Ferns Suppl. (1917) 417; Ching, Sunyatsenia 5, 4 (1940) 261; Pichi Sermolli, Webbia 31, 2 (1977) 417. --- Polypodium # Dryostachyum (J. Smith) Christ, Farnkr. (1897) 121. --- Aglaomorpha # Dryostachyum (J. Smith) Copel., Phil. J. Sci. [Bot.] 6, 3 (1911) 140; 9, 1 (1914) 8; C. Chr., Ind. Fil. suppl. 2 (1917) 3; Copel., Univ. Calif. Publs Bot. 16, 2 (1929) 117; Gen. Fil. (1947) 201; Fern Fl. Philipp. 3 (1960) 493. --- Type: D. splendens.

Photinopteris J. Smith, Hook. J. Bot. 3 (1841) 403; 4 (1842) 155; Hook. & Bauer, Gen. Fil. (1842) T. 9 2; Fée, Mém. Foug. 2, Acrost. (1844-'45) 24, 102; C. Presl, Epim. Bot. (1849) 190; Fée, Mém. Foug. 5, Gen. Fil. (1850-'52) 61; Bedd., Ferns br. Ind. (1866) T. 211; Diels in E&P, Nat. Pfl. Fam. 1, 4 (1902) 328; Copel., Dep. int. Bur. Govern. 28 (1905) 134; Copel., Phil. J. Sci. [Bot.] 6, 3 (1911) 140; Univ. Calif. Publs Bot. 16, 2 (1929) 122; Backer & Posthumus, Varenfl. Java (1939) 234; Ching, Sunyatsenia 5, 4 (1940) 262; Tardieu & C. Chr. in Lecomte, Fl. gén. Indo-Chine 7, 2 (1941) 502; Holttum, Fl. Mal. 2, Ferns (1954) 187; Copel., Fern Fl. Philipp. 3 (1960) 495; Pichi Sermolli, Webbia 31, 2 (1977) 379. --- Lomariopsis # Drynaria Mett., Fil. HB. Lips (1856) 22. --- Acrostichum # Photinopteris (J. Smith) Hook. Sp. Fil. 5 (1864) 281; Baker in Hook. & Baker, Syn. Fil. (1868) 424. --- Lectotype: P. horsfieldii J. Smith.

Polypodium # Drynariopsis Copel., Dep. int. Bur. Govern. 28 (1905) 133; C. Chr., Ind. Fil. (1906) 663; Copel., Philipp. J. Sci. [Bot.] 6, 3 (1911) 140; Sarawak Mus. J. 2, 3 (1917) 407. --- Polypodium # Pleopeltis c. Chrysopteris \*\*\* Drynariopsis (Copel.) v. A. v. R., Mal. Ferns (1908) 670. --- Pleopeltis # Eupleopeltis c. Chrysopteris \*\*\* Drynariopsis (Copel.) v. A. v. R., Bull. Dép. Agric. Indes néerl. 27 (1909) 11. --- Aglaomorpha subgen. Drynariopsis

(Copel.) Copel., Univ. Calif. Publs Bot. 16, 2 (1929) 117. --- Drynariopsis (Copel.) C. Chr. in Verdoorn, Manual Pterid. (1938) 548; Ching, Sunyatsenia 5 (1940) 262; Copel., Gen. Fil. (1947) 200; Fern Fl. Philipp. 3 (1960) 492; C. Chr., Ind. Fil. suppl. 4 (1965) 106; Pichi Sermolli, Webbia 31, 2 (1977) 379. --- Type: P. heracleum Kunze.

Thayeria Copel., Philipp. J. Sci. 1, suppl. 2 (1906) 165; Phil. J. Sci. [Bot.] 6, 3 (1911) 140; 7, 1 (1912) 41; v. A. v. R., Mal. Ferns Suppl. (1917) 416; Copel., Univ. Calif. Publs Bot. 16, 2 (1929) 121; Gen. Fil. (1947) 202; Fern Fl. Philipp. 3 (1960) 495; Pichi Sermolli, Webbia 31, 2 (1977) 379. --- Drynaria # Thayeria (Copel.) v. A. v. R., Mal. Ferns (1908) 700. --- Type: T. cornucopia Copel.

Merinthosorus Copel., Phil. J. Sci. [Bot.] 6, 2 (1911) 92; C. Chr., Ind. Fil. suppl. 2 (1917) 50; Copel., Univ. Calif. Publs Bot. 16, 2 (1929) 122; C. Chr., Gen. Fil. suppl. 3 (1934) 127; Ching, Sunyatsenia 5 (1940) 262; Copel., Gen. Fil. (1947) 202; Holttum, Fl. Mal. 2, Ferns (1954) 186; Pichi Sermolli, Webbia 31, 2 (1977) 379. --- Type: M. drynarioides (Hook.) Copel.

Aglaomorpha # Hemistachyum Copel., Phil. J. Sci. [Bot.] 6, 3 (1911) 140; C. Chr., Ind. Fil. suppl. 2 (1917) 3; Copel., Univ. Calif. Publs Bot. 16, 2 (1929) 117; C. Chr., Ind. Fil. suppl. 3 (1934) 110; Copel., Gen. Fil. (1947) 201. --- Hemistachyum (Copel.) Ching, Sunyatsenia 5 (1940) 262; C. Chr. Ind. Fil. suppl. 4 (1965) 154. --- Type: A. brooksii Copel.

Aglaomorpha subgen. Holostachyum Copel., Phil. J. Sci. [Bot.] 9, 1 (1914) 8; C. Chr., Ind. Fil. suppl. 2 (1917) 3; Copel., Univ. Calif. Publs Bot. 16, 2 (1929) 117. --- Holostachyum (Copel.) Ching, Sunyatsenia 5 (1940) 262; Copel., Gen. Fil. (1947) 202; C. Chr., Ind. Fil. suppl. 4 (1965) 156; Pichi Sermolli, Webbia 31, 2 (1977) 379. --- Type: A. buchananii Copel.

Aglaomorpha subgen. Pseudodrynaria C. Chr., Ind. Fil. suppl. 3 (1934) 13. --- Pseudodrynaria (C. Chr.) C. Chr. in Verdoorn, Manual Pterid. (1938) 548; Ching, Sunyatsenia 5, 4 (1940) 262; 6 (1941) 10; Copel., Gen. Fil. (1947) 201; B. K. Nayar, Bull. natn. bot. Gdns Lucknow (1961) 17; C. Chr., Ind. Fil. suppl. 4 (1965) 258; Nakaike, Enum. Pterid. Jap. (1975) 350; De Vol in Li et al., Fl. Taiwan 1 [Pterid.] (1975) 214, Pl. 75; E. Walker, Fl. Okinawa & S. Ryukyu (1976) 121; Pichi Sermolli, Webbia 31, 2 (1977) 379; Ching & S. K. Wu in C. Y. Wu, Fl. Xizang. (1983) 348. --- Type: A. coronans (Wallich ex Mett.) Copel.

Usually epiphytic, forming ring-shaped circular basket around boles, or spirally or vertically climbing, often epilithic, occasionally terrestrial, forming ring-shaped basket or linearly creeping.--- Rhizome (1--2--5 cm Ø, phyllopodia usually absent, sometimes present, fronds <10 or >20 cm apart, rachises not persistent, 20--100 vascular bundles, arranged in 1 or 2 (p.p.) elliptical rows with a dorsal protrusion or in 1 or 2 (p.p.) with conspicuous dorsal invaginations and sometimes enclosed circle, scale attachment more or less sunken, sclerenchyma strands absent.--- Rhizome scales adpressed or obliquely spreading, monomorphic, usually basifix or pseudo-peltate, sometimes peltate, margin toothed or with protuberances, glandular top cell present, midrib present or absent.--- Fronds usually internally dimorphic, sometimes monomorphic or dimorphic, usually lobate and/or pinnatifid, sometimes pinnate, sessile, base dilated, or stalked, petiole usually winged, sometimes unwinged, pinnae usually equally wide throughout, sometimes with a basal constriction, decreasing in size towards the apex, margin entire, apex acute to acuminate, apical pinna present, nectaries situated in the lower angle between costa and Vp (or Vp and Vs).--- Venation of sterile pinnae: Vs running more or less straight or regular zigzagging, Asec usually containing simple and once dichotomous, occasionally more dichotomous included veins, free vein endings often running diffuse, usually excurrent and recurrent, all terminated by a

hydathode, A1c irregular. --- Fertile frond (parts) sometimes + similar to sterile frond parts, usually clearly contracted, then usually linear triangular, sometimes "string of beads"-like shaped, Vs and Vt reduced, venation diploidesmic. --- Sori sometimes present, round or elliptic, distributed all over the abaxial frond surface, in rows parallel to Vt or in 1 row parallel to Vs, usually soral patches present, round, quadrangular, elliptic, or linear, distinctly restricted to the apical two-third or less of the frond, arranged in 1 row parallel to the Vp. --- Anatomy: epidermis usually red-, sometimes blue-coloured, hypodermis in sterile pinnae usually present ad- and abaxially, sometimes absent abaxially, xylem without sclerenchymatous strands. --- Indument: laminar trichomes present, glandular, usually acicular also, not densely set or tomentose, laminar scales scattered around costa only; receptacular hairy paraphyses present, with 1 or 2 glandular cells, receptacular scaly paraphyses absent; deviating sporangia usually present, occasionally present, sporangial paraphyses usually absent, sometimes present, acicular. --- Spores usually of quercifolium-type, sometimes of meyeniana-type.

#### 17. *Aglaomorpha x leporella* (Goebel) C. Chr.

*Aglaomorpha x leporella* (Goebel) C. Chr., Ind. Fil. suppl. 3 (1934) 197. --- *Drynaria leporella* Goebel, Ann. Jard. bot. Buitenz. 39 (1928) 145, T. 15, 18; Copel., Univ. Calif. Publs Bot. 16, 2 (1929) 117. --- Lectotype: Alston 11305, origin botanic gardens Munich (BM).

Forming ring-shaped circular basket. --- Rhizome 2-->3 cm Ø, phyllopodia absent, fronds <10 cm apart, dilated frond bases imbricate, rachises not persistent, 30--40 vascular bundles, all + equally-sized, bundle sheath absent, epidermis cells flattened or isodiametric, scale attachment more or less sunken, sclerenchyma strands absent. --- Rhizome scales obliquely spreading, pseudo-peltate, with short or long auricles, triangular/ovate to linear/filiform, index 4--8, 12--28 by 2--3 mm, margin toothed, teeth biseriolate, 1-celled, top united, apex long filiform to short filiform/narrow acuminate, glandular top cell present, glandular indument present throughout, 1- or 2-celled, indument inserted marginally only, lignified cells absent, sometimes present around the point of attachment only. --- Fronds internally dimorphic, pandurate, lobate and pinnatifid, sessile, index + 3, 75--120 by 25--40 cm, base dilated, sterile pinnae equally wide throughout or sometimes with a clear basal constriction, index 4.5--5.5, 12--20 by 2.5--4 cm, incisions up to >0.2 cm from the costa, increasing towards the base, margin entire, apex acuminate, apical pinna present, nectaries situated in the lower angle between costa and Vp (or Vp and Vs). --- Venation of sterile pinnae: Vs running more or less straight or regular zigzagging, Vt branching from Vtc basically recurrent, free vein endings running diffuse or largely running excurrent and recurrent, all terminated by a hydathode; A1c sometimes absent, usually present, irregularly shaped, bordering part of basal and of apical Vs shortened, all containing 1, 2, or more included veins, simple, once dichotomous, at partly anastomosed; A1 divided into 3 or 4 Asec, areole layering comprising 5 or 6 A1, distinct, regularly shaped throughout, Asec sometimes empty or largely containing simple veins. --- Fertile frond parts + contracted, pinna index 5--10, 10--15 by 1--3 cm, Vs and Vt reduced, diploidesmic, areole layering still present, free ending veins shortened Vt directed to the nearby sorus, A1c not soriferous. --- Soral patches irregularly quadrangular, 2-->4 mm Ø, distinctly restricted to the apical two-third or

less of the frond, in the basal fertile pinnae sometimes in the apical part only, arranged in one row parallel to the Vs, on branching points of more than 4 veins, pustulate.--- Anatomy: costa near the base rounded, >11 vascular bundles, costa in middle part rounded, 1--3 vascular bundles, bundle sheath present, brown-coloured; lamina: stomata 1500--2100 /um<sup>2</sup>, epidermis red-coloured, hypodermis present ad- and abaxially, marginal sclerenchymatous strand with >25 cells, in fertile pinnae somewhat less developed; Vp rounded, vein sheath continuous, in fertile pinnae ill-developed, interrupted, cortex blue- to red-coloured, sclerenchymatous or firm parenchymatous, 1 vascular bundle, bundle sheath brown-coloured, xylem arrangement T- to V-shaped, sclerenchymatous strands absent, veinlet sheath extensions sclerenchymatous from epidermis to epidermis; receptacle with more or less isodiametric cell arrangement, 1--4 veinlets.--- Indument: laminar trichomes present, glandular and acicular not densely set, glandular trichomes >95% unbranched, 2 cells long, 90--100 /um long, type II glandular trichomes present, acicular trichomes in tuft on abscission vein only, 1--3 cells long, 200--280 /um long; laminar scales scattered around costa only, basifix, triangular/ovate to linear/filiform, teeth biseriate, glandular indument present throughout, 1- or 2-celled, indument inserted marginally only, lignified cells absent, apex filiform/narrow acuminate; receptacular hairy paraphyses >90% unbranched, 1 or 2 glandular cells, 2 or 3 cells long, (80--90--150(--180) /um long, receptacular scaly paraphyses absent; deviating sporangia absent, sporangial paraphyses absent.--- Sporangium 260--310 by 180--235 /um, annulus with 11 or 12 indurated cells, 3 or 4 epistomium cells, 3 hypostomium cells, in total (19)20 cells.--- Spores of quercifolium-type, perispore smooth sometimes folded, ultrastructure smooth, basal layer inconspicuous, spines absent, baculae absent, globules present, exospore smooth.

Note: hybrid; inferred parent species are nos. 19 and 23.

#### 18. *Aglaomorpha brooksii* Copel.

*Aglaomorpha brooksii* Copel., Phil. J. Sci. [Bot.] 6, 3 (1911) 141, t. 25; v. A. v. R., Mal. Ferns Suppl. (1917) 418; C. Chr., Ind. Fil. suppl. 2 (1917) 3; Copel., Univ. Calif. Publ. Bot. 16, 2 (1929) 117. --- Polypodium brooksii (Copel.) C. Chr., Ind. Fil. suppl. 1 (1913) 58. - Hemistachyum brooksii (Copel.) Ching, Sunyatsenia 5 (1940) 262; C. Chr., Ind. Fil. suppl. 4 (1965) 154. --- Type: Brooks 39, Borneo, Sarawak, Penrissan Mt. (holo: NY).

Epiphytic, forming ring-shaped circular basket around boles.---Rhizome 2-->3 cm Ø, phyllopodia absent, fronds <10 cm apart, delated frond bases imbricate, rachises not persistent, >40 vascular bundles, all vascular bundles + equally-sized, arranged in 2 rows (p.p.) with conspicuous invaginations and sometimes enclosed circle, bundle sheath well-developed, brown-coloured, epidermis cells isodiametric, scale attachment more or less sunken, sclerenchyma strands absent.--- Rhizome scales obliquely spreading, basifix, pseudo-peltate with short auricles, triangular/ovate to linear/filiform, index 5--10, 7--26 by 1.2--3 mm, margin toothed and with short protuberances, teeth/protuberances uniseriate and biseriate, 1-celled, top united or T-shaped, apex long filiform to short filiform/narrow acuminate, glandular top cell present, glandular indument present throughout, 1- or 2-celled, indument inserted marginally and

abaxially, midrib present.--- Fronds internally dimorphic, pandurate, lobate and pinnatifid, sessile, index + 3, 80-->110 by 25--50, base dilated, sterile pinnae equally wide throughout or sometimes with a basal constriction, index 4.5--6.5, 16--30 by 2.5--5.5 cm, incisions up to >0.2 cm from the costa, increasing towards the base, margin entire, apex acute to acuminate, apical pinna present, nectaries situated in the lower angle between costa and Vp (or Vp and Vs).--- Venation of sterile pinnae: Vs running more or less straight, Vt branching from Vtc basically excurrent and recurrent, free vein endings running diffuse or largely running excurrent and recurrent, all terminated by a hydathode; A1c always present, irregularly shaped, both branching points of the Vtc and Vs equally distant from the Vp or bordering part of basal Vs shortened, all containing 2 or more included veins, simple, once dichotomous, partly anastomosed; A1 divided into 3-->4 Asec, areole layering comprising 6--8 A1, distinct regularly shaped throughout, Asec containing simple or once dichotomous or twice or more dichotomous veins.--- Fertile frond parts clearly contracted, pinnae index (6-->)10--16, up to 10--18 by 1--2 cm, Vs and Vt strongly reduced, diplodesmic, areole layering still present, free ending veins shortened or absent, Vt directed to the nearby sorus, A1c not soriferous.--- Soral patches irregularly quadrangular, 3--6 by 2--5 mm  $\emptyset$ , distinctly restricted to the apical two-third or less of the frond, in the basal fertile pinnae sometimes in the apical part only, arranged in 1 row parallel to the Vp, on branching points of more than 4 veins, pustulate.--- Anatomy: costa near the base rounded or invaginated, up to 1.5 cm  $\emptyset$ , >11 vascular bundles, costa in middle part rounded or angular or invaginated, >6 vascular bundles, bundle sheath blue- or brown-coloured; lamina: stomata 1500--2100 / $\mu\text{m}^2$ , epidermis blue-or red-coloured, hypodermis in sterile pinnae present ad- and abaxially, in fertile pinnae adaxially, marginal sclerenchymatous strand with >25 cells, in fertile pinnae somewhat less developed; Vp rounded, vein sheath continuous, in fertile pinnae interrupted, cortex blue-coloured, parenchymatous, 1--3 vascular bundles, bundle sheath blue- or brown-coloured, xylem arrangement V-shaped, sclerenchymatous strands absent, vein sheath interrupted, veinlet sheath extensions sclerenchymatous from epidermis to epidermis; receptacle with more or less isodiametric cell arrangement, 3--6 veinlets.--- Indument: laminar trichomes present, glandular and acicular, not densely set, glandular trichomes >95% unbranched, 2(3) cells long, (60-->)70--120(--140) / $\mu\text{m}$  long, type II glandular trichomes absent, acicular trichomes in tuft on abscission vein only, 1 cell long, 65--150 / $\mu\text{m}$  long; laminar scales scattered around costa only, basifix, pseudo-peltate with short auricles, triangular/ovate to linear/filiform, teeth/protuberances uniseriate or biseriate, glandular indument present throughout, 1- or 2-celled, indument inserted marginally and sometimes abaxially, midrib present, apex filiform/narrow acuminate to apex acute (acuminate); receptacular hairy paraphyses >90% unbranched, 1 or 2 glandular cells, (2)3 or 4(5) cells long, (70-->)80--180(--230) / $\mu\text{m}$  long, receptacular scaly paraphyses absent; deviating sporangia absent, sporangial paraphyses absent.--- Sporangium 265--330 by 190--230 / $\mu\text{m}$ , annulus with 13(14) indurated cells, 3(4) epistomium cells, 3--5 hypostomium cells, in total (21)22 or 23(--25) cells.--- Spores of quercifolium-type, perispore smooth sometimes folded, ultrastructure smooth, basal layer inconspicuous, spines absent, baculae absent, globules present, exospore smooth.

Distribution: Borneo (Sarawak, Sabah).

Habitat: Primary forest. Alt. 1000-1800 m.

19. *Aglaomorpha splendens* (J. Smith) Copel.

*Aglaomorpha splendens* (J. Smith) Copel., Phil. J. Bot. [Bot.] 6, 3 (1911) 141; v. A. v. R., Mal. Ferns Suppl. (1917) 417; C. Chr., Ind. Fil. suppl. 2 (1917) 3; Copel., Univ. Calif. Publs Bot. 16, 2 (1929) 117; Gen. Fil. (1947) 202; Fern Fl. Philipp. 3 (1960) 494. --- *Dryostachyum splendens* J. Smith, Hook. J. Bot. 3 (1841) 399; 4 (1842) 62; Hook. & Bauer, Gen. Fil. (1842) t. 95; Kunze, Farnkr. (1840-'47) 141; Fée, Mém. Foug. 5, Gen. Fil. (1850-'52) 275; Mett., Fil. HB. Lips (1856) 20; T. Moore, Ind. Fil. (1862) 350; J. Smith, Hist. Fil. (1875) 109; Diels in E&P, Nat. Pfl. Fam. 1, 4 (1902) 328, Fig. 170:A-C; Copel., Dep. int. Bur. Govern. 28 (1905) 134; Philipp. J. Sci. 1, suppl. 2 (1906) 165, Pl. 26, 27; C. Chr., Ind. Fil. (1906) 301; v. A. v. R., Mal. Ferns (1908) 701; Rosenstock, Nova Guinea 8 (1912) 729; C. Chr., Ind. Fil. suppl. 1 (1913) 4; v. A. v. R., Mal. Ferns Suppl. (1917) 417. --- *Polypodium splendens* (J. Smith) Hook., Spec. Fil. 5 (1864) 95 [non p. 52] (nom. illeg.); Baker in Hook. & Baker, Syn. Fil. (1868) 367; Christ Farnkr. (1897) 121. --- *Drynaria splendens* (J. Smith) Bedd., Ferns br. Ind. (1869) T. 316; Suppl. Ferns S. Ind. & Br. Ind. (1876) 23; Handb. Ferns Br. Ind. (1883) 339, Fig. 188. --- Type: Cuming 87, Philippines, Luzon, Tayabas (holo: BM; iso: B, GH, K, L, NY, S, US, W).

Usually epiphytic, sometimes epilithic, forming ring-shaped, circular basket (around boles).--- Rhizome 2-->3 cm Ø, phyllopodia absent, fronds <10 cm apart, delated frond bases imbricate, rhachises not persistent, >40 vascular bundles, all ± equally-sized, arranged in 1 row with a conspicuous dorsal invagination, bundle sheath ill-developed, blue-or brown-coloured, epidermis cells flattened, scale attachment more or less sunken, sclerenchyma strands absent.--- Rhizome scales obliquely spreading, basifix, pseudo-peltate with short auricles, triangular/ovate to linear/filiform, index 6--13, (7--10--22 by 1--3 mm, margin toothed and with short protuberances, teeth/protuberances uniseriate or biseriate, 1-celled, top united, rounded or T-shaped, apex long filiform to short filiform/narrow acuminate, glandular top cell present glandular indument present throughout, 1- or 2-celled, indument inserted marginally and abaxially, midrib present.--- Fronde internally dimorphic, pandurate, lobate and pinnatifid, index 2.5--4, 75--200 by 25--50 cm, sessile, base dilated, sterile pinnae equally wide throughout, index 4--6.5, 10--35 by 3--6.5 cm, incisions up to >0.5 cm from the costa, increasing towards the base, margin entire, apex acute to acuminate, apical pinna present, nectaries situated in the lower angle between costa and Vp (or Vp and Vs).--- Venation of sterile pinnae: Vs running more or less straight, Vt branching from Vtc basically excurrent and recurrent, free vein endings running diffuse or largely running excurrent and recurrent, all terminated by a hydathode; A1c sometimes absent, usually present, irregularly shaped, bordering part of basal Vs shortened and bordering part of apical Vs shortened, all containing 2 or more included veins, simple, once dichotomous, partly anastomosed; A1 divided into 3 or 4 or more Asec, areole layering comprising 6--9 A1, distinct, regularly shaped throughout, Asec containing simple, once or twice or more dichotomous veins.--- Fertile frond parts clearly contracted, pinnae index 15--20, 5--35 by 0.5--2.5 cm, Vs and Vt strongly reduced, diplodesmic, areole layering clearly present, free ending veins shortened, Vt directed to the nearby sorus, A1c not soriferous.--- Soral patches (rarely irregularly) quadrangular, 3--10 by 2--7 mm Ø, distinctly restricted to the apical two-third or less of the frond, in the basal fertile pinnae often in the apical part only, arranged in 1 row parallel to Vp, on branching points of more than 4 veins, pustulate.--- Anatomy: costa near the base elliptical or invaginated, up



to 1.5 cm  $\emptyset$ , >11 vascular bundles, costa in middle part rounded, >6 vascular bundles, bundle sheath blue- to brown-coloured; lamina: stomata 1500<--2100 /um<sup>2</sup>, epidermis red-coloured, in fertile pinnae blue-coloured, hypodermis in sterile pinnae present ad- and abaxially, in fertile pinnae adaxially, marginal sclerenchymatous strand with >25 cells, Vp rounded, vein sheath interrupted, cortex blue-coloured, parenchymatous, 1 vascular bundle, bundle sheath blue- or brown-coloured, xylem arrangement V-shaped, sclerenchymatous strands present, veinlet sheath extensions sclerenchymatous from epidermis to epidermis; with some irregularities; receptacle with more or less isodiametric cell arrangement, 3--6 veinlets.--- Indument: laminar trichomes present, glandular and acicular, not densely set, glandular trichomes >95% unbranched, 2 cells long, 105--120(--155) /um long, type II glandular trichomes present, acicular trichomes more or less scattered throughout, (1)2(3) cells long, 105--165(--300) /um long; laminar scales scattered around costa only, basifix, pseudo-peltate, with short auricles, triangular/ovate to linear/filiform, teeth/protuberances uniseriate and biseriate, glandular indument present throughout, 1- or 2-celled, indument inserted marginally only, midrib present, apex filiform/narrow acuminate to acute (acuminate); receptacular hairy paraphyses >90% unbranched, 1 or 2 glandular cells, 4--7 cells long, (230--)300--630 /um long, receptacular scaly paraphyses absent; deviating sporangia present, sporangial paraphyses absent.--- Sporangium 305--360 by 225--270 /um, annulus with (13)14 or 15 indurated cells, 3 or 4(5) epistomium cells, (3)4 or 5 hypostomium cells, in total (22)23--26(28) cells.--- Spores of quercifolium-type, perispore smooth sometimes folded, ultrastructure smooth, ultrastructure verruculate, basal layer inconspicuous, spines absent, baculae absent, globules present, exospore smooth.

Distribution: Philippines (Luzon, Negros, Mindanao).

Habitat: Primary forest, usually high-epiphytic. Reported on Quercus spec., Ficus spec. Alt. 550--800(--1300) m.

## 21. Aglaomorpha novoguineensis (Brause) C. Chr.

Aglaomorpha novoguineensis (Brause) C. Chr., Ind. Fil. suppl. 2 (1917) 3; Copel., Univ. Calif. Publ. Bot. 16, 2 (1929) 117. --- Dryostachyum novoguineense Brause, Bot. Jb. 49, 1 (1912) 56, f. 3D; C. Chr., Ind. Fil. suppl. 1 (1913) 41; v. A. v. R., Mal. Ferns Suppl. (1917) 417. --- Type: Schlechter 18266, Papua New Guinea, "Kaiser Wilhelmsland", Kani Mts (holo: B).

Usually epiphytic, spirally climbing, rarely epilithic or terrestrial.--- Rhizome 1--3 cm  $\emptyset$ , phyllopodia absent, fronds >20 cm apart, dilated frond bases separate, forming individual nests, rachises not or rarely persistent, 20-->40 vascular bundles, dorsal  $\pm$  4 large(r) sized, arranged in 1 or 2 (p.p.) elliptical rows with a dorsal protrusion or in 1 or 2 (p.p.) rows with conspicuous dorsal invaginations and sometimes enclosed circle, bundle sheath absent, epidermis cells isodiametric or erect, scale attachment more or less sunken, sclerenchyma strands absent.--- Rhizome scales adpressed to obliquely spreading, pseudo-peltate with short or long auricles, triangular/ovate to linear/filiform, index 4--10(--20), 5--20 by 0.5--1.5 mm, margin clathrate, toothed, teeth biseriate, 1-celled, top united, apex short filiform/narrow acuminate to acute

(acuminate), glandular top cell present, glandular indument present throughout, 2-celled, indument inserted marginally only, midrib present.--- Fronde internally dimorphic, pandurate to quadrangular, lobate and pinnatifid, index 2.5--3, 70--110 by 30--40 cm, sessile, base dilated, sterile pinnae equally wide throughout, index 5.5--6.5, 15--25 by 2.5--4 cm, incisions up to >0.2 cm from the costa, increasing towards the base, margin entire, apex acute to acuminate, apical pinna present, nectaries situated in the lower angle between costa and Vp (or Vp and Vs).--- Venation of sterile pinnae: Vs running more or less straight or regular zigzagging, Vt branching from Vtc basically recurrent, free vein endings running diffuse or excurrent and recurrent, all terminated by a hydathode; A1c always present, (ir)regularly shaped throughout, bordering part of basal Vs shortened, all containing 1, 2, or more included veins, simple, once dichotomous or more extensively branched, partly anastomosed; A1 divided into 3 or 4 Asec, areole layering comprising 4 or 5 A1, distinct, regularly shaped throughout, Asec containing simple or once dichotomous veins.--- Fertile frond parts clearly contracted, pinnae index >15, up to 10--20 by 0.7--1.4 cm, Vs and Vt strongly reduced, diplodesmic, areole layering vaguely present, free ending veins shortened or absent, Vt directed to the nearby sorus, A1c not soriferous.--- Soral patches round, 2--4 mm  $\emptyset$  distinctly restricted to the apical two-third or less of the frond, in the basal fertile pinnae sometimes in the apical part only, arranged in 1 row parallel to the Vp, on branching points of more than 4 veins, pustulate.--- Anatomy: costa near the base rounded or invaginated, up to 0.8 cm  $\emptyset$ , >11 vascular bundles, costa in middle part rounded, angular or invaginated, 4 vascular bundles, bundle sheath blue-, red- or brown-coloured or sometimes absent; lamina: stomata <1500 / $\mu\text{m}^2$ , epidermis red-coloured, hypodermis in sterile pinnae present ad- and abaxially, in fertile pinnae adaxially, red-coloured, in fertile pinnae blue-coloured, marginal sclerenchymatous strand with >25 cells, in fertile pinnae sometimes somewhat less developed; Vp angular, in fertile pinnae rounded, vein sheath interrupted, cortex blue-coloured, parenchymatous, 1 vascular bundle, bundle sheath (at least p.p.) red-coloured, open sclerenchyma cells, otherwise blue-coloured, xylem arrangement T- to V-shaped, sclerenchymatous strands absent, in fertile pinnae rounded, veinlet sheath extensions sclerenchymatous from epidermis to epidermis; receptacle with more or less isodiametric cell arrangement, 3 or 4 veinlets.--- Indument: laminar trichomes present, glandular and acicular, not densely set, glandular trichomes >95% unbranched, 2 or 3(4) cells long, (80--95--140--200) / $\mu\text{m}$  long, type II glandular trichomes absent, acicular trichomes in tuft on abscission vein only, 1--3 cells long, 120--220 / $\mu\text{m}$  long; laminar scales scattered around costa only, basifix, pseudo-peltate with short auricles, triangular/ovate to linear/filiform, teeth biseriate, glandular indument present throughout, 1- or 2-celled, indument inserted marginally only, midrib present, apex filiform/narrow acuminate to acute (acuminate); receptacular hairy paraphyses >90% unbranched, 1 or 2 glandular cells, (2)3 or 4(5) cells long, (70--90--240--420) / $\mu\text{m}$  long, receptacular scaly paraphyses absent; deviating sporangia present, sporangial paraphyses absent.--- Sporangium 325--380 by 235--265 / $\mu\text{m}$ , annulus with (12--14 or 15(16) indurated cells, (2)3 or 4 epistomium cells, 4 or 5 hypostomium cells, in total (22--24 or 25(26) cells.--- Spores of quercifolium-type, perispore smooth sometimes folded, ultrastructure smooth or verruculate, basal layer inconspicuous, spines absent, baculae absent, globules present, exospore smooth.

Distribution: New Guinea (W. Irian, Papua)

Habitat: Forest (a.o. Dacrydium-), growing 0--20 m above the ground. Alt. 1100--1800(--2300) m.

Notes. 1. Vern. name: Moena (Kapaukoe lang., W. Irian).

2. Terminal cladon no. 20 (based on Gibbs 5970, BM, from Arfak Mts, W. Irian) differs from the typical specimens of the present species as regards: rhizome scales with 1-celled glandular trichomes also, frond base only slightly dilated, included veins simple or once dichotomous only, soral patches 2--3 mm  $\emptyset$ , costa in middle part rounded or invaginated, stomata 2100--2700 / $\mu\text{m}^2$ , Vp rounded, bundle sheath blue-coloured, acicular trichomes 1 or 2 cells long, 100--200 / $\mu\text{m}$  long, receptacular hairy paraphyses 2 or 3(4) cells long, (70--)100--300(--350) / $\mu\text{m}$  long, sporangium 280--340 by 205--225 / $\mu\text{m}$ , 3 or 4 hypostomium cells, in total 22 or 23 annulus cells.

## 22. Aglaomorpha cornucopia (Copel.) Roos

Aglaomorpha cornucopia (Copel.) Roos, Blumea (1985). --- Thayeria cornucopia Copel., Philipp. J. Sci. 1, suppl. 2 (1906) 165, T. 28; Phil. J. Sci. [Bot.] 6, 3 (1911) 140; 7, 1 (1912) 41, T. 1; v. A. v. R., Mal. Ferns Suppl. (1917) 416; Copel., Univ. Calif. Publs Bot. 16, 2 (1929) 121; Gen. Fil. (1947) 202; Fern Fl. Philipp. 3 (1960) 495. --- Drynaria cornucopia (Copel.) v. A. v. R., Bull. D  pt. agric. Ind. n  erl. 21 (1908) 8; Mal. Ferns (1908) 700; C. Chr., Ind. Fil. suppl. 1 (1913) 29. --- Type: Copeland 1770, Philippines, Mindanao, Zamboanga, Mt. Balabae, (holo: NY; iso: B, S).

Usually epiphytic, spirally climbing, sometimes (?) epilithic.---Rhizome 1--3 cm  $\emptyset$ , conspicuous phyllopodia present, fronds >20 cm apart, dilated frond bases separate, forming individual nests, rachises not persistent, 20-->40 vascular bundles, all + equally-sized, arranged in 1 elliptical row with a dorsal protrusion or in 1 row with conspicuous dorsal invaginations, bundle sheath absent, epidermis cells flattened, isodiametric, or erect, scale attachment more or less sunken, sclerenchyma strands absent.--- Rhizome scales obliquely spreading, pseudo-peltate with short and long auricles, rounded, triangular/ovate to umbonately cone-shaped, index 1.5--3, 2--5 by 1--3 mm, apex acute (acuminate), rounded, glandular top cell present, glandular indument present throughout, 1-celled, indument inserted marginally and abaxially, midrib present.--- Fronds internally dimorphic, pandurate to quadrangular, lobate and pinnatifid, sessile, index 2--3, 50--80 by 25--30 cm, base dilated, sterile pinnae equally wide throughout, index 3.5--6, up to 7--15 by 2--2.5 cm, incisions up to >0.5 cm from the costa, increasing towards the base, margin entire, apex acute to obtuse, apical pinna present, nectaries situated in the lower angle between costa and Vp (or Vp and Vs).--- Venation of sterile pinnae: Vs running more or less straight, Vt branching from Vtc basically excurrent and recurrent, free vein endings running diffuse or excurrent and recurrent, all terminated by a hydathode; A1c always present, irregularly shaped, bordering part of basal Vs and of apical Vs shortened, all containing 1, 2, or more included veins, simple or once dichotomous, partly anastomosed; A1 divided into 3 or 4 or more Asec, areole layering comprising 5--7 A1, distinct, regularly shaped throughout, Asec containing simple or once dichotomous veins.--- Fertile frond parts clearly contracted, pinnae "string of beads"-like shaped, index >15, up to 10--18 by 0.5--1 cm, Vs and Vt strongly reduced, diplodesmic, areole layering absent, free ending veins shortened or absent, Vt directed to the

nearby sorus, A1c not soriferous.--- Soral patches round, 2--3 mm  $\emptyset$ , distinctly restricted to the apical two-third or less of the frond, in the basal fertile pinnae sometimes in the apical part only, arranged in one row parallel to the Vp, on branching points of more than 4 veins, pustulate.--- Anatomy: costa near the base rounded, 5--8 vascular bundles, costa in middle part rounded or angular or invaginated, 1--3 vascular bundles, bundle sheath present, blue- or brown-coloured; lamina: stomata 1500--2100 / $\mu\text{m}^2$ , epidermis blue- or red-coloured, hypodermis in sterile pinnae present ad- and abaxially, in fertile pinnae adaxially, marginal sclerenchymatous strand with >25 cells, in fertile pinnae somewhat less developed or (nearly lacking); Vp angular, in fertile pinnae rounded, vein sheath continuous, ill-developed and interrupted, cortex blue-coloured, parenchymatous, 1 vascular bundle, bundle sheath (at least p.p.) red-coloured, open sclerenchyma cells, otherwise blue-coloured, xylem arrangement V-shaped, in fertile pinnae T-shaped, sclerenchymatous strands absent, veinlet sheath extensions sclerenchymatous from epidermis to epidermis; receptacle with more or less isodiametric cell arrangement, 3--6 veinlets.--- Indument: laminar trichomes present, glandular and acicular not densely set, glandular trichomes 25--50% branched, 2 cells long, 65--95 / $\mu\text{m}$  long, type II glandular trichomes absent, acicular trichomes in tuft on abscission vein only, 1--3 cells long, 80--190 / $\mu\text{m}$  long; laminar scales scattered around costa only, pseudo-peltate with short auricles, triangular/ovate to linear/filiform, teeth/protuberances uniseriate or biseriate, glandular indument absent, rarely present, throughout, 1- or 2-celled, indument inserted marginally only, lignified cells absent, apex acute (acuminate) to apex rounded; receptacular hairy paraphyses 5--10% branched, 1 or 2 glandular cells, 2 cells long, 50--75 / $\mu\text{m}$  long, receptacular scaly paraphyses absent; deviating sporangia absent, sporangial paraphyses absent.--- Sporangium 265--295 by 225--245 / $\mu\text{m}$ , annulus with (12)13 or 14 indurated cells, 3(4) epistomium cells, 3 hypostomium cells, in total 20--22 cells.--- Spores of quercifolium-type, perispore verrucate, ultrastructure smooth, basal layer thin, spines present, sharp and smooth, baculae absent, globules present, globules absent, exospore with globular excrescences.

Distribution: Philippines (Luzon, Mindanao).

Habitat: Primary forest and open vegetation. Alt. 1100--2200 m.

### 23. *Aglaomorpha coronans* (Wallich ex Mett.) Copel.

*Aglaomorpha coronans* (Wallich ex Mett.) Copel., Univ. Calif. Publ. Bot. 16, 2 (1929) 117; C. Chr., Ind. Fil. suppl. 3 (1934) 20; Tag., Acta phytotax. geobot. Kyoto 8, 4 (1939) 234; Tardieu & C. Chr. in Lecomte, Fl. gén Indo-Chine 7, 2 (1941) 488, Fig. 57:3, 4; Holttum, [Fl. Thail. 1] Dansk. Bot. Ark. 20, 1 (1961) 21; Tag. in H. Hara, Fl. E. Himal. (1966) 489. --- Polypodium coronans Wallich, List 288 (1828) (nomen nudum); Mett., Farngatt. 1, Polyp. (1857) 121, T. 3:f. 40, 41; Hook., Fil. Exot. (1859) Pl. 91 [excell.]; Spec. Fil. 5 (1864) 95; Ettingh., Farnkr. Jetztw. (1865) T. 27:Fig. 8, T. 32:Fig. 3, 9, T. 34:Fig. 5; C. B. Clarke, Trans. Linn. Soc. Lond. ser. 2, 1 (1880) 557; Christ, Farnkr. (1897) 117, Fig. 333; Diels in E&P, Nat. Pfl. Fam. 1, 4 (1902) 319; C. Chr., Ind. Fil. (1906) 518; Copel., Phil. J. Sci. [Bot.] 6, 3 (1911) 140; Ching, Bull. Fan Mem. Inst. Biol. 1 (1930) 152. --- Phymatodes coronans Wallich ex C. Presl, Tent. Pterid. (1836) 198 (nomen nudum). --- Drynaria coronans Wallich ex J. Smith, Hook. J. Bot. 3 (1841) 399 (nomen nudum); 4 (1842) 61 (nomen nudum); Hook., Hook.

J. Bot. 9 (1857) 357 (nomen nudum); J. Smith, Cult. Ferns cat. (1857) 14 (nomen nudum); in Seemann, bot. Voy. Herald [Fl. Hongkong] (1875) 426 (nomen nudum); T. Moore, Ind. Fil. (1862) 345, Pl. 63A; Bedd., Ferns br. Ind. (1865) T. 13; J. Smith, Ferns Br. & For. (1866) 103; Hist. Fil. (1875) 108; Bedd., Handb. Ferns Br. Ind. (1883) 338, Fig. 187; Christ, J. Bot. Paris, ser. 2, 1 (1908) 238. --- Pseudodrynaria coronans (Wallich ex Mett.) Ching, Sunyatsenia 5,4 (1940) 262; 6 (1941) 10; Copel., Gen. Fil. (1947) 201; B. K. Nayar & Kachroo, Phytomorph. 4 (1954) 379; B. K. Nayar, Bull. natn. bot. Gdns Lucknow (1961) 20, Fig. 5; C. Chr., Ind. Fil. suppl. 4 (1965) 258; Holttum, [Fl. Thail. 33] Dansk. Bot. Ark. 23, 2 (1965) 231; Iconogr. Cormoph. Sinic. 1 (1972) 273; Nakaike, Enum. Pterid. Jap. (1975) 350; E. Walker, Fl. Okinawa & S. Ryukyu (1976) 121; Ching & S. K. Wu in C. Y. Wu, Fl. Xizang. (1983) 348. --- Pleopeltis coronans (Wallich ex Mett.) v. A. v. R., Bull. Dép. Agric. Indes néerl. 27 (1909) 11. --- Type: Wallich 288, Nepal, Nookete, Mt. Pandera (holo: B; iso: BM, BR, G, GH, K, L, P, US, W).  
Polypodium conjugatum Baker in Hook. & Baker, Syn. Fil. (1868) 366 [non Poit., 1804; non Kaulf., 1827] (nom. illeg.). --- Drynaria conjugata Baker ex Bedd., Suppl. Ferns S. Ind. & Br. Ind. (1876) 23. --- Type: not traced.  
Drynaria esquirolii C. Chr., Bull. Géogr. bot. 23 (1913) 139; Ind. Fil. suppl. 2 (1917) 13. --- Type: Esquirol 2569, China, Kouy-Tchéou, Thouly (holo: BM).

Usually epiphytic, often epilithic, forming ring-shaped circular basket (around boles).--- Rhizome 2-->3 cm Ø, phyllopodia absent, fronds <10 cm apart, dilated frond bases imbricate, rachises not persistent, >40 vascular bundles, all + equally-sized, arranged in 1 or 2 p.p. rows with conspicuous dorsal invaginations and sometimes enclosed circle, bundle sheath ill-developed, blue- or red-coloured, epidermis cells isodiametric, scale attachment more or less sunken, sclerenchyma strands absent.--- Rhizome scales obliquely spreading, basifix, pseudo-peltate with short auricles, triangular/ovate to linear/filiform, index (6-->10-->25, 5-->20 by 0.5-->1 mm, margin toothed, teeth biseriate, 1-celled, top united or top T-shaped, apex short filiform/narrow acuminate, glandular top cell present, glandular indument present throughout, 1- or 2-celled, indument inserted marginally only, lignified cells absent.--- Fronds monomorphic, pandurate, lobate and pinnatifid, index 3-->6, 70-->170 by 20-->45 cm, sessile, base dilated, pinnae equally wide throughout, clearly decreasing in size towards apex or + equally wide all over, index 5-->7(-->10), up to 15-->35 by 1.5-->5 cm, incisions up to >0.2 cm from the costa, increasing towards the base, margin entire, apex acute to apex acuminate, apical pinna present, nectaries situated in the lower angle between costa and Vp (or Vp and Vs).--- Venation of sterile pinnae: Vs running more or less straight or a regular zigzagging, Vt branching from Vtc basically recurrent, free vein endings running diffuse, all terminated by a hydathode; A1c always present, + regularly shaped throughout bordering part of basal Vs shortened, largely containing 1, 2, or more included veins, simple, once dichotomous, partly anastomosed; A1 divided into 2-->4 Asec, areole layering comprising 4-->8 A1, distinct, regularly shaped throughout, Asec empty or containing simple or once dichotomous veins.--- Fertile frond parts + similar to sterile foliage frond parts, venation slightly less complex, free ending veins shortened, Vt directed to the nearby sorus, A1c not soriferous.--- Sori elliptic, 1-->3 mm long, distributed all over the abaxial frond surface, in the basal pinnae usually in the apical part only, arranged in one row parallel to the Vs, one per A1, near the Vs margins, midway on anastomosed veins or on branching points of 2-->4 veins, slightly pustulate.--- Anatomy: costa near the base rounded, up to 1(-->1.5) cm Ø, 7-->11 vascular bundles, costa in middle

part rounded, 4 or 5 vascular bundles, bundle sheath brown-coloured; lamina: stomata 2100--2700 / $\mu\text{m}^2$ , epidermis red-coloured, hypodermis present ad- and abaxially, marginal sclerenchymatous strand with >25 cells, Vp rounded, vein sheath interrupted, conspicuously sclerenchymatic, cortex blue- to red-coloured, sclerenchymatous or firm parenchymatous, 1 vascular bundle, bundle sheath blue- to brown-coloured, xylem arrangement T- to V-shaped, sclerenchymatous strands absent, veinlet sheath extensions sclerenchymatous from epidermis to epidermis; receptacle with more or less isodiametric cell arrangement, 1 or 2 veinlets.--- Indument: laminar trichomes present, glandular, not densely set, >95% unbranched, 2 cells long, 85--115 / $\mu\text{m}$  long, type II glandular trichomes absent, acicular trichomes absent, laminar scales scattered around costa only, basifix, linear/filiform, teeth biseriate, glandular indument absent, indument inserted marginally only, lignified cells absent, apex long filiform; receptacular hairy paraphyses 10--25% branched, 1 or 2 glandular cells, 2--4 cells long, 85--150(--180) / $\mu\text{m}$  long, receptacular scaly paraphyses absent; deviating sporangia absent, sporangial paraphyses absent.--- Sporangium 275--305 by 220--250 / $\mu\text{m}$ , annulus with (12--14 or 15(--17) indurated cells, 3(4) epistomium cells, 3 or 4(5) hypostomium cells, in total (21)22 or 23(--25) cells.--- Spores of quercifolium-type, perispore smooth sometimes folded, ultrastructure smooth, basal layer inconspicuous, spines present, sharp and smooth, with apical constriction, baculae absent, globules absent, exospore with globular excrescences.

Distribution: Bangla-Desh, India (Uttar-Pradesh, Sikkim, Assam, Manipur), Nepal, Bhutan, China (Yunnan, Guangsu, Guizhou, Guangdong, Hainan), Taiwan, Ryukyu Isl., Birma, Thailand, Laos, Vietnam, Penang, Malay Peninsula.

Habitat: Primary and secondary forest (a.o. evergreen-, mixed deciduous-, bamboo-), sometimes in more open vegetation. Usually growing in the shade, 0--25 m above the ground. Reported on Quercus spec., Pinus spec. Alt. 100--1800(--2000) m.

Notes. 1. Vern. names: Gwu-on (Yunnan, China)

Yan-zhe-ji (Ping-bien, China)

Bai kut om (= enclosing; Laos)

2. Koelz 10555 (US): 'grows in ring around tree'

Kerr 9934 (K): 'usually forming a complete circle around bole of tree'

Kingdom-Ward 20458 (BM, GH): 'base of leaf forms a cup or purse in which humus collects, the roots from rhizome grow into this'

3. McClure 2170 (C.C.C. 8574; B): 'Rootstock used in chinese pharmacy'

4. Dilated frond base sometimes ill-developed, resembling a wing.

5.  $2n = 72?$ ,  $74?$  (Lbve, Lbve, & Pichi Sermolli, 1977)

#### 24. Aglaomorpha heraclea (Kunze) Copel.

Aglaomorpha heraclea (Kunze) Copel., Univ. Calif. Publ. Bot. 16, 2 (1929) 117; C. Chr., Ind. Fil. suppl. 3 (1934) 20; Backer & Posthumus, Varenfl. Java (1939) 232; Holttum, Fl. Mal. 2, Ferns (1954) 185; [Fl. Thail. 1] Dansk Bot. Ark. 20, 1 (1961) 21. --- Polypodium heracleum Kunze, Bot. Ztg 6, 7 (1848) 117; Mett., Farngatt. 1, Polyp. (1857) 117, T. 3, 52; Hook., Gard. Ferns (1862) Pl. 1; Sp. Fil. 5 (1864) 93; Mett., Filices 2 (1866) 230 (21); Baker, in Hook. & Baker, Syn. Fil. (1868) 366; J. Linn. Soc. Lond. (Bot.) 15 (1877) 110; Christ, Farnkr. (1897) 116; Racib., Pterid. Fl. Buitenzorg (1898) 116; Diels in E&P, Nat. Pfl. Fam. 1, 4 (1902) 319; Copel., Dep. int. Bur. Govern. 28 (1905) 133; C. Chr., Ind. Fil. (1906) 532; Copel., Philipp.

J. Sci. [Bot.] 6, 3 (1911) 140; Sarawak Mus. J. 2, 3 (1917) 407; Brause, Bot. Jb. 56, 1 (1920) 204. --- Drynaria heraclea (Kunze) T. Moore, Ind. Fil. (1862) 346; J. Smith, Ferns Br. & For. (1866) 103; Hist. Fil. (1875) 108. --- Pleopeltis heraclea (Kunze) v. A. v. R., Bull. D p. Agric. Indes n erl. 27 (1909) 11. --- Drynariopsis heraclea (Kunze) Ching, Sunyatsenia 5 (1940) 262; Copel., Gen. Fil. (1947) 201; Holttum, Fl. Mal. 2, Ferns (1954) 185; Copel., Fern Fl. Philipp. 3 (1960) 492; C. Chr., Ind. Fil. suppl. 4 (1965) 106. --- Type: Zollinger 977, Java, Prov. Bogor, Mt Balang (B, n.v.).  
Drynaria morbillosa auct non C. Presl; J. Smith, Hook. J. Bot. 3 (1841) 398 p.p.; Cult. Ferns cat. (1857) 14.

Usually epiphytic, forming ring-shaped circular basket around boles, rarely epilithic.--- Rhizome 2-->3 cm  $\emptyset$ , phyllopodia absent, fronds <10 cm apart, dilated frond bases imbricate, rhachises not persistent, >40 vascular bundles, all + equally-sized, arranged in 1 or 2 p.p. rows with conspicuous invaginations and sometimes enclosed circle, bundle sheath ill-developed, blue-coloured, epidermis cells flattened, scale attachment more or less sunken, sclerenchyma strands absent.--- Rhizome scales obliquely spreading, basifix, pseudo-peltate with short auricles, triangular/ovate, linear/filiform, or spatulate, index 6--25(--35), 7--40 by (0.6--1--2.5 mm, margin toothed, teeth biseriate, 1-celled, top united, apex long filiform, glandular top cell present, glandular indument present throughout, 1- or 2-celled, indument inserted marginally and abaxially, midrib present.--- Fronds monomorphic, pandurate, lobate and pinnatifid, sessile, index 3--7, (60--100--200(--350) by 20--65(--100) cm, base dilated, pinnae equally wide throughout, clearly decreasing in size towards the apex, index 4--8, up to 15--65 by 3--14 cm, incisions up to >0.5 cm from the costa, increasing towards the base, margin entire, apex acute to acuminate, apical pinna present, nectaries situated in the lower angle between costa and Vp (or Vp and Vs).--- Venation of sterile pinnae: Vs running more or less straight, Vt branching from Vtc basically excurrent and recurrent, free vein endings running diffuse, all terminated by a hydathode; A1c sometimes absent, usually present, irregularly shaped, bordering part of basal Vs and of apical Vs shortened, all containing 1, 2, or more included veins, simple or once dichotomous, partly anastomosed; A1 divided into 3 or 4 or more Asec, areole layering comprising 6--9 A1, distinct, regularly shaped throughout the frond, Asec largely containing simple veins.--- Fertile frond parts + similar to sterile frond parts, A1c sometimes soriferous.--- Sori round, 1--2 mm  $\emptyset$ , distributed all over the abaxial frond surface, in the basal pinnae usually in the apical part only, arranged in 2 rows parallel to the Vtc, many per A1, near the Vtc margins, terminal and subterminal on free veins, midway on anastomosed veins, or on branching points of 2--4 veins, slightly pustulate.--- Anatomy: costa near the base elliptical or invaginated, up to 2.5 cm  $\emptyset$ , >11 vascular bundles, costa in middle part rounded, >6 vascular bundles, bundle sheath blue- or brown-coloured; lamina: stomata 1500--2100 / $\mu\text{m}^2$ , epidermis red-coloured, hypodermis present adaxially, marginal sclerenchymatous strand with >25 cells; Vp rounded, vein sheath interrupted, cortex blue- to red-coloured, sclerenchymatous or firm parenchymatous, 1--3 vascular bundles, bundle sheath blue- or brown-coloured, xylem arrangement V-shaped, sclerenchymatous strands absent, veinlet sheath extensions sclerenchymatous from epidermis to epidermis; receptacle with more or less isodiametric cell arrangement, 1 or 2 veinlets.--- Indument: laminar trichomes present, glandular and acicular, not densely set, glandular trichomes >95% unbranched, 2 or 3 cells long, 85--120(--230) / $\mu\text{m}$  long, type II glandular trichomes absent, acicular trichomes more or less scattered throughout, (1)2 cells long, 160--190 / $\mu\text{m}$  long; laminar scales scattered around costa

only, basifix, linear/filiform, teeth biseriate, glandular indument present throughout, 1- or 2-celled, indument inserted marginally only, lignified cells absent, apex long filiform; receptacular hairy paraphyses >90% unbranched, >5% branched, 1 or 2(--4) glandular cells, (2)3 or 4 cells long, 135--215 /um long, receptacular scaly paraphyses absent; deviating sporangia absent, sporangial paraphyses absent.--- Sporangium 280--365 by 220--280 /um, annulus with (12)13--15(--17) indurated cells, 3 epistomium cells, 3--5 hypostomium cells, in total (21)22--24(--27) cells.--- Spores of quercifolium-type, perispore smooth sometimes folded, ultrastructure smooth, basal layer inconspicuous, spines absent, baculae absent, globules present, exospore smooth.

Distribution: Sumatra, Malay Peninsula, Bangka, Billiton, Java, Sumba, Borneo (Kalimantan, Sabah), Philippines (Luzon, Mindoro, Panay, Leyte, Samar, Mindanao), Celebes, Moluccas, Waigeo, New Guinea (W. Irian, Papua), New Britain, New Ireland, Solomons.

Habitat: Primary and secondary forest (a.o. dry evergreen-, Castanopsis-, mixed oak-). Growing in the shade, 0--25 m (rarely higher) above the ground. Reported on Erythrina spec., Intsia bijuga. Alt. 0--1700 m.

Notes. 1. Vern. names: Sarawkong (Davao, Mindanao, Philippines)

Dopa dopa (Manobo; Agusan, Mindanao)

2. Surbeck 1118 (L): 'in richtigen Rosetten am Boden.'

## 25. Aglaomorpha meyeniana Schott

Aglaomorpha meyeniana Schott, Gen. Fil. (1835 or '36) ad tab. 19; Kunze, Farnkr. (1840-'47) 191, t. 81; J. Smith, Hook. J. Bot. 3 (1841) 398; 4 (1842) 62; Hook. & Bauer, Gen. Fil. (1842) t. 91; Fée, Mém. Foug. 5, Gen. Fil. (1850-'52) 266; Brackenbridge, U. S. Expl. Exp. 16 (1854) 56; Mett., Fil. HB. Lips (1856) 38; T. Moore, Ind. Fil. (1862) 42; Ettingh., Farnkr. Jetztw. (1865) 54, Fig. 23, 24, T. 38; Fig. 12 ["meyeniana"]; J. Smith, Hist. Fil. (1875) 110; Copel., Phil. J. Sci. [Bot.] 6, 3 (1911) 141; v. A. v. R., Mal. Ferns Suppl. (1917) 418; C. Chr., Ind. Fil. suppl. 2 (1917) 3; Copel., Univ. Calif. Publ. Bot. 16, 2 (1929) 117; Fern Fl. Philipp. 3 (1960) 494; De Vol in H. L. Li et al., Fl. Taiwan 1 [Pterid.] (1975) 211, Pl. 73. --- Polypodium meyenianum (Schott) Hook., Spec. Fil. 5 (1864) 94; Baker in Hook. & Baker, Syn. Fil. (1868) 366; Christ, Farnkr. (1897) 117; Bull. Herb. Boissier 6, 3 (1898) 202; Diels in E&P, Nat. Pfl. Fam. 1, 4 (1902) 319; Copel., Dep. int. Bur. Govern. 28 (1905) 133; C. Chr., Ind. Fil. (1906) 544. --- Pleopeltis meyeniana (Schott) v. A. v. R., Bull. Dép. Agric. Indes néerl. 27 (1909) 11. --- Dryostachyum meyeniana (Schott) Brause, Bot. Jb. 49, 1 (1912) 57. --- Type: Cuming 49, Philippines, Luzon, Prov. Laguna (iso: B, BM, K, L).

Psygmium elegans C. Presl, Tent. Pterid. (1836) 199. --- Type: Meyen herb s.n., Philippines, Luzon, Manila (holo: PRC, n.v.; iso: B).

Epiphytic, forming ring-shaped circular basket around boles sometimes epilithic.--- Rhizome 2-->3 cm Ø, phyllopodia absent, fronds <10 cm apart, dilated frond bases imbricate, rachises not persistent, >40 vascular bundles, all + equally-sized, arranged in 2 p.p. elliptical rows or in 1 row with conspicuous dorsal invaginations, bundle sheath ill- to well-developed, blue- or red-coloured, epidermis cells isodiametric, scale attachment more or less sunken, sclerenchyma strands absent.---



Rhizome scales obliquely spreading, basifix, pseudo-peltate with short auricles, triangular/ovate to linear/filiform, index 12--20, 6--15 by 0.4--1.0(--1.3) mm, margin toothed, teeth biseriate, 1-celled, top united, apex long filiform to short filiform/narrow acuminate, glandular top cell present, glandular indument present throughout, 2-celled, indument inserted marginally only, lignified cells absent.--- Fronds internally dimorphic, pandurate, lobate and pinnatifid, sessile, index 2.5--4.5(--5.5), (35--40--90(--105) by 15--30, base dilated, sterile pinnae equally wide throughout, index (2.5--4--6(--7), up to 7.5--15 by 1.5--3.5, incisions up to >0.2 cm from the costa, increasing towards the base, margin entire, apex acute to acuminate, apical pinna present, nectaries situated in the lower angle between costa and Vp (or Vp and Vs).--- Venation of sterile pinnae: Vs running more or less straight or regular zigzagging, Vt branching from Vtc basically recurrent, free vein endings running diffuse or excurrent and recurrent, all terminated by a hydathode; A1c always present, usually regularly shaped throughout, sometimes irregularly shaped, bordering part of basal Vs shortened, all containing 2 or more included veins, simple, once dichotomous, or more extensively branched, partly anastomosed; A1 divided into 3, 4, or more Asec, areole layering comprising 4--6 A1, distinct, regularly shaped throughout the frond, Asec containing simple, once dichotomous, or twice or more dichotomous veins.--- Fertile frond parts clearly contracted, pinnae "string of beads"-like shaped, index >15, up to 5--20(--30) by 0.4--0.8 cm, Vs and Vt strongly reduced, diplodesmic, areole layering absent, free ending veins shortened or absent, Vt directed to the nearby sorus, A1c not soriferous.--- Soral patches round, on small half-circular lobes, 1--3 mm  $\emptyset$ , distinctly restricted to the apical two-third or less of the frond, in the basal pinnae sometimes in the apical part only, arranged in 1 row parallel to the Vp, on branching points of more than 4 veins, pustulate.--- Anatomy: costa near the base rounded, up to 0.7 cm  $\emptyset$ , 7-->11 vascular bundles, costa in middle part rounded, 3--5 vascular bundles, bundle sheath blue- or brown-coloured; lamina: stomata <1500 / $\mu$ m<sup>2</sup>, in fertile pinnae epidermis red-coloured, hypodermis present ad- abaxially, marginal sclerenchymatous strand with >25 cells, in fertile pinnae epidermis blue-coloured, hypodermis absent, marginal sclerenchymatous strand less developed to (nearly) lacking; Vp rounded, vein sheath continuous, in fertile pinnae interrupted, cortex blue-coloured, parenchymatous, 1 vascular bundle, bundle sheath blue-coloured, xylem arrangement V-, in fertile pinnae T-shaped, sclerenchymatous strands absent, veinlet sheath extensions sclerenchymatous from epidermis to epidermis; receptacle with perpendicular cell arrangement, 1--4 veinlets.--- Indument: laminar trichomes present, glandular and acicular, not densely set, glandular trichomes >5% branched, 2 cells long, 75--110 / $\mu$ m long, type II glandular trichomes present, acicular trichomes in tuft on abscission vein only, 3 cells long, 140--180 / $\mu$ m long; laminar scales scattered around costa only, basifix, linear/filiform, teeth biseriate, glandular indument present throughout, 1- or 2-celled, indument inserted marginally only, lignified cells absent, apex filiform/narrow acuminate; receptacular hairy paraphyses >90% unbranched, 1 or 2 glandular cells, 2 cells long, (50--60--75(--100) / $\mu$ m long, receptacular scaly paraphyses absent; deviating sporangia absent, sporangial paraphyses absent.--- Sporangium 290--320 by 240--270 / $\mu$ m, annulus with (11)12(--14) indurated cells, (2)3 epistomium cells, 2 or 3 hypostomium cells, in total (18)19 or 20(21) cells.--- Spores of meyeniana-type, perispore verrucate, ultrastructure smooth, basal layer thick, spines absent, baculae present, globules absent, exospore smooth.

Distribution: Taiwan, Philippines (Luzon, Mindoro, Catanduanes, Cebu).

Habitat: Primary forest. Usually growing exposed. Alt. 450--800(--1600) m.

## 26. *Aglaomorpha drynarioides* (Hook.) Roos

*Aglaomorpha drynarioides* (Hook.) Roos, *Blumea* (1985). --- *Acrostichum drynarioides* Hook., *Sp. Fil.* 5 (1864) 284; Baker in Hook. & Baker, *Syn. Fil.* (1868) 425. --- *Photinopteris drynarioides* (Hook.) Bedd., *Ferns Br. Ind.* (1869) T. 325; *Handb. Ferns br. Ind.* (1883) 442, Fig. 270). --- *Dryostachyum drynarioides* (Hook.) Kuhn, [Miq.] *Annls Mus. Bot. Lug. -Bat.* 4 (1869) 296; Diels in E&P, *Nat. Pfl. Fam.* 1, 4 (1902) 328; C. Chr., *Ind. Fil.* (1906) 301; suppl. 1 (1913) 50; Rech., *Denkschr. Akad. Wiss. Wien* 89 (1913) 480. --- *Polypodium drynarioides* (Hook.) Christ [non Gris.], *Farnkr.* (1897) 117, nom. illeg. --- *Merinthosorus drynarioides* (Hook.) Copel., *Phil. J. Sci. [Bot.]* 6, 2 (1911) 92; C. Chr., *Ind. Fil. suppl.* 2 (1917) 48; Copel., *Univ. Calif. Pubs Bot.* 16, 2 (1929) 122; Gen. Fil. (1947) 202; Holttum, *Fl. Mal.* 2, Ferns (1954) 186; Brownlie, *beih. Nova Hedw.* 55 [Pterid. Fiji] (1977) 364. --- Lectotype: Norris s.n., s.d., Malayan Peninsula, Penang (holo:K; iso: B).

*Acrostichum thomsoni* Baker, *J. Linn. Soc. Lond. (Bot.)* 15 (1877) 111; Hook. f., *Hook. Ic. Pl. ser. 3* (1887) Pl. 1694. --- *Dryostachyum thomsoni* (Bak.) Diels in E&P, *Nat. Pfl. Fam.* 1, 4 (1899) 328; C. Chr., *Ind. Fil.* (1906) 301; suppl. 2 (1917) 48 (added *Photinopteris* and *Merinthosorus* with question mark). --- *Photinopteris thomsoni* (Baker) C. Chr., *Ind. Fil. suppl.* 2 (1917) 48 (with question mark). --- *Merinthosorus thomsonii* (Bak.) Copel., *Univ. Calif. Pubs Bot.* 18, 10 (1942) 226; C. Chr., *Ind. Fil. suppl.* 4 (1965) 194. --- Type: Moseley s. n., Admiralty Islands (holo: K).

*Dryostachyum singulare* Mett. ex Kuhn, [Miq.] *Annls Mus. Bot. Lug. -Bat.* 4 (1869) 296 (nom. illeg.). --- Type: Korthals (?), Sumatra (holo: L).

Usually epiphytic, forming ring-shaped circular basket around boles, sometimes epilithic or terrestrial. --- Rhizome 2-->3 cm  $\emptyset$ , phyllopodia absent, fronds <10 cm apart, dilated frond bases imbricate, rachises not persistent, >40 vascular bundles, all  $\pm$  equally-sized, arranged in 1 row with a conspicuous dorsal invagination, bundle sheath ill-developed, blue- or red-coloured, epidermis cells flattened or isodiametric, scale attachment more or less sunken, sclerenchyma strands absent. --- Rhizome scales obliquely spreading, basifix, pseudo-peltate with short auricles, triangular/ovate to linear/filiform, index 8--20, 10--21(--27) by 0.7--1.5 mm, margin toothed, teeth biseriate, 1-celled, top united or T-shaped, apex long filiform to short filiform/narrow acuminate, glandular top cell present, glandular indument present throughout, 1- or 2-celled, indument inserted marginally only, lignified cells absent. --- Fronds internally dimorphic, pandurate, lobate and pinnatifid, sessile, index 3--5.5, 50--175 by 15--45 cm, base dilated, sterile pinnae equally wide throughout or with a basal constriction, index 3.5--6.5, 9--26 by 2--5.5 cm, incisions up to >0.5 cm from the costa, increasing towards the base, margin entire, apex acute to acuminate, apical pinna present, nectaries situated in the lower angle between costa and Vp (or Vp and Vs). --- Venation of sterile pinnae: Vs running more or less straight or regular zigzagging, Vt branching from Vtc basically recurrent, free vein endings running diffuse or excurrent and recurrent, all terminated by a hydathode; A1c sometimes absent, usually present, irregularly shaped, bordering part of basal Vs and of apical Vs shortened, all containing 2 or more included veins, simple or once dichotomous, partly anastomosed; A1 divided into 3, 4, or more Asec, areole layering comprising 6--8 A1, distinct, regularly shaped

throughout the frond, Asec containing simple, once dichotomous, or twice or more dichotomous veins.--- Fertile frond parts clearly contracted, pinnae index >30, up to 10--45 by 0.3--0.5 cm, Vs and Vt strongly reduced, diploidesmic, areole layering absent, free ending veins shortened or absent, Vt directed to the nearby sorus, A1c not soriferous.--- Soral patches linear, sometimes elliptic, distinctly restricted to the apical two-third or less of the frond, in the basal fertile pinnae sometimes in the apical part only, in 1 string/row parallel to the Vp, on branching points of more than four veins, pustulate.--- Anatomy: costa near the base rounded, up to 1--1.5 cm Ø, 9-->11 vascular bundles, costa in middle part rounded, 4 vascular bundles, bundle sheath brown-coloured; lamina: stomata 1500--2100 /um<sup>2</sup>, epidermis red-coloured, hypodermis in sterile pinnae present ad- and abaxially, in fertile pinnae adaxially, red-coloured, in fertile pinnae blue-coloured, marginal sclerenchymatous strand with >25 cells, in fertile pinnae (nearly) lacking; Vp rounded, vein sheath interrupted, in fertile pinnae ill-developed, cortex blue-coloured, parenchymatous, 1 vascular bundle, bundle sheath present, in fertile pinnae thin, blue- or brown-coloured, xylem arrangement T- to V-shaped, sclerenchymatous strands absent, veinlet sheath extensions sclerenchymatous from epidermis to epidermis; receptacle with more or less isodiametric cell arrangement, 1 or 2 veinlets.--- Indument: laminar trichomes present, glandular and acicular, not densely set, glandular trichomes 25--50% branched, 2--4 cells long, 110--180(--250) /um long, type II glandular trichomes present, acicular trichomes more or less scattered throughout, 2--4(--6) cells long, (150--)210--400 /um long; laminar scales scattered around costa only, basifix, pseudo-peltate with short auricles, linear/filiform, teeth biseriate, glandular indument present throughout, 1- or 2-celled, indument inserted marginally only, lignified cells absent, apex filiform/ narrow acuminate to acute (acuminate); receptacular hairy paraphyses 10--25% branched, 1 or 2(--4) glandular cells, 2--4(5) cells long, 160--390(--500) /um long, receptacular scaly paraphyses absent; deviating sporangia present, sporangial paraphyses absent.--- Sporangium 275--350 by 235--280 /um, annulus with (12)13 or 14(15) indurated cells, 3 or 4(5) epistomium cells, 3 or 4(5) hypostomium cells, in total (21)22 or 23(--26) cells.--- Spores of quercifolium-type, perispore smooth sometimes folded, ultrastructure smooth, ultrastructure verruculate, basal layer inconspicuous, spines absent, baculae absent, globules present, exospore smooth.

Distribution: Sumatra, Penang, Malay Peninsula, Riau Arch., Borneo (Sarawak, Sabah), Moluccas, New Guinea (W. Irian, Papua), New Britain, New Ireland, Solomon Isl., Louisiades.

Habitat: Primaru and secondary forest (a.o. Dipterocarp-, mangrove-), open vegetations, and several kinds of plantations (coconut-, coffee-, cacao-, rubber-). Usually growing rather exposed, (0-->5--30 m above the ground. Reported on Ayer mancier, Leucaena spec., Cocos nucifera, Cycas spec., Pandanus spec. Alt. 0--1800 m.

Notes. 1. Vern. names: Kwara 'ae, Tataleoleo (St. Ysabel, Solomons)  
 Kàh (Kerenci, Sumatra)  
 Zalatay (Boana, Morobe Prov., Papua New Guinea)  
 Lucka (Bougainville, Solomons)  
 Tali nali (Kulumo lang., W. New Britain)

2. Chromosomes: 2n = 72 (Lbve, Lbve, & Pichi Sermolli, 1977)

3. LAE 66597 (LAE): (for epilithic specimen) 'forming dense circular clumps'

4. Kajewski 2039 (A, BRI, MICH): 'Opossums sleep at the base of these clumps' (of plants of A. drynarioides).

## 27. *Aglaomorpha speciosa* (Blume) Roos

*Aglaomorpha speciosa* (Blume) Roos, *Blumea* (1985). --- *Lomaria speciosa* Blume, *Enum. Pl. Javae* Fil. (1828) 202. --- *Photinopteris speciosa* (Blume) Presl, *Epim. Bot.* (1849) 264; Diels in E&P, *Nat. Pfl. Fam.* 1, 4 (1902) 328, Fig. 170:D-F; Copel., *Dep. int. Bur. Govern.* 28 (1905) 134; C. Chr., *Ind. Fil.* (1906) 492; Christ, *J. Bot. Paris*, ser. 2, 1 (1908) 239; Gibbs, *J. Linn. Soc. Bot.* 42 (1914) 204; Copel., *Univ. Calif. Publ. Bot.* 16, 2 (1929) 122; Backer & Posthumus, *Varenfl. Java* (1939) 235, Fig. 55; Tardieu & C. Chr. in Lecomte, *Fl. gén. Indo-Chine* 7, 2 (1941) 502; Copel., *Gen. Fil.* (1947) 203; Holttum, *Fl. Mal. 2, Ferns* (1954) 187; Copel., *Fern Fl. Philipp.* 3 (1960) 496; Hennipman, *Blumea* 22, 1 (1974) 51. --- *Dryostachyum speciosum* (Blume) Kuhn, [Miq.] *Annls Mus. Bot. Lug.* -Bat. 4 (1869) 296. --- *Polypodium speciosum* (Blume) Christ [non Blume (1828) 132], *Farnkr.* (1897) 121 (nom. illeg.). - Type: Blume s.n., 1824, Java (holo: L).

*Acrostichum rigidum* Wallich, *List no.* 27 (1828) nomen nudum; Hook., *Sp. Fil.* 5 (1864) 281; Baker in Hook. & Baker, *Syn. Fil.* (1868) 424. --- *Photinopteris rigida* (Wallich ex Hook.) Bedd., *Ferns br. Ind.* (1866) T. 211; *Handb. Ferns br. Ind.* (1883) 442, Fig. 269. --- Type: Wallich 27, Singapore (holo: K).

*Photinopteris simplex* J. Smith, *Hook. J. Bot.* 3 (1841) 403 (nomen nudum); 4 (1842) 155; --- Type: Cuming 64, Philippines, Luzon (holo: BM; iso: B, GH, K).

*Photinopteris horsfieldii* J. Smith, *Hook. J. Bot.* 3 (1841) 403 (nomen nudum); 4 (1842) 155; Hook. & Bauer, *Gen. Fil.* (1842) 92; Fée, *Mém. Foug.* 2, *Acrost.* (1844-'45) 102; C. Presl, *Epim. Bot.* (1849) 191; Fée, *Mém. Foug.* 5, *Gen. Fil.* (1850-'52) 62; Brackenridge, *U. S. Expl. Exp.* 16 (1854) 88. --- *Lomariopsis horsfieldii* (J. Smith) Mett., *Fil. HB. Lips* (1856) 22; Ettingh., *Farnkr. Jetzdwelt* (1865) 15, T. 8: Fig. 4, T. 9: Fig. 8). --- Type: Cuming 362, Philippines, Mindoro (holo: BM; iso: B, GH, K, L, MICH, US, W).

*Photinopteris cumingii* Presl, *Epim. Bot.* (1849) 192. --- Type: Cuming 362 p.p., Philippines, Mindoro (iso: B, BM, GH, K, L, MICH, US, W).

*Acrostichum acuminatum* Willd., *Spec. Plant. ed. 5*, 5 (1810) 116, p.p. --- *Photinopteris humboldtii* Presl, *Epim. Bot.* (1849) 192. --- *Photinopteris acuminata* Morton, *Contr. US Nat. Herb.* 38 (1967) 31 (nom. illeg.). --- Type: *Herb. Willdenowii* 19539, Philippines (Peruvia is erroneous) (holo: B).

Often epiphytic, spirally or vertically climbing, often epilithic, linearly creeping.--- Rhizome 1-2 cm Ø, phyllopodia absent, fronds >20 cm apart, rachises not persistent, 15-30 vascular bundles, dorsal + 4 large(r) sized, arranged in 1 or 2 p.p. elliptical rows with a dorsal protrusion, bundle sheath rarely absent, usually well-developed, brown-coloured, epidermis cells isodiametric, scale attachment more or less sunken, sclerenchyma strands absent.--- Rhizome scales obliquely spreading, pseudo-peltate with long auricles, triangular/ovate, linear/filiform to spatulate, index 5--10, 3--7.5(--10) by 0.5--1.2 mm, margin with short protuberances, teeth/protuberances uniseriate and biseriate, 1-celled, top united, rounded, or T-shaped, apex short filiform/narrow acuminate, glandular top cell absent, glandular indument present throughout, 1- or 2-celled, indument inserted marginally only, lignified cells absent or present around the point of attachment only.--- Fronds internally dimorphic, once pinnate, up to 40--115 cm long, stalked, petiole up to 10--35 by 0.4--0.7 cm, not winged; lamina quadrangular to ovate, index 2--4, (30--) 45--90 by 15--30 cm, sterile pinnae with a clear basal constriction, ovate, index 2--3.5, 7--30 by 3.5--10 cm, margin entire, apex acuminate, apical pinna present, nectaries situated in the lower angle between costa and Vp, quadrangular.--- Venation of sterile pinnae: Vs running in a regular

zigzagging way, Vt branching from Vtc basically recurrent, free vein endings largely running excurrent and recurrent, all terminated by a hydathode; A1c always present, usually regularly shaped throughout, sometimes irregularly shaped, both branching points of the Vtc and Vs equally distant from the Vp or shortened, all containing 1, 2, or more included veins, simple, once dichotomous or more extensively branched, partly anastomosed; A1 divided into 3 or 4 Asec, areole layering comprising 6--9 A1, distinct, regularly shaped throughout the frond, Asec containing simple and largely once and twice or more dichotomous veins.--- Fertile frond parts clearly contracted, index >25, up to 10--27 by 0.4--0.7 cm, Vs and Vt of fertile frond parts strongly reduced, diplodesmic, areole layering absent, free ending veins shortened or absent, Vt directed to the nearby sorus, A1c not soriferous.--- Soral patches linear, rarely elliptic, distinctly restricted to the apical two-third or less of the frond, in the basal fertile pinnae sometimes in the apical part only, sometimes in elliptical patches, on branching points of more than 4 veins, pustulate.--- Anatomy: petiole rounded or elliptical, 7--10 vascular bundles, rhachis rounded or invaginated, 3--5 vascular bundles, bundle sheath blue-coloured; lamina: stomata 2100--2700 / $\mu\text{m}^2$ , epidermis blue- or red-coloured, fertile pinnae blue-coloured, hypodermis in sterile pinnae present ad- and abaxially, in fertile pinnae adaxially, marginal sclerenchymatous strand with >25 cells, in fertile pinnae somewhat less developed; Vp rounded, vein sheath continuous, in fertile pinnae interrupted, cortex blue- to red-coloured, sclerenchymatous or firm parenchymatous, 1 vascular bundle, bundle sheath (at least p.p.) red-coloured, open sclerenchyma cells, otherwise brown-coloured, in fertile pinnae blue, xylem arrangement T-shaped, sclerenchymatous strands absent, veinlet sheath extensions sclerenchymatous from epidermis to epidermis; with some irregularities; receptacle with more or less isodiametric cell arrangement, 3 or 4 veinlets.--- Indument: laminar trichomes present, glandular and acicular, tomentose, glandular trichomes >5% branched, 2 cells long, 85--105(--120) / $\mu\text{m}$  long, type II glandular trichomes absent, acicular trichomes more or less scattered throughout, 1--3(--22) cells long, 100--3000 / $\mu\text{m}$  long; laminar scales scattered around rhachis only, basifix, pseudo-peltate with short auricles, linear/filiform, teeth/protuberances uniseriate and biseriate, glandular indument present near the base only, 1- or 2-celled, indument inserted marginally only, lignified cells absent, apex long filiform; receptacular hairy paraphyses >90% unbranched, 1 or 2 glandular cells, 2 or 3 cells long, 80--150(--210) / $\mu\text{m}$  long, receptacular scaly paraphyses absent; deviating sporangia absent, sporangial paraphyses absent.--- Sporangium 245--285 by 205--240 / $\mu\text{m}$ , annulus with 12 or 13 indurated cells, (1)2 or 3 epistomium cells, 2 or 3 hypostomium cells, in total 18--20 cells.--- Spores of quercifolium-type, perispore smooth sometimes folded, ultrastructure smooth, basal layer inconspicuous, spines absent, baculae absent, globules present, exospore with globular excrescences.

Distribution: Thailand, Laos, Vietnam, Mentawai Isl., Sumatra, Malay Peninsula, Singapore, Bangka, Java, Borneo (Kalimantan, Sarawak, Sabah), Philippines (Luzon, Mindoro, Catanduanes, Panay, Negros, Cebu, Leyte, Mindanao), Celebes.

Habitat: Primary and secondary forest (a.o. Dipterocarp-, pine-), epilithic on sand- and limestone. Growing exposed or shaded, 0--40 m above the ground. Reported on Ficus fistulosa, Gonystylus bancanus, Eleais guineensis, Anisoptera spec. Alt. 0--1600(--2300) m.

- Notes. 1. Vern. names: Qeqapatpat di doplah, E apatpat di doplah, A patpat di batu (Ifugao, Luzon, Philippines)  
 Locdo (Damaguete, Negros, Philippines)  
 Libagod (Mt. Apo, Mindanao, Philippines)  
 Paku topèng (Preangger, Java)
2. Hennisman 4012 (L): 'Powder made from the rhizome is used when people are bitten by animals.' (Thailand)
3. Hennisman 5704 (L): 'Fronds when young hairy, white spotted or not, some glabrous. Larger fronds hairless, rhizome whitish'. (Celebes)
4. Pinnae are conspicuously acuminate.
5.  $2n = 72$  (Llave, Llave, & Pichi Sermolli, 1977)

## 28. *Aglaomorpha latipinna* (C. Chr.) Roos

*Aglaomorpha latipinna* (C. Chr.) Roos, *Blumea* (1985). --- *Holostachyum hieronymi* var. *latipinna*, C. Chr., *Svensk Bot. Tids.* 16 (1922) 96. --- Type: Kaudern 52, N. Celebes, Bolaang-Mongodou (holo: S).

Epiphytic, spirally or vertically climbing, or epilithic, linearly creeping.--- Rhizome 1--2 cm  $\emptyset$ , phyllopodia absent, fronds >20 cm apart, rhachises not persistent, 15--30 vascular bundles, dorsal + 4 large(r) sized, arranged in 1 or 2 p.p. elliptical rows with a dorsal protrusion, bundle sheath ill- to well-developed, blue- or brown-coloured, epidermis cells isodiametric, scale attachment more or less sunken, sclerenchyma strands absent.--- Rhizome scales adpressed, pseudo-peltate with long auricles, triangular/ovate, index 3--7, 4--8 by 0.8--1.8 mm, margin with elongated protuberances, protuberances uniseriate and biseriate, 1-celled, top T-shaped, apex short filiform/narrow acuminate to acute (acuminate), glandular top cell absent, glandular indument present throughout, 2-celled, indument inserted marginally only, lignified cells present around the point of attachment only.--- Fronds internally dimorphic, pinnatifid, 50--100 cm long, stalked, petiole inconspicuously winged, wing sinusoid, lamina + ovate, index 2.5--4, 40--80 by 15--28 cm, sterile pinnae equally wide throughout, index 4--8, 8--16 by 1.5--3 cm, incisions up to 0.0--<0.2 cm from the costa, margin entire, apex acuminate, apical pinna present, nectaries situated in the lower angle between costa and Vp (or Vp and Vs).--- Venation of sterile pinnae: Vs running in a regular zigzagging way, Vt branching from Vtc basically recurrent, free vein endings largely running excurrent and recurrent, all terminated by a hydathode; A1c always present, regularly shaped throughout, rarely irregularly shaped, bordering part of basal Vs shortened, all containing 1, 2, or more included veins, simple, once dichotomous or more extensively branched, partly anastomosed; A1 divided into 3 or 4 Asec, areole layering comprising 5 or 6 A1, distinct regularly shaped throughout the frond, Asec containing simple and once dichotomous veins.--- Fertile frond parts clearly contracted, index >18, 12--26 by 0.6--1 cm, Vs and Vt strongly reduced, diplodesmic, areole layering still + present, free ending veins shortened Vt directed to the nearby sorus, A1c not soriferous.--- Soral patches quadrangular, 3-->4 mm  $\emptyset$ , distinctly restricted to the apical two-third or less of the frond, in the basal fertile pinnae often in the apical part only, arranged in 1 row parallel to the Vp, on branching points of more than 4 veins, pustulate.--- Anatomy: petiole rounded, 7--8 vascular bundles, costa in middle part rounded, 2 vascular bundles, bundle sheath blue-coloured; lamina: stomata 1500--2100 / $\mu\text{m}^2$ , epidermis blue- or red-coloured, in fertile pinnae blue-coloured,

hypodermis in sterile pinnae present ad- and abaxially, in fertile pinnae adaxially, marginal sclerenchymatous strand with >25 cells, in fertile pinnae somewhat less developed; Vp rounded, vein sheath continuous, in fertile pinnae interrupted, cortex blue-coloured, parenchymatous, 1 vascular bundle, bundle sheath (at least p.p.) red-coloured, open sclerenchyma cells, xylem arrangement flattened V-shaped, sclerenchymatous strands absent, veinlet sheath extensions sclerenchymatous from epidermis to epidermis with some irregularities; receptacle with more or less isodiametric cell arrangement, 5 or 6 veinlets.--- Indument: laminar trichomes present, glandular and acicular, tomentose, glandular trichomes 25-50% branched, 2 cells long, (75--90--115 /um long, type II glandular trichomes present, acicular trichomes more or less scattered throughout, 1 or 2(--7) cells long, 60--750 /um long; laminar scales scattered around costa only, basifix, pseudo-peltate with short auricles, linear/filiform, teeth biseriate, glandular indument present near the base only, 1- or 2-celled, indument inserted marginally only, lignified cells absent, apex long filiform; receptacular hairy paraphyses >90% unbranched, 1 or 2 glandular cells, (2)3 or 4(5) cells long, (70--90--300(--390) /um long, receptacular scaly paraphyses absent; deviating sporangia absent, sporangial paraphyses absent.--- Sporangium 250--280 by 200--230 /um, annulus with (8)9--14(15) indurated cells, 2 or 3(4) epistomium cells, (1)2 or 3 hypostomium cells, in total (14--20--22(23) cells.--- Spores of quercifolium-type, perispore smooth sometimes folded, ultrastructure smooth, basal layer inconspicuous, spines absent, baculae absent, globules present, exospore with globular excrescences.

Distribution: Celebes.

Habitat: Primary and secondary forest. Alt. 1000-1350 m.

Note. 1. Hennipman 5590 (L, U): 'fronds with lime patches on hydathodes'.

## 29. *Aglaomorpha pilosa* (J. Smith) Copel.

*Aglaomorpha pilosa* (J. Smith) Copel., Phil. J. Sci. [Bot.] 6, 3 (1911) 141; C. Chr., Ind. Fil. suppl. 2 (1917) 3; Copel., Univ. Calif. Publ. Bot. 16, 2 (1929) 117; Gen. Fil. (1947) 202; Fern Fl. Philipp. 3 (1960) 493. --- *Dryostachyum pilosum* J. Smith, Hook. J. Bot. 3 (1841) 399; 4 (1842) 62; Hook. & Bauer, Gen. Fil. (1842) t. 95; Kunze, Farnkr. (1840-'47) 139, t. 61; Fée, Mém. Foug. 5, Gen. Fil. (1850-'52) 275; Mett., Fil. HB. Lips (1856) 20; T. Moore, Ind. Fil. (1862) 350; J. Smith, Hist. Fil. (1875) 109; Copel., Philipp. J. Sci. [Bot.] 1, suppl. 2 (1906) 165; Brause, Bot. Jb. 49, 1 (1912) 55. --- *Polypodium splendens* var. *pilosum* (J. Smith) Hook., Spec. Fil. 5 (1864) 96. --- *Polypodium pilosum* (J. Smith) Salomon, Nomenclator (1883) 314. --- *Dryostachyum splendens* var. *pilosum* (J. Sm) C. Chr. Ind. Fil. (1906) 301; v. A. v. R., Mal. Ferns (1908) 701; C. Chr., Ind. Fil. suppl. 1 (1913) 4. --- Type: Cuming 90, Phillipines, Luzon (holo: BM; iso: B, F, GH, K, L, NY, US, W).

Usually epiphytic, spirally or vertically climbing, sometimes terrestrial, linearly creeping.--- Rhizome 1--2 cm Ø, phyllopodia absent, fronds >20 cm apart, rhachises not persistent, 15--20 vascular bundles, dorsal ± 4 large(r) sized, arranged in 1 or 2 p.p. elliptical rows with a dorsal protrusion, bundle sheath well-developed, blue- or brown-coloured,

epidermis cells isodiametric, scale attachment more or less sunken, sclerenchyma strands absent.--- Rhizome scales adpressed, pseudo-peltate with long auricles, triangular/ovate, index 2.5--5, 3--7 by 0.8--2.5 mm, margin with elongated protuberances, protuberances uniseriate and biseriate, 1-celled, top T-shaped, apex acute (acuminate), glandular top cell absent, glandular indument present throughout, 1- or 2-celled, indument inserted marginally only, lignified cells present around the point of attachment only.--- Frons internally dimorphic, 30--105 cm long, pinnatifid, stalked, petiole 3--16(--30) by 0.4--0.6 cm, inconspicuously winged, wing sinusoid; lamina quadrangular to ovate, index 1.7--3.5, 25--75 by 8--30 cm, sterile pinnae equally wide throughout, index 3.5--6, 5--16 by 1--3.5 cm, incisions up to <0.2 cm from the costa, margin entire, apex acuminate, apical pinna present, nectaries situated in the lower angle between costa and Vp (or Vp and Vs).--- Venation of sterile pinnae: Vs running in a regular zigzagging way, Vt branching from Vtc basically recurrent, free vein endings largely running excurrent and recurrent, all terminated by a hydathode; A1c always present, regularly shaped throughout the frond(part), sometimes irregularly shaped, both branching points of the Vtc and Vs equally distant from the Vp or shortened, all containing 1, 2, or more included veins, simple, once dichotomous or more extensively branched, partly anastomosed; A1 divided into 3 or 4 Asec, areole layering comprising 4--6 A1, distinct regularly shaped throughout the frond, Asec containing simple and once dichotomous veins.--- Fertile frond parts clearly contracted, pinnae index (6.5--9--20, up to 4--14(-- ) by 0.4--1(--1.5)cm, Vs and Vt strongly reduced, diplodesmic, areole layering still (clearly) present, free ending veins shortened, Vt directed to the nearby sorus, A1c not soriferous.--- Soral patches quadrangular, 3--5 by 2--4 mm  $\emptyset$ , distinctly restricted to the apical two-third or less of the frond, in the basal fertile pinnae sometimes in the apical part only, arranged in 1 row parallel to the Vp, on branching points of more than 4 veins, pustulate.--- Anatomy: petiole rounded or invaginated, 7--10 vascular bundles, costa in middle part rounded or invaginated, 1 or 2 vascular bundles, bundle sheath blue-coloured; lamina: stomata <1500 / $\mu\text{m}^2$ , epidermis red-coloured, hypodermis present ad- and abaxially, marginal sclerenchymatous strand with >25 cells, in fertile pinnae somewhat less developed; Vp rounded, vein sheath continuous, in fertile pinnae ill-developed, interrupted, cortex blue-coloured, parenchymatous, 1 vascular bundle, bundle sheath (at least p.p.) red-coloured, open sclerenchyma cells, bundle sheath blue-coloured, xylem arrangement T-shaped, sclerenchymatous strands present, veinlet sheath extensions sclerenchymatous from epidermis to epidermis; receptacle with more or less isodiametric cell arrangement, 5 or 6 veinlets.--- Indument: laminar trichomes present, glandular and acicular, tomentose, glandular trichomes >50% branched, 2 cells long, 60--90(--105) / $\mu\text{m}$  long, type II glandular trichomes absent, acicular trichomes more or less scattered throughout, 1--4(--6) cells long, (60--80--420(--630) / $\mu\text{m}$  long; laminar scales scattered around costa only, basifix, pseudo-peltate with short auricles, triangular/ovate to linear/filiform, margin with short protuberances, protuberances uniseriate and biseriate, glandular indument present throughout, 1- or 2-celled, indument inserted marginally only, lignified cells absent, apex filiform/narrow acuminate; receptacular hairy paraphyses 25--50% branched, 1 or 2(--4) glandular cells, 2 or 3(4) cells long, 80--180(--210) / $\mu\text{m}$  long, receptacular scaly paraphyses absent; deviating sporangia absent, acicular sporangial paraphyses present, 1--6 trichomes, 1 or 2 cells long, 90--170 / $\mu\text{m}$  long, two-sided; glandular sporangial paraphyses absent.--- Sporangium 250--310 by 200--235 / $\mu\text{m}$ , annulus with 12--14(15) indurated cells, (2)3 epistomium cells, (2)3(4) hypostomium cells, in total (18--21) or 22(23) cells.--- Spores of quercifolium-type, perispore smooth sometimes folded, ultrastructure



smooth, basal layer inconspicuous, spines absent, baculae absent, globules present, exospore smooth.

Distribution: Philippines (Luzon, Negros, Mindanao).

Habitat: Almost no data available. Usually(?) growing high-epiphytic. Alt. 200--550 m.

### 30. *Aglaomorpha hieronymi* (Brause) Copel.

*Aglaomorpha hieronymi* (Brause) Copel., Philipp. J. Sci. [Bot.] 9, 1 (1914) 9; C. Chr., Ind. Fil. suppl. 2 (1917) 3; Copel., Univ. Calif. Publ. Bot. 16, 2 (1929) 417. --- *Dryostachyum hieronymi* Brause, Bot. Jb. 49, 1 (1912) 55; C. Chr., Ind. Fil. suppl. 1 (1913) 41; v. A. v. R., Mal. Ferns Suppl. (1917) 417; Copel., Univ. Calif. Publ. Bot. 18, 10 (1942) 226 (with question mark); Gen. Fil. (1947) 203 (with question mark). --- Type: Schlechter 17850, Papua New Guinea, "Kaiser Wilhelmsland", Kani Mts (holo: B).

*Merinthosorus hieronymi* Copel., Univ. Calif. Publ. Bot. 18, 10 (1942) 226; Gen. Fil. (1947) 203; C. Chr., Ind. Fil. suppl. 4 (1965) 194. --- Type: Brass 11700, New Guinea, Irian Jaya, Balim River (holo: NY; iso: GH, L, BM).

Usually epiphytic, spirally or vertically climbing, sometimes terrestrial, linearly creeping.--- Rhizome 1--2 cm  $\emptyset$ , phyllopodia absent, fronds >20 cm apart, rhachis not persistent, 10--20 vascular bundles, dorsal + 4 large(r) sized, arranged in 1 elliptical row with a dorsal protrusion, bundle sheath well-developed, brown-coloured, epidermis cells isodiametric, scale attachment more or less sunken, sclerenchyma strands absent.--- Rhizome scales adpressed, pseudo-peltate with long auricles, triangular/ovate, index 2.5--7, 2.5--7.5 by 0.8--1.6 mm, margin with elongated protuberances, protuberances uniseriate and biseriate, 1-celled, top united or rounded or T-shaped, apex short filiform/narrow acuminate to acute (acuminate), glandular top cell absent, glandular indument present near the base, 1--2-celled, indument inserted marginally only, lignified cells present around the point of attachment only.--- Fronds internally dimorphic, pinnatifid, 55--115 cm long, stalked, petiole up to 8--25(--35) by 0.4--0.6 cm, inconspicuously winged, wing sinusoid; lamina quadrangular to ovate, index 2--5, 40--95 by 12--25 cm, sterile pinnae equally wide throughout, index 4--8, up to 6--16 by 1--3 cm, incisions up to 0.0--<0.2 cm from the costa, margin entire, apex acuminate, apical pinna present, nectaries situated in the lower angle between costa and Vp (or Vp and Vs).--- Venation of sterile pinnae: Vs running in a regular zigzagging way, Vt branching from Vtc basically recurrent, free vein endings largely running excurrent and recurrent, all terminated by a hydathode; A1c always present, regularly shaped throughout sometimes irregularly shaped, both branching points of the Vtc and Vs equally distant from the Vp or sometimes bordering part of apical Vs shortened, all containing 1, 2, or more included veins, simple, once dichotomous or more extensively branched, partly anastomosed; A1 divided into 2--4 Asec, areole layering comprising 3--5 A1, distinct, regularly shaped throughout the frond, Asec containing simple and once dichotomous veins.--- Fertile frond parts clearly contracted, pinnae index >20, up to 10--27 by 0.3--1 cm, Vs and Vt strongly reduced, diplodesmic, areole layering absent, free ending veins shortened or absent, Vt directed to the nearby sorus, A1c not soriferous.--- Soral patches linear, often elliptic, 3-->4 mm long, distinctly restricted to the apical two-third or less of the frond, in the basal fertile pinnae usually in the

apical part only, often in elliptic patches, arranged in 1 row parallel to the Vp, on branching points of more than 4 veins, pustulate.--- Anatomy: petiole elliptical or invaginated, 9--10 vascular bundles, costa in middle part rounded, 1 vascular bundles, bundle sheath blue-or brown-coloured; lamina: stomata <1500 /um<sup>2</sup>, epidermis red-coloured, in fertile pinnae blue-coloured also, hypodermis present adaxially, marginal sclerenchymatous strand with 10-->25 cells, in fertile pinnae somewhat less developed; Vp rounded, vein sheath continuous, in fertile pinnae interrupted, conspicuously sclerenchymatic, cortex blue- to red-coloured, sclerenchymatous or firm parenchymatous, 1 vascular bundle, bundle sheath (at least p.p.) red-coloured, open sclerenchyma cells, otherwise blue-coloured, xylem arrangement T-shaped, sclerenchymatous strands absent, veinlet sheath extensions sclerenchymatous from epidermis to epidermis; receptacle with perpendicular cell arrangement, 3--6 veinlets.--- Indument: laminar trichomes present, glandular and acicular, tomentose, glandular trichomes >50% branched, 2 cells long, (70-->85--120 /um long, type II glandular trichomes absent, acicular trichomes more or less scattered throughout, 1--6(--9) cells long, 60--750(--900) /um long; laminar scales scattered around costa only, basifix, pseudo-peltate with short auricles, triangular/ovate to linear/filiform, teeth biseriate, glandular indument absent, indument inserted marginally only, lignified cells absent, apex long filiform; receptacular hairy paraphyses >90% unbranched, 1 or 2 glandular cells, 3 or 4 cells long, (110-->150--300(--390) /um long, receptacular scaly paraphyses absent; deviating sporangia present, acicular sporangial paraphyses present, 1--3 trichomes, 1 or 2 cells long, 30--130 /um long, one-sided; glandular sporangial paraphyses absent.--- Sporangium 255--285 by 205--230 /um, annulus with (11)12--14(15) indurated cells, 3(4) epistomium cells, 3 hypostomium cells, in total (19)20--22(23) cells.--- Spores of quercifolium-type, perispore smooth sometimes folded, ultrastructure smooth, basal layer inconspicuous, spines absent, baculae absent, globules present, exospore with globular excrescences.

Distribution: New Guinea (W. Irian, Papua).

Habitat: In primary and secondary forest, epilithic on limestone. Growing 0--15 m above the ground. Reported on Pandanus spec. Alt. 1000--1800 m.

### 31. Aglaomorpha parkinsoni (Baker) Crouxall & Roos

Aglaomorpha parkinsoni (Baker) Crouxall & Roos, Blumea (1985). --- Polypodium parkinsoni Baker, Ann. Bot. 5 (1891) 480. --- Drynaria parkinsoni (Baker) Diels in Schum. & Laut., Fl. deut. Südsee (1901) 143 [parkinsonii]; C. Chr., Ind. Fil. (1906) 248; Brause in Engl., Bot. Jb. 56 (1920) 207. --- Type: Parkinson (Herb. Von Mueller 377), New Britain (holo: K).

Polypodium ludovicianum Baker, Ann. Bot. 8 (1894) 131. --- Type: MacGregor (Herb. Mueller 100 + 104), Louisiades, South-East Island (holo: K).

Polypodium schlechteri Brause, Bot. Jb. 49, 1 (1912) 54, F. 3C; C. Chr., Ind. Fil. suppl. 1 (1913) 62. --- Aglaomorpha schlechteri (Brause) Copel., Phil. J. Sci. [Bot.] 9, 1 (1914) 9; C. Chr., Ind. Fil. suppl. 2 (1917) 3; Copel., Univ. Calif. Publ. Bot. 16, 2 (1929) 117. --- Pleopeltis schlechteri (Brause) v. A. v. R., Mal. Ferns Suppl. (1917) 395. --- Type: Schlechter 16614, Papua New Guinea, "Kaiser Wilhelmsland, Djamu Klamm" (holo: B; iso: US, K).

Dryostachyum mollepilosum Rechinger, Denkschr. Akad. Wien 89 (1913) 480. --- Type: Rechinger 4443, Ins. Bougainville, Djup (holo: W).

Aglaomorpha buchananii Copel., Phil. J. Bot. [Bot.] 9, 1 (1914) 8; C. Chr., Ind. Fil. suppl. 2 (1917) 3; Copel., Univ. Calif. Publ. Bot. 16, 2 (1929) 117. --- Pleopeltis buchananii (Copel.) v. A. v. R., Mal. Ferns Suppl. (1917) 396. --- Holostachyum buchananii (Copel.) Ching, Sunyatsenia 5 (1940) 262; Copel., Gen. Fil. (1947) 202; C. Chr., Ind. Fil. suppl. 4 (1965) 156. --- Type: King 412, Papua New Guinea, Gewagewa, Tameta Creek (holo: NY; iso: MICH, NSW).

Polypodium ledermannii Brause, Bot. Jb. 56, 1 (1920) 202, (nom. illeg.) --- Aglaomorpha ledermannii Brause ex C. Chr., Ind. Fil. suppl. 3 (1934) 20. --- Dryostachyum ledermannii (Brause ex C. Chr.) Copel., Gen. Fil. (1947) 202. --- Lectotype: Ledermann 8373, Hunsteinspitze, New Guinea (holo: B).

Drynaria amphilogos v. A. v. R., Nova Guinea 14 (1924) 16; C. Chr., Ind. Fil. suppl. 3 (1934) 79. --- Type: Lam 700, Irian Jaya, Mamberamo River near Pionier Bivak (holo: L).

Often epiphytic, spirally or vertically climbing, often terrestrial or epilithic, linearly creeping.--- Rhizome 1--2 cm  $\emptyset$ , phyllopodia absent, fronds >20 cm apart, rhachises not persistent, 10--20 vascular bundles, dorsal + 4 large(r) sized, arranged in 1 elliptical row with a dorsal protrusion, bundle sheath well-developed, brown-coloured, epidermis cells isodiametric, scale attachment more or less sunken, sclerenchyma strands absent.--- Rhizome scales adpressed, peltate, triangular/ovate, index 2.5--7, 3--7 by 0.5--2.5 mm, margin with short and elongated protuberances, protuberances uniseriate and biseriate, 1-celled, top united or rounded or T-shaped, apex acute (acuminate), glandular top cell absent, glandular indument present near the base, 1- or 2-celled, indument inserted marginally only, lignified cells present around the point of attachment only.--- Fronds dimorphic, sterile and fertile; sterile fronds pinnatifid, 30--75 cm long, stalked, petiole 3--17 by 0.3--0.6 cm, inconspicuously winged, wing sinusoid; lamina ovate, index 1.5--3, 25--65 by 12--25 cm, pinnae equally wide throughout or with a basal constriction, index 2--4, up to 7--15 by 2.5--4 cm, incisions up to 0.2--0.5 cm from the costa, margin entire, apex acute to acuminate, sometimes obtuse, apical pinna present, nectaries situated in the lower angle between costa and Vp (or Vp and Vs).--- Venation of sterile pinnae: Vs running in a regular zigzagging way, Vt branching from Vtc basically recurrent, free vein endings largely running excurrent and recurrent, all terminated by a hydathode; A1c always present, regularly shaped throughout, sometimes irregularly shaped, bordering part of basal Vs shortened, all containing 2 or more included veins, simple, once dichotomous, partly anastomosed; A1 divided into 3 or 4 Asec, areole layering comprising 5--6 A1, distinct regularly shaped throughout the frond, Asec largely containing simple, once dichotomous and twice or more dichotomous veins.--- Fertile fronds contracted, ovate to quadrangular, + similar, 35--75 cm long, petiole 13--35 by 0.4--0.5 cm, lamina index 1.5--3, 17.5--45 by 10--20(--25) cm, Vs and Vt slightly reduced and less complex, diplodesmic, free ending veins shortened, Vt directed to the nearby sorus, A1c not soriferous.--- Sori round, sometimes elliptic, 1--4 mm  $\emptyset$ , distributed all over the abaxial frond surface, in the basal pinnae often in the apical part only, arranged in 1 row parallel to the Vs, 1 per A1, near or in the centre, on branching points of more than 4 veins, pustulate.--- Anatomy: petiole rounded, 9--10 vascular bundles, costa in middle part rounded, 2 or 3 vascular bundles, bundle sheath blue- or brown-coloured; lamina: stomata 1500--2100 / $\mu\text{m}^2$ , epidermis red-coloured, in fertile pinnae blue-coloured also, hypodermis present adaxially, marginal sclerenchymatous strand with >25 cells, in fertile pinnae somewhat less developed to (nearly) lacking; Vp rounded, vein sheath interrupted, in fertile pinnae ill-developed, cortex blue-coloured,

parenchymatous, 1 vascular bundle, bundle sheath (at least p.p.) red-coloured, open sclerenchyma cells, brown-coloured, xylem arrangement T-shaped, sclerenchymatous strands present, veinlet sheath extensions sclerenchymatous from epidermis to epidermis with some irregularities; receptacle with more or less isodiametric cell arrangement, 3--6 veinlets.--- Indument: laminar trichomes present, glandular and acicular, tomentose, glandular trichomes >50% branched, 2 cells long, (75--85--110(--120) /um long, type II glandular trichomes present, acicular trichomes more or less scattered throughout, 1 or 2 cells long, 95--450 /um long; laminar scales scattered around costa only, basifix, pseudo-peltate with long auricles, triangular/ovate to linear/filiform, margin with short protuberances, protuberances uniseriate and biseriate, glandular indument present throughout, 1- or 2-celled, indument inserted marginally only, lignified cells present around the point of attachment, apex filiform/narrow acuminate to acute (acuminate); receptacular hairy paraphyses >50% branched, 1 or 2 glandular cells, (2)3 cells long, 100--150(--180) /um long, receptacular scaly paraphyses absent; deviating sporangia absent, acicular sporangial paraphyses present, 1--3 trichomes, 1 or 2 cells long, 110--240 /um long, one-sided; glandular sporangial paraphyses absent.--- Sporangium 250--285 by 200--240 /um wide, annulus with (10)11--13(14) indurated cells, (2)3(4) epistomium cells, (2)3 hypostomium cells, in total (18)19--21(22) cells.--- Spores of quercifolium-type, perispore smooth sometimes folded, ultrastructure smooth, basal layer inconspicuous, spines absent, baculae absent, globules present, exospore with globular excrescences.

Distribution: Moluccas, New Guinea (W. Irian, Papua), Manus Isl., New Britain, New Ireland, Solomon Isl., Louisiades.

Habitat: Primary and secondary forest (o.a. Araucaria), epilithic on limestone or granite. Growing 0--30 m above the ground. Reported on Cocos nucifera, Pandanus spec., Parartocarpus spec., Calophyllum spec. Alt. 0--1600 m.

Notes. 1. Vern. name: Kage (Hagen, Togoba, Eastern Highlands, Papua New Guinea)

2. Nectaries are conspicuously present in sinuses of wing.

### 32. Aglaomorpha nectarifera (Baker in Becc.) Roos

Aglaomorpha nectarifera (Baker in Becc.) Roos, Blumea (1985). --- Polypodium nectariferum Baker in Becc., Malesia 2 (1886) 247, T. 65; Christ, Farnkr. (1897) 118. --- Drynaria nectarifera (Baker in Becc.) Diels in E&P, Nat. Pfl. Fam. 1, 4 (1902) 330; C. Chr., Ind. Fil. (1906) 248; v. A. v. R., Mal. Ferns (1908) 700; C. Chr., Ind. Fil. suppl. 1 (1913) 104; Brause in Engl., Bot. Jb. 56 (1920) 207. --- Thayeria nectarifera (Baker in Becc.) Copel., Philipp. J. Sci. 1, suppl. 2 (1906) 165; Phil. J. Sci. [Bot.] 6, 3 (1911) 140; 7, 1 (1912) 41; v. A. v. R., Mal. Ferns Suppl. (1917) 416; Copel., Univ. Calif. Pubs Bot. 16, 2 (1929) 121; Gen. Fil. (1947) 202. --- Type: Beccari S.N., 1875, New Guinea, Vogelkop Peninsula, Mt. Arfak (a Putat) (holo: FI; iso: K).

Rhizome with conspicuous phyllopodia.--- Rhizome scales adpresses, peltate, rounded, margin toothed, teeth uni- and biseriate, 1-celled, top united, apex round, glandular top cell present, glandular indument present

throughout, 1- or 2-celled, indument inserted marginally only, lignified cells present around the point of attachment only.--- Fronds dimorphic with sterile and fertile fronds.--- Sterile frond sessile, lobate, base dilated, lobe apex round.--- Fertile frond internally dimorphic, stalked, pinnatifid, sterile pinnae with basal constriction, index + 6, margin entire, apex acute, apical pinna present; fertile frond parts clearly contracted, pinnae "string of beads"-like shaped, index >15.--- Soral patches round, distinctly restricted to the apical two-third or less of the frond, arranged in 1 row parallel to the Vp.

Distribution: W. Irian (Arfak Mts).

Habitat: no dat available.

Note. This species is collected only once, by Beccari.



## 16. DRYNARIA

### *Drynaria* (Bory) J. Smith

*Drynaria* (Bory) J. Smith, Hook. J. Bot. 3 (1841) 397 [nom. cons.: Pichi Sermolli, Taxon 21 (1972) 707]; [Gaud., Bot. Voy. Uranie & Physic. (1826) 354 (invalid.)]; 4 (1842) 60; Fée, Mém. Foug. 5, Gen. Fil. (1850-'52) 269; Brackenridge, U. S. Expl. Exp. 16 (1854) 42; J. Smith, Cult. Ferns cat. (1857) 13; Bedd., Ferns S. Ind. (1863) 63; J. Smith, Ferns Br. & For. (1866) 102; Hist. Fil. (1875) 107; Bedd., Handb. Ferns Br. Ind. (1883) 338; Diels Bot. Jb. 29, 1 (1900) 207; in E&P, Nat. Pfl. Fam. 1, 4 (1902) 328; Copel., Dep. int. Bur. Govern. 28 (1905) 135; C. Chr., Ind. Fil. (1906) 247; v. A. v. R., Mal. Ferns (1908) 696; Engl., [Veg. Erde 9] Pfl. Welt Afr. 2 (1908) 55; Copel., Phil. J. Sci. [Bot.] 6, 3 (1911) 140; C. Chr., Ind. Fil. suppl. 1 (1913) 29; v. A. v. R., Mal. Ferns Suppl. (1917) 415; C. Chr., Ind. Fil. suppl. 2 (1917) 13; Blatter & d'Almeida, Ferns Bomb. (1922) 167; Copel., Univ. Calif. Publs Bot. 16, 2 (1929) 117; C. Chr., Ind. Fil. suppl. 3 (1934) 79; Backer & Posthumus, Varenfl. Java (1939) 232; Ching, Sunyatsenia 5, 4 (1940) 261; Tardieu & C. Chr. in Lecomte, Fl. Gén. Indo-Chine 7, 2 (1941) 516; Copel., Gen. Fil. (1947) 203; Holttum, Fl. Mal. 2, Ferns (1954) 182; Alston, Ferns W. Trop. Afr. [suppl.] (1959) 48; Copel., Fern Fl. Philipp. 3 (1960) 496; B. K. Nayar, Bull. natn. bot. Gdns Lucknow (1961) 2; Tind., Contr. NSW natn. Herb., Flora ser. 208-211 (1961) 29; C. Chr., Ind. Fil. suppl. 4 (1965) 106; Brownlie in Aubrév., Fl. N. Caled. 3 (1969) 278; Morton, Taxon 19, 4 (1970) 647; Schelpe, Pterid. in Exell & Laundert, Fl. Zamb. (1970) 149; Pichi Sermolli, Webbia 31, 2 (1977) 379; Schelpe & Diniz in Mendes, Fl. Moç amb., Pterid. (1979) 152; Ching & S. K. Wu in C. Y. Wu, Fl. Xizang. (1983) 342. --- *Polypodium* subgen. *Drynaria* Bory, Anns Sci. nat. 5 (1825) 464; Mett., Farngatt. 1, Polyp. (1857) 114; Hook., Gard. Ferns (1862) Pl. 1; Spec. Fil. 5 (1864) 93; Mett., Filices 2 (1866) 21, 230; Baker in Hook. & Baker, Syn. Fil. (1868) 366; C. B. Clarke, Trans. Linn. Soc. Lond. ser. 2, 1 (1880) 555; Christ, Farnkr. (1897) 116; Bull. Herb. Boissier 6, 3 (1898) 202. --- *Phymatodes* # *Drynaria* (Bory) C. Presl, Tent. Pterid. (1836) 197; Hook. & Bauer, Gen. Fil. (1842) T. 21. --- *Drynaria* \*\*\* *Drynaria* (Bory) J. Smith, Hook. J. Bot. 4 (1842) 61. --- *Drynaria* sect. *Eudrynaria* Fée, Mém. Foug. 5, Gen. Fil. (1850--'52) 170 (nom. inval.); 11 (1866) 72; Diels in E&P, Nat. Pfl. Fam. 1, 4 (1902) 329; v. A. v. R., Mal. Ferns (1908) 697; Suppl. (1917) 415. --- Type: *D. quercifolium* (L.) J. Smith. *Drynaria* # *Poronema* J. Smith, Hist. Fil. (1875) 108; Diels in E&P, Nat. Pfl. Fam. 1, 4 (1902) 330; v. A. v. R., Mal. Ferns (1908) 679; Suppl. (1917) 415; Copel., Gen. Fil. (1947) 204. Type: *D. diversifolium* (R. Brown) J. Smith.

Usually epiphytic, spirally climbing or encircling the bole many times, often epilithic, occasionally terrestrial, linearly creeping or forming crust.--- Rhizome 1<-->3 cm Ø, phyllopodia absent, fronds usually <10 cm, sometimes 10--18 cm apart, rachises often persistent, occasionally not so, 15-->40 vascular bundles, arranged in 1 or 2 (p.p.) elliptical row(s) with a dorsal protrusion, scale attachment usually more or less sunken, occasionally protruding, sclerenchyma strands usually absent, sometimes present.--- Rhizome scales perpendicularly or obliquely spreading, or adpressed, usually monomorph, occasionally of two types, peltate or basifix, margin toothed and/or with protuberances, apex with distinct glandular top cell, midrib present or absent.--- Frondes usually dimorphic with base and foliage fronds, sometimes monomorph. --- Base fronds sessile, rounded,

ovate, elongated/lanceolate, or elliptical, entire to lobate, lobes up to 2/3 or more of the width, apex usually rounded to acute, sometimes acuminate; A1c along costa absent or present, either inconspicuous, irregular, or conspicuous, large-sized, regular.--- Foliage fronds usually internally monomorphic, sometimes slightly internally dimorphic, usually pinnatifid, sometimes pinnate, stalked, petiole often winged, occasionally unwinged; pinnae equally wide throughout or with a basal constriction, all + equally-sized or decreasing in size towards the apex, margin entire or serrate, apex acute, acuminate, or obtuse, apical pinna usually aborted, sometimes present, nectaries situated in the upper angle between costa and Vp (and Vp and Vs).--- Venation of foliage fronds: Vs usually running irregular or more or less straight, sometimes zigzagging, hydathodes usually absent, occasionally present, A1c irregular or regular, Asec usually empty or containing simple included veins, often containing once dichotomous, and sometimes more dichotomous veins, rarely forming loops, free vein endings usually running diffuse, occasionally excurrent, sometimes recurrent, venation fertile frond parts similar to sterile frond parts. --- Sori round, distributed all over the abaxial frond surface, arranged in 1 row parallel to Vp, or in 1 or 2 rows parallel to the Vs. --- Anatomy: epidermis red- or blue-coloured, hypodermis usually absent, sometimes present adaxially, xylem usually without, sometimes with sclerenchymatous strands. --- Indument: laminar trichomes present, glandular, occasionally acicular also, not densely set, laminar scales scattered throughout on lamina, scattered around rhachis/costa, or especially against rhachis; receptacular hairy paraphyses present, usually with 1 or 2, sometimes also 3 or 4 glandular cells, receptacular scaly paraphyses absent or present; deviating sporangia absent, sporangial paraphyses usually absent, sometimes present, glandular.--- Spores usually of quercifolium-type, sometimes of pleuridioides-type.

### 1. *Drynaria sparsisora* (Desv.) T. Moore

*Drynaria sparsisora* (Desv.) T. Moore, Ind. Fil. (1862) 348; C. Chr., Ind. Fil. (1906) 249; v. A. v. R., Mal. Ferns (1908) 699; Copel., Phil. J. Sci. [Bot.] 6, 2 (1911) 91; C. Chr., Bull. Geogr. bot. 23 (1913) 140; Brause in Engl., Bot. Jb. 56 (1920) 208; v. A. v. R., Nova Guinea 14 (1924) 15; Copel., Univ. Calif. Publ. Bot. 16, 2 (1929) 119; Bull. Bernice P. Bishop Mus. 59 (1929) 96; C. Chr., & Holttum, Gdns' Bull. Straits Settl. 7, 3 (1934) 315; Copel., Gen. Fil. (1947) 204; Holttum, Fl. Mal. 2, Ferns (1954) 183; Copel., Fern Fl. Philipp. 3 (1961) 497; B. K. Nayar, Bull. natn. bot. Gdns Lucknow (1961) 13; Tind., Contr. NSW natn. Herb., Flora Ser. 208--211 (1961) 29; Holttum, [Fl. Thail. 33] Dansk Bot. Ark. 23, 1 (1965) 231; Jones & Clemesha, Austr. ferns (1976) 182, Fig. 145. --- Polypodium sparsisorum Desv., [Ges. Naturf. Fr.] Berl. Mag. 5 (1811) 315; Mem. Soc. Linn. Paris 6 [Prodr. Foug.] (1827) 235. --- Type: not traced (S?).

Polypodium linnei Bory, Annl. Sci. nat. 5 (1825) 464 p.p., T. 12; Mett., Farngatt. 1, Polyp. (1857) 122; Filices 2 (1866) 231; Baker in Hook. & Baker, Syn. Fil. (1868) 368; C. B. Clarke, Trans. Linn. Soc. Lond. ser. 2, 1 (1880) 556; Christ, Farnkr. (1897) 118; Racib., Pterid. Fl. Buitenz. (1898) 118. --- Drynaria linnei (Bory) Bedd., Ferns br. Ind. (1869) Pl. 315; Handb. Ferns Br. Ind. (1883) 343; Diels in E&P, Nat. Pfl. Fam. 1, 4 (1902) 329; Copel., Dep. int. Bur. Govern. 28 (1905) 135. --- Type: Gaudichaud s.n., s.d., Rawak near Java (P, n.v.).



Usually epiphytic, spirally climbing, occasionally epilithic or terrestrial, linearly creeping.--- Rhizome 1-->3 cm  $\emptyset$ , phyllopodia absent, fronds <10 cm apart, rachises not or rarely persistent, base fronds contiguous, mainly imbricate; 20-->40 vascular bundles, all  $\pm$  equally-sized, arranged in 1 or 2 (p.p.) elliptical row(s) with a dorsal protrusion, bundle sheath absent, epidermis cells flattened or isodiametric, scale attachment more or less sunken, sclerenchyma strands absent.--- Rhizome scales perpendicularly spreading, of two types, peltate, rounded, triangular/ovate, spatulate, index 1--8.5, 1.5--11 by 1--2.5 mm, margin toothed; teeth biseriate, 1-celled, top united or rounded; apex acute (acuminate) to rounded, distinct glandular top cell present, glandular indument present throughout, 1- or 2-celled; indument inserted marginally and abaxially; midrib present.--- Fronks dimorphic with base and foliage fronds.--- Base fronds rounded to ovate, index 1--1.5, (10-->)15--35 by (10-->)15--25 cm, (clearly) sinusoid to lobate, lobes up to 1/3 of the width, margin entire, apex rounded.--- Venation of base fronds: Vs running more or less straight or irregularly, Vt branching from Vtc basically excurrent and recurrent, free vein endings running excurrent and recurrent or diffuse; A1c generally present, rarely absent, irregularly shaped, both branching points of the Vtc and Vs equally distant from Vp or shortened, all containing 1 or 2 (or more) veins, simple, once dichotomous, or more extensively branched, partly anastomosed; A1c along costa present, inconspicuous, irregularly shaped, or nearly absent; A1 divided into 2--4 Asec, areole layering comprising 1--4 A1, distinct, irregularly shaped, Asec largely empty, containing simple veins.--- Foliage fronds 35--100 cm long, pinnatifid, stalked, petiole (5-->)10--18 by 0.4--0.6 cm, conspicuously winged; lamina quadrangular to ovate, index 2--4, 30--80 by 15--30 cm, pinnae usually equally wide throughout, sometimes with a clear basal constriction, all equally-sized, index 3.5--6(--8), up to 10--20 by 1.5--3.5 (--4.5)cm, incisions up to 0.2--0.5 cm from the costa, margin entire, apex acute, acuminate to obtuse, apical pinna aborted, nectaries situated in the upper angle between costa and Vp (and Vp and Vs).--- Venation of foliage fronds: Vs running more or less straight, Vt branching from Vtc basically recurrent, free vein endings running diffuse, hydathodes absent; A1c always present, irregularly shaped, both branching points of the Vtc and Vs equally distant from the Vp, or shortened, all or largely containing 2 or more included veins, simple or once dichotomous, partly anastomosed; A1 divided into 3 or 4, or more Asec, areole layering comprising 4--6 A1, distinct, regularly shaped throughout the frond, Asec irregularly shaped, largely empty or largely containing simple veins; venation of fertile frond parts  $\pm$  similar to sterile foliage frond parts, Vt directed to the nearby sorus, A1c sometimes soriferous.--- Sori round, 1<--2 mm  $\emptyset$ , distributed all over the abaxial frond surface, in the basal pinnae usually in the apical part only or medially or indifferent, arranged in  $\pm$  2 irregular rows parallel to the Vs, near the Vs margins, 2--7 per A1, midway on anastomosed veins, on branching points of 2--4 or more veins, slightly pustulate.--- Anatomy: petiole elliptical, or invaginated, 3--8 vascular bundles; costa rounded, 1--3 vascular bundles, bundle sheath blue- or brown-coloured; sterile lamina: stomata 1500--2100 / $\mu$ m<sup>2</sup>, epidermis red-coloured, hypodermis present adaxially, marginal sclerenchymatous strand with >25 cells; Vp rounded, vein sheath interrupted, cortex blue-coloured, parenchymatous, 1 vascular bundle, bundle sheath blue-, red-, or brown-coloured, xylem arrangement T- or V-shaped, sclerenchymatous strands absent, veinlet sheath extensions sclerenchymatous from epidermis to epidermis; receptacle with more or less isodiametric cells, 1 or 2 veinlets.--- Indument: laminar trichomes present, glandular, not densely set, >90% unbranched, 2 cells long, 75--80 / $\mu$ m long, laminar scales scattered throughout, pseudo-peltate to peltate, triangular/ovate, teeth biseriate, glandular indument absent,

indument inserted marginally only, lignified cells present forming a midrib, apex filiform/narrow acuminate to acute; receptacular hairy paraphyses >90% unbranched, 1 or 2 glandular cells, 2 cells long, 70--110 /um long, receptacular scaly paraphyses absent; deviating sporangia absent, sporangial paraphyses absent.--- Sporangium 245--345 by 220--300 /um, annulus with (12--14(--17) indurated cells, 3(4) epistomium cells, 3(4) hypostomium cells, in total (20--22(--24) cells.--- Spores of quercifolium-type, perispore verrucate, ultrastructure smooth, basal layer thin, spines present, with apical constriction, baculae absent, exospore smooth.

Distribution: [Ceylon?], Bangla-Desh, [India: Assam?], China (Yunnan), Birma, Thailand, Cambodja, Vietnam, Enggano, Sumatra, Penang, Malay Peninsula, Singapore, Riau Arch., Bangka, Java, Borneo (Kalimantan, Sarawak, Sabah), Philippines, (Luzon, Palawan, Negros, Leyte, Samar, Basilan, Mindanao), Celebes, Moluccas, New Guinea (W. Irian, Papua), New Britain, New Ireland, Louisiades, Solomon Isl., Queensland.

Habitat: Several kinds of primary and secondary forest (a.o. swamp-, Eucalyptus-, heath-, Melaleuca-, dipterocarp-, evergreen-), savannah, shrub- (Dendrobium-), beach-, and Kerangas vegetation. Growing 0--35 m above the ground. Reported on Artocarpus heterophyllum, Gonystylus bancanus, Cassia siamea, Calophyllum inophyllum, Intsia bijuga, Elaeis guineensis, Cocos nucifera, Parashorea spec., Pumeria spec., Quercus spec., Aromadendron spec. Alt. 0--1400(--1700) m.

Notes. 1. Vern. names: Kangkoms (Biak. dial., W. Irian)

Kojang (Bangka)

Talinalina (Kulumo lang., W. New Britain)

Talwala (Orne lang., Walwali, Sepik, Papua New Guinea)

Kobkab (Tanbatto dial., Palawan, Philippines)

Paku kadaka langlajangan (Sundanese, Java)

Simban kural, simban baneng (Palembang, Sumatra)

Apatpat di batu (Ifugao, Mt. Province, Luzon, Philippines)

Kakayan (Serakau, Sematan, Sarawak, Borneo)

Glemu (Zomboanga, Mindanao, Philippines)

Kusi kusi (Ternata lang., Halmahera, Moluccas)

2. Juvenile foliage fronds often have a (somewhat) dilated frond base.
3. Smith 9846 (L, BRI): 'oak-leaf fronds developed only where the rhizome emerges from the ground to climb on the base of tall trunks.'
4. Chromosomes:  $2n = 74$  (Löve, Löve, & Pichi Sermolli, 1977).
5. Brass 19243 (L, BRI): 'usually without sterile shield leaves.'
6. Mamit S34593: 'The Salakans bring this plant whenever they intend to walk past Ficus or insert the plant near the base of the stem on the ground if they want to fell the Ficus. They believe that if they have the plant with them the evil spirits cannot see them.'
7. PNH 37993 (A, L, PNH): 'medicine for eyes; roots applied to snake-bite'
8. PNH 78646 (A, L, PNH, US): 'used for rat scare-crow.'

## 2. *Drynaria quercifolia* (L.) J. Smith

*Drynaria quercifolia* (L.) J. Smith, Hook. J. Bot. 3 (1841) 398; 4 (1842) 61; Fée, Mém. Foug. 5, Gen. Fil. (1950-'1852) 271; Brackenridge, US Expl. Exp. 16 (1854) 55; Hook., Hook. J. Bot. 9 (1857) 357; J. Smith, Cult. Ferns cat. (1857) 14; in Seemann, bot. Voy. Herald [Fl. Hongkong] (1857) 426; T. Moore, Ind. Fil. (1862) 347; Bedd., Ferns S. Ind. (1863) 63, Pl. 187; Mett.,

Filices 2 (1866) 230 (21); J. Smith, Ferns Br. & For. (1866) 103; Hist. Fil. (1875) 108; Bedd., Suppl. Ferns S. Ind. & Br. Ind. (1876) 24; Handb. Ferns Br. Ind. (1883) 343, Fig. 191; Diels in E&P, Nat. Pfl. Fam. 1, 4 (1902) 329; Copel., Dep. int. Bur. Govern. 28 (1905) 135; C. Chr., Ind. Fil. (1906) 249; Christ, J. Bot. Paris, ser. 2, 1 (1908) 238; v. A. v. R., Mal. Ferns (1908) 698; Copel., Phil. J. Sci. [Bot.] 6, 2 (1911) 91; v. A. v. R., Mal. Ferns Suppl. (1917) 415; Brause in Engl., Bot. Jb. 56 (1920) 208; Blatter & d'Almeida, Ferns Bomb. (1922) 167; Copel., Univ. Cal. Publs Bot. 16, 2 (1929) 119; C. Chr. & Tardieu, Phanérogamie 8, 4 (1939) 208; Tardieu & C. Chr. in Lecomte, Fl. gén. Indo-Chine 7, 2 (1941) 518; Copel., Gen. Fil. (1947) 204; B. K. Nayar & Kachroo, Phytomorph. 3 (1953) 411; Holttum, Fl. Mal. 2, Ferns (1954) 182; Copel., Fern Fl. Philipp. 3 (1960) 496; Tind., Contr. NSW natn. Herb., Flora ser. 208-211 (1961) 29; B. K. Nayar, Bull. natn. bot. Gdns Lucknow (1961) 9, Fig. 2; Holttum, [Fl. Thail. 33] Dansk. Bot. Ark. 23, 2 (1965) 231; Tag. in H. Hara, Fl. E. Himal. (1966) 493; Jones & Clemesha, Austr. Ferns (1976) 180, Fig. 143, Pl. 10. --- Polypodium quercifolium L., Spec. Pl. (1753) 1087; Poir. in Lam., Encycl. Meth., Bot. 5 (1804) 517; Sw., Syn. Fil. (1806) 32; R. Brown, Prod. Fl. N. Holl. (1810) 147; Willd., Spec. Pl. 5 (1810) 170; Kaulf., Enum. Fil. (1824) 97; Bory, Anns Sci. nat. 5 (1825) 465; Gaud., Bot. Voy. Uranie & Physic. (1826) 353; Desv., Mem. Soc. Linn. Paris 6 [Prodr. Foug.] (1827) 235; Blume, Enum. Pl. Javae, Fil. (1828) 135; Fl. Javae, Fil. (1829) 153 (58); Mett., Fil. HB Lips (1856) 38; Farngatt. 1, Polyp. (1857) 122; Hook., Spec. Fil. 5 (1864) 96; Ettingh., Farnkr. Jetztw. (1865) 51, T. 29:Fig. 4, T. 37:Fig. 11; F. Muell., Fragm. phytogr. Austr. 5 (1865-'66) 129; Mett., Filices 2 (1866) 230 (21); Baker in Hook. & Baker, Syn. Fil. (1868) 367; Cesati, Atti R. Accad. Sci. F&M Napoli 7 (1876) 28; Benth., Fl. Austral. 7 (1878) 772; C. B. Clarke, Trans. Linn. Soc. Lond., ser. 2, 1 (1880) 555; F. M. Bailey, Syn. Qnsld Fl. (1883) 718; Becc., Malesia 2 (1884) 246; 3 (1886) 25; Christ, Farnkr. (1897) 118, Fig. 337; Bull. Herb. Boissier 6, 3 (1898) 202; Racib., Pterid. Fl. Buitenz. (1898) 118; F. M. Bailey, Queensl. Fl. 4 (1902) 1987. --- Phymatodes quercifolia (L.) C. Presl, Tent. Pterid. (1836) 198; Hook. & Bauer, Gen. Fil. (1842) T. 21. --- Type: Herb. Linné (Microfiche no. 1251.12).

Polypodium sylvaticum Schkuhr, Kr. Gew. 1 (1809) 22, T. 8b. --- Phymatodes sylvatica (Schkuhr) C. Presl, Tent. Pterid. (1836) 198. --- Type: Schkuhr, Kr. Gew. (Fil.) 1 (1809) Pl. 8b.

Polypodium schkuhrii Bory, Anns Sci. nat. 5 (1825) 467. --- Type: Schkuhr, Kr. Gew. (Fil.) 1 (1809) Pl. 13.

Polypodium morbillosum C. Presl, Reliq. Haenk. 1 (1825) 22, T. 3, F. 3; Mett., Fil. HB Lips. (1856) 37, T. 20:9; Farngatt. 1, Polyp. (1857) 117. ---

Phymatodes morbillosa (C. Presl) C. Presl, Tent. Pterid. (1836) 198. --- Drynaria morbillosa (C. Presl) J. Smith, J. Bot. 3 (1841) 398 p.p.; Cat. Cult. Ferns (1857) 14 p.p.; T. Moore, Ind. Fil. (1862) 347. --- Type: not traced (PRC?).

Polypodium brancaefolium C. Presl, Rel. Haenk. 1 (1825) 22. --- Phymatodes brancaefolia (C. Presl) C. Presl, Tent. Pterid. (1836) 198. --- Type: not traced (PRC?).

Usually epiphytic, spirally climbing, occasionally epilithic or terrestrial, linearly creeping.--- Rhizome 2-->3 cm Ø, phyllopodia absent, fronds < 10 cm apart, (many) persistent naked rhachises present, base fronds contiguous to spreading, mainly imbricate; 20-->40 vascular bundles, + equally-sized, arranged in 1 or 2 (p.p.) elliptical row(s) with a dorsal protrusion, bundle sheath absent, epidermis cells isodiametric, scale attachment more or less sunken, sclerenchyma strands absent.--- Rhizome scales obliquely spreading, basifix, pseudo-peltate or peltate, triangular/ovate to

linear/filiform, index 10--25, 6--20 by 0.5--1 mm, margin toothed; teeth biseriate, 1-celled, top united or rounded, apex acute (acuminate), distinct glandular top cell present, glandular indument present near the base, 1- or 2-celled, indument inserted marginally only, lignified cells present around the point of attachment only.--- Fronds dimorphic with base and foliage fronds.--- Base fronds rounded to ovate, index 1--1.4, (10--15--40 by 10--30 cm, (clearly) sinusoid, margin entire.--- Venation of base fronds: Vs running more or less straight, or irregular zigzagging, Vt branching from Vtc basically excurrent and recurrent, free vein endings running excurrent and recurrent or diffuse; A1c always present, irregularly shaped, both branching points of the Vtc and Vs equally distant from Vp, shortened, all containing 2 or more included veins, simple, once dichotomous or more extensively branched, partly anastomosed; A1c along costa present, inconspicuous, irregularly shaped, or nearly absent; A1 divided into (3--4) or more Asec, areole layering comprising 3--4(--6) A1, distinct, irregularly shaped, Asec empty or containing simple veins.--- Foliage fronds 55--130(--180) cm long, pinnatifid, stalked, petiole up to 15--30(--35) by 0.4--0.8 cm, inconspicuously or not winged; lamina quadrangular to ovate, index 2.5--4, 40--100(--150) by 15--50 cm, pinnae equally wide throughout, all equally-sized, index 4--6, up to 10--25(--30) by 2--4.5 cm, incisions up to 0.2--0.5 cm from the costa, margin entire, apex acute, apical pinna aborted, nectaries situated in the upper angle between costa and Vp (and Vp and Vs).--- Venation of foliage fronds: Vs running more or less straight, Vt branching from Vtc basically recurrent, free vein endings running diffuse, hydathodes absent; A1c sometimes absent, usually present, irregularly shaped, both branching points of the Vtc and Vs equally distant from the Vp or shortened, all or largely containing 2 or more included veins, simple or once dichotomous, partly anastomosed; A1 divided into to 3 to more than 4 Asec, areole layering comprising 5--8 A1, distinct, regularly shaped throughout the frond, Asec empty or containing simple veins; venation of fertile frond parts  $\pm$  similar to sterile foliage frond parts, Vt directed to the nearby sorus, A1c not soriferous.--- Sori round, 1--2 mm  $\emptyset$  distributed all over the abaxial frond surface, in the basal pinnae usually in the apical part only or medially or indifferent, arranged in two regular rows parallel to the Vs, near the Vs margins, two per A1, on branching points of 2--4 or more veins, slightly pustulate.--- Anatomy: petiole rounded, or invaginated, >11 vascular bundles, costa rounded, or invaginated, 5--6 vascular bundles, bundle sheath blue- or brown-coloured; sterile lamina: stomata 1500--2700 / $\mu\text{m}^2$ , epidermis red-coloured, hypodermis present adaxially, marginal sclerenchymatous strand with >25 cells, Vp rounded, vein sheath interrupted or continuous, cortex blue-coloured, parenchymatous, 1 vascular bundle, bundle sheath blue- or brown-coloured, xylem arrangement T-shaped, sclerenchymatous strands absent, veinlet sheath extensions sclerenchymatous from epidermis to epidermis; receptacle with more or less isodiametric cell arrangement, 1 or 2 veinlets.--- Indument: laminar trichomes present, glandular, not densely set, >90% unbranched, 2(3) cells long, 90--120(--135) / $\mu\text{m}$  long, type II glandular trichomes absent, laminar scales scattered throughout, peltate, triangular/ovate, teeth biseriate, inserted marginally only, glandular indument absent, lignified cells cells absent, apex filiform/narrow acuminate to acute; receptacular hairy paraphyses >90% unbranched, 1 or 2 glandular cells, 2(3) cells long, 90--120 / $\mu\text{m}$  long, receptacular scaly paraphyses absent, deviating sporangia absent, sporangial paraphyses absent.--- Sporangium 260--330 by 225--270 / $\mu\text{m}$ , annulus with (12)13--15(--18) indurated cells, 3(4) epistomium cells, (2)3 hypostomium cells, in total 21--23(--26) cells.--- Spores of quercifolium-type, perispore verrucate, ultrastructure smooth, basal layer thin, spines present, with

apical constriction, baculae absent, exospore smooth.

Distribution: Ceylon, India (W. Ghats, Madras, W. Bengal, Sikkim, Assam), Nepal, Bhutan, Bangla-Desh, Birma, Thailand, Laos?, Cambodja, Vietnam, Andaman Isl., Nicobar Isl., Simuelue, Sumatra, Penang, Malay Peninsula, Singapore, Anambas Isl., Riau Arch., Bangka, Java, Boerneo (Kalimantan, Sarawak, Sabah), Sulu Isl., Philippines (Luzon, Mindoro, Palawan, Panay, Negros, Cebu, Leyte, Samar, Basilan, Mindanao, Sarangani), Celebes, Siau Isl., Butung, Lesser Sunda Isl. (Lombok, Sumba, Sumbawa, Flores, Timor), Moluccas, Tanimbar Isl. Papua New Guinea, Northern Territory, Queensland.

Habitat: Several kinds of primary and secondary forest (a.o. tidal-, mangrove-, swamp-, gallery-, open-, evergreen-, deciduous dipterocarp-, dry-, Melaleuca-, Tectona-), plantation (rubber-, coconut-), and savannah. Growing 1-10 m (or more) above the ground, in shade or exposed. Reported on Artocarpus heterophyllum, Acacia leucophylla, Borassus flabellifera, Cocos nucifera, Shorea robusta, Cycas media, Elaeis guineensis, Lagerbostomia spec., Vatica spec., Hevea spec., Ficus spec., Litsaea spec., Samanea spec. Alt. 0--1200(-1900) m.

- Notes. 1. Vern. names: Kabkab (Bic., Albay, Luzon, Philippines)  
Pak pak lawin tag (Mt. Maquiling & Batangas, Luzon, Phillipines)  
Palaypay buladlad (Mang., Hanunuo, Mansalay, Mindoro, Philippines)  
Yupal manteg (Sam., Zambales, Luzon, Philippines)  
Araucan (Todaya, Davao, Mindanao, Philippines)  
Banog banog (Cebuano, Davao, Mindanao, Philippines)  
Paipai-amo (Butuan, San Mateo, Tungao, Agusan, Philippines)  
Kaleo-keo (= kite; Tonsea, Minahassa, Celebes)  
Halu kut (lang. Wanokaka, Sumba)  
Topèh (Timor)  
Pek baang (Loi, Hainan, China)  
Hujue (China)  
Thil-ka-sen (Wakema, Birma)  
Kyaukpyu (Ramree Isl., Birma)  
Kra-plog (Chantaburi, Thailand)
2. Chromosomes:  $2n = 74$  (Lbve, Lbve, & Pichi Sermolli, 1977)
3. Bolster 117 (MO): 'Often kept as house plant.'
4. PNH 12588 (MICH): 'Medicine for stomach ache. Reduce stem into five pieces, soak in water. The liquid is then taken.'

### 3. *Drynaria bonii* Christ

*Drynaria bonii* Christ, *Phanerogamie* 1 (1909) 186; C. Chr., *Ind. Fil. suppl.* 1 (1913) 29; C. Chr. & Tardieu, *Phanerogamie* 8, 4 (1939) 207; Tardieu & C. Chr. in Lecomte, *Fl. gèn. Indo-Chine* 7, 2 (1941) 517; Holttum, [*Fl. Thail.* 1] *Dansk Bot. Ark.* 20, 1 (1961) 20; [33] 23, 1 (1965) 231; *Iconogr. Cormop. Sinic.* 1 (1972) 272. --- Lectotype: Bon 3204, Bau Phêk Tonkin, Vietnam (P).

*Drynaria meeboldii* Rosenstock in Fedde, *Repert.* (1913). --- Type: Meebold 7058, Manipur, Phaleng, Nagaberge (M, n.v.)

Usually epilithic (or terrestrial), linearly creeping, often epiphytic, spirally climbing.--- Rhizome 1--3 cm Ø, phyllopodia absent, fronds < 10 cm apart, rachises not or rarely persistent, base fronds contiguous, mainly imbricate; 15--30 vascular bundles, all ± equally-sized, arranged in 1

elliptical row with a dorsal protrusion, bundle sheath absent, epidermis cells flattened, scale attachment more or less sunken, sclerenchyma strands absent.--- Rhizome scales perpendicularly spreading, of two types, peltate, rounded, triangular/ovate or spatulate, index 1.5--6, 2--12 by 1.5--3 mm, margin toothed, teeth biseriate, 1-celled, top united, apex acute (acuminate), distinct glandular top cell present, glandular indument present throughout, 2-celled; indument inserted marginally only, lignified cells present around the point of attachment only.--- Fronds dimorphic with base and foliage fronds.--- Base fronds rounded, index 1--1.3, 5--12 by 5--10 cm, (nearly) entire.--- Venation of base fronds: Vs running more or less straight or irregularly, Vt branching from Vtc basically excurrent and recurrent, free vein endings running excurrent and recurrent or diffuse; A1c sometimes absent, usually present, irregularly shaped, both branching points of the Vtc and Vs equally distant from Vp, largely empty, rarely containing 1 recurrent included vein, simple, free; A1c along costa present, large sized, conspicuous, somewhat irregularly shaped, with included free veins; A1 undivided or divided into 2 more or less equal Asec, areole layering comprising 1 or 2 A1, distinct, irregularly shaped, Asec always empty.--- Foliage fronds 30--65 cm long, pinnatifid, stalked, petiole up to 15(--20) by 0.3--0.5 cm, conspicuously winged; lamina quadrangular to ovate, index 2--3, 25--50 by 15--25 cm, pinnae with a clear basal constriction, all equally-sized, index 3--4, up to 7--15 by 2.5--4.5 cm, incisions up to 0.2--0.5 cm from the costa margin entire, apex acute, acuminate, or obtuse, apical pinna aborted, nectaries situated in the upper angle between costa and Vp (and Vp and Vs).--- Venation of foliage fronds: Vs running more or less straight or irregularly, Vt branching from Vtc basically recurrent, free vein endings running diffuse, hydathodes absent; A1c always present, irregularly shaped, both branching points of the Vtc and Vs equally distant from the Vp or shortened, largely containing 1--2 or more recurrent included veins, simple or once dichotomous, partly anastomosed; A1 divided into 3 or 4 Asec, areole layering comprising 4--7 A1, distinct, regularly shaped throughout the frond, Asec largely empty or containing simple veins; venation of fertile frond parts + similar to sterile foliage frond parts, Vt directed to the nearby sorus, A1c sometimes soriferous.--- Sori round, 1--2 mm  $\emptyset$ , distributed all over the abaxial frond surface, in the basal pinnae medially or indifferent, arranged in 2 irregular rows parallel to the Vs, 2--4 per A1, near the Vs margins, subterminal on free veins, midway on anastomosed veins, on branching points of 2--4 veins, slightly pustulate.--- Anatomy: petiole rounded or invaginated, 3--6 vascular bundles, costa rounded, 1 or 2 vascular bundles, bundle sheath blue- or brown-coloured; sterile lamina: stomata 2700-->3300 / $\mu\text{m}^2$ , epidermis red-coloured, hypodermis absent, marginal sclerenchymatous strand with >25 cells; Vp rounded, vein sheath interrupted, cortex blue- to red-coloured, sclerenchymatous or firm parenchymatous, 1 vascular bundle, bundle sheath blue- or brown-coloured, xylem arrangement T- to V-shaped, sclerenchymatous strands absent, veinlet sheath extensions sclerenchymatous from epidermis to epidermis with some irregularities; receptacle with more or less isodiametric cell arrangement, 1 or 2 veinlets.--- Indument: laminar trichomes present, glandular, not densely set, >90% unbranched, 2 cells long, 90--120 / $\mu\text{m}$  long, type II glandular trichomes absent, acicular trichomes absent, laminar scales scattered throughout, basifix, pseudo-peltate with short auricles to peltate, triangular/ovate, teeth biseriate, glandular indument present throughout, 1- or 2(3)-celled, indument inserted marginally and abaxially, lignified cells absent or midrib present, apex filiform/narrow acuminate to acute (acuminate); receptacular hairy paraphyses >90% unbranched, 1 or 2 glandular cells, 2 or 3 cells long, 80--130 / $\mu\text{m}$  long, receptacular scaly paraphyses absent; deviating sporangia absent, sporangial paraphyses

absent.--- Sporangium 260--300 by 215--260  $\mu$ m, annulus with (12--14 or 15(16) indurated cells, 2 or 3(4) epistomium cells, 3(4) hypostomium cells, in total (20)21--23(24) cells.--- Spores of quercifolium-type, perispore verrucate, ultrastructure smooth, basal layer thin, spines present, sharp and smooth, baculae absent, globules absent, exospore smooth.

Distribution: India (Assam), China (Yunnan, Guansi, Guangdong, Hainan), Thailand, Cambodja, Vietnam, Penang.

Habitat: Several kinds of forest (a.o. open-, gallery-, evergreen-, deciduous, dipterocarp-). Often growing on lime rocks, 0--10 m above the ground. Reported on Lithocarpus spec. Alt. 100--1300(---1700) m.

Notes. 1. Vern. name: Jan hue (Hainan, China)

Tuanye hujue (China)

2. Ching 6751 (PE): 'fleshy rhizomes for medical use.'

3. Incisions in between the pinnae are usually very broad, + quadrangular in outline.

#### 4. *Drynaria involuta* v. *A. v. R.*

*Drynaria involuta* v. *A. v. R.*, Bull. Dépt. agric. Ind. néerl. 21 (1908) 8, T. 4; Mal. Ferns (1908) 700; C. Chr., Ind. Fil. suppl. 1 (1913) 29; v. *A. v. R.*, Mal. Ferns Suppl. (1917) 415. --- *Drynaria convoluta* v. *A. v. R.*, Bull. Jard. bot. Buitenz., ser. 2, 1 (1911) 6 (nomen illeg.). --- Lectotype: Teysmann 8577, Borneo, Sintang (holo: L).

Epiphytic, spirally climbing.--- Rhizome <1 cm  $\emptyset$ , phyllopodia absent, fronds < 10 cm apart, rhachises not or rarely persistent, base fronds contiguous, mainly imbricate; 15--20 vascular bundles, dorsal + 4 larger sized, arranged in 1 elliptical row with a dorsal protrusion, bundle sheath sometimes absent, sometimes well-developed, blue- or brown-coloured, epidermis cells isodiametric, scale attachment more or less sunken, sclerenchyma strands absent.--- Rhizome scales perpendicularly spreading, of two types, peltate, rounded, triangular/ovate or spatulate, index 1--4, 1--8 by 0.5--2 mm, margin toothed, teeth biseriate, 1-celled, top united, apex acute (acuminate) to rounded, distinct glandular top cell present, glandular indument present throughout, 1- or 2-celled, indument inserted marginally only, midrib present.--- Fronde dimorphic with base and foliage fronds.--- Base fronds rounded to ovate, index 1--1.4, 5--10 by 4--8 cm, (nearly) entire to sinusoid.--- Venation of base fronds: Vs running more or less straight or irregularly, Vt branching from Vtc basically excurrent and recurrent, free vein endings running excurrent and recurrent or diffuse; A1c sometimes absent, usually present, irregularly shaped, both branching points of the Vtc and Vs equally distant from Vp or bordering part of basal Vs shortened, largely containing containing 1 or 2, or more included veins, simple, once dichotomous, or more extensively branched, partly anastomosed; A1c along costa present, inconspicuous, irregularly shaped, or nearly absent; A1 undivided or A1 divided into 2--4 Asec, areole layering comprising 1--4 A1, distinct, irregularly shaped, Asec largely empty.--- Foliage fronds 25--55 cm long, pinnatifid, stalked, petiole up to 12 by 0.3--0.5 cm, inconspicuously winged, lamina quadrangular, index 2--3, 20--45 by 12--25 cm, pinnae with a clear basal constriction, all equally-sized, index 3--4, 7--15 by 2.5--4.5 cm, incisions

up to 0.0--<0.2 cm from the costa, margin entire, apex acute to acuminate, apical pinna aborted, nectaries situated in the upper angle between costa and Vp (and Vp and Vs).--- Venation of foliage fronds: Vs running more or less straight, Vt branching from Vtc basically recurrent, free vein endings running diffuse, hydathodes absent; A1c always present, somewhat irregularly shaped, both branching points of the Vtc and Vs equally distant from the Vp or shortened, largely containing 1 or 2, or more included veins, simple, partly anastomosed; A1 divided into 3 or 4, or more Asec, areole layering comprising 5--7 A1, distinct, regularly shaped throughout the frond, Asec containing simple, or once dichotomous veins; venation of fertile frond parts + similar to sterile foliage frond parts, Vt directed to the nearby sorus, A1c not soriferous.--- Sori round, 1--2 mm  $\emptyset$ , distributed all over the abaxial frond surface, in the basal pinnae usually in the apical part only, or medially or indifferent, arranged in 2 irregular rows parallel to the Vs, 2 or 3 per A1, near the Vs margins, subterminal on free veins, midway on anastomosed veins, or on branching points of 2--4 veins, slightly pustulate.--- Anatomy: petiole rounded, 5--6 vascular bundles, costa angular, 2 vascular bundles, bundle sheath present, brown-coloured; sterile lamina: stomata 1500--2700 / $\mu\text{m}^2$ , epidermis red-coloured, hypodermis present adaxially, marginal sclerenchymous strand with >25 cells; Vp rounded, vein sheath interrupted, cortex blue-coloured, parenchymatous, 1 vascular bundle, bundle sheath brown-coloured, xylem arrangement T-shaped, sclerenchymatous strands absent, veinlet sheath extensions sclerenchymatous from epidermis to epidermis; receptacle with more or less isodiametric cell arrangement, 1 or 2 veinlets.--- Indument: laminar trichomes present, glandular, not densely set, >90% unbranched, 2 cells long, 80--95 / $\mu\text{m}$  long, type II glandular trichomes absent, acicular trichomes absent, laminar scales scattered throughout, basifix, triangular/ovate, teeth/protuberances uniseriate and biseriate, glandular indument absent, indument inserted marginally only, lignified cells absent, apex acute (acuminate); receptacular hairy paraphyses >90% unbranched, 1-2 glandular cells, 2 cells long, 60--75 / $\mu\text{m}$  long, receptacular scaly paraphyses absent; deviating sporangia absent, sporangial indument absent.--- Sporangium 235--270 by 190--220 / $\mu\text{m}$ , annulus with (12)13 or 14(--16) indurated cells, 3(--5) epistomium cells, (2)3(4) hypostomium cells, in total (20)21 or 22(--24) cells.--- Spores of quercifolium-type, perispore verrucate, ultrastructure smooth, basal layer thin, spines present, sharp and smooth or with apical constriction, baculae absent, globules absent, exospore smooth or with globular excrescences.

Distribution: Borneo (Kalimantan, Sarawak).

Habitat: Peat swamp forest. Growing 1--5 m above the ground. Reported on Dyospyros spec. Alt. sealevel.

##### 5. Drynaria descensa Copel.

Drynaria descensa Copel., Philipp. J. Sci. (Bot.) 3, 1 (1908) 36; v. A. v. R., Mal. Ferns (1908) 698; C. Chr., Ind. Fil. suppl. 1 (1913) 29; Copel., Univ. Calif. Publ. Bot. 16, 2 (1929) 119; Fern Fl. Philipp. 3 (1960) 497. --- Lectotype: Copeland 2061 [P. P. E. 42], Philippines, Luzon, prov. Nueva Ecija, Munos (B, BM, G, K, L, NY, S, NSW).



Usually epiphytic, spirally climbing, often terrestrial or epilithic, linearly creeping.--- Rhizome 1--3 cm  $\emptyset$ , phyllopodia absent, fronds < 10 cm apart, rachises not or rarely persistent, base fronds contiguous, mainly imbricate; 20--30 vascular bundles, all equally-sized, arranged in 1 elliptical row with a dorsal protrusion, bundle sheath absent, epidermis cells flattened, scale attachment more or less sunken, sclerenchyma strands absent.--- Rhizome scales perpendicularly spreading, of two types, peltate, rounded, triangular/ovate, or spatulate, index 1--5, 1--6 by 1--2 mm long, margin toothed, teeth uniseriate or biseriata, 1-celled, top united, rounded or T-shaped, apex acute (acuminate) to rounded, distinct glandular top cell present, glandular indument present throughout, 1- or 2-celled, indument inserted marginally only, midrib present.--- Fronds dimorphic with base and foliage fronds.--- Base fronds rounded to ovate, index 1--1.4, 5--10 by 4--9 cm, (nearly) entire to sinusoid, margin irregularly denticulate.--- Venation of base fronds: Vs running more or less straight or irregularly, Vt branching from Vtc basically excurrent and recurrent, free vein endings running excurrent and recurrent or diffuse; A1c sometimes absent, usually present, irregularly shaped, both branching points of the Vtc and Vs equally distant from Vp or shortened, largely containing 1 recurrent included vein, simple or once dichotomous, free; A1c along costa present, inconspicuous, irregularly shaped, or nearly absent; A1 undivided or divided into 2 more or less equal Asec, areole layering comprising 1--4 A1, distinct, irregularly shaped, Asec largely empty.--- Foliage fronds 35--85 cm long, pinnatifid, stalked, petiole up to 5--15 by 0.3--0.5 cm, conspicuously winged; lamina quadrangular to ovate, index 2--3.5, 30--70 by 12--25(--30) cm, pinnae with a + clear basal constriction, all equally-sized, index 5--8, up to 8--18 by 1--2.5 cm, incisions up to 0.2--0.5 cm from the costa margin entire, apex obtuse, apical pinna aborted, nectaries situated in the upper angle between costa and Vp (and Vp and Vs).--- Venation of foliage fronds: Vs running more or less straight or irregularly, Vt branching from Vtc basically recurrent, free vein endings running diffuse, hydathodes absent; A1c always present, irregularly shaped, both branching points of the Vtc and Vs equally distant from the Vp or bordering part of apical Vs shortened, largely containing 1 or 2, or more included veins, simple or once dichotomous, partly anastomosed; A1 divided into 3 or 4 Asec, areole layering comprising 4 A1, distinct, sometimes indistinct, (ir)regularly shaped throughout the frond, Asec largely empty or containing simple and once dichotomous veins; venation of fertile frond parts + similar to sterile foliage frond parts, Vt directed to the nearby sorus, A1c sometimes soriferous.--- Sori round, 1--2 mm  $\emptyset$ , distributed all over the abaxial frond surface, in the basal pinnae usually in the apical part only or medially or indifferent, arranged in 2 irregular rows parallel to the Vs, 2 or 3 per A1, near the Vs margins, subterminal on free veins, midway on anastomosed veins, or on branching points of 2--4 veins, slightly pustulate.--- Anatomy: petiole rounded, 3--6 vascular bundles, costa angular, 1 or 2 vascular bundles, bundle sheath blue-coloured; sterile lamina: stomata 2100--2700 / $\mu\text{m}^2$ , epidermis red-coloured, hypodermis absent, marginal sclerenchymous strand with 10--20 cells; Vp rounded, vein sheath continuous, cortex red-coloured, sclerenchymatous or firm parenchymatous, 1 vascular bundle, bundle sheath blue- or brown-coloured, xylem arrangement T-shaped, sclerenchymatous strands absent, veinlet sheath extensions sclerenchymatous from epidermis to epidermis; receptacle with more or less isodiametric cell arrangement, 1 or 2 veinlets.--- Indument: laminar trichomes present, glandular, not densely set, >90% unbranched, 2(3) cells long, 85--110 / $\mu\text{m}$  long, type II glandular trichomes absent, acicular trichomes absent, laminar scales scattered throughout, basifix to peltate, triangular/ovate, teeth/protuberances uniseriate or biseriata, glandular indument present near the base only,

1--2-celled, indument inserted marginally only, lignified cells absent, apex acute (acuminate); receptacular hairy paraphyses >90% unbranched, >5% branched, 1 or 2 glandular cells, 2(3) cells long, 70--100 /um long, receptacular scaly paraphyses absent; deviating sporangia absent, sporangial paraphyses absent.--- Sporangium 295--330 by 255--285 /um, annulus with (11)12--14(15) indurated cells, (2)3 epistomium cells, (2)3 hypostomium cells, in total (19)20--22(23) cells.--- Spores of quercifolium-type, perispore verrucate, ultrastructure smooth, basal layer thin, spines present, sharp and smooth, baculae absent, globules absent, exospore smooth.

Distribution: Philippines (Luzon).

Habitat: Open forest. Reported on Elaeis guineensis. Alt. + 1600 m.

#### 6. Drynaria Laurentii (Christ ex De Wild. & Durand) Hieron.

Drynaria Laurentii (Christ ex De Wild. & Durand) Hieron. in Engl., [Veg. Erde 9] Pfl. Welt Afr. 2 (1908) 57, Fig. 54; C. Chr., Ind. Fil. suppl. 1 (1913) 29; Dansk Bot. Ark. 7 (1932) 162; Exell, Cat. Vasc. Pl. S. Tomé (1944) 90; Tardieu, Mém. Inst. fr. Afr. noire 28 (1953) 216, Pl. XLIII: Fig. 2, 3; Alston, Ferns W. Trop. Afr. [suppl.] (1959) 48, Fig. 11; Tardieu, in Aubrév., Fl. Cameroun 3 (1964) 337, Pl. LIV: Fig. 2, 3; Fl. Gabon 8 (1964) 199, Pl. XXXII: Fig. 2, 3; Schelpe, Contr. Bolus Herb. 1 (1969) 93; Consp. Fl. Angol. (1977) 115; Pichi Sermolli, Webbia 32, 1 (1977) 70; Benl, Acta bot. Barcin. 33 (1982) 10. --- Polypodium propinquum Wallich ex Mett. var. Laurentii Christ ex De Wild. & Durand, Anns Mus. Congo [Bot.], ser. 2, 1 (1899) 70; 5, 1 (1903) 6, T. 2. --- Lectotype: Laurent s.n., s.d., Zaire, Bas Congo, Inkisi (BR).

Drynaria viridis Barter, Journ. Proc. Linn. Soc., Bot. IV (1860) 22 (nomen nudum).

Polypodium propinquum Wallich ex Mett. var. intermedium De Wild., Anns Mus. Congo [Bot.], ser. 5, 1 (1903) 6, T. 3. --- Lectotype: Gillet 1864, Zaire, Bas-Congo, Kisantu (BR).

Polypodium willdenowii auct. non Bory p.p.; Baker in Henriq., Bol. Soc. Brot. 4 (1887) 155.

Polypodium astrosorum Christ, Journ. Bot. 22 (1909) 22. --- Type: not traced.

Generally epiphytic, spirally climbing, rarely epilithic, linearly creeping.--- Rhizome 1--3 cm Ø, phyllopodia absent, fronds < 10 cm apart, many persistent naked rachises present, base fronds spreading, mainly imbricate; 30--40 vascular bundles, all + equally-sized, arranged in 1 elliptical row with a dorsal protrusion, bundle sheath absent, epidermis cells erect, scale attachment more or less sunken, sclerenchyma strands absent.--- Rhizome scales obliquely spreading, peltate, triangular/ovate to linear/filiform, index 6--15, 6--20 by 0.8--1.7 mm, margin with elongated protuberances, protuberances uniseriate, 1 to more-celled, top rounded, apex long filiform, distinct glandular top cell present, glandular indument present throughout, 1- or 2-celled, indument inserted marginally only, lignified cells present around the point of attachment only.--- Fronds dimorphic with base and foliage fronds.--- Base fronds ovate to elongated/lanceolate, index 1.8--2.5, 15--30(--40) by 6--15(--20) cm, lobate, lobes up to 1/3--1/2 of the width, margin entire or irregularly denticulate, apex acute. --- Venation of base fronds: Vs

running more or less straight or regular zigzagging, Vt branching from Vtc basically excurrent and recurrent, free vein endings running excurrent and recurrent or diffuse; A1c sometimes absent, usually present, irregularly shaped, both branching points of the Vtc and Vs equally distant from Vp or shortened, all containing 2 or more included veins, simple, once dichotomous or more extensively branched, partly anastomosed; A1c along costa + absent; A1 divided into 3 or 4 Asec, areole layering comprising 3 or 4 A $\bar{1}$ , distinct, irregularly shaped, Asec empty or containing simple veins.--- Foliage fronds 45--90(--125) cm long, pinnatifid, stalked, petiole up to 15(--25) by 0.5--0.6 cm, not winged; lamina quadrangular to ovate, (30--40--70(--100) by 20--30(--50) cm, index 2--3, pinnae equally wide throughout,  $\pm$  equally-sized or decreasing in size towards the apex, index 4.5--6(--7), up to 12--20(--28) by 2--4 cm, incisions up to 0.2--0.5 cm from the costa, margin serrate, incisions in between the subsequent Vs, apex acute to obtuse, apical pinna aborted, nectaries situated in the upper and lower angle between costa and Vp (and Vp and Vs).--- Venation of foliage fronds: Vs running more or less straight, Vt branching from Vtc basically recurrent, free vein endings running diffuse, hydathodes absent; A1c always present, irregularly shaped, both branching points of the Vtc and Vs equally distant from the Vp, bordering part of basal Vs shortened, all containing 1 or 2, or more included veins, simple or once dichotomous, partly anastomosed; A1 divided into 3 or 4, or more Asec, areole layering comprising 4--5 A1, distinct, regularly shaped throughout the frond, Asec empty or containing simple veins; venation of fertile frond parts  $\pm$  similar to sterile foliage frond parts, Vt directed to the nearby sorus, A1c not soriferous.--- Sori round, 1--3 mm  $\emptyset$ , distributed all over the abaxial frond surface, in the basal pinnae medially or indifferent, arranged in 1 row parallel to the Vp, 1 per A1, near or in the centre, on branching points of more than 4 veins, pustulate.--- Anatomy: petiole rounded, >11 vascular bundles, costa rounded, 4 vascular bundles, bundle sheath blue- or brown-coloured; sterile lamina: stomata 2100--2700 / $\mu\text{m}^2$ , epidermis blue-coloured, hypodermis often present adaxially, marginal sclerenchymous strand with 10--20 cells; Vp rounded, vein sheath interrupted or continuous, cortex red-coloured, sclerenchymatous or firm parenchymatous, 1 vascular bundle, bundle sheath blue- or brown-coloured, xylem arrangement T-shaped, sclerenchymatous strands absent, veinlet sheath extensions sclerenchymatous from epidermis to epidermis with some irregularities; receptacle with more or less isodiametric cell arrangement, 3 or 4 veinlets.--- Indument: laminar trichomes present, glandular, not densely set, >90% unbranched, 2 cells long, (80--90--120(--135) / $\mu\text{m}$  long, type II glandular trichomes present, acicular trichomes absent, laminar scales scattered throughout, basifix to peltate, round, triangular/ovate, or linear/filiform, margin with short and long protuberances, protuberances uniseriate, glandular indument absent, indument inserted marginally only, lignified cells absent, apex filiform/narrow acuminate; receptacular hairy paraphyses 25--50% branched, 1 or 2 glandular cells, 2--4 cells long, 85--180 / $\mu\text{m}$  long, receptacular scaly paraphyses present, complex; deviating sporangia absent, sporangial paraphyses absent.--- Sporangium 300--335 by 210--250 / $\mu\text{m}$ , annulus with 13--16(--18) indurated cells, 3 or 4(5) epistomium cells, 3--6 hypostomium cells, in total (21)22--25(--27) cells.--- Spores of quercifolium-type, perispore verrucate, ultrastructure smooth, basal layer thin, spines absent, baculae present, globules absent, exospore with globular excrescences.

Distribution: Guinea, Sierra Leone, Liberia, Ivory Coast, Ghana, Togo, Nigeria, Sao Tomé, Principe, Cameroun, Gabon, Zaire, Angola, Uganda, Burundi, Kenya, Tanzania.

Habitat: Primary rain forest (a.o. gallery-), tree savannah, and bush vegetation (a.o. Brachystegia microphylla-), sometimes in (coffee) plantation. Usually growing high epiphytically, 0--40 m above the ground. Reported on Parinari calaense, Brachystegia microphylla, Ceiba pentrandra, Mangifera indica, Dichristachys nutans, Elaeis guineensis, Entandrophragma utile, Marquesia acuminata, Scoratophoeus zencheri, Jacaranda mimosifolia, Ficus spec., Albizzia spec., Baphia spec., Panisetum spec., Cassipourea spec., Bridelia spec., Upace spec., Pycnanthus spec., Oxystigma spec. Alt. 0--1450(--1800) m.

Notes. 1. Vern. names: Ngagalala (Usambara, Tanzania)

Pombe (Mobwase, Zaire)

Bonkenkele (dial. Lokundu, Zaire)

Liombombo, Lilele (dial. Turumbu, Zaire)

Kinkunda-nkunda (Popokabaka, Zaire)

Dilde-lele (Kizulu, Zaire)

Moukir (Vaku, Zaire)

2. Most obvious differences with species no.7 concern the rhizome scales (which are dull and brown in the present species) and the spores.

3. Chromosomes:  $2n = 74$  (Löve, Löve, & Pichi Sermolli, 1977)

4. Bos 2029 (Z): 'Plants dropped on the forest floor continue to grow.'

5. Dawkins D864 (K): 'Growing in large masses, like Hedera helix in all directions irrespective gravity, ...fertile, horizontal or pendulous leaves, Holst 8734 (B) & Volkens 62 (B): 'covers often the boles and trunks completely.'

Newbould 811 (K): 'Rhizomes run longitudinally up and down trunk.'

6. Faden et al. 70/683 (K): 'Often with Asplenium megalura.'

## 7. Drynaria volkensis Hieron. in Engl.

Drynaria volkensis Hieron. in Engl., [Veg. Erde 9] Pfl. Welt Afr. 2 (1908) 57; Hieron., Bot. Jb. 46, 3 (1911) 393; C. Chr., Ind. Fil. suppl. 1 (1913) 29; Dansk Bot. Ark. 7 (1932) 162; Tardieu, Mém. Inst. fr. Afr. noire 28 (1953) 214; Alston, Ferns W. Tr. Afr. [suppl.] (1959) 48; Tardieu in Aubrev., Fl. Cameroun 3 (1964) 336, Pl. LIII, Fig. 4-6; Cuf., Senckenbergiana biol. 50, 3--4 (1969) 257; Schelpe, Contr. Bolus Herb. 1 (1969) 93; Pterid. in Exell & Raunert, Fl. Zamb. (1970) 149, T. 46:f. 1-4; Kornaš, Pterid. Zamb. (1979) 75; Schelpe & Diniz in Mendes, Fl. Moç amb., Pterid. (1979) 152; Benl, Acta bot. Barcin. 33 (1982) 11. --- Type: Volkens 735, Tanzania, Kilimanjaro (holo:B; iso: K).

Drynaria volkensis var. macrospora Hieron., Bot. Jb. 46, 3 (1911) 394. --- Lectotype: Mildbread 1288, Tanzania, "Deutsch Ostafrika", Ninagongo, Kissenge (B).

Drynaria volkensis Hieron. in Engl. var. uondensis Fiori, Nuovo Gior. bot. ital. 47 (1940) 25. --- Type: Saccardo s.n., 1937, between Uondo and Agheresalam, Ethiopia (FI, n.v.).

Drynaria saccardi Cuf., Senckenbergiana Biol. 50, 3--4 (1969) 256, Fig. 12. -Type: Kuls 215, Bera, Ethiopia (holo: FR).

Generally epiphytic, spirally climbing, rarely epilithic, linearly creeping.--- Rhizome 1--3 cm Ø, phyllopodia absent, fronds < 10 cm apart, many persistent naked rachises present, base fronds spreading, mainly imbricate; 20--30 vascular bundles, all + equally-sized, arranged in 1 elliptical row with a dorsal protrusion, bundle sheath absent, epidermis cells erect, scale attachment more or less sunken, sclerenchyma strands

absent.--- Rhizome scales obliquely spreading, basifix, triangular/ovate to spatulate, index 2--8, 2--10 by 1--2 mm, margin toothed, teeth uniseriate, 1-celled, top rounded, apex long filiform, distinct glandular top cell present, glandular indument present throughout, 2-celled, indument inserted marginally only, midrib present.--- Fronds dimorphic with base and foliage fronds.--- Base fronds elongated/lanceolate, index 1.5--2, (10--15--35(--40) by (5--10--18(--23) cm, lobate, lobes up to 1/3 or more of the width, margin irregularly denticulate, apex blunt.--- Venation of base fronds: Vs running more or less straight or Vs regular zigzagging way, Vt branching from Vtc basically excurrent and recurrent, free vein endings running excurrent and recurrent or diffuse; A1c always present, regularly shaped throughout the frond(part), bordering part of basal Vs shortened, all containing one recurrent included vein; included vein(s) once dichotomous or more extensively branched, partly anastomosed; A1c along costa + absent; A1 divided into 2 more or less equal Asec, areole layering comprising 3 or 4 A1, distinct, regularly shaped throughout the frond, Asec largely containing simple or once dichotomous veins.--- Foliage fronds 40--100 cm long, pinnatifid, stalked, petiole up to 15(--20) by 0.5--0.6 cm, inconspicuously winged; lamina quadrangular to ovate, index 2--3, 35--80 by 15--35 cm, pinnae equally wide throughout, all equally-sized, index 4--7, 8--25 by 2--4 cm, incisions up to 0.2<--0.5 cm from the costa throughout, margin serrate, incisions in between the subsequent Vs, apex acute to obtuse, apical pinna aborted, nectaries situated in the lower angle between costa and Vp (and Vp and Vs).--- Venation of foliage fronds: Vs running more or less straight, or irregularly, Vt branching from Vtc basically recurrent, free vein endings running diffuse, partly terminated by a hydathode; A1c always present, irregularly shaped, bordering part of basal Vs shortened, all containing two or more included veins, simple, once dichotomous, or more extensively branched, partly anastomosed; A1 divided into 3 or 4, or more Asec, areole layering comprising 3 or 4 A1, distinct, regularly shaped throughout the frond, Asec empty or containing simple veins; venation of fertile frond parts + similar to sterile foliage frond parts, Vt directed to the nearby sorus, A1c not soriferous.--- Sori round, 1--3 mm  $\emptyset$ , distributed all over the abaxial frond surface, in the basal pinnae usually in the basal part only, or medially or indifferent, arranged in one row parallel to the Vp, 1 per A1, near or in the centre, on branching points of more than four veins, pustulate.--- Anatomy: petiole elliptical, or invaginated, 7--8 vascular bundles; costa rounded or invaginated, 4 vascular bundles, bundle sheath blue-or brown-coloured; sterile lamina: stomata >3300 / $\mu\text{m}^2$ , epidermis blue-coloured, hypodermis absent, marginal sclerenchymous strand with 10--20 cells, Vp rounded, vein sheath continuous, cortex blue-coloured, parenchymatous, 1 vascular bundle, bundle sheath brown-coloured, xylem arrangement T-shaped, sclerenchymatous strands absent, veinlet sheath extensions sclerenchymatous from epidermis to epidermis; receptacle with more or less isodiametric cell arrangement, 3 or 4 veinlets.--- Indument: laminar trichomes present, glandular not densely set, >90% unbranched, 2 or 3 cells long, 100--150(--180) / $\mu\text{m}$  long, type II glandular trichomes absent, acicular trichomes absent, laminar scales scattered throughout, basifix, pseudo-peltate, or peltate, triangular/ovate, linear/filiform, teeth uniseriate or biseriate, glandular indument absent, indument inserted marginally only, lignified cells often present forming a midrib, apex filiform/narrow acuminate to acute (acuminate); receptacular hairy paraphyses >90% unbranched, >5% branched, 1 or 2 glandular cells, 2--4 cells long, (120--145--180) / $\mu\text{m}$  long, receptacular scaly paraphyses present, simple and complex, deviating sporangia absent, sporangial paraphyses absent.--- Sporangium 285--315 by 220--265 / $\mu\text{m}$ , annulus with 13 or 14 indurated cells, (2)3--5 epistomium cells, 3--5(6) hypostomium cells, in

total (22)23 or 24(25) cells.--- Spores of quercifolium-type, perispore smooth sometimes folded, ultrastructure smooth, basal layer inconspicuous, spines absent, baculae absent, globules present, exospore with globular excrescences.

Distribution: Fernando Poo, Cameroun, Zaire, Sudan, Ethiopia, Uganda, Rwanda, Burundi, Kenya.

Habitat: Several types of (sub)montane primary and secondary forest (a.o. galery-, evergreen cloud-, cola-, open-, dry evergreen-, Podocarpus-), sometimes in savannah or (coffee)plantation. Growing 2--10 m above the ground. Reported on Cussonia spicata, Teclea simplicifolia, T. nobilis, Ceasaeria engleri, Dombeye leucoderma, Olinia macrantha, Peddeia volkensii, Juniperus procera, Erythrina abyssinica, Ocatea usambarensis, Bersema abyssinica, Olea africana, Acacia spec., Musa spec., Albizia spec., Ficus spec., Cassipourea spec., Podocarpus spec., Syzygium spec., Mitrangina spec. Alt. (450--1150--2750 m.

Notes. 1. Vern. names: Mikossa (Uhehe, Zaire)

Tsherera tshiragaga (Bashi, Zaire)

Mbalalizi (Mashi, Zaire)

Likang amnur, Mgaretue (Iringa, Tanzania)

Lukeke leva nginda (Nuassa, Tanzania)

2. Rhizome scales characteristically glossy and dark red-brown to blackish (cf. species no. 6).

3. Migeod 72 (BM, K): 'Dries up in dry season.'

Rankin 75 (MICH, K): 'Foliage fronds dry up and are lost during the dry season.'

4. Tweedie 2799 (K): 'Growing spirally on tree trunk.'

5. Zogg et al. 275/1 (Z): 'Rhizome green in section.'

6. Strange 115 (U, K): 'Heavily infested with spiders.'

7. Troll 5469 (B): 'Growing adjacent to Platyterium spec.'

## 8. Drynaria willdenowii (Bory) T. Moore

Drynaria willdenowii (Bory) T. Moore, Synops. (1857) LXXIX; Ind. Fil. (1862) 348; J. Smith, Hist. Fil. (1875) 108; Diels in E&P, Nat. Pfl. Fam. 1, 4 (1902) 330; C. Chr., Ind. Fil. (1906) 250; Engl., [Veg. Erde 9] Pfl. Welt Afr. 2 (1908) 57; Anonymous, Bolm. Soc. broteriana 27 (1917) 179; C. Chr., Dansk Bot. Ark. 7 (1932) 162; Tardieu, Polyp. 2 in Humbert, Fl. Madag. (1960) 100, Fig. 23:3-5. --- Polypodium willdenowii Bory, Anns Sci. nat. 5 (1825) 468, t. 13; Desv., Mem. Soc. Linn. Paris 6 [Prodr. Foug.] (1827) 235; Blume, Fl. Jav., Fil. (1829) 156 p.p.; Mett., Farngatt. 1, Polyp. (1857) 120, T. 3:48, 49; Hook., Gard. Ferns (1862) Pl. 35 p.p.; Spec. Fil. 5 (1864) 97; Kuhn, Filic. Afric. (1868) 154; Baker in Hook. & Baker, Syn. Fil. (1868) 367; Fl. Maur. & Seych. (1877) 508; Jacob Cord., Fl. Réunion (1895) 90. --- Type: Bory?, Mt. Pouce, Ile de France (holo: P, n.v.).

Phymatodes thouarsii Willd. ex C. Presl, Tent. Pterid. (1836) 198 (nomen nudum). --- Polypodium thouarsii Willd. ex Mett., Farngatt. 1, Polyp. (1857) 120. --- Type: specim. Thouarsianum, Willdenow herb. 19643, Madagascar (B).

Drynaria propinqua var. comorensis Hieron. ex Engl., [Veg. Erde 9] Pfl. Welt Afr. 2 (1908) 56 (nomen nudum).

Epiphytic, encircling the bole many times.--- Rhizome 1--3 cm Ø, phyllopodia absent, fronds < 10 cm apart, many persistent naked rhachises present,

base fronds spreading, mainly imbricate; 20--30 vascular bundles, dorsal + 4 large(r) sized arranged in 1 elliptical row with a dorsal protrusion, sheath ill-developed, blue-coloured, epidermis cells isodiametric to erect, scale attachment more or less sunken, sclerenchyma strands in roots.--- Rhizome scales obliquely spreading, peltate, triangular/ovate to linear/filiform, index 3--6, 4--8 by 1--1.5 mm, (Madagascar), index 7.5--25, 7--22 by 0.7--1.2 mm, (Mascarenes), margin toothed, teeth biseriate, 1-celled, top united apex long filiform to short filiform/narrow acuminate, distinct glandular top cell present, glandular indument present near the base or throughout, 2 or 3 (or more) celled, indument inserted marginally only, lignified cells present around the point of attachment only.--- Fronde dimorphic with base and foliage fronds.--- Base fronds ovate to elongated/lanceolate, index 1.7--2.2, 15--25 by 8--15 cm, lobate, lobes up to 1/3 of the width, margin irregularly denticulate, apex rounded.--- Venation of base fronds: Vs running more or less straight, or irregularly, Vt branching from Vtc basically excurrent, free vein endings running excurrent and recurrent; or diffuse; A1c sometimes absent, usually present, irregularly shaped, both branching points of the Vtc and Vs equally distant from Vp or shortened, empty, containing one recurrent included vein, once dichotomous, free; A1c along costa + absent; A1 divided into 2 more or less equal Asec, areole layering comprising 1 or 2 A1, distinct, irregularly shaped, Asec empty or containing simple veins.--- Foliage fronds 40--100 cm long, pinnatifid, stalked, petiole 7--15 by 0.6 cm, inconspicuously winged; lamina ovate, index 2--4, 35--85 by 15--30 cm, pinnae equally wide throughout, clearly decreasing in size towards the apex, index (5--6)--8, up to 8--18 by 1--3 cm, incisions up to <0.2 cm from the costa margin serrate, incisions in between the subsequent Vs, apex obtuse, apical pinna aborted, nectaries situated in the lower angle between costa and Vp (and Vp and Vs).--- Venation of foliage fronds: Vs running more or less straight, or irregularly, Vt branching from Vtc basically recurrent, free vein endings running diffuse, hydathodes absent; A1c always present, irregularly shaped, both branching points of the Vtc and Vs equally distant from the Vp, or shortened, all containing 1 or 2, or more included veins, simple, once dichotomous, partly anastomosed; A1 divided into 3 or 4, or more Asec, areole layering comprising 3 or 4 A1, distinct, sometimes indistinct, irregularly shaped, Asec empty or containing simple veins; venation of fertile frond parts + similar to sterile foliage frond parts, Vt directed to the nearby sorus, A1c not soriferous.--- Sori round, 1--3 mm  $\emptyset$ , distributed all over the abaxial frond surface, in the basal pinnae usually in the apical part only, arranged in one row parallel to the Vp, 1 per A1, near or in the centre, on branching points of more than 4 veins, pustulate.--- Anatomy: petiole rounded, 9-->11 vascular bundles, costa rounded, or invaginated, >6 vascular bundles, bundle sheath blue- or red-coloured; sterile lamina: stomata 1500--2700 / $\mu\text{m}^2$ , epidermis blue-coloured, hypodermis absent, marginal sclerenchymous strand with 10--20 cells, in fertile pinnae somewhat less developed; Vp rounded, vein sheath interrupted or continuous, cortex blue-coloured, parenchymatous, 1 vascular bundle, bundle sheath blue- brown-coloured, xylem arrangement T-shaped, sclerenchymatous strands absent, veinlet sheath extensions sclerenchymatous from epidermis to epidermis; receptacle with more or less isodiametric cell arrangement, 3--6 veinlets.--- Indument: laminar trichomes absent, type II glandular trichomes absent, acicular trichomes absent, laminar scales scattered throughout, peltate, triangular/ovate to linear/filiform, teeth/protuberances biseriate, glandular indument present near the base only, 1- or 2-celled, indument inserted marginally only, lignified cells absent, apex long filiform; receptacular hairy paraphyses 25--50% branched, 1 or 2 glandular cells, 2(--4) cells long, 60--125 / $\mu\text{m}$  long, receptacular scaly paraphyses present, complex deviating sporangia

absent, sporangial paraphyses absent.--- Sporangium 295--320 by 235--260 /um, annulus with (13)14--15(16) indurated cells, 3 epistomium cells, 3(4) hypostomium cells, in total (21)22--23(24) cells (Madagascar), 265--290 by 215--250 /um, (12)13 or 14(15) indurated cells, 3(4) epistomium cells, 3(4) hypostomium cells, in total (20)21--23 cells (Mascarenes).--- Spores of quercifolium-type, perispore verrucate, ultrastructure smooth, basal layer thin, spines present, sharp and smooth, with apical constriction, exospore with globular excrescences.

Distribution: Comores (Grande Comore, Anjouan), Madagascar, Mascarenes (Reunion, Mauritius).

Habitat: Primary forest. Growing  $\pm$  10 m above the ground. Reported on 'Copalier'. Alt. 50--650 m.

Notes. 1. Vern. names: Elakélaka (dial. Betsimisarake, Madagascar)

Ampanga (Madagascar)

Ramandrakotra (dial. Mag., Madagascar)

2. Rhizome scales dull and brown.

3. Lorence M126 (K): 'Forming large, basket-like colony around trunk.'

4. The similarities in growth habit between the present species and species no. 10 are very striking. This is strengthened by the numerous persistent, glabrous rachises present in the bulky baskets of specimens of both species. The differences in foliage fronds, pinnate (no. 10) resp. pinnatifid (no. 8), are even from a rather short distance inconspicuous, as those of the present species have very deep incisions reaching up to nearly the costa.

5. Base fronds and rhizome are sold on the market in Madagascar, as they are used as medicine and in magic (pers. comm. mr Aptroot).

## 9. *Drynaria pleuridioides* (Mett.) Diels

*Drynaria pleuridioides* (Mett.) Diels in E&P, Nat. Pfl. Fam. 1, 4 (1902) 350; C. Chr., Ind. Fil. (1906) 249; v. A. v. R., Mal. Ferns (1908) 697; Mal. Ferns Suppl. (1917) 415; C. Chr., Ind. Fil. suppl. 2 (1917) 13; Backer & Posthumus, Varenfl. Java (1939) 234; Tag., Acta Phytotax. Geobot. 25, 4--6 (1973) 96. --- *Polypodium pleuridioides* Mett., Ann. Lugd. Bat. (Filices) 2 (1866) 230; Baker in Hook. & Baker, Syn. Fil. (1868) 367; Salomon, Nomenclator (1883) 314; Racib., Pterid. Fl. Buitenz. (1898) 117. --- Type: Blume s.n., s.d., Java, Gunung Gedeh (holo: L).

*Drynaria pleuridioides* var. *amboinensis* v. A. v. R., Mal. Ferns (1908) 697. --- Type: Boerlage, Amboyna (holo: L).

*Drynaria propinqua* var. *sumatrana* v. A. v. R., Mal. Ferns (1908) 698. Type: Anonymous, Sumatra (n.v.).

*Polypodium willdenowii* auct. non Bory p.p.; Blume, Fl. Jav., Fil. (1829) 156, T. 66.

Epiphytic, either encircling the bole many times, or spirally climbing.--- Rhizome 1--2 cm  $\emptyset$ , phyllopodia absent, fronds < 10 cm apart, many persistent naked rachises present, base fronds contiguous or spreading, mainly imbricate; 20--30 vascular bundles, dorsal  $\pm$  4 large(r) sized, arranged in 1 elliptical row with a dorsal protrusion, bundle sheath ill-developed, blue-coloured, epidermis cells isodiametric, scale attachment more or less sunken, sclerenchyma strands in roots and cortex.--- Rhizome scales obliquely spreading, peltate, triangular/ovate to linear/filiform, index 6--11, 4--8 by 0.7--1.2 mm long, margin toothed and with short protuberances, teeth/protuberances biseriate, 1 to more-



celled, top united, rounded, or T-shaped, apex short filiform/narrow acuminate, distinct glandular top cell present, glandular indument present throughout, 2-celled, indument inserted marginally only, lignified cells present around the point of attachment only.--- Fronds dimorphic with base and foliage fronds, fertile frond parts often somewhat contracted.--- Base fronds ovate to elongated/lanceolate, index 1.3--1.7, 10--30 by 7--18 (---22) cm, lobate, lobes up to 1/3--1/2 of the width, margin irregularly denticulate, apex blunt to acute. --- Venation of base fronds: Vs running more or less straight to zigzagging, Vt branching from Vtc basically recurrent or excurrent and recurrent, free vein endings running excurrent and recurrent or diffuse; A1c sometimes absent, usually present, regularly shaped throughout, bordering part of apical Vs shortened, all containing 1 or 2, or more included veins, simple, once dichotomous, or more extensively branched, free; A1c along costa ± absent; A1 divided into 2 more or less equal Asec, areole layering comprising 3 or 4 A1, distinct, regularly shaped throughout the frond, Asec largely containing simple veins.--- Foliage fronds 50--125 cm long, pinnatifid, stalked, petiole up to 10--25 by 0.6--0.8 cm, conspicuously winged; lamina quadrangular to ovate, index 2--4 (---5), 40--100 by 20--40 cm, pinnae equally wide throughout, clearly decreasing in size towards the apex, index 6--8, 12--25 by (1---)2--3.5 cm, incisions up to <0.2--0.5 cm from the costa margin entire, apex acute to obtuse, apical pinna aborted or sometimes present, nectaries situated in the upper angle between costa and Vp (and Vp and Vs).--- Venation of foliage fronds: Vs running in a regular zigzagging way, Vt branching from Vtc basically recurrent, free vein endings running diffuse, occasionally developing loops, often terminated by a hydathode; A1c always present, irregularly shaped, bordering part of basal Vs shortened, all containing two or more included veins, simple, once dichotomous or more extensively branched, partly anastomosed; A1 divided into 3 or 4 Asec, areole layering comprising 5 A1, distinct, regularly shaped throughout the frond, Asec containing simple, twice or more dichotomous veins; venation of fertile frond parts ± similar to sterile foliage frond parts, Vt directed to the nearby sorus, A1c not soriferous.--- Sori round, 2--3 mm Ø, distributed all over the abaxial frond surface, in the basal pinnae usually in the apical part only, 1 per A1, arranged in one row parallel to the Vp, near or in the centre, on branching points of more than 4 veins, pustulate.--- Anatomy: petiole rounded, or invaginated, >11 vascular bundles, costa rounded, or angular, invaginated, 2-- 4 vascular bundles, bundle sheath blue-coloured; sterile lamina: stomata 1500--2700 /um<sup>2</sup>, epidermis blue-coloured, hypodermis absent, marginal sclerenchymatous strand with 10--20 cells, in fertile pinnae somewhat less developed; Vp rounded, vein sheath continuous, cortex blue- or red-coloured, sclerenchymatous or firm (parenchymatous), 1 vascular bundle, bundle sheath blue-coloured, xylem arrangement T-shaped to flattened U-shaped, sclerenchymatous strands absent, veinlet sheath extensions sclerenchymatous from epidermis to epidermis; receptacle with more or less isodiametric cell arrangement, 3--6 veinlets.--- Indument: laminar trichomes present, glandular, not densely set, 25-50% branched, 2 cells long, 80--145 /um long, type II glandular trichomes absent, acicular trichomes absent, laminar scales scattered round rachis only, basifix, linear/filiform, teeth/protuberances uniseriate or biseriate, glandular indument present throughout, indument inserted marginally only, lignified cells absent, apex filiform/narrow acuminate to acute (acuminate); receptacular hairy paraphyses 25--50% branched, 1 or 2 glandular cells, 2 or 3(4) cells long, (75---)90--135 /um long, receptacular scaly paraphyses present, complex; deviating sporangia absent, sporangial paraphyses absent.--- Sporangium 190--235 by 145--170 /um, annulus with 12--14 indurated cells, (2)3 or 4 epistomium cells, (2)3(4) hypostomium cells, in total 20--22 cells.--- Spores of

pleuridioides-type, perispore smooth sometimes folded, ultrastructure smooth, basal layer inconspicuous, spines absent, baculae absent, exospore verrucate.

Distribution: Sumatra, Java, Lesser Sunda Isl. (Bali, Flores, Alor), Celebes, Moluccas (Ambon).

Habitat: Primary and secondary forest, occasionally (coffee) plantation. Growing high-epiphytically. Reported on Casuarina junghuniana, Hevea spec. Alt. (50--550--1400--1550) m.

Notes. 1. Vern. name: Tameti (Alor)

2. Rhizome scales are dull and brown.

3. According to the field notes, the present species shows variation as to its growth habit:

Lörzing 15268 (L): 'Forming nests on trunks and branches.'

Hochreutiner 2760 (G, Z, S, L): 'Fougère formant une coupe autour du tronc...'

Bünnemeyer 3728 (U, L, K, B0): 'Fronds together forming a basket...'

Donk s.n. (L): '...entirely covering the trunk.'

4. Du Bois 47 (B0): 'Roots used as an areca substitute. Leaves used magically as theft curse. Placed on bamboo pole near areca trees. Thief supposed to be affected with insanity if he disregards the curse.'

#### 10. Drynaria rigidula (Sw.) Bedd.

Drynaria rigidula (Sw.) Bedd., Ferns br. Ind. (1869) T. 314; Suppl. Ferns S. Ind. & Br. Ind. (1876) 24; Handb. Ferns Br. Ind. (1883) 344, Fig. 192; Diels in E&P, Nat. Pfl. Fam. 1, 4 (1902) 330, Fig. 34B; Copel., Dep. int. Bur. Govern. 28 (1905) 135; C. Chr., Ind. Fil. (1906) 249; Christ, J. Bot. Paris, ser. 2, 1 (1908) 238; v. A. v. R., Mal. Ferns (1908) 699; Bull. Jard. bot. Buitenz., ser. 2, 1 (1911) 6; Copel., Phil. J. Sci. [Bot.] 6, 2 (1911) 91; v. A. v. R., Mal. Ferns Suppl. (1917) 415; Brause in Engl., Bot. Jb. 56 (1920) 208; Compton, J. Linn. Soc. Lond. (Bot.) 45 (1922) 452; Copel., Bull. Bernice P. Bishop Mus. 59 (1929) 96; C. Chr., Vjschr. Naturf. Ges. Zürich 77 [Beibl. 19] (1932) 36; Backer & Posthumus, Varenfl. Java (1939) 233, Fig. 54; C. Chr. & Tardieu, Phanérogamie 8, 4 (1939) 208; Tardieu & C. Chr. in Lecomte, Fl. gén. Indo-Chine 7, 2 (1941) 421; C. Chr., Bull. Bernice P. Bishop Mus. 177 (1943) 120; Copel., Gen. Fil. (1947) 204; Holttum, Fl. Mal. 2, Ferns (1954) 183; Copel., Fern Fl. Philipp. 3 (1960) 497; Tind., Contr. NSW natn. Herb., Flora ser. 208-211 (1961) 30; Holttum, [Fl. Thail. 1] Dansk. Bot. Ark. 20, 1 (1961) 20; Guillaumin, Mém. Mus. natn. Hist. nat. Paris [Bot.] 8, 3 (1962) 202; Brownlie in Aubrév., Fl. N. Caled. 3 (1969) 279, Pl. 37:Fig. 2, 3; Jones & Clemesha, Austr. Ferns (1976) 182, Fig. 144, Pl. 48; Brownlie, beih. Nova Hedw. 55 [Pterid. Fiji] (1977) 363. --- Polypodium rigidulum Sw., Schrad. Journ. Bot. 1800, 2 (1801) 26; Mett., Filices 2 (1866) 231 (22); Baker in Hook. & Baker, Syn. Fil. (1868) 368; Benth., Fl. Austral. 7 (1878) 771; F. M. Bailey, Syn. Qnsld Fl. (1883) 718; Christ, Farnkr. (1897) 119, Fig. 341; in Reinecke, Bot. Jb. 23 (1897) 357; Racib., Pterid. Fl. Buitenz. (1898) 117; F. M. Bailey, Queensl. Fl. 6 (1902) 1987; Jaenp., Bull. Mus. natn. Hist. nat. 7 (1911) 577. --- Goniophlebium rigidulum (Sw.) T. Moore, Ind. Fil. II (1862) 396. --- Type: Thunberg, Java (holo: S; iso: UPS, n.v.).

Polypodium diversifolia R. Brown, Prod. Fl. N. Holl. (1810) 147 [non Willd.]; Desv., Mem. Soc. Linn. Paris 6 [Prodr. Foug.] (1827) 237; Kunze, Bot. Ztg. 4, 25 (1846) 423; 6, 7 (1848) 119; Mett., Farngatt. 1, Polyp.

(1857) 121; Hook., Gard. Ferns (1862) Pl. 5; Spec. Fil. 5 (1864) 98; F. Muell., Fragm. phytogr. Austr. 5 (1865-'66) 127; Baker, J. Bot. (Lond.) 14 (1876) 345. --- Drynaria diversifolia (R. Brown) J. Smith, Hook. J. Bot. 3 (1841) 397; 4 (1842) 61; Brackenridge, US Expl. Exp. 16 (1854) 55; J. Smith, Cult. Ferns cat. (1857) 14; T. Moore, Ind. Fil. (1862) 345; J. Smith, Ferns Br. & For. (1866) 103; Fourn., Bull. Soc. bot. Franc. 6 (1869) 423; Anns Sci. nat. ser. 5, Bot. 18 (1873) 284; J. Smith, Hist. Fil. (1875) 108. --- Type: R. Brown 15 (or 31), 21-7-1802, Sandy Cape, Harvey's Bay (holo: BM; iso: K, S).

Polypodium gaudichaudii Bory, Anns Sci. nat. 5 (1825) 471, T. 14; Blume, Enum. Pl. Javae, Fil. (1828) add.; Fl. Jav., Fil. (1829) 158; Mett., Farngett. 1, Polyp. (1857) 120, T. 3, 46-47. --- Drynaria gaudichaudii (Bory) Gaud., Freyc. Voy. Bot. (1827) 355 (inval.). --- Phymatodes gaudichaudii (Bory) C. Presl, Tent. Pterid. (1836) 198. --- Type: Gaudichaud s.n., Rawak near Java (P, n.v.).

Polypodium glaucistipes Wallich, List (1828) 298 (nomen nudum).  
Drynaria pinnata Fée, Mém. Foug. 5, Gen. Fil. (1850-'52) 272. --- Type: Cuming 263, Philippines, Luzon, Prov. N. Ilocos (B, BM, K, L, W).

Drynaria baudouini Fourn., Anns Sci. nat. ser. 5 Bot. 18 (1873) 285; Diels in E&P, Nat. Pfl. Fam. 1, 4 (1902) 330; C. Chr., Ind. Fil. (1906) 247; Guillaumin, Mém. Mus. nat. Hist. nat. Paris [Bot.] 8, 3 (1962) 202. ---

Polypodium baudouini (Fourn.) Baker, Ann. Bot. 5 (1891) 480. --- Type: Baudouin, New Caledonia (holo: P, n.v.).

Polypodium speciosum Blume, Enum. Pl. Javae, Fil. (1828) 132. --- Type: Blume, Java (holo: L; iso: B).

Polypodium rigidulum var. vidgeni F. M. Bailey, Syn. Qnsld Fl. (1883) 718; Queensl. Fl. 4 (1902) 1987. --- Type: Vidgen, Queensland, Brisbane River, Oxley (n.v.).

Drynaria rigidula var. koordersii v. A. v. R., Bull. Jard. bot. Buitenz. ser. 2, 1 (1911) 6. --- Type: Koorders 24098 B, Java, Probolinggo Residentie (holo: L).

Usually epiphytic, encircling the bole many times, occasionally epilithic, forming crust.--- Rhizome 1--2 cm Ø, phyllopodia absent, fronds < 10 cm apart, many persistent naked rachises present, base fronds spreading, mainly imbricate; 15--30 vascular bundles, dorsal + 4 large(r) sized, arranged in 1 elliptical row with a dorsal protrusion, bundle sheath ill-developed, blue-coloured, epidermis cells isodiametric or cells erect, scale attachment more or less sunken, sclerenchyma strands in cortex present.--- Rhizome scales obliquely spreading, peltate, triangular/ovate to linear/filiform, index 4--17.5, 5--13 by 0.5--1.5 mm, margin with short and elongated protuberances, protuberances uniseriate, 1-celled, top T-shaped, apex acute (acuminate), distinct glandular top cell present, glandular indument present throughout, 1- or 2-celled, indument inserted marginally only, lignified cells present around the point of attachment only.--- Fronds dimorphic with base and foliage fronds.--- Base fronds ovate to elongated/lanceolate, index 1.5--2.3, 10--30 by 5--15 cm, lobate, lobes up to 1/3 of the width to clearly sinusoid, margin irregularly denticulate, apex rounded.--- Venation of base fronds: Vs running more or less straight, or irregularly, Vt branching from Vtc basically excurrent, free vein endings running excurrent and recurrent or diffuse; A1c always present, irregularly shaped, both branching points of the Vtc and Vs equally distant from Vp or bordering part of apical Vs shortened, largely empty, rarely containing 1 or 2, or more included veins; simple, once dichotomous, free; A1c along costa inconspicuous, irregularly shaped, or large sized, conspicuous, somewhat irregularly shaped, with included free veins; A1 divided into 2 more or less equal Asec, areole

layering comprising 1 or 2 A1, distinct or indistinct, irregularly shaped, Asec largely empty or containing simple veins.--- Foliage fronds 35--150 cm or more long, once pinnate, stalked, petiole up to 40 by 0.8 cm, nor winged; lamina quadrangular to ovate, index 2--4(--6), 25--100(--200) by 12--49(--50) cm, pinnae with a clear basal constriction, decreasing in size towards apex or  $\pm$  equally-sized all over, index 6--20, up to 8--25 (--30) by 0.5--3 cm, margin serrate, incisions in between the subsequent Vs, apex acute to obtuse, apical pinna aborted, nectaries situated in the lower angle between costa and Vp (and Vp and Vs).--- Venation of foliage fronds: Vs running more or less straight, or irregularly, Vt branching from Vtc basically recurrent, or excurrent, free vein endings running diffuse, hydathodes absent; A1c always present, regularly shaped throughout, both branching points of the Vtc and Vs equally distant from the Vp, largely containing 2 or more included veins, simple, once dichotomous, free; A1 divided into 2--4 Asec, areole layering comprising 3--5 A1, distinct or indistinct regularly shaped throughout the frond, Asec empty or containing simple veins; venation of fertile frond parts  $\pm$  similar to sterile foliage frond parts, Vt directed to the nearby sorus, A1c not soriferous.--- Sori round, 1<--2 mm  $\emptyset$ /long, distributed all over the abaxial frond surface, in the basal pinnae usually in the basal part only or medially or indifferent, 1 per A1, near the centre, arranged in one row parallel to the Vp, on branching points of 2--4 or more veins, pustulate.--- Anatomy: petiole rounded or invaginated, 9-->11 vascular bundles, rachis rounded, 4-->6 vascular bundles, bundle sheath absent or present, brown-coloured; sterile lamina: stomata 1500<--2100 / $\mu$ m<sup>2</sup>, epidermis blue- or red-coloured, hypodermis absent, marginal sclerenchymatous strand with 10--20 cells, Vp rounded, vein sheath interrupted or continuous, cortex blue-coloured, parenchymatous, 1 vascular bundle, bundle sheath blue-, red- or brown-coloured, xylem arrangement T-shaped, sclerenchymatous strands absent, veinlet sheath extensions sclerenchymatous from epidermis to epidermis; with some irregularities; receptacle with more or less isodiametric cell arrangement, 1--4 veinlets.--- Indument: laminar trichomes present, glandular (in mature fronds often absent), not densely set, >5--25% branched, 2 cells long, (90--120 / $\mu$ m long), type II glandular trichomes absent, acicular trichomes absent, laminar scales scattered throughout, basifix, peltate, round, linear/filiform, margin with short or long protuberances, uniseriate, glandular indument absent, indument inserted marginally only, lignified cells absent, apex filiform/narrow acuminate, acute (acuminate) to apex rounded; receptacular hairy paraphyses >50% branched, 1 or 2 glandular cells, (3)4-->8 cells long, (135-->240--480 / $\mu$ m long, receptacular scaly paraphyses present, all intermediates between trichomes and scales; deviating sporangia absent, sporangial paraphyses absent.--- Sporangium 220--245 by 200--220 / $\mu$ m, annulus with 12--14(15) indurated cells, (2)3(4) epistomium cells, (2)3(--5) hypostomium cells, in total 20--22(--24) cells.--- Spores of quercifolium-type, perispore verrucate, ultrastructure smooth, basal layer thin, spines present, sharp and smooth, with apical constriction, baculae present, globules absent, exospore smooth.

Distribution: Birma, Thailand, Laos, Cambodja, Vietnam, China (Hainan), Mentawai Isl., Sumatra, Penang, Malay Peninsula, Singapore, Java, Borneo (Kalimantan, Sarawak, Sabah), Philippines (Luzon, Mindoro, Panay, Mindanao), Celebes, Moluccas, New Guinea (W. Irian, Papua), Manus Isl., New Britain, New Ireland, Solomon Isl., Queensland, New South Wales, Vanuata, New Caledonia, Norfolk Isl., Fiji Isl., Tonga Isl., Samoa Isl.

Habitat: Several kinds of primary and secondary forest (a.o. Eucalyptus-, evergreen-, mangrove-, beach-, Castanopsis-, open-, pine-, gallery-, dry-,

deciduous-, Callitris-, swamp-, diptrocarp-, vine-), savannah, and plantation (a.o. oilpalm-, rubber-). Growing 0--35 m above the ground. Reported on Nimupos obtusifolia, Ficus involucrata, Tristana conferta, Pinus khasya, Dillenia allata, Phoenix dactylifera, Cocos nucifera, Hevea spec., Eucalyptus spec., Casuarina spec., Eugenia spec., Melastoma spec., Albizia spec., Rhizophora spec., Pandanus spec., Artocarpus spec. Alt. 0--2000(--2400) m.

Notes. 1. Vern. names: Weka weka (Halmahera, Moluccas)

Kedah klà (Wangka, Neeckey, Thailand)

Peta (Guadalcanal, Solomons)

Poto (Tari, Southern Highlands, Papua New Guinea)

Paku kadaka (Gunung Cisalak, Java)

Simpar lajangan (Java)

Pinog yupar (dial. SAM, Zambales, Luzon, Philippines)

Tjekee (Dani lang., Balim, W. Irian)

Hare hare mombang (Tomuan Dolok, E. Sumatra)

Rakuraku (= light in weight; Bougainville, Solomons)

Hakato (Eua, Tonga)

Hujue (China)

2. The present species often shows aberrant juvenile fronds, i.e. intermediates between base and foliage fronds.

3. Chromosomes:  $2n = 74$  (Löve, Löve, & Pichi Sermolli, 1977)

4. Yates 2390 (NY): 'Always infected with colonies of black ants.'

Bloembergen 30 (L): 'Dead leaves forming a nest with many ants.'

5. Molesworth Allen 2179 (BM): 'Nearly all fronds dead, only rachises left, pinnae having fallen (seasonal?).' See also note to species no. 8.

6. Waterhouse 534 (K): 'Natives of Treasury Isl. used this (fern) as remedy for sea sickness. Natives belief that if certain parts of plants are chewed it conduces to make warriors light-footed and agile.'

## 11. Drynaria propinqua (Wallich ex Mett.) Bedd.

Drynaria propinqua (Wallich ex Mett.) J. Smith, Hook. J. Bot. 4 (1842) 61 (nomen nudum); Cult. Ferns cat. (1857) 13 (nomen nudum); Bedd., Ferns br. Ind. (1866) 160; J. Smith, Ferns Br. & For. (Oct. 1866) 103; Hist. Fil. (1875) 108; Bedd., Suppl. Ferns S. Ind. & Br. Ind. (1876) 23; Handb. Ferns Br. Ind. (1883) 339, Fig. 189; Diels, Bot. Jb. 29, 1 (1900) 208; in E&P, Nat. Pfl. Fam. 1, 4 (1902) 330; Christ, Bull. Soc. bot. Fr. [ser. 4, 5] 52, Mém. 1 (1905) 22; Christ, Bull. acad. intern. geogr. bot. 15 [ser. 3, 199--201] (1906) 108; C. Chr., Ind. Fil. (1906) 249; v. A. v. R., Mal. Ferns (1908) 698; Engl., [Veg. Erde 9] Pfl. Welt Afr. 2 (1908) 56 p.p.; C. Chr. & Tardieu, Phanérogamie 8, 4 (1939) 208; Tardieu & C. Chr. in Lecomte, Fl. gén. Indo-Chine 7, 2 (1941) 521; B. K. Nayar & Kachroo, Phytomorph. 3 (1953) 411; Holttum, [Fl. Thail. 1] Dansk. Bot. Ark. 20, 1 (1961) 20; B. K. Nayar, Bull. natn. bot. Gdns Lucknow (1961) 9, Fig. 1; Tag. in H. Hara, Fl. E. Himal. (1966) 493; Iconogr. Cormop. Sinic. 1 (1972) 272; Ching & S. K. Wu in C. Y. Wu, Fl. Xizang. (1983) 342. --- Polypodium propinquum Wallich, List 293 (nomen nudum); Mett., Farngett. 1, Polyp. (1857) 120, T. 3, 50; Hook., Spec. Fil. 5 (1864) 97; Mett., Filices 2 (1866) 230 (21); Baker in Hook. & Baker, Syn. Fil. (1868) 367; C. B. Clarke, Trans. Linn. Soc. Lond., ser. 2, 1 (1880) 556; Christ, Farnkr. (1897) 119, Fig. 340; De Wild., Annls Mus. Congo [Bot.] ser. 5, 1 (1903) 6 p.p. --- Phymatodes propinqua (Wallich ex Mett.) C. Presl, Tent. Pterid. (1836) 198 (nomen nudum). --- Type: Wallich 293, Nepal (holo: B; iso: BM, C, G, K, L, M, MO, P, US, W).

Drynaria propinqua (Wallich ex Mett.) J. Smith var. mesosora Christ, Bull.

Acad. intern. geogr. bot. 15 [ser. 3, 199--201] (1906) 108. --- Type: Wilson 5340, W. China, Omei shan (iso: BM, K, P).

Epiphytic, spirally climbing, or epilithic (or terrestrial), linearly creeping.--- Rhizome 1--2 cm  $\emptyset$ , phyllopodia absent, fronds < 10 cm apart, rhachises not or rarely persistent, base fronds spreading; 10--20 vascular bundles, all + equally-sized, arranged in 1 elliptical row with a dorsal protrusion, bundle sheath absent or ill-developed, epidermis cells isodiametric, scale attachment more or less sunken, sclerenchyma strands absent.--- Rhizome scales adpressed, peltate, triangular/ovate, index 2.5--4, 3--6 by 1--1.5 mm, margin with elongated protuberances, protuberances uniseriate, 1- or more celled, top T-shaped, apex short filiform/narrow acuminate to acute (acuminate), distinct glandular top cell present, glandular indument present throughout, 1--3- or more celled, indument inserted marginally only, lignified cells present around the point of attachment only.--- Fronds dimorphic with base and foliage fronds.--- Base fronds rounded to ovate, index 1--1.4, 10--20 by 7--18 cm, lobate, lobes up to 2/3 or more of the width, margin regularly denticulate, apex blunt to acute. --- Venation of base fronds: Vs running more or less straight or regular zigzagging, Vt branching from Vtc basically excurrent and recurrent, free vein endings running excurrent and recurrent or diffuse; A1c sometimes absent, usually present, irregularly shaped, bordering part of basal Vs shortened, all containing 1 recurrent included vein; simple or once dichotomous, partly anastomosed; A1c along costa present, large sized, conspicuous, somewhat irregularly shaped, with included free veins; A1 divided into 3 or 4 Asec, areole layering comprising 3 or 4 A1, distinct, irregularly shaped, Asec empty or containing simple veins.--- Foliage fronds (30--40--70(--85) cm long, pinnatifid, stalked, petiole up to 10--20(--25) by 0.4--0.5 cm, inconspicuously winged; lamina triangular to ovate, index 1.5--2.5, (20--30--50(--60) by (12--20--30 cm, pinnae equally wide throughout, sometimes with a basal constriction, decreasing in size towards the apex or all + equally-sized, index 5--8, up to (5--10--15 by 1--2.5 cm, incisions up to <0.2 cm from the costa, margin serrate, incisions in between the subsequent Vs, apex acute, apical pinna aborted, nectaries situated in the lower angle between costa and Vp (and Vp and Vs).--- Venation of foliage fronds: Vs running more or less straight or irregularly, Vt branching from Vtc basically excurrent or excurrent and recurrent, free vein endings running diffuse, partly terminated by a hydathode; A1c always present, regularly shaped throughout, both branching points of the Vtc and Vs equally distant from the Vp or bordering part of basal Vs somewhat shortened, largely empty, often containing 1 recurrent included vein, simple, free; A1 divided into 2--4 Asec, areole layering comprising 3--5 A1, distinct or sometimes indistinct, regularly shaped throughout the frond, Asec empty or containing simple veins; venation of fertile frond parts + similar to sterile foliage frond parts, Vt directed to the nearby sorus, A1c not soriferous.--- Sori round, 1--2 mm  $\emptyset$ , distributed all over the abaxial frond surface, in the basal pinnae usually in the basal part only, arranged in 1 row parallel to the Vp, 1 per A1, near or in the centre, midway on anastomosed veins or on branching points of 2--4 or more veins, on branching points of more than four veins, pustulate.--- Anatomy: petiole rounded, 5--6 vascular bundles, costa angular, 1 vascular bundle, bundle sheath blue- or brown-coloured; sterile lamina: stomata 2100--3300 / $\mu\text{m}^2$ , epidermis blue-coloured, hypodermis absent, marginal sclerenchymatous strand with <10 cells; Vp rounded or angular, vein sheath interrupted, cortex blue- to red-coloured, sclerenchymatous or firm parenchymatous, 1 vascular bundle, bundle sheath blue- or brown-coloured, xylem arrangement

T-shaped, sclerenchymatous strands present, veinlet sheath extensions sclerenchymatous from epidermis to epidermis with some irregularities; receptacle with more or less isodiametric cell arrangement, 1 or 2 veinlets.--- Indument: laminar trichomes present, glandular and acicular, not densely set, glandular trichomes 10--25% branched, 2 or 3(4) cells long, (75--90--120(--140)), type II glandular trichomes absent, acicular trichomes more or less scattered throughout, 3 cells long, 210--240 /um; laminar scales sometimes scattered throughout, usually especially against the rhachis, basifix, pseudo-peltate with short auricles, triangular/ovate to linear/filiform, margin with short and long protuberances, uniseriate and biseriate, glandular indument absent, indument inserted marginally only, lignified cells absent, apex filiform/narrow acuminate to acute (acuminate); receptacular hairy paraphyses >50% branched, 1 or 2 glandular cells, 3--6 cells long, (70--240--600(--660)), receptacular scaly paraphyses present, all intermediates between trichomes and scales; deviating sporangia absent, sporangial paraphyses absent.--- Sporangium 300--355 by 255--305 /um, annulus with (12)13 or 14(15) indurated cells, (2)3(4) epistomium cells, (2)3(4) hypostomium cells, in total (19--21 or 22(--24)) cells.--- Spores of quercifolium-type, perispore verrucate, ultrastructure smooth, basal layer thin, spines present, sharp and smooth or with apical constriction, baculae present, globules absent, exospore with globular excrescences.

Distribution: India (Uttar Pradesh?, Sikkim, Assam, Manipur), Nepal, Bhutan, China (Yunnan, Szechuan, Guizhou, Guangsi), Birma, Thailand, Laos, Vietnam.

Habitat: Several kinds of forest (open-, evergreen-, pine-, Quercus griffithii-, mixed oak and pine-, Castanopsis-, shrubby-). Growing in shade or exposed, often found on limestone. Reported on Ficus spec., Lithocarpus spec. Alt. 350--2500(--2800) m.

- Notes. 1. Vern. name: Guang yehujue (China)  
 2. Foliage fronds with 7--15 pairs of pinnae.  
 3. Chromosomes:  $2n = 72?$  (LØve, LØve, & Pichi Sermolli, 1977)

## 12. Drynaria parishii (Bedd.) Bedd.

Drynaria parishii (Bedd.) Bedd., Suppl. Ferns S. Ind. & Br. Ind. (1876) 24; C. Chr. & Tardieu, Phanérogamie 8, 4 (1939) 208; Tardieu & C. Chr. in Lecomte, Fl. gén. Indo-Chine 7, 4 (1941) 520; C. Chr., Ind. Fil. suppl. 4 (1965) 106. --- Pleopeltis parishii Bedd., Ferns br. Ind. (1866) T. 125. --- Type: Parish, Burmah, Moulmein (holo: K).

Drynaria mutilata Christ, J. Bot. Paris, ser. 2, 1 (1908) 238, 271; C. Chr., Ind. Fil. suppl. 1 (1913) 29. --- Lectotype: Eberhardt 79, Vietnam, 'Annam français', plateau de Dalat (P, BM).

Usually epiphytic, spirally climbing, sometimes epilithic, linearly creeping.--- Rhizome 1--2 cm Ø, phyllopodia absent, fronds 10--18 cm apart, rhachises not or rarely persistent, 15--20 vascular bundles, dorsal + 4 large(r) sized, arranged in 1 elliptical row with a dorsal protrusion, bundle sheath ill-developed, blue-coloured, epidermis cells isodiametric, scale attachment more or less sunken, sclerenchyma strands absent.--- Rhizome scales adpressed, peltate, triangular/ovate, index 3--4.5, 4--7 by 1--1.8 mm, margin with elongated protuberances, protuberances uniseriate, 1- or more celled, top T-shaped, apex short filiform/narrow

acuminate to acute (acuminate), distinct glandular top cell present, glandular indument present throughout, 1- or 2-celled, indument inserted marginally only, lignified cells present around the point of attachment only.--- Fronds monomorphic, up to 15--35(--45), pinnatifid, stalked, petiole 5--10 by 0.2--0.3 cm, inconspicuously winged; lamina triangular, index 0.9--1.5(--2), 12--25(--35) by 10--18 cm, pinnae with a basal constriction, all equally-sized, index 4--6.5, up to 4--10 by 1--1.5(--2) cm, incisions up to 0.0--<0.2 cm from the costa, margin serrate, incisions in between the subsequent Vs, apex obtuse, apical pinna aborted, nectaries situated in the lower angle between costa and Vp (and Vp and Vs).--- Venation: Vs running more or less straight or irregularly, Vt branching from Vtc basically excurrent, free vein endings running diffuse, partly terminated by a hydathode; A1c always present, regularly shaped throughout, both branching points of the Vtc and Vs equally distant from the Vp, largely empty, rarely containing 1 included veinlet, free; A1 divided into 2--4 Asec, areole layering comprising 2 or 3 A1, distinct or indistinct, regularly shaped throughout the frond, Asec largely empty, sometimes containing simple veins; venation of fertile frond parts + similar to sterile foliage frond parts, Vt directed to the nearby sorus, A1c not soriferous.--- Sori round, 1<--2 mm  $\emptyset$ , distributed all over the abaxial frond surface, in the basal pinnae usually in the basal part only, arranged in 1 row parallel to the Vp, 1 per A1, near or in the centre, midway on anastomosed veins or on branching points of 2--4 veins, pustulate.--- Anatomy: petiole rounded, 3 or 4 vascular bundles, costa rounded, 1 vascular bundle, bundle sheath brown-coloured; sterile lamina: stomata 2100--3300 / $\mu\text{m}^2$ , epidermis blue- or red-coloured, hypodermis absent, marginal sclerenchymatous strand with <10 cells; Vp rounded or angular, vein sheath interrupted or continuous, cortex red-coloured, sclerenchymatous or firm parenchymatous, 1 vascular bundle, bundle sheath blue- or brown-coloured, xylem arrangement T-shaped, sclerenchymatous strands absent, veinlet sheath extensions sclerenchymatous from epidermis to epidermis; receptacle with more or less isodiametric cell arrangement, 1 or 2 veinlets.--- Indument: laminar trichomes present, glandular and acicular, not densely set, glandular trichomes 25-50% branched, 3 cells long, 130--145 / $\mu\text{m}$  long, type II glandular trichomes absent, acicular trichomes in tuft on abscission vein only, 1 or 2 cells long, 200--250 / $\mu\text{m}$  long; laminar scales sometimes scattered throughout, usually especially against the rhachis, basifix, pseudo-peltate with short auricles, triangular/ovate to linear/filiform, margin with short and long protuberances, uniseriate and biseriate, glandular indument absent, indument inserted marginally only, lignified cells absent, apex filiform/narrow acuminate to acute (acuminate); receptacular hairy paraphyses >50% branched, 1--4 glandular cells, (3--)5--9 cells long, (150--)240--570 / $\mu\text{m}$  long, receptacular scaly paraphyses absent; deviating sporangia absent, sporangial paraphyses absent.--- Sporangium 275--320 by 245--275 / $\mu\text{m}$ , annulus with (13)14 indurated cells, 3 epistomium cells, (2)3 hypostomium cells, in total 21 or 22 cells.--- Spores of quercifolium-type, perispore verrucate, ultrastructure smooth, basal layer thin, spines present, sharp and smooth or with apical constriction, baculae present, globules absent, exospore with globular excrescences.

**Distribution:** India (Assam?), China (Yunnan), Birma, Thailand, Laos, Vietnam.

**Habitat:** Several kinds of primary and secondary forest (a.o. mixed deciduous-, dry evergreen-, dipterocarp-, open oak-). Growing 10--15 m above the ground. Reported on Pinus toeda, Ficus altissima. Alt. 500-1600 m.



- Notes. 1. Vern. name: Xiao hujue (China)  
 2. Foliage fronds with 5--7 pairs of pinnae.  
 3. Garrett 1393 (K): 'climbing vertically.'

### 13. *Drynaria delavayi* Christ

*Drynaria delavayi* Christ, Bull. Soc. bot. Fr. [ser. 4, 5] 52, Mém. 1 (1905) 22; Bull. acad. intern. geogr. bot. 15 [ser. 3, 199--201] (1906) 108; C. Chr., Ind. Fil. (1906) 247; Copel., Philipp. J. Sci. (Bot.) 3, 1 (1908) 36; Univ. Calif. Pubs Bot. 16, 2 (1929) 119; Ching & S. K. Wu in C. Y. Wu, Fl. Xizang. (1983) 348. --- Lectotype: Delavay 1166, China, Mt de Kouang-yun-chan, près Long-kong (K, P).

*Drynaria rivalis* var. *yunnanensis* Christ, Bull. Herb. Boissier 7, 1 (1899) 6. --- Type: Henry 11512, China, Mengtze (iso: K, MO, US).

Epilithic, linearly creeping, or epiphytic, spirally climbing.--- Rhizome 1--2 cm Ø, phyllopodia absent, fronds < 10 cm apart, many persistent naked rhachises present, base fronds spreading; 15--20 vascular bundles, all + equally-sized, arranged in 1 elliptical row with a dorsal protrusion, bundle sheath ill-developed, blue-coloured, epidermis cells flattened, scale attachment protruding, sclerenchyma strands in roots.--- Rhizome scales obliquely spreading, basifix, pseudo-peltate with short auricles, triangular/ovate to linear/filiform, index 5--15, 4--10 by 0.5--1 mm, margin toothed, teeth biseriate, 1-celled, top united, apex short filiform/narrow acuminate to acute (acuminate), distinct glandular top cell present, glandular indument absent, indument inserted marginally only, lignified cells absent.--- Fronds dimorphic with base and foliage fronds.--- Base fronds ovate to elliptical, index 1.5--1.8, 6--14 by 4--9 cm, lobate, lobes up to 2/3 or more of the width, margin irregularly denticulate, apex blunt.--- Venation of base fronds: Vs running more or less straight or regular zigzagging, Vt branching from Vtc basically excurrent and recurrent, free vein endings running excurrent and recurrent or diffuse; A1c always present, irregularly shaped, both branching points of the Vtc and Vs equally distant from Vp or bordering part of basal Vs shortened, largely empty, rarely containing 1 recurrent included vein, simple, free; A1c along costa present, large sized, conspicuous, somewhat irregularly shaped, with included free veins; A1 divided into 2 more or less equal Asec, areole layering comprising 1 or 2 A1, distinct, irregularly shaped, Asec largely empty.--- Foliage fronds 30--55 cm long, pinnatifid, stalked, petiole 3--9 by 0.3--0.4 cm, conspicuously or inconspicuously winged lamina quadrangular, index 2--3.5, 25--45 by 12--18 cm, pinnae equally wide throughout, clearly decreasing in size towards the apex, index 3.5--5, 4--9 by 1.2--2 cm, incisions up to <0.2 cm from the costa margin serrate, incisions in between and near the subsequent Vs, apex acute to obtuse, apical pinna aborted, nectaries situated in the lower angle between costa and Vp (and Vp and Vs).--- Venation of foliage fronds: Vs running more or less straight or irregularly, Vt branching from Vtc basically excurrent and recurrent, free vein endings running diffuse, hydathodes absent; A1c always present, regularly shaped throughout, bordering part of basal Vs shortened, largely containing 1 or 2, or more recurrent included veins, simple or once dichotomous, free; A1 divided into 3 or 4 Asec, areole layering comprising 4--5 A1, distinct or indistinct, regularly shaped throughout the frond, Asec empty or containing simple and once dichotomous veins; venation of fertile frond parts +

similar to sterile foliage frond parts, Vt directed to the nearby sorus, Alc not soriferous.--- Sori round, 1--3 mm Ø, distributed all over the abaxial frond surface, in the basal pinnae usually in the basal part only or medially or indifferently, arranged in 1 row parallel to the Vp, 1 per A1, near or in the centre, on branching points of more than four veins, superficial.--- Anatomy: petiole elliptical or invaginated, 3 or 4 vascular bundles, costa rounded, 1 vascular bundle, bundle sheath blue- or brown-coloured, sterile lamina: stomata >3300 /um<sup>2</sup>, epidermis blue-coloured, hypodermis absent, marginal sclerenchymatous strand with <10 cells; Vp rounded, vein sheath interrupted, cortex blue- to red-coloured, sclerenchymatous or firm parenchymatous, 1 vascular bundle, bundle sheath blue- or brown-coloured, xylem arrangement T-shaped, sclerenchymatous strands absent, veinlet sheath extensions sclerenchymatous from epidermis to epidermis with some irregularities; receptacle with more or less isodiametric cell arrangement, 1--4 veinlets.--- Indument: laminar trichomes present, glandular and acicular, not densely set, glandular trichomes 5--10% branched, 2(--4) cells long, (100--120--150(--180) /um long, type II glandular trichomes absent, acicular trichomes more or less scattered throughout, 2 cells long, 255--270 /um long; laminar scales especially against the rachis, basifix, triangular/ovate, teeth biseriate, glandular indument absent, indument inserted marginally only, lignified cells absent, apex filiform/narrow acuminate to acute (acuminate); receptacular hairy paraphyses 10--25% branched, 1 or 2 glandular cells, 2--4 cells long, (100--120--240 /um long, receptacular scaly paraphyses absent; deviating sporangia absent, glandular sporangial paraphyses present; acicular sporangial paraphyses absent.--- Sporangium 300--330 by 240--285 /um, annulus with 12--15 indurated cells, (3)4 or 5(6) epistomium cells, (3)4 or 5 hypostomium cells, in total (20--23--26(27) cells.--- Spores of pleuridioides-type, perispore smooth sometimes folded, ultrastructure smooth, basal layer thin, spines present, sharp and smooth or with apical constriction, baculae absent, globules absent, exospore verrucate.

Distribution: Bhutan, China (Xijiang, Yunnan, Szechuan, Kansu), Birma.

Habitat: Several kinds of forest (a.o mixed-, galery-, oak-, pinus-, shrubby-) and grass land. Reported on Boloti capiosa, Quercus spec., Salix spec.

Notes. 1. Vern. name: Kouyi hujue (China)

2. Lack 990 (K): 'The young sporangia are enveloped in mucilage which under low power [magnification?] resembles an indusium. The mucilage readily dissolves in water.' This indicates the function of the sporangial glandular paraphyses.

3. Very few herbarium specimens were found with the apical pinna present.

#### 14. *Drynaria sinica* Diels

*Drynaria sinica* Diels, Bot. Jb. 29, 1 (1900) 208; Christ, Bull. Soc. bot. Fr. Eser. 4, 5] 52, Mém. 1 (1905) 23; C. Chr., Ind. Fil. (1906) 249; Copel., Philipp. J. Sci. (Bot.) 3, 1 (1908) 36; C. Chr., Ind. Fil. suppl. 3 (1934) 79; Ching & S. K. Wu in C. Y. Wu, Fl. Xizang. (1983) 346. --- Type: Bock-von Rosthern 3121, W. Central China, Sechuan, Wen chuan, T'ao-kuan, He-ai-wo (holo: B).

*Drynaria baronii* (Christ) Diels, Bot. Jb. 29, 1 (1900) 208; in E&P, Nat. Pfl. Fam. 1, 4 (1902) 330, Fig. 171:C; Christ, Bull. Soc. bot. Fr. Eser. 4,

5] 52, Mém. 1 (1905) 23. --- *Polypodium baronii* Christ in Baroni & Christ, Nu. Giorn. bot. It. n. s. 4 (1897) 100, T. 2 [non Baker, 1887] (nom. illeg.); Farnkr. (1897) 120. --- *Drynaria reducta* Christ in C. Chr., Ind. Fil. (1905) 249 (nom. illeg.); Copel., Philipp. J. Sci. (Bot.) 3, 1 (1908) 36. --- Type: Giraldi s.n., 10/12-8-1894, Zu-Lu, Shensi, China (iso: K).  
*Drynaria sinica* var. *intermedia* Ching & S. K. Wu in C. Y. Wu, Fl. Xizang. (1983) 347. --- Type: YU 9895, China, Yunnan, Dechen (Atungtze), (holo: PE).

Usually epilithic, linearly creeping, sometimes epiphytic, spirally climbing.--- Rhizome 1--2 cm Ø, phyllopodia absent, fronds < 10 cm apart, many persistent naked rachises present, base fronds spreading; 15--20 vascular bundles, dorsal + 4 large(r) sized, arranged in 1 elliptical row with a dorsal protrusion, bundle sheath absent, epidermis cells isodiametric, scale attachment protruding, sclerenchyma strands absent.--- Rhizome scales obliquely spreading, pseudo-peltate with short auricles, triangular/ovate, index 4--10, 4--11 by 0.5--1.5 mm, margin toothed, teeth biseriolate, 1-celled, top united, apex long filiform, short filiform/narrow acuminate, to acute (acuminate), distinct glandular top cell present, glandular indument present throughout, indument inserted marginally only, lignified cells absent.--- Fronds dimorphic with base and foliage fronds, fertile frond parts sometimes somewhat contracted.--- Base fronds elliptical, index 2--3, 5--15 by 3--6 cm, lobate, lobes up to 2/3 or more of the width, margin (ir)regularly denticulate, apex blunt to acute. --- Venation of base fronds: Vs running more or less straight or regular zigzagging, Vt branching from Vtc basically recurrent or excurrent and recurrent, free vein endings largely running excurrent and recurrent or diffuse; A1c sometimes absent, generally present, regularly shaped throughout, bordering part of basal Vs shortened, largely empty, rarely containing 1 recurrent included vein, simple, free; A1c along costa present, large sized, conspicuous, regularly shaped, empty; A1 divided into 2--4 Asec, areole layering comprising 1--4 A1, distinct, regularly shaped throughout the frond, Asec largely empty.--- Foliage fronds 25--60 cm long, pinnatifid, stalked, petiole 2--10 by 0.2--0.3 cm, conspicuously winged; lamina ellipsoid, index (3--)4--5, 22--50 by 7--12 cm, pinnae equally wide throughout, clearly decreasing in size towards the apex, index 6--8, 4--7 by 0.5--1.2 cm, incisions up to 0.2--0.5 cm from the costa, margin serrate, incisions in between and near the subsequent Vs, apex obtuse, apical pinna aborted or present, nectaries situated in the lower angle between costa and Vp (and Vp and Vs).--- Venation of foliage fronds: Vs running irregularly, Vt branching from Vtc basically excurrent or recurrent and recurrent, free vein endings running diffuse, hydathodes absent; A1c always present, regularly shaped throughout, bordering part of basal Vs or of apical Vs shortened, empty, or containing 1 recurrent included vein, simple or once dichotomous, free; A1 divided into 2--4 Asec, areole layering comprising 2--4 A1, distinct or indistinct, regularly shaped throughout the frond, Asec empty or containing simple veins; venation of fertile frond parts + similar to sterile foliage frond parts, Vt directed to the nearby sorus, A1c not soriferous.--- Sori round, 1--2 mm Ø, distributed all over the abaxial frond surface, in the basal pinnae usually in the apical part only, arranged in 1 row parallel to the Vp, 1 per A1, near or in the centre, midway on anastomosed veins, on branching points of 2--4 veins, superficial.--- Anatomy: petiole rounded, elliptical, or invaginated, 3--6 vascular bundles, costa angular, 1 vascular bundle, bundle sheath blue- or brown-coloured; sterile lamina: stomata 2700--3300 /µm<sup>2</sup>, epidermis blue-coloured, hypodermis absent, marginal sclerenchymous strand with <10 cells; Vp rounded, vein sheath interrupted, cortex blue-coloured, parenchymatous, 1 vascular bundle, bundle sheath blue-coloured, xylem arrangement T-shaped,

sclerenchymatous strands absent, veinlet sheath extensions sclerenchymatous from epidermis to epidermis with some irregularities; receptacle with more or less isodiametric cell arrangement, 1 or 2 veinlets.--- Indument: laminar trichomes present, glandular and acicular, not densely set, glandular trichomes >90% unbranched, 2 or 3(4) cells long, (85--100--190 (---230) /um long, type II glandular trichomes present, acicular trichomes more or less scattered throughout, 1 or 2(3) cells long, (150--180--400 (---450); laminar scales especially against the rhachis, basifix, pseudo-peltate with short auricles, triangular/ovate to linear/filiform, teeth biseriate, glandular indument absent, indument inserted marginally only, lignified cells absent, apex filiform/narrow acuminate to acute (acuminate); receptacular hairy paraphyses >90% unbranched, 1 or 2 glandular cells, 2--4 cells long, (90--115--195(---235) /um long, receptacular scaly paraphyses absent; deviating sporangia absent, glandular sporangial paraphyses generally absent (rarely present); acicular sporangial paraphyses absent.--- Sporangium 300--360 by 250--300 /um, annulus with 13--16(17) indurated cells, 3 or 4 epistomium cells, 3--5 hypostomium cells, in total 21--24(---28) cells.--- Spores of pleuridioides-type, perispore smooth sometimes folded, ultrastructure smooth, basal layer inconspicuous, spines present, sharp and smooth or with apical constriction, baculae absent, globules absent, exospore verrucate.

Distribution: China (Xijiang, Quinghai, Szechuan, Kansu, Shansi).

Habitat: Several kinds of forest (a.o. Pinus yunnannensis-, Abies-, Betula-, Quercus pannose-, mixed-), shrub vegetation (a.o. Sagretia-), and grass land. Alt. (1000--1900--3800(---4200) m.

Notes. 1. Vern. name: Ku-qui-fen (China, Szechuan)

2. Upper pinnae clearly bent to the frond apex.

3. A few specimens were studied showing glandular sporangial paraphyses.

### 15. Drynaria mollis Bedd.

Drynaria mollis Bedd., Ferns br. Ind. (1866) T. 216; Suppl. Ferns S. Ind & Br. Ind. (1876) 23; Handb. Ferns Br. Ind. (1883) 341, Fig. 190; Diels in E&P, Nat. Pfl. Fam. 1, 4 (1902) 330; C. Chr., Ind Fil. (1906) 248; Ching & S. K. Wu in C. Y. Wu, Fl. Xizang. (1983) 346. --- Type: Dyas 6, India, Nynce Tal (holo: K).

Polypodium rivale Mett. ex Baker in Hook. & Baker, Syn. Fil. (1868) 367; C. B. Clarke, Trans. Linn. Soc. Lond. ser. 2, 1 (1880) 556; Christ, Farnkr. (1897) 121. --- Drynaria rivalis (Mett. ex Baker) Christ, Bull. Herb. Boiss. 7, 1 (1899) 6. --- Type: not traced.

Drynaria tibetica Ching & S. K. Wu in C. Y. Wu, Fl. Xizang. (1983) 342. --- Type: Chang et al. 4560, China, Xizang, Zham (holo: PE).

Drynaria costulifera Ching & S. K. Wu in C. Y. Wu, Fl. Xizang. (1983) 345. --- Type: Qinghai-Xizang Complex Exp. (Sectio Supplement.) 75-1732, China, Xizang, Cona (iso: PE).

Usually epiphytic, spirally climbing, occasionally epilithic, linearly creeping.--- Rhizome 1--2 cm Ø, spirally climbing trees or linearly creeping when epilithic, phyllopodia absent, fronds < 10 cm apart, many persistent naked rhachises present, base fronds spreading; 20--30 vascular bundles, all + equally-sized, arranged in 1 elliptical row with a dorsal protrusion, bundle sheath absent, epidermis cells isodiametric,

scale attachment protruding, sclerenchyma strands absent.--- Rhizome scales obliquely spreading, basifix, pseudo-peltate with short auricles, triangular/ovate to linear/filiform, index 6--15, 5--11 by 0.5--1.2 mm, margin toothed, teeth biseriate, 1-celled, top united, apex short filiform/narrow acuminate to acute (acuminate), distinct glandular top cell present, glandular indument absent, indument inserted marginally only, lignified cells absent.--- Fronde dimorphic with base and foliage fronds.--- Base fronds elliptical, index 1.8--2.5, 7--15 by 3--7 cm, lobate, lobes up to 2/3 or more of the width, margin regularly denticulate, apex blunt to acute. --- Venation of base fronds: Vs running more or less straight or regular zigzagging, free vein endings running excurrent or excurrent and recurrent; A1c sometimes absent, usually present, regularly shaped throughout, bordering part of basal Vs shortened, empty, A1c along costa present, large sized, conspicuous, regularly shaped, empty; A1 undivided or divided into 2 more or less equal Asec, areole layering comprising 1 or 2 A1, distinct, regularly shaped throughout the frond, Asec always empty.--- Foliage fronds 20--55 cm long, pinnatifid, stalked, petiole up to 3--10 by 0.2--0.3 cm, conspicuously or inconspicuously winged; lamina ellipsoid, index 2--3.5, 20--40(--50) by 7--12(--15) cm, pinnae equally wide throughout, clearly decreasing in size towards the apex, index 3--4.5, up to 3--8 by 1--1.5 cm, incisions up to 0.0--<0.2 cm from the costa, margin entire, apex obtuse, apical pinna present, nectaries situated in the lower angle between costa and Vp (and Vp and Vs).--- Venation of foliage fronds: Vs running irregularly, Vt branching from Vtc basically excurrent and recurrent, free vein endings largely running excurrent, partly terminated by a hydathode; A1c always present, regularly shaped throughout, bordering part of basal Vs and sometimes also of apical Vs shortened, largely empty, rarely containing 1 recurrent included vein, simple, free; A1 undivided or divided into 2 Asec, areole layering comprising 2 or 3 A1, distinct or indistinct, regularly shaped throughout the frond, Asec empty or containing simple veins; venation of fertile frond parts + similar to sterile foliage frond parts, Vt directed to the nearby sorus, A1c not soriferous.--- Sori round, 1--2 mm  $\phi$ , distributed all over the abaxial frond surface, in the basal pinnae usually in the basal part only or medially or indifferent, arranged in 1 row parallel to the Vp, 1 per A1, near or in the centre, midway on anastomosed veins or on branching points of 2--4 veins, superficial.--- Anatomy: petiole rounded, 3--6 vascular bundles, costa rounded, 1 vascular bundle, bundle sheath absent or present, brown-coloured; sterile lamina: stomata 2700--3300 / $\mu\text{m}^2$ , epidermis blue-coloured, hypodermis absent, marginal sclerenchymatous strand with <10 cells; Vp rounded, vein sheath continuous, conspicuously sclerenchymatic, cortex blue-coloured, parenchymatous, 1 vascular bundle, bundle sheath blue- or brown-coloured, xylem arrangement flattened U-shaped, sclerenchymatous strands absent, veinlet sheath extensions sclerenchymatous from epidermis to epidermis with some irregularities; receptacle with more or less isodiametric cell arrangement, 1 or 2 veinlets.--- Indument: laminar trichomes present, glandular and acicular, densely set, glandular trichomes 10--25% branched, 2(3) cells long, 90--120(--150) / $\mu\text{m}$  long, type II glandular trichomes present, acicular trichomes more or less scattered throughout, 2 or 3 cells long, (150--)240--420(--480) / $\mu\text{m}$  long; laminar scales especially against the rachis, basifix, pseudo-peltate with short auricles, triangular/ovate to linear/filiform, teeth biseriate, glandular indument absent, indument inserted marginally only, lignified cells absent, apex long filiform to apex filiform/narrow acuminate; receptacular hairy paraphyses 10--25% branched, 1 or 2 glandular cells, (2)3(4,11) cells long, 120--180(--390) / $\mu\text{m}$  long, receptacular scaly paraphyses absent; deviating sporangia absent, sporangial paraphyses absent.--- Sporangium 265--305 by 225--255 / $\mu\text{m}$  wide,

annulus with (12)13 or 14(15) indurated cells, (2)3(4) epistomium cells, (2)3(4) hypostomium cells, in total (20)21 or 22(23) cells.--- Spores of quercifolium-type, perispore verrucate, ultrastructure smooth, basal layer thin, spines present, sharp and smooth or spines with apical constriction, baculae present, exospore smooth.

Distribution: India (Uttar Pradesh, Sikkim), Nepal, Bhutan, China (Xijiang, Yunnan?).

Habitat: Several kinds of forest (a.o. oak-, tsuga-, dry mixed-). Reported on Quercus dilatata, Q. semicarpifolia. Alt. (1500--2200--3400--3950) m.

Notes. 1. Vern. name: Maoye hujue (China)

2. All pinnae straight, + perpendicular to the costa.

3. Chromosomes:  $2n = 74$  (Lbve, Lbve, & Pichi Sermolli, 1977)

4. De Haas 2082B (U): 'remarkable skeletons of bracts.'

#### 16. *Drynaria fortunei* (Kunze ex Mett.) J. Smith

*Drynaria fortunei* (Kunze ex Mett.) J. Smith in Seeman, bot. Voy. Herald [Fl. Hongkong] (1857) 425; T. Moore, Ind. Fil. (1862) 346; J. Smith, Hist. Fil. (1875) 108; Diels Bot. Jb. 29, 1 (1900) 207; in E&P, Nat. Pfl. Fam. 1, 4 (1902) 330; Christ, Bull. Soc. bot. Fr. [ser. 4, 5] 52, Mém. 1 (1905) 22; C. Chr., Ind. Fil. (1906) 247; Y. C. Wu et al., Bull. Dep. Biol. Sun Yatsen 3 (1932) 342, 364, T. 162; C. Chr. & Tardieu, Phanérogamie 8, 4 (1939) 208; Tardieu & C. Chr. in Lecomte, Fl. gén Indo-Chine 7, 2 (1941) 520; Iconogr. Cormop. Sinic. 1 (1972) 271; De Vol in H. L. Li et al., Fl. Taiwan 1 [Pterid.] (1975) 211, Pl. 74. --- Polypodium fortunei Kunze ex Mett., Farngett. 1, Polyp. (1857) 121, T. 3:42-45; Hook., Spec. Fil. 5 (1864) 95; Baker in Hook. & Baker, Syn. Fil. (1868) 367; Christ, Farnkr. (1897) 119. --- Type: Fortune A78, China borealis, Hongkong (iso: G, K).

Usually epilithic, linearly creeping, often epiphytic, spirally climbing.--- Rhizome 1--2 cm Ø, phyllopodia absent, fronds < 10 cm apart, rachises not or rarely persistent, base fronds contiguous, spreading, mainly imbricate; 15--20 vascular bundles, dorsal + 4 equally-sized, arranged in 1 elliptical row with a dorsal protrusion, bundle sheath absent, epidermis cells flattened, scale attachment more or less sunken, sclerenchyma strands absent.--- Rhizome scales obliquely spreading, peltate, triangular/ovate, linear/filiform, index 6--10, 7--12 by 0.8--1.5 mm, margin toothed, teeth biseriate, 1-celled, top united or rounded, apex short filiform/narrow acuminate to acute (acuminate), distinct glandular top cell present, glandular indument present throughout, 1- or 2-celled, indument inserted marginally only, lignified cells present around the point of attachment only.--- Fronds dimorphic with base and foliage fronds.--- Base fronds rounded, index 1.2--1.5, (3--5)--9 by (2--3)--7 cm, clearly sinusoid to lobate, lobes up to 1/3 of the width, margin entire, apex of basal lobes blunt to acute, of apical lobes acuminate.--- Venation of base fronds: Vs running more or less straight or irregularly, free vein endings running excurrent or excurrent and recurrent; A1c sometimes absent, usually present, irregularly shaped, bordering part of basal Vs shortened, largely empty, rarely containing 1 or 2 recurrent included veins, simple, free; A1c along costa present, large sized, conspicuous, somewhat irregularly shaped, with included free veins; A1 undivided, areole layering comprising 1 or 2 A1, distinct, irregularly

shaped, Asec always empty.--- Foliage fronds 25--55 cm long, pinnatifid, stalked, petiole up to 4--7(--10) by 0.2--0.4 cm, conspicuously winged; lamina ellipsoid to ovate, index 2--3, 20--45 by 10--15(--20) cm, pinnae equally wide throughout, clearly decreasing in size towards the apex, index 3--5, up to 6--10 by 1.5--3 cm, incisions up to 0.2--0.5 cm from the costa, margin serrate, incisions in between the subsequent Vs, apex obtuse, apical pinna present, nectaries situated in the lower angle between costa and Vp (and Vp and Vs).--- Venation of foliage fronds: Vs running in a regular zigzagging way, Vt branching from Vtc basically excurrent and recurrent, free vein endings running diffuse, occasionally developing loops, partly terminated by a hydathode; A1c always present, regularly shaped throughout, bordering part of basal Vs shortened, all containing 1 or 2, or more included veins, once dichotomous or more extensively branched, partly anastomosed; A1 divided into 2--4 Asec, areole layering comprising 4--5 A1, distinct, regularly shaped throughout the frond, Asec containing simple, once dichotomous or twice or more dichotomous veins; venation of fertile frond parts + similar to sterile foliage frond parts, Vt directed to the nearby sorus, A1c not soriferous.--- Sori round, elliptic, 1--2 mm  $\emptyset$ , distributed all over the abaxial frond surface, in the basal pinnae usually in the basal part only, arranged in 1 row parallel to the Vs, 1 per A1, near or in the centre, midway on anastomosed veins or on branching points of 2--4 or more veins, superficial.--- Anatomy: petiole rounded, 3 or 4 vascular bundles, costa rounded, 1--3 vascular bundles, bundle sheath absent or present, brown-coloured; sterile lamina: stomata 2700--3300 / $\mu\text{m}^2$ , epidermis blue-coloured, hypodermis absent, marginal sclerenchymous strand with 10--20 cells; Vp rounded, vein sheath continuous, conspicuously sclerenchymatic, cortex blue- or red-coloured, sclerenchymatous or firm parenchymatous, 1 vascular bundle, bundle sheath blue-, red-, or brown-coloured, xylem arrangement T- to flattened U-shaped, sclerenchymatous strands absent, receptacle veinlet sheath extensions extremely sclerenchymatous with some irregularities; receptacle with more or less isodiametric cell arrangement, 1 or 2 veinlets.--- Indument: laminar trichomes present, glandular and acicular, not densely set, glandular trichomes >50% branched, 2 cells long, 130--150 / $\mu\text{m}$  long, type II glandular trichomes absent, acicular trichomes more or less scattered throughout, 1 or 2 cells long, 60--150(--210) / $\mu\text{m}$  long; laminar scales especially against the rhachis, basifix, triangular/ovate to linear/filiform, teeth biseriate, glandular indument absent, indument inserted marginally only, lignified cells sometimes present forming a midrib, apex long filiform to filiform/narrow acuminate; receptacular hairy paraphyses >50% branched, 1 or 2 glandular cells, 2--3 cells long, 70--140 / $\mu\text{m}$  long, receptacular scaly paraphyses absent; deviating sporangia absent, sporangial paraphyses absent.--- Sporangium 305--330 by 255--285 / $\mu\text{m}$ , annulus with (12--14(--16)) indurated cells, 3 or 4 epistomium cells, 3(4) hypostomium cells, in total (21)22 or 23(24) cells.--- Spores of quercifolium-type, perispore verrucate, ultrastructure smooth, basal layer thin, spines absent, baculae absent, globules absent, exospore with globular excrescences.

Distribution: China (Szechuan, Yunnan, Hupeh, Guizhou, Hunan, Guangsi, Guangdong, Kiangsi, Chekiang, Fukien, Hainan), Taiwan, Laos, Vietnam.

Habitat: Several kinds of forest (a.o. gallery-, dry-, swamp-). Often growing in shade, on lime stones and city walls, 0--13 m above the ground. Reported on Ficus spec., Ilex spec., Pterocarya spec. Alt. 50--1300 m.

- Notes. 1. Vern. name: Zhonghua hujue (China)  
Hou sen chan (= monkey's gingler; Chekiang, China)  
Kwat sui po (Guandong, China)  
Ha ji (Chekiang, China)
2. To Kang Peng (& Groff) 139 (C.C.C. Herb. 2899; US, NY): 'Used for medicine called Kwat sui po.'
3. Anonymous s.n. (P): 'Rhizome can be used as medicine, tonic against pain in "pidney" and by broken bones, antibiotic.'





## APPENDICES

**APPENDIX 1. CHARACTERS STUDIED AND STATES RECOGNIZED**

**Foliage fronds:**

**Shape and venation pattern:**

**Secondary vein (Vs)**

1. running more or less straight
2. running irregularly zigzagging, or more or less straight
3. running in a regular zigzagging way only
4. running in a zigzagging way
5. running irregular

**Tertiary vein (Vt)**

6. Vt branching from Vtc predominantly excurrent
7. Vt branching from Vtc predominantly recurrent
8. Vt branching from Vtc predominantly excurrent and recurrent

**Free veinlets**

9. predominantly running excurrent
10. running diffusely
11. predominantly running excurrent and recurrent
12. occasionally developing "loops" in primary order areoles

**Hydathodes**

13. all free veins terminated by a hydathode
14. part of the free veins terminated by a hydathode
15. free veins never terminated by a hydathode

**Costal areole (A1c)**

16. present in all frond parts
17. absent in at least part of the fronds or frondparts

**Shape of A1c**

18. regular throughout the frond- (part)
19. regular only
20. irregular

**Branching points of Vtc and Vs**

21. both branching points clearly distant from the Vp
22. 21 only
23. bordering part of basal Vs shortened
24. 23 only
25. bordering part of apical Vs shortened

**Included venation of A1c**

26. empty
27. containing 1 recurrent included vein
28. containing 2 or more included veins
29. 28 only
30. 28 especially not

**Relative amount of A1c containing included venation**

50. all or largely containing included venation
51. largely empty, rarely containing (one) included veinlet

**Branching of included veins in A1c**

31. simple
32. once dichotomous
33. more extensively branched

**Complexity of included veins in A1c**

34. free
35. (at least partly) anastomosed

**First order areoles (A1)**

36. undivided
37. divided into 2, more or less equal Asec
38. divided into 3 or 4 Asec
39. divided into more than 4 Asec

**Number of A1 in layering**

40. 1 or 2 A1 present between adjacent Vs
41. 3 or more A1 present between adjacent Vs
42. 2
43. 3
44. 4
45. 5
46. 6
47. 7
48. 8
49. 9

**Bordering venation of A1**

52. distinct (prominent)
53. indistinct (immersed or irregular)

Shape of A1

- 54. regularly shaped throughout the frond
- 55. irregularly shaped

Second order areoles (Asec)

- 56. largely empty
- 57. largely containing simple veins
- 58. largely containing once dichotomous veins
- 59. largely containing twice or more dichotomous veins

Venation of fertile frond(part)s compared to sterile frond(part)s

- 60. similar to sterile foliage fronds or frondparts
- 61. Vs & Vt strongly reduced
- 62. Vs & Vt diplodesmic
- 63. free ending veins shortened or absent (at least partly)
- 64. Vt directed to the nearby sorus

A1c

- 65. soriferous (at least in part of the frond)
- 66. not soriferous

Distribution of sori relative to the frond surface

- 67. over the entire abaxial frond surface
- 68. restricted to the upper 2/3 or less of the frond.

Differentiation of distribution of sori relative to the pinna surface, from the basal towards the apical fertile pinnae

- 69. from costa towards the apex
- 70. from apex towards the costa
- 71. indifferent or from the middle towards both the costa and the apex

Distribution of sori relative to the veins

- 72. terminal on free veins
- 73. subterminal on free veins
- 74. midway on anastomosed veins
- 75. on branching points of 2--4 veins
- 76. on branching points of more than 4 veins

Main distribution pattern of sori

- 77. in 1 row parallel to the Vp
- 78. in 1 row parallel to the Vs
- 79. in 2 rows parallel to the Vs
- 80. in rows parallel to each Vtc (one on each side)

Distribution of sori relative to the A1

- 81. seemingly scattered over the entire surface of primary order areoles
- 82. near the Vs-margins of primary order areoles
- 83. near the Vtc-margins of primary order areoles
- 84. near or in the centre of primary order areoles

Number of sori relative to the areoles

- 85. 1 sorus per A1
- 86. 2 sori per A1
- 87. >2 sori per A1

Relation sori-lamina

- 88. sori superficial
- 89. sori slightly pustulate
- 90. sori pustulate (impressed)

Shape of Lamina

- 91. pandurate
- 92. triangular
- 93. quadrangular
- 94. ellipsoid
- 95. ovate

Lobation

- 96. pinnatifid
- 97. once pinnate

Frond base/stalk

- 98. frond base dilated
- 99. stalk conspicuously winged
- 100. stalk inconspicuously winged
- 101. stalk unwinged
- 102. wing lobed
- 103. nectaries quadrangular

Pinna shape

- 104. pinna equally wide throughout
- 105. pinna with a clear constriction in the basal part

Appendix 1 cont.

- Contraction of fertile pinnae  
 106. fertile pinnae clearly contracted  
 107. fertile pinnae not or only slightly contracted

- Relative size of pinnae  
 108. pinnae clearly decreasing in size and width towards apex  
 109. pinnae ± equally sized and wide all over  
 110. pinnae always equally sized

- Pinna apex  
 111. pinnae apex acute  
 112. pinnae apex acuminate  
 113. pinnae apex obtuse

- Apical pinna  
 114. apical pinna aborted  
 115. apical pinna present and "straight"

- Dimorphism  
 116. fronds monomorphic, all fronds basically similar  
 117. fronds dimorphic, base and foliage fronds  
 118. foliage fronds internally dimorphic, fertile frond parts somewhat contracted  
 119. foliage fronds internally dimorphic, fertile frond parts clearly contracted  
 120. foliage fronds dimorphic, fertile fronds clearly contracted

- Shape of contracted fertile pinnae  
 121. string-of-beads like  
 122. linear, margin entire  
 123. linear, with sinusses near Vs

- Position of nectaries  
 124. (predominantly) situated in the upper angle between costa and Vp (or Vp and Vs)  
 125. (predominantly) situated in the lower angle between costa and Vp (or Vp and Vs)

- Margin of pinna  
 126. serrate, incisions near subsequent Vs  
 127. serrate, incisions in between Vs  
 128. entire

- Marginal strand  
 129. conspicuous  
 130. inconspicuous or absent

- Relative size of the stomata (grid measurements)  
 131. <25 = <1500 /um<sup>2</sup>  
 132. 25--35 = 1500--2100 /um<sup>2</sup>  
 133. 35--45 = 2100--2700 /um<sup>2</sup>  
 134. 45--55 = 2700--3300 /um<sup>2</sup>  
 135. >55 = > 3300 /um<sup>2</sup>

- Incisions in between the lobes  
 136. >0.5 cm, increasing towards the base  
 137. >0.2 cm, rapidly increasing  
 138. 0.2--0.5 overall  
 139. =<0.2 cm  
 140. + 0  
 141. incisions of fertile frond (part) similar to those of sterile frond(part)  
 142. incisions sterile part =<1 mm; fertile part less so

- Sori shape  
 143. round  
 144. elliptic  
 145. linear  
 146. in patches  
 147. irregular

- Soral patches  
 148. round  
 149. elliptic  
 150. quadrangular

- Size of sori or soral patches  
 151. =< 1 mm  
 152. 1--2 mm  
 153. 2--3 mm  
 154. 3--4 mm  
 155. >= 4 mm

- Sporangium (values refer to >10 % of the counted sporangia):  
 Number of indurated annulus cells  
 156. 11  
 157. 12  
 158. 13  
 159. 14  
 160. >=15

Appendix 1 cont.

- Number of epistomium cells  
 161. 2  
 162. 3  
 163. 4  
 164. 5
- Number of hypostomium cells  
 165. 2  
 166. 3  
 167. 4  
 168. 5
- Total number of annulus cells  
 169. =<19  
 170. 20  
 171. 21  
 172. 22  
 173. 23  
 174. 24  
 175. 25  
 176. 26
- Length of capsule  
 177. =<215 /um  
 178. 215--240 /um  
 179. 240--265 /um  
 180. 265--290 /um  
 181. 290--315 /um  
 182. 315--340 /um  
 183. >=340 /um
- Width of capsule  
 184. =<180 /um  
 185. 180--200 /um  
 186. 200--220 /um  
 187. 220--240 /um  
 188. 240--260 /um  
 189. >=260 /um
- Spore  
 Perispore  
 190. smooth, sometimes folded  
 191. verrucate
- Ultrastructure  
 192. smooth  
 193. verruculate
- Basal layer  
 194. inconspicuous  
 195. thin  
 196. thick
- Spines  
 197. present  
 198. absent
- Shape of spines  
 199. sharp  
 200. with apical constriction
- Baculae  
 201. present  
 202. absent
- Globules  
 203. present  
 204. absent
- Exospore  
 205. smooth  
 206. with globular excrescences  
 207. verrucate
- Spore type  
 208. meyeniana-type  
 209. pleuridioides-type  
 210. quercifolia-type
- Base fronds:  
 Shape and venation pattern: Vs  
 211. running more or less straight  
 212. running in a regular zigzagging way  
 213. running irregularly
- Vt  
 214. Vt branching from Vtc basically excurrent  
 215. Vt branching from Vtc basically recurrent  
 216. Vt branching from Vtc basically excurrent and recurrent
- Free veins  
 217. free vein endings largely running excurrent  
 218. free vein endings largely running excurrent and recurrent  
 219. free vein endings running diffuse
- A1c  
 220. present in all frond parts  
 221. absent in at least part of the fronds or frondparts
- Shape of A1c  
 222. regularly shaped throughout the frond(part)  
 223. irregularly shaped

Appendix 1 cont.

- Branching points of Vtc and Vs  
 224. both branching points clearly distant from the Vp  
 225. bordering part of basal Vs shortened  
 226. bordering part of apical Vs shortened

Included venation of A1c

227. empty  
 228. 1 recurrent included vein  
 229. 2 or more included veins

Relative amount of A1c containing included venation

230. all or largely containing included venation  
 231. largely empty, rarely containing included venation

Branching of included venation of A1c

232. simple  
 233. once dichotomous  
 234. more extensively branched

Complexity of included veins of A1c

235. free  
 236. (at least partly) anastomosed

Subdivision of A1

237. undivided  
 238. divided into 2, more or less equal Asec  
 239. divided into 3 or 4 Asec

A1c along costa

240. large-sized, trapezium-shaped, regular, empty  
 241. large-sized, trapezium-shaped  
 242. + present, inconspicuous and irregular  
 243. large-sized, + trapezium-shaped, somewhat irregular, included free veins present  
 244. absent

Number of A1 in layering

245. 1 or 2 A1 present between adjacent Vs  
 246. 3 or more A1 present between adjacent Vs

Bordering venation of A1

247. distinct (prominent)  
 248. indistinct (immersed or irregular)

Shape of A1

249. regular throughout the frond  
 250. irregular

Asec

251. always empty  
 252. largely empty  
 253. largely containing simple veins  
 254. largely containing once dichotomous veins

Lobation

255. lobate, lobes up to 2/3 or more of the width  
 256. lobate, lobes up to 1/2 of the width  
 257. lobate, lobes up to 1/3 of the width  
 258. (clearly) sinusoid  
 259. (almost) entire

Margin

260. entire  
 261. regularly denticulate  
 262. irregularly denticulate

Lobe apex

263. acuminate  
 264. acute  
 265. blunt

Frond shape

266. rounded  
 267. ovate  
 268. elliptical  
 269. elongated

Index

270.  $\geq 1.5$   
 271.  $\leq 1.5$

Indument:

Laminar glandular trichomes (l.g.t.)

272. present  
 273. absent

Branching of l.g.t.

274. >90% unbranched  
 275. 10--25% branched  
 276. 25--55% branched  
 277. >50% branched  
 278. >5% branched

Appendix 1 cont.

|   |   |
|---|---|
| Branching of receptacular hairy paraphyses (r.h.p.)         | Differences in length between l.g.t. vs. r.h.p. |
| 279. >90% unbranched  | 315. + equally long                             |
| 280. 10--25% branched                                       | 316. r.h.p. somewhat shorter                    |
| 281. 25--50% branched                                       | 317. r.h.p. much longer                         |
| 282. >50% branched  |   |
| 283. >5% branched   | Laminar acicular trichomes                      |
|   | 318. absent                                     |
| Number of glandular cells per r.h.p.                        | 319. present                                    |
| 284. 1,2  |   |
| 285. 3,4  | Position of l.a.t.                              |
| Length in cells of l.g.t.                                   | 320. in tuft apically on abscission "vein" only |
| 286. 2 cells long >90%                                      | 321. more or less scattered throughout          |
| 287. 3 cells long >10%                                      |   |
| 288. 4 cells long >10%                                      | Density of l.a.t.                               |
|   | 322. tomentose                                  |
| 299. 2 cells long >25%                                      | 323. inconspicuously set or absent              |
| 300. 3 cells long >25%                                      |   |
| Number of cells per l.g.t.                                  | Length in cells of l.a.t.                       |
| 289. 2-celled >90%  | 324. 1,2 cells long                             |
| 290. 3-celled >10%  | 325. 3 cells long                               |
| 291. more celled present                                    | 326. 4 cells long                               |
|   | 327. >= 5 cells long                            |
| 301. 2 celled >25%  | Type II laminar glandular trichomes             |
| 302. 3 celled >25%  | 328. present                                    |
| 303. 4 celled >25%  | 329. absent                                     |
| Length in cells of r.h.p.                                   | Deviating sporangia                             |
| 292. 2 cells long >90%                                      | 330. present                                    |
| 293. 3 cells long >10%                                      | 331. absent                                     |
| 294. 4 cells long >10%                                      |   |
| 295. 5 cells long >10%                                      | Glandular sporangial paraphyses                 |
| 296. >= 5 cells long present                                | 332. present                                    |
|   | 333. absent                                     |
| 304. 2 cells long >25%                                      | Acicular sporangial paraphyses                  |
| 305. 3 cells long >25%                                      | 334. present                                    |
| 306. 4 cells long >25%                                      | 335. absent                                     |
| 307. >= 5 cells long >25%                                   |   |
| Number of cells per r.h.p.                                  | Position of acicular sporangial paraphyses      |
| 297. 4 or more celled >25%                                  | 336. one-sided                                  |
| 298. 3 or less celled >75%                                  | 337. two-sided                                  |
|   | Receptacular scaly paraphyses                   |
| 308. 2 celled >25%  | 338. present                                    |
| 309. 3 celled >25%  | 339. absent                                     |
| 310. 4 celled >25%  |   |
| 311. >= 5 celled >25%                                       |   |
| Differences between l.g.t. vs. r.h.p. as to length in cells |   |
| 312. equally long   |   |
| 313. r.h.p. 1 cell longer                                   |   |
| 314. r.h.p. 2 cells longer                                  |   |

Appendix 1 cont.



Complexity of receptacular scales  
paraphyses

- 340. comprising all intermediates  
between hairs and scales
- 341. simple and complex
- 342. complex only
- 343. complex

Fronde scales:

Position

- 344. on lamina
- 345. scattered around rhachis/costa
- 346. especially against the rhachis/  
costa

Attachment

- 347. basifix
- 348. pseudo-peltate, short  
auriculate
- 349. pseudo-peltate, long auriculate
- 350. peltate

Shape

- 351. round
- 352. triangular/ovate
- 353. linear/filiform

Marginal protuberances

- 354. short
- 355. long

Marginal protrusions

- 356. uniseriate
- 357. biseriate

Marginal glandular trichomes

- 358. present
- 359. absent

Position of marginal glandular  
trichomes

- 360. near the base only
- 361. overall

Length in cells of marginal  
glandular trichomes

- 362. 1-celled
- 363. 2-celled
- 364. more celled

Insertion of marginal indument

- 365. marginally only
- 366. marginally and abaxially

Lignified cell walls

- 367. inconspicuous
- 368. conspicuous around the point of  
attachment only
- 369. conspicuous, forming a midrib

Apex

- 370. long filiform
- 371. filiform/narrow acuminate
- 372. acute (acuminate)
- 373. rounded

Rhizome:

Size (Ø)

- 374. <1 cm
- 375. 1--2 cm
- 376. 2--3 cm
- 377. >3 cm

Number of vascular bundles in main  
arrangement

- 378. 10--15
- 379. 15--20
- 380. 20--30
- 381. 30--40
- 382. >40

383. many auxilliary vascular  
bundles, throughout or mainly  
dorsally

384. many auxilliary vascular  
bundles ventrally only

Stele

- 385. 1 elliptical row of vascular  
bundles
- 386. p.p. 2 elliptical rows of  
vascular bundles
- 387. complex, 1 row of vascular  
bundles, with conspicuous  
dorsal invaginations
- 388. complex, p.p. 2 rows of  
vascular bundles, with  
invaginations and usually an  
enclosed circle
- 389. vascular bundles almost ad  
random distributed, very  
complex, elliptical with well-  
developed protrusion

Bundle sheath

- 390. absent
- 391. ill-developed
- 392. well-developed

Appendix 1 cont.

Colour of bundle sheath

- 393. blue
- 394. red
- 395. brown

Shape of epidermis cells

- 396. flattened
- 397. isodiametric
- 398. erect

Number of epidermis cells per adjacent cortex cell

- 399. 1--1.3
- 400. 1.4--1.6
- 401. 1.7--2.0
- 402. >2.0

Insertion of scales

- 403. sunken in invaginations (scale base adpressed)
- 404. on pustulate protrusions

Scale colour

- 405. brown
- 406. blue

Sclerenchyma strands

- 407. present in roots
- 408. present in cortex
- 409. absent

Cuticle

- 410. absent or nearly so
- 411. present, inconspicuous
- 412. present, conspicuous
- 413. red-coloured

Relative size of vascular bundles

- 414. all + equally sized
- 415. dorsal + 4 large(r) sized

Growth habit

- 416. encircling the bole many times or forming crusts when terrestrial
- 417. spirally climbing or linearly creeping
- 418. forming ring shaped basket around bole
- 419. spirally or vertically climbing, loosely attached, or linearly creeping
- 420. spirally climbing, frond base forming individual basket, firmly attached

Insertion of fronds

- 421. <10 cm apart
- 422. >> 20 cm apart

Persistent, naked rachises

- 423. present, many
- 424. not or rarely present

Phyllopodia

- 425. present, conspicuous
- 426. absent

Position of base fronds

- 427. contiguous
- 428. spreading
- 429. mainly imbricate

Position of dilated bases

- 430. imbricate
- 431. separate

Anatomy of lamina and petiole:

Hypodermis sterile foliage fronds:

- adaxially
- 432. absent
- 433. present

abaxially

- 434. absent
- 435. present

Colour of epidermis cells

- 436. blue
- 437. red

Hypodermis in sterile vs. fertile pinnae

- 438. similar
- 439. absent vs. present adaxially
- 440. present vs. absent abaxially
- 442. present vs. absent ad- and ab-axially
- 441. epidermis red vs. blue

Marginal sclerenchymatous strand

- 443. ill-developed (<10 cells)
- 444. moderately developed (10--20 cells)
- 445. well-developed (>25 cells)

Marginal strand in fertile vs. sterile pinnae

- 446. equally developed
- 447. (almost) lacking vs. conspicuous
- 448. less developed

Appendix 1 cont.

- Vp  $\emptyset$   
449. rounded  
450. angular
- Vein sheath  
451. interrupted  
452. continuous
- Development of vein sheath  
453. conspicuous, clearly sclerenchymatous  
454. inconspicuous, slightly sclerenchymatous
- Cortex  
455. blue, parenchymatous  
456. red, sclerenchymatous or firm parenchymatous
- Bundle sheath  
457. (at least p.p.) red-coloured, open sclerenchyma cells  
458. blue  
459. blue and/or brown  
460. red  
461. brown
- Vascular bundle(s) Vp  
462. 1  
463. 2,3
- Arrangement of xylem in Vp  
464. T-shaped  
465. V-shaped  
466. flattened U-shaped
- Sclerenchymatous strands  
467. present  
468. absent
- Differences in Vp of fertile vs. sterile pinnae  
469. +similar  
470.  $\emptyset$  rounded vs. angular  
471. bundle sheath blue p.p. vs. red  
472. xylem T- vs. V-shaped  
473. vein sheath ill- vs. well-developed  
474. bundle sheath thin vs. thick  
475. vein sheath interrupted vs. continuous
- Sclerenchymatous sheath of higher order veins  
476. red, well-developed from epidermis to epidermis  
477. red, with some irregularities  
478. orange, extremely developed
- Cell arrangement in receptacle  
479. rectangular  
480. + isodiametric
- Number of supporting veins per sorus  
481. 1,2  
482. 3,4  
483. 5,6
- Sclerenchymatous vein sheathes of supporting veins  
484. present, conspicuous  
485. present, inconspicuous  
486. + absent
- Petiole/costa  $\emptyset$   
487. rounded  
488. elliptical  
489. invaginated
- Number of vascular bundles in petiole/rhachis  
490. 3,4  
491. 5,6  
492. 7,8  
493. 9,10  
494. >11
- Rhachis/costa  $\emptyset$   
495. rounded  
496. angular  
497. invaginated
- Number of vascular bundles in rhachis/costa  
498. 1  
499. 2  
500. 3  
501. 4  
502. 5  
503. >6
- Bundle sheath of vascular bundles in rhachis/petiole  
504. present, blue  
505. present, blue and/or brown  
506. present, red  
507. absent  
508. present, brown

Appendix 1 cont.

Rhizome scales:

Attachment

- 509. basifixed, truncate or short auriculate
- 510. pseudo-peltate, short auriculate
- 511. pseudo-peltate, long auriculate
- 512. peltate

Shape

- 513. rounded
- 514. triangular/ovate
- 515. linear/filiform
- 516. spatulate
- 517. cone-shaped

Length

- 518. <7 mm
- 519. 7--14 mm
- 520. 14-->22 mm

Index

- 521. <4
- 522. 4--6
- 523. 6--10
- 524. 10-->25

Distinct apical glandular trichome

- 525. present
- 526. absent

Margin

- 527. "clathrate"
- 528. toothed
- 529. with short protuberances
- 530. with elongated protuberances

Marginal protrusions

- 531. uniseriate
- 532. biseriate

Apex of marginal protrusions

- 533. with united apex or rounded top
- 534. with T-shaped apex

Length in cells of marginal protrusions

- 539. 1-cell
- 540. more cells

Glandular indument

- 535. absent
- 536. present

Position of glandular indument

- 537. near the base
- 538. overall

Length in cells of glandular indument

- 544. 1-cell
- 545. 2-cells
- 546. more cells

Exposition

- 541. adpressed
- 542. spreading
- 543. perpendicular

Insertion of marginal indument

- 547. marginally only
- 548. marginally and abaxially

Lignified cell walls

- 549. inconspicuous
- 550. conspicuous around the point of attachment
- 551. conspicuous, forming a midrib

Dimorphy in scales

- 552. only one type of scale present
- 553. two types of scales present

Apex

- 554. long filiform
- 555. short filiform/narrow acuminate
- 556. acute (acuminate)
- 557. rounded

Appendix 1 cont.

APPENDIX 2. DATAMATRIX

horizontally from right to left: terminal clada 1--31  
 vertically: character states 1--557 arranged in complementary sets

|    | p | h | p | l | s | d | m | h | c | c | n | n | s | b | l | f | m | s | d | p | p | r | p | w | v | l | d | i | b | q | s |   |   |   |   |   |   |   |   |   |
|----|---|---|---|---|---|---|---|---|---|---|---|---|---|---|---|---|---|---|---|---|---|---|---|---|---|---|---|---|---|---|---|---|---|---|---|---|---|---|---|---|
| 1  | 0 | 0 | 0 | 0 | 0 | 1 | 1 | 1 | 1 | 1 | 1 | 1 | 1 | 1 | 1 | 0 | 0 | 0 | 1 | 1 | 1 | 1 | 0 | 1 | 1 | 1 | 1 | 1 | 1 | 1 | 1 | 1 |   |   |   |   |   |   |   |   |
| 2  | 0 | 0 | 0 | 0 | 0 | 1 | 1 | 1 | 1 | 1 | 1 | 1 | 1 | 1 | 1 | 1 | 1 | 1 | 1 | 1 | 1 | 1 | 1 | 1 | 1 | 1 | 1 | 1 | 1 | 1 | 1 | 1 |   |   |   |   |   |   |   |   |
| 3  | 1 | 1 | 1 | 1 | 1 | 0 | 0 | 0 | 0 | 0 | 0 | 0 | 0 | 0 | 0 | 0 | 0 | 0 | 0 | 0 | 0 | 0 | 0 | 0 | 0 | 0 | 0 | 0 | 0 | 0 | 0 | 0 |   |   |   |   |   |   |   |   |
| 4  | 1 | 1 | 1 | 1 | 1 | 1 | 0 | 1 | 0 | 1 | 1 | 0 | 0 | 1 | 1 | 0 | 0 | 0 | 0 | 0 | 0 | 0 | 0 | 1 | 0 | 0 | 0 | 0 | 0 | 0 | 0 | 0 | 0 |   |   |   |   |   |   |   |
| 5  | 0 | 0 | 0 | 0 | 0 | 0 | 0 | 0 | 0 | 0 | 0 | 0 | 0 | 0 | 0 | 1 | 1 | 1 | 1 | 1 | 1 | 1 | 0 | 1 | 1 | 0 | 1 | 0 | 1 | 0 | 1 | 0 | 0 |   |   |   |   |   |   |   |
| 6  | 0 | 0 | 0 | 0 | 0 | 0 | 0 | 0 | 0 | 0 | 0 | 0 | 0 | 0 | 0 | 0 | 0 | 0 | 0 | 0 | 0 | 0 | 1 | 0 | 1 | 1 | 0 | 0 | 0 | 0 | 0 | 0 | 0 | 0 |   |   |   |   |   |   |
| 7  | 1 | 1 | 1 | 1 | 1 | 1 | 0 | 1 | 0 | 1 | 1 | 0 | 0 | 1 | 0 | 0 | 0 | 0 | 0 | 0 | 0 | 0 | 1 | 1 | 1 | 1 | 1 | 1 | 1 | 1 | 1 | 1 | 1 | 1 |   |   |   |   |   |   |
| 8  | 0 | 0 | 0 | 0 | 0 | 0 | 0 | 1 | 0 | 1 | 0 | 0 | 1 | 1 | 0 | 1 | 1 | 1 | 1 | 0 | 1 | 1 | 0 | 0 | 0 | 0 | 0 | 0 | 0 | 0 | 0 | 0 | 0 | 0 | 0 |   |   |   |   |   |
| 9  | 0 | 0 | 0 | 0 | 0 | 0 | 0 | 0 | 0 | 0 | 0 | 0 | 0 | 0 | 0 | 0 | 0 | 0 | 0 | 0 | 0 | 0 | 1 | 0 | 0 | 0 | 0 | 0 | 0 | 0 | 0 | 0 | 0 | 0 | 0 |   |   |   |   |   |
| 10 | 0 | 0 | 0 | 0 | 0 | 1 | 1 | 1 | 1 | 1 | 1 | 1 | 1 | 1 | 1 | 0 | 1 | 1 | 1 | 1 | 1 | 1 | 1 | 1 | 1 | 1 | 1 | 1 | 1 | 1 | 1 | 1 | 1 | 1 | 1 |   |   |   |   |   |
| 11 | 1 | 1 | 1 | 1 | 1 | 1 | 0 | 0 | 1 | 1 | 1 | 1 | 1 | 1 | 0 | 0 | 0 | 0 | 0 | 0 | 0 | 0 | 0 | 0 | 0 | 0 | 0 | 0 | 0 | 0 | 0 | 0 | 0 | 0 | 0 | 0 |   |   |   |   |
| 12 | 0 | 0 | 0 | 0 | 0 | 0 | 0 | 0 | 0 | 0 | 0 | 0 | 0 | 0 | 0 | 1 | 0 | 0 | 0 | 0 | 0 | 0 | 0 | 0 | 0 | 0 | 0 | 0 | 0 | 0 | 0 | 0 | 0 | 0 | 0 | 0 |   |   |   |   |
| 13 | 1 | 1 | 1 | 1 | 1 | 1 | 1 | 1 | 1 | 1 | 1 | 1 | 1 | 1 | 1 | 0 | 0 | 0 | 0 | 0 | 0 | 0 | 1 | 0 | 0 | 0 | 0 | 0 | 0 | 0 | 0 | 0 | 0 | 0 | 0 | 0 |   |   |   |   |
| 14 | 0 | 0 | 0 | 0 | 0 | 0 | 0 | 0 | 0 | 0 | 0 | 0 | 0 | 0 | 0 | 1 | 1 | 0 | 0 | 1 | 1 | 0 | 0 | 0 | 1 | 0 | 0 | 0 | 0 | 0 | 0 | 0 | 0 | 0 | 0 | 0 |   |   |   |   |
| 15 | 0 | 0 | 0 | 0 | 0 | 0 | 0 | 0 | 0 | 0 | 0 | 0 | 0 | 0 | 0 | 0 | 0 | 0 | 0 | 0 | 0 | 0 | 1 | 1 | 0 | 0 | 1 | 0 | 1 | 0 | 1 | 1 | 1 | 1 | 1 | 1 |   |   |   |   |
| 16 | 1 | 1 | 1 | 1 | 1 | 0 | 1 | 0 | 1 | 1 | 1 | 0 | 1 | 0 | 1 | 1 | 1 | 1 | 1 | 1 | 1 | 1 | 1 | 1 | 1 | 1 | 1 | 1 | 1 | 1 | 1 | 1 | 1 | 1 | 1 | 0 | 1 |   |   |   |
| 17 | 0 | 0 | 0 | 0 | 0 | 1 | 0 | 1 | 0 | 0 | 0 | 0 | 1 | 0 | 1 | 0 | 0 | 0 | 0 | 0 | 0 | 0 | 0 | 0 | 0 | 0 | 0 | 0 | 0 | 0 | 0 | 0 | 0 | 0 | 0 | 0 | 1 | 0 |   |   |
| 18 | 1 | 1 | 1 | 1 | 1 | 0 | 1 | 0 | 1 | 0 | 1 | 1 | 0 | 0 | 0 | 1 | 1 | 1 | 1 | 1 | 1 | 1 | 1 | 1 | 1 | 0 | 0 | 0 | 0 | 0 | 0 | 0 | 0 | 0 | 0 | 0 | 0 | 0 |   |   |
| 19 | 0 | 0 | 0 | 0 | 0 | 0 | 0 | 0 | 0 | 0 | 0 | 0 | 0 | 0 | 0 | 1 | 1 | 1 | 1 | 1 | 1 | 1 | 1 | 1 | 0 | 0 | 0 | 0 | 0 | 0 | 0 | 0 | 0 | 0 | 0 | 0 | 0 | 0 |   |   |
| 20 | 1 | 1 | 1 | 1 | 1 | 1 | 1 | 1 | 1 | 1 | 1 | 1 | 1 | 1 | 1 | 0 | 0 | 0 | 0 | 0 | 0 | 0 | 0 | 0 | 0 | 0 | 0 | 0 | 0 | 0 | 0 | 0 | 0 | 0 | 0 | 0 | 0 | 0 |   |   |
| 21 | 0 | 1 | 1 | 0 | 1 | 0 | 0 | 0 | 0 | 0 | 0 | 0 | 0 | 0 | 1 | 0 | 0 | 0 | 0 | 0 | 0 | 0 | 1 | 1 | 1 | 0 | 1 | 0 | 1 | 1 | 1 | 1 | 1 | 1 | 1 | 1 | 1 |   |   |   |
| 22 | 0 | 0 | 0 | 0 | 0 | 0 | 0 | 0 | 0 | 0 | 0 | 0 | 0 | 0 | 0 | 0 | 0 | 0 | 0 | 0 | 0 | 0 | 0 | 0 | 0 | 0 | 0 | 0 | 0 | 0 | 0 | 0 | 0 | 0 | 0 | 0 | 0 | 0 |   |   |
| 23 | 1 | 0 | 1 | 1 | 1 | 1 | 1 | 1 | 1 | 1 | 1 | 1 | 1 | 1 | 1 | 1 | 1 | 1 | 1 | 1 | 1 | 1 | 0 | 1 | 0 | 1 | 1 | 1 | 1 | 0 | 1 | 1 | 1 | 1 | 1 | 1 | 1 | 1 |   |   |
| 24 | 1 | 0 | 0 | 1 | 0 | 0 | 1 | 0 | 1 | 0 | 1 | 1 | 0 | 0 | 0 | 1 | 0 | 0 | 0 | 1 | 0 | 0 | 0 | 0 | 0 | 0 | 0 | 0 | 0 | 0 | 0 | 0 | 0 | 0 | 0 | 0 | 0 | 0 | 0 |   |
| 25 | 0 | 1 | 1 | 0 | 1 | 1 | 0 | 1 | 0 | 1 | 0 | 0 | 1 | 0 | 1 | 0 | 1 | 1 | 0 | 0 | 0 | 0 | 0 | 0 | 0 | 0 | 0 | 0 | 0 | 0 | 0 | 0 | 0 | 0 | 0 | 0 | 0 | 0 | 0 |   |
| 26 | 0 | 0 | 0 | 0 | 0 | 0 | 0 | 1 | 0 | 0 | 0 | 0 | 0 | 0 | 0 | 1 | 1 | 1 | 1 | 1 | 1 | 1 | 0 | 0 | 0 | 0 | 0 | 0 | 0 | 0 | 0 | 0 | 0 | 0 | 0 | 0 | 0 | 0 | 0 |   |
| 27 | 0 | 1 | 1 | 0 | 1 | 0 | 0 | 1 | 1 | 1 | 1 | 1 | 1 | 0 | 1 | 1 | 1 | 1 | 1 | 1 | 0 | 1 | 1 | 1 | 0 | 1 | 0 | 1 | 0 | 1 | 1 | 1 | 1 | 1 | 1 | 0 | 0 | 0 |   |   |
| 28 | 1 | 1 | 1 | 1 | 1 | 1 | 1 | 1 | 1 | 1 | 1 | 1 | 1 | 1 | 1 | 0 | 0 | 0 | 0 | 0 | 0 | 0 | 0 | 0 | 0 | 0 | 0 | 0 | 0 | 0 | 0 | 0 | 0 | 0 | 0 | 0 | 0 | 0 | 0 |   |
| 29 | 1 | 0 | 0 | 1 | 0 | 1 | 1 | 0 | 0 | 0 | 0 | 0 | 0 | 0 | 0 | 0 | 0 | 0 | 0 | 0 | 0 | 0 | 0 | 0 | 0 | 0 | 0 | 0 | 0 | 0 | 0 | 0 | 0 | 0 | 0 | 0 | 0 | 0 | 0 |   |
| 30 | 0 | 0 | 0 | 0 | 0 | 0 | 0 | 0 | 0 | 0 | 0 | 0 | 0 | 0 | 0 | 0 | 0 | 0 | 0 | 0 | 0 | 0 | 0 | 0 | 0 | 0 | 0 | 0 | 0 | 0 | 0 | 0 | 0 | 0 | 0 | 0 | 0 | 0 | 0 |   |
| 31 | 1 | 1 | 1 | 1 | 1 | 1 | 1 | 1 | 1 | 1 | 1 | 1 | 1 | 1 | 1 | 0 | 1 | 1 | 1 | 0 | 1 | 1 | 1 | 0 | 1 | 1 | 1 | 1 | 1 | 1 | 1 | 1 | 1 | 1 | 1 | 1 | 1 | 1 | 1 |   |
| 32 | 1 | 1 | 1 | 1 | 1 | 1 | 1 | 1 | 1 | 1 | 1 | 1 | 1 | 1 | 1 | 1 | 0 | 1 | 1 | 0 | 0 | 0 | 1 | 1 | 1 | 1 | 1 | 1 | 1 | 0 | 1 | 1 | 1 | 1 | 1 | 1 | 1 | 1 | 1 |   |
| 33 | 0 | 1 | 1 | 1 | 1 | 0 | 1 | 0 | 0 | 0 | 1 | 0 | 0 | 0 | 0 | 1 | 0 | 0 | 0 | 0 | 0 | 0 | 0 | 0 | 0 | 0 | 0 | 0 | 0 | 0 | 0 | 0 | 0 | 0 | 0 | 0 | 0 | 0 | 0 | 0 |













3|3|2|2|2|2|2|2|2|2|2|1|1|1|1|1|1|1|1|1|0|0|0|0|0|0|0|0|0  
 1|0|9|8|7|6|5|4|3|2|1|0|9|8|7|6|5|4|3|2|1|0|9|8|7|6|5|4|3|2|1

|     |   |   |   |   |   |   |   |   |   |   |   |   |   |   |   |   |   |   |   |   |   |   |   |   |   |   |   |   |   |   |   |   |   |   |   |   |   |   |   |
|-----|---|---|---|---|---|---|---|---|---|---|---|---|---|---|---|---|---|---|---|---|---|---|---|---|---|---|---|---|---|---|---|---|---|---|---|---|---|---|---|
| 237 | 0 | 0 | 0 | 0 | 0 | 0 | 0 | 0 | 0 | 0 | 0 | 0 | 0 | 0 | 0 | 0 | 0 | 0 | 0 | 0 | 0 | 0 | 0 | 0 | 0 | 1 | 1 | 1 | 0 | 0 |   |   |   |   |   |   |   |   |   |
| 238 | 0 | 0 | 0 | 0 | 0 | 0 | 0 | 0 | 0 | 0 | 0 | 0 | 0 | 0 | 0 | 0 | 0 | 0 | 1 | 1 | 1 | 0 | 0 | 1 | 1 | 1 | 1 | 0 | 1 | 1 | 0 | 1 |   |   |   |   |   |   |   |
| 239 | 0 | 0 | 0 | 0 | 0 | 0 | 0 | 0 | 0 | 0 | 0 | 0 | 0 | 0 | 0 | 0 | 0 | 0 | 0 | 1 | 0 | 0 | 1 | 0 | 0 | 0 | 0 | 1 | 0 | 1 | 0 | 1 |   |   |   |   |   |   |   |
| 240 | 0 | 0 | 0 | 0 | 0 | 0 | 0 | 0 | 0 | 0 | 0 | 0 | 0 | 0 | 0 | 0 | 0 | 0 | 0 | 1 | 1 | 0 | 0 | 0 | 0 | 0 | 0 | 0 | 0 | 0 | 0 | 0 |   |   |   |   |   |   |   |
| 241 | 0 | 0 | 0 | 0 | 0 | 0 | 0 | 0 | 0 | 0 | 0 | 0 | 0 | 0 | 0 | 0 | 0 | 0 | 0 | 1 | 1 | 1 | 0 | 1 | 1 | 0 | 0 | 0 | 0 | 0 | 1 | 0 | 0 |   |   |   |   |   |   |
| 242 | 0 | 0 | 0 | 0 | 0 | 0 | 0 | 0 | 0 | 0 | 0 | 0 | 0 | 0 | 0 | 0 | 0 | 0 | 0 | 0 | 0 | 0 | 0 | 0 | 0 | 0 | 1 | 0 | 0 | 0 | 1 | 0 | 1 |   |   |   |   |   |   |
| 243 | 0 | 0 | 0 | 0 | 0 | 0 | 0 | 0 | 0 | 0 | 0 | 0 | 0 | 0 | 0 | 0 | 0 | 0 | 0 | 1 | 0 | 0 | 1 | 0 | 1 | 1 | 0 | 0 | 0 | 0 | 0 | 1 | 0 | 0 |   |   |   |   |   |
| 244 | 0 | 0 | 0 | 0 | 0 | 0 | 0 | 0 | 0 | 0 | 0 | 0 | 0 | 0 | 0 | 0 | 0 | 0 | 0 | 0 | 0 | 0 | 0 | 0 | 0 | 0 | 0 | 1 | 1 | 1 | 0 | 0 | 0 | 0 |   |   |   |   |   |
| 245 | 0 | 0 | 0 | 0 | 0 | 0 | 0 | 0 | 0 | 0 | 0 | 0 | 0 | 0 | 0 | 0 | 0 | 0 | 0 | 1 | 1 | 1 | 1 | 0 | 0 | 1 | 0 | 1 | 0 | 0 | 1 | 1 | 1 | 0 | 1 |   |   |   |   |
| 246 | 0 | 0 | 0 | 0 | 0 | 0 | 0 | 0 | 0 | 0 | 0 | 0 | 0 | 0 | 0 | 0 | 0 | 0 | 0 | 0 | 0 | 0 | 0 | 0 | 0 | 0 | 1 | 0 | 1 | 0 | 1 | 1 | 1 | 1 | 0 | 1 |   |   |   |
| 247 | 0 | 0 | 0 | 0 | 0 | 0 | 0 | 0 | 0 | 0 | 0 | 0 | 0 | 0 | 0 | 0 | 0 | 0 | 0 | 1 | 1 | 1 | 1 | 0 | 1 | 1 | 1 | 1 | 1 | 1 | 1 | 1 | 1 | 1 | 1 |   |   |   |   |
| 248 | 0 | 0 | 0 | 0 | 0 | 0 | 0 | 0 | 0 | 0 | 0 | 0 | 0 | 0 | 0 | 0 | 0 | 0 | 0 | 0 | 0 | 0 | 0 | 0 | 0 | 0 | 1 | 0 | 0 | 0 | 0 | 0 | 0 | 0 | 0 |   |   |   |   |
| 249 | 0 | 0 | 0 | 0 | 0 | 0 | 0 | 0 | 0 | 0 | 0 | 0 | 0 | 0 | 0 | 0 | 0 | 0 | 0 | 0 | 1 | 1 | 0 | 0 | 0 | 0 | 1 | 0 | 1 | 0 | 0 | 0 | 0 | 0 | 0 |   |   |   |   |
| 250 | 0 | 0 | 0 | 0 | 0 | 0 | 0 | 0 | 0 | 0 | 0 | 0 | 0 | 0 | 0 | 0 | 0 | 0 | 0 | 1 | 0 | 0 | 1 | 0 | 1 | 1 | 0 | 1 | 0 | 1 | 1 | 1 | 1 | 1 | 1 |   |   |   |   |
| 251 | 0 | 0 | 0 | 0 | 0 | 0 | 0 | 0 | 0 | 0 | 0 | 0 | 0 | 0 | 0 | 0 | 0 | 0 | 0 | 1 | 1 | 0 | 0 | 0 | 0 | 0 | 0 | 0 | 0 | 0 | 0 | 0 | 1 | 0 | 0 |   |   |   |   |
| 252 | 0 | 0 | 0 | 0 | 0 | 0 | 0 | 0 | 0 | 0 | 0 | 0 | 0 | 0 | 0 | 0 | 0 | 0 | 0 | 0 | 1 | 1 | 0 | 1 | 1 | 0 | 1 | 0 | 1 | 1 | 1 | 0 | 1 | 1 | 1 |   |   |   |   |
| 253 | 0 | 0 | 0 | 0 | 0 | 0 | 0 | 0 | 0 | 0 | 0 | 0 | 0 | 0 | 0 | 0 | 0 | 0 | 0 | 0 | 0 | 0 | 0 | 0 | 0 | 0 | 1 | 1 | 1 | 1 | 1 | 1 | 0 | 0 | 0 | 1 |   |   |   |
| 254 | 0 | 0 | 0 | 0 | 0 | 0 | 0 | 0 | 0 | 0 | 0 | 0 | 0 | 0 | 0 | 0 | 0 | 0 | 0 | 0 | 0 | 0 | 0 | 0 | 0 | 0 | 0 | 0 | 0 | 0 | 0 | 0 | 0 | 0 | 0 | 0 |   |   |   |
| 255 | 0 | 0 | 0 | 0 | 0 | 0 | 0 | 0 | 0 | 0 | 0 | 0 | 0 | 0 | 0 | 0 | 0 | 0 | 0 | 0 | 1 | 1 | 1 | 0 | 1 | 0 | 0 | 0 | 1 | 0 | 0 | 0 | 0 | 0 | 0 | 0 |   |   |   |
| 256 | 0 | 0 | 0 | 0 | 0 | 0 | 0 | 0 | 0 | 0 | 0 | 0 | 0 | 0 | 0 | 0 | 0 | 0 | 0 | 0 | 0 | 0 | 0 | 0 | 0 | 0 | 0 | 1 | 0 | 0 | 1 | 0 | 0 | 0 | 0 | 0 |   |   |   |
| 257 | 0 | 0 | 0 | 0 | 0 | 0 | 0 | 0 | 0 | 0 | 0 | 0 | 0 | 0 | 0 | 0 | 0 | 0 | 0 | 1 | 0 | 0 | 0 | 0 | 0 | 0 | 1 | 1 | 1 | 0 | 1 | 0 | 0 | 0 | 0 | 1 |   |   |   |
| 258 | 0 | 0 | 0 | 0 | 0 | 0 | 0 | 0 | 0 | 0 | 0 | 0 | 0 | 0 | 0 | 0 | 0 | 0 | 0 | 0 | 1 | 0 | 0 | 0 | 0 | 0 | 1 | 0 | 0 | 0 | 0 | 1 | 1 | 0 | 1 | 1 |   |   |   |
| 259 | 0 | 0 | 0 | 0 | 0 | 0 | 0 | 0 | 0 | 0 | 0 | 0 | 0 | 0 | 0 | 0 | 0 | 0 | 0 | 0 | 0 | 0 | 0 | 0 | 0 | 0 | 0 | 0 | 0 | 0 | 0 | 0 | 0 | 1 | 1 | 1 | 0 | 0 |   |
| 260 | 0 | 0 | 0 | 0 | 0 | 0 | 0 | 0 | 0 | 0 | 0 | 0 | 0 | 0 | 0 | 0 | 0 | 0 | 0 | 0 | 1 | 0 | 0 | 0 | 0 | 0 | 0 | 0 | 0 | 0 | 0 | 1 | 1 | 1 | 1 | 1 | 1 |   |   |
| 261 | 0 | 0 | 0 | 0 | 0 | 0 | 0 | 0 | 0 | 0 | 0 | 0 | 0 | 0 | 0 | 0 | 0 | 0 | 0 | 0 | 1 | 1 | 0 | 0 | 1 | 0 | 0 | 0 | 0 | 0 | 0 | 0 | 0 | 0 | 0 | 0 | 0 |   |   |
| 262 | 0 | 0 | 0 | 0 | 0 | 0 | 0 | 0 | 0 | 0 | 0 | 0 | 0 | 0 | 0 | 0 | 0 | 0 | 0 | 0 | 0 | 1 | 0 | 0 | 1 | 1 | 1 | 1 | 1 | 1 | 1 | 0 | 0 | 0 | 0 | 0 | 0 |   |   |
| 263 | 0 | 0 | 0 | 0 | 0 | 0 | 0 | 0 | 0 | 0 | 0 | 0 | 0 | 0 | 0 | 0 | 0 | 0 | 0 | 0 | 1 | 0 | 0 | 0 | 0 | 0 | 0 | 0 | 0 | 0 | 0 | 0 | 0 | 0 | 0 | 0 | 0 | 0 |   |
| 264 | 0 | 0 | 0 | 0 | 0 | 0 | 0 | 0 | 0 | 0 | 0 | 0 | 0 | 0 | 0 | 0 | 0 | 0 | 0 | 0 | 1 | 1 | 1 | 0 | 1 | 0 | 1 | 0 | 1 | 0 | 0 | 0 | 0 | 0 | 0 | 0 | 0 |   |   |
| 265 | 0 | 0 | 0 | 0 | 0 | 0 | 0 | 0 | 0 | 0 | 0 | 0 | 0 | 0 | 0 | 0 | 0 | 0 | 0 | 0 | 1 | 1 | 0 | 0 | 1 | 1 | 1 | 1 | 0 | 1 | 1 | 0 | 0 | 1 | 1 | 1 | 1 |   |   |
| 266 | 0 | 0 | 0 | 0 | 0 | 0 | 0 | 0 | 0 | 0 | 0 | 0 | 0 | 0 | 0 | 0 | 0 | 0 | 0 | 0 | 1 | 0 | 0 | 0 | 0 | 1 | 0 | 0 | 0 | 0 | 0 | 1 | 1 | 1 | 1 | 1 | 1 |   |   |
| 267 | 0 | 0 | 0 | 0 | 0 | 0 | 0 | 0 | 0 | 0 | 0 | 0 | 0 | 0 | 0 | 0 | 0 | 0 | 0 | 0 | 0 | 0 | 0 | 0 | 0 | 0 | 1 | 0 | 1 | 1 | 1 | 1 | 0 | 1 | 1 | 1 | 0 | 1 |   |
| 268 | 0 | 0 | 0 | 0 | 0 | 0 | 0 | 0 | 0 | 0 | 0 | 0 | 0 | 0 | 0 | 0 | 0 | 0 | 0 | 0 | 1 | 1 | 1 | 0 | 0 | 0 | 0 | 0 | 0 | 0 | 0 | 0 | 0 | 0 | 0 | 0 | 0 | 0 |   |
| 269 | 0 | 0 | 0 | 0 | 0 | 0 | 0 | 0 | 0 | 0 | 0 | 0 | 0 | 0 | 0 | 0 | 0 | 0 | 0 | 0 | 0 | 0 | 0 | 0 | 0 | 0 | 0 | 0 | 0 | 0 | 0 | 1 | 1 | 1 | 1 | 0 | 0 | 0 | 0 |
| 270 | 0 | 0 | 0 | 0 | 0 | 0 | 0 | 0 | 0 | 0 | 0 | 0 | 0 | 0 | 0 | 0 | 0 | 0 | 0 | 0 | 1 | 1 | 1 | 0 | 0 | 1 | 1 | 1 | 1 | 1 | 0 | 0 | 0 | 0 | 0 | 0 | 0 | 0 |   |
| 271 | 0 | 0 | 0 | 0 | 0 | 0 | 0 | 0 | 0 | 0 | 0 | 0 | 0 | 0 | 0 | 0 | 0 | 0 | 0 | 0 | 1 | 0 | 0 | 0 | 0 | 1 | 0 | 1 | 0 | 0 | 0 | 1 | 1 | 1 | 1 | 1 | 1 | 1 |   |
| 272 | 1 | 1 | 1 | 1 | 1 | 1 | 1 | 1 | 1 | 1 | 1 | 1 | 1 | 1 | 1 | 1 | 1 | 1 | 1 | 1 | 1 | 1 | 1 | 1 | 1 | 1 | 1 | 1 | 1 | 1 | 1 | 1 | 1 | 1 | 1 | 1 | 1 | 1 |   |
| 273 | 0 | 0 | 0 | 0 | 0 | 0 | 0 | 0 | 0 | 0 | 0 | 0 | 0 | 0 | 0 | 0 | 0 | 0 | 0 | 0 | 0 | 0 | 0 | 0 | 0 | 0 | 0 | 0 | 0 | 0 | 0 | 0 | 0 | 0 | 0 | 0 | 0 | 0 |   |
| 274 | 0 | 0 | 0 | 0 | 0 | 0 | 0 | 1 | 1 | 0 | 1 | 1 | 1 | 1 | 1 | 0 | 0 | 1 | 0 | 0 | 0 | 0 | 0 | 0 | 0 | 0 | 0 | 0 | 1 | 1 | 1 | 1 | 1 | 1 | 1 | 1 | 1 | 1 |   |
| 275 | 0 | 0 | 0 | 0 | 0 | 0 | 0 | 0 | 0 | 0 | 0 | 0 | 0 | 0 | 0 | 0 | 0 | 0 | 0 | 0 | 1 | 0 | 0 | 0 | 1 | 0 | 0 | 0 | 0 | 0 | 0 | 0 | 0 | 0 | 0 | 0 | 0 | 0 |   |
| 276 | 0 | 0 | 0 | 1 | 0 | 1 | 0 | 0 | 0 | 1 | 0 | 0 | 0 | 0 | 0 | 0 | 0 | 0 | 0 | 0 | 0 | 0 | 0 | 0 | 0 | 1 | 0 | 0 | 1 | 0 | 0 | 0 | 0 | 0 | 0 | 0 | 0 | 0 | 0 |
| 277 | 1 | 1 | 1 | 0 | 0 | 0 | 0 | 0 | 0 | 0 | 0 | 0 | 0 | 0 | 0 | 0 | 0 | 0 | 0 | 0 | 1 | 0 | 0 | 0 | 0 | 0 | 0 | 0 | 0 | 0 | 0 | 0 | 0 | 0 | 0 | 0 | 0 | 0 |   |
| 278 | 1 | 1 | 1 | 1 | 1 | 1 | 0 | 0 | 1 | 0 | 0 | 0 | 0 | 0 | 0 | 0 | 0 | 0 | 0 | 0 | 1 | 1 | 0 | 1 | 1 | 1 | 1 | 1 | 0 | 0 | 0 | 0 | 0 | 0 | 0 | 0 | 0 | 0 |   |

Appendix 2 cont.

















APPENDIX 3. PARTIALLY MONOTHEIC SETS OF THE DRYMARIOIDEAE

left: sequence number  
middle: terminal clada comprising the set  
right: defining character states

|    |             |                 |     |                      |               |
|----|-------------|-----------------|-----|----------------------|---------------|
| 1  | 3           | 366 402         | 87  | 10 12 16 21          | 507           |
| 2  | 7           | 354 361 438     | 88  | 4 12 19 21           | 175           |
| 3  | 8           | 373             | 89  | 14 3 17 22           | 216           |
| 4  | 9           | 177 184         | 90  | 11 12 21 22          | 459           |
| 5  | 10          | 244             | 91  | 1 3 4 24             | 81            |
| 6  | 12          | 303             | 92  | 1 2 8 24             | 85            |
| 7  | 12          | 332             | 93  | 3 4 8 24             | 73            |
| 8  | 13          | 9 36            | 94  | 1 4 22 25            | 293           |
| 9  | 16          | 243 476         | 95  | 20 21 22 23          | 148           |
| 10 | 21          | 327             | 96  | 12 14 21 26          | 309           |
| 11 | 22          | 423 317         | 97  | 13 14 21 26          | 288           |
| 12 | 24          | 72 88 83        | 98  | 12 13 22 26          | 380           |
| 13 | 25          | 196 208 318 442 | 99  | 19 22 24 26          | 134           |
| 14 | 26          | 474             | 100 | 2 8 19 27            | 101           |
| 15 | 27          | 102 471         | 101 | 9 19 16 28           | 466           |
| 16 | 29          | 322             | 102 | 4 8 9 29             | 221           |
| 17 | 31          | 120 349 348     | 103 | 12 24 26 29          | 285           |
| 18 | 6 9         | 254             | 104 | 15 16 33 30          | 453           |
| 19 | 8 10        | 351             | 105 | 27 28 29 30          | 227           |
| 20 | 8 10        | 214             | 106 | 22 23 26 31          | 467           |
| 21 | 9 10        | 468             | 107 | 11 19 20 31          | 467           |
| 22 | 9 11        | 546             | 108 | 16 29 30 31          | 279           |
| 23 | 10 11       | 540             | 109 | 1 2 3 4 5            | 79 88         |
| 24 | 10 12       | 22              | 110 | 1 2 4 3 10           | 262           |
| 25 | 11 12       | 82              | 111 | 4 7 8 9 10           | 269           |
| 26 | 7 13        | 164             | 112 | 7 11 13 14 15        | 239           |
| 27 | 9 14        | 215             | 113 | 11 12 13 14 15       | 443           |
| 28 | 13 14       | 127             | 114 | 3 10 11 13 16        | 245           |
| 29 | 11 15       | 273             | 115 | 3 4 8 15 16          | 237           |
| 30 | 12 15       | 533             | 116 | 7 11 12 16 16        | 16            |
| 31 | 14 15       | 340             | 117 | 1 5 4 5 22           | 313           |
| 32 | 9 16        | 12              | 118 | 1 5 4 5 24           | 87            |
| 33 | 15 16       | 217             | 119 | 1 10 19 22 26        | 348           |
| 34 | 3 18        | 366             | 120 | 18 20 21 23 24       | 348           |
| 35 | 17 18       | 147             | 121 | 2 17 19 24 26        | 17            |
| 36 | 13 19       | 174             | 122 | 2 10 23 23 27        | 302           |
| 37 | 8 21        | 396             | 123 | 9 12 22 24 28        | 274           |
| 38 | 10 22       | 275             | 124 | 3 3 4 27 28          | 340           |
| 39 | 21 22       | 420 470         | 125 | 17 18 19 24 28       | 150           |
| 40 | 18 24       | 443             | 126 | 19 20 21 26 30       | 330           |
| 41 | 22 25       | 121 472         | 127 | 24 27 28 29 30       | 326           |
| 42 | 10 27       | 87              | 128 | 3 7 10 11 31         | 413           |
| 43 | 25 30       | 479             | 129 | 10 11 12 16 31       | 242           |
| 44 | 24 31       | 326             | 130 | 18 21 25 26 31       | 142           |
| 45 | 1 4 3       | 537             | 131 | 17 22 26 29 31       | 473           |
| 46 | 2 4 3       | 259             | 132 | 27 28 29 30 31       | 3 322 419 328 |
| 47 | 1 5 8       | 33              | 133 | 1 2 4 6 7 9          | 234           |
| 48 | 4 8 9       | 342             | 134 | 1 2 4 6 7 11         | 324           |
| 49 | 4 9 10      | 178             | 135 | 6 7 8 9 10 11        | 338           |
| 50 | 8 9 10      | 416             | 136 | 1 2 4 6 11 16        | 239           |
| 51 | 8 9 12      | 407             | 137 | 7 8 11 13 14 15      | 264           |
| 52 | 11 12 14    | 4               | 138 | 10 11 12 13 14 15    | 34            |
| 53 | 9 13 14     | 207 309         | 139 | 1 2 4 5 10 14        | 258           |
| 54 | 11 14 15    | 261             | 140 | 1 8 8 9 10 16        | 257           |
| 55 | 12 14 15    | 40 42           | 141 | 3 11 12 14 15 16     | 134           |
| 56 | 13 14 15    | 268 436         | 142 | 11 12 13 14 15 16    | 240           |
| 57 | 1 10 16     | 440             | 143 | 4 7 8 10 21 22       | 398           |
| 58 | 3 13 14     | 231             | 144 | 1 2 3 5 5 23         | 82            |
| 59 | 14 15 16    | 94              | 145 | 2 8 10 18 19 24      | 503           |
| 60 | 9 16 17     | 119             | 146 | 6 10 11 12 13 25     | 201           |
| 61 | 4 17 18     | 183             | 147 | 12 13 14 21 24 26    | 191           |
| 62 | 20 21 22    | 431             | 148 | 4 12 13 15 28 30     | 160           |
| 63 | 18 19 24    | 384             | 149 | 17 18 19 22 29 30    | 153           |
| 64 | 15 23 24    | 116             | 150 | 9 10 18 19 27 31     | 329           |
| 65 | 19 21 24    | 193             | 151 | 14 19 20 21 28 31    | 122           |
| 66 | 23 25 26    | 394             | 152 | 6 10 11 12 29 31     | 354           |
| 67 | 19 24 27    | 49              | 153 | 1 2 3 4 5 8 9        | 124           |
| 68 | 3 27 28     | 161             | 154 | 1 2 8 6 8 9 10       | 324           |
| 69 | 25 27 28    | 163             | 155 | 1 2 3 4 3 7 12       | 119           |
| 70 | 26 27 30    | 143 149         | 156 | 1 2 3 4 8 9 14       | 260           |
| 71 | 14 23 31    | 78 144          | 157 | 1 2 3 4 5 9 16       | 427           |
| 72 | 23 27 31    | 169             | 158 | 1 2 4 4 9 10 16      | 229           |
| 73 | 17 28 31    | 154             | 159 | 1 2 3 4 5 11 16      | 264           |
| 74 | 24 29 31    | 102             | 160 | 3 8 10 13 14 16      | 221           |
| 75 | 11 30 31    | 378             | 161 | 3 10 11 12 14 15 16  | 241           |
| 76 | 29 30 31    | 234             | 162 | 10 11 12 13 14 15 16 | 19            |
| 77 | 1 3 4 3     | 345 353         | 163 | 1 2 6 17 20 21 22    | 381           |
| 78 | 6 7 8 9     | 264 343         | 164 | 6 7 13 14 19 21 24   | 174           |
| 79 | 6 9 11 12   | 340             | 165 | 2 9 16 17 19 22 24   | 399           |
| 80 | 8 10 11 12  | 333             | 166 | 1 2 3 4 5 23 24      | 89            |
| 81 | 3 7 12 16   | 123             | 167 | 12 17 18 20 21 22 23 | 320           |
| 82 | 7 9 14 18   | 222 309         | 168 | 9 17 18 20 21 23 25  | 137           |
| 83 | 11 12 14 15 | 30 31           | 169 | 1 11 14 19 21 24 26  | 183           |
| 84 | 4 13 14 15  | 374             | 170 | 17 18 19 23 24 25 26 | 418 430       |
| 85 | 13 14 15 16 | 88              | 171 | 1 3 4 3 7 24 27      | 314           |
| 86 | 10 11 12 19 | 295 307 311     |     |                      |               |

|     |                                 |         |     |  |         |
|-----|---------------------------------|---------|-----|--|---------|
| 172 | 2 18 19 23 24 26 27             | 48      | 280 | 1 2 4 5 6 7 8 11 12 14 15 16                           | 225     |
| 173 | 10 11 12 14 19 20 28            | 314     | 281 | 3 4 5 8 10 11 12 13 14 15 22 23                        | 199     |
| 174 | 17 19 28 27 28 29 30            | 132     | 282 | 1 2 3 4 8 10 11 12 14 15 24 26                         | 131     |
| 175 | 8 9 13 14 15 28 31              | 406     | 283 | 6 7 8 9 10 11 12 13 14 15 22 25                        | 77      |
| 176 | 2 4 8 10 11 30 31               | 537     | 284 | 2 7 11 12 13 14 18 19 20 21 24 26                      | 257     |
| 177 | 21 22 27 28 29 30 31            | 457     | 287 | 1 2 4 6 7 8 18 19 22 24 25 26                          | 39      |
| 178 | 1 2 3 3 7 8 10                  | 350     | 288 | 7 12 14 19 20 21 22 23 24 25 26                        | 445     |
| 179 | 1 2 6 7 8 9 10 11               | 255     | 289 | 8 9 10 11 12 13 19 23 24 25 26                         | 291     |
| 180 | 3 8 9 7 8 10 12 14              | 242     | 290 | 17 18 19 20 21 22 23 25 26 27 28 29                    | 435     |
| 181 | 6 7 8 9 10 13 14 19             | 270     | 291 | 11 14 19 17 21 22 25 26 27 28 29 30                    | 325     |
| 182 | 1 2 3 4 5 9 10 14               | 53      | 292 | 17 18 19 20 21 22 23 24 27 28 29 30                    | 61      |
| 183 | 1 2 3 4 5 9 11 14               | 213     | 293 | 6 7 8 9 10 11 12 13 14 15 16 21                        | 84      |
| 184 | 1 2 3 4 5 9 11 14               | 271     | 294 | 6 7 8 9 13 17 20 21 22 23 25 31                        | 133     |
| 185 | 1 2 3 4 5 11 12 13 14           | 49      | 295 | 1 3 4 5 10 11 12 17 18 20 27 31                        | 103     |
| 186 | 1 2 3 4 5 10 13 14 16           | 99      | 296 | 3 4 10 11 13 14 15 16 19 27 28 31                      | 477     |
| 187 | 3 4 5 10 13 14 15 16            | 227     | 297 | 1 2 5 8 11 13 15 22 25 27 28 31                        | 401     |
| 188 | 1 3 5 12 13 14 15 16            | 490     | 298 | 2 7 11 12 13 15 16 22 29 30 31                         | 108     |
| 189 | 1 3 7 16 18 19 20 21            | 349     | 299 | 1 2 3 4 8 10 17 27 28 29 30 31                         | 179     |
| 190 | 1 3 4 5 9 11 14 15 22           | 491     | 300 | 8 9 17 18 21 22 25 27 28 29 30 31                      | 448     |
| 191 | 4 9 11 16 18 21 22 31           | 496     | 301 | 1 2 3 4 5 6 7 8 9 10 11 13 14                          | 319     |
| 192 | 6 7 13 14 16 18 21 24           | 168     | 302 | 1 2 3 4 5 10 11 12 13 14 15 16 19                      | 452     |
| 193 | 19 20 21 22 23 24 25 26         | 387     | 303 | 1 2 3 4 5 10 11 12 14 15 16 23 24                      | 73      |
| 194 | 13 14 15 17 23 25 26 27         | 548     | 304 | 3 4 5 8 10 11 12 13 14 16 22 23 25                     | 204     |
| 195 | 10 11 13 16 19 21 26 28         | 296     | 305 | 4 8 9 10 12 13 19 23 24 25 26 29                       | 293     |
| 196 | 16 19 20 21 22 26 27 28         | 466     | 306 | 2 3 4 5 6 7 10 11 12 13 25 26 30                       | 486     |
| 197 | 1 2 20 21 23 27 28 29           | 266     | 307 | 3 5 6 8 11 12 14 15 17 23 24 27 29                     | 656     |
| 198 | 1 7 20 23 25 27 28 29           | 492     | 308 | 1 3 5 11 12 13 14 15 16 17 22 29 30                    | 498     |
| 199 | 7 10 11 12 14 15 16 20          | 42      | 309 | 1 2 3 4 5 6 8 9 10 11 12 16 21                         | 312     |
| 200 | 3 4 6 7 8 10 14 20              | 445     | 310 | 6 7 8 9 10 11 12 13 14 15 16 23 21                     | 489     |
| 201 | 10 11 12 14 15 16 23 30         | 37      | 311 | 2 9 17 18 20 21 22 24 25 26 29 31                      | 241     |
| 202 | 1 7 13 14 19 24 27 30           | 648     | 312 | 11 12 13 14 15 16 17 20 21 24 25 30 31                 | 150     |
| 203 | 10 11 14 16 19 21 28 30         | 304     | 313 | 4 6 7 8 11 12 16 22 23 27 28 30 31                     | 208     |
| 204 | 8 10 14 23 24 27 30 31          | 370     | 314 | 1 3 4 5 7 11 12 21 22 28 29 30 31                      | 521     |
| 205 | 17 20 21 22 27 28 29 30         | 311     | 315 | 2 4 10 11 12 14 16 22 23 26 29 31                      | 279     |
| 206 | 17 18 22 25 27 28 29 30         | 473     | 316 | 3 6 7 10 11 12 18 19 27 28 29 30 31                    | 521     |
| 207 | 4 7 8 10 18 22 23 31            | 412     | 317 | 3 4 6 8 10 17 18 20 27 28 29 30 31                     | 186     |
| 208 | 1 9 14 17 23 25 27 31           | 800     | 318 | 11 13 14 15 16 19 24 26 27 28 29 30 31                 | 321     |
| 209 | 9 14 18 19 26 27 31             | 59      | 319 | 17 18 19 20 21 22 23 24 27 28 29 30 31                 | 11      |
| 210 | 19 21 23 26 27 28 30 31         | 441     | 320 | 9 14 19 20 21 22 23 24 27 28 29 30 31                  | 82 108  |
| 211 | 8 10 11 12 28 29 30 31          | 520     | 321 | 1 2 3 4 8 9 7 8 9 10 11 12 13 14                       | 114     |
| 212 | 17 18 19 21 28 29 30 31         | 134     | 322 | 1 2 3 4 8 9 7 8 9 10 11 13 14 16                       | 233     |
| 213 | 11 12 20 21 23 28 30 31         | 324     | 323 | 1 2 3 4 5 6 7 8 10 11 13 15 18 22                      | 197     |
| 214 | 4 18 27 28 29 30 31             | 392     | 324 | 1 2 3 4 5 6 8 10 11 12 15 16 23 25                     | 191     |
| 215 | 4 18 25 27 28 29 30 31          | 392     | 325 | 1 3 3 4 5 6 8 10 11 12 15 22 25                        | 191     |
| 216 | 1 2 4 5 6 7 8 9 11              | 230     | 326 | 2 5 6 7 8 12 14 16 18 19 20 23 24 26                   | 173     |
| 217 | 1 2 4 5 6 7 8 10 12             | 234     | 327 | 2 4 9 10 17 18 19 20 21 22 24 25 28                    | 494     |
| 218 | 1 2 4 5 6 7 9 11 14             | 266     | 328 | 2 13 14 15 17 18 19 20 21 22 23 24 26 29               | 510     |
| 219 | 1 2 6 7 8 10 11 13 14           | 220     | 329 | 1 2 3 4 6 7 8 9 10 15 21 22 27 30                      | 44      |
| 220 | 2 8 7 8 9 10 13 14 19           | 423     | 330 | 1 2 3 4 5 6 8 10 11 12 18 27 29 30                     | 81      |
| 221 | 1 2 8 7 9 11 13 14 15           | 212     | 331 | 1 2 4 8 9 10 17 18 19 22 24 26 28 31                   | 132     |
| 222 | 8 10 11 13 15 16 16             | 126     | 332 | 4 5 6 7 8 10 11 18 18 22 27 29 31                      | 396     |
| 223 | 1 2 5 4 5 17 20 22 25           | 298     | 333 | 4 8 9 10 12 14 16 20 21 27 28 29 30 31                 | 413     |
| 224 | 2 6 8 17 18 19 23 24 28         | 330     | 334 | 8 9 10 12 18 19 25 26 27 28 29 31                      | 254     |
| 225 | 1 2 17 18 19 23 24 28 28        | 377     | 335 | 7 17 18 19 20 21 22 24 26 27 28 29 30 31               | 293     |
| 226 | 16 19 21 22 24 25 28 29 30      | 191     | 336 | 17 18 19 20 21 22 23 25 26 27 28 29 30 31              | 63      |
| 227 | 7 9 14 21 23 27 28 29 30        | 52      | 337 | 1 2 3 4 5 6 7 8 9 10 11 13 14 16 18                    | 117     |
| 228 | 1 2 7 9 18 25 26 28 31          | 20      | 338 | 1 2 3 4 5 6 7 8 10 11 12 13 15 16 22                   | 88      |
| 229 | 6 14 19 17 19 25 26 28 31       | 338     | 339 | 1 2 3 4 5 6 7 10 11 12 13 15 16 22 24                  | 197     |
| 230 | 8 10 23 24 26 27 29 30 31       | 493     | 340 | 1 3 3 4 5 6 7 16 17 18 19 20 21 23 24                  | 274     |
| 231 | 8 9 18 19 22 28 29 30 31        | 482     | 341 | 6 7 8 9 10 11 12 13 14 15 16 18 22 27 28               | 436     |
| 232 | 12 20 21 23 27 28 29 30 31      | 493     | 342 | 1 3 3 7 9 10 13 14 15 18 20 21 24 26 28 30             | 489     |
| 233 | 1 2 5 3 6 7 8 9 10 11           | 253     | 343 | 1 2 3 4 5 6 7 9 10 13 14 15 16 21 22 27 30 31          | 92      |
| 234 | 1 2 6 3 4 6 8 9 10 11 13        | 267     | 344 | 1 3 5 6 7 8 9 10 12 13 14 16 22 31                     | 113     |
| 235 | 1 2 3 4 5 6 8 10 11 13 14       | 345     | 345 | 1 2 3 5 6 11 12 19 20 21 23 25 28 29 30 31             | 411     |
| 236 | 1 2 3 4 5 6 8 10 11 13 14       | 71      | 346 | 8 10 11 12 13 15 19 20 21 24 26 27 28 29 30 31         | 317     |
| 237 | 1 2 3 4 5 6 7 10 13 15          | 263     | 347 | 2 4 6 7 8 11 12 13 14 15 16 28 29 30 31                | 139     |
| 238 | 1 2 3 7 8 10 11 12 13 14 19     | 549     | 348 | 8 10 11 12 13 14 16 18 19 21 24 25 26 29 30 31         | 310     |
| 239 | 1 2 4 5 8 10 13 15 16 15        | 245     | 349 | 2 3 4 8 9 10 11 12 16 17 27 28 29 30 31                | 358     |
| 240 | 3 4 5 10 11 12 13 14 15 23      | 24      | 350 | 7 9 16 17 18 19 20 21 24 26 27 28 29 30 31             | 198     |
| 241 | 10 11 13 14 13 16 18 19 22 24   | 8       | 351 | 9 10 11 12 13 15 16 22 25 26 27 28 29 30 31            | 378     |
| 242 | 1 4 5 7 18 19 20 21 22 24       | 351     | 352 | 1 2 3 7 8 11 12 14 16 19 21 24 25 26 28 30 31          | 149     |
| 243 | 1 2 3 4 5 6 11 17 22 25         | 289     | 353 | 1 2 3 4 5 6 7 11 14 13 16 17 20 21 23 27               | 390     |
| 244 | 1 3 5 13 16 17 19 22 24 26      | 396     | 354 | 1 2 3 4 5 10 15 17 18 19 20 21 24 25 26 29             | 293     |
| 245 | 6 7 8 14 17 18 19 24 25 26      | 556     | 355 | 1 2 4 6 7 10 11 12 13 14 15 16 20 22 23 24             | 358     |
| 246 | 2 7 13 13 18 19 23 24 25 26     | 309     | 356 | 1 2 3 4 5 8 14 13 17 19 22 24 27 29 30                 | 44      |
| 247 | 17 18 19 20 21 22 23 24 25 26   | 91      | 357 | 1 2 3 4 5 9 17 18 19 20 21 24 23 26 27 28 29 31        | 339     |
| 248 | 2 3 14 19 22 23 24 28 27        | 67      | 358 | 3 5 9 17 18 19 20 21 22 24 25 26 27 28 29 31           | 343 245 |
| 249 | 6 7 9 10 20 21 22 25 26 27      | 801     | 359 | 1 2 3 7 17 18 19 20 21 22 24 25 26 27 28 29 31         | 46      |
| 250 | 2 7 8 9 18 20 21 22 27 29       | 497     | 361 | 6 7 8 9 10 12 13 17 18 19 20 21 23 27 30 31            | 483     |
| 251 | 8 13 15 16 17 18 19 20 28 29    | 485     | 362 | 2 3 6 5 8 9 10 11 12 14 15 22 28 29 30 31              | 171     |
| 252 | 9 12 14 15 16 17 24 26 27 30    | 410     | 363 | 1 2 3 3 6 7 8 9 10 11 12 16 17 18 20 21 23 27 30 31    | 196     |
| 253 | 1 2 3 5 6 7 9 14 16 31          | 128     | 365 | 1 2 3 3 6 7 8 9 10 11 16 27 28 29 30 31                | 93      |
| 254 | 3 8 14 16 21 22 25 26 27 31     | 446     | 366 | 9 17 18 19 20 21 22 23 24 25 26 27 28 29 30 31         | 365     |
| 255 | 7 9 13 16 20 21 23 25 28 31     | 24      | 366 | 1 2 3 6 8 11 12 13 14 16 18 19 20 21 24 23 24          | 182     |
| 256 | 1 3 4 5 6 7 8 9 10 20 21        | 499     | 367 | 1 2 3 4 5 10 11 12 13 14 15 16 17 23 24 25 26          | 481     |
| 257 | 1 3 16 23 25 26 27 28 31        | 343     | 368 | 1 2 3 4 5 6 7 8 9 10 11 17 18 19 20 21 23 24 25 26     | 414     |
| 258 | 9 10 17 20 22 27 28 30 31       | 170     | 368 | 1 2 3 5 6 7 11 13 15 17 18 19 22 23 24 25 26           | 379     |
| 259 | 1 2 3 4 5 6 7 8 10 11 12        | 344     | 369 | 1 2 3 5 6 7 9 17 16 19 20 21 22 23 24 25 26            | 308     |
| 260 | 1 2 3 4 5 6 7 8 10 11 13 14     | 216     | 371 | 6 7 8 10 11 13 14 15 16 19 20 21 23 24 26 28 30        | 294     |
| 261 | 1 2 3 4 5 6 7 8 11 13 14        | 334     | 372 | 1 3 7 11 12 14 15 16 19 20 21 22 24 27 28 29 30        | 348     |
| 262 | 1 3 4 5 6 7 8 9 10 12 14 15     | 429     | 373 | 1 3 3 7 8 10 12 14 15 16 17 18 20 21 27 28 29 30 31    | 383     |
| 263 | 1 2 3 4 5 6 8 10 11 13 14       | 223 250 | 374 | 4 10 11 12 13 14 15 16 20 21 23 27 28 29 30 31         | 18      |
| 264 | 1 2 4 7 8 10 11 13 14 15 16     | 221     | 375 | 7 9 13 14 17 18 19 20 21 23 24 26 27 28 29 30 31       | 190     |
| 265 | 1 2 4 5 6 7 8 9 10 12           | 428     | 376 | 1 3 4 17 18 19 20 21 23 24 25 26 27 28 29 30 31        | 112     |
| 266 | 1 2 3 4 5 6 7 10 11 12 22       | 218     | 377 | 9 16 17 18 19 20 21 22 23 24 25 26 27 28 29 30 31      | 15      |
| 267 | 1 3 6 8 10 11 12 13 14 15 23    | 208     | 379 | 2 6 8 9 10 13 15 16 17 18 19 20 21 22 24 23 25 26 27   | 69      |
| 268 | 1 3 6 5 11 12 13 14 15 23 24    | 74      | 380 | 1 2 3 4 5 6 8 9 12 14 16 17 19 20 21 22 23 27 29       | 315     |
| 269 | 6 9 10 11 12 13 14 15 23 24     | 168     | 381 | 1 2 3 4 5 8 9 13 14 16 17 20 23 23 25 26 27 29         | 312     |
| 270 | 1 3 5 8 13 14 16 18 21 25 24    | 160     | 382 | 7 14 15 19 20 21 22 24 25 27 28 29 30 31               | 279     |
| 271 | 6 7 9 13 14 16 17 20 21 26      | 183     | 383 | 2 6 7 8 9 10 12 13 14 17 18 22 23 27 28 29 30          | 432     |
| 272 | 6 7 12 14 18 19 20 21 22 24 26  | 167     | 384 | 1 2 3 4 5 6 7 8 9 10 11 12 13 14 15 16 24 31           | 143     |
| 273 | 2 6 8 10 12 13 15 16 23 24 26   | 324     | 385 | 1 2 3 4 6 8 10 11 12 13 14 19 20 21 23 24 26 31        | 451     |
| 274 | 1 2 18 19 20 21 22 23 24 25 26  | 343     | 386 | 3 5 6 7 8 9 10 11 12 13 14 19 20 21 23 24 26 29 31     | 283     |
| 275 | 2 4 5 6 8 9 11 13 20 27         | 133     | 387 | 12 13 14 15 16 17 18 19 20 21 22 24 25 27 28 29 31     | 324     |
| 276 | 9 10 12 14 16 21 22 23 25 34 31 | 203     | 388 | 4 3 9 13 16 18 19 20 21 22 23 25 27 28 29 31           | 56      |
| 277 | 2 4 5 6 8 9 11 13 20 27         | 137     | 389 | 1 2 3 4 5 6 7 10 11 13 14 15 16 19 20 21 23 24         | 416     |
| 278 | 5 9 10 13 17 23 27 28 29 30 31  | 232     | 390 | 1 2 3 5 6 7 9 12 14 15 16 18 22 23 24 25 26 27 28 31   | 646     |
| 279 | 1 2 3 4 5 6 9 10 11 13 14 16    | 280     | 391 | 8 9 11 12 13 14 15 16 17 18 19 20 21 22 23 25 27 28 30 | 255     |

Appendix 3 cont.

|     |   |                                 |
|-----|---|---------------------------------|
| 392 | 1 2 3 4 5 6 7 8 9 10 11 12 13 14 15 16 22 24 31                                     | 87                              |
| 393 | 1 2 3 4 5 6 7 8 10 11 12 13 14 15 16 23 24 31                                       | 132                             |
| 394 | 1 2 3 4 5 6 7 9 10 11 12 13 14 18 19 20 21 22 26 31                                 | 372                             |
| 395 | 1 2 3 4 5 6 7 8 9 10 11 12 13 14 15 16 24 31  | 424                             |
| 396 | 1 2 3 4 5 6 7 8 9 10 11 12 13 14 15 16 20 21 22 28 29 30 31                         | 556                             |
| 397 | 3 7 9 13 14 15 16 17 18 20 21 22 24 26 27 28 29 30 31                               | 300                             |
| 398 | 1 2 3 4 17 18 19 20 21 22 23 24 25 26 27 28 29 30 31                                | 463                             |
| 399 | 1 2 4 6 17 18 19 20 21 22 23 24 25 26 27 28 29 30 31                                | 433                             |
| 400 | 9 11 15 16 17 18 19 20 21 22 23 24 25 26 27 28 29 30 31                             | 119                             |
| 401 | 1 2 3 4 5 6 7 8 9 10 11 12 13 14 15 16 19 20 23 24                                  | 468                             |
| 402 | 1 2 3 4 5 6 7 8 11 12 13 14 15 16 19 21 22 23 24 26 27                              | 188                             |
| 403 | 1 2 3 4 5 6 7 8 11 12 13 14 15 16 19 21 22 23 24 26 27                              | 111                             |
| 404 | 1 2 3 4 5 6 7 8 9 11 12 13 14 15 16 19 20 21 22 23 24 26 27                         | 405                             |
| 405 | 1 2 3 4 6 7 9 10 11 12 13 14 15 16 19 20 21 22 23 24 26 27                          | 411                             |
| 406 | 7 8 10 12 13 14 15 16 17 18 19 20 21 22 23 24 26 27 28 29 30 31                     | 159                             |
| 407 | 3 5 6 7 9 13 14 15 16 17 18 20 21 22 23 24 26 27 28 29 30 31                        | 309 313                         |
| 408 | 1 2 3 4 7 9 12 13 17 18 20 23 24 26 27 28 29 30 31                                  | 180                             |
| 409 | 8 7 8 9 10 11 12 13 14 15 16 17 18 19 20 21 22 23 24 26 27 28 29 30 31              | 90                              |
| 410 | 11 12 13 14 15 16 17 18 19 20 21 22 23 24 26 27 28 29 30 31                         | 310                             |
| 411 | 1 2 3 4 5 7 8 9 13 14 15 16 17 18 19 20 21 22 23 24 25 26                           | 188                             |
| 412 | 1 2 3 4 6 7 8 10 12 13 14 15 16 17 18 19 20 21 22 23 24 25 26 27                    | 519                             |
| 413 | 2 4 7 8 9 10 12 13 14 15 16 17 18 19 20 21 22 23 24 25 26 27                        | 542                             |
| 414 | 3 4 5 6 8 10 11 12 14 15 16 17 18 19 20 21 22 23 24 27 29 30                        | 37                              |
| 415 | 1 2 4 5 6 10 11 12 14 16 17 18 19 20 21 22 23 24 26 27 28 29 30 31                  | 264                             |
| 416 | 6 7 8 9 10 11 12 13 14 15 16 17 18 19 21 22 23 24 26 27 28 29 30 31                 | 297                             |
| 417 | 1 2 3 4 5 6 7 8 9 10 11 12 13 14 15 16 17 18 19 20 21 22 23 24 27 29 30 31          | 7                               |
| 418 | 1 2 3 4 5 6 7 8 9 10 11 12 13 14 15 16 17 18 19 20 21 22 23 24 25 26                | 421                             |
| 419 | 1 2 3 4 5 6 7 8 10 11 12 13 14 15 16 17 18 19 20 21 22 23 24 25 26                  | 1                               |
| 420 | 1 2 3 4 5 7 8 9 10 11 12 13 14 16 18 20 21 22 23 24 27 29 30                        | 329                             |
| 421 | 1 2 3 4 5 8 9 10 11 12 13 14 16 18 20 22 23 24 26 28 29 30                          | 172                             |
| 422 | 1 2 3 4 5 8 9 10 11 12 13 14 16 17 18 19 20 21 22 23 24 26 27 31                    | 461                             |
| 423 | 1 2 3 4 5 8 9 10 11 12 13 14 16 17 18 19 20 21 22 23 24 26 27 31                    | 371                             |
| 424 | 1 6 7 8 9 10 12 14 15 16 17 18 19 20 21 22 23 24 26 27 28 30 31                     | 523                             |
| 425 | 1 2 3 4 5 8 9 10 11 12 13 14 15 16 17 21 22 23 24 26 30 31                          | 438                             |
| 426 | 1 2 3 4 5 6 7 9 11 12 13 14 15 16 20 21 22 27 28 29 30 31                           | 417                             |
| 427 | 1 2 3 4 6 7 9 10 11 12 13 14 15 16 20 21 22 27 28 29 30 31                          | 373                             |
| 428 | 1 3 4 5 7 8 9 10 11 12 13 14 15 16 20 21 22 27 28 29 30 31                          | 518                             |
| 429 | 2 4 5 6 7 8 9 10 11 12 13 14 15 18 20 22 23 24 26 27 28 29 30 31                    | 158                             |
| 430 | 1 2 3 4 6 7 8 10 12 17 18 19 20 21 22 23 24 26 27 28 29 30 31                       | 187                             |
| 431 | 1 2 3 4 5 10 12 17 18 19 20 21 22 23 24 25 26 27 28 29 30 31                        | 637                             |
| 432 | 1 2 3 4 6 7 9 10 11 12 13 14 15 16 21 22 23 24 25 26 30 31                          | 128                             |
| 433 | 1 3 4 5 6 11 12 16 17 18 19 20 21 22 23 24 25 26 27 28 29 30 31                     | 624                             |
| 434 | 1 2 3 4 6 7 8 9 11 12 13 14 15 16 17 18 19 20 22 23 24 25 26 29                     | 181                             |
| 435 | 1 2 3 4 5 6 7 8 9 10 12 13 14 15 16 17 18 19 20 21 22 23 25 26 29 30                | 400                             |
| 436 | 1 2 3 4 5 6 7 8 9 10 12 13 14 16 18 20 21 22 23 25 26 28 29 30 31                   | 332                             |
| 437 | 1 2 3 4 5 6 7 8 9 11 12 13 14 15 16 17 18 19 20 21 22 29 30 31                      | 504                             |
| 438 | 2 3 5 6 7 8 9 10 12 13 14 15 16 17 18 20 21 22 23 24 26 27 28 29 30 31              | 293                             |
| 439 | 1 2 6 7 8 9 10 11 12 13 14 17 18 19 20 21 22 23 26 27 28 29 30 31                   | 76                              |
| 440 | 1 2 3 4 6 9 10 11 12 14 15 17 18 20 21 22 23 25 26 27 28 29 30 31                   | 397                             |
| 441 | 1 2 4 5 6 7 8 9 10 11 12 14 15 16 17 18 19 20 21 22 23 25 26 27 28 29 30 31         | 70                              |
| 442 | 1 2 3 4 6 7 8 9 10 11 12 16 17 18 19 20 21 22 23 24 25 26 27 29 30                  | 445                             |
| 443 | 1 2 3 4 6 7 10 11 12 13 14 15 16 17 18 19 21 22 23 24 25 26 30 31                   | 308                             |
| 444 | 1 2 3 4 6 7 8 9 10 11 12 13 14 16 17 20 21 22 26 27 29 30 31                        | 464                             |
| 445 | 1 2 3 4 5 6 7 8 9 10 11 12 13 14 16 17 20 21 22 26 27 29 30 31                      | 383                             |
| 446 | 1 2 3 4 5 7 9 12 14 16 17 18 19 20 21 22 23 24 26 27 28 29 30 31                    | 302                             |
| 447 | 1 2 3 4 5 6 7 8 9 11 12 13 14 15 16 17 18 19 20 21 22 23 24 26 27 28 29 30 31       | 30                              |
| 448 | 1 2 3 4 5 6 7 8 9 10 11 12 13 14 16 17 18 19 20 21 22 23 24 25 26                   | 10                              |
| 449 | 1 2 3 4 6 8 9 10 11 12 13 14 15 16 17 18 19 20 21 22 23 24 25 26 29 30              | 658                             |
| 450 | 2 3 4 5 6 7 8 9 10 11 12 13 14 15 16 17 18 19 20 21 22 23 24 26 27 28 29 30         | 267                             |
| 451 | 2 3 4 5 6 8 9 10 11 12 13 14 15 16 17 18 20 21 22 23 24 26 27 28 29 30              | 647                             |
| 452 | 1 2 3 4 5 6 7 8 9 13 14 15 16 17 18 19 20 21 22 23 24 25 26 27 30 31                | 533                             |
| 453 | 1 2 3 4 5 8 9 12 14 15 16 17 18 19 20 21 22 23 24 25 26 27 28 29 30 31              | 532                             |
| 454 | 1 2 3 4 5 6 7 8 9 10 11 12 13 14 15 16 17 18 19 20 21 22 23 24 26 27 28 29 30 31    | 30                              |
| 455 | 6 7 8 9 10 11 12 14 15 16 17 18 19 20 21 22 23 24 25 26 27 28 29 30 31              | 345                             |
| 456 | 1 2 3 4 5 12 13 14 15 16 17 18 19 20 21 22 23 24 25 26 27 28 29 30 31               | 339                             |
| 457 | 6 7 8 9 10 11 12 13 14 15 16 17 18 19 20 21 22 23 24 25 26 27 28 29 30 31           | 125                             |
| 458 | 1 2 3 4 5 6 7 8 9 10 11 12 13 14 15 16 17 18 19 20 21 22 23 24 25 26                | 823                             |
| 459 | 1 3 4 5 6 7 8 9 10 11 12 13 14 15 16 17 18 19 20 21 22 23 24 25 26                  | 1                               |
| 460 | 1 2 3 4 5 6 7 8 9 10 11 12 13 14 15 16 19 20 21 22 23 24 26 27 28 29 30             | 159                             |
| 461 | 1 2 3 4 5 6 7 8 9 10 11 12 13 14 15 16 17 18 20 21 22 23 24 25 27 28 29 31          | 331                             |
| 462 | 1 2 6 7 8 9 10 11 12 13 14 15 16 17 18 19 20 21 22 23 24 25 26 28 29 30 31          | 104                             |
| 463 | 1 2 3 4 5 6 7 8 9 10 11 12 13 14 15 16 18 20 21 22 23 25 27 28 29 30 31             | 16                              |
| 464 | 2 3 4 5 6 7 8 9 10 11 12 13 14 15 16 17 18 20 21 22 23 24 25 26 27 28 29 30 31      | 247                             |
| 465 | 1 2 3 4 5 6 7 8 9 10 12 13 14 15 16 17 18 20 21 22 23 24 25 26 27 28 30             | 468                             |
| 466 | 1 2 3 4 5 6 7 8 9 10 11 12 13 14 17 18 19 20 21 22 24 25 26 27 28 29 31             | 656                             |
| 467 | 1 2 3 4 6 7 8 9 11 12 13 14 15 16 17 18 19 20 21 22 23 24 25 26 27 28 29 31         | 23                              |
| 468 | 1 2 3 4 5 6 7 8 9 10 11 12 13 14 15 16 17 18 19 20 21 22 23 24 25 26 27 28 29 31    | 319                             |
| 469 | 2 4 6 7 8 9 10 11 12 13 14 15 16 17 18 19 20 21 22 23 24 25 26 27 28 29 30 31       | 64                              |
| 470 | 1 2 3 4 5 6 7 8 9 10 11 12 13 14 15 16 17 18 19 20 21 22 23 24 25 26 27 28 29 30 31 | 545                             |
| 471 | 3 4 5 6 7 9 10 11 12 13 14 15 16 17 18 19 20 21 22 24 25 26 27 28 29 30 31          | 247                             |
| 472 | 1 2 3 4 5 6 7 8 9 10 11 12 13 14 15 16 17 18 19 20 21 22 23 24 25 26 27 28 29 30 31 | 321                             |
| 473 | 1 2 3 4 5 6 7 8 9 10 11 12 13 14 16 17 18 19 20 21 22 23 24 25 26 27 28 29 30 31    | 32                              |
| 474 | 1 2 3 4 6 7 8 9 10 12 13 14 15 16 17 18 19 20 21 22 23 24 25 26 27 28 29 30 31      | 493                             |
| 475 | 1 2 3 4 5 6 7 8 9 10 11 12 13 14 15 16 17 18 19 20 21 22 23 24 25 26 27 28 29 30 31 | 609                             |
| 476 | 2 4 7 8 9 10 11 12 13 14 15 16 17 18 19 20 21 22 23 24 25 26 27 28 29 30 31         | 552                             |
| 477 | 1 2 3 4 5 6 7 8 9 10 11 12 13 14 15 16 17 18 19 20 21 22 23 24 25 26 27 28          | 337                             |
| 478 | 1 2 3 4 5 6 7 8 9 10 11 12 13 14 15 16 17 18 19 20 21 22 23 24 25 26 27 28          | 323                             |
| 479 | 1 2 3 4 5 6 7 9 10 11 12 13 14 15 16 17 18 19 20 21 22 23 24 25 26 27 30 31         | 301                             |
| 480 | 1 2 3 4 5 6 7 8 9 10 11 12 13 14 15 16 17 18 20 22 23 24 25 26 27 28 29 30 31       | 164                             |
| 481 | 1 2 3 4 5 6 7 8 9 10 11 12 13 14 15 16 17 18 19 20 21 22 23 24 25 26 27 28 29 30 31 | 603                             |
| 482 | 1 2 3 4 5 6 7 8 9 10 12 13 14 16 17 18 19 20 21 22 23 24 25 26 27 28 29 30 31       | 50                              |
| 483 | 1 2 3 4 7 8 9 10 11 12 13 14 15 16 17 18 19 20 21 22 23 24 25 26 27 28 29 30 31     | 455                             |
| 484 | 1 2 3 4 5 6 7 8 9 10 11 12 13 14 15 16 17 18 19 20 21 22 23 24 26 27 28 29 31       | 680                             |
| 485 | 1 2 3 4 5 6 7 8 9 11 12 13 14 15 16 17 18 19 20 21 22 23 24 25 26 27 28 29 30 31    | 96                              |
| 486 | 1 2 3 4 5 6 7 8 9 10 11 12 13 14 15 16 17 18 19 20 21 22 23 24 25 26 27 28 29 30 31 | 648                             |
| 487 | 1 2 3 4 5 7 8 9 10 11 12 13 14 15 16 17 18 19 20 21 22 23 24 25 26 27 28 29 30 31   | 339                             |
| 488 | 1 2 3 4 5 8 7 8 9 10 11 12 13 14 15 17 18 19 20 21 22 23 24 25 26 27 28 29 30 31    | 31                              |
| 489 | 1 2 3 4 5 6 7 8 9 10 11 12 13 14 15 16 17 18 19 20 21 22 23 24 25 26 27 28 29 30 31 | 129                             |
| 490 | 1 2 3 4 5 6 7 8 9 10 11 12 13 14 15 16 17 18 19 20 21 22 23 24 25 26 27 28 29 30 31 | 556                             |
| 491 | 1 2 3 4 5 6 7 9 10 11 12 13 14 15 16 17 18 19 20 21 22 23 24 25 26 27 28 29 30 31   | 286 299                         |
| 492 | 1 2 3 4 6 7 8 9 11 12 13 14 15 16 17 18 19 20 21 22 23 24 25 26 27 28 29 30 31      | 337                             |
| 493 | 1 2 3 4 5 6 7 8 9 10 11 12 13 14 15 16 17 18 19 20 21 22 23 24 25 26 27 28 29 30 31 | 639                             |
| 494 | 1 2 3 4 5 6 7 8 9 10 11 12 13 14 15 16 17 18 19 20 21 22 23 24 25 26 27 28 29 30 31 | 64                              |
| 495 | 1 2 3 4 5 8 7 8 9 10 11 12 13 14 15 16 17 18 19 20 21 22 23 24 25 26 27 28 29 30 31 | 438                             |
| 496 | 1 2 3 4 5 6 7 8 9 10 11 12 13 14 15 17 18 19 20 21 22 23 24 25 26 27 28 29 30 31    | 476                             |
| 497 | 1 2 3 4 5 6 7 8 9 10 11 12 13 14 16 17 18 19 20 21 22 23 24 25 26 27 28 29 30 31    | 182                             |
| 498 | 1 2 3 4 5 6 7 8 9 10 11 12 13 14 15 16 17 18 19 20 21 22 23 24 25 26 27 28 29 30 31 | 162 333                         |
| 499 | 1 2 3 4 5 6 7 8 9 10 11 12 13 14 15 16 17 18 19 20 21 22 23 24 25 26 27 28 29 30 31 | 375                             |
| 500 | 1 2 3 4 5 6 7 8 9 10 11 12 13 14 15 16 17 18 19 20 21 22 23 24 25 26 27 28 29 30 31 | 368                             |
| 501 | 1 2 3 4 5 6 7 8 9 10 11 12 13 14 15 16 17 18 19 20 21 22 23 24 25 26 27 28 29 30 31 | 41 50 54 57 192 284 442 508 514 |

Appendix 3 cont.



APPENDIX 4. PARTIALLY MONOTHETIC SETS OF AGLAOMORPHA

for legenda see Appendix 3

|     |                |                                |     |                           |                    |
|-----|----------------|--------------------------------|-----|---------------------------|--------------------|
| 1   | 1              | 118                            | 111 | 4 9 11 12 13              | 461                |
| 2   | 2              | 366                            | 112 | 1 6 10 13 15              | 472                |
| 3   | 3              | 176 295 307 311                | 113 | 1 6 12 13 15              | 499                |
| 4   | 4              | 506 507 527                    | 116 | 4 12 13 14 15             | 171                |
| 5   | 5              | 193 373 425 491 513 517        | 114 | 11 12 13 14 15            | 95 322 379 419 526 |
| 6   | 7              | 36 82 109 200 319              | 115 | 2 3 4 5 8                 | 331                |
| 7   | 8              | 65 72 73 89 81 83 87 131       | 117 | 1 2 4 5 6 9               | 320                |
| 8   | 9              | 196 201 208 389 442            | 118 | 1 2 4 5 7 9               | 137                |
| 9   | 10             | 476                            | 119 | 2 3 4 5 8 10              | 287                |
| 10  | 11             | 97 101 102 471                 | 120 | 1 2 3 7 10 10             | 330                |
| 11  | 12             | 466                            | 121 | 2 3 4 7 8 10              | 173                |
| 12  | 13             | 281 337                        | 122 | 1 2 3 8 9 10              | 354                |
| 13  | 14             | 42 444                         | 123 | 2 3 6 8 9 10              | 39                 |
| 14  | 15             | 84 120 138 282 349 366 413 512 | 124 | 2 3 7 8 9 10              | 569                |
| 15  | 1 2            | 167 183                        | 125 | 2 3 7 9 10 11             | 66                 |
| 16  | 3 3            | 175                            | 126 | 4 5 7 9 10 11             | 501                |
| 17  | 1 6            | 316                            | 127 | 3 7 8 9 10 12             | 391                |
| 18  | 5 6            | 308 420 450 470                | 128 | 2 4 5 6 11 13             | 697                |
| 19  | 1 7            | 36                             | 129 | 1 2 3 6 12 12             | 488                |
| 20  | 4 7            | 197 199                        | 130 | 4 5 9 11 12 13            | 386                |
| 21  | 2 8            | 465                            | 131 | 6 7 9 11 12 13            | 492                |
| 22  | 7 8            | 46 74 75 88 107 168 116        | 132 | 1 2 3 12 13 14            | 155                |
| 23  | 6 9            | 77 121 191 292 472             | 133 | 3 9 11 12 13 14           | 23                 |
| 24  | 3 10           | 288 300                        | 134 | 2 3 9 10 11 15            | 30                 |
| 25  | 7 10           | 280                            | 135 | 5 6 9 10 11 13            | 466                |
| 26  | 8 11           | 316                            | 136 | 2 3 4 8 12 13             | 123                |
| 27  | 11 12          | 181 260                        | 137 | 4 5 7 9 12 13             | 26                 |
| 28  | 7 14           | 37 452                         | 138 | 1 2 9 10 12 13            | 328                |
| 29  | 9 14           | 679                            | 139 | 6 7 8 10 13 15            | 283                |
| 30  | 10 16          | 140                            | 140 | 3 3 6 11 13 15            | 336                |
| 31  | 6 15           | 291                            | 141 | 6 7 11 12 14 15           | 208                |
| 32  | 7 15           | 78 85 164                      | 142 | 5 4 10 13 14 15           | 302                |
| 33  | 8 15           | 143                            | 143 | 4 5 12 13 14 15           | 341                |
| 34  | 10 15          | 508                            | 144 | 5 6 12 13 14 15           | 521                |
| 35  | 13 15          | 326                            | 145 | 1 11 12 13 14 15          | 179 330            |
| 36  | 14 15          | 336 378 337                    | 146 | 1 2 2 4 3 7 8             | 274                |
| 37  | 2 5 4          | 496                            | 147 | 2 3 4 5 7 8 10            | 167                |
| 38  | 6 5 5          | 631                            | 148 | 2 3 4 6 8 9 10            | 182                |
| 39  | 2 3 8          | 324 362                        | 149 | 1 2 5 7 8 9 10            | 377 418 421 430    |
| 40  | 3 9            | 174                            | 150 | 3 5 6 7 8 9 10            | 188                |
| 41  | 1 7 9          | 289                            | 151 | 2 3 6 7 8 10 11           | 47                 |
| 42  | 6 7 9          | 264                            | 152 | 1 4 6 7 9 11 13           | 304 308            |
| 43  | 3 8 10         | 193                            | 153 | 2 7 8 9 10 12 13          | 393                |
| 44  | 3 8 10         | 291                            | 154 | 2 3 4 5 8 13 14           | 469                |
| 45  | 7 9 10         | 390                            | 155 | 1 3 10 11 12 13 14        | 122                |
| 46  | 4 7 11         | 133                            | 156 | 1 4 5 6 7 9 13            | 153                |
| 47  | 3 8 11         | 49                             | 157 | 2 3 4 5 6 10 15           | 372                |
| 48  | 7 9 11         | 302                            | 158 | 3 5 5 7 8 10 15           | 431                |
| 49  | 6 10 12        | 274                            | 159 | 1 4 5 8 9 14 15           | 130                |
| 50  | 9 11 12        | 163                            | 160 | 1 6 9 11 12 14 15         | 179                |
| 51  | 8 10 13        | 283                            | 161 | 3 3 7 8 13 14 15          | 438                |
| 52  | 10 11 14       | 145 149                        | 162 | 7 9 10 11 13 14 15        | 693                |
| 53  | 7 8 12         | 97                             | 163 | 2 3 6 10 13 14 15         | 483                |
| 54  | 9 11 15        | 169                            | 164 | 4 5 6 12 13 14 15         | 356                |
| 55  | 1 12 13        | 156                            | 165 | 2 3 11 12 13 14 15        | 395 331            |
| 56  | 3 13 13        | 467                            | 166 | 4 5 11 12 13 14 15        | 615                |
| 57  | 12 13 15       | 192                            | 167 | 5 6 11 12 13 14 15        | 437                |
| 58  | 3 14 15        | 424                            | 168 | 1 9 11 12 13 14 15        | 157                |
| 59  | 13 14 15       | 277 334                        | 169 | 2 9 11 12 13 14 15        | 392                |
| 60  | 2 3 4 5        | 349                            | 170 | 1 2 2 6 7 8 9 10          | 434                |
| 61  | 1 4 5 6        | 381                            | 171 | 3 5 5 6 7 8 9 10          | 387                |
| 62  | 2 4 5 8        | 188                            | 172 | 2 3 4 8 6 10 11 12        | 460                |
| 63  | 1 3 6 8        | 399                            | 173 | 2 6 7 8 9 10 11 12        | 215                |
| 64  | 2 3 6 8        | 3 548                          | 174 | 1 4 6 7 9 10 11 12        | 312                |
| 65  | 3 4 7 8        | 469                            | 175 | 1 3 6 8 10 11 12 14       | 25                 |
| 66  | 2 4 7 8        | 160                            | 176 | 3 5 6 8 9 12 13 14        | 131                |
| 67  | 1 4 6 8        | 398                            | 177 | 1 4 5 6 11 12 13 14       | 311                |
| 68  | 4 5 6 9        | 148                            | 178 | 1 2 6 8 11 12 13 14       | 432 473            |
| 69  | 1 3 8 10       | 17                             | 179 | 1 2 3 7 8 10 11 13        | 461                |
| 70  | 5 5 9 10       | 183                            | 180 | 1 2 3 6 8 10 12 13        | 132                |
| 71  | 2 6 8 10       | 156                            | 181 | 3 4 5 7 9 12 13 15        | 411                |
| 72  | 2 6 11 12      | 436                            | 182 | 2 9 10 11 12 13 15        | 382                |
| 73  | 5 6 7 14       | 358                            | 183 | 2 5 6 10 11 12 14 15      | 441                |
| 74  | 2 7 8 16       | 426                            | 184 | 1 2 3 8 12 13 14 15       | 156                |
| 75  | 3 6 11 14      | 488                            | 185 | 2 3 3 10 12 13 14 15      | 310                |
| 76  | 2 3 12 14      | 314                            | 186 | 1 2 4 11 12 13 14 15      | 186                |
| 77  | 1 6 13 14      | 498                            | 187 | 4 5 6 11 12 14 15         | 375 385 417 423    |
| 78  | 2 11 13 14     | 21                             | 188 | 3 8 10 11 12 13 14 15     | 221                |
| 79  | 11 12 13 14    | 327                            | 189 | 6 9 10 11 12 13 14 15     | 278                |
| 80  | 2 6 8 13       | 412                            | 190 | 1 2 2 4 5 7 8 9 10        | 494 328            |
| 81  | 7 8 9 13       | 152                            | 191 | 2 3 4 5 6 7 8 9 10        | 382                |
| 82  | 6 9 10 13      | 467                            | 192 | 1 2 3 4 3 8 9 10 13       | 205                |
| 83  | 2 3 11 13      | 329                            | 193 | 2 4 5 7 8 10 12 14        | 294                |
| 84  | 3 11 12 13     | 477                            | 194 | 2 4 6 7 8 10 12 13 14     | 329                |
| 85  | 12 13 14 15    | 100 139 330                    | 196 | 1 5 6 8 10 11 12 13 14    | 172                |
| 86  | 2 4 5 7 8      | 388                            | 197 | 1 2 3 4 5 9 10 13 15      | 325                |
| 87  | 3 4 5 7 8      | 466                            | 198 | 1 2 3 4 3 6 12 14 15      | 371                |
| 88  | 1 3 4 5 10     | 163                            | 199 | 1 4 5 7 10 11 13 14 15    | 332                |
| 89  | 1 3 6 8 10     | 396                            | 200 | 3 4 5 8 10 11 13 14 15    | 464                |
| 90  | 3 5 8 9 10     | 180                            | 201 | 1 2 4 5 11 12 13 14 15    | 317                |
| 91  | 1 7 8 9 10     | 481                            | 202 | 4 5 6 7 11 12 13 14 15    | 522                |
| 92  | 3 7 8 9 10     | 326                            | 203 | 4 5 7 8 11 12 13 14 15    | 518                |
| 93  | 1 4 8 6 11     | 390                            | 204 | 2 5 7 10 11 12 13 14 15   | 18                 |
| 94  | 1 7 9 10 11    | 349                            | 205 | 1 2 3 4 5 6 7 8 9 10      | 354                |
| 95  | 2 3 5 10 12    | 296                            | 206 | 1 2 3 4 3 7 8 9 10 11     | 313 319            |
| 96  | 4 3 6 11 12    | 330                            | 207 | 1 2 3 4 6 7 8 9 10 13     | 181                |
| 97  | 1 2 3 12 13    | 150                            | 208 | 1 3 4 8 6 7 8 11 13 14    | 27                 |
| 98  | 1 3 3 10 14    | 380                            | 209 | 3 4 5 7 8 10 12 13 14     | 139                |
| 99  | 1 7 8 11 14    | 436                            | 210 | 2 4 5 6 7 9 10 12 13 14   | 400                |
| 100 | 1 8 10 11 14   | 610                            | 211 | 2 3 4 3 6 10 11 10 13 14  | 348                |
| 101 | 2 3 3 12 14    | 308                            | 212 | 1 6 7 8 9 10 11 12 13 14  | 347                |
| 102 | 7 8 11 12 14   | 370                            | 213 | 2 4 6 8 7 8 9 10 13       | 111                |
| 103 | 1 7 8 13 14    | 141                            | 214 | 1 2 6 7 8 9 11 12 13 13   | 331                |
| 104 | 5 7 9 13 14    | 44                             | 215 | 1 2 3 4 5 8 9 11 14 15    | 442                |
| 105 | 5 6 11 13 14   | 92                             | 216 | 1 4 3 6 7 9 12 13 14 15   | 43                 |
| 106 | 10 11 12 13 14 | 326                            | 217 | 2 3 7 8 10 12 13 14 15    | 297                |
| 107 | 2 3 9 10 15    | 162                            | 218 | 1 2 3 6 9 11 12 13 14 15  | 668                |
| 108 | 1 6 9 11 15    | 800                            | 219 | 2 4 6 8 10 11 12 13 14 15 | 138                |
| 109 | 1 2 10 11 15   | 103                            | 220 | 1 2 3 6 3 6 7 8 9 10 11   | 342                |
| 110 | 2 9 10 12 15   | 29                             |     |                           |                    |

```

321 | 1 2 3 4 5 6 8 9 11 12 14
322 | 1 2 3 4 5 7 9 10 11 12 14
323 | 2 3 4 5 6 7 8 9 10 13 14
324 | 1 2 3 4 5 6 8 9 10 13 15
325 | 1 2 3 5 6 7 8 9 10 14 15
326 | 2 4 5 6 7 9 11 12 14 15
327 | 1 4 5 7 9 10 11 12 14 15
328 | 1 2 3 4 5 6 7 8 9 10 11 12
329 | 1 2 3 4 5 6 7 9 10 11 12 13
330 | 1 2 4 5 6 7 8 9 10 11 12 14
331 | 1 2 3 4 5 6 9 10 11 12 14
332 | 1 2 3 4 5 8 7 8 9 10 11 13
333 | 1 2 4 5 6 7 9 10 11 12 13 15
334 | 1 2 3 4 5 8 9 10 11 12 13 15
335 | 2 3 4 5 6 7 8 9 10 11 12 13 15
336 | 1 2 3 4 5 7 8 9 10 11 14 15
337 | 1 2 3 4 5 7 8 10 11 12 14 15
338 | 1 2 3 4 6 7 8 10 11 13 14 15
339 | 2 3 4 5 6 8 9 11 12 13 14 15
340 | 1 2 3 4 5 8 10 11 12 13 14 15
341 | 2 3 4 5 6 8 10 11 12 13 14 15
342 | 1 2 4 5 7 8 10 11 12 13 14 15
343 | 1 2 4 6 7 8 10 11 12 13 14 15
344 | 1 2 3 4 5 6 7 8 9 10 11 12 13
345 | 1 2 3 4 5 6 7 8 9 10 11 13 14
346 | 1 2 3 4 5 6 7 8 10 11 12 13 15
347 | 1 2 3 4 5 6 8 9 10 11 12 13 15
348 | 1 2 3 4 5 6 8 10 11 12 13 14 15
349 | 1 2 3 4 5 7 8 10 11 12 13 14 15
350 | 1 2 3 4 5 8 9 10 11 12 13 14 15
351 | 1 2 4 5 6 7 8 10 11 12 13 14 15
352 | 2 3 4 5 6 7 8 10 11 12 13 14 15
353 | 1 2 3 4 7 8 9 10 11 12 13 14 15
354 | 1 2 4 6 7 8 9 10 11 12 13 14 15
355 | 1 2 4 5 6 7 8 9 10 11 12 13 15
356 | 1 2 3 4 5 6 7 8 9 10 11 12 14 15
357 | 1 2 3 4 5 6 7 8 9 10 11 13 14 15
358 | 1 2 3 4 5 6 7 8 9 10 12 13 14 15
359 | 1 2 3 4 5 6 7 8 10 11 12 13 14 15
360 | 1 2 3 4 5 6 7 9 10 11 12 13 14 15
361 | 1 2 3 4 5 6 8 9 10 11 12 13 14 15
362 | 1 2 3 4 5 7 8 9 10 11 12 13 14 15
363 | 1 2 3 4 5 6 7 8 9 10 11 12 13 14 15

```

```

| 279
| 355
| 438
| 341
| 308
| 16
| 6 7 347
| 335
| 435
| 448
| 61 88 119 166
| 322
| 487
| 359
| 46
| 333
| 323
| 346
| 306
| 198
| 290
| 293 305 309 313
| 189
| 338
| 405
| 480
| 363 363 434
| 302 324
| 190 194
| 11 62 78 99 106
| 307
| 38
| 449
| 166
| 23
| 301
| 459
| 94 104
| 187 203 210
| 63 64 66
| 319
| 112 247 428 332 339 345
| 13 29 28 31 32 35 38 41 58 39 34 37 78 115 123 126 129
162 192 272 286 286 299 335 339 345 353 357 365 403 409 426 435 437 443
455 462 476 492 505 514 526

```

Appendix 4 cont.

|                            |                             |
|----------------------------|-----------------------------|
| 1 = terminal cladon no. 17 | 9 = terminal cladon no. 25  |
| 2 = terminal cladon no. 18 | 10 = terminal cladon no. 26 |
| 3 = terminal cladon no. 19 | 11 = terminal cladon no. 27 |
| 4 = terminal cladon no. 20 | 12 = terminal cladon no. 28 |
| 5 = terminal cladon no. 21 | 13 = terminal cladon no. 29 |
| 6 = terminal cladon no. 22 | 14 = terminal cladon no. 30 |
| 7 = terminal cladon no. 23 | 15 = terminal cladon no. 31 |
| 8 = terminal cladon no. 24 |                             |



APPENDIX 5. PARTIALLY MONOTHETIC SETS OF DRYNARIA

for Legenda see Appendix 3

|     |             |                     |     |                        |             |
|-----|-------------|---------------------|-----|------------------------|-------------|
| 1   | 1           | 348                 | 111 | 1 3 4 3 3              | 516         |
| 2   | 2           | 17 48               | 112 | 1 3 4 3 9              | 499         |
| 3   | 3           | 181 364 368 402     | 113 | 1 2 4 3 10             | 242         |
| 4   | 4           | 133 392 393         | 114 | 3 4 8 8 10             | 186         |
| 5   | 5           | 302 354 361 439     | 115 | 8 8 8 9 10             | 496         |
| 6   | 6           | 273 506             | 116 | 6 7 8 9 10             | 269         |
| 7   | 7           | 137 177 184 345     | 117 | 2 8 9 10 11            | 537         |
| 8   | 8           | 97 121 368 375      | 118 | 3 9 10 11 12           | 534         |
| 9   | 9           | 378 487             | 119 | 6 7 8 9 13             | 153         |
| 10  | 10          | 114 285 303 329 422 | 120 | 4 5 9 11 14            | 496         |
| 11  | 11          | 176 332             | 121 | 6 10 11 12 13          | 201         |
| 12  | 12          | 9 26                | 122 | 8 9 13 14 15           | 406         |
| 13  | 13          | 78 144 263 277 478  | 123 | 7 11 13 14 15          | 233         |
| 14  | 1 2         | 377 382 383 386     | 124 | 11 12 13 14 15         | 463         |
| 15  | 1 3         | 465                 | 125 | 1 3 3 12 16            | 396         |
| 16  | 1 4         | 292                 | 126 | 4 5 9 13 16            | 38          |
| 17  | 4 9         | 316                 | 127 | 3 10 11 13 16          | 243         |
| 18  | 1 7         | 492                 | 128 | 9 10 12 14 16          | 352         |
| 19  | 3 9         | 381                 | 129 | 3 4 5 15 16            | 257         |
| 20  | 6 9         | 236                 | 130 | 7 11 12 15 16          | 16          |
| 21  | 8 9         | 648 485             | 131 | 9 13 14 15 16          | 410         |
| 22  | 2 10        | 302                 | 132 | 11 13 14 15 16         | 321         |
| 23  | 6 10        | 351                 | 133 | 12 13 14 15 16         | 284         |
| 24  | 8 10        | 214 493             | 134 | 1 2 4 6 7 8            | 39          |
| 25  | 9 10        | 608 329             | 135 | 1 2 4 6 7 9            | 234         |
| 26  | 8 11        | 346                 | 136 | 1 2 3 6 8 10           | 179         |
| 27  | 10 11       | 340                 | 137 | 1 2 4 6 8 10           | 123         |
| 28  | 9 12        | 278                 | 138 | 1 2 4 6 9 11           | 226         |
| 29  | 10 12       | 29                  | 139 | 6 7 8 9 10 11          | 538         |
| 30  | 11 12       | 92 450 541          | 140 | 5 6 7 10 11 12         | 531         |
| 31  | 6 13        | 175                 | 141 | 6 7 8 9 10 13          | 482         |
| 32  | 7 13        | 164                 | 142 | 6 8 9 10 12 13         | 282         |
| 33  | 9 14        | 118 213             | 143 | 8 9 10 11 12 15        | 391         |
| 34  | 12 14       | 300                 | 144 | 1 2 4 6 11 14          | 239         |
| 35  | 13 14       | 127 288             | 145 | 2 7 11 12 13 14        | 287         |
| 36  | 11 15       | 273                 | 146 | 2 6 8 10 13 15         | 226         |
| 37  | 13 15       | 280 326             | 147 | 6 10 11 12 13 15       | 317         |
| 38  | 14 15       | 340                 | 148 | 7 9 11 13 14 15        | 264         |
| 39  | 9 16        | 6 12 13 59          | 149 | 10 11 12 13 14 15      | 36          |
| 40  | 15 16       | 217 433             | 150 | 1 2 4 5 10 16          | 259         |
| 41  | 1 3 4       | 81 112              | 151 | 1 6 8 9 10 14          | 257         |
| 42  | 2 3 4       | 67                  | 152 | 6 7 9 13 14 16         | 163         |
| 43  | 1 3 5       | 83                  | 153 | 3 11 12 14 15 16       | 154         |
| 44  | 1 4 5       | 237                 | 154 | 10 11 12 14 15 16      | 37          |
| 45  | 3 4 5       | 72 239              | 155 | 10 11 13 14 15 16      | 8           |
| 46  | 1 3 6       | 381                 | 156 | 11 12 13 14 15 16      | 120 319 346 |
| 47  | 1 5 6       | 35                  | 157 | 1 2 3 5 6 7 8          | 276         |
| 48  | 3 3 8       | 368 342 363         | 158 | 1 2 3 6 8 6 9          | 124         |
| 49  | 2 4 8       | 326                 | 159 | 1 2 5 6 8 9 10         | 224         |
| 50  | 6 8 9       | 281 342             | 160 | 1 2 3 6 8 6 11         | 248         |
| 51  | 2 6 10      | 101                 | 161 | 1 2 3 4 5 7 12         | 170         |
| 52  | 2 8 10      | 393                 | 162 | 1 2 3 4 5 10 12        | 437         |
| 53  | 4 9 10      | 178                 | 163 | 1 2 3 5 6 11 12        | 411         |
| 54  | 3 9 10      | 176                 | 164 | 1 3 4 5 7 11 12        | 321         |
| 55  | 8 9 10      | 416                 | 165 | 1 3 4 5 10 11 12       | 103         |
| 56  | 10 11 10    | 293 296 307 311 314 | 166 | 6 7 8 9 10 11 12       | 90          |
| 57  | 8 9 12      | 427                 | 167 | 1 2 3 4 5 7 14         | 279         |
| 58  | 7 9 14      | 194                 | 168 | 1 2 3 6 8 13 14        | 169         |
| 59  | 1 11 14     | 182                 | 169 | 1 2 3 6 8 9 13         | 129         |
| 60  | 10 11 14    | 204                 | 170 | 1 2 3 4 5 10 13        | 203         |
| 61  | 11 12 14    | 8                   | 171 | 1 3 3 8 11 13 15       | 401         |
| 62  | 9 12 14     | 207 208             | 172 | 1 3 4 5 11 14 15       | 491         |
| 63  | 12 13 14    | 281                 | 173 | 1 3 7 11 12 14 15      | 242         |
| 64  | 6 14 13     | 328                 | 174 | 7 8 10 11 12 14 15     | 43          |
| 65  | 11 14 13    | 281 325             | 175 | 1 2 3 4 5 6 16         | 260         |
| 66  | 12 14 13    | 46 42               | 176 | 1 2 3 4 5 9 16         | 427         |
| 67  | 13 14 13    | 288 404 349         | 177 | 1 2 4 6 9 10 16        | 229         |
| 68  | 1 9 16      | 308                 | 178 | 5 6 7 8 10 16          | 444         |
| 69  | 2 9 16      | 339                 | 179 | 1 2 3 4 5 11 16        | 264         |
| 70  | 7 9 16      | 33 198              | 180 | 1 3 4 5 11 12 16       | 424         |
| 71  | 1 10 16     | 440                 | 181 | 4 6 7 8 11 12 16       | 266         |
| 72  | 3 15 16     | 251                 | 182 | 4 8 9 10 12 14 16      | 415         |
| 73  | 8 15 16     | 370                 | 183 | 9 10 11 12 13 15 16    | 278         |
| 74  | 9 15 16     | 464                 | 184 | 5 7 9 12 14 15 16      | 205         |
| 75  | 10 15 16    | 507                 | 185 | 3 8 10 13 14 15 16     | 251         |
| 76  | 14 15 16    | 94                  | 186 | 3 10 11 13 14 15 16    | 241         |
| 77  | 1 2 3 4     | 46 443              | 187 | 8 10 11 13 14 15 16    | 310         |
| 78  | 1 2 4 5     | 87 213 343 353      | 188 | 10 11 12 13 14 15 16   | 19          |
| 79  | 1 2 4 6     | 433                 | 189 | 1 2 2 3 6 7 8 10       | 350         |
| 80  | 1 4 5 7     | 351                 | 190 | 1 2 4 7 8 9 10 11      | 233         |
| 81  | 1 2 7 9     | 29                  | 191 | 2 4 5 6 8 9 11 12      | 133         |
| 82  | 2 3 8 9     | 339                 | 192 | 4 5 6 7 9 10 11 12     | 356         |
| 83  | 2 7 8 9     | 497                 | 193 | 1 2 3 4 5 6 7 14       | 274         |
| 84  | 6 7 8 9     | 204 243             | 194 | 1 2 4 3 6 8 9 14       | 79          |
| 85  | 4 7 8 10    | 412                 | 195 | 1 2 3 7 8 10 12 14     | 322         |
| 86  | 6 7 8 10    | 398                 | 196 | 1 2 3 7 9 10 12 14     | 489         |
| 87  | 6 7 9 10    | 391                 | 197 | 5 6 7 8 9 10 13 14     | 262         |
| 88  | 3 7 10 11   | 413                 | 198 | 1 2 3 6 7 8 10 13      | 187         |
| 89  | 6 9 11 12   | 348                 | 199 | 1 2 3 4 7 8 13 15      | 189         |
| 90  | 8 10 11 12  | 354 335 336         | 200 | 2 4 7 8 11 12 13 15    | 100         |
| 91  | 5 9 10 13   | 127                 | 201 | 1 2 3 4 5 8 14 15      | 25          |
| 92  | 6 7 8 14    | 354                 | 202 | 6 7 8 9 10 13 14 15    | 270         |
| 93  | 1 7 13 14   | 488                 | 203 | 6 7 8 10 11 12 14 15   | 294         |
| 94  | 5 7 13 14   | 135                 | 204 | 3 8 10 11 12 13 14 15  | 333         |
| 95  | 6 7 13 14   | 187 168 174         | 205 | 1 2 3 4 5 8 10 16      | 213         |
| 96  | 7 9 13 14   | 190                 | 206 | 1 2 3 4 5 9 11 16      | 271         |
| 97  | 2 7 12 13   | 308                 | 207 | 3 5 8 9 11 12 13 16    | 434         |
| 98  | 4 12 13 13  | 140                 | 208 | 2 3 5 7 8 13 14 16     | 173         |
| 99  | 7 9 14 13   | 322 249             | 209 | 3 4 10 11 12 13 14 16  | 274         |
| 100 | 11 12 14 13 | 30 31               | 210 | 2 6 8 9 10 13 15 16    | 313         |
| 101 | 2 13 14 13  | 216                 | 211 | 6 7 10 11 12 13 15 16  | 69          |
| 102 | 4 13 14 13  | 374                 | 212 | 1 3 5 9 13 14 15 16    | 99          |
| 103 | 1 3 7 16    | 369                 | 213 | 3 4 7 9 13 14 15 16    | 309 315     |
| 104 | 10 11 12 16 | 282                 | 214 | 3 4 5 10 13 14 15 16   | 227         |
| 105 | 7 9 12 16   | 24                  | 215 | 3 6 10 11 13 14 15 16  | 477         |
| 106 | 3 9 14 16   | 484                 | 216 | 1 3 5 12 13 14 15 16   | 499         |
| 107 | 8 13 15 16  | 485                 | 217 | 7 9 16 12 13 14 15 16  | 293         |
| 108 | 9 14 15 16  | 115                 | 218 | 8 9 11 12 13 14 15 16  | 535         |
| 109 | 12 14 15 16 | 88                  | 219 | 4 10 11 12 13 14 15 16 | 18          |
| 110 | 1 2 3 4 5   | 79 82 86 89 294     | 220 | 1 2 3 4 3 6 7 8 9      | 20          |

|     |                              |               |     |  |                     |
|-----|------------------------------|---------------|-----|--|---------------------|
| 221 | 1 2 4 5 6 7 8 9 11           | 220           | 294 | 1 2 3 4 5 7 8 10 11 12 13 14           | 372                 |
| 222 | 1 2 4 5 6 7 10 11 12         | 484           | 292 | 2 4 5 6 7 8 9 10 11 12 13 15           | 158                 |
| 223 | 1 2 3 4 5 6 8 10 13          | 224           | 296 | 1 2 3 4 5 8 10 11 12 13 14 15          | 197                 |
| 224 | 1 2 4 5 6 7 9 11 14          | 244           | 297 | 1 2 3 4 5 6 8 9 10 11 12 16            | 312                 |
| 225 | 1 2 4 7 8 10 11 12 14 15     | 226           | 298 | 1 2 3 4 5 6 7 8 9 10 13 16             | 28                  |
| 226 | 1 2 3 5 7 8 9 10 13          | 280           | 299 | 1 2 3 5 6 7 8 9 10 13 14 16            | 33                  |
| 227 | 1 5 3 3 6 7 11 12 13         | 414           | 300 | 1 2 3 4 5 6 9 10 11 12 14 16           | 232                 |
| 228 | 2 6 7 8 9 10 13 14 15        | 423           | 301 | 1 2 4 8 7 8 9 10 11 12 14 16           | 228                 |
| 229 | 1 2 6 7 9 11 13 14 15        | 312           | 308 | 1 2 4 5 6 8 10 11 12 13 16             | 191                 |
| 230 | 1 2 4 5 10 11 12 13 14 15    | 76            | 303 | 1 2 3 6 7 8 9 10 12 13 14 16           | 495                 |
| 231 | 1 2 4 5 6 10 11 12 16        | 344           | 304 | 1 2 3 4 5 6 7 11 12 14 13 16           | 499                 |
| 232 | 2 3 6 8 9 10 11 12 16        | 350           | 305 | 1 2 3 4 5 7 8 9 13 14 13 16            | 398                 |
| 233 | 1 2 3 5 6 7 9 14 16          | 138           | 306 | 1 2 4 5 6 7 8 11 13 14 13 16           | 223                 |
| 234 | 6 7 8 10 11 12 13 14 16      | 126           | 307 | 1 2 6 7 8 9 10 11 13 14 13 16          | 184                 |
| 235 | 1 3 4 5 11 12 14 13 16       | 74            | 308 | 1 2 3 4 5 10 11 12 13 14 13 16         | 441 330             |
| 236 | 8 8 9 10 11 13 14 13 16      | 108           | 309 | 1 2 4 6 7 10 11 13 13 14 13 16         | 330                 |
| 237 | 1 2 3 11 12 13 14 13 16      | 498           | 310 | 2 4 6 7 8 9 10 11 12 13 14 13 16       | 352                 |
| 238 | 1 2 3 4 5 6 7 9 9 16         | 7 318         | 311 | 8 6 7 8 9 10 11 12 13 14 13 16         | 382                 |
| 239 | 1 2 4 3 6 7 8 8 10 11        | 322           | 312 | 1 2 3 4 5 6 7 8 9 10 11 13 14          | 219                 |
| 240 | 1 2 3 4 5 6 7 10 11 12       | 109           | 313 | 1 2 3 3 6 7 8 10 11 12 13 14 15        | 56                  |
| 241 | 1 2 3 4 5 6 8 10 11 12       | 21            | 314 | 1 3 4 3 7 8 9 10 11 12 13 14 15        | 318                 |
| 242 | 1 2 3 4 5 6 7 9 10 12        | 92            | 315 | 1 2 3 4 5 6 7 8 9 10 11 12 16          | 452 342             |
| 243 | 1 2 3 4 6 7 9 10 11 12       | 111           | 316 | 1 2 4 5 7 8 9 10 11 12 13 16           | 229                 |
| 244 | 1 2 4 5 6 8 9 10 11 12       | 267           | 317 | 1 3 4 5 6 7 8 9 10 11 12 14 16         | 228                 |
| 245 | 1 2 3 4 5 6 8 10 13 14       | 15            | 318 | 1 2 3 4 5 6 7 8 9 10 13 14 16          | 30                  |
| 246 | 1 2 4 5 6 8 10 11 13 14      | 232           | 319 | 1 2 4 5 6 7 8 9 10 12 13 14 16         | 440                 |
| 247 | 1 2 3 4 5 6 8 7 10 12 15     | 71            | 320 | 1 2 3 4 5 6 7 8 10 11 12 13 16         | 210                 |
| 248 | 1 2 5 6 8 9 10 11 14 15      | 265           | 321 | 1 2 3 4 5 6 7 8 10 11 12 13 16         | 107                 |
| 249 | 1 2 4 8 9 10 11 12 14 15     | 297           | 322 | 1 2 3 4 5 6 8 10 11 12 13 15 16        | 192                 |
| 250 | 1 2 4 8 10 11 12 13 14 15    | 204           | 323 | 1 2 3 4 5 8 9 10 11 12 14 15 16        | 172                 |
| 251 | 3 4 5 8 10 11 12 13 14 15    | 199           | 324 | 2 3 4 5 6 8 9 10 11 12 14 15 16        | 487                 |
| 252 | 3 5 7 8 10 11 12 13 14 15    | 3             | 325 | 1 2 3 4 5 9 7 8 9 15 14 13 16          | 352                 |
| 253 | 4 7 8 9 10 11 12 13 14 15    | 77            | 326 | 1 2 3 4 6 7 8 9 11 13 14 15 16         | 25                  |
| 254 | 1 2 3 4 5 6 7 8 9 10         | 35            | 327 | 1 2 3 4 7 8 9 10 11 13 14 15 16        | 495                 |
| 255 | 1 2 3 4 6 9 10 11 13 16      | 42            | 328 | 1 2 5 6 7 8 9 10 12 13 14 13 16        | 113                 |
| 256 | 1 2 4 7 8 9 10 11 13 16      | 76            | 329 | 1 2 3 6 7 8 11 12 13 14 15 16          | 131 188             |
| 257 | 1 2 3 4 5 6 9 13 14 16       | 312           | 330 | 1 2 3 4 6 7 10 11 12 13 14 13 16       | 508                 |
| 258 | 1 2 3 4 5 7 9 13 14 16       | 202           | 331 | 1 2 3 6 7 9 10 11 12 13 14 15 16       | 271                 |
| 259 | 1 2 3 4 5 8 9 13 14 16       | 308           | 332 | 2 4 6 7 9 10 11 12 13 14 15 16         | 347                 |
| 260 | 1 2 5 6 8 11 12 13 14 16     | 182           | 333 | 2 4 6 7 8 9 10 11 12 13 14 15 16       | 64                  |
| 261 | 2 3 5 6 10 11 12 13 14 16    | 204           | 334 | 3 5 8 9 9 10 11 12 13 14 15 16         | 432                 |
| 262 | 2 5 6 7 8 9 10 12 13 16      | 452           | 335 | 1 2 3 4 5 6 7 8 9 10 11 12 13 14       | 114 454             |
| 263 | 6 7 8 9 10 11 12 14 15 16    | 352           | 336 | 1 2 3 4 5 6 7 8 10 11 13 14 15         | 31                  |
| 264 | 1 3 4 5 9 10 13 14 15 16     | 242           | 337 | 1 2 3 4 5 6 7 8 9 10 11 12 13 16       | 129                 |
| 265 | 1 4 7 8 9 10 13 14 15 16     | 523           | 338 | 1 2 3 4 5 6 7 8 9 10 11 12 14 16       | 324                 |
| 266 | 2 4 6 7 8 9 10 13 14 15 16   | 342           | 339 | 1 2 3 4 5 6 7 8 9 10 11 13 14 16       | 253                 |
| 267 | 1 2 3 4 9 12 13 14 15 16     | 339           | 340 | 1 2 3 4 3 6 7 8 10 11 12 13 13 16      | 461                 |
| 268 | 6 7 8 10 11 12 13 14 15 16   | 125           | 341 | 1 2 3 4 5 6 7 9 10 11 13 14 13 16      | 386 299 301         |
| 269 | 1 2 3 4 5 6 7 9 10 11 12     | 246           | 342 | 1 2 3 4 5 6 7 8 11 12 13 14 15 16      | 352                 |
| 270 | 1 2 3 4 5 6 7 9 11 13 14     | 216           | 343 | 1 2 3 4 5 6 7 9 11 12 13 14 15 16      | 617                 |
| 271 | 1 2 3 5 6 7 8 9 11 13 14     | 304           | 344 | 1 2 3 4 5 7 8 9 11 12 13 14 15 16      | 357                 |
| 272 | 1 2 3 4 6 8 10 11 12 13 14   | 451           | 345 | 1 2 3 4 6 6 7 10 11 12 13 14 13 16     | 446                 |
| 273 | 2 3 4 5 6 9 10 11 12 14 15   | 171           | 346 | 1 2 3 8 8 9 10 11 12 13 14 15 16       | 438                 |
| 274 | 1 3 4 5 7 8 9 10 12 14 15    | 228           | 347 | 1 3 5 6 7 8 9 10 11 12 13 14 15 16     | 375                 |
| 275 | 1 2 3 4 5 6 7 8 9 10 16      | 429           | 348 | 1 2 3 4 5 6 7 8 9 10 11 12 13 14 15    | 476                 |
| 276 | 1 2 3 5 6 7 8 9 10 11 16     | 85            | 349 | 1 2 3 4 5 6 7 8 9 10 11 12 13 14 16    | 10 38 465           |
| 277 | 1 2 3 4 5 6 7 10 11 12 16    | 405           | 350 | 1 2 3 4 3 6 7 8 9 10 11 12 14 13 16    | 162 164 333         |
| 278 | 1 2 3 4 5 6 8 10 11 12 16    | 223 238       | 351 | 1 2 3 4 3 6 7 8 9 10 11 12 14 15 16    | 117 211 218 297 421 |
| 279 | 1 2 3 4 5 6 8 9 12 14 16     | 304           | 352 | 1 2 3 4 3 6 7 8 9 10 12 13 14 15 16    | 468                 |
| 280 | 1 3 5 6 7 8 10 11 13 14 16   | 46            | 353 | 1 2 3 4 3 6 7 8 9 11 12 13 14 15 16    | 96 161              |
| 281 | 1 2 3 5 7 8 11 12 13 14 16   | 189           | 354 | 1 2 3 4 5 6 7 8 10 11 12 13 14 15 16   | 152                 |
| 282 | 1 2 3 4 5 6 7 11 14 15 16    | 390           | 355 | 1 2 3 4 5 6 7 9 10 11 12 13 14 15 16   | 272                 |
| 283 | 1 3 4 3 6 8 9 11 14 15 16    | 321           | 356 | 1 2 3 4 5 6 8 9 10 11 12 13 14 15 16   | 428                 |
| 284 | 1 2 3 4 5 10 11 12 14 15 16  | 75 151        | 357 | 1 2 3 4 5 7 8 9 10 11 12 13 14 15 16   | 329                 |
| 285 | 1 2 3 3 6 7 9 13 14 15 16    | 319           | 358 | 1 2 4 5 6 7 8 9 10 11 12 13 14 15 16   | 363                 |
| 286 | 1 2 3 4 5 8 9 12 14 15 16    | 332           | 359 | 1 3 4 5 6 7 8 9 10 11 12 13 14 15 16   | 16                  |
| 287 | 2 3 5 6 7 8 9 13 14 15 16    | 158           | 360 | 2 3 4 5 6 7 8 9 10 11 12 13 14 15 16   | 267 567             |
| 288 | 1 2 3 4 7 8 10 13 14 15 16   | 319           | 361 | 1 2 3 4 5 6 7 8 9 10 11 12 13 14 15 16 | 2 41 52 54 57       |
| 289 | 3 4 5 6 8 10 11 13 14 15 16  | 27            |     |  | 80 64 67 143 159    |
| 290 | 2 6 7 8 9 10 11 13 14 15 16  | 428           |     |  | 192 284 323 331 339 |
| 291 | 2 4 6 7 8 11 12 13 14 15 16  | 129           |     |  | 325 428 434 449 458 |
| 292 | 4 7 8 9 10 11 12 13 14 15 16 | 84 85 297 434 |     |  | 462 469 480 505 514 |
| 293 | 1 2 3 4 5 6 7 8 10 11 12 13  | 1             |     |  |                     |

Appendix 5 cont.

**APPENDIX 6. DISTRIBUTION MAPS**

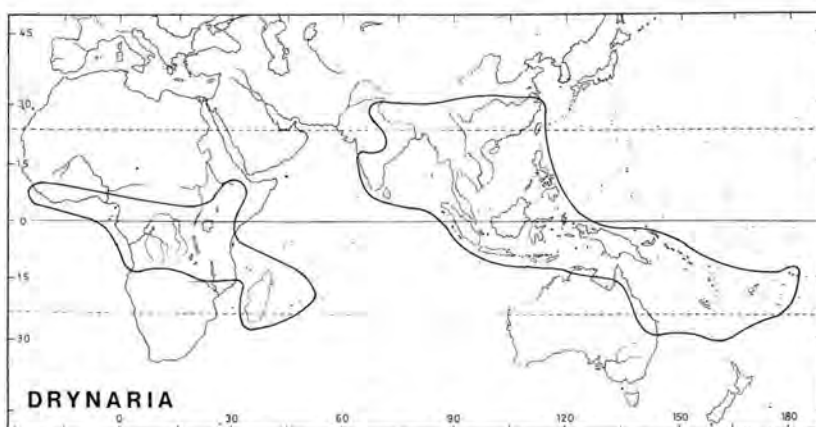
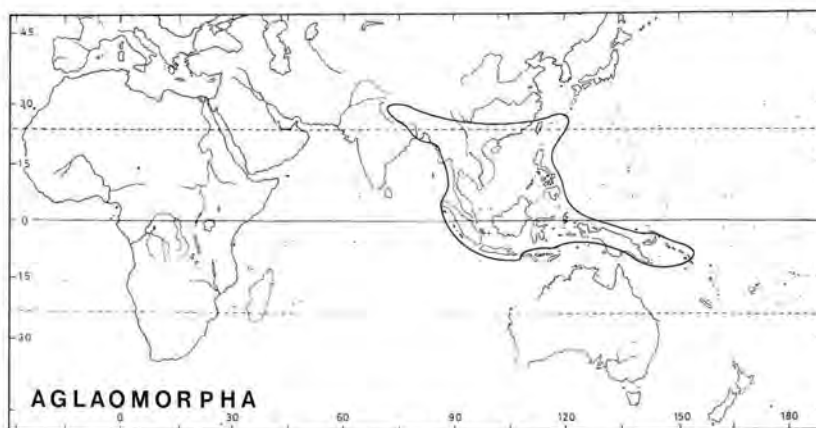

Distribution maps of the species

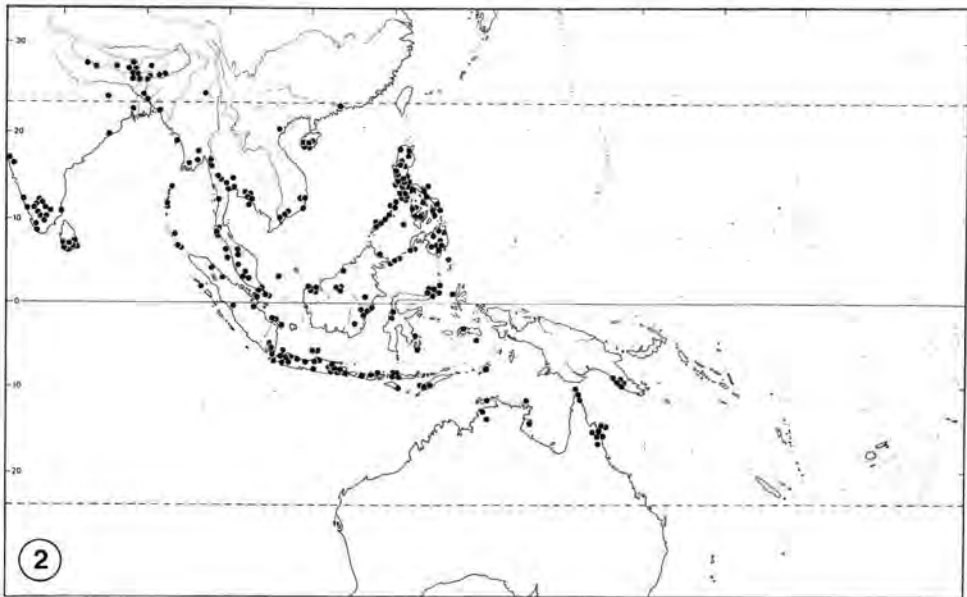
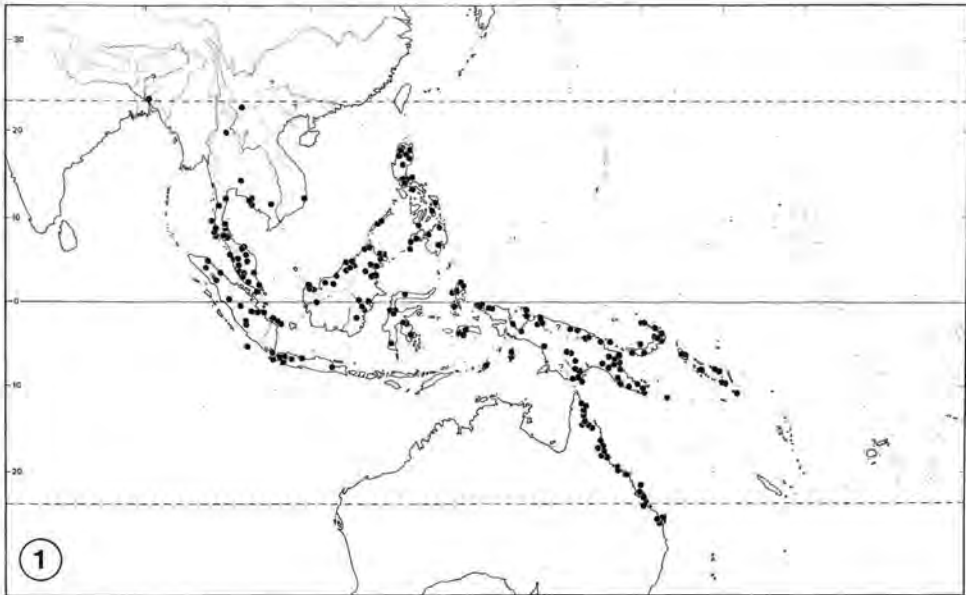

Appendix 6 cont.

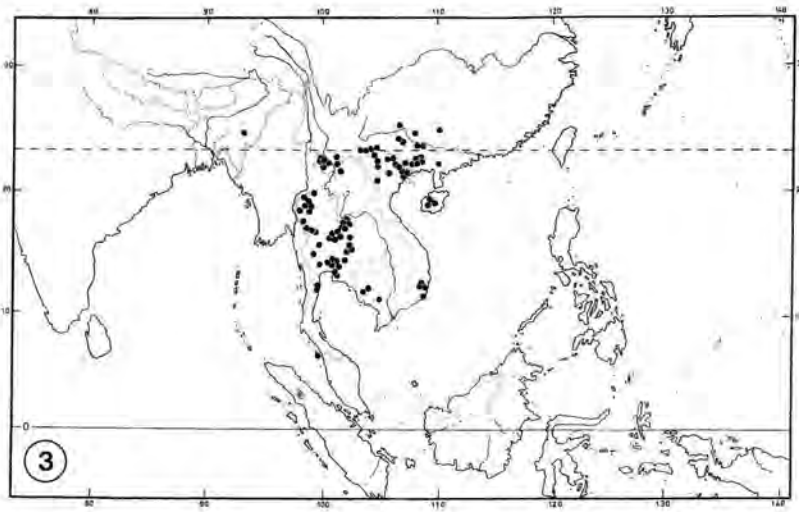

Appendix 6 cont.

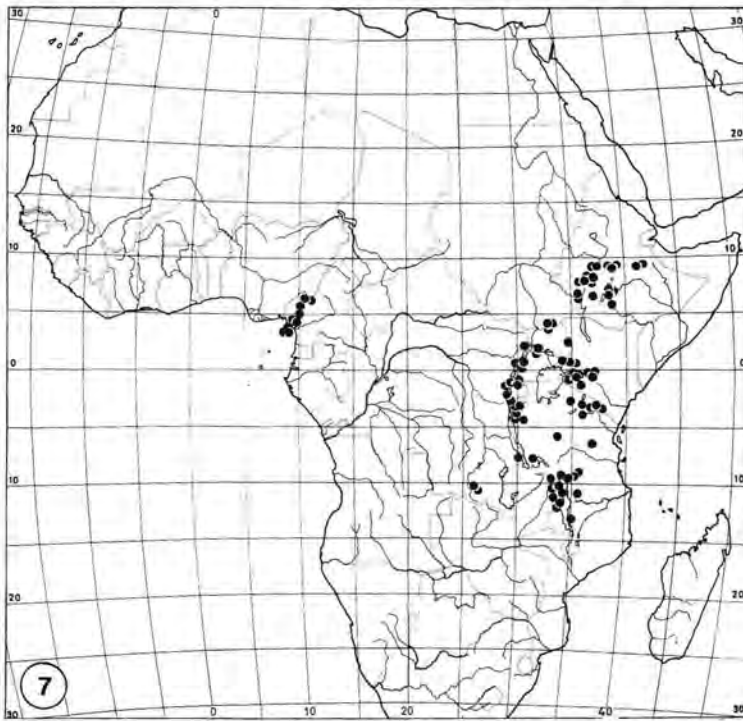
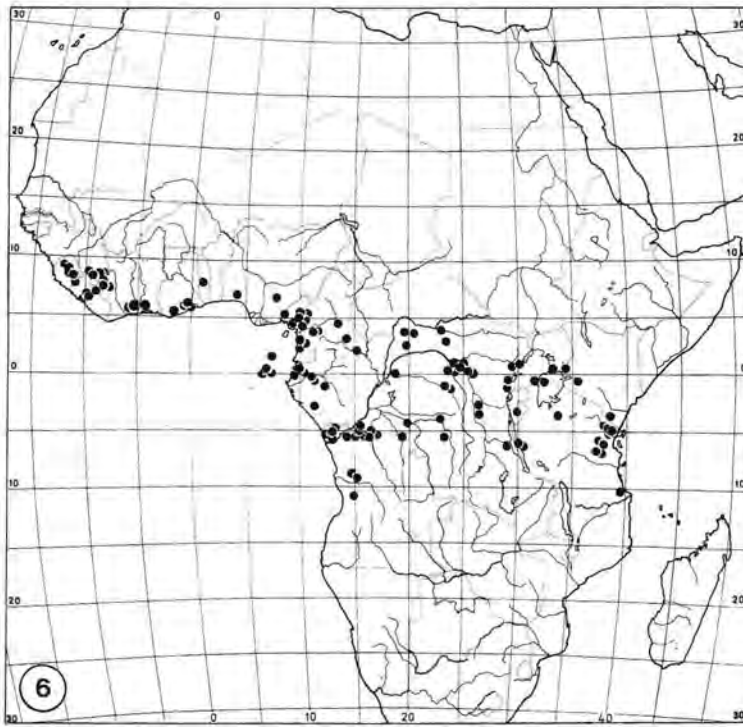

Appendix 6 cont.

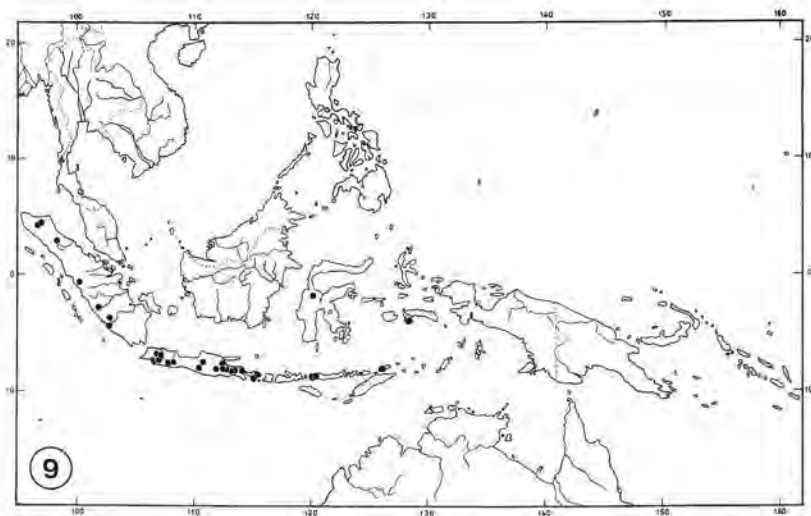

Appendix 6 cont.

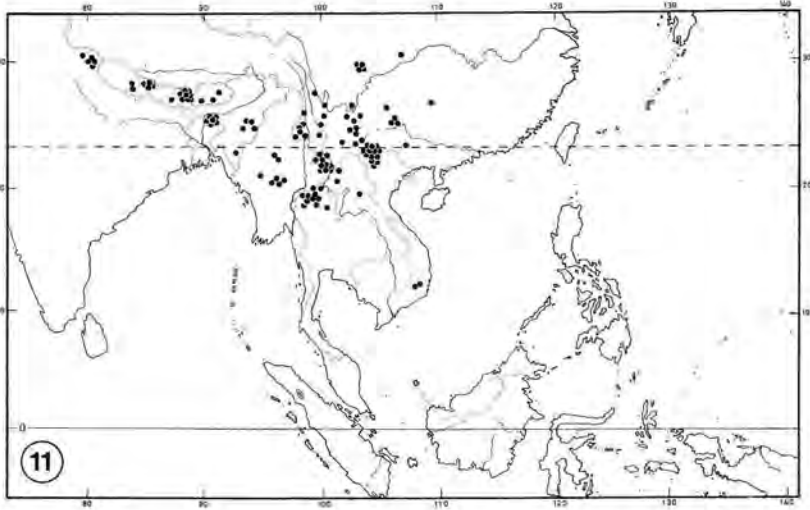
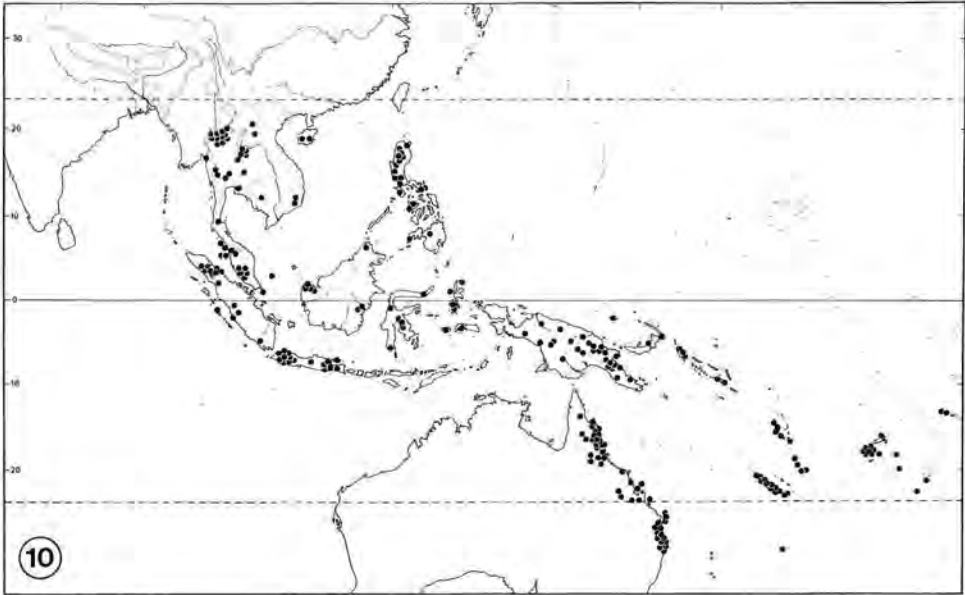

Appendix 6 cont.



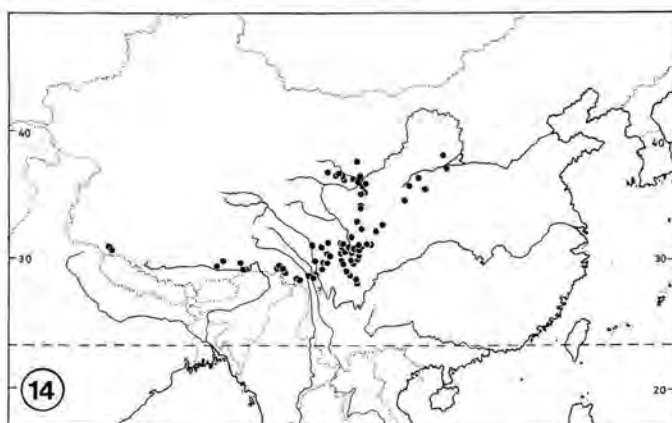
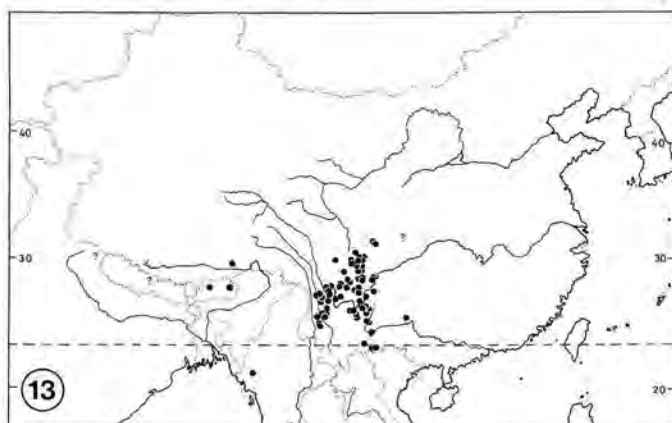
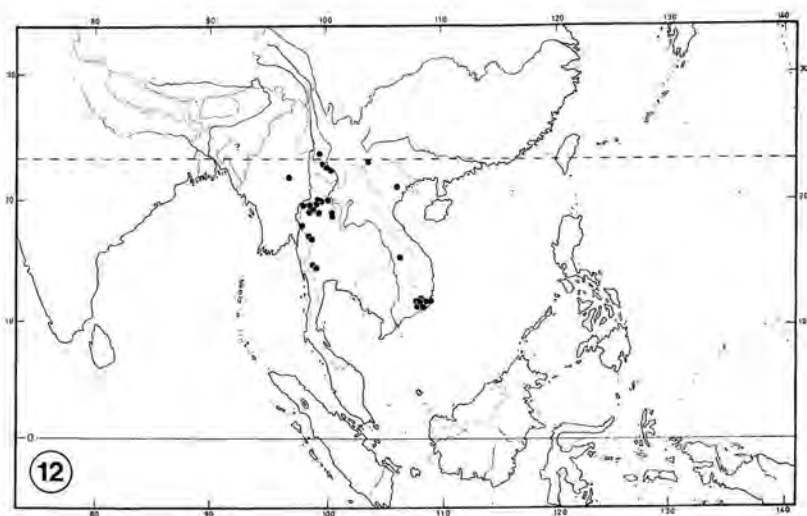

Appendix 6 cont.

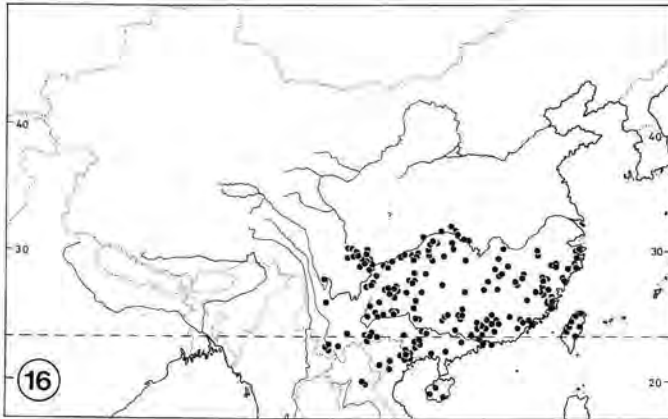
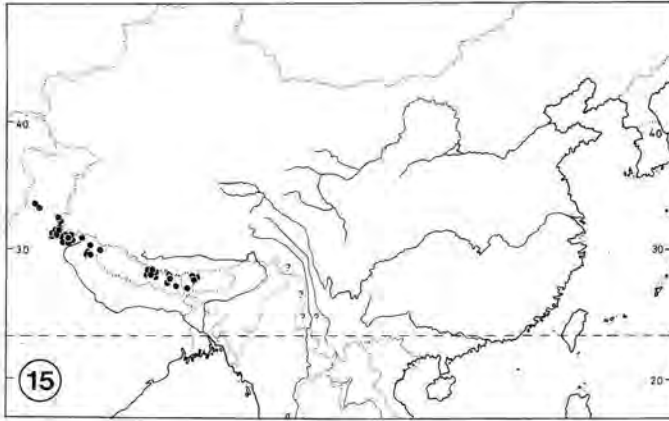

Appendix 6 cont.

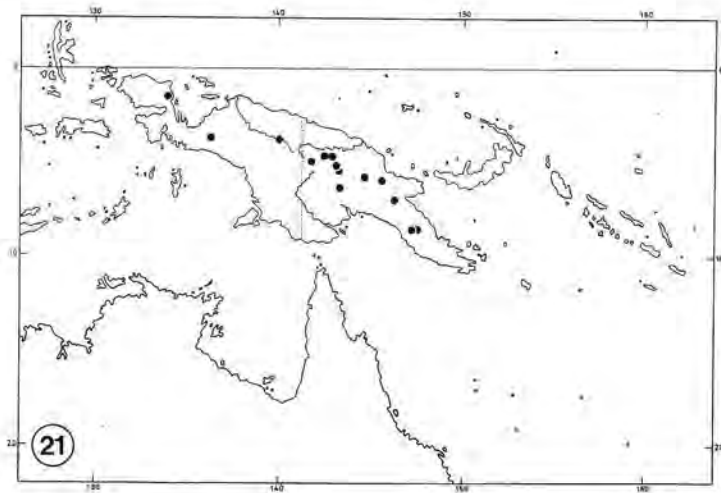
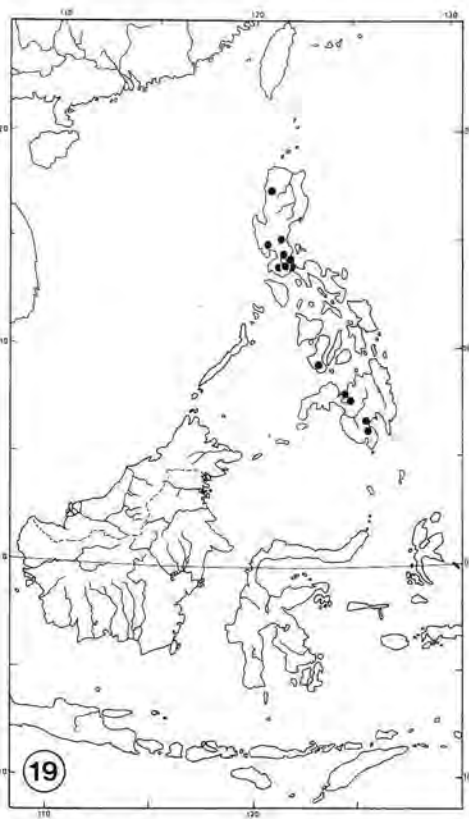

Appendix 6 cont.

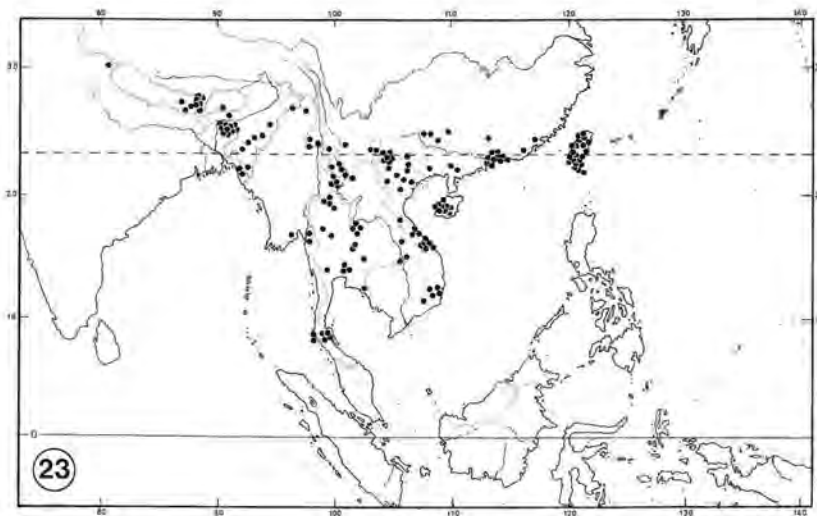
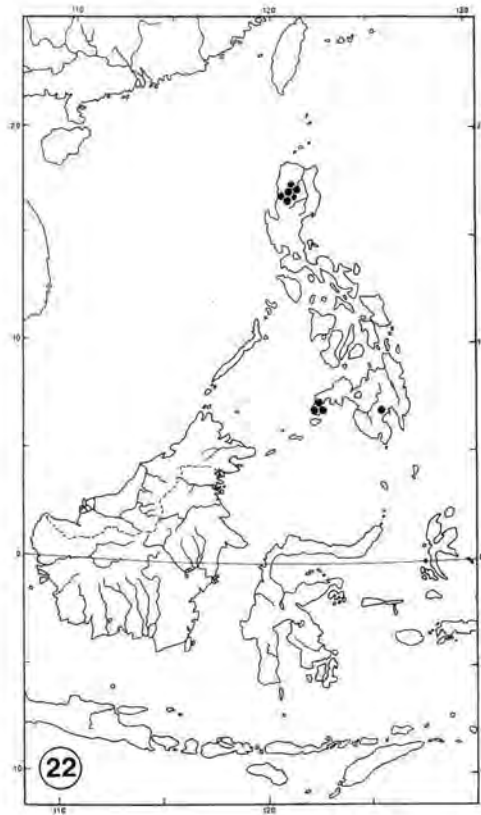

Appendix 6 cont.

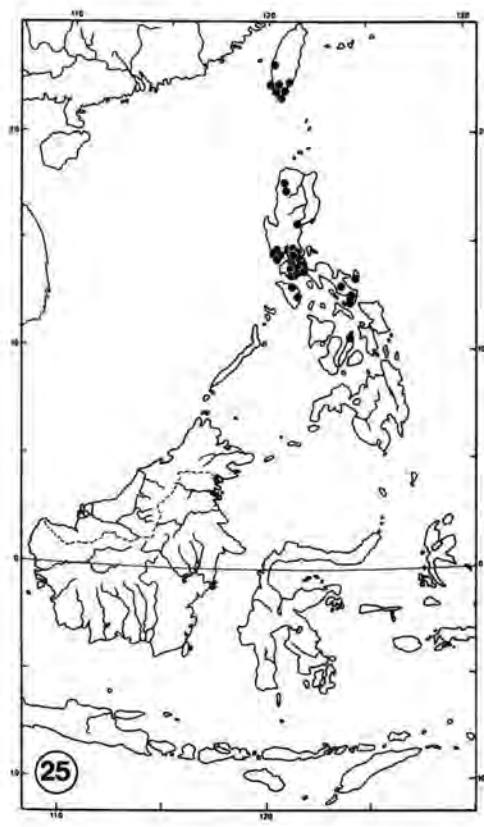
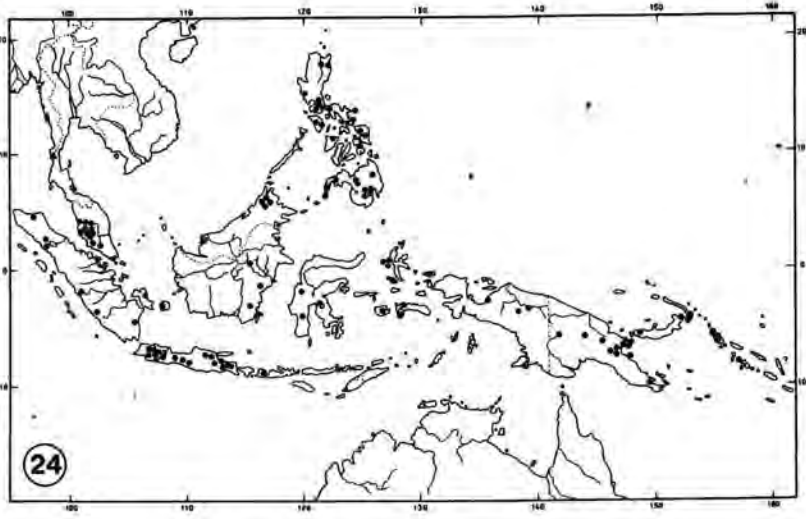

Appendix 6 cont.

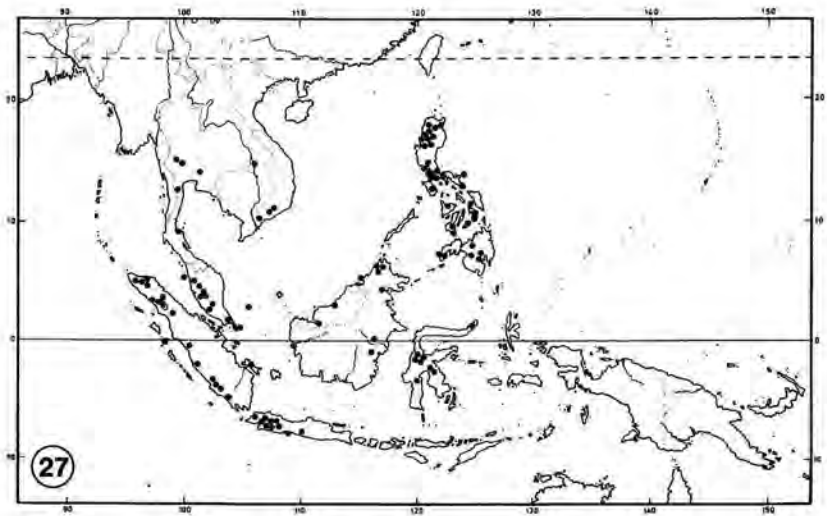
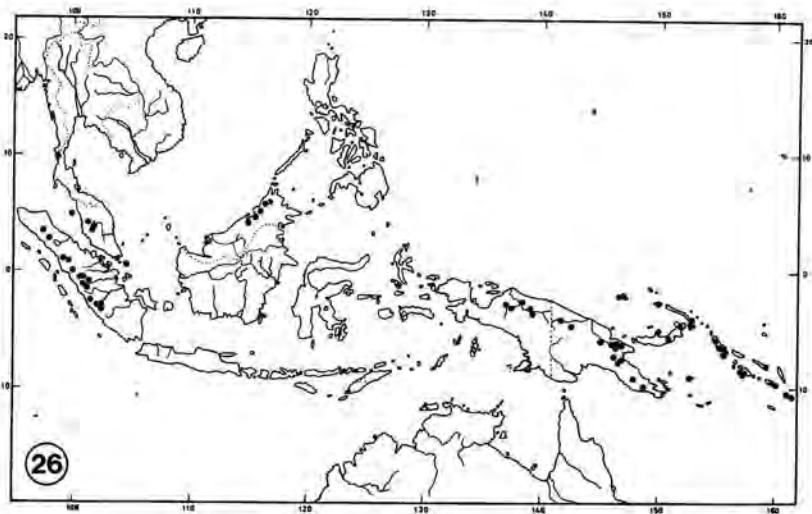

Appendix 6 cont.

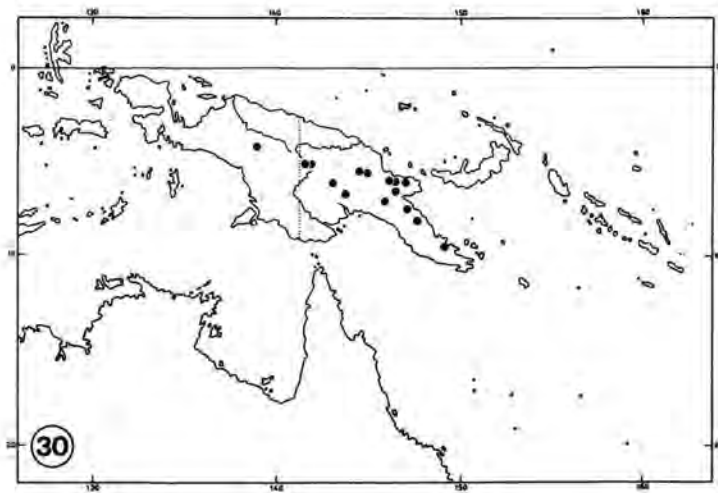
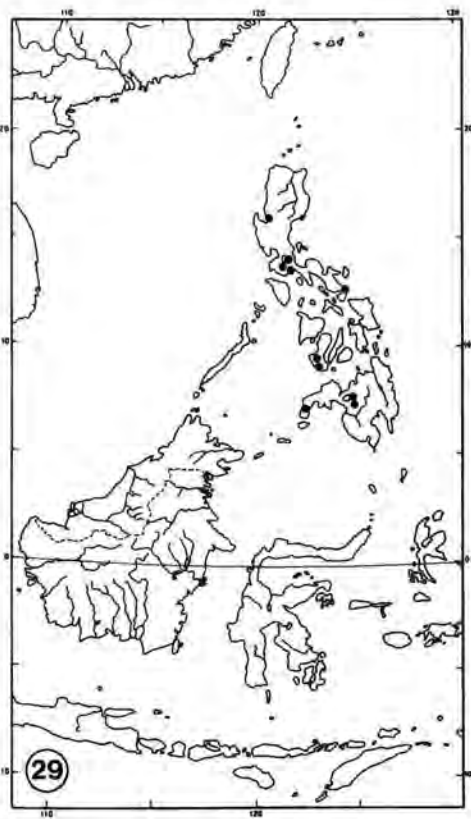

Appendix 6 cont.

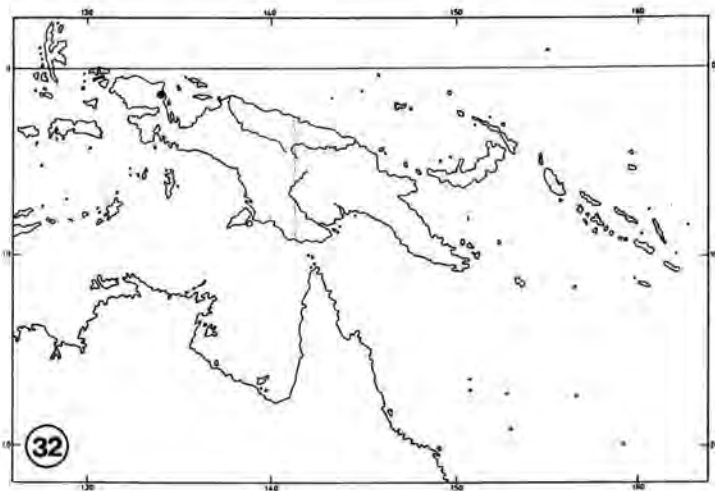
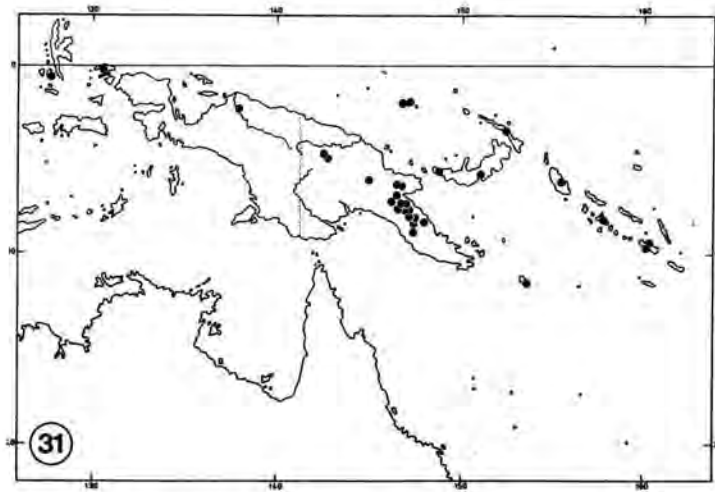

Species

- |                          |                            |                              |                            |
|--------------------------|----------------------------|------------------------------|----------------------------|
| 1. <i>D. sparsisora</i>  | 9. <i>D. pleuridioides</i> | 18. <i>A. brooksii</i>       | 26. <i>A. drynarioides</i> |
| 2. <i>D. quercifolia</i> | 10. <i>D. rigidula</i>     | 19. <i>A. splendens</i>      | 27. <i>A. speciosa</i>     |
| 3. <i>D. bonii</i>       | 11. <i>D. propinqua</i>    | 21. <i>A. novoguineensis</i> | 28. <i>A. latipinna</i>    |
| 4. <i>D. involuta</i>    | 12. <i>D. parishii</i>     | 22. <i>A. cornucopia</i>     | 29. <i>A. pilosa</i>       |
| 5. <i>D. descensa</i>    | 13. <i>D. delavayi</i>     | 23. <i>A. coronans</i>       | 30. <i>A. hieronymi</i>    |
| 6. <i>D. laurentii</i>   | 14. <i>D. sinica</i>       | 24. <i>A. heraclea</i>       | 31. <i>A. parkinsonii</i>  |
| 7. <i>D. volkensii</i>   | 15. <i>D. mollis</i>       | 25. <i>A. meyeniana</i>      | 32. <i>A. nectarifera</i>  |
| 8. <i>D. willdenowii</i> | 16. <i>D. fortunei</i>     |                              |                            |

Appendix 6 cont.



**APPENDIX 7. HISTOGRAMS OF THE ALTITUDINAL RANGES OF THE SPECIES**

horizontally: percentage of records  
vertically: altitudinal categories

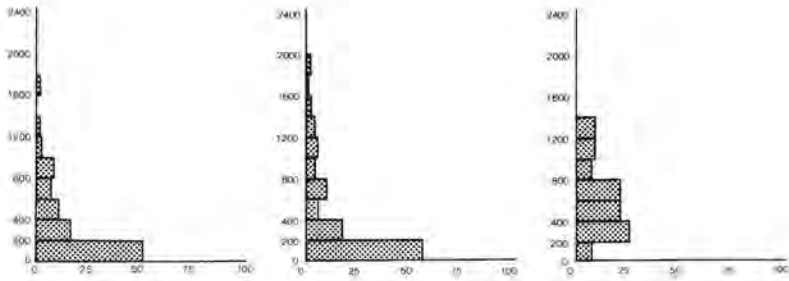

species nos 1--3

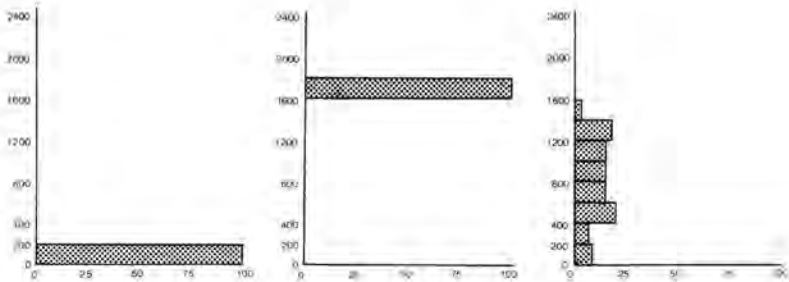

species nos 4--6

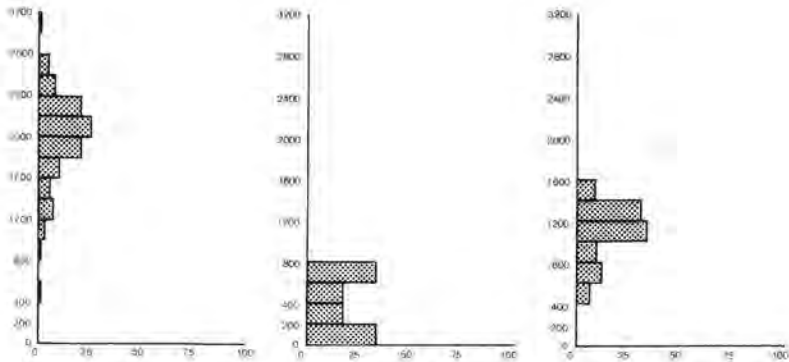

species nos 7--9

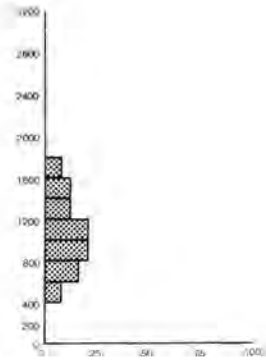
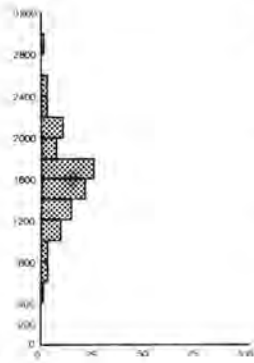
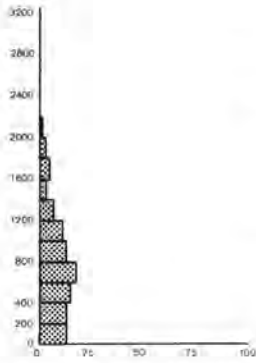

species nos 10--12

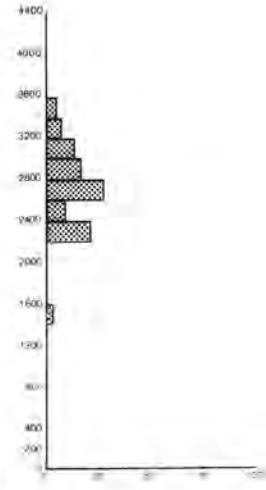
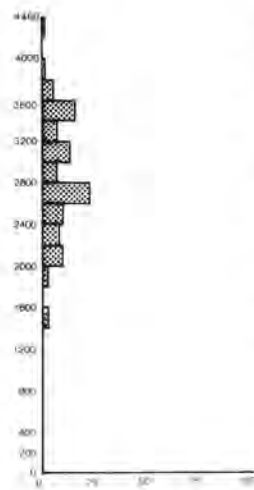
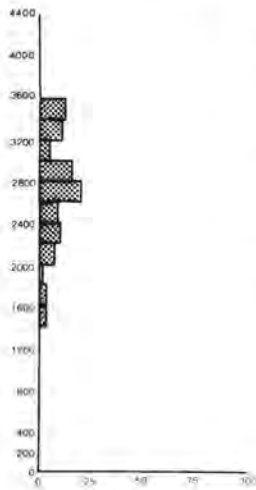

species nos 13--15

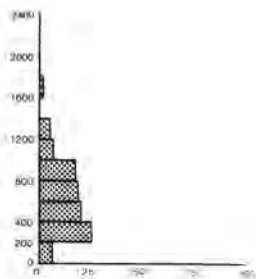

species no. 16

Appendix 7 cont.

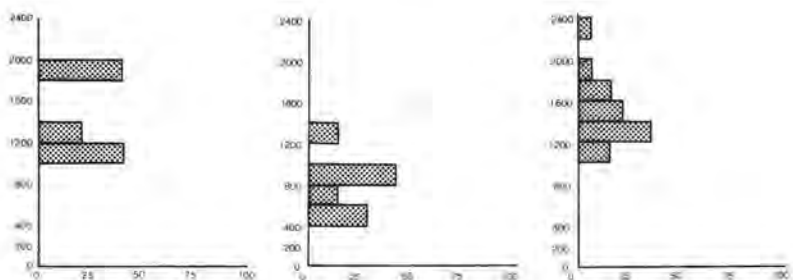

species nos 18, 19, 21

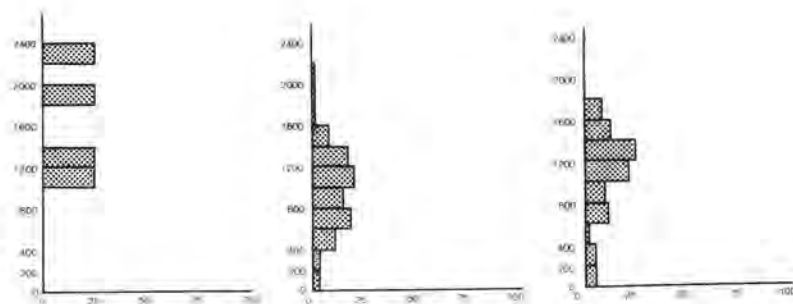

species nos 22--24

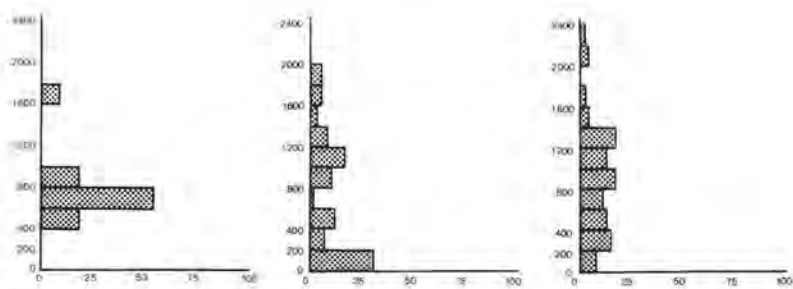

species nos 25--27

Appendix 7 cont.

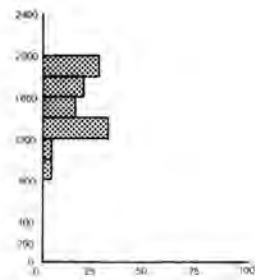
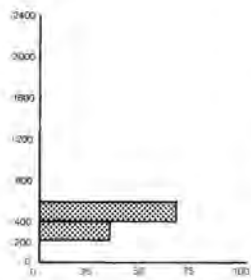
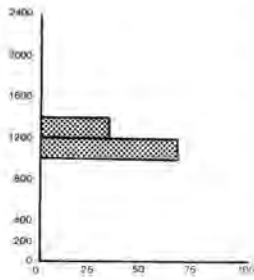

species nos 28--30

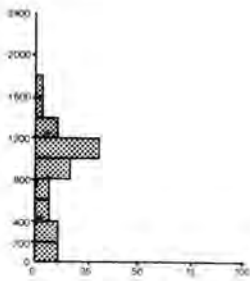

species no. 31

## 17. INDEX OF COLLECTIONS

Anonymous s.n., s.d.: 1; s.n., s.d.: 5; s.n., s.d.: 10; (Fortune?) s.n., s.d.: 16; s.n., s.d.: 26; s.n., s.d.: 27; (ex. Hook & Baker). s.n., s.d.: 25; s.n., 1831: 2; s.n., 1861: 2; s.n., 1880: 23; s.n., 1886: 10; s.n., 1887: 16; s.n., 1902: 26; s.n., 1915: 25; s.n., 1909: 13; s.n., 1940: 1; 7065? , 1940: 10; s.n., 1953: 10; s.n., 1955: 10; s.n., 1955: 27; s.n., 1968: 27; s.n., 1971: 1; s.n., 1975: 23; 6: 8; 8: 2; 24: 10; 31: 1; 48: 16; 50A: 9; 77: 10; 174: 10; 189: 1; 190: 16; 201: 9; 221: 26; 225: 10; 226: 10; 227: 10; 238: 16; 274: 1; 277: 9; 283: 1; 316: 3; 376/379: 26; 705: 26; 899: 11; 1663: 25; 1701: 16; 1876: 25; 2103: 12; 2131: 13; 6004: 3; 8953: 14; 9036: 13; 9461: 13; 10117: 23; 23268: 14; 55129: 11; 101096: 13 -- Abel s.n., s.d.: 16 -- A.C.J. & A.M.P. s.n., 1979: 10 -- Act & Idjan 425: 1 -- Adam 4030: 6; 4155: 6; 4959: 6; 5438: 6 -- Adams 975: 6; 2673: 6; 4617: 6; 21185: 6 -- Adelbert 283: 1 -- Agn an 958: 13 -- Alexander s.n., s.d.: 2; s.n., s.d.: 16 -- d'Alleigette s.n., s.d.: 23; s.n., 1908: 3; 12: 3 -- Alluad 351: 7 -- Alston 11305(T): 17; 12957: 9; 13764: 1; 13849: 2; 15017: 26; 15018: 27; 15123: 24; 15252: 10; 16041: 2; 16042: 2; 16135: 1; 16136: 27; 17006: 26; 17691: 10 -- Alther s.n., s.d.: 2 -- Herb. Amani 392: 6 -- Amdjah 698: 2 -- Amnaj 85, (R.F.D. 11287): 3 -- An-Jiang agricultural School 49: 16 -- An-Snang Exp. 45: 16 -- Anaife s.n., 1903: 10 -- Anderson 2846: 10; S7927: 4; 8529: 4; 9074: 2; 9075: 10; 9187: 4; 9188: 1; 12205: 27 -- Andrews & Simon 131: 10; 133: 10; 142: 10; 146: 1; 151: 1 -- Andrews & Dockrill 219: 1 -- Anglade 898: 2 -- Annet 359: 6; 393: 6 -- Gudwin Anster s.n., s.d.: 23 -- A.N.U.(Wheeler) 1703: 2; 5695A: 21 -- Archbold 2606: 7 -- Archer 15010: 6 -- Armbruster s.n., s.d.: 7 -- Arsin s.n., s.d.: 10 -- Ash 296: 7 -- Atkinson s.n., s.d.: 10; -- Auguier 3529: 7 -- d'Avigdor 41: 6 -- Ayres s.n., s.d.: 8.

Bacfour s.n., 1877: 10 -- Backeley s.n., 1902: 23 -- Backer s.n., 1908: 1; s.n., 1928: 2; 130: 9; 157: 9; 31414: 27 -- Backer & Posthumus 112: 10; 113: 10; 434: 24 -- Bai Se Expedition 1901: 3 -- Bailey s.n., s.d.: 10; 1889: 1 -- F. & Ch. Baker s.n., 1914: 23 -- Baker 210: 10 -- Bakhuizen & v/d Brink jr. 2286: 27; 2407: 1; 2599: 2; 2954 (2955): 24; 2977: 1; 4962: 27; 5790: 27; 5866: 24; 7845: 1 -- Balakrishnan 621: 2; 2797: 2 -- Balansa 40: 16; 75: 10; 138: 3; 139: 3; 140: 16; 153: 16; 1910: 23; 1911: 23 -- v.Balگوو 3754: 1 -- Ballard 1095: 1; 1370/1371: 1; 1521: 2; 1544: 2 -- Bally B4871: 7; B6467: 7 -- Bamler s.n., 1885: 1; 22: 1; 59: 24 -- Banerji s.n., s.d.: 15; 1551: 23 -- Banks & Solander s.n., 1770: 10 -- S.Y. Bao et al. 542: 14 -- Baranda s.n., s.d.: 2; s.n., s.d.: 24 -- Barchet 683: 16 -- Barker & Croft 67655: 30 -- Barkly s.n., 1870: 24 -- Barkly & Barkly 187: 2 -- Baron 4645: 8; 5484: 8; 5723: 8 -- Barrow 21: 2 -- Barter s.n., s.d.: 6; s.n., 1859: 6; 1921: 6 -- Bartlett 14137: 2; 14452: 5; 15349: 5; 15676: 24; 15819: 1 -- Bartsch 126: 24; 385: 27; 410: 27; 513: 2; 524: 2 -- Batianoff & McDonald 572: 1; 696: 1 -- Baudon 90: 6 -- Baudouin s.n., s.d.: 2; 124: 10 -- Bauer s.n., s.d.: 5 -- Baumann 5453: 10; 13597: 10 -- Bcesley 138: 6 -- Beala B163: 7 -- Beccari s.n., 1865: 1; s.n., 1875(T): 32; 588: 26 -- de Beck s.n., s.d.: 1; s.n., s.d.: 2 -- Beddome s.n., s.d.: 2 -- Beguin 68: 9; 882: 1; 1340: 10 -- Behr M4: 1; M16: 2 -- Bell 510: 10 -- Bels 268: 2 -- Van der Ben 2290: 6 -- Benl Ka75/96: 7 -- Benl & Benl FP162: 7; FP315: 7; FP458: 7; FP554: 7; FP580: 7; FP592: 7; FP611: 7 -- Bequaert 2501: 6; 3021: 6; 4341: 7 -- Bergman 659: 10; 754: 10; 895: 1 -- Bernardi 15638: 2; 19944: 23 -- Betche s.n., 1881: 1 -- van Beusenkom & Charoenpol 1837: 10; 1857: 3 -- van Beusenkom & Phengkhilai 363: 23; 422: 12; 684: 2; 847: 23; 870: 23; 1100: 10; 1266: 11; 1837: 10; 4526: 10 -- van Beusenkom & Santisuk 2858: 3 -- van Beusenkom, Phengkhilai, Geesink & Wongwan 4197: 23; 4284: 23 -- Bhargawa 2348: 2 -- Bi-Zhang Expedition 281: 16 -- Bigger 1964: 7 -- Billet s.n., s.d.: 23 -- Bir 185: 11; 740: 11 -- Biswas 5462: 11 -- Bj rnstad AB1892: 6 -- B.K.F. (Winit) 1068: 23; (Bunchuai & Nimanong) 1352: 11; (Bunnak) 9694:

2; (Bunchuai 1682) 40409 : 3 -- Blachiston s.n., s.d.: 16 -- Blake 22711: 10; 23503: 2 -- Blanford s.n., 1880: 15; s.n., 1883: 15; s.n., 1884: 15; s.n., 1885: 15; s.n., 1886: 15 -- Bleis 229: 15 -- Blinkworth s.n., s.d.: 23 -- Bliss 1088 (88?): 15 -- Bloembergen, Kwai Noi River Basin Expedition 30: 10; 39: 2; 3350: 2 -- Blume s.n., s.d.(T): 9; s.n., s.d.(T): 10; s.n., 1824(T): 27; 224: 10; 278: 10 -- Blydenstein s.n., 1960: 26 -- Bock-Von Rosthern 3121(T); 14 -- Boden-Kloos s.n., 1912: 10 -- Bodinier 1564: 16; 2551: 11 -- Boerlage s.n., s.d.(T): 9; s.n., 1888: 1; s.n., 1897: 2 -- Boikau 2676: 8 -- du Bois 47: 9 -- du Bois-Reymond 43: 16; 377: 16; 999: 16; 1000: 16 -- Boivin s.n., s.d.: 8; s.n., 1846-'48: 8; 1854: 8 -- Bolster 117: 2 -- Bon 2390: 23; 2422: 3; (leg. R.P. Berthet) 3204(T): 3; 3421: 3; 3481: 3 -- Boom 21024: 24; 21065: 25 -- Booth s.n., s.d.: 2 -- Boott s.n., s.d.: 2 -- Bor's Coll. 117: 11 -- Bor 16020: 11 -- Bor & Kirat Ram 20084: 15 -- Si Borea 10048: 10 -- Borgesen s.n., 1928: 2 -- Borgmann 567: 10 -- v. Borssum Waalkes 1941: 1; 2825: 24; 2847: 26; 3368: 1 -- Bory, Wallich & Carmichael s.n., s.d.: 8 -- Bos 2029: 6 -- Bouillod s.n., s.d.: 23; s.n., s.d.: 27 -- Bourick 71: 23 -- Bourne 4957: 2 -- Bourret 115,41: 3 -- Bowring s.n., s.d.: 23; 31: 23 -- Bowman s.n., s.d.: 2; s.n., s.d.: 10 -- Box 3274: 6; 3435: 6 -- Boyland 8: 10; 347: 10; 489: 10 -- Bradley 225: 2 -- Braithwaite s.n., 1965: 1; s.n., 1971: 10; 2616: 10; 4119: 10; 4164: 26; 4549: 31; 4591: 1; 4624: 31; 4636: 31 -- Brass 1480A: 1; 1503: 26; 2001: 1; 2116: 10; 3565: 1 p.p., 2 p.p., 5230: 21; 5259: 21; 5425: 31; 5731: 1; 6453: 1; 6685: 1; 6747: 10; 6863: 24; 7105: 26; 7760: 1; 8120: 1; 11648: 10; 11688: 10; 11700(T): 30; 12823: 21; 13645: 24; 14077: 26; 18640: 2; 19153: 1; 19243: 1; 20009: 10; 20260: 1; 21658: 1; 22140: 1; 24130: 1; 28821: 26; 29216: 1; 32068: 24 -- Braun 16: 6 -- Von Brehmer 416: 6 -- Breyne 863: 6 -- Britton Herb. 365: 2 -- Brooke 8051: 1; 8842: 4 -- Brooks s.n., 1907: 1; s.n., 1907: 10; s.n., 1907: 27; s.n., 1910: 2; 22: 1; 25: 9; 37: 18; 39(T): 18; 120: 10; 254.S: 26; 276.S: 24; 426.S: 26; 468.S: 9; 474.S: 1; 2718: 27; 15926: 27; 17756: 24 -- Brown s.n., s.d.: 1; s.n., s.d.: 2; s.n., s.d.: 10; s.n., 1802: 2; s.n., 1802: 10; (ex Herb.) s.n., 1828: 8; 15 & 31(T): 10; 73: 16 -- Brummitt 10774: 7 -- Bryan jr. 424: 10 -- B.S. (Vanoverbergh) 315: 27; (Ramos) 626: 25; (Vanoverbergh) 638: 1; (native collector) 745: 2; (Foxworthy) 868: 1; (Vanoverbergh) 898: 10; (Ramos) 960: 2; (native coll.) 955: 1; (Ramos) 982: 5; (Merrill) 1204: 2; (Foxworthy) 1661: 25; (Ramos) 3292: 2; (Maximo Ramos) 3353: 5; (Ramiz) 3359: 10; (Mearns) 4207: 27; 4208: 10; (Maximo Ramos) 7192: 22; (Merrill) 7375: 5; 7548: 5; (Curran) 7865: 25; (Ramos) 8234: 2; (McGregor) 10304: 1; 10731: 1; (Loher) 12045: 25; (Ramos) 12076: 24; 12116: 19; (Loher) 12598: 25; (Fenix) 12745: 10; (Foxworthy & Ramos) 13147: 2; (Loher) 13312: 5; (Ramos) 13626: 25; (Fenix) 12741: 1; (Ramos) 13649: 25; (McGregor) 14298: 5; (Ramos) 14788: 19; (Loher) 14962: 27; 14973: 27; (Ramos) 15024: 1; (Fenix) 15530: 2; (Reillo) 16231: 24; (Curran, Merritt, Zschokke) 16282: 10; (Reillo) 16291: 2; (Ramos) 16602: 25; (Otanés) 17668: 5; (Ramos) 19554: 25; (Escritor) 20690: 1; (Ramos) 20981: 25; (Escritor) 21254: 2; (Fenix) 28357: 24; (Ramos & Edano) 29264: 25; (Fenix) 29876: 10; (Ramos & Edano) 31156: 24; 31489: 2; (McGregor) 32546: 10; (Ramos) 33157: 27; (Ramos & Edano) 38575: 19; (Ramos) 41210: 2; (Ramos & Edano) 44210: 2; 45121: 25; 49577: 19; 74659: 2; 75677: 25; 75685: 27; (Edano) 76510: 25; 78735: 27 -- B.S.I.P. (Brown) 1248: 26; (Whitmore & Grubb) 2050: 26; 2105: 24; (Beer's coll.) 7272: 26; (Nakisi) 8062: 1 -- Buchholtz s.n., 1874: 6 -- Bullock 1938: 7 -- Bunchuai & Nimanong 1369: 12; 1457: 12 -- Bünnemeyer 1487: 2; 1661: 1; 2366: 2; 3728: 9; 4130: 26; 5884: 2; 6127: 2; 6230: 2; 6509: 2; 8004: 26; 10612: 2; 10790: 2; 11482: 24; 11685: 10; 12491: 10 -- Burbidge 132: 26 -- Burch 6810: 10 -- Burck 115: 8; 209/210: 10; 241: 10 -- Burgeff s.n., s.d.: 25 -- Burger 1695: 7; 1798: 7 -- Burkill & Holtum 8764: 24; 8845: 27 -- Burmann 396: 10 -- Burret 143: 24 -- Burt 3165: 7 -- Buse s.n., s.d.: 9 -- Busse 2606: 6 -- Butaye (coll. Gillet 2225, 2282) s.n., 1901: 6 -- Buwalda 4226: 1 -- Buysman s.n., s.d.: 10; s.n., 1907: 9; s.n.,

1907: 10; s.n., 1908: 2; s.n., 1911: 10; (Herb.Anal.) 49: 24; 50: 9;  
 (Herb.Anal.) 163: 24; 164: 2; 327: 9; 2747: 9; (Herb.Anal.) 2821: 24.  
 Cadière s.n., s.d.: 3; s.n., s.d.: 23; 18: 23; 79: 23; 108: 2; 108 [17]:  
 23; 1015: 11; 1921: 23 -- Cairns s.n., s.d.: 10 -- Caldwell s.n., 1868: 10  
 -- Calvert s.n., s.d.: 10 -- Cameron s.n., s.d.: 2 -- Campbell & Hope 106:  
 11 -- Canright 981: 1 -- Z.Y. Cao 950: 3; 958: 16 -- Cao-He Expedition 2778:  
 13 -- Carmichael s.n., s.d.: 8; 1654: 7 -- Carr 11211: 2; 11407: 2; 11538:  
 2; 11863: 2; 12119: 31; 14467: 10; 14719: 30; 14875: 30; 15621: 26; 16040:  
 31 -- Carrick & Enoch 117: 2 -- Cavalerie s.n., 1912: 3; 2807: 3; 3711: 16;  
 3735: 11; 3739: 11; 4227: 11; 7284: 11; 7306: 3; 7650: 3; 7797: 16 -- Chai  
 S.38705: 1 -- Chaloner 16/1: 6 -- Chambers s.n., 1963: 10 -- Chamisso s.n.,  
 s.d.: 2 -- Chand 1540: 11; 3156: 11; 7727: 11 -- Casstrom s.n., s.d.: 2 --  
 Chandler & Hancock 1776: 6; 2529: 7 -- Chandra 92435: 23 -- Chandra & Party  
 94125: 23 -- Chanei & Streimann 30939: 30 -- C. Chang 12822: 23 -- J.W.  
 Chang 497: 14; 1262: 14 -- Q.S. Chang 4705: 13 -- Z.C. Chang et al 4560(T):  
 15; 4950: 11; 6230: 11; 6366: 11; 6695: 11; 6960: 11; 8098: 3 -- Z.Y. Chang  
 11972: 3; (et al.) 22849: 13 -- C.H. Chao 409861: 13 -- Z.L. Chao et al.  
 21537: 13; 21775: 13 -- Chapman s.n., s.d.: 7; 83: 7 -- Charoenphol, Larsen  
 & Warncke 4028: 1; 5026: 2 -- Chase 31807: 7 -- Cheesman s.n., s.d.: 1; 181:  
 10 -- J.S. Chen s.n., 1956: 16 -- S.C. Chen 13024: 16; 14975: 16; 62812: 16  
 -- Z.Z. Chen 50465: 16 -- S.Q. Cheng 11965: 3 -- Cheo 493: 16 -- Chevalier  
 s.n., s.d.: 23; 14291: 6; 21060: 6; 21220: 6; 21381: 6; 29713: 3; 30731: 23  
 -- Chiao 908: 16; 1630: 13; 14207: 16 -- Chien et al. 1836: 16 -- Chin 1764:  
 3 -- Chinese-Russian Expedition 719: 23; 755: 3; 870: 3; 1047: 11; 1093: 3;  
 1518: 11; 1922: 3; 3188: 3; 3392: 11; 5203: 23; 5748: 16; 5915: 12; 7709: 3;  
 7754: 12; 8141: 11; 8160: 12; 8343: 11; 9737: 23; 10040: 3 -- China-Vietnam  
 Expedition 384: 11; 2188: 3 -- R.C. Ching 903: 16; 1580: 16; 2771: 11; 5554:  
 16; 6751: 3; 7204: 11; 7891: 23; 21150: 13; 21537: 13; 21775: 13; 23157: 13;  
 23393: 13; 23796: 13; 25437: 13; 50262: 11; 50315a: 11; 50364: 11 -- Chipp  
 54: 7; 555: 6 -- P.C. Chiu s.n., s.d.: 1; 117: 16; 1187: 16; 1375: 16; 4033:  
 16; 4868: 16; 4907: 16; Chiu 4950: 16 -- Chow 7209: 16; (et al.) 78393: 23  
 -- H.C. Chow 453: 13; 1842: 16; 8474: 16 -- K. Chow s.n., s.d.: 16 -- N.S.  
 Chow 41: 16 -- T.Y. Chow 580: 11 -- Christ s.n., 1895: 27 -- Christiaensen  
 227: 7 -- Christophersen 2949: 10 -- Chu 2992: 13 -- K.L. Chu 7710: 14 --  
 Y.P. Chu 1623: 13 -- Z.Y. Chu 1220: 16 -- Chuang Chao & Kao 6160: 16 -- W.M.  
 Chui 14: 13; 1721: 13; (et al.) 1773: 11; (et al.) 3624: 13; -- Y.W. Chui  
 4159: 13 -- Chun 68: 23; 5565: 16; 30514: 16 -- N.K. Chun 43630: 2 -- S.H.  
 Chun 10666: 23; 12238: 23; 13088: 3 -- S.Q. Chun 536: 16 -- Chun & Tso  
 43630: 2 -- Chung 971: 16; 7562: 16; 8022: 16 -- H.H. Chung 903: 16; 3605:  
 16; 8022: 16 -- S.H. Chung 11335: 23 -- S.T. Chung 301407: 3 -- Chung-Dien  
 Expedition 1009: 13 -- Clarke s.n., s.d.: 23; 1049: 23; 6176: 23; 7372: 11;  
 9139: 11; 142558: 1; 16612: 11; 16877: 15; 19253: 11; 19757: 23; 37274A: 23;  
 40984: 11; 41491: 23 -- McLelland s.n., s.d.: 2 -- Clemens s.n., s.d.: 23;  
 s.n., 1905: 29; s.n., 1907: 1; s.n., 1907: 2; s.n., 1907: 24; s.n., 1907:  
 27; s.n., 1943: 10; s.n., 1945: 10; s.n., 1946: 10; s.n., 1949: 10; 550: 19;  
 578: 24; 3910: 23; 4225a: 10; 7727: 10; 8621: 26; 9482: 2; 11026b: 26;  
 11184a: 26; 11339-B: 31; 12110: 30; 29668: 24; 40719: 31; 40964: 30; 41113:  
 30; 41467: 26; 42765: 10; 43702: 10 -- J. & M.S. Clemens 1226: 10; 20458: 2;  
 20758: 2; 20759: 2; 21488: 1; 22057: 10; 22059: 1; 22178: 2; 26005: 27;  
 28684: 1; 29011: 26; 29038: 18; 32122: 18; 40457: 10 -- Clunie & Katik  
 63505: 30 -- Coert 908: 10; 1540: 2 -- Colani s.n., s.d.: 23; s.n., 1925:  
 3; s.n., 1926: 16; (Herb. Petelot) s.n., 1931: 10; 1583: 11; 4199: 16; 4467:  
 11 -- Collins 146: 2 -- Colvin s.n., 1946: 15 -- Compere 1584: 6 -- Cooper  
 (coll. for Bulley) 1127: 11; 1466: 13; 3061: 13 -- Cook, Rix & Schneller 34:  
 2 -- Copeland s.n., s.d.: 22; (Herb.) s.n., 1904: 24; (Herb) s.n., 1905: 27;  
 s.n., 1906: 2; s.n., 1909: 2; (Herb.) s.n., 1909: 25; s.n., 1910: 22; (&  
 Merrill) s.n., 1910: 22; (Herb.) s.n., 1932: 24; s.n., 1933: 2; 70: 2; 146:  
 27; 280: 29; 649: 27; 1285: 19; 1321: 2; 1386: 25; 1600: 24; 1644: 10; 1666:

29; 1753: 1; 1770(T): 22; 1823: 10; 1824: 27; (Herb.) 1927: 22; 1977: 25;  
 (P.P.E. 42) 2061(T): 5; (Herb) 9499: 10; (Herb.) 9528: 25; (Herb.) 9537: 25;  
 9540: 29; (Herb.) 9547: 19; (Herb.) 9550: 19; (Herb.) 9553: 19; 9564: 27;  
 (Herb.) 9569: 27; (Herb.) 12431: 5; 13505: 29; (Herb.) 13506: 19; Pterid.  
 Philip. Exsiccata 3 1906: 25; P.P.E. 42(T): 5; P.P.E. 200: 22; P.P.E. 281:  
 19; P.P.E. 282: 24; P.P.E. 17718: 22; P.P.E. 17725: 22; P.P.E. 17726: 22;  
 P.P.E. 17727: 22; P.P.E. 17737: 22; P.P.E. 17738: 22; P.P.E. 17775: 22 --  
 Corbisier 128: 6 -- Couderc s.n., 1883-'85: 2 -- Coveny & Hind 6720: 10;  
 6745: 10; 7142: 1; 7204: 10 -- Craib 557: 23 -- Craven (& Schrodde) 91: 10;  
 134: 10; 401: 26 -- Cribs 501: 10 -- Croft 32A: 30; 64: 1; 422: 10; 444: 24;  
 676: 31; 689: 26; 1095: 31; 1242: 26; 1353-B: 31; 65722: 30 -- Corner s.n.,  
 1935: 27 -- P.T. Cui 4924: 3 -- Y.W. Cui 5571: 14 -- Cuming s.n., s.d.: 2;  
 s.n., s.d.: 10; s.n., s.d.: 27; 25: 2; 44: 27; 49(T): 25; 64(T): 27; 87(T):  
 19; 90(T): 29; 236: 10; 248: 10; 263(T): 10; 273: 2; 330: 24; 342: 27; 352:  
 27; 362(T): 27; 363: 27; 414: 2 -- Cunniff 21: 10; 31: 10 -- Cunningham  
 s.n., s.d.: 2; s.n., s.d.: 10 -- Curtis (Flora Penang) 620: 26.  
 Daemel s.n., s.d.: 2; s.n., s.d.: 10 -- Dalhousie & Collett. (Herb. Fraser  
 3) s.n., 1831: 15 -- Dallachy s.n., s.d.: 2; s.n., s.d.: 10 -- Damange 357:  
 16 -- Danbenberger s.n., 1910: 7 -- Daniel 36: 10 -- Dbniker s.n., 1925: 10;  
 954: 10; 1074: 10 -- Danser 6672: 27 -- Darbyshire & Hoogland 7996: 1 --  
 Darke D.424: 19 -- Darnaedi 197: 10; 286: 9; 1937: 10 -- Darnton 322: 2;  
 494: 27 -- David s.n., 1868: 16; 393: 16 -- Dawe 155: 7; 669: 7 -- Dawkins  
 D864: 6 -- Deans Cowan s.n., s.d.: 8 -- Herb. Debeaux s.n., 1902: 16; 357:  
 16 -- Deighton 2546: 6 -- Deka 3880: 23 -- Delacour 27: 10 -- Delavay s.n.,  
 s.d.: 13; s.n., 1883: 13; 2: 11; 3: 11; 47: 16; 1166(T): 13 -- Dellore &  
 Hooller 343: 24 -- Demaret 5176 E: 7 -- Deplancke s.n., s.d.: 10; 1578: 10  
 -- Deschamps s.n., 1889: 2 -- Desvaux s.n., 1820: 2 -- De Vore & Hoover 161:  
 2 -- Devred 809: 6; 2617: 6; 3996: 6 -- Dewulf 462: 6 -- Dickason s.n.,  
 1935: 2; 6A: 11; F6: 11; F167: 2; F169: 11; F190: 2; 414: 2; 420: 12; F420A:  
 11; 558: 11; 7822: 2; 7882: 11; 9207: 11; 9222: 23; 9305: 11; 9678: 23;  
 10006: 2 -- Diels 8338: 10 -- Dietrich s.n., s.d.: 10; s.n., 1863-'65: 10;  
 380: 10; 380: 10; 381: 1 -- Dinklage 521: 6; 3050: 6 -- Dissing 2701: 24 --  
 Dissing, Koie & Sandermann Olsen 2318: 24 -- Djak coll. s.n., 1910: 10 --  
 Dobremez (D.B.R., N.E.P.) 750: 11; 3272: 11 -- Dockdrill 148: 10; 257: 1;  
 601: 1; 678: 1 -- Docters v. Leeuwen-Reynvaan 1660: 2 -- Docters v. Leeuwen  
 9740: 26; 10058: 26; 10563: 10; 10997: 10 -- Don s.n., s.d.: 6; s.n., 1822: 6  
 -- Dong 81: 16 -- Donk s.n., 1940: 9; s.n., 1941: 9 -- Dransfield 3670: 27  
 -- Drucker s.n., 1973: 2 -- Drummond & Hemsley 1889: 6 -- Du 931: 16 --  
 Ducloux 40: 13; 958: 13; 959: 13; 2812: 13; 5007: 13; 50006: 11 -- Dudgeon &  
 Kenoyer 1: 15 -- Dugatitow s.n., 1805: 8 -- Dummer 1716: 7; 3158: 6 -- Dunn  
 (Hongkong Herb.) 3807: 16 -- Duthie s.n., s.d.: 2; 442: 15; 3689: 11 -- Dyas  
 6 (& 71)(T): 15.  
 Eberhardt s.n., s.d.: 2; s.n., s.d.: 10; s.n., s.d.(T): 12; s.n., s.d.:  
 23; s.n., s.d.: 27; 1: 2; 79(T): 12; 99: 23; 100: 12; 117: 12; 130: 2; 3392:  
 3; 5237: 3 -- Economical Plant Expedition 268: 16; 431: 16 -- Edano 5267: 29  
 -- Edgeworth s.n., s.d.: 11; s.n., 1838: 15 -- Edwards s.n., s.d.: 8; s.n.,  
 1973: 1; s.n., 1974: 19; H.S.2: 24; 712: 29 -- Elmer 6192: 1; 6424: 10;  
 6475: 10; 6745: 25; 7023: 2; 9785: 27; 10012: 29; 10034: 1; 10069: 19;  
 10495: 24; 11112: 2; 11125: 27; 13807: 24; 16829: 2; 16969: 25; 16998: 27;  
 17604: 1; 17697: 27; 17859: 25 17950: 19; 18072: 24; 18171: 29; 21481: 1;  
 22077: 19 -- Elmer & Merrill 3224: 25 -- Endert 2003: 1; 2582: 1; 2967: 26;  
 4594: 24; 5366: 2; 5386: 27 -- Engler 5098: 9; 5433: 11 -- Ernst s.n., 1906:  
 1; 34: 10; 35: 9; 258: 24; 373: 2; 920: 24; 978: 10 -- Esterhuysen 25310: 7  
 -- Esquirol s.n., 1917: 11; 46: 23; 311: 16; 2569(T): 23; 2569: 23; 2720: 1;  
 3274: 23; 4024: 23; 6326: 11 -- Evans 145: 10; 168: 24 -- Everett 77: 23;  
 270: 25; 272: 25 -- Evrard s.n., s.d.: 10; s.n., 1884: 16; 126: 10; 1255:  
 12; 1907: 11; 1965: 10; 2314: 3; 2356: 2; 2432: 3; 3880: 6 -- J. Nat. Excen.  
 s.n., 1908: 10; s.n., 1909: 10 -- Eyma 184: 24; 2355: 10.



Faber s.n., s.d.: 16; s.n., s.d.: 23; 1071: 11; 1072: 16; 1615: 16 --  
 Faden & Evans 69/2058: 7 -- Faden, Evans & Pocs 70/382: 6 -- Faden, Pocs,  
 Harris, Csontos & Csontos 70/683; 6 -- Faden, Faden & Cameron 72/287: 7 --  
 Fairchild & Dorsett 546: 27 -- Falconer (Herb.) s.n., s.d.: 11; s.n., s.d.:  
 15; 943: 15; 1308: 2 -- Fan & Li 59: 16; 111: 16; 682: 16 -- Fang 35: 16;  
 1716: 16; 3425: 16; 13071: 11 -- C. Fang 20396: 3 -- W.P. Fang s.n., s.d.:  
 16; 35: 16; 1425: 14; 1716: 16; 3425: 16; 9081: 13; 9090: 13; 3687: 14;  
 9736: 16; 9904: 16; 11021: 14; 14549: 16; 15408: 16; 18135: 16; 46655: 14;  
 Fang et al 46673: 14; 10387: 14; 11773: 16; 11864: 16; 33152: 16 -- Faller  
 630: 31 -- Faucheux s.n., 1939: 2 -- Faurie 197: 23; 202: 16; 601: 16; 8122:  
 16; 15941: 23 -- F.B. (Ritchie) 36: 2; (Borden) 1346: 25; (Aherm) 1499: 25;  
 (Curran) 4952: 10; (Curran, Merrit & Schokke) 16281: 27; (Curran) 17216: 24;  
 (Miranda) 18246: 27; (Mabesa) 26117: 25 -- J.J. Fei 9493: 3; 10053: 3 --  
 Fendler 48/381: 2 -- Feng 2335: 13; 2850: 13; 3687: 13; 9081: 13; Feng 9090:  
 13 -- G.C. Feng 1089: 13; 21150: 13 -- G.M. Feng 4675: 3 -- K.M. Feng 2335:  
 13; 2913: 14; 4869: 13; 5546: 13; 5662: 13; 5931: 13; 8878: 13; 9385: 13;  
 12393: 23; 12735: 11; 12736: 11; 23901: 13 -- Fenix (medicinal) 40: 5 --  
 Ferguson 48/381 (186): 2 -- Fielding 13401: 2 -- Fikert 1: 7; 1a: 7 --  
 Fitzalan s.n., s.d.: 10 -- Fitzgerald 16: 1; 22: 1 -- Flamigni 28: 6; 82: 6  
 -- Fleischer 69: 10; 609: 24; 701: 9; 706: 9 -- Fleming 68: 15; 875: 11;  
 941: 11; 1391: 15; 1452: 11; 1845: 15; 2289: 23; 2349: 15; 2802: 2 -- Fleury  
 (Chevalier, Plantes de L'Indochine 38690) s.n., 1918: 23; 3058: 6; (Herb.  
 Chevalier) 26372: 6; (Herb. Chevalier) 27372: 6 -- Flora of Thailand  
 (Hansen, Seidenfaden & Smitinand) 11363: 27 -- Floto 7396: 23; 7461: 10;  
 7752: 3 -- Floyd 5241: 31; 5597: 1; 6661: 26 -- Floyd & Womersley 6836: 24  
 -- Fo-Dang University 50866: 16; 56229: 16 -- Foid s.n., 1888: 23 -- Forbes  
 580: 23; 780: 1; 1283: 2 -- Ford s.n., s.d.: 16 -- Forest & Economical  
 Plants Expedition 65-0367: 13 -- Forrest 11776: 11; 19829: 13; 24702: 11;  
 28445: 13 -- Forster s.n., s.d.: 2 -- Fortune (Herb. Zuccarinii) A78(T): 16;  
 32: 16; 34: 16 -- Fournier s.n., 1874: 2 -- Franc s.n., 1906: 10; 331: 10;  
 331: 10; 655: 10; 658: 10 -- Francis s.n., s.d.: 16; s.n., 1919: 10 --  
 Franck s.n., 1929: 3; 245: 1 -- Franken & Roos 298: 2; 358: 1 -- Fraser  
 s.n., s.d.: 10; 102: 10 -- Fredericq (De Witte 8197) s.n., 1952: 7; (De  
 Witte 8978) s.n., 1953: 7 -- Freeman 316, 319: 2; 317, 318: 2 -- Fries &  
 Fries 615: 7 -- Froggatt s.n., 1885: 1 -- Früs, Houde & Jacobsen 60: 7 --  
 K.S. Fu 970: 15; 1096: 15 -- K.T. Fu 927: 14; 1990: 14 -- Fung 20051: 2.  
 Gamble 869: 2; 1398: 23; 6361A: 11; 1436A: 15; 7060: 11; 7346: 23; 7927:  
 2; 8246: 23; 8342: 2; 14616: 2; 17966: 2; 26548: 15 -- Gammie s.n., 1884:  
 23; s.n., 1884: 23; s.n., 1884: 11; 221F: 11 -- Gardner 1142: 2; 2536: 7 --  
 Garrett 261: 3; 812: 11; 1393: 12; 1453: 10 -- Gaudichand s.n., s.d.(T): 1;  
 s.n., s.d.: 2; s.n., s.d.(T): 10; s.n., s.d.: 23; s.n., 1822: 1; s.n., 1837:  
 3; s.n., 1839: 23; 29: 23; 1841: 25 -- Geay s.n., s.d.: 8; 33 à 37, 8241: 8;  
 38: 8 -- Gebo 1599: 10 -- Geesink & Hattink s.n., 1974: 2; 6400: 2 --  
 Geesink & Santisuk 5158: 23; 5267: 2 -- Geesink, Hattink & Phengkai 6504:  
 1; 6844: 3; 7006: 3 -- Geesink, Hattink & Maxwell 6780: 3 -- Geesink,  
 Phanichapol & Santisuk 5510: 3; 5961: 12; 5988: 3 -- Geheeb (Herb.) s.n.,  
 s.d.: 2; s.n., 1866: 1 -- Gentry s.n., 1941: 10 -- Geolash s.n., 1896: 16 --  
 Geolave s.n., 1877: 23 -- P.C. Ger 20928: 14 -- Germain 2: 10; 8: 2 -- Ghose  
 5: 15; 12: 23; 33: 11 -- Gibbs 4338: 27 -- Gilbert 422: 7 -- MacGill 7: 10  
 -- Gillespie 3727: 10 -- Gillet 1864(T): 6 -- Gillevray s.n., s.d.: 2; s.n.,  
 1854: 10; 7: 10; 24: 10; 734: 10; 735: 10; 878: 10 -- Gilli 20: 10 -- Gillis  
 9491: 23 -- Gilon 367: 7 -- Giraldis s.n., 1894(T): 14 -- de Gironcourt 464:  
 6 -- Gittins s.n., 1965: 1; B/2: 10 -- Gledhill 853: 6 -- Glynne 216: 6;  
 254: 7 -- Gocker 105: 6 -- Godefroy s.n., s.d.: 2; s.n., s.d.: 10; 28: 10;  
 (Lebenf) 531: 10; 572: 3 -- Goebel s.n., s.d.: 1; s.n., s.d.: 2; s.n., 1886:  
 10; s.n., 1927: 10 -- Goenong Tjialak 72: 10 -- Goetze 82: 7; 619: 7; 620:  
 7 -- Goodley s.n., 1915: 1 -- Gossweiler 9039: 6; 12512: 6 -- Gough 3243/34:  
 2 -- Gould 651: 11 -- Goy s.n., 1935: 10; 180: 10; 181: 1 -- Goy & Smith

440: 10; 452A: 10 -- Grabowsky s.n., 1882: 2 -- Graeffe 41: 10 -- Gram & Syrach-Larsen s.n., 1957: 2; 15: 1 -- Granger s.n., 1925: 16 -- Grashoff 11: 1; 18: 27 -- Herb. Gray 380: 15 -- Greenway & Kanuri 12110: 7 -- Greenwood 1818: 10 -- Grether 3562: 2; 4553: 10 -- Grether & Wagner jr. 3965: 31; 3973: 26; 4045: 10; 4219: 1 -- v. Gricken 44: 10; 73: 10; 79: 10 -- Grierson & D.G. Long 2372: 11 -- Griffith s.n., s.d.: 1; s.n., s.d.: 2; s.n., s.d.: 10; s.n., s.d.: 11; s.n., s.d.: 23; s.n., 1845: 1 -- Grondal (Herb. Swartz) s.n., s.d.: 2 -- Grote 7651: 6 -- De Grys s.n., 1864: 16 -- K.G. Guan et al. 2186: 13; 2999: 13 -- Z.T. Guan 6301: 16; 6755: 13; 6968: 13; 80154: 14 -- K. Guang et al. 806: 13 -- Guangxi Botanical Expedition 480: 3; 1014: 16; 1224: 23; 1901: 3; 2690: 16; 4028: 16 -- Guangxi University Biological Department 128: 16 -- Guêho & Staub 11951: 8 -- Guerrero 3: 5 -- Guiliet s.n., 1967: 2 -- Guillam & Baum-Bod 7180: 10; 8992: 10; 9419: 10; 12186: 10; 12218: 10 -- Guillaumin & Baumann 7180: 10; 9149: 10; 12,218: 10 -- Gulliver s.n., s.d.: 2 -- Guillot 88: 8 -- Gupffert 12: 6; 142: 6 -- Guppy 100: 26 -- Gurgung 34: 10 -- Gutzwiller 3562: 6.

De Haas 2082-B: 15; 2632: 15 -- Hagerup s.n., 1917: 10 -- Hainan Exp. 358: 3 -- Hale 95: 7 -- Hall 53: 6 -- Hallé 639: 6 -- Hallé & Cours 6155: 6 -- Hallier s.n., s.d.: 24; 664: 1 -- Halsey s.n., s.d.: 8 -- Hanbank 1336: 2 -- Hance 160: 23; 1313: 23; 1409: 16 -- Hancock s.n., s.d.: 16; (Kew no. 3) s.n., 1892: 9; 11: 13; 25: 16; 19: 27; 38: 26; 41: 9; 46: 16; 69: 23; 87: 12; 112: 16; 117: 11; 158: 3; 174: 23 -- v. Handel-Mazzetti 2610: 13; 3332: 13; 3421: 11; 7747: 13; 10337: 16; 10860: 23 -- Van Haneveld Luko 83: 9 -- W.Y. Hang 1561: 13 -- Hannington s.n., s.d.: 6 -- Hansen, Seidenfaden & Smitinand 11105: 3; 11363: 27 -- Hansen & Smitinand 12330: 1; 12965: 23 -- K.S. Hao 108: 16 -- Hara, Kanai, Murata & Togashi 6302034: 11 -- Hara, Kanai, Murata, Togashi & Tuyama 2127: 11 -- v. Hardeveld & v/d Werff 228: 2 -- Harley F 49: 6 -- Harmand 531: 10 -- Harnke s.n., s.d.: 24 -- Harris & Mwasumbi 1046: 6 -- Harrold 364: 10 -- Hartley 10575: 10 -- Hartmann 48: 1 -- Harvey s.n., 1855: 10 -- Hasland 160: 23 -- v. Hasselt s.n., s.d.: 2 -- Hasskarl s.n., 1858: 24 -- Hayata s.n., s.d.: 23; 649: 12 -- Y.Z. He 639: 13 -- Z.G. He 545: 13 -- Z. He 16387: 13 -- Hedberg 790: 7 -- Heindrickx (coll. J. Gillet) s.n., 1903: 6 -- Heinrich 86: 13 -- Helfer s.n., s.d.: 2 -- v. Hellendoorn 60: 1 -- Henderson H44: 10 -- Henderson, Andrews & Sharpe 604: 10 -- Henderson, Moriarty & Swan H2225: 1 -- Hendrickx 330 Bot.: 7; 4843: 7; 8015 Bot.: 7 -- Hennipman 1617: 24; 3012: 3; 3067: 23; 3118: 3; 3147: 11; 3182: 12; 3206: 11; 3333: 3; 3470: 10; 3524: 3; 3623: 3; 3762: 2; 3838: 23; 3891: 23; 3949: 1; 3995: 23; 4012: 27; 4151: 25; 5001: 2; 5015: 1; 5041: 2; 5080: 23; 5590: 28; 5685: 9; 5704: 27; 5707: 1; 5714: 1; 5793: 10; 5852: 27; 5864: 27; 5895: 1; 5940: 10; 5949: 23; 6091: 23; 6359: 2; 6370: 1 -- Henry s.n., s.d.: 23; 393: 16; 586: 25; 748: 16; 1071: 11; 1482: 23; 3704: 16; 3716: 11; 9557: 3; 9557: 1; 9993: 11; 10177: 16; 10177A: 16; 10177B: 16; 10394: 23; 11512(T): 13; 12625: 11; 12737: 11; 13092: 11; 13359: 13 -- Herre 81: 10; 89: 10; 115: 24; 394: 2; 1057: 2 -- Herus 24: 10 -- Heyligers 1093: 24; 1136: 2 -- Hieronymus 2276: 6 -- Higgings s.n., 1919: 10 -- Herb. Hildebrand s.n., s.d.: 9; (herb. Othmer) s.n., s.d.: 25 -- Hill s.n., s.d.: 10 -- Hind 826: 23; 1841: 31 -- Hintz s.n., 1910: 6 -- Hirano & Hotta 321: 1 -- G. Ho 11864: 16 -- Y.Q. Ho 931: 14; 4710: 14; 5383: 14 -- Ho-Ch'ang Chow 1842: 16 -- Hobson s.n., 1897: 15 -- Hochreutiner 31: 24; 2515: 2; 2760: 9 -- Den Hoed (Kwai Noi River Basin Expedition) 907: 2 -- Hoffmannsegg 286: 9 -- Hohenacker 599: 2 -- Hollzung 445: 1 -- Holtum s.n., 1925: 10 -- Holst 2276: 6; 8734: 6 -- Holstvoogd 734: 2; 790: 9; 791: 24 -- Hoogerwerf 218: 2 -- Hoogland 8949: 1; 8950: 10 -- Hoogland & Craven 10813: 26 -- Hoogland & Pullen 5352: 31; 6257: 21 -- Hooker f. & Thomson s.n., 1850: 2; s.n., s.d.: 23 -- Hooker s.n., s.d.: 16; 64: 11 -- J.D. Hooker 65: 2 -- Hope s.n., 1885: 15; s.n., 1886: 15; s.n., 1894: 11; 120: 11 -- Hope & Campbell s.n., 1890: 11 -- Horne s.n., 1877-178: 10 -- Hornemann (Herb.) s.n., s.d.: 11 -- Horsley s.n., s.d.: 2 -- Horsfield s.n., s.d.: 27; 48: 9 -- Hose s.n.,

1882: 1; s.n., 1887: 24; s.n., 1890: 2; s.n., 1895: 2; s.n., 1896: 26; 214:  
 27 -- Hosseus 314A: 23 -- Hotha 15726: 27 -- X.Y. Hou 21171: 3 -- Hove s.n.,  
 s.d.: 2 -- How 70345: 23 -- Howe s.n., 1853: 10 -- Howard 288: 1 -- H.S. 38:  
 25 -- W.Y. Hsia 5296: 14 -- C.C. Hsieh 40785: 16 -- Y.T. Hsieh 2031: 14 --  
 Hsu 337: 23 -- Hu 96: 16 -- C.M. Hu 1967: 16; 2973: 16; 2980: 16 -- S.J. Hu  
 1939: 16 -- C. Huan 163887: 16 -- Z.H. Huan 906: 16 -- Huang 1956: 16 -- K.  
 Huang et al. 584: 14 -- Y.S. Huang 11137: 16 -- Z.C. Huang 163887: 16 -- Z.P.  
 Huang 1225: 14 -- Huang, Kao & Kou 1044: 23 -- Huango (Yellow River)  
 Expedition 548: 14; 1794: 14; 1833: 14; 3147: 14; 3401: 14; 3484: 14; 4348:  
 14 -- Hubbard s.n., 1930: 10; 3386: 10; 3727: 10; 4166: 10; 4469: 10 --  
 Hubbard & Winders 6493: 10 -- Hugel 3088, 4125, 4608, 4612, 4742, 4888: 2;  
 5053: 2 -- Hulstijn & Atje 378: 27 -- Humbert 569: 8; 7462: 7; 13859: 8;  
 20543: 8 -- Humblot 341: 8; 392: 8 -- Hürlimann 625: 10; 1521: 10; 1531: 10  
 -- Hutchison s.n., 1957: 26; s.n., 1958: 10; s.n., 1958: 25; s.n., 1958: 26;  
 s.n., 1959: 24; 2771: 26; 55385: 10.  
 Idjan & Mochter 355: 1 -- Investigation Team Yunnan University 105: 12 --  
 Irvine 1177: 6 -- Ito s.n., 1936: 23 -- Iwatsuki, Kato, Murata & Mogeia B442:  
 1; B777: 27; B778: 1; B2135: 1; B2721: 2; B-2788: 27; B 2966: 24; B2974: 10  
 -- Iwatsuki, Fukuoka & Hutch M13655: 24 -- Iwatski, Murata & Gutierrez P75:  
 2; P880: 1; P995: 1 -- Iwatsuki, Murata, Dransfield & Saerudin S262: 2;  
 S350: 1; S718: 27; S1506: 27; S1782: 24 -- Iwatsuki & Fukuoka T 7174: 23;  
 T10264: 10; T10921: 10 -- Iwatsuki, Koyama, Fukuoka & Nalampoon T9401: 11 --  
 Iwatsuki, Koyama & Fukuoka T9436: 10 -- Iwatsuki, Fukuoka & Chintayungkun  
 T9587: 11 -- Iwatsuki T27769: 2.  
 Jackson s.n., 1932: 10 -- Jacobs 7579: 22; 7962: 25; 7967: 19; 8735: 21  
 -- Jacobsen s.n., s.d.: 2 -- Jagor s.n., 1859: 1; s.n., 1859: 10; s.n.,  
 1859: 24; 174: 2; 638: 2; 910: 1; 938: 2; 1038: 27; 1037: 2; 1047: 2 --  
 Jameson 451: 15 -- Jansen 2149: 7; 5445: 7; 5481: 7; 6552: 7 -- Jarrett  
 s.n., 1971: 1 -- Jarrett, Saldanka & Ramanoorthy HFP 636: 2 -- Jeanpert  
 (Herb.) 13649: 25 -- Jelinck 44: 2 -- Jenker 261: 6 -- Jenkins s.n., s.d.:  
 23 -- Jensen s.n., 1900: 2 -- Jerdon s.n., s.d.: 11; s.n., s.d.: 23 -- Jermy  
 8091: 1; 13087: 1; 13737: 1 -- Jermy & Rankin J14882: 26; J14915: 1 --  
 Jespersen 177: 6; 198: 6 -- T.S. Jia 270: 14 -- S. Jiang 424: 14; 725: 14;  
 2465: 14; 2967: 14; 9439: 14; 9916: 14 -- Jiangxi Expedition 2716: 16 --  
 Jiangxi Teachers College 21355: 16 -- Jochems 265: 27; 573: 9 -- de La  
 Joncke 79: 16 -- John 18046: 10 -- Johnson 1138: 10 -- de Joncheere s.n.,  
 1965: 23; ETS 15: 7; BCO 69: 6; BCO 73: 6 -- Jones s.n., 1974: 1 -- Jones  
 F34: 6; F37: 6 -- Jordan 2093: 6 -- Jouan s.n., s.d.: 10; s.n., 1885: 3 --  
 Jukes (1842-46): 10 -- Junghuhn s.n., s.d.: 2; s.n., s.d.: 9; s.n., s.d.: 10;  
 s.n., s.d.: 24; s.n., s.d.: 27.  
 Kajewski 834: 10; 1767: 24; 1949: 26; 2039: 26; 2132: 10; 2685: 10 -- De  
 Kalk Purrell 6: 1 -- Kao 3780: 16 -- Karapanum 56: 10 -- Karta 285: 2 --  
 Kato s.n., 1931: 23 -- Kato, Murata & Mogeia B3868: 24 -- Kaudern 24: 2; 32:  
 10; 52(T); 28; 66: 10 -- Keenan, Tun Aung & Ruk 919: 10 -- Y.L. Keng 57: 16  
 -- Keng & Kao K2669: 23 -- F.Kehding s.n., 1879: 2 -- Kerfoot 2767: 7 --  
 Kern 8583: 10; 8614: 9 -- Kerr s.n., s.d.: 1; 9934: 23 -- Keysser 62: 26;  
 242: 24 -- Kew Distributions 941: 10; (Herb. Griffith) 942: 11; 944: 24;  
 945: 2; 946: 8; 947: 23; 948: 2; 1186: 27; (Norris) 1187: 26; (Jameson)  
 1309: 11; (Herb. Falconer) 1310: 15 -- Khoon Winit 49-918: 10 -- Khwanjer  
 1241: 11; 1244: 15 -- Kiang & Kao KT 436: 23 -- Kibui 42: 7 -- Kinder s.n.,  
 s.d.: 2; s.n., 1858: 24; s.n., 1859: 24 -- King 127: 10; 207: 1; 225: 10;  
 231, 242: 1; 288: 26; 295: 1; 296: 10; 327: 1; 327: 2; 412(T): 31; 8087: 1  
 -- King's collector s.n., 1882: 15; s.n., 1886: 11; 332: 2; 861: 27; 1601:  
 10; 3487: 1; 6302: 24; (B.p.d.) 8015: 27 -- Kingdom-Ward 17596: 11; 20458:  
 23 -- Kink s.n., 1877: 6 -- Kjellberg 2: 2; 1215: 2; 1661: 27; 3516: 27;  
 3582: 1 -- Ko 55499: 16 -- B.Z. Ko 7239: 14 -- S.P. Ko 50181: 16 -- Koch  
 s.n., 1927: 27 -- Koelz 10555: 23; 20656: 11; 22747: 11; 22924: 23 -- Kóie  
 1817: 1 -- Kooper s.n., 1933: 2 -- Koorders 219: 2; 1492B: 27; 17041B: 2;

21181B: 2; 24098B: 10; 34312B: 2; 35356B: 2 -- Kornassi 16: 1 -- Korthals  
 s.n., s.d.: 1; s.n., s.d.: 2; s.n., s.d.: 10; s.n., s.d.: 24; s.n., s.d.(T):  
 26; s.n., s.d.: 27; 7: 24; 94: 9; 96: 9; 221: 2; 244(?): 1; 274B: 2; 369: 27  
 ; 703: 26 -- Kostermans s.n., 1969: 24; 78: 10; 137: 1; 338: 1; 969: 1;  
 1341: 2; 5658: 1 -- Kramer 67: 24 -- Kramer, Zogg & Gassner 8167: 16; 8180:  
 16 -- K.J. Kuan et al. 114: 14; 304: 16; 678: 14; 1343: 14; 3414: 16 -- K.J.  
 Kuan 77282: 14 -- Kuan & Wang 114: 13; 2186: 13; 2999: 13; 3414: 16 -- Kuhl  
 v. Clafelt 242: 24 -- Kuhn s.n., 1858: 24 -- Kuls 215(T): 7 -- S.S. Kung  
 1755: 14 -- Künstler 3487: 1 -- Kuntze (Herb.) s.n., s.d.: 11; 5289: 2;  
 7072: 23 -- Kuo s.n., 1979: 25; 4: 16; 1915: 23; 2977: 23 -- Kurz s.n.,  
 s.d.: 9; s.n., s.d.: 11; s.n., s.d.: 23; s.n., s.d.: 24; s.n., s.d.: 27;  
 s.n., 1867: 2; 26021: 2 -- Kyoji Yoda 994: 10.  
 Lack 990: 13 -- L.A.E. (Floyd) 5597: 1; (Stone & Galore) 53335: 1; (Stone  
 & Streimann 10440) 53740: 26; (Stevens & Lelean) 58580: 10; (Croft et al.)  
 61150: 1; 61269: 1; (Croft) 61860: 10; 65535: 1; (Croft & Lelean) 65668: 1;  
 (Croft) 65548: 26; 65726: 21; 65861: 10; (Conn & Katik) 66012: 1; (Barker &  
 Vinas) 66583: 1; 66597: 26; (Croft) 68279: 24; 68288: 26; (Katik & Henty)  
 74798: 10 -- S.K. Lai 1219: 16; 2054: 16; 2415: 16; 2973: 16; 2980: 16;  
 3777: 16; 4946: 16; 5310: 16 -- Lam 445: 1; 700(T): 31; 701: 26; 1148: 1;  
 1150: 1; 1274: 24; 2469: 2; 2470: 2; 3386: 2; 3503: 1; 3622: 10; 3721: 24;  
 7584: 10 -- Lam & Meeuse 5615: 8; 5874: 8 -- Lamont 1039: 23; 1093: 16 -- de  
 Lanessan s.n., s.d.: 2 -- K.Y. Lang 3066: 16 -- Lang 3425: 16 -- Larsen  
 1396: 24; 3204: 11; 3337: 10; 3687: 10; 3845: 10; 4460: 3; 7455: 10; 7461:  
 10; 7752: 3; 8797: 2; 9477: 23; 10111: 2; 10573: 2; 10581: 10; 10634: 3 --  
 Larsen, Smitinand & Warncke 240: 23; 574: 3; 1366: 3 -- Larsen, Santisuk &  
 Warncke 1997: 10; 2092: 12; 2418: 3; 3025: 12 -- Larsen, Larsen, Nielsen &  
 Santisuk 31393: 3; 31776: 3; 32273: 1; 32426: 2 -- Larsen & Larsen 33907: 12  
 -- J.T. Last s.n., 1890: 8 -- Latz 3507 (N.T. 37031): 2 -- Lau s.n., s.d.:  
 2; 674: 16; 1715: 10; 4810: 10; 6212: 2 -- Lau S.K. 1592: 23; 3917: 16;  
 5254: 23; 26380: 23 -- Lau Y.S. 2081: 23 -- Laubert s.n., 1826: 23 --  
 Laurent s.n., s.d.(T): 6; s.n., 1893: 6; s.n., 1895: 6; 1553: 6 -- Laurent &  
 Laurent s.n., 1903: 6 -- Lauterbach s.n., s.d.: 19; 70: 1 -- Law s.n., s.d.:  
 23 -- Lazarides & Adams 239: 2 -- Lebrun 7159: 7; 8454: 7 -- Leconte & Finet  
 s.n., s.d.: 23; 58: 16; 494: 11; 757: 3 -- Ledermann 448: 6; 5775: 7; 6179:  
 1; 7262: 1; 7730: 10; 7998: 1; 8108: 26; 8373(T): 31; 9093: 10; 9600: 31;  
 11402: 21; 11462A: 21; 12808: 21; 13020: 21 -- Leeuwenberg 2985: 6; 3086: 6;  
 3088: 6; 9531: 7 -- Leeuwenberg & Voorhoeve 4658: 6; 4950: 6 -- Lefevre 205:  
 2 -- Leflor s.n., 1825: 1 -- Leiberg 6064: 25 -- Leighton s.n., 1917: 7 --  
 Lejeune s.n., 1960: 6; 249: 6; 343: 7 -- Leonard 1055: 6; 1887: 6 -- Lemaire  
 249: 6 -- Letouzey 212: 6; 4458: 6 -- C. Leu 288: 16 -- Levine (Canton  
 Christian College Herb.) 1973: 23; 3557: 16 -- Levinge s.n., 1871: 23; s.n.,  
 187?: 15; s.n., 1880: 11; 8077: 11 -- Lewalle 28: 7; 4867: 7 -- B.G. Li et  
 al. 5414: 16 -- H.J. Li 1450: 16; 8914: 16 -- J.K. Li 1136: 16 -- K.F. Li  
 60032: 16; 60053: 16; 60161: 16; 60250: 16; 64964: 16 -- X. Li 22849: 13;  
 23013: 14; 23109: 14; 23268: 14; 71721: 14; 71933: 14; (et al.) 73615: 14;  
 75268: 14; 75537: 14; 75885: 14; 76243: 14; 78289: 14; 78578: 14 -- Y. Li  
 71721: 14 -- Y.H. Li 1737: 23; 2735: 3; 11763: 23; 12269: 12; 12521: 11 --  
 Z.H. Li et al. 1058: 16 -- Z.T. Li 601794: 3; 601953: 16; 603941: 16 -- Li-  
 Po Expedition 1663: 16; 1697: 16; 1721: 16 -- Liang 62580: 10; 62667: 23;  
 64777: 23; 66098: 16 -- H.Y. Liang 60590: 16 -- Z.F. Liang 30820: 16 -- M.X.  
 Lie 5681: 16 -- Y.X. Lie (et al.) 2049: 16; (et al.) 2209: 16; 6341: 16;  
 7397: 16; (et al.) 8941: 16 -- Liebman (Herb.) s.n., s.d.: 11; s.n., s.d.:  
 16 -- Lignes V20d: 7 -- Lin Pi 6094: 16 -- Lin Y. T. 11170: 16 -- Lindblom  
 s.n., 1920: 7 -- Linné (Microfiche no. 1251.12) (T): 2 -- Linsley Gressitt  
 303A: 23; 845: 23; 1189: 23 -- Limpricht 1185: 16 -- K.M. Liou 6487: 14;  
 6972: 14 -- T.N. Liou 9634: 14; 10407: 11; 18259: 16; 18895: 11; 22444: 11  
 -- T.N. Liou & C. Wang 1444: 16 -- Lipke 10: 7 -- Litke 453: 1 -- C.S. Liu  
 705: 14 -- C.Z. Liu 10095: 16 -- L.H. Liu 9734: 16; 15511: 16; (et al.)

16451: 16 -- S.L. Liu et al. 1067: 16 -- Q.X. Liu 3a: 16 -- Y.K. Liu 739: 16; 2900: 16 -- Z.A. Liu 48: 16 -- Z.S. Liu 705: 13 -- Lo (Benati) 41: 13 -- Lobb s.n., s.d.: 2; s.n., s.d.: 24; s.n., 1857: 27 -- Loher s.n., s.d.: 2; s.n., s.d.: 24; s.n., s.d.: 25; s.n., s.d.: 27; s.n., 1906: 25; 820: 25; 892: 27; 1176: 2; 1177: 2; 1213: 27; 12029: 10 -- Lorence M126: 8 -- Lorrain s.n., s.d.: 1; s.n., s.d.: 2 -- Lörzing 772: 10; 2572: 24; 5268: 10; 6896: 27; 7013: 9; 12807: 10; 14149: 27; 15268: 9; 15609: 10 -- Louis 4383: 6; 5104: 7; 6012: 6 -- Lovell s.n., s.d.: 10 -- Loveridge 117: 7; 381A: 7; 487: 7 -- Lowe 272: 1 -- Lu-Gi Expedition 504: 23; 564: 23 -- Luartz s.n., 1919: 23 -- Lübke s.n., 1885: 1 -- Ludwigs 30: 6 -- Luerssen s.n., s.d.: 10; (Herb.) s.n., s.d.: 16 -- C. Lui et al. 1981: 16 -- C.E. Lui 22444: 11 -- L.Lui et al. 577: 14 -- Y. Lui 48: 16 -- Y.W. Lui 5840: 14 -- Z.W. Lui 73.311: 13 -- Lui-Chun Expedition 354: 11 -- Lukes s.n., 1842-'46: 10 -- Luming 89: 29 -- Lütjiharms 5214: 1.

Maas Geesteranus 5615: 7; 5807: 7 -- Mabblerley 1344: 7 -- MacGregor s.n., s.d.: 8; (Herb. Mueller 100 & 104) (T): 31; 101-103: 1 -- MacInnes 431: 7 -- MacKinnon & MacKinnon s.n., 1878/79: 11; s.n., 1878/79: 15 -- MacLeay s.n., s.d.: 1; s.n., s.d.: 9; 57: 7 -- Macleod (Herb.) s.n., 1873: 10; s.n., 1883: 11 -- Mactier s.n., s.d.: 27 -- Magr s.n., s.d.: 2 -- Main 528: 1; 1757: 1; 1846: 1 -- Main & Aden 1127: 1 -- Maingay 1794: 2; 1795: 10 -- Maire s.n., s.d.: 11; s.n., s.d.: 13; s.n., s.d.: 16; s.n., 1912: 11; s.n., 1913: 13; s.n., 1916: 16; 11: 13; 131: 13; 133: 13; 958: 13; 1373: 13; 6006: 15; 6006b: 13; 6057b: 13; 6496b: 13; 6559b: 13; 6616b: 13 -- Malhotra 115: 11 -- Mamit S34593: 1 -- Herb. Mana s.n., s.d.: 27 -- Manberg s.n., s.d.: 13; s.n., 1907: 13 -- Manford s.n., 1886: 15 -- Manickam 1337: 2 -- Mann s.n., s.d.: 7; s.n., 1880: 2; s.n., 1880: 23; s.n., 1886: 2; s.n., 1886: 11; s.n., 1886: 23; s.n., 1887: 23; s.n., 1888: 11; s.n., 1888: 23; s.n., 1889: 2; s.n., 1889: 11; s.n., 1889: 23; s.n., 1894: 2; 339: 7; N339: 7; 1062: 11 -- Manner & Street 538: 10 -- Manseima 16: 1 -- Manton P158: 2 -- Manuel de Silva 3850: 6 -- P.Y. Mao 859: 13 -- Marcan 746: 3 -- Maries s.n., s.d.: 16 -- Marlier 893: 7 -- Marten s.n., 1897: 15 -- Martensz AE311: 2 -- Maskuri 753: 1; 871: 1 -- Masuda 117: 25 -- Masamume s.n., 1938: 23; 2151: 16 -- Matthew s.n., 1906: 1; s.n., 1906: 10; s.n., 1906: 24; s.n., 1907: 16; s.n., 1907: 23; s.n., 1908: 1; s.n., 1911: 27; s.n., 1912: 9; s.n., 1912: 26; s.n., 1912: 27; s.n., 1906: 26 -- Matuda 366: 16 -- Maxwell 73-564: 3; 74-1000: 3; 75-325: 10; 75-569: 10 -- Mayer s.n., 1895: 2 -- McClure B47: 16; 1605: 16; 2170: 23; 8102: 23; (Canton Christian College Herb.) 8382: 23; 8574: 23 -- McDonell s.n., 1884: 15 -- McKee 2031: 10; 2035: 10; 12131: 10; 15802: 10 -- McLelland s.n., s.d.: 2 -- Mearns 1233: 7 -- Meebold 2077: 23; 2078: 11; 2079: 2; 2593: 15; 3611: 10; 5685: 2; 7673: 10; 16368: 11; 16592: 10 -- Van Meel 102: 6 -- Meidner 115: 7 -- Menzies s.n., s.d.: 2 -- Merrill s.n., s.d.: 2; 311: 2; 558: 2; (Spec. Blancoanae) 640: 2; 1204: 2; 1800: 24; 3224: 25; 6007: 24 -- Mertens s.n., 1862: 2 -- Mettenius s.n., s.d.: 24 -- Metzner 70: 2 -- Meurillon 655: 6 -- Meyen s.n., 1833: 2; s.n., 1833(T): 25 -- Meyer 636: 1; 656: 10; 2004: 1; 3063: 26; 5663: 10; 7679: 7 -- Meyer Drees 403: 26 -- Micholitz s.n., 1883: 2; s.n., 1883: 27 -- Mier s.n., 1838: 27 -- Migeod 72: 7; 434: 7 -- Mildbread 895: 7; 1288(T): 7; 5387: 6 -- Miles Moss 2: 2 -- Milne s.n., s.d.: 1; s.n., s.d.: 24; s.n., s.d.: 26; s.n., 1853: 10; 54: 1; 132: 10; 197: 10; 212: 2; 308: 10; 410: 10; 525: 1; 583: 26 -- Milne-Redhead & Taylor 9017: 7 -- Miranda s.n., 1909: 1; s.n., 1910: 5 -- Mo-Wen Expedition 2778: 13 -- Mjöberg s.n., 1923: 1; s.n., 1923: 2; s.n., 1924: 1; s.n., 1924: 2; s.n., 1924: 10; s.n., 1934: 1; 2/8: 1; 20/4: 1; 29/9: 1 -- Moewis s.n., 1885: 11; S5: 23 -- Molesworth-Allen 1074: 24; 1080: 10; 1416A: 24; 1522b; 1; 1612: 27; 2179: 10; 2254: 10; 2503: 26; 2580: 27; 2612: 10; 2625: 1; 2633: 26; 2791: 2; 2820: 2; 4251: 27; 4296: 24; 4595: 26 -- Molhuysen s.n., 1898: 2; s.n., 1899: 2; s.n., 1899: 9; s.n., 1902: 9; s.n., 1904: 2; s.n., 1904: 24 -- Molhuysen s.n., 1963: 24 -- Müllks s.n., 1897: 10 -- Müller s.n., s.d.: 6; s.n., 1897: 24; (Fl. Afr. Exsicc.) 57: 6

-- Monod de Froideville 365: 10 -- Mooney 613: 2; 5932: 7; 9168: 7 -- Moreau & Moreau 28: 7 -- Morrison s.n., 1896: 10 -- Morse 2: 16; 3: 3; 4: 3 -- Moseley (et.al., Challenger) s.n., s.d.: 24; s.n., s.d.(t): 26; s.n., s.d.: 27; s.n., 1874: 2; s.n., 1874: 24; s.n., 1875: 2; s.n., 1875: 26; s.n., 1875: 26 -- Moupet (Herb. Sabransky) s.n., s.d.: 24 -- Mousset s.n., 1908: 10; s.n., 1911: 9; 50: 9; 162: 10; 163: 24; 164: 2 -- Moszkowski 375: 1 -- Mtui, E.M. (& C.M. Kisera) 119: 6 -- Mulder s.n., 1971: 7 -- Von Mueller s.n., s.d.: 1; s.n., s.d.: 2; s.n., s.d.: 10; s.n., 1855: 10; (Herb. Javanicum 162) 41: 10 -- Mueller-Dombois & Comanor 67072556: 2 -- Murata, Fukuoka & Phengklai T16256: 1; T17425: 1 -- Murata, Fukuoka & Sukasdi J564: 24 -- Murata, Iwatsuki & Phengklai T14955: 12; T15233: 11; T16255: 10; T16934: 12; T17084: 3; T17086: 3; T17425: 2 -- Murata, Iwatsuki, Phengklai & Charamphol T15463: 10.

Nakahara s.n., 1905: 16 -- Nan-Kai University s.n., 1953: 16 -- Naumann s.n., 1875: 1; s.n., 1875: 2; s.n., 1875: 10 -- Nayar & Partz 30778: 2; 44497: 2; 49865: 23 -- Naylor Beckett 230: 1 -- Z.F. Nei 120741: 16 -- Nelson (Herb. Copeland 12786) s.n., 1925: 16 -- Newbould 811: 6; 6552: 7 -- Newbould & Harley 4493: 6 -- Newbould & Jefford 2721: 6 -- Newcomb s.n., 1957: 26 -- N.G.F. (Millar & Dockrill) 12079: 24; (Croft & Katik et al.) 12982: 1; 15584: 24; (Millar & Holttum) 15710: 10; (Millar) 23258: 1; (Lavarack & Ridsdale) 31368: 10; (Streimann & Katik) 34054: 10; (Streimann & Kairo) 39141: 10; (Coode, Dockrill & Foreman) 40436: 26; (Vanderberg & Mann) 42276: 1; (Streimann) 44291: 1 p.p., 24 p.p.; (Streimann) 47810: 24 -- Nguyen van Khien s.n., 1970: 2 -- Nicklès s.n., s.d.: 6 -- M.C. Nie 5358: 16; 7397: 16 -- Van Niel 3518: 1 -- Nielsen 615: 2; 785: 2 -- Nietner s.n., s.d.: 2 -- Nooteboom 1197: 26; 1065: 1; 1374: 24 -- Nooteboom & Chai 1885: 18 -- Norris s.n., s.d.: 1; s.n., s.d.: 10; s.n., s.d.: 24; s.n., s.d.(T): 26; 89: 2; 941: 10; 947: 23 -- (North) Guizhou Expedition 313: 16; 1399: 16; 2549: 16 -- North Wood s.n., 1905: 7 -- N.S.W. (Watts s.n., 1913) P2321: 10; (Rawnsky, Herb. Archer 1852) P2322: 10; (Boorman s.n., 1899) P2323: 10; (Bailey) P2324: 10; (Waller s.n., 1908) P2325: 10; (Stephenson) P2326: 10; (Staan s.n., 1910) P2329: 10; (Boorman s.n., 1912) P2330: 10; (Davies s.n., 1943) P4585: 10; (Kennedy) P5560: 10; (Boorman s.n., 1912) P5879: 10; (Banks & Solander 17700) P6057: 2 p.p., 10 p.p.; (Boorman s.n., 1912) P6107: 10; (McAnliffe s.n., 1914) P6108: 10; (King s.n., s.d.) P7935: 1; (Watts s.n., 1913) P8016: 10; (McKee 6146A) P8254: 11; (Goadley) P9733: 1; (Waterhouse) P9737: 10; P9738: 10; P9739: 10; (Quaife) P9740: 10; P9741: 10; P9742: 10; P9745: 8; P9747: 27; P9748: 26; (King 288) P72855: 26.

Oldfield s.n., s.d.: 10; s.n., s.d.: 23 -- Oldham 55: 16; 56: 23 -- Oldmann s.n., s.d.: 23 -- Olorunfemi, Ariwaodo, Fagbemi OAF11: 6 -- d'Orléans s.n., s.d.: 13 -- O'Shanesy s.n., s.d.: 10 -- Othmer (Herb.) s.n., 1897: 25.

Palis 21: 31; 24: 1 -- Palm s.n., 1921: 10; 290: 24; 573: 9 -- Palm & Bryant 451: 24 -- Pancher s.n., s.d.: 10; s.n., 1870: 10 -- Parker 76(T): 15 -- Parkinson (Herb. Von Mueller 377) (T): 31 -- Parks 16201: 10; 20003: 10; 20308: 10; 20727: 10 -- Parrish s.n., s.d.: 12; s.n., s.d.: 23; 65: 2; 99: 23 -- Pauwels 299: 6; 1502: 6 -- Pawek 1613: 7; 2025: 7 -- Pedersen 531: 7 -- Pedro & Pedrôgão 4084: 7 -- Peekel 513: 26 -- C. Pei 7731: 16 -- C.J. Pei 81986: 23 -- S.J. Pei 59-11214: 23 -- Percival s.n., 1972: 1 -- Perny s.n., 1858: 16 -- Perrier de la Bathie 7635: 8 -- Petelot s.n., s.d.: 11; s.n., s.d.: 23; s.n., 1925: 3; s.n., 1926: 23; s.n., 1929: 16; 221: 1; (Herb.) 463: 16; 1583: 11; 1585: 23; 1922: 7; 4199: 16; 4255: 2; 4872: 16; 4912: 3 -- Peter s.n., 1914: 6; 35: 6; 2611: 7; 3747: 6; 9874: 6; 13005: 6; 15252: 6; 15755: 6; 16750: 6; 16751: 6; 38827: 7; 40083: 6; 40163: 6; 42151: 7 -- Petit 298: 7 -- Pfliserer s.n., 1904: 2 -- Phengklai 649: 23 -- Phengnaren 177: 3 -- Phillips 35319: 10 -- Phloenchit 1186: 12 -- Pichi Sermolli 4401: 7; 5202: 7; 5261: 6; 6735: 7; 6754: 7; 6790: 7; 7008: 7 -- Pierre s.n., s.d.: 27; s.n., 1866: 23; 5712: 7; 5723: 2 -- Piggott 1493: 1; 1590: 1;

1657: 2; 1720, 1821: 24; 1750: 10; 1855: 26; 1927: 24; 2225: 1; 2258: 1; 2280: 5; 2357: 24; 2359: 10 -- Pinwill s.n., 1866: 1; s.n., 1866: 2; s.n., 1866: 10 -- Plason s.n., s.d.: 2 -- Pleyte 18: 2; 55: 24 -- Ploem s.n., s.d.: 27; 553: 24; 554: 24; 564: 9 -- P.N.H.(Edano) 496: 2; 696: 2; (Sulit) 2975: 25; (Celestino) 3046: 27; (Fox) 3947: 10; (447B) 3955: 2; (Alcasid & Edano) 4803: 27; (Alcasid & Celestino 643) 7504: 2; (McVittie) 8818: 24; 9363: 27; (Edano) 12588: 2; 15154: 1; (Sulit & Conklin 4685) 16679: 2; (Mendoza 1486) 17246: 2; (Sulit & Conklin) 17262: 10; (Edano) 17293: 1; (Sulit 5688) 36214: 2; (Conklin 1040) 37578: 2; (Frake FN 380) 37993: 1; (Kondo & Edano 9024) 38642: 2; (117) 38683: 2; (9000) 38697: 2; (Edano FN 9668) 40512: 1; (Mendoza 61-131) 41971: 2; 42331: 1; (61-664) 42493: 2; (Steiner 970) 63591: 27; (Banlugan et al.) 72570: 24; 78645: 1; (Conklin & Buwaya) 78646: 1; 80682: 27; (I-1398) 80682: 27; (Gutierrez & Espiritis 60) 80794: 2; (Mendoza) 81865: 2; 97460: 27; 97905: 2; (Juan & Vendivil) 126057: 1 -- Pobéguin 26: 6 -- Pocs 6152/L: 6 -- Podenzana s.n., 1891: 10; s.n., 1891-'93: 10; s.n., 1892: 10 -- Poelt R15 (34): 15; R22A (355): 15 -- Poilane (Chevalier, plantes de l'Indo-Chine 1843) s.n., 1920: 23; (Chevalier, plantes de l'Indo-Chine 4101) s.n., 1922: 23; s.n., s.d.: 23; 1360: 10; 1383: 23; 1965: 10; 3768: 2; 3790: 10; 3868: 2; 3869: 2; 3930: 12; 4109: 12; 4571: 23; 4599: 3; 4610: 10; 5248: 3; 5291: 3; 5300: 2; 7671: 23; 7949: 23; 15544: 12; 15696: 11; 15759: 27; 16153: 23; 16854: 11; 17479: 3; 17558: 3; 19454: 3; 22251: 2; 22334: 1; 22417(bis): 10; 22550: 12; 22667: 27; 28565: 23 -- Poland 75: 10 -- Polhill & Panko 1778: 7 -- de Poli s.n., 1874: 2; s.n., 1877: 9 -- Polunin 1620: 15 -- Polunin, Sykes & Williams E002.F. (1350): 15; 195: 13; 3298: 15 -- Pool s.n., s.d.: 8; A78: 8 -- Poore 701: 26; 906: 27 -- Posthumus 2174: 1; 2389: 10; 2403: 1; 3367: 2; 3653: 9 -- Powell 1637: 30 -- Powles s.n., s.d.: 9 -- Prabha & Ramola 6329: 15 -- Prain s.n., 1889: 2; s.n., 1886: 23 -- Prawiroatmodjo & Soewoko s.n., 1978: 1 -- Preuss 213: 6 -- Price 1049: 25; 1182: 19; 1371: 27; 1708: 29 -- Price & Hernaez 447: 24 -- Prince s.n., 1898: 10 -- Pulle s.n., 1906: 2; s.n., 1906: 24; 27: 1; 61: 10 -- Pullen 2811: 10; 6723: 2; 8471: 24 -- Purseglove P.5246: 24.

Qing-Shai Expedition 73-184: 14 -- Qinghai-Gansu Expedition 1426: 14; 2616: 14; 3388: 14 -- Qinghai-Tibet Expedition 74-1955: 14; 74-2275: 15; 1424: 11; 3580: 15; 4599: 11; 4697: 15; 5059: 11; 5315: 15; 6308: 11; 6335: 15; 11359: 14; 12325: 14; 12506: 14 -- Qinghai-Xizang complex Expedition (sectio suppl.) 75-0764: 14; 75-1319: 14; 75-1732(T): 15 -- Qu 4158: 16; 6495: 16 -- G.L. Qu 2992: 13 -- Quarré 7188: 7; 7356: 7 -- B.Y. Qui 57886: 16 -- P.J. Qung 8953: 14.

Raciborski s.n., s.d.: 1; s.n., s.d.: 2; s.n., s.d.: 9; s.n., s.d.: 10; s.n., s.d.: 24; s.n., s.d.: 27; s.n., 1897: 1; s.n., 1897/8: 24; s.n., 1897-'9: 9; s.n., 1897-'9: 2; s.n., 1898: 1; 98 (1898?): 2; 123: 10; 238: 9 -- Rae C2: 7 -- de Raemer s.n., 1839: 9 -- Rahmat Si Boela 6403: 1; 10048: 10 -- Rajewski 1767: 24 -- Ramaley 311: 24 -- Rammeloo 4666: 7; 4724: 7 -- Ramoß s.n., 1919: 27; 23446: 29 -- Randall s.n., s.d.: 2; 6: 1 -- Rankin 75: 7 -- Le Rat 141/481: 10; 409-A: 10 -- R.W. Rawson 902: 8 -- J. & A. Raymal 10682: 6 -- Rechinger 21: 10; 1724: 10; 2460: 2; 3554: 1; 3668: 1; 3853: 1; 4321: 1; 4443(T): 31; 4765: 1 -- Redfield (Herb.) 1301: 23 -- Reekmans 164: 7; 1217: 7; 7770: 7 -- Reeve & Cruttwell 606: 30 -- Reinecke 137: 10 -- Reinwardt s.n., s.d.: 1; s.n., s.d.: 24; (Herb.) s.n., s.d.: 2; s.n., s.d.: 27 -- Y.X. Ren 2252: 16 -- Q.R. Reng 1093: 16 -- Rensch 598: 2 -- Richards s.n., s.d.: 26; 4377: 7; 10523: 7; 14049: 7; 20055: 7; 26716: 7 -- Ridley 4352: 1; 4353: 2; 5157: 10; 6945: 10 -- Den Rietz 4396: 10 -- Robertson s.n., 1772: 2 -- Robinson s.n., s.d.: 2; s.n., 1974: 2; (Pl. Rumphianae Amboinenses) 450: 1; 3022: 7; 6227: 10 -- Robson 474: 7 -- Rock 368: 11; 512: 3; 2033: 23; 2513: 3; 2756: 3; 4290: 13; 6175: 13; 7102: 11; 7122: 11; 10534: 13 -- v. Rockondt 16: 7 -- Rodatz & Klirck s.n., 1899: 26 -- Roemer s.n., 1909: 1 -- Von Roemer 76,318: 19 -- Rohmo Lepcha 559: 15 -- Rolla

Seshagiri Rae 7399: 11 -- Roos 83.61: 10; 83.62: 26; 83.64: 31; 83.68: 30; 83.77: 31; 83.79: 31; 83.82: 31; 83.85: 21; 83.86: 30; 83.113: 1; 83.122: 1 -- Rosenstock, Fil. Chinensis Exsicc. 10: 16; 11: 3; 137: 11; (Fil. Formosanae Exsicc.) 183: 23; (Fil. Jav. Orient. Exsicc.) 2: 9; 57: 24; 78: 10; 124: 2; (Fil. Neocaledon Exsicc.) 21: 10; (F.N.G. Exsicc.) 105: 24; (Fil. Sum. Exsicc.) s.n., s.d.: 2; 161: 24; 162: 10; 163: 1; (Winkler 199) 193: 27 -- Ross s.n., 1974: 10 -- Rothdansch s.n., 1875: 5 -- Rottler s.n., s.d.: 2 -- Rouyer s.n., 1905: 2; s.n., 1905: 10; s.n., 1905: 26 -- van Royen 3538: 1; 5213: 24; 5493: 31 -- Royle s.n., s.d.: 15 -- Roxburgh s.n., s.d.: 2 -- Rua 435: 31 -- Rutten 21: 2; 49: 2; 475: 1; 649: 1; 1786: 2; 1963: 24.

S. (Wright & Ismawi) 32552: 1 -- S. (Mamit) 35111: p.p1, p.p2 -- Samat & Abdullah 89: 10; 209: 27; 248: 2; 333: 27 -- Sample 81: 7 -- Samson Laup (S.L. 32) s.n., 1979: 1 -- S.A.N. (Kanis & Sinanggul) 52640: 1; (Kodoh & Lasan) 87532: 1 -- Sandermann Olsen 125: 10 -- Sangster 55: 7 -- Santos 185: 25; 420: 24; 539: 25; 4529: 2; 4703: 2; 5695: 27 -- Sarasin 618: 10 -- Coll. Sarel s.n., s.d.: 16 -- Sasaki 1530: 16; 12397: 16; 21339: 16 -- Sauliere 445: 2 -- Sawada s.n., 1909: 23; s.n., 1909: 25 -- Scallan s.n., 1899: 16 -- Schelpe 2436: 7 -- v. Schiffner s.n., 1894: 2; s.n., 1894: 10; s.n., 1894: 24; P184: 26 -- Schild s.n., 1902: 1; s.n., 1902: 27 -- Schilling & Sayers 340: 2 -- Schindler 401: 16 -- Schlagintweit 12401: 11 -- Schlechter 13740: 26; 16427: 26; 16614(T): 31; 17850(T): 30; 18266(T): 21 -- Schlegel s.n., s.d.: 2 -- Schlieber 148: 7; 823: 7; 3336: 6 -- Schmid, pl. Neilgh. N. 161, 168: 2 -- Schmid 1129-1132: 2 -- Schmidt 227: 1; 726: 2 -- Schmitz 3855: 7; 7132: 7 -- Schmutz 1831: 2; 3369: 2; 3380: 9; S.V.D. 5350A: 2; S.V.D. 5396: 9; S.V.D. 5561: 2 -- Schneider s.n., s.d.: 24; 2821: 13; 2991: 13 -- Schnell 679: 6; 1192: 6; 2579: 6 -- Schodde (& Craven) 4021: 26 -- Schomburgh s.n., s.d.: 2; 342: 2 -- Von Schönau s.n., 1916: 5; s.n., 1929: 24; 44: 1 -- Schottmueller 251: 2; 267: 10 -- Schram B.W.14881: 1 -- Schultz 2: 2; 17: 2; 674: 2 -- Schweinfurth 3373: 6 -- Scottechini s.n., s.d.: 2; s.n., s.d.: 10; s.n., s.d.: 27; s.n., 1884: 26; 228: 24; 379: 24; 431: 1 -- Scott Elliot 7993: 7 -- Seegeler 2542: 7 -- Seemann 3; 10; 733: 10; 2300: 1 -- Seidenfaden 2012: 1; 2918: 1 -- Herb. Selim Birger (Rosenstock) s.n., 1897: 25 -- Selinek 45: 2 -- Selling 19: 10 -- U. Sen 79/5: 11 -- U. & T. Sen 79/19: 23 -- Serres s.n., 1912: 3 -- Setchell & Parks 15026: 10 -- S.F. (Hanniff and Nur) 4258: 3; (Hose) 4848: 10; 5010: 2; (Chipp) 5959: 2; (Hose) 14358: 2; (Henderson) 19576: 1; 20224: 2; (Holtum) 25593: 24; 25624: 26; (Henderson) 29069: 10; 29128: 2; 29168: 10; (Corner) 30715: 27; (Nur) 32935: 24; 33983: 2; 34341: 2; 34368: 10; (Sinclair) 39552: 27 -- Shaanxi Herbs Expedition 2080: 14 -- Shaanxi-Gansu Expedition 10290: 14 -- R.C. Shan 5652: 16 -- R.H. Shan 697: 16 -- Sharpe 14: 1; 368: 10; 1674: 10 -- Shiang et al. 94: 16 -- Shimada 31: 16 -- Shimizu, Fukuoka & Nalampoon T7716: 3; T8082: 2 -- Shimizu, Hotoh & Chaiglom T8969: 10 -- Shimizu & Hutok T10190: 11 -- Shimizu & Kao 11946: 25 -- Shimizu, Toyokuni, Koyama, Yahara & Santisuk T13174: 23 -- Shimizu, Toyokuni, Yahara & Niyomdham T22329: 3 -- Shimizu, Toyokuni, Koyama, Yahara & Niyomdham T23177: 23 -- Shimswa & Bisillia 2697: 11 -- J.S. Shing 559: 23 -- K.H. Shing et al. 1359: 16; 1368: 16; 1910: 16 -- Shirley s.n., s.d.: 1; s.n., s.d.: 10 -- Shiu Ying Hu 6198: 23; 9035: 23; 9680: 23 -- X.H. Shu 749: 16 -- Y.P. Shu 1172: 13 -- Sichuan Botanical Expedition 1111: 14; 1982: 14; 2046: 14; 2373: 14; 6390: 14; 6413: 14 -- Sichuan Economical Plants Expedition 72: 16; 125: 13; 268: 16; 417: 16; 429: 14; 431: 16; 971: 16; 1125: 13; 1208: 13; 1616: 16; 2208: 11; 2227: 16; 2558: 16; 2778: 13; 3803: 13; 4096: 16; 4290: 13; 5122: 16; 5437: 16 -- Sichuan Forest Expedition, 2e team 8-224: 14; 29-329: 14; 41-516: 14; 8e team 2405: 14; 5556: 14; 5644: 14 -- South Sichuan Expedition 1125: 13; 1184: 13; 3771: 13; 3803: 13; 4248: 13 -- West Sichuan Expedition 114: 13 -- Sidney 67: 2 -- Sieber, syn. fil. 172: 8; syn. fil. 173: 8 -- da Silva 2432: 6; 3850: 6 -- Simond s.n., s.d.: 16 -- Simonds



s.n., 1895: 10 -- Simons s.n., s.d.: 2; s.n., s.d.: 11; s.n., s.d.: 23 -- Simozawa s.n., 1937: 25; 411: 16; 699: 23 -- Sin 8125: 16 -- Skottsberg 156(bis): 10 -- Sledge 1777: 10 -- Slee 375: 23 -- v. Slooten 489: 10 -- v. Slooten & Backer 35028: 2 -- Smeds F/1: 7 -- Smith s.n., 1858: 10; s.n., 1866: 8; s.n., 1866: 11; s.n., 1866: 23; 49: 2; 376: 1; 430: 3; 465: 12; 589: 12; 594: 10; 643: 23; 846: 24; 1141: 23; 1545: 23; 1546: 23; 1940: 13; 2801: 27; 2803: 4; 4165: 1; 4294: 10; 6903: 10; 7447: 10; 9393: 10; 9846: 1; 10004: 16; 10480: 13 -- Smitinand 343: 10; 1442: 2; 1678: 12; 5890 (R.F.D.24130): 3; 6052: 12 -- Smitinand & Sleumer c.al. 1279: 10; 1345: 3 -- Snowden 518: 7; 790: 6; 790: 7 -- Soegeng Reksodihardjo 225: 1; 464: 10; 465: 10; 488: 1 -- Sokai 187: 10 -- Z.P. Song 39049: 13; 39220: 13; 39355: 13 -- Sørensen, Larsen & Hansen 3204: 11; 3337: 10; 3338: 23; 3687: 10; 3845: 10; 4460: 3 -- South Guizhou Expedition 227: 16; 313: 16; 748: 16 -- Sowerby s.n., 1922: 16 -- Specht 658: 2 -- Spire 122: 2 -- Splitberger s.n., 1837: 10 -- Stainton, Sykes & Williams 2768: 11; 3641: 15; 4031: 11 -- Stanffer 524: 7 -- Stanley & Clarkson 12: 10 -- v. Steenis 3432: 10; 3464A: 27 -- Steere s.n., s.d.: 16; (1808) s.n., s.d.: 16 -- Stevens & Veldkamp 54023: 30 -- Steward 881: 16; 2661: 16; 5477: 16; 11290: 15; 14234: 15; 15634: 15; 21257: 15 -- Steward, Chiao & Cheo 881: 16 -- Stocker 49: 2 -- Stocks (Herb. Hooker & Thompson) s.n., s.d.: 2 -- Stoddart 4343: 10; 4718: 2 -- Stolz 482: 7; 1044: 7 -- Stone 5531: 1; 8650: 24 -- Stool 14754: 10 -- Strachey & Winterbottom 9: 11; 11: 15 -- Strange s.n., s.d.: 10; 115: 7 -- Streimann & Kairo 39116: 31 -- Stresemann 35: 29 -- Strickland s.n., s.d.: 6 -- Strong & Clemens s.n., 1907: 29 -- Stuhlman 1223: 6 -- Suman 2300: 1 -- B.X. Sun s.n., 1954: 11 -- H.T. Sun s.n., s.d.: 10; s.n., s.d.: 1 -- Sun Hong-Fan Herb. 9176: 2; 9268: 24 -- Surbeck 577: 10; 579: 26; 718: 27; 782: 10; 884: 10; 1013: 10; 1020: 27; 1101: 26; 1118: 24 -- Suzuki 6097: 23; 8363: 23 -- Swartzii (Herb.) s.n., s.d.: 2 -- Swingle (coll.'s) s.n., 1919: 23 -- Swinhoe s.n., s.d.: 23; s.n., 1862: 23 -- Symoens 13071: 6 -- Synge 5620: 2.

Taam 1406: 23; 1861: 23 -- Tagawa s.n., 1934: 25; 971: 25; 989: 23; 1552: 23; 2029: 23; 2565: 23; 2571: 23; 2582: 23; 2933: 23; 2987: 16; 3211: 16; 3255: 23 -- Tagawa & Yamada T148: 2; T179: 1 -- Tagawa, Iwatsuki & Fukuoka T378: 23; T383: 3; T387: 23; T586: 10; T1116: 3; T1830: 23; T1841: 10; T2027: 2; T2032: 3; T2259: 3; T2433: 10; T5280: 27; T5286: 23; T6817: 23; T6972: 1 -- Tagawa, Iwatsuki, Koyama & Chintayungkun T8583: 3 -- Tagawa, Iwatsuki, Koyama, Fukuoka, Nalampoon & Chintayungkun T9239: 12; T9333: 11 -- Tagawa, Shimizu, Hutok, Koyama & Nalampoon T9830: 12 -- Tagawa, Shimizu, Koyama, Hutok & Nalampoon T10008: 11 -- Tagawa, Iwatsuki, Shimizu, Fukuoka & Hutch T11211: 3 -- Tagawa T11804: 10 -- Y.Taira s.n., 1937: 23 -- Tamura, Shimizu & Chao 20052: 23 -- Tan 74-20: 27 -- Tanaka 10460: 16 -- Tanant s.n., s.d.: 16 -- Tang 1190: 23 -- J.H. Tang 5652: 16 -- P.K. Tang 59880: 16 -- P.S. Tang 62346: 16; 62629: 16; 63285: 16 -- Tang Sui Ging 5629: 16; (Metcalf) 5868: 16; 6848: 16; 6960: 16; 7104: 16; 7304: 16 -- D.D. Tao 1036: 11 -- Tate s.n., 1863: 23 -- Taton 375: 7; 1475: 7 -- Taylor s.n., s.d.: 2 -- Team 2428: 3 -- Telfair s.n., s.d.: 8 -- S. Tèn 302: 13; 958: 13; 1374: 13 -- L. Teng 2177: 23; 4266: 16; 7142: 16; 8586: 16 -- S.W. Teng 90085: 16 -- Le Testu 1740: 6 -- Teuscher s.n., s.d.: 2; s.n., s.d.: 4; s.n., 1882: 27 -- Teysmann s.n., s.d.: 1; s.n., s.d.: 2; s.n., 1869: 10; 7: 1; 36: 1; 37: 27; 84: 24; 211, 304, 310: 2; 8577(T): 4; 8590: 4 -- Thakur Rup Chand 1607: 23; 3988: 23; 4548a: 23 -- Thomas 366: 7; 1891: 7; 1999: 6; 2404: 7 -- Thomerson 506: 7 -- Thomson s.n., s.d.: 11; 696: 1; 698: 1 -- Thony 67: 1 -- Thorel s.n., s.d.: 3; s.n., s.d.: 23; s.n., 1866-'68: 10; 1515: 2; 2485: 10 -- Thoret s.n., s.d.: 10 -- Thorey 136: 10 -- Thozet s.n., s.d.: 10 -- Thulin & Mhoro 950: 6 -- Thunberg s.n., s.d.(T): 10 -- Thwaiter s.n., s.d.: 10; 3265: 2 -- Tibet Herbs Expedition 1187: 15; 3590: 14; 3613: 14; 4119: 14; 4545: 14 -- Tisserant 1182: 6 -- Tixier s.n., s.d.: 27 -- To Kang P'eng (& Croff) 139: 16 -- Leroy Topping 174: 2; 245: 19; 344: 1; 408: 25; 802: 25

; 876: 10; 965: 5; 991: 24; 1006: 5; 1008: 2; 1050: 5; 1222: 2; 1244: 5; 1321: 2; 1380: 1; 1624: 18; 1805: 24; 1893: 27; 6147: 23 -- Touar s.n., 1864: 10 -- de La Touche 79: 16 -- Toussaint (207): 10; 2056: 6 -- Trapnell s.n., 1964: 10; 124A: 1 -- Trapnell & Williams 162: 2 -- Treutler 793: 23 -- Troll s.n., 1928: 27; 5469: 7 -- Troth 71: 11; 84: 15; 905: 2 -- Trotter s.n., 1887: 15 -- Tryon s.n., 1906: 1; s.n., 1906: 10 -- T.S. & C.P. 8856: 3 -- Tsai s.n., 1932: 23; 50823: 16; 51476: 16; 52551: 23; 52592: 23 -- H.T. Tsai 53388: 11; 55413: 11; 55465: 11; 57592A: 13; 58572: 13; 59863: 13; 60343: 11; 60962: 11; 61917: 11; 62031: 23; 62187: 11 -- Tsang 21803: 16; 21858: 3; 22215: 23; 23585: 16; 24083: 23; 29762: 23; A.L. Tsang 100967: 13 -- T.H. Tsang 1452: 13 -- W.C. Tsang 26082: 16 -- W.T. Tsang 23376: 16 -- Tsang Fang Fung 17681: 23 -- Tsang Wai-Tak 397: 23 -- Tsang Wai Tak & Wong Kam Chow (Canton Christian College Herb.) 2952: 16; 14568: 23 -- Tsiang 4585: 11; 4597: 11; 4901: 16; 8472: 16; 10228: 16 -- H.L. Tsiang 11152: 13 -- Y. Tsiang 4533: 16; 11791: 13 -- C.L. Tso 20159: 23; 20500: 16; 21538: 16 -- B.C. Tsoong 427: 16 -- K.K. Tsoong 277: 16; 2255: 13 -- P.C. Tsoong (et al.) 70: 16; 277: 16; 21291: 16; A62812: 16 -- Z.P. Tsoong s.n., 1954: 13 -- Tsuang-Jing Exp. 3017: 13 -- T.,M. Tsui 416: 16; 477: 16 -- Turnau 901: 1 -- Turner s.n., s.d.: 10 -- Turrall s.n., s.d.: 7 -- Tutcher (Hongkong herb.) 10626: 16 -- Tweedie 2799: 7 -- P.S. Tzu 39118: 13; 39220: 13; 39355: 13. Uchida Seiji P.: 16 -- Uhlig 1106: 7 -- U.P.N.G. (Posile David 79) s.n., 1979: 1 -- D'Urville s.n., 1825: 1 -- Herb. Underwood s.n., 1890: 24 -- University of San Carlos 82: 25; 675A: 22 -- U.S. South Pacific Exploring Expedition (Wilkins 23) s.n., 1838-'42: 10; s.n., 1838-'42: 25; s.n., 1838-'42: 27; 22: 2.

Vanderyst s.n., 1906: 6; 5641(bis): 6; 8594: 6; 14393: 6; 14411: 6; 14405: 6; 15708: 6; 17582: 6; 21337: 6; 26991: 6; 27002: 6; 27002: 6 -- Vanoverbergh 3547: 27 -- Veitch s.n., 1867: 1 -- Van de Veken 8902: 7 -- Veldhuis s.n., 1929: 24 -- Veldkamp & Stevens 5564: 26 -- Verdcourt 51: 6 -- Verheyen 845: 2 -- Versteeg 1013: 1; 1820: 26 -- Versteegh B.W.12556: 10 -- Vessey s.n., 1962: 1; s.n., 1962: 10 -- Vesterdal s.n., 1928: 23 -- Veterov et al. 226: 16 -- Vidal s.n., 1884: 2 -- Vidgen s.n., 1875: 10 -- Vieillard 1/78: 10; 112: 10; 1578: 10 -- Vignier s.n., s.d.: 8 -- Vignier & Humbert 518: 8 -- Herb. de Vilmorin 10: 23; 10: 16 -- Vincens s.n., s.d.: 2 -- Vink & Schram 8618: 21 -- de Vogel 3323: 1; 3537: 31; 3545: 10 -- Voigt s.n., s.d.: 2 -- DeVol s.n., 1933: 16; 6059: 23 -- Volkens 62: 6; 735(T): 7 -- De Vore & Hoover 161: 2 -- de Vriese s.n., s.d.: 1; s.n., s.d.: 10; s.n., s.d.: 27; (4) s.n., 1857-61: 24; 2: 10; 10: 10; (18?): 2; 19 (57?): 24; 24 (211): 2; 24: 9; 25 (52?): 9; (25?, 41?): 2; 60: 10; 62: 2; 63: 10; 252: 24; 306 + 318: 1; 327: 2; 509: 27 -- de Vriese & Teysmann 6: 10; 17: 10.

Wagemans 870: 6; 1045: 6 -- Waitz 153: 27 -- Wakefield 1448: 10; 1450: 1 -- Walker 1: 1; 4: 10; 17: 2; T12-244: 24; 8765: 30; T8867-9: 30; T8871-2: 30 -- Wall s.n., s.d.: 2 -- Wallace 9108: 2 -- Wallich s.n., s.d.: 2; s.n., s.d. (Galathea 701): 2; s.n., s.d.: 8; s.n., s.d.: 13; s.n., s.d.: 27; s.n., 1818: 11; 11: 11; 27: 23; 27(T): 27; 69: 10; 103: 2; 154: 15; 208: 8; 288(T): 23; 289: 11; 291: 2; 293(T): 11; 297: 10 -- Walter s.n., s.d.: 2; s.n., s.d.: 10 -- H. & E. Walter 2395: 10 -- Wang 528: 16; 34398: 23; 34750: 10; 35343: 23 -- C. Wang 31707: 16; 33096: 2 -- C.W. Wang 55465: 11; 63807: 13; 66152: 13; 68022: 13; 69118: 13; 69338: 13; 69775: 14; 70175: 14; 71358: 13; 73035: 23; 73392: 23; 74031: 11; 74264: 11; 75234: 11; 75725: 3; 76014: 3; 76444: 11; 76949: 23; 77084: 11; 77303: 11; 81795: 16; 81986: 23; 82040: 23; 82081: 11; 82084: 11; 82529: 11; 83688: 11 -- F.T. Wang 21818: 14; 22831: 16 -- G.M. Wang 16114(A): 3 -- H.C. Wang 1561: 13; 1886: 16; 3533: 13 -- P.S. Wang 1136: 16 -- P.W. Wang 1001: 16 -- S.C. Wang 1009: 11 -- T.F. Wang 7167: 14 -- T.P. Wang 4463: 14; 10815: 16; 14289: 14 -- W.M. Wang 10037: 3 -- Y.J. Wang 29234: 16 -- Warbur s.n., s.d.: 8 -- Warburg s.n., s.d.: 1; s.n., 1888: 16; (?) 12209: 2; 12210: 1; 14141: p.p.1, p.p.2; (?) 16535: 1 -- Iter Warburgianum s.n., s.d.: 1; s.n., s.d.: 24; 3446: 10;

17808: 1 ; 17846-17833: 24; 19339: 1 -- Warlet s.n., s.d.: 6 -- Warnecke 392: 6 -- Warpur s.n., s.d.: 8 -- Warren & Merrill s.n., s.d.: 25 -- Waterhouse s.n., s.d.: 1; s.n., 1931: 26; 242: 26; 341: 6; 534: 10; P9737: 10 -- Watt s.n., s.d.: 1; 6654: 3; 12461: 2 -- Watts s.n., 1913: 1; s.n., 1913: 10; s.n., 1916: 1 -- Webb & Tracey 6058A: 2; 6452: 1; 8006A: 1; 9260: 10; 9685: 1; 9770: 1; 9834: 1; 10019: 10; 10038: 1; 10225: 10; 10722: 1 ; 10917: 1 ; 10949: 10; 11311: 1 -- Weber 19: 10 -- Wellens 341: 6 -- Welwitsch s.n., s.d.: 6; (Iter Angolense) 69: 6 -- Wenger 6: 11; 83: 23 -- Wenzel 263: p.p.1,p.p.2; 1218: 27 -- Westphal & Westphal-Stevens 1697: 7 -- Whellan 1318: 7 -- Whistler W2684: 10 -- White s.n., 1915: 10; 646: 10; 1/20: 10; 10/21: 10; 1354: 7; 2726: 7 -- Whiet 2786; 7 -- Whitford 221: 25; 372: 2 -- Whitmee 189: 10 -- Whyte s.n., 1896: 7 -- Wight s.n., 1835: 2; 36: 2; (Herb.) 62: 2; (Herb.) 82: 2; (Herb.) 3162: 2; 3185: 23 -- Wild s.n., s.d.: 10; s.n., 1891: 1; s.n., 1891: 10 -- de Wilde 4754: 7; (& Voorhoeve) 3885: 6 -- de Wilde & de Wilde-Duyfjes 6371: 7; 6439: 7; 12555: 26; 12822: 1; 14411: 10 -- Herb. De Wildeman s.n., 1917: 6 -- Wilferd 364: 23 -- Wilhelmi s.n., 1855: 10 -- Wilhelms s.n., 1865: 1 -- Wilkes 23: 10 -- Willdenow 19539(T): 27; (specim. Thonarsianum) 19643(T): 8 -- Williams 42: p.p.2,p.p.5; 1478: 1; 1481: 27; 1507: 5; 1511: 29; 1833: 27; 2295: 24; 2819: 2 -- Willink s.n., 1850 & 1852: 24 -- Wilson s.n., 1957: 12; 691: 10; 726: 1; 1656: 7; 2646: 16; 5335: 14 ; 5340(T): 11 -- Winkel 17088: 27 -- Winit s.n., s.d.: 1; 1016: 12; 1091: 1 -- Winkler 67: 27; 252: 6; 1226: 1; 2138: 2; 2422: 2 -- Wiriadinata 535: 2 -- De Witte 1257: 7; 1401: 7; 1565: 7; 12017: 6 -- Womersley & Lloyd s.n., 1951: 26 -- Womersley & Millar 7614: 30 -- Wrigley & Melville 429: 7 -- C.A. Wu 7214: 16 -- C.Y. Wu 4663: 14; 5242: 14 -- S.K. Wu 209: 11; 1007: 13; 1053: 13; 1161: 13; 2208: 11; 3515: 13; 4167: 11; 6028: 13; 6594: 13; 6873: 13 -- Z.L. Wu 32796: 14 -- Z.Y. Wu 1264: 11.

G.C. Xia et al 96: 15; 542: 14; 1086: 14 -- K.Z. Xia 96: 15; 542: 14 -- W.X. Xi 63: 11 -- Xi-Jian 96: 15; 122: 15 -- J.Y. Xin 443: 11 -- Y. Xiang 16010: 11 -- Xinjiang Scientific Expedition 12506: 14; 751319: 14 -- Y.K. Xiang 6190: 16 -- J.H. Xong 90427: 16 -- B.Y. Xu 60537: 11 -- W.S. Xu 63: 11 -- Y.G. Xuang 5116: 16; 6244: 16.

J.Q. Yang 2370: 14 -- K.H. Yang 55974: 16; 57062: 11; 65650: 16 -- Yates 952: 2; 2390: 10; 3012: 24 -- E.Z. Yi s.n., s.d.: 13 -- C.W. Yi 100967: 13 -- T.P. Yi 79043: 14 -- T.S. Yin et al. 404: 14; 646: 14; 1084: 14; 4256: 13; 4359: 11; 4662: 14; 4663: 14 -- W.C. Ying 60-1184: 11 -- Y.C. Yong 1550: 14 -- Yong-Lian Expedition 9304: 11 -- Yong-Lian Research team 9412: 23 -- Young s.n., s.d.: 1; s.n., 1923: 1; s.n., 1942: 23 -- Younghusband s.n., 1904: 13 -- Yousset 162: 10; 164: 2 -- C.Z. Yu 958: 16 -- S.L. YU 900496: 16 -- T.T. YU s.n., 1970: 16; 3183: 16; 4050: 13; 7508: 13; 8463: 13p.p.,14p.p.; 9432: 14; 9895(T): 14; 10120: 14; 10312: 14; 12848: 14; 13239: 14; 13579: 13; 14082: 14; 15259: 13; 16301: 11; 23113: 11 -- Yu-shih Liu 2093: 16 -- J.S. Yuaoe 1482: 16; 2645: 16; 2889: 16 -- J.S. Yue 41149: 16 -- Yuncher 15,610: 10 -- (East) Yunnan Expedition 968: 16 -- (North) Yunnan Expedition 9461: 13; 10473: 13 -- (North-West) Yunnan Exp. 63-6028: 13; 6594: 13 -- (South-West) Yunnan Exp. 63-6872: 13.

Zao-He Expedition 3147: 14 -- Herb. Zappelli 178: 7; 233: 7 -- Zenker 261: 6; 4139: 6 -- D.H. Zhang 1256: 16 -- S.Y. Zhang 2755: 16; 4553: 16; 4827: 16; 6997: 16 -- X.S. Zhang et al. 7007: 14 -- Y.T. Zhang et al. 188: 14; 474: 14; 1291: 14; 4560: 15; 22849: 14 -- Z.S. Zhang et al. s.n., 1960: 16; 226: 16; 708: 16; 816: 16; 1156: 16; 1462: 16; 1468: 16; 2262: 16; 2331: 16; 2674: 16; 3127: 16; 3329: 16; 3555: 16; 3756: 16; 4134: 16; 5803: 16; 6230: 11; 6695: 11; 7602: 16; 400169: 16; 401444: 16 -- L.L. Zhao et al. 800317: 14; 900392: 13 -- Zhejiang Botanical Expedition 25890: 16; 26320: 16; 27202: 16; 28595: 16 -- Z.S. Zheng 753: 11 -- Zhu 16: 3; 1497: 3; 2476: 3 -- K.L. Zhu 21538: 16 -- T.P. Zhu 2549: 16 -- T.Y. Zhu et al. 35: 14; 283: 14; 336: 14 -- W.M. Zhu s.n., 1959: 3; 2: 13; 16: 3; 188: 11; 431: 13; 483:

3; 503: 16; 577: 12; 590: 11; 677: 14; 899: 13; 1048: 13; 1104: 13; 1497: 3;  
2476: 3 --Y.P. Zhu 1168: 14 -- Zimmermann 142: 11; 1639: 15 -- Zippelius  
s.n., s.d.: 1; s.n., s.d.: 10; s.n., s.d.: 26; s.n., s.d.: 27; 116 (?): 1;  
263: 2 -- Zogg & Gassner 33/10: 7 -- Zogg, Kramer & Gassner 267/1: 7; 275/1:  
7 -- Zollinger 240: 10; 294: 2; 655: 10; 735: 1; 781: 10; 906: 9; 978: 27;  
994: 2p.p., 2p.p.; 1300: 10; 1622B: 10; 2386: 10; 3270: 9; 3347 (3003): 27 --  
Herb. Zuccarinii s.n., 1829: 15.

## 18. INDEX TO TAXONOMIC NAMES

Accepted names underlined; numbers refer to species numbers.  
A = Aglaomorpha; D = Drynaria

|                             |    |                         |    |
|-----------------------------|----|-------------------------|----|
| <u>Acrostichum</u>          |    | <u>Drynaria</u>         |    |
| # <u>Photinopteris</u>      | A  | <u>involuta</u>         | 4  |
| <u>acuminatum</u>           | 27 | <u>laurentii</u>        | 6  |
| <u>drynarioides</u>         | 26 | <u>leporella</u>        | 17 |
| <u>rigidulum</u>            | 27 | <u>linnei</u>           | 1  |
| <u>thomsoni</u>             | 26 | <u>meeboldii</u>        | 3  |
|                             |    | <u>mollis</u>           | 15 |
| <u>Aglaomorpha</u>          | A  | <u>morbillosa</u>       | 2  |
| subg. <u>Drynariopsis</u>   | A  | <u>nectarifera</u>      | 32 |
| subg. <u>Holostachyum</u>   | A  | <u>parishii</u>         | 12 |
| subg. <u>Pseudodrynaria</u> | A  | <u>parkinsoni</u>       | 31 |
| # <u>Dryostachyum</u>       | A  | <u>pinnata</u>          | 10 |
| # <u>Hemistachyum</u>       | A  | <u>pleuridioides</u>    | 9  |
| # <u>Psygium</u>            | A  | var. <u>amboinensis</u> | 9  |
| <u>brooksii</u>             | 18 | var. <u>sumatrana</u>   | 9  |
| <u>buchananii</u>           | 31 | <u>propinqua</u>        | 11 |
| <u>cornucopia</u>           | 22 | var. <u>comorensis</u>  | 8  |
| <u>coronans</u>             | 23 | var. <u>mesosora</u>    | 11 |
| <u>drynarioides</u>         | 26 | <u>quercifolia</u>      | 2  |
| <u>heraclea</u>             | 24 | <u>reducta</u>          | 14 |
| <u>hieronymi</u>            | 30 | <u>rigidula</u>         | 10 |
| <u>latipinna</u>            | 28 | var. <u>koordersii</u>  | 10 |
| <u>ledermannii</u>          | 31 | <u>rivalis</u>          | 15 |
| x <u>leporella</u>          | 17 | var. <u>yunnanensis</u> | 13 |
| <u>meyeniana</u>            | 25 | <u>saccardi</u>         | 7  |
| <u>nectarifera</u>          | 32 | <u>sinica</u>           | 14 |
| <u>novoguineensis</u>       | 21 | var. <u>intermedia</u>  | 14 |
| <u>parkinsoni</u>           | 31 | <u>sparsisora</u>       | 1  |
| <u>pilosa</u>               | 29 | <u>splendens</u>        | 19 |
| <u>schlechteri</u>          | 31 | <u>tibetica</u>         | 15 |
| <u>speciosa</u>             | 27 | <u>viridis</u>          | 6  |
| <u>splendens</u>            | 19 | <u>volkensis</u>        | 7  |
|                             |    | var. <u>macroSORA</u>   | 7  |
| <u>Drynaria</u>             | D  | var. <u>uondensis</u>   | 7  |
| sect. <u>Eudrynaria</u>     | D  | <u>willdenowii</u>      | 8  |
| sect. <u>Poronema</u>       | D  |                         |    |
| sect. <u>Thayeria</u>       | A  | <u>Drynariopsis</u>     | A  |
| # <u>Drynaria</u>           | D  | <u>heraclea</u>         | 24 |
| <u>amphilogos</u>           | 31 |                         |    |
| <u>baronii</u>              | 14 | <u>Dryostachyum</u>     | A  |
| <u>baudouinii</u>           | 10 | <u>drynarioides</u>     | 26 |
| <u>bonii</u>                | 3  | <u>hieronymi</u>        | 30 |
| <u>convoluta</u>            | 4  | <u>ledermannii</u>      | 31 |
| <u>cornucopia</u>           | 22 | <u>meyenianum</u>       | 25 |
| <u>coronans</u>             | 23 | <u>mollepilosum</u>     | 31 |
| <u>costulisora</u>          | 15 | <u>novoguineensis</u>   | 21 |
| <u>delavayi</u>             | 13 | <u>pilosum</u>          | 29 |
| <u>descensa</u>             | 5  | <u>singulare</u>        | 26 |
| <u>diversifolia</u>         | 10 | <u>speciosum</u>        | 27 |
| <u>esquirolii</u>           | 23 | <u>splendens</u>        | 19 |
| <u>fortunei</u>             | 16 | var. <u>pilosum</u>     | 29 |
| <u>gaudichaudii</u>         | 10 | <u>thomsoni</u>         | 26 |
| <u>heraclea</u>             | 24 |                         |    |

|                  |    |  |
|------------------|----|--|
| Goniophlebium    |    |  |
| rigidulum        | 10 |  |
| Hemistachyum     | A  |  |
| brooksii         | 18 |  |
| Holostachyum     | A  |  |
| buchananii       | 31 |  |
| hieronymi        | 30 |  |
| var. latipinna   | 28 |  |
| Lomaria          |    |  |
| speciosa         | 27 |  |
| Lomariopsis      |    |  |
| # Drynaria       | D  |  |
| horsfieldii      | 27 |  |
| Merinthosorus    | A  |  |
| drynarioides     | 26 |  |
| hieronymi        | 30 |  |
| thomsoni         | 26 |  |
| Photinopteris    | A  |  |
| acuminata        | 27 |  |
| cumingii         | 27 |  |
| drynarioides     | 26 |  |
| horsfieldii      | 27 |  |
| humboldtii       | 27 |  |
| rigida           | 27 |  |
| simplex          | 27 |  |
| speciosa         | 27 |  |
| thomsoni         | 26 |  |
| Phymathodes      |    |  |
| # Drynaria       | D  |  |
| brancaefolia     | 2  |  |
| coronans         | 23 |  |
| gaudichaudii     | 10 |  |
| morbillosa       | 2  |  |
| propinqua        | 11 |  |
| quercifolia      | 2  |  |
| sylvatica        | 2  |  |
| thouarsii        | 8  |  |
| Pleopeltis       |    |  |
| # Eupleopeltis   |    |  |
| **** Aglaomorpha | A  |  |
| *** Drynariopsis | A  |  |
| buchananii       | 31 |  |
| coronans         | 23 |  |
| heraclea         | 24 |  |
| meyeniana        | 25 |  |
| parishii         | 12 |  |
| schlechteri      | 31 |  |
| Polypodium       |    |  |
| subg. Drynaria   | D  |  |

|                  |    |  |
|------------------|----|--|
| Polypodium       |    |  |
| # Dryostachyum   | A  |  |
| # Drynariopsis   | A  |  |
| # Pleopeltis     |    |  |
| **** Aglaomorpha | A  |  |
| *** Drynariopsis | A  |  |
| astrosorum       | 6  |  |
| baronii          | 14 |  |
| baudouinii       | 10 |  |
| brancaefolium    | 2  |  |
| brooksii         | 18 |  |
| conjugatum       | 23 |  |
| coronans         | 23 |  |
| diversifolium    | 10 |  |
| drynarioides     | 26 |  |
| fortunei         | 16 |  |
| gaudichaudii     | 10 |  |
| glaucistipes     | 10 |  |
| heracleum        | 24 |  |
| ledermannii      | 31 |  |
| linnei           | 1  |  |
| ludovicianum     | 31 |  |
| meyenianum       | 25 |  |
| morbillosum      | 2  |  |
| nectariferum     | 32 |  |
| parkinsoni       | 31 |  |
| pilosum          | 29 |  |
| pleuridioides    | 9  |  |
| propinquum       | 11 |  |
| var. intermedium | 6  |  |
| var. laurentii   | 6  |  |
| quercifolium     | 2  |  |
| rigidulum        | 10 |  |
| var. vidgeni     | 10 |  |
| rivale           | 15 |  |
| schkuhrii        | 2  |  |
| schlechteri      | 31 |  |
| sparsisorum      | 1  |  |
| speciosum        | 27 |  |
| splendens        | 19 |  |
| var. pilosum     | 29 |  |
| sylvaticum       | 2  |  |
| thouarsii        | 8  |  |
| willdenowii      | 8  |  |
| Pseudodrynaria   | A  |  |
| coronans         | 23 |  |
| Psygium          | A  |  |
| elegans          | 25 |  |
| Thayeria         | A  |  |
| cornucopia       | 22 |  |
| nectarifera      | 32 |  |