

SIEMENS



Home

Built-in appliances 2015 Spring/Summer collection

siemens-home.co.uk | siemens-home.com/ie

Siemens. The future moving in.





The future moving in.

Imagine a world where functional doesn't mean boring, where outstanding becomes the standard and where you are no longer pressed for time. Welcome to the new world of Siemens. For a life less ordinary.

Introducing fully coordinated and intelligently designed appliances, where you can discover the new iQ700 built-in range – for even more flexibility and time-saving solutions that help with our increasingly busy and exciting lifestyles. An oven that saves time, speeding up your cooking by up to 50%. Award-winning dishwashers featuring

the world's first Zeolith® drying system; a technological innovation that sets new standards for performance and energy efficiency. Fridge freezers with food preservation technology and outstanding freezers that never have to be defrosted. All working together to create a spectacular kitchen for your home.

Stunning designs that your friends will envy, clean lines that coordinate with the rest of your living space and high quality materials come as standard with all Siemens appliances. Offering you the perfect balance between modern design and innovative technology, Siemens appliances sit seamlessly together in your home.

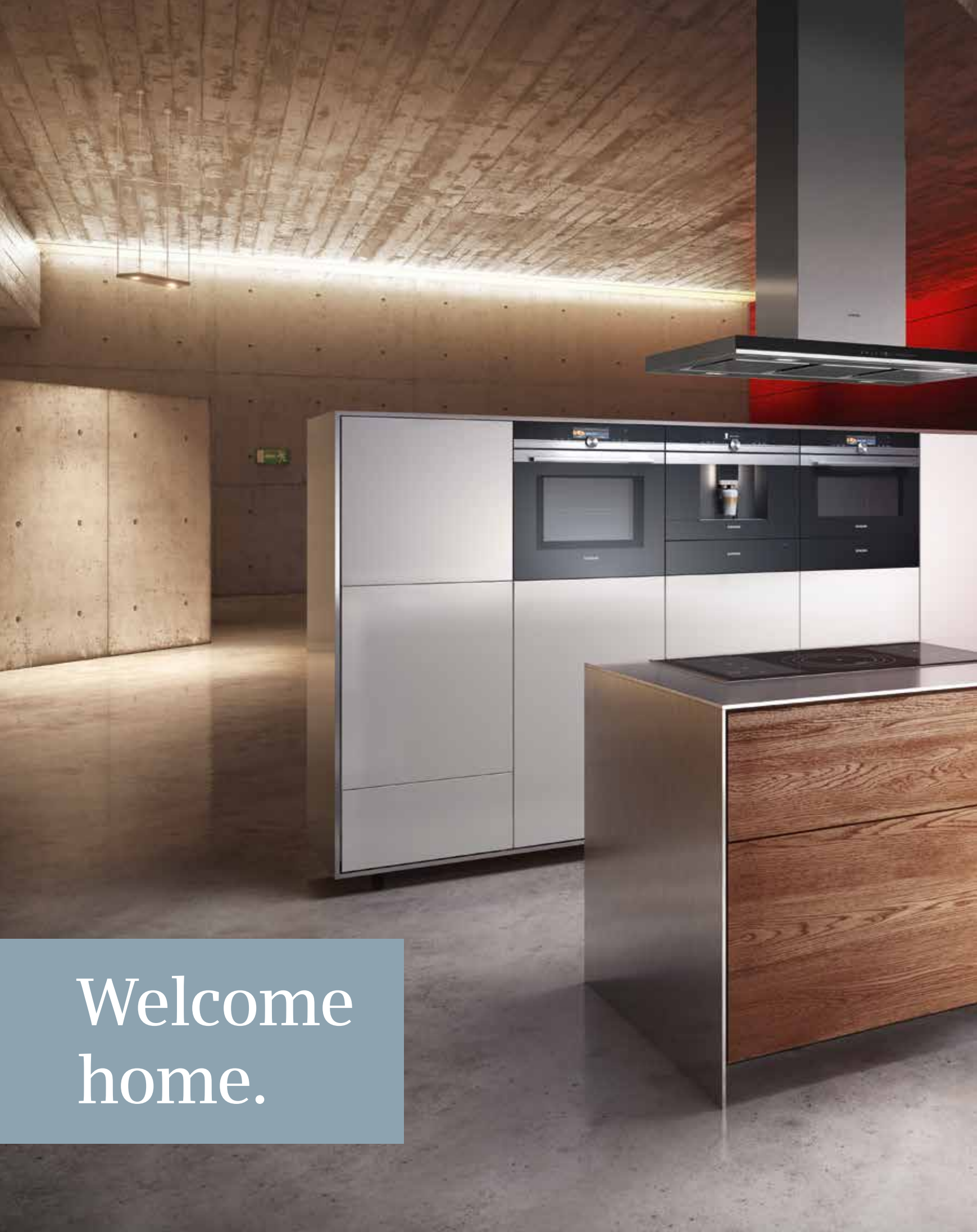

Welcome
home.



Ovens

04-23

Single ovens
Double ovens
Built-under double ovens

Compact appliances

24-39

compact45 steam ovens
compact45 multi-function ovens with microwave
compact45 microwave combination ovens
compact45 microwave oven
compact45 coffee centre
Microwave ovens
Warming and accessory drawers

Hobs

40-67

flexInduction hobs
Induction hobs
Quick-lite ceramic hobs
Ceramic glass gas hobs
Tempered glass gas hobs
Stainless steel gas hobs
Domino hobs

Hoods

68-91

downDraft hood
Ceiling hoods
Island hoods
Box chimney hoods
Angled hoods
Slim pyramid hoods
Glass chimney hoods
Telescopic hoods
Integrated hoods
Canopy hoods
Built-under hood

Cooling

92-119

aCool built-in cooling appliances
coolConcept built-in cooling appliances
Built-in fridge freezers
Built-in fridges
Built-in freezers
Built-under fridges and freezer
Wine coolers
American-style fridge freezers

Dishwashers

120-141

Full-size
Slimline

Home laundry

142-149

Washing machines
Washer dryers

Services

150-157

Customer service
Greener products, cleaner planet
Contact us
Siemens online

Cooking

Cooling

Dishwashers

Home Laundry

Services



Ovens

As intuitive as cooking itself.

SIEMENS



Model shown: HN678G4S1B.



Model shown: HN678G451B.

Outstanding taste, cooked in the time you have.

The iQ700 Ovens with varioSpeed.



There are things in life that are worth spending more time on like a business meeting, a weekend adventure or getting to read a few more pages of a bedtime story. Whenever you find yourself in a situation where you want to spend your time differently, but not necessarily cooking, varioSpeed allows you to. No matter whether it's a little snack or a masterful salmon recipe, you can now adjust the cooking time to your own speed of life. Ultimately giving you all the flexibility your less ordinary life requires.



Twice as fast in combination: by choosing the integrated microwave function with a conventional cooking option, you can speed up the preparation of your dishes when you need to – without compromising on the quality you would expect. Save up to 50% of your time, to give you the freedom when you require it.

From desserts to roasts and even frozen food, varioSpeed can be conveniently selected to cook a variety of meals when you want to take your time on other things. For even more flexibility; cooking, reheating or quickly defrosting a meal at the end of the day is fast and efficient thanks to the simultaneous heating using microwaves, and a conventional cooking function such as 4D hot air. Save time in the kitchen when you want to and spend it doing the things you love. For a life less ordinary.

varioSpeed saves up to 50% of your time and allows you to adjust the cooking time to your own speed of life.



Simply the best.

Life's pleasures often lie in the simplest things. A philosophy that is essential to the design of the iQ700 ovens with their easy to use clearText TFT display and time saving activeClean® self-cleaning system. Supreme features that mean you can enjoy cooking even more.



iQ700 Ovens with TFT touchDisplay Plus.

It's never been this easy to keep an eye on your cooking. Bigger size, brighter colours, higher contrast and better resolution. And now controllable with the touch of a finger. The new TFT touchDisplay Plus is the most innovative and intuitive user interface available for an oven.

Say goodbye to multiple dials and printed icons, the **TFT touchDisplay Plus** offers more than just control of your oven. It gives tips and information on each programme, full colour graphics and images, it can even suggest the correct way to cook your dishes with cookControl Plus. Clear to read from any angle, it's advanced yet easy-to-use technology for effortless cooking.

Three types of TFT displays are also now available across the iQ700 oven range. The slightly smaller **TFT touchDisplay** offers all the functionality of a touchscreen display with crisp text and images. Smaller still, the **TFT Display** can be operated with touchControl buttons either side of the screen, yet still has clear programme information. Thanks to the menu structure on all of our ovens, which is optimised for convenient and easy-to-use touch navigation, it's even easier to select the perfect settings. Designed to serve one purpose: giving you full control.



TFT touchDisplay Plus – the most intuitive way to use your oven.



The easiest way to clean an oven: let the oven clean itself.



iQ700 Ovens with activeClean.

Enjoy preparing food without worrying about the consequences. No matter how creative it gets in the oven interior, you no longer need any chemical treatments to get it clean again – only the push of a button. Hassle-free, the oven cleans itself thoroughly with activeClean. It does so by heating up to very high temperatures – turning all residues into ash, which can easily be wiped away. This process is called pyrolysis and is the most convenient and efficient way to clean the whole interior of your oven.

And now, even the telescopic rails, bars and tray are specially designed to be used with activeClean so you don't need to remove them at all. Only the wire shelf needs to be removed. activeClean makes it possible to forget about the chore of cleaning your oven and gives you back your time to spend on the things you love. For a life less ordinary.



activeClean® – ovens that clean themselves.



Models shown: HN678G4S1B single oven with microwave and pulseSteam, CS658GRS1B compact steam oven and BI630CNS1B warming drawer.

The finest ingredients. For the finest kitchen interiors.

Perfect built-in design.

Seamless design that complements every kitchen. All appliances in the iQ700 Built-in Appliances Range can be combined perfectly with each other. The iQ700 ovens, compact ovens, coffee centres and warming drawers all line up thanks to the coordinated front panels. It doesn't matter whether you arrange the appliances horizontally or vertically: the result always pleases the eye. Even our iQ700 hoods have the same front panel design for a coordinating look throughout your kitchen.

Each oven features blue illuminated hard key buttons, integrated into a sleek, chrome-effect strip that provides the most important operations from turning the oven on to starting your cooking. The central stainless

steel disc control is a constant design feature across the range, with a precise operation that clicks when rotated to give you ultimate satisfaction when using each appliance. Combined with the touchscreen navigation, this method of operation is both familiar and intuitive.

The trend-setting iQ700 ovens feature a smaller profile oven door handle that blends into the stainless steel panels to offer more flexibility with handleless kitchen design, yet still having the highest build quality & feel. While the precise lines of the black glass and stainless steel create a definitive aesthetic worthwhile of any modern, less ordinary kitchen.



More to explore.



Pre-installed settings guarantee the best results for numerous dishes: cookControl Plus.

Simply select the required dish and enter the weight – the cookControl Plus function immediately provides full colour images with individual recommended settings for perfectly cooking the dish you want. Using cookControl Plus you can achieve the best results for a variety of meals with less to worry about and complete peace of mind.



An oven door that opens and closes gently and quietly thanks to the intelligent mechanism: softMove.

For a calmer kitchen, softMove offers softer opening and closing of the oven door without having to push and pull. The intelligent dampers ensure that the oven door is left to open and close gently and quietly. Available on all iQ700 built-in ovens.

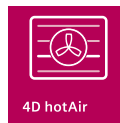

Best cooking results regardless of which shelf you choose: 4D hotAir.

Be flexible with your cooking. Choose which shelf you want to cook your food on, now with even more choice. The innovative technology of the fan motor enables optimum heat distribution around the interior of the oven. Your food therefore always turns out perfectly just as you want it, no matter which shelf you choose to place it on.



Everything put in a good light.

Depending on the model, there are different kinds of illumination inside the oven. Whether it's the standard Halogen light, LEDs or the most advanced Multilevel LED strip, they all provide a brilliant view of your dishes without having to open the oven door.





An oven that can detect when the baking process is complete: the bakingSensor.

All that's left for you to do when baking: prepare the pastry or mix and select the required dish. Innovative sensor technology fitted inside the oven can automatically control the baking process for consistently delicious baking. The bakingSensor constantly measures the moisture levels in the oven interior and is therefore able to tell you when the dish is fully cooked and ready.



Achieve the best roasting results – easier than ever before: roastingSensor Plus.

Thanks to three measuring points, the innovative roasting thermometer is able to precisely and reliably measure the core temperature of your dishes. Ideal for meat, poultry and fish, it can even be combined with the integrated microwave and the pulseSteam function. Without the need to keep checking, the roastingSensor gives you the freedom to get on with the rest of your cooking.



Finally, pre-heating is no longer necessary and you can save time: the coolStart function.

Cooking frozen convenience food in the oven is now even faster thanks to the innovative coolStart function. Using an intelligent heating phase, you can now successfully cook frozen food quickly and without the need to wait for the oven to preheat. Simply place the frozen food into the cold oven, press start, and the dish will be ready according to the manufacturers' stated cooking time.



More space in your kitchen and flexibility with your cooking: the integrated microwave.

The iQ700 ovens with integrated microwave can be used in combination with your regular oven or individually as a fully functional microwave, offering more flexibility in your kitchen. This can also free up space due to not needing a separate microwave.

Freedom & flexibility.

More possibilities in the kitchen, all in one appliance.



The iQ700 Oven with microwave and pulseSteam offers a truly flexible cooking experience to give you choice like never before. Choose to speed up your dishes by up to 50% using varioSpeed. Or add steam for tastier dishes at the touch of a finger, with the intuitive TFT touchDisplay Plus. The sleek design fits perfectly into any modern kitchen and houses an impressive range of state-of-the-art features like activeClean and coolStart to help you save time and lead a life less ordinary.



The larger TFT touchDisplay Plus.

Cutting-edge design meets time-saving technology. For a life less ordinary.

Save up to 50% of your time.

Whenever you want to take your time, varioSpeed lets you. Using the microwave and conventional cooking function in combination, varioSpeed is fast and effective at cooking your meal in up to half the time it would normally take, without any loss of quality.

You can choose to add steam.

The benefits of adding steam are now available with the Siemens iQ700 oven with microwave. Prepare perfectly crispy and juicy dishes with pulseSteam, ideal for adding moisture and avoiding dried out food when reheating. pulseSteam offers more flexibility in just one appliance.

No more waiting.

With coolStart, waiting for the oven to preheat is a thing of the past. coolStart cooks frozen convenience food directly from the freezer without having to preheat your oven. Simply time the food according to the cooking time on the packet. Perfect for a quick and easy meal that you don't have to wait around for.

iQ700
HN678G4S1B



At a glance

- Capacity – 67 litres
- TFT touchDisplay Plus – provides clear vision from all angles
- Multifunction oven – 15 functions
- activeClean® – self-cleaning programme
- roastingSensor Plus – precisely check the core temperature of dishes
- bakingSensor – automatic control of the baking process
- Conventional heatEco – single shelf cooking using minimal energy
- Intensive hot air – extra heat from the bottom of the oven
- 5 shelf positions
- softMove drop down oven door – effortless opening and closing
- coolStart – removes the need to preheat
- Integrated microwave
- varioSpeed – up to 50% time saving

Go to pages 17-23 to view the whole range.

Advanced cooking.

Innovations behind every door.



No matter which model you choose from the iQ700 range of ovens, they each come equipped with the latest innovations that save you time and hassle. activeClean cleans the oven for you while the coolStart programme can cook frozen food without the need to preheat. And everything is controlled by the bright and crisp TFT touchDisplay with full colour images and touch navigation. Not to mention the sleek, sharp and fully coordinated design.



activeClean® – no need for cleaning products.

Cleaning the oven has never been so easy.

The new generation of iQ700 Ovens come with the self-cleaning activeClean function. This heats the oven to high temperatures, turning all residues into ash to wipe away. To save even more time, the telescopic rails, bars and trays can be used with activeClean – you only have to remove the wire shelf and get on with life.

Full control at a touch.

Keep an eye on your cooking with the new TFT touchDisplay. With clear text and images so you can quickly glance at the screen, discover each programme and option with ease. Intuitively select each function using the touch navigation and scroll through each option with the central control dial, making precise adjustments with minimal effort.

A smoother action for all.

Every oven in the new iQ700 range features softMove: softer opening and closing of the oven door thanks to an intelligent damper mechanism. The oven door will always close gently and quietly.

iQ 700

HB676GBS1B



At a glance

- Capacity – 71 litres
- TFT touchDisplay
- Multifunction oven – 13 functions
- activeClean® – self-cleaning programme
- softMove drop down oven door – effortless opening and closing
- hotairEco – energy efficient single shelf cooking
- 5 shelf positions

Go to pages 17-23 to view the whole range.

Double bake.

Beautiful innovative double ovens.



Our stylish double ovens are definitely worth a second look. Designed for use in built-in units or built-under a counter top they will sit beautifully in any kitchen design. The ecoClean® programme and 3D hot air function is standard across the range, whilst selected models feature multi-functions. If you're looking for extra capacity with a separate grill and oven you will never be short of space.



Main lower oven Secondary upper oven



ecoClean® – excellent cleaning performance.

Cutting corners to achieve perfect results

Experience unprecedented convenience with 3D hot air. 3D hot air is the perfect time saver for dinner parties, allowing you to cook sweet and savoury at the same time. This function gives great results whether you're cooking on one, two or three shelves as you have no intermingling of flavours.

What's the best way to clean the oven? Automatically

ecoClean® uses liners to absorb grease and dirt, keeping the oven aesthetically pleasing on the inside. ecoClean® liners are four times more efficient than standard catalytic liners, providing excellent cleaning performance time after time.

Energy-efficiency never tasted so good.

hotairEco provides perfect results for one-shelf cooking, at 30% less energy than the maximum allowed for an A rated oven. Experience delicious food whilst being kinder to the environment.

All the extra capacity you need, with design details that will sit beautifully in your kitchen.

iq 500

HB55MB551B

At a glance

Main Lower Oven

- Capacity – 67 litres
- Electronic control
- Multifunction oven
- 9 functions
- ecoClean® – never manually clean the oven again
- 3D hot air – no intermingling of flavours
- hotairEco – eco-friendly single shelf cooking

Secondary Top Oven

- Capacity – 35 litres
- 4 functions
- ecoClean®

Go to pages 17-23 to view the whole range.

Welcome to a range designed around you.

Intended for effortless cooking, Siemens iQ700 ovens feature high-quality, full-steel rotary controls with the latest touch sensitive display technology.

Including cookControl Plus, which will automatically cook and time your food to perfection so you don't have to and activeClean® our ultimate self-cleaning system, that means you never need to clean the oven again. With all this power at your fingertips cooking will become quick and simple, so you can sit back and enjoy the finer things in life and of course the striking clean lines and sleek exterior of your new Siemens oven. For a life less ordinary.

iQ 700

Reserved for our premium single oven range. iQ700 stands for exceptional design allied with seriously intelligent and innovative technology.

iQ 500

Defining our double oven range, iQ500 double ovens exude class and refinement. They are appliances that unite first-class features with top-class technology.



Single ovens

Stunningly, uniquely Siemens, our iQ700 single ovens convey an elegant impression of absolute quality and intelligent innovation.

HN678G4S1B stainless steel

iQ 700



- Capacity – 67 litres
- TFT touchDisplay Plus – provides clear vision from all angles
- softMove drop down oven door – effortless opening and closing
- Multifunction oven – 15 functions
- Conventional heatEco – single shelf cooking using minimal energy
- activeClean® – self-cleaning programme
- roastingSensor Plus – precisely check the core temperature of dishes
- bakingSensor – automatic control of the baking process
- pulseSteam – easily add steam
- coolStart – removes the need to preheat
- Integrated microwave
- varioSpeed – up to 50% time saving
- cookControl Plus – pre-installed settings for effortless cooking

HM678G4S1B stainless steel

iQ 700

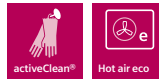

- Capacity – 67 litres
- TFT touchDisplay Plus – provides clear vision from all angles
- softMove drop down oven door – effortless opening and closing
- Multifunction oven – 15 functions
- Conventional heatEco – single shelf cooking using minimal energy
- activeClean® – self-cleaning programme
- roastingSensor Plus – precisely check the core temperature of dishes
- bakingSensor – automatic control of the baking process
- coolStart – removes the need to preheat
- Integrated microwave
- varioSpeed – up to 50% time saving
- cookControl Plus – pre-installed settings for effortless cooking

Single ovens (continued)

HM676G0S1B stainless steel

iQ 700



- Capacity: 67 litres
- TFT touchDisplay
- softMove drop down oven door – effortless opening and closing
- activeClean® – self-cleaning programme
- 13 main functions including – 4D hot air and hot air Eco
- Conventional heatEco – single shelf cooking using minimal energy
- coolStart – removes the need to preheat
- Integrated microwave
- varioSpeed – up to 50% time saving

HB676GBS1B stainless steel

iQ 700



- Capacity: 71 litres
- TFT touchDisplay
- softMove drop down oven door – effortless opening and closing
- activeClean® – self-cleaning programme
- 13 main functions including – 4D hotAir and hot air Eco
- Conventional heatEco – single shelf cooking using minimal energy
- coolStart – removes the need to preheat
- Energy consumption 4D hotAir – 0.69 kWh

Single ovens

The simple, yet stylish, Siemens iQ700 single ovens, are as easy to use as they are on the eye.

HB672GBS1B stainless steel

iQ 700



- Capacity: 71 litres
- TFT Display
- softMove drop down oven door – effortless opening and closing
- 8 main functions including – 4D hotAir and hot air Eco
- activeClean® – self-cleaning programme
- coolStart – removes the need to preheat
- Energy consumption 4D hotAir – 0.69 kWh

HM656GNS1B stainless steel

iQ 700



- Capacity: 67 litres
- TFT touchDisplay
- softMove drop down oven door – effortless opening and closing
- 13 main functions including – 4D hotAir and hot air Eco
- ecoClean Direct – never manually clean the oven again
- coolStart – removes the need to preheat
- Integrated microwave
- varioSpeed – up to 50% time saving

Single ovens (continued)

HB656GBS1B stainless steel

iQ 700



- Capacity: 71 litres
- TFT touchDisplay
- softMove drop down oven door – effortless opening and closing
- 13 main functions including – 4D hotAir and hot air Eco
- ecoClean Direct – never manually clean the oven again
- coolStart – removes the need to preheat
- Energy consumption 4D hotAir – 0.69 kWh

HB632GBS1B stainless steel

iQ 700



- Capacity: 71 litres
- TFT Display
- drop down oven door – effortless opening and closing
- 8 main functions including – 4D hotAir and hot air Eco
- ecoClean Direct – never manually clean the oven again
- coolStart – removes the need to preheat
- Energy consumption 4D hotAir – 0.69 kWh

Double ovens

The same uncluttered fascia and innovative programmes as our single ovens they are designed to coordinate with all Siemens appliances.

HB55MB551B stainless steel

iQ 500



Main oven Top oven



Main lower oven

- Capacity – 67 litres – Large
- Largest baking sheet area – 1350 cm
- Time to cook standard load* – 44 mins
- Energy consumption hotairEco – 0.69 kWh
- Multifunction oven – 9 functions
- ecoClean® – never manually clean the oven again
- hotairEco – energy efficient single shelf cooking

Secondary top oven

- Capacity – 35 litres – Medium
- Largest baking sheet area – 1350 cm
- Time to cook standard load* – 46 mins
- Energy consumption conventional – 0.79 kWh
- 4 functions • ecoClean® – never manually clean the oven again

HB43MB520B stainless steel

iQ 500



Main oven Top oven



Main lower oven

- Capacity – 67 litres – Large
- Largest baking sheet area – 1350 cm
- Time to cook standard load* – 47 mins
- Energy consumption 3D hot air – 0.79 kWh
- Multifunction oven – 5 functions
- ecoClean® – never manually clean the oven again

Secondary top oven

- Capacity – 35 litres – Medium
- Largest baking sheet area – 1350 cm
- Time to cook standard load* – 44 mins
- Energy consumption conventional – 0.79 kWh
- 3 functions • ecoClean® – never manually clean the oven again

Double ovens (continued)

HB13MB521B stainless steel

HB13MB621B black

iQ 500



Main oven Top oven



Main lower oven

- Capacity – 71 litres – Large
- Largest baking sheet area – 1350 cm
- Time to cook standard load* – 47 mins
- Energy consumption 3D hot air – 0.79 kWh
- Hot air oven – 2 functions
- ecoClean® back liner – never manually clean the oven again

Secondary top oven

- Capacity – 35 litres – Medium
- Largest baking sheet area – 1350 cm
- Time to cook standard load* – 44 mins
- Energy consumption conventional – 0.79 kWh • 3 functions
- Back and roof ecoClean® liner – never manually clean the oven again

Built-under double ovens

Siemens built-under double ovens are perfect for smaller spaces.

HB55NB550B stainless steel

iq 500



Main lower oven

- Capacity – 50 litres – Medium
- Largest baking sheet area – 1350 cm
- Time to cook standard load* – 47 mins
- Energy consumption 3D hot air – 0.79 kWh
- Multifunction oven – 8 functions
- ecoClean® – never manually clean the oven again

Secondary top oven

- Capacity – 35 litres – Medium
- Largest baking sheet area – 1350 cm
- Time to cook standard load* – 44 mins
- Energy consumption conventional – 0.79 kWh
- 4 functions • ecoClean® – never manually clean the oven again

HB43NB520B stainless steel

iq 500



Main lower oven

- Capacity – 50 litres – Medium
- Largest baking sheet area – 1350 cm
- Time to cook standard load* – 47 mins
- Energy consumption 3D hot air – 0.79 kWh
- Multifunction oven – 5 functions
- ecoClean® – never manually clean the oven again

Secondary top oven

- Capacity – 35 litres – Medium
- Largest baking sheet area – 1350 cm
- Time to cook standard load* – 44 mins
- Energy consumption conventional – 0.79 kWh
- 3 functions • ecoClean® – never manually clean the oven again

Built-under double ovens (continued)

HB13NB521B stainless steel
HB13NB621B black

iq 500



Main lower oven

- Capacity – 56 litres – Medium
- Largest baking sheet area – 1350 cm
- Time to cook standard load* – 47 mins
- Energy consumption 3D hot air – 0.79 kWh
- Hot air oven – 2 functions
- Back ecoClean® liner – never manually clean the oven again

Secondary top oven

- Capacity – 35 litres – Medium • Largest baking sheet area – 1350 cm
- Time to cook standard load* – 44 mins
- Energy consumption conventional – 0.79 kWh
- 3 functions
- Back and roof ecoClean® liner – never manually clean the oven again

Installation diagrams

Single ovens with 96mm fascia

HN678G4S1B
HM678G4S1B
HM676G0S1B
HB676GBS1B
HB672GBS1B
HM656GNS1B
HB656GBS1B
HB632GBS1B

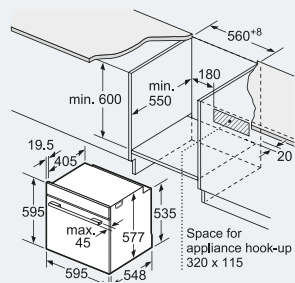

Installation with a hob.

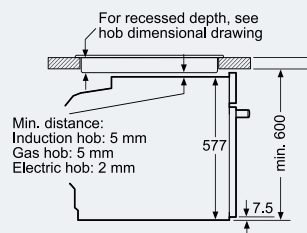

Built-in double ovens

HB55MB51B
HB43MB520B
HB13MB521B
HB13MB621B

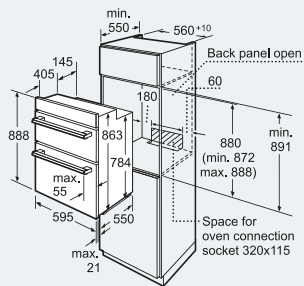

Built-under double ovens

HB55NB50B
HB43NB520B
HB13NB521B
HB13NB621B

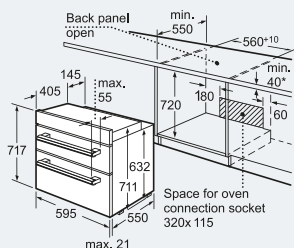

* For installation under an induction hob min. 50 mm

Oven accessories.

The perfect accessories, designed especially for your new oven. Why look elsewhere when we can supply original accessories that help you with your cooking. Great for tailoring your oven to your individual needs, you can choose between the telescopic rails, deep roasting pan or even a quality ceramic oven to table dish.

Thanks to the new design of our iQ700 oven and compacts range, roasting pans and wire racks are now universal and interchangeable between all enamelled oven cavities.



Telescopic rails

Convenient and easy to use, all Siemens iQ700 ovens with microwave feature a telescopic rail system with stop function as standard. For all other models, you also have the option to upgrade, with up to three levels. To make cleaning the oven even easier, all telescopic rails and bars are now pyrolytic-proof so they can be kept in the oven during the self-cleaning process. The shelves glide out effortlessly and safely so you don't have to reach inside a hot oven to check your food.

1 level pyrolytic-proof telescopic rail set – HZ638170



Other accessories

Deep Roasting Pan

Full width enamelled baking tray for iQ700 60cm single and 45cm compact ovens – HZ631070



Small oven to table dish

HZ36D513P (part no. 573899)



Large oven to table dish

HZ36D533P (part no. 573900)

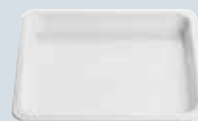

3 level telescopic shelf rail

HZ638370



To view available accessories in the oven range please ask your retailer or visit siemens-home.co.uk/store



Compact appliances

For a less ordinary kitchen

Clockwise from left to right: CT636LE51 compact45 coffee centre, CN678G451B compact45 oven with microwave, HN678G451B single oven with microwave, pulseSteam and roastingSensor Plus, HM678G451B single oven with microwave and pulseSteam.





Models shown: CT636LES1 compact45 coffee centre, CS658GRS1B compact45 hot air steam oven, CM678G4S1B compact45 multi-function oven with microwave, CS658GRS1B compact45 hot air steam oven.

Designed around you.



Above (clockwise from top left): Multi-functional cooking, multi-functional ovens – Siemens compact45. Elegant impressions and perfect coordination, come as standard: An ideal solution for warming plates – the Siemens Warming Drawer; Advanced technology for effortless cooking – the TFT touchDisplay.

The iQ700 range of compact45 appliances give you the freedom and flexibility to design your kitchen to your needs and cook how you want to. For a life less ordinary.

Featuring time-saving programmes such as varioSpeed and coolStart, or flexible cooking functions like fullSteam and pulseSteam, the functionality of our compact45 appliances match our iQ700 single oven range.

Whether you choose a steam oven or a coffee centre, the iQ700 compact45 appliances are all beautifully synchronised in looks – creating the perfect line up whether placed side by side or above and below. This is achieved by a clean-cut and consistent front panel design. And because they feature the exact same fascia as the iQ700 single oven range, there are even more possibilities in selecting a combination of ovens that do more than just look good.

Giving you more choice, the Siemens range of iQ700 compact45 appliances can be combined to suit your lifestyle.

Innovations come as standard across the range: the sharper and brighter TFT touchDisplay Plus – the largest touch navigation display available – offers an easier way to control your appliance with full colour icons and graphics. While the fascia panel lifts automatically to reveal a more convenient way to fill the water tank for healthy steam cooking.

For the ultimate kitchen experience, choose warming drawers to perfectly fit under each compact45 appliance. And for those who love coffee and love to entertain, the sleek iQ700 coffee centre allows you to enjoy an even larger selection of coffees. Even your own personalised coffee is available with the myCoffee function, selected using the advanced TFT touchDisplay.

Cooking with steam.

The healthy alternative for more flexibility in the kitchen.



The iQ700 compact45 steam ovens offer even more possibilities to prepare perfectly tasty dishes with ease. Use fullSteam to cook vegetables, fish or potatoes, without losing taste, colour or vitamins. And since no oil is needed, you can cook in the healthiest possible way. Since all compact45 appliances are coordinated in design, match with the iQ700 single oven with microwave and pulseSteam (model HN678G4S1B) for all the functions you could need.



Convenient access to the water tank.

More cooking possibilities.

Our steam ovens are multi-functional meaning you can cook as a conventional oven or in combination with the pulseSteam function. Whether it's a quick and healthy meal after work or an impressive weekend fish dish, a Siemens compact45 steam oven lets you choose how you want to cook your food.

The easiest way to cook with steam.

Cooking with steam is simple with an iQ700 compact45 steam oven. Open the fascia with the touch of a finger and the front panel automatically lifts to reveal the 1 litre capacity water tank. As the water tank is outside of the oven cavity, it's now possible to refill the tank while cooking, without losing any steam or disturbing your cooking.

The many benefits of steam.

As well as healthy cooking, steam is ideal for reheating and defrosting food. As the process gently adds moisture, you can reheat dishes when in a hurry, without losing taste, or spontaneously defrost food quickly.

Steam opens up a whole new world of cooking.

iQ700
CS658GRS1B



At a glance

- Capacity – 47 litres
- TFT touchDisplay Plus
- softMove drop down oven door – effortless opening and closing
- roastingSensor Plus – precisely check the core temperature of dishes
- bakingSensor – automatic control of the baking process
- fullSteam – healthy cooking using only steam
- pulseSteam – easily add steam
- 15 main functions including: 4D hotair, coolStart
- ecoClean Direct – never manually clean the oven again
- cookControl Plus – pre-installed settings for effortless cooking

Go to pages 33-39 to view the whole range.

Better together.

Cook faster, using the microwave and conventional function.



Get more from your oven with the iQ700 compact45 oven with microwave. Choose to cook using varioSpeed and you could save up to 50% of your time. Or use as a conventional oven or solely as a microwave, adapting to whatever situation you may find yourself in. Not to mention the fully coordinated design and intuitive TFT touchDisplay, you'll be cooking in no time.



The perfect lineup.

Save up to 50% of your time.

Whenever you want to take your time, varioSpeed lets you. The function is fast and effective at cooking your favourite dishes in up to half the time it would normally take, without any loss of quality or taste.

Full control at a touch.

Keep an eye on your cooking with the new TFT touchDisplay. With clear text and images so you can quickly glance at the screen, discover each programme and option with ease. Intuitively select each function using the touch navigation and scroll through each option with the central control dial, making precise adjustments with minimal effort.

Never manually clean the oven again.

Siemens iQ700 compact45 Ovens come with the self-cleaning activeClean programme, or ecoClean Direct coated side liners, ceilings and back panels. This special coating makes cleaning the oven easy. The coated areas clean themselves while the oven is on or can be activated with a cleaning programme.

varioSpeed saves up to 50% of your time.

iQ 700

CM656GBS1B



At a glance

- Capacity – 45 litres
- TFT touchDisplay
- softMove drop down oven door – effortless opening and closing
- 13 main functions including: 4D hotair, coolStart
- ecoClean Direct – never manually clean the oven again
- cookControl Plus – pre-installed settings for effortless cooking
- Integrated microwave
- varioSpeed – up to 50% time saving

Go to pages 33-39 to view the whole range.

Always pleases the eye.

The same coordinated design, throughout the iQ700 range.



Different models come with different functionalities, however with the iQ700 range of compact45 appliances, the design and style is always coordinated to offer more flexibility when designing your kitchen.



The TFT Display clearly shows programme information and is controlled by touch buttons either side.

The iQ700 compact45 range: the perfect solution for complete coordination in your kitchen.

Every appliance upgraded.

No matter which model you choose from the iQ700 range, they all feature a TFT display to show programme information. The smallest TFT Display is operated by touch-control buttons either side of the screen and can be read from any angle. No more confusing icons, the screen displays text to make it even easier to use your appliance.

A smoother action for all.

Every oven in the new iQ700 range features softMove: softer opening and closing of the oven door thanks to an intelligent damper mechanism. The oven door will always close gently and quietly. For a calmer kitchen.

More options in one.

As well as multifunction ovens with microwave, the iQ700 range can also be used as microwaves on their own. Power levels ranging from 90W to 1000W mean the microwave function can be used for gently defrosting food, reheating, cooking and quickly heating up drinks.

iQ 500

CM633GBS1B



At a glance

- Capacity – 45 litres
- TFT Display
- softMove drop down oven door – effortless opening and closing
- 6 main functions including: 4D hotAir, coolStart
- ecoClean Direct – never manually clean the oven again
- Integrated microwave
- varioSpeed – up to 50% time saving

Go to pages 33-39 to view the whole range.

Coffee indulgence.

Extra convenience for those passionate about coffee.



Compact appliances

The finishing touch for your kitchen or dining area, a Siemens coffee centre is the ultimate appliance for coffee lovers and those who like to entertain. Enjoy a better selection of coffee with the touch of a finger, all made to the optimum temperature to release the best taste and aroma using the intelligent sensoFlow heater inside.



Perfect results and at the size you want.

No more waiting around thanks to a fastest first cup every time.

Coordinate your coffee.

The iQ700 coffee centre creates a sensational line up in your kitchen with other iQ700 compact45 appliances and ovens. The design of the central control dial and TFT touchDisplay continues the clean lines of other Siemens appliances, while the milk container is now hidden behind the front panel for a less cluttered look.

No mess or fuss.

Designed with easy access to the water tank, bean holder and insulated milk jug, the coffee centre has front access thanks to a hinged front panel – so it's quick to replace the water or beans. The milk tubes are also cleaned with steam after every coffee with milk.

Two of your favourites at the same time.

The new oneTouch DoubleCup function means you can make two of the same coffees simultaneously, even those that use milk, so you can enjoy coffee with family or friends quickly and easily. You can save your favourite coffee settings to your name using the myCoffee menu on the TFT touchDisplay.

iQ 700

CT636LES1



At a glance

- TFT touchDisplay
- One touch function
- Frothing nozzle
- aromaDoubleShot – provides flexibility in strength and size
- My Coffee: Memory function to make your perfect coffee with the touch of a button
- sensoFlow System
- oneTouch DoubleCup

Go to pages 33-39 to view the whole range.

The ideal solution.

Great for storing plates.
Perfect for keeping them warm.



A sleek design and a flush finish make these drawers at home in any kitchen, whether they're simply used as extra storage or as a warming drawer. The warming drawers are ideal for heating coffee cups to the optimum temperature before use, as well as being able to keep food warm for up to an hour – perfect for a demanding lifestyle.



Keeps food hot for up to an hour.

Dinner party guests are running late?

A warming drawer is the ideal solution. With an adjustable temperature range of 40°C – 80°C, the warming drawer will warm dinnerware, but it can also keep food hot for up to 1 hour, safely and hygienically. Not only that, but you can use your warming drawer to prove dough, gently thaw delicate items and warm-up breads and pancakes.

Cleaning made simple

The warming drawer's easy to clean smooth and hard wearing ceramic glass base is recessed, which allows for any spills to be easily contained.

Easy access

The fully extendable pull-out drawer allows easy access to the contents and can accommodate up to 25kg.

An elegant handleless design to complement our other compact45 appliances.

iq 700

BI630DNS1B

At a glance

- 290mm high
- Handleless push-pull mechanism
- Telescopic pull-out drawer
- Easy to clean toughened glass heating plate
- Adjustable temperature range from 40°C – 80°C
- Accommodates up to:
 - 40 plates, 192 espresso cups
- Weight capacity: 25kg

Go to pages 33-39 to view the whole range.

Welcome to a range designed around you.

For the perfect built-in kitchen that is bespoke to you, look no further than the Siemens range of iQ700 compact45 appliances.

Whether you choose a steam oven with the latest cooking innovations and the self-cleaning activeClean® function, a combination microwave oven that uses varioSpeed to cut cooking times in half, or even a barista in the kitchen with our coffee centre. Siemens compact45 appliances are designed to make cooking simple, enjoyable and flexible. For a life less ordinary.

iQ 700

Reserved for our premium compact45 appliance range. iQ700 stands for exceptional design allied with seriously intelligent and innovative technology.

Compact appliances



compact45 oven

CB675GBS1B stainless steel

iQ 700



- Capacity: 47 litres
- TFT Display
- softMove drop down oven door – effortless opening and closing
- 13 main functions including – 4D hotAir and hot air Eco
- ecoClean Direct – never manually clean the oven again
- coolStart – removes the need to preheat
- Energy consumption 4D hotAir – 0.61 kWh

compact45 steam ovens

Siemens steam and steam combination ovens are quick and easy to install as they don't require any plumbing.

CS658GRS1B stainless steel

iQ 700



- Capacity – 47 litres
- softMove drop down oven door – effortless opening and closing
- roastingSensor Plus – precisely check the core temperature of dishes
- bakingSensor – automatic control of the baking process
- fullSteam – healthy cooking using only steam
- pulseSteam – easily add steam
- Functions with steam: reheating, Dough proving, defrost
- 15 main functions including: 4D hotAir
- coolStart – removes the need to preheat
- ecoClean Direct – never manually clean the oven again
- cookControl Plus – pre-installed settings for effortless cooking
- Energy consumption 4D hotAir – 0.61 kWh
- TFT touchDisplay Plus

compact45 steam ovens (continued)

CS656GBS1B stainless steel

iQ 700



- Capacity – 47 litres
- softMove drop down oven door – effortless opening and closing
- fullSteam – healthy cooking using only steam
- pulseSteam – easily add steam
- Functions with steam: reheating, Dough proving, defrost
- 13 main functions including: 4D hotAir
- coolStart – removes the need to preheat
- ecoClean Direct – never manually clean the oven again
- cookControl Plus – pre-installed settings for effortless cooking
- Energy consumption 4D hotAir – 0.61 kWh
- TFT touchDisplay Plus

CD634GBS1 stainless steel

iQ 700



- Capacity: 38 litres
- TFT Display
- softMove drop down oven door – effortless opening and closing
- Automatic programmes
- Functions with steam including: reheating, Dough proving, defrost

compact45 ovens with microwave

CM656GBS1B stainless steel

CM633GBS1B

iQ 700



- Capacity – 45 litres
- TFT touchDisplay
- softMove drop down oven door – effortless opening and closing
- 13 main functions including: 4D hotair
- ecoClean Direct – never manually clean the oven again
- coolStart – removes the need to preheat
- cookControl Plus – pre-installed settings for effortless cooking
- Integrated microwave
- varioSpeed – up to 50% time saving
- LED illumination

iQ 700



- Capacity – 45 litres
- TFT Display
- softMove drop down oven door – effortless opening and closing
- 6 main functions including: 4D hotair
- ecoClean Direct – never manually clean the oven again
- coolStart – removes the need to preheat
- Integrated microwave
- varioSpeed – up to 50% time saving
- LED illumination

compact45 coffee centre

Coffee at the touch of a button.

CT636LES1 stainless steel

iQ 700



- TFT touchDisplay
- One touch function
- Frothing nozzle
- aromaDoubleShot – provides flexibility in strength and size
- My Coffee: Memory function to make your perfect coffee with the touch of a button
- senseFlow System
- OneTouch DoubleCup

Microwave ovens

Perfect when you need food fast, Siemens microwave ovens feature easy to use electronic controls and automatic cooking programmes.

BE634LGS1B stainless steel

iq 700



- Capacity: 21 litres
- TFT Display
- Left hinged door
- Built-In microwave with 2 heating methods

BF634LGS1B stainless steel

iq 700



- Capacity: 21 litres
- TFT Display
- Left hinged door
- Built-In microwave

HF24M564B stainless steel

iq 700



- Capacity: 25 litres
- 1 main function: microwave
- 8 automatic cooking programmes
- Frameless integrated design
- Max. 900W microwave power

Microwave ovens (continued)

HF15M564B stainless steel



- Capacity: 20 litres
- 1 main function: microwave
- 8 automatic cooking programmes
- Frameless integrated design
- Max. 900W microwave power

HF15M664B black



- Capacity: 20 litres
- 1 main function : microwave
- 8 automatic cooking programmes
- Frameless integrated design
- Max. 800W microwave power

Warming and accessory drawers

The ideal solution for warming plates, a Siemens warming drawer will also keep food warm for up to 1 hour, safely and hygienically.

BI630DNS1B stainless steel

BI630CNS1B stainless steel



- 290mm high
- Handleless push-pull opening mechanism
- Telescopic pull-out draw
- Can accommodate up to 40 plates, 192 espresso cups
- Weight capacity 25kg



- 140mm high
- Handleless push-pull opening mechanism
- Telescopic pull-out draw
- Can accommodate up to 12 plates, 64 espresso cups
- Weight capacity 25kg

Installation diagrams

Compact45
oven and
Compact45
with microwave

CB675GBS1B
CM656GBS1B
CM633GBS1B

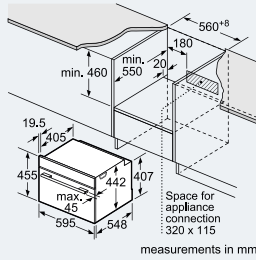

measurements in mm

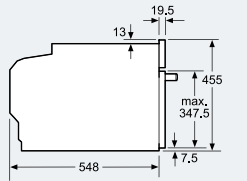

measurements in mm

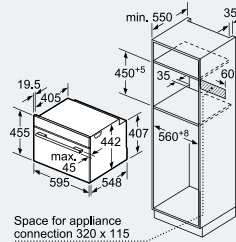

Space for appliance connection 320 x 115

Installation with a hob.

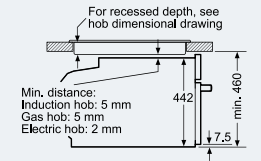

measurements in mm

Compact45
steam ovens

CS658GRS1B
CS656GBS1B
CD634GBS1

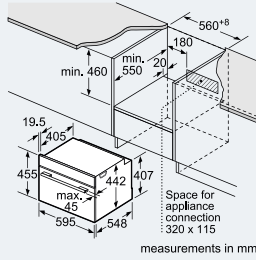

measurements in mm

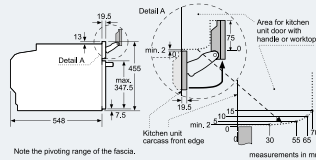

measurements in mm

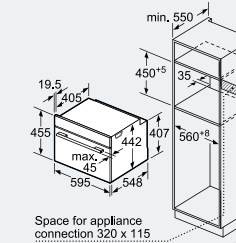

Space for appliance connection 320 x 115

Installation with a hob.

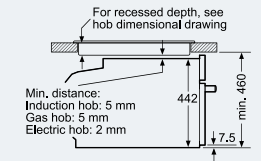

measurements in mm

Microwave
ovens

BE634LGS1B
BF634GLS1B

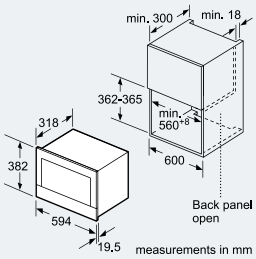

measurements in mm

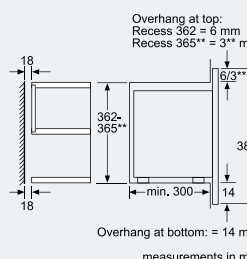

measurements in mm

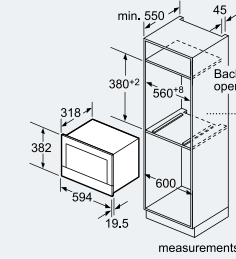

measurements in mm

Microwave
ovens

HF24M564B

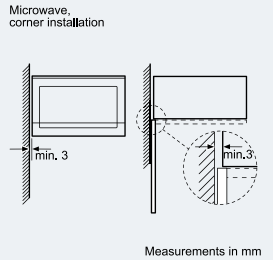

Measurements in mm

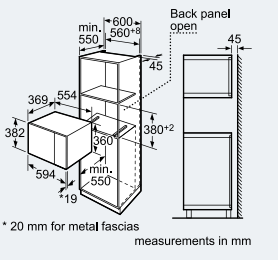

measurements in mm

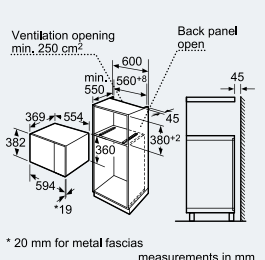

measurements in mm

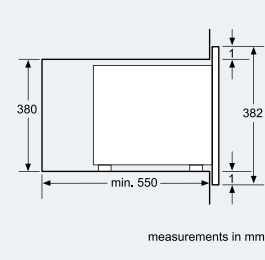

measurements in mm

Microwave
ovens

HF15M564B
HF15M664B

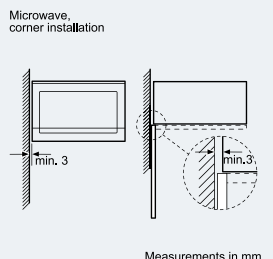

Measurements in mm

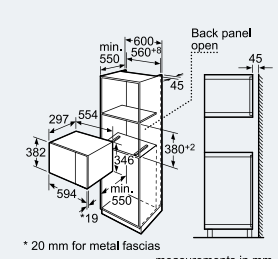

measurements in mm

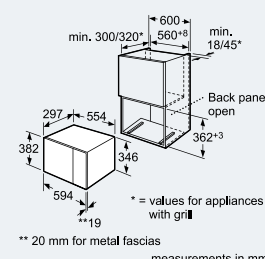

measurements in mm

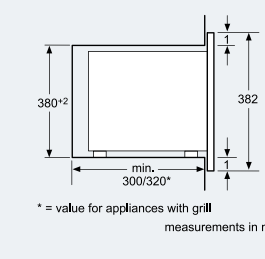

measurements in mm

Installation diagrams

Compact coffee centre

CT636LES1

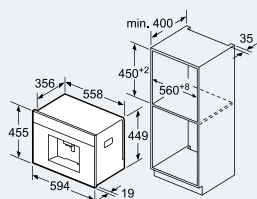

Bohnen- und Wasserbehälter werden nach vorne entnommen.
Empfohlene Einbauhöhe 95-145 cm.
Maße in mm

Left corner installation

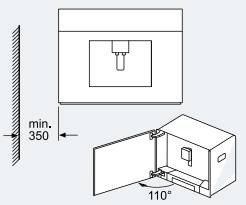

measurements in mm

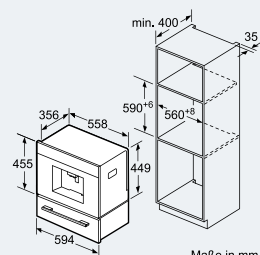

Maße in mm

Warming drawer

BI630DNSIB
BI630CNSIB

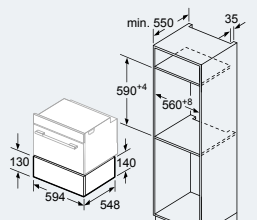

measurements in mm

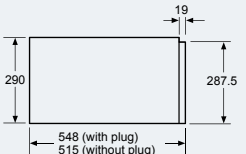

Ovens with an appliance height of 595 mm can be installed above a warming drawer.
An intermediate floor is not required.

measurements in mm

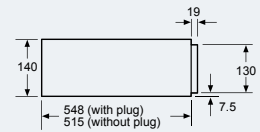

Compact ovens with an appliance height of 455 mm can be installed above a warming drawer.
An intermediate floor is not required.

measurements in mm



Induction & ceramic hobs

Easy to clean, easy to cook with.



Model shown: EH675MV17E flexInduction hob with griddle pan accessory (HZ390522).

Enjoy a new cooking experience.

The Siemens hob range combines eye-catching design with razor-sharp looks, together with innovative technology and ergonomic design. All created to coordinate beautifully with other Siemens appliances.



Single flexInduction – model shown EH675MN27E.



flexInduction

A hob that fits in with your lifestyle, flexInduction is no-compromise cooking at its best.

Siemens flexInduction hobs are a must for diverse cooking. The cooking area can be tailored to your needs, enabling you to use a small area as traditional induction hobs with four or five separate zones, for boiling rice, for example, or you can choose to link the zones together to form one zone for larger cooking pans. The new extended cooking surface can

accommodate pans of any size, even several pans placed anywhere on the surface at the same time. With all the advantages of induction cooking, flexInduction also includes boost settings, automatic pan recognition and touchSlider controls.

Each flexInduction zone uses four innovative elongated oval inductors beneath the glass, each of which can act independently to sense the presence of cookware on the hob. Only if cookware is detected will the individual

inductors work, ensuring efficient operation whether a 10cm diameter milk pan is placed in one corner or a large griddle plate covers the whole zone. With only specific areas active at any particular time, no energy is wasted. And for an even more versatile cooking experience the newly designed triple flexInduction hob provides the ultimate in flexible cooking with three flexInduction zones, fitting in with your lifestyle, flexInduction is no-compromise cooking at its best.

Hob accessories

For additional cooking flexibility Siemens provide a range of accessories for our flexInduction hobs.

For more details on the range of accessories available please ask your retailer or visit siemens-home.co.uk/store

Stop making dinner and start enjoying a cooking experience.

Teppan yaki – Heating extremely quickly the Teppan yaki is great for fast Japanese cooking. Perfect for a cooked breakfast or a healthy stir-fry, the pan comes in two sizes that fit across either three or four flexInductors.

Accessories code:
2 sizes available 40x20cm HZ390512 and 30x20cm HZ390511.



Griddle pan – Specially designed for use across four flexInductors the griddle pan maintains an even heat, perfect for frying steak.

Accessories code:
HZ390522.



Roasting dish with steamer – Perfect for use with flexInduction hobs this multipurpose dish is a must when cooking for a crowd. A removable steamer insert is available to compliment this dish and perfect for steaming vegetables.

Accessories code:
Roasting dish HZ390011 and steamer insert HZ390012.





IN
boost



Speed. Energy-efficiency. Style.

Our traditional induction hob range feature automatic pan recognition ensuring that only the pan in contact with the surface heats up. Induction cooking is quicker than gas and much more energy efficient, allowing you to enjoy speedy food whilst being kinder to the environment.



Model shown: EH875FM27E Induction hob.

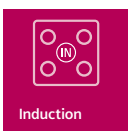

Induction cooking

Induction cooking is recognised as being one of the quickest, safest and most efficient methods of cooking available. When a pan with a ferrous or magnetic metal base is placed on the hob, the coil situated below the ceramic surface uses an electromagnetic field to create heat, almost instantly heating the pan. With only the base of the pan heated the cooking zone stays cooler.

Easier to clean and safer to use, because the ceramic cooking top is warmed only by the heat transferred back from the cookware and its contents, spillages are less likely to burn on, and there is normally no need to wait for the glass to cool down before simply wiping it over with a cloth. And if you turn on an induction hob without having a pot or pan on it, there is no risk of burning yourself, because the hob itself doesn't heat up.



Easier to clean and safer to use, Siemens induction hobs stand out in your kitchen.



Automatic pan recognition

Energy-efficiency is at the heart of Siemens products, and is at the heart of automatic pan recognition. Only the area of the hob in contact with the pan receives energy, meaning energy isn't wasted by heating the entire unit. Not only will this lower your carbon footprint, but it will also reduce your utility bills.

Faster cooking made quicker

Power boost increases the power output of selected zones by 50%, allowing precision heat when you need it most – perfect when time is of the essence.



Precision control at the touch of a button.

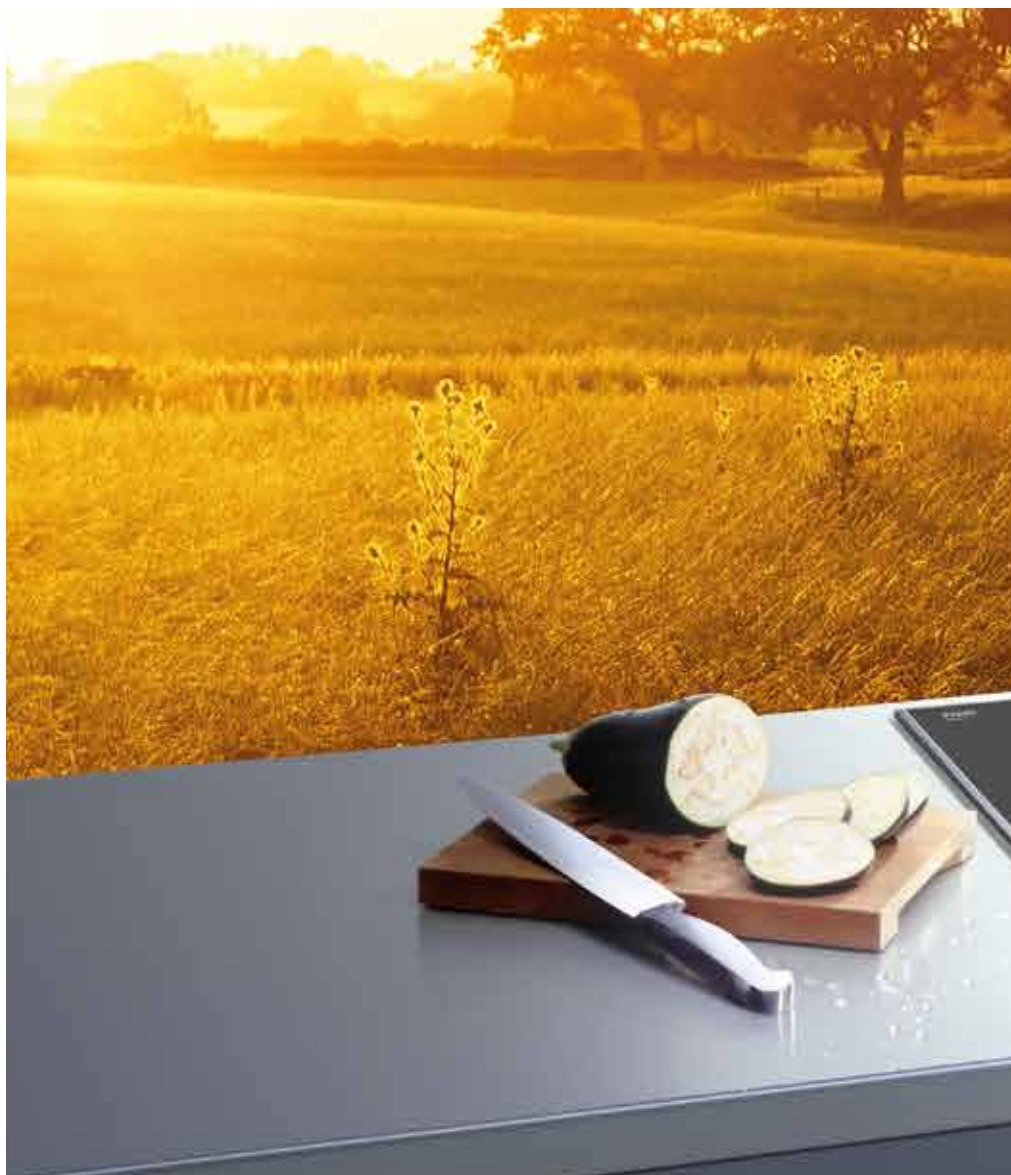

Model shown: EH975SK11E.



The stylish design of the touchSlider sits flush to the appliance; similar to the touch pad of a laptop, technology and design enthusiasts alike will revel in its functionality. Not only does the touchSlider allow for a great degree of cooking control, it's also easy to clean as there are no protruding parts.

Designed with sleek controls that are simple to use, and state-of-the-art technology that gives you a precise control over your hob. When activated, the power level is displayed for each zone, allowing you to monitor their status at a glance.

The stylish and ergonomic touchSlider allows you to simply slide your finger across the temperature scale to the desired setting, with control advances in half-levels from 1 to 9. You can also touch the desired level directly for faster adjustments to the cooking zone temperature. All 60cm models are controlled with one single 9.5cm touchSlider control, while the extra wide models have one, four or five 8cm touchSlider controls.



Hobs



Greater control with touchSlider.



Easy to monitor status.



Models shown: Models shown: EH975SZ17E flex induction hob, LF91BA582B island hood, CT636LES1 compact45 coffee centre, CS658GRS1B compact45 hot air steam oven, HN678G4S1B single oven with microwave and pulseSteam, BI630CNS1B warming drawer.

Perfectly framed.



Induction hobs are perfect for a wide variety of cooking and in a range of finishes you can truly make your kitchen bespoke.

Hobs

With their slim 4mm profile and tough, stain and scratch resistant wipe-clean surface, it's easy to see why our smooth, high-gloss finish glass induction hobs are the perfect choice for many people.



Facetted design

Great for blending in with your existing kitchen and worktop or maybe a Teppan yaki domino hob, a facetted induction hob with slim steel side trim features a slightly raised edge around its circumference.



Flat frame design

Perfect for coordinating with your kitchen, hood and other Siemens appliances, this modern flat frame design has a sleek stainless-steel frame around its edge to contain spills and protect the glass edge.



Flush-fitting design

The flush-fitting smooth glass finish makes this induction hob practical and easy to clean, whilst sitting flush and neat in your contemporary kitchen.



Bevelled-edge design

A traditional bevelled edge design induction hob is easily blended into any kitchen aesthetic, yet still features all the great flexibility of an induction hob.

Enjoy a new cooking experience.

flexInduction is no-compromise cooking at its best.



The iQ700 flexInduction range is available in a variety of models. Including the extra wide twin flexInduction with a triple-circuit cooking zone to a single flexInduction hob with 2 induction zones. With differing sizes, trims and colours to choose from the range also boasts up to 17 power levels and all with the simplicity of the touchSlider temperature scale to select the desired heat setting. There is something to suit all kitchen styles and cooking preferences.



flexInduction – place your pans anywhere.

Tailored to your needs

flexInduction is a must for diverse cooking. The cooking area is tailored to your needs, enabling you to use a small area for boiling rice, or the whole strip for large cooking pots. A hob that fits in with your lifestyle, flexInduction is no-compromise cooking at its best.

The options are endless

The triple flexInduction model allows you to have numerous cooking choices. The model boasts 5 induction zones in total. 2 flexInduction zones with different usage possibilities either 2 single induction zones of 480cm² or 1 full zone of 960cm². The central area of the hob has 1 flexInduction zone which is 720cm².

Precision control at the touch of a button

The stylish design of the touchSlider sits flush to the appliance; similar to the touch pad of a laptop, technology and design enthusiasts alike will revel in its functionality. Not only does the touchSlider allow for a great degree of cooking control, it's also easy to clean as there are no protruding parts.

Stop making dinner and start enjoying a cooking experience.

iQ 700

EH975MV17E

At a glance

- 3 flexInduction zones – provides flexibility in cooking
- 5 induction zones
- 17 power levels – for greater temperature control
- touchSlider operation – smooth and accurate control
- Front facette with side trim
- Optional accessories – griddle plate, Teppan yaki, roasting dish and steamer insert

Go to pages 57-67 to view the whole range.

Speed. Energy- efficiency. Style.

Welcome to
induction cooking.



Hobs

With the iQ500 induction range cooking could not be easier. Recognised as being one of the quickest, safest and most efficient methods of cooking available Siemens offer a collection of models to suit all requirements. From the extra wide 912mm models with 5 induction zones, as featured below, to the 592mm models with 4 induction zones. Some models have the reStart and quickStart functions and most can be installed with our stylish domino hobs to add versatility, catering for all methods of cooking whilst creating your own bespoke look.



Precision heat when you need it.

Lowering the cost of every meal through energy-efficiency

Energy-efficiency is at the heart of Siemens products, and is at the heart of automatic pan recognition. Only the area of the hob in contact with the pan receives energy, meaning energy isn't wasted by heating the entire unit. Not only will this lower your carbon footprint, but it will also reduce your utility bills.

Be in control of the uncontrollable

A busy lifestyle can involve being pulled in many directions. Should that happen while you're cooking, control panel pause will shut down all power at the touch of a button, ensuring that your meal isn't ruined. At the second touch all will resume as if you were never interrupted.

All the power at the touch of a button

Speed. Power. Efficiency. Power boost increases the power output of selected zones by 50%, allowing precision heat when you need it most – perfect when time is of the essence.

Induction cooking
is quicker than gas
and much more
energy efficient.

iQ 300

EH975SK11E

At a glance

- 5 induction zones – with automatic pan recognition
- 1 dual/extendable zone – for large or smaller pans
- Power boost – setting for when time is limited
- Control panel pause – shuts down power
- Can be installed with domino hob

Go to pages 57-67 to view the whole range.



Gas hobs

High-performance, high-speed.



Modern yet traditional.

Beautiful, durable, black ceramic glass base with cast iron pan supports for a contemporary look.



The stunning ceramic black glass hobs offer a range of carefully designed configurations which coordinate perfectly with the Siemens domino collection, to give the ultimate in flexible and bespoke cooking options. Many of the hobs are equipped with the latest high-speed wok burner technology, offering you a faster, stronger heat for quick cooking and convenience.

912 mm
Width



Flexible cooking with our domino hob range.

Traditional precision cooking that puts you in the driving seat.

Total convenience guaranteed

Swift, fluid motions and ease of use are the focal points of control dial ignition. Ignite the flame whilst setting its intensity by simply turning and pushing the individual hob control with one hand, whilst preparing food with the other. Total convenience guaranteed.

High-performance. High-speed. Experience the wok burner

The only way to cook a stir fry – enjoy precision cooking with the dual controlled wok burner. The inner and outer flame can be controlled independently, with the power burner allowing for extremely fast cooking.

Best of both worlds

When your heart is still ruled by the traditional method of cooking with gas but you would like to have the option of being more flexible with your cooking, you can add the more energy efficient flexInduction domino hob or really stand out of the crowd with the Teppan yaki cooktop enjoying the best of both worlds.

iq 700

ER926SB70E

At a glance

- Black ceramic glass
- 1 x 6.0 kW dual wok burner
- 4 gas burner hobs – includes 1 high speed, 2 standard and 1 economy burner
- 3 cast iron pan supports – dishwasher safe
- Can be installed with Siemens domino hobs

Go to pages 57-67 to view the whole range.

High performance. High speed.

Highest quality stainless steel for a sleek, professional finish.



Hobs

The stainless steel range of gas hobs feature wok burners that deliver ranges of power depending on the model, meeting the increasing demand for high speed cooking. The classic yet modern looking cast iron pan supports* can be easily removed for easy cleaning.

702 mm
Width



Independently controlled dual wok burner.

Ideal for the perfect jus

Ideal for simmering the perfect jus, the simmer burner cap fits on the smallest burner and diffuses the minimum power heat over a wider surface area, avoiding hot spots, perfect for simmering.

High-performance. High-speed. Experience the wok burner

The only way to cook a stir fry – enjoy precision cooking with the dual controlled wok burner. The inner and outer flame can be controlled independently, with the power burner allowing for extremely fast cooking.

Safety first.

When you have a window open nearby whilst cooking, the flame can sometimes be extinguished. All Siemens gas hobs feature a flame failure safety device, which cuts-off the supply of gas to the individual burner should the flame accidentally go out.

The only way to cook a stir fry – enjoy precision cooking with the dual controlled wok burner.

*only on ceramic glass hobs



iQ 500

EC745RC90E

At a glance

- Stainless steel finish
- 1 x 5.0 kW dual control wok burner
- 4 gas burner hobs – including 1 high speed burner, 2 standard and 1 economy burner
- 3 cast iron supports – dishwasher safe
- Flame failure safety device

Go to pages 57-67 to view the whole range.

Mix and match.

The modular domino hobs can be mixed and matched with each other and even with other hobs in the Siemens range.



Whether it is an induction hob with a single wok burner or a Teppan yaki and domino gas hob, Siemens domino hobs are designed to fit side by side, creating individual, bespoke cooking areas for your kitchen or living space.

Domino hobs; cooking pleasure tailored to you.



Traditional Japanese cooking was made to be shared

The Teppan yaki cook top offers a healthy cooking experience as only a small amount of oil is needed. Ideal for dinner parties as the two heating zones allow you to divide the surface so you can continue cooking on one section whilst keeping food warm on the other for your guests to enjoy.

All the features you would expect

Though small in size the domino hob collection have all the top line controls and features as our full size models. The flexInduction domino and Teppan yaki feature touchSlider for precision control at the touch of button and both the domino gas hob and wok burner make them easy to clean with their dishwasher safe cast iron supports.

High-performance. High-speed. Experience the wok burner.

The only way to cook a stir fry – enjoy precision cooking with the dual controlled wok burner. The inner and outer flame can be controlled independently, with the power burner allowing for extremely fast cooking.

iQ 700 ER326AB70E

At a glance

- Width: 302mm
- 1 x 6.0 kW dual control wok burner
- Cast iron pan supports – dishwasher safe
- Front facette with side trim

Go to pages 57-67 to view the whole range.

iQ 500 ET475MY11E

At a glance

- Teppan yaki – extremely quick heat for Japanese style cooking
- 2 cooking zones
- 9 power levels for greater temperature control
- touchSlider operation for smooth and accurate control
- Ceramic black glass cover – provides a seamless look with other Siemens appliances

Go to pages 57-67 to view the whole range.

Welcome to a range designed around you.

Siemens hobs bring together eye-catching looks, innovative technology and ergonomic design.

Whether you choose cutting-edge innovation with our triple flexInduction, or a more traditional stainless steel gas cook-top, all of our hobs are built with easy to use temperature controls. You can choose the modern touchSlider on induction or a choice of mounted knobs or electronic controls on ceramic bases. Which ever design you decide, all of our hobs are designed to coordinate beautifully with other Siemens appliances

iQ 700

Exceptional design allied with seriously innovative technology is the basis of these, our premium models.

iQ 500

Exuding class and refinement, these machines unite first-class features with top-class technology.

iQ 300

Good looking appliances with Siemens build quality equipped with an attractive selection of smart features.



flexInduction hobs

flexInduction hobs are a must for diverse cooking enabling you to tailor the zones to your needs. flexInduction just got functional.

EH975MV17E black glass with stainless steel side trim

iQ 700



- 3 flexInduction zones – provides more flexibility in cooking
- 5 Induction zones
- 17 power levels – for greater temperature control
- touchSlider operation – smooth and accurate control
- Power boost function – shorter heating times
- Can be installed with a domino hob
- Front facette with side trim
- Optional accessories: griddle plate, Teppan yaki, roasting dish, steamer insert

EH675MV17E black glass

iQ 700

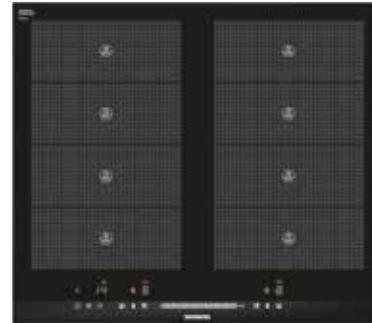

- 2 flexInduction zones – provides more flexibility in cooking
- 4 Induction cooking zones
- 17 power levels – greater temperature control
- touchSlider operation – smooth and accurate control
- Power boost function – shorter heating times
- Front facette with side trim
- Optional accessories: griddle plate, Teppan yaki, roasting dish, steamer insert

flexInduction hobs (continued)

EH601MV17E black glass

iQ 700

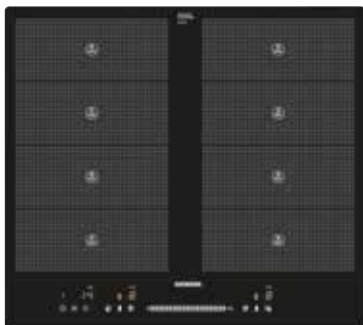

- 2 flexInduction zones – provides more flexibility in cooking
- 4 Induction cooking zones
- 17 power levels – greater temperature control
- touchSlider operation – smooth and accurate control
- Flush fitting design
- Optional accessories: griddle plate, Teppan yaki, roasting dish, steamer insert

EH975SZ17E black glass with stainless steel side trim

iQ 700

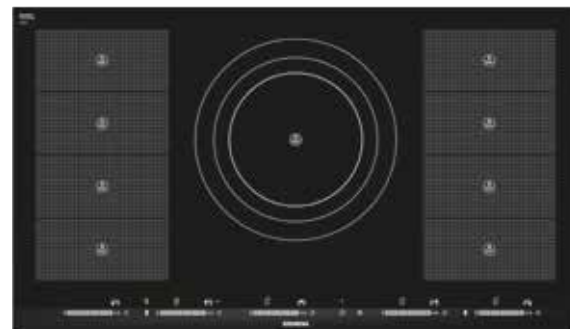

- 2 flexInduction zones – provides more flexibility in cooking
- 5 Induction cooking zones
- 1 triple-circuit central cooking zone
- 17 power levels – greater temperature control
- touchSlider operation – smooth and accurate control
- Power boost function – shorter heating times
- Front facette with side trim
- Can be installed with a domino hob
- Optional accessories: griddle plate, Teppan yaki, roasting dish, steamer insert

flexInduction hobs (continued)

EH879SP17E metal look glass with stainless steel side trim
EH875MP17E black glass with stainless steel side trim

iQ 700



- 1 flexInduction zone – provides more flexibility in cooking
- 5 Induction cooking zones
- 17 power levels – greater temperature control
- touchSlider operation – smooth and accurate control
- Power boost function – shorter heating times
- Side profiles (EH879SP17E)
- Front facette with side trim (EH875MP17E)
- Can be installed with domino hob
- Optional accessories: griddle plate, Teppan yaki, roasting dish, steamer insert

EH679MN27E metal look glass with stainless steel side trim
EH675MN27E black glass with stainless steel side trim

iQ 700

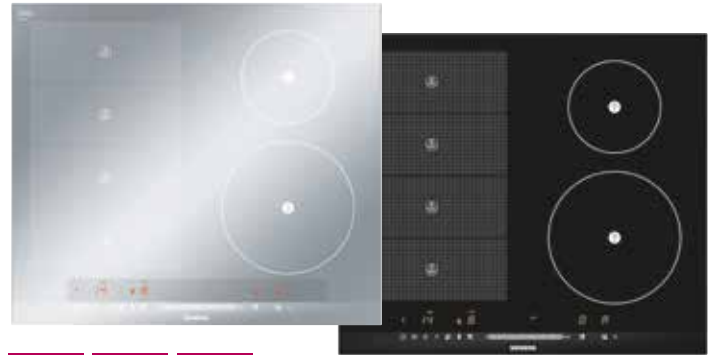

- 1 flexInduction zone – provides more flexibility in cooking
- 4 Induction cooking zones
- 17 power levels – greater temperature control
- touchSlider operation – smooth and accurate control
- Power boost function – shorter heating times
- Side profiles (EH679MN27E)
- Front facette with side trim (EH675MN27E)
- Can be installed with domino hob
- Optional accessories: griddle plate, Teppan yaki, roasting dish, steamer insert

flexInduction hobs (continued)

EH651FV17E black glass

iQ 700



- 2 flexInduction zones – provides more flexibility in cooking
- 4 Induction cooking zones
- 17 power levels – greater temperature control
- touchSlider operation – smooth and accurate control
- Power boost function – shorter heating times
- quickStart function – start cooking quickly
- 3 sided bevelled frameless finish

EH651BN17E black glass

iQ 700

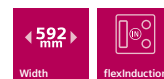
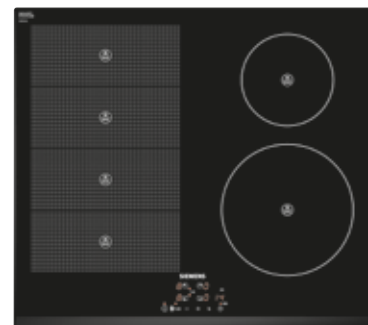

- 1 flexInduction zone – provides more flexibility in cooking
- 4 induction cooking zones
- 17 power levels – greater temperature control
- touchControl – experience intuitive control
- quickStart function – start cooking quickly
- 3 sided bevelled frameless finish

Induction hobs

Convenient cooking with Siemens automatic pan recognition technology. Induction hobs are also up to 35% more resource efficient than cooking with gas.

EH975SK11E
black glass with stainless steel side trim

iQ 300

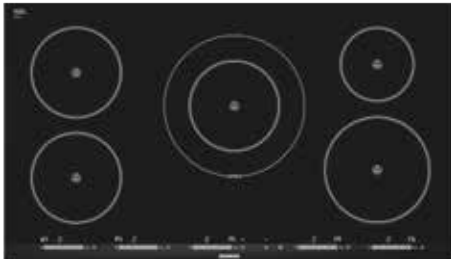

- 5 induction cooking zones
- 1 dual/extendable zone – accommodates larger pans
- 17 power levels for greater temperature control
- touchSlider operation – smooth and accurate control
- Power boost setting – shorter heating times
- Front facette with side trim
- Can be installed with domino hob

EH975ME11E
black glass with stainless steel side trim

iQ 100



- 4 induction cooking zones
- 17 power levels – greater temperature control
- touchSlider operation – smooth and accurate control
- Power boost setting – shorter heating times
- Front facette with side trim

EH875FM27E
black glass with stainless steel side trim

iQ 100

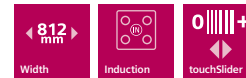

- 5 induction cooking zones
- 17 power levels – greater temperature control
- touchSlider operation – smooth and accurate control
- Power boost function – shorter heating times
- quickStart function – start cooking quickly
- Energy consumption display
- Front facette with side trim
- Can be installed with domino hob

Induction hobs (continued)

EH801FM17E
black glass

iQ 100

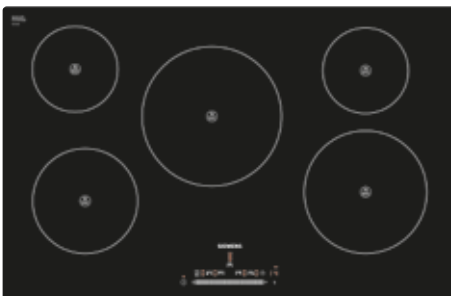

- 5 induction cooking zones
- 17 power levels – greater temperature control
- touchSlider operation – smooth and accurate control
- Power boost function – shorter heating times
- quickStart function – start cooking quickly
- Energy consumption display
- Flush fitting design

EH675FE27E
black glass with stainless steel side trim

iQ 100

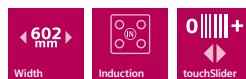
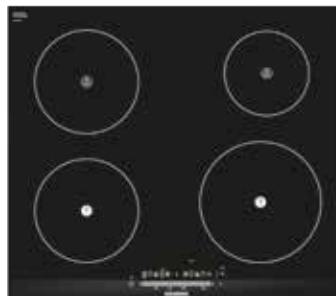

- 4 induction cooking zones
- 17 power levels – greater temperature control
- touchSlider operation – smooth and accurate control
- Power boost function – shorter heating times
- quickStart function – start cooking quickly
- Energy consumption display
- Front facette with side trim
- Can be installed with domino hob

EH601FE17E
black glass

iQ 100

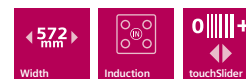
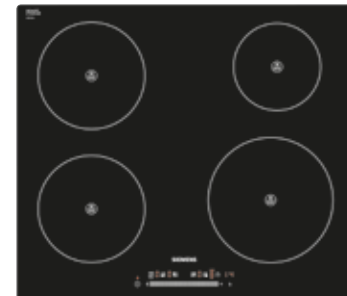

- 4 Induction cooking zones
- 17 power levels for greater temperature control
- touchSlider operation – smooth and accurate control
- Power boost function – shorter heating times
- quickStart function – start cooking quickly
- Energy consumption display
- Flush fitting design

Induction hobs (continued)

EH845FL17E
black glass with all-round stainless steel trim

iQ 100



- 4 induction cooking zones
- 17 power levels – greater temperature control
- touchSlider operation – smooth and accurate control
- Power boost function – shorter heating times
- quickStart function – start cooking quickly
- Energy consumption display
- All round trim

EH645FE17E
black glass with all-round stainless steel trim

iQ 100

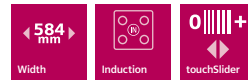

- 4 induction cooking zone
- 17 power levels – greater temperature control
- touchSlider operation – smooth and accurate control
- Power boost function – shorter heating times
- quickStart function – start cooking quickly
- Energy consumption display
- All round trim

EH631BE18E
black glass

iQ 100

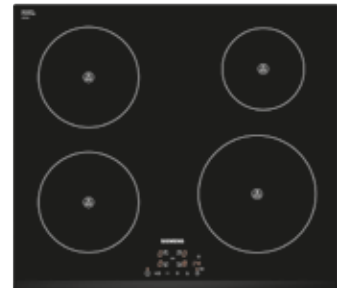

- 4 induction cooking zones
- 17 power levels – greater temperature control
- touchControl – experience intuitive control
- Power boost function – shorter heating times
- quickStart function – start cooking quickly
- Bevelled front

Induction hobs (continued)

EH631BA68B
black glass

iQ 100



- 4 induction cooking zones
- 17 power levels – greater temperature control
- touchControl – experience intuitive control
- Power boost function – shorter heating times
- quickStart function – start cooking quickly
- 13A plug – easy install
- Bevelled front

EH611BA18E
black glass

iQ 100

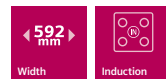

- 4 induction cooking zones
- 17 power levels – greater temperature control
- touchControl – experience intuitive control
- Power boost function – shorter heating times
- quickStart function – start cooking quickly
- Frameless design

Quick-lite ceramic hobs

Our ceramic hobs look stylish in any modern kitchen and feature touchControl for easy use.

ET851FC17E
black glass

iQ 300

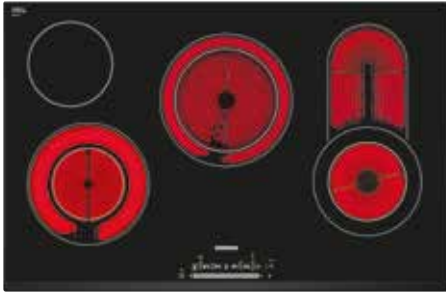

◀ 802 mm ▶
Width

- 4 quick-lite cooking zones
- 3 dual/extendable zones – greater flexibility
- 17 power levels – greater temperature control
- touchSlider operation – smooth and accurate control
- reStart function

ET845BN17E
black glass with all-round stainless steel trim

iQ 300

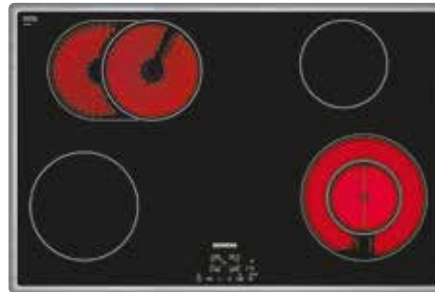

◀ 765 mm ▶
Width

- 4 quick-lite cooking zones
- 2 dual/extendable zones – greater flexibility
- 17 power levels – greater temperature control
- touchControl – experience intuitive control
- reStart function

ET651HE17E
black glass

iQ 100



◀ 592 mm ▶
Width

- 4 quick-lite cooking zones
- 17 power levels – greater temperature control
- touchControl – experience intuitive control
- reStart function
- 3 sided bevelled frameless finish

Quick-lite ceramic hobs (continued)

ET645HF17E
black glass with all-round stainless steel trim

iQ 100



◀ 583 mm ▶
Width

- 4 quick-lite cooking zones
- 9 power levels – greater temperature control
- Side mounted control knobs

ET645CE17E
black glass with all-round stainless steel trim

iQ 100

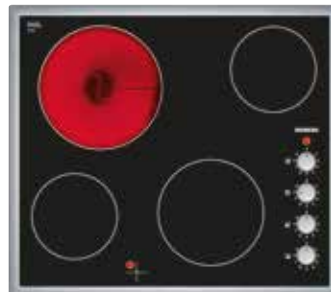

◀ 583 mm ▶
Width

- 4 quick-lite cooking zones
- 9 power levels – greater temperature control
- Side mounted control knobs

Ceramic glass gas hobs

A contemporary twist on a traditional gas cook-top and easy to clean too.

ER926SB70E
black glass with stainless steel side trim

iQ 700

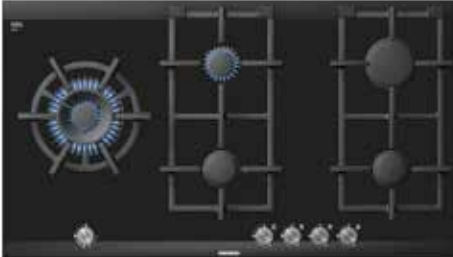

◀ 912 mm ▶
Width

- 1 x 6.0kW dual control wok burner
- 4 gas burners – includes 1 high speed, 2 standard and 1 economy burner
- 3 cast iron pan supports – dishwasher safe
- Ignition via control dials
- Can be installed with domino hob

ER726RB71E
black glass with stainless steel side trim

iQ 700



◀ 710 mm ▶
Width

- 1 x 4.2kW dual control wok burner
- 4 gas burners – includes 1 high speed, 2 standard and 1 economy burner
- 2 cast iron pan supports – dishwasher safe
- Ignition via control dials
- Can be installed with domino hob

ER626PB70E
black glass with stainless steel side trim

iQ 700

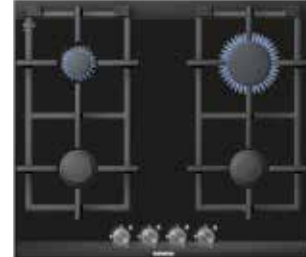

◀ 602 mm ▶
Width

- 4 gas burners – includes 1 high speed, 2 standard and 1 economy burner
- 2 cast iron pan supports – dishwasher safe
- Ignition via control dials

Stainless steel gas hobs

Perfect for your modern kitchen choose between a 4, 5 or 6 gas burners to suit your cooking needs.

EC945TB91E stainless steel

iQ 500



◀ 915 mm ▶
Width

- 2 x 3.3kW wok style burners
- 4 gas burners – includes 2 standard and 2 economy burners
- 3 cast iron pan supports – dishwasher safe
- Ignition via control dials

EC745RC90E stainless steel

iQ 500



◀ 702 mm ▶
Width

- 1 x 5.0kW dual control wok burner
- 4 gas burners – includes 1 high speed, 2 standard and 1 economy burner
- Simmer cap – great for sauces
- 3 cast iron pan supports – dishwasher safe
- Ignition via control dials

EC645HC90E stainless steel

iQ 500



◀ 582 mm ▶
Width

- 1 x 3.3kW wok style burner
- 3 gas burners – includes 2 standard and 1 economy burner
- Simmer cap – great for sauces
- 2 cast iron pan supports – dishwasher safe
- Ignition via control dials

Stainless steel gas hobs (continued)

EC715RB90E stainless steel

iQ 500



◀ 702 mm ▶
Width

- 1 x 3.3kW wok style burner
- 4 gas burners – includes 1 high speed, 2 standard and 1 economy burner
- 3 cast iron pan supports – dishwasher safe
- Ignition via control dials

EC615PB90E stainless steel

iQ 500

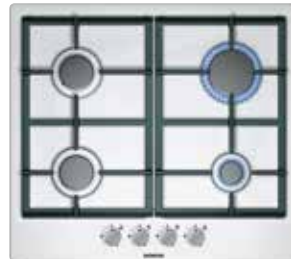

◀ 582 mm ▶
Width

- 4 gas burners – includes 1 high speed, 2 standard and 1 economy burner
- 2 cast iron pan supports – dishwasher safe
- Ignition via control dials

EB6B5HB60 stainless steel

iQ 100

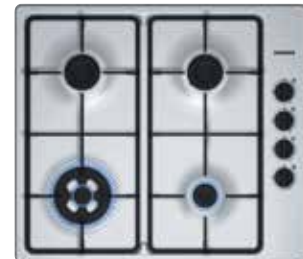

◀ 580 mm ▶
Width

- 4 gas burners – includes 2 standard, 1 economy and 1 high speed wok burner
- 2 cast iron pan supports
- Ignition via control dials

Tempered glass gas hobs

Cooking made stylish with tempered glass hobs.

EP916QB91E
black glass

iQ 500

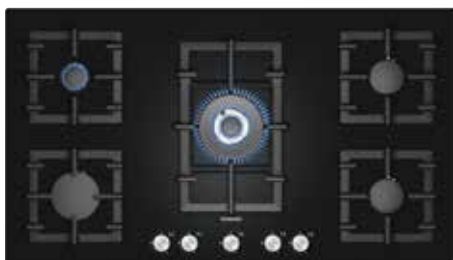

◀ 910 mm ▶
Width

- 1 x 4.0kW wok burner
- 4 gas burners – includes 1 high speed, 2 standard and 1 economy burner
- 5 individual cast iron pan supports – dishwasher safe
- Ignition via control dials

EP716QB91E
black glass

iQ 500

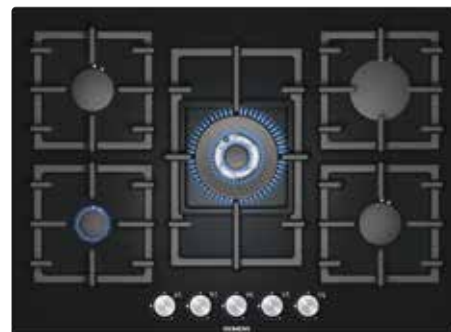

◀ 710 mm ▶
Width

- 1 x 4.0kW wok burner
- 4 gas burners – includes 1 high speed, 2 standard and 1 economy burner
- 5 individual cast iron pan supports – dishwasher safe
- Ignition via control dials

EP616HB91E
black glass

iQ 500



◀ 590 mm ▶
Width

- 1 x 3.3kW wok burner
- 3 gas burners – includes 2 standard and 1 economy burner
- 2 individual cast iron pan supports – dishwasher safe
- Ignition via control dials

Domino hobs

Create your own bespoke cooking area, mixing and matching to suit your needs. All domino hobs sit seamlessly side by side and with other Siemens hobs.

EH375MV17E flexInduction hob
black glass with stainless steel side trim

iQ 700



- 1 flexInduction zone – provides more flexibility in cooking
- 2 Induction zones
- 17 power levels – for greater temperature control
- touchSlider operation – smooth and accurate control
- Power boost function – shorter heating times
- Front facette with side trim

ET475MY11E Teppan yaki
stainless steel trim

iQ 500



- Teppan yaki – extremely quick heat for Japanese style cooking
- 2 cooking zones
- 9 power levels – greater temperature control
- touchSlider operation for smooth and accurate control
- Removable ceramic black glass lid
- Front facette with side trim

Domino hobs (continued)

ER326AB70E Wok burner
black glass with stainless steel side trim

iQ 700



- 1 x 6.0kW dual control wok burner
- 1 cast iron pan support – dishwasher safe
- Ignition via control dials

ER326BB70E Gas hob
black glass with stainless steel side trim

iQ 700



- 2 gas burners – includes 1 high speed and 1 standard
- 1 cast iron pan support – dishwasher safe
- Ignition via control dials

Domino hob accessories



Assembly kit – accessories code HZ394301.

Possible combinations:

When installing a domino unit right next to a hob, an assembly kit is required.

When installing two or more domino units side-by-side, one or more assembly kits are required. (2 units = 1 assembly kit, 3 units = 2 assembly kits, etc.)

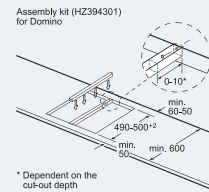

* Dependent on the cut-out depth

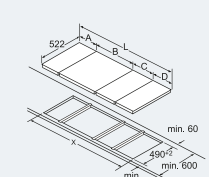
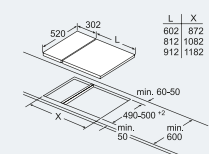
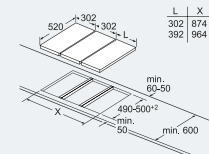
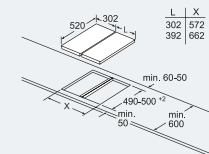

Measurements in mm. Line drawings are for reference only. Please download the latest installation guidelines from siemens-home.co.uk

Siemens can not accept responsibility for incorrect planning or installation as a result of the use of these line drawings.

Installation diagrams

EH975MV17E
EH975SZ17E
EH975SK11E

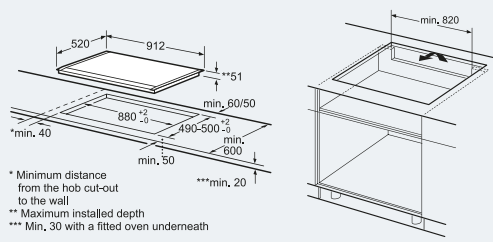

* Minimum distance from the hob cut-out to the wall
** Maximum installed depth
*** Min. 30 with a fitted oven underneath

EH675MV17E
EH679MN27E
EH675MN27E
EH675FE27E
EH651FV17E

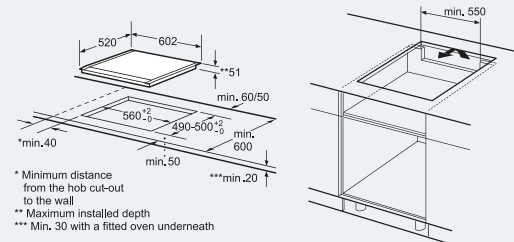

* Minimum distance from the hob cut-out to the wall
** Maximum installed depth
*** Min. 30 with a fitted oven underneath

EH601MV17E
EH601FE17E

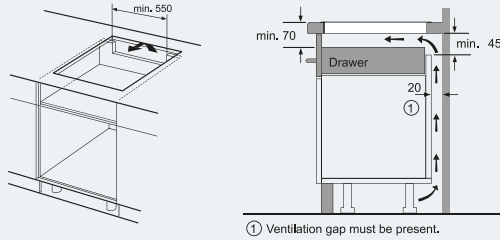

① Ventilation gap must be present.

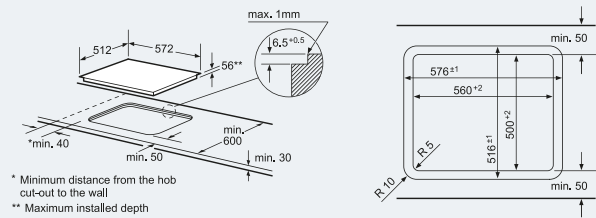

* Minimum distance from the hob cut-out to the wall
** Maximum installed depth

EH879SP17E
EH875MP17E
EH875FM27E

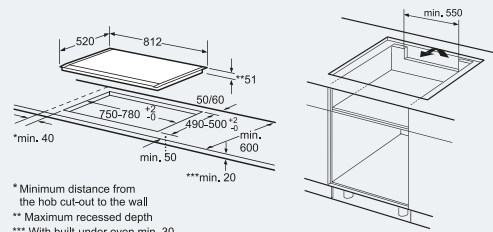

* Minimum distance from the hob cut-out to the wall
** Maximum recessed depth
*** With built-under oven min. 30

EH651BN17E
EH631BE18E
EH631BA68B
EH611BA18E

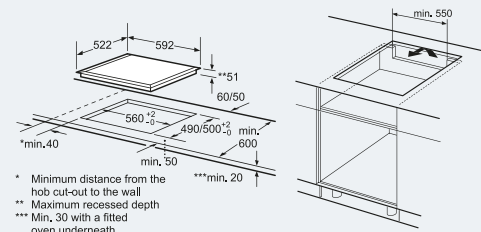

* Minimum distance from the hob cut-out to the wall
** Maximum recessed depth
*** Min. 30 with a fitted oven underneath

EH801FM17E

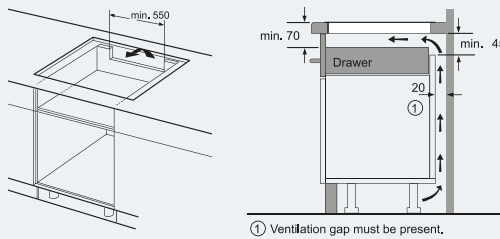

① Ventilation gap must be present.

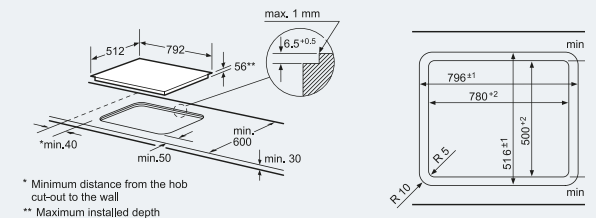

* Minimum distance from the hob cut-out to the wall
** Maximum installed depth

EH975ME11E

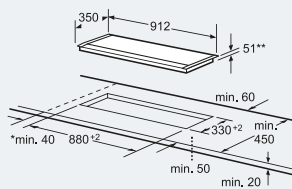

* Minimum distance from the hob cut-out to the wall
** Maximum recessed depth

EH845FL17E

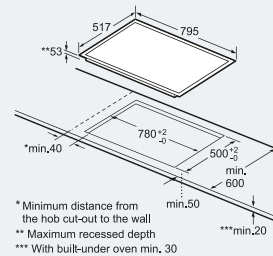

* Minimum distance from the hob cut-out to the wall
** Maximum recessed depth
*** With built-under oven min. 30

EH645FE17E

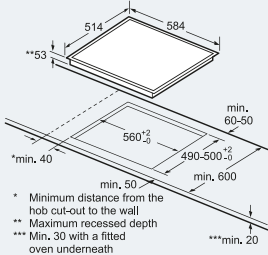

* Minimum distance from the hob cut-out to the wall
** Maximum recessed depth
*** Min. 30 with a fitted oven underneath

ET845BN17E

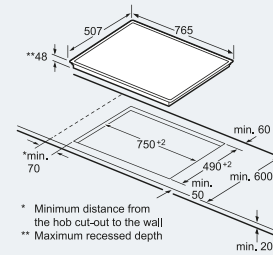

* Minimum distance from the hob cut-out to the wall
** Maximum recessed depth

ET645HF17E

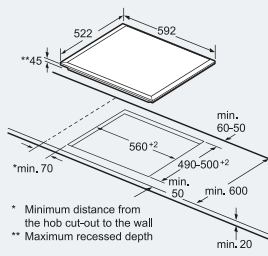

* Minimum distance from the hob cut-out to the wall
** Maximum recessed depth

ET651FC17E

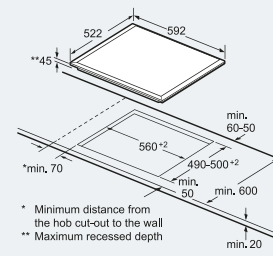

* Minimum distance from the hob cut-out to the wall
** Maximum recessed depth

Installation diagrams

<p>ET651HE17E EP916QB91E</p>	<p>* Minimum distance from the hob cut-out to the wall ** Maximum recessed depth</p>	<p>ER926SB70E</p>	<p>* Minimum distance from the hob cut-out to the wall ** Position of the gas connection in the cut-out</p>
<p>ER726RB71E</p>	<p>* Minimum distance from the hob cut-out to the wall ** Position of the gas connection in the cut-out</p>	<p>ER626PB70E</p>	<p>* Minimum distance from the hob cut-out to the wall ** Position of the gas connection in the cut-out</p>
<p>EP716QB91E</p>	<p>for installation flush with surrounding surfaces</p> <p>* Minimum distance from the hob cut-out to the wall ** Position of gas connection in the cut-out</p>	<p>EP616HB91E</p>	<p>for installation flush with surrounding surfaces</p> <p>* Minimum distance from the hob cut-out to the wall ** Position of gas connection in the cut-out</p>
<p>EC945TB91E</p>	<p>* Minimum distance from the hob cut-out to the wall ** Position of the gas connection in the cut-out</p>	<p>EC745RC90E EC715RB90E</p>	<p>* Minimum distance from the hob cut-out to the wall ** Position of the gas connection in the cut-out</p>
<p>EC645HC90E EC615PB90E</p>	<p>* Minimum distance from the hob cut-out to the wall ** Position of the gas connection in the cut-out</p>	<p>EB6B5HB60</p>	<p>* Minimum distance from the hob cut-out to the wall ** Position of gas connection in the cut-out</p>
<p>ET475MY11E</p>	<p>* Minimum distance from the hob cut-out to the wall ** Maximum recessed depth</p>	<p>EH375MV17E</p>	<p>* Minimum distance from the hob cut-out to the wall ** Maximum installed depth</p>
<p>ER326BB70E</p>	<p>* Minimum distance from the hob cut-out to the wall ** Position of the gas connection in the cut-out</p>	<p>ER326AB70E</p>	<p>* Minimum distance from the hob cut-out to the wall ** Position of the gas connection in the cut-out</p>

Hobs

Hoods

Outstanding performance,
intelligently designed.



Model shown: LD97AA670B downDraft hood.





Enjoy a fresher kitchen.



Tackle demanding food smells with intensive setting, which creates a powerful boost of extraction. **Model shown:** LC98KA570B.

The finishing touch for your kitchen, our iQ700 range of hoods benefit from a fully coordinated design with all other iQ700 appliances. They banish unwanted steam, grease and cooking smells efficiently. No more misted windows, or greasy surfaces – just fresh-smelling surroundings.

The technology built into Siemens iQ700 range of hoods eliminates grease, steam and odours, effortlessly and quietly from your cooking space. We know that a kitchen is not only a place to cook; it is a place to entertain, relax after a hard day's work, or spend time with friends and family. The powerful motors in our cooker hoods and the specially designed

housing mean an even quieter operation and fewer disturbances for you.

climateControl uses an ultra-sound sensor to detect the level of steam or air and adjusts the extraction power automatically. You can use the intensive setting to temporarily boost the extraction rate to cope with particularly demanding cooking conditions, for instance when stir-frying. Models that feature this will revert back to normal automatically after ten minutes so you don't have to remember to switch it back yourself.

Ideal for removing strong, lingering cooking odours like curry or fish, or simply to keep your kitchen fresh throughout the day the interval operation setting will turn the hood on to ventilate the kitchen for a couple of minutes every hour. Some models even have an automatic run-on facility, the hood works for an additional ten minutes to deal with any

With open plan living becoming more and more popular, a quiet, efficient and powerful extractor is necessary.

How to choose your hood.

With the trend for open-plan living, a quiet, efficient and powerful extractor is essential to deal with the strong cooking odours and grease-laden air that can otherwise linger throughout the house. There are two vital points to consider when choosing a hood, the first is whether you want the hood to be ducted or re-circulating, and the second is its power rating. Here are some helpful pointers.

Ducted or recirculated?

For optimum performance, your extractor hood should be ducted to the outside of the house, so that the extracted air is vented outside. But sometimes this is not practical, so most Siemens hoods can also operate in re-circulating mode; where the air is passed through the metal filter to remove grease, and then through a carbon filter to remove odours before being directed back into the kitchen. Although the extraction rate is slightly lower when using this method than ducted extraction and the carbon odour filter will need to be replaced, re-circulating the air offers an energy efficient benefit; cool air is retained in the home in the summer and warm air does not vent out during winter months.

The power to perform

A chosen hood must be powerful enough to effectively remove moisture and cooking odours from a kitchen. The hood should be able to change the air in the kitchen 10 times per hour. Using this quick calculation, consumers can check whether a hood is sufficiently powerful. Firstly, calculate the volume of the kitchen (HxWxD metres). Next multiply that figure by 10. The resulting figure is the ideal extraction rate required. Match this to a lower power level on the hood to avoid having to run at full power for increased efficiency.



Our hood range is also equipped with the energy-saving, powerful yet quiet and durable iQDrive motor, capable of handling smoke and grease in the most challenging cooking situations. Specially designed to last longer, the motor comes with a 10-year motor guarantee and a 5-year parts and labour guarantee.

For example

Room:
 $4\text{m} \times 4\text{m} \times 2.5\text{m} = 40\text{m}^3$

10 changes per hour:
 $10 \times 40\text{m}^3 = 400\text{m}^3/\text{h}$

So the hood must achieve
a minimum of $400\text{m}^3/\text{h}$.



Complete freedom to plan your kitchen.



The downDraft hood provides a modern extraction solution that perfectly integrates into your kitchen without compromising on design.

880 mm
Width

Hoods



With this style solution in mind, the new Siemens downDraft hood emerges and disappears with the touch of a button and with its convenient LED light strip aiming the focus on what you are cooking, no space is lost. Due to its unique design and placement, it not only catches all unwanted odours but it also catches every eye.

Space saving

Banish unwanted steam, grease and cooking smells from your kitchen, and not have to worry about where to place that unsightly hood. Siemens new downDraft hood is conveniently placed under the counter-top so unless you want to see it, the hood only needs to be on show when you are cooking.

LED illumination

Both illuminating your hob as well as making it an attractive feature, the downDraft hood features LED lights that can be turned on and off with the use of the extraction settings, or with the use of the softLight can be used to create ambiance in the kitchen.

Electronic touch controls

Beautifully designed the hood features control options that coordinate with Siemens iQ700 hobs and compact appliances; five control options with electronic touch controls. When you are busy cooking, you shouldn't have to stop to think about how your cooker hood works.



iQ 700

LD97AA670B

At a glance

- touchControl with digital display – for ease of use
- softLight with dimmer function – creates ambiance
- 1 x LED light strip
- 3 power settings
- 2 intensive settings – power boost for extra strong smells
- Grease and charcoal saturation indicators – time to change the filter
- Automatic after running – ensures no smells linger
- Auto intensive revert – keeps energy consumption low
- Max extraction rate: 510 m³/h
- Max noise level: 49 dBA re 20 Pa (power level 3 ducted circulation)

Go to pages 77-91 to view the whole range.

Exceptional extraction.

Ceiling hoods, the perfect space-saving solution.



This powerful but unobtrusive ceiling hood has the ability to free up valuable space in your kitchen and creates a beautiful integrated look. Additionally this stylish hood benefits from rim ventilation, remote control operation and uses energy-efficient, dimmable LED lights for a completely clean and modern look in your kitchen. Suitable for ducted installation.

1200 mm
Width



The freshness of outdoors in your kitchen... all day long

Smells and steam may still linger after you've finished cooking, which is where the automatic after running can assist. It continues running for 10 minutes after the hood is switched off, allowing you to dine in fresh-smelling surroundings.

Convenient remote control

Our ceiling hoods are operated via remote control, so it doesn't matter if it is out of reach. You also have the option to dim the LED lights with ease creating the perfect kitchen ambiance when entertaining.

The low-fat option for your kitchen

Our patented rim ventilation extracts air around the edges of an attractive dishwasher-safe steel cover that conceals the grease-collecting filters. Changing the filters is easy thanks to the convenient and secure cover mechanism.

The stylish solution to uncluttered and modern living.

iq 700

LF159RF50B

At a glance

- Remote control
- White electronic display
- Dimmer function
- Automatic intensive revert
- 2 filter cassettes
- Rim ventilation
- Max extraction rate: 480 m³/h
- Max noise level: 57 dBA re 20 µPa (power level 3 ducted circulation)

Go to pages 77-91 to view the whole range.

Energy efficient extraction.

iQ700 chimney hood, state-of-the-art efficiency.



Sleek designs allied with seriously innovative technology and energy efficiency, our chimney hoods are perfect for large, modern kitchens. Whether you choose the aesthetics of glass, angled or boxed, all iQ700 hoods are designed to match our iQ700 ovens and hobs. The iQ700 model highlighted below is much more than just a standard cooker hood. With the powerful yet energy efficient iQDrive motor, LED lights and electronic touch controls, this hood is perfect for anyone looking for a state-of-the-art high performance, energy saving chimney hood.

◀ 900 mm ▶
Width

Hoods



iQDrive motor ensures this hood requires little energy to run.

climateControl Sensor extracts unwanted steam and grease only when needed.

State-of-the-art efficiency

The LF91BA582B hood features innovative technology that saves energy. This is thanks to the highly efficient, durable brushless iQDrive motor which is powerful, but requires very little energy to run. The bright long-lasting LED lights also contribute to the energy savings whilst perfectly illuminating your cooking area.

touchSlider control

Allows your hood to fit in seamlessly with other Siemens appliances, adding to the individual style of your kitchen while being incredibly easy to use. There's also the added convenience of being able to easily see the current setting of your hood as well as having all options accessible at the touch of a finger.

Reduce your energy bills

Auto intensive revert automatically turns off the intensive setting if left idle. Lower energy consumption is not only good for reducing your carbon footprint, but will reduce your energy bills too.

iQ 700

LF91BA582B

At a glance

- Electronic control via Touch control
- 3 power levels and 2 intensive settings
- Boost function
- 4 x LED lights
- Grease filter saturation indicator – time to change the filter
- Automatic after running – ensures no smells linger
- Max extraction rate: 570 m³/h
- Max noise level: 63 dBA re 20 µPa (power level 3 ducted circulation)
- climateControl sensor – automatic power management

Go to pages 77-91 to view the whole range.

High-design easy access.

iQ700 angled chimney hood, striking and practical.



The eye-catching sleek design of our angled chimney hood range, allows them to be less intrusive when it comes to taking up space in a smaller kitchen. The high-design also makes for easier access to all areas of your hob, even the rear zones. The iQ700 hood below benefits from softLight with dimmer function, which creates beautiful atmospheric lighting for your kitchen. And, featuring a black glass canopy with electronic power display and steel filter covers for a truly striking hood.



The dimmer switch creates the perfect ambient lighting.

Illuminate your culinary creations in style

Adds to the ambiance of your kitchen, providing a soft and cool light in an area that can be difficult to illuminate. The dimmer switch allows the light to always compliment the atmosphere, creating the perfect evening accompaniment.

Stand out from the crowd

The eye-catching design of black glass is striking and will ensure that this hood will stand out and make a feature in any kitchen as well compliment and coordinate with other Siemens appliances.

Extra power to keep your kitchen smelling fresh

Intensive setting creates a powerful boost of extraction, perfect for tackling demanding food such as stir fry or steamed vegetables. This ensures moisture is properly eradicated, without misting windows and keeping the kitchen air fresher.

The final piece of
your fitted kitchen.

◀ 900 mm ▶
Width



iQ700

LC98KA570B

At a glance

- touchControl – for ease of use
- LED lights
- softLight with dimmer function – creates ambiance
- 3 power settings
- 1 x Intensive setting – power boost for stronger smells
- Automatic after running – ensure no smells linger
- Grease and charcoal filter saturation indicators – time to change the filter
- 1 x filter cassette
- Glass filter cover
- Rim ventilation
- Max extraction rate: 740 m³/h
- Max noise level: 44 dBA re 20 μPa (power level 3 ducted circulation)

Go to pages 77-91 to view the whole range.

Welcome to a range designed around you.

Your kitchen is not only a place to cook, it is a place to entertain, relax after a hard day's work, or spend time with friends and family.

Siemens hoods work hard to keep your kitchen space fresh, and full of cleaner air whilst also providing ambient lighting. Whether you choose a top-of-the-range iQ700 hood, the state-of-the-art downDraft hood, a classic chimney hood or something built-into your kitchen cupboards, all Siemens hoods come with a quiet and energy efficient motor so you can enjoy your living space.

iQ 700

Reserved for our premium hood range. iQ700 stands for exceptional design allied with seriously intelligent and innovative technology.

iQ 500

Exuding class and refinement, these machines unite first-class features with top-class technology.

iQ 300

Good looking appliances with Siemens build quality equipped with an attractive selection of smart features.

downDraft hood

Designer extraction.

LD97AA670B stainless steel

iQ 700



◀ 880 mm ▶
Width

- touchControl – experience intuitive control
- Electronic control and power level display
- 3 power levels
- 2 intensive settings – power boost for extra strong smells
- softLight with dimmer function – creates ambiance
- 1 x LED light strip
- Max extraction rate: 510 m³/h
- Max noise level: 49 dBA re 20 μPa (power level 3 ducted circulation)

Ceiling hoods

These powerful but unobtrusive, space saving hoods offer the added advantage of being stylish and functional.

LF159RF50B stainless steel

iQ 700



◀ 120 mm ▶
Width

- Remote control
- Dimmer function
- Automatic intensive revert
- 2 filter cassettes
- Rim ventilation
- Max extraction rate: 480 m³/h
- Max noise level: 57 dBA re 20 μPa (power level 3 ducted circulation)

LF959RA51B stainless steel

iQ 700



◀ 900 mm ▶
Width

- White electronic display
- Soft touch button control for extractor speeds and light
- For ceiling mounted installation
- Remote control
- Automatic after running (10 minutes)
- Grease filter saturation indicator
- Max extraction rate: 570 m³/h
- Max noise level: 63 dBA re 20 uPa

Ceiling hoods (continued)

LF959RB51B stainless steel

iQ 700



◀ 900 mm ▶
Width

- Electronic control via soft touch button control
- Remote control
- Intensive setting – power boost for extra strong smells
- 4 x 1W LED lights
- Automatic after running – ensure no smells linger
- Max. extraction rate: 570 m³/h
- Max noise level: 56 dBA re 20 μPa (power level 3 ducted circulation)

Island hoods

Choose an island hood with the wow-factor to make a feature of your cooking space.

LF91BA582B stainless steel

iQ 700



◀ 900 mm ▶
Width

- Electronic control via Touch control
- 3 power levels and 2 intensive settings
- Boost function
- 4 x LED lights
- Grease filter saturation indicator – time to change the filter
- Automatic after running – ensures no smells linger
- Max extraction rate: 570 m³/h
- Max noise level: 63 dBA re 20 μPa (power level 3 ducted circulation)

LF98GB542B stainless steel

iQ 500



◀ 900 mm ▶
Width

- Soft touch button control
- Electronic control and power level display
- 3 power levels
- 2 x intensive settings – for stronger smells
- 4 x LED lights
- softLight with dimmer function – creates ambiance
- Auto intensive revert – keeps energy consumption low
- Automatic after running – ensures no smells linger
- Grease and charcoal filter saturation indicators – time to change the filter
- Max extraction rate: 440 m³/h
- Max noise level: 44 dBA re 20 μPa (power level 3 ducted circulation)

Box chimney hoods

With sleek integrated lighting and softLight dimmer functions, Siemens boxed chimney hoods create ambiance in your living space whilst being functional.

LC98KA570B stainless steel and black glass

iQ 700



◀ 900 mm ▶
Width

- touchControl – experience intuitive control
- Electronic control and power level display
- LED lights
- softLight with dimmer function – creates ambiance
- 3 power levels
- Intensive setting – power boost for stronger smells
- Automatic after running – ensures no smells linger
- Grease and charcoal filter saturation indicators – time to change the filter
- Glass filter cover
- Max extraction rate: 740 m³/h
- Max noise level: 44 dBA re 20 µPa (power level 3 ducted circulation)

LC91KB672B stainless steel

iQ 700



◀ 900 mm ▶
Width

- White electronic display
- Touch control for extractor speeds and light
- For wall mounted installation
- Boost function
- Automatic after running (10 minutes)
- Grease filter saturation indicator
- Max extraction rate: 580 m³/h
- Max noise level: 62 dBA re 20 µPa

LC98KC652B stainless steel and black glass

iQ 700



◀ 900 mm ▶
Width

- Soft touch button control
- Electronic control and power level display
- 3 power levels
- 2 x intensive settings – for stronger smells
- 2 x LED lights
- softLight with dimmer function – creates ambiance
- Auto intensive revert – keeps energy consumption low
- Grease and charcoal filter saturation indicators – time to change the filter
- Max extraction rate: 420 m³/h
- Max noise level: 44 dBA re 20 µPa (power level 3 ducted circulation)

Box chimney hoods (continued)

LC98GA572B stainless steel

iQ 700



◀ 900 mm ▶
Width

- Touch control for extractor speeds and light
- 2 intensive settings – power boost for stronger smells
- Automatic after running – ensure no smells linger
- Grease and charcoal filter saturation indicators – time to change the filter
- 2 x LED lights
- softLight with dimmer function – creates ambiance
- Max extraction rate: 430 m³/h
- Max noise level: 58 dBA re 20 µPa (power level 3 ducted circulation)

LC98GB542B stainless steel, 900mm
LC68GB542B stainless steel, 600mm

iQ 500



◀ 900 mm ▶ ▶ 600 mm ▶
Width Width

- Soft touch button control
- Electronic control and power level display
- 3 power levels
- 2 intensive settings – for stronger smells
- LED lights
- softLight with dimmer function – creates ambiance
- Auto intensive revert – keeps energy consumption low
- Automatic after running – ensures no smells linger
- Grease and charcoal filter saturation indicators – time to change the filter
- Max extraction rate: 510 m³/h
- Max noise level: 47 dBA re 20 µPa (power level 3 ducted circulation) – LC98GB542B
- Max noise level: 48 dBA re 20 µPa (power level 3 ducted circulation) – LC68GB542B

LC97GB532B stainless steel, 900mm
LC67GB532B stainless steel, 600mm

iQ 300



◀ 900 mm ▶ ▶ 600 mm ▶
Width Width

- Backlit push button control
- 3 power levels
- Intensive setting – for stronger smells
- LED lights
- Metal grease filter – dishwasher safe
- iQDrive – innovative noise reduction motor technology
- Auto intensive revert – keeps energy consumption low
- Max extraction rate: 440 m³/h
- Max noise level: 45 dBA re 20 µPa (power level 3 ducted circulation) – LC97GB532B
- Max noise level: 55 dBA re 20 µPa (power level 3 ducted circulation) – LC67GB532B

Box chimney hoods (continued)

LC94GB522B stainless steel, 900mm
LC64GB522B stainless steel, 600mm

iq 100

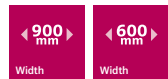

- Rocker switch control
- 3 power levels
- 2 x halogen lights
- Metal grease filter – dishwasher safe
- Max extraction rate: 450 m³/h
- Max noise level: 48 dBA re 20 µPa (power level 3 ducted circulation) – (LC94GB522B/LC64GB522B)

Chimney extractor hoods

LC91BA582B stainless steel

iq 700



- Electronic control and white electronic display
- 3 power levels
- 2 intensive settings
- Automatic after running – ensure no smells linger
- Grease filter saturation indicators
- 3 x LED lights
- softLight with dimmer function – creates ambience
- Max extraction rate: 690 m³/h
- Max noise level: 71 dBA re 20 µPa (power level 3 ducted circulation)

LC98BA572B stainless steel, 900mm
LC68BA572B stainless steel, 600mm

iq 700

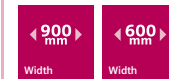

- lightControl soft touch keys with illuminated retractable control dial
- Electronic control via touch control
- 3 power levels
- 2 intensive settings
- Automatic after running – ensure no smells linger
- Grease filter saturation indicators
- 2 x LED lights
- softLight with dimmer function – creates ambience
- Max extraction rate: 760 m³/h
- Max noise level: 72 dBA re 20 µPa (power level 3 ducted circulation)

Chimney extractor hoods (continued)

LC97BF532B stainless steel, 900mm
LC67BF532B stainless steel, 600mm

iq 700

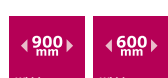

- Soft touch button control
- Electronic control and power level display
- 3 power levels
- Intensive setting – for stronger smells
- 3 x LED lights (90cm)
- 2 x LED lights (60cm)
- Auto intensive revert – keeps energy consumption low
- Max extraction rate: 460 m³/h (LC97BF532B)
- Max noise level: 55 dBA re 20 µPa (power level 3 ducted circulation)

LC97WA532B stainless steel, 900mm
LC77WA532B stainless steel, 700mm
LC67WA532B stainless steel, 600mm

iq 300



- Soft touch button control
- Electronic control and power level display
- 3 power levels
- Intensive setting – for stronger smells
- LED lights
- Metal grease filter – dishwasher safe
- Auto intensive revert – keeps energy consumption low
- Max extraction rate: 460 m³/h (LC97WA532B)
- Max extraction rate: 440 m³/h (LC77WA532B/LC67WA532B)
- Max noise level: 40 dBA re 20 µPa (power level 3 ducted circulation) LC97WA532B
- Max noise level: 44 dBA re 20 µPa (power level 3 ducted circulation) LC77WA532B/LC67WA532B

LC97BE532B stainless steel, 900mm
LC77BE532B stainless steel, 700mm
LC67BE532B stainless steel, 600mm

iq 300



- Backlit push button control
- 3 power levels
- Intensive setting – for stronger smells
- LED lights
- Metal grease filter – dishwasher safe
- Auto intensive revert – keeps energy consumption low
- Durable brushless motor – energy saver
- Max extraction rate: 460 m³/h (LC97BE532B)
- Max extraction rate: 440 m³/h (LC77BE532B/LC67BE532B)
- Max noise level: 40 dBA re 20 µPa (power level 3 ducted circulation) – LC97BE532B
- Max noise level: 44 dBA re 20 µPa (power level 3 ducted circulation) – LC77BE532B/LC67BE532B

Chimney extractor hoods (continued)

LC94BA521B stainless steel, 900mm
LC64BA521B stainless steel, 600mm

iQ 100



- Rocker switch control
- 3 power levels
- Halogen lights
- Metal grease filter – dishwasher safe
- Max extraction rate: 450 m³/h
- Max noise level: 48 dBA re 20 µPa (power level 3 ducted circulation) – (LC94BA521B/LC64BA521B)

LC94WA521B stainless steel, 900mm
LC74WA521B stainless steel, 700mm LC64WA521B stainless steel, 600mm

iQ 100

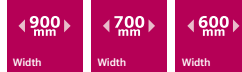

- Rocker switch control
- 3 power levels
- Halogen lights
- Metal grease filter – dishwasher safe
- Max extraction rate: 400 m³/h
- Max noise level: 51 dBA re 20 µPa (power level 3 ducted circulation) – (LC94WA521B/LC74WA521B/LC64WA521B)

Telescopic hoods

Extremely functional and the perfect solution if you would rather keep the sleek, clean and continual lines in your kitchen.

LI49632GB metallic silver

iQ 700



- For installation in a 600mm wide kitchen cabinet
- Soft touch button control
- varioControl panel – can be fitted separately
- 3 power levels
- Intensive setting – power boost for stronger smells
- Halogen lights
- softLight with dimmer function – creates ambiance
- Automatic after running – ensures no smells linger
- Grease and charcoal filter saturation indicators – time to change the filter
- Max extraction rate: 450 m³/h
- Max noise level: 43 dBA re 20 µPa (power level 3 ducted circulation)

LI46931GB metallic silver

iQ 500



- Slider switch control
- Steel finish profile/handle
- 3 power levels
- Intensive setting – power boost for stronger smells
- Halogen lights
- Grease and charcoal filter saturation indicators – time to change the filter
- Metal grease filter – dishwasher safe
- Max extraction rate: 450 m³/h
- Max noise level: 47 dBA re 20 µPa (power level 3 ducted circulation)

Telescopic extractor hoods

Keep the sleek, clean and continual lines in your kitchen.

LI46631GB metallic silver

iq 500



600 mm

Width

- Slider switch control
- Steel finish profile/handle
- 3 power levels
- Intensive setting – power boost for stronger smells
- Halogen lights
- Grease and charcoal filter saturation indicators – time to change the filter
- Metal grease filter – dishwasher safe
- Max extraction rate: 450 m³/h
- Max noise level: 47 dBA re 20 μPa (power level 3 ducted circulation)

LI23031GB metallic silver

iq 300



598 mm

Width

- Steel finish profile/handle
- Rocker switch control
- 3 power levels
- 40W lights
- Metal grease filter – dishwasher safe
- Max extraction rate: 400 m³/h
- Max noise level: 52 dBA re 20 μPa (power level 3 ducted circulation)

Integrated extractor hoods

For installation between cupboard walls.

LE64130GB metallic silver

iq 100



900 mm

Width

- Rocker switch control
- 3 power levels
- 40W lights
- Dishwasher safe metal grease filters
- Max extraction rate: 360 m³/h
- Max noise level: 50 dBA re 20 μPa (power level 3 ducted circulation)

Integrated extractor hoods (continued)

LE62031GB metallic silver, 600mm

iq 100



600 mm

Width

- Rocker switch control
- 3 power levels
- 40W lights
- Dishwasher safe metal grease filters
- Max extraction rate: 260 m³/h
- Max noise level: 54 dBA re 20 μPa (power level 3 ducted circulation)

Canopy extractor hoods

Siemens built-in canopy hoods, designed for installation in a modified cupboard, above a hob.

LB79585GB stainless steel

iq 700



700 mm

Width

- Electronic control
- 3 power levels
- 2 lights
- Washable synthetic grease filter
- Max extraction rate: 570 m³/h

LB78574GB stainless steel, 700mm
LB57574GB stainless steel, 520mm

iq 500



700 mm

Width

520 mm

Width

- 3 power levels
- 2 lights
- Washable synthetic grease filter
- Max extraction rate: 630 m³/h – LB78574GB
- Max extraction rate: 560 m³/h – LB57574GB

Canopy extractor hoods (continued)

LB75564GB metallic silver, 700mm
LB55564GB stainless steel, 530mm

IQ 300



700
mm

Width

530
mm

Width

- Slider switch control
- 3 power levels
- Intensive setting – power boost for stronger smells
- Halogen lights
- Metal grease filter with aluminium trim
- Max extraction rate: 400 m³/h
- Max noise level: 47 dBA re 20 µPa (power level 3 ducted circulation) – LB75564GB
- Max noise level: 45 dBA re 20 µPa (power level 3 ducted circulation) – LB55564GB

LB23364GB metallic silver

IQ 100



530
mm

Width

- Rocker switch control
- 2 power levels
- Intensive setting – power boost for stronger smells
- 40W lights
- Max extraction rate: 210 m³/h

Installation diagrams

LD97AA670B

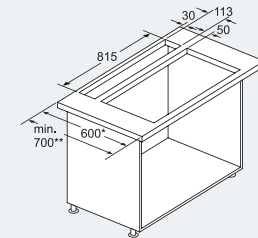
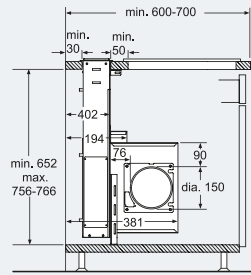
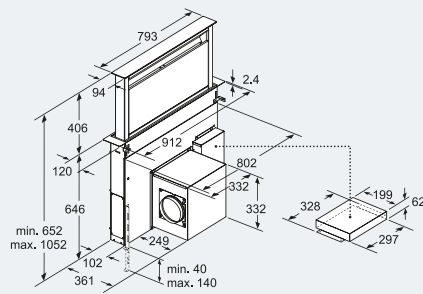

* 600 mm depth only in combination with slim hobs.
** min. 700 mm for hobs with 500 mm cut-out depth.

LF159RF50B

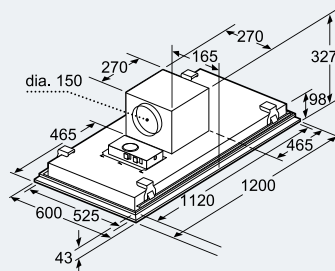

measurements in mm

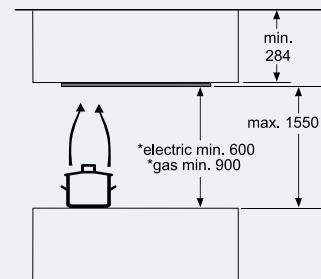

* from upper edge of pan support
measurements in mm

LF959RA51B

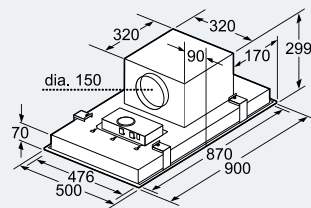

measurements in mm

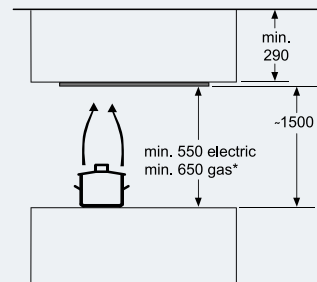

* from upper edge of pan support
measurements in mm

Installation options

The ceiling hood is designed to be a fitted flush ceiling installation. If the ceiling is not suitable for flush fitting, the hood can be integrated into a specially designed suspended ceiling.

LF959RB51B

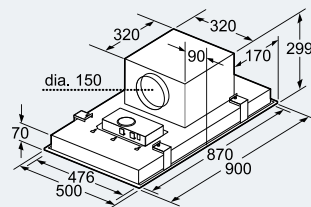

measurements in mm

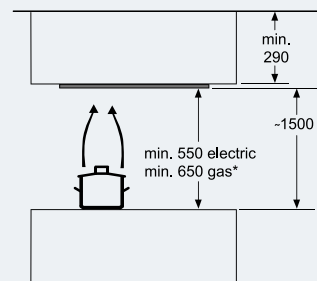

* from upper edge of pan support
measurements in mm

Installation options

The ceiling hood is designed to be a fitted flush ceiling installation. If the ceiling is not suitable for flush fitting, the hood can be integrated into a specially designed suspended ceiling.

Installation diagrams

LF91BA582B

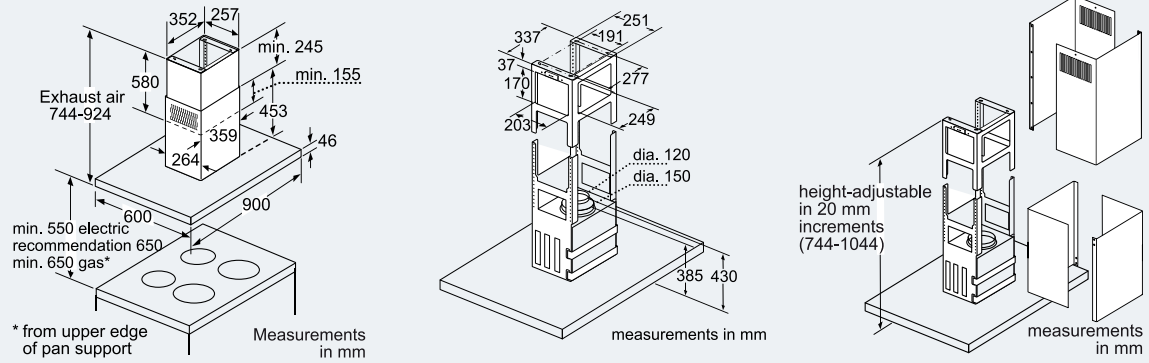

LF98GB542B

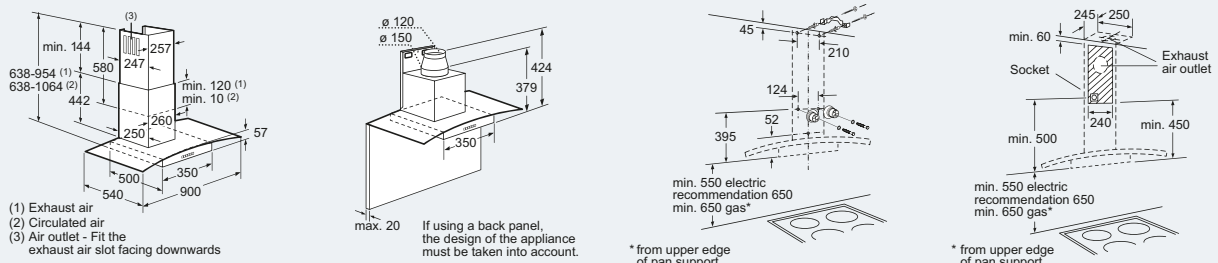

LC98KA570B

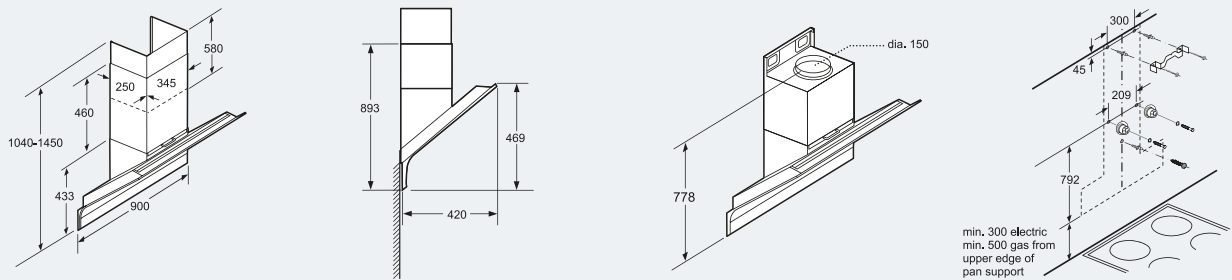

LC91KB672B

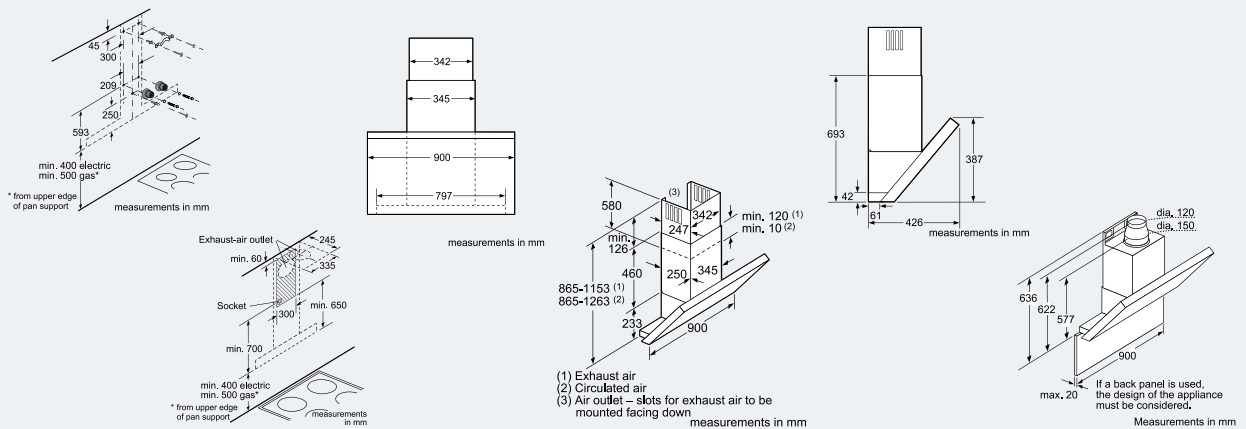

Installation diagrams

LC98KC652B

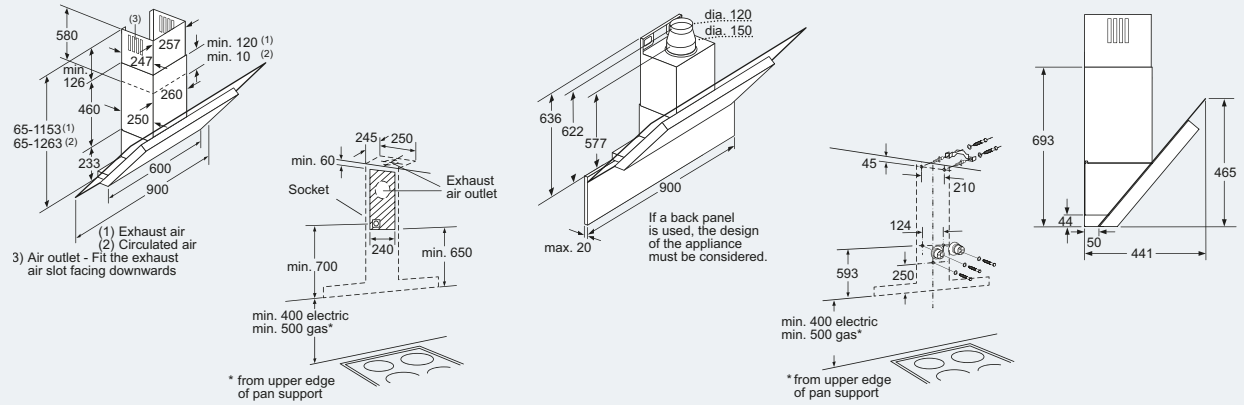

LC98GA572B

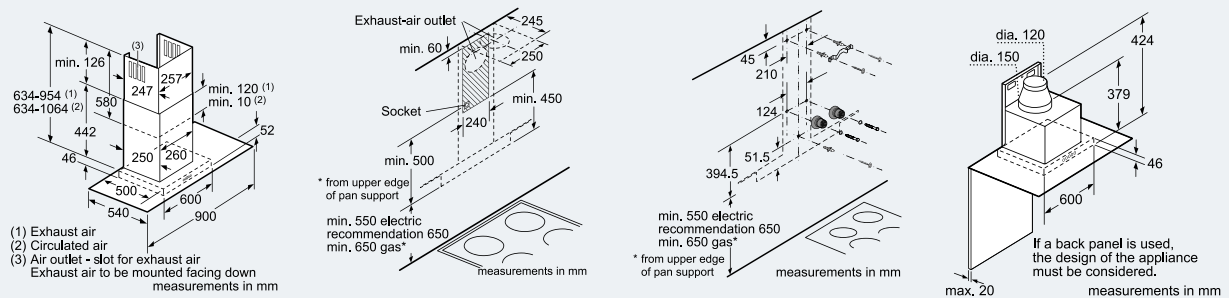

LC97GB532B
LC98GB542B
LC94GB522B

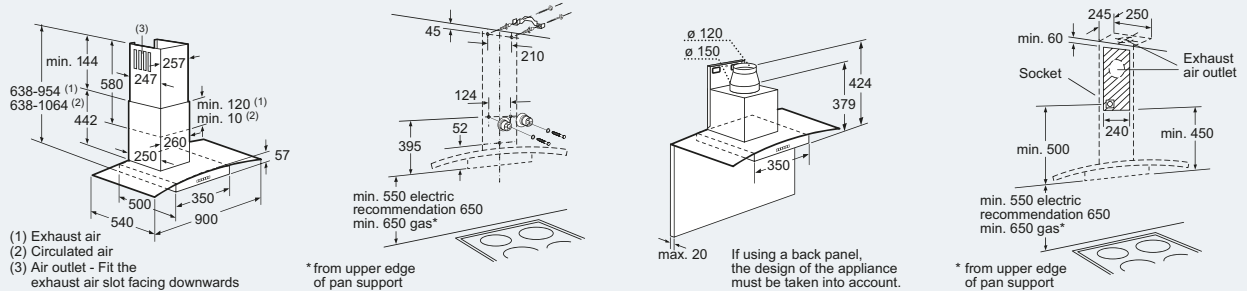

LC68GB542B
LC67GB532B
LC64GB522B

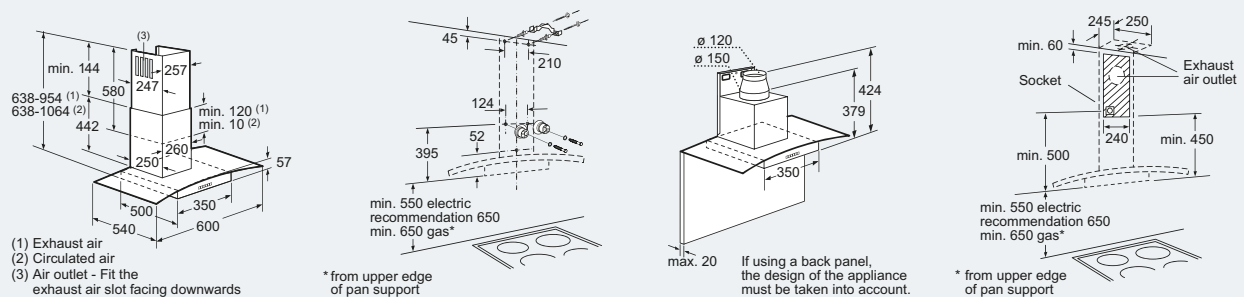

Installation diagrams

LC68BA572B
LC97BF532B
LC67BF532B
LC91BA5F2B
LC98BA572B

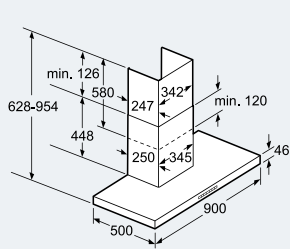

measurements in mm

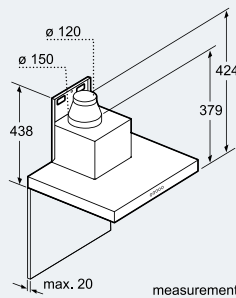

measurements in mm

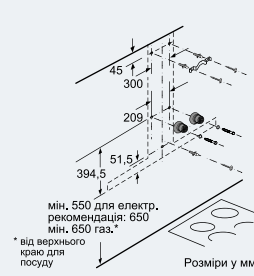

Розміри у мм

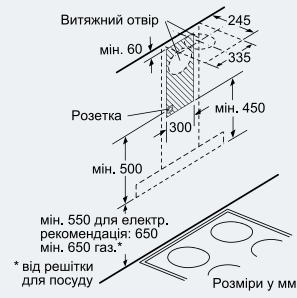

Розміри у мм

LC97WA532B
LC77WA532B
LC67WA532B

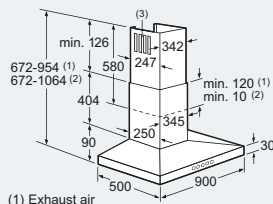

- (1) Exhaust air
- (2) Circulated
- (3) Air outlet - For exhaust air, fit with the slots facing downwards

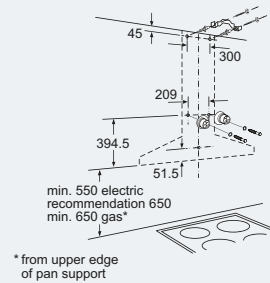

* from upper edge of pan support

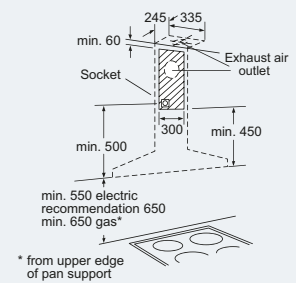
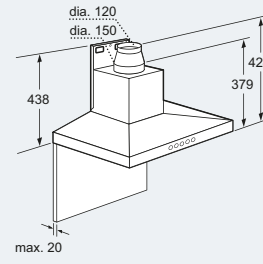

* from upper edge of pan support

LC97BE532B
LC77BE532B
LC67BE532B

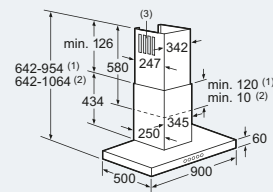

- (1) Exhaust air
- (2) Circulated air
- (3) Air outlet - install with vent at bottom for exhaust air

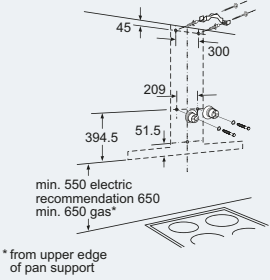

* from upper edge of pan support

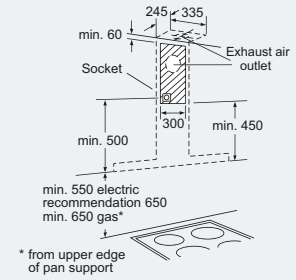
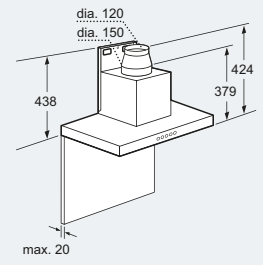

* from upper edge of pan support

LC94BA521B
LC64BA521B

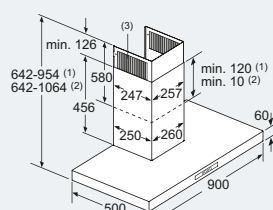

- (1) Exhaust air
- (2) Circulated air
- (3) Air outlet - slots for exhaust air to be mounted facing down

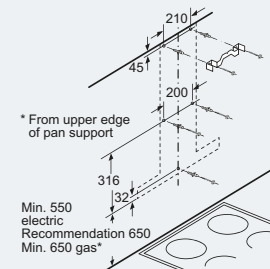

* From upper edge of pan support

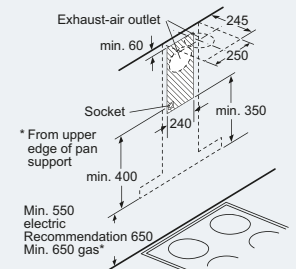
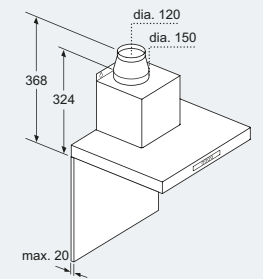

* From upper edge of pan support

Installation diagrams

LC94WA521B
LC74WA521B
LC64WA521B

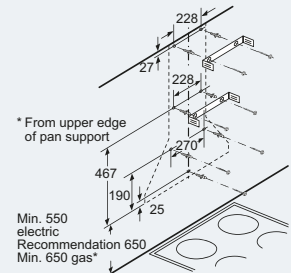
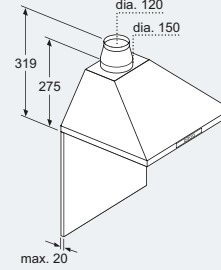
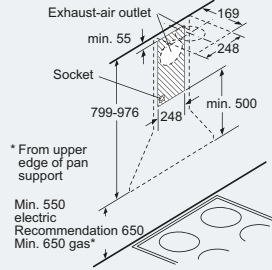
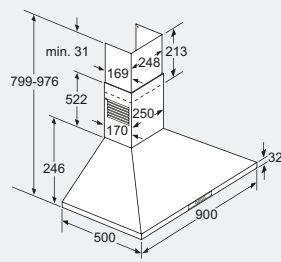

LI49632GB

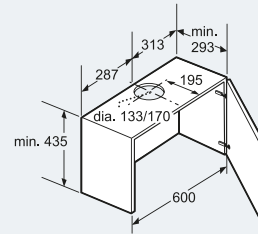
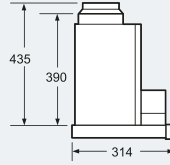
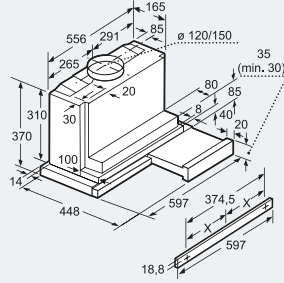

LI46931GB

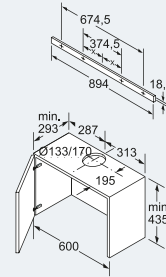
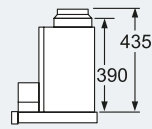
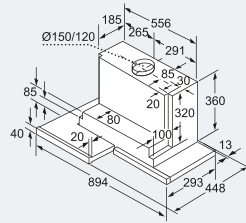

LI46631GB

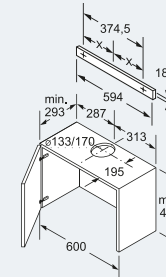
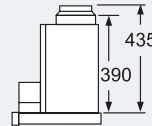
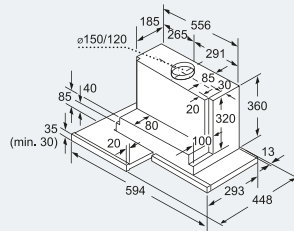

LE64130GB
LE62031GB

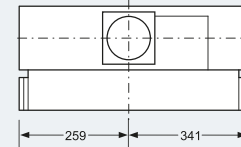
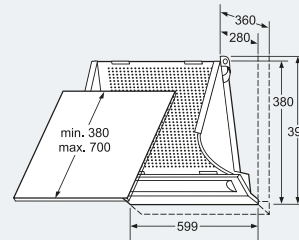
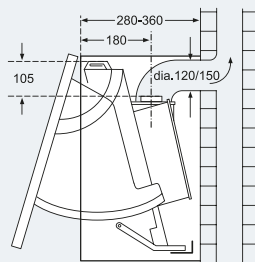

LI23031GB

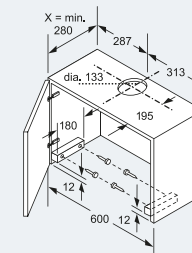
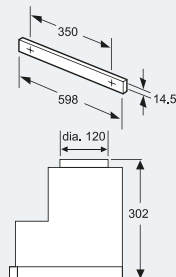
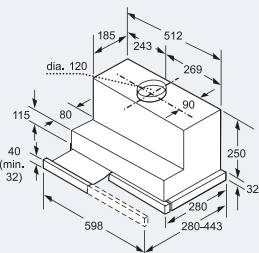

Installation diagrams

LB79585GB
LB78574GB

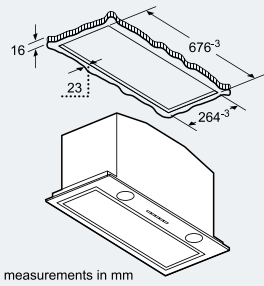

measurements in mm

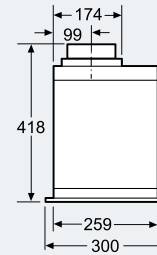
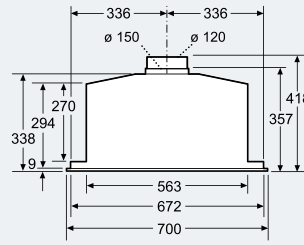

LB57574GB

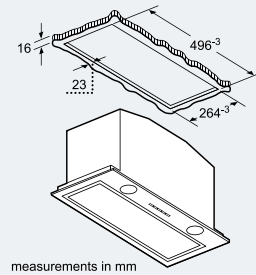
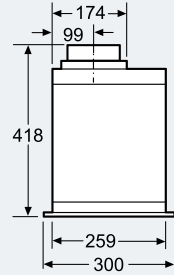

measurements in mm

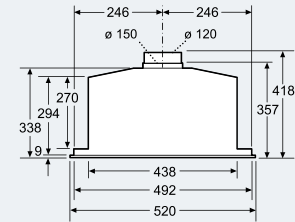

measurements in mm

LB75564GB

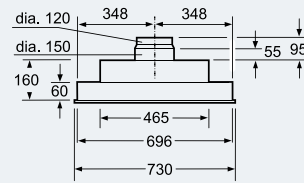
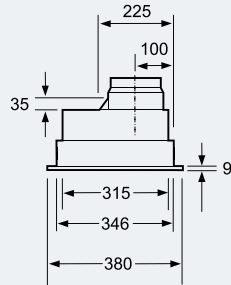

measurements in mm

LB55564GB

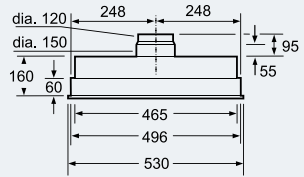
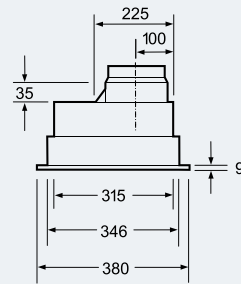

measurements in mm

LB23364GB

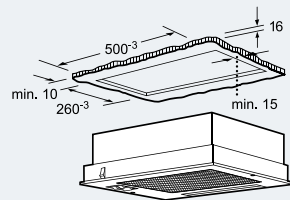

measurements in mm

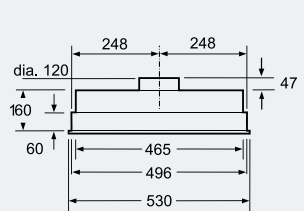

measurements in mm

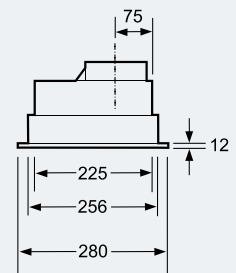



Quick wash 40°C
4:12:45
SIEMENS



Hoods

Cooling

Super efficient, super stylish.





Models shown: aCool wine cabinet CI24WP02, aCool freezer with indoor ice and water dispenser FI24DP32, aCool fridge CI30RP01.

The perfect environment for fresh food.

Food preservation technologies that mean you can store a lettuce for up to 20 days and it will still taste as fresh as the day you bought it.



Above (from top to bottom): hydroFresh drawer, vitaFresh drawer, freshProtect box.

There's nothing worse than stocking your fridge full of fresh food, only to find that a few days later it is no longer edible. Saving you time and money Siemens fridge freezers feature new technology that is going to prolong the life of your fresh produce, meaning there will be fewer trips to the supermarket so you can enjoy your favourite foods for longer.

These benefits include; keeping your food at the correct temperature, locking in the nutrients with our innovative hydroFresh drawer, and the airFresh filter that helps to separate the smells in your fridge meaning no cross contamination between sweet and savoury foods. A Siemens fridge freezer is the smartest way to preserve your food.



Fresh food up to three times longer

Keeping foods fresher for up to 3 times as long compared to a conventional vegetable drawer. The "dry" zone and "dewpoint" zone within vitaFresh drawers determine how much humidity food receives. Storing meat and dairy at their optimum humidity creates less food wastage and cuts down on your food bills.



Preserves food up to twice as long

Fresh food can last twice as long as it would in a standard vegetable drawer in the Siemens hydroFresh drawer. With an innovative humidity control, the drawer keeps minerals and nutrients in vegetables, salad and fruit for longer, increasing their use by date – saving you time and money.



Fridge freezer KI87SAF30G.



Technology never tasted so good

A box in the fridge with an individual temperature control; freshProtectbox can be set to 0°C for meat and fish, 2°C for milk products and 4°C for fruit and vegetables, providing the optimum temperature for individual foods, allowing them to stay fresher for longer. Fresh ingredients are the basis for delicious meals, but also count for less wastage and fewer trips to the supermarket.



Ideal storage for meat and fish

Ideal for storing meat and fish, the coolBox creates an environment that is almost 3°C cooler than the rest of the fridge. The coolBox stores meat and fish at the optimum preservation temperature, whilst allowing other food in the fridge to be chilled at around 4°C. Food tastes better for longer and there is less food wastage.

Keeps food smells separate

Shelves separate food, the airFresh filter separates smells, ensuring that the fridge smells fresh at all times. The filter neutralises odours in the fridge, ensuring that smells don't transfer between foods, while the anti-microbial filter stops the transfer of germs and bacteria. Sweet and savoury can sit side-by-side and you can enjoy a fresh smelling fridge every time you open the door.

Optimum temperature guaranteed

Monitoring the temperature of the room, sensors in the fridge detect how much power is needed to maintain optimum fridge and freezer temperatures. Less fluctuation in temperature ensures food is stored safely and also helps to make sure only the energy needed is used. Food preservation and energy-efficiency go hand-in-hand with vitaControl.

Freshness at its best.

Longer lasting food is good for the environment.

Research shows that UK households are throwing away £12 billion worth of food every year. That means the average household with children throws away about £50 worth of food and drink a month.* Thanks to the advanced technology in Siemens refrigeration appliances, food stays fresher for longer.



For example the hydroFresh vegetable drawer, which is available on many of our built-in fridge freezers, maintains the correct humidity of the contents. This means fruit and vegetables can

be kept for up to twice as long, giving you longer to use them. Ensuring you get more out of the food you buy and waste less.

coolBox – Food storage times		
Meat	Max. storage time (days)	Handling recommendation
Beef	5	Keep in original packaging, cover tightly
Poultry	3 – 5	
Game	5	
Lamb	3 – 5	
Pork	3 – 5	
Minced meat	1	
Meat products	Max. storage time (days)	Handling recommendation
Cold cuts	5 – 7	Keep in original packaging, cover tightly
Sausages	5 – 7	
Cooked leftovers	3 – 5	Store in plastic or glass container, cover tightly, refrigerate quickly

vitaFresh – Food freshness	
Food type	Freshness (days)
Yoghurt	30
Sushi	2
Stoned fruit	30
Raspberries	5
Cherries	14
Carrots	150
Lettuce	20
Pears	90
Asparagus	14
Mushrooms	7
Strawberries	7
Salmon	3
Poultry	5
Gruyère	14
Gouda	21
Roquefort	14



Cooling

Designed for an easy life.



easyLift shelves – even when full, you can raise or lower the shelf.

Although they may be behind closed doors Siemens elegant and functional range of built-in fridge freezers are going to become the talking point in any kitchen.

Whether its an American-style fridge freezer that has the wow-factor; an aCool appliance that allows you to create your own bespoke designs; stand alone, or undercounter option that is going to save space, Siemens has a wide range to choose from. Energy efficient, our appliances are packed with flexible storage solutions and technologies that are going to suit your hectic lifestyle.

With noFrost technology you'll never have the job of defrosting the freezer again.



You never need to defrost the freezer again

Who has time to defrost the freezer? Those with a Siemens noFrost freezer do, because there simply is no need to. Using an air circulation system to remove humidity and stop frost and ice building up on the freezer walls and packaging your freezer will look after itself. No longer will you have to run-down your freezer to defrost and remove the ice build-up. Hassle free, you can enjoy fresher food, no more soggy packaging and a frost free freezer for life.



Because life's too short

For those models that come with lowFrost, life is still made easier. lowFrost reduces the build-up of frost by up to 50%, meaning that you don't need to defrost the freezer as often, only once every 18 months to 2 years. Designed to save you time and provide added convenience, you can spend your time on the things you enjoy, not defrosting your freezer.

With noFrost technology you'll never have the job of defrosting the freezer again.



Cooling

Model shown: aCool fridge freezer CI36BP01.



Models shown: coolConcept freezer GI38NP60, coolConcept fridge KI42FP60.



Minimum energy consumption 24/7, 365 days a year.

We are committed to developing energy saving technology that makes a difference.



Packed with ingenious and energy efficient solutions, a Siemens appliance is perfectly designed for your convenience and practicality. Not only is it going to do what you expect, there is so much more that you don't see, including the environmental benefits. Perhaps the most important energy efficiency technology is that designed to keep your food fresher for longer. Storing foods at their optimum humidity and temperature creates less food wastage, meaning fewer trips to the supermarket, cutting down on your food bills.

Keeping food at the optimum temperature the multiAirflow System helps to circulate air around the fridge evenly, meaning that temperatures on all shelves are maintained.

Ensuring freshness as well as saving energy the multiAirflow System cools down new warmer food entering the fridge 40% faster than a standard fridge as the motor doesn't need to work as hard to cool the fridge down.

When you're on holiday or a long business trip Holiday Mode will ensure that your food in the freezer stays cold enough to maintain freshness whilst reducing energy output – saving you money, and helping the environment. Our fridges also feature a warning alarm that signals you when the fridge door has been left open, ensuring that energy isn't needlessly wasted and preserving the food inside, both are saving you money and energy usage.



Superb styling, superb freshness.



Unique storage solutions.



Bespoke combinations to suit your needs.



In-door ice and water dispensers.

Although they may be behind closed doors our elegant and functional range of built-in fridge freezers are going to become the talking point of any kitchen. Whether its an American-style fridge freezer that has the wow-factor; stand alone, or under counter option that is going to save space, Siemens has a wide range to choose from. Energy efficient, our appliances are packed with food preservation and flexible storage solutions that are going to suit consumers hectic lifestyles.

Individual flare

For professional quality storage and care of wine, both white and red, choose the elegant and stylish aCool wine cabinet. Great for showing off large collections, there is room for 98 bottles, all beautifully presented and conveniently accessible on telescopic storage shelves, and with two independently adjustable temperature controls the system can accurately maintain temperatures from 5°C to 18°C.

Sophisticated storage, stunning functions

With a digital display that keeps consumers informed of the precise temperature and helps navigate easily through the operating menus, a door sensor that sets off a warning alarm if the door is left open for any reason; aCool appliances from Siemens feature top of the range technologies.

Seamlessly integrated into the sidewall of the fridge for maximum illumination and no loss of fridge space, the LED lighting is both energy efficient and practical. While the conveniently placed in-door ice and water dispenser featured in certain aCool freezers delivers chilled water, crushed ice and ice cubes at the touch of a button.



aCool appliances allow you to create bespoke designs, suiting individual tastes and making kitchens unique to you.

Individual flare.

Show your individual side with aCool appliances, bespoke designs to suit your individual taste.



With a digital display that keeps you informed of the precise temperature and helps you to navigate easily through the operating menus, a door sensor that sets off a warning alarm if the door is left open for any reason and an eco mode which can be selected to save energy; the aCool appliances from Siemens features top of the range technologies.



Technology never tasted so good

The freshProtectbox provides the optimum temperature for individual foods, allowing them to stay fresher for longer. Fresh ingredients are the basis for delicious meals, but also count for less wastage and fewer trips to the supermarket – saving you time and money.

Precision control at the touch of a button

With easy to use electronic controls Siemens fridge freezers never leave you in the dark. The electronic display allows you to precisely set and change the temperature of your fridge and freezer and select certain modes, such as Eco and Holiday Mode, at your finger tips.

Refreshing ice-cool water, whenever you want it

Filtered cold water and ice at the touch of a button. The chilled water and ice dispenser is a convenient time saver, serving a refreshing drink whenever you want.



iQ 700 CI24RP01

At a glance

- Dimensions (cm): 213x60x61
- Noise level: 40dB
- freshProtectbox – individual control for longer freshness
- 2 humidity controlled drawers on telescopic rails
- superCool – newly added food is cooled quickly and safely
- 4 glass shelves – 3 height adjustable for added flexibility
- LED light – illuminates interior so no food is hidden
- multiAirflow – improves circulation around the fridge
- softClose door – provides smooth, effortless closure

Go to pages 109-119 to view the whole range.



iQ 700 FI24DP32

At a glance

- Dimensions (cm): 213x60x61
- Noise level: 41dB
- noFrost – never defrost the freezer again
- Indoor ice and water dispenser
- multiAirflow – improves circulation around the freezer
- softClose door – provides smooth, effortless closure

Go to pages 109-119 to view the whole range.

Style statement.

Impress your friends with the stunning aCool fridge freezer, brimming with style and top-class features.



Packed with the latest innovations this stylish iQ700 fridge freezer is going to keep your food fresher for longer with a multiAirflow system that improves the circulation of air around the fridge and freezer and noFrost technology that is going to leave your freezer, frost free for life.



Food preservation storage solutions.

Excellent food preservation systems as standard

The multiAirflow system moderates the fridge temperature when new food is added, cooling down food 40% faster than a standard fridge. Well cared for ingredients help to make delicious meals... get ready to impress your friends.

Shelves separate food. The airFresh filter separates smells

The airFresh filter neutralises odours in the fridge, ensuring that smells don't transfer between foods. Enjoy a fresh smelling fridge every time you open the door.

Ice and a slice?

Positioned inside the fridge freezer drawer, the ice cube maker can produce up to 1.8kg of ice cubes in 24 hours! Perfect for dinner parties and social occasions.



Cooling

iQ700

CI36BP01

At a glance

- Dimensions (cm): 213x91x61
- Noise level: 42dB
- noFrost – never defrost the freezer again
- 3 humidity controlled drawers on telescopic rails
- superCool – newly added food is cooled quickly and safely
- 3 glass shelves – 2 height adjustable for added flexibility
- Freezer drawers – pantry style design on telescopic rails
- Internal ice maker
- LED light – illuminates interior so no food is hidden
- multiAirflow – improves circulation around the fridge
- softClose door – provides smooth, effortless closure

Go to pages 109-119 to view the whole range.

Serious refrigeration just got seriously cool.

Show off your wine collection.

Beautifully presented and conveniently accessible storage for all wines.



A perfect addition to other aCool appliances, our full height aCool wine cabinet stores up to 98 bottles whilst adding glamour and individuality to your kitchen. Though if your collection is not so vast, we also offer a wineCooler, in the built-in cooling range, which can hold up to 32 bottles.



Professional quality storage and care of wine

Great for showing off your collection, there is room for 98 bottles (of 0.75 litres), all beautifully presented and conveniently accessible on telescopic storage drawers, and with two independently adjustable temperature controls the system can accurately maintain temperatures from 5°C to 18°C.

Elegant and practical lighting

To further highlight your collection of fine wines, the interior of the wine cabinet has elegant, energy efficient LED lights. Which not only provide ambiance in the kitchen but allow for maximum illumination, so you can be sure you choose the correct wine for dinner.

The acoustic door warning signal ensures you're in control

The acoustic door open warning signal alerts you if the door has been left ajar, or if there is no power getting to the fridge. Both energy and wine are safe from being needlessly wasted, saving you money.

Professional storage for your wine collection.



iq 700

CI24WP02

At a glance

- Dimensions (cm): 213x60x61
- Noise level: 42dB
- LED light – illuminates interior so nothing is hidden
- activeCooling – quick and even temperature distribution
- Capacity: 98 bottles of 0.75 litres
- Exclusively for the storage of wine

Go to pages 109-119 to view the whole range.

Super efficient, super stylish.

The coolConcept range from Siemens.



Some models in the range feature vitaFresh® drawers that control humidity and keep your food fresher for longer, easyLift glass shelves that are adjustable to suit your ever changing storage needs and noFrost technology that means you'll never have to defrost the freezer again.



Top marks for energy efficiency

Every model in the coolConcept range is rated A++ for energy efficiency in the EU energy-labelling scheme. Using up to 40% less energy than their A-rated equivalents our range of coolConcept appliances also feature noFrost technology for your ultimate convenience, saving you money and providing you with clever storage spaces.

Advanced technology making food taste as nature intended

The "dry" zone and "dewpoint" zone within vitaFresh determine how much humidity food receives. Storing foods at their optimum humidity can help them last up to 3 times as long. This creates less food wastage, meaning fewer trips to the supermarket and lower food bills.

Storage space that adapts to your needs

Expect nothing but convenience with easyLift shelves. Even when full, you can raise or lower the shelf by 6cm to make room for taller items – ideal for serving jugs.

iq 500 KI42FP60GB

At a glance

- Dimensions (cm): 177x56x55
- Noise level: 39dB
- vitaFresh® – food stays fresher for up to three times longer
- superCool – newly added food is cooled quickly and safely
- 7 glass shelves – 3 height adjustable for added flexibility
- 1 easyLift glass shelf – provides added flexibility
- LED light – illuminates interior so no food is hidden
- softClose door – provides smooth, effortless closure

Go to pages 109-119 to view the whole range.



iq 500 GI38NP60GB

At a glance

- Dimensions (cm): 177x56x55
- Noise level: 40dB
- noFrost – never defrost the freezer again
- 5 freezer drawers – includes bigBox for extra large food items
- LED light – illuminates interior so no food is hidden
- softClose door – provides a smooth, effortless closure

Go to pages 109-119 to view the whole range.



Style, capacity and innovation in one.

American big thinking
meets German ingenuity.



Our coolDuo, American-style fridge freezers have all the innovations you would expect from Siemens. Including noFrost; freshProtectbox, multiAirflow cooling and in-door ice and water dispensers, whilst also providing you with additional capacity and flexibility for all your shopping needs.



Crushed or cubed ice and chilled water at the touch of a button.

Everything to hand when you need it

The fully extendable drawers on telescopic rails slide smoothly and surely, fully extending for complete accessibility for the wanted item at the back of the fridge.

Technology never tasted so good

The freshProtectbox provides the optimum temperature for individual foods, allowing them to stay fresher for longer. Fresh ingredients are the basis for delicious meals, but also count for less wastage and fewer trips to the supermarket – saving you time and money.

Refreshing ice-cool water, whenever you want it

Filtered cold water and ice at the touch of a button. The chilled water and ice dispenser is a convenient time saver, serving a refreshing drink whenever you want.

Elegant, ingenious and
convenient American style,
Siemens style.



iq 700
KA62DS50GB

At a glance

- Dimensions (cm): 176x91x73
- Noise level: 44dB
- Ice and water dispenser
- noFrost – never defrost the freezer again
- freshProtectbox – individual control for longer freshness
- 1 easyLift shelf – for added storage flexibility
- Twin cooling – independent temperature for the fridge and freezer
- multiAirflow system – improves circulation around the fridge
- dayLight – bright interior light

Go to pages 109-119 to view the whole range.

Welcome to a range designed around you.

Elegant, functional and packed with technology your new Siemens fridge freezer is going to become a talking point in your kitchen.

Whether you want an American style fridge freezer that has the wow-factor; stand alone, under counter or a side by side option that is going to save you space, Siemens has a wide range to choose from. Energy efficient our appliances are packed with food preservation and flexible storage solutions that are going to suit your hectic lifestyle. With a stylish design that fits into any modern home our high spec fridge freezers are no longer just a place to store your favourite foods.

iQ 700

Exceptional design allied with seriously innovative technology is the basis of these, our premium models.

iQ 500

Exuding class and refinement, these machines unite first-class features with top-class technology.

iQ 300

Good looking appliances with Siemens build quality equipped with an attractive selection of smart features.



aCool built-in cooling appliances

Stunning inside and out, our top-of-the-range models.

CI36BP01

iQ 700



- Dimensions (cm): h213 x w91 x d61
- Noise level: 42dB
- noFrost – never defrost the freezer again
- 3 humidity controlled drawers on telescopic rails
- 3 glass shelves – 2 height adjustable for added flexibility
- Freezer drawers – pantry style design on telescopic rails
- Internal ice maker
- LED light – illuminates interior so no food is hidden
- multiAirflow – improves circulation around the fridge
- softClose door – provides smooth, effortless closure
- Annual energy consumption – 423 kWh
- Fridge net capacity – 380 litres • 4 star freezer net capacity – 146 litres
- Storage period in event of power failure – 22 hours
- Freezing capacity – 22 kg/24 hours • Climate class* – SN-T

FI24DP32 left hinged door
FI24DP02 right hinged door

iQ 700



- Dimensions (cm): h213 x w60 x d61
- Noise: 41dB
- noFrost – never defrost the freezer again
- In-door ice and water dispenser
- multiAirflow – improves circulation around the freezer
- softClose door – provides smooth, effortless closure
- Annual energy consumption – 347 kWh
- 4 star freezer net capacity – 306 litres
- Storage period in event of power failure – 14 hours
- Freezing capacity – 14 kg/24 hours
- Climate class* – SN-T

aCool built-in cooling appliances (continued)

CI30RP01

iQ 700



- Dimensions (cm) : h213 x w76 x d61
- Noise level: 40dB
- freshProtectobox – individual control for longer freshness
- 2 humidity controlled drawers on telescopic rails
- 4 glass shelves – 3 height adjustable
- LED light – illuminates interior so no food is hidden
- softClose door – provides smooth, effortless closure
- Annual energy consumption – 182 kWh
- Fridge net capacity – 479 litres
- Climate class* – SN-T

CI24RP01

iQ 700



- Dimensions (cm): h213 x w60 x d61
- Noise level: 40dB
- freshProtectobox – individual control for longer freshness
- 2 humidity controlled drawers on telescopic rails • 4 glass shelves – 3 height adjustable for added flexibility
- LED light – illuminates interior so no food is hidden • multiAirflow – improves circulation around the fridge
- softClose door – provides smooth, effortless closure
- Annual energy consumption – 169 kWh
- Fridge net capacity – 369 litres
- Climate class* – SN-T

F124NP31

iQ 700



- Dimensions (cm): h213 x w60 x d61
- Noise level: 41dB
- noFrost – never defrost the freezer again
- Internal automatic ice maker
- 2 freezer drawers on telescopic rails
- superFreeze – moderates the temperature of new food
- softClose door – provides smooth, effortless closure
- Annual energy consumption – 359 kWh
- 4 star freezer net capacity – 324 litres
- Storage period in event of power failure – 17 hours
- Freezing capacity – 18 kg/24 hours
- Climate class* – SN-T

CI24WP02

iQ 700



- Dimensions (cm): h213 x w60 x d61
- Noise level: 42dB
- Wine cabinet
- LED light – illuminates interior so nothing is hidden
- activeCooling – quick and even temperature distribution
- Capacity: 98 bottles of 0.75 litres
- Exclusively for the storage of wine
- Annual energy consumption – 237 kWh
- Fridge net capacity – 390 litres
- Climate class* – SN-T

coolConcept built-in cooling appliances

Top marks for energy efficiency, capacity and convenience.

KI34NP60GB

iQ 500



- Dimensions (cm): h177 x w56 x d55
- Noise level: 39dB
- noFrost – never defrost the freezer again
- 1 humidity controlled drawer on telescopic rails
- 3 glass shelves – 2 height adjustable for added flexibility
- 1 varioShelf – easily adjusted for ever changing storage needs
- 3 freezer drawers – including 1 bigBox for extra large food items
- LED light – illuminates interior so no food is hidden
- softClose door – provides smooth, effortless closure
- Annual energy consumption – 238 kWh
- Fridge net capacity – 186 litres
- 4 star freezer net capacity – 73 litres
- Storage period in event of power failure – 16 hours
- Freezing capacity – 15 kg/24 hours
- Climate class* – SN-T

KI42FP60GB

iQ 500



- Dimensions (cm): h177 x w56 x d55
- Noise: 39dB
- vitaFresh® – food stays fresher for up to 3 times longer
- superCool – newly added food is cooled quickly and safely
- 7 glass shelves – 3 height adjustable
- 1 easyLift glass shelf – provides added flexibility
- LED light – illuminates interior so no food is hidden
- softClose door – provides smooth, effortless closure
- Annual energy consumption – 133 kWh
- Fridge net capacity – 302 litres
- Climate class* – SN-T

coolConcept built-in cooling appliances (continued)

KI25RP60

iQ 500



- Dimensions (cm): h140 x w56 x d55
- Noise: 39dB
- superCool – perfect for adding new room temperature wine
- 2 humidity controlled drawers on telescopic rails
- 3 glass shelves – 3 height adjustable
- 1 easyLift glass shelf – provides added flexibility
- LED light – illuminates interior so no food is hidden
- softClose door – provides smooth, effortless closure
- Annual energy consumption – 109 kWh
- Fridge net capacity – 255 litres
- Climate class* – SN-T

GI38NP60GB

iQ 500



- Dimensions (cm): h177 x w56 x d55
- Noise level: 40dB
- noFrost – never defrost the freezer again
- 5 freezer drawers – including 1 bigBox for extra large food items
- LED light – illuminates interior so no food is hidden
- softClose door – provides smooth, effortless closure
- Annual energy consumption – 243 kWh
- 4 star freezer net capacity – 212 litres
- Storage period in event of power failure – 11 hours
- Freezing capacity – 25 kg/24 hours
- Climate class* – SN-T

GI25NP60

iQ 500



- Dimensions (cm): h140 x w56 x d55
- Noise level: 40dB
- noFrost – never defrost the freezer again
- LED light – illuminates interior so no food is hidden
- 4 freezer drawers – including 1 bigBox for extra large food items
- softClose – provides smooth, effortless closure
- Annual energy consumption – 208 kWh
- 4 star freezer net capacity – 158 litres
- Storage period in event of power failure – 11 hours
- Freezing capacity – 25 kg/24 hours
- Climate class* – SN-T

*Climate zone SN = designed to operate in ambient temperature of +10°C to 32°C.
Climate zone N = designed to operate in ambient temperature of +16°C to 32°C.

Climate zone ST = designed to operate in ambient temperature of +18°C to 38°C.
Climate zone T = designed to operate in ambient temperature of +18°C to 43°C.

Built-in fridge freezers

A range with a host of great features and benefits.

KI85NAD30G

iQ 500



- Dimensions (cm): h177 x w56 x d55
- Noise level: 39dB
- noFrost – never defrost the freezer again
- hydroFresh – humidity-controlled storage for fresher food
- freshSense – detects changes in temperature and adjusts so food stays fresher for longer
- 4 glass shelves – 3 height adjustable for added flexibility
- 4 freezer drawers – including 1 bigBox for extra large food items
- Annual energy consumption – 232 kWh
- Fridge net capacity – 154 litres
- 4 star freezer net capacity – 92 litres
- Storage period in event of power failure – 13 hours
- Freezing capacity – 9 kg/24 hours
- Climate class* – SN-ST

KI87SAF30G

iQ 500



- Dimensions (cm): h177 x w56 x d55
- Noise level: 39dB
- lowFrost – spend less time defrosting the freezer
- hydroFresh – humidity-controlled storage for fresher food
- freshSense – detects changes in temperature and adjusts so food stays fresher for longer
- 5 glass shelves – 4 height adjustable for added flexibility
- 2 freezer drawers – including 1 bigBox for extra large food items
- Annual energy consumption – 225 kWh
- Fridge net capacity – 209 litres
- 4 star freezer net capacity – 61 litres
- Storage period in event of power failure – 7 hours
- Freezing capacity – 7 kg/24 hours
- Climate class* – SN-T

KI86SAF30G

iQ 500



- Dimensions (cm): h177 x w56 x d55
- Noise level: 35dB
- lowFrost – spend less time defrosting the freezer
- hydroFresh – humidity-controlled storage for fresher food
- freshSense – detects changes in temperature and adjusts so food stays fresher for longer
- 5 glass shelves – 4 height adjustable for added flexibility
- 3 freezer drawers – including 1 bigBox for extra large food items
- Annual energy consumption – 218 kWh
- Fridge net capacity – 191 litres
- 4 star freezer net capacity – 74 litres
- Storage period in event of power failure – 7 hours
- Freezing capacity – 7 kg/24 hours
- Climate class* – SN-ST

Built-in fridge freezers (continued)

KI86NVF30G

iQ 300



- Dimensions (cm): h177.5 x w56 x d55
- Noise level: 39dB
- noFrost – never defrost the freezer again
- 1 vegetable/salad drawer with rippled base for improved air circulation
- 4 glass shelves – 3 height adjustable for added flexibility
- 3 freezer drawers – including 1 bigBox for extra large food items
- Annual energy consumption – 222 kWh
- Fridge net capacity – 188 litres
- 4 star freezer net capacity – 67 litres
- Storage period in event of power failure – 15 hours
- Freezing capacity – 8 kg/24 hours
- Climate class* – SN-ST

KI38VA50GB

iQ 300



- Dimensions (cm): h177 x w54 x d55
- Noise level: 40dB
- Manual defrost freezer
- 1 vegetable/salad drawer with rippled base for improved air circulation
- 5 glass shelves – 4 height adjustable for added flexibility
- 3 freezer drawers
- Annual energy consumption – 275 kWh
- Fridge net capacity – 218 litres
- 4 star freezer net capacity – 58 litres
- Storage period in event of power failure – 22 hours
- Freezing capacity – 6 kg/24 hours
- Climate class* – SN-ST





KI32VA50GB

iQ 300







- Dimensions (cm): h177 x w54 x d55
- Noise level: 40dB
- Manual defrost freezer
- 1 vegetable/salad drawer with rippled base for improved air circulation
- 4 glass shelves – 3 height adjustable for added flexibility
- 4 freezer drawers
- Annual energy consumption – 283 kWh
- Fridge net capacity – 165 litres
- 4 star freezer net capacity – 92 litres
- Storage period in event of power failure – 24 hours
- Freezing capacity – 6 kg/24 hours
- Climate class* – SN-ST

Built-in fridge freezers (continued)	Built-in fridges Varying heights for any kitchen design.		
---	---	--	--

KI38VX22GB	KI81RAD30	KI81RAF30G	KI82LAF30G
<p>iQ 300</p>  <p>A+ Energy</p> <p>eco+ More efficiency, more performance</p> <p>hydroFresh</p> <ul style="list-style-type: none"> • Dimensions (cm): h177 x w54 x d55 • Noise level: 40dB • Manual defrost freezer • 1 vegetable/salad drawer with rippled base for improved air circulation • 5 glass shelves – 4 height adjustable for added flexibility • 3 freezer drawers • Annual energy consumption – 275 kWh • Fridge net capacity – 217 litres • 4 star freezer net capacity – 59 litres • Storage period in event of power failure – 13 hours • Freezing capacity – 6 kg/24 hours • Climate class* – SN-ST 	<p>iQ 500</p>  <p>A++ Energy</p> <p>eco+ More efficiency, more performance</p> <p>hydroFresh</p> <ul style="list-style-type: none"> • Dimensions (cm): h177.5 x w56 x d55 • Noise level: 37dB • hydroFresh – humidity-controlled storage for fresher food • 7 glass shelves – 6 height adjustable • dayLight – brighter interior fridge • softClose door – provides smooth, effortless closure • Annual energy consumption – 116 kWh • Fridge net capacity – 319 litres • Climate class* – SN-ST 	<p>iQ 500</p>  <p>A++ Energy</p> <p>eco+ More efficiency, more performance</p> <p>hydroFresh</p> <ul style="list-style-type: none"> • Dimensions (cm): h177.5 x w56 x d55 • Noise level: 37dB • hydroFresh – humidity-controlled storage for fresher food • 7 removable safety glass shelves – 6 easy pull out • dayLight – brighter interior fridge • superCool – newly added food is cooled quickly and safely • Annual energy consumption – 116 kWh • Fridge net capacity – 319 litres • Climate class* – SN-T 	<p>iQ 500</p>  <p>A++ Energy</p> <p>eco+ More efficiency, more performance</p> <p>hydroFresh</p> <ul style="list-style-type: none"> • Dimensions (cm): h177.5 x w56 x d55 • Noise level: 36dB • Ice box capacity – 35 litres • 1 humidity controlled vegetable/salad drawer on telescopic rails • 5 glass shelves – 4 easy pull out, 1 Easy access – extendable glass shelf • dayLight – brighter interior fridge • softClose door – provides smooth, effortless closure • hydroFresh – humidity-controlled storage for fresher food • Annual energy consumption – 209 kWh • Fridge net capacity – 252 litres • Climate class* – SN-ST

Built-in fridges (continued overleaf)			
---------------------------------------	--	--	--

KI82LAD30	KI41RAD30	KI41RAF30G	KI42LVS30G
<p>iQ 500</p>  <p>A++ Energy</p> <p>eco+ More efficiency, more performance</p> <p>hydroFresh</p> <ul style="list-style-type: none"> • Dimensions (cm): h122.5 x w56 x d55 • Noise level: 37dB • Ice box capacity – 15 litres • hydroFresh – humidity-controlled storage for fresher food • Improved air circulation • 5 removable safety glass shelves – 4 easy pull out, 1 Easy access – extendable glass shelf • dayLight – brighter interior fridge • superCool – newly added food is cooled quickly and safely • Annual energy consumption – 172 kWh • Fridge net capacity – 180 litres • Climate class* – SN-T 	<p>iQ 500</p>  <p>A++ Energy</p> <p>eco+ More efficiency, more performance</p> <p>hydroFresh</p> <ul style="list-style-type: none"> • Dimensions (cm): h122.5 x w56 x d55 • Noise level: 33dB • 1 vegetable/salad drawer on rippled base for improved air circulation • 6 removable safety glass shelves – 5 easy pull out, 1 Easy access – extendable glass shelf • dayLight – brighter interior fridge • softClose door – provides smooth, effortless closure • Annual energy consumption – 105 kWh • Fridge net capacity – 211 litres • Climate class* – SN-T 	<p>iQ 500</p>  <p>A++ Energy</p> <p>eco+ More efficiency, more performance</p> <p>hydroFresh</p> <ul style="list-style-type: none"> • Dimensions (cm): h122.5 x w56 x d55 • Noise level: 33dB • 1 vegetable/salad drawer on rippled base for improved air circulation • 6 removable safety glass shelves – 5 easy pull out, 1 Easy access – extendable glass shelf • dayLight – brighter interior fridge • Annual energy consumption – 105 kWh • Fridge net capacity – 211 litres • Climate class* – SN-T 	<p>iQ 300</p>  <p>A++ Energy</p> <p>eco+ More efficiency, more performance</p> <p>hydroFresh</p> <ul style="list-style-type: none"> • Dimensions (cm): h122.5 x w56 x d55 • Noise level: 38dB • 1 vegetable/salad drawer on rippled base for improved air circulation • 5 removable safety glass shelves – 4 easy pull out, 1 Easy access – extendable glass shelf • Bright interior LED fridge light • vitaControl • Annual energy consumption – 172 kWh • Fridge net capacity – 180 litres • Climate class* – SN-ST

*Climate zone SN = designed to operate in ambient temperature of +10°C to 32°C.
Climate zone N = designed to operate in ambient temperature of +16°C to 32°C.

Climate zone ST = designed to operate in ambient temperature of +18°C to 38°C.
Climate zone T = designed to operate in ambient temperature of +18°C to 43°C.

Built-in fridges (continued)

Built-in freezers

When space is an issue.

KI41RVS30G

KI31RVS30G

GI38NA55GB

GI18DA50GB

iQ 300



- Dimensions (cm): h122.5 x w56 x d55
- Noise level 37dB
- 1 vegetable/salad drawer on rippled base for improved circulation
- 6 removable safety glass shelves of which 5 are easy to pull out
- Bright interior LED fridge light
- vitaControl – constant temperature by intelligent sensor technology
- Annual energy consumption – 105kWh
- Fridge net capacity – 211 litres
- Climate class* – SN-T

iQ 300



- Dimensions (cm): h102.5 x w56 x d55
- Noise level 36dB
- 1 vegetable/salad drawer on rippled base for improved circulation
- 4 removable safety glass shelves of which 3 are easy to pull out
- Bright interior LED fridge light
- vitaControl – constant temperature by intelligent sensor technology
- Annual energy consumption – 100kWh
- Fridge net capacity – 172 litres
- Climate class* – SN-T

iQ 300



- Dimensions (cm): h177 x w56 x d55
- Noise level: 40dB
- noFrost – never defrost the freezer again
- 5 freezer drawers – including 1 bigBox for extra large food items
- 2 freezer flaps – allowing for easy access
- superFreeze – moderates the temperature of new food
- LED light – illuminates interior so no food is hidden
- softClose door – provides a smooth, effortless closure
- Annual energy consumption – 310 kWh
- 4 star freezer net capacity – 212 litres

iQ 300



- Dimensions (cm): h87 x w54 x d54
- Noise: 36dB
- superFreeze – moderates the temperature of new food
- 4 freezer drawers
- Annual energy consumption – 192 kWh
- 4 star freezer net capacity – 94 litres
- Storage period in event of power failure – 25 hours
- Freezing capacity – 12 kg/24 hours
- Climate class* – SN-ST

Built-under freezer

When space is an issue.

Built-in fridges

When space is an issue.

Built-under fridges

When space is an issue.

GU15DA50GB

KI21RAF30G

KI21RVF30G

KU15LA60GB

iQ 300



- Dimensions (cm): h82 x w60 x d55
- Noise level: 38dB
- superFreeze – moderates the temperature of new food
- 3 freezer drawers
- Freezer net capacity – 98 litres

iQ 500



- Dimensions (cm): h88 x w56 x d55
- Noise level: 33dB
- 1 vegetable/salad drawer on rippled base for improved air circulation
- 4 removable safety glass shelves – 3 easy pull out, 1 Easy access – extendable glass shelf
- dayLight – brighter interior fridge
- superCool – newly added food is cooled quickly and safely
- Annual energy consumption – 97 kWh
- Fridge net capacity – 144 litres
- Climate class* – SN-T

iQ 500



- Dimensions (cm): h88 x w56 x d55
- Noise level 33dB
- 1 vegetable/salad drawer on rippled base for improved circulation
- 4 removable safety glass shelves of which 3 are easy to pull out
- Bright interior LED fridge light
- vitaControl – constant temperature by intelligent sensor technology
- Annual energy consumption – 97kWh
- Fridge net capacity – 144 litres
- Climate class* – SN-T

iQ 300



- Dimensions (cm): h82 x w60 x d55
- Noise level: 38dB
- Ice box capacity – 15 litres
- dayLight – brighter interior fridge light
- 1 vegetable/salad drawer on rippled base for improved air circulation
- 2 glass shelves – 1 height adjustable for added flexibility
- Annual energy consumption – 140 kWh
- Fridge net capacity – 108 litres
- Climate class* – SN-ST

Built-under fridges

When space is an issue.

KU15LA60GB

iQ 300



- Dimensions (cm): h82 x w59 x d55
- Noise level: 38dB
- dayLight – brighter interior fridge light
- 1 vegetable/salad drawer on rippled base for improved air circulation
- 3 glass shelves – 3 height adjustable for added flexibility
- Annual energy consumption – 118 kWh
- Fridge net capacity – 137 litres
- Climate class* – SN-ST

Wine coolers

A stunning addition in any kitchen

KF18WA43 left hinge door
KF18WA42 right hinge door

iQ 300



- Dimensions (cm): h87 x w54 x d54
- Noise level: 37dB
- Wine cooler – holds up to 32 wine bottles (0.75 litres)
- touchLight – interior light activates when touching the handle
- 6 shelves
- Right hand hinged door
- Annual energy consumption – 150 kWh
- Fridge net capacity – 149 litres
- Climate class* – N

American-style fridge freezers

A striking collection with innovative food storage solutions.

KA62DS50GB black glass
KA62DS21 white glass (dot pattern)

iQ 700



- Dimensions (cm): h176 x w91 x d73
- Noise level: 44dB
- Ice and water dispenser
- noFrost – never defrost the freezer again
- freshProtectbox – for longer food freshness
- 4 shelves – 3 height adjustable, 1 extendable, 1 easyLift
- multiAirflow system – improves circulation around the fridge/freezer
- dayLight – bright interior light
- Annual energy consumption – 463 kWh
- Fridge net capacity – 351 litres
- 4 star freezer net capacity – 177 litres
- Storage period in event of power failure – 16 hours
- Freezing capacity – 12 kg/24 hours
- Climate class* – SN-T

American-style fridge freezers

A striking collection with innovative food storage solutions.

KA62DP92GB stainless steel anti-fingerprint

iQ 700



- Dimensions (cm): h176 x w91 x d73
- Noise level: 44dB
- Ice and water dispenser
- noFrost – never defrost the freezer again
- freshProtectbox – for longer food freshness
- 4 shelves – 3 height adjustable, 1 extendable, 1 easyLift
- multiAirflow system – improves circulation around the fridge/freezer
- dayLight – bright interior light
- Annual energy consumption – 463 kWh
- Fridge net capacity – 351 litres
- 4 star freezer net capacity – 177 litres
- Storage period in event of power failure – 16 hours
- Freezing capacity – 12 kg/24 hours
- Climate class* – SN-T

KA62DA71GB stainless steel anti-fingerprint

iQ 500



- Dimensions (cm): h176 x w91 x d73
- Noise level: 44dB
- Ice and water dispenser
- noFrost – never defrost the freezer again
- freshProtectbox – individual control for longer freshness
- 4 glass shelves – 3 adjustable, 1 extendable, 2 easyLift
- multiAirflow system – improves circulation around the fridge/freezer
- LED lights – illuminates interior so no food is hidden
- Annual energy consumption – 463 kWh
- Fridge net capacity – 351 litres
- 4 star freezer net capacity – 177 litres
- Storage period in event of power failure – 16 hours
- Freezing capacity – 12 kg/24 hours
- Climate class* – SN-T

KA62DV00GB white

iQ 500



- Dimensions (cm): h176 x w91 x d73
- Noise level: 44dB
- noFrost – never defrost the freezer again
- freshProtectbox – individual control for longer freshness
- 4 safety glass shelves – 3 adjustable, 1 extendable, 1 easyLift
- multiAirflow system – improves circulation around the fridge/freezer
- dayLight – bright interior light
- Annual energy consumption¹ – 454 kWh
- Fridge net capacity – 382 litres
- Frost free freezer net capacity – 177 litres
- Storage period in event of power failure – 10 hours
- Freezing capacity – 12 kg/24 hours
- Ice and water dispenser
- Climate class* – SN-T

*Climate zone SN = designed to operate in ambient temperature of +10°C to 32°C.
Climate zone N = designed to operate in ambient temperature of +16°C to 32°C.

Climate zone ST = designed to operate in ambient temperature of +18°C to 38°C.
Climate zone T = designed to operate in ambient temperature of +18°C to 43°C.

Installation diagrams

<p>CI30RP01</p>		<p>* Thickness dependent on the kitchen unit door used, 19 corresponds to stainless steel door (special accessory).</p>	
<p>FI24NP31</p>	<p>** Base adjustment variable water connection at the appliance</p>	<p>* Thickness dependent on the kitchen unit door used, 19 corresponds to stainless steel door (special accessory).</p>	
<p>CI24RP01</p>	<p>** Base adjustment</p>	<p>* Thickness dependent on the kitchen unit door used, 19 corresponds to stainless steel door (special accessory).</p>	
<p>FI24DP32 FI24DP02</p>	<p>**min 102*79 Variable water connection</p>	<p>* Thickness dependent on the kitchen unit door used, 19 corresponds to stainless steel door (special accessory).</p>	
<p>CI36BP01</p>	<p>** Base adjustment</p>	<p>Variable water connection to the appliance</p>	<p>* Thickness dependent on the kitchen unit door used, 19 corresponds to stainless steel door (special accessory).</p>
<p>CI24WP02</p>	<p>**min 102*79 ** base adjustment</p> <p>¹⁾ variable from 65-82 with furniture fronts</p> <p>* incl. 19 mm kitchen unit door corresponding to stainless steel door (special accessory)</p> <p>** Base adjustment</p>	<p>* Thickness dependent on the kitchen unit door used, 19 corresponds to stainless steel door (special accessory).</p>	

Installation diagrams

<p>KI34NP60GB</p>		<p>560 recommended min. 550</p> <p>Electrical connection above or to the side of the appliance</p> <p>1,772^{+max.8}</p> <p>Double-floor installation and intermediate floor installation also possible</p> <p>min. 100</p> <p>350</p> <p>min. 560</p>	<p>B=Overlap of front panel</p> <p>There shall be no drawer under the built-in appliance</p> <p>A=Lower edge of front panel</p> <p>Ventilation area in the base min. 200 cm²</p>
<p>GI38NP60GB KI42FP60GB GI38NA55GB</p>		<p>560 recommended min. 550</p> <p>Electrical connection above or to the side of the appliance</p> <p>1,772^{+max.8}</p> <p>Double-floor installation and intermediate floor installation also possible</p> <p>min. 100</p> <p>350</p> <p>min. 560</p>	<p>B=Overlap of front panel</p> <p>There shall be no drawer under the built-in appliance</p> <p>A=Lower edge of front panel</p> <p>Ventilation area in the base min. 200 cm²</p>
<p>GI25NP60 KI25RP60</p>		<p>560 recommended min. 550</p> <p>Electrical connection above or to the side of the appliance</p> <p>1,397^{+max.8}</p> <p>Double-floor installation and intermediate floor installation also possible</p> <p>min. 100</p> <p>350</p> <p>min. 560</p>	<p>B=Overlap of front panel</p> <p>There shall be no drawer under the built-in appliance</p> <p>A=Lower edge of front panel</p> <p>Ventilation area in the base min. 200 cm²</p>
<p>KI85NAD30G</p>		<p>Air outlet min. 200 cm²</p> <p>min. 560</p> <p>560 recommended min. 550</p> <p>1772⁺⁸</p> <p>max. 2200</p> <p>Ventilation space in the base min. 200 cm²</p>	<p>Front panel overhang</p> <p>Lower edge of front panel</p> <p>The specified unit door dimensions are valid for a door gap of 4 mm.</p>
<p>KI87SAF30G</p>		<p>Air outlet min. 200 cm²</p> <p>min. 560</p> <p>560 recommended min. 550</p> <p>1772⁺⁸</p> <p>max. 2200</p> <p>Ventilation space in the base min. 200 cm²</p>	<p>Front panel overhang</p> <p>Lower edge of front panel</p> <p>The specified unit door dimensions are valid for a door gap of 4 mm.</p>
<p>KI86SAF30G</p>		<p>Air outlet min. 200 cm²</p> <p>min. 560</p> <p>560 recommended min. 550</p> <p>1772⁺⁸</p> <p>max. 2200</p> <p>Ventilation in the base min. 200 cm²</p>	<p>Front panel overhang</p> <p>Lower edge of front panel</p> <p>The specified unit door dimensions are valid for a door gap of 4 mm.</p>

Installation diagrams

<p>KI32VA50GB</p>		<p>The given measurements are for a door gap of 4mm. If using a different width of gap (max. 14mm) the measurements must be adjusted when planning the kitchen.</p>
<p>KI38VA50GB</p>		<p>The given measurements are for a door gap of 4mm. If using a different width of gap (max. 14mm) the measurements must be adjusted when planning the kitchen.</p>
<p>KI38VX22GB</p>		<p>The specified cabinetry door dimensions apply for a door gap of 4 mm.</p>
<p>KI81RAD30 KI82LAF30G KI81RAF30G KI82LAD30</p>		
<p>KI86NVF30G</p>		
<p>KI41RAD30 KI41RAF30G</p>		

Installation diagrams

<p>KI42LVS30G</p>																	
<p>KI41RVS30G KI31RVS30G</p>																	
<p>KI21RVF30G</p>																	
<p>KF18WA42 KF18WA43</p>		<p>GI18DA50GB</p>															
<p>KU15LA60GB KU15RA51GB GU15DA50GB</p>																	
<p>KA62DS50GB KA62DS21 KA62DP92GB KA62DA71GB KA62DV00GB</p>	<table border="1" data-bbox="1281 1736 1571 1998"> <thead> <tr> <th>X₁ (unit depth)</th> <th>a</th> <th>b</th> </tr> </thead> <tbody> <tr> <td>600</td> <td>24</td> <td>24</td> </tr> <tr> <td>650</td> <td>24</td> <td>100</td> </tr> <tr> <td>700</td> <td>24</td> <td>175</td> </tr> <tr> <td>X₂ (wall)</td> <td>90</td> <td>464</td> </tr> </tbody> </table>		X ₁ (unit depth)	a	b	600	24	24	650	24	100	700	24	175	X ₂ (wall)	90	464
X ₁ (unit depth)	a	b															
600	24	24															
650	24	100															
700	24	175															
X ₂ (wall)	90	464															



Dishwashers

Extra innovations for extra shine.



Clever lighting.

Less ordinary lighting innovations that create ambiance in your living space and keep you informed, Siemens dishwashers feature an internal blue emotionLight that has the wow-factor; once you've seen it in action you'll be sure to want to show off brilliantly cleaned glasses in your own home.



Above: timeLight usable on any surface or any colour.
Below: Cool glow of emotionLight.



With our dishwashers being so quiet, how else would you know they were on?

Useable on any surface of any colour, the innovative timeLight projects the remaining time of the dishwasher cycle on to the floor. With our dishwashers being so quiet it can be hard to tell when they are on or off. This is the perfect solution to let you know the dishwasher is running at a glance, so you can avoid opening the door mid cycle and get on with your day. The equally as innovative infoLight also projects a dot of light onto the floor so you can see instantly if the dishwasher is running.



Cool glow of emotionLight

Creating a relaxed ambiance in your living space, the emotionLight uses LED lights to reflect off your brilliantly-cleaned glasses and create a cool blue glow emanating from inside your dishwasher. LED lights high in the door frame bathe the interior of the dishwasher in beautiful blue light when you open the door, and switch off again when you close it. The LED lights never need to be changed and will last the lifetime of your dishwasher.



Door openAssist

A modern handleless kitchen deserves appliances that can blend in seamlessly with their surroundings, yet still offer excellent results with innovations that support your busy life. A Siemens iQ700 dishwasher is no exception. With door openAssist you can open fully integrated dishwashers by simply touching the front of the unit. The dishwasher automatically opens so you can load or unload the dishwasher with ease. This removes the need for a handle and is the perfect solution and choice for designer kitchens. Innovative and modern, for a life less ordinary.



TFT Display

Advanced technology meets sophisticated design. The TFT Display integrated into the top control panel of our dishwashers is the perfect match for the seamless design of our handleless openAssist models. Readable from any angle, the clearText TFT display makes it easy to see all selected programme information at a glance. What's more, the helpful information button allows you to quickly discover the programmes and options of your dishwasher with ease, as well as see the exact start, end and running times. For a life less ordinary.

The safer way to clean your wine glasses.

The wine glass holder accessory is specially designed to save you time as well as giving you complete peace of mind.



Wine glass holder accessory

No longer will you choose to wash your wine glasses by hand. Available as standard in all iQ700 dishwashers, this accessory holds and optimally cleans up to four long stemmed wine glasses safely and securely. The innovative lock mechanism ensures your glasses are stable in the basket, yet with minimal contact areas to avoid any water pooling or streaks. The result? Sparkling glasses that have been safely cleaned and dried, every time. The accessory is also available to buy from the Siemens website (accessory code SZ73300).

Saving energy naturally.

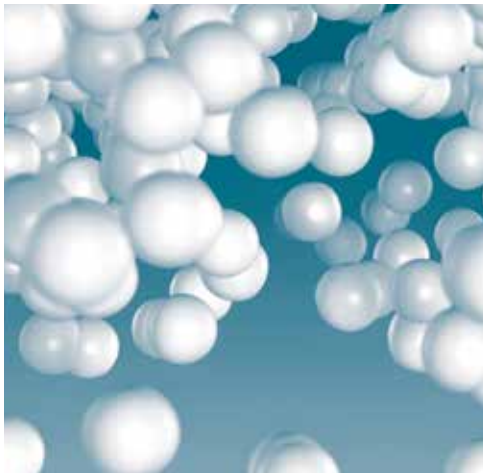

Energy efficiency meets cutting edge design.

Using advanced drying technologies, Siemens dishwashers keep energy consumption to a minimum. Zeolith®, a form of naturally occurring mineral, has the astonishing ability to absorb moisture and convert it to heat.

What does this mean for you? The heat produced naturally by the Zeolith® is used for the drying cycle. No additional energy is therefore required to heat up the contents of your dishwasher for the drying process (as with a standard drying system). This results in perfect drying, with less energy usage.

The Zeolith® mineral is stored in the depths of the dishwasher; this regenerates itself and keeps working for the entire lifetime of the machine. Combine this with the economy 50 programme to get brilliant results with minimal energy.

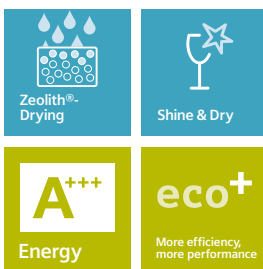

Add an extra shine

Shine & Dry is a unique energy efficient function that produces table ready, gleaming glassware by harnessing the power of Zeolith®. This special drying cycle not only brings out a streak free shine in most delicate glassware and tableware but also means extra dry and stain free plastics, pots and pans.

Drying phase – Zeolith® absorbs moisture and converts it to heat energy.

Cleaning phase – As the mineral is heated during the cleaning cycle, it is recharged and ready to absorb moisture once more.



Clean dishes before the evening is over.

Perfectly clean and dry dishes in a third of the time. Flexible dishwashing, for a life less ordinary.



Ever needed your dishes cleaned quickly, forgotten to put the dishwasher on in the morning, or simply need clean plates before your guests arrive?

That's why we've introduced varioSpeed Plus, the perfect time saver. Giving you the flexibility to spend time on more important things, varioSpeed Plus reduces the time it takes to wash and dry a full load down to a third.

Ideal when you need your cutlery and plates in a hurry, just press the varioSpeed Plus button in conjunction with your desired programme* and it will run the dishwasher significantly

faster without compromising on wash quality. Used together with the Eco 50 programme, varioSpeed Plus will wash and dry a full load in just over an hour. Giving you time saving solutions when you need them the most and sparkling clean dishes fast.

*Except quick wash 45°C programme



Dishwashers

Fully integrated iQ500 dishwasher.
Model shown: SN66P050GB.

Top drawer.

Dishwasher interior design at its highest level.

Keeping the design of your dishwasher just as sleek on the inside as it is out, Siemens dishwashers house various features that will benefit you when washing your dishes. These include adjustable drawers and baskets for larger pans or serving plates, extra slats for wine glasses and crockery, a cutlery drawer and a basket that helps to disperse detergent more effectively.



rackMatic™

Ever found yourself loading and unloading the dishwasher because the last pan doesn't fit? rackMatic™ conveniently allows you to raise and lower the height of the top basket, even when the dishwasher is full. With the simple flick of a lever you can raise or lower the basket to suit your washing needs. This increased flexibility ultimately saves you time and takes the stress out of a mundane chore.

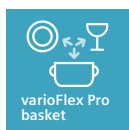

varioFlex Pro basket system and varioDrawer Pro

Making the most of space within the dishwasher, varioFlex Pro allows you to create extra room for pots and pans. Now with an optimised lower basket design for large plates and adjustable tines highlighted with blue touchpoints, your dishwasher can adapt to any load quickly and easily. Adding a third shelf for cutlery, varioDrawer Pro removes the need for a cutlery basket and creates more space. Perfect for the extra-large dinner party, you can fit more in, making the after dinner clean up quick and simple. Enjoy fewer washes and more flexibility.

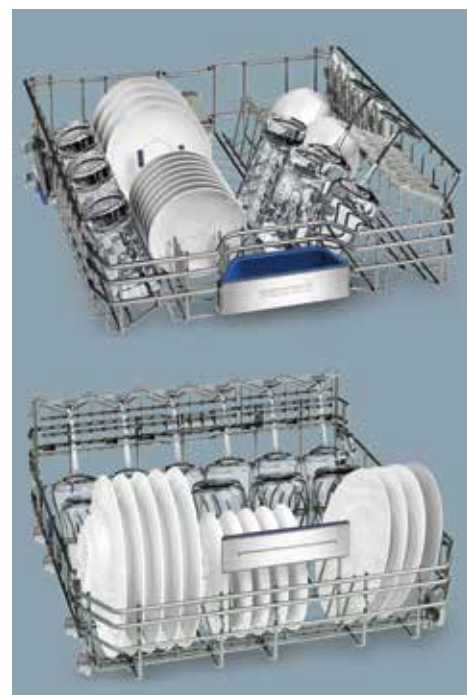



dosageAssist

Ensuring that your dishes receive the best possible clean every time, dosageAssist quickly and evenly dissolves your dishwasher tablets throughout the entire machine, leaving no mess for you to clean at the end of the cycle. Rather than the detergent tablet dropping to the bottom of your machine, it falls into an innovative basket at the front, allowing it to dissolve completely leaving no mess and a brilliant clean.

Siemens recommends using Finish dishwashing products

Siemens has tested and recommends using Finish dishwashing products. For the ultimate clean and shine, plus added protection against corrosion, Siemens recommends new Finish Quantum Shine & Protect.



Added extras.

Convenience and cutting-edge technology stunningly combined. Siemens dishwashers give you more than just clean dishes. Functional programmes with benefits you will want to see, no longer will you want to select the quickest wash.



Model shown: SN66P050GB stainless steel dishwasher.

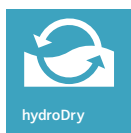

hydroDry

Protect your glasses from cracking with hydroDry. Heat generated during the wash cycle is used to pre-heat the rinsing water to stop glasses being put under stress. The system also optimises the drying process. Not only does this ensure your favourite glasses are hygienically cared for as no external air is brought into the machine to dry them, but as no existing heat is used to gently warm the rinse water, it is energy-efficient too.

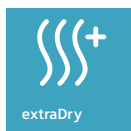

extraDry

Why spend time towel-drying plasticware when extraDry does it for you? extraDry is designed to make sure that plasticware comes out of the dishwasher bone dry – no more water droplets, no more hand drying.



halfLoad

The halfLoad function is great for couples and smaller households. Letting you place items anywhere in the dishwasher, it is ideal for smaller loads and uses up to 20% less water and 10% less energy to produce a brilliant clean. A dishwasher uses water and energy most efficiently when run with a full load. However, with halfLoad you have a resource saving option for when you can't wait until the dishwasher is full.



10-year anti-rust warranty

Due to advanced materials and manufacturing technologies, in addition to our standard appliance warranty, we are able to provide a free of charge warranty against rusting-through of the dishwasher's inner cavity.

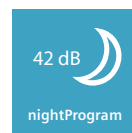

Night Programme

Sleep well and take advantage of cheaper electricity rates at night whilst benefitting from a super-quiet cycle. The Night Programme is a specially adapted, energy efficient Eco50°C programme that achieves a noise reduction of 2 dB by decreasing the spray pressure and extending the run time. Wake up to perfectly clean dishes, washed using less resources and saving money at the same time.

The Hygiene option

Great for cleaning food containers and utensils, babies' bottles and chopping boards the hygiene option kills 99.9% of bacteria and germs. Providing a simple solution to the upkeep of your family's health, the final rinse heats up to 70°C regardless of the cycle you choose.*

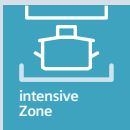

intensiveZone

With intensiveZone, you can wash delicate glasses and burnt cooking pans in the same wash. The higher temperature and increased spray pressure in the lower basket ensures stubborn stains are removed, whilst delicate items are protected in the top basket. This means there is no need to separate washes in to different loads, and no need to soak heavily soiled pans overnight. First-class convenience guaranteed.

Delicate

Intensive



Dishwashers

Space-saving lifesaver.

Working twice as hard to give you even better cleaning results.

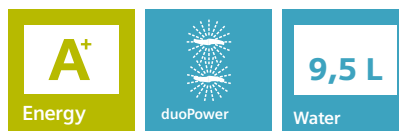

The less space available, the more valuable that space becomes. This is especially true of a small kitchen, where a lot of space can be gained by using it efficiently, a 45cm dishwasher can help you to do just that.

Although the built-in dishwasher in the 45cm series may be small, it is still intelligent when it comes to powerful cleaning. Benefitting from 2 spray arms under the top basket as opposed to just one, duoPower ensures that your dishes receive the best possible clean, with 2 duoPower arms working doubly hard to reach every inch of the basket.

Featuring the innovative Siemens duoPower double spray arm and the time saving varioSpeed option, this model also features the varioDrawer cutlery tray, giving you nothing but outstanding results. Siemens dishwashers

are designed to thoroughly clean dishes, but quietly whilst using minimal water and energy. With Siemens, dishes have nowhere to hide.

Resource efficiency

The 45cm built-in dishwasher from Siemens uses only 9.5 litres of water to wash 10 standard place settings in one cycle, making them resource efficient too.



SIEMENS
03 6:00 min 40°C
4 124W
SIEMENS

Dishwashers

Saving energy naturally.

Utilising natural technology for unprecedented drying.



Keeping your energy consumption to a minimum, a Siemens iQ700 dishwasher uses Zeolith®, a naturally occurring mineral, to create the heat and energy needed for drying dishes. This combined with varioSpeed Plus for a significantly faster wash, and the innovative, convenient varioDrawer Pro gives you a dishwasher that is easy to use and designed to perform.

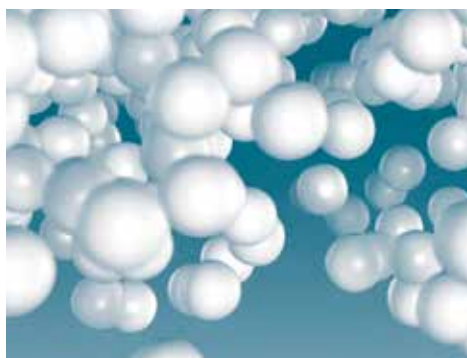

Harnessing the power of nature – Zeolith® natural minerals.

Brilliant drying

The energy-efficient Zeolith® utilises natural minerals that release moisture as energy. Receive brilliant drying, costing as little as 10p per cycle, whilst being kinder to the environment

Add an extra shine

Experience instant sparkling and streak free glasses with Shine & Dry – making the perfect impression for any occasion without the need to hand dry glasses. It perfectly dries plasticware too, saving you the trouble of drying them yourself.

More space

The varioDrawer Pro frees up space as you don't need a cutlery basket, creating ample room in your dishwasher for more place settings in the lower basket – ideal for larger dinner parties. Blue touchpoints indicate all of the adjustment options too, meaning you can quickly and easily fit espresso cups in the drawer with the simple flick of a catch. More flexibility thanks to the varioDrawer Pro.

Energy efficiency meets cutting edge design.

iQ 700
SN678D00TG

At a glance

- 14 Place settings
- 8 Programmes
- 5 options
- varioSpeed Plus
- Door open assist
- TFT display
- varioDrawer Pro
- varioFlex Pro
- Noise level: 42dB
- Dimensions (cm): h81.5 x w59.8 x d55

Go to pages 137-141 to view the whole range.

Clever lighting.

Lighting innovations that create ambiance in your living space and keep you informed.



The iQ700 dishwashers come with less ordinary innovations that make your life easier and your kitchen better equipped. timeLight is the perfect solution to knowing when your dishwasher is on and to see how long is left at a glance. Whilst the emotionLight uses blue LED lights to reflect off your brilliantly-cleaned glasses, for a modern finish to your kitchen.



timeLight: projects programme time remaining.

timeLight: Information with no need to open the door

Useable on any surface of any colour, timeLight projects the remaining time of the dishwasher cycle on to the floor. With our dishwashers being this quiet, it's the perfect solution to let you know the machine is switched on.

The cool glow of emotionLight accents any atmosphere

Show off brilliantly-cleaned glasses and enhance a relaxed atmosphere in your kitchen with emotionLight. The cool blue light emanates from the dishwasher, adding to the ambiance of the room.

Perfect time saver

varioSpeed Plus is the perfect time saver, reducing washing and drying times down to a third. Enjoy the flexibility of a dishwasher that can finish faster and make sure you're never caught out if you forget to start the dishwasher before work.

With our dishwashers being so quiet, how else would you know they were on?

iQ 700

SN677X00TG

At a glance

- 14 Place settings
- 7 Programmes
- 4 options
- TFT display
- varioFlex Pro basket system
- Noise level: 44dB
- Dimensions (cm): h81.5 x w59.8 x d55

Go to pages 137-141 to view the whole range.

Space saving.

Use every square centimetre of living space efficiently.



The less space available, the more valuable that space becomes. This is especially true of a small kitchen, where a lot of space can be gained by using it efficiently. A 45cm slimline dishwasher can help you to do just that.



Power spraying with duoPower.

Nowhere to hide

duoPower provides 2 powerful spraying arms that work in unison to reach every corner of the dishwasher, leaving nothing but outstanding results – every time.

More space

varioDrawer frees up space as you don't need a cutlery basket, creating ample room in your dishwasher for more place settings – ideal for larger dinner parties.

Efficient and effortless drying.

The ecoDry setting automatically opens the dishwasher door ajar at the end of each cycle. This allows room temperature air to naturally dry the contents of the dishwasher without using any additional energy. Perfect for leaving the dishwasher to finish at night, or when you need to spend time on the more important things in life.

Small but still intelligent when it comes to powerful cleaning.



iq 500

SR66T090GB

At a glance

- 10 place settings
- 6 programmes
- 3 options
- timeLight information projection
- varioDrawer – additional loading level for cutlery
- varioFlex Plus basket system
- Noise level: 44dB
- Dimensions (cm): h81.5 x w44.8 x d55

Go to pages 137-141 to view the whole range.

Welcome to a range designed around you.

As you'd expect, Siemens dishwashers take full advantage of our latest technologies and innovations.

Designed to fit around your individual lifestyle each dishwasher features efficient, time saving and environmentally friendly programmes that make your dishes sparkle. For those that want the most advanced, choose a sleek and stylish iQ700 dishwasher to complement your modern home. For a life less ordinary.

iQ 700

Reserved for our premium dishwasher range. iQ700 stands for exceptional design allied with seriously intelligent and innovative technology.

iQ 500

Exuding class and refinement, these machines unite first-class features with top-class technology.

iQ 300

Good looking appliances with Siemens build quality equipped with an attractive selection of smart features.

Dishwashers

Featuring ground-breaking technology Siemens built-in dishwashers provide clean dishes every time, whilst using minimum water and energy.

SN578S00TG

iQ 700



- 14 Place settings
- 8 Programmes
- 5 Options
- varioFlex Pro basket system
- varioDrawer Pro
- Interior blue emotionLight
- TFT display with real time clock
- ecoDry – efficient and effortless drying
- varioSpeed Plus – significantly faster without compromising on wash quality
- Noise level 41dB

SN56M531GB

iQ 500



- 13 Place settings
- 6 Programmes
- 4 Options
- varioSpeed Plus – significantly faster without compromising on wash quality
- varioFlex basket system
- Noise level: 44dB

SN678D00TG

iQ 700

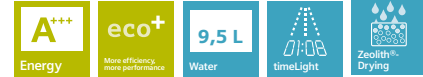

- 14 Place settings
- 8 Programmes
- 5 Options
- Zeolith® – energy efficient drying
- Interior blue emotionLight
- varioDrawer Pro
- varioFlex Pro
- TFT display with real time clock
- varioSpeed Plus – significantly faster without compromising on wash quality
- timeLight – projects the time remaining on to the floor
- Glass holder tray
- Noise level: 42dB

Dishwashers (continued)

SX778D00TG extra height model

iQ 700



- 14 Place settings
- 8 Programmes
- 5 Options
- varioSpeed Plus – significantly faster without compromising on wash quality
- varioDrawer Pro
- varioFlex Pro basket system
- TFT display with real time clock
- Glass holder tray
- Noise level: 41dB

SN678D10TG

iQ 700



- 14 Place settings
- 8 Programmes
- Interior blue emotionLight
- varioDrawer Pro
- varioFlex Pro
- Zeolith® – energy efficient drying
- Interior blue emotionLight
- TFT display with real time clock
- Glass holder tray
- Noise level: 41dB

SN677X00TG

iQ 700



- 14 Place settings
- 7 Programmes
- 4 Options
- varioSpeed Plus – significantly faster without compromising on wash quality
- varioDrawer Pro
- varioFlex Pro
- Interior blue emotionLight
- TFT display with real time clock
- Glass holder tray
- Noise level: 44dB

Slimline Dishwashers

Small in stature, big on features.

SR66T090GB

iQ 500



- 10 Place settings
- 6 Programmes
- 3 Options
- timeLight – projects the time remaining on to the floor
- varioDrawer
- varioFlex Plus
- Noise level: 44dB

SR65T081GB

iQ 500



- 10 Place settings
- 5 Programmes
- 3 Options
- varioDrawer
- varioFlex
- rackMatic™
- Noise level: 48dB

Installation diagrams

SN578S00TG
SN56M531GB

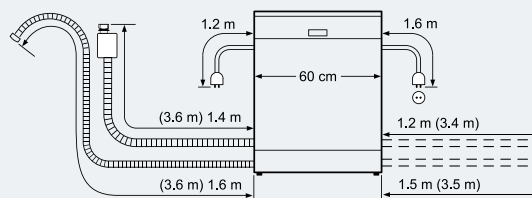
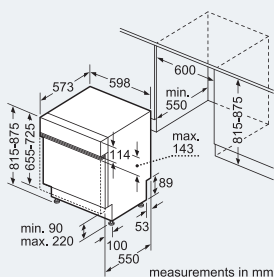

() values with extension kit

SN678D00TG
SN678D10TG
SN677X00TG
SN66P050GB
SN66M050GB
SN65M032GB
SN66L080GB
SN66D000GB

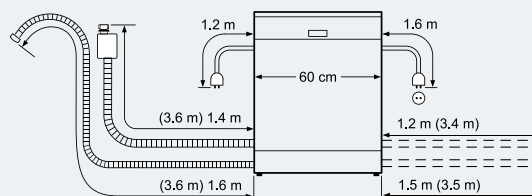
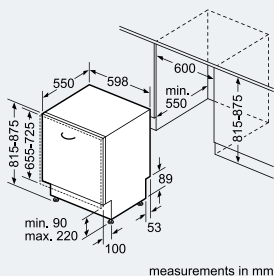

() values with extension kit

SX778D00TG

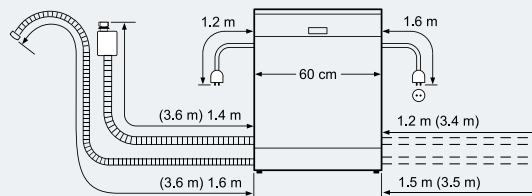
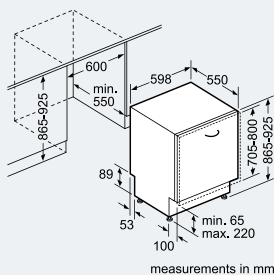

() values with extension kit

SR66T090GB
SR65T081GB

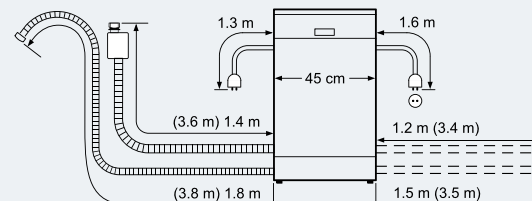
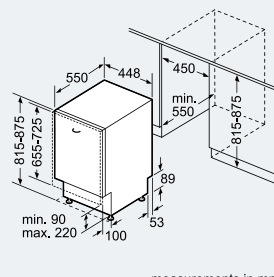

() values with extension kit

Dishwashers (continued)

SN66P050GB

iQ 500



- 13 Place settings
- 6 Programmes
- 4 Options
- Zeolith® – energy efficient drying
- hydroDry hygienic and efficient drying
- timeLight – projects the time remaining on to the floor
- varioFlex Pro
- Noise level: 42dB

SN66M050GB

iQ 500



- 13 Place settings
- 6 Programmes
- 3 Options
- hydroDry hygienic and efficient drying
- timeLight – projects the time remaining on to the floor
- varioFlex Plus
- Noise level: 44dB

SN65M032GB

iQ 500



- 13 Place settings
- 5 Programmes
- 1 Option
- varioFlex basket – allows greater flexibility for individual needs
- varioSpeed
- infoLight
- Noise level: 48dB

Dishwashers (continued)

SN66L080GB

iQ 300



- 13 Place settings
- 6 Programmes
- 2 Options
- varioFlex basket – allows greater flexibility for individual needs
- varioSpeed Plus – significantly faster without compromising on wash quality
- infoLight
- Noise level: 46dB

SN66D000GB

iQ 300



- 12 Place settings
- 6 Programmes
- vario basket system
- Controls on top edge of door
- 1 Option
- varioSpeed
- infoLight
- Noise level: 48dB



SIEMENS



Start
Pause



Intensive
Wash



Pre-
wash



Less
Ironing



Extra
Rinse

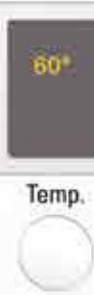

SI 14·44 totalTextile Management

Home Laundry

Smarter thinking, smarter clothes.

1400
2:40

mp. rpm Finish in

Off
Easy-Care Dark
Shirts/Business
Outdoor Wear
PowerWash 60'
Rapid 15'
Low spin
Empty
Cottons/Coloureds
Coloureds eco
Easy-Care
Mixed Fabrics
Delicates/Silk
Wool
Rinse
Spin



Behind closed doors.

Cleverly designed and quietly efficient our built-in washing machines and washer dryers work away behind closed doors, producing beautifully clean clothes without ruining the beautifully clean lines of your living space.

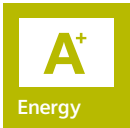

Built-in to a modern kitchen or utility room, Siemens washing machines and washer dryers not only look great, they perform too. With state-of-the-art technology they are extremely energy efficient, easy to use and save time and money. From the sophisticated sensor

technology and cutting edge engineering, to the carefully designed range of programmes and options offered our built-in laundry appliances are designed, from the ground up to help manage the range and complexity of modern textiles, quietly behind closed doors.



Discreetly efficient.



Siemens built-in washing machines perform efficiently behind closed doors whilst keeping your kitchen's sleek lines and clean design.



With many special programmes to choose from, for all your needs. Our iQ500 washing machine caters for your hectic lifestyle without you even knowing.

What can you do in 15 minutes?

Add the laundry to your list. rapid15 rinses, washes and spins lightly soiled clothing in just 15 minutes, meaning your favourite shirt will be ready for the evening before you've finished dinner.

Moderates foam, keeping clothes immaculate

Too much foam can ruin clothes, so it's important to moderate how much is in the wash. The foam detection system accurately achieves this, adding extra rinse cycles to remove excess foam.

Welcome the logical solution for clean clothes

Clothes are usually dirty from day-to-day wear, only needing a light clean. Inverse logic is the default setting that produces perfect results for daily-worn clothes, reducing washing times by up to 40%. It's the logical solution.



iQ 500

WI14S440GB

At a glance

- Capacity: 7kg
- Spin speed: 1400rpm
- 5 special programmes – including rapid15 and Shirts/Blouses/Time Remaining
- Time delay – wash when the time is right for you
- Inverse logic – reduces wash times by up to 40%
- Large display – for easy navigation

Go to pages 147-149 to view the whole range.

Taking the chore out of laundry.

The last word in convenience.



When your living space is limited Siemens washer dryers combine your laundry duties all-in-one. With a non-stop wash and dry programme for a 4kg load, we take care of your laundry so you don't have to.



In conjunction with Nikwax, we can prolong the life of your clothes.

Night wash

A special programme that minimises noise reduction, providing the perfect wash without disturbing your sleep.

Perfect when speed is the only option

The flexiTime function is designed for when speed is the only option, reducing laundry cycles by up to 30%.

Keeping clothes multi-functional

Working with Nikwax, this programme applies a waterproof treatment to breathable fabrics, prolonging the life of high quality functional clothing like winter jackets, fleeces and ski suits. Simply add the Nikwax treatment to your detergent drawer and select the Textile Guard option.

Wash and dry up to 4kg of laundry non-stop.



iq 500

WK14D540GB

At a glance

- Capacity: 6kg washing: 3kg drying
- Spin speed selection: 1400rpm to 600rpm
- Non-stop wash and dry programme: 4kg
- 6 special programmes – including night wash, rapid15 and outdoor wear
- 1 special drying programme – fluff removal cycle
- Time delay/time remaining – wash and dry when right for you
- Large display – for easy navigation

Go to pages 147-149 to view the whole range.

Welcome to a range designed around you.

Siemens have created a built-in laundry range that is cleverly designed and quietly energy efficient, developed to make laundry easier and less of a chore.

iQ 500

Exuding class and refinement, these machines unite first-class features with top-class technology.

iQ 300

Good looking appliances with Siemens build quality equipped with an attractive selection of smart features.

Washing machines

Built with the latest innovations Siemens built-in washing machines are going to provide you with clean laundry time and time again.

WI14S441GB white

iQ 500



- Capacity: 7kg
- Noise (wash, spin) – 46dB(A) re 1 pW, 64dB(A) re 1 pW
- Max. spin speed: 1400rpm
- 5 special programmes – including rapid15 and Shirts/Blouses
- Time delay – wash when the time is right for you
- Inverse logic – reduces wash times by up to 40%
- Large display – for easy navigation
- Energy consumption per cycle – 0.98 kWh 60°C cotton wash
- Moisture content % on dry load after max. spin – 54%
- Estimated annual energy and water consumption (Wash 200 full loads) – 220 kWh; 11000 litres
- Washing time – 165 minutes

WI12S141GB white

iQ 300



- Capacity: 7kg
- Noise (wash, spin) – 46dB(A) re 1 pW, 63dB(A) re 1 pW
- Max. spin speed: 1200rpm
- 3 special programmes including handwash/wool
- Inverse logic – reduces wash times by up to 40%
- Energy consumption per cycle – 0.98 kWh 60°C cotton wash
- Moisture content % on dry load after max. spin – 59%
- Estimated annual energy and water consumption (Wash 200 full loads) – 220 kWh; 11000 litres
- Washing time – 165 minutes

Washer dryers

Keeping your living space to a minimum a Siemens washer dryer combines your laundry duties all-in-one. With all the same great benefits and easy to use programmes, resulting in perfectly clean and dry laundry.

WK14D540GB white

iQ 500



- Capacity: 6kg washing; 3kg drying
- Noise (wash, spin, dry) – 57dB(A) re 1 pW, 74dB(A) re 1 pW, 60dB
- Spin speed selection: max. 1400rpm to 600rpm
- Non-stop wash and dry programme; 4kg
- 6 special programmes – including night wash, rapid15 and outdoor wear
- 1 special drying programme – fluff removal cycle
- Time delay/time remaining – wash and dry when right for you
- Large display – for easy navigation
- Energy consumption per cycle – 1.02 kWh wash; 4.85 kWh wash & dry
- Water consumption per cycle – 83 litres wash & dry
- Estimated annual energy and water consumption (Wash & dry 200 full loads) – 970 kWh; 16600 litres
- Estimated annual energy and water consumption (Wash only 200 full loads) – 204 kWh; 9000 litres
- Washing and drying time – 229 minutes

WK14D320GB white

iQ 300



- Capacity: 6kg washing; 3kg drying
- Noise (wash, spin, dry) – 57dB(A) re 1 pW, 74dB(A) re 1 pW, 60dB
- Spin speed selection: max. 1400rpm to 600rpm
- Non-stop wash and dry programme; 4kg
- 3 special wash programmes – including handwash/wool
- 1 special drying programme – fluff removal cycle
- Time delay/time remaining – wash and dry when right for you
- Large display – for ease navigation
- Energy consumption – 1.02 kWh wash – 4.81 kWh wash & dry
- Water consumption – 79 litres wash & dry
- Estimated annual energy and water consumption – 15800 litres; 962 kWh
- Estimated annual energy and water consumption (Wash only 200 full loads) – 204 kWh; 9000 litres
- Washing and drying time – 338 minutes

Installation diagrams

WI14S441G
WI12S140GB

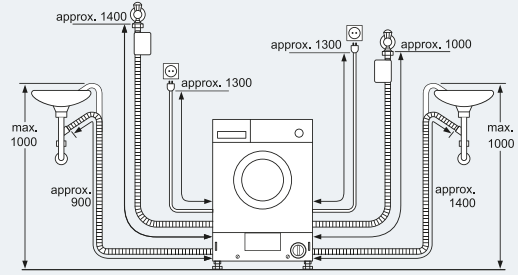
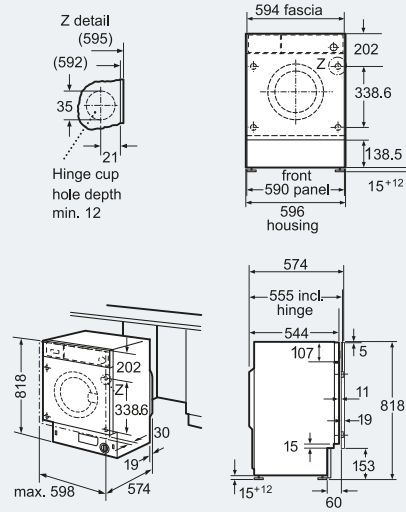

If, after fitting, the HydroSafe inlet hose to the installation is not long enough, it can be lengthened with the connecting kit WZ 10130 (length 2.5 m).

WK14D540GB
WK14D320GB

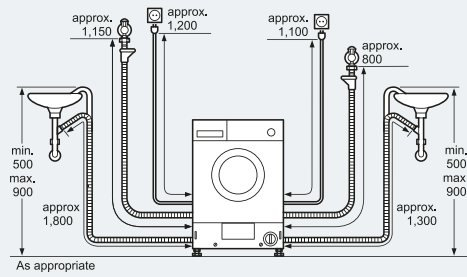
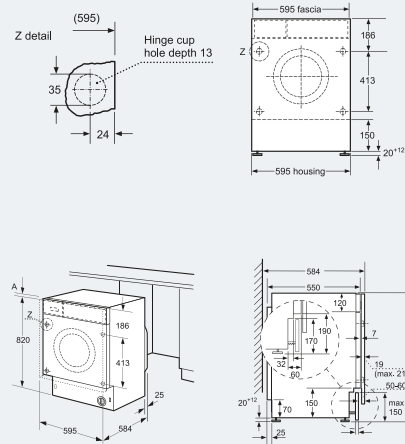

Services

For the lifetime of your appliance.





Customer service.

Knowledge and expertise, where you need it, when you need it.



Purchasing a Siemens appliance gives you access to our expert customer service team; for the lifetime of your appliance. With 2-5 year guarantees on offer and multi-award winning products to choose from and assistance from an outstanding customer service department, you can be assured that the appliance you are buying will offer peace of mind.



Siemens Customer Service has received the Highly Commended accolade in the Domestic and General Total Excellence and Quality Award 2014.

Expert advice

Siemens Customer Service staff are full of knowledge and expertise, whether you have a simple question, want to order a spare or replacement part or require an engineer to visit your home. With engineers based locally across the country*, no one is better suited to help, and all Siemens repairs are analysed in advance so that we bring the correct replacement spare parts likely to be needed on the first visit.**

This is all supported by our outstanding online services, available 24 hours a day. Visit siemens-home.co.uk for product information, downloadable brochures, videos, instruction manuals and FAQs.

Telephone:
UK: **0344 892 8999** – Options 3 and 4
IRL: **(01) 450 2655**



Original replacement spare parts

Order replacement parts online and access exploded diagrams to help you locate the correct part. As a manufacturer we only use original spare parts we keep a comprehensive range of parts available for up to ten years.

Telephone:
UK: **0344 892 8999** – Option 2
IRL: **(01) 450 2655**

[siemens-home.co.uk/store](https://www.siemens-home.co.uk/store)
[siemens-home.com/ie/store](https://www.siemens-home.com/ie/store)

Accessories and cleaning products

Order accessories and cleaning products quickly and easily via our online store. The Siemens store has an extensive selection of accessories to help you make the most of your Siemens appliance. With our range of tested and approved cleaning and care products you can keep your appliance looking good and working to optimum performance.

Telephone:
UK: **0344 892 8999** – Option 2
IRL: **(01) 450 2655**

[siemens-home.co.uk/store](https://www.siemens-home.co.uk/store)
[siemens-home.com/ie/store](https://www.siemens-home.com/ie/store)

Siemens engineers ready to help

Need to arrange an engineer visit? No problem, simply call our Customer Service team to discuss the issue with your appliance and if needed we will arrange a home appointment with an engineer at your convenience. You can book an appointment online or by telephone and we repair both in and outside the manufacturer's warranty period.

Telephone:
UK: **0344 892 8999** – Option 1
IRL: **(01) 450 2655**

[siemens-home.co.uk](https://www.siemens-home.co.uk)
[siemens-home.com/ie](https://www.siemens-home.com/ie)

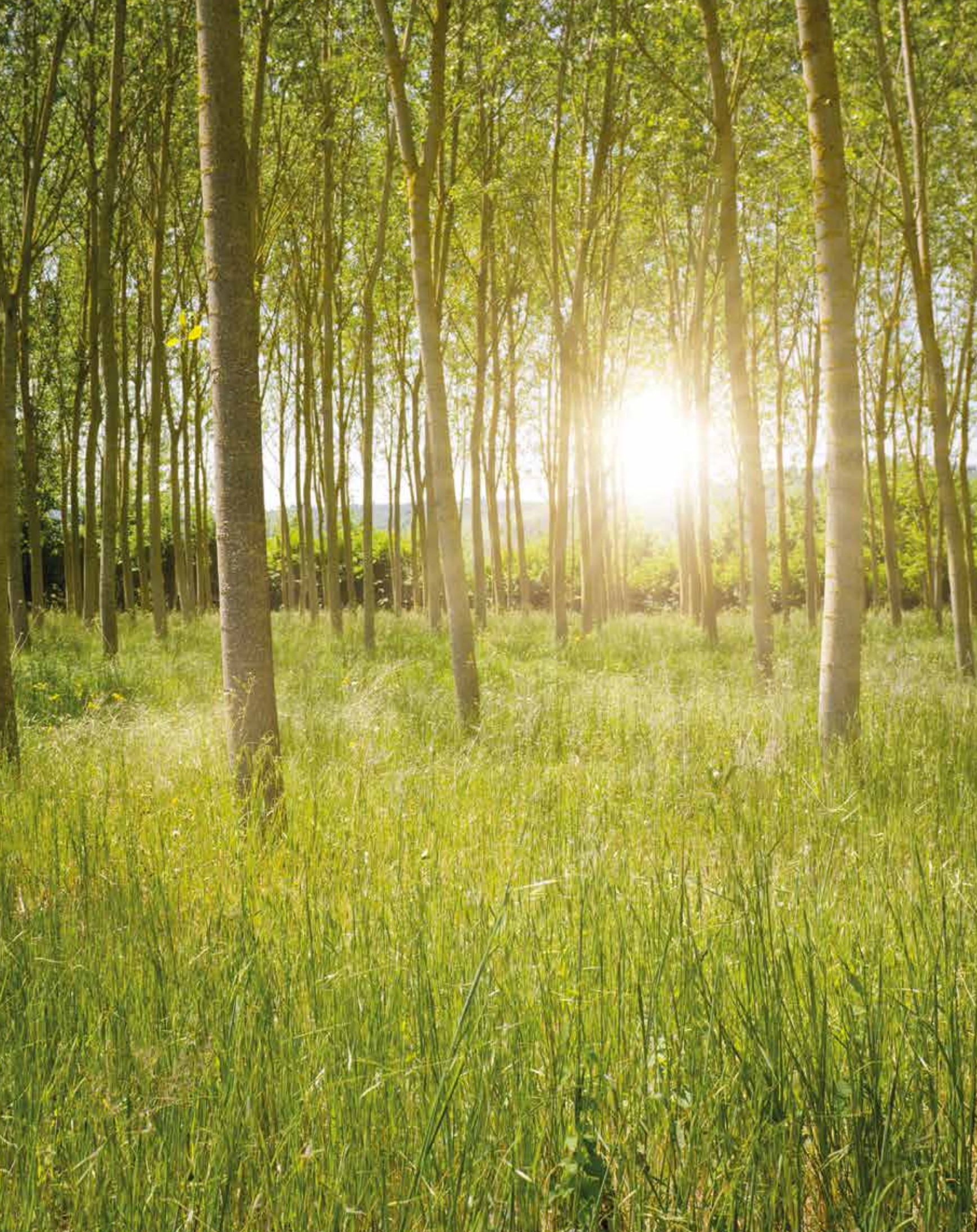

Greener products, cleaner planet.



World-class performance.
Minimum environmental impact.

Investing in the future, Siemens is committed to protecting the Earth's natural resources.

More than 80 percent* of the environmental impact occurring over a home appliance's lifetime is attributable to the usage phase. This is why, over the last few decades, BSH developers have been focusing on designing appliances that consume less energy, water and detergent. Environmental protection and energy efficiency are core topics within our corporate strategy.

What does this mean to you?

Our innovative energy-saving solutions from leading energy saving motors, to the brightest white, low-energy (LED) light can save you money and decrease your energy usage.

Energy saving comes automatically

Supporting environmental initiatives, the EU energy efficiency label is carried on all appliances; class A+++ being the most energy efficient. Reinforcing our focus on reducing energy consumption of our appliances reducing our carbon footprint, and passing on this energy saving to you, the consumer.

World-class performance

We make sure that Siemens ovens are as efficient as possible, with all our single and double oven cavities achieving a class A rating for energy efficiency. Selected models that feature hotairEco, a single shelf cooking programme, require 30% less energy than A rated appliances when hotairEco is used. And to top that, all of them are at least 20% more efficient than the standard requirements to achieve an A rating.

Most of our extractor hoods feature energy efficient low-voltage halogen lights; these offer excellent illumination of the hob space underneath but require replacing much less often. That means you don't have to worry about changing them or their effect on the environment.

If all UK consumers who bought an A rated fridge-freezer in 2011 had purchased an A+++ rated appliance instead, UK households would have saved £24 million in energy costs and

100,000 tonnes of carbon in one year (the equivalent carbon saving of taking over 30,000 cars off the road for a year). The Siemens range of super efficient fridge freezers offers a simple way to reduce your energy consumption. Much is the same for dishwashers with all of Siemens range rated at least A+ for energy efficiency and some offering the most efficient A+++ rating.

Built with ground-breaking technology, all Siemens washing machines automatically adapt the wash time and energy consumption to the amount of laundry in the machine.

In buying a Siemens product you can expect outstanding world-class performance, as well as a clear conscience.

*Source: BSH Bosch und Siemens hausgerate GMBH, Our Super Efficiency Portfolio.

Contact us.

You can reach us
24 hours a day by
calling 0344 892 8999
or online at
siemens-home.co.uk



Our advisors provide expert advice

- Product information before and after purchase
- Tips on functions and operation
- User related queries
- Queries about Siemens promotions

Telephone:

UK: **0344 892 8999** – Option 3 and 4 (option 4 for user assistance)

For product support available 24 hours a day visit online for:

- Product information
- Downloadable brochures
- Videos
- Instruction manuals
- FAQs

siemens-home.co.uk
siemens-home.com/ie

Accessories and cleaning products

- Original accessories for Siemens appliances
- Tested and approved cleaning and care products

Telephone:

UK: **0344 892 8999** – Option 2
IRL: **(01) 450 2655**

Order accessories and cleaning products quickly and easily via our online store

The Siemens online store has an extensive selection of accessories to help you make the most of your Siemens appliance. With our range of tested and approved cleaning and care products you can keep your appliance looking good and working to optimum performance.

siemens-home.co.uk/store
siemens-home.com/ie/store

Replacement spare parts

- Original spare parts
- Comprehensive range of parts kept available for up to 10 years

Telephone:

UK: **0344 892 8999** – Option 2
IRL: **(01) 450 2655**

Order replacement parts online and access exploded diagrams to help you locate the correct part

As the manufacturer we only use original spare parts. Customers can browse appliance diagrams to find the parts needed.

siemens-home.co.uk/store
siemens-home.com/ie/store

Arrange an engineer visit

- Call to discuss the issue with an appliance or check online for help
- Engineer appointments at your convenience

Siemens appliances are built to the highest standards but if you do require an engineer to visit your home, we are here to help, both in and outside the manufacturer's warranty period.

Our engineers are employed and trained by Siemens and are based locally around the country.* No one knows our appliances better, and all repairs are analysed in advance by a technical team so that the parts likely to be needed to complete the repair are sent to the engineer's van the night before the visit.**

Telephone:

UK: **0344 892 8999** – Option 1
IRL: **(01) 450 2655**

Book an engineer visit online

siemens-home.co.uk
siemens-home.com/ie†

Register an appliance for a guarantee FREE 2 year guarantee

You can register by telephone:

UK: **0800 519 2116**

IRL: **(01) 230 0344**

Or register online:

siemens-home.co.uk
siemens-home.com/ie

FREE 10 year Anti-Rust Warranty for dishwashers

Covers rusting throughout the inner cavity of all dishwashers from the inside out.

This warranty can be registered during the 2 year Siemens registration process.

FREE 10 year iQDrive Motor Guarantee

Covers the cost of a replacement motor †† and is available on selected washing machines and washer dryers. Please keep a proof of purchase if you own an applicable appliance to register the iQDrive motor guarantee.

Brochures

24-hour hotline or visit our website.

Call us on:

UK: **0344 892 8999** – Option 3

IRL: **(01) 450 2655**

Lines are open 24 hours a day. Our specialist advisors are available to help Monday to Friday 8am to 8pm, Saturday 8am to 4pm and Sunday 9am to 3pm.

siemens-home.co.uk
siemens-home.com/ie

Order your brochures or download PDF copies from our website.

*In certain areas we may use an approved service partner. **This process may vary where approved service partners are used by us. †Online booking not available in Ireland.

†† iQDrive warranty covers the cost of a replacement motor only. All labour and call-out charges outside of the 5-year guarantee are not covered. A full copy of our guarantee terms and conditions is available on request, or can be viewed via the Siemens website.

Calls to 0344 numbers are charged at the basic rate, please check with your telephone service provider for exact charges.





Siemens online.

To keep up to date with all of Siemens activities please visit siemens-home.co.uk

Here you will find out about our latest promotions and product news, plus a chance to discover our full range of intelligent appliances in even more detail.

Like and follow Siemens Home UK on Facebook and Twitter for the latest updates about our products, features and innovations. Not to mention competitions, preview videos, exclusive content and a chance for you to get involved with Siemens Home Appliances and have your say.



/SiemensHomeUK



@SiemensHomeUK

Siemens, a division of
BSH Home Appliances Ltd,
Grand Union House,
Old Wolverton Road,
Wolverton,
Milton Keynes,
MK12 5PT
Tel: 0344 892 9040
Fax: 01908 328499

siemens-home.co.uk

BSH Home Appliances Ltd,
M50 Business Park,
Ballymount,
Dublin 12
Tel: 1890 626041
(Northern Ireland 00353 1 8930201)
Fax: 1890 626042
(Northern Ireland 00353 1 8930209)

siemens-home.com/ie

BSH Group is a Trademark Licensee
of Siemens AG

Disclaimer

This brochure is current as from the publication date and supersedes all previous brochures for these products. Whilst BSH Home Appliances Ltd believes that all information contained within this brochure is correct at the time of going to print, no representation or warranty, express or implied, is or will be made and no responsibility or liability is or will be accepted by BSH Home Appliances Ltd in relation to the accuracy or completeness of this information and any liability is expressly disclaimed. To the extent permitted by law, BSH Home Appliances Ltd expressly excludes: i) all conditions, warranties and other terms which might otherwise be implied by statute, common law or the law of equity and ii) any liability for any direct, indirect or consequential loss or damage (including, without limitation, damages for loss of business or loss of profits) arising in contract, tort or otherwise from the use of or reliance on any information contained within this brochure or from any action or decision taken as a result of such use or reliance. BSH Home Appliances Ltd reserves the right to modify technical data and all other information contained within this brochure without notice. All rights reserved. No part of this publication may be reproduced in any form or without the prior written permission of BSH Home Appliances Ltd.

This brochure should not be regarded as an infallible guide nor as an offer of sale for a particular product. Due to variables in the reproduction process, colours of actual products may vary slightly from those depicted. We recommend a visit to a Siemens dealer to confirm that specifications and colours are to your satisfaction.

Valid from April 2015

