

# EHEIM



Innovative aquarium technology  
**Trade catalogue**



**Aquariums | Filters | Filter media  
Pumps | Accessories  
Food | Water care**

Product range

## 2019/2020

Dear Business Partner,

digitalisation is continuing to advance the Aquatics hobby

In this catalogue, we present an enormous variety of novelties and innovations - once again proving EHEIM to be a pioneer in progressive technologies.

Inside, you will find the new "**streamcontrol**", an electronic controller designed for both circulation and flow pumps to simulate natural water flow in the aquarium (page 55).

We have also developed the new "**LEDcontrol+**" - a wireless electronic lighting control system for determining light levels and natural lighting scenarios in both freshwater and marine aquariums (page 71).

The precision heater is now also available in an electronic version (pages 74-75).

The "**thermocontrol-e**" measures, regulates and maintains the water temperature in the aquarium with even greater precision than before.

With the new "**classicLED plants**" we have created a specific classicLED light for aquatic plants (page 65).

The revised "**proxima**" (page 16) and "**incipiria**" (pages 14/15 and 22/23-24/25) combinations are also new - both in technology and design.

In addition to these highlights you will find a large number of other innovations: The offer ranges from the new corner interior filter "**aqua**" (page 32), the new powerful water pumps "**compactON 9000 + 12000**" (page 53), the new flow pumps "**streamON+**" (page 54), the new air pump "**air**" (page 57), the new skimmer "**skimmarine 600**" (page 61), the new automatic refill "**waterrefill**" (page 62), the "**dimmer day&night**" controller for "classicLED" lights (page 65), the new size for the "**rapidCleaner**" pane cleaner and the new fishing nets (page 84), the new **CO2** sets (pages 76-83) as well as various optimised accessories through to **food** (page 94) and the proven **water treatment** products (page 95).

Browse through – you will be impressed, once again, by EHEIM's vast range and variety of products.

We look forward to working with you in the future.

Your EHEIM Team





## Contents

More and more people are turning to fish keeping these days. In Germany alone, 85 million fish are swimming around in 3 million aquariums.

There are many reasons why people love aquariums. The bold and fascinating colours of an underwater world help you get lost in a calm and relaxing environment and, for the adults, it makes a statement in a home. Children love aquariums because it brings them a little closer to nature. If you look closely, aquarium life is exciting – a lot is happening in there.

EHEIM has always offered leading technology, aesthetic and functional design and lasting solutions. Our ground breaking inventions, ingenious innovations and highest quality have set the benchmark worldwide. Aquarists love to see Made in Germany on their products.

The name EHEIM is synonymous with quality, durability and reliability. Going back more than half a century our founder and engineer, Gunther Eheim, invented the aquarium suction filter and the engineer Eugen Jäger invented the “stick” heater. Both of these inventions helped pave the way to the modern aquarium and fish keeping hobby we know today.

### Aquariums



Starter sets		Seite
Aquarium sets	aquastarLED	8
	aquaproLED	9
Stands for sets	aquacab	10



Combinations			
Fresh water	incpiria	14/15	<b>new</b>
	proxima	16	<b>new</b>
	vivalineLED	18/19	



Marine water	incpiria marine	22/23	<b>new</b>
	incpiria reef	24/25	<b>new</b>

Glass tanks	Glass aquariums	11
	Aquarium cover	11

### Filter



Micro filters	miniUP	28
	miniFLAT	29

Hang-on filters	LiBERTY	31	<b>new</b>
Corner filters	aqua	32	

Internal filters	aquacorner60	33
	PowerLine	34
	pick up	35
	aquaball	36
	biopower	37
	classic	38
	ecco pro	39
	eXperience	40
	professionel 4+	41
	professionel 3	41



External canister filters	professionel 4+	42/43
	professionel 3°	42/43
electronic	Thermofilter	44/45
thermo		



Filter media		46-51
--------------	--	-------



Pumps	compactON	52/53	<b>new</b>
	streamON+	54	
	universal	56	
	air	57	
	streamcontrol	55	<b>new</b>



Flow simulator			
----------------	--	--	--

### Accessories

UV-sterilizer	reflexUV	58
Cleaning/care	skim350	59
	skimmarine	60/61

Automatic refill	waterrefill	62	<b>new</b>
Lighting	classicLED	64/65	<b>new</b>
	powerLED+	66-69	

Lighting control	LEDcontrol	70	
	LEDcontrol+	71	<b>new</b>

Aquarium heater	thermopreset	72	
	thermocontrol	73	
	thermocontrol e	74/75	<b>new</b>

CO <sub>2</sub> -sets	CO <sub>2</sub> -sets	76-83	<b>new</b>
-----------------------	-----------------------	-------	------------

Fish feeder	autofeeder	86
	TWINfeeder	86
	turtlefeeder	86



Food		92-94
Fresh water	Food	94
Marine water	Food	94



Water care	Water care	95
------------	------------	----

### Service

Technical data	Filter	96/97
	Pumps	98/99
	Aquariums	100
	Recommended filters	101
	Brochures	102
	Technical support	103

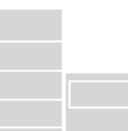

Sales aids (POS)	Shop fitting systems	105-109
------------------	----------------------	---------

### shopDesign





EHEIM incipria 530 marine

**EHEIM lighting – two ideally matched lighting concepts. Technically perfect. Safe and efficient. With a daylight spectrum similar to sunlight.**

#### EHEIM powerLED+

- High-quality and efficient alternative to T5 fluorescent tubes
- Full depth lighting - even in deep aquariums
- LED strips can be combined to create the perfect balance for plant or coral growth
- Full sunlight spectrum with maximum output for photosynthesis (fresh water)
- Reproduces the natural colours in the aquarium
- High-quality, solid aluminium housing (anodised), marine water resistant
- Highly efficient safety power supply (24V) saves energy

#### EHEIM classicLED

- Alternative to T5/T8 fluorescent tubes - interchangeable with adapter set (accessory)
- LED strip easy to install
- 4 lengths for aquariums from 55 - 120 cm width (continuously adjustable) due to extendable support brackets
- High-quality, sturdy aluminium housing
- Absolutely waterproof (IPx7) and particularly safe due to low-voltage technology
- Natural, unadulterated colour rendering
- Full illumination to the bottom of the aquarium



#### Highest quality combined with good design, simple convenience and reliable safety

Decades of experience in the production of aquariums and aquarium furniture, forward-looking innovations and a wide product range make EHEIM one of the outstanding brands in the aquatics world. Quality made by EHEIM.

- All glass aquariums for all-round viewing; no unnecessary frames or braces
- High quality float glass, flaw free with diamond cut edges
- Extra thick glass with secure joints to withstand high water pressure
- Hidden crosspiece strengthens the upper area; the full volume of the aquarium can be utilised
- Bottom trims and aquarium hoods are manufactured using the new EHEIM thermo-bonding process; a further technical innovation

- Hermetic sealing and precise production according to ISO standard and DIN 32622 guarantees the highest security
- VARILUX aquarium hoods with sliding light units, "Air-flow"-technology, wider access to the aquarium and many more advantages
- Specially adapted lighting concept
- Customised Tech Packs, furniture and Starter Sets complete the range

A wide choice of aquarium and furniture designs with a variety of possible combinations can satisfy every taste and compliment every environment.



EHEIM vivalineLED 126



EHEIM Starter sets are the ideal solution for beginners.

**EHEIM**



**Starter sets**

Technical data	Fresh water		Marine water
	aquastar 54 LED	aquastar 63 Limited Edition	aquastar 63 marine
Volume approx.	54 l	63	63
Tank dim. WxDxH	60x30x30 cm	60x30x35	60x30x35
Glass thickness	4 mm	5	5
Lighting classic/LED	1x7,7 daylight W	1x7,7 daylight	2x7,7 hybrid
Weight	9 kg	12	14
Art. No. (Europe)	black 0340645	0340708	0340701
Art. No. (UK)	black 0340647	-	0340703
Art. No. (Europe)	white 0340646	-	0340702
Art. No. (UK)	white 0340648	-	0340704
<b>Accessories</b>			
EHEIM internal filter/pump	2008	2401	2204/3701/1180/3551
EHEIM heater	50 W thermocontrol	50 W thermocontrol	-
Thermometer	+	+	+
Fish net	-	+	-
<b>Extras</b>			
Bottom trim	+	+	+

Fresh water		
aquaproLED 84	aquaproLED 126	aquaproLED 180
84	126	180
60x35x40	80x35x45	100x40x45
5/6	6/8	6/
1x7,7 daylight	1x10,6 daylight	1x13,5 daylight
16	23,8	31
0340698	0340898	0341098
0340697	0340895	0341095
0340699	0340899	0341099
0340700	0340896	0341096
<b>Accessories</b>		
2402	2402	2403
75 W thermocontrol	100 W thermocontrol	150 W thermocontrol
+	+	+
+	+	+
<b>Extras</b>		
+	+	+

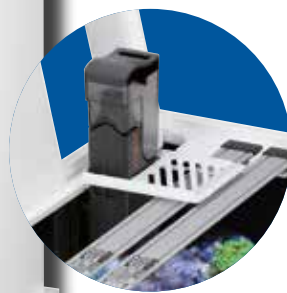

**aquastar aquarium set**  
 Complete with high quality accessories.  
 Available as fresh and marine water sets. With LED lighting.  
 Can be combined with the "aquacab" stand (page 10).

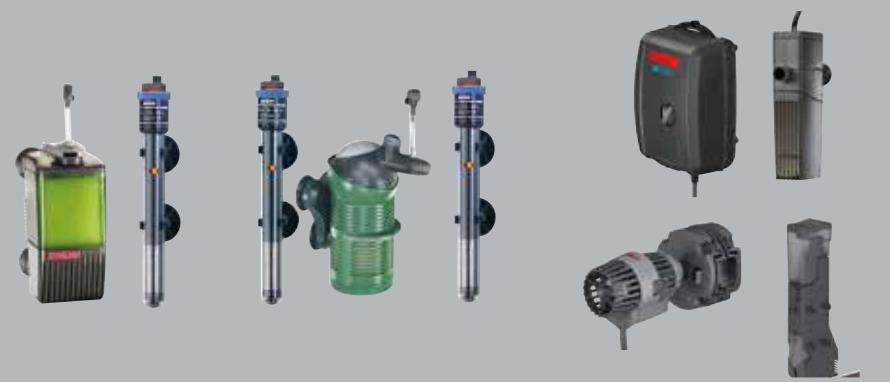

**Professional aquarium set**  
 complete professional sets for beginners. As well as energy saving LED lighting, a filter, heater and thermometer are also included for perfect coordination.  
 Extra large tank volume. Can be combined with „aquacab“ (aquaproLED 84/126) and cabinet „vivalineLED“ (aquaproLED 180) page 10.



The cover can be completely removed for care and maintenance work: LED lamp remains in the aquarium and can be easily moved.



Opening (with lid) for food; suitable for feeding station and for use of automatic feeder (EHEIM autofeeder)





EHEIM furniture kits – suitable for starter sets.  
Value for money and easy to assemble.

Tanks and covers for customised solutions.

**EHEIM**



**Furniture**

**Technical data**

	aquacab 54	aquacab 84	aquacab 126
Dimensions w x d	61x31	61x36	81x36
Height cm	85	85	85
Weight kg	14	14,5	20
Art. No. <b>black</b>	0220639	0220649	0220839
EAN 4010251	133019	133033	133057
Art. No. <b>white</b>	0220633	0220643	0220833
EAN 4010251	133002	133026	133040
<b>Suitable for set</b>			
aquastar 54/LED/63 marine	●		
aquaproLED 84		●	
aquaproLED 126			●
aquaproLED 180		MB vivalineLED 180	

**EHEIM aquacab – customised cabinet kit for the EHEIM complete sets.**

Reasonable price, easy to assemble.

- Ideally suited for EHEIM aquastar54 LED complete sets, aquastar63 marine, aquaproLED 84 and aquaproLED126
- Pleasant viewing height of 85 centimeters
- Reasonable price and easy to assemble
- Additional storage space for your aquarium accessories



aquaproLED 180 (Page 9)



aquaproLED 126 (Page 9)



aquaproLED 84 (Page 9)



aquastar54 LED (Page 8)



aquastar63 marine (Page 8)

Whether used as a breeding tank, as an individual tank in a home environment, in combination with our furniture kits or as a complete set – you can be certain of one thing: with our glass tanks you have made the right choice. Because high quality, strong glass, the best of workmanship and additional strengtheners ensure complete safety.



		Volume litre	Weight kg	Glass mm	Art. No.	EAN 4010251	Dim. cm WxDxH
GB 30	Breeder tank	12	2,8	4	0330300	074121	30x20x20
GB 40	Breeder tank	25	4,2	4	0330400	074138	40x25x25
GB 60	Tank for set aquastar, MB aquacab 54	54	7,4	4	0330604	114049	60x30x30
GB 60XL	Tank for MB aquacab 84	84	12,5	6	0330612	096437	60x35x40
GB 61	Tank for set aquastar marine, MB aquacab 54	63	10,3	5	0330613	117729	60x30x35
GB 80	Tank for set aquastar	96	16,8	6	0330800	083918	80x30x40
GB 82	Tank for set aquapro, vivalineLED and MB aquacab 126	126	19,2	6/8	0330820	089194	80x35x45
GB 105	Tank for set aquapro, vivalineLED	180	28,3	6/8	0331060	116821	100x40x45
GB 123	Tank for vivalineLED	240	47	8/10	0331230	131558	120x40x50
GB proxima 175		175	29,5	8	0330750	122600	70x50x50
GB proxima 250		250	43	8/10	0331031	122617	100x50x50
GB proxima 325		325	71	12	0331310	122471	130x50x50

**Aquarium cover**

VA 80 LED black   1x10,6W classicLED daylight	0540858	137239	81,5x36,5x8,5
VA 80 LED white   1x10,6W classicLED daylight	0540853	137246	81,5x36,5x8,5
VA 100 LED black   1x13,5W classicLED daylight	0541058	137253	101,5x41,5x8,5
VA 100 LED white   1x13,5W classicLED daylight	0541053	137260	101,5x41,5x8,5
VA 120 LED black   1x16,5W classicLED daylight	0541258	137277	121,5x41,5x8,5
VA 120 LED white   1x16,5W classicLED daylight	0541253	137505	121,5x41,5x8,5

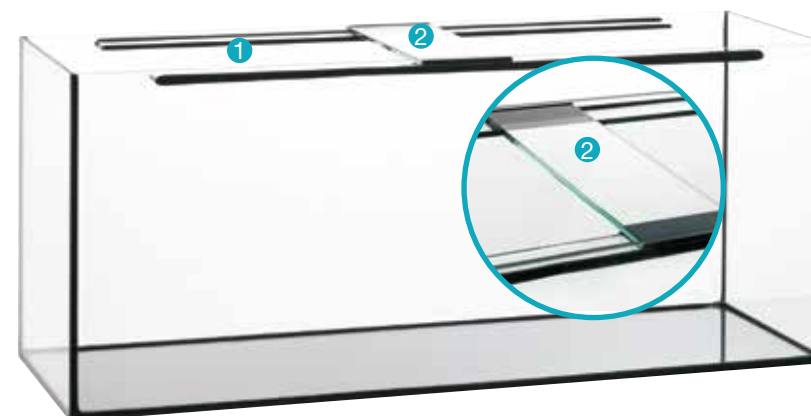

All aquariums comply with DIN standards and, depending on the size, come in various versions including strengthened front glass panes, glass struts 1 or additional strengthening bars 2.

EHEIM all glass aquariums are available in a wide range of sizes.

**EHEIM Guarantee of quality:**  
3 years' guarantee with the silicone sealing on all aquariums.



Made in Germany







Shaft positioned in the corner – for more space for design and decoration of your underwater world



Convenient sliding cover made of high-quality black glass



Additional ventilation in the sliding cover

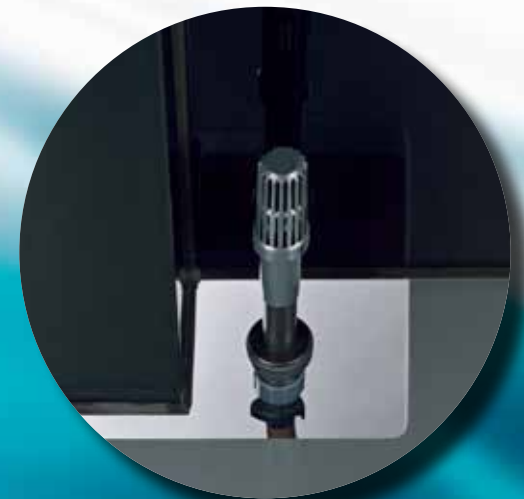

Unobtrusive water return to the external filter through a hole in the base at the back of the aquarium

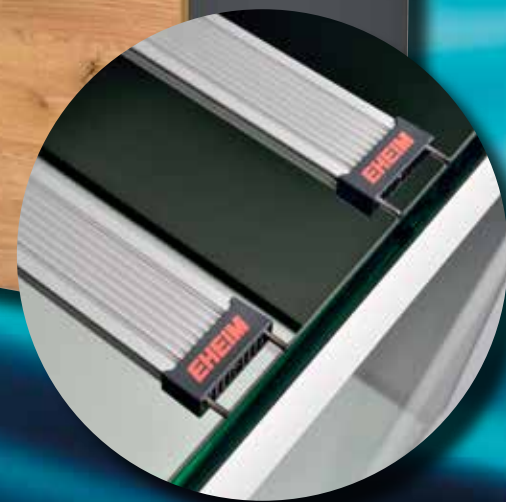

Including powerLED+ lighting



Sufficient space for technology in cabinet



Atmospheric LED lighting in the cabinet with remote control (dimnable, 640.000 colours, 20 automatic programmes)





## Top design and technology

All-inclusive aquarium combination.  
Complete with high quality technology.

**EHEIM**  
incpiria

Pre-assembled

new



new



new



new



alpin

alpin/  
nature

graphit

graphit/  
nature

## Combination

### Technical data

	incpiria 230				incpiria 330				incpiria 430				incpiria 530			
Volume approx.	230				330				430				530			
Tank dim. WxDxH	70x60x65				100x60x65				130x60x65				160x60x65			
Glass thickness	8				10				12				12			
Lighting powerLED+	1x17,3 daylight / 1x19,7 plants				1x25,9 daylight / 1x29,5 plants				1x34,6 daylight / 1x39,4 plants				1x43 daylight / 1x49 plants			
Dim. compartment WxD	14,5x10				14,5x10				14,5x10				14,5x10			
Bottom hole compartment Ø	1x55				1x55				1x55				1x55			
Bottom hole return pipe Ø	1x27				1x27				1x27				2x27			
Complete dim. WxDxH	70x60x140				100x60x140				130x60x140				160x60x140			
Weight	99				139				190				226			
Decor	alpin nature	alpin	graphit nature	graphit	alpin nature	alpin	graphit nature	graphit	alpin nature	alpin	graphit nature	graphit	alpin nature	alpin	graphit nature	graphit
Art. No. (Europe)	0692111	0692113	0692118	0692119	0693111	0693113	0693118	0693119	0694111	0694113	0694118	0694119	0695111	0695113	0695118	0695119
Art. No. (UK)	0692121	0692123	0692128	0692129	0693121	0693123	0693128	0693129	0694121	0694123	0694128	0694129	0695121	0695123	0695128	0695129

**EHEIM incpiria 530**  
Designed for the operation of external filters with 2 x suction side through 2 bottom holes.  
(professional 3 1200XL/1200XLT)



### EHEIM incpiria – the aquarium combination with an avant-garde design

- All aquariums 60cm deep
- LED-lighting – 1x powerLED+ daylight; 1x powerLED+ plants
- Integrated supply shaft (black glass) to hide hoses and power cables
- Water outflow individually configured by using the „InstallationsSet 2“ (included) - (set can be mounted at the front to achieve better flow)
- Unobtrusive water return to the external filter through a hole in the base at the back of the aquarium
- Cabinets available with high-gloss finish (alpine and graphite) or with (pleasantly textured) wooden front
- Fully assembled cabinet

### EHEIM CO<sub>2</sub>-fertiliser unit (optional):

EHEIM CO<sub>2</sub> sets offer a simple and reliable way to supply the correct amount of CO<sub>2</sub> into your aquarium for healthy plant growth (from Page 76).



new



### Lighting extension for incpiria 530

Consisting of powerLED+ in the respective light colour, separate powerLED+ power supply for operation required.

Art. No. EU	powerLED+	Watt
0585116	fresh daylight	43
0585117	fresh plants	49

**Accessories (optional):**  
double tap Art. 4005410  
skim350 Art. 3536220  
LEDcontrol+ Art. 4200140

**Recommended EHEIM technology**  
Page 101



powerLED+ fresh daylight



powerLED+ fresh plants

### EHEIM rear wall kit - to use your incpiria as a partition.

Description	Decor	Art. No.	EAN 4010251
EHEIM rear wall kit for incpiria 330	alpin	0712313	144633
EHEIM rear wall kit for incpiria 330	graphit	0712314	144640
EHEIM rear wall kit for incpiria 430	alpin	0712315	144657
EHEIM rear wall kit for incpiria 430	graphit	0712316	144664
EHEIM rear wall kit for incpiria 530	alpin	0712317	144671
EHEIM rear wall kit for incpiria 530	graphit	0712318	144688





The aesthetically pleasing aquarium combination.

**EHEIM**  
proxima

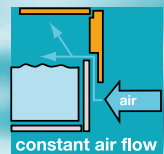

**Combination**

**Technical data**

		proxima 175	proxima 250	proxima 325
Volume approx.	l	175	250	325
Tank dim. WxDxH	cm	70x50x50	100x50x50	130x50x50
Glass thickness	mm	8	8/10*	12
Lighting classicLED	W	2x8,6 daylight	2x13,5 daylight	2x16,5 daylight
Length classicLED	mm	640-725	940-1025	1240-1325
Complete dim. WxDxH	cm	71x51x132	101x51x132	131x51x132
Weight	kg	73	96	136
Dekor white	Art. (Euro)	0491213	0492213	0493213
Dekor white	Art. (UK)	0491223	0492223	0493223
Dekor urban	Art. (Euro)	0491211	0492211	0493211
Dekor urban	Art. (UK)	0491221	0492221	0493221
Dekor oak	Art. (Euro)	0491214	0492214	0493214
Dekor oak	Art. (UK)	0491224	0492224	0493224

\* Side glass panes/Front

**EHEIM proxima 175/250/325**

**Closed aquarium combination** with a brushed aluminium Varilux light support and bottom frame

- 50 cm depth – ideal for aquascaping underwater biotopes
- Sliding glass covers made from high quality black glass
- Two integrated free moving classicLED daylight strips
- Light colour 6500 K, similar to daylight (Sunrise and sunset can be simulated by using a dimmer)
- Handle free doors with dampened „push to open“ door hinge technology
- Plenty of space in the cabinet for filters and accessories
- One cabinet compartment with shelf
- Opening for cables and hoses at rear

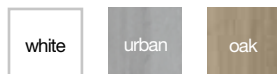

**Recommended EHEIM technology**  
Page 101

Made in Germany



**Accessories**

**Original EHEIM accessories for fresh water aquariums**

**UV-steriliser - EHEIM reflexUV**

Reduces germs in water, quickly and effectively  
Removes clouding caused by algae or bacteria  
reflexUV 350 Art. 3721210 (Europe) / 3721350 (UK)  
reflexUV 500 Art. 3722210 (Europe) / 3722350 (UK)  
reflexUV 800 Art. 3723210 (Europe) / 3723350 (UK)  
Page 58

**Surface skimmer - EHEIM skim350**

Small surface skimmer for aquariums up to 350 litres.  
Removes deposits of dirt and microorganisms from the surface of the water  
skim350 Art. 3536220 (Europe) / 3536340 (UK)  
Page 59

**Automatic gravel cleaner - EHEIM Quick Vac pro**

The battery operated gravel cleaner is used to clean the gravel substrate and can also be used between water changes.  
Quick Vac pro Art. 3531000  
Page 84

**EHEIM autofeeder/TWINfeeder**

If you don't always have time an automatic fish feeder is ideal. Also when on holiday.  
autofeeder Art. 3581000  
TWINfeeder Art. 3582000  
Page 86

**EHEIM feedingSTATION**

The added extra for improving life in your aquarium. The aquarium water will stay cleaner for longer and you can keep an eye on all of your fish.  
feedingSTATION Art. 4001020  
Page 87

**EHEIM MultiBox**

A clever and extremely practical idea for both aquarium maintenance and aquascaping, keeping everything you need at your fingertips.  
MultiBox Art. 4001010  
Page 89

For further details visit: [www.eheim.com](http://www.eheim.com)





Individual home environments fully equipped with high quality technical equipment



**Combination**

**Technical data**

		vivaline 126 LED			vivaline 150 LED			vivaline 180 LED			vivaline 240 LED		
Volume approx.	l	126			150			180			240		
Tank dim. WxDxH	cm	80x35x45			60x50x50			100x40x45			120x40x50		
Glass thickness	mm	6/8			8			6/8			8/10		
Lighting classicLED	W	1x10,6			2x7,7			1x13,5			1x16,5		
Complete dim. WxDxH	cm	81x36x119			61x51x124			101x41x119			121x41x124		
Weight	kg	48			55			60			82		
Decor		oak grey	white	anthracite	oak grey	white	anthracite	oak grey	white	anthracite	oak grey	white	anthracite
Art. No. (Europe)		0613001	0613003	0613009	0613021	0613023	0613029	0613041	0613043	0613049	0613061	0613063	0613069
Art. No. (UK)		0615001	0615003	0615009	0615021	0615023	0615029	0615041	0615043	0615049	0615061	0615063	0615069

EHEIM vivalineLED is the fresh water aquarium combination in four different sizes and countless colour combinations.

- Trendy cabinet – in three different basic colours (white, anthracite, oak grey)
- Including energy efficient and high performance EHEIM classic LED lighting
- Interchangeable decorative panel in different trendy colours
- Sliding LED lights for easy access
- Glued frame with cut outs for all pipework and cables
- Sliding panes made of high quality aluminium composite panels (black/white)
- Fully equipped with high quality EHEIM technical equipment and biological filter media



Sliding panes made of high quality aluminium composite panels

**Including EHEIM technology:**

Filter	biopower	ecco pro	Heater thermocontrol
vivalineLED 126	160	-	100 W
vivalineLED 150	200	-	100 W
vivalineLED 180	200	-	150 W
vivalineLED 240	-	300	150 W

All vivalineLED cabinets are supplied with matching decorative boards in oak grey, white or anthracite. As well as these three standard colours, the interchangeable panels are also available in bordeaux, candy, lemon, sky and urban (light grey). The panels are simple to replace and can be screwed onto the cabinet even when the aquarium is full.



EHEIM vivalineLED 180 - white with decorative board in bordeaux

Cover with glass tank and cabinet are also available separately.



Made in Germany



# EHEIM incpiria marine/reef

**EHEIM**  
incpiria marine

**EHEIM**  
incpiriareef



Atmospheric LED lighting in the cabinet with remote control (dimnable, 640.000 colours, 20 automatic programmes)



Shaft positioned in the corner – for more space for design and decoration of your underwater world. Patented, noiseless drainage shaft

- ❶ Supply shaft (black glass) to hide hoses and cables
- ❷ Overflow protection (emergency overflow even in case of power failure)
- ❸ Return flow
- ❹ Overflow comb



Three openings with cover grid for the patented, noiseless overflow shaft at the technology shaft



Pipework pre-assembled: Fixed pipework made of PVC-U; silicone hose as coupling piece to the feed pump (plug & play system)



Large filter sump with storage chamber for osmosis water

Filter sump with splash guard and constant water level (important for constant skimming quality)

Overflow protection (emergency overflow even in case of power failure)

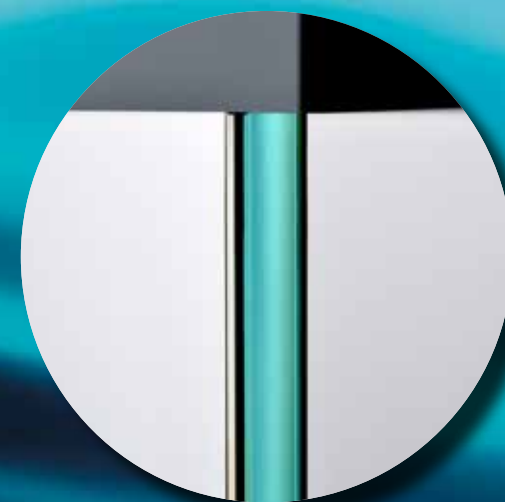

Flawless, natural blaze of colour due to the pure white glass panes



The marine water aquarium combination suitable.

Pre-assembled

new

new

new

new

alpin

alpin/  
nature

graphit

graphit/  
nature

Marine water

Technical data

	incipria 230 marine				incipria 330 marine				incipria 430 marine				incipria 530 marine			
Volume approx.	230				330				430				530			
Tank dim. WxDxH	70x60x65				100x60x65				130x60x65				160x60x65			
Glass thickness	8				10				12				12			
Lighting powerLED+	3x19,7 hybrid / 1x17,3 actinic				3x29,5 hybrid / 1x25,9 actinic				3x39,4 hybrid / 1x34,6 actinic				3x49,2 hybrid / 1x43 actinic			
Dim. compartment WxD	28,5x14,2				28,5x14,2				28,5x14,2				28,5x14,2			
Complete dim. WxDxH	70x60x140				100x60x140				130x60x140				160x60x140			
Weight	127				168				220				261			
<b>Filtration tank</b>																
Normal operation	39				39				39				49			
Rev. osmosis water supply	12				12				12				12			
Tank dimensions WxDxH	56x46,4x35/50				56x46,4x35/50				56x46,4x35/50				68x46,4x35/50			
<b>EHEIM pump</b>																
EHEIM compactON	3000				3000				3000				3000			
Decor	alpin nature	alpin	graphit nature	graphit	alpin nature	alpin	graphit nature	graphit	alpin nature	alpin	graphit nature	graphit	alpin nature	alpin	graphit nature	graphit
Art. No. (Europe)	0692511	0692513	0692518	0692519	0693511	0693513	0693518	0693519	0694511	0694513	0694518	0694519	0695511	0695513	0695518	0695519
Art. No. (UK)	0692521	0692523	0692528	0692529	0693521	0693523	0693528	0693529	0694521	0694523	0694528	0694529	0695521	0695523	0695528	0695529

Accessories - optional



EHEIM streamON+ circulation pump, Page 54

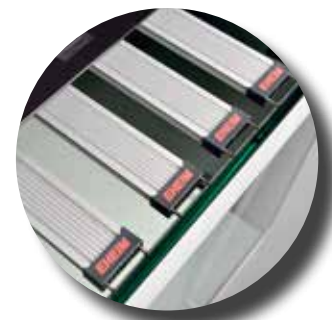

Including powerLED+ lighting

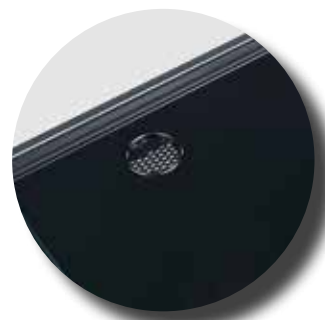

Additional ventilation in the sliding cover



powerLED+marine hybrid



powerLED+marine actinic

- All aquariums 60cm deep
- Flawless, natural blaze of colour due to the pure white glass panes
- Internal, well-coordinated LED lighting  
3x powerLED+ hybrid;  
1x powerLED+ actinic
- Integrated supply shaft (black glass) to hide hoses and cables
- Shaft positioned in the corner – for more space for design and decoration of your underwater world
- Patented, noiseless drainage shaft
- Internal cabinet joints sealed with silicone
- Cabinet with high-gloss finish (alpine and graphite) or with modern, (haptically) pleasantly textured wooden front
- Return pump included (EHEIM compactON 3000)



Convenient sliding cover made of high-quality black glass



EHEIM skimmarine 600 protein skimmer, Page 61



Made in Germany



The open topped version of the incipria marine.  
With no cover or lighting

Pre-assembled

new

new

new

new

alpin

alpin/  
nature

graphit

graphit/  
nature

Marine water

Technical data

Volume approx. l  
Tank dim. WxDxH cm  
Glass thickness mm  
Dim. compartment WxD cm  
Complete dim. WxDxH cm  
Weight kg

Filtration tank

Normal operation l  
Rev. osmosis water supply l  
Tank dimensions WxDxH cm

EHEIM pump

EHEIM compactON

Decor

Art. No. (Europe)

Art. No. (UK)

	incipria 230 reef				incipria 330 reef				incipria 430 reef				incipria 530 reef			
Volume approx. l	230				330				430				530			
Tank dim. WxDxH cm	70x60x65				100x60x65				130x60x65				160x60x65			
Glass thickness mm	8				10				12				12			
Dim. compartment WxD cm	28,5x14,2				28,5x14,2				28,5x14,2				28,5x14,2			
Complete dim. WxDxH cm	70x60x140				100x60x140				130x60x140				160x60x140			
Weight kg	118				156				204				243			
Normal operation l	39				39				39				49			
Rev. osmosis water supply l	12				12				12				12			
Tank dimensions WxDxH cm	56x46,4x35/50				56x46,4x35/50				56x46,4x35/50				68x46,4x35/50			
EHEIM compactON	3000				3000				3000				3000			
Decor	alpin nature	alpin	graphit nature	graphit	alpin nature	alpin	graphit nature	graphit	alpin nature	alpin	graphit nature	graphit	alpin nature	alpin	graphit nature	graphit
Art. No. (Europe)	0692611	0692613	0692618	0692619	0693611	0693613	0693618	0693619	0694611	0694613	0694618	0694619	0695611	0695613	0695618	0695619
Art. No. (UK)	0692621	0692623	0692628	0692629	0693621	0693623	0693628	0693629	0694621	0694623	0694628	0694629	0695621	0695623	0695628	0695629



Elegant design, high quality workmanship and construction, perfect technology, quiet performance and optimum safety – all fully assembled with the exception of the lights. This is the incipria reef.

The panes of pure white glass give a clear view of the exotic underwater world. The integrated overflow protection gives additional security and the spacious filter sump makes maintenance easy. The system runs quietly due to the patented, noiseless drainage shaft. The EHEIM compactON 3000 return pump is included and all pipework and cables are pre-assembled for 'plug & play'.

You choose the lighting to suite your individual requirements.

Stunningly beautiful and technically perfect

- Open marine water aquarium combination without cover
- Without lighting - for individual light selection
- All aquariums 60cm deep
- Flawless, natural blaze of colour due to the pure white glass panes
- Integrated supply shaft (black glass) to hide hoses and cables
- Shaft positioned in the corner – for more space for design and decoration of your underwater world
- Patented, noiseless drainage shaft
- Internal cabinet joints sealed with silicone
- Cabinet with high-gloss finish (alpine and graphite) or with modern, (haptically) pleasantly textured wooden front
- Return pump included (EHEIM compactON 3000)

Accessories - optional

Circulation pumps – EHEIM streamON+

Compact circulation pumps with magnetic mounting bracket - for aquariums between 35 and 500 litres  
EHEIM streamON+ 3500 Art. 1180220 / 1180340 (UK)  
EHEIM streamON+ 6500 Art. 1181220 / 1181340 (UK)  
EHEIM streamON+ 9500 Art. 1182220 / 1182340 (UK)  
Page 54



Flow simulator

Controller for aquarium pumps  
streamcontrol Art. 3500210 / 3500350 (UK)  
Seite 55



Skimmers - EHEIM skimmarine

For aquariums up to 600 lt  
skimmarine 100 Art. 3551000  
skimmarine 300 Art. 3549220 (Europe) / 3549340 (UK)  
skimmarine 600 Art. 3552220 (Europe) / 3552340 (UK)  
Page 60/61



Made in Germany



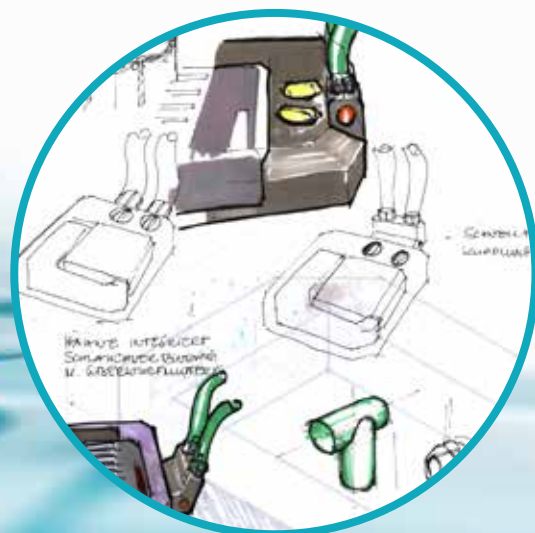

### EHEIM internal filter Versatile, functional and made with exceptional quality.

Whether for breeding, quarantine tanks or simply for typically smaller "home" aquariums: internal filters are ideal. They take up little room and are extremely flexible. EHEIM offers various options for aquariums from 45 up to 260 litres: all of them (apart from the pickup) are modular and can be extended or reduced to suit all requirements. They can all be filled with various types of filter media. Technically perfect filters of outstanding quality, with reliable performance and guaranteed durability.

### EHEIM external canister filters

With our large range of external filters you are sure to find exactly the right filter to suit your needs – for the smallest breeding tanks to aquariums up to 1500 lt.

All EHEIM aquariums have one thing in common: QUALITY. We work with the best materials, precise engineering and, with over 60 years of experience, we guarantee the highest quality products. Our canister filters are consistent, reliable and offer a long service life. Furthermore, you can be sure that the filter, accessories and filter media are tailored to complement each other.

### EHEIM High Performance Ceramics

The impeller shafts and bushings (axles and bearings) (eccopro, eXperience, professionnel 3 and professionnel 4+) are made of high performance ceramics. This means exceptionally smooth and quiet running, maximum resilience and an extremely long service life.

### With EHEIM pumps you can move a lot of water – reliably, quietly and continuously.

With an output of between 100 and 5000l/h, the EHEIM range of pumps and air pumps can be used in all aquatic applications, from small to large aquariums and planted aquascapes to ponds, water features and fountains. EHEIM pumps can be used anywhere to provide air and clean water conditions. They can be used in or out of water, for fresh or marine aquariums – whatever the application; EHEIM has a comprehensive range of products and features that can match any requirements. Their quality upholds the EHEIM promise: innovative technology, the best materials, outstanding workmanship, quiet running and guaranteed reliable continuous performance.

Small and large compact pumps, circulation pumps, a marine water pump for protein skimmers, universal pumps and air pumps – the choice is yours.

**EHEIM filter technology**  
From the classic to the newest high-tech models with electronic control.  
With or without a heater.

**EHEIM pumps – the all purpose product range for aquariums and ponds, for fresh and salt water and for large and small applications – range includes air pumps.**





Designed for the smallest tanks.  
Attractive, slim design.

**EHEIM**  
miniUP

For frogs, amphibians & co.  
Simple to install, connect and start up.

**EHEIM**  
miniFLAT



**Micro filter**

**Technical data**

		miniUP
Aquarium size up to	l	30
Pump output	l/h / gph	300 / 79
Delivery head	Hmax m	0,5
Filter volume	cm <sup>3</sup>	78,9
Hose connection pressure side	ø mm	13
Power consumption	W	5
Dimension HxWxD	mm	128x33,4x54
Art.No. (Europe)		2204020
Art.No. (UK)		2204510
Packing dim. HxWxD	cm	13,5x9,0x8,15
Master pack quantity	pcs.	4
Filter media included	<b>media+</b>	+



**The micro-internal filter for the smallest of aquariums (nano tanks) 25 to 30 l**

It is small, attractive, gives excellent performance and is easy to attach to the tank with suction cups. The filter draws in the water from the front through vents, pumps it through the filter sponge and directs it, filtered, back into the tank. You can also attach an outflow hose to enable you to adjust the outlet direction.

- Attractive, slim design
- Front water intake
- Connector for outlet hose
- Comes fully equipped with filter sponge, ready for immediate use
- Only 5 W energy usage



**Accessories (optional)**

Suction cups 4x	7445848
Connector-Set	4009800



**Filter media**

EHEIM miniUP		Pk
Filter cartridge	2 x 2616030	1

**Micro filter**

**Technical data**

		miniFLAT
Pump output	l/h / gph	300 / 79
Delivery head	Hmax m	0,5
Filter volume	cm <sup>3</sup>	39,4
Hose connection pressure side	ø mm	13
Power consumption	W	5
Dimension HxWxD	mm	127x33,4x54
Art.No. (Europe)		2203020
Art.No. (UK)		2203510
Packing dim. HxWxD	cm	13,5x9,0x8,15
Master pack quantity	pcs.	4
Filter media included	<b>media+</b>	+



**Micro internal filter for terrariums and paludariums with a shallow water area or water bowls**

(e.g. for frogs, semi-aquatic reptiles, cray fish etc.)

This unique little flat water filter is designed differently to an internal aquarium filter: It doesn't hang on to anything, but rather sits horizontally in the water. It is fixed to the tank/bowl with suction cups. It draws the water in from below, pumps it through the filter sponge and directs it out, filtered, at the top. The surface water movement makes the reptiles drinking water visible. If you want to attach an outlet hose, you can attach an outlet hose.

- Water intake from below
- Connection for water outlet hose
- Completely equipped with original EHEIM filter pad and ready to use
- Only 5 Watt power consumption

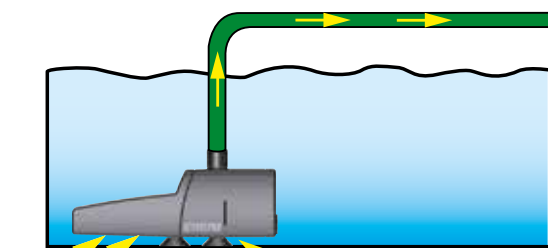

Example of usage with inlet pipe

**Filter media**

EHEIM miniFLAT		Pk
Filter cartridge	2 x 2616030	1

**Accessories (optional)**

Suction cups 4x	7445848
Connector- Set	4009800
Inlet pipe	7304450

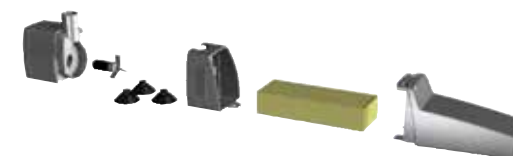





Fully equipped and ready to use. Ideal for beginners but also for professionals and breeders.

**EHEIM**  
LIBERTY



**Hang-on filter**

**Technical data**

		LIBERTY 75	LIBERTY 130	LIBERTY 200
Aquarium size up to approx.	l	75	130	200
Pump output approx.	l/h / gph	150-380 / 40-100	220-570 / 58-151	320-760 / 85-201
Power consumption	W	2,5	3	4
Canister volume approx.	l	0,6	1,0	1,3
Filter volume approx.	cm <sup>3</sup>	240	400	650
Dimensions HxWxD approx.	mm	180x105x135	180x145x135	180x195x135
Art. No. (Europe)		2040020	2041020	2042020
Packing dimensions HxWxD	cm	18,9x11,3x13,9	18,9x13,9x15,5	20x14,1x18,9
Master pack quantity	pcs.	3	3	3
Filter media included	<b>media+</b>	+	+	+

- **media+**: Comes complete with filter media
- Large filter sponge for high biological filter efficiency and longer life – can be removed for cleaning
- Various filtration options with different inserts
- Ready for immediate use
- Recommended for breeding tanks (use cartridge 2615270 on intake), goldfish and quarantine tanks
- Adjustable priming tube

- ❶ Silent inlet and perfect water distribution through water slides
- ❷ Adjustable pump output

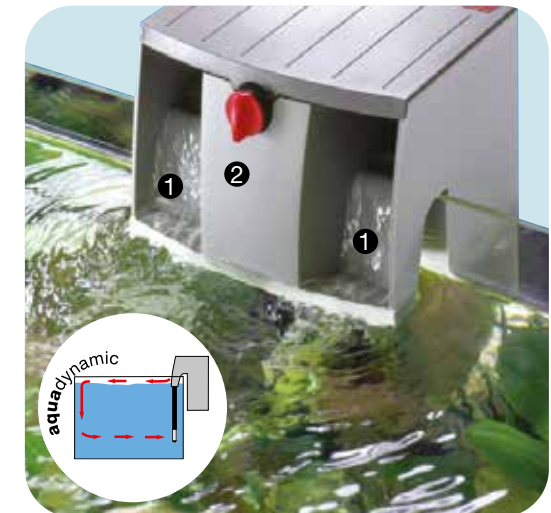

Silent inflow and output control



**Filter media**

EHEIM LIBERTY		75/130/200	Pk
Filter sponge cartridge	1 x	2617411	6
Activated carbon cartridge	12 x	2628411	1
Activated carbon cartridge	2 x	2628401	6
Biofilter cartridge	2 x	2617401	6





The modular internal corner filter with click together filter containers. Ideal for beginners with small to medium sized aquariums.

**EHEIM**  
aqua



**Corner filter**

**Technical data**

	aqua60	aqua160	aqua200	
Aquarium size up to approx.	l	30-60	60-160	100-200
Pump output approx.	l/h / gph	160-300 / 42-79	210-440 / 55-116	210-440 / 55-116
Delivery head approx.	Hmax m	0,30	0,50	0,50
Power consumption	W	4,5	4,7	4,7
Filter volume approx.	cm <sup>3</sup>	160	240	320
Dimensions WxH	mm	66x166	66x202	66x243
Art. No. (Europe)		2206020	2207020	2208020
Art. No. (UK)		2206510	2206510	2206510
Packing dim. HxWxD	cm	20,8x9,1x8,4	28,8x9,1x8,4	28,8x9,1x8,4
Master pack quantity	pcs.	22	16	16
Filter media included	<b>media+</b>	+	+	+

The EHEIM aqua corner is a multi-functional internal filter with compact dimensions and a clever modular design.

- Modular internal corner filter for small and medium-sized aquariums from 30 to 200 litres
- Ideal for beginners
- Compact and space-saving
- Practical suction cup attachment (4 suction cups)
- Powerful pump
- Simple adjustable output
- Large suction area to utilise the full filter volume
- Mediabox for different filter media (e.g. EHEIM AKTIV Kohle (carbon), SUBSTRATpro, phosphateout etc.)
- Clip-in filter containers (cartridges) for easy cleaning and expansion if necessary
- Includes diffuser and hose
- Supplied complete with filter cartridges for mechanical-biological filtration
- Including EHEIM AKTIV KOHLE (carbon - 20 g) for the Mediabox
- Suitable for fresh and marine water

**Filter media**

EHEIM aqua	Art.	Pk
EHEIM SUBSTRATpro	180 g 2510021	6
EHEIM AKTIV	140 g 2513021	6
EHEIM phosphateout	130 g 2515021	6
Filter sponge	2 x 2617050	6



**Accessories (optional)**

Upgrade-Kit Art. 4020050



Upgrade-Kit for internal filter EHEIM aqua to increase your filter volume by 80 cm<sup>3</sup>

- Filter basket with filter cartridge

Connector-Set Art. 4009800



The corner internal filter for open top aquariums.

**EHEIM**  
aqua**Corner 60**



**Corner filter**

**Technical data**

	aquaCorner 60	
Aquarium size up to approx.	l	10-60
Glass thickness up to	mm	5
Pump output approx.	l/h / gph	200 / 53
Delivery head approx.	Hmax m	0,4
Power consumption	W	4
Dimensions HxWxD approx.	mm	209x90x80
Art. No. (Europe)		2000020
Art. No. (UK)		2000510
Packing dimensions HxWxD	cm	26,5x9,3x8,3
Master pack quantity	pcs.	4
Filter media included	<b>media+</b>	+



**Powerful corner internal filter** for aquariums of 10-60 litres (glass thick max. 5 mm)

The EHEIM aquaCorner 60, specially designed for small aquariums is the heartbeat of your aquarium (up to 60l) and is specifically designed for use with a small volume of water. It maintains the balance of the eco-system, ensures constant water movement, prevents differing temperature layers. As a corner filter it takes up little space in the aquarium and therefore leaves more room for plants and other decoration. Its suction power is precisely regulated, so that small livestock (e.g. young shrimps) are not sucked in.

Fully equipped with filter sponge and bio-filter media EHEIM SUBSTRATpro

- Simple assembly
- Easy cleaning
- Easy to hang onto the glass, filter easy to flip open for cleaning
- Suitable for up to 5 mm glass thickness
- Pre-filter sponge integrated in the head
- Motor unit remains in tank during cleaning

1 **Dosage chamber** for fertiliser etc.

2 **Mediabox** for the bio-filter media, active carbon, phosphate remover, etc.

**Filter media**

EHEIM aquaCorner 60	Art.	Pk
EHEIM SUBSTRATpro	180 g 2510021	6
EHEIM AKTIV	140 g 2513021	6
EHEIM phosphateout	130 g 2515021	6
Filter sponge	2 x 2616000	6



Made in Germany





The tried and tested internal filter for powerful water circulation and intense oxygen enrichment.

**EHEIM**  
PowerLine



**Internal filter**

		PowerLine 200	PowerLine XL
<b>Technical data</b>			
Aquarium size up to	l	100-200	200
Pump output approx.	l/h / gph	600 / 159	1200 / 317
Delivery head	Hmax m	1,5	2,0
Power consumption	W	10	28
Filter volume approx.	cm <sup>3</sup>	390	700
Dim. HxWxD	mm	285x65x75	335x75x80
Art. No. (Europe)		2048020	2252020
Packing dim. HxWxD	cm	31,8x12,5x8,5	36,5x12,7x8,7
Master pack quantity	pcs.	1	1
Filter media included	<b>media+</b>	+	+

- Adaptor for connecting EHEIM installationSET 2 (on pressure side)
- Efficient modular internal filter for powerful flow in the aquarium
- Intense oxygen enrichment through supplied diffuser
- ① Variable filter volume: can be extended with additional modules
- ② Alternate partial cleaning of the cartridges in order to maintain good bacteria modular design

- **Easy fit media+** complete with Original EHEIM filter media

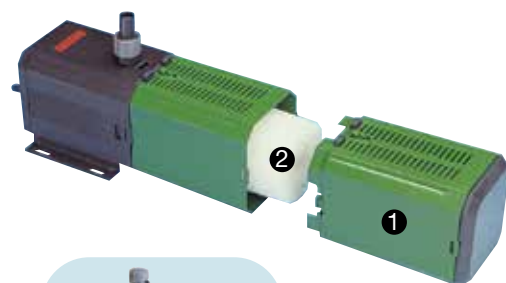

includes adaptor and diffuser



Upgrade-Kit PowerLine 200 Art. 7478860

**Accessories (optional)**

Additional modules 2048	Art. 7478860
Additional modules 2252	Art. 7478050
Spray bar for InstallationSET 2	Art. 4009620
Wide-jet nozzle	Art. 4009680
Nozzles and adapters	Art. 4009700

**Filter media**

EHEIM PowerLine	200	Pk	XL	Pk
Filter cartridge	2x 2615480	6	2615510	1
Carbon cartr.	2x 2625480	6	2625520	1

3 year guarantee EHEIM 2252



Fully equipped and ready to use. Ideal for beginners.

**EHEIM**  
pickUp



**Internal filter**

		pickup 45	pickup 60	pickup 160	pickup 200
<b>Technical data</b>					
Aquarium size up to	l	max. 45	30-60	60-160	max. 200
Pump output approx.	l/h / gph	50-180 / 13-48	150-300 / 40-79	220-500 / 58-132	220-570 / 58-151
Delivery head	Hmax m	0,35	0,35	0,40	0,40
Power consumption	W	3,5	4	6	6
Filter volume approx.	cm <sup>3</sup>	85	195	330	470
Dim. HxWxD	mm	135x50x63	163x75x96	218x75x96	275x75x96
Art. No. (Europe)		2006020	2008020	2010020	2012020
Art. No. (UK)		2006510	2008510	2010510	2012510
Packing dimensions HxWxD	cm	19x11x6,5	20,1x15,5x7,9	22,8x15,5x7,9	28,5x15,5x7,9
Master pack quantity	pcs.	4	4	4	2
Filter media included	<b>media+</b>	+	+	+	+

A special feature of the pickup is that the filter canister and the cartridge can be removed from above but the pump unit remains in the water. This is a practical solution for cleaning or changing the filter cartridge and impeller without having to remove the entire filter.

- Water inlet is in the bottom of the filter
- Outlet nozzle rotates so that you can adjust the direction of the flow
- Filter canister and cartridge are easy to remove from above
- **Easy fit media+** Complete with filter cartridge
- Activated carbon cartridges can also be used (recommended during aquarium start-ups or after treating with medication)



**Filter media**

EHEIM pickup		45	Pk	60	Pk	160	Pk	200	Pk
Filter cartridge	2x	2615060	6	2617080	6	2617100	6	2617120	6
Carbon cartr.	2x	2625060	6	2627080	6	2627100	6	2627120	6





Spherical head provides all round flexibility.

**EHEIM**  
aquaball



**Internal filter**

**Technical data**

	aquaball 60	aquaball 130	aquaball 180	aquaball powerhead 650
Aquarium size up to approx. l	30-60	60-130	80-180	-
Pump output approx. l/h / gph	150-480 / 39-127	180-550 / 48-145	210-650 / 56-172	210-650 / 56-172
Delivery head approx. Hmax m	0,37	0,43	0,43	0,43
Power consumption W	5	6	6	6
Filter volume approx. cm <sup>3</sup>	180	320	460	-
Dimensions WxH mm	96x160	96x215	96x270	96x150
Art. No. (Europe)	2401020	2402020	2403020	1212010
Art. No. (UK)	2401510	2402510	2403510	1212110
Packing dim. HxWxD cm	22,3x9,5x10,8	27,8x9,5x10,8	33,5x9,5x10,8	13,5x9,5x11
Master pack quantity pcs.	4	4	2	1
Filter media included <b>media+</b>	+	+	+	

- Multi-directional head for individual adjustment of the outflow direction
  - Accessories include: power diffusor for extra aeration and spray bar for natural water surface movement
  - Filter clip ensures secure support and ease of removal
  - Filter media box for different filter media solutions. New blue foam filter pad
  - = mechanical / biological filtration  
Fine filter pad = fine filtration  
SUBSTRATpro = the best biological filtration  
EHEIM AKTIV = adsorptive filtration
- Easy fit media+** complete with Original EHEIM filter media



**EHEIM aquaball powerhead 650**  
Universal pump for general water circulation and under-gravel filters



**Accessories (optional)**  
Wide-jet nozzle Art. 4009680  
Nozzle and adapter set Art. 4009700  
Extension piece for InstallationSET1 Art. 4009610  
Spray bar for InstallationSET2 Art. 4009620

Made in Germany



The first internal filter with external filter technology and multi-layer filtration.

**EHEIM**  
biopower



**Internal filter**

**Technical data**

	biopower 160	biopower 200	biopower 240
Aquarium size up to approx. l	80-160	100-200	160-240
Pump output approx. l/h	180-550 / 48-145	210-650 / 55-172	280-750 / 74-198
Delivery head approx. Hmax m	0,43	0,43	0,60
Power consumption W	6	6	8
Filter volume approx. cm <sup>3</sup>	380	530	680
Dimensions WxH mm	96x215	96x270	96x325
Art. No. (Europe)	2411020	2412020	2413020
Art. No. (UK)	2411510	2412510	2413510
Packing dim. HxWxD cm	25x12x10,6	30x12x10,6	34x12x10,6
Master pack quantity pcs.	4	4	2
Filter media included <b>media+</b>	+	+	+

**biopower – High performance internal filter**

- Multi-layer filtration just like an external filter
- Modular construction with closed filter baskets, filled with EHEIM SUBSTRATpro; inlet basket with filter cartridge
- Easy-Klick function to easily put together and take apart filter baskets with a single click
- Fitted with power diffusor for strong oxygen enrichment and a wide jet nozzle for natural surface water movement
- Easy fit media+** fully equipped

**Accessories (optional)**

Wide-jet nozzle	Art. 4009680
Nozzle and adapter set	Art. 4009700
Spray bar for InstallationSET 2	Art. 4009620

**Filter media**

EHEIM biopower	160/200/240	Pk
Filter cartridge	2x 2618060	6
Filter cartridge	2x 2618080	6
Carbon cartridge	2x 2628080	6
EHEIM phosphateout	2x 2638080	6
EHEIM SUBSTRATpro	180 g 2510021	6
EHEIM AKTIV	140 g 2513021	6
EHEIM bioMECH	710 g 2508051	6
EHEIM phosphateout	130 g 2515021	6



Made in Germany

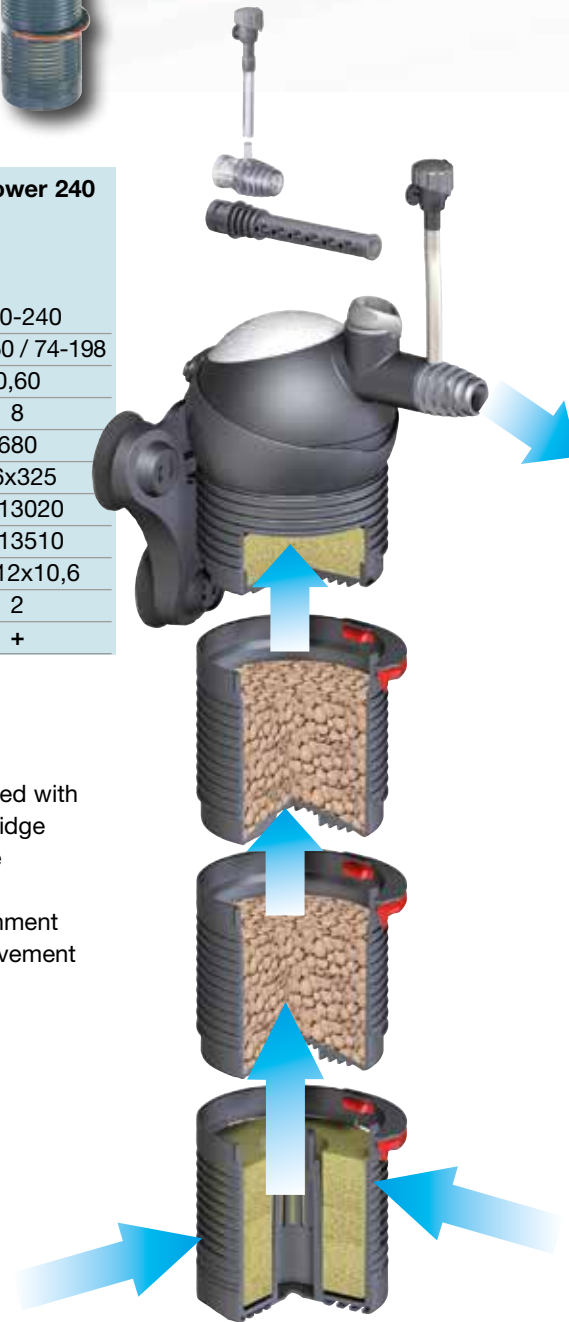

biopower 200



\* for filter media box (4)



Outstanding quality and economically priced.

**EHEIM**  
classic



**External filter**

	classic 150	classic 250	classic 350	classic 600	classic 1500XL
<b>Technical data</b>					
Aquarium size up to approx.	l 50-150	80-250	120-350	180-600	300-1500
Pump output approx.	l/h / gph 300 / 79	440 / 116	620 / 164	1000 / 264	2400 / 634
Delivery head approx.	Hmax m 1,2	1,5	1,8	2,3	3,7
Power consumption	W 5	8	15	20	65
Canister volume	l 1,3	3,5	4,8	6,6	23
Filter volume	l 1	3	4	6	18
Hose- ø suction/pressure side	mm 12/16 / 9/12	12/16 / 12/16	12/16 / 12/16	16/22 / 12/16	25/34 / 16/22
Dimensions WxH	mm 110x290	160x355	185x370	205x400	355x570
Art. No. (Europe)	2211010	2213 010/020/050 <sup>1</sup>	2215 010/020 <sup>1</sup>	2217 010/020 <sup>1</sup>	2260010
Art. No. (UK)	-	2213 500/510/520 <sup>2</sup>	2215520	2217520	2260500
Packing dimensions HxWxD	cm 36,5x17,8x16,3	37x22x16	41x29x21	41x29x21	59x33x33
Master pack quantities	pcs. 1	1	1	1	1

<sup>1</sup> 010 without filter media/020 with pads and double taps/050 with bio media and double taps  
<sup>2</sup> 500 without filter media/510 with pads and double taps/520 with bio media and double taps

- Permo-elastic silicon sealing ring ①, fixed on the pump head for easy and safe closing after cleaning
- Equipped with filter sponges and/or loose filter media
- Many different accessories
- classic 150 compact sized and stand supplied ② (fits the filter securely and safely)
- classic 250 with filter basket, each with one filter sponge, one filter pad and one activated carbon pad
- classic 1500XL for large aquariums, pump unit can be operated separately from the canister
- classic 1500XL with practical drain tap



**Accessories included**

Filter basket (only classic 250), spray bar, inlet pipe, hose and installation accessories (more accessories on page 84-91)

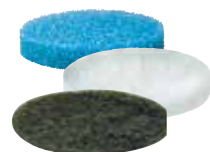

Filter media	EHEIM classic		150		Pk 250		Pk 350		Pk 600		Pk 1500XL	
	QTY	Art. No.	QTY	Art. No.	QTY	Art. No.	QTY	Art. No.	QTY	Art. No.	QTY	Art. No.
Coarse filter pad	2x	2616111	6	2616131	6	2616151	6	2616171	6	2616191	6	2616211
Fine filter pad	3x	2616115	4	2616135	6	2616155	5	2616175	5	2616195	5	2616215
Carbon pad	3x	2628110	1	2628130	6	2628150	1	2628170	1	2628190	1	2628210
Filter wadding	1x	-	-	2616130	1	-	-	-	-	-	-	-

Made in Germany (classic 1500XL)



Less energy consumption with more power.

**EHEIM**  
ecco pro



5 Watt



5 Watt



8 Watt

**External filter**

	ecco pro 130	ecco pro 200	ecco pro 300
<b>Technical data</b>			
Aquarium size up to approx.	l 60-130	100-200	160-300
Pump output approx.	l/h / gph 500 / 132	600 / 158	750 / 198
Delivery head approx.	Hmax m 1,4	1,4	1,9
Power consumption	W 5	5	8
Canister volume	l 3,0	4,0	5,0
Filter volume	l 1,2+0,3 (prefilter)	2,0+0,3 (prefilter)	2,8+0,3 (prefilter)
Hose- ø suction/pressure side	mm 12/16 / 12/16	12/16 / 12/16	12/16 / 12/16
Dimensions WxH	mm 205x298	205x355	205x416
Art. No. (Europe)	2032020	2034020	2036020
Art. No. (UK)	2032510	2034510	2036510
Packing dimensions HxWxD	cm 38,7x20,7x18,4	42,2x23,5x18,4	44,0x24,5x18,4
Master pack quantities	pcs. 1	1	1
Filter media included	media+ +	+	+

- Low energy consumption with high performance
- Excellent biological and mechanical filtration due to optimum water throughflow
- ① Multi-function handle (for carrying + opening/closing + priming)
- Large volume self-priming
- ② Rotating shut off taps (more convenient handling)
- Runs extremely quietly due to ceramic axles and sleeves
- ③ Practical filter baskets, can be filled according to individual requirements
- ④ Additional prefilter (giving longer cleaning intervals for the other filter media)
- Long-life elastic silicon sealing ring in pumphead
- ⑤ **media+**: Completely equipped with original EHEIM filter media (pre-filled baskets)

**Accessories included**

2 x shut-off taps, outlet elbow, suction pipe, EHEIM quality hose, set-up accessories (further accessories on page 84-91)

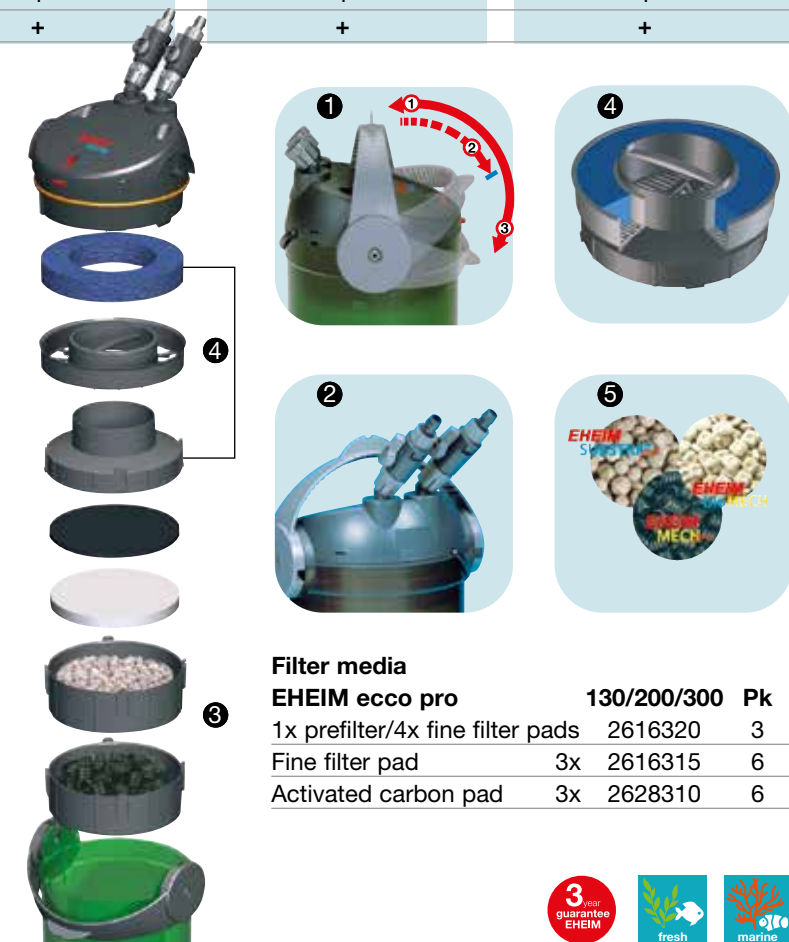

**Filter media**

EHEIM ecco pro	130/200/300	Pk
1x prefilter/4x fine filter pads	2616320	3
Fine filter pad	3x 2616315	6
Activated carbon pad	3x 2628310	6

You can find a film clip of the external canister filter on our website at [www.eheim.com](http://www.eheim.com)

Made in Germany



39

38



The sturdy basic model in our external filter generation with a square shape.

**EHEIM**  
eXperience



**External filter**

**Technical data**

		eXperience 150	eXperience 250	eXperience 350
Aquarium size up to approx.	l	80-150	120-250	180-350
Pump output approx.	l/h / gph	500 / 145	700 / 185	1050 / 277
Delivery head approx.	Hmax m	1,3	1,5	2,0
Power consumption	W	8	8	24
Canister volume	l	5	6	9
Filter volume	l	2,3	3,0	4,9
Hose- ø suction/pressure side	mm	12/16 / 12/16	12/16 / 12/16	16/22 / 16/22
Dimensions HxWxD	mm	290x178x178	340x178x178	375x210x210
Art. No. (Europe)		2422020	2424020	2426020
Art. No. (UK)		2422510	2424510	2426510
Packing dimensions HxWxD	cm	34x27x19,5	38x27x19,5	42x29x22
Master pack quantities	pcs.	1	1	1
Filter media included	<b>media+</b>	+	+	+

- Square base shape for large filter volume and high stability
- Detachable hose adapter with integrated shut-off taps, hose safety cut-off and locking lever as complete unit
- Removable filter media baskets with fold-away handles for easy handling and convenient cleaning

**Accessories (included)**

Spray bar, suction pipe, outlet pipe, EHEIM quality hose, all set-up accessories (further accessories on page 84-91)



**Filter media**

EHEIM eXperience	150/250	Pk	350	Pk
1 x coarse filter/2x fine filter pad	2616220	6	2616260	5
Coarse filter pad	3x 2616221	6	2616261	5
Fine filter pad	3x 2616225	6	2616265	5
Activated carbon pad	3x 2628220	4	2628260	4

Made in Germany



High-end, top quality technology.

**EHEIM**  
professionel4+

**EHEIM**  
professionel3



**Xtender**



**External filter**

**Technical data**

		professionel 4+ 250	professionel 4+ 350	professionel 4+ 600	professionel 3 1200XL
Aquarium size up to approx.	l	120-250	180-350	240-600	400-1200
Pump output approx.	l/h / gph	950 / 251	1050 / 277	1250 / 330	1700 / 449
Delivery head approx.	Hmax m	1,5	1,8	1,8	2,6
Power consumption	W	12	16	16	25
Canister volume	l	6,1	7,4	9,2	25
Filter volume	l	3,0+0,5 (prefilter)	4,5+0,5 (prefilter)	6,0+0,5 (prefilter)	12,0+1,5 (prefilter)
Hose- ø suction/pressure side	mm	16/22 / 16/22	16/22 / 16/22	16/22 / 16/22	2x16/22 / 16/22
Dimensions HxWxD	mm	358x238x244	398x238x244	453x238x244	567x330x330
Art. No. (Europe)		2271020	2273020	2275020	2080010
Art. No. (UK)		2271510	2273510	2275510	2080500
Packing dim. HxWxD	cm	40x29,5x24	44,3x29,8x24	49,5x29,8x24	70x38x38
Master pack quantities	pcs.	1	1	1	1
Filter media included	<b>media+</b>	+	+	+	

**EHEIM professional 4+**

The latest evolutionary development with emergency button (Xtender)

- Additional control function to counteract blocked filter media and extend intervals between cleaning
- Also available with integrated heater, page 44 „thermofilters”

**Accessories (included)**

1 x suction pipe (1200XL only = 2x suction pipes)  
1 x spray bar, EHEIM quality hoses, set up accessories, prefilter drip tray (1200XL only)



professionel 4+ Normal operation (-)

professionel 4+ Xtender opened (+)

**EHEIM professional 3 1200XL**

- Triple hose connector (2x inlet pipes, 1x outlet pipe) for perfect water circulation in large aquariums
- Handling features: recessed handles, transport castors, 4 sturdy clips, multifunction adapter
- Maintenance and flow rate indicator (1200XL)
- Also available with integrated heater p. 45



**Filter media EHEIM**

	professionel 4+ 250/350/600	Pk	professionel 3 1200XL	Pk
1x pre-filter/4x fine filter pad	2617710	3	2616802	1
Activated carbon pad	3x 2628710	4	-	
Complete filter media set*	-		2520800	1

\* MEDIA SET page 49

Made in Germany





The first aquarium filter in the world with electronic control.

Multiple features, constant monitoring, easy to regulate – even via a PC.

**EHEIM**  
professional 3<sup>e</sup>



USB connection



electronic

External filter

Technical data

	professional 4 <sup>+</sup> 350	professional 3 <sup>e</sup> 450	professional 3 <sup>e</sup> 700
Aquarium size up to approx.	l 180-350	240-450	300-700
Pump output approx.	l/h / gph 1500 / 396	1700 / 449	1850 / 489
Delivery head approx.	Hmax m 2,2	2,4	2,6
Power consumption	W 10-35	10-35	10-35
Canister volume	l 7,4	12,5	14,5
Filter volume	l 4,5+0,5 (prefilter)	6,0+0,6 (prefilter)	8,0+0,6 (prefilter)
Hose- ø suction/pressure side	mm 16/22 / 16/22	16/22 / 16/22	16/22 / 16/22
Dimensions HxWxD	mm 398x238x244	474x264x264	534x264x264
Art. No. (Europe)	2274020	2076010	2078010
Art. No. (UK)	2274510	2076500	2078500
Packing dimensions HxWxD	cm 44,3x29,8x24	51x33,5x27	57x33,5x27
Master pack quantities	pcs. 1	1	1
Filter media included	media+		

- 1 Integrated **self primer** for quick filling of the canister
- 2 Easy shut off **Safety hose adapter**; removal of the adapter is only possible when the taps are closed
- 3 **Electronic control** at the touch of a button
- 4 Top **prefilter** effectively traps large dirt particles and allows for longer intervals between cleaning. Easy to remove and simple to clean
- 5 Individual filter baskets professional 4<sup>+</sup> 350 **fully equipped** with Original EHEIM filter media
- 6 **Easy Clean** - simple and easy cleaning of the filter media using the cleaning tray (professional 4<sup>+</sup> 350)
  - **High quality ceramic axle** guarantees extremely quiet running and very long life
  - **Easy fit: media+** Complete with Original EHEIM fine and coarse filter pads and installation accessories



professional 4<sup>+</sup> 350

Optional EHEIM Interface

Accessories not included

Revolutionary features and multiple settings – from your PC



Art. 4020740

The USB converter (length 3m.) makes it possible to connect the EHEIM professional 3<sup>e</sup>/4<sup>+</sup> external filter via a USB port to a computer. With the EHEIM ControlCenter Software the functions can be easily adjusted, monitored and updated. The EHEIM ControlCenter Software can be downloaded free of charge from [www.eheim.com](http://www.eheim.com)

System requirements:  
Windows® 10, Windows® 8/8.1, Windows® 7, Windows® Vista (32/64-Bit), Windows XP™

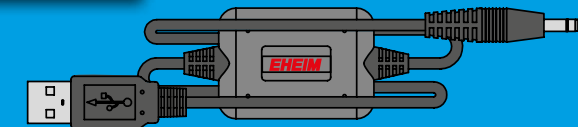

The user-friendly electronics offer a range of tangible benefits just a touch of a button or a mouse click away!



**output control:** The water flow can be increased or decreased for optimum conditions at the push of a button.



**constant flow:** Your selected flow rate is maintained even when the filter media starts to get blocked. The filter adjusts the pump power automatically



**stream function:** Electronically adjusted alternating flow creating a natural wave-like effect in your aquarium

**12h bio function:** You can set up two different flow rates within one day - like a day/night effect. Ideal for planted tanks.



**service indicator:** At the push of a button, the remaining time until the next cleaning interval is displayed by LEDs



**auto air out:** Air trapped under the pump head is recognised and automatically diverted



**electronic error indicator:** Permanent electronic system monitoring. Any imbalance is recognised and shown on the display. Simultaneously a programme starts, which automatically attempts to remedy the causes.



Accessories included

- 1x Suction pipe
- 1x Spray bar
- Outlet pipe
- EHEIM quality hose
- Set-up accessories
- Prefilter sponge
- Mains adapter 24V-DC
- CD ControlCenter

You can find a film clip of the external canister filter on our website at [www.eheim.com](http://www.eheim.com)



Filter media EHEIM	professional 3 <sup>e</sup>		professional 4 <sup>+</sup>	
	450/700	Pk	350	Pk
1x coarse pre-filter/4x fine filter pad	2616760	1	2617710	3
Activated carbon pad	3x 2628760	1	2628710	4
Complete filter media set*	2520780	1	-	

\* MEDIA SET page 49



# External thermofilters Filtration plus heating

**EHEIM**  
professionel4+

Only from EHEIM.

**EHEIM**  
professionel3<sup>e</sup>



**thermo**

only for fresh water

## External filter

### Technical data

	professionel 4+ 250T	professionel 4+ 350T	professionel 3 1200XLT	professionel 3e 600T
Aquarium size up to approx.	l	120-250	180-350	400-1200
Pump output approx.	l/h / gph	950 / 251	1050 / 277	1700 / 449
Delivery head approx.	Hmax m	1,5	1,8	2,6
Power consumption	W	12	16	25
Heating power	W	210	210	500
Canister volume	l	7,1	8,9	25
Filter volume	l	3,0+0,5 (prefilter)	4,5+0,5 (prefilter)	12,0+1,5 (prefilter)
Hose- ø suction/pressure side	mm	16/22 / 16/22	16/22 / 16/22	2x 16/22 / 16/22
Dimensions HxWxD	mm	398x238x244	453x238x244	567x330x330
Art. No. (Europe)		2371020	2373020	2180010
Art. No. (UK)		2371510	2373510	2180500
Packing dimensions HxWxD	cm	44,3x29,8x24	49,5x29,8x24	70x38x38
Master pack quantities	pcs.	1	1	1
Filter media included	<b>media+</b>	+	+	

The powerful and very convenient EHEIM thermofilters are not only equipped with the full range of features of the professional filter range, but also with a high quality heating element. They heat and filter your tank easily and simply.

- An easy to read and precise LED display shows the exact water temperature
- With a simple press of a button, the desired temperature can be precisely and easily set
- The integrated temperature control gives an accurate setting of 18-34°C (or 65-93°F only on 1200XLT)
- 2+1 safety hose adapter - 2 inlet connections and 1 outlet connection ensure optimum water circulation throughout the aquarium (only on 1200XLT)
- Output display - easily visible in the adapter - shows the filter's performance (only on 1200XLT)
- Heater element protected in the base of the filter canister
- Heat probe located in filter container
- Supplied with 1x coarse filter pad, 1x fine filter pad and filter baskets



Accurate LED display  
professionel 4+ 250T/350T  
professionel 3e 600T

**EHEIM professional 4+ 250T/350T**  
**EHEIM professional 3e 600T**  
integrated LED Display ①

**EHEIM professional 3 1200XLT**  
integrated LED Display ②

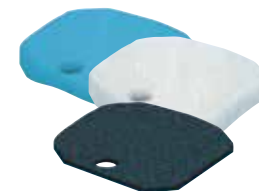

### Filter media thermofilters

EHEIM	professionel 4+ 250T/350T	Pk	professionel 3 1200XLT	Pk	professionel 3 <sup>e</sup> 600T	Pk
1x prefilter pad /4x fine filter pad Set	2617710	3	2616802	1	2616760	1
Activated carbon pad	3x 2628710	4	-	-	2628760	1
Complete filter media set <sup>1</sup>	-	-	2520800	1	2520780	1

<sup>1</sup> MEDIA SET page 49





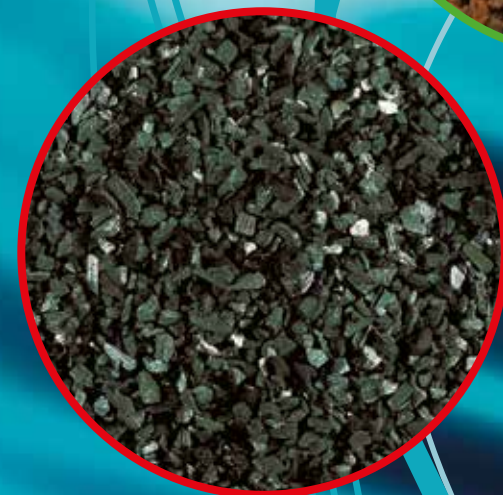

## EHEIM Filter media – The Original

EHEIM filter media – highly efficient, developed in our own laboratory, produced from the only the best raw materials, continuously checked and guaranteed free from pollutants.

Even the best internal and external filters are ineffective if they are not filled with the correct filter media. Filter media are made from various materials which perform multiple functions: they trap dirt and fine particles, provide biological decomposition of harmful substances, remove contaminants or effect a chemical change. Depending on the size and stocking levels of the aquarium, the type of filter used and the local water quality – appropriate filter media needs to be used and combined. The correct layering of the filter media is also critical to the water quality.

## Mechanical filter media

Mechanical filter media trap dirt and fine particles. This takes place before the water flows through the rest of the cleaning process and also at later stages in the filtration.

## Biological filter media

The main task of biological filter media is to offer the best colonisation conditions for bacteria cultures. The purification bacteria convert harmful substances in a natural way.

## Mechanical-biological filter media

Dirt-trapping pockets in the media capture particles but at the same time the pore structure provides colonisation for purification bacteria.

## Adsorptive filter media

Adsorptive filter media remove and retain harmful substances from the water - for example; chlorine, remains of cleaning agents, water treatments, colouring agents and so on.

## Chemical filter media

Depending on which type, these filter media control the ph-value and the water hardness - or lower the phosphate content and inhibit the growth of algae.

## Coarse and fine filter pads

Coarse and fine filter pads perform different functions in the media layering in EHEIM filters and, depending on the model, combine mechanical, biological and adsorptive filtration.

## Filter cartridge for internal filters

The cartridges consist of special foam material, fit the appropriate internal filters and clean both mechanically and biologically. Adsorptive filter cartridges can be used to remove phosphate.

## Media Sets

Filter Media Sets are customised to suit the different EHEIM filters. This means that all the medias necessary for the filtration of any particular filter, are in a single all-in-one pack.





# EHEIM filter media for the best water in the world

# EHEIM



**MEDIA SET**



## Filter media

Filter media have various functions. They trap dirt and floating matter and perform the biological conversion or chemical alteration of the water. They are therefore divided into the following types: mechanical, biological, adsorptive and chemical filter media.

### Mechanical filter media

Coarse material works directly where the filtration process begins. The water is swirled around and larger dirt particles become trapped. The water then flows through the rest of the filtering process. Various media perform this function. Particularly effective are EHEIM MECH and EHEIM bioMECH.

### Biological filter media

After the initial mechanical media treatment, biological media begin the most important task in the filter. With the colonisation of important purification bacteria, a kind of bacterial lawn is formed, which feeds on and transforms all kinds of dirt particles harmful to the aquarium. The main role of the biomedium is to offer the best colonisation conditions for the purification bacteria. EHEIM biological media ensure stable conditions in the tank due to the best possible surface structure (eg. EHEIM SUBSTRATpro).

**Tip:** Never wash or change all the biomedium at the same time. This would destroy the colonies and hinder re-colonisation. The filter baskets in the external filter and the filter module in aqua/aquaball/biopower are ideal for partial cleaning.

### mechanical

EHEIM SYNTH	Pk
Filterwadding/Fine filtration	
50 g 2504051	6
100 g 2504101	5

EHEIM FIX	Pk
Pre-filtering medium/ Fine filtration ●	
50 g 2506051	6
250 g 2506751	1

EHEIM MECH	Pk
Pre-filtering medium ●	
840 g 2507051	6
1680 g 2507101	5
4200 g 2507751	1

EHEIM MECHpro	Pk
Pre-filtering medium ●	
90 g 2505051	6
180 g 2505101	5

### mechanical/biological

EHEIM bioMECH	Pk
Filter medium ●	
710 g 2508051	6
1420 g 2508101	5
3550 g 2508751	1

### biological

EHEIM SUBSTRAT	Pk
Sintered glass granulate ●	
620 g 2509051	6
1240 g 2509101	5
3100 g 2509751	1

EHEIM SUBSTRATpro	Pk
Sintered pearl-shaped glass ●	
180 g * 2510021	6
720 g 2510051	6
1440 g 2510101	5
3600 g 2510751	1

EHEIM LAV	Pk
Volcanic rock ●	
1270 g 2519051	6
6350 g 2519751	1

\* Filter media box aqua/aquaball/  
biopower  
● reusable

### Tip: Use of EHEIM filter media

The use of biological filter media such as EHEIM SUBSTRAT, SUBSTRATpro and LAV as well as mechanical filter media like EHEIM MECHpro and MECH are only recommended for tanks that solely stock fish.

However, EHEIM SYNTH, FIX, AKTIV and phosphateout can be used in marine water aquariums which stock both fish and corals.

### Adsorptive filter media

This type of filter material draws out and retains pollutants from the water. These can be chemical compounds, such as chlorine from tap water used when setting up your tank or chemical remains after the treatment of livestock.

**TIP:** Since adsorptive filter media retain pollutants but do not really convert them, they need to be changed regularly.

### Chemical filtration

EHEIM TORFpellets chemically influence the pH value and water hardness.

**TIP:** TORF expands in water, therefore lightly rinse, not wash, before use. TORF must be changed after 3-6 weeks. Do not use TORF with activated carbon.

EHEIM phosphateout binds phosphate to iron and extracts it from the water circulation – hindering the growth of algae in the aquarium. Free from harmful substances and suitable for both fresh and marine water.

### adsorptive

EHEIM KARBON **	Pk
Activated carbon	
225 g 2501051	6
450 g 2501101	5
1125 g 2501751	1
225 g net bag 2501401	6
450 g net bag 2501451	5

EHEIM AKTIV	Pk
Special activated carbon	
140 g * 2513021	6
560 g net bag 2513101	6
1120 g net bag 2513051	5

### chemical

EHEIM TORFpellets**	Pk
Filter peat	
1,0 l 2511051	6
<b>EHEIM phosphateout</b>	
Phosphate remover	
130 g * 2515021	6
390 g 2515051	6

Dosage phosphateout	
130 g * 2x 65 g	100 l
390 g 6x 65 g	300 l

Made in Germany  
(not EHEIM AKTIV)

\*\*only for fresh water  
\* filter media box aqua/aquaball/  
biopower

### Perfectly matched

These complete media sets are perfectly matched to our EHEIM filters. Your customers can have the correct media for their filter in one convenient pack.

### EHEIM MEDIA SETs

professional 3	2080/2180	Pk
Art. No.	2520800	1
MECH	3360 g	
SUBSTRATpro	5760 g	
Prefilter pad	1x	
Fine filter pad	1x	

professional 3e	2076/2078/2178	Pk
Art. No.	2520780	1
MECHpro	360 g	
SUBSTRATpro	1440 g	
bioMECH	1420 g	
Prefilter pad	1x	
Fine filter pad	1x	

The porous material becomes evenly soaked with water and traps large and small dirt particles. After a short start-up period purification bacteria, which provide intensive biological decomposition of harmful substances, colonise the specially structured foam.

The fine and coarse filter pads are reusable many times over. To clean them simply rinse and squeeze out, so that the bacteria cultures are not completely destroyed.

- Porous material traps large and small dirt particles
- Good colonisation conditions for bacteria cultures
- Reusable several times over
- To clean just rinse and squeeze out



# Original EHEIM Cartridges and filter pads



# EHEIM media set-up



Most EHEIM filters come pre-filled with the correct filter media. For after sales or for customised filtration we offer you a variety of media in complete filter media sets or single packs.

## Filter media

### EHEIM filter cartridges for internal filters

These are made of phenol-free foam materials and offer a large colonisation area. They can be easily changed and after a short run-in period they provide biological decomposition of harmful pollutants in addition to mechanical water cleaning. Specially treated activated carbon cartridges are also available which are excellent for adsorptive filtration.

### EHEIM filter pads / foam filter pads

Specially structured materials provide outstanding purification. Water permeates them evenly, coarse particles and even the finest particle residues are trapped mechanically. After a short run-in period, purification bacteria lodge in the special foam material and ensure the intensive, biological decomposition of toxins. In addition, carbon pads have an adsorptive effect: dissolved pollutants are trapped on their surface and therefore removed from the water cycle.

### EHEIM phosphate remover

**phosphateout Art. 2638080** for aquaball 60/130/180 biopower 160/200/240 prefilter 4004320

These foam cartridges are soaked in an iron compound for chemical filtration that binds the phosphate to the iron and removes it from the water circulation. This lowers the phosphate content and inhibits the growth of algae in your aquarium. The cartridges are free from harmful substances. When the levels of phosphates in the aquarium begin to rise again, the cartridge is ready to be changed. These cartridges are for one time use only and can be used in fresh or marine water set ups.

All filter cartridges and fleeces can be found on: [www.eheim.com](http://www.eheim.com)

### Filter cartridges

For filter Art.	Art. No.	Pk
2000	2616000	6
2006	2615060	6
2008	2617080	6
2010	2617100	6
2012	2617120	6
2048	2615480	6
2203/2204	2616030	1
2206-2208 (aqua)	2617050	1
2252	2615510	1
2400	2618060	6
2401-2403	2618080	6
2411-2413	2618060/080	6
3536	2615360	1
4003000	2615300	6

### Carbon cartridges

Art. No.	Pk
-	-
2625060	6
2627080	6
2627100	6
2627120	6
2625480	6
-	-
2625520	1
-	-
2628080	6
2628080	6
-	-
-	-

### Fine filter pad

Art. No.	Pk
2004/2005	3x 2616265 5
2026-2128	3x 2616115 4
2211	3x 2616135 6
2213	3x 2616135 6
2215	3x 2616155 5
2217	3x 2616175 5
2222-2324	3x 2616225 6
2226-2328	3x 2616265 5
2231/33/35	3x 2616315 6
2232/34/36	3x 2616315 6
2401-2403	3x 2616080* 6
2422/2424/2124	3x 2616225 6
2426	3x 2616265 5

### Activ. carbon fine filter pads

Art. No.	Pk
2628040	6
2628110	1
2628130	6
2628150	1
2628170	1
-	-
2628310	6
2628310	6
-	-
-	-

### Set filter pad/coarse foam filter pad

Art. No.	Set	Art. No.	Pk
2004/2005	Set	2616040 (1x prefilter pad/1x filter pad/3x fine filter pad)	4
2026-2128	Set	2616260 (1x coarse filter pad/2x fine filter pad)	5
2032-2036	Set	2616320 (1x prefilter pad/4x fine filter pad)	3
2071-2075	Set	2616710 (1x prefilter pad/4x fine filter pad)	3
2271-2275	Set	2617710 (1x prefilter pad/4x fine filter pad)	3
2076/2078	Set	2616760 (1x prefilter pad/4x fine filter pad)	1
2080/2180	Set	2616802 (1x prefilter pad/4x fine filter pad)	1
2222-2324	Set	2616220 (1x coarse filter pad/2x fine filter pad)	6
2226-2328	Set	2616260 (1x coarse filter pad/2x fine filter pad)	5
2422/2424/2124	Set	2616220 (1x coarse filter pad/2x fine filter pad)	6
2426	Set	2616260 (1x coarse filter pad/2x fine filter pad)	5

### Coarse foam filter pad

Art. No.	Pk
2211	2x 2616111 6
2213	2x 2616131 6
2215	2x 2616151 6
2217	2x 2616171 6
2231/33/35	3x 2616310 6
2232/34/36	3x 2616310 6
2026-2128	3x 2616261 5
2071-2075	-
2271-2275	-
2076/2078	-
2222-2324	3x 2616221 6
2226-2328	3x 2616261 5
2401-2403	2x 2616085* 6
2422/2424/2124	3x 2616221 6
2426	3x 2616261 5

### Activ. carbon filter pads

Art. No.	Pk
-	-
2628260	4
2628710	4
2628710	4
2628760	1
2628220	4
2628260	4
-	-
2628220	4
2628260	4

\* Filter media box aquaball

### EHEIM classic

- EHEIM coarse and fine filter pads  
These guarantee the basic mechanical and biological filtration.

### EHEIM eXperience

- EHEIM fine filter pads – for additional mechanical and biological filtration.
- EHEIM SUBSTRAT – Standard biofilter medium with a large colonisation area for bacterial cultures
- EHEIM coarse filter pads – for mechanical (and biological) filtration

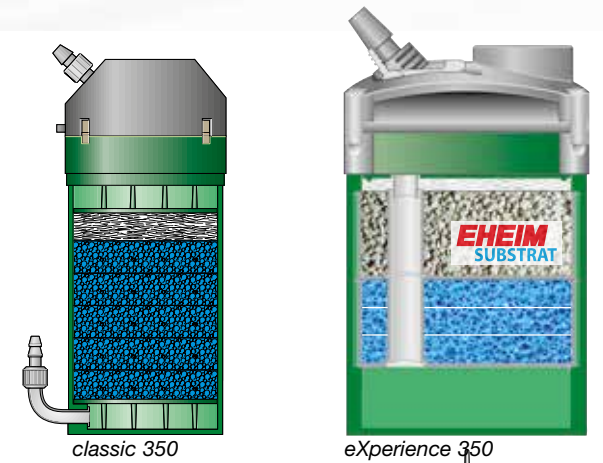

### EHEIM ecco pro

- EHEIM filter pad – for additional mechanical and biological filtration.
- EHEIM fine filter pad - for fine filtration
- EHEIM SUBSTRATpro – bio-filter medium with perfect volume utilisation, longer cleaning intervals and high decomposition performance
- EHEIM bioMECH – mechanical-biological filter medium for combined water treatment
- EHEIM MECHpro – mechanical prefilter medium which although is mainly for trapping dirt particles, also encourages the colonisation of purification bacteria.

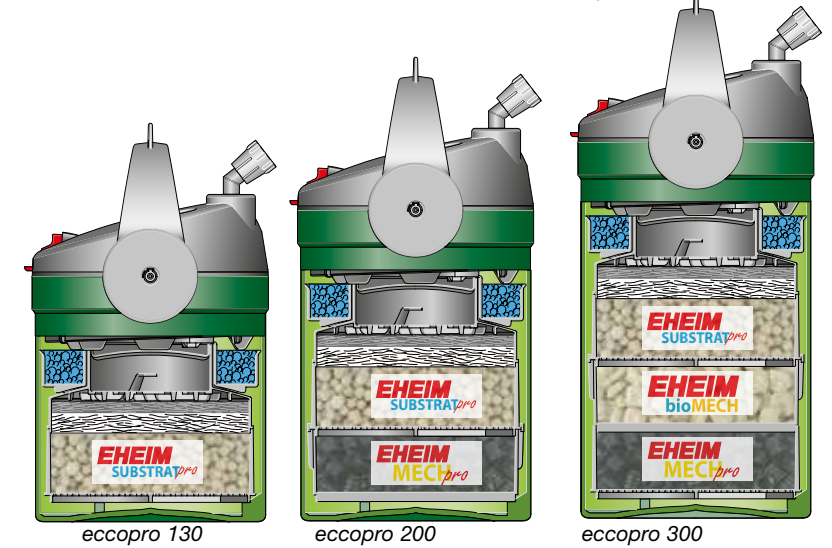

### EHEIM professional 3 / EHEIM professional 4+

- EHEIM coarse filter pads – for additional mechanical and biological filtration and longer intervals between cleaning
- EHEIM fine filter pad - for fine filtration
- EHEIM SUBSTRATpro – biofilter medium with perfect volume utilisation, longer cleaning intervals and high decomposition performance
- EHEIM bioMECH – mechanical-biological filter medium for combined water treatment
- EHEIM MECHpro – mechanical prefilter medium





Compact, powerful and silent  
Improved performance values and versatile accessories.

**EHEIM**  
compactON



**Pumps**

**Technical data**

		compactON 300	compactON 600	compactON 1000	compactON 2100	compactON 3000	compactON 5000	compactON 9000	compactON 12000
Pump output approx.	l/h / gph	170-300 / 45-79	250-600 / 66-159	400-1000 / 106-264	1400-2100 / 370-555	1800-3000 / 476-793	5000 / 1321	9000 / 2378	12000 / 3170
Delivery head approx.	Hmax m	0,6	1,0	1,4	2,4	2,7	3,6	3,7	4,2
Power consumption	W	7	7	15	38	55	70	80	110
Connection on pressure side	ø	12/16	12/16	16/22 19/27	19/27 25/34	19/27 25/34	25/34 1 - 1 1/4"	25/32/38 1 - 1 1/2"	25/32/38 1 - 1 1/2"
	suction side ø	-	-	16/22 19/27	19/27 25/34	19/27 25/34	25/34 1 - 1 1/4"	25/32/38 1 - 1 1/2"	25/32/38 1 - 1 1/2"
Dimensions HxWxD	mm	72x38x62	72x38x62	79x47x73	142x70x109	142x70x109	154x92x142	185x110x175	185x110x175
Art. No. (Europe)		1020220	1021220	1022220	1030220	1031220	1032220	1033220	1034220
Art. No. (UK)		1020340	1021340	1022340	1030340	1031340	1032340	1033340	1034340
Packing dimensions HxWxD	cm	12x9,7x7,4	12x9,7x7,4	14x12x7	15x14x10	15x14x10	18x18,7x11	18,6x23x11,5	18,6x23x11,5
Master pack quantities	pcs.	1	1	1	1	1	1	1	1

**EHEIM compactON is the compact and yet powerful aquarium pump. Available in eight sizes, for flow rates from 170 to 12000 liters per hour.**

The EHEIM compactON aquarium pump is characterized by its name through a compact design and is thanks to the included accessory bag appropriate for versatile use – the EHEIM compactON 2100-12000 can also be modified for the use outside of the water. Thanks to the high quality material it is also possible to use them without problems in marine water.

For even more flexibility, the flow rate is adjustable for all models, except for the EHEIM compactON 5000/9000/12000.

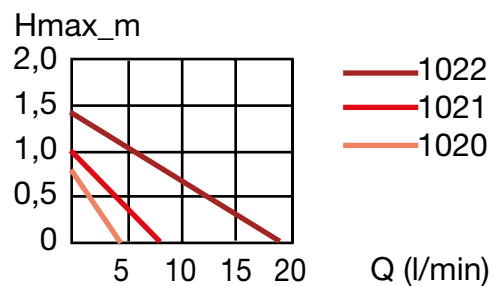
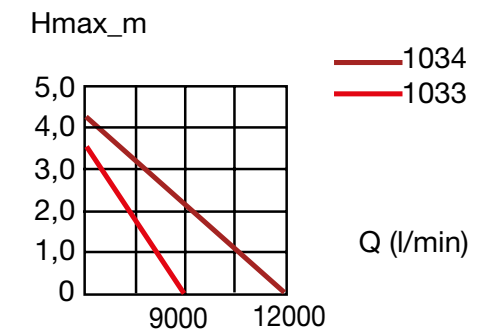
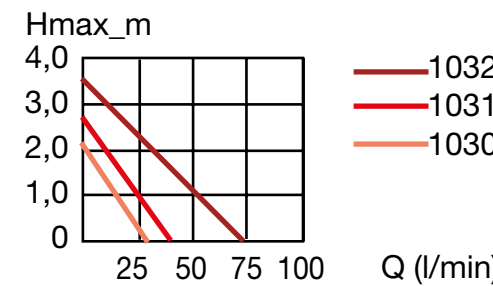

**Accessories (included)**

- compactON 300/600: [Image of accessories]
- compactON 1000: [Image of accessories]
- compactON 2100/3000: [Image of accessories]
- compactON 5000: [Image of accessories]
- compactON 9000/12000: [Image of accessories]

adjustable flow rate  
EHEIM compactON  
300/600/1000/2100/3000

not adjustable  
EHEIM compactON  
5000/9000/12000





Extra performance and efficiency

**EHEIM**  
streamON+

Customised flow

**EHEIM**  
streamcontrol



**Pumps**

**Technical data**

	streamON+ 3500	streamON+ 6500	streamON+ 9500
Aquarium size up to approx. l	35-200	150-350	350-500
Pump output approx. l/h / gph	1500-3500 / 396-925	3500-6500 / 925-1717	6500-9500 / 1717-2510
Power consumption W	2,5	6	12
Glass thickness mm	3-8	6-12	6-12
Dimensions HxWxD mm	55x47x110	72x59x131	88x70x138
Art. No. (Europe)	1180220	1181220	1182220
Art. No. (UK)	1180340	1181340	1182340
Packing dim. HxWxD cm	13,8x12,2x70	14,5x14,5x10	14,5x14,5x10
Master pack quantities pcs.	24	12	12

The new EHEIM streamON+ is small, compact and extremely energy efficient. The pump is attached to the aquarium with a magnetic holder and can be easily adjusted on the glass.

- Compact streaming pump (3 models) for aquariums from 35 to 500 l
- Suitable for both marine and fresh water
- Ideal for simulating natural water flow found in rivers and coral reefs, etc.
- Optimal water circulation for a natural, smooth current
- Increases the oxygen content, creating natural living conditions
- Vital for corals in marine water and beneficial for fish in fresh water
- Securely attached with a magnetic holder, can be easily adjusted
- Ball joint allows pump to swivel in all directions (3D function)
- Variable outflow capacity
- Extremely quiet and low-maintenance
- Low power consumption and high energy efficiency
- Integrated cable duct
- Maximum safety and reliability



streamON+ 3500

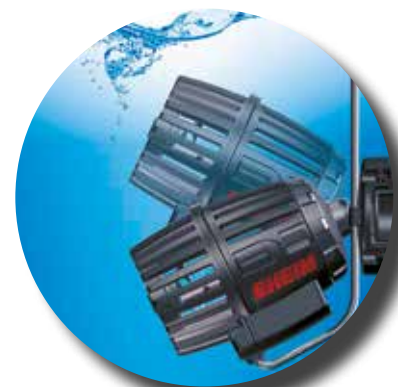

streamON+ 6500/9500



new

**Accessories**

**Technical data**

	streamcontrol
Connections for aquarium pumps W	max. 2x100
Dimensions streamcontrol HxWxD mm	38x150x67
Dimensions socket strip HxWxD mm	55x170x75
Art. No. (Europe)	3500210
Art. No. (UK)	3500350
Packing dim. HxWxD cm	13,7x22x13,2
Master pack quantities pcs.	1



The control system for circulation and flow pumps to simulate natural water flows in the aquarium.

- Controller for aquarium pumps
- Suitable for circulation and flow pumps
- Dual connector strip (supplied)
- Connection for two (or more) pumps
- Load per socket max. 100 W
- Two different programs:
  - a) alternating flow - this means the pumps are switched on and off alternately or
  - b) synchronous flow - meaning both pumps are switched on and off simultaneously.
- Individually adjustable time intervals from 1 to 60 minutes
- Program runs permanently - for an unlimited period of time
- Break button for feeding (food button)
- Suitable for fresh and marine water
- Highest safety and reliability - 3 years warranty

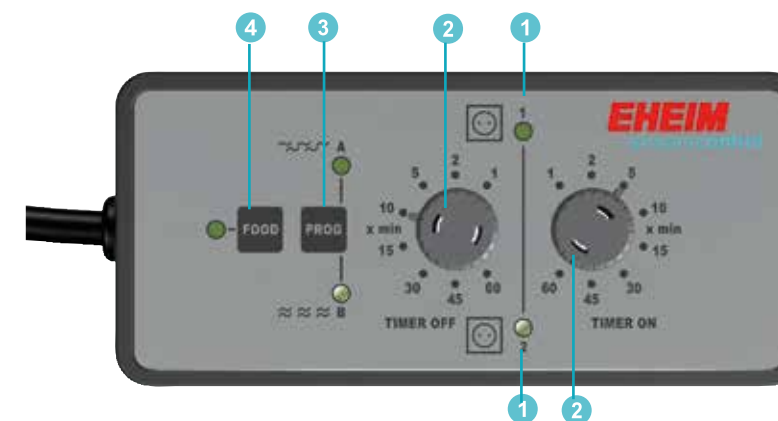

- 1 LED Pump operation
- 2 Knob for ON/OFF times Pump frequency
- 3 Selection of frequency program
- 4 Pause button feeding





Power for all occasions.

**EHEIM**  
universal



**Pumps**

	universal 1005	universal 300	universal 600	universal 1200	universal 2400	universal 3400
<b>Technical data</b>						
Pump output approx. l/h / gph	270 / 71	300 / 79	600 / 159	1200 / 317	2400 / 634	3400 / 898
Delivery head Hmax m	0,75	1,2	1,5	2,0	3,7	3,6
Power consumption W	4	5	10	28	65	80
Connection ø mm/Thread						
on intake side	17 / -	13 / G3/8"	13 / G3/8"	18 / G1/2"	28 / G3/4"	28 / G3/4"
on pressure side	13 / -	11 / G1/8"	13 / G1/4"	13 / G3/8"	18 / G3/4"	18 / G3/4"
Dimensions HxWxD mm	87x66x88	103x146x75	115x147x75	121x178x96	161x218x116	161x218x116
Art. No. (Europe) 1,5 m	1005215	1046219	1048219	1250219	1260210	1262210
Art. No. (UK) 1,5 m	-	-	-	-	1260350	1262350
Art. No. (Europe) 10 m	-	1046019	1048019	1250019	1260010	1262010
Art. No. (UK) 10 m	-	1046119	1048119	1250119	-	-
Packing dim. HxWxD cm	9,8x12,5x15,5	10x21x15	10x21x15	14x26,5x17	13,5x26,5x17	13,5x26,5x17
Master pack quantities pcs.	1	1	1	1	1	1

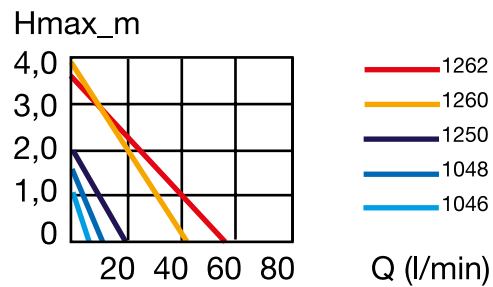

Universal pumps output diagram

**EHEIM universal pumps**

- Durable
- Ceramic shaft
- Designed for continuous use in or out of the water
- Hermetically sealed motor body guarantees continuous operation
- ① Integrated pre-filter
- ② Inlet connector for hose connection
- ③ Variable fixing options

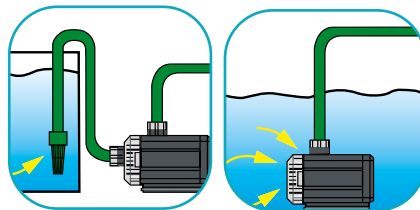

Filter media	universal 300	600	1200	2400/3400	Pk
Coarse filter 2x	2615465	2615485	2615500	2615600	1

**Types of usage in marine aquariums**

Return (circulation) pump in sump tank

	Aquarium size up to approx.
EHEIM universal 1200	200
EHEIM universal 2400	300-500
EHEIM universal 3400	500-600

Made in Germany



Silent Air.

**EHEIM**  
air

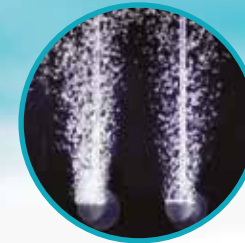

**Pumps**

	air 100	air 200	air 400
<b>Technical data</b>			
Pump output approx. l/h / gph	100 / 26	200 (2x100) / 53	400 (2x200) / 106
Power consumption W	3,5	3,5	4
Delivery head Hmax m	2	2	2
Hose connections	1	2	2
Hose diameter mm	4/6	4/6	4/6
Dimensions HxWxD mm	150x92x76	150x92x76	150x92x76
Art. No. (Europe)	3701010	3702010	3704010
Art. No. (UK)	3701110	3702110	3704110
Packing dimensions HxWxD cm	24x14,5x8,5	24x14,5x8,5	24x14,5x8,5
Master pack quantities pcs.	3	3	3

The **EHEIM air** offers several benefits:

- Continuously quiet operation
- Air flow can be regulated on the pump ①/②
- Additional adjustment of the air flow and bubble effect using the diffuser ③
- Vibration-resistant rubber feet
- Hook for hanging vertically
- Fully equipped with

<b>Diffuser</b>	
air 100	1x
air 200/400	2x
<b>Air hose</b>	
air 100	1 m
air 200/400	2 m
<b>Check valve</b>	
air 100	1x
air 200/400	2x
<b>Y-piece</b>	
air 200/400	1x

**EHEIM diffuser**

- Adjustable air flow and bubble pattern
- Replaceable felt pad (Art. No. 7400030)
- Clever design
- Durable



Individually adjustable air flow: air 200/400

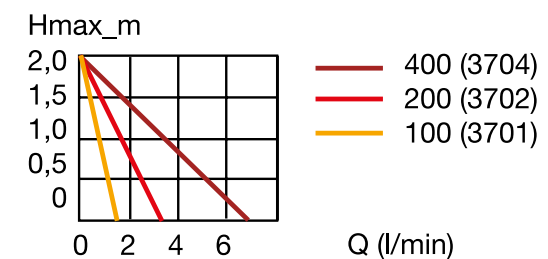

Air pump output diagram

③ Adjustable diffuser Article No. 4002650 (Also available individually as an accessory)



**Accessories (optional):** air filter (page 87) Art. No. 4003000





The UV-steriliser with a new kind of reflector technology.

**EHEIM**  
reeflexUV



**UV-steriliser**

**Technical data**

		reeflexUV 350	reeflexUV 500	reeflexUV 800
Aquarium size up to approx.	l	80-350	300-500	400-800
Dimensions HxWxD approx.	mm	309x106x128	383x106x149	523x106x149
Hose- ø	mm	ø 12/16	ø 16/22	ø 16/22
Pressure max.	bar	0,8	0,8	0,8
Turbidity	l/h	400	800	1200
Reduction of germs	l/h	200	400	600
Power consumption	W	9	10	13
Art. No. (Europe)		3721210	3722210	3723210
Art. No. (UK)		3721350	3722350	3723350
Packing dimensions HxWxD	cm	31,7x18,8x11	36,2x18,8x11	49,2x18,8x11
Master pack quantities	pcs.	1	1	1

**1,8 times higher effectiveness and less energy consumption compared to conventional technology.**

- Quickly and effectively reduces micro-organisms in the water
- Eliminates turbidity caused by algae or bacteria
- Internally fitted high gloss aluminium reflects the UV-C light and ensures extra efficient sterilisation
- No performance loss as, using a special design, the water is not redirected
- Ideal for use in breeding tanks, reduces risk of infection
- Colonised bacteria are retained in the filter as only floating organisms are eradicated
- Simple and safe maintenance and cleaning
- AUTO-OFF: automatic safety cut-off when the light is being changed
- Simple bracket for attaching UV to either the cabinet or the side of the tank

**Accessories included**

EHEIM UV-C-lamp, bracket, ballast with power cable, 2x hose connection taps ø 12/16 mm (reeflexUV 350) ø 16/22 mm (reeflexUV 500 und 800).

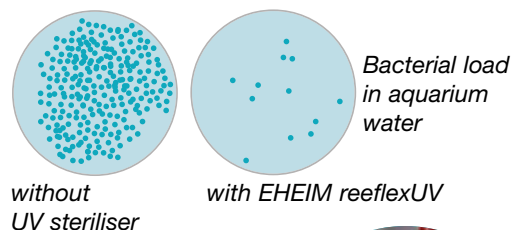

**Accessories (optional)**

**Original EHEIM replacement lamp 2G7**

		Art. No.
7 Watt	for reflexUV 350	4110010
9 Watt	for reflexUV 500	4111010
11 Watt	for reflexUV 800	4112010

	ø 12/16 mm	ø 16/22 mm
Hose, 3 m	Art. 4004943	Art. 4005943
Shut-off tap	Art. 4004512	Art. 4005510
Reducer	16/22 > 12/16	Art. 4004980

The micro surface skimmer for smaller aquariums up to 350 l

**EHEIM**  
skim350



**Accessories**

**Technical data**

		skim350
Aquarium size up to	l	350
Pump output	l/h / gph	300 / 79
Delivery head	Hmax m	0,5
Prefilter volume	cm³	19,7
Hose connection		
pressure side	ø mm	13
Power consumption	W	5
Dimension HxWxD	mm	132x40,5x54
Art. No. (Europe)		3536220
Art. No. (UK)		3536340
Packing dimensions HxWxD	cm	13,5x9,0x8,15
Master pack quantities	pcs.	1
Filter cartridge included	media+	+



**Simple, quick and easy to set up. For alternate use in different aquariums. Ready for immediate use.**

- Small surface skimmer for aquariums up to 350 l
- Removes dirt residue and microorganisms from the water surface (surface scum)
- This promotes natural gas exchange
- Practical for constant or intermittent use
- Quick set-up – easy to attach to the tank glass with suction cups
- For use when necessary – also adaptable to a range of different aquariums (be careful that no algae spores etc. are transferred)
- Connector for outlet hose
- Only 5 W energy consumption



**Accessories (optional)**

Suction cup 4x	7445848
Connector set	7481200

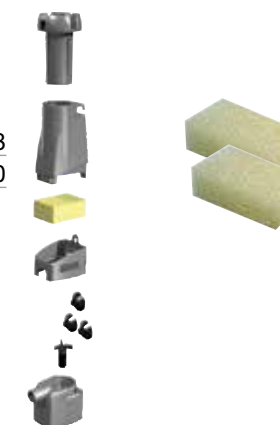

**Filter media**  
**EHEIM skim350**

Filter cartridge	2 x	2615360	Pk
			1

Made in Germany





Protein skimmer  
for marine water aquariums

**EHEIM**  
skimmarine

Effective solution for  
clean marine water

**EHEIM**  
skimmarine

Marine

Marine

Skimmer



Technical data

		skimmarine 100	skimmarine 300
Aquarium size up to	l	100	300
Pump output	l/h / gph	100* / 26*	500 / 132
Volume skimmer cup	ml	65	270
Dimensions HxWxD	mm	25x7,5x4,5	347x153x91
Art. No. (Europe)		3551000	3549220
Art. No. (UK)		3551000	3549340
Packing dimensions HxWxD	cm	32,5x17,5x5,0	39x18,7x11,6
Master pack quantities	pcs.	1	1

\* only in conjunction with EHEIM air 100

Technical data

		skimmarine 600
Aquarium size up to	l	600
Pump output	l/h	480-1900 / 127-502
Air intake	l/h	300-540
Volume skimmer cup	ml	600
Body Ø	cm	16
Water level	mm	180-240
Footprint	mm	190x160
Power consumption	W	19-40
Dimensions HxWxD	cm	52,5x19x19
Art. No. (Europe)		3552220
Art. No. (UK)		3552340
Packing dimensions HxWxD	cm	73,5x25,5x26,5
Master pack quantities	pcs.	1

**EHEIM skimmarine 100**  
Nano skimmer

- For small marine water aquariums up to approximately 100 litres
- Small and compact design
- Simple installation
- Can be removed for cleaning
- Silent due to the lime wood diffuser
- Does not disturb the natural plankton in the aquarium

Air pump required to operate skimmarine 100

**EHEIM air 100**  
Art.No. (Europe) 3701010  
Art.No. (UK) 3701110



EHEIM skimmarine 300

**EHEIM skimmarine 300**  
Motorised mini skimmer for marine  
aquariums up to 300 litres

- Easily installed using the magnetic holder
- Completely detachable for cleaning
- Silent
- Highly efficient skimmer pump with a needle wheel impeller
- Air intake: Self-priming (Dispersant principle)
- Adjustable air intake
- Low energy consumption
- High skim rate
- Ozone-resistant
- Compact design

**The EHEIM skimmarine 600 - a high-performance skimmer combined with innovative technology and optimum skimming regulation.**

The EHEIM skimmarine 600 is ideal for larger marine water aquariums. It works according to the countercurrent principle and is therefore very efficient. The special needle wheel pump produces an extremely fine-bubble/ air-water mixture. The formation of foam or flotote is correspondingly high and the ceramic axle ensures particularly smooth running and a very long service life.

For optimum skimming, you can adjust and control the air intake, the water level in the reaction chamber and the positioning in the filter sump.

- For marine aquariums up to approx. 600 l
- Skimmer pump with highly efficient needle wheel technology and ceramic axle
- Independent air intake (dispergator principle)
- Quiet operation due to adjustable water outlet
- Flexible silencer
- Effective 3-way control for optimal skimming:
  1. adjustable air intake at silencer
  2. adjustable water level in the reaction chamber
  3. adjustable positioning (height) in the filter sump
- Small footprint due to internal skimmer pump
- Easy to disassemble for cleaning





The intelligent automatic refill, that remembers all details. For fresh water and marine water tanks. Especially important during holidays.

**EHEIM**  
waterrefill



## Automatic refill

### Technical data

		waterrefill
Pump output approx.	l/h / gph	350 / 92
Delivery head	Hmax m	1,5
Power consumption	W	8
Glass thickness	mm	4-10
Pump dimensions HxWxD	cm	4,5x6x5,5
Sensor dimensions HxWxD	cm	3x6x1
Controller dimensions HxWxD	cm	6,5x4x2,5
Art. No. (Europe)		3548220
Art. No. (UK)		3548340
Packing dimensions HxWxD	cm	23,6x16x9
Master pack quantities	pcs.	1



Accessories included

With the automatic refill EHEIM waterrefill you can keep your aquarium water always on a healthy level. For certain.

- Automatic refilling of evaporated water.
- Perfect during holidays.
- The sensor with LED display is permanently measuring the water level.
- Fastening of the sensor easily accessible outside of the glass pane of the aquarium – or in case of a marine water tank alternatively at the filter tank in the cabinet (sump).
- Works with most common glass thicknesses 4 - 10 mm.
- Intelligent controller with LED display regulates the refilling. It memorizes the filling quantity and the filling times and this way adapts the water quantity to the tank size and the changes (e.g. seasonal).
- Safety: In case of significant irregularities the refilling process will be stopped and this prevents an overflowing.
- Energy saving low voltage pump (12 v), maintenance-free when operating with ultrapure water (osmosis water).
- Refilling tube and drainage elbow can be securely and easily attached to the aquarium using the holder (holder and clamp included)
- All components are of high quality and work extremely reliable.
- All required parts are included in the scope of delivery.

Unpack - assemble - plug in - switch on - running!

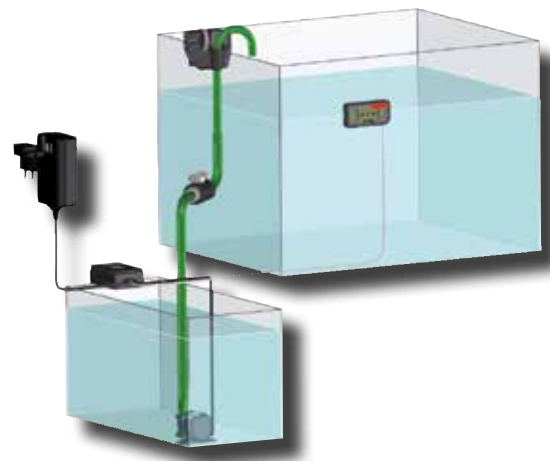

Installation example

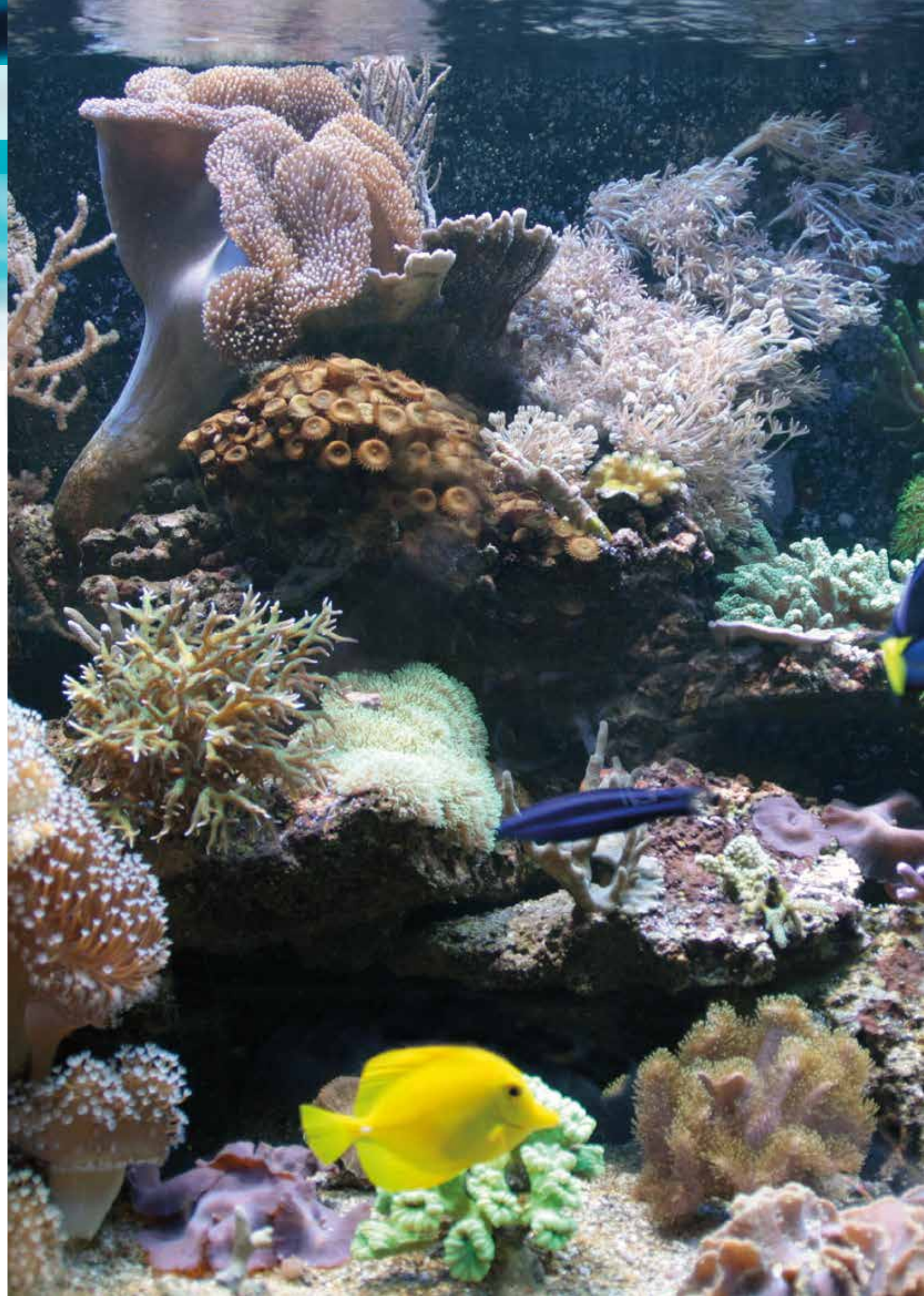



## Natural colours – freshwater LED lights

**EHEIM**  
classicLED

## Lighting for plants

**EHEIM**  
classicLED



### Lighting

Technical Data		classicLED daylight fresh water	classicLED daylight fresh water	classicLED daylight fresh water	classicLED daylight fresh water
Performance	W	7,7	10,6	13,5	16,5
Overall length	mm	550	740	940	1140
Aquarium size up to	mm	550-635	740-825	940-1025	1140-1225
Light colour	K	6500	6500	6500	6500
Rated light flux	lm	810	1120	1420	1740
Energy efficiency class		A+	A+	A+	A+
Art. No. (Europe)		4261011	4262011	4263011	4264011
EAN	4011708	002384	002407	002421	002445
Packing dimensions HxWxD	cm	71,4x15x4	71,4x15x4	110x15x6	130x15x6
Master pack quantities	pcs.	1	1	1	1
Replacement for EHEIM T8		T8/15 W 438 mm	T8/18 W 590 mm	T8/30 W 895 mm	T8/38 W 1047 mm
Replacement for EHEIM T5		-	T5/24 W 549 mm	T5/39 W 849 mm	-
Replacement for T5		T5/24 W 438 mm	T5/28 W 590 mm	T5/45 W 895 mm	T5/54 W 1047 mm
Suitable for EHEIM		vivalineLED 150 aquaproLED 84 aquastar 54 LED	vivalineLED 126 aquaproLED 126	vivalineLED 180 aquaproLED 180	vivalineLED 240
		-	-	proxima 250	-

#### EHEIM classicLED daylight

##### Freshwater LED light

- Including safety power supply
- Various fitting options
- Waterproof (IPx7)
- Cost effective LED for beginners
- Compact
- Suitable for all aquariums 550 – 1225 mm
- Easy to fit using the extendable brackets
- Can be used to replace T5/T8 fluorescent tubes
- Enables the exchange of high energy fluorescent tubes to energysaving, environmentally friendly LED lighting
- Beam angle 120°

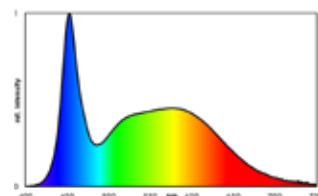

Colour spectrum classicLED daylight

#### Original EHEIM Accessories

classicLED Adapterset T5/T8  
Art. No. (Europe) 4200130 EAN 4011708003275

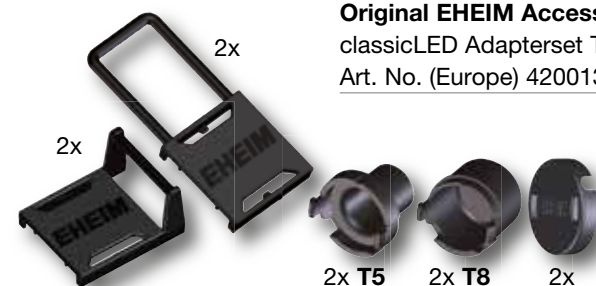

### Lighting

Technical Data		new classicLED plants fresh water	new classicLED plants fresh water	new classicLED plants fresh water	new classicLED plants fresh water	new classicLED plants fresh water	new classicLED plants fresh water
Performance	W	7,7	8,6	10,6	13,5	16,5	17,7
Overall length	mm	550	640	740	940	1140	1240
Aquarium size up to	mm	550-635	640-725	740-825	940-1025	1140-1225	1240-1325
Light colour	K	8350	8350	8350	8350	8350	8350
Rated light flux	lm	630	700	840	1070	1310	1410
Energy efficiency class		A	A	A	A	A	A
Art. No. (Europe)		4261021	4265021	4262021	4263021	4264021	4266021
EAN	4011708	006412	009482	006429	006436	006443	009505
Packing dim. HxWxD	cm	71,4x15x4	71,4x15x4	71,4x15x4	110x15x6	130x15x6	130x15x6
Master pack quantities	Stück	1	1	1	1	1	1
Replacement for EHEIM T8		T8/15 W 438 mm	T8/18 W 590 mm	T8/18 W 590 mm	T8/30 W 895 mm	T8/38 W 1047 mm	-
Replacement for EHEIM T5		-	T5/24 W 549 mm	T5/24 W 549 mm	T5/39 W 849 mm	-	T5/54 W 1149 mm
Replacement for T5		T5/24 W 438 mm	T5/28 W 590 mm	T5/28 W 590 mm	T5/45 W 895 mm	T5/54 W 1047 mm	-
Suitable for EHEIM		vivalineLED 150 aquaproLED 84 aquastar 54 LED	-	vivalineLED 126 aquaproLED 126	vivalineLED 180 aquaproLED 180	vivalineLED 240	-
		-	proxima 175	-	proxima 250	-	proxima 325

#### EHEIM classicLED plants

##### Freshwater LED light

- Alternative to T5/T8 fluorescent tubes - interchangeable with adapter set (accessory)
- 6 lengths for aquariums from 55 - 120 cm width (continuously adjustable) due to extendable support brackets)
- High-quality, sturdy aluminium housing
- Absolutely waterproof (IPx7) and particularly safe due to low-voltage technology
- Bright sunlight (8350 K) and light spectrum matched to aquatic plants (photosynthesis) with high red components
- Promotes healthy growth in plants and animals
- Natural, unadulterated colour rendering
- Beam angle 120°
- Full illumination to the bottom of the aquarium
- Average life min. 35 000 hours (9-10 years at 10 hours/day)
- High energy efficiency and light output (approx. 80 lm/W)

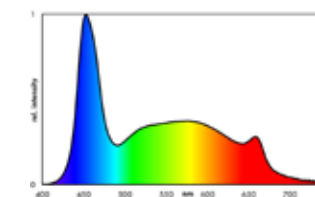

Colour spectrum classicLED plants

#### Original EHEIM Accessories

Dimmer classicLED  
Art. No. (Europe) 4200110 EAN 4011708420706



- Automatically running sunrise and sunset
- Moonlight
- „Plug & Play“ – The dimmer is inserted between the EHEIM classicLED and the 24 V power supply unit.





The new and efficient aquarium lighting for optimum illumination down to the bottom.

For fresh water aquariums  
Ideal for fish and aquatic plants.

**EHEIM+**  
powerLED+



LEDs for a golden sunlight

## Lighting

### EHEIM powerLED+

		fresh daylight							
Total length	mm	360	487	664	771	953	1074	1226	1349
for aquariums up to	mm	372-540	499-667	680-844	787-951	973-1133	1094-1254	1250-1406	1373-1529
<b>Technical data</b>									
Power consumption	W	8,6	13,0	17,3	21,6	25,9	30,2	34,6	38,9
Power supply	W	20	20	20	20-40	20-40	20-40	20-40	20-40
Light colour	K	6750	6750	6750	6750	6750	6750	6750	6750
Rated light flux	lm	1298	1946	2595	3244	3893	4542	5191	5839
Energy efficiency class		A++	A++	A++	A++	A++	A++	A++	A++
Art. No.		4251011	4252011	4253011	4254011	4255011	4256011	4257011	4258011
EAN	4011708	000069	000113	000168	000212	000267	000311	000366	000410
Packing dimensions H	mm	544	544	828	828	1129	1129	1405	1405
Packing dimensions BxT	mm	65x49	65x49	65x49	65x49	65x49	65x49	65x49	65x49
Master pack quantities	pcs.	1	1	1	1	1	1	1	1

		fresh plants							
Total length	mm	360	487	664	771	953	1074	1226	1349
for aquariums up to	mm	372-540	499-667	680-844	787-951	973-1133	1094-1254	1250-1406	1373-1529
<b>Technical data</b>									
Power consumption	W	9,8	14,8	19,7	24,6	29,5	34,4	39,4	44,3
Power supply	W	20	20	20	20-40	20-40	20-40	20-40	40-62
Light colour	K	9200	9200	9200	9200	9200	9200	9200	9200
Rated light flux	lm	970	1456	1941	2426	2911	3397	3882	4367
Energy efficiency class		A	A	A	A	A	A	A	A
Art. No.		4251021	4252021	4253021	4254021	4255021	4256021	4257021	4258021
EAN	4011708	000076	000120	000175	000229	000274	000328	000373	000427
Packing dimensions H	mm	544	544	828	828	1129	1129	1405	1405
Packing dimensions BxT	mm	65x49	65x49	65x49	65x49	65x49	65x49	65x49	65x49
Master pack quantities	pcs.	1	1	1	1	1	1	1	1



### For fresh water aquariums

#### EHEIM powerLED+ fresh daylight

- Bright daylight with sunlight full spectrum
- Maximum energy efficiency (150 lm / W) and light output
- For demanding aquatic plants and brilliant colour reproduction, can also be combined with powerLED+ fresh plants
- One EHEIM powerLED+ fresh daylight replaces one T5-/T8 fluorescent tube of the appropriate length including reflector
- Beam angle 120°
- Average life > 50.000 hours (13-14 years at 10 hours per day)

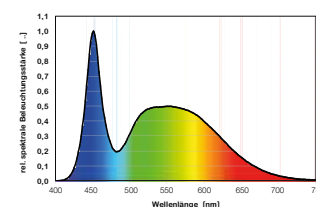

Colour spectrum powerLED+ fresh daylight

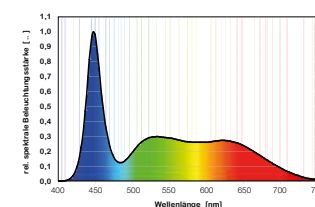

Colour spectrum powerLED+ fresh plants

#### A safety power supply is required for the operation of the LED.

Cable length: approx. 2 Meter

	Art.No Europe	Art.No UK
Power supply 20 Watt	4204210	4204350
Power supply 20-40 Watt	4205210	4205350
Power supply 40-62 Watt	4209210	4209350
Power supply 80 Watt	4206210	4206350
Power supply 130 Watt	4207210	4207350

#### Original EHEIM Accessories

1 Adapter Set: 1xT5, 1xT8	4200000
2 Connector	4200050
3 Suspension wires	4200060
4 Double suspension wires	4200030
5 Mounting bracket	4200040



Made in Germany

### For fresh water aquariums

#### EHEIM powerLED+ fresh plants

- Promotes healthy growth of even the most demanding aquatic plants
- Emphasizes blue and red colouring of fish and aquatic plants in a natural way
- Very natural colour reproduction (simulates sunshine in the aquarium)
- Very high energy efficiency (100 Lm/W) and light output
- Can be used as the sole source of light or in combination with EHEIM powerLED+ fresh daylight
- Beam angle 120°
- Average life > 50.000 hours (13-14 years at 10 hours per day)



Application using mounting brackets

**EHEIM LEDcontrol** (optional) Art.No 4200120  
Designed to control the different lighting options required to simulate nature's colours and moods. Especially developed for the EHEIM powerLED+ series (page 70).

**EHEIM LEDcontrol+** (optional) Art.No 4200140  
The wireless lighting control for simulating light as in nature. Operation via smartphone, tablet or PC/Mac. Especially for EHEIM powerLED+ lamps (page 70).



new





The new and efficient aquarium lighting for optimum illumination down to the substrate.

For marine water aquariums  
Ideal for corals and invertebrates.

**EHEIM+**  
powerLED+

Marine

Lighting

EHEIM powerLED+

EHEIM powerLED+		marine hybrid							
Total length	mm	360	487	664	771	953	1074	1226	1349
for aquariums up to	mm	372-540	499-667	680-844	787-951	973-1133	1094-1254	1250-1406	1373-1529
<b>Technical data</b>									
Power consumption	W	9,8	14,8	19,7	24,6	29,5	34,4	39,4	44,3
Power supply	W	20	20	20	20-40	20-40	20-40	20-40	40-62
Rated light flux	lm	770	1156	1541	1926	2311	2697	3082	3467
Energy efficiency class		A	A	A	A	A	A	A	A
Art. No.		4251032	4252032	4253032	4254032	4255032	4256032	4257032	4258032
EAN	4011708	000090	000144	000199	000243	000298	000342	000397	000441
Packing dimensions H	mm	544	544	828	828	1129	1129	1405	1405
Packing dimensions BxT	mm	65x49	65x49	65x49	65x49	65x49	65x49	65x49	65x49
Master pack quantities	pcs.	1	1	1	1	1	1	1	1

EHEIM powerLED+		marine actinic							
Total length	mm	360	487	664	771	953	1074	1226	1349
for aquariums up to	mm	372-540	499-667	680-844	787-951	973-1133	1094-1254	1250-1406	1373-1529
<b>Technical data</b>									
Power consumption	W	8,6	13,0	17,3	21,6	25,9	30,2	34,6	38,9
Power supply	W	20	20	20	20-40	20-40	20-40	20-40	20-40
Rated light flux	lm	89	134	179	223	268	313	358	402
Energy efficiency class		-	-	-	-	-	-	-	-
Art. No.		4251041	4252041	4253041	4254041	4255041	4256041	4257041	4258041
EAN		000106	000151	000205	000250	000304	000359	000403	000519
Packing dimensions H	mm	544	544	828	828	1129	1129	1405	1405
Packing dimensions BxT	mm	65x49	65x49	65x49	65x49	65x49	65x49	65x49	65x49
Master pack quantities	pcs.	1	1	1	1	1	1	1	1

Examples of use  
EHEIM powerLED+



With single suspension wires



With double suspension wires



With mounting bracket



with T5 or T8 adapter

For marine water aquariums

EHEIM powerLED+ marine hybrid

- Optimal combination of white and royal blue light (1:1)
- High light output and coordinated spectrum in the areas important for photosynthesis
- Promotes colour reproduction (fluorescence) and the growth of corals
- One EHEIM powerLED+ marine hybrid replaces one T8-/T5 fluorescent tube of the appropriate length including reflector
- Royal blue LEDs (445 nm)
- Beam angle 120°
- Average life > 50.000 hours (13-14 years at 10 hours per day)

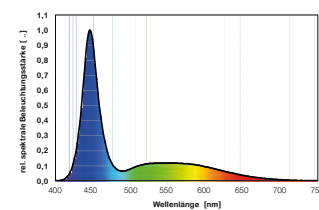

Colour spectrum powerLED+ marine hybrid

A safety power supply is required for the operation of the LED.

Cable length: approx. 2 Meter

	Art.No Europe	Art.No UK
Power supply 20 Watt	4204210	4204350
Power supply 20-40 Watt	4205210	4205350
Power supply 40-62 Watt	4209210	4209350
Power supply 80 Watt	4206210	4206350
Power supply 130 Watt	4207210	4207350

Original EHEIM Accessories

1 Adapter Set: 1xT5, 1xT8	4200000
2 Connector	4200050
3 Suspension wires	4200060
4 Double suspension wires	4200030
5 Mounting bracket	4200040



For marine water aquariums

EHEIM powerLED+ marine actinic

- Pure actinic light
- Royal blue LEDs (445 nm)
- Enhances the natural fluorescence of corals and invertebrates
- Can be combined with EHEIM powerLED+ marine hybrid
- Beam angle 120°
- Average life > 50.000 hours (13-14 years at 10 hours per day)

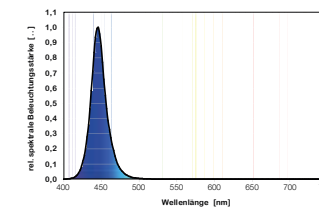

Colour spectrum powerLED+ marine actinic

EHEIM LEDcontrol (optional) Art.No 4200120

Designed to control the different lighting options required to simulate nature's colours and moods. Especially developed for the EHEIM powerLED+ series (page 70).

EHEIM LEDcontrol+ (optional) Art.No 4200140

The wireless lighting control for simulating light as in nature. Operation via smartphone, tablet or PC/Mac. Especially for EHEIM powerLED+ lamps (page 71).

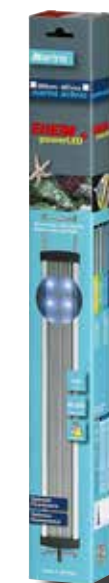
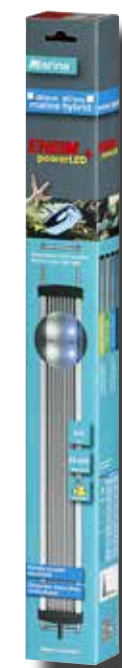

new



Designed to control the different lighting options required to simulate nature's colours and moods.

**EHEIM**  
LEDcontrol

The wireless lighting control for simulating light as in nature.

**EHEIM**  
LEDcontrol+

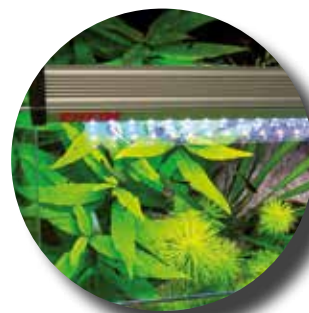
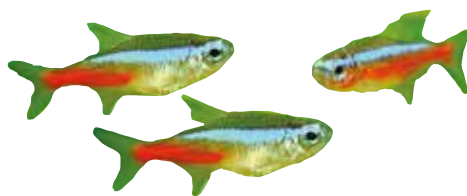

### Lighting control

Technical data		LEDcontrol
Performance	W	max. 180
Channels		5
Power supply		USB 5V DC powerLED+ 24V DC
System requirements		Windows XP up to Windows 10
Dimensions LEDcontrol HxWxD	mm	90x85x25
Art. No. (Europe)		4200120
EAN	4011708	002124
Packing dim. HxWxD	cm	19x11,1x4,4
Master pack quantities	pcs.	1

Using the EHEIM LEDcontrol, you can control the lighting in the aquarium to create the ideal light to benefit both fish and plants.

- Control of the aquarium lighting – only in conjunction with EHEIM pow-erLED+ light units
- Simulation of the light variations and ambiance found in nature
- Ideal for 'fresh plants' or 'marine hybrid' lights as you can adapt the brightness as well as the colours, individually
- For 'fresh daylight' or 'marine actinic' lights, you can only vary the brightness
- Pre-installed connectors for EHEIM powerLED+ lamps
- Including accessories: USB card with software, operating manual and pre-programmed lighting scenarios for fresh and marine water
- Possibility to use preset lighting modes
- Individual light options can be programmed
- Quick start with pre-programmed lighting modes
- Fast forward mode to check the selected settings
- Switch between Summer and Winter GMT simply by synchronizing with the PC (brightness and colour variations remain unchanged)

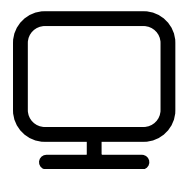

LED Controller  
PC



WiFi

### Lighting control

Technical data		LEDcontrol+
Performance	W	max. 180
Channels		3
Power supply		powerLED+ 24V DC
System requirements		All WiFi devices Smartphone, tablet, PC/MAC
Dimensions LEDcontrol+ HxWxD	mm	97x97x27
Art. No. (Europe)		4200140
EAN	4011708	005606
Packing dim. HxWxD	cm	13,5x10,2x3,4
Master pack quantities	pcs.	1

With EHEIM LEDcontrol+ you can easily control the brightness curve and the lighting mood in your aquarium - without cables.

- Control of the aquarium lighting - only in combination with EHEIM powerLED+ lights
- Integrated plug-in connections
- Wireless operation via smartphone, tablet or PC/Mac via your own network
- Simulation of the light variations and light moods as in nature
- Pre-installed lighting scenarios for fresh and marine water including quick-start guide
- Individually programmable lighting sequence and control of the colour channels
- Freely configurable: sunrise, sunset (up to 3 hours each), cloud effects, moonlight etc.
- Lighting scenarios can also be shared with other aquarists
- Expert mode with additional setting options
- Acclimatisation mode, e.g. when setting up new aquariums
- Ideal for the "fresh plants" and "marine hybrid" luminaires; here you can individually adjust the brightness curve as well as the light colours
- With the "fresh daylight" or "marine actinic" luminaires, you can only define the brightness curve
- Fast forward to check the selected settings
- Easy change from summer to winter time at the touch of a button
- Updates free of charge for download on the EHEIM website



**Control lamp on LEDcontrol+**  
White (flashing): Search network  
Blue: New network created  
Green: Connection to MasterController established  
Fast color change: Carrying out an update

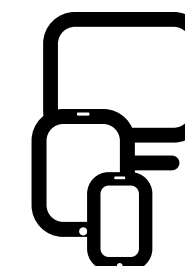

Wireless LED  
Controller  
Smartphone  
Tablet  
PC/MAC





## Aquarium heater with fixed temperature.

**EHEIM**  
thermopreset

**e**  
electronic  
heater



### Preset heater

#### EHEIM thermopreset

#### Technical data

		50	100	150	200
Aquarium size up to	l	25-60	100-150	200-300	300-400
Performance	W	50	100	150	200
Total length	mm	168,5	183,5	223,5	253,5
Diameter	mm	28,2	28,2	28,2	28,2
Art. No. (Europe)		3652010	3654010	3656010	3657010
Art. No. (UK)		3652110	3654110	3656110	3657110
Packaging diameter HxWxD	cm	24,5x8,1x4,2	24,5x8,1x4,2	32x8,1x4,2	32x8,1x4,2
Master pack quantities	pcs.	1	1	1	1



#### EHEIM thermopreset Aquarium heater with fixed temperature of 25°C

- Compact and user-friendly
- High temperature accuracy by electronic control
- Mechanical stability due to plastic protection
- With thermo-safety control (auto shut-off)
- Even heat distribution by highly efficient heating element
- Suction cups (included) for secure attachment
- Suitable for fresh and marine water



On/off indicator light



## Precision aquarium heater.

**EHEIM**  
thermocontrol



### Heater

#### EHEIM thermocontrol

#### Technical data

		25	50	75	100	125	150	200	250	300
Aquarium size up to	l	20-25	25-60	60-100	100-150	150-200	200-300	300-400	400-600	600-1000
Performance	W	25	50	75	100	125	150	200	250	300
Total length	mm	243	243	270	319	319	345	406	452	506
Diameter	mm	36	36	36	36	36	36	36	36	36
Art. No. (Europe)		3611010	3612010	3613010	3614010	3615010	3616010	3617010	3618010	3619010
Art. No. (UK)		3611110	3612110	3613110	3614110	3615110	3616110	3617110	3618110	3619110
Packing dim. HxWxD	cm		34,5x6,5x5		42,5x6,5x5				58,5x6,5x5	
Master pack quantity	pcs.	6	6	6	6	6	6	6	6	6

#### With the EHEIM precision heater your fish have exactly the right temperature – in any aquarium.

- 1 Precise temperature adjustment from 18 to 34 °C
- 2 Simple and safe recalibration ( $\pm 2$  °C)
  - Temperature control accuracy  $\pm 0,5$  °C
  - Heat kept at a constant level
- 3 Heating function is indicated by a control lamp
  - Completely submersible (watertight)
  - With automatic dry run shut-off (Thermo Safety Control)
  - A glass jacket increases the heating surface and ensures optimum even heat emission
  - Practical cable length ca. 170 cm
  - Includes double suction cup holder
  - 9 sizes available for aquariums from 20 to 1000 lt
  - Suitable for fresh and marine water

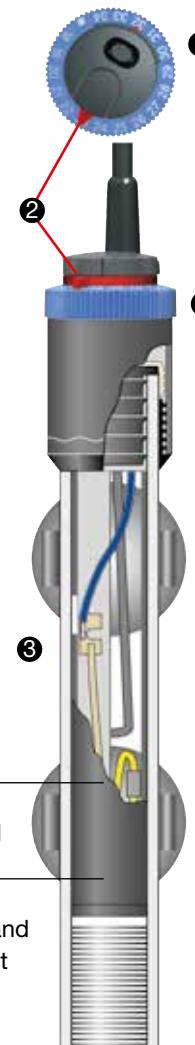

Heat shield

Chrome-nickel coil

Temperature and shock resistant



Made in Germany

3 year  
guarantee  
EHEIM





With electronics for a comfortable climate



**Electronic heater**

**EHEIM thermocontrol e**

**Technical data**

		25	50	75	100	125	150	200	250	300	400
Aquarium size up to	l	20-25	25-60	60-100	100-150	150-200	200-300	300-400	400-600	600-1000	1000-1200
Performance	W	25	50	75	100	125	150	200	250	300	400
Total length	mm	233	233	260	309	309	335	396	442	496	496
Diameter	mm	36	36	36	36	36	36	36	36	36	36
Art. No. (Europe)		3631010	3632010	3633010	3634010	3635010	3636010	3637010	3638010	3639010	3640010
Art. No. (UK)	4011708	004838	004845	004852	004869	004876	004883	004890	004906	004913	004920
Packing dim. HxWxD	cm	34,5x6,5x5	34,5x6,5x5	34,5x6,5x5	42,5x6,5x5	42,5x6,5x5	42,5x6,5x5	42,5x6,5x5	58,5x6,5x5	58,5x6,5x5	58,5x6,5x5
Master pack quantity	pcs.	6	6	6	6	6	6	6	6	6	6

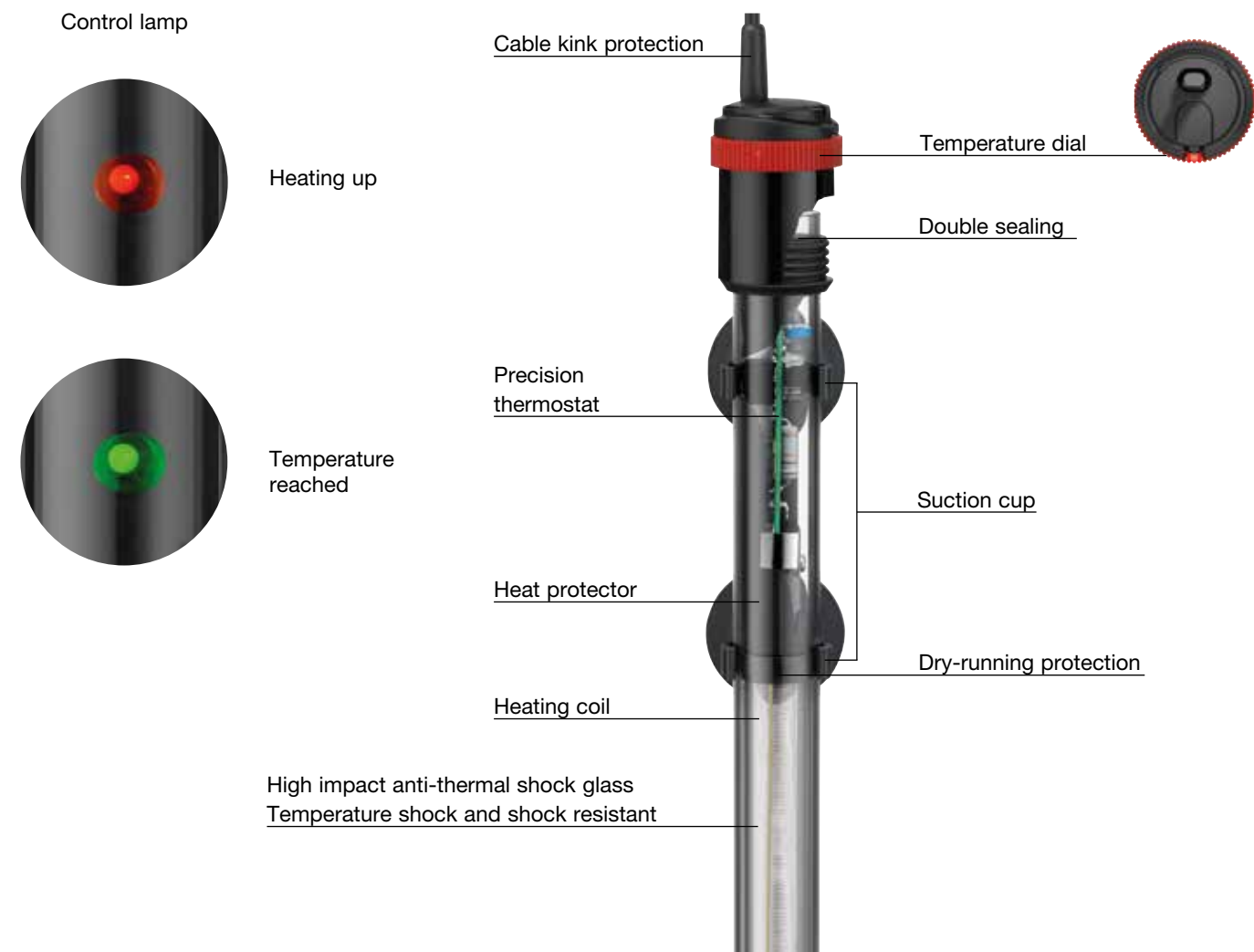

**With the EHEIM thermocontrol-e heating element your fish get the right temperature even more precisely - in every aquarium.**

The obvious ideas are often the best. This also applies to the aquarium heating element. It is simply hung in the water and heats it up. The principle is the same as it was decades ago. But in the meantime the EHEIM controller heater has become an ultra-modern thermal device. The temperature can be set precisely and is measured even more precisely and kept more constant by the electronics. The coating made of special laboratory glass increases the heating surface, serves as a heat shield and ensures even heat emission. And whether you want to heat a 20 or 1200 litres aquarium - you can choose from 10 sizes.

- Precise temperature adjustment from 20 to 32 °C
- No readjustment necessary
- Control accuracy ± 0.5 °C
- The heat is kept constant
- Control lamp indicates the heating function (red: heating up; green: temperature reached)
- Fully submersible (waterproof)
- With dry-running protection (Thermo Safety Control)
- Glass coating increases the heating surface and ensures optimum, even heat output
- Convenient cable length approx. 170 cm
- Including double suction holder
- 10 sizes for aquariums from 20 to 1200 litres
- Suitable for fresh and marine water





CO<sub>2</sub>

**EHEIM**





EHEIM CO<sub>2</sub> sets offer a simple and reliable way to supply the correct amount of CO<sub>2</sub> into your aquarium for healthy plant growth.

**EHEIM**



**CO<sub>2</sub> - set**



**EHEIM CO<sub>2</sub>-fertiliser unit**

**CO<sub>2</sub>SET 200 incl. bottle** Art. No. 6063200  
 EAN 4011708006856 Pk 1

**CO<sub>2</sub> fertiliser system – a complete set for aquariums up to 200 litres.**

- CO<sub>2</sub> disposable bottle (500 g) with integrated stand
- Precision pressure reducer for disposable systems with precision dosing valve
- Hose connection – rotates 360°
- CO<sub>2</sub> special safety hose, pressure resistant, 3m, ø 4/6 mm
- CO<sub>2</sub> safety diffuser up to 400 l including bubble counter and non-return valve for effective CO<sub>2</sub> dosing.
- CO<sub>2</sub> long-term test and indicator reagent for constant direct monitoring of the CO<sub>2</sub> content in the aquarium
- 5 x water test strips for analysis of the initial water values
- Safe and tool free installation
- Optional accessories (not included): CO<sub>2</sub> magnetic valve (night shut-off)



**CO<sub>2</sub>SET 400 incl. bottle** Art. No. 6063400  
 EAN 4011708006863 Pk 1

**CO<sub>2</sub> fertiliser system – a complete set for aquariums up to 400 litres.**

- CO<sub>2</sub> reusable bottle (500 g) with stand
- CO<sub>2</sub> precision pressure reducer with manometers for reusable systems and a precision dosing valve
- Hose connection – rotates 360°
- CO<sub>2</sub> special safety hose, pressure resistant, 3m, ø 4/6 mm
- CO<sub>2</sub> safety diffuser up to 400 l including bubble counter and non-return valve for effective CO<sub>2</sub> dosing.
- CO<sub>2</sub> long-term test and indicator reagent for constant direct monitoring of the CO<sub>2</sub> content in the aquarium
- 5 x water test strips for analysis of the initial water values
- Bottle with standardised connection for refilling (at the specialist dealer or at an appropriate CO<sub>2</sub> refilling station)
- Safe and tool free installation
- Optional accessories (not included): CO<sub>2</sub> magnetic valve (night shut-off)



**CO<sub>2</sub>SET 600 incl. bottle** Art. No. 6063600  
 EAN 4011708006870 Pk 1

**CO<sub>2</sub> fertiliser system - a complete set for aquariums up to 600 litres.**

- CO<sub>2</sub> reusable bottle (2000 g) with stand
- CO<sub>2</sub> Precision pressure reducer with manometers for reusable systems and a precision dosing valve
- CO<sub>2</sub> special safety hose, pressure resistant, 3m, ø 4/6 mm
- CO<sub>2</sub> safety diffuser up to 600 litres including bubble counter and non-return valve for effective CO<sub>2</sub> dosing
- CO<sub>2</sub> long-term test and indicator reagent for constant monitoring of the CO<sub>2</sub> content in the aquarium
- 5 x water test strips for analysis of the initial water values
- Bottle with standardised connection for refilling (at the specialist dealer or at an appropriate CO<sub>2</sub> refilling station)

**CO<sub>2</sub> - set with night shut-off**

**CO<sub>2</sub>SET 400 incl. bottle, with night shut-off** Art. No. 6064214  
 EAN 4011708008225 Pk 1

**CO<sub>2</sub>SET 600 incl. bottle, with night shut-off** Art. No. 6064216  
 EAN 4011708008232 Pk 1





EHEIM CO<sub>2</sub> sets offer a simple and reliable way to supply the correct amount of CO<sub>2</sub> into your aquarium for healthy plant growth.

**EHEIM**



CO<sub>2</sub> - set

CO<sub>2</sub> - set with night shut-off

**EHEIM CO<sub>2</sub>-fertiliser unit without bottle**

**CO<sub>2</sub>SET 400 without bottle** Art. No. 6063300  
 EAN 4011708008249 Pk 1

**For aquariums up to 400 litres.**

- CO<sub>2</sub> precision pressure reducer with manometers for reusable systems and a precision dosing valve
- Hose connection – rotates 360°
- CO<sub>2</sub> special safety hose, pressure resistant, 3m, ø 4/6 mm
- CO<sub>2</sub> safety diffuser up to 400 l including bubble counter and non-return valve for effective CO<sub>2</sub> dosing.
- CO<sub>2</sub> long-term test and indicator reagent for constant direct monitoring of the CO<sub>2</sub> content in the aquarium
- 5 x water test strips for analysis of the initial water values
- Safe and tool free installation
- Optional accessories (not included): CO<sub>2</sub> magnetic valve (night shut-off)

**CO<sub>2</sub>SET 600 without bottle** Art. No. 6063500  
 EAN 4011708008256 Pk 1

**For aquariums up to 600 litres.**

- CO<sub>2</sub> precision pressure reducer with manometers for reusable systems and a precision dosing valve
- Hose connection – rotates 360°
- CO<sub>2</sub> special safety hose, pressure resistant, 3m, ø 4/6 mm
- CO<sub>2</sub> safety diffuser up to 600 l including bubble counter and non-return valve for effective CO<sub>2</sub> dosing.
- CO<sub>2</sub> long-term test and indicator reagent for constant direct monitoring of the CO<sub>2</sub> content in the aquarium
- 5 x water test strips for analysis of the initial water values
- Safe and tool free installation
- Optional accessories (not included): CO<sub>2</sub> magnetic valve (night shut-off)



**CO<sub>2</sub>SET 400 without bottle, with night shut-off**  
 EAN 4011708008263

Art. No. 6064213  
 Pk 1

**CO<sub>2</sub>SET 600 without bottle, with night shut-off**  
 EAN 4011708008270

Art. No. 6064215  
 Pk 1



3 year guarantee EHEIM





EHEIM CO<sub>2</sub> sets offer a simple and reliable way to supply the correct amount of CO<sub>2</sub> into your aquarium for healthy plant growth.

**EHEIM**



CO<sub>2</sub> - Zubehör

CO<sub>2</sub> - Zubehör



**CO<sub>2</sub> disposable bottle 500g** Art. No. 6063000 EAN 4011708006887 **Pk 1**  
 Recyclable, disposable bottle for the complete EHEIM CO<sub>2</sub>SET200 fertiliser system – suitable for aquariums up to 200 ltrs. TÜV-tested. The empty disposable bottle is recyclable and can be disposed of in a recyclable waste container or bin or at a household rubbish tip. Your aquatic retailer may also take the empty bottles back for recycling.



**CO<sub>2</sub> reusable bottle 500g, with bottle holder** Art. No. 6063010 EAN 4011708006894 **Pk 1**  
 Refillable bottle for the complete EHEIM CO<sub>2</sub>SET400 fertiliser system – suitable for aquariums up to 400 ltrs. CO<sub>2</sub> bottle with safety guard (pressure and valve protection) and handle. 250 bar TÜV-tested. Height: 440 mm (with safety guard), diameter: 61 mm.

The CO<sub>2</sub> reusable bottle is made of high-quality steel and complies with all German and European safety regulations. The empty CO<sub>2</sub> bottle can be refilled by your (approved) specialist dealer or an appropriate CO<sub>2</sub> refilling station.



**CO<sub>2</sub> reusable bottle 2000g** Art. No. 6063020 EAN 4011708006900 **Pk 1**  
 Refillable bottle for the complete EHEIM CO<sub>2</sub>SET600 fertiliser system – suitable for aquariums up to 600 ltrs. CO<sub>2</sub> bottle with safety guard (pressure and valve protection) and handle. 250 bar TÜV-tested. Height: 455 mm (with safety guard), diameter: 120 mm

The CO<sub>2</sub> reusable bottle is made of high-quality steel and complies with all German and European safety regulations. The empty CO<sub>2</sub> bottle can be refilled by your (approved) specialist dealer or an appropriate CO<sub>2</sub> refilling station.



**CO<sub>2</sub> pressure reducer - Disposable system** Art. No. 6063040 EAN 4011708006801 **Pk 1**  
 ■ Precision pressure reducer for disposable bottles  
 ■ Suitable for the complete EHEIM CO<sub>2</sub>SET200 fertiliser system  
 ■ EHEIM bubble counter for precise and continuous CO<sub>2</sub> dosing  
 ■ 360° rotating hose connection  
 ■ Tool free assembly



**CO<sub>2</sub> pressure reducer with manometer - Reusable system** Art. No. 6063050 EAN 4011708006825 **Pk 1**  
 ■ Precision pressure reducer for reusable systems  
 ■ Suitable for complete EHEIM CO<sub>2</sub>SET400 and EHEIM CO<sub>2</sub>SET600 fertilizer systems  
 ■ 2 x pressure gauges to show working (system) pressure and cylinder pressure  
 ■ EHEIM bubble counter for precise and continuous CO<sub>2</sub> dosing  
 ■ 360° rotating hose connection  
 ■ Tool free assembly  
 ■ Replacement seal included

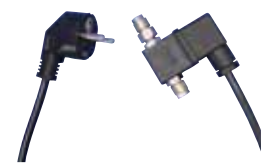

**CO<sub>2</sub> hose 3m** Art. No. 7206228 EAN 4011708006788 **Pk 1**



**CO<sub>2</sub> night shut-off 230V** Art. No. 6064210 EAN 4011708006917 **Pk 1**  
 The magnetic valve operates with a 230V alternating current and works best when connected to the aquarium light timer. This allows the magnetic valve to be switched off at the same time as the lights.

- Maintenance free
- Silent operation
- Includes non-return valve
- Includes 1.5m cable



**CO<sub>2</sub> night shut-off connection to powerLED+** Art. No. 6064380 EAN 4011708006924 **Pk 1**

This magnetic valve has been specially developed for the EHEIM LEDcontrol+ lighting control system. It is connected to the EHEIM powerLED+ lighting and LEDcontrol+ and switches off the supply of CO<sub>2</sub> during the sunset phase overnight. At dawn, the CO<sub>2</sub> supply is reactivated. The magnetic valve can also be operated without LEDcontrol+ with a standard timer. Attention: The magnetic valve is not dimmable.

- Maintenance free
- Silent operation
- Includes non-return valve
- Includes 1.5m cable



**CO<sub>2</sub> diffuser 400l** Art. No. 6063070 EAN 4011708006948 **Pk 1**

For small and medium aquariums up to 400 l.  
 ■ Small, space-saving device  
 ■ Highly efficient diffuser  
 ■ Bubble counter for visual control of CO<sub>2</sub> dosing  
 ■ Non-return valve prevents water returning to the CO<sub>2</sub> system  
 ■ Hose protection  
 ■ Powerful suction holder



**CO<sub>2</sub> diffuser 600l + Bubble counter with non-return valve** Art. No. 6063080 EAN 4011708006955 **Pk 1**

For larger aquariums up to 600 l.  
 ■ User-friendly device with large diffuser area  
 ■ Optimum distribution of CO<sub>2</sub> bubbles in large aquariums  
 ■ Separate bubble counter for visual control of CO<sub>2</sub> dosing  
 ■ Integrated non-return valve prevents water returning to the CO<sub>2</sub> system  
 ■ Safe hose connection  
 ■ Space-saving corner mounting with two powerful suction holders



**CO<sub>2</sub> long-term test with indicator reagent and 3 test strips** Art. No. 6063090 EAN 4011708006832 **Pk 1**

**CO<sub>2</sub> test Indicatorreagent (10ml)** Art. No. 6063095 EAN 4011708006849 **Pk 1**

**CO<sub>2</sub> test strip - 5 times (50 stripes)** Art. No. 4500100 EAN 4011708006986 **Pk 1**



A well-balanced range of useful and functional products. All meeting the highest standard of quality, reliability and functionality.

**EHEIM**



**Accessories**



**Glass scraper for fresh and marine water aquariums**

<b>rapidCleaner 25cm</b>	Art. No. 3591050	EAN 4011708007808	<b>Pk 1</b> <b>new</b>
<b>rapidCleaner 48cm</b>	Art. No. 3591000	EAN 4011708350355	<b>Pk 1</b>
<b>rapidCleaner 58cm</b>	Art. No. 3591100	EAN 4011708004692	<b>Pk 1</b> <b>new</b>

**For easy and effective cleaning of interior aquarium glass**

- No tools necessary to change the blade
- Quick cleaning due to the extra wide 8cm working width
- Precision cut blade and blade protection
- Integrated silicone protection prevents the blade cutting into the sealant

**Accessories:** Algae brush (Art. 3591001), cleaning sponge (Art. 3591002), cleaning sponge 90° (Art. 3591003), blade holder (Art. 3591004), fishnet (120x190mm/165x190mm/220x190mm - Art. 3591010/3591011/3591012)



**Automatic gravel cleaner**

<b>Quick Vacpro</b>	Art. No. 3531000	EAN 4011708 350140	<b>Pk 4</b>
---------------------	------------------	--------------------	-------------

The battery operated gravel cleaner is used to clean the gravel substrate and can also be used between water changes. The power of the cleaner is designed to remove dirt without disturbing the gravel and the purifying bacteria. The mesh filter compartment retains the dirt while letting the filtered water straight back into the aquarium. The filter compartment is simple to remove and easy to clean. Not suitable for sand.

- Batteries included



<b>Gravel cleaner set</b>	Art. No. 4002510	EAN 4011708 401651	<b>Pk 3</b>
---------------------------	------------------	--------------------	-------------

The perfect tool for the convenient and safe cleaning of the aquarium substrate while doing a partial water change. A number of new functions and fittings have improved use, safety and convenience.

- Integrated priming support for a convenient and hygienic start to the process
- Quick stop button, stalls the water flow immediately
- The hose clip 1 (also available separately, Art. no. 4002520) safely attaches the hose to the bucket
- Supplied complete with EHEIM quality hose and hose clip. Length 492 mm, can be extended with installation SET accessories
- Rounded triangular shape enables optimum cleaning in all areas of the tank base and guarantees easy access to corners

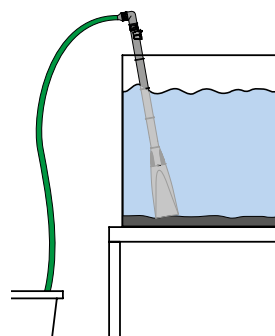

<b>Surface skimmer</b>	Art. 3535000	EAN 4011708 350027	<b>Pk 1</b>
------------------------	--------------	--------------------	-------------

With floating inlet and automatic valve control. The device ensures a permanently clean water surface without film residue. For all EHEIM external filters (apart from 2074/2076/2078/2178/2274).



**InstallationsSET 1** (suction/inlet side)

Modular installation set for easy connection to all external filters. Safe and water tight connection to hose. (The hose can be easily cleaned without removing the connection hose.) The inlet pipe can be lengthened or shortened as required. Safe and permanent fixing in the tank with EHEIM quality suction cup.

Versions:

Hose diameter 12/16 mm	Art. No. 4004300	EAN 4011708 401378
Hose diameter 16/22 mm	Art. No. 4005300	EAN 4011708 401361

**InstallationsSET 2** (pressure/outlet side)

Ideal for the customised design of the outlet. Safe and water tight connection from the hose to InstallationSET 2. The hose can be easily cleaned without disconnecting the kit.

Versions:

Hose diameter 12/16 mm	Art. No. 4004310	EAN 4011708 401392
Hose diameter 16/22 mm	Art. No. 4005310	EAN 4011708 401385



There are a wide range of clever accessories for the installationsSETs 1 + 2. They can be used to create different water movement and flow possibilities in the aquarium.

**Accessories for InstallationsSET 1+2**

Art. No.	EAN	4011708	Description
4003651	401668	①	Diffuser for InstallationsSET 2 and for hose ø 12/16 mm, suitable for filters 2213, 2222/2224, 2322/2324, 2422/2424/2124
4004651	401606	①	Diffuser for InstallationsSET 2 and for hose ø 12/16 und 16/22 mm, suitable for filters 2048, 2215/17, 2226/28, 2250
4005651	401613	①	Diffuser for InstallationsSET 2 and for hose ø 16/22 mm, suitable for filters 2026/2028, 2080, 2126/2128, 2252, 2260, 2426
4005600	401576	②	Ball joint for InstallationsSET 2
4009610	401491		Extension pipe for InstallationsSET 1 (2 pieces)
4009620	401507		Spray bar for InstallationsSET 2 (2 pieces)
4009630	401514	③	Elbow for InstallationsSET 1+2
4009640	401545	④	T piece for InstallationsSET 1+2
4009650	401521	⑤	Flow rate indicator for InstallationsSET 2
4009660	401712	⑥	Nozzle clip, adjustable for InstallationsSET (4 pieces)
4009670	401729	⑦	Diffuser clip for InstallationsSET 2
4009680	401736	⑧	Wide-jet nozzle for InstallationsSET 2
4009690	401743	⑨	Adapters from InstallationsSET to hose for hose diameter 12/16 and 16/22 mm
4009700	401750	⑩	Nozzles and adapters from hose to InstallationsSET for hose diameter 12/16 and 16/22 mm
7438018	744345	⑪	Adapter connector for 1250 and 2252 PowerLine
7440148	744338	⑫	Adapter connector for 1048 and 2048 PowerLine

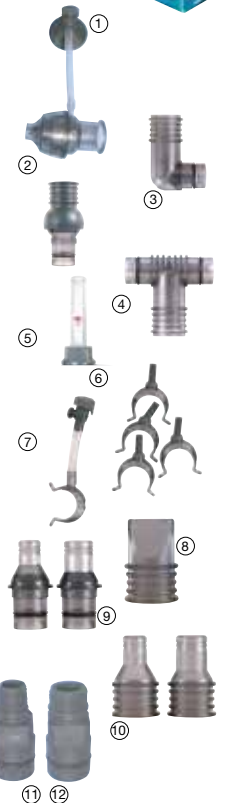



# EHEIM automatic fish feeders

## The best care for your fish

**EHEIM**



### Accessories

**EHEIM autofeeder** Art. No. 3581000 EAN 4011708 350102 **Pk 5**  
**Compact autofeeder with a rotating feeding chamber – mainly for flake food**

**EHEIM turtlefeeder** Art. No. 3581001 EAN 4011708 350300 **Pk 5**  
**Feeding unit for terrarium inhabitants (e.g. water turtles)**  
**Types of food: Fresh water shrimps, shrimps, food sticks and granules**

- Easy to understand programming, includes batteries
- An additional programme for double feeding
- Actively aerated food chamber
- Capacity approx. 100 ml
- Additional “snacks” possible at the touch of a button
- Function keys are splash resistant
- Warning system quickly indicates low battery level
- Including bracket for mounting on an open-top aquarium or terrarium



**EHEIM TWINfeeder** Art. No. 3582000 EAN 4011708 350171 **Pk 1**  
**Automatic feeder with 2 separate chambers for different types of food**

- For granules, sticks, pellets, flakes
- Drums can be programmed individually
- Random dosing for natural feeding
- Both drums are aerated
- 2 types of food can be fed in parallel; the advantage of this is a food supply for all livestock in the swimming zones
- Large display
- Warning system quickly indicates low battery level
- Includes batteries
- Made in Germany

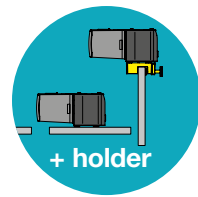
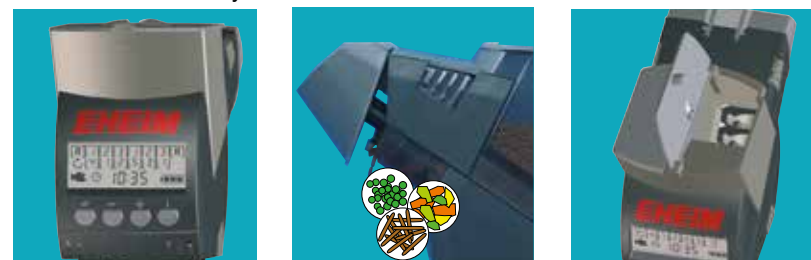

**EHEIM feedingSTATION** Art. No. 4001020 EAN 4011708 402030 **Pk 1**  
**Platform for EHEIM autofeeders**

- Universal clamp for attachment to frames, glass brace bars and centre support bars,  
**Feed chute** (without platform) also suitable for the feeder opening in EHEIM Varilux aquarium covers  
 Can also be used without the autofeeder (for manual feeding)  
 Feeding cylinder can also be used to thaw out diced frozen food
- Less food loss as food doesn't disperse
  - Less water pollution (nitrates and phosphates)
  - No oxygen depletion from bacterial decomposition
  - Less expense due to less wastage
  - All fish gather in one place so ideal for visual inspection of livestock



**Prefilter** Art. No. 4004320 EAN 4011708 401910 **Pk 3**

- Traps larger dirt particles in the inlet area, preventing early blocking of the filter media
- The filter basket is simple to remove (Easy-Klick) as well as easy to clean
- All round suction for gentle filtration
- Comprises 2 filter containers with filter cartridges
- Can be extended at will and fit InstallationsSET 1
- For all EHEIM external filters (apart from 2274/2074/2076/2078/2178/2260)



**Air filter**  
 EHEIM air filter Art. No. 4003000 EAN 4011708 401828 **Pk 1**

- For quarantine and breeding tanks.  
 Modular construction for use with the EHEIM air pump or other aquarium air pumps.  
 The compact filter cartridge ensures good filtration and protects small and weak aquarium inhabitants.  
 Extendable in many different ways using the EHEIM installationSET accessories.  
 Art. 4003010 EAN 4011708 401835 ExtensionSET for air filter 4003000  
 Art. 2615300 EAN 4011708 260920 Filter cartridge to air filter 4003000 (2 pieces)

Examples of use





You can completely rely on original EHEIM accessories – in every respect.

**EHEIM**



**Accessories**

**EHEIM flowpipe** Art. No. 4005730 EAN 4011708 402061

Lily Pipe, natural flow pipe

- Gentle water flow
- Appropriate for fish preferring calmer water with plant growth
- Variable outlet direction

**Undergravel filter**

**Reverse flow principle 1** Art. No. 3540000 EAN 4011708 350034

The purified water is taken up through the gravel floor and the floating particles of dirt are then taken to the priming area of the filter.

**Suction principle 2** Art. No. 3541000 EAN 4011708 350041

It works the opposite way round, operating as an additional biological filter. It is particularly suitable for marine water aquariums and tanks without plants.

**Accessories** Art. No. 3545000 EAN 4011708 350065

Extension set for undergravel filter (6 plates)

**Diffuser**

Works with a filter to give a measured supply of oxygen into the aquarium (recommended only for aquariums with little plant growth or high fish stocking levels).

**Double tap - quick release**

With a flick of the wrist, you can disconnect and connect the hose safely, cleanly and without water backflow. With EHEIM quality hoses, they make safe and functional hose connections. Available in different sizes and types.

**Wide-jet pipe and outlet pipe**

The wide-jet nozzle with its flat outlet ensures high surface movement. There is less movement with the outlet pipe but the direction of flow can be adjusted as required.

**EHEIM hoses**

EHEIM quality hoses are available in different sizes and lengths (by the metre, 3m packs and as rolls). EHEIM hose is phenol-free, supple, kink-free but rigid enough to ensure safe hose connections. EHEIM shut-off taps and hose accessories guarantee safe and secure connections for all fishkeeping requirements.

Air line	ø 4/6 mm:	3 m	Art. No. 4002943	100 m roll	Art. No. 4002949
Hose	ø 9/12 mm:	3 m	Art. No. 4003943	70 m roll	Art. No. 4003949
	ø 12/16 mm:	3 m	Art. No. 4004943	50 m roll	Art. No. 4004949
	ø 16/22 mm:	3 m	Art. No. 4005943	30 m roll	Art. No. 4005949
anthracite	ø 16/22 mm:	3 m	Art. No. 4005843		

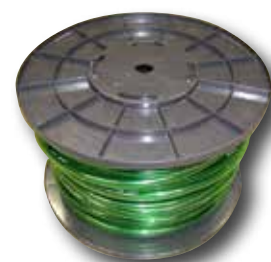

**EHEIM MultiBox** Art. No 4001010 EAN 4011708 402009 Pk 1

- Practical, hook-on container for maintenance work and aquascaping
- Compartment for plant remains, algae and other waste
- Can be used to transport wet items (internal filters) to the sink or waste to the bin
- Compartment for acclimatising new inhabitants to a different or new environment
- Can be used for quarantine and/or treatment
- Two-part lid prevents fish from jumping out
- Easy to hang over the aquarium glass or (if the aquarium cover does not permit it) on the cabinet door
- Hanger adjustable from 4 mm (aquarium glass) to 20 mm (cabinet door)
- Spacers for vertical adjustment
- 6 eyelets for hanging tools (tweezers, scissors, fish net, etc.)

**Water-neutral aquarium maintenance spray** Art. No. 4001000 EAN 4011708 723920

CFC-free, does not contain solvents or oils, free from environmentally toxic substances and harmless to fish. Moving filter parts which are subjected to aquarium water regularly tend to get tight or seize up entirely after some time. Just apply the spray to the part concerned and it soon becomes loose again. Supplied with spray tube for inaccessible areas.

Particularly recommended for ball valves, taps, hose adapter, sealing rings and much more.

**Plant tongs**

40 cm	Art. No. 3590050	EAN 4011708 350096
60 cm	Art. No. 3590000	EAN 4011708 350089

**Cleaning brushes for hoses**

100 cm	9/12 mm	Art. No. 4003551	EAN 4011708 401804
100 cm	12/16 mm	Art. No. 4004551	EAN 4011708 401798
100 cm	16/22 mm	Art. No. 4005551	EAN 4011708 401781
100 cm	19/27 + 25/34 mm	Art. No. 4007551	EAN 4011708 401774

**Universal-Cleaning brushes** Art. No. 4005570 EAN 4011708 401873  
for hoses 9/12, 12/16, 16/22, 19/27, 25/34 mm

**Cleaning brush-Set** Art. No. 4009560 EAN 4011708 401842  
For all EHEIM internal and external filters and EHEIM universal and compact pumps

**fish nets 5" (12 x 10 cm)** Art. No. 0691502 EAN 4010251 090404

**Thermometer** Art. No. 0360300 EAN 4010251 083512

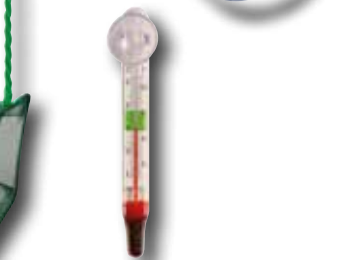

**TIP**



So you will always recommend the right product:

EHEIM accessories for external canister filters



	<b>ecco</b> <b>eccopro</b>		<b>classic</b> <i>professionnel</i> <b>eXperience</b>			<b>classic</b> <i>professionnel</i>		<b>professionnel III</b> <i>professionnel</i> <b>eXperience</b> 3°/4+/4°+		<b>classic</b>	
External filter	2231/2233/2235 comfort 2232/2234/2236 eccopro 2032/2034/2036		2211/2213/2215 2222/2224 / 2322/2324 2422/2424/2124			2217 2226/2228 / 2326/2328		2026/2028 / 2126/2128 2271/2273/2275/ 2071/2073/2075/2080 2371/2373/2171/2173/2180 2274/2074/2076/2078/2178 / 2426		2260	

Intake side/ Pressure side Diameter mm	Inlet 12/16	Outlet 12/16	Inlet 12/16	Outlet 12/16	Outlet 9/12 (only 2211)	Inlet 16/22	Outlet 12/16	Inlet 16/22	Outlet 16/22	Inlet 25/34	Outlet 16/22
---	----------------	-----------------	----------------	-----------------	----------------------------	----------------	-----------------	----------------	-----------------	----------------	-----------------

	Hoses 3 m/per m	4004943	4004943	4004943	4004943	4003943	4005943	4004943	4005943	4005943	4007940*	4005943
	Hoses 3 m/per m (anthracite)	-	-	-	-	-	-	-	4005843	4005843	-	-
	Double tap	4004412	4004412	4004412	4004412	4003412	4005410	4004412	4005410	4005410	4007410	4005410
	Shut-off tap	4004512	4004512	4004512	4004512	4003512	4005510	4004512	4005510	4005510	4007510	4005510
	InstallationsSET 1	4004300	-	4004300	-	-	4005300	-	4005300	-	-	-
	InstallationsSET 2	-	4004310	-	4004310	-	-	4004310	-	4005310	-	4005310
	Quick release coupling	4004522	4004522	4004522	4004522	4003522	4005520	4004522	4005520	4005520	-	4005520
	Elbow piece	4014050	4014050	4014050	4014050	4013000	4015100	4014050	4015100	4015100	4017200	4015100
	Hose holder	4014300	4014300	4014300	4014300	4013300	-	4014300	-	-	-	-
	T-piece	4004950	4004950	4004950	4004950	4003950	4005950	4004950	4005950	4005950	4007950	4005950
	Hose connection piece	4004970	4004970	4004970	4004970	4003970	4005970	4004970	4005970	4005970	4007970	4005970
	Suction cup with clip	4014100	4014100	4014100	4014100	4013050	4015150	4014100	4015150	4015150	4017300	4015150
	Variable outlet pipe	-	4004600	-	4004600	-	-	4004600	-	-	-	-
	Diffuser	-	4003651 <sup>1)</sup> 4004651 <sup>2)</sup>	-	4003651	4003660	-	4004651	-	4005651 <sup>3)</sup>	-	4005651
	Hose clamp	4004530	4004530	4004530	4004530	4003530	4005530	4004530	4005530	4005530	4007530	4005530
	Cleaning brush	4004551	4004551	4004551	4004551	4003551	4005551	4004551	4005551	4005551	4007551	4005551
	All-purpose brush	4005570	4005570	4005570	4005570	4005570	4005570	4005570	4005570	4005570	-	4005570
	Wide-jet pipe	-	4004700	-	4004700	4003700	-	4004700	-	4005700	-	-
	Outlet pipe	-	4004710	-	4004710	4003710	-	4004710	-	4005710	-	4005710
	Outlet pipe (anthracite)	-	-	-	-	-	-	-	-	4005750	-	-



**InstallationsSET 1**  
Modular inlet kit for easy connection to all external filters.



**Diffuser**  
Precisely dosed supply of oxygen into the aquarium.



**Wide-jet pipe**  
Ensures high surface movement.



**InstallationsSET 2**  
Modular outflow kit for easy connection to all external filters – to customise the water flow



**Cleaning brush**  
For thorough cleaning – different sizes for different hose diameters



**Quick release joint**  
With a flick of the wrist, you can disconnect the hose.

<sup>1)</sup> 2032/2034 eccopro

<sup>2)</sup> 2036 eccopro

<sup>3)</sup> not for professional 3° 2074/2076/2078, 4°+ 2274



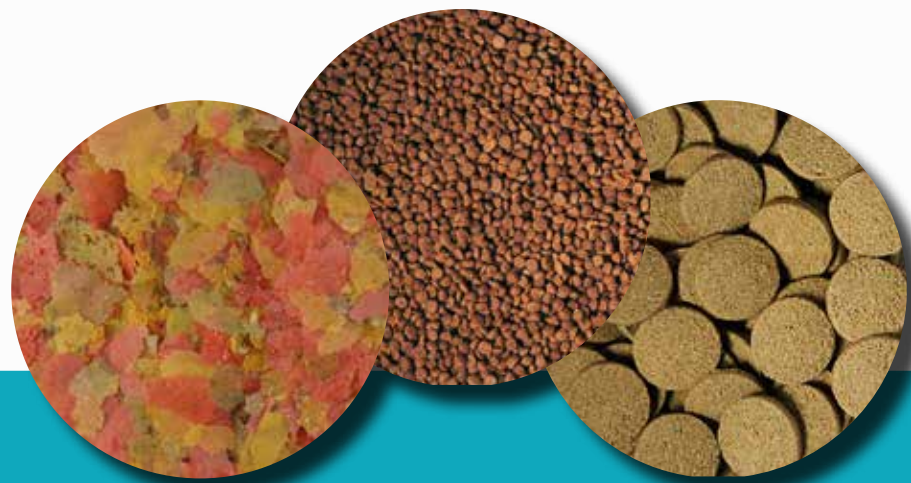

**EHEIM Food**  
Only the best for your fish

The new quality benchmark by the pioneers in aquatics. Healthy diet – ideal for both fish and water. Natural and fresh ingredients, no harmful contents, extremely digestible, less water pollution and no clouding. Your fish will love it.

A lot depends on what you feed your fish (and the other occupants of your aquarium): their health and their well-being, their fertility (reproductive capabilities), the splendour of their colours and ultimately their lifespan. The most important criteria for fish foods are therefore: the right kind of diet, the quantity, quality, digestibility and disposability of nutrients and everything which the metabolism leaves behind: excreta. We know a lot about the pollution of water – the natural element of fish - and we also know all about water.

EHEIM food is a particularly nutritious food which guarantees a healthy diet and less water pollution.



The EHEIM comfort programme for fish: food, water care and high-quality equipment – perfectly balanced

**The best ingredients, used sparingly, for a healthy diet**

EHEIM food only contains what your fish need. No artificial enticements, harmful bacteria or ridiculous extracts. It consists, for the most part, of fresh ingredients such as fresh kelp and wild caught whole herrings and shrimps. The use of whole fish makes for a more natural and healthy diet.

A new and careful production process ensures that the natural ingredients – and especially the proteins, fats and vitamins – are not contaminated.

**Stable consistency – no clouding – clear water**

EHEIM food does not make the water cloudy. Food which is not eaten straight away does not dissolve, but maintains its shape. This means no food is wasted and the vitamins are not washed away - the fish can eat it all and the water will remain clear.

The basis for a stable consistency is the high proportion of fresh herring and fresh shrimp in the recipe as this promotes a high protein binding capacity. For this reason, the food does not need large amounts of starch (which is water soluble) to act as a glue, as the freshly cooked raw proteins act as a binding agent.

**Minimal raw fibre – minimal raw ash – minimal water pollution**

Raw fibre and raw ash form a thick pulp in a fish's digestive tract. Too high a concentration will impede digestion and the fish will suffer. The water will also be polluted by the increased amounts of excreta.

**Only a 2 % content of raw fibre**

Raw fibre refers to the indigestible connective tissue and cellulose contained in food. It acts as a platform for the bacteria and micro-organisms essential to digestion - but only a very small amount is needed.

A high proportion of raw fibre will inhibit the digestibility of the food and be excreted as mulm.

At just 2 % EHEIM food is the premium food with the lowest proportion of raw fibre.

**Only an 8 % content of raw ash**

Raw ash is the non-organic component of food and includes sand and other indigestible minerals, seeds etc. A high proportion is indicative of a high fishmeal content so the lower the percentage of raw ash in fish food the more nutritious it will be. The food will be digested more easily, absorbed more thoroughly, the fish will excrete less and the quality of the water will improve.

At just 8 % EHEIM food is the premium food with one of the lowest percentages of raw ash.

**Less than 0.8% phosphate**

The usual source of phosphate in fish food is excessive amounts of fishmeal. High levels of phosphate are excreted by the fish and this results in severe water pollution.

At only 0.8 % EHEIM food is the premium food with one of the lowest phosphate contents.

**Optimum ratio of protein to fat – optimum metabolism**

Fish food must exhibit the best possible ratio of raw protein to raw fat - the two substances having a mutual effect on each other. For most fish, a protein-to-fat ratio of 3:1 is ideal. EHEIM food has this 2:1 ratio.

**2 parts protein (raw protein)**

Protein is composed of amino acids and contains about 16% nitrogen which assists growth, cell regeneration and the formation of reproductive products. In comparison with the food offered by most other suppliers, EHEIM food contains less protein. A ratio of 2:1 exactly reflects the correct amount of protein relative to fat! A considerably greater proportion would be harmful.

**1 part fat (raw fat)**

Fat is the primary source of energy for fish. Thanks to a special production process, the natural fats (e.g. from whole high-fat herrings) in EHEIM food remain in their original state. No "foreign" fats must be added.





EHEIM food for fresh- and marine water  
Maximum quality from the aquatic experts.

**EHEIM**

Outstanding products. Without aggressive  
chemicals. At one with nature.

**EHEIM**



**Food**

**Fresh water**

EHEIM Food	FLAKES	GRAN	micro GRAN	TABS	green FLAKES	green GRAN	green TABS	color FLAKES
Filling quantity g	28	98	120	118	28	98	118	28
Category	Mainfood				Greenfood			Colourfood
Art. No.	4901110	4910110	4924210	4907210	4905110	4913110	4906110	4908110
EAN	4011708 490020	490259	005330	490198	490136	490327	490167	490211
Master pack quantity pcs.	1	1	1	1	1	1	1	1

**Marine water**

EHEIM Food	marin GRAN	marin greenGRAN	green FLAKES
Filling quantity g	120	98	28
Category	Mainfood	Greenfood	Greenfood
Art. No.	4931010	4935010	4905110
EAN	4011708 490433	490495	490136
Master pack quantity pcs.	1	1	1



**Flakes**

This food consists of flakes of various sizes and mixtures. The flakes swell up in water and then slowly sink to the bottom, ensuring the food reaches all the fish in all areas of the aquarium.

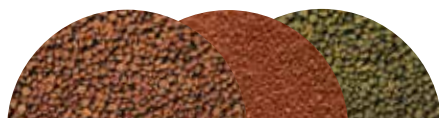

**Granules**

Granules consist of small compressed pieces which remain stable for a long time in water. They absorb water and are eaten whole by the fish and for this reason, the size of the granules must suit the size of the fish. Granules are especially suitable for cichlids.



**Tablets**

Tablets are the best form of food for demersal (bottom-dwelling) species of fish. They consist of pressed flakes and sink quickly to the bottom. Tablets are useful for examining fish as they spend a long time nibbling at them.

**Watercare**



**Fresh water**

EHEIM Watercare	bacteriaSTART	aquaCARE	aquaCARE	nitratBIOex	ALGOZID	ALGOZID
Filling quantity	50g	250ml	500ml	250ml	100ml	250ml
Art. No.	4803000	4801110	4801210	4802110	4806000	4806110
EAN	4011708 005347	480021	480038	480052	005354	480151
Master pack quantity pcs.	1	1	1	1	1	1

**EHEIM water care products support the technology – on a natural basis and without aggressive chemicals.**

Our water care products consist mainly of microbiological substances, as they occur in nature. This means careful handling of the vital element of animals and plants. Gentle, but effective improvement of the environment, without upsetting the ecological balance.

Please remember that: With everything you add to the water, you can change its texture. Proceed with caution. Less is often more.

**EHEIM bacteriaSTART - fresh water filter starter**

Natural bacterial cultures for inoculating filter material.

Concentrated, freeze-dried mixture of natural bacterial cultures for inoculating filter material. Reduces harmful substances, especially nitrogen components, promotes biological self-cleaning and regenerates organically contaminated water. Extends the lifetime of the filter. The bacterial species complex is specifically for fresh water aquariums.

**EHEIM aquaCARE - water purifier**

For binding heavy metals and harmful substances in tap water.

Treatment of the tap water for natural water quality, immediate binding of harmful substances such as chlorine and heavy metals, enrichment of the water with valuable vitamins for stress reduction and the protection of mucous membranes.

**EHEIM nitratBIOex**

For the initial filling and water change – for the active decomposition of nitrate in fresh water and saltwater aquariums.

Immediate biological activity, removes harmful organic substances from the aquarium in a very short period of time, lowers the nitrate level, reduces organic sludge on the bottom and in the filter.

**EHEIM ALGOZID**

Biocide for algae control.

Provides reliable help, even in case of acute algae infestation – as a precaution and to prevent the formation of new algae. Reliable algae control for green, beard, brush and blue-green algae.

Use biocidal products carefully!  
Always read the label and product information before use.





So you will always recommend the right product:

## Technical data of filters



Type	Aquarium size up to l	Pump output l/h	Canister volume l	Filter volume l	Filter media containers pcs.	Delivery head Hmax m	Power consumption W pump/heater	Dimensions mm HxWxD	Installation height* max cm	Hose connection Art./inlet side ø mm	Hose connection Art./outlet side ø mm
<b>EHEIM Hang-on filters</b>											
LIBERTY 75	75	150-380	0,6	240 cm <sup>3</sup>	1	-	2,5	180x105x135	-	-	-
LIBERTY 130	130	220-570	1,0	400 cm <sup>3</sup>	3	-	3	180x145x135	-	-	-
LIBERTY 200	200	320-760	1,3	650 cm <sup>3</sup>	4	-	4	180x195x135	-	-	-
<b>EHEIM Micro internal filters</b>											
miniUP	30	300	-	78,9 cm <sup>3</sup>	1	0,5	5	128x33,4x54	-	-	13
miniFLAT	-	300	-	39,4 cm <sup>3</sup>	1	0,5	5	127x33,4x54	-	-	13
<b>EHEIM Internal filters</b>											
aqua 60	30-60	160-300	-	160 cm <sup>3</sup>	2	0,30	4,5	166x66x66	-	-	-
aqua 160	60-160	210-440	-	240 cm <sup>3</sup>	3	0,50	4,7	202x66x66	-	-	-
aqua 200	100-200	210-440	-	320 cm <sup>3</sup>	4	0,50	4,7	243x66x66	-	-	-
aquacorner 60	10-60	200	-	140 cm <sup>3</sup>	1	0,40	5	209x90x80	-	-	-
aquaball 60	30-60	150-480	-	180 cm <sup>3</sup>	1	0,37	5	160xø 96	-	-	-
aquaball 130	60-130	180-550	-	320 cm <sup>3</sup>	2	0,43	6	215xø 96	-	-	-
aquaball 180	80-180	210-650	-	460 cm <sup>3</sup>	3	0,43	6	270xø 96	-	-	-
biopower 160	80-160	180-550	-	380 cm <sup>3</sup>	2	0,43	6	215xø 96	-	-	-
biopower 200	100-200	210-650	-	530 cm <sup>3</sup>	3	0,43	6	270xø 96	-	-	-
biopower 240	160-240	280-750	-	680 cm <sup>3</sup>	4	0,60	8	325xø 96	-	-	-
PowerLine 200	100-200	600	-	390 cm <sup>3</sup>	-	1,5	10	285x65x75	-	-	4004940 / 12/16
PowerLine XL	> 200	1200	-	700 cm <sup>3</sup>	-	2,0	28	335x75x80	-	-	4004940 / 12/16
pickup 45	45	50-180	-	85 cm <sup>3</sup>	-	0,35	3,5	135x50x63	-	-	-
pickup 60	30-60	150-300	-	195 cm <sup>3</sup>	-	0,35	4	163x75x96	-	-	-
pickup 160	60-160	220-500	-	330 cm <sup>3</sup>	-	0,40	6	218x75x96	-	-	-
pickup 200	200	220-570	-	470 cm <sup>3</sup>	-	0,40	6	275x75x96	-	-	-
<b>EHEIM External filters</b>											
classic 150	50-150	300	1,3	1,0	-	1,2	4	290xø 110	180	4004940 / 12/16	4003940 / 9/12
classic 250	80-250	440	3,5	3,0	1	1,5	8	355xø 160	180	4004940 / 12/16	4004940 / 12/16
classic 350	120-350	620	4,8	4,0	-	1,8	15	370xø 185	180	4004940 / 12/16	4004940 / 12/16
classic 600	180-600	1000	6,6	6,0	-	2,3	20	400xø 205	180	4005940 / 16/22	4004940 / 12/16
classic 1500XL	300-1500	2400	23	18,0	-	3,7	65	570xø 355	150	4007940 / 25/34	4005940 / 16/22
ecco pro 130	60-130	500	3,0	1,5	1	1,4	5	298xø 205	150	4004940 / 12/16	4004940 / 12/16
ecco pro 200	100-200	600	4,0	2,3	2	1,4	5	355xø 205	150	4004940 / 12/16	4004940 / 12/16
ecco pro 300	160-300	750	5,0	3,1	3	1,9	8	416xø 205	150	4004940 / 12/16	4004940 / 12/16
eXperience 150	80-150	500	5,0	2,3	2	1,3	8	290x178x178	180	4004940 / 12/16	4004940 / 12/16
eXperience 250	120-250	700	6,0	3,0	2	1,5	8	340x178x178	180	4004940 / 12/16	4004940 / 12/16
eXperience 350	180-350	1050	9,0	4,9	2	2,0	24	375x210x210	180	4005940 / 16/22	4006940 / 16/22
professionel 3 1200XL	400-1200	1700	25	13,5	3+1	2,6	25	567x330x330	180	2x 4005940 / 16/22	4005940 / 16/22
professionel 3 1200XLT thermo	400-1200	1700	25	13,5	3+1	2,6	25 / 500	567x330x330	180	2x 4005940 / 16/22	4005940 / 16/22
professionel 3e 450	240-450	1700	12,5	6,6	3	2,4	10-35	474x264x264	180	4005940 / 16/22	4005940 / 16/22
professionel 3e 700	300-700	1850	14,5	8,6	4	2,6	10-35	534x264x264	180	4005940 / 16/22	4005940 / 16/22
professionel 3e 600T thermo	300-600	1850	14,2	8,6	4	2,6	10-35 / 210	534x264x264	180	4005940 / 16/22	4005940 / 16/22
professionel 4+ 250	120-250	950	6,1	3,5	2	1,5	12	358x238x244	180	4005940 / 16/22	4005940 / 16/22
professionel 4+ 250T thermo	120-250	950	7,1	3,5	2	1,5	12 / 210	398x238x244	180	4005940 / 16/22	4005940 / 16/22
professionel 4+ 350	180-350	1050	7,4	5,0	3	1,8	16	398x238x244	180	4005940 / 16/22	4005940 / 16/22
professionel 4+ 350T thermo	180-350	1050	8,9	5,0	3	1,8	16 / 210	453x238x244	180	4005940 / 16/22	4005940 / 16/22
professionel 4+ 600	240-600	1250	9,2	6,5	4	1,8	16	453x238x244	180	4005940 / 16/22	4005940 / 16/22
professionel 4e+ 350	180-350	1500	7,4	5,0	3	2,2	10-35	398x238x244	180	4005940 / 16/22	4005940 / 16/22



So you will always recommend the right product:

## Technical data pumps



Type	Aquarium size up to l	Pump output l/h	Canister volume l	Filter volume l	Filter media containers pcs.	Delivery head Hmax m	Power consumption W pump/heater	Dimensions mm HxWxD	Installation height* max cm	Hose connection Art./inlet side ø mm	Hose connection Art./outlet side ø mm
<b>EHEIM compact pumps</b>											
compactON 300	-	170-300	-	-	-	0,6	7	72x38x62	-	-	4004940 / 12/16
compactON 600	-	250-600	-	-	-	1,0	7	72x38x62	-	-	4004940 / 12/16
compactON 1000	-	400-1000	-	-	-	1,4	15	79x47x73	-	4005940 / 16/22 19/27	4005940 / 16/22 19/27
compactON 5000	-	5000	-	-	-	3,6	70	154x92x142	-	4007940 / 25/34 1- 1 1/4"	4006940 / 19/27 25/34
compactON 12000	-	12000	-	-	-	3,8	110	185x110x175	-	4007940 / 25/32/38 1- 1 1/2"	4006940 / 19/27 25/34
compactON 12000	-	12000	-	-	-	3,8	110	185x110x175	-	4007940 / 25/32/38 1- 1 1/2"	4007940 / 25/34 1 1/4"
<b>EHEIM universal pumps</b>											
universal 300	-	300	-	-	-	1,2	5	103x145x75	-	4004940 / 12/16	4003940 / 9/12
universal 600	-	600	-	-	-	1,5	10	115x147x75	-	4004940 / 12/16	4004940 / 12/16
universal 1200	-	1200	-	-	-	2,0	28	121x178x95	-	4005940 / 16/22	4004940 / 12/16
universal 2400	-	2400	-	-	-	3,7	65	161x218x116	-	4007940 / 25/34	4005940 / 16/22
universal 3400	-	3400	-	-	-	3,6	80	161x218x116	-	4007940 / 25/34	4005940 / 16/22
aquaball powerhead 650	-	210-650	-	-	-	0,43	6	150xø 96	-	-	4006940 / 19/27
<b>EHEIM marine water flow pumps</b>											
streamON+ 3500	200	3500	-	-	-	-	2,5	55x47x110	-	-	-
streamON+ 6500	350	6500	-	-	-	-	6	72x59x131	-	-	-
streamON+ 9500	500	9500	-	-	-	-	12,0	88x70x138	-	-	-
<b>EHEIM air pumps</b>											
air 100	-	100	-	-	-	2,0	3,5	150x92x76	-	-	4002940 / 4/6
air 200	-	200	-	-	-	2,0	3,5	150x92x76	-	-	4002940 / 4/6
air 400	-	400	-	-	-	2,0	4	150x92x76	-	-	4002940 / 4/6

\* Filter base to water surface



## So you will always recommend the right product: Technical data of aquariums

Typ	Volume	Glass thickness mm	Lighting	Dim. WxDxH cm
<b>Aquarium starter kits</b>				Tank
aquastar 54 LED	54	4	1x7,7 W LED daylight	60x30x30
aquastar 63 marine	63	5	2x7,7 W LED hybrid	60x30x35
aquaproLED 84	84	5/6	1x7,7 W LED daylight	60x35x40
aquaproLED 126	126	6/8	1x10,6 W LED daylight	80x35x45
aquaproLED 180	180	6/8	1x13,5 W LED daylight	100x40x45
<b>Cabinets</b>				
Panels	panel 1	panel 2	Height	
Dimensions	B x T cm	B x T cm	cm	
aquacab 54	61x31	-	85	
aquacab 84	61x36	-	85	
aquacab 126	81x36	-	85	
<b>Aquarium combinations</b>				complete
incpiria 230	230	8	powerLED+	70x60x140
incpiria 330	330	10	powerLED+	100x60x140
incpiria 430	430	12	powerLED+	130x60x140
incpiria 530	530	12	powerLED+	160x60x140
proxima 175	175	8	classicLED	71x51x132
proxima 250	250	8/10	classicLED	101x51x132
proxima 325	325	12	classicLED	131x51x132
vivalineLED 126	126	6/8	classicLED	81x36x119
vivalineLED 150	150	8	classicLED	61x51x124
vivalineLED 180	180	6/8	classicLED	101x41x119
vivalineLED 240	240	8/10	classicLED	121x41x124
<b>Marine water aquarium combinations</b>				
incpiria 230 marine	230	8	powerLED+	70x60x140
incpiria 330 marine	330	10	powerLED+	100x60x140
incpiria 430 marine	430	12	powerLED+	130x60x140
incpiria 530 marine	530	12	powerLED+	160x60x140
incpiria 230 reef	230	8	-	70x60x140
incpiria 330 reef	330	10	-	100x60x140
incpiria 430 reef	430	12	-	130x60x140
incpiria 530 reef	530	12	-	160x60x140

## Recommended EHEIM technology

# EHEIM



Fresh water aquariums	EHEIM classic	EHEIM ecco pro	EHEIM eXperience	EHEIM professionnel 4+	EHEIM professionnel 4e+	EHEIM thermocontrol Präzisionsheizer
proxima 175	250	200	250	250	350	125 W
proxima 175	-	-	-	250T (Thermo)	600T (Thermo)	-
proxima 250	350	300	350	350	350	150 W
proxima 250	-	-	-	350T (Thermo)	600T (Thermo)	-
proxima 325	350	300	350	600	450	200 W
proxima 325	-	-	-	350T (Thermo)	600T (Thermo)	-
incpiria 230	-	-	-	250	350	150W
incpiria 230	-	-	-	250T (Thermo)	-	-
incpiria 330	-	-	-	350	350	200 W
incpiria 330	-	-	-	350T (Thermo)	<b>professionel 3e</b> 600T (Thermo)	-
incpiria 430	-	-	-	600	450	250 W
incpiria 430	-	-	-	-	600T (Thermo)	-
incpiria 530	-	-	-	<b>professionel 3</b> 1200XL	-	250 W
incpiria 530	-	-	-	1200XLT (Thermo)	-	-
Page	38	39	40	41/44	42/43	73



Modular  
solutions  
for  
pet shops

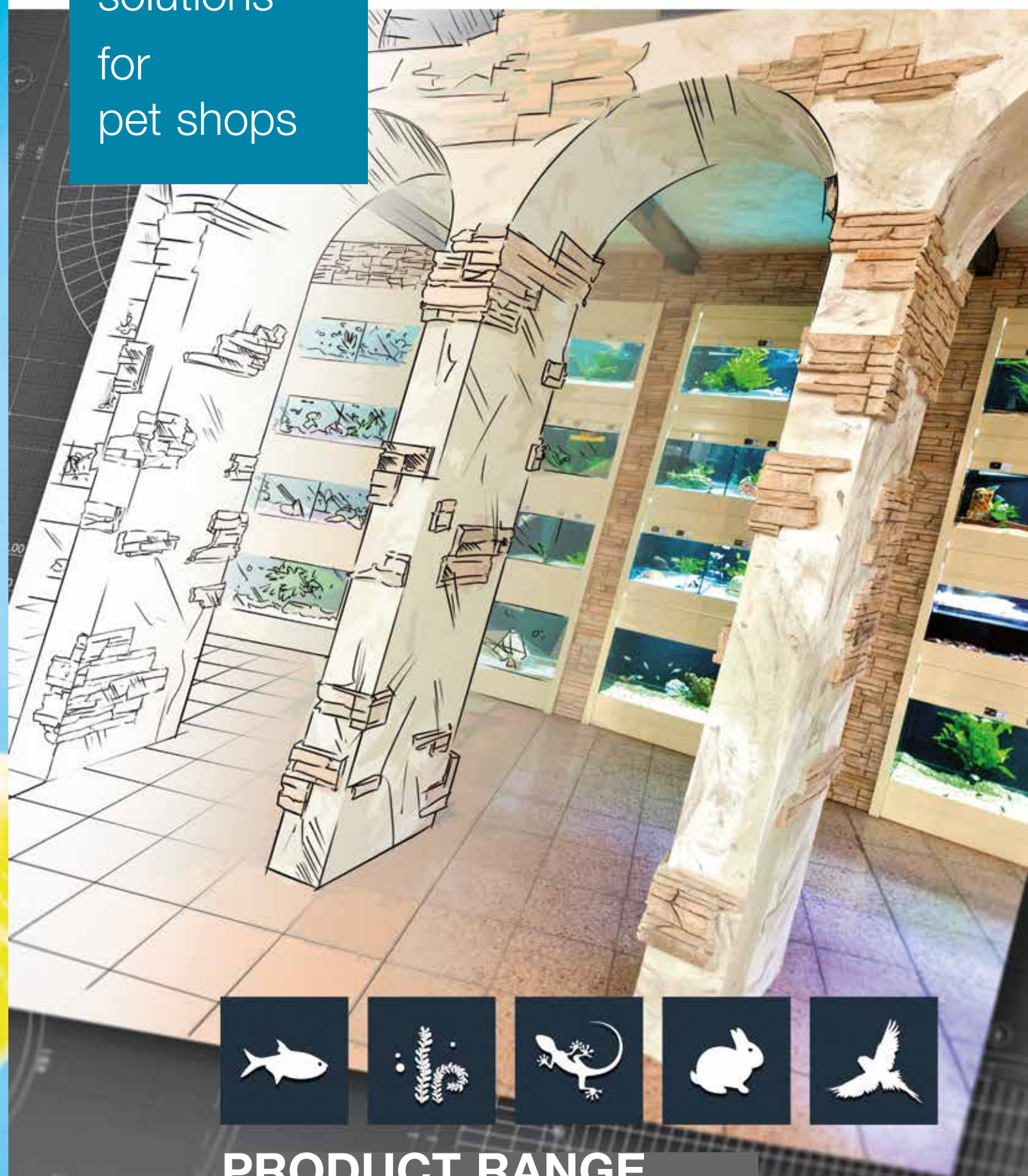

**PRODUCT RANGE**



Sales effective shop fitting units  
in experience oriented design.



You will find detailed information  
in the shopDesign catalogue Art. 7990220  
or as download: [www.eheim-shopdesign.de](http://www.eheim-shopdesign.de)

## ShopDesign

Animals and pets in general generate emotions in all of us. Emotions will generate sales. EHEIM shopDesign provides you with the right displays and where necessary can help create a real world of senses.

EHEIM shopDesign is your one stop partner. Get everything from a single source. Technology is manufactured by EHEIM in Germany and the units are individually planned by our CAD designers. If need be an interior designer can suggest a theme which meets desires and budgets. The close cooperation with BNA the federation for nature and protection of species guarantees that EHEIM shopDesign is always up-to-date in animal welfare. Our own installation engineers ensure a clean, fast and precise installation on site.

## Experience-oriented worlds

From dream to reality

No matter what you are looking for whether it be a Maya temple, a jungle book inspired theme, a Roman building or a Mediterranean feeling, we can do it for you. Just provide us with a key word – and we get started. EHEIM shopDesign is the ideal partner at your side from the first sketches to the finished installation in your pet shop. Sales psychology included.



## Fittings

The equipment of your salesrooms gives an overall impression of your pet shop and therefore weighs significantly on the success of your pet shop area. Do you want to emphasize your professional competence? Do you need a counter where you can give your customers professional advice? Or are you looking for a practical packing table, lighting, shelving systems and a promotional presentation system? EHEIM shopDesign always has the right solutions ready.

Please contact us at:  
phone +49 6361 - 9216 - 0  
**More information: [www.eheim-shopdesign.de](http://www.eheim-shopdesign.de)**

## Animal Sales Displays

Irrespective of the model you choose, being professional or basic, the fish racks from EHEIM shopDesign are all based on modular systems. Detailed advice and concrete proposals for the installation are all part of the service. You select the size and the equipment as well as the desired trusted EHEIM mechanical and biological filtration technology ... and we do the rest.



### Quality

By using high-quality materials and guaranteeing high manufacturing and assembly precision, the highest standards are met. The sophisticated technology and many years of experience ensure the smooth operation of the system.

### Safety

All electric connections and cables have been manufactured in accordance with the VDE (German Association of Electrotechnical Engineers) recommendations. The units are earthed. Even with water installations and aquariums, safety is assured.

### Maintenance

By providing technically advanced systems and intelligent construction, we help to keep care and cleaning time to a minimum.

### Expert planning

We plan everything for you right down to the very last detail. Comprehensive offers, expert CAD drawings, installation plans and personal visits are all part of our normal sales presentation.

### Species-friendly husbandry

The best sales argument is healthy and lively animals. For this reason, we are mindful of species-appropriate husbandry and we adhere strictly to all rules and regulations of the TVT (German Veterinary Animal Welfare Association).

### Design, colour and decor

The units can be designed according to your specific wishes. The surfaces can be swapped and customised at any time. The unit surfaces can be styled individually and can be replaced at any time. This way, a new ambience is created in your showroom again and again in a fast and uncomplicated way.



Carefully thought of, practical, species and maintenance friendly.

shopDesign



**Aquatics**

- User friendly and maintenance poor
- Tested and recognized materials thanks to decades of experience
- EHEIM equipment or made in-house
- Many additional options possible
- Modules are easily customised
- Assembled by our own engineers
- Modern aeration technology and ventilation where required
- Invisible corner connectors on the shop side
- Practical, prize winning flap doors



**Reptiles**

- Terrarium dimensions and equipment in accordance with veterinarian guidelines
- Generous ventilation areas for optimum air circulation
- Top covers made of Plexiglas = UV-transparent
- Elstein lamp (ceramic infrared lamp) with protective grid for reptile unit
- All units made with safety glass and lockable sliding doors
- Sprinkling unit, mister or heating on request
- All maintenance done from the front, even lamp changes
- Lower row suitable for dry goods merchandising



**Are you looking for a perfect way to show your fish?**

EHEIM shopDesign has a vast selection of standard racks in its portfolio whether it be for the individual pet shop or the large retail chain. EHEIM shopDesign can make your wishes come true. Possibilities are endless with the reputation of EHEIM technology coming as a standard.

**Exoticism, thrill and amazement** are key words in the vocabulary of reptiles enthusiasts. These sensations can be duplicated and brought forward to your customers with the high-quality reptile units from EHEIM shopDesign. Even the most unusual and demanding species will thrive in a carefully studied environment finished in a contemporary and stylish look.



**Rodents**

- High quality aluminium frame
- Unit sizes and equipment in accordance with veterinarian guidelines
- Generous ventilation areas for optimum air circulation
- All units with lockable sliding glass doors
- Includes drinking bottles with bracket
- Removable divider panels available
- Hygienic husbandry conditions by use of easy to clean materials



**The rodent area is simply the most magical attraction for all kids and adults alike.**

EHEIM shopDesign provides ideal habitats for hamsters and other rodents. Spacious glass surfaces offer a perfect view and also keeps the small curious hands at bay. Easy-to-clean materials are the best prerequisites for hygienic conditions.



**The aquatic plant sales unit is a real eye catcher in any aquatic department.**

EHEIM shopDesign is the ideal partner by your side to advise you to choose the right unit for a flourishing plant display. Perfectly coordinated tank heights for the different kind of plants, suitable lighting and the legendary EHEIM filtration technology.

**Aquatic plants**

- High quality aluminium frame
- Corner connector with V2A steel core
- Double price tag rails
- EHEIM filter with integrated heater
- Water cascade made of V2A steel
- Plant baskets available on request
- Granite packing table top
- Customised lighting
- LED lighting optional



**Birds**

- Species-appropriate ventilation
- Handmade cages
- Litter tray made of stainless steel
- Anti-dirt seals in the cage bottom
- Antiglare shield (pearl Plexiglas)
- Adjustable perches and removable feeding trays
- Storage area underneath
- Removable divider panels made of PVC
- Aviaries with stainless steel bottoms
- Standard units according to veterinarian guidelines

**The bird installation is a unique, acoustic, and visual addition to any each pet shop.**

EHEIM shopDesign not only designs and builds practical bird cages and aviaries but also takes important details into considerations to ensure the wellbeing of your birds (such as pivoting food and water bowls for stress free feeding).



## These logos stand for your safety and quality



Product complies with the European guidelines



**Safety tested:**

Verified by the Verband Deutscher Elektrotechniker  
(Association for Electrical, Electronic & Information  
Technologies)



Approved by the Technischen Überwachungsverein  
(German Technical Supervisory Association)



DIN aquarium production standard  
(mp reg. no. 191/07)



Waterproof IPX7



EHEIM quality guarantee



Suitable for fresh water



Suitable for marine water



**EHEIM High Performance Ceramics:**

The axles and bearing sleeves of the impellers  
(ecco, professional, professional II, professional 3, 3e, 4+,  
4e+) are made of High Performance Ceramics. This means  
exceptionally quiet running, smoothness,  
maximum resilience and extremely long service life.





7992020/09.19-GB/UK Subject to technical alterations without notice/Errors excepted. © EHEIM



# **EHEIM**

**EHEIM GmbH & Co. KG**  
Plochinger Str. 54  
73779 Deizisau  
Germany  
Tel. +49 7153/70 02-01  
Fax +49 7153/70 02-174



[www.eheim.com](http://www.eheim.com)