

Subject	Chemistry
Paper No and Title	11. Inorganic Chemistry –III (Metal π -Complexes and Metal Clusters)
Module No and Title	Module 13. Modes of coordination and bonding in dinitrogen complexes
Module Tag	CHE_P11_M13

Principal Investigator		Co- Principal Investigator and Technical Coordinator
Prof A.K.Bakhshi Sir Shankar Lal Professor, Department of Chemistry University of Delhi		Dr Vimal Rarh Deputy Director, Centre for e-Learning and Assistant Professor, Department of Chemistry, SGTB Khalsa College, University of Delhi <i>Specialised in : e-Learning and Educational Technologies</i>
Paper Coordinator	Content Writer	Reviewer
Prof. Ranjit K. Verma Professor Department Of chemistry Magadh University, Bodh Gaya, Bihar	Dr. M. Sathiyendiran Asst Professor Department of chemistry University of Delhi Dr. Deepak Gupta Assistant Professor Kirori mal college University of Delhi	Prof. B.S. Garg Emeritus Professor Department of Chemistry University of Delhi
Anchor Institute : SGTB Khalsa College, University of Delhi		

CHEMISTRY
PAPER No. : 11. Inorganic Chemistry –III (Metal π -Complexes and Metal Clusters)

MODULE No. : Module 13. Modes of coordination and bonding in dinitrogen complexes

TABLE OF CONTENTS

1. Learning Outcomes
2. Introduction
3. Modes of Bonding
 - 3.1. Terminal mode
 - 3.2. Bridging Mode
 - 3.3. Side-on Mode
4. Preparation
5. Reactions of N₂ Complexes
 - 5.1. Hydrogenation
 - 5.2. Functionalization beyond hydrogenation
6. Nitrogen fixation in biological Systems
7. Summary

CHEMISTRY

PAPER No. : 11. Inorganic Chemistry –III (Metal π -Complexes and Metal Clusters)

MODULE No. : Module 13. Modes of coordination and bonding in dinitrogen complexes

1. Learning Outcomes

After studying this module, you shall be able to know about

- Metal complexes of dinitrogen
- Bonding modes of dinitrogen as ligand
- Preparation of dinitrogen metal complexes
- Reactions of N_2 Complexes

2. Introduction

Metal dinitrogen complexes are coordination compounds that contain the dinitrogen (N_2) as a ligand. Dinitrogen is very inert, and few systems are able to reduce it catalytically under the mild conditions employed by nitrogen fixing enzyme, nitrogenase. N_2 reacts with Li and Mg to give nitrides, but the only other nonbiological reaction of N_2 under mild conditions is the formation of N_2 complexes. More than 100 examples are now known, of which many contain Fe or Mo. The discovery of coordination compounds containing the nitrogen molecule as a ligand is one of the most exciting recent developments in the chemistry of nitrogen. It is not that such compounds were unexpected; they had been so long in anticipation that most chemists had begun to believe that they could not exist. In 1930 Bortells showed that traces of molybdenum was essential for the growth of nitrogen-fixing bacteria in the absence of any source of nitrogen other than dinitrogen, but in the presence of urea or ammonia the bacteria appeared to grow happily in the absence of molybdenum. Thus the molybdenum appeared to be directly involved with the nitrogen molecule in the process of fixation. This knowledge led to attempts to produce dinitrogen complexes by compressing the gas over molybdenum compounds but with no success. Similarly, a development of interest in olefin and acetylene complexes during the 1950s, led to attempts to prepare dinitrogen analogues of the complex compounds of acetylene, but again of no avail.

Indeed, all attempts to produce dinitrogen complexes were so negative that chemists were convinced that they would not exist as stable entities, and the energy levels of the molecular orbitals in dinitrogen, provided sufficient reason. The electron energy levels of dinitrogen differ from those found in any common analogous molecule, such as acetylene or dioxygen, in two important respects. First, the highest occupied molecular orbital is a σ -orbital and not a π -orbital. Secondly, the highest filled energy-level is of a very low energy (-156 eV), whereas the highest vacant level is an antibonding π -level with a relatively high energy (-7 eV) (Fig. 1). The extremely low energy of the filled, and the high energy of the unfilled orbitals, explains the uniquely inert character of dinitrogen. Neither reduction nor oxidation of dinitrogen is easy, because it is difficult to remove electrons from the bonding orbital at -156 eV or, to put them into the lowest energy level, which is vacant, at -7 eV.

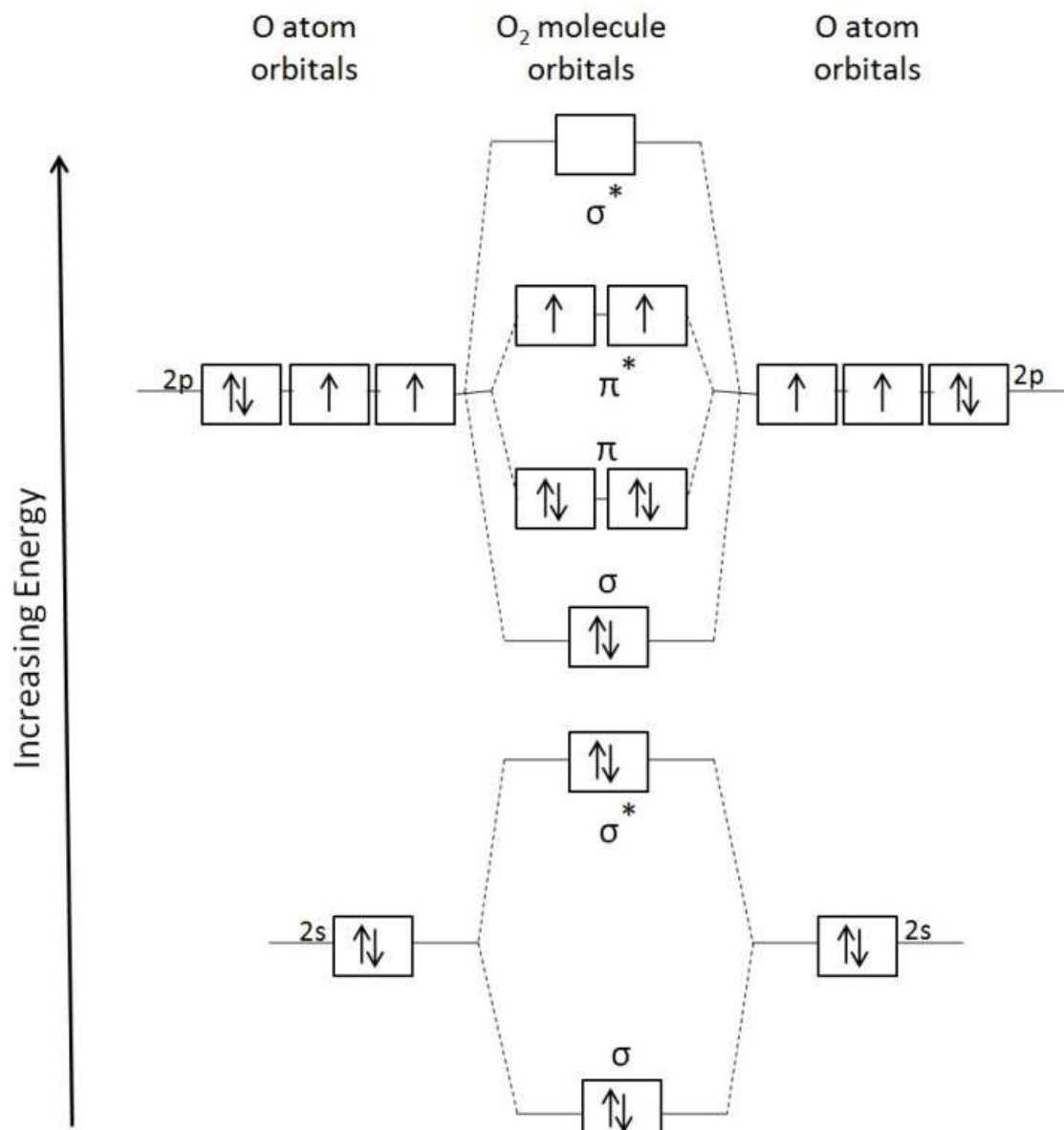

Fig. 1a MO diagram of O_2

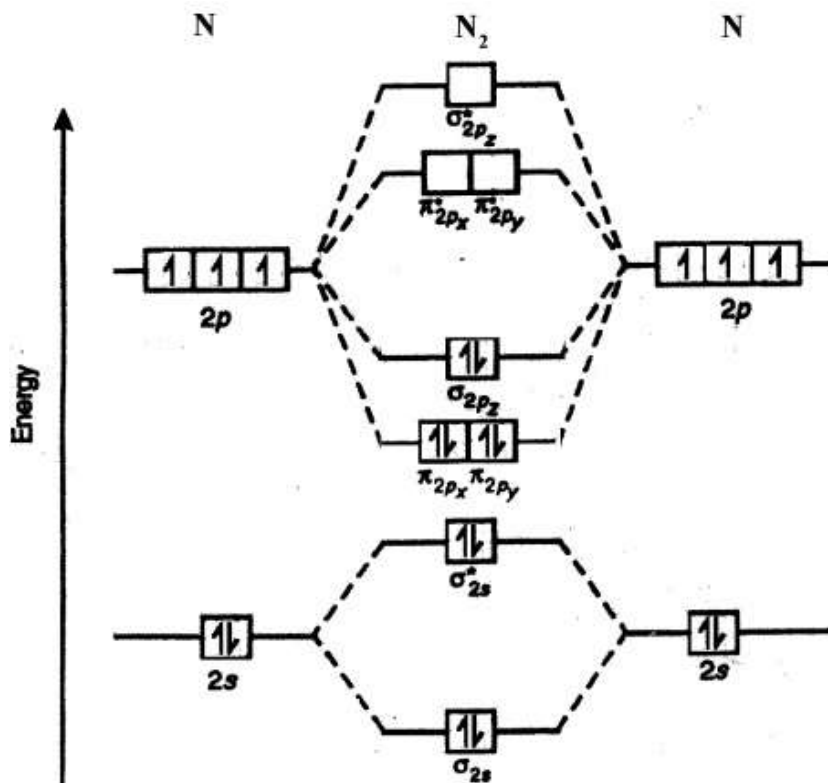

Fig. 1b MO diagram of N₂

3. Modes of Bonding

Three types of bonding modes are observed in dinitrogen complexes which are terminal (1), bridging (2, 3) and side-on (4) (Fig. 2).

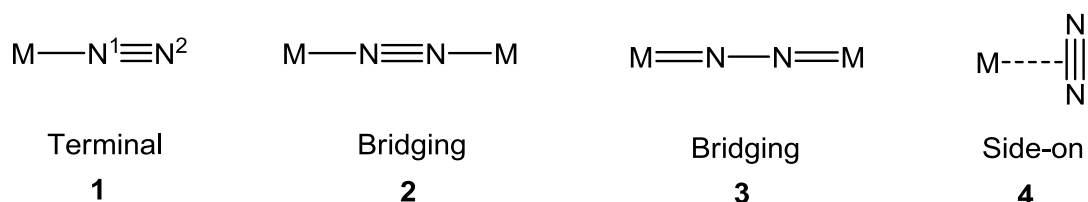

Fig. 2 Modes of dinitrogen bonding

3.1 Terminal mode

In most cases, the N_2 is terminally bonded by one N atom, as in 1. N_2 is isoelectronic with CO, so a comparison between the two ligands is also useful. CO has a filled σ -lone pair orbital located on carbon, with which it forms a σ bond to the metal, and an empty π orbital for back bonding. N_2 also has a filled σ lone pair, but it lies at lower energy than the corresponding orbital in CO, probably because N is more electronegative than C, and so N_2 is weaker σ donor. N_2 also has an empty π^* orbital. Although it is lower in energy, and so more accessible than the CO π^* orbital, it is equally distributed over N^1 and N^2 and therefore the M–N π^* overlap is smaller than for M–CO, where the π^* is predominantly located on carbon. The result is that N_2 binds very less efficiently than CO. The Group 6 transition metals (W, Mo, Cr) are believed to have the greatest orbital-overlap with end-on bound molecular nitrogen. The nitrogen molecule associates with the metal center of either electron rich low valent metals or electron deficient metals in high oxidation states. π -back bonding from electron rich metal centers is the reason for the stability of molecular nitrogen association and the σ -bond from the lone-pair on dinitrogen is the stabilizing interaction for electron deficient metal centers. The first dinitrogen complex to be recognized, $[Ru(NH_3)_5(N_2)]^{2+}$, was isolated in 1965 by Allen and Bottomley during the attempted synthesis of $[Ru(NH_3)_6]^{2+}$ from $RuCl_3$ and hydrazine hydrate and it contained N_2 in terminal bonding mode (Fig. 3).

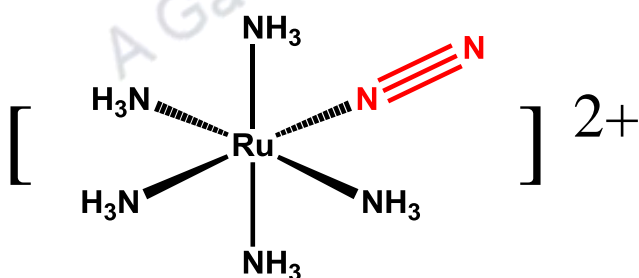
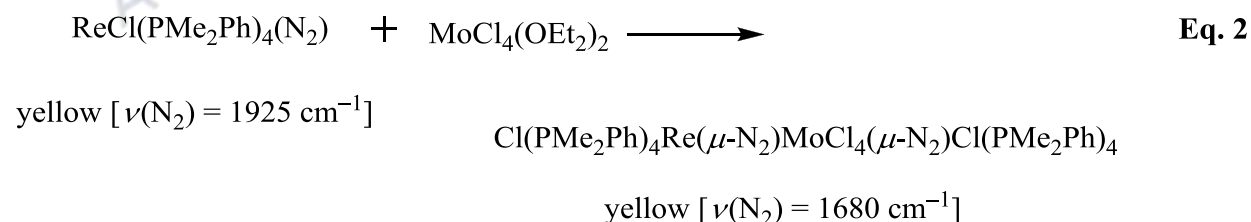
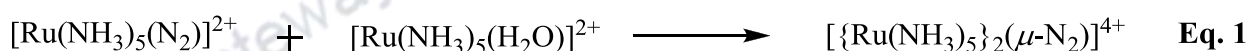

Fig. 3 $[Ru(NH_3)_5(N_2)]^{2+}$

The N–N distance of this and related N₂ complexes is only slightly different (1.05–1.16 Å) from that of N–N distance in free N₂ molecule (1.1 Å). An important property of the mono nuclear complexes is the strong IR absorption due to the N–N stretch at 1920–2150 cm⁻¹. Free N₂ is inactive in the IR, but binding to the metal causes a strong polarization of the molecule, with N¹ becoming positively charged and N² negatively charged. This contributes both to making the N–N stretch IR active and to the chemical activation of the N₂ molecule.

3.2. Bridging Mode

Because the two ends of N₂ are the similar, the molecule can easily act as a bridging ligand between two metals as in fig. 2(2). If the back donation is large, the N₂ can be reduced to a hydrazide complex. Some examples of complexes in which the N₂ bridges to two metals are shown in Eqs. 1 and 2. In the ruthenium case, the system resembles fig.2(2) and N–N distance in μ-N₂ is little different in length from the terminal N–N distance in [Ru(NH₃)₅(N₂)]²⁺ itself. Some dinitrogen complexes are appreciably basic at N², showing once again the strong polarization of the N². These can bind Lewis acids at N² to give adducts, some of which have very low N–N stretching frequencies, and these seem to resemble fig.2(3).



3.3. Side-on Mode

The side-on bonding mode is rare. First side-on N_2 complex was synthesized by Ozin and Vander Voet in 1973 and first side-on N_2 complex crystal structure was determined by Crissey in 1982 (Fig. 4). In this complex N_2 binds in η^1 - and (μ_2, η^2) - fashion to two Ti_2 units. Side-on overlap gives other ligands access to both N_2 π^* MOs (Fig. 5). Some more examples of side-on complexes of N_2 are shown in Fig. 6.

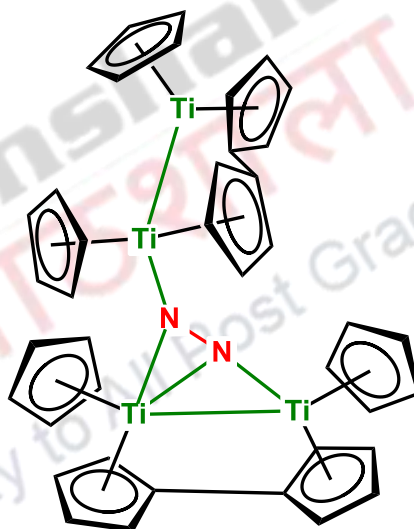

Fig. 4

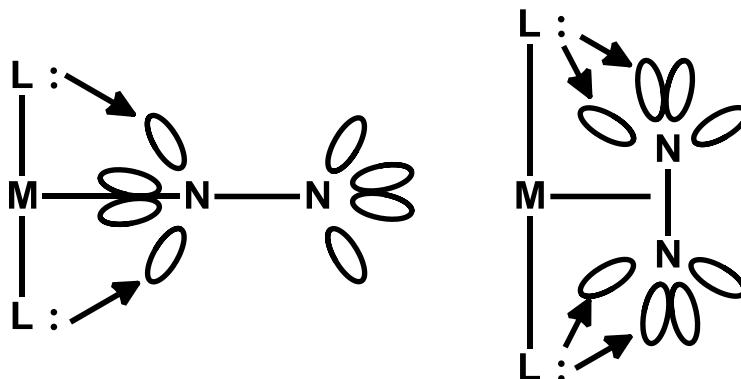

Fig. 5

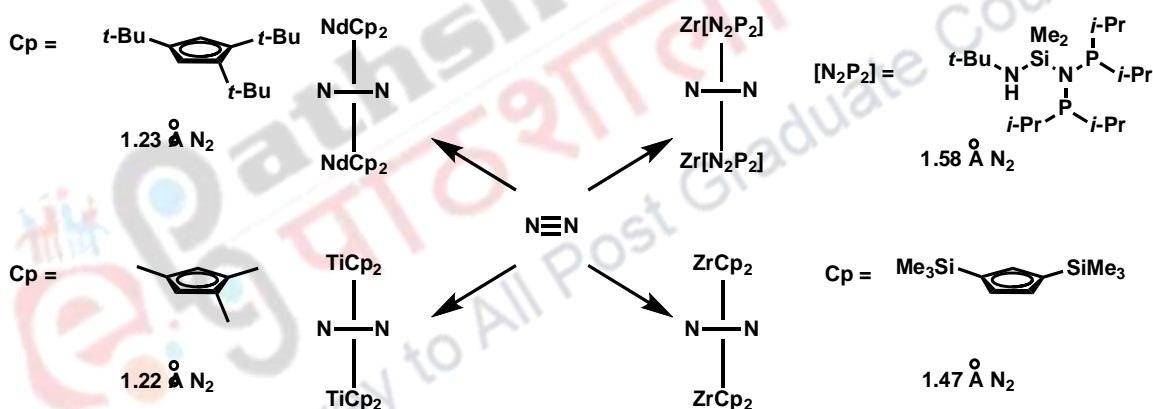
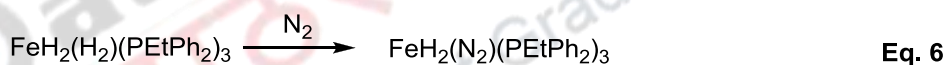
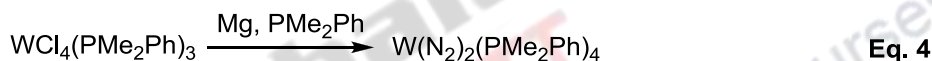
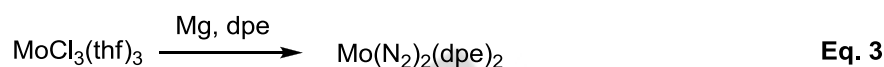

Fig. 6

For side-on mode of binding of N_2 more electrophilic early transition metals are often needed and as lower row transition metals are larger in size so provide enough space for side-on N_2 binding. Ligands around the metal center should be finely tuned as spacing and electronics around N_2 binding site strongly affect bonding mode and degree of activation of N_2 . Metallocenes happen to have correct steric and electronic factors to facilitate end on binding of N_2 .

4. Preparation

Common preparative routes are reduction of a phosphine-substituted metal halide in the presence of N₂ (Eqs. 3 and 4), degradation of a nitrogen-containing ligand (Eq. 5), and displacement of a labile ligand by N₂ (Eqn. 6). N₂ can often displace η²-H₂, as shown in Eq. 6; if this were the last step in the catalytic cycle, it would explain why nitrogenase always produces at least one mole of H₂ per mole of N₂ reduced.



5. Reactions of dinitrogen complexes

5.1. Hydrogenation

Only the most basic N₂ complexes, notably the bis-dinitrogen Mo and W complexes, can be protonated. According to the exact conditions, various N₂H_x complexes are obtained, and even, in some cases, free NH₃ and N₂H₄. As strongly reduced Mo(0) and W(0) complexes, the metal can apparently supply the six electrons, and so the metals are oxidized during the process. Note that in Eq. 7, the loss of the very strong N–N triple bond is compensated by the formation of two N–H bonds and a metal nitrogen multiple bond.

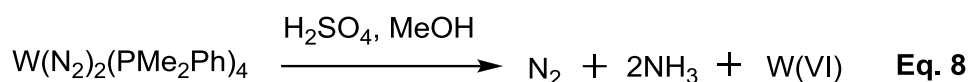
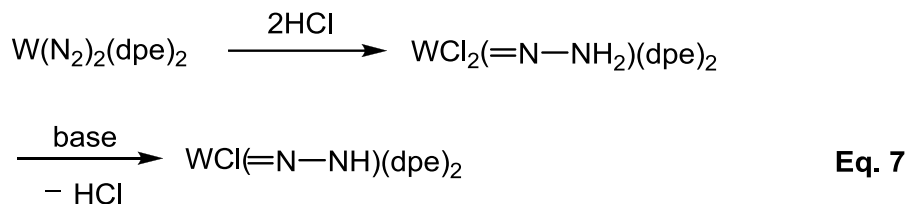

The mechanism shown in Eq. 9 (Chatt cycle) has been proposed for the N_2 reduction observed in these experiments. N_2 is a net electron acceptor from the metal, and so loss of the first N_2 leads to the metal acquiring a greater negative charge, and thus back donating more efficiently to the remaining N_2 , which is therefore polarized and activated even further. To be noted is the fact that the final N–N bond breaking is again accompanied by the formation of a metal nitride; such species are known to hydrolyze easily to give ammonia. It is likely that the natural system may also go by similar intermediates.

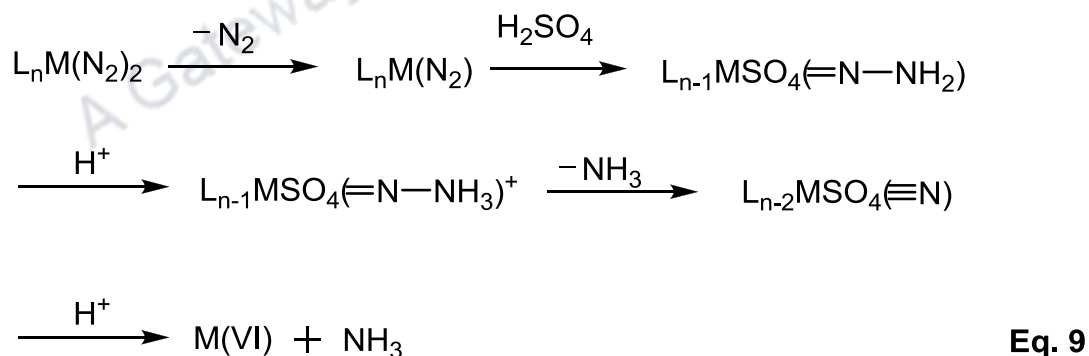

Greatest weakening of the N–N bond is also expected for early d^2 metals, which back-bond the most strongly to π -acceptor ligands. Cp_2^*Ti reacts with N_2 as shown in Eq.10, where $\text{Cp}_2^*\text{Ti}(\text{N}_2)$ seems to have η^1 and η^2 forms and protonates with HCl to give N_2H_4 . These show different $\nu(\text{N}_2)$ frequencies in the IR (2056 and 2023 cm^{-1} , respectively) and, most significantly, the ^{15}N NMR shows two mutually coupled ($J = 7$ Hz) resonances for the η^1 and a single resonance for the η^2 form.

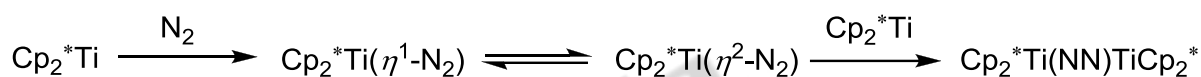

Eq. 10

Schrock et al. have made $\text{Cp}^*\text{Me}_3\text{M}=\text{N}=\text{N}=\text{MMe}_3\text{Cp}^*$ ($\text{M} = \text{Mo}$ or W), where the back donation is so strong that the N_2 is now effectively reduced to a hydrazide tetraanion, as shown by the N–N distance of 1.235 \AA (Mo). Ammonia is formed with lutidine hydrochloride as proton source and Zn/Hg as reductant. Dinitrogen can also be reduced to ammonia at room temperature and 1 atm with the molybdenum catalyst $\text{LMo}(\text{N}_2)$, where L is the bulky trianionic tripodal triamide [$\{3,5\text{-}(2,4,6\text{-i-Pr}_3\text{C}_6\text{H}_2)_2\text{C}_6\text{H}_3\text{NCH}_2\text{CH}_2\}_3\text{N}$]. Addition of a lutidine salt as proton source, and decamethyl chromocene as reductant, gave four catalytic turnovers. In this system, the N_2 is reduced at a sterically protected, single molybdenum center that cycles from $\text{Mo}(\text{III})$ through $\text{Mo}(\text{VI})$.

The Zr and Hf octamethyl metallocenes containing side-on mode of N_2 bonding undergo reduction of N_2 under facile conditions as shown in Fig. 7.

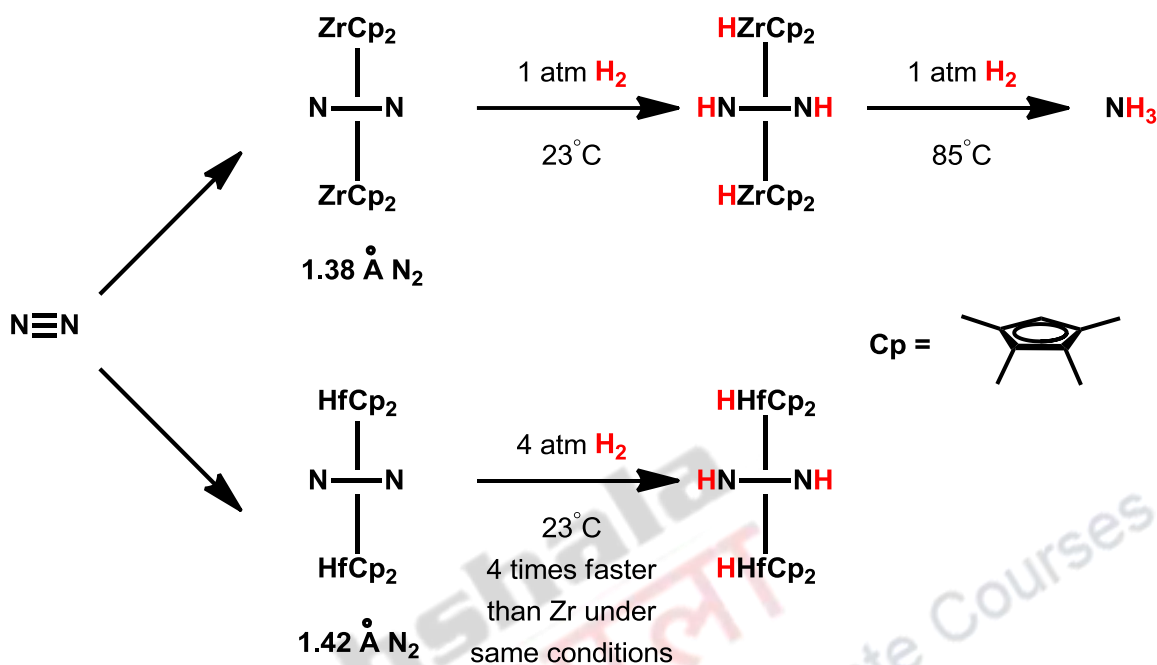

Fig. 7

Zirconocene performs first hydrogenation at ambient conditions while needs higher temperatures to hydrogenate fully. On the other hand, hafnocene performs first step faster, but needs higher pressure. But both the processes require the presence of alkali amalgams.

5.2. Functionalization beyond hydrogenation

Following reactions illustrate wherein the dinitrogen is functionalized with the aid of dinitrogen complexes.

Carboxylation and alkylation

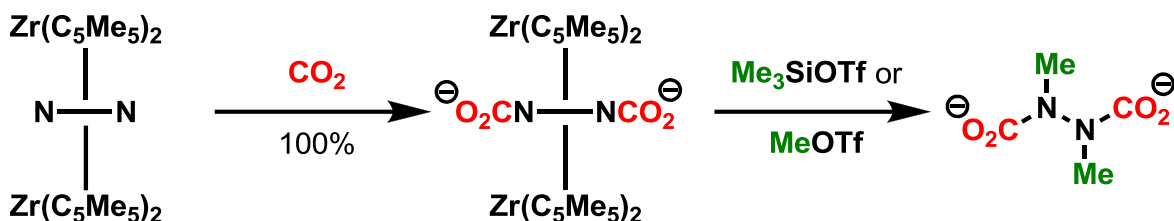

Functionalization with alkene unit

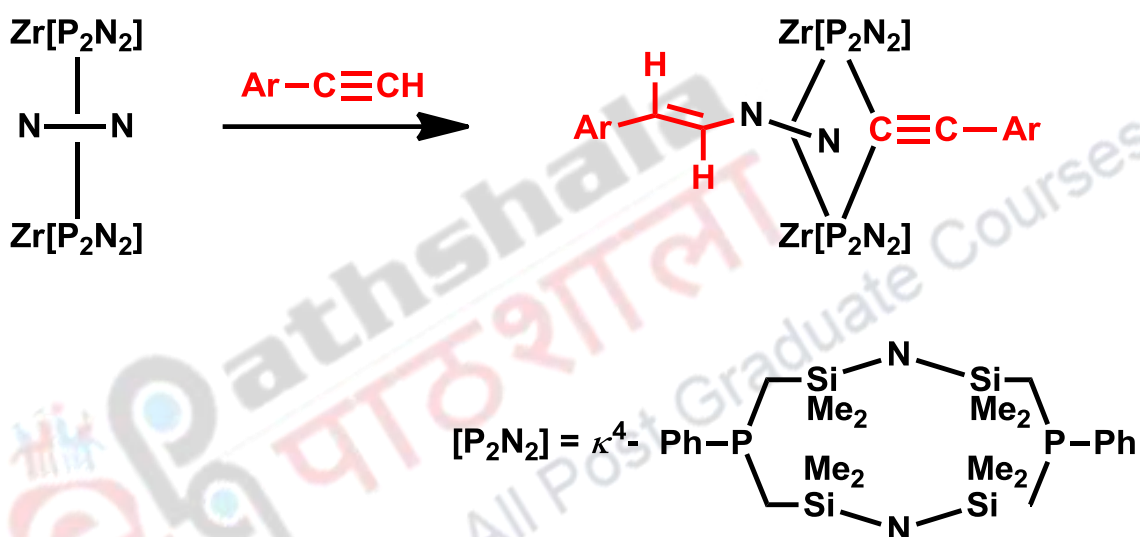

Full N–N cleavage

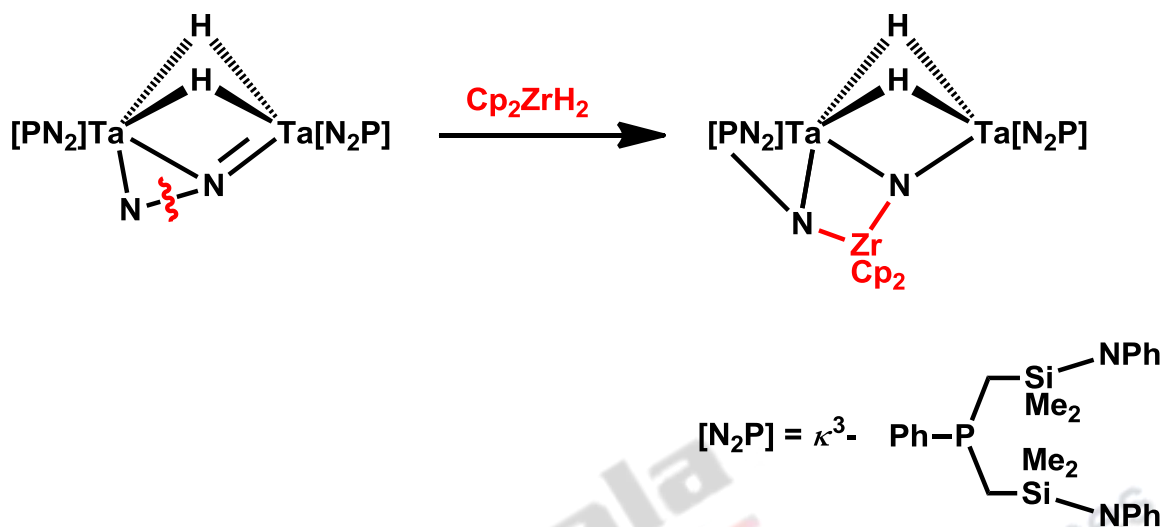

6. Nitrogen fixation in biological systems

The enzyme system responsible for fixing nitrogen is known as nitrogenase. Nitrogenase plays the vital role of fixing gaseous nitrogen and making nitrogen compounds available for plants. It is distributed in a group of symbiotic bacteria and also in non-symbiotic or asymbiotic bacteria. Symbiotic bacteria are those, which are fixing dinitrogen in association with plants e.g. the bacterium *Rhizobium* which is associated with the nodules on the roots of leguminous plants. Asymbiotic bacteria are certain free living bacteria which can fix atmospheric nitrogen e.g. *Azotobacter*. The enzymes isolated from the sources mentioned above are among the most complicated of all enzymes. Long and intensive studies have revealed that nitrogenases are composed of two proteins; one is called the Mo-Fe protein and the other Fe protein. They are not active individually. The Mo-Fe protein contains molybdenum as well as iron-sulfur groups, and the Fe protein is an iron-sulfur protein. The smaller, Fe protein has a molecular weight of 57,000-73,000 and contains Fe_4S_4 cluster (one cluster per protein). The larger MoFe protein has a molecular weight of 2,20,000-2,40,000 and contains both metals (1 atom Mo, 32 atoms Fe). Fe-Mo protein further consists of Mo-Fe cofactor and protein P-cluster (Figs. 8 and

9). Fe-Mo cofactor structure model is recently deduced from single-crystal X-ray analysis for Fe-Mo proteins of *Azotobacter vinelandii* and *Clostridium pasteurianum*, which contains the cuboidal Fe_4S_3 and Fe_3MoS_3 units bridged by three sulfides (Fig. 8). N_2 molecule binding to the active site is still uncertain. At a glance, a trigonal prismatic cavity surrounded by six coordinatively unsaturated Fe atoms seems to be susceptible to N_2 insertion, giving the $\mu_6\text{-N}_2$ ligand, but the cavity size is considered to be too small to accommodate N_2 . Alternatively, extended Huckel type calculations suggested the coordination of N_2 rather to the edge or the face of the Fe_6 trigonal prism as a bridge between two cuboidal units. On the other hand, coordination of CN^- to the isolated FeMo cofactor has been reported to take place at the Mo atom from the EXFAS criteria.

Electrons flow from a reducing agent (Fd_{red}) in to Fe-protein then into Mo-Fe protein and finally on to the substrate (Figs. 10 and 11). MgATP, which binds to the Fe-protein, is hydrolyzed as the substrate is reduced. The precise time at which MgATP binds and dissociates, and the exact role it plays in the reduction process have not been fully elucidated. The electrons that are utilized to reduce the substrates come through the enzyme, ultimately from such electron donors as ferredoxin. In vitro, nitrogenase requires the delivery of a considerable amount of energy by the act of ATP hydrolysis. The ATP requirement is highly specific and no other nucleotide works.

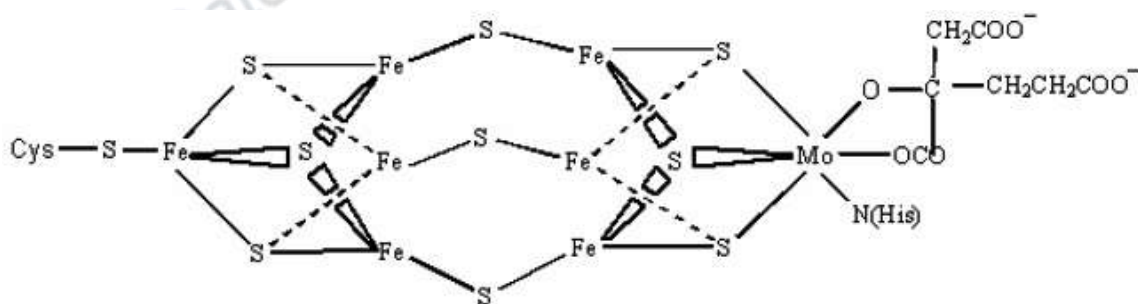

Fig. 8 The structure of Fe-Mo cofactor.

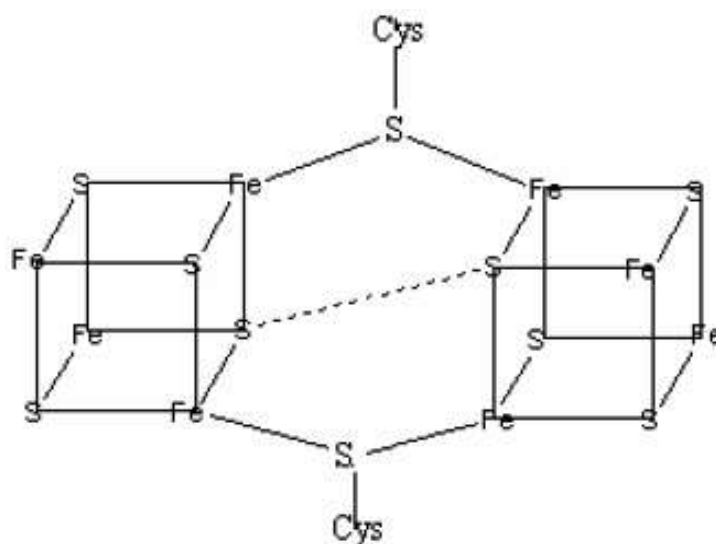

Fig. 9 The structure of P-cluster.

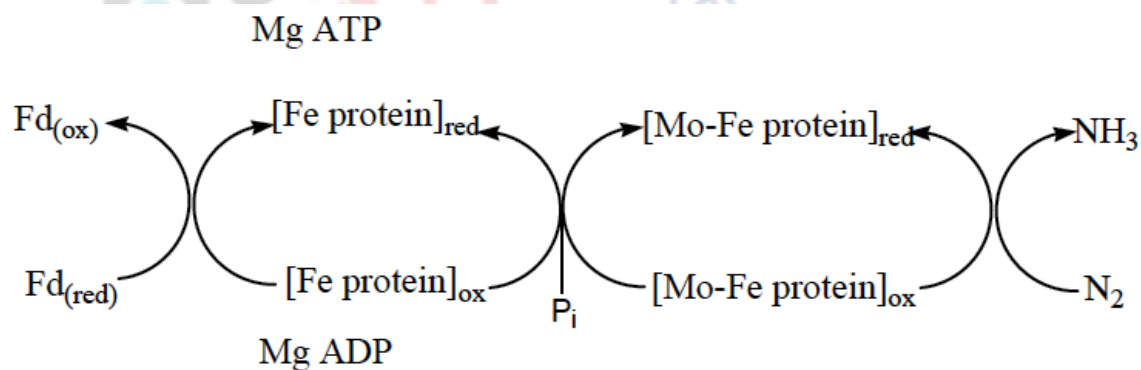

Fig. 10 Electron flow path for reduction of N_2 by nitrogenase.

For every N_2 reduced by nitrogenase, one H_2 is produced and as yet unexplained waste of electrons by the system. Indeed, some organisms incorporate a hydrogenase to recycle some of this H_2 . The stoichiometry of the biological reaction is thus:

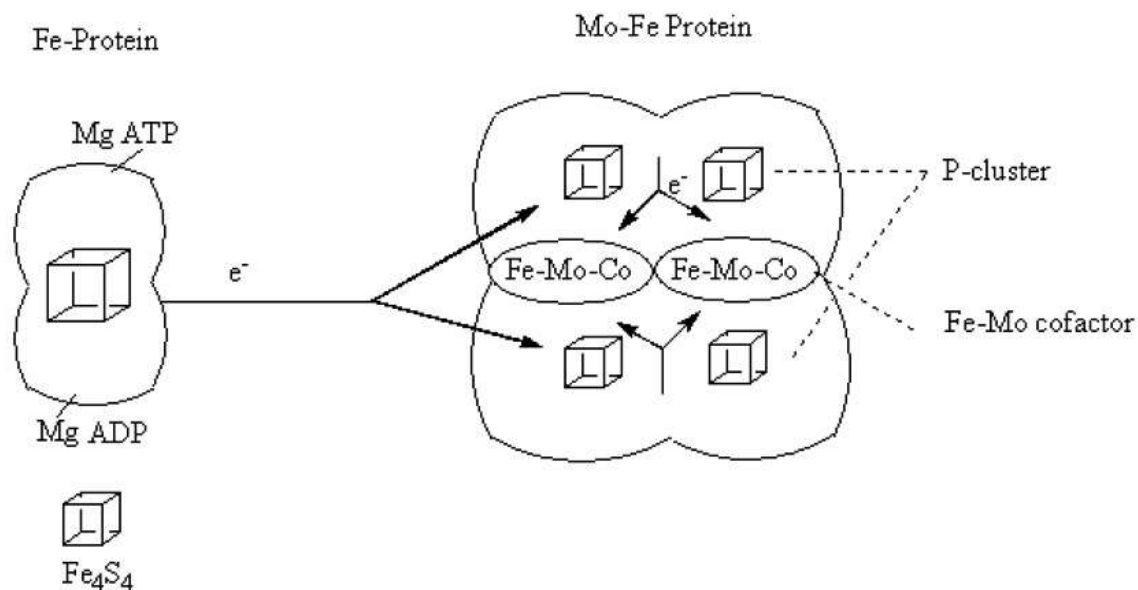
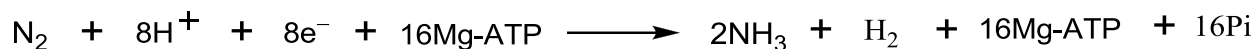

Fig. 11 Structural model of nitrogenase for N_2 fixation.

7. Summary

- The dinitrogen complexes are known for early or middle transition elements with N_2 displaying either terminal, bridging or side-on coordination mode
- Some of these complexes activate the rather inert N_2 for further functionalization
- However, the hydrogenation reaction is facile only in a few instances and cannot compare to biological nitrogen fixation
- Still the N_2 complexes of transition metals serve as suitable models for active sites of nitrogenase and provide a suitable platform for further improvisations to enable conversion of N_2 into hydrides as well as functionalization for conversion in other useful molecules